

FLYING THE CHINA CLIPPERS

POPULAR MECHANICS



MAGAZINE

WRITTEN SO YOU CAN UNDERSTAND

REG. D. TRADE MARK, GREAT BRITAIN, NO. 410424

REG. U.S. PAT. OFF.

APRIL
25 CENTS

SEE PAGE
508



NOW! A Million More Homes Can Afford a Genuine G-E Refrigerator!

SO LITTLE MONEY buys so much G-E Refrigerator this year that practically everybody can afford this finest and thriftiest refrigeration service. First choice of millions, the G-E is now popularly priced! See the beautiful new models at your dealer's. You'll find many important new features, including the fast-freezing, instant-release, Quick Trays.



Triple-Thrift

REFRIGERATOR

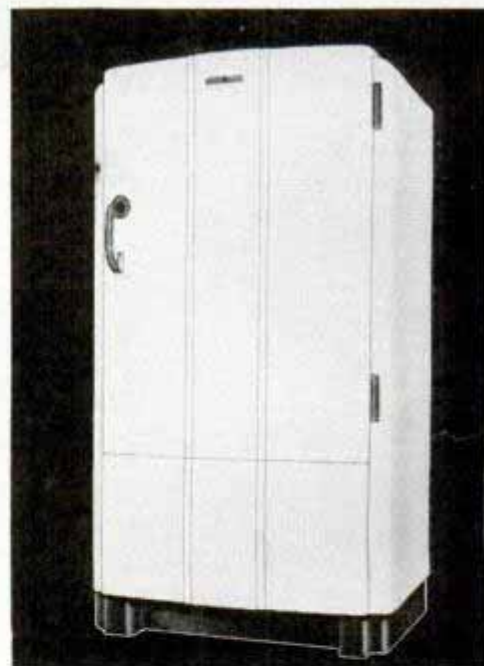

YOU SAVE THREE WAYS!

BIGGER VALUE! More G-E for your money than ever before.

LOWER CURRENT COST! Oil cooling assures greater economy—much more efficiency.

LONG LIFE! Your G-E will serve you faithfully month after month, year after year.

CHOOSE FROM 14 strikingly beautiful new models for 1938! Big, roomy cabinets are ALL-STEEL, interiors one-piece porcelain, and all G-E Refrigerators have modern convenience features. Priced right—convenient terms available.

OIL COOLING. This feature of the General Electric's sealed-in-steel Monitor Mechanism assures quieter operation, more cold with less current consumption, and *enduring* economy.

GENERAL ELECTRIC CO., SPECIALTY APPLIANCE DIVISION, NELA PARK, CLEVELAND, O.

GENERAL ELECTRIC

THE ORIGINAL ALL-STEEL REFRIGERATOR

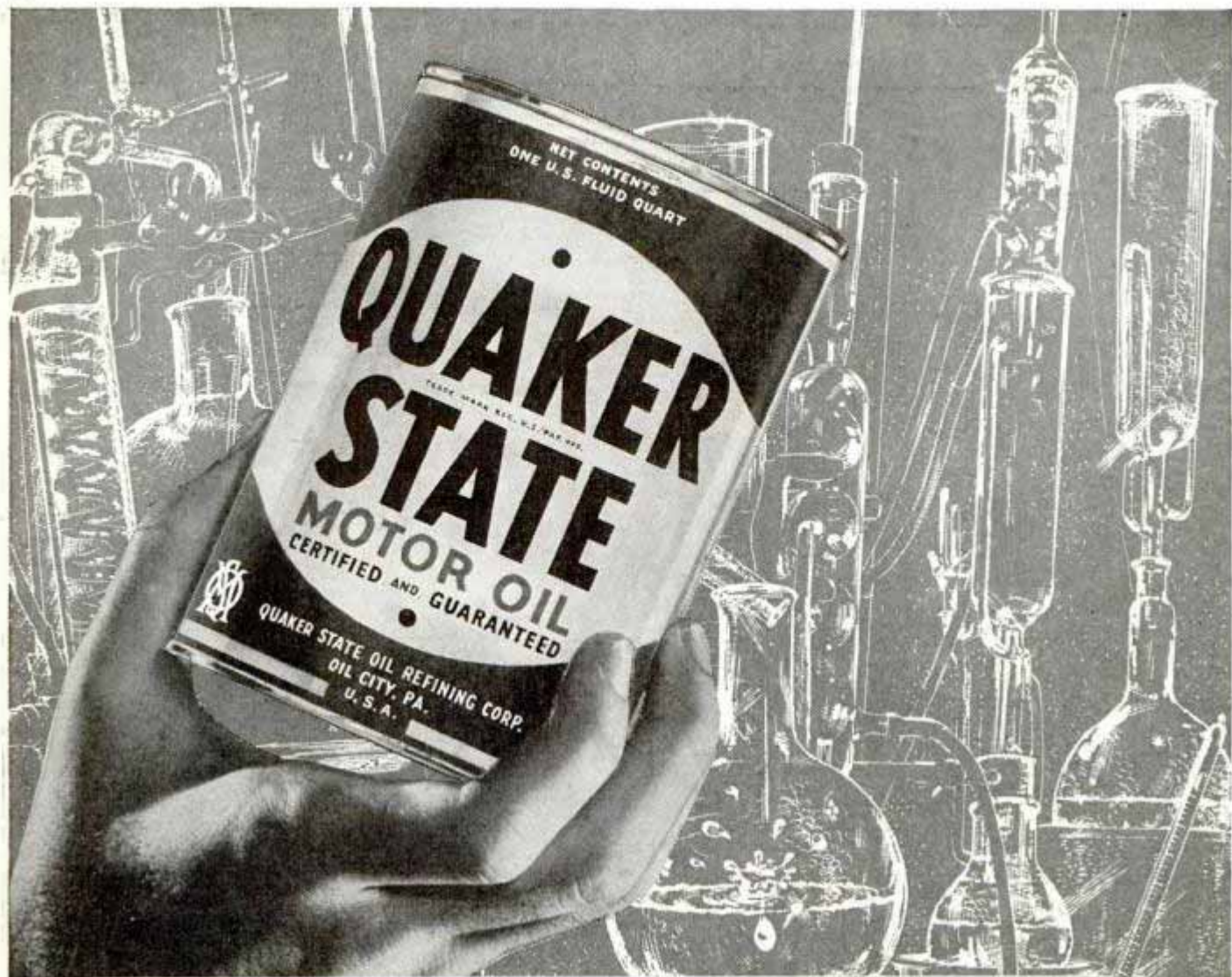

Modern Refining Methods Achieve a Miracle of Purity

Half a century of scientific research is behind the *Acid-Free Quaker State* Motor Oil you buy today. In four great, modern refineries, the finest Pennsylvania crude oil is freed of all trace of impurities . . . resulting in an oil *so pure* that motor troubles due to sludge, carbon or corrosion are wholly overcome. Your car deserves the best. Have your dealer, today, drain out that worn Winter oil and refill with *Acid-Free Quaker State*. Retail price, 35¢ a quart. Quaker State Oil Refining Corp., Oil City, Pa.

Buy Acid-Free Quaker State
it Makes Cars Run Better, Last Longer

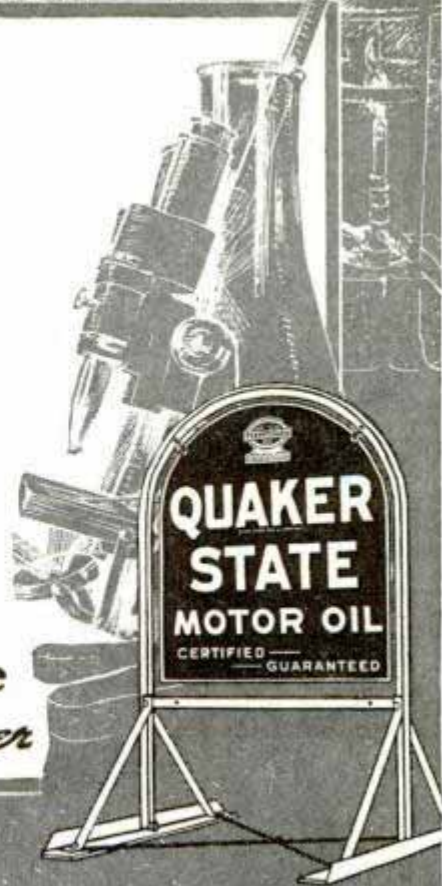

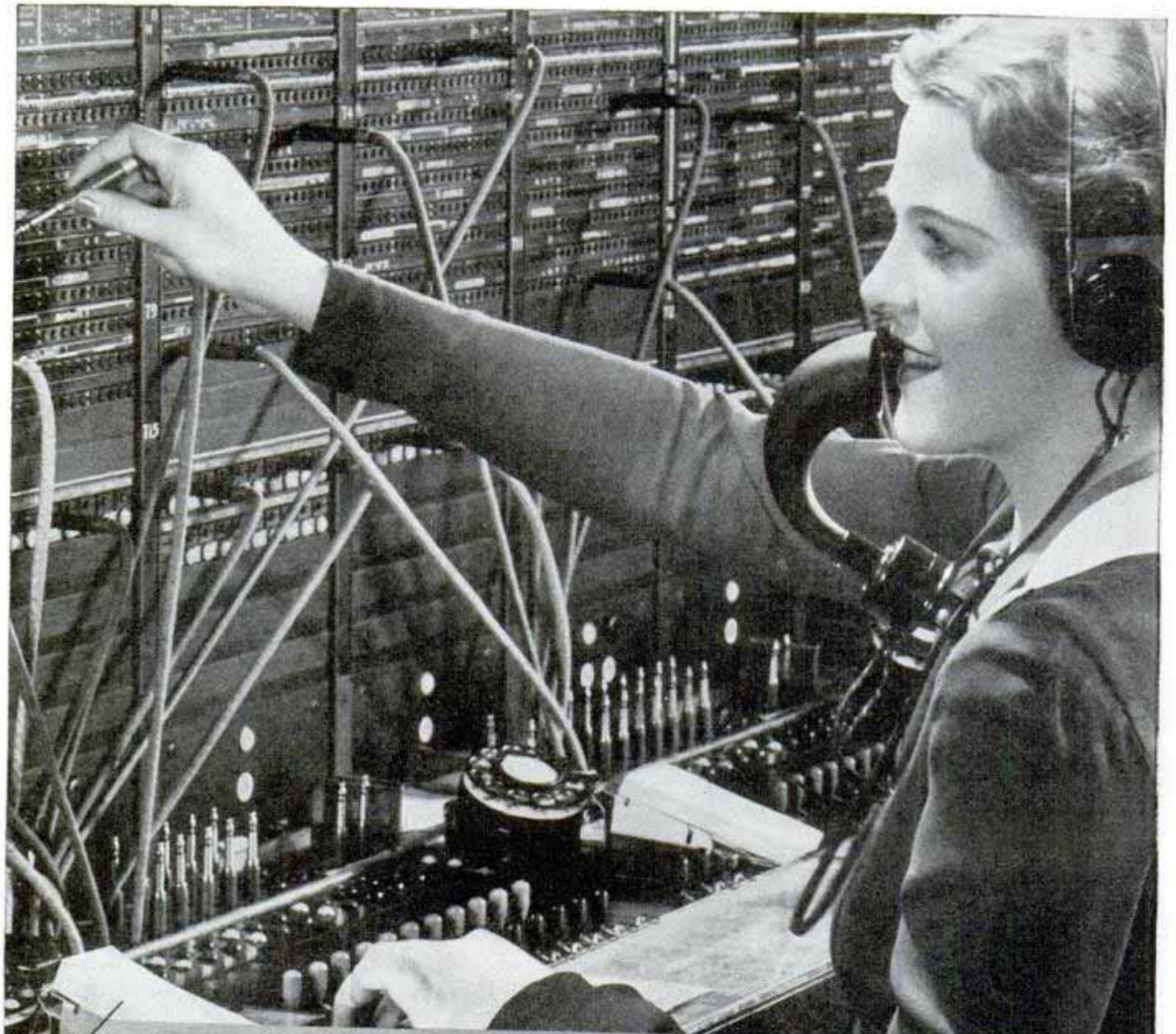

SHE SAYS *"Please"* AND *"Thank You"*

The alert, courteous voice of the telephone operator is known to all who use the telephone.

To the little old lady in the shawl, the man in the big house on the hill, or a tiny tot of six, the words are the same, "Number, please" and "Thank you."

The Bell System appreciates

your patronage and tries to deserve it. In everything that concerns telephone service, we hope you can say: "They're nice people to do business with."

170,000 WOMEN EMPLOYED BY THE BELL SYSTEM—More than half of the 315,000 employees of the Bell System are women. Their average length of service is about ten years.

BELL TELEPHONE SYSTEM



Popular Mechanics Magazine

H. H. WINDSOR, Founder

H. H. WINDSOR, Jr., Editor and Publisher

April, 1938

Vol. 69, No. 4

Special Features

The Biggest Thing on Earth	Coloroto
<u>Flying the China Clippers</u>	500
<u>New Warships to Cost \$70,000,000</u>	508
<u>Beating Burglars with Black Light</u>	514
<u>Wild Life Goes to Town</u>	520
<u>Bad Weather Photography</u>	530
<u>These Lights Must Not Fail</u>	538
<u>Across Africa on One Lung—Part II</u>	546
<u>The Spotlight on Puppets</u>	552
<u>Now You See It, Now You Don't</u>	562
<u>"Stand By for an SOS"</u>	570

(Continued on next page)

The Phantom Cars

THROUGH the gates of a Detroit automobile plant rolls a phantom caravan—cars without names or other identifying insignia. They are next year's models in disguise and are headed for the world's greatest proving ground, America's 3,000,000 miles of highways. At the steering wheels are the "hell drivers," keen-eyed professionals prepared to push these glistening cars mercilessly, day after day, up and down mountains, across deserts, through mud, pounding over gravel, struggling through sand. In three weeks, the cars, muddy and travel-stained, will speed home. Weary drivers will climb out. But there will be no rest for the phantom fleet. A fresh crew will step in, and back on the road it will go for another beating. The road test, however, is only part of the punishment new models must survive as you'll find next month when you read the first of two articles on "The Phantom Fleet of the Highway."

Next Month

NEXT year millions will explore a new island in San Francisco bay more fabulous than the treasure island of storybook fame. Raised from the bottom of the sea, the 400-acre tract will be the scene of the 1939 Golden Gate International Exposition. An article in the May issue describes what you will find there, and eight pages of Coloroto pictures give you a pre-view.

Gold Digger

NEARLY one-third of all the gold mined in the west comes from ground so poor you could sift through it for hours and never find a single flake of the metal. This gold is recovered by a 20,000-ton monster which handles 15,000 cubic yards of gravel in a week. Read next month how giant dredges reclaim gold from ground once considered worthless.

Making Metal "Talk"

OUR ancestors had cruel but effective tools for prying secrets from stubborn lips. Torture, they found, made men talk. Torture makes metal "talk," too, men of science have discovered. So today, when they want to pry from a stubborn alloy the secrets of its strength and weakness, they torture it to destruction. And making metal "talk" saves you money, as you'll find by reading the article, "Torturing Metal to Make It Talk," in the May issue.

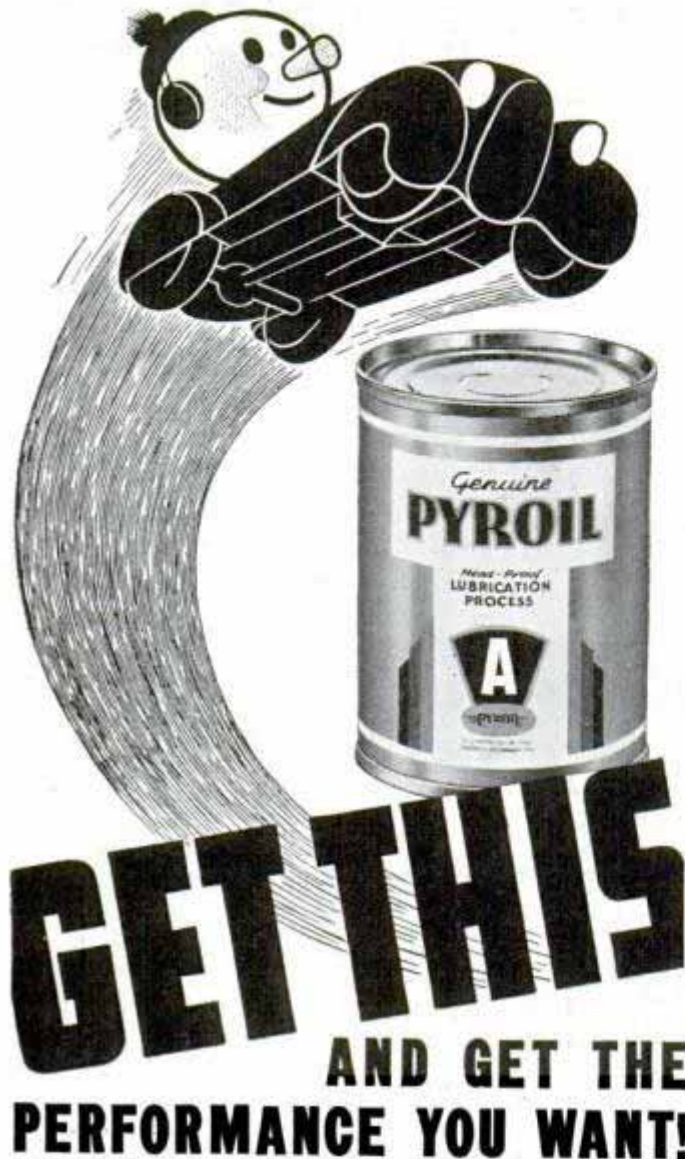

When Pyroil starts ridding your engine of sludges and gums—of hard carbon and acids that cause corrosion (metal wear)—you will realize how important this famous lubrication process is to you.

Pyroil does a job that often saves many dollars in repairs. It safeguards new cars. It restores efficiency in old ones.

Costs but a few cents per 3 ounce tin—sufficient for 250 miles of driving. Ask your service station attendant about Pyroil, today—or mail coupon. Manufactured and Guaranteed by Pyroil Company, W. V. Kidder, Founder, 54 Pyroil Bldg., LaCrosse, Wisconsin, U. S. A.

DISTRIBUTORS, CHECK AND MAIL COUPON FOR FRANCHISE FACTS

PYROIL COMPANY

54 Pyroil Bldg., LaCrosse, Wis., U.S.A.

Please send complete Pyroil facts.

Also send details of your plan for Distributors.

Name.....

Address.....

City.....County.....State.....

(Contents—Continued)

AUTOMOTIVE

Light on wrist aids auto repair work	499
Curtain of hot air at factory's door	505
Portable plywood cottage packs on a trailer.....	507
One-third of world's highways in America	512
Tire spreaders help in removal of tube	512
Raised ramp in road guides military trains	513
Small safe for autos fastens on steering post	517
Feather-edge sander speeds auto painting	518
Diesel engine exhaust contains no carbon monoxide.....	524
Traveling lamps bake paint on autos	529
Twin-rail buffer protects safety zone in street.....	529
Trailer straddles a tractor to pick it up.....	535
Auto tire remover uses air pressure	542
Two-faced fire truck for New York tunnel	551
Blinker on top of cab is "SOS" signal	557
Shotgun shell starts gasoline engine	557
Engine turned around gives space to car	561
Portable traffic light post guards school crossing.....	575
Meter shows horn's loudness	576

AVIATION

System of vanes guides pilot to runway	518
Flying school trains transatlantic pilots	519
Big transatlantic dirigible rushed to completion.....	537
Weather studied by pilots to make flying safer.....	537
Highway "flight strips" for emergency airports.....	544
Ocean-flying German liner attains high speed.....	550
Speedy air fighter carries guns and bombs	561
Anti-static loop on ground makes flying safer.....	567
One-motor plane like clippers	567
Radio static detective for air liners	574

CONSTRUCTION

Newsprint cores used to build "log" houses	504
Hydraulic road scraper indicates depth of cut.....	506
"Centipede" tester shows irregularity in pavement.....	525
Sphere tank saves sewer gas to burn garbage	550
Glass stairs at Paris fair	559
One man takes down steeple	560

HOUSEHOLD

Luminous stars glow on ceiling	524
Pump lifts water eighty feet	542
Top of floor sweeper opens for cleaning	544
Decorative wall designs applied with water.....	574
Up-to-date "papoose board"	576

MODELS

Statuettes made with welding torch and pliers.....	524
Airport and trains modernize model village	527
Carving wildfowl decoys in home workshop	568

MOVIES AND PHOTOGRAPHY

Camera with a twenty-foot bellows	506
Lens-shaped bulb serves as photo spotlight	528
Movies flow from mirror belt of projector	536
Baby photo-flash bulb handy for photographer	544
Abrasive in photo-flood lamp cleans bulb	545
Portable photo copying machine	559
Metal frame for mounting color films	122A

RADIO AND ELECTRICITY

One-man "sound factory" for radio station	498
Granddaddy of electric motors built by smithy.....	513
Night light with rotary switch	526
Ten-watt lamp applies heat to skin	526
Greetings wired in handwriting by telegraph	557
Odd trait of tungsten explains sudden burnout.....	576
Push-button tuning for your receiver	577
One-tube short-wave flashlight battery receiver.....	578
How to build a simple decade resistance test box.....	580
Practical radio suggestions	581
Adjustable all-purpose power-line filter	582
Convertible farm battery or power-operated receiver.....	582
Pocket trouble-shooting guides for radio servicemen.....	582
World time clock for short-wave listeners	582

RAILWAYS

Aluminum double-deck cars carry more passengers.....	505
Auto converted for use on Alaskan railroad	506
Trains floodlighted at crossings to reduce accidents.....	543
Long freight train's "stretch" helps get it started.....	550
Compressed air smooths road for streamliner	556
"Floating" railway cars ride like a hammock	566

SCIENCE AND INDUSTRY

Fiber of yucca plant creates new industry	512
Flexible rubber coupling for drive shaft	526
Animals grow larger in cold countries	527
Aluminum wire finer than hair	534
Gearless speed-reduction drive	544

(Continued to page 6A)

YOU CAN DEPEND ON CHAMPIONS



For Sustained High-Speed PERFORMANCE

Ab Jenkins recently broke 87 World's, International and American speed records, on the Bonneville Salt Beds, averaging 157.27 miles per hour for 24 hours.

In this astounding record of perfect engine performance—the most destructive service conceivable—Champion Spark Plugs played a vital part to perfection. Not one spark plug was changed throughout the entire run, nor in the run he made previously in which 72 stock car records were broken.

Thus once again the soundness of

Champion's 27-year-old policy of constant and tireless research and engineering, applied to the only product manufactured by Champion, has been confirmed. This concentration has kept Champion Spark Plugs everlastingly ahead in performance and dependability.

Every engine performs better with Champion Spark Plugs. The same quality of materials and design, the same exclusive and patented features are used throughout the entire Champion line, right down to the tiny spark plugs built for model airplanes.

Demand Champions for all engines because you can depend on them.

Champion "V" Spark Plugs



$\frac{3}{8}$ " 24 Thread
Actual Size, 65c

Specially designed for model gas engines giving the same dependable performance as regular Champions. Absolutely gas-tight, alloy needlepoint electrode, one-piece construction. If not available through your dealer, write Champion Spark Plug Company, Toledo, Ohio.

CHECK AND CLEAN SPARK PLUGS WHEN YOU CHANGE OIL

When writing to advertisers please mention Popular Mechanics

FOR MEN WHO DON'T MEAN MAYBE!



● Spick-and-span every minute is the first big **MUST** at Annapolis—and that doesn't mean maybe! Midshipmen have to be well-groomed—get clean, close, long-lasting shaves in *double-quick* time. Half-mown whiskers are out! Only perfect shaves pass inspections. That's why 7 out of 10 men at the U. S. Naval Academy use Gillette Blades in their Gillette Razors every morning.



● Your face is *always* on parade—wherever you go, night or day! Don't make it a proving ground for shaving experiments. Demand Gillette Blades and get the world's best shaves for *less than a cent a day!*

Speed shaving—tone the skin—with Gillette Brushless Shaving Cream made with peanut oil. Big tube 25¢.



**LESS
THAN A DAY**
*buys the world's
finest blades*

PRECISION - MADE
FOR EACH OTHER

Gillette Blades

MORE SHAVING COMFORT FOR YOUR MONEY

When writing please mention Popular Mechanics

(Contents—Continued)

Bombing sea floor to find lost continent	545
Thrust bearing to run in oil bath	551
Insect outstrips fastest plane	560
Giant shovel balances itself	569

TOOLS

Portable shaper for surfacing small castings	517
Demagnetizer for tool room plugs in socket	526
Blade set with diamonds cuts brittle materials	542
Surveyors mount instruments on truck roof	575

MISCELLANEOUS

Printing tint blocks useful for business	497
Glass-insulated shoes resist weather	499
Trainer and pony jump barrier	499
Volcanoes yield gold, silver, oil and diamonds	504
Muffler for drum practice	518
"Napkin ring" operating table for canary surgeon	524
Funnelless liner to have exhaust at stern	525
Compartments in sample case adjustable for display	528
London sinking as wells tap its foundation	528
Big oil tanks guarded against flood	534
Costly golden silky fabric comes from shellfish	534
Anti-air-raid canvas tank helps firemen	535
Mattress tester in prison finds hidden weapons	536
Mysteries of ocean depths challenge explorers	536
Noiseless theater programs made of blotting paper	542
Chute unloads dustless coal quietly and quickly	543
Classify heat rating and ash content of coal	556
Drill boats blast rock from river bottom	558
Velvet-lined house for dog	560
Tailor-made easy chair built to fit you	569
Wooden dishes for antarctic expedition	157A

Craftsman and Shop Notes

ART AND ARTISTS

Sandpaper to point pencils in sketch book	598
Drawing board tilted by doorstops	620
String and vacuum cup to scribe large arcs	625

AUTOMOTIVE

Lubrication data for cars given on chart	633
Helps for the motorist	637
Brake testing by skid marks aided with whiting	638
Electrical outlet on dash panel	638
Extra rear mirror helps avoid accidents	638
Identification papers carried in rear-window curtain	638
Protecting elbows on oil filters	638
Anchoring stakes in truck body	639
Broken axle shaft pulled from housing	639
Broken gas line repaired with raw potato	639
Rubber grip for extension lamp	639
Air dome in fuel line increases mileage	640
Brake drum supports jack on soft ground	640
Erratic "miss" in motor traced	640
Shoe-shining stand in trailer	640

ELECTRICAL

Spacing turns of wire in resistance coil	608
Electro-engraving on metal articles	621
Test-bench prods on weighted cord	623
Metal tubes annealed with resistance wire	634

FARM

Easy way to dress fowls	585
Oil drums keep rabbits away from trees	592
Seedlings protected by springs from auto cushion	592
Keeping trash from lodging in plow-beam	628

FURNITURE

Portable hose and shoe cabinet	588
Novelty tables have mirror tops	591
Tilt-top bed table adjusted instantly	593
Latest hall clocks serve dual purposes	600

HAND TOOLS

Metal shears improvised from ice skates	586
Scale on adjustable wrench to measure diameters	586
Heating soldering iron over gas-stove burner	592
Drawing-knife handles have hand guards	598
Miter clamps improvised from angle iron	598
Oilstone has non-slip feet	616
How to use a star drill	625
Coil springs help perforate metal rapidly	626
Level on drill helps bore straight holes	634

HOUSEHOLD

Paste from condensed milk	585
Reading lamp slides on back of davenport	587
Door bolt secured with padlock	590

(Continued to page 8A)



Plan Your Future

Choose Your Field NOW For Success

Will you master fate or will fate master you? That's a question deserving your honest answer . . . right now! Actually it is all up to you. You can do with Life almost what you will. LaSalle will help you establish yourself for real success by providing you with the comprehensive, specialized training for which it is so famous. Choose your field . . . now! Check the coupon below for the free booklet you want us to send you. It can be your first step toward assured success.

Opportunities in Traffic Management

The field of Traffic Management offers real opportunity only to the man who knows. Spare time study and the will to succeed have pushed scores of Traffic employees up the ladder to financial success. Many LaSalle-trained traffic managers—both in the railroad and industrial field—now command salaries of \$3,000.00 to \$5,000.00 a year—and better. Investigate. Find out how you can qualify for these higher positions through LaSalle home-study and guidance.

Law for Business Success

And it isn't necessary to practice law to get this Success. In fact probably most of the men who study law today have no idea of taking the bar examination or becoming lawyers—they want law training to give them mastery of men and situations in business. You know that—

- (1) the man with legal training is a leader—not a follower.
- (2) legal training keeps your mind—clears away the problems that stump the ordinary fellow and makes you master instead of man.
- (3) knowledge of law simplifies the complications of executive work.
- (4) Many top executive places are filled by men who have studied law.

No matter whether you are in a big corporation or a small business—in a great city or a little town—a practical knowledge of law cannot fail to be of real and vital help to you in making a more successful career.

In every state in the union you'll find law-trained men who came up through LaSalle. What others have done, you can do.

And LaSalle offers either a full law course leading to LL. B. or a shorter business law training—whichever you prefer. All text material, including valuable 14-volume Law Library. Training comprises the most effective features of modern law instruction.

Executive Training

Executives who are efficient managers command responsible positions and good incomes. And the need for

trained executives is growing rapidly. We train you thoroughly at home in your spare time for every type of executive work—teach you the principles and practices used by our most successful business leaders and help you develop your management capacity—by a training built with the aid of outstanding executives.

Become an Expert Accountant The Profession That Pays

The demand for skilled accountants—men who really know their business—is increasing rapidly. New state and federal legislation requires much more, and more efficient accounting from business—big and small. Corporations are in constant need of expert counsel in matters relating to Auditing, Cost Accounting, Business Law, Organization, Management, Finance. Men who prove their qualifications in this important branch of business are rapidly promoted to responsible executive positions—given an opportunity to earn real salaries. The range is from \$3,000.00 to \$10,000.00 a year—even to higher income figures.

Under the LaSalle Problem Method you can at home acquire a thoro understanding of Higher Accountancy, master its fundamental principles, become expert in the practical application of these principles—this without losing an hour of work or a dollar of pay.

Your training will be under the direct supervision of a staff of legal, organization and management specialists, business efficiency engineers and Certified Public Accountants.

Preliminary knowledge of bookkeeping is unnecessary. We train you from the ground up, or from where you now are, according to your individual needs.

Mr. Salesman: What's Wrong?

Why aren't you making more sales—more money? Is it you—or your proposition? Check up first on yourself. Other men—no better than you—have found their earnings jump and stay up when they trained with LaSalle. Literally thousands of men—many of them years at the game—have increased their sales volume and earnings through home study with LaSalle guidance. Sound—practical—usable—right from field experience. Train for top-notch production with LaSalle.

LASALLE EXTENSION ^{Adult} Business Training Dept. 464-R, Chicago

I would like to have your special booklet—without any cost or obligation to me—about my opportunities and your success training in the business field I have checked.

- | | | |
|---|--|--|
| <input type="checkbox"/> Higher Accountancy | <input type="checkbox"/> Commercial Law | <input type="checkbox"/> Business English |
| <input type="checkbox"/> Law: Degree of LL.B. | <input type="checkbox"/> Expert Bookkeeping | <input type="checkbox"/> Business Correspondence |
| <input type="checkbox"/> Traffic Management | <input type="checkbox"/> C. P. A. Coaching | <input type="checkbox"/> Effective Spe |
| <input type="checkbox"/> Modern Salesmanship | <input type="checkbox"/> Industrial Management | <input type="checkbox"/> Stenotypy |
| <input type="checkbox"/> Business Management | <input type="checkbox"/> Modern Foremanship | |

Name.....Age

Position.....Address.....



This One



GAA7-27Q-D5JF

WET CELLARS MADE DRY from the Inside!

DAMP musty cellars are unsanitary, a danger to health and a poor place to store valuable material.

Where ground water or moisture seep in through cracks or porous spots in the floor or walls, you can make and keep your cellar dry and sweet—a fit place to work, free from odor, mold and rust—by filling the cracks and coating the moist surface with Smooth-On No. 7.

This is the one practical waterproofing that you can apply yourself, easily, from the inside, to wet or dry surface and with every assurance of thorough watertightness, even in the wettest seasons.

Excellent also for patching concrete floors, waterproofing boiler and machinery pits, sumps, garage, stable and washroom floors, brick walls, cisterns, septic tanks, water troughs, fountains, fish ponds, swimming pools, manure pits, etc.

Working Smooth-On No. 7 into the original construction is economical procedure, but where this has been overlooked, Smooth-On No. 7 can be applied to the existing structure quickly and at low cost and is entirely dependable.

Specifications, working directions, diagrams, and typical examples of what may be accomplished will be found in the Smooth-On Home and Auto Repair booklet. Get the booklet by returning the coupon and get Smooth-On No. 7 in 1 or 5-lb. can or 25 or 100-lb. keg from your supply house or from us. About 25 lb. required for each 100 sq. ft. of surface covered.



Write for
FREE BOOK



SMOOTH-ON MFG. CO., Dept. 37
524 Comerunipaw Ave.,
Jersey City, N. J.

Please send Smooth-On Home Repair Book.

Name.....
Address.....
4-38.....



Do it with
SMOOTH-ON No. 7

When writing please mention Popular Mechanics

(Contents—Continued)

Pincushion on sewing machine always at hand.....	590
Guide on chair for knitting yarn.....	596
Neat patches in screen door.....	597
Disinfectant and deodorizer.....	606
Portable doorbell rings when knob is turned.....	607
Flower-vase frog improvised from paraffin.....	608
Marble and porcelain cleaner.....	610
Rustic beverage set for den.....	615
Doorstops on kitchen table protect wall.....	617
Home problems easily solved.....	618

OFFICE

Renewing pencil sharpener blades.....	610
Large bottles handled easily with canvas strip.....	626
Blueprints kept rolled by can lids.....	628
Blueprints coated with clear lacquer withstand wear.....	634

PHOTOGRAPHY

Photo printer has automatic switch.....	583
Stopper for bottles of photographic solutions.....	590
Magnifying glass aids in taking closeup photos.....	597
Disk with pinhole improves photos.....	598
Marking roll films for printing.....	598
Clip on filter container prevents losing it.....	608
Eye dropper helps glue snapshots in album.....	608
Safelight for darkroom made from carton.....	609
Photo chemical solutions stored in fruit jars.....	616
Newspaper aids in ferrotyping photo prints.....	624

POWER TOOLS

Auxiliary table to drill angular holes.....	624
Lathe parting tools made from saw blades.....	624
Lathe drill pad made from pipe fittings.....	625
Goggle case over grinder switch as reminder.....	635

STORE AND SHOP

Overhead pulley lubricated with oil-soaked sponge.....	616
Billiard-table cover mounted on rollers.....	626
Fishhooks dispensed with magnets.....	626
Glass-tumbler polisher saves time.....	628
Mirror aids in trimming windows.....	628
Meat-slicing board for chefs.....	634
Bag on push truck to hold papers.....	636
Rule on wrist always handy.....	636
Scale weights kept in can lids.....	636

TOYS AND NOVELTIES

Toy-train signals operate on flashlight cells.....	607
Decorative novelties from auto gas line.....	609
Kite made from toy rubber balloon.....	610
Block on scooter keeps foot from slipping.....	617

WOODWORKING

Wood cracker tray cut on circular saw.....	585
Cardboard in scroll-sawed stack provides pattern.....	586
Chalk used in laying out scroll-saw projects.....	592
Pattern sanding gives true curves.....	627

MISCELLANEOUS

Scalded fish scale easily.....	586
Weather vanes of bird silhouettes are decorative.....	587
Hot-tar ladle made from headlight case.....	590
Wire staples on dog leash discourage chewing.....	592
Styptic pencil fits inside razor handle.....	593
Watch kept in pocket by rubber disk.....	593
"Miracle plants" grow in liquid.....	594
Two novel uses for Cellophane-ribbon.....	597
Holder keeps nuts and washers assorted.....	599
Mucilage for unused stamp taken from envelope.....	599
Snow removed from pond by old truck wheel.....	599
Student's portable writing "desk".....	599
Bird perches from wood disk and coat hook.....	608
Folding supports for small flags.....	610
Numbers kept under base of telephone.....	610
Pottery clay fired in your kitchen oven.....	611
Scallops in picket fence gauged uniformly.....	616
Streamlined "saddlebags" for your bicycle.....	617
Inducing canary to bathe.....	620
Cement for sealing pipe joints.....	623
Water-color box has detachable handle.....	624
To buff and to polish.....	629
Homemade expansive bolt has many uses.....	634
Portable gas lamp gives bright light.....	635
Anchoring partitions to concrete floors.....	636
An exterminator.....	636

IMPORTANT NOTICE

It is the intention of this magazine to provide its readers with information regarding the latest developments in the mechanical arts. We take no responsibility as to whether the disclosures contained in our articles are covered by patents and advise readers to investigate this subject before making, using, or selling any of the products, machines, or processes described, in order to avoid possible liability for patent infringement.



Does your
PAY ENVELOPE
keep you out
of this picture?

If it does, do something about it! Get a raise in salary—but first get the training that will entitle you to this raise. Thousands of men in the same fix as you have gotten this training by spare-time study of an I. C. S. Course. Mail the coupon today!

INTERNATIONAL CORRESPONDENCE SCHOOLS

BOX 5510-J, SCRANTON, PENNA.

★ Without cost or obligation, please send me a copy of your booklet, "Who Wins and Why," and full particulars about the subject *before* which I have marked X: ★

- | | | | |
|---|---|--|--|
| <input type="checkbox"/> Architect | <input type="checkbox"/> Sheet Metal Worker | <input type="checkbox"/> Plumbing | <input type="checkbox"/> Bridge Engineer |
| <input type="checkbox"/> Architectural Draftsman | <input type="checkbox"/> Boilermaker | <input type="checkbox"/> Heating | <input type="checkbox"/> Bridge and Building Foreman |
| <input type="checkbox"/> Building Estimating | <input type="checkbox"/> Telegraph Engineer | <input type="checkbox"/> Air Conditioning and Cooling | <input type="checkbox"/> Chemistry |
| <input type="checkbox"/> Contractor and Builder | <input type="checkbox"/> Telephone Work | <input type="checkbox"/> Steam Engineer | <input type="checkbox"/> Pharmacy |
| <input type="checkbox"/> Structural Draftsman | <input type="checkbox"/> Mechanical Engineering | <input type="checkbox"/> Steam Electric Engineer | <input type="checkbox"/> Coal Mining |
| <input type="checkbox"/> Structural Engineer | <input type="checkbox"/> Mechanical Draftsman | <input type="checkbox"/> Marine Engineer | <input type="checkbox"/> Mine Foreman |
| <input type="checkbox"/> Management of Inventions | <input type="checkbox"/> Machinist | <input type="checkbox"/> R. R. Locomotives | <input type="checkbox"/> Fire Bosses |
| <input type="checkbox"/> Electrical Engineer | <input type="checkbox"/> Patternmaker | <input type="checkbox"/> R. R. Section Foreman | <input type="checkbox"/> Navigation |
| <input type="checkbox"/> Electric Lighting | <input type="checkbox"/> Diesel Engines | <input type="checkbox"/> Air Brakes | <input type="checkbox"/> Cotton Manufacturing |
| <input type="checkbox"/> Welding, Electric and Gas | <input type="checkbox"/> Aviation Engines | <input type="checkbox"/> R. R. Signalmen | <input type="checkbox"/> Woolen Manufacturing |
| <input type="checkbox"/> Reading Shop Blueprints | <input type="checkbox"/> Automobile Mechanic | <input type="checkbox"/> Highway Engineering | <input type="checkbox"/> Agriculture |
| <input type="checkbox"/> Heat Treatment of Metals | <input type="checkbox"/> Commercial Refrigeration | <input type="checkbox"/> Civil Engineering | <input type="checkbox"/> Fruit Growing |
| | | <input type="checkbox"/> Surveying and Mapping | <input type="checkbox"/> Poultry Farming |
| BUSINESS TRAINING COURSES | | | |
| <input type="checkbox"/> Business Management | <input type="checkbox"/> Bookkeeping | <input type="checkbox"/> Service Station Salesmanship | <input type="checkbox"/> Grade School Subjects |
| <input type="checkbox"/> Industrial Management | <input type="checkbox"/> Secretarial Work | <input type="checkbox"/> First Year College Subjects | <input type="checkbox"/> High School Subjects |
| <input type="checkbox"/> Traffic Management | <input type="checkbox"/> Spanish | <input type="checkbox"/> Business Correspondence | <input type="checkbox"/> College Preparatory |
| <input type="checkbox"/> Accountancy | <input type="checkbox"/> French | <input type="checkbox"/> Stenography and Typing | <input type="checkbox"/> Illustrating |
| <input type="checkbox"/> Cost Accountant | <input type="checkbox"/> Salesmanship | <input type="checkbox"/> Civil Service | <input type="checkbox"/> Cartooning |
| <input type="checkbox"/> C. P. Accountant | <input type="checkbox"/> Advertising | <input type="checkbox"/> Mail Carrier | <input type="checkbox"/> Lettering Show Cards |
| | | <input type="checkbox"/> Railway Mail Clerk | <input type="checkbox"/> Signs |
| DOMESTIC SCIENCE COURSES | | | |
| <input type="checkbox"/> Home Dressmaking | <input type="checkbox"/> Advanced Dressmaking | <input type="checkbox"/> Millinery | <input type="checkbox"/> Foods and Cookery |
| <input type="checkbox"/> Professional Dressmaking and Designing | | <input type="checkbox"/> Tea Room and Cafeteria Management, Catering | |

Name.....Age.....Address.....

City.....State.....Present Position.....

If you reside in Canada, send this coupon to the International Correspondence Schools Canadian, Limited, Montreal, Canada

There's Quicker, Bigger MONEY for YOU in POULTRY RAISING!



Wherever You Live—Whatever You Do Now—Extra Money Can Be Yours This Year

Spare Time or Full Time Make \$1000 to \$2500 a Year

Whether you want a job at good pay or a highly profitable business of your own—Poultry Raising offers you more than any other easily-learned trade or profession. Poultry meat and eggs are always in demand—and there is a shortage of trained poultrymen. My Home Study Course trains you quickly to fill a good job in poultry—and my Personal Employment Assistance will help you get one!

My Proved Methods Assure Success Right from START

All the "mystery and guess work" are taken out of poultry raising by my sure, tested, **proved** methods. My home study course, produced by eighteen famous experts and endorsed by thirty leading Agricultural Schools, puts in your hands the success-secrets of leaders. Satisfaction absolutely guaranteed, if you follow our methods. Decide now to get into this fascinating, healthful, profitable business. Be your own boss—make extra money in your spare time—or qualify for a fine salary in one of the big established poultry plants. From now on, let the other fellow pay YOU the fancy prices—Become depression-proof.

FREE BOOK EXPLAINS

My big, new, free book, "How to Raise Poultry for Profit" will amaze you! Brings **absolute proof** of what my course and training have done for thousands of others. My 44 years' experience as Commercial Poultryman and former Senior Poultryman in the U. S. Dept. of Agriculture is yours to use and profit by. Get in line for **QUICKER, BIGGER MONEY**. Don't delay a day. Get this coupon into the **very next mail**.

PROOF

Investment Will Pay Many Times Over Says Kravets

"I am perfectly satisfied with your course and wish to say that my investment will pay me over and over many times. Anyone who enrolls with you can make a success in the Poultry field." Michael Kravets, Terra Haute, Ind.



\$45 a Week As Poultry Manager

"Your course enabled me to secure a splendid position in charge of a Private Poultry Farm. My pay is equal to \$45 per week. I also have free house rent, water, lights, fuel and all the poultry and eggs my family can use. I secured this position after completing only the eighteenth lesson of the course." Louis D. Baker, Reynolds, N. C.

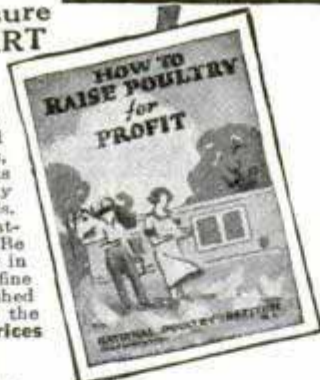

32 Pages of Money-making FACTS

Get this **FREE** Book **NOW!**

Harry M. Lamon, President, The National Poultry Institute, Dept. 30-D, Adams Center, N. Y.

I want to know how to make big money raising poultry. Send me your **FREE** book explaining your home-study course and **PROVED** methods.

Name.....
 Address.....
 City..... State.....



Learn to Write

BEGIN TODAY! Write for our Free Book, "HOW TO BECOME A GOOD PENMAN"

It contains specimens and tells how others learned to write in spare time. Your name beautifully written on a card if you enclose stamp for postage. Over 40 years experience teaching by mail. **WRITE TODAY**

THE TAMBLYN SCHOOL OF PENMANSHIP
 418 Ridge Bldg. Kansas City, Mo.

The Tambllyn School

BE AN ARTIST

WE CAN TEACH YOU DRAWING in your own home during your spare time. Thirty-five years of successful teaching proves our ability. Artists receive large salaries.

Write today for Art Year Book

SCHOOL OF APPLIED ART

Dept. 148 10 E. Huron St., Chicago, Ill.



Be a DENTICIAN

Learn at home to make Crowns, Plates, Bridgework, etc., for Dentists. Easy, practical way to learn mechanical dentistry at home in spare time. Full Equipment of Tools and Materials Included with Course. Low tuition. Easy terms. Write for **FREE BOOK** about this money-making profession that is not affected by "machine age."



McCARRIE SCHOOL OF MECHANICAL DENTISTRY
 207 No. Broad St., Dept. 732, Philadelphia, Pa.

ANY BOOK IN PRINT!

Delivered at your door. We pay postage. Standard authors, new books, popular editions, fiction, reference, medical, mechanical, children's books, etc.—all at **guaranteed savings**. Send card now for Clarkson's 1938 Catalog.

Thousands of Books at 1/2 Price and less

FREE Write for our great illustrated book catalog. A short course in literature. The buying guide of 300,000 booklovers. The selection of a Metropolitan book store brought to your home. **FREE** if you write **NOW—TODAY!**

CLARKSON PUBLISHING COMPANY
 Dept. P. M. 8—1253 So. Wabash Ave., Chicago, Ill.

Yes! YOU CAN MAKE BIG MONEY WITH HOOVER UNIFORMS!



Big earnings for ambitious men and women in new uncrowded field with famous nationally-advertised Hoover line of smart, exclusive Uniforms for restaurants, fountains, hotels, taverns, stores, offices, etc. Not home-to-house. No experience—no money needed to get into this new, big-income business. Mail postcard now for beautiful new Uniform Style presentation, actual samples and money-making equipment—sent **FREE**.

HOOVER 251 West 19th St., Dept. CH-9, New York, N. Y.

Photography for PLEASURE or PROFIT



Prepare for profitable business or fascinating hobby, at home under guidance of qualified instructors. No previous experience necessary, common school education sufficient. Many earn while learning. Our practical studio methods also qualify for well-paying positions upon graduation. Send coupon below at once for free booklet "Opportunities in Modern Photography", particulars and requirements.

AMERICAN SCHOOL OF PHOTOGRAPHY
 3601 Michigan Avenue Dept. 1354 Chicago, Illinois
 Send booklet, "Opportunities in Modern Photography", full particulars and requirements.
 Name..... Age.....
 Address.....
 City..... State.....



H. C. Lewis

QUICK, EASIER WAY
TO TRAIN FOR ELECTRICITY
12 Weeks ACTUAL SHOP WORK
Not by Books

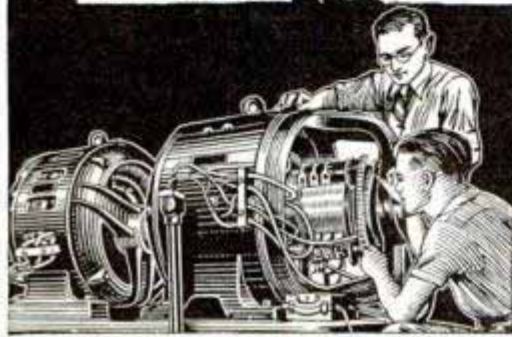

FIRST--You are told and shown how to do it.

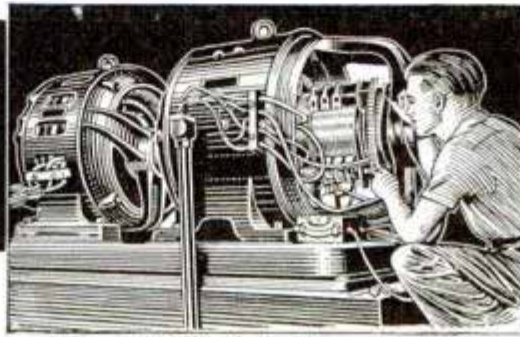

THEN--You do the job yourself.



HOUSE WIRING
 only one of the many branches you "Learn By Doing."

WANT TO EARN MORE MONEY?

Have you ever dreamed of holding down a steady, good pay job? Have you ever dreamed of doing the work you really like in a job that holds promise of a real future in the years ahead?

Well, we all know that you can't get the good things in life by just dreaming about them. Hundreds of fellows are today holding down mighty fine jobs with prospects of a bright future. They are filling these jobs because they had the foresight to equip themselves with the right kind of training. Most of these men were only average fellows a short time ago, but the proper training helped to lift them out of the low pay ranks of unskilled workers. The same opportunity is now offered to you.

The great fascinating field of **ELECTRICITY** offers a real future to many men and young men who are willing to prepare for a place in this giant industry.

I'LL FINANCE YOUR TRAINING

You can get this training first—then pay for it later in easy monthly payments, starting 60 days after your 12 weeks' training period is over—then you have 18 months to complete your payments.

If you need part time work to help out with expenses while training in my shops, my employment department will help you get it. Then after graduation this department will give you valuable lifetime employment service.

Send the coupon today for all details. When I get it I'll send you my big free book containing dozens of pictures of students at work in

H. C. LEWIS, President
COYNE ELECTRICAL SCHOOL
 500 S. Paulina St., Dept. 48-72, Chicago

Here at my school in Chicago, the world's Electrical Center, you can get 12 weeks' Shop Training in **ELECTRICITY**, that can help give you your start towards a better job.

You will be trained on actual equipment and machinery and because of our method of training, you don't need previous experience or a lot of education. Many of my successful graduates never even completed Grammar School.

Here in my school you work on generators, motors, dynamos, you do house wiring, wind armatures and do actual work in many other branches of electricity and right now I'm including valuable instruction in Diesel, Electric Refrigeration and Air Conditioning at no extra cost. Our practical shop methods make it easier to learn—First the instructors tell you how a thing should be done—then they show you how it should be done—then you do the actual work yourself.

"... Everything was just as stated in literature. And by Coyne methods plenty of instructors to take care of everything, easy to learn. I really was satisfied with Coyne Training."
 J. Halak, Canada

"... Coyne has first class instructors to teach you the simplest things to start with and they have the equipment to show you these things as you advance."
 Ben Rickman, S. Car.



my shops. I'll also tell you about my "Pay After Graduation" plan, how many earn while learning and how we help our students after graduation. Fill in, clip coupon, mail today for your start toward a brighter future.



H. C. LEWIS, President.
COYNE ELECTRICAL SCHOOL.
 500 S. Paulina Street, Dept. 48-72, Chicago, Ill.

Dear Sir: Please send me free your big catalog and full particulars of your present offer, also your "Pay-Tuition-After-Graduation" Plan.

NAME.....
 ADDRESS.....
 CITY..... STATE.....

**This
MACHINISTS'
Home-Study
Course
helps men get ahead**



Newly assembled—specially priced—these five recent books give you the practical facts on modern machines, up-to-date methods, you need to advance in machine shop work. Take advantage of the other man's experience as found in books, to solve your problems, increase your efficiency, with

**The NEW AMERICAN
MACHINISTS' LIBRARY**

5 volumes—2014 pages—1853 illustrations

(A combined home-study course and reference library)

This library of machine shop practice was written for practical men. It gives you the best methods for every kind of machine shop work. It fully explains lathes, drills, and other machine tools and their operation, automatic screw machines, speeds and feeds, gear design and production, punch and die work, metal surfacing, etc., etc. Plainly written—completely illustrated—the best kind of help to the machine shop man who wants to advance himself.

No money down—special price—easy payments.

FREE EXAMINATION COUPON

McGraw-Hill Book Co., 330 W. 42nd St., New York

Send me for ten days' free examination the new American Machinists' Library. If satisfactory I will send you \$1.50 in 10 days and \$3.00 monthly until the price of \$16.50 is paid. If not wanted, I will return the books postpaid. (To insure prompt shipment write plainly and fill in all lines.)

Name.....
Home Address.....
City and State.....
Position.....
Name of Company..... PM-4-38

**Learn this
Profitable
Profession**



in 90 Days at Home

Hundreds of men and women of all ages 18-50 make \$10.00 to \$20.00 in a single day giving scientific Swedish Massage and Hydro-Therapy treatments. There is a big demand from Hospitals, Sanitariums, Clubs, Doctors and private patients as well as opportunities for establishing your own office. Learn this interesting money-making profession in your own home by mail, through our home study course. Same instructors as in our **NATIONALLY KNOWN** resident school. A diploma is awarded upon completion of the course. Course can be completed in 3 to 4 months. High School training is not necessary. Many earn big money while learning.



Anatomy Charts & Sample Lessons FREE

Enroll now and we will include uniform coat, medical dictionary, patented reducing roller and Hydro-Therapy supplies without extra cost. The reducing course alone may be worth many times the modest tuition fee.

Send coupon now for booklet containing photographs and letters from successful graduates, illustrated sample lesson sheets and Anatomy Charts. These will all be sent postpaid—FREE.

THE College of Swedish Massage (Successor to National College of Massage)
Dept. 464—1601 Warren Boulevard, Chicago

You may send me **FREE** and postpaid, Anatomy Charts, illustrated sample lesson sheets and booklet containing photographs and letters from graduates.

Name.....
Address.....
City..... State.....

When writing please mention Popular Mechanics

EASY

**SOPRANI AMPLIPHONIC
Simplifies Playing**

Lighter, easier to play, less bellows-ing, plus more beautiful tone and volume,—that's how Soprani's exclusive Ampliphonic feature has simplified this accordion. Assures rapid progress. Home trial. Easy terms. See your music dealer or send for beautiful free book. Write today.



Nunzio, New York, with his Soprani

182

SOPRANI, INC.

Dept. 429, 630 S. Wabash Ave. Chicago, Illinois

You Can Regain Perfect Speech, if you

STAMMER

Send today for beautifully illustrated book entitled "DON'T STAMMER," which describes the Bogue Unit Method for the scientific correction of stammering and stuttering. Method successfully used at Bogue Institute for 37 years—since 1901. Endorsed by physicians. Full information concerning correction of stammering sent free. No obligation. Benjamin N. Bogue, Dept. 189 Circle Tower, Indianapolis, Indiana.

**AUTOMOTIVE
ENGINEERING**



Bachelor of Science Degrees—in Automotive, Aeronautical, Architectural, Chemical, Electrical, Industrial and Mechanical engineering! Modern equipment. All college activities. Low tuition. Write today for Catalog.

A NON-PROFIT COLLEGE

LAWRENCE INSTITUTE OF TECHNOLOGY
15102 Woodward Ave. DETROIT, MICH.

CATALOG ON REQUEST



Operator No. 38

FOLLOW THIS MAN

Secret Service Operator No. 38 is on the job! Running down dangerous Counterfeit Ganz. Tell-tale finger prints in murdered girl's room.

Free The Confidential Report Operator No. 38 made to his chief. Write for it.

Earn a Regular Monthly Salary

YOU can become a Finger Print Expert at home, in your spare time, at small cost. Write for confidential full report and details. Literature will be sent only to persons stating their age.

INSTITUTE OF APPLIED SCIENCE

1920 Sunnyside Ave. Dept. 1354 Chicago, Ill.

CARTOONING

PAYS WELL Turn your talent into dollars. Develop your ability with personal instruction from an internationally-known cartoonist. His exclusive, successful method of drawing and creating ideas makes it easy to attain success. Write for Free Booklet and details of this exceptional home-study course. The National School of Cartooning, 437 Penton Bldg., Cleveland, Ohio

GOV'T. JOBS

SALARY TO START \$90 to \$175 MONTHLY MEN WOMEN Age Range 18 to 50

- () Railway Mail Clerk
- () P. O. Laborer
- () R. F. D. Carrier
- () Special Agent
- () Statistical Clerk
- () City Mail Carrier
- () P. O. Clerk
- () Stock Clerk
- () Special Investigator
- () Typist
- () POSTMASTER
- () Elev. Conductor
- () Auditor
- () Stenographer
- () U. S. Border Patrol
- () Telephone Opr.
- () Watchman
- () Meat Inspector
- () Secret Service Opr.
- () File Clerk

GOVERNMENT INSTRUCTION SERVICE, Dept. 111, ST. LOUIS, MO.

Send me **FREE** particulars "How to Qualify for Government Positions" marked "X". Salaries, locations, opportunities, etc. ALL SENT FREE.

Name.....
Address.....

Become a Draftsman

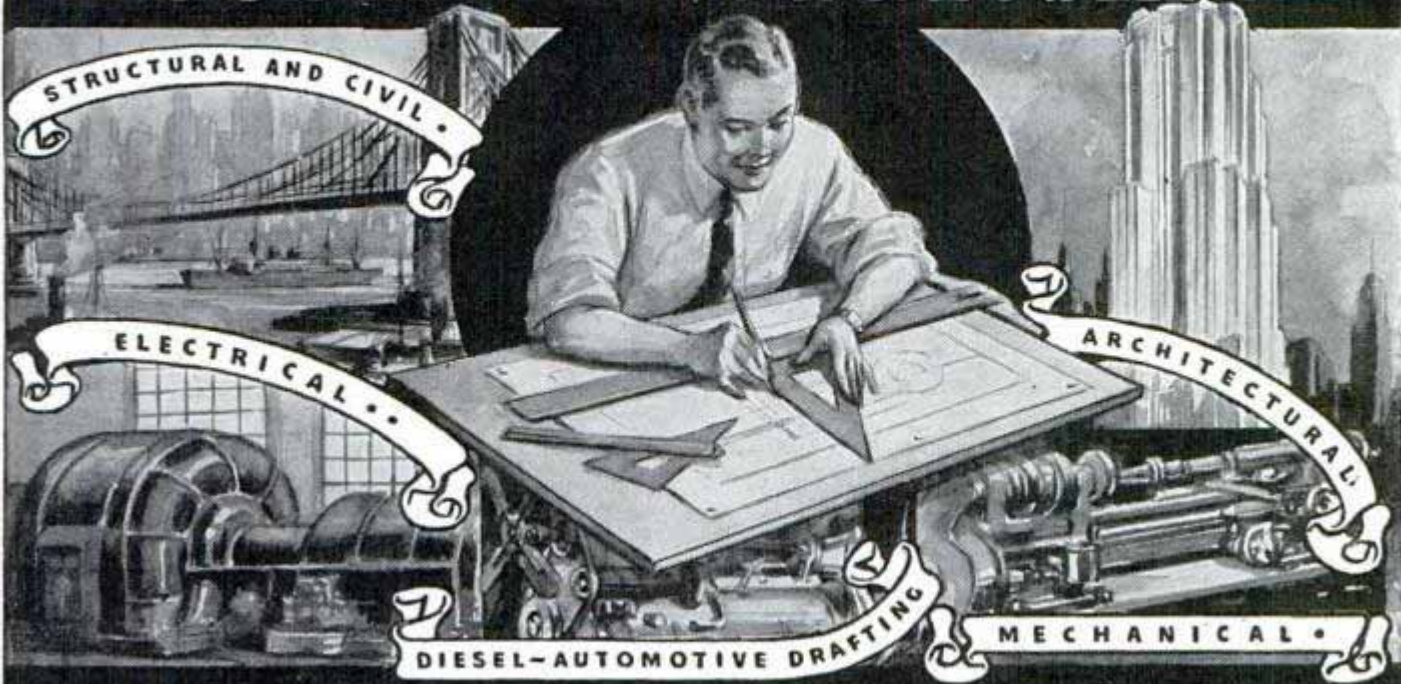

Enjoy a Real Job in Industry

Steady Work

As nearly all manufacturing—construction—building starts on the drafting table, the draftsman is one of the first to be hired and one of the last to be laid off. It is his blueprints, his specifications, that give the last word in what the workmen are to do. No article—building or construction job is started before the plans drawn by the draftsman have been officially approved.

Good Pay

The draftsman has been called the Junior Engineer which title just about describes his work—position and pay. He combines his knowledge of principles, mechanism and construction details with the ability to draw and reproduce motions and methods on paper. On the average, his salary is considerably above the wages of the mechanic and, of course, less than that of the engineer.

Chance for Promotion

Working on plans, helping design new machines or new methods of construction, the draftsman is working directly with the important men of the organization. Consequently he knows what is being considered and planned. It may be the superintendent—the engineer—or even the prospective buyer with whom he consults. Because of these contacts, his experience and knowledge of the business in general he is in an excellent position to be promoted when next there is a good opening.

Young at 40

Athletes—farmers—and factory and shop workers who rely on muscle start growing old even before they reach 40 while office workers—executives—teachers—professional men, in fact, all kinds of brain-workers are just approaching their prime at 40 to 50. Training increases your value at once and continues to help boost your earning power as you mature and as you increase your experience and background for forming judgments of the firm's policies and methods.

Don't grow old at 40. Train now for the job you want at 50. Training helps you to be independent—self-supporting. It helps you to enjoy associations that are denied the untrained man. Training helps you to increase your earning power and by so doing to offer members of your family advantages far in excess of what you could give them as an untrained man. Train and enjoy **PROGRESS—CONTENTMENT—INDEPENDENCE.**

American School, Drexel at 58th, Chicago



Mail Coupon for 2 Lessons Free

American School, Dept. DD-445
Drexel Ave. at 58th St., Chicago

Without the slightest obligation, send 2 beginning Drafting Lessons and free Bulletin.

Name..... Age.....

Address.....

City..... State.....

2 Lessons Free

Test yourself — see how readily  you, too, can learn Drafting

"Mother, why don't Butterflies fly around the lamp as Moths do?"

"Our New Merriam-Webster gives an interesting reason"

WHEN your boy asks questions, or when you want information on any subject, Webster's New International Dictionary, Second Edition, is ready to help you. Somewhere in the 3,350 pages of this greatest of all single reference volumes you will find the facts you need. 600,000 entries—122,000 more than in any other dictionary. The genuine Merriam-Webster is identified by the circular trade-mark on the cover. Accept nothing less than this "Supreme Authority." See the New Merriam-Webster at your bookdealer's, or write for free booklet to G. & C. MERRIAM CO., 893 Broadway, Springfield, Mass.



WEBSTER'S NEW INTERNATIONAL DICTIONARY • Second Edition

PLUMBERS & STEAM FITTERS
Audels Plumbers and Steamfitters Guides
4 Vols. \$6



A practical, illustrated, Reference Library and Study-Course for Master Plumbers, Journeymen and Apprentice Steamfitters, Gas Fitters and Helpers, Sheet Metal Workers, Draughtsmen, Master Builders, Engineers and all Building Trade Students. This valuable set of handy, pocket-size Guides explains in practical concise language and well-done illustrations all the principles, advances and short cuts of the Plumbing and Heating trade—based on modern practice. Contains careful, detailed instructions on how to figure and estimate various jobs. Use FREE COUPON below to examine, without obligation, this valuable work.

INSIDE TRADE INFORMATION ON:

Soldering, tinning, Joint wiping, bending, beating. Pipe—iron—steel, threading. Mathematics, tables, physics. Materials—iron, steel, copper, brass, lead, tin, antimony, etc. Sheet metal—galvanized—plate. Sanitation, syphonage, tanks. Drainage, sewage, purification. Fixtures—bath—kitchen. Pipe fittings, soil pipe, tools. Laying out work. Roughing. Screwed fittings, flanges, joints. Pipe bending, examples. Elbows. Heating, ventilation, air conditioning, refrigeration. Water supply, mains, wells, tanks. Gas-fittings. Sheet metal work, problems, methods. Brazing, heating, lead burning. Welding, various welds, methods. Blacksmithing, forges, tools.

THEO. AUDEL & CO., 49 W. 23rd St., New York City

Mail Audels Plumbers Guides, 4 vols., on 7 days' free trial. If O. K. I will remit \$1 in 7 days, and \$1 monthly until \$6 is paid. Otherwise I will return them. No obligation unless I am satisfied.

Name.....
Address.....
Occupation.....
Reference..... P. M



When writing please mention Popular Mechanics

EASIEST to Master

This New P-A

Such beautiful tone, and so easy to play! Just touch a key and blow normally; you can't miss. Nothing to compare with these new P-A Saxes, Clarinets, Trumpets, and other P-A instruments. Fully guaranteed; your success assured. See your music dealer or write direct for beautiful, free book. No obligation. Easy terms. 1286

PAN-AMERICAN
403 P-A Building Elkhart, Indiana

AVIATION APPRENTICES

BIG PAY GOOD FUTURE

IF YOU ARE INTERESTED IN WORKING YOURSELF INTO A HIGHLY PAID POSITION IN AVIATION—Write, immediately, enclosing stamp—

MECHANIX UNIVERSAL AVIATION SERVICE CO.
Strathmoor Station Dept. E Detroit, Mich.

LEARN WATCH REPAIRING

AT HOME You can learn by our modern and original system of instruction every part of the Watch Repairing Trade at home. You can earn money while learning and prepare yourself for a well paying position or start in business after completing our course of instruction. Good watch repairers are in demand and generally earn very good salaries. For particulars apply to the

Wisconsin School of Watch Repairing
524 E. Mason St., MILWAUKEE, WIS.

WHY NOT spend spring, summer, fall, gathering butterflies, insects. I buy hundreds of kinds for collections. Some worth \$1 to \$7 each. Simple outdoor work with my Instructions, pictures, price list. Profit—pleasure. Send 10c (not stamps) for Illustrated Prospectus before sending butterflies.

MR. SINCLAIR, DEALER IN INSECTS
Dept. 6, Box 1424 San Diego, Calif.

Learn CHALK TALKING

Entertain for all occasions. Send \$1.00 for Laugh Producing Program of 23 Trick Drawings with Instructions. Catalog of Chalk Talk Supplies 10c.

BALDA ART SERVICE, Dept. K, Oshkosh, Wis.

SAVE THAT OLD TIRE

Amazing new plastinoid "putty"—SO-LO ONLY—fills cracks, holes in old tires, shoes, boots—anything of rubber, leather or cloth. Spreads on like butter. Dries tough overnight. Waterproof, flexible, non-skid. Won't come off—guaranteed! 25c package (25 repairs) shows many uses. Get SO-LO at any 10c or hardware store.

1¢ SO-LO

MAIL FOR FREE INFORMATION

BEDFORD YMCA TRADE SCHOOL

1117 Bedford Ave., Dept. PM-59 Brooklyn, New York City, N. Y.

- Diesel Engines
- Diesel Engineering
- Aviation Mechanic
- Aeronautical Engineering
- Auto Mechanic
- Refrigeration
- Radio and Television Mechanic
- Air Conditioning
- Architectural-Mechanical Drafting
- Electrical
- Armature Winding
- Oil Burner
- Welding
- Machine Shop
- Window Display

Name.....
Address.....

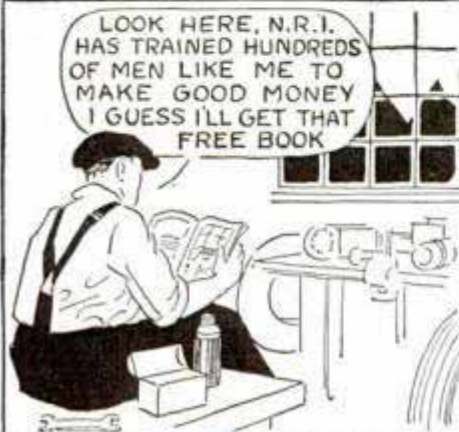

I'LL TRAIN YOU AT HOME in Your Spare Time For A GOOD RADIO JOB

Many Radio Experts Make \$30, \$50, \$75 a Week

Do you want to make more money? Broadcasting stations employ engineers, operators, station managers and pay up to \$5,000 a year. Spare time Radio set servicing pays as much as \$200 to \$500 a year—full time servicing jobs pay as much as \$30, \$50, \$75 a week. Many Radio Experts own their own full or part time Radio businesses. Radio manufacturers and jobbers employ testers, inspectors, foremen, engineers, servicemen, paying up to \$6,000 a year. Radio operators on ships get good pay and see the world. Automobile, police, aviation, commercial Radio, loud speaker systems offer good opportunities now and for the future. Television promises many good jobs soon. Men I trained have good jobs in these branches of Radio.



**J. E. SMITH, President
National Radio Institute**
Established 1914

The man who has directed the home study training of more men for the Radio Industry than any other man in America.

Many Make \$5, \$10, \$15 a Week Extra in Spare Time While Learning

Almost every neighborhood needs a good spare time serviceman. The day you enroll I start sending Extra Money Job Sheets showing how to do Radio repair jobs. Throughout your training I send plans and ideas that made good spare time money for hundreds. I send Special Equipment to conduct experiments, build circuits, get practical experience. I GIVE YOU A COMPLETE MODERN PROFESSIONAL ALL WAVE, ALL PURPOSE RADIO SET SERVICING INSTRUMENT TO HELP SERVICE SETS QUICKER—SAVE TIME, MAKE MORE MONEY.

Find Out What Radio Offers You

Mail the coupon now for "Rich Rewards in Radio." It's free to any fellow over 16 years old. It points out Radio's spare time and full time opportunities, also those coming in Television; tells about my Training in Radio and Television; shows you letters from men I trained, telling what they are doing, earning; shows my Money Back Agreement. MAIL COUPON in an envelope, or paste on a post card—NOW!

**J. E. SMITH, President, Dept. 8DP,
National Radio Institute, Washington, D. C.**

**J. E. SMITH, President, Dept. 8DP,
National Radio Institute, Washington, D. C.**

Dear Mr. Smith: Without obligating me, send "Rich Rewards in Radio," which points out the spare time and full time opportunities in Radio and explains your 50-50 method of training men at home in spare time to become Radio Experts.

NAME.....AGE.....
ADDRESS.....
CITY.....STATE.....

**THIS
FREE BOOK
HAS HELPED
HUNDREDS OF
MEN MAKE
MORE MONEY**

HERE'S PROOF THAT MY TRAINING PAYS



**Chief Operator
Broadcasting
Station**
"When I completed 20 lessons I obtained my Radio Broadcast Operator's license and immediately joined station WMPC, where I am now Chief Operator."
HOLLIS F. HAYES,
85 Madison St., LaPeer, Mich.

**Over
\$1,000
Before
Graduating**



"Before completing half the N.R.I. Course I was servicing sets, and I made \$1,000 to \$1,200 before graduating. I am doing Radio service work for myself now."
ASHLEY G. ALDRIDGE,
1228 Shepherd St., Petersburg, Va.



**\$200 to \$300
a Month
in Own
Business**
"For the last 18 months I have been in business for myself, making between \$200 and \$300 a month. I have N.R.I. to thank for my start in this field."
ARLIE J. FROEHNER, 224 W. Texas Ave., Goose Creek, Texas.



DRAFTING

Is *YOUR* Opportunity

You'll be amazed at the speed with which you can learn in your spare time.



for **MORE PAY** and a **BETTER JOB**

Let Engineer Dobe Train You at Home

Engineer Dobe can prepare you just as he has trained thousands of successful students, aged 16 to 18 to past 50. His practical "Work-Job" method requires no previous experience. High school education not needed. He offers you a real opportunity to get a complete training in drafting right in your home in a surprisingly few months. Engineer Dobe teaches his students until thoroughly trained and until holding a good paying job.

The draftsman has rich opportunities for advancement and better pay in scores of fields. In Machinery, Building, Aviation, Electricity, Transportation, Automotives—draftsmen must be used. Many trained draftsmen will be needed on better jobs at better pay and shorter hours.

Jobs Now Open

Mail the coupon today for FREE illustrated book "Successful Draftsmanship" and full details of Engineer Dobe's remarkable offer that includes all necessary tools and equipment. Learn just how you can be trained successfully at home in your spare time. Time is money. Now is the time to prepare. Don't wait another day.

Send the coupon below NOW for Engineer Dobe's FREE Book.



THESE TOOLS and other equipment FURNISHED When You Start

SEND FOR FREE BOOK

ENGINEER DOBE, Div. 3374, Libertyville, Ill.
Send me your free book "Successful Draftsmanship." Please explain how you assist your graduates to good positions as draftsmen.

Name _____
Address _____
Town _____
State _____ Age _____

When writing to advertisers please mention Popular Mechanics

PARKS AIR COLLEGE

PARKS AIRPORT EAST ST. LOUIS, ILL.

Offers COLLEGE and PROFESSIONAL TRAINING
Majoring in AVIATION

FOUR courses lead to B.S. degrees in Professional Piloting, Aviation Operations, Aviation Mechanics, Aeronautical Engineering.
TWELVE TRAINING PLANES are used in professional flight training which prepares graduates for airline flight operations. 74% of graduates enter air transportation in North and South America. 64,000 hours flight training given, 650 hours being flown monthly.
FACULTY of 33 specialists in various fields of aviation.
1477 graduates, Capacity enrollment of 302 for Fall term.
100-acre airport, 14 buildings devoted to school purposes exclusively. Dormitories and dining hall on the Field.
Accredited by the Illinois Superintendent of Public Instruction. Government approved as a Transport Ground and Flying School and Mechanics' School. Open to high school graduates.
Spring term March 28. Send postcard for new 60-page catalog.
Registrar, Dept. PM-4
11th YEAR PARKS AIR COLLEGE, East St. Louis, Ill.

GAG-CARTOON!



AND MAKE BIG MONEY—AT HOME—BY MAIL!
Magazines pay up to \$200.00 per cartoon. Get in this NEW FIELD and be your own boss! My 50 lesson—1000 Illustration course shows you how. FREE CATALOG MARKETS INCLUDED—
All for..... **\$280**
Send for FREE details.
FREE drawing set with course.

MOON GAG-CARTOON SCHOOL
Paramount Bldg. Dept. A-5, Fall Creek, Wis.



BE A RAILWAY TRAFFIC INSPECTOR

WRITE TODAY

Good Pay—and a Job with a Future

Trained Railway and Bus Traffic Inspectors are in constant demand. Our graduates are placed in positions at up to \$135 per month, plus expenses to start, or we refund tuition. Rapid advancement for ambitious men—19 to 50, who complete our easy, home-study course. Write for Free Booklet with FACTS.

STANDARD BUSINESS TRAINING INSTITUTE
Div. 204 Buffalo, N. Y.

FREE SUITS & BIG PROFITS

AS A BONUS Sell "MOVIE STAR" Styles.



In Made-to-Order Suits **\$15.95 UP**
Show friends Made-to-Order Clothes "Styled for the Stars" at big savings. New Fashions Fabrics, inspired by Hollywood's fashion plates, Buddy Rogers, Cesar Romero, others. Take orders spare time. Earn big profits, your own suits Free as bonus. Our clothes guaranteed to fit and satisfy. Big outfit 100 large samples Free. Write today.
JIM FOSTER, Inc., 2253 S. Spaulding Ave., Dept. A-4, Chicago, Ill.

Learn Public Speaking

At home—in spare time. Many overcome "stage-fright," gain self-confidence and increase earning power, this easy way. Write for free booklet, *How to Work Wonders With Words* and requirements.
North American Institute, Dept. 1354
3601 Michigan Ave., Chicago, Illinois



Minstrels Comedy Skits & Plays
Unique First Parts for complete show with special songs and choruses. Make-up. Catalog Free.
T. S. Denison & Co. 203 N. Wabash, Dept. 19, Chicago

REFINISHES AUTOS Like NEW!



PAYS UP TO \$7.00 AN HOUR

KAR-NU refinishes any color automobile easily, quickly and economically without polishing, waxing, rubbing or painting.
JUST WIPE IT ON WITH A CLOTH!
Magic-like fluid covers old paint with tough, elastic coat. Absolutely transparent, self-leveling, self-polishing. Guaranteed. Lasts 8 to 12 months. Equal in beauty to repaint job costing \$10 to \$35. Write for Free Sample to prove our claims and Territory offer.
KAR-NU CO. Dept. D-30, Oakley Sta. Cincinnati, O.

FOR MEN WHO WANT TO LEARN A PROFITABLE TRADE



Complete **DIESEL** *Training*



HOME OF NATIONAL SCHOOLS

A million-dollar trade school, occupying its own modern three-story building, exclusively devoted to training ambitious men. Latest equipment; selected, experienced staff of engineers and instructors; practical, thorough training.

with all types INTERNAL COMBUSTION ENGINES, ELECTRIC POWER GENERATION, etc.

YOU MEN who are sincerely ambitious to make good in the Diesel and related industries, want to know the true facts—you want to know about employment opportunities and employment requirements. For 33 years, National Schools, a recognized leader in the field of trade education, has played a vital part in helping wide-awake men to qualify for success in industry. National Schools—a million-dollar trade school—will supply you with a sincere, honest statement of facts on what you should do to get into the profitable Diesel Industry. No exaggerations—no mis-statements.

nearest point of entry.) Student social life includes inspection trips, excursions, athletic activities, etc. Special doctor service. Personality coaching. **Many students are helped with spare-time jobs to earn room and board while learning.** (Canadians excepted.) Graduate employment cooperation.

PUBLIC SCHOOL SUPERINTENDENT PROFITS BY NATIONAL TRAINING

"I have attended two state universities and two state normal schools and I want you to know that I feel I have received more for my money at National than at any other school I have attended. One cannot be too high in praise of the instructors—of their determination to see that each student received complete instruction and thorough understanding of each assignment."

J. Stover, Jr.,
Sup't., Palouse Public Schools,
State of Washington.

YOU NEED REAL SHOP EXPERIENCE WITH TIME-TESTED TRAINING

Mail the coupon below. In the literature you will be sent, you will see exactly how other men like you are preparing themselves for success in National's modern training shops. You learn on the latest, finest equipment. You do real job work. You learn by time-tested, shop practice methods. Your training is fascinating in every detail. You are taught how to make good, and helped to make good after you graduate. All of this and much more is clearly pictured for you in the Free Book of Facts we will send to you.

TRANSPORTATION ALLOWED TO LOS ANGELES

National Students are allowed coach railroad fare from any point in U. S. (Canadian students from

National Training is so thorough and all-inclusive, that no ambitious man can afford to consider Diesel Training without first knowing all of the facts regarding the many advantages available to him as a National Student. INVESTIGATE.

NATIONAL SCHOOLS *Los Angeles*

SEND FOR YOUR COPY TODAY
—Real Facts on Diesel
Employment Requirements

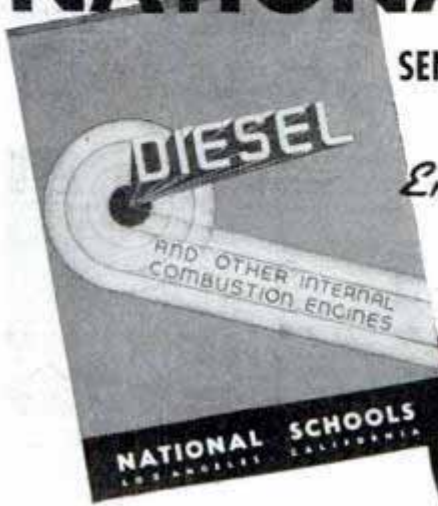

Free
NEW BOOK
OF
TRAINING FACTS

Request for Free Book
NATIONAL SCHOOLS
 (established 1905) Dept. PMA-4
 4000 S. Figueroa St., Los Angeles
 Please send me, without obligation, your FREE BOOK and information regarding Diesel Employment Opportunities and Requirements.

NAME _____ AGE _____
 ADDRESS _____
 CITY _____ STATE _____



High School Course at Home

Many Finish in 2 Years

You can complete this simplified High School Course as rapidly as your time and abilities permit. Equivalent to resident school work—prepares you for entrance to college. Standard H. S. texts supplied—Diploma. Credit for H. S. subjects already completed. Single subjects if desired. High School education is very important for advancement in business and industry and socially.

College Entrance

During the past 14 years, our High School graduates have been admitted to 531 different Universities, Colleges, Junior Colleges and Normal Schools—80% of them without entrance examination. Course also prepares for teachers' certificate and pre-professional examinations.

Business—Industry

To get and hold a good position in Business today you must be able to write clear, accurate letters and reports—do figuring involving Algebra and Geometry—talk intelligently on matters requiring a knowledge of Geography, History, and Economics.

In Industry—Mechanical and Engineering lines—you must have at least an elementary knowledge of Physics and Chemistry—be able to figure quickly and accurately—know something of Mechanical Drawing and blueprints—and be able to talk and write accurately and clearly on both your work and ordinary topics of conversation.

Our High School course meets the preparatory educational requirements for Business and Industry.

An Educational Institution

The American School was chartered in 1897 as an educational institution, not for profit—and is exempt from paying Federal income tax, like the best resident colleges and universities.

Don't Be Handicapped— Complete Your Training Now

Be a High School Graduate! Prepare yourself for promotion in Business and Industry—for the Professions, College Entrance and social success. No matter what line you may select, High School training will prove invaluable to you! Our moderate fees cover all instruction, standard textbooks and Diploma. Easy monthly terms. Get ahead in life. Start your training NOW!

20 Other Courses

Over 150 noted Educators, Engineers, and Business Men helped prepare our special instruction material, which is used by many resident schools and colleges, U. S. Navy, and Province of Manitoba, Canada. We offer you quality training at home for the best-paying lines of Industry and Business, as listed in the coupon.

Mail coupon for information about line that interests you
American School, Drexel at 58th, Chicago

American School, Dept. H445, Drexel at 58th, Chicago
Tell me how to train for success in line checked. No obligation.

- | | |
|--|--|
| <input type="checkbox"/> Accounting & Auditing | <input type="checkbox"/> Diesel Engineering |
| <input type="checkbox"/> Architecture & B'lding | <input type="checkbox"/> Drafting & Design |
| <input type="checkbox"/> Automotive Engin'ring | <input type="checkbox"/> Liberal Arts |
| <input type="checkbox"/> Business Management | <input type="checkbox"/> Private Secretary |
| <input type="checkbox"/> Com'ercial Aeronautics | <input type="checkbox"/> Hi'er Ac't'g (C.P.A.) |
| <input type="checkbox"/> Electrical Engineering | <input type="checkbox"/> Highway Engin'g |
| <input type="checkbox"/> Electrical Refrigerat'n | <input type="checkbox"/> Mechanical Eng'g |
| <input type="checkbox"/> Air Conditioning | <input type="checkbox"/> Radio & Television |
| <input type="checkbox"/> Civil Engineering | <input type="checkbox"/> Salesmanship |
| <input type="checkbox"/> Complete Law | <input type="checkbox"/> Steam Engineering |

Name.....
Address.....

When writing please mention Popular Mechanics



NEW! COMPLETE and Up-to-the Minute Book on HOUSE WIRING

Covers, in great detail, all phases of practical wiring for homes, garages, farm buildings, etc. Written in the simplest language; describes and illustrates fuses, circuits, switches, installation plans; also wiring diagrams; over 200 illustrations; cloth binding \$1.50 post-paid. 5-day money-back guarantee.

FREE Complete catalog of practical books on Painting; Decorating; Commercial Art; Sheet Metal;

Welding; Radio; Electricity; Engineering; Carpentry and Building; Plumbing; Heating and Ventilating. **WRITE TODAY.**

FRED'K J. DRAKE & CO., 185 N. Michigan Av., Chicago

Write
and
Speak

MASTERLY ENGLISH



Learn correct English with Sherwin Cody's new invention. No rules to memorize. Like a fascinating game. Spare-time study, 15 minutes each day quickly gives you command of English. Send for free book, "How You Can Master Good English in 15 Minutes a Day." Write today. SHERWIN CODY SCHOOL OF ENGLISH
54 Searle Bldg. Rochester, N. Y.



TRI-STATE COLLEGE

B. S. Degree in 2 years. World famous for technical 2-year courses in Civil, Electrical, Mechanical, Chemical, Radio, Aeronautical Engineering; Business Administration and Accounting. Those who lack high school may make up work. Low tuition. Low living costs. Located in picturesque hill and lake region. Students from every state and many foreign countries. 55th year. Enter September, January, March, June.

Write for catalog.

448 College Ave.

ANGOLA, IND.



PLAY A SAW!

Produce wonderful music in 5 days... quickly play popular and classical numbers. No notes to read, no dreary practice—success guaranteed. Since 1924 thousands of my students have amazed friends, starred in shows and broadcasting orchestras. Without obligation, write for 5 DAY TRIAL OFFER now.

MUSSEHL & WESTPHAL

132 W. Water St., Fort Atkinson, Wis.

ARTISTS MAKE MONEY

Find out your ability. Send name, age, occupation and address for Free Vocational Art Test. Federal Schools, Inc., 4138 Federal Schools Bldg., Minneapolis, Minn.

LEARN WATCHMAKING AND ENGRAVING

BY OUR PROFIT-SHARING PLAN
OUR GRADUATES SUCCEED

One of our Iowa students started in a very small way—now doing over \$30,000 a year. Another in Wisconsin, over \$10,000 the first year. Day or night classes. Call or write for FREE BOOK. Chicago School of Watchmaking, Dept. 6201, 155 N. Clark St., CHICAGO.

How To Secure A Government Position

Why worry about strikes, layoffs, hard times? Train now for a Government job. Increased salaries, steady work, travel, good pay. Let us help you become a Railway Postal Clerk, Post Office Clerk, City Mail Carrier, Rural Carrier—or help you get another position in Government Classified Service. I was a Civil Service Examiner for nearly 8 years. This coaching has helped thousands. My 32-page book tells **FREE BOOK** about Government jobs and how our instruction helps to qualify you to get the one you want. Send for a free copy TODAY.



A. R. Patterson, Civil Service Expert
PATTERSON SCHOOL, 84 Mercantile Bldg., Rochester, N. Y.
Send without obligation, free book "How to Secure Government Position."

Name.....
Address.....

What's all this Talk...

ABOUT OPPORTUNITIES IN TECHNICAL FIELDS?

- What do authorities say about today's opportunities?
- What are some of the really **big** fields for men?
- How does a person get into a chosen field?
- Is special training necessary today?

Vocational Service stands ready to help you answer these questions. As a part of its service there are now available interesting and authoritatively written booklets regarding several leading technical fields and training institutions. Use the coupon below specifying which one field interests you most.

The aim of Vocational Service is to aid men in selecting their fields of greatest opportunity, no matter where they live,—and to help certain technical institutions find the right type of men for their training programs.

VOCATIONAL SERVICE

Boston, 902 Statler Building; New York, 420 Lexington Avenue;
Detroit, 2411 Fourteenth Street; Chicago, 228 North La Salle
Street; Memphis, 3rd and Madison Streets; Los Angeles, 3455
Eagle Rock Boulevard; Seattle, 2nd Avenue at Madison; Van-
couver, B.C., Cambie and Hastings Streets.

VOCATIONAL SERVICE, Dept. M-4
(send to address nearest you)

GENTLEMEN: I am between 18 and 45 and am interested in hearing from you further. Without obligation please send booklet on the field I have checked—the one which interests me most.

AIRCRAFT AIR CONDITIONING DIESEL

Name

Street or Rural Route

City State P-2-m

DO YOU JUST DREAM OF FAT PAY ENVELOPES?



● **DREAMING** is a grand pastime but it will never add a single dollar to your pay envelope. The truth is, the only safe way to get more money is to deserve more money! You will never be surprised in the pay envelope unless you surprise somebody on the job. **TRAINING** (you can acquire it through spare-time study of an I. C. S. Course) is the answer! This coupon is the first step.

INTERNATIONAL CORRESPONDENCE SCHOOLS

Box 5512-J, Scranton, Penna.

Without obligation, please send full particulars about the subject before which I have marked X:

TECHNICAL AND INDUSTRIAL COURSES

- | | |
|--|---|
| <input type="checkbox"/> Architect | <input type="checkbox"/> Diesel Engines |
| <input type="checkbox"/> Architectural Draftsman | <input type="checkbox"/> Aviation Eng. <input type="checkbox"/> Auto Mechanic |
| <input type="checkbox"/> Building Estimating | <input type="checkbox"/> Plumbing <input type="checkbox"/> Heating |
| <input type="checkbox"/> Contractor and Builder | <input type="checkbox"/> Air Conditioning and Cooling |
| <input type="checkbox"/> Structural Draftsman | <input type="checkbox"/> Commercial Refrigeration |
| <input type="checkbox"/> Structural Engineer | <input type="checkbox"/> Steam Engineer |
| <input type="checkbox"/> Electrical Engineer | <input type="checkbox"/> Steam Electric Engineer |
| <input type="checkbox"/> Electric Lighting | <input type="checkbox"/> Marine Engineer |
| <input type="checkbox"/> Welding, Electric and Gas | <input type="checkbox"/> Civil Engineer <input type="checkbox"/> Highway Engineer |
| <input type="checkbox"/> Reading Shop Blueprints | <input type="checkbox"/> Bridge Engineer |
| <input type="checkbox"/> Telegraph Engineer | <input type="checkbox"/> Bridge and Building Foreman |
| <input type="checkbox"/> Telephone Work <input type="checkbox"/> Radio | <input type="checkbox"/> Surveying and Mapping |
| <input type="checkbox"/> Mechanical Engineer | <input type="checkbox"/> R. R. Locomotives <input type="checkbox"/> Air Brakes |
| <input type="checkbox"/> Mechanical Draftsman | <input type="checkbox"/> R. R. Section Foreman |
| <input type="checkbox"/> Machinist <input type="checkbox"/> Toolmaker | <input type="checkbox"/> R. R. Signalmen |
| <input type="checkbox"/> Patternmaker | <input type="checkbox"/> Chemistry <input type="checkbox"/> Pharmacy |
| <input type="checkbox"/> Foundry Practice | <input type="checkbox"/> Coal Mining <input type="checkbox"/> Navigation |
| <input type="checkbox"/> Sheet Metal Worker | <input type="checkbox"/> Cotton Manufacturing |
| <input type="checkbox"/> Boilermaker | <input type="checkbox"/> Woolen Manufacturing |
| <input type="checkbox"/> Heat Treatment of Metals | <input type="checkbox"/> Agriculture <input type="checkbox"/> Fruit Growing |
| <input type="checkbox"/> Management of Inventions | <input type="checkbox"/> Poultry Farming |

BUSINESS TRAINING COURSES

- | | |
|--|--|
| <input type="checkbox"/> Business Management | <input type="checkbox"/> Lettering Show Cards <input type="checkbox"/> Signs |
| <input type="checkbox"/> Industrial Management | <input type="checkbox"/> Stenography and Typing |
| <input type="checkbox"/> Traffic Management | <input type="checkbox"/> Civil Service <input type="checkbox"/> Mail Carrier |
| <input type="checkbox"/> C. P. Accountancy | <input type="checkbox"/> Railway Mail Clerk |
| <input type="checkbox"/> Bookkeeping | <input type="checkbox"/> Grade School Subjects |
| <input type="checkbox"/> Secretarial Work | <input type="checkbox"/> High School Subjects |
| <input type="checkbox"/> Cost Accountant | <input type="checkbox"/> College Preparatory |
| <input type="checkbox"/> Salesmanship <input type="checkbox"/> Advertising | <input type="checkbox"/> First Year College Subjects |
| <input type="checkbox"/> Service Station Salesmanship | <input type="checkbox"/> Illustrating <input type="checkbox"/> Spanish |
| <input type="checkbox"/> Business Correspondence | <input type="checkbox"/> Cartooning <input type="checkbox"/> French |

DOMESTIC SCIENCE COURSES

- | | |
|---|--|
| <input type="checkbox"/> Professional Dressmaking and Designing | <input type="checkbox"/> Millinery |
| <input type="checkbox"/> Home Dressmaking | <input type="checkbox"/> Foods and Cookery |
| <input type="checkbox"/> Advanced Dressmaking | <input type="checkbox"/> Tea Room and Cafeteria Management, Catering |

Name.....Age.....
 Address.....
 City.....State.....

Present Position.....
 If you reside in Canada, send this coupon to the International Correspondence Schools Canadian, Limited, Montreal, Canada

When writing please mention Popular Mechanics

NOW I KNOW WHAT FRED MEANT WHEN HE SAID HE GOT HIS PAY BOOST OUT OF A TWO DOLLAR BOOK.



PAY RAISING EXTRA MONEY BOOKS THAT WILL HELP YOU WIN SUCCESS

You, too, will find the selected list of practical books below just what you need to help you improve your job, prepare for a better one, or add to your income through spare time earnings. Thousands give these books credit for their success.

SEND NO MONEY! Use this advertisement as an order blank. Check books wanted. Add name and address and mail. Just pay postman price plus few cents postage. (In U. S. and possessions.) Or remit with order and add 10 cents per book for postage.

POPULAR MECHANICS PRESS

Room 438B 200 East Ontario Street Chicago

- | | |
|---|---|
| AIR CONDITIONING
Live Field; Great Future.....\$3.50 | LOG CABINS
Easy Plans; Build for Profits, Value.....\$2.50 |
| AUTO ENCYCLOPEDIA
The Famous Dyke's Latest Edition.....\$6.00 | MATHEMATICS
Easy Guide for the Practical Man.....\$1.50 |
| 110-V. GENERATORS
Made From Old Auto Units.....\$1.00 | MECHANICAL DRAWING
Learn Drafting; Good Salaries.....\$1.00 |
| BIRD HOUSES
Build to Sell; Easy Designs.....\$1.00 | MONEY MAKING IDEAS
1000 Ways to Make \$1000.....\$2.50 |
| BLUEPRINT READING
for the Building Trades.....\$1.25 | OFFICE MACHINES
All Makes. Care and Operation.....\$2.50 |
| BOAT BOOK
Power, Sail, Rowing, Paddle Plans.....\$3.00 | PLUMBING
500 Facts Every Homeowner Should Know.....\$1.50 |
| BOY MECHANIC
Hundreds Things Boys Can Make.....\$2.00 | TEST GOLD—PLATINUM
Identify—Buy—Sell. By C. M. Hoke....\$1.00 |
| CARPENTRY, PRACTICAL
Complete 436 pages. Revised Edition...\$2.00 | POWER TOOLS
For Home Workshop...\$1.75 |
| CHEMISTRY, PRACTICAL
Make Hundreds Things Daily Use...\$2.00 | PROSPECTORS' HANDBOOK
How to Mine, Appraise, Equip.....\$3.00 |
| CIVIL SERVICE
Home Study Courses Federal, State, City Positions.....\$1.00 | RADIO SERVICING
Profit by Knowing Costs, Kinks, Etc...\$4.00 |
| CONCRETE
1001 Ideas for Using. New Popular Mechanics Book...\$5.00 | REFRIGERATION
Electric. Gas. Be a Service Expert.....\$5.00 |
| DIESEL HANDBOOK
New! Latest Information.....\$5.00 | REWINDING ELECTRIC MOTORS
Fractional Sizes. Value!.....\$2.50 |
| ELECTROPLATING
With Copper, Nickel and Chromium Technical bulletin.....\$1.00 | SHIP MODEL
Entire Text, Famous "Sovereign" of 1637...\$1.00 |
| FORD V-8 CARS, TRUCKS
New, 700 Pages, Includes Details 1937 Cars.....\$2.50 | SHOP NOTES LIBRARY
5 Vol. 2000 Wonderful Shop Ideas.....\$2.50 |
| FORMULAS
1059 Money Making. Start a Business....\$1.25 | STAMP ALBUM
Modern, 400 Pages...\$1.00 |
| A.C. POWER WIRING
Covers all uses of a.c. for power.....\$4.00 | STEEL SQUARE
How to Figure Angles of Rafters, Roofs, Etc.....\$1.00 |
| FURNITURE MAKING
Tools, Materials, Design.....\$2.50 | TOYS
For Amusement or Profit. Saleable Designs.....\$1.50 |
| HOUSES, SMALL
Book of, for Home Builders.....\$2.00 | TRAILER BUILDING
New Book.....\$1.00 |
| HYPNOTISM
How to Become an Expert.....\$2.00 | UPHOLSTERY
Always a Big Market. Start Own Business...\$2.00 |
| LATHE WORK (Metal)
Drilling, Threading...\$1.00 | WOOD FINISHING
Methods, Tools, Materials.....\$2.00 |
| LOCOMOTIVE
Folding Chart Shows all Parts.....\$1.00 | |



Life's Most Embarrassing Moment



WHEN THE GIRL YOU WERE KEEN ABOUT SAW YOU IN A BATHING SUIT AND YELLED—

"HELLO, SKINNY!"

I'LL PROVE IN 7 DAYS THAT I CAN MAKE YOU A NEW MAN!

YES—right in these first 7 days I'll start to PROVE I can turn YOU into a man of might and muscle. And it will be PROOF that you (and anyone else) can SEE, FEEL, MEASURE with a tape!

In even one short week I guarantee you'll feel new muscles rising where only flabby flesh had been before! Your whole body will glow with health, surge with new power.

Just tell me where you want to add inches of muscle or solid flesh, and which parts of your body are under-developed. And in double-quick time I'll turn them into champion measurements!

I was only a 97-pound weakling. A nervous, easily tired, anaemic runt. Something had to be done. Ordinary "exercising" did no good. And THEN—I discovered DYNAMIC TENSION! I built my body into the picture of health and strength you see here—and won, in Madison Square Garden, the title, "World's Most Perfectly Developed Man"!

DYNAMIC TENSION worked miracles! Friends who used to laugh at my physique now stared at me in amazement. Would I show them how I accomplished it? I DID. I worked wonders for them. And now I'm ready to show YOU my secret of building big, prize-winning muscles with the measurements of a real HE-MAN and the power of a human dynamo!

No Apparatus, Pills or Diets

I have no use for pills, freak diets, or apparatus that might strain your heart or other vital organs. DYNAMIC TENSION is the natural way to build up your body, strengthen you inside and out. It not only makes you an "Atlas Champion," but goes after constipation, pimples, skin blemishes, and other weaknesses. And it starts ridding you of them at once.

Actual Photographs Will Show You

Let my FREE BOOK—Everlasting Health and Strength—show you photographic proof of what DYNAMIC TENSION has done for others. It tells about my amazing secret of physical development. It tells you how to develop courage, confidence, and will-power—and how I can make you THE MAN YOU WANT TO BE! . . . This valuable book is absolutely FREE! Send for it TODAY! Address me personally: CHARLES ATLAS, Dept. 84, 115 East 23rd St., New York, N. Y.

CHARLES ATLAS, Dept. 84
115 East 23rd Street, New York, N. Y.

I want proof that your system of DYNAMIC TENSION will make a new man of me—give me a healthy, husky body and strong, powerful muscles. Send me your free book—Everlasting Health and Strength.

NAME.....
(Please write plainly or print.)
ADDRESS.....
CITY..... STATE.....

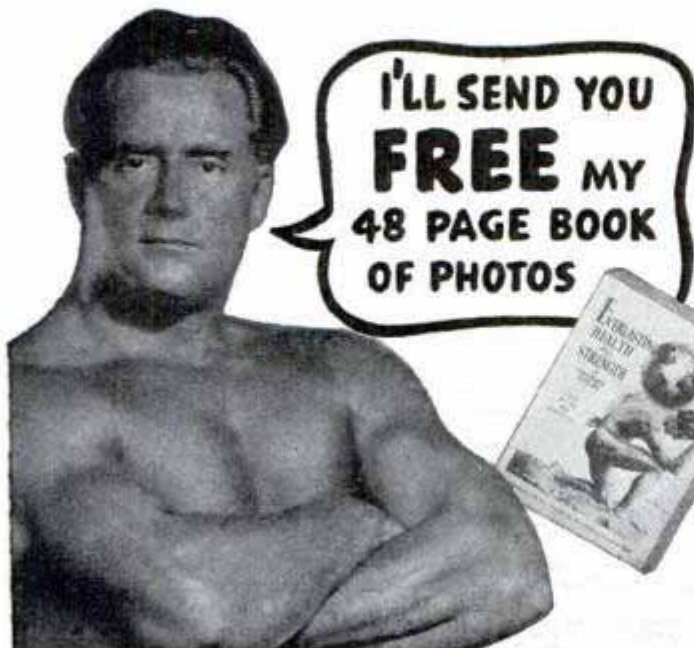

An unretouched photo of Charles Atlas, "The World's Most Perfectly Developed Man."

**ARE YOU
ONE OF THESE**
4 Types of

WIN

WHAT OUR PATENT SERVICE DOES

THE first important step in securing a patent is to obtain the services of a Registered Patent Attorney. The U. S. Patent Office advises that you secure the aid of a Registered Patent Attorney to prepare your application and counsel you.

We have secured patents for inventors located in every state in the Union. Our organization is a large and efficient one. Our practice is confined entirely to Patents, Trade-Marks, and Copyrights. We have had years of experience in Patent Matters. When you place your invention in our hands, we are in position to proceed at once to secure protection for you.

Don't worry about finances. Our fees are very reasonable—we can arrange convenient terms of payment. It is our custom to permit clients to pay for our services in installments as the application progresses in our office.

1 IF YOU ARE THINKING OF INVENTION AS A CAREER

There are many people today who are making a good living from inventions. If you have inventive originality and the ability to recognize human needs, you should go far in the commercial world. If you are considering Invention as a career, write for our FREE BOOK at once.

2 IF YOU HAVE A MECHANICAL INVENTION

There is probably a bigger demand for mechanical inventions today than any other type. If your invention is of a mechanical nature, the first step is to have a search made at the U. S. Patent Office to ascertain that no one has gotten ahead of you. You will find this FIRST STEP fully covered in our FREE BOOK, "Patent Guide for the Inventor."

THE ANSWER TO YOUR QUESTION "HAVE I A SALEABLE INVENTION?"

Some of the most successful commercial inventors—men who amassed large fortunes—reaped their rewards on simple everyday creations; the kind of things that make thousands ask themselves the question: "why didn't I think of that myself?" If you can beat the other fellow to the little gadgets always cropping up that make life more comfortable, easier, or exciting, you may succeed as a successful inventor. Are you convinced that you have "something?" Then don't flounder around trying to make up your mind to start; ascertain right now if you have hit upon an original idea by having us institute a Search of the U. S. Patent Office Records to determine if your invention has been anticipated.

IMPORTANCE OF ACTION

The greatest curse of the average inventor is delay in making practical use of his invention. The day-dreaming inventor may have wonderful ideas but unless he gets a Patent on his invention he is likely to remain a dreamer all his life.

Your invention of a practical article or an improvement upon an old one should be patented NOW. Frequently many of the thousands of applications filed in the U. S. Patent Office each year are for the same or almost the same invention. In such case, the burden of proof rests with the last applicant to file. Sometimes a delay of even a few days in filing the application means the total loss of the patent. LOSE NO TIME.

CLARENCE A. O'BRIEN & HYMAN BERMAN

70-F ADAMS BUILDING, WASHINGTON, D. C.
Registered Patent Attorneys before U. S. Patent Office

When writing to advertisers please mention Popular Mechanics

INVENTORS

3

IF YOU HAVE A NOVELTY INVENTION

Go through the 10c stores and see the millions of articles offered for sale. The majority of these simple gadgets are patented, manufactured in big quantities at a substantial profit. If you have a novelty invention, get information on direct steps necessary to obtain Patent. Send for our FREE BOOK.

4

IF YOU HAVE A GENERAL UTILITY INVENTION

Have you an invention that makes home life easier and more attractive or serves a general purpose of utility? Some of the simplest inventions have found a quick market and earned immediate incomes for the inventor. Learn all about the possibilities of General Utility inventions. Write today for our FREE BOOK.

OUR OFFICES IN THE HEART OF THE NATION'S CAPITAL

Located in Washington, D. C., within a few blocks of the U. S. Patent Office, we are able to give you immediate advice and accurate, authentic information on all matters concerning Patents and Trade-Marks, particularly if it is necessary to examine the records in U. S. Patent Office.



This FREE BOOK TELLS HOW

There are certain definite facts the inventor must know to Patent and market his invention. Our FREE BOOK gives complete information: How Patent Application is made, what kind of drawings and sketches are necessary, what papers must be filled out, the value of action in applying for patent, how the patent laws protect you, why it is necessary to secure patent to protect your invention, etc. Don't be discouraged or disheartened about the future until you get our FREE BOOK and learn how other inventors succeeded despite lack of funds, remoteness from market, lack of mechanical skill, education, and other handicaps. Send coupon for this FREE BOOK today!



FREE RECORD OF INVENTION FORM

This FREE Record of Invention Form enables you to make in convenient form a sketch of your invention and have it witnessed in a manner of value to you should the occasion for evidence arise. MAIL THE COUPON TODAY and obtain our FREE BOOK and Record of Invention Form.



CLARENCE A. O'BRIEN & HYMAN BERMAN
 70-F ADAMS BUILDING
 WASHINGTON, D.C.
 REGISTERED PATENT ATTORNEYS
 BEFORE U.S. PATENT OFFICE

Please send me at once your Big FREE 48-Page Book, "Patent Guide for the Inventor" and your Specially Prepared "Record of Invention" form. This request does not obligate me.

NAME.....
 ADDRESS.....

(Please write or print plainly)

Don't Buy Mandolin Guitar or Drums



Gene Krupa World's Greatest Swing Drummer Uses Slingerland Drums with Benny Goodman's orchestra.

Don't buy Guitar Mandolin, Banjo, Electric Guitars, Bugles or Drums until you have seen and tried the Slingerland May-Bells. Guaranteed More for your Money. Wonderful, snappy, powerful, pleasing tone. No equal in price. Sold on easy payments and 5 days free trial by all leading music dealers.

Cut this Adv. Out—Good for \$1.00 Credit. Ask for Special Information on How to Organize Drum and Bugle Corps. Send for free catalog. Mention instrument wanted.

Write today:

Slingerland Musical Instrument Mfg. Co.
1330 Belden Ave., Chicago, Illinois



QUICK CASH IN NEW POTATO CHIPS

START AT HOME

Here's your chance—a money-making business of your own. Turn potatoes into cash by making new kind of Potato Chips with my improved outfit. Makes delicious, superior, "NON-GREASY" Chips at low cost. A few hours' practice does it. Begin anywhere—city, village, town. Potatoes cheap and plentiful. Wholesale or retail. Steady year 'round business. Groceries, markets, restaurants, taverns, do the retailing for you.



WE HELP START YOU IN BUSINESS
Great quantities of Chips are eaten daily. Profit large—unusually so. You can start this money-making business on a "next to nothing" outlay of cash. Write for Potato Chip Booklet.

LONG-EAKINS COMPANY, 428-S High St., Springfield, Ohio



VOICE

100% Improvement Guaranteed

We build, strengthen the vocal organs—not with singing lessons—but by fundamentally sound and scientifically correct silent exercises... and absolute guarantee to improve any singing or speaking voice at least 100%. Write for wonderful voice book—sent free. Learn WHY you can now have the voice you want. No literature sent to anyone under 17 years unless signed by parent.

PERFECT VOICE INSTITUTE, Studio 1354
64 E. Lake St., Chicago



LAW STUDY AT HOME

Legally trained men win higher positions and bigger success in business and public life. They command respect. Greater opportunities now than ever before. Big corporations are headed by men with legal training.

More Ability: More Prestige: More Money

We guide you step by step. You can train at home during spare time. Degree of LL. B. conferred. Successful graduates in every section of the United States. We furnish all text material, including fourteen-volume Law Library. Low cost, easy terms. Get our valuable 64-page "Law Training for Leadership" and "Evidence" books FREE. Send for them NOW. LASALLE EXTENSION, Dept. 464-L Chicago



AUTO BOOKS SENT FREE

on approval. Just mail the coupon and we'll send you a set of these remarkable auto books, just off the press. Whether you are a mechanic or helper, expert or apprentice, auto owner or driver, if you're interested in knowing all about automobile mechanics, take advantage of this FREE OFFER.



GET A BETTER JOB

A better job—in the gigantic auto industry. BIGGER PAY—a chance to go into business for yourself and get a share of the huge profits, are waiting for any man who even half tries to improve himself. Learn auto engineering with these wonder books a new way—without studying or memorizing. Simply use the JIFFY INDEX to look up the answer to any auto problem. Built by eleven of America's greatest automobile engineers, and written in simple language so you can understand it. Very newest cars, all covered.

FREE Privilege of consulting Automobile Engineers of American Technical Society for one year without cost if you mail coupon immediately

Books also include valuable articles on Service Shop Management.

CAN YOU FIX IT?

These wonder books tell step by step HOW to take out "play" in differential — to kill the shimmy in steering—to set TIMING—how to put your finger instantly on engine trouble and then the quick expert way to FIX it. Newest improvements fully covered. Equal to a complete trade course at less than a fourth the cost.

6 BIG VOLUMES
Brand New Edition
2500 pages, 2000 illustrations, wiring diagrams, etc., including Marine Engines, Aviation Motors, Diesel engines, etc. De Luxe edition, gold-stamped flexible binding.

AMERICAN TECHNICAL SOCIETY,
Drexel Ave. & 58th St., Dept. A419, Chicago, Ill.
I would like to see the new 6-volume edition of your AUTO BOOKS. I will pay the few cents delivery charges only, but if I choose to, I may return them express collect. If after 10 days use I prefer to keep them, I will send you \$2 and pay the balance at the rate of only \$3 a month, until \$24.80 is paid. Please include free consulting membership as per your offer above.
Name
Address
City State
Attach letter stating age, occupation and name and address of employer and that of at least one business man as reference.

LE'S Correspondence Courses in RADIO and ELECTRICAL ENGINEERING

SPECIAL Only \$25

ELECTRICAL ENGINEERING. Get good grasp of wide electrical field. Modern. Very understandable.
RADIO ENGINEERING. Extra fine course in radio, public address, photo-electric work. Trains you to be super-service man, real vacuum tube technician. Tuition ONLY \$25, either course. Deferred payment plan. Experiment kits furnished. **WRITE TODAY** for free copies of school catalogs, student magazines, etc. LINCOLN ENGINEERING SCHOOL, Box 931-71, Lincoln, Nebr.

AVIATION CAREER OFFERS YOU GREAT FUTURE!

Demand for trained aircraftmen in Southern California plants is increasing and already exceeds supply. Curtiss-Wright Technical Institute, Aviation's foremost and oldest school, is located in heart of this activity and specializes in Sheet Metal, Master Mechanics and Aero Engineering. (No flying involved.) Graduates are obtaining immediate employment. Write for details NOW! Curtiss-Wright Technical Institute, Glendale, (Los Angeles) Cal., Dept. PM -4

RAISE GIANT FROGS

FREE BOOK "GOOD PRICES YEAR ROUND!"
Nation-wide markets waiting for all you can ship. Sell to us also. **WE BUY!** Get ready now for next spawn. Breeder lays 20,000 eggs yearly. Start with a small pond, creek, marsh or lowland. Free book shows sketch. Men & Women starting in every state and Canada. See what others are doing. Send no money. Just write your name and address on a postcard and get our special offer to beginners. Write today!
AMERICAN FROG CANNING CO., Dept. 133-D, New Orleans, La.

I WANT MEN

FORDS GIVEN
TEA AND COFFEE ROUTES
PAYING UP TO \$60.00 IN A WEEK
National company needs more men at once to make regular calls on local routes. No experience needed. Operate on our capital. I give producers brand-new Ford cars as bonus. Rush name on postcard for FREE facts.
ALBERT MILLS
5129 Monmouth Cincinnati, Ohio



Over 700,000 People have studied music this easy way

Now You Can Learn to Play Your Favorite Instrument Without a Teacher

Easy as A-B-C

MOST of these 700,000 students didn't know one note from another—yet in an amazingly short time they learned to play their favorite instrument. Best of all they found learning music *amazingly easy*. No drudgery—no expensive teachers. This simplified method, perfected by the U. S. School of Music, made learning music as easy as A-B-C.

From the start you are learning *real* tunes by *note*. Every step, from beginning to end, is right before your eyes in print and picture. First you are *told* how to do a thing, then a picture *shows* you how, then you do it yourself and *hear* it. And almost before you know it, you are playing many of your favorite pieces—jazz, ballads, classics. No private teacher could make it clearer. The cost is surprisingly low—averaging only a few cents a day—and the price is the same for whatever instrument you choose.

Learn now to play your favorite instrument and surprise all your friends. Change from a wallflower to the center of attraction. Musicians are invited everywhere. Enjoy the popularity you have been missing. Start now!

**Free Booklet
Demonstration Lesson**
If you really *do* want to play your favorite instrument, fill out and mail the coupon asking for our

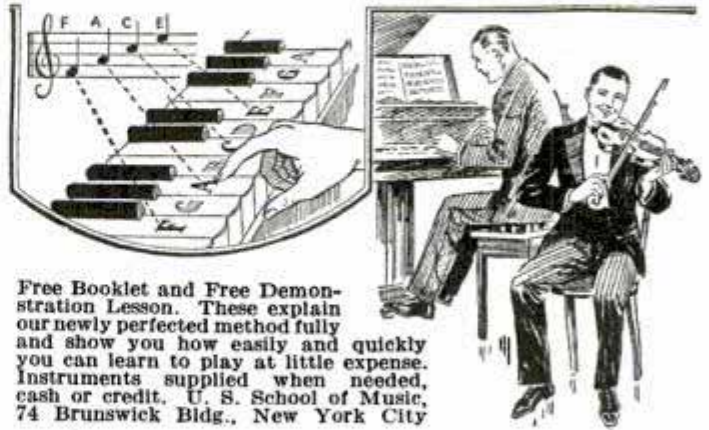

Free Booklet and Free Demonstration Lesson. These explain our newly perfected method fully and show you how easily and quickly you can learn to play at little expense. Instruments supplied when needed, cash or credit. U. S. School of Music, 74 Brunswick Bldg., New York City

**U. S. School of Music,
74 Brunswick Bldg., New York City**

Send me your amazing free book, "How You Can Learn Music in Your Own Home," with inspiring message by Dr. Frank Crane; also Free Demonstration Lesson and particulars of your easy payment plan.

Name.....
Address.....
Instrument..... Have you Instr?.....

**LEARN TO PLAY
BY NOTE**
Piano Guitar
Violin Saxophone
Organ Mandolin
Tenor Banjo
Hawaiian Guitar
Piano Accordion
Or Any Other
Instrument

Free AIR CONDITIONING AND REFRIGERATION TRIAL LESSON

Trained men needed. Good pay. Opportunities. Learn easily AT HOME in spare time. Write today for **FREE TRIAL LESSON**.
CHICAGO TECHNICAL COLLEGE
D302 Tech Bldg., 118 E. 26th St., Chicago, Ill.
If you can go away to college to learn Air Conditioning, Engineering, Architecture, Drafting, Electricity, or Radio, send for **Free Blue Book**.

Auto-Diesel

Master a real trade. Auto Mechanics, Diesel Mechanics, Arc Welding, Acetylene Welding, etc. Let us train you to be an expert Auto-Diesel Mechanic and help you get a good job. The cost to you is reasonable. Learn on modern equipment with tools under experienced instructors. Real shop work. Steam heated buildings. Room and board in our steam heated dormitory. We pay your fare to Nashville. For free catalog write

Nashville Auto-Diesel School, Dept. 75, Nashville, Tenn.

LEARN RADIO TELEVISION

Midland's Color-Coded Extension Training fits you for better radio jobs—prepares for future television opportunities. Backed by 5000-watt Columbia basic network broadcasting station, KMBC. Graduates qualified to take Government operator's license exams. Lifetime employment service. All necessary equipment for "home laboratory" experiments furnished; 90 illustrated lessons, 16 laboratory manuals. After "home training," bus ticket to Kansas City for 4 weeks' intensive training in laboratories. Get facts—write for free catalog.

**MIDLAND TELEVISION, Inc., Power & Light Bldg.,
106-D W. 14th St., Kansas City, Mo.**

Refrigeration

1 **Text-Book for Home Study**
This complete, up-to-the-minute, practical book will teach you quickly how to service all types of refrigerators. Page after page of useful, easy to understand facts. Refrigeration is the big money field and you can get into it after studying this textbook. Size 8 1/2 x 11 in. Priced at only \$1.00, postpaid. Send for this book today.
**SUPREME PUBLICATIONS 3727 W. 13th St.
Dept. E, Chicago, Ill.**

AUDELS Carpenters and Builders Guides 4 vols. \$6



Inside Trade Information for Carpenters, Builders, Joiners, Building Mechanics and all Woodworkers. These Guides give you the short-cut instructions that you want—including new methods, ideas, solutions, plans, systems and money saving suggestions. An easy progressive course for the apprentice and student. A practical daily helper and Quick Reference for the master worker. Carpenters everywhere are using these Guides as a *Helping Hand to Easier Work, Better Work and Better Pay*. To get this assistance for yourself, simply fill in and mail the **FREE COUPON** below.

Inside Trade Information On:
How to use the steel square—How to file and set saws—How to build furniture—How to use a mitre box—How to use the chalk line—How to use rules and scales—How to make joints—Carpenters arithmetic—Solving mensuration problems—Estimating strength of timbers—How to set girders and sills—How to frame houses and roofs—How to estimate costs—How to build houses, barns, garages, bungalows, etc.—How to read and draw plans—Drawing up specifications—How to excavate—How to use settings 12, 13 and 17 on the steel square—How to build hoists and scaffolds—skylights—How to build stairs—How to put on interior trim—How to hang doors—How to lath—lay floors—How to paint.



THEO. AUDEL & CO., 49 W. 23rd St., New York City

Mail Audels Carpenters and Builders Guides, 4 vols., on 7 days' free trial. If O.K. I will remit \$1 in 7 days, and \$1 monthly until \$6 is paid. Otherwise I will return them. No obligation unless I am satisfied.

Name.....
Address.....
Occupation.....
Reference..... P.M.

Do you like RADIO? Does the future of TELEVISION

Interest You?

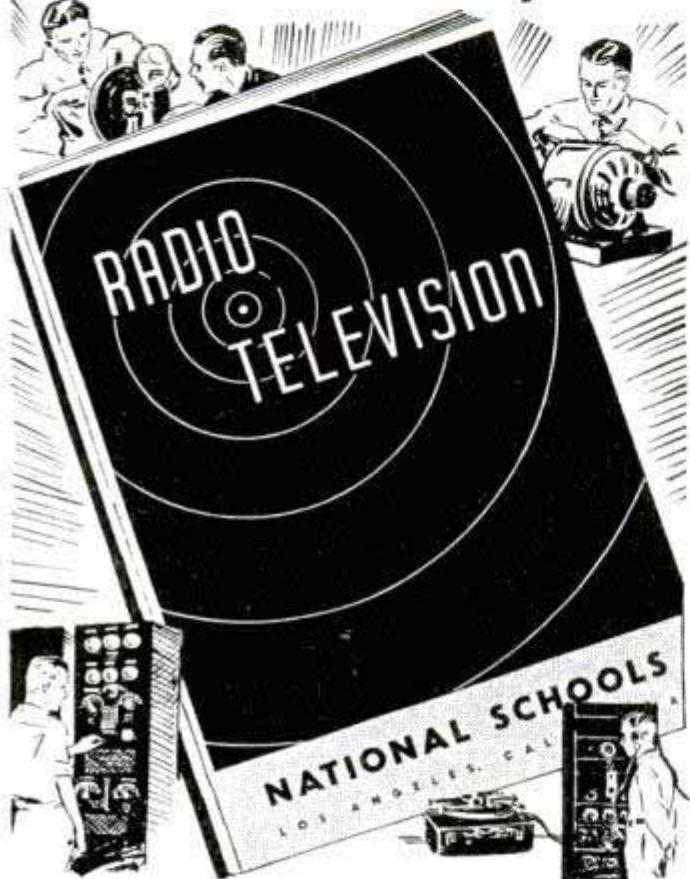

Send for your FREE COPY of this book of FACTS

Full of Instructive Information on
Employment Opportunities and
Requirements

You men who are sincerely ambitious to make good in radio and related industries will want a copy of this new book about employment opportunities and requirements. Written in plain, understandable language with no exaggerations and no mis-statements, this free book gives you facts you want to know about these profitable trades. 95 illustrations. Major subjects include Television Theory and Construction, Pick-up Systems, Amplifiers, Transmitters, Receivers, Cathode Tubes, Sound-Recording on disc, Loud Speakers, Talking Picture Projection and Radio Communication.

NATIONAL SCHOOLS is the oldest trade institution in the West. Established in 1905. Occupies its own modern three-story building, exclusively devoted to training ambitious men. Latest equipment. Selected, experienced staff of engineers and instructors. Many students can earn room and board while learning. National students are allowed coach railroad fare from any point in the United States.

NATIONAL SCHOOLS

Los Angeles

Request for FREE BOOK of Details

NATIONAL SCHOOLS

Dept. PMR-4 4000 So. Figueroa Street, Los Angeles, Calif.

NAME _____ AGE _____

ADDRESS _____

CITY _____ STATE _____

TECHNICAL BULLETINS

Technical Data
Simplified for the
Practical Man

A Valuable
Popular Mechanics
Service • \$1⁰⁰ Each

Here is a valuable, inexpensive service for mechanics, inventors, technical specialists and practical craftsmen of all kinds. Popular Mechanics Technical Bulletins give the needed basic and practical information on a wide variety of subjects —

briefly, concisely and simply presented—yet complete in every detail. No advanced mathematics, chemistry or physics needed to understand them. Material never before in print, now specially prepared in bulletin form. Postpaid \$1 each or sent C.O.D. in United States. Ask for list of complete bulletin service.

D-101—Using Nichrome Resistance Wire.—Features electrical appliance repairs.

D-102—Cleaning Products for all Purposes.—Includes ten formulae for making.

D-103—Automobile Specialty Chemical Products.—Complete instructions for making wide-selling products.

D-104—Silver Soldering and Brazing.—Includes data, methods and materials needed.

D-105—Latest Gas-Welding Practice.

D-106—Rewinding Electric Motors.—A difficult subject made simple and easy.

D-107—Electro-Plating with Copper, Nickel and Chromium.

D-108—Electro-Plating with Gold and Silver.

D-109—Electro-Plating with Zinc and Cadmium.

D-110—Electro-Plating Non-Metallic Objects and Electro-Forming.

D-111—Designing and Building Transformers.

D-112—Designing Electro-Magnets.

D-113—How to Design Solenoids and Plunger Magnets.

D-114—Designing Thermostats for Air Conditioning and Heat Control Purposes.

D-115—Flexible Molds for Casting Small Objects.

D-116—Printing Photos on Cloth, Paper, Etc.

D-117—The A B C of Air Conditioning.

LATEST BULLETINS—JUST PUBLISHED

D-118—Electrical Water Pipe Thawing Equipment.

D-119—Electroplating with Alloys.—Bronze, brass and cadmium silver alloys.

D-120—Gas Fired Blast Furnace for Melting Metals, Alloys and Heat Treating.

D-121—Corrosion, Causes and Preventative Measures.

D-122—Stainless Steel Easily Soldered, Brazed or Welded.

D-123—Mirror Silvering.—Silvering glass, resilvering old mirrors, and making new ones.

D-124—Soldering.—Brass, copper, lead and low-melting point metals, stainless steel, aluminum, etc.

D-125—Buffing and Polishing Metals.

D-126—How to Design and Build Hydraulic Rams.

D-127—Small Electric Light Plants, Design and Construction.—For cottages, camps or country homes.

D-128—Diesel Engines, Operation and Service.—For the mechanic or layman.

D-129—Coloring Metals Chemically.—No knowledge of chemistry required for success. Instructions for producing colored finishes on brass, copper, iron, aluminum and alloys.

POPULAR MECHANICS PRESS

Room 438B

200 East Ontario Street

Chicago

BUILD a BOAT AT HOME

Have Your Own
Boat This Year
or Build Them
to Sell



FOR
PLEASURE OR
PROFIT

Now you can have just the boat you've always wanted—power, sail, or rowboat—and at rock bottom cost, plus the fun of building. Make a nice profit if you want to sell. Get the

BOAT BOOK—New Edition

This famous book with 6 new boats added, shows exactly how to build 15 different popular boats. Step-by-step instructions with hundreds of pictures. Gives all plans, methods and materials. Includes racing, hydroplane, inboards, outboards, sailing and sectional boat to carry on car. Also old Ford motor for marine use and all boating terms, pilot rules, boat kinks, navigation rules, etc. You can't go wrong. Specially prepared for those with limited tools and skill. Price only \$3. Write for descriptive folder or order now and pay postman on delivery.

Popular Mechanics
Press
Room 438B
200 East Ontario Street,
CHICAGO

TO YOUNG MEN— STENOTYPY THE WAY TO SUCCESS

Stenotypy, the new profession, offers unusual opportunities to ambitious young men. It's a man's way of recording speech in this machine age—a silent little machine that types plain print letters faster than anyone can talk. It opens up preferred jobs now—leads to executive careers later. One of the surest, quickest ways to get into Business on the right basis.

Now you can learn Stenotypy in your spare time. Low cost—convenient terms. Get full details. Write for valuable free booklet, "Advantages to You in Stenotypy," describing the unusual opportunities for young men in this growing field and telling how you may enter it successfully. Write Dept. 464-BT.

THE STENOTYPE COMPANY
4101 S. Michigan Ave., Chicago III.



AIR CONDITIONING AND ELECTRIC REFRIGERATION INDUSTRY NEEDS TRAINED MEN

34 year-old organization now receiving applications of men to prepare for positions in Air Conditioning and Electric Refrigeration. Quality in 3 months for Estimating, Installation, Service, Maintenance and Sales positions. No experience needed—we train you under actual working conditions in our own air conditioned laboratories. Free employment service. Get free book "Step Up to Success"—just off the press. Write

MILWAUKEE
SCHOOL of ENGINEERING
Institute of Electrotechnics
1820-A North Broadway, Milwaukee, Wis.



THERE'S MONEY IN YOUR CAMERA!

Others make good incomes selling pictures to publications. **FREE BOOKLET** describes home-study course (which may be paid for in easy installments) and tells how YOU can do it too! **Universal Photographers, Dept. 74, 10 West 33 Street, N. Y. C.**

ENGINEERING DEGREE IN TWO YEARS

B.S. DEGREE courses in engineering: Electrical, Civil, Chem., Mechanical, Mech. Drafting, Radio and Television, or Aeronautical. Intense, practical, thorough program. No extras for prep. or review. Earn while you learn in this industrial center. Low tuition. Enter March, June, Sept., Dec. Write for catalog. 229 E. Washington Blvd., Fort Wayne, Ind.

INDIANA TECHNICAL COLLEGE

LEARN CARTOONING

by the method that has developed hundreds successfully. Send name, address and age for free chart to test your ability.

THE LONDON SCHOOL, 1737 National Bldg., Cleveland, Ohio

Print Your Own

Cards, stationery, circulars, tags, labels, advertising, etc. Save money. **Print for Others; Big Profits;** easy rules sent. Will do popular Raised Printing like Engraving. Junior outfit \$9. Senior outfit \$17 and up. Send for free catalog and all details. **THE KELSEY COMPANY, D-37 MERIDEN, CONN.**

HOME STUDY COURSES

Home Study Courses leading to Degrees in Arts and Sciences: Philosophy; Education; Writing; Psychology; Chemistry; Theology; Law; Agriculture; Business, Accounting, Sales; Advertising; Electrical, Civil, Mechanical, Diesel, Architectural, Aeronautical, Automotive, Drafting, Radio, Air Conditioning and Chemical Engineering. Many Others. **McKinley-Roosevelt Graduate College, 4223 Clarendon Ave., Chicago**

MONEY-MAKING OPPORTUNITY

for men of character. Over \$1,600 per month earned by California man. Over \$400 a week by Georgia man. \$1,000 in a month by Delaware man. Exclusive franchises available for an invention expected to replace a multi-million dollar industry. Install on free trial. Sells itself. Repeats. Exclusive proposition. Write **F. E. Armstrong, Dept. 1112-D, Mobile, Alabama.**

Learn a TRADE in 8 weeks

Many Good-Pay Jobs Are Available Trained men are in demand and earn good money in these fascinating well-paying trades. This is not a correspondence school—no books—no lessons. Don't look for a job—TRAIN FOR IT. Read below how a McSweeney-trained man made good.

- AUTO MECHANICS
- AVIATION MECHANICS
- DIESEL MECHANICS
- Collision Repair (Complete)
- Body and Fender Repair
- Auto Painting
- WELDING—Arc and Gas

You Get Actual Shop Training

Work on real equipment with real tools. In a few weeks you should be trained by actual work to hold down a Good Pay Job.

We get many letters like this

1801 E. 65th St., Cleveland, O. Dear Mac—Immediately after leaving school I went to work for United Motors and am now located in Cleveland where I hold a good position. I have been able to take care of the most complicated electrical jobs. I think I have done fine considering I had no experience before coming to your school. — Hubert Todd

LEARN NOW—PAY LATER!

We will give you complete information on how to get your training now and pay for it later out of your earnings.

FREE Write today for Big Free Book. Get the facts about jobs; and low Tuition Offers. Mailing the coupon does NOT obligate you. It obligates ME to tell YOU how you can train for Big Money in a few short weeks. Address Dept. 10-52

McSWEENEY SCHOOLS

DETROIT, MICH. and KANSAS CITY, MO.

Write Our School Nearest You



DETROIT

In Big New McSweeney Buildings

The finest of their kind. Every modern facility for thorough instruction.



KANSAS CITY

McSWEENEY TRADE SCHOOL

Dept. 10-52, Detroit, Mich., or Kansas City, Mo.

Without cost or obligation send me your big FREE Book.

I am interested in the course on _____

Name _____

Street _____

Town _____ State _____ Age _____

A frank man to PATENTS-INVENTIONS

THE world of invention moves on. About a hundred years ago people were saying, "There's nothing left to invent"—today we know that is one of the funniest things ever said. Just think what has happened in the last hundred years! Autos, radios, airplanes, and thousands of useful, practical devices for home, shop and office have been invented and put on the market. Inventors are constantly making the world a better place to live in. Did you see a notice in the paper that an obscure worker, Hans Wach, has invented a simple device to utilize exhaust steam on steam boats? *Already, the report states, the steamship lines have saved more than \$15,000,000 in fuel bills with his invention.* Almost in the same breath the Dept. of Commerce announced that it will soon test out a new, non-crashable aeroplane, which the average man can learn to fly in a day, which will travel at 110 miles an hour and sell at the price of a cheap automobile. An unknown Seattle man has invented a robot to go 5,000 feet under the sea and recover millions and millions of dollars worth of gold lying at the bottom of the ocean since the days of the early Spaniards.

Remember this: For every outstanding big invention there are thousands of small, simple things for use in the home, the office, the factory, on the farm, on every sort of travel conveyance. Little articles like you find on the counters of a 10-cent store, hardware store, drug store, toy and novelty shop.

Many Little Ideas Have Big Commercial Possibilities

A person finds something he's using doesn't work right, or it's clumsy, or costs too much. He gets a happy thought. He improves the old Article. That's contribution to human progress. That's the way that many, many men have reached the goal of financial comfort, independence and even wealth. Most of the things millions of us use didn't come from the brains of engineers and physicists. They came from the mind and maybe the crude home work bench of Mr. Average Man, busily engaged in earning his bread and butter at whatever chance or circumstance has given him to do. The "little" man's opportunity as an inventor was never greater than it is today.

Who Are Inventors?

You'd be amazed at the men we contact in the course of a busy year. Most of them do not consider themselves inventors at all. During their work or leisure they get an idea. They work it out on paper. They get in touch with us about Protection. Did you know that a dentist invented the stock ticker, a school teacher the telephone, a farmer the typewriter, an artist the telegraph? Did you know that the crinkly hair pin—sold by millions now—came about because a husband saw his wife twisting the old-fashioned straight hair pin to make it stay in place? **Poor men who have no thought of invention now will be financially well-fixed in a few years because of a happy thought that the world could use to advantage.**



Can You Answer These Questions?

Ask yourself these questions: How do the Patent Laws protect me? What easy steps can I take, without cost, to put myself in position to support my belief that I am the first man to think of my invention? Is a Patent worth the cost? Do I need a model? Should I try to sell my invention before I have it Patented? Is there any safe, business-like way to secure financial help? If I do apply for a Patent, how shall I reach people who can market my invention? Can I protect and sell an improvement on some invention that has already been patented? These are but a few of the questions which usually confront the average man. You need the answers! **YOU CAN HAVE THEM, without cost, trouble, or delay.**

Our Business Is to Help You. Write Us Today

For more than forty years, this firm has been helping men with an inventive turn of mind. We maintain a large staff of trained, experienced specialists—**Registered Patent Attorneys, Draftsmen, and Searchers to help our clients secure all the protection to which they are entitled.** Fees are reasonable. Deferred payments frequently arranged. Questions promptly answered. Write us frankly with absolute assurance that what you say will be treated with strictest secrecy. **But FIRST, send for the FREE BOOKS shown on the opposite page.** They are filled with facts, pictures and suggestions. They tell you things about Patents, Inventions and Selling Inventions that we have learned in our long experience. **They may save you time, expense, EVEN LATER DISAPPOINTMENT.** Simply fill in the coupon. No charge, no obligation. Write us TODAY.

RUSH COUPON TO WASHINGTON, D.C. TODAY.

man talk about - SELLING INVENTIONS

115 Mechanical Move- ments Like These

Besides many other features and facts there are 115 different mechanical movements and principles in the big 48-page Book below. Maybe there is just the idea you need to solve some mechanical problem. Use the coupon or write us a card or letter.

2 FREE BOOKS
with
68 PAGES
of Facts and Pictures!

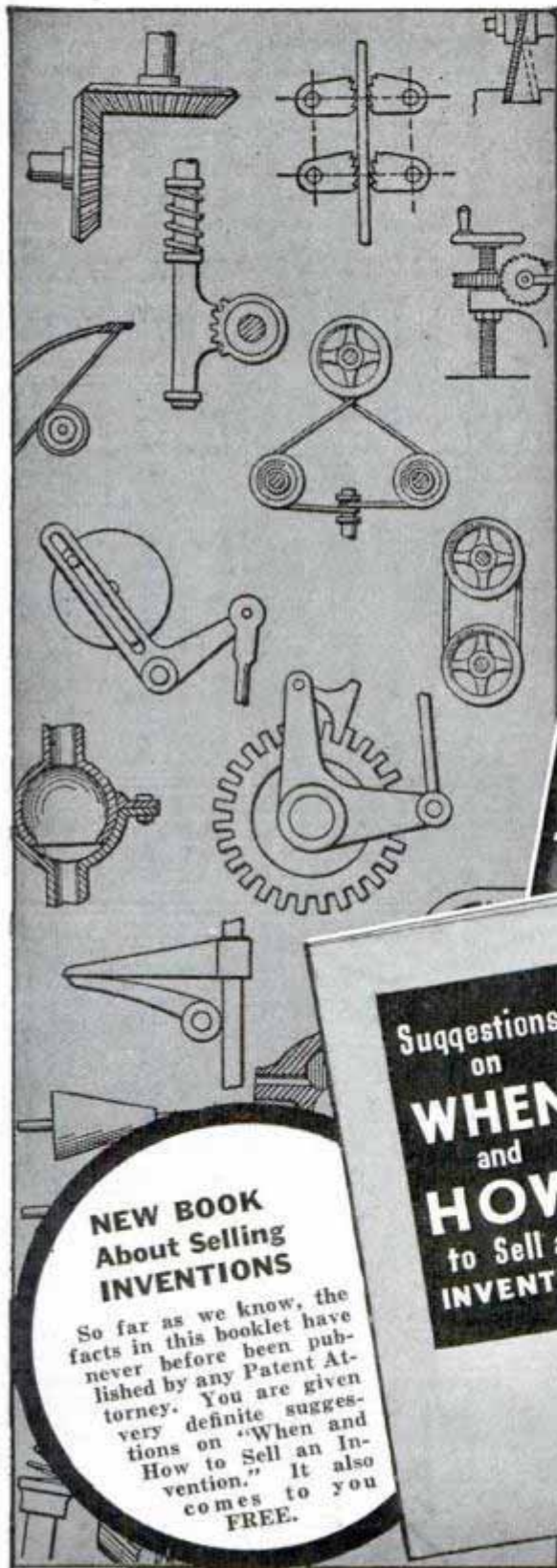

Suggestions on
WHEN
and
HOW
to Sell an
INVENTION

NEW BOOK About Selling INVENTIONS

So far as we know, the facts in this booklet have never before been published by any Patent Attorney. You are given very definite suggestions on "When and How to Sell an Invention." It also comes to you **FREE.**

VICTOR J. EVANS & Co.

REGISTERED PATENT ATTORNEYS

Main Office: 20-D, Victor Building,
Washington, D. C.

Other Offices: 2610-N, Singer Bldg., New York
1445-N, Monadnock Bldg., Chicago
1010-N, Hobart Bldg., San Francisco
405-N, Garfield Bldg., Los Angeles
514-N, Empire Bldg., Pittsburgh

Send me FREE copies of your books, "Patent Protection" and "When and How to Sell an Invention." (Note: Same books supplied by any of branch offices listed above.)

Name.....
Street and No.....
City or Town..... State.....

PATENTS

Booklet Free Highest References
Promptness Assured Best Results

Send drawing or model.

ALL BUSINESS GIVEN PROMPT AND PROPER ATTENTION

Listed Patent Lawyer in the latest editions of the Rand-McNally Directory of Bankers and Bank-Recommended Attorneys, published by Rand-McNally & Co., Chicago, Ill.; The Baggott & Ryall Directory of Guaranteed Attorneys, published by Legal Directory Corporation, Boston, Mass.; American Lawyers Annual, Cleveland, Ohio; Bankers Service Legal Directory, published by Bankers Service Co., Boston, Mass.; Eyre's Law List, 9 Park Place, New York City; Snow-Church Directory Co. Lawyers List, published in New York City, and the Central Guarantee Co., Bankers and Lawyers Directories, 630 Fifth Avenue, New York City.

WATSON E. COLEMAN,
REGISTERED PATENT LAWYER

Victor Building, 724 Ninth Street, N. W.
WASHINGTON, D. C.

INVENTORS PATENT YOUR IDEAS SEND FOR FREE BOOK



HOW TO OBTAIN A PATENT

Written by a Former Member of the Examining Corps (1922-24) of the U. S. Patent Office. If you want to profit by your idea, you should take steps to apply for a U. S. Patent at once. Your first step is to get this Free Book. This interesting illustrated book contains valuable information you should have. It tells you fully how to obtain a patent on your idea in the quickest way. With this Free Book you will also receive a "Record of Invention" form on which you can easily record your idea. Personal and Confidential Service: Your case will be personally handled only by a Registered Patent Attorney who is also a Former Member of the Examining Corps of the U. S. Patent Office. All communications confidential.

MAIL COUPON TODAY for FREE PATENT BOOK and RECORD OF INVENTION Form.

CARL MILLER

REGISTERED PATENT ATTORNEY
FORMER MEMBER EXAMINING CORPS U. S. PATENT OFFICE

Woolworth Bldg., 35th Floor, Dept. 48A, New York City
MILLER BUILDING, Dept. 48A, WASHINGTON, D. C.

Please send me your Free Book, "How to Obtain a Patent," and your "Record of Invention" form.

NAME.....

ADDRESS.....

PATENTS TRADE MARKS

47 years actual experience before the U. S. Patent Office and courts.

Personal attention to inquiries. All matters held strictly confidential. Write **to-day** for free information regarding your problems and patent procedure.

GOULD & GOULD MUNSEY BLDG.,
WASHINGTON, D. C.

PATENTS—TRADE MARKS

All inventions submitted held confidential and given personal attention by members of the firm. Form, "Evidence of Conception" and instructions, "How to Establish Your Rights"—FREE!

LANCASTER, ALLWINE & ROMMEL
Patent Law Offices

412 Bowen Bldg. Washington, D. C.



G E A R S

In Stock—Immediate Delivery

Gears, speed reducers, sprockets, thrust bearings, flexible couplings, pulleys, etc. A complete line is carried in our Chicago stock. Can also quote on special gears of any kind. Send us your blueprints and inquiries.

Write for Catalog No. 10

CHICAGO GEAR WORKS
769-773 W. Jackson Blvd. CHICAGO, ILL.

Inventions Wanted Patented or Unpatented

We have been successfully selling inventions, patented and unpatented, since 1924. Write for proof, and tell us what you have for sale.

Chartered Institute of American Inventors
Dept. 4, Barrister Building, Washington, D. C.

INVENTORS who derive largest profits know and heed certain simple but vital facts before applying for patents. Our book, Patent-Sense, gives those facts; sent free. Trade Marks—Copyrights.
LACEY & LACEY, Est. 1869, 635 F St., N. W., Dept. 5, WASHINGTON, D. C.

ALBERT E. DIETERICH

THEODORE H. RUTLEY

REGISTERED PATENT LAWYERS

512 B Colorado Bldg. WASHINGTON, D. C.

Booklet on Patents sent free



BUCHSTEIN'S FIBRE LIMB

Is soothing to your stump—strong, cool, neat, light. Easy payments. Braces for all deformities. Agents wanted.

D. BUCHSTEIN CO.
610 3rd Ave., So., MINNEAPOLIS, MINN.



Itching TORTURE This Quick Way

For quick relief from the itching of eczema, blotches, pimples, athlete's foot, scales, rashes and other externally caused skin eruptions, use cooling, antiseptic, liquid **D.D.D. PRESCRIPTION**. Doctor Dennis' original formula. Greaseless and stainless. Soothes the irritation and quickly stops the most intense itching. A 35c trial bottle, at drug stores, proves it—or money back. Ask for **D.D.D. PRESCRIPTION**.

To PROTECT YOUR INVENTION—Use this coupon, NOW

Delays are dangerous and may be very costly. My personal service assures prompt action, strict confidence, and a minimum of expense. I suggest that you send me a model or drawing, or sketch and description of your invention, and \$5.00. I will make a search and report

promptly as to its patentability and send you a copy of my 72-page booklet. Or, if you prefer to read my booklet first, mail the attached coupon at once. I will also send my "Record of Invention" form. (Over 38 years experience as a Registered Patent Attorney.)

L. F. Randolph, 302-D Victor Bldg., Washington, D. C.

Please send me at once, free of charge, your 72 page booklet and "Record of Invention" form.

Name.....

Address.....

A PERSONAL CONFIDENTIAL PATENT SERVICE



EXTRA MONEY

\$10 to \$25 a week

Yes, you — anybody can make a lot of money right at home, and what's more, have real fun doing it. We show you how, we furnish everything necessary on an easy basis.

COSTS NOTHING to learn about our plan, all details are given you free. Write today for idea book full of colored pictures telling all about our methods which have made so many people independent. Learn how easy it is to make from \$10 to \$25 per week in the most delightful home work you can imagine. Don't miss this opportunity. *Write Now—It's FREE!*

FIRESIDE INDUSTRIES, Dept. 66-D, Adrian, Mich.

ENGINEERING

DEGREE IN TWO YEARS

TECHNICAL AND APPLIED COURSES. Nonessentials omitted. **TIME AND MONEY SAVED.** Degree 2 yrs., diploma 1 yr. Electrical, Mechanical, Architectural, Structural, Civil, Aeronautical, Highway. All courses include Air Conditioning, Electric Refrigeration and Diesel. Short intensive courses 3 and 4 months in Electricity, Power Plant, Diesel-Electric, Air Conditioning, Electric Refrigeration, Drafting. Extensive modern equipment. **LOW TUITION.** Part-time work for room and board. Thousands of successful graduates in U. S. and foreign lands. Approved by Industry, endorsed by educators, recommended by alumni. One and two-year courses open in Sept., short courses open year round. 39th YEAR. Catalog free.

FINLAY ENGINEERING COLLEGE

1001 Indiana Avenue Kansas City, Mo.

Established 1902

New York Electrical School

Ask for free booklet

44 West 17th St., N. Y. C.

AUTO-MECHANICS & WELDERS

Auto Mechanics and Welders are in big demand. Complete courses in arc and acetylene welding, body and fender bumping, spray painting and metal finishing. Pay after graduation plan. Special low rates. Write today.

MICHIGAN TRADE SCHOOL
3758 Woodward Ave., Detroit, Mich.

Write for FREE CIRCULAR

RADIO ENGINEERING

broadcasting, aviation and police radio, servicing, marine and Morse telegraphy taught thoroughly. Nine months' engineering course equivalent to three years' college radio work. School established 1874. All expenses low. Catalog free.

Dodge's Institute, Ada St., Valparaiso, Ind.

Learn ADVERTISING at Home

Greater opportunities now in advertising. Learn easily and quickly in spare time. Practical work. No text books. Old established school. Low tuition—Easy terms. Send for free booklet and requirements.

Page-Davis School of Advertising
Dept. 1354, 3601 Mich. Av., Chicago

M.M. EARNED \$1174 at Home!

Earn Cash at Home!

We paid M. M. \$1174 for exceptional "cellar crop" SNOW-KING mushrooms! Big free picture book tells if your cellar, shed, barn suitable. We furnish materials, buy all crops. Write today. Est. 1908. UNITED CO., 3848 Lincoln Ave., Dept. 310, Chicago.

NEW SCIENTIFIC WONDER

"X-RAY" CURIO



Reg. U.S. Pat. Off.

10c
3 for 25c

"Silver Only"

BOYS BIG FUN. You apparently see thru cloth, Wood, Stone, any object. See Bones in Flesh. **FREE PACKAGE** radio picture films, take pictures without camera. **IT'S GREAT SPORT!** 1 package with each 25c order.

MARVEL MFG. CO., Dept. 80-B NEW HAVEN, CONN.

Inventors

TAKE THIS FIRST STEP TO PROTECT YOUR INVENTION



Suggestions on how to COMMERCIALIZE

HOW WE PROTECT YOU



Find Out Now If Your Invention Is Patentable

It is not necessary to make an expensive model or finished drawings. A description and sketch is all we need to help you. The important thing is to get started NOW, just as quickly and as economically as possible. But FIRST, send for our free Patent and Selling Guides. Know where you stand NOW in regard to Patent Protection.

Our Free Books Tell You What Every Inventor Wants to Know

They tell you why delay can prevent you from securing Patent Protection. How to avoid costly mistakes. How to get your invention saleable as quickly as possible. Whom to sell it to. How patent laws protect you. What a Patent costs. What kind of Patents are granted. The importance of secrecy in Patent matters. How a skilled Patent Attorney can secure you better Patent Protection. The difference between a good patent and a worthless one.

C. A. Snow's 62 Years of Experience Can Be of Real Value to You

We have served inventors in every state in the Union . . . in every field of invention. In fact, we have secured Patents for inventors in every civilized nation in the world. To help inventors get started without delay, we offer a convenient **DEFERRED PAYMENT PLAN.** By this plan, the cost of your patent is spread over several months.

Your Patent Application Personally Prepared By a U. S. Registered Patent Attorney

Every member of our firm is a U. S. Registered Patent Attorney. Therefore, your patent application will be carefully prepared **IN STRICT CONFIDENCE** by a skilled specialist. A specialist who will secure for you the broadest possible patent protection, because, as a member of our firm, he has a personal pride in your patent.

Send for These FREE Patent Guides Today

C. A. SNOW & CO.

Registered Patent Attorneys Since 1875

1030 Snow Building, Washington, D. C.

Gentlemen: Send me your free handbooks for inventors by return mail. No obligation on my part.

NAME

ADDRESS

CITY STATE

When writing please mention Popular Mechanics

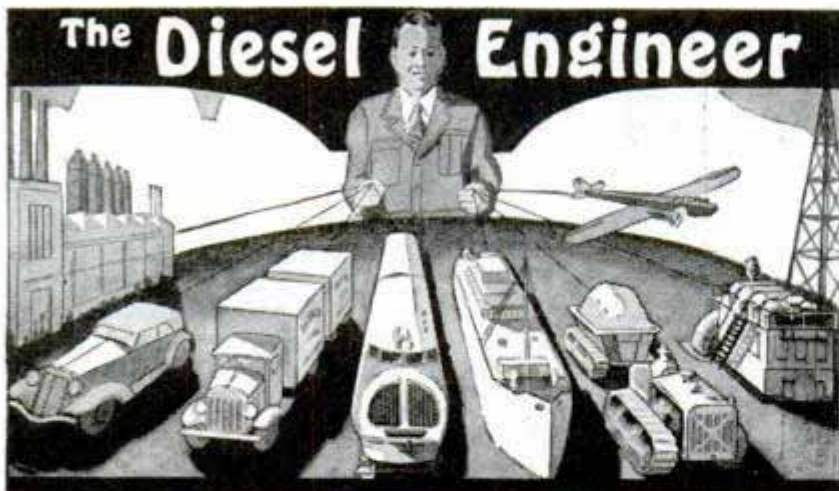

The Diesel Engineer

Is Your Job Safe?

Just as the gasoline engine changed the jobs of thousands who depended on horse-drawn vehicles for their living—so now the Diesel engine is fast invading both the power and transportation fields, and threatening the present jobs of thousands.

What This Field Offers You

Diesel engines are replacing steam and gasoline engines in power plants, motor trucks and busses, locomotives and ships, aircraft, tractors, dredges, pumps, etc.—opening up well-paid jobs for Diesel-trained men. You get all the latest Diesel developments in our course. Special diagrams for quick understanding of this new power.

2 Diesel Lessons Free

Men Over 18—Under 40

This opportunity is NOT open to boys under 18 or men over 40. But if you are WITHIN these ages, you owe it to yourself to investigate this opportunity of acquainting yourself with Diesel—the new, fast-growing field.

In your own home, learn about Diesel

No experience necessary. At our expense, see how plain every point is made—how thoroughly you grasp it—how greatly you will enjoy the work. If you are over 18 and under 40, send postcard, state age, and get 2 beginning lessons FREE. No obligation. This may be the turning point in your life, so write TODAY!

AMERICAN SCHOOL, Dept. D-445, Drexel Avenue at 58th Street, Chicago, Illinois

Test Yourself for a Good Pay Job—Steady Work



CARTOONING

You can now get personal instruction in this fascinating and well paid profession by one of America's leading cartoonists. Why be satisfied with less? It costs no more. Approved by the nation's foremost cartoonists. Write for free details about this "easy to learn" home study course.

DORMAN H. SMITH, Box C597, San Rafael, California



SEND FOR FREE COPY of Rhyming Dictionary and Instruction Book on How to Write Popular Songs. Submit best poems, melodies today for our bonafide, superior offer.

MMM Publishers, Dept. 33B, Portland, Ore.

In answering advertisements always write name and full address clearly.

Tells How to Use—

Concrete About the Home; Concrete in the Garden and Yard; Concrete About the Farm; Concrete Homes and Buildings; Making Recreation Devices; Concrete in the Workshop; Concrete Products for Manufacture; Concrete in Business and Industry, etc. Gives 146 Concrete Kinks.



The Book of the hour for the workshop fan, handy man and home owner.

NEW Concrete BOOK
Makes Cement Work of All Kinds Easy

Money Making Facts - Best Methods - Materials - New Colored Concrete - 146 Kinks

"1001 Ways to Use Concrete!" strips the mystery from the fascinating work of making useful articles and permanent improvements with concrete. This book, just published covers every known use of concrete for the home, farm, building, business and industry, plus newer uses in decoration and arts. Includes new fast setting and gloriously colored concrete and 146 valuable usable kinks. 1001 uses of concrete including homes, garden furniture, pools, statuary, etc., recreation devices, farm improvements, driveways, walks, etc. Describes all methods and materials. Shows how to do real professional type jobs.

256 Pages — 16 Colored Plates, Hundreds of Pictures

Large book 7 x 10 inches. Handsome cloth binding. Sent post-paid for only \$5. Sent COD in U. S. if preferred. Order today. Make concrete work a fascinating hobby or a profitable business.

POPULAR MECHANICS PRESS - 200 East Ontario St., Dept. 438C - CHICAGO

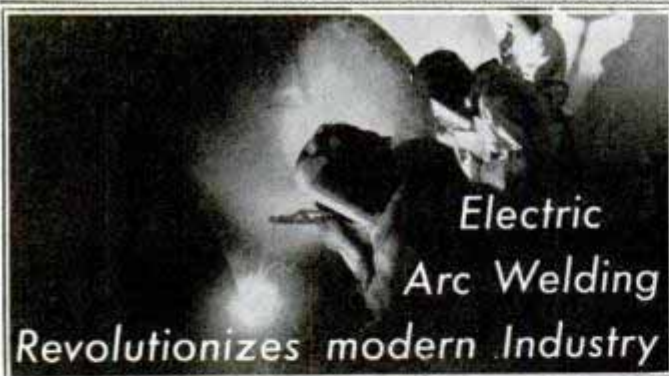

Electric Arc Welding
Revolutionizes modern Industry

U.S. Manufacturers desire men to learn Electric Arc Welding and get practical experience under actual production conditions in the laboratories of the School of Engineering. Moderate training Fee. Accepted applicants will be fully trained until ready to pass rigid test and assisted in securing employment.

ARC WELDING

presents one of the outstanding opportunities for steady income and future success. Welding is growing rapidly, replacing large and intricate castings, rivets, nuts, bolts, screws. It is commonly used in assembling cranes, hoists, bridges, structural steel work, etc. No limit to the application of welding to industry, increasing durability and reducing manufacturing costs. There is a decided shortage of properly trained Welding Operators, Technicians, and Welding Engineers. Why be content with ordinary work, hit and miss jobs and low pay when in a short time you can become a trained Specialist in Welding?

MILWAUKEE SCHOOL of ENGINEERING

Institute of Electrotechnics

Dept. PM-438, Broadway & E. State, Milwaukee, Wis.

Without obligation send Free Booklet "The Dawn of a Gigantic Industry and its Outstanding Opportunity." Also tell me How to Become an
 Arc Welding Operator (3 mo.) Air Conditioning & Refrig. Tech. (3 mo.)
 Gas Welding Operator (6 wks.) Radio Serviceman (6 mo.)
 Welding Technician (6 mo.) Commercial Electrical Engineer (1 yr.)
 Welding Engineer (1 yr.) Commercial Radio Engineer (1 yr.)
 Electrical Engineer Student Loan Plan
 B. S. Degree (4 yrs.) Earn Part Expense Plan

Name..... Age.....
 City..... State..... (PM-438)

NO BATHING SUITS FOR ME!

ASHAMED TO GO SWIMMING

*Because He Couldn't Stand
Kidding About His*

Weak Skinny Body

**But He Added 7 Husky
Lbs. With First Bottle of
Kelpamalt — Now He
Looks Fine—Feels Great!**

**All Skinny Fellows Should
Read This Actual Letter
From our Files.**

"Kelpamalt Company:

Five weeks ago I had some visitors from out of town, and for amusement they suggested we attend the nearby swimming pool. At this point I suggested a show as I have always done because I was ashamed to show my skinny figure. That night I was reading a magazine when I came to an advertisement reading as follows: "Weak, Rundown, Nervous, Skinny Folks." I immediately read it completely and decided to try it. Today, I am the one to suggest going to the pool — thanks to Kelpamalt. I have gained not five pounds the first week, but SEVEN. —Mr. E.B., Raleigh, N. C."

Why "Eating Enough" Often Can't Help Skinny Folks

Don't be fooled by a good appetite. If you are skinny, weak, tired-out, sickly, unable to gain an ounce of flesh or strength, no matter what you eat, you may actually be suffering from "Mal-Nourishment". Doctors now know that unless the food you eat contains certain minerals essential for the body's chemical processes, even a lot of food can fail to yield adequate nourishment. Digestion, in such cases, is incomplete, assimilation poor, and digested food isn't being changed to energy, strength and flesh.

With Kelpamalt, the new mineral concentrate from the sea, you get

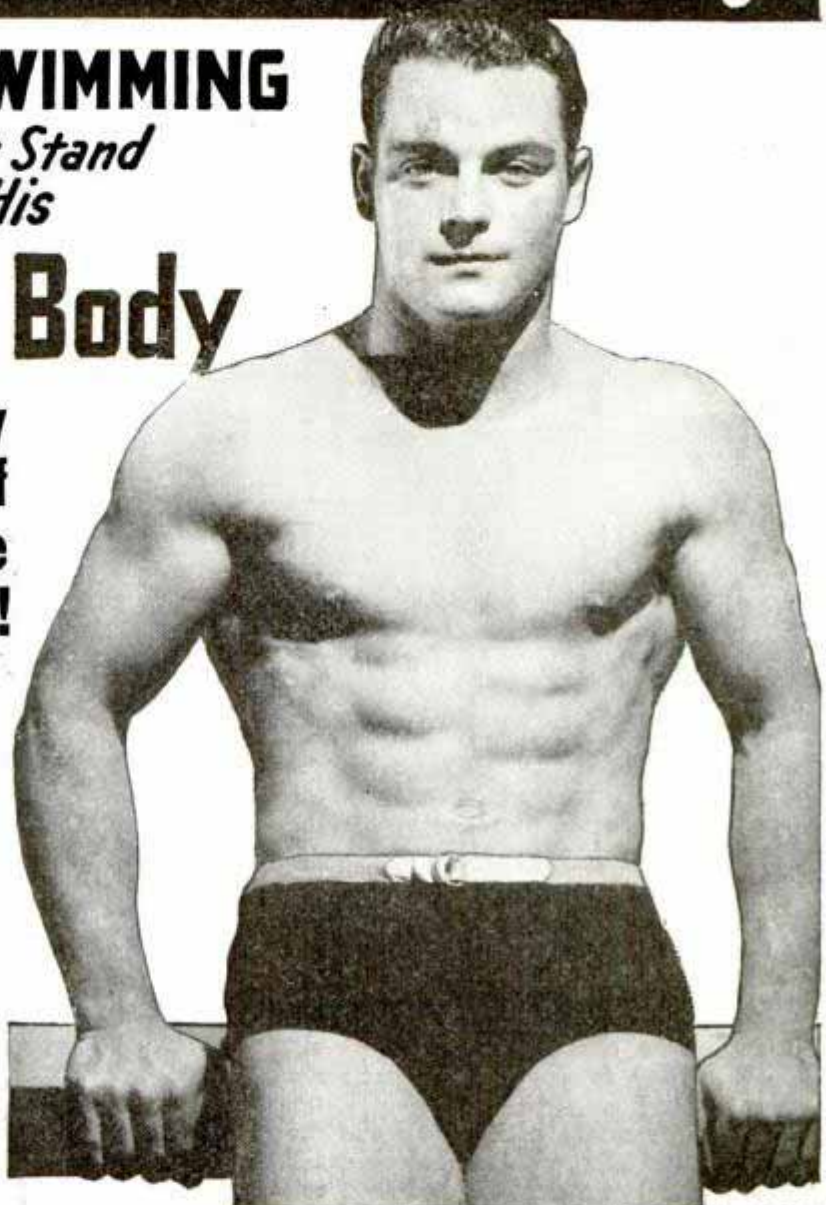

Posed by Professional Model

essential minerals in their naturally occurring form, such as assimilable iron, copper, etc., and, most important, natural iodine (not the chemical liquid kind). This is the substance, scientists say, that is vitally important to the health and proper functioning of blood, liver and glands. Kelpamalt is richer in iodine than oysters, hitherto considered the best source.

5 Extra Lbs. in 1 Week — Reported Regularly

Try Kelpamalt for a single week. Thousands report they are amazed at the improvement Kelpamalt has brought them. Gains of 5 to 15 Lbs. in a few weeks are not uncommon, new strength, new en-

ergy, better digestion and elimination. They eat better, sleep better, and almost invariably say they now feel fine. Costs but little to use and is sold at all good drug stores. If your dealer has not yet received his supply, send \$1.00 for special introductory size bottle to address below. And remember—your money back if you are not completely satisfied.

SPECIAL FREE OFFER

Write today for fascinating instructive 50-page booklet on How Thousands Have Built Strength, Energy and Added Lbs. Quickly. Mineral and Vitamin contents of food and their effects on the human body. New facts about NATURAL IODINE. Standard weight and measurement charts. Daily menus for weight building. Absolutely free. No obligation. Kelpamalt Co., (Dept. 1409), Borden Ave. & 21st St., L. I. City, N. Y.

Name.....
Street.....
City.....

SEEDOL
Kelpamalt Tablets

KNOWLEDGE
THAT HAS
ENDURED WITH
THE PYRAMIDS



A SECRET METHOD FOR THE MASTERY OF LIFE

WHENCE came the knowledge that built the Pyramids? Where did the first builders in the Nile Valley acquire their astounding wisdom that started man on his upward climb? Did their knowledge come from a race now submerged beneath the sea? From what concealed source came the wisdom that produced such characters as Amenhotep IV, Leonardo da Vinci, Isaac Newton, and a host of others?

Today it is known that they discovered and used certain *Secret Methods* for the development of their inner power of mind. They truly learned to master life. This secret art of living has been preserved and handed down throughout the ages and today is extended to those who dare use its profound principles to meet and solve the problems of life in these complex times.

This Sealed Book -- FREE

Has life brought you that personal satisfaction, the sense of achievement and happiness that you desire? If not, it is your duty to yourself to learn about this rational method of applying natural laws for the mastery of life. To the thoughtful person it is obvious that everyone cannot be entrusted with an intimate knowledge of the mysteries of life, for everyone is not capable of properly using it. But if you are one of those possessed of a true desire to forge ahead and wish to make use of the subtle influences of life, the Rosicrucians (not a religious organization) will send you A Sealed Book of explanation without obligation. This Sealed Book tells how you, in the privacy of your own home, without interference with your personal affairs or manner of living, may receive these secret teachings. Not weird or strange practices, but a rational application of the basic laws of life. Obtain your complimentary copy by addressing your inquiry to Scribe C.N.X.

The ROSICRUCIANS
(A M O R C)
San Jose, California

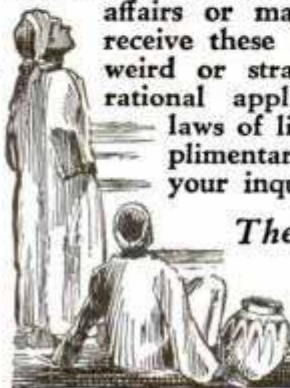

FUN!

MAKE THIS Squirrel Lamp

Yes sir, out of a real squirrel! Also make ash-trays, book-ends, etc., using rabbits, frogs, etc. LEARN AT HOME TO MOUNT BIRDS, ANIMALS & FISH; tan skins and make rugs. Decorate your room.

It's FUN! BIG profits in spare time!

Free book tells how.

FREE BOOK! Write TODAY for beautiful free book telling how to learn this fine hobby. Book is free. Contains many fine pictures. STATE YOUR AGE.



N. W. School of Taxidermy, 3374 Elwood Bldg., Omaha, Nebr.

RADIO-TELEVISION



OFFERS YOU A GREAT FUTURE

Our training prepares you for Govn't Radio Operators Exams., Radio Servicing, Installing Public Address Systems. You can become a Radio Expert. Free Employment Service. Write for Free booklet, "Better Jobs in Radio".

NORTHWESTERN RADIO TELEVISION INST.
2530 Hennepin Ave., Minneapolis, Minn.

CARTOON YOUR WAY TO SUCCESS!



DON'T COPY — LEARN TO ORIGINATE!

RAYE BURNS will teach you HOW TO CREATE ORIGINAL CARTOONS at home that you can SELL! Course contains 26 lessons and over 600 illustrations. All for Only . . .

\$3.85

Send name and address for free details.
RAYE BURNS SCHOOL, Dept. M, BOX 2194, Cleveland, Ohio



The **BRISCHOGRAPH** makes you an artist INSTANTLY. Use any size copy. Junior covers 4 x 4 inches at one time. Projects in colors and up to life size. Comes completely wired, with lamp, lenses and transpose mirror. Dealers in principal cities and foreign countries. Send \$10, money order, try it ten days. Money back guaranteed. Commercial models \$25., \$50. and \$100.

The **BRISCHOGRAPH CO.**, 24 W. Welsheimer Rd. Columbus, O. Established 1928. Canada: Winnipeg Map & Blue Print Co., 318 Donald St; Winnipeg, Man.

GUITAR

You'll enjoy learning for less than 2c a day. Full particulars Free. Write today.

HAMANN INSTITUTE, 3016 N. 24th Place, R-4, MILWAUKEE, WIS.

STUDY ENGINEERING AT HOME

Home Study Courses leading to Degrees in Electrical; Civil; Mechanical; Diesel; Architectural; Aeronautical; Automotive; Drafting; Radio; Air Conditioning; Refrigeration; Highway, Mining, Petrolium, Industrial Steam, Chemical Engineering; Arts; Sciences; Philosophy; Education; Writing; Psychology; Chemistry; Theology; Law; Agriculture; Business; Advertising; Sales; Accounting; Public Speaking. **McKINLEY-ROOSEVELT GRADUATE COLLEGES, 4246 Clarendon Ave., Chicago.**

TRAIN FOR Radio-12 WEEKS

SHOP TRAINING
EASY PAYMENT PLAN
Get Details of My Amazing Offer!

Prepare for jobs in the many profitable branches of Radio by twelve weeks of practical shop work in the great Coyne Radio Shops, on real actual equipment. You don't need advanced education or experience. Free Employment Service for life. Many earn while learning. Mail coupon today for free book which tells you how hundreds have become successful Radio men after getting a training and all details of my "Pay-Tuition-After-Graduation" Plan.

H. C. LEWIS, Pres., COYNE RADIO SCHOOL
500 S. Paulina Street, Dept. 45-3H, Chicago, Illinois
Send Free Radio Book and facts. Tell how I can pay for my course on easy payment plan after getting my 12 weeks' training.

NAME _____ AGE _____
ADDRESS _____
CITY _____ STATE _____

Get Into AVIATION Train At LINCOLN



Now is the time to get into aviation! Airplane factories are flooded with orders! Airlines continue to expand! Airline Pilots earn up to \$6000 a year—mechanics up to \$2400! Come to LINCOLN now and train for one of the many good pay jobs open to Lincoln-trained men.

Lincoln Government Approved Flight Training prepares you for any Pilot's License including Commercial (Transport). Lincoln Government Approved Mechanics Training prepares you for your Mechanic's License. 14 Modern Training Planes. 12 Shops and Laboratories, with wide variety of modern airplanes and engines for practical experience. Now in 28th year, 18th year teaching aviation. Lincoln graduates in demand. We assist graduates in locating positions. WRITE now for complete information. State your age.

LINCOLN AIRPLANE & FLYING SCHOOL
207-H Aircraft Bldg. Lincoln, Nebr.

JOBS for PHOTO-ENGRAVERS!!

EARN WHILE LEARNING PHOTO-ENGRAVING IN SPARE TIME—Photo-Engravers are needed to operate Tasope' Photo-Engraving Equipment we sell to publishers everywhere . . . Start training at home in spare time. We furnish all equipment including photo-engraving camera with lamps, lens and screen. Earn while learning by making engravings for local advertisers, newspapers, printers, etc. Copper plate for picture shown here, size 8x10 inches sells for \$15.37. SEND TODAY for job plan details and catalog illustrated with pictures engraved by equipment we furnish. No cost! No obligation.



THE AURORA SCHOOL OF PHOTO-ENGRAVING
Dept. 148 Aurora, Missouri

EARN THE DEGREE

Doctor of Psychology (Ph.D.), Philosophy, Science, General Courses—Arts, Law, Business, etc. "CHARTERED BY STATE OF MONTANA." Send for 32-page FREE Bulletin at once. No Obligation. Temple Bar College, Dept. 2-R, 213 East Main Street, Missoula, Montana, U. S. A.

NEW YORK SCHOOL of MECHANICAL DENTISTRY

Earn big money in a few months. We show you how. Real Laboratory Training. OLDEST school, Day, Eve. Easy terms. Ask for free Catalog P and tool offer. N. Y. SCHOOL of MECHANICAL DENTISTRY, 125 W. 31 St., N. Y. C.

do-it-with-squabs



Ready for market ONLY 25 DAYS OLD. Write a post-card, get FREE EYE-OPENING Picture Book. Why breed for ordinary trade when these great luxury national markets are wide open for all the SQUABS you can ship, every day in the year? Go after this desirable, profitable trade now.

RICE FARM, 636 H St., Melrose, Mass.

OLDEST BEST POULTRY JOURNAL NINE ISSUES 25c

Helps increase Poultry Profits. Send coin or stamps. Only \$1.00 for 3 years or 25 cents for 9 months trial. Agents wanted. American Poultry Journal 532 So. Clark Street, Chicago, Illinois

No JOKE TO BE DEAF

—Every deaf person knows that—
Mr. Way made himself hear his watch tick after being deaf for twenty-five years, with his Artificial Ear Drums. He wore them day and night. They stopped his head noises. They are invisible and comfortable, no wires or batteries. Write for TRUE STORY. Also booklet on Deafness.



Artificial Ear Drum
THE WAY COMPANY
729 McKerney Bldg. Detroit, Michigan

Save Your Feet

Thousands get relief from painful feet and walk freely with HEEFNER ARCH SUPPORTS

Write for FOOT FACTS
Tells how to aid nature in strengthening weak feet. It's FREE

HEEFNER ARCH SUPPORT CO., 663 Lewis Bldg., Salem, Virginia

RAILWAY POSTAL CLERK, GOVERNMENT CLERK, MAIL CARRIER, POSTOFFICE CLERK

Start \$1260 to \$2100 a Year

42,766 Appointments in 1937 Government Year

MANY 1938 APPOINTMENTS EXPECTED

Railway Postal Clerks

Railway Postal Clerks get \$1,900 the first year regular, being paid on the first and fifteenth of each month. (\$79.17 each pay day.) Their pay is automatically increased yearly to \$2,450. Advance may be had to Chief Clerk at \$2,700 a year. (\$112.50 each pay day.)



3 Days On—3 Days Off—Full Pay

Railway Postal Clerks on long runs usually work 3 days and have 3 days off duty or in the same proportion. During this off duty their pay continues just as though they were working. They travel on a pass when on business. When they grow old, they are retired with a pension.

City Mail Carriers, Post Office Clerks

Clerks and Carriers now get \$1,700 the first year on regular and automatically increase \$100 a year to \$2,100 and \$2,300.

Customs Inspector

Salary \$2,100 to start. Men 23 to 45. Work connected with examining baggage and merchandise entering the country from foreign parts covering boats, trains, roads, automobiles, etc.

Many Other Positions

Many other positions are obtainable. Those wishing these positions should qualify at once.



Get Free List of Positions

Fill out the following coupon. Tear it off and mail it today—now, at once.

This investment may result in your getting a big-paid government job.

FRANKLIN INSTITUTE, Dept. P173, Rochester, N. Y.

Rush to me, entirely free of charge (1) a full description of U. S. Government Jobs; (2) Free copy of illustrated 32-page book, "How to Get a U. S. Government Job"; (3) List of U. S. Government Jobs; (4) Tell me what to do to qualify for a U. S. Government Job.

Name

Address

Use This Coupon Before You Mislays It. Write or Print Plainly.

When writing please mention Popular Mechanics



14-59

COMFORT for the automobile tourist is offered by a convertible seat which



has been patented. Installed in the front compartment, the seat has a back which may be let down, forming a sort of lounge or bed. Sliding bolts provide a means of adjusting

the back of the seat to the position desired, modified or full reclining. Stop pins support the cushion in horizontal position.

FARMERS would find a recently patented clamp a convenience in stretching fence wire.

The clamp is designed to grip the wire in its jaws and to guide the wire into position. A pull chain and a pulley permit tightening of the fence wire to the tension desired.

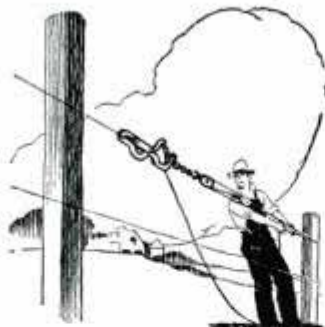

APPEARANCE of the poultry yard can be improved by the addition of a newly patented watering device. The waterer, which supplies poultry with fresh water with little attention, consists of a cylindrical reservoir, with a circular trough at



the bottom. Means is provided for letting water out of the reservoir into the trough as it is needed. A cover on the reservoir prevents contamination of the water.

POSSIBLY pointing the way to the rear-engine automobile is a recently patented engine-cooling system.

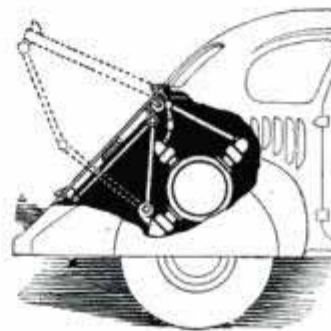

Should the motor be placed in a compartment at the rear, the radiator would be positioned in the lid of the compartment. The system

provides for mounting the radiator so that it may be moved out of the way, permitting inspection and repair of the motor. A folding pipe connects the radiator to the engine so that the cooling system may serve its usual purpose. The invention, aside from its possible application for the rear-engine car, is a space-saver.

INTENDED to improve radio reception for the motorist is an antenna system

upon which a patent has been issued. The system includes a pair of insulating tubes, probably flexible cable, with transformer windings within each cable. The windings of one cable have conductors adapted for connecting with the antenna, and the windings of the other cable have conductors adapted

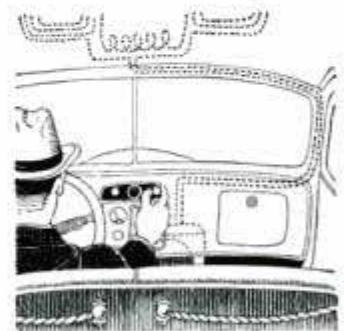

(Continued to page 39A)



USERS REPORT
3 TO 7 MILES MORE
PER GALLON
MOTORIST SAVES
\$180.00 A YEAR

VACU-MATIC
the Carburetor Control that "BREATHES"

AT LAST! Automotive engineers have smashed down the barriers to perfected combustion! The new VACU-MATIC solves the secret of greater power! With almost magical action, this amazing invention instantly puts new life and pep in any motor. It adds mileage to every gallon of gasoline . . . produces split-second pick-up, sensitive accelerator response, quicker starting, greater speed and smoother running.

Automatic -- Nothing Like It!

The self-starter—four wheel brakes—knee action—stream-lining . . . and now VACU-MATIC! The sensational money-saving invention! With it, engineers have achieved a practical means of balancing air and gasoline automatically for all speeds.

Vacu-matic is *entirely different!* It operates on the super charger principle by automatically adding a charge of extra oxygen, drawn free from the outer air, into the heart of the gas mixture. It is entirely AUTOMATIC and allows the motor to "breathe" at the correct time, opening and closing automatically as required. No idling troubles—no carburetor adjustments necessary. It is so simple it will amaze you—so practical it will save you many dollars on gas costs.

Agents and Salesmen

VACU-MATIC offers a splendid opportunity for unusual sales and profits. Every car, truck, tractor and motorcycle owner a prospect. Valuable territories now being assigned. Check and mail coupon.

Guaranteed Gas Savings

VACU-MATIC proves itself on every car. It is guaranteed to give worthwhile gas savings, quicker pick-up, and more power or it costs you nothing. You can instantly tell the difference in added power and motor performance — you quickly notice the cash savings on gasoline.

Fits All Cars

VACU-MATIC is constructed of six parts, assembled and fused into one unit, correctly adjusted and *sealed at the factory*. Nothing to regulate. Any motorist can attach VACU-MATIC in ten minutes. Once in, its only reminder is the surge of instant power and speed it gives to the motor and the savings it affords your pocketbook.

Free Details

You owe it to yourself to know all about this remarkable discovery. Mail the coupon below. Start saving gas with VACU-MATIC and enjoy a new driving thrill! There's no obligation—so get the facts now! Write today!

--- FREE OFFER COUPON ---

THE VACU-MATIC COMPANY
 7617 - 371 W. State St., Wauwatosa, Wis.
 Gentlemen: Please send me full particulars concerning the Vacu-matic and details of your Free Offer. This of course does not obligate me in any way.

Name

Address

City State.....

Check here if interested in selling proposition.

The VACU-MATIC Co.

Wauwatosa, Wis.

NEW ELECTRIC LIBRARY

\$ 1.50 A VOLUME



WHAT EVERY ELECTRICIAN WANTS TO KNOW!

is easily found in AUDEL'S NEW ELECTRIC LIBRARY. Electricity made simple as ABC. Up-to-date, trade dope for the expert and ALL electrical workers.

Questions, answers, diagrams, calculations, underwriter's code; design, construction, operation and maintenance of modern electrical machines and appliances FULLY COVERED.

All available at small cost, easy terms. BOOK-A-MONTH service puts this NEW information in your hands for 6c a day. You can start your subscription with any volume. Write TODAY for electric Folder and FREE TRIAL offer.

THEO. AUDEL & CO., 49 W. 23rd St., New York City

Mail Vol. I, Electric Library on 7 days' free trial. If O. K. I will remit \$1.50, otherwise I will return it. I also request you to mail one book each month on same terms. No obligation unless I am satisfied.

Name.....
 Address.....
 Occupation.....PM

GET ready for A BETTER JOB

Knowledge of drafting and plan-making big help to future executives. Practice at home. Make drawings for home remodeling, garden layouts, home woodworking, wiring improvements. Get this special big saving combination:

Handy Drawing Board—13" x 19"
T Square—19"—One 5" 45 Deg. Triangle—One 7" 30 x 60 Deg. Triangle—Special Slide Lock T Square and Two Triangles to Board When Not in Use—Drawing Paper—50 Sheets 12" x 18", Fine for Ink, Pencil or Water Color—Protractor—Pencil Pointer—Pencils—Scale—Thumb Tacks—

ALL FOR \$3.00

Save C.O.D. charges. We pay the postage when you enclose Money Order or Cash with order. Satisfaction guaranteed or money refunded.

Address: Dept. A., Frederick Post Co., 3635 N. Hamlin Ave., Chicago

FREE New! Sensational!

"SUCCESS PLAN" for Distributors of Justrite COMBINATION SOLDERING IRON AND BLOW TORCH



Amazing, New "Success Plan" banishes guesswork for Distributors of the famous Justrite Combination Soldering Iron and Blow Torch. Questions answered on major points of selling!

BIG MONEY—full or part time for men who will call on Mechanics, Engineers, Plumbers, Sheet Metal Workers, Garage Men, Battery Shops, etc., to demonstrate this **MARVELOUS TOOL!** Operates with 100% satisfaction on less than 1/4 cent per hour—with NO stoves, NO charcoal, NO air pumps, NO electricity. Fully portable. For hundreds of uses in shops, plants, homes.

ACT NOW! Distributorships open for men of ability. Write for Complete Information TODAY!

JUSTRITE MANUFACTURING CO.
 Dept. 154, 2061-81 Southport Ave., Chicago, Ill.

Increase Your Earning Power

Apply time and labor-saving kinks to your work. Your efficiency will soon be recognized and you will be in line for advancement.

If you do machine shop work of any kind, sheet-metal work, painting, carpentry, auto repairing, farming, concrete work, plumbing, electrical work, welding, building-glass work, general repairing, tool-making, poultry raising, masonry or home repair work, get this

LIBRARY OF 2000 TIME AND LABOR SAVING IDEAS FOR SHOPMEN AND HANDYMEN

JUST OUT

SHOP NOTES for 1938

318 Articles
 645 Illustrations
 224 Pages
 Price 50c
 See partial list of contents below

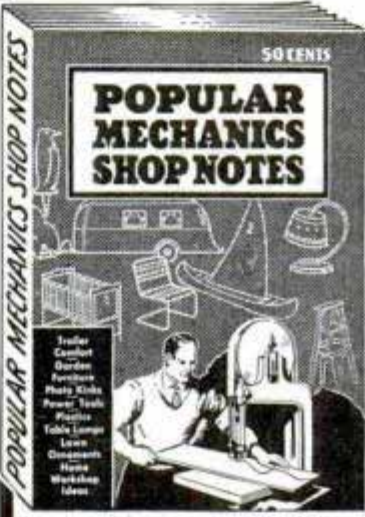

Including the new 1938 issue illustrated above, there are five volumes in the Shop Notes Library of 2000 easily understood short cuts to every-day jobs. Here are just a few of the subjects taken from the latest issue:

- | | | |
|--|---|---|
| Arc Welder, Auto Motor Rims | Garden Furniture, Metal Gas Engine Midget | Plastic Ornaments |
| Bits, Wood-boring | Hacksaw, Electrically Driven | Sail Rig, Airstream Sander, Oscillating Saw, Power-Driven Table |
| Cabinet Humidifier over Radiator | Hydraulic Rams for Country Homes | Shaper Projects |
| Carpenter, Hints for Child's Crib | Jigs for Belt Sander | Snow Plow, Small Rotary Table Lamp from Plastics and Metal |
| Corrosion, Guarding Against | Jigs for the Shaper | Temperature Indicator, Electric |
| Drilling, Safe | Kinks for Photographers | Trailer Brakes, Vacuum Trailer Comfort |
| Drills, Using | Ladder Chair | Torch, Electric Arc |
| Driveway, Durable | Laundry Cart | Wood Turning Kinks |
| Electroplating | Lawn Ornaments | |
| Frozen Water Pipes, Thawing Electrically | Movie Film, Power Reel for Developing | |
| Garage, Profit Makers for | Photographic Equipment | |

Each volume contains approximately 400 articles and 600 illustrations and has 200 or more pages. This unrivaled library of shop helps may be secured for a limited time only. After the present supply of books is exhausted the offer must be withdrawn.

***Send No Money**

POPULAR MECHANICS PRESS,
 200 E. Ontario St., Room 438, Chicago, Ill.

Send me, as per your offer, the following books. I will pay postman price and small amount of postage. My money will be refunded if I am not satisfied. (Check what you want.)

1938 Shop Notes and Lathe Handbook (Metal Working), both for 98c.

Shop Notes Library (5 vols.) \$2.50.

Name.....

Street and No.....

City.....State.....

**C. O. D. applies to U. S. and possessions only. If you reside elsewhere, remittance must accompany order.*

When writing please mention Popular Mechanics

NEW INVENTIONS

(Continued from page 36A)

for connecting to the radio receiver. Other transformer windings about the cables are inductively coupled with the inner windings and a pair of leads join the outer windings of one cable with the outer windings of the other. A fabricated sheath of metallic strands overlies the leads and the transformer windings, compressed about the conductors between the winding and the antenna and the receiver respectively. The whole comprises a harness adapted for coupling the remotely situated antenna to the receiver.

BETTER traction is claimed for a tire tread patented recently. The tread

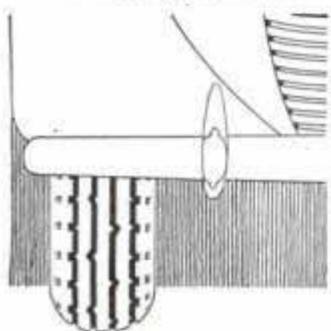

has its ground engaging surface interrupted by a number of slits. At the center of the tread the slits are substantially cross-wise. Those near the shoulders extend circumferentially of the tread and those in the intermediate areas have intermediate-inclined directions cross-wise of the directions of certain movements of the rubber while the tire is in use on an automotive vehicle.

ententially of the tread and those in the intermediate areas have intermediate-inclined directions cross-wise of the directions of certain movements of the rubber while the tire is in use on an automotive vehicle.

FOR persons hard of hearing, a group audiphone system patented recently

offers a means of enjoying theatrical performances. The system consists of microphone, an amplifier and a line extending from stage to the point desired in the theater, or other public assembly hall. At each row of seats is a connection for a number of audiphones, depending upon the number of hard-of-hearing persons in the audience. The system is arranged so that the load on the source of sound transmission remains constant regardless of the connection and disconnection of individual audiphones. All

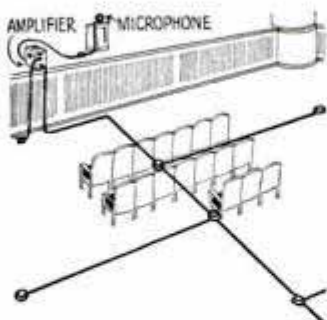

(Continued to page 43A)



TRAIN FOR MORE MONEY IN RADIO

I SET YOU UP...Ready for Business and Profits!

Here is a great opportunity for preparing yourself to enter a fast moving industry in which the money-making possibilities are practically unlimited and where a bright future looms for hundreds of ambitious men. I offer you a new and different kind of Radio training that does more than teach you about all branches of Radio. It teaches you modern Radio business methods and practical means of getting started in the job of making money.

MAKE MONEY WHILE YOU LEARN

I GIVE YOU SPECIAL RADIO BUSINESS BUILDERS WHICH SHOW YOU HOW TO GET SPARE TIME RADIO JOBS AND HOW TO DO THEM.

NO EXPERIENCE NECESSARY TRAINING COVERS ALL BRANCHES

Even though you have done no work whatsoever in Radio, my Course starts right at the beginning, takes you through all branches and phases . . . fits you for spare or full time work or jobs in Radio service, broadcasting, aviation Radio, sound work, etc.

BIG PROFESSIONAL OUTFIT GIVEN

No matter what kind of Radio Training you take, it is absolutely necessary that you have equipment of this kind before you are ready to start making real money. YOU GET A THREE-IN-ONE TESTER, RIDER MANUALS, TOOL KIT, ELECTRIC EYE OUTFIT AND EXPERIMENTAL APPARATUS. Upon completion, you have business experience and technical Radio training plus needed equipment to enter business for full or part time profits.

THESE FELLOWS Made Good . . . So Can You!

Cleared \$150. In Spare Time
"Since enrolling I have cleared a net profit of more than \$150. in spare time alone . . . And I am not one-half through the course yet. Honestly, I cannot understand how you can give so much 'dope' for so little money." A. H. Lanoie, Northbridge, Mass.

Earns \$25. Monthly Spare Time

"I am now doing spare time service work as a result of your training. Make around \$25. per month installing auto Radio receivers." George Herrington, B. C. Canada.

Mahoney Gets Job With Sears

"I found that after three months of study I was able to service sets in a much more professional manner. Business certainly showed an increase. I recently received an offer from Sears Roebuck which I could not have accepted without having had your training." Joseph Mahoney, Rhode Island.



REMEMBER, The Sprayberry Course Is Sold Under An Iron-Clad, Money Back Agreement.

GET THE FACTS!



Mail Coupon Now

SPRAYBERRY ACADEMY of RADIO

F. L. Sprayberry, Pres.
110-D University Place, N. W.
Washington, D. C.

Please send me free copy of "More Money In Radio."

Name Age

Address

City State

(Mail in envelope or paste coupon on postcard.)

STEP INTO THE *Spotlight*



FREE LESSONS... A YEAR TO PAY

Banish Boredom . . . Earn Extra Money START TO PLAY VERY FIRST DAY

Picture the joy of playing a snappy foxtrot, dreamy waltz or mellow old favorite on the Xylorimba. No reason why you shouldn't! Xylorimba is **easiest** of instruments to play and yet the most spectacular. In constant demand by orchestras, radio stations, at lodge meetings and parties. Marvelous opportunity to increase popularity, make big spare-time money. No bothersome practice or exercises. With Free easy lessons you actually **Start to Play Very First Day.**

BIG FREE BOOK tells all about Deagan line, liberal trial offer and easy payments. Send coupon today for your free copy.

J. C. Deagan, Inc., Dept. 2454, 1770 Berceau Ave., Chicago
Send me, without obligation, full details of Free Trial offer and easy-payment plan on the Deagan Xylorimba.

Name.....
Address.....

A GOOD JOB—A BETTER FUTURE

The increased use of metal in aircraft construction has created a steadily growing demand for specialists in sheet metal work. Take a thorough, practical, complete, specialized and proven

AIRCRAFT SHEET METAL COURSE

at Roosevelt Aviation School and you will hold the key to a good job and a better future in a great and growing industry.

Complete information without obligation. Get the facts about this and ten other courses. State age.

Write Today to Dept. P. M.

ROOSEVELT AVIATION SCHOOL

AT ROOSEVELT FIELD
MINEOLA, LONG ISLAND, NEW YORK

52 BULLETINS on DIESEL ENGINES



Sponsored by the

DIESEL USERS' ASSOCIATION

They are chock full of practical information and will fit you to earn a steady living in this rapidly expanding field. They are the result of years of experience of the leading operators and owners of Diesel engines. Profit by their knowledge! Associate yourself with the Diesel Users' Association! Write for full information to—

Diesel Users' Pub. Co., Inc., 2 West 45th St., New York

ELECTRICAL ENGINEERING ONE YEAR CONDENSED COURSE

Prepares for technical work in the electrical field. Thorough training in principles, with practical applications in laboratory and shop. High placement record. Modern buildings, dormitory, dining hall. Campus. 46th year. Catalog on request.



BLISS

ELECTRICAL SCHOOL
134 Takoma Ave., Wash., D. C.

Sensational New Kind of LACO OIL HEAT

**Very Low Price!
Real Fuel-Saver!**

Here's a new, simplified, improved Automatic Oil Burner you can easily afford! Actually costs \$100 under some others—provides uniform heat, without attention, at Low Cost! Saves usual furnace dirt and work. Amazingly quiet. Only 1 moving part. Approved by Underwriters' Lab'y. Guaranteed. 65,000 LACOs in use.

WRITE See your local LACO dealer or send name for Free Book and the very Low Price. Find out how much you can save by installing the new LACO. Don't delay, **SEND NOW!**

LACO OIL BURNER CO., 148 Union Avenue, Griswold, Iowa



DEALERS:

Hundreds of dealers say KOZY is easiest to sell! Investigate our Free Sample Burner offer. **WRITE!**

148 Union Avenue, Griswold, Iowa

DO YOU LIKE TO DRAW?

It's easy to learn when shown in the right way.

E. C. SEGAR who draws "POPEYE," **CHESTER GOULD** who draws "DICK TRACY," "LANK," **LEONARD** — "MICKY FINN" and many other famous cartoonists and comic strip artists learned how to draw during their spare time by following **CARTOONIST EVANS' SIMPLE, EASY, INEXPENSIVE COURSE.** Send 6c in stamps for full details.

THE W. L. EVANS SCHOOL OF CARTOONING
521 Premier Bldg. Cleveland, Ohio



CATCH FISH!

minnows, eels, mink, muskrat with our folding galvanized Steel Wire Traps. Greer Patent Lever Hooks are so constructed that when a fish gives the slightest pull on the bait the upper hook reaches down and gets a hold that lands him. 3 for 50c. Write for descriptive catalog of Traps, Hooks, Lures, and other specialties. **Walton Supply Co., 3507B Junata St., St. Louis, Mo.**



FREE WHOLESALE CATALOG

Shows 4000 World Wide Bargains, 260 pages of Big Values, 15 selling plans. This fascinating Book of Opportunity is **FREE.** Write for a copy today.

GUARANTEED FOR LIFE PEN

No. R317, Pump filler fountain pen. Fitted with the new improved, stainless durium point. Has large transparent ink reservoir, holds many days supply of ink—always visible. Comes in popular, pearl-effect colors. Guaranteed to satisfy or money back. Suggested Selling price 59c. Sample, 25c Dozen, \$2.80

No. H5 Guaranteed, double edge razor blades. First quality.

STEEL RULES

No. H82. Steel rule. 72 inch length. Marked in feet, inches and fractions as low as sixteenths. Twist it—Bend it—It will not break. Suggested selling price 50c. Sample 18c Dozen \$1.85

No. H81. Thirty-six inch steel rule in metal case. No spring to get out of order. Suggested selling price 25c. Sample 9c Dozen 98c

Makes shaving a pleasure. Must please or money back.

DREXEL
BLUE STEEL DOUBLE EDGE BLADES

15 blades 20c 100 blades 69c

Spors Co. 2-38 Main St., Le Center, Minnesota

When writing please mention Popular Mechanics

\$30⁰⁰ TRADE-IN ALLOWANCE DURING THIS MIDWEST FACTORY-TO-YOU SALE



16 TUBES
TOUCH BUTTON TUNING
30 DAYS FREE TRIAL
EASY TERMS

FACTORY-TO-YOU PRICE... \$69.95
LESS \$30.00 ALLOWANCE
You pay only **\$39⁹⁵** COMPLETE

SEND for this marvelous new COMPLETE 1938 Midwest 16-tube radio... on 30 days FREE Home Trial. Big beautiful console—10,000 mile range—world-wide reception—glorious new tone—and Dial-A-Matic Tuning.

Midwest Radio Corporation
Dept. PP-15 Cincinnati, Ohio

Write for FREE 1938 Factory Catalog.

LEARN TELEVISION

... at home! Absolutely NEW kind of training. In ADDITION to text books you get complete practical Television Equipment that actually transmits and receives. Easy time payments... only 30c a day pays for BOTH training and equipment. Write for complete details and FREE book. No obligation.

American Television Institute
Dept. PM 438, 433 E. Erie St., Chicago, Ill.



Government Jobs
EXAMINATIONS SOON VALUABLE INFORMATION FREE
COLUMBIAN CORRESPONDENCE COLLEGE
WASHINGTON, D. C.

FACTORY TO YOU
NEW REMINGTON NOISELESS PORTABLE

AT LAST! The famous Remington NOISELESS Portable is yours for only ten cents a day. Brand new. Not rebuilt. Standard keyboard and every modern feature. Free carrying case and typing course. 10-Day free trial. You don't risk a penny. WE PAY ALL SHIPPING CHARGES. Act now! Write Remington Rand Inc., Dept. 152-4, 465 Washington St., Buffalo, N. Y.



10c A DAY

Make Big Money BE A BUYER for us! NOTHING TO SELL

We furnish the money, and tell you how and what to buy. Make steady, daily income. No experience necessary. Send for complete plan.

Republic M. S. Co., 904 W. Jackson Blvd., Chicago, Ill.

SEND FOR FULL DETAILS!

New 3-Way Surface Test Indicator

SHOP AGENTS WANTED

For Machine and Tool Work and Quick Set-ups. Send for descriptive literature and particulars.

A. R. REICH MFG. CO.
326 Triangle House Dayton, Ohio

NEW BIG TRAILER PARTS CATALOG

Shows hundreds of house trailer items. Build your own trailer or re-equip old trailer. Wholesale prices. Quality merchandise. Prompt shipment. Send 10c for this money saving catalog today.

C. M. Hoof Company, 1736 S. Michigan Ave., Dept. P-4, Chicago, Ill.

NOW YOU CAN GET A HEAVY DUTY INDUSTRIAL WELDER

Works Off 110-Volt Light Socket

This marvelous DYNAMIC Power Welder will do the work of much higher priced types. It is easily portable. WELDS Cylinder Blocks, Bumpers, Fenders, Tanks, Farm Machinery, and etc. Will also solder and brace on the lightest material. Works on iron, steel, tin, brass, copper and all other metals. Men without previous experience can make as much as \$5.00 on a one hour repair job. Go into business—Open a Welding Shop NOW.

AGENTS—Make big profits selling to garages, factories, janitors and machine shops. Write TODAY for our 10-DAY TRIAL OFFER.

DYNAMIC WELDER COMPANY
2226-DC Silverton Road Chicago, Illinois

for Only **\$195** RETAIL



DRAFTING



BOOKS SENT FREE!

ON APPROVAL
5 VOLUMES BRAND NEW EDITION

Only 15 minutes a day with these WONDER BOOKS can prepare you for a good drafting job in less than a year. Mechanical and architectural drafting from simple straight lines to important complex plans *A step at a time!* Built especially for beginners, for men with only grammar schooling. Drafting room practice. PLUS ENGINEERING, made easy and clear. Includes complete course in blueprint reading.

Big Field Big Demand Big Pay

Competent draftsmen are urgently needed right now in all building and manufacturing lines at \$30.00 to \$75.00 a week. That's just the beginning—FOR DRAFTSMEN HAVE THE BEST CHANCES FOR ADVANCEMENT. Pleasant, fascinating work, easy to learn and do. Learn quickly with these books—send coupon for a set and see for yourself.

A year's consulting membership in the American Technical Society now given to all readers of this famous encyclopedia of drafting. Many say that it is worth more than the cost of the books.

Complete set of drawing instruments if you send for these drafting books NOW

These instruments are made of the finest of German silver, are absolutely accurate and are packed in velvet lined leatherette pocket case. Real \$10 value, but included with these books.

AMERICAN TECHNICAL SOCIETY
Dept. D419, Drexel at 58th St., Chicago, Ill.

American Technical Society, Dept. D419, Drexel at 58th St., Chicago, Ill.
Send for 10 days' trial New 5 volume set of drafting. I will pay the few cents delivery charges. If I wish, I may return books in 10 days and owe you nothing but if I decide to keep them, I will send \$2.00 after 10 days, then only \$5.00 a month until \$24.80, the advertising price, is paid. Send latest edition and include drawing instruments and Membership Certificate.

Name.....
Address.....
Attach letter stating age, occupation, employer's name and address and that of at least one business man as a reference.

Learn this Profitable Profession



in 90 Days at Home

Hundreds of men and women of all ages 18-50 make \$10.00 to \$20.00 in a single day giving scientific Swedish Massage and Hydro-Therapy treatments. There is a big demand from Hospitals, Sanitariums, Clubs, Doctors and private patients as well as opportunities for establishing your own office.

Learn this interesting money-making profession in your own home by mail, through our home study course. Same instructors as in our NATIONALLY KNOWN resident school. A diploma is awarded upon completion of the course. Course can be completed in 3 to 4 months. High School training is not necessary. Many earn big money while learning.



Anatomy Charts & Sample Lessons FREE

Enroll now and we will include uniform coat, medical dictionary, patented reducing roller and Hydro-Therapy supplies without extra cost. The reducing course alone may be worth many times the modest tuition fee.

Send coupon now for booklet containing photographs and letters from successful graduates, illustrated sample lesson sheets and Anatomy Charts. These will all be sent postpaid—FREE.

THE College of Swedish Massage (Successor to National College of Massage)
Dept. 477—1601 Warren Boulevard, Chicago
You may send me FREE and postpaid, Anatomy Charts, illustrated sample lesson sheets and booklet containing photographs and letters from graduates.

Name.....
Address.....
City..... State.....

When writing please mention Popular Mechanics

Only 22¢ a Day
Puts This All-Purpose ELECTRIC ARC WELDER IN YOUR SHOP



TEN DAY TRIAL GUARANTEED

STOP THROWING AWAY PROFITS! DO YOUR OWN WELDING! That's the modern way to increase income and customer satisfaction. And, it takes only 22c a day to do it. Yes, you get the sensational, professional, ALL-PURPOSE, Commonwealth Arc Welder—Model 120-FS, for only 22c a day. Ten whole months to pay out of profits. Now, for the first time, it is EASY for every inventor, laboratory, home workshop owner, garage, repair shop, and factory to afford a complete welding service for manufacturing, maintenance, experimental or repair work.

Details FREE

Works on 110 or 220-Volt A. C.

Simply plug into a 110 or 220-volt, 60-cycle A.C. line. Economical—costs only a few pennies an hour to operate. Often pays for itself on first or second job. Portable—can be carried right to outside jobs in auto, truck, or side car. Anyone can weld with its easy-striking, automatically-stabilized arc. Comes complete with helmet, electrode holder, welding rod, etc. Nothing else to buy. Fully Guaranteed. Breath-taking low price! Saves and makes hundreds of dollars.

Handles ALL Welding Sheet Metal to Heavy Castings

Model 120-FS is a big, 110-pound, man sized, heavy-duty welder with efficiency of machines costing many dollars more. Welds iron, steel, cast iron, cast steel, and alloys of them. Six heats handle everything from fenders and light sheet metal to motor blocks and heavy castings. Also fine for soldering and brazing. Uses standard welding rods. No experience or special training needed to operate. Simple, complete instructions for doing all kinds of welding jobs included. MAIL COUPON BELOW for complete FREE details.

COMMONWEALTH MFG. CORP.
 Dept. G-51, Cincinnati, Ohio



MAIL COUPON FOR DETAILS GET 22¢ A DAY PLAN

Commonwealth Mfg. Corp., Dept. G-51, 4208 Davis Lane, Cincinnati, Ohio. Please rush me at once, FREE, all details about Model 120-FS Electric Arc Welder with DeLuxe Accessories and your 22c-a-day plan.

Name.....
 Address.....
 Town..... State.....



Easy

YOU'LL advance faster with an easy playing Conn. Choice of world's greatest artists. Many exclusive features yet they cost no more. Home trial. Easy payments. See your dealer or write for freebook. Mention instrument.

C. G. CONN, Ltd., 431 Conn Bldg. ELKHART, IND.



When writing please mention Popular Mechanics

Extra Money From Books

SEND NO MONEY • Books Sent C.O.D. Anywhere in U. S. These famous Pay-Raising, Extra Money Books have helped thousands of others. Let them help you too. Check this list and mail with your name and address. Pay postman on delivery plus few cents postage. Send 3c stamp to cover postage and ask for catalog of other books.



SELECT FROM THIS LIST

- ARMATURE WINDING**
For A.C. and D.C. Machines.....\$2.00
- AUTO REFINISHING**
Duco With Spray Gun.....\$1.50
- BLUEPRINT READING**
For Machine Trades...\$1.50
- BRICKLAYING**
Plain and Fancy.....\$1.50
- CARBURETORS (All Makes)**
New, Revised Edition...\$3.00
- CHEVROLET SIX**
Car, Truck, Operation Repair.....\$2.50
- COLONIAL FURNITURE**
Making, 95 Pieces.....\$3.50
- DANCE**
Learn at Home Without Music or a Partner...\$2.00
- DIE CASTING**
Machines, Dies, Alloys...\$3.00
- ELEMENTS DIESEL**
Engineering Questions and Answers.....\$4.00
- FOUNDRY WORK**
Molding, Casting, etc...\$2.00
- FURNITURE REPAIRING**
Finishing and Decoration.....\$3.00
- HEATING, VENTILATING**
Homes and Buildings...\$2.50
- HIGH-SPEED DIESELS**
New, practical, non-technical.....\$2.50
- INVENTIONS**
1500 Needed.....\$2.50
- LEATHER MAKING**
and Home Tanning...\$1.00
- MACHINE SHOP WORK**
Tools and Methods...\$2.50
- MAGICIAN'S MANUAL**
New, 100 Tricks for Amateurs.....\$1.39
- METAL SPINNING**
Practical New Book...\$1.00
- MONEY MAKING FORMULAS**
10,000 Practical.....\$4.00
- MOTOR VEHICLE**
Trouble Shooters' Handbook.....\$2.00
- PLASTERING**
Best Instruction Manual.....\$1.25
- RADIO PHYSICS COURSE**
New edition. Everything about Radio...\$4.00
- SHEET METAL**
Construction Work...\$2.50
- STEAM ENGINEER'S LICENSE**
How to Obtain.....\$2.00
- STEEL SQUARE**
Hodgson. 500 pp. 300 Illustrations...\$2.00
- TAXIDERMY, HOME**
Mount Trophies Profit, Pleasure...\$1.50
- WROUGHT IRON WORK**
Practical.....\$1.35

POPULAR MECHANICS PRESS
 Room 438A 200 E. Ontario St., Chicago

\$ MONEY-MAKING \$ OPPORTUNITIES

For those who need larger incomes or must seek new occupations. The following workable, tested plans are adaptable both to the needs of the country or city dweller either for part time development or principal income source.

Every idea set forth in these books has been used by others for profit. They are well worth your consideration.

Plan No. 1—1000 Ways to Make \$1,000. Practical new book of tried, tested methods that work that you too, can use. Price \$2.65.

Plan No. 2—Radio Servicing. Let an expert teach you how to engage in this money making business. Price \$4.15.

Plan No. 3—Refrigeration Service. Official manual covers all makes. Good service men are needed. Price \$5.00.

Plan No. 4—Automobile Refinishing. Start a lucrative business of your own. Fine possibilities here. Excellent new instruction book. Price \$1.50.

Plan No. 5—Outdoor Opportunities. The raising of small animals, birds and plants for profit. Price \$2.00.

Plan No. 6—10,000 Money-Making Formulas. Complete instructions for the making of commodities at small cost that may be sold at a handsome profit. Price \$4.00.

Plan No. 7—1000 Spare Time Money Making Ideas. A job for everybody. 146 page book tells how. Price \$1.00.

Plan No. 8—100 Civil Service Examinations. Covering steady Government jobs. All types of positions. Better business means thousands of new jobs. Prepare now by studying this new book. Price \$2.50.

Plan No. 9—Making Poultry Pay. The proper breeding and management of fowls for higher egg production. Price \$2.00.

Plan No. 10—A Living from the Land. Answers the question "How can I successfully get established in the country?" Price \$1.50.

Plan No. 11—Rabbits for Food and Fur. A complete guide to the successful rearing and breeding of rabbits. Price \$2.00.

Plan No. 12—The Frog Industry. Should be considered more as a side line than as a major means of income. Price \$1.00.

Plan No. 13—Is There Money in Welding? Factual information shows welding is a growing field offering opportunity to anyone looking for a trade. Price \$1.00.

Plan No. 14—Auto Service Shop Management. Money-saving and business-producing ideas by two men who know just what is essential to a profitable service shop business. Price \$1.50.

Any of the above mailed postpaid upon receipt of price or sent C.O.D. anywhere in U. S. Pay postman price and few cents postage.

POPULAR MECHANICS PRESS
 Room 438 200 E. Ontario St. Chicago, Illinois

NEW INVENTIONS ¹⁸⁵⁹

(Continued from page 39A)

audiphones on an entire row of seats may be used or disconnected without affecting reception.

GARMENTS may be dried quickly in the cleaning and dyeing shop if a recently patented drier is used. The device consists of a frame over which the garment is draped and of an electric fan which produces a drying air current. The garment is suspended from a hanger above the frame. Clamps on the outside of the frame hold the garment in place.



OFFERED to increase safety is a bumper for automobiles. It consists of two slightly curved steel plates, piston push rods mounted between the plates and master coil springs encircling the push rods for absorbing the shock. The three push rods and various bracing members give the bumper unusual resistance to shocks.

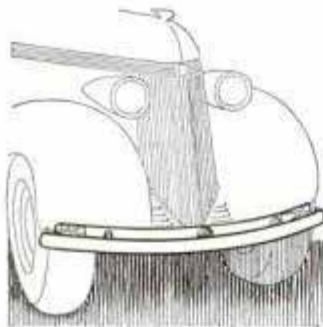

SIMPLIFYING the task of jacking up the automobile when a tire goes flat, a jack that is attached permanently to the car frame has been patented. When the jack is not in use, it is swung up and out of the way, being held by stops on the frame. Permanent attachment assures the motorist that the jack always will be in the correct position when needed, saving the time usually spent in trying to find a place under the car for the tool.

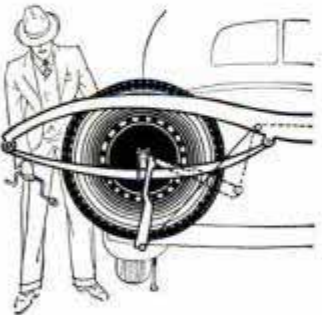

(Continued to page 61A)

Here I Am At WORK
Making GOOD MONEY

thanks to this
**Free TRIAL LESSON in
DRAFTING**

Yes, this free lesson proved that drafting is easy, mighty interesting work . . . proved beyond a doubt that

Drafting by the fascinating C.T.C. method can be mastered easily AT HOME in SPARE TIME.

So I enrolled. Today I know my job is secure. For draftsmen are always needed in construction, manufacturing and industry . . . and in those new Diesel and Air Conditioning plants. Draftsmen can't be replaced with machines! Mail the coupon TODAY for FREE TRIAL LESSON. Drafting will take care of you TOMORROW.



YOU GET THIS COMPLETE DRAWING OUTFIT without a penny extra. These are quality instruments—the kind that professional draftsmen use. With them you can put your ideas on paper quickly and with accuracy. With this outfit and C. T. C. training, you're all set to master draftsmanship in months—not years—at home, and you can use these very same instruments some day soon in a good paying job as Draftsman.

**LEARN AT HOME
IN SPARE TIME**

A few hours of pleasant home study every week—that's all! No interference with your present job. You train yourself step by step. This tested method—developed over 35 years of C. T. C. progress—will fit you for a job in months—a job we'll help you get.

Get this: Terms are low. You can't honestly say, "I can't afford it." There isn't a reason why you shouldn't mail us the coupon today. When you get your FREE TRIAL LESSON, you'll say, "I never knew learning could be so easy and enjoyable."



CHICAGO TECHNICAL COLLEGE

D209 Tech Bldg., 118 E. 26th Street, Chicago, Illinois

Please send me FREE Trial Lesson in DRAFTING and show me how I can prepare for a good position in spare time AT HOME.

Name Age

Address

P. O. State

Why Trained Accountants Command High Salaries

—and how ambitious men are qualifying by the LaSalle Problem Method

GET this straight.

By "accountancy" we do not mean "bookkeeping." For accountancy begins where bookkeeping leaves off.

The skilled accountant takes the figures handed him by the bookkeeper, and *analyzes* and *interprets* them.

He knows how much the costs in the various departments should amount to, how they may be lowered.

He knows what profits should be expected from a given enterprise, how they may be increased.

He knows, in a given business, what per cent of one's working capital can safely be tied up in merchandise on hand, what per cent is safe and adequate for sales promotion. And these, by the way, are but two of *scores* of percentage-figures where-with he points the way to successful operation.

He knows the intricacies of government taxation.

He knows how to *survey* the transactions of a business over a given period; how to show in cold, hard figures the progress it has made and where it is going. He knows how to *use* these findings as a basis for constructive policies.

In short, the trained accountant is the *controlling engineer* of business—one man business cannot do without.

Small wonder that he commands a salary two to ten times as great as that of the bookkeeper. Indeed, as an independent operator (head of his own accounting firm) he may earn as much as the president of the big and influential bank in his community, or the operating manager of a great railroad.

Some Examples

Small wonder that accountancy offers the trained man such fine opportunities—opportunities well illustrated by the success of thousands of

LaSalle accountancy students.* For example—one man was a plumber, 32 years old, with only an eleventh grade education. He became auditor for a large bank with an income 325 per cent larger.

Another was a drug clerk at \$30 a week. Now he heads his own very successful accounting firm with an income many times as large.

A woman bookkeeper—buried in details of a small job—is now auditor of an apartment hotel, and her salary mounted in proportion to her work.

A credit manager—earning \$200 a month—moved up quickly to \$3000, to \$5000, and then to a highly profitable accounting business of his own which netted better than \$10,000 a year.

And What It Means to You

Why let the other fellow walk away with the better job, when right in your own home you may equip yourself for a splendid future in this profitable profession?

Are you really *determined* to get ahead? If so, you can start at once to acquire—by the LaSalle Problem Method—a thorough understanding of Higher Accountancy, master its fundamental principles, become expert in the practical application of those principles—this without losing an hour from work or a dollar of pay.

Preliminary knowledge of bookkeeping is unnecessary. You will be given whatever training, instruction or review on the subject of bookkeeping you may personally need—and without any extra expense to you.

If you are dissatisfied with your present equipment—if you recognize the opportunities that lie ahead of you through home-study training—you will do well to send at once for full particulars. The coupon will bring them to you without any obligation, also details of LaSalle's convenient payment plan.

Check, sign and mail the coupon NOW.



LASALLE EXTENSION

DEPT. 464-HR CHICAGO

Opportunities in Accountancy—Check below and we will send you a copy of "Accountancy, the Profession that Pays," without obligation.

Higher Accountancy:

Other LaSalle Opportunities: If more interested in one of the other fields of business indicated below, check here:

- | | |
|---|---|
| <input type="checkbox"/> Business Management | <input type="checkbox"/> Commercial Law |
| <input type="checkbox"/> Modern Salesmanship | <input type="checkbox"/> Modern Foremanship |
| <input type="checkbox"/> Traffic Management | <input type="checkbox"/> Expert Bookkeeping |
| <input type="checkbox"/> Law: Degree of LL. B. | <input type="checkbox"/> C. P. A. Coaching |
| <input type="checkbox"/> Industrial Management | <input type="checkbox"/> Business English |
| <input type="checkbox"/> Business Correspondence | <input type="checkbox"/> Stenotypy |
| <input type="checkbox"/> Credit and Collection Correspondence | <input type="checkbox"/> Effective Speaking |
| | <input type="checkbox"/> Railway Accounting |

Name

Present Position

Address

*Names available on request.

When writing to advertisers please mention Popular Mechanics

**WORLD'S
BEST
WANT AD
MEDIUM**

CLASSIFIED Advertisements



Advertisements in this section, 35 cents per word, each insertion, minimum 10 words, payable in advance

To be inserted under proper classification in May issue, copy should be in our office March 8th

May issue on sale April 1st

Popular Mechanics Magazine, 200 East Ontario Street, Chicago, Illinois

YOU'LL PROFIT

By reading and answering the classified ads in this section. Hundreds of opportunities to make and save money.

F. W. Johnson,
Manager Classified Advertising, Popular Mechanics

Dear Sir: Naturally I know that an advertisement in your magazine brings results, otherwise I wouldn't keep on sending you copy. But I can go further than that. I can honestly state that a few words in your Classified Advertising brings more results than the same money spent in any other mediums. I always expect from 300 to 500 answers from each insertion which makes my advertising cost but very little for each new customer, and I must add that Popular Mechanics never falls below my expectations.

Yours very truly,
C. W. CLEVELAND, JR.

(Original letter on file in our office)

AUTOMOBILES

MIDGET Racing book; facts for fans, builders, drivers; track sizes, regulations; pictures, specifications, working drawings. \$1.00 postpaid. \$1.15 C.O.D. Ray Kuns, Department 24, Madisonville, Cincinnati, Ohio.

MIDGET Cars, parts, plans. Catalog dime. Derby Midget Cars, Woodstock, Ill.

ENGINES, Propellers, for sleds, midget cars Circulars dime. Storms, 199 Broadway Asheville, N. C.

1938 IGNITION Supercharger. Quick starting, wet or cold. Mileage, pep, power, less carbon. \$1.25. E. G. Sales Co., 321 Broadway, New York.

R & R Mfg. Co., Anderson, Ind. Racing cars and midgets catalogue 25c. Foreign coins accepted.

REBUILD Ford motor into fast pumping air compressor. Instructions \$1.00. Tuck's Garage, 73 Shirley, Pontiac, Mich.

GUARANTEED 65% Savings in motor operation. Autosavings, 2112 Addison, Berkeley, California.

MIDGETS! Motors! Parts! Used, new; sport, racing. Over 20 midgets, 60 motors, \$4.00 up. Latest lists, 20c. Shipps Midgets, Box 543-H, Zanesville, Ohio.

FORD V-8s, 1935-38; gasoline saving device, \$1. Walert Co., 3429 No. 10th St., Milwaukee, Wis.

AUTO TRAILERS

BUILD The famous, low-cost Jim Dandy Cabin Trailer. Complete plans and instructions 50c. Plans to build the beautiful, streamlined Jim Dandy Cabin Cruiser, \$1.00. Trailer Builders Manual and catalog of trailer parts, supplies and equipment—over 100 interesting, illustrated pages, 25c. Order today. Satisfaction guaranteed. Trailer Supply Co., 411-A Jackson St., Wausau, Wisconsin.

AUTO SUPPLIES AND EQUIPMENT

AUTO Parts: Springs, spring leaves, armatures, generators and starters, bearings, axle shafts, etc., for most all makes and models. Big saving. Special prices to dealers and mechanics. Auto Tire & Parts Company, Cape Girardeau, Missouri.

AUTOMOBILE Paint striping made easy. Tools \$1.50. Write, Wendell, 2531N Ashland, Chicago.

DEMONSTRATORS. Compressor, test bench, 8-hour battery charger, arc welder. Guaranteed. Trial and terms. Hobart Welders Exchange, Box M-482, Troy, Ohio.

CHEVROLET Rocker arm shock absorbers, 1929 to 1933, \$3.00 postpaid. J. M. Cagany, 1728 Hazelwood, Fresno, Calif.

"SAVEU-GAS." Save 30% on gasoline. Fits all cars. \$1.00 instructions and drawings. 1229 Elizabeth, Madison, Wis.

PLATING Outfits for auto parts. Connect to a battery. No tanks used. Free particulars and proofs. Gunmetal Co., Ave. J, Decatur, Ill.

MOTORCYCLES, BICYCLES AND SUPPLIES

ALLOY Pistons—Harley, Indian, Henderson, Excelsior, Cleveland. New and used parts for less. Cylinder grinding. Catalogue and wings pin 10c. Ballak, 1115 Chestnut, St. Louis, Mo.

NEW Free catalog just out, used Indians, Harleys, Auto-Glide motor scooters, Servicycle light motorcycles \$29 down. Motorcycle speed books \$1.50 each. Diesel books, goggles, stop watches, helmets, Hepolite speed pistons. American, foreign auto and motorcycle racing publications. Clymer Motors, Dept. P.M., 434 West Pico, Los Angeles, Calif.

SEND 10c For Handbook of Information, listing new and used parts, for Indian, Harley, Excelsior, Henderson; accessories, batteries. Bootz, 622 East Grand, Des Moines, Iowa.

REBUILT Motorcycles, all makes, new and used Harley-Davidson parts. Send 10c for bulletin. Western Harley-Davidson Distributors, 914 E. 15, Kansas City, Mo.

INSIDE Dealer prices. Overstocked, all models, Indians and Harleys. Rebuilt, guaranteed. Dime brings latest list. Crandall-Hicks, Boston, Mass.

RECONDITIONED Motorcycles. New—used parts for all makes. Authorized Harley-Davidson dealer. Whitman Motorcycle & Supply Co., 405-9 Southwest Blvd., Kansas City, Mo.

SEND 15c For illustrated used motorcycle catalog. Bargains. Largest stock genuine Indian parts and motorcycles. Indian Motorcycle Sales, Kansas City, Mo.

MOTORCYCLE Bargains, lowest prices, bargain sheets for stamp. Motorcycle accessories. Rochester Harley Davidson Corp., 129 W. Main St., Rochester, N. Y.

AVIATION

SCHOOL Of aeronautics—Welding, drafting. Swallow Airplane Company, Wichita, Kansas.

PROPELLERS — Sled-airplane, lowest prices. Catalog 10c. Woodcraft Propellers, Hillside Station, Wichita, Kansas.

HOW To fly. Send fifty cents stamps for student's manual. Anderson Flying Service, City Airport, Detroit, Michigan.

AVIATION. "How to get into." Send stamp. Meyer, Box-8, Hempstead, N. Y.

FREE Aeroplane with motor purchase. Easy payments. Propellers 98c up. Sensational prices. Illustrated information 25c. Universal Aircraft, Fort Worth, Texas.

AERO-SLEDS For ice or snow transportation. Supplies. Details dime. Adastik Bros., Grand Rapids, Mich.

AIRPLANES \$50 Up. Motors, crackups, salvage. Complete directory 25c. Used Aircraft Directory, Athens, Ohio.

HEATH Airplane, motor, propeller literature, dime. Heath Aviation Company, Benton Harbor, Michigan.

PROPELLERS For airplanes, sleds. Also iced blueprints. Catalog dime. Lorenzen Propellers, Niles, Michigan.

AVIATION Apprentices. Good pay—Big future. Write, immediately, enclosing stamp. Mechanix Universal Aviation Service, Strathmoor Station, Dept. E2, Detroit, Michigan.

GET Into aviation. Air transport pilots get up to \$7,000 per year; mechanics \$2,500. Learn at this government approved school. Write for complete information. State age. Lincoln Flying School, 2004 Aircraft Bldg., Lincoln, Nebr.

BATTERIES, GENERATORS, ETC.

A. C. Generators, hand-driven, generates 110 volts, original price \$5.50. Special 98c. Electrical Salvage, Box 524-75, Lincoln, Nebr.

LIGHT Plants \$38. New 5 tube radio \$15. Typewriter \$18. Holton, 503 S. High, Columbus, Ohio.

FIFTY Twelve volt, 400 watt, heavy duty motor bus generators. Perfect condition. \$8.50 each f.o.b. Other units in stock. State Sales Co., 52 Cullerton St., Chicago, Ill.

FREE Electricity from wind. Build your own windcharger. Cost 98c for material plus used car generator. Drawings—instructions 10c. Wesco, Minneapolis, Minn.

EDISON Lifetime storage batteries for light and power. Eliminates acid battery diseases. Long guarantee. All kinds rebuilt generating plants, motors, and miscellaneous articles at bargain prices. Free interesting literature. T. Hawley Smith Co., Croton Falls, N. Y.

EDISON Storage batteries for light-power systems. Non-acid. Odorless. fifteen year life. Five year unconditional guarantee. Bargains in complete lighting systems. Low prices. Free illustrated literature. "See-Jay" Battery Co., 82 Sterling Ave., Yonkers, N. Y.

AIR CONDITIONING

AIR Conditioning. \$1.00 lesson. Home Tutor Inst., 1191 Summit Ave., Jersey City, N. J.

BUILD Your own air-conditioning outfit. Have "mountain air," year-around health, and comfort in your home, store, office, workshop. Seven units—Summer, winter, year-around. Materials picked up at small cost. Complete diagrammed Servatex instructions, seven blueprints, make construction simple and easy. Send no money. Return in five days or remit \$1.00. Servatex Company, 898-PM Madison Building, Milwaukee, Wisconsin.

ELECTRICAL SUPPLIES—EQUIPMENT

ELECTRIC Pen, engraves hardest steel. Dollar prepaid. Hudson Bros., East Syracuse, N. Y.

ELECTRO-SCRIBE: Electric pencil writes, engraves all metals. \$1.00 postpaid. Details free. Beyer Mfg. Co., 4515-K Cottage Grove, Chicago.

ELECTRIC Eye control unit kit. Complete with wiring instructions. \$5.98. Completely wired ready for installation. \$8.95. Operates on 110 v., ac-dc. (Not a toy, but proven equipment.) Used for light controls, alarms, signals, and other electronic applications. Terms, 1/3 with order, bal. C.O.D. We can fill your electronic needs. Electric Eye Devices Co., 51 E. 125th St., New York City.

ULTRA Violet—Infra red. Dual ray health lamp. Two separate units in one. Promotes sun tan—vitamin "D." Automatic control. AC-DC current. \$3.90 postpaid. Details free. Beyer Mfg. Co., 4515-P Cottage Grove, Chicago.

DEALERS. Sell motors, grinders, blowers, exhaust fans, air compressors, spray guns, spray outfits. Wholesale catalog. CMCO, 1111 Washington, Chicago.

MAGNET Lifts 50 times own weight. Recover lost articles. \$1.00 postpaid. Particulars stamp. Amfadco, 861, Minneapolis, Minn.

ELECTRIC FENCING

MAKE Electric fencer. It's easy with our simple plans to convert Ford T coil. No further costs. Complete plans 35c. LeJay Mfg., 847 LeJay Bldg., Minneapolis, Minn.

WELDING AND SOLDERING

REMOTE Control: Arc-welder 25-125 amperes, 40 volts, d.c., dual control 25-200. Home-made from North-East (Dodge) automobile generators, without rewinding armature. New method designed for beginners. Over 3,000 words, real facts, actual welding videos. Certified instructive plans \$1.00 C.O.D. \$1.12. Airmail 12c extra. Welders' Club of America-A, B-3432, M-Mart, Chicago.

SOLDERING Materials kit. All metals. Fluxes, confiner, solder. 50 cents coin postpaid. Larley, Box 360, Montclair, N. J.

WELDER Shortage. Big pay. Finest training and employment help. Wonderful climate. Folder. Dunn Welding School, 1308 N. E. Union, Portland, Oregon.

SOMETHING New—110 volt electric brazing torch. Instantly produces a 3 inch flame similar to an acetylene torch. Requires no gas or upkeep. Guaranteed. Complete with accessories \$12.50. Dept. B, Apollo Mfg. Co., 319 Union, Memphis, Tenn.

ARC-WELDER Home-made from original North-East (Dodge) 12 volt automobile generator. No rewinding. Plans \$1.00. Welders' Club of America-A, B-3432, M-Mart, Chicago.

DEMONSTRATORS. Electric arc welders. Money-saving prices. Used by the government. Trial and terms guaranteed. Hobart Welders, M-483, Troy, Ohio.

BOOK of 100 of the most practical conversion plans, \$1.25. Practical Methods, Box 165, St. Paul, Minn.

BUILD Your own a.c. arc welder 115 or 230 volts. Normal capacity 3 k.w. Plans and instructions \$1.00. C.O.D. No stamps. Box 48, Fairview, N. J.

ELECTRIC Welders, 110-220 volt, fan-cooled, can be used for hours, \$75.00. Box 331, Hamilton, Ohio.

GENUINE Dodge arcwelder economically built without rewinding. Plans \$1. Particulars free. Pulis, Booker, Texas.

ENGINES, MOTORS, DYNAMOS

ALTERNATING Current motors, grinders, drills, electrical appliances. Home workshop tools. Bargain pricelist free. Mailorder Electric Co., 713 South Dearborn, Chicago.

MOTOR Speed reducer, ratio 144 to 1, rating up to 1/4 h.p. with friction clutch for overload protection, \$3.95. Send for catalog: compressors, paint sprayers. National Electric Tool Co., 558 Washington, Chicago.

GUARANTEED. Rebuilt, 1/4 hp. a.c. motors, \$3.50. Send m.o. Lawrence Elec., 746 Racine St., Racine, Wis.

MAKE Money. Rewind washing machine motors, auto generators. Each book \$1.00. Write for particulars. Ernest Knight, LaSalle, Ill.

1/4 H.P. General Electric motors, \$3.50, guaranteed. Larger sizes, list 10c. A.C. Motors, 3008 Bailey, Philadelphia, Penna.

THREE To ten KVA alternating generators. Motors, converters. Queen City Electric, 519 South California, Chicago.

GUARANTEED. Slightly used 1/2 horse, 110 volt, alternating motors \$7.90. Willmot Auto Supply, 2247 St. Paul Ave., Chicago.

BARGAIN—1/2 Hp. motors, 60 cycle, 1 phase, 110 volt, like new, guaranteed, \$8.25. Send check to Erie Electric Motor Co., 120 Church, Buffalo, N. Y.

WINDING Data, 225 motors, single and three phase. Price \$1. Motor Data Co., Box 7631, Kansas City, Mo.

MACHINERY, TOOLS AND SUPPLIES

THREADING Dial indicator for South Bend workshop lathes, \$3. Circular free. Unique Manufacturing Company, 4809 No. 31 Ave., Omaha, Nebr.

MODEL T starting motor makes powerful drill. Battery operated, instructions 3 dimes. Harry Maxwell, 1114 Buenavista, Waukesha, Wisconsin.

WHOLESALE Prices: Shop supplies, tools, small motors, speedreducers, gears, rotary pumps. Catalog 10c. Kostka, 2348-C South Crawford, Chicago.

PAINT Spray portable set \$19.50. Bench lathes \$22.50. Circulars. Burk Machinery, 1314 Prospect, Toledo, Ohio.

KELEGG Air compressors, \$6.00. Electric refrigerators, \$25.00. Spring making kits, \$1.00. Taylor, 105 East 102nd Street, New York.

EXPERIMENTERS. Inventors, manufacturers—Giant gadget kit. Practical, useful parts and supplies. Washers, screws, nuts, brackets, gears, rivets, bushings, springs, etc. Over ten lbs.—1000 items. Price \$1.50. Worth \$7.50. Money back guarantee. Manufacturers Supply House, 217 W. Illinois, Chicago.

NEW Copyrighted calculator adds, subtracts fractions and decimal equivalents of an inch. Big time saver for designers, tool-makers, etc. 50c postpaid. G. Ohlhaber, 1173 Lenox, Detroit, Michigan.

BARGAINS. Demonstrators, electric arc welders, guaranteed, 30 days trial and terms. Write Hobart Welder Exchange, Box M-484, Troy, Ohio.

SEND For your free catalog of machinery, tools, supplies, etc. Homecraft Tool Supply, 236 Neptune Avenue, Brooklyn, New York.

MAKE Your own power drill press. Economical, simple, practical. Plans one dollar. Chour, 115 Burton, Waukegan, Illinois.

PLASTICS. Brass, aluminum, Dowmetal, monel, stainless steel, gears, etc. Catalog 10c. Hobby Supply House, Box 2014, Pittsburgh, Penna.

12" x 6" SEBASTIAN Geared head motor drive Gold Seal lathe. Excellent condition. Write for bargain price. Cincinnati Machinery & Supply Co., 219 E. Second St., Cincinnati, Ohio.

BOATS, OUTBOARD MOTORS, ETC.

KAYAK Construction kits—New designs in lightweight canvas kayaks and canoes. Nine to fifteen feet from \$9.95 to \$39.50. Also sold assembled. Mail time for literature. Jamestown Specialty Co., Dept. P438, Titusville, Penna.

ASSEMBLE Your own boat. Our finished knock-down frames and materials save you 2/3 builder's cost. All types and sizes. Send 25c for big catalog. Brooks Boat Co., Inc., D4, Saginaw, Mich.

12-FOOT Flat bottom rowboat—complete plans 25c. Free boatbuilding catalog. The Rudder, 15 Murray St., New York.

BUILD Electric outboard motor from automobile generator. Operates with car battery. Complete plans and valuable catalog 10c. LeJay Mfg., 547 LeJay Bldg., Minneapolis, Minn.

NEW. Used outboard parts, motors and accessories. All makes and models. Cramer's, 1500 N. Wells, Chicago.

USED Outboard motors, all makes. Send stamp for list rebuilt motors. Used parts, propellers and accessories 1/2 list price. Outboard Headquarters, No. 305 Atlantic Ave., Boston, Mass.

OUTBOARDS—Save 1/2. Good used parts, all makes and models. Bargains rebuilt motors. Crandall Hicks Co., 959 Commonwealth, Boston, Mass.

BUILD A boat by the Welch system. Save on the cost. Send 10c for 32 page catalog of boats, motors and marine equipment. Welch Boat Company, Station K-1, Milwaukee, Wisconsin.

COMPLETE Your own boat with our pre-fabricated frames and materials. They're different. Save 2/3s and costly mistakes. Send requirements for quotations. Illustrated catalog 100 boats, 10c. Bay City Boats, Inc., Bay City, Mich., 1552 Adams St.

PLANS And full-size paper patterns for cabin cruisers, sailboats, runabouts, etc. Send 10c for catalog. Melrose Boat Works, Magnolia Springs, Alabama. (On the gulf coast.)

BUILD Your boat and save; using our knock down frames. Muller Boats, 4920 Seventh Ave., Brooklyn, N. Y.

FORD Marine conversion parts and kits. Models A, B, V8 (domestic or foreign). Catalogue 25c (coin). Osco Motors Corp., 3101 C St., Philadelphia, Penna.

BOAT Designers are highly paid professionals. Complete course by mail. Catalog. Westlawn, Montville, N. J.

SPORTING GOODS, GUNS, FISHING TACKLE, ARCHERY

CATALOG. Illustrated, 2000 pieces, new and used, modern and antique firearms, send coin 25c. Carl Zeiss 8X30 lightweight prism binoculars, brand new, \$60.00. Winchester target rifle model 52, slow lock, fine condition, bargain \$32.50. Public Sport Shops, 13 So. 16th Street, Philadelphia, Penna.

BARGAINS. Guns, ammunition, outboard motors. Flaig Bros., 817 East Ohio, Pittsburgh, Penna.

FENCING Equipment. Foils, swords, masks, etc. Low price. Free catalog. Industrial Products, Dept. PM4, 48 W. 48th Street, New York.

NATIONALLY Known and advertised fishing tackle at bargain prices. Catalogue free. Tackle Store, Sac City, Iowa.

ATTENTION Boys! Money in spare time! Sell fishermen 10 sizes of clincher sinkers. Free samples, prices. Martin Szulerecki, Sauk Rapids, Minn.

DUCK Stamps. Any year. We pay 15c-30c each. Robertson Stampco. Nampa, Idaho.

MOCCASINS. Gun cases, etc. Free catalog. Manufacturers fishing, camping, hunting equipment. Nichols Corporation, Yarmouth, Maine.

TENTS. Factory to you. Catalog free. Willis Co., Everett, Mass.

BUCKTAILS \$6.00 Dozen. Flytieg material. Hofmann Co., 992 Gates Avenue, Brooklyn, N. Y.

HUDSON Bay blankets, Indian pack baskets, camp stoves, knives, compasses, outdoor equipment. Free catalog. Howe Fur Co., Box P, Coopers Mills, Maine.

FIELD GLASSES, TELESCOPES AND MICROSCOPES

TELESCOPES. Binoculars, microscopes. Lowest prices. Free catalog. The Hobby Man, Jefferson, Iowa.

TELESCOPES. Microscopes, binoculars; 1938 bargain catalog free. Brownscope Company, 5 West 27th Street, New York.

SOLAR Spectroscope \$1. Laboratory spectrometer \$5. Kutting Sons, Campbell, Calif.

EXPERIMENTERS—Assortment 18 unmounted lenses. Suitable telescopes, microscopes, etc. \$1.00 postpaid. Optical Works, Milton, Penna.

TELESCOPES. Microscopes, binoculars, mineralogy, chemistry. Catalog free. Teeko, Evanston, Illinois.

BUILD Reflecting telescopes; catalog free. Instruction 10c. Optical Laboratories, Larchmont, N. Y.

ANTIQUES, RELICS, INDIAN GOODS

SASKATCHEWAN Arrows, rainbow beauties from glacier. Don McKillop, 2136 Smith, Regina, Sask.

100 GOOD Arrowheads \$3. Catalog. 5c. H. Daniel, Hot Springs, Ark.

100 GOOD Arrowheads, \$3.00. Satisfaction guaranteed. George Holder, Glenwood, Ark.

INDIAN Relics, beadwork, coins, curios, minerals. Catalog 6c. Indian Museum, Northbranch, Kansas.

TAXIDERMISTRY

TIGERS, Bears, African antelope. Supplies—eyes, instructions. Hofmann Co., 992 Gates Avenue, Brooklyn, N. Y.

TAXIDERMISTRY Supplies—Quality artificial eyes, teeth, genuine Jonas head forms. Tools, materials, etc. Everything for the progressive taxidermist. Send 10c for big illustrated catalogue. Jonas Bros., 1049 Broadway, Denver, Colo.

DOGS, PETS, BIRDS

WOOLLY, Baby Saint Bernards! Dime brings delightful prospectus! Royal Kennels, No. 8, Chazy, N. Y.

SEND Dime. "Flash-Guts" (dog merchandisers). Jaques Flocker, Sharpsburg, Penna.

BEAUTIFUL Pure white police dogs. Ansonia Kennels, Mose, N. Dak.

POULTRY AND FARM SUPPLIES

MAKE Money raising poultry. Always a demand for eggs. Read America's leading poultry magazine, learn how others succeed. \$1.00 for 3 years; 25c for 9 months' trial. Poultry Tribune, Dept. E-93, Mount Morris, Ill.

MAKE More profits with Salem's AA chicks. Write for prices and free catalogue. We pay postage and ship C.O.D. Salem Hatchery, Rt. 19, Salem, Indiana.

BLUE Prints for building low cost chick brooder. Not a toy. Ideal for back lot poultrymen. Send \$1.00. Lampkin Poultry Farm, Starkville, Miss.

DAVIS Chicks for broilers and layers. 21 different breeds. Sexed chicks. Poults \$3.50—100 and up. Free catalog. Davis Poultry Farm, Route 34, Ramsey, Indiana.

BUY Seymour chicks and see more profits this year. AA grade Barred, Buff, White Rocks, Reds, Wyandottes \$8.45. Leghorns \$7.45. A grade \$1.00—100 less. Free catalog. Seymour Hatchery, Box 36, Seymour, Indiana.

SEX-LINKED Chicks, famous Austrawhites, 5 other Hybrids and 52 purebreeds. Beautiful catalog free. Mrs. Berry's Farm, Rt. A, Clarinda, Iowa.

TREES, SHRUBS, ROOTS, HERBS

JUST Out! World's greatest "Herbalist Almanac." Beautifully illustrated in natural colors. Contains over 200 old-fashioned herb medicine recipes for home use. 10c postpaid. Worth dollars! Botanics, 145 W. 112th St., Chicago.

GINSENG Planting instructions free, seeds reasonable. Specialty Farm, Rockford, Minn.

FARMS AND FARM LANDS

FARMS That pay in the Great Northern Railway agricultural empire, Minnesota, North Dakota, Montana, Idaho, Washington, Oregon. Fertile black soil, high producing crops, grain, fruit, vegetables, feed and livestock. Many kinds of farms for selection. Write for lists and Zone of Plenty book. E. C. Leedy, Dept. 457, Great Northern Railway, St. Paul, Minnesota.

OREGON Farms, walnut filbert groves. Free list. Calkins, Newberg, Oregon.

GOVERNMENT Lands ten cents acre up. Information all states twenty-five cents. National Tax Service, 600A Majestic Bldg., Detroit, Mich.

STROUTS New spring catalog, over 1500 properties; operating farms, state road places, businesses, summer homes, sportsmen tracts; this great bargain list free. Strout Ag'y, 255-P 4th Ave., New York City.

BARGAINS In land! Where crops are dependable. Washington, Minnesota, Montana, Idaho, Oregon and North Dakota. Literature. Impartial advice. Specify state. J. W. Haw, 119 Northern Pacific Ry., St. Paul, Minn.

WANT To hear from owner of property for sale or trade. Details free. Real Estate Salesman, Desk B, Lincoln, Nebr.

40 ACRES, Near White River, unimproved; poultry land. \$175, \$5 down, \$5 monthly. Free list and literature. Hubbard, 216 Grossman Bldg., Kansas City, Kans.

PROFITABLE OCCUPATIONS

M. M. earned \$267, three weeks, raising mushrooms in cellar! Exceptional, but your cellar, shed perhaps suitable. We buy crops. Book free. United, 3848 Lincoln Ave., Dept. 62, Chicago.

"RAISE Frogs!" We buy! Good prices year round. Start small pond. Free book shows sketch. American Frog Canning, (153D) New Orleans, Louisiana.

WE Start you in business, furnishing outfits and instructions, operating Specialty Candy Factory home. Men and women, earn \$25 up to \$60 weekly, all or spare time. (Our 29th year.) Booklet free. W. Hillyer Ragsdale, Inc., Drawer 62, East Orange, N. J.

A SELF-HELP Cooperative in your community will relieve unemployment. Practical, workable, easily established. Write for details. Organized Self-Help, 532 16th Street, Oakland, California.

"FOUR Years With Frogs." Experience arranged in questions and answers describing ponds, vegetation, sex and marketing. Twenty-five cents coin. Lafayette Frog Farm, Lafayette, Louisiana.

HOW To market earthworms. Send card. California Earthworm Farms, Highland Park, Los Angeles.

RAISE Rabbits and cavies for us. We buy at top prices. Complete details in catalog, contract and magazine. 10 cents. Stahl, Box 1, Holmes Park, Mo.

COUNTRY Drives or movies afternoons! Work mornings home. No canvassing! Folio-H, Station D, Los Angeles.

FREE Booklet describes 107 plans for making \$20-\$100 weekly, in home or office, business of your own. Elite Co., 214 Grand St., New York.

RAISING Jumbo frogs. Interesting. Big future. Females lay 10,000 eggs. Free literature. American Frog Industries, Box 336, Rayne, La.

NEW Industry. Growing tomatoes, plants and flowers without soil. Big profit selling produce or supplies. Send \$1 for trial package and booklet. Chemiculture Laboratories, 1629 So. Vanness, Los Angeles, Calif.

OLD BOOKS WANTED

WE Pay up to \$5000 each for old books, also high cash prices for old magazines, letters, newspapers. A single story book, school book, old Bible, travel book, almanac, etc., that looks worthless may bring you \$50, \$100 or \$500 in cash. Thousands wanted. Send 10c now for latest price list. American Book Mart, 140 S. Dearborn, Dept. 2313, Chicago.

BOOKS, PERIODICALS, PICTURES, POSTCARDS

JAPANESE Postcards, Japo-Chinese war, native scenes, etc. 50 different for \$1 bill. Miss Hoshino, 2351 Kotakecho, Itabashiku, Tokyo, Japan.

EXCLUSIVE Photographs; samples, complete list 10c. Albert McGoldrick, Mansfield, Mass.

YOUR Favorite magazines—Half price. Catalog, 10c. Magazine Exchange, Base-line, San Bernardino, Calif.

JOIN The Sleuths Club! Your choice of the month's best detective novel for \$1.00. Write now for further details. Fred Buse, 720 St. Mary's St., New York.

OLD Books wanted—An old book in your home may bring you \$10, \$50, \$100 and as much as \$6000.00. Check up on what you have. Send 10c for our 72 page catalogue. New England Book Company, Dept. 38A, Nantasket, Massachusetts.

NEWEST Radio, electrical experiment books, 20c up. Amazing values. Catalog free. Electronic Publishing Co., Box 323-AB, Lincoln, Nebr.

RARE Antique books. Some two hundred years old. List, ten cents. Friday, Streator, Ill.

GAMES—ENTERTAINMENT

SPELLING Bee, newest card game hit. Educational fun for everybody. 60c per deck, 2 for \$1.00. Circular free. Sign Publishing Co., 1925 Franklin, St. Louis, Mo.

DOMINO Players. New game called Jackpot Domino. Most interesting. Send 10c in stamps for rules and regulations to Ralph Forge, 270 Riverside Dr., New York City, N. Y.

NEW Invented game. Math-O-Lette, 72 different choices, players unlimited, sensational, entertaining, educational. Demonstration sold hundreds. Well constructed. Instructions simple. Fun galore. Manufacturers price \$1 prepaid, foreign \$1.25. Matholette Co., Box 818, New Haven, Conn.

PLAYS, Operettas, musical comedies, complete minstrel first-parts with song programs, blackface skits, vaudeville acts, monologs, dialogs, recitations, juvenile plays and songs, musical readings, entertainments, make-up goods. Catalog free. T. S. Denison & Co., 203 N. Wabash, Dept. 11, Chicago.

MAGIC TRICKS, PUZZLES, JOKER NOVELTIES

FREE Ventriloquist figure, 20 cents for card, catalog of tricks, novelties, 7 cents. League Brothers, 107 East Pleasant, Baltimore, Maryland.

VENTRILLOQUISM, Spiritualism, magic 35c. Eckam, 1407 East Main, Rochester, New York.

NEW "Ride-Em Puzzle" will coin money. Dime brings sample and dealer's offer. Coleman's, Smithboro, N. Y.

KNIFE Throwing secrets exposed! Beginners and experts get this book now! 40 tricks and throws used by professionals, \$1.00 postpaid. Frank Dean, 1294 E. San Fernando, San Jose, Calif.

LEARN Ventriloquist art. Easy. Low cost. Details stamp. Apex, 221 E. 31, New York.

MYSTIFY Friends. New, clever brown jug trick. Complete 15c. Paramount Title, 19 West 44 St., New York.

JUST Off the press! Our large catalog of magic for everyone. From the beginner to the professional magician. Send 25c for your copy. Chicago Magic Co., 2300 N. Mason Ave., Chicago.

BE A magician. Large professional magic catalogue of latest tricks 25c. Cash paid for complete Tarbell magic courses. Write, Ireland, C-109 North Dearborn, Chicago.

VENTRILLOQUISM, Complete instructions and dialog \$1.00. 24 page illustrated catalog 25c. Frank Marshall, 837 No. State St., Chicago, Ill.

LEARN Fire eating, ventriloquism, sword swallowing. Manly, 1315 Ferris, Los Angeles.

FREE Tricks! Join Magicians' Fraternity! Monthly magazine, sample 10c. International Magicians, Mount Morris, Ill.

EARN Money in any crowd. Call names of strangers, tell unspoken questions. Professional course mind reading, spirit writing, etc., \$1. Henderson, Box 341, San Bernardino, Calif.

LEARN Ventriloquism, 3c stamp brings particulars. Smith, 125 N. Jefferson, Peoria, Ill.

LARGE Professional magic catalogue, 25c. Holden, 220 W. 42nd St., New York.

MAGIC Catalogue, latest tricks, 10c. Frank Lane, Little Bldg., Boston, Mass.

PASTIME For the whole family. Boys and girls puzzle. 1000 problems. 25 cents, no stamps accepted. Watchmans Puzzle, 105 Brookview Ave., Troy, N. Y.

SVENALI Magic decks. Bridge size, new style. Demonstrators sell them for one dollar. Dozen \$3.25. Sample postpaid thirty-five cents. Catalog 300 jokes and magics free. Adams Company, Asbury Park, N. J.

RARE COINS

ANCIENT Greek coin; genuine, 2000 years old, 15c postpaid. Paper money catalog and old bill, 10c postpaid. Webb, 406 Sutter, San Francisco, Calif.

OLD Money wanted. Will pay fifty dollars for nickel of 1913 with Liberty head (no buffalo). We pay cash premiums for all rare coins. Send 4c for large coin folder. May mean much profit to you. Numismatic Co., Dept. 20, Fort Worth, Texas.

COMMEMORATIVE Half dollars, Lincoln, Stone Mountain, Oregon, Texas, Cleveland, Kentucky, San Diego, Long Island, \$1.50 each. Illustrated catalogue No. 14, 25c. Norman Shultz, Salt Lake, Utah.

SOME Specimens 1909 cent worth \$10. We buy certain coins, common and rare. Others worth to \$6000; certain 1864-1865 Indian head cents \$100 each; dimes before 1895, \$450; Liberty head nickels before 1914, \$300; large pennies \$2000; encased postage stamps, \$13; half cents, \$275; half dimes, \$175; quarters, \$300; fractional currencies; paper money; gold dollars, \$1,500; colonial coins, \$300; silver dollars, \$4,000; 1933, 50c, \$4.00; foreign coins \$165, etc. Only certain coins worth top prices, but others have premium value too. Send 15c today for illustrated 1938 coin book, before sending coins. National Coin Corp., (80), Daytona Beach, Florida.

INDIAN Head cent, and list 10c. Charles Banker, Salina, Kansas.

50 OLD Coins, all different \$1.00. 20 different dates large cents \$2.00. Robinson half-dollar unc. \$1.50. Claud Denney, Box 1825, Dallas, Texas.

CALIFORNIA Gold quarter and list. 25c. 20 different fine coins, 25c; 60, \$1.00. Bishoff, 500 E. 8th, Kansas City, Mo.

33 COINS. Bills, tokens, 25c. Otto Oddehen, 106E8, Kansas City, Mo.

COMMEMORATIVE 1/2s. Five different, \$5.00. Beginner's United States type packet, fifteen coins from half-cent to half-dollar, \$3.75. 100 assorted foreign coins, copper, nickel, silver, \$3.00. Spanish pieces-of-eight \$1.50 postpaid. S. Koepfel, Merritt Bldg., Los Angeles, Calif.

50,000 COINS, Medals, papermoney, newspapers, stamp collections, arrowheads. Catalogue free. Coinshop, 8P South 18th, Philadelphia, Penna.

12 LARGE Cents \$1.00. Radtke, 56 Dale, Rochester, New York.

FIVE Different large cents 50c. Five different two cents 50c. Five different three cents 50c. Twenty different Indianhead cents 50c. Twenty-five different foreign 50c. Lists free. Illustrated buying list 15c. Hussman, 211 South 7th, St. Louis, Mo.

\$5.00 TO \$2500.00 Paid for rare coins. Send 15c for 1938 newest 36 page illustrated coin buying book. Charles Fisher, (1) Chagrin Falls, Ohio.

FREE! Foreign coin, banknote, and large illustrated coin catalogue. Send 4c postage. Coin approvals sent. Tatham Coinco, Springfield-125, Mass.

GET Profit and pleasure in collecting old coins. Send 10c for 56-page illustrated coin catalog. You'll be delighted with it. Send for it now. B. Max Mehl, 370 Mehl Bldg., Fort Worth, Texas. Largest rare coin establishment in U. S. Established 38 years.

\$5 TO \$500 Each paid for hundreds of old or odd coins. Keep all until posted. Many very valuable. Send 10 cents for illustrated Coin Value Book, 4x6. Guaranteed buying and selling prices. 31 years in business. Coin Exchange, Box 5, Le Roy, N. Y.

UNITED States coins at bargain prices. 2c piece and newest 1937 selling price list 10c. Em. Cohen, Box 3507, Cleveland, Ohio.

RARE U. S., foreign coins, war medals. Catalogue 10c. Mengelle, Colorado Springs, Colo.

UNITED States. Large cent, 2c bronze, 3c nickel and bargain list, 25c. Eleven dates large cents, \$1. George P. Coffin Co., Augusta, Maine.

STAMP COLLECTING

DIAMOND Shaped air mail—Big packet 105 all different, including air mail, commemoratives, Congo, Epirus, Manchukuo, etc.; set of two ex-King Edwards and Costa Rica diamond shaped air mail; scarce U. S. telegraph, cat. 30c; pkt. British Colonies—Gwalior, Hyderabad, Silver Jubilees; big lists. Everything for 5c to approval applicants. Send today! Mystic Stamp Co., Dept. 80, Camden, New York.

1938 STAMP Annual free: Describes and illustrates albums, supplies, United States, coronations, British Colonials, Canadians, and foreign stamps. This fifty page catalog free. Gray Stamp Company, Dept. P.M., Toronto, Canada.

FREE—New Costa Rica philatelic exhibition triangles to approval applicants. Charles Cleveland, 808 North Humphrey, Oak Park, Illinois.

35 DIFFERENT Unused stamps including Epirus, White Russia, Czecho charities, Bosnia, etc., 6c. Approvals, Matthews, Washougal, Wash.

101 DIFFERENT 101 Countries 25c. Reitter-Imhoff, 111 West Jackson, Chicago.

ALLOW 60 Cents worth general foreign approvals for 100 current commemoratives sent. Hays, Southgate, Calif.

STAMP Album, your name printed large in gold on black cover, 35c. Printery, Mariemont, Ohio.

FREE Palestine! Approval applicants, 3c postage. Oriental Stamps, Box 1, Kensington Station, Brooklyn, N. Y.

ONE, Two cents approvals, References. Auer, 16 Duerstein, Buffalo, N. Y.

FREE! 101 Foreign stamps, 3c postage. Approvals. Quality Stamp Shop, Englewood, Colorado.

SENSATIONAL Value! 256 different U. S., foreign, coronations, jubilees, miniature sheet, new issues and old. Catalogue value \$8.00 for \$1.00. Universal, 56 Sullivan, Rochester, N. Y.

OPPORTUNITY! Packet containing over 100 different. Catalogue value \$1.98, guaranteed. Includes scarce Epirus set, Natal, etc. All 10c to approval applicants. Melvin Jackel, 3999 Dickinson Ave., New York.

DOLLAR Album free. Better approvals by countries. Creevey, Berwick, Penna.

\$2.00 CATALOGUE Value 10c. Approvals. Hilco, 840 Cory, Fostoria, Ohio.

SEALED Sacks containing 1000 British Colonials, from empire missions, \$1. Price, 9, Blythe Street, Liverpool, England.

FREE, Queen Astrid set! Twenty beautiful commemoratives, dime; forty quarter; hundred, one dollar. Botton, 511 Boite, Bruxelles, Belgium.

A BIG Bargain—All for only 55c. Stamp album, providing spaces for 2200 stamps with 700 illustrations, packet of 500 different stamps, 500 hinges, and millimetre measure. Free with each order our pamphlet which tells "How To Make A Stamp Collection Properly" and our price list of albums, supplies and hundreds of bargains in sets and packets. Queen City Stamp Co., Room 36, 604 Race St., Cincinnati, Ohio.

SAMPLE Dozen printed to order stationery 25c. Sicocan, 2038 Ohear, St. Louis.

DANZIG, Germany, Peru approvals. Zimmer, 722 Culver Road, Rochester, N. Y.

FIRST Day covers from all European countries! Interesting booklet free! Frischer, Althanplatz No. 9, Vienna IX, Austria.

25 DIFFERENT United States and 50 different foreign from 50 different countries. All for 10c to approval applicants. K&K Stamp Shop, Halcyon Arcade, Miami, Florida.

TRY My approvals 1/2c each. Olivo Alvos, Box 132, Guadalupe, Calif.

NEW Irish souvenir stamps. A set of beautiful and interesting souvenir stamps has been issued by Irish Hospitals' Trust Ltd. A specimen sheet of 24 of these stamps may be obtained free of charge on applying to Dept. P.M. Mr. J. O'Sheehan, 28 Earlsfort Terrace, Dublin, Ireland.

EXCHANGE Stamps, postcards by "Exchangers." BRY, pres, 126 Paris, France. Information free.

BOY Scout world jamboree (Holland) three complete, 10c. Approvals. Lester Brand, 635 Straight, Cincinnati, Ohio.

WHOLESALE: 100 Different Canada 65c; 100 different U. S. and book, "How to Deal in Stamps," both 53c. Haynes, 115th, Toledo, Ohio.

I SEND Stamp approvals. Leon, Linea, 707 Vedado, Havana, Cuba.

500 WORLD'S Most beautiful stamps 25c. Williams, Box 774, Anson, Texas.

20 DIFFERENT Irac only 10c to approval applicants. Sundman, D60, Bristol, Conn.

LEARN How—Send for highly instructive book on stamp collecting. Contains philatelic dictionary. Only 25c. Lester Howard, 10322 Elk Ave., Cleveland, Ohio.

PENNY Stamps. Lists free. Moulblow, Box 11, Rosebank, New York.

UNITED States mixture 1000—35c. Mint commemoratives, Schiffermuller, Bellerose, New York.

1,000 DIFFERENT French Colonies \$7.00. 1,000 different British Colonies \$12.00. Lecomte, Rue Frere Orban, Jumet, (Belgique).

PERFECT Penny approvals. Pleasing premium. Dee Jay, Glenwood, Menands, N. Y.

BEST One cent approvals in America. Elvin Stanton, Niantic, Conn.

TWENTY Airmails. Dime approvals. Ntro Stampco, 4909 North Seeley, Chicago.

COMPLETE Country mint 6c. Approvals. Wehrle, 875 Main, Passaic, N. J.

WORLD'S Smallest airmail, free stamp magazine, \$2.00 U. S., animals, bird, train, Indian, airplane, commemoratives, scarce stamps 25 countries, 5c with approvals. Capital Stamps, Dept. PM6, Little Rock, Arkansas.

"GOYA Nude" stamp 5c to approval applicants. "Jewells," Tamaqua, Penna.

IVORY Coast girls; four beauties. Ten coronation souvenir stamps. 25 others, 3c. Approvals. Cowan, 16152 Snowden, Detroit, Michigan.

APPROVALS, Foreign, Educational, colorful, intriguing, with set and package, nickel. Lumbee Stamp Co., Lumberton, N. C.

500 MIXED Foreign 10c. Approvals included. Hecht Co., Belle Plaine, Iowa.

UNITED States 51 different with price lists 10c. Hamilton Stamp Company, 1141 East 13 Street, Brooklyn, N. Y.

GERMAN Zeppelin Von Hindenburg (35c value), coronations from Jamaica, Bahamas, Turks, England, Ceylon for 5c with approvals. Extra! Scarce Ceylon Queen Victoria 1872 stamp. Plymouth, Dept. A32, Bell, California.

100 UNITED States different postage issues, wonderful value, only 40c. Approvals. Newcastle Stamp Company, Newcastle, N. H.

100 DIFFERENT 5c Includes Peru, Canada, catalogues over \$3.00 with approvals. Majestic Stamp Company, Box 72, Sylvania Station, Fort Worth, Texas.

FREE! Two coronation sets. Postage 3c. Roberts, 312F Shearerbig, Bay City, Mich.

BIGGEST 25c, 500 Fine mixed United States and scarce cacheted cover. Approvals. Wright, 201 Mealey, Hagerstown, Md.

MIDGET Mixture—100 foreign stamps—Asia, Malta, Europe, etc., 5c. Elsea, Bowling Green, Ohio.

GIANT-SIZED Russian zeppelin stamp, cat. val. 20c, and beautiful Lithuania air mail triangle; also big packet of 53 different stamps including Azerbaijan, Epirus, new Martinique, etc., and illustrated lists, all for 5c to approval applicants! World-Wide Stamp Co., Box 600, Camden, New York.

STAMP Dealers—Special latest wholesale catalogue, featuring Canadians, Newfoundland, British Colonials. Free to dealers. Empire Stamp Company, Dept. 5, Toronto, Canada.

APPROVAL Offer supreme. Collection of 120 different stamps, including jubilees, coronations, airmails, animals, map, Australian savage, Netherland triangle, Costa Rica diamond, etc. Only 15c to serious applicants for my really fine approvals. Bill Boyd, 3422 Tuxedo Ave., Dept. M, Cleveland, Ohio.

FREE Packet U. S. (including \$5.00) revenues. With approvals 3c. McKay, 7200 Yale, Chicago.

PICTORIALS, British, French Colonials, animals, birds. Forty different 5c. with approvals. "Crescent Stamps," London, Canada.

FREE! Two U.S.A. \$5.00 stamps, 3c postage. Vanvoorhis, Hyndman, Penna.

FREE, Beautiful loose-leaf album to approval customers. Freeman, Tobey Road, Belmont, Mass.

AIR Mails free! Fine packet 60 different stamps, (no trash) for 5c to approval applicants. Set of three airmails free with each order. W. H. Watson, Dept. M, Havre, Mont.

COIN Collectors send stamp for sales list. Acorn Stamp & Coin Co., So. Norwalk, Conn.

UNITED States nineteenth century, 25 different, 25c. Approvals, Sibley, Glendale, Missouri.

175 U. S. Commemoratives, etc., 10c; 500—25c. Box 457, Newark, N. J.

UNPICKED! 100 U. S. revenues on documents, 10c! 1,000, 60c. Vanvoorhis, Hyndman, Pennsylvania.

U. S.—57 Different (commemorative, airmail, etc.) with approvals 9c. Bargain lists free. Moseley, 4932 Forestpark, St. Louis, Mo.

TRIANGLES! Five different 5c, including approvals. Rosenberg, 3544 12th Place, Chicago.

FREE 100 Different stamps to approval applicants, 3c postage. Evanston Stamp Shop, Box 200, Evanston, Ill.

6 TINY Parcel post stamps, 25 others 3c with approvals. Lejac, Chowchilla, Calif.

FREE. Peru postman. Bargain list 10,000 different mounted \$49.95; 5,000, \$12.95; 1,000, 90c; 200 airmails, \$3.95. Dutton Efker, Anaheim, Calif.

UNITED STATES—45 different, perforation gauge, hinges, bargain pricelist—all for 10c. Seidenberg, Baroda, Mich.

FREE—Eight beautiful airmails including triangle, to approval applicants enclosing postage. Green and Company, Norwood, Ohio.

SACRIFICING 15,000 Sets! Airmails, commemoratives, pictorials! No common Europe, 3c each, 35 different sets, \$1.00. Rierdan's, 1738 Longfellow, Detroit, Mich.

UNITED STATES and foreign approvals. Welker, 1320 Liverpool, Pittsburgh, Penna.

U. S. Mixture, unpicked, pound 75c; 3 lbs. \$2.00. Brooks, 2502 Kenmore Place, Brooklyn, N. Y.

150 U. S. 5c. Approvals. Killam, 106 Onondaga Rd., Syracuse, N. Y.

1897 GRANDE Comore Islands, rare old genuine Baden, Turks Caicos, \$5 U. S., British Colony map stamp, Western Samoa, etc. Everything 3c with approvals. Viking 1-Z Hanson Place, Brooklyn, N. Y.

IS Your album still in the "horse and buggy" days? Modernize your album by interleaving with Transwrap, a clear transparent material made of acetate cellulose. Is moistureproof, will not injure stamps over a long period of time, adds lustre and beauty. Also used for wrapping blocks, mint sheets and covers. A 100 foot roll 20 inches wide, regular \$2.50 value, send \$2.00 to-day, postpaid. Poole Transparent Products Co., Rockefeller Building, Cleveland, Ohio.

200 **BRITISH**, including 50 different with Edward, coronation, silver jubilees, 15c with approvals. Mantle Stamp Company, London, Canada.

CORONATIONS, 3 Different 5c, approvals included. Stampex, 326 North Harrisburg, Atlantic City, N. J.

SPANISH, Civil War stamps! 50 different, \$1.00. Beal, 451 Perry, Oakland, California.

PRODIGIOUS Gift! Fantastic Indochina, German state, savage Somalcoast, Perak, Selangor, Negri Sembilan, bicolored banana airmail, Siberia. Absolutely free with approvals! Postage 3c. Saxon Company, Dept. 65, Albee Bldg., Brooklyn, N. Y.

BRITISH Colonials, 40 different with approvals, five cents. Nacado Stamp Co., Box 4229, Washington, D. C.

CORONATIONS, Jubilees: 12 different with bargain list only 10c; 20, 25c. Lamb, Box 334, Flint, Michigan.

UNUSUAL Values. Approvals arranged alphabetically. Mitchell, Box 23, Jersey City, New Jersey.

ONLY 10c For 40 selected United States airmails, commemoratives, old issues, dollar values, etc., to approval applicants. Kessels, Tucson, Arizona.

NIAGARA Tarnish proof loose-leaf sections for U. S. regular and commemorative singles and blocks. Your inquiry solicited. Frank W. Jeffs, 234 Park Avenue, Dept. AZ, Lockport, N. Y.

MOUNT Your collection on Artex album sheets. You'll be delighted. Sample free. Artex, 1714 John, Baltimore, Md.

100 **DIFFERENT 5c** With approvals. Winder, 3518 Jones St., Omaha, Nebr.

U. S. POSSESSIONS. Hawaii and the Philippines, the two largest possessions of the United States, have issued very few stamps, most of which are expensive. All Hawaii stamps are old 19th century, none having been issued during the last 40 years. The outstanding Philippine issue is the Eucharistic Congress commemorative of 1937. We shall send the 12c blue Eucharistic Congress No. 427, showing map, symbolical of spreading the light of Christianity, also Hawaii No. 75, showing view of Honolulu, and 8 other good U. S. possessions all for only 10c to approval applicants. Approval Headquarters, Globus Stamp Company, 268 - 4th Ave., New York City, Dept. 201.

U. S. 50 Different with approvals 10c. Astor Stamp, 42 Astor Place, Jersey City, N. J.

ATTRACTIVE Canada or Swedish packet free with approvals. Petersen, Box 300, St. Paul, Minn.

DIAMOND-SHAPED Stamp, Liberia gunboat triangle, two other triangles, silver jubilee, 27 others, 5c. Crowder Co., 127E North, Baltimore, Md.

ATTENTION—World's largest diamond shaped airmail, new rare King Edwards, Canadian Niagara Falls, Cartier, others. All 10c provided you desire approvals. Fair-Play Stamp Service, 1215 Browning Blvd., Los Angeles, Calif.

FREE! 25 Different Norway. Send return postage. Clyon, Clifton, New Jersey.

U. S. Approvals that please. Valuable premiums included. Dealing, Mound, Minnesota.

FREE. 25 Different South Americans to approval applicants. Harlan, 5307 S. Marshfield, Chicago.

54 **DIFFERENT** British Colonies including jubilees and coronations, ten cents with approvals. Swedell, 3129 Garfield, Minneapolis, Minn.

200 **VARIETIES** United States \$1.03; 100—28c. Wright, Dover, Mass.

LIBERIA Snake triangle, giant Spanish triangle, 50 other stamps, 5c. Wright Co., 2527 Guilford, Baltimore, Md.

WHOLESALE Job lots. Many bargains! List free to dealers. Midwood Stamp Company, Box 6S, Midwood Station, Brooklyn, New York.

CORONATION Packet of Malta, Bahamas, Cayman Is., Turks Is. and England. These stamps are the best and most popular this year and will prove to be immensely valuable. Only 5c to serious approval applicants. Potomac Stamp Co., Dept. 103-A, Washington, D. C.

PACKET Of coronations—Jubilees, Edwards, with 20 different British Colonies—all 5c to approval applicants. R. F. Stern, 23-45P Crescent St., Long Island City, N. Y.

15 **AIRMAILS 7c**. U. S., airmail approvals. George Davis, Webster, Mass.

"**MIRACLE** Stamp Remover," stamps removed with Miracle are in perfect condition. No soaking or fading. Guaranteed results. Send 10c coin plus 3c postage. Miracle, 4258 Adams, Chicago, Ill.

HELLO Boys. 150 all different U. S. postage, only one dollar. Jungkind, Box 806P, Little Rock, Ark.

\$2.50 VALUE For 10c! Stamps from every independent country of South and Central America. Includes commemoratives, map, animal, diamond-shaped stamps. Also early Honduras; Costa Rica triangles; large Nicaragua airmail; old Salvador stamp printed in gold! Everything for 10c to approval applicants! R. V. McAllester, Dept. 1, 153 Linden Street, Everett, Mass.

RARE Old Newfoundland 1/2c dog stamp, 10c with quality approvals. (References required.) Roger Newberry, 946 Fort, Victoria, Canada.

1000 **DANDY** Mixed stamps 25c. Monjar, 1542 Waverly, Cincinnati, Ohio.

4 1/2 **TRIANGLES!** Guatemala bisect (diagonal half-stamp), beautiful Liberia, three additional triangles, 27 other stamps, 5c. Abell Co., 1818 St. Paul, Baltimore, Md.

100 **DIFFERENT** Hungary 7c, approvals. Hazett Stamp Shop, 701P Fourth, Baycity, Mich.

FREE 25 Different Japan. 3c postage. Stamp Center, Milwaukee, Wis.

200 **FOREIGN** Mixed, approval applicants, 5c. Dewey, 1265 Broadway, New York City.

LIBERIA And India triangles; large Costa Rica diamond; Egypt, Lebanon, Mozambique and Ecuador airmails; rare Borneo, Congo and many others. 6c with approvals. Eureka, Box 602, Burbank, Calif.

CANNON! Set of stamps showing cannon, firing squad, cavalry charge and 200 other different stamps, only 10c to approval applicants. L. H. Reich Stamp Co., 4225 Broadway, Chicago.

1000 **HINGES** With nice approvals, 10c. Harvey Teeple, Decatur, Ind.

PENNY Approvals that please. Haywood, 395 Adams St., Pomona, Calif.

51 **DIFFERENT** United States cataloging \$1.60, including commemoratives, air and \$5 or 51 different Canada, only 18c. Jones, Box 146, Norristown, Penna.

FREE! Triangle airmail! Coronation! Pictorials! British Colonies! Wonderful packet 110 different, 5c to approval applicants. Bargain Co., Box 39P, Times Square Station, New York.

ILLUSTRATED U. S. list, price 50c, large complete U. S. price list free. Send postage. Stanley Gibbons, 38P Park Row, N. Y.

SUPER-WONDER Packet offered, containing 60 different stamps from Afghanistan, Transjordan, North Borneo, Manchukuo, Sudan, Guadeloupe, Iraq, Sarawak, French and British Colonies, including natives, beasts, ships, etc., all for only 5c to approval applicants. Big illustrated lists free. Kent Stamp Company, Box 87 (9), Brooklyn, N. Y.

PANAMA Triangle and 50 others free to approval applicants sending 3c postage. Tatham Stampco, Springfield-30, Mass.

FREE! "United States and British North America"—our valuable, complete, illustrated, 64-page catalog quoting lowest prices. Big illustrated list of foreign stamps also included. H. E. Harris & Co., 137 Transit Building, Boston, Mass.

60 U. S. Different 15c. 50 U. S. different commemoratives 25c. Steger, Box 154, Crown Point, Ind.

300 **DIFFERENT** Stamps 20c; 600, 50c; 1000, \$1; 2000, \$3; 3000, \$7. Fred Onken, 630 79th St., Brooklyn, N. Y.

QUEEREST Stamps packet. Receive one of world's smallest stamps; scarce Vatican City; Greek Red Cross (coiled snake in Garden of Eden!); Manchukuo; Soruth (mountain lion); Mozambique (giraffe); Palestine; many others. Also big packet 25 dif. Japan, (including earthquake stamp) and pkt. 15 dif. China. Everything for only 5c to approval applicants! R. M. Stamp Co., Box 230P, Port Chester, N. Y.

EARN Cash, stamps. Sell my approval books—nickel packets. Ellison, 2841 West 37th Street, Brooklyn, New York.

ILLUSTRATED Album. Spaces 4000 stamps; to approval applicants 20c. Swan Stamps, 604 Swan, Dunkirk, N. Y.

50 **DIFFERENT**, Fine U. S. including perforation gauge, 10c with approvals. The Stamp Shop, 809 Holland Bldg., St. Louis, Mo.

25 **DIFFERENT** South American 10c. No approvals. Burkhart Stamps, Sandwich, Ill.

200 **DIFFERENT** 10c. Big 50% approvals. Covert Stamp, 39 State, Rochester, N. Y.

NEWFOUNDLAND, 15 Different 5c with approvals. Frederick Brown, Plainfield, N. J.

FREE! 110 Different stamps to approval applicants. 3c postage. Zephyr, 5124 George, Chicago.

FREE—\$2 And 15 other U. S. Foreign approvals. Postage 3c. Wm. Clatworthy, Upland, Calif.

STAMPS. A superb selection sent on approval. Quality at low prices. Fred Herzberg, Box 91-P, Elmhurst, Ill.

U. S. Approvals only. Send post card for selection of U. S. stamps on approval: 19th century, commemoratives, air mails, revenues. John C. Daub, Dept. E, Wabash Bldg., Pittsburgh, Penna.

FREE—The Stamp Finder! Our new 24 page edition, fully illustrated, which will enable you to instantly identify all difficult stamps. Also fine packet of odd and unusual stamps from Bosnia-Herzegovina, Monaco, Patiala, Eritrea, etc., including maps, ships, animals and strange scenes. All free to approval applicants inclosing 3c postage. Garcelon Stamp Co., Box 900, Calais, Maine.

50 **DIFFERENT** British Empire including jubilee, Edwards, 50 different new, recent and pictorial world issues, 15 different airmails, 500 hinges, perforation gauge, all for 25c. Approvals sent. Lists free. Victoria Stamp Co., London, 4, Canada.

BRAZIL, 50 Different 10c with bargain approvals. Davis, Silver Lake, Ind.

ASK For our wonderful one cent approvals. Prospect Stamp Co., 225 Broadview, Toronto, Canada.

WHOLESALE Catalog for dealers. Illustrated. Postage 5c. Frank Co., 4900 Chalgrove, Baltimore, Md.

PENNY Approvals, that satisfy. Neil Gronberg, Box 5441-P, Philadelphia, Penna.

WEEKLY Stamp magazine, thirteen weeks, 10c. Stamp Journal, Kalamazoo, Mich.

30 **DIFFERENT** Angola, Cape Verde, Guinea, Portugal, Mozambique, St. Thomas and Prince 5c. Approvals. Depraw, Ocean Park, Calif.

FREE, 50 Stamps, Manchukuo, etc. Postage 1c. Album 3c. U. S. bargains. Bullard, 268 Northampton, Boston, Mass.

APPROVAL Sheets. One to three cents. Frederick B. Driver, 2009 Finance Bldg., Philadelphia, Penna.

STAMP Dealers. your ad here will bring wonderful returns. Ask me for proof. F. W. Johnson, Manager, Classified Advertising, Popular Mechanics Magazine, 200 E. Ontario St., Chicago.

25 UNITED States, including \$4 and \$5 stamps free to approval applicants. 3c postage. Brownie Stamp Shop, Flint, Mich.

HOBBIES AND COLLECTORS

EXCHANGE Postcard views. Addresses 200 exchangers for dime. Dean Fox, Argos, Indiana.

PHOTO FINISHING

FILMS Developed. Two beautiful glossy, double weight, professional enlargements and 8 prints all for 25 cents coin. Reprints 3 cents. Dependable quality and service. Allied Photo Service Company, Drawer 289, Sparta, Wisconsin.

20 REPRINTS 25c. Films developed, 16 prints 25c. Enlargements 8x10, 25c; 5x7, 10c. Low Photo, M-2657 Neva, Chicago.

PHOTO Mill. Immediate service! No delay! Roll developed, carefully printed and choice of two beautiful 5x7 double weight professional enlargements, one tinted enlargement, or eight reprints—for 25c coin. Reprints 2c each. The Photo Mill, Box 629-12, Minneapolis, Minnesota.

DEVELOP And print your own pictures. Save time, money with our complete outfit, \$1.95 plus postage, or sent C.O.D. Includes electric ruby lamp, printing frame, photo paper, chemicals and equipment. One of hundreds of amazing bargains in our free, newest, money-saving bargain book. Send for it today! Central Camera Co., 230 So. Wabash, Dept. 24-K, Chicago.

LATEST in photo finishing. Miniature rolls developed and printed 3x4—5c each print. Radio Film, LaCrosse, Wisconsin.

20 REPRINTS 25c. 100 Reprints \$1. Roll developed with 16 prints 25c. Newtowne, 4, Maywood, Ill.

VELOX Fadeless reprints 3c. Rolls developed and printed 25c. Leslie's, 1518 West 65 Place, Los Angeles, California.

BIGGEST Bargain: Film developed and prints on postcards 25c coin. Sterling, Box 5556, Cleveland.

PROMPT Service! Rolls developed, two Velox prints each negative 25c. Hensch Studios, Harrisburg, Penna.

IDEAL Photos. 25c per roll, finished with round corner prints. To get acquainted! Coupon and snapshot folder free! Ideal Photo, Box 2255, Paterson, N. J.

PHOTO Mill. Immediate service! No delay! Roll developed, carefully printed and choice of two beautiful 5x7 double weight professional enlargements, one tinted enlargement, or eight reprints—25c coin. Reprints 2c each. The Photo Mill, Box 629-12, Minneapolis, Minnesota.

20 REPRINTS 25c. Rolls developed 2 prints each negative 25c. Fred Weick, 2840 Zenobia, Denver, Colorado.

FILMS Developed 2 prints of each 25c; 20 reprints 25c. Pine Photo, M-5134 Nevada, Chicago.

FREE—4 Big enlargements—8 prints every roll 25c. 20 reprints 25c; 100—\$1.00. Filmco, Albany, Wis.

BE Modern! Get Modern service. Modern quality. Modern prices. Our modern methods give quick service and bright guaranteed neverfade pictures. Roll developed 16 prints, 25c coin. 16 reprints, 25c. Enlargement coupon. Send next roll or reprint order to Modern Finishers, 3537-C, St. Paul, Minn.

ROLLS Developed, 8 prints, two glossy enlargements 25c. Argus or Bantam rolls developed free and printed 3x4, 4c each. The Picture Folks, Lincoln, Nebraska.

ROLLS Developed and printed plus two enlargements 25c. Reprints 3c. Art Photo, 1783 Delaware, Detroit.

FILMS Developed, 8 glossy Velox prints 25c. Kalata, Ironwood, Michigan.

20 REPRINTS 25c. Films developed, two prints each negative 25c. Skrudland, 6970-8 George, Chicago.

COMPARE The difference! Roll developed, two professional double weight enlargements, 8 guaranteed prints, 25c coin. Excellent service. Nationwide Photo Service, Box 3333, St. Paul, Minn.

TWENTY Reprints 25c. Roll developed and two prints each negative, 25c. Star Photos, 109 N. Dearborn, Chicago.

GET The best. Roll developed, beautiful hand colored enlargement, 8 neverfade border prints, 25c coin. Prompt service. Sun Photo Service, Drawer T, St. Paul, Minn.

SNAPSHOTS Expertly colored 10c. Price list free. Mumber's Color Service, 5410 Wellington, Chicago.

TIN-TYPES! Genuine! Rare! Reproduced from any snapshot or photograph 25c. Start collection! Roy Monsen, 1404 N. Leamington, Dept. A, Chicago.

ROLL Developed, printed 20c; Univex 15c. Tellez, B623PM3, Pecos, Texas.

INTRODUCTORY Offer. Beautiful Platesunk etched enlargement free with roll developed printed 25c coin. 24 hour service. The Artists, Box 230, Minneapolis, Minn.

FADELESS Reprints 1c each. Satisfaction guaranteed. Henke Studio, Armstrong, Iowa.

ARGUS, Bantam, all 35mm. fine grain 25c roll. 3x4 enlarged glossy prints 4c each. Mulson's, 1490 Stratford Ave., Bridgeport, Conn.

ROLL Developed, 8 brilliant fadeproof Velox prints and two professional enlargements 25c. Overnight service. Young Photo Service, 405-C, Albany, N. Y.

MILLIONS Now know "Hollytints Means Better Prints." Two professional enlargements with trial roll—25c. Fascinating premiums. Unequaled service. Hollytints, P-1350, Hollywood, California.

CASH Paid for snapshots! Thousands wanted. Stamp brings information. Division 61; International Photos, Hohm Building, Sixth and Western, Hollywood, California.

AMAZINGLY Beautiful, roll developed, 8 Natural Color prints, 25c. Reprints, 3c. Natural Color Photo, D-54, Janesville, Wis.

LIMITED Time only. 4x6 Natural Color enlargement from your negative, 10c. Natural Color Photo, Janesville, Wis.

TWO Prints each with every roll developed, 25c. Very finest quality. Reprints 2c each. Brown Photo Company, 1910-34 Emerson, Minneapolis, Minnesota.

LARJARGRAPH Reprints: Five 5x7 enlargements 25c. Cardinal Photoers, Summit, N. J.

ROLLS Developed, two sets prints plus enlargement coupon 25c. Reprints 3c. Over 19 reprints 2 1/2c. Jones Studios, Davenport, Iowa. "Where the West Begins."

ROLLS Developed, 16 guaranteed prints, two coupons on plain or colored enlargement 25c. Smart Photo, Winona, Minn.

GUARANTEED. 20 Prints 25c. Rolls developed, 16 prints 25c. Quality Photo, Hutchinson, Kansas.

AT Willard's, Box 3535-A, Cleveland Heights, Ohio, you'll get quicker service, beautiful quality. Roll developed, 2 prints each negative 25c. Enlargement coupon. (Trial offer.)

KODAK Enlargement 5x7, 10c; 3 for 25c coin. Send best negatives (film). Dept. 5, Xint Photo Lab., Cedar Rapids, Iowa.

IMMEDIATE Service! Better pictures. Two beautiful heavy-weight professional enlargements and eight guaranteed Perfectone prints 25c coin. Sixteen pictures from roll 25c. Eight beautiful enlargements from roll only 25c. Candid rolls developed free—prints enlarged to 3x4, only 4c each. Pictures sent back same day film is received. American Studios, Box B, LaCrosse, Wis.

ROLLS Developed, 2 prints each and 2 free enlargement coupons, 25c; reprints, 2c each; 100 or more, 1c. Summer's Studio, Unionville, Mo.

ENLARGEMENTS 4x6, Five for 25c. 5x7 three for 25c. 8x10 three for 35c. Hand colored and framed each 4x6, 30c. 5x7, 35c. 8x10, 45c. Send film negatives. Enlargers, Maywood, Ill.

ROLL Developed and 8 beautiful Velox glossy prints 25c coin or stamps. Reprints 3c each. Fotoprint Service, Box E, Roanoke, Va.

FINER Finishing. Rolls developed and printed, with one colored enlargement, or two professional enlargements. All for 25c (coin). Genuine, nationally known. Moentone superior quality. Moen Photo Service, La Crosse, Wis.

ROLLS Developed—Two new Beautitone Dubiwater professional enlargements, 8 guaranteed fadeless Beautitone prints, 25c. Giant Snapshots, Inc., 667A, Green Bay, Wis.

BEAUTIFUL 5x7 Enlargements from your favorite negatives 17c each; three for 50c. Eight exposure roll developed and printed 25c. Work guaranteed. Jeems Service, Box 137, Ann Arbor, Mich.

FOR The discriminating amateur, roll developed and carefully printed 25c, reprints 3c. Superior workmanship, same day service. Paramount Co., 327 E. 92nd St., New York.

TWO Glossy enlargements, 1 colored with roll 25c. Arbor Service, 10, Joliet, Ill.

CAMERAS—PHOTO SUPPLIES

RICH Custom tailored cowhide Eveready case for your camera. Postpaid \$4.50. Guaranteed satisfaction. Quentin Products, West Salem, Illinois.

ARGUS Owners: Get the Don Focusing Mount; focus exactly from 3 feet to infinity. Adjusted on your camera with microscope; \$5. Free circular. Pattee Scientific Development Company, Niantic, Conn.

MAKE Money in photography. Learn quickly at home. Spare or full time. Easy plan. Previous experience unnecessary. Common school education sufficient. Interesting booklet and requirements free. American School of Photography, 3601 Michigan Ave., Dept. 3432, Chicago.

CAMERAS And supplies. Free illustrated catalog listing everything photographic—still and movie cameras, films, lenses—at tremendous savings. Hundreds of bargains, new and used. All guaranteed. We take your old camera or equipment in trade. Write now for your free copy of our newest money-saving bargain book—just out! Limited edition. Hurry! Central Camera Co. (Photographic Headquarters since 1899), 230 South Wabash, Dept. 4-K, Chicago.

CAMERAS And shutters repaired. Leather bellows installed in folding and view cameras. Bellows made to order. United Camera Company, Inc., A-1515 Belmont, Chicago.

"MINICAMERA Hand-Pod indispensable," users say. Only 50c. Lorenz, Madison, Indiana.

DUPONT Superior panchromatic, 35 mm. 25 foot roll, \$1. Optical Laboratories, Larchmont, N. Y.

WANTED. Your name and address to send you catalogs and prices. German cameras, field glasses, movie cameras and projectors. Ask for prices and catalogs. Mexico Camera Specialist, Foto Mantel Suer, Rudolf Rudiger, V. Carranza 11, Postbox 1459, Mexico City, 105. Branch: Tijuana, Baja, California.

ROLL-O-POD: A complete full-size tripod to fit your vest pocket. Most compact tripod ever built. Sturdy, steady, with built-in swivel tilt-top. Order by mail, \$5.25. Money-back guarantee. Free literature. D.M.D. Photo Supply Company, Dept. PM, 178 Prince Street, New York City.

BASS—Camera crossroads of the world. We will mail you at once our new 52 page still camera special Bargaingram No. 233 teeming with good values in candid and other cameras, new and used and complete list of photo accessories. Note unusual values: Dollina 0 candid camera, 36 shot, F:4.5 extremely fine Anastigmat lens at only \$18.90. Dollina Model II, coupled range finder, F:2.9 Anastigmat lens, Rapid Compur shutter, \$49.75. DeFranne Argonaut half No. 120 candid camera, with fine Anastigmat F:2.9 lens in Compur shutter at only \$27.75. These and other values mailed under our fourteen day money back guarantee. Write for your copy of this great new Bargaingram No. 233 and read what real service and value means. Bass Camera Company, Dept. AG, 179 W. Madison St., Chicago, Illinois.

CAMERAS Films, paper 25% to 35% discount. Paramount Photo Division, 327 East 92nd St., New York.

INCOME From your camera instead of expense. Low cost home course teaches you to make photographs for magazines, newspapers, advertisers. Tremendous demand. Earn good money wherever you live. Free book. Universal Photographers, Dept. 104, 10 W. 33rd St., New York.

HAVE You a camera? Send ten cents for recent number of our big magazine, showing how to make better pictures and earn money. American Photography, 116 Camera House, Boston, 17, Mass.

WE Purchase and accept in trade used photographic equipment. Send for bargain list. Potoshop, 134R W. 32nd, New York City.

MOTION PICTURES AND SOUND EQUIPMENT

WANTED: Good 16 mm. camera, projector and associated supplies. What have you? L. O. Evans, 2025 Prospect Ave., Cleveland, Ohio.

DE VRY 35MM. 1000 Watt sound projector, complete, \$95.00. Cine Bargains, 550 Wabash, E4, Kansas City, Mo.

BARGAINS! 8mm., 16mm., Free literature. Elder, B-739 Boylston, Boston, Mass.

CENTRAL'S Free, new, money-saving bargain book explains latest movie developments, offers money-saving bargains in cameras, lenses, projectors, films. Used equipment taken in trade. Write for free copy. Central Camera Co., (Photographic Headquarters since 1899), 230 S. Wabash, Dept. 14-K, Chicago.

35MM. SILENT Features, shorts. Lists. Grossman, 1438 N. Talman, Chicago, Ill.

HEMENWAY Passion Play, half price, others. Adrian Thompson, Tusculumbia, Alabama.

TALKIE Pictures rented, sold. Projectors. Simpson, 1275 So. Broadway, Dayton, Ohio.

OIL Painting from photograph, \$5. Portraiture, 826 Noble, Chicago.

8MM.-16MM. RENTAL Library. Large selection. Lowest rates. Shipped anywhere. Sale 50-100 ft. subjects. Include postage for free catalogs. National Cinema Service, 3 West 29th St., New York.

35MM. FILMS. Cheap. Lists free. Demsey, 1223 Berkley, Youngstown, Ohio.

16MM. FILMS \$3.50 Up. Florenz, 34 W. 6th, Cincinnati, Ohio.

INVENTORY Sale! 16mm. sound film machines complete, ready for use, 750W Universal 15W output, \$228.75; RCA Victor \$95; 500W Victor Animatophone 7 1/2 W output, \$149.50; Model 24B, \$395. 16mm. "Standard" silent, 750W projector \$87.00; 6x8 ft. screen, \$7.95; 8mm. Univex projector, camera, complete, \$19.50; 35mm. DeVry 500W projector, \$29.50; 16mm. Automatic movie camera, \$6.95; 35mm. DeVry portable 1000W sound, complete with amplifier, \$198.50; 35mm. silent shorts, features, complete, title ends, \$1.00; 8-9 1/2-16mm. silent-sound-film for sale. New, used. Nationwide film library. Sent everywhere, low rates. Free catalog. Trades accepted. McGull's, 1944-J Boston Road, New York City.

8MM. AND 16MM. positive title film, 35c up. Developing, 25 feet, 50c. Titlers for 8mm. and 16mm. cameras, \$3.75 and \$5.45. New 8mm.-16mm. film rewinds, \$3.50 pair. Catalogs free! Hollywood Cine Film Distr's, Dept. P-4, 1431 No. Highland Ave., Hollywood, Calif.

BIG Bargain lists 35mm. 10c. Calderara, 5119 South St. Louis, Chicago.

RENTAL Professional 35-16mm. talkies. Film Service, Mabscott, W. Va.

35MM. ACME Projector \$35, sound-on-disc \$50. Films. Virgil Poe, Walla Walla, Wash.

8 16MM. ALL Latest subjects silent and sound, sale, rent and exchange. Film rented everywhere. Free illustrated catalog (with sample film 10c.) Garden Exchange, 317 West 50th, New York.

BARGAINS In beaded screens. 3235 South Springfield Ave., Chicago, Ill.

"THE World's greatest of all Passion Plays," 16mm. 8 reels. Sound with dialogue or silent. Rent or purchase. Superior than Oberammergau stage play. Write Hemenway Film Co., 37 Church St., Boston, Mass.

FREE List and sample, 8mm., 16mm. Goodwill Company, Jackson, Tennessee.

200 FT. Genera 8mm. film, \$1.95 postpaid. Separates without slitting. Any 8mm. camera. Sample free. Fromaders, Davenport, Iowa.

MOVIE Film. Develop yourself. All kinds. Chemical samples 15c. Lake Camera Exchange, Gary, Indiana.

PROFESSIONAL 35mm. Cameras, sacrificed \$20.00. Avond, 747 6th Avenue, New York.

8MM. AND 16MM. home movie films exchanged. Lists free. Hertwig, Reedley, California.

NEW Complete 8mm. popular star movies 60c. 16mm. color film sample 50c. Free 16mm., 8mm. bargain lists. Home Movies, Box 216, Easton, Penna.

35MM. TALKIES For rent. Shermco, 6101 Orchard Grove Ave., Cleveland, Ohio.

BASS, Camera crossroads of the world, invites you to drop in when you are in Chicago or send for the great Bargaingram No. 230 of Cine apparatus in 8 mm., 16 mm., 35 mm. silent and sound. A few specials from this list: Cine kodak Model A with F:1.9 lens, hand crank for animation or professional use, \$49.50. 750 watt Weber 16 mm. sound on film projector, complete with 1600 ft. reel arms and amplifier at \$135.00. Victor Model 12A sound on film projector and amplifier, \$195.00. Trick Effects with the Cine Camera, a new manual at \$1.00. Cine Titling Simplified \$1.00. Exposing Cine Film, \$1.00. Ideas for Short Films, \$1.00. 8 mm. Handbook of Cinematography, \$1.00. Write today. Bass Camera Company, Dept. A, 179 W. Madison St., Chicago, Illinois.

35MM FILMS Rented, 50c weekly. Lists 3c. Hoffman Film Service, 57 Broad, Albany, N. Y.

LEARN Motion picture theatre business. Home-study training; management, advertising, projection. Free catalog. Theatre Institute, Elmira, N. Y.

WESTERNS, Comedies, 500 feet 75c. Jersey Films, 2075 Richland, Lakewood, Ohio.

8-16MM. TITLES, 2c Word. Catalogue. Cineshop, 1812 Piedmont, Charleston, West Virginia.

WORLD'S Best passion play, seven reels, new version all talking sound and silent 16 and 35 mm. rent or sale. All-Sacred Film Co., 50 Melrose Street, Boston, Mass.

15% TO 25% Discount on still or movie cameras. Free circular. Paramount Co., 327 E. 92nd St., New York City.

RADIOS, SUPPLIES, INSTRUCTION

AGENTS Wanted, nationally advertised radios, Philco, GE, RCA, Zenith, etc., send for bargain set and part catalog. United Radio, N-Newark, N. J.

"**SHORTWAVE**" Crystal set! Illustrated plans 10c. Unicraft, 4932 8th, Philadelphia.

PLANS 18 Distance record crystal sets; "Radiobuilder"—year; 25c. Laboratories, 151-C Liberty, San Francisco.

RADIO Engineering, broadcasting, aviation and police radio, servicing, marine and Morse telegraphy taught thoroughly. All expenses low. Catalog free. Dodge's Institute, Ames St., Valparaiso, Ind.

MUSIC AND MUSICAL INSTRUMENTS

REBUILT Band and orchestra instruments. Honestly rebuilt, fully guaranteed. Catalog on request. Specify instrument interested in. Weymann Co., Dept. M-4, 1613 Chestnut St., Philadelphia.

PIANISTS: Free booklet describes method improving your technique, accuracy, sight reading, memorizing. Write Dept. 423-D Broadwell Studios, Bendix Bldg., Los Angeles.

SENSATIONALLY Economical instrument instruction books by masters. Descriptive literature 10c. Pasreno's, Laurier, Manitoba.

VIOLINS—Handmade masterpieces, best since Stradivarius. Free trial. John Lehto, San Pedro, Calif.

B-FLAT Bazooskas! Send for free circular. Roscoe Company, Box 324, Maywood, Illinois.

SONGWRITERS: Send best poem today for exceptional offer. Richard Brothers, 24 Woods Building, Chicago.

MUSIC Composed to words. Rhyming pamphlet free. Phonograph recording of song free. Keenan, 259 Beach St., Bridgeport, Conn.

FREE Melody to songpoems. Publishing. National Songland, "PM," Thomaston, Maine.

SONGWRITERS! Amazing convincing proposition. Hibbeler, C-5, 2157 No. Avers, Chicago.

POEM Wanted. Free melody. We publish. Great Eastern, Thomaston, Maine.

ORIGINAL Music composed to your words: \$5. Song printed. Reginald Belcher, Chatham, New Jersey. 30 years church organist.

SONGPOEMS Revised, set to music, 5 copies. Modern expert service \$2.00. Roy Allen, Kitchel, Ind.

SONGWRITERS. Real opportunity. Details. Edward Madden, 113 Michaels, Syracuse, N. Y.

GIVE Your lyrics a break! For best musical setting and legitimate proposition, write Barbara Seville, Suite P-4, 126 Lexington Ave., New York.

COMPOSERS—Word or music—Brilliant opportunity. Write immediately. Vanburen, B42, Rockhaven, Ky.

ACCORDIONS: Bargain, close out, new 120 bass, 4 reeds, pearl throughout, \$115. Only a few left. Write for catalogue. Oakley Music House, 2244 West Harrison Street, Chicago, Illinois.

LEARN Swing piano! Postal brings free booklet. Christensen, 751 Kimball Hall, Chicago.

MUSIC Composed, arranged, revised. Charges reasonable. Len Fleming, Wellsboro, Penna.

MELODY For words, \$2.00. Littig, 215 Mason Theatre, Los Angeles, California.

POEM Writers, songwriters—Send for free rhyming dictionary—songwriters' guide. Submit best poems, melodies today for bonafide, superior offer. MMM Publishers, Dept. 33A, Portland, Oregon.

SONGWRITERS! Marvelous opportunity. Investigate. Standard Song Service, 1412 Great Northern Bldg., Chicago.

SONGS Published, arranged and composed. Royalty basis. West Coast Music Publishing Co., 942 Market St., San Francisco, Calif.

SONGWRITERS Wanted, write for free book. Indiana Song Bureau, Salem, Ind.

MUSIC Composed to song-poems. Orchestration arranged. Frank Wildt, Lancaster, Pennsylvania.

SONGWRITERS—Get "How to Write Songs" by famous Broadway composer and free rhyming dictionary. Songwriters Institute, 1234-C Broadway, New York City.

MUSIC Composed to words. Wonderful proposition. Bauer Bros., Oshkosh, Wis.

DUO-FLEX Reeds for clarinets, and saxophones eliminate your reed troubles. Write for circular. Duo-Flex Reeds, 1204 1st Ave., Evansville, Ind.

WRITE Songs. Big money and reputation. Write for information. J. Gordon Pub. Co., 201 N. Hoyne, Ave., Chicago.

WANTED! Lyrics, melodies for songs. We arrange, publish, sell. Superior Song Studios, Passaic, N. J.

BUSINESS OPPORTUNITIES

GET Into the newest business boom! Enlarge and develop candid snapshots at home. Biggest photo scoop of year. New photo enlarger and complete developing outfit puts you in business at small cost—300% profit. No experience needed. Everyone taking candid snapshots—everyone a prospect. Booklet C tells how. Atlantic Photo Supply Co., 11 West 42nd St., New York.

FASCINATING Business. Repair, adjust typewriters, adding machines. Learn easily at home from factory expert. Earn up to \$15 daily. Complete instructions covering all makes \$3 postpaid or sent C.O.D. Adding Machine Equipment Service, 3601 Michigan, Dept. 3434, Chicago.

AMAZING Opportunity! Learn to make genuine rubber molds. Instructions free. Stewart's Studio, 2927 Wilcox, Chicago.

SNAP Into it! Be independent! Send now for full, unusually valuable particulars. Marlborough Co., Box 81, Astor Station, Boston, Mass.

COLOR Concrete surface with chemical solutions. Beautiful pottery without moulds. Garden wishing-wells. Stucco rock. Glazing concrete. Sample 10c. Hollywood Cement Craft, 8527 Wonderland, Hollywood, California.

FORMULAS—Fast selling products. Guaranteed. Laboratory tested. Lowest prices. Catalog free. Kemico, 55S, Park Ridge, Ill.

PRACTICAL Furniture finishing—old or new—walnut, oak, mahogany. Complete \$1.00. Bergh, 232 W. Keefe, Milwaukee, Wis.

REPRINT "Breniser dollar mail-treatise, circular matter. 25c coin, 6c stamps. Green, 15788 Parkside, Detroit, Mich.

START A business by mail. Literature free. Morey, 87P Somerset St., Springfield, Mass.

SELL By mail. Suggestions free. Steinger, 7706 West North, Pittsburgh, Penna.

RAISE Rabbits. We pay to \$7.00 each. Catalogues 10c. Rabbitries, Bowling Green, Kentucky.

M. M. earned \$267, three weeks, raising mushrooms in cellar! Exceptional, but your cellar, shed perhaps suitable. We buy crops. Book free. United, 3848 Lincoln Ave., Dept. 61, Chicago.

CHINESE Relics, where to buy wholesale, 20c. Harwood, 904 Madison St., Brooklyn, New York.

YOU'LL Like resilvering mirrors, auto-parts, reflectors, making chipped glass signs. Write, Sprinkle, Plater, 127, Marion, Indiana.

MANY New guaranteed big paying mail-order and local business. Dime brings complete plan, novelties, valuable literature. Patek's, BPM896, Spuzzum, B. C.

1939 PROPOSITION. Just out, for opportunity seekers. Dime brings particulars. F. Hutchison, 314 North 4th St., Camden, New Jersey.

BURGLAR And fire alarm. Simply, \$8.00. Five windows, one door. 30 cents additional opening. Mention if electric available. Hart Alarm Co., 3029 Lorain Ave., Cleveland, Ohio.

INCORPORATE In Delaware. Special low rates to investors forming small companies. Free information. Corporation Guarantee and Trust Company, 927 Market Street, Wilmington, Delaware.

MAKE Artificial marble, glazed tiles, uncanny. Tabletops, plaques, floors, hones, novelties. Hard, fireproof, inexpensive, cement secrets. Brilliant tile and liquid rubber samples 3c. John A. Payn, 945 Grande Vista Avenue, Los Angeles, Calif.

COMPLETE Service for mail dealers. Folder free. Delmaco, Box 1123D, Wilmington, Del.

MAKE Rubber molds that need no greasing. Castings come out with glass like smoothness. Beginners outfit \$1.00. Satisfaction guaranteed. Details free. June, 101-B Beech, Holyoke, Mass.

START Candy kitchen, \$15. Course in candy making only \$2.00. Earn \$100 weekly. Cicerone, 966 2nd Ave., New York.

INDEPENDENCE! Earn substantial income, prosperity; year-round, no canvassing. Free facts. McArthur, Drawer 339-5, Butte, Montana.

MONEY In butterflies, moths. See Sinclair Display Advertisement on page 14A.

FORMULAS! Best produced for exceptional popular necessities. All lines. (Not stock-formula catalog stuff.) Get these unusual offers—stamp brings them. Miller, Industrial Chemist, Tampa, Florida.

LEARN Motion picture theatre business. Training: Management, advertising, projection. Catalog free. Theatre Institute, 335 Washington, Elmira, N. Y.

OPPORTUNITIES Aplenty! Money-makers that "click"! Unusual idea service! Bulletin A free! Cee-Tee Company, 1079 Madison Street, Brooklyn, N. Y.

START Two-way plan—local and mail order. Thrives during depression or prosperity. All or part time. Free circular. Reber, Stowe, Penna.

107 NEW Successful home business plans. Century, 1261-PC Broadway, New York.

FREE! New home money making plan. No canvassing. Julius, Amarillo 12, Texas.

RECAST Old batteries into new. Latest achievements. Battery Laboratories, St. Paul, Minn.

SOMETHING New. Moore's money making manuals. Three subjects. Only 20c each, all three 50c. Details free. Agents wanted. A. Moore, 160 Broad St., Newark, N. J.

MAIL Offering wonderful opportunities. Stamp appreciated. Castell, 1663 Madison St., Brooklyn, N. Y.

AMAZING. New, economic plant fertilizer. 25c. Sanquist Co., Pomeroy, Iowa.

\$100 STARTS "Chain" of chewing gum and confection vending machines. Steady cash income. Details free. Robbins Co., 1141P DeKalb Ave., Brooklyn, New York.

IF You'd like an extremely profitable, lifetime business, operate a collection-credit agency. Free folder. Cole Associates, Syracuse, N. Y.

\$25 HUNDRED Stamping name, address on key holder plates. Particulars and sample 25c. Evans Co., Tyrone, Ark.

CAST Novelties! Beat depression! Catalogue molds. Colonial Arts, Derry, N. H.

"WORLD'S Newest Co-op Plan" sells your product or ours. Easy, simple, sure, no canvassing, peddling. Free particulars. Lewis, Box 243, Minneapolis.

START Your own business—"120 Ways to Make Money" tells how. Details free. Samuel R. Graham, Warrenton, Virginia.

EARN While learning marbling, rubber mold making. Send dime for samples. Cowell Institute, Grayling, Michigan.

\$1,000,000 IDEA. The secret how to remove shine from clothes. Details free. Leon, 31 New York Ave., Atlantic City.

PUBLISH Magazines, syndicate newspapers. 10c. (100—\$1.) Newspaper, Winchester, Ohio.

MAKE \$21 Per 100 stamping names on keychecks. Samples and instructions 25c. Either sex. Keytagsmm, 689 E. 48th St., Brooklyn, N. Y.

"MAKE Mirrors at home." Big profits. Little outlay. Also emboss, grind—foil, gold leaf, frost, chip and make imitation stained glass. Instruction course \$1.00. Bestovall, 4047-P N. Whipple, Chicago.

DOUBLE Your income—Join the leaders of the mail order field, publish your own magazine. Instructions 25c. Sheboygan Publishing Company, Sheboygan, Wis.

"PROFITIPS," 52 Page magazine 10c. R. Lundquist, Redfield, So. Dakota.

HUGE Profits growing without soil. Produce fruits, flowers, vegetables anywhere all year with chemicals. Season's supply, directions \$2.00. Formula, bibliography, \$1.00. Both for \$2.50. Chemiculture, 4701 Sheridan Rd., Chicago.

DOLLARS And leisure on few cents capital! Make alluring marble granite, etc., at home. Sell on sight. Free information. Cement Arts, 514 Davis Building, Portland, Oregon.

START Profitable mailorder business at home. Literature free. Ideal Service, 179, Park Ridge, Ill.

LIQUID Marble—anyone can make! Colorful, glazed! Moulded, brushed, sprayed. Rubberlastic moulds. Composition flooring. Big money in these! Particulars free. Marbelizing Service, Edwardsville, Ill.

INCREASE Your prestige and business. Just 1c daily for personal or 2c for business purposes, maintains permanent New York office. Co-Operative Mail Service, 126P Lexington Ave.

\$65 A WEEK. Home work. Details for stamp. Hadmeyer, Box 316, Rochester, Minnesota.

PROFIT With new products. Make, sell, repeat. Analysis, Research. Guaranteed formulas. Biggest catalog free. Special prices, leads. Gibson Laboratory, Chemists, BD-1142 Sunnyside, Chicago.

OPPORTUNITY Guide 10c. Satisfaction guaranteed. Vixon, Winton Place 15, Cincinnati.

\$80.00 WEEKLY; Mail selling instructions, 144 plans; sample, particulars 25c. Sheal, Box 263, Duluth.

MAKE Money repairing automobile radiators. Opportunity where you are. Learn at home spare time. Information free. Radiator Service Dept., Maryville, Mo.

OWN Your own business—make \$3.00 on each quick sale. Many report 6 sales a day. Unlimited prospects. Write for special offer and illustrated folder today. Scott Mfg. Co., 4242 East 54th Terrace, Kansas City, Mo.

MAKE Money direct from factory. Little Nut Vendor, Lansing, Michigan.

107 WAYS To make money, in home or office, business of your own. Full particulars free. Elite Co., 214 Grand St., New York.

AFTERNOONS Free for outdoors, shows, \$340 month home. Unique plans. No canvassing. Prepare for surprise. Polio-F, Station D, Los Angeles.

MANUFACTURE Patented rubber mat from junk tires. Cooperative Crafts, White Plains, N. Y.

ADDED Income ideas. Mail Sales News magazine, copy 10c. Katz, 4254 No. Kimball, Chicago.

WHERE To buy at lowest wholesale prices. Information free. Yorena, Box P-312, Bayonne, N. J.

MERITORIOUS Enterprises organized, developed, incorporated, products marketed, prospectus prepared, filed. Actual broker connections. Suttle, 509 Fifth Ave., New York.

FREE Circulars describing hundreds of moneymaking opportunities by mail. Newest methods. Pleasant surprise. Write now. Progress Publishing Co., 2513A N. 9th St., Milwaukee, Wis.

PLASTEX Industries offers industrious men an opportunity to start a business of their own, manufacturing art goods, novelties, souvenirs, etc., in Plastex and marble imitation. 5c material makes \$1 articles. Rubber moulds furnished for speed production. Small investment brings big returns. You are just in time for the big 1938 season now starting. Write for interesting booklet mailed free. Plastex Industries, Dept. A, 1085 Washington Ave., New York.

MANUFACTURE From Phospholene. Cleaning fluid 1c gallon; bleach 2c gallon; and ten fast sellers. Sample 25c. Details free. Western, 6615 Denison Ave., Cleveland, Ohio.

OPERATE Chain world's finest money making vending machines. Sells four products, same time. Instant success! Small capital, profits immediately. Penny King, 1233 Chouteau, St. Louis.

AT Last! Book of moneymaking plans. Start at home, full or spare time. Send for descriptive folder free. Paramount Sales Service, Box 1784 Wilshire-LaBrea Sta., Los Angeles, Calif.

"SUCCESS Beacon," 52 pages! Money-making schemes, ideas, plans. Dime. Jay, Publishers, 6054-p Kenwood, Chicago.

DONUT. Potato chip, cheese pop corn. Home made. Big profits. Vanderpol, Springfield, Ohio.

WE Start you in business, furnishing outfits and instructions, operating Specialty Candy Factory home. Men and women, earn \$25 up to \$60 weekly, all or spare time. (Our 29th year.) Booklet free. W. Hillyer Ragsdale, Inc., Drawer 4, East Orange, N. J.

SUCCEED With your products. Make-sell them. Formulas, Processes, Accurate analyses. Catalog free. B. Thaxly Co., Washington, D. C.

PROFITABLE Home business. Legitimate. No canvassing. Maywood Publishers, P-923 Broadway, New York.

MAKE Your own products. Employ agents yourself. Toilet articles, soap, extracts. We furnish everything. Valuable book free. National Scientific Laboratories, 1950W Broad, Richmond, Va.

SELL By mail. Books, novelties. Bargains! Big profits! Particulars free. B. Elfco, 438 N. Wells, Chicago.

FREE Booklet describes 107 plans for making \$20-\$100 weekly, in home or office, business of your own. Elite Co., 214 Grand St., New York.

I WANT To send you proof of the wonderful pulling power of Popular Mechanics Magazine's classified pages. What's your proposition? Write me today. F. W. Johnson, Manager Classified Advertising, 200 E. Ontario St., Chicago, Ill.

CHARTERS: Delaware; best, cheapest; free forms. Colonial Charter Co., Wilmington, Del.

CASH Every week clipping and preparing news items for publishers. Simple, fascinating work. Experience unnecessary. Stamp brings information. Division 55, National Press, 3923 W. Sixth, Los Angeles, Calif.

DELAWARE Charters: Complete service \$35. Submitted forms. Chas. G. Guyer, Inc., Wilmington, Del.

ARTIFICIAL Marble sanitary flooring, instruction covering wood or cement flooring 1/2 inch thick, fireproof, all colors, low cost, ornamental casting, concrete, plaster, papier-mache, garden furniture, statuary, flexible molds, particulars free. Chris Mahler, Elmont, N. Y.

MAIL Order business is your opportunity. Many began small, now earn thousands yearly. No personal contact. Boundless opportunities. Have had over 30 years experience; will help you succeed. Send 25c for valuable booklets, none free. B. Brenner, 257 S. 21st, Philadelphia.

100 PROFITABLE Mail order and local plans. Gilbert Supply, 1107 Broadway, New York.

MONEYMAKING OPPORTUNITIES

"SPARETIME Roads to Riches," explains hundreds new easy moneymaking opportunities, 10c. Lewis Co., 828-M Carpenter, Oak Park, Illinois.

MAKE Photo rings at home! New easy way to big money! Everyone wants gold or silver plated rings with picture of loved one enshrined in gem-like setting. We supply everything. Low cost—tremendous profits. Photo Jewelry Company, Dept. A-200, Cincinnati, Ohio.

MAKE Beautiful glass and illuminated signs, emblems, picture-mounts, mirror silvering. No brush or lettering skill required. Cheney Signs, 325 Ohio, Wichita, Kansas.

SCORES Of money-making opportunities await you. Information for stamp. James, Box 1436, Long Beach, California.

350 NEW Ideas for making money. 96 page book postpaid 25c. New Ideas, 101 Hudson Street, New York City.

BIG Profit formulas and trade secrets. Lists free. Hayes, 60 E. 18th, Chicago.

YOU'LL Like resilvering mirrors, auto-parts, reflectors, making chipped glass signs. Write, Sprinkle, Plater, 287, Marion, Indiana.

DIME Brings copy National Mail Order News. Three months 25c. Box 1773-PM4, Roanoke, Virginia.

1,000,000 ARTICLES Wholesale. Directory 10c. Jelmsmith, 163 Myrtle, Waltham, Mass.

EARN \$50-\$100 Weekly. Permanent advertising business at home. Biggest idea yet! No experience. Little capital. Exclusive rights. Pennysaver, Penn Yan, N. Y.

YEAR 'Round income. Satisfaction assured. No canvassing. Good's, Paragould, Ark.

HOME Industry Guild needs you. Write for money-making offer. Coleman's Service, Smithboro, N. Y.

HUNDREDS Of home moneymaking opportunities. Details 3c. Sanvoy, Arlington, Kentucky.

\$10.00 DAILY Stamping names on key checks. Outfits furnished. Sample. Name-address 25c. Bohn Co., Box 86-A, Wilkes-Barre, Penna.

EARN Money at home—electrifying clocks, cleaning clocks, watches, jewelry. Send only 25c for full instructions and formula. Improved cleaning solution. William T. Reif, 44 Main Street, Lockport, N. Y.

HOME Industries, forty pages, subscription 10c. Melotz, Publisher, Benson, Nebr.

"NEW Opportunities Budget" of money-making information. Only 10c. Roberts-co, Frenchburg, Ky.

TURN Spare time into cash with typewriter! Addressing envelopes, mailing circulars, typing! Dime brings information, none free. Ace PMB, 322 Empire, Birmingham, Ala.

MAKE Money! Dime brings Golden Opportunities Magazine; dozens moneymaking offers. Southeastern Publishers, Monroe, North Carolina.

"NEWEST Mail proposition"! Different! Safe! Profitable! Food concentrates, vitamins, endocrines. "6000 word folio." Samples, dime. Gardena Institute, 128B, Station "S," Los Angeles.

MONEY In butterflies, moths. See Sinclair Display Advertisement on page 14A.

MONEY In milk delivery; year around job, depression-proof, few lay-offs; learn how from The Milk Salesman magazine, only milkmen's instruction of its kind; 5x7 inches, 16 pages monthly; used by big dairies to train routemen. 5 back issues postpaid only \$1.00; none free; year's subscription \$3.50. Send at once. Best trained men get choicest routes. The Milk Salesmen, Publication Building, Pittsburgh, Penna.

START Now! Make money casting book ends, plaques, etc. 1c material makes 25c seller. Sample of necessary materials, rubber mold, full instructions only \$1.00. Plastic Arts, Box 26, Homewood, Ala.

\$25.00 A DAY Plan 50c. Details 3c stamp. Chas. Fowzer, 426½ N. Beaudry, Los Angeles, Calif.

GET Money by mail; 100 smart secrets and Lucky Breaks Monthly, one year; all \$1. Postoffice Box 4, Indianapolis, Ind.

SWAP & Sell magazine. "The Nation's Market Place." Get the things you want without paying for them. Magazine prints your ads free. Sample copy 10c. Swap & Sell, 99M Hudson Street, New York City.

GUARANTEED Moneymaking mail business. 25c brings information, sample. Sharpley, Cedar Falls, Iowa.

300 TESTED Moneymakers, 64 page book, 10c postpaid, business secrets, formulas, wholesale supply sources, galore. Book has no ads, meat only. Moneyback if dissatisfied. National Plans Institute, 246M Fifth Avenue, New York City.

NEW UNUSUAL Opportunity spare time. \$350.00 month. Permanent. Different. Fascinating. Particulars free. Leadway Service, 30 N. LaSalle, Chicago.

BE Independent! Huge profits with cheese coated popcorn. Easily prepared at home. Complete instructions \$1.00. Liberty Sales Co., Effingham, Illinois.

NOW Make money! A \$1.00 magazine (40th year), filled with schemes, tips, business opportunities, formulas, sent six months for only 30c. "Schemer Monthly," Alliance, Ohio.

HOW And where to obtain capital fully explained, free particulars. Star Service, Wapakoneta, Ohio.

GET Dollar bills in your mail daily. Nearly all profit. Particulars free. Homecraft Arts, Lakeside, Calif.

SELL By mail; big profits; free literature. Hunt Products, 49 Edgemere, Trenton, N. J.

STOP Squealing—Start crowing! Work mornings home—country drives or movies—afternoons! No canvassing! Folio-A, Station "D," Los Angeles.

SELL By mail—"Mailorder Digest" tells how. Copy 10c. 126 Cannons, Louisville, Kentucky.

MILLIONS Jobs! Get dollars in mail daily, like we do, for amazing employment information. Keep money; we fill your orders free. Stamp brings details. Co-Operative Service, 77 Swan, Buffalo, N. Y.

AUTHENTIC Prosperity plans bring \$8.75 daily. Start on \$1.25. Literature free. Direct mail. Box 344, Summit, New Jersey.

PROFIT In vegetables, flowers, using chemicals. Remarkable yields. Proven formulas. Chemicals for 48 gallons solution. Instructions \$1.00 postpaid. Quick Growth, Hollywood Sta., Box 648, California.

START Mailorder business. Details free. Pederson, 1609½ East Fifth, Duluth, Minn.

MAN In each town to plate auto parts, reflectors, bicycles, fixtures, mirrors, by late method. Simple plan of manufacturing at home starts you in good paying business. Free particulars and proofs. Gunmetal Co., Ave. N, Decatur, Ill.

RAISE Earthworms for profit. Information free, stamp appreciated. Bureau Zoological Research, 106A Broadway, Peoria, Ill.

MOULDS, Guaranteed, for casting toy soldiers, Indians, trappers, warships, sinker moulds, 244 kinds. Send 5c for illustrative catalogue. Henry C. Schlercke, 645 Spencer, Ghent, N. Y.

WHOLESALE Sources, 500,000 articles. Free directory. Maywoode, 925 Broadway, New York.

107 PLANS For making \$20-\$100 weekly in home or office business of your own. Descriptive booklet free. Elite Co., 214 Grand St., New York.

LIKE To draw? Earn steady income tracing and duplicating advertising cartoons. Ad-Service, Argyle, Wis.

FORMULAS, PLANS, ETC.

ALUMINUM Solder. Apply with soldering iron. Requires no flux—50c. Guaranteed. Ricketts, Box 749, Lubbock, Texas.

THIRTY Profitable formulas. Guaranteed. Quarter. Woerner Formulae, 70 St., Glendale, Long Island.

PERFECTED Formulas free with service and problems solved. 25c. Alembic Laboratories, Chemists and Chemical Engineers, Box 1277, Chicago, Illinois.

GUARANTEED Formulas—New fast sellers. None better. Lowest prices. Catalog free. Kemico, 498, Park Ridge, Ill.

FORMULAS, All kinds. Wickesser, 114 12th Ave., Newark, New Jersey.

SOILLESS Plant culture. Raise tomatoes, potatoes, flowers, etc., in shallow tank of water containing 21 chemicals. Tomato vines 20 feet, bear for year, 20 pounds per vine, quality better than soil grown. Instructions, formula \$1.00. Purdy's Chemicals, 1852 E. Slauson Ave., Los Angeles.

CHEMICAL Analysis. Practical formulas. Ideas developed. Associated Chemists, Indianapolis, Indiana.

10 PROVEN Money-making formulas 50c coin. Broukins, Box 82, Stoneham, Mass.

MONEY Making formulas. Dime stamps brings list. Paul Bumbal, 735 East 163rd Street, Bronx, New York.

STAMP Brings free instructions for making fastest selling, big profit products. No formulas needed. Concentrated Products, Dept. 1591, Tampa, Florida.

SOLDER Iron and steel formula 50c. Ernest Isaacson, Wataga, Ill.

ENTER Your own business. 15 sure-fire money making formulas; including "Luminous Paint" in 5 different colors; mirror silvering; repeatedly igniting match, etc., \$1.00. Additional formulas, 5 for 50c. Victor, 15532 W. Warren, Detroit, Mich.

ANALYSIS, Research. Newest guaranteed formulas. Biggest catalog free. Special prices, leads. Gibson Laboratory, Chemists, BD-1142 Sunnyside, Chicago.

LUCKY Seven money making formulas, own your own business, become independent, money back guarantee. Send 25c silver. Plan Distributors, No. 900 Faxon, Memphis, Tenn.

THREE Dimes brings 101 hygrade formulas. Household, cosmetics, remedies. Helpsall, 21 Geraud Ave., North Plainfield, New Jersey.

PROFIT With your products. Learn how. VG Chemical, Box 4651, Pittsburgh, Penna.

MEN! Shave without razor! Send 25c for formula for self-shaving soap. Carl Greiner, 5112 N. Oakley Ave., Chicago, Ill.

FORMULAS! Best produced for exceptional popular necessities. All lines. (Not stock-formula catalog stuff.) Get these unusual offers—stamp brings them. Miller, Manufacturers' Chemist, Tampa, Florida.

100 MONEYMAKING Formulas 25c. Descriptive literature free. Harvey Teeple, Decatur, Ind.

THAXLY Formulas for perfect products. Accurate analysis assured. Resultful research. Catalog free. B. Thaxly Co., Washington, D. C.

MAKE Your own products. Employ agents yourself. Toilet articles, soap, extracts. We furnish everything. Valuable book free. National Scientific Laboratories, 1950W Broad, Richmond, Va.

FORMULAS, Latest money makers. Literature free. Belfort, 4042 N. Keeler, Chicago.

CHEMISTRY

CHEMICALS, Glassware, apparatus, instruments. Leading laboratory supply house offers scientific supplies of professional quality at lowest prices. Send 3c postage for free illustrated catalogue and latest chemical price-list. New York Scientific Supply Co., Dept. 15, 111 E. 22nd St., New York City.

FREE Chemical, apparatus catalog. Guaranteed lower prices. Meshna, Malden, Mass.

CHEMICALS, Laboratory glassware, apparatus. Send 3c for catalog CP1. Biological Supply Company, 1176 Mt. Hope Avenue, Rochester, N. Y.

ANALYSIS, Research. Newest guaranteed formulas. Biggest catalog free. Special prices leads. Gibson Laboratory, Chemists, CT-1142 Sunnyside, Chicago.

CHEMISTRY, Biology, mineralogy supplies, microscopes, telescopes. Catalog free. Teeko, Evanston, Ill.

RUBBER Latex. Dime brings literature, twenty experiments. Eastern Latex Labs., Box 53, Canton, Mass.

HANDBOOK For chemical experimenters, hundreds of experiments, illustrated, 50c. Experiment booklet, 15c. Chemical catalogue, 10c. Reading Scientific Co., Reading, Penna.

FREE Chemistry catalog. Supplies at 5c! Equip complete laboratory. Send 3c for postage. Kemkit Scientific Corp., 397P Bridge St., Brooklyn, N. Y.

AGENTS WANTED

STARTLING Invention—Pocket adding machine. Nationally advertised \$2.50. Whirlwind seller. Big profits. Calculator Mfg. Co., Box 1118, Chicago.

RELIABLE Manufacturer offers opportunity to earn up to \$5.00 a day besides liberal monthly cash bonuses. Show complete line tailored shirts, neckwear, trousers, hosiery, underwear, belts, other apparel. Experience unnecessary. Full or part time. Handsome outfit free. Write today. Packard Corporation, Dept. S-392, Terre Haute, Indiana.

AGENTS! Crew managers! 62c profit on sensational 99c flavoring deals! 23 flavors! Experience unnecessary! Sample 25c. Glenwood Products, McLean, Virginia.

450% PROFIT Quick-Action automatic gas lighter. No flint. 25c seller to every home, office and restaurant. Free sample. New Method Co., Box PMG-64, Bradford, Penna.

BUSINESS Proposition: Resilvering mirrors, autosparts, reflectors, making chipped glass signs. Write, Sprinkle, Plater, 128 Marion, Indiana.

IF Interested in chipped glass name plates, numbers, checkerboards, mirrors, signs, get my fortieth anniversary money-making offer. Illustrated literature free. E. Palmer, 512, Wooster, Ohio.

100% PROFIT. Solid perfumes, exquisite odors. Supplement your present line. Sample 25c. H. E. Kellar Company, Albert Lea, Minn.

100% PROFIT In new perfected (1938) quick-action self-starting cigar lighter. No flint or friction. No wind can blow it out. Retail 25c. Costs you \$1.75 dozen. Sample and can fluid 25c. New Method Co., Box PM-64, Bradford, Penna.

AGENTS Make bigger profits on food products, bargain deals. Low wholesale prices. Big display case sent on trial. Ho-Ro-Co, 2803-R Dodier, St. Louis, Mo.

AT Home, your own manufacturing business, making popular \$1 novelties. Cost you 3c to 15c. Everything supplied. Write So-Lo Works, Dept. D-842, Cincinnati, Ohio.

UP To \$6.00 an hour. Amazing Karnu refinishes autos like new without rubbing, polishing, waxing or painting. Inexpensive—costs little. Wipes on with cloth. Lasts 8 to 12 months. Free sample. Karnu, Dept. D-8, Cincinnati, Ohio.

MARVELOUS Han-Dee-Cloths quickly polish all metals. Rapid 25c seller. Gratifying profits. Ruskin Company, 1907 Rosemont, Cleveland.

AGENTS, Canvassers. New bluing device. Sample 10c. Blue Boy Co., Chicopee Falls, Mass.

WANTED—District purchasing agents. No experience or money required. Write Purchasing Manager, 174 N. Halsted, Chicago.

GIVEN—Packard Lektro shaver. Make \$10 quick. Free sample card. Details. Golden Rule Co., Box 285, Altoona, Penna.

500% PROFIT Selling new 20-in-1 kitchen utensil. Retail 25c. Costs you \$1 a dozen or \$6 a gross. Sample 10c. New Method Co., PMM-64, Bradford, Penna.

NEW Kind of heat boils water instantly. Make to \$30 daily. Pocket size minute demonstration. No installation. Free offer. No investment. Write the Lux Co., Dept. B-204, Elkhart, Indiana.

MYSTEX Cuts down stocking runs. Big profits. Postal brings complete information. Becker, 22-P Hale Avenue, Brooklyn, N. Y.

NEWEST Sensational souvenir. Agents sample 25c. Hobby Shop, Gaylord, Mich.

MEN—Women earn big money selling all kinds of insurance. Full or spare time. We train you and help you get started. Write Vocational Guidance Institute, Boonton, New Jersey.

MAGIC Electric brush retails \$1.50—your profit 75c. Uses static electricity. No wires, batteries or expense. Carry in your pocket, unbreakable. Send for sample and particulars. Donald Brush Co., Advertising Dept., Camden, N. J.

SELL Midget religious mottoes. Fast sellers. Novelty Signs, Stryker, Ohio.

200% PROFIT. Noknot clothes line reel sells on sight at 25c. Carl Clouser, 11 Glynn Terrace, Quincy, Mass.

MONOGRAMMING Automobiles biggest money maker today. New type requiring no varnish to apply. Write for samples, International Monogram & Transfer Co., Box 9360, Philadelphia, Penna.

EXCLUSIVE Representatives appointed. Faucet water softener. Revolutionary. Luxosoft, Sausalito, California.

AERIAL Eliminator—Tiny instrument equals 75 foot outside aerial. 10 days free trial. Tone, volume, sensitivity, reception improved or money back. Makes radio complete—move anywhere. Send \$1.00 or C.O.D. plus postage. Agents write V&R Electro, Detroit Lakes, Minnesota.

MONEY In butterflies, moths. See Sinclair Display Advertisement on page 14A.

COMBINATION Tool pencilknife—Sharpens pencils, cuts string, opens envelopes, pipe cleaner, nailpick, etc. Sample, and novelty catalog, 10c. P. Artform Co., 1710 Undercliff Avenue, New York.

500% PROFIT. Stores, homes, patented curtain tieback holder. Beautiful sample 6c. Weldon Mfr., Maryland Heights, Mo.

500% PROFIT! Gold reflecting letters for store windows. Large sizes 1c. Free samples. Modernistic Sign, B-3004 Lincoln Ave., Chicago.

PRIVATE Brand cosmetics and toilet preparations. We print your name on the labels. 200% to 400% profit. Send for complete details and prices. National Scientific Laboratories, 1910W Broad, Richmond, Va.

INVEST \$1.00—Make \$25.00! You can do it, with our new, amazing easy sales plan. Selling done without high pressure or long drawn out sales talk. Prospects everywhere. Send for free, full information that shows how. Or remit dollar for sample, complete sales plan. Blue Bonnet Chemical Co., Gainesville, Texas.

NEON-LIKE Signs. 8"x14" cost 3c—retails 25c. Over 1000 designs. Catalog and sample free. Lowy, Department 805, 8 West Broadway, New York.

GET Into the grocery business. No money risk. Operate from home and clear up to \$45 first week. Not a store. Plan mailed free. Albert Mills, 6222 Monmouth, Cincinnati, Ohio.

PROFIT With new products. Make, sell, repeat. Analysis. Research. Guaranteed formulas. Biggest catalog free. Special prices, leads. Gibson Laboratory, Chemists, BD-1142 Sunnyside, Chicago.

PERMANENT. Exclusive county agents. Special household products for every home. Free goods campaigns get the customers—quality keeps them. Credit arranged. Rayburn Chemical Specialties, 5946 Eggleston, Chicago.

BIG Money spectacles, hog, poultry remedies. Snoddys Co., St. Louis, Mo.

RAZOR Blades. Agents wanted. Big profit. Louis Eugene, 277 Broadway, New York.

SELL Made to measure raincoats. Outfit free. Goodyear Rainwear, 106 E. 19th, New York.

MAKE Big money! Give away nationally advertised \$15.00 Packard Lektro shavers. Dime brings outfit. Liberty, Box 235, Effingham, Ill.

KNOCK Them cold deal 100% profit. Send 10 cents postage for sample outfit. Southern Supply, 1017 Seventh, Washington, D. C.

ATLAS Window sign letters. Large sizes, penny each. Beautiful free samples. Atlas, 7941 Halsted, Chicago.

MEXICAN Curios, tremendous money-makers. Samples 10c. Marquez-P, Apartado 1176, Mexico City.

BIG Money applying initials on automobiles. Easiest thing today. Free samples. Also, sideline salesmen for name plates and tire cover transfers. "Ralco," 1305 Washington, Boston, Mass.

300% PROFIT Selling bankrupt bargain merchandise. Southerners, 164-M Henry, New York.

BIG Money taking orders; shirts, ties, hosiery, underwear, raincoats, pants, uniforms, etc. Sales equipment free! Experience unnecessary. Write Nimrod, Dept. 8, 4922-28 Lincoln, Chicago.

FREE Sample—Fast selling necessity. Kleen-Brite, Southside, Oil City, Penna.

500% PROFIT! Gold and colored sign letters for windows, offices, trucks, signs. Auto monograms. Easily applied by agent or customer. Neonite, Akron, Ohio.

AGENTS: Smash go prices! Santos coffee 12c lb. 4 oz. vanilla 8½c. Razor blades 10 for 8½c. 100 sticks chewing gum 12c. 150 other bargains. Premiums. Experience unnecessary. Carnation Co., PO, St. Louis, Mo.

GUARANTEED Gold leaf letters for store and office windows. 500% profit. Free samples. Metallic Co., 438-B N. Clark, Chicago.

BIG Money applying initials on automobiles; \$1.45 profit on each sale. Write for particulars and free samples. American Monogram Co., Dept. 40, Dunellen, N. J.

MAN In each town to plate auto parts, reflectors, bicycles, fixtures, mirrors, by late method. Simple plan of manufacturing at home starts you in good paying business. Free particulars and proofs. Gunmetal Co., Ave. H, Decatur, Ill.

SELL Novelty fun cards, novelties, etc. Samples 10c. National, Box 500M, Cincinnati.

BIG. Steady weekly profits for men and women with cut price food route. More than 300 fast selling household and farm necessities. Sensational premium deals get quick cash and build profitable routes quickly. Write Bleecker, 259 E. 4th St., St. Paul, Minn.

AGENTS—To mail our literature. Good profits. Home business. Maywood, 149 Fifth Ave., New York.

SUCCEED With your products. Make-sell them. Formulas. Processes. Accurate analyses. Catalog free. B. Thaxly Co., Washington, D. C.

AGENTS—Opportunity to make money; book containing 107 successful business plans; home or office; send for free introductory booklet. Elite Co., 214 Grand St., New York.

FREE Sample—Amazing cleaner; sells homes, taverns, everywhere. Big profit—fast repeater. Betco, 5007 Irving Park, Chicago.

DO You want agents for your proposition? Your ad in this space will place your message before hundreds of men seeking fast-selling products. My folder "How to Secure Agents," is filled with proof. I'll gladly send you a copy free. P. W. Johnson, Manager Classified Advertising, Popular Mechanics Magazine, 200 E. Ontario St., Chicago.

AGENTS: Stamping names on pocket-key protectors. Sample check with your name, address, 25c. Stamping outfits. Emblem checks, check-fobs, name plates. Hart Mfg. Co., 303 Degraw St., Brooklyn, N. Y.

MANUFACTURE Specialties, hire agents yourself. Big money. Free literature. Gilbert Supply, 1107-P Broadway, New York.

ENGRAVED Name plates, numbers, signs, etc., easily sold, profits large. Brett Bros., Winthrop, Mass.

HIGH-GRADE SALESMEN

CALENDAR Salesmen wanted—For liberal commissions and something new get our 1938 proposition. We introduce this year an unusual idea in commercial calendars—different, artistic and a good will builder for every business. Plus our famous embossed line for funeral directors. State experience, age and territory desired. Write Budget Press, Salem, Ohio.

SALESMEN: Sell business stationery, book matches, social security books, advertising pencils, shelf moulding, labels, salesbooks, pricing sets, tags, office supplies. Business cards \$1.50 thousand. 35% comm. daily. Free deals. Sales portfolio free. Willens, 2130 Gladys, Dept. XS, Chicago.

SALESMEN Sell suits on our easy credit plan. Free suits and pants given as bonus besides large cash profits, premiums and gifts. Sell only (5) suits to get a free suit. No limit to number of free garments you may earn. Wholesale prices \$16.95 and up. Sample line free. No experience needed to make easy sales. All garments individually cut and tailored to measure. Satisfaction or money back guarantee. Three Star Clothes, Inc., 330 South Franklin St., Dept. BA-2, Chicago, Ill.

DID You make \$50 last week? Does your job offer you real future? If not, why not start a wholesale business of your own? Little or no capital needed. Handle line 200 nationally advertised 5c-10c products. Show merchants new plan for increasing sales and profits. Handle everything from your home at start. Chance to operate one of our Silver Fleet service trucks. Facts free. World's Products Co., Dept. 4810, Spencer, Ind.

DON'T Be a job hunter—Start your own business on our capital. No hard times; no lay-offs; always your own boss. Hundreds average \$3,000 to \$5,000 annual sales year after year. Sales way up this year. We supply stocks, equipment on credit. 200 home necessities. Selling experience unnecessary. Wonderful opportunity to own pleasant, dignified, profitable business backed by world-wide industry. Write Rawleigh's, Dept. D-U-PPM, Freeport, Ill.

BEEMANS Air Vac. Cleans automobile upholstery. Sells to garages and service stations. Operates from standard air hose. Price \$7.95. Guaranteed superior in performance to any \$75.00 vacuum cleaner. Beeman Co., 46 South Broadway, Denver, Colo.

SALES Resistance? Earn dollars—not dimes. Stamp appreciated. Anderson, 4341 No. Meade, Chicago.

20,000 MILES From weak, discarded tires with Tire Armor—A selling sensation! We deliver. Liberal commission. Motor Products, 1760 Lunt, Chicago.

A SURE Cure for clogged drains. This tool sells on sight. Get a city and become independent. Silent Valve Co., 3420 Fletcher Drive, Eagle Rock, Calif.

UP To \$95.00 weekly. Also open to side line men. \$500,000 punch board firm announces new items. No investment. Complete sales kit free. K&S Sales Co., 6227 Broadway, Dept. C124, Chicago.

SALESMEN: Sell advertising novelties, calendars, fans, thermometers, etc., for nationally known firm. Liberal commissions. Stanwood Hillson Corp., 21 Station St., Brookline, Mass.

WANTED. County distributors. Excellent opportunity for earnings. Nationally advertised product. Large company. Dept. 257, Fyr-Fyter Company, Dayton, Ohio.

BIG Money taking orders; shirts, ties, hosiery, underwear, raincoats, pants, uniforms, etc. Sales equipment free! Experience unnecessary. Write Nimrod, Dept. 65, 4922-28 Lincoln, Chicago.

NEW Liquid shaving cream. Salesmen, dime brings sample. Benton and Bonds, Nocona, Texas.

NEW Reflecting skeleton face, thrills motorists. Red-hot counter card seller. First sales guaranteed. Superior Specialties, Springfield, Illinois.

SELL Reprograph duplicators and supplies. Good profits. Stowe, Bartlesville, Oklahoma.

SALESMEN. Amazing magnetic brush. Pocket size. Creates static electric suction. Excels vacuum cleaner. Newway Brush Company, Hartford, Conn.

IMMEDIATE Opening selling advertising matches to taverns, cafes, beauty shops, etc. Cash commission, bonus. Outfit free. Gem Match, 74 West Washington, Dept. 54, Chicago.

EXECUTIVE Past forty interview church societies. Ramo, Brighton, Rochester, N. Y.

WANTED. Monumental salesman everywhere. Marble-Granite Company, A-17, Oneco, Fla.

BRUSH Salesman—If you ever sold brushes write for our money making proposition. Donald Brush Co., Camden, N. J.

SENSATIONAL Money maker! Sell celluloid calendar business cards to banks, insurance companies, factories. Free samples. P. Pricing Card Co., 124 White St., New York.

BLADES. Factory prices. Free delivery. Ace Blades, Dept. 5-B, Rochester, N. Y.

COPYRIGHTED! Something new. Sweeping country. 2 3/4 x 4 1/2 vest pocket "Skillwin," three-in-one item. Game, souvenir, advertisement. Assemble in spare time. Parts 6c. Assembled 9c. Sell wholesale 15c. Retail 25c. Send 25c coin for sample and territory. Skillwin Co., South Bend, Ind.

NEW. Improved liquid breath purifier. Rid, guaranteed harmless, sells and repeats to drug stores, taverns, restaurants, hotels, etc.; beautiful 4-color display creates tremendous demand; merchants everywhere are ordering and reordering Rid; 40% more profit; be first in your territory; free particulars. All American Industries, Dept. 13, 1226 Metropolitan Bldg., Chicago.

ADVERTISING Book match factory offers you amazing opportunity. We are largest in world selling direct. Big cash commissions. Full-part time. Big repeats. Samples and kit free. Match Corp. of America, Dept. E-4, 6041 Grand, Chicago.

NEW Patented toy. Adults love it too. Possibilities equal Yo-Yo. Sells on sight. Send 25 cents for sample. Bernett Products, Commercial Bank Bldg., Kansas City, Kans.

WAGON Jobbers—Distributors! Supply service stations Husco Special Tube Patching Kits! Excellent sideline! Quality, flash, price makes sales easy, repeats quick, profits great! General conditions booming demand! Husco-PM, Atlanta, Georgia.

ATLAS Window sign letters. Large sizes. Penny each. Beautiful free samples. Atlas, 7941 Halsted, Chicago.

TEXTILE Salesmen succeed selling dry-goods, hosiery, household supplies for entire family. Samples furnished. Fitz-Charles Company, Trenton, N. J.

TIRE Accessories. Guaranteed 10,000 mile Tiger Grip Tire Patch, and complete fast-selling line auto accessories. Salesmen-distributors easily make up to \$75 weekly, and over. Protected territory. Economy Rubber Products Co., 850 Burkhardt, Dayton, Ohio.

OUR New 1938 complete line of brushes now ready. Largest commissions. Write for sales plan. Wire Grip Sanitary Brush Company, 2300 5th Ave., New York.

SALESMEN To sell hardware stores and garages. Powerful new fast-selling specialty. Liberal commissions. Repeats. Coronado, St. Paul, Minn.

NEW Specialty—Sells every business and professional man. Four \$15 sales daily pay \$280 weekly. Farrell cleared over \$1,000.00 monthly. Write, F. E. Armstrong, President, Dept. PM, Mobile, Ala.

GREATER Commissions. Increase your income selling \$10,000 accident and health policy; \$25-\$50 weekly benefits. \$10.00 yearly. Other amounts proportionate. Guaranteed renewal income. \$1,045.318.19 securities deposited. Universal Policy, Dept. O, 11 Commerce St., Newark, N. J.

GUARANTEED Gold leaf letters for store windows. Free samples. Liberal offer to car owners. Metallic Co., 438-A N. Clark, Chicago.

MAKE More money with Red Comet Automatic Fire Extinguishers. Low price. Proved seven years. Splendid sales outfit free. Some good territory open. Exclusive. Write quick. 704 Red Comet Bldg., Littleton, Colo.

FREE Booklet describes 107 plans for making \$20-\$100 weekly, in home or office, business of your own. Elite Co., 214 Grand St., New York.

SPARKLING Glo-Brite signs sell fast to stores, restaurants, taverns. Lasting gold finish. Plenty profit. J. A. Baxter, Cambridge, Ohio.

HELP WANTED

CASH In on new line made-to-measure low priced pants \$3.75 up. Every pair made individual measure. Newest spring and summer shades and patterns. Advanced commissions plus cash bonuses. No investment. Complete sample outfit of swatches free. Hutchins Tailoring, Dept. D-206, Cincinnati, Ohio.

WANTED—Men to represent large shoe company. Good pay every day. No experience needed. Complete sales outfit sent free. Write Consolidated Shoe System, Dept. S30, Chippewa Falls, Wisconsin.

MEN—Women. Wear fine hose I send without cost with outfit while taking orders for amazing new hosiery. Replacement guaranteed against holes, snags, and runs. Rush name and hose size. Wilknit, Desk 37-D, Greenfield, Ohio.

DISTRICT Service managers. No selling. Permanent, profitable. Stamp. "Scientifico," 119 South Maple, Sturgis, Mich.

OPENING New local coffee agencies. Need men immediately to supply regular consumers. Start with earnings up to \$45.00 in a week. Must write quick. Albert Mills, 6216 Monmouth, Cincinnati, Ohio.

STEADY Work, good pay. Reliable man wanted to call on farmers. No experience or capital required. Pleasant work. Home every night. Make up to \$12 a day. Wonderful new proposition. Particulars free. Write McNess Co., Dept. 137, Freeport, Ill.

CIVIL Service. Home study. Federal, state, city. \$1.00. Popular Mechanics, 200 E. Ontario St., Chicago.

EDUCATIONAL AND INSTRUCTION

LEARN Fascinating profitable profession of Swedish massage in great resident school in Chicago. Short course. Write for free illustrations of massage technique. Low tuition. The College of Swedish Massage, 1601 Warren Blvd., Dept. C2, Chicago, Illinois.

FREE And rental non-theatrical motion picture directory. 3000 subjects 16mm and 35mm fully described. Rates, terms of U. S. distributors. Subscriber writes, "The best non-theatrical directory I have ever seen." Subscription \$2.00 year. Free literature. Motion Pictures of the World, 40 Mt. Vernon St., Boston, Mass.

JOURNALISM Course, bargain. Also other courses. John Hahn, Cullom, Illinois.

INSIDE Legal information. It pays to know the answers. Price 25 cents. Dept. B, 234 Hurst Bldg., Buffalo, N. Y.

BECOME An investigator. Remarkable "Test Question, Problem and Lesson Correction Method." Modern, practical, thorough. Profusely illustrated. Particulars free. International Secret Service Institute, PM 48, Hoboken, N. J.

MEN—Women. Get 1938 government jobs. \$105-\$175 month. Dependable. Prepare immediately for next examinations. Full particulars, list positions, free. Write today. Franklin Institute, Dept. P3, Rochester, N. Y.

SUCCEED! Helpful booklet free! Johnston, 257-P North Washington, Tiffin, Ohio.

SUMMER Hotel positions. Beginners instructed. Lee Institute, 88 Tremont Street, Boston.

AUCTIONEERS Big guide \$1.00. 4,200 graduates. American Auction College, Beverly Hills, California.

CIVIL Service arithmetic made easy. 300 problems explained, \$1.00. Hanley's School, Holyoke, Mass.

SECRET Investigations. Experience unnecessary. Detective particulars free. George Wagner, M-2640 Broadway, New York.

"SHORTHAND Simplified" complete \$1.00. Folder-lesson dime. Simmons, Rocky Hill, Conn.

LEARN Motion picture theatre management, advertising, projection. Free catalog. Theatre Institute, 325 Washington, Elmira, N. Y.

SHORTHAND With both hands. Shorthand for everybody. Longhand shorthand for typewriter or pencil. Miraculously simple. Also Rite-it-Rite, the perfect shorthand—shorthand. Each system complete course fifty cents. McDevitt's, 2079 Sutter, San Francisco.

BE A radio announcer, actor, singer, writer. Learn at home. Free information. Radio Arts Academy, 3823 Wilshire, Hollywood, Calif.

PRACTICAL Arithmetic, algebra, geometry, for shop and office. Simplified short cuts. Complete course \$1.00. Slide rule free. Mathematician, Box 434, Duluth, Minn.

FEATURE Writing simplified. Complete instructions and how to market, \$1.00. C. B. Riddle, P. O. Box 442, Washington, D. C.

MASSAGE, Hydrotherapy, dietetics, drugless therapeutics, chiroprody, taught by mail. Evans Correspondence School, Montgomery, Ala.

MAKE More money. Get a U. S. government job. Get our new plan for obtaining one—no obligations. Age 18-50. Write, Instruction Service, 101, St. Louis, Mo., immediately.

BECOME Business investigator. Earn good fees in pleasant spare-time work. Write! Business Detective System, 1009 Oak, Elmira, N. Y.

GOV'T Jobs start \$1260-\$2100 year. Men-women age 18-50. Former examiner's tested method helps qualify you. Particulars, list jobs free. Write today. Patterson School, 8C Mercantile Bldg., Rochester, N. Y.

DEGREES Earned by home study in arts, sciences, philosophy, education, psychology, theology, law, chemistry, engineering, business, agriculture. McKinley-Roosevelt College, Chicago.

EARN Extra money! Clipping and preparing newspaper articles for publishers. Simple; fascinating; profitable. Send stamp. Division 55A, National Press, 3923 W. Sixth, Los Angeles, Calif.

LEARN Machinist trade, tool, die making. Automatic and hand screw machines. Modern shop methods. Actual work. Jobs open for trained men. Employment help. Illustrated booklet free. Allied Screw Machine Co., 601 Lake St., Chicago.

LEARN Auto mechanics, body, repairing, welding, electricity, refrigeration, Diesel. Stevinson's, 2008A Main, Kansas City, Mo.

EVERYMAN'S Legal Manual. Authoritative advice. \$1.00. Popular Mechanics, 200 E. Ontario St., Chicago.

PLAYS, STORIES, MANUSCRIPTS

POORLY Written stories rewritten for marketing. Welton Tinney, Winnsboro, Texas.

WANTED—Authors' manuscripts. Immediate marketing. Revel, 41 West 45, New York.

SHORT Stories typewritten, marketed. Hursh Service, Box P-1013, Harrisburg, Penna.

POEM Writers, songwriters—Send for free rhyming dictionary—songwriters' guide. Submit best poems, melodies today for bonafide, superior offer. MMM Publishers, Dept. 33C, Portland, Oregon.

CARTOONING, COMMERCIAL ART, SHOWCARD WRITING, SIGN PAINTING

LEARN Cartooning, 48 easy lessons, over 650 illustrations. Complete course, including supplies, \$1. Fordhamco, Knickerbocker Bldg., New York City.

25th ANNUAL Art supply catalog on request. Ask for yours. Bart Supplies, Dept. M, 915 Marquette, Minneapolis, Minn.

SELL Drawings. Read Art Advisor Monthly. Parkville, Missouri. Samples 20c.

SHOWCARD, Poster lettering. A child can learn. Complete instructions \$1.00. P. O. Box 2003, Hollywood, Calif.

CARTOONISTS! Sell your work. Free details. Cartoon Studios, LaCrosse, Wis.

LETTERING Made easy with "A to Z" lettering aids. Samples free. Stein Studios, Flatiron Building, New York.

THE Mur-O-Graph enables one to draw anything without training. Guaranteed. One dollar postpaid. Literature free. Murray Bros., Irving, Texas.

ART Magazine. Helps you sketch human figure, paint, model, carve, cartoon, sell drawings, exhibit, form clubs. Regular 50c value—two for 25c while samples last. Artist, 320 West Doty, Madison, Wis.

ARTISTS Earn big money with our practical plans. Particulars free. Publishers' Xchange, Bedford Bldg., Chicago.

CHALK Talks. Laugh producing program, \$1.00. Catalog 10c. Balda, the Cartoonist, Oshkosh, Wisconsin.

EARN cash income, copying and duplicating simple cartoons for advertisers. 3-M Service, Argyle, Wis.

MAKE Art Pay. Advanced art students. \$1.00. Popular Mechanics, 200 E. Ontario St., Chicago.

ADVERTISING AGENCIES, FOR ADVERTISERS, LETTER WRITERS

LEARN Advertising quickly at home. Easy practical plan. No text books. Common school education sufficient. Interesting booklet and requirements free. Page-Davis School of Advertising, 3601 Michigan Avenue, Dept. 3432, Chicago.

HARD-HITTING. Persuasive sales letters! \$10, 3 for \$25. Julian J. Behr Co., Cincinnati.

BEFORE Advertising get our free Ad-Guide. Important information. Free copy assistance. Mail order specialists 37 years. Chicago Union Agency, 20 West Jackson, Chicago.

COLLECTION Letters written, that bring results. Set of six \$5.00. Walter Fugill, 12 Garrow, Auburn, N. Y.

24 WORDS, 40 Newspapers, \$2.00. Good-all Agency, 742 Market, San Francisco.

GET into advertising—15-60% profit, \$12.50 starts you. Write. Classified, Warm Springs, Ga.

18,000 CIRCULATION "Golden Opportunities," mail order magazine. Classified 3c per word. Inch \$2.00. Vicker's Advertising Service, Chapmansville, W. Va.

INCH Display advertisement 30 magazines year \$24. Wood's Popular Services, Atlantic City, (N. J.)

ADVERTISE: 24 Words in 250 newspapers \$10. Lists free. Advertising Bureau, 4515-C Cottage Grove, Chicago.

FREE—New Advertisers Rate Guide, 44 pages. Includes everything. Lowest rates. E. H. Brown Advertising Agency, 140 S. Dearborn, Chicago.

ADVERTISING Placed anywhere. Helpful, free service. Rate guide book free. Baker Advertising Agency, 189 W. Madison, Chicago. Successors to Ankrum Advertising Agency. Established 27 years.

BUSINESS SERVICE

MAIL Received and forwarded. \$1 monthly. Personal problems answered. Inventors Confidential Service, 2212 Mission, San Francisco.

WASHINGTON, D. C., mail address. For business or personal purposes. Hawkins Mail Service, 817 Fourteenth.

\$2.00 MONTHLY Maintains Boston address. Globe Reference, 11 Pemberton Square.

25c MONTHLY Maintains mailing-forwarding address. 207 East 84, New York.

CHICAGO Mail address \$1 monthly. Your personal, business mail forwarded daily. Established 1919. General, 56 West Washington.

FLORIDA Mailing address. \$3.00 per month. Universal, Box 546, Jacksonville.

MAIL Headquarters—Message Bureau, 214 Masonic Temple Building, Minneapolis, Minn.

\$2.00 MONTHLY Maintains Los Angeles address. Dickey, 628 W. 9th.

RUBBER STAMPS AND OFFICE SUPPLIES

CUSHION Mounted one-two lines 25c; three 35c. 100 letterheads, 100 envelopes \$1.00. Hauer Press, 1314 Ford, Youngstown, Ohio.

ORIGINAL, Cushion mounted. One, two lines 25c; three 35c; four 45c. Facsimile signature \$1.50. Stamp Works, 814 Bradley, Peoria, Illinois.

SUPERIOR, Sharp stamps, supplies. Rock bottom prices! Details. Molders, Watertown, N. Y.

CUSHION Mounted one, two lines, 25c; 3 lines, 35c. Stamp Works, Hastings, Nebraska.

NAME, Address, 2 lines 25c; 3 lines 35c. Stamp Works, Auburn, Nebr.

2 LINES 25c, 3 Lines 35c. Stamp Works, Centerport, N. Y.

TYPEWRITERS, DUPLICATORS, OFFICE DEVICES

STENOGRAPHERS' Carbon paper \$1.00 a box. Typewriter ribbons 50c each. Ribbon Ink Co., Cicero, Ill.

MIMEOGRAPH Inks, \$1.00 quart. Order now! Buden-Kayes Enterprises, East Plymouth, Penna.

NEW \$3.75 Automatic adding machine. Fully guaranteed. Bassett, Box 302D, Altadena, Calif.

TYPEWRITERS, Duplicators, multi-graphs. Write for free list office machine bargains. Save half. Pruitt, 518 Pruitt Bldg., Chicago.

INCREASE Business now. "Excelligraph" Rotary Stencil Printer reprints thousands everything you typewrite, handwrite, draw or trace. Colors. \$19.75 to \$44. Terms. Illustrated literature free to business or professional men. Pittsburgh Typewriter Supply, Department K-2, Pittsburgh, Penna.

PRINTING, MULTIGRAPHING, MIMEOGRAPHING, GUMMED LABELS

PHOTO Engravings at new low prices. Copper halftones \$1.50 minimum. Zincs \$1.00. Night-day. Knickerbocker Photo Engraving Co., 37 E. 12 Street, New York City.

HAMMERMILL Letterheads, 300, 8½x11, any color paper and ink; 6 lines; \$1.48 postpaid. Free particulars. Woodruffs', 217A Lewis, Duluth, Minn.

250 ENVELOPES Or small letterheads, each \$1.00. Printery, Mariemont, Ohio.

125 8½x11 LETTERHEADS And 125 envelopes \$1.00 postpaid. Benneville, 907 West Roosevelt, Philadelphia.

FINEST Quality letterheads, 1000, \$3.75; 500, \$1.95; 250, \$1.20. Precision Press, Vanport, Penna.

5000 BOND 6¾ Opakway envelopes, samples, prepaid \$8.90. Printery, Mariemont, Ohio.

PHOTO Engravings—Zinc line cuts made, 10 square inches, \$1 up; halftones; electros; artist; speedy; free price list. Riteway Engraving, 1457P Broadway, New York.

UNION Printing, 500 bond envelopes or large letterheads \$1.95, prepaid. Printery, Mariemont, Ohio.

ENGRAVURE Printing, lowest possible prices. Samples free. Sunco, Mohawk, N. Y.

ZINC Cuts, halftones, to 8 square inches, \$1.00 net. Printwell, Wyoming, Penna.

100 ENVELOPES And small letterheads \$1.00 prepaid. Printery, Mariemont, Ohio.

CARDS 500—69c; 1000—\$1.00. Canary's Press, East Moline, Illinois.

ADVERTISING Book matches. Lowest prices. (Salesmen wanted.) Sanderson's, Ottawa, Illinois.

WHOOPIE! Knockout "Comic Kards." Surprise! Packet, 10c. VanDorn's, Ottawa, Illinois.

COUPON Books—Ice, gasoline, merchandise. CVDS, 1130 LaSalle, Ottawa, Illinois.

SEND Dollar bill for 1000 business cards. Woodprint, Woodstock, Virginia.

1000 6x9 CIRCULARS, Letterheads, envelopes, postcards, \$2.95; 5000, \$9.45. All printing reasonable. Samples. Cuts. Goodprint, Harrisonburg, Va.

LETTERHEADS, Envelopes, ruled statements padded, circulars, \$2.75 thousand; 20-lb. bond. Anything quoted. Ireland Printing Co., Berkely Heights, Route 7, Dayton, Ohio.

MIMEOGRAPHING, Neat work, reasonable prices, samples. Thornber, Box 342, San Diego, California.

HAMMERMILL Bond—500 8½x11 letterheads with envelopes \$3.50. Service letterheads 1000, \$2.95; 5000, \$8.85. Samples. Croydon Press, 108 Fourth Avenue, New York.

DOLLARS For you. Print your own circulars, etc., by the hundreds at scarcely no expense. Machinery unnecessary. Send 25c for complete instructions. Address A. B. Kayes Co., 13 State St., Schenectady, N. Y.

HARVEY Labels—Sensational values—samples free. 6618T Quimby, Cleveland, Ohio.

500 LETTERS Reproduced exactly as if typewritten, \$1.70 (20 lines). Multigraphers, Box 8275, Ashland, Virginia.

500 LARGE Copies of photograph, drawing (with typed description) testimonial letters, etc., white bond 8½x11", \$4.85. 1000 copies \$8.00. Samples. Alderman Company, 669 McClurg Court, Chicago.

PLAIN Envelopes or letterheads 500, 95c; 250, 55c; 100, 30c. Feld, Elmwood Place, Ohio.

NEARGRAVURE Processes! Distinctively different. Samples. Solidays, Letterhead Specialists, Knox, Indiana.

250 5½x8½ LETTERHEADS, 150 Envelopes \$1.00. Abbott Press, Oswego, Kansas.

LOWEST Prices! Best printing—all kinds. Samples free. Rapido Service, Edwardsville, Illinois.

STATEMENTS, 6¾" Envelopes, \$2.45 per 1000. Business cards, 1000, \$1.75. Universal Supply, Orange, Mass.

LABELS: All kinds. Write, samples. JBSCO, Box 93, Holyoke, Mass.

BUSINESS Cards postpaid \$1.00 thousand. McBride Printery, 912 Towne Ave., Los Angeles, Calif.

EXTRA—1000 Letterheads, envelopes, 6x9 circulars, postcards, statements, \$2.25; 5000, \$8.00 postpaid. Guaranteed. Sudden service. Reasonable in all printing. Try and be convinced. Established 1899, Hustler, Advance, Indiana.

LETTERHEADS, Envelopes, cards, blotters, circulars, statements, etc. 1938 price-list free. McCall Printing Company, 1326 So. 27th, Omaha, Nebr.

BETTER Grade printing, reasonable priced. Free samples. Economic Press, Leonia, N. J.

500 ¾x2¼ FOUR Line gummed stickers, 25c. Moritz Printery, Saginaw, Mich.

PRINTING OUTFITS AND SUPPLIES

PRESSES \$5.00. Type 30c. Bargain catalog. Stamp please. Bradshaw, 3214-P Huron, Chicago.

PRINT Your own cards, stationery, circulars, advertising. Save money. Easy rules furnished. Print for others, big profits. Junior outfit \$9.00; job presses \$11 up. Details free. Kelsey Co., D-11, Meriden, Conn.

HAND Presses, type, supplies. Catalogue for stamp. Printers Sales, 114 S. Howard St., Baltimore, Maryland.

STOCK Cuts 40c up. Catalog 10c. Gregor's, 79-N Main Street, Belleville, N. J.

HAND Press, type and complete printers' supplies. Advise equipment you need and we quote prices; or send stamp for catalog. P. Peiffer, 7-C; 6 Columbia St., Newark, N. J.

6x9" OUTFIT Complete \$2.00. Lininger Co., 1157-H E113th, Cleveland, Ohio.

BUILD 9x15 Printing press. Details free. Huebl Coaches, LeSueur, Minnesota.

HAND Presses, type, supplies. Big lists 3c. Landis, Richland, Penna.

BARGAINS, Presses, type. List 3c. Exchange D-15, 22 Orient, Meriden, Conn.

BARGAINS — Presses, type, supplies. Send stamp. 159 Harvard, Cambridge, Mass.

PATENT ATTORNEYS

PATENTS—Before too heavy an outlay of time or money is made on an invention, a search of the Patent Office records should be made to determine as nearly as possible whether or not the same idea has been patented before. The cost of this search is small, while the value of the facts it uncovers is often considerable. We offer inventors and manufacturers a thorough prompt, confidential search service—plus experienced counsel and assistance in every phase of Patent and Trade-Mark practice. Write for our new free book containing valuable information relating to patent procedure. Clarence A. O'Brien and Hyman Berman, Registered Patent Attorneys, 58-A Adams Bldg., Washington, D. C.

SELL Your unpatented ideas. I tell you how; help you make the sale. Particulars free. Write Wilson Holmes, 907 Barrister Bldg., Washington, D. C.

INVENTORS: Send immediately for your copies of our new free books, "Patent Protection" and "Suggestions on Selling an Invention." Sixty-eight pages of interesting facts. They tell how patent laws protect you; kind of sketch or model needed; simple steps to take without cost; how successful inventors have secured financial assistance; show interesting inventions; illustrate important mechanical movements. With books we also send free Evidence of Invention form to help establish date of disclosure. Prompt service, reasonable fees, special deferred payment plan. Strictest secrecy. Thirty-nine years experience. Highest references. Write us today. The facts in our books, are worth money to the man with a good invention. Address: Victor J. Evans & Co., Registered Patent Attorneys, 12-D Victor Building, Washington, D. C.

PATENTS—Personal, confidential services for protection of your invention at reasonable cost. Preliminary information and approximate cost of patent furnished without obligation. John B. Thomas & Co., 902 F St., N. W., Washington, D. C.

INVENTIONS Patented, sold; free advice. Patent applications prepared \$60—trade-marks \$40; payments accepted. Schneebaum, 17 Park Row, New York.

DON'T Tell anybody the secret of your invention! Take steps to protect it before it's too late! Get our free "Certification of Invention" and two free books. They answer hundreds of patent questions and explain our deferred payment plan. Strictly confidential service. U. S. registered patent attorneys. Over 62 years' experience serving inventors all over the world. Write for free books today! C. A. Snow & Co., Inquiries Division, Snow Building, Washington, D. C.

DIETERICH & Rutley, Registered Patent Lawyers, 512 Colorado Bldg., Washington, D. C.

PATENTS—Any country. Reasonable rates. Free information. Ramsay Company, 273 Bank St., Ottawa, Canada.

WE Successfully sell inventions, patented and unpatented. Write for proof, and tell us what you have for sale. Chartered Institute of American Inventors, Dept. 4-C, Washington, D. C.

"**INVENTOR'S** Guide." 100 mechanical movements, free; advises on patenting, selling inventions. Frank Ledermann, Tribune Bldg., New York.

PATENTS. Instructions "How to Establish Your Rights" and form, "Evidence of Conception"—sent free! Lancaster, Allwine & Rommel, 411 Bowen Bldg., Washington, D. C.

PATENTS. Booklet free. Highest references. Best results. Promptness assured. Watson E. Coleman, Patent Lawyer, 724 Ninth St., Washington, D. C.

L. F. RANDOLPH, 302-B Victor Bldg., Washington, D. C. Low cost. Book and information free.

INVENTORS—Send for free booklet "Patent-Sense." Information based on 64 years experience. Lacey & Lacey, Dept. 5A, 635 F St., Washington, D. C.

PATENTS—Trade marks. Preliminary advice, book and disclosure form free. Personal service. Irving L. McCathran, 1060 International Bldg., Washington, D. C. Registered Patent Attorney.

PATENTS. Protect your idea by securing free "Proof of Invention" folder. Exceptional personal service. Established 1906. E. E. Vrooman, 871 Woodard Bldg., Washington, D. C.

FOR INVENTORS

INVENTORS: Send immediately for your copies of our new free books, "Patent Protection" and "Suggestions on Selling an Invention." Sixty-eight pages of interesting facts. They tell how patent laws protect you; kind of sketch or model needed; simple steps to take without cost; how successful inventors have secured financial assistance; show interesting inventions; illustrate important mechanical movements. With books we also send free Evidence of Invention form to help establish date of disclosure. Prompt service, reasonable fees, special deferred payment plan. Strictest secrecy. Thirty-nine years experience. Highest references. Write us today. The facts in our books are worth money to the man with a good invention. Address: Victor J. Evans & Co., Registered Patent Attorneys, 13-D Victor Building, Washington, D. C.

PATENTS—Before too heavy an outlay of time or money is made on an invention, a search of the Patent Office records should be made to determine as nearly as possible whether or not the same idea has been patented before. The cost of this search is small, while the value of the facts it uncovers is often considerable. We offer inventors and manufacturers a thorough prompt, confidential search service—plus experienced counsel and assistance in every phase of Patent and Trade-Mark practice. Write for our new free book containing valuable information relating to patent procedure. Clarence A. O'Brien and Hyman Berman, Registered Patent Attorneys, 58-A Adams Bldg., Washington, D. C.

UNPATENTED Ideas can be sold. I tell you how and help you make the sale. Particulars with list of manufacturers and wanted inventions, sent free on request. Write Wilson Holmes, 907-A Barrister Building, Washington, D. C.

TO Inventors: We are in the market to purchase a good patent, preferably in the automobile accessory line. Will purchase outright or on royalty basis. Purchasing Agent, 241 Front St., New York, N. Y.

BUYERS Located meritorious patented, unpatented inventions. Our free booklet outlines valuable marketing plan. If will sell, reply promptly. Invention Reporter, D-11236 So. Fairfield, Chicago.

WE Make working models, tools, dies for stamping and special machinery. Send 3 cents for catalog of gears and supplies. Pierce Model Works, 28 N. Clinton, Chicago.

INVENTORS—Send for 72-page book on patents. Reasonable terms. Conscientious treatment to inventors. L. F. Randolph, Registered Patent Attorney, 302-E Victor Bldg., Washington, D. C.

INVENTORS: "Making Inventions Pay," our 32-page illustrated book, mailed upon receipt of 3c postage. Crescent Tool Co., Dept. Z, Cincinnati, Ohio.

SELL Your patent through a small classified ad in Popular Mechanics. Many inventors have found buyers in this way. Ask me for proof—I'll gladly send it to you. F. W. Johnson, Manager Classified Advertising, 200 E. Ontario St., Chicago.

I **SELL** Patents. Established in 1900. Charles A. Scott, 773PM Garson Ave., Rochester, N. Y.

INVENTOR'S Universal Educator; contains 900 mechanical movements; 50 perpetual motions; instruction on procuring and selling patents and selecting an attorney, etc. Suggests new ideas. Price \$1 post-paid in U.S.A. Address Albert E. Dietrich, 511-B Colorado Bldg., Washington, D. C.

HAVE You a sound, practical invention for sale, patented or unpatented? If so, write Chartered Institute of American Inventors, Dept. 4-A, Washington, D. C.

INVENTIONS WANTED

SMALL Inventions wanted by manufacturers. I'll help you sell your invention. Write for free circular. Stanley Hull, 7829-K Euclid Ave., Cleveland, Ohio.

WANTED: We have a client interested in manufacture and distribution on royalty of a volume production item to retail \$25.00 or over. Patents must be granted and all engineering completed and ready for the market. Will H. Wade & Co., Investment Bankers, 134 So. LaSalle St., Chicago, Illinois.

PATENTS, Unpatented inventions, commercialized. Plans to suit inventors. Details and booklet free. Write fully. Inventors Service Agency, Box, 15, Penns-grove, N. J.

INVENTIONS Wanted for promotion and commercialization. Write Pacific Inventors Agency, P. O. Box 1792, San Francisco, California.

CASH For unpatented ideas. Stamp for particulars. Mr. Ball, 9441-A Pleasant, Chicago.

SIMPLE, Practical inventions wanted by manufacturers, patented or unpatented. For information write Chartered Institute of American Inventors, Dept. 4-D, Washington, D. C.

PATENTS FOR SALE

ARCH Support, sure cure. Also rat trap catches alive continuously. Outright sale. E. Salo, Box 195, Gardner, Mass.

COLLAPSIBLE Tube dispenser. Dime item. Practical household wire item. Royalty or outright. Burkitt, Box 512, Palestine, Texas.

RAIL Steel tie, a great safety device for railroads. Also patent fountain tooth brush, connects to water faucet, flushing mouth while cleaning teeth. Both very reasonable. Mortka, 58 Hinckley Ave., Stamford, Conn.

MANUFACTURING

RELIABLE National company will manufacture your products complete or will finance, manufacture and market sound useful articles or proven saleable patented products. National Die Casting Company, 612 North Albany, Chicago, Illinois.

ANALYSIS. Research. Newest guaranteed formulas. Biggest catalog free. Special prices, leads. Gibson Laboratory, Chemists, DS-1142 Sunnyside, Chicago.

DIES, Stampings, wire forming, complete manufacturing. Southern Products, Independence, Missouri.

MACHINE Work wanted for precision bench lathes. Automatic screw machine products—short runs. Small stampings, blanking dies. Fisher Model Shop, 1003 Etowah Ave., Royal Oak, Mich.

INVENTIONS Manufactured in any quantity at low cost. Stampings, dies, models, etc. Estimates and free catalog. Crescent Tool Co., Dept. X, Cincinnati, Ohio.

MANUFACTURING. Dies, machinery, models, brasswork, white metal casting moulds. Catalog 3c. Baum's Metal Specialties, Kansas City.

MODELS AND MODEL SUPPLIES

MECHANICAL Models for railroads, shipmodelers, yachtsmen, speed boat, gasoline and steam engine builders. New, really practical magazine. Five issues only \$1 or year \$2. Single 25c. Mechanical Models, 236R W. 55th St., New York. Ask at your hobby store.

RAILROADERS—44 Copiously illustrated pages for model railroads each month. Sample 20c, year \$2.00. Model Railroader, 7603 State, Wauwatosa, Wis.

STREAMLINE Paint striping made easy. Tools \$1.50. Write. Wendell, 2533N Ashland, Chicago.

ENGINE Catalog 20c. Particulars free. Evraymesco, 28 N. Clinton, Chicago.

SHIP And yacht model fittings; construction sets; model yacht sails; illustrated catalog 20 cents. A. J. Fisher, 1002-1 Etowah Avenue, Royal Oak, Mich.

IDEAS Developed into actual mechanisms, confidential service, bank reference. B. B. Korn Specialty Mfg. Co., 7520 Melrose Ave., Los Angeles, Calif.

3/4" SCALE Steam locomotive easily built by "Step" method. Catalog of castings, instructions, boiler fittings, track material, etc. 25c coin (returned first order.) Little Engines, Box B15, Wilmington, Calif.

MODEL Supplies for the inventor. Send 3c stamp for catalog. Pierce Model Works, Tinley Park, Ill.

MODELS—Your ideas developed into practical working models. 30 years' successful experience; thousands of satisfied customers. Confidential service guaranteed. Bank references. Send 3c postage for 32-page book—"Making Inventions Pay." Crescent Tool Co., Dept. Y, Cincinnati, Ohio.

RAILWAY Models. Catalog handbook 25c. Walthers, 247 E. Erie, Milwaukee.

BLUEPRINTS AND PLANS

FIFTY Cents brings you a book containing complete instructions, diagrams and specifications for building fireplaces at less than half cost. Fireside Company, Albany, Oregon.

MAKE, Read blueprints. Particulars free. Dorris Blueprint Co., Moorcroft, Wyoming.

NEW Invention. Nothing like it. Hot, clean, safe, efficient oil burner. Made from pipe fittings. Make yourself. Works like a pressure burner. No motor. For any purpose. Inexpensive to make. Very powerful. Drawings, complete instructions, \$1.00. Kinney Burner Sales, Anoka, Minn.

PURPLE Martin birdhouse blueprints. Twelve \$1. Albert Publishers, Des Plaines, Ill.

HOME CRAFTSMEN

SQUAREKNOTTERS! Make belts, handbags, etc. Quality cord samples with catalog, free. Beginners book, catalog and samples, 10c. Special! Regular \$1 book with 50c beginners outfit, all for \$1. P. C. Herwig Co., Dept. J-4, 121 Sands St., Brooklyn, N. Y.

MORRIS, Lawn chair and bench, several new features giving additional beauty and comfort. Full size patterns, pictures and instructions, all for 50c cash. Make for home or sale, 100% profit at attractive sales price. Thomson Company, Wingdale, New York.

MAKE Your metal workshop pay. Particulars. Hess, 30 N. Belvidere, York, Penna.

MAKE, Sell your own products, amazing profits. 20 lawn ornament patterns, designed by artist at Dayton Art Institute. 25c. Wickman, 738 Brooklyn Ave., Dayton, Ohio.

DECORATIVE Paint striping made easy. Tools \$1.50. Write. Wendell, 2537N Ashland, Chicago.

LATHES—Bench type—Metal turning. Circulars free. Gardner Electrical Supply, Defiance, Ohio.

LEATHERCRAFTSMEN—Write for free instructions and price list of leather, tools, etc. Sample cards 5c. Wilder & Co., Dept. F, 1038 Crosby St., Chicago, Ill.

"**MODERN** Wood Sculpture." Complete instruction book on carving statues \$1.00. Lee Wood Art Studio, Centerville, Iowa.

DESIGN Your own furniture. Our complete course shows you how. Only \$8.50. Invaluable to home craftsmen. Write for descriptive folder. Klok Institute, 430 Lyon, Grand Rapids, Mich.

HEAVY-DUTY Jigsaw, home workshop shaper, drum sander and 458 other practical articles in Vol. 28 Shop Notes only 50c postpaid. Popular Mechanics Press, Room (C38), 200 E. Ontario St., Chicago.

OLD GOLD, WATCHES, JEWELRY, PRECIOUS STONES

WATCH Bargains, used Elgins. Lon Harmon, Sugar Grove, No. Car.

5000 REBUILT Open face Waltham, Elgin watches. New chromium open face cases. Make big money! 12 size, 7 jewel, \$4.75; 16 size, 17 jewel, \$7.50. Send 3c stamp for free watch and diamond catalog. The New York Jobbers, Dept. M, 74 Bowery, New York, N. Y.

ALARM Clocks overhauled 50c coin. Guaranteed. Davis, 3423 DeSota, Cleveland, Ohio.

HIGHEST Prices for old gold, teeth, watches, jewelry. Full cash value mailed day shipment received. Satisfaction guaranteed or articles cheerfully returned. Information free, or ship today. Chicago Gold Smelting Co., 300-P Champlain Bldg., Chicago.

GOLD \$35 Ounce. Ship old gold teeth, crowns, jewelry, watches—receive cash by return mail. Satisfaction guaranteed. Free information. Dr. Weisberg's Gold Refining Co., 1500-Q Hennepin, Minneapolis, Minn.

AUSTRALIA'S Lovely opals. Illustrated catalogue free. Good selection \$5. Norman Seward, Melbourne, Australia.

HOW To identify and determine value of old precious metals. Where to buy. To whom to sell. Reliable and up-to-date information. Complete instructions only \$1 postpaid. Popular Mechanics Press, Room (C38), 200 E. Ontario St., Chicago.

TOBACCO

PREPAID, Long, clean, juicy Red Leaf chewing, mild and sweet, 10 lbs. \$1.30. Mild smoking, 10 lbs. \$1.20. Farmers Tobacco Pool, Martin, Tennessee.

GUARANTEED: Cigarette, pipe or chewing, 5 lbs., \$1.00; ten, \$1.75. Pay when received. Pipe and box cigars free. Rives Tobacco Co., Paducah, Ky.

HIGHER Quality! Golden smoking or rich ripe chewing, four pounds guaranteed and postpaid, \$1.00. Riverside Ranch, 151, Hazel, Kentucky.

FREE Spokes—Name favorite pipe tobacco. Free sample mild natural flavored smokes. Pete Moberly, Box 1042, Owensboro, Kentucky.

RAZOR BLADES—SHARPENING

100 KEENEST Double edge razor blades, 75c. Acme, Clarion, Mich.

100 FINEST Razor blades. Double or single edge 90 cents. Fifty, 55 cents. Postpaid anywhere. Louis Eugene, 277 Broadway, New York.

SURVEYING INSTRUMENTS

GUARANTEED Factory rebuilt transits and levels for rent (with purchase option) or sale (cash or terms). Order now before prices advance. We will repair, trade in, or buy your old instruments. Ship prepaid for estimate and valuation. Write for List M-34 and complete information to Warren-Knight Co., 136 N. 12th St., Philadelphia, Penna.

WANTED—MISCELLANEOUS

CASH For used microscopes, binoculars, cameras, slide rules, drawing sets, surveying, scientific instruments, mechanical and electrical hand tools. Highest prices paid day shipment received. Satisfaction guaranteed or shipment promptly returned. Elman's, 2302 VanBuren, Chicago.

PERSONAL

POEM Writers, songwriters—Send for free Rhythming Dictionary—Songwriters' Guide. Submit best poems, melodies today for bonafide, superior offer. MMM Publishers, Dept. 33D, Portland, Ore.

FEET Hurt? Do away with athletes' foot. \$1.00 bottle prepaid. WSS, Box 434, Berkeley, California.

ATHLETES' Foot remedy, guaranteed. Cured thousands. \$1.00 bottle prepaid. Dr. W. J. Renz, D.S.C., Room 3, Chavanne Bldg., Lake Charles, La.

CHICAGO Real estate owners get the facts. Bernard Wells answers all title, tax, management, market questions. Impartial appraisals for heirs and mortgage holders. Records investigated. Quotation free. 852 George, Chicago.

"**SO-LONG-BUGS!**" Is a sure cure for bed bugs, cockroaches, and other insects. Large sample 25c. Walters, 37 Milburn Ave., Maplewood, N. J.

PERSONALITY, Business necessity. Booklet including correct behavior technique, voice improvement. 15c refund guarantee. Richert, 167 Pine, Jersey City, New Jersey.

REDUCE Your weight. No drugs, diet or apparatus. Particulars free. Read, 3401 Parnell Ave., Chicago.

WIN Prize money: Booklet—"Successful Contesting"—shows how. 10c postpaid. Bulletin listing \$200,000.00 prizes included free! World Publishers, 4515-B Cottage Grove, Chicago.

NERVOUSNESS, Nervous fear! Afflicted? Free, interesting information. Investigate! John Englund, Ontonagon, Mich.

STUTTERING And stammering corrected at home. Descriptive booklet free. Paul J. Wolfe, Box 52, Pittsburgh, Penna.

MISCELLANEOUS

GUARANTEED Genuine granite monuments erected on your cemetery lot at factory price. Winona Monument Co., Winona, Minn.

3 ROOM Apt. furnished at beach. \$18.00 month. Landow, Keansburg, New Jersey.

RATS, Mice. New "Ketch All" trap. 32 caught one night. Send ten cents for complete trap. Modern Mfg. Co., 2341 North Thomas Ave., Minneapolis, Minn.

OPPORTUNITY Extraordinary! Base of 5 perfume oils creates hundreds exquisite fragrances! Complete instruction \$1.00. Hadlee-Anaide, 4756 Arizona Street, San Diego, California.

BUSINESS Proposition resilvering mirrors, autographs, reflectors, making chipped glass signs. Write. Sprinkle, Plater, 288, Marion, Indiana.

SEEKING Information? Any subject. International Research, 952 Magnolia Ave., Los Angeles.

SONGS—Arranged, revised by arranger "Cherry Blossom Lane," "Gypsy Tea-room," others. Send for details. Harrold Potter, 1619(P) Broadway, New York.

MEXICAN Legal matters. American Attorney, Box 1736, El Paso, Texas.

KEY Machines—lowest prices. Christison's, 1019 Fourteenth St., Denver, Colo.

SKETCHES, Full size for signs, trucks, windows, etc., up to 10 square feet \$1.00; perforated \$2.00; with full instructions \$3.00. The Mackraft Shops, Ypsilanti, Michigan.

LIKE Pen and ink sketches? Send 25c for original drawing, guaranteed to please. Holmes, 1714 M St., Bedford, Ind.

BUILDING Material bargains. Buy direct from mill and save! Low prices on everything needed to build, repair or remodel—lumber, roofing, flooring, screens, windows, hardware, barn sash, paint, etc. Free estimates on lumber bills. Guaranteed materials. Big new building material catalog free. Write Gordon Van Tine Company, Dept. B11, Davenport, Iowa.

RUBBER, Vulcanized liquid, any quantity, particulars free. Sample 10c. Service, Box 42-M, Lancaster, Ohio.

67 PENMANSHIP Copies \$1.00. 6 cards and samples 10c. Bert Rich, Wizard of the Pen, Ocala, Florida.

10,000 MONEY-MAKING Formulas. Tells you how to make and sell almost everything under the sun; cosmetics, mucilage, anti-freeze solutions, battery solution, beverages, cheese, chewing gum, cleaning preparations, extracts, hair preparations, inks, bluing, leather polish, mirrors, perfumes, polishes, typewriter ribbons, carbon paper, washing powders, liquid soap, and hundreds of other profitable articles. \$4 postpaid. Popular Mechanics Press, Room (C38), 200 E. Ontario St., Chicago.

PLAYING Cards. Three monogrammed initials on backs. Prepaid 50c, samples. Feld, Reading, Ohio.

MONEY In butterflies, moths. See Sinclair Display Advertisement on page 14A.

\$1,000 BUNDLE Of stage money! 10c. Unicraft, 4932 Eighth, Philadelphia.

RATS Dine then die when they eat Rat Lunches. No poison. Guaranteed. Kills rats and mice only. Ready to use anywhere, anytime. Only 50c at dealers, or order from ad. Dealers wanted. Big profits. Write Rat Lunches Company, Carroll, Iowa.

GOOD Eyesight without glasses. No drugs. Representatives wanted. Arthur Jacobson, Upsala, Minnesota.

GARAGE Door holders or checks, 65c pair; 2 pairs \$1.00. Gasco Products, Box 409, Virginia, Minn.

LIKE To draw? Earn steady income tracing and duplicating advertising cartoons. Ad-Service, Argyle, Wis.

SWAPPER'S Friend, R4, Saline, Mich. Interests swappers, collectors, sportsmen. 50c year, sample 10c.

COMPLETE COURSE DIESEL for less than one day's pay!

Big corporations now making thousands of Diesel engines. Trained men needed for big pay jobs. Get ready quickly! Write at once for details of "Elements of Diesel Engineering"—latest and best self-instruction course. Costs less than a day's pay! Sent to you for Free Examination. No obligation whatever.

FREE DIESEL ENGINE TROUBLE WALL CHART
Explains Diesel operation almost at a glance! Sent free with the course if you act promptly. Write today to
GARGOYLE PRESS Dept. 4E, 70 Fifth Ave. New York City

LETTERING ARTISTS MAKE Big MONEY



BE A SUCCESS—LEARN SHOW CARD PROFESSION "THE ACME STUDIO WAY"—Spend 2 full weeks our Big Chicago Studios—finish training spare time at home. Hundreds taught this way now receive Big Pay. Free Employment service. Positions waiting. Earn while learning. E & Z low terms within reach of all. **MONEY BACK GUARANTEE—NO RISK—PROVED PLAN.** Name, address and present occupation brings **FREE ABILITY TEST AND BOOKLET.**

ACME STUDIOS, Dept. PM-4, 24 W. Hubbard St., Chicago, Ill.

TRAIN FOR PAY RAISE

Just out—Simplified instructions giving technical information for practical men. 20 revealing lessons on secrets of Air Conditioning, Refrigeration, Diesel and other engines. This special spare time home coaching service offered limited number of men in this and related field. By mail only. Write today. Full information free.

THERMOSCHOOL, Box 302, Dept. 2-D, Lexington, Ky.

MASTER CHEMISTRY AT HOME

BIG JOBS IN CHEMISTRY. BIG PAY. Become a Chemical Engineer. Home Study Courses leading to Degrees in Chemistry and Chemical Engineering; also Electrical, Mechanical, Civil, Diesel, Automotive, Aeronautical, Architectural, Drafting, Air Conditioning, Refrigeration, Radio, Highway, Mining, Petroleum, Industrial, Steam Engineering. McKinley-Roosevelt Graduate College, 4242-C Clarendon Ave., Chicago

LAW HIGH-GRADE INSTRUCTION BY CORRESPONDENCE

College, Post, Grad, and Bar Ex. Rev. Courses. Law has attracted more keen, brainy men than any other calling. Send today for catalog. Low cost, easy terms. Text books loaned free.
Chicago School of Law Dept. 801, Reaper Block CHICAGO, ILL.

LOCKSMITHS FREE BOOK

If you are a locksmith, or cut keys, this Book will be invaluable. Write for it on your letterhead or business card. It's FREE.
H. HOFFMAN CO., 6844 N. Western Ave., Chicago

AGENTS! BIG PROFITS! NEW 10-IN-1 GARDEN TOOL!

Wonder Cultivator! 10 labor-saving, money-saving tools in one! Does ALL work easier, quicker, better—spading, hoeing, trimming, raking, plowing, clearing. Sells to homes, farms, parks, cemeteries, golf courses, etc., on sight. Amazingly low priced! Big profits! Send for details—NOW.

WONDER MFG. CO., 325 W. Huron St., Dept. 114, Chicago, Ill.

YOU'LL LIKE RESILVERING MIRRORS, REFINISHING

Plated articles, Autoparts, Reflectors, Tableware. Making Chipped Glass Name Plates, Signs. Experience Unnecessary. Write, **SPRINKLE, Plater, 129, Marion, Indiana**

EASY TO MAKE SPOT WELDER



Capable of welding two pieces of 22 gauge or lighter iron. Operates from car battery which produces over 1000 welds. 35c brings complete plans and valuable catalog listing over 500 electrical items.

LEJAY MFG. CO., 947 LeJay Bldg., Minneapolis, Minn.

MOUNT BIRDS—MAKE MONEY \$1

This COMPLETE course tells and shows all! Simple words and clear pictures explain how to mount birds, animals, fish, tan hides, make novelties. New! **7 GREAT BOOKS** Modern! Was \$15—NOW \$1—Get this AMAZING offer NOW! Absolute satisfaction or money back. Send JUST \$1, that pays ALL.
SCHMIDT SCHOOL OF TAXIDERMY, Dept. J-4, MEMPHIS, TENN.

ATLAS Stick-On Letters WINDOW SIGNS

Beautiful GOLD Colored. New Styles. 5 year Guarantee. Large Sizes—Penny each. Tremendous Demand. Amazing Profits. Write for FREE SAMPLES and Starting Equipment. HURRY!
ATLAS Sign Works, 7943 Halsted, Chicago

MONUMENT \$11.00 Freight Paid or UP Erected.



Genuine Marble, also Granite. Lettered Free. Freight paid. Erected if desired. Thousands satisfied customers. FREE Catalog and samples.
U.S. MARBLE & GRANITE CO. A-18 Oneco, Fla.

Become an expert photographer

for Pleasure or Career!

Did you ever wish that you could make photographs like you see in the popular picture magazines, newspapers, in advertisements and in photo galleries? You can! By means of the famous method of N. Y. I. personalized training you can qualify as an expert in **Commercial, News, Portrait, Advertising, Candid or Motion Picture Photography.** Wonderful money-making opportunities! Fascinating hobby!

Learn at Home or at our New York Headquarters



The New York Institute, with its modern completely equipped studios, is the only school of photography that offers both Personal Attendance and Home Study training. All instruction is given by an experienced staff of noted experts. (You will see their names in our booklet.)

← Send for big free booklet

NEW YORK INSTITUTE OF PHOTOGRAPHY
10 West 33 St. (Dept. 49) New York City

JUST OUT!

AUDEL'S DIESEL ENGINE MANUAL
QUESTIONS AND ANSWERS

If you are interested in the construction, operation and maintenance of modern Diesel engines, you will want this new timely book of practical, useful information.

"AUDEL'S DIESEL ENGINE MANUAL" with Questions and Answers explains in simple, concise language the Fundamental Diesel Principles—Operating Principles—Engine Starting—Air Starting Valves—Fuel Spray Valves—Inlet and Exhaust Valves—Valve Timing—Fuel Pumps—Fuel Injection Compressors—Starting Air Compressors—Scavenging Air Compressors—Pistons and Piston Rings—Cylinders—Lubrication—Cooling Systems—Fuel Oil—The Engine Indicator—Governors—Engine Reversing—Semi-Diesel Engines—High Speed Diesel Engines—Answers on Operation—Horse Power Calculations.

The illustrations and texts are clear and easy to understand. All details are plainly brought out. This book is of extreme value to engineers, operators, students and all who desire a knowledge of the Diesel engine. A handsome book, flexible, with gilt edges. 300 pages—illustrated.

Send for free Diesel folder today.

FREE EXAMINATION COUPON THEO. AUDEL & CO., 49 W. 23rd St., New York City
Please mail a copy of AUDEL'S DIESEL ENGINE MANUAL. If satisfactory, I will remit \$2 on its safe arrival, otherwise I will return the book. **\$2**

Name

Address

Occupation PM

BUSINESS SUCCESS NOT ACCIDENTAL



Those who have business training get ahead. Today's preparation is tomorrow's reward. Thousands of high pay executives trained themselves at home.

For 15 years Standard Business Inst. courses have helped train executives, secretaries—quickly, easily. Let us tell you how.

Learn in your spare time. The BIG moment is now. Fill in coupon and check courses you are interested in.

STANDARD BUSINESS INSTITUTE
130 N. Wells St. • CHICAGO, ILL.

Without obligating myself, I would like to learn about your Business Administration Accounting Course Secretarial Course.

NAME.....
ADDRESS.....
TOWN..... STATE.....
AGE..... OCCUPATION..... PM4

FREE/SAMPLE COPY

Have you seen STRENGTH and HEALTH magazine? Its 48 pages contain many fine articles on health and exercises by world famous authorities. Packed full of photos of the most outstanding physiques of the day! The latest news from the world of strength and body-culture. A sample copy is waiting for you!

WRITE NOW! Enclose a 3-cent stamp to cover postage

STRENGTH & HEALTH Co.

Dept. 8 YORK, PA. U.S.A.



In answering advertisements always write name and full address clearly.

IN 5 MINUTES LEARN TO THROW YOUR VOICE



VENTRILOQUIST MOUTHPIECE AND DUMMY FREE

Be the hit of every party! Amazing easy method shows you in 5 minutes HOW TO THROW YOUR VOICE.

Everything Complete

The Mac Method of Ventriloquism is so easy, anyone can become an expert quickly. No skill or experience needed to throw your voice and fool everyone. Talk, whistle, sing, make funny noises. Full size 30-inch Ventriloquist Dummy and special Ventriloquist Mouth-Piece included at no extra cost. Dummy's head made of double cast material with movable mouth. Easy to operate. Dummy alone worth more than \$1.00.

triloquist Mouth-Piece included at no extra cost. Dummy's head made of double cast material with movable mouth. Easy to operate. Dummy alone worth more than \$1.00.

SEND NO MONEY—WRITE! Order complete "Mac Method of Ventriloquism" today with Full Size Dummy and humorous dialogues. Send no money—just mail name and address. Pay postman only \$1.00 plus few cents postage for everything—complete. Nothing else to buy. Rush order NOW.

MAC METHOD, DEPT. G-2055, CINCINNATI, OHIO

COMPLETE ELECTRIC PLANTS

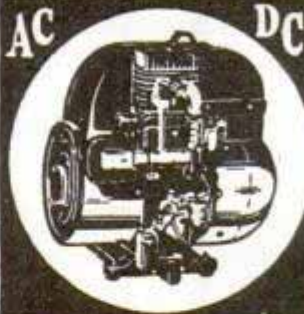

Onan A.C. plants furnish same current as city lines, 110 Volt, 60 Cy. For farms, camps, construction jobs. Operate radios, water systems, all appliances. New models, 350 to 5000 watts, 6, 12, 32 and 110 volt D.C. Models \$57.50 and up Also combination A.C.-D.C. units Shipped complete, ready to run.

Write for details.
D. W. ONAN & SONS
1016 Royalston Ave
Minneapolis Minnesota

BE A CARTOONIST



AT HOME IN YOUR SPARE TIME under personal supervision of the famous cartoonist **NORMAN MARSH** creator of "DAN DUNN" appearing every day in big papers, Success—Fame—Real Money may be Yours when you learn Marsh's easy simple methods and secrets. Send name and address for free details of **MARSH'S Personal course. ACT TODAY!**

MARSH CARTOON SCHOOL
Chicago Daily News Bldg., Dept. I-D, Chicago, Ill.



LOOK! Baby Chicks

THOUSANDS WEEKLY ALL YEAR

Finest quality & Layers in 40 breeds, Hybrid Baby Pullets and Cockerels, B. W. D. Tested. Ducklings, Goslings, Baby Turkeys, Guineas. In business 28 years. Catalog free. Nabob Hatcheries, Box M, Gambier, Ohio.

FLY WITH THE DAWN PATROL

Government Approved. Unequaled advantages in location, equipment, type training, for obtaining License Transport, Limited Commercial, Private Flying, Sheet Metal, Radio, Mechanical. For complete illustrated catalog write today to **SPARTAN SCHOOL OF AVIATION, J. D. Green, Director, Dept. PM6, Tulsa, Okla.**

OFFICE MACHINES—Care

and operation of 29 different makes. Typewriters, adding machines, duplicators, etc. Only book on subject, 384 pages, illustrated. \$2.50 postpaid.

POPULAR MECHANICS PRESS
200 East Ontario Street Chicago

STRIPE YOUR OWN CAR

Anyone can stripe a car with an automatic ROLL-A-STRIPE. You can save the price of your striping job and earn money doing others. Specially knurled roller and dependable gauges. Paint, lacquer, enamel or varnish may be used. Stripe signs, furniture, models, etc. See any Duro Dealer today or send direct. Postpaid \$1.50.

MODCRAFT INDUSTRIES, Dept. T-44, 2908 N. Nordica Ave., CHICAGO, ILL.



Mathematics Made Easy by ROPP'S CALCULATOR AND SHORT-CUT ARITHMETIC

Shows the Answer as Quickly as a Watch shows the Time to all Problems likely to occur in the Office, Store, Shop, Bank, Farm, or Factory.

Over 2,000,000 Sold Explains and simplifies every principle in Arithmetic, Mechanics, and Mensuration.

PRICES POSTPAID
Desk Size, Flexible Keratol Binding.....\$2.00
Pocket Size, Art Leather Binding.....\$1.00
Pocket Size, Cloth Binding, \$0.50

POPULAR MECHANICS PRESS
Room P-3 200 E. Ontario St. CHICAGO

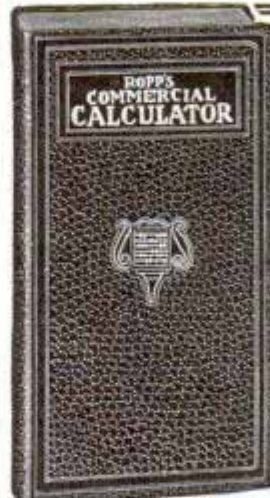

"I WANT TO TAKE THIS OPPORTUNITY TO THANK YOU FOR DOING ME A FAVOR BY SELLING ME MY HOBART WELDER. I CERTAINLY AM WELL PLEASED WITH IT AND IT HAS HELPED ME BUILD MY BUSINESS MORE THAN I CAN SAY."
DANBURY, CONN.

SIMPLIFIED ARC WELDING BRINGS BIG PROFITS EVERY MONTH

New low prices make this profitable welding service available to everyone. Opens doors to big pay jobs that carry real profit. Hobart welders are easy to operate, faster, guaranteed to bring you quality welding business... extra profits will pay for welder without expense to you.

NO INVESTMENT TERMS—PROFITS PAY FOR IT

Extra earnings and savings possible with Hobart Welders make it easy to own without expense. Write for details.

HOBART BROS., Box M-481, TROY, OHIO



NEW INVENTIONS

(Continued from page 43A)

PERMITTING the skater to walk on ground or pavement without removing his ice skates, a handy attachment has been granted patent protection. The attachment is a tread unit which lifts the runner off the ground, high enough to prevent damage while walking. It is fastened to that part of the skate just below the shoe, being looped around the runner in a protective manner. A hasp around the runner may be tightened to prevent looseness, thus saving the blade from injury. With this attachment on his skates, the wearer may walk from the ice to his home or to his auto before removing the skates.



It is fastened to that part of the skate just below the shoe, being looped around the runner in a protective manner. A hasp around the runner may be tightened to prevent looseness, thus saving the blade from injury. With this attachment on his skates, the wearer may walk from the ice to his home or to his auto before removing the skates.

FOR the golfer, back-yard or basement practice is made possible by a new invention. The outfit consists of club, a resilient grip which fits over the upper end of the club, and a practice ball attached to the grip by means of an elastic cord. The grip may be detached from the club. The cord limits the travel of the ball when it is struck by the club.



The grip may be detached from the club. The cord limits the travel of the ball when it is struck by the club.

DESIGNED to save time and to eliminate errors, an automatic control for the gasoline pump hose at filling stations has been patented. When the dial showing the number of gallons desired has been set, the pump supplies gasoline through the hose into the customer's tank until the predetermined gallonage has been delivered. Then a switch is thrown and the gasoline flow is cut off.



Then a switch is thrown and the gasoline flow is cut off.

START DRAWING BIG MONEY!



LEARN TO DRAW AT HOME

It's actually "fun" to learn at home in your SPARE TIME. The growing Art field offers opportunity for ambitious men and women. Trained artists are capable of earning \$35, \$50, \$75 a week. A few pleasant hours of study and drawing practice a week during the course should enable you to acquire the ability you desire. Since 1914 WSA graduates have been making good—many without previous Art training or experience.

COMMERCIAL ART CARTOONING, DESIGNING All in ONE PRACTICAL COURSE

Our proven method of instruction includes all important branches of Commercial Art. Experienced Art instructors correct and criticize the drawings you submit. You start by drawing straight lines and in advancing from lesson to lesson you receive all the constructive help you need.

IT'S AS EASY AS One - Two - Three!

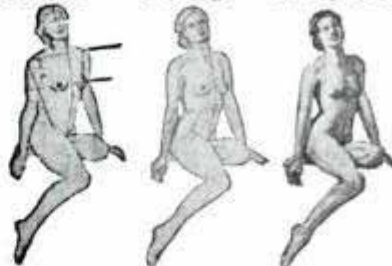

From a simple framework to the finished figure. Art made easy by simple steps that the average person can follow. The above is one of the 16 key poses in our illustrated LIFE CLASS BOOK included in course.

TWO Artists' Outfits Given—AT NO EXTRA COST! Include everything you need to get started in Art. Mail coupon today for complete details.



This FREE BOOK Shows How

WASHINGTON SCHOOL OF ART Studio 124E, 1115-15th Street, N.W. Washington, D. C.

I am interested in knowing the advantages of your Art training, please send me a FREE copy of your Book, "Art for Pleasure and Profit."

Name..... Age.....
 Address

City..... State.....

PICTURE BRINGS \$25
 —Miss G. A. Hill of Cedar Vale, Kans. has sold several paintings. One small picture for \$25.

\$500 IN SPARE TIME

—E. Gandre of Sheboygan, Wis. averages that amount per year for spare time Art work.

ENROLLED WHEN 40

—E. Kucher of Hillsdale, N. J. was 40 when he enrolled with WSA. Has had several pictures in exhibits.



Know Electricity as Experts Know It—and Get an Expert's Pay!

Recovery has begun! The months ahead are charged with significance and expectation. What will you do to get the jump on the other fellow?
Thousands of men have used

The Croft Library of Practical Electricity

The Croft Library is a complete electrical educator. It is founded on practice—on 20 years of shirt-sleeve experience—on work as it is actually done. It is jammed from cover to cover with the kind of hard-headed facts you want. Written so that the beginner can easily understand it, yet so sound, so thorough, that it is the daily guide of 50,000 highly paid electrical workers and engineers. Croft tells you the things you need to know about motors, generators, armatures, commutators, transformers, circuits, switchboards, distribution systems—electrical machinery of every type—wiring for light and power—wiring of finished buildings—underwriters' and municipal requirements—illumination in its every phase—the most improved methods of lighting—lamps and lamp effects, etc.—how to do a complete job, from estimating it, to completion.

No money down—easy payments

Fill in and mail the coupon attached and we will send you the entire set of seven volumes for ten days' Free Examination. We take all the risk—you assume no obligation. If you decide to keep the books, send \$1.50 in ten days and the balance at the rate of \$2.00 a month. Send the coupon NOW and see the books for yourself.

FREE EXAMINATION COUPON

McGraw-Hill Book Co., 330 W. 42nd St., New York

Send me for ten days' free examination the Croft Library of Practical Electricity. If satisfactory I will send you \$1.50 in 10 days and \$2.00 monthly until the price of \$19.50 is paid. If not wanted, I will return the books postpaid. (To insure prompt shipment write plainly and fill in all lines.)

Name.....

Home Address.....

City and State.....

Position.....

Name of Company..... PM-4-38

MEMORY POWER

How To Think Clearly Nothing To Learn or Study

My secret of Memory Power clarifies mental confusion. Indelibly imprints upon your mind, lessons, experiences, faces, names, words, spelling, pronunciation, arithmetic, geography, cards, music. Anything and Everything. Overcomes fear. Calms the mind. Gives you poise, confidence. Most simple mind assimilating in that ever discovered. Send for it now. Complete method

\$2.00, or C. O. D. plus postage. Money refunded if after 15 minutes reading it does not prove an amazing revelation in mind improvement.

SAMUEL D. CATES, 207 N. MICHIGAN AVE., STU. 21, CHICAGO, ILL.

TIRED OF LOATHSOME SCHOOL-AGE PIMPLES?

Let millions of tiny, living plants help keep blood free of skin irritants

Thousands of young people have said good-bye to the curse of youth—a pimply skin. They know what happens between the ages of 13 and 25, the time of life when important glands develop. Your system is upset. Poisons may pollute your blood stream and bubble out on your skin in ugly pimples. Then you need to cleanse and purify your blood.

Let Fleischmann's Yeast help remove these impurities the natural way. Millions of tiny, active, living yeast plants will help keep poisons from the blood and help to heal your broken-out skin. Many report amazing results in 30 days or less. Start eating Fleischmann's Yeast now. Buy some tomorrow!

Copyright, 1938, Standard Brands Incorporated



You Can Have Faith in EN-AR-CO (Japanese Style) OIL

For over 50 years it has kept faith with millions—given them quick relief from the pains and discomforts of neuralgia, muscular soreness, aches and pains caused by fatigue and exposure. Excellent for discomfort of head colds and bronchial irritations. Get a bottle today. 60c at all druggists. AMERICAN MADE! AMERICAN OWNED!

USED CAR SECRETS REVEALED

Select bargain cars with Used Car Value Guide. Discover weak and strong points. Confidential; proved by experience. Send 25c to

AUTOMOBILE RESEARCH BUREAU

Dept. 2-D

520 N. Michigan Ave.

Chicago

CARTOONING AND SEMI-ILLUSTRATING

Elementary and advanced course of Motion Picture animation, newspaper and magazine work. Latest methods just released \$1.00 per lesson. Children & adults. This field needs you. Write now. Free charts from Studio No. 2, Canton, Ohio.

HOLLYWOOD-CANTON-SCHOOL OF CARTOONING



WELDERS WANTED!



ELECTRIC ARC—OXY-ACETYLENE

Skilled Welders earn \$8 to \$15 a day. The demand now greater than the supply. Learn this highly paid trade in 4 weeks by actual shop work. One of America's leading schools. Established 1902. 7 floors of shops. Endorsed by welding industry. Limited number of students. 4 weeks course in Electric Arc or Acetylene Welding, including room and board, only \$159. Write or wire for reservation. Ask for "Welding Facts." State age.

GREER COLLEGE, Dept. 148, 2024 S. Wabash Ave., Chicago

MAKE MONEY with "SHOP NOTES" Ideas, Kinks, Helps

1938 SHOP NOTES and
LATHE HANDBOOK

Extra Big Book
Value—ONLY 98c

For Both

Be the man who knows the easiest and best ways of doing things—the fellow who is up-to-date—cash in on handy kinks and short cuts. Get Shop Notes for 1938 and make money. For many years the helpful, handy guide for men doing mechanical, carpentry, auto repairing, concrete, plumbing, electrical, building, masonry, farming, home repair work, etc. Now ready—1938 edition and famous Lathe Handbook—both for only 98 cents.

2000 Money Making Ideas for Shop and Handy Men

Get the Shop Notes Library. Complete set 5 books—Over 1100 pages—3000 pictures—2000 money making facts, methods, processes and time saving kinks. They'll pay for themselves over and over. Whole set only \$2.50. Order now. Supply soon exhausted.

Popular Mechanics Press, Room 536A, 200 East Ontario St., Chicago



A FEW OF 318 ARTICLES IN 1938 SHOP NOTES

Shop Notes for 1938 has 224 pages—318 articles—645 illustrations. Some of the subjects are:

Arc Welder
Bits, Wood-boring
Carpenter's Hints
Drills, Using
Electroplating
Garden Furniture
Jigs for the Shaper
Lawn Ornaments
Photographic Equipment
Plastic Ornaments
Shaper Projects
Table Lamps
Trailer Comfort
Torch, Electric Arc
Wood Turning Kink.

SEND NO MONEY!

Combination offer above 98 cents. Shop Notes Library—5 books—\$2.50. Pay postman plus few cents delivery in U. S. and possessions. Elsewhere remit with order. Order now.

A WORLD CHAMPION TELLS HOW TO BUILD A POWERFUL BODY

THE SECRET'S OUT: Well, fellows — here's the low-down. Don't think I always had this swell physique—and don't think it just naturally grew on me. When I first started boxing, I was tipped off that a champion must be able to take it — as well as dish it out. The fighting game is hardly a ping-pong contest. You have to meet not only scientific boxers but human gorillas. To stand up and swap punches for twelve and fifteen rounds requires an enormous amount of energy and stamina—That is why it was necessary for me to first build up a sturdy frame work for my body before I could ever amount to anything as a fighter. And that is just what I did.

A NEW LIFE To win my first important fight was nothing compared to the joys I experienced from possessing this strong, healthy body. From that day on, I decided I would possess a perfect physique as well as be a boxing champion. My record speaks for itself as to whether I accomplished my ambition.

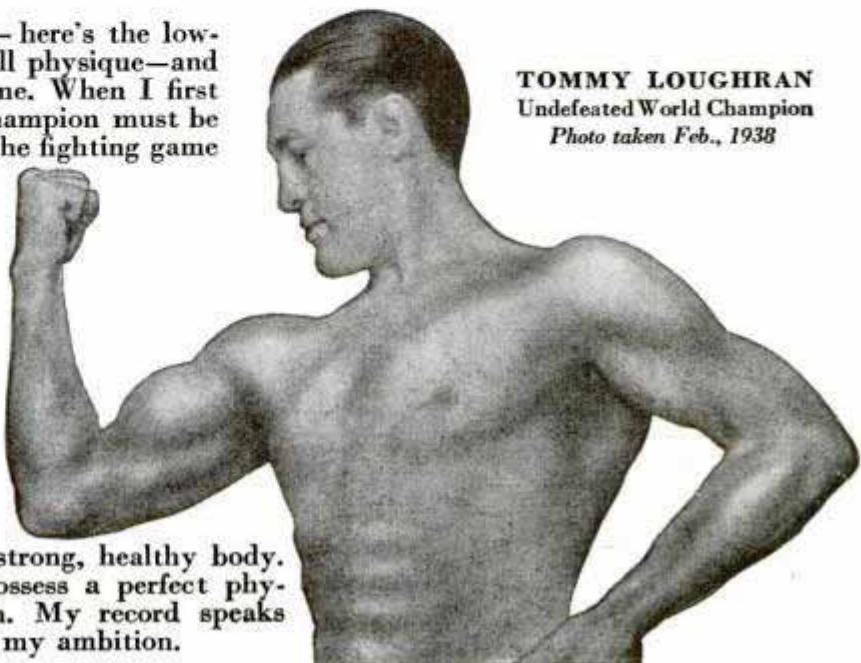

TOMMY LOUGHRAN
Undeclared World Champion
Photo taken Feb., 1938

All these years while I was working my way to the top, I kept investigating and studying every known method of physical development until I finally discovered the secret of "PUISSANT POWER."

Learn from a Champion

It took me years of study and research — also thousands of dollars to acquire this knowledge of building muscles which possessed the power of an ox, but the speed and agility of a panther. These are the only type of muscles which enable you to engage in active sports or to really accomplish anything. It was not long until I was receiving offers galore, if I would only impart this knowledge and train others through this short but certain method of body building. Days were all too short to satisfy the demands on my time. I decided to have duplicates made of my apparatus and put the instructions into printed form. In this way I am now enabled to spread the joyful message to the world.

Send For My **FREE** Book, "Puissant Body Building"

This contains numerous photos of some of the athletes and strong men I have trained. It will be an impetus and an inspiration to you. I don't ask you to buy it. I want to spread the glad news. It is absolutely free. Yours to keep. *Don't delay.* This does not obligate you in any way whatever. It is merely an inspirational talk and will show what I have done for so many others.

TOMMY LOUGHRAN

Dept. 41 4 So. 15th Street, Philadelphia, Pa.

COME TO ME

Do you wish these mighty dynamic muscles for yourself? Would you like to feel the joys of a strong, healthy body? Write me at once and I will tell you how you can not only be the envy of your friends from an outward physical viewpoint but I will also build up those inner muscles around your vital organs. You will feel the thrill of a new life pulsing through your veins — you will feel like shouting to the world "I am a man and I can prove it."



227
fights in
18 years

That's
stamina
and mus-
cle power.
How did
I do it?
That's my
secret. I'll
reveal it
to you.

FREE

For the next thirty days only will I send you with my free book, a beautiful reproduction of my portrait, made by a famous artist. This drawing has never been used in newspapers or magazines. And only those who send for my booklet will have this autographed reproduction.

TOMMY LOUGHRAN, Dept. 41

4 So. 15th Street, Philadelphia, Pa.

Dear Tommy: — Please send that book "Puissant Body Building." I want a strong, active body like yours. This book is absolutely FREE with the understanding that I am not obligated in any way.

Name

Street

City State



AREN'T YOU GLAD DON INVITED US TO SPEND THE DAY AT HIS BEACH CLUB, DAD?

YOU BET. I'D LIKE NOTHING BETTER TODAY THAN TO SIT BACK AND ENJOY MY PIPE



HELLO, DON. DOESN'T THE WATER LOOK WONDERFUL TODAY?

YES, IT'S SWELL. BUT HOW ABOUT SITTING DOWN A BIT BEFORE WE GO IN. I'VE GOT A NEWS-PAPER FROM BACK HOME



WELL, WE KNOW WHAT THAT KIND OF WEATHER IS LIKE, TOO. I'LL BET EVEN THE SHERIFF'S BADGE IS FROZEN TODAY



WOULDN'T YOU KNOW IT? GREEN'S TOBACCO SHOP IS HAVING A SALE ON THEIR FINEST PIPES WHILE I AM AWAY!

SAY JUDGE, THIS IS ONE OF THEIR PIPES, BUT I DON'T SEEM TO GET GOOD RESULTS WITH IT



WELL, DON, EVEN THE BEST PIPE IS NO BETTER THAN THE TOBACCO THAT'S IN IT. YOU KNOW I'VE SUGGESTED BEFORE THAT YOU TRY PRINCE ALBERT

I'VE ALWAYS MEANT TO TRY PRINCE ALBERT



THERE'S NO TIME LIKE THE PRESENT. HERE FILL UP YOUR PIPE AND TASTE THE DIFFERENCE

THANKS, JUDGE, I SURE WOULD LIKE TO FIND A REALLY MILD TOBACCO WITH LOTS OF BODY TO IT



JUDGE, THIS IS WHAT I CALL REAL PIPE PLEASURE. PRINCE ALBERT IS EVERYTHING YOU'VE SAID AND MORE! I'LL FILL UP AGAIN, IF YOU DON'T MIND

Copyright, 1938, R. J. Reynolds Tobacco Co.

FOR THE REAL PLEASURE IN SMOKING

—JOIN THE PIPE-JOY CLUB!



I SMOKE FOR PLEASURE, AND THERE'S MORE PLEASURE IN PRINCE ALBERT. IT'S NO-BITE TREATED!

REPORTER

I GET MY MONEY'S WORTH OUT OF P.A.'S CRIMP CUT. IT PACKS AND DRAWS BETTER, SMOKES MELLOWER

REPAIRMAN

I'VE SMOKED TOBACCOS AT ALL PRICES, BUT GIVE ME PRINCE ALBERT FOR RICH, TASTY, YET EXTRA-MILD SMOKING!

EXECUTIVE

TO WIN NEW FRIENDS—MONEY-BACK OFFER!

Smoke 20 fragrant pipefuls of Prince Albert. If you don't find it the mellowest, tastiest pipe tobacco you ever smoked, return the pocket tin with the rest of the tobacco in it to us at any time within a month from this date, and we will refund full purchase price, plus postage. (Signed) R. J. Reynolds Tobacco Company, Winston-Salem, N. C. **GUARANTEED MILD, TASTIER FOR "MAKIN'S" SMOKES TOO**



PRINCE ALBERT

THE NATIONAL JOY SMOKE

Popular Mechanics Magazine

REGISTERED IN U. S. PATENT OFFICE AND CANADA

WRITTEN SO YOU CAN UNDERSTAND IT

Vol. 69

APRIL, 1938

No. 4

H-766

EXPLORING WORLD'S DEEPEST MYSTERY

By Emile C. Schnurmacher, ⁷²⁷
Park Ave New York City

WHEN the plans of Otis Barton, designer of the bathysphere, mature, scientists for the first time will be able to investigate mysteries of mile-deep ocean bottoms in a diphrobenth or undersea chariot, towed along by a cable attached to a surface vessel.

Barton and Dr. William Beebe have made many successful deep-sea descents and in 1934 observed marine life one-half mile down, but no man has yet seen the ocean bottom at a depth greater than approximately 525 feet.

"It is beyond that depth where the world's greatest mystery, the ocean bottom, is waiting to be explored," said Barton. "While it is true that we have descended

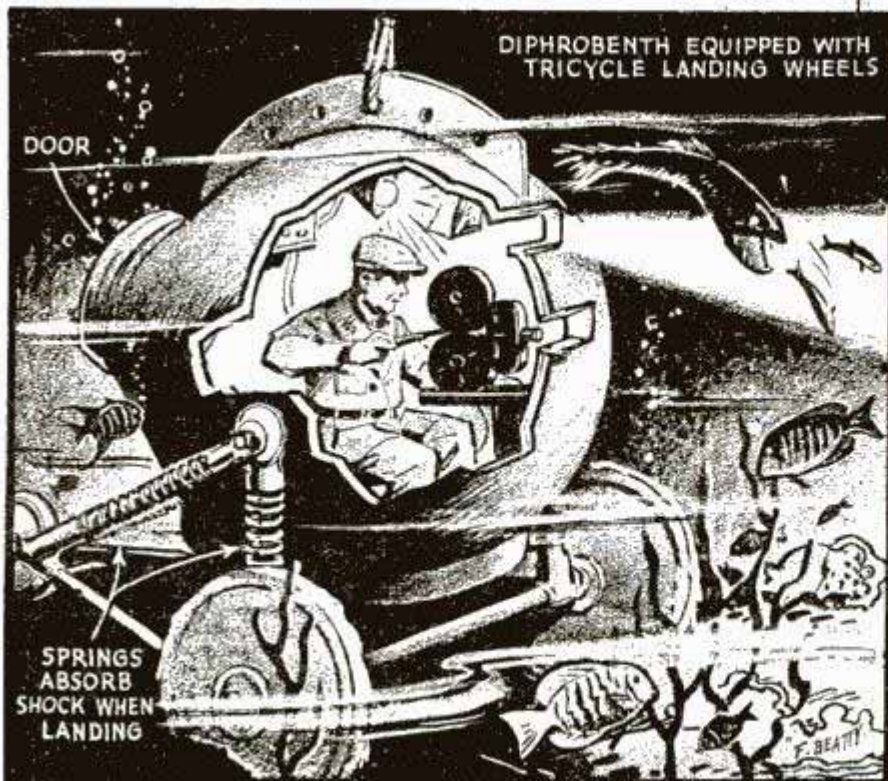
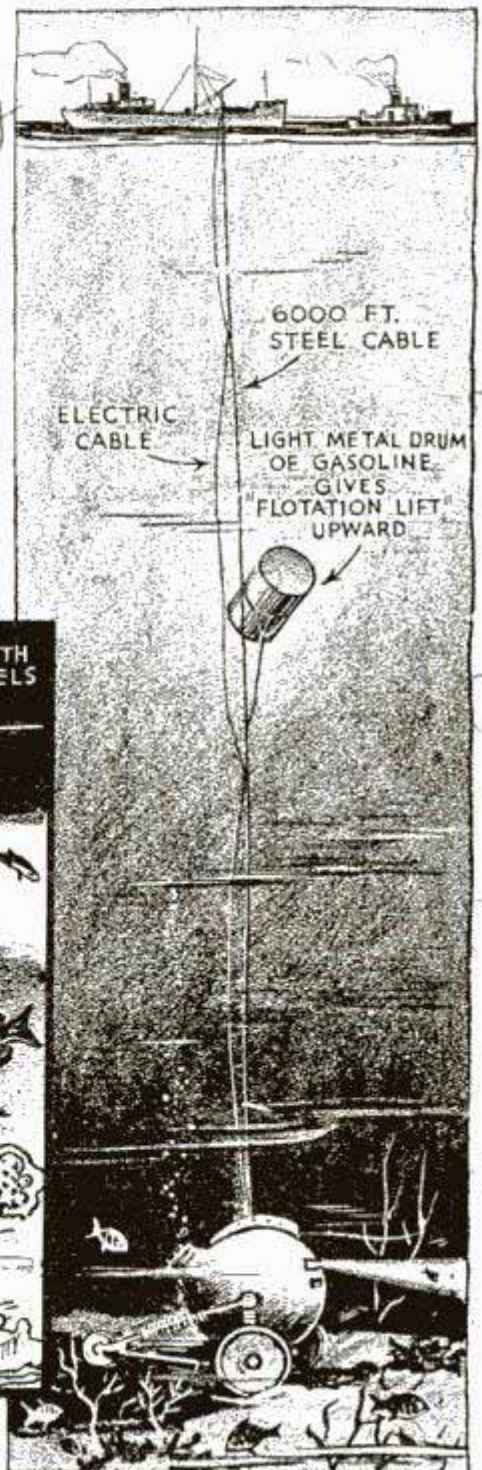

Left, the diphrobenth as it is expected to appear in operation. Right, apparatus will be towed by surface vessel, with drum, or several drums, of gasoline to give buoyancy

109. Tide in. and (something) 2.5

Strong back to light rays - illumination



York Zoological Society, probably will let Barton use the same huge five-ton winches and other equipment used in the bathysphere descents.

The diphrobenth, now in blueprint form in the drafting room of the Watson-Stillman Hydraulic company plant which built the bathysphere, differs considerably from it.

"One of the most noticeable differences, of course, is the wheels," said Barton. "There are two large wooden wheels in front and a smaller one

(Continued to page 158A)

a much greater distance in the bathysphere, that apparatus was suspended on a cable and did not touch bottom. Such marine life that swam or floated by the thick observation windows of fused quartz could be watched, but not the undersea life on the ocean bottom itself.

"It is for this purpose that I devised the diphrobenth, which is Greek for 'chariot of the bottom.' In it, I hope not only to explore the ocean bottom at a depth of one mile, but also to investigate the interesting sub-surface cliffs and chasms off the Bermudas. Here, in the underwater crevices and canyons at depths between 500 and 1,000 feet, is teeming marine life which is far less known than that which has been observed at much greater depths from the bathysphere. As for the bottom of the ocean, a full mile down, no diving apparatus has descended that distance and I am hoping to be the first human being to make observations there, perhaps with Dr. Beebe, if he should decide to join me."

Dr. Beebe has shown great interest in the diphrobenth and, with the cooperation of the New

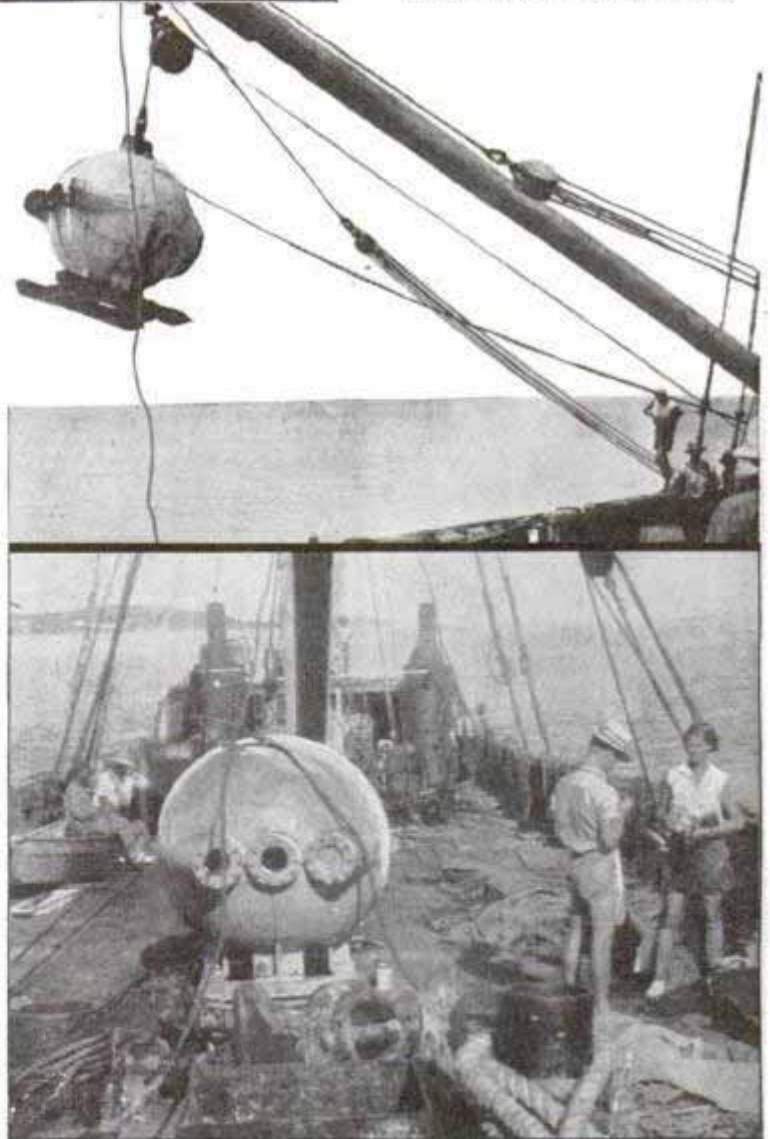

Top, Otis Barton snapped through window of diving apparatus. Center, the bathysphere going over. Bottom, bathysphere on deck of ship

H-71
Fast Air Liner Is Convertible into a Bomber

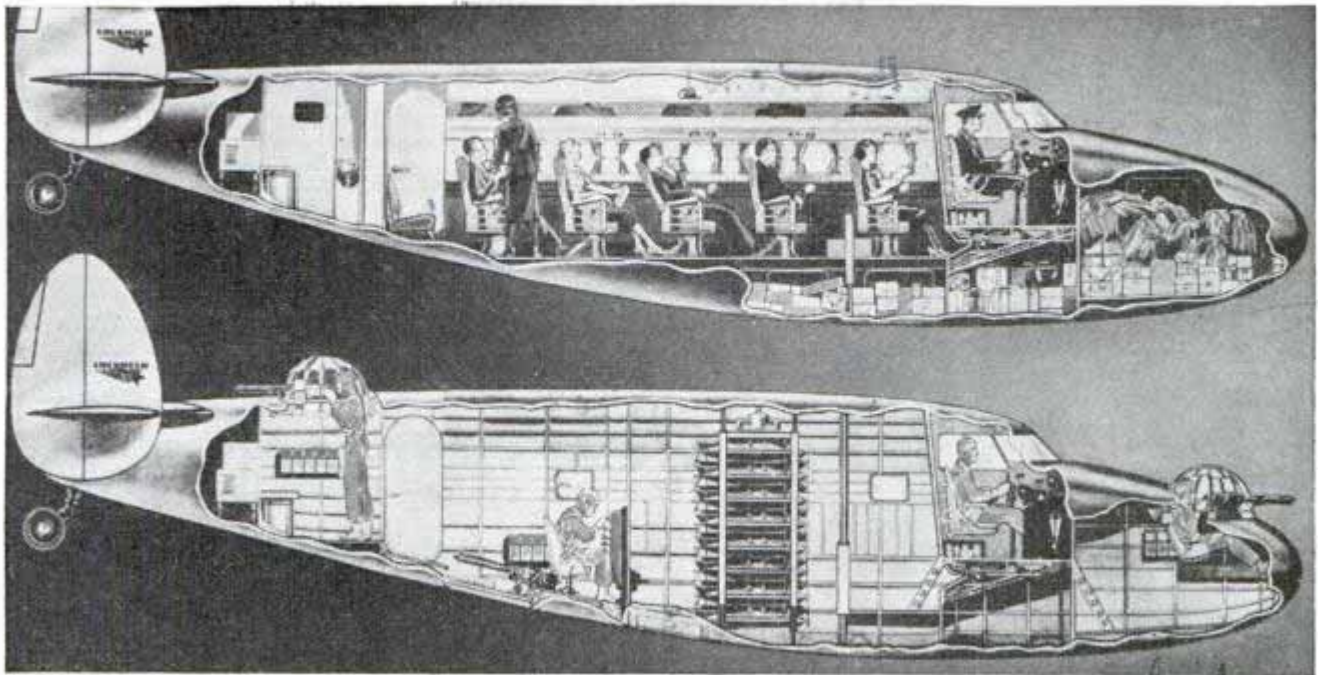

These two cross-section drawings show (top) arrangement of the speedy air liner in passenger service and (bottom) how same craft might be turned into a formidable bombing plane

Regarded as one of the most powerful in the world, an American transport plane lends itself to conversion into a formidable bombing plane. In air-passenger service, it has accommodations for eleven passengers and a steward, as well as pilot and co-pilot. As a bomber, the ship would

carry a crew of four, including two machine-gunners and a man to release bombs. The bomb racks would be located near the center of the ship. Gun turrets would be fore and aft. Cruising speed of the ship is 230 miles per hour, the maximum speed 260 miles an hour.

H-76
Exposure Meter with a Hood Gets Light Like Camera

Designed for use over a wide range of illumination levels, an exposure meter announced by General Electric company uses a hood to limit more effectively the angle of the light received to approximate-

ly that of a camera. The particular shape of the opening in the hood is advantageous because, when pointed at a normal scene, the full angular width of the camera is included in a horizontal direction, but in the vertical direction a much narrower angle is used. This lessens the error of indication caused by strong sky light. When not extended for taking readings, the hood slips snugly over the meter, protecting the face and the light cell. The hood, in addition to being very directional, is provided with a hinged, slotted cover which increases the sensitivity of the instrument by ten to one when opened. In extremely low illumination, the hood may be removed and another increase in sensitivity of ten to one obtained.



Two views of handy light meter devised for amateur or professional photographer

At current rates of consumption, it is estimated that our lead and copper mines will be exhausted in less than 100 years.

Scientific Monthly
Jan 1937

Columbia Street
New York

H-116

Non-Removable Meat Label Guards Against Fraud



Small machine which places the non-removable labels in each sausage

Placed in sausage and other meats stuffed in natural casings, a non-removable label protects the public against bootlegging of meat which has not been inspected properly. A machine is used for labeling.

*I dentification. due 2.2.2
W. J. Adams. Chicago*

pat'd. (Acme)

*W. S. Stackhouse Phila.
219 N. 65th St.*

H-106

Tire regroover cuts tread to make driving safer

Anti-slip qualities of automobile tires may be revived after the tread has worn off by regrooving the tires with a tool now on the market. The tool is a pull-type electric regroover, the essential part of which is a "U"-shaped knife which cuts the thread of rubber from the tread, leaving the groove.



These grooves may take the form of a pattern, with both circumferential and cross cuts, or diagonal cuts, or simply a number of circumferential grooves. Usually the operator can put on the pattern chosen by the tire owner. Regrooving is not recommended when there is less than three-

leaving the groove.

Patented and Michael Long

sixteenths inch of good tread rubber on the fabric carcass; when there are patches worn through the tread to the fabric, and when there are cuts in the tread or sidewall that would allow water to enter the tire structure and rot the fabric. Tires in which these flaws do not exist may be regrooved, since the process simply gives the tread a design with sharp edges which increase the resistance to skidding. Frequently a tire with tread worn smooth may be run 10,000 miles more, in safety, if the tread is renewed by regrooving.

H-108

Auto Runs on Acetylene Gas Generated in Trunk

Acetylene gas, generated in a trunk on the rear, operates an automobile fitted with a special carburetor invented in Italy. The trunk contains the granular calcium carbide that is used to form the gas. Carburetion is automatic and the engine performs well on the gas, having a powerful stroke. The gas burns cleanly, leaving little residue. The invention may solve the problem of Italy's dependency upon other nations for motor fuel.

Acme photo

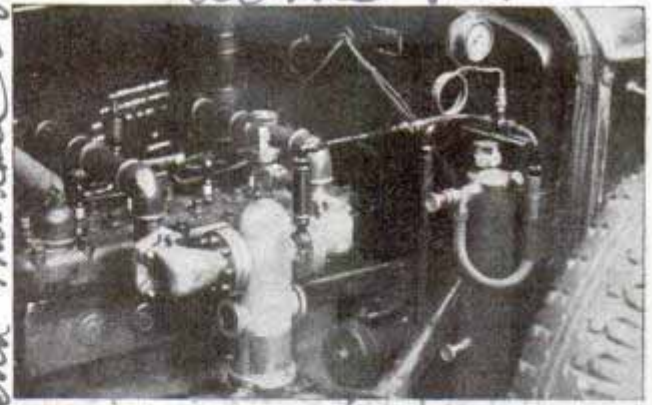

Top, acetylene-gas carburetor. Bottom, trunk containing calcium carbide

Antonio F. ...

#158. Cont. ... 45 W. 15. H. 11 nyl

The "TOPS" in STARS

LARGEST FOUND OBJECT IN THE SKY IS A "GHOST" STAR AND IS INVISIBLE TO THE EYE!

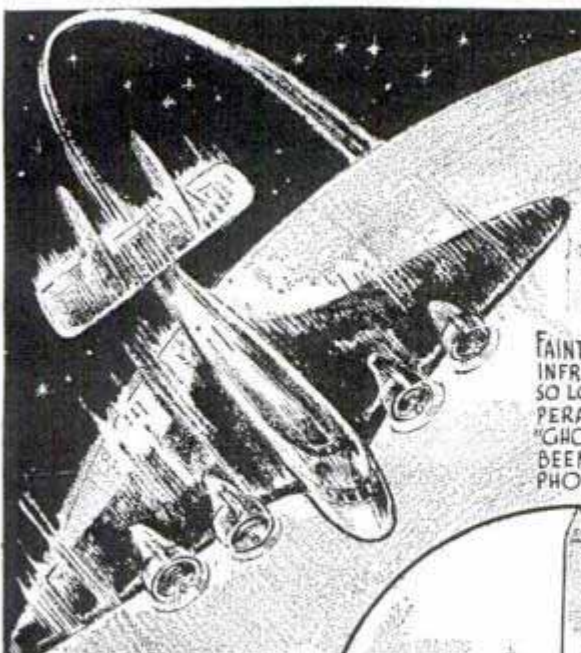

FLYING AT 500 MILES AN HOUR A PLANE WOULD REQUIRE 1,721 YEARS TO ENCIRCLE THIS GREAT STAR

FAINTLY RADIATING INFRA RED LIGHT, SO LOW IS ITS TEMPERATURE, THIS "GHOST" HAS NEVER BEEN SEEN NOR PHOTOGRAPHED!

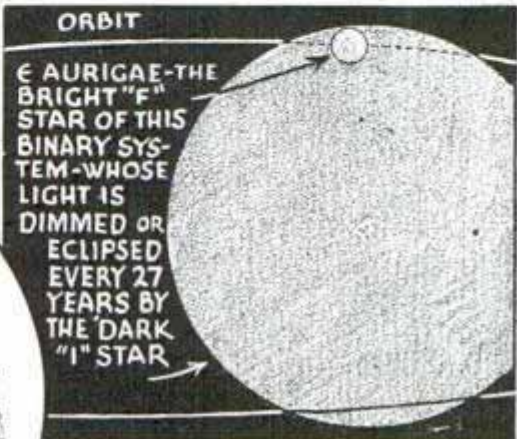

THROUGH SPECTROSCOPIC AND OTHER OBSERVATIONS ASTRONOMERS HAVE DISCOVERED THAT THE STAR ε AURIGAE IS ACCOMPANIED BY A GIANT "DARK" STAR AND THAT THEY REVOLVE AROUND EACH OTHER

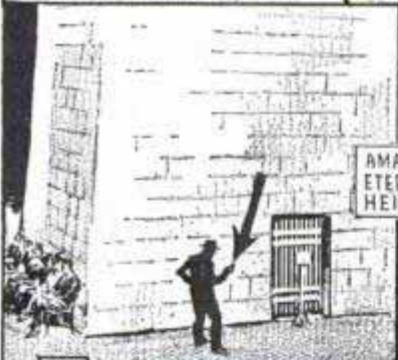

AMAZING CONTRASTS IN SIZES SEEN IF DIAMETER OF BIG STAR WERE REDUCED TO EQUAL HEIGHT OF WASHINGTON MONUMENT



POSITION OF THE "GHOST" STAR AND ITS COMPANION WITH REFERENCE TO THE GREAT DIPPER



OBSERVERS NOW SEE LIGHT FROM ε AURIGAE AS IT LEFT THAT STAR 3,000 YEARS AGO WHEN EGYPT WAS YOUNG

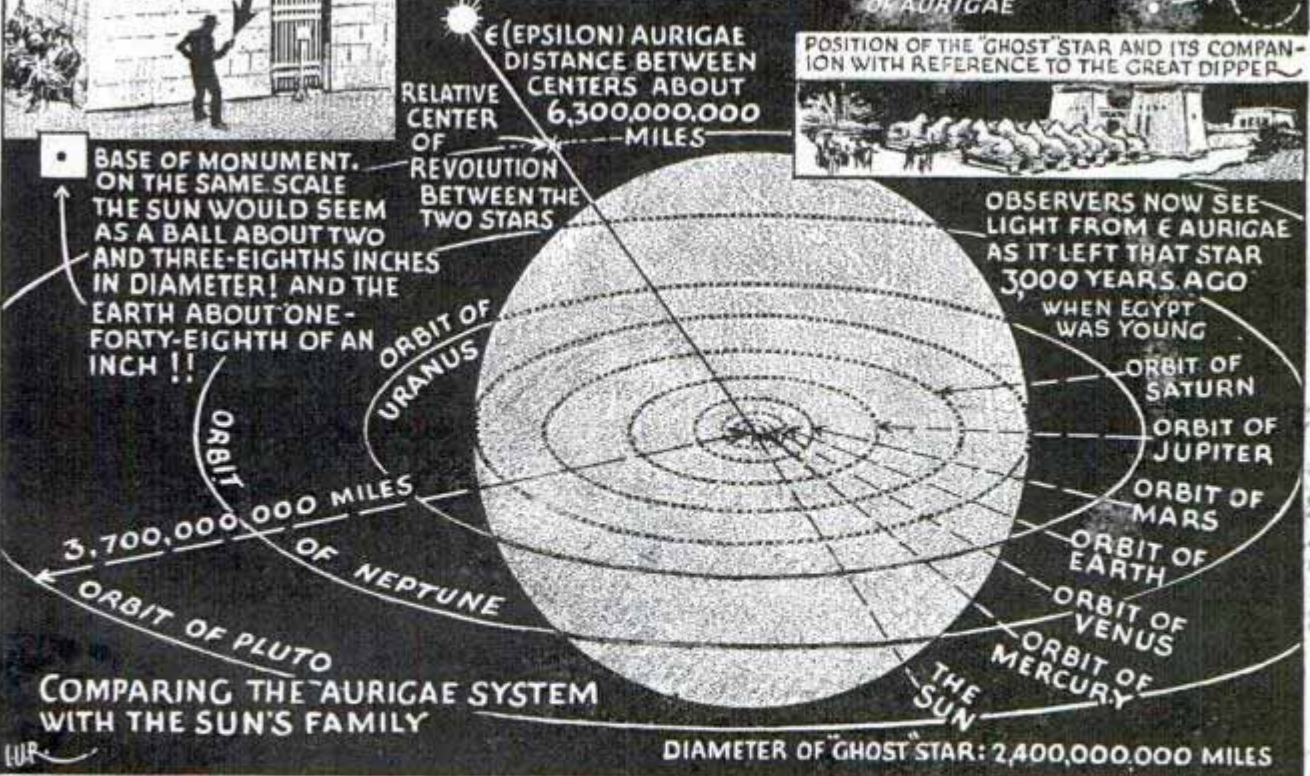

COMPARING THE AURIGAE SYSTEM WITH THE SUN'S FAMILY

Thirty-nine years ago an astronomer at Yerkes Observatory, Williams Bay, Wis., detected variation in brightness of star Epsilon Aurigae which observers have now determined is caused by its eclipse by largest star yet detected. This star, however, is so dark and cool it has not yet been seen or photographed

Mushroom Roof over Band Broadcasts Concert



Umbrella-shaped roof of bandstand acts as megaphone while loudspeaker in pinnacle broadcasts sound

Bandstands aren't what they used to be. In the square at Canton, Ill., is a new "mushroom" bandstand incorporating both a megaphone and loudspeaker in its roof. The ceiling is fifteen feet from the base, and lined with inch-thick sound-insulating material, designed to reflect music outward over a wide area. Built into a twelve-foot pinnacle rising from the center of the roof is a loudspeaker distributing sound in four directions so that music picked up by the microphones in the stand itself can be heard several blocks away, and controlled so that it blends perfectly with the tones heard directly from the megaphone stand.

Self-Sharpening Food Mincer Is Easy to Use and Clean



Easy to use and easy to clean, a self-sharpening mincing outfit for the kitchen chops, grates and grinds all raw foods. It offers a quick and easy way to prepare parsley, mint, onions, pimento,

meat, fish, bread, potatoes, carrots, cheese, nuts, mushrooms and other foods. The mincer is placed over a plate. A back-and-forth movement of a paddle accomplishes the cutting of the food and forces it through the perforations in the bottom.

Luminous Bob for Casting Useful Day or Night

With its upper half luminous, a new casting bob is useful for day or night fishing. The bob is attached to the line by turning a core to expose a slot. After a knot is tied in the line at the depth desired for fishing, the line is inserted in the slot and a button

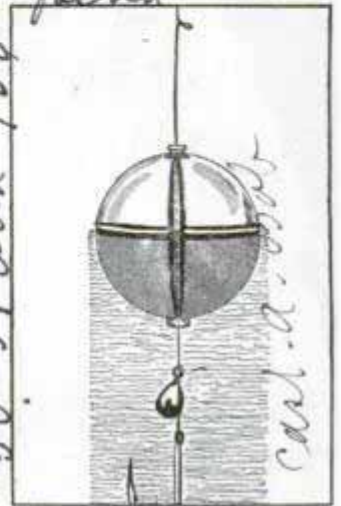

This leaves the bob free on the line. The weight of the sinker then carries the free line through the bob until the knot stops it. Bait and bob may be cast like an ordinary plug. The fisherman will experience no trouble in getting the line out or in reeling it in with the bob on it.

Abrasive Holders to Fit Work Offered in Various Shapes

Abrasive holders that can be supplied with refills of various paper and cloth abrasives are offered now in several shapes. Designed to fit the particular job at hand for the machinist, model maker, die, tool and cabinet maker, there are round, square, triangular and flat holders.

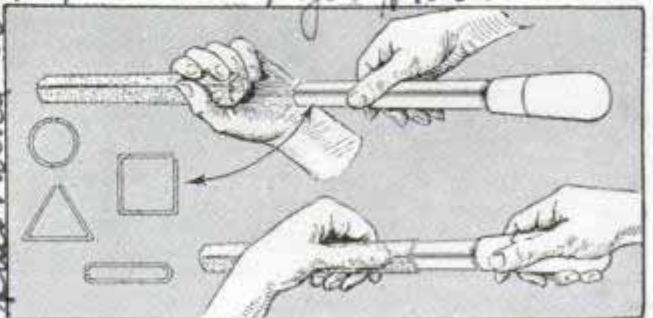

Paper and cloth abrasives of special shapes shown at left are slipped over standard holder

*Cent. J. ranch Conty 986 A
Pennsylvania St. Clancy
Holey Mfg Co
9-11 main St. N. B. Minn.
Chicago - Field's.
H-111
\$1.50
H-70
40x sel - 4 for \$1.50
H-70
H-70
H-70
H-70*

How. Jue Boat Co. Chicago

Keeler Mfg Co

Double-Deck Gyro Car Travels on Monorail

On an electric monorail built over a model city in a Lansing, Mich., home runs a double-deck streamline car with a gyroscope stabilizer to maintain its equilibrium. An automobile design engineer constructed this monorail system and made blueprints from which you can duplicate it in your own home. Balanced on the same gyroscopic principle used in automatic airplane pilots and ocean liners, this

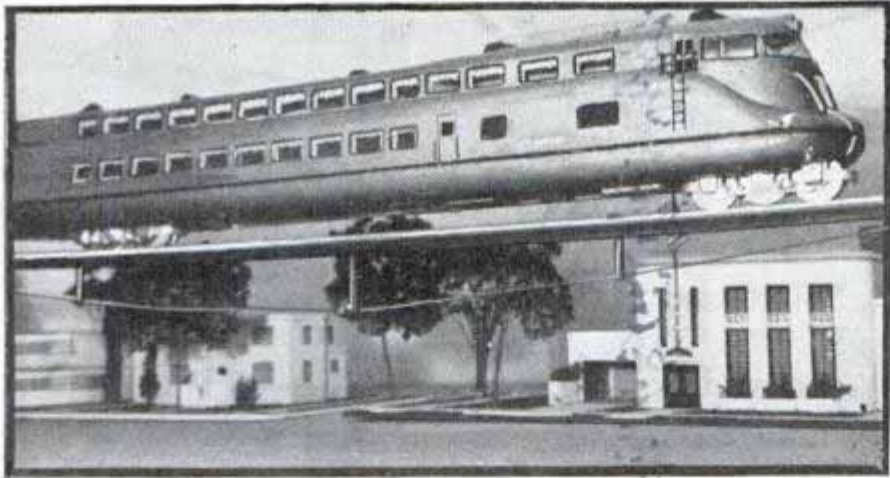
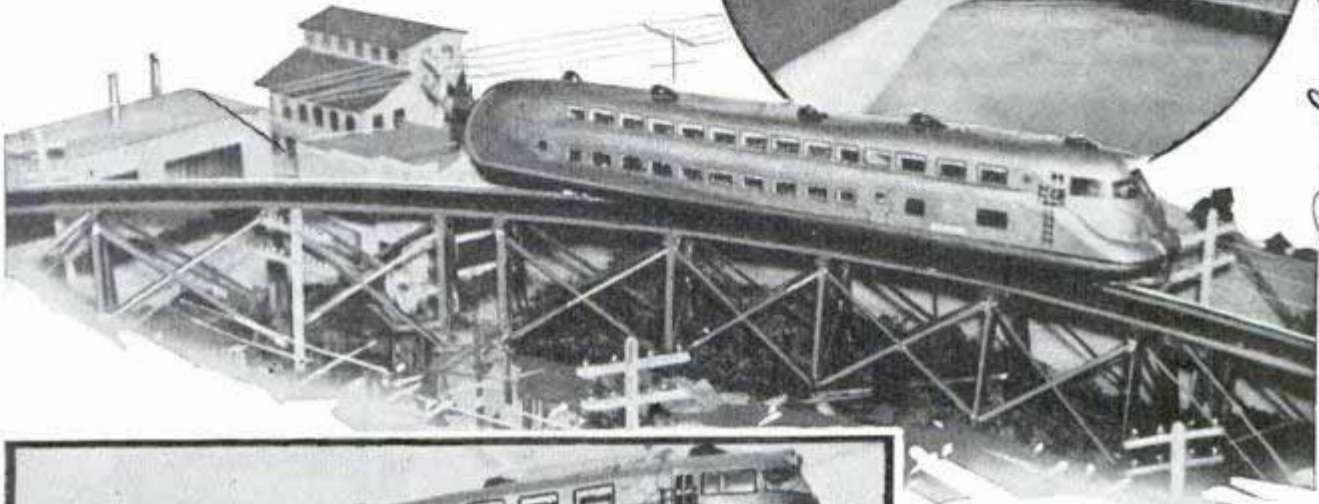
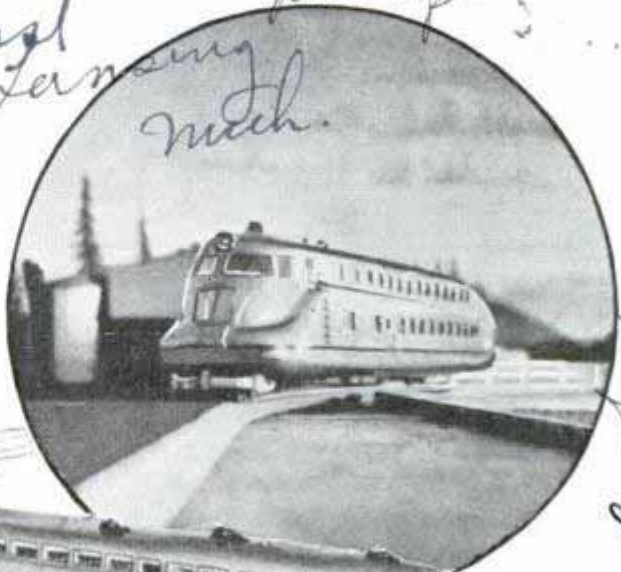

Running on a street-level monorail or speeding over a model city on its elevated structure, the streamline double-deck car is balanced by gyroscope. It remains upright even when alternating current is cut for a station stop, since direct current operates the gyro

twenty-eight inch car banks itself around curves and remains upright for several minutes after the current is turned off. The car weighs nine pounds; its stabilizer weighs three pounds, and consists of a heavy flywheel driven by an electric motor using direct current. Another motor drives the rear wheels through a flexible drive shaft. The two motors are operated by remote control simultaneously or separately. When the alternating-current circuit is closed, the car travels around the track; when that circuit is opened the car stops, but the direct-current circuit remains closed and the gyro stabilizer continues to function. The monorail is made

of two separate half-rails of brass, insulated from each other so that a circuit can be made, and straddled by double flanges of the car wheels. All wheels except the accumulator wheel are of plastic material; the accumulator wheel is steel, and consists of two insulated sections which contact brushes leading to the relay. The car is built to a scale which would represent a "rail land yacht" twice as long and as high as conventional railroad cars, and twenty-two feet wide, as compared with the normal ten-foot width. Sectional plans show seating arrangements in upper and lower decks, dining room, observation room, pilot's cabin, stairs, bulkheads and lights.

453 Kensington Road

plans available

East Lansing Mich.

453 Kensington Road East Lansing Mich.

P. L. Johnson

Hobby Railroad in Yard Becomes a Business

L. W. Jenkins, Star, N. C.

H-100

Several views of owner operating the back-yard railroad. Bottom, this is how coal is loaded into the tender. Circle, owner turns engineer

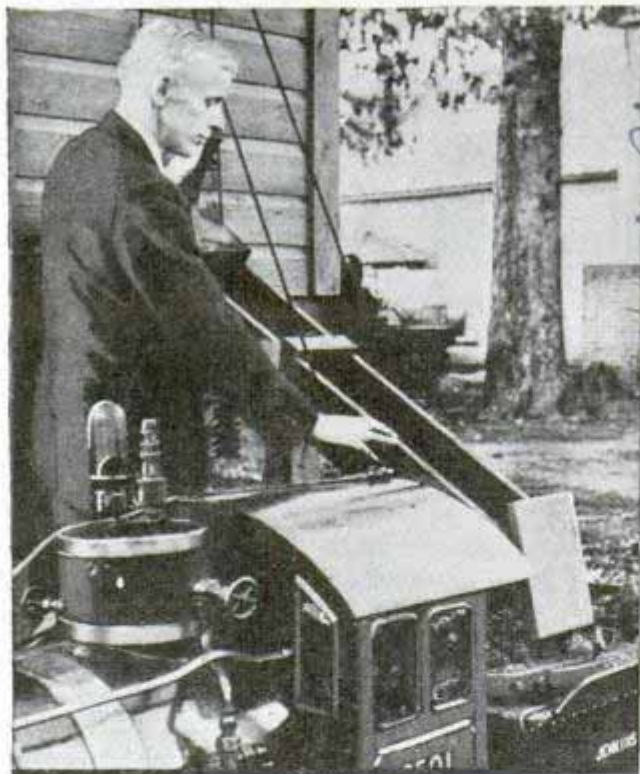
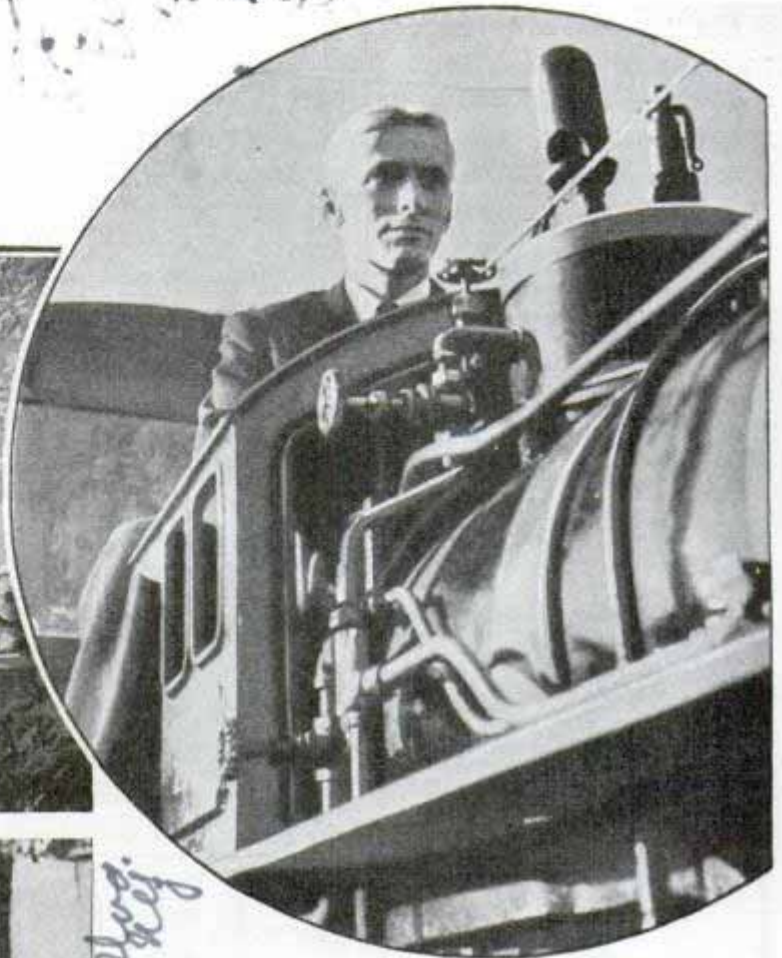

a quarter-mile track in his large yard. So steadily has business increased that the railway is being moved to a larger place where more space is available for tracks and where a bridge and a tunnel will be added to the system.

Billiard Cue Mounted on Wheel for a One-Armed Player

When a billiard player lost one arm in an accident he did not give up billiards. He put a small, rubber-tired wheel on a frame that slipped over the tip of the cue and was fastened in place with a thumbscrew. It can easily be moved toward or away from the tip to change the angle of the shot, and requires only a little practice to maneuver skilfully.



Some
FROM an oil man's hobby a back-yard railroad has developed into a business. The owner's sons have collected \$5,000 in nickels from child passengers in the last four years. The business began when the owner took a small-size locomotive, three passenger cars and two flat cars out of storage and started operating the train on

Emb. W. D. Messenger, 46 Bridge St., Albany, N. Y.
(The Snake River Canyon in Idaho is more than 6,000 feet deep, exceeding even the depth of the Grand Canyon.

Scientific Monthly
Feb. 18 3 P. 1911

es, by J. Lewis
Walter H. Church and Stirrard

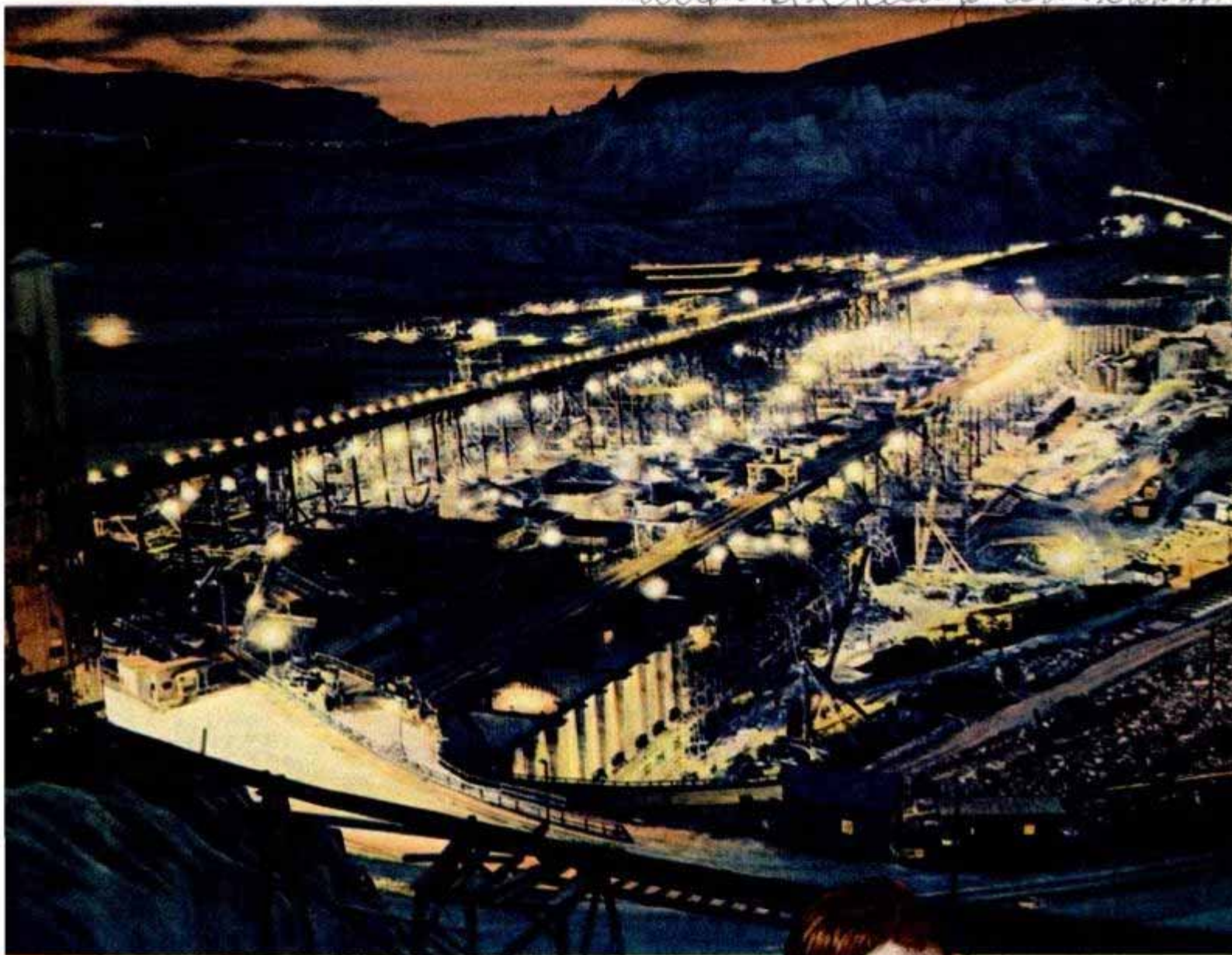

The **BIGGEST THING** *on* **EARTH**

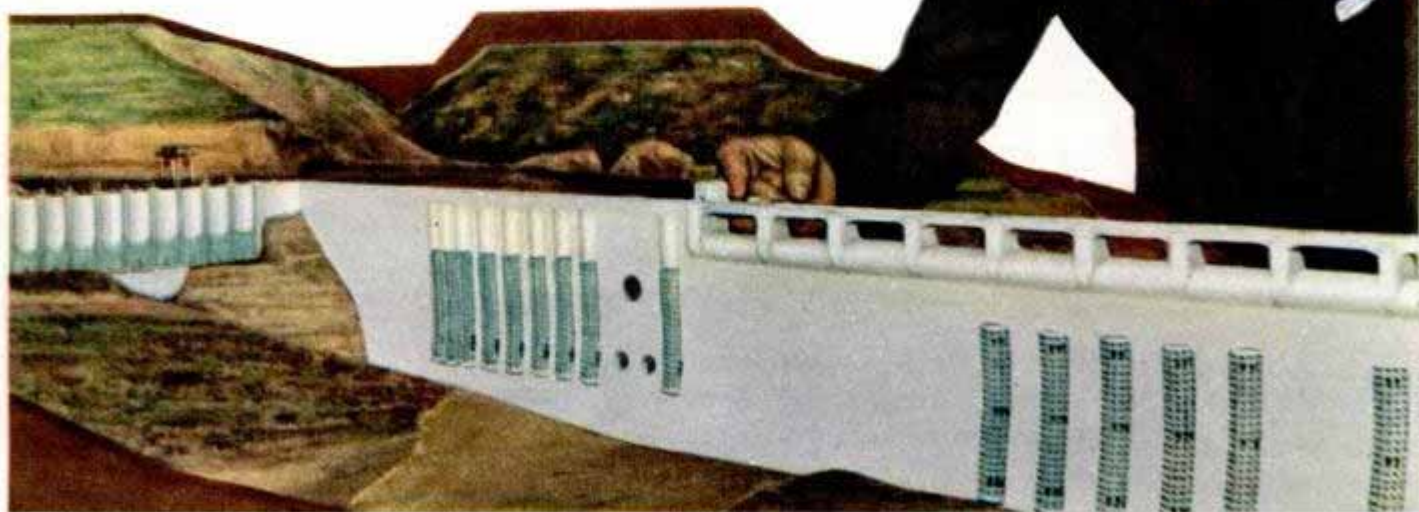

MODEL of part of Grand Coulee dam, showing up-stream face with pumping units at left.
Top, Grand Coulee at night. Row of lights is on suspension bridge.

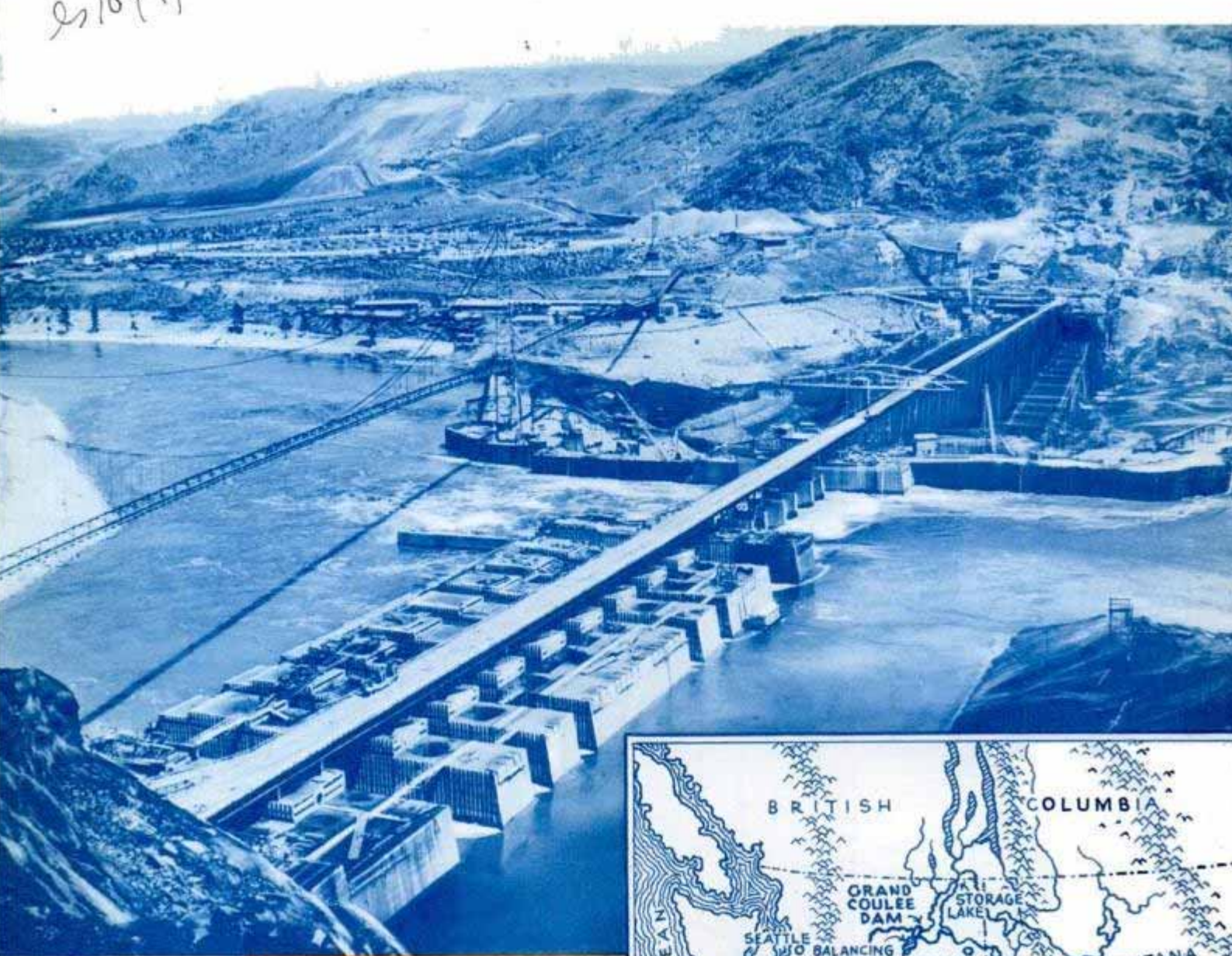

VIEW of construction area at Grand Coulee with the contractors' town, Mason City, in background. Map shows watershed drained by Columbia river and location of Grand Coulee dam.

BOULDER dam is the largest structure ever built by man, yet it could be buried in the base alone of a concrete colossus which engineers are raising above the Columbia river in Washington.

Called the "biggest thing on earth," the Grand Coulee dam, when finished, will be three times the size of Boulder, will develop one and a half times as much power, and will provide irrigation for

an area one and a half times the size of Rhode Island.

The dam will be as high as a forty-six-story building and as long as fourteen ordinary city blocks. Its bottom will be as thick as the length of a six-car train, and four vessels the size of the "Queen Mary" could be spaced along its top. The twenty-three million tons of concrete will bulk four times the volume of the Great Pyramid and would require

en169-1

a train 500 miles long, from New York to Detroit, to move at one time. It could be used to build a solid monument one city block square and three times the height of the Empire State building. When finished, the entire population of the United States, every man, woman and child in the country, could be placed inside its dimensions with room to spare.

If you should visit the dam today, you literally become a twentieth-century Gulliver. From a vista house perched part way up the canyon wall you peer down at a man-made mountain of concrete along the flanks and shoulders of which crawl toy engines and trains, tiny cranes, and pygmy trucks. The men who are building the monster are simply black moving dots.

But when you get down closer



COMPARATIVE SIZES OF THE WORLD'S LARGEST DAMS

0 500 1000 1500 2000 2500 3000 3500 4000 4500

GRAND COULEE DAM
COLUMBIA RIVER, WASHINGTON

LENGTH 4300 FEET
WIDTH AT BASE 500 FT.
HEIGHT (COMPLETE DAM) 550 FT.

SURFACE LEVEL BACKWATER 151 MILES

MUSCLE SHOALS DAM
TENNESSEE RIVER

LENGTH 4300, HEIGHT 142 FT.

ROOSEVELT DAM
SALT RIVER, ARIZONA
LENGTH 1080 FT.
HEIGHT 280 FT.

DNEIPER RIVER DAM, RUSSIA

LENGTH 2500, HEIGHT 200 FT.

BOULDER DAM, COLORADO RIVER
HEIGHT 730 FT., LENGTH 1180 FT., WIDTH AT BASE 650 FT.
SURFACE LEVEL BACKWATER 115 MILES

JACKHAMMER men, above, removing weathered surface rock from abutments of dam. Below, upper part of model shows portion of Grand Coulee which was excavated. Lower part shows dam set in excavation.





47699 EAST side mixing plant. At top are sand and gravel bins, below are scale hoppers and below the hoppers are four concrete mixers, all controlled from one central point.

the toy engines loom up as ten-ton Diesel-electric locomotives running on standard-gauge track and the tiny trains become long flatcars loaded with huge buckets of concrete. This dam is so huge that an entire railroad system, complete to dispatcher, switching yards and signal systems, runs all over it. Wise spectators bring their own binoculars to study the work. Professional photographers are stumped because if they get close to the dam they can get only part of it on their film, and if they move off a mile or two to get the whole picture, details are lost.

Yet the gigantic mass to be seen today is not much more than the mere foundation of the whole structure. When finished the dam will be nearly a mile

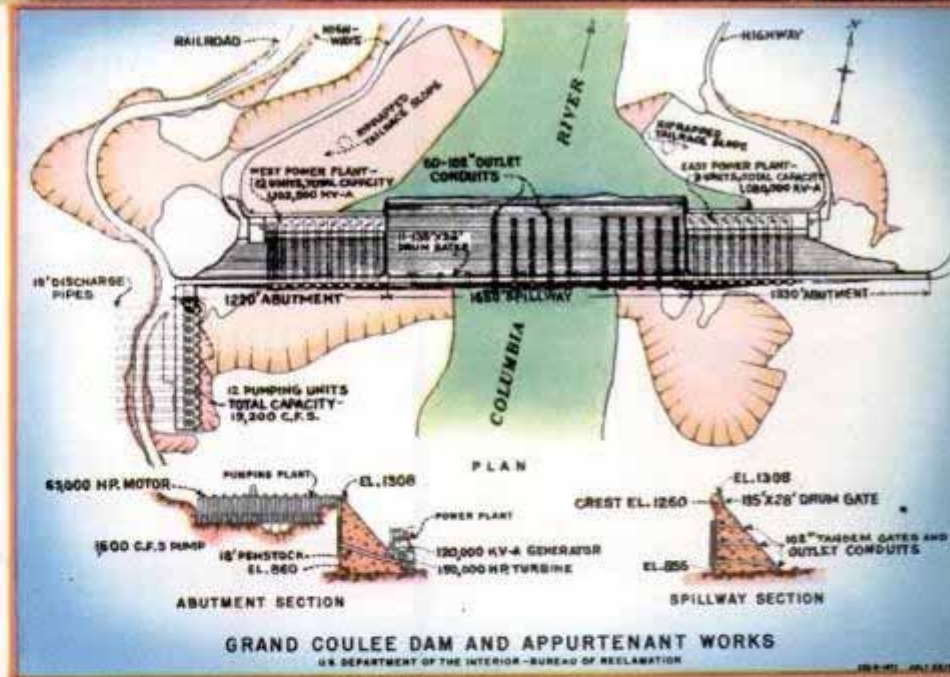

long and three times as high as Niagara Falls. It will back up a lake 151 miles long clear to the Canadian border and its generators will develop the equivalent of 2,700,000 horsepower, more than the hydroelectric power of all seven dams of the Tennessee Valley Authority combined.

The gorge of the Columbia river is too big to permit an arch-type dam. Grand

5109
Coulee must depend upon its massive weight alone to resist the pressure of the water it will back up. At the dam site the river is 700 feet wide and at times seventy feet deep, flowing fourteen miles an hour, and has an average annual runoff of 79,000,000 acre-feet, five times that of the Colorado at Boulder dam. It is estimated that potentially this one river alone, exploited under a huge ten-dam program of which the Grand Coulee is one and the Bonneville dam now being built 300 miles down stream is another, can turn up energy amounting to more than half the total hydroelectric power developed in the United States today.

When the engineers selected the present site on the Columbia they took advantage of an event that

GIANT concrete bucket, right, dumped by opening gate in the bottom. Below, traveling cranes by which concrete is delivered, from tracks on steel trestle supporting them, into the forms.

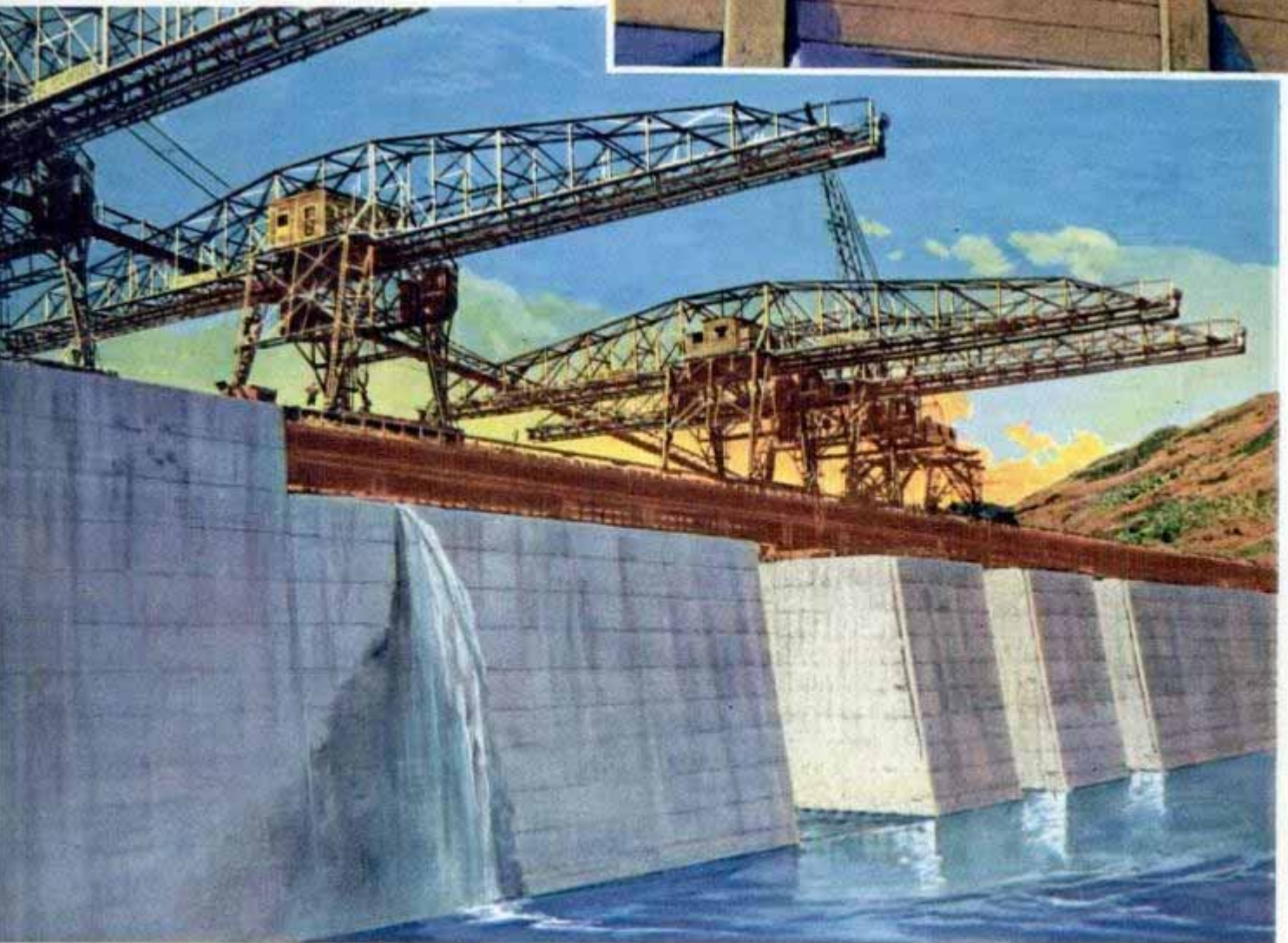
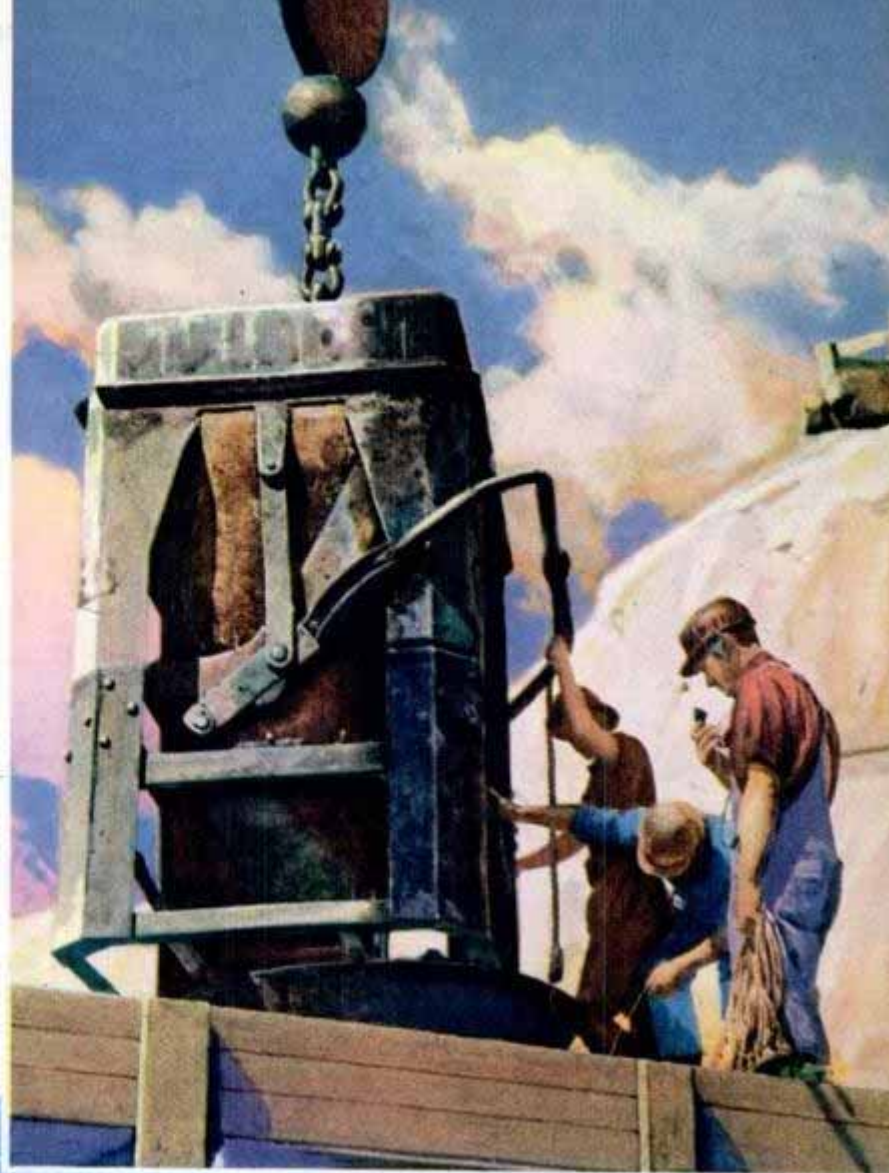

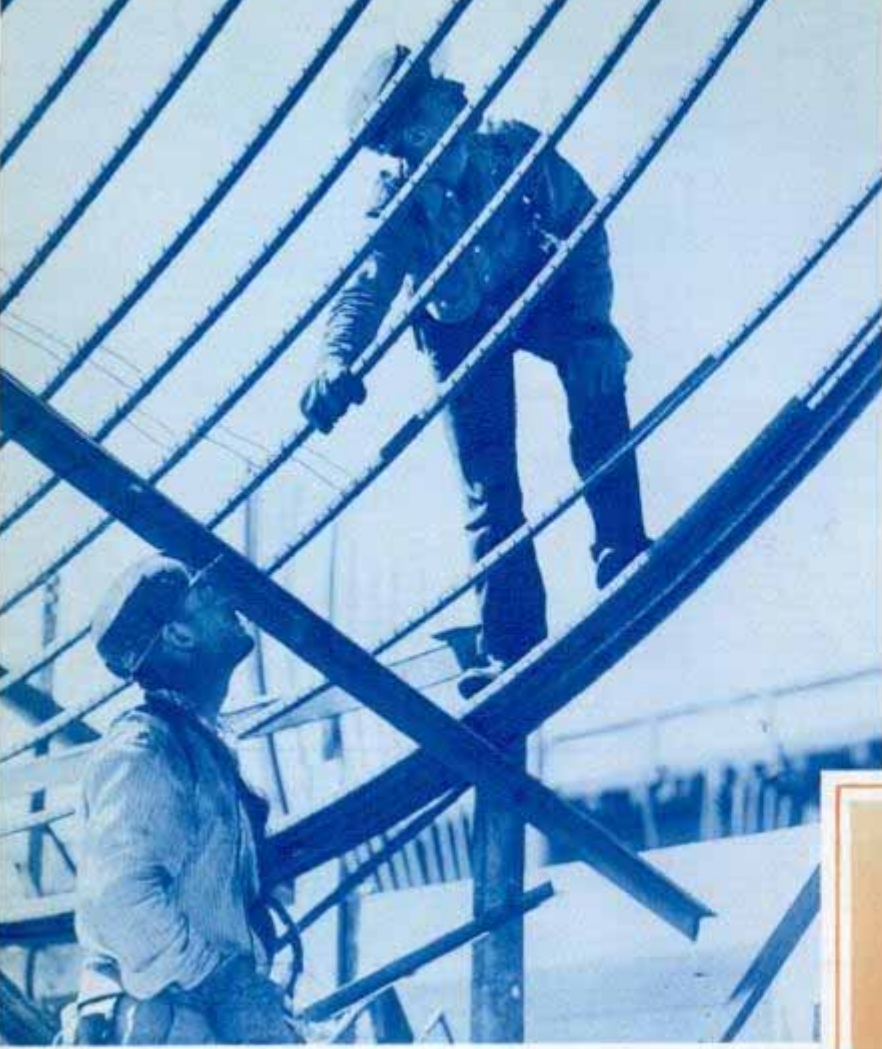

es/09'

present idea is to pump billions of gallons of water up from behind the new dam into the extinct river bed and use twenty-three miles of this trough both as a canal and a balancing reservoir to carry part of the Columbia to the arid acres of the Big Bend country. It took daring imagination to plan such a tremendous project.

Everything about the Grand Coulee dam is "bigger than ever before." Never before has a river the size of the Columbia been dammed, or a steel cofferdam 3,000 feet long been sunk to bedrock to hold back the swirling waters while work was

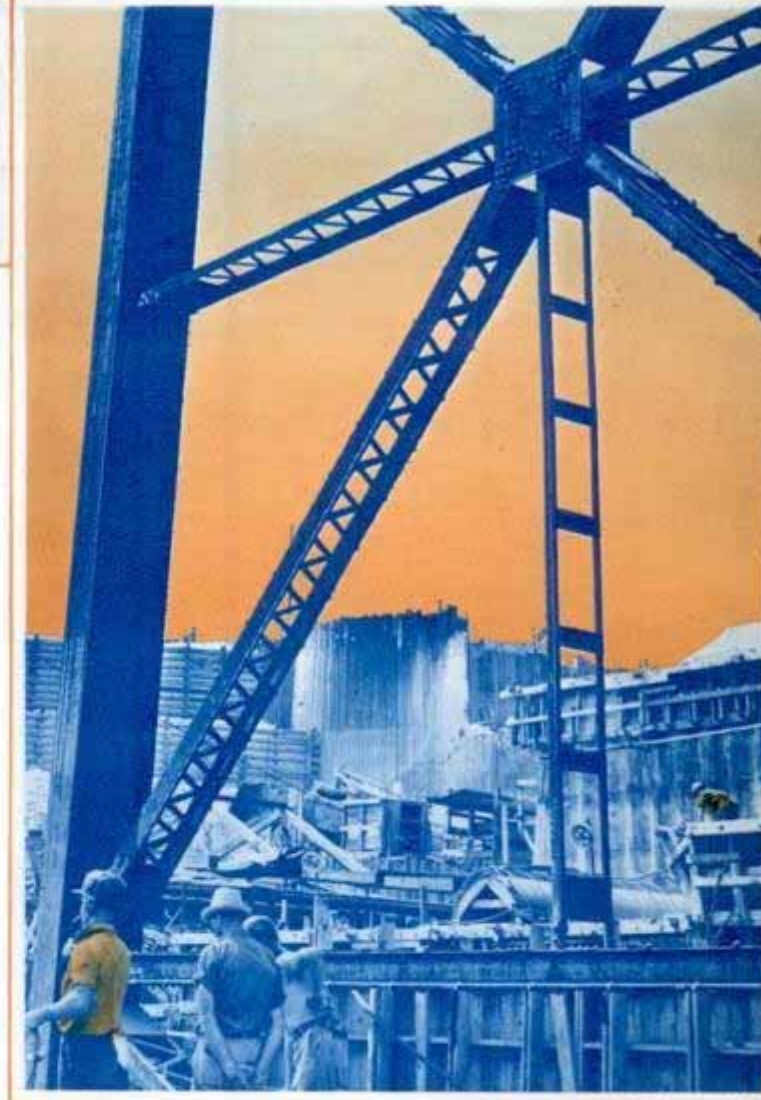

happened millions of years ago. During the last great ice age a glacier flowed into the present river bed and dammed the river as effectively as the modern concrete structure will. The impounded waters gradually filled the canyon and then overflowed the walls, cutting out a new river channel to the south. For centuries the river flowed along its new bed and then, when the ice retreated, resumed its age-old path.

That left a dry river bed high on the canyon wall, pointing away almost in the opposite direction from the great gorge of the Columbia. This dry river bed, or Grand Coulee, is a great trough two to five miles wide and fifty-six miles long. At the far end of this old channel lie 1,200,000 acres of the richest arid agricultural land in the country. The



SUPPORT of bridge for dam work which will be swallowed by rising concrete. Above, placing reinforcing steel in what will be a tunnel in the dam. Left, comparative power capacity of large dams.

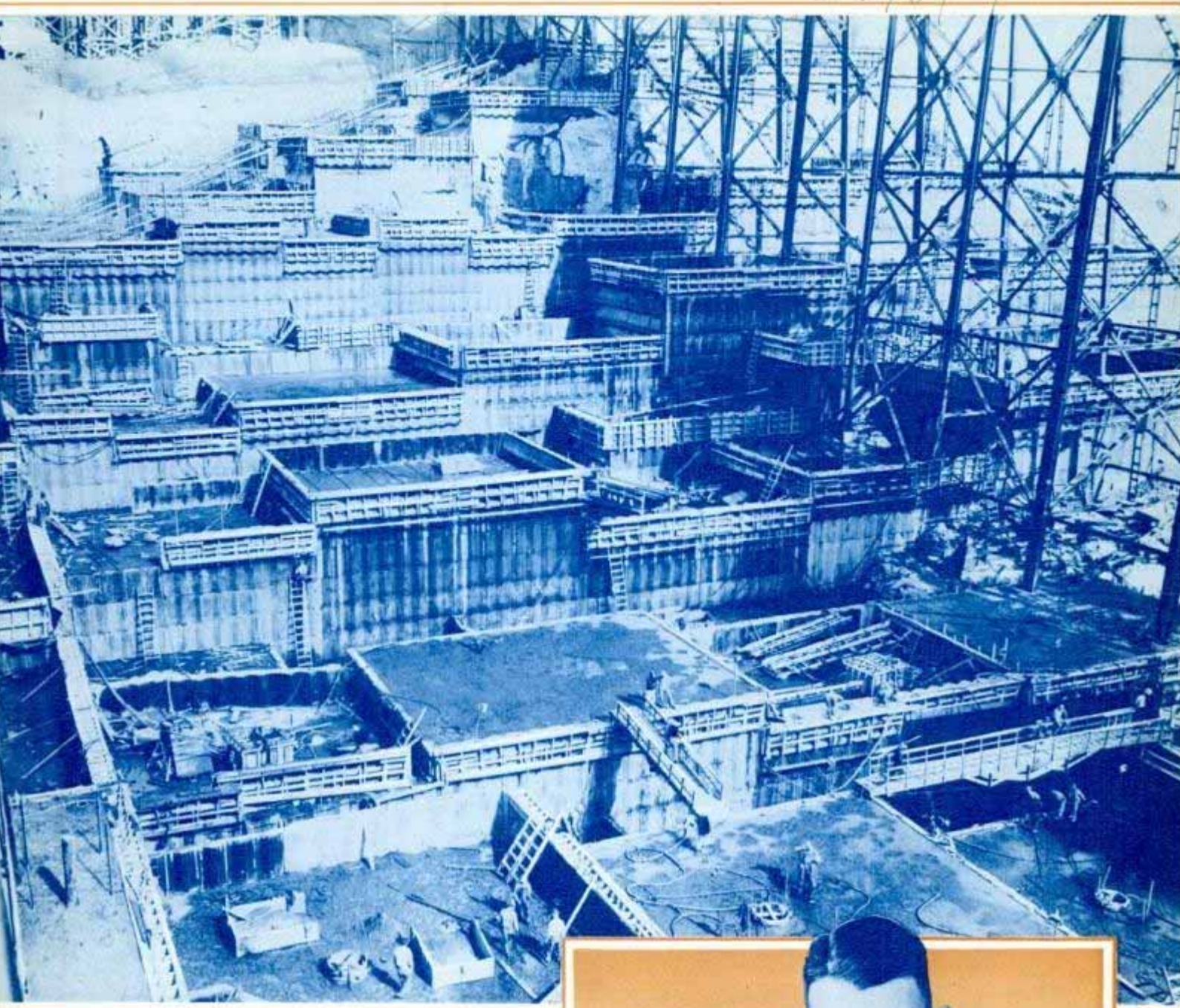

started. Never before had it been necessary to excavate and carry away 20,000,000 cubic yards of material to scratch down to bedrock. Most of this material has been moved one and a half miles away by conveyor belts where it filled a convenient ravine. Today the conveyor belts have reversed their direction and are bringing endless streams of materials down out of the hills to the concrete mixers.

Getting ready to build the dam was a major job in itself. Two towns, a "contractors' town" and a "government town," were built on opposite sides of the river for the nearly 6,000 workmen and engineers. A large permanent highway bridge, a railroad bridge and a suspension bridge for carrying cement across the river had to be built, as well as several pile

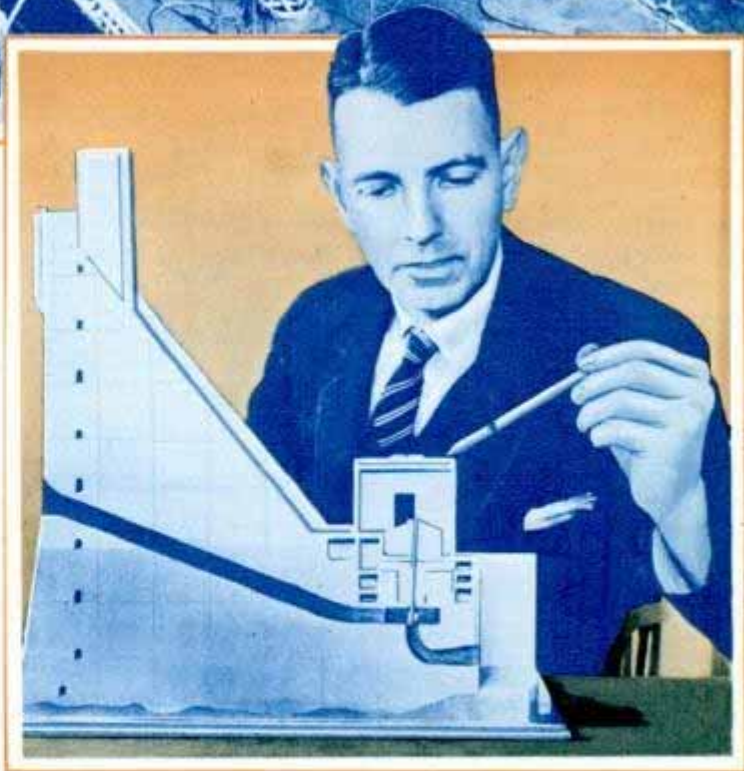

CUTAWAY model showing a cross section of dam as it will appear when completed. Picture at top shows how the dam is built up in "lifts."

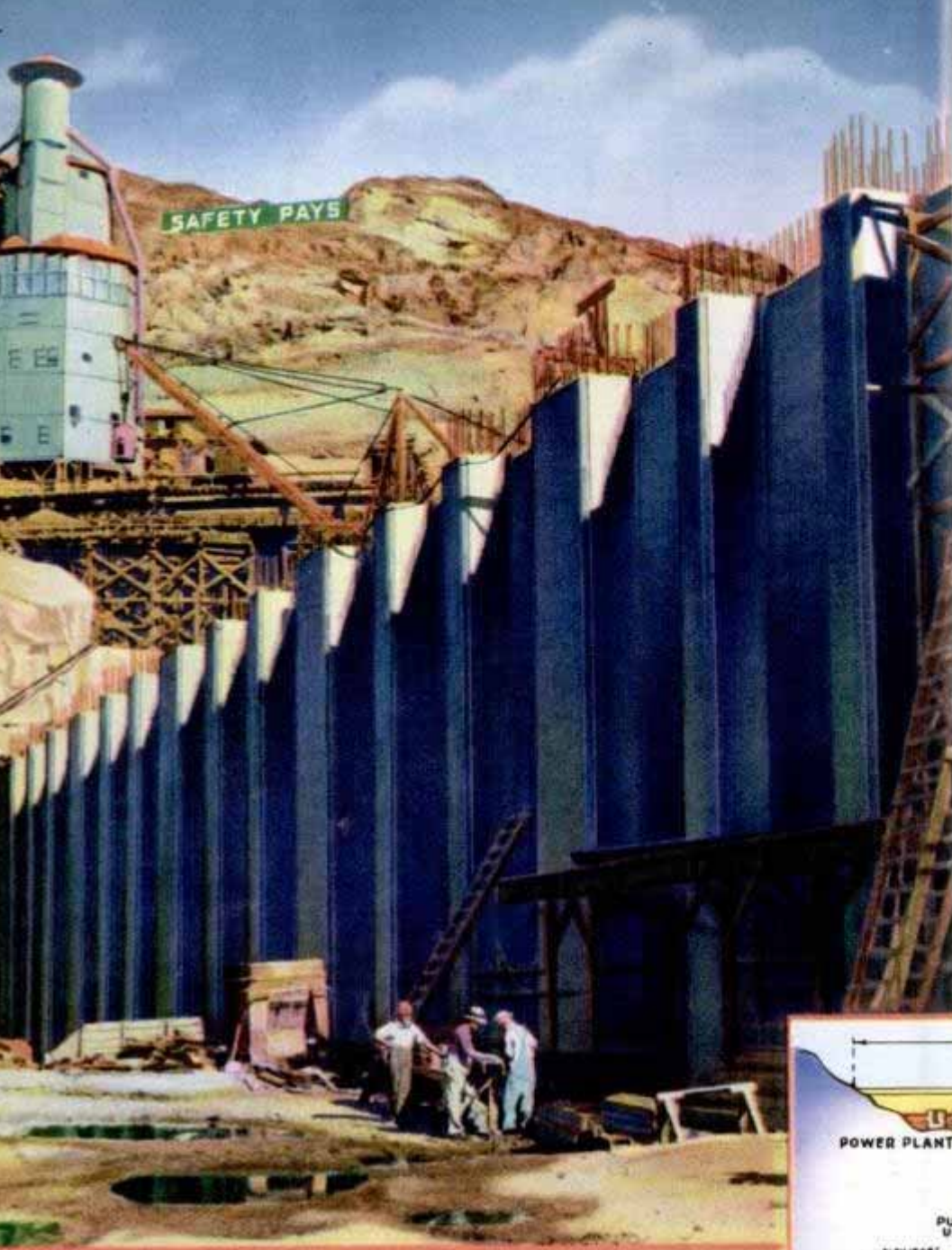

251091
bridges and catwalks. In drilling down to bedrock to insure firm foundations for the dam the drillers wore away nearly forty-nine miles of hardened drill steel. To make sure that the foundation granite itself is as strong as possible, ten miles of grout holes were drilled into it and 12,500 tons of cement "grout" were forced down the holes under pressure to fill every crack and seam.

The dam looked more like a bridge than a dam during the first year or so of construction and that is just about what it really was. Before the first slab of concrete was poured an 11,000-ton steel trestle was built across the (Continued to page 128A)

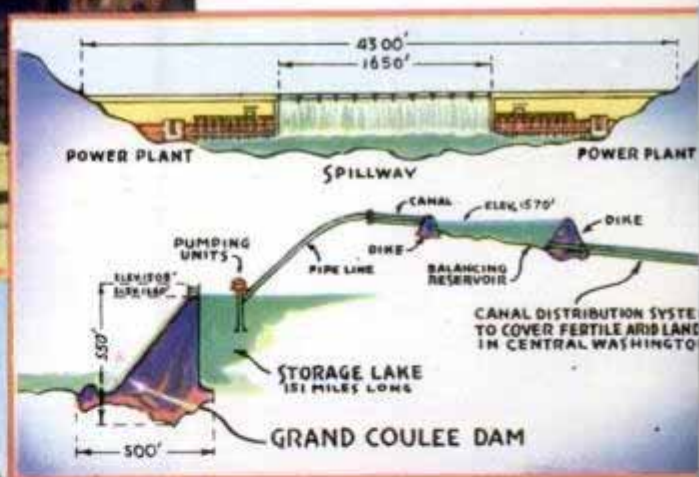
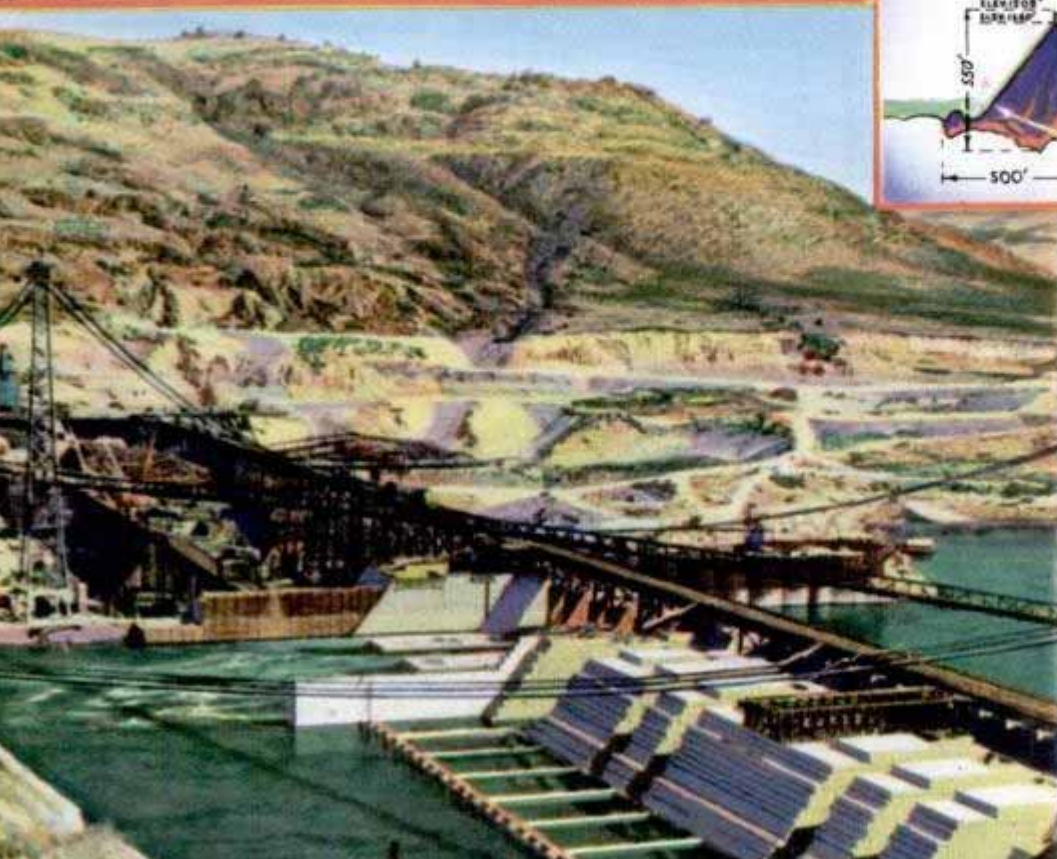

BASE, at top of page, of east side powerhouse and, above it, the east side mixing plant which turned out 9,290 cubic yards of concrete in twenty-four hours. Left, partly completed base of dam with turbine pits in foreground. Finished dam will be 300 feet higher than concrete shown. Diagram shows how water will be captured and delivered for irrigation.

Printing Tint Blocks Also Useful for Hobby

Tint blocks, used for borders, color backgrounds and panels of solid colors in printing, may be prepared easily with a linoleum composition, a specially processed, pure-white surfaced, toughened material easy to engrave. The blocks can be sawed and cut from the materials to varying sizes and shapes and may be used repeatedly. No special tools are needed other than a saw and a knife. On involved jobs, a solid block of color with reverse lettering may be used. Another practical use is the framing of half-tone engravings in color backgrounds. To do this a tint block is cut to the desired shape and size.

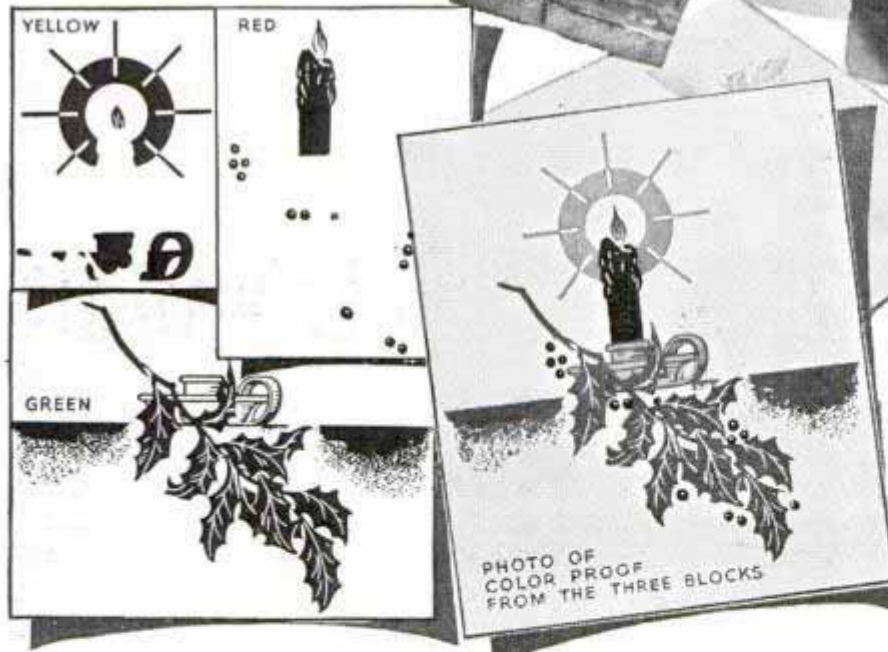

Top, routing out composition from around design intended for simple color printing. The work is easy. Below, proofs of three blocks required in three-color job, together with the final proof

Then a proof of the cut to be registered is taken and placed face down in position on the tint plate. Then the transfer of the cut is burnished down, giving a sharp line to cut to. All that is necessary is to outline the cut and rout out the dead area. Careful cutting insures perfect register for the color. Many schools and artists are taking

up engraving on linoleum, which also may be made an interesting hobby. With this new material, the amateur or professional can achieve a perfection of detail hitherto unknown to the linoleum engraver, particularly in the use of stippled color tones. The composition plates use all inks and may be electrotyped or stereotyped.

Blod Chicago
Altn. Lloyd H. Isler -
Comp. Lin.
see data.
2-90 per 1.00
eg. tool
minimum \$1.00
Tel. Dearborn 2425
see data
1938

Radio Station Has a One-Man 'Sound Factory'

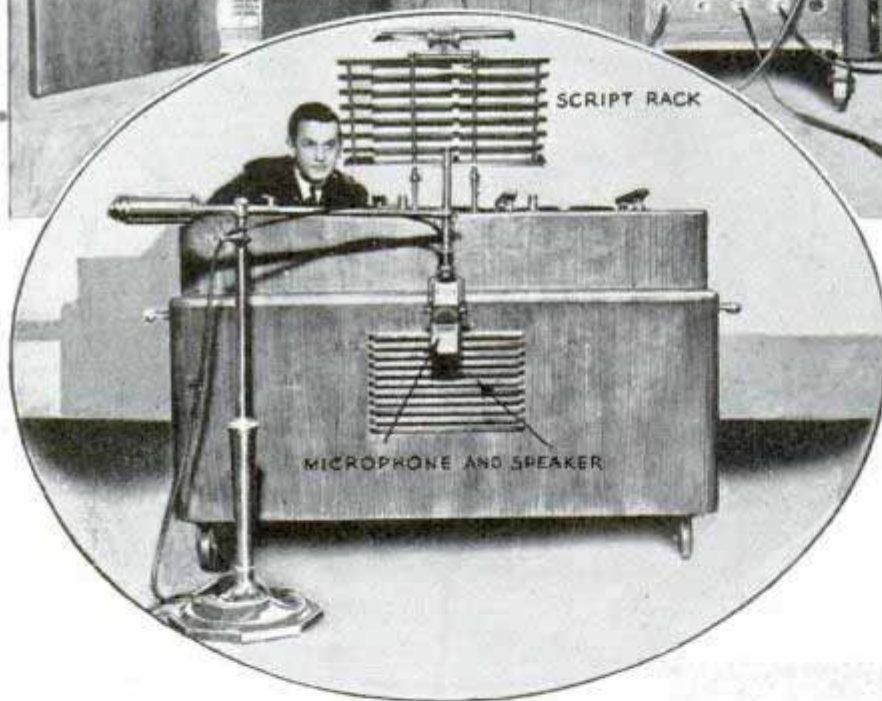
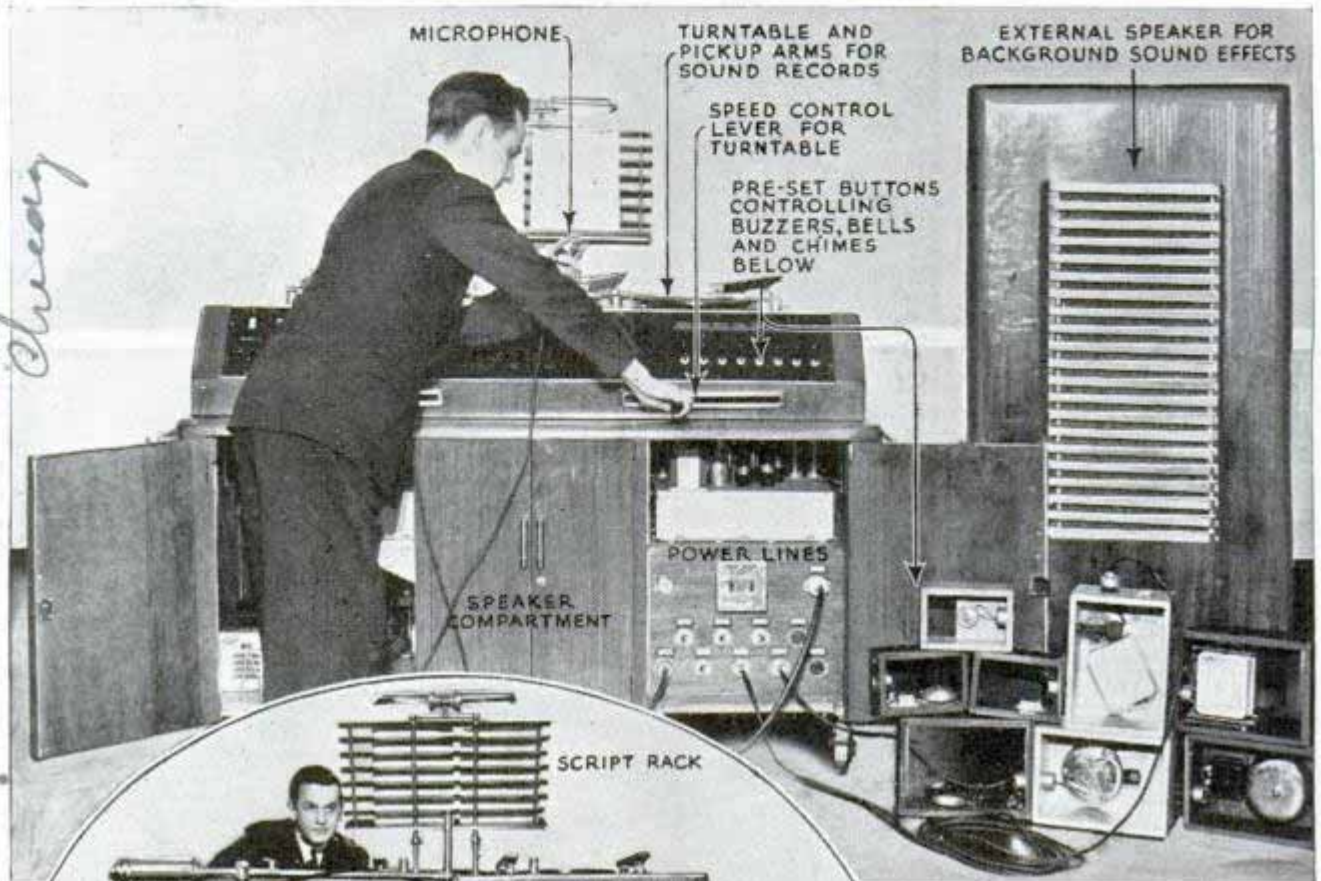

Front and back views of portable sound table in WGN studio. Pedestal microphone picks up effects from inclosed speaker, hand "mike" is for off-stage and telephone effects. Three turntables play sound records; eight buttons control special pre-set sounds, such as bells and buzzers

Manual tooting of horns and jangling of bells by the sound-effects crew in the radio studio is outmoded by the versatile one-man electric table developed by engineers of station WGN, Chicago. All of the sound effects required for a dramatic broadcast can be delivered into the microphone from this one source, for it includes not only three electric turntables for tuning in sound records, but eight pushbuttons which produce various other sound effects pre-arranged for individual program requirements. This complete "sound factory" is mounted on six-inch solid rubber wheels, easily movable from studio to studio, and

a single technician can operate it, following the script on a rack over the table and pushing buttons or dropping pick-up arms on the turntables as the cues dictate. There is not only individual volume control for the turntables, but on the front of the table are two levers which can vary the speed of the record from zero to 120 revolutions per minute. It is also possible to reproduce "off-stage" voices, a voice heard over the telephone, or to distort the voice in various ways; a microphone at the center of the board can be plugged in and the quality of the voice varied by rheostatic controls. All the sounds emanate from a speaker

Equipment built to order by Jenkins and
 Davis 3333 Belmont Ave
 Chicago

inclosed in the lower middle section of the board, but an additional speaker can also be attached to produce background tones. Two of these portable sound factories are used daily in producing dramatic programs.

Glass-Insulated Shoes Resist Weather

Glass-insulated shoes, with fibrous glass converted into an adhesive paste and packed into the tiny crevices underneath the rim of the insole, have been found cooler in summer and warmer in winter than ordinary shoes. Tested on policemen, temperatures of the bottom of the soles, the insoles and feet were checked. A variance of twenty degrees was found between the glass-insulated shoes and those made in the usual way. It also was discovered that the fibrous glass kept the wearer's feet dry.

Always study news 1/6/38

Pony Taught to Take Barrier by Hurdle-Jumping Trainer



Here is the trainer going over the barrier with the pony. Note that the trainer knocked down the top pole at the jump.

While Bell Metal, a Shetland stallion, was being exercised for the royal show at Flemington, Australia, his trainer taught the pony how to take the jumps. At one barrier, the trainer beat the animal over the jump, but he knocked down the top rail. At that moment an alert photographer snapped his camera. The resulting picture showed the trainer going over and the pony just preparing for the jump.

Australian

Test Light on Worker's Wrist Aids in Auto Repair Work

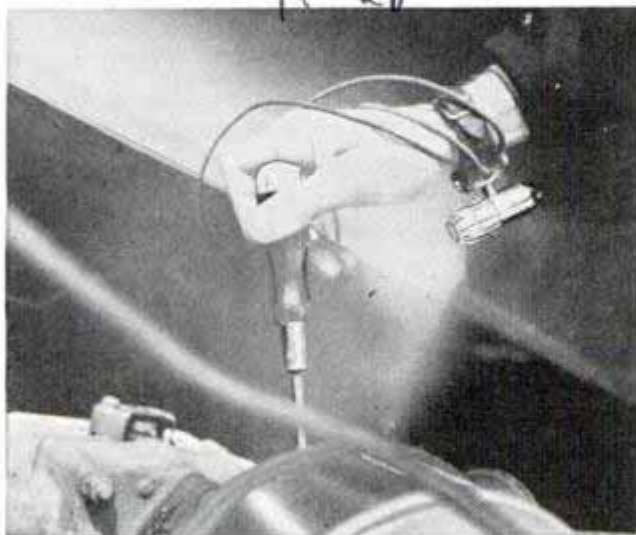

Testing auto wiring with handy combination service and test light worn on mechanic's wrist

Attached to the worker's wrist, a small combination service and test light now on the market simplifies auto electrical repair work. Constant light on the work is afforded by a six-candlepower lamp, soldered on the cover of a buzzer box and attached to a leather wristband. A battery clip attached to any metal part of the car affords a common ground for both buzzer and light circuit. There are two needle or detector points to perforate insulation and make contact with circuits to be tested. One point connected to an open circuit turns on the lamp, illuminating the instrument in use. In seeking short circuits, the second point sounds the buzzer with each contact until the short is reached.

Mr. Robert L. Gray, 270 Beach

es 1476

Capt. Thomas & Stevenson Jr.
1055 G. Holman Ave.
Los Angeles, Calif

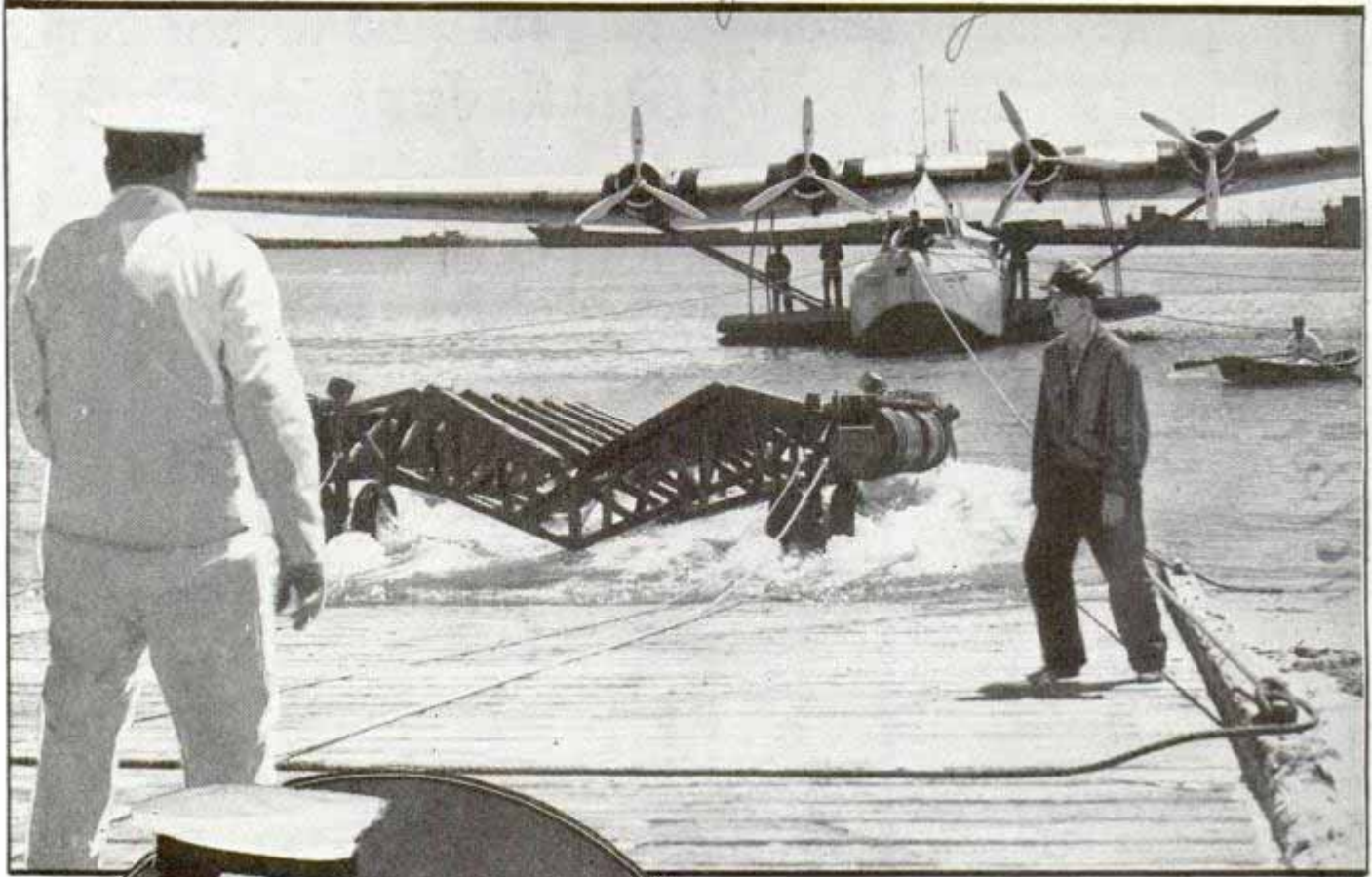

Top, launching the beaching gear for clipper to be brought ashore. Bottom, Guam airport manager preparing clearance papers for clipper about to depart

FLYING

port job that "couldn't be done." Now regular passenger schedules are being maintained across the world's greatest ocean through all four seasons of the year. More than 2,000 passengers and half a million pounds of ocean air mail and cargo have been carried across the Pacific.

NINE thousand miles to China and less than six days to get there!

Two years ago that was an impossible trip. Today you can cross the Pacific in less than a week, flying in safety and comfort and sleeping ashore every night but one on the islands that dot Pan American's trans-Pacific route. It's five days and five hours to Asia this year, sixty hours of flight time.

Not so long ago this was the air trans-

To conquer the Pacific, Pan American first used its Caribbean lines as a laboratory in which to perfect men and methods. Four-engine flying boats larger than ever used in regular service before were built and tested. Then, while the mid-Pacific bases were still under construction, flight after flight was made to Honolulu, to Midway, then to Wake, then to Guam. Nearly a half million miles were flown before the airway was opened to passengers.

Reference - H. M. Walton
Pan American Airways,

429 Bond St. San Francisco Calif

2-14-36

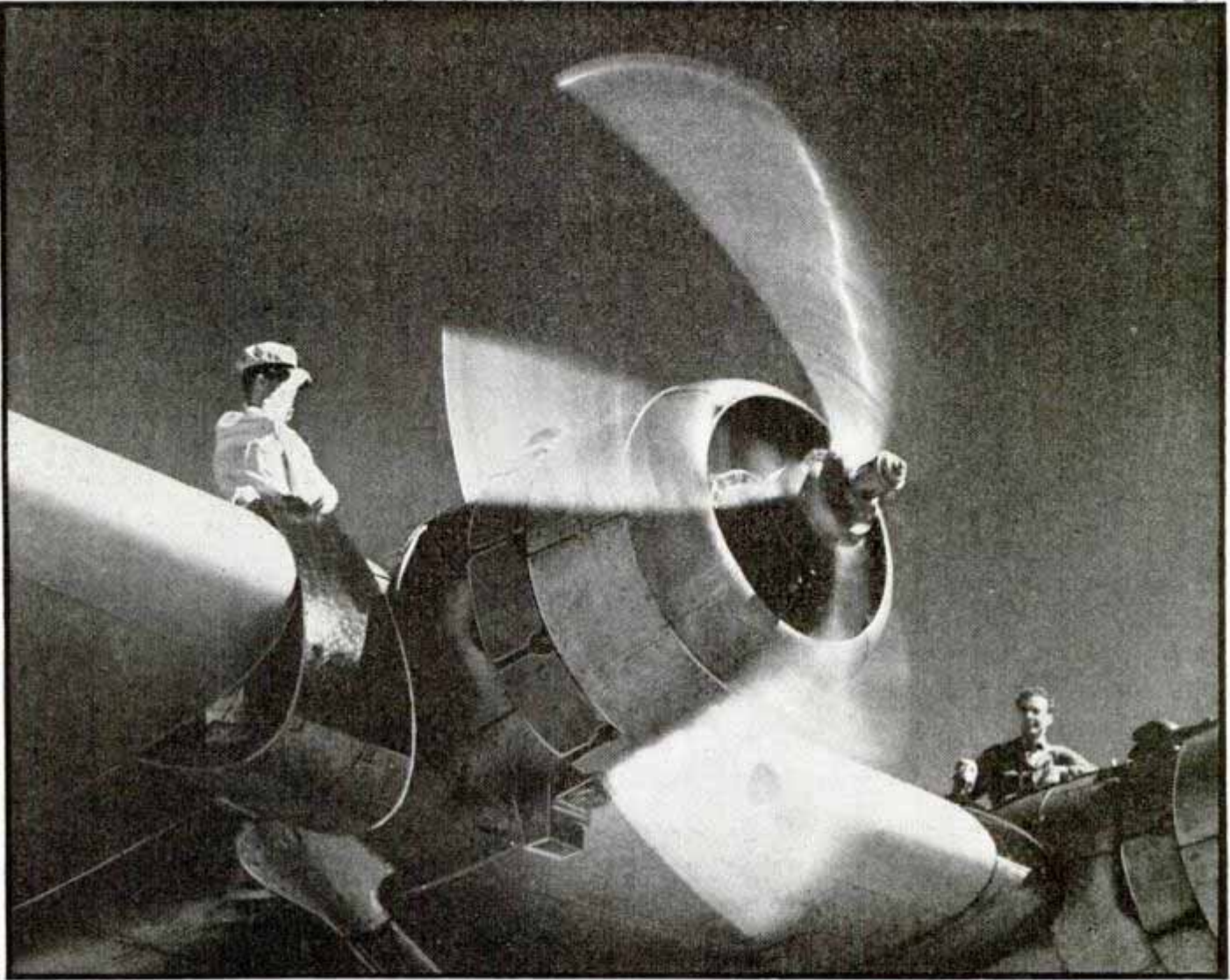

the CHINA CLIPPERS

Flying the ocean is an entirely different art from ordinary transport flying over land. Crews have to be trained mariners as well as airmen. The pilot in charge is officially the captain and the cockpit is called the bridge.

Pan American operates on the principle that when one of its clippers goes to sea it must take care of itself as ably as a big liner. The flying boat has to be both air-worthy and seaworthy, able to make a landfall without outside aid. The great clippers are navigated over the ocean exactly the same way as are surface vessels. The captain uses dead reckoning, celestial observations, radio bearings, and combinations of these methods for making his way across the sea. There is no flying the beam on the ocean.

The clippers use the same basic princi-



Top, testing engine. Bottom, releasing aluminum powder bomb. Drift indicator on window is used to sight the bright spot the powder makes on water

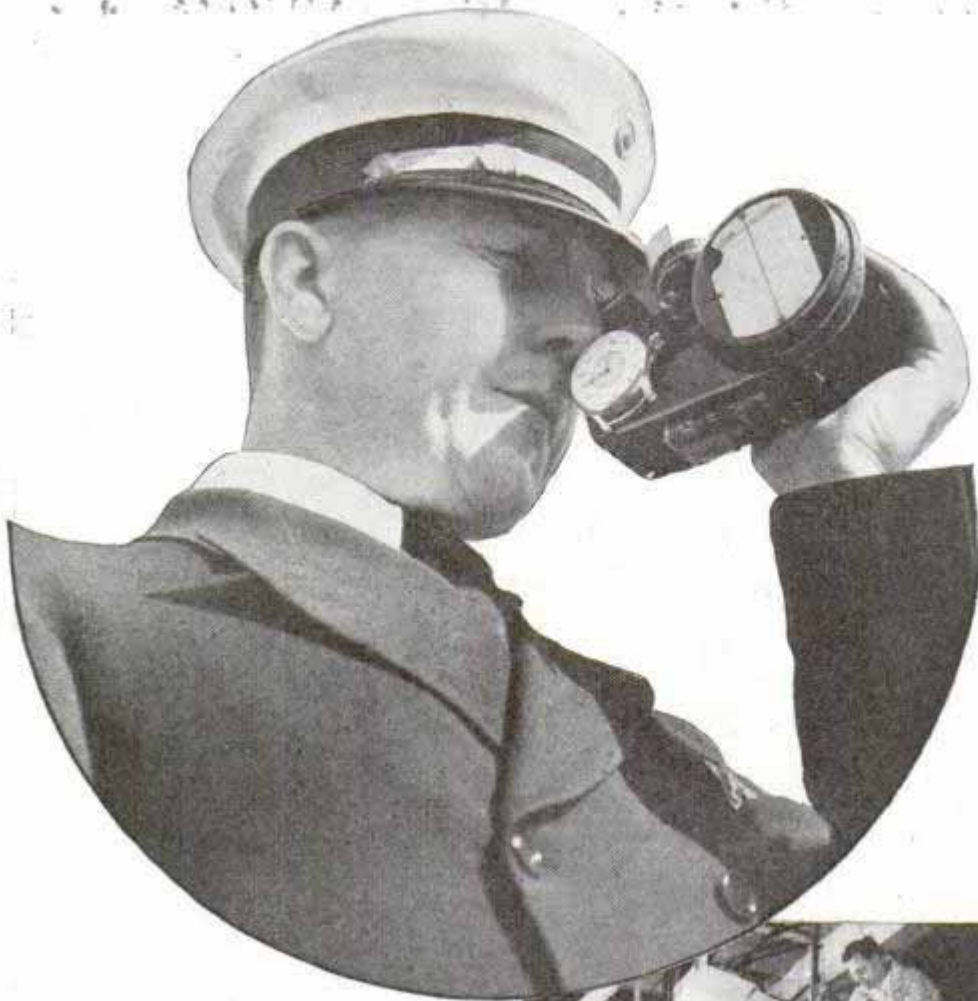

To get an idea of what flying the Pacific is like, let's put ourselves on board the Philippine Clipper, eastbound out of Hawaii. It is four o'clock in the morning and the passengers who left Honolulu yesterday afternoon are asleep in their staterooms. The clipper is flying at 7,800 feet and is due to land at Alameda on San Francisco bay in another five hours.

In the subdued glow of the instrument lights on the bridge, up on the flight deck, the chief officer and his junior

ples of celestial navigation that were used in the old days of the sailing clippers, simplified for convenience in the air. The navigator often combines this art with radio in a number of ways, such as crossing a radio bearing with a sun line to get his position or by taking a radio bearing on a near-by ship whose position is known. If all radio communication should fail the clipper could make its way home.

Between San Francisco bay and Manila the airway uses three twenty-six-ton Martin flying boats, the China Clipper, the Hawaii Clipper, and the Philippine Clipper. The great ninety-foot hull of one of these boats is divided into six watertight compartments, any two of which could keep the plane afloat if necessary. A clipper can cruise and climb on any three of its four engines. At Manila you transfer to a four-engined Sikorsky for the final five-hour jump to Asia.

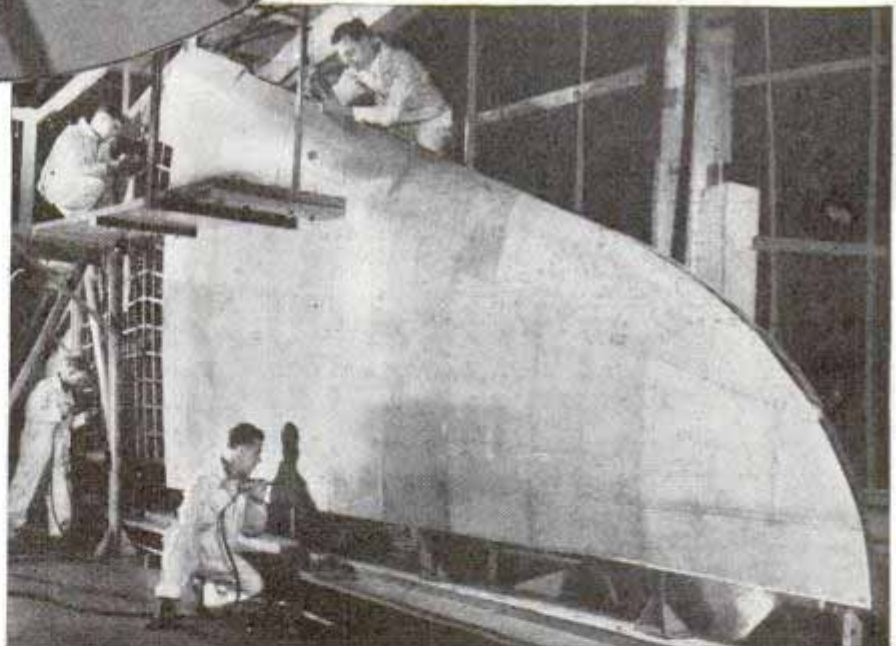

Top, clipper navigator demonstrating use of octant. Bottom, workmen busy on tail surfaces of new clipper

control surface shop - Boeing officer are sitting at the controls as the plane flies under the guidance of the automatic pilot. The plane is hundreds of miles from the nearest land. Right now it is nearly time for the hourly radio report and every officer on watch is busy preparing for it.

The engineering officer at his post up under the wing has just inspected his four

engines with a flashlight. This is simply a safety check because the light blue exhausts, the steady drumming of the power plants, and the needles of his instruments tell him that all is going well. Right now he is checking over most of his 181 instruments and levers before writing up the engineering log.

The navigator has just returned to the chart room on the lower deck after making a celestial

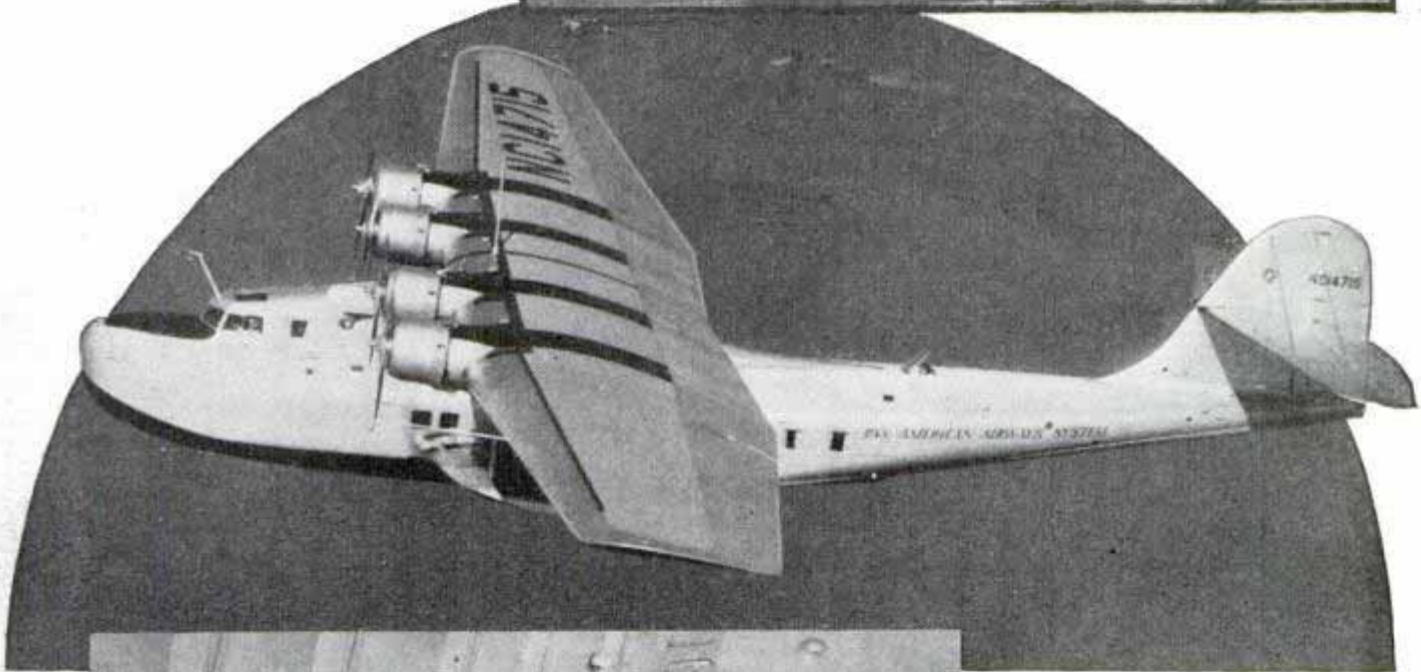

Top, crew going aboard a clipper. Center, Pan American clipper departing on overnight hop to Honolulu. Bottom, passengers at table in main saloon of the clipper as it wings its way across the Pacific

observation. To do this he walked through the plane to the after companionway where he slid back the hatch and obtained a "star fix" by sighting the star through the eyepiece of his octant and bringing it down to the level of his instrument's artificial horizon. The master compass and chronometer in the chart room, as well as air speed indicators and altimeters duplicating those on the bridge, will help him work out the problem. The clipper's

(Continued to page 118A)

from Alameda

Cont. Mrs. and M. Kelley
42 Charlton St. New York

Newsprint Cores Used to Build 'Log' Houses

Potentialities of a new building material have been demonstrated by a development in Texas. It started when a Dallas editor built a playhouse for his daughter and used cores from newsprint rolls like logs. The cores, whose composition mainly is paper and glue, are treated with linseed oil and then painted, pre-

Led Dealey
Dallas News



Views of cabins built with newsprint cores. The resemblance to logs is remarkable. Top, note interior of cabin papered with old newspaper mats

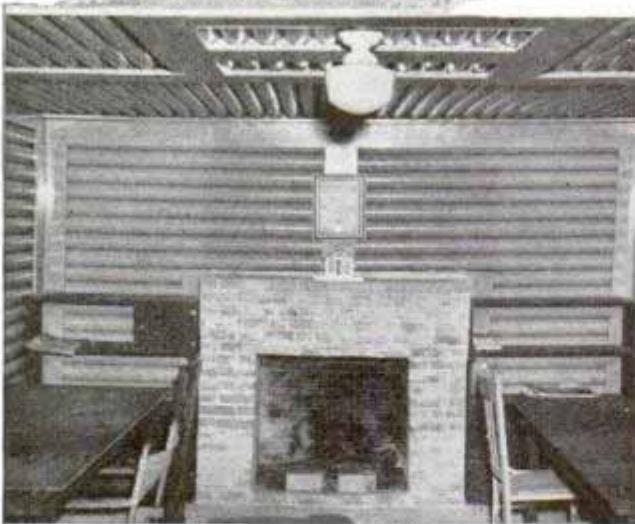

thus benefiting both. Eleven and one-half feet square, the playhouse contains 160 cores, each sixty-eight and one-half inches long. Total labor cost was forty dollars. Among other core houses erected in the same section is a Boy Scout cabin, measuring twelve by eighteen feet, in which 300 cores were used. Perhaps the most elaborate structure is a five-room house. Because of the resemblance of cores to logs, this house has the appearance of an expensive log cabin. Between 1,200 and 1,500 paper cores were used, most of which were split lengthwise. The half cores were joined at the corners with asphalt. The interior of the house is stucco-finished, with pine paneling, while the exterior is "painted" with linseed oil to make it waterproof.

venting moisture from penetrating them. Previously considered a nuisance around printing plants, the cores should last as long as brick or wood, the editor points out. Through establishing their value as a building material, the editor believes newspaper owners may sell the cores at perhaps ten cents each to persons unable to pay regular prices for building supplies,

Ancient Volcanoes Yield Gold, Silver, Oil and Diamonds

From the craters of ancient volcanoes come gold, silver, oil and diamonds, members of the nation's geological survey, department of interior, have revealed. \$375,000,000 in gold has been taken from the crater of an extinct volcano in the

H 125
at Geological Society
in a session

Cripple Creek district of Colorado. This volcano erupted about twenty-five million years ago, after which the deposition of large quantities of gold ore in fractures and fissures of the crater occurred. Also in Colorado, veins related to Silverton volcano in the San Juan mountains have produced \$270,000,000 worth of gold and silver. Several important oil pools lie in volcanic cones and necks in Texas. The ancient volcanoes of the Gulf coastal plain which extends through Texas, Arkansas and Mississippi erupted about eighty million years ago, but only since 1915 have their oil deposits been known. In the throats of this same group of volcanoes, in Arkansas, diamond deposits have been found. The largest crater known is in New Mexico.

4.5
**Aluminum Double-Deck Cars
 Give More Passenger Space**

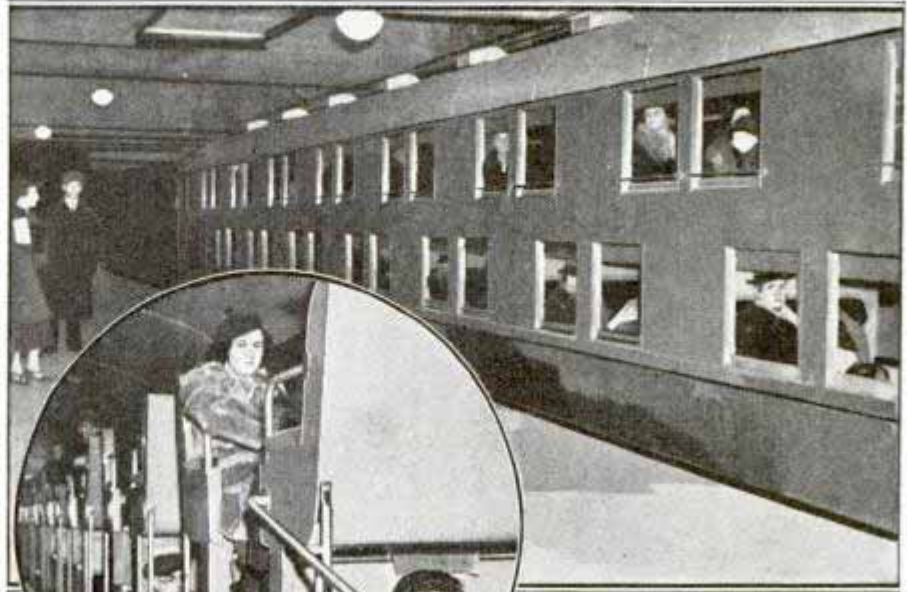

Two views of the double-decker train. Inset, the interior view shows how passengers are seated

Designed to relieve traffic congestion, all-aluminum double-deck railroad cars have been placed in service on the Long Island railroad. Each car seats 136 passengers, considerably more than could be carried by the ordinary car.

H 95
Curtain of Hot Air Bars Cold at Factory's Open Door

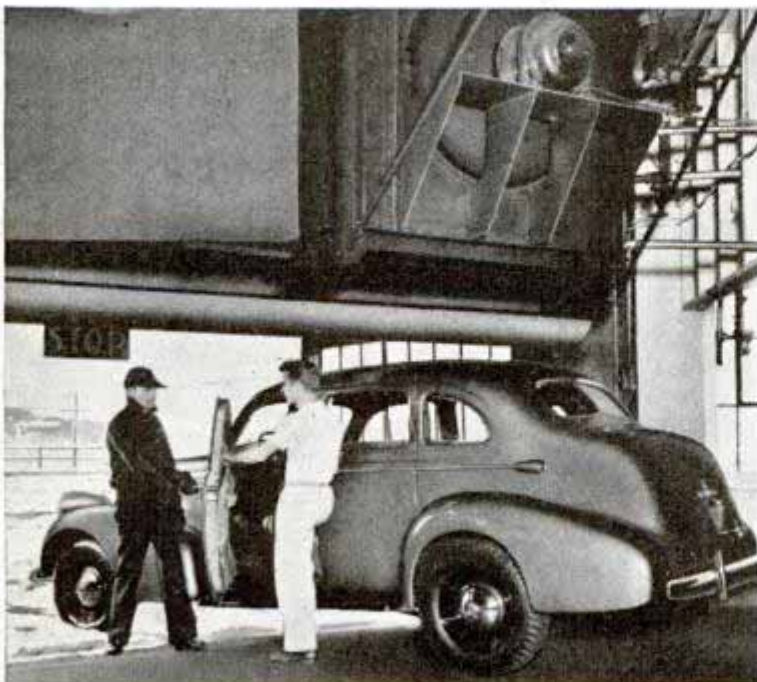

Worker at left, outside hot-air curtain, wears heavy clothing. Worker at right is comfortable in light clothing

Also motor works.
 Although the big door near the end of the assembly line in one big automobile plant is left open frequently, workers do not suffer from winter's chilling blasts. A curtain of hot air keeps out the cold. A huge rotary fan drives air through steam-heating coils and then downward to the floor through a narrow overhead vent extending the full width of the door. The warm downward current excludes the outside air to a large extent and mixes with such cold air as does filter through. As a result it is possible, even in zero temperatures, to leave the door wide open for the passage of new cars while assembly men near by work in an even temperature of seventy-two degrees.

Camera Giant Stretches Bellows Twenty Feet

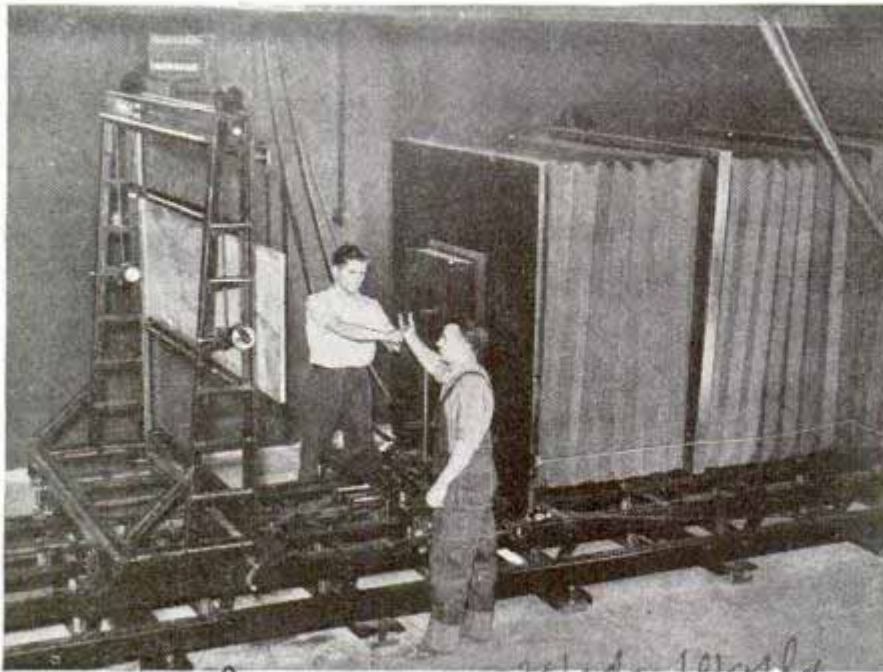

In the heyday of the miniature camera, a camera taller than a man is news. A Cleveland factory has just installed this photographic giant, for color separation work. It registers on a plate about five feet square, and its bellows stretches out to a length of twenty feet. The camera cost \$25,000.

Here is a camera too big to squeeze into its own picture! Used for color separation work, it requires a plate five feet square and its bellows stretches out twenty feet

Hydraulic Highway Scraper Shows Depth of Cut on Dial

Road grading with considerable accuracy is possible with a hydraulic scraper which has an indicator dial showing the operator the exact depth of the cut, or the height of the bowl above the ground when spreading. Three identical hydraulic cylinders are required to operate it. The power is furnished by a specially designed rotary gear pump.

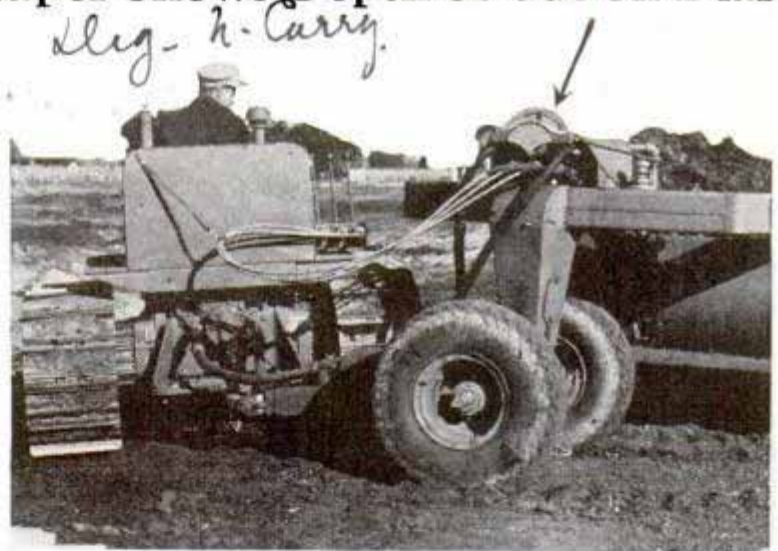

Arrow points to dial which tells operator exact depth of slice the road grader is cutting. This one is turning on a twenty-six foot fill

Automobile Converted for Use on Railroad Travels Alaskan Line



With flanges bolted on its wheels, an automobile is used on the Alaska Railroad as the private car of Col. Otto Ohlson, general manager. Of the sedan type, the auto travels at good speed to all parts of the line. In winter, it moves along behind snowplows clearing away snow, since the car is not heavy enough to buck big snowdrifts.

Names and addresses of manufacturers and dealers in articles described in this magazine will be furnished by our Bureau of Information upon request accompanied by stamped, self-addressed envelope.

Automobile used as private car by general manager of Alaska railroad © Delano

Heil Co. 3000 W. Myrtle St. Milwaukee, Wis.
Delano, Leonard Delano, 607 N. Knott Portland Ore.

Delano - h. Carry. 1700 London Road.

#102

Wide World

Delg - h. Carry.

#88

Portable Plywood Cottage Packs on a Trailer

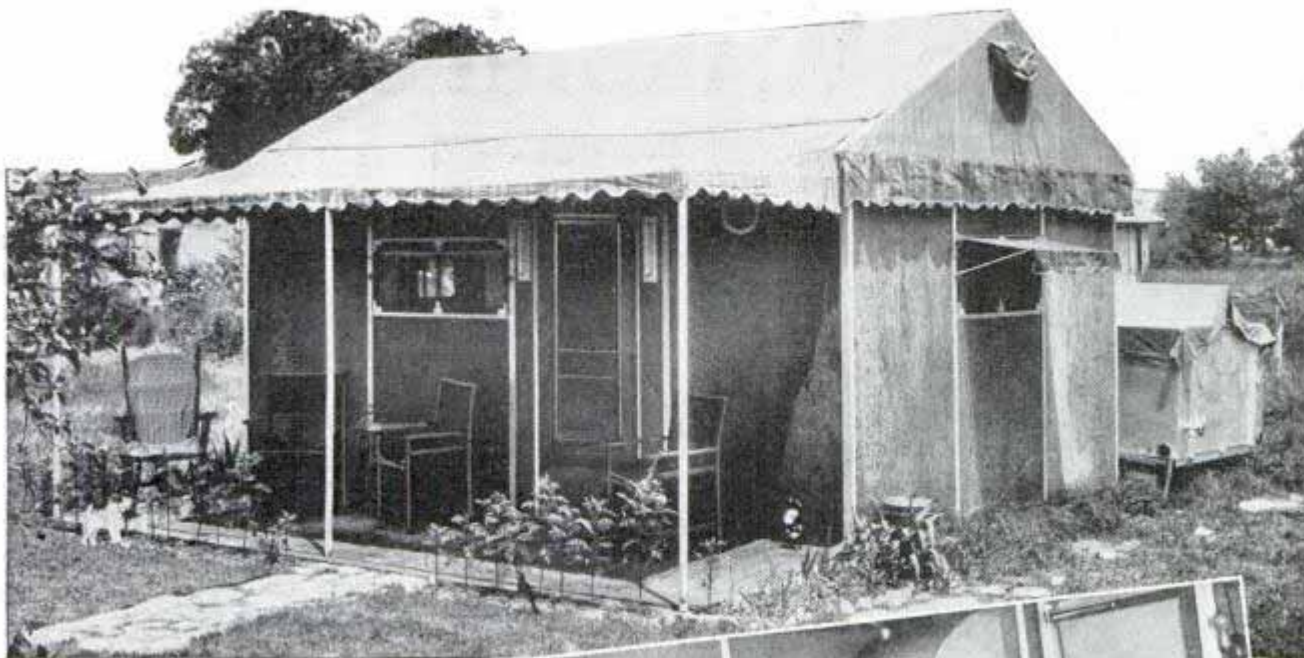

For summer home or camping trip, here is a portable cottage of pre-built sections combining the security of a permanent dwelling with the freedom of a tent. Its walls are four-foot plywood units with phenolic resin binder for weather-resistance, and aluminum alloy extruded shapes for rigidity and lightness. It can be assembled or disassembled in a few hours, and folds compactly in a semi-trailer. Above is a front view of the house, the walk and garden giving it a homey appearance. Its roof is of fifteen-ounce canvas, and extends over a floored veranda. Ridgepole and rafters are aluminum tubing

*Chassis - Covered
Warm*



Interior views of cabin, above and at bottom, show how roomy it is. Floor area is twelve by sixteen feet, ample for twin beds and cot, chests, stove and sink, table and chairs, all of which pack in trailer



Sixteen-foot semi-trailer, above, is low enough to permit rear-view vision when towed yet can carry not only portable cottage but all its furnishings and a fourteen-foot outboard motor boat. After cabin is erected, trailer can be used for side trips, carrying boat and accommodating four cots for overnight camp



*Aluminum Company of America
1856 Lehigh Valley, Pottsville, Pa.*

*616 Cass St
Detroit, Mich*

Mr. ...
111-7th St
San Pedro, Caly

1489

The WORLD'S MOST COSTLY MOVING THINGS

NEW U.S. WARSHIPS *to Cost*

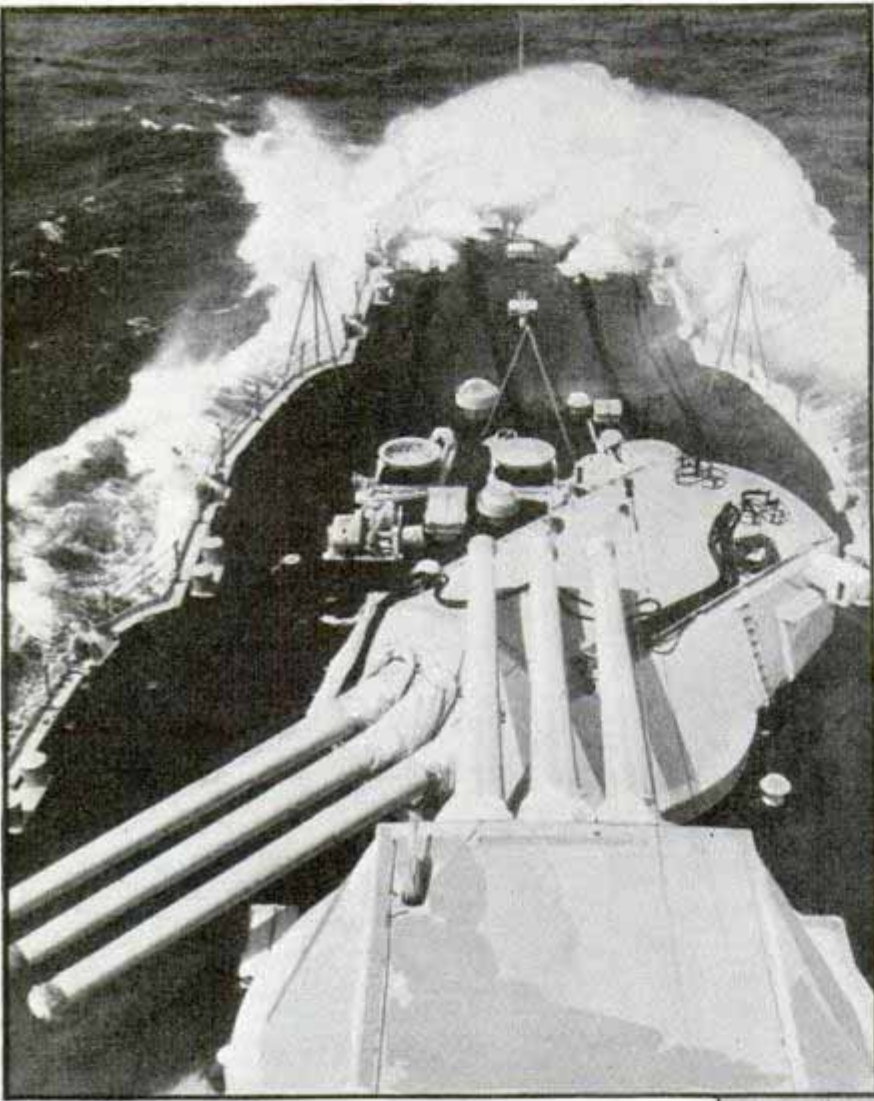

than battleships. There is no word that adequately describes their enormous tactical value, and the only phrase that fits them is "mobile naval bases."

The terrific striking power of their nine sixteen-inch guns, with an effective range of twenty miles, will be merely their chief offensive reason for existence. They, and their projected sister ships, actually will be relatively impregnable rallying points for all other arms

PIONEERING a new type of fighting vessel, the \$70,000,000 battleships "North Carolina" and "Washington" now under construction are rated as the most costly moving things ever devised. The "North Carolina" is being built at New York, the "Washington" at Philadelphia.

Exciting more interest among the world's naval powers than did Germany's "pocket battleships," the two ships are expected to be the hardest-hitting, most nearly invulnerable fighting craft in history. Experts prophesy that when the "North Carolina" and "Washington" are commissioned in 1942, they will have in their 40,000 odd tons vastly more of human ingenuity than Germany's 10,000-ton "Deutschlands."

Of vast importance to naval science is the promise that the two battleships will be more



Top, U.S.S. "Pennsylvania," flagship of the fleet, forging ahead in maneuvers. Bottom, new type 1,850-ton destroyer leader "Balch"

241489

\$ 70,000,000 EACH

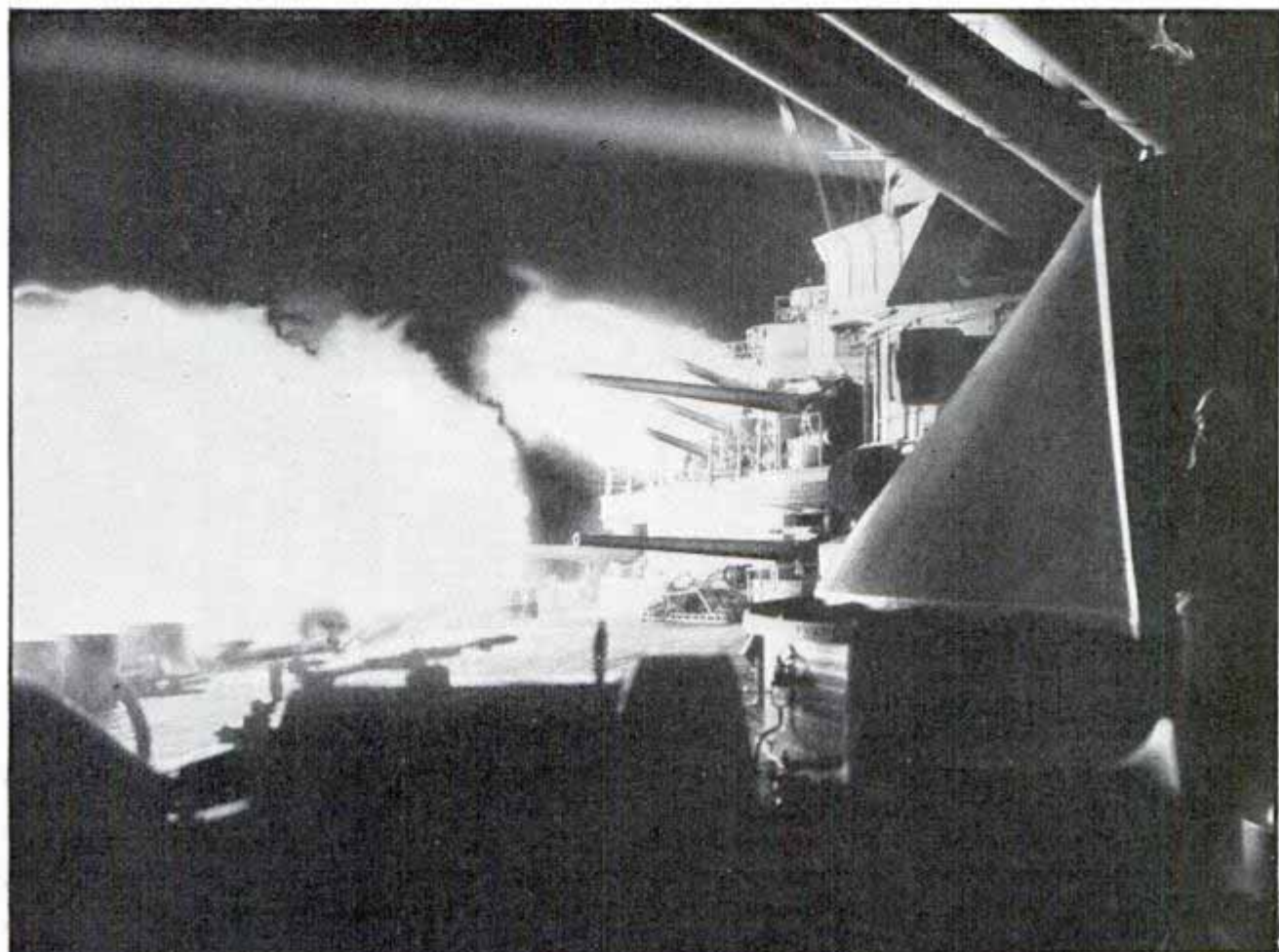

Top, Flagship "Pennsylvania" engaging in night battle practice. Here the secondary battery hurls projectiles at distant targets. Bottom, the battle line, with the U.S.S. "Arizona" leading



Battleship "New Mexico," which with her sisters, the "Idaho" and the "Mississippi," was reconstructed. At a cost of \$42,000,000 the ships were made the most modern units of the U. S. battle line

of the United States fleet. A favorite plaint of self-appointed naval critics has been this nation's lack of naval bases, particularly in the Pacific. The United States navy believes that these ships will meet this need to a great extent. In other words, ships of this type are not going to be mere sea-going platforms for their main batteries, but actual centers of protection, intelligence, communication and sustenance for squadrons of lesser power and radius.

These factors explain why the navy department has guarded details of their design so jealously and why their cost will be so great. Indicative of the vast amount of fighting gear to be packed into their great gray hulls is the fact that the battleship "Pennsylvania," present flagship of the U. S. fleet, was built at a cost of \$7,260,000. The "Pennsylvania," recently modernized, is of top rank today as a first-line battleship. Further, the \$70,000,000 cost figure announced for each of the new-type ships is an arbitrary one, which may be increased by \$10,000,000 before they go into commission. In short, the new ships will cost ten times as much as the "Pennsylvania."

Why will the new ships cost such huge sums?

Simply because they will be huge intricacies of naval science far in advance of any capital ships now built and because they will contain facilities for offense, defense and other equally vital factors of naval warfare probably unthought of for other capital ships now building.

The navy commissioned its last battleship, the "West Virginia," in 1923. Yet in the interim, when limitation treaties and other factors prevented replacement of obsolete ships, the navy has not rested on its oars. It has carried on an intensive, long-range program of research and experimentation against the day when it could begin the rebuilding of its pre-Jutland battle line.

This work, almost all of which has been carefully shielded from public knowledge, has included tests of armor plate and watertight compartmentation with shells, torpedoes, mines and aerial bombs under closely simulated conditions of actual battle; tests of ship models in model basins, under accurately imposed conditions of stress of weather and damaged hulls; secret development of gas and chemical offense and defense methods; development of new fire-control systems of startling accuracy and speed of calculation; develop-

ment of geared turbine main engines with high-pressure steam, thus gaining a power plant of superior efficiency and reliability, yet several hundred tons lighter and more compact than existing installations; the utilization of new metals and electric welding to reduce greatly the weight of hull structures while increasing their inherent strength, thus making more weight available for armor and armament; perfection of new-type guns for both main and secondary batteries, assuring greater effective ranges as well as increased volume and accuracy of fire.

All of these things, and hundreds of others as important, are being incorporated in the design of the "North Carolina" and "Washington."

They have been announced as of "35,000 tons displacement" but indications are that, when com-

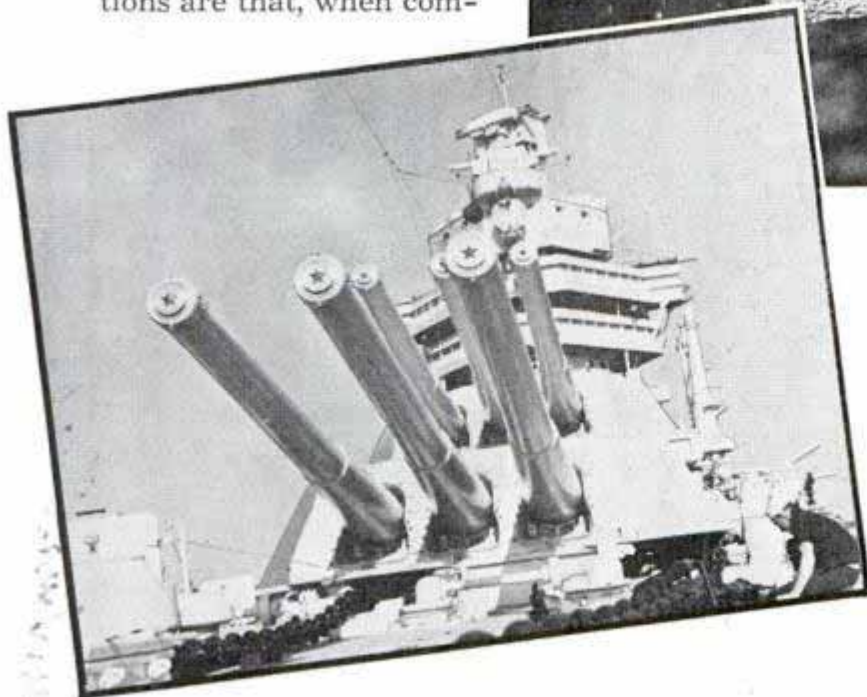
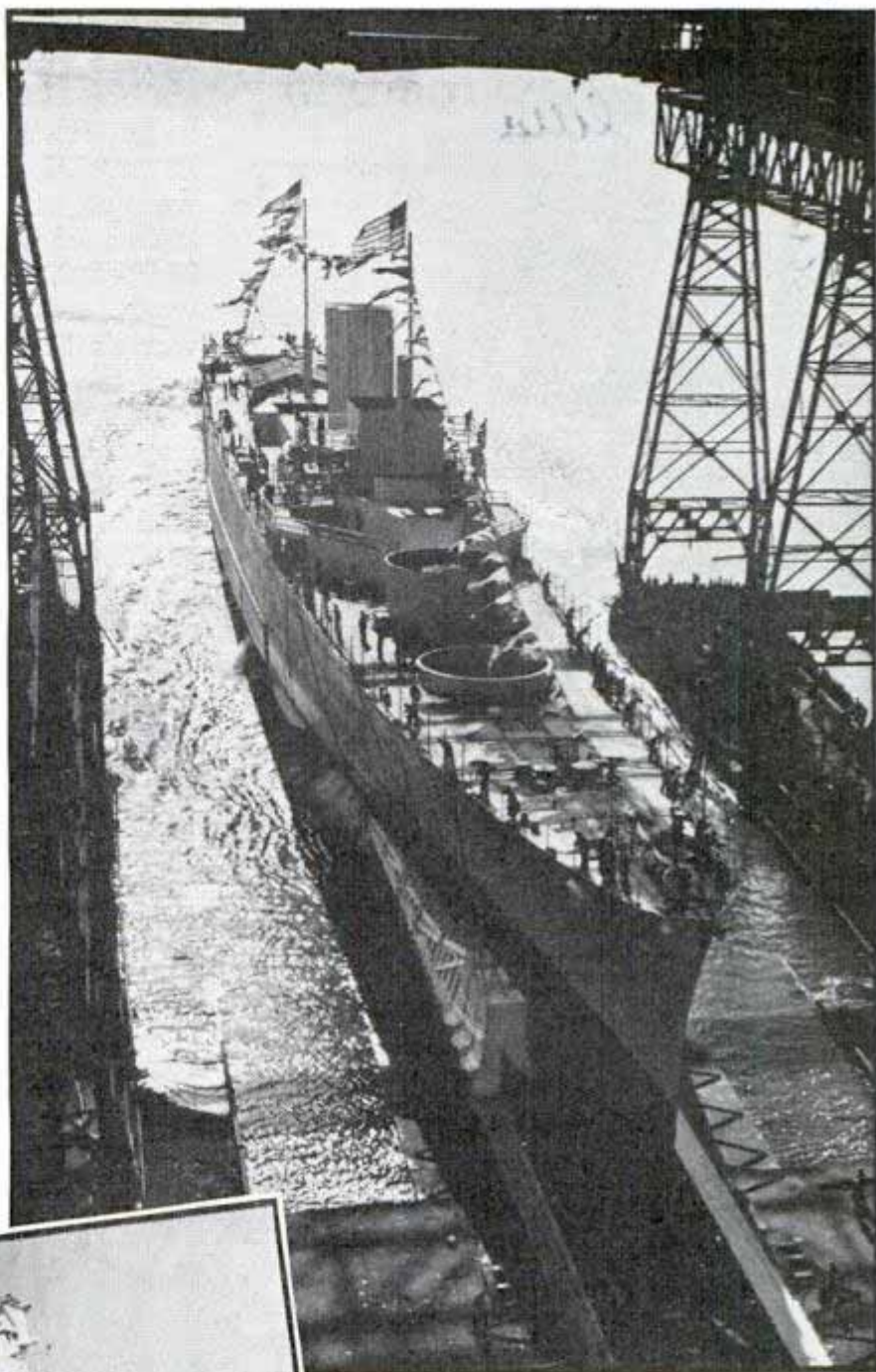

Official Navy photo

Top, launching of the 10,000-ton "Wichita," cruiser with main battery of nine eight-inch guns. Bottom, forward turrets of the "New Mexico"

pleted and ready for sea, their actual displacement will be well in excess of 40,000 tons and their length in excess of 700 feet.

On much the same type of installation as on our newest heavy cruisers of the "Astoria" class, the new ships will mount nine sixteen-inch guns in three, three-gun turrets. Details of their broadside battery are being closely guarded, but best information is that it will be twelve five-inch guns. These probably would be mounted in two-gun "bee-hive" turrets, with extreme elevation so

(Continued to page 154A)

Fiber from a Desert Flower Creates a New Industry

see title



This basket is one of the products made from fibers of yucca, the flower that grows wild in desert

Yucca, the wild flower that thrives on western deserts where little else can grow, is the basis of a new industry. Machinery has been developed for processing the fibers in its leaves, and experimental farms have grown thirty tons of yucca worth around three dollars a ton on an acre of desert land valued at two dollars or less. Indians have used this "Spanish dagger" plant for many years, but commercial development has only begun. Experiments in Arizona indicate yucca fiber is no more difficult to produce than hemp, jute and sisal, of which \$150,000,000 worth were imported from foreign lands in 1936.

One-Third of World's Highways Located in America

Nearly one-third of the world's 9,687,000 miles of highways was located in the United States at the start of 1937, accord-

ing to a survey by the Automotive-Aeronautics Trade division, bureau of foreign and domestic commerce. The United States had approximately 3,065,000 miles of roads. In countries covered by the survey there were registered about 40,549,000 motor vehicles, of which the United States has 28,520,500, or more than two-thirds of the world total. At the close of 1929, the world's highways totaled 6,582,000 miles and the motor vehicle registration was 32,034,600. Thus in eight years, the highway mileage of the world increased more than 3,105,000 miles and the number of motor vehicles increased approximately 12,028,400. The use and the number of motor vehicles are progressing at a faster rate than the extension of new highways, since an increasing proportion of road funds is being used to reconstruct existing routes.

Tire Spreaders Form an Easel for Handy Removal of Tube

By placing a pair of the latest type tire spreaders opposite each other, on each side of the casing, you can spread the beads around the entire circumference of the tire. At the same time the handles of these spreaders form an easel, which holds the tire in an oblique position that makes removal of the tube, inspection of the casing and reinsertion of the tube easy. The spreaders are durable and resistant to rust.



Handles of these twin tire spreaders support tire in easy position for inspection and repair

U. S. Bureau of Plant Industry Desert Laboratory Tucson Ariz. and Arizona Univ. Tucson Ariz.

Pass. \$1.55 - Incl 70.95

*Dept of Commerce
Picas memo 1/17/35*

*Motory Specialty Co
113 5 10 7 1/2*

Columbus. Ohio.

H-43 *Comp. Carl W. summary Head*
and industries Smithsonian
Institution Washington
Dec

Electric Motor's 'Granddaddy' Built by Smithy

Just past its hundred-year mark is that granddaddy of electric motors, the model on which an obscure village blacksmith of Brandon, Vt., was granted a patent in 1837. Like many inventors, his brainchild did him little good, for electricity was too rare and costly to make use of engines, and Thomas Davenport, the smithy who obtained patent No. 132 on his method of obtaining rotary motion from an electromagnet, died without seeing his motor adopted by industry.

In 1833 Davenport had driven to Crown Point, N. Y., to see an electromagnet used by a foundry. Impressed, he bought the magnet for \$75, took it apart to see what made it work, then built a larger one. He mounted an iron bar on an axis, free to revolve across the poles of his magnet, and by making and breaking current manually he produced rotary motion. Not until 1837 did he obtain enough money to build the patent model, now in the national museum at Washington. It embodies all the essentials of modern direct-current motors, with revolving armature, commutator and brushes. Davenport also built an operating model of an electric railway to demonstrate the possibilities of his motor.

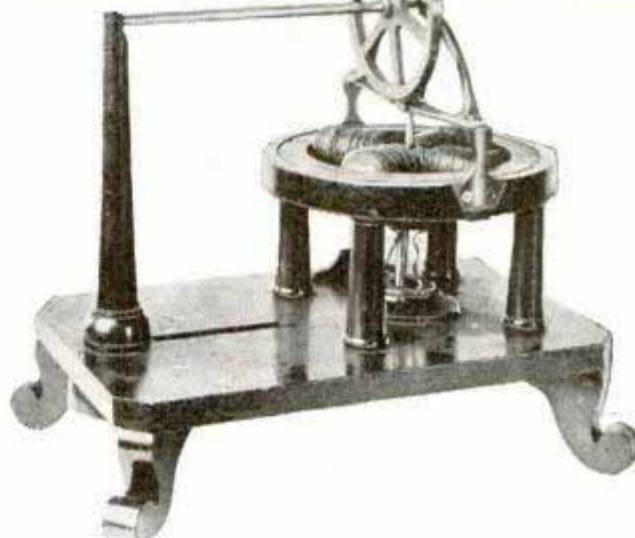

Top, Thomas Davenport demonstrating his operating model showing the possibilities of an electric railway motor. His invention is 100 years old. Below is Davenport's patent model of electric motor

211552

Raised Ramp in Middle of Road Guides Army Trucks

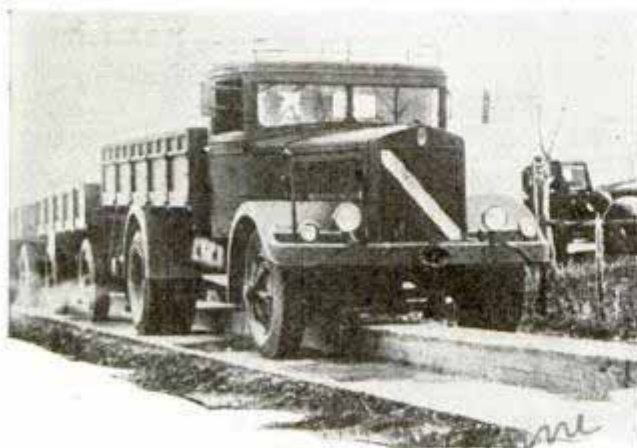

Here is the military train on specially built road. Note raised ramp in center

Expected to prove invaluable in military operations, a new type road in Italy has a raised ramp which serves as a guide for trailers drawn by army trucks. Beneath the truck and trailer are guide rods which fit as flanges on either side of the ramp. The ramp is in the middle of the road. By means of the ramp, one big truck or tractor can tow several trailers without danger of running off the road on curves.

Send return postage to our Bureau of Information to learn the name of the maker of any device described in this magazine.

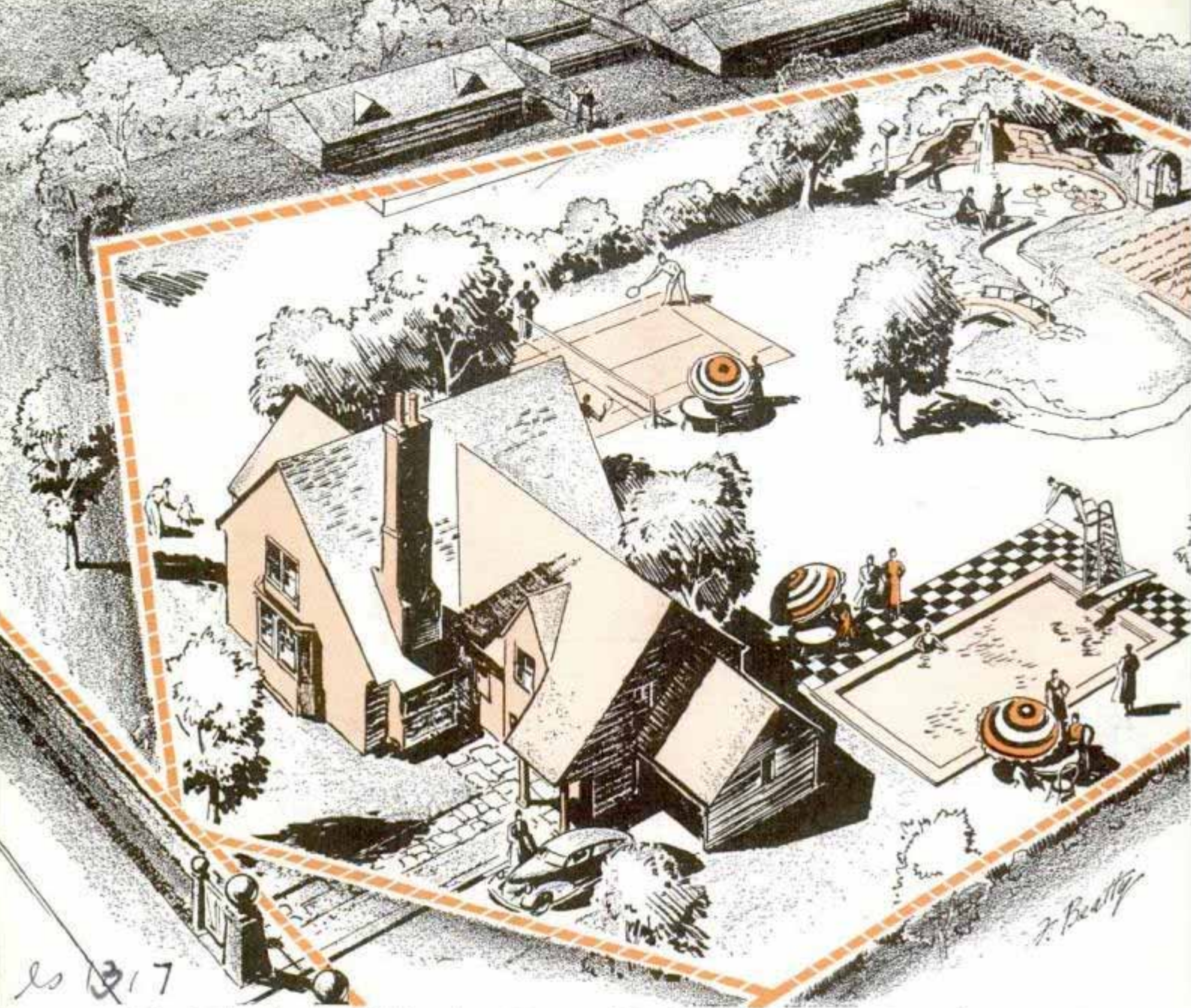

es 317

BEATING BURGLARS

Drawing shows how grounds of estate may be protected against intruders by black-light alarm system. Red line indicates position of the invisible beams

LA TE one night recently the watchman of a Santa Barbara estate completed his hourly tour of the gardens and retired inside the house. He had been especially alert because kidnaping threats had been sent his employer.

A few minutes later three masked men vaulted a low street wall and dashed toward a side door. Before they were half way across the lawn powerful floodlights flashed on and a siren on the roof sounded. The watchman reappeared and started firing, routing the intruders.

The thugs probably blamed their defeat

on the mere chance that the watchman happened to see their advance. Actually, they were beaten by black light. Infrared beams, crisscrossing the grounds around the house, had tipped off their presence as definitely as if they had rung the front doorbell. No one could pass through the invisible net without announcing himself.

There is nothing new in the idea of using a light ray focused on a photoelectric cell as a barrier beam. Interruption of the ray operates a relay, causing an alarm to be sounded. But the ordinary white light electric-eye hook-up can be detected when

*Western Electronic Corp
 2820 Melrose Ave.
 Hollywood, Calif.*

Chas. Thomas & Sons, Inc.
 20555 Hollywood Ave
 Los Angeles Calif

es 1319

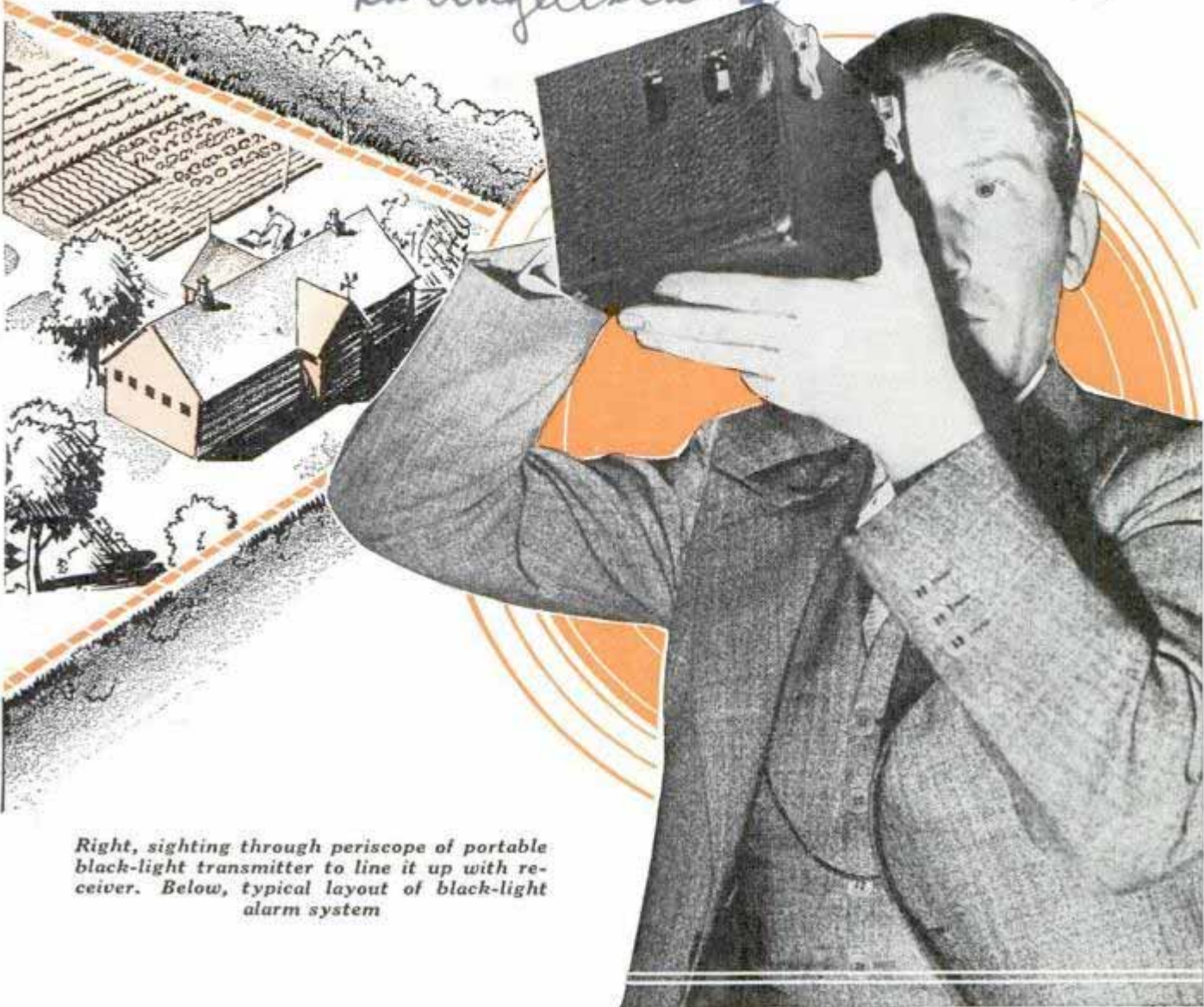

Right, sighting through periscope of portable black-light transmitter to line it up with receiver. Below, typical layout of black-light alarm system

With BLACK LIGHT

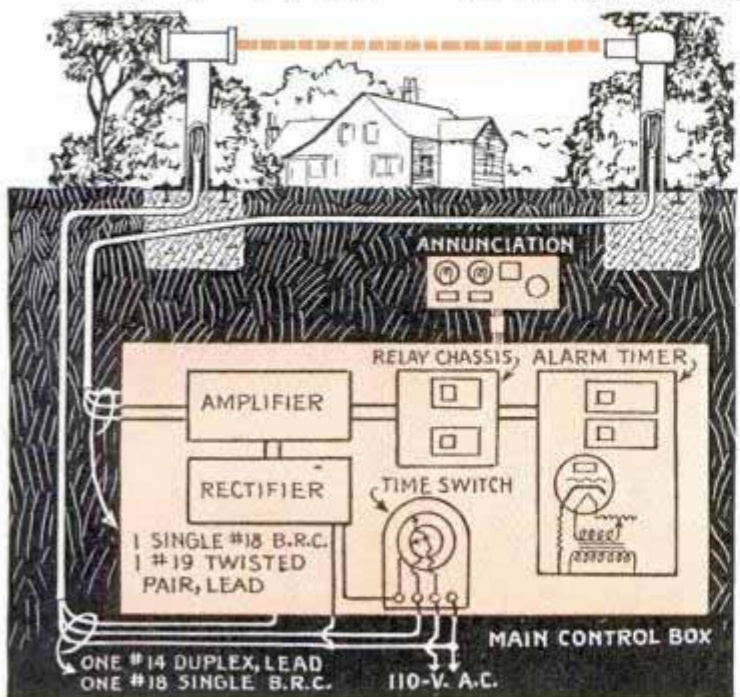

used in a burglar-alarm system. Its visible rays give it away.

The black beams used on the Santa Barbara estate, being invisible, never betray themselves or their sources. The beams consist of electromagnetic waves in the infrared portion of the spectrum and can pass through rain, fog, and dust as readily as through ordinary air. They are heat waves instead of light waves. They can even be made to work under water. They work as well by day as by night and are not affected by any rays aside from those coming from an installed source. Even the experts who install a black-light burglar-alarm system are unable to get through one of them without setting off the alarm.

Black light is being used as a never-sleeping watchman for guarding houses



Photocell in currency drawer gives alarm when certain sheaf of bills is removed

and estates, for protecting commercial buildings and factories, for guarding prison walls, and for similar purposes. Interlopers never know when they will be exposed because they have no way of finding out where the beams are. In commercial installations a loud gong, in addition to the floodlights, frequently serves to scare away intruders even when no watchman is present.

In an installation that has guarded a Hollywood home for four years, thirty-two beams are used inside and outside the house. Projectors and electric-eye receivers set in permanent standards are concealed in shrubbery, rock walls, sun-dial bases and similar garden ornaments. At some of the corners of the estate are tiny panchromatic mirrors that reflect the beams. Each beam has a throw of from 100 to 180 feet and the ends of consecutive

beams are crossed so as to "lock up" every foot of the grounds. The beams are less than an inch in cross section and are usually placed twenty to twenty-eight inches above the ground. Sensitivity of this system is such that birds or falling leaves have no effect, yet it never fails if a person attempts to run or jump through one of the infra-red paths.

In this installation the hook-up really consists of two individual closed circuits, one of which is turned on and off by automatic clockwork, the other being operated manually by the watchman. Doorways are guarded by as many as three separate beams. If any beam is intercepted or if tampering is attempted on any part of the circuit, the entire grounds and interior of the house are flooded with light, a siren on the roof

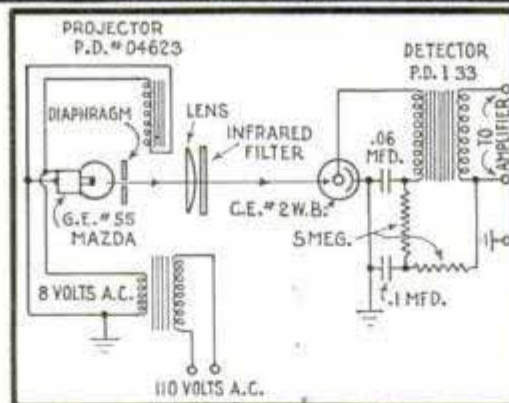

Center, typical hookup of projector and detector. Bottom, projector consists of tiny light, diaphragm, lens and infrared filter. It may be mounted in steel or concrete post

251 517

altm. m. p. 2 8 2 melrose

begins to howl, a buzzer in the watchman's quarters sounds and a red light flashes on an annunciator board. One look at the board tells the watchman the exact scene of the trouble. Finally, if the watchman does not return and lock off still another circuit within a certain number of minutes, a signal automatically flashes at police headquarters. The annunciator board shows the condition of each part of the circuits. It is also equipped with switches so that any beam can be shut off temporarily, as when the owner desires to unlock the driveway beam to permit an automobile to enter. Beams that guard doors and hallways inside the house can be unlocked by members of the family or by servants who need to pass through. After unlocking one of the beams they must pass through its path within thirty seconds because the beam automatically switches on at the end of that period. If the power source that operates the black lights fails or if the wires are cut, the entire system automatically switches over to stand-by batteries and an alarm that indicates the trouble sounds.

On this estate the owner sometimes proposes a new game to his guests, telling them that anyone who succeeds in leaving the house and grounds without setting off an alarm will win a prize. No one has been able to do it yet, though guests have tried crawling, high jumping, and hoisting themselves along the walls. An elaborate installation of this kind may cost as high as \$20,000. One feature of black-light protection is its lack of service requirements.

Black-light protection of this kind was developed by C. W. Larson and M. B. Gilbert, former sound technicians of the motion-picture studios. The Western Electronic Corporation of Los Angeles, which they have formed, has provided installations for nearly 100 estates in southern California.

The source of one of these invisible beams is nothing more than an ordinary six-volt lamp such as is used to illuminate an automobile instrument board. Light from the lamp passes through a small hole in a diaphragm and is collected by a focusing lens in the patented projector so that the beam will be confined to a small cross section. An almost opaque glass filter in

(Continued to page 134A)

Portable Shaping Machine Surfaces Small Castings

amined

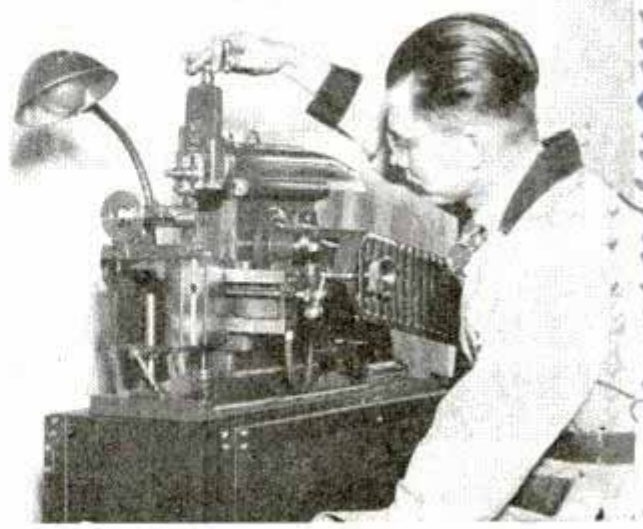

This portable shaper is quickly adjustable from zero to six and one-half inch stroke

Small, irregular castings can be surfaced and finished with a six-inch crank shaper mounted on rollers so that it can be moved to the job quickly. It is equally useful for machining out blanking dies and for flat work that requires slotting or grooving. The stroke is adjustable from zero to six and one-half inches, and this is done very rapidly by loosening a single bolt. It takes only two or three minutes to change over for another job. This shaper has a three-step cone pulley and its helical-cut drive gear is made of Bakelite.

es, 537

Small Safe for Automobiles Fastens on Steering Post



Compact, fire-proof and burglar-resistant, a small safe for the automobile is attached to the steering post. It is opened and locked by a simple combination lock mechanism. The safe, al-

though attached to the steering post by two strong metal clamp assemblies, can be removed by one screw only when its door is open. The safe is useful for salesmen, paymasters and others who must carry valuables in their work.

Automobile maintenance machinery Co. 2100 Kenmore Ave. Chicago, Ill.

Kaufm. Co. 521-38th St. No. 10

H 56
~~2-15-53~~
**Feather-Edge Sanding Tool
Speeds Auto Painting**



Pat # 2,078,004
Here is the feather-edge sander in use, removing paint from auto body

Eliminating all hand work in connection with sanding and grinding, a new feather-edge sander saves labor in automobile body and fender painting. One sander, together with accessories, does all the sanding, including feather-edging reversed curves, paint removal and grinding needed on body or fenders. Feather edging may be done in one-twelfth the time required under hand methods. All filing and scraping on reversed curves are eliminated.

H 55
**Muffler for Drum Practice
Eliminates the Din**

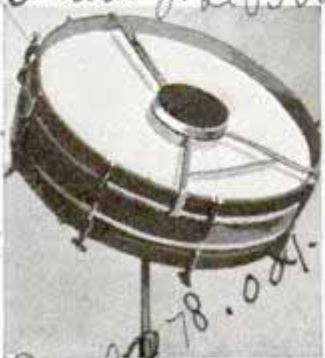

Drummers can practice at home now without disturbing the family and arousing the neighbors. A muffler that clamps over the drum head enables the player to practice

his rolls and figures, getting the "feel" and hearing the rhythm of the sticks without creating a loud noise. The muffler is adjustable to fit any size drum, and furnishes a round playing surface four inches in diameter, resilient like the drum head itself. Being centered, it trains the player to strike at the center of the drum.

H 49
**System of Vanes Guides Pilot
to Proper Runway**

Incoming airplanes are guided to the proper runway by an automatic vane system designed for busy airports. The principle involved is that a conspicuous air vane, or series of vanes on the field, shall be under the control of the traffic officer, this control being exercised electrically from the airport tower. When there is little or no wind, the control officer may designate by means of the vanes the runway to be used by incoming craft. The automatic system makes it unnecessary for the officer to notice changes in direction or increase in velocity of the wind. Should the wind veer or increase above a previously determined velocity, the air pressure overcomes the electrical control and all the

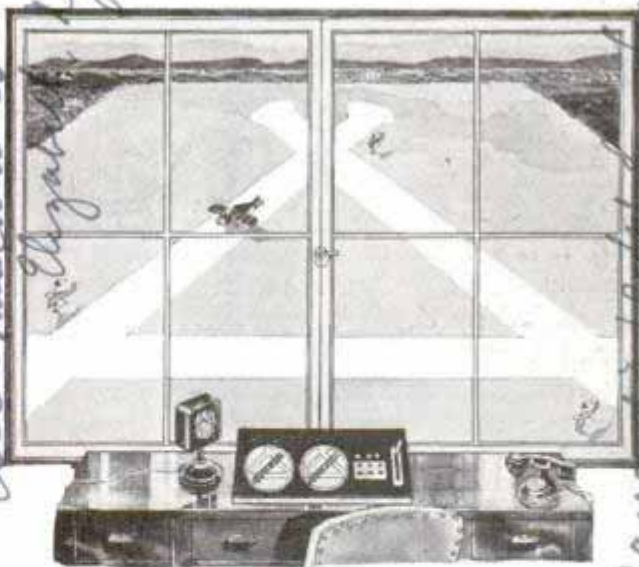

Sketch shows how system of vanes directs pilot to proper runway at airport

vanes indicate the true direction of the wind. In case of a lull, the vanes return to the direction originally set by the control officer, leaving him free to concentrate on other matters confident he is not instructing a pilot to use a runway made unsuitable by wind conditions at the moment.

Milwaukee Electric Tool Corp.
10 S. W. Water St.
single \$2.50
5 at 2.00 each
Pat. 2,078,004

Canadian
Stuart
Hessid

The Springfield Co. / H. S. Graham

201533

Flying School Trains Transatlantic Pilots



Club

Two views of trans-oceanic pilots' school. Top, group of students using instruments employed in navigation. Bottom, studying rules of the air with the aid of table on which are demonstrated the various marine lights

Croydon England

With transatlantic passenger service by air only a matter of a few months, Imperial Airways of England is conducting a training school for ocean-flying pilots. Only serving officers with at least a second-class air navigator's license are admitted. The course includes a navigation class

which studies sextants and other instruments. Students are instructed in the rules of the air road by means of a table showing the system of marine lights on surface craft, navigation booms and related information. The school is at Croydon airport, principal terminus of Imperial Airways.

some out all part

25 1424

Slater

1932

WILD LIFE GOES *to*

Cubs from California zoo at Los Angeles.



By Charles Morrow Wilson

New York, N.Y.

TOMORROW may find bears, foxes and minks in the barnyard, deer in pastures, quail and pheasant in the poultry house, moose crossed with cattle and waste lands being used profitably as range for wild life.

Recreation is a billion-dollar-a-year industry and almost half of all recreation trades follow the roads to hunting and fishing. Wild life, both the oldest and one of the newest of national resources, is beginning to pay dividends in dollars as well as in sport.

Native game birds are becoming the new American poultry. Deer and moose are finding new homes on the private range and fur-bearing animals are becoming the most valuable livestock in the nation. Such developments are typical of the new age of conservation.

There are two distinct types of game farming. The older deals with breeding and raising fur animals which supply a hundred-million-dollar industry. About

Top, baby playing with lion and tiger cubs. Bottom, small variety of the kangaroo family makes lovable pet for Australian child

from Australian Zoo

TOWN



© Planet News, Ltd.

twenty-three per cent of all furs bought in the United States are home-raised. The silver fox and the mink are the leading domestic fur animals.

Average cost of raising a market mink is about two dollars and the average pelt value is about eighteen dollars. Cost of producing foxes is approximately one-half that of raising dogs. The value of good breeding animals is five to ten times their pelt values. Both foxes and minks mature the best grades of fur in northern climates. Nowadays fur growers are developing a "feeder" system similar to that used in the cattle industry. Young animals raised in the south or Pacific coast areas are shipped to northern Maine so that their pelts may "ripen" in cold, windy locations. Domestic propagation develops furs of higher market standards than the native catch and distributes the supply over the entire winter period, thereby enabling the home-raiser to sell at prices which average



Top, out for a stroll with Himalayan bears. Bottom, holding a silver fox

*Joy Williams
cut at Gray Lion Farm*



Circle, lion cub makes a pet while small, but you should watch those sharp claws. Bottom, state officer at trap with captured beaver

Prineville Oregon



higher than those received for native furs.

The newest type of wild life farming is directed toward replenishment and sporting demand. It includes the native game birds and water fowl, sporting animals such as the raccoon and red fox; also rabbits, deer, bear and moose. Predators such as wildcats and owls are domesticated to learn their habits so that the creatures can be combated in their native haunts.

Home game raising is filling a fast-growing demand for breeding stock of many native species; also a growing demand for "chase" animals such as raccoons and foxes, which are frequently purchased by hunting clubs or dog breeders associations. Public zoos and private exhibits of native animals and birds are another important outlet for the wild life barnyard. The nation has about 950 public zoos and about 1,400 licensed private zoos.

Most important is the demand for home-raised wild life for use in replenishment work being carried forward by state and county game commissions and hunting clubs. Such states as Maine, Wisconsin, Michigan and Idaho are finding that every dollar of public money spent for game replenishment yields as much as three or four dollars a year to the state in the form

of hunting-license fees and extra income to private citizens. And the well-managed game farm is becoming the best source of such planting stock. Most game commissions are planting yearling birds in the spring so they may have the summer in which to become accustomed to a given countryside. This makes home-raised game birds an annual crop. Most of the fur bearers are a two-year crop, though minks and beavers usually reach maturity sooner.

The U. S. Biological Survey, Washington, D. C., has introduced a plan whereby the survey supplies an individual with eggs or hatchery stock of game birds. The person agrees to give a permanent range to the birds and feed during the winter.

see April 1937

errata ref. to State Game Commission

es 1424

Su-Lie Brookfield gas

After two or three years the raiser is entitled to open his land to hunters, limit the kill to a given percentage of the bird population and charge hunters on a toll basis for the number of birds shot.

Game laws of most states allow a person to trap breeding stock of game birds or native animals during the open seasons. Cage traps are used in catching breeding stock. All states recognize the domestic breeding and raising of native wild life as a legitimate business or hobby, but some states list animals such as moose, caribou, elk, otter and beaver as "sanctuary species," or as state property only. In such states the



San Diego

raiser must secure permission before experimenting with rare game. Several states send game experts without cost to advise persons who wish to breed or domesticate game birds or animals for replenishment purposes.

A big percentage of the game birds and animals of the United States can be "made at home" in almost any state or section. Deer, raccoon and fox are native to almost every state, quail is native to about forty states, and the pheasant usually can be grown anywhere poultry can be raised.

Typical of the newest steps in wild life propagation is the establishment of McNeil Browne of Gray, Maine. Game birds have

(Continued to page 141A)



© Planet News, Ltd.
Top, weighing famous baby giant panda. Center, seals in kindergarten class at zoo. Bottom, wild sheep born in London zoo

Punjab

*Mrs. Wm. Harbender, Jr.
Charles. Arnold
Prayer, Los. California
Pacific International Co. Boston*

Statuettes Made by Welder with Torch and Pliers



Welded of wire, figures of prospector and cow with newborn calf are less than inch and one-half tall

Tiny statuettes that bring praise from sculptors are fashioned by a David City, Neb., machinist with only a welder's torch and a pair of pliers for tools. He uses iron and copper wire for materials, welding them into miniature but well-proportioned figures. They are no taller than an inch and three-eighths.

"Napkin Ring" Operating Table Holds Canary for Surgeon

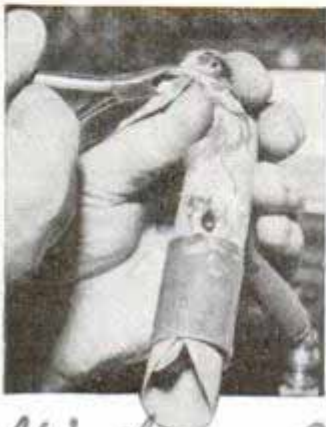

In order to have both hands free to operate, a canary surgeon has devised an operating table that resembles a napkin ring mounted on a ball swivel pedestal. He wraps the bird in a snug sheet of celluloid and slips

this through the metal ring, which can be swung to the most convenient position for operating. The canary is held firm while the doctor uses two hands at his work.

see letter

Harmless Gas of Diesel Motors Fits Them for Use in Mines

Because there is virtually no carbon monoxide in the exhaust gases from Diesel engines, they are regarded by the Bureau of Mines as "reasonably safe" for use in mines and tunnels where the gasoline engine is dangerous. Tests of the exhaust of the average gasoline engine show a fraction over seven per cent carbon monoxide, and men cannot endure for long a concentration of more than one part carbon monoxide in 1,000 parts of air. The amount of this poisonous gas in a Diesel engine exhaust is so small that tests fail to reveal it.

Luminous Stars Glow on Ceiling with Light-Absorbent Paint

Paper stars and crescent moons that glow on the ceiling when the lights are turned out are available now for the nursery, sunroom and playroom. They are coated with a luminous paint that absorbs light when the electric bulb is on, then

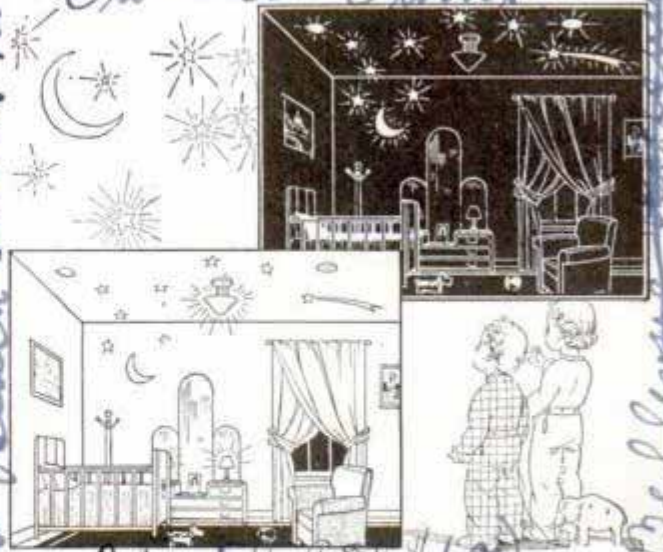

Stars pasted on walls of bedroom glow softly for hours after lights are turned out

sheds a soft glow for five or six hours in the darkened room. Available in sets, the stars are simply pasted on walls or ceiling. One child forgot her fears of the dark in watching the stars glow overhead.

Del. & Co. 54 52nd St. N.Y.C.

From Diesel Power Co. Jan 1930
Richard Beach Road, North East Pa.

Birth to elements, cold make locomotives.

Luminous novelty Co
Attn: Sales Dept. U.S.

William A. Welby
Walter Pen Co.

Exhaust at Stern of Liner Replaces Funnels



Proposed design for giant streamline passenger ship which would have exhaust vent at stern, doing away with traditional funnels entirely. The plan of this 1,350-foot vessel was suggested by French Line official

Funnels were once regarded as the measure of greatness in an ocean liner—the more smokestacks, the greater power and speed. Not so today, for the French Line proposes to build a giant passenger liner without funnels, exhausting its gases at the stern. The ship would be 1,350 feet long,

320 feet longer than the sister ship of the British liner "Queen Mary," designated "No. 552," in the shipyards where it is being built. The design, suggested by a French Line official, is that of a streamline craft of thirty-seven knots speed, capable of crossing the Atlantic in three and one-half days.

"Centipede" Pavement Tester Shows Irregular Surface

If there is an irregular spot in the road, Britain's nineteen-wheel tester will find it. The British Ministry of Transport employs this peculiar contrivance to check the smoothness of streets and highways and to test various types of surfacing. As it is rolled over the pavement, any irregularity is recorded by a graph on a revolving drum mounted in the elevated housing. The apparatus is delicate enough to show even minor hollows.



While one man propels this multi-wheeled road tester, another keeps watch on graph where irregularities in pavement are recorded

Used in Harmondsworth, London

1538

Wide World

610.5th Ave New York

H-52

Industrial Research, Road Research Laboratory developed by Dept. of Scientific and Technical Research

Aschley, Road Research Lab. Attn. Mr. Scott

Ten-Watt Heat Applicator

Treats Small Area

retail about \$3.50



Using the heat-ray applicator on face. Inset, the ten-watt lamp equipment

For the application of heat to small areas of the human skin, a ten-watt lamp is on the market. It consists of a metal housing, the inside surface of which is a highly polished reflector that directs the lamp's rays toward a small circular opening; a ten-watt lamp colored to permit the passage of only infrared or heat rays, and a handle and switch. In spite of its small size, the lamp generates about all the heat that the human skin can bear.

Flexible Rubber Shaft Coupling

Takes Up Vibration of Drive

To dampen vibration, noise and shock on fractional horsepower drives, a flexible rubber coupling for the drive shaft has

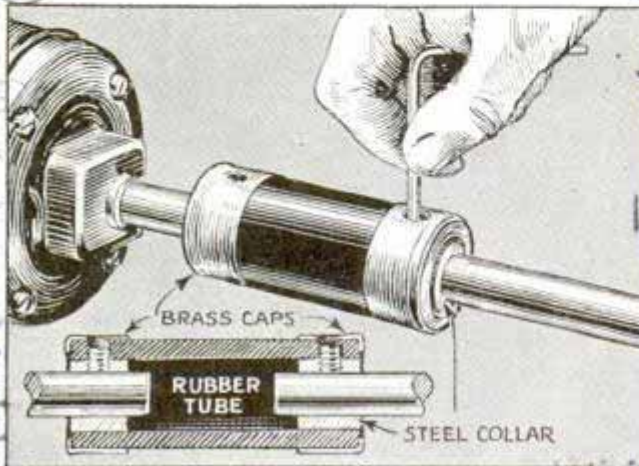

Drawing shows how vibration and minor errors in alignment are absorbed by flexible rubber coupling

been developed. The rubber is molded, the ferrules are brass, bushings are rust-proofed and the couplings are available in lengths ranging by quarter inches from two to six inches.

Demagnetizer for Tool Room

Plugs into Power Socket

Operating on 110-volt, alternating current, sixty cycle, a demagnetizer is available for the tool room of factory or shop. The machine is of the transformer type. Drawing ten amperes, it handles dies up to five inches in thickness. It is suitable for demagnetizing deep drawing and blanking dies.

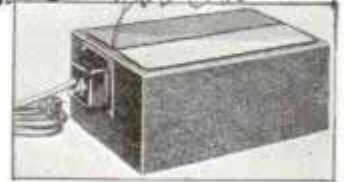

Night Light with Rotary Switch

Has Many Uses in Home

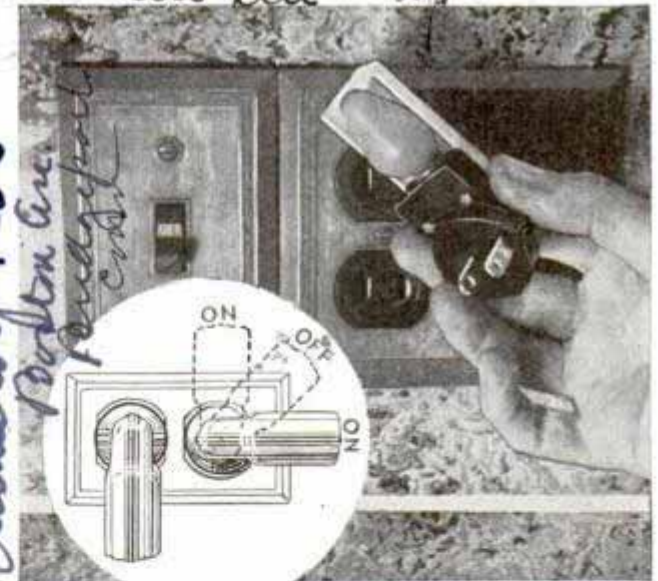

Ready to plug in small night light. Inset, how light is turned on and off

Shaped so that it fits close to the wall, a small night light with rotary switch is available for the nursery, hall, kitchen, sickroom and other places where low-intensity illumination is required. A translucent, plastic shade, which also serves as the handle of the switch, can be swung to a vertical or horizontal "on" position. The "off" position is a point halfway between vertical and horizontal. The lamp is equipped with a seven-watt bulb and with standard prongs to fit any outlet.

General Electric Co
Mela Park, Cleveland, Ohio

Flexible Coupling Mfg. Co
Chicago, Ill.

Clavox
430 Screen Chicago

Est. J. Cuddeback

Monowatt Electric Corp 1286
Boston Ave
Plymouth, Mass

Monowatt Electric

1503

Airport and Train Modernize Model Village

When Bekonscot, a model village in England, was modernized recently, a miniature streamline locomotive and coaches, railroad station and complete track system were added. At the same time an airport with models of modern aircraft was made another feature of the small-scale town. At one spot in the layout is a peaceful lake on which ride model ocean liners and seaplanes. Reminder of earlier days is a miniature stage coach.

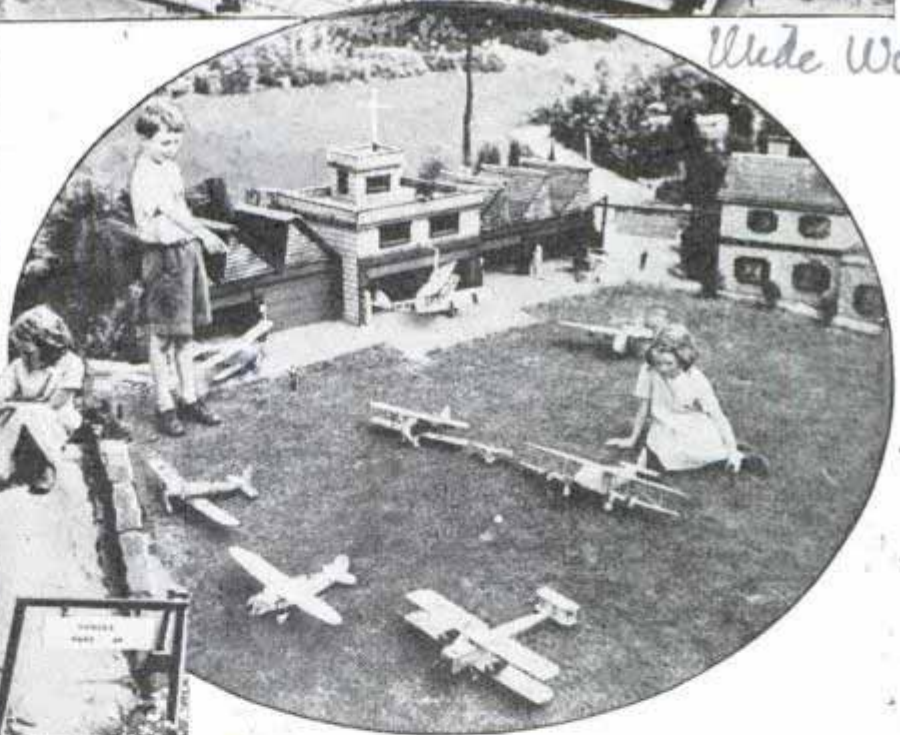
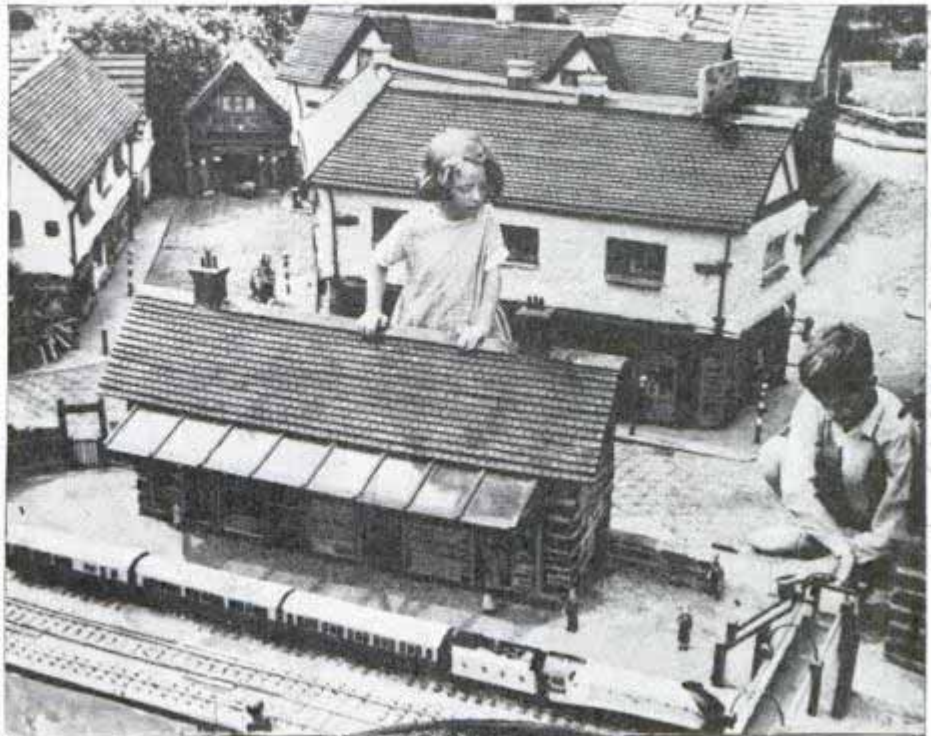

Model World

Top, view of the model railroad station. Bottom, left, model liner and flying boat in harbor. Right, airport with models of various types of planes. Note the hangar buildings

1547

Animals Grow Larger in Cold Climates Than in Warmer Regions

Men and animals living in cold regions, either on mountain heights or in northern countries, generally are larger than those of the warmer lands. Scientists have long observed this fact, and in recent laboratory studies a positive effect of temperature on insects was noticed. Central European but-

terflies in the pupa or intermediate stage were exposed to both cold and heat. The latter developed into butterflies resembling those found in the warm Mediterranean areas, while the chilled pupae grew into butterflies similar to those of the colder regions of northern Scandinavia.

Science Monthly P. 64

Prof. Theodosius Dobzhansky

Lens-Shaped Photo Bulb Serves as a Spotlight



H-17
Bridgeway Electric Co. Boston

Silvered inside, this spotlight for photographers reflects own rays through lens-shaped end of bulb

Reflector and lens are self-contained in a spotlight bulb for the amateur photographer which serves the same purpose as the more elaborate lighting equipment of the professional. It screws into any socket like an ordinary bulb, but its lens-shaped end concentrates the rays into a spot. The side walls are silvered on the inside and form a reflector.

London Quakes, Sinks Steadily as Wells Tap Its Foundation

The Sphere
Jan. 1938 p. 21

St. Paul's Cathedral is beginning to tip, the Tower of London is creeping toward the Thames river, the whole London area is sinking at a rate of one inch every four years and some localities have sunk a foot since 1914. This city of 11,000,000 population rests on a cushion of underground water, and wells are drawing off this unstable foundation at an alarming rate. The level of one well has receded ninety-three feet in fifty years. Once the famous fountains in Trafalgar Square were played by natural water pressure, but today they require pumps, for the subterranean water level has dropped 120 feet since they were built. Under London is a "pancake" of clay 400 feet thick; beneath it a thick bed

2553 Loyola
St. Louis, Mo.

of chalk which is full of fissures charged with water that exerts an upthrust of three tons per square foot, enough to support the weight of the metropolis as long as the pressure is steady and evenly distributed. But London has been diminishing its underground store of water at an annual rate of 80,000,000,000 gallons for a half century, and is currently lowering the level of its wells three feet every year. Earth movements are becoming noticeable. Severe quakes occurred in 1750, and a shock in 1850 damaged 2,000 buildings. Geologists say the London area has sunk seventy feet since the Stone Age. City engineers are now endeavoring to stop depletion of the underground water reservoir by sinking wells at a safe distance away from London, building new reservoirs, and perhaps boring through the bed of the Thames to let it sink into the chalk bed during flood times and thus replenish the water supply.

Compartment in Sample Case Adjustable for Display

Adapted for all ordinary lines, a new sample case permits the making up of compartments to fit various items in the line to produce the best display effects. It is possible to pre-design a sample-room display. Reference marks on the samples guide them to their places in the case and insure their return to the indexed compartments. This feature minimizes loss of goods by omission in packing.

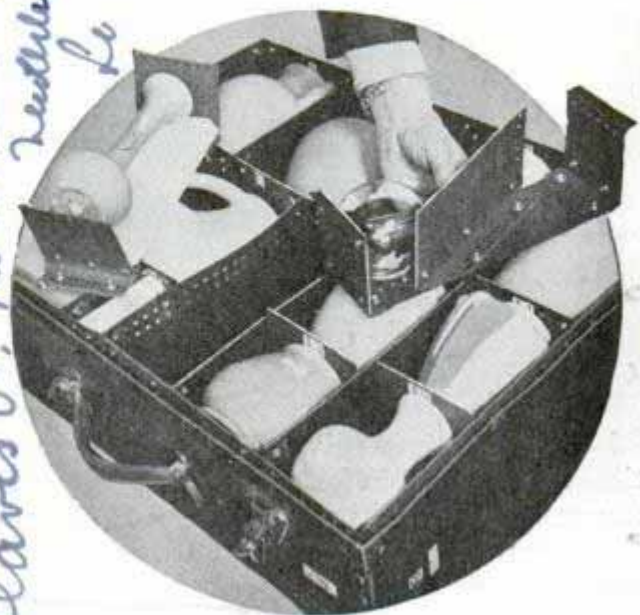

Special case packed with pottery. Note how compartments are arranged for the display

See inside for details

Traveling Lamps Bake Paint on Auto Bodies

Motor Co. Dearborn, Mich. patented process.

Prime coats of paint on auto bodies are baked by traveling lamps. The arrangement, in the Ford plant, consists of a series of double clamshells carrying infrared lights spaced to heat the bodies and bake the prime coat in seven minutes instead of the usual sixty minutes. The auto bodies travel on an overhead conveyor which carries them between two synchronized conveyors that carry the clamshells of lights. The temporary assembly of lights and bodies travels together for seven minutes and then the bodies emerge, with the lights traveling back for another round of the cycle. Since the radiant heat from the lights heats the metallic body, which in turn heats the enamel, the heat loss in the room is remarkably low. Smaller batteries

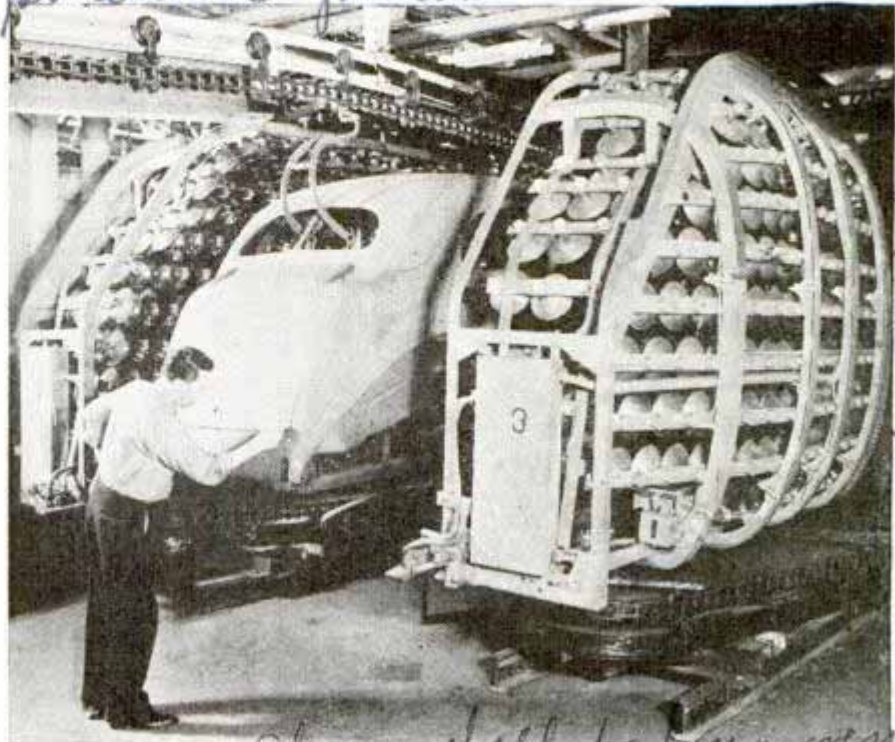

Clamshell baking oven
Two banks of lights baking paint on auto body as the entire assembly moves along the line. Time of baking is only seven minutes

of infrared lights are used in making repairs if the bodies are marred in handling. This method of baking the finish is said to be less costly than that of steam ovens.

*Lamps made by Ford Company
Patented Lamp Co. St. Louis, Mo.
1014 Taylor*

Twin-Rail Buffer Guards Safety Zone from Automobiles



Reckless drivers who encroach on this safety zone may end ride with the car nose pointed to the sky, but it's a safe place for pedestrians

Hamtramck
Twin steel rails that curve upward somewhat like the bumper at the end of the railway siding form a simple and effective buffer protecting a street safety zone in a Detroit suburb. The uprights are eight feet high, the rails extending out twelve feet. When a car hits them it is raised off the ground and brought to a quick stop. There has not been a fatal accident at this spot since the guard was erected.

☞ Copper, tin, gold, silver and lead were used by man 6,000 years ago, but iron was not known until 2,000 years later.

*Carl W. K. Grossman
9015*

*Scientific Monthly
Sept 27 1914*

es 1388 Eastman Kodak Co Rochester, NY

BAD WEATHER



not have to be a rapid-lensed "advanced" camera. Inexpensive box cameras often do the job as well.

Nor does the bad-weather photographer have to risk a great deal of discomfort. Snowstorms and rainstorms can be

WHY stow your camera away in a dresser drawer just because it's blustery and gray outdoors?

Anyone can snap pictures on a sunny day. As a matter of fact, anyone can snap pictures on a stormy day—and with more exciting results, too—but not so many do it. No amateur photographer has covered the full range of picturemaking until he has clicked the shutter on some of those scenes offered only in gloomy weather.

The patter of rain on gleaming wet streets, the white swirl or long soft sweep of falling snow, crisp jagged lightning against a night sky, sunlight imprisoned in the heart of an icicle, mist or steam hovering over water after a rain, the play of light from street lamps across rough snow at night, telephone wires and evergreen branches festooned with sparkling sleet—all these are missed by the camera worker who allows bad weather to intimidate him and stays indoors planning pictures to make when the sun comes out.

Any sort of bad weather holds abundant opportunities for pictures filled with mood and atmosphere and feeling. And, for a great many bad-weather pictures, it does



Raindrops on glass make effective picture from outside or inside. For outdoor work on wet days, be sure to shield your lens from rain

PHOTOGRAPHY



pictured from the shelter of a porch, or through a window. Rainy-weather snapshots on the streets are much better made from the shelter of a doorway or awning. Indeed, shelter and comfort for himself and protection for his camera, should be the bad-weather worker's first considerations. On one point especially he should be watchful—not to click a picture when droplets of water have blown on the lens surface. These should be wiped off carefully with lens tissue or a clean linen handkerchief.

Fast lenses are useful in bad-weather photography chiefly when there is motion to be stopped, or when it is inconvenient to use a tripod. A fairly rapid lens is an advantage when people are to be included in street pictures, fighting their way through snow or rain. However, in many pictures where the chief point is the weather itself, it is undesirable to "freeze" motion. Snowflakes, for instance, if snapped at a high speed will appear as mere

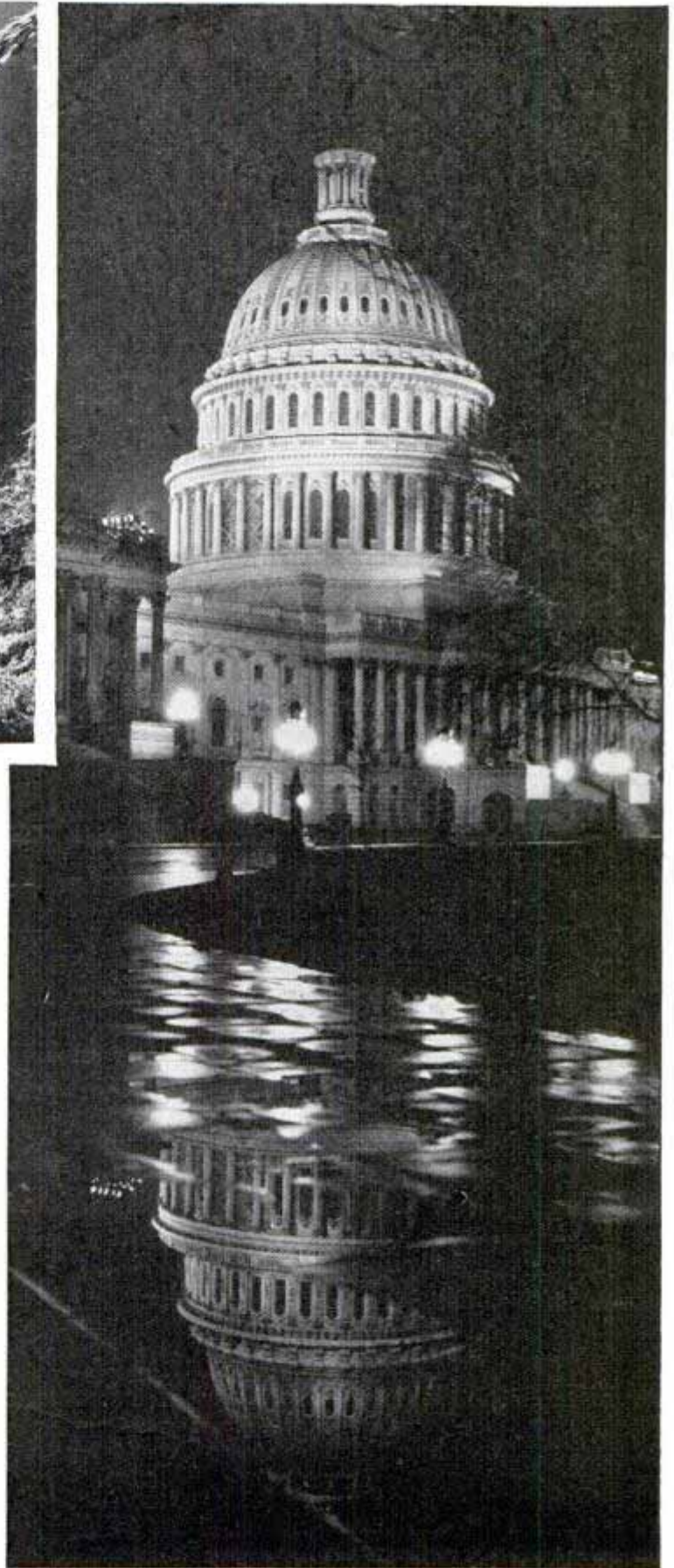

Left, "stormy weather" scene taken in comfort on a table top. Right, night view of capitol mirrored in sidewalk pool required an eight-minute exposure at f.16

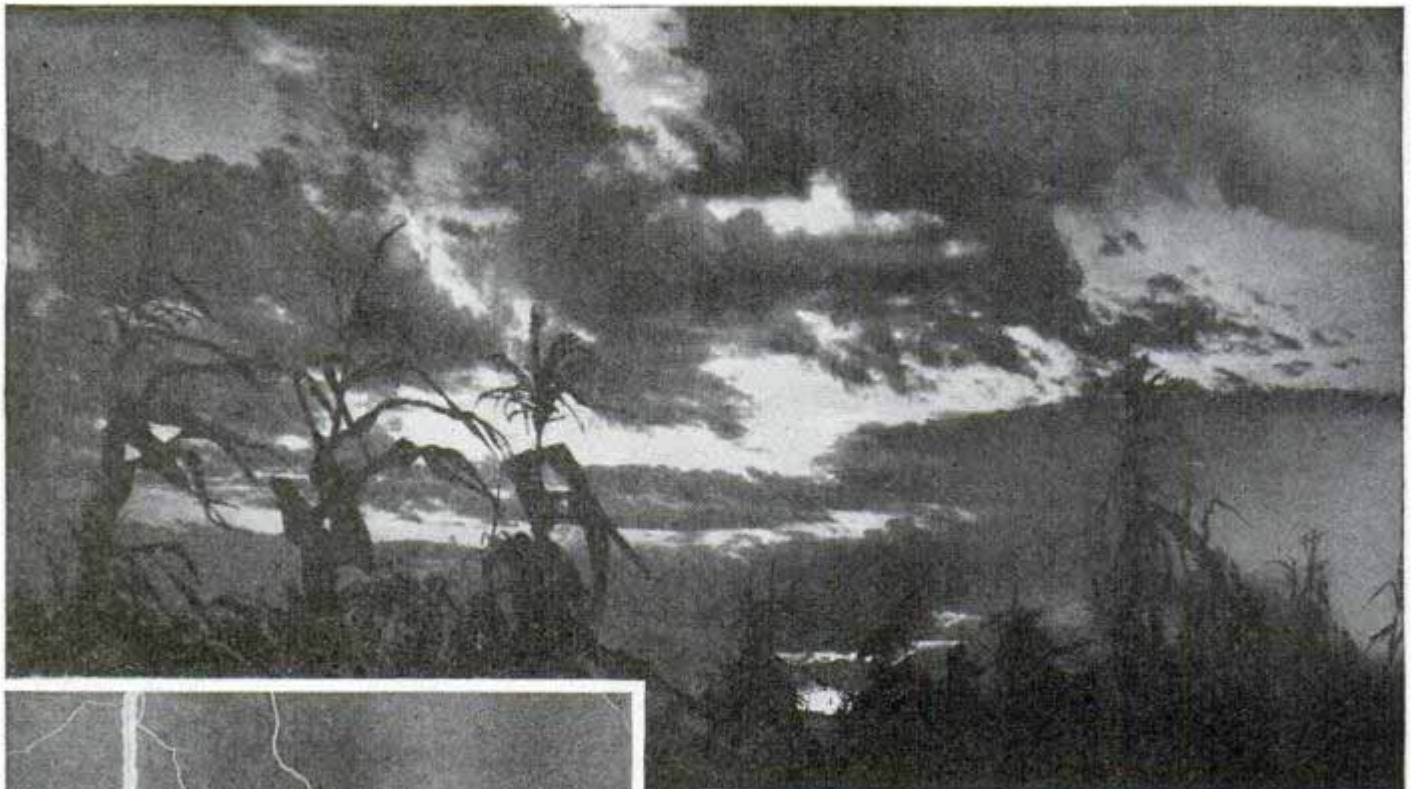

Red filter helps bring out contrast in storm clouds, and camera "stops" lightning with vivid effect

flecks in the print, and rain will rarely show at all.

Falling snow seldom should be snapped at a shutter speed higher than one twenty-fifth second. With a slow speed like one-tenth, the flakes appear as short streaks and their downward motion is emphasized. Longer exposures are often desirable. As

the exposure time is lengthened, the flakes appear as longer and longer lines, and with a very extended exposure, the snow appears as a filmy veil over the scene.

Successful photography of falling rain requires that the photographer choose an angle at which the raindrops catch as much light as possible. Each falling drop is a sphere, which behaves like a lens or burning glass except that the light it catches is brought to a focus within the droplet. Hence, when the photographer shoots at certain angles across or into the light, the falling raindrops are brightly illuminated. If these angles are such as to permit use of a dark background in the picture, the brilliance of the rain is heightened.

Rain falls more rapidly than snow and here again it is desirable to use fairly slow exposures, so that drops are drawn out in lines to give a "driving" effect.

Rain can be pictured in another manner—that is, coursing down a windowpane in rivulets or as individual drops scattered on the glass. Many interesting pictures can be made in this fashion. An automobile windshield, for instance, serves nicely as the frame for a landscape picture: the camera is focused on the rain-spattered glass, and the landscape scene beyond appears as a soft blur of tones and masses, quite in keeping with the rainy-day idea.

In shooting "weather" pictures, the pho-

tographer should use weather conditions chiefly to establish the mood or psychological "key" of his picture. To be effective, the picture must have a central idea, point, or composition which the weather helps carry out.

Lightning pictures are pretty much beyond planning. The only practical way to take lightning pictures is to place the camera on a tripod or win-

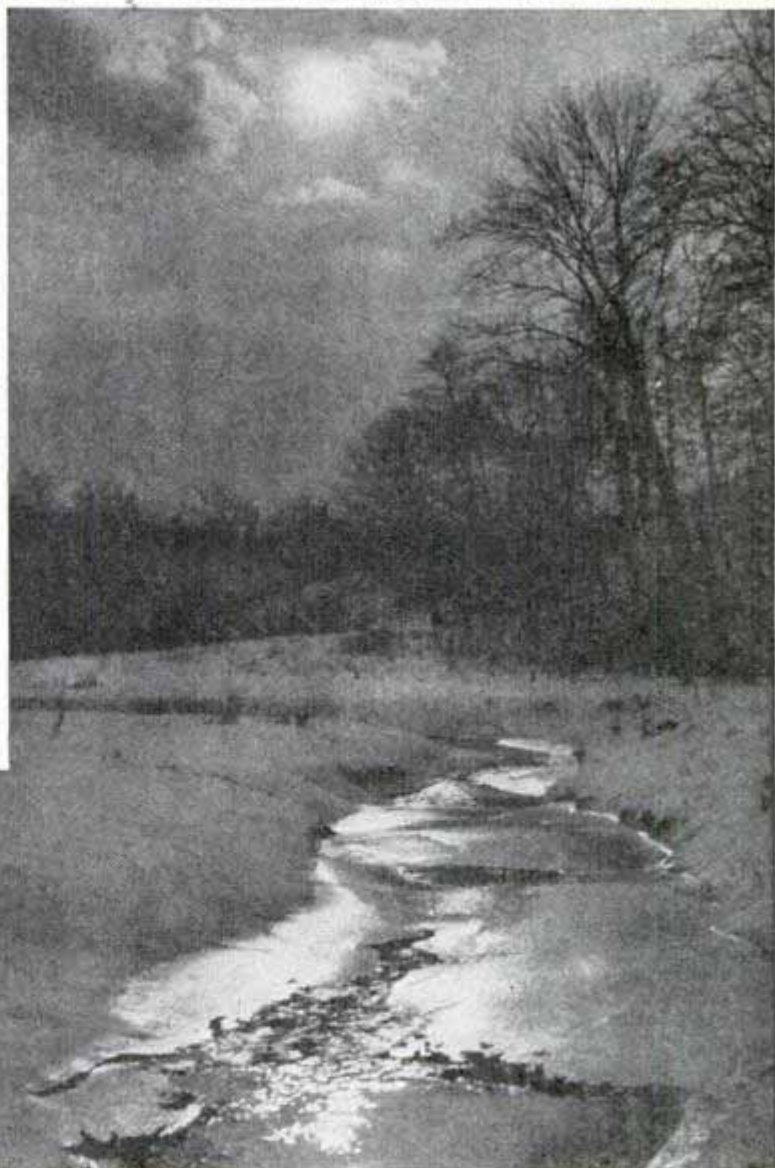
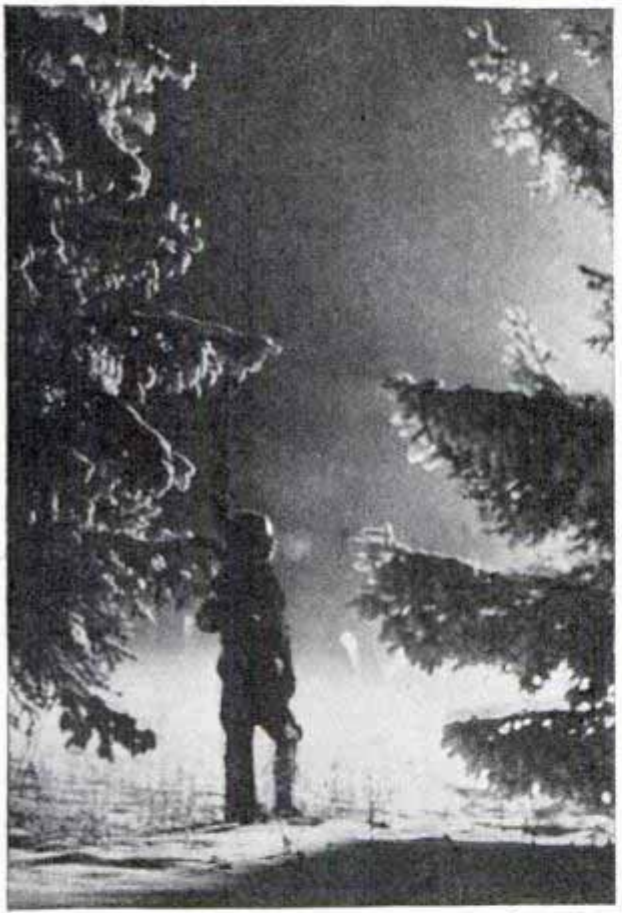

dow-sill, aiming it so that a suitable foreground of landscape or city skyline appears below plenty of sky; open the shutter, and wait until a flash of lightning strikes within the sky area covered by the view finder. The film is then wound and the camera opened for the next shot. Seldom does the

(Continued to page 116A)

Top, slow shutter speed allows rain to register in short streaks. Striking picture at left was made with automobile lights. Below, headlights on ice, dull sky and heavy overprinting of negative create graphic effect

Expensive Silklike Fabric Made from Shellfish



Glove made of silky fabric derived from the giant pinna held by the young woman

One of the most delicate silklike fabrics in the world, more expensive and more beautiful in color than the finest silk, comes from a shellfish in the Mediterranean. It is woven from the fine hairlike excrescence by which the giant pinna attaches itself to rocks along the shore. This substance, which is naturally a beautiful golden color, has great strength. On account of its fineness, a large amount is necessary to obtain enough thread for a pair of gloves. As a result, gloves woven out of the substance are more expensive than the finest silk. Because of its golden color, the substance is called "golden fleece." Greek writers of ancient days knew of this. They also called it sea wool. It is considered possible that from this knowledge of the golden fleece came the story of "Jason and the Golden Fleece."

Aluminum Wire Finer than Hair Costs \$216,000,000 a Pound

Aluminum wire drawn so fine that twenty-five strands would be only as thick as a human hair is being manufactured in a

New Jersey plant. A customer recently inquired for a sample of this wire and asked for quotation on a pound. At that time the wire, one ten-thousandth inch thick, sold at \$1.50 a lineal foot and there are 108,000,000 feet—more than 20,000 miles—in a pound. The customer was told he could have a pound for \$164,000,000. He ordered two feet instead! The price has since advanced, so that a pound would cost \$216,000,000. It is used for stringing galvanometers and other super-sensitive scientific instruments.

Water Helps Guard Oil Tanks Against Flood

Water will be used to protect oil storage tanks against floods in an eastern state. During the 1936 floods, an oil company suffered a heavy loss when all but one giant tank were swept away. At present the plant consists of eight tanks with a total capacity of ten million gallons. Accomplished at a cost of \$25,000, the flood plan calls for placing four H-shaped girders around each tank. Sixty feet long, the girders penetrate the ground thirty feet and are imbedded in six feet of concrete. Heavy steel cables strung from the girders

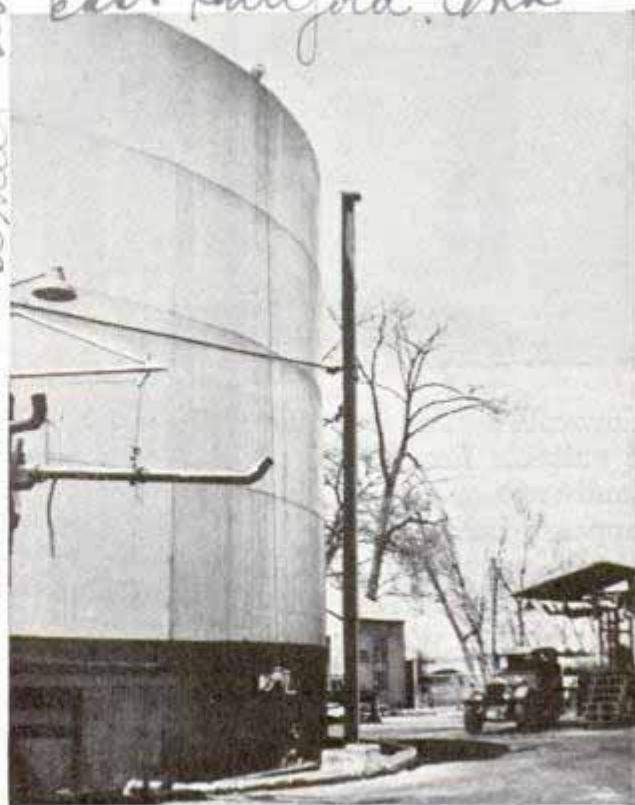

One of the big oil tanks is shown anchored by steel rail and heavy steel cable

Baker & Co. 60 Austin St

Authority - Dr. Henry A. Pillsbury
Academy of Natural Science
Phila

Cont: George A. Eckhardt
2047 N. Park Ave

H 58

H 26

Shellfish
Carl
Curtis
Curtis
Curtis

around the tanks are set to allow the tanks to move slightly with the rising water, lessening the danger of the cables breaking. A pump with a capacity of 16,000 gallons per minute, powered by a six-cylinder gasoline engine, is connected to each of the tanks by a manifold system of pipe lines. In case of another flood, observation stations along the river on which the tank firm is located would give warning. Water then would be pumped into tanks that were not full, through the bottom, forcing the oil to the top. Thus the tanks would be weighted down and prevented from moving to any great extent. The pipe lines also are connected to a fire-fighting system over the top of each tank. This system would be employed in case fire attacked the tanks.

H-4/
**Anti-Air-Raid Canvas Tank
 Helps Firemen Fight Blaze**

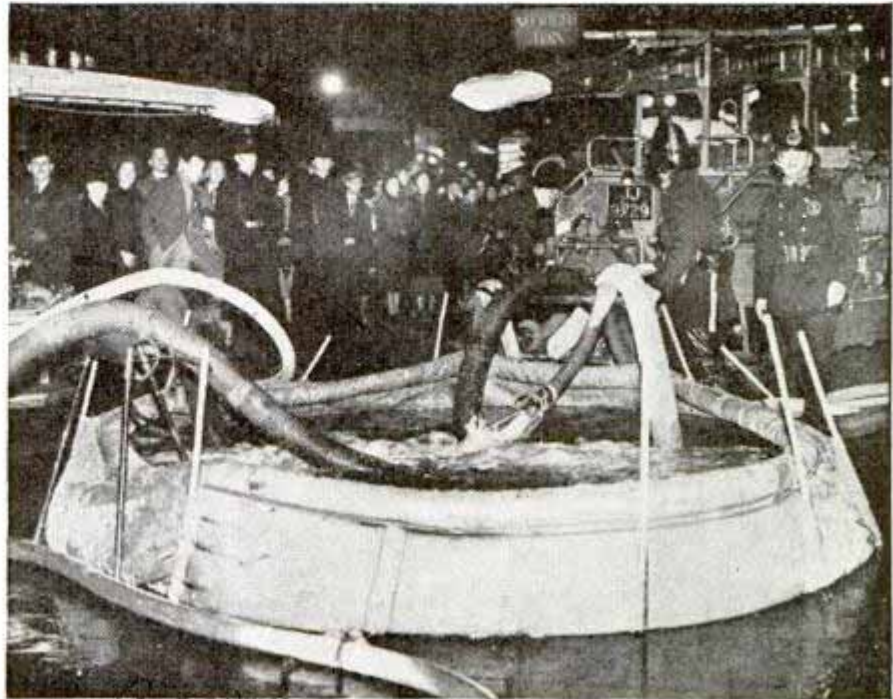

Collapsible canvas tank is shown in use during London fire. The tank is intended for use during raids by enemy planes

Designed for emergency use during air raids, a large canvas tank was demonstrated recently in London during a fire. When extra pressure was needed for fire hose, the tank was placed in the street and set up to aid in supplying water.

H-10
Trailer Straddles a Tractor to Carry It Along Highway

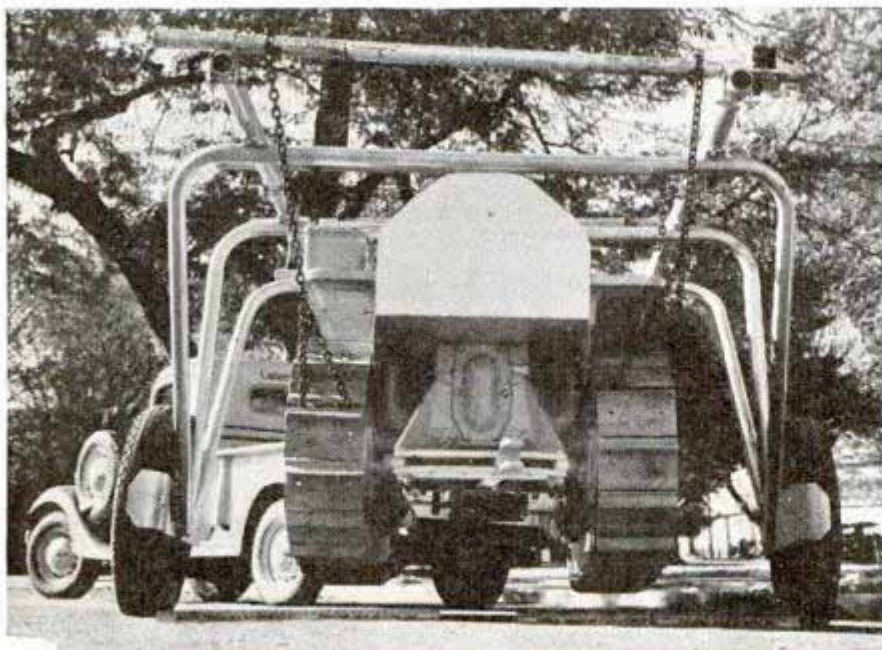

Farm machinery and tractors with lugs cannot be driven on paved highways in some states, and to transport them a huge trailer was developed. It straddles its load, lifts it off the ground with winch and chain, and is hauled away by truck. The wheels of the trailer, equipped with pneumatic tires, are seven feet apart.

Names and addresses of manufacturers and dealers in articles described in this magazine will be furnished by our Bureau of Information upon request accompanied by stamped envelope.

Trailer with seven-foot span between its wheels carries a big tractor

Straddlemax Machine Works

Mattress Tester in Prison Finds Hidden Weapons



Putting a prison mattress through the electrical detector in search for weapons

Hidden weapons made of metal may be detected in mattresses by a machine now in use at two penitentiaries in Illinois. As it is wheeled through the prison, every mattress is run through it. If any metal is in the mattress, a bell rings, warning prison attendants.

Mysteries of Ocean Depths Challenge Explorers

Challenging the modern explorer are the vast, mysterious areas under the seven seas, 140,000,000 square miles. Little by little the secrets of the oceans' depths are being discovered. Within the last ten years daring scientists have descended to great depths in diving suits and in sealed containers, such as the bathysphere. The diver is limited to depths of about 500 feet, the sealed container to slightly more than one-half mile, by pressure of the water above. Floors of some parts of the various oceans lie more than six miles under the surface, five miles below the deepest point man now hopes to reach. Dredges have brought up strange forms of life from the great deeps, but dredging is slow and expensive. Quick

and accurate methods for mapping the ocean floor have been developed. Sound waves have replaced the great lengths of steel wire which formerly probed the depths and sensitive pendulums swung in submarines have measured the density of rocks far below the surface. Magnetic instruments have revealed the shifting of the magnetic field in the sea bottom and cannon-like tubes have been lowered to punch out sections of the ocean floor. Chemical studies of the rock samples show that many strange things are going on in the regions never visited by man. Much new information has been obtained, but the work has hardly begun. A vast undersea area still remains to be explored.

Movies Flow from Mirror Belt of Shutterless Projector

Flickerless motion pictures flow in an endless stream from a movie projector which substitutes a chain of mirrors for the usual shutter. In the conventional projector, the shutter swiftly curtains the lens after each individual frame of the film, which comes to rest twenty-four times every second. The strain on mechanism and film of this constant interruption of

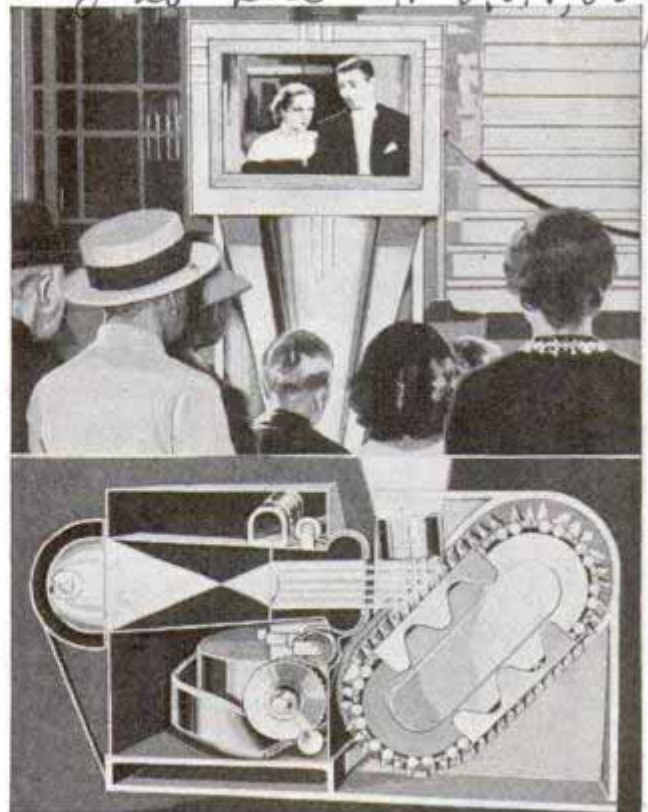

Audience watching continuous movie projected by mirror chain, diagram of which is shown below

Adytagraph Corp

Edward Fred Gump
Edward Capt. Joseph Fort

H-28

Warden Joseph E. Angelo

Gene
John S. Stalville

Filo Lite # 2,018,069

H-73

Donald L. Des. staff writer
Gene S. Stone. 1/10/38

201451
**Weather Studied by Pilots
 to Make Air Travel Safer**

motion is eliminated by the mirror projection method. The endless film is inserted, a switch turned on and projection is continuous. An automobile headlight in a reflector dome shines through a condensing lens which focuses the light through the film aperture upon the moving belt of pyramidal mirrors which compensate the motion of the film. The reflected pictures pass through a series of double lenses which make it possible to superimpose two frames to create a stereoscopic effect. The mirrors are of unbreakable metal. The light projection is efficient, the movies showing as brilliantly by day as by night. The unit is designed especially for use in theater lobbies to show previews of coming pictures, and for continuous projection of advertising films.

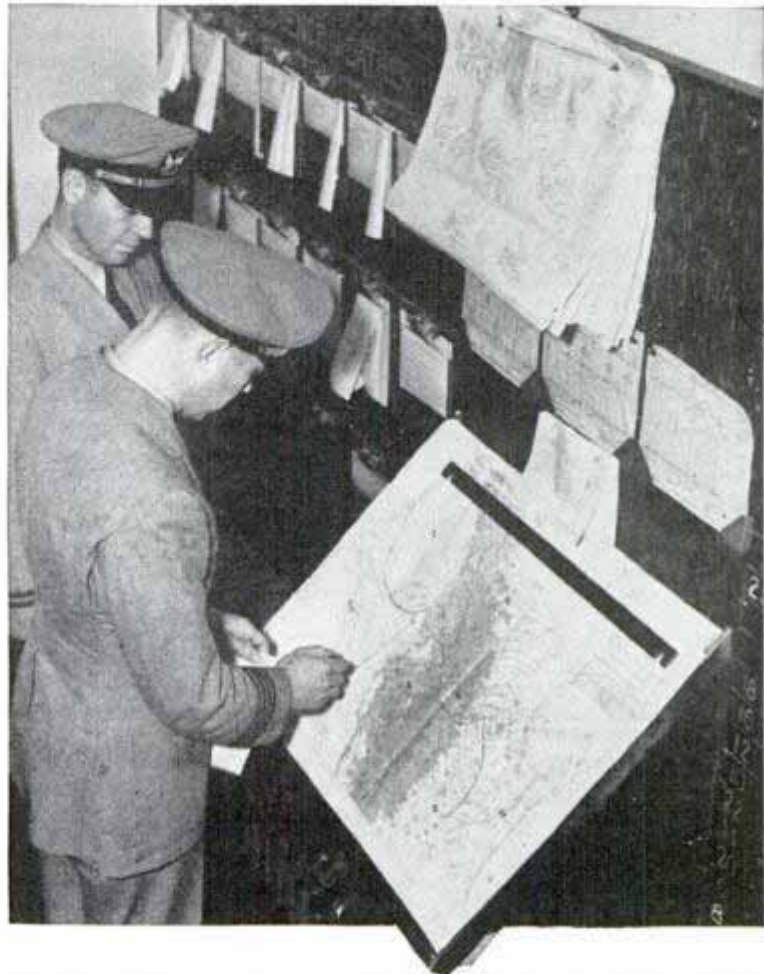

Air-line pilots are shown making a last-minute study of government reports before beginning another flight

H 27
**Big Transocean Dirigible
 Rushed to Completion**

Rapidly nearing completion at Friedrichshafen, Germany, is the "LZ-130," new luxury airship. Following test flights, the dirigible is expected to make her maiden voyage across the Atlantic in the early summer. Inflated with helium, the ship is scheduled to make fifteen to eighteen round trips between Frankfort, Germany, and Lakehurst, N. J., this year.

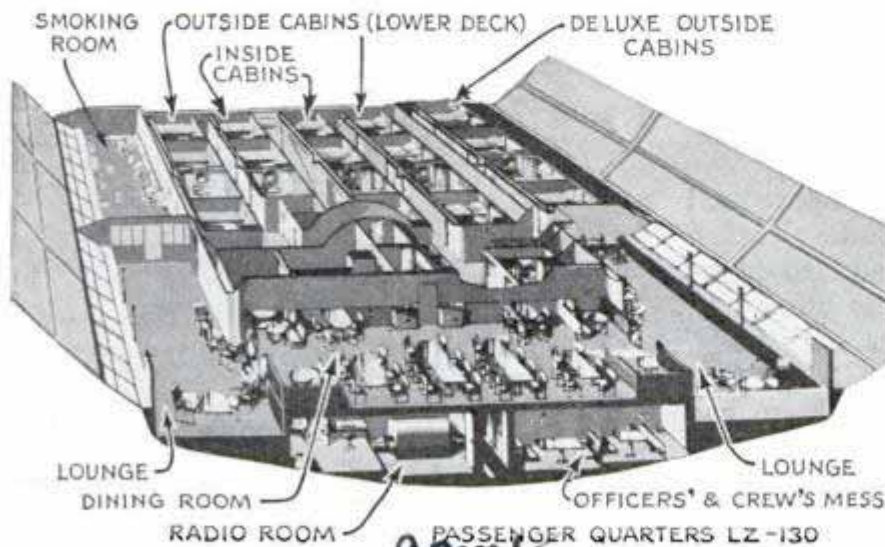

acome
 Sketch reveals accommodations aboard the new transatlantic dirigible for passengers, officers and the crew

Every precaution known is being employed to make air travel safe, including a last-minute study of government weather reports by the pilot before he takes his loaded passenger ship off the ground. Every flight across the continent or between major

cities is plotted carefully by the pilot and checked with the dispatcher at the various airports. Often it is necessary to detour many miles in the air to avoid possible inclement weather. Study of the weather reports shows the pilot where he may encounter bad weather.

Corrosion of iron causes an economic loss of \$3,000,000,000 a year, but addition of chromium to make it rustless is reducing that waste.

Scientific Monthly
 11/1937

United Air Lines, 2219 La Salle Street

James M. ...
431 W. 60th Terrace
Kansas City, Mo

THESE LIGHTS

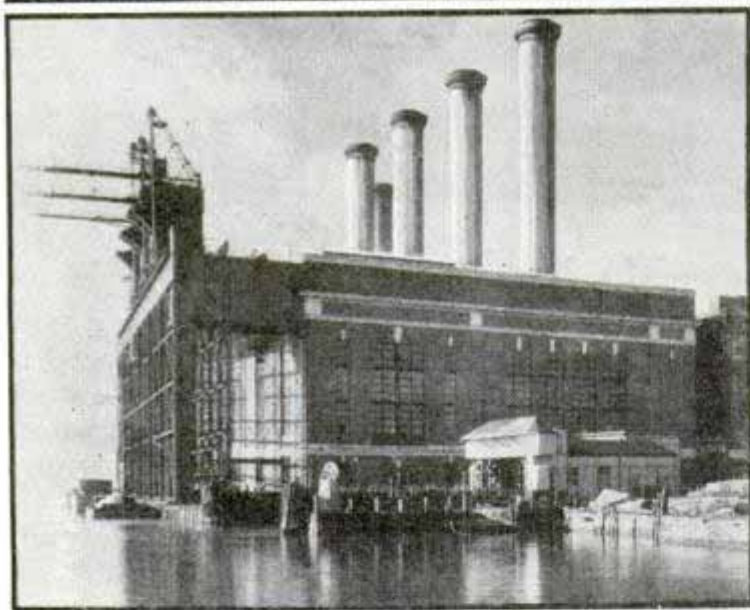
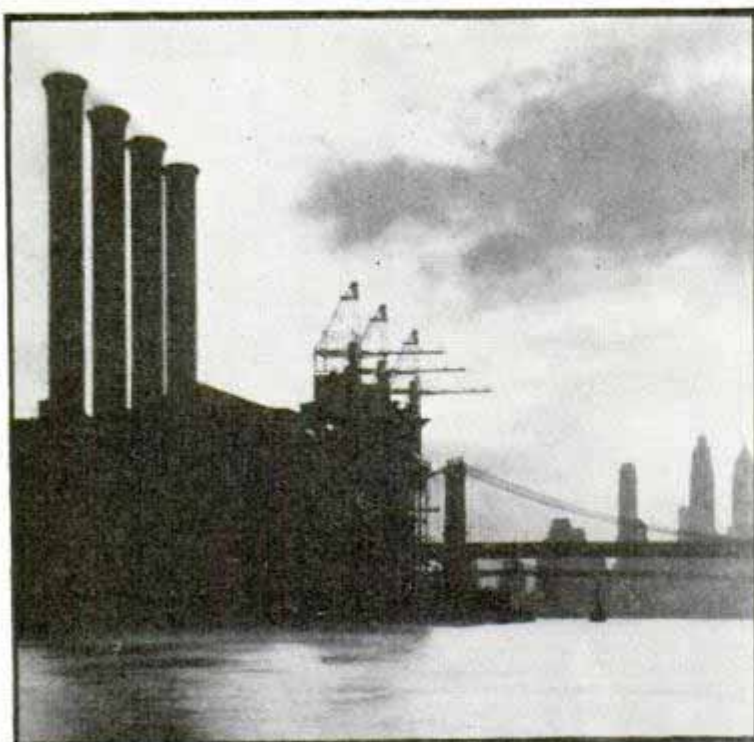

LIGHTS flicker and then go out. Nine o'clock and a great city's power dynamos cease to function. Homes, apartment buildings, motion-picture theaters, cafes, and store windows are plunged into darkness. Automatic traffic signals blink out. Except for bus and motorcar headlights, the streets are dark.

Subways, elevated trains and surface lines are tied up and their passengers left in darkness. Elevators are stalled, some between floors. Steam trains halt when the automatic signal systems that protect the safety of the passengers are put out of

commission. The radio and telephone are struck dumb, the roar of newspaper presses silenced.

Grim drama is enacted on many fronts. In the operating room of a hospital, a surgeon is performing a delicate operation when the lights go out. There is a delay while internes and nurses scurry around for candles. The delay may mean death. Likewise, lives are at stake at the city's airport when the radio and traffic control equipment cease functioning and field lights go out.

Electric locks on bank vaults and jewelers' vaults are thrown out of kilter. Police with crippled communication facilities are hampered in maintaining close vigil. Fires go unchecked because of the failure of the box alarms.

Furnaces with electric pumps and controls are put out of commission and hotel guests, apartment dwellers and home owners



Top, Hudson Avenue power station. Center, Hell Gate station. Bottom, sketch of buildings which housed first central electric-lighting station

256 Pearl St
1887

Greenwich
Budget
Looking
from
Bldg
51399

MUST NOT FAIL



face a heatless night. After a night of fears, the full force of the power suspension is felt. The office worker cannot get to his desk without climbing interminable flights of stairs. Even then, only simple business can be carried on because of the condition of the lights, the telephone, and automatic business machines. Factory workers, machinists, builders—all must remain idle because the wheels of their machines are without power.

Thus within a few hours, the entire routine of a city can be changed.

Although our modern public-utility systems are so designed that power failures have become a rarity, there is nothing like one to impress a city dweller with the importance of electricity in his particular sphere. Breakdowns of short duration are the result of severe lightning storms or equipment failures while those of a prolonged nature may be attributed to such causes as hurricanes, tornadoes, sleet storms, serious power-station fires and floods. The task of coping with these prob-

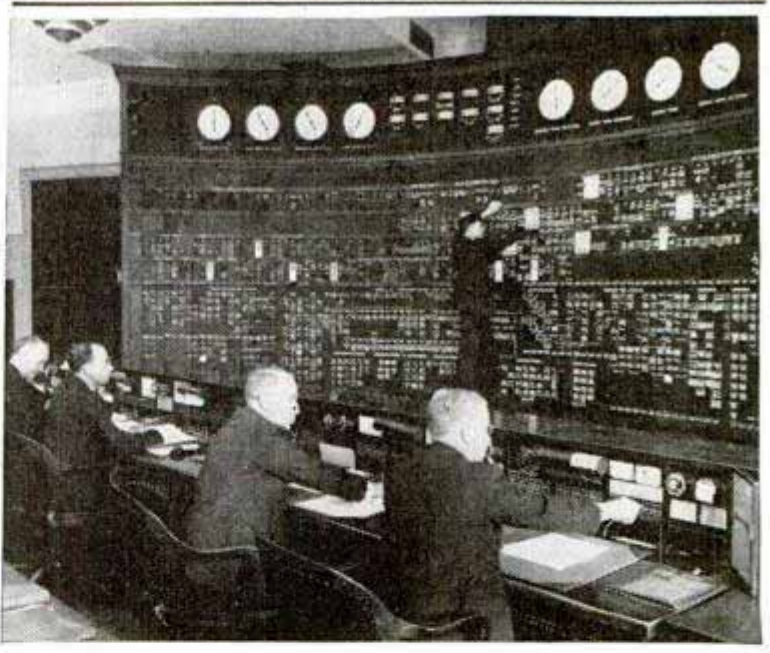

Top, striking night view of Manhattan shows New York's myriad lights and takes in a distance of about seven miles. Bottom, operator removing protection indicator from board. The indicator tag designates apparatus on which work is being done

lems of electric-power distribution is that of the utility company's chief of operations.

Let's look in on the operator of the world's largest system, that of the Consolidated Edison company in New York, as he sits at his keyboard watching the clock, the weather, and a number of scientific instruments that comprise his tools. Before him

Bugh Camera System
539
Polaroid

es 13 9 7

Louisville Kentucky
Hotel

Chaff

Chaff
Lauffer



The interconnection of the generating plants forms what might be termed a power pool. At all times there is a certain amount coming in and going out of the reservoir. The volume in each case depends entirely on the time of day and the anticipated demand. If the day is bright, the operator knows the peak of the load for lighting will be much lower than it would be if the day were dark and cloudy. When the great office buildings and manufacturing plants release their workers at Saturday noon, he must make provision for a sharp drop in the demand for current. He must know in advance the approach of a storm, for this means lights will be snapped on everywhere, requiring an additional supply of current. Approximately one hour is consumed from the time

is a giant board: the nerve center of New York's electricity supply. Lights on the board indicate every important piece of equipment in the system and he has at his fingertips working plans to meet every difficulty the blinking lights present.

Seven and a half million persons living in the most densely populated section of the world depend upon him to supply their electrical needs and annually he supervises the distribution of more than 4,840,000,000 kilowatt-hours. From the system operator's board you learn there are nine generating stations, ranging in capacity from 20,000 to 770,000 kilowatts, all interconnected and operated as an integrated unit under his control. There is also a connection with the steam and hydroelectric system of the Niagara-Hudson corporation in upper New York.

As the operator presses one key and then another, the generating units spring into life. Hundreds of thousands of kilowatts are poured into the high-tension galleries of the plants where, in turn, the power is relayed to the district stations to be flooded into the city's outlets, for the subways, electric toasters on breakfast tables, street signals, newspaper presses and other uses.

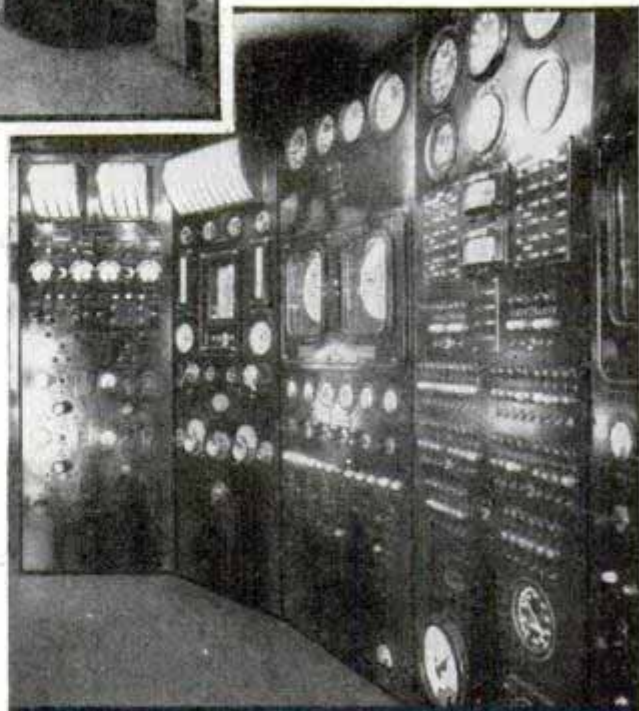

Top, lamps must serve when electricity fails. Center, examining boiler through eye-protecting slide. Bottom, boiler control room

Welltrate general

2-13-77

East River boiler

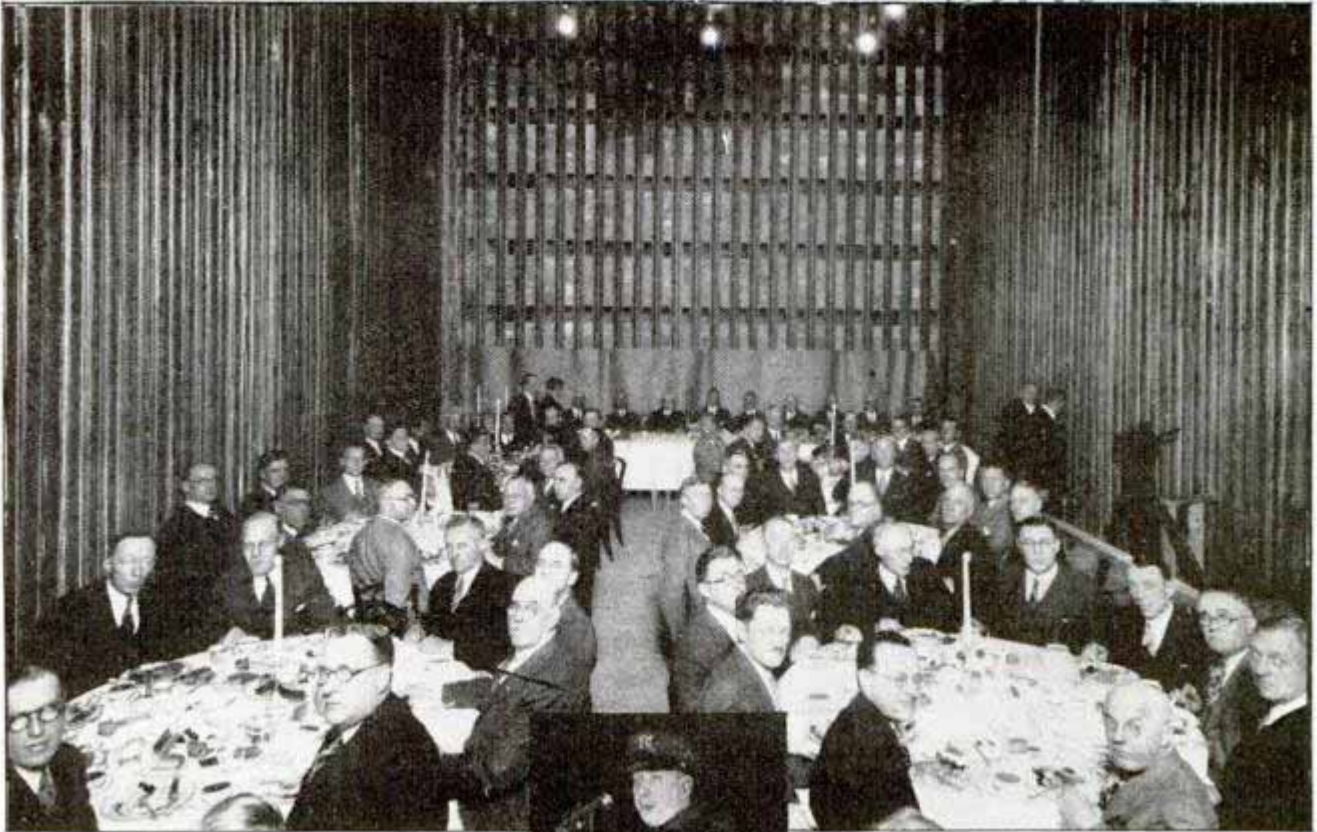

banked boilers start working until the generators start feeding current to the lines, hence the system operator must be certain of his calculations.

Experts are employed to study the power markets. They know there will be a year to year in-



crease in "load" growth, and provision must be made for this normal increase. Business trends and labor conditions are checked with the mass of data and statistics available, so the power requirements may be determined with reasonable accuracy.

Weather reports are carefully scrutinized by the system operator and word is flashed to him from the various plants and substations when a storm approaches. An electrostatic machine, a special radio, registers storm rumblings and rings a bell in the operator's room. The louder the bell rings, the closer the storm.

In meeting some temporary emergency, the dispatcher may have to revamp his whole distribution of power within a short time, calling this unit into play, dropping that one out, and detouring around something else. Supposing a storm comes up suddenly on a bright afternoon around 2:00 o'clock. By 3:30 o'clock it is not unlikely that a demand for 223,000 extra kilowatt-hours over normal requirements would be made. In round numbers, the storm in the space of an hour and a half creates the ne-



Top, ninety men dining in boiler just before it was fired up. Center, directing traffic with flashlight. Bottom, checking smoke from boiler chimneys

(Continued to page 144A)

newall n-j

Blade Set with Diamonds Cuts Brittle Materials

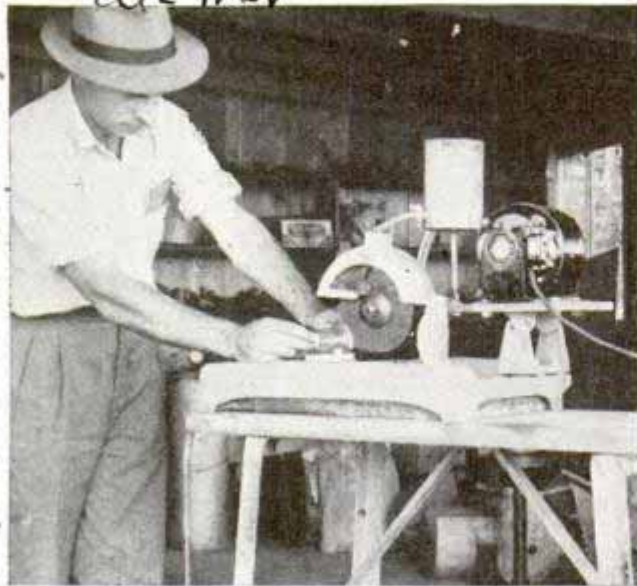

Cutting glass with the diamond-impregnated blade. The work is remarkably clean

Impregnated with diamonds, a new circular blade cuts brittle materials with remarkable cleanness. It handles tile, glass, stone, non-laminated plastics, porcelains, refractories, natural shell and vitrified products. The blade has no projecting teeth and it cannot break or fly to pieces. A one-quarter horsepower motor supplies power to drive the blade through such substances as one-inch plate glass. One of the blade's advantages is that it can cut the most delicate porcelains and leave the glaze intact. It cuts optical glass cleanly and ores and stone to wafer-thin dimensions for specimen examination. The width of the cut is only three-sixty-fourths inch. A portable machine using the blade is built to operate on 110 volts.

Auto Tire Removed from Rim by Air-Pressure Tool



Automobile tires can be removed from the rims safely with a tool that uses ordinary air pressure, exerting from one to 1,000 pounds thrust under precise control with a double-acting valve in the

hand grip. Placed around the tire, it compresses it and separates the bead from the rim. This method avoids possible damage to the tire by the use of heavy tools.

Noiseless Concert Programs Made of Blotting Paper

Printed on heavy sheets of colored blotting paper, the latest concert programs are noiseless, thus eliminating the disturbance created by the usual paper programs when they are folded or dropped. The blotting paper programs may be dropped, folded, wrinkled and handled freely by the concert patron without annoying others.

Pump Lifts Water Eighty Feet Eliminating Deep Pit

Pumping of water beyond the theoretical limit of twenty-five or thirty feet is now possible without the added cost of a deep well pit and electric service to a pump in the well. Water can be lifted as high as eighty feet by a method just devised. Using about half the water ordinarily pumped by a shallow well pump in the basement, an injector placed in the well pipe "jets" the water to a point where it can be picked up. The pump can be located right in the cellar, remote from the well.

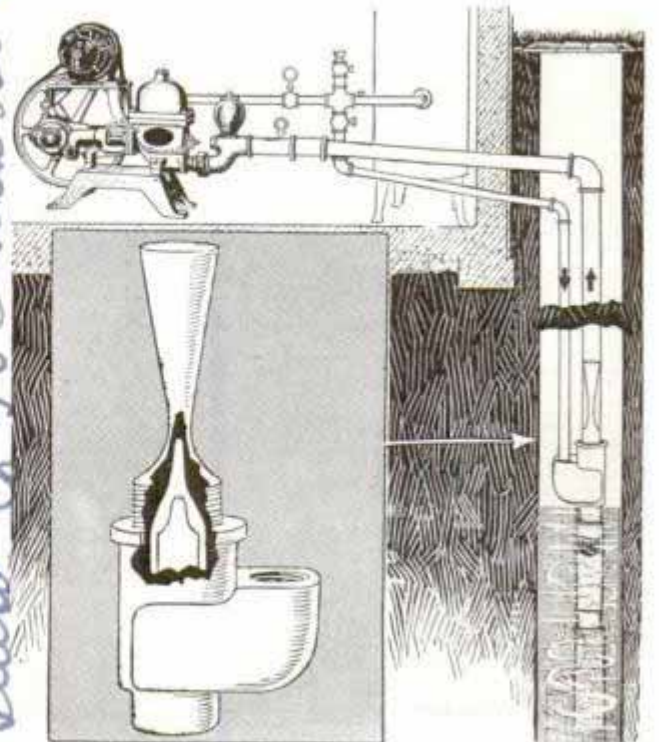

Drawing indicates how water can be lifted eighty feet by using injector to "jet" water inside pipe

Leo Angeles
Caly
Musto - Beerian Ca }
1801 Soto St }
Es 1539
Es 1394
The Rev. Ca 50 Church St
also monument fire
Shawton Chew

John Kazanovoy
319 Pleasant St
Northampton Mass

H 92.

H-47

To lift

Floodlighting Rail Crossing Checks Accidents

Because a startling number of grade-crossing accidents involve, not trains hitting automobiles, but automobiles crashing into the sides of trains, the Chicago & Illinois Midland railway has adopted a plan of floodlighting its cars at highway crossings. Directional floodlights installed on poles at each side of the tracks throw a bright blanket of light against any locomotive or car blocking the road, making it visible to motorists for some distance from the rails. An astro-nomic time switch which compensates for seasonal changes keeps the lights turned on during the hours of darkness. The floodlights are an especial safeguard at crossings where train movements are slow or freights frequently block the highway while switching.

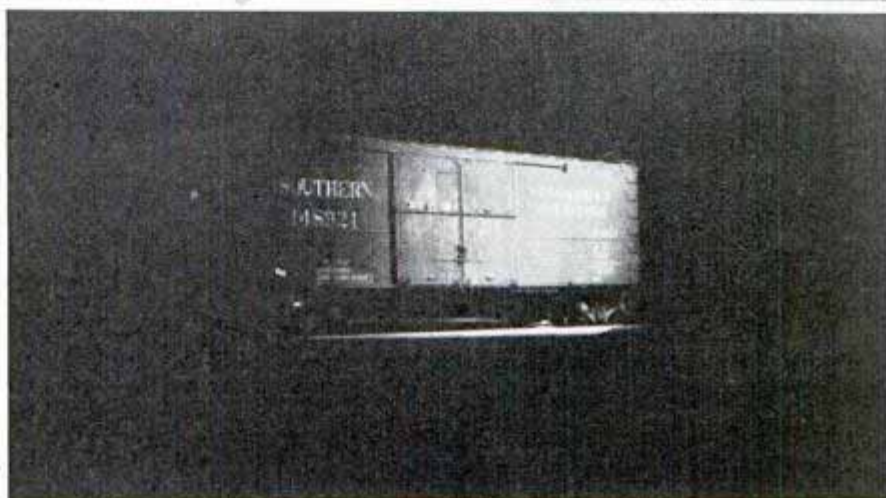
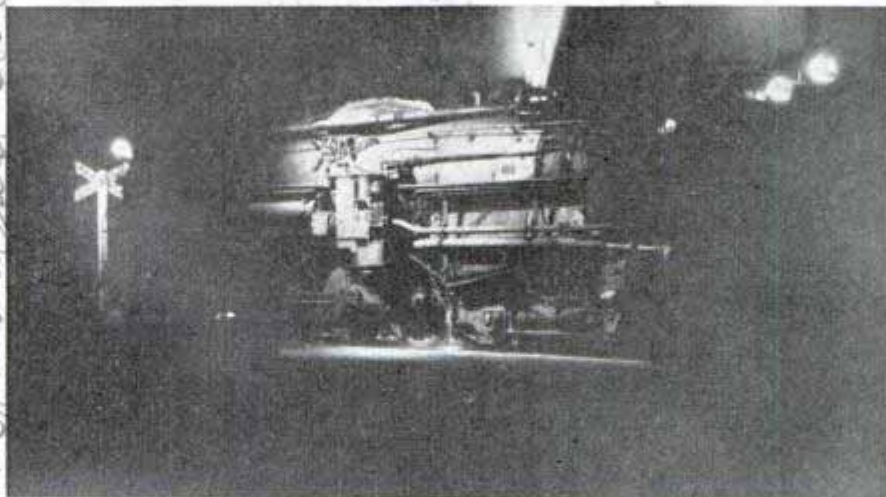

Locomotive and freight car passing floodlighted crossing. This helps prevent a common type of accident—motorists driving into side of trains

Noiseless and Dustless Coal Unloader Does Job Quickly

Noiseless, dustless coal delivery may become common as the result of a new type



Unloading coal with noiseless and dustless mechanism

of truck. An experimental truck, built from discarded automobile gears and parts by a North Carolina coal dealer, delivers stoker and small lump coal without noise, dust or spilling and does it fifty times faster than ordinary unloading devices. The truck has a hopper bed equipped with a half-inch conveyor belt fourteen inches wide down the center of the bottom of the truck. At the back of the bed it dumps the coal into a detachable chute that has another conveyor belt. Both belts are operated by the truck motor, and run fast enough to unload three tons in two minutes. A device at the intersection of the two belts sprays the coal with oil vapor, eliminating dust.

Send return postage to our Bureau of Information to learn the name of the maker of any device described in this magazine.

Gearless Speed-Reducing Drive

Uses Cams and Levers

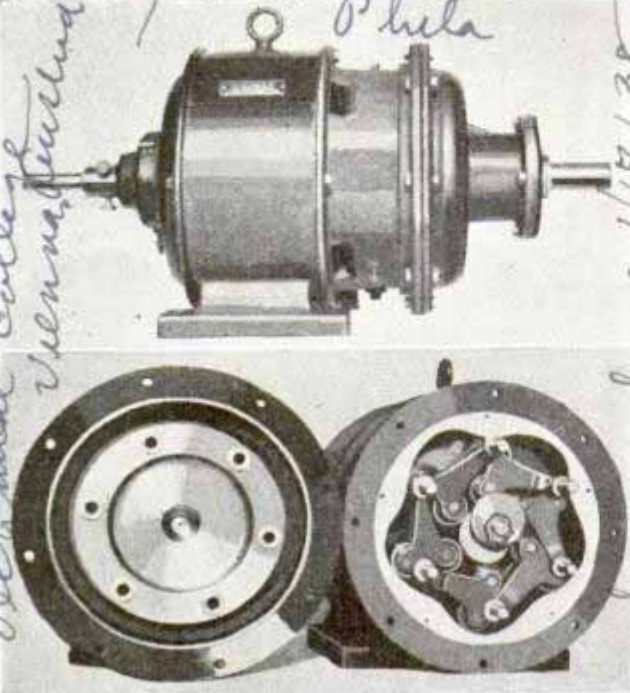

Cams, levers and eccentrics are used instead of conventional gears in this speed-reduction drive

Speed-reduction drives without gears, without the noise, wear and inefficiency of the conventional type, are being introduced in this country by an Austrian engineer. His invention involves the use of an eccentric fastened to the high-speed shaft, acting, as it revolves, on a series of levers. These levers in turn act upon a stationary series of cams. The levers are fastened to a disk on the slow-speed shaft, which is thus made to revolve at a reduced speed. Gear teeth are eliminated entirely. The speed-reduction ratio is determined by the relation of eccentric to levers to cams.

Top of Floor Sweeper Opens for Easy Cleaning



Cleaning dirt and dust out of the latest floor and carpet sweeper is made easy by a patented top which opens. After the top is open, the pan may be lifted out and its contents emptied. The brush also may be snapped out and cleaned. Most models of the machine are equipped with a

removable steel comb which cleans the brush as the sweeper operates. A clean, empty shell remains after the pan and brush are removed.

Highway "Flight Strips" Proposed for Emergency Landings

"Way stations" for aircraft along the main highways throughout the states are being proposed, both as a convenience to private fliers and as emergency landing fields for lost or fog-bound planes. Forced to find a safe place to land when fuel or equipment fails or bad weather sets in, the pilot could simply follow a principal highway to one of these "flight strips" built beside the road at intervals. The strips would be built and maintained by state highway departments, and would range from 200 to 740 feet wide and from 1,800 to 5,000 feet long according to the type of aircraft they are planned to accommodate.

Baby Photo-Flash Bulb Handy for the Photographer



Thirty "baby" photo-flash bulbs are shown fitted in the photographer's hat

So small that thirty of them will fit into a man's hat or twelve into a coat pocket, a baby photo-flash bulb now on the market is convenient for the photographer. The bulbs are said to synchronize perfectly and to be effective on routine shots at 1/200 of a second, distances of eight to ten feet, with the camera lens stopped down to f.32 and f.45. The bulb is effective for closeups up to a distance of eighteen feet.

*Dr. Frank Kubay, Engineer
Electro-Technical Institute
Technical College
Menasha, Wis.*

*Proposed by: Dr. Col. Steinarik Hauas
Al American Road*

same device 1/17/38

*Walsh Photo Lab
375 Cambridge St
Brooklyn
N.Y.*

*H-39
O-Pan-Top*

Carl W. Newton and

see May 1941
Bombing the Sea Floor to Find Lost Continent

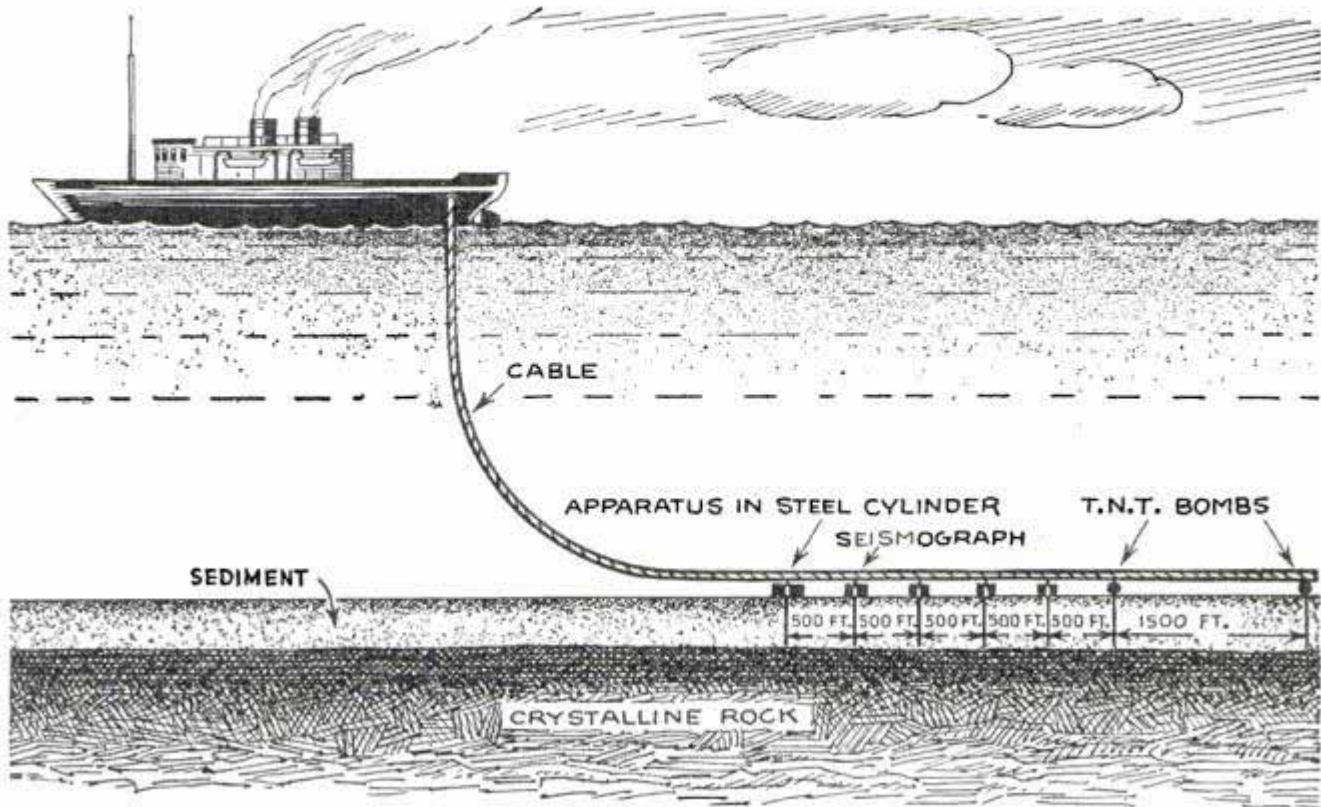

Bethlehem, Pa
Bombs set off at intervals send vibrations through sediment of sea bed, and when they rebound from deep rock the vibrations are recorded, furnishing data for study of rocks beneath the ocean floor

One of the last frontiers to resist man's curiosity, the rock bed deep below the ocean floor, is beginning to yield at last to the scientific explorer. Seismographs and explosives soon may tell whether a lost continent of Appalachia lies beneath the sand and mud and silt at the bottom of the Atlantic. Dr. Maurice Ewing of Lehigh University has devised a method of submarine exploration with a seismograph similar to that used by oil prospectors. Science has long since sounded the depth of the ocean, and sampled the topmost eight or ten feet of its floor. Now, by detonating small charges of TNT and recording the vibrations after they are reflected back from the rock subfloor, Dr. Ewing expects to learn the depth and perhaps the composition of the undersea rock structures. His method is to drop overside from the research ship a long steel cable to which is attached all the apparatus: first, a twenty-pound charge of TNT in a container proof against the high pressure of ocean depths; after a 1,500-foot interval of cable, a smaller charge of explosive; then, at 500-foot intervals, four geophones which catch the vibrations; and finally a steel cylinder containing the recording instruments. A

timer in the cylinder sets off the TNT blasts separately. The vibrations travel down through the sediment to the rock bottom, bounce back to the geophones and are recorded automatically in the cylinder. The two explosions provide separate sets of data to be checked against each other. By this system submarine geologists will test the theory that a vanished continent exists submerged in the Atlantic and from it, in some past age, the sediment flowed to form the Appalachian mountain range.

H-40
**Abrasive in Photo Flood Lamp
 Cleans Bulb When Shaken**



more flood
 To keep a high-powered photo flood lamp up to its top efficiency, the latest bulb contains a small quantity of abrasive

metal chips. When the lamp begins to cloud up, it is swirled about and the abrasive chips clean off the dark deposit which forms on the interior of the glass, restoring its original transparency.

magazine
 Westinghouse Electric
 and Mfg Co 35

1083

ACROSS AFRICA



Top, a tribesman helps install a new rear axle. Bottom, two of the chiefs who rode into the French fort to honor the adventurers

2340 Lahlia St Denver, Colo



Romba *in quinine*

points. Too big a load. With our camping equipment whittled down to two blankets, a pan and kettle, spoons, a fork, two jackknives, a medical kit and our mosquito net, we could hardly eliminate anything more. There wasn't anything else but gas and oil, tires, tools and spare parts, and the last month had taught us we couldn't cut down there. So we attacked the Sahara as we had the jungle.

A thin, white little ribbon of a road, traversed twice a week by the lorries of the French trading company, led 250 miles north across the hot sands to Zinder,

southern terminus of a dozen caravan routes, and first French post in the Sahara. Here, at the invitation of the commandant, we made our headquarters in the great mud fort. Gasoline was ninety cents a gallon in Zinder. We strapped four ten-gallon cases to our luggage carriers, enough, we hoped, to get to the fort and radio station at Mao, 800 miles farther on. With tears

PART II

By James C. Wilson

AT LAST we had reached Kano, gateway to the Sahara. But our motorcycles, after the heart-breaking, month-long trek through 800 miles of jungle and forest, had given way at a dozen crucial

es1083

on ONE LUNG



Hansa

Top, native merchants in French West Africa. Right, chief who honored the white men traveling on mechanical camels. Bottom, looking at a clay cathedral built by termites

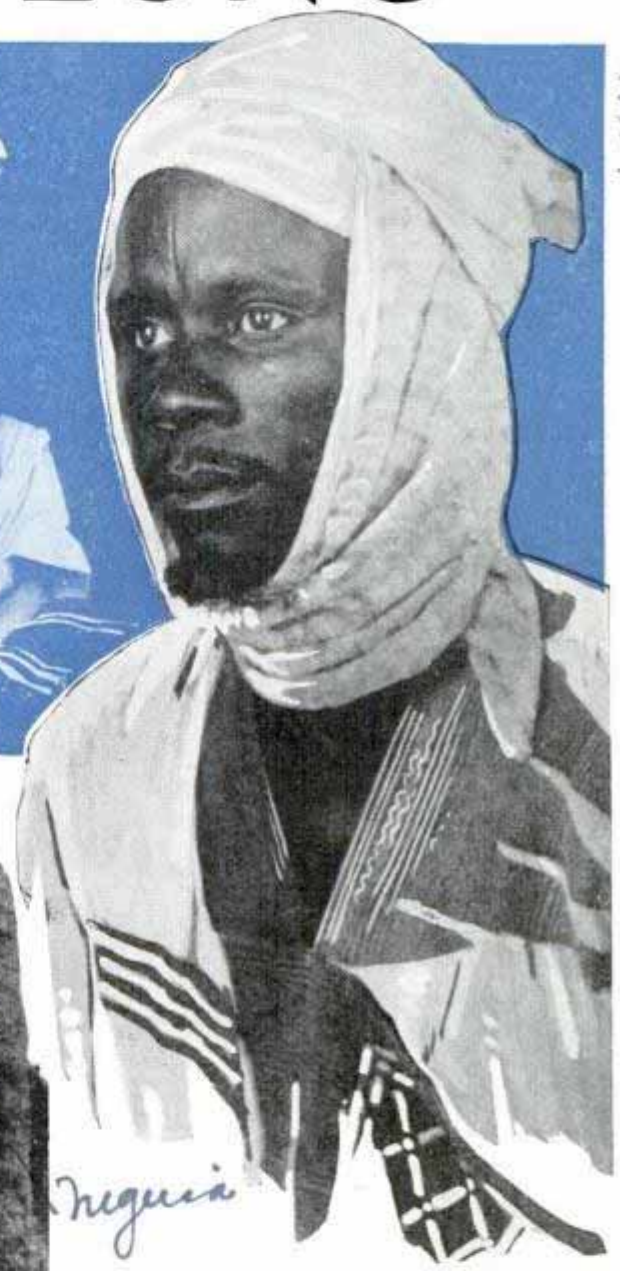

Negua

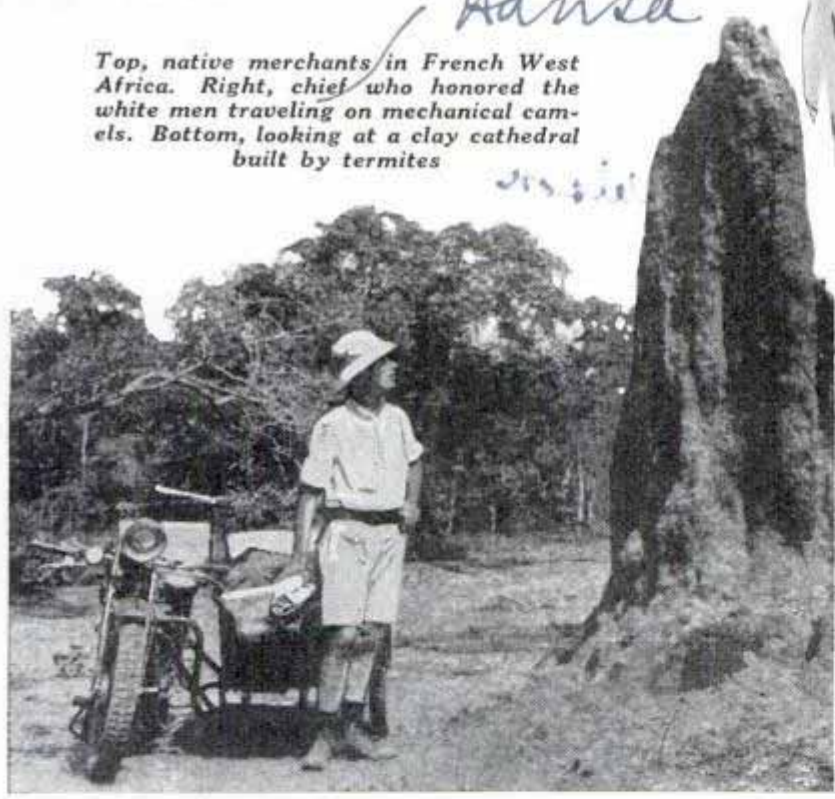

French: "Last seen at Zinder, December twenty-fourth," and signed his name.

Two hours later we dropped off the end of the road, the last real road in over 2,000 miles, into the deep soft sand of the caravan trail. I always rode behind to pick up nuts and bolts my partner lost.

in his eyes, the commandant begged us to turn back.

"I am sorry," said Flood, "but we are determined to cross Africa by motorcycle."

Without a word, the commandant dipped pen in ink, reached for our passports, and solemnly wrote across the face of each in

Flood plowed ahead for a few yards, then jumped off and pushed until his motor stopped. The sand trickled from his wheels in streams, and the heat shimmered from the smoking cylinder fins. Yes, this was the Sahara.

"Let some of the air out of your back

son of Fylaric's



tire, put her in low, stand on the back axle and bear down," I yelled. "That'll take the weight off the sidecar wheel and give you more traction." He did. Slowly we moved forward.

That night, since it looked as if we'd have to ride the rear axles from then on, I set to work making strap-iron foot-rests. I didn't have a big enough drill. We built a fire, heated the irons, and tried to worry the holes through with a punch, but couldn't get them hot enough.

"Just wait till morning, and lay the irons out in the sun," suggested Flood.

I had a better idea. Just strip all the gadgets off a pair of straight sport handlebars and you've a first-class blowpipe. It wasn't the neatest job in the world, but we weren't worrying much about looks.

On Christmas morning we sprang a leak in one of our gasoline cans just 750 miles from the next filling station. We'd either have to push the last hundred miles, or take a chance on soldering the can. So we built a brushwood fire and soldered the leaking can. As a matter of fact, it wasn't taking a chance at all. The career of many a



Jim Wilson

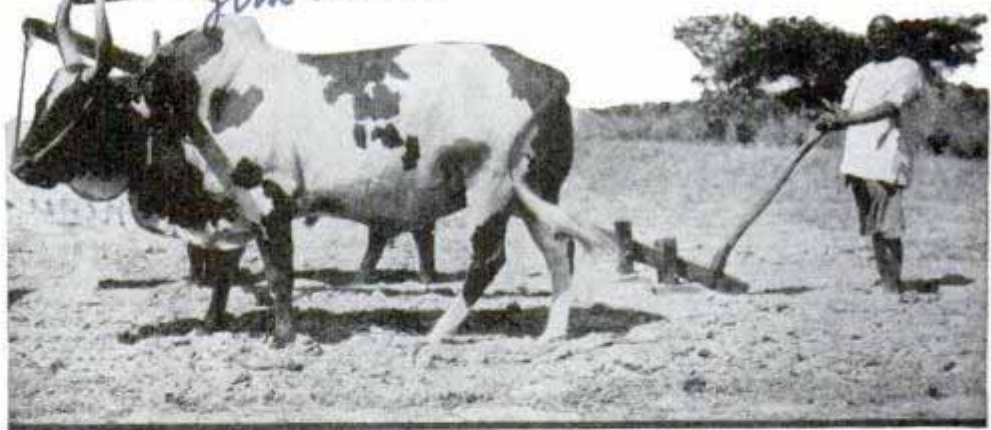

Top, a native goes for his first motorcycle ride. Center, the author, after a month in the desert. Bottom, latest means of farming in Africa

promising young mechanic has been terminated abruptly as he tried to solder an "empty" gasoline can, but the lad who makes sure there is a mass of liquid directly beneath the leak to absorb the heat runs little risk.

The French authorities were surveying for a military road from Zinder to Lake Chad and native road gangs were "paving" the middle stretch, mixing straw with clay from the cuvettes or basins, and dumping it down in hunks across the desert for the sun to bake. So, with a dead weight of 160 pounds of gasoline hammering at my rear axle, I didn't blame it for breaking after two hours of jolting over the cobblestone-like surface.

We installed a spare, transferred our gasoline to the sidecars, and

French West
crawled along at three miles an hour in low. We thought it was time to stop when the main leaf of Flood's sidecar C-spring snapped in two. Thank heaven for strap iron. We made a clamp for the broken leaf, but somehow we had to give those springs more "fight."

"Say, didn't we bring along a couple of extra coil springs for the front forks?" asked Flood. With all the excess weight

to the rear, we'd never need those springs for the front forks. If you've seen the auxiliary coil springs for cars with trailers, you'll know exactly what use we made of those front-fork springs.

Our old enemy, the caravan trail, looked mighty good to us after that "paved road." Day after day we roared along in low gear, through a blazing wilderness of sand. We anticipated that our air-cooled motors would overheat under the broiling desert sun. Amazingly enough, they never did, except the time Flood forgot to turn on his oil.

But we had plenty of trouble without that—sand. Giving up all hope of carrying our reserve supplies on our machines, we chartered a pair of camels for twenty-



five cents a day, complete with drivers, loaded them up and sent them off across the desert with a litter of spare tires, extra cylinders and gasoline tins. Even then we couldn't make any headway unless we ran with the rear tires almost empty, and then the tire slipped on the rim and tore out the valve stem. This happened seven times in one day, ruining two good tubes.

Finally, I split the ruined tubes lengthwise and installed them in the casings as inner linings with a flap sticking out all the way around between tire and rim. This

(Continued to page 124A)



at M'gairni
Top, guests of a native chieftain in his mud palace. Center, native garrison turns out to welcome the adventurers. Bottom, camel pressed into service to carry luggage and spare parts over one particularly bad stretch of desert

Ernest J. Perrin.
Bureau

es1531
Fast German Air Liner to Fly the Atlantic

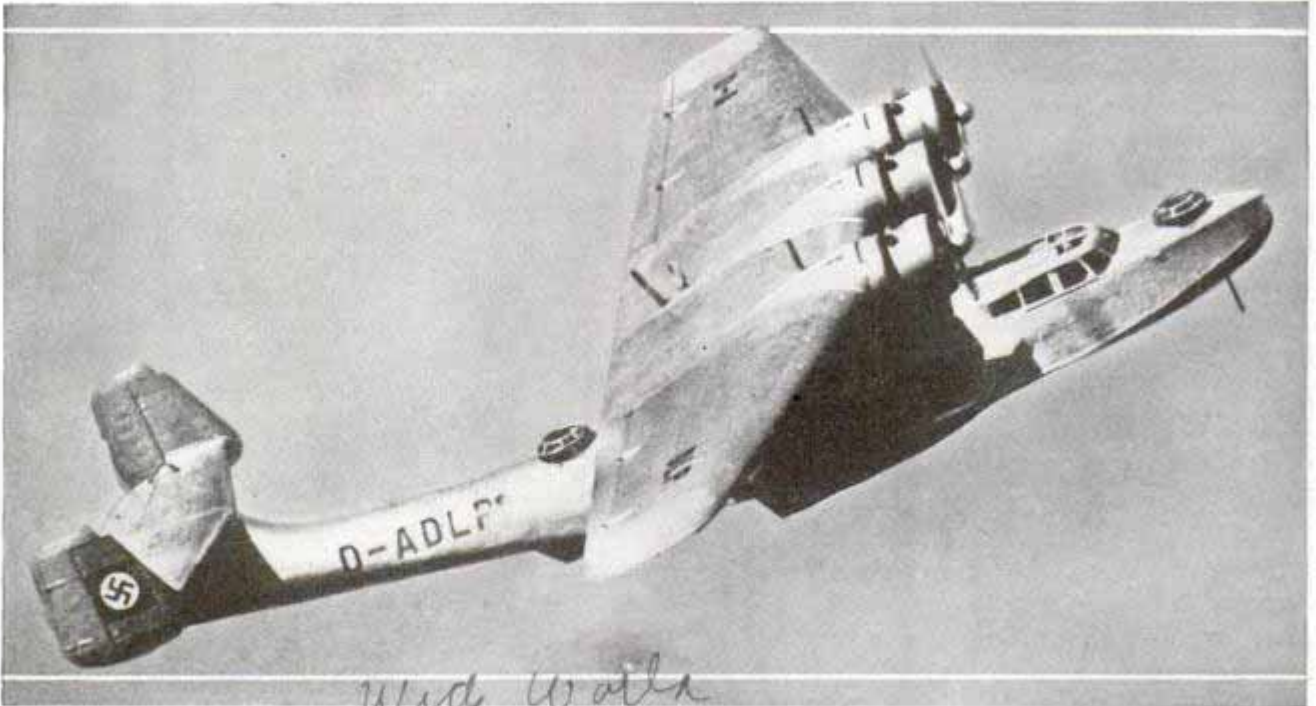

Wide Wings
 Here is Germany's latest air liner. Designed for transatlantic passenger service, the giant craft is expected to exceed 185 miles an hour on its ocean journeys. It is an all-metal ship

Capable of speeds above 185 miles per hour, the latest German air liner is designed for flights across the oceans. It was completed recently at the Dornier airplane

works at Friedrichshafen. Built of all metal, the single-wing flying boat has a wingspread of eighty-seven feet and a length of seventy-one feet.

es1534.
Sphere Tank Saves Sewer Gas to Burn City's Garbage

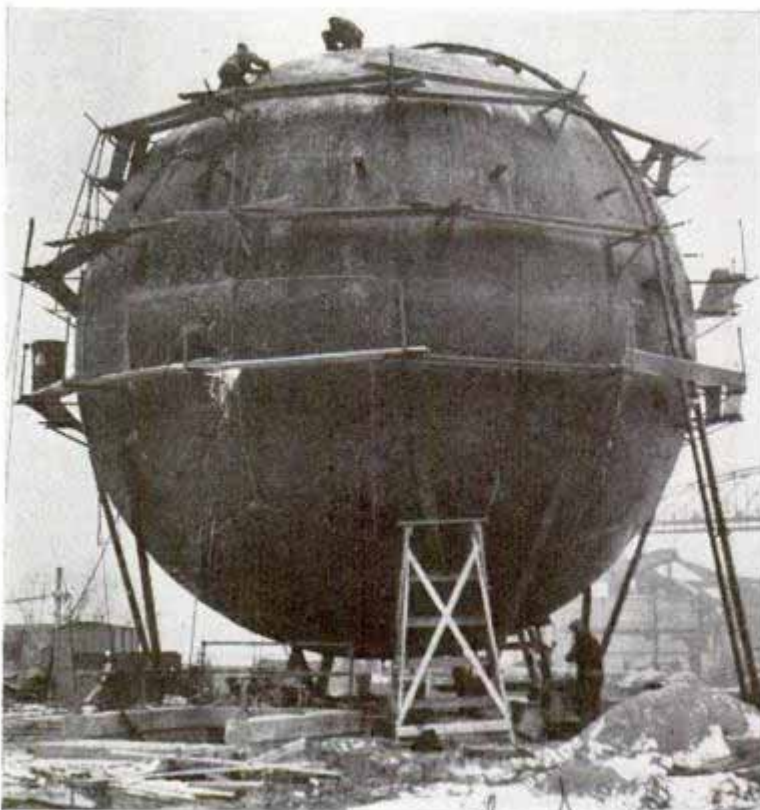

dm
 Sewer gas captured in this tank is used to burn garbage

On the lake front in Cleveland passersby used to wonder at a bright flame that appeared to come from the ground. It was sewer gas, burning as it escaped into the air. No longer is it being wasted, however. A huge spherical tank has been built over the vent to capture the gas and store it for use in burning garbage at a disposal plant.

H21
Long Train's "Stretch" Helps Get It Started

Between the time the locomotive starts and the caboose of a long freight train begins rolling, there is a lapse whose length depends upon the number of cars in the train. Couplings are designed so that there is a play of about twelve inches between each car and the one following. Thus, in a

train of 100 cars, the play or "stretch" would amount to 100 feet. This stretch makes it possible for the locomotive to move a long train, since it starts with only one car, then begins pulling two, three and so on. As the play is taken up by the pull of the locomotive, a distinct click may be heard from each coupling. The stretch explains why a pusher and a puller locomotive may be used without perfect synchronization. The play acts as a buffer.

Two-Faced Rescue Truck Fights Fires in Tunnel

When fire breaks out or automobiles collide in the new Lincoln tunnel connecting Manhattan with Hoboken, N. J., a two-headed emergency truck is ready to speed to the rescue. It is a specially built car equipped with extinguishers, acetylene torch, inhalators and towing apparatus. It has a gasoline-electric drive, with an electric motor, steering and driving controls at each end. The truck must be able to tow a seventy-ton load up a three and one-half per cent grade at twenty miles per hour, and its cranes can carry a ten-ton load. A twelve-ton dolly is mounted under each end. The truck is steered hydraulically and it can be turned in a radius of twenty-two and one-half feet. All four wheels have air brakes.

Big Thrust Bearing for Dam Is Built to Run in Bath of Oil



Polishing one of two 105-inch thrust bearings for Pickwick Landing Dam power plant. They will carry 2,500,000-pound load

Two tremendous thrust bearings will support the 2,500,000-pound load of the moving parts in the generators and water wheels, and the water thrust of the Pickwick Landing Dam power plant. Pat-

terned after a giant washer with a diameter of 105 inches, the bearings have a running plate of polished cast iron resting on ten bearing shoes, operating in a bath of oil so that the rotating parts actually float on oil. It will take 6,500 gallons of oil to bathe the bearings. To dissipate the small amount of heat generated, 100 gallons of water per minute will flow through coils immersed in the oil.



Ready for wreck or rescue in New York's Lincoln Tunnel is this gasoline-electric emergency truck which can be driven and steered from either end

Acme Mack International Motor Truck Co. 48th Ave and 34th St.

Westinghouse Electric and Mfg. Co. Pittsburgh Pa

es1345

Cont. James H. Quincy
431 W 60th Street
Kansas City, Mo

The SPOTLIGHT on



PUPPETRY, a graybeard among the arts, is coming into its own in America.

Not so long ago, interest was limited to a few professional touring companies and a handful of amateurs, but puppets have gone democratic and their popularity has skyrocketed.

Marionettes, number one branch of the puppet family, have invaded our business and economic life. When a refrigerator company wants to tell the merits of its machine at a world's fair, a puppeteer is summoned. He works out a complete production with special script, characters, costumes and settings. When the show is presented he and his assistants control the characters and read the lines. Thus the sales message is put across in a dramatic and entertaining manner.

Harry Fetterer, 18136 Oak Park Ave
Lambert Park, St. Louis, Mo

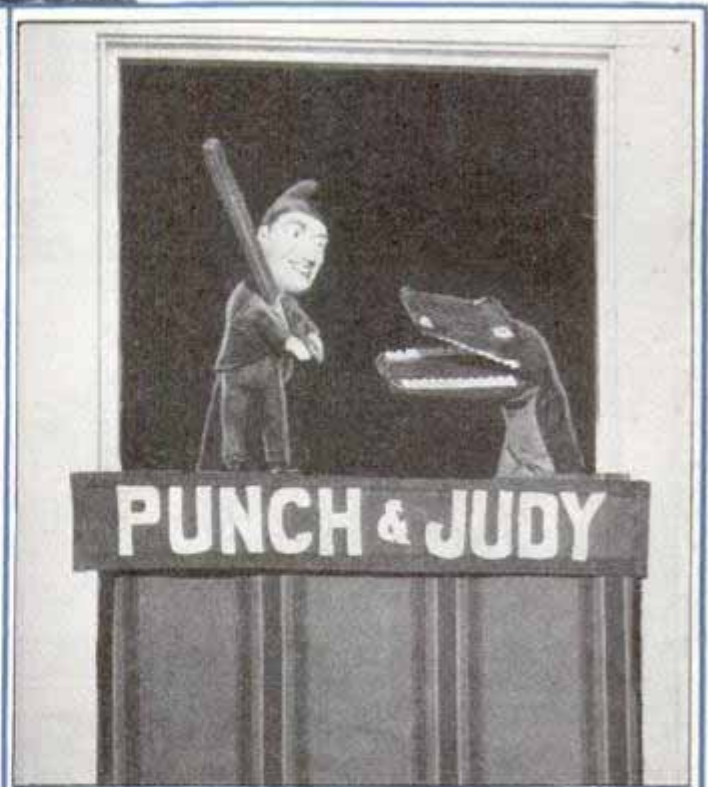

Top, puppeteer with some of his hand puppets. Bottom, left, how Punch and Judy show looks from the rear. Right, how it appears to the audience

21275

PUPPETS



Free marionette plays based on fairy tales and legends are used as magnets to draw holiday shoppers into department stores. The commercial side is but one phase of the movement. Storybook heroes are brought to life in the public libraries' weekly story hours through this medium. In elementary schools it is used in similar fashion, particularly in the dramatization of historical incidents. A number of colleges and universities offer complete courses in puppet making and designing, manipulating, producing and stage lighting.

But greater than any of these special applications is the widespread public interest in puppets. There are more than fifty professional companies with a repertory of some 500 plays giving shows. The federal theater is active in the puppet field as are Junior League chapters, and hundreds of dramatic groups in high schools and colleges. There are a few theaters devoted exclusively to the production of puppet plays, serious efforts such as Doctor

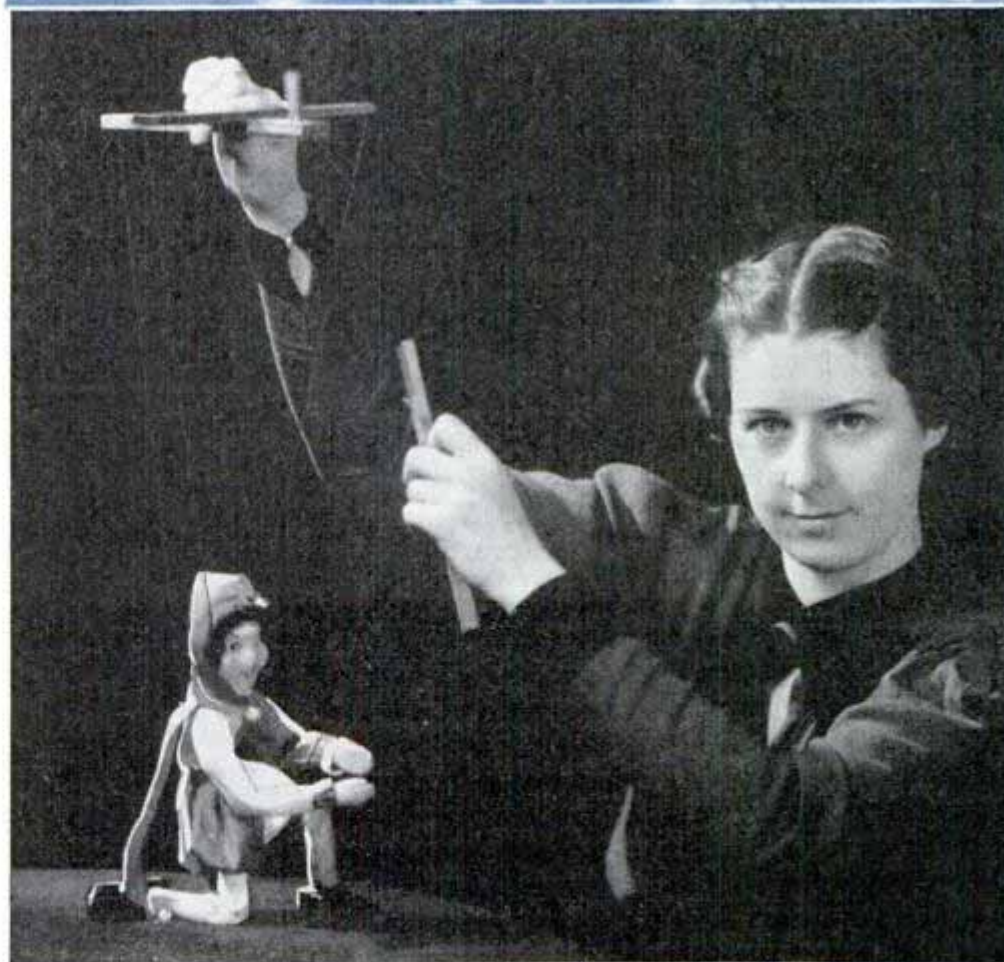

Top, left and right, two scenes in which Paramount used marionettes for novel effect in movie. Bottom, Hazelle Hedges with marionette she designed for beginners

*Artist and model
Hazelle's Marionettes
553
Cincinnati*



Top photo
© Paramount
Pictures

545
Marathon
Hollywood
Caley



Four years ago she was just another art student with time on her hands. One day, a small boy showed her a marionette he had received from a relative. The youngster suggested that she try making a mate to go with the puppet. The experiment worked out so well that she made several more and started writing playlets to go with them. The director of the William Rockhill Nelson Gallery of Art in Kansas City employed her to conduct classes for children. When the courses were announced, children responded in droves and Miss Hedges, with eight

assistants, started instructing them. The children made puppets, clothed them to represent figures in important paintings and acted out little scenes built around the works of art. The children had a lot of fun and, at the same time, learned to appreciate the world's finest paintings.

In looking over the field, Miss Hedges discovered there were fewer than a dozen persons making puppets to sell and the bulk of these were catering to advanced puppeteers. Upon learning that the big department stores were buying their marionettes in France,

Faustus, the Passion Play, and Taming of the Shrew. Operettas, children's plays, folklore, religious themes—all are suitable to the marionette stage.

In thousands of garages, store rooms and homes men and women devote their recreational hours to working with puppets for the benefit of themselves and their children. They are simply hobbyists who have been bitten by the puppet bug and their ranks are increasing daily.

Hazelle Hedges was among the first to see the commercial possibilities in this branch of the art.



Top, Russell Patterson with marionette. Center, manipulating finger puppet. Bottom, Miss Hedges and assistant putting finishing touches on marionettes

Italy, and Czechoslovakia, she decided to bring out an American-made puppet. When she did she found a waiting market and today she employs a large staff of craftsmen. Not only does she sell American stores but ships her creations to stores in English-speaking countries all over the world.

Another success story in the puppet field is that of Russell Patterson's. When the depression started, his income as an illustrator dwindled. Patterson harnessed up his experience as a stage and costume designer with his mechanical talents and built a number of miniature stages. These he



© Paramount Pictures

New York artist

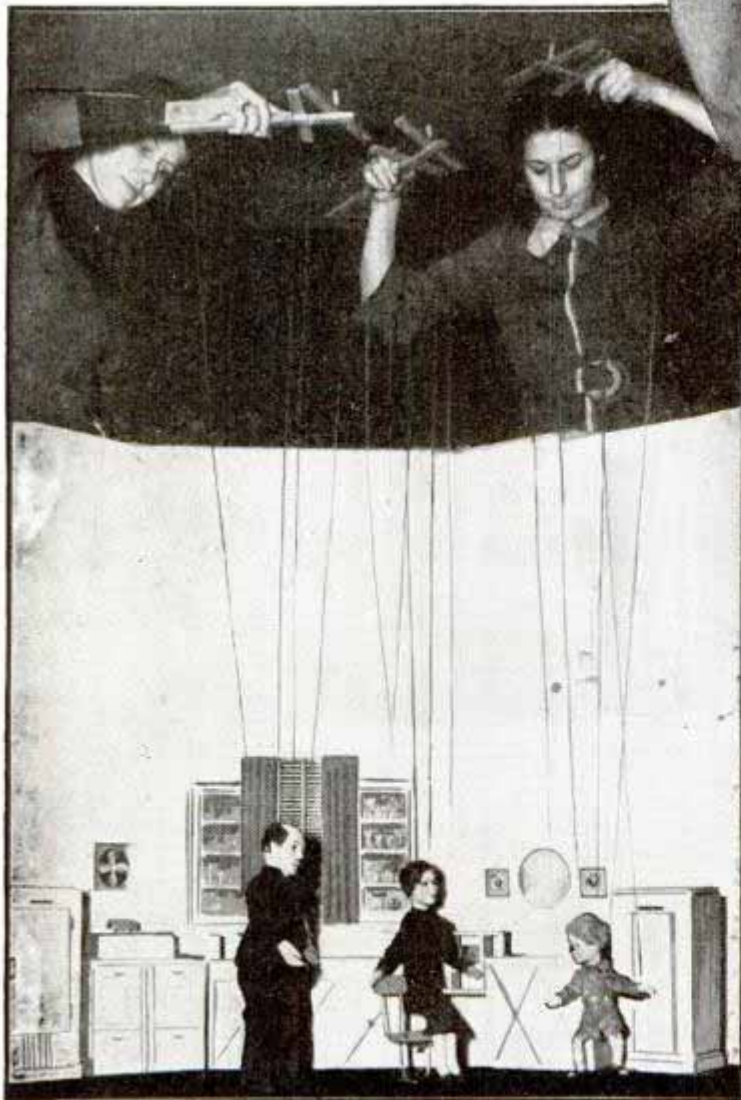

Top, Artist Patterson with marionette. Bottom, puppet show aids in dramatizing sales message

dressed to scale and then fashioned a group of figurines to people them. His best was one of a Manhattan office. He worked out two characters, a stenographer and her boss, for the setting and then he photographed it. The first editor who saw the picture bought it as a cover for his magazine. Patterson profited handsomely from subsequent orders and before long he had a pay roll of doll dress-makers, modelers and carvers that more than topped his former salary as an illustrator.

His first venture with marionettes was a sophisticated show that was "tailor-made" for New York's smart supper clubs. Buoyed up by this success, he tried the movies. For a series of shorts using puppet characters, he made a few experiments and decided to follow the stop-

(Continued to page 130A)

14-24. C. J. Russell - Rand &

11 Broadway, New York

Compressed Air Smooths Way for Streamliner



Compressed air replaces section hands' swinging arms in driving spikes in railroad ties. At left, pneumatic tampers pound ballast; below, air compressor cars feed as many as sixteen spike-driving hammers at once

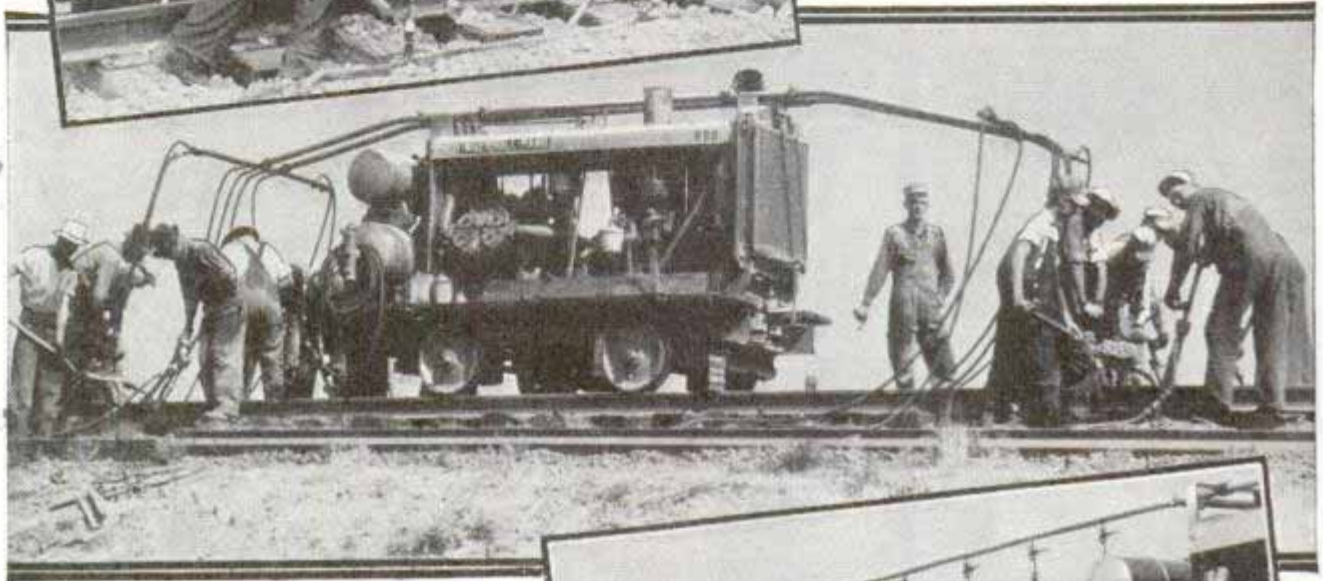

From Compressed Air Magazine

Sledge hammers swinging from muscular arms have pounded spikes into ties for a hundred years of railroad building, but today compressed air furnishes the muscle for the pneumatic hammers tamping ties and ballast and driving spikes. The rails are being straightened out for a smoother, swifter road for the streamliners. Even three-degree curves are smoothed out; on the Santa Fe railway the track relocation calls for a maximum curve of one degree thirty minutes to permit hundred-mile-an-hour streamline trains to keep up their steady pace. As the track is relaid, air-compressor cars move along with the gangs, supplying pressure to as many as sixteen tools at a time, and the ballast is pounded down, ties are leveled and spikes are driven into place to the noisy tattoo of the pneumatic hammer at many times the speed of the old-time section gangs.

Heat Rating and Ash Content of Coal to Be Classified

Soon you will be able to buy coal with foreknowledge of the exact amount of heat and ashes you are getting for your dollar. Until recently, buying coal was a matter of specifying anthracite, bituminous, or lignite; perhaps of ordering coal from a specific region or mine; but the purchaser seldom knew the exact heat value he paid for. Now engineers of the U. S. Geological

See Service 12/15/17

Survey are testing coal for heating value and carbon content, and when classification is complete you can buy coal with a definite amount of heat per dollar, burning at a specified speed and containing a known amount of ash.

Shotgun Shell Starts Engine When Fired into a Cylinder



Inserting shotgun shell into special firing chamber in cylinder and touching it off with plunger to start gasoline engine

When emergency calls for the use of a standby motor to operate a drawbridge between Troy and Watervliet, N. Y., a shotgun shell starts the engine. Normally the city power lines furnish electricity for the bridge. In case of power failure, however, the four-cylinder gasoline engine is ready. To start the big four-cycle motor, a ten-gauge shell is inserted in a special firing chamber on one cylinder. Then the motor is primed and set just beyond dead center with respect to this cylinder by means of a gauge on the flywheel. When the shell is fired by means of a plunger, the explosion turns the motor over.

Popular Mechanics Magazine can furnish the name and address of the maker of, or dealer in, any article described in its pages. If you wish this information, write to the Bureau of Information, inclosing a stamped, self-addressed envelope.

Greetings Wired in Writing by "Facsimile" Telegraph

Photographic messages and greetings in the sender's own handwriting are now sent by wire in England. The British post office inaugurated this service during the Christmas holidays as a unique way of sending greetings, the method being similar to the "facsimile" telegram and the wiring of news photographs in America. Dress designers use this service to telegraph patterns, and police and banks dispatch facsimiles of signatures and handwriting.

'SOS' Blinker on Cab Roof Is Driver's Holdup Signal

On the roof of a taxicab in Washington, D. C., is a lamp that looks like an ordinary "empty" signal. In reality it is the driver's secret signal to police that he is being held up. The cabman installed it himself. When he pushes a switch above the clutch, the light starts blinking and continues to signal for help until turned off.



When cab driver switches on this blinking light, it is a signal to police that he is being robbed

Dep. of Commerce Press mem. 1/6/38
Crittenden
W. L. Cox
Suggested blinder light - W. L. Cox

454
429
Ca 55 S. Main St. Middletown Conn
P-L League
H C

Comb. H. S. Whitehead
207 Hoosick St. Troy, N.Y.

Drill Boats Blast Rock from River Bottom



Top, explosive hurls water and rock into air. Right, preparing dynamite charge. Bottom, a drill boat in action. Note the eighty-foot tower supporting the hammer



WHEN government dredges encounter flintlike rock on river bottoms, a call goes out for the drill boat and its crew of professional rock-breakers. The drill boat is a large barge equipped with machinery for drilling holes under water and to load them with dynamite for blasting. After the drill crew has given the river bottom a treatment, with the explosive ripping the rock off the river bed, a dredge follows to remove the pieces of rock, clearing the channel and making the stream safer for navigation. The drill boat is operated by skilled men with a knowledge of how to

combat the difficulties they encounter. In spring and summer, the water frequently is high, forcing the dynamite load from the holes and breaking mooring cables. In fall and winter, the water is low, making it hard to move the drill boat and dangerous to change crews. Wind, lightning, snow, ice, fog and other handicaps must be overcome. The drill boat usually operates twenty-four hours a day until the job is

Capt. John W. Doyle, 1313 Highland
 Bremerton Wash

Photo of Government by Mrs. J. W. Doyle
 1015 11th St. Bremerton Wash

es/468.
**Glass Stairs at Paris Fair
Lead to the Glass Pavilion**

completed. Lengthwise, one half of the boat is housed by a two-story structure. Perched on top of this is the lever room which contains all the controls for moving the barge. On the other half is a large carriage mounted on railroad wheels, enabling it to travel the full length of the deck. From the carriage rises an eighty-foot steel tower which supports the hammer and the sand column. The hammer, operated by steam, drills the holes in the rock, striking seventy-five to 100 blows per minute. As the drill cuts into the rock, the hole is kept clear by a high-pressure water feed which is forced down through the hollow drill. After the hole reaches the proper depth, it is loaded with dynamite forced down through a tube, and gravel is poured on top to keep the load from shifting. The carriage is then moved and another hole sunk, until seven have been drilled and loaded. When the barge has been moved to a safe distance, the dynamite loads are set off by electricity, hurling thousands of gallons of water and large pieces of rock into the air. It is slow work, for the rows are only eight feet apart and there are usually seven holes to a row. With the rig running continuously, the average is about twenty-one holes every twenty-four hours.

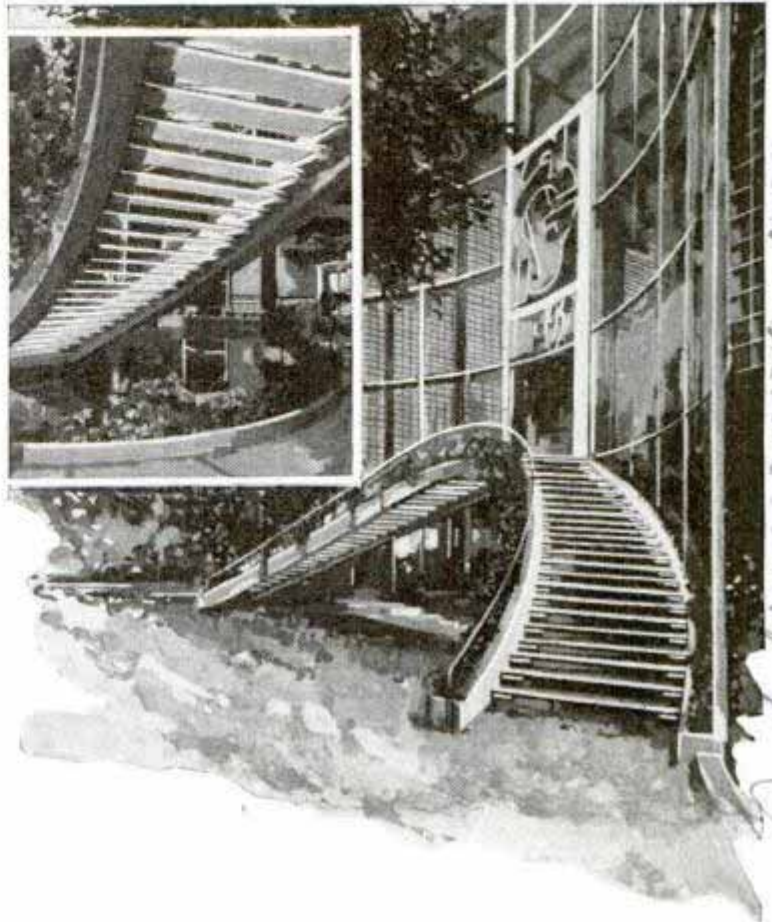

Glass stairway leading to entrance of pavilion of glass at Paris international exposition. Inset shows underside of stairs

Even the stair treads leading to the glass pavilion at the Paris Exposition are made of glass. The broad glass stairway arches up to the elevated entrance in a beautiful, sweeping curve, and the front of the building itself is of curved-glass panels, the side walls being constructed of glass bricks.

es/524
Portable Photo Copy Machine Will Enlarge or Reduce

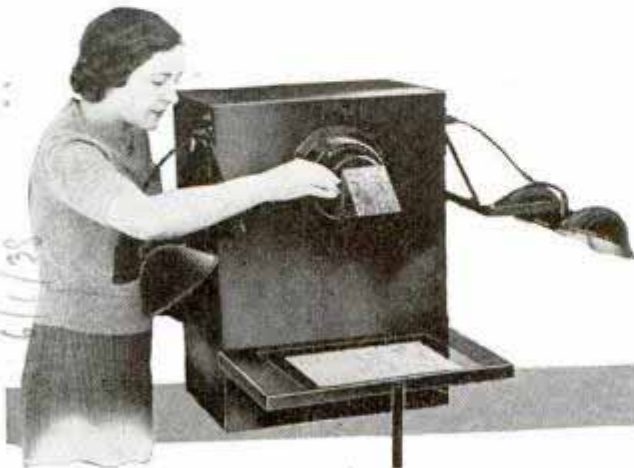

Photographing letter with portable copying camera which can enlarge, reduce or reproduce same size

Enlargements, reductions or facsimiles can be made without expert help by using a portable photograph copying machine just put on the market. It handles both photographic film and sensitized paper, and the average office boy can operate it in ordinary office light. The page to be copied is lighted by four lamps with reflectors. There are two sizes, the larger machine handling copy up to twenty by twenty-eight inches.

Send return postage to our Bureau of Information to learn the name of the maker of any device described in this magazine.

es/524
Duplex Corp.
25 E 92nd St New York

Architectural Forum Dec 1937

Peter Coyne
83 Center St.

H-8.
**Velvet-Lined Dog House
Has Auto-Type Cushion**



Chip
Dog in its de luxe house. Note the folding roof and the window at the rear

Complete in all its appointments, a de luxe home for "Chipper," a Sealyham dog, has velvet-lined walls. An automobile-type mohair cushion is among its furnishings and it has a window at the rear.

H-65.
**Fastest Plane Left Far Behind
by 818-Mile-an-Hour Insect**

Only one living thing can still outrace the fastest airplane man has built—a little deerfly that travels 818 miles an hour on gauzy wings! Man himself is relatively slow of foot; Jesse Owens has been clocked at a fraction above twenty-one miles an hour for 100 meters. But man has devised machines to carry him faster in the air, the sea and on land than anything living save this deer botfly, observed by a scientist in New Mexico at a speed faster than sound. Man's record speed in air is 440.6 miles an hour; the duck hawk has been timed at 180 miles an hour. On land, men have traveled 311 miles an hour by automobile, 120 miles an hour by train; the cheetah, swiftest of animals, runs seventy miles an hour, the jackrabbit forty-five,

the race horse forty-two, the greyhound thirty-six. The fastest man on foot is slower than the clumsy elephant, which can charge at twenty-four and a half miles an hour. On water, man's record is 129.6 miles an hour. Flying fish have been clocked at thirty-five miles an hour, the speed of the "Normandie"; pike and submarines have a top speed of ten miles an hour submerged.

H-46

**One Man Takes Down a Steeple
in Less Than Two Days**

Contractors estimated it would take several men a full week to dismantle the steeple of a church in Windsor Locks, Conn., first building up staging to the full height of the steeple. A carpenter volunteered to do it alone, and he did—in less than two days. Instead of erecting staging, he worked his way up inside the tower to the base of the cross; cut the braces which anchored the cross, cut an opening in the side of the steeple, and with a pulley block and tackle lowered the eleven-foot cross 175 feet to the ground single-handed. The rest of the wrecking job was simpler, and he finished the second day.

St. Mary's Catholic Church

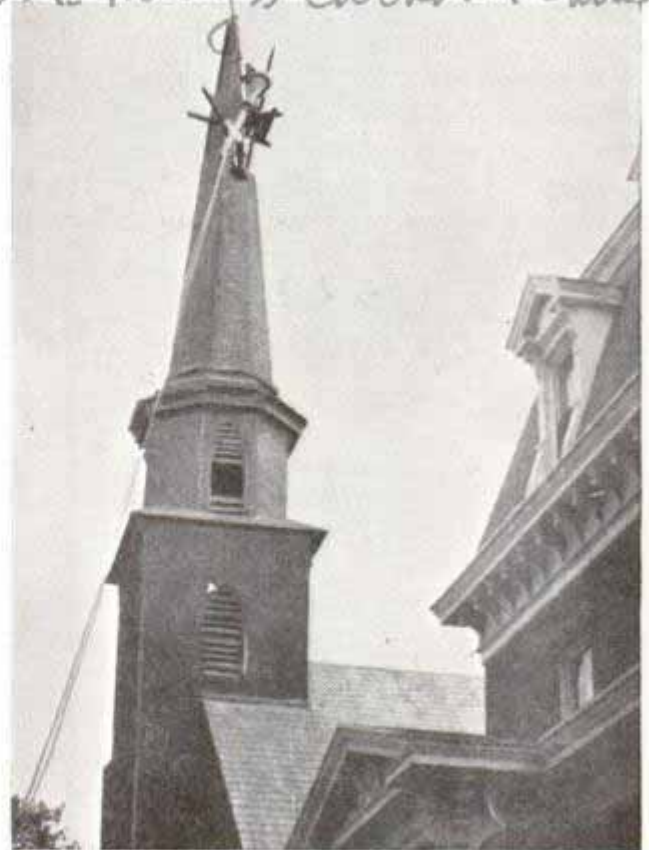

Carpenter lowers eleven-foot cross 175 feet to street after cutting hole from inside steeple

Owner: Barbara Tichy
Lynbrook, N.Y.

Illustrated by
P. 11, 19, 20

Speedy Air Fighter Carries Guns and Bombs

Fitted with two machine guns, two small cannon and bomb-dropping apparatus, the latest German air fighter attains a top speed of 302 miles per hour. It is a single seater powered by a 685-horsepower engine. The effective range of the plane is 685 miles. It is capable of an altitude of 28,000 feet.

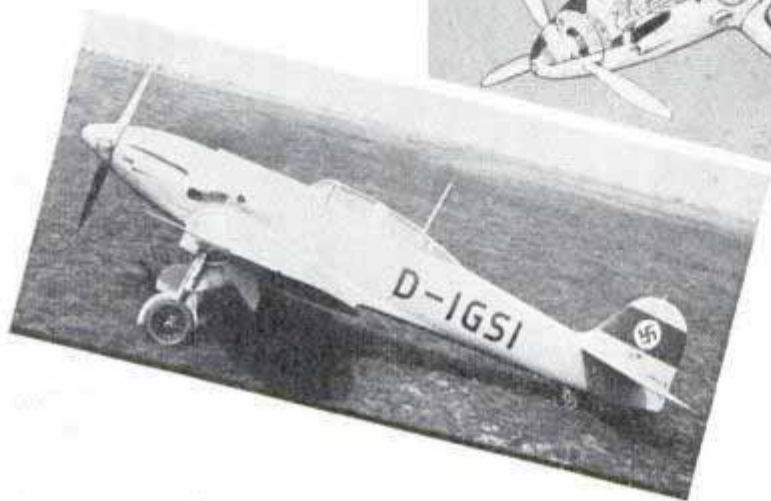
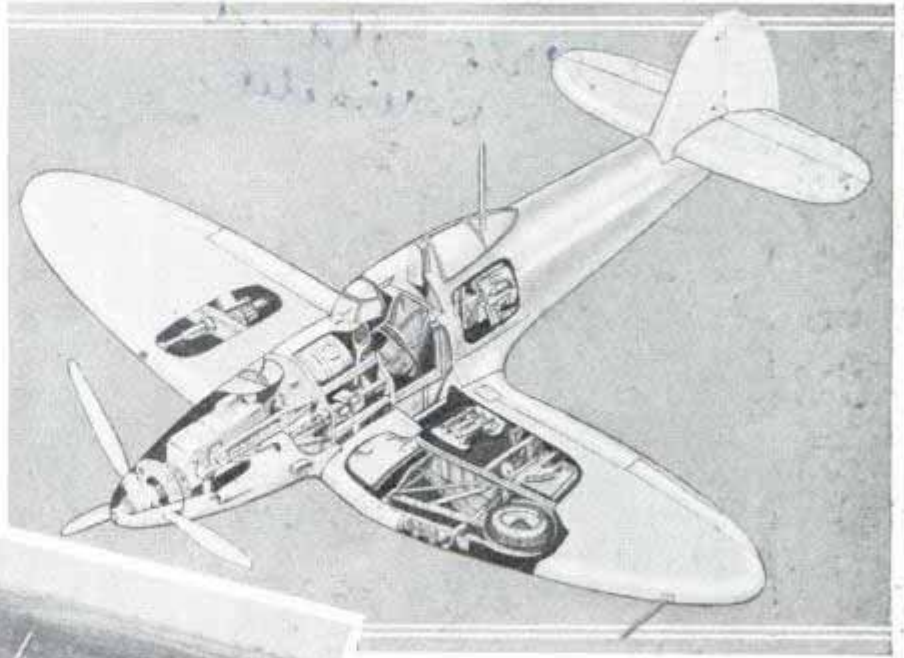

Two views of speedy fighting plane. Above, cutaway drawing shows landing gear retracted into wings. Left, the ship at rest

The machine guns fire through the propeller, while the cannon fire from the wings. For attacking targets on the ground, the

plane is equipped with two bomb racks which have a capacity of six bombs weighing twenty-two pounds each.

Engine ¹⁶⁴ Turned Around to Give Adequate Space in Car

By turning the engine end-for-end, with the radiator at the rear instead of the front of the motor, manufacturers of a foreign car now being sold in the United States achieve an increase in passenger space. The radiator rests just above the clutch cover. Better visibility is attained by this

arrangement because it makes possible the sloping of the hood down over the engine, out of the driver's line of vision. The hood, hinged at the front lower end, exposes the entire engine when it is swung downward from the top. The engine is mounted slightly ahead of the front axle, with the passenger seats squarely between the wheels, at almost the exact center of the wheel base, to give smooth riding. Steering gear, transmission and other drive units are arranged so that two six-foot passengers can be accommodated comfortably although the car is unusually small in overall dimensions.

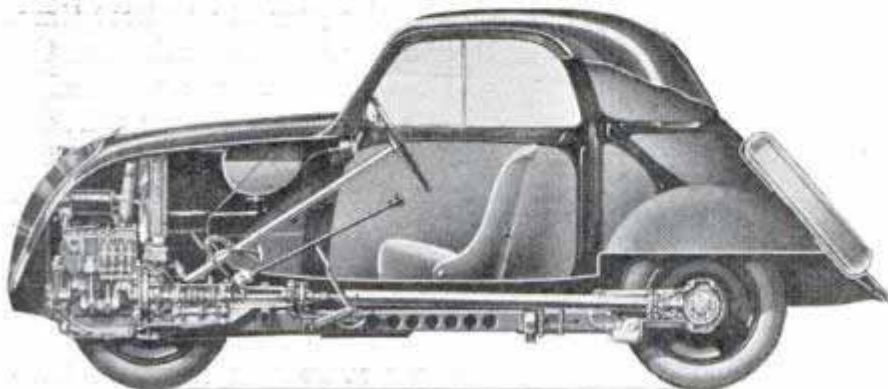

This cross-section of light foreign auto shows how the manufacturer increased passenger space by setting engine ahead of front axle

Frak. New York City New York

207401

NOW YOU SEE IT,

Emb. Maxwell Reid, Srant!
54 1/2 Blendale Blvd
Los Angeles, Calif

Three Rand
perimeter



MISSING three passes in one football game resulted in no condemnation for a University of California fullback. Instead, the team's mentor, noticing that each time the ball had come over the player's left shoulder, sent him to the "eye coach."

"Why, my eyes are normal—I can read every line on the chart," protested the athlete; but the optometrist had him look at a little white target which he moved on a semicircular track until it came into the player's line of sight.

On the right side, the player detected its approach immediately, but on the left he didn't see it until it was almost directly in front of him. So far as moving objects were concerned, he was almost blind on that side. The doctor found the player had an infected tooth. Dental services and subsequent recovery to normal vision put the

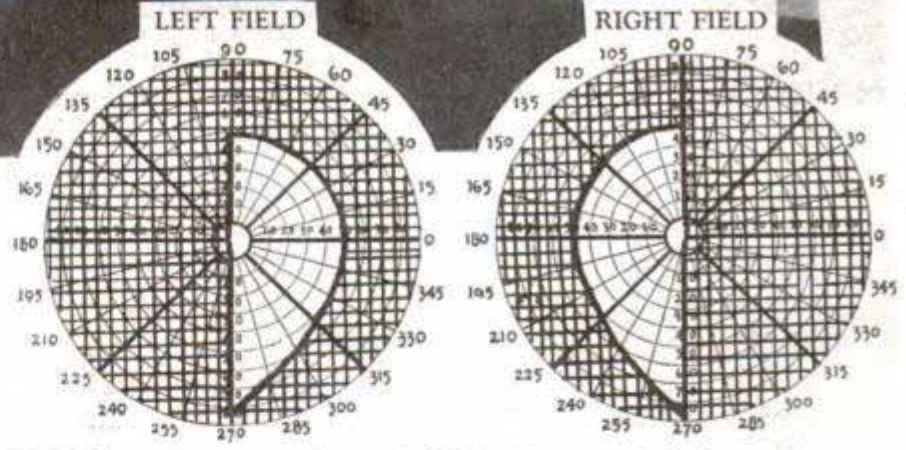

Top, measuring extent of visual fields. Bottom, shaded areas in circles are blind patches in visual field of fatal-accident driver, who could see only about fifty degrees to each side

player back into the game in a short time.

At the University of California and the University of San Francisco, eye coaches check players at the beginning of each season and measure their vision for moving objects. If a backfield man is blind in the "tail" of his left eye, he is put on the left side of the line, where his handicap won't prevent him from seeing opposing interference when he runs with the ball.

Even though you're not near or far-sighted, you may be quite blind in the tail of the eye, say the experts. With special

es 740)

NOW YOU DON'T



testing equipment they will show you, too, that your vision fluctuates from hour to hour with your physical condition. An extra cup of coffee or a cocktail may dull your eyesight and make you fail to notice an oncoming vehicle, a boulevard stop or a pedestrian running across the street. A bad tooth or an infected sinus may narrow your field of vision so it isn't safe for you to work around machinery or at a factory bench. And the trouble is, you probably do not realize your deficiency, although it can be detected easily and, in many cases, cured.

At the Los Angeles School of Optometry, Dr. Ernest A. Hutchinson uses a variety of instruments in training his student doctors to chart the ability to see moving objects. They seat you before a blackboard and have you look straight ahead while a small white target about the size of a dime is moved about at the end of a long wand. As the target passes about the

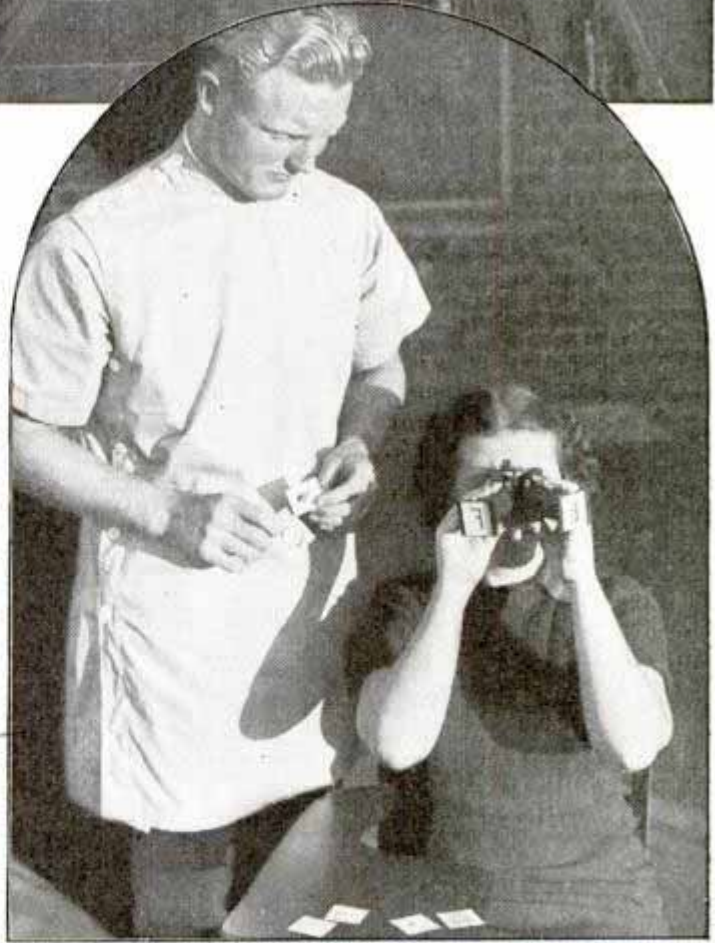

Top, tail-of-eye blind driver of car at point of V-shaped light area cannot see car entering from right. Bottom, instrument which helps restore vision

Amblyoscope

22/401

Stereo Compometer

side of your head, it finally disappears. The examining doctor makes chalk marks on the board showing the limits of vision, until the visual field is entirely charted out. If you're normal your field will be oval-shaped, but if the oval's lopsided, you'll know one eye has a restricted field. Sometimes there are sizable spots in the middle, caused usually by disease or actual eye injuries.

If the charted field is a small circle, the doctor knows you have "tunnel" vision and can only see those things directly ahead of you. If this is the case, you ought to know it, for as a driver you're a menace to yourself and everyone else. Only by keeping abnormally

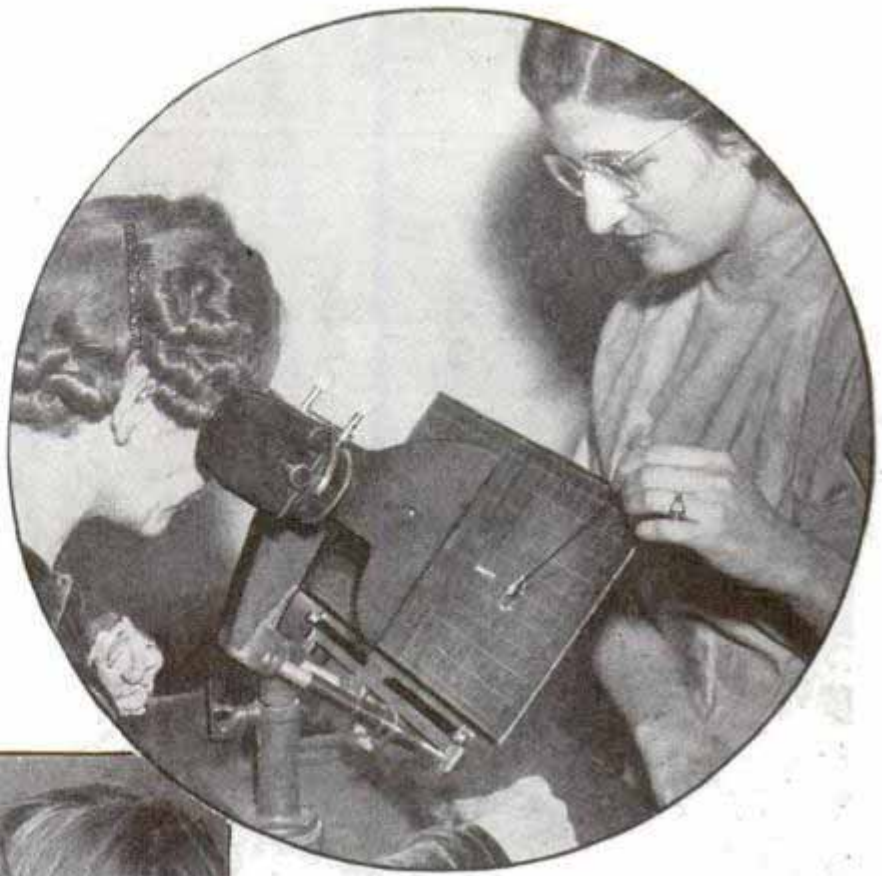

Top, using instrument to detect blind spots. Bottom, instrument for "re-educating" eyes of squinting children



Rotoscope

alert and constantly turning your head to look from side to side, can you hope to avoid trouble.

You can easily test your own "tail-of-the-eye" field of vision for moving objects. Have some one face you in a good light, holding a light-colored pencil at eye level. While you look him steadily in the face, have him move the pencil to one side until it disappears from view. Note how far it had to travel. You ought to be able to see at least over a ninety-degree angle. If it disappears within seventy degrees, there is something wrong and you should consult an eye specialist.

Everybody "sees double," say the experts, for the eye is really a double-seeing machine. Behind your eyeballs lie two sets of apparatus—one for looking sharply at things, the other for detecting moving objects. You see keenly with the "fovea," a pinhead spot on the eye's sensitive retina, where seven million microscopic nerve endings are concentrated. These tiny, color-sensitive cells, or "cones," do all your exact seeing.

Surrounding this spot are other millions of cells called "rods." Altogether, the retina has more nerve endings than there are hairs on the heads of 1,500 people. The rods see nothing very distinctly, and they don't know one color from another, but they are amazingly sensitive to light. Any moving object instantly attracts attention. A message is flashed to the brain, warning it to turn the eyes that way.

Because the fovea is actually a depressed spot in the retina, doctors compare your eye to a catcher's mitt, spread wide to stop the ball, and with a central "hole" to hold it. Unfortunately, when light is dim, the

Handwritten scribbles at the bottom of the page.

Kalmeler

fovea doesn't register as well. Then you have to rely upon the sensitive rods used in tail-of-the-eye vision. That means you can't see colors well at twilight. And the fact that your keen-vision apparatus isn't working, is one reason why there are so many automobile accidents at dusk.

Applying the same fact in an unusual way, astronomers sometimes succeed in making out a very

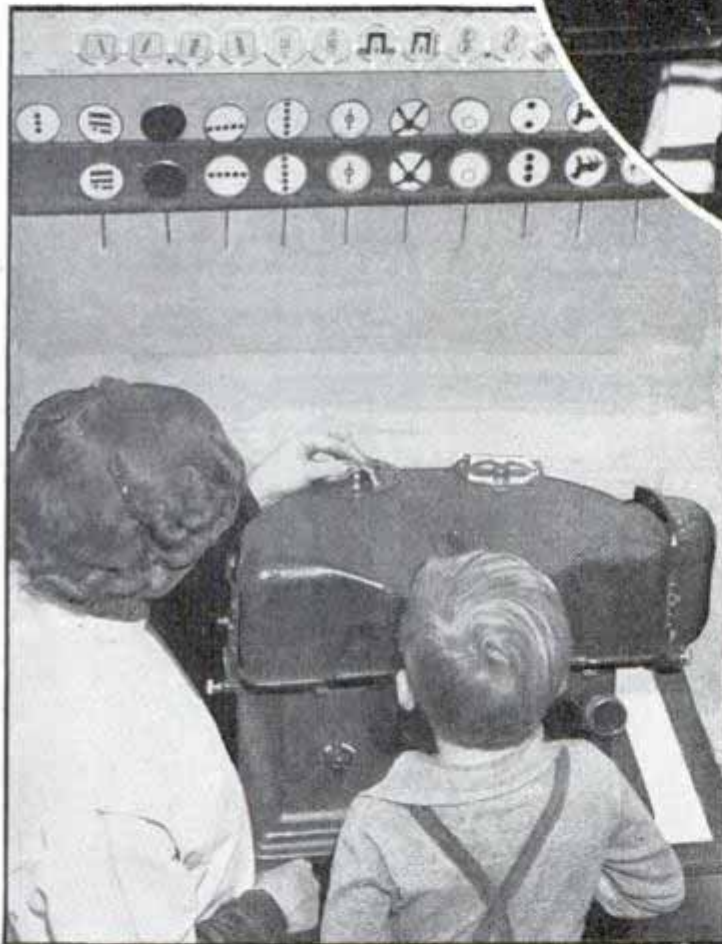

Top, using instrument for developing coordination between the eyes to eliminate "limping" vision. Bottom, teaming up eyes of squinting child

faint double star by looking slightly to one side so it may actually be seen better with the more sensitive rods outside of the central "hot spot."

As a matter of fact, you don't do any actual seeing while your eyes are moving. In reading, for example, the eyes move across the page in a series of jerks, and the brain gets a series of snapshots instead of a con-

tinuous picture. While the eye is traveling, the sense of vision seems to be paralyzed—otherwise things would blur when you turned your eyes. Your speed of reading therefore depends upon the shortest time your eyes can stop. On the average, the eyes remain focused on a spot for seventeen hundredths second. The shortest time recorded is seven hundredths second. At this rate your eyes are working about as fast as the shutter of an ordinary movie camera, which makes sixteen frames per second.

Even if your eyes are in excellent condition you still have a small blind spot, because at the place in the retina where the optic nerve enters the eye, there are no rods or cones with which to see. Make a cross on a piece of paper; then, about two inches to the right, make a round dot about the size of a pea. Close the left eye and focus the right eye on the cross. Then bring the diagram closer. At about seven inches the black dot will disappear—it has reached your blind spot.

That blind spot may not look big—but it's big enough for a person with one eye shut to lose sight of a man if he is standing thirty yards away and six to eight yards

(Continued to page 122A)

Stereo. Autographic

es 15 35

Com. Linton Eccles

of Pasadena Star has

Pasadena, Calif

'Floating' Railway Cars Ride Like a Hammock

see letter

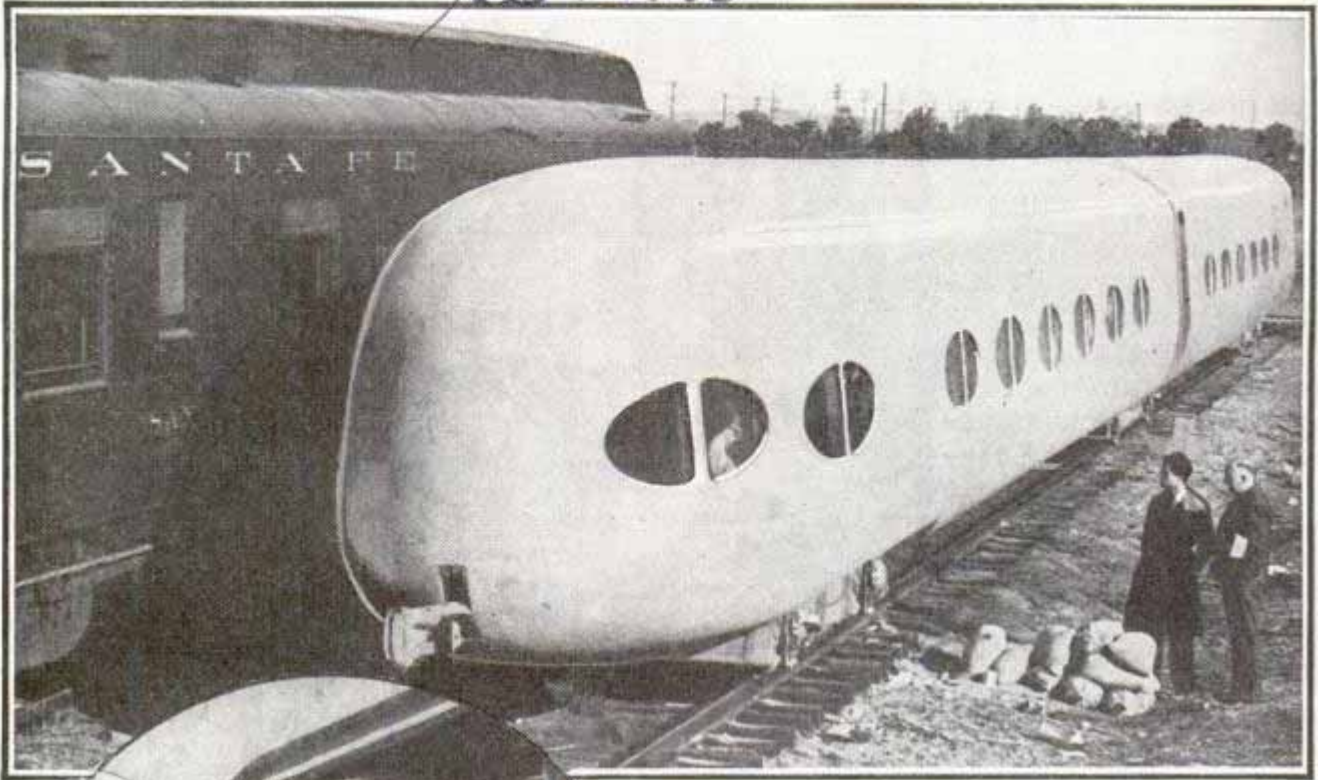

Upper view shows how low the new streamliners are when compared with standard car on adjoining track. At left is a glimpse of coil spring on which car body "floats." Notice ample head room in unfinished interior, below



Streamline railroad cars that swing like a hammock, embodying radical changes from traditional design, have just undergone their first high-speed track tests. Banking themselves on curves, smoothing out the jolts in the track, these new cars "float" like a suspension bridge, for the bodies are hung from bulkhead assemblies in towers erected at the four corners. In the bulkheads are very soft springs, cushioned with rubber for a maximum of riding comfort. Conventional railway cars have their spring system in

the trucks, below the center of gravity; with the springing above the center of gravity in the new coaches they bank like an airplane. The floor level is only thirty inches above the rails compared with fifty-two inches in conventional cars; the roof is eleven feet high, lower by three feet than

Designer, Carlisle J. Hill

the former style, yet there is eight feet of head room inside. Development of this design was sponsored by Cortlandt T. Hill, grandson of James J. Hill, "empire-builder" of the Great Northern railway, and among the engineers engaged on the plans were several aircraft and automotive designers whose influence is seen in the monocoque or "stressed skin" body adapted from modern airplanes. The outer shell of the car serves as a supporting structure instead of being merely a covering. The cars weigh only 30,000 to 40,000 pounds, less than half as much as standard coaches or sleeping cars.

4014977
One-Motor Clipper Cruises at Eighty-Five

Closely resembling the clipper planes except that it has only one motor, a new forty-horsepower flying boat recently was put through its paces at a bay near Garden City, L. I. It has a top speed of ninety-three to 100 miles per hour and a cruising speed of eighty-five. It is powered by a nine-cylinder engine mounted on the wing above the pilot's compartment.



Here is the clipper ship, powered with a single motor, after a test. Its motor develops forty horsepower

es 1526
Anti-Static Loop on Ground Aids Air-Line Communication



Demonstrating the size of anti-static loop for ground stations. The loop is intended to reduce interference in plane-ground communication

4014977
 Designed to improve ground-to-plane communication and make flying safer, a large anti-static loop antenna for ground radio stations has been placed in service at Cheyenne, Wyo., by United Air Lines. It is the latest equipment devised for suppression of snow and rain static, which frequently has

interfered with communication between ground stations and air liners. A smaller, but similar, loop is mounted on each United plane beneath the fuselage. The ground loop is five and one-half feet in diameter and is mounted outside the radio room. The loop casing is aluminum and the antenna is a single strand of one-sixteenth-inch copper wire supported inside the loop by porcelain beads.

Designed by Gilbert Trimmer and Louis Purchase

Carving Wildfowl Decoys in Home Workshop



posts of proper size are often used for the bodies, and the heads are sawed out in the rough. In earlier times, gunners used a sharp hatchet for preliminary shaping, but a broad chisel, very sharp, and a leather mallet are the tools recommended today. If the decoy sculptor lacks a regular workbench with end vise, a small vise can be used to hold the rough body by the keel while working. A spokeshave and drawknife are the other necessary tools. The bird's head is doweled on, then fastened with wrought-iron toenails.

For the final sanding, a wedge-shaped piece of cork is used, selected to fit the hand easily. The plumage pattern can be sketched on the decoy with pencil, and when the final coat of paint is be-

Top, decoy sculptor sketches plumage pattern on a wooden duck. At left is a giant swan decoy and several miniatures. Below, drilling the hole in which the head is doweled

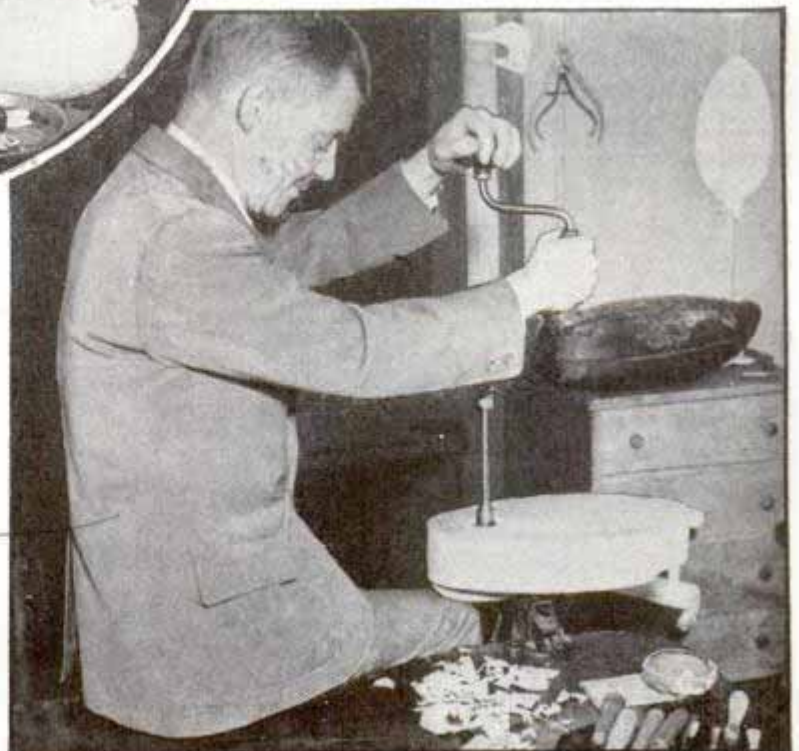

WOODEN ducks and sculptured swans, once the product of the huntsman's shanty, today are being chiseled and painted by amateur sculptors and sportsmen in homes and shops around the country. Joel Barber, New York architect who has collected thousands of these wildfowl decoys—some a century old—calls the making of game-bird effigies "the one native, original American art." The best materials for wooden decoys are white pine or cedar; cedar

50 E 66 St New York

ing applied the glass eyes, available at a taxidermist supply shop, can be fitted into reamed-out sockets. The fresh paint is enough to hold them in place. Mr. Barber, who not only collects but makes decoys in his studio apartment, anticipates renewed interest in decoy sculpture through sports exhibitions during National Wildlife Restoration Week this spring.

'Tailor-Made' Chair Built to Your Measure

Just as the tailor or dressmaker takes your measure for clothing, the furniture maker can fit you with a "tailor-made" easy chair. Your measurements are taken with an adjustable upholstered chair which registers the size of your neck, back and legs, and your height and width. From these dimensions a chair is built to fit.



Chairs can be built to your measure now by taking your dimensions in this adjustable measuring chair

Huge Shovel Balances Itself with Mercury-Switch 'Brain'

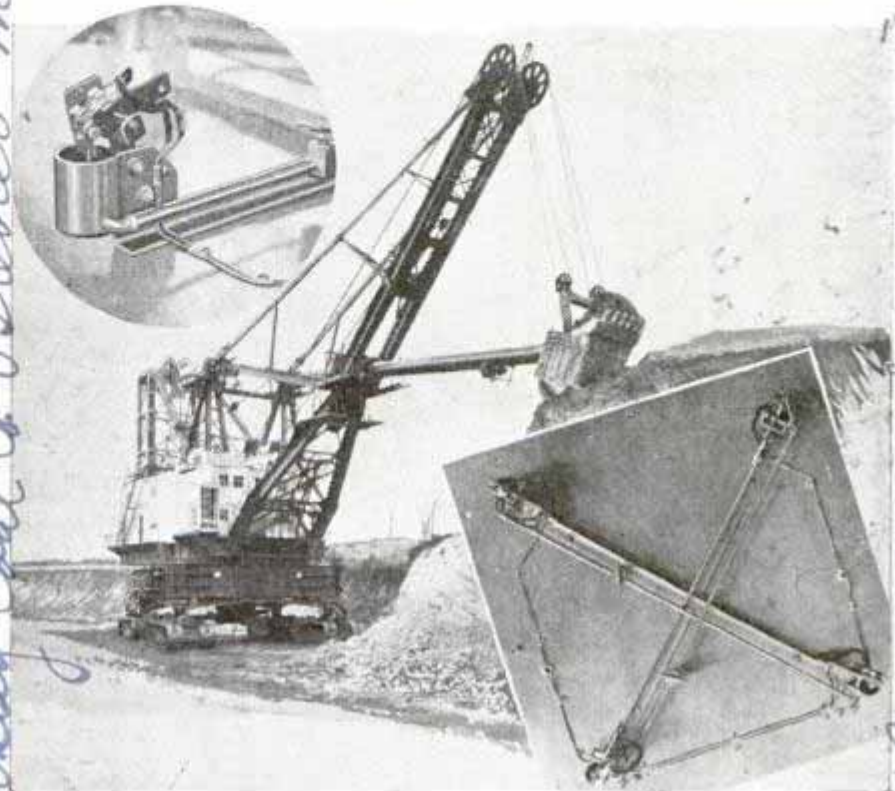

Huge electric coal-stripping shovel is kept level by four mercury switches (upper inset) mounted at corners of control table, shown at right

Four tiny mercury switches mounted on a plane table are the "nerve center" that gives a sense of balance to the giant electric power shovel that is scooping coal in a Missouri strip mine at a rate of thirty-three cubic yards to the dipper. This 2,500,000-pound mechanical monster travels on four "legs," each leg resting on a tractor with twin crawler belts and individual electric drive. Thus each tractor supports more than a half million pounds of working weight. Moving along on irregular ground, or settling down at one corner on soft terrain, the shovel might tilt badly off balance but for the hydraulic jack on each leg. Each jack raises or lowers its corner at the automatic direction of the four mercury switches, for, as the plane table tilts with the shovel, mercury flows from one end of the switch tubes to the other, completing a circuit which controls operation of the pumps operating the hydraulic jacks. As the stripper returns to level, the mercury switch resumes its open-circuit position.

Inquiries as to makers of articles described in Popular Mechanics, will be answered by our Bureau of Information upon receipt of return postage.

Winkley Coal Co. Brewer, Mo.
South Milwaukee Wis.
Priceyus.

Property of Jamestown Royal Upholstery

Mr. Thomas G. Sumner Jr
10555 Holmoria Ave
Los Angeles, Calif

"STAND BY for an

Reference: Lyndley W. Wiser Chief Operator
R. H. Mackay Radio Telegraph Co.
16 W. 6th St
Los Angeles
Calif

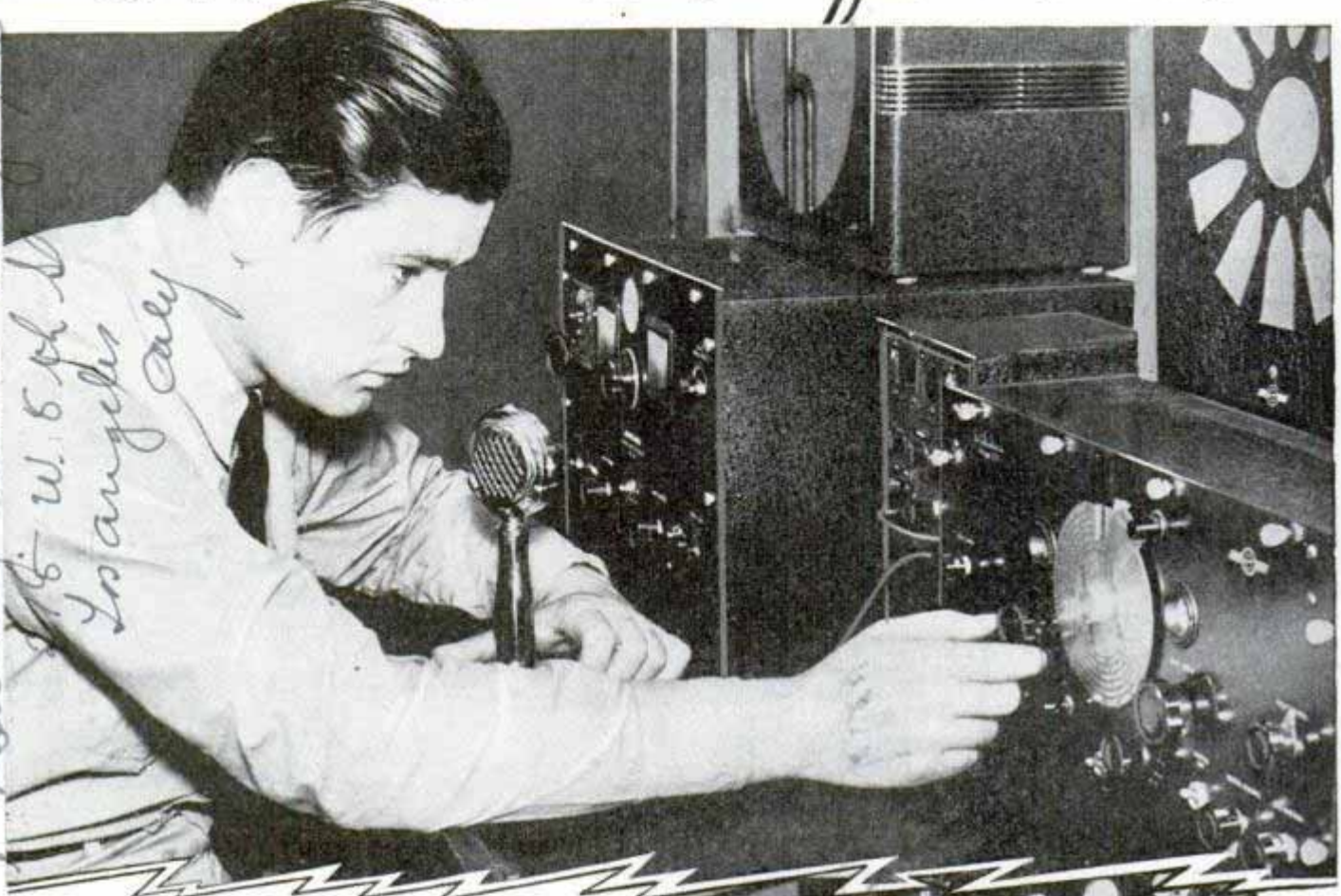

Ship operator talking to another ship by means of the radio telephone

WHEN a ship calls for help, radio stations on shore go to its aid just as rapidly as do vessels near by.

A great ship-to-shore radio station is much more than a mere relay point for transmitting messages. It is a clearing house for marine disasters and a nerve center for arranging rescue work. Sitting in front of his panels, the shore operator never can tell when a few short signals that spell trouble at sea will come in through his earphones.

"QRA? What ship is that? Have you suffered any damage?" Snapping through the air without previous warning, the questions tell of a sudden emergency. The operator knows the ship that signed the message is due in port in four hours. Right now it is twenty miles off the coast. The last weather report from the shore station included a warning of heavy fog. These facts, plus the radio queries, tell the operator just what has happened. Hampered by low visibility, the ship has collided with

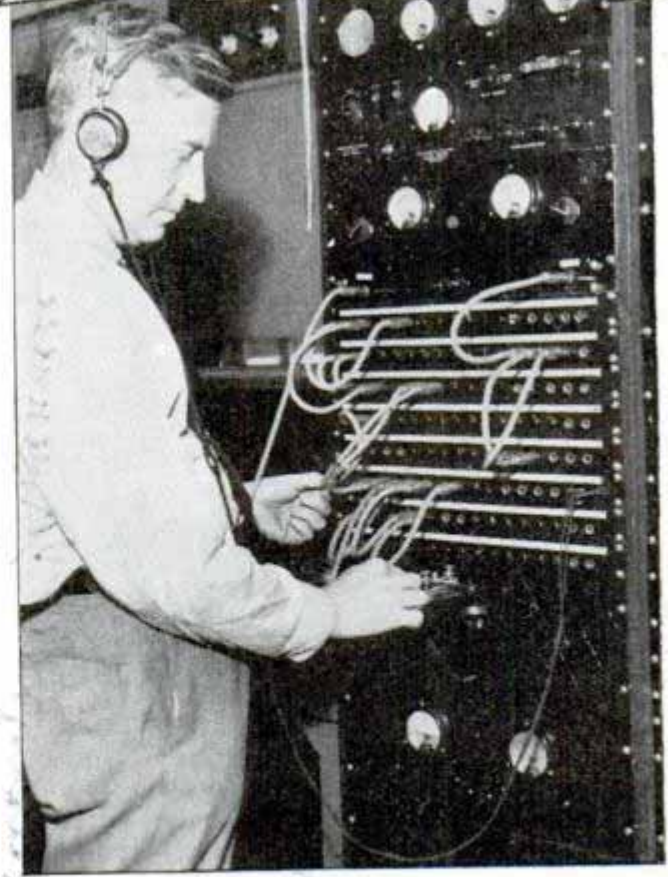

Radio switchboard through which messages from several different receiving sets can be hooked to headphones or relayed to land wires

SOS

an unknown vessel and now the captains are communicating by radio.

As the reply comes through, the land operator copies every word. Damage is compared by both ships. If one is badly rammed the passengers and crew may have to be transhipped at once. The land station may be asked to phone for a tug. The coast guard may be asked to rush a cutter. In any event, the owners of the ships must be notified.

At KOK, the Manhattan Beach marine station of the Mackay radio system near Los Angeles, an operator sits on watch day and night. He guards two or three different wave channels at the same time with "split" earphones. One earphone is connected to a set tuned to the 600-meter international calling band and the other is connected to two short-wave sets tuned to different frequencies. When a message on any one frequency comes through for him he can cut out the other phone circuits with a switch. While on watch he continually swings the connected dials of the short-wave receivers so as to "guard" the whole width of the bands.

During the last dozen years the KOK operators have had an active connection with about ten SOS calls in which they handled traffic from disabled vessels or forwarded messages for assistance. The station has

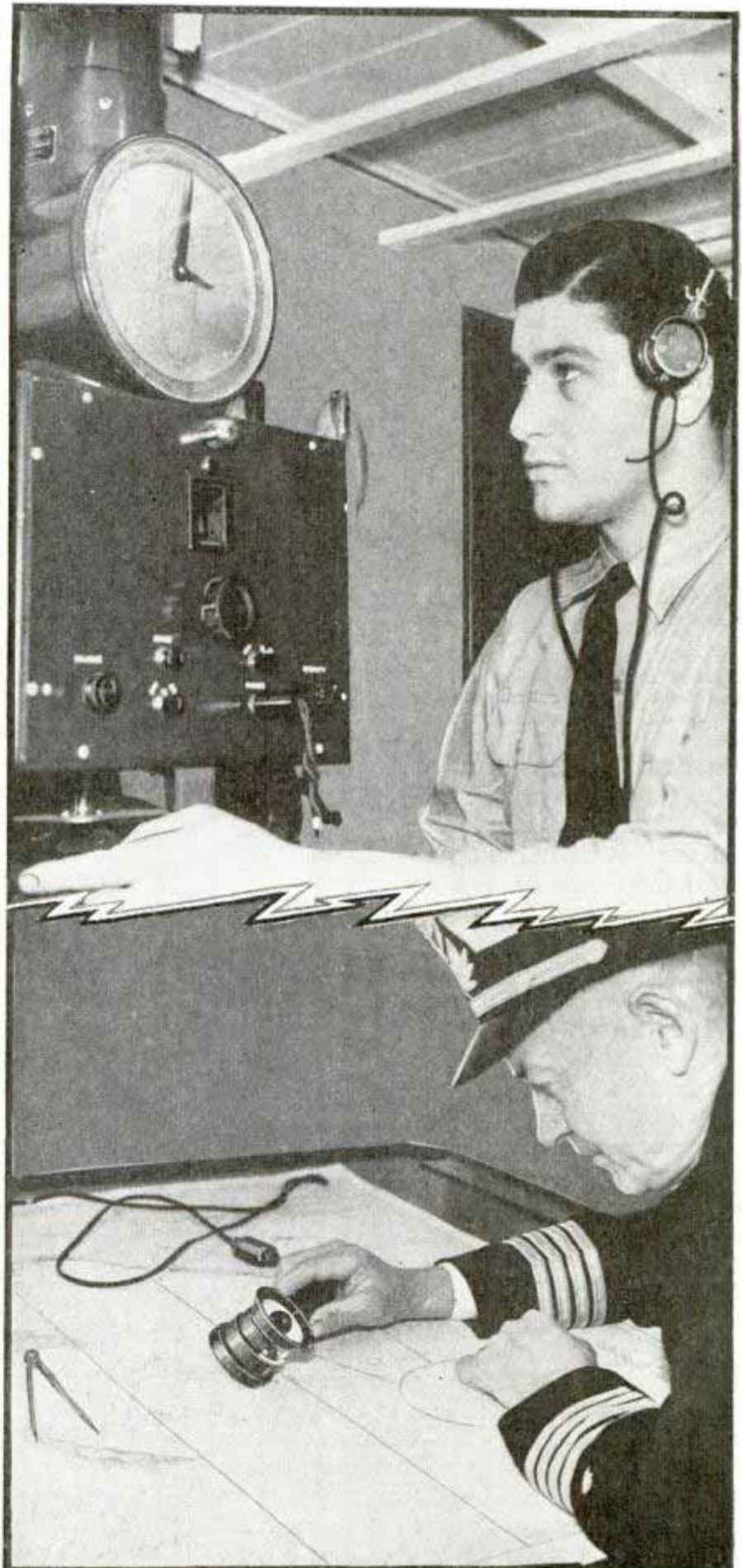

Top, radio direction finder on ship shows direction of incoming signals. Bottom, navigator in chart room studying, by means of magnifying glass, location of ship requesting assistance

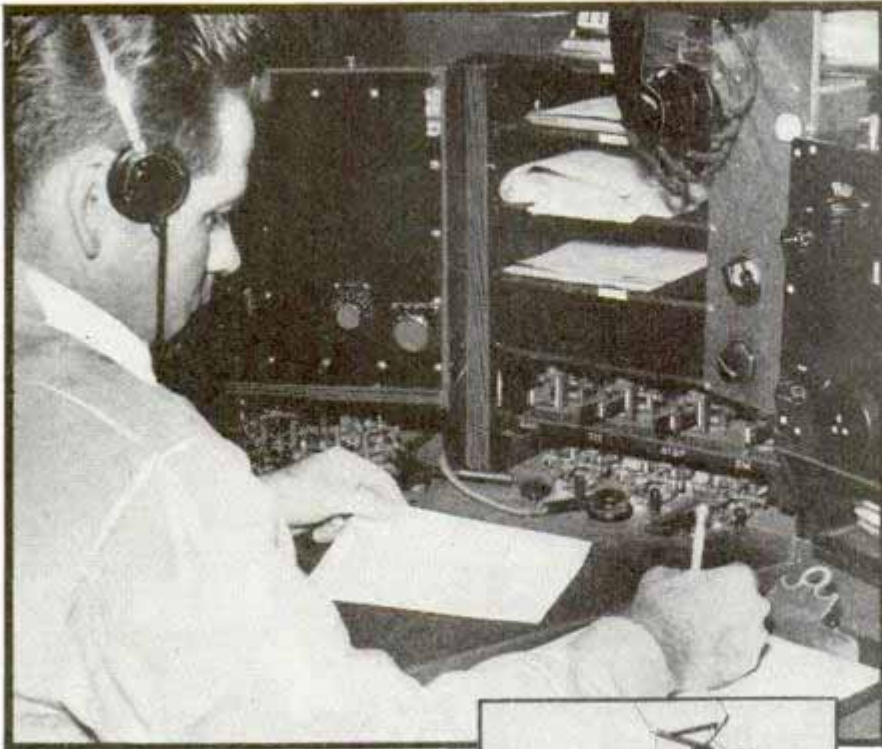

Above, close-up of operator's desk at land station, showing numerous keys used for transmitting on different wave lengths

listened to dozens of other SOS calls, both on the Atlantic and Pacific, that were too far away for the operators to give assistance. In such case they shut down their transmitters so they will not interfere with stations closer to the disaster.

The idea of a land station 1,800 miles away from a ship sending out an emergency call for it may seem strange, but that happened a few years ago. Early one evening Lindley Winser, chief operator at KOK, was called on short wave by the tanker "Australia" far out in the north Pacific.

"Stand by. Stand by," the message read. "There has just been an explosion on board. Stand by for an emergency call." The ship operator went on to explain that he was alone in the radio cabin in the forward part of the ship, a terrific explosion had occurred amidships, the ship was on fire, and the captain was in the stern. He kept giving details while awaiting official word to send the emergency call. Finally the operator told Winser that the captain had made his way forward and was order-

ing an SOS. It was going to take a little time for the operator on the "Australia" to shift over to 600 meters and warm up his transmitter. Every minute counts in such an emergency, so Winser substituted for him. Without any delay he immediately rapped out a series of SOS calls on 600 meters with his own powerful transmitter, giving the vessel's position and signing off with its call letters instead of his own. That quieted down everyone within range and gave ships in the same area a chance to start estimating their distances from the tanker. Then the tanker came on the air and rescue work was arranged. After several hours the crew subdued the fire and the ship proceeded.

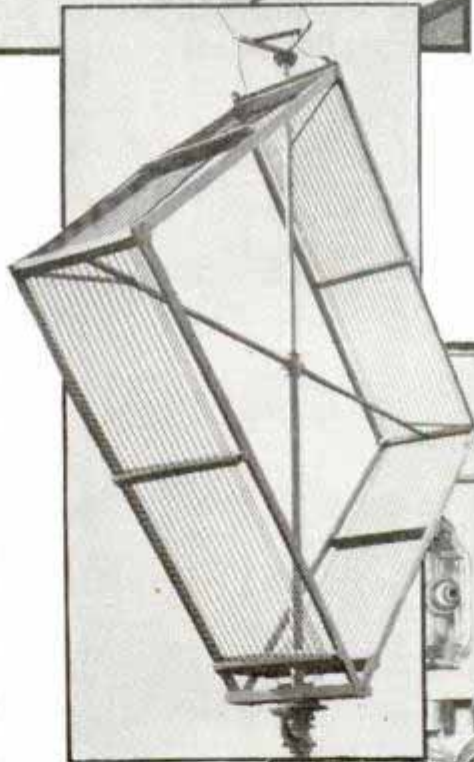

Center, fixed loop antenna used for reception of point-to-point radio messages. Bottom, water-cooled tube used in 5,000-watt transmitter

But SOS messages are only a fraction of all emergency traffic. Few accidents at sea are sufficiently serious enough to require the "come and get us" message. If a ship goes aground and is in no immediate danger the captain never issues such an order. What he usually does is rush a message to its owners, explaining his condition and asking for whatever aid the circumstances demand. Possibly a tug must be sent to drag the ship clear. When a ship loses its propeller or snaps its tail shaft at sea it may be in no actual danger at the time but messages for a tow or for instructions from the owner must be handled with emergency dispatch. No one can tell

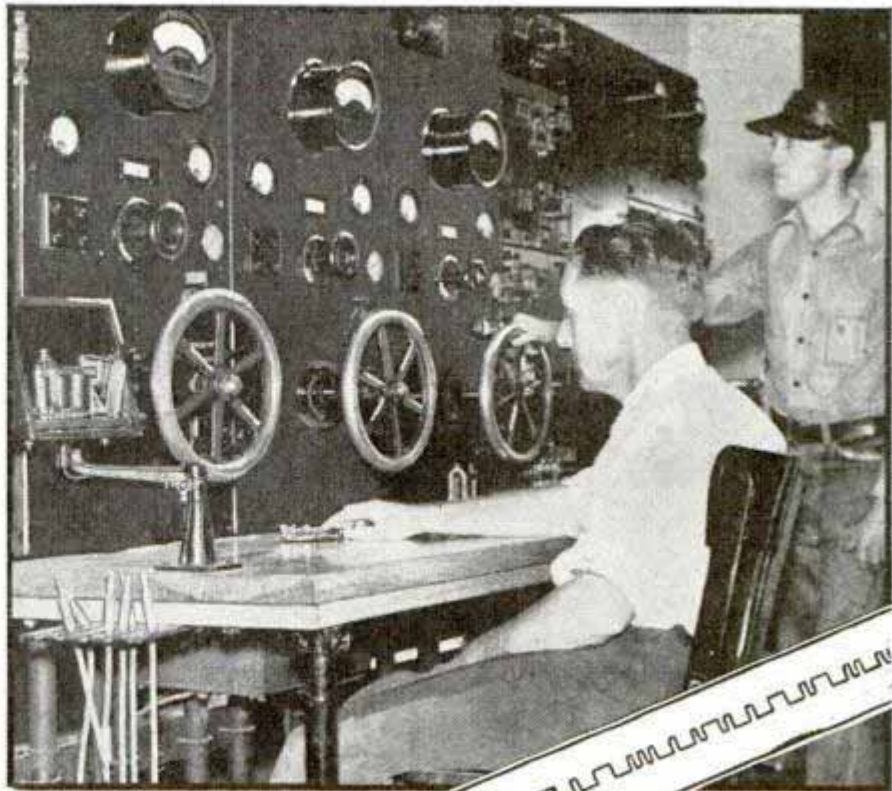

when a storm might arise that would increase the damage.

KOK is the land station chiefly used by the west coast tuna clipper fleet. Eighty or ninety of these 120-foot fishing boats cruise as far south as the coast of South America. All of them rely on short-wave radio for communication, hence when one finds itself in trouble it is unable to ask for help on 600 meters, the wave length on which distress calls are supposed to be sent. Usually the vessel calls KOK on short wave and arranges for whatever rescue work is needed.

Hardly a month goes by without some accident happening to the fishing fleet. That is because the nature of the work requires the boats to ride through heavy storms that send larger ships far out of their way. While following schools of fish the boats have to skirt dangerous reefs or work in close to rocky shores.

The Mackay station handles an average of five or six "Medico" calls a month, sometimes as many as eighteen a month, many of which originate among the fishing boats. If a fishing captain's sketchy knowledge of doctoring and the contents of his medicine chest aren't sufficient to help a

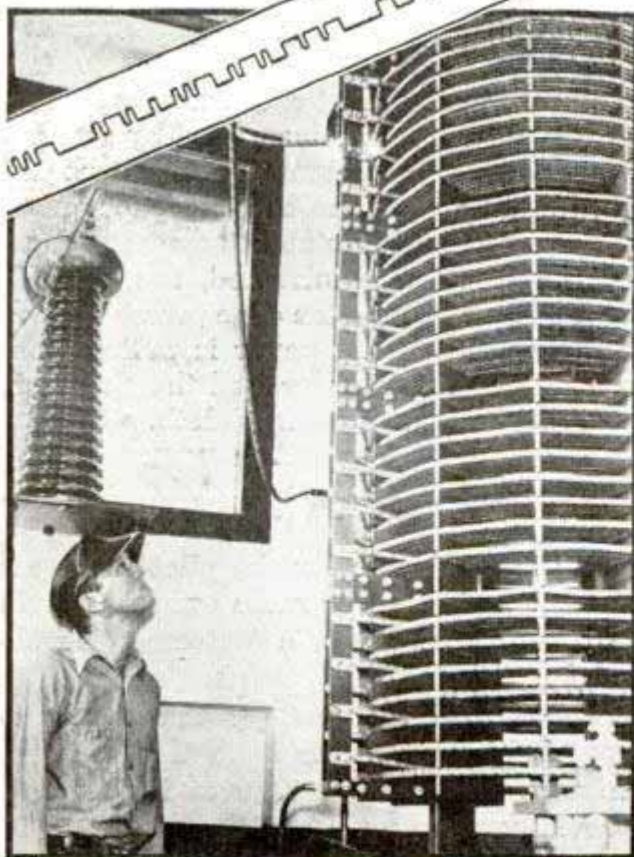

Top, control-panel of transmitting station. Center, automatic tape used in high-speed transmission. Bottom, part of transmitter's tuning coil

(Continued to page 149A)

S 1549

Decorative Wall Designs Applied with Water

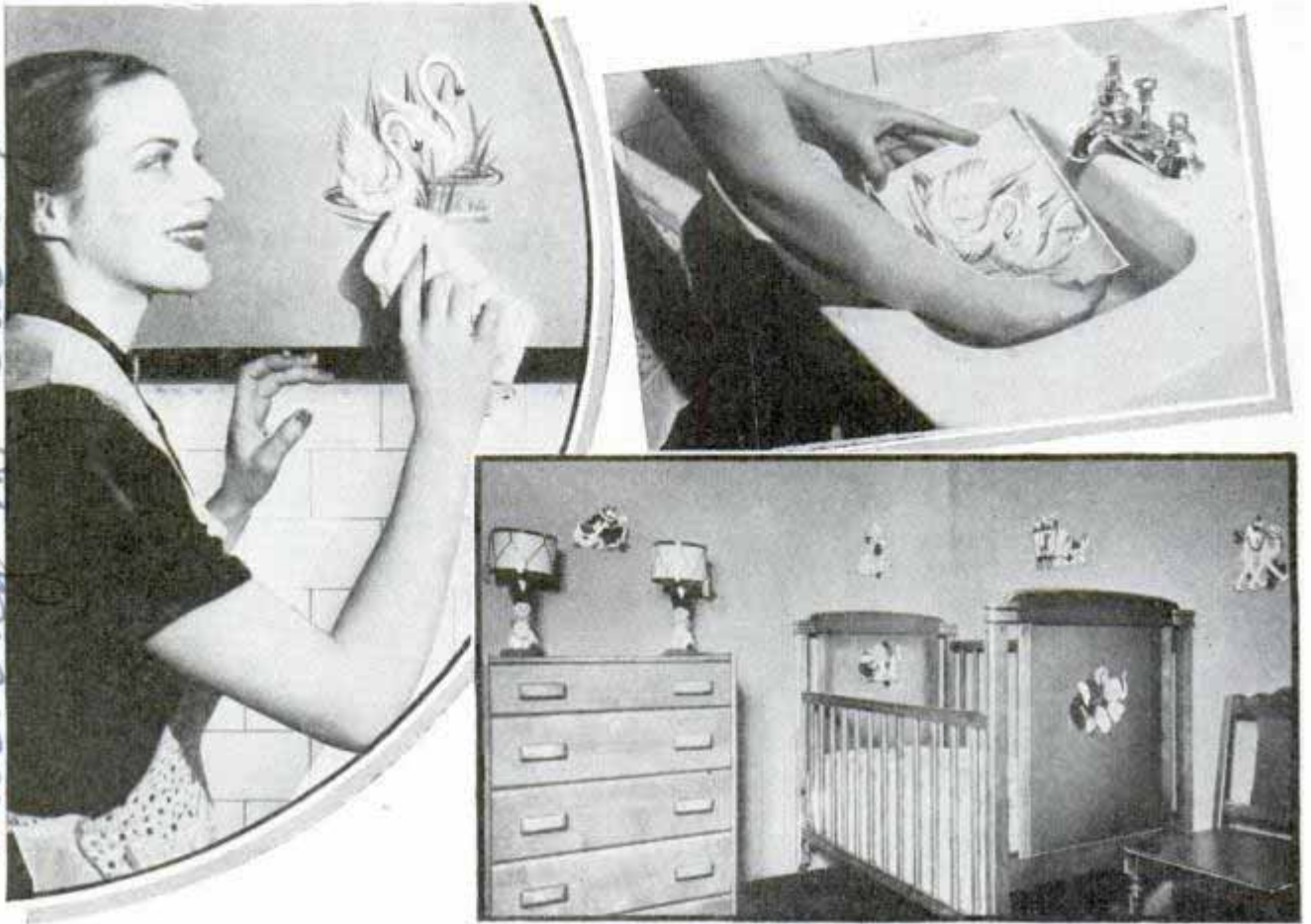

Here are several views of the wall decorations. Left and top, right, steps in application of the designs. Bottom, right, effect achieved by decorating walls and furniture with the transfers

Made in a variety of brightly colored designs, simplified decorative transfers for walls, ceilings and furniture are available. The transfers can be applied in about one minute. Best results are obtained when they are applied to wood, metal, glass and washable wallpapers. For the bathroom there are transfers depicting fish, sailboats, lighthouses, swans, water lilies, and flamingoes. Gay circus scenes and animal

pictures comprise the nursery appointments. The transfer is applied by soaking in warm water for ten to fifteen seconds, then sliding it off the backing paper until it projects about two inches over the edge. Next the wall is moistened, the transfer applied face up, and the edge pressed down. Finally the backing paper is pulled from the rest of the transfer and the design is smoothed out with a damp cloth.

Static "Detective" Warns Air-Liner Pilot of Interference

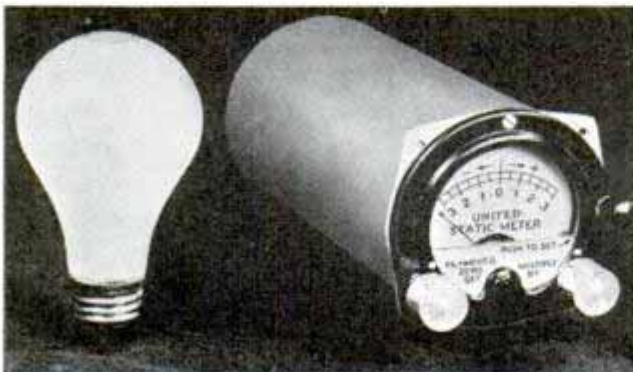

Airplane static meter beside a bulb to show size

Static too feeble for the pilot of an air liner to notice in his radio earphones will tilt the needle of a static "detective" developed by United Air Lines engineers. The instrument, scarcely larger than an ordinary light bulb, shows instantly the presence of static and measures its volume, providing data useful to the engineers in coping with the problem of interference from rain and snow static in the sky. It shows both plus and minus charges; a pilot

New Bureau 221 N La Salle
Chicago

The Meyers Co. 208 W. Washington Chicago

H-18

flying between two cities on an air route may observe a plus area of static, and after passing its peak he will see the meter needle swing to the negative side. It is planned to have transport pilots report on static conditions along with their regular position and weather reports.

es 1523
Temporary Signal Guards School Crossing

Made lightweight so that it may be carried easily, a small traffic-light standard has been produced for protection of school crossings. In use, the light stands in the center of a busy intersection, its electric connections made to an underground power line. It is controlled by an automatic switch. When pupils are in classes or at home, the standard is disconnected and carried into the school building. A cover protects the underground power outlet. The lamp housing may be carried in one hand, the standard in the other after being taken apart for storage when not needed.



Temporary traffic light at school crossing

Surveyor on Roof of Truck Sights above "Heat Waves"



With instruments on top of truck, surveyors are ready for quick moves across desert and sighting is unaffected by "heat waves" near ground

Engineers surveying desert areas in the state of Washington speed up their work and attain greater accuracy by mounting their plane tables and other instruments on the roofs of their trucks. Here the apparatus is ready for immediate use, and the surveyor is high enough above the ground to escape the shimmering "hot stove" effect of heat waves along the surface on hot days. The surveying in Washington is a prelude to the development of a vast region of desert which is to be supplied with water diverted from the Grand Coulee dam.

Our Bureau of Information keeps on file the names and addresses of makers of, and dealers in, all devices described in the pages of Popular Mechanics Magazine. We are glad to furnish this information to our readers upon request, accompanied by stamped, self-addressed envelope.

J. A. Roberts, Construction Engineer, Bureau of Reclamation, Coulee Dam

Lewis Kelly

Up-to-Date "Papoose" Board Has Sunshade for Baby



Soft pad, supporting laces and sunshade keep this baby comfortable in modern version of papoose board

Believing it would help his infant son to grow strong and straight, a father in Ogden, Utah, has built a "papoose board" similar to that of the early American Indians. The baby is tucked into the cradle board and laced in, protected by a soft, removable pad, so that the child's body cannot slump and there is no weight on his feet. The board is made of wood and canvas. A strong wire band projects over the baby's head with a sunshade attached, and mosquito netting is added at nap time.

Odd Trait of Tungsten Explains Sudden Burn-Out of Lamps

Why do electric lamps suddenly burn out a moment after they are turned on? A peculiarity of tungsten, the metal used in the filament, explains. Tungsten has less resistance to the passage of electric current when cold than when it is hot. Consequently, for a fraction of a second after the switch is turned on, the filament may carry several times as much current as when

heated—as much as fourteen times the normal amperage. If the filament is already weak, the initial shock may burn it in two. Because of this characteristic of tungsten, lamps used in motion-picture work and other applications where sudden burn-outs would be costly are sometimes never completely turned off, but are turned down by rheostat, leaving the filament glowing with a dull red heat.

Meter Tests Horn's Loudness for Traffic Safety

Equipped with microphone and mechanism to indicate degree of loudness, a new instrument shows whether the automobile horn is too loud or too weak. It is used by highway traffic officers and in safety-test lanes, service stations and garages. Self-contained and requiring no batteries or outside source of power, the meter measures sound levels in a frequency of 300 to 1,500 cycles per second and measures over a sound range of ninety-six to 130 decibels. The decibel is the unit employed in sound measurement. The mechanic or traffic officer holds the meter in front of the car while the horn is sounded. If the reading shows the sound is too loud or too weak for traffic safety, the horn may be adjusted to produce the tone volume desired.



Here the mechanic is testing horn for volume by means of a handy meter

Maurice L. Howe, Ogden, Utah

Ed. Walter & Burge, 6032 Florida Av., Alim, Okla.

1536

1540

General Editor to Chevrolet

R A

D I O . . .



PUSH-BUTTON TUNING

for Your Receiver

WITH only three wires to connect, this push-button tuning unit brings your receiver up to date. It can be used with any radio set that employs a two or three-gang tuning condenser, and almost every receiver except the very old ones has one.

While most of the new sets provide for automatic tuning, many of us have slightly out-of-date receivers and have been looking forward to some simple means for adding the convenience of push-button tuning for favorite local stations. The unit, various views of which are shown in photos A, B and C, is available in kit form.

Anyone can assemble and install the

(Continued to page 136A)

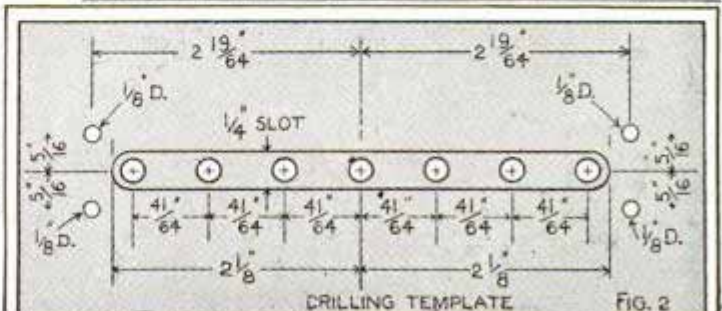
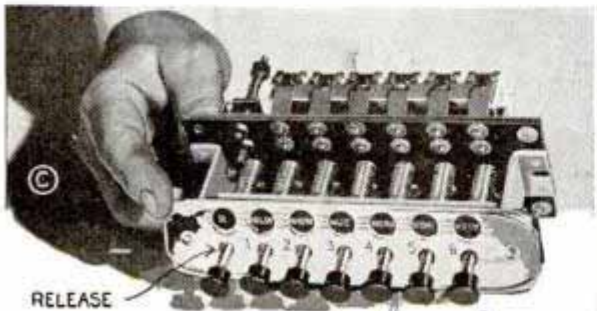
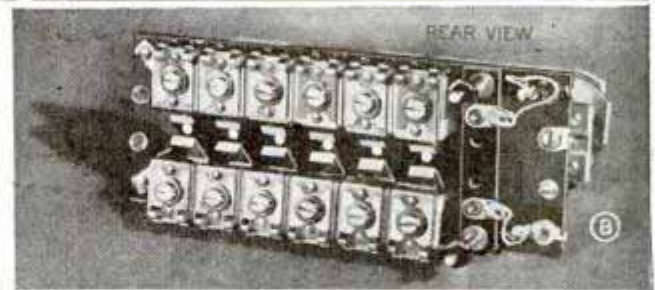
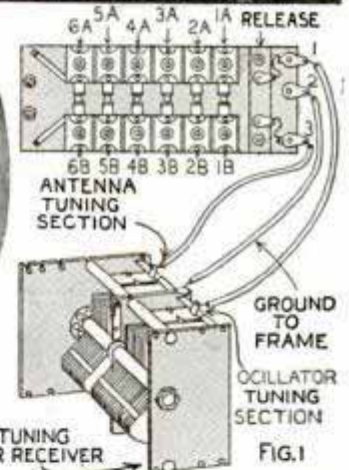
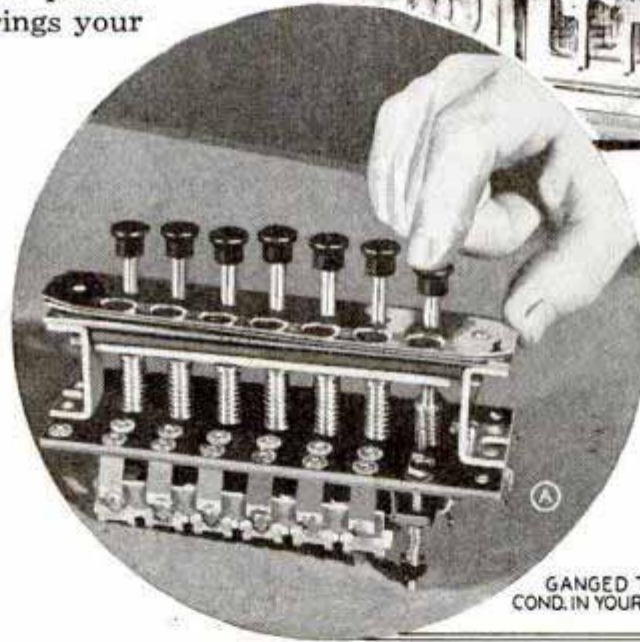

Wholesale Radio Service Co.
 901 W. Jackson, Chicago

SHORT-WAVE SET

in series. Like the broadcast-band set, this receiver uses a type-49 tube in a space-charge circuit which provides surprising results with very low "B" voltage. A single flashlight battery of the type available in five and ten-cent stores lights the tube filament, and two 3-volt "pen-light" cells in series supply 6 volts of "B" battery and the necessary grid-bias voltage. The drain is so low that the "A" battery will give many hours of intermittent service and the "B" batteries should last for several months.



Four hand-wound plug-in coils are employed. These 4-prong coil forms are available from radio parts houses for ten cents each. However, old tube bases can be used for all coils except No. 4. Drill small holes, and wind all coils in the same clockwise direction as clearly shown in Fig. 1. Leads are brought down through prongs and soldered in prong ends. Coil positions, when plugged into coil socket, are illustrated in Fig. 1-A. If a coil refuses to oscillate over a portion of the dial, add a turn or two to the tickler coil.

A schematic circuit diagram appears in Fig. 2 and the simplified wiring diagram in Fig. 3. Photos Figs. 3-A, 3-B and 3-C show front and rear views of the completed receiver. The small metal panel serves to eliminate hand capacity, and is fastened to the baseboard with wood screws. No. 18 hook-up

(Continued to page 138A)

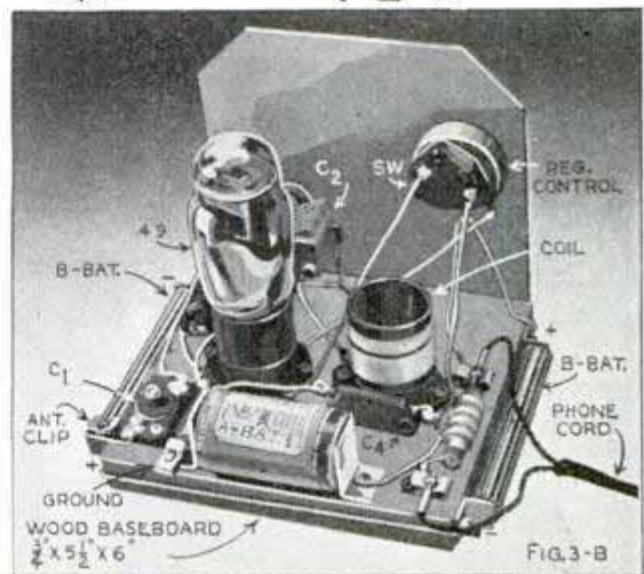
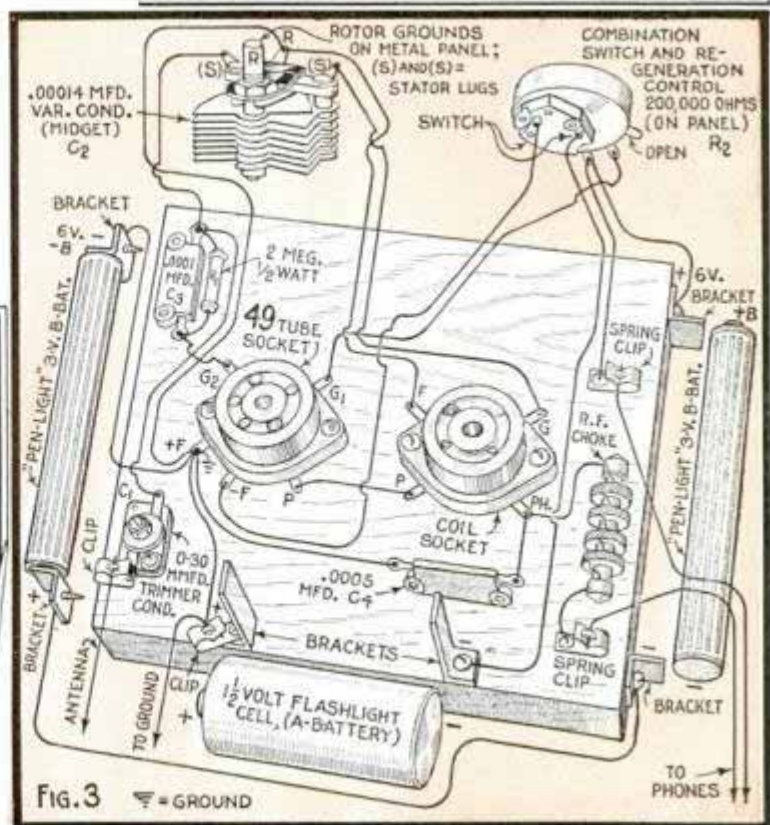
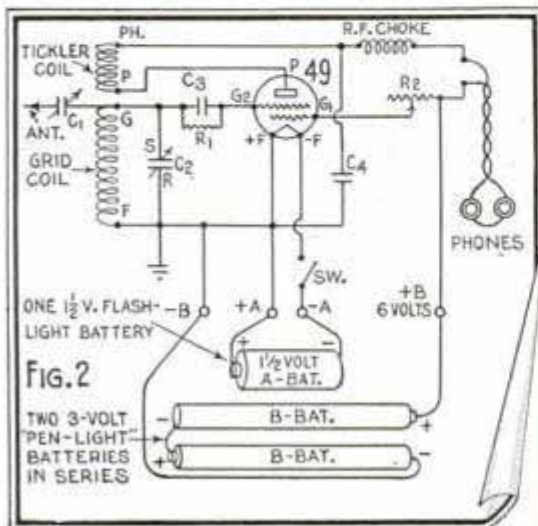

FIG. 3-B



Practical RADIO SUGGESTIONS

Right, auto-radio antenna adjustable from driver's seat to any desired height, extends above top of car just the required distance for best reception in city or country; disappears entirely when not in use

General Electric Radio Co. - Rockford, Ill.

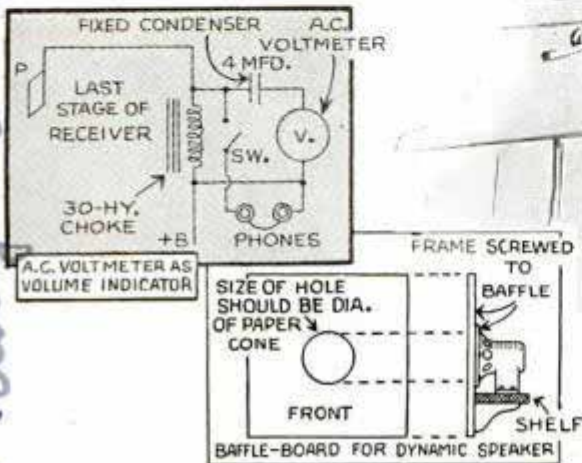

Above, 0 to 5-volt, or lower reading a.c. voltmeter used as a volume indicator for testing purposes. The baffle-board suggestion for wall niche or corner installation, improves tone of small sets. Board is 1½ by 32 by 32 in.

Right, dating and marking kit for metal or glass tubes, handy for servicemen and set owners, does away with paper labels that drop off

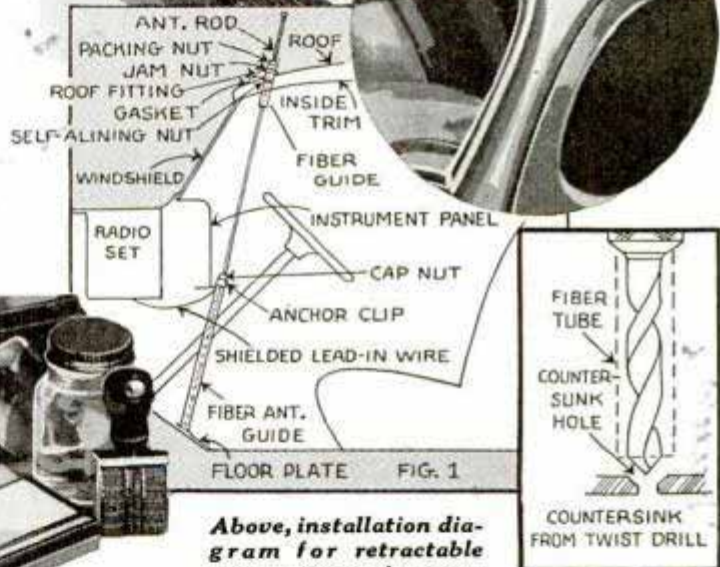
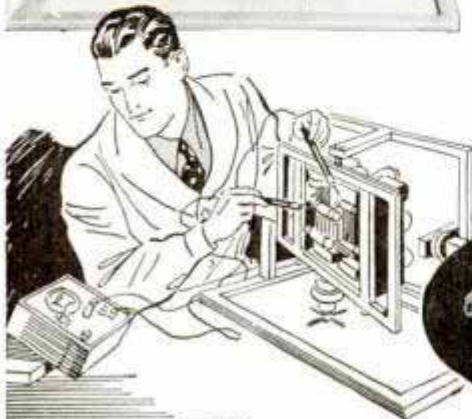
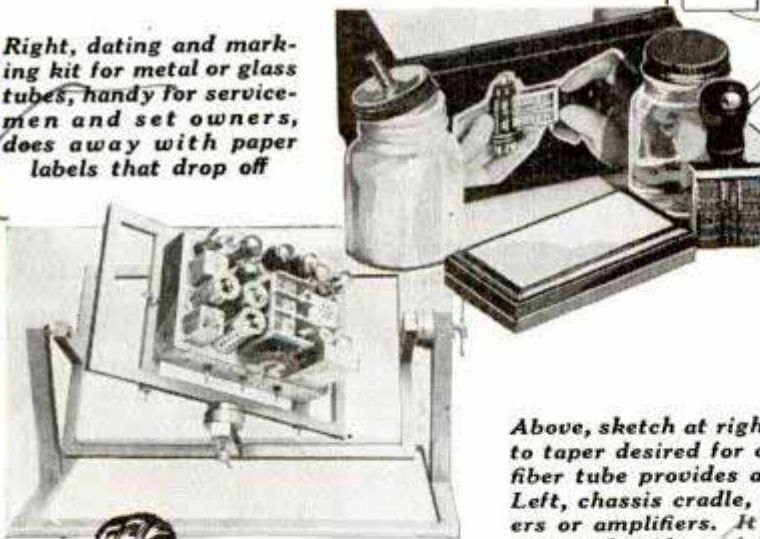

Above, installation diagram for retractable auto antenna in suggested location for easy adjustment and short lead to receiver

Above, sketch at right shows ordinary twist drill with point ground to taper desired for countersinking flat-head machine screws. The fiber tube provides a stop so that operator will not drill too deep. Left, chassis cradle, or "gimbal," for testing and repairing receivers or amplifiers. It can be set to any desired angle and permits top, underside and left or right side examination. Below, large bull's-eye pilot light for 110-volt operation in receivers or transmitters, uses regular No. 5-6, 3 or 6-watt candelabra bulbs. Available in three colors which are visible only when the light is on

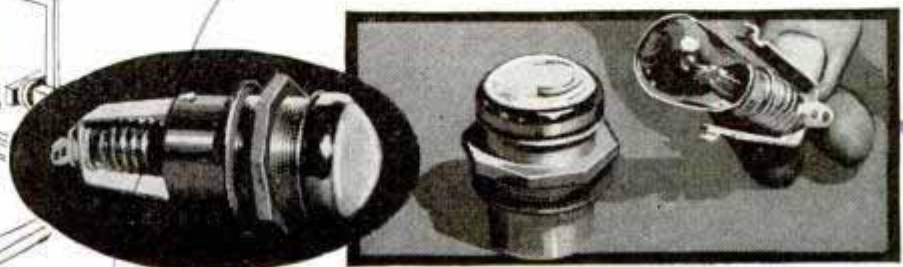

Drake Mfg. Co. 1715 Hubbard, Chicago

Wm. A. Thomas Co. 111 N. Dearborn

World Time for S.-W. Listeners

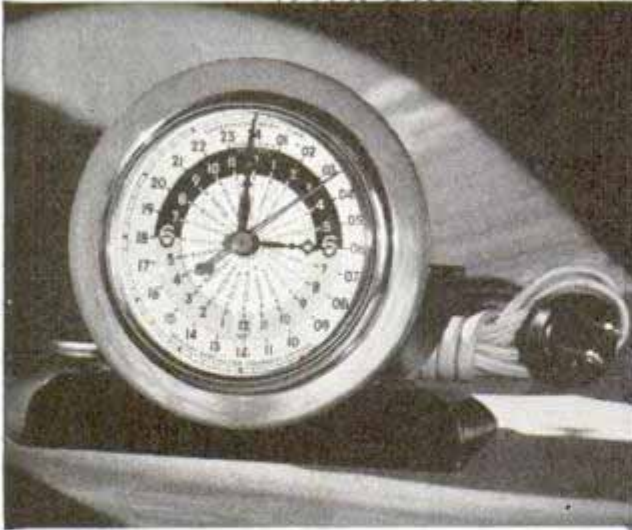

This electric clock gives GMT and standard world time for all of the twenty-four time zones around the globe, thus making it easy for amateur operators and short-wave listeners to maintain accurate schedules without referring to time charts. It operates on 110-volt, 60 cycle, a.c. line.

Radio Trouble-Shooting Guides

Handy trouble-shooting guides are now available in tabulated card form to fit the radio serviceman's pocket. Hinged for



quick reference, one series is for home sets and the other for auto-radio trouble symptoms and suggested remedies.

All-Purpose Power-Line Filter

It is no longer necessary to have a special filter for each individual type of electrically operated apparatus to keep interference out of power lines. This unit is said to be suitable for any filter application by simply making the correct internal connections.

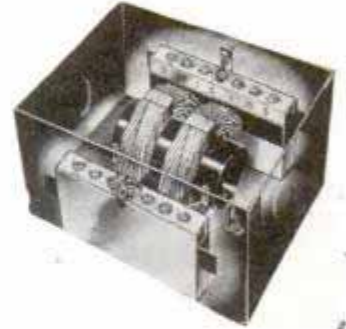

Convertible Battery or A.C. Set



Operating either on a 6-volt storage battery or 110-volt a.c. line supply, this 5-tube superheterodyne receiver is designed for rural families living in areas where electric power is a possibility, but not yet an actuality. Change-over from battery to power operation is automatic.

Blueprints covering radio construction articles in past issues are available for 25 cents each; original material lists and additional information can be obtained from our Radio Department without charge upon receipt of postage.

NEXT MONTH—How to Build an A.C.-D.C. Hearing Aid. A compact and efficient portable hearing-aid unit that will operate on any 110-volt house-lighting line. Enables hard-of-hearing to join conversations, or listen to radio at ordinary volume level. Also—**Homemade Speaker Cabinet of Advanced Design**

Radio and Technical Publications Co. 45 a stop place

Radio and Technical Publications Co. 45 a stop place

Radio and Technical Publications Co. 45 a stop place

Isardon Specialties & L.W. Miller Co. 440 Dearborn 5917 Main St. Los Angeles Calif



Photo PRINTER

has automatic switch

By
FLOYD MIX

THIS photo printer, which is shown in Fig. 1, is constructed entirely of plywood and is especially suited to the needs of the amateur photographer. It will take negatives up to $6\frac{1}{2}$ by $8\frac{1}{2}$ in. in size. Construction begins with the lamp box, which is shown in Fig. 6. The various parts of the box are cut to size, and the sides are rabbeted to take the end pieces. All cuts must be made accurately so that there will be no light leaks at the joints. The sides and one end are fastened to the base, using $1\frac{1}{4}$ -in. flat-head screws, after which three porcelain lamp receptacles are mounted in the approximate positions shown in Fig. 2. After the other end has been fitted in place, you can start on the lid, Fig. 5.

The lid is a single piece of $\frac{1}{2}$ -in. plywood, the center portion of which is removed with a scroll saw. The frame, shown in Fig. 4, serves the dual purpose of supporting an 8 by 10-in. ground glass to diffuse the light, and a piece of $\frac{1}{4}$ -in. plate glass of the same size set flush with the top of the lid, to serve as a negative rest when printing. Try the frame pieces for fit, Fig. 3, then assemble and fasten them in place with No. 9, $1\frac{1}{2}$ -in., flat-head screws

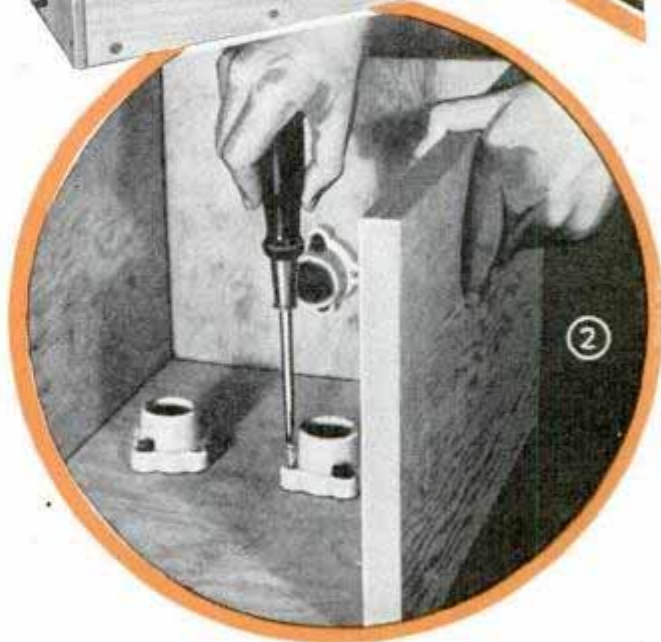

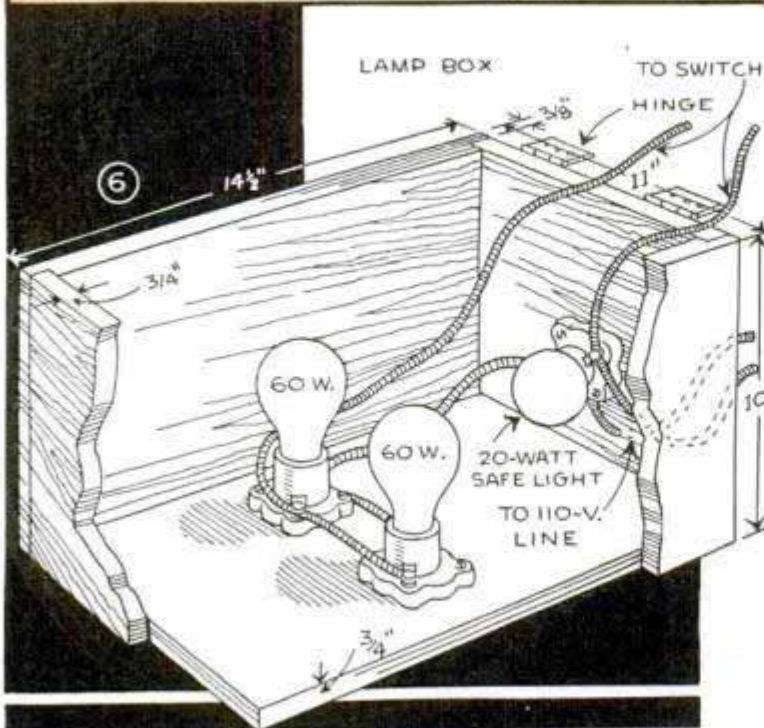
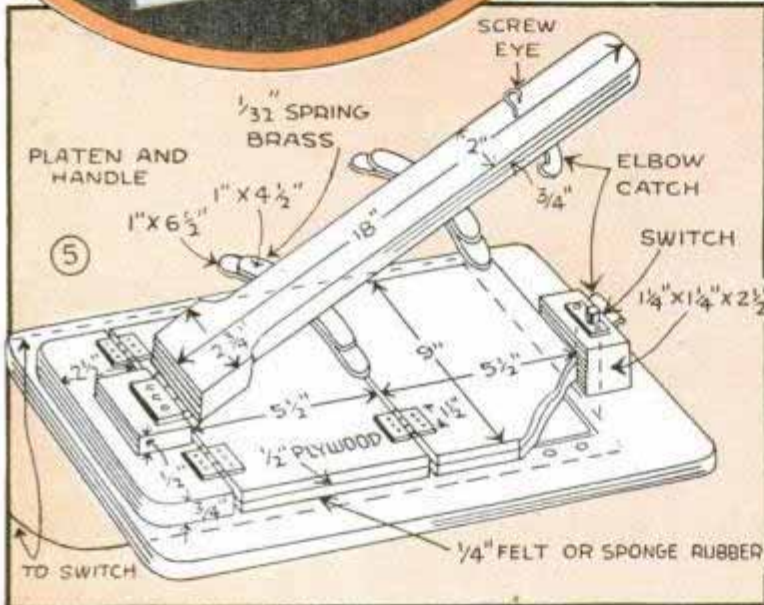
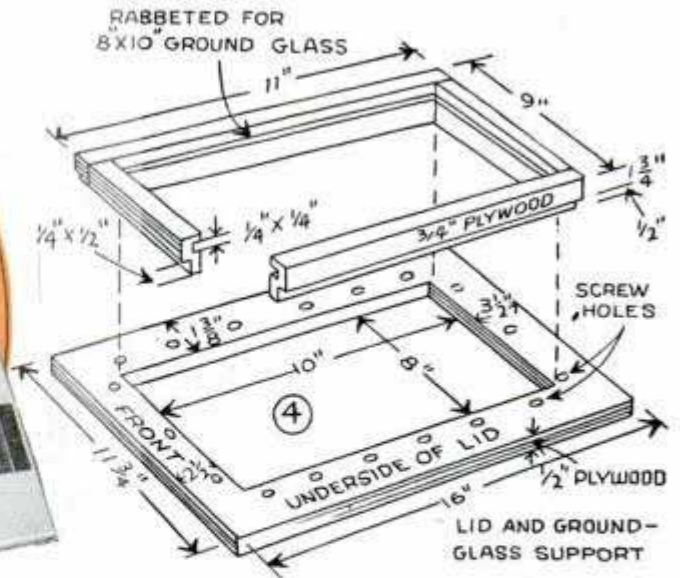
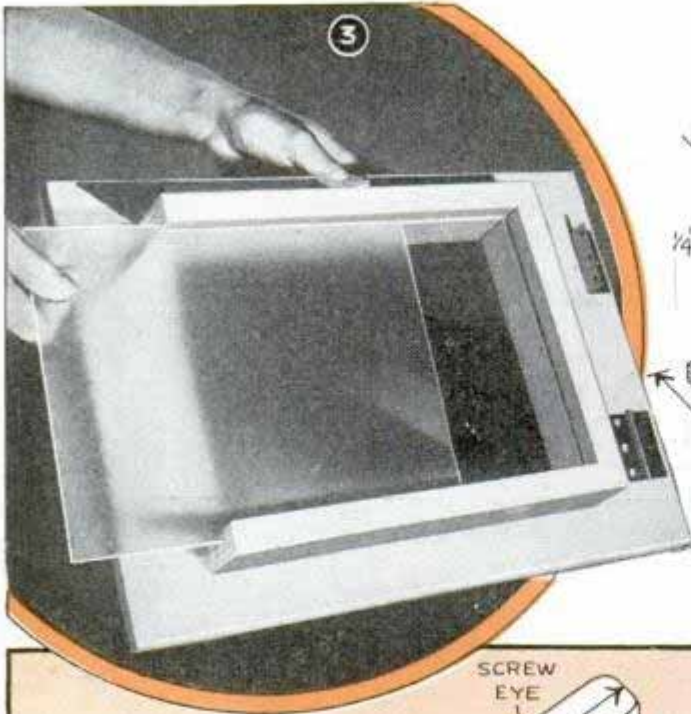

from the top side. For the platen you will need a piece of $\frac{1}{2}$ -in. plywood 9 by 11 in. Cut this in the center to form two pieces $5\frac{1}{2}$ in. wide, and use $1\frac{1}{2}$ -in. brass hinges to fasten them together. Glue resilient felt or sponge rubber $\frac{1}{4}$ in. in thickness to the underside of the platen to assure even contact of the negative and printing paper. Then, hinge the platen to the $2\frac{1}{2}$ by 9-in. piece at the back and proceed with the handle. Pressure bars are made of $\frac{1}{32}$ -in. spring brass and are screwed to the underside of the handle. A screen-door spring fastened to screw eyes in the handle and back of the lamp box, as shown in Fig. 1, keeps the handle in a raised position when adjusting the negative and printing paper. A 6-in. length of light chain connects the platen to the handle.

The switch used is a regular make-and-break door switch altered so that two 60-watt lamps will light when the handle is depressed. An elbow catch automatically engages to hold the handle down for the required time, and the light turns off when the handle is raised. A 20-watt ruby lamp connected direct to the power line serves as a safe light. Giving the inside of the box a couple coats of white or aluminum paint, and staining the outside, completes the job.

Solid-Wood Cracker Tray Cut on Circular Saw

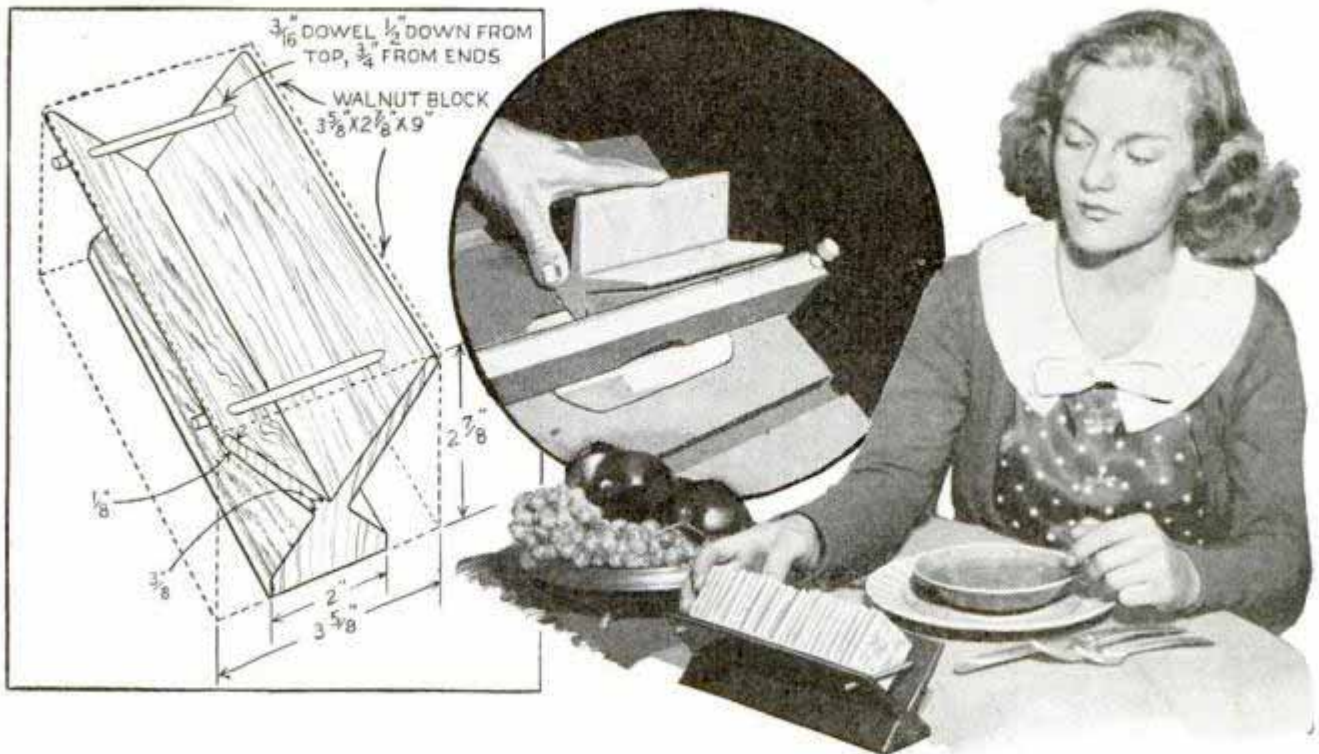

This solid walnut cracker tray was cut entirely on a circular saw and finished in one evening. After laying out the design on the end of a wood block, the saw table was tilted to 45° to make the V-shaped top and the sloping sides of the base. The sides of the top portion of the tray were cut at

50° angles, which was done by driving short brads into the sides of the work to tilt it an extra 5°, as the saw table could be tilted only to 45°. Two maple dowels, which keep crackers from sliding out, were glued in holes. These were drilled before cutting the block.

Fowls Dusted with Rosin Are Dressed Easily When Scalded

When you have a number of fowls to dress, especially ducks or geese, try this trick, which many poultry dealers use. Hang the bird above a box of powdered rosin as shown and work the powder well into the feathers with a whisk broom. Then scald it in the usual manner. You'll find that the rosin has matted the feathers so they can be pulled out in handfuls, bringing most of the pinfeathers with them.

Paste from Condensed Milk

When you want a little paste in a hurry, just use a few drops of condensed milk, which dries quickly, and is neither messy nor lumpy. Where flour paste sours and dries out quickly in a container, one small can of milk will last for days in a cool place, and will last indefinitely if a strip of adhesive tape is placed across the two openings in the top of the can.



Pinfeathers on ducks and geese removed with feathers if latter are dusted with rosin before scalding

Cardboard in Scroll-Sawed Stack Provides New Pattern



Cardboard placed between stacked work before sawing produces extra pattern without effort

Desiring to replace the original thin paper pattern of a cut-out design with a durable one of cardboard, one home craftsman cemented the thin pattern to the top of the stack and then, before nailing together in the waste, he slipped in a piece of stiff cardboard. When the cutting was completed, an accurate pattern was produced without added effort.

Sheet-Metal Shears on Bench from Old Ice Skates

Needing a pair of metal-cutting shears for light work, I rigged up one from a pair of old ice skates.

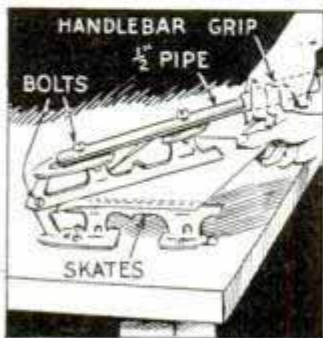

These were pivoted together with a strong bolt at the toe end of the blades, after which one of the skates was screwed to the bench top and the other was provided with a pipe handle. A bicycle

handlebar grip was slipped over the end of the pipe. In assembling such a cutter, the

skates should be pivoted together so that the edges of the blades bear firmly against each other as the shears close.

—John P. La Rosa, Port Chester, N. Y.

Scalded Fish Scale Easily

If you dislike to scale small fish, try this idea, which is advocated by a Wisconsin sportsman. Simply dip the fish in a kettle of scalding water for a moment, after which the scales will almost roll off under the scaling knife. If a number of small fish are to be cleaned, it's a good idea to do the scalding by suspending them from a barbless hook and line, as shown.



Steel Rule Riveted to Wrench Speeds Up Measuring Job

With this tool, which is made by riveting a steel rule to an adjustable wrench of the kind shown, measuring the diameter of rods or the thickness of various materials is simply a matter of closing the wrench

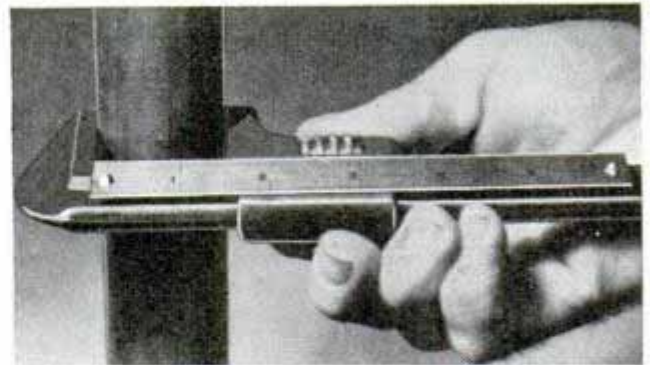

Scale on adjustable wrench makes it easy to measure diameter of work at a glance

over the stock and glancing at the rule. The ends of the rule should be annealed before drilling the holes for the rivets, and spacers should be used between the rule and wrench so that the movable jaw will slide freely.—A. H. Waychoff, Tempe, Ariz.

Blackbird and Pelican Point into the Wind

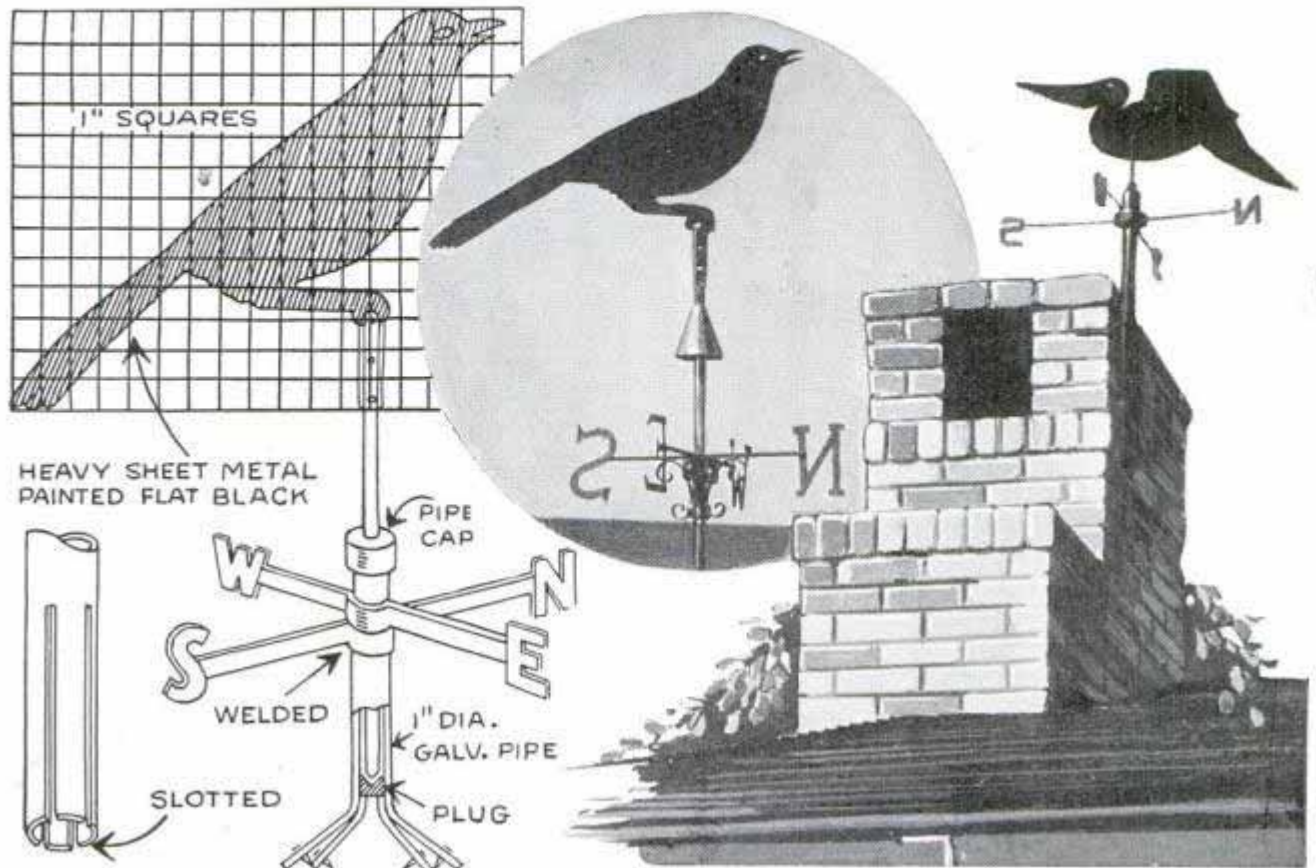

Those who desire appropriate garden weathervanes can devise an endless number of bird designs. Sheet metal, painted black, may be cut to produce an effective silhouette of a blackbird—or you may prefer a pelican. The silhouette is riveted in the slotted end of a $\frac{5}{8}$ -in. steel rod, which is ground to a point at the other end. The

point rests in a depression or countersink bored in an iron plug near the bottom of a pipe standard. This is slotted and the ends are bent outward to straddle the ridge pole of a building. The upper end of the pipe is fitted with a cap drilled to take the rod. Flat-iron arms, welded to the standard, support the points of the compass.

Reading Lamp for the Davenport Slides from End to End

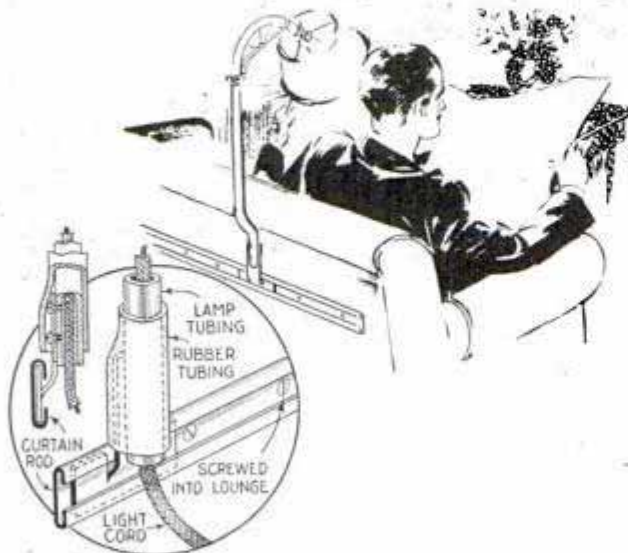

When you sit on a davenport to read, this lamp can be slid to throw the light on your paper

No matter where you sit on a davenport to read, this lamp is quickly moved to throw the light right on your paper. The lamp slides in a track, which is a piece of telescoping curtain rod screwed to the back of the davenport. The bracket that slides in the track, and to which the lamp standard or tubing is bolted, can be a regular T-brace obtainable in almost any hardware store. Or, you can make a bracket from a piece of $\frac{1}{8}$ -in. iron. After shaping the bracket, the rough edges should be smoothed so that it will slide easily.

☞ Rub the inside surfaces of molds with salad oil before making a gelatine dessert and it will slip out easily.

Portable HOSE and

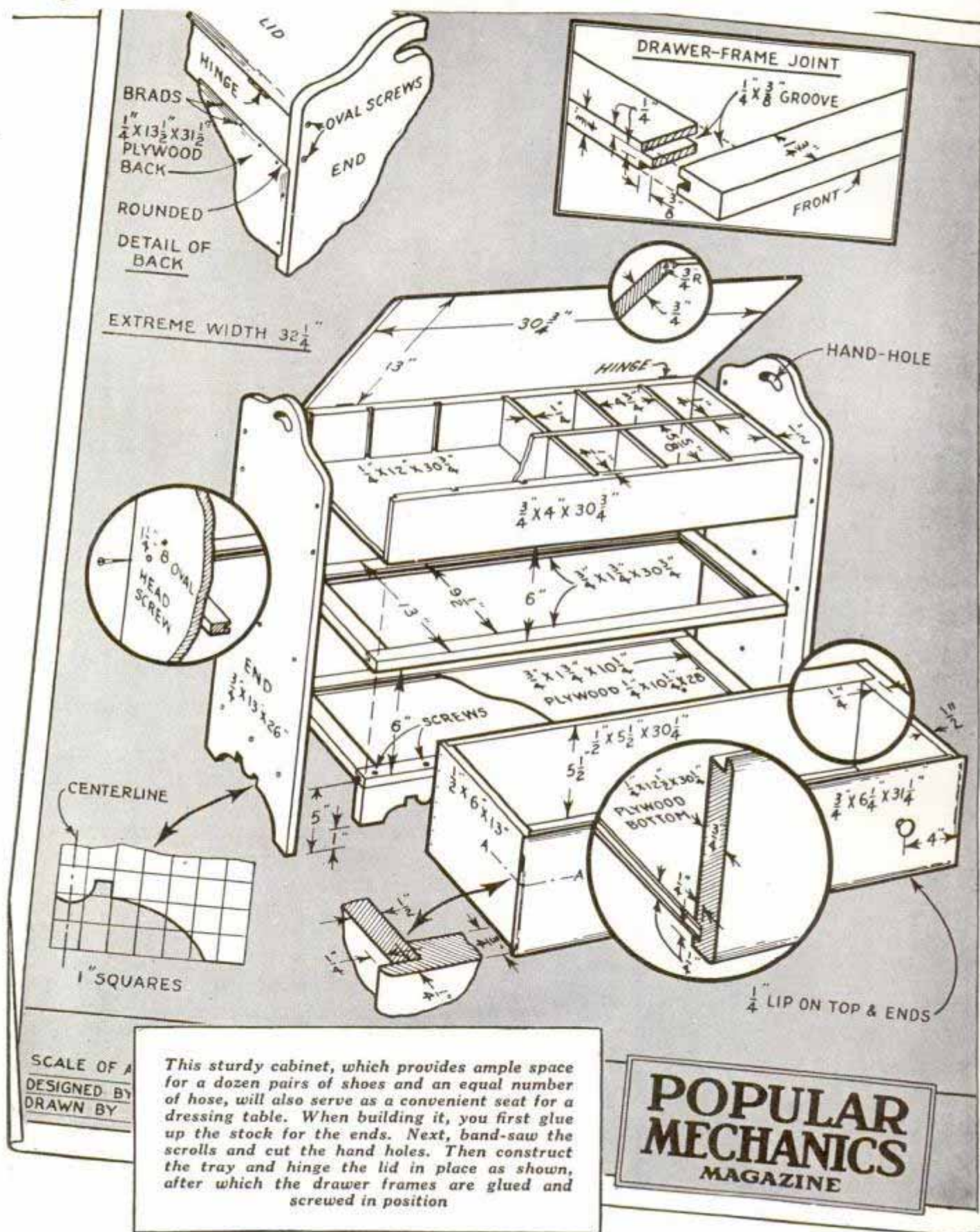

SHOE CABINET

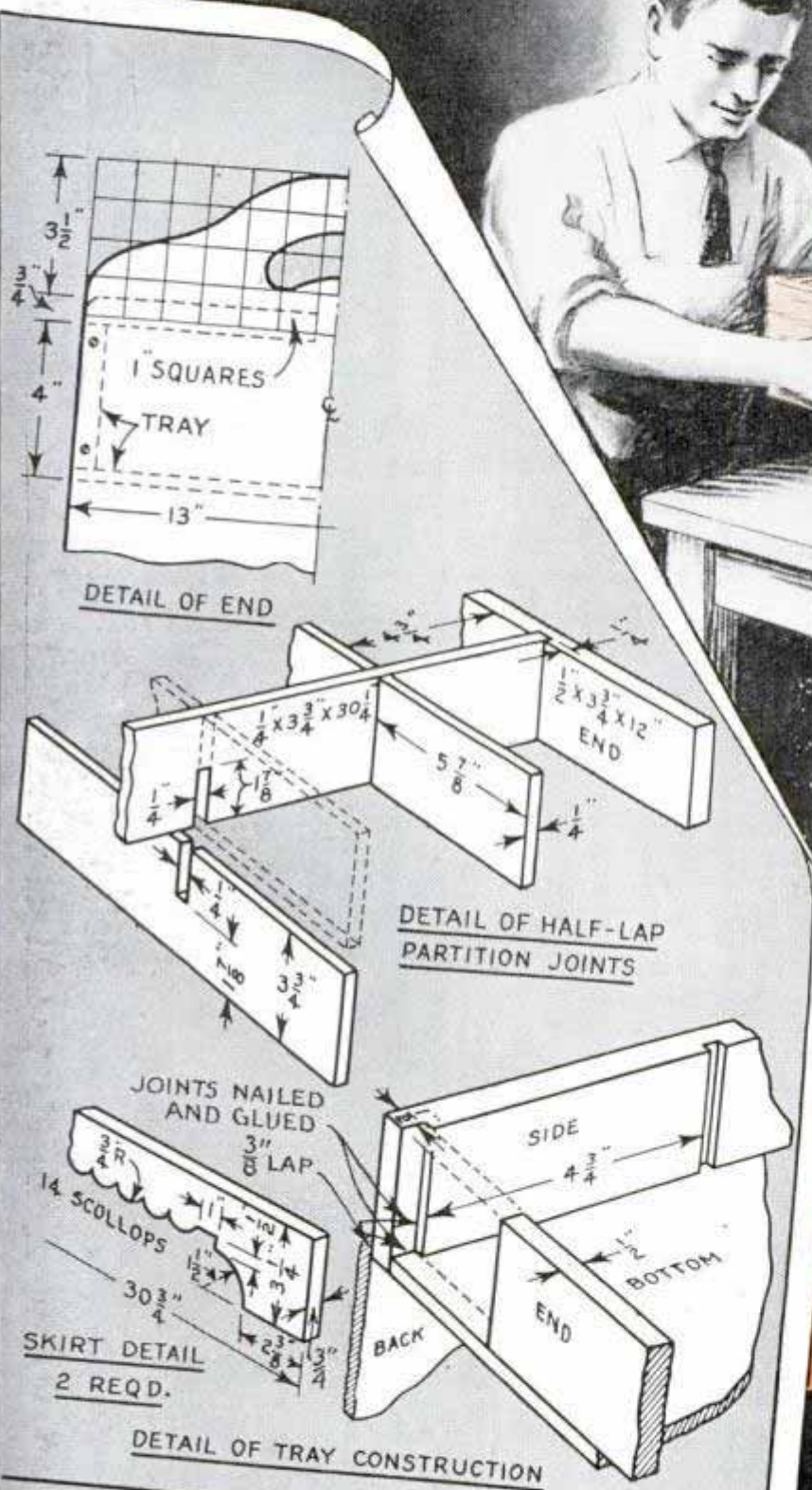

BILL OF MATERIAL

- 1 Top $\frac{3}{4}$ "x13"x30 $\frac{3}{4}$ "
- 2 Ends $\frac{3}{4}$ "x13"x26"
- 1 Back $\frac{1}{4}$ "x13 $\frac{1}{2}$ "x31 $\frac{1}{2}$ " (Plywood)
- 2 Sides of tray $\frac{3}{4}$ "x4"x30 $\frac{3}{4}$ "
- 1 Tray partition $\frac{1}{4}$ "x3 $\frac{3}{4}$ "x30 $\frac{3}{4}$ " (Plywood)
- 5 Cross partitions $\frac{1}{4}$ "x3 $\frac{3}{4}$ "x12"
- 2 Tray ends $\frac{1}{2}$ "x3 $\frac{3}{4}$ "x12"
- 1 Tray bottom $\frac{1}{4}$ "x12"x30 $\frac{3}{4}$ " (Plywood)
- 4 Drawer frames $\frac{3}{4}$ "x1 $\frac{3}{4}$ "x30 $\frac{3}{4}$ "
- 4 Drawer frames $\frac{3}{4}$ "x1 $\frac{3}{4}$ "x10 $\frac{1}{4}$ "
- 1 Dust bottom $\frac{1}{4}$ "x10 $\frac{1}{4}$ "x28" (Plywood)
- 2 Drawer fronts $\frac{3}{4}$ "x6 $\frac{1}{4}$ "x31 $\frac{1}{4}$ "
- 2 Drawer backs $\frac{1}{2}$ "x5 $\frac{1}{2}$ "x30 $\frac{3}{4}$ "
- 4 Drawer ends $\frac{1}{2}$ "x6"x13"
- 2 Drawer bottoms $\frac{1}{4}$ "x12 $\frac{1}{2}$ "x30 $\frac{3}{4}$ " (Plywood)
- 2 Skirt pieces $\frac{3}{4}$ "x3 $\frac{3}{4}$ "x30 $\frac{3}{4}$ "

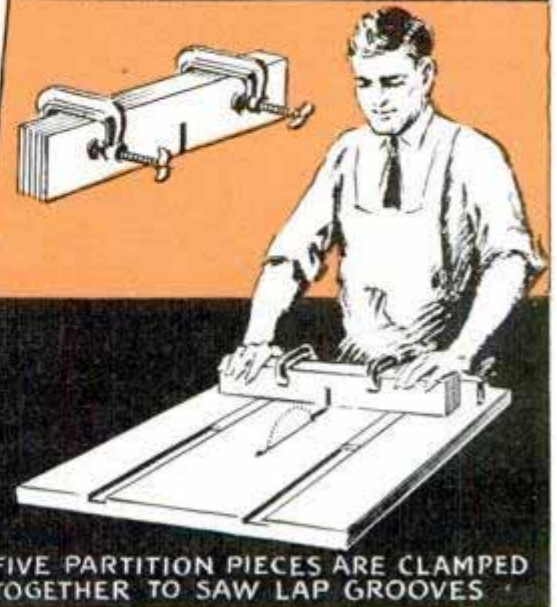

POPULAR MECHANICS MAGAZINE
 200 E. ONTARIO ST. CHICAGO
BLUEPRINT No. SN 975

Ladle to Handle Hot Roofing Tar Made from Headlight Case



Bolt a broom handle to an old auto headlight case, fill all rivet holes and you have a ladle for hot tar

Needing a ladle to dip molten roofing tar, I found that a good one could be made from the case of an old auto headlight. After removing all the fittings, the bolt and rivet holes were filled with solder, and two holes were drilled for attaching a broom handle. Headlight cases of the desired shape can be picked up for a few cents at almost any junk yard.

—R. A. Diel, Katonah, N. Y.

Rubber-Ball Stopper for Bottles of Photographic Solutions

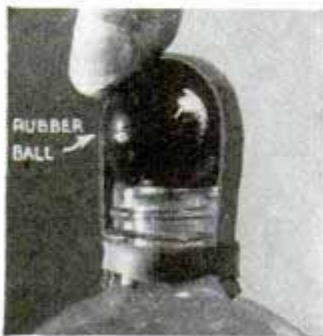

As photographic developing solutions remove oxygen from the air and create a partial vacuum in the bottles in which they are stored, a small rubber ball attached over the

bottle mouth makes a very effective stopper. Developer can be poured out by merely slipping the rubber ball aside with

the thumb. The ball is attached with two narrow strips of tire-patching rubber, one of which is cemented around the bottle neck as indicated.

—Kenneth Murray, Sturgis, Mich.

Door Bolt Secured with Padlock

A door bolt of the type shown that has no provision for locking it can be secured with a padlock. The large part of the bolt, which is screwed to the door, is drilled near the rear end

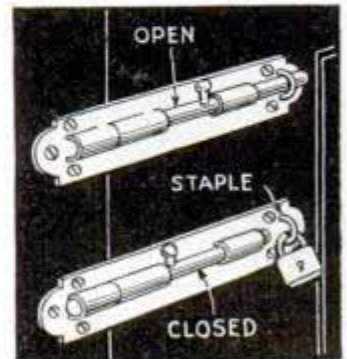

so that a staple can be driven through it into the door to take a small padlock. When the shackle of the latter is in place, the bolt cannot be slipped past it.

Pincushion on Sewing Machine Is Always at Hand

Wrapped around the head of your sewing machine and stitched in place, a piece of heavy flannel provides a handy pincushion. It is especially useful when stitching a seam which has been temporarily tacked with pins that must be removed as the seam is sewed. The pincushion also keeps a supply of needles right where you need them.

Piece of flannel wrapped around sewing machine keeps a supply of needles and pins near your work

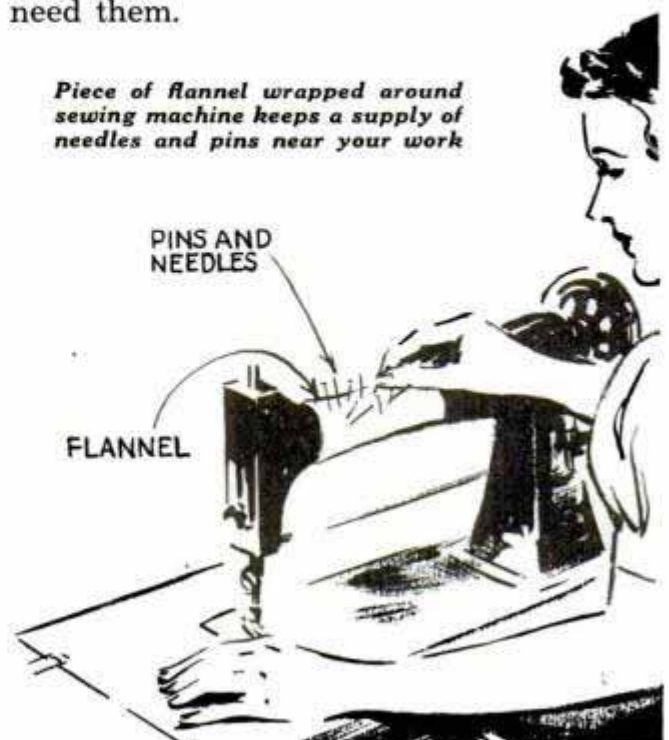

NOVELTY TABLES

have mirror tops

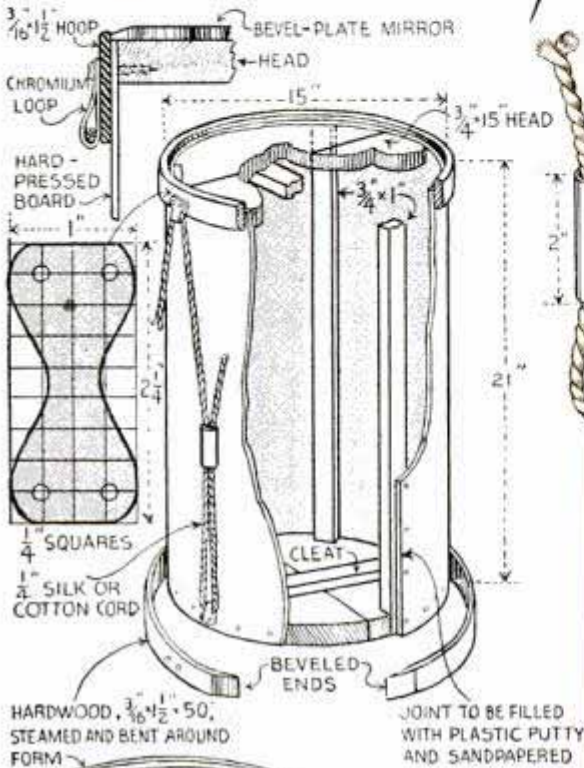
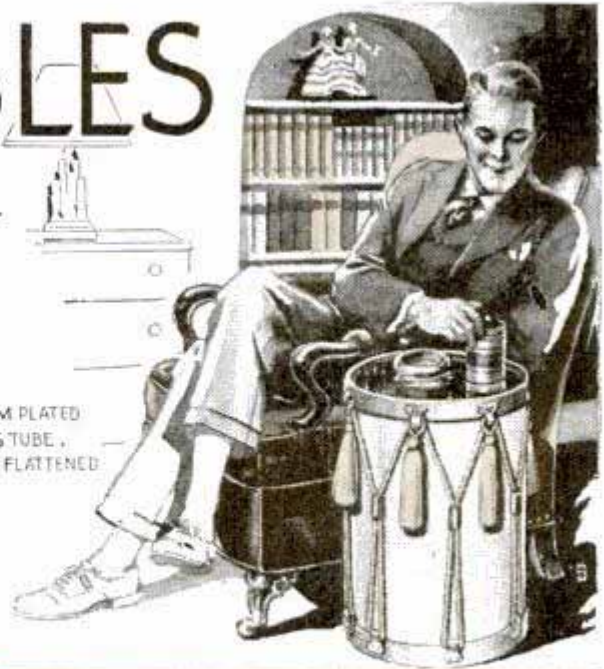

There's always room in the home for a drum table like the one shown at the left. It consists simply of a cylinder of thin, hard-pressed board bent around a circular wood frame. Top and bottom of the frame are disks cut from 3/4-in. stock. Pine is used for all these parts, as they are concealed, the top being covered with a mirror. Metal fittings for the decorative cord are chromium-plated and the finish is lacquer or ivory enamel

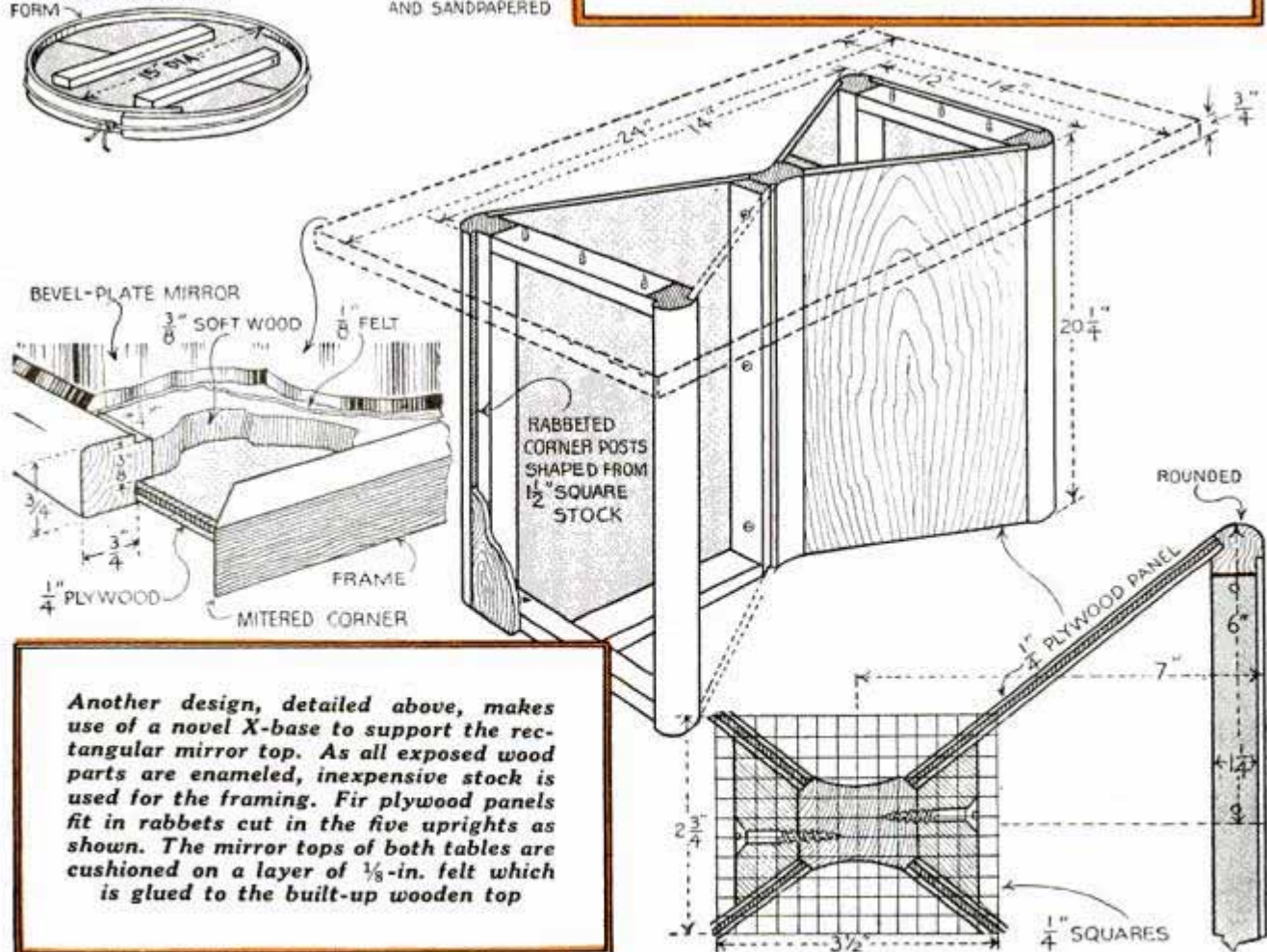

Another design, detailed above, makes use of a novel X-base to support the rectangular mirror top. As all exposed wood parts are enameled, inexpensive stock is used for the framing. Fir plywood panels fit in rabbets cut in the five uprights as shown. The mirror tops of both tables are cushioned on a layer of 1/8-in. felt which is glued to the built-up wooden top

Soldering Iron Heated Quickly over Gas-Stove Burner



Top of tin funnel altered to hold soldering iron over gas burner and conserve flame for quick heating

To concentrate the flame of a gas-stove burner to heat a soldering iron, you can use a tin funnel altered as shown. Cut off the neck of the funnel at the point indicated by the dotted lines in the detail to form an oval-shaped opening. Then make a couple of V-notches at the ends of the opening and compress it slightly by squeezing with the hands. This tends to give the opening the shape of the soldering-iron copper so too much heat does not leak past.

Small Trees Protected in Winter by Using Oil Drums



A farmer solved the problem of rabbits eating his young fruit trees by protecting the latter with oil drums. These were cut in half and openings made in the ends, after which half of a drum was set over

a tree as indicated. In the spring, the drums are removed, to simplify cultivating the orchard, and stored for use the next winter.—Grover Brinkman, Okawville, Ill.

Plants Are Shielded in Springs from Auto Cushion

Coil springs taken from a discarded auto cushion will serve to protect small plants in the garden from destruction by chickens or household pets. Each spring should be mounted on a sharp stake which is driven into the ground beside the plant.

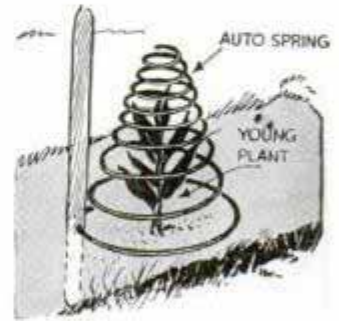

Dog Leash Covered with Staples to Discourage Chewing

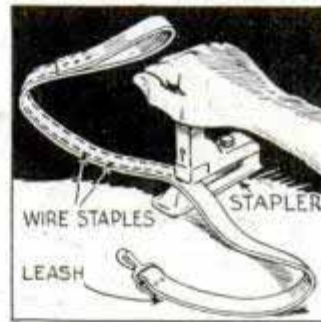

Does your dog chew his leather leash? If so, you can break him of the habit by putting a couple rows of wire staples in the leather. About $\frac{1}{8}$ in. space should be left between

the staples so the leash will retain its flexibility.—Morris Katz, Aurora, Ill.

Chalk Makes Pencil Lines Visible on Scroll-Saw Projects

Pencil lines on dark wood used in a scroll-saw project are usually difficult to follow. One craftsman first goes over the design with a piece of white chalk flattened on the end to make a wide mark, then traces over this with a pencil in the usual way. With the white background the narrow black lines can be followed without any trouble.

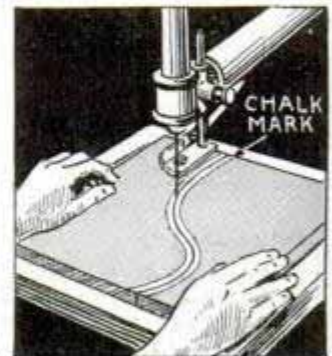

Tilt-Top Bed Table Can Be Adjusted Instantly

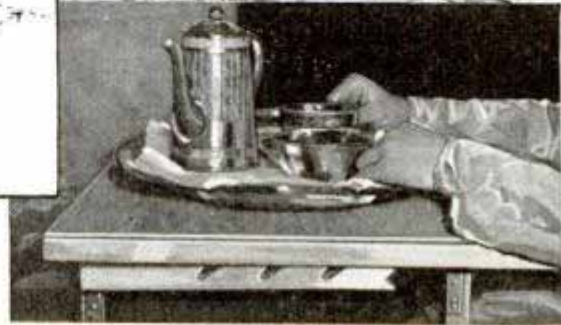
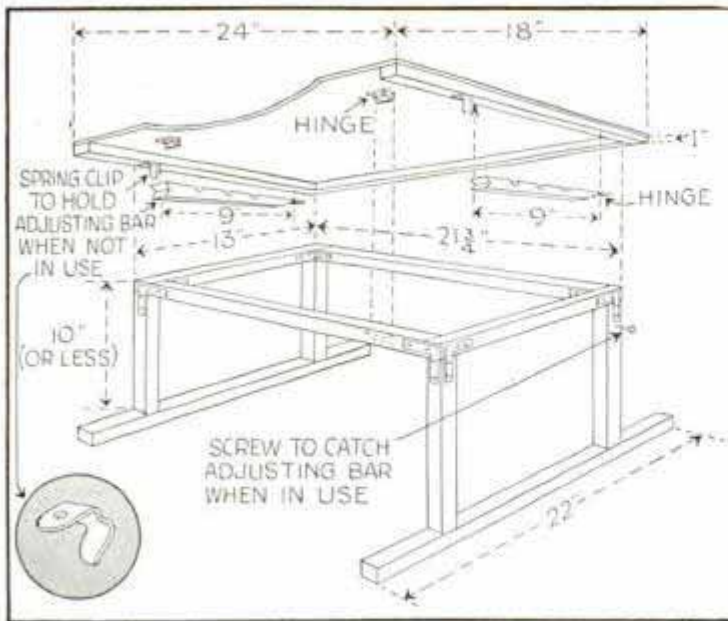

Quickly dropped to a horizontal position to support a tray of food, or raised to various angles to serve as a reading or writing desk, this bed table is light and rigid. It rests on two horizontal strips, which prevent it from sinking into the bed clothing and make it more stable than if it were mounted on legs. A top is sawed from $\frac{1}{4}$ -in. plywood and is hinged to a frame of 1 by $\frac{7}{8}$ -in. pine strips assembled with small angle and corner irons. Notched

strips, to support the top at an angle, are hinged to the upper corners of the top, to engage screws, which are driven half their length into two legs. When not in use, the strips are held against the underside of the top with spring clips.

—Everett Rudloff, Oceanport, N. J.

Styptic Pencil in Handle of Safety Razor Always at Hand

If you use a safety razor of the type shown, your styptic pencil can be kept inside the hollow handle where it is always at hand when needed. With only a small portion of the pencil projecting, the razor handle will still fit in the case and the astringent can be withdrawn as consumed.

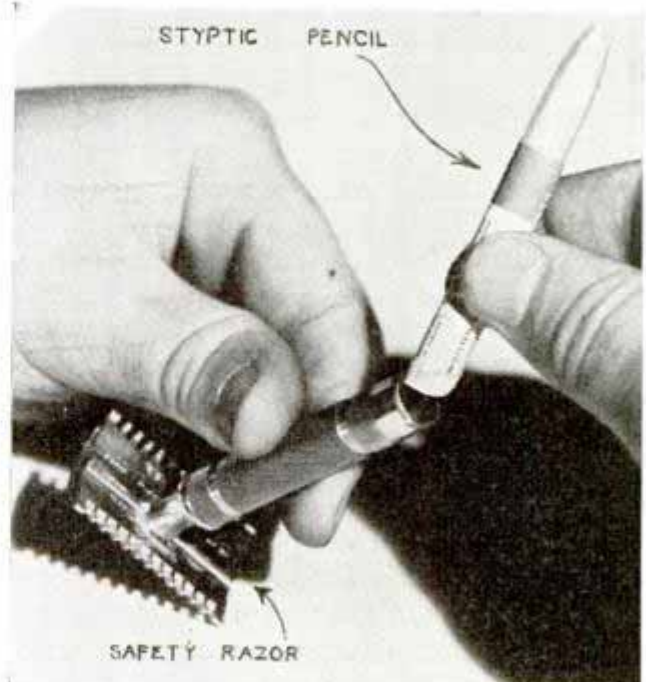

Knurled knob of safety razor is removed so that styptic pencil fits inside hollow handle

Watch Is Kept in Pocket by Rubber Disk

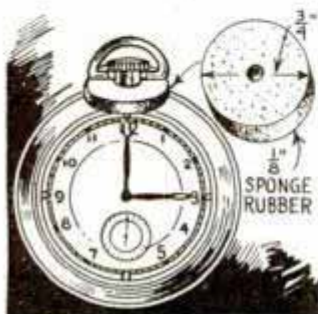

A disk of sponge rubber slipped over the stem of a watch will provide enough friction with the pocket to keep the watch from sliding out.—H. England, Winnipeg, Man., Can.

"MIRACLE

Roots of plants are suspended in a solution of chemicals providing a well-balanced plant food which is always in contact with roots and available for constant consumption

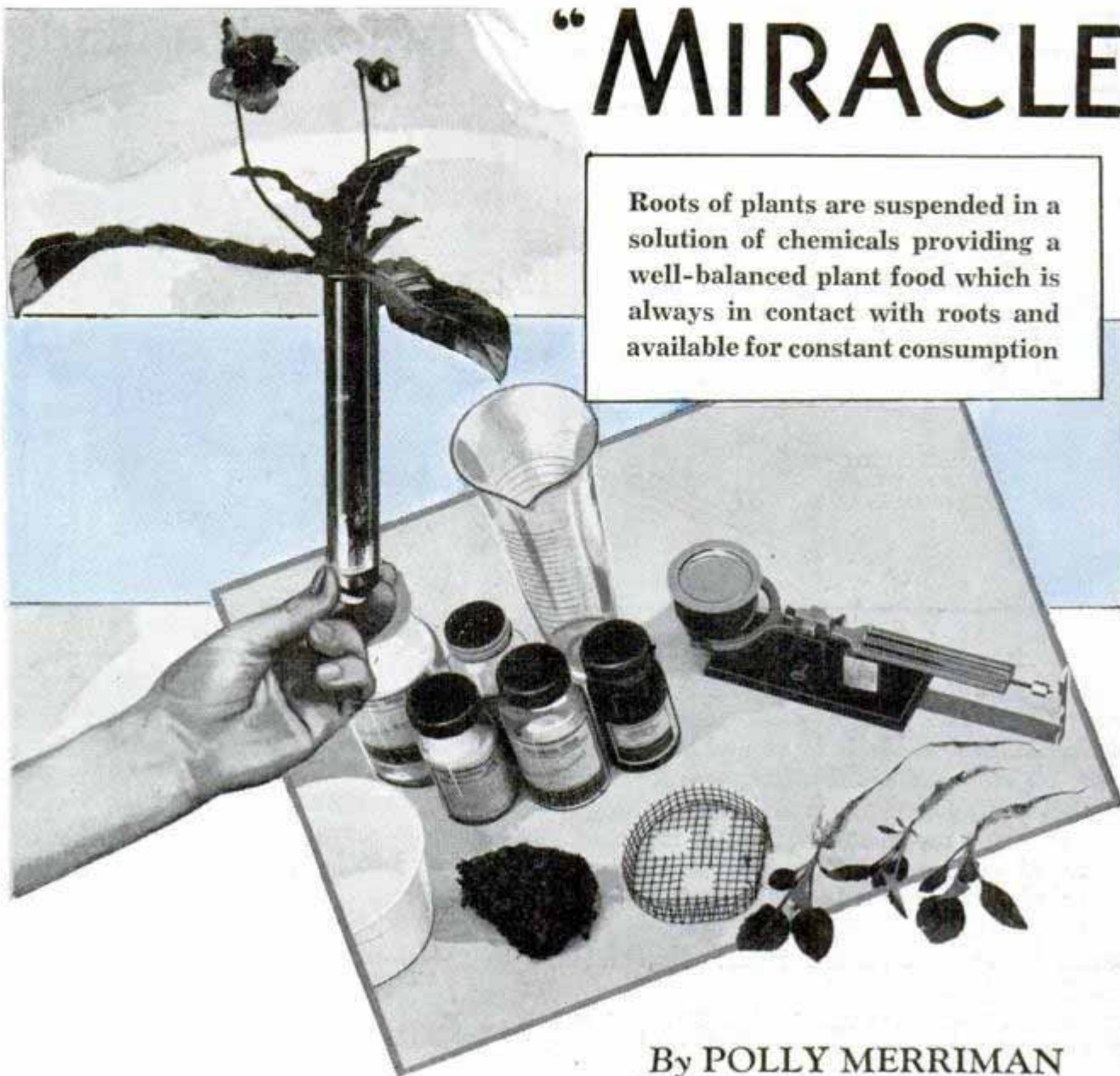

By POLLY MERRIMAN

PLANTS and flowers that are unusually large in size and are prolific bearers can be produced right in your own home. The process followed is known as nutrient-solution culture, and it enables plants to grow without any necessity of rooting in soil. The roots are suspended in a solution of chemicals which provide a well-balanced diet. In this way the roots absorb nutrients in better proportions than is ordinarily possible when food is being collected through a root system imbedded in soil, because all the food required for the plant is always in contact with the roots and thus available for constant consumption. Of course, the same solution applied to soil in which plants are grown will also cause them to thrive better than plants not provided with such additional nutrition.

The nutrient-culture process enables you to grow a plant in a test tube if you desire, or in any pot that will hold liquid. All you need to start such an experimental garden is some bottles of inexpensive chemicals which will cost only a few dollars; a pair of laboratory balances and a graduate for accurate measuring; some peat moss, excelsior, glazed pots and a flat of seedlings. Each pot must be fitted with a tray constructed of $\frac{1}{4}$ -in. galvanized-wire mesh, placed inside the top so that the mesh will rest about 1 in. above the surface of the solution when it is added. See sectional view of the flowerpot. The roots of the plant pass through the wire mesh into the solution and the foliage will rise above the pot. Place the pots where you would place them if you were growing plants in soil.

PLANTS "grow in liquid



Hydrangeas above were grown in a pot arranged as shown in the cutaway view and then fed with a chemical solution given in the table at the left

(BY WEIGHT)	
A	1 GRAM
B	1 GRAM
C	1 GRAM
D	4 GRAMS
E	JUST A TRACE

CHEMICALS MIXED TOGETHER, THEN ADDED TO WATER: 7 LITERS (1 LITER = 1.0567 U.S. LIQUID QT.)

A	POTASSIUM NITRATE (KNO_3)
B	POTASSIUM PHOSPHATE (KH_2PO_4)
C	MAGNESIUM SULPHATE ($MgSO_4$)
D	CALCIUM NITRATE ($Ca(NO_3)_2$)
E	FERROUS SULPHATE ($FeSO_4$)

Formula for a 0.1 Per Cent Plant-Food Solution

these elements must be added. Carbon, hydrogen, oxygen, nitrogen, phosphorus, potassium, sulphur, magnesium, calcium and iron are essential elements in plant growth and development. Of these, carbon, oxygen and hydrogen are obtained by plants from the air in the form of carbon dioxide and water. Nitrogen, phosphorus, potassium, sulphur, magnesium, calcium and iron must be supplied in form of salts. You buy these salts from any chemical supply house and mix your own solutions, using the quantities given in the table. It is in measuring the salts that the laboratory balances and the graduate are needed.

If soil-grown pansies do well in your sun-parlor window, you can grow them there in nutrient solution. If you must grow certain plants under glass in your part of the country, you'll have to keep your nutrient-grown plants in approximately the same temperature. Sufficient humidity also should be maintained when plants are grown indoors during the winter months.

Making up the nutrient solution is very simple. Use of ordinary city water is recommended because it usually contains minute quantities of manganese, zinc, copper, boron, aluminum, lithium, nickel, cobalt, iodine and sodium which are necessary but are not required in large amounts. If rain water is used, minute quantities of

Now fill the pots to within 1 in. of the mesh trays with the solution. Spray the roots of the seedlings to remove the soil. Then slip the roots through the mesh so that they are suspended in the solution. Cover the trays with a 1-in. layer of peat moss. Follow this with a layer of straw or similar material to keep out the light. Then place the plants where they will have the same light and temperature that soil-



In small pots, you can grow plants 40 to 50 in. in diameter. The yardstick was not long enough to measure this one

grown plants would require. Every seven or eight days, renew the solution, gradually increasing the concentration, in a period of two or three months, from .1 per cent to .5 per cent for mature plants. Right here the opportunities for experimentation are almost limitless. Variations in quantities of each of these essential elements affect the plant's development. By slight modification here and there you can intensify color of blossom, lengthen and strengthen flower stalks, produce more foliage or more bloom. Begonias, cannas and other

flowers of a tuberous type, offer particularly promising opportunities for amateurs. You will find that, when grown in nutrient solution, they will materially increase both in size and number of flowers. Potatoes and tomatoes also flourish when grown in tanks, but experience is required before the amateur can expect as great reward from most other vegetables.



Knitting Yarn Kept from Tangling by Guide on Chair Leg

When you sit down for an evening's knitting, just run the yarn through this guide which is slipped over one of the chair legs. The guide holds the yarn at your side and keeps it from moving around and getting entangled in your clothing. To make the guide, rivet together two lengths of spring steel shaped as shown and fit them with a metal ring into a hole at the outer end. Cover the clamp with rubber tubing to avoid marring the chair leg.

☐ When boiling eggs, wetting the shells with cold water before dropping them in the hot water, will help prevent cracking.

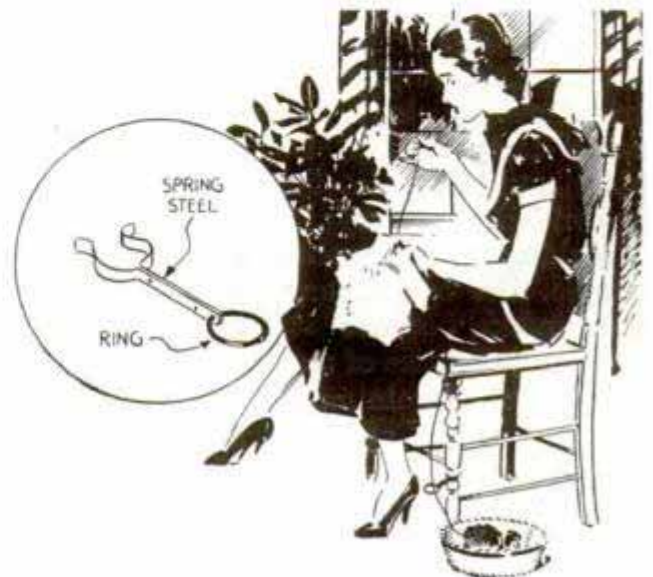

Dennison May Co
21 Birmingham, Mass
Two Novel Uses for "Cellophane" Ribbon



Snappy, professional-appearing signs are assembled easily by cutting the necessary letters from various widths of Cellophane ribbon. First, you make the letters by cementing strips of the ribbon together, using two parallel lines drawn on a piece of cardboard as a template to get the letters of uniform size. Then use cellulose cement to attach the letters permanently to glass,

wood or metal. The ribbon also makes an attractive inlay on wood. Simply turn or rout a shallow groove to take the strip snugly, then, after fitting carefully at the ends, cement in place.

Celluloid Corp. Suite 1100. 10 E. 40th
Closeups Taken with Small Camera Through Reading Glass

As the bellows of many inexpensive cameras used by amateur photographers cannot be extended sufficiently to take closeup photos that cover the negative, the problem often can be solved with an ordinary magnifying glass. This is held in front of the lens as indicated and the object is focused on the ground glass. Small objects can be photographed full size or larger.

Neat Patches in Screen Door

To repair a hole in wire screen so that it will not be noticeable, first trim the hole neatly, as nearly rectangular as possible. Then cut a piece of screen wire about 1 in. larger than the hole each way. Unravel the edges for about three or four strands back. With a straightedge turn the projecting ends up to a sharp right angle. Insert them carefully through the screen, turn them down and tap them flat, using a hammer and a back support to prevent bending the screen out of shape.

—Austen Bolam, Brewster, N. Y.



MAGNIFYING GLASS

Mitering Clamps Are Improved from Angle Iron

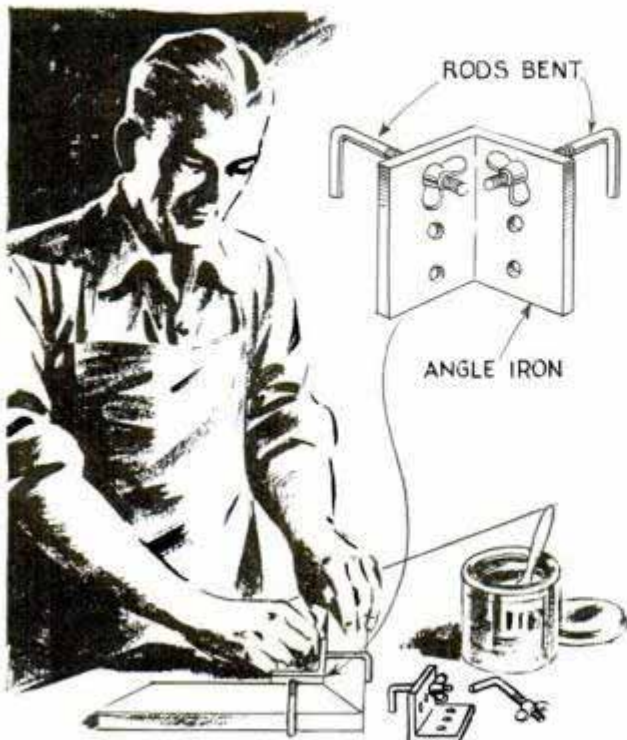

Clamps made from angle iron hold mitered corners in alignment for nailing and gluing

Clamps to hold mitered frames while nailing or gluing them are improvised easily from short pieces of angle iron. They are drilled as indicated to take L-hooks, which are threaded for wing nuts. In use, an angle is set in each corner of the frame, the hooks slipped over the outer edge of the work and the nuts tightened to pull the pieces snugly together at the corner.

Using Pinhole Disk in Camera to Improve Photos

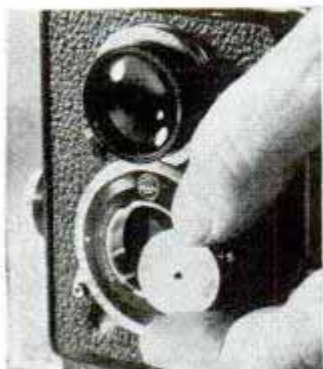

By punching a pinhole in the center of a thin brass disk and inserting it behind the front lens element of a camera, the pinhole takes the place of the shutter iris. The result is pictures having microscopic sharpness, remarkable depth of focus and great detail. Punch the hole with a medium-size needle and finish with a file or emery cloth. Paint both sides of the disk a dead black. As the pinhole is

considerably smaller than the smallest opening ordinarily provided by the shutter iris, a tripod will have to be used and the exposure will have to be prolonged.

considerably smaller than the smallest opening ordinarily provided by the shutter iris, a tripod will have to be used and the exposure will have to be prolonged.

Guards on Drawing-Knife Handle Protect Your Knuckles

When using a drawing knife, there is little danger of cutting the knuckles on the sharp edge of the knife if these metal guards are provided. Each guard consists of a piece of thin metal clamped to the upper end of the grip and screwed or soldered to the lower end.

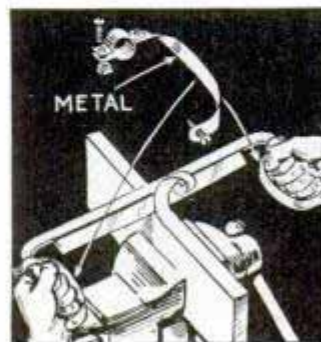

Sandpaper to Point Artist's Pencil Fastened Inside Sketch Book



To assure that a piece of sandpaper would always be at hand for pointing his pencils, one artist fastened it inside the cover of his sketch book with gummed reinforcements.

When the paper is worn or dirty, it's a simple matter to substitute a new piece.

—Thomas Rimac, Chicago.

Film Marking Made Easy

Marking roll films for printing can be accomplished easily by using small tabs of cellulose tape folded over the edge as indicated. Be careful that the end of the tape does not extend onto the exposed part of the film. Film thus marked can be "read" instantly in the darkroom. This

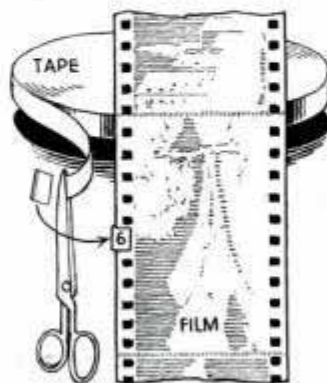

method is much handier than going back and forth to a lighted area to check a list of exposure numbers for a printing order—and is much faster. It is better, too, than nicking or cutting film edges, as the film thus treated is permanently marred and may become scratched or torn.

—Don W. Sigler, Lincoln, Nebr.

Mucilage for Unused Stamp Taken from Envelope

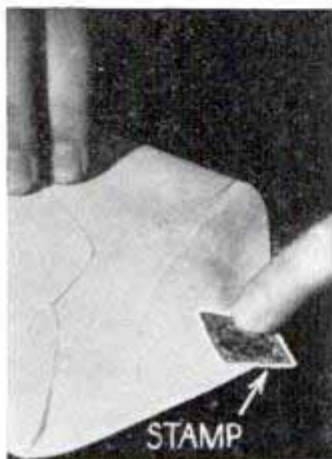

When you transfer an uncanceled postage stamp from one envelope to another, and there is no mucilage at hand, just moisten the flap of the envelope and rub the stamp over it. Enough of the mucilage will adhere to the stamp to make it stick.

Snow Cleared from Skating Pond by Old Truck Wheel

If your favorite skating pond is covered with snow a few inches deep, paths can be cleared easily with an old truck wheel and rim. A pipe handle can be fastened in the hub to push it over the ice, or you can pull it with a rope. If there is only a rim at hand, it can be weighted and the rope fastened into the valve-stem hole with wire.



Paths can be cleared for skating by pushing truck wheel over snow-covered ice

Student's Portable Study Case Holds Writing Materials

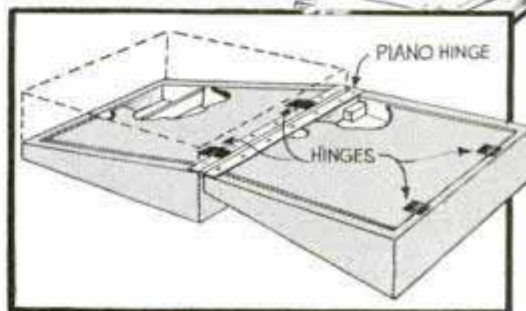

This box keeps your writing materials together, and can be taken any place you want to use it

Here's a handy case for the student who likes to do his home work in different places. It holds pencils, paper and other writing materials, and even serves as a writing desk in an emergency. Made of plywood, it consists of two parts hinged together as indicated and, when opened, two hinged covers provide writing surfaces. The covers can be raised for access to the compartments inside which can be partitioned as desired.

—M. B. Birge, Hinsdale, Ill.

Holder for Nuts and Washers Permits Rapid Selection

Made by soldering lengths of iron rod to a metal disk, this holder keeps spare nuts and washers assorted as to size and type. It is especially handy for the mechanic who must carry extra washers and nuts to different jobs.



Caddy balls, chromium tubing, Co. Krumpholtz - Sullenberg - Clow

Latest

HALL



45° as detailed in Fig. 3. A 3-in. radius is then marked on each end of the stock and a hand plane is used to shape the work roughly down to line. You can speed up this job considerably by first removing most of the waste stock on the jointer. Running part way up the front of each corner piece, a rabbet is cut

By WAYNE C. LECKEY

MADE further useful when fitted with a shelf for books or a small radio, the stately grandfather clock lends itself well to other modern adaptations of finish and fittings. Gleaming metal and bone-white color combinations effect a pleasing new harmony which goes well with almost any modern home furnishings. You can follow any of these designs easily and inexpensively right in your home workshop, using plywood for the greater part of the construction.

To make the clock shown in Fig. 4, your first step is to form the rounded corners of the case as in Figs. 2 and 3. These are cut from flat stock with the saw table set at

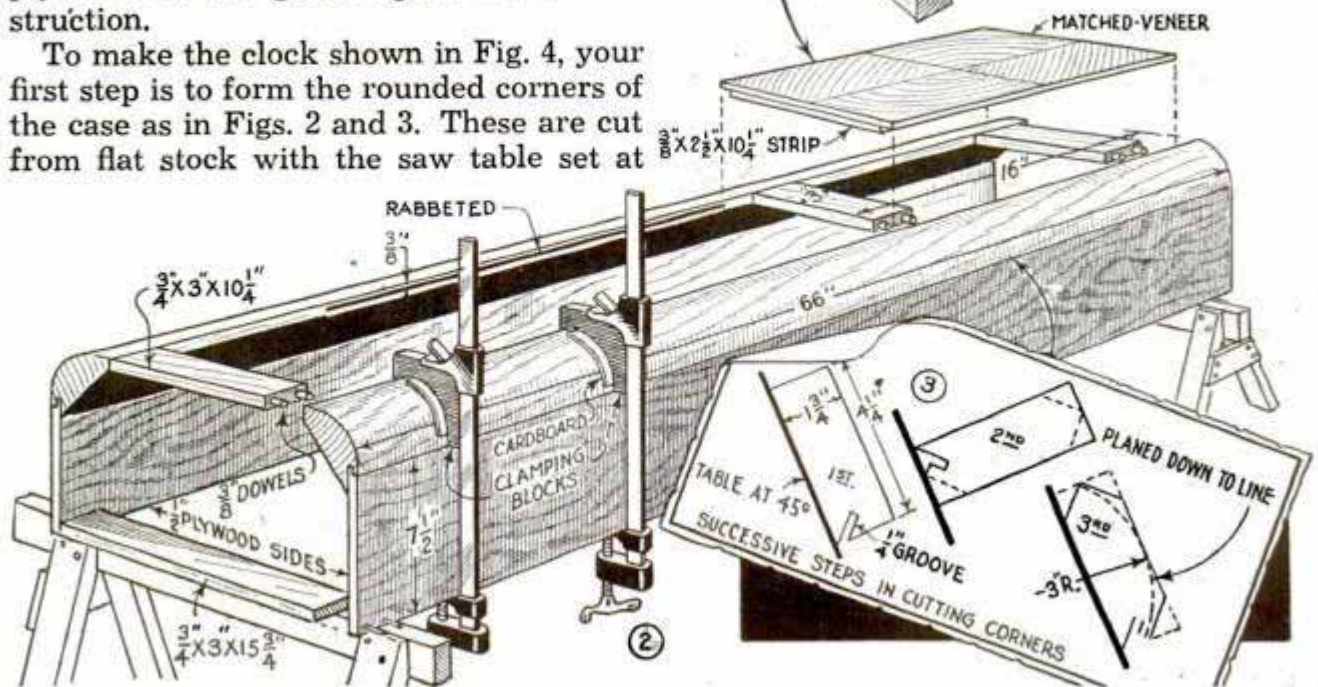
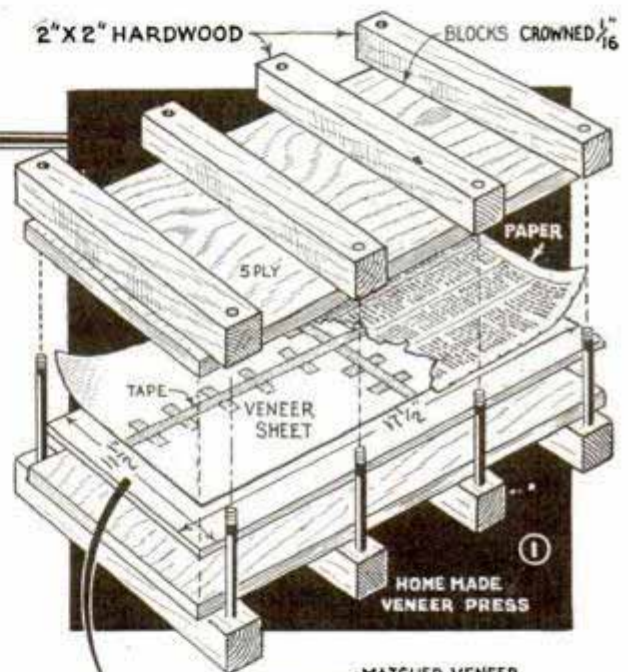

CLOCKS

serve dual purposes



in the edge $\frac{3}{8}$ in. in from the face as shown in the second operation, Fig. 3. These rabbets are later used when stretching the radio cloth across the front of the case.

The corners now can be assembled with three crosspieces doweled and spaced as shown. Several clamping blocks cut from scrap stock will facilitate clamping the work squarely. Plywood side pieces are next cut to size and rabbeted to fit the corner joints and are likewise glued and clamped. These also may be nailed through into the corners. Aprons across the top and bottom give support to the sides at the back. A large, flat block wrapped with sandpaper is used to smooth the corners down flush with the sides and any openings should be well filled with a crack filler to give a smoothly rounded corner.

To match-veneer the panel which is



Chromium-plated caddy balls turned into equally spaced holes drilled on the minute circle serve as numerals. Matching hands are made of chrome tubing

glue over the panel and when very tacky, center the veneer sheet, taped side up, and place it in the press as in Fig. 1. A piece of wax paper or newspaper should be placed on top of the veneer before applying pressure. Allow the work to remain clamped for at least 24 hrs. When dry, trim the edges of the panel square, and across the back, at the top, glue a $\frac{3}{8}$ -in. strip to form a rabbet edge as in Fig. 2.

glued to the front of the case at the bottom, use four selected pieces of $\frac{1}{20}$ -in. walnut burl or crotch veneer. These are arranged to form a diamond-shaped pattern by matching the grain of the four pieces. Trimming the thin stock accurately is best done by clamping the veneer sheet between two lengths of soft stock and planing straight as one piece. Cutting across the grain is done with a metal straightedge and a sharp penknife or a veneer trimming knife, if one is available. Pieces of corresponding grain are then cross-banded together with short lengths of gummed tape to form the pattern. In case you lack a sufficient number of hand screws to apply clamping pressure, a simple, homemade press can be made quickly as shown in Fig. 1. This consists of a number of 2 by 2-in. hardwood strips fitted with short bolts. The work is placed between two panels of heavy, flat stock. A piece of $\frac{1}{4}$ -in. plywood serves as the core to which the veneer is glued. Spread a uniform film of

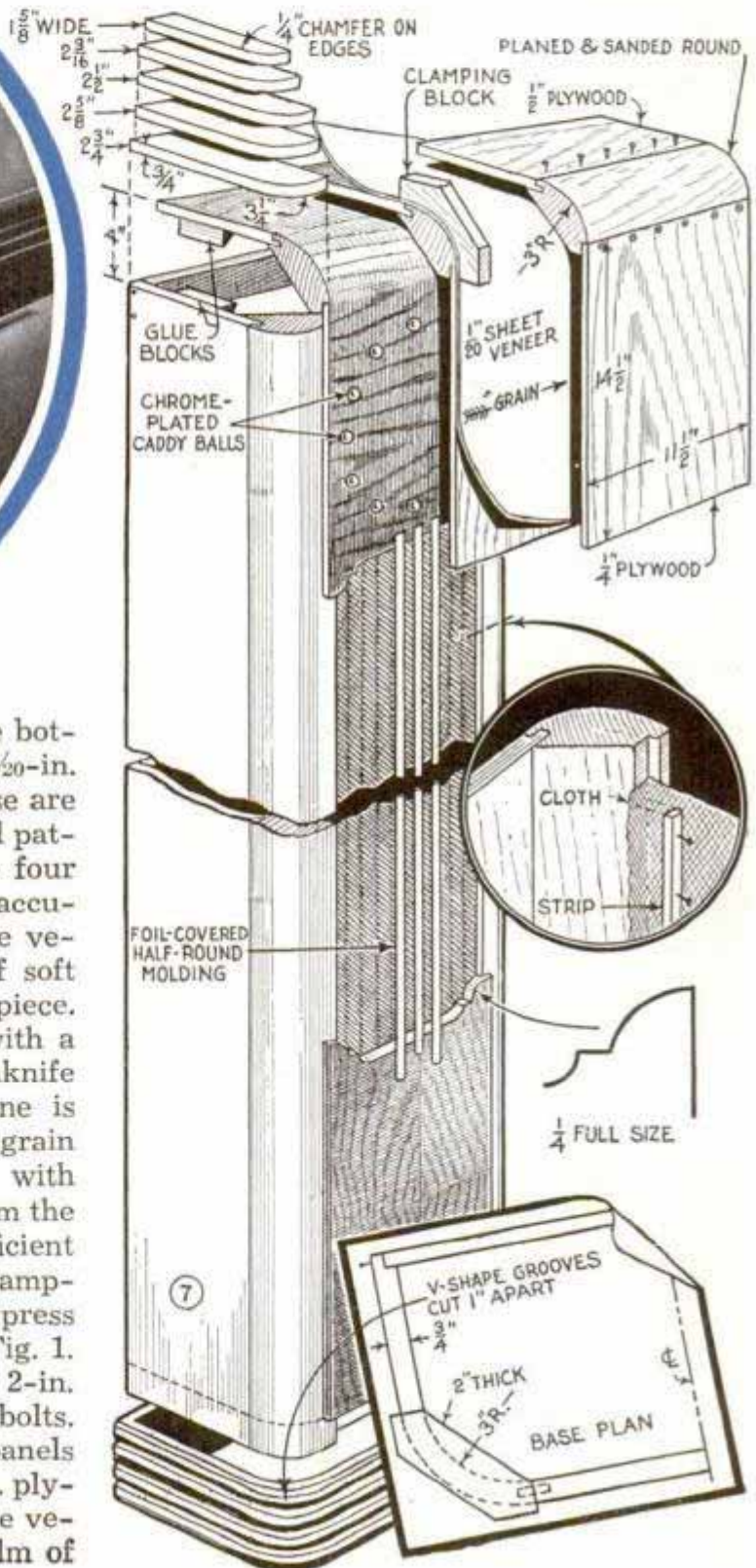

After jigsawing the scrolled edge, Fig. 7, the panel is glued and clamped to the face of the case 2 in. up from the bottom.

Veneering the curved top panel is done in much the same way as just described. A core of plywood and solid stock is first built up as shown at Fig. 7. The rounded corner, to which $\frac{1}{4}$ and $\frac{1}{2}$ -in. plywood is glued and screwed, is cut in the same manner as described for the rounded corners of the case. Veneering this will be found a little more difficult, but if the veneer is applied in stages good results will be obtained. Accu-

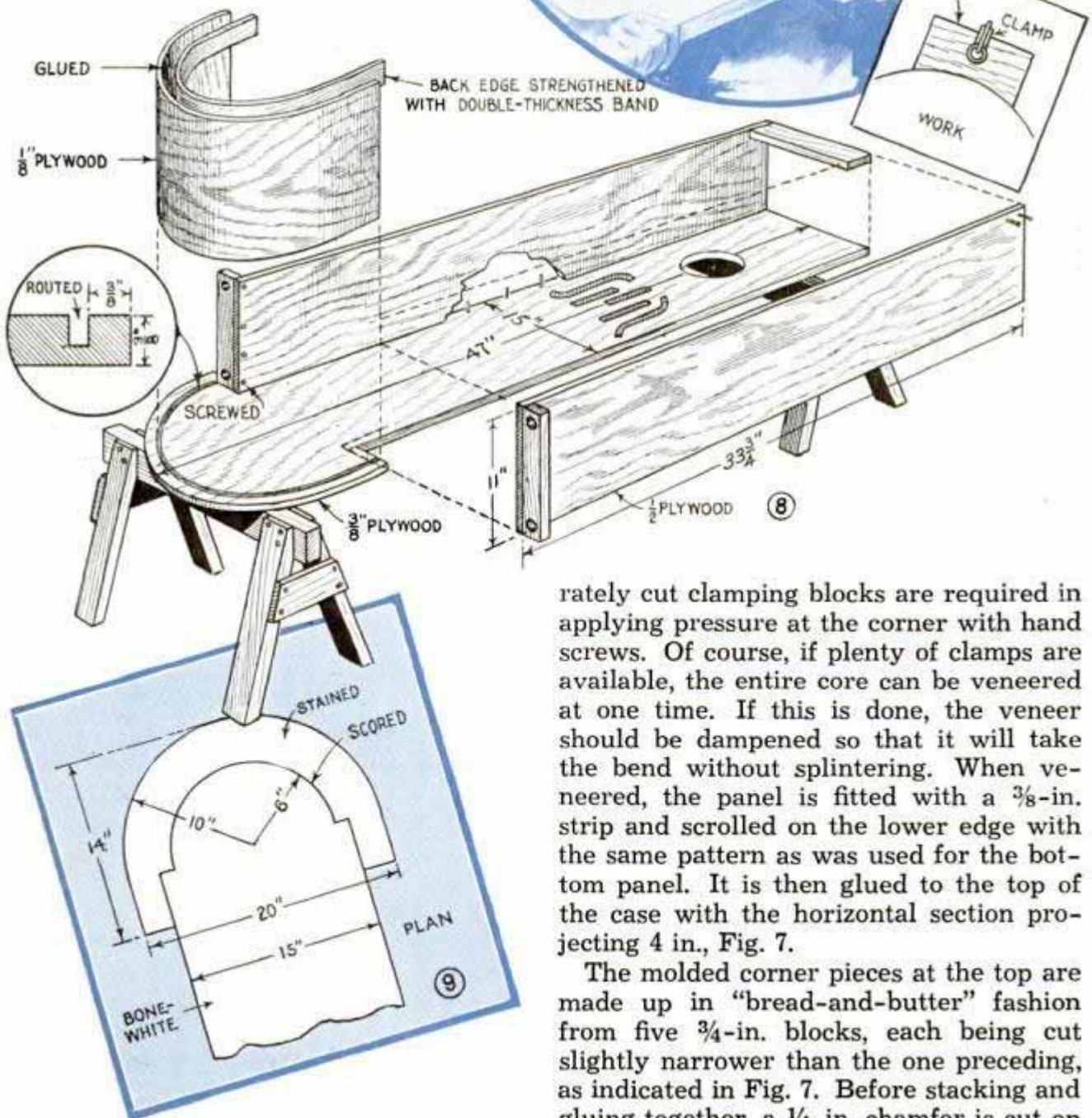

rately cut clamping blocks are required in applying pressure at the corner with hand screws. Of course, if plenty of clamps are available, the entire core can be veneered at one time. If this is done, the veneer should be dampened so that it will take the bend without splintering. When veneered, the panel is fitted with a $\frac{3}{8}$ -in. strip and scrolled on the lower edge with the same pattern as was used for the bottom panel. It is then glued to the top of the case with the horizontal section projecting 4 in., Fig. 7.

The molded corner pieces at the top are made up in "bread-and-butter" fashion from five $\frac{3}{4}$ -in. blocks, each being cut slightly narrower than the one preceding, as indicated in Fig. 7. Before stacking and gluing together, a $\frac{1}{4}$ -in. chamfer is cut on

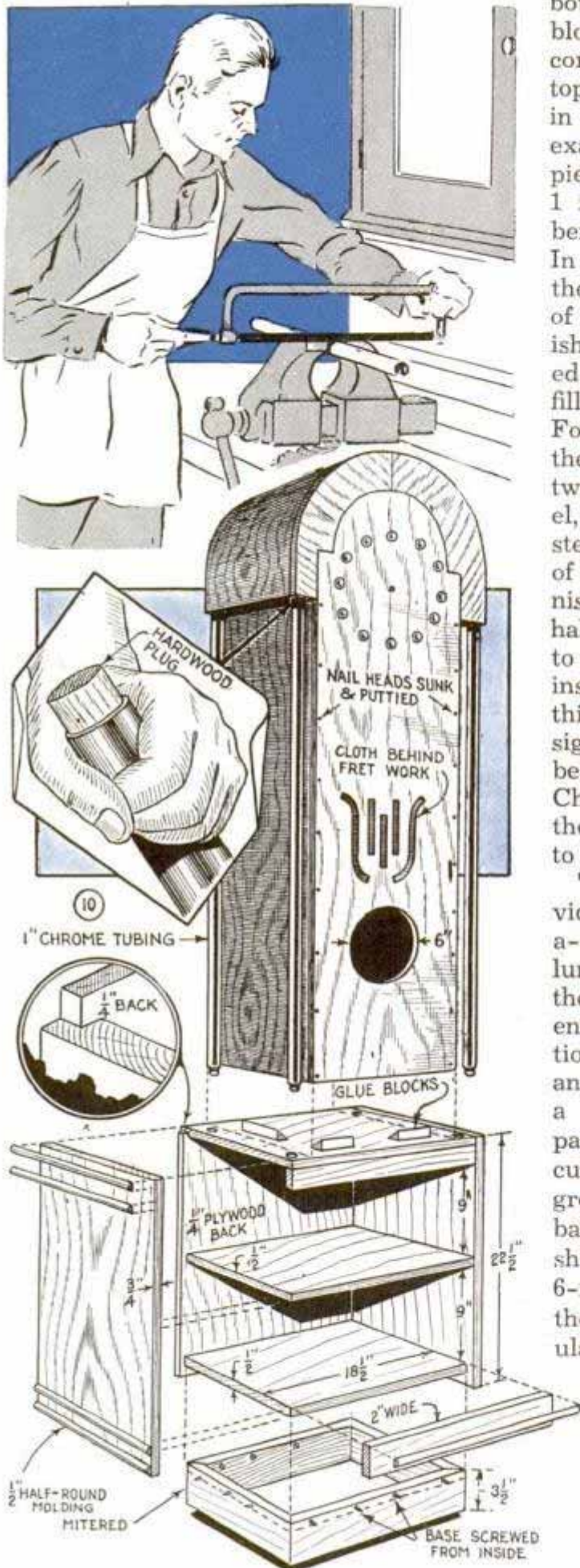

both edges of each piece. Triangular glue blocks fitted to the inside help hold the corner pieces in place at each side of the top. The curved base is formed with set-in corners bandsawed to conform to the exact contour of the corresponding corner pieces of the case. Three V cuts, spaced 1 in. apart, are run around the surface before attaching to the case with screws. In shaping, the work is held on edge with the spindle collar bearing against the face of the work. At this point it is well to finish the clock. The entire job is first sanded down to a smooth finish, with paste filler being added to the veneered surfaces. Following this, an undercoat is applied to the surfaces to be painted and over this two coats of semi-gloss, bone-white enamel, rubbing down between coats with fine steel wool. The stained surfaces should, of course, be shellacked and waxed or varnished. After finishing, three strips of half-round silver-foil molding are attached to the center of the opening with screws inserted from the back. You can purchase this foil-covered molding from your local sign maker. Radio cloth is then stretched behind the moldings as shown in Fig. 7. Chromium-plated caddy balls which form the clock dial are screwed in a 9-in. circle to the face of the top panel.

The case shown in Fig. 5, which provides space at the bottom for books, bric-a-brac, etc., makes the swinging pendulum visible through a circular opening in the front. The upper assembly, which is entirely of plywood, is of simple construction and is fully dimensioned in Figs. 8 and 10. For the $\frac{3}{8}$ -in. front piece, select a finely grained panel such as birch, as part of the top is to be stained dark. After cutting the front panel to shape, a $\frac{1}{4}$ -in. groove is routed around the edge on the back side in which is fitted the circular-shaped hood, Fig. 8. The location of the 6-in. hole in the front is dependent upon the length of the pendulum of the particular clock movement to be used. When the necessary jigsawed cuts are made in the front piece, you can begin assembling the side pieces. These are nailed to the front and screwed to narrow horizontal strips bored for the column tenons. The hood is bent to conform with the routed groove, from $\frac{1}{8}$ -in. plywood, afterward being

reinforced at the edges by gluing in a narrow plywood band as shown in Fig. 8. Sink all nail heads and fill the holes with putty. Fig. 10 details the manner in which the lower unit is assembled. Simple butt joints are employed and the back is inclosed with a $\frac{1}{4}$ -in. plywood panel. Before joining the two sections together with screws and glue blocks, corresponding holes must be bored in alinement to take the 1-in. chrome tubing which forms corner posts on each side of the case. The joint across the front where the two sections meet is concealed by narrow strips of half-round molding. In finishing, the tubing can be protected from paint by wrapping with paper. Give the entire job, except the stained portion around the face at the top, a bone-white finish.

The clock case shown in Fig. 6 and detailed in Figs. 12 to 15 inclusive, is suitable for the installation of a small radio chassis. This case is also made almost entirely of plywood. The lower section is a simple, box-like structure

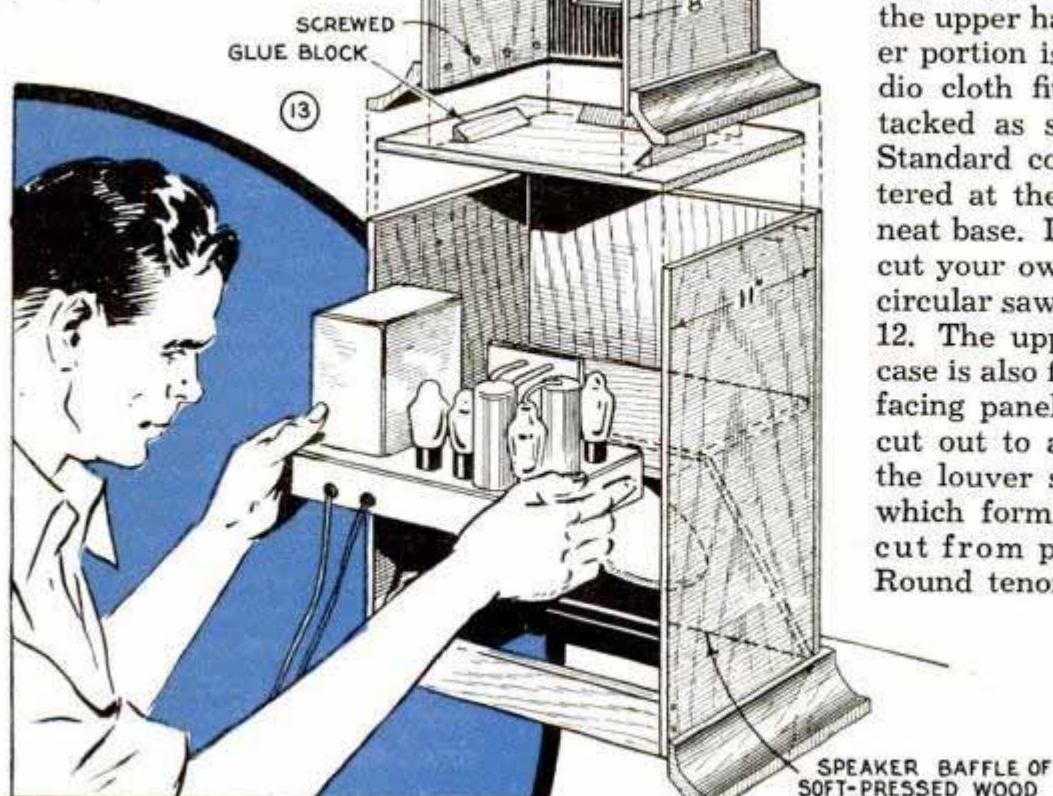

with a suitable shelf fitted to accommodate the chassis and speaker at hand. The front is partly covered with a scroll-cut panel which is nailed flush with the sides. Holes for the dial mountings are made in the upper half, while the lower portion is backed with radio cloth fitted with strips tacked as shown in Fig. 10. Standard cove molding mitered at the corners forms a neat base. If desired, you can cut your own molding on the circular saw as in Figs. 11 and 12. The upper section of the case is also fitted with a $\frac{1}{4}$ -in. facing panel nailed flush and cut out to admit the slats of the louver section. The slats which form the louver are cut from pine lattice stock. Round tenons are formed on the ends of the slats by first cutting a square tenon as in Fig. 10. This can be

The case below is especially designed for the dual purpose of housing the clock movement and a radio chassis. A novel shuttered front, extreme simplicity of line and an enameled finish make it unusually attractive

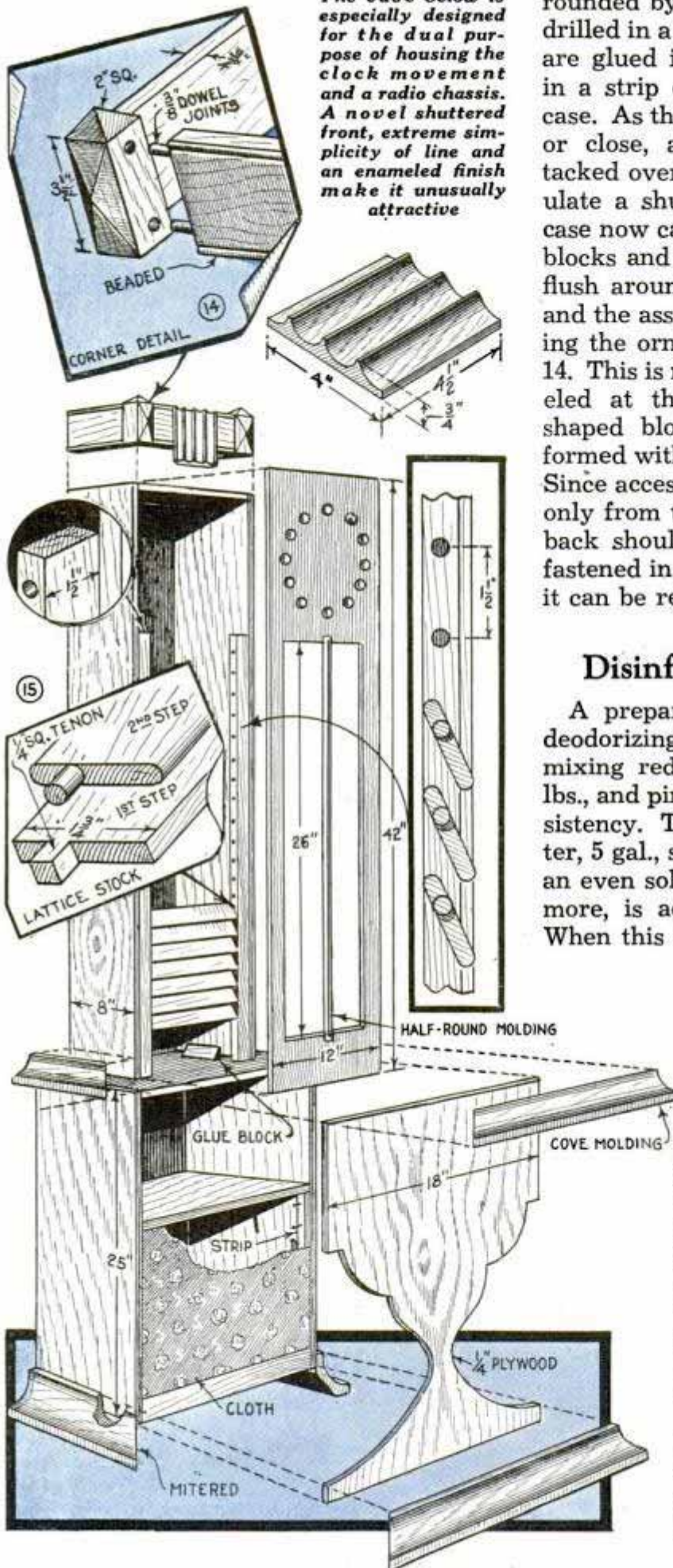

rounded by twisting through a $\frac{1}{4}$ -in. hole drilled in a scrap of flat iron. These tenons are glued in equally spaced holes drilled in a strip extending up each side of the case. As the louver is not intended to open or close, a narrow strip of molding is tacked over the center of the slats to simulate a shutter. The two sections of the case now can be joined together with glue, blocks and screws. Cove molding is fitted flush around the top of the lower section and the assembly job is completed by adding the ornamental top as detailed in Fig. 14. This is made up from $\frac{3}{4}$ -in. stock doweled at the front corners to diamond-shaped blocks. A small fluted over-layer formed with a gouge is glued to the center. Since access to the clock works can be had only from the back on all these cases, the back should be fitted with a light panel fastened in place with small screws so that it can be removed easily.

Disinfectant and Deodorizer

A preparation having disinfecting and deodorizing properties may be made by mixing red oil, 6 lbs., triethanolamine, 3 lbs., and pine oil, 30 lbs., until of even consistency. To this soapy mixture, add water, 5 gal., slowly while stirring to produce an even solution. Next, pine oil, 60 lbs. or more, is added while continuing to stir. When this is evenly mixed into the milky solution, add water, $7\frac{1}{2}$ gal., and again stir until mixed. For use, water is added to this concentrated product while stirring in the proportions of one part of concentrated solution to 15 or 20 parts of water. The diluted solution has a refreshing odor and may be sprinkled or sprayed in outbuildings, etc., where a deodorant and disinfectant are desirable. The concentrated product will keep well, and may be made up in quantity and stored for use as required.

☐ Metal separators of ice-cube trays provide good biscuit and cookie cutters if they are first dried and dipped in flour.

Toy-Train Signals Operate on Flashlight Cells

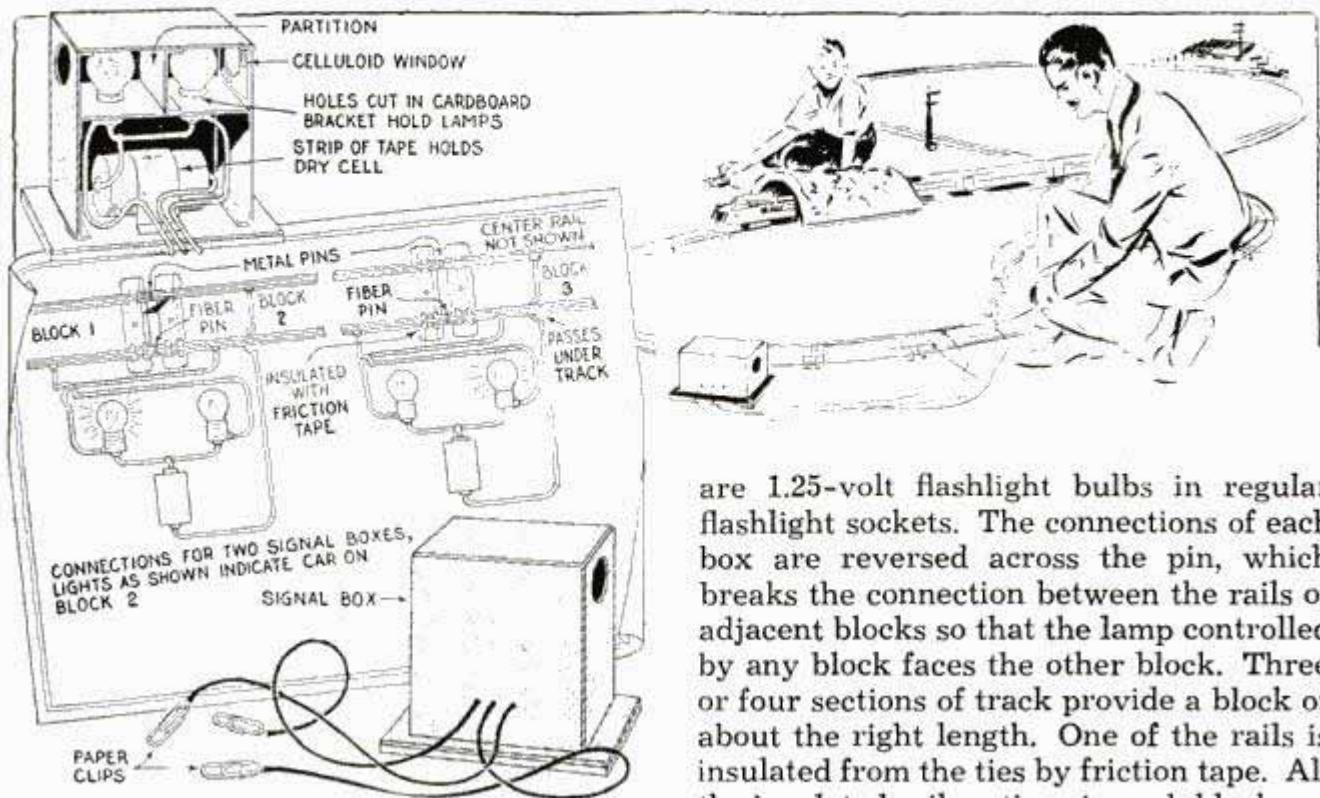

These inexpensive toy-train block signals are operated by flashlight cells so that they are suitable for electric or spring-wound trains. Each signal is a self-contained unit, and consists of one cell and two lamps inside of a cardboard box, which is assembled with paper tape. The lamps

are 1.25-volt flashlight bulbs in regular flashlight sockets. The connections of each box are reversed across the pin, which breaks the connection between the rails of adjacent blocks so that the lamp controlled by any block faces the other block. Three or four sections of track provide a block of about the right length. One of the rails is insulated from the ties by friction tape. All the insulated rail sections in each block are joined by metal pins, and the connections between the blocks are made with wood or fiber pins. All wire connections are soldered. However, if removable connectors are desired, paper clips soldered to the ends of the wires are convenient.

—John Little Story, Oklahoma City, Okla.

Bell Suspended on Door Rings when the Knob Is Turned

Those who desire to leave a door unlocked but connected to an alarm which will sound if the door knob is turned, will find this portable bell just the thing. It consists of an electric doorbell or buzzer and a flashlight cell mounted on a base. A length of heavy wire is pivoted to the base and is provided with a hook to slip snugly over the knob shank. One wire runs from the flashlight cell to one terminal of the bell and a second wire runs from the other terminal of the bell to the pivot point of the support wire. When the bell is hung in place and the knob turned, the free end of the support wire contacts the flashlight cell and closes the circuit.

—L. B. Johnson, Spokane, Wash.

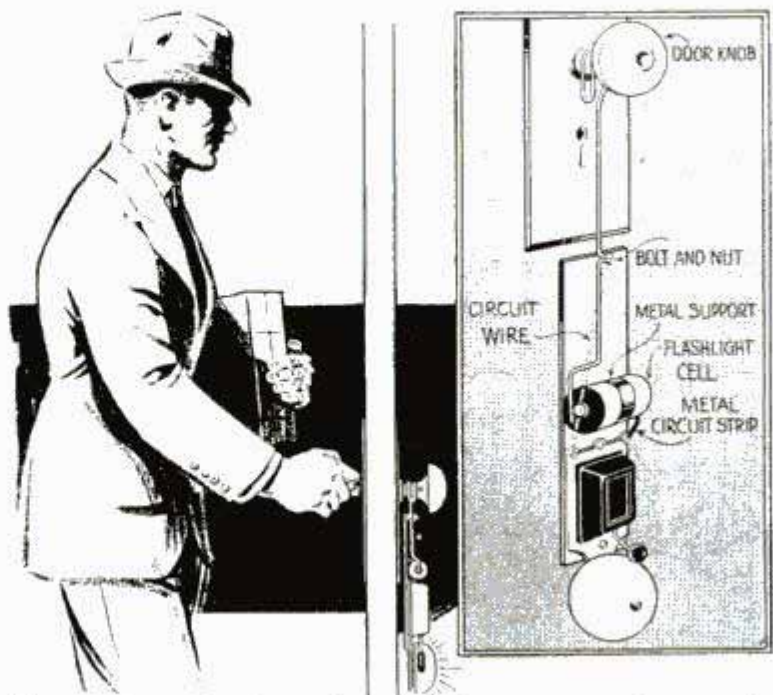

You can leave the door unlocked without worrying because the bell will ring when the knob is turned

Spacing Wire in Resistance Coil Uniformly by Using Weight

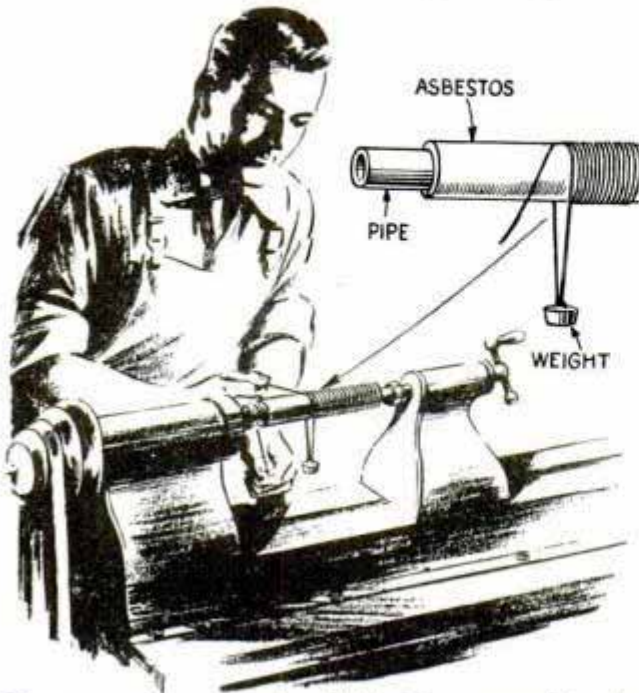

You can get any spacing desired by suspending the weight with a cord or wire having the right diameter

When winding a resistance coil, I space the windings uniformly by a small weight suspended from the tube or core on which the coil is being wound. The weight moves forward as each turn is made, and spaces the windings a distance equal to the thickness of the cord or wire with which the weight is suspended.

—J. F. Docker, Vancouver, B. C., Can.

Bird Perches from Coat Hooks

Neat perches in your aviary or pigeon pen can be improvised by screwing small wood platforms to the ends of common wire coat hooks as indicated. The portions

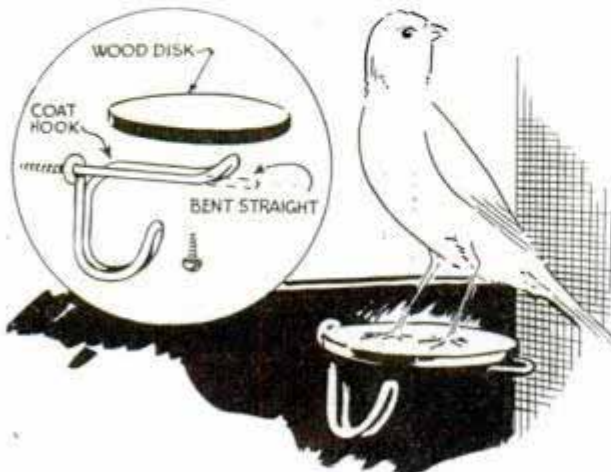

Attach a wood disk to a coat hook and you have a perch that can be driven into the aviary wall

of the hooks that are turned up at the ends should be straightened with a pair of pliers so that the platforms will be horizontal.

Camera Filter Held in Pocket by Pencil Clip

Soldered to a camera-filter case, a pencil clip prevents losing the case from your pocket and keeps it in a handy position. This idea is especially useful when only one filter is carried because you haven't space for a regular filter case which holds several.

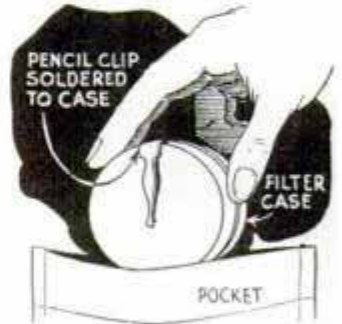

Flower-Vase Frog Improvised from Paraffin

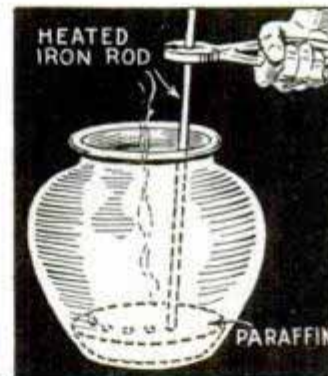

The next time you need a frog to hold cut flowers in a vase, pour some melted paraffin into it, and, when cool, use a heated iron rod to form the holes in the wax. Heat the vase in warm water to remove the paraffin

after it has served its purpose.

—Mrs. E. H. Lott, Baton Rouge, La.

Snapshots Glued in Album with Aid of Eye Dropper

When mounting snapshots in an album, you can do a neat job if the mucilage is applied with an ordinary eye dropper having a piece of cigarette-lighter wick projecting slightly from the end. The dropper is filled with mucilage



and is used as a brush, which leaves a narrow line of glue on the backs of prints.

From Auto Gas Lines to Decorative Novelties

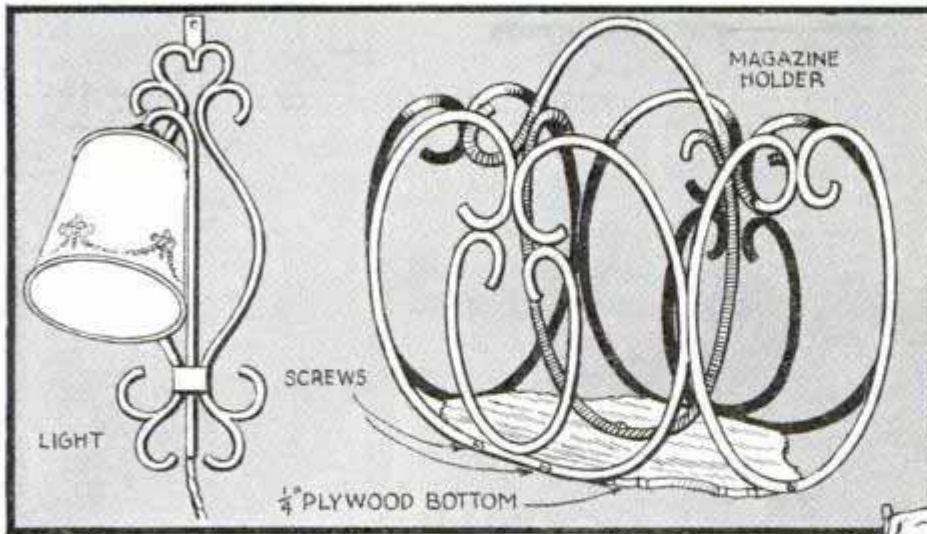

Offering the metal worker a little change from the usual hammered-copper work, these two articles are made of $\frac{1}{4}$ -in. copper tubing—old auto gas lines and refrigerator lines furnishing the materials. Old tubing should be straightened carefully and all grease, dirt or paint removed. If a lustrous finish is desired, polish the tubing thoroughly before forming. Sketch the center lines of the curves and bend the tubing as shown at the right. Pinch the ends to close the openings and file the rough edges. In assembling the magazine holder, solder the parts for the sides together first. Then cut out the bottom and screw the sides and ends to it before soldering the corners. Solder the handle in place and finally the division. For the pin-up lamp, the tubing should be flattened a

distance of 3 in. at each end. The flattened part is cut down the middle with shears and the two halves bent to form the curves at the top and bottom. The tube through which the cord is carried is made of $\frac{3}{8}$ -in. tubing and has a socket sweated on one end. A piece of sheet copper $\frac{3}{8}$ by 1 in., with a small hole in one end, is soldered to the top to provide a means of hanging. When a polished finish is wanted, a narrow band of sheet copper carefully sweated over the joints will conceal the solder.

Carton with 'Cellophane' Cover Makes Darkroom Safelight

Suitable for both printing and enlarging, this photo safelight is made from a pint

ice-cream carton and a small piece of Cellophane. A hole is cut in the bottom of the carton to take a two-piece porcelain receptacle to which a cord is attached. Then the cardboard disk is removed from the lid and a piece of Cellophane—red for enlarging, yellow for contact printing—is placed over the open end of the carton and the lid put back in place. Trimming off the rough edges of the Cellophane with scissors or razor blade completes the job.



These photo safelights are so easy to make that you'll want several of them for your darkroom

—Arthur Trauffer, Davenport, Ia.

Kite Made from Rubber Balloon Flies in Light Breeze



All you need for this kite is a toy balloon, a piece of balsa two-thirds as long as the balloon, and string

Here is a kite that you can make for a few cents, and you can fly it any day because it takes little breeze to raise it aloft. It consists of a sausage-type toy rubber balloon fitted with a balsa wing 3 in. wide, which is attached with a paper band about one-third the distance from the tip. In assembling the kite, deflate the balloon a trifle so that the paper band will grip tightly when the balloon is again inflated. The kite harness consists of two strings attached near the wing tips as indicated.

Pencil-Sharpener Blades Whetted to Renew Dull Cutting Edges

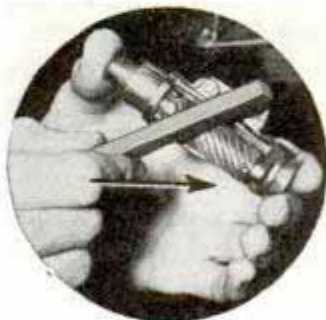

Pencil sharpeners dull with use like other cutting tools, but they can be renewed with an ordinary pocket whetstone. The rotary assembly is removed from the frame and a whetstone rubbed across the blades in the direction indicated by the arrow, causing the cutter to rotate and the blades to sharpen evenly. After making thirty to forty light

strokes on each cutter, the sharpener should be ready to reassemble.

—Marvin F. Carter, Memphis, Tenn.

Special Numbers Are Handy under Base of Telephone

Special or personal telephone numbers, which one may wish to use frequently without reference to the book, or those which are unlisted and it is desired to keep them from view of other persons who



might use the phone, may be written on a piece of paper which is then pasted on the underside of the phone base. To protect the paper it may be given a coat of shellac or covered with a piece of Cellophane.

Flag Supported on Your Lawn with Umbrella Frame

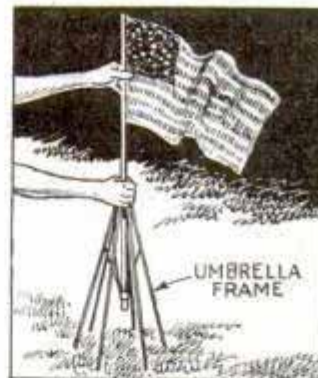

Old umbrella frames will serve to support flags that are to be set on a lawn or other places where the staff is usually driven into the ground. Half of the ribs are removed and the flag staff is fitted into

the permanent and sliding sockets in place of the umbrella handle. When not in use, the frame is folded against the staff.

Marble and Porcelain Cleaner

Marble and porcelain are readily cleaned by applying the following mixture with a stiff brush: diatomaceous earth, 3 oz., sodium sulphate, 5½ lbs., and sulphuric acid (conc.), 9 oz. The acid is corrosive and should be handled with care. The finished product may be stored in glass bottles. After applying the cleaner it is washed away with water to prevent pitting.

slage 2oz. 36 cents

see ad 163a. 1 lb. 25 cents 5 lb. \$1.00 X 505



ad in page 153a

NEW POTTERY CLAY

fired in your kitchen oven

By R. O. BUCK

WITH low-temperature potter's clay now available at nominal cost, the work can be fired in the oven of your kitchen stove. The new clay has the same characteristics as ordinary pottery clay and is worked in the same manner. It is purchased in powder form and mixed with water to a consistency where it can be handled without sticking to the fingers. A number of small articles that anyone can make are shown in Fig. 1. Some of these may be ornamented by inscribing designs on the soft clay with a sharp instrument as in Fig. 2. The clay is thoroughly kneaded with the hands, as in Fig. 5, to eliminate air bubbles and produce a uniform texture. The mixed clay is kept in a glass or earthenware jar and covered with a damp cloth. Unused clay that has hardened but has not been fired can be remixed by pulverizing it and mixing with water in the original manner.

Pottery is best manipulated on disks of plaster of paris, called "bats," which are made by the simple method shown in Fig. 3 and the right detail of Fig. 4. Perhaps the simplest method of making small pottery pieces is by means of successive coils of clay placed one on the other. Taking the



DESIGNS MAY BE "ETCHED" IN CLAY BEFORE FIRING

simple bowl shown in the left detail of Fig. 4 for an example, you first flatten a piece of well kneaded clay on one of the bats as in Fig. 6 until it is about $\frac{3}{8}$ in. thick and cut it down with a knife to a disk of the size desired for the bottom of the bowl. A drinking glass or other circular object may be used for a pattern. A piece of clay about the size of an egg is next rolled on some flat surface with the palm of the hand to produce a "rope" about $\frac{1}{2}$ in. in diameter. After dampening the



very important for if it were fired before drying thoroughly steam would be formed and the piece would crumble. At the end of the drying period further smoothing and polishing with sandpaper is possible and usually advisable.

Firing is next. The piece, which should be perfectly dry, is first coated with a special liquid glaze, applied with a brush. Apply as many coats as necessary to produce a surface that remains glossy. Allow the glaze to dry for 30 min., then place the piece in the center of a kitchen-stove oven where it will heat uniformly on all sides. Heat the oven slowly until a maximum temperature of 250 degrees Fahr. is reached. Keep this temperature for 15 min.,

then turn off the heat but leave the piece in the oven until it has cooled. When the piece is removed it will be hard and water resistant. Oil colors, enamels, lacquers or even show-card colors may be used for coloring your pieces as desired.

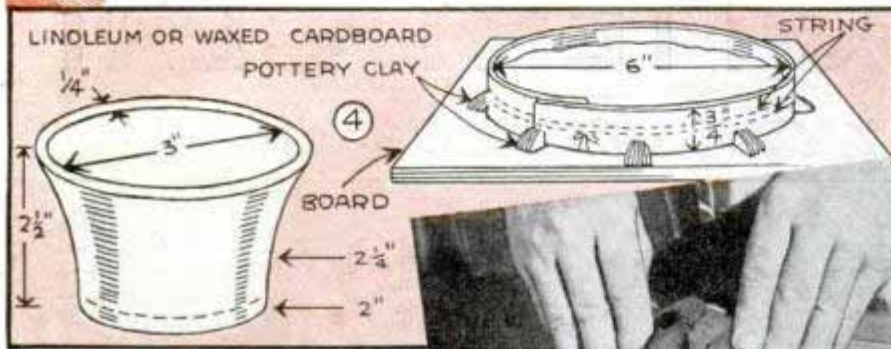

bottom disk slightly with a sponge, start building up the side walls of the bowl by placing a coil on the disk at the edge, as in Fig. 7. The joint between the ends of the coil should be beveled off with a knife to form a lap. Press the coil into contact, both inside and out, with the fingers to form a firm bond. Now add another coil in the same manner, taking care to dampen the surfaces between them, and continue until the object has been built up to the desired size and shape. A small paring knife, held flat against the work, is used for "welding" the coils and also for smoothing the surfaces. Increasing the diameter of the coils produces the flaring top shown. Cut the top off straight with the knife, smooth the surface by moistening slightly and polishing with the side of the knife blade. Depressions may be filled and leveled by working bits of soft clay into them with the knife after the piece has partly hardened. At least 24 hrs. should be allowed for the clay to dry out. This is



If glaze is applied over the color a high gloss will be produced.

Plaster-of-paris molds greatly enlarge the scope of pottery work. A mold is made by pouring plaster over a model which may be either of pottery, metal or clay. Fig. 10 shows the steps in making a plaster mold. For a beginning it is desirable to make a simple mold of some basic shape such as a hemisphere, from which a variety of combinations is possible. A well rounded, small bowl is suggested for a model. After the mold has set and the model is removed, the process is very simple. First moisten the inside of the mold with a clean sponge, then dust with ground flint or talcum powder to prevent the clay from sticking to it. Now take a lump of well worked clay, flatten it into a disk and lay it over the mold, pressing it firmly on all sides to the shape of the depression in the mold as in Fig. 11. Care must be taken to maintain an even thickness throughout.

The excess clay around the top is trimmed off and the work is set away for a few minutes. As the plaster mold absorbs the moisture from the clay, the latter will loosen from the walls and the piece may be eased from the mold by tipping it upside down. If the clay is inclined to stick in the depressions, gentle tapping will loosen it. As the clay is still very soft it must be handled carefully and set away to dry before continuing.

Flat objects, such as book ends, are made by joining flat pieces of clay

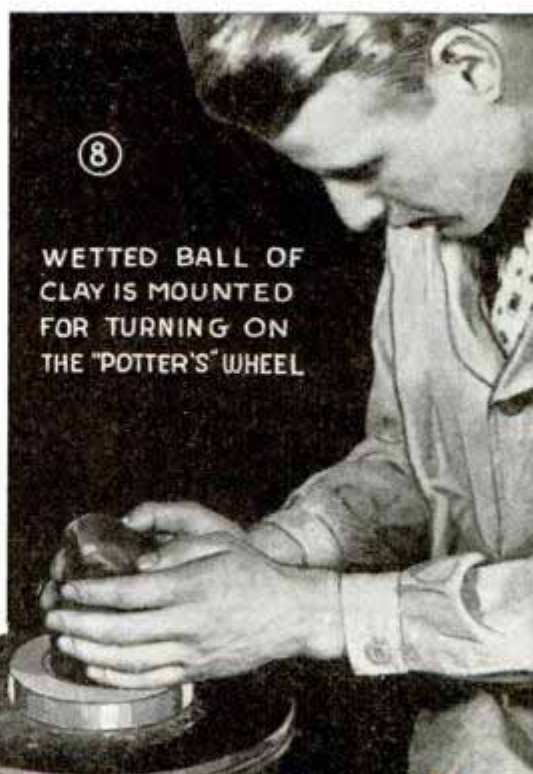

8
WETTED BALL OF CLAY IS MOUNTED FOR TURNING ON THE "POTTER'S" WHEEL



9
CENTERING THE CLAY BALL

together and adding cast or modeled ornaments. Separate pieces such as handles and feet are fastened on with "slip," which is simply clay thinned with water to the consistency of cream. Because of the danger of cracking, due to contraction when firing, it is unwise to have the pieces thicker than $\frac{3}{8}$ in. Where greater thickness at the

outside is desirable, the back should be recessed out leaving the full thickness at the edges. Molded figures can be hollowed out with a knife after they are partly dry.

Having "graduated" from the simpler phases of pottery making, you will want to try your hand at the potter's wheel. Fig. 12

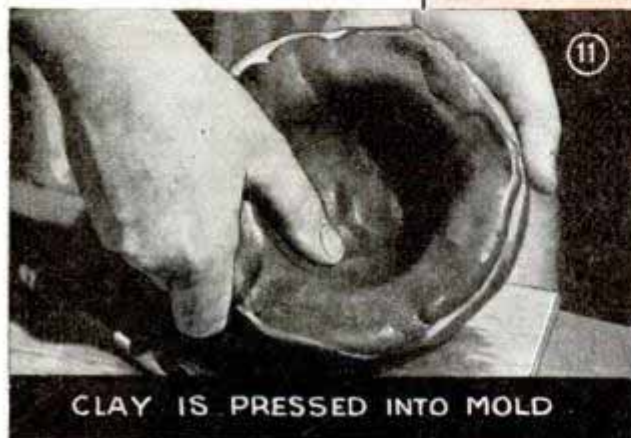

11
CLAY IS PRESSED INTO MOLD

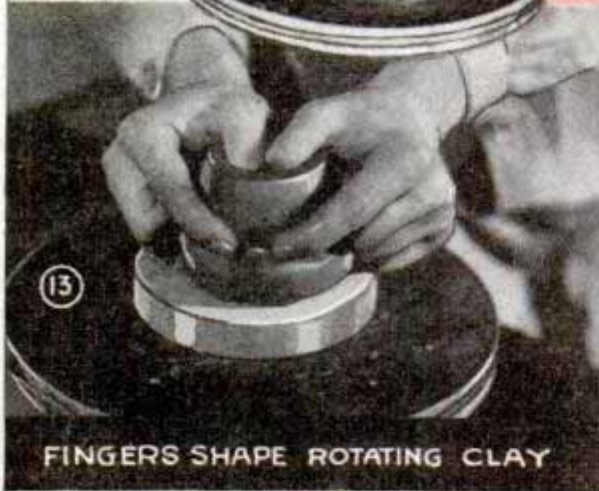
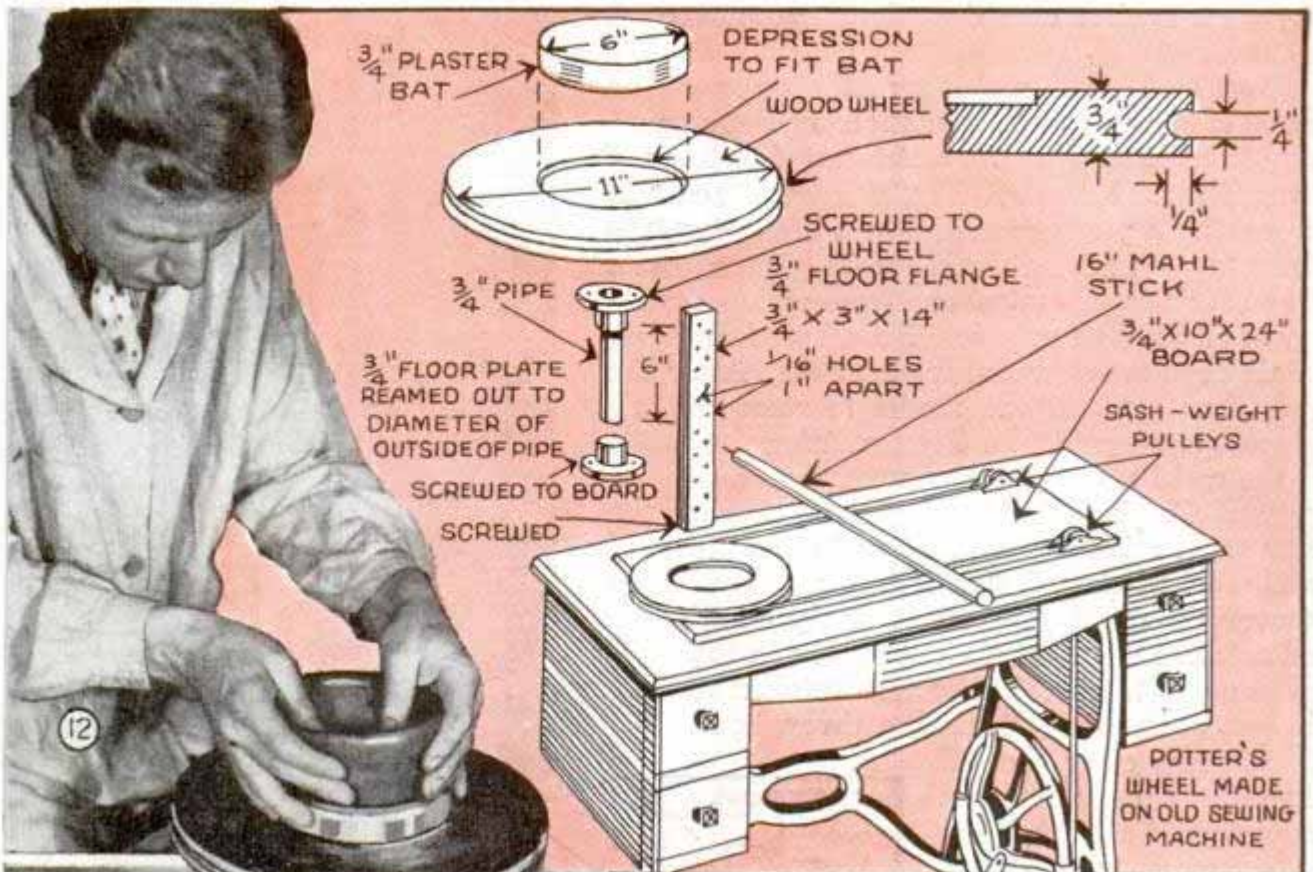

FINGERS SHAPE ROTATING CLAY

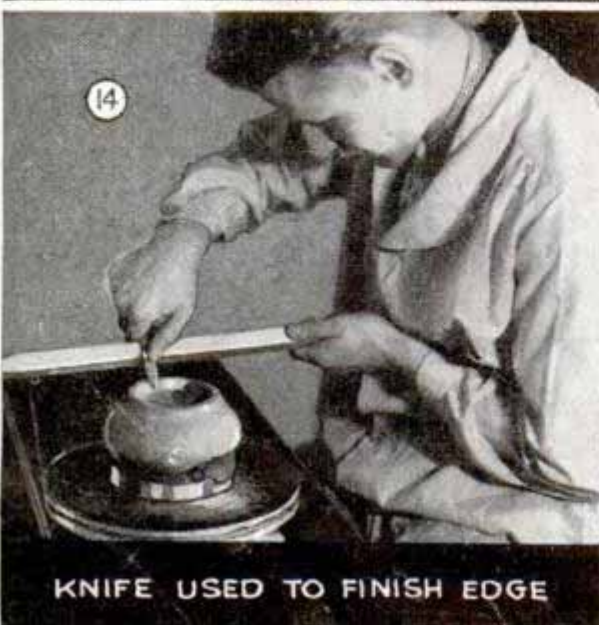

KNIFE USED TO FINISH EDGE

shows a simple type of wheel that can be made readily with an old sewing-machine frame. The manipulation of the potter's wheel requires some practice, but as the clay may be used over and over, early failures are not serious. For a beginning, take a small ball of clay about the size of a fist. Dip the clay in water and mount on a plaster bat which in turn is mounted on the wheel as in Fig. 8. The piece should be centered as nearly as possible by drawing a circle on the bat with a pencil held firmly against the mahlstick as shown in Fig. 9, and the clay forced into place equidistant from the circle. Now start the wheel revolving again, wet the hands and with the hands held in the position shown in Fig. 12, shape the clay into a cylinder. The inside is hollowed out by holding the thumbs at the center, the fingers at the outside and working the clay toward the outside in the manner shown in Fig. 13. A knife and mahlstick may be used to finish the edge as shown in Fig. 14. By wetting the surface the piece can be made fairly smooth on the wheel, after which it should be removed, on the bat, and set aside to dry to leather-like hardness. Pieces like the fluted lamp base, in Fig. 1, are built in layers formed separately, and united after they have attained the hardness of leather. The flutes are cut with a knife or a gouge.

Novel Rustic Wood Beverage Set for Your Den

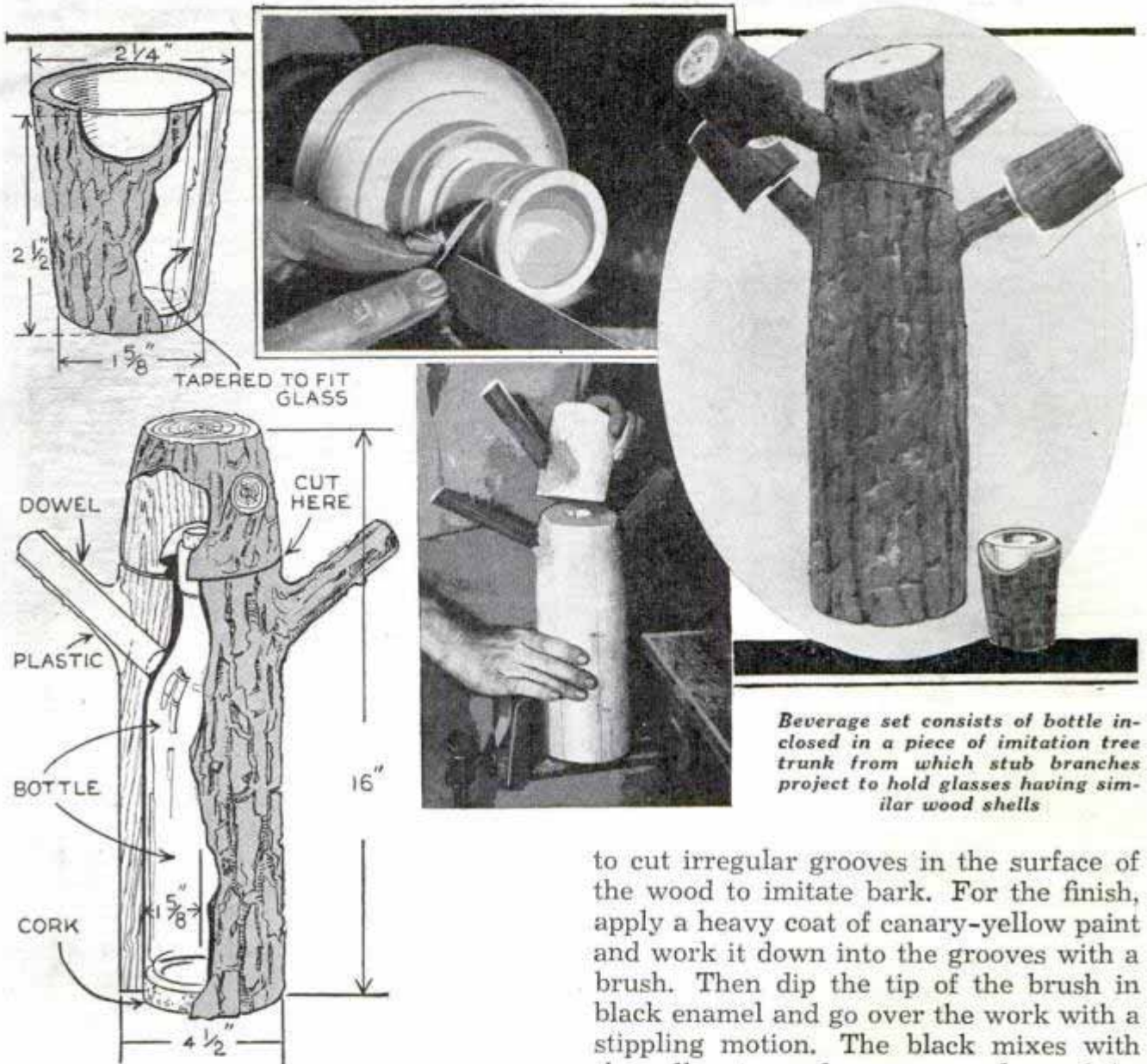

Resembling an old weathered tree trunk with a few branch stubs projecting from its sides, this unusual beverage set is decorative and useful for your den. The trunk consists of two $2\frac{1}{2}$ by 5 by 17-in. pine blocks gouged out inside to take a bottle, and then glued together after which they are turned down on a lathe. The lower end is open and is fitted with a large cork so that the bottle can be removed. After turning the block to shape, the upper end is sawed off to form a cap as indicated. The branch stubs to hold beverage glasses are short dowels set into holes drilled in the trunk, and to give a realistic effect, plastic wood putty is applied to the dowels where they join the trunk. A carving tool or small routing bit on a flexible shaft is used

to cut irregular grooves in the surface of the wood to imitate bark. For the finish, apply a heavy coat of canary-yellow paint and work it down into the grooves with a brush. Then dip the tip of the brush in black enamel and go over the work with a stippling motion. The black mixes with the yellow to produce a gray color and the sides of the grooves pick up more than the rest so that they are automatically shaded darker, giving a good imitation of bark. The glasses or cups can be made in the same way or they can be turned. If you have a band saw, considerable work can be saved by sawing cylindrical pieces from a block to the approximate shape and size of the cups, after which they are turned, and tapered openings are bored out to take small glass tumblers. These should fit tightly in the openings. A portion of the upper edge of each wood cover is cut away to provide a place for your lips.

—D. C. Marshall, Manhattan, Kan.

☞ An emergency supply of mending yarn may be obtained by unraveling the top of a discarded woolen stocking.

Scallops in Picket Fence Gauged Uniformly with Curved Guide

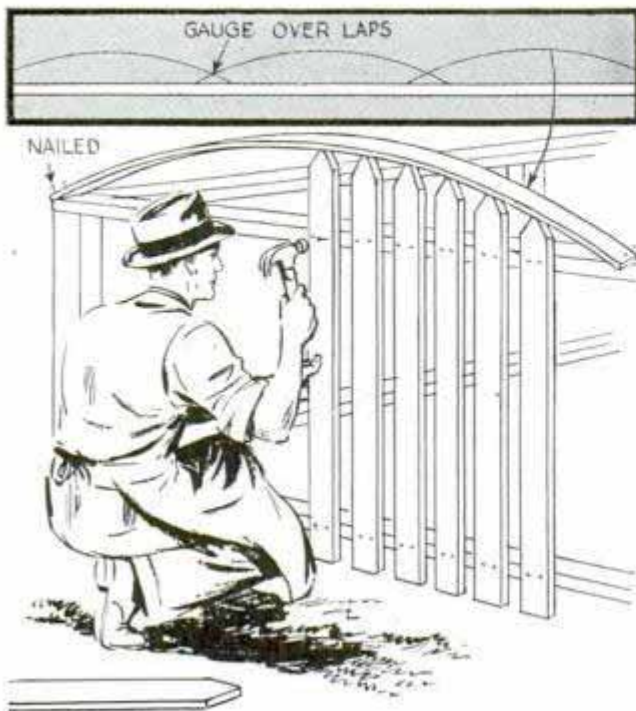

Overlap spacing of gauge each time it is moved to get the short pickets uniform between scallops

Difficulty of uniformly gauging the pickets in a scalloped-top fence was overcome by one carpenter, who formed a temporary guide by bending a narrow strip of plywood to the proper curvature, against which the tops of the pickets could be butted before cutting them to length. The guide is tacked to the top of the fence rail within a predetermined distance, and each time it is moved to form a new scallop, the end should overlap the space previously occupied so that the pickets at the bottom of each scallop will project above the rail. The distance overlapped should be the same each time the gauge is moved, to get the pickets uniform in height between each scallop.—Wayne C. Leckey, Aurora, Ill.

Containers for Photo Chemicals



Many of the solutions used in photography are better preserved by storing them in containers from which air and light are excluded. For this purpose, pint or quart fruit jars

of the type shown have been found satisfactory. They have an airtight seal, and a mouth large enough to assure quick and easy pouring. To make them light-tight, coat the outside with asphalt varnish.

Overhead Pulley Is Lubricated with Oil-Soaked Sponge

An overhead pulley that is hard to reach may be lubricated with an oil-soaked sponge which is tied to the rope or cable running through the pulley. The sponge should be large enough to be squeezed as it passes through the latter, causing the oil to run down onto the shaft.



Oilstone Has Non-Slip Feet of Rubber Hose

To prevent an oilstone from sliding back and forth, when sharpening chisels or other tools, cut two sections of garden hose, slit these at one side and open them to engage the ends of the stone. Hose that has a corrugated surface will serve best.



Slit pieces of garden hose over ends of oilstone provide friction against bench top

Streamlined "Saddlebag" for Your Bicycle

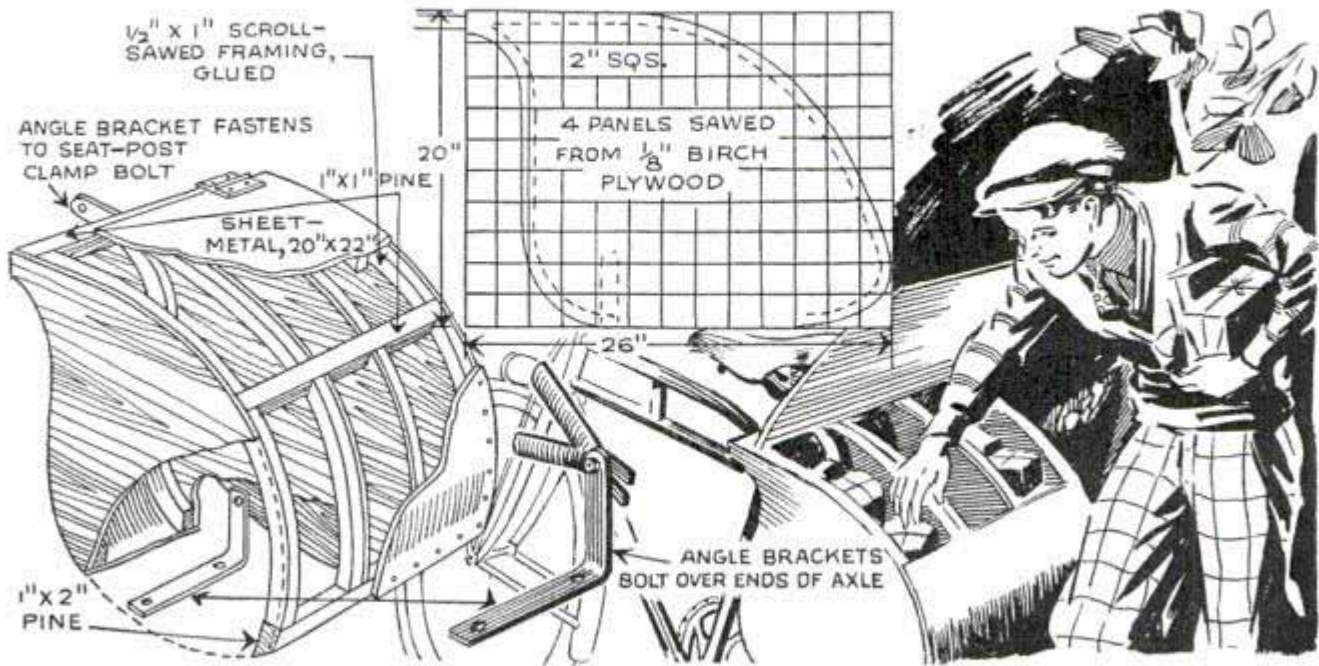

As it straddles the rear wheel of your bicycle, this parcel carrier is something like an old-type saddlebag. It is just the thing to make light deliveries, carry daily orders of groceries or packs of newspapers. The curved portion is covered with sheet metal fastened with brass escutcheon nails. The plywood panels are assembled in pairs and joined by the cross members. The latter are set in notches in the two inner

panels flanking the wheel. There are no notches in the outer panels, which are nailed and glued to the ends of the cross members. The carrier is mounted on two angle brackets bolted to the ends of the rear axle and one bracket to the seat-post clamp bolt, just under the saddle. Two curved cleats keep the sheet-metal lid in the proper curved shape. It is fitted with a drawer pull for raising and lowering.

Doorstops on Rear Legs of Table Protect Kitchen Walls

If you have a kitchen worktable next to the wall, it's a good idea to provide cushioned bumpers to keep the edge of the table top from bumping the wall when kneading bread, rolling pastry crusts, etc. Ideal bumpers can be had by screwing rubber-tipped doorstops into the rear legs.



These stops prevent edge of table from bumping wall when kneading dough or doing other work

Small Block on Child's Scooter Keeps Foot from Slipping



Screwed to the platform of a scooter, a small block of wood keeps a child's foot from slipping when he pushes. The block should fit under the in-
step as shown.



1: Knots in a quilt are spaced uniformly with the aid of a wire frame on which cross strings are tied to form squares. Pins are stuck into the quilt at points where the strings cross each other. 2: This clothes-pin dispenser hangs on the line and the pins are delivered, one at a time, from the bottom. Four brass strips projecting beyond the bottom keep the clothes-pins from falling out

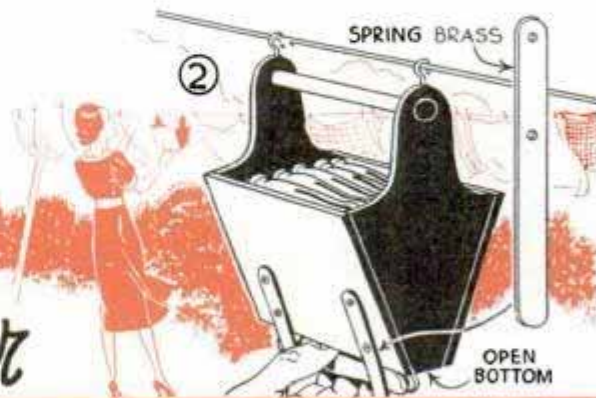

Your

HOME



3: Spots removed from clothing by rubbing with padded end of a salt shaker containing water-and-soap solution. Pad is formed with rubber disk and flannel as indicated. 4: Multiple spool holder on sewing machine, for several kinds of thread, is rotated to bring desired spool in line with the threading eye of the machine

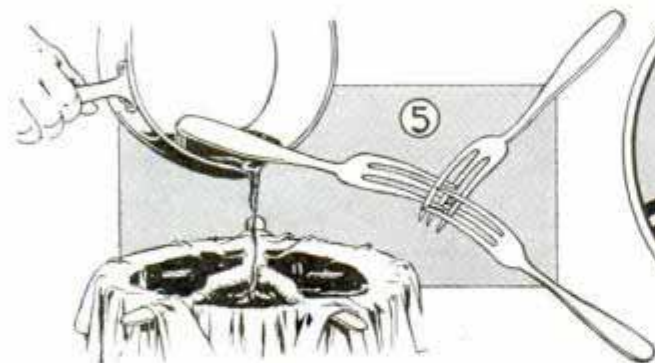
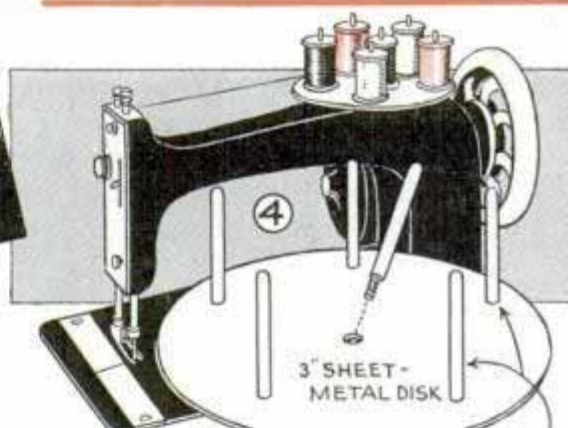

5: Emergency support for a cloth strainer quickly improvised by arranging three table forks to bridge the top of a container as indicated. 6: To assure uniform thickness of pie crusts, one housewife suggests the use of two heavy rubber bands, slipped over the ends of the rolling pin. If single bands do not raise the rolling pin enough, two or three can be used at each end, placing them on each other

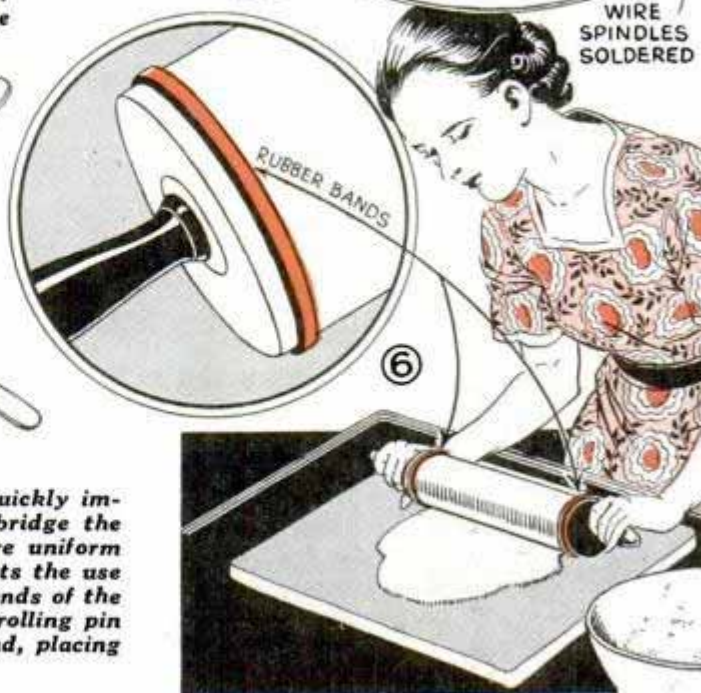

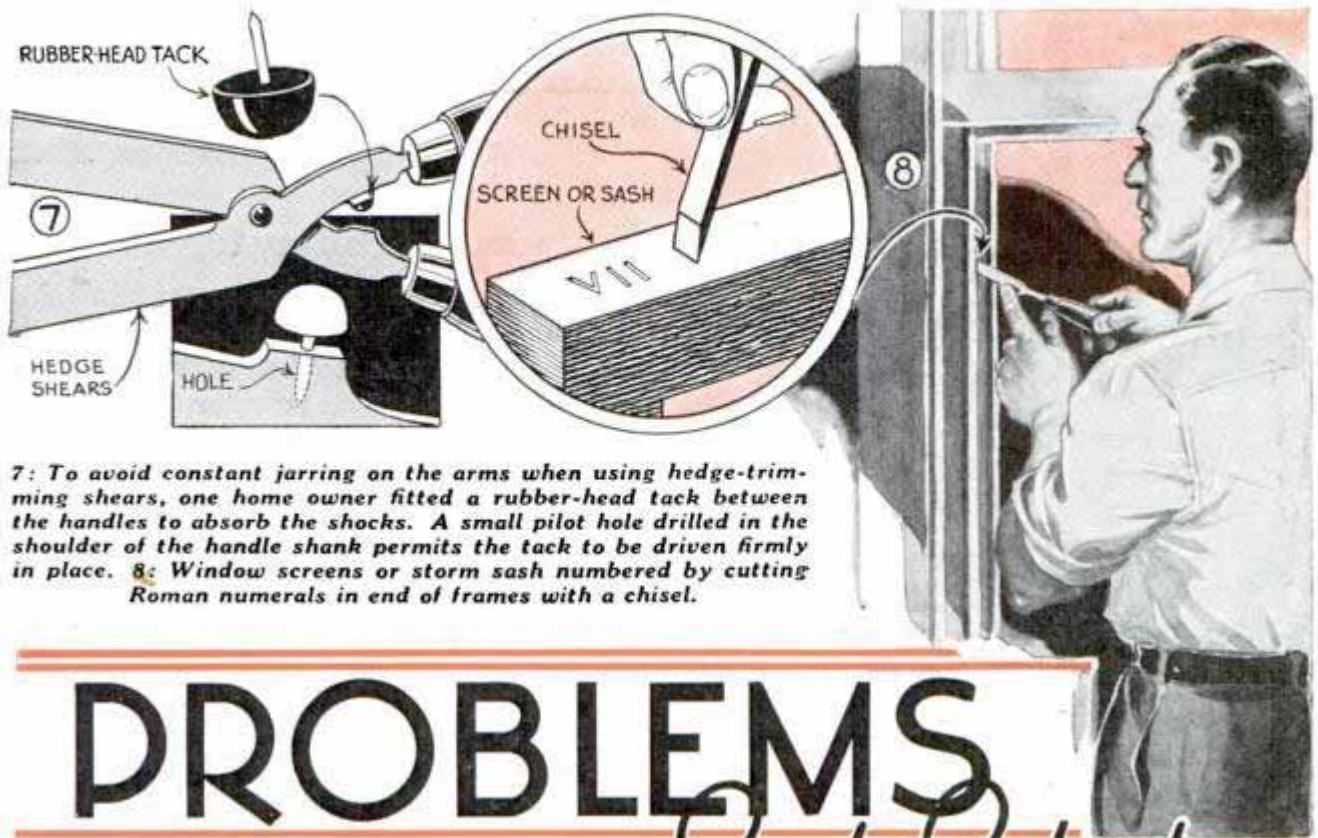

7: To avoid constant jarring on the arms when using hedge-trimming shears, one home owner fitted a rubber-head tack between the handles to absorb the shocks. A small pilot hole drilled in the shoulder of the handle shank permits the tack to be driven firmly in place. 8: Window screens or storm sash numbered by cutting Roman numerals in end of frames with a chisel.

PROBLEMS

Easily Solved

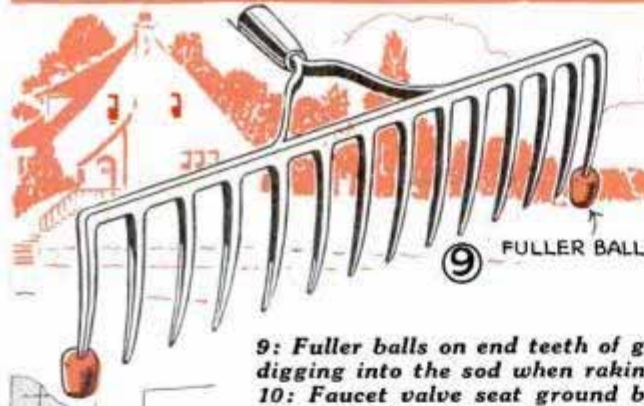

9: Fuller balls on end teeth of garden rake keep it from digging into the sod when raking leaves from the lawn. 10: Faucet valve seat ground by rotating head of carriage bolt against it with hand drill. Several slots are made in the bolt head, which is then covered with fine valve-grinding compound

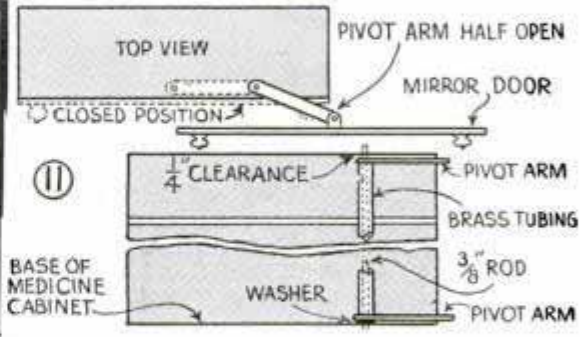
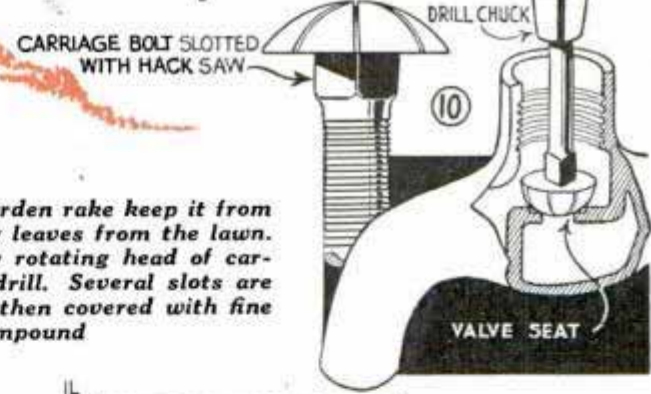

11: To avoid repeatedly opening the mirrored door of his bathroom medicine cabinet while shaving, one home owner pivoted the door on metal arms so that it could be moved forward and then swung to one side with the mirror facing him. A rod is run vertically through the cabinet at one side near the front to take a brass tube snugly. The arms are soldered to the ends of the tube and pivoted to the door

Drawing Board Tilted at Angle by Doorstops



Two rubber-tipped doorstops driven into drawing board near rear edge tilt it at easy-working angle

When using a drawing board on a table, drive a couple of doorstops into it near the rear edge to tilt it at an angle. Use the

type of doorstops that have rubber-covered ends, and locate them accurately by drawing a line across the board with the aid of your T-square.

—Arthur A. Klebba, Bozeman, Mont.

Inducing Canary to Bathe

If your canary seems reluctant to take his daily bath, and merely dips his beak into the water and applies it to his plumage in a half-hearted manner, it is probably because you give him his bath water in a glass or china dish. If his attempt to bathe in this slippery receptacle results in a fall or plunge into the water, you may be assured that he will shun a bath from then on. Instead of scolding the little fellow for not following his daily habits of sanitation, provide a rubber soap dish for his bathtub. He will feel safe-footed in this and, once his confidence returns, will surprise you in the thorough way he takes to the water.

It's Easy to Build Bird Houses

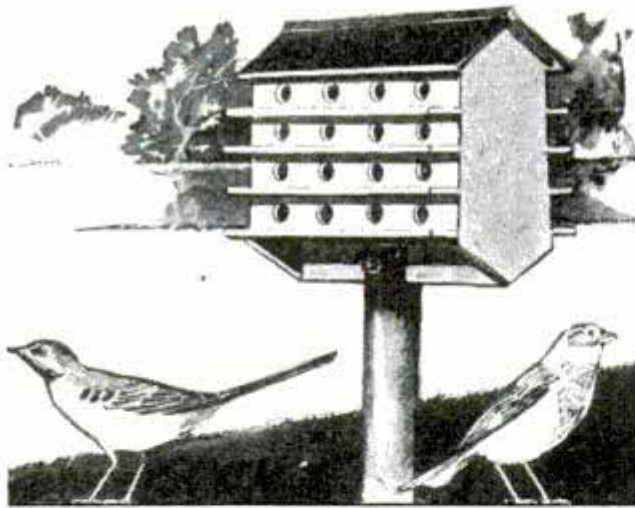

that will attract peppery little wrens, martins, bluebirds and others. Our plans include a wide variety of nesting boxes that not only look good to the songsters, but also add a delightful touch to the garden.

COLONY HOUSES AND APARTMENT LOG CABINS—884 and 885. Only a saw, hammer, nails and easily obtainable material required. Two prints 50c.

SINGLE APARTMENTS IN RUSTIC DESIGN—886: Fourteen easy-to-build houses on one print. 25c.

Outstanding Spring Numbers

TRELLIS SUGGESTIONS—639: Six types that will help beautify your home. 25c.

LAWN CHAIR—529: Plain sawed from $\frac{3}{4}$ -in. stock. Easily made with hand tools. 25c.

ORNAMENTAL WOOD FENCES—640: Five artistic designs for standard wood stock. 25c.

CIRCULAR ARBOR AND GATE—637: Popular style anyone can build. 25c.

LAWN AND GARDEN FURNITURE—920 to 922 incl.: Collection of designs for arbor-and-seat combinations and swings. (3 prints) 75c.

DUTCH WINDMILL AND WATER WHEEL—911: Mill, 40 in. high. Small water wheel. 25c.

LOG-CABIN CONSTRUCTION—916: Two floor plans. Shows how to make corner joints. 25c.

17-FT. KAYAK—928 and 929: Light framework covered with canvas. One-man size. 50c.

12-FT. UTILITY ROWBOAT—707: Flat bottom. Four seats. Sturdy design. 25c.

"ZIP," MODEL RACING YACHT—880 to 884: 50 in. long. Plans include full-size lift templates. Four prints \$1.00.

Any six of these blueprints (not projects) will be sent postpaid upon receipt of \$1.00

Address Blueprint Dept., Popular Mechanics Magazine, 200 E. Ontario St., Chicago



SHOP NOTES

ELECTRO-ENGRAVING

with a bottle cork

Tools,
Golf Clubs,
Nameplates,
etc., Are Easily
Engraved with
this Simple
Apparatus

by C.A. Crowley



WITH the simple device described in this article it is easy to engrave your name on tools and other metal articles as in Fig. 1. Once the design has been carved in cork, initials may be applied as many times as required. The apparatus is by no means limited to the marking of names or initials as designs of various sorts also can be applied to metal articles quickly. The apparatus operates on ordinary 110-volt alternating or direct current, or it can be operated on a low-voltage storage-battery circuit, and the time required for a good permanent etch is remarkably short.

A cork die must first be cut with the name, initials or other design to be engraved. A large tapered bottle cork of suitable size is most satisfactory for this purpose. For engraving a large design, or a name in large letters, a section of cork cut from a thick sheet or block must be



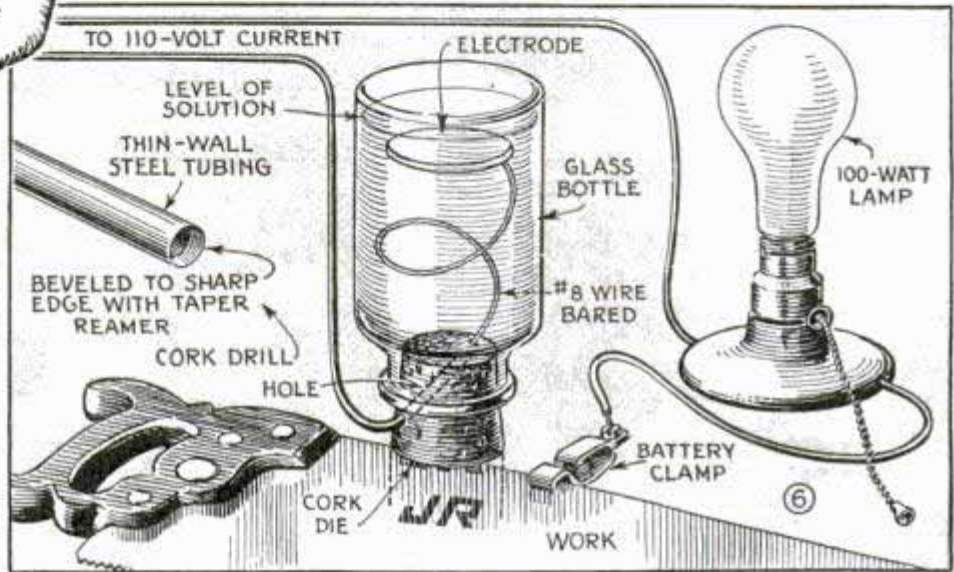
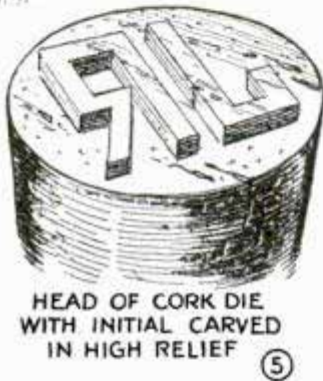

print with the originally drawn face of the paper down as in Fig. 3.

There are two methods of applying the cork against the work to be engraved. A portable marker as illustrated in Fig. 6, consists of a wide-mouth bottle into which the cork fits snugly. The bottle is filled with a solution made by dissolving ammonium chloride, $\frac{1}{4}$ lb., and water, 1 quart. Notice how one side of the line goes to an electrode in the bottle while the other goes to a 100-watt lamp to limit the flow of current. The lamp is connected to the work by means of a battery clamp. While the

used. The cork selected should be close-grained and free from irregularities, deep lines, or other defects. The best way to cut cork is to use a razor blade as in Fig. 4. A single-edge blade is preferable for safety's sake. If desired, a very sharp penknife or linoleum carving tools can be used also. If proper care is exerted, an electric pyrographic needle can be used for cutting detailed designs. It must be remembered that the die is a negative of the design to be printed; accordingly, the part that is to be etched on the work must be raised on the die, and all letters and designs must be cut backward. Block letters are the best and easiest to cut. They should be raised $\frac{3}{16}$ to $\frac{1}{4}$ inch. See Fig. 5. All designs should be cut to this depth. To expedite the backward drawing, the design may be drawn first on paper with the aid of a sheet of carbon paper backed up against it as shown in Fig. 2. To transfer the design to the cork simply place carbon paper black face down on the cork and trace over the carbon im-

portable outfit is handy for work that is too large to be set inside of a jar or crock, the latter method is shown in Fig. 7. In this case the cork should be kept submerged in the solution—same ingredients and proportions as listed above—until it is ready to be used. A simple steel clamp should be made next to hold the die against the work. The size and shape of the clamp must be governed by the size and shape of the work and the die. The clamp must press the entire printing surface of the die against the work, and exert an even pressure over this surface. The jaws of the clamp must be insulated to prevent contact between the clamp and the metal being engraved. Rubber tubing can be slipped over the jaws, or they may be wrapped with electricians' rubber tape. Next, an electrode should be cut from iron or steel, as large as the bottom of the container. The container must be of glass, porcelain, stoneware or other insulating material. An ordinary tumbler can be used for small

jobs as shown in Fig. 8. A heavy copper wire is soldered to the electrode and covered with rubber tubing where it passes through the solution, to prevent accidental contact with the work. If the work is heavy, it should be propped in place with wooden blocks. The 100-watt lamp is essential if the apparatus is used on the house circuit. On direct current, it is absolutely necessary that the work to be engraved be connected to the positive terminal. When using 110 volts, the current should be left on for 2 or 3 minutes. The apparatus can be adapted to operation on a storage bat-

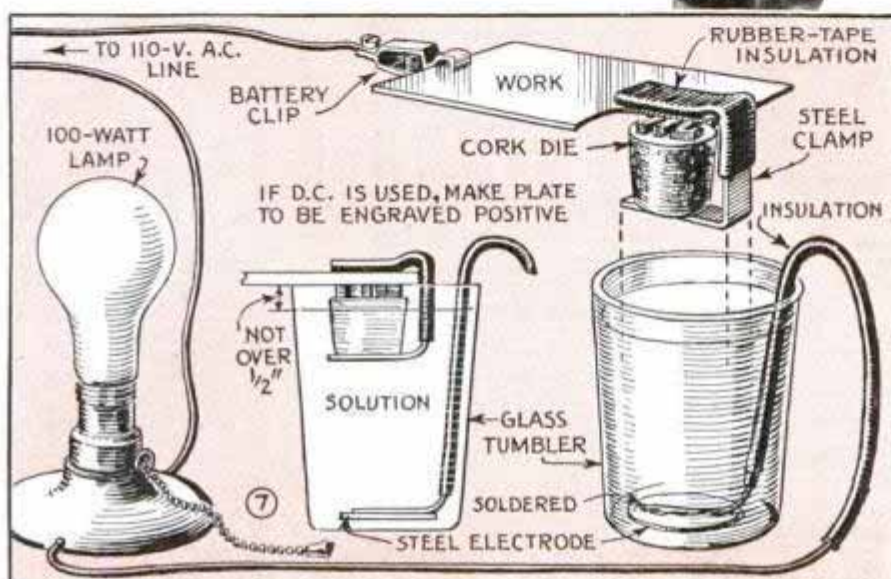

tery by omitting the 100-watt lamp and connecting the positive terminal of the battery to the work and the negative to the electrode. Where engraving is done with a storage battery supplying the current it will take 15 or 20 minutes, or even longer for a deeper cut.

Test-Bench Prods on Weighted Cord Kept Out of the Way

By counterweighting the cord to which electrical test prods are attached, they will be out of the way, yet are within easy reach. The cord is led through a hole in the backboard, the hole being fitted with a rubber or fiber sleeve. Of course, a lamp is connected in series with one of the test prods to limit the flow of current. A pulley and small weight hold the prods against the backboard when not in use.

Cement Makes Tight Pipe Joints

A good cement for sealing pipe joints of all kinds, except those in gasoline or oil lines, is made by mixing portland cement with linseed oil to the consistency of paint. The mixture is sufficiently abrasive to "grind in" a pipe thread and make a tight joint that would otherwise leak. It dries slightly pliable so that the joints come apart easily years later.

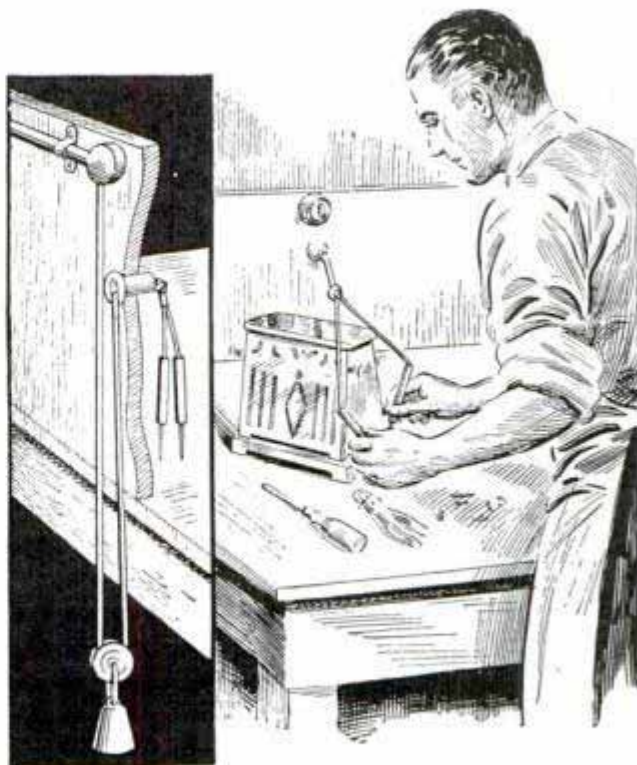

Auxiliary Table on Drill Press Tilts to Any Angle

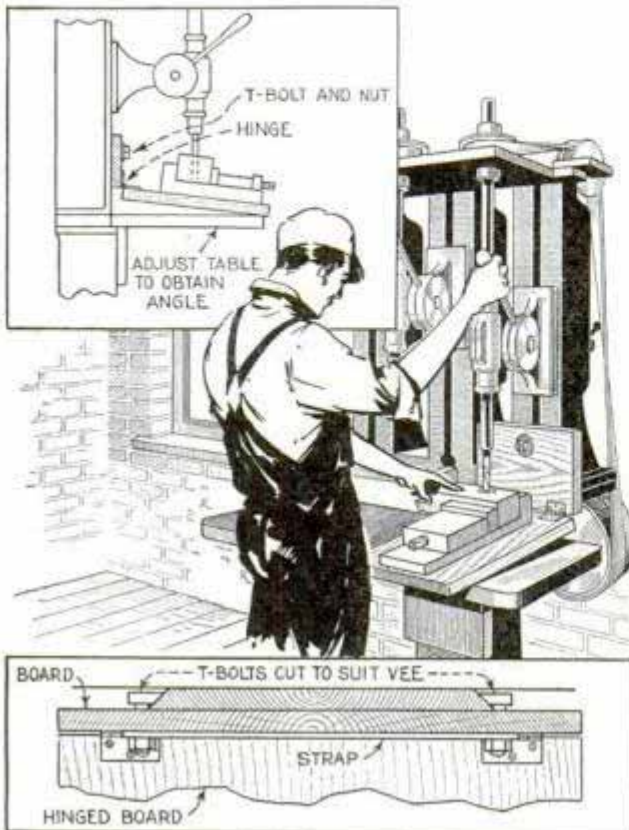

This auxiliary table is quickly adjusted with a protractor to desired angle

Here is a simple method of using an auxiliary table to drill holes at various angles on either a single or multiple drill press. Two hardwood boards are hinged together as indicated, after which one is bored for a T-bolt. This slides in a T-slot of the drill-press frame and is tightened to hold the table after it has been set at the correct angle with a protractor. If the slots in the frame are V-shaped, two bolts can be used, the T-ends being cut away to suit the slide.

—H. Moore, Hamilton, Ont., Can.

Water-Color Box with Handle Is Easy to Hold

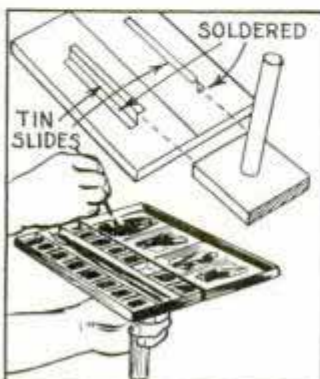

When sketching with water colors where you have to stand up and hold the box in one hand, this handle will be found a real convenience. It consists of a small block of wood drilled in

the center to take a length of dowel, which serves as a grip. V-shaped slides soldered to the underside of the box take the handle, which is removed when not needed.

Saw-Blade Lathe Parting Tools Fit in Special Holder

Lathe operators can make their own parting tools from old power hacksaw blades. The tools are ground to the shape desired and fit in a special holder. This consists of a piece of steel slotted on one side to take the blade and slotted all the way through on the opposite side so that a single tightening of the tool-post screw grips both the holder and the parting tool at the same time.

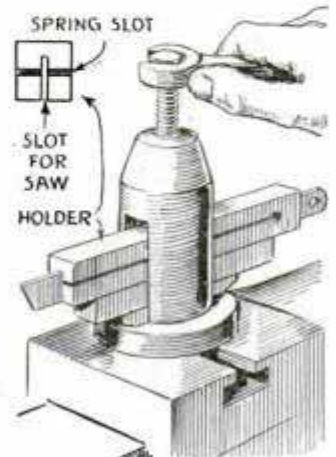

Newspaper Aids in Ferrotyping Small Glossy Prints

When a number of small glossy prints are to be squeegeed to a ferrotype plate, the tendency to slide about can be over-

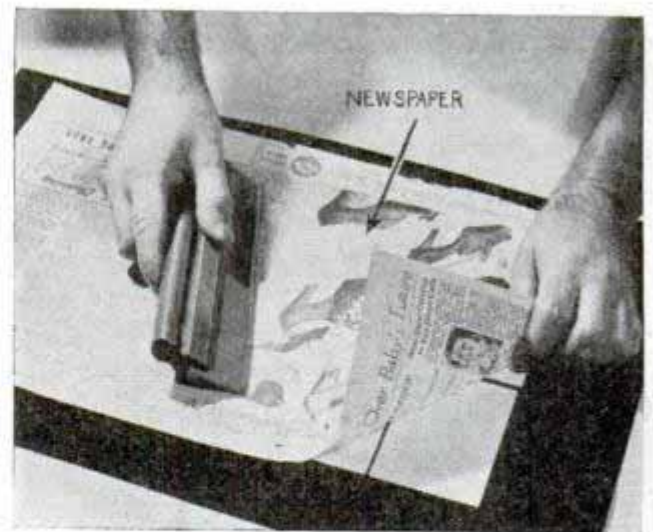

By covering small photo prints with a piece of old newspaper, you can squeegee them in place easily

come by covering them with a sheet of old newspaper while squeegeeing. Afterward, you can use another sheet of newspaper to remove the excess moisture.

Lathe Drill Pad Is Made from a Pipe Flange

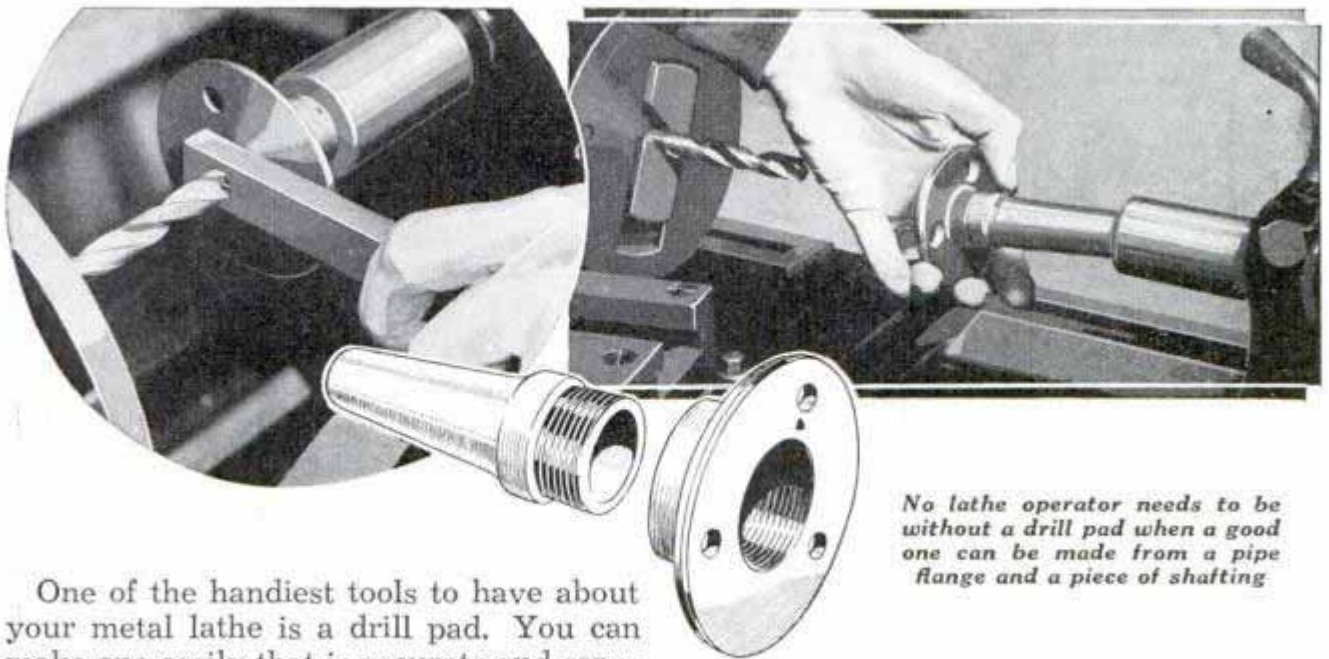

No lathe operator needs to be without a drill pad when a good one can be made from a pipe flange and a piece of shafting

One of the handiest tools to have about your metal lathe is a drill pad. You can make one easily that is accurate and serviceable from a pipe flange and a short length of cold-rolled shafting. The latter is turned to a taper that will fit the tailstock quill with about 1 in. of the straight section projecting. This is threaded to re-

ceive the flange, which is turned tightly against the shoulder of the taper. You simply set up the whole thing in the headstock and true up the edge and face of the flange.
—Walter E. Burton, Akron, Ohio.

Makeshift Compass Scribes Large Arcs on Show Windows

A signwriter's compass that can be carried right in the pocket is assembled quickly from a piece of string and a small vacuum cup of the type provided with a small bolt. The cup is stuck to the work, after which one end of the string is tied to the bolt. Then, holding the other end in the hand along with a piece of chalk, it's a simple matter to scribe an arc of any radius.

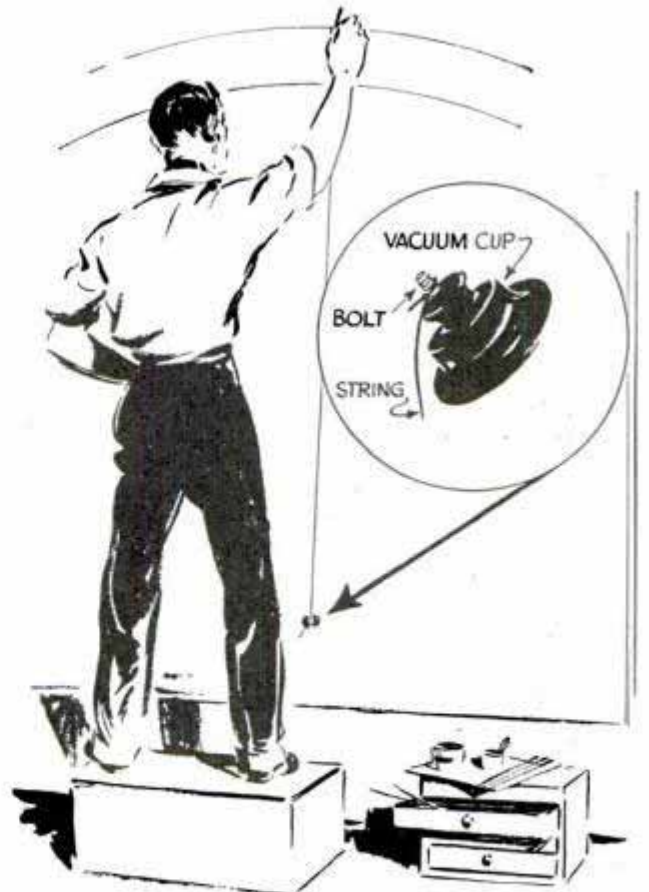

Using a string attached to a vacuum cup, it's a simple matter to scribe an arc of almost any radius

How to Use a Star Drill



Instead of striking heavy blows on a star drill with a large hammer, take a small hammer and tap the drill with light blows in rapid succession, turning the drill each time you raise the hammer. A series of

light taps are more effective in chipping the work than the other way.

—Robert E. Davy, Represa, Calif.

Large Bottles Handled Easily with Help of Canvas Strip

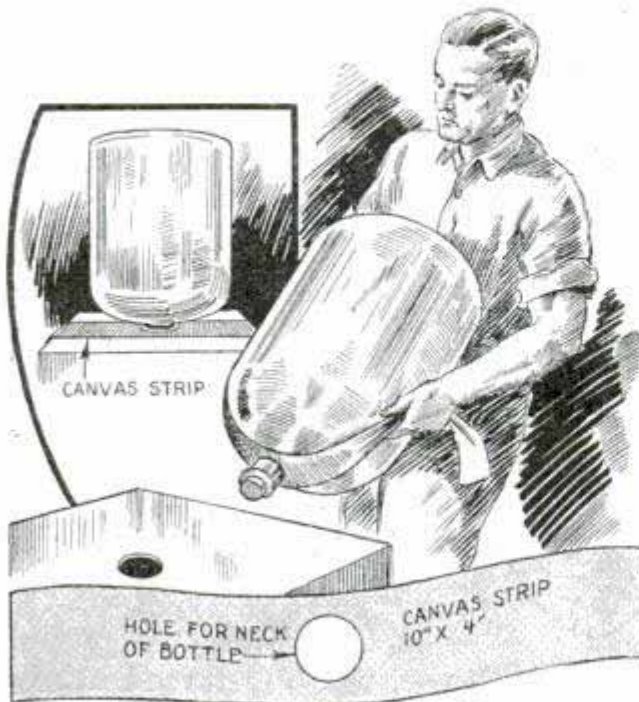

It's no trick to lift a large bottle of water to a cooler if a strip of canvas is used in this way

The difficult job of changing large water bottles on a cooler, is done easily by using a strip of canvas with a hole cut in the center to lift them to the cooler. The canvas should be kept clean as it is left on the cooler until the empty bottle is removed.

Billiard-Table Covers Mounted on Window-Shade Rollers

One billiard-table owner conceived the idea of attaching the cover to a pair of shade rollers, and fastening the roller brackets under each end of the table. The cover cloth was divided in the center and one-half mounted on each roller. The free

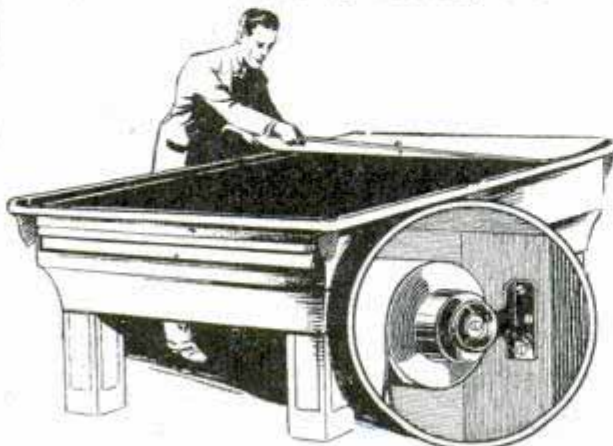

Cover for billiard table mounted on window-shade rollers is quickly pulled into place when needed

ends were hemmed to take curtain sticks, which permitted the pieces to be drawn together and fastened with a small hook over the center of the table.

Fishhooks Dispensed in Store with Small Magnet

To avoid injuring the fingers in removing small fishhooks from drawer compartments, when selling or invoicing, one merchant employs a small magnet. This lifts the hooks so that any number may be removed. The same idea can be used by fishermen who lose hooks or small flies in the grass while fishing. The magnet will locate and pick up the hooks that could seldom be found in the usual manner.

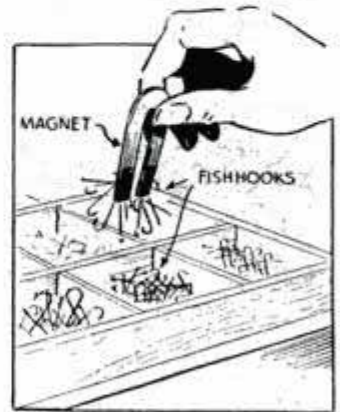

Spring Aids in Perforating Jobs



The next time you have a job of perforating some work which requires several hundred holes, try using a small compression spring under the nail or perforating tool, as indicated. When the tool is driven

through the work, the spring pulls it out again instantly, thus enabling you to tap the nail with a hammer and move it to the location of the next hole rapidly.

☐ We need and pay good rates for short, illustrated articles describing simple solutions for everyday problems around the home, the home workshop, or pertaining to trades and professions. These solutions must be practical and of general interest to most of our readers, but they should be exceptional and different from material that we have already published.—Address Homcraft Editor.

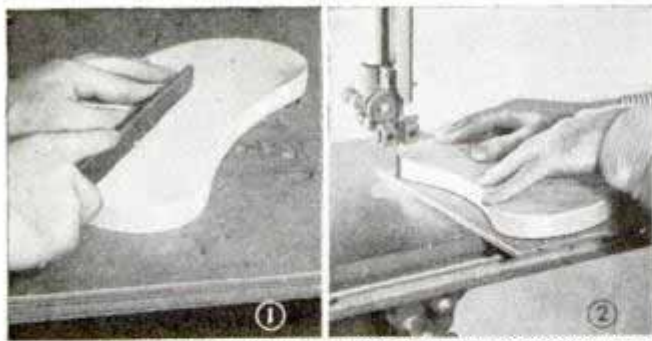

① FITTING ANCHOR POINTS

② BAND-SAWING WORK OVERSIZE



③ SET-UP FOR SANDING

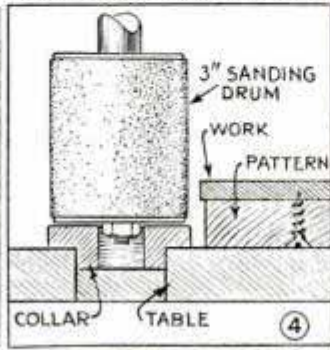

④ HOW SET-UP WORKS



⑤

PATTERN SANDING

gives true curves

SANDING with a pattern is an accurate method of finishing edges, and is of special value on duplicate work. The pattern is usually made from $\frac{3}{4}$ -in. stock, carefully smoothed to the exact size, and is fitted with two or more anchor points to hold it in place on the work. The best anchor point is made by driving a wood screw through the pattern, and then filing off the projecting end, Fig. 1, to form a point.

Using the pattern as a guide, the work is band-sawed slightly oversize, as shown in Fig. 2, after which it is sanded to the same exact shape as the pattern, Fig. 5. Figs. 3 and 4 show the set-up, which consists of a wooden ring of the same diameter as the sanding drum, the ring being nailed to an auxiliary wood, drill-press table or fitted in the opening in the table. The ring must be aligned exactly below the sanding drum.

Pattern sanding can be done also on a disk sander, Fig. 8. The guide is a thin metal strip fastened to an auxiliary wood table, as shown in Fig. 7. The pattern rides against the guide, cutting the work to the same shape as the pattern, Fig. 6. It will be noticed, however, that the pattern must be made about $\frac{1}{8}$ in. smaller all around to compensate for the space taken up by the guide, as indicated.

When using a sanding pattern, it must be smaller than the work on account of a metal guide plate which is fastened to the auxiliary wood table

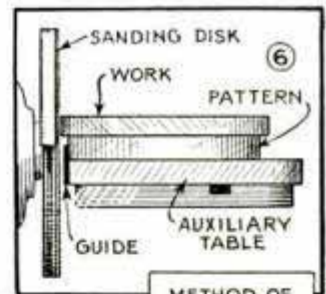

METHOD OF PATTERN SANDING WITH DISK

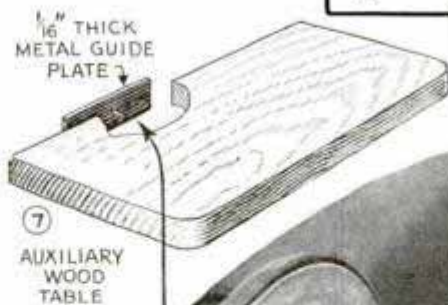

⑦ AUXILIARY WOOD TABLE

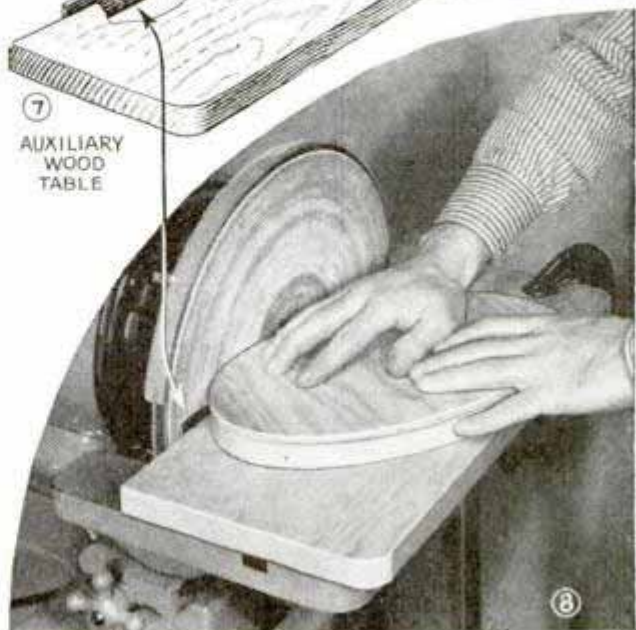

⑧

Window Trimmer Dresses Model with Aid of Mirror

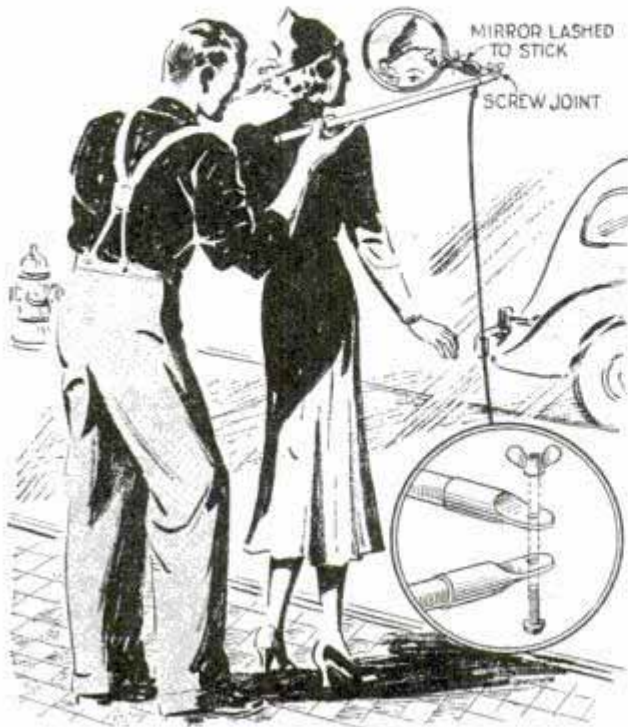

Trimmer adjusts clothing on show-window manikins by holding mirror in front of them

When working in a narrow or crowded window, one trimmer uses a mirror to see the front of the models. This saves many steps in going outside to see if the clothing is adjusted correctly. The mirror is lashed to a stick, which is pivoted as indicated in the detail so that the mirror can be set at any angle desired.

—Opie Read, Jr., Chicago.

Polishing Tumblers Quickly



In restaurants and other places where there are a number of tumblers to clean, this polisher will save time and help assure a good job. It consists of a piece of sponge rubber shaped to fit inside the tumbler snugly and provided with a handle. This is a piece of dowel

rod fitted with a grip at one end. The other end is drilled to take a small, short dowel or pin at right angles. The handle is pushed

into the rubber and the pin is forced into the hole to anchor it. When using the polisher, a towel is wrapped around the rubber as indicated.

Ends of Blueprints Protected by Can Lids

Rolls of blueprints are protected against damage at the ends if baking-powder can lids are used as shown. Holes are punched in opposite sides of each lid to attach rubber bands, which hold them on the roll. As the lids are easy to remove and replace, workmen are not likely to neglect referring to the plans frequently as is often the case with less convenient containers.

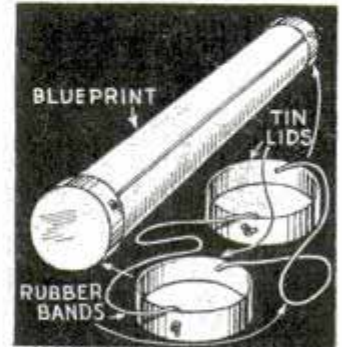

Plow Beam Can't Clog with Trash When This Shield Is Used

When plowing fields in which there may be weeds or cornstalks, clogging of the plow at the curve of the beam above the moldboard can be avoided by using a sec-

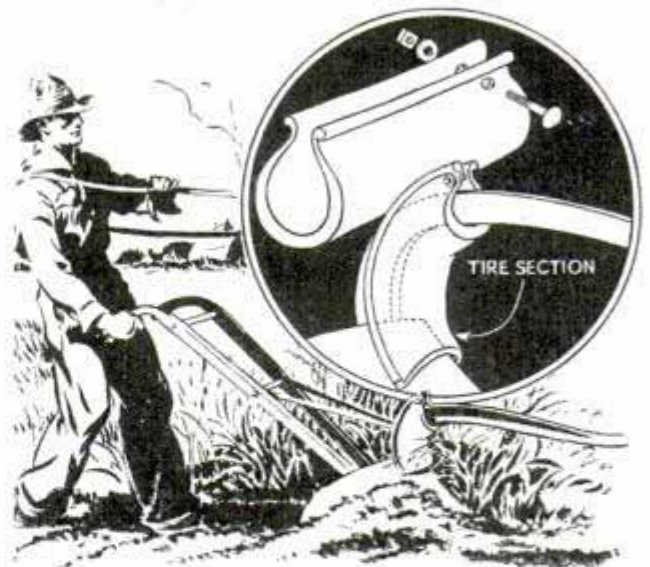

Section of auto tire at curve of beam enlarges it so that trash does not lodge at this point

tion of old auto tire at this point. The piece of tire is slipped in place as indicated, where it is held by a bolt through two holes drilled at the upper end.

To BUFF and To POLISH

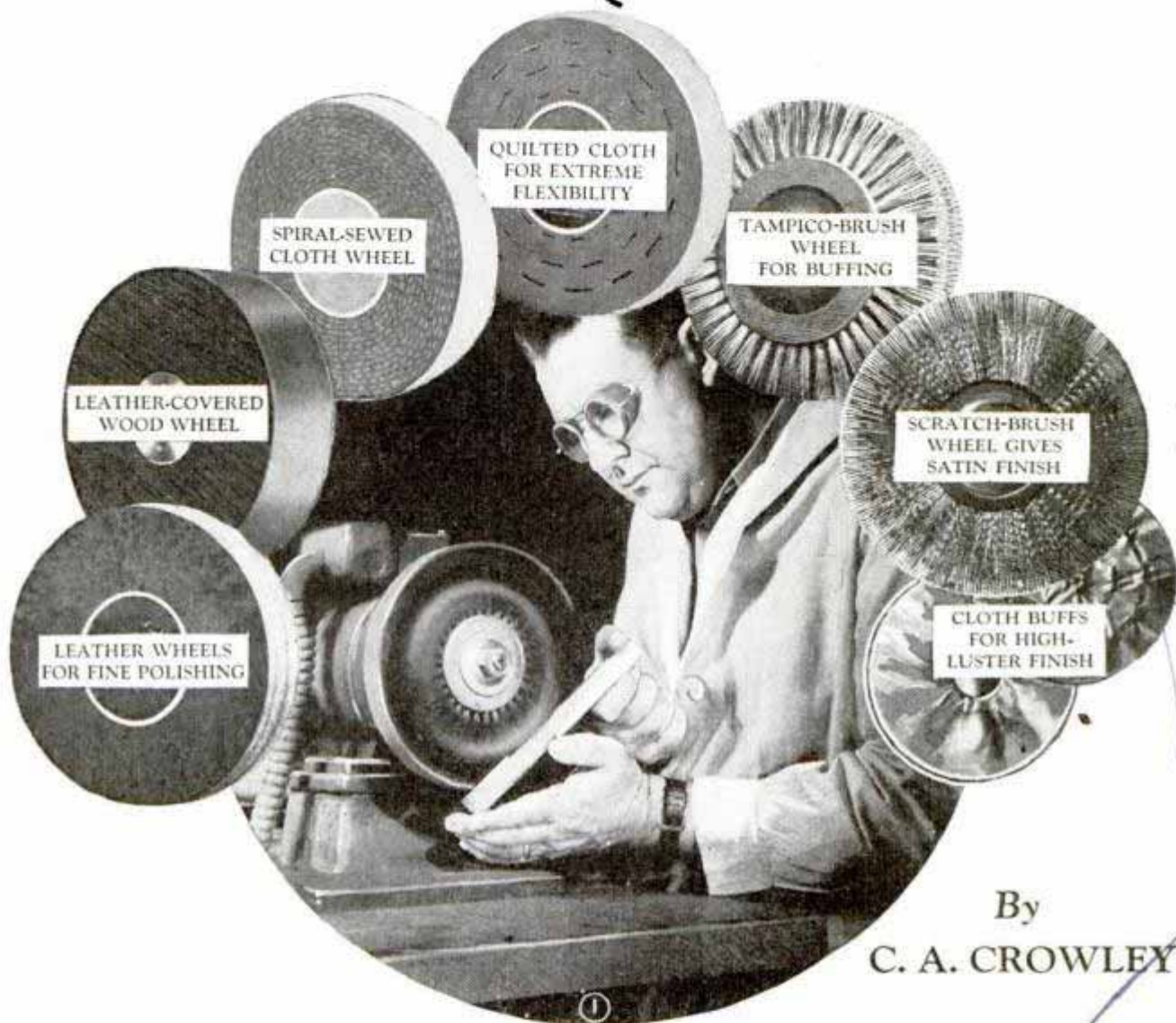

By
C. A. CROWLEY

*Norton Co., Worcester, Mass.
Carborundum Co., Niagara Falls, N.Y.*

PRODUCING a high-luster finish on a metal surface divides itself into three distinct processes; grinding, polishing proper, and buffing. Grinding with an emery wheel leaves a multitude of fine scratches on the surface. Polishing simply removes these finer marks by grinding away small amounts of metal. Where a very fine finish is desired, the polishing operations are followed by buffing with a soft wheel and very fine abrasives. This removes even the fine marks left by the polishing abrasives and leaves a surface which is glass smooth.

Polishing and buffing are similar processes, the only difference being that in polishing the abrasive is glued permanently to the wheel, while in buffing the abrasive is fed to the wheel during the operation. Polishing abrasives usually are identified

by number, from No. 120 to No. 220, while buffing abrasives are numbered above 220. Polishing wheels, Fig. 1, are made from a number of materials. Wood faced with leather, sheepskin, bull neck and walrus leather, canvas, felt, muslin, and flannel are materials commonly used. Leather-faced wooden wheels are, of course, rigid, and are suitable only for polishing flat work. For curved surfaces wheels faced with the more flexible materials are used. Soft buffs are made of disks of cloth or sheepskin loosely sewed together.

On polishing wheels such artificial grits as aluminum oxide, silicon carbide and natural emery are most generally used. For buffing, a number of natural abrasives are used, these being in the form of a cake made of the abrasive and grease or tallow so that the grit may be applied to the buf-



COMPOSITION OF GLUE FOR POLISHING WHEELS

Abrasive grain size	Dry glue % by weight	Cold water % by weight
30 - 36	50	50
46 - 54	45	55
60 - 70	40	60
80 - 90	35	65
100 - 120	33	67
150	25	75
220	20	80



ing wheel by friction, as shown in Fig. 8. The ordinary buffing compounds, in descending order of hardness and sharpness, are emery, tripoli, pumice, crocus, lime and rouge.

Animal-hide glue in the ground form is generally used for applying abrasives to polishing wheels. It should be mixed with water by weight as shown in Figs. 2 and 3. The water must be measured accurately as in Fig. 4 on the basis of 1 oz. avoirdupois equals 1 fluid oz. The glue should soak in cold water for one hour. After soaking, the glue solution is carefully heated to a temperature of 140° F., in either a water-jacketed gluepot or one electrically heated as in Fig. 5. Once the glue is melted, it should be applied quickly to the wheel with a brush, Fig. 6. It's a good idea to have the wheel heated to the same temperature to avoid chilling and jelling of the glue. The glue-coated wheel is then rolled through a sheet-metal trough containing the abrasive until it is thoroughly and evenly coated, as shown in Fig. 7. Let it dry for 24 hours. A new wheel should always be given a thin sizing coat of glue followed with two coats of abrasive. If an old wheel is to be recoated, first true it up with a silicon-carbide stick and then treat it as a new wheel.

Abrasives used in buffing have special characteristics, each one being suited to its own particular uses. Emery cake comes in a great variety of degrees of fineness. It is frequently used as a preliminary buffing compound for "cutting down" the last fine scratches left by polishing. It should not be used on stainless steels, however, as it contains iron. Tripoli is composed of soft, porous grains without sharp, hard surfaces. It produces a very high polish on soft metals such as brass and aluminum. Crocus is sometimes used for a high finish on iron or steel. Vienna lime or venetian lime is extensively used in polishing nickel-plate while rouge is one of the softest buffing compounds and is used for the finest finish. Chromium oxide or "green rouge" is used for the final finishes on stainless steel, Monel metal and nickel. Fig. 12 gives suggested motor sizes for operating wheels of various diameters. Although not essential, it is better to have the wheel run clockwise as viewed from the operator's left, as this makes it handier to hold the larger work.

In any case the wheel should run toward the operator so that the work can be held against the wheel at a point below the horizontal center line as in Fig. 10.

Both polishing and buffing wheels are operated at speeds varying from 2,500 to 7,500 surface feet per minute, and sometimes higher, the most general practice being operation at 3,000 to 6,000 s.f.m. Fig. 13 shows you how to translate surface feet per minute to revolutions per minute for various wheel sizes. To use the chart, find the diameter of the wheel on the bottom of the graph, then follow the vertical line corresponding to this diameter up to the curve marked with the desired surface speed and from this point read straight across to the left-hand margin where the r.p.m. can be found. Should you require a surface speed not shown, for example, if a speed of 3,500 s.f.m. is desired, the r.p.m. can be found by averaging the next smaller and the next larger values. These wheel speeds are only approximate and there is no necessity for adjusting them closer than within 100 or 200 s.f.m.

Now the sequence of operations followed in polishing and buffing any metal article must be determined by the condition of the work, the final finish desired, and the metal of which the article is made. Soft metals may need fewer operations than harder metals. A rough casting will require more polishing than a sheet of metal that is already quite smooth. If a mirror finish is desired, operations must be continued down to the softest buffing materials; if a duller surface is satisfactory, perhaps no buffing operations at all will be needed. The skill of the operator also has much to do with the final result. Naturally a skillful workman will produce a given finish with fewer operations than a less experienced man. Hence, the following suggestions are only general. In certain cases wheel speeds have been suggested; where they have not, a speed of 5,000 to 6,000 s.f.m. will be satisfactory. For polishing steel, use first a No. 120 abrasive on a dry-rag wheel, followed with a No. 150 on a greased-rag wheel, and finally with No. 180 on a greased-rag or sheepskin wheel. The article can then be buffed with No. 180 emery cake or paste on a Tampico brush wheel. Rough steel castings or forgings, can be given a preliminary rough polishing

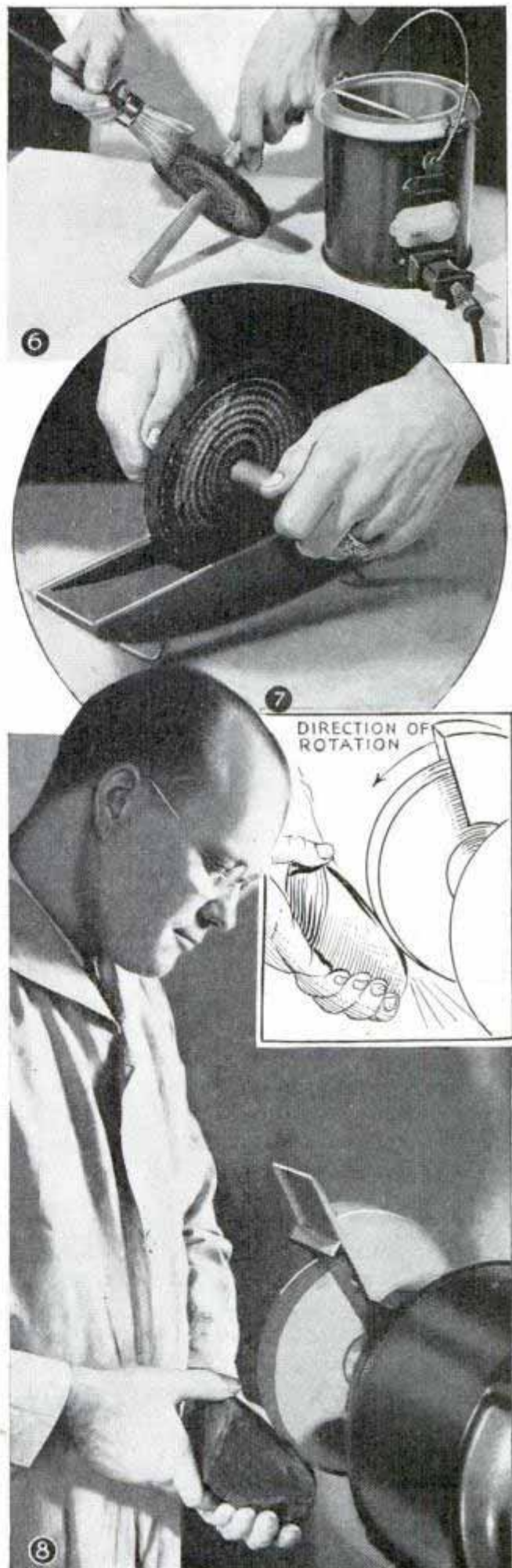

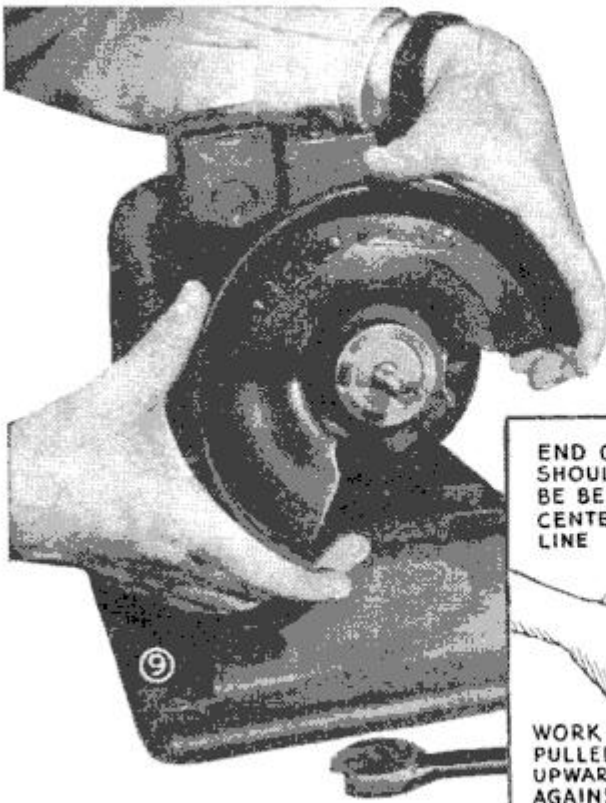

off and the article is plated. Castings may be buffed also with tripoli and lime.

Aluminum is very soft, and hence it is desirable to lubricate all the finer polishing wheels used on aluminum to prevent tearing of the metal. All wheels finer than No. 120 used on aluminum should be greased. The wheel is greased by applying a tallow stick or cake to its surface while it is running. Kerosene is sometimes used as a lubricant. Aluminum articles should be pol-

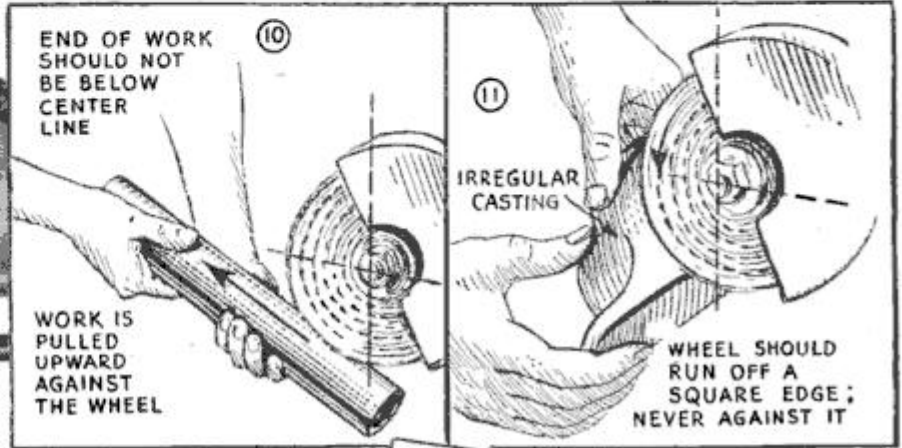

with a No. 60 polishing wheel. This gives a final finish which is suitable for plating. Generally synthetic aluminum-oxide grits are used for the polishing and the first buffing operations on stainless steel. Tripoli may also be used for buffing, and the highest luster developed with chromium-oxide or green rouge. A suggested sequence of operations would be polishing with No. 90 and No. 120 artificial alumina on dry-rag polishing wheels, a final polish with No. 180 on a greased polishing wheel, and buffing with tripoli. For a mirror finish, the article is buffed again with very fine aluminum-oxide buffing compound, and finally with green rouge. For a satin finish the final operation is brushing with pumice on a Tampico brush.

Brass, being softer, will usually require fewer polishing and buffing operations. Castings can be polished with No. 80 and No. 120 and finally with No. 180 on a greased wheel, and then buffed with an emery-grease compound. Stampings can be polished similarly at 5,500 or 6,000 s.f.m. and then buffed on a loose muslin buff at a slower speed, such as 4,000 s.f.m. Buffing may be done with fine tripoli. For nickel-plating there should be a final buffing with lime on a muslin or linen wheel, after which the buffing compounds are cleaned

MOTOR SIZES FOR POLISHING AND BUFFING

Diameter of wheels inches	Horsepower required
6	1/4
10	1
12	2
14	3

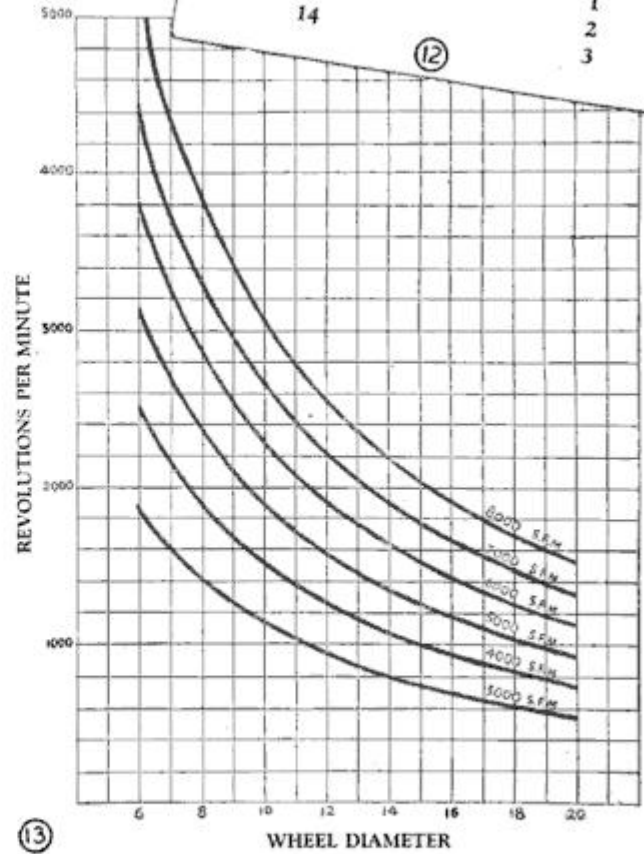

13

ished at 5,500 s.f.m. using Nos. 80, 120 and 180 grits on the wheels. The No. 80 wheel may be used dry. Then the work is buffed with tripoli and lime on a muslin buff, and finally with rouge. The buffing operations can be carried out at a somewhat higher speed, 7,000-7,500 s.f.m. Scratch-brushing at low speeds, 600 r.p.m. with a 6-in. brush, produces a dull gray finish. A satin finish can be produced by brushing with fine alumina on a Tampico brush at 3,000 s.f.m. A

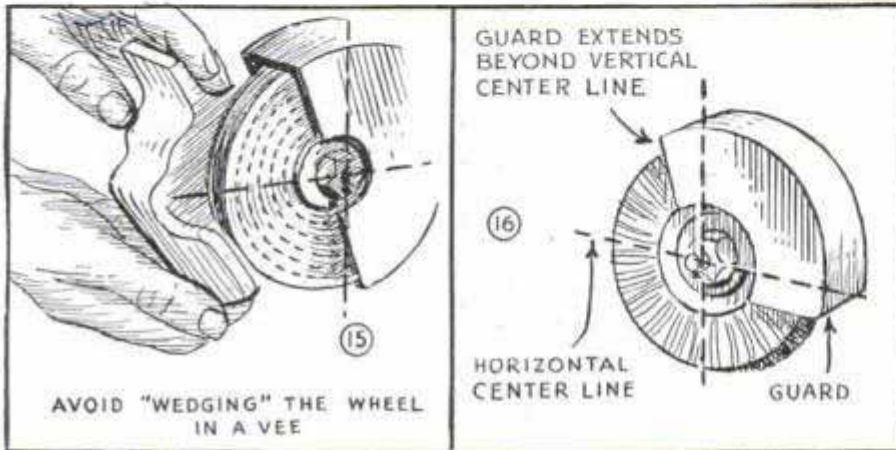
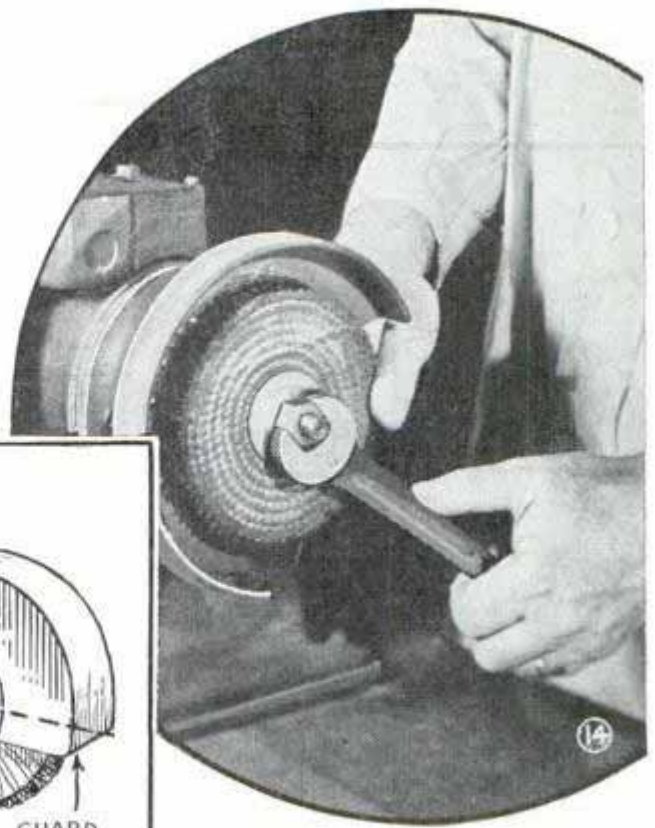

similar finish can be produced on brass or steel with pumice and water at 3,000 s.f.m.

Zinc die castings can be polished with No. 120 grits then buffed with tripoli, and finally buffed at 6,000 s.f.m. with a soft buffing compound. As an alternative final operation, zinc articles can be brushed with fine pumice and water on a Tampico brush at a low speed. Zinc-plated surfaces can be buffed with tripoli and lime. Nickel and copper-plated surfaces should be buffed with lime on a soft wheel, and then with rouge. A nickel surface which is to be chromium-plated requires careful buffing, as the final finish will show up any marks left after buffing. Monel metal can be buffed with fine emery cake, then tripoli,

then with lime or chromium-oxide rouge.

Where buffing and polishing is done with a small bench grinder, such as that shown in Figs. 9 and 14, some precaution must be taken to assure safety as well as good work. First see that the guard is set properly to clear the work, Figs. 9 and 16. Then make sure that the wheel is tight on the shaft and that it runs true, Fig. 14. Some grinders of this type may require an extra washer to hold cloth buffing wheels. Figs. 11 and 15 show two things to avoid in any polishing or buffing operation. In either case should the wheel run against a square edge or into a vee in the casting or other object, the work is likely to be thrown from the hands with dangerous force.

Parking-Garage Charts Give Customers Lubrication Data

For the convenience of his customers, one owner of a parking garage has a blackboard hung on the wall at each parking stall showing the customer's name, stall number and the mileage at which the car should be greased and the oil changed. The garageman claims that his customers appreciate this service and they give him most of their lubrication jobs.

—Opie Read, Jr., Chicago.

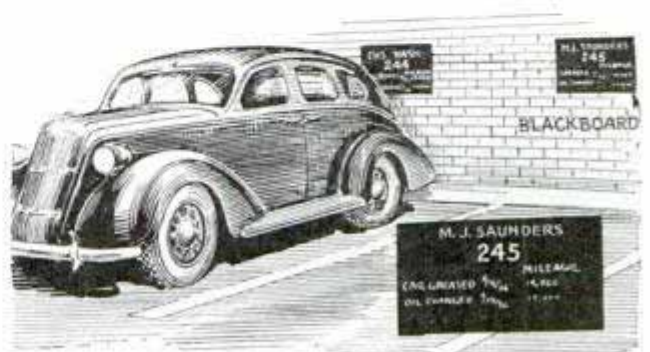

Meat-Slicing Board for Chefs Protects Clothes

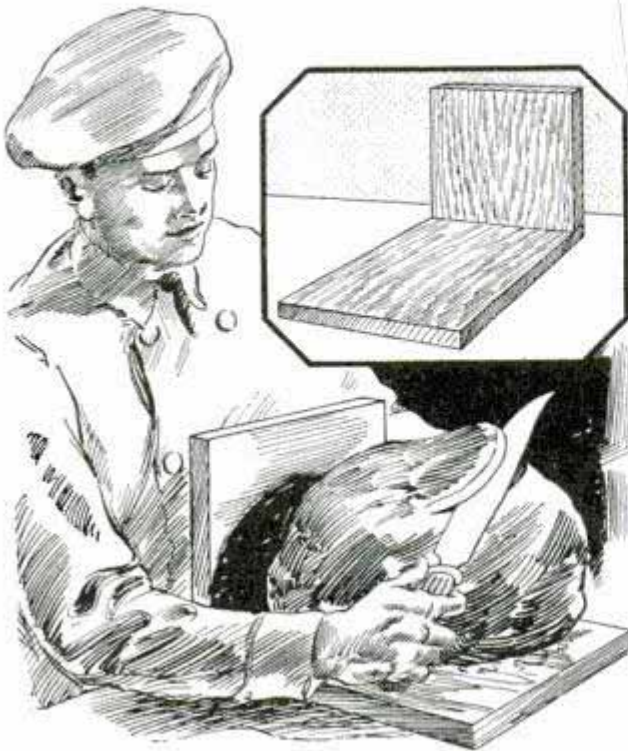

Two blocks joined at right angles provide handy board to hold meat while slicing it

In restaurants this slicing board enables a chef to hold a roast or ham rigidly and in a sanitary manner, without any possibility of cutting himself, even when pulling the knife toward him. And, as the board consists of two wood blocks joined at right angles, two cutting surfaces are provided so that the meat can be laid down or stood up vertically.

Expansive Bolt from Tubing and Long Machine Screw

The next time you want to use a bolt in a place where it is impossible to start the

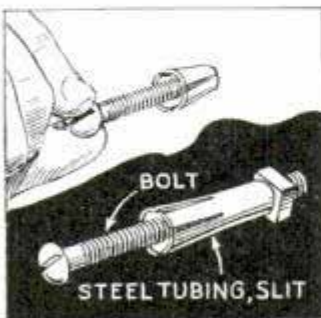

nut, use an expansive bolt made as follows: Take a short piece of steel tubing, make several slits from one end to the center, and slip it over a long machine screw as indicated.

Then run the nut on the end of the screw, drill your hole large enough to take the nut and push the assembly in place. When tightened by

turning the screw, the slit end of the tubing will spread against the back of the work so that the bolt can be tightened.

Portions of Metal Tube Annealed with Resistance Wire

To anneal certain portions of monel-metal tubes so that they could be bent, I did the job by using coils of resistance wire. The coils were stretched slightly to separate the turns, after which they were coated with refractory cement to insulate them.

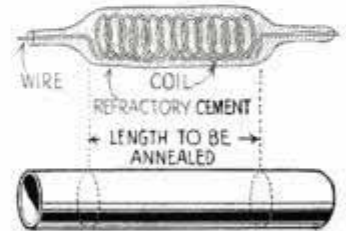

After the cement had dried, they were inserted into the tube and connected to the 110-volt line. The wire quickly heats the tubes to a light red heat, which is ample for monel metal or steel.

—H. G. Pack, Los Angeles, Calif.

Level on Electric Drill

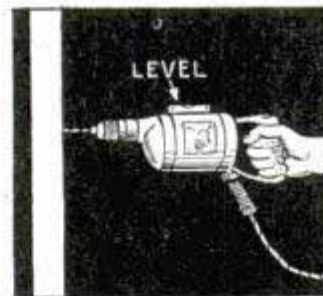

Workmen who have trouble in drilling a hole straight horizontally with an electric drill, can overcome this difficulty by mounting a small level on top

of the drill housing as indicated. The level should be mounted parallel with the shank.

—Joseph Chalala, Lancaster, Pa.

Blueprints Sprayed with Lacquer

Immediately after getting blueprints for a job, an Arizona contractor applies a thin coating of transparent lacquer to them with a small insect sprayer. He claims that this waterproofs the prints, gives them a tough coating which makes them tear-resistant, and also permits them to be cleaned easily with a damp cloth.

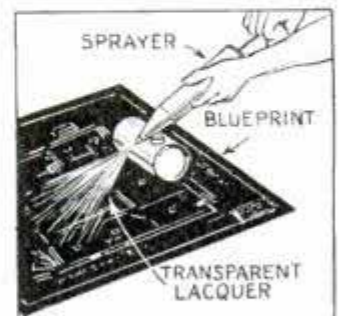

Portable Gas Lamp Illuminates a Large Area

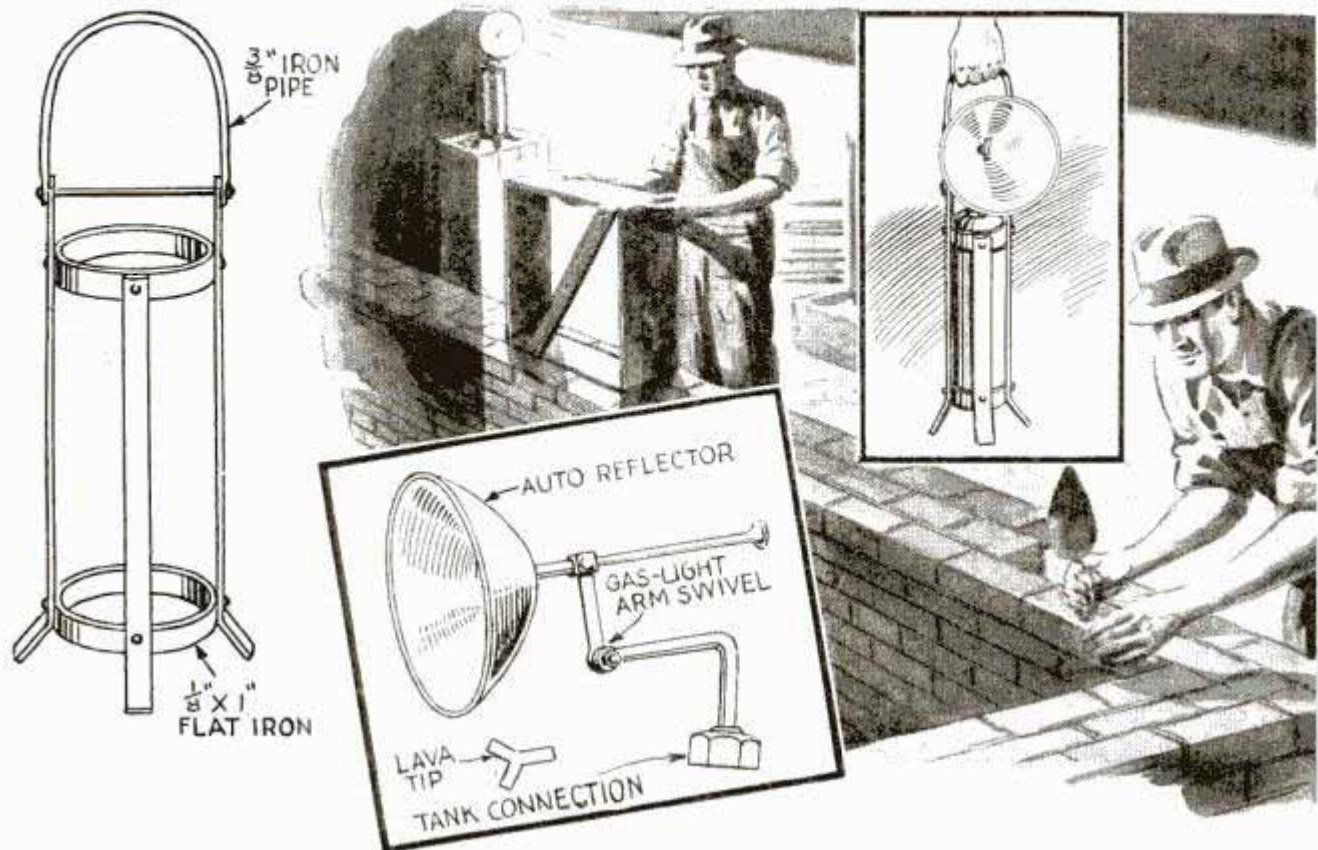

On rush construction jobs where gas or electricity is unavailable for night illumination, this portable gas light is just the thing. It consists of an old auto headlight reflector, a swiveled gas light fitting and lava tip, and a "basket" or holder made of flat iron, for the pressure tank. The latter can be of the generating type used on autos before the storage battery came into

universal use. The holder is provided with a swinging bail or handle and the whole thing is riveted together as shown. The height and inside diameter must be made to suit the tank at hand. The latter is held in place with wedges. There should be a shut-off cock in the swiveled arm so that the gas pressure can be controlled.

—A. Campbell, Clarendon Hills, Ill.

Goggle Case on Grinder Switch Reminder to Protect Eyes

Do you forget sometimes to put on a pair of goggles when using a grinding wheel? If so, make a case of light wood to hold the goggles and mount it over the grinder switch so that the goggles have to be removed before the switch can be turned on. If the switch is located so that a case cannot be used, remove it and mount it on the grinder bench or table. Provide the box with a tight-fitting cover to keep out dust. It's best to use a spring, as indicated, to close the cover so that it will not be left open.—W. C. Wilhite, Carlinville, Ill.

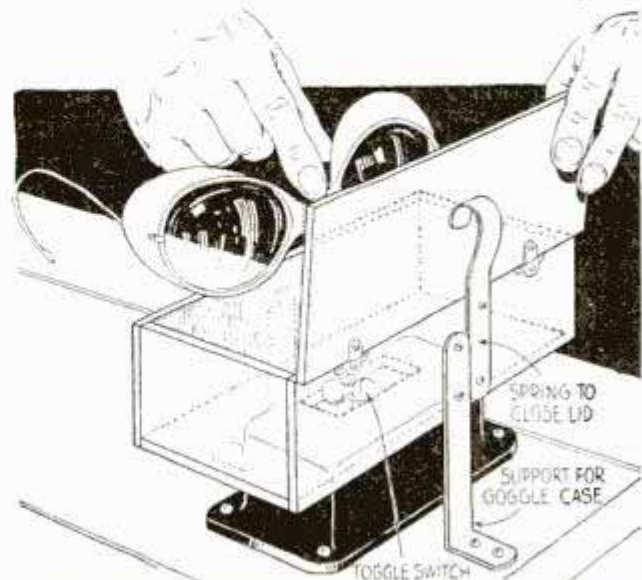

Case must be opened and goggles removed before grinder switch can be operated

☞ An easy way to clean carved furniture is to rub it with an old toothbrush dipped in furniture polish.

Bag on Handles of Push Truck to Carry Papers



Papers are always at hand for reference, are not mislaid and are protected against soiling

Fastened to the underside of the handles of a push truck, a canvas bag similar to a boy scout's knapsack provides a good place to carry papers when using the truck to gather merchandise from a warehouse floor. By keeping the papers in the bag, they will not be inadvertently mislaid and are not likely to become soiled.

Steel Rule Held on Your Arm for Production Work



When a number of small parts are to be dressed to measure on an emery wheel, the mechanic will find that a bicyclist's trouser guard soldered to a steel rule will hold the

rule conveniently on his forearm in position for taking measurements. This leaves both hands free for the work in operation.

Ant Exterminator

Paradichlorbenzene is effective as an ant exterminator. For this purpose one pound of the crystals are dissolved in carbon tetrachloride or kerosene, 2 qts., and the solution poured into the ant holes. If carbon tetrachloride is used, the solution has the

advantage of being non-inflammable. A chemical often used for this purpose is carbon disulphide; however, this substance is poisonous and dangerously inflammable. Ants may be prevented from entering buildings by sprinkling oil of sassafras around the entrance.

Pipe Supports for Partitions Anchored to Concrete

Instead of using three or four bolts and a plate to anchor each standard of a pipe-supported partition to a concrete floor, use a pipe cap and one bolt as shown. You'll find that this method results in a neater job than if plates are used. It also saves labor as only one hole has to be drilled in the floor for each standard.

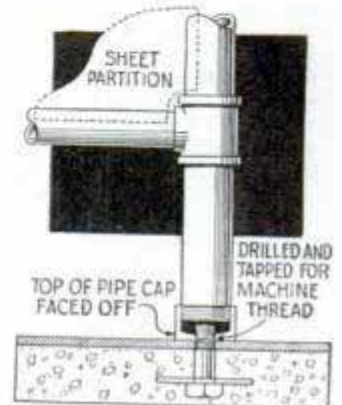

—L. H. Georger, Buffalo, N. Y.

Weights in Can Lids on Scales Can't Fall to Floor

Placed in can lids screwed to the top of a platform scale, weights are always neatly arranged for quick selection, and there is no danger of them being knocked off on your feet. Portions of the lids should be cut out on opposite sides so that the fingers can grip the weights easily.

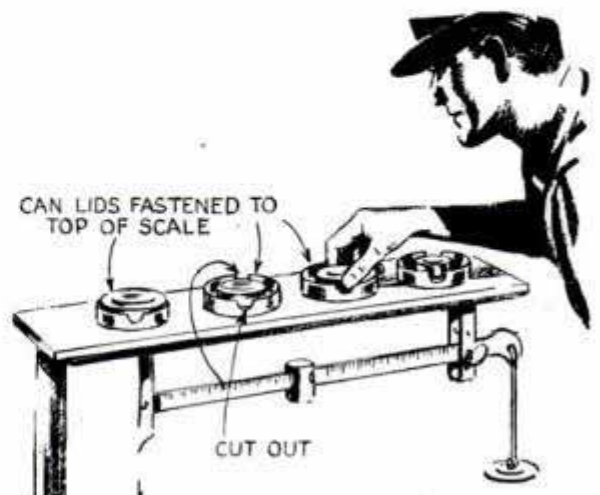

These scale weights are separated for quick selection and there's no danger of knocking them off

Helps for the MOTORIST

Your jack and handle will be kept in a neat bundle if encased in a rubber sack—an inner tube sewed together at one end. The sack prevents marring or tangling with other tools, and its compactness permits easy removal from the tool compartment. Below, a trap door in the shelf above spare tire increases trunk space as it allows small articles to be stored in the hub and wheel.

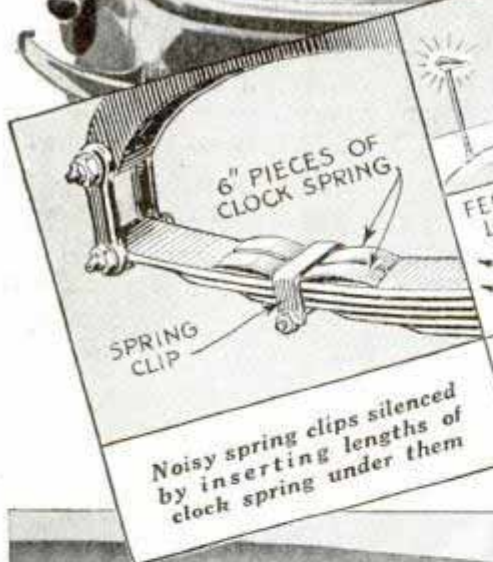
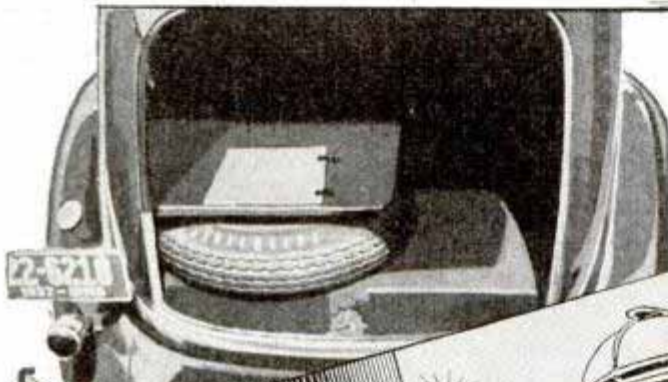
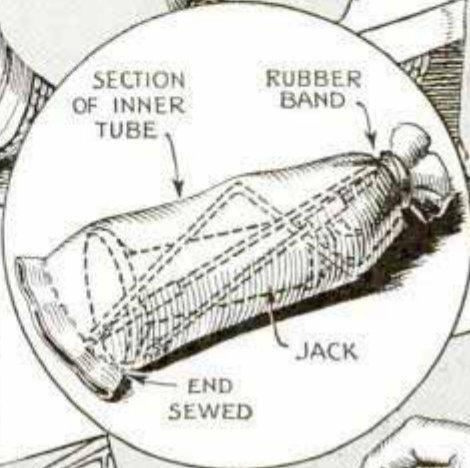

Noisy spring clips silenced by inserting lengths of clock spring under them

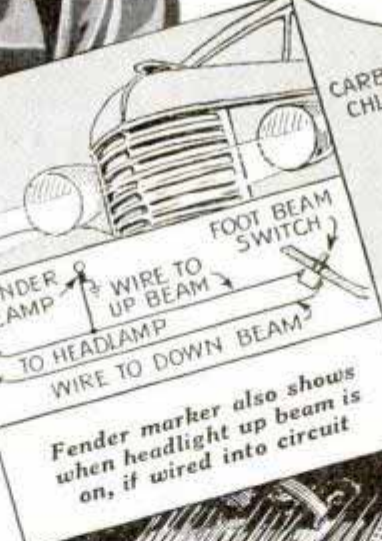

Fender marker also shows when headlight up beam is on, if wired into circuit



Carbon tetrachloride softens rubber tubing to slip over nipples easily

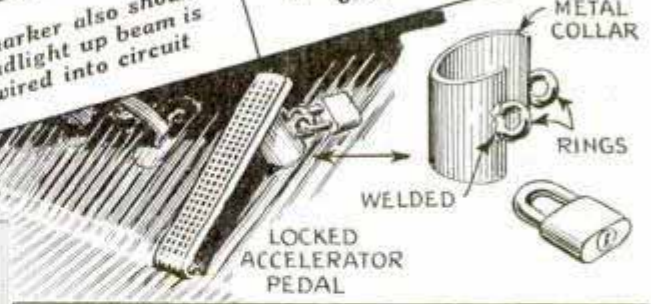

It will be difficult for anyone to drive your car away if a strip of sheet metal is clamped under the accelerator pedal with a padlock when you park. Two rings welded to the strip take the lock shackle. The metal should be wide enough to keep the pedal raised as high as possible. It is claimed that strips of tape, such as masking tape, around the edge of your windshield on the inside, as at the left, will reduce glare when driving toward the sun

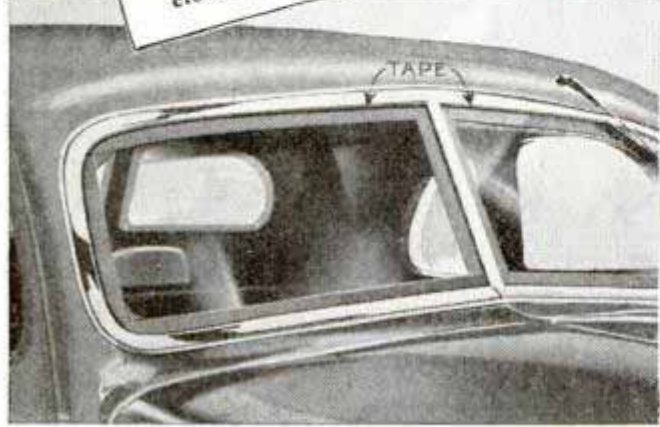

Extra Rear-View Mirror Reduces Part of Blind Spot Behind Car

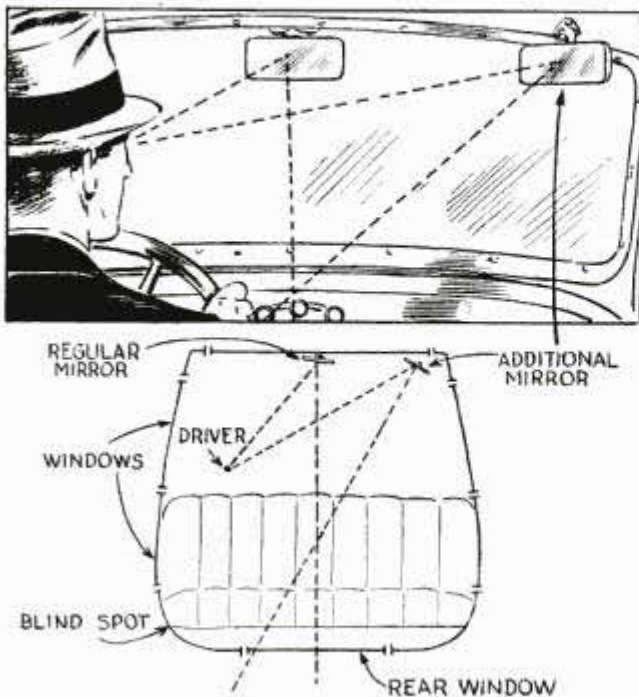

Extra mirror at right-hand corner of windshield permits driver to see car about to pass on left side

By attaching an extra rear-view mirror near the upper right-hand corner of the windshield, you will be able to see a car that is about to pass on the left side. This is especially true on coupes and convertible sedans, which usually have small rear windows. An extra mirror has helped me avoid several accidents by making it possible to see a car coming up behind me on the left.—Richard A. Ehrmin, Toledo, Ohio.

Powdered Whiting on Floor for Brake Testing

When testing newly adjusted brakes by skidding the tires on the garage floor, one

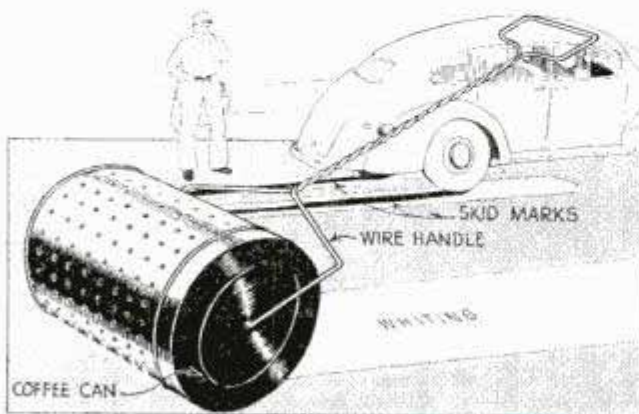

Tire marks show clearly when skidding wheels to test brakes if whiting is spread on floor

mechanic sprinkles powdered whiting on the floor so that the skid mark of each tire can be seen clearly. To save time in applying the whiting, a perforated coffee can with a removable wire handle is used.

Electrical Outlet on Dash Panel Has Many Uses

I mounted a single-circuit radio jack on the dash panel of my car and found that it provided a handy electrical outlet for quickly attaching a defroster, trouble light, etc.

One side of the jack is wired to the ammeter and the other is grounded. Of course, it will be necessary to fit each appliance cord with a special plug to fit the jack.

—Charles E. Travers, Titusville, N. J.

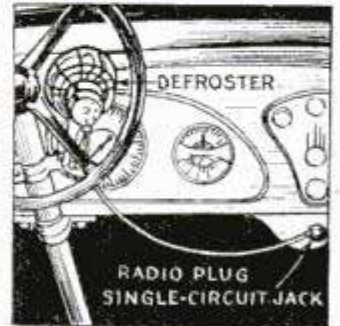

Identification Papers Carried on Rear-Window Curtain

To assure that my registration, insurance and identification papers will always be in the car with little possibility of them being lost, I keep them rolled up in the curtain of the rear window. The curtain is merely pulled down part way and the edges



of the papers stuck under the roller, after which the curtain is rolled up.

—Erwin E. Williams, So. Windham, Me.

Protecting Elbows on Oil Filters When Removing Them

When installing or removing certain types of oil filters, I have often experienced trouble by accidentally crushing the brass elbows. To avoid this, I drive a cap



screw into each one to strengthen it. After the filter is in place, the cap screws are removed.

—Allan Clisbee, Petaluma, Calif.

Mechanic's Extension Lamp Has Rubber Handle



Slipped over the cord of an extension lamp as indicated, a bicycle handlebar grip provides a good grip for the lamp that tends to insulate the wire and helps to avoid wear on the covering.

A coil spring or a spiral of heavy wire is first slipped over the cord and the end soldered to the socket, then the rubber is pushed in place, the lower end being drilled to take the cord.

Claws Cut in Old Exhaust Pipe Pull Broken Axle Shaft

Sharp triangular claws cut with a cold chisel in an exhaust pipe will grip and remove a broken axle shaft from a housing. The pipe should be one that is just small enough to slip into the housing, and the claws should be sprung in far enough to give them plenty of "bite" even though they may contact only the smallest diameter of the axle.

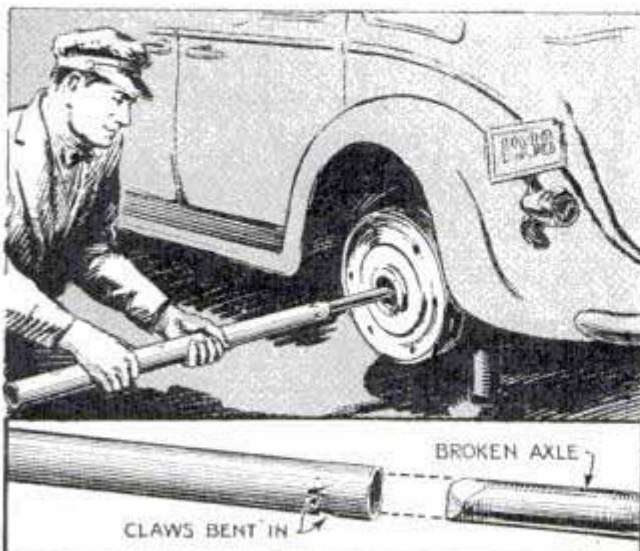

When this pipe is pushed over end of broken axle, it grips the metal so that shaft can be pulled out

Stakes in Body of Truck Held by Hooks and Screw Eyes

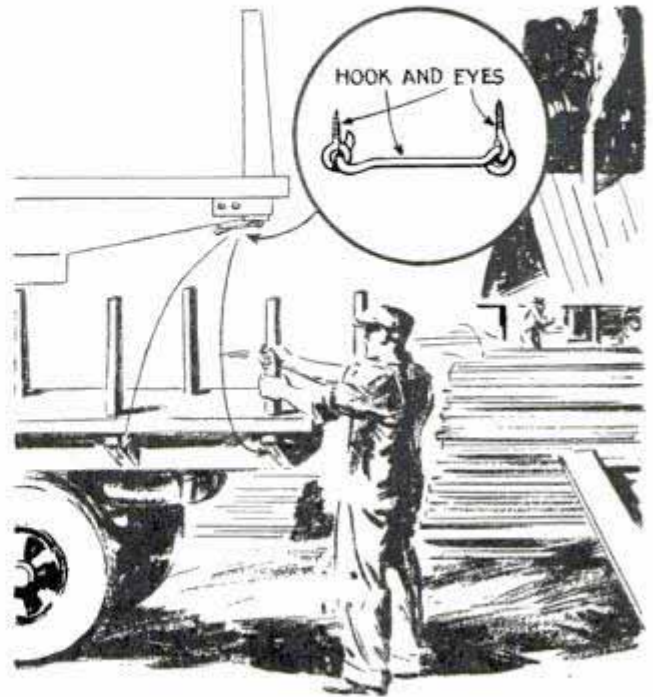

Stakes in truck body can't jump out when held by these hooks, yet are easily removed to load truck

To avoid the tendency of stakes to jump out of a truck body when driving over rough ground, I anchored them with large hooks and screw eyes. The hooks are attached to the cross members of the body and the screw eyes are driven into the lower ends of the stakes.

—Virgil J. Mara, Prairie du Chien, Wis.

Gas Line Repaired in Emergency with Raw Potato

If you have a gas-line fracture or break-in-two on the road, and there is no material at hand to make a temporary repair, a small, raw potato slipped over the break will enable you to drive to a garage. A hole can be reamed through the potato with the small blade of a pocketknife to take the tubing snugly. Care should be taken when inserting the ends to avoid scraping off small particles of the potato, which might get into the fuel line and clog it.

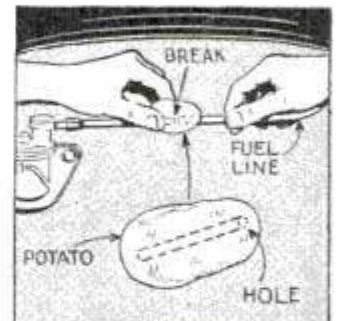

—Ivan J. Stretten, Detroit, Mich.

Shoe-Shining Stand in Trailer Folds Out of Sight

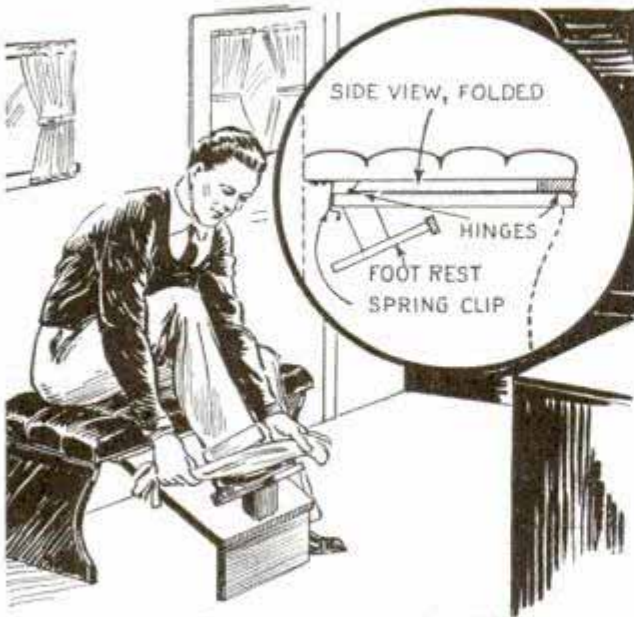

With this stand, you can sit comfortably on a seat while shining your shoes

Folding up under one of the seats in a trailer, this hinged stand is instantly lowered to support your foot while shining the shoe. It is held under the seat by a spring clip, which was shaped from a piece of clock spring. If desired, a shallow drawer to hold polishing paste, brushes and daubers, can be fitted to pull out from under the seat.

—Kenneth Murray, Sturgis, Mich.

Air Dome in Fuel Line of Car Increases Mileage

Working on the same principle as the air dome in fire-engine water pumps, this small dome on the gasoline line between

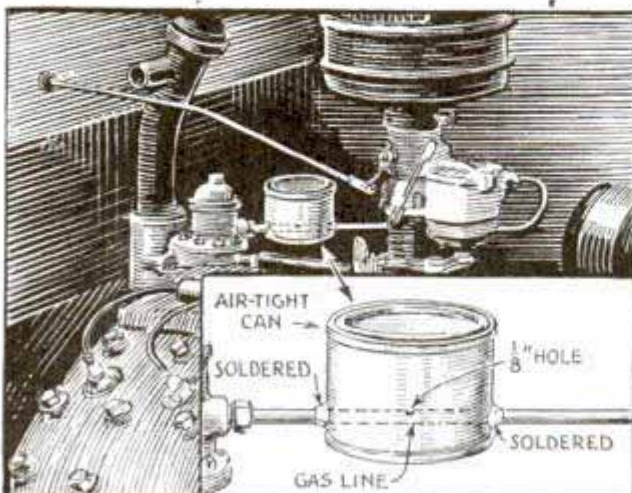

Air dome in gas line eliminates pump pulsations, which often cause uneven motor operation

the fuel pump and the carburetor minimizes surging of the fuel in the carburetor. This in turn maintains a uniform fuel mixture by eliminating rising and falling of the gasoline level. The dome is a small can with a press-fit lid, and is pierced on opposite sides to let the gas line pass through. Piercing is better than drilling as the torn metal forms a good foundation when soldering the line to the can. A $\frac{1}{8}$ -in. hole is drilled in one side of the line inside the can.—C. E. Packer, Chicago.

Brake Drum Supports Auto Jack on Soft Ground

A discarded brake drum provides a dandy support for the jack when a truck wheel has to be raised on soft or spongy

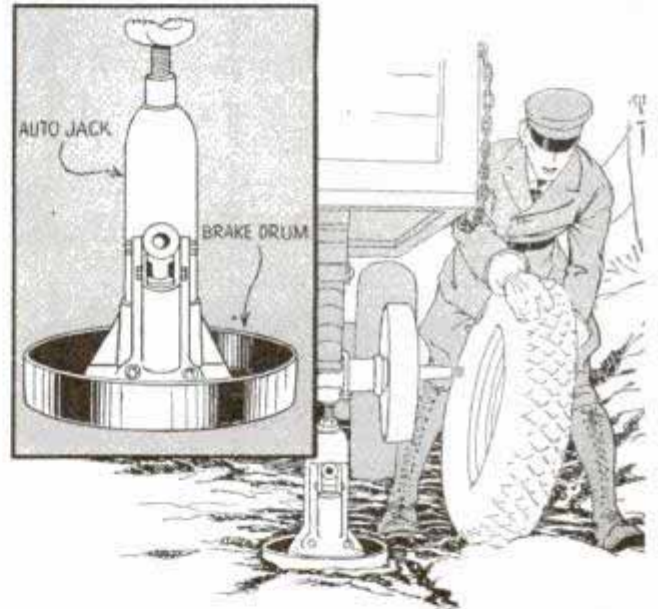

Brake drum carried in toolbox always at hand to support jack when changing tire on soft ground

ground to change a tire. The drum can be stored in the toolbox where it will always be at hand when needed.

Erratic "Miss" in Motor Traced to Shorted Distributor Wire

An erratic miss in some motors is often caused by a short-circuit between the low-tension distributor wire and the clip that holds it on the valve push-rod cover. The wire is fairly taut and movement of the rubber-cushioned motor soon chafes the wire. Heavy wrappings of tape at this point usually stop the trouble.

—Emil J. Novak, Omaha, Nebr.

*An exciting new field for
your picture-taking skill*

Snapshots at Night



ALL YOU NEED—
Your present camera
loaded with Kodak
"SS" Film



Two or three
Photoflood lamps
in Kodak
Handy Reflectors



SNAPSHOOTING indoors after dark, you discover scores of new and fascinating picture chances. You get good results from the start, and really great snapshots as you become increasingly skillful in placing your subject, arranging your lights.

The equipment is both simple and inexpensive. You don't need a high-priced camera. Any camera that can be loaded

with Kodak "SS" Film will do the trick—even the simplest Brownie.

With "SS" Film, you use two or three of the new No. 2 Mazda Photoflood lamps, which last for hours, together with inexpensive Kodak Handy Reflectors. If your particular camera is equipped with an *f.6.3* or faster lens, then No. 1 Photoflood lamps are quite powerful enough.

FREE BOOKLET . . . Suggests a variety of picture opportunities . . . shows you how to arrange your lights . . . how to place your subject . . . tells you everything you need to know about two ways to make night pictures—*snapshots* with Photoflood lamps, *fast exposures* with Photoflash lamps. (You can use Photoflash lamps, each good for one picture, if your camera can be set for "time.") Get a copy at your dealer's today . . . Eastman Kodak Company, Rochester, N. Y.



When writing to advertisers please mention *Popular Mechanics*

"Are Camels Really different from other Cigarettes?"

A QUESTION OF INTEREST TO EVERY SMOKER

...When H. W. DALY, 34, rayon salesman, says "Yes, Camels are different," millions of other steady smokers stand ready to back him up. And that explains why Camels are preferred by the largest, as well as the most enthusiastic, body of smokers ever known.



MARITA (Mrs. Daly) is planning a grand feed. The Dalys agree about most things. Among them, Camels. Mrs. Daly smoked them first, soon noticed a difference. "Now we find that Camels agree better with both of us," she says.



ON WEEK-ENDS, Bill's a candid camera fan. On week days he "pounds the streets." "You have to keep the pressure on to get along, selling," he says. "When my energy begins to fail, I get a quick, pleasant 'lift' with a Camel."

ONE SMOKER
TELLS ANOTHER.. **"Camels"**

"I've never been very fussy about cigarettes myself. Do you think that Camels are really as different as some people say, Bill?"

"You bet they are, John! A fellow in any work as hard as selling has to figure a lot of angles on his smoking, such as how it agrees with him. And just notice how many salesmen smoke Camels. I changed to Camels—smoked 'em steadily—and I found a distinct difference in the way I enjoyed all-day smoking and in the way I felt. Camels *agree* with me!"

A FRIEND DROPS IN to see Bill. Daly passes the Camels and answers a question about smoking: "That all-cigarettes-are-alike talk doesn't square with my experience. Steady smoking is the test that shows Camels in a class by themselves. They don't make my nerves 'edgy.'"

PEOPLE DO APPRECIATE THE
COSTLIER TOBACCOS
IN CAMELS

THEY ARE THE
LARGEST-SELLING
CIGARETTE IN AMERICA

•
A matchless blend
of finer—**MORE**
EXPENSIVE
TOBACCOS
—Turkish and
Domestic
•

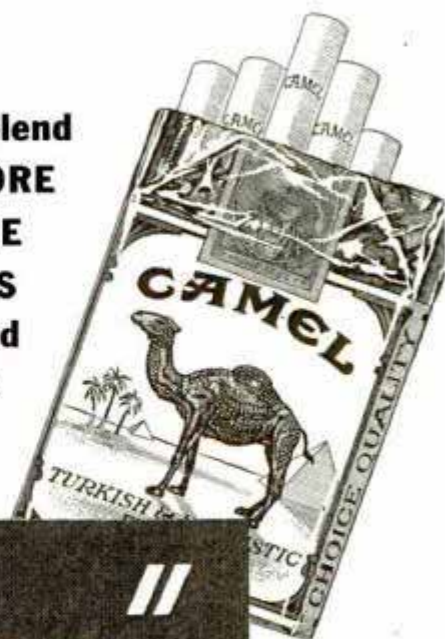

agree with me //

Copyright, 1938,
R. J. Reynolds
Tobacco Company,
Winston-Salem,
N. C.

Bad Weather Photography

(Continued from page 533)

photographer have much idea of his picture until the prints are made. Since lightning is extremely brilliant, the camera lens can be well stopped down.

Snow photography is hardly bad-weather photography, because as a rule the camera worker waits for the snow to stop and the sun to come out so that there is an interesting play of light and shadow. Most amateurs have pictured snow by day, but few try it at night by the light of street lamps. This is unfortunate, for many interesting and striking effects can be obtained by time exposures at night. Such



Street lamps reflected on wet pavement enhance an otherwise dull scene; three-minute exposure at f.16

street-light pictures depend for quality almost entirely on the photographer's choice of viewpoint, and the way in which he works tree branches, masses of snow-laden shrubbery, and shadows into his picture composition. Exposures are necessarily long—the average will be about fifteen or twenty minutes with a box camera or a focusing camera set at f.16 or f.11. The photographer should select a quiet street and stay close by to place a hand over the lens whenever automobiles pass—otherwise their headlights may produce parallel horizontal streaks of white in the picture. Passers-by will not appear in the picture, unless, perchance, they pause for a minute or two under a street light. Then the print may contain a "ghost" or two.

In photography of ice and icicles, the rule

for picturing rain can be applied—choose an angle at which light is caught and imprisoned within the icicles. This effect is more marked if the sun is shining, and it can be made stronger, in cases where the icicles are pictured with the sky as a background, if a deep red filter is used over the lens. With such a filter, the sky comes out black. The filter cuts off much light, so exposures must be several times longer than normal.

Supersensitive panchromatic film is useful in most bad-weather photography, because of its speed, but when the photographer is picturing fog and mist, he should use one of the ordinary or chrome-type films. This film intensifies the whiteness and atmospheric quality of the mist, while panchromatic film has a tendency to "cut through" haze and vapor, reducing its brightness.

If you wish to picture bad weather and can't find any, make your own on a table top, using windblown twigs for trees, cotton for snow, and zigzags of white paper on dark cardboard for lightning. Moreover, if you have trouble getting rain into your negatives, you can still put it into your prints. The trick is this: before the sheet of enlarging paper is put on the enlarger easel, brush it lightly, in a swift straight motion, with a wet sponge, so that little streaks and droplets of plain water are distributed over the surface. Then print, and the streaks show up white and gray—not the equivalent of genuine rain, but often amusing.

15-91 Mop Adjustable for Corners and Narrow Places

Easily convertible into a narrow mop for cleaning between pieces of furniture and in corners, a mop now on the market also may be used



the broad way for cleaning open spaces of floor quickly. The handle is on a pivot so that a one-quarter twist makes the required adjustment.

W. Way Products Co
445 So Jefferson

Velvet
PIPE AND CIGARETTE
TOBACCO
LIGGETT & MYERS TOBACCO CO.
REG. U.S. PAT. OFF.

*“Mate it’s
a swell wind
that blows
a man
Velvet!”*

*Better
smoking
tobacco*

- the **MILDNESS**
of fine old
Kentucky Burley
aged in wood
- the **FLAVOR**
of pure maple
sugar for extra
good taste

*Velvet packs easy in a pipe
Rolls smooth in a cigarette
Draws right in both*

Flying the China Clippers

(Continued from page 503)

captain, sitting in his office off the chart room, is writing up the ship's log and is assembling data for the coming radio report. Meanwhile the radio officer at his panels right behind the bridge has just contacted Alameda and has been given a bearing from the shore station.

The report that the radio officer will pound out on his key will include the temperature and altitude, wind velocity and turbulence of the air, latitude and longitude and how the position was ascertained such as by dead reckoning or by a line of position crossed by a radio bearing, the

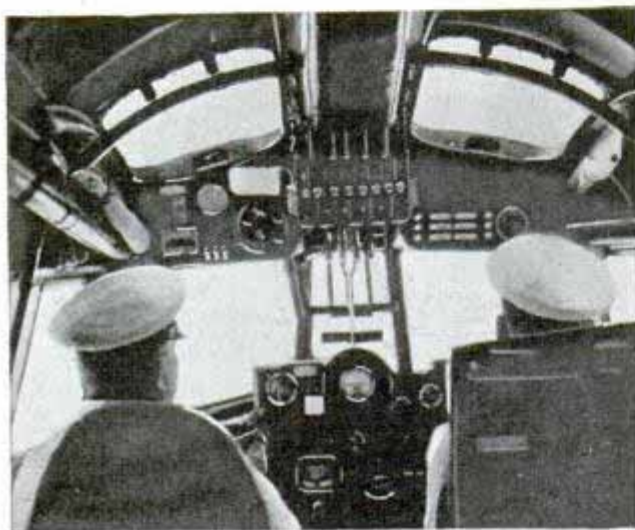

First officer and junior flight officer at the controls of clipper in flight

ground speed in knots, the general state of the weather, the intended course for the next half hour, kind and height of cloud masses, and condition of the sea if visible. Half an hour later, with the clipper continuing to close in on the coast, the captain will prepare an abridged report so the land bases can keep exact track of the plane.

If the navigator finds that a cross wind is setting him off his course he tosses a glass bomb filled with aluminum powder out of a cabin window. Shattering on the surface, the bomb spreads the light powder out into a shimmering spot and this can be followed by means of a drift indicator set up in the window. After dark a chemical that flames on the water, instead of aluminum powder, is used. When he has estimated his drift, the navigator can calculate a course that compensates for the cross wind.

One hundred miles out from the terminal starts the meticulous work of making

an accurate landfall. At the radio officer's request the naval radio compass stations at Point Reyes, Montara Point, and the Farallon Islands swing their loops to tune in his signals. They triangulate their bearings and radio back to the flying boat its exact position. At the same time Pan American's own direction-finding station takes a series of radio bearings on the plane and radios back the "on course" report. As long as the bearings remain the same, the captain knows that he is flying directly toward the direction-finding station. In thick weather the plane operator locks his key fifty miles offshore so that the air line's shore station can take continuous bearings until the plane arrives overhead, when the signal "R" is sent to the plane to indicate its position.

The radio operator stands watch constantly while the plane is in the air and he can receive and transmit on eleven different frequencies. He uses two receiving sets and two transmitting sets in which wavelength changes are made with fixed coils. He guards the 600-meter band and one of the short-wave bands with split receivers.

The equipment permits communication on twenty-four, thirty-six, fifty-eight and 100 meters as well as "working" waves for these frequencies. Six hundred meters are used for working ships at sea, and 183 meters and 800 meters are used for radio compass and directional signals. The plane also is equipped for communicating on 1,000 meters, the international calling band for aircraft. Like all other aircraft, the planes have call letters of five symbols. The China Clipper, for instance, is KHAGV and the Hawaii Clipper is KHABZ.

To insure the utmost reliability over long distances, the clippers communicate with dot-and-dash code instead of by voice. All radio work and, in fact, all operations work is based on Greenwich time.

Between Alameda and Honolulu the operator may contact as many as a dozen surface ships and exchange weather and bearings with them. Every fifteen minutes he radios a flight "O.K." to the terminal bases, sends a position report every half hour, and the complete weather and position report on the even hours.

(Continued to page 120A)

Tracer Lights in Night Photo Show Level Knee-Action Ride

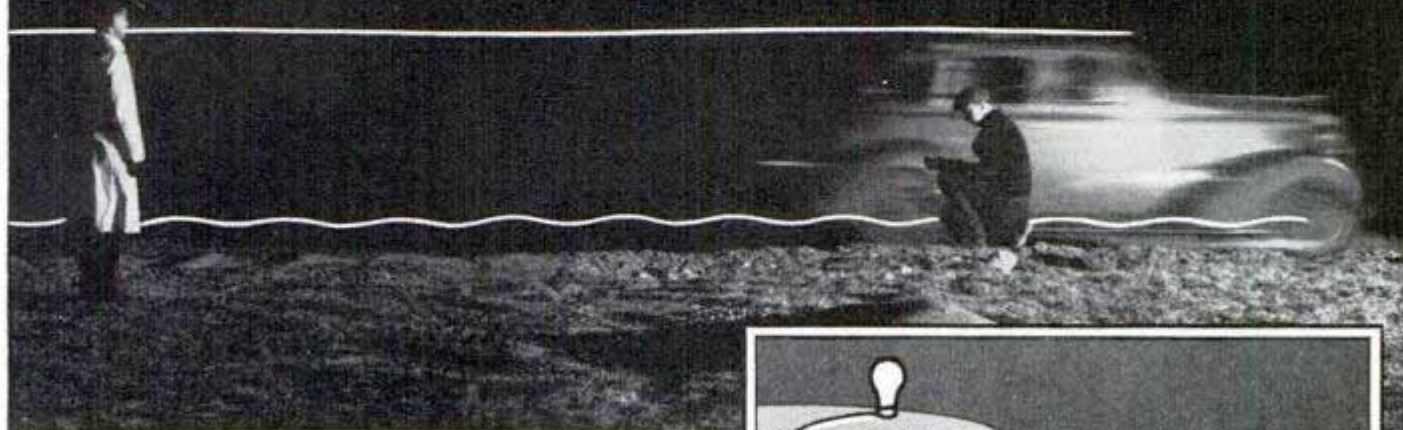

TO OBTAIN a visual record of the ride-leveling effects of individual front wheel suspension, or Knee-Action, Chevrolet engineers resorted to night photography, and made the car itself trace its ride diagrams on camera plates.

The tests were made at the proving ground, a Knee-Action Chevrolet being run at varying speeds over a specially constructed stretch of concrete paving having a washboard surface. To trace the indicator lines, two electric lights were used, one mounted on top of the body and the other attached to the end of the front wheel spindle.

To record the graph of the ride, the camera was placed well back from the track, far enough to include several car lengths in its field. As the car approached, the camera shutter was opened and held open while the car passed across the field of exposure. Positive prints of the negative show two lines of white on a black background, one tracing the travel of the front wheel, the other showing the path followed by the body. The front wheel is shown to have followed the road surface closely, moving up and down at a high rate, while the car body was virtually unaffected by the bumps in the road.

The night photograph at the top of this page was obtained in the manner just described except that a flash bulb was set off as the car was about to leave the field of the camera, so that the car itself

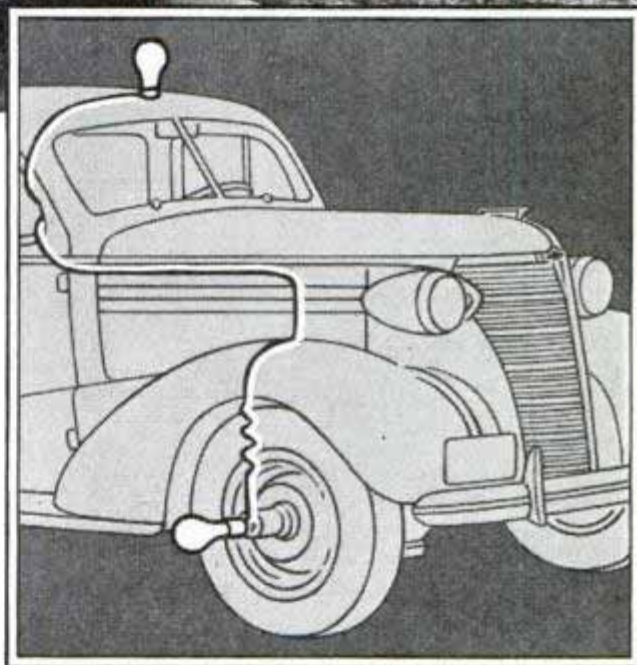

Top—The upper line shows the body movement, the lower line the up-and-down movement of the front wheel, of a Knee-Action car on a washboard road. Bottom—Tracer lights are mounted on the roof and on the front wheel spindle.

was photographed on the same plate with the previously recorded tracer lines.

By turning the illustration sidewise and sighting along the line made by the light on the body, one can note waves of far less amplitude and frequency than those made by the light on the wheel spindle. The diagram thus affords visual proof of the ride-leveling effects of Knee-Action.

All Chevrolet Master De Luxe models have Knee-Action.

CHEVROLET MOTOR DIVISION, General Motors Sales Corporation, DETROIT, MICHIGAN
General Motors Instalment Plan—Convenient, Economical Monthly Payments. A General Motors Value.

You'll be **AHEAD** with a
CHEVROLET

When writing to advertisers please mention Popular Mechanics

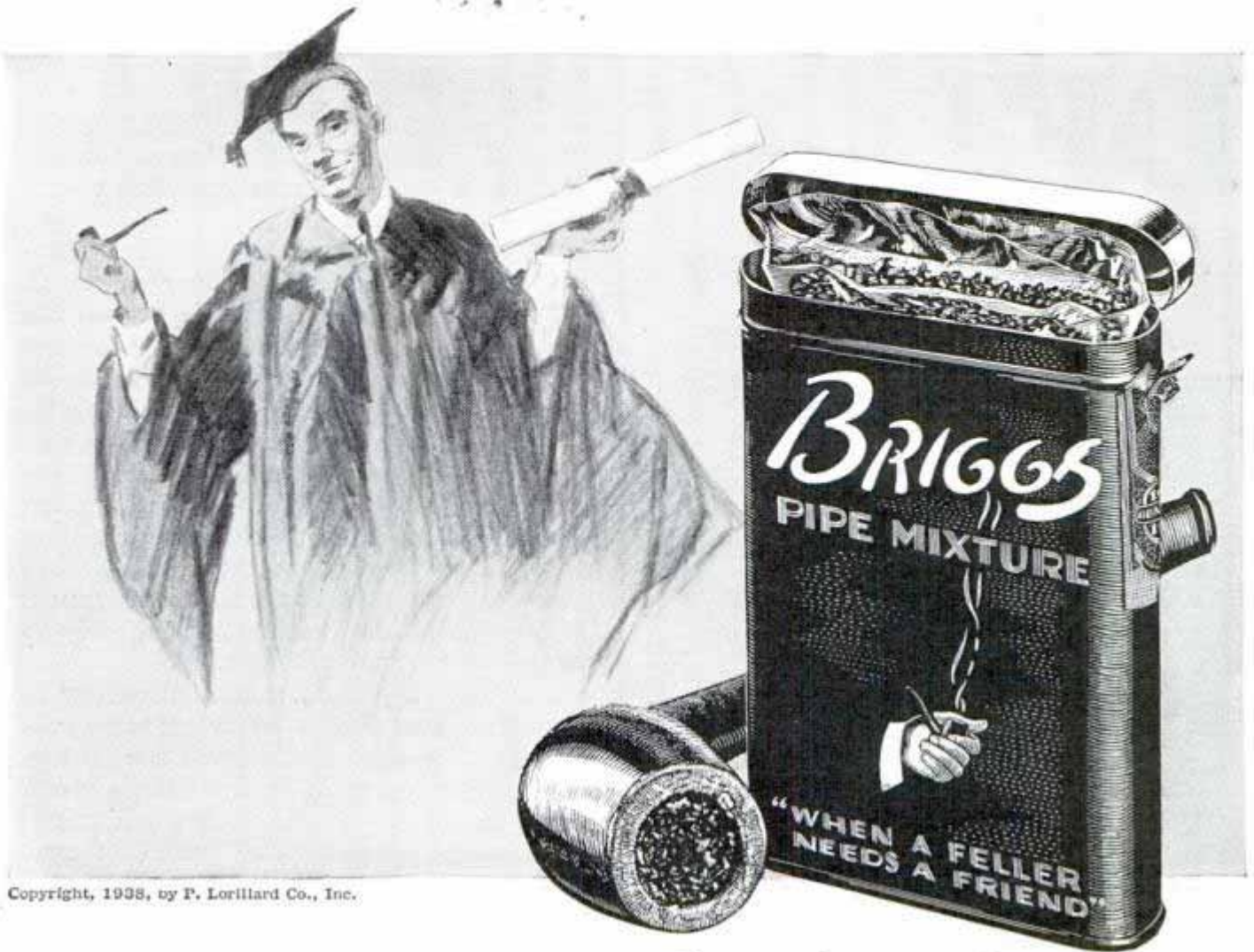

Copyright, 1938, by P. Lorillard Co., Inc.

Never read a book ...yet wins M.M. degree

*Idling through a 4-year course
... BRIGGS earns diploma as
"Master of Mellowness"*

WE KEEP a high standard here at old Alma Mater Briggs.

Our student body comes only from the first tobacco families of America. The leaves have been brought up properly; they're plump, tender, got fine stuff in 'em.

Once these leaves get by our Board of Regents, they're enrolled for a 4-year course in stout oaken barrels where they lose all

their greenness, rawness and cussedness.

Few tobaccos, even those which sell for five dollars and more per pound, have been aged longer than Briggs.

This university course for smoking tobacco costs us a lot, but Briggs costs you only a few cents more than ordinary uneducated tobaccos!

And Briggs will always be your fellow alumnus after the first tin!

BRIGGS
4
CASK-MELLOWED **4** FULL YEARS

When writing to advertisers please mention Popular Mechanics

THE NEW DELCO

End-to-End Battery

A REAL INNOVATION



A typical Delco end-to-end battery installation on a 1938 Pontiac.

AUTOMOTIVE mechanics and repair men have long felt the need for a battery that could be serviced conveniently. Delco-Remy engineers have met this need with the new Delco end-to-end battery, a real innovation. Mounted under the hood, this new Delco end-to-end battery provides these important advantages:

Easily seen—closer check can be kept on water level and other service needs.

Can be serviced without disturbing occupants of the car.

No possibility of acid damage to upholstery.

Sealed connectors minimize short-circuiting from tools inadvertently placed on the battery.

Double baffle vent plugs, as illustrated, aid in condensing acid vapors, and prevent acid from escaping.

Corrosion and loose connections can be detected quickly and corrected easily.

Battery case cannot be damaged by thrown stones on gravel roads.

Shorter cable to the starting motor assures more reliable winter starting.

The new Delco end-to-end battery is standard equipment on all 1938 Buicks, Oldsmobiles and Pontiacs. Its long, narrow shape also makes it ideal for motor boats, trailers, and other uses. Sales and service requirements are available at United Motors Service Stations.



Delco-Remy

ANDERSON, INDIANA

World's Largest Manufacturer of Automotive Electrical Equipment

201401
Now You See It, Now You Don't

(Continued from page 565)

to one side of the point at which you are looking. The moral is that when you are driving a car you must keep both eyes open and on the move.

When you get tired, you may be virtually blind in the tail of the eye, which means you no longer are safe behind the wheel of a car, nor at your job at a factory bench. In a wire-cloth factory, ninety-six per cent of the workmen were able to pass army and navy eye tests; but further examination revealed that three out of four had eyes that began to play tricks when fatigue set in. Early in the morning, they tested high, but by lunch time they were partially blind to motion. After lunch, their vision came back to normal, only to fail again toward quitting time.

Another surprising recent discovery is that the visual field is wider for some colors than for others. You will see an approaching fire engine sooner than a green or black truck. A smart football coach would have his men wear green uniforms. Red ones, on the other hand, would be so conspicuous they would make things much easier for the opposing team's interference.

The tail of the eye is amazingly sensitive to the body's general condition. Fatigue, hysteria, infections, or poisons taken into the body—all dull the sight, especially vision for moving objects. Often this condition shows up first by making the eye very unresponsive to certain colors. In testing for poor tail-of-the-eye vision, Dr. Charles A. Pons, Los Angeles optometrist, first checks the field with different colored targets. A telltale dullness to green may warn of infections or faulty diet.

Individuals vary as to their ability to withstand various poisons. Most people are adversely affected by alcohol, nicotine and caffeine. Some have peculiar sensitivity to unexpected substances. Some people's eyes go bad in a room where there is wet wallpaper, because of arsenic or other substances released.

"Limping" eyes may cause many automobile crashes, experts are beginning to suspect. Not long ago, orders went out from the office of Paul Mason, chief of the division of drivers' licenses of the California Motor Vehicle Department, that all applicants are to have their eyes examined

es 140

separately. If your eyes show more than twenty points difference between them, you must either wear glasses, or be treated as a one-eye person and carry an extra rear-view mirror on the blind side. Tests have shown that imbalance of the eye muscles, inequality between the eyes, is more dangerous than mere lack of keen vision. Recently, California motor vehicle experts tested seventy-six drivers for a company which had an average of less than half an accident per man in a six-year period. They found only two cases of imbalance—but these two men accounted for nine accidents between them!

Don't imagine you're a freak simply because you find you need glasses, for your chances of having correct natural vision are only about one in four. "Seventy-five per cent of the Caucasian race are born with defective eyesight," says Dr. Arthur Hoare, Los Angeles eye specialist. "The typical Caucasian face, with deep-set aquiline feature, usually has a short eyeball and hence is farsighted. Asiatics and Teutons, however, have long eyeballs and are nearsighted."

If you're suffering from eyestrain you'll notice one or more of the following symptoms: headache; pain in and around the eyes; dread of light; blurring and jumping of the type when you read; sties; inflammation or watering of the eyes; dryness and itching of eyeballs and lids; feeling of "sand in the eyes," drowsiness, or even nausea.

es 1440

**Metal Frame for Color Film
Makes Projection Easy**

Increasing popularity of natural color photography has resulted in the development of a metal frame for mounting two-by-two inch color films for projection. Replacing the binding tape previously used, it consists of two interlocking metal pieces which frame the film after it is mounted between glass plates.



Kodaslide

Send return postage to our Bureau of Information to learn the name of the maker of any device described in this magazine.

Eastman Kodak Co.



**Every 4,000 Miles
GET YOUR
PLUGS CLEANED
by The AC Method**

Flowmeter fuel consumption tests have proved that dirty or worn plugs waste as much gas as one gallon in ten. The oxide coating which causes this waste by short-circuiting the current when the engine is laboring can only be removed by the gentle scouring action of a specially crushed, semi-soft rock under controlled air pressure. "The AC Method" cleans plugs this way. Seventy thousand Registered AC Cleaning Stations render this service, while you wait, for only 5c a plug.



Look for this SIGN
When you need plugs or plug service.



**REPLACE PLUGS
THAT ARE WORN
WITH AC
THE QUALITY
SPARK PLUG**

AC SPARK PLUG DIVISION
General Motors Corporation, FLINT, MICHIGAN

YOUR HOBBY Rates Top Notch Tools!

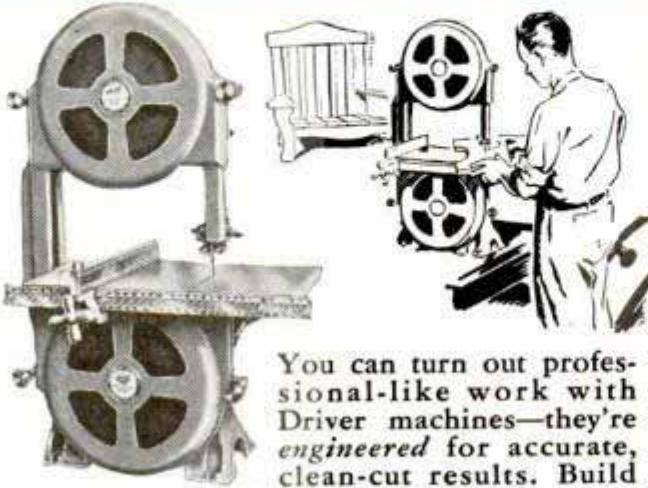

You can turn out professional-like work with Driver machines—they're engineered for accurate, clean-cut results. Build trellises, garden furniture, porch furniture, flower boxes—yes, a myriad of projects—in less time—with greater economy; no waste motions or material. Your friends will be surprised at the beauty of line in your work—you're bound to get greater satisfaction out of your hobby.

MOST COMPLETELY EQUIPPED BAND SAW BUILT!

BN 730 — 12" BAND SAW
\$34.95, less motor, belt and motor pulley

Here's a lot of machine for little money—made possible by efficient Driver factory methods. Guards, ripping guide, table extension, improved cushion-type spring tensioner, are all part of this great value. Ball bearings throughout. Geared control mechanism for tilting table. Handles big, little and difficult jobs with the ease of a champion.

BN560—10" Model Band Saw with bronze bearings, \$19.95.

THIS BENCH SAW HAS EVERYTHING!



B 737—8" BENCH SAW
\$27.95, as shown, with self-indexing mitre gauge—72-page manual.

One home craftsman says, "I've looked everywhere and I can't find a machine to compare for the money." 19" x 15" machine-ground iron table tilts to 45 degree angle. Ball bearings. Saw blade raised by precision worm gear. Maximum depth of cut, 2 3/4".

B575—Same superior workmanship, 7" size, \$12.35.

Ask your local Driver dealer for a demonstration—write today for catalog containing complete details on these and other Engineered Power Tools. Walker-Turner Co., Inc., 148 South Ave., Plainfield, N. J.

DRIVER Engineered POWER TOOLS

Across Africa on One Lung

(Continued from page 549)

produced enough friction to grip the tire.

Down in the jungle, where the thick, steamy air hangs over the land like a blanket, it had been hot day and night. But up in the desert, the fierce daytime heat escapes through the thin, dry air as soon as the sun goes down. With only two thin cotton blankets, we were cold at night. One day Flood dickered with a band of wandering Tuaregs, mysterious veiled riders of the Sahara, and got two gorgeous sixteen-foot hand-woven blankets. At home, as collectors' pieces, they would have been all but priceless, but we were glad enough to sleep in them now.

We battled our way through an endless wilderness of dunes, vast, towering mountains of sand that rose ever higher and



Rear tires were run almost flat to get proper traction in the desert sand

higher as we pushed on toward a French fort on Lake Chad. The caravan trail stretched away in a series of endless corrugations like the track of a gigantic roller coaster made of deep, soft, shifting sand. We took off fenders, taillights—everything that would make our outfits an ounce lighter—and floundered on.

Our only breathing spells were the cuvettes, those oasis-like depressions in the sand, whose level floors seemed smoothly paved with hard, black dirt. Occasionally there was a pond in the lowest spot, its waters impregnated with salt or sodium carbonate. Primitive tribesmen poured the water into thick grass evaporating cones, shaped like inverted umbrellas, collected

the bitter crystals which formed on the bottom, and traded them to passing caravans for the necessities of life.

One afternoon we lost the trail and came to a halt at the foot of the biggest dune of all. Like Mount Everest it towered above us in the evening sun. Flood dropped off his kit, took a run for it, with his machine bucking and plunging through the sand like a broncho, and I tried to push him to the top. We didn't get half way.

Five attempts we made, and failed. Gasping for breath, we threw ourselves on the sand. Then we thought of the Tuareg blankets. We spread out those beautiful hand-woven masterpieces, with our tarpaulin and two American blankets, at intervals up the face of the dune, and shinned and slithered up over them to the top! Then, we staggered up with our kit.

Next morning a black-bearded Frenchman came trotting up on his horse. He was a surveyor, laying out the route for the projected military road.

"Don't lose heart, my friends," he said. "The dunes are not made for motorcycles. Forget the trail and follow the cuvettes. The longest way around is the shortest way to the Red sea. And if you get lost, the natives will always guide you to the next fort. The Sahara is a friendly place, if you learn to understand it and are not afraid."

From then on we followed the cuvettes, and used the caravan trail only as a landmark to steer by. Sometimes we were miles to the north of it, sometimes miles to the south.

When we reached the French fort on Lake Chad, swift runners set out to carry the news to outlying native chiefs. By camel, horseback, donkey-back, attended by their councillors and legions, they came to do honor to these two incredible white men who were crossing Africa on their mechanical camels. Many of the warriors wore chain mail, like the knights of old.

"Most of that armor came from Birmingham, England, within the last fifty years," said the commandant. "A mill there caters to the African and Arab trade. A few of the suits, however, were worn by the Crusaders hundreds of years ago, captured by the Arabs, and eventually carried across the desert."

The natives staged a grand fantasia and

(Continued to page 126A)

Treet Topics

TO MAKE A THIN
DIME

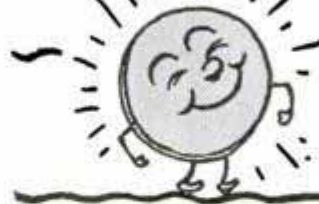

LOOK LIKE A
FAT QUARTER

AND TO MAKE YOUR
FACE LOOK AND
FEEL LIKE



DO THIS:

TREET
BLADES!

YESSIR
4 FOR 10¢



-AND TREET YOURSELF
TO A PACK OF
PERFECT SHAVES!



4 FOR 10¢

Single-
Edge

BLADES

FOR GEM AND EVER-READY RAZORS

Treet Safety Razor Corporation, Newark, New Jersey

es 1083

(Continued from page 125A)



Bewise - Alkalize

An Alka-Seltzer Tablet in a glass of water makes a sparkling pleasant-tasting solution. Drink it and it gives quick relief from Headaches, Sour Stomach, Distress after meals and other common ailments. It also helps correct the cause of the trouble when associated with an excess acid condition.

TUNE IN
THE NATIONAL
BARN DANCE
SATURDAY NIGHT
NBC-NETWORK
30¢ & 60¢ PKGS.
OR BY THE GLASS
AT DRUG STORE
SODA FOUNTAINS

WITH ALL THEIR LITTLE
ACHES AND PAINS
AND "MORNING-AFTER" WOES,
WHO'D WANT TO LIVE
WITHOUT A MAN?
I WOULDN'T, - GOODNESS KNOWS!

MINE OVERSTUFFS
AND THEN COMPLAINS,
HIS STOMACH'S "ON A TEAR,"
BUT A GLASS OF ALKA-SELTZER
SETTLES THINGS
RIGHT THEN AND THERE

WHEN COLDS OR HEADACHES
GET MY MAN
SAY! HE'S NO "ANGEL CHILD."
I GIVE HIM
ALKA-SELTZER
BEFORE HE DRIVES ME WILD



Alkalize with Alka-Seltzer AT ALL DRUGGISTS



EARN MONEY MAKE COLOR-GLAZED CONCRETE PRODUCTS

New low cost method. No molds or costly tools. You build your own equipment from plans we furnish. Easy to make pottery, statuary, giftware—in home or shop—to earn money.

MEN—Send 10c TODAY for booklet, details.

NATIONAL POTTERIES COMPANY
Room 6, 13 W 26th St., Minneapolis, Minn.

cavalry demonstration in our honor. We were two renowned and mighty knights, visitors at an African King Arthur's court. I took the old Kanouri emir, "King Arthur" himself, for a ride in my sidecar. But a Mohammedan emir's clothes aren't made for motorcycling. His flying robes got caught in the spokes and wrapped around the axle, pulling his head down over the side of the little tin bathtub so far that his ear was badly burned by the spinning tire before I could stop. But he came up grinning and thought it was all part of the ride.

The trail from Nguigni to Mao, we were told, would be sandier than anything we had had yet. But we were in no mood to give up now. We demounted the sidecars, draped them across the hump of a camel, let still more air out of our back tires, and learned to skim over the soft sand like an aquaplane rider. Flood, who had never ridden a two-wheeled contraption, took sixteen falls the first day and I took eleven.

Then came the morning Flood forgot to turn on his oil. Before he realized what was wrong, the damage had been done. Only a burnt-out wristpin bushing, but out there in the desert, a thousand miles from a garage, it certainly sounded like the end. We took off the cylinder. The piston wobbled crazily, but a paper-thin layer of bronze was left. How long would it hold out? Maybe we could find something at Mao but we were still 200 miles from Mao, and running low on gas.

That afternoon we lost the trail again. That wouldn't have been serious except that without the sidecars we could carry only two gallons of water apiece. We were down to two quarts each, and pretty thirsty, when we went to bed that night.

By noon next day there was just a swallow or two left in each of our water cans, and apparently there wasn't a human habitation within a thousand miles. By four o'clock we could hardly stay upright on our machines and our tongues had swollen. Still no sign of a village or the trail.

There was nothing to do but wait. We lay down in the scanty shade of our motorcycles to conserve what little moisture was left in our bodies.

It looked very much as if the Flood-Wilson Trans-African Motorcycle Expedition was bushed.

(Concluded next month)

Try a Vegetable Laxative

See the difference



I TOOK ONE NR TABLET LAST NIGHT AND THIS MORNING I FEEL GRAND

Whether your constipation is chronic or occasional—one trial of Nature's

Remedy (NR Tablets) will show why millions prefer this ALL-VEGETABLE Laxative. One NR Tablet convinced me . . . so mild, thorough, refreshing and invigorating.

Dependable relief for sick headaches, bilious spells and that tired-out feeling, when caused by or associated with constipation.

Without Risk get a 25c box of NRs from any druggist. Use for one week, then if you are not more than pleased, return the box and we will refund the purchase price. That's fair. Try it—NR Tonight—Tomorrow Alright.



← "THE NEON LIGHT sets you RIGHT"

★ TEST-O-LITE

At Electrical Stores or \$1.50 Postpaid
Handiest electrical tester made: quickly locates trouble in electric circuits, fuses, cut-outs, motors, radios, etc. Has 1,001 uses for electricians or home. Tests any voltage 110 to 550; tells A.C. from D.C. Excels ordinary clumsy test bulb. Fountain-pen size; with pocket clip. Lifetime guarantee.
L. S. BRACH MFG. CORP., 55 Dickerson St., Newark, N. J.

TRAILER BUILDERS · BUYERS · OWNERS

Send 25c for this Big Book Today
Over 100 pages! Beautifully Printed and Illustrated! Trailer Suggestions and Ideas galore! Catalog shows America's greatest line of Trailer Parts and Equipment at lowest prices. Everything from wheels to top. Rush 25c today. Satisfaction positively guaranteed!
TRAILER SUPPLY CO. Box 438-A WAUSAU, WIS.



BUILD IT YOURSELF
The Jim Dandy Cabin Cruiser
The Trailer that has everything. Clean! Roomy! Easy to build in any size with my simplified Plans and Instructions—Price \$1.00. Rush dollar bill today to JIM DANDY Box 125-A WAUSAU, WIS.

PINS FREE TREASURE BOOK!
30¢ This Class Pin, any letters, any numerals, Silver Plated 25 or more, 30¢ each; 7 to 24, 55¢ each; 1 to 6, 40¢ each. Gold Plated add 10¢ each to above prices; Sterling Silver add 20¢ each; Sterling Silver Ring as shown, 26 or more \$1.50 each; 12 to 25, \$1.75 each; 1 to 6, \$1.95 each. Write for Big FREE Treasure Book.
Metal Arts Co., Inc., Factory 44, Rochester, N.Y. **RINGS**

S AGENTS 500% Profit SIGN LETTERS
For Store Fronts and Office Windows. Anyone can put them on. Free samples. Liberal Offer to general agents.
METALLIC LETTER CO., 438 N. Clark St., Chicago

STANDARD GARDEN TRACTORS
Powerful Gas Tractors for Small Farms, Gardeners, Florists, Nurseries, Fruit Growers, Poultrymen.
1 & 2 Cylinders
High Wheels, Rubber or Steel Tires. Walk or Ride.
Do Belt Work—Free Catalog
STANDARD ENGINE CO.
Minneapolis, Minn. Philadelphia, Pa. New York, N. Y.
3221 Como Ave. 2546 Market St. 290 Cedar St.



ALL winter long, rust and sediment have accumulated in your radiator. Fine scale is choking the cooling system of your car. Clean it out! It's easy and inexpensive. Do it yourself in a few minutes. Use SANI-FLUSH.

There is nothing in SANI-FLUSH that can injure your motor or radiator-fittings. It is a scientific powder that removes damaging dirt from the cooling system. Just pour 10c worth in the radiator. (25c for the largest trucks and tractors.) Follow directions on the can. Run the engine. Drain. Flush. Refill with clean water. Your motor will run cool. You save fuel. You don't take chances on costly repairs. You'll find SANI-FLUSH in most bathrooms for cleaning toilets. Sold by grocery, drug, hardware, and five-and-ten-cent stores. 25c and 10c sizes. The Hygienic Products Company, Canton, Ohio.

Sani-Flush Safe NOT CAUSTIC
KEEPS RADIATORS CLEAN

NEW BRUSH PLATING OUTFIT For AUTO PARTS
Connects to a battery with no tanks necessary. Plates on iron, steel, brass, copper, etc. Almost as simple as painting. Hundreds of car owners waiting for this low-cost plating. Improves appearance and value of the car. Your opportunity to make good income plating auto parts, bathroom fixtures, reflectors, mirrors, etc.
FREE PROOF
Write quick—big season here. Get FREE PROOF and particulars that put you in a paying business of your own.
GUNMETAL COMPANY
AVENUE M DECATUR, ILL.

The Biggest Thing on Earth

(Continued from Coloroto Section)

river so huge hammerhead cranes could move back and forth to place the concrete. As the concrete now rises up around it this enormous steel skeleton is being buried in the dam. Aside from this metal, 72,000,000 pounds of reinforcing steel are being placed in the powerhouse bases at either side of the dam and around the inspection galleries that weave back and forth through the mass. Two thousand miles of steel tubing are being set in the concrete so cooling water can be circulated through it to carry off the heat created by the chemical action of cement hydration.

Today the nerve centers of the dam are in the two roaring, vibrating "houses of magic" where the concrete that goes into the dam is mixed. Into these houses pour endless streams of aggregates every hour of the night and day. Between them, "Eastmix" and "Westmix" digest 15,000 barrels of cement, 21,750 tons of sand and gravel, and 360,000 gallons of water every day. On an average 15,000 cubic yards of concrete are mixed and placed in a twenty-four-hour period.

If a government inspector should accompany you to the eight-sided, eight-story "Eastmix" plant you would climb up into the ear-splitting din of a gloomy room where four four-yard revolving mixers alternately gulp meals of cement, rock, and water from a central feeding chute and then, two minutes later, tilt over and discharge their loads of finished concrete into another chute that carries the material to buckets resting on flatcars below.

Above the mixing chamber, in the comparative quiet of a glassed-in office, the chief mixer controls and regulates each batch of concrete. His office is almost as complicated as the cockpit of a transcontinental passenger plane. Flickering red and green lights on a dispatch board tell him which crews far out on the dam want concrete, and the amount and type of material they need. In front of him and above his head are push-button controls and valves by which the automatically measured doses of water and materials that go into the mixing machines are released, as well as time controls that automatically stop and dump each batch at the right time.

Every action is timed to the split second.

Sixteen seconds are allowed for loading a mixer, two minutes for mixing, and six seconds for the mixer to discharge its load. Thirty-two cubic yards of concrete are mixed by the two plants every two and one-half minutes. Against one wall of the chief mixer's office a dozen electrically operated steel pens ink jagged lines on the moving paper of a huge graph, telling the mixer as a visual check the exact amount of materials that go into each batch and the viscosity of the finished concrete.

Down below, the loaded flatcars are taken in tow by a locomotive and are switched to the track that leads to that part of the dam where concrete is needed. At the end of the trip the tackle from a hammerhead crane or a gantry crane noses down, picks up a four-yard bucket of concrete as lightly as a feather, and swings it out and down to a waiting crew. The foreman of the crew wears a telephone set inside his "iron hat" so that he can tell the crane operator, who may possibly be out of sight far above him, just where to place the big bucket.

The dam grows in five-foot "lifts" of wet concrete, placed in alternate blocks measuring up to fifty feet square. The forms that hold each block are shaped to provide vertical keys so that when concrete is poured in the intervening blocks the adjoining masses become locked and tied in to each other. With both mixing plants in operation a cubic yard of concrete is added to the dam every five and one-half seconds.

Aside from the agricultural empire that is to be made possible by the dam, it will generate enough power to serve markets as far away as Idaho and Oregon, even after pumping requirements are subtracted. The reservoir behind the dam will have an area of 128 square miles and a maximum depth of 375 feet. Its capacity of 10,000,000 acre-feet of water will be equivalent to 2,000 gallons for every person on earth. After one-tenth of the Columbia's flow is diverted for irrigation more than enough water will always be available to keep the generators in continuous operation and to maintain the river level at approximately twice its past minimum flow. A huge fish hatchery is planned below the dam to raise and dis-

(Continued to page 130A)

New Utility Lathe

Ball Bearing Equipped—12" Swing

Developed by Delta Engineers after a long period of careful study — incorporating sound engineering principles — only embodying every feature that adds to accuracy, dependability and convenience.



Built Up to "Delta" Standards

Here is the ideal general utility lathe—for the school shop—for the general woodworking shop—for the home workshop. Can be adapted for metal-turning. It has a heavy, rigid bed of fine-grained cast iron, with accurately machined and polished ways . . . a substantial cast-iron headstock, with built-in, removable belt guard . . . four-speed, efficient V-pulley drive, with double-row indexing mechanism for dividing, fluting, etc. . . . heavy steel hollow spindle, threaded front and rear for faceplates, etc., and with No. 2 Morse-taper centers . . . carried on pre-loaded New Departure self-sealed bearings which never require lubrication . . . exceptionally handy, free-moving universal tool support, locked to bed at any angle by convenient handle at front, and fitted with two tool rests . . . substantial cast-iron tailstock, locked by front lever, and with self-ejecting center actuated by large, convenient ball-end crank handle. Get the full story of this remarkable new lathe!



Can Be Adapted For Metal Turning

The addition of a compound slide rest to this lathe turns it into a fine speed lathe for toolroom, garage, service station and general shop. Industrial shops of all types find a lathe of this type ideal for special production jobs, since it is economical enough to be kept set up constantly, and versatile enough to be adaptable to a wide range of tooling.

Send for Special Circular

Check the proper square in the coupon below and you will be sent the special circular giving full details and prices on the new Delta Utility Lathe. If you have not received the 1938 Delta Catalog showing the complete line of latest Delta motor-driven tools—send the coupon for your copy as well as special circular on new Delta Utility Lathe—and the latest Delta Project Book No. 4—packed full of new and different things to make, with many photographs, working drawings, and complete instructions. Enclose 10c for Project Book. Catalog will be mailed postpaid.

DELTA MFG. CO.
DEPT. A438
600-634 VIENNA AVE., MILWAUKEE, WIS.

DELTA MANUFACTURING CO., Dept. A438	
600-634 E. Vienna Ave., Milwaukee, Wis.	
<input type="checkbox"/> I enclose 10c (stamps or coin) for which please send me one copy of the new 1938 Book No. 4 of "Practical Delta Projects." Also place me on your mailing list to receive 1938 Delta catalog of quality motor-driven woodworking tools.	
<input type="checkbox"/> Send me special circular on new Utility Lathe.	
Name
Address
City.....	State.....

25104

WITH P.W. I'LL PUT THAT ON TO STAY



RESULTS ARE AMAZING

Now if you have a broken chair—loose caster—crack or nick in woodwork, floor, plaster or tile—loose drawer pull—do a quick, expert job of repairing with wood in cans—**PLASTIC WOOD**—that handles like soft putty and hardens into wood. Paint, hardware and 10¢ stores sell **PLASTIC WOOD** in 10¢ and 25¢ tubes and 35¢ cans.



PLASTIC WOOD

HERE'S THE MASTER FIXER

Quickly, permanently joins and repairs china, glass, wood, celluloid, etc. Transparent—or Metal color. Get it at paint, hardware or 10¢ stores.

Old English CEMENT

MADE BY THE MASTERS OF PLASTIC WOOD

CLAMPS

"Good clamps and plenty of them" is a basic rule of fine cabinet work. It's the secret of firm joints, of rigid set-ups for gluing, drilling, sawing or welding, of accurately matched parts and perfectly aligned holes, etc. Standardize on "Jorgensen", "Pony" and "Mark" clamps, the clamps used in industry. If your dealer hasn't them, order direct.

Pony "50" Fittings on ordinary 1/2" pipe. Any length. Send \$3.00 plus postage (6 lb.) for fittings for two Pony "50" Clamps. Also Fittings for "52" Pony—pipe—2 sets for \$1.50 plus postage.

Genuine "Jorgensen" Hand-screws, slip joints, angles, never slip, split or loosen. All sizes. Send \$3.20 plus postage (7 lbs.) for 2 No. 1 Hand-screws—open 6".

Pony Miniatures 9 types—1" to 3/8" cap. Not toys but fine tools with 100 uses.

Catalog ADJUSTABLE CLAMP CO. "The Clamp Folks" FREE 421 N. Ashland Ave., Chicago, U. S. A.

(Continued from page 128A)

tribute young salmon, since the hordes of salmon that normally travel to the upper reaches of the river will be unable to get by the dam.

Settlement of the Columbia basin area will not start before 1942 and authorities think that it will take from twenty-five to forty years to irrigate and settle the region. Farmland speculation is being prevented. Crops that are non-competitive with those of rainfall areas are to be selected.

Construction of the Grand Coulee dam started in 1934 under a \$29,300,000 contract awarded to the Mason-Walsh-Atkinson-Kier company by the Bureau of Reclamation. This initial contract, calling for construction of the dam up to a height of 177 feet, is now being completed. Additional contracts are to be awarded for finishing the dam. It is estimated that the dam and powerhouses will cost a total of \$178,790,000 and that the combined dam and irrigation project will represent a total investment of \$376,631,000.

When finished, the dam will be 550 feet high, 4,300 feet long at the crest, 500 feet wide at the base, and thirty feet wide at the crest. It will contain a total of 11,200,000 cubic yards of concrete, and probably will require another three years, at the present rate of work, to complete.

25104

The Spotlight on Puppets

(Continued from page 555)

action principle. This would eliminate strings. Instead, he set them in position between each exposure. This technique had the advantage of being three-dimensional.

While his experiments were going forward, a Russian film based on Gulliver's travels was brought to this country for a limited showing. Its cast was made up of a fourteen-year-old boy and 3,000 puppets and was filmed by the stop-action method. Convinced he was on the right track, Patterson went to Hollywood. Paramount became interested in his ideas and intends to produce some short subjects in this manner within the near future. Meanwhile, Patterson is working before the camera with his troupe of marionettes—or "personettes," as he calls them. They stand about three feet high and are operated by complicated sets of strings, which control

(Continued to page 133A)

You are Invited to Come to
LINCOLN
for Complete Training
for a
GOOD PAY JOB
in
AVIATION

Learn Aviation at Lincoln. Prepare Yourself now for a Big Pay Job in Aviation. Exceptional opportunities for trained men. Airline Pilots earn up to \$700 a month; Mechanics up to \$200 a month. Airlines adding millions of miles to flight schedules—hundred million dollars being spent on new airplanes. Lincoln Training prepares you for your Government Rating. 14 MODERN TRAINING PLANES. 12 practical shops and laboratories. You get experience on wide variety of airplanes and engines. Instructors hold Government Rating. Lincoln Graduates in demand. We assist graduates in locating positions. Write today for complete information. State age.

LINCOLN AIRPLANE & FLYING SCHOOL
 208-H Aircraft Bldg. Lincoln, Nebr.

TYPEWRITER 1/2 Price
 Easy Terms
Only 10c a Day

Save over 1/2 Mfg.'s Orig. Price on all standard up-to-date office models.

SEND NO MONEY

Sensational saving on all late models completely refinished like new. **FULLY GUARANTEED.** Big Free Catalog shows all makes in full colors. Send post-card for lowest prices.

SPECIAL PORTABLE BARGAINS —
 Brand New FEATHERWEIGHT—Latest Model Portable—up-to-date streamline features—now offered at amazing low price. Fully Guaranteed—10 day trial—only 10c a day. Full details sent free!

Free course in typing included.

International Typewriter Exch., 231 W. Monroe St. Dept. 401, Chicago

CATCH MORE FISH
 Send for **FREE BAIT BOOK**

This practical handbook, for fishermen, is a fascinating, reliable guide to better fishing! It tells how and why Creek Chub True-to-Nature Lures and Flies Catch More and Bigger Fish! Beautifully illustrated! Sent FREE upon request!

CREEK CHUB BAIT COMPANY
 414 Randolph St. Garrett, Ind.

CHEAPER TENNIS
EARN MONEY, TOO!

NOW—you can buy Wills' fresh, genuine Eclipse **SPLIT GUT** tennis strings direct-from-factory for as little as \$2.25 PER SET postpaid. Also—excellent quality **SILK** at only 65c per 37 ft. coil, postpaid. Rush your order now! Satisfaction **GUARANTEED.** New 1938 CATALOG of Tennis Frames, Vises, equipment now ready. Get your **FREE** copy. Send today. **H. E. WILLS CO.,** Dept. 1354, 1047 W. 47th St., CHICAGO, U.S.A.

BURN YOUR NAME ON TOOLS
 WITH THE **ARKOGRAF**

PROTECT YOUR TOOLS FROM THEFT
 Write with electricity any name or design on the hardest and finest tools and instruments, or any metal, like writing on paper with pen or pencil. **Complete Outfit \$3.50—Prepaid Anywhere** Interesting illustrated circular free. Write today. Agents wanted.

ARKOGRAF PEN CO., 3927 S.E. Stark St., Portland, Ore.

OTTAWA LOG SAW
only \$39

GREATEST OFFER EVER MADE

Make Money! Wood is valuable. Saw 15 to 20 cords a day. Does more than 10 men. Ottawa easily operated by man or boy. Falls trees—saws limbs. Use 4-hp. engine for other work. Write today for **FREE** book.

OTTAWA MFG. CO., 427 Wood St., Ottawa, Kansas

Get a Real Kick Out of Life!

C'MON BILL, I'LL SHOW YOU HOW TO HAVE FUN!

Motorcycling is the world's greatest outdoor sport! Good times all the time for the owner of a Harley-Davidson. Ride with the happy members of your local motorcycle club. Go on gypsy tours, reliability runs, tourist trophy races; take in hillclimbs, race meets and other thrilling events. See the classy 1938 models at your Harley-Davidson dealer. Ask about his Easy Pay Plans—mail coupon NOW!

Harley-Davidson
KING OF THE HIGHWAYS

HARLEY-DAVIDSON MOTOR CO.
 Dept. P-438, Milwaukee, Wis.

I'm rarin' to be a rider. Send **FREE** motorcycling magazine, "The Enthusiast" and illustrated literature. Stamp is enclosed to cover postage.

Name _____ Address _____
 City _____ State _____
 My age is () 16-19 years, () 20-30 years, () 31 years and up, () under 16 years. Check your age group.

When writing please mention Popular Mechanics

★ Cash FOR SPARE TIME!

MAKE \$25 TO \$30 PER WEEK AT HOME IN YOUR SPARE TIME

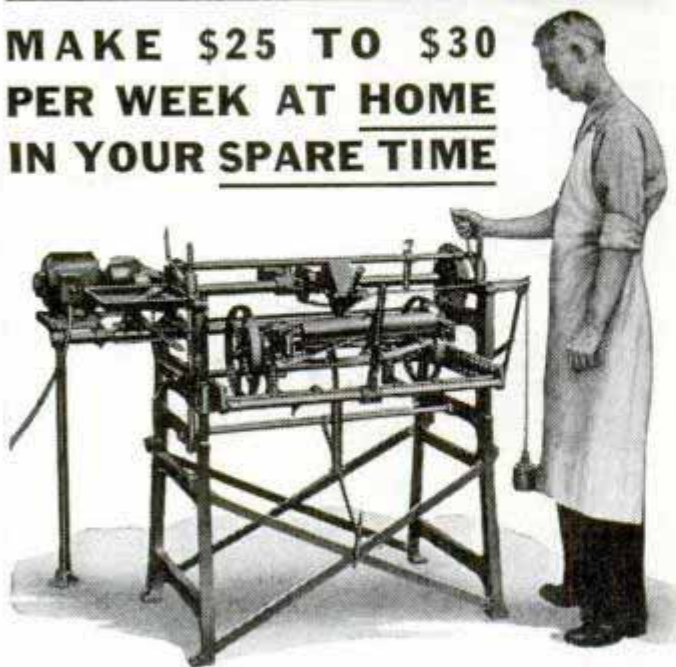

THE IDEAL LAWNMOWER SHARPENER

Like magic, the Ideal Lawnmower Sharpener makes old, dull, half worn-out mowers cut like new. Simply set the mower in the Ideal and the machine does the rest. Sharpens any lawnmower to a perfect edge in 15 to 20 minutes . . . usual charge \$1.00 to \$1.50. Attach to light socket. Start in your basement or garage. Work in spare time. Attachments furnished for grinding skates, grass shears, hedge shears, sickles, scythes, axes, etc. **FREE CATALOG** tells complete story.

WHAT THESE MEN DID . . . YOU CAN DO

Remember, no experience is necessary. Most men sharpen lawnmowers in spare time only. J. B. Van Dien writes: "Some weeks I earned \$40 a week with my Ideal just as a side line." "I have sharpened over 500 mowers and every customer is well pleased." A. M. Larsen writes: "I average 9 mowers a day." Roy F. Stier says: "I live in a town of 500 and to-date have sharpened 200 mowers at \$1.25." Edward A. Mynderse writes: "Have sharpened around 500 mowers this season." Nick Baltes says: "Last summer I sharpened 200 mowers at \$1.00 each." Bucher Battery Co. writes: "We sharpened over 600 mowers last year at \$1.50 each."

FREE BOOK Shows How!

Right now, before you forget it, send for a copy of our **FREE BOOK**. "How To Make \$25 to \$30 per week in SPARE TIME."

SEND POST CARD TO **THE FATE-ROOT-HEATH CO.** 308 Bell Street Plymouth, Ohio



TRUCUT TAILSTOCK REST

HANDY, efficient, indispensable for machining armatures. Furnished with shank to fit any lathe. TRUCUT holds centerless armatures steady without holders or bushings. Positively eliminates inaccurate centers. Adjustable by turn of wrist to take shafts 1/4" to 1" dia. Centering ends of shafts eliminated; furnished with tapered arbors to fit any tailstock sleeve. It's guaranteed.—Write for illustrated folder No. 45. Also mfrs. TRUCUT COMMUTATOR LATHE

FRANK N. WOOD CO. WAUWATOSA, WIS.

Work Faster Make More Money with the

Red E UNIVERSAL TRACTOR

With this practical machine and attachments you can do all field and belt work hours faster at the low cost of 33c per day. Many units pay for themselves the first season. Unusually easy to handle and operate. Absolutely safe. Hundreds of users. Buy direct at low factory price. Two weeks' trial—satisfaction guaranteed. Write for colorful, free catalog.

PIONEER MFG. CO. Dept. V-48 West Allis, Wis.

FISHERMEN GET THIS THRILLING NEW BOOK ON FISHING Free!

"Ozark Ripley Tells About Fishing." Page after page of thrills covering all types of angling—written by Ozark Ripley, master fisherman. Also valuable information on outboard motors and boats. Write for your copy. **Free!** JOHNSON MOTORS, 1211 Pershing Road, Waukegan, Ill.

RE-STRING RACKETS AT HOME • EARN MONEY •

Instructions FREE

FREE

It's pleasant, profitable work. No experience or skill required. Easy to Learn. Full line of guaranteed stringing tools, frames, gut and silk strings for your selection. Every item highest quality. Write for complete details.

Write for our 1938 Illustrated Catalog and Instruction Book. **W. A. BICKEL & Co., Dept. A-4, 137 N. Marion, Oak Park, Ill.**

BUILD THE CUTTY SARK

2 ft. MODEL OF THE FAMOUS CLIPPER SHIP

Everything . . . including CARVED WOOD HULLS, Printed-Salsa Decks, Cast-Metal Life-boats, Anchors, Bits, Steering Wheel, Churn, Mast, Spars, Rigging, Cement, Colored Lacquer—Full-Size Plans and Instructions.

Send for Catalog of all these new Models. **IDEAL AIRPLANE & SUPPLY COMPANY, INC.** 28 West 19th Street, New York

Complete kit makes perfect building toy **2.50** plus 15¢ postage

SEND FOR FREE CATALOG—OVER 300 DESIGNS!

CLASS PINS 35' RINGS \$1.60

Beautiful, smart, up-to-the-minute designs. Pins in 2 colors with any 3 or 4 letters and year. Handsome sterling silver rings. Oldest, largest makers; famous for quality for 43 years. Lowest prices, too!

BASTIAN BROS. CO. 92 BASTIAN BLDG. ROCHESTER, N. Y.

DO YOU WANT a new business profession of your own, with all the trade you can attend to? Then become a foot correctionist, and in a few weeks earn big income in service fees,—not medical nor chiropody—easy terms for home training, no further capital needed, no goods to buy, no agency. Established 1894. Address Stephenson Laboratory, 1 Back Bay, Boston, Mass.

Radio-Electrical EXPERIMENT KIT **Only \$3.99** **6 Books FREE**

25 pieces genuine commercial apparatus with illustrated manual! Build radio circuits, 110-volt motor, extension phone, third detector, arc light, arc furnace, electric stove, generate ultra-violet rays, scores more! Used by leading schools! **SAVE 60%.** Send only \$3.99 for kit and 6 Radio-Electrical books (value over \$10.) Or, sent C. O. D. Money back if not 100% pleased. No stamp brings Baryain Catalog! **ELECTRICAL SALVAGE CO.,** Box 524-73, Lincoln, Nebr.

FACTORY TO YOU **WRITE for FREE CATALOG**

NEW SUPER-QUALITY KITSELMAN FENCE

Heavier, tougher pure zinc galvanizing. Stronger, tougher Copper-Bearing Steel. **Same low Factory Prices.** WE PAY FREIGHT, 160 styles and heights Farm, Poultry and Lawn Fence; Steel Posts, Gates, Barb Wire, Paints, Roofing. Write today. **KITSELMAN BROTHERS** Box 94 Muncie, Indiana

251345
(Continued from page 130A)

not only their limbs and necks but even their finger joints, lips and eyelids. The artist has been working on a group of puppet caricatures of actors and actresses.

Finger and hand puppets, fashioned so the operator's fingers may be inserted and made to serve as a character's arms or legs, have many devotees. Contrary to popular belief, Mr. and Mrs. Punch, their dog, Toby, and their neighbors who entertained audiences for three hundred years, are not dead. Far from it. Harry Fetterer, one of the third generation of a famous English family of puppeteers, makes a profitable occupation out of giving Punch and Judy shows.

To Tony Sarg, dean of the marionette world, and his staff go the credit for the origination of such stunts as having puppets pick up and lay down objects, smile, smoke pipes and other amazing feats. The

James O'Leary puppeteer

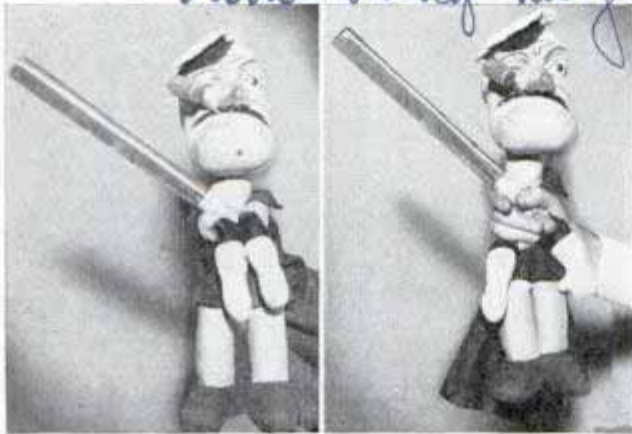

These two pictures show how a puppet is held. At right, ready to strike blow

pipe-smoking trick has never been surpassed. In one of his plays, an inn keeper was shown smoking a long pipe. This was effected by means of a rubber tube running through his body and coming out at the middle of his back. There was another tube going through the legs of the chair in which he sat, the latter running backstage. The tubes were so arranged that when the puppet was seated, the tube in the character's back would connect with the tube in the chair and when he arose, he disconnected himself. Backstage the puppeteer, with a lighted cigarette, watched the puppet's action through a hole in the curtain and when he put his pipe into his mouth, the operator would blow smoke through the tube. To the audience it appeared as if the character were smoking. The real "punch" came when he arose and walked off without showing the tube.

18136 Oak Park Ave
18136 Oak Park Ave
18136 Oak Park Ave
James O'Leary puppeteer

UNRULY HAIR

James O'Leary puppeteer
James O'Leary puppeteer
James O'Leary puppeteer

Stays Neatly Combed

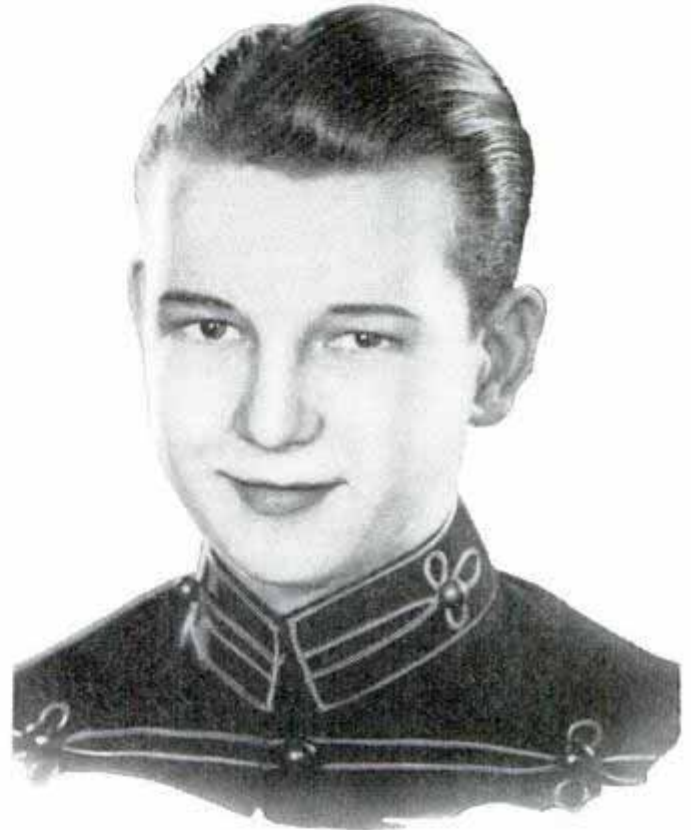

Costs but a few cents to use
— a bottle lasts for months

IS YOUR HAIR difficult to keep in place? Does it lack natural gloss and lustre? It is very easy to give it that rich, glossy and orderly appearance so essential to well-groomed boys.

Just rub a little Glostora through your hair once or twice a week — or after shampooing, and your hair will then stay, each day, just as you comb it. Glostora gives your hair that natural, rich, well-groomed effect, instead of leaving it stiff and artificial looking as waxy pastes and creams do.

Try it! A large bottle of Glostora costs but a trifle at any drug store.



Glostora
FOR THE HAIR

AMERICA'S No. 1 MOVIE CAMERA



\$9.95

Richard Arlen, star of
Columbia's "No Time
To Marry."

With F:3.5 Lens . . . \$19.95

UNIVEX CINE "8"

Over 200,000 enthusiastic Univex owners will tell you why this amazing movie camera, in one short year, outsold those of all other makes combined! Compact, lightweight, easy to load and operate, and always dependable—it's the only movie camera in the world that uses the inexpensive 60¢ Univex Cine Film and takes theatre-quality movies at less cost than snapshots! See it at your dealer's today, or send for booklet 29.

New! UNIVEX MINICAM



\$3.50

The lowest-priced precision-built Miniature ever offered! Uses Univex 10¢ roll film.

The only one taking six exposures, thus eliminating unnecessary picture-taking and delay! Fitted with new-type Achromar Precision Lens—individually focused, adjusted and tested. Shutter speeds for time exposures and 1/50-of-a-second snapshots; spy-glass-type view-finder. Self-opening. Antique bronze finish. Clear, sharp, negatives 1½" x 1⅛" that make excellent 3" x 4" larger-prints. See it at your dealer's, or send for booklet 30.

Universal Camera Corp., New York, N. Y.

Univex

Beating Burglars with Black Light

(Continued from page 517)

front of the lens stops all light rays in the visible spectrum, permitting only infrared waves to pass through. At a distance of 210 feet from the projector the beam is only seven-sixteenths of an inch in diameter.

In the photoelectric receiving target a collecting area one inch in diameter is used, consisting of a phototube of the modern cesium-oxide type which is especially sensitive to red and infrared rays. This cell is so sensitive that it is able to measure the reduced amount of light reflected from a building 300 feet away when the shadow of a man falls across it. In the burglar-alarm system the minute amount

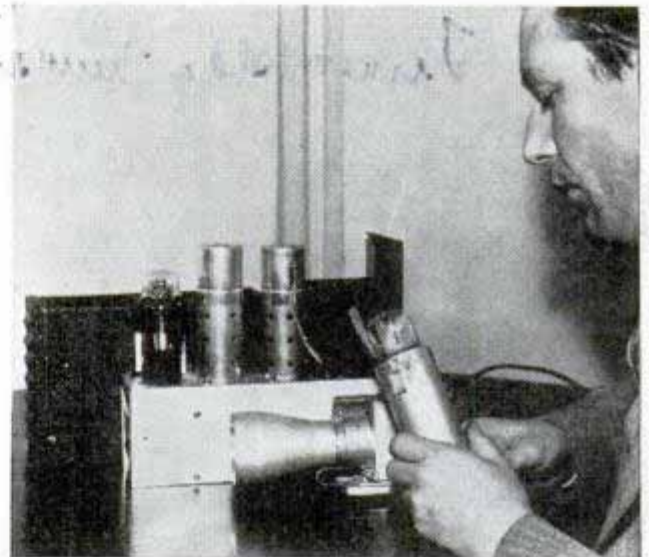

Cesium-oxide type of photocell. Behind it are projector and amplifying units

of current generated in the photocell is amplified several million times by conventional radio-type apparatus so that it can actuate the relays that operate the annunciator panel and alarms.

Infrared rays and electric-eye systems have many uses aside from protective alarm systems. They are useful in fire detection, automatic control of furnace combustion by measurement of the smoke density, and control of boiling points in industrial processes as well as temperatures in greenhouses and storage vaults. They automatically turn on pedestrian safety crossing lights, switch on sodium-vapor fog lights at intersections when fog density reaches a certain level and even measure the weight of excessively loaded trucks crossing bridges.

Thompson BEATS the World on BOATS



Better Built Lower Prices

- Canoes \$84 and up
- Rowboats \$42 and up
- Outboards \$42 and up
- Very fast utility model

Only Boats With Full Length Spray Rails
Keep passengers perfectly dry—even at high speeds. Catalog also shows today's five most popular models of sailboats. Two big factories. Prompt shipment.

CATALOG FREE
Write for your copy. State kind of boat in which you are interested.

THOMPSON BROS. BOAT MFG. CO. (87)
213 Ann St., PESHIGO, WIS. (Write to either place)
113 Elm St., CORTLAND, N. Y.

CAMERA BOOK



FREE!



Explains latest inventions, methods of Photography and Home Movie Making, for fun and profits. Offers hundreds of amazing money-saving Bargains in still and movie Cameras, Lenses, Films, etc. Used equipment accepted in trade. Satisfaction guaranteed!

WRITE FOR FREE BARGAIN BOOK!

Central Camera Co., 230 S. Wabash, Dept. K-4, Chicago, U. S. A.

Amazing TYPEWRITER BARGAINS



SAVE ONE-HALF—10c A DAY! Nationally known standard models reconditioned, refinished. Fully guaranteed! Look and operate like new! ALSO PORTABLES, FREE SHORTHAND AND TYPING COURSE. Easy terms or as low as \$10 cash. **MONEY BACK GUARANTEE.** Send for illustrated circular **FREE TRIAL!** and details TODAY. Special prices on Duplicators, Addressographs, Adders, Multigraphs. **PRUITT CO., 789 PRUITT BLDG., CHICAGO**



FREE ELECTRICITY
From Wind. Build your own windcharger. Cost 98c for material plus used car generator. Send 10c for copyright drawings, instructions today.
WESCO, 8 Terminal, Minneapolis, Minn.



QUALITY Tool Chests
Built by Gerstner for the better Mechanics. Free Catalog for Machinists and Toolmakers.
GERSTNER TOOL CHESTS
438 Columbia St. Dayton, Ohio

Print Your Own



Cards, stationery, circulars, tags, labels, advertising, etc. Save money. **Print for Others; Big Profits;** easy rules sent. Will do popular Raised Printing like Engraving. Junior outfit \$9. Senior outfits \$17 and up. Send for free catalog and all details.
THE KELSEY COMPANY, E-37, MERIDEN, CONN.

NEW TYPE CHEAP OIL BURNER

Sweeping the Country!!

COOK and HEAT Without Coal or Wood
In Your Present Stove or Furnace—**HOTTER—CHEAPER—No Dirt or Ashes—Twice the Heat Quick at SMALLER COST.**
COOK and HEAT for LESS



Beats any oil burner ever gotten out for low cost, perfect performance. Burns cheap oil a new way, without pre-generating or clogging up. Quick intense heat by Simple Turn of Valve.

Try At Our Risk 30 DAYS' TRIAL
Prove it ends drudgery and dirt of coal or wood; cuts fuel bills in half, pays for itself quickly by what IT SAVES.

FREE SAMPLE FOR AGENTS
offered to one energetic man or woman in each locality who will demonstrate and take orders. Write quick, be first to learn how to make REAL MONEY right now, spare or full time mail it postcard today.
UNITED FACTORIES, D-751 Factory Bldg., Kansas City, Mo.

AGENTS Salesmen BIG MONEY
Drop Everything for this quick seller. Get YOUR OWN oil burner FREE and make REAL Money. Write now.



Quick HEAT at Turn of Valve!

TRY THIS ALL-PURPOSE MOTO-TOOL



10 DAY MONEY BACK TRIAL

saves time and labor on all craft work

Everybody who works with his hands—at home, shop, school, or profession—can use the efficient, attractive Moto-Tool to advantage. With this practical machine you can do in seconds jobs that require hours of hard hand work. Moto-Tool handles hair-line precision work or does power jobs with equal ability. Plug in any AC or DC socket. Absolutely safe. There are thousands in use.

Model 1 \$9.85 POSTPAID

Model 2 \$16.50 POSTPAID



20 pc. craftsman's tool set, for either model \$5.75 Post-paid

Two sturdy Moto-Tools serve every purpose of the craftsman. The No. 1 machine—weighs 6 oz., 25,000 r.p.m.—is recommended for light bench jobs. Model 2—weighs 13 oz., 27,000 r.p.m.—is a more powerful, rugged machine with extra mechanical refinements that shop men want and appreciate. Order on 10-day money back trial. Send for FREE booklet.

DREMEL MFG. CO. 2828 CT., Racine, Wisconsin



DRILL-INDEX Keep your drills in a DRILL-INDEX. Works like a card index. A flip of the wrist opens the case. Six sizes. Ask your dealer or write to **Huot Mfg. Co., 127 E. 9th, St. Paul, Minn.**

MADE \$102500

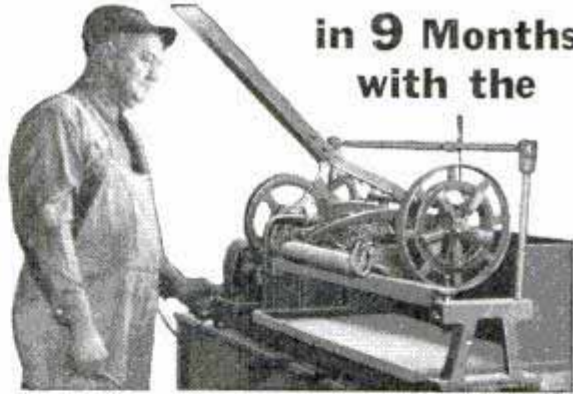

in 9 Months with the

FOLEY LAWN MOWER SHARPENER

"A substantial increase in grind jobs each year, proves beyond any doubt that Foley Grinders do very satisfactory work. We have ground 723 mowers since February 1 to date, November 9. Our total receipts on lawn mower service alone during that period have grossed us \$1,025.00. The prevailing price of grinding and adjusting service is \$1.00 and \$1.25—repairs and parts extra."—W. A. Tulip, Phoenix, Ariz.

You Too Can Make Big Money

Free plan tells you how to start. The Foley Lawn Mower Sharpener turns out perfect work quickly and easily, no experience needed. Simply put the mower in the machine and turn on the power. Uses same system as lawn mower factories. Sharpens all sizes and types in 15 or 20 minutes. **Special Offer:** Attachment for grinding axes, hatchets, knives, etc., included FREE with Foley Lawn Mower Sharpener on our Special Offer, brings you business the year around. Send coupon today.

FOLEY MFG. CO. 407-8 Foley Bldg., Minneapolis, Minn.

Send Free Plan for making money sharpening lawn mowers, and Special Offer on the Foley Lawn Mower Sharpener.

Name.....
Address.....

When writing please mention Popular Mechanics

EVERYTHING *New*
IN RADIO

IN ALLIED'S
Spring Catalog
JUST OUT!

NEW TESTERS! **NEW HAM GEAR!** **NEW KITS!**

NEW SETS! **NEW P.A.!**

At Radio's Lowest Prices!

Write today for ALLIED'S big Spring Catalog—just off the press. 164 pages packed with everything **NEW** in Radio! 62 sensational new "Knight" Radio sets; advanced Push-Button Tuning models at new low prices, new inexpensive Auto Radios, Phono-Radio combinations, 6 volt-110 volt farm radios, latest portable models, new radios with Hush-a-Tone attachment, and others. Radios from 5 to 16 tubes for every purpose. Models for AC, AC-DC, 6 volt, 32 volt, battery, and auto operation. Set-Builders' Kits of all types, including new simple transmitter kits, Electric Fence Control kit, and other new circuits. Amateur Gear—all leading lines; latest transmitters, receivers, transceivers. Amazing new Public Address equipment—portable, mobile, permanent—from 10 to 80 watts. All standard lines of test equipment, books, tools, replacement parts, etc. Everything you need in one great book—arranged for instant selection.

ALLIED'S FAST SERVICE and **COMPLETE STOCKS** save you time—**ALLIED'S LOW PRICES** save you money. That's why thousands find their radio dollar buys more at ALLIED! Send coupon now for ALLIED'S new Spring and Summer Catalog. It's Free!

FREE PARTS LISTS—We supply matched kits for any radio circuit described in this or any other magazine. Write for Free Parts Lists.

FREE SEND COUPON

ALLIED RADIO CORP.

833 W. Jackson Blvd.
Chicago, Illinois

Dept. 5-D-8

Name.....

Address.....

City..... State.....

Push-Button Tuning for Receiver

(Continued from page 577)

device; no test instruments are required. When put together, the controls should work as shown in photo A; the selection of any one button releases any other that may be in the down position. The tuner is mounted as close to the variable ganged condenser in the set as possible. In most cases the best location is directly above the dial as shown in the upper sketch. Four holes are drilled for the mounting screws, and a 1/4-in. slot is cut in the receiver cabinet to accommodate the seven push rods as indicated in the drilling template Fig. 2. When the unit is installed this slot is covered by the escutcheon.

The connections to the stationary-plate terminals of a 2-gang tuning condenser are clearly shown in Fig. 1. If the set is a TRF type using a 3-gang condenser, the first (or antenna) section of the condenser is not connected. In superheterodyne receivers with 3-gang condensers, one of the sections connected must be the one that controls the oscillator. The other connection can be made to either of the other two sections in the condenser. Ground is always soldered to the condenser frame.

A sheet of call-letter labels for the various broadcasting stations is supplied with the kit; any six of these may be selected. To make the first adjustment, set your receiver for the broadcast band and turn the dial pointer to where stations at about 1,700 kc. are tuned in. The stations desired for automatic tuning should now be tuned in by adjusting the trimmer condensers on the tuning unit with a small screwdriver, in the manner to be described. Buttons 1 and 2 are used for stations between 530 and 900 kc.; buttons 3 and 4 for stations between 700 and 1,250 kc. Buttons 5 and 6 are for those above 1,200 kc.

For example, starting with the station selected for button No. 1, press the button in and adjust trimmer 1-A until the station is heard; then adjust trimmer 1-B for maximum volume. The first trimmer is then readjusted for best results and you are ready to work on the next button for another station. To operate the push-button tuning unit, leave the broadcast dial at the highest kilocycle reading; for regular manual tuning, press the release button and tune in stations in the usual manner.

DISCOVER THE OPEN ROAD



Indian JUNIOR SCOUT

F.O.B. FACTORY
\$215.
 FULLY EQUIPPED

The lowest priced "twin" in America! There's a real thrill in its easy riding, peppy power and 70-miles-to-the-gallon economy. No wonder it's the greatest motorcycle "buy" in all the world!

PAY AS YOU RIDE

The Indian Junior Scout—and any of the new 1938 Indian models, for that matter—can be bought on an easy, pay-as-you-ride plan. Ask your Indian dealer to demonstrate these magnificent machines for you today.

3 OTHER NEW 1938 MODELS

DE LUXE 4—the only American-made 4-cylinder motorcycle.

CHIEF 74—a peerless "top speed" performer.

SPORT SCOUT—a winner all around.



FREE!
 Get this RIDER'S HELMET and INDIAN PIN

MAIL COUPON TODAY!



INDIAN MOTORCYCLE CO., Springfield, Mass.

Please send me at once, without obligation, your illustrated Folder showing the new 1938 Indian Motorcycles, and CERTIFICATE OF VALUE entitling me to FREE RIDER'S HELMET and INDIAN PIN, as illustrated, when I place my order.

Name.....

Address.....

Please be sure to check your age group PM 48

16-19 years 20-30 years 31 years and up under 16 years

PIONEER non-sinkable BOATS



Time tested for 27 years—America's outstanding values in Row Boats, Fishing, Hunting, Outboard Motor, Ice and Sail Boats! Always ready to use! Endorsed by leading summer camps and resorts! Send post card for 24 page catalog! It's FREE!

PIONEER MFG. CO., 414 Perry St., Middlebury, Ind.



STOP Backtracking

Haven't you often driven the wrong road and had to backtrack many miles? The Hull Streamline Auto Compass always shows your direction of travel, prevents backtracking, saves money and time for only \$2.95 at your dealer. Two-piece model \$1.95. Write for circular.

HULL MFG. CO., P. O. Box 246-Dv, WARREN, OHIO

HANDEE TOOL OF 1001 USES

Grinds - Drills - Cuts - Polishes
 Carves - Routs - Saws - Sands
 Sharpens - Engraves

A whole shop full of tools in one for work on all metals, alloys, bone, resins, glass, stone, wood, etc. Uses 200 accessories. Saves hours of tedious work. 13,000 r.p.m. A C or DC, 110 volts. \$10.75 and up, postpaid. 3 Accessories Free.



Plug in any Socket

DE LUXE MODEL

For constant service, nothing compares with this easy-to-handle production tool. Saves time and labor. Fastest, smoothest, most powerful tool for its type and weight. 25,000 r.p.m. \$18.50 postpaid, 6 Accessories Free.



Get a Demonstration at Your Dealer's or Order Either Model on 10-days Money-Back Trial. Catalog Free.

CRAFTSMAN'S PROJECT BOOK
 "Pleasure and Profit with a Handee"
 Easy working plans for making many interesting and unusual projects, 25c stamps or coin.

CHICAGO WHEEL & MFG. CO., 1101 W. Monroe, Dept. Q, CHICAGO

Send Catalog Project Book
 \$10.75 Model De Luxe Send C. O. D. PM-4

Name.....

Address.....

Is FISHING Your Hobby?

SEND FOR THIS 132-PAGE FISHING GUIDE

FREE! NOTED anglers as Courtney Riley Cooper, Ozark Ripley and others helped edit it. Identifies fish in colors. Bait and fly casting lessons. Fishing hints. Every angler wants this book. **Write today!** SOUTH BEND BAIT COMPANY 502 High St. South Bend, Ind.



FREE! A Postal Gets It.

SOUTH BEND

FREE 180 PAGES OF RADIO VALUES!

RUSH COUPON NOW!

GREATEST RADIO CATALOG EVER PUT OUT!

Get your **FREE** copy of this dollar-saving radio catalog. Use it as your buying guide. Compare prices of famous equipment listed. 50,000 items—parts, tubes, tools and the famous "line of 70" Lafayette radios. Get the best, **FOR LESS**. Mail coupon **NOW!**

WHOLESALE RADIO SERVICE CO. INC.
 NEW YORK, N.Y. • CHICAGO, ILL. • ATLANTA, GA.
 100 SIXTH AVENUE 901 W. JACKSON BLVD. 205 PEACHTREE STREET
 BOSTON, MASS. • BRONX, N.Y. • NEWARK, N.J. • JAMAICA, L.I.

WHOLESALE RADIO SERVICE CO., INC. RESERVE THE NEW SPRING CATALOG WITH THIS COUPON!
 901 W. JACKSON BLVD., CHICAGO, ILL.

Rush **FREE** general Catalog No. 69-7D8
 Reserve Catalog No. 71-7D8

Name.....
 Address.....
 City.....State.....

PASTE COUPON ON PENNY POST CARD

NEW BENJAMIN AIR PISTOLS \$7.50

Powerful - Accurate - Economical - Practical - Adjustable Shooting Force - Amazing Maximum Velocity - cal. 177 or 22 and BB - For Target and Small Game - the only Genuine Compressed Air Pistol for Shooting BB on the market - Single Shot with Bolt Action - Hammer Fire - Hair Trigger - Safety. Price \$7.50. Holster \$2.00. Also 177 and 22 Single Shot Air Rifles \$7.50 - Single Shot BB Air Rifle \$6.00 - 25 Shot BB Repeater Air Rifle \$7.50 - at Dealer or Direct - No license required - Sale for indoor use.

FULL DETAILS - TARGETS - FREE WRITE TODAY
 Benjamin Air Rifle Co., 831 Marion St., St. Louis, Mo.

60 POWER TELESCOPE . . . \$2.19

VARIABLE EYEPIECE 20X-40X-60X

NEW! Three telescopes in one. 3 different magnifications. 20 power for ultra-bright images with 40 and 60 power for extra long range. Guaranteed to bring distant objects, people, sports events, ships, moon, stars, etc., 60 times as close.

Most powerful made for anywhere near the money. Closes to less than a foot in length. Multiple lens system. 30 mm. objective, in heavy brass mount. Directions included for using as a compound 4 lens microscope. American made. We pay the postage. Only \$2.19. Catalog of Microscopes, Binoculars, etc. **FREE** on request. **BROWNSCOPE CO., Dept. 44, 5 W. 27th St., New York, N. Y.**

FENCING World's Finest Sport Exciting Fun—Harmless

Boys! Become the best swordsmen in your neighborhood. Develops both body and mind. **Harmless**, because the spring-steel 3 ft. long foils are equipped with rubber buttons. Cup shaped hand guards. Complete set of two foils (swords) and free instruction booklet only \$1.98 postpaid. **Order Now.**

INDUSTRIAL PROD. CO., Dept. 4M, 48 W. 48th St., NEW YORK, N. Y.

BABY CALCULATOR CHICAGO, U.S.A. PATENT APPLIED FOR

VEST POCKET ADDING MACHINE
 IDEAL FOR BUSINESS OR PERSONAL USE: Adds, subtracts, multiplies, divides. Does work of more costly machines. Counts up to million, made of steel—weighs 8 ounces. Simple, accurate. Not a toy. Guaranteed 5 years.

— FREE TRIAL — SEND NO MONEY! \$2.50 Total Cost

Order from ad, not sold in stores. Just send name and address. On delivery pay postman \$2.50 (plus few cents postage). (If outside U. S. send cash.) 10c additional in Leatherette Case. If not satisfied after 10 days' trial you get your money back. Thousands of satisfied users. Write for Agent's proposition. **CALCULATOR MACHINE CO. (Mrs.) Dept. 104, P. O. Box 1118, Chicago, Illinois.**

One-Tube DX Short-Wave Set

(Continued from page 579)

wire, with push-back insulation, is used, and all connections should be soldered carefully with rosin-core solder. The r.f. choke is a 2½ millihenry type. A list of the original parts, with additional tuning data, can be obtained from Popular Mechanics radio department without charge. The blueprint number is R-252.

Use a good outdoor antenna and connect the ground to a cold-water pipe if possible. Headphones should be sensitive low-resistance type not exceeding a total resistance of 2,000 ohms; a single-phone unit is recommended. To avoid "dead spots" in the tuning range, the antenna trimmer

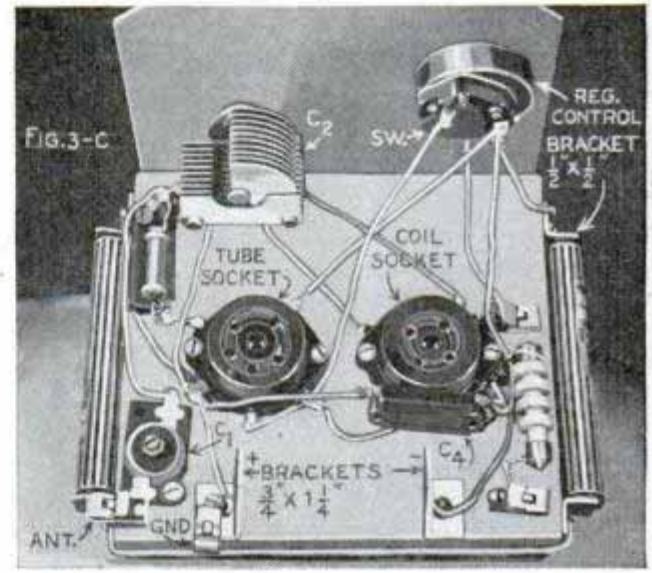

condenser (C₁) should be turned almost open, with a small screwdriver, for the 18 to 31-meter band and closed slightly for each of the longer wave-length bands. Tightening antenna coupling in this manner increases volume but if carried too far will prevent oscillation. In tuning, advance regeneration control until a soft thud, indicating oscillation, is heard; now back off the control slowly until oscillation ceases. The point just before oscillation begins is the most sensitive position for DX reception of foreign short-wave phone stations.

If the builder wishes to increase the volume of the set, he may add the one-tube audio amplifier shown with the broadcast receiver R-227 of this same type, which appeared in the October, 1937, issue. This amplifier diagram is included in R-252. An additional 6-volt flashlight "B" battery is required to operate the amplifier.

COLUMBIAN METAL BOATS

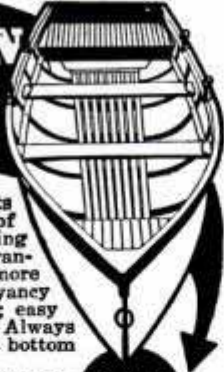

Light weight, durable, carefully built boats at remarkably low prices. Made of toughest galvanized copper bearing steel. Wood gun-wales. Heavy transoms for outboard motors. Two or more built-in air chambers for extra buoyancy in case of upset. Real wave riders; easy to handle. Never leak or warp. Always ready for use. Both round and flat bottom boats; all sizes and styles.

Write For Free Boat Booklet with description and prices of complete line of metal boats—knockabouts for fishermen, light weight lively boats for parks and resorts, heavy duty craft for outboard motors.

Dealers Wanted—who can develop volume sales.

FREE BOOK

COLUMBIAN STEEL TANK COMPANY,
P. O. Box 4226A Kansas City, Missouri

UTILITOR TRACTORS



Your most Economical Power for small farm plowing, discing, cultivating, mowing, hauling, etc. Thousands in use 10 to 15 years and still going. New improved riding and walking models, 3 to 12 h.p. Before you buy INVESTIGATE THE UTILITOR. WRITE FOR FREE CATALOG

DAYTON, OHIO
UTILITOR CO. DEPT. A

BILD-UR-OWN

COASTERS • MIDGET AUTOS • SCOOTERS • BIKES TRAILERS, ETC.

Want the best for your motor scooter? Then equip it with our DISC WHEELS and Balloon Tires. Your choice of famous (GOODRICH—GOOD YEAR—FIRESTONE)

At lowest prices. We provide Scooter Kits at big savings. Build Now! We also carry larger Tires, Wheels, Motors, etc. Write for prices.

BILD-UR-OWN DEVICES, 5237 Lake St., Dept. A-4, CHICAGO, ILL.

SAVES YOU MONEY TOO!

A AND N SUPPLY CO.

Bargains—Military, Sport Goods, Firearms, Clothes, Shoes, etc. Send 10¢ for new catalog, to be redeemed on first order.

EST. 1868 A & N Supply Co., 4772 Lester St., Richmond, Va.

BUILD CLOCKS

for PLEASURE—PROFIT



Hall clocks are high priced in stores—you can make good money building them or electrifying spring clocks. Dime brings drawing of easily built Grandfather Case with "HOW" Book pricing bands, desk, mantel, spring. ELECTRIC chime. BATTERY CLOCKS from \$1.40. Hall clock. Brass weight chime movements from \$16.95. Start now. KUEMPEL CHIME CLOCK CO. Building 15 Guttenberg, Iowa

YOUR OWN MOVIES! 10¢ A DAY!

NATIONALLY ADVERTISED 8MM and 16MM Movie cameras, projectors. For home, business, church, school, club. MONEY BACK 10 DAY TRIAL. Payments as low as 10¢ A DAY. Satisfied customers throughout the world. FREE details. WRITE TODAY. Don Elder's Home Movies. Dept. A-4, 739 Bayiston St., Boston, Mass.

RAISE GIANT FROGS

FREE BOOK

"GOOD PRICES YEAR ROUND!" Nation-wide markets waiting for all you can ship. Sell to us also. WE BUY! Get ready now for next spawn. Breeder lays 20,000 eggs yearly. Start with a small pond, creek, marsh or lowland. Free book shows sketch. Men & Women starting in every state and Canada. See what others are doing. Send no money. Just write your name and address on a postcard and get our special offer to begin with. Write today! AMERICAN FROG CANNING CO., Dept. 133-DD, New Orleans, La.

ENGINES

A real money maker for farm or factory. Uses Cheap fuels. Pays for itself out of savings. Costs Less to Own—Less to Operate.



LOG SAWS

Make Money—Start a wood sawing business—turn spare timber into cash. Factory Prices—Cash or Terms—FREE Catalog.

WITTE ENGINE WORKS
1744 OAKLAND AVE., KANSAS CITY, MO.

1.2 H.P. SINGLE \$39.50



Best Performance
LOWEST COST

Just what you want in a motor! Easy to start, plenty of speed and power, quality construction - at a price you can afford to pay! Ask to see the new 1938 NEPTUNES - you'd never believe so much quality could be bought for so little.

Six sturdy models priced from \$39.50 up. Improved features include: combination air and water cooling, automotive float-feed carburetor, high tension fly-wheel magneto, Monel metal shafts, underwater silencing, gasoline control in steering handle.

FREE Send for illustrated folder giving details and prices

MUNCIE GEAR WORKS, Inc.
Muncie, Indiana

NEPTUNE Motors

BUILT FOR SALT WATER AS WELL AS FRESH WATER

Simply SHOW IT and POCKET THE PROFIT

Women ARE GOING WILD ABOUT THIS New **WRIST-ACTION CORD!**



Here is no ordinary new product. This new Wrist-Action Plug is one of the most remarkable new devices ever offered in the Direct Selling Field! You never saw anything like it. Housewives are fascinated—held spellbound by the instant demonstration you can give with this new electric iron cord that swings freely in any direction. Ends kinking and twisting—prevents broken wires, burned fuses. Swivel action plug spins round and round—swings from side to side—keeps cord out of the way—no wonder housewives say, "Just what I want," as soon as they lay eyes on it!

Sales are instant—sure! Nothing like it ever before. Here is the self selling big money maker you can clean up with. Get the story at once. Learn how you can GET YOUR DEMONSTRATOR FREE. All territories virgin—wide open. Write immediately for sensational money making plan.

FREE

WRITE NOW!

NO-TRO ELECTRIC APPLIANCE CORPORATION
820 W. Erie St. Dept. P-4 Chicago, Ill.

**MORE PEOPLE
MORE FUN
in this sturdy boat**



• **OLD TOWN BOATS** take a tremendous load for their size. They're trim craft, with graceful lines for speed and comfort. Built and braced to stand the heaviest outboard motors.

You never have to baby an Old Town. There are tough, fast, open-deck models for sport. Big seaworthy boats for the family. Made of the finest materials by expert craftsmen.

FREE CATALOG illustrates boats for sport, big all-wood boats for the family, and all kinds of Canoes, Outboard Boats, rowboats, dinghies. Write today. Address Old Town Canoe Company, 434 Main Street, Old Town, Maine.

"Old Town Boats"

**White's FAUCET COP
STOPS
HOT WATER LEAKS**



Dripping faucets are costly . . . especially if they drip hot water. Dripping faucets occur in every home. This waste goes on unnoticed. Not where the **WHITE FAUCET COP** is installed. This device **STOPS** hot water losses from dripping faucets. Dividends frequently 500%. **THINK OF IT . . .** five times its cost in one year. Simple to install, will not rust or lime up. Get yours today.

LIST PRICE **\$2.50**

See your local Hardware or Plumbing Dealer or order direct from the factory.

WHITE PRODUCTS CORPORATION

Dept. 20

Lansing, Mich.

Stoves AT FACTORY PRICES!



Sale Catalog — FREE

Nearly 200 Styles and Sizes of Stoves, Ranges, Furnaces at Factory Prices. Easy Terms—as little as 12c a day. 30 Days Trial. 24 Hour Shipments. Write today for this **FREE CATALOG**. Over 1,200,000 Satisfied Users. 38 Years in Business. **KALAMAZOO STOVE & FURNACE CO.**

391 Rochester Ave.
Kalamazoo, Michigan

"A Kalamazoo Direct to You"

FREE CATALOG

Synco JIG SAW

FASTER—SAFER—CLEANER

Astounding performance! Cuts up to 1" or more, with smooth, clean edges. No sanding required. Accurate, sturdy, efficient—a revelation to skilled craftsmen in handling both intricate designs and heavy work. Ideal for cutting light metals, veneers and plastics. Operates on 60 cycle, 110 volt AC, without motor or any reciprocating parts. Requires no oiling. 10" square table; 13 1/2" throat; adjustable guide; variable stroke. Complete with underwriters approved cable and rubber plug. Built for years of continuous service.

Electric Operation



7200 Strokes per Minute

No Motor Required

FREE FOLDER

GET FREE LITERATURE TODAY Ask your dealer to show you the models now available. Or send your name for full information and illustrated literature, **FREE.**

SYNCO DEVICES, INC.
511 Boydell Building Detroit, Mich.

MANUFACTURING OPPORTUNITIES



18 SIZES

IN BUILDING INDUSTRY—with machine and process producing permanent construction with savings of 1/3 labor, 1/2 mortar, and 1/3 material costs—ashlar, hollow, veneer or solid walls—plain or 40 colors.

WE EQUIP YOU with Automatic Machinery—large production only one or two men. Equipment costs but fraction of other processes with equal capacity.

INVESTIGATE—let us show you why building today offers you the greatest opportunity for growth, expansion and profit in a business of your own, using raw materials available in your territory. Write today.

W. E. DUNN MFG. CO.
600 West 24th St. Holland, Michigan



GET THIS HANDY METAL PUNCH!

For punching holes up to 3/4" in metal up to 16 gauge thickness. Forged steel handles. Clean-cutting. Will punch in center of 3" disc. Height of gap 1/4". Weight only 2 1/2 lbs. Furnished complete in metal box with magazine and 7 sets of punches and dies. Standard set 1/2" to 3/4" by 32nds—or your choice any 7 from 1/8" to 3/4" by 64ths. Cash with order or C.O.D. only. We pay postage. **\$6.75**

WHITNEY METAL TOOL CO., 80 Forbes St., Rockford, Ill.



CAPE COD CHAIRS

Style "B", "C", "A". Blueprint 50c. All 3 for \$1.00, M10 — Martin

House 8 family Beautiful Castle Style. Blueprint only 65c. For catalog illustrating over 75 practical projects, send 10c. Free with order. **"Over 35,000 Satisfied Customers."**

CRAFTSMAN'S MODEL CO., Dept. P-16, 2030 N. 41st Street, Milwaukee, Wisconsin

Big Quick Cash Profits

***AMAZING New KUSHIONTRED Shoes**



YOUR OWN SHOES FREE

Start your own business without investment. Steady income all year showing outstanding new Spring line Men's, Women's, Children's shoes. Over 150 styles, \$10,000 Gold Bond guarantees satisfaction. Free shirts, ties, hosiery offers to customers. Wonderful self-adjusting inbuilt arch. We pay postage. No experience needed. **Big \$30 Sample Case of Shoes Free!** Write TODAY for full information, money-making plan and **Free Selling Kit.**

TANNERS SHOE CO., 760 C St., BOSTON, MASS.

WRITE FOR FREE OUTFIT



NEED MONEY? Men or Women

Part time or full time to sell

GENUINE LEATHER TIES

Sell on sight—they are neat, novel and practical. Big profits for you. No sales ability needed. Everybody wants them. Your first hour will be a pleasant, profitable surprise. Young man made \$8 one night after school. Send 50c for samples of 4-in-Hand and Bow. **CENTURY TIE CO., 2345-L, W. Grand Blvd., Detroit, Mich.**

Wild Life Goes to Town

(Continued from page 523)

been his principal crop. He hatches the eggs, feeds the birds and places them with the state game commission for "planting" in various hunting areas. This year he placed about 9,000 pheasants and 600 quail and carried over a laying flock of about 1,200 birds for next year's business. He hatches the eggs in an electric incubator with a capacity of 7,500 eggs. Hatching efficiency for pheasant and quail is about eighty-three per cent. The incubation period is twenty-four to twenty-six days.

Browne uses a modern twenty-four-pen brooder house with wire-inclosed runways and a capacity of 4,800 chicks. Each pen is heated with an electric brooder stove sup-



Banding the leg of a home-raised pheasant about to be freed for breeding purposes

plemented by an oil burner in event power service should fail. Young game birds chill more easily than ordinary chicks and any break in power service might kill the hatch. He paints all windows red to prevent cannibalism among the game birds.

Feeding is a matter of halving the modern chick ration and increasing the protein content to about twenty per cent. After the brooder age the birds are placed on fenced range, rough pasture and broken woods striped by six-foot rows of tall seed-bearing grass bordered with drilled rows of native sunflowers. This coverage helps shelter the birds from wind and rain. The game birds are as hardy as chickens.

Browne also raises native animals and fur bearers. Raccoons are his biggest animal crop. He keeps about forty and dis-

(Continued to page 142A)



ARE YOU DOUBLE-CROSSED BY GLUES THAT "DRY LOOSE"?



Here's why CASCO makes permanent home repairs:

● It sets chemically... forms a heat-proof, damp-proof bond. CASCO joints *can't be weakened* by heat and moisture changes in your home like old-style liquid glues that set merely by evaporation. CASCO saves you time and trouble, because you need make a CASCO joint only *once*.

EASY TO USE. Just mix one part CASCO powder in one part water. No mess. No heating. And no waste...you mix it as you need it.

ECONOMICAL. CASCO plus cold water makes a *full-strength* glue at less cost than ordinary liquid glues. CASCO has *many* household uses. (Send for the free book offered below.)



HERE'S PROOF OF CASCO'S STRENGTH

World's Largest Wood Airplane Propeller is Made with CASCO

16 feet long... weighs 194 pounds!
Built up of 13 plies... made to stand terrific strain under all weather conditions. One of hundreds of CASCO'S industrial uses that require a glue with utmost strength and proof against moisture, heat and cold.

FREE! NEW 1938 EDITION—CASCO GLUING GUIDE

Fully illustrated, tells how to make lifetime home repairs... also how to make water-resistant paint, wallpaper paste... tile cement... crack filler... Swedish putty. New methods for erecting fibreboard... flush door construction... veneering... inlays.

Send request on penny postcard to
CASEIN COMPANY OF AMERICA
Dept. PM 438
350 Madison Avenue, New York, N. Y.

CASCO

**WEATHERPROOF
POWDERED CASEIN GLUE**



4 Handy Sizes—10c to 65c—At Your Hardware Dealer's

201424

(Continued from page 141A)



Think of getting for only \$19.75 — not only a more accurate timepiece, but ALSO:—

1. A **STOP WATCH** that at the touch of a lever checks off the time in seconds and fifths of seconds!
2. A **TACHOMETER** that gives you at a glance the exact speed at which any moving object is traveling over a measured distance!
3. A **TELEMETER** which tells the distance you are away from any simultaneous source of light and sound!

WRITTEN GUARANTEE

Smart, trim and compact, the Pierce 4-in-1 Watch is simplicity itself to operate. And it's unconditionally guaranteed against any mechanical defect for one full year! See this amazing Pierce Watch at any good dealer today. If he cannot supply you mail order direct.

PIERCE WATCH CO., DEPT. 12
22 W. 48th St., N. Y. C.

- () Please send me free literature describing the sensational new Pierce 4-in-1 Watch. I understand there is no obligation.
- () Enclosing check or money order for \$19.75. Please send my Pierce Watch at once.

Name.....
Address.....
Town..... State.....

POWERlite
ELECTRIC LANTERN



The most powerful, serviceable hand electric lantern for all needs — home, work, fishing, camping.

80 to 100 Hours Light
On One 6-Volt Dry Battery

2 lights on a double action switch. 800 ft. spot beam from the front reflector; broad floodlight from top. Handle reverses. Unbreakable lens. 6½ inches high. At sport, hardware, electrical dealers or write

DELTA ELECTRIC COMPANY
Marion, Indiana Dept. 300

\$3.35
Less
Battery

Get only a **GENUINE DELTA**

poses of them to hunting clubs and for state replenishment work. He feeds the 'coons a prepared dog ration and finds that production costs are about ten dollars per year per animal, or about half the cost of keeping one dog. He keeps the raccoons in small, wire-inclosed kennels. The 'coons become devoted pets.

Browne's deer raising is still in experimental stages. To date, sixteen illegally captured fawns have been given him by state game wardens and he is raising the fawns with the hope that the second generation may prove suitable for return to the wilds. The deer breed well in captivity, but become trustful and affectionate pets, grow fat and slow-moving, and are usually incapable of roughing it in the wilds. A mature deer flourishes on half the feed of a milk cow, and makes excellent use of pasture. Browne believes that home production of venison might prove profitable, but this is illegal in a few states.

The mink is a small hardy animal comparatively easy to raise. It eats meat. Brooder houses with fenced runways of the type used in raising chickens make ideal mink quarters. The one serious difficulty lies in getting the minks to breed.

Though one of the scarcest of the fur bearers, the beaver now appears as a truly important fur crop. Prime pelts are among the most valuable on the market and the beaver is one of the healthiest, fastest multiplying, and least expensive of "livestock." The animal builds its own "houses," makes its own ponds, and feeds itself principally from the nourishment contained in wood. Browne raises beaver and wild ducks and geese together, leaving the former to make ponds and puddles for the latter.

Browne finds that foxes are the worst enemies of native game birds and also advises vigilance against stray cats and against sparrows which carry contagious diseases to all forms of poultry.

Probably the most marked breeding success to date has been that of crossing the black fox and silver fox to produce a more rugged animal with a more dependable pelt value. Crossing of cattle and Indian water buffalo was one of the most spectacular developments in the cattle industry. Maine authorities are seeking to crossbreed the moose with beef cattle to produce a range animal with greater food value.

\$190⁰⁰ in 8 DAYS STUCCO SPRAYING



Philip J. Hershberger writes: "Thought you would like to know how I am getting along. Well, my first home was Colocrete and this job brought me three more homes in Colocrete which I did in eight days, netting me a profit of \$190.00 and now I have three homes and a basement added to Colocrete."

COLORCRETE MAKES NEW OR OLD BUILDINGS MORE ATTRACTIVE and waterproof.

It fuses with any masonry surface. It fills all cracks and can be sprayed in any thickness and in 30 colors. Fully proven by over twelve years actual use under all conditions and every climate. **OFFERS BIG EARNINGS.** Operators report costs of 2c and up per sq. ft. and sell up to 7c. Some have paid for their equipment from first few jobs. Machine capacity up to 1,000 sq. ft. per hour. **GET THE FACTS.** Send for **COLORCRETE** Book "Proven Business Opportunity." Write today.



COLORCRETE INDUSTRIES, INC.
570 Ottawa Ave., Holland, Mich.

Spindle SHAPER \$3

less cutters (C. O. D. or outside U. S. \$3.85)

Make tongue and groove joints; shape mouldings, picture frames, plaques, etc. Limitless projects can be given a professional finish with this shaper. It has 8" x 5 3/4" steel table; stands 5 3/4" high. Uses standard 5/16" hole cutters. (Cutters 55c each). **Oilless bearings.** Your fractional H. P. motor runs it.

FREE CATALOG describing and illustrating complete power tool line: Circ. Saw with oilless bearings, \$3; Drill Press, \$2.50; completely equipped Lathes, \$2 & \$4.90; Sander, \$1, etc. Order today or send card for Catalog.

J & H Metal Products Co. 5 Commercial St. Rochester, N. Y.

ARC WELDER FROM OLD DODGE GENERATOR

For light or heavy work

75-200 amps. 35c brings complete plans and valuable catalogue listing 500 electrical items. Over 100 other generator changes.

LEJAY MFG., 347 Lejay Bldg. Minneapolis Minn.

KINKADE GARDEN TRACTOR and Power Lawnmower

A Practical Power Plow and Cultivator for Gardeners, Suburbanites, Florists, Truckers, Nurserymen, Fruit Growers.

Low Prices—Easy Terms

AMERICAN FARM MACHINE CO.
1058 33rd Ave. SE., Minneapolis, Minn.

NEW CATALOG

LOW FACTORY PRICES

20 Kayak designs also assembling kits with instructions for home building. Aquaplanes, Outboards, Rowing Sculls, Ice Yachts, Sailboats, Snipes & National one design.

SPECIAL GIFT OFFER, \$6 DOUBLE PADDLE FREE. While they last. Write today.

KAYAK BOAT CO.
152 EAST 129 ST.
NEW YORK, N. Y.

Complete Cut-to-Fit Assembling Kits

SEND 10¢ for BIG CATALOG

UNSIGHTLY WALLS MADE GOOD AS NEW

RUTLAND PATCHING PLASTER

You can easily repair holes in walls with Rutland Patching Plaster. Anyone can make a perfect job with Rutland.

MEGOW'S MODEL KITS

Most extensive line of ship and boat kits for the constructive hobby crafter, ranging from 10c to \$6.00. **MAYFLOWER**, 17 1/2", printed deckpiece, \$2.50. With carved hull, \$3.00. Postage 15c. **MODEL SPEED BOAT**. Clock mechanism, motor and prop. in one unit. Capable 800 ft., or 5 to 7 min. drive, \$1.95. With elec. outboard motor less batteries, \$4.95. Postage 15c.

Send 5c postage for complete 52-pg. illus. catalog showing scores of latest ship and airplane models, also ready-made parts, engines and supplies.

MEGOW'S Dept. PM., Howard & Oxford Sts. Phila., Pa. or 217 N. Desplaines St., Chicago, Ill.

Saw-Filing

Pays up to \$2 or \$3 an Hour in Spare Time—No experience needed

A **FOLEY** Automatic Saw Filer files hand, circular and band saws better than the best hand filer. Cash business, no canvassing, no eye-strain. Louis P. Wadwick, Ohio, says, "I have filed 764 saws in spare time and have earned \$850.00 in carpenter work due directly to my saw filing contracts." Send coupon for **FREE PLAN**, no obligation.

FOLEY MFG. CO., 416-B Foley Bldg., Minneapolis, Minn.

Send Free Plan on Saw Filing business.

Name:

Address:

When writing please mention Popular Mechanics

These Lights Must Not Fail

(Continued from page 541)

cessity for twenty-nine per cent additional power. In certain instances, power increases up to sixty-two per cent over average needs have been noted.

The behemoth of the New York network is the Hudson avenue generating station in Brooklyn, which has a capacity of 770,000 kilowatts. Close at its heels is the Hell Gate station in the Bronx, its capacity being 605,000 kilowatts. Their over-all assessments for 1937 were \$69,495,800 and \$63,493,700 respectively. For the previous year, the eighty-four-storied Empire State building was assessed at \$28,500,000.

The greatest task ever confronting the dispatcher occurred one rainy afternoon a few years ago when he glanced at the Hell Gate section of the automatic board. It was blazing with green lights: a danger signal in reverse, for on this board, red lights mean switches closed and working, while green means open.

In an instant he saw his problem: every switch letting current out of the second largest generating station had dropped. The automatic bell system was set to ringing in every powerhouse and substation—a major service interruption of unknown duration. He then called the Hell Gate station supervisor by telephone. The connection was made without difficulty, as the wires had been placed in four cables, each being routed through a different street to guard against an interruption in service. A short circuit in a cable leading from a turbine to the high-tension galleries, he learned, had caused every piece of apparatus to stop dead.

A ready supply of electricity was his first problem. At 4:00 o'clock, fifteen minutes before the accident, Hell Gate had been producing 240,000 kilowatts. The supply from the connection with the Niagara-Hudson system, which is ordinarily distributed through Hell Gate, had been 75,000. The total loss for the moment was 315,000 kilowatts. This represented nearly half of the average 4:00 o'clock load for the whole system, which would normally climb toward a 6:00 o'clock peak above 900,000.

The operator's first move was to draw on the reserve capacities of the Hudson avenue station, the Niagara-Hudson system with new distribution, the Sherman

Creek station in upper Manhattan, which usually generates little but distributes current from the crippled station, and the frequency changers, which convert twenty-five-cycle current into sixty-cycle alternating. Twenty-five cycle current was available from three points, including Hell Gate. By drawing 570,000 kilowatts from the Brooklyn station; 75,000 kilowatts from the upper Manhattan plant and 125,000 kilowatts from the Niagara-Hudson company, 700,000 kilowatts were available at 5:00 o'clock, one hour after the breakdown.

Then it was discovered that the bus bar at Hell Gate was crippled and current could not be distributed through it. A bus bar is a device to which current is carried after it has been generated. It is about six inches by eight inches in cross section and approximately 400 feet long.

Tapping the bar at intervals are feeder cables carrying current to a section of the city. When the short circuit occurred in one of the cables leading from the generators to the bar, which is divided into six sections, it instantly increased the power enormously with the result that the cable became overloaded and was fused. The sudden excess of power also burned out the cables, which, in turn, grounded the generators and fused and destroyed parts of the bus bar. After another series of short circuits from another cause, five of the six sections were out of service.

By repairing certain sections of this bar and re-routing current through another station, service was restored everywhere except in one area of Manhattan proper. Here it was necessary to start from a complete standstill. The immediate demands made by lights and machinery left anticipatorily on, produced a pull on the wires. As a result fuses popped, transformers burned and cables melted.

Every fuse the company had in stock was used in this emergency. More than 1,000 men were sent into the district to throw out every switch they found closed but not at the moment carrying current. In this way the demand was reduced to a point where it did not greatly exceed the supply. From this balanced situation, it was possible to build the load up gradually instead of trying to do it all at once.

Thrilling NEW
EVINRUDE
"Ranger"
ONLY \$47.50



A brand new Evinrude . . . amazingly light, handy and powerful. Weighs only 16 lbs., and cruises 3 hours on a single fill! Literally packed with big-value features including famed Hooded Power — Evinrude Co-Pilot — Underwater Silencing. Starts instantly! — spins into action with a flick of the starting cord. Costs less than 3¢ an hour to operate. Send for catalog!

ELTO PAL only \$37.50

Elto PAL (built by Evinrude) weighs only 14 pounds, and drives boats at twice the speed of oars. Elto ACE, \$47.50 — the husky Hand-twin, only \$67.50. Each an outstanding value! Address **EVINRUDE MOTORS**, 6431 N. 27th St. Milwaukee Prices F. O. B. Factory

FREE Catalogs!
Write for 1938 Evinrude and Elto catalogs . . . Boat Directory and Boat-and-Motor Selector.



EVINRUDE OUTBOARD MOTORS



...AND THE MOST IMPORTANT THING ABOUT OIL IS...

KEEP IT CLEAN!

To keep repair bills down—Keep your oil clean! Naturally present in petroleum products, *sludge* tends to stick to road dust, core sand, or metal scrapings. The result is an abrasive so harsh it could be used to grind valves! Prevent this damage to your motor by providing Purolator-protection. Replace your Purolator cartridge every 8000 miles—or whenever an examination of the oil indicates the need. Motor Improvements, Inc., Newark, N. J.

Replace your Purolator cartridge regularly!



E-Type Purolator



N-Type Purolator

PUROLATOR

THE OIL FILTER ON OVER 85% OF ALL 1938 FACTORY EQUIPPED CARS

SKOOT-MOBILE

The Only **MOTORIZED SKOOTER HAVING**

ALL THESE FEATURES

The **DE LUXE SPORTSTER**



SKOOT-MOBILE, America's finest skooter, is designed and built like an automobile. Note to the right the photograph of the two-speed transmission and clutch, which provides low gear for power and hill climbing and high gear for speed and economy. Note also the large size automobile-type brake which provides plenty of stopping power for any emergency. The knee-action front end smooths out the roughest roads, assuring comfortable riding, and the compact, air-cooled engine delivers up to 120 miles per gallon of fuel.

SKOOT-MOBILE'S main frame is of welded tubular steel construction and assures ample rigidity and freedom from warping and weaving.

The Economy Car, shown below, has a capacity up to a quarter of a ton and makes an ideal delivery service for retail merchants who demand speed and bed-rock economy. Every **SKOOT-MOBILE** is guaranteed for one year against defective parts and workmanship.



The sturdy two-speed transmission and clutch.



Large, quick-acting brakes.



Knee-action front.



Welded steel tubular main frame, re-enforced.

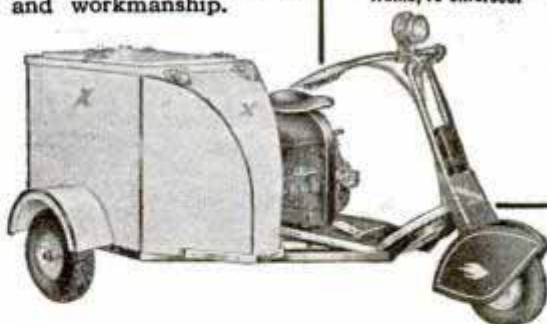

SEND FOR DESCRIPTIVE LITERATURE... FREE

USE THIS COUPON NOW

SKOOT-MOBILE, INC.
5835 Ravenswood Ave., Dept. 384, Chicago, Ill.
Please send me full details and descriptive literature on **SKOOT-MOBILE**. I am interested, as the check mark will indicate.

For personal transportation For Delivery
 Dealer

NAME _____

ADDRESS _____

CITY _____ STATE _____

When writing please mention *Popular Mechanics*

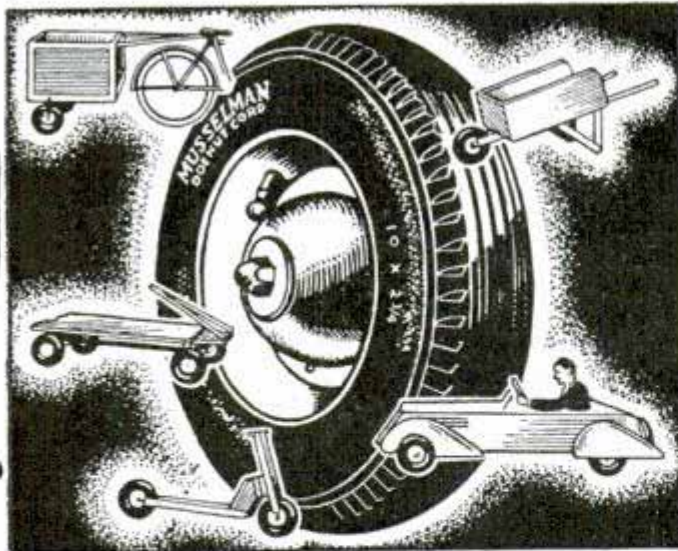

Build it with DOENUTS and our BLUE PRINT DRAWINGS

Build your wheelbarrow, scooter, express wagon, bicycle trailer or midget auto with the most remarkable tire and wheel ever invented for such uses. Designed and patented by the originator of the airwheel for airplanes. Single tube cord construction. Operates as low as 15 lbs. air pressure. Absorbs road shocks, eliminates jolts and coasts 25% to 50% farther. Handles the same loads with less than half the effort. Tire size 10" x 2 3/4". Large size 12" x 3.30". Any boy can build all of the 5 vehicles shown, with our simple blue print drawings. Send 25c for drawing of any one vehicle or 50c for all 5 drawings. Write for free illustrated folder.

MUSSELMAN PRODUCTS COMPANY
6247-Z St. Clair Ave. Cleveland, Ohio

FLAME-GUN Destroys Weeds Does Work of 4 Men!



Hauk Kerosene Flame-Gun—2000° F. controlled heat—quickly, easily, economically destroys weeds (seeds and all), brush, other objectionable growths. Keeps roadways, fences, irrigation ditches, orchards, etc., clean. Hundred and one uses. Inexpensive—Safe—Easy to use. Pays for itself in time and money saved. 10 day Free Trial. Write for Free booklet and special introductory price.

Hauk Mfg. Co., 131 Tenth St., Brooklyn, N. Y.

AUTOMATIC TUNING!



PUSH THE BUTTON
ZIP...There's
Your Station!

EVERYBODY wants automatic tuning—the modern robot that increases the pleasure of radio a thousand times. SILVER offers a complete line of radios with this amazing feature. No need to pay fancy prices when you can buy Silver guaranteed quality radios at saving up to 60%.

FREE HOME TRIAL
Every radio guaranteed ONE FULL YEAR. Money-back with a smile if not 100% satisfied!

THE BIGGEST "BUY" IN RADIO HISTORY!

A beautiful radio with 5 genuine RCA tubes. AC-DC. Long and short wave (gets police calls, amateurs). Large size: 15x8 3/4 x 6 1/2 in. Complete with aerial. Walnut finish. (Ivory \$1 extra)

Order Now! **\$10⁹⁴**
Rush \$2 Dep. Balance C.O.D.



"GIVE-AWAY" PLAN
Send 10c for sample sales-card. Give radios away FREE. Make \$15.82 on every deal.

FREE CATALOG
50 beautiful models for farms, homes and cars. 5 to 15 tubes. Write for it!

SILVER MANUFACTURING CO., Inc.
2868 ELSTON AVE. Dept. P-4 CHICAGO

How to Build a Resistance Box

(Continued from page 580)

range and connections to the various contacts on the top and bottom decks of the switch. Each of the four double-deck switches are wired in exactly the same manner. All of the wiring on each switch should be completed first and the resistors attached later. The assembly is such that the resistors mount in line with the shaft of each rotary switch, and always between terminals in line with each other. This permits the use of short leads and makes for compact assembly. The various contact

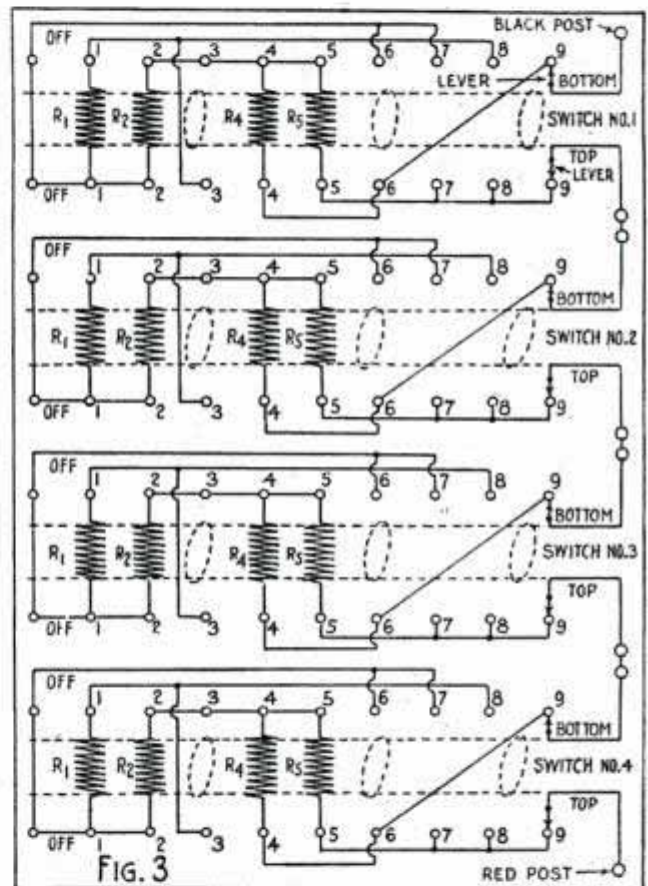

points are so arranged that it is possible to have only four resistors in each decade. Please note that points 1, 2, 4 and 5 permit the operator to obtain any number from 1 to 9 by means of different combinations.

Figs. 2 and 2-A show the switch and resistor grouping looking at the rear of the panel assembly; a top view appears in photo Fig. 2-B. Series connections for each of the four decades, and the start and finish leads to the binding posts, are indicated in Fig. 2. Only two binding posts are necessary, as, at the "off" position of the switch, a shunt eliminates all resistors from the circuit. The schematic diagram is given in Fig. 3.

DO YOU KNOW—

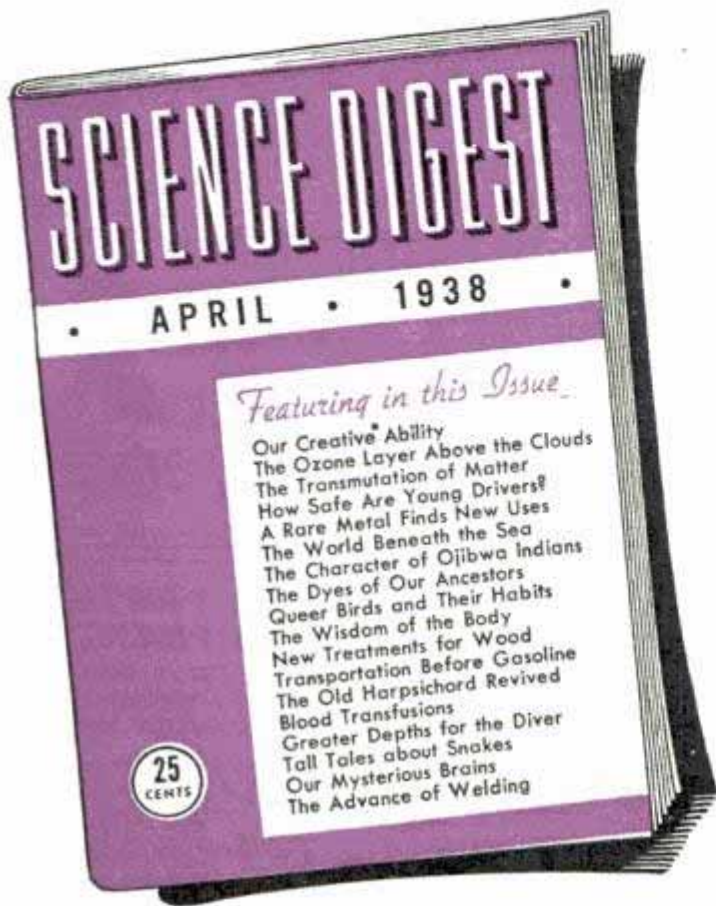

SCIENCE DIGEST gives an interesting monthly report of the progress of Science in all parts of the world, in all its branches. Scientists, manufacturers, teachers, students find Science Digest helpful, informative, time-saving. Hundreds of scientific publications are studied for this monthly ninety-six page digest that is given to you—for only twenty-five cents—in concise, clear, easy-to-read form. Buy the April issue at a newsstand today—or mail this coupon for a year's subscription. Whatever your business or profession you'll get more than your money's worth.

Whether man could live without ozone

Why young men make more than their share of great discoveries

What reptile plays dead

How the master gage makes mass production possible

What gland of the body is best protected

How safe are young drivers

The function of hard, fast breathing after exertion

What tropical bird guards the poultry yard

How the world's diving record was made possible

Why people like to dance

Whether snakes ever bite themselves

Answers to these and hundreds of other questions are in the 96-page April issue of Science Digest — on newsstands today.

SCIENCE DIGEST, INC.

631-643 St. Clair Street, Chicago, Ill.

Gentlemen: Please send me Science Digest for one year beginning with the April 1938 issue.

I enclose \$2.50 Please bill me
 Outside United States and Possessions, Canada, Newfoundland, Labrador, and countries of the Pan-American Postal Union, including Spain, please add 50 cents to cover overseas postage.

Name.....

Street.....

City.....State.....

I'M THE BEST GLUE AND THE CHEAPEST IN THE END



LEPAGE'S
strength
FOUR FLUID OUNCES
LIQUID GLUE

The household "utility-man".
For craftsmen and manual training.
Use for fixing and repair work.
In bottles, tubes and cans.

HANDY TAP and DIES . . .
Accurate—carefully hardened and tempered. Complete range of sizes at your local five and ten cent store.
HENRY L. HANSON, WORCESTER, MASS.

THIS BOOK FREE
where you buy your Sluggers



When you go into your dealer's to buy a new model LOUISVILLE SLUGGER be sure to ask him for a copy of "Famous Sluggers of 1937" with Tips on Batting. We have sent him a supply of these interesting informative books in order to make it easy for you to get one. If your dealer does not happen to have a copy, send 5c in stamps to Dept. P-31, and we will mail it to you. **HILLERICH & BRADSBY CO., INC., Louisville, Kentucky.**

LOUISVILLE SLUGGER
HILLERICH & BRADSBY CO.
LOUISVILLE, KY.
TRADE MARK REG. U.S. PAT. OFF.

Autographed
LOUISVILLE SLUGGER BATS

NEW!

3-WHEEL "SIDE-KAR" Auto-Glide



Carries Extra Person or 250-Lb. Load
New speedy Side-Kar model AUTO-GLIDE! Carries extra passenger comfortably, or big pay load, for deliveries. Heavy steel trunk. Removable cover has lock. Side-Kar unit on or off in 5 min. Powerful 1 1/2 or 2 H. P. engine. Clutch. Brake. Balloon tires. Windshield available. **ONLY 1/2c PER MILE OPERATING COST!** Drug store increased delivery business 800%—while cutting delivery costs 75%!

FREE BOOK with photos, complete details and the very Low Priced! Send card or letter today. **DEALERS:** Send quick for Special Offer!

WRITE TODAY!
THE CUSHMAN MOTOR WORKS, Dept. N-4, Lincoln, Nebr.

PARMAK ELECTRIC FENCER



With Amazing **FLUX DIVERTER**
Thousands of **PARMAKS** now in use. One used barbed wire on light stakes cuts fencing cost to \$10 a mile. Only **PARMAK** has exclusive New Flux Diverter—doubles life of **SAFE 6 volt** batteries; fences entire farm; gives sting that holds stock like steel and concrete.

Free Catalog
Sent on 30 DAYS TRIAL
Write today for **FREE CATALOG** and long term guarantee.
AGENTS—Write for money-making and exclusive territory plan.

\$12.50

PARKER-McCRORY MFG. CO., 100-D, 2509 Walnut, Kansas City, Mo.

TRAILER PARTS AND EQUIPMENT
for building any type of trailer.
WRITE FOR FREE LITERATURE.
HAMMER BLOW TOOL COMPANY, Dept. 104



WAUSAU, WIS.

VELVET SPRAYED FROM A GUN!!

Anything from a candy box to walls and ceilings can now be covered with suede velvet felt or velour finish with our newly developed hand spray set. (See page 253 February issue.) The Binder is first applied, the object is then sprayed with pulverized fabrics! Can be applied to paper, cloth, wood, leather, plaster and metal—Drying time 15 minutes.

Introductory offer 1 Binder Gun, 1 Fabric Gun and enough binder and pulverized fabric (suede) to cover about 15 sq. ft. for only \$1.95 plus postage (shipping weight 3 lbs.) in any of the following colors—tan, blue, navy, brown, black, red. Be the first to profit by this new discovery! Order your outfit now! Send for free circular—10c brings four attractive finished samples.

MODERN ART MATERIAL SERVICE, 173 No. Michigan Ave., Chicago, Ill.

WIND ELECTRIC PLANT
Build Your Own—We Show You How!
Easily made from old auto generator. Dime brings complete plans and 1938 catalog. 100 other generator changes to 6, 12, 32, 110 volt plants, motors, welders, elec. fence, etc.
LeJay Mfg., 447 LeJay Bldg., Minneapolis, Minn.



"Handy" HAND PUMPS



for shop, garage or home—pump oils, gas, paints, etc., from drums and barrels. Easy turning—no priming—capacities up to 20 gallons per minute . . . **LOW PRICED.**
FREE BULLETIN shows 14 Different Models by a nationally known builder of rotary pumps.

BLACKMER PUMP CO., 1801 CENTURY AVE., GRAND RAPIDS, MICH.

SPARE TIME MONEY . . .

There's a big demand for the many hand-tooled articles you can make with the **Easco Leathercraft Set**. Easily learn to make good money in your spare time. Complete outfit including tools, leathers, patterns, etc., and full instructions, only \$2.00—on sale at leading Department Stores or order direct and pay postman on arrival. \$2.50 outside U. S.

LEATHERCRAFT

Free When ordering direct, clip name of your Department Store to this ad, and we will include with your set, one extra free project. Illustrations catalogue 10c.

E. A. SWEET CO., Dept. A-11 Binghamton, N. Y.

"Stand by for an SOS"

(Continued from page 573)

sick or injured man, he asks for advice through KOK. Sometimes the proper treatment can be radioed back from a hospital, sometimes a coast guard amphibian is sent down to pick up the man, or arrangements are made via the radio for a steamer to meet the fishing boat and carry the sick man to the next port.

KOK handles an average of fifty routine ship-to-shore messages every day. During a month's time the station contacts as many as 300 different ships, including Japanese boats that use a language reduced to English letters, and Hungarian vessels that sail under their own flag although their country has no seaport. Questions having to do

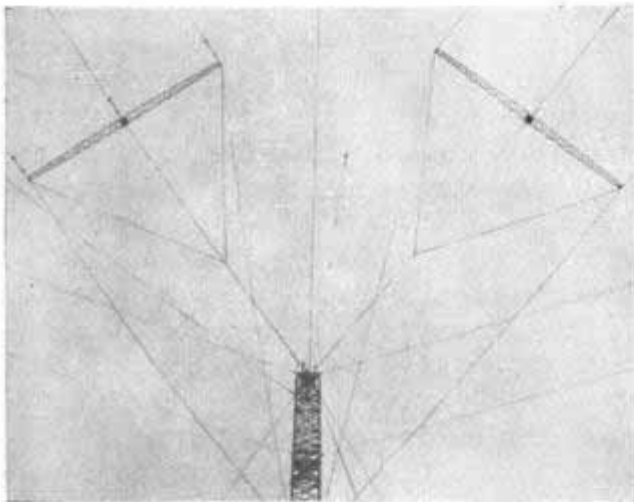

Part of the complex antenna system used at the land radio transmitting station

with the safety of a ship, obtaining bearings and compass courses, and similar routine communications are handled by means of "Q" signals, an international radio code.

Ordinarily a land station works ships in its own general vicinity, within a radius of less than 1,000 miles. Beyond that distance a ship is usually able to contact a different land station closer to it although on occasion KOK, as well as other modern marine stations, is able to "follow" a ship clear around the world on eighteen, twenty-four, or thirty-six meters, talking on a pre-arranged time schedule. Now and then KOK works with one ship all through a voyage, handling all of its traffic on a trip from the west coast to London and back, or across the Pacific to Melbourne, up to Manila, and return.

(Continued to page 150A)

WHY THESE 1938 G-E BULBS ARE BRIGHTEST IN ALL HISTORY!

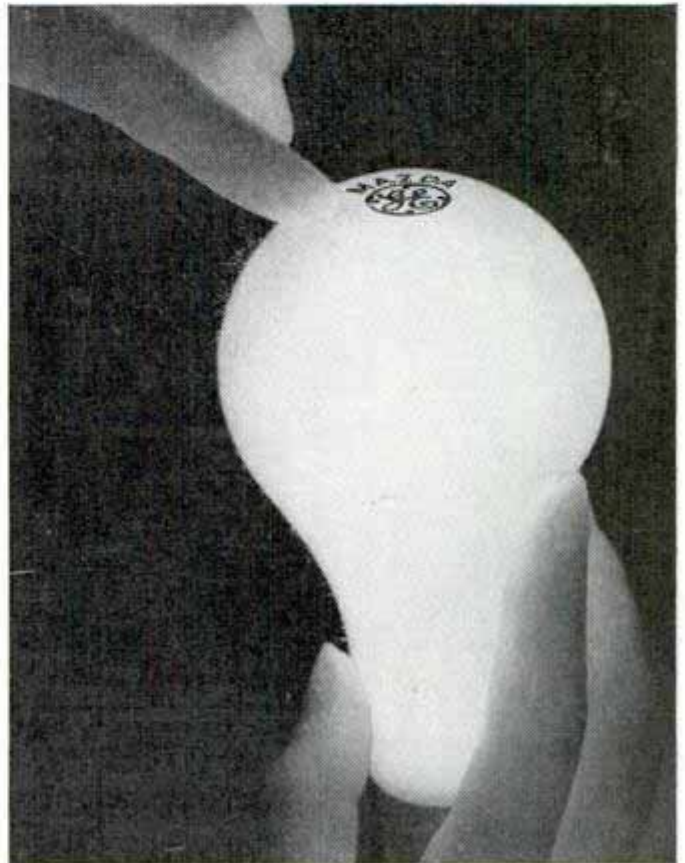

Thanks to MAZDA lamp research and scientific development, General Electric now offers the most economical MAZDA lamps in all history... economical because they give more light *at no increased cost for current or bulbs.*

Within the past year alone, several important technical improvements have been made... including the new high-efficiency filament that gives more light than ever before. The 60-watt Edison MAZDA lamp of today, for example, gives 25% more light than the same size lamp in 1928.

CHANGE TO NEW G-E BULBS AND SEE THE DIFFERENCE

Replace burned-out or blackened bulbs with these latest G-E lamps today... and enjoy their brighter light. Get a supply of the larger sight-saving sizes... 75, 100, and 150-watts... and see what a difference they make as you read, or play, or work.



BUY LAMPS WHERE YOU SEE THIS EMBLEM

EDISON MAZDA LAMPS

GENERAL  ELECTRIC

Now!..New Departure Gives You

2-SPEED DRIVE!

*EASIER ON
THE HILLS!*



Easier on the Hills..Quicker Get-away..More Speed on the Level!

A flick of the finger lever shifts from low to high. With this 2-speed drive you also have the greater braking power and dependable safety control of the famous New Departure Coaster Brake.

Be sure your new bicycle has the New Departure 2-speed drive Coaster Brake. Look for the New Departure name. Get the genuine!

NEW DEPARTURE
BRISTOL, CONN.

GOOD NEWS! Your present bicycle may be converted to 2-speed drive...if it has a New Departure Coaster Brake. Your local dealer can make the change-over quickly. Ask him about it at once!



NEW DEPARTURE

2-SPEED DRIVE COASTER BRAKE

201368

(Continued from page 149A)

A few years ago the operator standing the "mid watch," from midnight until eight in the morning, had the busiest shift. Earlier types of equipment had poor daylight range, and transmission was best after midnight. Today an operator can communicate with nearly any ship equipped with short-wave apparatus almost any time he has messages for it.

KOK is also the Los Angeles end of a Los Angeles-San Francisco point-to-point low-frequency domestic radio service. Three big receiving panels in the operating room pick up incoming signals from three fixed receiving loops outside the station, amplify the signals, and transfer them to land wires that carry them direct into Los Angeles. The point-to-point service uses three channels between 4,000 and 6,000 meters, employs arc-type transmitters, and is of the high-speed automatic type, both transmission and reception being tape-fed at the rate of 125 words per minute. Short-wave circuits parallel these low-frequency bands and can be substituted for them if conditions demand.

In order to minimize interference between transmitting and receiving sets, all of the transmitting equipment of the station is located at Clearwater, fifteen miles from the receivers. Aside from the arcs used in the point-to-point circuit, 5,000-watt transmitters are used for intermediate and short-wave marine transmission. Four steel towers 300 feet high are used to suspend a complex antenna system for the transmitters.

When an operator goes on duty at the KOK receiving station he sits down in front of a maze of panels and telegraph keys. Directly in front of him is the main intermediate wave receiver, covering from 600 to 800 meters and having a normal daylight range of up to 700 miles. To his right are two world-wide short-wave receivers tuned to different wave lengths and tied together with a dial connector so that one motion of his hand moves the tuning dial of each set. Stand-by receivers for monitoring on the station's transmission and for test work are also on the table. A group of switches enables the operator to connect the output of any receiver to a loudspeaker so that he can guard a wave length not connected to his headset.

(Continued to page 152A)

THE ATLAS HAS EVERYTHING I WANT

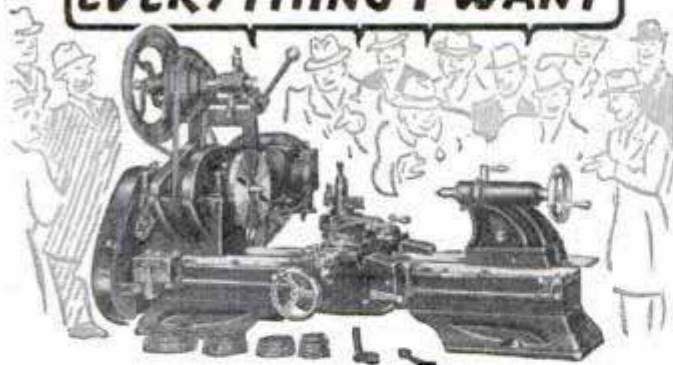

All who see the Atlas lathes and other shop equipment talk about the power, versatility, and extra features of these modern machine tools. The 10-inch back-geared model illustrated is only \$98.50 complete with countershaft, V-belt drive, change gears to cut hundreds of threads, automatic, reversible power feeds, and many other exclusive special features. Atlas gives you greater values because our up-to-date factory is equipped to take advantage of all the savings made possible by modern engineering technique and the latest precision production methods. Send for Catalog.

ATLAS PRESS COMPANY

443 N. Pitcher St., Kalamazoo, Mich.

FACTORY DISPLAYS AT

CHICAGO—35 E. Wacker at Wabash
NEW YORK—130 W. 42nd St.
PHILADELPHIA—113 N. Third St.



DRILL PRESSES
\$17.75 to \$45.75

NEW 7" BENCH SHAPER

Has all the accuracy and power of larger machines built down to scale. Has 7-inch stroke, 4 speeds, and 5 surface feeds in either direction to handle all metal shaping operations with 1/2 H.P. motor. \$215 with guards, less motor.



"A Triumph of Modern Engineering"



NEW SMALL LATHE

The sensational back-geared, screw-cutting metal lathe with 16 speeds, Timken bearings, V-belt drive, etc. 12-inch and 18-inch between centers—6-inch swing. \$59.50 and \$64.50, less motor.

Free NEW CATALOG

Shows the complete new Atlas Equipment for metal and wood working. Send coupon for your copy today.



ATLAS PRESS CO., 443 N. Pitcher St., Kalamazoo, Mich.

Kindly send me your 1938 Catalog. I am interested in:

- New Small Lathe
- Metal Lathes
- New Shaper
- Drill Presses
- Arbor Presses
- Wood Lathes

Name

Address

City and State

LATHES · DRILL PRESSES · ARBOR PRESSES · SHAPERS

COMPLETE ELECTRIC PLANTS

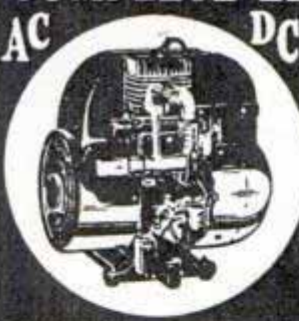

Onan A.C. plants furnish same current as city lines, 110 Volt, 60 Cy. For farms, camps, construction jobs. Operate radios, water systems, all appliances. New models, 350 to 5000 watts, 6, 12, 32 and 110 volt D.C. Models \$57.50 and up. Also combination A.C.-D.C. units. Shipped complete, ready to run.

Write for details.

D. W. ONAN & SONS
1017 Royalston Ave
Minneapolis Minnesota

TWO-CYLINDER STEAM ENGINE

for small boat models complete with propeller, shaft, fire screen, denatured alcohol torch and fuel tank. Torch will start cold engine in 2 minutes, run it for 12 minutes.

Price complete as described \$3.00 postpaid
Shawnee Engine Co., Box 162, Station D, Cincinnati, O.



WET BASEMENTS!

Amazing new Seal-Seep method, anyone can use. Applied to inner masonry wall and floor surfaces; no digging. Guaranteed permanently effective. Agents write for unusual earnings opportunity. Details FREE.

Waterproof Your Own
Save up to \$100 to \$150

National Seal-Seep Co., Dept. 492, Cincinnati, O.



AS LOW AS

\$89

F.O.B. CHICAGO

You'll find new fun—new thrills—new delight the first time you sit comfortably aboard the amazing new Moto-Scout and go whizzing off across country! Care and worry are quickly left behind! You can forget expense—because there are 120 sparkling miles in every gallon of gas you buy for Moto-Scout! It's the world's cheapest power transportation! Prices now lower than ever. New improvements mean easier control, easier riding. Write for FREE BOOKLET and name of nearest dealer.

There's only one genuine, original MOTO-SCOOT!
MOTO-SCOOT MANUFACTURING CO.
219 So. Western Ave. Chicago, Ill.

★ NEW BOOK CRAFTSMEN SHOULD HAVE ★

100 PAGES—No. 10—MAKE BEAUTIFUL FURNITURE

10c
Rebated on First Order

at a fraction of store cost. 14 pages of lumber with prices. Veneers and plywoods of all woods cut in usable sizes without waste. USE THE CRAFTSMAN new process of inlaying, using our new process ART INLAY GLUE, needing no clamps for the finest work. Hard-to-find rare grains for all woods, including foreign—special hard-to-find hardware, mouldings, turned legs, etc. Lists and illustrates 76 blueprints of scroll patterns, inlay table tops—Kits for inlaid art boxes, plaques, trays, book ends, etc., that anyone can make—22 pages in color. **VENETIAN BLINDS** for one-third of usual price. All material requiring only a saw, screw driver, a tack hammer and paint to assemble.

CRAFTSMAN WOOD SERVICE CO. 2722 MARY STREET CHICAGO



251368
(Continued from page 150A)

DURO
Announces
A NEW
METAL CUTTING
BAND SAW



Especially adapted for use in foundries and other machine shops for cutting metal. This unit is driven by a series of pulleys to obtain the proper speed for cutting metal. The method of adapting this unit from wood to metal working is simple and inexpensive and can be readily accomplished. A metal guard to cover the pulleys and jack shaft can also be purchased.

For metal cutting or woodworking, the Duro 16-inch Band Saw is outstanding in design and durability. This unit is more heavily built, more carefully designed and more capable of standing up under heavy production work than any unit in this price range.

DURO METAL PRODUCTS CO.
2649 NORTH KILDARE AVE., CHICAGO
258 BROADWAY, NEW YORK CITY



SEND FOR **FREE** CATALOG



FLY FISH —

Free with "Popstreamer", the sensational new 25¢ bass-bug, one copy Weber's 24-page "Moviegram" Fly Casting Instructions, and Weber's 96-page color-catalog of fly casting lure and tackle. Send 25¢ today—to world's largest in fly tackle:
Weber Lifelike Fly Co.
Box 3862
Stevens Point, Wisconsin



Weber

DIESELECTRIC PLANTS

MAKE YOUR ELECTRICITY FOR 1¢ PER KILOWATT

Make your own electric light and power the "Diesel Way" with WITTE Dieselectric Plants, 2500, 4000, 8000 watts, for Less Than ONE CENT per KILOWATT on cheap non-explosive fuel. 110 volt A. C. or D.C. for direct lighting, 32 volt for battery operation. Charging costs lowered 75%. Easily installed in small space. Also stationary Diesel Engines 4, 6 and 12 H. P. Use a Diesel for Economy and Safety.

4744 Oakland Ave.

\$650

and up
F. O. B.
K. C., Mo.

Easy Payment Plan



2500
Watts

Kansas City, Mo.

WITTE ENGINE WORKS

Three keys in front of the chief operator, one for intermediate wave transmission, one for short-wave, and one for a Morse telegraph circuit to Los Angeles, are duplicated by similar keys to one side so that two operators can work at once when traffic is heavy. A third group of keys is used to switch wave lengths from calling waves to working waves at the transmitter by remote control. From this table different



Operator tuning receiver at station KOK

messages on different wave lengths can be sent at the same time, or if the operator has a roll call of ships to broadcast, press, or other general interest information, he can hook the transmitters tuned to several different wave lengths together and operate them simultaneously with one key.

The most stirring incident in Winsler's memory happened a number of years ago, when a rescue plane was dispatched from San Francisco to hunt for a missing flier in the San Francisco-Honolulu Dole race.

"The key of the radio transmitter on the rescue plane was kept tied down so that it would give a steady signal," Winsler recalls. "That way, we could be sure that all was well. Now and then the operator would open the key so that he could give a position report.

"Everything was fine for five or six hours, and then suddenly there was a momentary break and waver in the signal that sounded almost as if something was happening to the plane. Right afterward the operator broke the signal and tapped out 'Thought we were gone then. The plane was in a spin.' A few minutes later the plane operator opened up again: 'In another spin.' Then the signals stopped. No trace of the plane was ever found."

**3-IN-ONE OIL
KEEPS GOOD
TOOLS GOOD!**

For cleaning and oiling tools, for adding smoothness and speed to action points of braces, always use 3-In-One Oil. Its "triple-action" cleans, oils, prevents rust. At hardware, drug, grocery and 10¢ stores.

3-IN-ONE OIL

**BUILD YOUR OWN
GRANDFATHER'S CLOCK
WITH OUR HELP**

Cash in on the demand for Mantel, Banjo, GRANDFATHER'S CLOCKS. Ask about our new, low-priced Hall Clock and Special Blue Print Offer. Send dime for illustrated working drawing of Hall Clock; 25¢ for plans of 15 Mantel & Banjo Clocks. Catalog FREE.

AMERICAN CHIME CLOCK CO.
1677 Ruffner St. (Established 1877) Philadelphia, Pa.

STAR METAL BOATS

★ **NON-SINKABLE
CARE-FREE
ECONOMICAL**

Only complete line of rubber cushioned metal row boats, outboard motor and sail boats, including a new utility inboard model. Better quality, lower prices.

STAR TANK & BOAT CO., Dept. P GOSHEN, INDIANA

free Catalog

**SERA'MO AMAZING NEW
POTTERY CLAY**

... fired in your Kitchen Oven

EASY to shape! Models like clay . . . fire in kitchen oven for 15 minutes. Makes beautiful vases, plaques, art objects, etc. inexpensively. 1 lb. 25c, 5 lbs. \$1.00. **ORDER TODAY.**

FAVOR RUHL & CO., 425 S. Wabash Ave., Chicago, Ill.

**2400 DEGREES FAHRENHEIT!!
BRONZE FOUNDRY**

for Schools and Home Workshops

Complete Foundry Outfits are available in three sizes and make it possible for you to produce beautiful bronze, silver or aluminum castings in your home workshop from scrap metal. Presents such as book ends, ash trays, dishes, paper weights, letter openers, bottle openers, statuary, etc., can be quickly made by the sand casting process. Existing objects can be used as patterns, and sand moulds made in a few minutes' time. Previous experience unnecessary. Domestic gas supply and 110 volt energy required for operation.

Size	Crucible Capacity	Shipping Wt.	Price Complete
351	6 cu.in.	25 lbs.	1 1/2 lbs. \$13.50
352	12 cu.in.	40 lbs.	3 lbs. 19.00
353	24 cu.in.	65 lbs.	6 lbs. 27.50

Universal motor blower operates on either AC or DC. Prices f. o. b. K. C. Check or money order acceptable, express charges C. O. D. Write for circular.

KANSAS CITY SPECIALTIES CO.
P. O. Box 6022 Kansas City, Mo.

**A New
JOHNSON
Sea-horse
17 lbs.**

**ONLY
\$49.50
F.O.B.
FACTORY**

**Speed up to
6 M. P. H.**

● Now — a bantam-weight outboard motor with typical Sea-Horse refinements, including underwater exhaust and 360° steering and reverse, plus Johnson's famous "Single Shaft" construction! Write for new Sea-Horse Handy Chart describing all 9 models for '38 — the most important Handy Chart ever published. Sent free.

JOHNSON MOTORS
400 Pershing Road, Waukegan, Illinois
Johnson Motors of Canada, Peterboro, Canada

FREE!

**Amazing NEW GLAZE
Beautifies and Protects**

Car Owners! Meet MASTER GLAZE — the sensationally different luster for new and used cars!

Not a wax — not an oil polish — not a paint — nothing that "smears" over the surface. A creamy liquid — quick and easy to apply! Gives a hard, glass-like surface. Even gasoline cannot dull it! Lasts six months to a year! Amazing luster — beautiful, sparkling clean and brilliant! Doesn't fingermark — doesn't smear! Seals the pores — protects! Nothing like it!

AGENTS
Unusual opportunity. Quick demonstrator — big profits. Good territory. Write today.

FREE Write now for Free booklet and **SAMPLE OFFER**. Free Trial offer. Just send your name and address.

MASTER GLAZE CO., 7720-25 W. HARWOOD AVE., MILWAUKEE, WIS.

**NOW—CUPBOARDS, SASH, DOORS
ARE EASY TO MAKE
WOODWORKERS . . . Big Money**

making cupboards, panelled doors, hotbed sash, storm windows, etc. New **BOICE-CRANE** Dual-duty Shaper and Ogee sash cutter set make perfect fitting coped joints quickly. The preferred joint for this work. *Your products therefore bring top prices.* **BOICE-CRANE** Saw & Jointer get out dimension stock quick, easy and accurate for fast assembly.

GET COMPLETE CATALOG

BOICE-CRANE equips large and small shops complete with *Saws, La. Res. Jig and Band Saws, Shapers, Sanders, Thickness Planers.* Write for **BIG** catalog. Include 10¢ for 16 page illustrated instruction book on Lathes Metal Spinning. A Profitable New Lathe Craft!

BOICE-CRANE CO. Dept. 248 TOLEDO, O.



12

**ASSORTED
NEEDLE FILES**
*in a Box
which becomes
a Bench Stand*

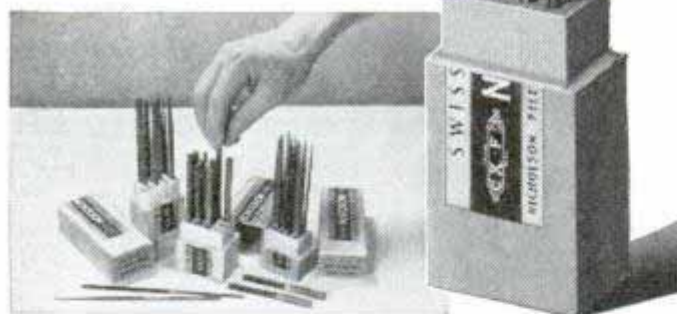

EXTRA →  FINE

You'll like this new, economical, convenient way to buy Nicholson X.F. Swiss Pattern Knurled Handle Needle Files . . . the files that will help you do the most delicate filing work with precision.

12 different-shaped files . . . a complete assortment for every delicate filing need . . . now available in convenient box. Lift off the top and the box becomes a handy bench stand . . . keeps files within easy reach and prevents them from rubbing.

You can equip yourself to do all types of precision filing by asking your hardware dealer for the new set of Needle Files in the box that becomes a bench stand. If he cannot supply you, write us direct. Nicholson File Company, Providence, R. I., U. S. A.

A FILE FOR EVERY PURPOSE

es 1489 New U. S. Warships

(Continued from page 511)

that they would serve a double purpose, as an anti-aircraft battery or in repulsing light surface craft, as destroyers or submarines. In addition, their upper works will bristle with the navy's fifty-caliber machine guns, which have shown remarkable efficiency against aerial dive-bombing and strafing attacks.

It has been announced that the ships' top speed will be about twenty-seven knots, but informed observers believe that when they run their trials they will show speeds of nearer thirty knots. This would indicate main engines of well over 100,000 horsepower, against the 40,000 horsepower housed in the modernized "Idaho," with top speeds of twenty-two knots.

In contours, the new craft promise to have low, rakish outlines of warlike aspect, resembling closest, among existing capital ships, France's new "Strasbourg" and "Dunkerque." Their bridge structure will be a heavily armored tower, far more nearly impervious to shell fragments than the similar structure gracing the reconstructed "Idaho."

Undoubtedly, the new ships each will carry four observation seaplanes, but whether these "fire-control eyes" will be launched by catapults, as are the planes of our existing battleships, is another matter about which the navy is keeping silent. There remains the possibility that before they are commissioned the observation planes may be shifted to either small battle-line aircraft carriers or even to cruisers.

The navy department has announced its intention of laying down two more battleships during the coming year and it is expected that three others will be started shortly thereafter. Seven of the U. S. navy's fifteen battleships will have passed the age of obsolescence before the "North Carolina" and "Washington" are completed and other leading powers already are building far beyond America's modest program.

Under great secrecy, Japan is this year laying down the first two of four projected battleships. They are expected to displace 40,000 tons and mount sixteen-inch guns.

In the 35,000-ton "Jean Bart" and "Richelieu," France is well underway with two remarkable battleships, which probably

(Continued to page 157A)



"Take advantage of Royal's FREE HOME TRIAL offer. Send in the coupon below right away. I got a big raise—shortly after purchasing a Royal."

GET AHEAD FASTER . . . EARN MORE MONEY

GET A FREE HOME TRIAL! Without risking a penny—prove that a Royal Portable will help you get that raise. Whatever your job—salesman, executive, inventor, engineer, teacher, student—prove that a Royal will help

you think faster, write faster—get your ideas, letters and reports down on paper easily—in modern, readable, saleable form. Prove that it will pay you (your family, too—if you are a family man) to own a Royal Portable!

OWN A ROYAL PORTABLE ON YOUR OWN TERMS!



READ WHAT ROYAL GIVES YOU: These great features explain why so many thousands of families are Royal owners. Built by the world's largest company devoted exclusively to typewriters—with standard, full-sized keyboard and easy, effortless action: Touch Control, Finger Comfort Keys, Complete Dust Protection, Genuine Tabulator and numerous other office features. Royal Typewriter Company, Inc., 2 Park Avenue, New York City.

ACT NOW!

SEE what a latest model, factory-new Royal Portable can do for your family. Then own it on your own terms—cash or only a few cents a day. Mail the coupon today!

ROYAL TYPEWRITER COMPANY, Inc.
Department B-85, 2 Park Avenue, New York, N. Y.

SEND NO MONEY!

Please tell me how I can own—
for only a few cents a day—a
latest model Royal Portable—
complete with free Carrying Case
and Instant Typing Chart.

I now own a
Typewriter, Serial No.
Tell me how much you will give
on it as CASH allowance on
a Royal Portable.

Name Street
City State

**ONLY A FEW
CENTS A DAY!**

**FREE!
FREE!**

With every Royal Portable a handsome, all-weather Carrying Case.

Royal's Instant Typing Chart—it shows you how to type right!

free!

MONEY-SAVING CANDID CAMERA

Catalog No. 235 . . . brand new! Lists hundreds of "Saving" items — Save Money on Candid Cameras, Enlargers, Still Cameras, and Accessories. Write for this remarkable Bass Bargaingram and check your photographic needs . . . acclaimed the best candid camera list of all times. WRITE DEPT. P.



Bass CAMERA CO.
179 W. MADISON ST., CHICAGO, ILL.

Send for CATALOG



Folding Puncture Proof Canvas Boats

Light, easy to handle, no leaks or repairs; carry by hand and on auto; safe for family; all sizes; non-sinkable, stronger than wood; used by U. S. and foreign governments. Awarded First Prize at Chicago and St. Louis World's Fairs. Catalog.

KALAMAZOO CANVAS BOAT CO.
450 Harrison Street Kalamazoo, Michigan

GOVERNS SPEED OF ANY GAS ENGINE

It's easy and economical to supply your own power for operating all types of machinery, and do more work for less money. Simply remove the engine from a used automobile or truck, set it up where you like, attach a PIERCE UNIVERSAL GOVERNOR, start the engine and you have constantly controlled power for the operation of electric lighting plants, arc welders, refrigerating units, air compressors, feed grinders, hoists, saw mills and innumerable other applications.

The load may change but the PIERCE UNIVERSAL GOVERNOR will maintain a uniform engine speed. For close regulation of speed and dependable performance PIERCE GOVERNORS are never equalled. Installation is simple. Either V or flat belts can be used. Complete Governor outfits are also available for nearly all makes and models of industrial engines.

Write for illustrated literature and prices.
THE PIERCE GOVERNOR COMPANY
1601 Ohio Avenue, Anderson, Indiana



PIERCE GOVERNORS
THE BRAINS OF ANY GAS ENGINE

THE HANDIEST POCKET KNIFE EVER DESIGNED!

● Neat, handy, useful and durable . . . Brass frame, heavily chromium plated . . . Blade of finest razor steel.

Smart . . . practical
Graceful design, light weight, fine enough to wear on your silver, gold or platinum chain.

Three blades in one

Instantly opened or closed with one hand. No broken fingernails. Blade locks easily in any one of 3 lengths . . . really three blades in one.

GUARANTEED TO PLEASE

THE CHRISTY CO., Fremont, Ohio.

Enclosed is \$1.00 for a Christy Sport Knife. If I am not entirely satisfied, I may return it and my \$1.00 will be refunded. (Ohio orders add 3c for sales tax.) This offer good in U.S.A. only.



PM-8

Actual Size

When writing please mention Popular Mechanics

Get Your SHAW TRACTOR AT LOW FACTORY PRICE!

DOES ALL FARM WORK

• And it's a big **money-maker** and **time-saver** for truck gardens, orchards, nurseries, poultry ranches, golf courses, suburban homes, estates as well as for farms and ranches. DU-ALL does all field road and belt work for only 3c an hour operating cost. Can be run by a woman or boy. Spectacular new features make the new DU-ALL the finest tractor of its type on the market. It has 3 speeds forward (6 when ordered special) and reverse. Runs from 1/8 to 15 miles per hour. New **Power Turn** enables DU-ALL to turn in its tracks. Has powerful **Briggs & Stratton 4-cycle air-cooled engine**. **Air Cleaner, Patented Tool Control** for the shifting of cultivating depth. Convenient **Jiffy Hitches, Power Take-Off Pulley**. Tool and riding attachments for all purposes. Four models, 2 to 5 H. P.

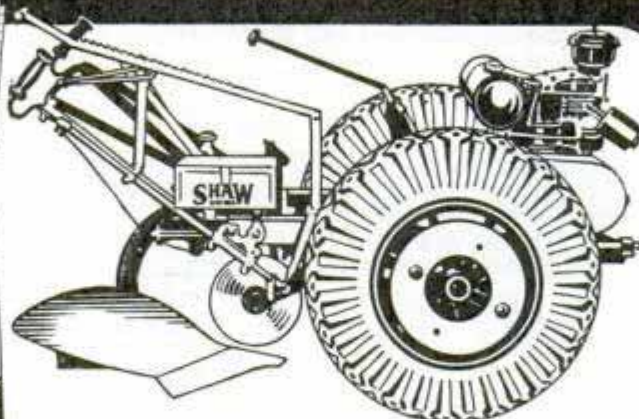

AIR TIRES —A proven economy. Enable a tractor to run easier . . . save 25% fuel cost . . . allow greater traction in field without damaging field, crop or roots . . . and speed up highway travel. Resist side slip. Lug type wheels also available on the Shaw DU-ALL.



FREE CATALOG

Get this FREE book. Explains everything you want to know about DU-ALL. Tells what enthusiastic owners say. Shows actual photos of DU-ALL in action. Pictures and describes all models and attachments. Gives **LOW FACTORY-TO-YOU** price. Mail coupon now!

LOW FACTORY PRICE—Mail coupon for amazingly low one-profit price and terms.

10-DAY TRIAL OFFER

Coupon brings you details about how you can try out DU-ALL on your own work at our risk.

THE SHAW MFG. COMPANY

4504 Front St., Galesburg, Kans.; 5812-G
Magnolia Ave., Chicago, Ill.; 130-G West
42nd St., New York, N. Y.; 668-G North
4th St., Columbus, Ohio.



TAKE-ABOUT SANDERS

Give every job an expert finish in minutes instead of hours

Don't let slow, tiresome, tedious hand sanding and scraping spoil your finishing and refinishing pleasure. Do it this modern, efficient way with a Take-About. No experience necessary, just plug it into the nearest light socket and it will do your job in a jiffy. Use it on straight or slightly curved surfaces. Use the front pulley as a spindle sander on curved work.

Used in thousands of schools for instruction and refinishing desks and other maintenance work.

WRITE FOR DETAILS, PRICES AND TERMS TODAY

PORTER-CABLE MACH. CO.

Precision Tools Since 1906

2000-4 N. SALINA ST.

SYRACUSE, N. Y.

PAINT SPRAY OUTFIT \$6.95

A guaranteed outfit that does the work with little effort.



Consists of two valve air compressor, adjustable safety air release valve, pressure type spray gunnozzles for fan or round spray, aluminum cup, air hose and connections, mounting accessories and instructions. Uses a 1/4 H. P. Motor, which is NOT included. Works equally well with lacquer, enamel, or insecticide. Spray your car, radiators, furniture or house. Compressor develops up to 50 lbs. pressure and 20 inches of vacuum can be used for inflating tires, welding or laboratory work.

Send \$1.00 Balance C. O. D.
PHILADELPHIA MACHINERY CO.
118 N. Sixth St., Philadelphia, Pa.

ACE LATHE TOOL SET \$14.50



Be permanently tooled-up for every operation on your Metal Cutting Lathe

The ACE Set is complete—there's nothing more to buy. Drop forged by the manufacturers of cutting tools used by 96 per cent of the plants and shops in industry they are correctly designed, are of special steel, are finely finished, are stronger—will last a lifetime. You can cut easier, faster and more accurately with ACE TOOLS. At your Hardware Store—Circular FREE.

3 Turning Tools, 2 Cutting Tools, Knurling Tool, Boring Tool, Threading Tool, High Speed Steel Cutters and Blades, and 2 Wrenches in Fitted Steel Case.

ARMSTRONG BROS. TOOL CO.
"The Tool Holder People"
368 N. Francisco Ave., CHICAGO, U.S.A.



TURN SCRAP INTO MONEY

AUTOPOWER tells you how in plain, easy, simple and illustrated instructions that anyone can follow. Change auto generators into useful, practical A C and D C generators and motors with voltage from 2 to 1,000 volts, for power, light, welding, radio, sound, etc. No previous experience nor special tools needed. Generators can be driven by wind, water, fan belt, etc. **INSTRUCTIONS FOR BUILDING AN A C WELDER THAT ACTUALLY WORKS UP TO A 3/16" ROD. ALSO COMPLETE PLANS FOR WIND AND WATER POWER PLANTS.** Send for your copy of "AUTOPOWER," Already used and endorsed by thousands. Only \$1.00 postpaid.
S. W. DUNCAN, Publisher. 410 S. Hoyne Ave., Chicago



(Continued from page 154A)

will approach the new American craft in all-around battle effectiveness. Carrying eight fifteen-inch guns above the huge 160,000-horsepower plant necessary to give them a speed of thirty-three knots, the Jean Bart type ship nevertheless will devote 15,000 tons of their total displacement to armor. They will be squadron sisters to the "Strasbourg" and "Dunkerque," of 26,500 tons and mounting eight thirteen-inch guns. The "Dunkerque" already is in commission. The "Strasbourg" will be out this year. Five more 35,000-ton battleships are proposed in a five-year program.

Germany is building the 26,000-tonners "Scharnhorst" and "Gneisenau," of thirty-one-knot speed and mounting nine eleven-inch guns, and has just laid down two 35,000-ton ships, mounting fourteen-inch main batteries.

Across the Channel, Great Britain has a full-year's work completed on two 40,000-ton thirty-one-knot ships, the "King George V" and the "Prince of Wales," and soon will lay down three sister ships, the "Anson," "Beatty" and "Jellicoe."

Although all five leading naval powers are accompanying their capital ship construction with veritable fleets of new cruisers, submarines, aircraft carriers and destroyers, this huge battleship program is proof that their leaders believe that the capital ship has by no means outlived its usefulness, nor that the aerial bomb and poison gas endanger its existence.

Wooden Dishes at South Pole Keep Food from Freezing

Even hot soup cools off "twixt cup and lip" in eighty-below-zero weather at the South Pole, so there will be wooden dishes, wooden knives and forks and spoons aboard ship when Admiral Richard E. Byrd's next antarctic expedition sails. On his first voyage, food could not be kept warm in the usual metal and enamel dishes and steel cutlery. The intense cold even crystallized and snapped the metal parts of the dog harness. For his forthcoming antarctic trip, Admiral Byrd will use nests of wooden bowls six inches in diameter, designed so that one can fit over another for a cover, wooden spoons in three sizes, three-pronged forks, sharp wooden scrapers for seal meat and wooden toggles for the dog harness.

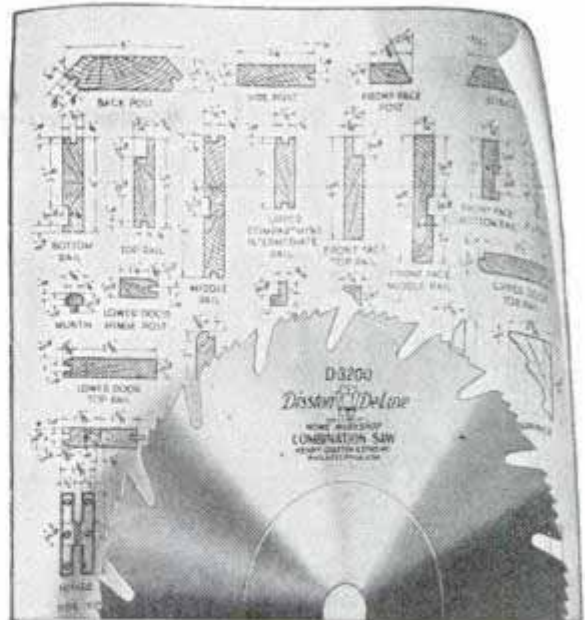

Fine Work Begins with a Disston Saw

The Disston DeLuxe is the finest home workshop saw you can buy. Disston steel! Disston workmanship, of the highest standard! On any job you do, Disston DeLuxe means easier cutting. On something that is a real challenge to craftsmanship, you will realize that the easy, accurate cutting of this fine blade is the beginning of fine work.

Ask your dealer for this saw by name: "Disston DeLuxe", etched on the blade. See the high, smooth finish... accurate fitting... keen teeth, that hold their cutting edge. Ownership of a Disston DeLuxe Saw is of itself inspiration to build pieces of which you can be proud.

Cross-Cut—Rip—Combination

6" (1/2" hole) \$2.70 8" (1/2", 5/8", 3/4" hole) \$3.50
7" (1/2" hole) \$3.10 10" (1/2", 3/4" hole) .. \$4.50

Hollow Ground Combination

6" (1/2" hole) \$4.30 8" (1/2", 5/8", 3/4" hole) \$5.40
7" (1/2" hole) \$4.90 10" (1/2", 3/4" hole) .. \$6.90

Use Disston Saws, Tools, Files

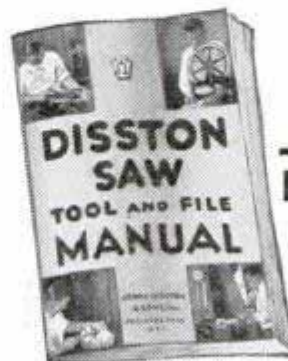

in your home workshop. How to choose, use, care for, these better tools and do better work — all is shown in this Disston Manual sent FREE.

MAIL COUPON

TO: HENRY DISSTON
& SONS, INC.

411 Tacony
Philadelphia, U. S. A.

Your name.....

Address.....

Check the Hardware Store for Value and Variety

A MOST TEDIOUS JOB

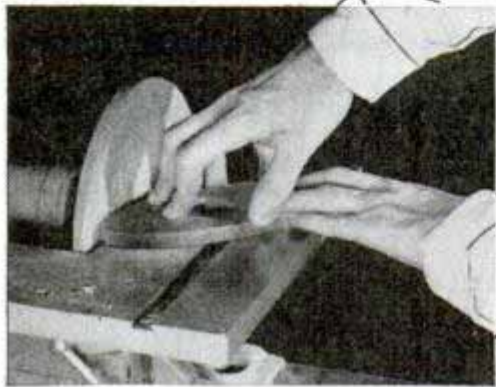

made easy with
CARBORUNDUM BRAND
REG. U. S. PAT. OFF.
COATED ABRASIVES

● Sanding is a tedious job at best. But it's a lot easier when you use one of the many types of sanding sleeves, discs and belts made by Carborundum. Your hardware dealer has them in stock.



Silicon Carbide Combination Stone in your kit. In several sizes at your hardware store.

● In sharpening a chisel, draw knife or gouge you get a better edge quicker when you have a Carborundum Brand

THE CARBORUNDUM COMPANY

REG. U. S. PAT. OFF.

Niagara Falls, N. Y.

[Carborundum is a registered trade-mark of The Carborundum Company]

CARBORUNDUM

REG. U. S. BRAND PAT. OFF.

ABRASIVE PRODUCTS



Exploring Deepest Mystery

(Continued from page 482)

in the rear, set on a carriage which allows a three-foot clearance above the ground. The two large wheels are set forward of the diphrobenth so that if the apparatus should hit anything while being towed, they will act as bumpers."

In lowering the diphrobenth to the sub-surface cliffs and valleys at the 500 to 1,000 foot levels there may be some difficulty with the undercarriage. Barton is prepared for trouble at this depth after having observed the rugged slopes from the bathysphere. For this reason, the wheels are easily replaceable if broken.

"At ocean bottom, at a depth of about a mile, however, the sub-sea floor is comparatively level," he said. "The diphrobenth's descent may then be compared to an airplane slowly coming in for a landing, except that when its wheels touch bottom, it will continue to move forward as it is towed.

"The diphrobenth will be much lighter in weight than the bathysphere. Made of welded steel, capable of standing a pressure of 2,650 pounds per square foot, at a depth of 6,000 feet it will weigh half a ton, as compared to the one-ton bathysphere. Loaded with equipment it will weigh three-quarters of a ton."

Barton estimates that with the 6,000 feet of steel hoisting cable weighing two tons and the one-ton electrical cable, the total weight of the underwater apparatus will not exceed three and three-quarters tons. The powerful five-ton winches used to lower the bathysphere should be ample for this load, but the explorer-inventor has an ingenious trick up his sleeve should there be the slightest trouble. He anticipated Professor Piccard's idea of using extra balloons to give added buoyancy by attaching drums of gasoline to his own particular vehicle for the same purpose.

"Gasoline is incompressible," he said. "In water, a drum of gasoline has a lifting power of about seventy-five pounds. If for any reason it is found advisable to reduce the weight of the diphrobenth, twenty or even thirty drums of gasoline could be attached to the underwater part of the steel cable."

The diphrobenth, which will be equipped

(Continued to page 160A)

Save AT FACTORY PRICES

Building Material Bargains direct from mill! Low prices on everything needed to build, repair or remodel. Free estimates on lumber bills. Guaranteed materials. Big new Building Material Catalog FREE. Write:

Gordon-Van Tine Co.
1813 Case St., DAVENPORT, IOWA

LUMBER
ROOFING
WINDOWS
SCREENS
HARDWARE
PAINT, ETC.



WORLD'S GREATEST all around ELECTRIC TOOL

You can do almost anything with the WHIZ ELECTRIC POWER TOOL. Sharpen knives, scissors, tools; grind axes, dies, molds; remove paint, rust from auto-fenders, woodwork, and metals; smooth rough surfaces; finish off machinery castings; sand woodwork; saw metals; drill holes in steel, wood; etch glass; polish metals; and 1001 other jobs—in the home-workshop or factory. Ready to work the instant you plug it into any light socket—110 volt. AC or DC powerful motor. 1 1/2 inch chuck capacity, ball bearing thrust. STANDARD MODEL with Normal Speed (uses 50 different accessories) only \$6.95. SPECIAL "2-SPEED" MODEL, combines Normal Speed and High Speed in one outfit (uses 200 different accessories) only \$8.95. Accessory outfit (worth \$2) includes set of drills, mounted 1 1/2" grinder, sanding discs, cutting wheels, mounted brush, polishing wheel, etc. FREE with either outfit ordered NOW. We pay postage on all orders. C.O.D. if desired. 10 Day Trial—Money Back GUARANTEE!

ONLY \$6.95 POSTPAID



NEW CAMERA BOOK FREE Brand new catalog. Just out. Pictures, describes, prices Candid and newest cameras, enlargers, amateur equipment, dark room supplies, paper, film, chemicals, etc. FREE. Send name and address. Ask for Camera Book No. 12. MEMPHIS PHOTO SUPPLY CO., MEMPHIS, TENN.

TELECHRON MOTORS 1 R.P.M. 2 Watt. \$2.00. Time switch and motor complete \$3.00. Other makes Synchronous motors \$1.50. Time Switches \$2.00. 3 Digit counters 35 cents. 110 Volt Cellanoids 35 cents. Electric Cellanoid valves \$1.50. All motors self-starting. Supply limited. Send cash with order. Eastern Salvage Company, 208 Lafayette Street, New York

MOW with ONE HAND Handiest power mower ever built—only one with easy one-hand control—cuts 18" swaths; mows large lawns in quarter of time for only 5c fuel cost. Quiet, easy starting 4-cycle motor: adjustable cutting heights; rubber tires. Easy terms. Model "D" \$110, Model "S" shown... \$89.50

Write EVINRUDE 1727 W. Hope Ave. Milwaukee, Wis. **EVINRUDE LAWN-BOY POWER MOWER**

In answering advertisements always write name and full address clearly.

FREE TO SERVICEMEN RADIO PROFITS Zenith, Crosley, Philco, RCA Victor, Grunow, Emerson. BUY WHOLESALE—SELL RETAIL. Complete Discount Sales Plan Sent.



Free Catalog Just Off the Press Fully illustrated, showing special footwear and clothing for fisherman and camper, also special fishing tackle. **L. L. BEAN, INC.** 176 Main Street FREEPORT MAINE

ON OATH SWEARS HE GAINED 12 LBS., NEW PEP, THIS WAY

"When I found myself losing weight and pep I felt discouraged. You see, I am a wrestler, and in wrestling you've got to keep in perfect shape. I tried everything but nothing helped until I got Ironized Yeast. In 6 weeks I gained 12 pounds and now am so chock full of pep I feel like I could take on three men at one time. Everybody admires my physique, too."

—Ralph Loeffler, Arlington, Wash.

Sworn to before me:
D. McGuigan, Notary Public



Ralph Loeffler with professional model

Thousands Gain 10 to 25 Pounds With New Ironized Yeast Tablets

NO LONGER need thousands of fellows remain skinny, puny, unable to win friends and have good times. You've seen what Ralph Loeffler swears to under oath above. Well, he's just one of thousands of thin, rundown people who've put on 10 to 25 pounds of solid, naturally good-looking flesh—gained new pep, new friends and popularity in a few weeks—with these amazing new Ironized Yeast tablets.

You see, scientists have discovered that many are thin and rundown only because they don't get enough Vitamin B and iron in their daily food. Without these vital elements you may lack appetite and not get the most body-building good out of what you eat. Now you get these exact missing elements in these new Ironized Yeast tablets. They're made from one of the richest known sources of health-building Vitamin B—the special yeast used in making English ale. By a new costly process, this rich yeast is concentrated taking 7 pounds of yeast to make just one pound of concentrate—thus making it many times more powerful in Vitamin B strength than ordinary yeast. Then 3 kinds of strength-building iron and pasteurized English ale yeast are added.

No wonder, then, that these new Ironized Yeast tablets have helped thousands of the skinniest people who needed these elements quickly to gain new normally attractive pounds and new pep.

Make this money-back test

Get Ironized Yeast tablets from your druggist today. If with the very first package you don't begin to eat better and get more benefit from your food—if you don't feel better, with more strength and pep—if you are not convinced that Ironized Yeast will give you the pounds of normally attractive flesh you need—the price of this first package will be promptly refunded. So start Ironized Yeast today.

Special offer!

To start thousands building up their health right away, we make this valuable special offer. Purchase a package of Ironized Yeast tablets at once, cut out the seal on the box and mail it to us with a clipping of this paragraph. We will send you a fascinating new book on health, "New Facts About Your Body." Remember, results with the very first package—or money refunded. At all druggists, Ironized Yeast Co., Inc., Dept. 534, Atlanta, Ga.

When writing please mention Popular Mechanics

BIG MONEY!

ASSEMBLING MEAD'S

New PORTABLE KI-YAK

IN A FEW DAYS AT HOME!



—from Complete Cut-To-Fit Construction Kit!

Weigh as little as 20 LBS.

Use with PADDLE! OARS! SAIL! MOTOR!

Assemble for PROFIT or Personal FUN! NO Experience Needed!

MEAD'S perfected, patented, aluminum-ribbed Cut-To-Fit Construction Kit GUARANTEES successful assembly easily, quickly, *INEXPENSIVELY*—in a few days at home with simple hand tools without previous experience. Build yours for personal sport use, or sell at splendid profit! Mead's quality KI-YAKS (available in 4 models, kits or factory assembled) are beautiful and PORTABLE, paddling, sailing, rowing, outboarding, touring, fishing, camping, hunting, Leak-proof, seaworthy, Durable, THOUSANDS in use. Strong as a giant—light as a feather! More fun at less cost! \$6.00 Double-Blade Paddle GIVEN with your CK KI-Yak—if you hurry! Mail 10c and Coupon below for Giant Colored Circular, Money-Making Plan, special offer, Low Introductory Price!



OK-2
Weights only 50 lbs.
Takes ANY Outboard 4 1/2 H. P. or less!

AMAZING LOW COST!

Don't buy any boat until you see the amazing Low Introductory Prices on MEAD KI-YAK Construction Kits and Factory-Built jobs. (You can even Pay As You Build, on our special Progressive Group plan!) **EARN** money assembling, selling! Remember, Mead KI-YAKS are unsurpassed... the lightest, strongest, most portable boats of their kind! Join in the FUN—and PROFITS being made. Rush Coupon and dime NOW for Free details BEFORE prices go up!



OK-2 as rowboat



OK-2 as motor boat. Convertible in 10 minutes into fast sailboat.

Mail Coupon NOW!

\$6 PADDLE GIVEN
with your CK-KI-YAK—if you hurry!

Gentlemen: I enclose 10c as handling, postage charge. Please rush your New Colored KI-YAK Circular, Low Introductory Prices, Money-Making Plan and \$6 Gift Paddle Offer. (Please Print Plainly.)

NAME.....
STREET & NO.....
CITY.....STATE.....

RUSH ME WITH 10c TO

MEAD GLIDERS
15 S. MARKET ST. DEPT. B-48 CHICAGO, U.S.A.

(Continued from page 158A)

with portable oxygen tanks and purifiers when Barton is in it, will have thirty-five cubic feet of air space compared to the forty-two cubic feet of the bathysphere. He considers this sufficient since both he and Dr. Beebe occupied the bathysphere for more than three consecutive hours at a time without discomfort.

Another difference in the two is that there will be but two fused quartz windows in the diphrobenth, recessed vertically in the front of the chamber to prevent damage in case of collision and with the lines of sight converging between the front wheels at a distance of between twenty and thirty feet, the limit of good visibility with a 2,000-watt light at great depths.

"The fused quartz window for under-sea observance was developed by the eminent scientist, Dr. E. E. Free, who has been doing a great deal of work along this line since 1928," said scientist Barton. "They are very expensive and we used twelve in the bathysphere, two of which broke. In the diphrobenth, Dr. Free has solved the problem by devising truncated cones with an internal diameter of three inches which will be sufficient for observing with the human eyes and for taking motion pictures.

"When completed, the diphrobenth will be subjected to at least ten experimental dives to the ocean floor before I will be lowered into it. In these tests, a motor-driven motion-picture camera will take movies of life on the bottom of the sea automatically. The electric cable which furnishes current for the 2,000-watt light will have two conductors, one for the camera which may be started from the surface vessel and one for the telephone which will be hooked up when I descend later.

"The light used for photographic purposes gives off considerable heat and it may not be feasible to operate the motion-picture camera while a human being is in the diphrobenth. In that event the camera will have to be operated automatically. As used in the bathysphere, the camera can run for six minutes without reloading.

"I am extremely hopeful of obtaining motion pictures, the like of which have never been seen before. As the marine life will be photographed with the ocean floor as a background, the pictures should

(Continued to page 163A)

WORMS KILL MANY DOGS

Worms may cause fits and convulsions, often with fatal results. Take no chances—worm your puppy or dog with Glover's Worm Medicines. In capsule form for Round Worms (Ascarids), Hook Worms and Tape Worms. Also Liquid Vermifuge for Round Worms (Ascarids).



Popular with many dog fanciers—

The New GLOVER'S Double Action CAPSULES

An effective combination of medicines to expel both Round Worms (Ascarids) and Hook Worms in puppies and dogs.

Write for new **FREE DOG BOOK**—address

GLOVER'S

Dept. Y, 462 Fourth Avenue, New York City

MAKE MONEY IN PAINTING BUSINESS



Paint walls, ceilings, screens, furniture, radiators, machinery faster, better! 1/4 H. P. motor 110 Volt 60 Cycle AC, complete with Spray Gun, 15 ft. hose. Weighs only 44 lbs. Carry anywhere. **FULLY GUARANTEED.** Only \$31.15 f. o. b. Chicago. \$5 Deposit, Balance COD, or SEE YOUR DEALER. Circular FREE. Get started making money NOW!

Ideal Automatic Pump Co., Dept. PM4, 801 Washington, Chicago **\$31.15** Complete



... SHOOTERS, HERE IS A CHALLENGE

ENJOY shooting the new Winchester Leader Stayless .22s. New flatter shooting—cuts down guesswork sighting and holding over your mark at longer ranges. New finer shooting—drilling shot after shot right through the bull's-eye. . . . Actually finer accuracy than possible only a short while back with best special target ammunition! No price increase over regular .22 rim fire smokeless. **NEW** bullet, strong brass case, Winchester Stayless non-corrosive priming—prevents rust and saves cleaning. In .22 Long Rifle exceptionally fine for pistols and revolvers. Ask your dealer today for the new Leader .22s. For **FREE** folder address Dept. 46-C, Winchester Repeating Arms Company, New Haven, Conn., U. S. A.

WINCHESTER

When writing please mention Popular Mechanics

YALE OIL

Made by YALE, maker of famous locking devices



THE BETTER LUBRICANT and RUST PREVENTER

Scientific tests proved the supremacy of this heavier bodied, finer quality oil for lubricating and rust-proofing. YALE OIL has a remarkable affinity for metal. Its amazingly strong film resists "air punctures", protects longer—ideal for electric motors, tools, machines, and general home use. It stays put—does not drip from bearings. Insist upon YALE OIL.

Used for 25 years on the world's finest bank vault mechanisms!

In handy tubes, 10c, 15c and 25c. At hardware and sporting goods stores.

If your dealer can't supply you, send 10c and we will mail a tube postpaid.

Address Department O.M.

THE YALE & TOWNE MFG. CO. STAMFORD CONN.

AUTOMATIC STENCIL DUPLICATOR

Amazing new Print-O-Press Stencil Duplicator. Automatic feeding. Automatic inking. Full 8 1/4 x 14 legal size. Other models also, at world's lowest prices. Details free, also free samples of work done. User-Agents write.

\$13.95

Complete

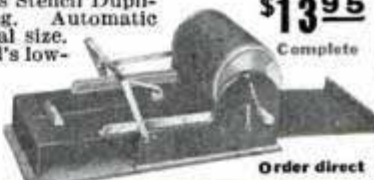

Professional Products Dept. 410, Silverton, O.

Order direct

EARN MONEY Stringing Tennis Rackets



STRINGING TENNIS RACKETS PAYS UP TO 140% PROFIT PER RACKET!

String your own racket and *Save Money!* String for Tennis Players and *Earn Money!*

It's easy—we teach you how to string—Show you how to get business. Your success is assured with our backing.

FREE

Write today and we will send you **FREE** plan and special offer on strings, stringing equipment and Tension-Master.

THOMPSON MFG. CO., 4535 Packers Ave., CHICAGO, U. S. A. Makers of TOMGUT "Court-Tested" Tennis & Badminton Strings. Send **FREE** plan and special offer. I string rackets,

NAME.....
ADDRESS.....
CITY.....

CAN YOU BEAT THESE POWER COSTS?

SAVE
up to
\$293⁸⁰
Per
Month
on
power
costs



with a KRW FORD V8 Unit

50 H. P. with KRW V8 Unit using natural gas (1125 BTU) @ 30c per 1000 cu. ft. \$ 46.80 per month
50 H. P. with KRW V8 Unit using gasoline @ 10c per gal. (no tax) \$ 145.60 per month

Above figures show primary fuel costs (lubricating oil not included) for operating a KRW V8 Unit to develop 50 H. P. for 10 hours per day—26 days per month. Compare this with electricity @ 3¢ per KWH which amounts to \$340.60 per month. You can pay for a KRW Unit in a few short weeks **out of actual savings!**

KRW V8 Units are daily saving money for operators of air conditioning and refrigeration equipment, mills, factories, shops, welders, compressors, pumps, well-drilling outfits, contractors' equipment, etc., etc.

For complete information, prices and data write us. You can buy through your local Ford Dealer and benefit by local service and low-cost Ford engine replacement feature.

K. R. WILSON 17 Lock St. BUFFALO, N. Y.
Builders of Shop Equipment for Ford Dealers Since 1916
West Coast Branch: 722 Mateo St., Los Angeles.
Export Office: 90 West St., New York.

Ride a SACHS MOTOR BIKE

Make Big Money

We pay you \$37.90 on every order. Simply ride and demonstrate this wonderful new motor-bike in your spare time. Many owners quickly pay for their own machine by sending us orders from friends.

100 MILES PER GALLON

The Sachs Motor-Bike is a powerful, high grade machine with chain drive, and speeds up to 40 Miles per Hour. Write quickly for special wholesale offer. Address,

STREIFTHAU MFG. CO., Dept. 20 Middletown, Ohio

HOME AUTOMATIC CIGARETTE MACHINE

Have YOUR OWN Monogrammed Cigarettes

Put tobacco and block of paper on machine. TURN THE CRANK—PRESTO—CIGARETTES. Easy—simple. All metal construction. Guaranteed. No cloth ribbons, no special tube or gummed papers required. **ASK FOR FREE ILLUSTRATED FOLDER.**

A. C. MACHINE WKS. P.M.-4. 1055-57 Devon Ave., Chicago, Ill.

Welding Business Earns \$150 to \$300 for You Each Month

"BUILD-YOUR-OWN"

Just couple your own engine to this unit, mount it on chassis and you have money making advantage of a portable welder at a saving of \$300 to \$500.

"Build-Your-Own" Unit

HOBART BROS., BOX M-48, TROY, OHIO
Gentlemen: Send me information on () Build Your Own Welder () Electric Drive Welder () 30 Days Trial, Easy Terms () Rental Plan. Also send me free books I've checked.
Name.....
Address.....

New WATER-PROOF ROOFING

Sheds Water Like a Duck

Protects SHINGLE, PAPER, METAL and GRAVEL Roofs

New amazing roof protection cuts repair cost and makes paper, metal or wood shingle roofs guaranteed waterproof. This extraordinary discovery, Aztec Cold Liquid Asphalt, may be used direct from container, without heating. Eliminates fire hazard. Readily applied to damp or dry surfaces alike. Comes in Black, Green, Red. Make old roofs look like new with Aztec at a fraction of cost of repairing. Excellent as non-skid, waterproof coating for boats. Contains no oil or solvent. Will not peel, check, run or crack.

EASILY APPLIED WITH ORDINARY BRUSH, BROOM OR MOP

Sold on an absolute money back guarantee. Write today for FREE details and liberal profit plan.

AZTEC WATERPROOF PRODUCTS CO.
173 W. Madison St. Dept. 10 Chicago, Illinois

KAL-KLOK THE CALENDAR ALARM CLOCK

"GIVE IT AWAY FREE" Earn big money doing it!

It's new! It's different! It's patented! Biggest money-maker in clock history! Think of a time-teller, a calendar and an alarm... all three combined in a clock of striking beauty. New salesboard plan taking country by storm. Write for FREE circular and prices—or send 10¢ for sample push-card.

SILVER MANUFACTURING CO., INC.
2865 ELSTON Ave. Dept. K-115 CHICAGO

Described on page 226 March 1938 Pop. Mech.

PHOTO ENLARGEMENTS

5¢ ANY SIZE

Is Photography your hobby? Do you want a profitable easy business at home? Make **PHOTO ENLARGEMENTS** for yourself and others. Your cost 5¢ each and less. The Ideal Photo Enlarger is **AUTOMATIC**. No experience required. Also **COPIES** any picture. **\$5.94 COMPLETE.** Interesting circular **FREE.**

IDEAL-O, 122 East 25th Street, New York City

Earn Cash at Home!

M.M. EARN \$1174 at Home!

We paid M. M. \$1174 for exceptional "cellar crop" SNOW-KING mushroom! Big free picture book tells if your cellar, shed, barn suitable. We furnish materials, buy all crops. Write today. Est. 1908. **UNITED CO., 3848 Lincoln Ave., Dept. 311, Chicago.**

PAINT SPRAY

Paint Spray Units, Air Compressors, Guns, Regulators, Pressure Switches, Safety Valves.

Send for free 32 page Catalog.

NATIONAL ELECTRIC TOOL CO.
560 Washington Dept. 30 Chicago, Ill.

Free! VALUABLE BOOKLETS ON WELDING. CHECK YOURS AND MAIL THE COUPON TODAY.

How to "Build-Your-Own"
 New Profits in Arc Welding
 New Arc Welding Catalog

HOBART
THE FASTEST SELLING ARC WELDER ON THE MARKET TODAY

Gas Engine Drive Electric Drive

(Continued from page 160A)

prove much more interesting than any taken in the bathysphere. The lens of the camera operating through the lower window will pick up everything in the path of the light ray shining through the upper one at a distance of twenty to thirty feet.

"To me the first dive of the diphrobenth to the ocean's bottom, more than a mile beneath the surface, will be the realization of a great ambition which came into being all the way back in 1923 when, as a paleontologist in the Philippines, I first began watching the pearl fishers dive off Zamboanga.

"Since that time I have been intensely interested in studying marine life in its native environment. The successful dives in the bathysphere which I conceived in 1928 and put into use with Dr. Beebe from 1930 to 1934 was a long step in that direction.

"I now believe that the final step is ready to be taken. With the building of the diphrobenth, science at last will be able to explore the world's greatest mystery—the unknown life on the ocean bottom."

Container for Traveler's Iron Forms Ironing Board

Where to iron is the traveler's problem solved by an unusual kit now on the market. The box for the iron is a sturdy car-

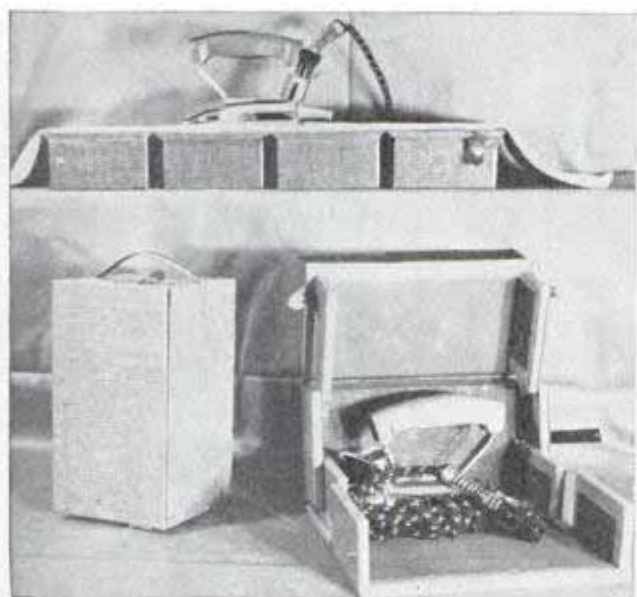

rying case which may be unfolded to form an ironing board. Although it is lightweight, the board is constructed to bear all the weight necessary in ironing.

*Persted Co.
211 Main Street*

OK! IT'S FROM REMINGTON RAND



\$15⁷⁵

IVORY MODEL
LEATHER
TRAVELING CASE

\$15.00
WITHOUT CASE

\$17.50 WITH
GOLD-PLATED HEAD

THE Remington Rand Close-Shaver shaves *close, clean, fast*, without injury to the skin, without weeks of learning how. No other shaver has all these advantages:

SHAVES from almost any angle. Doesn't have to be held "just so."

GREATER CUTTING SURFACE for faster, closer shaves.

COMBING BAR to lift flat hairs and guide them into the cutters.

HIGH-SPEED MOTOR that runs on A. C. or D. C.

LIGHT, COMPACT DESIGN to fit your hand and prevent slipping.

If your dealer can't supply you, send a check or money order (but be sure to mention your dealer's name) to General Shaver Corporation, Bridgeport, Conn.



REMINGTON RAND
ELECTRIC *Close-Shaver*

A BACK-GEARED SCREW-CUTTING PRECISION LATHE

Weight 320 Lbs.

\$85⁰⁰

Less Motor Drive Sold on Easy Payments as Low as \$6.00 a Month for 12 to 18 Months.

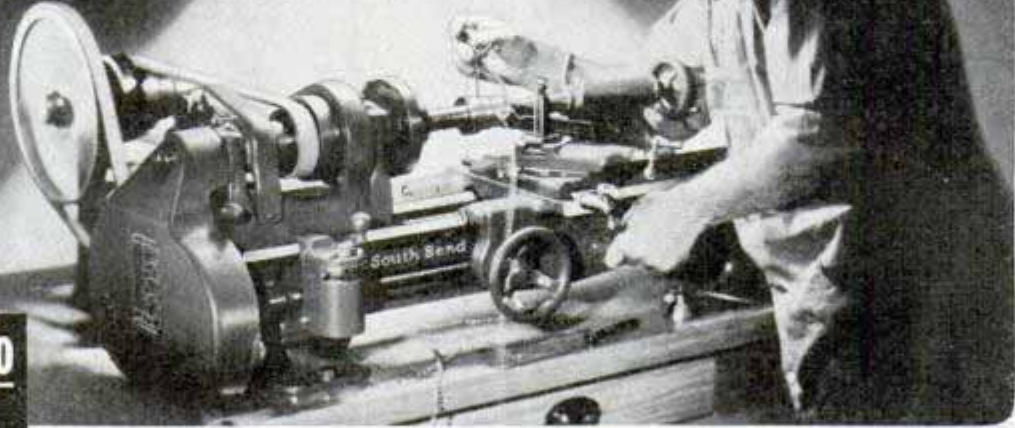

No. 415-YA, 9 1/4" swing by 3' bed Workshop Bench Lathe with Horizontal Motor Drive, 1/4 h.p. Reversing Motor, Switch, Belts and Adjustable Belt Tension Countershaft. **\$117.00**
(\$15 Down—\$6 Monthly for 18 Months)

**SOUTH BEND
9-INCH WORKSHOP
PRECISION LATHE**

Used by:

**MANUFACTURERS
TOOL ROOMS
LABORATORIES
MACHINE SHOPS**

—Automotive
—Electrical
—Gun Smiths

**U. S. GOVERNMENT
SCHOOLS
HOME WORK
SHOPS
INVENTORS**

**THE MOST USEFUL OF ALL TOOLS
IN ANY AUTO SERVICE SHOP**

CUT your investment in shop equipment, and do your work on this profitable all-purpose lathe. 95% of the modern motor service work can be done on the 9-inch "Workshop" South Bend Lathe. With attachments it handles the six most important auto jobs—refaces valves—finishes pistons—bores re-babbitted connecting rods—makes bushings—cuts screw threads—trues commutators. Also get the profits from other machine operations this all-around tool handles.

Features—Twin Gear Reverse to Lead Screw, Ball Thrust Bearing on spindle, cuts screw threads from 4 to 112 per inch, 3/4" spindle hole taking collets up to 1/2".

Made in 3', 3 1/2', 4' and 4 1/2' bed lengths. Operates from lamp socket at less than 2 cents per hour.

Write for information about the modern motor service shop. Learn how to do many profitable jobs.

SOUTH BEND LATHE WORKS

628 E. Madison St., South Bend, Ind.

LATHES STOCKED IN PRINCIPAL CITIES

- Chicago—C. B. Burns Mchry., 541 W. Wash. Blvd.
- New York—A. C. Colby Mchry., 183 Centre St.
- Philadelphia—W. B. Rapp Mchry., 132 No. 3rd.
- L. Angeles—Eccles & Davies Mch., 1910 Santa Fe.
- Detroit—Lee Mchry. Co., 6318 E. Jefferson Ave.
- Milwaukee—Voell Mchry. Co., 1533 No. 16th St.
- Boston—MacKenzie Mchry. Co., 36 Oliver St.
- Cleveland—Reynolds Mchry., 2034 E. 22nd St.

The 9" x 3' South Bend Precision Lathe does these operations:

**URNS—BORES
—CUTS SCREW
THREADS—FACES
—DOES MILLING,
CHUCKING, REAM-
ING, DRILLING,
FILING AND HUN-
DREDS OF OPERA-
TIONS IN STEEL,
IRON AND OTHER
METALS.**

Write

FOR THESE BOOKS
"How to Run a Lathe"—160 pages, over 300 illustrations on lathe operation. Auto Workshop Bulletin No. 33-G shows how to do auto service jobs. Catalog No. 46 shows, describes 9" lathe in all sizes. Use coupon.



SOUTH BEND LATHE WORKS,
628 E. Madison St., South Bend, Ind., U.S.A.
() No. 33-G Auto Workshop Bulletin, Free.
() No. 33LB "How to Run a Lathe," 25c.
() No. 46, 9" Workshop Catalog, Free.
() Easy Payment Plan.

Class of Work

Name

Address

City

State

There are 5 sizes of South Bend Lathes—9", 11", 13", 15" and 16" swing with bed lengths 3' to 12'. In motor or countershaft drives. Priced \$85 to \$1500.

SOUTH BEND Precision LATHES

THE HOUSE ROCKED LIKE A SHIP AT SEA!



Writes Mrs. Mildred R. Fredregill
of 1239 Ninth Ave.,
Helena, Montana.



"A terrific roar woke me. Above the screaming of my baby I heard crash of falling plaster. I flipped the light switch but no lights came on... but under my pillow was my flashlight.

"I rescued my four-year-old from her crib, carried her to the protection of a doorway, huddled there for hours while the house rocked like a ship at sea.



"Finally my flashlight attracted help; we were taken to the safety of an open field.

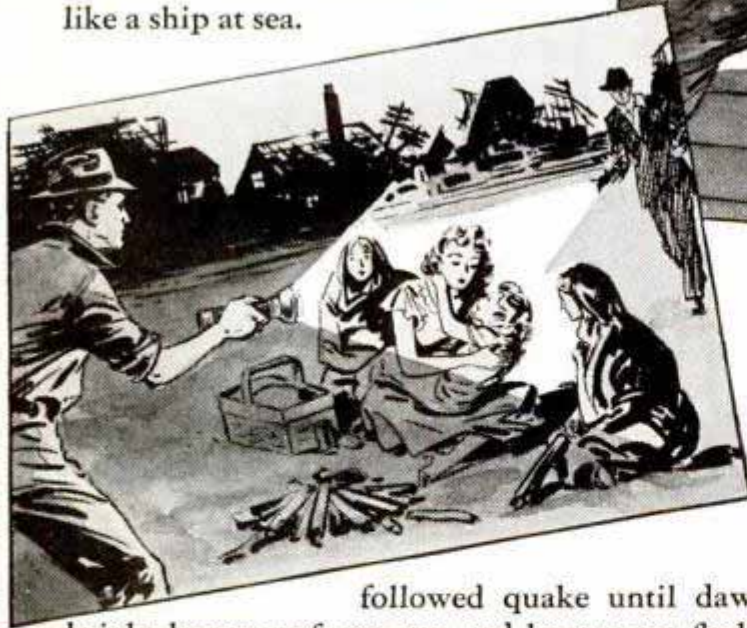

"Then we spent a long night of horror as quake

followed quake until dawn. But everywhere, like bright beacons of courage and hope were flashlights with fresh, DATED 'Eveready' batteries, like the one that helped me save my baby, then signalled our rescuers.

(Signed) *Mildred R. Fredregill*



FRESH BATTERIES LAST LONGER... Look for the DATE-LINE

NATIONAL CARBON COMPANY, INC., 30 EAST 42nd STREET, NEW YORK, N. Y.

CLAUDETTE COLBERT
Co-starring in Paramount's
"Bluebeard's Eighth Wife"



From Laughs to Tears in 30 Seconds



CLAUDETTE COLBERT tells how the throat-strain of emotional acting led her to Luckies

"Emoting to order" is a real strain on the throat. That's why an actress thinks twice before choosing a cigarette. Miss Colbert says: "After experimenting, I'm convinced that my throat is safest with Luckies."

Ask a tobacco expert why Luckies are so easy on the throat. He'll undoubtedly explain that the choice tobacco Lucky Strike buys, makes

for a light smoke. And he may add that the exclusive "Toasting" process takes out certain irritants found in *all* tobacco.

Here's the experts' actual verdict... Sworn records show that, among independent tobacco experts not connected with *any* cigarette manufacturer, Luckies have twice as many exclusive smokers as all other brands combined.

Sworn Records
Show That...

WITH MEN WHO KNOW TOBACCO BEST - IT'S LUCKIES 2 TO 1