

THE MAKING OF A RACE DRIVER

POPULAR MECHANICS

★

MAGAZINE

WRITTEN SO YOU CAN UNDERSTAND IT

REGD. TRADE MARK, GREAT BRITAIN, No. 410428

REG. U.S. PAT. OFF.

**FEB.
25 CENTS**



SEE PAGE 232

Suffocation Clawed Their Throats

Quick Wits Save Cave-In Victims in Old Gold Mine

"Two miners were entombed by a cave-in at the end of a drift 800 feet under ground," writes Mining Engineer P. Donald Ziemke of 2032 W. Keefe Ave., Milwaukee, Wis.

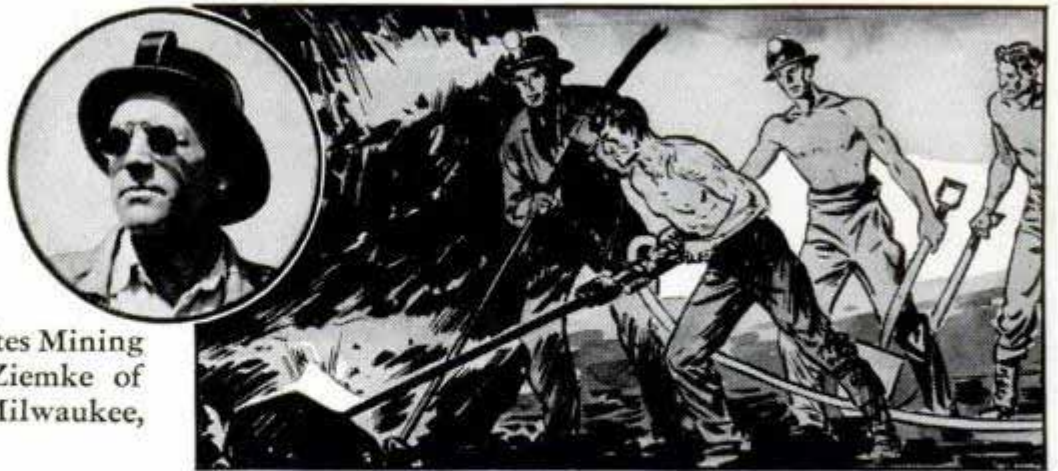

"A huge boulder lay in the path of the rescuers. We had to blast. We worked furiously...minutes might mean life or death. And then, with the blast ready...

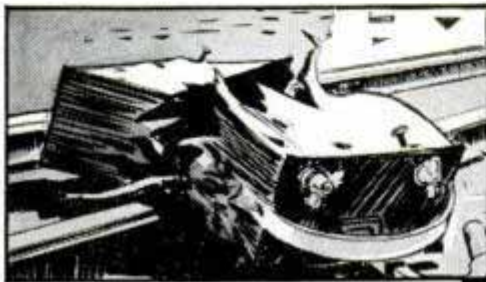

"We found the push-down generator (which furnishes spark for the charge) wrecked. In the excitement some one had pushed a mine car over it.



"But the shift boss kept his head. He ran to the dynamite magazine, where we always kept a flashlight, and brought it out on the double. He unscrewed the lens and bulb, flipped on the switch. Then he plunged the ignition wires in...and—

"The blast let go...the boulder was shattered...we got the men out, and not a second too soon. They were up to their armpits in water, with the air so bad their miner's light had gone out. No doubt about it, *fresh DATED 'Eveready' batteries saved these two lives.*

Signed

P. Donald Ziemke

FRESH BATTERIES LAST LONGER... Look for the DATE-LINE



NATIONAL CARBON COMPANY, INC., 30 EAST 42nd STREET, NEW YORK, N. Y.

PLYMOUTH BUILDS GREAT CARS

**YOU'LL BE
AMAZED AT
PLYMOUTH'S
LOW PRICE**

THE



BIGGEST BUY!

CHECK VALUES among Low-priced Cars—in Comfort, Beauty, Economy! Prove Plymouth's Easier Driving—NOW!

GET THE MOST for your money! When you look at cars—see what you *actually get!*

ONE LOOK will show how outstanding this new Plymouth is... how roomy and beautiful.

ONE SHORT DRIVE will demonstrate Plymouth's remarkable ride...its luxurious comfort.

OWNERS' FIGURES prove

Plymouth saves every way!

THE PRICE will delight you. Investigate Plymouth's easy terms at Dodge, De Soto and Chrysler dealers. See this new Plymouth—*today!* PLYMOUTH DIVISION OF CHRYSLER CORPORATION, Detroit, Michigan.

TUNE IN MAJOR BOWES' ORIGINAL AMATEUR HOUR, COLUMBIA NETWORK, THURSDAYS, 9-10 p.m., E.S.T.

PRICES ON ALL MODELS

Delivered in Detroit, including Federal taxes. Local, State taxes not included.

BUSINESS MODELS

Coupe, \$645; 2-Door Sedan, \$685; 4-Door Sedan, \$730.

DE LUXE MODELS

Coupe, \$730; Coupe with Rumble Seat, \$770; Convertible Coupe, \$850; 2-Door Sedan, \$773; 2-Door Touring Sedan, \$785; 4-Door Sedan, \$803; 4-Door Touring Sedan, \$815.

For delivered prices in your locality, see your Dodge, De Soto or Chrysler dealer.

SEE THE NEW PLYMOUTH

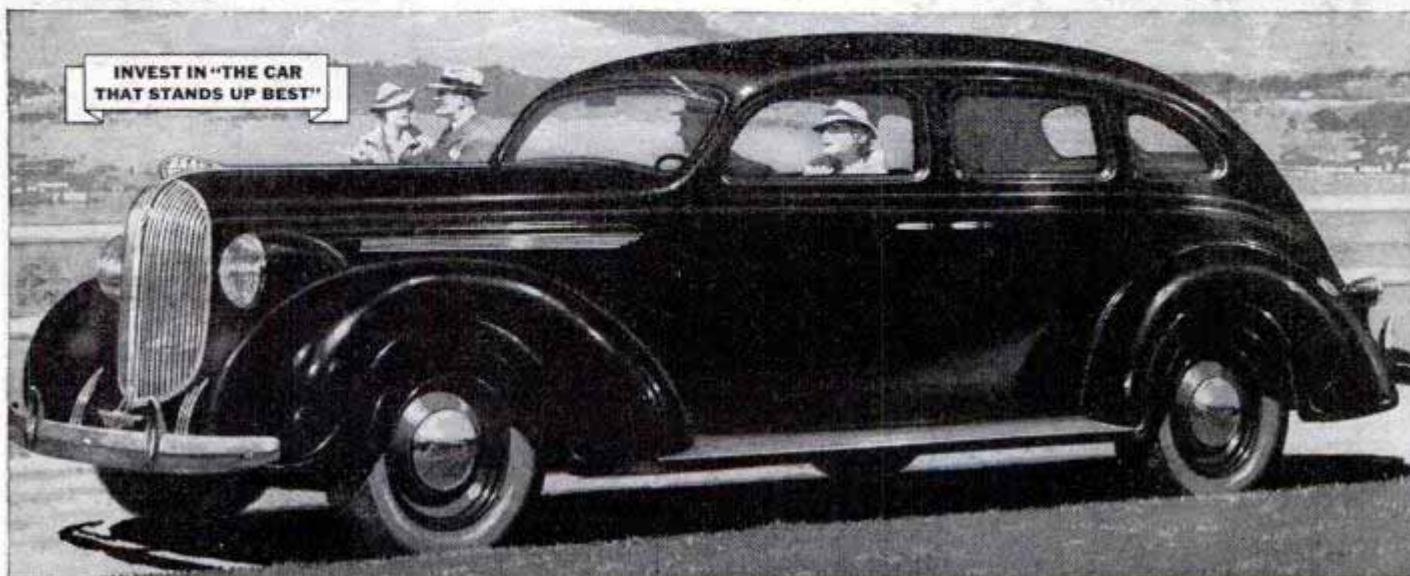

When writing to advertisers please mention Popular Mechanics

MORE SERVICE FOR MORE PEOPLE



There are more Bell telephones today than ever before.

More people can talk with you. You can talk with more people.

Bell telephone service now gives you more value than ever.

BELL TELEPHONE SYSTEM



Popular Mechanics Magazine

H. H. WINDSOR, Founder

H. H. WINDSOR, Jr., Editor and Publisher

February, 1938

Vol. 69, No. 2

Special Features

New Giants for the Air Lines	161
Chemistry and You—Part III	Coloroto
The Rough Road to Glory	178
The Toy That Grew Up	188
Hunting Oil with Earthquakes	194
Short Waves Rule the Seas	202
Shoot When They Don't Expect It	210
The Puzzle of the Ice Ages	220
Game Wardens with Wings	226
The Flying Wing of the Future	232
New Billion-Dollar Crop	238
Adventures of the Hurricane Hunters	242
The Hit and Run Fleet	250

(Continued on next page)

Across Africa on One Lung

WHEN Jim Wilson and Francis Flood, a couple of youngsters from Nebraska, arrived at Lagos, on the Gulf of Guinea, and announced their intention of crossing equatorial Africa on a couple of motorcycles "just for the fun of it," the little French consul all but exploded with excitement. "Nevaire!" he screamed. "Impossible! It's suicide! You're crazy!" Consider, he begged them, the 800 miles of jungle. Think of the futility of attacking other hundreds of miles of Sahara desert sands on motorcycles. Garages and filling stations, he shouted, were 2,000 miles apart. It might be done with camels, but with motorcycles—nevaire. It was all the French consul said—and then some—the young Americans agreed when, months later, they reached the Red sea. But they made it, and their experiences make an absorbing adventure story. You'll find the first of three installments in the March issue.

Next Month

TRY as you will, it's difficult to stay lost today if identification experts want to find you. They may not have your fingerprints but they have other methods of "putting the finger" on you. An article next month describes the latest identification processes.

Mining from the Air

LOCKED in the grip of the towering Andes is a valley rich with gold. Inca slaves once carried the yellow metal over treacherous mountain passes. Later mining engineers tried unsuccessfully to transport machinery into the valley, first with llamas, then with "supercharged" burros—animals with extra holes opened in nasal cavities to help them withstand the high altitude. Today airplanes have conquered the mountains by carrying more than a million pounds of mining equipment over the ranges and into the valley. An article next month explains how it was done.

Raising Bees for Fun

IF YOU'RE looking for a hobby, may we recommend a swarm of bees? There are more beekeepers living in cities than in the country today. An article next month ought to convince neighbors that you benefit your community by keeping bees. There's money in it, too. And, if you use your head, you won't get stung—we hope.



NOW—MERELY EMPTY ONE OF THESE TINS IN GASOLINE TANK EVERY 250 MILES OF DRIVING. CONVENIENT!

Cold weather terrors are less severe for the man whose car is Pyroil protected. Easier starting that saves battery drain—often saves a tow! Smoother running engine. More power. This is worth lots on frigid days!

And now—this new, convenient 3-ounce size, sealed container. Practical. Money saving. Ends the nuisance of measuring, spilling, wasting.

Ask your service station salesman for one of these 3 ounce tins, today. Carry several in your car. Just a few cents cost, each. They save dollars! Manufactured and Guaranteed by Pyroil Company, W. V. Kidder, Founder, 52 Pyroil Bldg., La Crosse, Wisconsin, U.S.A.

DISTRIBUTORS Check and mail coupon for facts of our unusual Sales Opportunity for you. Start now!

PYROIL COMPANY
52 Pyroil Bldg., LaCrosse, Wis., U.S.A.

Please send complete Pyroil facts.
 Also send details of your plan for Distributors.

Name.....
Address.....
City..... County..... State.....

(Contents—Continued)

AUTOMOTIVE

Bumpy arrows in pavement keep autos in lane.....177
 Car's top supports twelve tons in test.....177
 Safety lamp lights driver's signaling arm.....183
 One-track farm tractor replaces two horses.....185
 Super-car has front drive.....192
 Motorcycle racer wears streamline helmet.....198
 Castle on wheels used as popcorn stand.....207
 Log of auto speed kept by recording meter.....219
 Snowplow climbs curb to clean sidewalk.....219
 Copper-lead bearings resist wear on hard jobs.....224
 Traffic school on wheels broadcasts warnings.....230
 Fourteen car bodies loaded in trailer automatically.....231
 School stop sign changeable to suit traffic.....237
 New metals cut car's weight since 1910.....246
 Horn wakes driver quicker than a red light.....248
 Auto-tube vulcanizer shuts off automatically.....256
 Old-timer and 200-mile an hour racer.....256
 Self-centering coupler for trailers.....151A

AVIATION

Baby chicks shipped by plane to South America....186
 Self-opening parachute.....200
 Higher-test fuel for airplanes.....225
 Sky trips at five-mile height due soon.....236
 "Bulletproof" destroyer flies 310 miles an hour....241

CONSTRUCTION

Linoleum and rubber floors outlast concrete.....177
 Quakeproof water mains built of pipe that bends...192
 Medieval tower built as a hobby.....208
 Metallic glazer replaces putty in windows.....208
 Dry land ship is nautical cafe.....224
 Railway train is "crystal palace on wheels".....231
 Nail for concrete or metal.....236
 "Big Apple" is Kansas dance hall.....241

HOUSEHOLD

Adjustable chair has radio, clock and telephone....184
 Gas-oven thermostat shows temperature changes...184
 Clothes basket on wheels saves labor.....207
 Rubber clothespin will not hurt delicate fabric....215
 Indoor exerciser for city dog.....219
 Remote meter shows oil level in tank.....225
 Porous rubber clothes brush.....255

MODELS

"Working model" shows what makes man go.....193
 Boys' model house with garage and car.....249
 Decorating with "velvet" shot from a spray gun....253

MOVIES AND PHOTOGRAPHY

Swinging tripod head locks in any position.....200
 Elephant is "prop" of cameraman.....209
 Vest-pocket tripod has roll-away legs.....218
 Film viewer magnifies image.....235
 Photographer's folding ladder is mounted on truck.248

RADIO AND ELECTRICITY

Electric detector sorts tagged herring.....193
 Loudspeaker on truck directs attack on flames....208
 Cow painted in neon lights at fair.....219
 Photocell provides automatic control of room lights.230
 Electric eel lights a neon lamp.....246
 Million-cycle television cable removes flicker.....254
 Beginner's transmitter from kit of parts.....257
 Two-way inter-room communication system.....258
 High-fidelity amplifier for advanced experimenters.260
 Hints for radio experimenters.....261
 Automatic record changer.....262
 Cathode-ray oscillograph for students.....262
 Chairside receiver has motor driven tuning dial...262
 Ultra-short wave tube of advanced design.....262

SCIENCE AND INDUSTRY

Cosmic rays pierce earth surface 1,600 feet.....187
 "Elastic metal" made of steel and rubber.....192
 Elusive eighty-seventh element is discovered.....201
 Alaska "weather hop" previews winter in U. S....209
 New steels from study of molecules.....230
 Bacteria in wood glow with "cold light".....248

SHIPS AND SHIPPING

Racing yacht hides behind expanse of sail.....185
 Mail-carrying buoy floats ashore from ship.....235
 Ship with front-drive turbines.....237
 Repair of boat propellers is specialists' job.....256

(Continued to page 6A)

KNEE-ACTION EASED THE RIDE 2000 YEARS AGO

THE ANCIENT CHARIOT WAS A ROUGH-RIDING BUS, 100 PER CENT UNSPRUNG WEIGHT (IT HAD NO SPRINGS). BUT, THOUGH THE CHARIOT BOUNCED AND JOUNCED ALL OVER THE COBBLES, THE DRIVER DID NOT GET SHAKEN UP; HE ENJOYED A SMOOTH KNEE-ACTION RIDE.

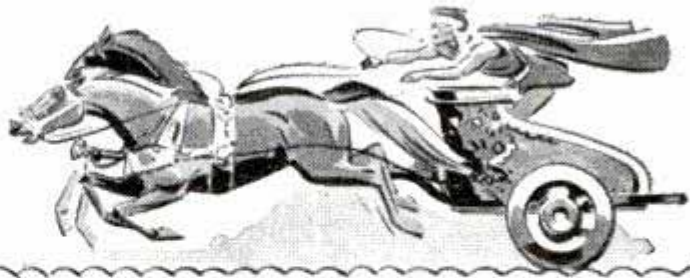

Ben Hur Knew Knee-Action ... Here's How He Took the Bumps



CHARIOTEERS KEPT THEIR KNEES BENT, MUSCLES NOT TENSE BUT READY TO YIELD TO THE UPS AND DOWNS OF THE CHARIOT.



WHEN BOTH WHEELS BOUNCED, BOTH LEGS YIELDED, AND THE DRIVER'S KNEE-ACTION ABSORBED THE ROAD SHOCKS.



WHEN ONE WHEEL HIT A BUMP, TILTING THE CHARIOT, ONLY ONE KNEE YIELDED, AND THE DRIVER REMAINED UPRIGHT.

Here's How Knee-Action Smooths the Bumps in a Modern Car

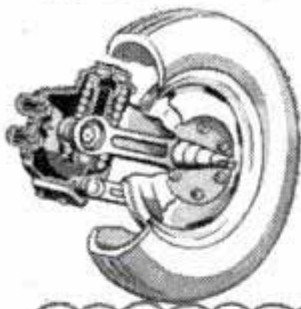

HERE'S A SIMPLE DIAGRAM OF THE KNEE-ACTION UNIT OF A MODERN CAR-CHEVROLET. EACH FRONT WHEEL IS INDIVIDUALLY SUSPENDED.

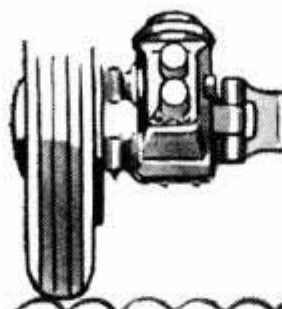

FRONT VIEW OF A CHEVROLET KNEE-ACTION WHEEL. NOTE THAT THE KNEE-ACTION UNIT PIVOTS WITH THE WHEEL IN STEERING.

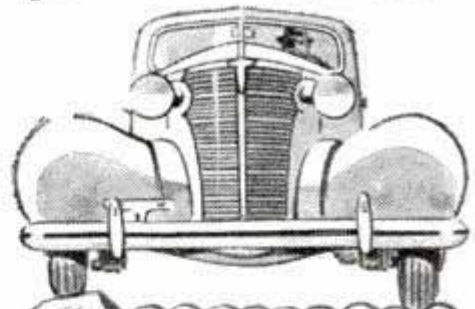

WHEN ONE WHEEL HITS A BUMP ITS KNEE-ACTION SPRING YIELDS. THE OTHER WHEEL IS NOT TILTED AND THE CAR NEITHER TILTS NOR PITCHES.

Before Knee-Action was introduced, front wheels of motor cars were mounted on a solid front axle. When either front wheel rose over a bump, it tilted the axle and the opposite wheel, causing difficulties with spring suspension and steering. Knee-Action lets each wheel act independently. Chevrolet's exclusive type of Knee-Action not only gives the

best ride known to motoring, but makes possible true shockproof steering, since no part of the steering linkage moves up and down with the front wheels. If you have never experienced the pleasure of driving a Knee-Action Chevrolet, try the new 1938 Master De Luxe model and see what a difference it makes.

CHEVROLET MOTOR DIVISION, General Motors Sales Corporation, DETROIT, MICHIGAN

You'll be **AHEAD** with a
CHEVROLET

DISSTON

FINEST



● Times change! Homecraftsmen, like mechanics, are buying the best saws made. The thriftiest home workshop circular saw is Disston DeLuxe. On any job, it means easier, more accurate cutting. It gives a lifetime's satisfaction.

DeLuxe Cross-Cut—Rip—Combination

6" (1/2" hole), \$2.70 8" (1/2", 5/8", 3/4" hole), \$3.50
7" (1/2" hole), \$3.10 10" (5/8", 3/4" hole) . . . \$4.50

DeLuxe Hollow Ground Combination

6" (1/2" hole), \$4.30 8" (1/2", 5/8", 3/4" hole), \$5.40
7" (1/2" hole), \$4.90 10" (5/8", 3/4" hole) . . . \$6.90



Above. D-23 Disston. One of the finest hand saws. Lightweight, straight back, narrow blade. Easy running, fast-cutting. Beautiful finish. 26" length . . . \$3.85

Also. D-8 Disston. Famous, world around, as the "Saw Most Carpenters Use." Wide blade. Skew back. Same in narrow blade for home workshop. 26" length . . . \$3.50

ASK DEALER for DISSTON SAWS

— — — — — FREE MANUAL — — — — —



Write us for "Saw, Tool and File Manual" telling How to Choose and Use Saws. FREE.

Henry Disston & Sons, Inc.,
211 Tacony, Philadelphia, U.S.A.

Name

Address

(Contents—Continued)

SPORTS

Blackboard used in boat races to signal pilot	186
Exerciser combines bike, horse and rowing	201
Boat-trailer for land or water	206
Bowling reduced to "exact science"	214
"Dry skiing" class practices on hayfield	218
Human sailboating is latest sport for swimmers	240
Man faster than horse in hurdles race	246
Automatic board scores baseball or football	247

TOOLS

Square rule for drawing board	199
Pressure belt for power tool	200
Tacking gun for house screens	207
Crimping tool takes up slack in wire fence	253

MISCELLANEOUS

Electric bulb to top Edison tower	184
Giant three-car locomotive to pull streamliner	184
Bird taught to work for food	186
Chain unrolls to form girder 250 feet high	187
Hydraulic squeeze packs boxes into freight cars	192
Iron ring around cliffs blamed for shipwrecks	192
Ink changes color by heat for printing	193
Gauge measures gems and estimates weight	198
Guitar with sliding keyboard	198
White "blackboards" save eyes of students	198
Rail is nerve and vein of electric line	199
Slide rule for musicians	200
Cathode-ray tuner finds pitch for instruments	201
Self-watering flowerpot has wick of clay	206
Collapsible pocket periscope for use in crowds	207
Figure of grasshopper tops financial building	215
"Wishbone tree" made from bones of fowl	215
Trained insects perform in strange circus	216
New water-lubricated bearings	218
Mechanical "fortune teller" shows typing aptitude	224
Beacon has half-billion candlepower beam	225
Carnival wheel for exercising weak eyes	236
Dog rides on bicycle carrier	236
Metal for casts has low melting point	240
Movable notes on table teach children music	240
Vacuum cleaner for your pipe	247
Drummer takes on a few sidelines	249
Anatomical shirt charts the human body	254
Mirror shows pianist's hands to audience	255
Pumpkin with human face grown in cast	255

Craftsman and Shop Notes

AUTOMOTIVE

Helps for the motorist	317
Driver's knee pad for long trips	318
Keeping ice from freezing in air-hose nozzle	318
Oil pan held by rubber "chains" to start screws	318
Temperature checks oil filter	318
Window-cleaning liquid applied with atomizer	318
Cigar lighter makes trailer drop light	319
Snowplow fits on auto bumper	319
Starter cable shielded to prevent short circuit	319

FARM

Pivoted cradle supports oil or gasoline drum	267
Scraper on scrub brush from old razor blade	288
Shielding corncrib against rats	300
Funnel keeps poultry out of water pan	304
Sealing wounds in pruned tree	305

FURNITURE

Hanging book shelf has scroll-sawed panels	268
Table lamp has mirror sides	271
Play pen for baby improvised from table	279
Drawing table tilted by casement-window adjuster	286
Portable typewriter stand	295

HAND TOOLS

Tap and die holder serves as selector	266
Polishing flutes of auger bits	290
Tack hammer from ruler and clothespin	290
Miter gauge made by clamping scale to nut	297
Prick punch has guide to space layout work	303
Small parts "well" in top of stepladder	312
Jig on anvil to bend metal easily	316

HOUSEHOLD

Window cornices for the home	263
Defrosting refrigerator quickly	272
Whitewashing furnace smoke pipe to prevent rusting	279
Furnace humidifier tilts down when dry	289

(Continued to page 8A)

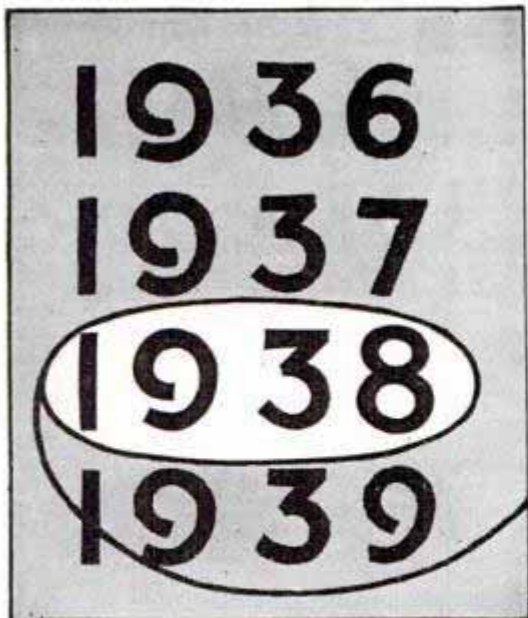

Now is the time!

Business is Searching for YOU, if

RIGHT now, in many lines, there is a search for really *good* men—managers, leaders—men who can take charge of departments, businesses, branch offices, and get things humming.

As always, there are not enough ordinary jobs to go 'round—but rarely before, in the history of American business, has there been so much room at the *top!* New jobs are being created by the business pick-up in almost all lines—jobs that pay splendidly and that open the way to lifetime success.

Ordinarily, there would be plenty of men to fill these jobs—men in junior positions who had been studying in spare time. But most men have been letting their training slide during these dark years of depression . . . “What’s the use?”—You have heard them say. Perhaps there has been some excuse for sticking to any old kind of a job one could get the past few years—but the door is wide open for the man with ambition and ability *NOW!*

And don’t let anyone tell you that “Opportunity Only Knocks Once”—that’s one of the most untruthful sayings ever circulated. Op-

portunities flourish for *every* American every day of his life.

Far more to the point is to be ready—to be *prepared*—to make yourself *interesting* to the big-time employer—and LaSalle offers you a short-cut method of qualifying for opportunity jobs in accounting, law, traffic, executive management, and kindred occupations.

LaSalle Extension is 30 years old—averages 40,000 enrollments a year—60 American firms each employ 500 or more LaSalle-trained men—surveys show that LaSalle students attain 40% average salary increase after graduation—10% of all C. P. A.’s in the U. S. A. are LaSalle-alumni.

Why not find out what LaSalle has done and is doing for men in *your* position? Send and get the facts; see what LaSalle can do for you, personally!

There’s no question about it—business is picking up—jobs are looking for *men*—the time has come for you to *qualify* for prosperity. Mail this coupon today!

LASALLE EXTENSION, Dept. 264-R Chicago

I am in earnest about my success and I would like to have your special booklet—without any cost or obligation to me—about my opportunities and your success training in the business field I have checked.

- | | |
|--|--|
| <input type="checkbox"/> Business Management | <input type="checkbox"/> Industrial Management |
| <input type="checkbox"/> Higher Accountancy | <input type="checkbox"/> Modern Foremanship |
| <input type="checkbox"/> Traffic Management | <input type="checkbox"/> Business Correspondence |
| <input type="checkbox"/> Modern Salesmanship | <input type="checkbox"/> Business English |
| <input type="checkbox"/> Commercial Law | <input type="checkbox"/> Effective Speaking |
| <input type="checkbox"/> Law: Degree of LL. B. | <input type="checkbox"/> Office Management |
| <input type="checkbox"/> Expert Bookkeeping | <input type="checkbox"/> Stenotypy |
| <input type="checkbox"/> C. P. A. Coaching | |

Name.....Age.....

Position.....Address.....

LASALLE EXTENSION

Ask for one of these booklets—or a similar one on your own field of business. They are free!



This One



2AE9-1QS-73A7



The Power
You've wanted in
a Drill You
can Afford!

New Black & Decker Utility Power Drills

THE new Utility Power Drills are designed for intermittent service, yet have the same high power and high torque as the heavier duty Black & Decker Production Line Units. They speed up and cut costs on hundreds of jobs now being handled by lower-powered service drills—and have the reserve power necessary to economically handle the heaviest type of work in any shop or plant. Made in $\frac{5}{8}$ " , $\frac{3}{4}$ " and $\frac{7}{8}$ " sizes. Mail the coupon today for name of the nearest dealer where you can see the new Utility Power Drills—and the many other Black & Decker Electric Tools that are "Helping Good Mechanics do Better Work."

Black & Decker

World's Largest Manufacturer of
PORTABLE ELECTRIC TOOLS

MAIL THIS COUPON NOW

**The Black & Decker Mfg. Co.,
602 Pennsylvania Ave., Towson, Md.**

Please send me literature describing the new Utility Power Drills, and the address of my nearest Black & Decker Dealer.

Name

Occupation

Address

City State

(Contents—Continued)

Sealing hot-air register against dust	289
Cleaning windows and mirrors	290
Dust cloth fastened to wrist saves time	290
Neon lamp makes good night light	294
Solving your home problems	298

PHOTOGRAPHY

Speed of photo film increased by mercury vapor	265
Water reflection in photo imitated with mirror	265
Evaporation of water reduces darkroom temperature	267
Notarial seals show clearly with carbon paper	270
Movie film cleaned while rewinding it	272
Rubber band holds camera tripod legs together	272
Better pictures with photofloods	274
Metal book ends hold camera rigidly	288
Developing solutions protected by wax paper	290
Photo prints dried by heating unit on fan	294
Arm strap and handle hold camera steady	297
Camera bellows repaired with light-tight varnish	300
Photo paper sticks to enlarging easel	303
In-and-out fade slides for movie cameras	311

POWER TOOLS

Drill press used as wood-turning lathe	279
Cutting disks on scroll saw	294
Steel tape measure on lathe saves time	296
"Sawing" glass on your lathe	301
Diameters measured without stopping lathe	305

STORE AND SHOP

Holder for card writer's brushes	286
Workman's apron held by strap removed easily	290
Chute in warehouse has wheel at curves	302
Ink tube suspended above press is handy	304
What makes water flow from faucet?	304
Imitation steaks show thickness of meat	305
Clamps hold screen wire for measuring and cutting	311
Brakes for hand truck	312
Type cleaner	312
"Staged" window display covered by curtains	315
Floor truck of auto springs and casters	319
Holder for soldering cylindrical objects	320

WOODWORKING

Duplicating wood carvings with wood putty	273
Bending plywood without cracking	293
Warped boards straightened in sun	297
Turning special spindles	306

MISCELLANEOUS

Adjustable copy holder for typists	266
Mounting bicycle tires	266
Repair shoe laces from electrician's tape	266
Adjustable drawing curve improvised inexpensively	270
Coin collection holder shows both sides	270
Hunter carries "stove" and fuel in pocket	270
Coiled pipe cleaner holds microscopic slides	272
Designs on stencils made with sandpaper cutouts	272
Trunnion made of pipe fittings	273
Canvas pockets are handy for small parts	278
Glass disks cut on drill press	278
Rack on scooter to carry school books	278
Turret drill stand you can make	278
Model of Grecian Trireme	280
Building the ice glider	286
Cardboard scored with glass cutter for boxes	288
Funnel in electric element to heat water	288
Nails removed from roofing without damage	288
Party tricks anyone can do	291
"Bottle-phone"—a novel musical instrument	293
Head of key altered to cut string	294
Repair for pocketknife with weak springs	294
Making good joints between posts and concrete	297
Covering fresh cement in winter	302
Aluminum ground on soap-lubricated wheel	304
How to handle wire rope	312
Equatorial telescope mount made from truck casters	313
Armature growler serves as magnetic "vise"	315
Cement for leather belts	316
Efficient method of locking screw collar on shaft	316
Paper dial on scales saves time in laboratory	316
Clck spring punched on babbitt "anvil"	320

IMPORTANT NOTICE

It is the intention of this magazine to provide its readers with information regarding the latest developments in the mechanical arts. We take no responsibility as to whether the disclosures contained in our articles are covered by patents and advise readers to investigate this subject before making, using, or selling any of the products, machines, or processes described, in order to avoid possible liability for patent infringement.



FOOD IN BOTH HANDS!

Lunch box in one hand, I.C.S. text-book in the other—all over this country today there are men who will devote those extra moments at the lunch hour to learning *something* that will help them on their present jobs—*something* that will help them prepare for the bigger, better paying jobs up the ladder. At home, in those evening hours, these ambitious men devote themselves to mastery of I.C.S. Courses—they know that their “*fu-tures*” depend upon their “*presents*”! When they realized it, they mailed the coupon of progress that now stares you in the face!

INTERNATIONAL CORRESPONDENCE SCHOOLS

BOX 5698-H, SCRANTON, PENNA.

★ Without cost or obligation, please send me a copy of your booklet, “Who Wins and Why,” and full particulars about the subject *before* which I have marked X: ★

TECHNICAL AND INDUSTRIAL COURSES

- | | | |
|--|--|--|
| <input type="checkbox"/> Architect
<input type="checkbox"/> Architectural Draftsman
<input type="checkbox"/> Building Estimating
<input type="checkbox"/> Contractor and Builder
<input type="checkbox"/> Structural Draftsman
<input type="checkbox"/> Structural Engineer
<input type="checkbox"/> Management of Inventions
<input type="checkbox"/> Electrical Engineer
<input type="checkbox"/> Electric Lighting
<input type="checkbox"/> Welding, Electric and Gas
<input type="checkbox"/> Reading Shop Blueprints
<input type="checkbox"/> Heat Treatment of Metals | <input type="checkbox"/> Sheet Metal Worker
<input type="checkbox"/> Boilermaker
<input type="checkbox"/> Telegraph Engineer
<input type="checkbox"/> Telephone Work
<input type="checkbox"/> Mechanical Engineering
<input type="checkbox"/> Mechanical Draftsman
<input type="checkbox"/> Machinist
<input type="checkbox"/> Patternmaker
<input type="checkbox"/> Diesel Engines
<input type="checkbox"/> Aviation Engines
<input type="checkbox"/> Automobile Mechanic
<input type="checkbox"/> Refrigeration | <input type="checkbox"/> Plumbing
<input type="checkbox"/> Heating
<input type="checkbox"/> Air Conditioning
<input type="checkbox"/> Steam Engineer
<input type="checkbox"/> Steam Electric Engineer
<input type="checkbox"/> Marine Engineer
<input type="checkbox"/> R. R. Locomotives
<input type="checkbox"/> R. R. Section Foreman
<input type="checkbox"/> Air Brakes
<input type="checkbox"/> R. R. Signalmen
<input type="checkbox"/> Highway Engineering
<input type="checkbox"/> Civil Engineering
<input type="checkbox"/> Surveying and Mapping |
|--|--|--|

BUSINESS TRAINING COURSES

- | | | |
|--|---|---|
| <input type="checkbox"/> Business Management
<input type="checkbox"/> Industrial Management
<input type="checkbox"/> Traffic Management
<input type="checkbox"/> Accountancy
<input type="checkbox"/> Cost Accountant
<input type="checkbox"/> C. P. Accountant | <input type="checkbox"/> Bookkeeping
<input type="checkbox"/> Secretarial Work
<input type="checkbox"/> Spanish
<input type="checkbox"/> French
<input type="checkbox"/> Salesmanship
<input type="checkbox"/> Advertising | <input type="checkbox"/> Bridge Engineer
<input type="checkbox"/> Bridge and Building Foreman
<input type="checkbox"/> Chemistry
<input type="checkbox"/> Pharmacy
<input type="checkbox"/> Coal Mining
<input type="checkbox"/> Mine Foreman
<input type="checkbox"/> Navigation
<input type="checkbox"/> Cotton Manufacturing
<input type="checkbox"/> Woolen Manufacturing
<input type="checkbox"/> Agriculture
<input type="checkbox"/> Fruit Growing
<input type="checkbox"/> Poultry Farming |
|--|---|---|

DOMESTIC SCIENCE COURSES

- | | | |
|--|---|--|
| <input type="checkbox"/> Home Dressmaking
<input type="checkbox"/> Professional Dressmaking and Designing | <input type="checkbox"/> Advanced Dressmaking | <input type="checkbox"/> Millinery
<input type="checkbox"/> Tea Room and Cafeteria Management, Catering
<input type="checkbox"/> Foods and Cookery |
|--|---|--|

Name.....Age.....Address.....

City.....State.....Present Position.....

If you reside in Canada, send this coupon to the International Correspondence Schools Canadian, Limited, Montreal, Canada

"This Girl Is Innocent! I Have the Guilty Man!"



When You're A Finger Print Expert You Speak With Authority!

You hold in the hollow of your hand the fate of many a criminal! As Secret Service Operator and Crime Detection Expert you have all the thrill of getting your man, with no danger to yourself. ALSO a regular monthly salary with the opportunity to share in rewards. Get FREE the confidential reports of Operator No. 38 and follow his exciting hunt for a murderous gang of counterfeiters. Also get FREE the fascinating "Blue Book of Crime"—illustrated in colors. Learn

how easily ANY man of average intelligence can become a Finger Print Expert. Train with an old established school whose graduates head 47% of ALL Identification Bureaus in America. Three-fourths of all American towns are STILL without such bureaus—300 were added in the last two years—and many more are bound to come. Make yourself ready for your opportunity! We show you how—just as we have shown the hundreds who are now in good pay positions.

Institute of Applied Science
1920 Sunnyside Ave., Dept. 1352, Chicago, Ill.

Gentlemen:

Without any obligation whatsoever send me the reports of Operator No. 38; also complete list of 600 bureaus employing your graduates, together with free, illustrated "Blue Book of Crime" and your low prices and Easy Terms offer. (Literature will be sent ONLY to persons stating their age.)

Name.....

Address.....

Age.....

FREE! The Confidential Reports No. 38 Made to His Chief

Here's your chance! Learn at home, in your spare time, and at low cost, the unique secrets of this young, fascinating, fast growing profession that offers pleasant, interesting work and steady employment at good pay. Write for complete list of over 600 institutions where from 1 to 15 of our graduates are now working. THEN ask the nearest graduate to tell you about us! Seize your chance to grow up with the profession. Take the first step NOW! Get FREE "Blue Book of Crime"—with colored illustrations. Mail coupon TODAY.

INSTITUTE OF APPLIED SCIENCE 1920 SUNNYSIDE AVE.
Dept. 1352, CHICAGO, ILL.

When writing to advertisers please mention Popular Mechanics



H. C. Lewis

**QUICK EASY WAY
TO TRAIN FOR
ELECTRICITY
IN 12 WEEKS
by Actual SHOP WORK NOT BOOKS**

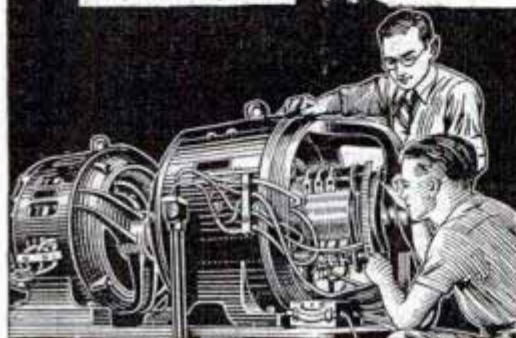

FIRST--You are told and shown how to do it.

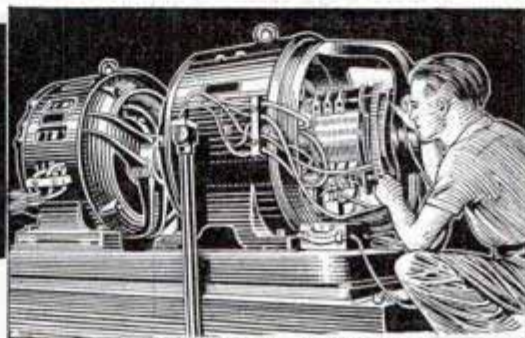

THEN--You do the job yourself.



HOUSE WIRING

only one of the many branches you "Learn By Doing."

WANT TO EARN MORE MONEY?

Have you ever dreamed of holding down a good pay job? Have you ever dreamed of all the things you could have in life if you had a steady job, free from worries, of layoffs? Have you ever dreamed of being secure for life with a real future ahead of you?

Then stop dreaming and prepare to get these things. Many fellows no different than you are holding jobs that give them everything they want in life—They are holding these jobs because they prepared themselves by training to hold the job they have.

The great fascinating field of Electricity offers you a real future if you will prepare for your place in this giant industry.

Here at my school you can get a training in 12 weeks that will give you your

I'LL FINANCE YOUR TRAINING

You can get this training first—then pay for it later in easy monthly payments, starting 60 days after your 12 weeks' training period is over—then you have 18 months to complete your payments.

If you need part time work to help out with expenses while training in my shops, my employment department will help you get it. Then after graduation this department will give you valuable lifetime employment service.

Send the coupon today for all details. When I get it I'll send you my big free book containing dozens of pictures of students at work in

H. C. LEWIS, President

COYNE ELECTRICAL SCHOOL

500 S. Paulina St., Dept. 28-72, Chicago

start towards a real job and a real future.

You will be trained on actual equipment and machinery and because of my method of training, you don't need previous experience or a lot of education. Many of my successful graduates never even completed Grammar School.

Here in my school you work on generators, motors, dynamos, you do house wiring, wind armatures and do actual work on many other branches of electricity and right now I'm including valuable instruction in Diesel, Electric Refrigeration and Air Conditioning at no extra cost. My method makes it easy to learn—First the instructors tell you how a thing should be done—then they show you how it should be done—then you do the actual work yourself.

my shops. I'll also tell you about my "Pay After Graduation" plan how many earn while learning and how I help my students to success after graduation. Fill in, clip coupon, mail it today for your start towards success.



"... Everything was just as stated in literature. And plenty of instructors to take care of everything—easy to learn. I really was satisfied with Coyne Training."
J. Halyk, Canada



"... Coyne has first class instructors to teach you the simplest things to start with and they have the equipment to show you these things as you advance."
Ben Rickman, S. Car.



H. C. LEWIS, President,
COYNE ELECTRICAL SCHOOL,
500 S. Paulina Street, Dept. 28-72, Chicago, Ill.

Dear Sir: Please send me free your big catalog and full particulars of your special offer, also your "Pay-Tuition-After-Graduation" Plan.

NAME.....
ADDRESS.....
CITY..... STATE.....

There's Quicker, Bigger MONEY for YOU in POULTRY RAISING!

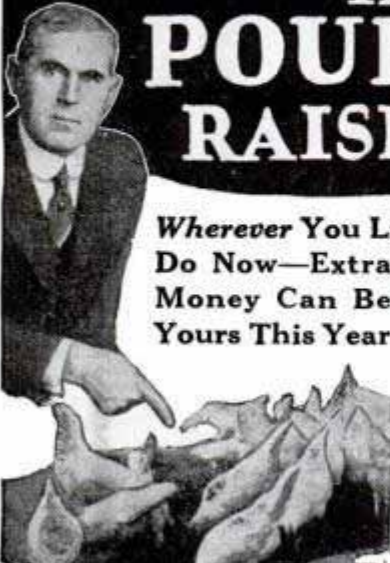

Wherever You Live—Whatever You Do Now—Extra Money Can Be Yours This Year

Spare Time or Full Time Make \$1000 to \$2500 a Year

Whether you want a job at good pay or a highly profitable business of your own—Poultry Raising offers you more than any other easily-learned trade or profession. Poultry meat and eggs are always in demand—and there is a shortage of trained poultrymen. My Home Study Course trains you quickly to fill a good job in poultry—and my Personal Employment Assistance will help you get one!

My Proved Methods Assure Success Right from START

All the "mystery and guess work" are taken out of poultry raising by my sure, tested, **proved** methods. My home study course, produced by eighteen famous experts and endorsed by thirty leading Agricultural Schools, puts in your hands the success-secrets of leaders. Satisfaction absolutely guaranteed, if you follow our methods. Decide now to get into this fascinating, healthful, profitable business. Be your own boss—make extra money in your spare time—or qualify for a fine salary in one of the big established poultry plants. From now on, let the other fellow pay YOU the fancy prices—**Become depression-proof.**

FREE BOOK EXPLAINS
My big, new, free book, "How to Raise Poultry for Profit" will amaze you! Brings **absolute proof** of what my course and training have done for thousands of others. My 44 years' experience as Commercial Poultryman and former Senior Poultryman in the U. S. Dept. of Agriculture is yours to use and profit by. Get in knee for **QUICKER, BIGGER MONEY.** Don't delay a day. Get this coupon into the very next mail.



32 Pages of Money-making FACTS

Get this FREE Book NOW!

Harry M. Lamon, President, The National Poultry Institute, Dept. 38-C, Adams Center, N. Y.

I want to know how to make big money raising poultry. Send me your FREE book explaining your home-study course and PROVED methods.

Name.....
Address.....
City..... State.....

PROOF

Investment Will Pay Many Times Over Says Kravets

"I am perfectly satisfied with your course and wish to say that my investment will pay me over and over many times. Anyone who enrolls with you can make a success in the Poultry field." Michael Kravets, Terre Haute, Ind.



\$45 a Week As Poultry Manager

"Your course enabled me to secure a splendid position in charge of a Private Poultry Farm. My pay is equal to \$45 per week. I also have free house rent, water, lights, fuel and all the poultry and eggs my family can use. I secured this position after completing only the eighteenth lesson of the course." Louis D. Baker, Reynolds, N. C.

I'LL SAY IT'S EASY!

You'll learn more quickly and easily to play a P-A Sax, Trumpet, Clarinet, or Trombone, because P-As are easier to blow and have such beautiful tone. Strongest factory guarantee. Moderate prices. Home trial. Easy terms. See your music dealer or write for beautiful free book. 1285



PAN-AMERICAN
203 P-A Bldg., Elkhart, Ind.

LEARN WATCH REPAIRING



AT HOME You can learn by our modern and original system of instruction every part of the Watch Repairing Trade at home. You can earn money while learning and prepare yourself for a well paying position or start in business after completing our course of instruction. Good watch repairers are in demand and generally earn very good salaries. For particulars apply to the Wisconsin School of Watch Repairing 524 E. Mason St., MILWAUKEE, WIS.

ELECTRICAL ENGINEERING

THE FIELD with a FUTURE

For those who cannot afford the expense of 4-year college training, Bliss offers a **CONDENSED ONE-YEAR** residence course, approved by educators; endorsed by industry. 44 years experience. Modern laboratory and shop equipment, suburban campus. Excellent faculty; wholesome, friendly atmosphere. 45th year begins September 29th. CATALOG!

BLISS ELECTRICAL SCHOOL
132 Takoma Ave., Washington, D. C.

LOOK! Baby Chicks
THOUSANDS WEEKLY ALL YEAR

Finest quality & Layers in 40 breeds. Hybrid Baby Pullets and Cockerels, B. W. D. Tested. Ducklings, Goslings, Baby Turkeys, Guineas. Mature Breeders priced right. In business 28 years. Catalog free. Nabob Hatcheries, Box M, Gambier, Ohio.

AVIATION APPRENTICES

BIG PAY GOOD FUTURE

IF YOU ARE INTERESTED IN WORKING YOURSELF INTO A HIGHLY PAID POSITION IN AVIATION—Write, immediately, enclosing stamp—

MECHANIX UNIVERSAL AVIATION SERVICE CO.
Strathmoor Station Dept. E Detroit, Mich.

GOV'T. JOBS

SALARY TO START \$90 to \$175 MONTHLY

MEN.. WOMEN
Age Range 18 to 50

() Railway Mail Clerk	() POSTMASTER
() P. O. Laborer	() Elev. Conductor
() R. F. D. Carrier	() Auditor
() Special Agent	() Stenographer
() Statistical Clerk	() U. S. Border Patrol
() City Mail Carrier	() Telephone Opr.
() P. O. Clerk	() Watchman
() Stock Clerk	() Meat Inspector
() Special Investigator	() Secret Service Opr.
() Typist	() File Clerk

GOVERNMENT INSTRUCTION SERVICE, Dept. 111, ST. LOUIS, MO.

Send me FREE particulars "How to Qualify for Government Positions" marked "X". Salaries, locations, opportunities, etc. ALL SENT FREE.

Name.....
Address.....

Become a Draftsman



Enjoy a Real Job in Industry

Steady Work

As nearly all manufacturing—construction—building starts on the drafting table, the draftsman is one of the first to be hired and one of the last to be laid off. It is his blueprints, his specifications, that give the last word in what the workmen are to do. No article—building or construction job is started before the plans drawn by the draftsman have been officially approved.

Good Pay

The draftsman has been called the Junior Engineer which title just about describes his work—position and pay. He combines his knowledge of principles, mechanism and construction details with the ability to draw and reproduce motions and methods on paper. On the average, his salary is considerably above the wages of the mechanic and, of course, less than that of the engineer.

Chance for Promotion

Working on plans, helping design new machines or new methods of construction, the draftsman is working directly with the important men of the organization. Consequently he knows what is being considered and planned. It may be the superintendent—the engineer—or even the prospective buyer with whom he consults. Because of these contacts, his experience and knowledge of the business in general he is in an excellent position to be promoted when next there is a good opening.

2 Lessons Free

Test yourself — see how readily  you, too, can learn Drafting

Young at 40

Athletes—farmers—and factory and shop workers who rely on muscle start growing old even before they reach 40 while office workers—executives—teachers—professional men, in fact, all kinds of brain-workers are just approaching their prime at 40 to 50. Training increases your value at once and continues to help boost your earning power as you mature and as you increase your experience and background for forming judgments of the firm's policies and methods.

Don't grow old at 40. Train now for the job you want at 50. Training helps you to be independent—self-supporting. It helps you to enjoy associations that are denied the untrained man. Training helps you to increase your earning power and by so doing to offer members of your family advantages far in excess of what you could give them as an untrained man. Train and enjoy **PROGRESS—CONTENTMENT—INDEPENDENCE.**

American School, Drexel at 58th, Chicago



Mail Coupon for 2 Lessons Free

American School, Dept. DD-245
Drexel Ave. at 58th St., Chicago

Without the slightest obligation, send 2 beginning Drafting Lessons and free Bulletin.

Name..... Age.....

Address.....

City..... State.....

READ THESE *Eight* OF MEN I TRAINED AT HOME FOR GOOD

Owns Large Radio Business

"I have recently moved into a new store which I believe is one of the most modern Radio stores in Alabama. I am enjoying a very good sales and service business. My Radio distributor mentions me as one of his largest dealers."
—NOEL W. RAY, 619 Broad Street, Gadsden, Alabama.



MANY RADIO EXPERTS open their own Radio businesses, selling, servicing all types of Radio sets.



BROADCASTING STATIONS employ engineers, operators, station managers and pay up to \$5,000 a year.

Chief Engineer in Broadcast Station

"I have made good progress in Radio, thanks to N. R. I. I recently have been appointed Chief Engineer for Broadcast Station WIBG, which represents a good step up for me. I want to thank you for all N. R. I. has done for me."
—JOHN H. HENNINGER, 2012 North Howard St., Philadelphia, Pa.



Operates Loud Speaker System

"I am P. A. operator at Perry Stadium, part time. I took your Course to be better able to take care of the P. A. work at the ball park, and since have installed a new system, which we think is one of the best."
—WILLIAM A. BROWN, 1517 W. Pruitt St., Indianapolis, Ind.



LOUDSPEAKER SYSTEMS, installing, servicing, operating, selling, is another profitable field for the trained Radio expert.



AUTOMOBILE RADIO sales, service, installation, is a growing field of opportunity for profit to trained Radio men.



Auto Radios Pay Good Money

"I am installing auto Radios for the Buick Motor Company, and am earning \$45 a week. Your Course has given me a practical view of the vast field which Radio embraces. I recommend N. R. I. Training."
—JOSEPH A. KORZ, 3910 Trumbull Ave., Flint, Mich.



Airline Operator at Cleveland

"I am now in charge of the Radio Department of American Airlines at the Cleveland Station, and enjoy the work very much. There are many opportunities for well trained men in the Radio field."
—WALTER B. MURRAY, Care American Airlines, Cleveland, Ohio.



AVIATION RADIO employs Radio trained men for fascinating jobs on the ground and in the air.



RADIO FACTORIES employ many men well trained in Radio in a wide variety of jobs, paying up to \$6,000 a year.



Gets Job Quick in Radio Factory

"After finishing ten lessons of the Course I had the confidence to apply for a position with Philco. I was hired immediately. At present I am working in the Radio Laboratory in charge of drawing up continuity and resistance tests and the construction and maintenance of test equipment."
—SAUL D. GILLES, 4734 N. Marshall St., Philadelphia, Pa.



True Experiences

SPARE TIME AND FULL TIME RADIO JOBS

Makes \$23.00 a Week in Spare Time

"Right now I am only working on Radios in my spare time. Within the last 12 months I've earned approximately \$1,200 through Radio service and selling. I earned around \$600 before graduating from your Course."—ALVIN E. BROUGH, 206 E. Naples St., Wayland, N. Y.



SPARE TIME SET SERVICING pays many N. R. I. men, even while learning, as much as \$5, \$10, \$15 a week extra without interfering with their regular jobs.



RADIO DEALERS, Jobbers, Manufacturers, employ salesmen, service and installation men, paying as much as \$30, \$50, \$75 a week.

Makes Good Money with Dealer

"I am working for the Denvers Appliance Company, Denvers, Mass., repairing Radios and selling Radios and electrical appliances. Have been doing very well and keeping busy all the time. I feel very proud to be a graduate of N. R. I."—LEO T. FAY, 49 Warren St., Salem, Mass.



J. E. SMITH, President
National Radio Institute
Established 1914

BE A RADIO EXPERT • Learn at home to make \$30, \$50, \$75 a week in RADIO

Do you want to make more money? Broadcasting stations employ engineers, operators, station managers and pay up to \$5000 a year. Spare time Radio set servicing pays as much as \$200 to

\$500 a year—full time servicing jobs pay as much as \$30, \$50, \$75 a week. Many Radio Experts operate full time or part time Radio businesses. Radio manufacturers and jobbers employ testers, inspectors, foremen, engineers, servicemen, paying up to \$6,000 a year. Radio operators on ships get good pay, see the world besides. Automobile, police, aviation, commercial Radio, loud speaker systems offer good opportunities now and for the future. Television promises many good jobs soon. Men I trained at home have good jobs in these branches of Radio.

Many Make \$5, \$10, \$15 a Week Extra in Spare Time While Learning

Almost every neighborhood needs a good spare time serviceman. The day you enroll I start sending you Extra Money Job Sheets. They show you how to do Radio repair jobs, how to cash in quickly. Throughout your training I send you plans and ideas that have made good spare time money—from \$200 to \$500 a year—for hundreds of fellows. I send you special Radio equipment and show you how to conduct experiments and build circuits which illustrate important Radio principles. My Training gives you PRACTICAL EXPERIENCE while learning.

I Give You a Professional Servicing Instrument

Here is the instrument every Radio expert needs and wants—an All-Wave, All-Purpose, Set Servicing Instrument. It contains

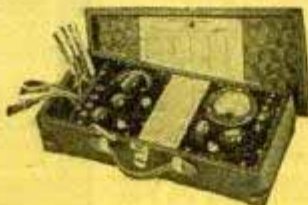

everything necessary to measure A. C. and D. C. voltages and current; test tubes, resistance; adjust and align any set, old or new. It satisfies your needs for professional servicing after you graduate—can help you make extra money servicing sets while training

Find Out What Radio Offers You

Mail the coupon now for "Rich Rewards in Radio." It's free to any fellow over 16 years old. It points out Radio's spare time and full time opportunities, those coming in Television; tells about my training in Radio and Television; shows you letters from men I trained, telling what they are doing, earning; shows my Money Back Agreement. MAIL THE COUPON in an envelope or paste it on a penny post card—NOW!



J. E. SMITH, President
National Radio Institute
Dept. 8BP
Washington, D. C.

J. E. SMITH, President
National Radio Institute, Dept. 8BP
Washington, D. C.

Dear Mr. Smith: Without obligating me, send "Rich Rewards in Radio," which points out the spare time and full time opportunities in Radio and explains your 50-50 method of training men at home to become Radio Experts. (Please write plainly.)

NAME.....AGE.....
ADDRESS.....
CITY.....STATE.....

Get into
DIESEL and

STOP worrying about the future. **LOOK** at these students and **LISTEN** to what graduates of the Hemphill Diesel Schools have to say:

"In charge of a Diesel plant for a large dredging company." ✓ —Oden Rost

"I landed a Diesel job which tripled my former income." ✓ —B. V. Miller

"First pay check was \$350 more than my tuition." ✓ —Harold Ikemura

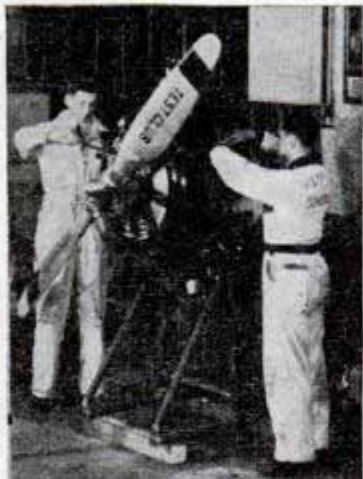

"I am now in line for a higher salary because of my training." ✓ —Roy Pike

"Since I have completed the course my earning power doubled." ✓ —Eldon Traylor

"Thanking you for placing me as port engineer." ✓ —Charles Cole

"Money I spent with Hemphill Schools is paying me dividends 100% per month." ✓ —Robert Lohet

Similar opportunities are open to you. Can you afford to let them go by? The book "March of Diesel" is now ready for distribution. Shows many types of Diesel applications and fully describes the growth of the industry since its inception over 40 years ago. Prepared after years of survey—your copy is ready for you. Send coupon today.

HEMPHILL DIESEL SCHOOLS

America's Original Exclusive Diesel training institution, located only at addresses shown

BOSTON, 114 Brookline Avenue
NEW YORK, 31-26 Queens Blvd., L. I. City
DETROIT, 2341 W. Lafayette Blvd
CHICAGO, 2014 Larrabee Street
MEMPHIS, 417 Monroe Avenue
LOS ANGELES, 2120 San Fernando Road
SEATTLE, 501 Westlake North
VANCOUVER, B. C., 1363 Granville Street

HEMPHILL DIESEL SCHOOLS

(use nearest address)

Please send me free copy of 32-page book, "March of Diesel," and full information on your Diesel courses.

Name _____ Age _____

Street _____

City _____ M-14-B

HEMPHILL TRAINING PAYS

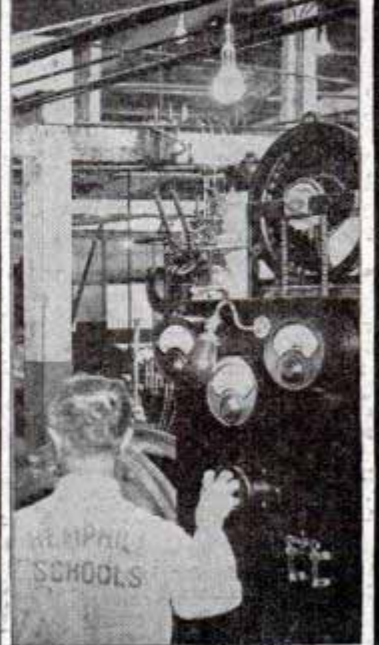
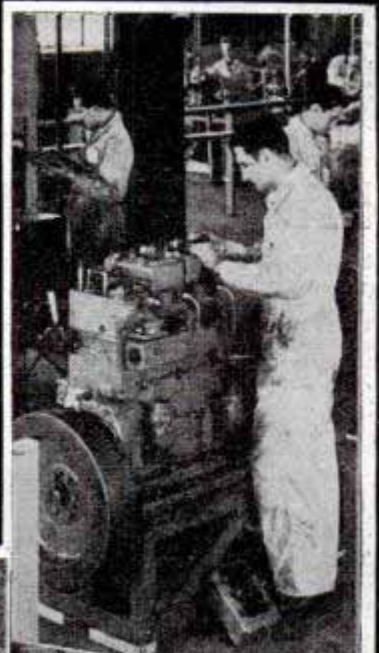

Let Engineer Dobe
Show YOU How to Get a
BETTER JOB
and **MORE PAY**

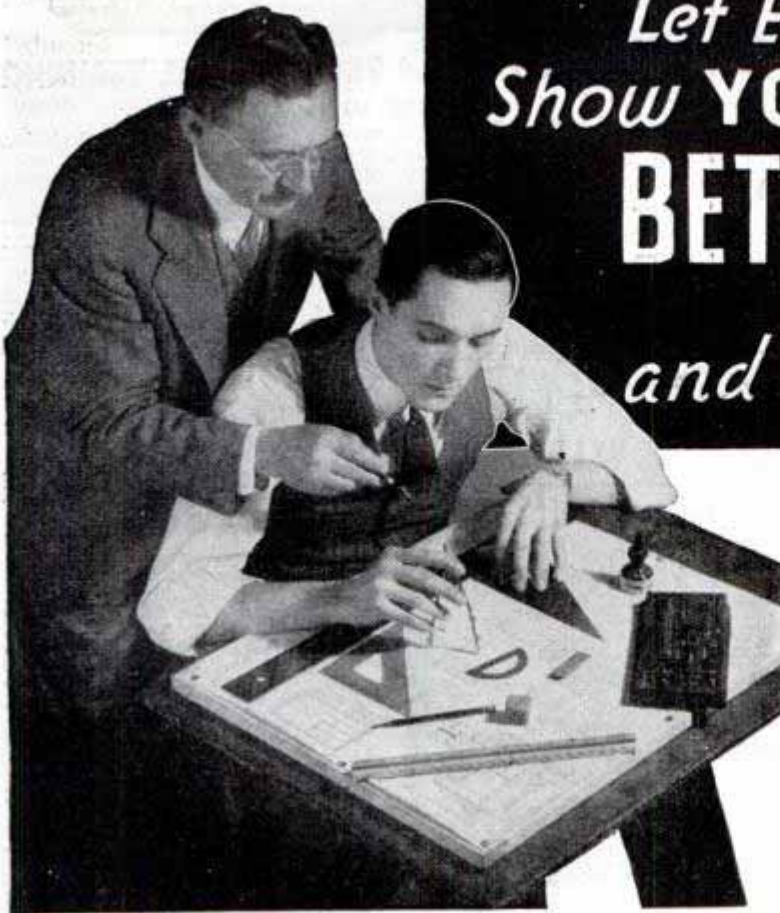

If you want to learn drafting as a profession—or if you want to learn drafting to advance in your present work—Engineer Dobe can train you at home in your spare time by his long established, proven-practical "Work-Job" Method. A knowledge of drafting is a vital aid to your success—for all modern industry begins with the draftsman. The drafting room is the nerve center of manufacturing, building and transportation. New inventions, new designs, new plans, basic improvements must begin with the draftsman.

He is the *key man* of our industrial system—with rich opportunities for advancement and better pay in scores of fields. In Machinery, Building, Aviation, Electricity, Transportation, Automotives—draftsmen must be used. Many trained draftsmen will be needed on better jobs at better pay and shorter hours.

Learn DRAFTING at Home

Engineer Dobe can prepare you just as he has trained thousands of successful students, aged 16 to 18 to past 50. His practical "Work-Job" method requires no previous experience. High school education not needed. He offers you a real opportunity to get a complete training in drafting right in your home in a surprisingly few months. Trained draftsmen enjoy good salaries. Engineer Dobe teaches his students until thoroughly trained and until holding a good paying job. That's Engineer Dobe's guarantee.

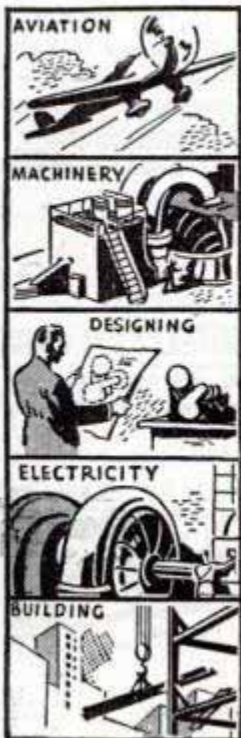

Send for
FREE BOOK

Mail the coupon today for FREE illustrated book "Successful Draftsmanship" and full details of Engineer Dobe's remarkable trial offer that includes all necessary tools and equipment. Learn just how you can be trained successfully at home in your spare time. Time is money. Now is the time to prepare. Don't wait another day. Send the coupon NOW for Engineer Dobe's FREE Book.

ENGINEER DOBE
Div. 3372 Libertyville, Ill.

You'll be amazed at the speed with which you can learn in your spare time by Engineer Dobe's Practical Method. Send coupon TODAY for free book entitled "Success in Draftsmanship."

All Working Tools Furnished

Here's a draftsman's set of tools—sent at once (also a drawing table)—all without extra charge the day you enroll.

Complete Outfit, size 20x25", furnished to you.

These TOOLS and Other
EQUIPMENT
Given When You Start

Free Book!

ENGINEER DOBE, Div. 3372 Libertyville, Ill.

Send me your free book "Successful Draftsmanship". Please explain how you assist your graduates to good positions as draftsmen.

Name

Address

Town

State Age



High School Course at Home

Many Finish in 2 Years

You can complete this simplified High School Course as rapidly as your time and abilities permit. Equivalent to resident school work—prepares you for entrance to college. Standard H. S. texts supplied—Diploma. Credit for H. S. subjects already completed. Single subjects if desired. High School education is very important for advancement in business and industry and socially.

College Entrance

During the past 14 years, our High School graduates have been admitted to 531 different Universities, Colleges, Junior Colleges and Normal Schools—80% of them without entrance examination. Course also prepares for teachers' certificate and pre-professional examinations.

Business—Industry

To get and hold a good position in Business today you must be able to write clear, accurate letters and reports—do figuring involving Algebra and Geometry—talk intelligently on matters requiring a knowledge of Geography, History, and Economics.

In Industry—Mechanical and Engineering lines—you must have at least an elementary knowledge of Physics and Chemistry—be able to figure quickly and accurately—know something of Mechanical Drawing and blueprints—and be able to talk and write accurately and clearly on both your work and ordinary topics of conversation.

Our High School course meets the preparatory educational requirements for Business and Industry.

An Educational Institution

The American School was chartered in 1897 as an educational institution, not for profit—and is exempt from paying Federal income tax, like the best resident colleges and universities.

Don't Be Handicapped—Complete Your Training Now

Be a High School Graduate! Prepare yourself for promotion in Business and Industry—for the Professions, College Entrance and social success. No matter what line you may select, High School training will prove invaluable to you! Our moderate fees cover all instruction, standard textbooks and Diploma. Easy monthly terms. Get ahead in life. Start your training NOW!

20 Other Courses

Over 150 noted Educators, Engineers, and Business Men helped prepare our special instruction material, which is used by many resident schools and colleges. U. S. Navy, and Province of Manitoba, Canada. We offer you quality training at home for the best-paying lines of Industry and Business, as listed in the coupon.

Prepare yourself for promotion in Business and Industry—for the Professions, College Entrance and social success. No matter what line you may select, High School training will prove invaluable to you! Our moderate fees cover all instruction, standard textbooks and Diploma. Easy monthly terms. Get ahead in life. Start your training NOW!

Mail coupon for information about line that interests you

American School, Drexel at 58th, Chicago

American School, Dept. H245, Drexel at 58th, Chicago

Tell me how to train for success in line checked. No obligation.

- | | |
|--|--|
| <input type="checkbox"/> Accounting & Auditing | <input type="checkbox"/> Diesel Engineering |
| <input type="checkbox"/> Architecture & B'ldg | <input type="checkbox"/> Drafting & Design |
| <input type="checkbox"/> Automotive Engin'ring | <input type="checkbox"/> Liberal Arts |
| <input type="checkbox"/> Business Management | <input type="checkbox"/> Private Secretary |
| <input type="checkbox"/> Commercial Aeronautics | <input type="checkbox"/> Hi'er Ac't'g (C.P.A.) |
| <input type="checkbox"/> Electrical Engineering | <input type="checkbox"/> Highway Engin'ring |
| <input type="checkbox"/> Electrical Refrigerat'n | <input type="checkbox"/> Mechanical Eng'ring |
| <input type="checkbox"/> Air Conditioning | <input type="checkbox"/> Radio & Television |
| <input type="checkbox"/> Civil Engineering | <input type="checkbox"/> Salesmanship |
| <input type="checkbox"/> Complete Law | <input type="checkbox"/> Steam Engineering |

Name.....

Address.....

PARKS AIR COLLEGE

PARKS AIRPORT EAST ST. LOUIS, ILL.

Offers COLLEGE and PROFESSIONAL TRAINING Majoring in AVIATION

FOUR courses lead to B. S. degrees in Professional Piloting, Aviation Operations, Aviation Mechanics, Aeronautical Engineering.

TWELVE TRAINING PLANES are used in professional flight training which prepares graduates for airline flight operations. 74% of graduates enter air transportation in North and South America. 64,000 hours flight training given, 650 hours being flown monthly.

FACULTY of 33 specialists in various fields of aviation. 1477 graduates. Capacity enrollment of 302 for Fall term.

100-acre airport, 14 buildings devoted to school purposes exclusively. Dormitories and dining hall on the Field.

Accredited by the Illinois Superintendent of Public Instruction. Government approved as a Transport Ground and Flying School and Mechanics' School. Open to high school graduates.

Spring term March 28. Send postcard for new 60-page catalog.

Registrar, Dept. PM-2
11th YEAR PARKS AIR COLLEGE, East St. Louis, Ill.

Be a DENTICIAN

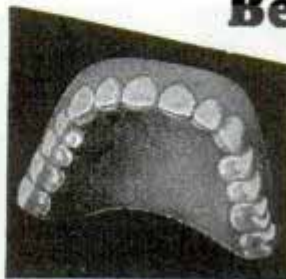

Learn at home to make Crowns, Plates, Bridgework, etc., for Dentists. Easy, practical way to learn mechanical dentistry at home in spare time. Full Equipment of Tools and Materials Included with Course. Low tuition. Easy terms. Write for FREE BOOK about this money-making profession that is not affected by "machine age."

McCARRIE SCHOOL OF MECHANICAL DENTISTRY
207 No. Broad St., Dept. 730, Philadelphia, Pa.



BE A RAILWAY TRAFFIC INSPECTOR WRITE TODAY

EARN BETTER PAY WITH THIS TRAINING

A GOOD POSITION is waiting for our trained Railway and Bus Passenger Traffic Inspectors. Simple, home-study course quickly qualifies you and upon completion, we help place you at up to \$135 per month, plus expenses, to start, or refund tuition. Ambitious men advance rapidly. Free booklet gives our 10-yr. record.

STANDARD BUSINESS TRAINING INSTITUTE, Div. 202 Buffalo, N. Y.



VOICE

100% Improvement Guaranteed

We build, strengthen the vocal organs—not with singing lessons—but by fundamentally sound and scientifically correct silent exercises... and absolutely guarantee to improve any singing or speaking voice at least 100%... Write for wonderful voice book—sent free. Learn WHY you can now have the voice you want. No literature sent to anyone under 17 years unless signed by parent.

PERFECT VOICE INSTITUTE, Studio 1352
64 E. Lake St., Chicago

ENGINEERING DEGREE IN TWO YEARS

B.S. DEGREE courses in engineering: Electrical, Civil, Chem., Mechanical, Mech. Drafting, Radio and Television or Aeronautical. Intense, practical, thorough program. No extras for prep. or review. Earn while you learn in this industrial center. Low tuition. Enter March, June, Sept., Dec. Write for catalog. 229 E. Washington Blvd., Fort Wayne, Ind.

INDIANA TECHNICAL COLLEGE

LEARN CARTOONING

by the method that has developed hundreds successfully. Send name, address and age for free chart to test your ability.

THE LANDON SCHOOL, 1737 National Bldg., Cleveland, Ohio

CRIME DETECTION
SECRET SERVICE
AND
FINGER PRINTS

SECRET SERVICE BOOK
FREE

Sent to you

For 30 Days Reading
No Money Down—Actual Crime Cases—
If You Act Quick! We will send you this stirring book on Crime Detection, Secret Service and Identification Work for 30 days free reading. Send no money. If you decide to keep it, then send us only \$1. If not, return it. WRITE TODAY. Literature will be sent only to persons stating their age.

T. G. COOKE, Dept. 1352, 1526 Sunnyside Ave., Chicago, Ill.

**FOR MEN
WHO WANT
TO LEARN A
PROFITABLE
TRADE**



Complete **DIESEL** *Training*



HOME OF NATIONAL SCHOOLS

A million-dollar trade school, occupying its own modern three-story building, exclusively devoted to training ambitious men. Latest equipment; selected, experienced staff of engineers and instructors; practical, thorough training.

PUBLIC SCHOOL SUPERINTENDENT PROFITS BY NATIONAL TRAINING

"I have attended two state universities and two state normal schools and I want you to know that I feel I have received more for my money at National than at any other school I have attended. One cannot be too high in praise of the instructors—of their determination to see that each student received complete instruction and thorough understanding of each assignment."

J. Stover, Jr.,
Sup't., Palouse Public Schools,
State of Washington.

**with all types INTERNAL COMBUSTION ENGINES,
ELECTRIC POWER GENERATION, etc.**

YOU MEN who are sincerely ambitious to make good in the Diesel and related industries, want to know the true facts—you want to know about employment opportunities and employment requirements. For 33 years, National Schools, a recognized leader in the field of trade education, has played a vital part in helping wide-awake men to qualify for success in industry. National Schools—a million-dollar trade school—will supply you with a sincere, honest statement of facts on what you should do to get into the profitable Diesel Industry. No exaggerations—no mis-statements.

nearest point of entry.) Student social life includes inspection trips, excursions, athletic activities, etc. Special doctor service. Personality coaching. **Many students are helped with spare-time jobs to earn room and board while learning.** (Canadians excepted.) Graduate employment cooperation.

**YOU NEED REAL SHOP EXPERIENCE
WITH TIME-TESTED TRAINING**

Mail the coupon below. In the literature you will be sent, you will see exactly how other men like you are preparing themselves for success in National's modern training shops. You learn on the latest, finest equipment. You do real job work. You learn by time-tested, shop practice methods. Your training is fascinating in every detail. You are taught how to make good, and helped to make good after you graduate. All of this and much more is clearly pictured for you in the Free Book of Facts we will send to you.

National Training is so thorough and all-inclusive, that no ambitious man can afford to consider Diesel Training without first knowing all of the facts regarding the many advantages available to him as a National Student. INVESTIGATE.

**TRANSPORTATION ALLOWED
TO LOS ANGELES**

National Students are allowed coach railroad fare from any point in U. S. (Canadian students from

NATIONAL SCHOOLS *Los Angeles*

SEND FOR YOUR COPY TODAY
*—Real Facts on Diesel
Employment Requirements*

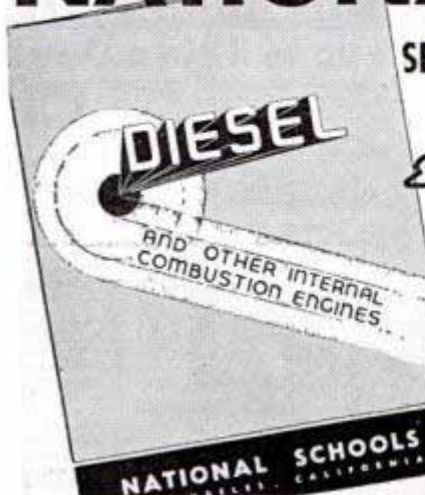

Free
**NEW BOOK
OF
TRAINING FACTS**

Request for Free Book
NATIONAL SCHOOLS
(established 1905) Dept. PMA-2
4000 S. Figueroa St., Los Angeles
Please send me, without obligation, your FREE BOOK and information regarding Diesel Employment Opportunities and Requirements.

NAME _____
ADDRESS _____ AGE _____
CITY _____ STATE _____

Aircraft leaders say-- GET INTO THIS PICTURE



**—WHERE YOU GET THE
FINEST AIRCRAFT TRAINING
FOR AIRCRAFT INDUSTRY CAREERS**

If you want to be a part of the great aircraft industry—if you want to get into the fascinating work of creating and building airplanes—then think of how much more secure your position will be with a background of Aero I.T.I. training.

At this new aircraft training school you learn aircraft construction from the ground up—your instruction procedure is supervised by the famous aircraft builders on the Executive Board—your course includes material never before released by the industry

You learn on actual aircraft plant equipment. Everything necessary, from the smallest hand tool to the huge hydraulic presses, is provided in the Aero I.T.I. shops—the same type modern equipment you will find in the leading aircraft plants.

In no other school have actual aircraft production methods and facilities been so thoroughly duplicated as at Aero I.T.I. Get full details of what this means to you. Send coupon now.

Executive Board

John K. Northrop
President, The Northrop Corp.

C. A. Van Dusen
Vice-President, Consolidated Aircraft Corp.

Robert E. Gross
President, Lockheed Aircraft Corporation

Aero I.T.I. students at a huge power brake.

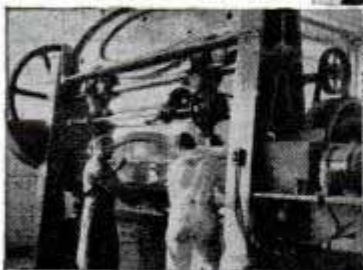

Future airplane builders practicing their craft.

AERO INDUSTRIES TECHNICAL INSTITUTE
5253 West San Fernando Road, Los Angeles, California

Please send complete information on the Aero I.T.I. training system and courses.

Name _____ Age _____

Street _____

City _____ State _____ a-6-p

Start a POTATO CHIP BUSINESS

IN YOUR KITCHEN and
MAKE MONEY!

Buy Potatoes
for 2c A POUND

Sell Them as
Vita-Seald Chips for
35c A POUND

THERE'S big money in potato chips for any man or woman who wants a business capable of paying big daily profits from the very start. Just think of it. You can install the wonderful new machine in your kitchen—just manufacture and suck a sensational new kind of "Greaseless" Potato Chip—and let the stores sell them for you. Only \$2.50 invested in raw materials brings back \$10.00 in cash.



EVERYTHING FURNISHED You don't have to have a lot of money to start this business. A small investment in the machine puts you in a big profit business of your own. I send you everything including speed-slicer, cooker, oil-extractor (for making new "GREASELESS" chip), a big supply of printed bags and free advertising material. No experience is needed as I send complete, simple instructions showing how to make a profit the first day. Prices, pictures, and complete plans will be sent free for the asking.

DON'T BUY ANYTHING Just send your name and address on a post-card for all this Free information including the "Secret of Making Greaseless Potato Chips." No obligation, but hurry, and you may become independent as so many others have done with these fast selling new "Greaseless" Chips. Address your card to

G. H. Hardt, 325 W. Huron St., Dept. D-52, Chicago, Illinois

KNOCK-EM-GOLD!

THE BIGGER THEY ARE, LEARN JIU JITSU!
THE HARDER THEY FALL

36 secret knock-out blows without fists by 15c
world famous Police Jiu Jitsu Instructor

A little jab with tip of fingers, or strike with edge of hand to right spot and tough guys go out like a light. Also many one fingered headlock breaks. Northwest "Mountien" use Jorgensen's system. G-Men must be Jiu Jitsu experts. He has personally taught many in U.S. Army, Navy, Marines, National Guard, Coast Guard, Immigration, Border Patrol, Police, etc. and performed for the Movies. Whether you are young or old, man or woman, send now for new illustrated course. Full Price 15c Size or strength mean nothing. Fear no man, gun, knife, club.



Minstrels Comedy Strips plays songs

Unique First Parts for complete show with special songs and choruses. Make-up Catalog Free.

T. S. Denison & Co. 283 N. Wabash, Dept. 19, Chicago

WILL YOU WEAR THIS SUIT and Make up to \$12 in a Day!

Let me send you this fine all-wool Union tailored suit FREE OF COST. Just follow my easy plan and show the suit to your friends. Make up to \$12 in a day easily. No experience—no canvassing necessary. Send for Samples—FREE OF COST Write today for FREE details. ACTUAL SAMPLES and "sure-fire" money getting plans. Send no money. M. J. Collin, Progress Tailoring Co., Dept. B-216, 500 S. Throop St. Chicago, Ill.

NEW SCIENTIFIC WONDER

"X-RAY" CURIO

10c 3 for 25c

BOYS BIG FUN. You apparently see thru cloth, Wood, Stone, any object. See Bones in Fish. FREE PACKAGE radio picture films, take pictures without camera. "Year'll like 'em." 1 package with each 25c order.

MARVEL MFG. CO., Dept. 80 NEW HAVEN, CONN.

WHAT INSTRUMENT DO YOU WANT TO LEARN TO PLAY?



QUICK WAY TO LEARN MUSIC

Thousands have learned to play at but a fraction of the old way costs

Simplified, quick method brings amazing results—over 700,000 students

Have you ever dreamed of the fun you'd have playing some musical instrument? Pictured yourself doing many of the popular hits, movie theme songs, even classical numbers?

Then here's grand news for you! It's news of an easy, fascinating simplified method whereby almost anyone can learn to play real music *by notes* in a remarkably short time! And what's more, you won't need a private teacher. You'll learn all by yourself—right in your own home. And best of all, the cost is only a small fraction of what it used to cost by old-fashioned methods.

No Special "Talent" Needed

You needn't even know one note from the other, for thousands have learned to play with the aid of this wonderful U. S. School of Music system of instruction. You learn to read regular notes—and to play them—just as

any real musician does. You start right in learning to play real little tunes almost from the very start. Gradually you master more and more difficult ones until—sooner than you ever expected—you find yourself entertaining your friends—playing at parties—and having the best times you ever had in your whole life.

Easy as A-B-C

The success of this U. S. School method of musical instruction is due to two things. One is the fact that it makes everything so simple—so crystal clear—so easy to understand. First

it tells you how to do a thing. Then it shows you in pictures how to do it. Then you do it yourself and hear it. What could be simpler?

The second reason for the success of this system is that it is so fascinating. Learning music this way is like playing a game. Practicing becomes real fun instead of a bore as it used to be with the old way.

Free Booklet and Demonstration Lesson

In order to show how easy—how simple—how pleasant this course is, the U. S. School of Music has prepared for you a free Demonstration Lesson and Explanatory Booklet. No matter what instrument you select to play the Free Demonstration Lesson and Booklet will show you at once the amazingly simple principles around which this method is built. And how it will enable you to become a popular musician in a surprisingly short time—at an average cost of only a few cents a day.

If you really want to learn music—if you want to win new popularity—if you want to enjoy musical good times galore—fill in and mail the coupon below. Don't delay—act at once. You'll not be obligated in any way. Instruments supplied when needed, cash or credit. U. S. School of Music, 72 Brunswick Bldg., New York City.

What Instrument for You?

- | | |
|--------------------------|-------------------------------------|
| Piano | Guitar |
| Violin | Saxophone |
| Organ | Mandolin |
| Cornet | Ukulele |
| Trombone | Harp |
| Piccolo | Clarinet |
| Flute | Cello |
| Hawaiian Steel Guitar | Trumpet |
| Piano Accordion | Italian and German Accordion |
| Voice and Speech Culture | Harmony and Composition |
| Drums and Traps | Banjo (Plectrum, 5-String or Tenor) |

START NOW TO MUSICAL GOOD TIMES

U. S. SCHOOL OF MUSIC
72 Brunswick Building, New York City

Please send me your free book, "How You Can Learn Music in Your Own Home," with inspiring message by Dr. Frank Crane, Free Demonstration Lesson, and particulars of your easy payment plan. I am interested in the following course:

Have you
Instr. ?

Name.....

Address.....

City..... State.....

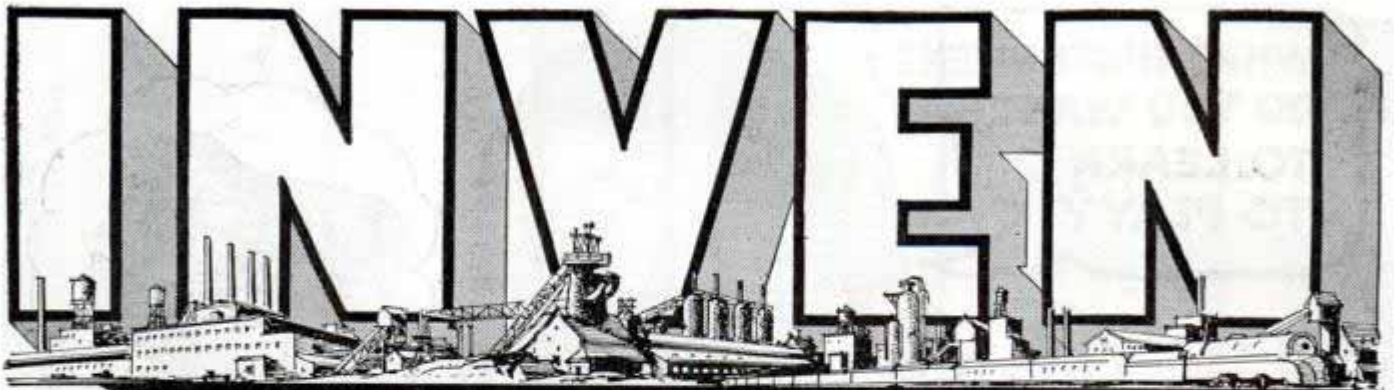

How to Determine The Patentability Of Your Invention

Before you spend money in making a model, or spend weeks in its design, we advise you first to have a preliminary search made through U. S. Patents in the U. S. Patent Office to see if there are inventions like yours already on record; and, if so, let us give you our opinion as to the patentability of what you have.

We employ experienced searchers to perform this service for you. From the reports of our searchers we can quickly form our opinion as to whether your invention is confronted with obstacles in the form of already granted patents. First get our FREE BOOK and read the chapter on "How Can I Know Whether My Idea is Patentable?"

HOW WE SERVE THE INVENTOR

We have secured patents for inventors located in every state in the Union. Our organization is a large and efficient one. Our practice is confined entirely to Patents, Trade-Marks, and Copyrights. We have had years of experience in Patent Matters. When you place your invention in our hands, we are in position to proceed at once to secure protection for you.

Learn How To Get Your

Our fees are reasonable, and, if you desire, we can arrange convenient terms of payment.

THIS FREE BOOK
FROM THE CRUDE INVENTOR'S SKETCH TO THE

WHAT HELP IS THE PATENT ATTORNEY?

Your invention may provide your life's greatest opportunity. If it is to bring income to you it should be legally yours. Upon your patent attorney's skill rests how completely your patent covers all the protectable points in your invention. The inventor may actually lose money on his invention by overlooking a single claimable point that a skilled patent attorney would not miss.

WHAT THE INVENTOR MUST KNOW

In order to proceed successfully, the inventor must follow certain definite steps that precedent has established as the quickest way to reach his goal. Our FREE BOOK, "Patent Guide for the Inventor," gives a concrete, logical, and thorough resume for the inventor to follow. It takes him, through 48 pages, from the crude first model to the finished commercial product. It shows the inventor how to avoid mistakes, how to shorten the road in getting his invention ready for market; it also points out how to save money and avoid the errors of inexperience in applying for patent. Getting our FREE BOOK should be the first step in definitely declaring yourself an inventor. After you get this illustrated, clearly worded guide of carefully compiled patent knowledge you will know how to proceed without expensive mistakes and discouraging setbacks from "wrong-track" methods.

CLARENCE A. O'BRIEN & HYMAN BERMAN

70-D ADAMS BUILDING, WASHINGTON, D. C.
Registered Patent Attorneys before U. S. Patent Office

When writing to advertisers please mention Popular Mechanics

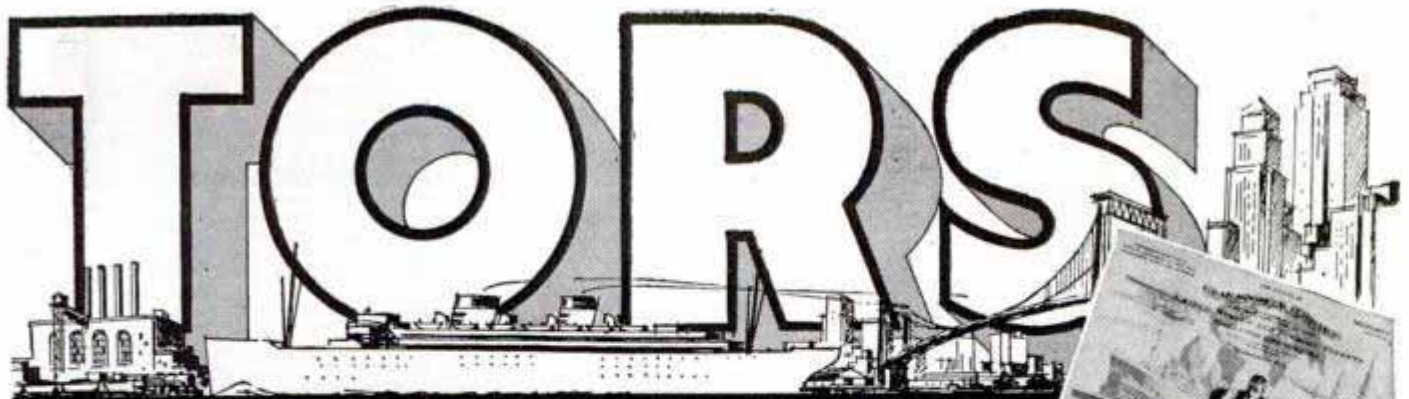

Invention Ready For These Waiting Markets

Keen competition in every form of industry has put manufacturers feverishly at work trying to speed up output, reduce overhead, save on materials, outsell trade opponents. The inventor is the key-man in making advancement possible to any business. Upon the inventor rests the success of many enterprises.

This does not mean that you must have something gigantic to win commercial success. A new way to open a door or button up a shirt may be the very thing hundreds of manufacturers are looking for. If you have something novel—if it is practical to manufacture—no matter whether it be an improved rattle for a child or a whistle for a mechanical automobile, there is likely a waiting market.

FREE RECORD OF INVENTION FORM.

This FREE Record of Invention Form enables you to make in convenient form a sketch of your invention and have it witnessed in a manner of value to you should the occasion for evidence arise. MAIL THE COUPON TODAY and obtain our FREE BOOK and Record of Invention Form.

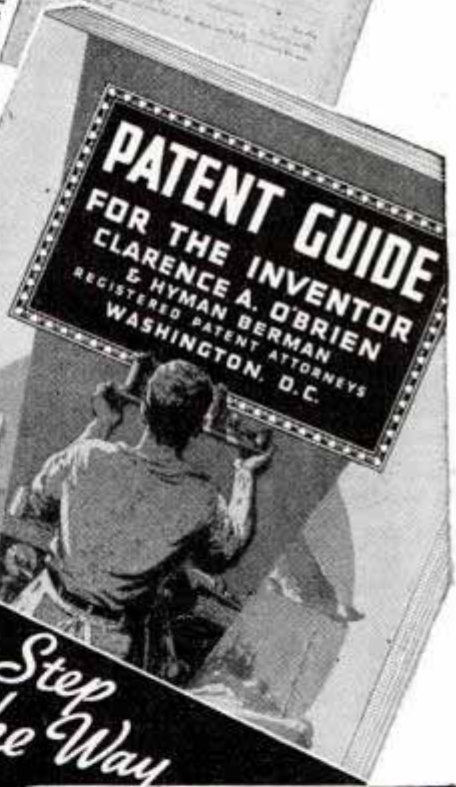

WILL SHOW YOU *Every Step of the Way*
FINISHED COMMERCIAL PRODUCT

THE IMPORTANCE OF IMMEDIATE ACTION

In making application for patent it is important to be first. Even if your application is delayed by a few days you may be placed at a disadvantage. The short time that elapsed between Elisha Gray's application for his telephone patent and the application of Alexander Graham Bell probably cost Gray the rights to the telephone.

TEAR OFF AND MAIL NOW!

CLARENCE A. O'BRIEN and HYMAN BERMAN

70-D Adams Building
 WASHINGTON, D. C.
 Registered Patent Attorneys
 Before U. S. Patent Office

Please send me at once your Big FREE 48-Page Book, "Patent Guide for the Inventor" and your Specially Prepared "Record of Invention" form. This request does not obligate me.

NAME.....

ADDRESS.....

(Please write or print plainly)



Go to High School at Home

You can secure a high school education in your spare time by studying the new courses prepared by the International Correspondence Schools.

These courses are equivalent to the courses given in resident high schools. They have been specially arranged for men and women who wish to meet college entrance examinations, to qualify for a business position, or to make up the education they missed in past years.

The lessons are easy to understand and you will make rapid progress because you will be in a class by yourself and you will study under the guidance of instructors who are sincerely interested in you.

Just mark and mail the coupon and we will gladly send you interesting free booklets describing the High School Courses of the I. C. S. or any other subject in which you are interested.

INTERNATIONAL CORRESPONDENCE SCHOOLS

Box 5699-H, Scranton, Penna.

Without cost or obligation, please send me a copy of your booklet, "Who Wins and Why," and full particulars about the subject before which I have marked X in the list below:

- College Preparatory Course
- High School Commercial Course
- High School English Course
- High School Vocational Course
- High School Agricultural Course

BUSINESS TRAINING COURSES

- | | |
|--|---|
| <input type="checkbox"/> Business Management | <input type="checkbox"/> Service Station Salesmanship |
| <input type="checkbox"/> Office Management | <input type="checkbox"/> Business Correspondence |
| <input type="checkbox"/> Industrial Management | <input type="checkbox"/> Lettering Show Cards |
| <input type="checkbox"/> Traffic Management | <input type="checkbox"/> Stenography and Typing |
| <input type="checkbox"/> Accountancy and C.P.A. Coaching | <input type="checkbox"/> Civil Service |
| <input type="checkbox"/> Bookkeeping | <input type="checkbox"/> Mail Carrier |
| <input type="checkbox"/> Secretarial Work | <input type="checkbox"/> Railway Mail Clerk |
| <input type="checkbox"/> Cost Accountant | <input type="checkbox"/> Grade School Subjects |
| <input type="checkbox"/> Salesmanship | <input type="checkbox"/> First Year College |
| <input type="checkbox"/> Wallpaper Decorating | <input type="checkbox"/> Illustrating |
| <input type="checkbox"/> Salesmanship | <input type="checkbox"/> Cartooning |
| | <input type="checkbox"/> Lumber Dealer |
| | <input type="checkbox"/> Spanish |
| | <input type="checkbox"/> French |
| | <input type="checkbox"/> Signs |

TECHNICAL AND INDUSTRIAL COURSES

- | | | |
|---|--|--|
| <input type="checkbox"/> Architect | <input type="checkbox"/> Plumbing | <input type="checkbox"/> Heating |
| <input type="checkbox"/> Contractor and Builder | <input type="checkbox"/> Air Conditioning | |
| <input type="checkbox"/> Structural Draftsman | <input type="checkbox"/> Sheet Metal Worker | |
| <input type="checkbox"/> Structural Engineer | <input type="checkbox"/> Steam Engineer | |
| <input type="checkbox"/> Electrical Engineer | <input type="checkbox"/> Civil Engineer | |
| <input type="checkbox"/> Reading Shop Blueprints | <input type="checkbox"/> Surveying and Mapping | |
| <input type="checkbox"/> Telegraph Engineer | <input type="checkbox"/> Refrigeration | |
| <input type="checkbox"/> Telephone Work | <input type="checkbox"/> R. R. Locomotives | <input type="checkbox"/> Air Brakes |
| <input type="checkbox"/> Mechanical Engineer | <input type="checkbox"/> R. R. Signalman | |
| <input type="checkbox"/> Mechanical Draftsman | <input type="checkbox"/> Highway Engineering | |
| <input type="checkbox"/> Machinist | <input type="checkbox"/> Chemistry | <input type="checkbox"/> Pharmacy |
| <input type="checkbox"/> Inventing and Patenting | <input type="checkbox"/> Coal Mining Engineer | |
| <input type="checkbox"/> Patternmaker | <input type="checkbox"/> Navigation | <input type="checkbox"/> Boilermaker |
| <input type="checkbox"/> Heat Treatment of Metals | <input type="checkbox"/> Textile Overseer or Supt. | |
| <input type="checkbox"/> Bridge Engineer | <input type="checkbox"/> Cotton Manufacturing | |
| <input type="checkbox"/> Gas Engines | <input type="checkbox"/> Woolen Manufacturing | |
| <input type="checkbox"/> Diesel Engines | <input type="checkbox"/> Agriculture | <input type="checkbox"/> Fruit Growing |
| <input type="checkbox"/> Aviation Engines | <input type="checkbox"/> Marine Engineer | <input type="checkbox"/> Radio |
| <input type="checkbox"/> Automobile Mechanic | | |

Name..... Age.....

Address.....

City..... State.....

Occupation.....

If you reside in Canada, Send this coupon to the International Correspondence Schools Canadian, Limited, Montreal, Canada

When writing please mention Popular Mechanics

A BUESCHER IS EASIEST TO MASTER

True Tone

● New exclusive features of the Buescher True Tone saxophone enable you to master tunes easily; qualify for band in a very short time. Then popularity plus; friends, good times; and money to spend. No other instrument equals the Buescher for quick results.

BUDDY MEYER, Amarillo, Texas, 14 year old contest winner with his Buescher Sax.

FREE TRIAL, easy payments, any instrument, sax, trumpet, trombone. See your music dealer or write for beautiful free book, mentioning instrument that interests you. Home trial. No obligation. Write today. 60

BUESCHER BAND INSTRUMENT CO.
210 Buescher Bldg. Elkhart, Indiana



AUTOMOTIVE ENGINEERING

Bachelor of Science Degrees—in Automotive, Aeronautical, Architectural, Chemical, Electrical, Industrial and Mechanical engineering! Modern equipment. All college activities. Low tuition. Write today for Catalog.

LAWRENCE INSTITUTE OF TECHNOLOGY
25127 Woodward Ave. DETROIT, MICH.

A NON-PROFIT COLLEGE

CATALOG ON REQUEST

You Can Regain Perfect Speech, if you STAMMER

Send today for beautifully illustrated book entitled "DON'T STAMMER," which describes the Bogue Unit Method for the scientific correction of stammering and stuttering. Method successfully used at Bogue Institute for 37 years—since 1901. Endorsed by physicians. Full information concerning correction of stammering sent free. No obligation. Benjamin N. Bogue, Dept. 187 Circle Tower, Indianapolis, Indiana.

RADIO ENGINEERING

broadcasting, aviation and police radio, servicing, marine and Morse telegraphy taught thoroughly. Nine months' engineering course equivalent to three years' college radio work. School established 1874. All expenses low. Catalog free.

Dodge's Institute, Ada St., Valparaiso, Ind.

MONEY-MAKING OPPORTUNITY

for men of character. Over \$1,600 per month earned by California man. Over \$400 a week by Georgia man. \$1,000 in a month by Delaware man. Exclusive franchises available for an invention expected to replace a multi-million dollar industry. Install on free trial. Sells itself. Repeats. Exclusive proposition. Write F. E. Armstrong, Dept. 1112-B, Mobile, Alabama.

CARTOONING

You can now get personal instruction in this fascinating and well paid profession by one of America's leading cartoonists. Why be satisfied with less? It costs no more to get the best. Write for details about this "easy to learn" home study course.

DORMAN H. SMITH, 597C, San Rafael, California

Photography

for 

PLEASURE or PROFIT

Prepare for profitable business or fascinating hobby, at home under guidance of qualified instructors. No previous experience necessary, common school education sufficient. Many earn while learning. Our practical studio methods also qualify for well-paying positions upon graduation. Send coupon below at once for free booklet "Opportunities in Modern Photography", particulars and requirements.

AMERICAN SCHOOL OF PHOTOGRAPHY
3601 Michigan Avenue Dept. 1352 Chicago, Illinois

Send booklet, "Opportunities in Modern Photography", full particulars and requirements.

Name..... Age.....

Address.....

City..... State.....

I have a Fine Job now, thanks to



DRAFTING

Am I glad I took up drafting! I used to slave at a mere job once. But now I'm in a fascinating profession . . . where the work is easy and pleasant . . . where every job is a new adventure. Believe me, it's a first rate thrill when you help design a new machine, a new building . . . when you actually create things like you do in DRAFTING. And I'm well paid, too. **I'm satisfied!**

LEARN AT HOME

IN SPARE TIME

AS I DID

I didn't learn drafting in college. Couldn't afford it. I got my training AT HOME—in my SPARE TIME. It may surprise you—I didn't even have any special talent—and just a grade school education. But don't give me too much credit. That belongs to C. T. C. Why, their lessons are so simple I couldn't help but get drafting into my system. Another thing—the training is inexpensive. You can afford it easily—because the terms are so low. Chances are, you'll probably find a drafting job before your training is complete . . . and pay for it with increased earnings!

SEND for FREE TRIAL LESSON



Act now—don't rob yourself of the better job and higher salary that might be yours. Find out for yourself how you can master drafting—in the shortest possible time . . . at the least expense. Do this:

Send the coupon today for the absolutely FREE LESSON. The lesson will prove to you beyond a doubt that the C. T. C. system is astonishingly simple. After examining it, you'll say to yourself, "This is college work—at home." You'll have to admit that C. T. C.—with 35 years of progress back of it—is perfectly equipped to train you.

NO MORE JOB AND PAY WORRIES

You're **sure** of your job when you're a draftsman. More and more draftsmen are needed every day. Steel mills, auto plants, railway companies—are desperately calling for them. Unusual opportunities are also offered in new industries—Diesels and Air Conditioning. Check the want ads in your newspaper and see how many fine jobs are offered almost daily.

No draftsman ever need fear that his job will run out. Before bridges, factories, office buildings, etc., can be built, they must be planned on the drafting table first. Thus, the draftsman is hired **first**—laid off **last**. That's security! Of course, you know that draftsmen are well paid. But that isn't all. Their work brings them in contact with engineers, industrialists, financiers, civic leaders. Through these associations they pave the way to **promotions** . . . or lay a foundation on which to build their own business. **Send now for complete information on how you too can share in the great advantages that life offers draftsmen. Use the coupon. Get your FREE TRIAL LESSON.**



This complete drawing outfit, including table, is given to each student. These are first class tools—the kind experts use. They'll assure clean, fast work—the professional touch.

CHICAGO TECHNICAL COLLEGE

B209 Tech Bldg., 118 E. 26th Street, Chicago, Illinois

MAIL THIS COUPON

CHICAGO TECHNICAL COLLEGE
B209 Tech Bldg., 118 E. 26th Street, Chicago, Illinois

Please send me *FREE Trial Lesson* in *DRAFTING* and show me how I can prepare for a good position in *spare time AT HOME*.

Name Age

Address

P. O. State

NOW FIX ANY MAKE OF AUTO



SIX BIG AUTO BOOKS ALL SHIPPED FREE

on approval; whether you want to qualify as garage owner, auto repair expert or merely wish to know how to keep your own car 100% efficient, look at these books—they are sent to you for free examination. This brand new edition has been prepared by a large group of America's greatest automotive engineers. Anybody who can read will understand them, for this great automobile encyclopedia is a veritable

gold mine of valuable facts. Take advantage of this offer now; send in the Coupon for FREE examination. You don't pay us a penny, you don't obligate yourself to pay us anything unless you decide to keep the books. Just tell us you want to see them and the full set of 6 great volumes. Just off the press, will be sent to you! Read them, look them over and prove to your own satisfaction that one fact alone, which you will find in them, may save you an expensive repair or help you to a better job.

Diesel Engines, Aviation Motors, Outboard Motors, Motorcycles, Tractors, Wiring Diagrams, Equipment Charts, Superchargers, Knee Action and other up-to-date features all included.

Brand New Edition

Imagine books which are so new that every page is right up to date—wiring diagrams, construction details, service problems—are all right up to the minute. Over a million dollars of resources have enabled us to give you the most authoritative books on the subject ever published. Everybody interested in automobiles in any way will welcome these books published by the world's largest publishers of Technical Cyclopedias (est. 1897) with agencies all over the world.



Can You Fix It?

Can you take out "play" in differential? Can you kill the "shimmy" in steering? Can you reset TIMING? Can you put your finger on engine trouble without guessing or tinkering? Can you pull the starter off and fix it? Can you adjust and repair transmission, engine, rear axle?

These Books Tell How and tell you how to do any and every auto job right, the first time, and in addition cover Service Shop Management.

6 Big Volumes, Beautifully Bound

Nearly 3,000 pages, over 2,000 illustrations, wiring diagrams, equipment charts, etc. De Luxe edition with gold-stamped flexible binding. Sent FREE for 10 days' use. If not wanted return express collect. If kept, send only \$2.00 after 10 days, then \$3.00 a month until advertising price, \$24.80, is paid.

A Year's Consulting Membership Included

Privilege of consulting engineers of million-dollar American Technical Society on any automotive problem for one year without charge. If you mail coupon immediately. AMERICAN TECHNICAL SOCIETY, Drexel at 58th St., Dept. A219, Chicago.

SEND NO MONEY

American Technical Society, Dept. A219
Drexel Ave. at 58th St.
Chicago, Illinois.

I would like to see the brand new 6-volume edition of your automobile books but without any obligation to buy. I will pay the few cents delivery charges only and will examine the books and return them at your expense in 10 days unless I like them, in which case I will send you \$2.00 then and only \$3.00 per month until the total price of only \$24.80 is paid. You are to include consulting membership certificate in the American Technical Society. Send Brand New Edition.

Name.....
Street.....
City..... State.....

Attach letter stating age, occupation and name and address of employer and that of at least one business man as reference.

When writing please mention Popular Mechanics



Don't Buy Mandolin Guitar or Drums



Gene Krupa World's Greatest Swing Drummer Uses Slingerland Drums with Benny Goodman's orchestra.

Don't buy Guitar Mandolin, Banjo, Electric Guitars, Bugles or Drums until you have seen and tried the Slingerland May-Bells. Guaranteed More for your Money. Wonderful, snappy, powerful, pleasing tone. No equal in price. Sold on easy payments and 5 days free trial by all leading music dealers.

Cut this Adv. Out—Good for \$1.00 Credit. Ask for Special Information on How to Organize Drum and Bugle Corps. Send for free catalog. Mention instrument wanted.

Write today:

Slingerland Musical Instrument Mfg. Co.
1325 Belden Ave., Chicago, Illinois

AVIATION CAREER OFFERS YOU GREAT FUTURE!



Demand for trained aircraftsmen in Southern California plants is increasing and already exceeds supply. Curtiss-Wright Technical Institute, Aviation's foremost and oldest school, is located in heart of this activity and specializes in Sheet Metal, Master Mechanics and Aero Engineering. (No flying involved.) Graduates are obtaining immediate employment. Write for details NOW! Curtiss-Wright Technical Institute, Glendale, (Los Angeles) Cal., Dept. PM-2

TRI-STATE COLLEGE



B. S. Degree in 2 years. World famous for technical 2-year courses in Civil, Electrical, Mechanical, Chemical, Radio, Aeronautical Engineering; Business Administration and Accounting. Those who lack high school may make up work. Low tuition. Low living costs. Located in picturesque hill and lake region. Students from every state and many foreign countries. 54th year. Enter September, January, March, June.

Write for catalog. 428 College Ave. ANGOLA, IND.

BE AN ARTIST

WE CAN TEACH YOU DRAWING in your own home during your spare time. Thirty-five years of successful teaching proves our ability. Artists receive large salaries.

Write today for Art Year Book
SCHOOL OF APPLIED ART
Dept. 128 - 10E. Huron St., Chicago, Ill.



350 MORE MEN NEEDED AT ONCE!

FORDS GIVEN

COFFEE ROUTES PAYING UP TO \$60



National company needs more men at once to make regular calls on local routes. No experience needed. Operate on our capital. Big bonus — \$500.00 cash or Ford Sedan—besides your weekly earnings. Rush name on postcard for FREE facts. ALBERT MILLS, 5000 Monmouth Ave., Cincinnati, Ohio



LEND ME 7 DAYS TO PROVE I CAN MAKE YOU A NEW MAN!

THAT'S all I ask. Give me just 7 DAYS, and I'll show you flesh-and-muscle **PROOF**—in your own mirror, right at home—that I can make you a **NEW MAN!**

I don't care how skinny or flabby you may be. You can't be worse off than I was! My mother forbade me to even ride a bicycle! I was the laughing stock of every fellow in town. Afraid to defend myself, too puny for sports, too ashamed of my skinny carcass to wear a bathing suit!

THEN I discovered the amazing secret that made me champion—won the international title, "The World's Most Perfectly Developed Man"! **NOW I AM READY TO TELL IT TO YOU!**

How to Get a Perfect Build Without "Apparatus"

I tried every type of "apparatus"—*without results*. It was my discovery of *Dynamic Tension* that did the work! I saw at once that the only "apparatus" you need is *your own body*. I have no use for dangerous contraptions that might strain your heart or other vital organs. My *Dynamic Tension* is the **NATURAL** method of developing you *inside and out*.

In just seven days you'll *feel* the new muscles starting to bulge! I'll trim your waistline into shape. Your arms, shoulders, legs will quickly be toned into tireless dynamos of **POWER**. If your neck, biceps or calves are scrawny now—watch them surge up to new, he-man measurements!

What's more, *Dynamic Tension* digs right down after such conditions as constipation, pimples, skin blotches—and gives Nature her first real chance to clear them up, *wash them away*—with a circulation of clean, purified, healthy blood!

Those are strong promises. I wouldn't **DARE** make them if I weren't ready to **PROVE** them. And I'll do that—give you **PROOF** absolute and positive—in exactly

7 days! Mail coupon for **FREE BOOK** telling about my amazing **SEVEN DAY TRIAL OFFER!**



How would YOU like the glorious health shown so clearly in this beach picture at the left? I'll give you the pep and vitality that others admire—abundant strength and energy for real living!



Charles Atlas

as he looks **TODAY**. This magnificent picture is taken from an actual, untouched snapshot—nothing added, nothing taken away.

Get My FREE BOOK OF PHOTOGRAPHS

SEND COUPON FOR THIS 48-PAGE FREE BOOK



The coupon below or a postcard will bring you **FREE** my new illustrated book, "Everlasting Health and Strength." This remarkable book contains actual photographs showing you how *Dynamic Tension* has developed thousands of others—what it can do for **YOU!** I

don't ask you to take my promises. I want you to **SEE** the **PROOF!** And I *guarantee* that you'll see plenty—in even the **FIRST WEEK!**

Where shall I send your **FREE** copy of "Everlasting Health and Strength"? Tell me at once, so I can get its valuable advice into your hands without delay. Write your name and address carefully on this coupon and mail it to me **NOW**. I want to **MAKE** you the **NEW MAN** you **WANT** to be—and I'm ready to do it *fast!* Address: **CHARLES ATLAS, Dept. 82, 115 East 23rd St., New York, N. Y.**

CHARLES ATLAS, Dept. 82, 115 East 23rd Street, New York, N. Y.

I want the proof that your system of *Dynamic Tension* will make a New Man of me—give me a healthy, husky body and big muscle development. Send me your free book, "Everlasting Health and Strength."

Name.....
 (Please print or write plainly)
 Address.....
 City..... State.....

David Sarnoff says:

David Sarnoff, once a poor lad and now the famous President of the Radio Corporation of America, in an article in Liberty Magazine states: "Civilization means elimination of unnecessary labor. The sewing machine and the vacuum cleaner save millions of women from backbreaking toil. The tractor makes the farmer's life bearable. The automobile lends wings to us all. The airplane is our magic carpet. It would be madness to slow up invention because our trouble is not that mechanical science moves too speedily, but that the governmental and social sciences move too slowly . . . In a world reorganized to vibrate within certain wave bands, human intelligence will be able to distribute equitably nature's bounties from above and below, and make princes of paupers."

INVENTORS

Send for Valuable Facts *about*

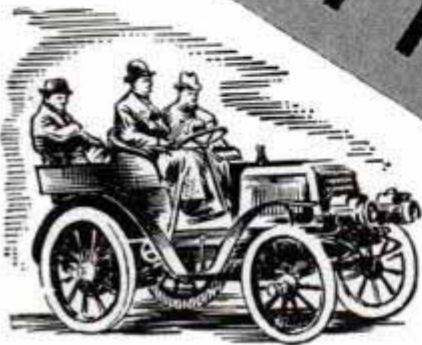

Since the "Horseless Buggy" Days, We Have Helped Inventors

Perhaps you have already heard about our firm, because one client tells another—and we have served men in every state in the Union, and in nearly every foreign country. We have been working with inventors since 1898. If you have a good invention—or an idea for one—and don't know what Victor J. Evans & Co. can do for you, NOW is the time to find out.

How We Can Help You

Both the Patent Office and the U. S. Supreme Court have made it clear that the inventor needs the assistance of a competent patent lawyer when it comes to protecting an invention. It is one thing to think up a good invention—it is another to get effective patent protection on it.

For more than a third of a century—it has been our business to give sound advice and counsel to inventors. Our free books (described on the opposite page) tell what steps to take first, how to protect yourself, how the laws protect you, what you must do, when to offer your invention for sale, how others have succeeded, and much more. You need this information.

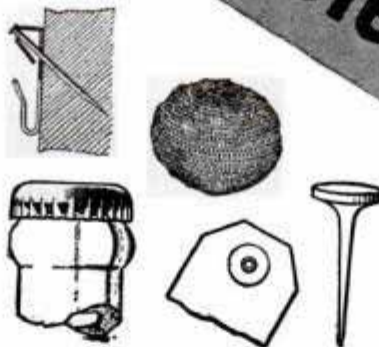

Simple Inventions May Have Excellent Commercial Possibilities

Frequently inventors confuse the size or the complication of a device with the question of commercial value and patentability. These two factors, of course, have no relation to each other. Most of our present-day complicated machines represent a process of evolution, a series of inventions. On the other hand, every so often some inventor comes along with a very simple "gadget" which possesses the elements of broad utility and is patentable. Some of the most profitable inventions have been of this latter class. Shown above are a few such examples. Whether a device is simple or complex, if it represents a forward step to save manufacturing costs, to save labor, or to add enjoyment to human life, it may prove patentable and profitable. This subject is more fully discussed in the booklet entitled "Patent Protection" shown on the opposite page.



What Will Be Next?

Ever since George Washington signed the first patent, America has led the world in inventions. It may be said that not a year has gone by without some important inventions being patented and commercialized. David Sarnoff, president of the Radio Corporation of America, sees a big future ahead for science and invention. Just as sure as the sunrise, 1938 will see new inventions come out—new wealth made from patents. Your idea may be one of them. You never can tell. For this reason you should send for our books today and get the facts about patents and inventions.

**Learn How Our Patent Laws
Protect You**

The U. S. has liberal patent laws, and much of our national wealth is based on patents. In fact, a Japanese commission decided that American progress was mainly due to our patent laws. These laws are made to protect you. Find out about them now. This is for your own good.



**These FREE
Books Tell You**

Get the answers to your questions: When can I protect my invention? When can I show my invention to manufacturers? When can I offer it for sale? How should I go about selling it? Can I get protection without a patent? What are my employer's rights? These and other important questions are fully answered.

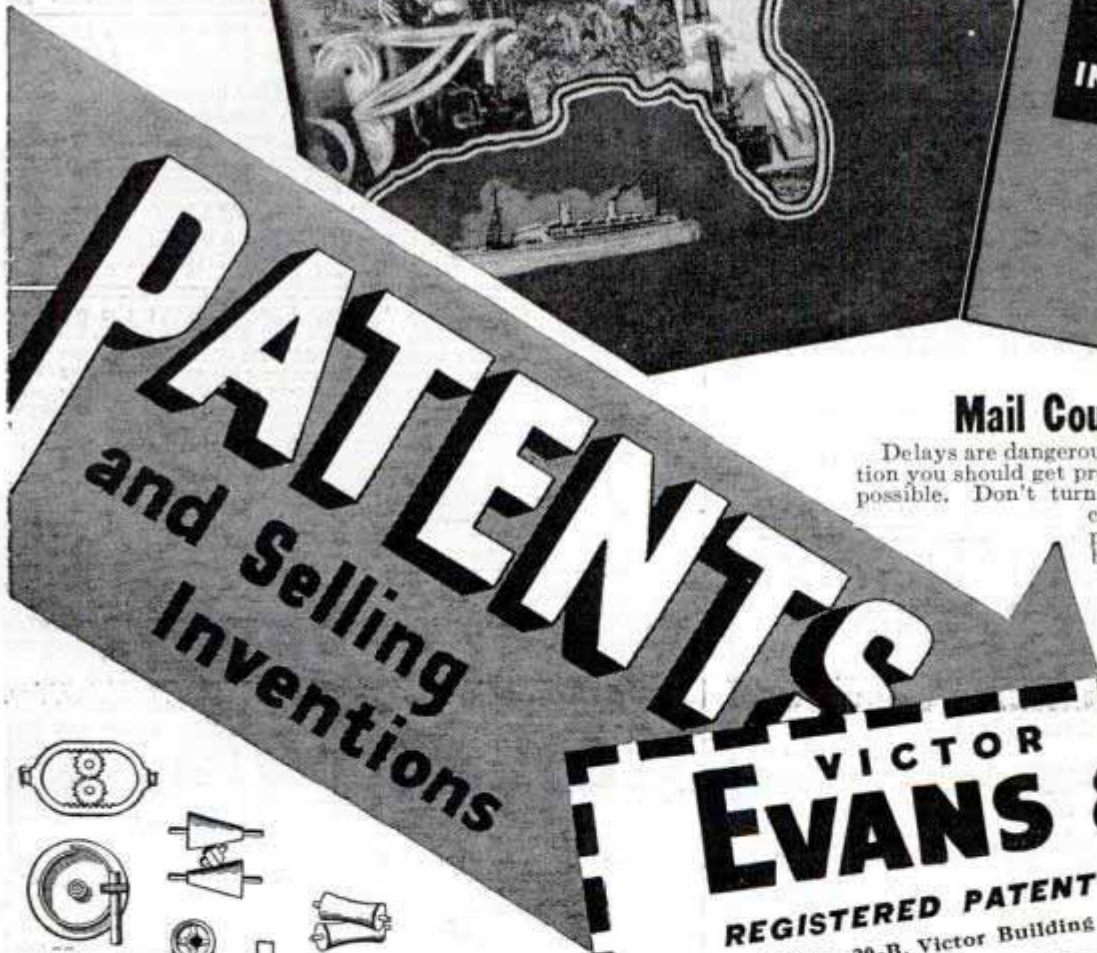

Mail Coupon Today

Delays are dangerous. If you have a good invention you should get protection for it just as soon as possible. Don't turn this page until you have clipped and mailed this coupon—you will hear from us by return mail.



115 Mechanical Principles Shown

Request the book "Patent Protection" (sent free to inventors). Not only does it tell you what to do for protection, and how to do it—it also shows you 115 different mechanical movements that you may use in developing your own inventions. Inventors tell us they have found these useful.

**VICTOR J.
EVANS & Co.**

REGISTERED PATENT ATTORNEYS

Main Office: 20-B, Victor Building
Washington, D. C.
Other Offices: 2610-N, Singer Bldg., New York
1445-N, Monadnock Bldg., Chicago
1010-N, Hobart Bldg., San Francisco
405-N, Garfield Bldg., Los Angeles

Send me FREE copies of your books, "Patent Protection" and "When and How to Sell an Invention." (Note: Same books supplied by any of branch offices listed above.)

Name.....
Street and No.....
City or Town..... State.....

PATENTS

Booklet Free Highest References
 Promptness Assured Best Results
 Send drawing or model.

ALL BUSINESS GIVEN PROMPT AND PROPER ATTENTION

Listed Patent Lawyer in the latest editions of the Rand-McNally Directory of Bankers and Bank-Recommended Attorneys, published by Rand-McNally & Co., Chicago, Ill.; The Baggott & Ryall Directory of Guaranteed Attorneys, published by Legal Directory Corporation, Boston, Mass.; American Lawyers Annual, Cleveland, Ohio; Bankers Service Legal Directory, published by Bankers Service Co., Boston, Mass.; Eyre's Law List, 9 Park Place, New York City; Snow-Church Directory Co. Lawyers List, published in New York City, and the Central Guarantee Co., Bankers and Lawyers Directories, 630 Fifth Avenue, New York City.

WATSON E. COLEMAN, Victor Building, 724 Ninth Street, N. W.
REGISTERED PATENT LAWYER **WASHINGTON, D. C.**

INVENTORS PATENT YOUR IDEAS SEND FOR FREE BOOK



HOW TO OBTAIN A PATENT

Written by a Former Member of the Examining Corps (1922-24) of the U.S. Patent Office. If you want to profit by your idea, you should take steps to apply for a U. S. Patent at once. Your first step is to get this Free Book. This interesting illustrated book contains valuable information you should have. It tells you fully how to obtain a patent on your idea in the quickest way. With this Free Book you will also receive a "Record of Invention" form on which you can easily record your idea. Personal and Confidential Service: Your case will be personally handled only by a Registered Patent Attorney who is also a Former Member of the Examining Corps of the U. S. Patent Office. All communications confidential.

MAIL COUPON TODAY for FREE PATENT BOOK and RECORD OF INVENTION Form.

CARL MILLER
 REGISTERED PATENT ATTORNEY
 FORMER MEMBER EXAMINING CORPS U. S. PATENT OFFICE

Woolworth Bldg., 35th Floor, Dept. 28A, New York City
 MILLER BUILDING, Dept. 28A, WASHINGTON, D. C.
 Please send me your Free Book, "How to Obtain a Patent," and your "Record of Invention" form.

NAME.....

ADDRESS.....

PATENTS—TRADE MARKS

All inventions submitted held confidential and given personal attention by members of the firm. Form, "Evidence of Conception" and instructions, "How to Establish Your Rights"—FREE!

LANCASTER, ALLWINE & ROMMEL

Patent Law Offices
 412 Bowen Bldg. Washington, D. C.



G E A R S

In Stock—Immediate Delivery

Gears, speed reducers, sprockets, thrust bearings, flexible couplings, pulleys, etc. A complete line is carried in our Chicago stock. Can also quote on special gears of any kind. Send us your blueprints and inquiries.

Write for Catalog No. 10

CHICAGO GEAR WORKS
 769-773 W. Jackson Blvd. CHICAGO, ILL.

Inventions Wanted Patented or Unpatented

We have been successfully selling inventions, patented and unpatented, since 1924. Write for proof, and tell us what you have for sale.

Chartered Institute of American Inventors
 Dept. 4, Barrister Building, Washington, D. C.

INVENTORS who derive largest profits know and heed certain simple but vital facts before applying for patents. Our book, Patent-Sense, gives those facts; sent free. Trade Marks—Copyrights. LACEY & LACEY, Est. 1869, 635 F St., N. W., Dept. 5, WASHINGTON, D. C.

ALBERT E. DIETERICH
THEODORE H. RUTLEY
 REGISTERED PATENT LAWYERS
 512 B Colorado Bldg. WASHINGTON, D. C.
Booklet on Patents sent free

No JOKE TO BE DEAF

—Every deaf person knows that—
 Mr. Way made himself hear his watch tick after being deaf for twenty-five years, with his Artificial Ear Drums. He wore them day and night. They stopped his head noises. They are invisible and comfortable, no wires or batteries. Write for TRUE STORY. Also booklet on Deafness.



729 McKenney Bldg. Detroit, Michigan

BUCHSTEIN'S FIBRE LIMB



is soothing to your stump—strong, cool, neat, light. Easy payments. Braces for all deformities. Agents wanted.

Send for Catalog Today

D. BUCHSTEIN CO.
 610 3rd Ave., So., MINNEAPOLIS, MINN.

SKIN RASH

RELIEVED...ITCHING STOPPED

For quick relief from itching of eczema, rashes, pimples, athlete's foot, and other externally caused skin eruptions, use cooling, anti-septic, liquid **D. D. D. PRESCRIPTION**. Greaseless, stainless, dries fast. Stops the most intense itching in a hurry. A 35c trial bottle, at all drug stores, proves it—or your money back.

D. D. D. Prescription

To PROTECT YOUR INVENTION—Use this coupon, NOW

Delays are dangerous and may be very costly. My personal service assures prompt action, strict confidence, and a minimum of expense. I suggest that you send me a model or drawing, or sketch and description of your invention, and \$5.00. I will make a search and report

promptly as to its patentability and send you a copy of my 72-page booklet. Or, if you prefer to read my booklet first, mail the attached coupon at once. I will also send my "Record of Invention" form. (Over 38 years experience as a Registered Patent Attorney.)

L. F. Randolph, 302-D Victor Bldg., Washington, D.C.

Please send me at once, free of charge, your 72-page booklet and "Record of Invention" form.

Name.....

Address.....

A PERSONAL CONFIDENTIAL PATENT SERVICE—

INVENTORS

Whether *YOUR* Invention Requires

A MECHANICAL
PATENT



A PROCESS OR
METHOD PATENT



A COMPOSITION
PATENT



A PLANT PATENT



A DESIGN PATENT



OUR FREE BOOKS Can Help YOU!

Our Patent Service Can Help YOU!

Securing broad patent protection for an invention requires specialized skill. Our business is confined exclusively to Patents, Trademarks and Copyrights. We have served inventors throughout the world for over 62 years. From the moment you send us a sketch and description of your invention, we take all the detailed work of the complicated patent process off your hands. Every member of our firm is a U. S. Registered Patent Attorney.

Take These Steps to Secure Broad Patent Protection

FIRST you will want to know exactly how the Patent Laws protect you, how much the cost will be, how to sell your invention. Our free books answer hundreds of questions about Patents and how to sell your invention. SECOND, we will make an examination through pertinent U. S. Patent Office records. Then we can tell you whether in our experienced opinion you can obtain a patent. THIRD, we will carry your case through the patent office with all possible speed, consistent with obtaining for you the broadest possible patent protection.

Finished Models or Drawings Are Not Necessary

Don't go to the expense of a costly model or finished drawings. All we need now is a sketch and description of your invention.

Our "Certification of Invention" illustrated on the right is valuable to you because after it has been properly filled out, signed, dated and witnessed, it can be offered as evidence in support of your claims should some other person endeavor to prevent you from protecting your invention by claiming prior rights. It is free. Send for it now and fill it out at once.



Don't Delay
Write Today!

• OUR DEFERRED PAYMENT PLAN

We have helped thousands of inventors with our deferred payment plan. This plan is very flexible. You may spread the cost of your Patent over several months in convenient payments.

The most important step is to GET STARTED. We can help you even though you cannot pay the full cost of your patent NOW.

Money Making Inventions Are Often Very Simple

Don't be discouraged if your invention isn't complicated. Many of the greatest money-making inventions are extremely simple. Then, too, your invention may be valuable even though it is very similar to an invention already patented. An improvement over some "gadget" already on the market may be patentable. Our free books go into this subject thoroughly.

Important Things to Remember

Secrecy in Patent matters is of the utmost importance. Your case will be treated with strict confidence from the moment you entrust us with your secret plans. We never buy inventions or sell them. Our only business is to serve inventors efficiently, quickly, and CONFIDENTIALLY.

C. A. SNOW & CO.

Registered Patent Attorneys Since 1875
SNOW BUILDING, WASHINGTON, D. C.



Suggestions
on how to
COMMERCIALIZE
INVENTION

HOW
WE
PROTECT
YOU

SEND FOR THEM TODAY!

C. A. SNOW & CO.

1010 SNOW BUILDING, WASHINGTON, D. C.

Gentlemen: Send me your free handbooks for inventors by return mail. No obligation on my part.

Name _____

Address _____

City _____ State _____

FREE "CERTIFICATION
OF INVENTION"

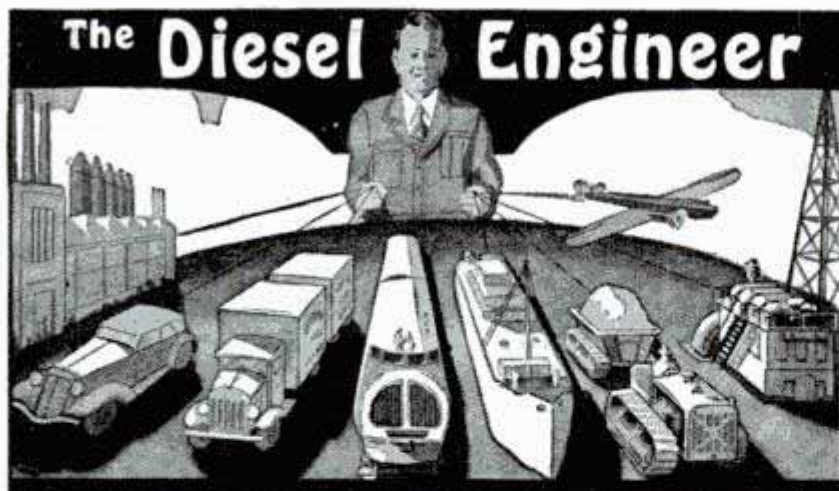

The Diesel Engineer

Is Your Job Safe?

Just as the gasoline engine changed the jobs of thousands who depended on horse-drawn vehicles for their living—so now the Diesel engine is fast invading both the power and transportation fields, and threatening the present jobs of thousands.

What This Field Offers You

Diesel engines are replacing steam and gasoline engines in power plants, motor trucks and busses, locomotives and ships, aircraft, tractors, dredges, pumps, etc.—opening up well-paid jobs for Diesel-trained men. You get all the latest Diesel developments in our course. Special diagrams for quick understanding of this new power.

2 Diesel Lessons Free

Men Over 18—Under 40

This opportunity is NOT open to boys under 18 or men over 40. But if you are WITHIN these ages, you owe it to yourself to investigate this opportunity of acquainting yourself with Diesel—the new, fast-growing field.

AMERICAN SCHOOL, Dept. D 245, Drexel Avenue at 58th Street, Chicago, Illinois

Test Yourself for a Good Pay Job—Steady Work

In your own home, learn about Diesel

No experience necessary. At our expense, see how plain every point is made—how thoroughly you grasp it—how greatly you will enjoy the work. If you are over 18 and under 40, send postcard, state age, and get 2 beginning lessons FREE. No obligation. This may be the turning point in your life, so write TODAY!

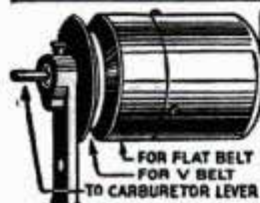

AUTO ENGINE SPEED CONTROL GOVERNORS

To control speed of any make of auto or truck engine, regardless of load changes, when used as a stationary or portable power plant. See Adv., Page 122A.

FOR FLAT BELT
FOR V BELT
TO CARBURETOR LEVER

CARTOON YOUR WAY TO SUCCESS!



DON'T COPY—LEARN TO ORIGINATE!

RAYE BURNS will teach you HOW to CREATE ORIGINAL CARTOONS at home that you can SELL! Course contains 26 lessons and over 600 illustrations. All for Only...

\$2.98

Send name and address for free details.

RAYE BURNS SCHOOL, Dept. 1, BOX 2194, Cleveland, Ohio

WANTED: TRAINED PILOTS and MECHANICS for BIG PAY JOBS IN AVIATION

Prepare Yourself at Lincoln for a Big Pay Job in Aviation. Exceptional opportunities for trained men. Airline Pilots earn up to \$700 a month; Mechanics up to \$200 a month. Millions of miles added to airline schedules—Hundred Million Dollars being spent this year on new airplanes. Lincoln Government Approved Flight Training prepares you for any Pilot's License including Commercial (Transport). Lincoln Government Approved Mechanics Training prepares you for Mechanic's License. 14 MODERN TRAINING PLANES. Lincoln has 12 laboratories and shops with large assortment of airplanes and engines for practical experience. Government Licensed Instructors. Lincoln Graduates in good demand. We assist graduates in locating positions. Write now for complete information. State age.

LINCOLN AIRPLANE & FLYING SCHOOL

265-H Aircraft Bldg.

Lincoln, Nebr.

LE'S Correspondence Courses in RADIO and ELECTRICAL ENGINEERING

SPECIAL Only \$2.5

ELECTRICAL ENGINEERING. Get good grasp of wide electrical field. Modern. Very understandable.
RADIO ENGINEERING. Extra fine course in radio, public address, photo-electric work. Trains you to be super-service man, real vacuum tube technician. Tuition ONLY \$25, either course. Deferred payment plan. Experiment kits furnished. WRITE TODAY for free copies of school catalogs, student magazines, etc.
LINCOLN ENGINEERING SCHOOL Box 531-62 Lincoln, Nebr.

Learn Public Speaking

At home—in spare time. Many overcome "stage-fright," gain self-confidence and increase earning power, this easy way. Write for free booklet, *How to Work Wonders With Words* and requirements.

North American Institute, Dept. 1352
3601 Michigan Ave., Chicago, Illinois



WHY NOT spend spring, summer, fall, gathering butterflies, insects. I buy hundreds of kinds for collections. Some worth \$1 to \$7 each. Simple outdoor work with my instructions, pictures, price list. Profit—pleasure. Send 10¢ (not stamps) for illustrated Prospectus before sending butterflies.
MR. SINCLAIR, DEALER IN INSECTS
Dept. 6, Box 1424 San Diego, Calif.

Men - Women (Age 18 to 50) 1938 GOVERNMENT JOBS

PAYING \$1260-\$2100 A YEAR TO START

Send for FREE LIST Telling About Jobs, Salaries, Automatic Raises, Vacations, Pensions

SOCIAL SECURITY EMPLOYEES TO BE HIRED THROUGH EXAMINATION

"We will advise you where examinations are held, and how to pass with a high rating for earliest possible appointment."

MAIL COUPON FOR FREE LIST

Arthur R. Patterson (Former Govt. Examiner), Principal, PATTERSON SCHOOL, 82 Case Bldg., Rochester, N. Y. Rush absolutely free, list of Govt. jobs, salaries paid, etc. Send the 48 page book telling how I may qualify.

Name.....
Address..... City..... State.....

Sickly, Skinny Pale-Faced Bill Had a Terrific Appetite—Yet Still Was MAL-

NOURISHED!

**No Wonder He Was Skinny,
Rundown, Tired-Out—With
Weakened Resistance**

**Your System Can Actually Starve On
a Full Stomach If It Does Not Get
Iron, Iodine and Vitamins That Enable
You to Get the Good Out of Food!**

**Thousands Report New Mineral—Vitamin
Concentrate From the Sea Adds Extra Pounds
of "Stay-There" Flesh, New Strength and
Energy the First Week!**

Malnourishment (an insufficient supply of minerals and vitamins) often explains why folks stay thin, ailing, worn out, with weakened resistance. Doctors know appetite satisfying foods are deceiving because frequently they lack vital minerals and essential vitamins needed for body building. As a result you do not get the good out of the food you eat and your system lacks in strength, energy and weight.

Many thousands of sickly, pale, ailing folks have found glorious relief with Kelpamalt. This amazing iron, iodine and vitamin concentrate is rich in vital elements necessary for the body's chemical processes. It contains assimilable iron, copper, phosphorous and calcium vitally needed for blood and tissue building. Most important is Kelpamalt's natural iodine—not to be confused with ordinary liquid, chemical iodine. Iodine, scientists say, is found in the blood, liver and glands. It is vitally important to their normal func-

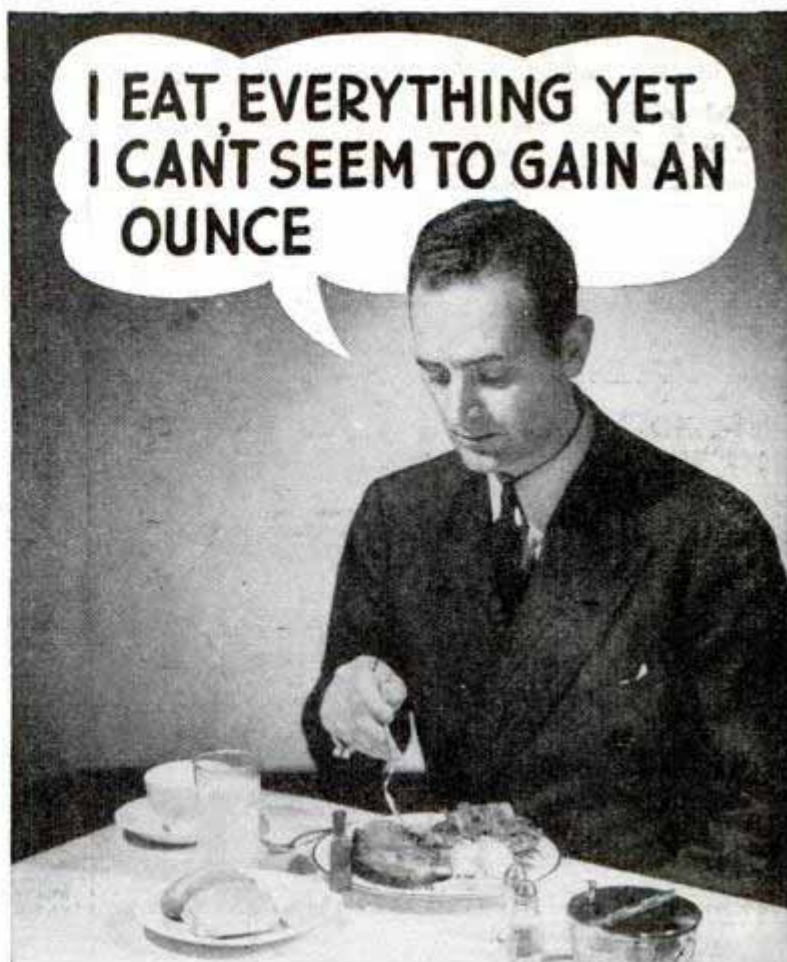

Posed by Professional Model

tioning. A recent report states that 60,000,000 people in the United States are not getting enough iodine in their daily food. Experts recommend the addition of two plates of oysters each week for their iodine, yet Kelpamalt is far richer in iodine than oysters.

In addition to these precious minerals, Kelpamalt contributes to the supply of the resistance building Vitamin A, the growth and body building Vitamin G, the blood building Vitamin C, and the bone building Vitamin D. It is only when there is an adequate supply of vitamins, plus minerals, that you can get the good out of your food.

Make This Simple Test

Try Seedol Kelpamalt for 1 week. See, if, like thousands of others you don't feel better, sleep better, eat better, and add at least 5 husky new pounds the first week. If you don't, the trial is free. It costs you nothing! Your own Doctor will approve this way. Get Seedol Kelpamalt now. It costs but a few cents a day to use and is sold at all good drugstores. Beware of cheap substitutes. Insist on the genuine.

SPECIAL FREE OFFER

Write today for fascinating instructive 50-page booklet on How Thousands Have Built Strength, Energy and Added Lbs. Quickly. Mineral and Vitamin contents of food and their effects on the human body. New facts about NATURAL IODINE. Standard weight and measurement charts. Daily menus for weight building. Absolutely free. No obligation. Kelpamalt Co., Dept. 1389, 27 W. 20th St., N. Y. C.

NAME.....
STREET.....
CITY.....

SEEDOL
Kelpamalt Tablets

**Turn JUNK
IN TO Cash!
TIRES
START
AT HOME**

The Most Sensational
Business Opportunity
Since 1929

Like turning lead into gold,
here is a business with gigan-
tic possibilities. Factories,
Clubs, Stores, Schools, Homes,
spend millions every year for
rubber mats. Think of your
profit when a

**HAND
MACHINE
and**

**5¢ TIRE
MAKES \$2.00 MAT**

Brand new. Fully patented. Few men already started
report unprecedented success. Wm. Eagle writes:
"Can't make mats fast enough. First week brought
over 200 orders for \$1.00 to \$10.00 each." Flash
from Harris says: "Orders enough to keep 15 men
busy all the time." Gunter got big order from
County Commissioners and now reports: "Just
signed up order for all Grade Schools and High
Schools." No wonder responsible men are
throwing everything else aside to establish
local FABRIX factories.

COSTS NOTHING to get complete facts. Just send name and address.
We'll send description of simple hand machine that quickly slices old
tire into strips; show you how patented method forms strips into thick,
springy, long-wearing FABRIX Mats—how five cents worth of Junk
Tires makes a \$2.00 Mat; how you can start on a reasonable investment
and build a business so big, so fast, that it will take your breath away.
Don't delay a minute. Write or wire today. All information is free.
FABRIX, Inc., 325 W. Huron St., Dept. 72, Chicago, Ill.



**Learn this
Profitable
Profession**



in 90 Days at Home

Hundreds of men and women of all ages 18-50 make \$10.00 to
\$20.00 in a single day giving scientific Swedish Massage and
Hydro-Therapy treatments. There is a **big demand** from
Hospitals, Sanitariums, Clubs, Doctors and private patients as
well as opportunities for establishing your own office.
Learn this interesting money-making profession in your own
home by mail, through our home study course. Same in-
structors as in our **NATIONALLY KNOWN** resident school.
A diploma is awarded upon completion of the course. Course
can be completed in 3 to 4 months. High School
training is not necessary. Many earn big money
while learning.

Anatomy Charts & Sample Lessons FREE

Enroll now and we will include uniform coat,
medical dictionary, patented reducing roller and
Hydro-Therapy supplies without extra cost. The
reducing course alone may be worth many times
the modest tuition fee.

Send coupon now for booklet containing photo-
graphs and letters from successful graduates,
illustrated sample lesson sheets and Anatomy
Charts. These will all be sent postpaid—FREE.



THE College of Swedish Massage (Successor to National College of Massage)
Dept. 277—1601 Warren Boulevard, Chicago
You may send me **FREE** and postpaid, Anatomy Charts, illustrated
sample lesson sheets and booklet containing photographs and letters
from graduates.

Name
Address
City..... State.....

**WIN A FREE TRIP
TO Italy (ALL EXPENSES PAID)**



Nunzio

● Would you like to take a trip
to Italy next summer, all ex-
penses paid? The opportunity
is yours. If you have never tried
to play an accordion, you are eli-
gible to enter Soprani's nation-
wide aptitude contest to win one
of these glorious vacation trips.
No special qualifications re-
quired. It is open to all ages;
juveniles will not have to com-
pete with adults. See your

SOPRANI ACCORDION dealer. Register im-
mediately with him. Or write direct for application
blank. But you must act at once. No applications
accepted after February 7. Final Contest July 9th. 188
SOPRANI, INC. Dept. 229, 630 S. Wabash Ave.
Chicago, Illinois

**Become an expert
photographer**

Get into this fascinating field. For pleasure or career. N. Y. L. famous method of
personalized instruction will make you an expert in **Commercial, News, Portrait,
Advertising, Candid or Motion Picture** photography. Big money-making oppor-
tunities. Personal Attendance and Home Study courses. 28th year. **Free booklet.**

NEW YORK INSTITUTE OF PHOTOGRAPHY
10 West 33 St. (Dept. 49) New York City

**Write
and
Speak
MASTERLY
ENGLISH**



Learn correct English with Sherwin Cody's new invention.
No rules to memorize. Like a fascinating game. Spare-
time study, 15 minutes each day, quickly gives you com-
mand of English. Send for free book, "How You Can
Master Good English in 15 Minutes a Day." Write today.
SHERWIN CODY SCHOOL OF ENGLISH
52 Searle Bldg. Rochester, N. Y.

MOUNT BIRDS — MAKE MONEY



**ALL
\$1**

COMPLETE TAXIDERMY COURSE
DIPLOMA FREE OF OTHER COST

**No
Other
Cost**

Due to tremendous sales volume, Schmidt's Original \$15.00 Professional Training in
Taxidermy **NOW ONLY \$1 COMPLETE.** 7 great books; 218 subjects; 62 lessons.
Has taught thousands to mount birds, animals, game heads, fish; make novelties.
All seven books—whole course—only \$1. Nothing more to pay. All comes at once!
Starts you mounting first day. Send \$1. or pay postman \$1 plus postage. (Foreign
orders \$1 cash.) If not 100 per cent satisfied, money refunded at once.

Schmidt School of Taxidermy, Dept. J-2, Memphis, Tenn.

LEARN WATCHMAKING AND ENGRAVING

**BY OUR PROFIT-SHARING PLAN
OUR GRADUATES SUCCEED**
One of our Iowa students started in a very small way—now
doing over \$30,000 a year. Another in Wisconsin, over \$10,000
the first year. Day or night classes. Call or write for **FREE BOOK.**
Chicago School of Watchmaking, Dept. 6001, 155 N. Clark St., CHICAGO.

Auto-Diesel

Master a real trade. Auto Mechanics, Diesel Mechanics, Arc Welding, Acetylene
Welding, etc. Let us train you to be an expert Auto-Diesel Mechanic and help
you get a good job. The cost to you is reasonable. Learn on modern equipment
with tools under experienced instructors. Real shop work. Steam heated build-
ings. Room and board in our steam heated dormitory. We pay your fare to
Nashville. For free catalog write

Nashville Auto-Diesel School, Dept. 75, Nashville, Tenn.

When writing please mention Popular Mechanics

Work on ELECTRIC MOTORS

Get into the profitable business of rewinding and repairing electric motors. This home-study course will help those who wish to increase their knowledge of the subject, and will be of value to others responsible for maintenance of domestic, office and factory equipment. Free booklet.



**INTERNATIONAL
CORRESPONDENCE SCHOOLS**
Box 5505-J, Scranton, Penna.

Sensational New Kind of LACO OIL HEAT

\$50 to \$100
UNDER OTHERS

Here is positively the greatest improvement ever made in Automatic Oil Heating! A remarkable new 1938 model of the famous LACO, priced \$50 to \$100 under others actually cuts fuel cost 25%! Needs no attention. Saves usual furnace dirt and work. Amazingly quiet. Only 1 moving part. Approved by Underwriter's Laboratories. Built by one of the world's largest manufacturers. Over 65,000 in use!

WRITE See your LACO dealer. Or, write us for special Direct Price!
DEALERS: Get Free Sample Burner Offer! Laco Oil Burner Co., 128 Union Ave., Griswold, Ia.



LACO HEATER

Clean, automatic oil heat without a basement. Inner heating unit saves fuel. Handsome as finest furniture. **WRITE!**



Earn Cash at Home!

Raise giant Patented Mushrooms! We supply materials, instruct with pictures, & our 25 branches buy all crops. Big **FREE** book, photos, tell if your cellar, shed, barn, etc., suitable. Write today.
Est. 1908. **UNITED CO.**, 3848 Lincoln Ave., Dept. 306, CHICAGO

EARN THE DEGREE

Doctor of Psychology (Ph.D.), Philosophy, Science, General Courses—Arts, Law, Business, etc. "CHARTERED BY STATE OF MONTANA." Send for **FREE** Bulletin at once. No Obligation.
Temple Bar College, Dept. 2-R, 213 East Main Street
Missoula, Montana, U. S. A.

TELEGRAPHY

both Morse and radio taught thoroly. R. R. retirement act creating splendid demand for Operators. Recognized outstanding school; estab. 1874. **All expenses low.** Catalog free.
DODGE'S INSTITUTE, Morse Street, Valparaiso, Ind.



Print Your Own

Cards, stationery, circulars, tags, labels, advertising, etc. **Save money. Print for Others: Big Profits;** easy rules sent. Will do popular Raised Printing like Engraving. Junior outfit \$8.85. Senior outfits \$12 and up. Send for free catalog and all details.
THE KELSEY COMPANY, D-37 MERIDEN, CONN.

MAIL FOR FREE INFORMATION

BEDFORD YMCA TRADE SCHOOL

1117 Bedford Ave., Dept. PM-57
Brooklyn, New York City, N. Y.

- Diesel Engines
- Diesel Engineering Oil Burner
- Aviation Mechanic Welding
- Aeronautical Engineering
- Auto Mechanic Talking Pictures
- Refrigeration Machine Shop
- Radio and Television Mechanic
- Air Conditioning
- Architectural-Mechanical Drafting
- Electrical Window Display
- Armature Winding

Name.....

Address.....

.....

NOW...YOU CAN LEARN TO DRAW AT HOME



ART BRINGS BOTH PLEASURE AND PROFIT

**USE
COUPON
FOR FREE
BOOK**

If you would like to acquire the ability to become an Artist, you can learn to draw AT HOME in your own SPARE TIME. Studying Art at home is actually fun. The new knowledge and skill you can gain this practical way should equip you to earn good money. Later you can start out "on your own"—and be your "own boss."

COMMERCIAL ART • DESIGNING • CARTOONING All in ONE Practical Course

Maybe you have never studied Art before—perhaps you have always wanted to—if so, it is not too late to start now. Washington School of Art has been established 24 years. Our intensive course of training includes all the important branches of Commercial Art. Our plan is fascinating, pleasant, and can be made profitable. We invite you to write for full details.

TWO ARTISTS' OUTFITS Included in the W. S. A. Course

Upon enrollment you will receive the first Commercial Artist's Outfit which includes everything needed to start the course. Later on a more advanced set of Art materials will be furnished. **Use Coupon Now! It brings you the details by return mail.**



★ FREE BOOK shows how! WASHINGTON SCHOOL of ART

EST
1914

Studio 122E, 1115—15th Street, N. W.
Washington, D. C.

I am interested in learning to draw. Please mail me your **FREE** Book, "Art for Pleasure and Profit."

Name.....

Address.....

City..... State.....

Age..... Occupation.....

It's Easy TO TRAIN FOR RADIO

IN MY BIG CHICAGO SHOPS



"LEARN BY DOING" IN 12 WEEKS

Here in Chicago, where my big Coyne Training Shops are located, you can train for your start for a good pay job. NOT by correspondence . . . or embarrassing reciting . . . but by **Actual, Practical Shop Work**, on real Radio, Television and sound equipment. You don't need previous experience or a lot of education, with our **Learn-by-Doing Methods**. You are first told how to do a thing—Then you are shown how to do it—Then you do the work yourself under the guidance of expert instructors.

PAY TUITION AFTER GRADUATION

Send the Coupon today and I'll tell you all about my quick, easy way to train for your start to a good pay job and a real future in the giant Radio Industry. I'll also tell you how you can get training first . . . then pay tuition in easy monthly payments starting 60 days after your regular 12 weeks' training period.

Earn While Learning Lifetime Employment Service

If you need Part Time Work to help pay living expenses while training, my Employment Department will help you get a part time job. Then after graduation, we will give you **FREE Lifetime Employment Service**.

ELECTRIC REFRIGERATION Training At No Extra Cost

This combination training (Radio and Refrigeration) can be of great value to you. Many Radio manufacturers also make Electric Refrigerators and men with this combination training are much more valuable. You can NOW get this training without extra cost.

SEND COUPON TODAY!

H. C. LEWIS, President,
Radio Division, Coyne Electrical School,
500 S. Paulina St., Dept. 28-3H, Chicago, Ill.
Dear Mr. Lewis: Please send me your Big FREE Book, and details of your "Pay-After-Graduation" Plan.

NAME.....
ADDRESS.....
CITY.....STATE.....



When writing please mention Popular Mechanics

TO YOUNG MEN—STENOTYPY THE WAY TO SUCCESS

Stenotypy, the new profession, offers unusual opportunities to ambitious young men. It's a man's way of recording speech in this machine age—a silent little machine that types plain print letters faster than anyone can talk. It opens up preferred jobs now—leads to executive careers later. One of the surest, quickest ways to get into Business on the right basis.

Now you can learn Stenotypy in your spare time. Low cost—convenient terms. Get full details. Write for valuable free booklet, "Advantages to You in Stenotypy," describing the unusual opportunities for young men in this growing field and telling how you may enter it successfully. Write Dept. 264-8T.

THE STENOTYPE COMPANY
4101 S. Michigan Ave., Chicago Ill.

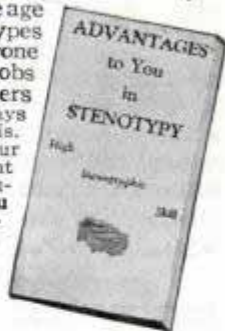

GAG-CARTOON!



AND MAKE BIG MONEY—AT HOME—BY MAIL! Magazines pay up to \$200.00 per cartoon. Get in this NEW FIELD and buy our own book! My 50 lesson—1000 illustration course shows you how. **FREE CARTOON MARKETS INCLUDED—\$280**

All for.....
Send for FREE details.
FREE drawing set with course.
MOON GAG-CARTOON SCHOOL
Paramount Bldg. Dept. A-5, Fall Creek, Wis.

Free AIR CONDITIONING AND REFRIGERATION TRIAL LESSON

Trained men needed. Good pay. Opportunities. Learn easily AT HOME in spare time. Write today for **FREE TRIAL LESSON**.

CHICAGO TECHNICAL COLLEGE
8302 Tech Bldg., 118 E. 26th St., Chicago, Ill.
If you can go away to college to learn Air Conditioning, Engineering, Architecture, Drafting, Electricity, or Radio, send for Free Blue Book

Tells How to Use—

Concrete About the Home; Concrete in the Garden and Yard; Concrete About the Farm; Concrete Homes and Buildings; Making Recreation Devices; Concrete in the Workshop; Concrete Products for Manufacture; Concrete in Business and Industry, etc. Gives 146 Concrete Kinks.



The Book of the hour for the workshop fan, handy man and home owner.

Money Making Facts - Best Methods - Materials - New Colored Concrete - 146 Kinks

"1001 Ways to Use Concrete" strips the mystery from the fascinating work of making useful articles and permanent improvements with concrete. This book, just published covers every known use of concrete for the home, farm, building, business and industry, plus newer uses in decoration and arts. Includes new fast setting and gloriously colored concrete and 146 valuable useable kinks. 1001 uses of concrete including homes, garden furniture, pools, statuary, etc., recreation devices, farm improvements, driveways, walks, etc. Describes all methods and materials. Shows how to do real professional type jobs.

NEW Concrete BOOK

Makes Cement Work of All Kinds Easy

256 Pages — 16 Colored Plates, Hundreds of Pictures

Large book 7 x 10 inches. Handsome cloth binding. Sent post-paid for only \$5. Sent COD in U. S. if preferred. Order today. Make concrete work a fascinating hobby or a profitable business.



What Strange Powers Did the Ancients Possess?

EVERY important discovery relating to mind power, sound thinking and cause and effect, as applied to self-advancement, was known centuries ago, before the masses could read and write. Much has been written about the wise men of old. A popular fallacy has it that their secrets of personal power and successful living were lost to the world. Knowledge of nature's laws, accumulated through the ages, is never lost. At times the great truths possessed by the sages were hidden from unscrupulous men in high places, but never destroyed.

Why Were Their Secrets Closely Guarded?

Only recently, as time is measured; not more than twenty generations ago, less than 1/100th of 1% of the earth's people were thought capable of receiving basic knowledge about the laws of life, for it is an elementary truism that knowledge is power and that power cannot be entrusted to the ignorant and the unworthy.

Wisdom is not readily attainable by the general public; nor recognized when right within reach. The average person absorbs a multitude of details about things, but goes through life without ever knowing where and how to acquire mastery of the fundamentals of the inner mind—that mysterious silent something which "whispers" to you from within.



Fundamental Laws of Nature

Your habits, accomplishments and weaknesses are the effects of causes. Your thoughts and actions are governed by fundamental laws. Example: The law of compensation is as fundamental as the laws of breathing, eating and sleeping. All fixed laws of nature are as fascinating to study as they are vital to understand for success in life.

You can learn to find and follow every basic law of life. You can begin at any time to discover a whole new world of interesting truths. You can start at once to awaken your inner powers of self-understanding and self-advancement. You can learn from one of the world's oldest institutions, first known in America in 1694. Enjoying the high regard of hundreds of leaders, thinkers and teachers, the order is known as the Rosicrucian Brotherhood. Its complete name is the "Ancient and Mystical Order Rosae Crucis," abbreviated by the initials "AMORC." The teachings of the Order are not sold, for it is not a commercial organization, nor is it a religious sect. It is a non-profit fraternity, a brotherhood in the true sense.

Not for General Distribution

Sincere men and women, in search of the truth—those who wish to fit in with the ways of the world—are invited to write for complimentary copy of the sealed booklet, "The Secret Heritage." It tells how to contact the librarian of the archives of AMORC for this rare knowledge. This booklet is not intended for general distribution; nor is it sent without request. It is therefore suggested that you write for your copy to the Scribe whose address is given in the coupon. The initial step is for you to take.

use
coupon
for free
copy of
booklet

Scribe: V. A. E., Rosicrucian Brotherhood, San Jose, California. Please send copy of sealed booklet, "The Secret Heritage," which I shall read as directed.

Name.....

Address.....

City.....



FOR applying liquids to the hair and scalp, a recently patented comb has a



reservoir with means for delivering the liquid over the length of each tooth. The reservoir, located in the head of the comb, has an opening through which the fluid is introduced.

Means for uniform distribution of the fluid to each tooth is another feature.

PREVENTING the electric cord from pulling out of service sockets, a recently patented device promises to solve one of the housewife's problems. It hooks on to the electric cord and the top of the light socket, or wall outlet, keeping the plug from pulling out until the housewife removes it. The device is handy for electric irons, toasters, vacuum sweepers and similar appliances used in the home.

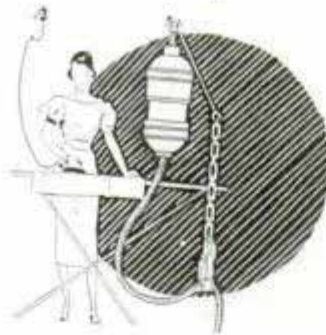

FOR distinguishing between genuine coins or like metallic articles having a known composition and spurious articles of other materials, an electrical device has been patented. First, the equipment produces an electric discharge having a spectrum characteristic of the material of the article being tested. Then the spectrum is directed toward a light-sensitive device, preventing all but certain pre-determined wave lengths peculiar to the spectrum of

a genuine article from affecting the device. The output of the light-sensitive device indicates whether the coin or article is genuine or spurious.

FOOTBALL players would welcome an invention, recently patented, which is



intended to relieve tackling practice of a certain amount of hazard. It consists of a flexible dummy, inside of which is a flexible, non-collapsible tube extending longitudinally.

The dummy is supported at top and bottom by a resilient suspension device extending into and through the tube. Thus, when a player hits the dummy, it gives way but does not fall nor swing outward, as do some practice devices now in use.

GOLFERS will find a recently patented club carrier convenient and less weighty. It has a frame made up of several sections, each section comprising a number of parallel tubes. Between each section is a plate and at each end of the frame the plates are countersunk to receive the ends of the tubes, providing a spacing and alining means for the corresponding tubes of each section. Certain of the plates are perforated to serve as separators for the clubs. A shoulder strap and a hand strap com-



(Continued to page 43A)

VACU-MATIC SCORES AGAIN!

BOB MCKENZIE
TRANSCONTINENTAL AUTOMOBILE CHAMPION
COAST TO COAST

WESTERN UNION
TIMED

NEW YORK
TO
LOS ANGELES
24 hrs. 45 min.

LOS ANGELES
TO
NEW YORK
27 hrs. 38 min.

CANADA
15,000 MILES
18 Days

LOS ANGELES
TO
NEW YORK
AND RETURN
181 hrs. 22 min.

WASHINGTON, D.C.
TO
MEXICO CITY
82 hrs. 27 min.

LOS ANGELES
TO
PHOENIX
8 hrs. 18 min.

MURKOC DRYLAKE
1937 M. IN 1 DAY

LOS ANGELES
TO
ANN ARBOR, MI.
3 hrs. 27 min.

ALIPAZ, NE.
HOUSTON, N. G.
4 hrs. 21 min.

Vacu-matic Carburetor Co.
7617 W. State St.
Wauwatosa, Wisconsin

Dear Sirs:

Having just completed a new speed record between Los Angeles and Chicago, driving a 1936 Chevrolet equipped with a Vacu-matic carburetor control, I thought you might be interested in knowing some of the facts and the important part Vacu-matic played in the success of the run.

The distance covered was 2322 miles in thirty nine hours and forty-two minutes, officially timed by Western Union, which gave me an average speed of 59.7 M.P.H. based on elapsed time and with the Vacu-matic averaged 18 1/2 miles per gallon on gasoline.

Before leaving Los Angeles, we made several test runs both with and without the Vacu-matic, and the tests proved that Vacu-matic increased my gas mileage 3 1/2 miles per gallon at the driving speed of 60 M.P.H. and also very noticeable increase in both acceleration and power.

After this experience with Vacu-matic, you can depend that on my future speed runs across country that I will be depending on Vacu-matic to give me the same added performance it has proven on this last record breaking drive.

Yours very truly,

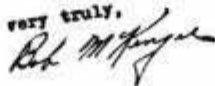

Sets New
Coast-to-Chicago
Record

New Supercharge
Principle
SAVES GAS

MORE POWER - MORE SPEED
FASTER PICK-UP - NEW LIFE

ESTABLISHING new mileage records on cars in all sections of the country, the Vacu-matic again scores in a new speed record established by Bob McKenzie transcontinental automobile champion. Los Angeles to Chicago—2,322 miles in 39 hours and 42 minutes—driving 75 and 80 to maintain a speed average of 59.7 miles per hour!

Here is speed—a gruelling grind—where quick acceleration, greater top speed—and less stops for gasoline mean those precious moments saved that make new speed records possible. The same Vacu-matic that helped Bob McKenzie establish this speed record and gave him such fine gas savings is now available for all car owners. It is positively automatic—simple to install—inexpensive—and pays for itself many times over in gas savings.

Automatic - - Nothing Like It!

Vacu-matic is *entirely different!* It operates on the supercharge principle by automatically adding a charge of extra oxygen, drawn free from the outer air, into the heart of the gas mixture. It is entirely AUTOMATIC and allows the motor to "breathe" at the correct time, opening and closing automatically as required. No idling troubles—no carburetor adjustments necessary. It is so simple it will amaze you—so practical it will save you many dollars on gas costs.

Fits All Cars

VACU-MATIC is constructed of six parts, assembled and fused into one unit, correctly adjusted and *sealed at the factory*. Nothing to regulate. Easily attached in ten minutes.

Agents and Salesmen

VACU-MATIC offers a splendid opportunity for unusual sales and profits. Valuable territories now being assigned. Check and mail coupon.

The VACU-MATIC Co. Wauwatosa, Wis.

Guaranteed Gas Savings

VACU-MATIC must prove itself on every car. It is guaranteed to give worthwhile gas savings, quicker pick-up and more power, or it costs you nothing. "On my V-8 Ford it works miracles", says Ralph Fields. James Seeley—"On an International Truck on a round trip to Cleveland, 385 miles, it saved 19 gallons of gas." A. V. Grove—"On the Buick it showed 5 miles more per gallon." F. S. Peck—"I average 22 miles per gal. on my Plymouth, an increase of 7 miles, for a saving of \$15.00 a month, or \$180.00 a year." Wm. Lyons—"Averaged 25 miles on a gal. with a Model A Ford at 40 miles per hour."

Free Details

You owe it to yourself to know all about this remarkable discovery. Mail the coupon below. Start saving gas with VACU-MATIC and enjoy a new driving thrill! There's no obligation—so get the facts now! Write today!

FREE OFFER COUPON

THE VACU-MATIC COMPANY
7617-300 W. State St., Wauwatosa, Wis.

Gentlemen: Please send me full particulars concerning the Vacu-matic and details of your Free Offer. This of course does not obligate me in any way.

Name

Address

City State

Check here if interested in selling proposition.

WORK FOR THE



GOVERNMENT START

\$1260 to \$2100 a Year

Many 1938 appointments expected

Railway Postal Clerks

Railway Postal Clerks get \$1,900 the first year regular, being paid on the first and fifteenth of each month. (\$79.17 each pay day.) Their pay is automatically increased yearly to \$2,450. Advance may be had to Chief Clerk at \$2,700 a year. (\$112.50 each pay day.)



Railway Postal Clerk, Minneapolis, Minn.

"I received my appointment as Railway Postal Clerk and have been working full time and some overtime. Your training taught me what to do and how to do it. To this training must go a large share of the credit."

O. K. Dornholdt,
Minneapolis, Minn.

3 Days On—3 Days Off—Full Pay

Railway Postal Clerks on long runs usually work 3 days and have 3 days off duty or in same proportion. During this off duty their pay continues just as though they were working. They travel on a pass when on business. When they grow old, they are retired with a pension.

City Mail Carriers, Post Office Clerks

Clerks and Carriers now get \$1,700 the first year on regular and automatically increase \$100 a year to \$2,100 and \$2,300.



Working Mail Carrier, Philadelphia, Pa.

"As a result of your training I stood 96.8 per cent and was appointed Mail Carrier soon after the examination and am now working. I was also offered a position as Railway Postal Clerk."

Kenneth Albert,
Philadelphia, Pa.

Customs Inspector

Salary \$2,100 to start. Men 23 to 45. Work connected with examining baggage and merchandise entering the country from foreign parts covering boats, trains, roads, automobiles, etc.

Many Other Positions

Many other positions are obtainable. Those wishing these positions should qualify at once.

Get Free List of Positions

Fill out the following coupon. Tear it off and mail it today—now, at once.

This investment may result in your getting a big-paid government job.

FRANKLIN INSTITUTE, Dept. M173, Rochester, N. Y.

Rush to me, entirely free of charge (1) a full description of U. S. Government Jobs; (2) Free copy of illustrated 32-page book, "How to Get a Government Job"; with (3) List of U. S. Government Jobs; (4) Tell me what to do to qualify for a U. S. Government Job.

Name.....

Address.....

Use This Coupon Before You Mislaid It. Write or Print Plainly.

When writing please mention Popular Mechanics

GET A JOB

in SCIENTIFIC
CRIME DETECTION

One of the world's most highly endorsed trainings, supervised by former

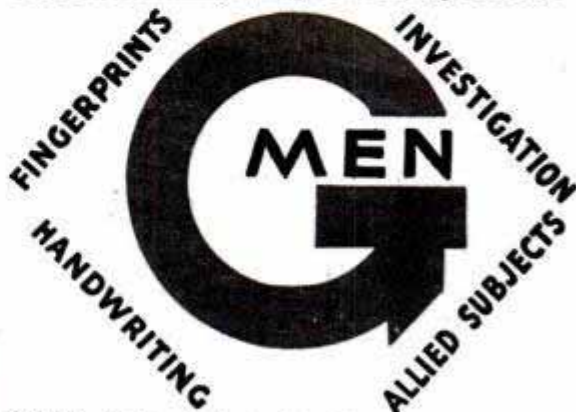

quickly puts students in direct line for important BIG PAY positions in this young, fast growing, lucrative profession.

If you are over 17 years of age, send TODAY for big FREE book containing full information and 14 famous scientifically solved crime cases.

Scientific Crime Detection Institute of America, Inc. J. T. Burdette, Pres.
Dept. 2B8 C & O Bldg.,
Huntington, W. Va.

LEARN RADIO TELEVISION

Color-Coded Extension Training fits you for better radio jobs—prepares for future television opportunities. Backed by 5000-watt Columbia basic network broadcasting station, KMBC. Graduates qualified to take Government operator's license exams. Lifetime employment service. All necessary equipment for 'home laboratory' experiments furnished; 90 illustrated lessons, 10 laboratory manuals. After "home training," bus ticket to Kansas City for 4 weeks' intensive training in laboratories. Get facts—write for free catalog.

MIDLAND TELEVISION, Inc., Power & Light Bldg.,
106-B W. 14th St., Kansas City, Mo.

LETTERING ARTISTS MAKE Big MONEY



BE A SUCCESS—LEARN SHOW CARD PROFESSION "THE ACME STUDIO WAY"—Spend 2 full weeks our Big Chicago Studios—finish training spare time at Home. Hundreds taught this way now receive Big Pay. Free Employment service. Positions waiting. Earn while learning. E Z low terms within reach of all. MONEY BACK GUARANTEE—NO RISK—PROVED PLAN. Name, address and present occupation brings FREE ABILITY TEST AND BOOKLET.

ACME STUDIOS, Dept. PM-2, 24 W. Hubbard St., Chicago, Ill.

FREE "Why Diesel Means Dollars to You!"

TELLS HOW YOU CAN EASILY LEARN DIESEL AT HOME . . . OR AT JOURDEN SCHOOLS in Philadelphia, Pittsburgh, Cincinnati or Baltimore.

WRITE TODAY for your copy of our Free Illustrated Booklet—"WHY DIESEL MEANS DOLLARS TO YOU!" Learn about the Big Opportunities for trained men. See how Jourden courses are helping men to get BIGGER PAY. They will help you, too. WRITE TODAY!

JOURDEN DIESEL SCHOOLS
2832A N. Broad St., Philadelphia, Pa.



WOULD YOU LIKE TO BE A PRACTICAL ELECTRICIAN?

● Do things around the house, develop a hobby, and maybe earn an extra dollar occasionally? Here's a spare-time course of study that will provide you with the training you need!

INTERNATIONAL CORRESPONDENCE SCHOOLS
Box 5504-J, Scranton, Penna.

CARTOONING

PAYS WELL

Turn your talent into dollars. Develop your ability with personal instruction from an internationally-known cartoonist. His exclusive, successful method of drawing and creating ideas makes it easy to attain success. Write for Free Booklet and details of this exceptional home-study course. No salesman will call.

National School of Cartooning, 437 Penton Building, Cleveland, Ohio

Learn ADVERTISING at Home

Greater opportunities now in advertising. Learn easily and quickly in spare time. Practical work. No text books. Old established school. Low tuition—Easy terms. Send for free booklet and requirements.

Page-Davis School of Advertising
Dept. 1352, 3601 Mich. Av., Chicago

GUITAR

HAMANN INSTITUTE, 3016 N. 24th Place, R-2, MILWAUKEE, WIS.

You'll enjoy learning for less than 2c a day. Full particulars Free. Write today.

MONEY MAKING

Formulas

NOW ONLY \$1.25



1059 Priceless Recipes. The kind that have made Fortunes for others. Now in Book Form.

Do you want to make extra money—establish a part-time or full-time business of your own? Then get **MONEY-MAKING FORMULAS** now. It tells you how to make hundreds of saleable products. Tells you what to use, where to get materials and how to turn

simple, inexpensive ingredients into real profits. No experience required. Practically no capital needed. Order this amazing 200-page book and get started on an interesting and profitable career.

Big fortunes have been made from a simple formula. Hundreds of well known, advertised articles you see in the stores were started on a "shoestring"—with a good formula and just a few dollars. The hit of this year might easily be yours—even bring you fame and fortune.

Complete in one book—1059 priceless formulas—all instructions and manufacturing processes—where to get the raw materials—everything you need to know. Send for your copy now.

Get the book that lifts the veil of secrecy from an interesting, fascinating and money-making business opportunity. Complete—Only \$1.25 postpaid. Write today.

Millions from Formulas Like These

- Cosmetics
- Remedies
- Auto Products
- Beverages
- Food Products
- Paints
- Glues
- Polishes
- Inks
- Fertilizers
- Preservatives
- Soaps
- Lubricants
- Metal Products, Etc.

Popular Mechanics Press, Dept. 238C, 200 E. Ontario St., Chicago

They Need MORE PICTURES!



HOW TO CASH IN WITH YOUR CAMERA!



PICTURES! PICTURES! Magazine and newspaper readers demand MORE! Editors are clamoring for them! Dozens of NEW picture magazines—and thousands of other magazines, newspapers, trade papers,—are paying HARD CASH for them!

How can YOU cash in on this demand? Use YOUR OWN CAMERA. You don't have to know how to take smart "angle" shots, "arty" views, or technically beautiful photographs! What editors are BUYING are pictures with news value, popular appeal, HUMAN INTEREST! Pictures you can take in your own backyard, on your own street, in your own home town.

Learn WHAT to photograph, HOW to photograph it, WHERE to SELL it, and you can "cash in"!

FREE BOOK

This FREE BOOK tells how you can learn to take the kind of pictures that sell—and all about the home-training course that has enabled hundreds of amateurs to turn their hobby into a profitable business. And you can pay for the course in small monthly payments!

Get YOUR share of the money being paid every month for photographs. The world is going PICTURE-CRAZY! Just look over the magazines on the newsstands YOURSELF! Find out NOW how to make money with YOUR camera. Send coupon for FREE BOOK—today! UNIVERSAL PHOTOGRAPHERS, Inc., Dept. 72, 10 W. 33rd St., N. Y. City.



3 Checks In 1 Week!

York McClary, of Belvidere, Ill., writes: "Have received 3 checks this week. One was for \$237.50." Olive Hastings, Dorchester, Mass.

Made \$237.50 While Still Learning!

"Have added up how much I have taken in since I sold my first picture. I have made \$237.50!" Olive Hastings, Dorchester, Mass.

\$50 For His Very First Work!

Well-known magazine paid L. D. Eldridge, of St. Paul, Minn., \$50.00 for very first work submitted.

UNIVERSAL PHOTOGRAPHERS, Inc., Dept. 72, 10 West 33rd Street, New York City

Please send me your FREE BOOK, "How To Make Money With Your Camera," which explains about your home study course. No salesman will call on me.

Name

Address

City..... State.....

When writing please mention Popular Mechanics

Get on the BIG AIR CONDITIONING AND REFRIGERATION PAYROLL

Air Conditioning and Refrigeration need YOU. There are thousands more good-pay jobs than trained men to fill them—in designing, manufacturing, distributing, selling, estimating, installing, and operating ends of this booming industry. Whatever your talents—mechanical, engineering, sales, or executive—here's interesting work with a big future . . . IF you get the NECESSARY training.

HERE'S HOW

Get this big FREE book, "The Air You Breathe." Tells how YOU can qualify for YOUR job . . . through Thermo Institute training. Three large, splendidly equipped schools bring your training closer home—OR, wherever you may live, you can get Thermo Institute training right in your own home. It's certainly worth sending the coupon for complete details.



THERMO AIR CONDITIONING INSTITUTE

RESIDENT SCHOOLS 1755-A Broadway, New York
125-A West Hubbard Street, Chicago
182 South Alvarado, Los Angeles

Please send free book on Air Conditioning and Refrigeration opportunities and complete information on Thermo Institute resident and "home-and-shop" courses.

Name _____ Age _____
Address _____
City _____ State _____ t-7-p



DRAFTING

BOOKS SENT FREE!

ON APPROVAL
5 VOLUMES BRAND NEW EDITION
Only 15 minutes a day with these WONDER BOOKS can prepare you for a good drafting job in less than a year. Mechanical and architectural drafting from simple straight lines to important complex plans. *A step at a time!* Built especially for beginners, for men with only grammar schooling. Drafting room practice. PLUS ENGINEERING, made easy and clear. Includes complete course in blueprint reading.

Big Field Big Demand Big Pay
Competent draftsmen are urgently needed right now in all building and manufacturing lines at \$30.00 to \$75.00 a week. That's just the beginning—FOR DRAFTSMEN HAVE THE BEST CHANCES FOR ADVANCEMENT. Pleasant, fascinating work, easy to learn and do. Learn quickly with these books—send coupon for a set and see for yourself.

A year's consulting membership in the American Technical Society now given to all readers of this famous cyclopedia of drafting. Many say that it is worth more than the cost of 12 books. Complete set of drawing instruments if you send for these drafting books NOW. These instruments are made of the finest of German silver, are absolutely accurate and are packed in velvet lined leatherette pocket case. Real \$10 value, but included with these books.

AMERICAN TECHNICAL SOCIETY
Dept. D219, Drexel at 58th St., Chicago, Ill.

American Technical Society, Dept. D219, Drexel at 58th St., Chicago, Ill. Send for 10 days' trial New 5 volume set of drafting. I will pay the few cents delivery charges. If I wish, I may return books in 10 days and owe you nothing but if I decide to keep them, I will send \$2.00 after 10 days, then only \$3.00 a month until \$24.80, the advertising price, is paid. Send latest edition and include drawing instruments and Membership Certificate.

Name _____
Address _____
Attach letter stating age, occupation, employer's name and address and that of at least one business man as a reference.

When writing please mention Popular Mechanics



Learn to Write

BEGIN TODAY! Write for our Free Book, "HOW TO BECOME A GOOD PENMAN"

It contains specimens and tells how others learned to write in spare time. Your name beautifully written on a card if you enclose stamp for postage. Over 40 years experience teaching by mail. **WRITE TODAY**

THE TAMBLYN SCHOOL OF PENMANSHIP
418 Ridge Bldg. Kansas City, Mo.

The Tamblyn School



DO YOU LIKE TO DRAW?

It's easy to learn when shown in the right way. E. C. SEGAR who draws "POPEYE," CHESTER GOULD who draws "DICK TRACY," "LANK" LEONARD — "MICKY FINN" and many other famous cartoonists and comic strip artists learned how to draw during their spare time by following **CARTOONIST EVANS' SIMPLE, EASY, INEXPENSIVE COURSE.** Send 6c in stamps for full details.

THE W. L. EVANS SCHOOL OF CARTOONING
521 Premier Bldg. Cleveland, Ohio

LEARN HOW TO Study!

GET MORE REAL HELP FROM YOUR BOOKS AND COURSES. Learn the best way to plan your work and work your plan. Amazing new course teaches you "How to Study and Work for Best Results." Used by home-study students, business and trade schools throughout world. Full price only \$1 postpaid. Or C O D, plus postage. Satisfaction or money back. For free details send penny postcard. No obligation. Write Today!
PLYMOUTH SCHOOLS, Dept. 205, 432 Plymouth Ct., Chicago

ARTISTS MAKE MONEY

Find out your ability. Send name, age, occupation and address for Free Vocational Art Test.
Federal Schools, Inc., 2138 Federal Schools Bldg., Minneapolis, Minn.

New Radio-Electrical Experiment LIBRARY

15-Vol. \$3.98
Newest, popular-size books now yours at Low Prices, only 20c, up! By nationally known authorities! Crystal-clear. Profusely illustrated. Set includes Short Courses in Radio, Electricity, Mathematics—Radio-Electrical Experiments—Etc., Etc. **POSTPAID.** Send only \$3.98 for complete 15-Vol. Library! Or, mail card for Free Folder describing our full line of Low Priced Books!
ELECTRONIC PUB. COMPANY, Box 323-U, Lincoln, Nebr.

CRIME DETECTION

Prepare for a Thrilling Career in Fingerprinting and Secret Service. Write for Free Publications and Particulars if age 17 or over.
NATIONAL INSTITUTE, 340-G Electric Bldg., Omaha, Nebr.

MAKE MONEY AT HOME!

Learn to color photos and miniatures in oil. No previous experience needed. Good demand. Send for free booklet, "Make Money at Home" and requirements.
NATIONAL ART SCHOOL
3601 Michigan Ave. Dept. 1352 Chicago

don't WORRY

Why put up with years of needless discomfort and worry? Try a Brooks Automatic Air Cushion. This marvelous appliance permits the opening to close, yet holds reducible rupture securely, comfortably—day and night. Thousands report amazing results. Light, neat-fitting. No hard pads or stiff springs to chafe or gouge. Made for men, women and children. Durable, cheap, **Sent on trial** to prove it. Never sold in stores. Beware of imitations. Write for Free Book on Rupture, no-risk trial order plan, and proof of results. All correspondence confidential.
BROOKS COMPANY, 111-M State St., Marshall, Mich.



NEW INVENTIONS ^{es 1296}

(Continued from page 38A)

plete the carrier. The apparatus is particularly useful in good weather because it is not covered with leather or fabric, relieving caddy or player of that much weight.

UNUSUAL construction is a feature of a newly patented internal combustion

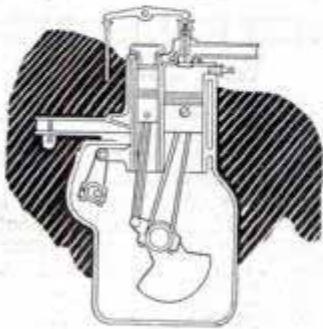

engine which has two cylinders, one large and one small. There is a means for developing high compression in the small cylinder and for opening a passage from the

small one into the large cylinder. Thus, after the charge is ignited in the small cylinder, it explodes into the large cylinder, entering with high velocity and creating intense turbulence before the spark ignites the charge in the large cylinder. Thus, the fuel mixture is more thoroughly atomized than in the ordinary engine.

AMONG the latest patents is one covering a method of silencing floor squeaks

in a laid wooden flooring in which there are cracks. The method consists of treating the squeaking portions of the floor through the cracks with a solution of paraffin



and rubber dissolved in a solvent. An applicator resembling an oil can is used.

FOR the home or office in regions where insects are numerous, a recent invention

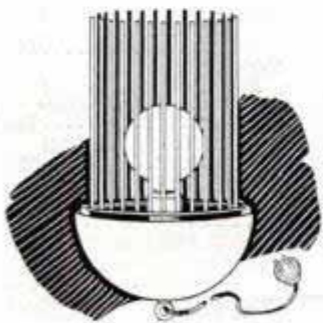

provides the means of electrocuting the pests. It consists of a socket into which is screwed an electric bulb. The socket may be hung on a nail. The device has

(Continued to page 70A)

Do you like RADIO? Does the future of TELEVISION

Interest You?

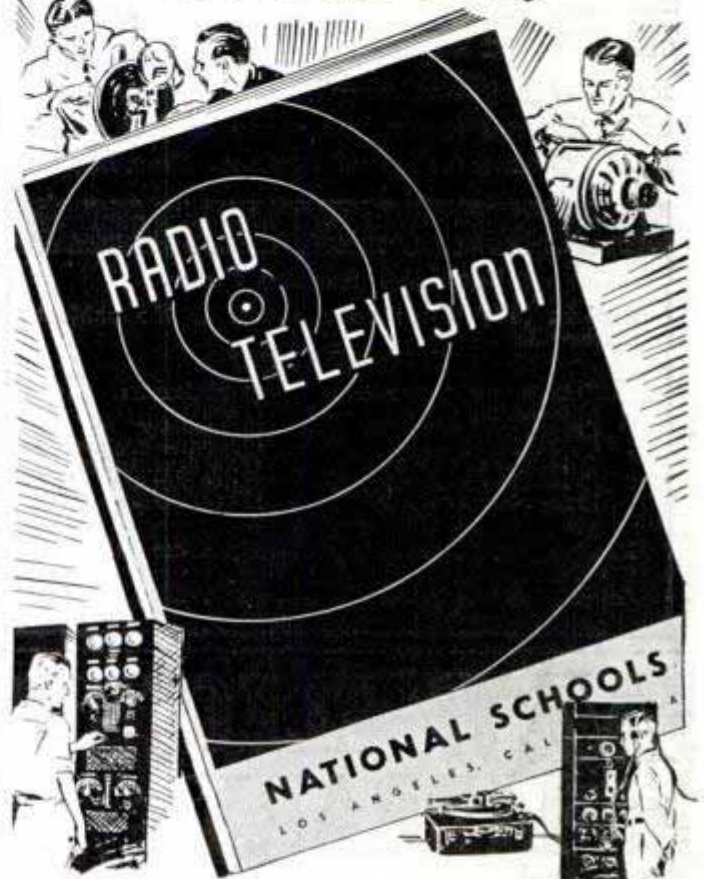

Send for your FREE COPY of this book of FACTS

Full of Instructive Information on
Employment Opportunities and
Requirements

You men who are sincerely ambitious to make good in radio and related industries will want a copy of this new book about employment opportunities and requirements. Written in plain, understandable language with no exaggerations and no mis-statements, this free book gives you facts you want to know about these profitable trades. 95 illustrations. Major subjects include Television Theory and Construction, Pick-up Systems, Amplifiers, Transmitters, Receivers, Cathode Tubes, Sound-Recording on disc, Loud Speakers, Talking Picture Projection and Radio Communication.

NATIONAL SCHOOLS is the oldest trade institution in the West. Established in 1905. Occupies its own modern three-story building, exclusively devoted to training ambitious men. Latest equipment. Selected, experienced staff of engineers and instructors. Many students can earn room and board while learning. National students are allowed coach railroad fare from any point in the United States.

NATIONAL SCHOOLS

Los Angeles

Request for FREE BOOK of Details

NATIONAL SCHOOLS

Dept. PMR-2 4000 So. Figueroa Street, Los Angeles, Calif.

NAME _____ AGE _____

ADDRESS _____

CITY _____ STATE _____

DIESEL POWER

A COMING AMERICAN INDUSTRY



Courtesy DIESEL PROGRESS

THE internal-combustion engine represents man's supreme triumph of machine power. Diesel engineers are in great demand.

Many are acquiring necessary knowledge through spare-time study of this modern I. C. S. Course on Diesel engines. Free booklet!

INTERNATIONAL CORRESPONDENCE SCHOOLS

Box 5502-J, Scranton, Penna.

Explain fully about your course in the subject marked X:

DIESEL POWER

- | | |
|---|---|
| <input type="checkbox"/> Mechanical Engineering | <input type="checkbox"/> Architecture |
| <input type="checkbox"/> Automobile Course | <input type="checkbox"/> Radio |
| <input type="checkbox"/> Concrete Construction | <input type="checkbox"/> Chemistry |
| <input type="checkbox"/> Civil Engineering | <input type="checkbox"/> Aviation Engines |
| <input type="checkbox"/> Gas Engine Operating | <input type="checkbox"/> Air Conditioning |
| <input type="checkbox"/> Electrical Engineering | <input type="checkbox"/> Refrigeration |
| <input type="checkbox"/> High School Subjects | <input type="checkbox"/> Civil Service |

Name..... Age.....

Address.....

NEW ELECTRIC LIBRARY

\$ 1.50 A VOLUME

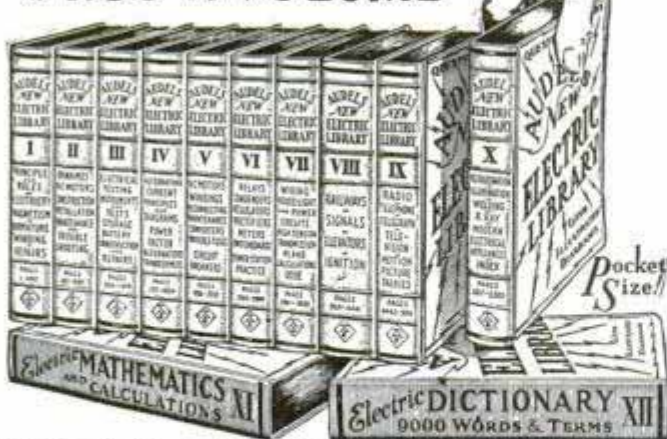

WHAT EVERY ELECTRICIAN WANTS TO KNOW!

Is easily found in AUDEL'S NEW ELECTRIC LIBRARY. Electricity made simple as ABC. Up-to-date, trade dope for the expert and ALL electrical workers. Questions, answers, diagrams, calculations, underwriter's code; design, construction, operation and maintenance of modern electrical machines and appliances FULLY COVERED.

All available at small cost, easy terms. BOOK-A-MONTH service puts this NEW information in your hands for 6c a day. You can start your subscription with any volume. Write TODAY for electric Folder and FREE TRIAL offer.

THEO. AUDEL & CO., 49 W. 23rd St., New York City

Mail Vol. I, Electric Library on 7 days' free trial. If O. K. I will remit \$1.50, otherwise I will return it. I also request you to mail one book each month on same terms. No obligation unless I am satisfied.

Name.....

Address.....

Occupation.....PM

NOW I KNOW WHAT FRED MEANT WHEN HE SAID HE GOT HIS PAY BOOST OUT OF A TWO DOLLAR BOOK.



PAY RAISING EXTRA MONEY BOOKS THAT WILL HELP YOU WIN SUCCESS

You, too, will find the selected list of practical books below just what you need to help you improve your job, prepare for a better one, or add to your income through spare time earnings. Thousands give these books credit for their success.

SEND NO MONEY! Use this advertisement as an order blank. Check books wanted. Add name and address and mail. Just pay postman price plus few cents postage. (In U. S. and possessions.) Or remit with order and add 10 cents per book for postage.

POPULAR MECHANICS PRESS

Room 238B 200 East Ontario Street Chicago

- AIR CONDITIONING**
Live Field; Great Future.....\$3.50
- AUTO ENCYCLOPEDIA**
The Famous Dyke's Latest Edition.....\$6.00
- 110-V. GENERATORS**
Made From Old Auto Units.....\$1.00
- BIRD HOUSES**
Build to Sell; Easy Designs.....\$1.00
- BLUEPRINT READING**
for the Building Trades.....\$1.25
- BOAT BOOK**
Power, Sail, Rowing, Paddle Plans.....\$3.00
- BOY MECHANIC**
Hundreds Things Boys Can Make.....\$2.00
- CARPENTRY, PRACTICAL**
Complete 436 pages. 1936 Edition.....\$2.00
- CHEMISTRY, PRACTICAL**
Make Hundreds Things Daily Use..\$2.00
- CIVIL SERVICE**
Home Study Courses Federal, State, City Positions.....\$1.00
- CONCRETE**
1001 Ideas for Using. New Popular Mechanics Book...\$5.00
- DIESEL HANDBOOK**
New! Latest Information.....\$5.00
- ELECTROPLATING**
With Copper, Nickel and Chromium Technical bulletin.....\$1.00
- FORD V-8 CARS, TRUCKS**
New. 700 Pages. Includes Details 1937 Cars.....\$2.50
- FORMULAS**
1059 Money Making. Start a Business...\$1.25
- FROG INDUSTRY**
New! Raise and Sell. Profits!.....\$1.00
- FURNITURE MAKING**
Tools, Materials, Design.....\$2.50
- HOUSES, SMALL**
Book of, for Home Builders.....\$2.00
- HYPNOTISM**
How to Become an Expert.....\$2.00
- LATHE WORK (Metal)**
Drilling, Threading...\$1.00
- LOCOMOTIVE**
Folding Chart Shows all Parts.....\$1.00
- LOG CABINS**
Easy Plans; Build for Profit, Value!.....\$2.50
- MATHEMATICS**
Easy Guide for the Practical Man.....\$1.50
- MECHANICAL DRAWING**
Learn Drafting; Good Salaries.....\$1.00
- MONEY MAKING IDEAS**
1000 Ways to Make \$1000.....\$2.50
- OFFICE MACHINES**
All Makes. Care and Operation.....\$2.50
- PLUMBING**
500 Facts Every Homeowner Should Know.....\$1.50
- TEST GOLD—PLATINUM**
Identify—Buy—Sell. By C. M. Hoke....\$1.00
- POWER TOOLS**
For Home Workshop..\$1.75
- PROSPECTOR'S HANDBOOK**
How to Mine, Appraise, Equip.....\$3.00
- RADIO SERVICING**
Profit by Knowing Costs, Kinks, Etc..\$4.00
- REFRIGERATION**
Electric. Gas. Be a Service Expert....\$5.00
- REWINDING ELECTRIC MOTORS**
Fractional Sizes. Value!.....\$2.50
- SHIP MODEL**
Entire Text, Famous "Sovereign" of 1637\$1.00
- SHOP NOTES LIBRARY**
5 Vol. 2000 Wonderful Shop Ideas.....\$2.50
- STAMP ALBUM**
Modern, 400 Pages...\$1.00
- STEEL SQUARE**
How to Figure Angles of Rafters, Roofs, Etc.....\$1.00
- TOYS**
For Amusement or Profit. Saleable Designs.....\$1.50
- TRAILER BUILDING**
New Book.....\$1.00
- UPHOLSTERY**
Always a Big Market. Start Own Business.\$2.00
- WOOD FINISHING**
Methods, Tools, Materials.....\$2.00



TIRE PUNCTURED 27 TIMES..

LEAKS NO AIR

1001 Repairs in Home, Auto, Farm For Only 1c EACH

New plastinoid "putty"—**SO-LO**—fills cracks, holes in tires, shoes, boots—anything of rubber, leather or cloth. Spreads on like butter. Dries tough. Waterproof, flexible, non-skid. Won't come off—guaranteed! 25c package (25 repairs) shows many uses. At any 10c or hardware store.

So-Lo

AIR CONDITIONING AND ELECTRIC REFRIGERATION INDUSTRY NEEDS TRAINED MEN

34 year-old organization now receiving applications of men to prepare for positions in Air Conditioning and Electric Refrigeration. Qualify in 3 months for Estimating, Installation, Service, Maintenance and Sales positions. No experience needed —we train you under actual working conditions in our own air conditioned laboratories. Free employment service. Get free book "Step Up to Success" —just off the press. Write

MILWAUKEE SCHOOL of ENGINEERING

1020-U North Broadway, Milwaukee, Wis.

JOBS for PHOTO-ENGRAVERS!!

EARN WHILE LEARNING PHOTO-ENGRAVING IN SPARE TIME—Photo-Engravers are needed to operate Tasope' Photo-Engraving Equipment we sell to publishers everywhere . . . Start training at home in spare time. We furnish all equipment including photo-engraving camera with lamps, lens and screen. Earn while learning by making engravings for local advertisers, newspapers, printers, etc. Copper plate for picture shown here, size 8x10 inches sells for \$15.37. SEND TODAY for job plan details and catalog illustrated with pictures engraved by equipment we furnish. No cost! No obligation.

THE AURORA SCHOOL OF PHOTO-ENGRAVING
Dept. 128 Aurora, Missouri

GUITAR

Gibson 88 PAGE CATALOG
WRITE FOR A COPY TODAY!

GIBSON, INC., Dept. D · Kalamazoo, Mich.

Learn CHALK TALKING

Entertain for all occasions. Send \$1.00 for Laugh Producing Program of 23 Trick Drawings with Instructions. Catalog of Chalk Talk Supplies 10c. BALDA ART SERVICE, Dept. K, Oshkosh, Wis.

Save Your Feet

Thousands get relief from painful feet and walk freely with **HEEFNER ARCH SUPPORTS**

Write for FOOT FACTS Tells how to aid nature in strengthening weak feet. It's FREE

HEEFNER ARCH SUPPORT CO. ... 661 Lewis Bldg., Salem, Va.

Learn a TRADE in 8 weeks

Many Good-Pay Jobs Are Available

Trained men are in demand and earn good money in these fascinating well-paying trades. This is not a correspondence school—no books—no lessons. Don't look for a job—TRAIN FOR IT. Read below how a McSweeney-trained man made good.

Trained men are in demand and earn good money in these fascinating well-paying trades. This is not a correspondence school—no books—no lessons. Don't look for a job—TRAIN FOR IT. Read below how a McSweeney-trained man made good.

- **AUTO MECHANICS**
- **AVIATION MECHANICS**
- **DIESEL MECHANICS**
- **Collision Repair (Complete)**
- **Body and Fender Repair**
- **Auto Painting**
- **WELDING—Arc and Gas**

You Get Actual Shop Training

Work on real equipment with real tools. In a few weeks you should be trained by actual work to hold down a Good Pay Job.

We get many letters like this

1801 E. 65th St., Cleveland, O. Dear Mac—Immediately after leaving school I went to work for United Motors and am now located in Cleveland where I hold a good position. I have been able to take care of the most complicated electrical jobs. I think I have done fine considering I had no experience before coming to your school. —Hubert Todd

LEARN NOW—PAY LATER!

We will give you complete information on how to get your training now and pay for it later out of your earnings.

FREE Write today for Big Free Book. Get the facts about jobs; and low Tuition Offers. Mailing the coupon does NOT obligate you. It obligates ME to tell YOU how you can train for Big Money in a few short weeks. Address Dept. 10-50

McSWEENEY SCHOOLS

DETROIT, MICH. and KANSAS CITY, MO.
Write Our School Nearest You

In Big New McSweeney Buildings

The finest of their kind. Every modern facility for thorough instruction.

DETROIT KANSAS CITY

McSWEENEY TRADE SCHOOL
Dept. 10-50, Detroit, Mich., or Kansas City, Mo.
Without cost or obligation send me your big FREE Book.

I am interested in the course on _____

Name _____

Street _____

Town _____ State _____ Age _____



MECHANICAL ENGINEERING

Pays Big NOW!

Less than 20 minutes a day with these 7 big mechanical engineering books entitled "Modern Shop Practice," will prepare you for a better job and bigger pay. Machine hands become foremen and superintendents, helpers become experts, foremen become managers. Any machinist, helper or factory employee can benefit QUICKLY and can command more money.

Your Opportunity Don't miss this chance to qualify for promotion, don't put off for one minute this Big Opportunity which is yours almost for the asking. Seven Big Books chockful of important mechanical facts told so simply and clearly that any one can understand them. Over 2600 pages, nearly 2700 illustrations cover every subject fully, including Tool Making, Pattern Making, Foundry Work, Mechanical Drawing, Forging, in fact anything you need to know. **Everything Sent FREE** for examination. Yes ALL of these books will be sent to you for examination. Decide in your own home or place of business whether or not you want to keep them, check up on any facts you want to. Note their great MONEY MAKING value, then, if you want them, pay on the easiest kind of payments.



Complete set of drawing instruments if you send for these books NOW. These instruments are made of the finest of German silver, are absolutely accurate and are packed in velvet lined leatherette pocket case. Real \$10 value but sent to you with these books without extra charge.

American Technical Society, Dept. 5213, Drexel at 58th St., Chicago
 You may send me the 7 big NEW books for free examination. I will pay the few cents delivery charges only unless I decide to keep them in which case I will send \$2.00 in ten days and \$3.00 per month until the total price of only \$29.80 is paid. If I return them in 10 days I will owe you nothing. Because I send now, you agree to give me a membership in the American Technical Society entitling me to Free consultation privileges with any of your experts for one year and set of drawing instruments.

Name.....
 Address.....
 Please attach a letter stating age, occupation, employer's name and address and that of at least one business man as reference.

AUDELS Carpenters and Builders Guides 4 vols. \$6



Inside Trade Information for Carpenters, Builders, Joiners, Building Mechanics and all Woodworkers. These Guides give you the short-cut instructions that you want—including new methods, ideas, solutions, plans, systems and money saving suggestions. An easy progressive course for the apprentice and student. A practical daily helper and Quick Reference for the master worker. Carpenters everywhere are using these Guides as a Helping Hand to Easier Work, Better Work and Better Pay. To get this assistance for yourself, simply fill in and mail the FREE COUPON below.

Inside Trade Information On:

How to use the steel square—How to file and set saws—How to build furniture—How to use a mitre box—How to use the chalk line—How to use rules and scales—How to make joints—Carpenters arithmetic—Solving mensuration problems—Estimating strength of timbers—How to set girders and sills—How to frame houses and roofs—How to estimate costs—How to build houses, barns, garages, bungalows, etc.—How to read and draw plans—Drawing up specifications—How to excavate—How to use settings 12, 13 and 17 on the steel square—How to build hoists and scaffolds—skylights—How to build stairs—How to put on interior trim—How to hang doors—How to lath-lay floors—How to paint.



THEO. AUDEL & CO., 49 W. 23rd St., New York City

Mail Audels Carpenters and Builders Guides, 4 vols., on 7 days' free trial. If O.K. I will remit \$1 in 7 days, and \$1 monthly until \$6 is paid. Otherwise I will return them. No obligation unless I am satisfied.

Name.....
 Address.....
 Occupation.....
 Reference..... P.M.

Increase Your Earning Power

Apply time and labor-saving kinks to your work. Your efficiency will soon be recognized and you will be in line for advancement.

If you do machine shop work of any kind, sheet-metal work, painting, carpentry, auto repairing, farming, concrete work, plumbing, electrical work, welding, building-glass work, general repairing, tool-making, poultry raising, masonry or home repair work, get this

LIBRARY OF 2400 TIME AND LABOR SAVING IDEAS FOR SHOPMEN AND HANDYMEN

JUST OUT

SHOP NOTES for 1938

318 Articles
 645 Illustrations
 224 Pages
 Price 50c
 See partial list of contents below

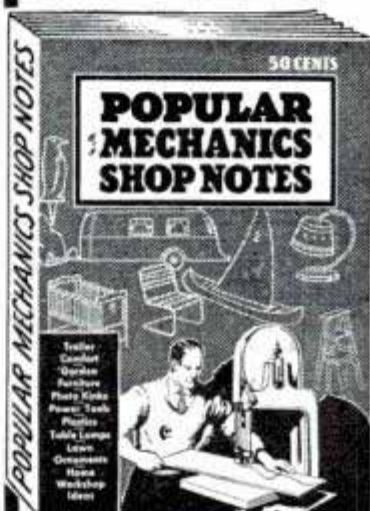

Including the new 1938 issue illustrated above, there are six volumes in the Shop Notes Library of 2400 easily understood short cuts to every-day jobs. Here are just a few of the subjects taken from the latest issue:

- | | | |
|--|--|---|
| Are Welder, Auto Motor Runs | Garden Furniture, Metal Gas Engine, Midget Hack-saw, Electrically Driven | Plastic Ornaments |
| Bits, Wood-boring Cabinet Humidifier over Radiator | Hydraulic Rams for Country Homes | Sail Rig, Airstream Sander, Oscillating Saw, Power-Driven Table |
| Carpenters, Hints for Child's Crib | Jigs for Belt Sander | Shaper Projects |
| Corrosion, Guarding Against | Jigs for the Shaper | Snow Plow, Small Rotary Table Lamps from Plastics and Metal |
| Drilling, Safe Drills, Using Driveways, Durable Electroplating | Ladder Chair | Temperature Indicator, Electric |
| Frozen Water Pipes, Thawing Electrically | Laundry Cart | Trailer Brakes, Vacuum Trailer Comfort |
| Garage, Profit Makers for | Lawn Ornaments | Torch, Electric Arc |
| | Movie Film, Power Reel for Developing | Wood Turning Kinks |
| | Photographic Equipment | |

Each volume contains approximately 400 articles and 600 illustrations and has 200 or more pages. This unrivaled library of shop helps may be secured for a limited time only. After the present supply of books is exhausted the offer must be withdrawn.

***Send No Money**

POPULAR MECHANICS PRESS, 200 E. Ontario St., Room 238, Chicago, Ill.

Send me, as per your offer, the following books. I will pay postman price and small amount of postage. My money will be refunded if I am not satisfied. (Check what you want.)

- 1938 Shop Notes and Lathe Handbook (Metal Working), both for 98c.
 Shop Notes Library (6 vols.) \$3.00.

Name.....
 Street and No.....
 City..... State.....
 *C. O. D. applies to U. S. and possessions only. If you reside elsewhere, remittance must accompany order.



NEW models EASIER TO PLAY

Find out about these sensational new Conn Band Instruments. Many wonderful, exclusive features! Today, *more than ever*, Conns are the "choice of the artists." You'll advance faster and take more pride in a genuine Conn—made by the world's largest manufacturer. See your dealer or write us for Home Trial, Easy Payment offer. Mention instrument.

C. G. CONN, LTD.
231 Conn Bldg., Elkhart, Ind.

CONN
BAND INSTRUMENTS

WRITE FOR FREE BOOK

YOU'LL LIKE RESILVERING MIRRORS, REFINISHING

Plated articles, Autoparts, Reflectors, Tableware. Making Chipped Glass Name Plates, Signs. Experience Unnecessary. Write, **SPRINKLE, Plater, 129, Marion, Indiana**

DENISON'S PLAYS Musical Comedies, Operettas, Vaudeville Acts, Minstrels, Comedy Songs, Make-up Goods. Catalog Free

60 YEARS OF HITS

T. S. Denison & Co., 203 N. Wabash, Dept. 9, Chicago

FLY WITH THE DAWN PATROL

Government Approved. Unequaled advantages in location, equipment, type training, for obtaining License Transport, Limited Commercial, Private Flying, Sheet Metal, Radio, Mechanical. For Complete Illustrated catalog. **SPARTAN SCHOOL OF AVIATION, J. D. Green, Director, Dept. PM4, Tulsa, Okla.**

RAISE GIANT FROGS

FREE BOOK

GOOD PRICES YEAR ROUND! Nation-wide markets waiting for all you can ship. Sell to us also. Get ready now for next spawn. Brooder lays 30,000 eggs yearly. Start with small pond, creek, lowland. **Free book** shows sketch, Men & Women starting in every state and Canada. See what others are doing. **Send no money!** Just write your name-address on postcard and get our special offer to beginners. **American Frog Canning Co. (Dept. 133-B), New Orleans, La.**

ARTIFICIAL EYES

Save Money—Fit Guaranteed

We send a large assortment for you to select from in your own home. Over 100,000 on hand at all times. All sizes, shapes, coloring. Finest quality obtainable—at substantial saving. Satisfactory fit and color guaranteed. Old reliable firm with thousands of regular customers. Send name of anyone who wears an eye for **FREE BOOK** that tells how we fit eyes for customers all over the world by mail.

DENVER OPTIC CO., 1201 University Bldg., Denver, Colo.

In answering advertisements always write name and full address clearly.

REFINISHES AUTOS Like NEW!

PAYS UP TO \$7.00 AN HOUR

KAR-NU refinishes any color automobile easily, quickly and economically without polishing, waxing, rubbing or painting. **JUST WIPE IT ON WITH A CLOTH!** Magic-like fluid covers old paint with tough, elastic coat. Absolutely transparent, self-leveling, self-polishing. **Guaranteed.** Lasts 8 to 12 months. Equal in beauty to repaint job costing \$10 to \$35. Write for **Free Sample** to prove our claims and Territory offer.

KAR-NU CO. Dept. B-30, Oakley Sta. Cincinnati, O.

When writing please mention Popular Mechanics

YOU CAN LEARN to DRAW!

AT HOME in your SPARE TIME

Learn to be an Artist and become your "own boss"! Some experienced graduates earn \$15, \$25, \$50 for single illustrations. However, training comes first. A few pleasant hours each week of study and drawing **AT HOME** should, upon completion of the course, give you a good understanding of Commercial Art, Cartooning and Designing. Write for our **FREE BOOK**, "Art for Pleasure and Profit." It tells all about our practical method of instruction and the **TWO ARTISTS' OUTFITS** each student receives during the course.



★ FREE BOOK shows how! WASHINGTON SCHOOL of ART EST 1914

Studio 122F, 1115—15th St., N.W., Washington, D. C.
I am interested in learning to draw at home in my spare time. Please send me your Book, "Art for Pleasure and Profit."

Name.....
Address.....
City..... State.....
Age..... Occupation.....



Know Electricity as Experts Know It—and Get an Expert's Pay!

Recovery has begun! The months ahead are charged with significance and expectation. What will you do to get the jump on the other fellow? Thousands of men have used

The Croft Library of Practical Electricity

The Croft Library is a complete electrical educator. It is founded on practice—on 20 years of shirt-sleeve experience—on work as it is actually done. It is jammed from cover to cover with the kind of hard-headed facts you want. Written so that the beginner can easily understand it, yet so sound, so thorough, that it is the daily guide of 59,000 highly paid electrical workers and engineers. Croft tells you the things you need to know about motors, generators, armatures, commutators, transformers, circuits, switchboards, distribution systems—electrical machinery of every type—wiring for light and power—wiring of finished buildings—underwriters' and municipal requirements—illumination in its every phase—the most improved methods of lighting—lamps and lamp effects, etc.—how to do a complete job, from estimating it, to completion.

No money down—easy payments

Fill in and mail the coupon attached and we will send you the entire set of seven volumes for ten days' Free Examination. We take all the risk—you assume no obligation. If you decide to keep the books, send \$1.50 in ten days and the balance at the rate of \$2.00 a month. Send the coupon NOW and see the books for yourself.

FREE EXAMINATION COUPON

McGraw-Hill Book Co., 330 W. 42nd St., New York

Send me for ten days' free examination the Croft Library of Practical Electricity. If satisfactory I will send you \$1.50 in 10 days and \$2.00 monthly until the price of \$19.50 is paid. If not wanted, I will return the books postpaid. (To insure prompt shipment write plainly and fill in all lines.)

Name.....
Home Address.....
City and State.....
Position.....
Name of Company..... PM-2-38

1939 1940 1941 1942 1943 1944 1945 1946 1947 1948



The leaders of the next ten years will largely be determined in the next ten months. Will you be one of them?

Will You Be Clerk or Manager Ten Years from Now?

"SURELY, this could never happen to me," you say—"that I should be sitting at the same desk—be doing the same work—for ten straight years!"

But wait a minute—

Exactly that same thing has happened to thousands upon thousands of men. It has probably happened to men right in the company you now are working for. And—unless you fit yourself for a better job—there is a very good chance that it may happen to you!

Unthinkable? That's what J. N. Dixon of Columbus, Ohio, said to himself. Yet lack of training kept him slaving away at low wages for a long time.

TRIPLES INCOME

Here is Mr. Dixon's own story—"Just after I returned from the war, one of your representatives found me plugging away at a bookkeeper's job in Marietta, Ohio. He performed a real service and explained to me the need of further training, and induced me to take the LaSalle training in Higher Accountancy. After a few months of study, I secured a position with the Trust Department of a National Bank. This was the stepping stone I needed to various responsible positions including handling of receiverships and other important duties. That quickly boosted my income several hundred percent."

ANOTHER AMAZING SUCCESS STORY

If you think Mr. Dixon's success story unusual, please read what J. H. Krouse of Memphis, Tennessee, says. "When I decided to take your training in Higher Accountancy, I was a clerk. Today I am Chief Consultant Accountant for the U. S. Engineer's Office in Memphis, Tenn. Whatever success or recognition I have had, I owe to your training. I have had no other specialized training along this line. Your method of teaching is not only instructive but highly engaging. I have observed other courses, but firmly believe LaSalle has the best to be had anywhere."

Another bit of proof is Mr. R. P. Barthalow's experience. Mr. Barthalow is Chief of the Sales Tax Section of the Tax Commission of Ohio. A department which handles over \$50,000,000 a year. Mr. Barthalow attributes much of his success to LaSalle training.

SEND FOR These Two Books and Start Toward Bigger Success

Need you hear more before you investigate the opportunities in Accountancy?

Or will you face the problem of your future NOW—and send to LaSalle and get further facts and particulars?

Without cost or obligation, the coupon will bring you two interesting books—one a 64-page book entitled, "Accountancy, the Profession that Pays"; the other "Ten Years' Promotion in One."

How about those next ten years—will you wait or will you START TODAY to realize the tremendous opportunities that may lie ahead of you through sound and practical home-study business training?

Measure your grit and ambition by what you do with this coupon—NOW.

LASALLE EXTENSION

LASALLE EXTENSION, Dept. 264-HR CHICAGO

Opportunities in Accountancy—Check below and we will send you a copy of "Accountancy, the Profession that Pays," also copy of "Ten Years' Promotion in One," all without obligation.

Higher Accountancy: Leading to position as Auditor, Comptroller, Certified Public Accountant, Cost Accountant, etc.

Other LaSalle Opportunities: If more interested in one of the other fields of business indicated below, check that.

Business Management
 Expert Bookkeeping
 C. P. A. Coaching
 Modern Salesmanship

Traffic Management
 Law: Degree of LL. B.
 Industrial Management
 Modern Business Correspondence

Stenotypy
 Business English
 Commercial Law
 Effective Speaking



Name

Present Position Address

When writing to advertisers please mention Popular Mechanics



CLASSIFIED

Advertisements



Advertisements in this section, 35 cents per word, each insertion, minimum 10 words, payable in advance

To be inserted under proper classification in March issue, copy should be in our office January 8th

March issue on sale February 1st

Popular Mechanics Magazine, 200 East Ontario Street, Chicago, Illinois

YOU'LL PROFIT

By reading and answering the classified ads in this section. Hundreds of opportunities to make and save money.

Popular Mechanics Magazine,
200 E. Ontario St., Chicago, Illinois

Dear Mr. Johnson: Considering the short time we have been an advertiser in Popular Mechanics, needless to say we are more than pleased with results from our classified ad, and a steady flow of inquiries in every mail. We hope to be in all the coming issues for some time. What we like about Popular Mechanics Classified inquiries, is the fact that they are from high class folks. They are alive and know a good offer when they read it. They have the money and are not afraid to spend it for what they want to buy. Thanking you for your co-operation in the past, we wish to remain

Yours very truly,

(Original letter on file in our office) **LIGHTNING SPEED MFG. CO.**

AUTOMOBILES

MIDGETS! Motors! Parts! Used, new; sport, racing. Over 20 midgets, 60 motors, \$4.00 up. Latest lists, 20c. Shipps Midgets, Box 543-H, Zanesville, Ohio.

FORD V-8s, 1935-38; gasoline saving device, \$1. Walert Co., 3429 No. 10th St., Milwaukee, Wis.

WANTED: Junk batteries, 6 or more. American Battery Company, 208 W. Kinzie, Chicago.

CONVERT. Automobile engine into a fast pumping air compressor. Instructions \$1.00. Box 48, Fairview, N. J.

TWELVE Photographs world's costliest, speediest automobiles \$1.00. International, Box 329, St. Cloud, Minnesota.

SELL Yourself a new Willys car or truck, 10% commission. No trades. Walraven's, Zanesville, Ohio.

R & R Mfg. Co., Anderson, Ind. Racing cars and midgets. Catalogue 25c.

MIDGET Racing book; facts for fans, builders, drivers; track sizes, regulations; pictures, specifications, working drawings. \$1.00 postpaid. \$1.15 C.O.D. Ray Kuns, Department 21, Madisonville, Cincinnati, Ohio.

CAR Owners—Eliminate "ping" and "buck" in acceleration. Smooth out pick-up and add 5% to 15% in fuel economy with Osco Fuel Flow Regulator. Agents wanted. This is no "gadget." Write Osmithson, 3103 C Street, Philadelphia.

1937 IGNITION Supercharger. Quick starting, wet or cold. Mileage, pep, power, less carbon. \$1.25. E. G. Sales Co., 321 Broadway, New York.

(POWERFUL) Leaky radiator sealer. (Harmless.) 40c coin. Agents wanted. E. O. K., Porterville, Calif.

MIDGET Cars, parts, plans. Catalog dime. Derby Midget Cars, Woodstock, Ill.

AUTO SUPPLIES AND EQUIPMENT

NEON Ignition timing stroboscope. Shows flywheel marks while running. Cuts job quarter time. Simple constructional plans \$6c M.O. General Physical Laboratory, 509 - 5th Ave., New York.

DEMONSTRATORS. Compressor, test bench, 8-hour battery charger, arc welder. Guaranteed. Trial and terms. Hobart Welder Exchange, Box M-281, Troy, Ohio.

SAVE Money on your car by doing things yourself. Information 25c postpaid. Money refunded if not satisfied. Hutchison, 314 North 4th, Camden, N. J.

SEND Ten cents for three rubber key holders. New invention. Holds keys without rattling in ignition lock. Jay J. Sandler, Malden, Mass.

SAFETY Shift attachment for any car \$1.50. 6201 Famous, St. Louis, Mo.

CURE Oil pumping. Restore pep, power. Increase gas, oil mileage. Easily installed segment rings, piston expanders. Guaranteed. Agents wanted. Haling, 4750A Sheridan, Chicago.

PLATING Outfits for auto parts. Connect to a battery. No tanks used. Free particulars and proofs. Gunmetal Co., Ave. J, Decatur, Ill.

AUTO TRAILERS

TRAILER Builders—Everything at bargain prices. Large catalog free. Easy to build de luxe plans 10c. National Trailer Equip. Co., 714 Wisconsin Ave., Milwaukee, Wis.

BUILD The famous, low-cost Jim Dandy Cabin Trailer. Complete plans and instructions 50c. Plans to build the beautiful, streamlined Jim Dandy Cabin Cruiser, \$1.00. Trailer Builders Manual and catalog of trailer parts, supplies and equipment—over 100 interesting, illustrated pages, 25c. Order today. Satisfaction guaranteed. Trailer Supply Co., 411-A Jackson St., Wausau, Wisconsin.

A. C. GENERATORS

PRACTICAL Changes for automobile generators. See our advertisement at bottom of page 137A. Autopower.

MOTORCYCLES, BICYCLES AND SUPPLIES

INSIDE Dealer prices. Overstocked, all models, Indians and Harleys. Rebuilt, guaranteed. Dime brings latest list. Crandall-Hicks, Boston, Mass.

RECONDITIONED Motorcycles. New—used parts for all makes. Authorized Harley-Davidson dealer. Whitman Motorcycle & Supply Co., 405-9 Southwest Blvd., Kansas City, Mo.

SEND 15c For illustrated used motorcycle catalog. Bargains. Largest stock genuine Indian parts and motorcycles. Indian Motorcycle Sales, Kansas City, Mo.

MOTORCYCLE Bargains. lowest prices, bargain sheets for stamp. Motorcycle accessories. Rochester Harley Davidson Corp., 129 W. Main St., Rochester, N. Y.

ALLOY Pistons—Harley, Indian, Henderson. Excelsior, new or used parts, cylinder grinding. Catalogue and wings pin 10c. Ballak, 1115 Chestnut, St. Louis, Mo.

BICYCLISTS. Attention. Lamps, horns, accessories at new low prices. Lists for stamp. Roscycle Supply Agency, 2714 3rd Avenue, New York.

AVIATION

WANT To contact individual promoter or group with potential wealth. For construction metal mechanical dirigible boat-airplane, Amphibian, Single wing. One driving motor. One for vertical propeller. Free revolving parachute. Thirteen and half tons, eleven people capacity, and plant. Patentable. To be built individually or co-operatively. Corporation title charter state recorded. Ready to be incorporated for three hundred thousand dollars or more. Requires few thousand dollars to start. Inventor. Constance Chermich, Post Office Box 1331, 25 South St., New York City, N. Y.

PROPELLERS For airplanes, sleds. Also iced sled blueprints. Catalog dime. Lorenzen Propellers, Niles, Michigan.

AVIATION Employment information. Send stamp. Aviation, 72 Monroe, Williamsville, New York.

AERO-SLEDS For ice or snow transportation, supplies. Details dime. Adastik Bros., Grand Rapids, Mich.

AVIATION Apprentices. Good pay—Big future. Write, immediately, enclosing stamp. Mechanix Universal Aviation Service, Strathmoor Station, Dept. E2, Detroit, Michigan.

HEATH Motor Manual, complete data conversion, installation, overhaul, trouble shooting, parts price list, invaluable to Henderson motorcycle and Heath owners. \$1.00 or COD. Heath Aviation, Benton Harbor, Mich.

REPOSSESSED Airplanes and trailers, your own terms. All bargains. Finance Co., Hemlock, New York.

AIRPLANES \$50 Up. Motors, crackups, salvage. Complete directory 25c postpaid. Used Aircraft Directory, Athens, Ohio.

PROPELLERS—Genuine mahogany. Stainless steel tips. 4 ft. \$9.00, 4½ ft. \$12.60, 5 ft. \$14.85, 6 ft. \$18.00. Literature free. Universal Aircraft, Fort Worth, Tex.

SLED Propellers—Harley \$2.98, Henderson \$4.50, Ford, Chev. \$7.50. Catalog free. Standard Propeller Co., Fort Worth, Tex.

GET Into aviation. Air transport pilots get up to \$7,000 per year; mechanics \$2,500. Learn at this government approved school. Write for complete information. State age. Lincoln Flying School, 2004 Aircraft Bldg., Lincoln, Nebr.

BATTERIES, GENERATORS, ETC.

EDISON Lifetime storage batteries for light and power. Eliminates acid battery diseases. Long guarantee. All kinds rebuilt generating plants, motors, and miscellaneous articles at bargain prices. Free interesting literature. T. Hawley Smith Co., Croton Falls, N. Y.

A. C. Generators. hand-driven, generate 110 volts, original price \$5.50. Special 98c. Electrical Salvage, Lincoln, Nebr.

BUILD Wind light plant. We show you how. Complete plans and valuable catalog 10c. Wind plant parts, welders, electric fences. LeJay Mfg., 647 LeJay Bldg., Minneapolis, Minn.

DODGE 12 Volts generators with field stripped. F.O.B. \$3.50. Fleck's Warren, Ohio.

AERODYNAMIC Windcharger propellers produce 10 to 30% more electricity. Factory prices. Kubat Mfg., St. Paul, Minn.

MAKE Money. Rewind auto generators. Pull instructions \$1.00. Also material. Ernest Knight, LaSalle, Illinois.

EDISON Storage batteries for light-power systems. Non-acid. Odorless, fifteen year life. Five year unconditional guarantee. Bargains in complete lighting systems. Low prices. Free illustrated literature. "See-Jay" Battery Co., 82 Sterling Ave., Yonkers, N. Y.

AIR CONDITIONING

BUILD Your own air-conditioning outfit. Have "mountain air," year-around health, and comfort in your home, store, office, workshop. Seven units—Summer, winter, year-around. Materials picked up at small cost. Complete diagrammed Servatex instructions, seven blueprints, make construction simple and easy. Send no money. Return in five days or remit \$1.00. Servatex Company, 868-PM Madison Building, Milwaukee, Wisconsin.

ELECTRICAL SUPPLIES, EQUIPMENT

BURGLAR Alarms from closed banks. Eighteen inch gongs, housings, instruments complete. Safety, Defiance, Game-well. Suitable wholesale houses, garages, department stores. Supplies, diagrams. Midnight Alarm System, Ponton, Mich.

"ELECTRIC Maintenance," motor care and light switch diagrams, \$1.00. Electric Maintenance, Box 7608, Kansas City, Mo.

VACUUM Cleaner spray gun \$1.25, complete motor driven paint spray \$9.85, other bargains. Marshall, 1111 Washington Blvd., Chicago, or P. O. Box 111, Philadelphia.

ELECTRIC Eye kit: Complete instructions and industrial quality parts for making smoke, fire, accident alarm; invisibly announce visitors to office, showroom, store; daylight control of signs, displays, office lighting; etc. Assemble and install these, earn money as photocell engineer. Not toys; unconditionally guaranteed. \$15.50 postpaid. Dept. 81, Photobell, 96 Warren, New York City.

ULTRA Violet—Infra Red. Dual ray health lamp. Two separate units in one. Promotes Sun Tan, Vitamin "D." Automatic control. AC-DC current. \$3.90 postpaid. Details free. Beyer Mfg. Co., 4515-P Cottage Grove, Chicago.

ELECTRICIAN'S Motorwinder's maintenance's formulas. "Maintenance," Fox Creek Station, Detroit, Mich.

HUNDREDS Of new, unusual, hard-to-get electrical items, replacement parts and supplies. Send for free wholesale catalog. Autopower, 410 S. Hoyne Ave., Chicago.

ELECTRIC Pen engraves all metals, dollar prepaid. Hudson Bros., East Syracuse, N. Y.

WELDING AND SOLDERING

LEARN To weld—By actual practice on an Apollo 110 volt electric torch. A new type, all electric, professional welder that produces a 3 inch flame similar to an acetylene torch. Complete with all accessories and instructions, \$12.50. Operating cost 3½ to 6 cents per hour. Year's guarantee. Apollo Mfg. Co., Dept. B, 319 Union, Memphis, Tenn.

75-125 AMPERE Arc welder from Dodge generator. Complete plans and valuable catalog 35c. 50 other generator changes. LeJay Manufacturing, 247 LeJay Bldg., Minneapolis, Minn.

DODGE Arc-welder, 40 volts, 25-200 amperes. Build it yourself, low cost and up-keep. Certified instructive plans \$1.00 COD., \$1.12, airmail 12c extra. Welders Club of America, Box 3432-A, Merchandise Mart, Chicago, Illinois. Special: Send this ad with above order at no additional cost and get extra drawings, etc. "How to build Dodge Arc-welder without rewinding."

REBUILT Electric arc welders, all sizes, a.c.—d.c. guaranteed. Lowest terms. Money-saving prices. Service Co., 3732 Cedar Ave., Cleveland, Ohio.

ELECTRIC Welders, 110-220 volt, fan-cooled, can be used for hours, \$75.00. Box 331, Hamilton, Ohio.

WELDER Shortage. Big pay. Finest training and employment help. Wonderful climate. Folder. Dunn Welding School, 1308 N. E. Union, Portland, Oregon.

GENUINE Dodge arcwelder economically built without rewinding. Plans \$1. Particulars free. Pulls, Booker, Texas.

DEMONSTRATORS, Electric arc welders. Money-saving prices. Used by the government. Trial and terms guaranteed. Hobart Welders, M-282, Troy, Ohio.

THE Aladdin a.c. arc welder \$39.25 factory price. Closing out stock at \$26.75. Rush order. Fred Allen, 1132 N. W. Glisan St., Portland, Oregon.

ENGINES, MOTORS, DYNAMOS

MAGNETOS Rebuilt like new \$6.00. Albert Schantz, Baden, St. Louis.

SMALL, Brand new vacuum machines \$4.95 postpaid and a 1/25 h.p. motor free with each. Supply limited. McConnell, 1619 Edgewood Ave., Racine, Wis.

NEW Motors: 1/20 h.p., 110 volts, 60 cycle, a.c.—d.c., double shaft, ¾" long, ½" dia., 5000 r.p.m.; \$4.50. Money order only. E.&P. Goetter Bros., 481 Dolores St., San Francisco, Calif.

GOVERNORS For auto engines. Read our ad on page 122A. Mfg. Candee-Smith Governors.

BARGAIN—½ Hp. motors, 60 cycle, 1 phase, 110 volt, like new, guaranteed, \$8.25. Send check to Erie Electric Motor Co., 120 Church, Buffalo, N. Y.

GUARANTEED Rebuilt and new motors, generators, fans. All kinds and sizes. Very reasonable prices. Tell us your needs. Queen City Electric, 519 S. California, Chicago.

WINDING Data, 225 motors, single and three phase. Price \$1. Motor Data Co., Box 7631, Kansas City, Mo.

MACHINERY, TOOLS AND SUPPLIES

PLASTICS, Brass, aluminum, Dowmetal, monel, stainless steel, gears, etc. Catalog 10c. Hobby Supply House, Box 2014, Pittsburgh, Penna.

WE Discovered fast gear cutting with lathe. Nothing else needed. Instructions \$2. Melic Research, 7340 Chestnut, Kansas City, Mo.

SURPLUS Tools below cost. Free circular. Schmidt, 3216 Olive, Chicago.

BARGAINS, Demonstrators, electric arc welders, guaranteed, 30 days trial and terms. Write Hobart Welder Exchange, Box M-283, Troy, Ohio.

MANUFACTURERS, Experimenters, inventors, model makers—Giant kit of practical, useful parts and supplies. Washers, screws, nuts, brackets, gears, rivets, bushings, springs, etc. Over 1000 items. Price \$1.50. Worth \$7.50. Money back guarantee. Manufacturers Supply House, 213 W. Illinois, Chicago.

12" x 6" SEBASTIAN Geared head motor drive Gold Seal lathe. Excellent condition. Write for bargain price. Cincinnati Machinery & Supply Co., 219 E. Second St., Cincinnati, Ohio.

BOATS, OUTBOARD MOTORS, ETC.

COMPLETE Your own boat with our pre-fabricated frames and materials. They're different. Save 2/3s and costly mistakes. Send requirements for quotations. Illustrated catalog 100 boats, 10c. Bay City Boats, Inc., Bay City, Mich., 1552 Adams St.

USED Outboard motors, all makes. Send stamp for list used parts and propellers, ½ list price. Outboard Headquarters, 305 Atlantic Ave., Boston, Mass.

NEW! Build your boat! Sunbathing float! Average \$4.75; 8 hrs. deflated, safest, light, cushions on car top! Collapsible. Directions 15c. Double car water heater output! Directions 15c. School-meesters, 216 N. Webster, Saginaw, Mich.

BUILD A boat by the Welch System. Save on the cost. Send 10c for 32 page illustrated catalog of boats, motors and marine equipment. Welch Boat Company, Station K-1, Milwaukee, Wisconsin.

PLANS And full-size paper patterns for cabin cruisers, sailboats, runabouts, etc. Send 10c for catalog. Melrose Boat Works, Magnolia Springs, Alabama. (On the gulf coast.)

BOOKS About boats. Send 10c for catalog of new, old and rare sea books, all subjects. Lauriat's, 91 Franklin St., Boston, Mass.

FORD And Zephyr marine engines. Send 10c coin. Lehman Engineering Company, Newark, N. J.

MAKE 12' Kayak, new easy way. Full size patterns \$1.50. Henry Bakewell, 44 Billings St., Lowell, Mass.

BUILD Your boat and save; using our knock down frames. Muller Boats, 4920 Seventh Ave., Brooklyn, N. Y.

ASSEMBLE Your own boat. Our finished knock-down frames save you 2/3 builder's cost. All types and sizes. Send 25c for big catalog. Brooks Boat Co., Inc., D4, Saginaw, Mich.

OUTBOARDS—Save ½. Good used parts, all makes and models. Bargains rebuilt motors. Crandall Hicks Co., 780 Commonwealth, Boston, Mass.

FORD Marine conversion parts and kits. Models A, B, V8 (domestic or foreign). Catalogue 25c (coin). Osmithson, 3101 G St., Philadelphia, Penna.

BOAT Designers are highly paid professionals. Complete course by mail. Catalog. Westlawn, Montville, N. J.

SPORTING GOODS, GUNS, FISHING TACKLE, ARCHERY

SKIERS! Free bargain ski catalog. Sportsmen! Free bargain gun catalog. J. Warshal & Sons, First and Madison-I, Seattle, Wash.

FISHERMEN! Tie your own flies. My book tells all. Profusely illustrated. Practical. Finest stock of materials in America. Send stamp for catalogue. Write, Paul H. Young, 8065-C3 Grand River Ave., Detroit, Mich.

SEND 3c For illustrated catalog of Lawrence leather belts, holsters, gun cases and other sporting equipment. George Lawrence Co., First Street, Portland, Oregon.

HUDSON Bay blankets, Indian pack baskets, camp stoves, knives, compasses, outdoor equipment. Free catalog. Howe Fur Co., Box P, Coopers Mills, Maine.

FIELD GLASSES, TELESCOPES AND MICROSCOPES

1600X Microscope \$5.90. 60X telescope \$2.29. 6X binocular \$4.45. Optical catalog free. Brownscope, 5 W. 27 Street, New York.

LOWEST Prices on telescopes, binoculars, microscopes. Free catalog. Hobby Man, State Street, Jefferson, Iowa.

BUILD Powerful astronomical telescope. Complete plans, diagrams, etc. 25c. Teeko Optical, Evanston, Illinois.

LENSES And instructions for giant powerful telescope \$2.00. Atemsco, Box 213p, Flushing, N. Y.

FREE Catalog listing microscopes, telescopes, field glasses, chemical and scientific supplies. Send 3c for postage. Kemkit, 397M Bridge St., Brooklyn, N. Y.

BUILD Reflecting telescopes; catalog free. Instruction 10c. Optical Laboratories, Larchmont, N. Y.

USED Microscopes, binoculars, astronomical telescopes, surveying instruments—Bought, sold, repaired. Send 10c for list. Rasmussen, P. O. Box 294, Amsterdam, N. Y.

ANTIQUES, RELICS, INDIAN GOODS

GENUINE Sinew sewed Indian bead work. Robert Bane, Kingfisher, Oklahoma.

GENUINE Sioux Indian beadwork. Souvenir and list ten cents. Otis Marske, Cannonball, North Dakota.

100 **GOOD** Arrowheads \$3. Catalog. 5c. H. Daniel, Hot Springs, Ark.

COLLECTION Antique firearms, 300 pieces for sale, not by piece. R. E. Brown, Anna, Ill.

100 **GOOD** Arrowheads, \$3.00. Satisfaction guaranteed. George Holder, Glenwood, Ark.

INDIAN Relics, beadwork, coins, curios, minerals. Catalog 6c. Indian Museum, Northbranch, Kansas.

TAXIDERMIST

NEW 32-Page catalog, eyes, etc., free. Taxidermic Manufacturers, Memphis, Tenn.

"MODERN Taxidermist Magazine," Greenfield Center, New York. Taxidermy articles, methods, photos. Two sample copies 25c.

GLASS Eyes. Taxidermists', furriers' supplies. Lowest prices. Forty page catalogue, free. Write today. Elwood Supply Co., 222 Smith Bldg., Omaha, Nebr.

TAXIDERMIST Supplies—Quality artificial eyes, teeth, genuine Jonas head forms. Tools, materials, etc. Everything for the progressive taxidermist. Send 10c for big illustrated catalogue. Jonas Bros., 1049 Broadway, Denver, Colo.

DOGS, BIRDS, PETS

SPORTSMEN: 200 Pointers, Setters, Straight Cooners, combination Hunters, Rabbit and Fox Hounds. Cheap. List free. Ramsey Creek Kennels, Ramsey, Ill.

"ROYALBRED" Saint Bernard puppies are excellent, satisfied customers prove this! Dime brings interesting photographic particulars. Royal Kennels, No. 8, Chazy, N. Y.

COLLIES, Shepherds, bull pups. Ship any where. R. Tonn, Dallas, Texas.

BIRDS? Get American Canary Magazine monthly. Year, \$1; six months, 50c. 2839-P N. Halsted, Chicago.

BEAUTIFUL Pure white police dogs. Ansonia Kennels, Mose, N. Dak.

POULTRY AND FARM SUPPLIES

SEX-LINKED Chicks, famous Australwhites, 5 other Hybrids and 52 purebreds. Beautiful catalog free. Mrs. Berry's Farm, Rt. A, Clarinda, Iowa.

MAKE Money with poultry. Read Poultry Tribune, monthly magazine that tells how leading poultry raisers succeed. Only poultry magazine operating its own experimental farm. Three years \$1.00, nine months trial 25c. Poultry Tribune, Department E-93, Mount Morris, Ill.

MAKE More profits with Salem's AA Chicks. Write for prices and free catalogue. We pay postage and ship C.O.D. Salem Hatchery, Rt. 19, Salem, Ind.

DEMAND Davis Chicks for broilers, layers. High priced broilers, low priced feed mean greater profits. Write for new catalog big advance order discount. Turkeys, sexed chicks. Davis Poultry Farm, Route 34, Ramsey, Indiana.

FARMS AND FARM LANDS

THE Great Northern Railway serves an agricultural empire of fertile productive farms where rents, prices and operating costs are low in Minnesota, North Dakota, Montana, Idaho, Washington and Oregon. Write for free book and full information. E. C. Leedy, Dept. 257, G. N. Ry., St. Paul, Minn.

38 ACRES, Village edge; horse, cow, flock hens, tools, hay, vegetables, etc., included; on state road, 1/2 mile depot and advantages; spring water, wood, variety fruit; cozy 6-room house, barn, hen house; bargain at \$1425, part down; page 50 free bargain catalog. Strout Ag'y, 255-P 4th Ave., New York City.

GOVERNMENT Lands ten cents acre up. Information all states twenty-five cents. National Tax Service, 600A Majestic Bldg., Detroit, Mich.

BARGAINS In land! Where crops are dependable. Washington, Minnesota, Montana, Idaho, Oregon and North Dakota. Literature. Impartial advice. Specify state. J. W. Haw, 119 Northern Pacific Ry., St. Paul, Minn.

CANADIAN Tax sale lands for a dollar an acre and up. Small monthly payments. Farms, timber, hunting and fishing camps, minerals. Limited number of properties. Write at once for free illustrated booklet. Tax Sale Service, Room 613, 72 Queen St. W., Toronto, Canada.

WANT To hear from owner of property for sale or trade. Details free. Real Estate Salesman, Desk B, Lincoln, Nebr.

40 ACRES, Near White River, unimproved; poultry land. \$175, \$5 down, \$5 monthly. Free list and literature. Hubbard, 216 Grossman Bldg., Kansas City, Kans.

PROFITABLE OCCUPATIONS

MUSHROOMS: Grown at home with newly patented tobacco stem spawn. Book, picture free. Tells all about this profitable business. Write Home Growers Service, Box 62, Dept. D-4, West Chester, Penna.

STUDENTS: Graduation cards free, represent Sharra-card, 325 Atwood, Pittsburgh, Penna.

DIME Brings copy National Mail Order News, Box 1773-PM3, Roanoke, Virginia.

MRS. M. earned \$267, three weeks raising mushrooms in cellar! Exceptional, but your cellar, shed perhaps suitable. We buy crops. Book free. United, 3848 Lincoln Ave., Dept. 70, Chicago.

"RAISE Frogs!" We buy! Good prices year round. Start small pond. Free book shows sketch. American Frog Canning, (153-B) New Orleans, Louisiana.

WE Start you in business, furnishing outfits and instructions, operating Specialty Candy Factory home. Men and women, earn \$25 up to \$60 weekly, all or spare time. (Our 29th year.) Booklet free. W. Hillyer Ragsdale, Inc., Drawer 62, East Orange, N. J.

CERTAIN Varieties of earthworms are profitable. Investigate. California Earthworm Farms, La Canada, California.

MAKE \$15-\$75 Weekly; home business. Booklet describing over 100 successful plans free. Century, 1261-PR Broadway, New York.

"FOUR Years With Frogs." Experience arranged in questions and answers describing ponds, vegetation, sex and marketing. Twenty-five cents coin. Lafayette Frog Farm, Lafayette, Louisiana.

DRIVE To country, movies afternoons! Work mornings home. No canvassing! Folio-H, Station D, Los Angeles.

FREE Booklet describes 107 plans for making \$20-\$100 weekly, in home or office, business of your own. Elite Co., 214 Grand St., New York.

RAISING Jumbo frogs. Interesting. Big future. Females lay 10,000 eggs. Free literature. American Frog Industries, Box 336, Rayne, La.

TREES, SHRUBS, ROOTS, HERBS

GINSENG Planting instructions free. Specialty Farm, Rockford, Minn.

JUST Out! World's greatest "Herbalist Almanac." Beautifully illustrated in natural colors. Contains over 200 old-fashioned herb medicine recipes for home use. 10c postpaid. Worth dollars! Botanic, 145 W. 112th St., Chicago.

OLD BOOKS WANTED

WE Pay up to \$5000 each for old books, also high cash prices for old magazines, letters, newspapers. A single story book, school book, old Bible, travel book, almanac, etc., that looks worthless may bring you \$50, \$100 or \$500 in cash. Thousands wanted. Send 10c now for latest price list. American Book Mart, 140 S. Dearborn, Dept. 2113, Chicago.

BOOKS, PERIODICALS, PICTURES, POSTCARDS

NEWEST Radio, electrical experiment books, 20c up. Amazing values. Catalog free. Electronic Publishing Co., Box 323-Y, Lincoln, Nebr.

BOOKS Bargains. Ross Swap Shop, 14 Merrill, Binghamton, N. Y.

SEA Books—Old, rare and new, all subjects. Send 10c for catalog of over 700 entries. Lauriat's, 91 Franklin St., Boston, Mass.

MAGAZINE Back numbers, all kinds. Charles, 506B Jones, Detroit, Michigan.

YOUR Favorite magazines—Half price. Catalog, 10c. Magazine Exchange, Baseline, San Bernardino, Calif.

RARE Antique books. Some two hundred years old. List, ten cents. Friday, Streator, Ill.

GAMES—ENTERTAINMENT

PLAYS, Operettas, musical comedies, complete minstrel first-parts with song programs, blackface skits, vaudeville acts, monologs, dialogs, recitations, juvenile plays and songs, musical readings, entertainments, make-up goods. Catalog free. T. S. Denison & Co., 203 N. Wabash, Dept. 11, Chicago.

MAGIC TRICKS, PUZZLES, JOKER NOVELTIES

BE A magician. Large professional magic catalogue of latest tricks 25c. Cash paid for complete Tarbell magic courses. Write, Ireland, C-109 North Dearborn, Chicago.

MAGIC Tricks at lower prices. South's largest line. My famous "Book 1000 Wonders" and "50 Magic Mysteries" postpaid 10c. Write today. You will be surprised. Lyle Douglas, Station A-5, Dallas, Tex.

SENSATIONAL Ventriloquism course free. Ventrilo, 15 cents complete, (coin). Avalon Enterprises, Box 923, Providence, Rhode Island.

KNIFE Throwing secrets exposed! Beginners and experts get this book now! 40 tricks and throws used by professionals, \$1.00 postpaid. Frank Dean, 1294 E. San Fernando, San Jose, Calif.

LEARN Ventriloquist art. Easy. Low cost. Free details. Apex, 221 E. 31, New York.

250 BOOK Magic tricks, great Hindoo mystery, coin mystery. All for 25c coin. Gilsdorf, Box 228, Muskegon, Michigan.

FREE Tricks! Join Magicians' Fraternity! Monthly magazine, sample 10c. International Magicians, Mount Morris, Ill.

VENTRILOQUISM, Spiritualism, magic 35c. Eckam, 1407 East Main, Rochester, New York.

JUST Off the press! Our large catalog of magic for everyone. From the beginner to the professional magician. Send 25c for your copy. Chicago Magic Co., 2300 N. Mason Ave., Chicago.

VENTRILOQUIST Figures, instruction and 24 page illustrated catalog 25c. Frank Marshall, 837 No. State Street, Chicago, Ill.

LARGE Illustrated magic catalogue 20c. Lynn, Midland Ave., Paramus, N. J.

EARN Money in any crowd. Call names of strangers, tell unspoken questions. Professional course mind reading, spirit writing, etc., \$1. Henderson, Box 341, San Bernardino, Calif.

LEARN Ventriloquism, 3c stamp brings particulars. Smith, 125 N. Jefferson, Peoria, Ill.

LARGE Professional magic catalogue, 25c. Holden, 220 W. 42nd St., New York.

MAGIC Catalogue, latest tricks, 10c. Frank Lane, Little Bldg., Boston, Mass.

SAMPLES Catalog, novelties, photos, 25c. P. O. Box 468-P, New Haven, Conn.

PASTIME For the whole family. Boys and girls puzzle. 1000 problems. 25 cents, no stamps accepted. Watchmans Puzzle, 105 Brookview Ave., Troy, N. Y.

EARN \$25 A night with magic. Make professional equipment at home for almost nothing. Stamp brings list and information. Merlini, 400 Linwood, Buffalo, N. Y.

RARE COINS

GET Profit and pleasure in collecting old coins. Send 10c for 56-page illustrated coin catalog. You'll be delighted with it. Send for it now. B. Max Mehl, 370 Mehl Bldg., Fort Worth, Texas. Largest rare coin establishment in U. S. Established 38 years.

20 DIFFERENT Coins, 25c; 60, \$1.00. Bishoff, 739 Locust, Kansas City, Missouri.

\$5.00 TO \$2500.00 Paid for rare coins. Send 15c for 1938 newest 36 page illustrated coin buying book. Charles Fisher, Chargin Falls, Ohio.

33 COINS, Bills, tokens, 25c. Otto Oddehon, 106E8, Kansas City, Missouri.

SOME Specimens 1909 cent worth \$10. We buy certain coins, common and rare. Others worth to \$6000; certain 1864-1865 Indian head cents \$100 each; dimes before 1895, \$450; Liberty head nickels before 1914, \$300; large pennies \$2000; encased postage stamps, \$13; half cents, \$275; half dimes, \$175; quarters, \$300; fractional currencies; paper money; gold dollars, \$1,500; colonial coins, \$300; silver dollars, \$4,000; 1933, 50c, \$4.00; foreign coins \$165, etc. Only certain coins worth top prices, but others have premium value too. Send 15c today for illustrated 1937 coin book, before sending coins. National Coin Corp., (80), Daytona Beach, Florida.

50 OLD Coins, all different, \$1.00. 20 different dates large cents \$2.00. Wisconsin half dollar unc., \$1.45. Claud Denney, Box 1825, Dallas, Texas.

OLD Money wanted. Do you know that coin collectors pay up to \$100.00 for certain U. S. cents? And high premiums for all rare coins? We buy all kinds. Send 4c for large coin folder. May mean much profit to you. Numismatic Co., Dept. 20, Fort Worth, Texas.

BEGINNERS Type packet fifteen coins, including all early type U. S. minor variety. Special—\$3.75 postpaid. S. M. Koepel, Merritt Bldg., Los Angeles, Calif.

PENNIES, Many worth dollars. All kinds bought and sold. Dime brings list. Bill Jacobsen, Watford City, North Dakota.

2½c COIN And note 10c. Maurice Gould, 73, Brighton, Mass.

COINS For sale. List 25c. Coins wanted. Catalog 50c. Radtke, 56 Dale, Rochester, New York.

\$5.00 TO \$2500.00 Each paid for rare coins. Send 15c for newest 36 page illustrated buying book. Bob Cohen, Box 3507-R, Cleveland, Ohio.

55 TO \$500 Each paid for hundreds of old or odd coins. Keep all until posted. Many very valuable. Send 10 cents for illustrated Coin Value Book, 4x6. Guaranteed buying and selling prices. 31 years in business. Coin Exchange, Box 5, Le Roy, N. Y.

UNITED States coins at bargain prices. 2c piece and newest 1937 selling price list 10c. Em. Cohen, Box 3507, Cleveland, Ohio.

RARE U. S., foreign coins, war medals. Catalogue 10c. Mengelle, Colorado Springs, Colo.

UNITED States. Large cent, 2c bronze, 3c nickel and bargain list, 25c. Eleven dates large cents, \$1. George P. Coffin Co., Augusta, Maine.

COMMEMORATIVE \$1½. Illinois, Oregon, Stone Mountain, San Diego, Texas, Long Island, \$1.50 each. Illustrated catalogue 10c. Norman Shultz, Salt Lake, Utah.

STAMP COLLECTING

KING Edward Morocco complete—30c. Free stamps and "The Hinger" sent approval applicants enclosing 3c postage. W. Torgesen, Teaneck, New Jersey.

AIRMAILS—Recent issues—Commemoratives, mainly 20th century, 75 different supremely popular stamps, 75c. Catalogue value over \$5.00. Approvals included. Shultes, Berne, New York. 24 British Colonials 3c.

FREE! 107 Different stamps from strange and distant lands, to applicants for really fine approvals, sending 6c to cover postage and mailing. Bill Boyd, 3422 Tuxedo Ave., Dept. M, Cleveland, Ohio.

AIRMAIL Collectors! 100 different airmail stamps \$2. 50 different 70c. Hamer Berry "Woodlee," Staunton, Virginia.

150 DIFF. Stamps! Including jubilee, coronation, 25 Japan. 5c to approval applicants. Gem Stamp Co., 1905 Carleton, Ft. Worth, Texas.

DOLLAR Bill brings great bulging package containing hundreds of stamps, sets, stamps mounted, etc. George Brodie, 5417 8th Avenue, Brooklyn, N. Y.

EXTRAORDINARY! Free collection! Azerbaijan, Tanganyika, Belgian Congo, etc., including approvals. Rosenberg, 3544 W-12th Place, Chicago.

GIGANTIC Bhopal triangle. Turks Caicos, \$5 U. S., Cayman Islands, rare genuine Baden. Everything free to approval applicants enclosing 3c postage. Viking 1-2 Hanson Place, Brooklyn, N. Y.

OVER 101 Stamps including siege gun, swan, kiwi, Ceylon coronation, Charkhari, and many others. Write today! Only 5c to approval applicants. Royal Stamp Company, 1805 Carleton, Fort Worth, Texas.

WORLD'S Smallest airmail, free stamp magazine, \$2.00 U. S., animals, bird, train, Indian, airplane, commemoratives, scarce stamps 25 countries, 5c with approvals. Capital Stamps, Dept. PM3, Little Rock, Arkansas.

FREE! "United States and British North America"—our valuable, complete, illustrated, 64-page catalog quoting lowest prices. Big illustrated list of foreign stamps also included. H. E. Harris & Co., 137 Transit Building, Boston, Mass.

FREE! 101 Foreign stamps 3c postage. Approvals. Quality Stamp Shop, Englewood, Colorado.

EDWARD VIII, "Morocco Agency," 11 values, 35 cents to approval applicants. Hobby Studio, 345 East Ocean Blvd., Long Beach, Calif.

DIAMOND Shaped air mail—Big packet 105 all different, including air mail, commemoratives, Congo, Epirus, Manchukuo, etc.; set of two ex-King Edwards and Costa Rica diamond shaped air mail; scarce U. S. telegraph, cat. 30c; pkt. British Colonies—Gwalior, Hyderabad, Silver Jubilees; big lists. Everything for 5c to approval applicants. Send today! Mystic Stamp Co., Dept. 80, Camden, New York.

OBSOLETE! Scarce \$1 Abyssinia elephant and thirty other rare stamps totaling \$1.25, sent approval applicants for 3c. Kumlir, King, Lancaster, Ohio.

UNITED States and foreign approvals. Welker, 1320 Liverpool, Pittsburgh, Penna.

FIFTY Different airmails, 40c. Approvals. Star Supply Company, Lima, Ohio.

U. S. Price list free. Send postage. M. G. Hanna, 335 Fifth Ave., Pittsburgh, Penna.

200 CANADIAN, Commemoratives, coronation, new issues, etc., wonderful lot \$1.00 postpaid. Canadian Philatelist, 1084 Drummond, Montreal, Canada.

FREE! 25 World wide. Approvals sent. Geo. Talady, New London, Wis.

TRIANGLES! Diamonds! Commemoratives, etc. Big packet 10c with approvals. Valley Stamps, Little Valley, New York.

PRODIGIOUS Gift! German state, Selangor, Perak, Trinidad, Negri Sembilan, foreign revenue, bicolored Banana airmail, Siberia—absolutely free with approvals! Postage 3c. Saxon Company, Dept. 65, Albee Bldg., Brooklyn, N. Y.

A SNAP—300 Different foreign and 60 different U. S. stamps, including \$1 value, for only 30c. Free with each order, our pamphlet telling "How To Make A Stamp Collection Properly," together with our price lists of albums, supplies and hundreds of bargains in sets, packets, etc. Queen City Stamp Co., Room 36, 604 Race St., Cincinnati, Ohio.

NYASSA, Liberia, Congo, packet 10c. Approvals. Giaquinto, 117 Madison Avenue, Paterson, New Jersey.

LATVIA, 50 Different; Lithuania, 50 different; 50c each, both for 90c. Schaper and Hayes, 279 Roseville, Newark, N. J.

BEST One cent approvals in America. Elvin Stanton, Niantic, Conn.

ALBUM 128 Pages fully illustrated, also attractive set, 20c with approvals. French, 1637 Superior, Cleveland.

EARLY U. S. Send for list. M. Place, Harding, Mass.

SENSATIONAL Values! Penny approvals. Ernest Springer, West Point Pleasant, New Jersey.

58 CORONATION, Jubilee, British Colonies, airmail, 10c. Approvals. Sachse Stamps, London, Canada.

25 DIFFERENT Peru—5c with approvals. James Onodera, Box 374, Seattle, Wash.

10 DIFFERENT Mint blocks—10c. Approvals. Max Pyka, 3118 Fullerton, Chicago, Illinois.

EXCELLENT General approvals. Reference appreciated. Anderson, Box 1203, Rapid City, So. Dak.

MIDGET Foreign mixture—100 stamps, including Malta, etc., 5c (stamps accepted). Elsea, Bowling Green, Ohio.

NEWFOUNDLAND, Canada, 100 different varieties. Jubilees, pictorials pricelist and premium worth \$1.00. All for \$1.00. Wick's Stamp Company, Brantford, Ont., Canada.

10 DIFFERENT U. S. dollar values for only 10c. No approvals. Stamp Center, Station F, Milwaukee, Wisconsin.

EXCHANGE Stamps, postcards by "Exchangers." BRY, pres, 126 Paris, France. Information free.

1/5 CATALOG Approvals, no German—sent with 250 different or 150 (no German)—choose—10c postage. Booher, Lomita, California.

1000 DANDY Mixed stamps 25c. Monjar, 1542 Waverly, Cincinnati, Ohio.

SURPRISE Packet 3c. approvals. Vernon Buss, 4027A Ashland, St. Louis, Mo.

QUALITY U. S., 50, 10c; 25 commemoratives 20c. Box 200, Parsons, Kansas.

FREE! New Dominican airmail and coronations to approval applicants. Charles Cleveland, 806 North Humphrey Avenue, Oak Park, Illinois.

FREE—15 Different Chinese beauties, to approval applicants. Burton Bros., 838 America, Baton Rouge, Louisiana.

OIL Painting from photograph, \$5. Por-titure, 826 Noble, Chicago.

WHY Gamble? Satisfaction or money refunded. Valuable premium (over 30 stamps) 10c with approvals. Brown, Box 4065, San Francisco, Calif.

1875 LIBERTY, Columbian, Pan-American, \$2.00 stamp, 5c. Approvals. Wood, 2915 Stafford, Pittsburgh, Penna.

1938 STAMP Annual free: Describes and illustrates albums, supplies. United States, coronations, British Colonials, Canadians, and foreign stamps. This fifty page catalog free. Gray Stamp Company, Dept. P.M., Toronto, Canada.

WORLDWIDE Penny approvals. Amazing values. L. D. Gibson, B-203, Bandana, N. Car.

FRANCE 1936 Commemorative 308-09 with approvals 6c. Co-Operative Stamp Co.-130 Bates, St. Paul, Minn.

LATIN America! 50 different 10c. Approvals. Thurman Bailey, Pierson, Florida.

GENERAL Collectors attention. Approvals made to order. Name countries you desire. Teichmann, 1685 Fillmore, Philadelphia, Penna.

FREE Set Rumania aviation fund to approval applicants for 3c postage. Gardner Stampco, P.O. Box 1232, Chicago.

OLD Stamps and envelopes wanted. Will pay \$85.00 for 1924 1c green Franklin, rotary perforated eleven (\$1000.00 if unused). Send 5c for large illustrated folder showing amazing prices paid. Vernon Baker, 444-PM-2, Elyria, Ohio.

100 BRITISH Colonials 10c to approval applicants. Capital Stamp Company, 565 Elliott, West Windsor, Ontario, Canada.

DISGUSTED? Try my approvals ½c up. Bargains galore. Viscusi, 4, Scotia, N. Y.

HITLER, Coronations, jubilees and others (cat. over \$1.00) 25c to approval applicants. Jones Stamp Company, Box 146P, Norristown, Pennsylvania.

U. S.—57 Different (commemorative, airmail, etc.) with approvals 9c. Bargain lists free. Moseley, 4932 Forestpark, St. Louis, Mo.

UNCROWNED King, mint set 15c with approvals. Ralph Tanner, Red Creek, N. Y.

WORLD'S Largest map stamp in packet containing Mohell, Oltre-Giuba, Allenstein, Mayotte, etc., 10c. Approvals sent. National Stamps, 10792 Rochester, Los Angeles.

DEAD Countries. Stamps from dead countries which are no longer able to issue additional stamps usually increase in value very fast. In order to attract collectors to our mailing list, we are offering a whole collection of these as an amazing bargain. Fiume, Saar, Bosnia, Memel, Eastern Rumania, Armenia, Azerbaijan, Transcaucasian Republic, Georgia, Upper Silesia, etc., are included. Total catalog value \$2.48. We shall send all these for only 10c to approval applicants. Approval Headquarters, Globus Stamp Company, 268 Fourth Ave., New York City, Dept. 50.

BIG Weekly stamp magazine, 10 cents per year. Excellent articles, latest news. International Stamp Review, St. Joseph, Missouri.

INTRODUCTORY Offer: Bloody Spain, 20 different, only 8c. (Approvals.) Widgren, 1301 Addison Street, Chicago.

FREE! 20 Different with approvals. Hawthorne Stamp Co., 3221 So. 53 Court, Cicero, Ill.

25 BRITISH Colonials 3c. (Approvals.) Porter, Box 863, Springfield, Ohio.

COLLECTOR'S Dollar outfit, album, stamps, and everything necessary. Cragin Stamps, Waterville, Maine

FREE, Dollar packet to approval applicants. Harlan, 5307 S. Marshfield, Chicago.

U. S. Collection. 210 different \$2.00. Bowers, 3423 Cherry, Kansas City, Mo.

100 UNITED States commemoratives, airmails. Approvals. 25c. Sibley, Glendale, Missouri.

U. S. Stamps—1847-1936. Completely illustrated, described in government book 25c postpaid. 50 different U. S. commemoratives 50c. Approvals. C. Roberts, 5932 Newburg, Chicago.

\$1, \$2, \$4, \$5, \$10 REVENUES. Also Civil War revenues, 19th century postage and commemoratives, battleships, a total of 30 stamps for only 15c to U. S. approval applicants. Metropolitan Stamps, 198 Broadway, New York.

MONTHLY Stamp and coin magazine, six months and 25 foreign stamps, 25c. American Stamp Journal, Cedar Rapids, Iowa.

STAMP Outfit free! Tannou Touva triangle; Cayman Islands (map); world's largest ship stamp; Sudan; handsome coronations; other unusual stamps in big wonder packet. Also watermark detector. All free to approval applicants sending 3c postage! Midwood Stamp Company, Department 4P, Midwood Station, Brooklyn, N. Y.

FREE! 15 Revenues, 5 commemoratives, Approvals. Postage 3 cts. Hutter, Cumberland, Maryland.

50 DIFFERENT United States postage stamps, 15c. Goldsmith, Box 200, Chicago.

60 U. S. Different 15c. 50 U. S. different commemoratives 25c. Steger, Box 154, Crown Point, Ind.

THE Most historic issue, the Bosnian Assassination, the spark that set the world afire! This complete set, complete Denmark ancient-ship set; King Edward set, coronation stamp and China and Japan sets, all for 10c. Pearson Bros., 68 Nassau St., New York.

CORONATION And British packet containing 5 different coronations, 2 varieties abdicated King Edward, jubilees, 10 different Canada, 10 different United States and Sierra Leone beautiful pictorial. All 10c to approval applicants. Stern, 23-45P Crescent St., Long Island City, New York.

300 DIFFERENT Stamps 20c; 600, 50c; 1000, \$1; 2000, \$3; 3000, \$7. Fred Onken, 630 79th St., Brooklyn, N. Y.

LARGE Columbus triangle and fine packet of 55 different stamps including valuable coronation stamp; odd Turks Is. and Leeward Is., birds, ships, etc. Only 5c to approval applicants. Potomac Stamp Co., Dept. 101-C, Washington, D. C.

FREE—Amazing Washington, D. C.—Money saving price lists: I—United States, possessions and B. N. A. II—Foreign—all countries. Either list, or both, to serious applicants. Enclose stamp. Approvals sent if you give size of collection. Fidelity Stamp Co., 945 Pa. Ave., N. W. (20), Washington, D. C.

FREE—25 Different United States. Bosley, Box 824, Tucson, Ariz.

QUEEREST Stamps packet. Receive one of world's smallest stamps; scarce Vatican City; Greek Red Cross (coiled snake in Garden of Eden!); Manchukuo; Soruth (mountain lion); Mozambique (giraffe); Palestine; many others. Also big packet 25 dif. Japan, (including earthquake stamp!) and pkt. 15 dif. China. Everything for only 5c to approval applicants! R. M. Stamp Co., Box 230P, Port Chester, N. Y.

20 GUATEMALA For 10c with approvals. Leon Rice, Girard, California.

500 DIFFERENT 35c; 1000, 90c; 5000, \$12.95. 100 airmails \$1.15. Three pounds worldwide \$1.00. Prepaid 50c rebate. Dutton, Efker, Anaheim, Calif.

EARN Cash, stamps. Sell my approval books—nickel packets. Ellison, 2841 West 37th Street, Brooklyn, New York.

UNITED States. Send \$1.00, receive \$5 worth approvals. Satisfaction or money back. Franklin, 225 Franklin St., Rochester, N. Y.

SURPRISE Packet free to approval applicants. First rate approvals. Alfred C. Johns, Sidney, Montana.

ILLUSTRATED Album. Spaces 4000 stamps; to approval applicants 20c. Swan Stamps, 604 Swan, Dunkirk, N. Y.

CANADA 1935 Dollar 20c. Approvals. Atkinson, 2273 Souvenir, Montreal, Canada.

"GOYA Nude" stamp 7c to approval applicants. Jewells, Tamaqua, Penna.

"GUATEMALA — Roosevelt miniature sheet," rare, 85c. GSCO, 613 Parrish, Philadelphia.

S.P.A. Sheet free with 50 different British Colonies 25c. (Approvals.) Paradise Stamps, Blawnox, Penna.

NEWFOUNDLAND And Canada. 75 different 30c. Coronation, jubilee included. Stampost, Mascouche, Que. Canada.

SPEND What you like, get double your money's worth. Send from 25c to \$5.00 and see the swell, high-class stamps you get. Refund guaranteed. Newberry, 946 Fort, Victoria, B. C.

300 DIFFERENT Stamps 10c with approvals. R. McKinney, Elsie, Michigan.

100 DIFFERENT Austria 10c, approvals. Hazett Stamp Shop, 701P Fourth, Bay City, Mich.

77 DIFFERENT Scandinavian, commemoratives, sets, 1874 issues to recent jubilees, 10c. Borkman, 115-22 Inwood, Jamaica, N. Y.

FREE! Triangle airmail! Coronation! Pictorials! British Colonies! Wonderful packet 106 different, 5c to approval applicants. Bargain, Box 39P, Times Square Station, New York.

FREE—Bargain list U. S., foreign. Approvals. Grems, Manchester, Iowa.

SENSATIONAL Offer! Real old United States collection, 35 different before 1905, 35c. Franklin, 225 Franklin, Rochester, N. Y.

25 DIFFERENT Peru 3c to approval applicants. Sundman, Dept. 14, Bristol, Conn.

SUPER-WONDER Packet offered containing 60 different stamps from Afghanistan, Transjordan, North Borneo, Manchukuo, Sudan, Macao, Iraq, Guadeloupe, French and British Colonies, including natives, beasts, ships, etc., all for 5c to approval applicants. Big illustrated lists free. Kent Stamp Company, Box 87 (9), Brooklyn, N. Y.

BIG Bargain! Triangle, coronations, Mongolia, Epirus, Albania and 100 diff. others cataloging up to 50c each. Everything only 10c to approval applicants. References. Pauly, Bad Axe, Michigan.

50 DIFFERENT, Fine U. S. including perforation gauge, 10c with approvals. The Stamp Shop, 809 Holland Bldg., St. Louis, Mo.

25 DIFFERENT South American 10c. No approvals. Burkhart Stamps, Sandwich, Ill.

200 DIFFERENT 10c. Big 50% approvals. Covert Stamp, 39 State, Rochester, N. Y.

PENNY Approvals are my specialty. Chas. Creek, San Gabriel, Calif.

NEWFOUNDLAND, 15 Different 5c with approvals. Frederick Brown, Plainfield, N. J.

CORONATIONS! Jubilees, airmails, Edwards, fine lot, 5c with approvals. Lew Ward & Sons, 116 Nassau, New York City.

FREE! New King George set. Postage 3c. Roberts, 901P Fourth, Bay City, Mich.

ELUSIVE United States on approval. Huber, 3 South 8th, Minneapolis.

FREE! 110 Different stamps to approval applicants. 3c postage. Zephyr, 5124 George, Chicago.

FREE—\$2 And 15 other U. S. Foreign approvals. Postage 3c. Wm. Clatworthy, Upland, Calif.

300 MIXED, Many countries, 15c. Approvals. Harvey Teeple, Decatur, Ind.

15 AIRMAILS Free to approval applicants. Globetrotter, Hotel LaSalle, South Bend, Ind.

DIAMOND Airpost commemorative issue complete, proletariat portraits complete, dragon stamp, with 117 additional, cataloging \$3.00, only 10c. Friendly Filatelists, Box 4428P, Philadelphia, Penna.

STAMPS. A superb selection sent on approval. Quality at low prices. Fred Herzberg, Box 91-P, Elmhurst, Ill.

U. S. Commemoratives, coronations, jubilees, British Colonies. Bargain lot, 5c with approvals. Hudson Co., 116 Nassau, New York City.

THE Gold and silver coronation set of Persia is one of the most beautiful issues of stamps in the world. Printed in actual gold and silver, the stamps show the glories of mystic Persia. We'll send the complete set of 17 varieties, all unused, at the special price of only 25c to approval applicants. The first hundred to answer this ad will be sent their stamps in a cover bearing the new S. P. A. 10c Smoky Mountain souvenir sheet without any extra charge! Rush your order for the most outstanding offer of 1937! Frasek Company, Dept. 55, White Plains, New York.

PACKET Bargains (non-duplicating): 10 Africa 2c; 15 China 3c; 25 Japan 3c; 1000 foreign 89c. Wright Company, 2527 Guilford, Baltimore, Md.

175 U. S. Commemoratives, etc., 10c.; 500 —25c. Box 457, Newark, N. J.

NEW Rivera nude stamp! World's largest triangle! Congo, Sudan, South Seas, bicolours, pictorials, and many others. Only 3c with approvals. Cactus Junior Approvals, Box 1870, Tucson, Ariz.

FREE. U. S. \$1, \$2, \$4 and \$5 stamps. Unbeatable U. S. approvals. Nelson, 78 E. 5th St., St. Paul, Minn.

U. S. Approvals only. Send post card for selection of U. S. stamps on approval: 19th century, commemoratives, air mails, revenues. John C. Daub, Dept. E, Wabash Bldg., Pittsburgh, Penna.

CANNON! Set of stamps showing cannon, firing squad, cavalry charge and 200 other different stamps, only 10c to approval applicants. L. H. Reich Stamp Co., 4225 Broadway, Chicago.

GIANT-SIZED Russian Zeppelin stamp, cat. val. 20c! and beautiful Lithuania airmail triangle; also big packet of 53 dif. stamps including Azerbaijan, Epirus, new Martinique, etc., and illustrated lists, all for 5c to approval applicants! World-Wide Stamp Co., Box 600, Camden, New York.

FREE—The Stamp Finder! Our new 24 page edition, fully illustrated, which will enable you to instantly identify all difficult stamps. Also fine packet of odd and unusual stamps from Bosnia-Herzegovina, Monaco, Patiala, Eritrea, etc., including maps, ships, animals and strange scenes. All free to approval applicants inclosing 3c postage. Garcelon Stamp Co., Box 900, Calais, Maine.

DIAMOND-SHAPED Stamp, Liberia gunboat triangle, two other triangles, silver jubilee, 27 others, 5c. Crowder Co., 127E North, Baltimore, Md.

FREE! 107 Different, 30 countries. Extra 25 U. S. including \$1 value, with approvals. Send 6c for packing, mailing. Ace Stamp, Colonial Arcade, Cleveland, Ohio.

50 DIFFERENT British Empire including jubilee, Edwards, 50 different new, recent and pictorial world issues, 15 different airmails, 500 hinges, perforation gauge, all for 25c. Approvals sent. Lists free. Victoria Stamp Co., London, 4, Canada.

BRAZIL, 50 Different 10c with bargain approvals. Davis, Silver Lake, Ind.

ASK For our wonderful one cent approvals. Prospect Stamp Co., 225 Broadview, Toronto, Canada.

WHOLESALE Catalog for dealers. Illustrated. Postage 5c. Frank Co., 4900 Chalmers, Baltimore, Md.

PENNY Approvals, that satisfy. Neil Gronberg, Box 5441-P, Philadelphia, Penna.

WEEKLY Stamp magazine, thirteen weeks, 10c. Stamp Journal, Kalamazoo, Mich.

U. S.—45 Different 10c. Free 25 different with approvals. Enclose 3c. Seidenberg, Baroda, Mich.

30 DIFFERENT Angola, Cape Verde, Guinea, Portugal, Mozambique, St. Thomas and Prince 5c. Approvals. Depraw, Ocean Park, Calif.

FREE, 50 Stamps, Manchukuo, etc. Postage 1c. Album 3c. U. S. bargains. Bullard, 268 Northampton, Boston, Mass.

ILLUSTRATED U. S. list, price 50c, large complete U. S. price list free. Send postage. Stanley Gibbons, 38P Park Row, New York.

APPROVAL Sheets. One to three cents. Frederick B. Driver, 2009 Finance Bldg., Philadelphia, Penna.

4½ TRIANGLES! Guatemala bisect (diagonal half-stamp), beautiful Liberia, three additional triangles, 27 other stamps, 5c. Abell Co., 1818 St. Paul, Baltimore, Md.

25 UNITED States, including \$4 and \$5 stamps free to approval applicants. 3c postage. Brownie Stamp Shop, Flint, Mich.

PHOTO FINISHING

ROLLS Developed, 8 prints, two beautiful glossy enlargements 25c coin. Candid rolls developed free—Prints enlarged to 3x4, only 4c each. 6 hour service. The Picture Folks, Box 911, Lincoln, Nebraska, Dept. X.

THE Photo Mill. Immediate service! No delay! Roll developed, carefully printed and choice of two beautiful 5x7 double weight professional enlargements, one tinted enlargement, or eight reprints—for 25c coin. Reprints 2c each. The Photo Mill, Box 629-12, Minneapolis, Minnesota.

FILMS Developed. Any 6 or 8 exposure roll and two Velox Deckledge prints each good negative, 25c coin on new cooperative plan. Photomail Service, A-81, Harrisburg, Penna.

SEND Us your films. Best work, 25c. Moore Studio, Alstead, N. H.

FILMS Developed 2 prints of each 25c; 20 reprints 25c. Pine Photo, M-5134 Nevada, Chicago.

QUALITY Reprints 3c. Rolls developed, 8 prints, 25c. Guaranteed. Major Photo, 5705-55 North Major, Chicago.

LEARN How to develop and print photographs. Booklet 25c. Anderson, 11010 State Street, Chicago, Illinois.

DEVELOP And print your own pictures. Save time, money with our complete outfit. \$1.95 plus postage, or sent C.O.D. Includes electric ruby lamp, printing frame, photo paper, chemicals and equipment. One of hundreds of amazing bargains in our free, newest, money-saving bargain book. Send for it today! Central Camera Co., 230 So. Wabash, Dept. 32-K, Chicago.

ROLLS Developed, two sets dated Velox prints, 25c. Hench Studios, Harrisburg, Penna.

IDEAL Photos. 25c per roll, finished with round corner prints. To get acquainted! Coupon and snapshot folder free! Ideal Photo, Box 2255, Paterson, N. J.

AN Outstanding offer. 2 lovely folders, 8 quality prints 25c. Adamson, Yale, Okla.

MAIL Your rolls to film center of the world. Any 6 or 8 exposure roll developed and printed 25c coin. DeLuxe enlargement coupon free! Photo Finishing Shop, Est. 23 yrs., 411-R Genesee Valley Trust Bldg., Rochester, N. Y. "The Camera City."

ROLLS Developed, two sets prints plus enlargement coupon 25c. Reprints 3c. Over 19 reprints 2 1/2c. Jones Studios, Davenport, Iowa. "Where the West Begins."

ROLLS Developed, 16 guaranteed prints, two coupons on plain or colored enlargement 25c. Smart Photo, Winona, Minn.

ROLLS Developed—One print and one enlargement of each exposure 25c. Trial. Reprints 20 for 25c. Skrudland, 6968-8 George, Chicago.

20 REPRINTS 25c. Films developed, 16 prints 25c. Enlargements 8x10, 25c; 5x7, 10c. Low Photo, M-2657 Neva, Chicago.

1938 PHOTO Calendars from your negative 10c each, 3 for 25c. Roll developed, 8 brilliant fadeproof Velox prints and two professional enlargements. 25c. Young Photo Service, 405-C, Albany, N. Y.

MILLIONS Now know "Hollytints means better prints." Two professional enlargements with trial roll—25c. Valuable premiums. Hollytints, P-1350, Hollywood, California.

THE Photo Mill. Immediate service! No delay! Roll developed, carefully printed and choice of two beautiful 5x7 double weight professional enlargements, one tinted enlargement or eight reprints—25c coin. Reprints 2c each. The Photo Mill, Box 629-12, Minneapolis, Minnesota.

GUARANTEED. 20 Prints 25c. Rolls developed, 16 prints 25c. Quality Photo, Hutchinson, Kansas.

TWENTY Reprints 25c. Roll developed and two prints each negative, 25c. Star Photos, 109 N. Dearborn, Chicago.

FILMS Developed, 6 or 8 print rolls with 2 professional enlargements. 25c coin. Dependable quality and service. Allied Photo Service Co., Box 289, Sparta, Wis.

PROFESSIONAL Quality service. Rolls developed, 8 prints and 2 enlargements 25c. The Film Capital Service, Box 504, Rochester, N. Y.

NEW Beautiful "Dated Border Prints" of Aristo quality. Roll developed, eight prints, free album, enlargement coupon, 25c. Aristo Photos, Dept. P, Box 5037, Chicago.

AT Last! All your prints in natural color. Amazingly beautiful. Roll developed, 8 natural color prints, 25c. Reprints, 3c. Fast service. Natural Color Photo, C-54, Janesville, Wis.

AT Willard's, Box 3535-A, Cleveland Heights, Ohio, you'll get quicker service, beautiful quality. Roll developed, 2 prints each negative 25c. Enlargement coupon. (Trial offer.)

ROLLS Developed, remarkable quality, two master enlargements, eight gloss prints 25c. Reprints 3c. World Famous Johnson Studio, Eau Claire, Wis.

KODAK Enlargement 5x7, 10c; 3 for 25c coin. Send best negatives (film). Dept. 5, Xlnt Photo Lab., Cedar Rapids, Iowa.

IMMEDIATE Service! Better pictures. Two beautiful heavy-weight professional enlargements and eight guaranteed Perfectone prints 25c coin. Sixteen pictures from roll 25c. Eight beautiful enlargements from roll only 25c. Candid rolls developed free—prints enlarged to 3x4, only 4c each. Pictures sent back same day film is received. American Studios, Box B, LaCrosse, Wis.

FINER Photos guaranteed. Rolls developed professionally. 8 Velox prints, 2 bromide enlargements, 25c coin. Finerfotos, Box D-898, Minneapolis, Minn.

ROLLS Developed, 2 prints each and 2 free enlargement coupons, 25c; reprints, 2c each; 100 or more, 1c. Summer's Studio, Unionville, Mo.

21 REPRINTS 25c. Rolls developed, 2 prints each negative, 25c. Fred Weick, 2840 Zenobia, Denver, Colo.

TWO Prints each with every roll developed, 25c. Very finest quality. Reprints 2c each. Brown Photo Company, 2209-34 Lowry, Minneapolis, Minnesota.

LATEST In photo finishing. Miniature films developed, printed 3x4—4c each. Two enlargements free each roll. Radio Film, LaCrosse, Wis.

ENLARGEMENTS 4x6, Five for 25c. 5x7 three for 25c. 8x10 three for 35c. Hand colored and framed each 4x6, 30c. 5x7, 35c. 8x10, 45c. Send film negatives. Enlargers, Maywood, Ill.

20 REPRINTS 25c. 100 Reprints \$1. Roll developed with 16 prints 25c. Nordskog, 4, Maywood, Ill.

ROLL Developed and 8 beautiful Velox glossy prints 25c coin or stamps. Reprints 3c each. Fotoprint Service, Box E, Roanoke, Va.

ROLLS Developed. Two beautiful double-weight professional enlargements and 8 guaranteed Never Fade Perfect Tone prints. 25c coin. Rays Photo Service, LaCrosse, Wis.

FINER Finishing. Rolls developed and printed, with one colored enlargement, or two professional enlargements. All for 25c (coin). Genuine, nationally known, Moentone superior quality. Moen Photo Service, La Crosse, Wis.

ROLLS Developed—Two new Beautitone Dubluate professional enlargements, 8 guaranteed fadeless Beautitone prints, 25c. Giant Snapshots, Inc., 667A, Green Bay, Wis.

BEAUTIFUL 5x7 Enlargements from your favorite negatives 17c each; three for 50c. Eight exposure roll developed and printed 25c. Work guaranteed. Jeems Service, Box 137, Ann Arbor, Mich.

FOR The discriminating amateur, roll developed and carefully printed 25c, reprints 3c. Superior workmanship, same day service. Paramount Co., 327 E. 92nd St., New York.

TWO Glossy enlargements, 1 colored with roll 25c. Arbor Service, 10, Joliet, Ill.

GET The best. Roll developed, beautiful hand colored enlargement, 8 neverfade border prints, 25c coin. Prompt service. Sun Photo Service, Drawer T, St. Paul, Minn.

COMPARE The difference! Roll developed, two professional double weight enlargements, 8 guaranteed prints, 25c coin. Excellent service. Nationwide Photo Service, Box 3333, St. Paul, Minn.

BE Modern! Get Modern service. Modern quality. Modern prices. Our modern methods give quick service and bright guaranteed neverfade pictures. Roll developed 16 prints, 25c coin. 16 reprints, 25c. Enlargement coupon. Send next roll or reprint order to Modern Finishers, 3537-C, St. Paul, Minn.

CAMERAS, PHOTO SUPPLIES

CAMERAS And supplies. Free illustrated catalog listing everything photographic—still and movie cameras, films, lenses—at tremendous savings. Hundreds of bargains, new and used. All guaranteed. We take your old camera or equipment in trade. Write now for your free copy of our newest money-saving bargain book—just out! Limited edition. Hurry! Central Camera Co., (Photographic Headquarters since 1899), 230 South Wabash, Dept. 2-K, Chicago.

MAKE Money in photography. Learn quickly at home. Spare or full time. Easy plan. Previous experience unnecessary. Common school education sufficient. Interesting booklet and requirements free. American School of Photography, 3601 Michigan Ave., Dept. 3432, Chicago.

CAMERAS Films, paper 25% to 35% discount. Paramount Photo Division, 327 East 92nd St., New York.

MAKE Photography a profitable hobby. The Photographic Digest tells how. Send 10c for sample to 1666 Linden Street, Brooklyn, N. Y.

CAMERAS And shutters repaired. Leather bellows installed in folding and view cameras. Bellows made to order. United Camera Company, Inc., 1515 Belmont Avenue, Chicago, Illinois.

TRADE Secrets. Booklet containing 101 photographic processes, tips, kinks. Have fun. Save money. 50c coin. Oylce, Photographer, 56 W. Washington, Chicago, Ill.

BEST Developing, printing, enlarging. Views and post cards of Mexico. Finest German cameras, field glasses, movie cameras and projectors. Ask for prices and catalogues. Foto Mantel Sucr. Rudolf Rudiger, V. Carranza 11.—Postbox 1459, Mexico, D. F.—105, Branch 3, No. 169 1/2 First Street, Tijuana, Baja California.

BASS—Camera crossroads of the world has ready for you a new 48 page Still Camera Bargaingram and that's news because Bass values are proverbial. Just think, a half No. 120 reinforced bakelite DeFranne roll film camera with F:2.9 Anastigmat lens in Compur shutter at \$27.75. A 9x12 cm. DeFranne Norfolk double extension plate and film pack camera, with F:6.3 lens in shutter, with film adapter and holder, new at \$16.75. Midget Marvel candid camera with F:4.5 lens at \$19.50. Dollina II coupled range finder 35 mm. candid camera with Radionar F:2.9 lens, Compur rapid shutter at \$49.75. Voigtlander Brilliant Reflex with F:7.7 lens at only \$7.50. Your money back at all times if any apparatus is not satisfactory. It is our policy for almost thirty years. Write for this latest Bass Bargaingram No. 233 and know what value and service really means. Bass Camera Co., Dept. AG, 179 W. Madison St., Chicago, Ill.

INCOME From your camera instead of expense. Low cost home course teaches you to make photographs for magazines, newspapers, advertisers. Tremendous demand. Earn good money wherever you live. Free book. Universal Photographers, Dept. 104, 10 W. 33rd St., New York.

HAVE You a camera? Send ten cents for recent number of our big magazine, showing how to make better pictures and earn money. American Photography, 116 Camera House, Boston, 17, Mass.

WE Purchase and accept in trade used photographic equipment. Send for bargain list. Fotoshop, 134R W. 32nd, New York City.

MOTION PICTURES AND SOUND EQUIPMENT

PROFESSIONALLY Lettered main title cards \$1.25. Readers 5c word. Ash Studios, 24 Figueroa, Santa Barbara, Calif.

CENTRAL'S Free, new, money-saving bargain book explains latest movie developments, offers money-saving bargains in cameras, lenses, projectors, films. Used equipment taken in trade. Write for free copy. Central Camera Co., (Photographic Headquarters since 1899), 230 S. Wabash, Dept. 22-K, Chicago.

DUPONT Superior panchromatic, 35 mm. 25 foot roll, \$1. Optical Laboratories, Larchmont, N. Y.

BARGAINS! 8mm., 16mm., Free literature. Elder, B-739 Boylston, Boston, Mass.

SPECIAL Movie screen, \$5.00 value, 26x34, table model, \$2.95. Shows better pictures. Mirotext, 6241 Southwood, St. Louis, Mo.

35MM. SILENT Talkies. List 3c. Bender, 5300 S. Talman, Chicago.

TALKIE Pictures rented, sold. Projectors. Simpson, 1275 So. Broadway, Dayton, Ohio.

35MM. LISTS 10c. Big variety. Calderara, 5119 South St. Louis, Chicago.

GET Hollywood quality in your 16mm. films. Our booklet "Making Professional 16mm. Movies" tells how. Full information about sound recording, printing, developing service. Price 10c. Bulletin free. Pan-American Laboratory, 5530 Lake Park, Chicago.

35MM. SILENT. Shorts, features, complete with title, \$1.00 per 1000'. DeVry portable silent projector, 500 watt, motor-driven (suitcase) \$29.50. DeVry 1000' capacity, 1000 watt sound-on-film projector, amplifier, speaker, tubes, complete, ready for show, \$198.50, fully guaranteed. Simplex-Holmes, silent, sound outfits at big savings. 8x10 screen \$10.00; Simplex double rewinds \$5.50. 16mm. silent, sound shorts, features for sale. 8mm. library, 100' fresh 16mm. camera film \$2.39, including processing. RCA Victor soundfilm 16mm. complete outfit \$149.50; Eastman 8 or 16mm. projectors \$18.00; Eastman 16mm. movie camera \$14.75; 1600' reel \$1.45. Save by buying direct from Mogull's House of Satisfaction, 1944-J Boston Road, New York.

16MM. MOVIE Titles 2c word or make your own. Complete lettering sets \$1.25. Wolfilms, 6858-T Stony Island, Chicago.

MOVIE Film. Develop yourself. Chemical samples 15c. Lake Camera Exchange, Gary, Indiana.

8MM. AND 16MM. Home movie films exchanged. Lists free. Hertwig, Reedley, California.

16MM. EQUIPMENT. Stamp brings cash prices. Care Box 5985, Cleveland.

FIRST Quality beaded screens 39x52", roller, blueprint for box, \$8.00. 3235 South Springfield Ave., Chicago, Illinois.

35MM. 1000 FEET. 75c. Projectors. Savarese, Woodcliff Lake, New Jersey.

8-16MM. FILMS "All subjects," for sale, exchange. Films rented everywhere. Bargains in cameras, projectors. Equipment, all makes and models, new and used. Trades accepted. Free illustrated catalogue, (with sample film 10c). Garden Exchange, 317 West 50th, New York.

"THE World's greatest of all Passion Plays," 16mm. 7½ reels. Sound with dialogue or silent. Rent or purchase. Superior than Oberammergau stage play. Write Hemenway Film Co., 37 Church St., Boston, Mass.

"MOVIE Making," 8mm., 16mm. Selecting equipment. Making scenes, titles. Animation, developing. Economies. 100 pages. 50c postpaid; no stamps. Lincoln Film Service, Box 793-A, Saginaw, Mich.

SPECIAL—8MM., 50 feet, \$1.27; 25 feet, 77c. Goodwill Company, Jackson, Tenn.

35MM. SOUND Films, projectors. Helmore, 15903 St. Mary's, Detroit.

SOUND And silent 16mm. films; list, samples, free. Pan-American Films, 5530 Lake Park, Chicago.

TITLERS For all Cine cameras, \$3.75 and \$5.45. 8mm. and 16mm. titling film, 35c up. Seemann splicer for 8mm.-16mm. films, \$2.95. "Baby Chrome" candid camera, \$9.95. New 16mm. Irwin cameras, \$12.50. Latest 16mm. Irwin projectors, \$18.00. 8mm. and 16mm. films, all subjects, sound and silent. Free catalogs. Hollywood Cine Film Distr's, Dept. P-2, 1431 No. Highland, Hollywood, Calif.

PROFESSIONAL 35mm. Cameras, sacrificed, \$22.00 up. Avond, 747 6th Avenue, New York.

AMAZING 16mm., 8mm. Movie bargains. Cine, 151 Broadway, Paterson, N. J.

NEW Complete 8mm. popular star movies 60c. 16mm. color film sample 50c. Free 16mm., 8mm. bargain lists. Home Movies, Box 216, Easton, Penna.

35MM FILMS Rented, 50c weekly. Lists 3c. Hoffman Film Service, 57 Broad, Albany, N. Y.

LEARN Motion picture theatre business. Home-study training; management, advertising, projection. Free catalog. Theatre Institute, Elmira, N. Y.

8MM. FILMS. Send for lists. Spring Films, Westboro, Mass.

WESTERNS, Comedies, 500 feet 75c. Jersey Films, 2075 Richland, Lakewood, Ohio.

BASS Invites you to drop in when you are in Chicago and see for yourself the largest stock of cine equipment in America, silent or sound. On sale a lot of brand new RCA Victor Model PG 71 16 mm. sound on film projectors, 750 watt bulb, 10 watt amplifier, a \$500 value at \$225. RCA 16 mm. sound on film camera, newsreel model, \$250. New Keystone 8 mm., 200 watt, motor drive projector, special at \$29.25. Moviematic still or movie camera, 16 mm., \$3.75. 8 mm. Kodascope projector, motor driven, 100 watt bulb, \$16.50. Bass Cine Bargaingram No. 230 is yours for the asking. Settles your movie problems—8 mm., 16 mm., 35 mm. sound or silent. Write to Camera Crossroads of the World, Bass Camera Co., Dept. A, 179 W. Madison St., Chicago, Ill.

8-16MM. TITLES, 2c Word. Catalogue. Clineshop, 1812 Piedmont, Charleston, West Virginia.

WORLD'S Best passion play, seven reels, new version all talking sound and silent 16 and 35 mm. rent or sale. All-Sacred Film Co., 50 Melrose Street, Boston, Mass.

15% TO 25% Discount on still or movie cameras. Free circular. Paramount Co., 327 E. 92nd St., New York City.

RADIOS, SUPPLIES, INSTRUCTION

MIDGET Cabinet radio. \$2.99 postpaid. Guaranteed. Wee Radio Co., Topeka, Kans.

THE Marvel—Long distance tubeless radio. No power required. Complete \$6.00 prepaid. Pocket radio, complete \$3.00 prepaid. Either radio for police use 50c extra. Allied Service, Dept. M, Seguin, Texas.

PLANS 18 Distance record crystal sets; "Radiobuilder"—year, 25c. Laboratories, 151-C Liberty, San Francisco.

RADIO Experimenters, set builders. Surprise package. Large box full of assorted parts—Transformers, condensers, chassis, resistors, wire, knobs, tubes, hardware, etc. Over \$10.00 worth for only \$2.00. Money back guarantee. International Radio Parts, 213 W. Illinois, Chicago.

SAVE Money on radios and radio parts. Send for our money saving catalogue. United Radio Company, N-Newark, N. J.

PARM-CITY Radios \$7.95 complete. Save half. Agents free offer. Amazing prices windchargers, power plants, accessories. Marco, 1244 McGee, Kansas City, Mo.

RADIO Engineering, broadcasting, aviation and police radio, servicing, marine and Morse telegraphy taught thoroughly. All expenses low. Catalog free. Dodge's Institute, Ames St., Valparaiso, Ind.

MUSIC AND MUSICAL INSTRUMENTS

LEARN Swing piano! Postal brings free booklet. Christensen, 751 Kimball Hall, Chicago.

PLAY Trap drums, no teacher required. Join orchestra immediately. Roll second week. Copyrighted system. Public schools everywhere use it. Complete course \$1.00. Class Drum Studios, 3609 Stoer, Cleveland, Ohio.

ITALO American accordion—easy payment plan. Free catalog. Metro Co., 3115 W. 13th, Dept. 7, Chicago.

PRINT Music by hand with the newly perfected Maze Manutype. Prints fast! Clean! Easily read! Write for illustrated pamphlet. Only \$2.25. Tan-Bar Products Co., Box 406, New Castle, Indiana.

SONGWRITERS! Outstanding convincing proposition. Hibbler, C-5, 2157 No. Avers, Chicago.

REBUILT Band and orchestra instruments. Honestly rebuilt, fully guaranteed. Catalog on request. Specify instrument interested in. Weymann Co., Dept. M-2, 1613 Chestnut St., Philadelphia.

PIANISTS: Free booklet describes method of improving your technique, accuracy, sight reading, memorizing. Write Dept. 423-B Broadwell Studios, Bendix Bldg., Los Angeles.

TWO Songs free if you send ten cents for song catalog. Dewey Music Publisher, 9825 Ave. M, Chicago.

WANTED Original poems, songs, for immediate consideration. Send poems to Columbian Music Publishers, Ltd., Dept. 42, Toronto, Can.

MUSIC Composed to words. Rhyming pamphlet free. Phonograph recording of song free. Keenan, 259 Beach St., Bridgeport, Conn.

WILF Carter (Montana Slim) cowboy folio, containing Moose River Rescue, Pete Knight, and many other cowboy songs. Words, music and guitar. 50c. Dominion Music Supply, Hermant Bldg., Toronto, Canada.

POPULAR Music Club, Bradenton, Florida. Rent music. Save money. Write.

SONGS Published, arranged and composed. Royalty basis. West Coast Music Publishing Co., 942 Market St., San Francisco, Calif.

POEMS Wanted. Free melody. We publish. Great Eastern, Thomaston, Maine.

SONGWRITERS. Real opportunity. Details. Edward Madden, 113 Michaels, Syracuse, N. Y.

COMPOSERS-LYRICISTS. Songs arranged, words or melodies, written, revised by arranger of "Cherry Blossom Lane," "Carolina Moon," "Treasure Island," many others. Send for details. Harold Potter, 1619(P) Broadway, New York.

ORIGINAL Music composed to your words: \$5. Song printed. Reginald Belcher, Chatham, N. Y. 30 years church organist.

VIOLINS—Handmade masterpieces, best since Stradivarius. Free trial. John Lehto, San Pedro, Calif.

SONGWRITERS Wanted, write for free book. Indiana Song Bureau, Salem, Ind.

LYRICWRITERS, Composers publication guaranteed. Sid Small, 647 Howard Avenue, Brooklyn, N. Y.

MUSIC Composed to song-poems. Orchestration arranged. Frank Wildt, Lancaster, Pennsylvania.

SONG Writers. Send for publishing agreement. McKinley Music Publishers, 1501 E. 55th St., Chicago.

SONGWRITERS—Get "How to Write Songs" by famous Broadway composer and free rhyming dictionary. Songwriters Institute, 1234-C Broadway, New York City.

MUSIC Composed to words. Wonderful proposition. Bauer Bros., Oshkosh, Wis.

SONG Poems wanted to be set to music. Free examination. Send poems to McNeil, Bachelor of Music, 4153-PM S. Van Ness, Los Angeles, Calif.

DUO-FLEX Reeds for clarinets, and saxophones eliminate your reed troubles. Write for circular. Duo-Flex Reeds, 1204 1st Ave., Evansville, Ind.

WRITE Songs. Big money and reputation. Write for information. J. Gordon Pub. Co., 201 N. Hoyne, Ave., Chicago.

SONG Poems wanted—Home, love, sacred, any subject. Send best poem today for offer. Richard Bros., 24 Woods Bldg., Chicago.

WANTED! Lyrics, melodies for songs. We arrange, publish, sell. Superior Song Studios, Passaic, N. J.

SURVEYING INSTRUMENTS

GUARANTEED Factory rebuilt transits and levels for rent (with purchase option) or sale (cash or terms). Order now before prices advance. We will repair, trade in, or buy your old instruments. Ship prepaid for estimate and valuation. Write for List M-32 and complete information to Warren-Knight Co., 136 N. 12th St., Philadelphia, Penna.

BUSINESS OPPORTUNITIES

THOUSANDS Of Chicago property owners are wild about Seal-Tite; saves money, saves buildings, keeps out cold, dampness, termites, insect pests. Has passed government test. Distributors write, Turner's Home Service, 1634 North McVicker Ave., Chicago, Ill.

FASCINATING Business. Repair, adjust typewriters, adding machines. Learn easily at home from factory expert. Earn up to \$15 daily. Complete instructions covering all makes \$3 postpaid or sent C.O.D. Adding Machine Equipment Service, 3601 Michigan, Dept. 3432, Chicago.

OPERATE A collection-credit agency. Quickly learned. Big income assured. Write Cole Associates, Syracuse, N. Y.

MAKE Artificial marble, glazed tiles, uncanny. Tabletops, plaques, floors, hones, novelties. Hard, fireproof, inexpensive, cement secrets. Brilliant tile and liquid rubber samples 3c. John A. Payne, 945 Grande Vista Avenue, Los Angeles, Calif.

MERITORIOUS Enterprises organized, developed, incorporated, products marketed, prospectus prepared, filed. Actual broker connections. Suttle, Hudson, N. Y.

\$100 STARTS "Chain" of chewing gum and confection vending machines. Steady cash income. Details free. Robbins Co., 1141P DeKalb Ave., Brooklyn, N. Y.

MRS. M. earned \$267, three weeks, raising mushrooms in cellar! Exceptional, but your cellar, shed perhaps suitable. We buy crops. Book free. United, 3848 Lincoln Ave., Dept. 69, Chicago.

FORMULAS—Fast selling products. Guaranteed. Laboratory tested. Lowest prices. Catalog free. Kemico, 55P, Park Ridge, Ill.

1000 OPPORTUNITIES! "Money by Mail"—10c. "1938 Plan" free. "Marconi," 126 Lexington Avenue, New York.

A MAIL Offering wonderful opportunities. Stamp appreciated. Joseph Castell, 1663 Madison St., Brooklyn, N. Y.

101 WAYS To make money and 700 money making secrets, both complete 50c. Lerner. G. P. O. Box 238, Brooklyn, N. Y.

YOU'LL Like resilvering mirrors, auto-parts, reflectors, making chipped glass signs. Write, Sprinkle, Plater, 127, Marion, Indiana.

INVESTIGATE Our sound mail order projects. Modest capital. Free folder. Steininger, 706 West North, Pittsburgh, Penna.

INCORPORATE Your business—Delaware. Many advantages. Basic cost \$22. Free booklet. Corporation Fiscal Co., Wilmington, Delaware.

PLASTEX Industries offers industrious men an opportunity to start a business of their own, manufacturing art goods, novelties, souvenirs, etc., in Plastex and marble imitation. 5c material makes \$1 articles. Rubber moulds furnished for speed production. Small investment brings big returns. You are just in time for the big 1938 season now starting. Write for interesting booklet mailed free. Plastex Industries, Dept. A, 1085 Washington Ave., New York.

DISTRIBUTE Your own catalogs. Details stamp. Getz's, P-129 Brick, Dickson, Penna.

MANUFACTURE From Phospholene. Cleaning fluid 1c gallon; bleach 2c gallon; and ten fast sellers. Sample 25c. Details free. Western, 6615 Denison Ave., Cleveland, Ohio.

LISTEN: If it's dollars you can't make, write B. F. Spencer, 447 Central Ave., Batesville, Ark.

MAKE Profits casting! Dollar kit makes three rubber molds. Express extra. Colonial Art, Derry, N. H.

44 STEPS To sure mail order success. New, easy, simple. No personal contacts. Free particulars. Thompson, Box 241, Duluth, Minn.

OPPORTUNITY Service. Members get plenty formulas, trade secrets, supply sources, samples, and information. Trial 10c. Waldo, Box 266, Dallas, Texas.

WORLD'S Newest co-op plan sells practically anything. Easy, simple, no canvassing, peddling. Free particulars. Lewis, Box 243, Minneapolis.

MAKE Rubber molds that need no greasing. Castings come out with glass like smoothness. Beginners outfit \$1.00. Satisfaction guaranteed. Details free. June, 101-B Beech, Holyoke, Mass.

YOUR Own business. Small investment. Details for stamp. Caldwell's, Pittsburgh, Penna.

WANT Spare-time mail order business in your home? Write Hottewitz, Drawer 1035-A, Tulsa, Oklahoma.

EASY Money. Moneymaking opportunities, many of them; anyone can work them, spare or full time. Details free. Lewis Co., 828-A, Carpenter, Oak Park, Ill.

AMAZING Opportunity! Learn to make genuine rubber molds. Instructions free. Stewart's Studio, 2927 Wilcox, Chicago.

NEW Unusual opportunity spare time \$350 month. No canvassing. Particulars free. Leadway Service, 5158 Madison, Chicago, Ill.

AMAZING. New, economic plant fertilizer. 25c. Sanquist Co., Pomeroy, Iowa.

OWN Growing business. \$2.00-\$5.00 hourly profit. Clean, mothproof upholstery, carpets, clothing in homes, hotels, institutions. "Earned \$90.00 one day"—Andersen. "Working 12 hours daily"—Lookiebill. "Repeat orders building business"—Hargrave. Portable electric machines, materials, advertising furnished. Little as \$88 establishes business. Write while territories open. Home Service, 163CT, Racine, Wisconsin.

OPPORTUNITY For man to get into something for himself—be own boss. No canvassing. Start with as little as \$75.00—a tried and proven moneymaker. No previous experience required. Write H. A. Wing, Box R, Central Station, Toledo, Ohio.

NEW Concentrate! You add only water to make four fast-selling products. \$1.00 brings enough for \$80.00 worth 10c retail item. Wemo Products, 183 Capen, Buffalo, N. Y.

MARBLEIZE Cements. Novelties or building material. Best rubber molds and beginner's outfit priced very low. Dime brings convincing samples. The Cowell Institute, Grayling, Mich.

REPAIRING Upholstered furniture pays well. Illustrated instruction book, covers most common repairs, estimating, where to buy supplies, etc., \$1.50. M. Swider, Dept. B, 260 19th St., Brooklyn, N. Y.

MANUFACTURE Polishpuffs. Amazing proposition 10c. Particulars free. Hickory-dell, Glenbeulah, Wis.

EARN Money in spare time—Others do. Catalog describing hundreds profitable money making items and ideas, free. Fedra, 7963A Kingston, Chicago.

"NEWEST Mail proposition!" Different! Safe! Profitable! Only 500 members accepted. "6000 word folio" 3c stamp. Gardena Institute, 128B, Station "S," Los Angeles.

WHERE To buy at lowest wholesale prices. Information free. Yorena, Box P-312, Bayonne, N. J.

MAKE \$15-\$75 Weekly; home business. Booklet describing over 100 plans free. Century, 1261-PC Broadway, New York.

MAKE Your molds with rubberite liquid rubber. Makes perfect impressions (see samples). Marblelike cement sets solid in 30 minutes. For slabs, any size, and novelties, anything, is waterproof. Free samples. Novelty Supply Co., Grayling, Mich.

MAKE Flexible molds for casting novelties, statuary, clock cases, other objects. Easy method. Complete formulas and working instructions, \$1.00. Bestoval, 4047-B North Whipple St., Chicago.

OPERATE Chain world's finest money making vending machines. Sells four products, same time. Instant success! Small capital, profits immediately. Penny King, 1233 Chouteau, St. Louis.

CASH, Quick action, unique plan. Instructions, materials, try-out, quarter coin. BBCO., Box 418, Gainesville, Texas.

START Profitable mailorder business at home. Literature free. Ideal, 179, Park Ridge, Ill.

PROFIT With new products. Make, sell, repeat. Analysis. Research. Guaranteed formulas. Biggest catalog free. Special prices, leads. Gibson Laboratory, Chemists, BD-1142 Sunnyside, Chicago.

"MAKE Mirrors at home." Big profits. Little outlay. Also emboss, grind—foil, gold leaf, frost, chip and make imitation stained glass. Instruction course \$1.00. Bestoval, 4047-B N. Whipple, Chicago.

FOR Successful mailorder plans write, Rich, 4511 N. E. 20th, Portland, Ore.

RAISE Mink. Bred females available. Dime for general information. Lomman's Fur Farm, Spangler, Penna.

AT Last! Book of moneymaking plans. Start at home, full or spare time. Send for descriptive folder free. Paramount Sales Service, Box 1784 Wilshire-LaBrea Sta., Los Angeles, Calif.

CHIPPING Glass signs. Booklet free. Beveridge, 160-22P Locust, Jamaica, N. Y.

EARN \$25.00 Weekly working two hours daily. No canvassing or manufacturing. Business opportunities. Box 5005, Dept. 44, Saint Paul, Minnesota.

PROFITS And pleasure making shell jewelry, novelties—newest field! Stamp appreciated. Challenge, A-10, St. Petersburg, Fla.

OPERATE Electric Simonizing station, full or part time. Cash in on national advertising with proved labor-saving invention for your car and business. Only \$29.50. Should net you approximately \$300-\$400 month. Write Bissell's Mfg. Co., 3320 Archer Ave., Chicago. Dealers wanted.

"SUCCESS Beacon," 52 pages! Moneymaking schemes, ideas, plans. Dime. Jay, Publishers, 6054-p Kenwood, Chicago.

ORDERS Waiting! Start home industry—help us fill tremendous demand for new, fascinating, simply-cast, china-like, artware. Nothing like it. Amazing profits. Your start to independence. Artware, 9 Indian Church Road, Buffalo, N. Y.

ANYONE With small garden can earn up to \$500.00 two months. Stamp brings particulars. Lightning Speed, Streator, Illinois.

START 1938 Right! Making newest staple products to sell, repeat, with Miller's Famous Certified Formulas. Investment small—profits great! Valuable literature free! Miller, Chemist, 1706-M Tampa, Florida.

AFTERNOONS Free for outdoors, movies, \$340 month home. Unique plans. No canvassing. Prepare for surprise. Folio-F, Station D, Los Angeles.

POPCORN, Crispette, carmelcrisp, potato chip, salted nut machines. Long Eakins, 1960 High St., Springfield, Ohio.

PLASTEX Industries offer industrious men an opportunity to start a business of their own, manufacturing art goods, novelties and utility products in Plastex and marble imitation. 1/2c materials makes regular 10c store sellers. Rubber moulds furnished for speed production. Small investment brings big returns. Nationwide demand in these low priced goods for coming X-mas holidays. Ambitious men have chance for real prosperity. Plastex Industries, Dept. A, 1085 Washington Ave., New York.

DONUT, Potato chip, cheezed pop corn. Home made. Big profits. Vandropol, Springfield, Ohio.

WE Start you in business, furnishing outfits and instructions, operating Specialty Candy Factory home. Men and women, earn \$25 up to \$60 weekly, all or spare time. (Our 29th year.) Booklet free. W. Hillyer Ragsdale, Inc., Drawer 4, East Orange, N. J.

LIQUID Marble—anyone can make! Colorful, glazed! Moulded, brushed, sprayed. Rubberlastic moulds. Composition flooring. Big money in these! Particulars free. Marbleizing Service, Edwardsville, Ill.

SUCCEED With your products. Make-sell them. Formulas, Processes. Accurate analyses. Catalog free. B. Thaxly Co., Washington, D. C.

PROFITABLE Home business. Legitimate. No canvassing. Maywood Publishers, P-923 Broadway, New York.

MAKE Your own products. Employ agents yourself. Toilet articles, soap, extracts. We furnish everything. Valuable book free. National Scientific Laboratories, 1950W Broad, Richmond, Va.

SELL By mail. Books, novelties. Bargains! Big profits! Particulars free. B. Eifco, 438 N. Wells, Chicago.

FREE Booklet describes 107 plans for making \$20-\$100 weekly, in home or office, business of your own. Elite Co., 214 Grand St., New York.

I WANT To send you proof of the wonderful pulling power of Popular Mechanics Magazine's classified pages. What's your proposition? Write me today. F. W. Johnson, Manager Classified Advertising, 200 E. Ontario St., Chicago, Ill.

CHARTERS: Delaware; best, cheapest; free forms. Colonial Charter Co., Wilmington, Del.

CASH Every week clipping and preparing news items for publishers. Simple, fascinating work. Experience unnecessary. Stamp brings information. Division 55, National Press, 3923 W. Sixth, Los Angeles, Calif.

HOW And where to obtain capital fully explained, free particulars. Star Service, Wapakoneta, Ohio.

DELAWARE Charters: Complete service \$35. Submitted forms. Chas. G. Guyer, Inc., Wilmington, Del.

ARTIFICIAL Marble sanitary flooring, instruction covering wood or cement flooring 1/2 inch thick, fireproof, all colors, low cost, ornamental casting, concrete, plaster, papier-mache, garden furniture, statuary, flexible molds, particulars free. Chris Mahler, Elmont, N. Y.

MAIL Order business is your opportunity. Many began small, now earn thousands yearly. No personal contact. Boundless opportunities. Have had over 30 years experience; will help you succeed. Send 25c for valuable booklets, none free. B. Brenner, 257 S. 21st, Philadelphia.

100 PROFITABLE Mail order and local plans. Gilbert Supply, 1107 Broadway, New York.

MONEYMAKING OPPORTUNITIES

HYDROPONICS: Grow plants and flowers without soil. Chemical crop culture. Interesting, educational. Unusual yields. Formulas, instructions and selected bibliography, \$1. Hydroponics, Box 613, Guthrie, Ky.

MONEY Making opportunities, plans, list and our magazine 10c. Sholtmir, 196 Ave. B, New York.

MILLIONS Jobless! Get dollars in mail daily, like we do, for amazing employment information. Keep money; we fill your orders free. Stamp brings details. Co-Operative Service, 77 Swan, Buffalo, N. Y.

\$500 A YEAR Raising canaries. Singing canaries sell for \$5 to \$15. My book tells you how. Only \$1.00 per copy. Esther Purcell, 752 S. Cassingham Rd., Columbus, Ohio.

MONEYMAKING Plans, schemes, formulas, ideas. Rowell, 240 Illinois, Rochester, N. Y.

FREE Sample—Fast selling necessity. Kleen-Brite, Southside, Oil City, Penna.

LATEST Novelty butterfly desk combination. Instruction sheet ten cents. Materials fifteen cents extra. Popular Art Studios, 740 Rush, Room 600, Chicago, Ill.

"MAKE It Yourself" perfumes. Sample, 25c. Belle Mead (N. J.) Laboratories.

DOLLARS Daily. Dime brings amazing plan. Leslie, 3415 Fort Independence St., New York.

HOME Industries, 44 pages, year 10c. Melotz, Publisher, Benson, Nebr.

MONEYMAKING Books, plans, ideas. Write quick. Strom, 302 Boyden, Maplewood, N. J.

1,000,000 ARTICLES Wholesale. Directory 10c. Jelsmith, 163 Myrtle, Waltham, Mass.

GET Dollar bills, quarters by mail galore. Nearly all profit. Particulars free. Stamp appreciated. Homecraft Arts, Dept. PM-2, Lakeside, California.

ANNOUNCING New book service opportunity. A thousand openings. Operate by mail, anywhere. Complete plan \$2. Folder. Julius, Amarillo, 30, Texas.

AUTHENTIC Prosperity plans bring \$8.75 daily. Start on \$1.25. Literature free. Direct mail. Box 344, Summit, New Jersey.

YOU'LL Like resilvering mirrors, autoparts, reflectors, making chipped glass signs. Write, Sprinkle, Plater, 287, Marion, Indiana.

"THE Schemer," Alliance, Ohio, prints schemes, ideas, business starters, formulas; winners: \$10,000 to \$25,000 reported. 40th year; \$1.00. Special: Trial six months only 30c.

PROFIT In vegetables, flowers, using chemicals. Remarkable yields. Proven formulas. Chemicals for 48 gallons solution. Instructions \$1.00 postpaid. Quick Growth, Hollywood Sta., Box 648, California.

NEED Money?? Need work? Hundreds of interesting money-making offers for a dime. Mention paper. Paramount Distributors, Box 864, Denver, Colo.

ALBERT Service, Six North Dearborn, Chicago. Publishers mailorder magazines. Four different 25c.

SELL Epsom salts \$16.00 lb. Plan 25c. Keith, Roscoe, Texas.

TURN Spare time into cash with typewriter! Addressing envelopes, mailing circulars, typing! Dime brings information, none free. Ace, TPM, 322 Empire, Birmingham, Ala.

PROVEN Home money making idea, 25c. Acme Manufacturing Co., 121 Miriam Ave., Rockford, Ill.

FINANCIAL Independence. Twenty money making secrets exposed \$1.00. Snyder Industries, 114 Ridge Ave., State College, Penna.

NEED Money? Earn \$35 to \$45 weekly at home. Dime brings details. Dawsonoa, Box 20PM, Sta. J, New York.

ARE You mechanical? Want steady job, good money? Write, Connan, 508 S. W. Second, Portland, Ore.

TAKE In the dollars with the money by mail system. Particulars free. Key Systems, Box 323, Jeannette, Penna.

SELL By mail—Mailorder Digest tells how. Copy 10c. 126 Cannons, Louisville, Ky.

REAL Opportunities for you. Home or office. Literature 10c. McCants Service, Weslaco, Texas.

WANT Extra income? Free folder describes 100 helpful plans. Dixon Co., 776F, Springfield, Mass.

START Mailorder business. Details free. Pederson, 1609 1/2 East Fifth, Duluth, Minn.

STOP Squealing—Start crowing! Work mornings home—drive to country—"movies"—afternoons! No canvassing! Follo-A, Station "D," Los Angeles.

MAN In each town to plate auto parts, reflectors, bicycles, fixtures, mirrors, by late method. Simple plan of manufacturing at home starts you in good paying business. Free particulars and proofs. Gunmetal Co., Ave. N, Decatur, Ill.

NEW All profit plans. Kurtz, 3541 94th St., Jackson Heights, N. Y.

RAISE Earthworms for profit. Information free, stamp appreciated. Bureau Zoological Research, 106A Broadway, Peoria, Ill.

MOULDS, Guaranteed, for casting toy soldiers, Indians, trappers, warships, sinker moulds, 244 kinds. Send 5c for illustration catalogue. Henry C. Schlercke, 645 Spencer, Ghent, N. Y.

WHOLESALE Sources, 500,000 articles. Free directory. Maywoode, 925 Broadway, New York.

107 PLANS For making \$20-\$100 weekly in home or office business of your own. Descriptive booklet free. Elite Co., 214 Grand St., New York.

LIKE To draw? Earn steady income tracing and duplicating advertising cartoons. Ad-Service, Argyle, Wis.

FORMULAS, PLANS, ETC.

"TWO Dimes" brings plan, formula, sample, that's sweeping country! Lin-O-Uth formula included free! Davis, Box 1484-PM, Clarksburg, W. Va.

EXCEPTIONAL, 28 Grams lilac blossom oil including perfume formula—\$1.00. Addison Laboratories, Pawling, N. Y.

GUARANTEED Formulas—New fast sellers. None better. Lowest prices. Catalog free. Kemico, 49P, Park Ridge, Ill.

1000 SELECTED Formulas, big mail, 25c. McGerty, B-451, Manhattan, Kansas.

ANY Formula, 5 for \$1.00. Free information. Kurtz, Glen Allen, Virginia.

ANY Formula 30c or money back. New catalog free. Ogg Laboratories, Tampa, Florida.

SOILLESS Agriculture. Raise tomatoes, potatoes, flowers, etc., in shallow tank of water containing 21 chemicals. Tomato vines 20 feet, bear for year. 20 pounds per vine, quality better than soil grown. Instructions, formula \$1. Purdy's Chemicals, 1852 E. Slauson Ave., Los Angeles.

ORDER Your formulas from experienced chemists. Anything analyzed. Duplication guaranteed. Associated Chemists, Indianapolis, Indiana.

RE-BLUE Guns for self! For profit! Formula and business instructions \$1.00 cash, 6c stamps. Jerz Lab., P. O. Box 677, New Haven, Conn.

"LUMINOUS Paint"; mirror resilvering. Formulas \$1.00! Guaranteed! Thomas Galluzo, Wilkensburg, Pennsylvania.

ANALYSIS, Research. Newest guaranteed formulas. Biggest catalog free. Special prices, leads. Gibson Laboratory, Chemists, BD-1142 Sunnyside, Chicago.

WE Give formula, instructions and quotation on ingredients, any product, \$1.00. Federal Laboratories, Box 200, Jersey City, N. J.

100 MONEYMAKING Formulas 25c. Descriptive literature free. Harvey Teeple, Decatur, Ind.

THAXLY Formulas for perfect products. Accurate analysis assured. Resultful research. Catalog free. B. Thaxly Co., Washington, D. C.

MAKE Your own products. Employ agents yourself. Toilet articles, soap, extracts. We furnish everything. Valuable book free. National Scientific Laboratories, 1950 W. Broad, Richmond, Va.

FORMULAS, Latest money makers. Literature free. Belfort, 4042 N. Keeler, Chicago.

CHEMISTRY

FREE Plans for inexpensive natural gas generator. New style bunsen burner for natural gas. Develops up to 2000 F., stays lit. \$1.00 postpaid. Angelus Mfg. Co., Box 885, San Angelo, Texas.

MAGIC Chemical submarine 10c coin. Clinton Chemical Company, Swedesboro, New Jersey.

RARE Chemicals. Sample, dime or stamps. Ernest Snow, Lexington, Mass.

CHEMISTRY Magazine—Research, experiments. Three months subscription 15c. Spanner, 100 Forsyth, New York.

LEADING School supply house offers chemicals and apparatus of professional quality at lowest school prices. Send 3c postage for free illustrated catalogue and latest chemical price-list. New York Scientific Supply Co., Dept. 15, 111 E. 22nd St., New York City.

RUBBER Latex. Dime brings literature, twenty experiments. Eastern Latex Labs., Box 53, Canton, Mass.

ANALYSIS, Research. Newest guaranteed formulas. Biggest catalog free. Special prices, leads. Gibson Laboratory, Chemists, CT-1142 Sunnyside, Chicago.

RE-BLUE Guns for self! For profit! Formula and business instructions \$1.00 cash, 6c stamps. Jerz Lab., P. O. Box 677, New Haven, Conn.

HANDBOOK For chemical experiments, hundreds of experiments, illustrated, 50c. Experiment booklet, 15c. Chemical catalogue, 10c. Reading Scientific Co., Reading, Penna.

FREE Chemistry catalog. Supplies at 5c! Equip complete laboratory. Send 3c for postage. Kemkit Scientific Corp., 397P Bridge St., Brooklyn, N. Y.

CHEMICALS, Laboratory glassware, apparatus. Send 5c for catalog CP-1. Biological Supply Co., 1176 Mt. Hope Ave., Rochester, N. Y.

HELP WANTED

MONEY In butterflies, moths. See Sinclair Display Advertisement on page 32A.

STOP Job-hunting. Be your own boss. Start profitable mail order business of your own. No selling. Write Hant Service, 516-Y Federal, Pittsburgh, Penna.

AGENTS WANTED

MAGIC Electric brush retails \$1.50—your profit 75c. Uses static electricity. No wires, batteries or expense. Carry in your pocket, unbreakable. Send for sample and particulars. Donald Brush Co., Advertising Dept., Camden, N. J.

LOCAL Agents wanted to wear and demonstrate free suits to friends. No canvassing. Up to \$12 in a day easy. Experience unnecessary. Valuable demonstrating equipment, actual samples free. H. J. Graves, Pres., 1300 Harrison, Dept. B-817, Chicago.

500% PROFIT! Gold and colored sign letters for windows, offices, trucks, signs. Auto monograms. Easily applied by agent or customer. Neonite, Akron, Ohio.

SELL Tinselled religious mottoes to homes. Big profits. Novelty Signs, Stryker, Ohio.

AGENTS—Mail dealers. Extremely good offer. Trowbridge, 7915 Parnell, Chicago.

JO-BO Rubber bow neckties. To show them is to sell them. Good sideline. Jo Bo Products Co., 3402 School, Des Moines, Iowa.

100% PROFIT In new perfected (1938) quick-action self-starting cigar lighter. No flint or friction. No wind can blow it out. Retail 25c. Costs you \$1.75 dozen. Sample and can fluid 25c. New Method Co., Box PM-62, Bradford, Penna.

SELL Modern slogan signs. Free samples. Special-Kut, Sidney, Ohio.

AT Home, your own manufacturing business, making popular \$1 novelties. Cost you 3c to 15c. Everything supplied. Write So-Lo Works, Dept. B-842, Cincinnati, Ohio.

NEED Money quick? Here's genuine opportunity to make up to \$42.50 in a week. Operate grocery business from your own home. Supply friends, neighbors, others. I send complete outfit on 30-day trial; no money risk. Details free. Albert Mills, 8836 Monmouth, Cincinnati, Ohio.

UNUSUAL Booklet for citizens. Sample ten cents. Ernest Gebbs, 7 East 76 Street, New York City.

UP To \$6.00 an hour. Amazing Karnu refinishes autos like new without rubbing, polishing, waxing or painting. Inexpensive—costs little. Wipes on with cloth. Lasts 8 to 12 months. Free sample. Karnu, Dept. B-8, Cincinnati, Ohio.

450% PROFIT Quick-Action automatic gas lighter. No flint. 25c seller to every home, office and restaurant. Free sample. New Method Co., Box PMG-62, Bradford, Penna.

STRANGE Chemical sponge cleans wallpaper like magic. Banishes housecleaning drudgery. Women amazed. Hustlers cleaning up. Details free. Kristee, 129, Akron, Ohio.

KIROPED Foot cream offers direct salesmen territories still open, showing big earnings and repeats. For details write Isobell Laboratories, Newark, New Jersey.

ATLAS Window sign letters. Large sizes, penny each. Beautiful free samples. Atlas, 7941 Halsted, Chicago.

BUSINESS Proposition: Resilvering mirrors, autoparts, reflectors, making chipped glass signs. Write, Sprinkle, Plater, 128 Marion, Indiana.

500% PROFIT Selling new 20-in-1 kitchen utensil. Retail 25c. Costs you \$1 a dozen or \$6 a gross. Sample 10c. New Method Co., PMM-62, Bradford, Penna.

PICTORIAL Map our army, \$1.00 postpaid. Agents. Roby, 1456 Ridge Ave., Evanston, Ill.

CASH In on amazing demand for new unique car washer. Every auto owner, service station, fleet owner wants one or more. Sight sells. Demonstration unnecessary. BECO., Box 418, Gainesville, Tex.

EUROPEAN Chef's seasoning. Sample 10c. Henri', 3413P Clarendon, Cleveland, Ohio.

DISTRIBUTORS—Supply revolutionary corn remedy to stores. New plan results in landslide of orders. 150% profit. Exclusive franchise. Reliable Specialty Corp., Buffalo, N. Y.

NO Peddling. Make \$15-\$75 weekly, home or office business. Free booklet describes over 100 successful plans. Century, 1261-PD Broadway, New York.

DOLLARS Daily. No canvassing. Details free. Co-Operative Service, PMA884, Spuzzum, B. C.

ELECTRIC Razor with heated blade. Wireless. Softens toughest whiskers. \$3.95. Agents' sample \$2.37. Razor Research, 130 Water, New York.

MONEY in butterflies, moths. See Sinclair Display Advertisement on page 32A.

PROFIT With new products. Make, sell, repeat. Analysis. Research. Guaranteed formulas. Biggest catalog free. Special prices, leads. Gibson Laboratory, Chemists, BD-1142 Sunnyside, Chicago.

STARTLING Invention—Pocket adding machine. Nationally advertised \$2.50. Whirlwind seller. Big profits. Calculator Mfg. Co., Box 1118, Chicago.

500% PROFIT! Gold reflecting letters for store windows. Large sizes 1c. Free samples. Modernistic Sign, B-3004 Lincoln Ave., Chicago.

MEXICAN Finest feather pictures: 4x9" costs 25c including duty, retails \$1.00. (Sample 20c stamps.) Embroidered tablecloths: 36x36" with napkins costs \$1.18. Retails \$2.50. (Sample \$1.00.) Free particulars. Marquez, Apartado 1176-P, Mexico City.

AGENTS: Smash go prices! Santos coffee 12c lb. 4 oz. vanilla 8½c. Razor blades 10 for 8½c. 100 sticks chewing gum 12c. 150 other bargains. Premiums. Experience unnecessary. Carnation Co., PO, St. Louis, Mo.

START 1938 Right! Making newest staple products to sell, repeat, with Miller's Famous Certified Formulas. Investment small—profits great! Valuable literature free! Miller, Chemist, 1706-M, Tampa, Florida.

GUARANTEED Gold leaf letters for store and office windows. 500% profit. Free samples. Metallic Co., 438-B N. Clark, Chicago.

BIG MONEY applying initials on automobiles; \$1.45 profit on each sale. Write for particulars and free samples. American Monogram Co., Dept. 40, Dunellen, N. J.

SELL Novelty fun cards, novelties, etc. Samples 10c. National, Box 500M, Cincinnati.

MAN in each town to plate auto parts, reflectors, bicycles, fixtures, mirrors, by late method. Simple plan of manufacturing at home starts you in good paying business. Free particulars and proofs. Gunmetal Co., Ave. H, Decatur, Ill.

BIG, Steady weekly profits for men and women with cut price food route. More than 300 fast selling household and farm necessities. Sensational premium deals get quick cash and build profitable routes quickly. Write Bleecker, 259 E. 4th St., St. Paul, Minn.

AGENTS—To mail our literature. Good profits. Home business. Maywood, 149 Fifth Ave., New York.

SUCCEED With your products. Make-sell them. Formulas. Processes. Accurate analyses. Catalog free. B. Thaxly Co., Washington, D. C.

MAKE Your own products. Employ agents yourself. Toilet articles, soap, extracts. We furnish everything. Valuable book free. National Scientific Laboratories, 1950W Broad, Richmond, Va.

AGENTS—Opportunity to make money; book containing 107 successful business plans; home or office; send for free introductory booklet. Elite Co., 214 Grand St., New York.

FREE Sample—Amazing cleaner; sells homes, taverns, everywhere. Big profit—fast repeater. Betco, 5007 Irving Park, Chicago.

WANTED—District purchasing agents. No experience or money required. Write Purchasing Manager, 174 N. Halsted, Chicago.

DO You want agents for your proposition? Your ad in this space will place your message before hundreds of men seeking fast-selling products. My folder "How to Secure Agents," is filled with proof. I'll gladly send you a copy free. F. W. Johnson, Manager Classified Advertising, Popular Mechanics Magazine, 200 E. Ontario St., Chicago.

AGENTS: Stamping names on pocket-key protectors. Sample check with your name, address, 25c. Stamping outfits. Emblem checks, check-fobs, name plates. Hart Mfg. Co., 303 Degraw St., Brooklyn, N. Y.

MANUFACTURE Specialties, hire agents yourself. Big money. Free literature. Gilbert Supply, 1107-P Broadway, New York.

ENGRAVED Name plates, numbers, signs, etc., easily sold, profits large. Brett Bros., Winthrop, Mass.

HIGH-GRADE SALESMEN

WANTED—District managers, distributors—age 25-55—to investigate and interview dealers for sensational merchandising plan. (Requires no selling.) 100% credit insurance on merchandise. Profits up to \$300.00-\$600.00 month. New scientific method conditions automobile motors few minutes, while motorists wait. (No graphite—no mica.) Easy to use. Saves time, money, gasoline, oil. Lloyds of London insurance to \$5000.00 protects users. Method and proposition alone in field. Guaranteed results. Your profits up to 233%. Write today for details free of risk test and "profits-or-money-back" plan. Territories going fast. Rush, Craver and Jay Company, Dept. 103, 21 West 10th, Kansas City, Mo.

MEN Wanted by shoe manufacturer established 34 years, for sales work. Ready cash daily and free shoes as bonuses to producers. No experience needed. Your own shoes at factory prices. Complete line showing 250 styles including famous Velvet-Eez air-cushion nailless insole shoes, sent free. Write Mason Shoe Manufacturing Company, Dept. D56, Chippewa Falls, Wisconsin.

START Big pay business of your own. Sell wholesale to stores. Easy plan starts you without capital. Show merchants new plan that increases sales and profits. Handle nationally advertised line 5c-10c counter display goods. 200 products. All daily necessities. Put up on flashing, self-help counter displays. Make up to 112% profit. Chance to drive one of our "Silver Fleet" service cars. Get facts. World's Products Co., Dept. 2810, Spencer, Ind.

SALESMEN: Sell business stationery, book matches, calendars, Xmas cards, advertising pencils, shelf moulding, labels, salesbooks, pricing sets. Business cards \$1.50 thousand. 35% comm. daily. Free deals. Sales portfolio free. David Lionel Press, 313 So. Hamilton, Dept. XE, Chicago.

"SAFETY Spacers" make flexible razor blades last longer. Shaves quickly, closely, safely. Send dime for sample and terms. A. W. Barnard, Orange Ave., Citra, Fla.

NO Selling! Steady work. Big pay daily. Be my local buyer. Money furnished. Details free. Pruitt, E-10 North Clark St., Chicago.

YOUR Opportunity for permanent income. Quality uniforms for quantity buyers! Exclusive styles and models—Large profits—Restricted territory! Free outfit. Write today. Lion Uniform Co., Dept. M-19, Dayton, Ohio.

SELL Gas stations new forms, ledgers, files. Symplex, Lamoni, Iowa.

SALESMAN Wanted. \$250 weekly profits made selling special tool set to garages. No competition. Write Mesco, Box 205P, Beaver City, Nebr.

WANTED County distributors. Excellent opportunity for earnings. Nationally advertised product. Large company. Dept. 253 Fyr-Fyter Company, Dayton, Ohio.

SELL Celluloid and cardboard pricing tickets, steel shelf moulding, changeable signs, menu covers. Every store prospect. P. Pricing Press, 124 White St., New York.

TOOL Salesmen; sell new inexpensive electrical trouble shooter. Every repairman buys on demonstration. Many making \$75 weekly as side line. Factory, 2812 Gilham, Kansas City, Mo.

SALESMEN To sell hardware stores and garages. Powerful new fast-selling specialty. Liberal commissions. Repeats. Coronado, St. Paul, Minn.

SELL Nothing. \$95 weekly. \$500,000 punchboard firm announces new, no investment plan. Season starting. K&S, Dept. C122, 6227 Broadway, Chicago.

IF You sell advertising specialties write Blue Book, Oak Park, Illinois.

RAWLEIGH Men make good money. Supply everyday household necessities to Raleigh routes of 800 family users. Ambitious men can start making \$30 weekly and up. Sales way up this year. We furnish everything but the car. Write today. Rawleigh's, Dept. B-A-PPM, Freeport, Ill.

ATLAS Window sign letters. Large sizes. Penny each. Beautiful free samples. Atlas, 7941 Halsted, Chicago.

SALESMEN Sell suits on our easy credit plan. Free suits and pants given as bonus besides large cash profits, premiums and gifts. Sell only (5) suits to get a free suit. No limit to number of free garments you may earn. Wholesale prices \$16.95 and up. Sample line free. No experience needed to make easy sales. All garments individually cut and tailored to measure. Satisfaction or money back guarantee. Three Star Clothes, Inc., 330 South Franklin St., Dept. BA-1, Chicago, Ill.

SALESMEN, Distributors. We pay higher commission, exclusive territory. 125 varieties brushes, mops, specialties. Neway Brush Co., Hartford, Conn.

TIRE Accessories. Guaranteed 10,000 mile Tiger Grip Tire Patch, and complete fast-selling line auto accessories. Salesmen-distributors easily make up to \$75 weekly, and over. Protected territory. Economy Rubber Products Co., 840 Burkhardt, Dayton, Ohio.

MERCHANDISE Sales display, dime seller. Enormous value. Big repeats. Particulars free. Brandt Company, 729 Baltimore, Kansas City, Missouri.

SELL Our special household products. Our free goods campaigns build profitable permanent business for you. Credit arranged. Rayburn Sons, 5946 Eggleston, Chicago.

IMMEDIATE Opening selling advertising matches to taverns, cafes, beauty shops, etc. Cash commission, bonus. Outfit free. Gem Match, 74 West Washington, Dept. 52, Chicago.

IMMEDIATE Openings for ambitious men! Wear, introduce "Fairbanks" individually tailored clothes. Enjoy fine income. Get new suits and overcoats without cost as bonus. Experience unnecessary. Low prices. Quick sales. Outfit free. Fairbanks Company, 2204 Wabansia, Chicago.

LUNCHEON Party organizers for few districts. Rare opportunity with fast growing business featuring chic food cutter equipment. Customers and organizers enthusiastic. Grisceer Industries, Fort Wayne, Indiana.

NATIONALLY Known chemical corporation considering applications from salesmen experienced in selling disinfectants, insecticides, cleaning compounds, floor maintenance products, deodorants, etc., to factories, schools, institutions, municipal and county buildings, and other direct bulk users. References required, own automobile, protective contract given, drawing account considered. The Federal Sanitation Co., Inc., 2340 Euclid Avenue, Cleveland, Ohio.

NEW Specialty—Sells every business and professional man. Four \$15 sales daily pay \$280 weekly. Parrell cleared over \$1,000.00 monthly. Write, P. E. Armstrong, President, Dept. PM, Mobile, Ala.

JUST Out. Big sensation. New hand cleaner, big profits. Money back guarantee. Full size box 25c. McArthur Products Company, 13332 Compass, Detroit, Mich.

GREATER Commissions. Increase your income selling \$10,000 accident and health policy; \$25-\$50 weekly benefits. \$10.00 yearly. Other amounts proportionate. Guaranteed renewal income. \$1,045,318.19 securities deposited. Universal Policy, Dept. O. 11 Commerce St., Newark, N. J.

GUARANTEED Gold leaf letters for store windows. Free samples. Liberal offer to car owners. Metallic Co., 438-A N. Clark, Chicago.

MAKE More money with Red Comet Automatic Fire Extinguishers. Low price. Proved seven years. Splendid sales outfit free. Some good territory open. Exclusive. Write quick. 704 Red Comet Bldg., Littleton, Colo.

BRUSH Salesman—If you ever sold brushes write for our money making proposition. Donald Brush Co., Camden, N. J.

FREE Booklet describes 107 plans for making \$20-\$100 weekly, in home or office, business of your own. Elite Co., 214 Grand St., New York.

SPARKLING Glo-Brite signs sell fast to stores, restaurants, taverns. Lasting gold finish. Plenty profit. J. A. Baxter, Cambridge, Ohio.

EDUCATIONAL AND INSTRUCTION

LEARN Boxing for self-defense. World's greatest and only correct system, which made Corbett and Jeffries world champions. Send \$1.50 for "The Van Court Scientific Boxing Course," to Carroll Van Court, 220 West 46 Street, Los Angeles, California.

AIR Conditioning, electric refrigeration industries demand trained men for installation, service, maintenance and sales. Qualify in 3 months. Free employment service. Established 34 years. Get new book "Step Up to Success" free. Write O. Werwath, President, 1020-T N. Broadway, Milwaukee, Wis.

IF You like to draw, sketch or paint—Direct your drawing talent into money making fields in your spare time. Inquire about it. Federal Schools, Inc., Dept. P28, Minneapolis, Minn.

CHEMISTRY. Acquire a thorough knowledge of chemistry. Facts, laws and theories clearly explained in text used successfully many years University of Colorado. Many famous chemists and chemical engineers obtained their first fundamental knowledge of chemistry from this text. Post free \$1.25. University Book Store, Boulder, Colorado.

COMMUNICATIONS Engineering instruction. Wayne Miller, Suite 200, Engineering Bldg., Chicago.

GET Yourself a 1938 government job. Start \$105-\$175 month. Dependable. Men-women. Prepare immediately. Common education. Experience usually unnecessary. Full particulars—list positions, free. Write today. Franklin Institute, Dept. M3, Rochester, N. Y.

BECOME An investigator. Remarkable "Test Question, Problem and Lesson Correction Method." Modern, practical, thorough. Profusely illustrated. Particulars free. International Secret Service Institute, PM 28, Hoboken, N. J.

AUTHENTIC Henry system. Diploma to graduates. (Either sex.) Circulars. Scientific Fingerprint Institute, Box 554, Worcester, Mass.

GOVERNMENT Job seekers. Attention: Amazing value. Three helpful books with questions answers; complete set \$1.00. Supply limited. Free descriptive folio. Merit Publications, Munsey Building, Washington, D. C.

RESORT Hotel positions. Beginners instructed. Lee Institute, 88 Tremont Street, Boston.

SECRET Investigations. Excellent opportunity. Particulars free. Write George Wagner, M-2640 Broadway, New York.

MASSAGE. Hydrotherapy, dietetics, drugless therapeutics, chiropody, taught by mail. Evans Correspondence School, Montgomery, Ala.

BE A radio announcer. Learn at home. Free information. Write Radio Arts Academy, 3823 Wilshire, Hollywood, Calif.

MATHEMATICAL Problems solved. Arithmetic, algebra, geometry, trigonometry, calculus, physics, drafting, surveying, building estimating, blueprint reading, engineers licenses, civil service, engineering examinations. Mondell Institute, 112 W. 42nd, New York.

"SHORTHAND Simplified" complete \$1.00. Folder-lesson dime. Simmons, Rocky Hill, Conn.

MAKE More money. Get a U. S. government job. Get our new plan for obtaining one—no obligations. Age 18-50. Write, Instruction Service, 101, St. Louis, Mo., immediately.

BECOME Business investigator. Earn good fees in pleasant spare-time work. Write! Business Detective System, 1009 Oak, Elmira, N. Y.

GOV'T Jobs start \$1260-\$2100 year. Men-women age 18-50. Former examiner's tested method helps qualify you. Particulars, list jobs free. Write today. Patterson School, 8C Mercantile Bldg., Rochester, N. Y.

DEGREES Earned by home study in arts, sciences, philosophy, education, psychology, theology, law, chemistry, engineering, business, agriculture. McKinley-Roosevelt College, Chicago.

HIGHER Arithmetic solves problems quickly. Frederick A. Smith, 2410 Bernard St., Chicago.

EARN Extra money! Clipping and preparing newspaper articles for publishers. Simple; fascinating; profitable. Send stamp. Division 55A, National Press, 3923 W. Sixth, Los Angeles, Calif.

LEARN Machinist trade, tool, die making. Automatic and hand screw machines. Modern shop methods. Actual work. Jobs open for trained men. Employment help. Illustrated booklet free. Allied Screw Machine Co., 601 Lake St., Chicago.

LEARN Auto mechanics, body, repairing, welding, electricity, refrigeration. Diesel. Stevinson's, 2008A Main, Kansas City, Mo.

PLAYS, STORIES, MANUSCRIPTS

WRITERS: Studios pay \$2500 to unknown writers for screen stories or ideas. "Screenwriters Handbook" tells how to construct and sell your story or idea. Endorsed by studio story editors. Used by successful professional and amateur screenwriters. Send \$2 (total cost) or order COD, today. Address Broadwell Studios, Dept. 342-B, Bendix Bldg., Los Angeles, Calif.

SHORT Stories revised, typewritten, marketed. Hursh Service, Box P-1013, Harrisburg, Penna.

WANTED—Authors' manuscripts. Immediate marketing. Revel, 41 West 45, New York.

WRITER'S Service. Particulars free. A. M. Seymour, 126 Lexington Avenue, New York, N. Y.

WANTED, Original poems, songs, for immediate consideration. Send poems to Columbian Music Publishers, Ltd., Dept. 209, Toronto, Can.

CARTOONING, COMMERCIAL ART, SHOWCARD WRITING, SIGN PAINTING

BIG Cartoon book and 5 splendid art magazines \$1. Can't be described. Satisfaction or refund. Lockwood Studio, Department 722, Kalamazoo, Mich.

PAINT Signs for profit. Fine lettering fast with Speedway patterns. Modern styles, many sizes. Free samples, literature. For 3-in. alphabet, enclose stamp. Display Letters Co., Station 235-G, New York.

CARTOONING Course \$1.00. Simplified home study course, 30 illustrated lessons, over 500 drawings, pens and pencils, \$1.00 complete, postpaid. Scovell Art Studios, Box 748-P, Hollywood, Calif.

REPRODUCTION Of drawing of your ambition in Bart O' Grams. It's easy on forms supplied with art supply catalog on request. Bart Supplies, 915 Marquette, Minneapolis, Minn.

CHALK Talks. Laugh producing program, \$1.00. Catalog 10c. Balda, the Cartoonist, Oshkosh, Wisconsin.

LEARN Sign, showcard lettering. Complete illustrated course \$1.00. Shows every stroke of brush. Free information. Lawver & Vernon, 858 E. 63rd, Chicago.

DRAFTSMEN, Students, showcard writers save time with patented Universal Drawing Instrument. Does wonders. Descriptive circular free. Box 451, Leominster, Mass.

CARTOONING, Sketching, etc.—46 lessons, 600 illustrations, including drawing paper, pens, pencils, \$1.00 complete. Fraba Service, Cashton, Wisconsin.

EARN cash income, copying and duplicating simple cartoons for advertisers. 3-M Service, Argyle, Wis.

ADVERTISING AGENCIES—FOR ADVERTISERS

LEARN Advertising quickly at home. Easy practical plan. No text books. Common school education sufficient. Interesting booklet and requirements free. Page-Davis School of Advertising, 3601 Michigan Avenue, Dept. 3432, Chicago.

"MAIL Sale Advertiser" Magazine—A nationally known syndicate. Reaches thousands spare time workers, dealers, agents and salesmen. Classified 4c per word. \$1.50 per inch. Copy 10c. Vicker's Advertising Service, Dept. P-M, Missouri Branch, W. Va.

24 WORDS, 40 Newspapers, \$2.00. Good-all Agency, 742 Market, San Francisco.

INCH Display advertisement 30 magazines year \$24. Wood's Popular Services, Atlantic City, (N. J.)

1000 MEXICAN Names. Well rated people. Good, unspoiled prospects most anything. \$3.00 express money order. Mexican Service, Apartado 762, Mexico City.

ADVERTISE: 24 Words in 250 newspapers \$10. Lists free. Advertising Bureau, 4515-C Cottage Grove, Chicago.

ADVERTISE Profitably: \$15 reaches 6,000,000 Sunday newspaper readers with 24 word ad. Newspaper, magazine, rate-guide, free. Chicago Union Agency, 20 W. Jackson, Chicago.

FREE—New Advertisers Rate Guide, 44 pages. Includes everything. Lowest rates. E. H. Brown Advertising Agency, 140 S. Dearborn, Chicago.

ADVERTISING Placed anywhere. Helpful, free service. Rate guide book free. Baker Advertising Agency, 189 W. Madison, Chicago. Successors to Ankrum Advertising Agency. Established 27 years.

BUSINESS SERVICE

YOUR Collections poor? Get experienced guidance. Producing letter, advice \$1. Save dollars. Arthur Kelley, Church, Montclair, New Jersey.

COLLECTIONS Slow? Use followup form letters. Samples dime. 1000, \$5.00. Charley's Sportshop, North Topeka, Kan.

CHICAGO: Mail address; branch office; representation; \$1 monthly. Letters, etc. forwarded daily. Established 1919. General Service, 56 West Washington.

ENGINEERING Calculations, designs, reports. Drafting service. 20 years practice. Ohio state registered. Carl E. Rett, 1426 East 88 St., Cleveland, Ohio.

WASHINGTON, D. C., mail address. For business or personal purposes. Hawkins Mail Service, 817 Fourteenth.

\$2.00 **MONTHLY** Maintains Los Angeles address. Dickey, 628 W. 9th.

RUBBER STAMPS AND OFFICE SUPPLIES

CUSHION Rubber stamps, 2 lines 25c; 3 lines 35c. Facsimile signature \$1.50. Stamp Works, Hastings, Nebr.

FIRST Quality cushioned stamps, modernistic printing. Harwill, Phelps, N. Y.

CUSHION Mounted, one-two lines 25c, three 35c; facsimile signatures \$1.50. Stamp Works, 814 Bradley, Peoria, Ill.

CUSHION Mounted, One-two lines 25c. Three lines 35c. 100 letterheads, 100 envelopes \$1.00. Hauer Press, 1314 Ford Ave., Youngstown, Ohio.

ONE-TWO Lines 25c; three 35c. Stamp Works, Indianapolis, Ind.

NAME, Address, 2 lines 25c; 3 lines 35c. Stamp Works, Auburn, Nebr.

2 LINES 25c, 3 Lines 35c. Stamp Works, Centerport, N. Y.

TYPEWRITERS, DUPLICATORS, OFFICE DEVICES

NEW \$3.75 Automatic adding machine. Fully guaranteed. Bassett, Box 302D, Altadena, Calif.

TYPEWRITERS, Duplicators, multi-graphs. Write for free list office machine bargains. Save half. Pruitt, 518 Pruitt Bldg., Chicago.

INCREASE Business now. "Excello-graph" Rotary Stencil Printer reprints thousands everything you typewrite, hand-write, draw or trace. Colors, \$19.75 to \$44. Terms. Illustrated literature free to business or professional men. Pittsburgh Typewriter Supply, Department K-2, Pittsburgh, Penna.

PRINTING, MULTIGRAPHING, MIMEOGRAPHING, GUMMED LABELS

LETTERHEADS, Envelopes, statements \$2.95 1000. Cards \$1.50. Balka, 1432 No. Washington, Dallas, Texas. Agents.

100 EACH 5 1/2 x 8 1/2 Atlantic bond letterheads, envelopes. \$1.00 postpaid 4th zone. Universal Supply, Orange, Mass.

ENGRAVURE Printing, lowest possible prices. Samples free. Sunco, Mohawk, N. Y.

BEST Printing—Lowest prices! Envelope, letterhead specials! Rapid Service, Edwardsville, Ill.

QUALITY Letterheads of standard workmanship. Electron Prints, New Orleans, La.

1,000 3 1/2 x 5 1/2 Printed adcards \$2.39. Free sample. Comstock, Charlestown, N. H.

MIMEOGRAPHING—Neat work, reasonable prices, samples. Thornber, Box 342, San Diego, California.

LETTERHEADS Artistically printed, \$1.50—1000. Jerome, 2260 Merchantville, Merchantville, N. J.

1000 STATEMENTS, 5 1/2 x 8 1/2, \$1.95. Samples. M. Myhaluk, East Paterson, New Jersey.

125 LETTERHEADS, 8 1/2 x 11 and 125 envelopes \$1.00 postpaid. Benneville, 907 West Roosevelt, Philadelphia.

FACTORY To you cuts from \$1.00 up. Speedy coast to coast service. Get our prices on linecuts; halftones. Atlas Engraving, 560-B Seventh Avenue, New York.

ILLUSTRATED Two color postals, 1000, \$4.00. Samples. Box 748, Dayton, Ohio.

PRINTING—All kinds, quality work. Low prices. Samples. Michaels Press, Box 103-G, Station W, Brooklyn, N. Y.

HARVEY Labels are verified better values. 6618-R Quimby, Cleveland, Ohio.

500 LETTERS Reproduced exactly as if typewritten, \$1.80 (20 lines). Multigraphers, Box 8275, Ashland, Virginia.

500 GUMMED Stickers, four lines 25c. Cott's Press, Spickard, Missouri.

LETTERHEADS, Envelopes, cards, blotters, circulars, statements, etc. 1938 price-list free. McCall Printing Company, 1326 So. 27th, Omaha, Nebr.

BETTER Printing, lower prices. Send for samples. Moore Brothers, Alstead, New Hampshire.

BUSINESS Cards, tickets, 69c 1000. Canary's Press, East Moline, Ill.

SAMPLES—Attractive assortment free. Lowest prices! Sanderson's Printing, Ottawa, Illinois.

THOUSAND Books advertising matches \$4.50. Sanderson's, Ottawa, Illinois. (Salesmen wanted.)

1000 6 3/4 ENVELOPES \$1.75; 5,000, \$7.00. Hunt, Printer, Morrisville, Penna.

EXTRA Special—500 envelopes and 500 letterheads \$2.50 postpaid. Bond paper. Guaranteed. Hustler, Advance, Indiana.

1000 6x9 CIRCULARS, Letterheads, envelopes, postcards, \$2.95; 5000, \$8.99. All printing reasonable. Samples. Cuts. Good-print, Harrisonburg, Va.

PHOTO Engravings—Zinc line cuts made, 10 square inches, \$1 up; halftones; electros; artist; speedy; free price list. Riteway Engraving, 1457P Broadway, New York.

BETTER Grade printing, reasonable priced. Free samples. Economic Press, Leonia, N. J.

500 3/4x2 1/4 FOUR Line gummed stickers, 25c. Moritz Printery, Saginaw, Mich.

PRINTING OUTFITS AND SUPPLIES

PRINT Your own cards, stationery, circulars, advertising. Save money. Easy rules furnished. Print for others, big profits. Junior outfit \$8.85; job presses \$11 up. Details free. Kelsey Co., D-11, Meriden, Conn.

HAND Press, type and complete printers' supplies. Advise equipment you need and we quote prices; or send stamp for catalog. P. Peiffer, 4-C; 6 Columbia St., Newark, N. J.

HAND Presses, type, supplies. Catalogue for stamp. Printers Sales, 114 S. Howard St., Baltimore, Maryland.

HAND Presses, type, supplies. Big lists 3c. Landis, Richland, Penna.

BARGAINS, Presses, type. List 3c. Exchange D-15, 22 Orient, Meriden, Conn.

BARGAINS — Presses, type, supplies. Send stamp, 159 Harvard, Cambridge, Mass.

PATENT ATTORNEYS

DON'T Tell anybody the secret of your invention! Take steps to protect it before it's too late! Get our free "Certification of Invention" and two free books. They answer hundreds of patent questions and explain our deferred payment plan. Strictly confidential service. U. S. registered patent attorneys. Over 62 years' experience serving inventors all over the world. Write for free books today! C. A. Snow & Co., Inquiries Division, Snow Building, Washington, D. C.

INVENTORS: Send immediately for your copies of our new free books, "Patent Protection" and "Suggestions on Selling an Invention." Sixty-eight pages of interesting facts. They tell how patent laws protect you; kind of sketch or model needed; simple steps to take without cost; how successful inventors have secured financial assistance; show interesting inventions; illustrate important mechanical movements. With books we also send free Evidence of Invention form to help establish date of disclosure. Prompt service, reasonable fees, special deferred payment plan. Strictest secrecy. Thirty-nine years experience. Highest references. Write us today. The facts in our books, are worth money to the man with a good invention. Address: Victor J. Evans & Co., Registered Patent Attorneys, 12-B Victor Building, Washington, D. C.

PATENTS—Any country. Reasonable rates. Free information. Ramsay Company, 273 Bank St., Ottawa, Canada.

PATENTS—Before too heavy an outlay of time or money is made on an invention, a search of the Patent Office records should be made to determine as nearly as possible whether or not the same idea has been patented before. The cost of this search is small, while the value of the facts it uncovers is often considerable. We offer inventors and manufacturers a thorough prompt, confidential search service—plus experienced counsel and assistance in every phase of Patent and Trade-Mark practice. Write for our new free book containing valuable information relating to patent procedure. Clarence A. O'Brien and Hyman Berman, Registered Patent Attorneys, 588 Adams Bldg., Washington, D. C.

PATENTS: G. P. Welch, Registered Patent Attorney, Plankinton Arcade, Milwaukee, Wisconsin.

WE Successfully sell inventions, patented and unpatented. Write for proof, and tell us what you have for sale. Chartered Institute of American Inventors, Dept. 4-C, Washington, D. C.

PATENTS—Personal, confidential services for protection of your invention at reasonable cost. Preliminary information and approximate cost of patent furnished without obligation. John B. Thomas & Co., 902 F St., N. W., Washington, D. C.

"INVENTOR'S Guide," 100 mechanical movements, free; advises on patenting, selling inventions. Frank Ledermann, Tribune Bldg., New York.

PATENTS, Instructions "How to Establish Your Rights" and form, "Evidence of Conception"—sent free! Lancaster, Allwine & Rommel, 411 Bowen Bldg., Washington, D. C.

PATENTS, Booklet free. Highest references. Best results. Promptness assured. Watson E. Coleman, Patent Lawyer, 724 Ninth St., Washington, D. C.

L. F. RANDOLPH, 302-B Victor Bldg., Washington, D. C. Low cost. Book and information free.

INVENTORS—Send for free booklet "Patent-Sense." Information based on 64 years experience. Lacey & Lacey, Dept. 5A, 635 F St., Washington, D. C.

PATENTS—Trade marks. Preliminary advice, book and disclosure form free. Personal service. Irving L. McCathran, 1060 International Bldg., Washington, D. C. Registered Patent Attorney.

PATENTS, Protect your idea by securing free "Proof of Invention" folder. Exceptional personal service. Established 1906. E. E. Vrooman, 871 Woodard Bldg., Washington, D. C.

FOR INVENTORS

INVENTORS: Send immediately for your copies of our new free books, "Patent Protection" and "Suggestions on Selling an Invention." Sixty-eight pages of interesting facts. They tell how patent laws protect you; kind of sketch or model needed; simple steps to take without cost; how successful inventors have secured financial assistance; show interesting inventions; illustrate important mechanical movements. With books we also send free Evidence of Invention form to help establish date of disclosure. Prompt service, reasonable fees, special deferred payment plan. Strictest secrecy. Thirty-nine years experience. Highest references. Write us today. The facts in our books are worth money to the man with a good invention. Address: Victor J. Evans & Co., Registered Patent Attorneys, 12-B Victor Building, Washington, D. C.

PATENTS—Before too heavy an outlay of time or money is made on an invention, a search of the Patent Office records should be made to determine as nearly as possible whether or not the same idea has been patented before. The cost of this search is small, while the value of the facts it uncovers is often considerable. We offer inventors and manufacturers a thorough prompt, confidential search service—plus experienced counsel and assistance in every phase of Patent and Trade-Mark practice. Write for our new free book containing valuable information relating to patent procedure. Clarence A. O'Brien and Hyman Berman, Registered Patent Attorneys, 588 Adams Bldg., Washington, D. C.

WE Make working models, tools, dies for stamping and special machinery. Send 3 cents for catalog of gears and supplies. Pierce Model Works, 28 N. Clinton, Chicago.

WORKING Models built. Tools, dies and experimental work. Engineering service. Ask for estimate. Esquire Tool and Die Corp., 3115 W. Cameron Ave., Milwaukee, Wis.

INVENTORS' Profitable information—tested, proven. How to finance, patent, sell, prove priority. Particulars free. Inventors' Counselor, Cantil, Calif.

25 MANUFACTURER'S Names \$1. State type of invention. E. Dunlap, Box 94, Greenbelt, Maryland.

LET Us develop and sell your ideas or patents. We build models. Development and Research Engineering Service, 209 South State St., Chicago, Illinois.

WE Locate buyers meritorious patented, unpatented inventions. If will sell reply immediately. Invention Reporter, D-11236 So. Fairfield, Chicago. Copyrighted booklet on request.

INVENTORS—Send for 72-page book on patents. Reasonable terms. Conscientious treatment to inventors. L. F. Randolph, Registered Patent Attorney, 302-E Victor Bldg., Washington, D. C.

INVENTORS: "Making Inventions Pay," our 32-page illustrated book, mailed upon receipt of 3c postage. Crescent Tool Co., Dept. Z, Cincinnati, Ohio.

SELL Your patent through a small classified ad in Popular Mechanics. Many inventors have found buyers in this way. Ask me for proof—I'll gladly send it to you. F. W. Johnson, Manager Classified Advertising, 200 E. Ontario St., Chicago.

TO Inventors: We are in the market to purchase a good patent, preferably a small item made of metal. Will purchase outright or royalty. Purchasing Agent, 241 Front St., New York, N. Y.

I **SELL** Patents. Established in 1900. Charles A. Scott, 773PM Garson Ave., Rochester, N. Y.

INVENTOR'S Universal Educator; contains 900 mechanical movements; 50 perpetual motions; instruction on procuring and selling patents and selecting an attorney, etc. Suggests new ideas. Price \$1 postpaid in U.S.A. Address Albert E. Dietrich, 511-B Colorado Bldg., Washington, D. C.

HAVE You a sound, practical invention for sale, patented or unpatented? If so, write Chartered Institute of American Inventors, Dept. 4-A, Washington, D. C.

INVENTIONS WANTED

SMALL Inventions wanted by manufacturers. I'll help you sell your invention. Write for free circular. Stanley Hull, 7829-K Euclid Ave., Cleveland, Ohio.

OWNERS Of patents or smart ideas useful in the garment industry please write Sytner, 37, Chestnut St., Manchester, 8, England.

PATENTS, Inventions commercialized. Plans to suit inventors. Details and booklet free. Inventors Service Agency, Box 15, Penns Grove, N. J.

CASH For unpatented ideas. Stamp for particulars. Mr. Ball, 9441-A Pleasant, Chicago.

SIMPLE, Practical inventions wanted by manufacturers, patented or unpatented. For information write Chartered Institute of American Inventors, Dept. 4-D, Washington, D. C.

PATENTS FOR SALE

FREE-WHEELING Lock for doors, tank valves, etc. Amazing, foolproof, tamper-proof. Tremendous market new and old homes. Have full set dies, tools, jigs, equipment and sizeable made-up stock. Recent patent granted. Have other interests—must sacrifice splendid opportunity. Oscar Hoffmann, 1503 N. 33rd St., Milwaukee, Wis.

SEVERAL Excellent hardware inventions, highly protected. Best pipe wrench known, 102207, pending. Manufacturing, cash-royalty, outright. Trade mark: "Buty." Business. Oscar D. Legg, Hillsboro, Ohio.

FILTER Patents, auto and industrial use, for sale. Other patents also. Box 306, Lynchburg, Va.

WANT Contact parties interested in closure patent. Outright or royalty. Bugh, 3711 Fillmore, San Francisco, Calif.

RAIL Steel tie, a great safety device for railroads. Also patent fountain tooth brush, connects to water faucet, flushing mouth while cleaning teeth. Both very reasonable. Mortka, 58 Hinckley Ave., Stamford, Conn.

PATENTED Metal window signal for bakers, ice men, etc. Stationary, self-contained. G. A. Brillinger, 3206 West 106th St., Cleveland, Ohio.

U. S. And Canadian patent on fenders for automobiles. A new safety device for the prevention of accidents. Anthony Grigas, 6 Carver St., Worcester, Mass.

MECHANICAL Air purifier. Wm. C. Hartzell, South River, New Jersey.

PEDESTRIANS Reflector belt. American, Canadian, Mexican. Seller, Thos. E. Miller, 2019 Locke, Nashville, Tenn.

MANUFACTURING

DIES, Manufacturing, stampings. Will finance, market, metal items of merit. F. B. Williams Co., 507 E. Pershing Rd., Chicago.

DIES And 1000 blanks stamped \$20 up. Manufacturing. Wire forming. Southern Products, P28, Independence, Missouri.

ANALYSIS. Research. Newest guaranteed formulas. Biggest catalog free. Special prices, leads. Gibson Laboratory, Chemists, DS-1142 Sunnyside, Chicago.

MACHINE Work wanted for precision bench lathes. Automatic screw machine products—short runs. Small stampings, blanking dies. Fisher Model Shop, 1002 Etowah Ave., Royal Oak, Mich.

INVENTIONS Manufactured in any quantity at low cost. Stampings, dies, models, etc. Estimates and free catalog. Crescent Tool Co., Dept. X, Cincinnati, Ohio.

MANUFACTURING, Dies, machinery, models, brasswork, white metal casting moulds. Catalog 3c. Baum's Metal Specialties, Kansas City.

MODELS AND MODEL SUPPLIES

SHIP And yacht model fittings; construction sets; model yacht sails; illustrated catalog 20 cents. A. J. Fisher, 1002-1 Etowah Avenue, Royal Oak, Mich.

MODEL Gasoline motors. Circular 10c. Anton Bohaboy, 2297 Price St., Rahway, N. J.

LATEST Catalogue. Locomotives. Gas, steam engines, castings, etc., 25c. Usual refund. Howardco, A-2417 N. Ashland, Chicago.

MODEL Supplies for the inventor. Send 3c stamp for catalog. Pierce Model Works, Tinley Park, Ill.

3 1/2" SCALE Steam locomotive easily built by "Step" method. Catalog of castings, instructions, boiler fittings, track material, etc. 25c coin (returned first order.) Little Engines, Box B15, Wilmington, Calif.

ENGINE Catalog 20c. Particulars free. Evramesco, 28 N. Clinton, Chicago.

MODELS—Your ideas developed into practical working models. 30 years' successful experience; thousands of satisfied customers. Confidential service guaranteed. Bank references. Send 3c postage for 32-page book—"Making Inventions Pay." Crescent Tool Co., Dept. Y, Cincinnati, Ohio.

RAILWAY Models. Catalog handbook 25c. Walthers, 247 E. Erie, Milwaukee.

BLUEPRINTS AND PLANS

ASSEMBLE Heavy duty blow torch from dollar's worth pipe fittings; uses illuminating gas and air from vacuum cleaner. Blueprint, instructions, 75c. Included free, blueprint excellent unique heavy bench grinder from fittings. Or separate 35c. Jewett, Racebrook, Woodbridge, Conn.

NOVELTY Shelves that are different. Small graceful designs. Very attractive. 12 prints \$1.00. Walter Kohlenberger, 14412 E. Vernor, Detroit, Mich.

HOME CRAFTSMEN

SQUAREKNOTTERS! Make belts, handbags, etc. Quality cord samples with catalog, free. Beginners book, catalog and samples, 10c. Special! Regular \$1 book with 50c beginners outfit, all for \$1. P. C. Herwig Co., Dept. J-2, 121 Sands St., Brooklyn, N. Y.

LEATHERCRAFTSMEN—Write for free instructions and price list of leather, tools, etc. Sample cards 5c. Wilder & Co., Dept. P. 1038 Crosby St., Chicago, Ill.

PLASTICS—50 Cents brings catalog and 12 pieces Catalin to make useful articles. Fanwood Specialties, Dept. B, Scotch Plains, N. J.

KNOCKDOWN Furniture, homecraft materials. Send 10c for catalog. Giles Kendall Co., Decatur, Alabama.

BIRD Houses, furniture, lawn ornaments. Prints: 40 popular objects 50c. "Rork's," Saginaw, Michigan.

20 FULL-SIZED Lawn ornament patterns of animals, birds, etc. 25c. Modern Woodcraft, Saginaw, Michigan.

BLUEPRINTS For chest of drawers. Handy for home workshop. \$2.00 postpaid. Craftco, Box 92, West Springfield, Mass.

"**MODERN** Wood Sculpture." Complete instruction book on carving statues \$1.00. Lee Wood Art Studio, Centerville, Iowa.

DESIGN Your own furniture. Our complete course shows you how. Only \$8.50. Invaluable to home craftsmen. Write for descriptive folder. Klok Institute, 430 Lyon, Grand Rapids, Mich.

OLD GOLD, WATCHES, JEWELRY, PRECIOUS STONES

HIGHEST Prices for old gold, teeth, watches, jewelry. Full cash value mailed day shipment received. Satisfaction guaranteed or articles cheerfully returned. Information free, or ship today. Chicago Gold Smelting Co., 300-P Champlain Bldg., Chicago.

LEARN Watchmaking. Instructions free with tools. Wholesale watch-material catalog 5c. Stewarts, Chemical Bldg., St. Louis, Mo.

POLISH Stones for jewelry and specimens. Book how to build and operate machine \$1.00. Stamp information. Home Lapidary Shop, Madera, Calif.

BIG Saving expert rebuilt guaranteed American watches. 1938 catalog. Standard, 316 Court Street, Brooklyn, N. Y.

GOLD \$35 Ounce. Ship old gold teeth, crowns, jewelry, watches—receive cash by return mail. Satisfaction guaranteed. Free information. Dr. Weisberg's Gold Refining Co., 1500-Q Hennepin, Minneapolis, Minn.

AUSTRALIA'S Lovely opals. Illustrated catalogue free. Good selection \$5. Norman Seward, Melbourne, Australia.

5000 REBUILT Open face Waltham, Elgin watches. New chromium open face cases. Make big money! 12 size, 7 jewel, \$4.75; 16 size, 17 jewel, \$7.50. Send 3c stamp for free catalog. The New York Jobbers, Dept. M, 74 Bowery, New York, N. Y.

FOR THE HOME

PICTURE Frames and portraits by mail. Claude Day, Arthur, W. Va.

TOBACCO

GUARANTEED: Cigarette, pipe or chewing, 5 lbs., \$1.00; ten, \$1.75. Pay when received. Pipe and box cigars free. Rives Tobacco Co., Paducah, Ky.

FREE Smokes—Tell me your favorite brands of tobacco, cigars, cigarettes. I'll send free samples and show you better smokes for less money. Pete Moberly, Box 1044, Owensboro, Kentucky.

CHEWING, 4 Pounds, \$1.25. Subac smoking Gold Leaf burley, Turkish tobacco, 3 pounds \$1.10 postpaid. Belmont Farms, Chatham, Va.

LOOK! Higher quality! Golden yellow smoking or rich ripe chewing, four pounds, guaranteed and postpaid, \$1. Riverside Ranch, Hazel, Ky.

RAZOR BLADES—SHARPENING

100 FINEST Double edge razor blades, \$1.00. Franal, Box 214, Pittsfield, Mass.

ONE Hundred quality double-edge razor blades only 85 cents postpaid anywhere in U.S.A. Star, 5012 South Ashland, Chicago.

SAFETY Razor blades sharpened free. Send four, any make, with three cents postage. Perfect edge guaranteed. Box 64, Frederic, Wisconsin.

100 FINEST Double edge razor blades, \$1.00. Franal, Box 214, Pittsfield, Mass.

WANTED—MISCELLANEOUS

CASH For used microscopes, binoculars, slide rules, drawing sets, cameras, surveying, scientific, and musical instruments, tools, motorboat equipment. Highest prices paid day shipment received. Satisfaction guaranteed or shipment promptly returned. Elman's, 2302 VanBuren, Chicago.

AGENT—Open for any invention or product. Must have protected New Jersey territory. Priore, 51 West Broadway, Paterson, N. J.

WANTED—Antique firearms. Also Currier-Ives pictures. Serven, Sonoita, Ariz.

PERSONAL

ATHLETES' Foot? Send dime for trial. Phelps Laboratories, 1900-A Euclid Ave., Cleveland, Ohio.

OMAK. Famous Scandinavian skin remedy relieves instantly athletes foot, poison ivy and other skin irritations. 60c postpaid. Omak Co., Fitchburg, Mass.

ATHLETE'S Foot remedy. Guaranteed. Cured thousands. \$1.00 bottle prepaid. Dr. W. J. Renz, D.S.C., Room 3, Chavanne Bldg., Lake Charles, La.

WIN Prize money: Booklet—"Successful Contesting"—shows how. 10c postpaid. Bulletin listing \$200,000.00 prizes included free! World Publishers, 4515-B Cottage Grove, Chicago.

NERVOUSNESS, Nervous fear! Afflicted? Free, interesting information. Investigate! John Englund, Ontonagon, Mich.

WANTED, Original poems, songs, for immediate consideration. Send poems to Columbian Music Publishers, Ltd., Dept. 33, Toronto, Can.

STUTTERING And stammering corrected at home. Descriptive booklet free. Paul J. Wolfe, Box 52, Pittsburgh, Penna.

MISCELLANEOUS

SPRING Steel chair runners tempered and formed with plans for application on new or old chairs. \$2.00 per pair fob. Minneapolis. Western Spring Mfg. Co., 37 Glenwood Ave., Minneapolis, Minn.

CALIFORNIA Novelty catalog and either package California sachet or two Sunkist double edge razor blades for dime or twelve cents in stamps. Western Sales, 25 North Mentor, Pasadena, California.

MEXICAN Jumping beans. Samples 25c. Paul Jewelry Co., La Crosse, Wis.

SPECIAL. 22 Year calendar 5c; three, 10c. Hughes Studio, Shillington, Penna.

DO You want a Marvel electric dry shaver free? Send for details. Star, 5012 South Ashland, Chicago.

FOUNDRY Experimental, brass, aluminum, plans 25c coin. Jorgenson, 3354 Russell, North Minneapolis.

KEY Machines—Lowest prices. Christon's, 1019 - 14th St., Denver, Colorado.

BUSINESS Proposition resilvering mirrors, autoparts, reflectors, making chipped glass signs. Write, Sprinkle, Plater, 288, Marion, Indiana.

KNOCK-EM-COLD! Learn police Jiu Jitsu! 36 secret knockout blows without fists, many one-fingered, headlock breaks, etc. New complete illustrated course by world-famous instructor, only 15c today. S. J. Jorgensen, 409 Maritime Bldg., Seattle, Wash.

RUBBER, Vulcanized liquid, any quantity, particulars free. Sample 10c. Service, Box 42-M, Lancaster, Ohio.

REVELATION, Mysticism, booklet entitled, the Champion of Protestantism. Heavenly, earthly, mysteries explained. 25c. Gust A. Johnson, Pomona, California.

USED Books. Catalog listing thousands free. Bookman, 369 Border, Boston, 28, Mass.

MONEY In butterflies, moths. See Sinclair Display Advertisement on page 32A.

SWAPPERS, Collectors, investigate free trading service. Exchange, Box 425, Detroit.

MEXICAN Finest feather pictures: 4x9" costs 25c including duty, retails \$1.00. (Sample 20c stamps.) Embroidered tablecloths: 36x36" with napkins costs \$1.18, retails \$2.50. (Sample \$1.00.) Agents wanted. Free particulars. Marquez, Apartado 1176-X, Mexico City.

LIKE To draw? Earn steady income tracing and duplicating advertising cartoons. Ad-Service, Argyle, Wis.

WATERPROOF Basement walls, floors. Inexpensive. Easy. F. Gerwin, Meeker, Oklahoma.

SWAPPER'S Friend, R4, Saline, Mich. Interests swappers, collectors, sportsmen. 50c year. sample 10c.

AMATEUR Tattooing outfits, illustrated catalog 6c. "Tatuco," 651A S. State, Chicago.

This MACHINISTS' Home-Study Course



helps men get ahead

Newly assembled—specially priced—these five recent books give you the practical facts on modern machines, up-to-date methods, you need to advance in machine shop work. Take advantage of the other man's experience as found in books, to solve your problems, increase your efficiency, with the new

Library of MODERN MACHINE SHOP PRACTICE

5 volumes—2000 pages—1600 Illustrations
(A combined home-study course and reference library)

This library of machine shop practice was written for practical men. It gives you the best methods for every kind of machine shop work. It fully explains lathes, drills, and other machine tools and their operation, automatic screw machines, speeds and feeds, gear design and production, punch and die work, metal finishing, etc., etc. Plainly written—completely illustrated—the best kind of help to the machine-shop man who wants to advance himself.

No money down—special price—easy payments.

FREE EXAMINATION COUPON

McGraw-Hill Book Co., 330 W. 42nd St., New York

Send me for ten days' free examination the Library of Modern Machine Shop Practice. If satisfactory I will send you \$1.50 in 10 days and \$3.00 monthly until the price of \$16.50 is paid. If not wanted, I will return the books postpaid. (To insure prompt shipment write plainly and fill in all lines.)

Name.....
Home Address.....
City and State.....
Position.....
Name of Company..... P M-2-38

There's MONEY IN ARC WELDING!



"No more tiresome work for me. I get a real thrill out of being an arc welder—and don't forget it, I'm getting more money than I ever earned on hit or miss jobs."

You, too, can become part of this great new industry! There's almost no limit to what welders can accomplish—they cut manufacturing costs way down. Because they know the "How and Why" of Welding, Metallurgy, Drawing, Blueprint Reading, Set-Up Work and Fabrication.

No wonder manufacturers all over the country are demanding practically trained School of Engineering Welding Operators, Welding Technicians, and Welding Engineers!

Don't be content with ordinary work at low pay—when in a short time you can become a thoroughly Trained Specialist in Welding.

MILWAUKEE SCHOOL of ENGINEERING

Institute of Electrotechnics

P.M. 238 Broadway and E. State, Milwaukee, Wis.

Send Free Booklet "The Dawn of Gigantic Industry and its Outstanding Opportunity." Also tell me how I can become an

- Arc Welding Operator in 3 months..... Gas Welding Operator (6 weeks).....
- Welding Technician (6 months)..... Welding Engineer (1 year).....
- Send details of Student Loan Plan..... Earn Part Expense Plan.....

Name..... Age.....
City..... State.....
(If interested in other courses, check here: Refrigeration and Air Conditioning Technician (3 mo.)..... Radio and Television Service Man (6 Mo.)..... Commercial Radio Engineer (1 Yr.)..... Electrical Engineer B.S. Degree (4 Yrs.).....

FREE BOOK Tells How to Earn Up to \$30-\$50 WEEKLY

ELECTRIC REFRIGERATION and AIR CONDITIONING



U.E.I. HELPS MEN GET JOBS

RIGHT NOW there are jobs for thousands in Electric Refrigeration and Air Conditioning. Prepare for your opportunity at home in spare time by U.E.I.'s low-cost, easy-pay plan. Learn Engineering, Estimating, Installation, Servicing under a system that has brought outstanding results for TEN years. Get practical experience in our large, completely equipped Laboratories. We'll help you get Big Pay Job. Hundreds of U.E.I. trained men now employed by leading manufacturers, distributors and service organizations. Employment Service offered FREE of extra cost. Get Book of Facts.

UTILITIES ENGINEERING INST., Est. 1927
400-410 N. Wells St., Dept. 128, Chicago, Ill.



PLAY A SAW!

Produce wonderful music in 5 days...quickly play popular and classical numbers. No notes to read, no dreary practice—success guaranteed. Since 1924 thousands of my students have amazed friends, starred in shows and broadcasting orchestras. Without obligation, write for 5 DAY TRIAL OFFER now:

MUSSEHL & WESTPHAL
126 W. Water St., Fort Atkinson, Wis.

New York Electrical School

Established 1902

Ask for free booklet
44 West 17th St., N. Y. C.

LEARN MECHANICAL DENTISTRY

SEND FOR FREE BOOK

Special Tool Offer—Now!

Don't waste the best years of your life. Learn this money-making business in a few months, Day or Evening, and become independent. Big demand. Highly endorsed—oldest school. Practical, individual training. Easy terms. Write NOW for free catalog P and trial offer.

New York School of Mechanical Dentistry,
125-127 West 31st Street, Dept. 9, New York City

MASTER CHEMISTRY AT HOME

BIG JOBS IN CHEMISTRY. BIG PAY. Become a Chemical Engineer. Home Study Courses leading to Degrees in Chemistry and Chemical Engineering; also Electrical, Mechanical, Civil, Diesel, Automotive, Aeronautical, Architectural, Drafting, Air Conditioning, Refrigeration, Radio, Highway, Mining, Petroleum, Industrial, Steam Engineering. McKinley-Roosevelt College of Engineering, 4242-C Clarendon Ave., Chicago

LAW HIGH-GRADE INSTRUCTION BY CORRESPONDENCE

College, Post, Grad. and Bar Ex. Rev. Courses, Law has attracted more keen, brainy men than any other calling. Send today for catalog. Low cost, easy terms. Text books loaned free.

Chicago School of Law Dept. 881, Roper Block CHICAGO, ILL.

ENGINEERING

DEGREE IN TWO YEARS

TECHNICAL AND APPLIED COURSES. Necessentials omitted. TIME AND MONEY SAVED. Degree 2 yrs., diploma 1 yr. Electrical, Mechanical, Architectural, Structural, Civil, Aeronautical, Highway. All courses include Air Conditioning, Electric Refrigeration and Diesel. Short intensive courses 3 and 4 months in Electricity, Power Plant, Diesel-Electric, Air Conditioning, Electric Refrigeration, Drafting. Extensive modern equipment. LOW TUITION. Part-time work for room and board. Thousands of successful graduates in U. S. and foreign lands. Approved by industry, endorsed by educators, recommended by alumni. One and two-year courses open in Sept., short courses open year round. 38th YEAR. Catalog free.

FINLAY ENGINEERING COLLEGE

1001 Indiana Avenue Kansas City, Mo.



BE A CARTOONIST

AT HOME IN YOUR SPARE TIME under personal supervision of the famous cartoonist NORMAN MARSH creator of "DAN DUNN" appearing every day in big papers. Success—Fame—Real Money may be Yours when you learn Marsh's easy simple methods and secrets. Send name and address for free details of MARSH'S Personal course. ACT TODAY!

MARSH CARTOON SCHOOL

Chicago Daily News Bldg., Dept. 1-B, Chicago, Ill.

QUICK CASH IN NEW POTATO CHIPS



START AT HOME
Here's your chance—a money-making business of your own. Turn potatoes into cash by making new kind of Potato Chips with my improved outfit. Makes delicious, superior, "NON-GREASY" Chips at low cost. A few hours' practice does it. Begin anywhere—city, village, town. Potatoes cheap and plentiful. Wholesale or retail. Steady year 'round business. Groceries, markets, restaurants, taverns, do the retailing for you.

WE HELP START YOU IN BUSINESS
Great quantities of Chips are eaten daily. Profit large—unusually so. You can start this money-making business on a "next to nothing" outlay of cash. Write for Potato Chip Booklet.

LONG-EAKINS COMPANY, 228-S-High St., Springfield, Ohio

NEW! COMPLETE and Up-to-the Minute Book on HOUSE WIRING



Covers, in great detail, all phases of practical wiring for homes, garages, farm buildings, etc. Written in the simplest language; describes and illustrates fuses, circuits, switches, installation plans; also wiring diagrams; over 200 illustrations; cloth binding \$1.50 post-paid. 5-day money-back guarantee.

FREE Complete catalog of practical books on Painting; Decorating; Commercial Art; Sheet Metal; Welding; Radio; Electricity; Engineering; Carpentry and Building; Plumbing; Heating and Ventilating. **WRITE TODAY.**

FRED'K J. DRAKE & CO., 175 N. Michigan Av., Chicago

Succeed in Landscaping

SEND FOR FREE CATALOG ON LANDSCAPE GARDENING

Gives full details about this profitable career. Successful graduates earned while they learned by mail, make up to \$100 a week. Field uncrowded; open to men, women. Write today.

AMERICAN LANDSCAPE SCHOOL
728 PLYMOUTH BLDG. DES MOINES, IA.

TO BE CURED OF STAMMERING

Write Wm. E. Bassett for Information

MONDELL INSTITUTE, Dept. B., 112 W. 42nd St., N. Y. C.

PLAY "SWING" PIANO!

New self-instruction book teaches you quickly, cheaply, easily. Postal brings free booklet.

CHRISTENSEN STUDIOS, 733 Kimball, Chicago

TRAIN FOR PAY RAISE

Just out—Simplified instructions giving technical information for practical men. 20 revealing lessons on secrets of Air Conditioning, Refrigeration, Diesel and other engines. This special spare time home coaching service offered limited number of men in this and related field. By mail only. Write today. Full information free.

THERMOSCHOOL, Box 302, Lexington, Ky.

LAW

STUDY AT HOME for Personal Success and Larger Earnings. 28 years of successful student guidance assures expert instruction. LL.B. Degree awarded. All text material furnished. Easy payment plan. Send for FREE BOOK—"Law and Executive Guidance," at ONCE.

AMERICAN EXTENSION SCHOOL OF LAW
Dept. 1-B, 737 N. Michigan Ave., Chicago, Ill.



TRAIN FOR MORE MONEY IN RADIO

I SET YOU UP... Ready for Business and Profits!

Here is a great opportunity for preparing yourself to enter a fast moving industry in which the money-making possibilities are practically unlimited and where a bright future looms for hundreds of ambitious men. I offer you a new and different kind of Radio training that does more than teach you about all branches of Radio. It teaches you modern Radio business methods and practical means of getting started in the job of making money.

THESE FELLOWS Made Good... So Can You!
Cleared \$150. in Spare Time
"Since enrolling I have cleared a net profit of more than \$150. in spare time alone... And I am not one-half through the course yet. Honestly, I cannot understand how you can give so much 'dope' for so little money." A. H. Lanoie, Northbridge, Mass.
Earns \$25. Monthly Spare Time
"I am now doing spare time service work as a result of your training. Make around \$25. per month installing auto Radio receivers." George Herrington, B. C., Canada.
Mahoney Gets Job With Sears
"I found that after three months of study I was able to service sets in a much more professional manner. Business certainly showed an increase. I recently received an offer from Sears Roebuck which I could not have accepted without having had your training." Joseph Mahoney, Rhode Island.

MAKE MONEY WHILE YOU LEARN
I GIVE YOU SPECIAL RADIO BUSINESS BUILDERS WHICH SHOW YOU HOW TO GET SPARE TIME RADIO JOBS AND HOW TO DO THEM.

NO EXPERIENCE NECESSARY TRAINING COVERS ALL BRANCHES
Even though you have done no work whatsoever in Radio, my Course starts right at the beginning, takes you through all branches and phases... fits you for spare or full time work or jobs in Radio service, broadcasting, aviation Radio, sound work, etc.

BIG PROFESSIONAL OUTFIT GIVEN
No matter what kind of Radio Training you take, it is absolutely necessary that you have equipment of this kind before you are ready to start making real money. YOU GET A THREE-IN-ONE TESTER, RIDER MANUALS, TOOL KIT, ELECTRIC EYE OUTFIT AND EXPERIMENTAL APPARATUS. Upon completion, you have business experience and technical Radio training plus needed equipment to enter business for full or part time profits.



GET THE FACTS!
This Coupon May Change Your Entire Life!

Mail Coupon Now

SPRAYBERRY ACADEMY of RADIO

F. L. Sprayberry, Pres.
110-B University Place, N. W.
Washington, D. C.

Please send me free copy of "More Money In Radio."

Name..... Age.....
Address.....
City..... State.....

(Mail in envelope or paste coupon on postcard.)

Be a Civil Engineer!
Learn—Quick Reference Way



It's Paying Big Right NOW

Earn \$3000

with the help of these books

a Year—and Up!

"Civil engineers are wanted NOW. Enormous amounts are being spent in all kinds of public works and not a dime is spent until the Engineer has prepared plans. Then he must direct the work. It's a big job and there are not enough men to go around. Everywhere you go, you see road work going on—water and sewer systems being built—vast projects of all kinds. Here is Your Opportunity to get the necessary training right at home. These books are complete and simply written so anyone can understand them. Start now on our FREE examination plan. Mail the coupon without obligation.

American Technical Society
Dept. C219 Drexel at 58th St., Chicago

American Technical Society
Drexel at 58th St., Dept. C219, Chicago

I want to examine the CIVIL ENGINEERING Cyclopaedia for 10 days FREE. I will gladly pay the few cents express, but I am to pay nothing for the 7 big volumes if I return them within 10 days. If I wish to keep them I will send you \$2 after the 10 days, then \$3 a month until advertising price, \$29.80 is paid. Send latest Edition and Slide Rule.

Name.....

Address.....

(Attach letter stating age, occupation, employer's name and address and that of at least one business man as reference.)

Cyclopaedia of Civil Engineering
7 great volumes.
2,800 pages.
1,600 illustrations.
New revised edition by twelve of America's greatest engineers.

Includes: Surveying, bridges, railroads, steel structures, municipal engineering, water supply, road building, etc.

Spanish Grain Flexible Covers Gold Stamped

Shipped Free

For Examination



Slide Rule

Be prompt and we will include a brand new, circular slide rule to carry in coat pocket. Invaluable in solving all kinds of engineering problems.

STEP INTO THE Spotlight



Banish Boredom . . . Earn Extra Money START TO PLAY VERY FIRST DAY

Picture the joy of playing a snappy foxtrot, dreamy waltz or mellow old favorite on the Xylorimba. No reason why you shouldn't! Xylorimba is **easiest** of instruments to play and yet the most spectacular. In constant demand by orchestras, radio stations, at lodge meetings and parties. Marvelous opportunity to increase popularity, make big spare-time money. No bothersome practice or exercises. With Free easy lessons you actually **Start to Play Very First Day.**

BIG FREE BOOK tells all about Deagan line, liberal trial offer and easy payments. Send coupon today for your free copy.

J. C. Deagan, Inc., Dept. 2452, 1770 Berceau Ave., Chicago

Send me, without obligation, full details of Free Trial offer and easy-payment plan on the Deagan Xylorimba.

Name.....

Address.....

When writing please mention Popular Mechanics

NOW YOU CAN GET A HEAVY DUTY INDUSTRIAL WELDER

WORKS ON 110-VOLT Electric Light CIRCUIT

for Only **\$19.75** RETAIL

At this unheard of price, you can get this marvelous DYNAMIC Super-Charged Welder—this welder is a radical departure from accepted welding practices. It will do the work of much higher priced types—efficiently cooled—light of weight—easily portable. Will solder and braze on the lightest material. Works on iron, steel, tin, brass, copper and all other metals.

WELDS Cylinder Blocks, Bumpers, Fenders, Tanks, Farm Machinery...

AGENTS

Make big profits selling to garages, factories, janitors and machine shops. Write TODAY and ask for our 10-DAY TRIAL OFFER.

With this Dynamic Super-Charged WELDER, a man without previous experience can make as much as \$5.00 on a repair job that can be done in less than one hour. Many welding operators make as much as \$15.00—\$20.00 a day—Go into business—Open a Welding Shop NOW.

DYNAMIC WELDER COMPANY
2225-Bl Silverton Road, Chicago, Illinois



FREE SUITS & BIG PROFITS as a Bonus Sell "MOVIE STAR" Styles



Buddy Rogers

In Made-to-Order Suits \$15.95 UP
Show friends Made-to-Order Clothes "Styles for the Stars" at big savings. New Fashions. Fabrics, inspired by Hollywood's fashion plates, Buddy Rogers, Cesar Romero, others. Take orders spare time. Earn big profits, your own suits Free as bonus. Our clothes guaranteed to fit and satisfy. Big outfit 100 large samples Free. Write today.

JIM FOSTER, INC., Dept. A-2
2253 So. Spaulding Ave. Chicago, Illinois

HOME STUDY COURSES

Home Study Courses leading to Degrees in Arts and Sciences; Philosophy; Education; Writing; Psychology; Chemistry; Theology; Law; Agriculture; Business, Accounting, Sales; Advertising; Public Speaking; Electrical, Civil, Mechanical, Diesel, Architectural, Aeronautical, Automotive, Drafting, Radio and Chemical Engineering. Many Others, **McKinley-Roosevelt Graduate College, 4228 Clarendon Ave., Chicago**

ZENDU. THE NEW SECRET LANGUAGE

MYSTIFYING yet amazingly simple, practical and quickly learned.

Booklet with full Instruction, 20c.

ZENDU, Dept. N. Burbank, Calif.

The World's Biggest

Get Shop Notes for 1938! Only 50 cents. May easily be best investment of your entire lifetime. Contains 318 money-making, time-saving ideas, kinks, short cuts for mechanics, farmers, home workshop fans, handymen—for everyone who uses tools. 224 pages, 318 articles, 645 illustrations. Get 1937 Shop Notes too. Only 50c.

POPULAR MECHANICS PRESS
Room 238-C, 200 E. Ontario St., Chicago

50¢ WORTH SHOP NOTES FOR 1938

BUILD a BOAT AT HOME

FOR PLEASURE OR PROFIT

Now you can have just the boat you've always wanted—power, sail, or rowboat—and at rock bottom cost, plus the fun of building. Make a nice profit if you want to sell. Get the

BOAT BOOK—New Edition

This famous book with 6 new boats added, shows exactly how to build 15 different popular boats. Step-by-step instructions with hundreds of pictures. Gives all plans, methods and materials. Includes raring, hydroplane, inboards, outboards, sailing and sectional boat to carry on car. Also old Ford motor for marine use and all boating terms, pilot rules, boat kinks, navigation rules, etc. You can't go wrong. Specially prepared for those with limited tools and skill. Price only \$3. Write for descriptive folder or order now and pay postman on delivery.

Popular Mechanics Press
Room 238B
200 East Ontario Street, CHICAGO



**GIVEN YOU
TO DECORATE**

Earn Money at Home

BIG FREE book in colors tells new easy way. You don't need experience. We show you how to decorate beautiful Art Novelties right in your own home by simple "3-step" method. No tedious study. Everything furnished including supply of Novelties for you to decorate and Homecrafters Outfit. Big profit per piece for decorating. Many sit at home, and make up to \$25 to \$50 a week—full time or spare time.

First Lesson Now Free!

Prizes, Toys, etc. More like fun than work and you earn as you learn. Hundreds making big money this fascinating way.

NO CANVASSING You risk nothing in sending for Free Lesson. So sure are we of your satisfaction we give an absolute Warranty backed by \$1,000 Bond. Costs nothing to find out. Openings for new workers now in every locality. Mail coupon immediately for Free Book and Free Lesson. Get started making money at once.

Just mail coupon and get first lesson *absolutely free*. Start right in decorating Gifts, Bridge



MAIL THIS!

FIRESIDE INDUSTRIES
Dept. 66-B, Adrian, Mich.

Please send big Free Book and FREE LESSON. This does not obligate me in any way.

Name.....
Address.....

AUDELS MATHEMATICS AND CALCULATIONS FOR Mechanics

\$2
A
HANDY BOOK

Good News! MATHEMATICS AND CALCULATIONS FOR HOME STUDY AND REFERENCE

PRACTICAL MATHEMATICS ILLUSTRATED. How to figure correctly. EVERY MECHANIC can use the new, correct, easy methods, covering a complete review of practical arithmetic—with examples including mensuration—plane and solid geometry—trigonometry—algebra—calculus—ELECTRICAL and MECHANICAL SHOP CALCULATIONS—practical tests—reference tables and data—how to use the slide rule—700 pages—550 illustrations—pocket size.

Highly endorsed. Let us mail you copy for free trial. Price \$2, postpaid

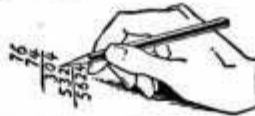

FREE EXAMINATION COUPON

THEO. AUDEL & CO.
49 W. 23rd St., N. Y. C.
Mail Audel's Mathematics on 7 days' free trial. If O. K. I will remit \$2, otherwise I will return it.

Name.....
Address.....
Occupation..... P. M.

U. S. GOVERNMENT JOBS!

\$1140 TO \$2100 FIRST YEAR

MANY 1938 APPOINTMENTS EXPECTED

Many Government examinations include Mental Tests. Try yourself. Answer the following problems and mail at once. Our examiners will correct your work, rate, and return it. The result should tell you the possibility of a high rating on the U. S. Government examination.

MENTAL TEST

1. How much is the interest on \$8,700 for half a year at three per cent?
Answer.....
2. An Implement is—(1) A punishable offense; (2) A reminder; (3) A tool.
Give number of correct answer.....
3. If you save 1/10 of your salary of \$1,500 and spend \$178 for education, and 20% of it for your share at home, how much would you have left?
Answer.....
4. Double entry means—(1) A punishable offense; (2) A method of indexing; (3) A system of bookkeeping; (4) A stub record of checks issued.
Answer.....
5. Technical means—(1) Mysterious; (2) Drawn in ink; (3) Scientific.
Answer.....
6. If you were earning \$.50 an hour, how much would you receive for 34 days, working 7 hours a day?
Answer.....
7. Albany is to New York as Augusta is to—(a) Michigan; (b) Maine; (c) Wisconsin.
Answer.....
8. The statement: "Never cry over spilt milk" means most nearly (a) "Accidents will happen in the best of regulated families," (b) "Waste not, want not," (c) "Tears will not mend broken crocks."
Answer.....

FRANKLIN INSTITUTE, DEPT. M195, Rochester, N. Y.
I send you my work on Mental Test No. 2. Kindly have your examiners correct this work and return to me with my rating and at no cost to me. Kindly send 32 page book "How to Get U. S. Government Job" and full information regarding Government Jobs. Send list of Jobs and tell me how to get one.

Name.....
Address.....
Age.....

AIR CONDITIONING

today's big opportunity!

AIR CONDITIONING is the next big industry. Mark that prediction! Its opportunities are as big in winter as in summer. Plumbing and heating engineers must know Air Conditioning—the field in its broader aspects invites ambitious men. And a new, up-to-the-minute course on Air Conditioning now offered by the I. C. S. will help you qualify for advancement in this new field. Full information—free.

INTERNATIONAL CORRESPONDENCE SCHOOLS

BOX 5503-J, SCRANTON, PENNA.

Explain fully about your course in the subject marked X:

AIR CONDITIONING

- | | |
|--|---|
| <input type="checkbox"/> Chemistry | <input type="checkbox"/> Accountancy |
| <input type="checkbox"/> Radio | <input type="checkbox"/> Advertising |
| <input type="checkbox"/> Aviation | <input type="checkbox"/> Electrical Engineering |
| <input type="checkbox"/> Refrigeration | <input type="checkbox"/> Drafting |
| <input type="checkbox"/> Inventing and Patenting | <input type="checkbox"/> Show Card Lettering |
| <input type="checkbox"/> Architecture | <input type="checkbox"/> Good English |

Name.....Age.....

Address.....

AUTO-MECHANICS & WELDERS

GOOD JOBS and Mighty GOOD PAY

Do you want to earn big money? If so let us know which of the following trades you prefer. You learn by doing. Practical work. Expert teachers. Low tuition. Personal attention. It will pay you to investigate AT ONCE. Just check the courses you'd like to take and mail today. You will receive full information, absolutely without cost or obligation. But don't delay.

Check the Trade You'd Like to Learn

- | | |
|--|--|
| <input type="checkbox"/> Auto Mechanics | <input type="checkbox"/> Welding |
| <input type="checkbox"/> Auto Collision | <input type="checkbox"/> Spray Painting |
| <input type="checkbox"/> Metal Finishing | <input type="checkbox"/> Torch Soldering |

Ask about our "Pay After Graduation Plan"

Name

Address

Mail the above to

MICHIGAN TRADE SCHOOL

Write for FREE CIRCULAR

3758 Woodward Avenue

DETROIT, MICH.

Get BIG PAY for YOUR Time

YOU SELL TO
Engineers,
Mechanics,
Sheet Metal
Workers,
Garage
Men
Etc.

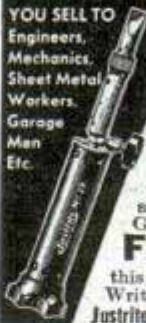

Demonstrating and Taking Orders for this
Justrite **COMBINATION SOLDERING
IRON AND BLOW TORCH**

Amazing Invention! Marvelous COMBINATION Soldering Iron and Blow Torch gives super, sizzling-hot blue-white flame automatically! NO stove, NO charcoal, NO pumps, NO electricity! Operates with 100% satisfaction on less than ¼ cent per hour. Guaranteed by famous 31-year old company.

FREE: New, sensational "Distributors' Success Plan," to Distributors of this Amazing Tool. No experience required. Write for Complete Information TODAY.

Justrite Mfg. Co., Dept. 152, 2061-81 Southport Ave., Chicago, Ill.



WELDERS WANTED!

ELECTRIC ARC — OXY-ACETYLENE
Skilled Welders earn \$8 to \$15 a day. The demand now greater than the supply. Learn this highly paid trade in 4 weeks by actual shop work. One of America's leading schools. Established 1902. 7 floors of shops. Endorsed by welding industry. Limited number of students. 4 weeks course in Electric Arc or Acetylene Welding, including room and board, only \$159. Write or wire for reservation. Ask for "Welding Facts," State age.

GREER COLLEGE, Dept. 128, 2025 S. Wabash Ave., Chicago

MATHEMATICS — DRAFTING

Arithmetic, Algebra, Geometry, Trigonometry, Calculus, Physics, Architectural, Airplane, Mechanical, Diesel, Electrical, Piping, Ship, Structural, Surveying, Building Estimating, Blueprint Reading, Engineers' Licenses, Civil Service Engineering Exams. Personalized instruction days, even.

MONDELL INSTITUTE, 112 W. 42nd St., N. Y.

STUDY ENGINEERING AT HOME

Home Study Courses leading to Degrees in Electrical; Civil; Mechanical; Diesel; Architectural; Aeronautical; Automotive; Drafting; Radio; Air Conditioning; Refrigeration, Highway, Mining, Petroleum, Industrial, Steam, Chemical Engineering; Arts; Sciences; Philosophy; Education; Writing; Psychology; Chemistry; Theology; Law; Agriculture; Business; Advertising; Sales; Accounting; Public Speaking. MCKINLEY-ROOSEVELT GRADUATE COLLEGES, 4246 Clarendon Ave., Chicago.



Build a BOAT

FOR PLEASURE OR PROFIT



Shows EXACTLY HOW TO BUILD 15 DIFFERENT BOATS

This is the new edition with 42 added pages, 6 new boats, and conversion of Ford motor for marine use. Full directions and details for cabin cruiser, racing, hydroplane, outboard runabout, sail boats, kayak, sled type—15 boats in all. Also sectional boat to carry on car.

SEND NO MONEY

Write for new edition of Boat Book today! Sent anywhere. Pay postman \$3.00 plus few cents postage. Outside U. S. and possessions remit with order. Money refunded if not satisfied.

EASY—LOW COST with POPULAR MECHANICS BOAT BOOK

Build a boat at home! You can do it. Just the kind you've wanted—power, sail, or row boat. The "Boat Book" shows you how in simple step-by-step directions. Specially prepared for those with limited tools, little skill and money. Build boats to sell for profit too. Book tells how.

GIVES PLANS, METHODS AND MATERIALS

Actual working plans and photos of real boats under construction makes building easy. Shows materials needed and rock-bottom costs. Hundreds of pictures. No chance for mistake. Includes also, navigation and pilot rules, handling sailing craft, boat kinks, boating terms. Everything a boat enthusiast should know. Size 7x10 inches, 312 pages. Fine cloth binding.

POPULAR MECHANICS PRESS—Room 238A
200 East Ontario St., Chicago

only
\$ **39**⁹⁵

FOR THIS NEW 1938
16-TUBE
TOUCH-BUTTON
MIDWEST
RADIO



During **MIDWEST'S**
18th Anniversary
SALE

TERMS AS LOW AS
50¢ A WEEK!

COMPLETE
IN RICHLY FINISHED CONSOLE—
NOTHING ELSE TO BUY—
READY TO PLUG IN AND PLAY!

... AND LOOK AT HOW MUCH MORE YOU GET FOR YOUR MONEY

- ★ 16 tubes for price of 8—
- ★ Faster Dial-A-Matic Tuning—
- ★ Not a cut-price set, but a bigger, more powerful, super performing **COMPLETE** radio in a big exquisitely designed console of matched Walnut—
- ★ Full Scope High Fidelity tone realism—
- ★ World-wide range—
- ★ Foreign stations like "locals".

JUST imagine a radio so big, so powerful, so luxurious—in a big, beautiful, richly-finished walnut console—selling at such an amazingly low factory-to-you price! It costs no more to operate, than an ordinary 6 or 8-tube set because its advanced circuit and improved design result in great current economy. In addition, its tremendous range (550 KC to 18,000 KC) and great reserve of power enable you to drive across the world and bring in weak, distant, foreign stations (10,000 and more miles away) like "locals". That's why careful buyers say: "Midwest gives you twice as much for your money."

GLORIOUS NEW TONE

Midwest gives you glorious, crystal-clear concert realism, brilliant world-wide reception and scores of advanced features, including Dial-A-Matic Tuning—at a sensationally low factory-to-you price! Zip!... Zip!... stations come in instantly, automatically, perfectly... as fast as you can push buttons. The famous Midwest factory-to-you plan, proven by 18 years of success, is just as exciting. It enables you to buy at wholesale prices... to save up to 50%... to make your radio dollar go twice as far... and to pay as little as 50 cents a week on the Midwest Easy Pay Plan. You get 30 days FREE home trial!



Write for FREE 1938 Catalog

MIDWEST *Factory-to-You* **RADIOS**

DEPT. MM-15 MIDWEST RADIO CORPORATION... CINCINNATI, OHIO, U.S.A.
Manufacturers of Quality Radios Since 1920

LET US SEND YOU THIS MAGNIFICENT NEW MIDWEST RADIO ON 30 DAYS FREE TRIAL IN YOUR OWN HOME!

PASTE COUPON ON 1¢ POSTCARD... OR

Write Today!

MIDWEST RADIO CORPORATION
Dept. MM-15 Cincinnati, Ohio
Send me your new FREE catalog, complete details of your liberal 30-day FREE trial offer, and factory-to-you wholesale prices. (Special offer and prices prevail only when dealing direct with factory by mail.)

Name.....
(PLEASE PRINT CLEARLY)

Address.....

Town..... State.....

User-Agents Make Easy Extra Money.
Check Here for details.

JUST OUT!



\$2

THEO. AUDEL & CO., 49 W. 23rd St., New York

FREE EXAMINATION COUPON

Please mail a copy of AUDEL'S DIESEL ENGINE MANUAL. If satisfactory, I will remit \$2 on its safe arrival, otherwise I will return the book.

Name

Address

Occupation PM

If you are interested in the construction, operation and maintenance of modern Diesel engines, you will want this new timely book of practical, useful information.

"AUDEL'S DIESEL ENGINE MANUAL" with Questions and Answers explains in simple, concise language the Fundamental Diesel Principles—Operating Principles—Engine Starting—Air Starting Valves—Fuel Spray Valves—Inlet and Exhaust Valves—Valve Timing—Fuel Pumps—Fuel Injection Compressors—Starting Air Compressors—Scavenging Air Compressors—Pistons and Piston Rings—Cylinders—Lubrication—Cooling Systems—Fuel Oil—The Engine Indicator—Governors—Engine Reversing—Semi-Diesel Engines—High Speed Diesel Engines—Answers on Operation—Horse Power Calculations.

The illustrations and texts are clear and easy to understand. All details are plainly brought out. This book is of extreme value to engineers, operators, students and all who desire a knowledge of the Diesel engine. A handsome book, flexible, with gilt edges. 300 pages—illustrated.

Send for free Diesel folder today.



Learn to MOUNT Birds and Animals

FUN-FASCINATION PROFITS — IN SPARE TIME

Learn TAXIDERMY at home BY MAIL. Save your hunting trophies, decorate your home and den, have a grand HOBBY. This old reliable school (with 250,000 students) will teach you at home to mount BIRDS, ANIMALS, FISH, GAME-HEADS—and to TAN hides and furs by wonderful KROMETAN system, also NOVELTY TAXIDERMY, using common specimens—no wild game needed.

FREE BOOK 100 beautiful pictures. Tell how YOU can learn Taxidermy easily, quickly, at home. Tells how to EARN FINE PROFITS in spare time. Rush letter or postal for this strange marvelous FREE BOOK. Write NOW—TODAY. State AGE.

N. W. School of Taxidermy • 3372 Elwood Bldg. • Omaha, Neb.

DIESEL

Get BETTER training. Realize Adcox advantages. Located in Pacific Northwest, a Diesel center. Established 28 years. Modern equipment, expert instructors. Close cooperation for YOUR success. Earn room and board while learning. Send for FREE big 40-page Diesel School Catalog No. 18. Home Study and Resident Courses.

L. L. ADCOX TRADE SCHOOL
Portland Oregon

Government Jobs

EXAMINATIONS SOON VALUABLE INFORMATION FREE

COLUMBIAN CORRESPONDENCE COLLEGE
WASHINGTON, D. C.

ATLAS Stick-On Letters WINDOW SIGNS

Beautiful GOLD Colored. New Styles. 5 year Guarantee. Large Sizes—Penny each. Tremendous Demand. Amazing Profits. Write for FREE SAMPLES and Starting Equipment. HURRY!

ATLAS Sign Works, 7943 Halsted, Chicago

Song Poem WRITERS

SEND FOR FREE COPY of Rhyming Dictionary and Instruction Book on How to Write Popular Songs. Submit best poems, melodies today for our bonafide, superior offer.

MMM Publishers, Dept. 33B, Portland, Ore.

SECRETS THAT MAKE MONEY

1059 Money Making Formulas in Book Form. While Supply Lasts, \$1.25

Start a spare-time or full-time business of your own making products that sell. A good formula has made fortunes for others—may bring fame and fortune to you. Get this big 200-page book—tells what to make—how to make it—where to get materials. Nothing else like it. Order Money Making Formulas today. Postpaid Only \$1.25.

Popular Mechanics Press, Dept. 238A, 200 E. Ontario St., Chicago

Learn this Profitable Profession



in 90 Days at Home

Hundreds of men and women of all ages 18-50 make \$10.00 to \$20.00 in a single day giving scientific Swedish Massage and Hydro-Therapy treatments. There is a big demand from Hospitals, Sanitariums, Clubs, Doctors and private patients as well as opportunities for establishing your own office. Learn this interesting money-making profession in your own home by mail, through our home study course. Same instructors as in our NATIONALLY KNOWN resident school. A diploma is awarded upon completion of the course. Course can be completed in 3 to 4 months. High School training is not necessary. Many earn big money while learning.

Anatomy Charts & Sample Lessons FREE

Enroll now and we will include uniform cost, medical dictionary, patented reducing roller and Hydro-Therapy supplies without extra cost. The reducing course alone may be worth many times the modest tuition fee.

Send coupon now for booklet containing photographs and letters from successful graduates, illustrated sample lesson sheets and Anatomy Charts. These will all be sent postpaid—FREE.



THE College of Swedish Massage (Successor to National College of Massage)
Dept. 264—1601 Warren Boulevard, Chicago

You may send me FREE and postpaid, Anatomy Charts, illustrated sample lesson sheets and booklet containing photographs and letters from graduates.

Name

Address

City

State

Mathematics Made Easy by ROPP'S CALCULATOR AND SHORT-CUT ARITHMETIC

Shows the Answer as Quickly as a Watch shows the Time to all Problems likely to occur in the Office, Store, Shop, Bank, Farm, or Factory.

Over 2,000,000 Sold

Explains and simplifies every principle in Arithmetic, Mechanics, and Mensuration.

PRICES POSTPAID

Desk Size, Flexible Keratol Binding.....\$2.00

Pocket Size, Art Leather Binding.....\$1.00

Pocket Size, Cloth Binding, \$0.50

POPULAR MECHANICS PRESS
Room P-2 200 E. Ontario St. CHICAGO



Only
22¢ a Day

Puts This
**All-Purpose
ELECTRIC ARC WELDER
IN YOUR SHOP**

**TEN DAY TRIAL
GUARANTEED
TEN MONTHS
TO PAY**

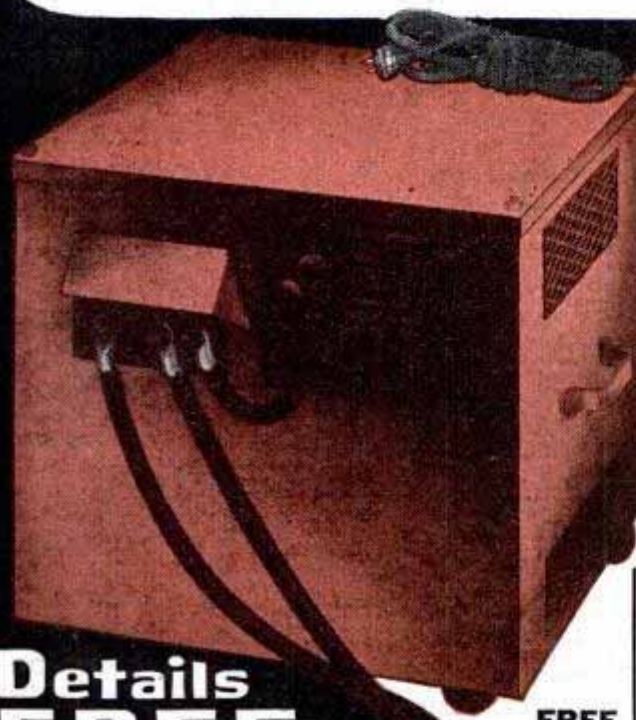

**Details
FREE**

**More Than Twenty-
Five Thousand Sold**

Commonwealth Arc Welders are in use in every section of the United States, and in practically every foreign country. They have been purchased for every welding purpose, and by every type and kind of business, from the smallest to the largest. The United States Government, Bethlehem Steel Company, Gulf Refining, American Elevator, Swift and Company, and scores of other nationally-known concerns are on our list of customers. The quality and efficiency of Model 120-FS are praised in hundreds of letters from enthusiastic, satisfied users.

**FREE
with
Every
Welder
Finest Quality
DeLUXE
ACCESSORIES**

Welding cables, electrode holder, extension cord, professional Welder's Helmet, supply of assorted welding rods, carbon rod, and instructions folio included without extra cost.

Get Amazing Details — FREE

Send today for amazing details about Model 120-FS—at a fraction of the price asked for others. Learn how, for only 22¢ a day, you can own this highly efficient, all-purpose, PROFIT-MAKING welding machine. Send NOW for full facts.

COMMONWEALTH MFG. CORP.
4208 Davis Lane, Dept. E-51
Cincinnati, Ohio

STOP THROWING AWAY PROFITS! DO YOUR OWN WELDING! That's the modern way to increase income and customer satisfaction. And, it takes only 22¢ a day to do it. Yes, you get the sensational, ALL-PURPOSE Commonwealth Arc Welder, Model 120-FS for only \$5.75 down, with Ten whole Months to pay balance out of profits. Now it is EASY for every inventor, laboratory, home workshop owner, garage, repair shop, and factory to afford a complete welding service for manufacturing, maintenance, experimental or repair work. Model 120-FS makes and saves money for you 1001 ways. Repairs gears, brackets, shafts, pump parts, sheet metal, machine parts, castings, stampings, motor blocks, auto frames, body metal, fenders, bumpers, etc. Ideal for making special tools, dies, jigs, fixtures, etc.

**Works On Both
110 or 220 Volt A. C.**

Simply plug into a 110 or 220-volt, 60-cycle A.C. line. Economical—costs only a few pennies an hour to operate. Often pays for itself on first or second job—yet you have ten whole months to pay us. Portable—move it anywhere in shop on its heavy-duty, tempered steel Casters, or carry it right to outside jobs in auto, truck, or side-car. Anyone can weld with its easy-striking, automatically-stabilized arc. Comes complete with all necessary accessories. Nothing else to buy. Fully guaranteed. Breath-taking low price! Saves and makes hundreds and even thousands of dollars.

**Handles All Welding, Sheet
Metal to Heavy Castings**

Model 120-FS is a big, 110-pound, man-sized, heavy-duty welder, with efficiency of machines costing many dollars more, and capable of doing exactly the same work. Welds iron, steel, cast iron, cast steel, and alloys of them. Six instantly obtained heats handle everything from fenders and light sheet metal to motor blocks and heavy castings. Also fine for soldering and brazing. Uses standard training rods. No experience or special training needed to operate. Simple, complete instructions for doing all kinds of welding jobs included. MAIL COUPON BELOW for complete FREE details.



MAIL COUPON FOR DETAILS GET 22¢ A DAY PLAN

Commonwealth Mfg. Corp., Dept. E-51
4208 Davis Lane, Cincinnati, Ohio.
Please rush me at once, FREE, all details about Model 120-FS Electric Arc Welder with Deluxe Accessories, and your 22¢-A-Day plan.

Name.....
Address.....
Town..... State.....

NEW INVENTIONS

(Continued from page 43A)

concentric electrodes in which are V-shaped depressions. Depressions in one electrode extend opposite to those in the other. Conducting means comprise adjacent conductors connected by a V-shaped portion. When the insect comes in contact with the conductors, it is electrocuted. The apparatus plugs into any house outlet.

SOME of mother's worry over keeping baby's head above water in his bath would be banished by a float protected by a recent patent. The float, which is inflated, is formed to fit the back of the infant's head and shoulders, keeping them out of the water



and exposing the rest of the body for washing. A body strap and a head strap hold the baby on the float.

PERSONS wearing glasses soon may be offered an eyeshade which will fit on the glasses, instead of interfering with them. The shade consists of a rectangular section to shield the eyes. On each side of the shade are slots into which fit the shafts in such a manner that the shade is held in bowed shape over the eyes. The shade may be removed if desired.



AMONG inventions patented recently are: an antiseptic toothbrush, impervious to water and with bristles impregnated with a germicidal mixture; a snow-scooter which is steered by shifting one's weight, as skis are steered; a smoking device in which tobacco, as a cigarette or in loose form, is inserted in a tube and a spring automatically pushes the tobacco toward the lighted end as it is consumed, and a borer which makes an air draught tube in the end of a cigar.

INTENDED to hold the golfer's arms in proper position as he swings, a practice device has been patented. It is a band adapted to embrace the right arm adjacent to the elbow, with a strap running across to another band about the left shoulder. This



connecting strap slides in such a manner that the right elbow may move freely in the direction of the extent of the strap. The apparatus has means for being attached to the golfer's belt.

FOR illuminating the motor compartment while repairs and adjustments are being made, a floodlight system has been patented. It consists of two electric lights, one on each side of the motor, supported by rods attached beneath the hood. When the hood is raised on either side, special contacts cause the lamp on that side to light, thus illuminating the motor. The lamps would be of especial value in case of motor trouble on the road and in private garages where overhead lighting is insufficient.

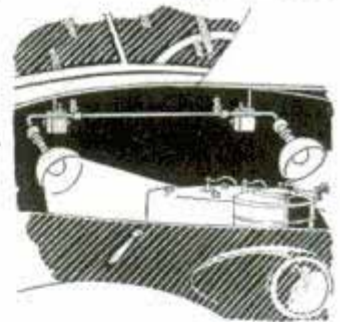

FOR making trailer travel more pleasant, a recently patented axle may be ad-



justed for driving on pavement or level roads and for rough roads. Many trailers cannot be taken on rough roads because they are built too low to the ground. One equipped with the special axle lends itself to an adjustment of clearance so that it might travel safely over deep ruts. The axle is equipped with its own brakes.

**JUST COMPLETED...AFTER YEARS OF PREPARATION...THE MOST *Comprehensive*
MOST *Authoritative* REFERENCE WORK OF PRACTICAL SCIENCE IN EXISTENCE**

VAN NOSTRAND'S Scientific Encyclopedia

BRAND NEW! UP-TO-DATE!

**Covers COMPLETELY
ALL of the Sciences**

in 10,000 Alphabetical Entries (Extensive Cross References)
1500 Pages • 1200 Illustrations

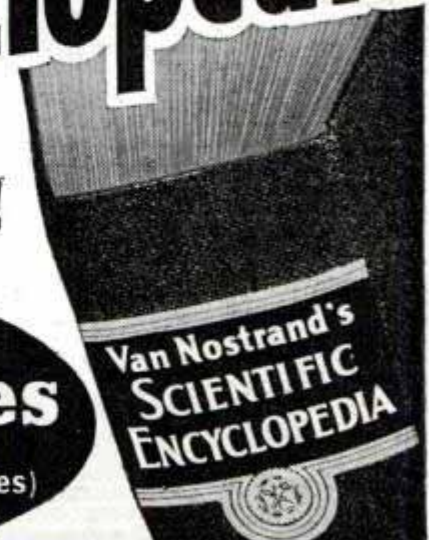

Here, for the first time in one volume, is all the knowledge of science known to man. In authority, in completeness, in sheer physical size it surpasses any similar volume ever published. If your work, study, or reading is concerned with any branch of science, this is just the volume you need.

**From Fundamentals to Latest Advanced Discoveries
Principles, Methods, Formulas—Clear Charts, Diagrams**

FOR the student, the hobbyist, the manual worker, each entry is explained in simple, easy terms. Detailed, more advanced information follows. Cross-references make it easy to follow a complete course of study on any subject. Thus, the professional scientist, who wants specific information in any field, can find it instantly in its alphabetical place—comprehensively treated in the language of science.

*The Instant
Question-Answerer for*
**LABORATORY & SHOP WORKERS
MECHANICS • HOME SCIENTISTS
AND STUDENTS**

Big 7¼x10¼x2½ Inch Size. Bound in Library Buckram, Thumb-Notch Index.

12 VOLUMES IN ONE

The contents of more than 12 average-size volumes. Here is a brief outline of some of the subjects:

CHEMISTRY: Chemical elements—symbols, atomic number, atomic weight, density, hardness, melting point, common reactions, occurrence in nature, production from ores, uses in industry. Compounds, manufacture and use. Organic compounds; industrial products. Agricultural chemistry, food chemistry.

PHYSICS: Mechanics, heat, light, sound, electricity, magnetism, X-rays, etc., etc.

MATHEMATICS: Arithmetic to algebra, geometry, trigonometry, calculus, differential equations, etc.; special emphasis on application to science.

ASTRONOMY: Covers the entire subject. Star map locates each important constellation in the sky. Planets, use of telescope, spectrometer, etc.

ZOOLOGY: All life from the tiniest single-celled organisms up to man, including insects, mollusks, worms; birds, fish, reptiles, mammals.

MEDICINE: Anatomy, circulatory system, nervous system, muscular system, skeletal system, excretory system, etc. Vitamins, hormones. Bacteriology. Diseases—symptoms, diagnosis, treatment. Drugs. Latest researches.

MECHANICAL ENGINEERING: Principles of mechanics, machine design, engineering parts and instruments. Types and functions of bolts, cams, gears, automobiles, aeroplanes, locomotives, etc. Steam, gas, gasoline, diesel engines.

CIVIL ENGINEERING: Surveying. Bridges, highways, railways.

ELECTRICAL ENGINEERING: Motors, generators, lighting, radio television.

The foregoing is only a partial list. Hundreds of articles on GEOLOGY, BOTANY, NAVIGATION, CHEMICAL ENGINEERING, etc., etc.

**Prepared by Foremost
Scientific Specialists**

21 Contributing and Consulting Editors:

- W. K. Green, Amherst College—Astronomy; F. T. Morse, of Virginia—Mechanical Engineering;
- L. L. Small, Lehigh U.—Mathematics; R. M. Field, Princeton—Geology; R. K. Strong, Rose Polytechnic—Chemistry; A. W. Lindsey, Denison U.—Zoology;
- L. D. Weld, Coe College—Physics; R. S. Mueller, M.D., Columbia—Medicine; R. M. Wheldon, M. I. T.—Botany; and many others.

SAVE 10%

The Scientific Encyclopedia, now coming from the press, will sell for \$10 or more—an amazingly low price for this great book. By placing your reservation now, however, you may have it at the special pre-publication price of only \$8.95—payable in easy monthly installments.

READ IT FREE

Send no money now. We will send the Scientific Encyclopedia to you for free examination. Read it, use it for 10 days. Then pay the special low pre-publication price of only \$8.95 in easy monthly installments, or return it and you will not be obligated in the least. Mail the coupon at once.

MAIL THIS COUPON—Send No Money Unless You Wish To
D. VAN NOSTRAND CO., INC.,
250 Fourth Avenue, N. Y.

Send me Van Nostrand's SCIENTIFIC ENCYCLOPEDIA, complete in one volume, 1500 pages, bound in library buckram. Within 10 days I will return it or pay the special pre-publication price of \$8.95 as follows: \$2.95 as first payment, and \$2.00 monthly for three months. (P.M. 2-38)

Name.....
Address.....
City and State.....
Reference.....
Address.....
 For free catalog of best books of practical instruction and technical information, check here. If you do not want the Scientific Encyclopedia cross out paragraph above.



Copyright, 1937, R. J. Reynolds Tobacco Co.

ALL ABOARD FOR PRINCELY SMOKING!

SAY THE THREE LEADING KINDS OF PIPE-SMOKERS



PRINCE ALBERT GOT ME OFF TO A GRAND START, ITS **NO-BITE MILDNESS** IS SO EASY ON THE TONGUE



MY PIPE IS ON **STEADY SCHEDULE** NOW, THANKS TO THE **SMOOTH MELLOWNESS** OF PRINCE ALBERT'S **CRIMP CUT**



PRINCE ALBERT IS MY TICKET TO **REALLY RICH, FULL-BODIED** SMOKING — AND THERE'S NO RAWNESS



SMOOTHER SMOKING WITH P. A. OR MONEY BACK!
Smoke 20 fragrant pipefuls of Prince Albert. If you don't find it the mellowest, tastiest pipe tobacco you ever smoked, return the pocket tin with the rest of the tobacco in it to us at any time within a month from this date, and we will refund full purchase price, plus postage. (Signed) R. J. Reynolds Tobacco Co., Winston-Salem, N.C.



Popular Mechanics Magazine

REGISTERED IN U. S. PATENT OFFICE AND CANADA

WRITTEN SO YOU CAN UNDERSTAND IT

Vol. 69

FEBRUARY, 1938

No. 2

201311

NEW GIANTS *for the* AIR LINES

IMAGINE a rubber tire as high as an automobile and so heavy that three men can hardly lift it. Tires that size are being tested today for the giant four-engined passenger transports to be launched this spring. Each tire weighs 360 pounds, exclusive of the forty-five-pound tube. A pair costs nearly as much as a new car.

The size of the tires alone will help give you an idea of how large these new planes are going to be. The four engines will develop nearly twice the power of the average passenger locomotive and each plane will carry up to forty people, in ad-

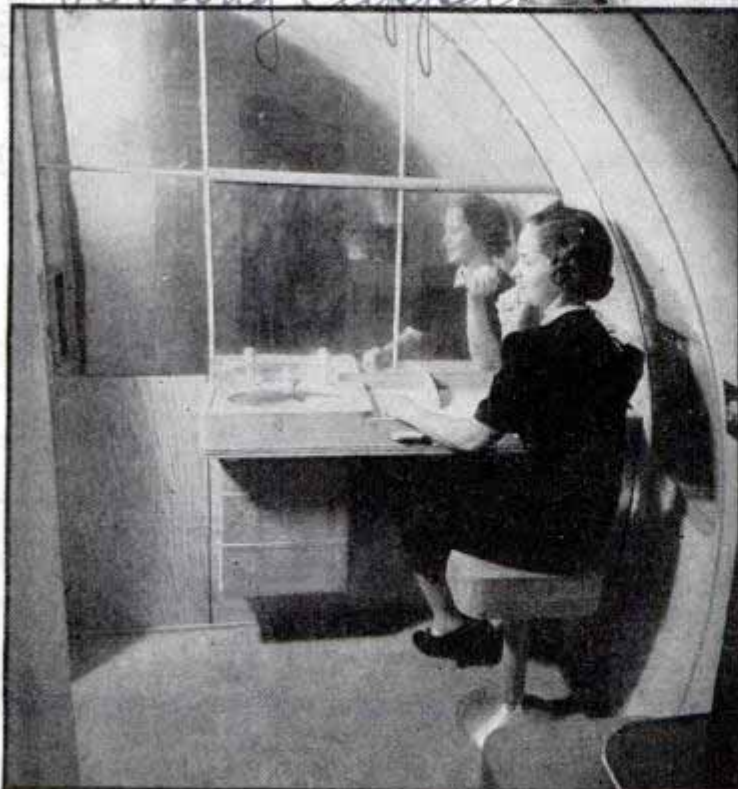

Boeing Clipper
Wide World
Top, pilots and engineers studying mock-up of cockpit instruments and controls of the giant four-engined transport. Bottom, part of ladies' dressing room on planes being built for TWA

dition to almost two tons of mail and express, which alone is more than the entire payload of most transport planes now in service.

"Nineteen thirty-eight will mark the beginning of the four-engined era in overland air travel," says C. L. Egtvedt, president of the Boeing Aircraft company. "The Model 307 land passenger transports under construction for TWA and Pan American have been preceded by the 'flying fortress' type of bomber adopted by the army air corps. Many of the lessons and engineering principles learned in developing

Harold Mansfield,
Publisher

Georgetown Station 161

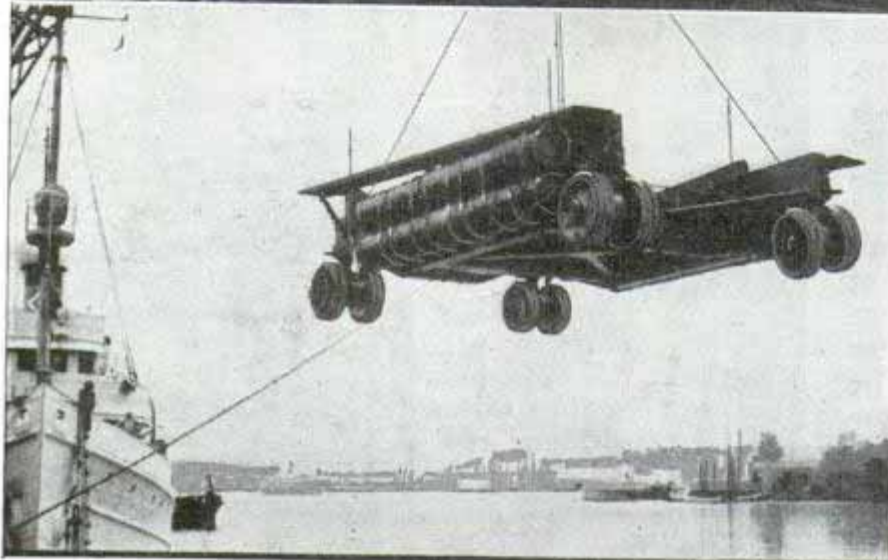
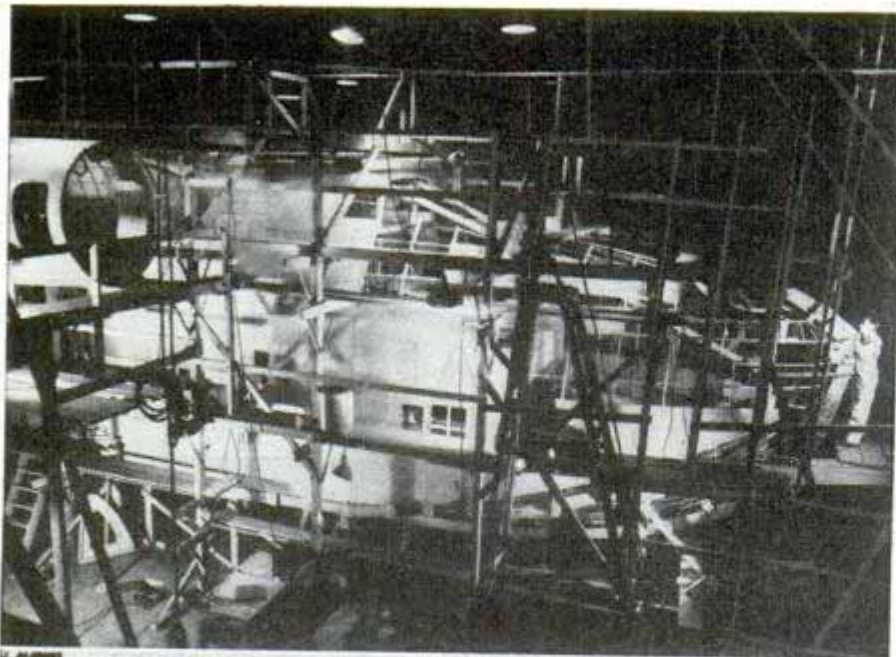

land transport will be. Another, looking like an unfinished motion-picture set on the outside, contains the complete cockpit and chart room of the new flying boat. A third represents a typical passenger compartment of the new land transport. Engineers, pilots, and department of commerce inspectors spend day after day in each of these structures, sitting in the seats, reaching for the controls, studying visibility, and suggesting minor changes.

The new overland passenger transports, which probably will go into service late in the summer, are to be all-metal low-wing monoplanes equipped with retractable landing gear and tail

the big fighting planes are being incorporated in the new passenger transports."

Boeing is building eight of the super-transport and Douglas is at work on the first of a similar series. The Douglas will be the first large transport to have level landing characteristics, a nose wheel permitting the plane to land level with the ground so that sleeping passengers will not be disturbed at each landing. At the same time, Boeing is building half a dozen tremendous flying boats far larger than the land planes. These will be veritable ocean liners of the sky.

At the Boeing factory in Seattle, where work on everything except four-motored airplanes has been discontinued, mechanics are swarming around huge hulls and are assembling gigantic wings that stretch from wall to wall. In other parts of the factory you find wood, metal, and cloth "mock-ups," full-scale facsimiles of the finished airplanes. One huge mock-up shows exactly what the exterior appearance of the new

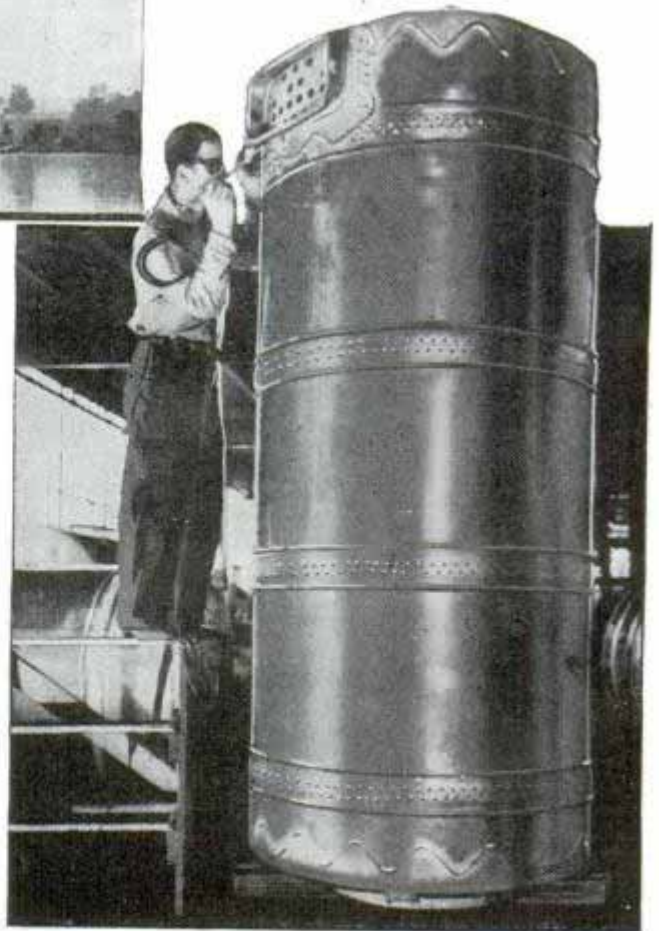

Top, scaffolding allows craftsmen to work on hull at five levels. Center, Clipper's launching gear. Bottom, 600-gallon wing tank

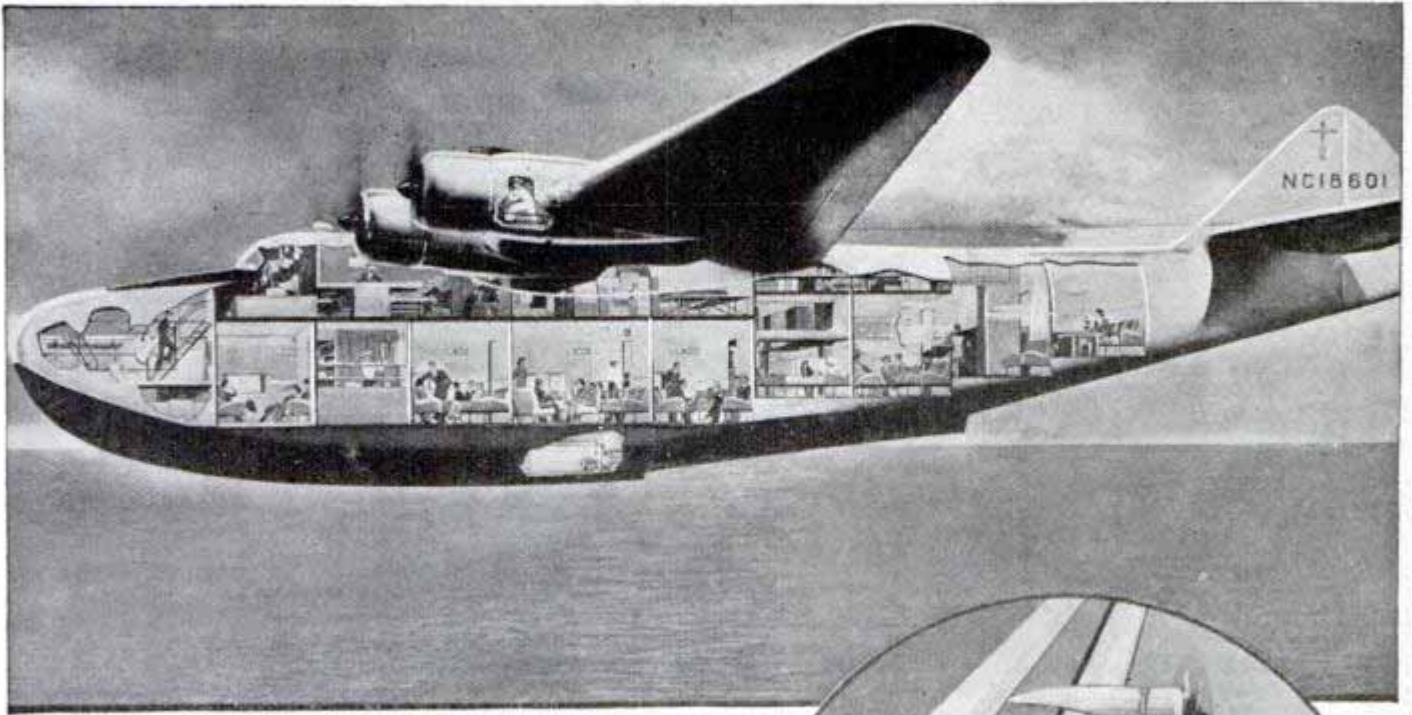

wheels. Perfect streamlining of the fuselage will give the planes the appearance of Zeppelins equipped with wings. Each plane will have a gross weight of 42,000 pounds, a wing span of 107 feet, a length of seventy-four feet, and will stand seventeen feet high. They will be powered with four 1,100-horsepower G-100 Wright Cyclones delivering a total of 4,400 horsepower.

In addition to a crew of four or five the transports will have accommodations for thirty-three passengers, or the interiors may be rearranged to carry twenty-five passengers on night flights, with sixteen passengers in sleeping berths and the others resting on reclining chairs. Behind the enlarged cockpit and auxiliary control room is a passenger baggage compartment accessible in flight, and beneath the floor are large cargo compartments. A men's washroom is provided forward of the main passenger cabin, with a ladies' room and galley at the rear.

At first appearance the cockpit of one of the new planes seems more complicated than ever before, but the instrument panels are arranged so that the pilot may control his plane with maximum ease. A compact group of flight instruments in front of the chief pilot's controls is duplicated by a similar set in front of the co-pilot. Between these two instrument groups is the automatic pilot panel with dials indicating the angle of the plane to the horizon and its

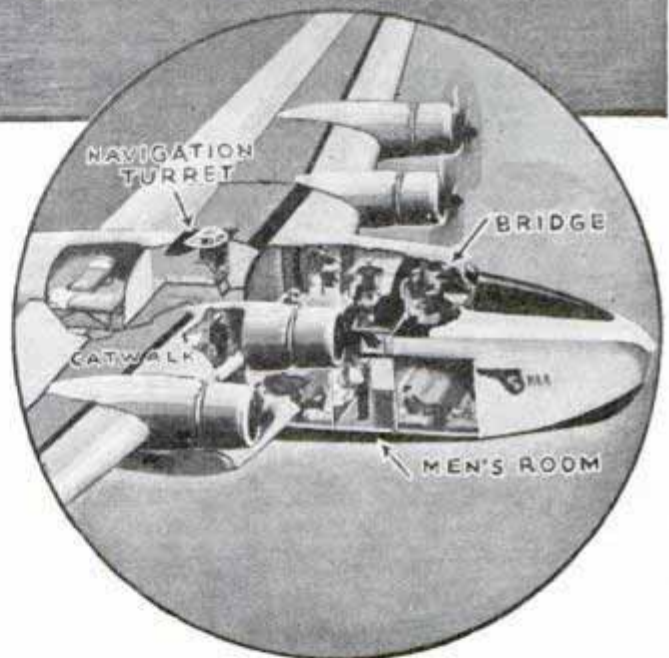

Two sketches showing various details of the clipper ship. Circle, note catwalk permitting servicing of engines in flight and the turret in which navigator may make observations

direction of flight. Between the two pilot seats is a pedestal on which are mounted fuel and other engine controls and the controls that govern the automatic pilot.

The pilot may operate all four engines, either pair in the port or starboard bank, or any one engine individually, by means of hand controls. Overhead, above the cockpit's forward windows, are the ignition switches, light switches, and dials that show the position of the landing flaps and wheels. The radio operator will sit behind the chief pilot on the left side of the cockpit, reaching across to his instruments behind the co-pilot.

These great airplanes are to be the first to be provided with sealed cabins for sub-

es1811



to 250 miles per hour will be possible because of the extremely low outside air pressure.

Since building its first four-engined bomber in 1935 Boeing has turned out nearly a score of these flying fortresses. Having slimmer fuselages than the coming transports, these great fighting planes can fly even faster than the passenger transports will.

(Continued to page 160A)

stratosphere operation. Transports today have a passenger comfort ceiling of less than 14,000 feet. That confines them to altitudes containing rough air and dangerous mountain peaks. The new Boeings will be able to fly at 20,000 feet, far above rough air and the highest mountain peaks in continental United States, with the passengers enjoying the same comfortable air pressure that they would at altitudes of 8,000 to 10,000 feet. Two of the new planes will be equipped for this type of operation at the outset while the balance are being built so that the auxiliary pressure equipment can be installed at any time.

All passenger and crew compartments inside the planes are being sealed through the use of a pressure-tight skin, reinforced windows, and pressure doors. The sealed plane can withstand a design pressure of six pounds to the square inch, although an operating pressure of only two and a half pounds to the square inch between inside and outside pressures is all that will be required. Two newly developed mechanical superchargers, each operating on a fraction of the horsepower of one engine, will draw air in through intake valves far out along the leading edges of the wings to build up air pressure inside the cabin. Ducts will distribute the air uniformly throughout the cabin and the air will be drawn off into an anti-pressure chamber at the rear containing exhaust valves. In upper level operation cruising speeds up

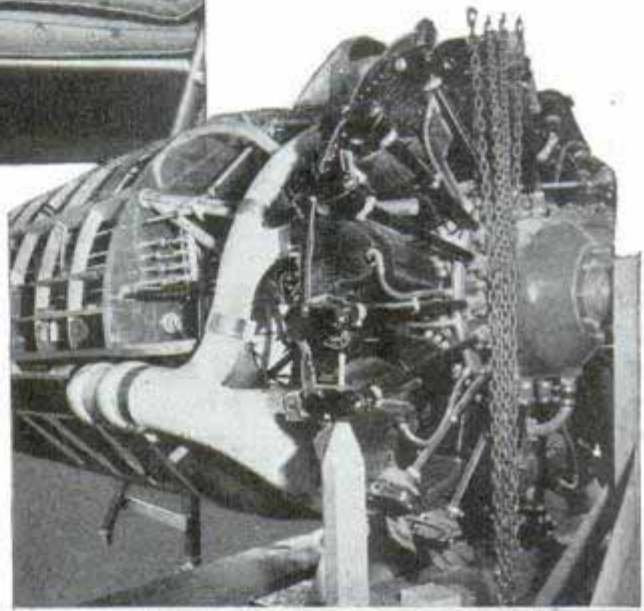

Top, passenger compartment, as seen from center aisle. Center, one of the giant engines installed in a wood and metal mock-up of nacelle. Bottom, engineer checking size of berth compartment

Spotlight Traces Football on Luminous Board

Trailing the ball with a glowing line that lingers several seconds, a luminous scoreboard for the theater dramatizes the action while loudspeakers describe the play. From the orchestra pit an operator directs the "football," a dot projected from a spotlight with a gun handle. The lens is covered with a tin shield pierced by a tiny hole which emits the spot of light. The playing field is painted with luminous paint which absorbs enough light from the projected beam to outline the path of the ball with a glow that fades away slowly. The play-by-play broadcast is delayed several seconds by an inductive device between the radio and the loudspeakers, giving the spotlight operator time to set the beam. He also controls the lights showing possession of the ball. Men behind the board take care of statistics.

LIGHT OF TEAM IN POSSESSION OF BALL CONTROLLED BY OPERATOR OF LIGHT BEAM ON ALTERNATING SWITCH

ARROW INDICATES THE DIRECTION EACH TEAM IS GOING

HEADSET TO RECEIVE SOUND THROUGH TRAP

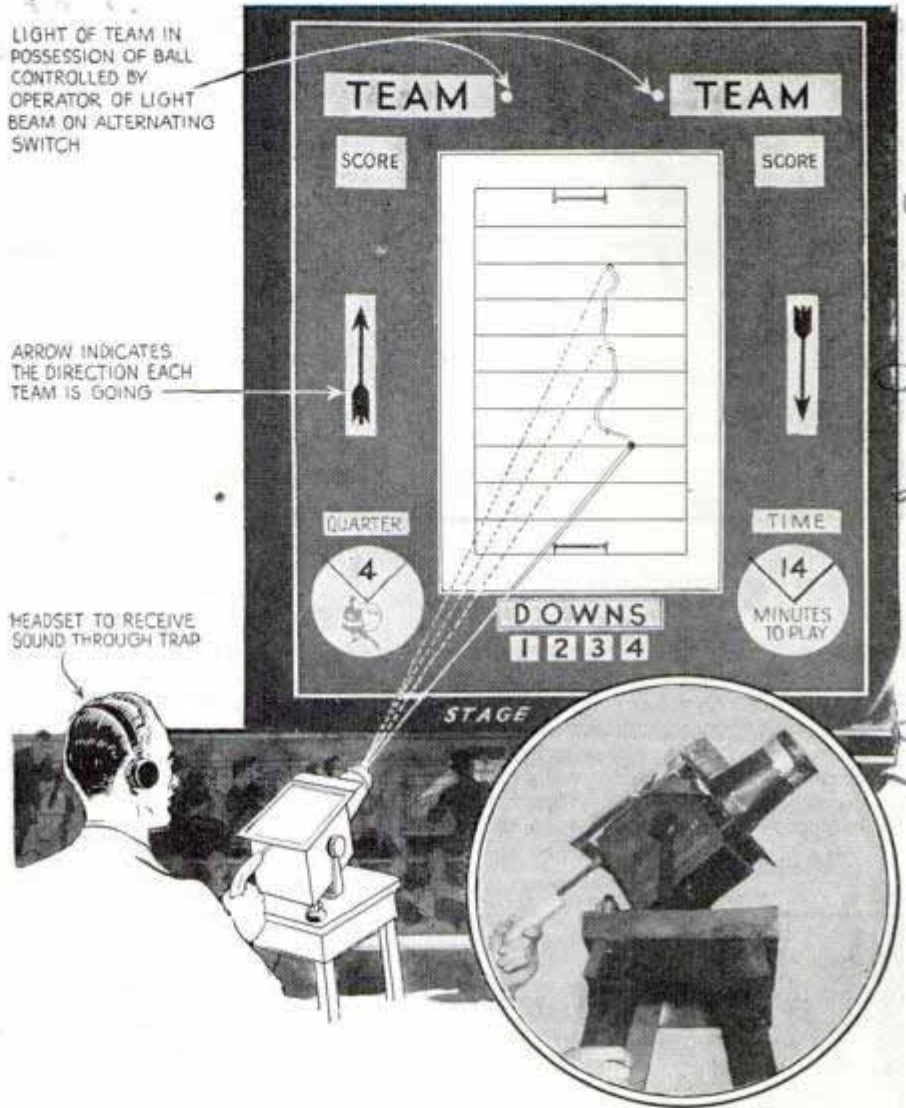

Curved line indicating football play is traced on board by sharp spotlight and holds glow for several seconds. Projector is shown in inset

Glass-Nosed Pusher Plane Gives Mapper a Clear View

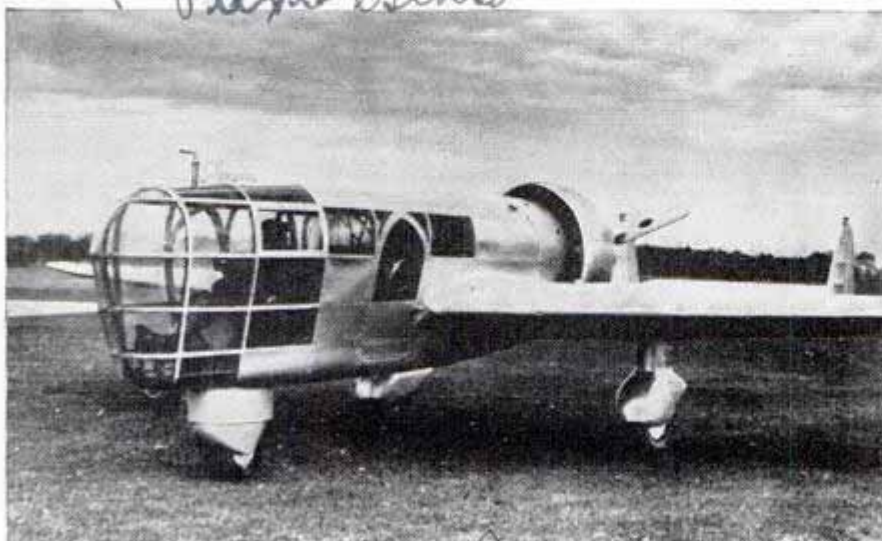

Built like a flying greenhouse, this plane allows the maximum vision for the aerial cameraman. Even engine and propeller are out of his way

Its forward cabin virtually a greenhouse of windows, a pusher plane designed for aerial photographers affords an unusually clear view. Engine and propeller are at the rear, out of the way of pilot and photographer, and the glass nose permits unobstructed sighting of the camera forward, downward and to right or left. The landing gear is the tricycle type, a wheel under the nose promoting safe landings.

Harbert Abrams, Aerial Survey Co

Curved line indicating football play is traced on board by sharp spotlight and holds glow for several seconds. Projector is shown in inset

Henry - Rocky - Kansas City - Paveriana
Light C. - Kansas City, Mo.

es 1387
Plexiglas

acme

Radio Reporters Follow the News in a Trailer

2013 copy of Columbia Broadcasting System, Inc. 4:10 P.M. Michigan Ave Chicago

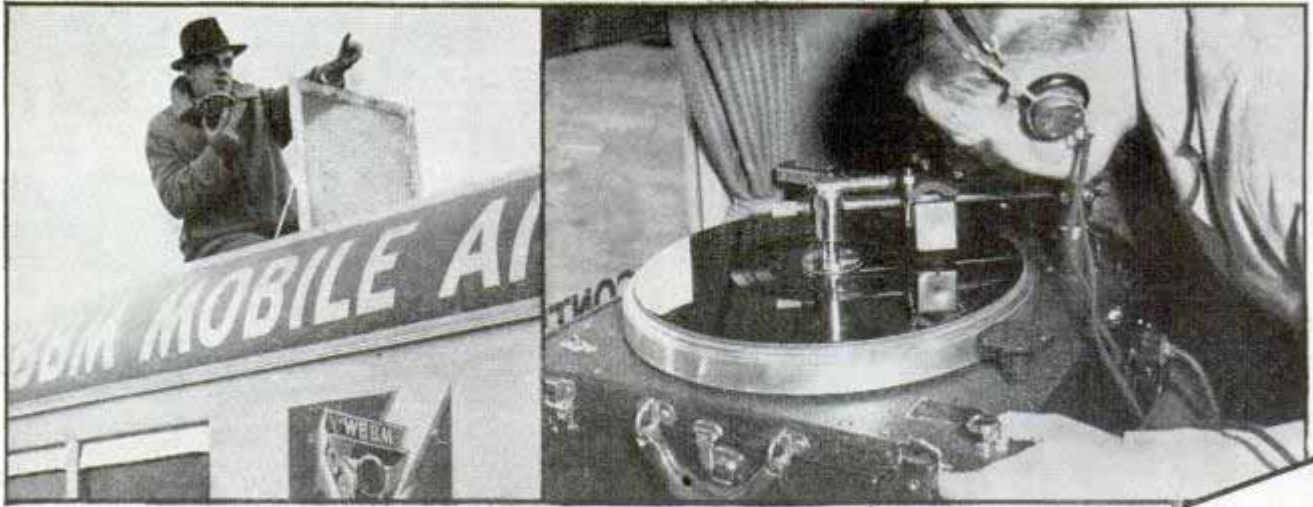

When disastrous flood or wreck, golf tournament or baseball training camps call out radio reporters of station WBBM Chicago, they speed to the scene in an air theater on wheels. Trailer fully equipped for broadcast, with telephone, telegraph, recording instruments and photo studio carries special events crew. Drawing at right shows arrangement

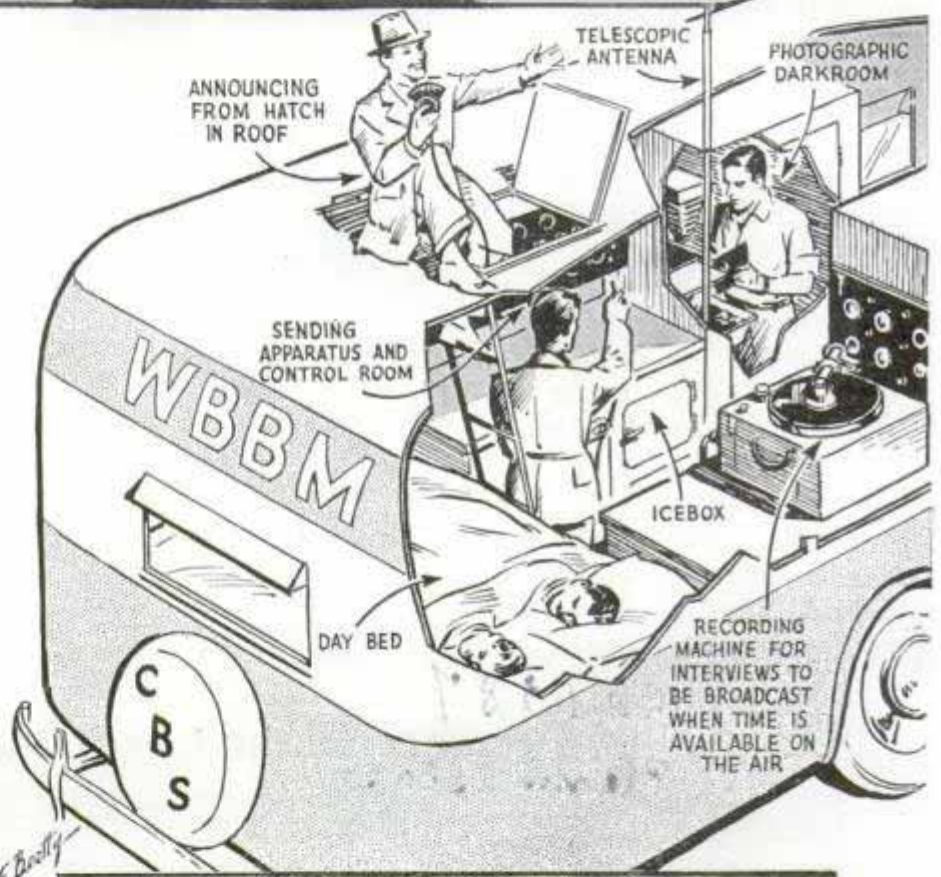

Top, announcer climbs through hatch in roof to describe parade, and engineer cuts electrical transcription of broadcast on aluminum acetate record. At left, below, the control room, with amplifier at left, recorder and refrigerator at right. Bottom, engineer keeps in touch with WBBM control room by direct telegraph



es 1391

Mobile Studio Is Fully Equipped Air Theater

Four members of crew sleep on double beds in trailer on overnight race to scene of spot news break. Announcer, right, reads dispatch from radio reporter in field, while below, newsmen use trailer office as "city desk" in preparing broadcast. Telephone is plugged in on nearest line. No matter what the local facilities, this traveling radio station can find a way out by phone or short wave. Thus it can help send rescue messages in emergency

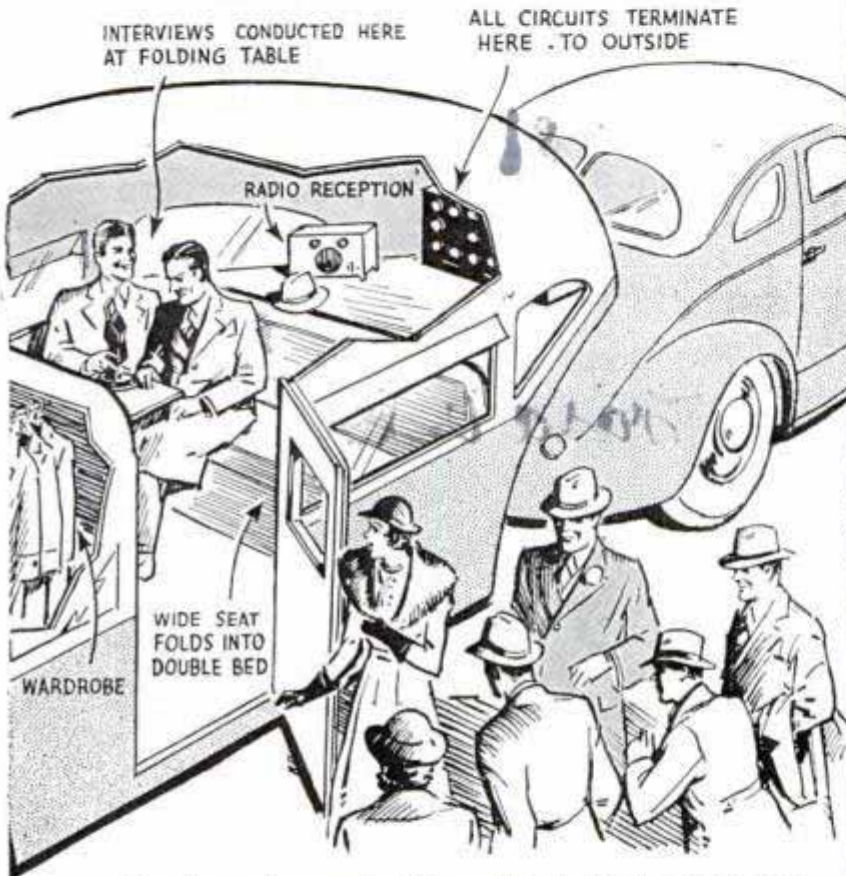

Regular assignment of the mobile air theater is to meet visiting celebrities. If time on Columbia network is unavailable, interview is recorded for later broadcast. Below, the studio on wheels "covers" an airport arrival

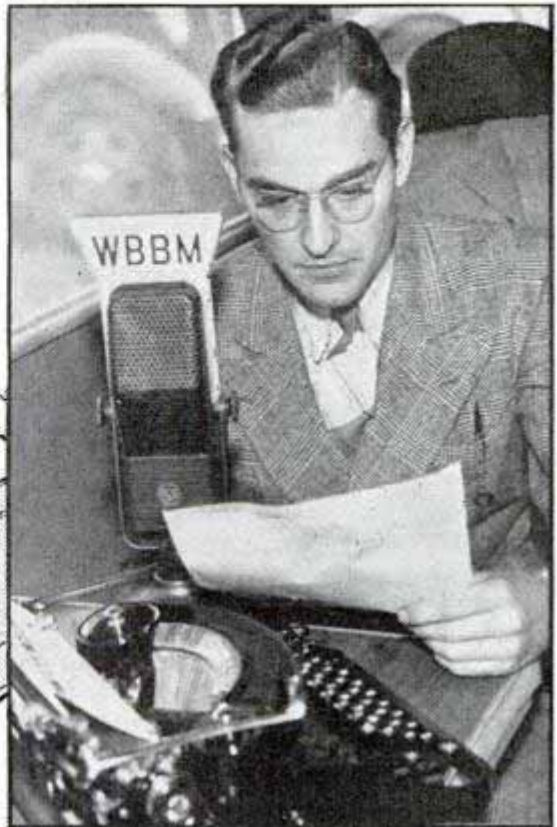

Studebaker President

Top of Show Auto Lifts to Reveal Interior

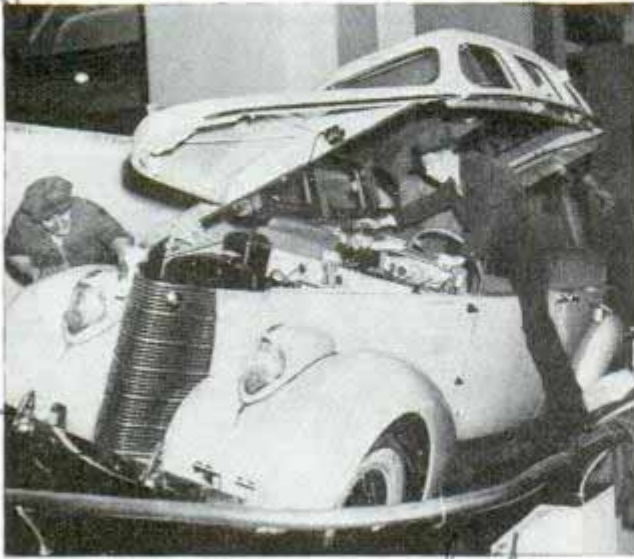

Top of car shown in elevated position, permitting thorough inspection

Novel among 1938 model automobiles exhibited at shows throughout the country was a car whose entire top could be lifted off. This permitted spectators to examine the interior appointments more closely than if the top had been attached.

Revolvers on Front of Auto Test Driver Reaction

Mounted on the front of a police test car, a device consisting of two revolvers and connections for firing them measures reaction time of automobile drivers. The motorist takes the wheel and the police inspector sits beside him. As the car reaches a predetermined speed, the inspector presses a bulb, firing one of the revolvers.

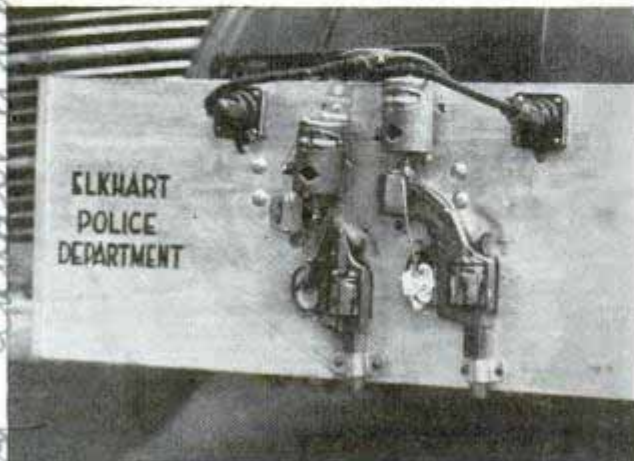

Revolvers strapped on front of test car, ready to show driver reaction

As the driver hears the report, he applies the brakes and a connection on the brake pedal discharges the other revolver. With its barrel pointed downward, the first revolver fires yellow chalk which leaves a mark on the pavement. The other revolver fires red chalk, also marking the pavement. Measuring the distance between the two chalk marks shows test officials how far the car travels before the driver reacts to the signal. By noting the distance from the red mark, where brakes are applied, to the point at which the car stops, officials determine effectiveness of brakes.

Car Seat Tilts In and Forward to Increase Passing Room

Designed to provide a wide passage into the rear compartment, the back of the front seat in the latest Ford two-door sedan is divided and hinged so that either



Back of divided front seat swings forward and inward in latest coach

section swings inward when it is tilted forward. This gives passengers more room to reach the back seat than they had in former models equipped with only the forward tilting seats. The front seat cushion is full width, only its back being divided. This design is offered as the solution to one of the industry's big problems.

Studebaker Corp., South Bend, Ind.

Police Dept. Highway & Traffic Dept. Elkhart, Ind.

Ford Motor Co.

FEBRUARY

CHEMISTRY

169

Dress - Pauline Fields, 498 - 7th Ave., N.Y.C.
Hat - Louisesanders, 711 - 5th Ave., N.Y.C.
Price \$20.00.

Bag - Lewis purses, 135 Madison Ave., N.Y.C.
Price, \$18.75.

Faint, illegible text on a piece of paper, possibly a document or letter, tilted at an angle. The text is mostly obscured by blurring and low contrast. Some faint words like "THE" and "OF" are visible.

CHEMISTRY and YOU

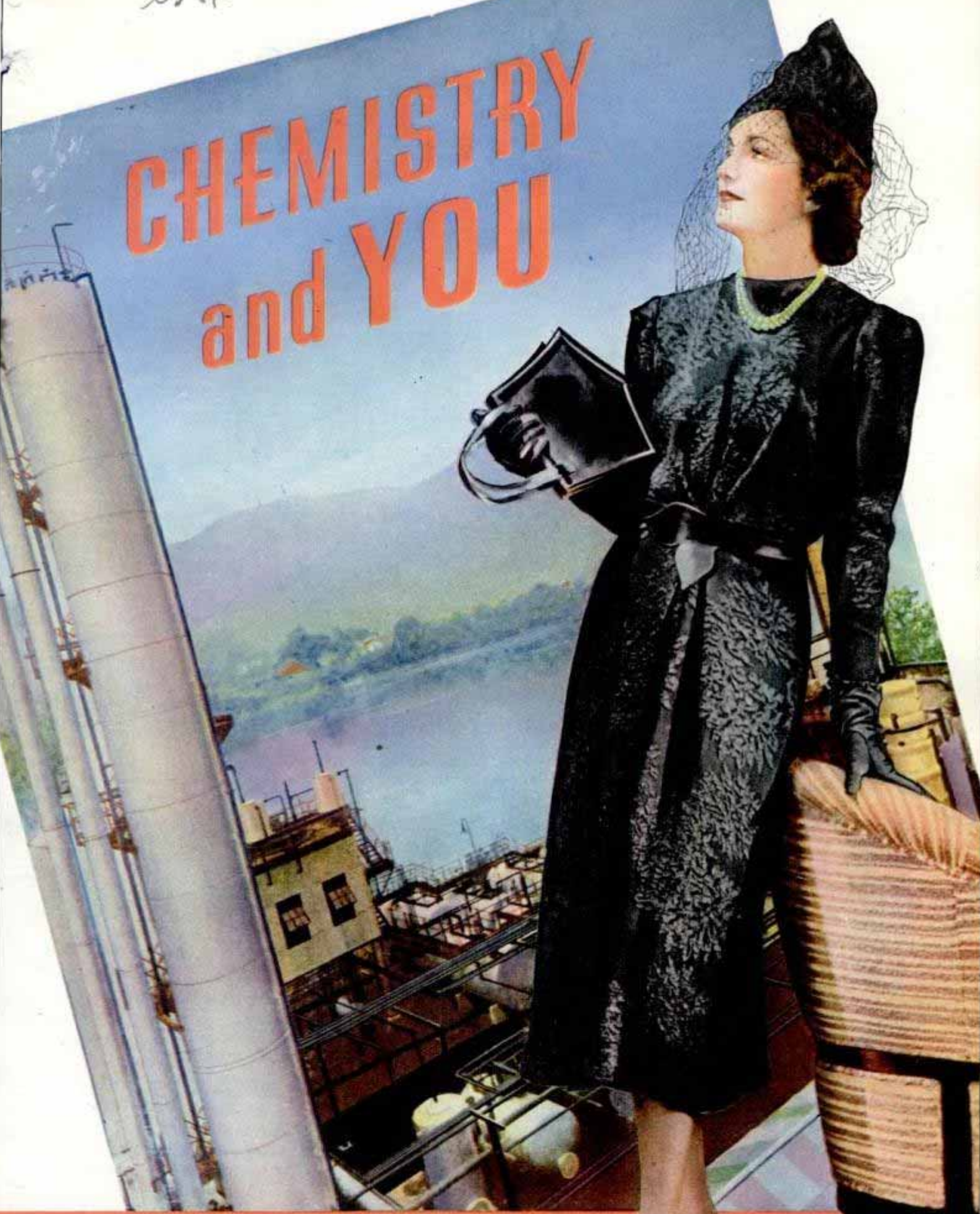

*Belle Charleston
near Charleston*

PART 3

TWO contrasting examples of chemistry's contributions to civilization—an ammonia plant in West Virginia and a rayon frock. Note both the dull and bright effect in the same fabric.

Benzol Recovery plant.



CROWNLESS "hat" of Cellophane made by braiding strips of the cellulose film after drawing them through a twister or button-hole to give the crushed or crinkled appearance. Below, the use of plastic material for furniture is demonstrated in this transparent cosmetic cart. It is light in weight, strong and virtually unbreakable.



By DR. C. M. A. STINE

Vice-President E. I. du Pont de Nemours and Company

Washington, D.C.

IN the rise of the petroleum industry, an impelling force has been the modern chemist. The general use of high-compression motors in automobiles, a development of depression years, was only made possible by the chemical improvement and stabilization of gasolines to give them and enable them to retain anti-knock qualities, and to inhibit the formation of gum. In recent tests motors have been run up to 100,000 miles without having to be overhauled for carbon removal.

Cracking became commercially practicable in 1912. Improvements in the process have resulted in sensational increases in the yields of gasoline from crude oils, and have probably extended the life of our oil deposits by many years. Late in 1932 two plants for cracking by hydrogenation began operating in this country. This process makes possible

yields of as high as 104 barrels of fuel from 100 barrels of low crudes that under old methods yielded as little as five barrels, a feat that sounds like black magic.

The rapid deterioration of cracked gasoline in storage now has been eliminated largely by the use of antioxidants which retard gum formation, and high test fuels may be stored for six months or longer as against the one-time limit of two or three weeks. Lubricating oil has been treated chemically and improved through the addition of extreme pressure lubricant bases. This has fitted it for gear loads double and quadruple what the untreated oil of a few years ago could carry, and made possible the use of im-

190



proved gears in the transmission of power.

Uncounted millions have been saved the daily consumers of oil by the chemical development of a host of petroleum by-products once wasted. The number of such by-products was estimated in 1928 to be about 1,000. Today it is double or treble that figure and includes detergents and lubricants for the textile industry, solvents of great importance in the lacquer industry, raw materials for synthetic resins, and chemicals for influencing the

TRANSPARENT piano case, above, and bench made of cellulose acetate plastic. Right, transparent tea bags of perforated Cellophane. Below, standard rubber mill used in blending Neoprene or man-made rubber.

Deepwater Point



es 8/2

Belle plant Ammonia Dept



CHEMISTRY on a huge scale. At top of a coke-oven battery, the coal is charged into ovens and volatile matter is distilled off, leaving coke used in making "blue" water gas.

172

ripening of fruits and destroying insects on farm crops, to say nothing of various oils for medicinal use.

Ever since 1913 there have been discussions on making oil from coal. In that year Bergius, a German chemist, startled the scientific world by his discovery that this could be done. And Germany now actually is producing from coal about 300,000 tons of gasoline yearly, at a cost, however, of three or four times the cost of petroleum gasoline. England too is manufacturing the "liquid coal." In the United States with our vast oil reserves we have been only casually concerned in this development, but recently the Bureau of Mines opened an experimental plant in Pittsburgh to make oil and gasoline from American coals by the Bergius process. This is a step in preparedness, because while experts disagree widely on the probable life of our oil deposits, they all agree that they will not last indefinitely. In the opinion of the Bureau of

Mines expert, Dr. Arno C. Fieldner, "the nation's proved oil supply can be depended on for only the next fifteen years," and he adds that about one-half of the world's coal reserves are in the United States and Canada.

Bergius also demonstrated that oil can be made indirectly from wood through first converting the wood into coal, which he did in a test tube. This suggests the possibility that oil might be made directly from wood, which is a replenishable resource. Still another possibility is that common plants grown on the farm might become the source of our motor fuels when petroleum deposits are exhausted; and research is going ahead in this field. It is extremely doubtful, however, as long as we have petroleum in abundance, if any substitute for it can be developed that will be able to compete with the low prices at which petroleum products are sold in America.

Closely associated with petroleum in

20812

1933

THERE'S a special kind of the man-made fabric called rayon for any style or design of dress. Below, toilet-ware, the handles of which are made of Lucite, a crystal-clear plastic developed recently by the du Pont company. The oval body is of Pyralin.



daily use are the various metals, and so closely associated are the sciences of metallurgy and chemistry that it is difficult to draw a sharp line between them. In our generation so many changes have been brought about in metals that today most of the metals in use seem new. Yet such "new" metals as tantalum, molybdenum, tungsten, platinum, cadmium and others have been known for a hundred years and more, usually in some form, however, that made them as unavailable as the moon and as costly or even costlier than gold. Modern science has not only made such rare metals available for innumerable uses but it also has created hundreds of alloys that in effect are wholly new metals.

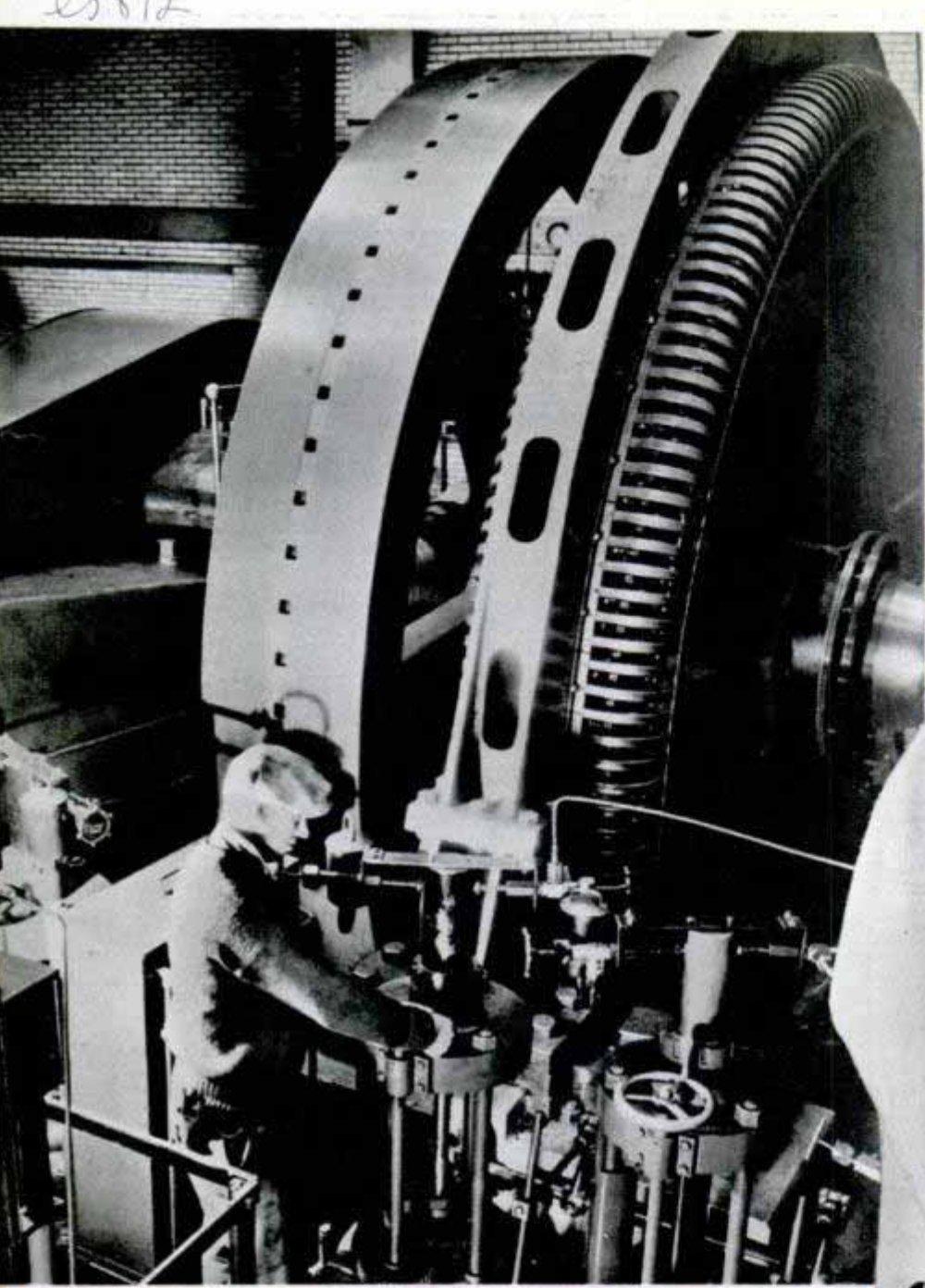

Belle W. Va.
DRIVE for a gas compressor, left, in an ammonia plant. Below, hydrogen peroxide bleaches have revolutionized the textile field. The pure white of this swagger suit and of the hat and gloves was made possible by peroxide bleaching.



174

The past fifteen years have been marked by metallurgical developments that are little short of the miraculous in compounding light metals of great strength and high resistance to rust and other forms of corrosion. The past five years have seen these new alloys applied in a revolutionary way to railroading in new fast, lightweight trains, to automobiles and aircraft, to tanks and other containers for storing and transporting foods and chemicals, to building construction, to machinery. The art of metal plating with chromium, cadmium, nickel and lately aluminum has been carried forward in striking manner, and we have learned how ordinary metals can be clad with coats of costlier metals, such as silver and stainless steel, to give them new surface properties.

So obvious are these changes in metals—you find them in profusion as close by as the kitchen—that it seems almost unnecessary to mention

CHEMISTRY at the beach. Bathing suits are of acetate rayon. Tablecloth is lacquered fabric. Food bags are Cellophane,



175
MOISTURE-proof Cellophane keeps food fresh and sanitary. Here a machine is wrapping bread in this transparent cellulose film—a chemical product.

them until one recalls that as recently as 1929 stainless steel, for instance, was little more than an industrial curiosity, and that the first lightweight streamline railroad train dates only from 1934. Entirely apart from the utility added by these new metals and the new operations they are making possible, they have a tremendous significance to our economy in supplying a direct means of reducing losses from rust that have been estimated at \$3,000,000,000 annually.

The elements, caesium and rubidium, were known to our scientific grandfathers, but only within recent years have they come into their own in a field so startling in its potentialities that the opening of it alone would stand as a gigantic achievement of our generation. An alkali metal such as caesium or rubidium is used as the essential element in the photoelectric cell or electric eye. This element might be called the retina of the electric eye. Such metals possess

Every State Supplies Materials Used in Automotive Industry

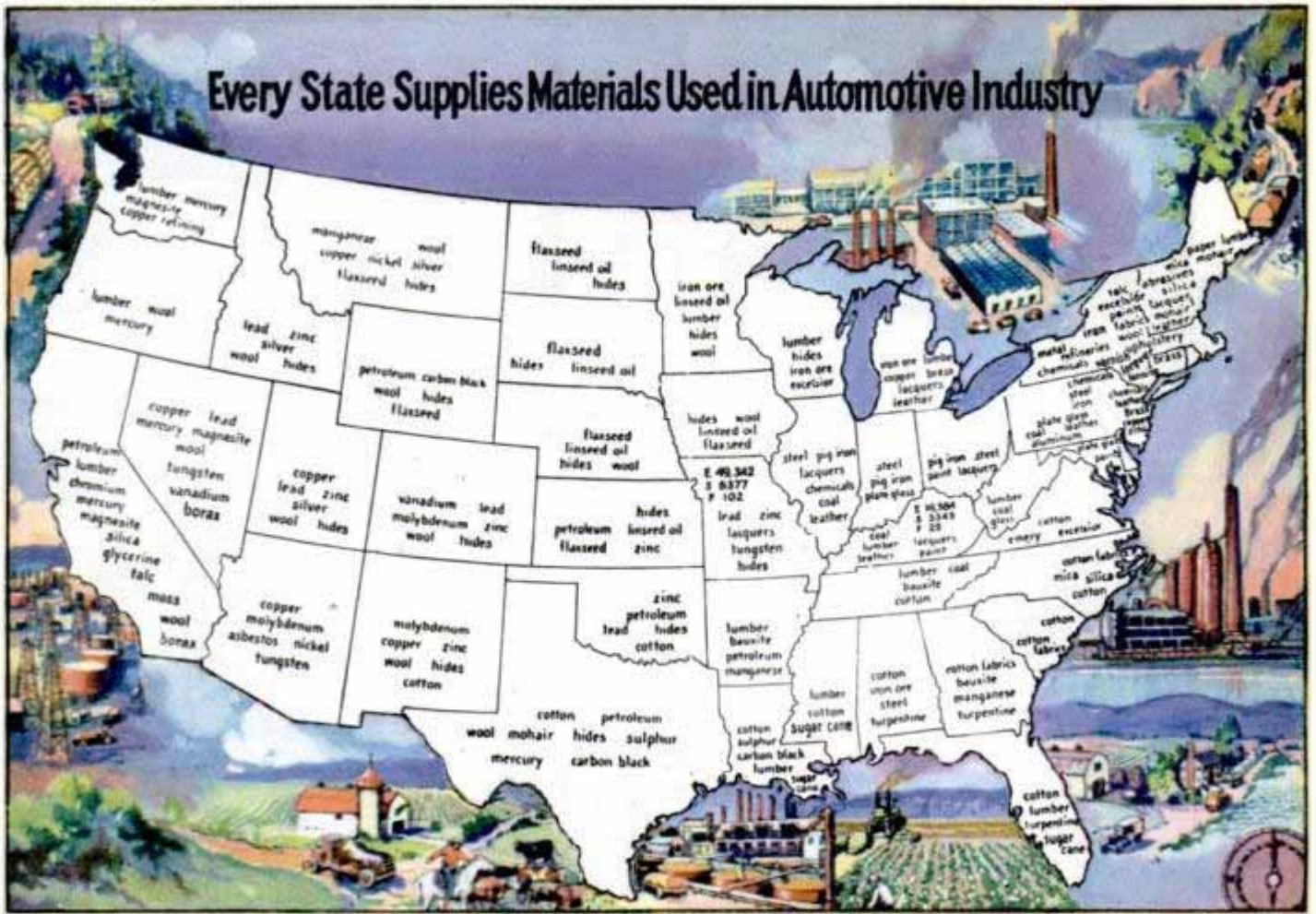

a sensitivity to light rays and colors that, in certain cases, is similar to and in some respects even superior to that of the human eye.

The photoelectric cell has an almost infinite range of actual and possible uses—in counting, sorting and in inspecting units, colors, and materials; in automatic alarm, signal and safety systems and, in fact, throughout mechanics; in photography, in communications, and notably in that fast developing new wonder of the air waves, television. They are being used in astrophysical and astronomical investigations to uncover the mysteries of stellar radiation. And some experimenters see in photoelectric cells the means by which man will in time convert to his use the vast and inexhaustible energy given off by the sun.

The vacuum tube is a triumph in the creation of new materials and the practical utilization of old materials such as tungsten and tantalum. Tubes are limited as yet in the amount of power they can handle, but work in progress with another rare metal, columbium, now indicates these limits may be extended to where tubes will be able to handle thousands instead of tens of kilowatts of power. Columbium is being put to other uses too, notably in alloying with stainless steel to give the property of cor-

(Continued to page 132A)

76
PORCELAIN book ends and statuettes decorated with American ceramic colors. Top, every state in the Union contributes something to your automobile.

es 1318

271102

Car's Top Supports Twelve Tons in Load Test

Recent tests of the ability of all-steel automobile tops to support great loads revealed that manufacturers have made the safety factor much larger at that point than the public might suspect. Bags of sand were piled on a special platform built on top of sedan in the tests at the Studebaker plant. Not until the load had reached twelve tons did the roof and body begin to show signs of collapsing. Finally, with 24,750 pounds piled on top, the car's structure gave way. The weight required to break down the car was seven times the weight of the car.



Here we see the automobile after it collapsed under a load of 24,750 pounds, seven times the weight of the sedan

Corporation South Bend, Ind.

es 1260

Bumpy Arrows in Pavement Keep Autos in Right Lane

Bumps in the middle of the street discourage motorists from wandering out of their proper lanes, and raised lines and

arrows have proved an effective method of separating traffic bound in opposite directions. The lines and arrows are painted white and raised about one inch above the pavement. It is not impossible to cross this middle strip, but the bumps make it a bit uncomfortable and drivers usually stay where they belong.



White pointers warn drivers to stay in their lanes, and are raised enough to make safety lane bumpy

Cont. Mr. D. Scott, Box 54, Carlsbad, Calif.

between Long Beach and Pasadena, Calif.

es 1393

Linoleum and Rubber Floors

Outlast Concrete, Asphalt - 10x

Floors of linoleum, flat-grained maple and rubber outlasted those of concrete and asphalt in a test to determine what materials would best withstand the wear of iron-wheeled post-office trucks. The 1,500-pound trucks were driven 60,000 times around a forty-foot track paved with the various materials, and the concrete and asphalt floors wore out first.

Names and addresses of manufacturers and dealers in articles described in this magazine will be furnished by our Bureau of Information upon request accompanied by stamped, self-addressed envelope.

Conducted by Warren & Emiley, and C. E. Hofer.

see letter
Standard, Wash., D.C.

The ROUGH ROAD

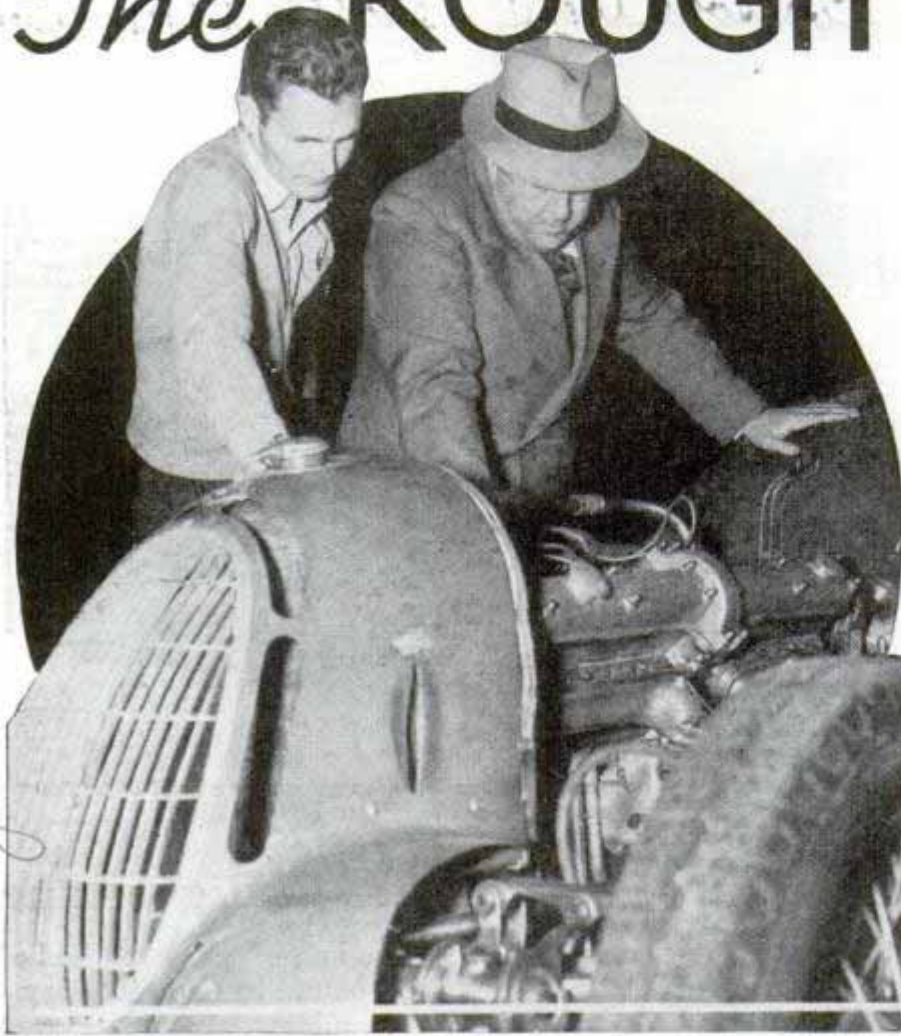

fellows today. Wherever there's an automobile on which to tinker, you'll find one of them tinkering—dissecting an old car in his dad's back yard, wielding a wrench in a neighboring garage, working without pay as a mechanic's helper at some local speed event. One and all, they dream of roaring to glory on the race track.

And some of them will do just that! Among these hundreds of young chaps with a consuming ambition to pilot a racer are the winners of future Indianapolis and Roosevelt Raceway classics. Two or three, perhaps, may become the American champions of tomorrow, men whose names will be-

By Maj. George H. Robertson
General Manager, Roosevelt Raceway

THE road to fame and fortune can be covered quickest in a racing car—that's the firm conviction of hundreds of young

come racing bywords, like De Palma and Oldfield.

But for each one of these ambitious boys who makes a success of racing, a host of others will fail. Racing is a truly great and fascinating sport but it is highly competi-

630 Fifth Ave New York

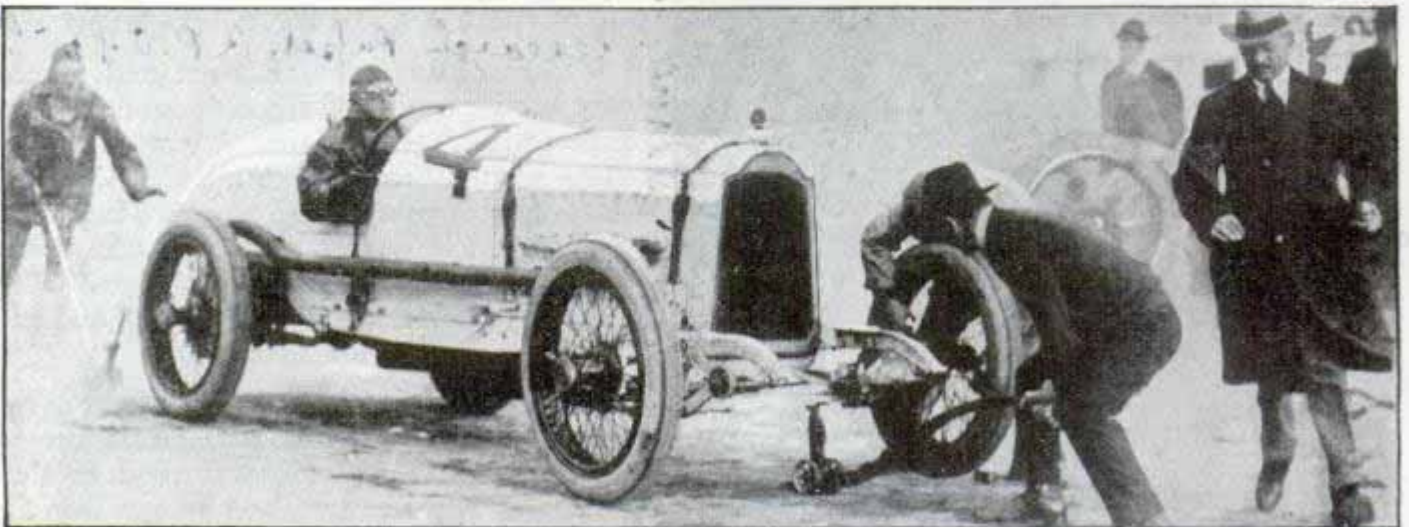

Al Poole in a Packard makes a pit stop during an early race. Top, Alfa Romeo which was remodeled and raced as a Bowes Sealfast Special at Indianapolis last year

es 1174



to **GLORY**

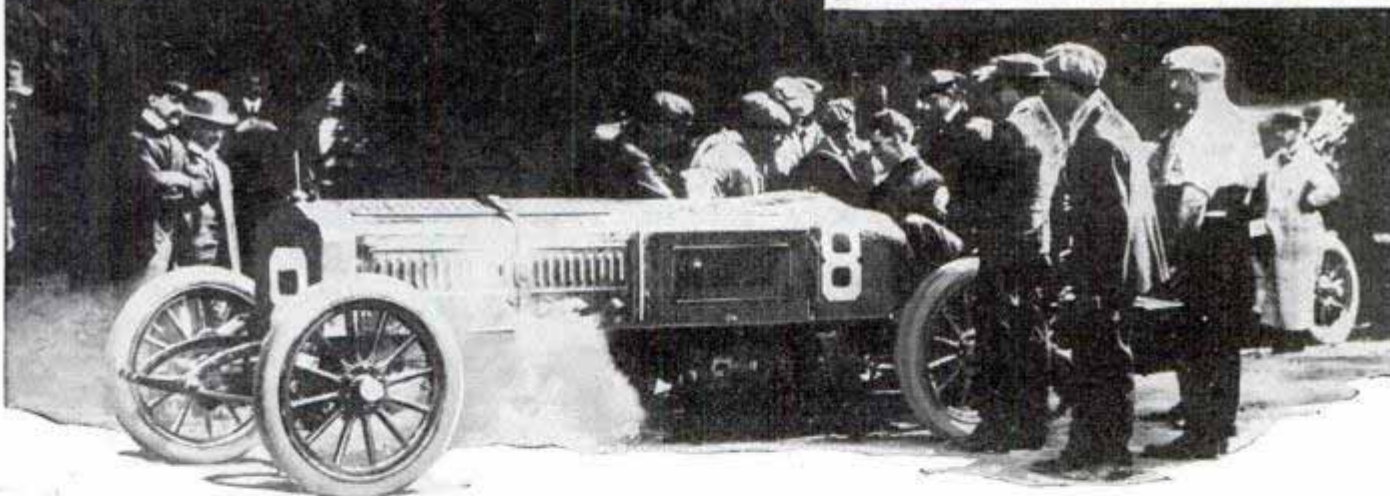

Mortimer Roberts in Thomas car practicing for 1908 Vanderbilt race. Top, start of a recent race in Berlin. Note the ultra-streamline design of the foreign cars

tive and, unfortunately, there is no royal road leading to a speed king's crown. It's a hard, tough climb from the bottom up. And the further up you go, the tougher becomes the going.

Racing cars cost money, not only to buy, but to maintain, and the only way to get this money is to win races, or at least place well up in most of your contests. One or two major crack-ups may take all you have made in months to get your car running again. You earn every dollar by licking stiff competition, and don't let anyone tell you the competition isn't tough.

But, despite all the handicaps, fame and

money await the young man who has the courage, the ability and the intelligence to pilot a racing car well enough to win more races than he loses. And, if you're determined to go into racing, there probably has never been a better time to start. In order to comply with the provisions of an international racing agreement, cars with smaller motors and minimum weight provisions will make their appearance in 1938.

This new breed of cars calls for a new breed of drivers, or at least for a change in driving technique. And that means that opportunity is knocking at the door of the beginner. But where to begin? That's the

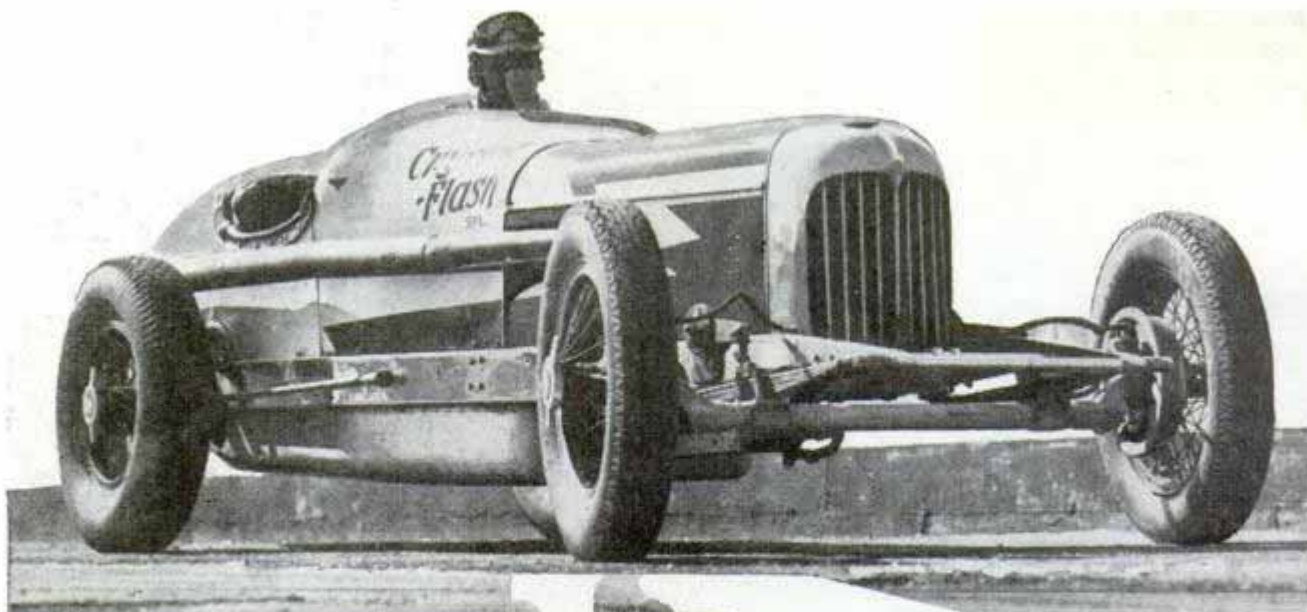

The old and the new. Top, Milt Marion in Marion Miller Special. Right, Walter Christie at wheel of Christie front drive. Below, Major Robertson in Locomobile in 1908

Photos below and right by Lazarnick

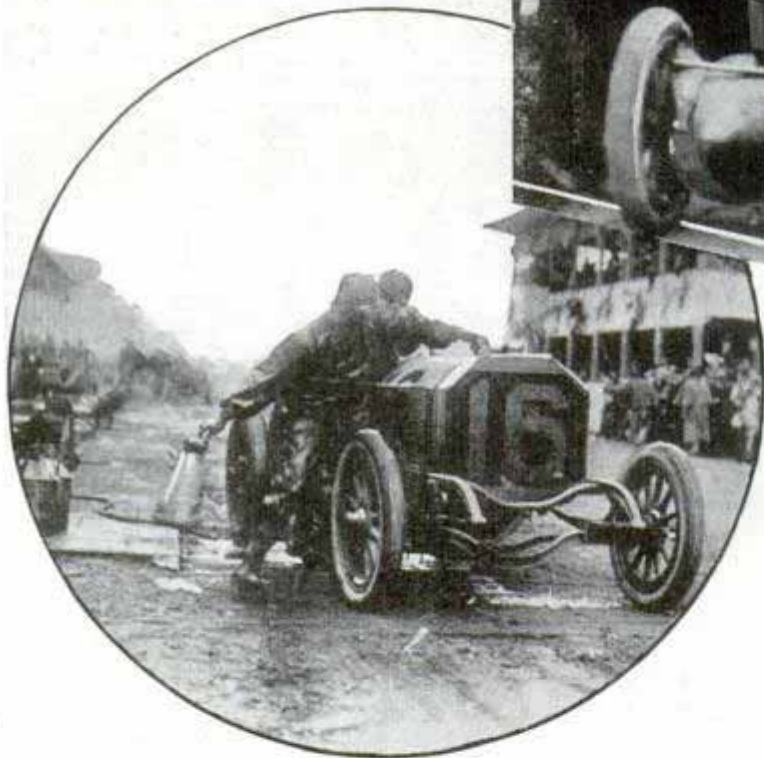
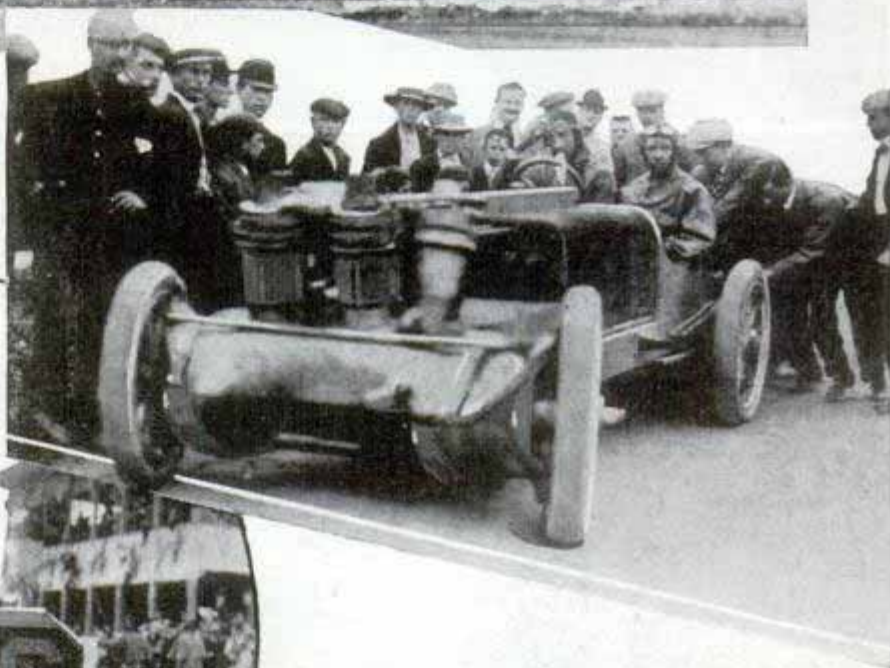

question that stumps nearly every would-be driver.

Don't begin at all unless you are a real "he-man." There's a thrill in every mile of every race—sometimes a hundred of them to the mile. You need more than courage and an ability to drive at high speed. You must be healthy, methodical, decent and have a mind for detail, accuracy and neatness. You need a brain capable of cool judgment and hair-trigger

thinking. And, last of all, you must have a real love of mechanics.

The average beginner picks up an old chassis and, spurred on by his ambition and love of things mechanical, starts tinkering with it. Perhaps he has a job of some sort during the week and uses evenings and week-ends for his "engineering." The money he saves from his job goes into parts when often it probably should go for food. Possibly there isn't any too much sleep for him during his "souping up" efforts, but who wouldn't lose a little sleep to become a speed king?

Finally his "racer" is completed and he whizzes around the neighborhood, the envy of small boys and the curse of the neighbors. Perhaps he does all the messy chores for some driver in local race meets

and eventually becomes a mechanic's helper, then finally applies and is accepted as a registered AAA mechanic.

Meanwhile he has been working on his old bus, tearing it down, rebuilding it, improving here and there as he gains experience, adding a few ideas of his own which probably don't work. Eventually he decides the old car is not what he needs for racing after all. He disposes of it to some less ingenious enthusiast, probably at a profit, and perhaps picks up an old race car he has seen on some local track. Lovingly he labors over the old racer and eventually he enters this "rebuilt" bus in a local event. Ten to one, he loses and starts



Top, in circle, an early Napier car on the sands at Daytona Beach, Florida

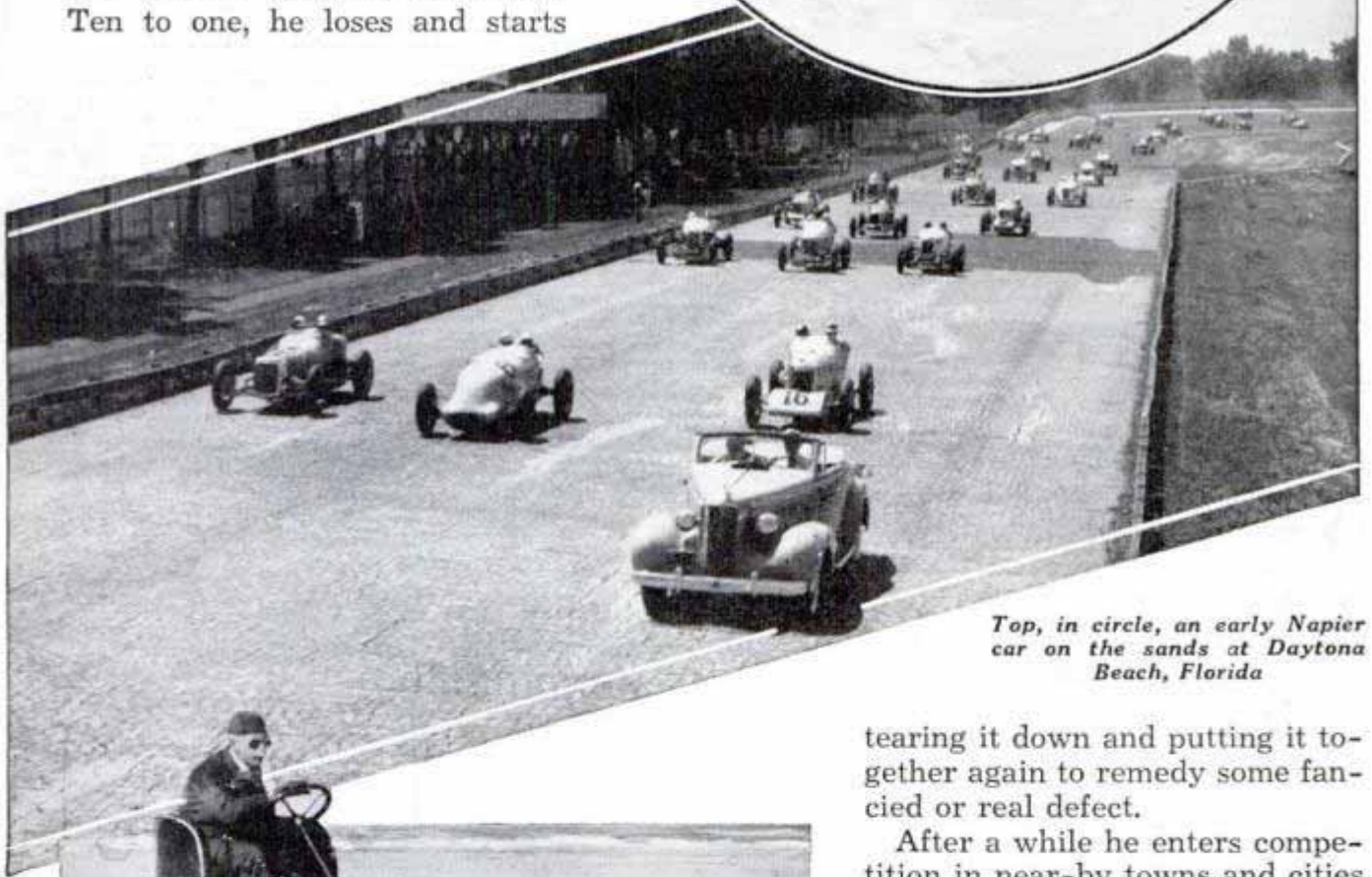

Alexander Winton in Winton Bullet. Above, pace lap at start of 1937 Indianapolis race

tearing it down and putting it together again to remedy some fancied or real defect.

After a while he enters competition in near-by towns and cities and eventually—much to his own amazement—he wins a race. About then he gives up his job to devote all his time to racing and he's definitely off on the road to success or failure in the racing game. Dirt tracks come next, with stiffer competition, or perhaps he goes in for the midgets.

In some such fashion has nearly every one of our present-day racing drivers developed. Most of

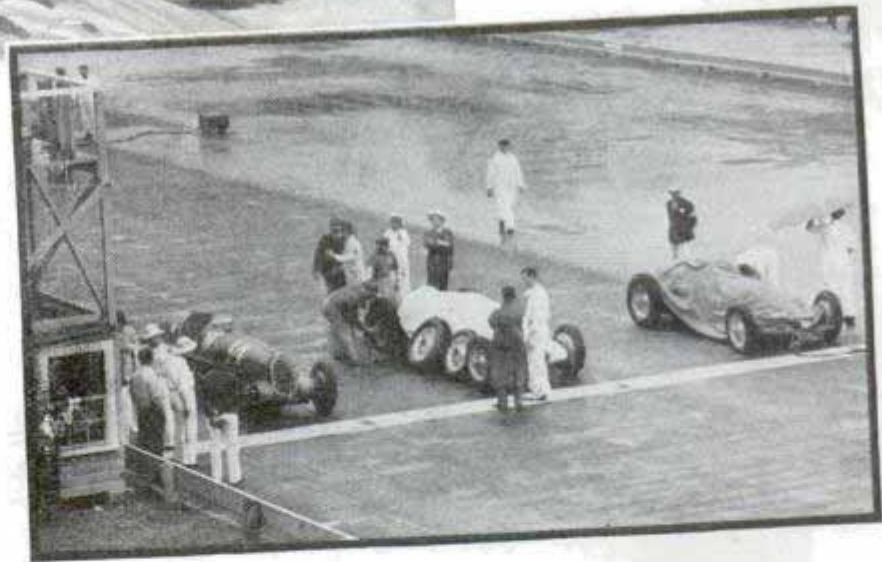
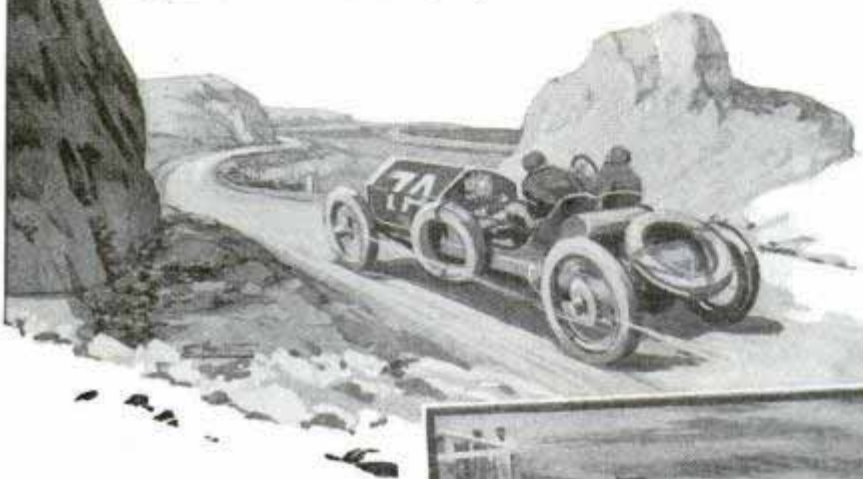
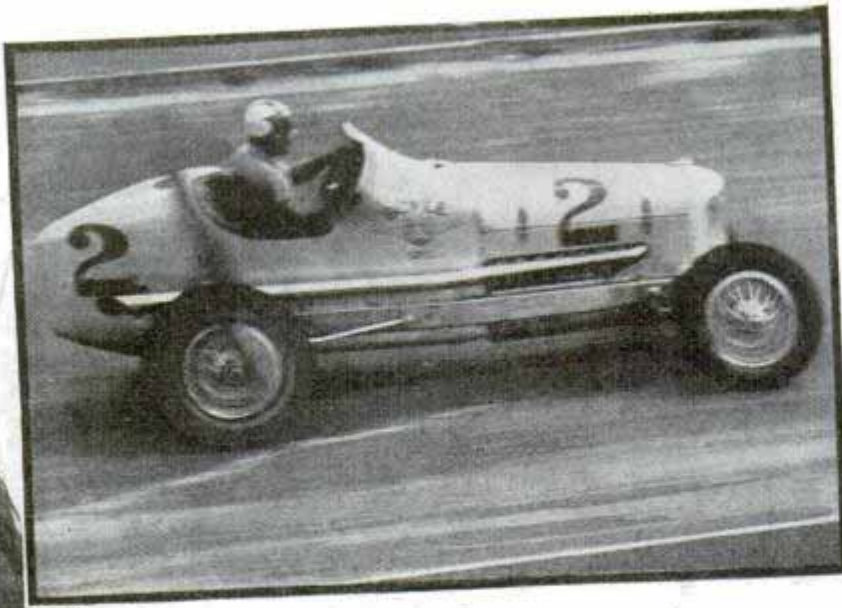

Top, a modern racer with Jimmy Snyder at the wheel. Center, an Isotta-Fraschini racer of 1908. Below, lineup for Vanderbilt cup race

smaller dirt tracks which give the experienced professionals many gray hairs. Usually the prize is not large enough to risk a crack-up and the professional is in a spot as he sees some local boy, with nothing much to lose, burning up the track and inviting the experienced man to take the same chances with so much more at stake. And to the everlasting credit of the modern driver, it must be added that, more often than not, the professional accepts the challenge, throws discretion to the winds along with his meal ticket and risks his neck and his car to give the youngster a lesson.

Sometimes I think we old-timers—De Palma,

them have come along the hard, rough road of experience, dependent upon their own initiative and resourcefulness to live and to succeed. Most of the top-notchers have earned their success and deserve a lot of credit.

In Europe, most race cars are designed, built and financed by motorcar manufacturers, and drivers are employed on a regular salary, along with a percentage of the cash prizes. If a car is wrecked, there is another to replace it. The driver has no worries but those of competition. At present few American drivers are financed either by individuals or accessory firms, so the American driver usually is handicapped constantly by financial worries.

Local youngsters, striving for reputations, sometimes take chances on the

Oldfield, Louis Chevrolet and the rest—had more on the ball than modern drivers. Then I consider the phenomenal engineering ability of some drivers today; men who, hampered by lack of finances, still manage to put together cars which win races, and I decide we oldsters perhaps were not so hot after all.

It takes nerve and hair-trigger thinking to drive a racing car today. But in the

early days, we had problems different from those of today. Our cars were heavy and without good brakes and the other refinements the cars have now. The roads were narrow, rough and, when oiled, very slippery. With it all, we did our part in the pioneering, and we all usually had a sense of humor.

Ralph De Palma had a sense of humor. In the 1912 Indianapolis race, he took the lead almost from the start. Three laps from the finish and when he was nearly five laps ahead of the second man, the motor bearings of his Mercedes burned out near the start and finish line. Knowing there was no hope of making repairs, he jumped out and pushed his car across the finish line to his pit. He was beaten but not licked, for he grinned as he pushed. Victory would have given him more than \$25,000 in prizes.

For sheer courage, Jimmy Murphy stands near the top. Jimmy was selected to drive one of three Duesenbergs entered in the French Grand Prix at Le Mans in 1921. A week before the race, he upset, suffering internal injuries. But he insisted on driving and went into the race with the entire upper part of his body tightly bandaged. And he won at an average of about seventy-eight miles per hour, the first time, before or since, that an American ever won a race in major European competition. The fly in the winning ointment came when the Duesenberg team attended a luncheon given by the mayor of Le Mans, supposedly for the winner. I was manager

(Continued to page 140A)

Driver's Signal Arm Lighted by Safety Lamp on Car Roof

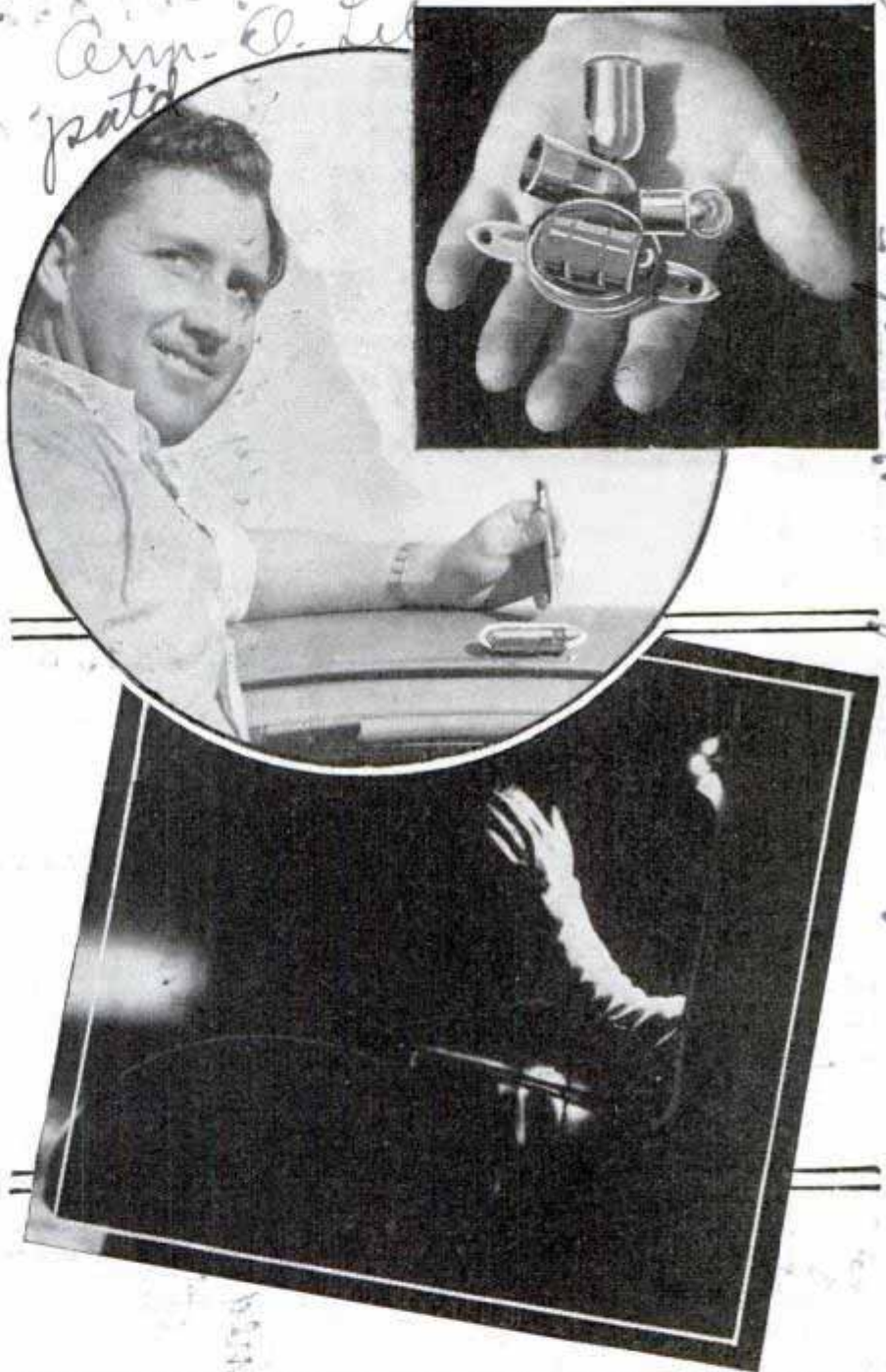

Motorist's signal might be unseen at night but for this small lamp illuminating his arm. At top are lamp parts and installation over car door

One of the latest aids to safe driving at night is a lamp that throws a beam directly down on the motorist's signaling arm when he extends it to indicate he is turning or stopping. The bulb is in a zepelin-shaped, chromium-brass shell screwed to the car roof and connected with the tail-light so that it is always lighted when the rear lamp is turned on. The light can be attached to any car in twenty minutes.

es 1194
es 1306
d. m. Arthur Vaughan Beach Calif
1636 E. 6th St. Long

Giant Electric-Light Bulb Tops Edison Memorial

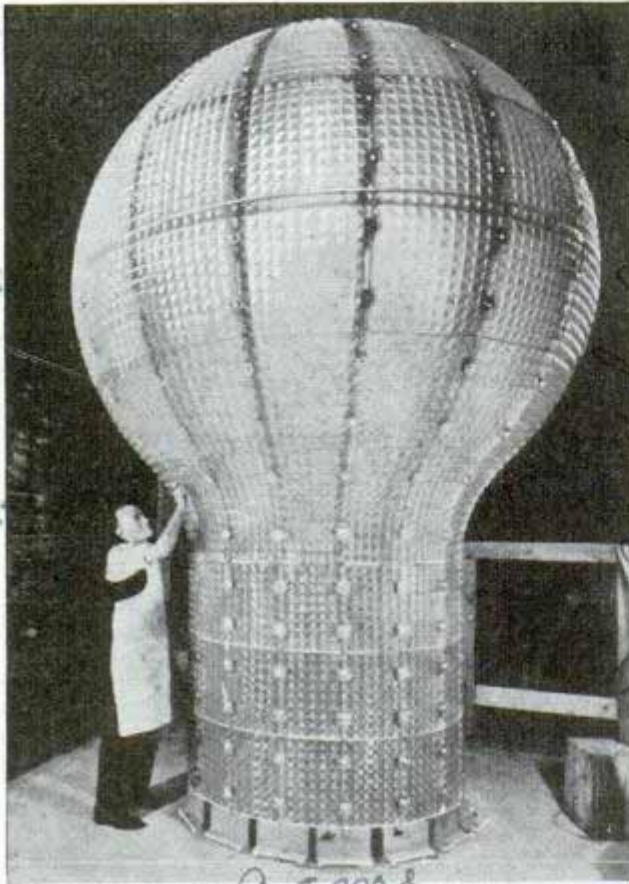

Huge electric-light bulb which will supply illumination for Edison memorial

Requiring eight months in construction by a crew of experts, a fourteen-foot electric-light bulb will surmount the Edison memorial tower at Menlo Park, N. J., in commemoration of the invention of the incandescent electric light. In preparing the bulb for shipment, the workers fitted more than 6,000 pounds of amber-tinted glass over a three-ton steel skeleton.

Gas-Oven Thermostat Shows Temperature Changes

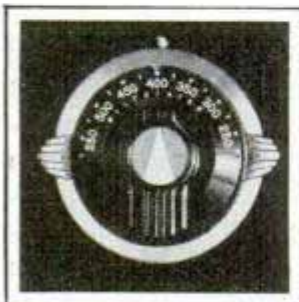

Showing the temperature changes from cold to cooking heat, a new oven thermostat is adaptable to all gas ranges. A visual pointer indicates the oven heat at all times, rotating gradually with each temperature change until it attains the mark set on the ther-

mostat dial for any cooking operation desired. As the oven cools the temperature change is shown and when the oven is not in use the unit indicates room temperature.

Three-Car Diesel Locomotive to Pull Streamliner

Consisting of three cars housing six 900-horsepower Diesel engines, a giant locomotive has been tested for pulling a long streamline train between Chicago and Los Angeles on a thirty-nine and three-quarter hour schedule. With the six engines synchronized, the locomotive develops 5,400 horsepower and speeds above 110 miles per hour. Each engine has twelve cylinders. Control of the entire power plant centers in the cab in the nose of the first car. The engines drive generators which provide electricity for the two traction motors on each of the six trucks.

Adjustable Chair Has Radio, Clock and Telephone

Almost everything for entertainment and comfort has been provided in a new chair now on the market. Upholstered in white antique leather and royal velvet, the chair has a release knob for raising or low-



This chair has many conveniences that will appeal to the stay-at-home occupant

ering the back for the occupant's convenience. Adjusting the back to horizontal position converts the chair into a bed. In the right arm of the chair is a radio with

es 1315
es 1362
es 1366
es 1364

City of Los Angeles
and N.W.
Treage Turned 1807
Fayon

The Wilcolator Co
17 Newark N.J.

Small Single-Track Tractor Replaces Two Farm Horses

illuminated dial, a telephone, an electric clock and a humidor for cigars and pipe tobacco. Beneath the arm is an electric phonograph, or a typewriter if the owner prefers. The left arm contains a desk or lap board which may be used as a meal tray or game board or as typewriter and writing table. There also is storage space for razor, pencils, notebooks, comb and brush and other accessories. Beneath the left arm is space for refreshment supplies, including glassware service for four persons. The radio's loudspeaker is concealed by the upholstery of the back. Above the back is a reading lamp.



Demonstrating how the small tractor can turn sharply while pulling farm implement. Note that the tractor has only one track

Racing Yacht Goes into Hiding Behind Vast Expanse of Sail

With all her canvas set, the racing yacht "Australia II" vanished behind the tremendous expanse of sails during a recent race. The photographer caught the unusual view of the "sails without a boat" as the wind drove the racer over the waters of Sydney harbor. The picture was taken during the running of the Epsom handicap.

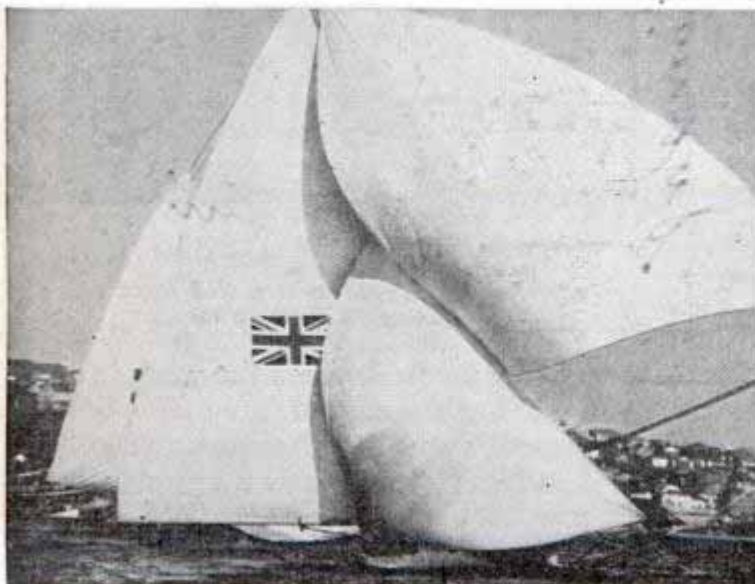

Plenty of sail, but no yacht in sight! You'll have to take our word that the "Australia II" is carrying all this canvas

Designed to do the work of two horses on the farm, a small single-track tractor has been tested with good results. It operates on a single-track unit which is both the means of steering and of propelling the machine. A two-cylinder motorcycle engine supplies the power. The tractor may be used with rear wheels and a drawbar or the rear wheels may be replaced by any horse-drawn implement, such as mower, ten-foot cultivator or two-row corn cultivator. Adaptation and attachment of the implements is simple. One man operates the tractor and the implement. The machine is so narrow that it may be used in row cultivation and so low that it can be used under trees. Weight of the machine is so distributed and steering-transmission so designed as to make for excellent traction and maximum ease in steering. The tractor may be run in small circles. It operates on about one-half gallon of gasoline per hour.

Send return postage to our Bureau of Information to learn the name of the maker of any device described in this magazine.

Unitrac
 Unitrac Electric Co. 505 Park St. Cambridge, Mass.
 Unitrac Electric Co. 505 Park St. Cambridge, Mass.

Blackboard Used in Boat Race to Flash Messages to Pilot



Race pilot's helper flashes message to speedboat occupants while standing in shallow water holding the big blackboard

Taking a tip from the speedways, pilots of speedboats are getting their signals from the "pits" by means of blackboards. The number of the lap and instructions are written on the blackboard, which is held up by a helper wading in shallow water.

and Texas to South and Central American points in perforated boxes. Chicken farm owners are regulating their hatching according to the amount of airplane space available, as the volume of business increases rapidly. Transport companies limit shipments to chicks less than twelve hours old because of the good health and cleanliness of the newly hatched chicks.

Bird Is Trained to Work for Its Food

When mealtime comes for Oscar, a trained goldfinch, the bird pulls a string, drawing a small truck up a runway to his cage. In the midget truck is the bird's food, seeds at

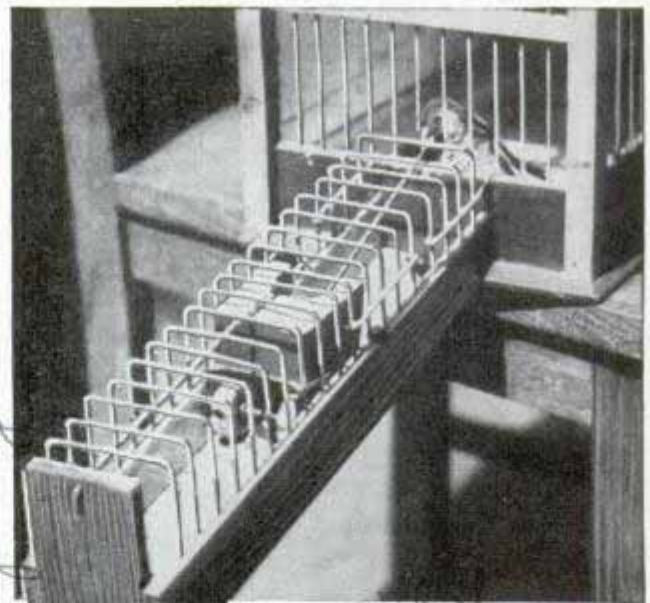

Trained bird snapped as it pulled small truck containing its food up incline

which he may peck when the work is done. The goldfinch seems to have learned that he can eat only when he works. The sight of the toiling bird attracts many sightseers.

Baby Chicks Shipped by Plane to South America

Twelve-hour chicks, transported by clipper planes, are being shipped from Florida

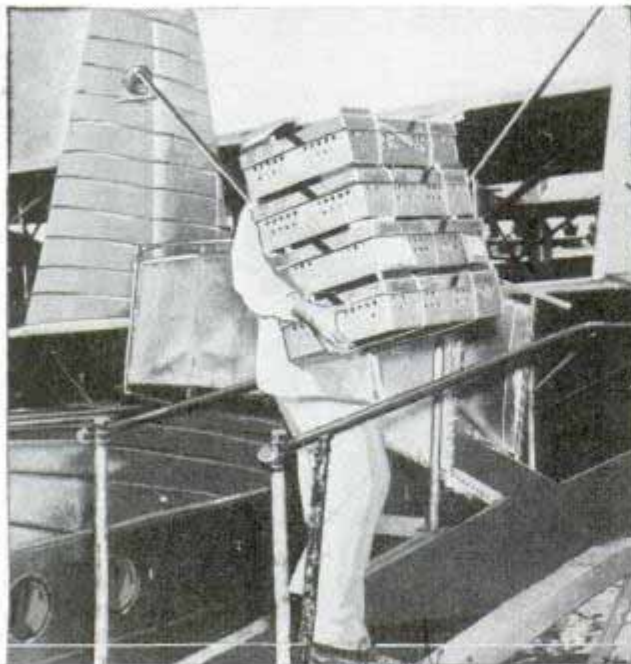

Loading boxes of baby chicks aboard clipper plane

Send return postage to our Bureau of Information to learn the name of the maker of any device described in this magazine.

Vertical handwritten notes on the left margin: "Year the machine was made", "Designer's initials", "es 1307", "Long Beach Calif", "es 1325", "Honey Australia", "es 1327", "Wide world"

es 1358

Chain Unrolls to Form Girder 250 Feet High

Thrusting itself straight up into the air in somewhat the manner of the Indian rope trick, a coiled chain invented by a French aviation mechanic is converted into a girder rising nearly 250 feet. It rolls up very compactly on a truck. Then at the turn of a wheel the interlocking parts of the chain close together and it becomes a rigid vertical girder, of use perhaps as radio antenna for a truck or a tank, or as a railway signaling device. It has been suggested that the chain girder could be raised from a sunken submarine as a signal.

*Michel
Le Rap
Paris, France*

*35, rue de la
Bienfaisance
Paris (8e)
France*

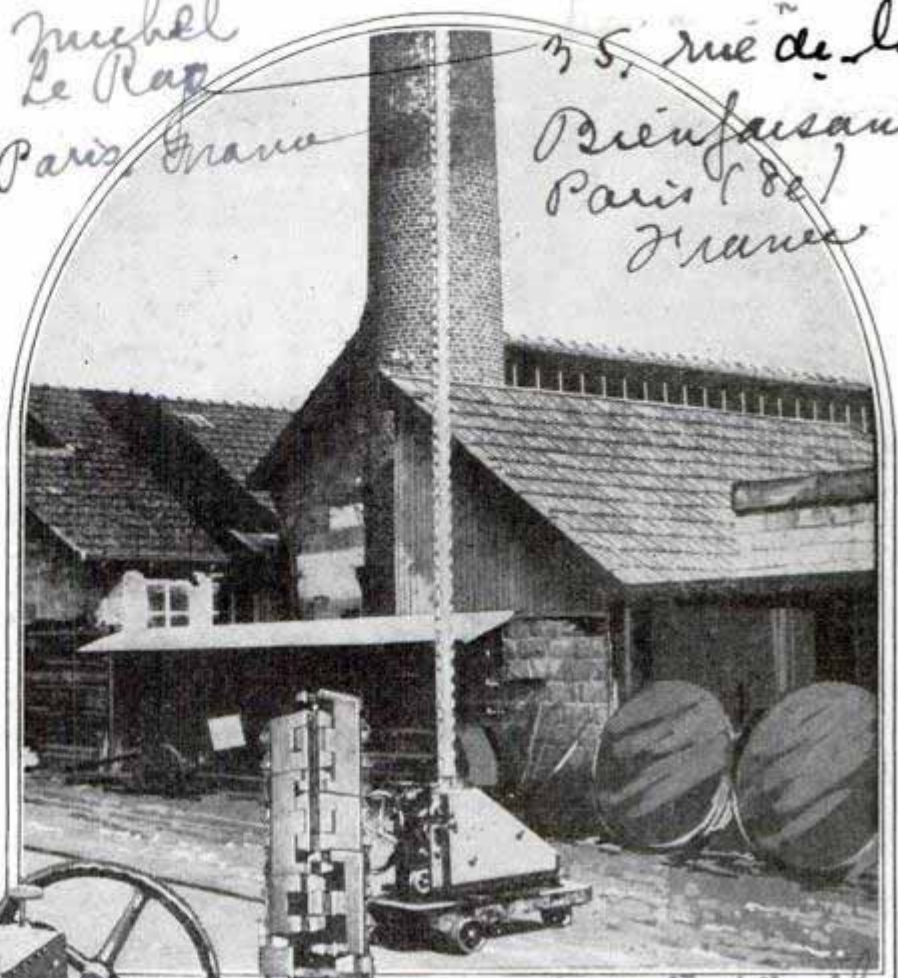

Wade Wolla

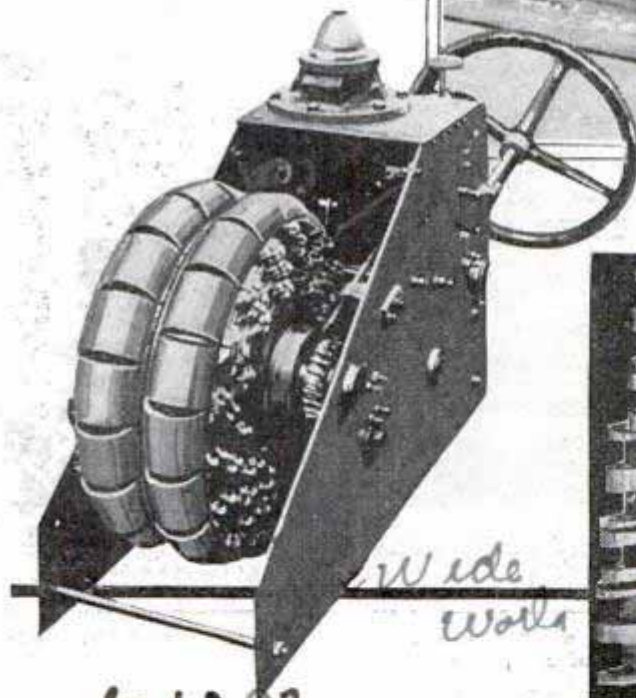

Wade Wolla

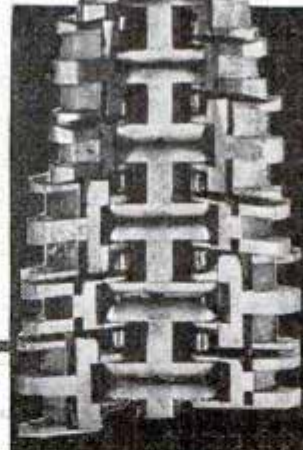

Top, the chain girder thrust upward from its truck, standing rigid as a mast. It can be raised thus to a height of close to 250 feet. At left is the chain coiled, showing wheel which raises or lowers it, and closeup illustrating how the parts interlock

201392

Cosmic-Ray Hunt in Mine Shaft Finds Rays Pierce Ground 1,600 Feet

Those mysterious cosmic rays that bombard the earth constantly pierce its rock crust to a depth of at least 1,600 feet. Scientists have studied the rays on mountain tops, in polar regions, in stratosphere balloons and deep under water. Recently a University of Chicago scientist took his instruments down into a mine shaft slanting

at thirty-four degrees to vertical, so that absorption of the rays could be measured at any depth of the rock surface. Even at 1,600 feet the rays were observed.

Send return postage to our Bureau of Information to learn the name of the maker of any device described in this magazine.

*Science Service
W 24137*

V.C. Wilson

es 1200

Sperry Gyroscope Co. Inc.

Manhattan Bridge Plaza.
Brooklyn, N.Y.

The TOY that

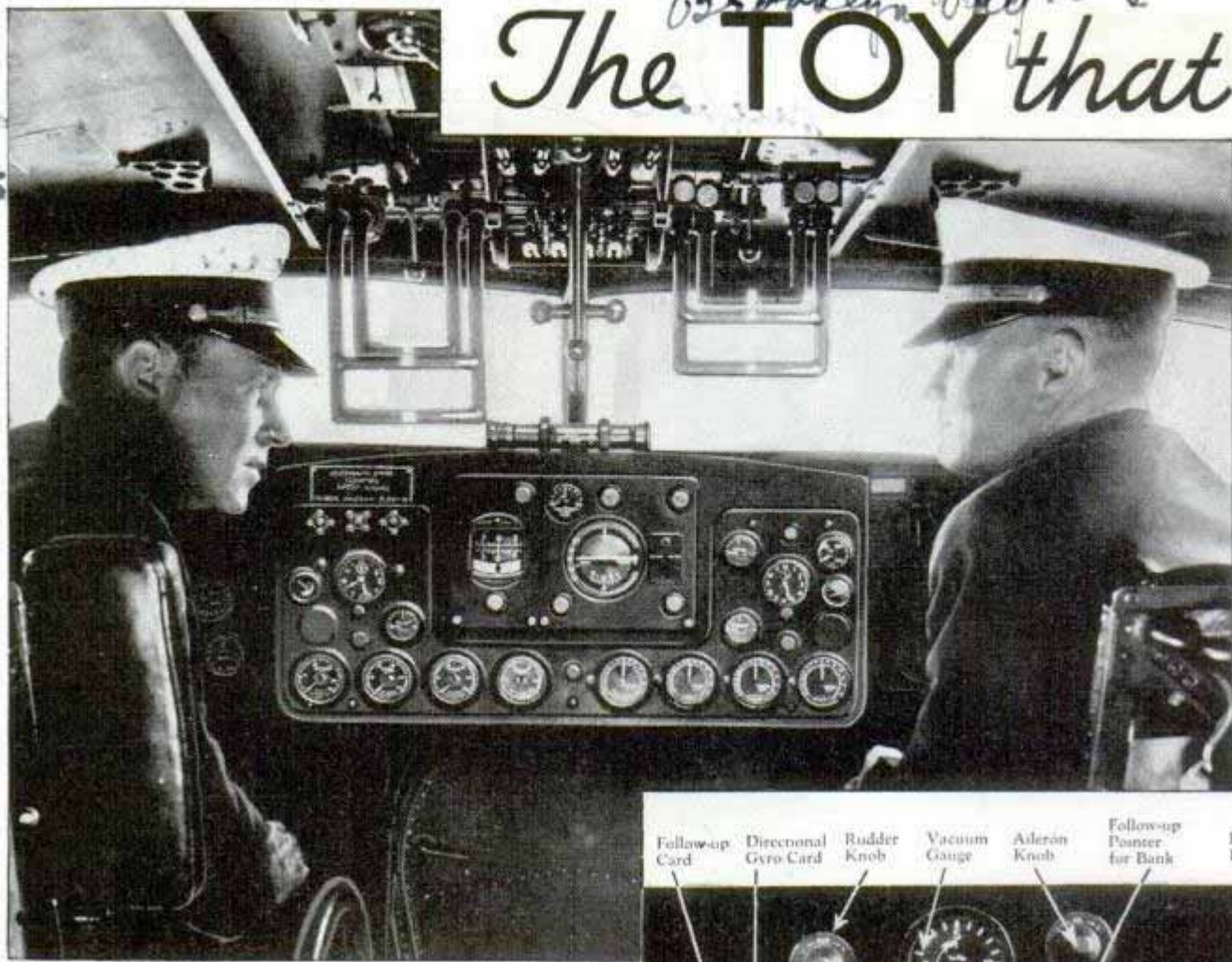

By H. W. Magee

CHILDREN were amused thirty years ago by a strange spinning toy which seemingly defied the laws of gravity—a little flywheel so mounted that it was free to turn in any position around its center of gravity, the only fixed point.

And because one man of vision was intrigued by such a toy, its uncanny balancing properties today are harnessed to the controls of ships and airplanes. "Metal mikes" steer ocean liners better than the best helmsmen, metal robots fly planes better than the best pilots, and travel by water and by air has been made safer and more comfortable for millions of people.

Not only has this toy grown up to fly planes and steer ships, but its properties have been applied to many of the instruments and controls governing both forms of travel. Its principles are incorporated in the non-magnetic compasses which keep thousands of vessels on course, for example, and in the aviation instruments which enable airplanes to fly "blind."

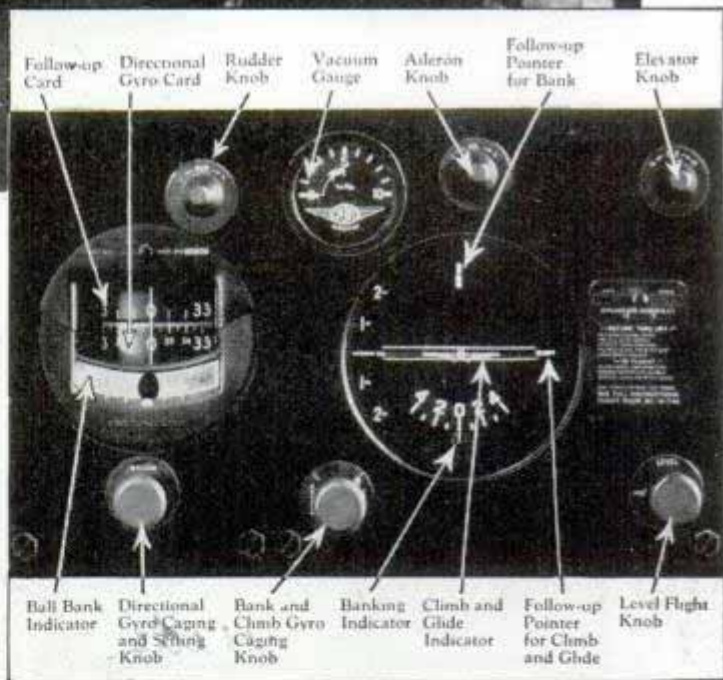

Pan American plane equipped with gyropilot. Control unit, below, is in center of instrument panel

The man who conceived the idea of developing a toy into a helmsman for ships and a pilot for planes was the late Dr. Elmer A. Sperry, inventor, and founder of the Sperry Gyroscope company. The little toy which fascinated him was called a magic top by youngsters; their scientific elders, to whom the toy presented interesting problems in higher mathematics, knew it as a gyroscope.

In 1904 Dr. Sperry bought a gyro model

Es. 12.00

GREW UP

for his children but the children had little chance to play with it. He became so interested in the unusual behavior of the little balancing wheel that he found it impossible to lay it aside. Its properties, he decided at once, could be put to some practical purpose. But what?

There was a pressing need at the moment for a non-magnetic compass for ships, a compass which would not be affected by magnetism of the vessel and its cargo, electrical disturbances or local

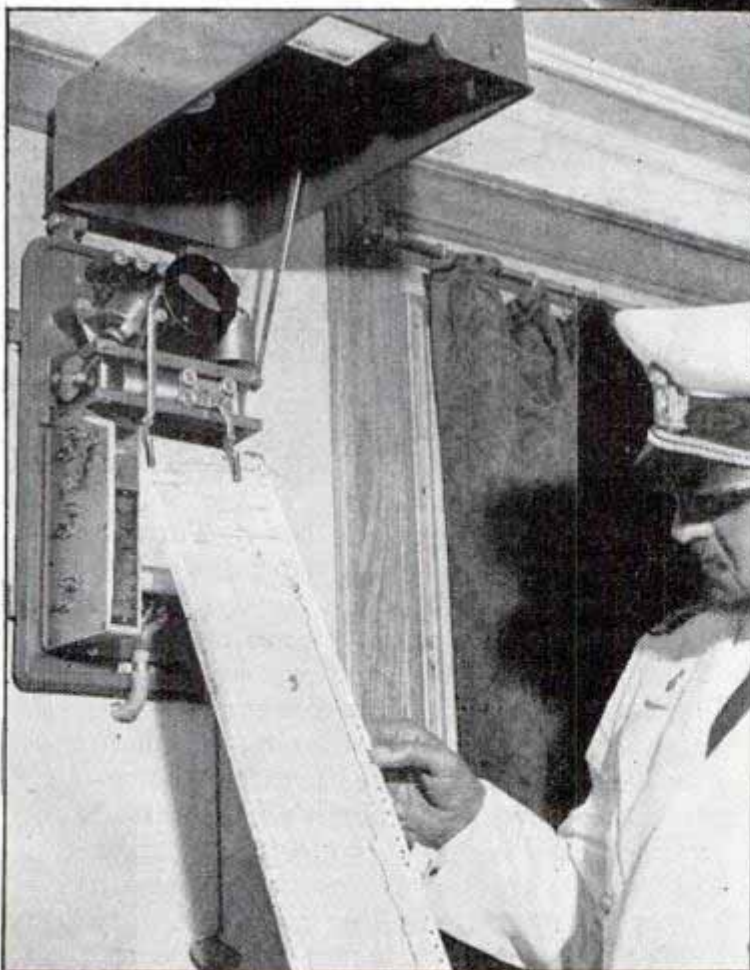

Top, navigating boat with aid of gyrocompass. Below, course of vessel throughout a voyage is transcribed on this course recorder chart

magnetic attractions. It had been demonstrated that a gyroscope can be so mounted that it will align its axis with the axis of any angular motion to which it is subjected—the earth's rotation, for example. Why not, reasoned Dr. Sperry, make practical use of the earth's rotation by using a gyroscope as a compass? And that is what he did.

He made a model of a gyrocompass utilizing the earth's rotation to give a true-north reading. A friend to whom he appealed for financial aid asked an unbiased engineer to investigate the proposition. The engineer reported that the meridian-seeking part of such a compass would have to weigh at least 100 pounds

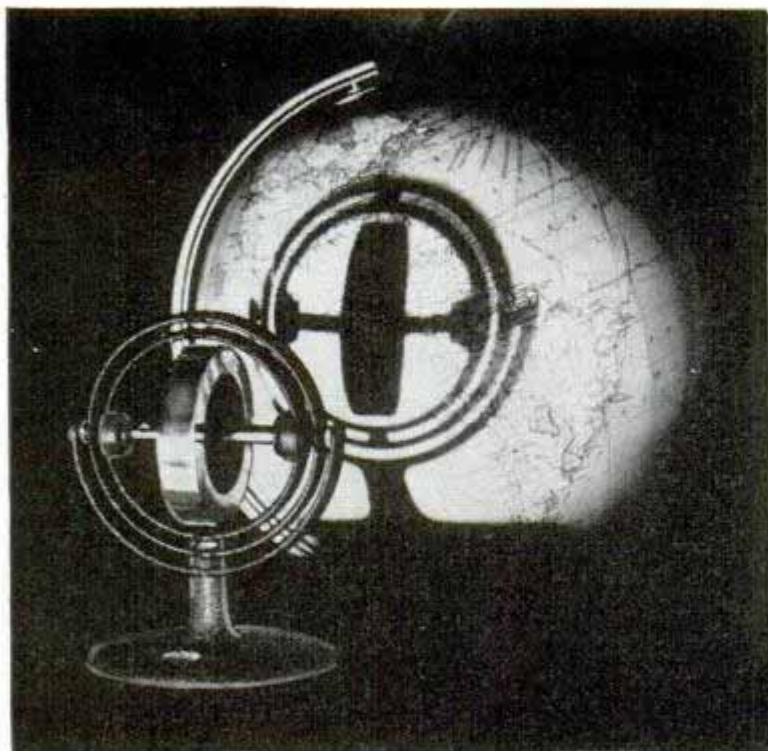

With the little gyro model, above, it is easy to simulate the action of the huge gyrostabilizer, right, on an Italian liner

and be suspended with such complete absence of friction that this 100-pound weight would move under a force equivalent to two-hundredths of an ounce—about half the force a healthy mosquito might exert. This, said the engineer, appeared mechanically impossible so the friend refused to invest.

Then the inventor reached a decision which was to influence the history of water and air transportation. He mortgaged everything he owned, formed his own company and financed the compass himself. Twenty-five years later more than 2,000 of these "mechanically impossible" compasses, forerunners of many other gyroscopic devices, were guiding vessels all over the world.

You can demonstrate the action of such a compass with a gyro model consisting of a wheel, or rotor, revolving in bearings in an inner ring which, in turn, is free to revolve in pivot bearings in an outer ring about an axis at right angles to the axis of rotation of the wheel. The outer ring likewise is free to revolve in pivot bearings in a supporting frame about an axis at right

angles to the axis of rotation of the inner ring. This universal mounting permits the wheel to turn about its vertical, horizontal and spinning axes.

Hold the model with the base against your body. The top of your head is the north pole, your waist is the equator. Represent the pull of gravity by holding the outer ring and supporting frame between thumb and forefinger. No matter which way the gyro axle points at first, it will move into a position parallel with the body, or axis of rotation, and the direction of rotation of the wheel will be

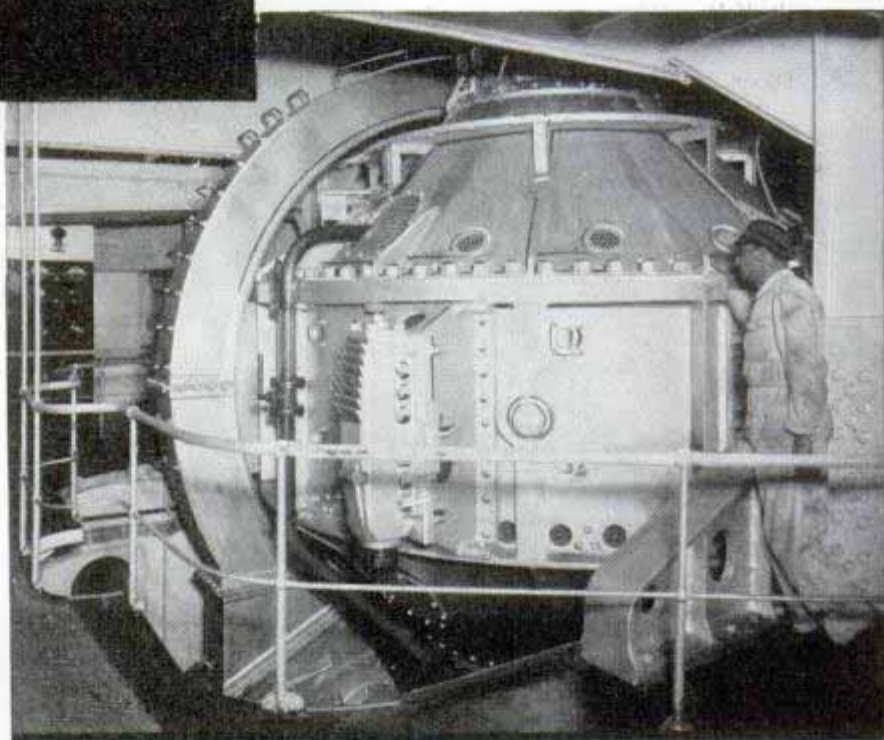

the same as that of your body. Turn in either direction and the gyro will assume a position in which it can revolve in the same direction in which you are turning.

The rotor of the gyrocompass behaves in like manner. As the earth revolves, the rotor aligns itself so its spinning axle is in line with the axis of the earth and pointing to the geographic north and south. A compass card is operated electrically from the gyro wheel so its north and south points always are in line with the gyro axle. Such a compass is non-magnetic and hence free from variation and deviation and its directive force is about 150 times that of a magnetic compass. In addition, in

modern installations an electrical transmission system makes it easy to operate repeater compasses in various parts of the ship as well as a course recorder which supplies a record on a printed chart of all changes in course during a voyage and the time each occurs.

Today the rotors or flywheels of various gyroscopic devices in use range all the way from two inches to thirteen feet in diameter and from twelve ounces to 110 tons in weight. The largest rotors are employed to keep ships from rolling.

The ability of the gyrocompass to operate repeater compasses led to the

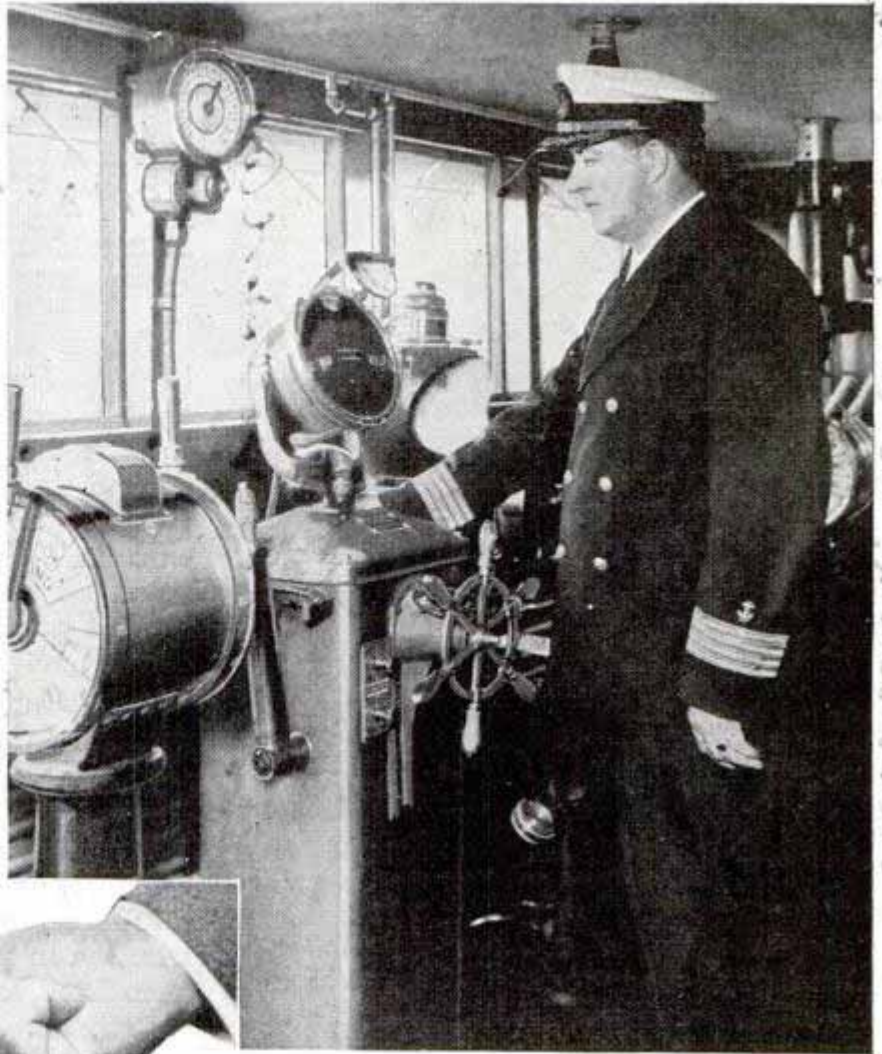

Steering repeater mounted on bridge unit of gyropilot. Left, demonstrating action of gyrostabilizer on ship. Below, gyro wheels or rotors

Photos courtesy Sperry Gyroscope Company

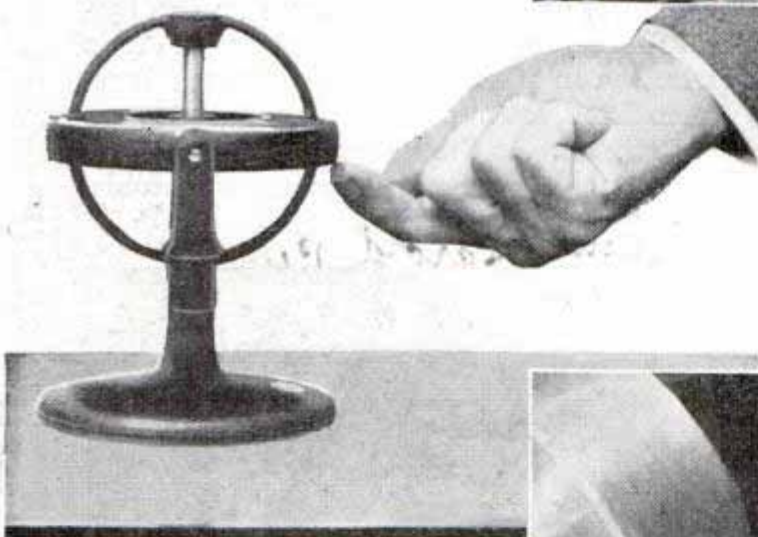

eventual development of the "iron quartermaster" or "metal mike," a gyropilot capable of steering a ship automatically, manipulating the controls more precisely than the most skilled hands. Departure of a ship from a set course is detected at once by a master compass and transmitted to a repeater motor which completes an electrical circuit. This, in turn,

(Continued to page 128A)

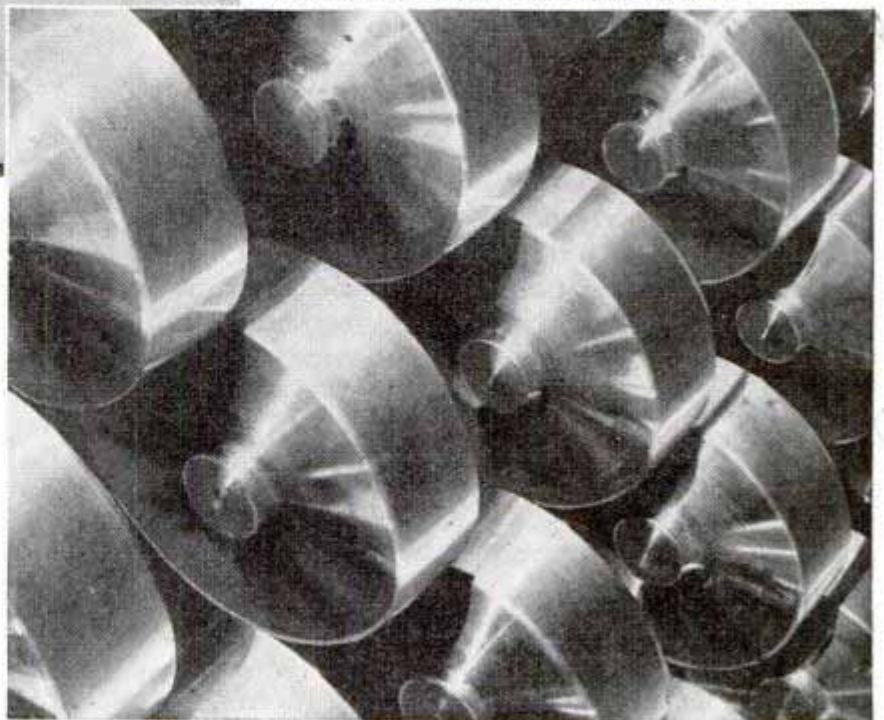

Chicago Tribune 11/25/37

Designed by Ruth Henry DeCaro Pasadena, Calif. 3/29/46

Super-Car Has Front Drive and Electric Gear Shift

Phantom Corsair

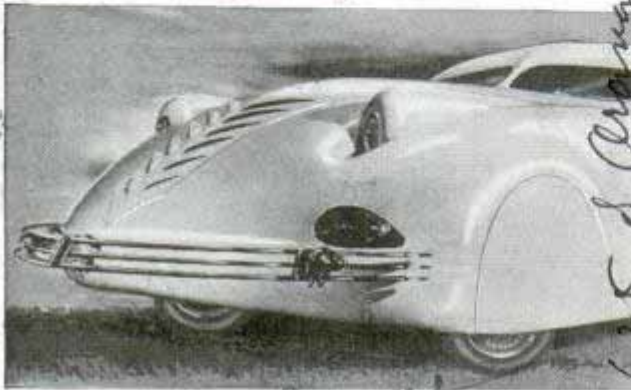
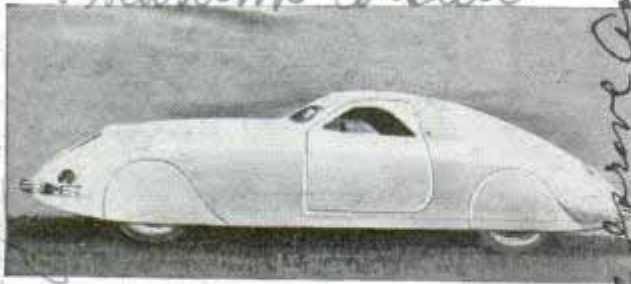

625 d Orange Grove Ave

Two views of specially designed car. Bottom, note unusual front end treatment

Expense was disregarded in the construction of a super-automobile exhibited recently. Considered one of the most striking and revolutionary cars ever built, it has a speed of 122 miles per hour developed by a small engine. Features include front drive, electric gear shift, four forward speeds, independently sprung wheels and an interior lining of rubber.

Scene from clip (Bertram) (Railroads)

es 1391 see letter.

"Elastic Metal" Made by Blend of Steel with Soft Rubber

By combining steel with soft India rubber, engineers have developed an "elastic metal" of value to industry. It is described as an excellent material for manufacturing springs and for machinery couplings, and is also used in sound-absorbing devices.

Quakeproof Water Mains Built with Pipes That Will Bend

If earthquakes come again to San Francisco, the city will not be caught as in 1906 with a disrupted water supply system. The water department engineers have mapped a quakeproof system of mains, using pipes that will bend without breaking, open con-

H. A. Eckert, Bureau of Water Supply

duits on the surface instead of buried pipes in particularly dangerous zones, and auxiliary reservoirs arranged so that no part of the city can be left without water even if isolated from other sections.

Ring of Iron around British Cliffs Is Blamed for Shipwrecks

Frequent foundering of ships on Flam- borough Head, a sharp point of land extending from the eastern coast of England, is blamed on a submerged "band of iron" around the cliffs. Four vessels have been sunk in the last year and an investigator expressed the belief that the iron mass, created by the sinking of many iron ships at that point, affects compasses and deceives navigating officers.

Hydraulic Squeeze Packs Boxes into Freight Cars

For packing boxes of uniform size into a freight car, a device known as the hydraulic squeeze has been invented. It is wheeled in after the ends of the car have been filled, set in place and an electric motor started. As the hydraulic pressure increases the squeezing apparatus unfolds, shoving the boxes into place.

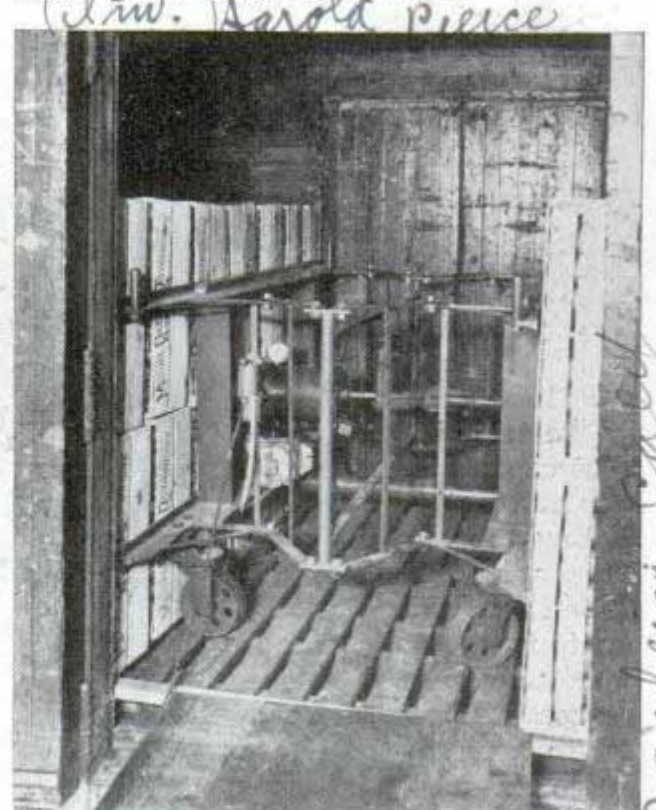

Here is the hydraulic squeeze packing fruit boxes securely in freight car

H. W. Pierce & Son, 756 N. Alvir.

Abraham, Calif

'Working Model' Shows What Makes Man Go

Man's inner construction and how his "plant" works can be seen in a series of "working models" on exhibit at the New York Museum of Science and Industry. One of these is an over-sized model of the human heart with valves that open and close while an electrical pump arrangement keeps the "blood" coursing through glass veins and arteries. Another is a human body in sections opening like the pages of a book, showing the arrangement of internal organs. The series of models tells the story of man from cell to adult.

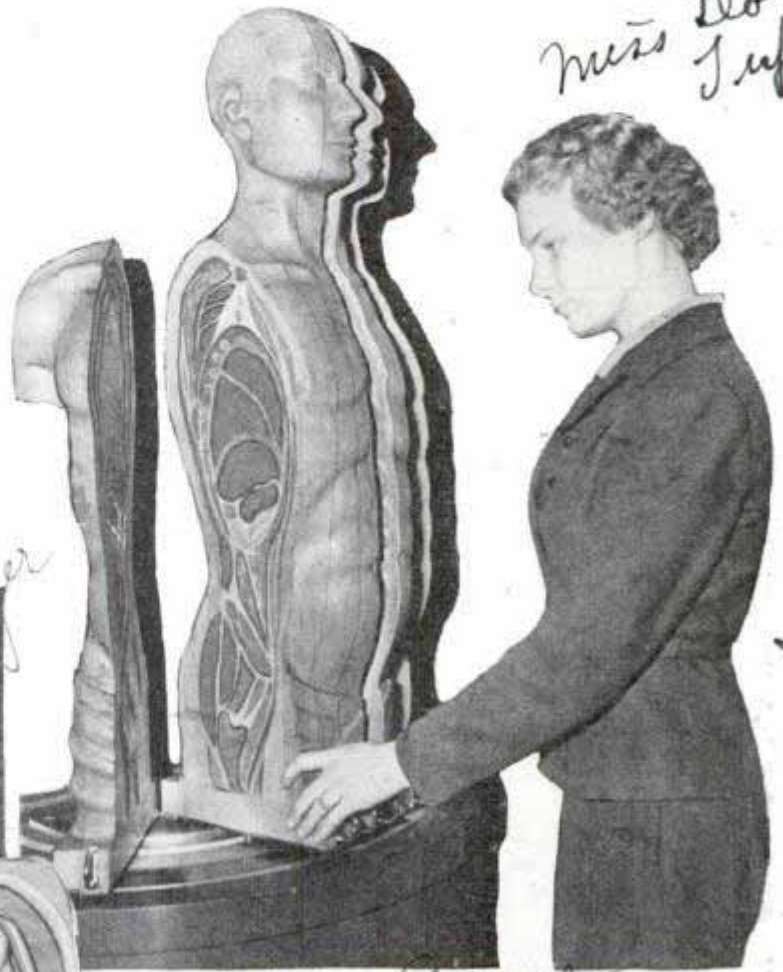

Miss Dorothy Tufts

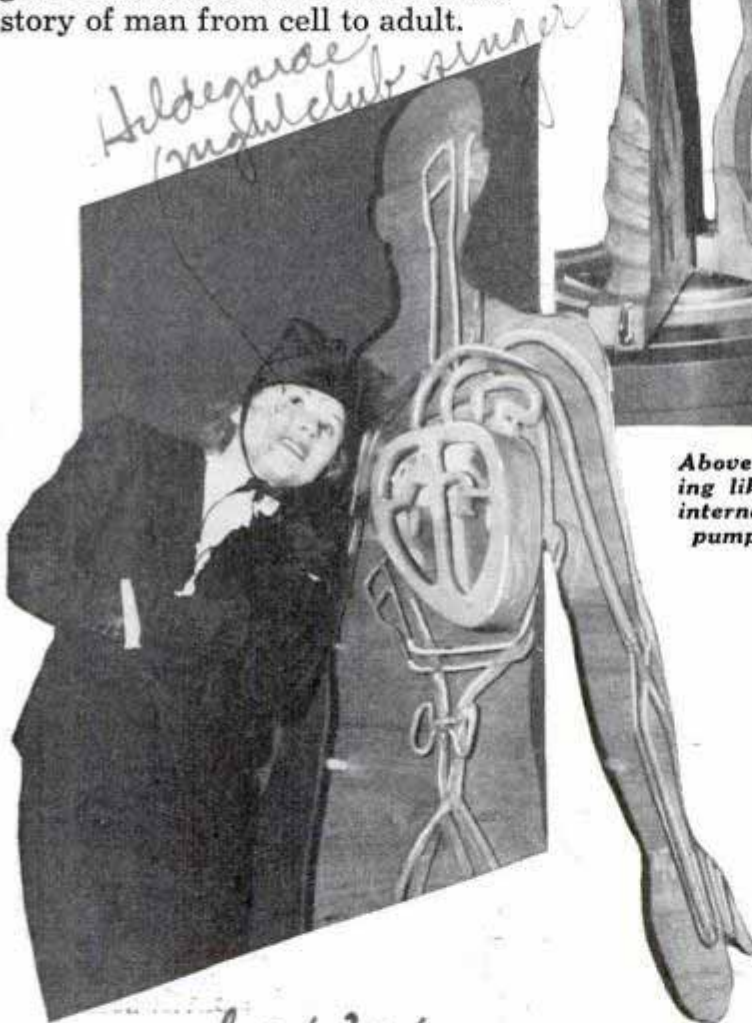

Hildegarde (model club singer)

Above, exhibit of human body built in "slices" opening like pages of a book, showing arrangement of internal organs. Left, model of heart with electric pump sending "blood" through arteries and veins

— 1339 —
Changing-Color Ink Used in Novelty Printing

Capable of changing from one color to another under heat, a new ink is expected to find wide usage for novelty printing. When heat is placed in proximity of printing in which the ink has been used, the red colored ink changes to black. When the heat source is removed the red color returns.

The Epkalin Co. 572 Greenwich New York City

— 1361 —
Electric Detector Sorts Out Herring Wearing Metal Identification Tags

Alaska herring are "frisked" for metal identification tags at the rate of 100 herring per second by an electric detector. Thousands of herring are tagged every year by the U. S. Bureau of Fisheries, and it would be impossible to sort the captured fish by hand, for the herring is marked

Washington, D. C.

with a tiny numbered steel plate inserted in the body cavity. The conveyors through which herring pass in unloading are surrounded by electric coils. The electric field is disturbed by the tiny metal tags and a trap door is closed until the tagged herring is removed.

Press memo, Dept of Commerce.

es 1189
Cmt. Thomas G. Stinson, Jr.
10555 Hollywood Ave
Los Angeles, Calif

HUNTING OIL

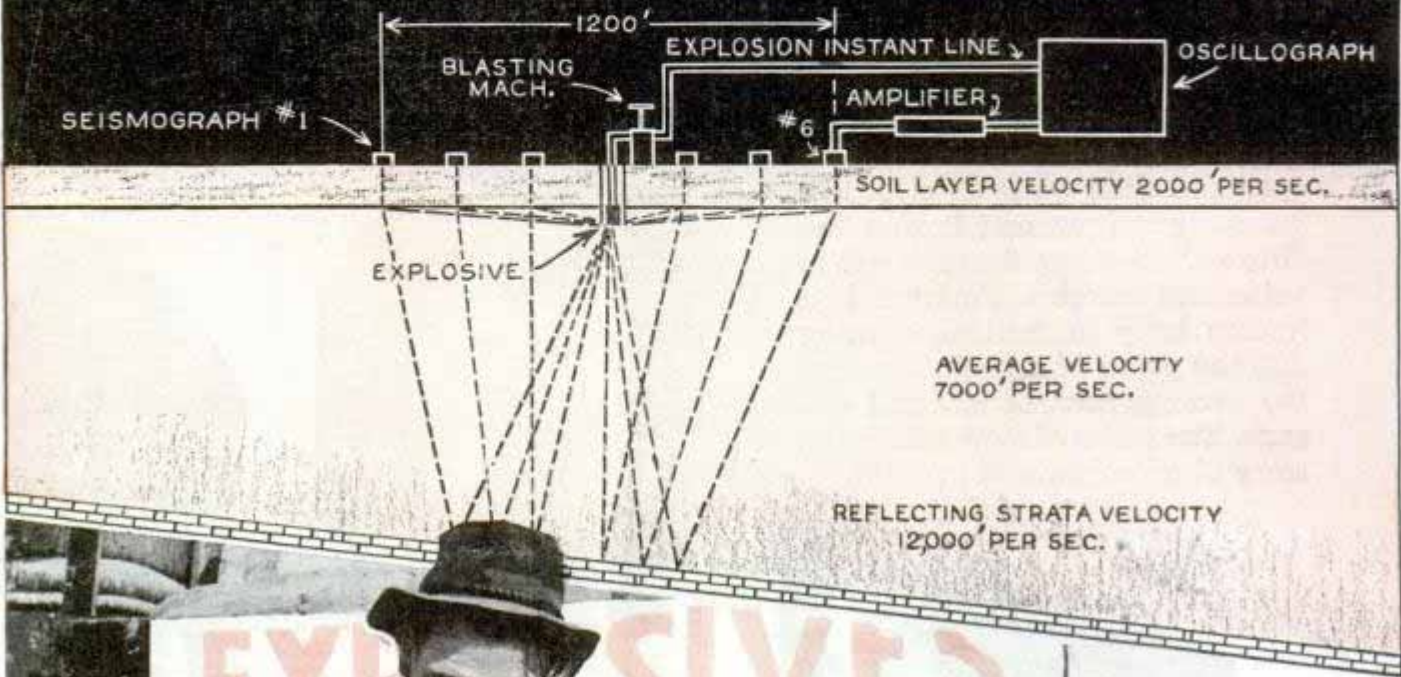

Top, diagram showing how earthquake waves are reflected by strata. Bottom, preparing to explode buried charge by pushing handle of blasting dynamo upon telephone order

But the third count is lost in the boom of a heavy explosion. The ground heaves and the truck rocks from the shock. Outside, near the explosives truck parked a short distance away, a rushing geyser of mud and water shoots high into the air. An actual earthquake rocks the earth, but it is one that was made to order. Twenty pounds of dynamite have been exploded underground. The tailor-made temblor was manufactured on the spot so that its vibrations would reveal the earth strata far below.

There is nothing new about the idea of getting a picture of sub-surface formations by studying reflected vibrations, but it is news

INSIDE the darkened mobile laboratory the chief geophysicist pushes twice on the warning buzzer and barks "Ready!" into the microphone. At once a voice comes back over the phone cables: "One! Two!—"

that exploring with dynamite has become an exact science. Until recently the technique of creating baby earthquakes and putting them to work was somewhat unreliable and far from fully developed.

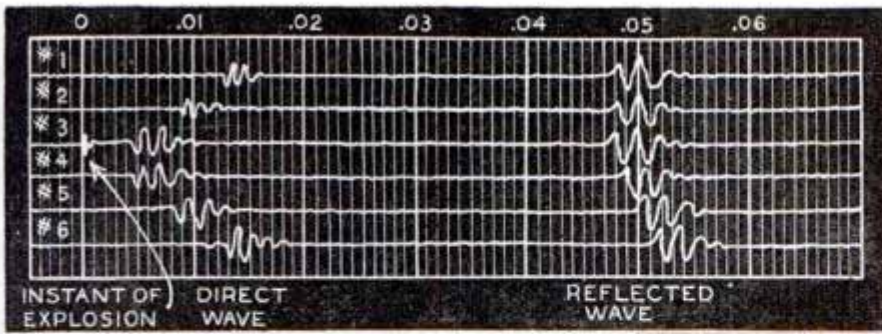

with EARTH-QUAKES

Today geophysicists are able to draw cross sections of the earth that show the profiles of every main subsurface fold and fault as far down as 20,000 feet, twice the depth that they could probe three or four years ago. From their work they can create vertical maps of amazing accuracy. Recently they have learned to interpret their charts so as to plot complex underground structures that baffled them in the past.

Studying the earth has

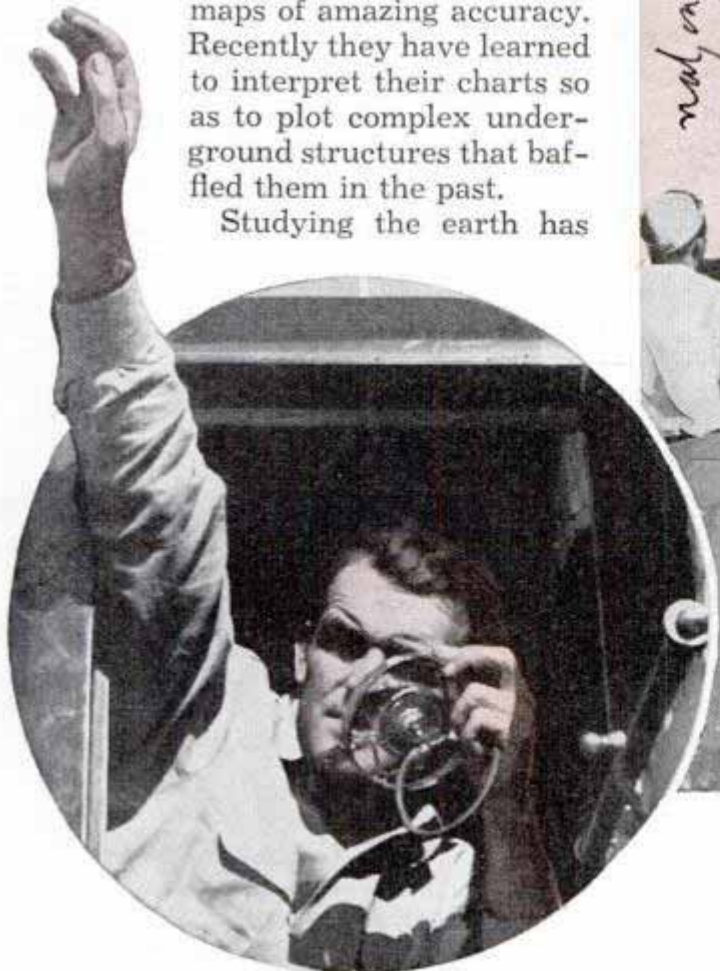

not on market - made up by Western Geophysical Co for their own use. Owners should be addressed to Mr. E. H. Sharpe, Western Geophysical Co, 606 Petroleum Building, San Diego, Calif.

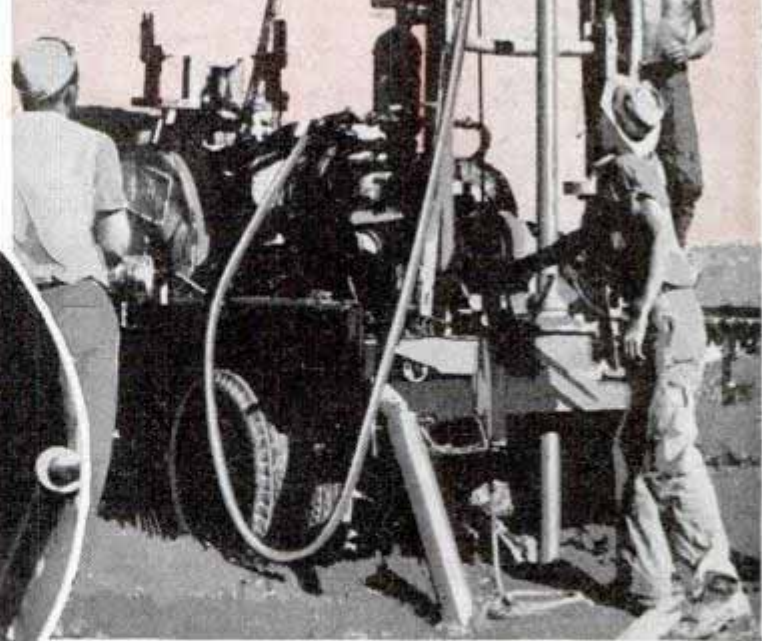

Top, simplified drawing of seismic record. Note record of reflected waves. Right, rig for drilling hole for explosive charge which creates man-made earthquake. Bottom, geophysicist signaling to crew from laboratory truck

Reference: Western Geophysical Co
 101 Potrero - San Francisco, Calif.

Los Angeles, Calif



become important because petroleum companies are anxious to discover new oil fields and to estimate our potential oil reserves. Geophysics has become a major aid in helping to point the drilling tools accurately. Fifteen million dollars are being spent annually in this kind of exploration and thousands of square miles in several states are being charted every year. Most of the recently discovered oil fields were either first pointed out or confirmed by geophysical prospecting before the first wells were drilled.

Specifically, what the scientists look for are faults, salt domes, or anticlines, which are arched subsurface strata that resemble underground hills. The anticlines are apt to hold trapped oil in their folds; oil or gas is often found



Top, interior of laboratory truck where seismic records are drawn on paper cylinder. Bottom, preparing to drive dynamite charge into hole. Drawing at right shows typical cross section of earth's crust

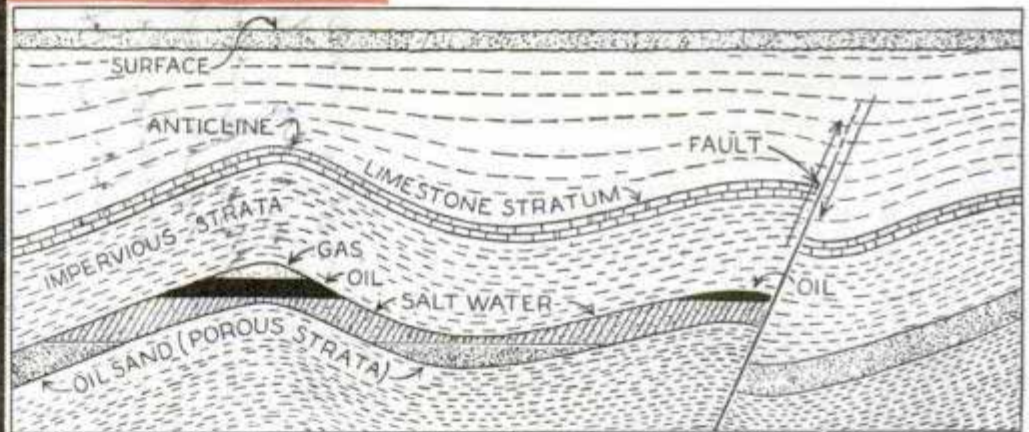

along fault lines, and frequently occurs along the flanks of salt domes. Other types of complex uplifts that can be detected by geophysics are also potential oil reservoirs.

While the batting average of wells drilled in locations that were recommended by such prospecting is extremely high, not all anticlines, for instance, contain oil. Geophysics merely locates structures in which oil often does occur.

Out in the field the men of the crew combine delicate scientific research with hard, roughneck work. Their heavy trucks may carry them into desert wastes twenty miles from the nearest road, or climbing into the hills where no one would dream trucks could be driven. The first thing on the program is to drill a shot hole, from twenty to 400 feet deep, depending upon the depth of the unconsolidated surface soil. The dynamite charge must be exploded against solid material. A portable rotary drilling rig that is a complete oil-well drilling outfit in miniature is carried on one truck.

After the hole is drilled the powder men on the dynamite truck prepare a charge of waterproof dynamite, poking it

Right, finished seismic record being drawn out of developing tank mounted on side of laboratory truck. Below, burying seismometer in hole. Inset, diagram of simple seismometer

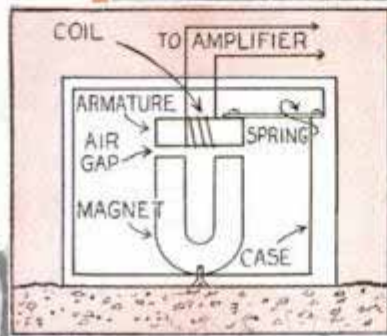
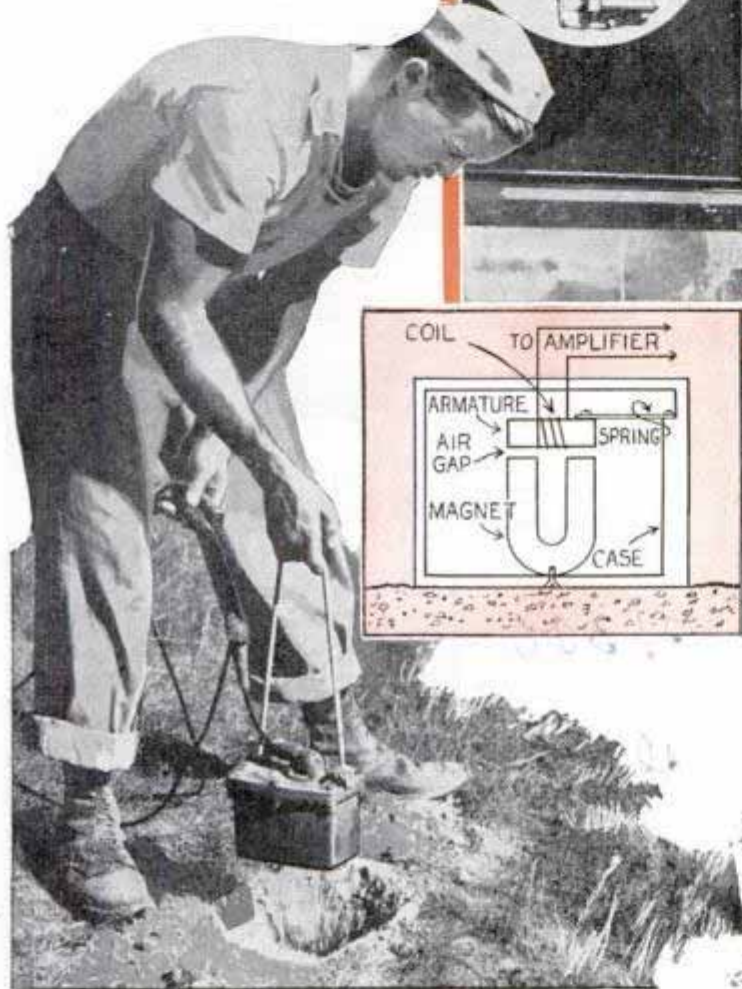
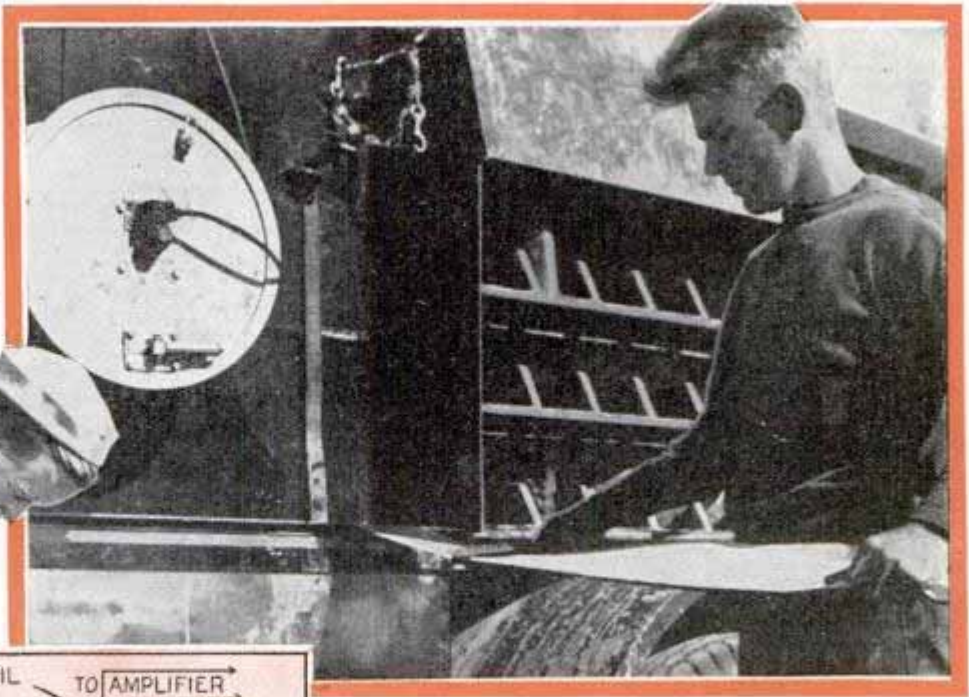

down the hole with long, jointed wooden rods. Depending upon the depth to be surveyed, the charge may consist merely of a detonating cap or may amount to forty pounds of explosive. An average charge is about five pounds and it is detonated electrically.

While this work is going on the other members of the crew have put the laboratory truck in low gear and have jumped out, leaving the truck to push its way across country unguided except for an occasional correcting twist on the steering wheel. Running alongside the truck one of the men yanks small but heavy metal boxes from their racks and spots them on the ground several hundred feet

apart. Another of the crew unreels long strings of insulated cable from the truck while a third hurriedly digs a small hole in the ground beside each of the metal boxes. A phone cable is laid out to the dynamite truck.

The heavy metal pots are earthquake registering seismometers, so ruggedly constructed that they can be tossed off the truck without harm,

(Continued to page 116A)

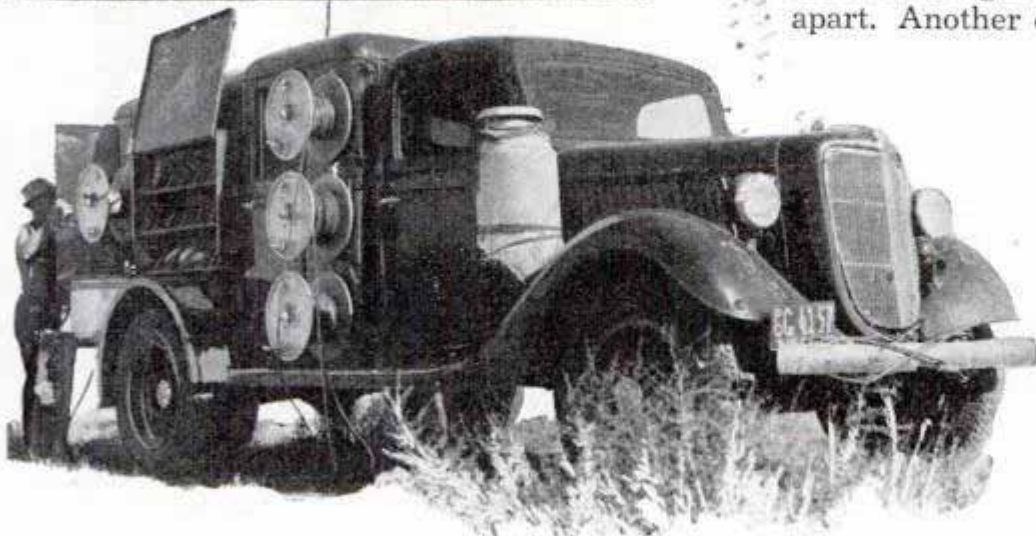

Bottom photo, one of the laboratory trucks in the field, completely equipped for "making" earthquakes and recording results. Note cable reels and racks for seismometers on side of the truck

es 1284

White Board, Black Chalk Save Eyes of Students

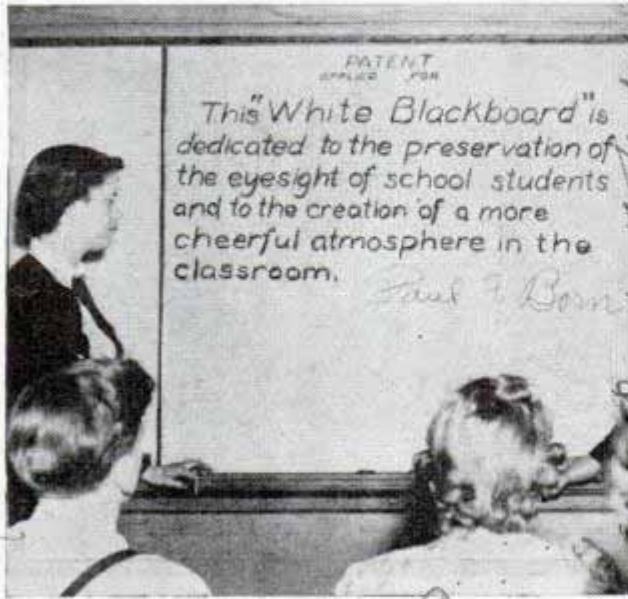

PATENT APPLIED FOR
This "White Blackboard" is dedicated to the preservation of the eyesight of school students and to the creation of a more cheerful atmosphere in the classroom.

White board on wall of an Elgin, Ill., school brightens the room and is easy on the eyes

White "blackboards" are being tried in the Elgin, Ill., high school on the theory that black "chalk" on a white board is easier to read than white chalk on black. Besides relieving eyestrain, the white boards combined with light-colored walls make the classroom seem more cheerful.

Guitar with a Sliding Keyboard Makes Chord Playing Easy

It takes but a few minutes even for a beginner to learn to play the harmony of any simple tune on a guitar which has a sliding keyboard. This keyboard moves freely along the full length of the neck.



White keyboard sliding along neck of guitar makes it possible to play harmonious chord at any position

making possible the vibrant quality of a steel guitar and requiring only three fingers to form any chord. The musician can play any close harmony of blending tones. At any position, the keyboard produces a perfectly harmonious chord. An electric model has also been developed.

Handy Gauge Measures Gems and Estimates Weight

Jewelry settings, mounted or loose, may be measured and their weight estimated by a simple gauge now on the market. Three-dimensional measurement of gems and the size of openings in metal are shown on a dial. Loose stones are placed on a built-in platform for measurement, while mounted stones are measured by projecting jaws.

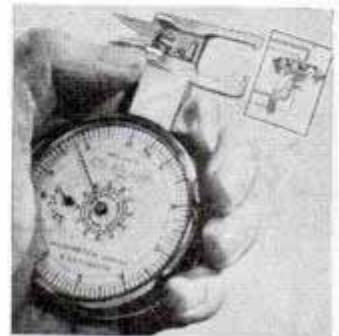

Racer with a Streamline Helmet Rides Streamline Motor Bike

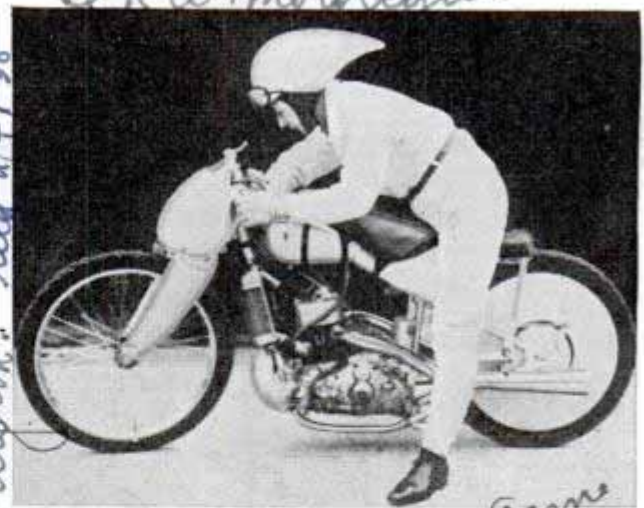

Helmet conforms to curve of motorcyclist's back when crouching and cuts wind resistance

To reduce wind resistance to a minimum, the rider of a German racing motorcycle wears a streamline helmet. The motor bike itself is also streamlined. It has participated in a racing meet for automobiles and motorcycles on the new "Reichsautobahn," the express highway near Frankfurt, and already has set speed records.

Paul F. Borah President Board of Education
Lulu
Mrs. J. W. Neal, 4926 N. Alloria Ave. Portland, Oregon 10/17/35

es 1342 London & Co
es 1300
es 1327

mess J. S. Dayton
Lo. V. Seagton
11/26/35

34 & E. 66th Ave.

es1302

Pennsylvania Co. N.

Rail Is Both Vein and Nerve of Electric Line

see also. Sept. 1939
128a

Steel rails do multiple duty on the modern electric railway, serving as both nerves and veins of the line as well as shouldering the burden of heavy steel trains. As nerves they must carry the low-voltage current that operates block signals, sets crossing signals at the approach of a train and flashes control signals to the engineer in his cab. But at the same time, as veins, they must carry the 11,000-volt power current on its return from the locomotive to the source at the powerhouse or sub-station. Signals are based on insulating one block from the next, yet the power circuit must flow continuously through the blocks. This put a problem up to the engineers, and they solved it by using different frequencies in the rails just as the "air" is divided into frequency bands for various radio broadcasting stations. The 11,000-volt power flows as alternating current at a frequency of twenty-five cycles per second. The block signals are actuated by an inter-rail circuit of about twelve volts on a 100-cycle per second frequency, and at the end of each block is an "impedance box" which acts as a filter, permitting a



Coil in front of locomotive's pony wheels picks up varying frequency current from track and operates signal lights in cab



frequency of twenty-five cycles to pass but holding back other frequencies; thus the return line of the power circuit is continuous but the track circuit is confined to its block. The cab signals use a current of varying frequency superimposed on the other circuits by a code transmitter. A coil on the locomotive picks up the varying frequency current from the coder, a frequency of 180 per minute lighting the "clear" signal; 120 per minute, two blocks clear, one occupied; eighty per minute, approach signal; no code, train in block ahead.

Four-Sided Rule Anchors Protractor to Drawing Board

es1331

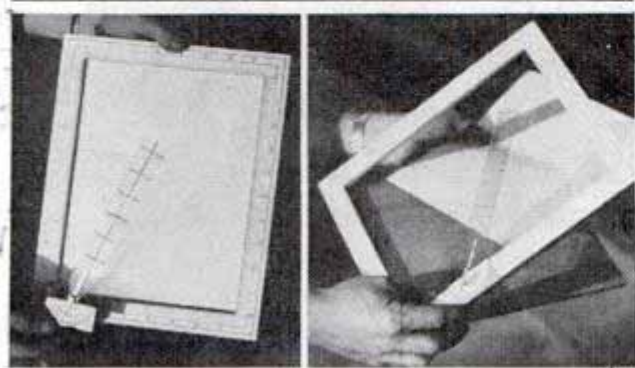

Rule acts as frame for drawing, and protractor can be fastened by clamp to any side of square

Designed for home, school or draftsman, a drawing board now offered is provided with a rule square which serves several purposes. It is a four-sided ruler, it holds the paper flat to the board, it provides a margin for the drawing, and it serves as anchorage for a protractor. The protractor is fastened to a clamp which can be attached to any side, and on the clamp is an arc indicator for projecting angles.

American railroads' water bill is \$50,000,000 a year.

Request form
Assn. American Railroads

Eng. Design by
 Eschbach
 2047 N. Park Ave Phil

Eng. Design by
 Eschbach

Tripod with Swinging Head Holds Camera at Angle



If camera has threads on only one side, swinging head on tripod permits mounting camera at any angle

For cameras which have tripod threads on only one side, a swinging tripod head is available. It permits the photographer to move his camera from horizontal to vertical position without removing it from the tripod. At the touch of a button the camera swings in an arc of ninety degrees and a slight twist of the tripod handle locks it in any desired position.

Slide Rule for Musicians Is Aid to Student and Composer

As an aid to the music teacher, student, composer and arranger a musical slide rule has been devised. It shows at a glance the



This slide rule enables composer or player to transpose quickly and helps teach fundamentals of music

major and minor scales, the various chords in every key, and helps to transpose complete orchestral parts quickly from one key to another. Correct keys for B-flat, F and E-flat instruments, working from any given concert key, are also shown.

Automatic Parachute Opens Self When Air Rushes Past

If an airplane pilot or passenger fails to pull the rip cord of his parachute as he drops to earth, an automatic parachute just patented will save him. It opens itself at a fixed interval after the wearer jumps from his plane. The self-opening 'chute was designed in two forms. In one the air rushing past the pack turns a small propeller which throws out the parachute after a certain number of revolutions. In the other, the pressure of the air opens the 'chute after a stated interval.

Pressure Belt for Power Tool Relieves Arms of Strain



Operator applying pressure on tool by means of belt. His hands guide the tool

Designed to relieve the operator's arms of strain in using portable power tools, a pressure belt now on the market leaves the hands free for the more important job of guiding the tool. The belt is equipped

Engineering Company 709 E. Catalina Blvd. Pasadena, Calif.

11/10/37

Es 1304. J.P. Soper Co. New York 2 Elmhurst N.Y.

W. Schmitt wanted

Es 1347
Es 1328
Pressure Belt for Power Tool
Relieves Arms of Strain
Schmitt and Wegel
comb. to manufacture

with a supporting rod which is attached securely to the handpiece of the tool by means of a sleeve and thumbscrew. The inner end of the rod is fitted with a hinge and thumbscrew so that the rod can be locked in place at any angle desired to do the job. With the rod locked in place, the operator can apply a large amount of force in any direction by merely shifting his body, throwing the strain on his back muscles and legs. A small transparent shield on the rod protects the operator's eyes from flying metal particles.

es 1263

Motor "Horse" Gives a Workout Like Rowing, Bike or Saddle

Bicycle, horse and rowboat are combined in a muscle-limbering exerciser run by an electric motor. Turning on the motorized "horse" you get the action of a canter in the bounding saddle. The handlebars serve as handgrips or footrests and go through rhythmic motions. The motor-driven pedals put you through the paces of bike riding, and you can relax and be exercised passively or resist the pedals for a more strenuous workout.

Exercise



Handlebars, seat and pedals of this exerciser all perform various rhythmic motions to limber body

Marlowe Equipment
C. 440

Cathode-Ray Tuner Finds Pitch for Orchestra Instruments



Finding proper pitch for instrument with the aid of cathode-ray tuning device

Designed to aid in establishing pitch for orchestras, a cathode-ray tuning device is on the market. It shows visibly when instruments are in tune. The device contains a series of twelve tuning forks tempered in the chromatic scale with "A" at 440. When tuning the orchestra for a radio program, the tuner is placed in the control room with the screen of the tube facing the players. The microphone for the broadcast pickup is used, thus enabling the conductor to obtain accurate tuning with minimum effort. Called the resonoscope, the device is made so that the tone produced by the tuning fork may be played back for audible comparison.

es 1393

Eighty-Seventh Element Found

Element Number Eighty-seven, which once before was reported discovered but afterwards disproved, has at last been found in the mineral pollucite and is named Madavium by its discoverer, Horia Hulubei. He used the curved crystal focusing spectograph in his discovery—an instrument so sensitive it can detect one part of a given element in ten millions parts of a chemical or mineral. Madavium was found in France.

Finance

Resonoscope
Epiphany
742 W. 14th
Technology
Announced by Dr. H. A. Hulubei
California Institute of Technology

es. 1183 Reference: Mr. Laugherty
 Publicity Manager. Esraee Line
 525 W. 6th St

SHORT WAVES

Los Angeles, Calif.

Cond. Thompson & Associates, Inc.
 10556 Holman Ave.
 Los Angeles

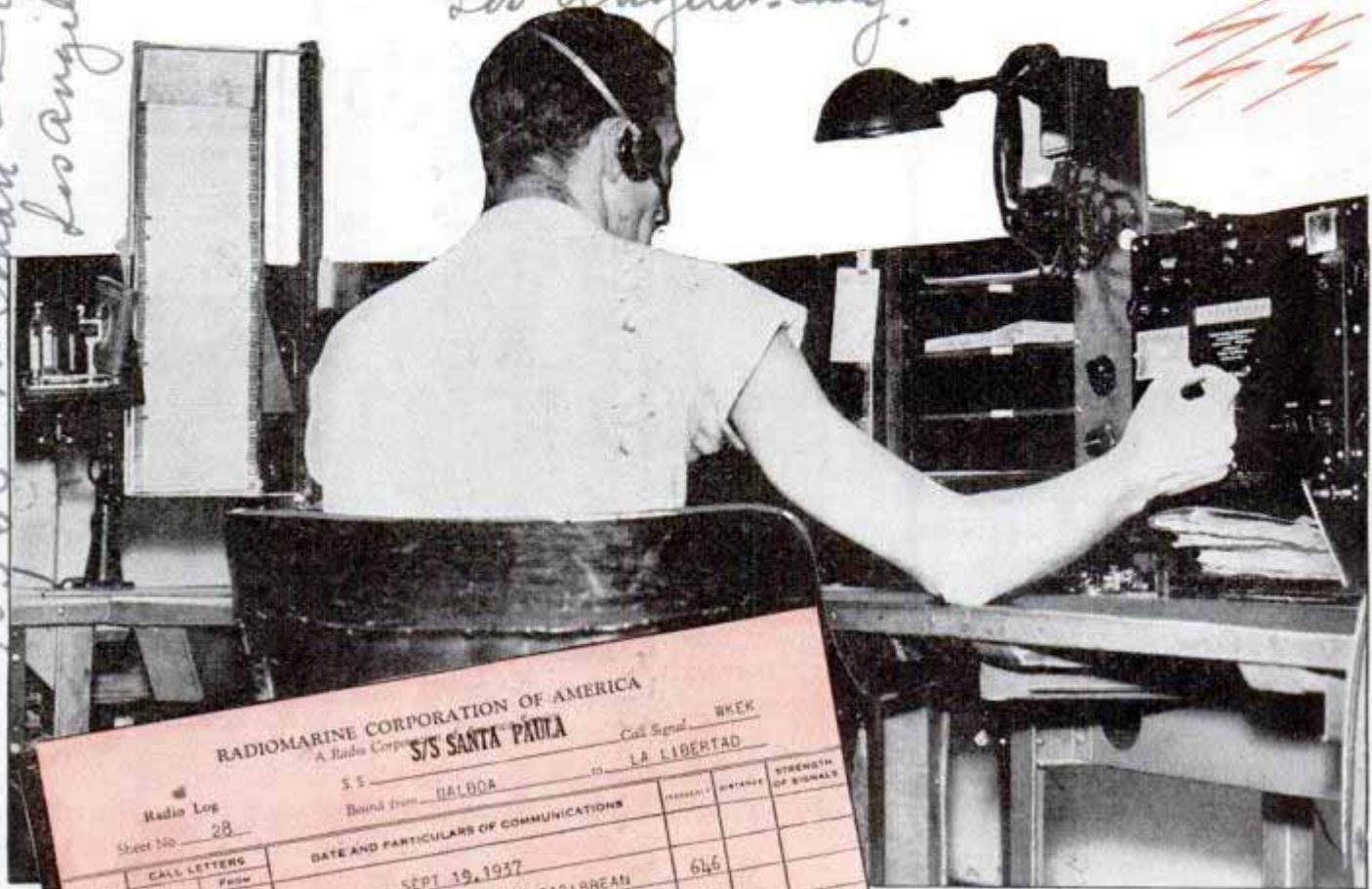

RADIOMARINE CORPORATION OF AMERICA
 A Radio Corp. S/S SANTA PAULA

Radio Log Sheet No. 28

Bound from BALBOA to LA LIBERTAD

TIME	CALL LETTERS	FROM	DATE AND PARTICULARS OF COMMUNICATIONS	STRENGTH OF SIGNAL
7:10	CQ	NAX	SEPT 19, 1957 SENT STORM WARNING FOR CARIBBEAN	646
7:15	NIL	NIL	QUIET NO SIGS S.P.	600
7:25	NAX	WKEK	SENT NR 1 P.	600
7:40	NAX	WJCM	CALLED QTC	600
7:45/48	NIL	NIL	QUIET NO SIGS S.P.	
7:00	CQ	WCC	TFC LIST -- ONLY QBT IDEF ICDV KDCB KDFL KHIT WJCM WKEK WJCM WJDS WKEK	

Top, operator at Mackay land station tuning in distant ship on short-wave receiver. Left, typical radio log of operator's activities on the "Santa Paula"

DROP in at the radio room of a big passenger liner and you begin to realize that the ship, out of sight of land for days, keeps in touch with the world as handily as you do with your telephone at home. If you have a message to send you have only to wait until the operator, pounding his key or his typewriter, finishes a transaction with some station thousands of miles away.

Let's sit in with Eugene Hatch, chief operator of the Grace liner "Santa Paula," as he starts his four-hour watch. The ship is down in the Pacific, en route from Balboa to La Libertad on a voyage from New York to San Francisco. It is a little after four in

the afternoon but the time on the radio clock above the receivers is 00:18, true Greenwich time on a twenty-four-hour dial. By his schedule it is time for Hatch to tune in on KSE, the Los Angeles RCA station, on the chance that the land station has some traffic for him. He barely sets the dials of the compact set when KSE comes in:

"CQ DE KSE QTC GLNZ JPZB KDCS WKEK KDHF."

The code symbol QTC tells Hatch that the station has messages for six ships, including WKEK, the call letters of the "Santa Paula." He pushes a button under the operating table that starts up the converter in the transmitting panel and reaches for his key, telling KSE to go

2/11/83

RULE *the* SEAS

ahead on the "Santa Paula" traffic. In the next thirty minutes he copies half a dozen messages that have gathered in Los Angeles for the ship, and taps back two others from passengers. He may have another dozen messages on file but instead of sending them all to one station he will wait until he can route them through stations close to their destinations.

At quarter of five Hatch breaks off and for three minutes the radio room is silent while he listens in on 600 meters, the international calling band. Three minutes are set aside each half hour for distress calls and no messages except the traditional "SOS" can be transmitted at those times. The letters "SOS," literally meaning

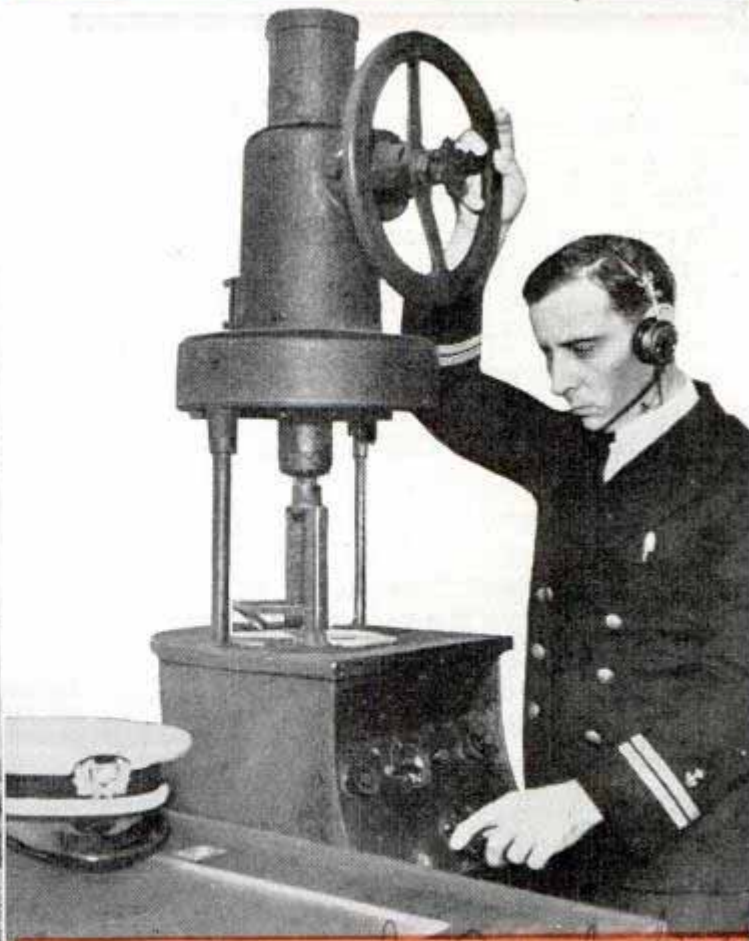
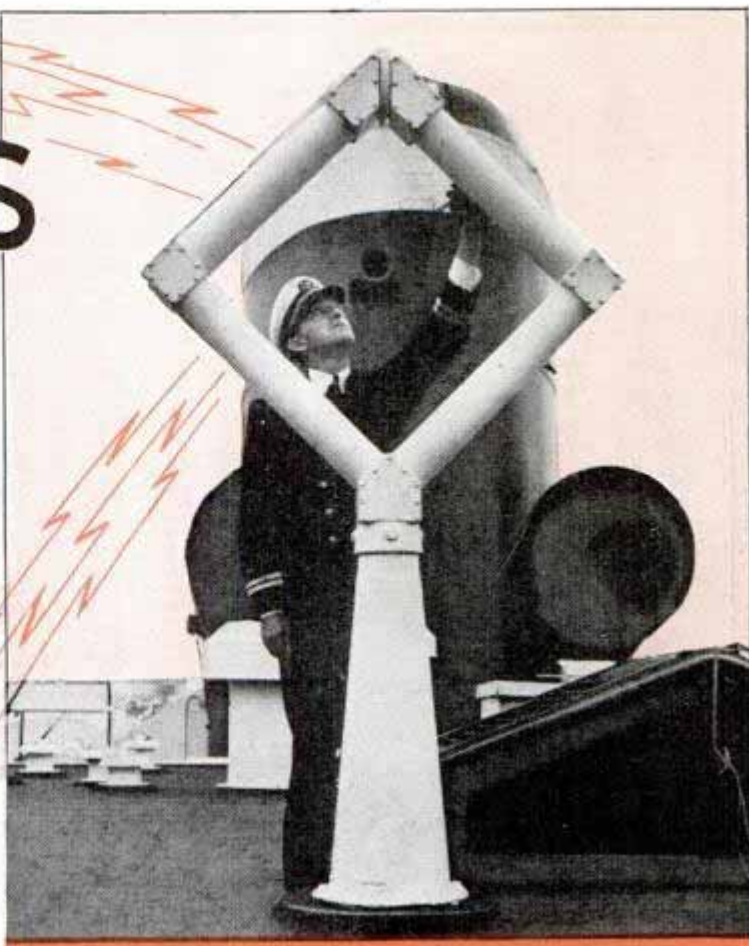

Los Angeles brasswater
Top, radio loop. Bottom, left, lighthouse sends automatic radio signals. Right, deck officer tuning direction finder to take bearing on land station



passing and in 1940 they will be outlawed. Reception is practically "around the world" on the compact short-wave receivers, and Hatch can "talk" to any station that he can hear. In addition to the 500-watt intermediate and short-wave transmitter the ship carries a long-range fifty-watt emergency transmitter that works between 600 and 700 meters. It is powered by a generator working from twelve-volt storage batteries, while the main set is operated by the ship's power supply.

Like other ships these days, the "Santa Paula" has various high-frequency bands that Hatch can use. For long-range work he selects the wave length that seems

"come and get us," are used because of the ease with which the three dots, three dashes, and three dots again, run in together, can be recognized.

In between times since he came on watch Hatch has been listening in on 600 meters and a while ago he acknowledged a call from a near-by freighter, equipped with a low-powered transmitter, that wanted him to relay a message. At the end of the silent period Hatch gives the freighter a call, shifts up to 700 meters to get off the 600-meter calling band, and copies the message that the freighter gives him. Then he tunes his own transmitter down to thirty-six meters and relays the message to WSC at Tuckerton, N. J.

Shipboard radio equipment looks far simpler today than it did a few years ago and it can do a lot of things that it couldn't do a few years ago. Ninety per cent of the traffic is handled by short wave. In the last few years short-wave transmission has revolutionized communication at sea, providing greater range with more reliability on much less power than was needed in the past. The day of the spark set is



Top, throwing switches that turn off radio transmitter, and actuate loop direction finder. Bottom, main electrical switchboard of ship from which current is supplied for operating radio, lights, pumps, and other equipment

to work best at that time of day. Eighteen meters is usually good in the morning, twenty-four meters in the afternoon, while thirty-six, forty-eight, and fifty-four meters are good at night. In the afternoon he works Pacific Coast stations on twenty-four meters but he switches to the thirty-

six meter band to talk to stations in the east because it is already dark over the Atlantic and the thirty-six-meter reception is best.

After handling the freighter's message Hatch tunes to KPH in San Francisco to learn whether that station has traffic for him, and later on he will listen to Florida, Massachusetts, and the Canal Zone. One of these stations may tell him that a European station, such as DAN in Germany, has traffic for him, and Hatch will tune directly to the distant station's band and work it from the ship without relaying. At seven o'clock he swings over to thirty-six meters to pick up the time ticks from NAA in Washington and plugs the receiver through to the bridge so that the officer on watch can use the ticks to check the chronometers. Then come the NAA weather reports, more passenger traffic, and at eight o'clock Hatch is relieved by the operator who will stand



the eight to midnight watch.

But this main outline tells only part of the story. Between routine calls and traffic Hatch has been asked by an oil tanker to repeat the latest weather report, has relayed several messages by short wave, and has asked

(Continued to page 146A)

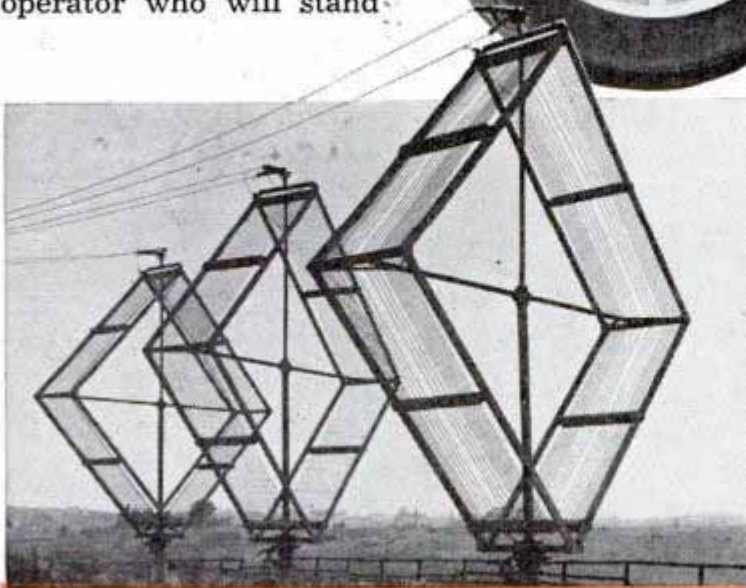

Top, copying press news. Center, radio clock with segments on dial marking "silent periods." Bottom, left, tuned loops of land station. Right, ship transmitter

es 1332

Boat-Trailer for Sportsman Travels on Land or Water

Patent by Mr. George W. Clark, and Roelyn
Ford Hodge, of Wash. D.C.



Top, boat secured to the trailer, ready for the road. Bottom, boat in water. Note false stern which makes removal from trailer easier

Equipped to go sailing, a novel trailer offers means of traveling on land or water. A sturdy, wide-beamed, flat-bottomed skiff forms the body of the trailer. It is mounted on a framework carrying rollers and is locked to the trailer frame by pins and straps. Upon reaching the water, the trailer is backed to the edge, with the prow toward the water. A false stern, with rounded bottom to aid in negotiating the rollers, is attached and the skiff is rolled down into the water. The skiff has a heavy canvas top mounted on a steel rod frame. It is equipped with bunks for two, a light gasoline stove, book and clothing lockers, pneumatic cushions, gasoline and oil tanks and other facilities. The transom is built sufficiently heavy so an outboard motor may be locked on it and

carried while the skiff is being transported. A hand-cranked propeller motor also is mounted on the transom. In addition the trailer may be propelled by oars or a small sail slung to a light mast which can be fitted to a notch in a bottom rib. Top and sides of the canvas hood may be rolled up to open the skiff or closed tightly enough to keep out driving rains.

es 1337

Self-Watering Flower Pot Has a Wick

Designed to insure uniform watering of any plant, a new kind of flower pot is on the market. The pot has a lower reservoir, into which a wick projects. The reservoir is covered with a removable lid, a portion of which is cut away to facilitate watering. In the middle of the lid is a hole for the wick, which comes through the bottom of the pot. The wick, made of burned clay, is removable. Its porosity is controlled by changing the formula of the clay, so different

See Mr. George W. Clark's patent

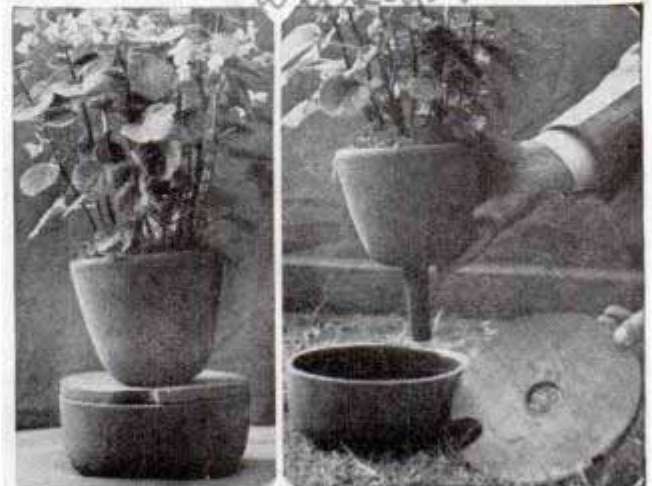

Two views of self-watering flower pot. Note wick in the photo at right

Donald G. Holm, Inc.
2157 E. 1st St. Los Angeles

Shereze
Berch-Plage, Paris-Calais, France
kinds of wicks may be obtained for plants requiring different amounts of water. Chemical foods in liquid form may be supplied to the plant by adding the fluid to the water. Both food and water are drawn up to the plant's roots by capillary action.

201350

Collapsible Pocket Periscope Sees over Heads in Crowd



Unlike the homemade arrangement of mirror on stick which requires the spectator to face away from the scene of action, a collapsible periscope recently invented allows the user to peer forward over the heads of the crowd at a parade or sports event.

This pocket periscope consists of an extension bracket with a mirror mounted on each end. It collapses into a handy case.

102233
10/23/07

Clothes Basket on Wheels Saves Stooping and Lifting



Collapsible cart holds clothes basket at waist level or folds close to floor for use as bassinet

Call it a clothes basket or bassinet or tea cart, a collapsible basket on wheels is a labor saver. It holds the clothes at waist level during laundering, and instead of carrying the basket of wet clothes it can be rolled on its two wheels. It folds down to a low level for ironing or use as a bassinet.

Tacking Gun for House Screens Speeds Carpenter's Work

Faster work on house screens is made possible by a tacking gun, a stapler which replaces tacks, brads and old-fashioned methods of fastening screen wire to frames. A trigger releases a two-pointed staple and the two points converge as they are driven into the wood. The tacker has two sharp prongs which stretch the wire as the carpenter works, resulting in a smooth, permanent job.

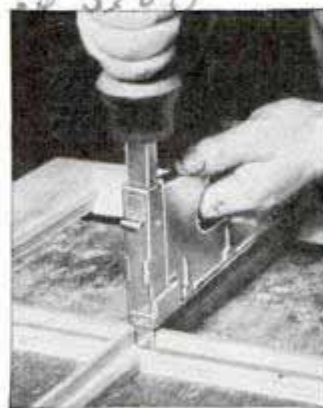

Trailer Like Castle on Wheels Used as Popcorn Stand

Resembling a small castle on wheels, a trailer built to special dimensions is being used as a popcorn stand. The owner peddles the confection along the road and at county fairs and other gatherings. His odd mobile stand attracts customers.

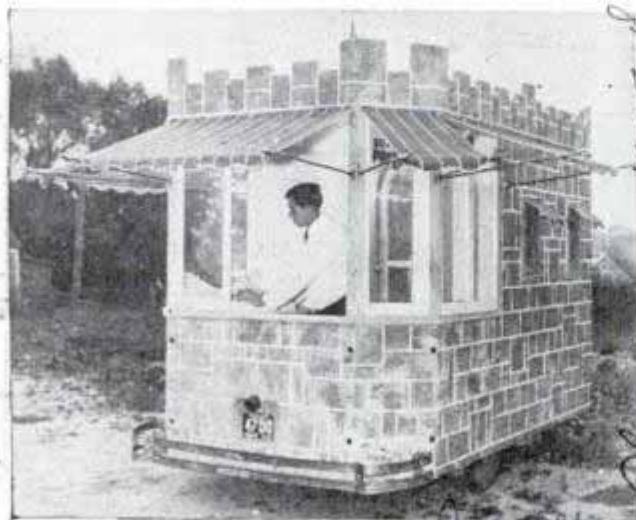

Here is the popcorn "castle" ready to travel wherever there may be customers

The U.S. Agent's name

Wind-over my Newton, Iowa

Chicago. 407-8-1111

Cleveland, Ohio

Owner - Martin Black

Seller Co.

*The Metallic Glazer
Co. 1250 Arlington Road
Lakewood, Ohio*

Loudspeaker on Fire Truck Directs Attack from Street



Portable microphone and loudspeaker enable commander to direct firemen from two blocks away

"Come to the edge of the roof, Lieutenant Brady. How many lines do you need? There are people waiting for ladders in a third-floor window." A loudspeaker is barking commands to firemen on a blazing building in Chicago. The fire marshal directing the fight watches the situation from a truck on which the loudspeaker is mounted, and talks into a portable microphone held in his hand. The loudspeaker can be heard easily two blocks away.

Metallic Glazer Replaces Putty as Permanent Window Seal

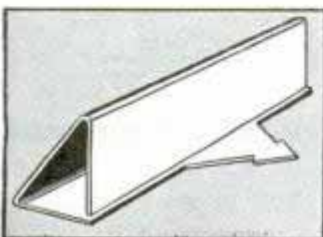

Metal strips are being used instead of putty for installing window glass. The metallic glazer is permanent, water-

proof, rust-resistant and can be used again if the window is broken. It consists of triangular strips of copper-bearing iron with a projecting point on the base which is driven into the wood as an anchor. A coat of thick paint applied first along the glass and wood surfaces acts as a seal.

Medieval Tower Built as Hobby Filled with Relics of Knights

Overlooking the Fox river valley at Elgin, Ill., is a fifty-foot medieval tower with drawbridge and moat, patterned after an ancient stone tower in Europe and furnished with household effects typical of the middle ages. The owner, an electrical engineer, interested from his youth in stories of knighthood, built the castellated tower as a hobby and uses it as a retreat for study and rest. Each of the four stories has one room, connected by a circular stairway around the inner wall. One room is a library containing books on medieval history and the evolution of armor. The owner has designed four suits of armor of the chain, scale and plate types. The furnishings include armor, crossbows, battle-axes, pitch torches and tallow lamps.

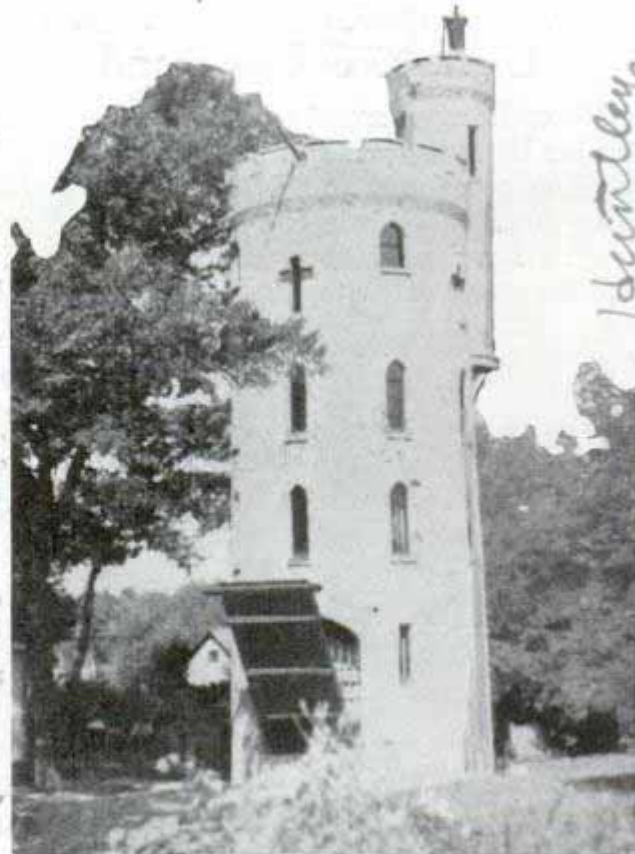

Drawbridge over "moat" is lifted, barring entrance to medieval tower at Elgin, Ill.

Edw. Thomas & Co. Elgin, Ill.

201301

201329

201343

201-365
Cmbr. Leonard...
607 N. Knott St.
Portland, Oregon.

Alaska 'Weather Hop' Previews U. S. Winter



Here are two means of winter travel in Alaska—dog team and airplane. The plane is ready for daily "weather hop" to sample conditions three miles up. Note frame for instruments attached to strut at right

Three miles high over Alaska the weather plane soars every day, in arctic blizzard or midwinter darkness, to sample the weather that's on its way to Kansas and Toronto and Chicago from the place where winter begins. From the data gathered on this "weather hop" the government meteorologists hope soon to make accurate long-range forecasts of United States weather. A blizzard headed for Indiana may be foretold days in advance. The plane takes off once each day for the 16,500-foot level on the short midwinter days at Fairbanks, and in early winter and spring it makes two flights, even in severe conditions that ground other aircraft. The motor oil is warmed over a portable gas stove, and a gas torch heats the canvas-blanketed motor for an hour before take-off. To the struts of the ship a cylindrical aerometeorograph is attached, to record temperature and humidity at prescribed altitudes. The readings are supplemented by data automatically transmitted by a two-tube short-wave radio sent up on a free balloon that may rise fifteen miles before it bursts and lets the instruments drop with a tiny parachute. The weather bureau offers a reward for any of these instruments recovered, but expects few to be found in the desolate Alaskan interior. This winter 190 balloons are to be released.

201375

Cameraman Poses an Elephant as "Prop" in Pictures

Unique stage "prop" of a Cincinnati photographer is an elephant which serves as background for pictures of children. Youngsters do not seem to have any fear of the big fellow, and he brings in plenty of business from boys and girls who like to pose with him.



Youngsters get an added thrill posing for their pictures with an elephant as their background

Cmbr. Day...
1404 Walnut St.
Cincinnati, Ohio

es 1142

SHOOT *when they*



usually just a dull record. Now there is a new standard; pictures must show life in motion; expressions must tell a story; photographs are made on the fly, often with the subject unaware a camera is in action.

To quote Rudolf H. Hoffman, expert candid cameraman of New York: "Candid pictures represent a record of what the eye of an unobserved observer has observed. It is assumed that the camera is used so inconspicuously that it is in position to record something that is intended actually to be off the record. Such is the true and simple meaning of candid photographs."

Candid pictures are easy. Modern shutters and highly sensitive plates and film do away with the necessity

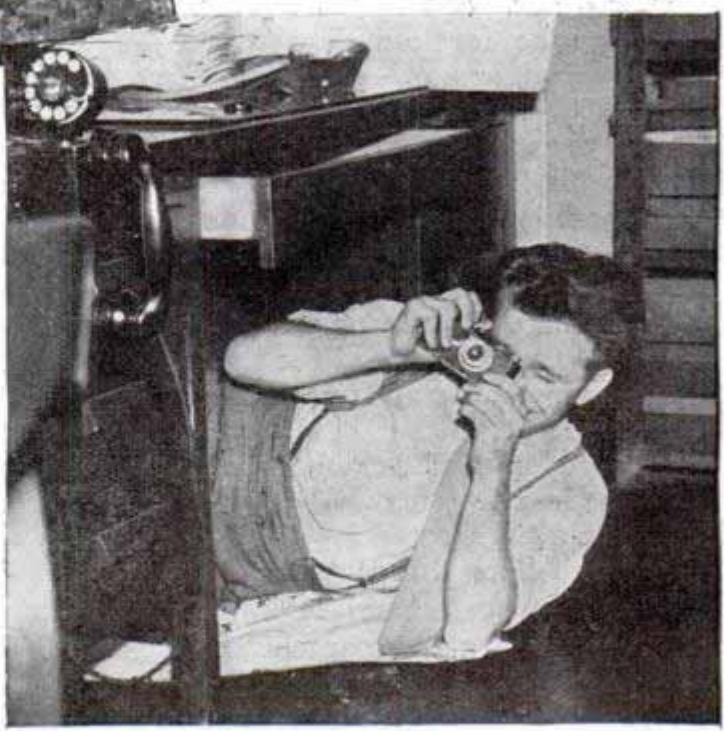

At top, child and puppy are caught in an unposed shot. Below, the candid cameraman slides under an office desk to "stalk" his game for off-guard picture

IS YOUR scrapbook full of frozen faces? Take the cure—candid photography! There is really no such thing as a candid camera. It's all in the way you use it. You may have the tiniest, trickiest three-hundred dollar camera; you level it at someone, tell him to hold still, snap the shutter. And with all your fancy equipment you get the same old stiff, stereotyped pose with an unnatural smile on your victim. Or you may tuck a plain dollar-ninety-eight camera under your arm, stalk your subject and shoot when he is not looking but being his normal self. Then you've got something, mister—a candid picture! In the old days, newspapers and magazines were full of frozen faces. The news photographers would ask their subjects to pose for their pictures, and the result was

Mr. Henry A. Scheerer,
223 S. W. Wabash
Chicago

2/14/42

DON'T EXPECT IT

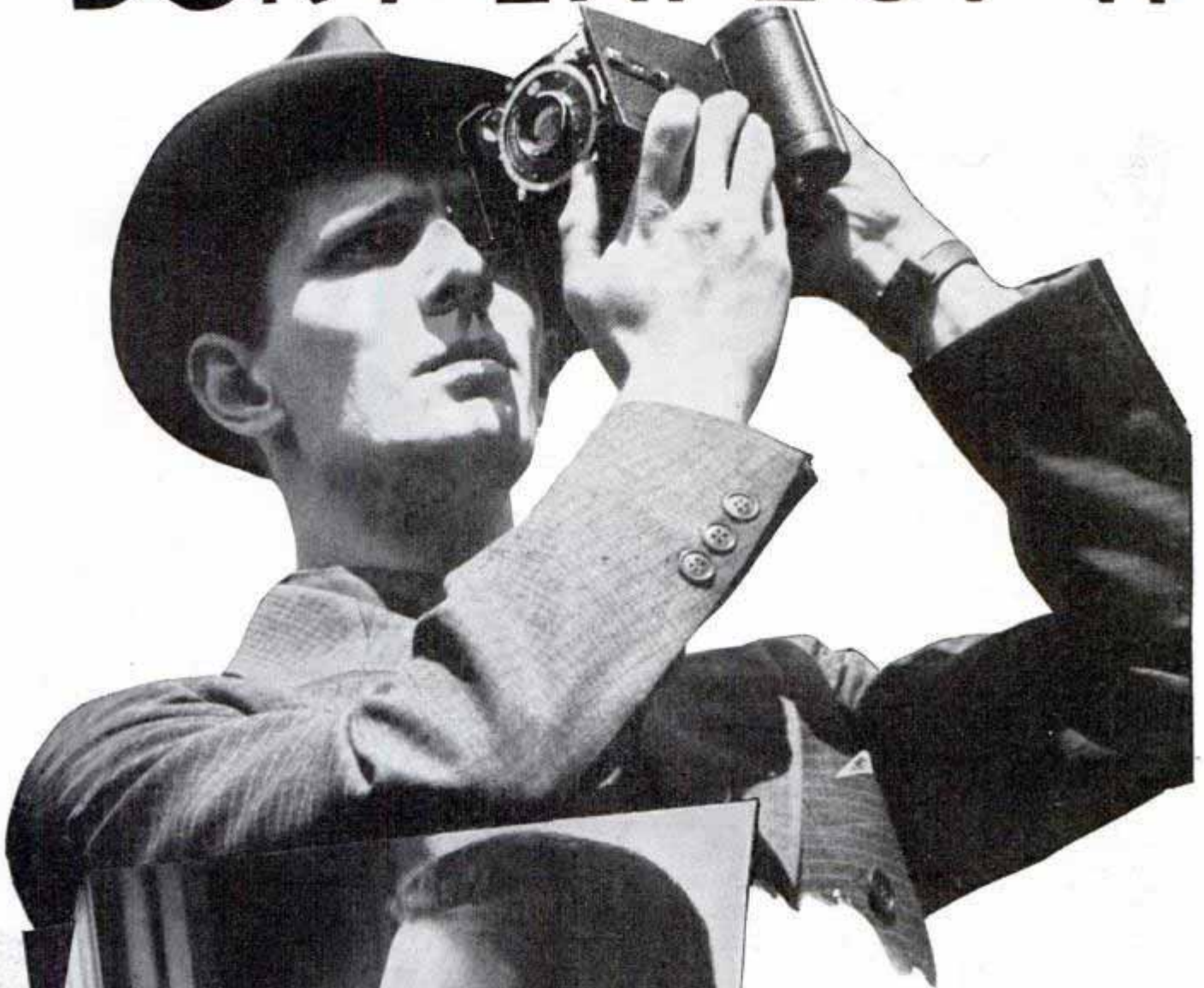

Above, photographer fools his subject by tipping his ordinary bellows camera sideways and sighting at right angle through the mirror view finder. Below is a candid shot for the family album

of posing as in the past. Expensive and elaborate equipment is not at all necessary. Using any camera that has a shutter speed of $\frac{1}{25}$ part of a second, you can make candid pictures which compare with the best ever made by either amateurs or professionals.

Although the smaller is always preferred, the size of the camera is of secondary importance. Edward McGill, candid ace on the staff of a Chicago newspaper, has obtained some of his most excellent pictures with a four by five size, focal plane camera. Carrying an additional dozen plateholders which themselves make a bulky

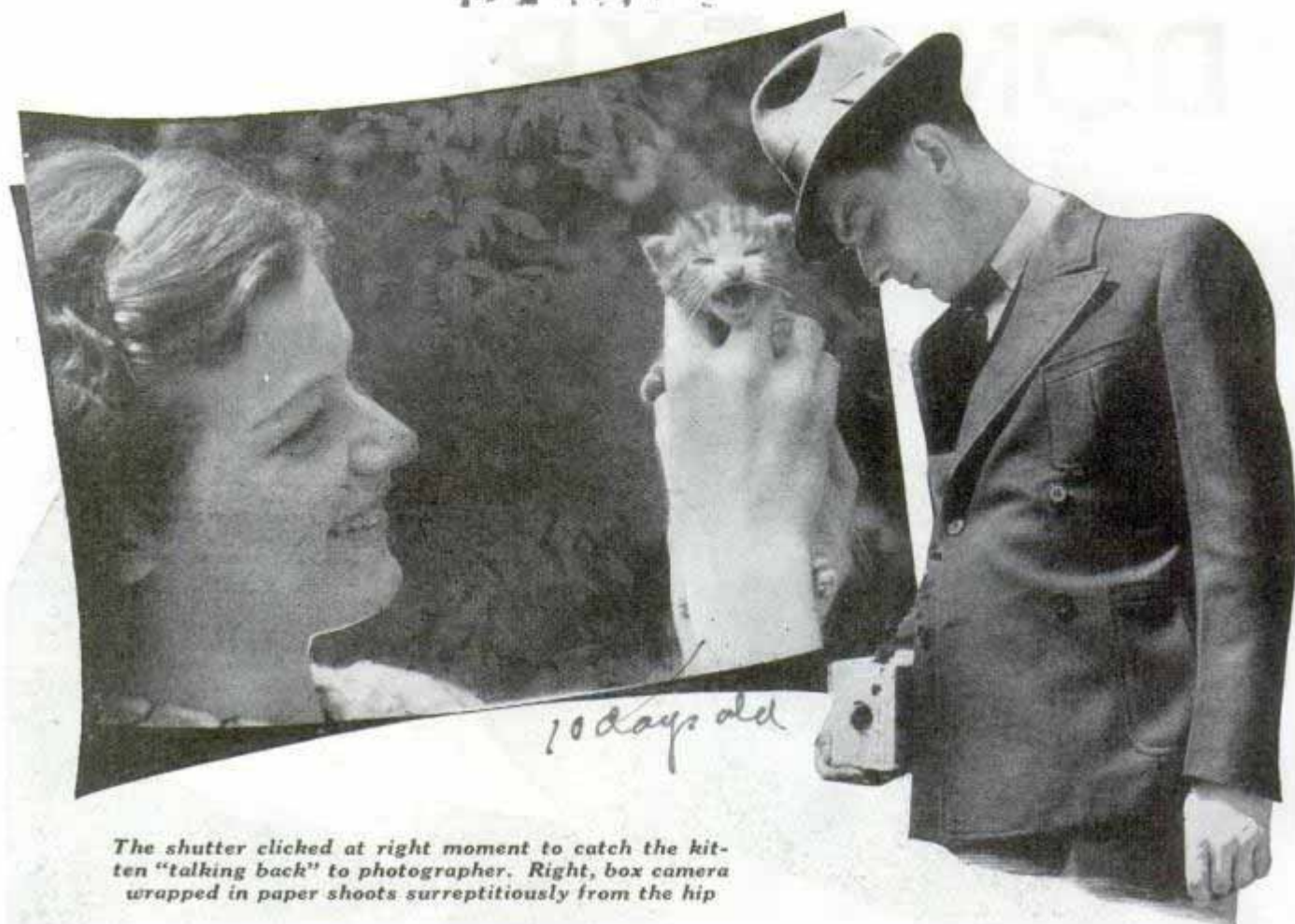

The shutter clicked at right moment to catch the kitten "talking back" to photographer. Right, box camera wrapped in paper shoots surreptitiously from the hip

enough package, he excels in candid work. His subjects seldom are aware that McGill is snapping pictures. With the camera under his arm, he can approach, maneuver for the best angle, open the camera and photograph the subject very smoothly without attracting attention.

One amateur has made unusual candid snaps with a box camera wrapped in a newspaper page to disguise it as an ordinary parcel. Cutting openings for the lens, rewind and rear window and a slit for the shutter lever, he carries it under his arm and makes interesting snapshots by pointing the lens toward his subjects, without even bothering to use the view finder. Another rabid camera fan, a New York merchant, carries his miniature in the palm of his hand and shoots candid scenes from the hip, on his way to and from work.

You will note that the camera does not actually have to be hidden or camouflaged with any great effort or expense. Candid picture taking is just as simple as any other form of photography with only one difference—your subjects should never be aware that they are being shot.

Some press photographers resort to ac-

tual concealment of the camera when making photographs during difficult assignments. One Chicago candid ace keeps a miniature with a powerful lens hidden under his coat to snap certain scenes. A series of several candid snaps taken inside of a gambling house brought about an expose by his newspaper which eventually resulted in the closing of the gambling place by the police. In making pictures under such trying conditions, even his life might be in danger, and amateurs are advised not to try to take pictures under similar circumstances.

The secret of successful candid photography will depend largely upon your method of operation. The ability to approach your subject without arousing his attention, the manner of keeping your camera out of his sight, and the skill with which you can quietly but quickly bring the camera into action when the moment arrives, are of greater importance than the possession of lavish equipment. And it is equally important to hold the camera absolutely steady when snapping the shutter. Camera movement has blurred many a good picture. This especially should be

281/42

Right, camera fan uses friend as "screen" to hide his snap-shooting intentions. Below, miniature camera held inconspicuously in palm of hand, ready for action. Below at right, two youngsters with Easter baskets. Children should never know they are being photographed

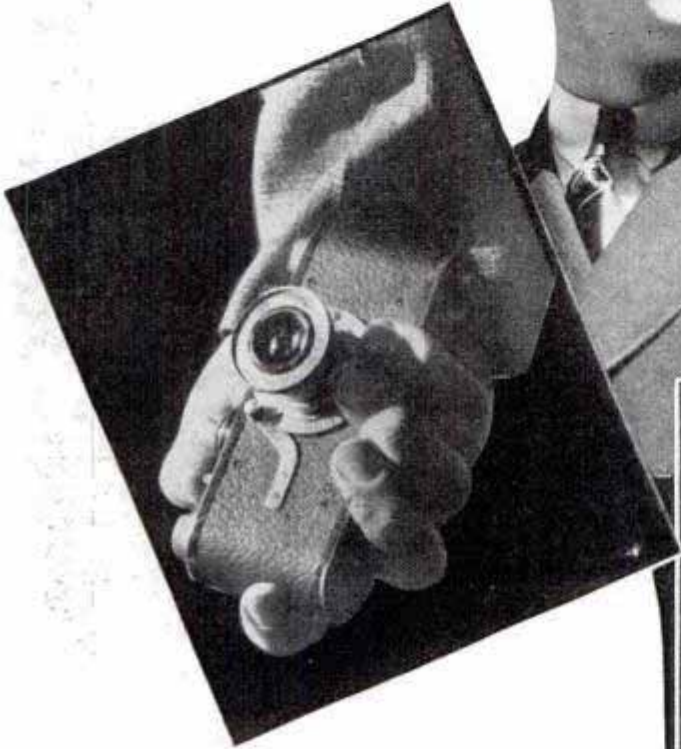

observed when working with a box camera or any other camera with slower speeds than $\frac{1}{100}$ of a second.

The shutter always should be set to fastest speed available. Although $\frac{1}{25}$ of a second is fast enough for stopping action of facial expressions and very slow hand or walking movements, it is inadvisable to use once the subject begins to move fast. If you use a box camera, pay strict attention to the slightest pauses or moments when the motion is slowest. For instance, in observing walking movements, you will notice that the motion is slowest the instant before the weight of the body is shifted from one foot to the other. Shoot the subject when he is moving either toward or at a forty-five-degree angle to the camera. Unless shutter speeds of $\frac{1}{100}$ or more are available, do not attempt to stop action of a subject moving directly across the camera range.

The view finders on the box of most

Beal and La Verne Keeler
folding cameras are so mounted that it is possible to shoot pictures at a right angle to yourself. For instance, you are facing forward but your subject is on your left. Do not turn to face the subject. Simply point the lens in his direction and by looking into the view finder you can still center your image with the same ease as if he was directly in front of you.

Using a friend as a decoy is another effective method of keeping the camera in-

(Continued to page 116A)

2013 5.7
214

American Bowling Congress
2200 North Dearborn St.
Milwaukee, Wis.

Tenpin Game Is Reduced to "Exact Science"

Brunswick-Balke
Collender Co. 623 J.
Wabash, Chicago

Right, "pin-spotter" sets them down precisely twelve inches apart. Below, hydraulic plunger slows ball returning to rack. Bottom, meter shows uneven surface of alley. Left, scales for balancing ball and measuring span of thumb and finger

Denny Troemner
911 Arch St.
Phila.

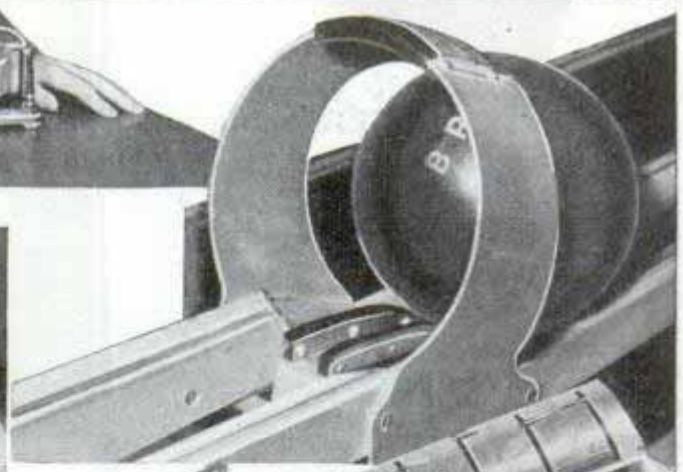
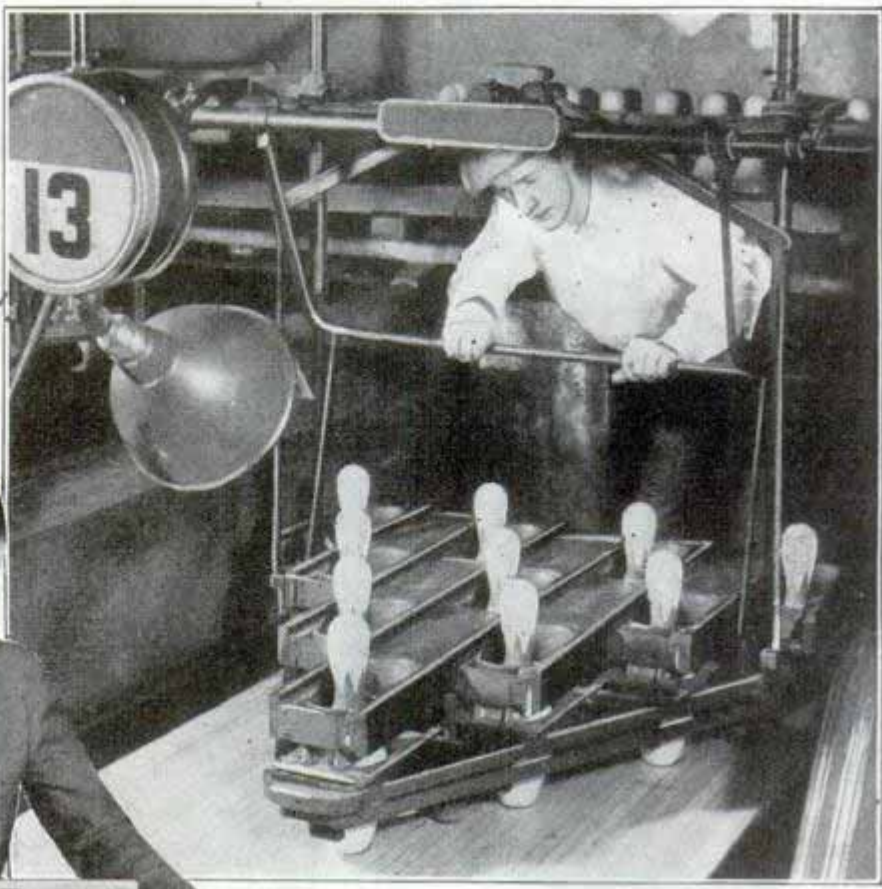

Meter - J. H. Foster.
1212 E. Jackson
Macomb, Ill.

When a bowler hurls the heavy ball down the alley he takes a chance on himself—his eye, his arm, his balance; but there must be nothing left to chance in the setup of the game itself. The alley itself must be smooth and level within 40/1000 of an inch; balls must be balanced, tenpins must be set exactly

where they belong. Bowling is reduced almost to an "exact science" by the latest mechanical aids and measuring devices. A sliding curved rule calibrated in fractions of inches is used to measure the span of a bowler's thumb and fingers so that the ball can be drilled for the best possible grip. A

special scale tests the balance of the balls, which may not exceed sixteen pounds in weight and must conform to a very small differential in weight between any two sides. Pin-spotting machines center the pins precisely on spots twelve inches from center to center. An alley meter which straddles the alley checks its surface for indentations, hollows, grooves and ridges, showing up these irregularities in hundredths of an inch or less so that resurfacing can be accomplished accurately. A hydraulic plunger device has also been introduced which acts as a brake on the bowling ball as it returns to the rack, preventing any bruised or crushed fingers as players pick up a ball.

Es 1357

Big Figure of Grasshopper Tops Financial Building

High over the city is the big figure of a grasshopper, topping the Royal Exchange in London. The grasshopper was the crest of Sir Thomas Gresham, wealthy merchant



© Planet News, Ltd.
Large figure of a grasshopper, atop Royal Exchange, as it was being regilded

and financier of the sixteenth century, who built the first Royal Exchange. Recently workmen regilded the grasshopper's figure.

Buckingham Yard

Twigs of "Wishbone Tree" Grew on Barnyard Fowl

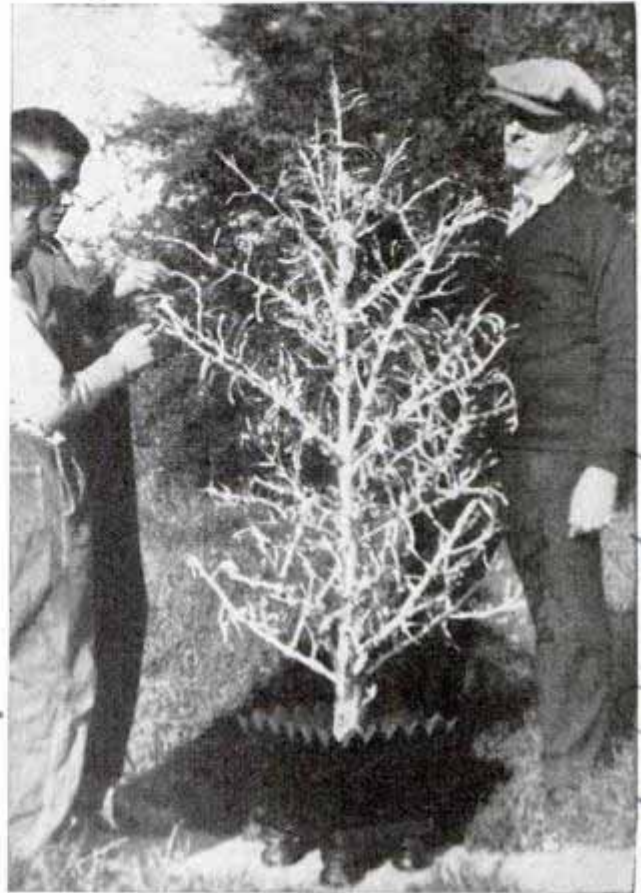

Hundreds of turkeys, pheasants and other fowl contributed their wishbones to this "skeleton" tree

For thirty-five years a Latonia, Ky., man has been "growing" a "wishbone tree." Standing four feet tall, its branches sprout twigs that have been taken from hundreds of fowl. Among the wishbone twigs are mementos of chicken and turkey dinners, quail, squab, ducks, capons, pheasants, guineas and pigeons.

Es 1395

Rubber Clothespin Is Harmless to Most Delicate Fabric

Even the most delicate silks and other fabrics are unharmed by soft rubber clothespins. There is no chance of the pin splitting or splintering. Non-porous, it is sanitary and washable. Due to its special construction, the rubber pin has a firm grip.

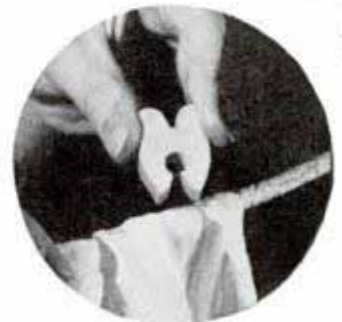

Fiber Plastic Corp.
1804 W. Roscoe St.

Cont. Roy Tuchenor, 1404 Walnut St.
Cincinnati, Ohio

J. D. Clinton, Danvers, Mass.
9-9-36

Trained Insects Perform in Strange Circus

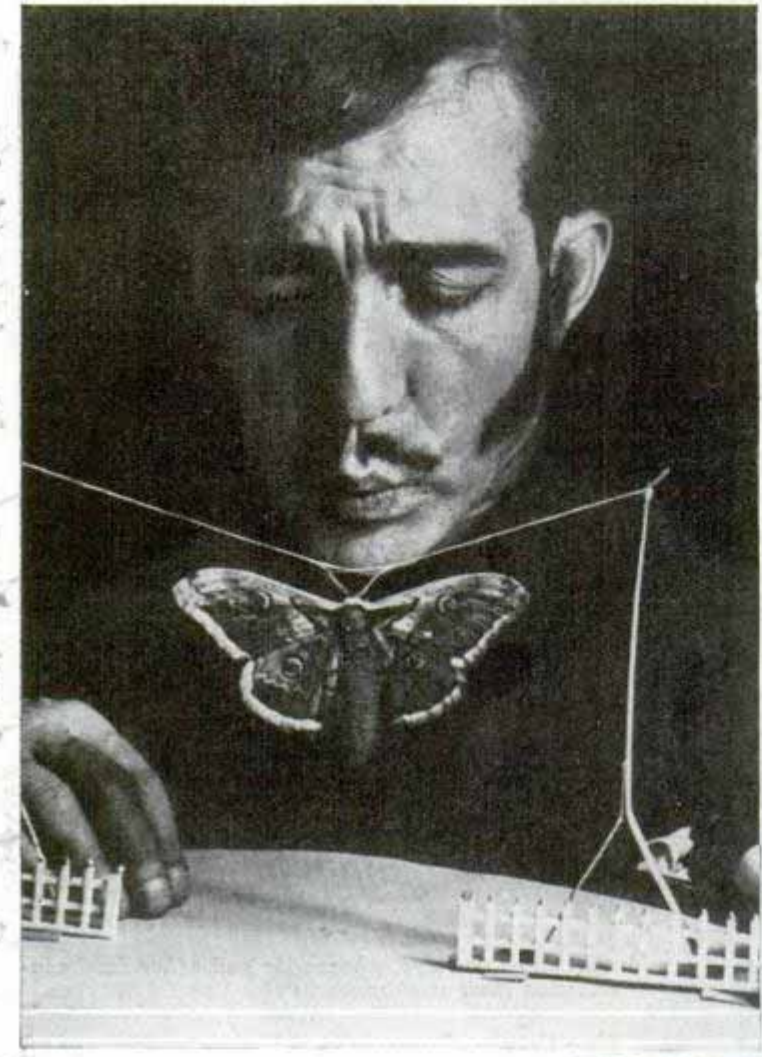

Above, director of insect circus presents his dancing butterfly which performs in amazing fashion on a miniature tightrope



© Z. Kluger & Co. Above, feeding the actors in insect circus which has been giving performances in Europe. The insects seem to learn difficult tricks easily. Note the insect climbing the side of the hat for its supper

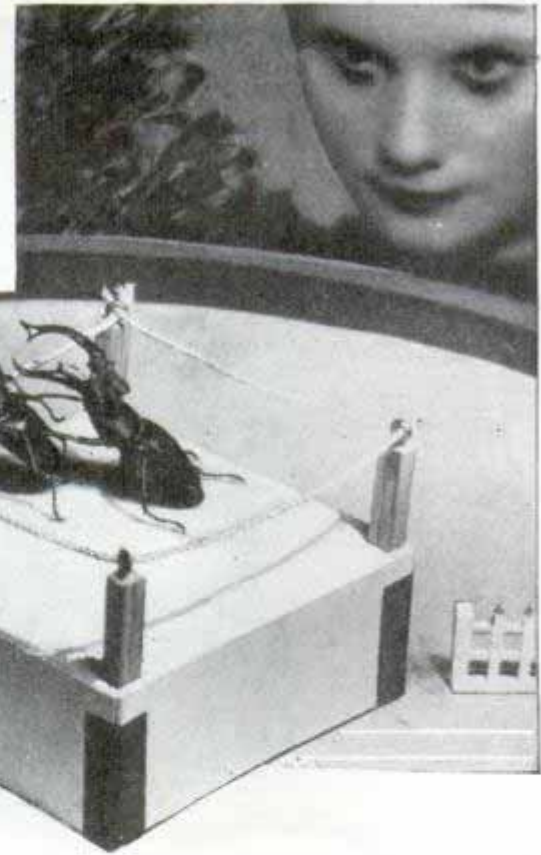

Above, this looks like the knockout in the high-spot of the circus, a ten-round match between the insect pugilists, Paulino and Pedro. Left, this is a bit of comedy between the acts, giving the insect clowns a chance to win the spectators' applause



20133
 My name is W. O. Schrapow
 of Anglo-Continental Studios
 Vienna, Austria
 I have trained insects to perform in a circus
 and I have written a book about it
 which is now being published by
 Popular Mechanics

Grasshoppers Star in Show's Hurdling Act



Above, unpretentious wooden door to the insect menagerie bears a big poster proclaiming the magnitude of the circus

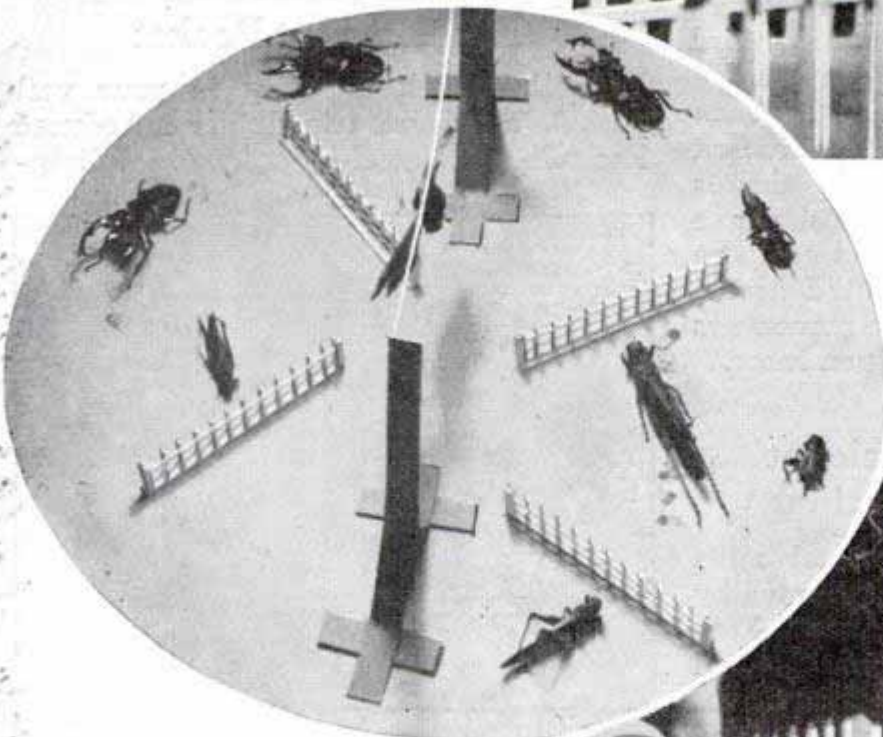

Above, perhaps this might be called the bare-back hurdling act. Note the stunt rider perched on the back of the grasshopper as they take the jumps, another big act in the circus. Below, one of the hurdling grasshoppers topping the timber in perfect form

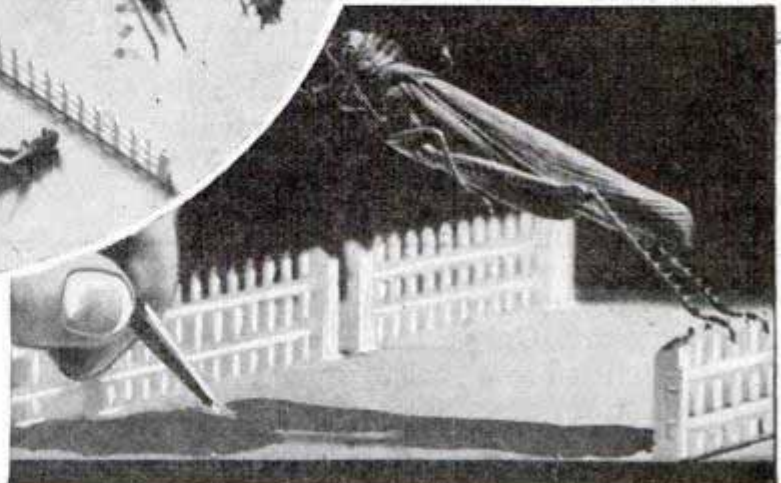

Above, the grand revue of the insect circus. While the dancing butterfly clings to the tightrope in the center and the grasshoppers hurdle the tiny fences the other performers parade in the best big-top style

Class in 'Dry Skiing' Trains on a Field Covered with Hay



Snow fields are miles away from the Stanford University campus, but the winter sports class goes through all the motions of skiing on hay field

When there's no snow to practice on, "dry skiing" on a hay field is next best. In fact, the coach of the ski class at Stanford University in California says that beginners who start with dry skiing have an advantage over those who take their first lessons on the snow. Stanford students can enroll in a regular ten-weeks' course in ski training, taking exercises on loose hay to develop the muscles used in the winter sport and practicing the maneuvers and turning positions of skiing on snow.

Water Used as Lubricant on Heavy-Duty Bearings

Contamination of ore in metal mills where oil flotation is used is prevented by using new water-lubricated bearings. Formerly oil from the bearings on the ball mills became mixed with the ground ore. The new bearing is made of compressed canvas with phenolic filler similar to modern fiber gears. Only a 180-degree bottom segment is used as wearing surface. Fifty gallons of water per minute are supplied to the two bearings, being sprayed on the axle. The water may be cooled and recir-

culated with little loss. When the mill is to be started, a booster pump forces water into the bottom of the bearing at 880 pounds to the square inch. Acting as a hydraulic lift, this allows the mill to start easily at full speed. When the mill is running the high-pressure water is shut off, all lubrication being supplied by three water sprays in the upper segment of the bearing. In addition to keeping the ore free from oil contamination, the new bearings save thirty per cent on power and have a greater life, due to being washed free of impurities and dust customary in mines and mills. Bearings of this type are being used in steel rolling mills.

Tripod with "Roll-Away" Legs Fits in a Vest Pocket

Small enough to carry in your vest pocket, a camera tripod just introduced has roll-away steel legs. The legs disap-



Legs of vest-pocket tripod stow away in a case as neatly as a steel tape measure

Westinghouse Electric Corp. E.P. Matherly Pa.

Cent. Jon Van Jon, 17 Kithridge Bldg

Sold by Ames - Gunmen's Berg. 10 & 40 St.

market... Roll-Away Tripod... Sold by Ames - Gunmen's Berg. 10 & 40 St.

Cent. Jon Van Jon, Box 2655, Stanford Univ. California

pear into a Bakelite case not much larger than a watch. It can be used with almost any camera, special threads being available for foreign makes and an extension for taking both vertical and horizontal pictures if the camera has but one socket.

es 1360

City Dogs Enjoy Indoor Romp on Rolling Exerciser

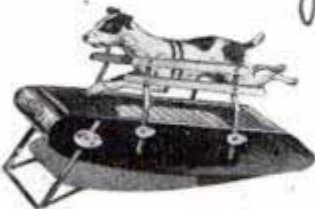

Auto Romp
Apartment-house dogs that don't have all the healthy outdoor exercise they'd like should try out the latest for dog

gymnasiums. It is a ramp with a moving floor on which the city-dwelling pup can run, walk, sit down or lie down as he pleases, and the dog that wants to run can get plenty of it in a few minutes. The treadmill is mounted in rubber, with brass roller bearings.

es 1286

Cow "Painted" in Neon Lights Marks Dairy Show at Fair

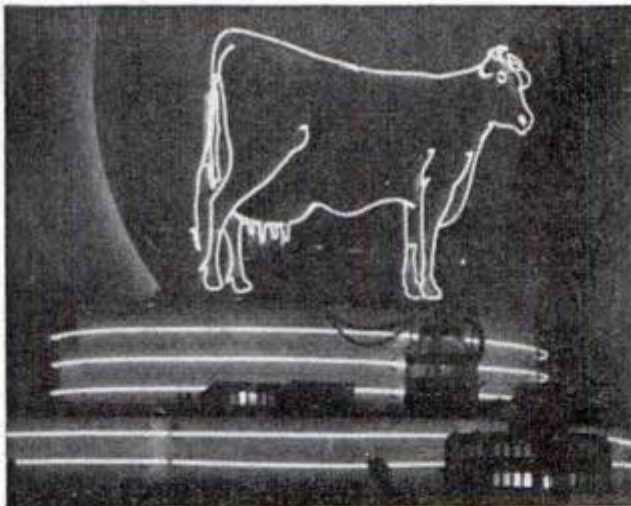

Beneath forelegs of "neon cow" is milking machine. Stream of light from udders indicated milk flow

Neon lights formed the outlines of a giant cow, stationed on a modernistic pedestal to mark the dairy exhibit at a recent fair. Below it was a huge milking machine, and the play of lights showed the flow of "milk" from the udders.

numbers state.

Send return postage to our Bureau of Information to learn the name of the maker of any device described in this magazine.

Telltale Log of Auto Speed Kept by Recording Meter

no info. 2/28/38

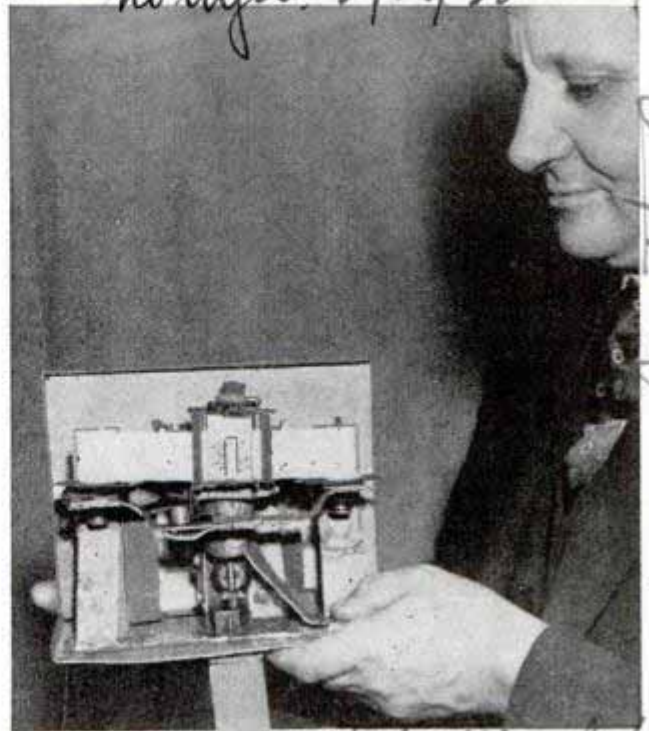

Recording speedometer punches paper tape every quarter mile to show speed of auto throughout trip

There can be no argument about car speed if the recording speedometer for automobiles comes into general use. From start to finish of a trip it keeps a written log of the speed, punching a paper roll each quarter mile with a barometer-like marking to show the rate in miles per hour.

es 1354

Snowplow Climbs the Curb to Clear Off Sidewalk

Mounted on the front of a small tractor, a snowplow of special design can clear the snow close to the sidewalk and then climb the curb to clean off the sidewalk itself. It removes even the hard-packed snow.



Curved scoop mounted on tractor cleans street up to curb and then climbs sidewalk to finish job

Anderson Engineering Co
21 Princeton St. Cambridge

Charles Fuld & Co Chicago

Wede World
max. 1000 ft. high. 200 ft. wide. 100 ft. long. 100 ft. deep. 100 ft. high. 100 ft. wide. 100 ft. long. 100 ft. deep.

es 1132

cont. Thomas & Stinson, Jr. 10555 Holman Ave Los Angeles Calif.

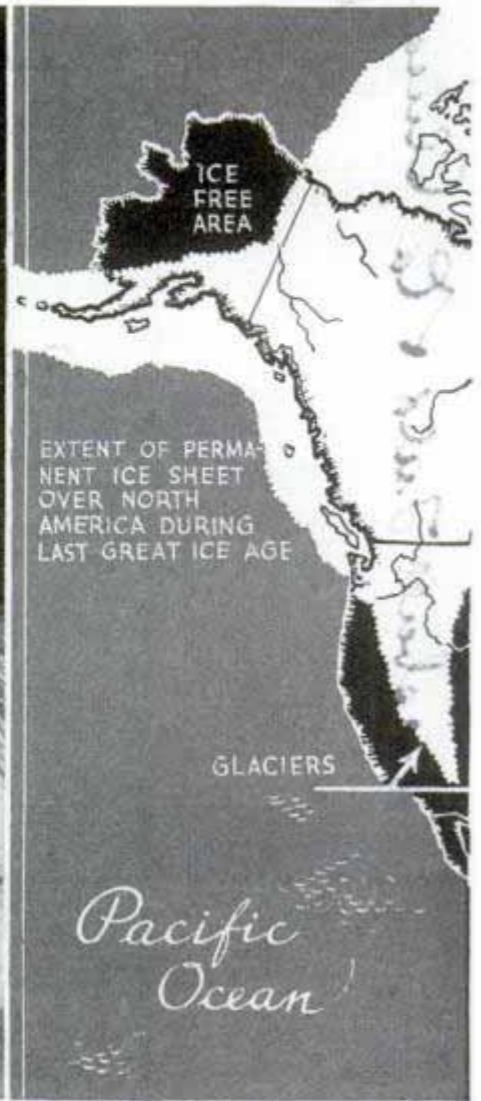

The PUZZLE of the

Left, model of typical volcano showing lava tubes and way cones are built. Right, map shows extent of permanent ice sheet over North America during the last ice age

IF THE average temperature of the United States should drop only eight or nine degrees Chicago would become buried under half a mile of ice and New York would be covered by an ice sheet thousands of feet thick.

A mere drop of a few degrees from normal summer temperatures and a corresponding drop through the rest of the seasons would be enough to put the earth on the verge of another great ice age and to move the Arctic Circle literally into the vicinity of Tennessee.

Such is the conclusion of scientists who are studying the last great ice age that covered large parts of the United States with an icy blanket. At that time all of

Canada and New England was covered by a permanent ice sheet that extended down into the middle west past Iowa and Nebraska as far south as Missouri and Kentucky. Hundreds of glaciers grew in the Rockies and in the Sierra Nevada. Scores of them still exist above the 12,000-foot level, including a large one less than 250 miles north of Los Angeles.

"Every one knows that weather and temperature changes go hand in hand, yet the consistency of the basic temperatures that control climate is one of the miracles of the universe," states Dr. Chester Stock of the California Institute of Technology. "Year after year, the annual average temperature of any region is practically the

Pasadena Calif



ICE AGES



Top, right, Dr. Stock studying fossil of saber-tooth tiger's skull. Early American lion's skull on table is twenty-five per cent larger than present type. Bottom, model of woolly mammoth that roamed this country 25,000 years ago

same. Life can exist on the earth only inside the narrow range of temperatures that we experience, and these temperatures are regulated by a sort of cosmic thermostat that is infinitely more sensitive than any heat-regulating device that man could make.

"Temperatures in the universe range from 454 degrees below zero in interstellar space to almost two million degrees above in some of the stars. On a scale fourteen inches long, with the lowest temperature at one end and the highest at the other, the normal range of temperatures on the earth would be represented by a line almost too narrow to be visible.

"Almost anything could happen to upset the inconceivably delicate balance of forces that keeps this temperature constant, but the more they study the history of

es 1132



that the earth will become considerably warmer before it grows colder again."

As a matter of fact, the last ice age hasn't ended yet for the people of Greenland. Echo soundings made with dynamite indicate that in the interior of Greenland the continental ice sheet is well over a mile deep. Eventually, thousands of years from now, much of this ice will return to the sea and the last ice age will be definitely over. When that time comes the seas north of the continents will

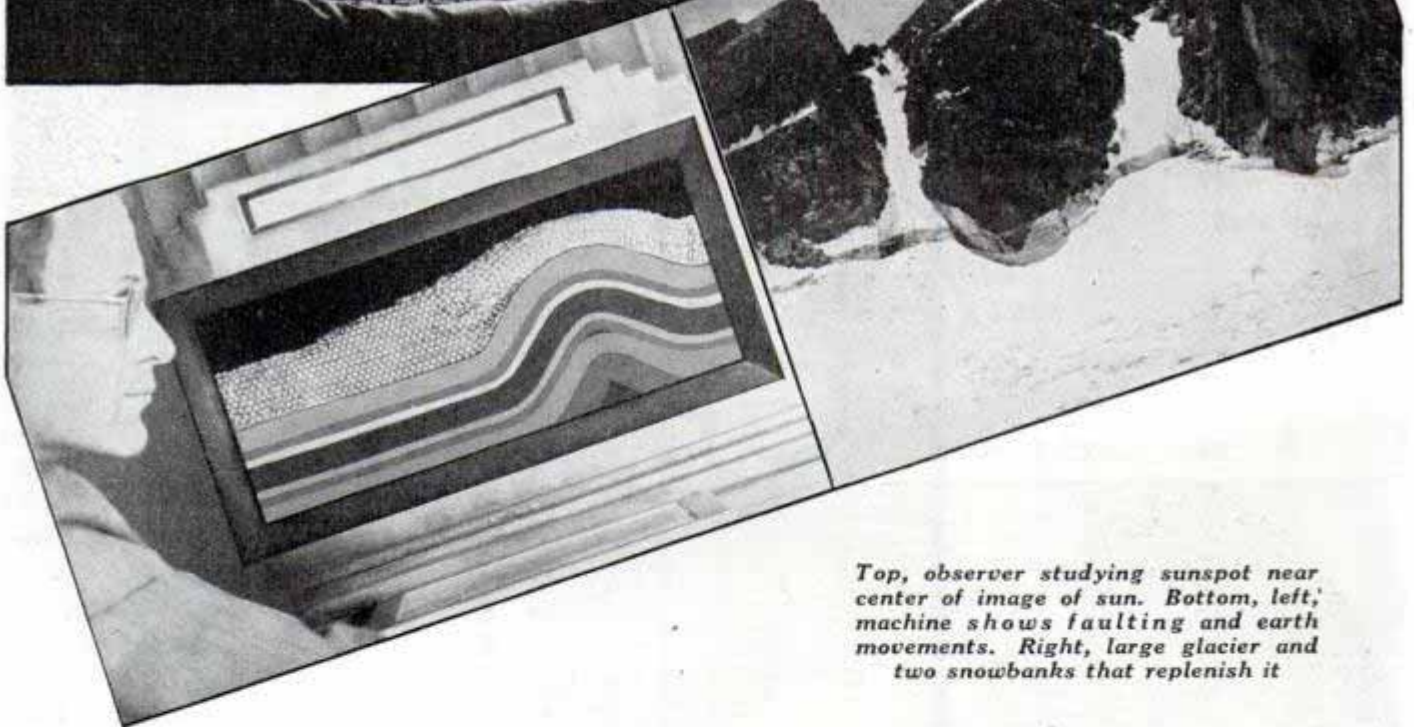

Top, observer studying sunspot near center of image of sun. Bottom, left, machine shows faulting and earth movements. Right, large glacier and two snowbanks that replenish it

temperatures the more certain are scientists that nothing is likely to happen for an extremely long time to come. Geological records indicate that long stretches of time have always elapsed between ice ages. In this sort of research a study of the past offers the best available key to the future. Interglacial stages in the past seem to have lasted at least as long as the glacial stages. The last great ice age, 25,000 years long, came to an end about 15,000 years ago. That suggests that it will be quite a while before another ice age starts, and

be comparatively free from ice, providing shorter maritime routes than those available today between centers of population. Polar lands may become useful regions and tropical vegetation may flourish as far north as the Canadian border.

In the last great ice age nearly four million square miles of North America were covered by ice sheets and the tremendous weight of this blanket deformed the earth so much that it is still springing back toward its original levels. Many current earth movements are merely adjustments

Top, left, ice column supporting big rock on surface of glacier. Right, cutaway model of earth with segment removed to show molten core and interior layers. Bottom, fossil skeleton of prehistoric American camel



following the removal of the load of ice.

Scientists who wonder about the cause of the last great ice age have come to the surprising conclusion that volcanic activity, with its heat and fire, is really the thing that touches off an ice age. Many other theories have been offered, including changes in solar radiation and distance, the passing of the solar system through nebulous material that reduces radiation from the sun, and changes in the amount of carbon dioxide in the air. The explanation is that in a great volcanic explosion quantities of almost microscopic dust are shot high into the outer atmosphere. High beyond the reach of winds and rain, the dust particles drift around the earth for several years before they settle to the surface, meanwhile materially lowering the amount of sunshine that reaches the earth.

Nearly every great volcanic explosion in history has had its effect on the world climate for a year or so. The year 1816,

(Continued to page 156A)

es 1267

Ship on Land Is a Nautical Cafe Tied to Roadside "Wharf"

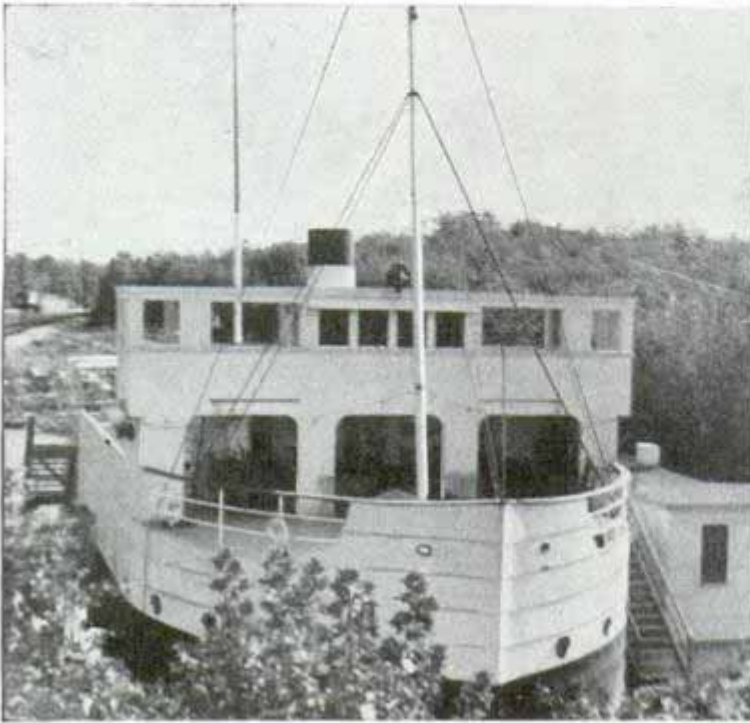

Deceivingly like a ship outside and decorated in nautical style, this roadside cafe attracts tourists in Massachusetts

Motorists near Lynnfield, Mass., are surprised to find a 108-foot ship tied up at a "wharf" on dry land at the roadside. It is a nautical cafe, built like a ship throughout, with a lounge in the bow and dining saloon in the stern. Between these rooms is the galley and the cashier's cage, called the "purser's" office. The boat is set below ground level and roped to poles along the pier, giving the impression of resting on the water. Diners enter it by a gangplank and find inside a linoleum floor bearing a map of the Atlantic ocean. There is a promenade deck with lifesavers and deck chairs, masts, bridge and funnel.

Copper-Lead Bearings Resist Wear on Hard Jobs

Reports of 20,000 hours and more of continuous service under extremely heavy-duty conditions have been made for bearings made from new special alloys of copper and lead. The bearings have been found useful where the loads are unusually great, due to considerable open throttle work and hard pulling. On one job, a Diesel-powered tractor fitted with the bearings operated on a road-grading project

for 18,000 hours without requiring adjustment or replacement of a bearing. The virtue of the copper-lead bearing is said to be its ability to stand unusual stresses without apparent wear. Marked economy results from the freedom from engine breakdowns.

Mechanical Fortune Teller Shows Aptitude for Typing

To determine a prospective stenographer's aptitude for typing, a Nebraska professor has invented a mechanical "fortune teller." While a metronome keeps time, the person undergoing the test strikes a staccato note on four keys like those of a typewriter, and a clocklike spring rolls the paper under an inked ribbon as each punch leaves the impression. A bell signals completion of 100 impressions. If the impression is true it shows a complete ring; untrue impressions are semicircles. Experience indicates that persons scoring highest are most efficient with typewriter, while those whose impressions are untrue are less likely to succeed as typists.



Testing stenographer's touch with 100 taps on keys of the mechanical "fortune teller"

Ship's Haven

Cletrac - used in Oregon

Newburyport Turnpike

Teachers College, Lincoln Neb
Univ. of Nebraska

Prof. Charles F. Jordan

Bohi Alumna and
Miss C. B. Muegan

Beacon Has Half-Billion Candlepower Beam

One of the most powerful in the world, a giant beacon exhibited at the Paris Exposition flashes a beam of one-half billion candlepower. It will be installed on the French coast at Groach d'Oues-sant to make sea lanes safer for shipping. During the exposition its glare added to the brilliancy of the illumination.

Top, attending to mechanism of giant beacon. Bottom, where the half-billion candlepower light is housed

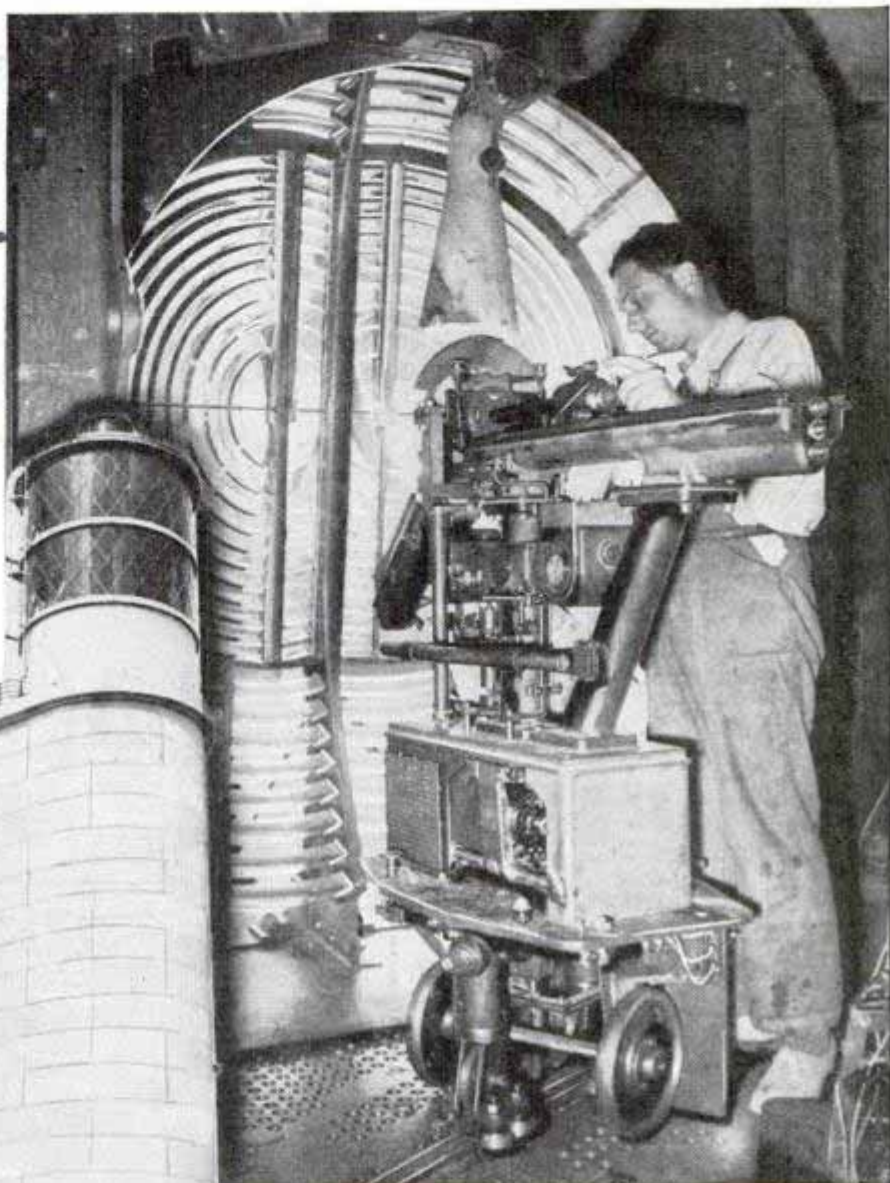

Science Service 11/4/37

Remote Meter Tells Level in Basement Fuel Tank

There is no need to run down to the basement regularly to check the oil level in your fuel tank. An electric gauge can be installed to give a remote reading of the fuel level anywhere in the house. It permits an immediate check on the quantity of oil delivered and

used, and obviates the old method of using a measuring stick. The meter calls for no maintenance or operating cost, and can be used in a tank any distance away.

on market

Our Bureau of Information will answer questions regarding articles in this magazine, if accompanied by return postage.

Higher-Test Fuel for Planes

Gasolines with anti-knock ratings in excess of 100, in the near future will reduce takeoff distance, increase power and permit use of smaller engines in airplanes, according to S. D. Heron of the Ethyl Gasoline Corporation. Aviation fuels now have an anti-knock rating of eighty-seven.

1358 42 ndy

*2013-34
Remote O. meter
C.A. Frye, Inc.
4903 N. 8th Ave
D.M.*

GAME

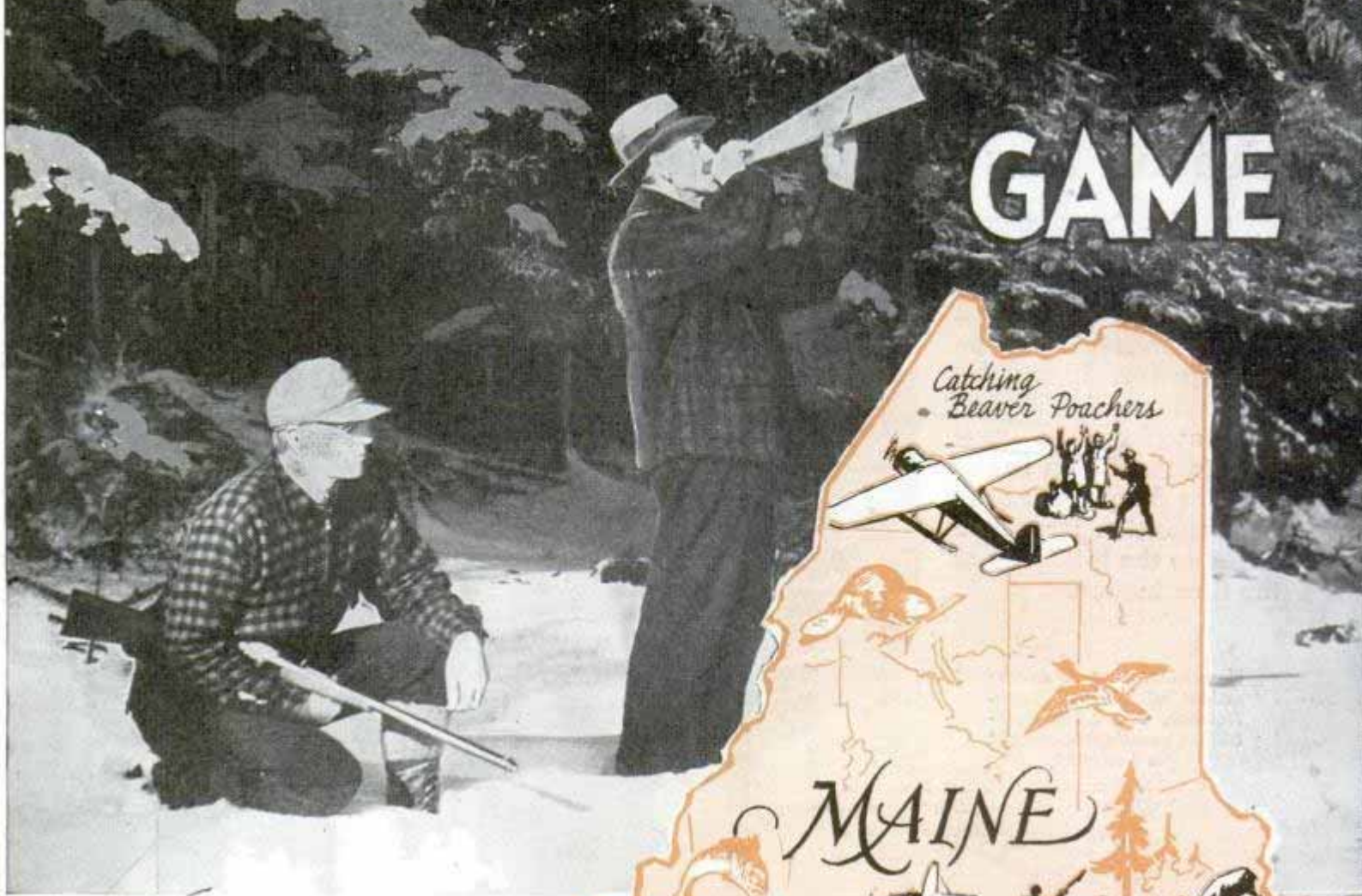

201195

By

Charles Morrow Wilson

New York N.Y.
FLYING game wardens are

patrolling the big, roadless woods of Maine, protecting wild life in an area of nine million acres. The plane helps to prevent forest fires; it enables conservation authorities to restock isolated woodland waters with fish; it provides a speedy means of moving game wardens in and out of snow-bound woods, and it is the only reliable means of saving tens of thousands of deer and moose from starving in winter.

The nation's first pilot-game warden is Ned Hutchinson of Boothbay Harbor, Me., who flies the semi-gull type plane used by the inland fish and game department. An expert on ski and pontoon landings, Hutchinson has put in more than 600 flight hours protecting the state's wild life. Though he makes ninety-five per cent of his landings and take-offs upon ice and snow or small ponds and rivers, many of which are not even mapped, he has not yet

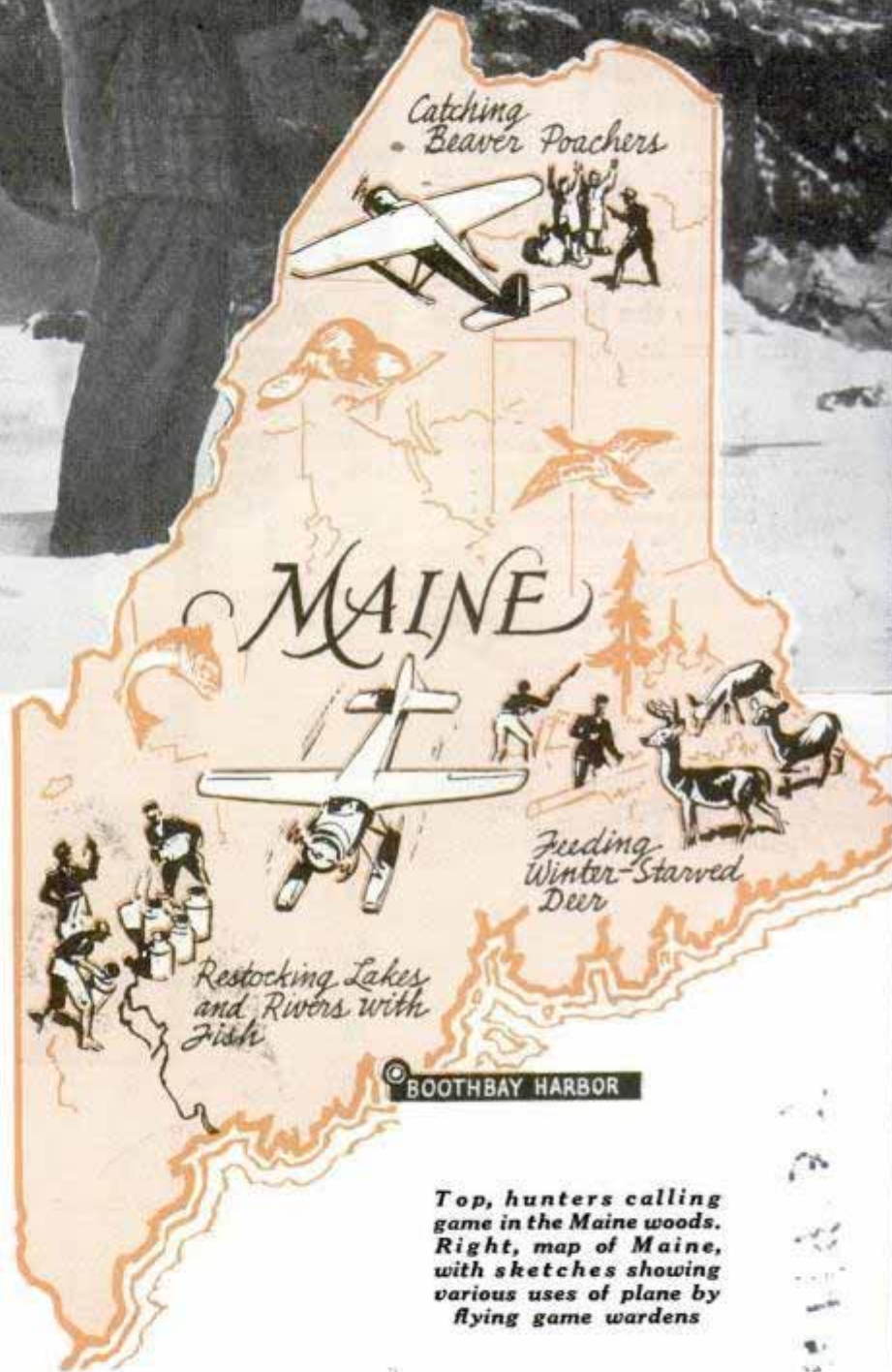

Top, hunters calling game in the Maine woods. Right, map of Maine, with sketches showing various uses of plane by flying game wardens

had a crackup. During spring, summer and early autumn he regularly uses pontoon gear to land and take off on small inland lakes or streams. In winter he uses ski gear to land on frozen ponds or open snow wastes. On duty he usually is accompanied by three fellow wardens.

Besides observation and photography, game feeding, fish stocking, and transporting fellow wardens and police, Hutchin-

WARDENS *with* WINGS



son's work includes air enforcement of game laws, detection of backwoods crime and fire, as well as criminal violation of game laws. During recent months he has made more than a dozen arrests for airplane poaching. The poachers fly over the big woods, make landings, fish out the backcountry waters without regard to legal catch limits, then fly away with the bounty.

Venison-running is a more serious form of air poaching. During fall and winter months when deer meat is in demand, the runner planes fly into the big woods, land parties of hunters who slaughter deer regardless of season,

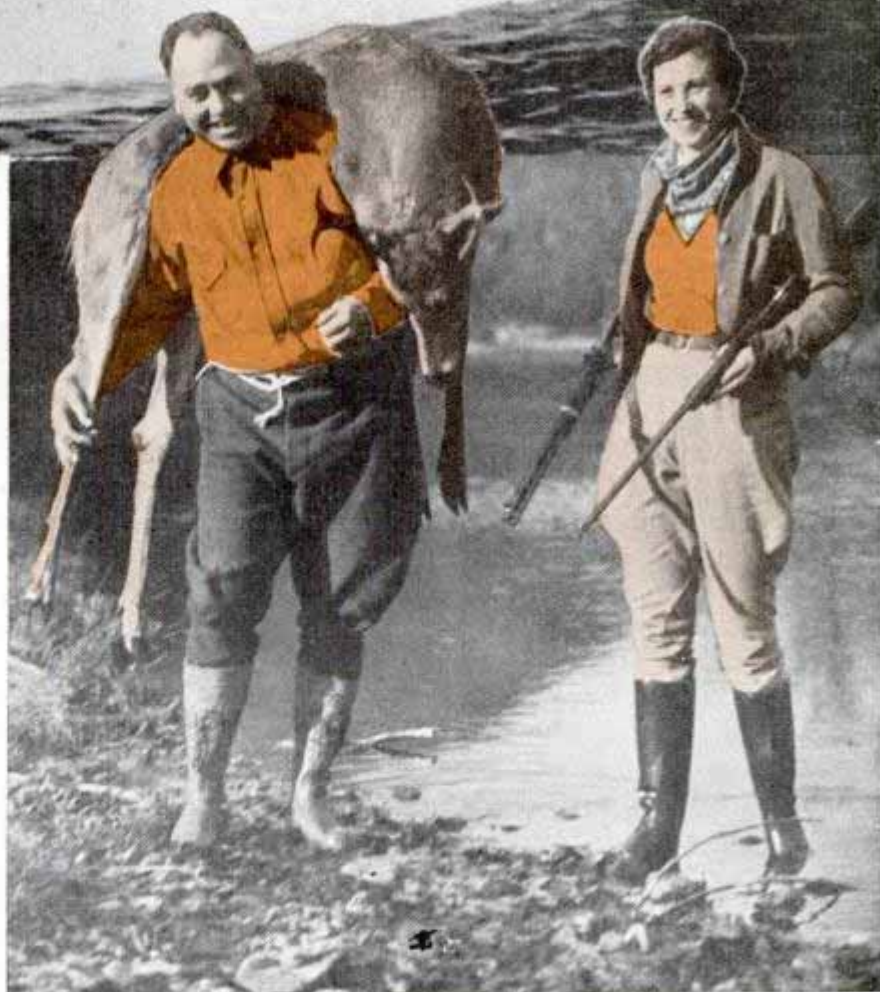

Top, Pilot-Warden Hutchinson ready to take off from backwoods pond. Bottom, reaping the rewards of systematic conservation—bringing home the result of a successful hunting trip



Top, new-style game warden depends upon a plane, instead of snowshoes and canoe, in his coverage of large areas. Right, wardens chopping feed for deer after landing from plane

age, or sex, load the most choice saddles of venison into the plane, fly it out and sell it for fancy prices to city hotels and markets. A plane cargo of 1,000 pounds of choice venison is usually worth about \$500. Recently an air crew of venison "pirates" was captured after they had run tons of venison into the Boston market.

George J. Stobie, conservation authority and Maine's commissioner of inland fish and game, began experimenting with air patrol of the big woods about three years ago. Lieut. Earl Crabb, ace of the Royal Flying Corps and pilot of the Curtis fire-patrol plane maintained by the state forestry department, began successful feeding of winter-starved moose and deer about four years ago. In 1937 Commissioner Stobie instituted the warden plane and the pilot-warden. He plans to extend the use of aviation facilities in maintaining game and fish resources which are said to bring the state at least \$35,000,000 annually.

About seventy-eight per cent of the entire area of Maine is forest land. About forty per cent of Maine is inaccessible to autos. These roadless forests are grouped in three areas. The biggest is in Piscataquis and Aroostook counties, a lake-dotted wilderness of about 5,000 square miles, where there are eighty or ninety-mile stretches of forest without a road. It is almost impossible to police such an area by land. Heretofore game wardens have traveled the wilderness by canoe in summer and on snowshoes or skis during winter. Such travel is extremely slow. During the summer months the big woods are ideal haunts and feeding grounds for game of all kinds. But during the long severe winters, when seven feet of snow is not exceptional, thousands of deer are frequently left to starve. At the beginning of winter



the animals band into herds and "pen up" in sheltered spots in the woods. For a long period the penned deer are usually able to tramp down the snow and to stay alive by eating evergreen foliage and tree bark. If the big snows persist such browse and bark eventually become eaten off as high as the deer can reach. If snows continue the deer starve. During deep-snow periods, game wardens find it impossible to patrol all important game areas afoot.

But the pens of deer are easily located from the air, particularly for a pilot who knows wintering habits of wild life. Maine's flying pilot takes several fellow wardens

es 1195

as assistants, cruises low to locate the deer pens, and stages a ski landing within walking distance of the location. Next the wardens put on snowshoes, take axes and chop quantities of evergreen trees near the captive deer, and open trails to the forage. Only a few hours of chopping can save a pen of from fifty to 100 deer from starvation. In extreme cases, feed can be dropped upon the locations from the plane.

Commissioner Stobie estimates that one plane actually doubles the winter work capacity of his force of 108 game wardens, since it more than doubles mobility of the force.

One of the most spectacular accomplishments of the warden plane was the capture of one of the most vicious teams of poachers in the state's history. For several years Maine has been making a successful effort to restore beaver in her back provinces. Late last winter when all roads were blockaded with snow a warden outpost reported that two trappers were slaughtering beavers by the hundreds. The poachers would cut a hole in the top of the beaver "house" or den, open a can of chloroform and dump it into the hole, then seal.

(Continued to page 153A)

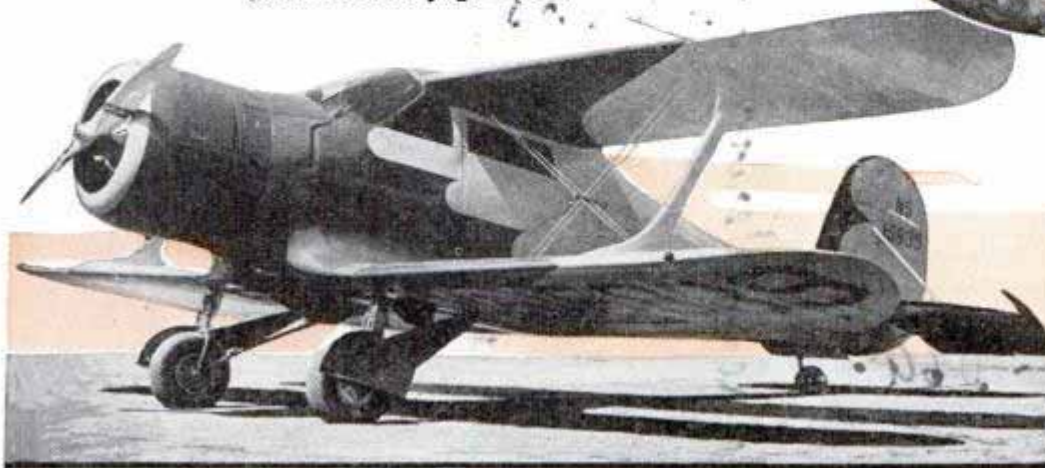

Top, since the big woods lack roads, hunters usually use canoe or snowshoes in bagging and carrying out the game. Center, insignie of game warden's plane. Bottom, plane capable of low-speed landing is most useful in game patrol work

1195

Safety School on Wheels Warns of Street Peril

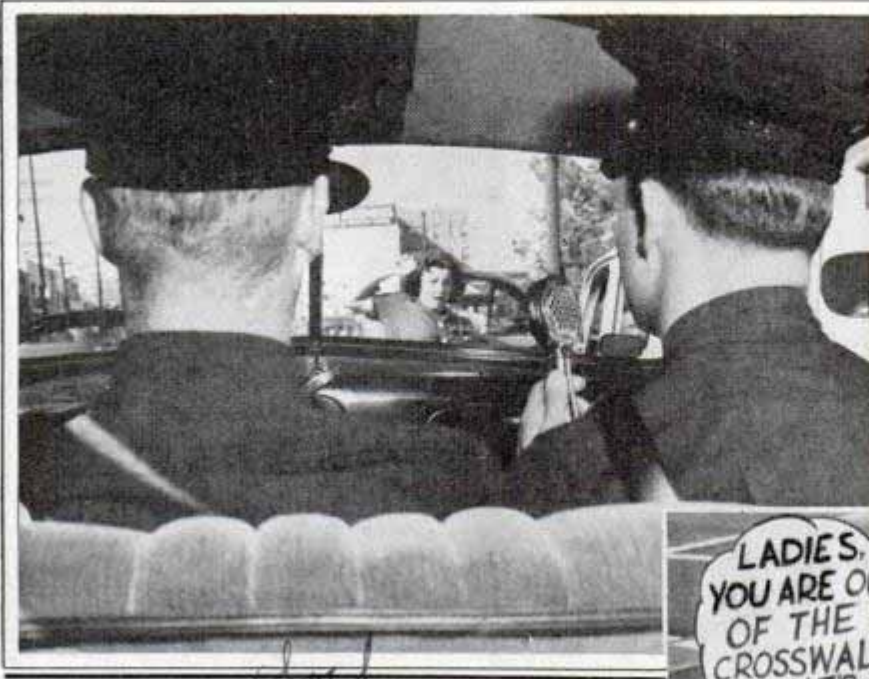

Left, a safety-squad officer, "mike" in hand, warns a young lady that it's dangerous to enter left door of her car while traffic is passing. Below, loudspeakers mounted on the safety car tell two "jaywalkers" they are breaking the law and risking their lives

Lessons in safe driving as well as safe walking are broadcast on Los Angeles streets from a traffic school on wheels. Two policemen of the safety squad tour the city in a white sedan with loudspeakers mounted above it. They watch not only for traffic violations but for carelessness on the part of motorists and pedestrians, and broadcast warnings on the spot.



es 1310

Photocell Turns on the Lights Whenever Daylight Wanes

are in catalog file

Adequate illumination in the room regardless of the time of day is assured by installing an automatic lighting control. A photoelectric relay turns on the lamps whenever natural light is not up to the level required for easy reading, and shuts off the lamps when natural light is sufficient. Thus the correct illumination value is maintained steadily and manual attention to switches is unnecessary.



CR. 7505-D69.

Our Bureau of Information will answer questions regarding articles in this magazine, if accompanied by return postage.

es 1351

New Steels Made Possible by Study of Molecules

American industry is entering a new era in the manufacture and use of tailor-made steels adapted to a wide variety of purposes and made possible by scientists studying iron molecules. Dr. John Johnston, director of research for the U. S. Steel corporation, says that control of the heating and cooling of iron and steel during manufacture so as to change the point at which iron changes from its "alpha" form to its "gamma" phase is making pos-

*General Electric Co
One River Road
New Haven, Conn.*

Price 11.45

71 Broadway

251323
 "Crystal Palace on Wheels"
 Is Railway Train of Glass

sible new types of material that can be fitted to new needs. Iron is known to exist in two forms, the alpha and gamma types. These two types, which differ in physical properties sufficiently to enable engineers to adapt them to practical use, owe their existence to different arrangements of iron atoms in the iron molecules. The change from one type to the other can be controlled by the processing which the iron receives. The emphasis on the iron and steel business today, Dr. Johnston explains, is on producing corrosion-proof metals. Stainless steel, most prominent member of the corrosion-resistant family, is valuable, among other things, because it does not rust and thin sheets can be used without fear that they will be damaged by long exposure.

21273.

Car Body Trailer Carries
 Fourteen at a Time

Fourteen automobile bodies may be transported from body factory to the assembly plant in an automatic trailer. Loading and unloading may be accomplished by driving the trailer onto rails which are electrically operated. When a button is pressed the tracks incline, permitting the bodies to slide on or off the trailer by gravity. Pressing another button closes the trailer gates.

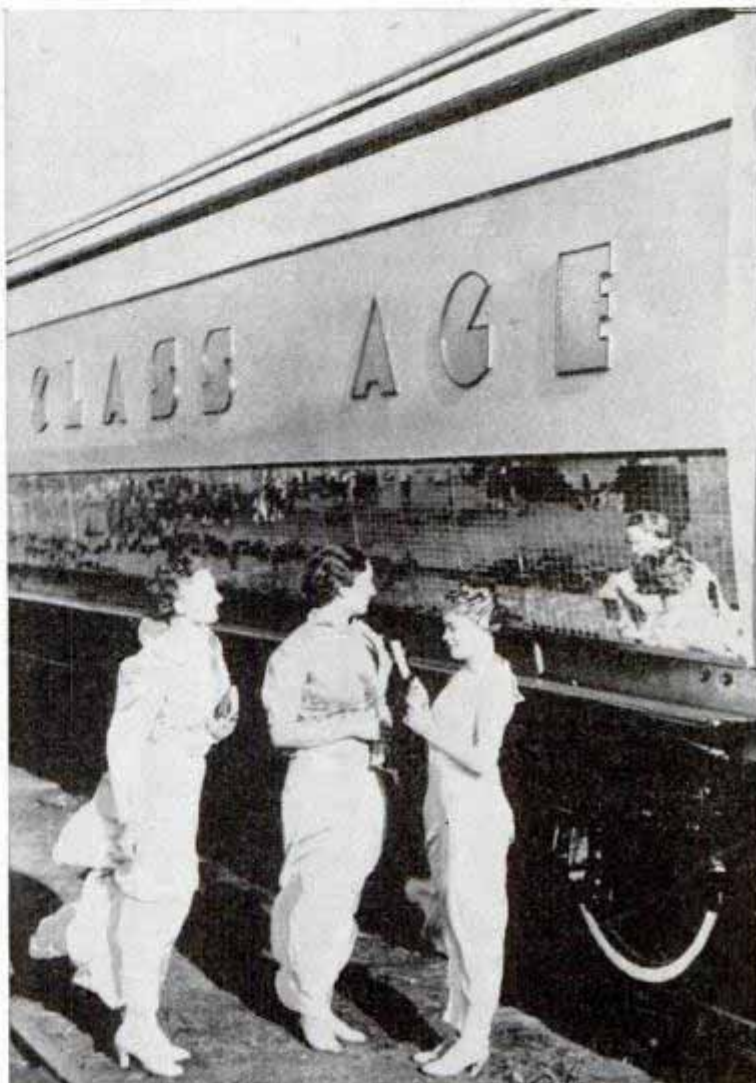

Britain's "crystal palace" railway coach is covered with mirrors. The train is a traveling exhibition of new uses of glass

To dramatize the "age of glass," a British railway train has been built of glass wherever glass could be used, and is on an exhibition tour of England.

The sides of one coach are covered with mirrors, the interiors are furnished with glass and inside are exhibits of the new uses and new types of glass. The train is a real "crystal palace on wheels."

ⒸBrazil, second in area only to Canada among the nations of the western hemisphere, is large enough to accommodate the United States and an extra Texas.

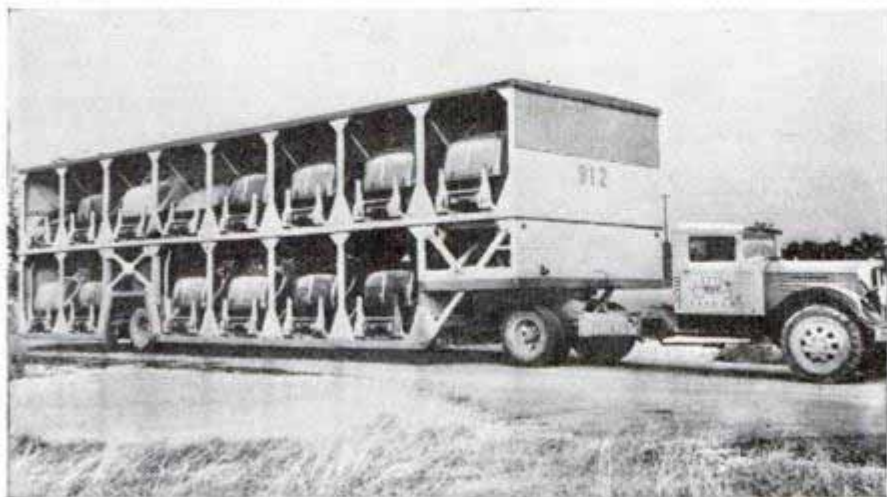

Faster transportation of bodies to auto assembly plant is made possible by this giant trailer which carries fourteen at a time

Mechanical Handling Systems due 4600 12
 Esographue news Bulletin 11/12/37

F1289 Capt. James Mc Guirey
9 & 45 th St., Kansas City, Mo

The FLYING WING



Building the first all-metal transport designed by the author. This is the Lockheed Electra, famed for its speed. Here we see workmen busy on wing and nose

By Hall L. Hibbard

Chief Engineer, Lockheed Aircraft Corporation

TOMORROW'S airplane—a giant flying wing without fuselage or cabin, carrying payloads of 150 passengers and tons of baggage.

Judging from present developments and trends in aircraft design, it is our belief that such is a rough sketch of the commercial transport that will be flying the sky trails within a decade or so. Of stainless-steel construction, it will be almost twice the size of any plane now under construction with a gross weight of 150,000 pounds and having a tip-to-tip wing spread of 300 feet. For power, it will use six 2,500-horsepower motors, so arranged that the mechanics may work on them during flight.

Travelers will ride inside the giant wing, which will be equipped with individual

staterooms, recreational facilities and a promenade deck. Curved windows will be placed in the leading edge of the wing, in the ceiling and parts of the floor. To complete the picture, the tricycle landing gear will be used to land the big transports.

The speed with which these flying wings will travel is difficult to predict. Because we have learned that size has little bearing on speed, 500 miles an hour is not improbable, if certain problems regarding altitude flying can be answered satisfactorily. Speed costs money. The faster a plane travels the more fuel used and the greater the depreciation on equipment, all of which means higher operating costs.

The prediction of such radical changes will not meet with the favor of those who

Electronics, Inc. Bristol, Pa.

of the

211789
FUTURE

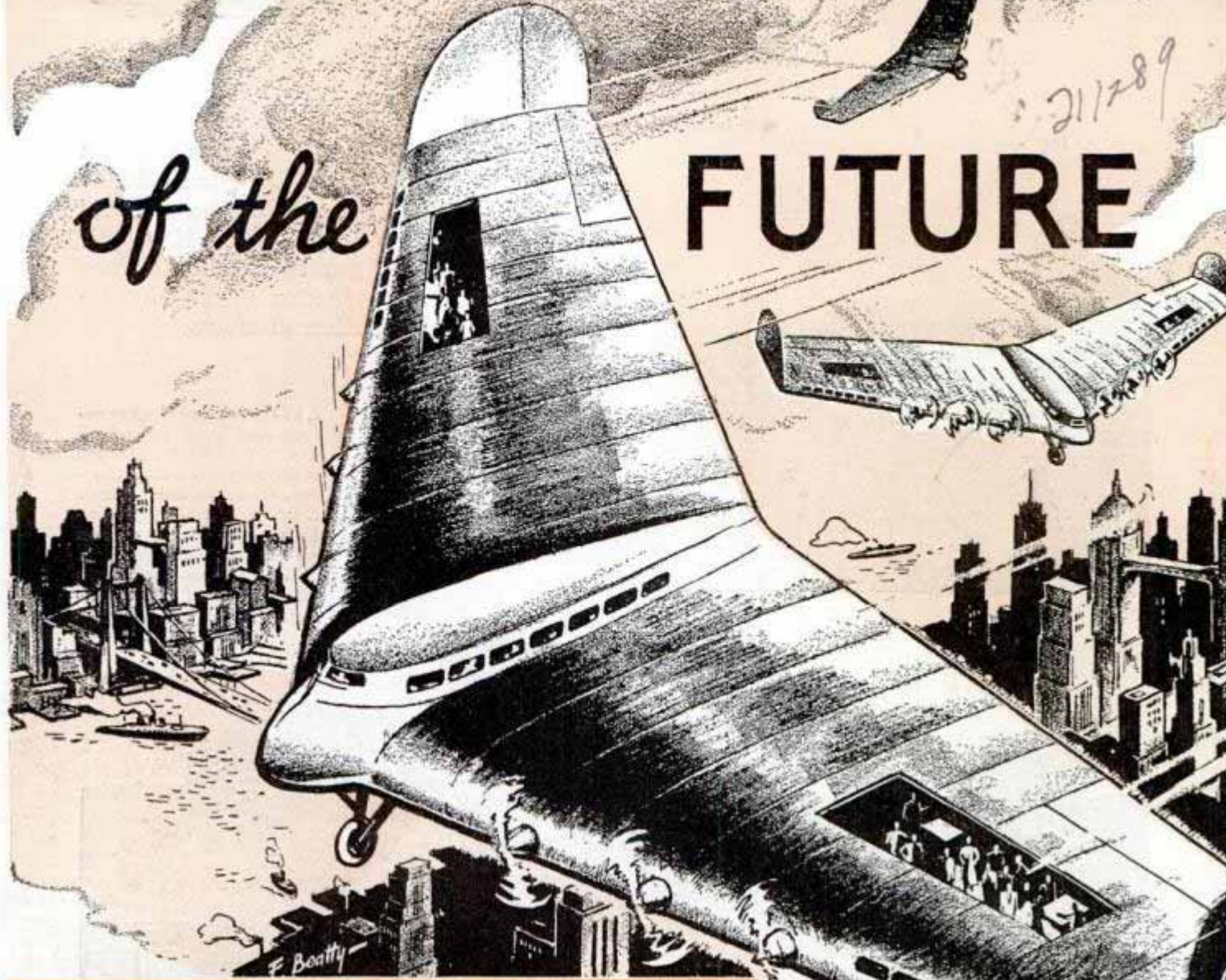

Top, drawing of the "flying wing" envisioned by the author. Left, static load test of a new Lockheed. Plane is inverted and sandbags weighing far in excess of any weight the plane will carry are placed on the wings

flying wing is not beyond the range of future possibility, we need only to compare one of the earlier planes with a modern transport.

feel the ultimate in aeronautical development has been reached. But aircraft designers are not hidebound by precedent or production methods. They have a way of looking beyond the artificial limitations of their tools and in so doing make possible the "impossible." For evidence that the

In efforts to improve aircraft, engineers and technicians have sought to eliminate useless, dragging elements. Struts, braces, and guy wires have disappeared. On the big ships, the next important step is removal of the fuselage. And with it will go the tail, lateral and vertical control being attained through

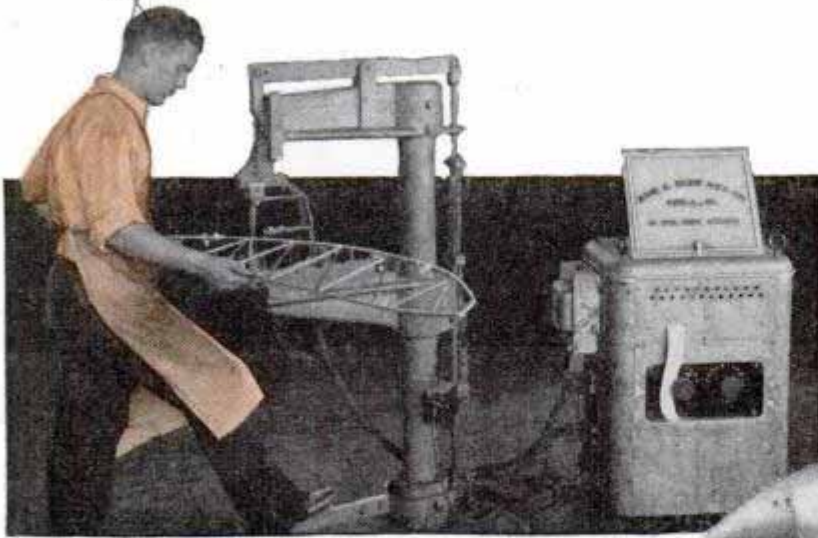

weight in a plane the size of a flying wing. Another advantage would be that a new method of fabricating this metal makes possible a further reduction in drag by the elimination of rivets.

Left, shot-weld apparatus, and tape on which are recorded the heat units in each weld. Center, stainless steel plane. Bottom, gigantic hydraulic metal-forming press at the Lockheed factory. This 175-ton machine stamps out parts formerly made by hand

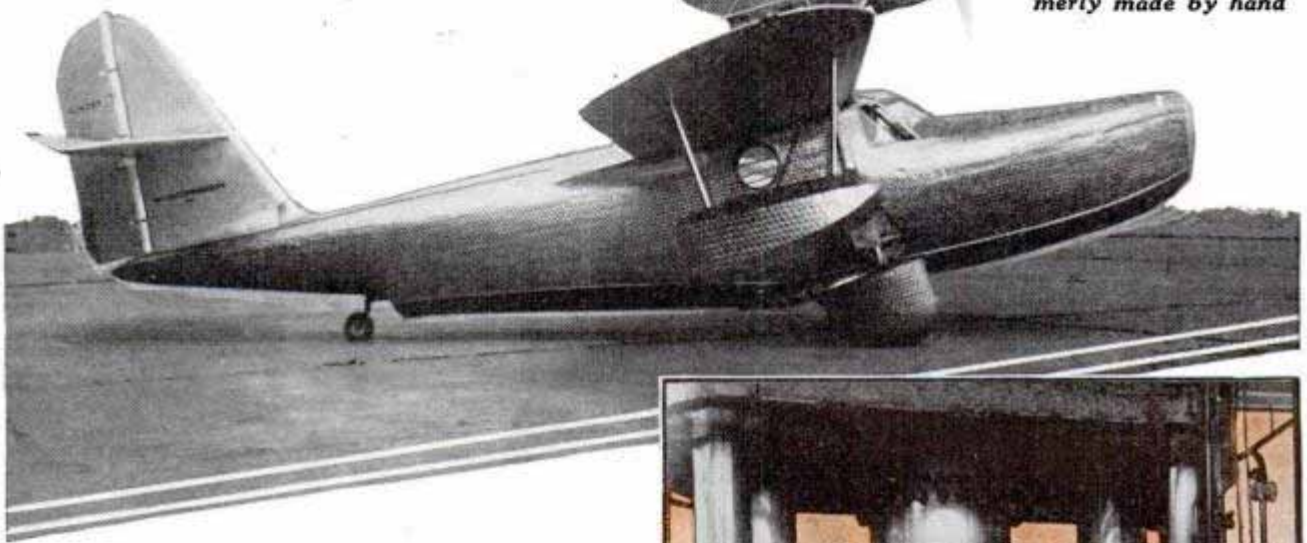

wing-tip fins and wing ailerons. If the size of this future plane seems a bit wild-eyed, consider present developments within the industry. It is no secret that transports are growing larger and larger. There is one plane under construction so big it cannot be assembled within the walls of one of our most modern factories. The building of great supercharged planes operating at 30,000 feet at cruising speeds of 250 miles per hour with flying ranges of between 3,000 and 4,000 miles is tea-time conversation among builders.

The next ten years should see stainless steel come into its own as an aircraft metal. Already aviation's spotlight is being focused upon its structural possibilities with the completion of the first all stainless-steel plane built for commercial purposes. Apart from its non-corrosive quality, stainless steel has much to recommend it. Although heavier than dural, its high tensile characteristics would be the means of saving considerable structural

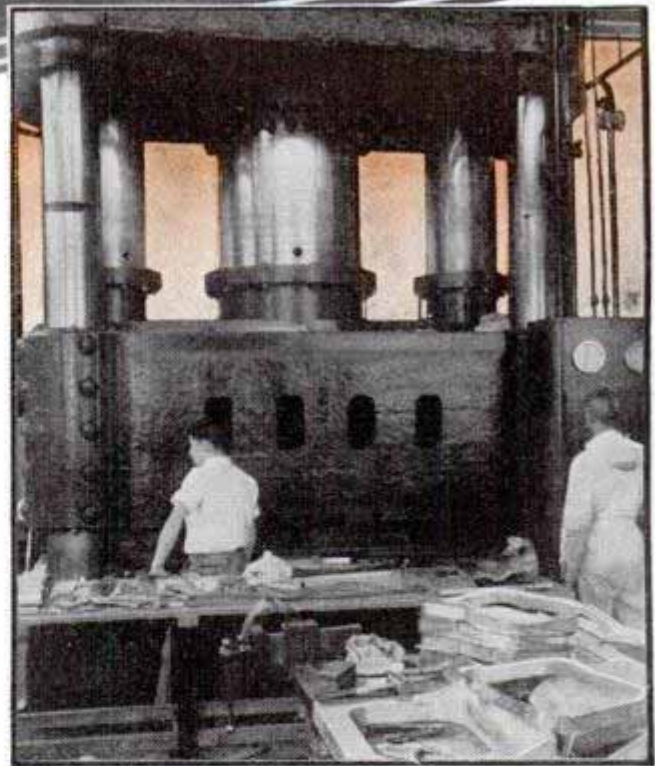

Stainless steel is more costly than other metals of this character but this is not an important obstacle. When the alloy was first introduced into the commercial field, it was selling for seventy-five cents a pound. It was substituted for a metal cost-

ing but four cents a pound. This cost was offset in other ways, however, particularly in the railroad streamliners, and increased production of the metal has made it considerably cheaper.

When stainless steel was first considered for airplane structures, engineers found it couldn't be handled in the manner of spruce, dural or high-tensile steel. This alloy attains its maximum resistance to corrosion by a special heat treatment. When cooled, it has ten times the electrical resistance of ordinary steel, is very ductile, and capable of being drastically cold worked. It was found, however, that any subsequent heating of the metal weakened its resistance to corrosion and impaired its general utility.

Because of this, ordinary welding methods were out of the question, so Col. E. J. W. Ragsdale, chief engineer at Budd Manufacturing company, developed what is known as "shot-welding." This consists of fusing together two separate sheets of metal by passing through them an electric current and generating heat through the resistance offered by the metal to the current. In principle, this is virtually the same as the light-bulb filament except here the current is not strong enough to fuse the filament. Because of the metal's high electrical resistance, the heating time is made so short that the alloy's stainless properties are not affected.

Time is not an essential factor of heat. Lightning has some excellent short-time melting jobs to its credit and some "shot welds" have been consistently made in .0001 second. Thus, a weld consistent with the high-tensile characteristic of the metal was developed. Engineer Ragsdale did not stop there, however. He made his fabricating methods virtually foolproof by designing a mechanism which accurately gauges and records the strength of every weld made or failed. On a tape is written the heat units entering into each weld and also giving notice of any variation.

The aircraft industry in this country has been built around the use of aluminum and its alloys, while in Europe, carbon steel is favored. These are both subject to corrosion. While mindful of the advantages of stainless steel, there is need for a comprehensive study of this metal in terms of modern aircraft requirements.

201121

Mail-Carrying Buoy Floats Ashore from Ship



Acme
Mail-carrying buoy which floated ashore from ship with letters to be forwarded

W.H. Leiby
When a passing tanker wished to send mail ashore on the Atlantic coast recently, a neatly constructed buoy containing eighteen letters was tossed overboard. The buoy was picked up six miles off shore at Miami, Fla., and the letters forwarded.

201341

Film Viewer Magnifies Image Bringing Out Sharp Detail

Miniature photo negatives can be inspected with a magnifying viewer which brings out the picture distinctly, considerably enlarged yet with clear detail. It takes the place of an enlarger for inspection purposes. The viewer has a notching punch to mark any negative frame for enlarging.



Send return postage to our Bureau of Information to learn the name of the maker of any device described in this magazine.

Capt. Thomas Chey-Tham
 Miami
 American Car
 Miami
 Miami

Dancing Dolls on a Wheel Exercise the Eyes



Steadying her head with chin rest, patient exercises eyes by watching antics of toys as wheel revolves

"Setting up exercises" for weak eyes are administered by a wheel resembling a carnival attraction with dancing dolls and toy animals. The eye muscles are strengthened as the patient watches the antics of the figures while the wheel spins. The chin rest keeps the head still and makes the eyes do the work.

Nail for Concrete or Metal Made by Secret Process

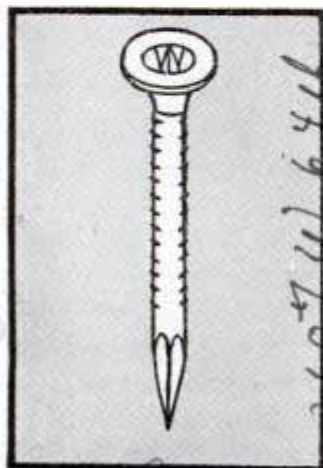

Tempered by a secret process, a nail with a soft core and a hard shell is available for concrete and metal work. Driven one-half inch into hard concrete, the nail requires a pressure of several hundred pounds to free it. Driven into

cast iron or cast steel, the nail usually breaks before it can be extricated. It has many uses. Metal lathers employ it in various sizes for nailing corner beads and metal channels and carpenters use it to nail carpet strips, sleepers, furring strips to concrete floors, ceilings and brickwork. Roofers and tanners use the nail to fasten metal flashing and roofing materials to concrete and bricks. Plumbers, electricians, sign painters and outdoor advertisers also find it useful.

Dog Rides on Bicycle Carrier at Master's Top Speed

Apparently enjoying the ride as much as his master, a Minnesota dog sits on the carrier of the bicycle while his master does



Where his master pedals the dog goes too, secure on the bicycle carrier

the pedaling. The dog leaps on and off the carrier without help. No matter what the speed, the animal never falls off. To make the ride easier, the carrier has padding.

Sky Trips at Five-Mile Height in Faster Ships Due Soon

Within eighteen months you may be able to board a 250-mile-an-hour sky liner in this country and ride in its sealed and supercharged cabin comfortably at 25,000 feet above the earth. The pioneering has been done to the satisfaction of the engineers, and most of the air lines are satisfied that supercharged motors and super-

Handwritten notes:
A. M. Henry
Akron Ohio
es 1293
es 1290
es 1326
Photo from Akron Times Press
W. O. I. Products Co.
3607 W. 64th
W. O. I. Conveying has 1 to
4018 W. 64th St

charged cabins can operate safely and efficiently at the high altitudes where weather is clear ninety-five per cent of the time. Stepping up the cruising speed from the current 190 miles an hour to 235 or 250 will enable the air lines to trim trans-continental time from seventeen to fourteen hours or less westbound and from fifteen and one-half hours eastbound to twelve hours.

Ship with Front-Drive Turbines Causes Fewer Waves in Canals

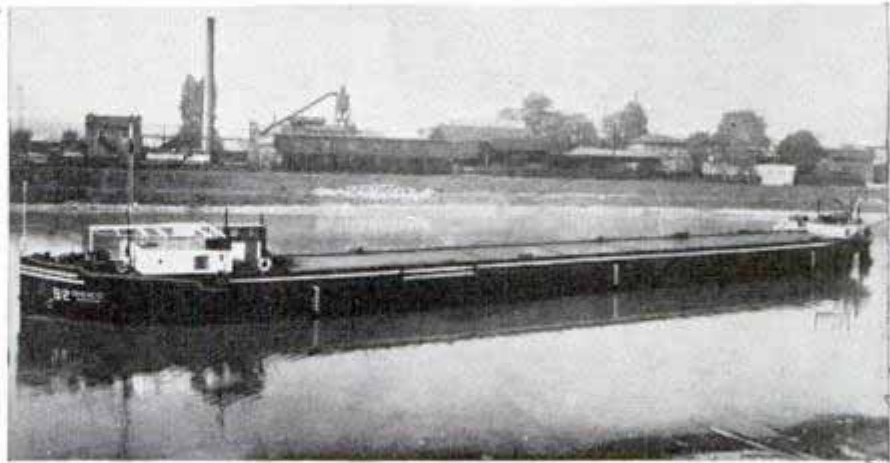

Top, latest watercraft designed for canals and small rivers. Bottom, front drive causes less disturbance of water than stern drive

School Stop Sign Changeable to Suit Traffic

Designed for use at schools where motor and pedestrian traffic hazards vary with the hour, a new traffic sign does double duty. It can be changed at danger hours from a "caution" to a "stop" sign by unlocking the back of the sign, shifting the caution and stop flaps by adjusting a movable back bar and replacing the lock. The flaps are mounted on hinges near the side corners of the octagonal-shaped sign.

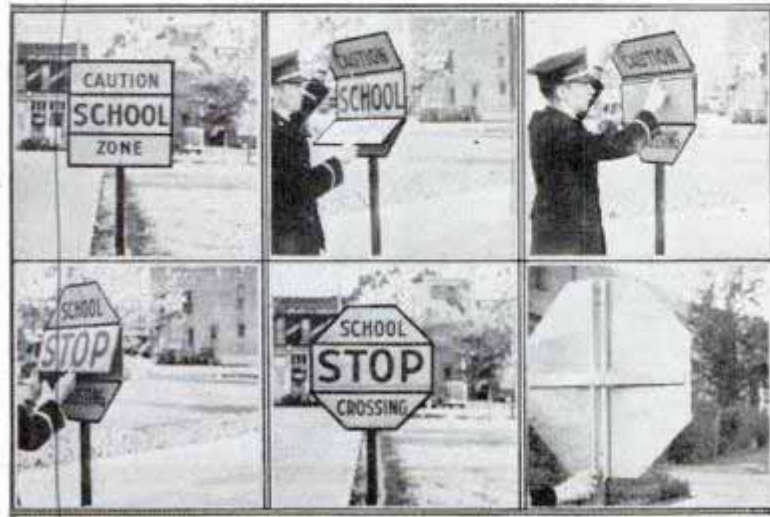

Several steps in changing caution sign to stop sign at school crossing. Changeable panels make this possible

Claimed to be the first steamship equipped with front-drive turbines, a German craft recently completed creates fewer waves than conventional ships. The turbines, installed at the bow instead of the stern, disturb the water very little, even at a speed of eight miles an hour. This feature is of particular value when the craft passes through canals or along small rivers on which light boats might be upset by the waves from the churning, stern-mounted propeller.

Whenever you find that you wish to know more about any article in this magazine, write our Bureau of Information, inclosing return postage.

by Lieut. Richard O. Bennett
Police Dept.

German
 Photo
 ad. manhattan
 N. York

es 11 79.

Refer to Fibrous Industries, Inc.
37th floor Bankers Bldg
Chicago

NEW

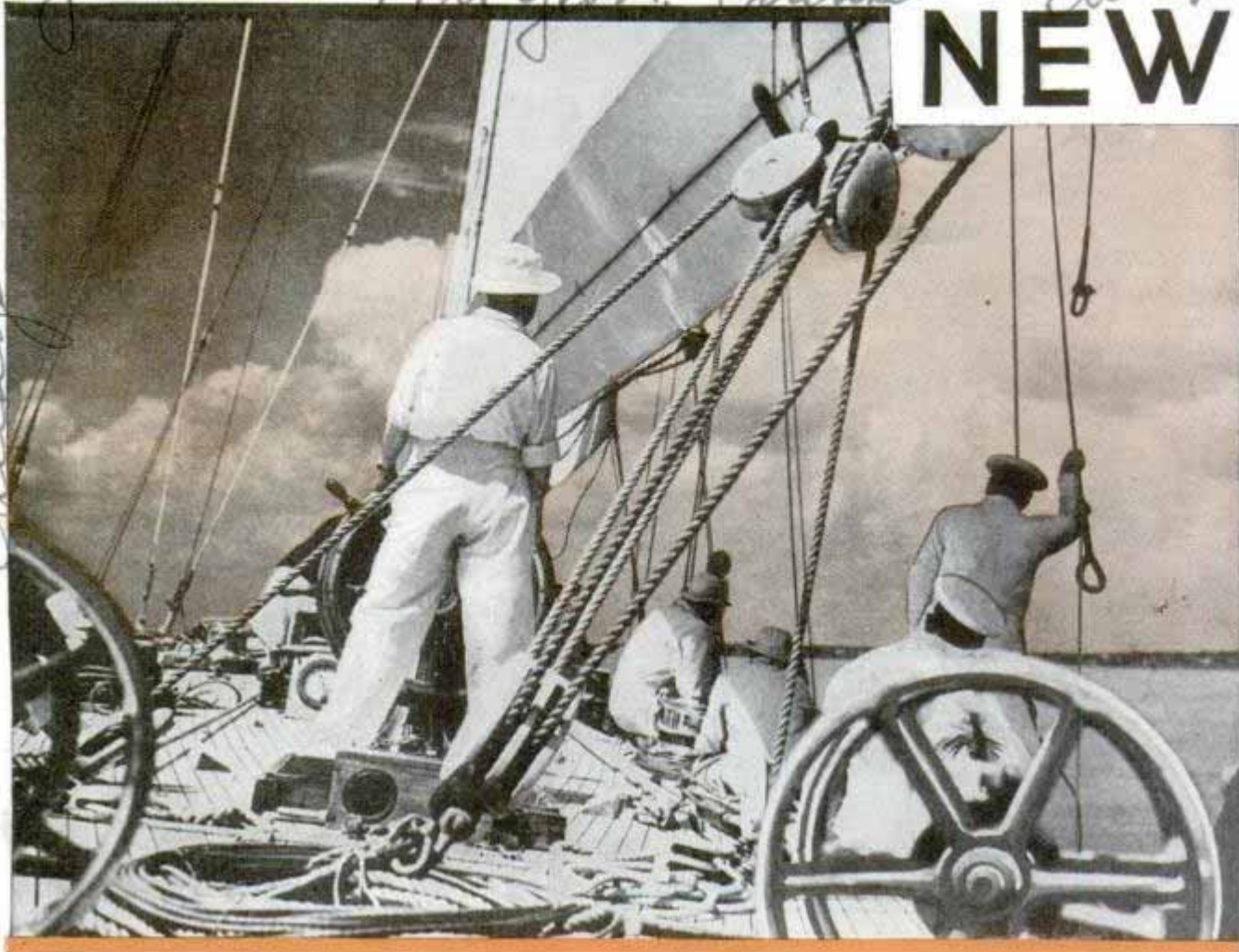

World Fiber Corp | 150 N La Salle St, Chicago

AMERICAN farmers are promised a new cash crop with an annual value of several hundred million dollars, all because a machine has been invented which solves a problem more than 6,000 years old. It is hemp, a crop that will not compete with other American products. Instead, it will displace imports of raw material and manufactured products produced by underpaid coolie and peasant labor and it will provide thousands of jobs for American workers throughout the land.

The machine which makes this possible is designed for removing the fiber-bearing cortex from the rest of the stalk, making hemp fiber available for use without a prohibitive amount of human labor.

Hemp is the standard fiber of the world. It has great tensile strength and durability. It is used to produce more than 5,000 textile products, ranging from rope to fine laces, and the woody "hurds" remaining

after the fiber has been removed contain more than seventy-seven per cent cellulose, and can be used to produce more than 25,000 products, ranging from dynamite to Cellophane.

Machines now in service in Texas, Illinois, Minnesota and other states are producing fiber at a manufacturing cost of half a cent a pound, and are finding a profitable market for the rest of the stalk. Machine operators are making a good profit in com-



Top, sailing the seas with sails and rope made of hemp. Bottom, hemp fiber being delivered from machine ready for baling. Pile of pulverized hurds beside machine is seventy-seven per cent cellulose

BILLION-DOLLAR CROP

petition with coolie-produced foreign fiber while paying farmers fifteen dollars a ton for hemp as it comes from the field.

From the farmers' point of view, hemp is an easy crop to grow and will yield from three to six tons per acre on any land that will grow corn, wheat, or oats. It has a short growing season, so that it can be planted after other crops are in. It can be grown in any state of the union. The long roots penetrate and break the soil to leave it in perfect condition for the next year's crop. The dense shock of leaves, eight to twelve feet above the ground, chokes out weeds. Two successive crops are enough to reclaim land that has been abandoned because of Canadian thistles or quack grass.

Under old methods, hemp

(Continued to page 144A)



Top, modern version of linen duster made from hemp. Bottom, harvesting hemp with a grain binder. Hemp grows luxuriously in Texas

Human Sailboats Try Racing in Outdoor Swimming Pool



All canvas set, the human sailboats get away for a race across the swimming pool. Some of them are sneaking a few kicks to help the wind

Human yacht races are the latest sports fad at Arrowhead Springs, Calif. The swimmer, face up, wears a stout belt to which a mast is attached, and manipulates the sail. From the picture, you may guess that a bit of kicking may help win human sailboat races on a calm day!

Children in a Cincinnati school learn music by moving little portable notes into position as they hear a tune played on a piano. This method trains both the ear and eye, and the teachers say it is an effective way of interesting and teaching the child music.

Pupils Learn Music by Moving Notes on Table

On a long table ruled for a musical score, chil-



Moving notes on table as they hear music played, children are trained to hear and read music quickly

Plastic Metal for Medical Casts Has Low Melting Point

With a melting point slightly above that of the human body, a newly developed metal lends itself to use in making medical casts, thus supplanting plaster of paris. It can be worked with the hands at a temperature no higher than that of hot water used for washing. Then it becomes solid metal at ordinary temperatures. The metal is indium, a soft white element, combined with Lipowitz's alloy, consisting of bismuth, lead, tin and cadmium. The metal, consisting of eighteen per cent indi-

Compressed Air Mag. Vol 42 No 8

15/11/90

Journal of the Franklin Institute

Cincinnati, Ohio

'Shotproof' Destroyer Flies 310 Miles an Hour

*Boversky Corp., Farmingdale
Lt New York*

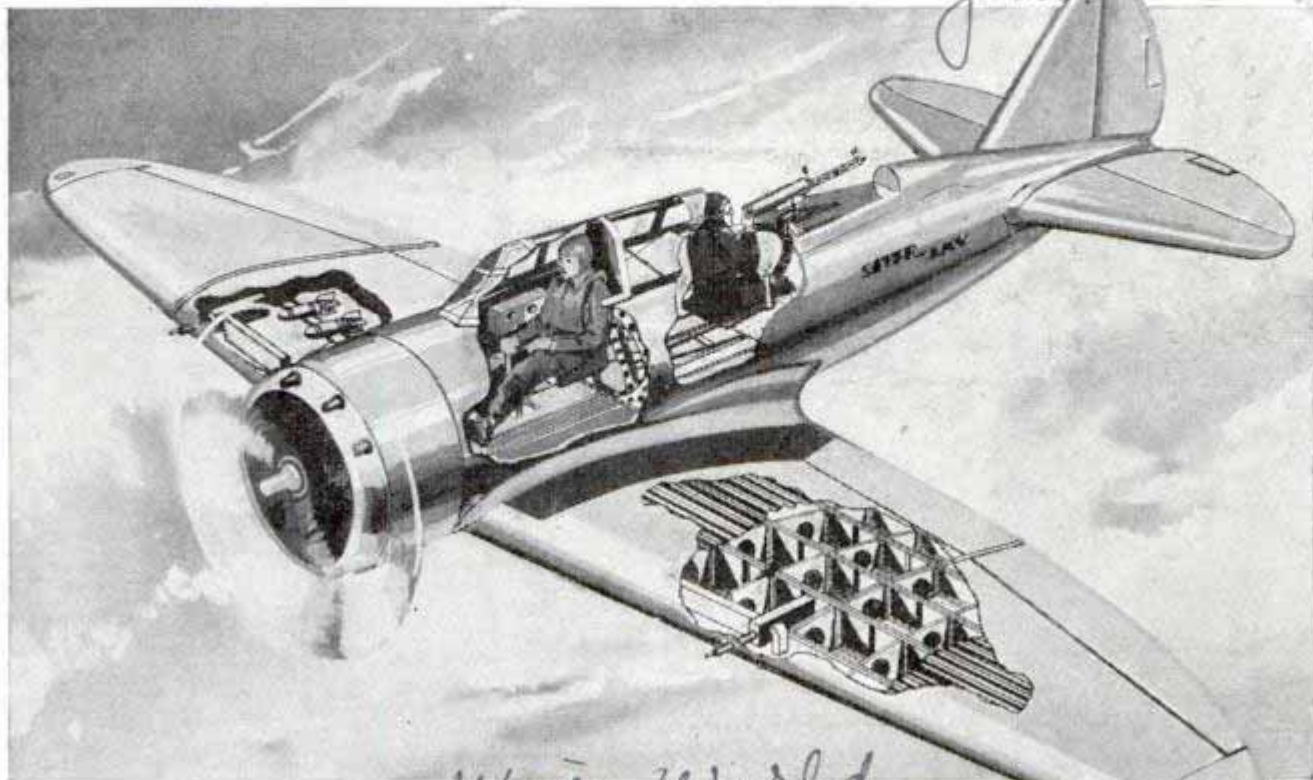

Wide World.

Notice the guns in front of pilot and in leading edge of wings. Cutaway sections show "cellular" construction of wings, and bombs carried in racks underneath

Sky destroyers that fly five miles a minute are ready for the next war in the air. A two-seat fighter with "bulletproof" wings and a 1,200-horsepower engine capable of 310 miles an hour has just been completed in an American factory. Six fifty-caliber machine guns are mounted in front of the ship, and a gunner in the rear cockpit maneuvers a flexible thirty-caliber machine gun. Six hundred pounds of

aerial demolition bombs carried in racks under the wings make this speedy craft one of the deadliest weapons in the sky. It is almost impregnable, for besides its terrific speed it has a wing construction that all but defies destruction. The interior of the wings consists of multiple spars and beams, and the wings could be riddled with bullets without affecting flight. The destroyer has a 3,000-mile cruising range.

"Big Apple" Used as Ballroom in Kansas Fruit Region

ls 1196

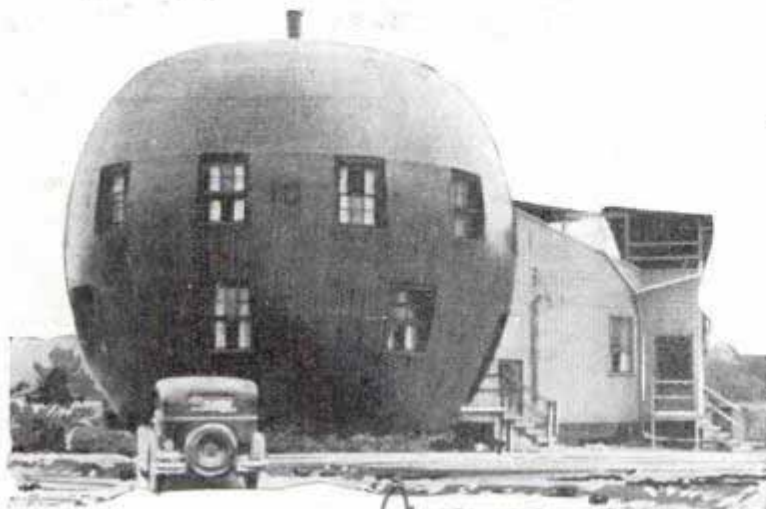

Acme

Long before the "Big Apple" became the popular dance from down south, "The Big Apple" was a ballroom and cafe in Kansas. It is a two-story building with the shape of an apple, its stem used as a chimney. The resort is in the apple orchard region near Wathena, Kans.

#534 Wild Bird Nesting

(Nesting materials by the box, bits of yarn to scatter in the yard as an encouragement to wild birds, are offered by an eastern mill.

*Hoffman Seed hulls Co
534 101 Broadway*

*Pat Bell
Bell Aircraft Corporation*

Reference for...

Es 10 21

10 55 5 Holman Ave
Los Angeles Calif

ADVENTURES of the

Reference for sea material - Capt. Chris Christianism, 20th Century Fox Studios, Los Angeles Calif



MOST sea captains dodge storms when they get advance warning of them, but in Hollywood a good storm is worth thousands of dollars and the studios often send ships far to sea in search of them. The director calls in a marine expert and issues sailing directions.

"Get me 10,000 feet of heavy weather," he orders. "I don't care if you have to go as far away as Alaska or down to the Canal, but get me a real hurricane. I want to see a ship staggering along in a gale with waves sweeping over her decks and some of her canvas carried away."

Orders like that are tough to fill. A movie windjammer may have to cruise thousands of miles before the right weather conditions are found. A powerful radio receiver is tuned constantly to the weather reports and at the first hint of rough weather the ship heads for it. Often when

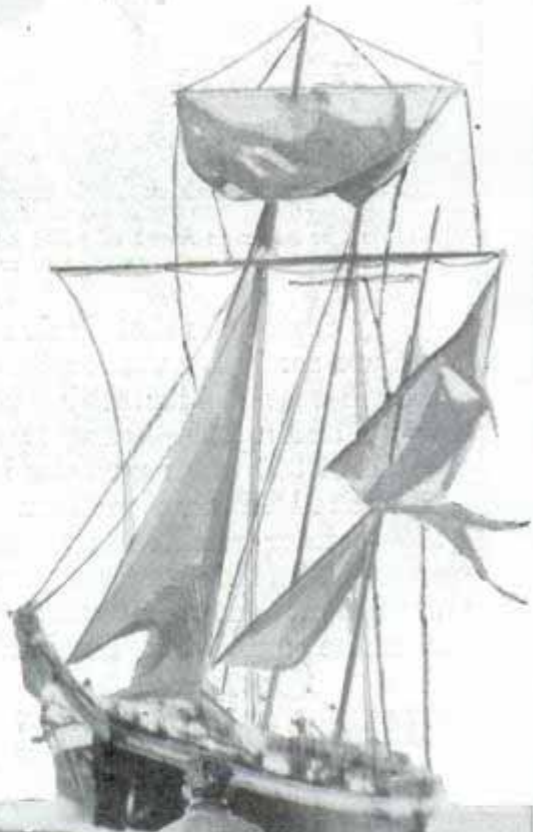

Top, stunt men preparing to rehearse diving from high in ship's rigging. Bottom, Paramount crew on tug filming ship in storm. Note the tattered sails



Is 1031
information. Robert Bruce,
Paramount Pictures Corp. 5451 Marathon
Los Angeles

•• HURRICANE HUNTERS ••

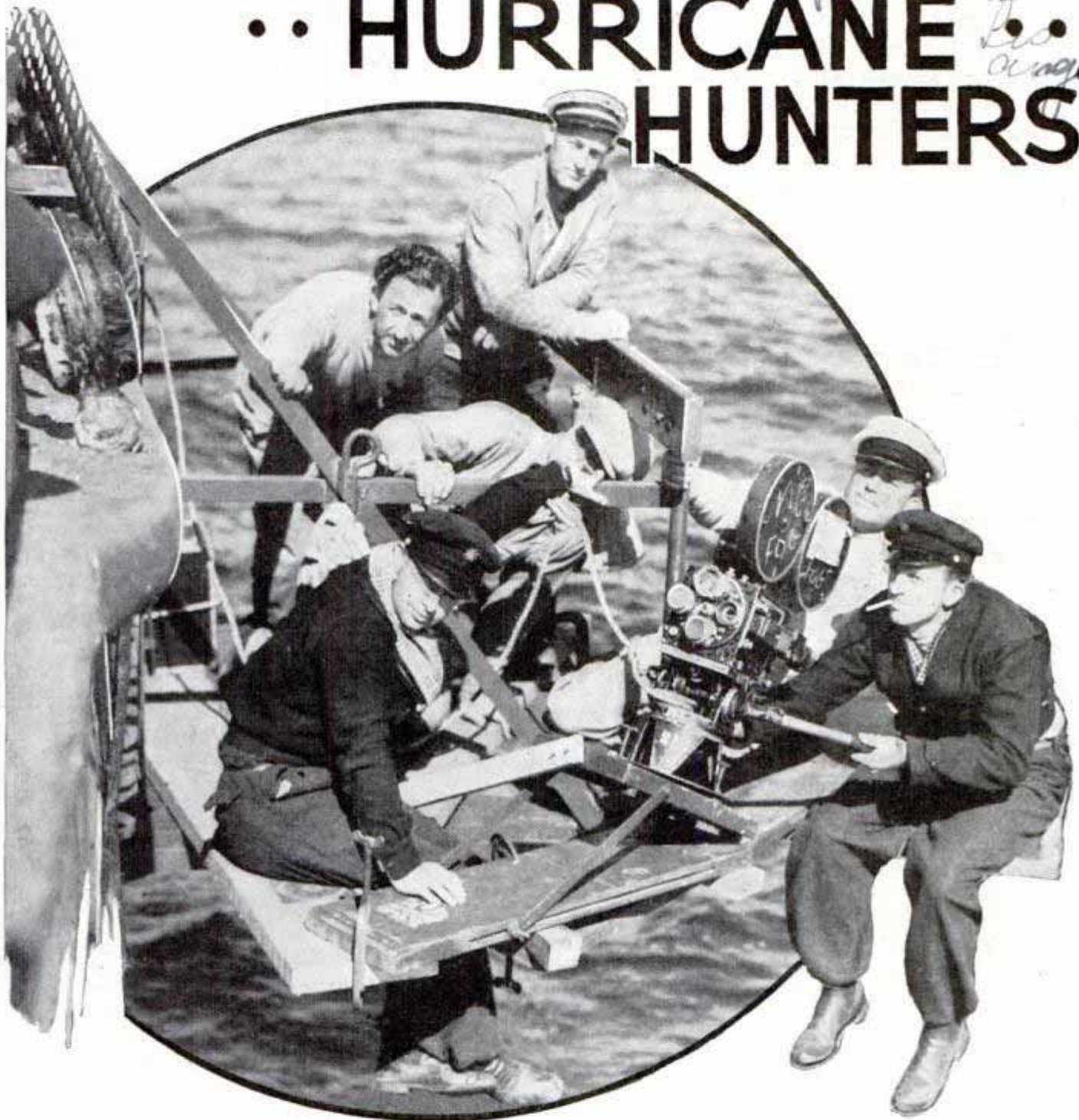

Twentieth Century-Fox camera crew suspended on scaffolding outside hull of sailing ship to get pictures of waves smashing against the bow

the ship reaches the storm area the weather is too rough and the movie men have to wait. The heaviest storms are too hard to catch on film because there is little or no light. An ideal condition is high waves and a high wind with practically no clouds.

Sailing a movie ship is a queer business and for lots of professional sailors one cruise is enough. It takes skill to handle a full-rigged ship with as many as eighteen sails, and in the movies a ship may have to be sailed in ways no experienced sailor

would dream, just to get the right motion or lighting angles. Men have been lost overboard, lifeboats lost, vessels have been capsized and the masts sailed out of others while making pictures but the Hollywood sailors take it all in their stride.

The camera crews live the hardest lives of all. For an angle shot the cameramen may be sent to the masthead ninety feet in the air. With the ship heeled over until there is nothing but blue water below them and with the masts swinging back and

forth in a twenty-five-foot arc, the cameramen practically hang on by their teeth while training their heavy equipment down toward deck.

If the director wants a close-up of the ship plunging into heavy seas, the camera crew is sent out on a platform built out off one bow and then the sails are trimmed so that the ship smashes heavily into the waves. The men rig up storm cloths to protect their camera and batteries and hang on. For distance shots the cameramen go out on an ocean tug or a smaller camera boat. The heavy camera is chained to the deck and some-



Top, movie ship rounding Catalina Island. Center, Goldwyn crew making fish-spearing scene in South Seas. Bottom, realistic picture of sinking ship made in Paramount tank



times life lines must be rigged so that the men can keep their feet.

"Hunting elusive hurricanes is not the only trouble we have," says Capt. "Chris" Christianson of Twentieth Century-Fox. "In making scenes for a period picture, using possibly an 1812 frigate, we have to find a lonely piece of ocean where fishing boats or big modern steamers won't spoil the effect by sailing across the background. If the scene is supposed to be far at sea we have to guard against catching a near-by shore. Porpoises and seals playing around the boats must be scared away, and sea gulls diving past the front of the camera have ruined many shots.

"In the old days when calm weather was holding



Center photo © Samuel Goldwyn

Movie 'American'

Es 16.31



back his schedule a director often had his ship towed backward by a tug outside of camera range so that the sails would fill. A trick like that is too easy to detect nowadays. The technical language, the position that an actor takes at the wheel, and the way actors and stunt men climb the rigging all have to be authentic."

The ocean is the last place in the world for making good pictures of a realistic storm. Scenes like the sinking of a ship, or the carrying away of rigging have to be made on solid ground right inside the studio walls. In a real hurricane, to take pictures of a slanting deck with waves sweeping over the actors, might mean that half the cast would be drowned and the camera with all its film lost overboard. When Paramount wanted to show a close-up of the sinking of a ship in "Souls at Sea" the studio built a full-sized replica of part of the ship in a huge tank on its lot, and mounted the ship on gigantic hydraulic jacks so that it would rock with the waves or list realistically as it went down.

The storm scenes in Samuel Goldwyn's "Hurricane" were manufactured the same way. Six twelve-cylinder wind machines,

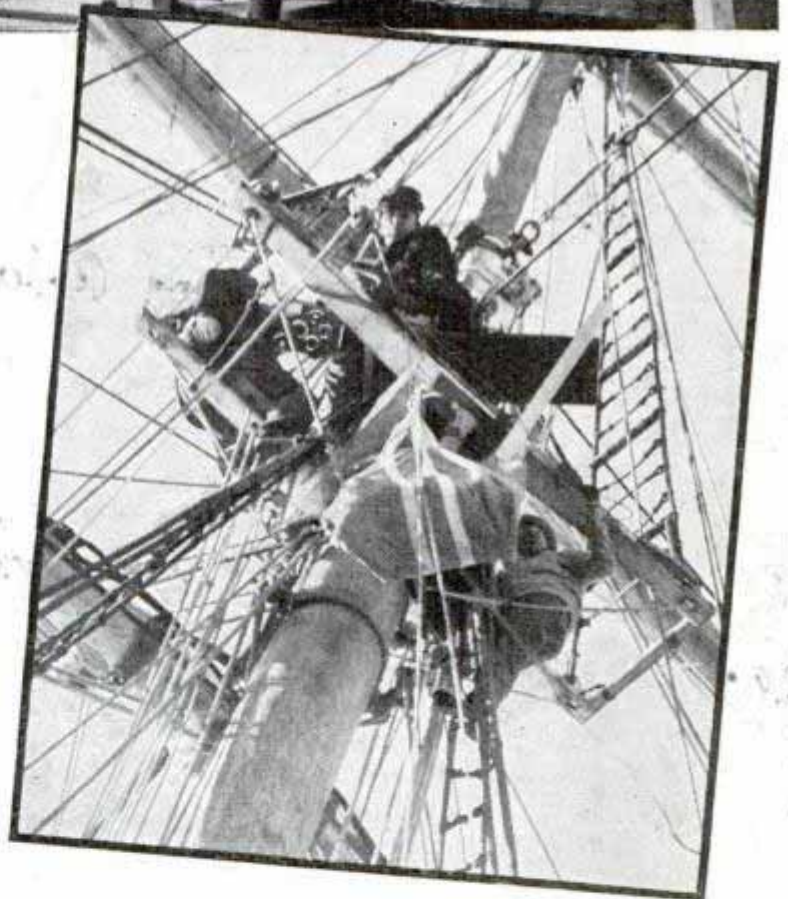

Top, full-sized ship built inside studio walls to get close-up pictures of action on deck. Bottom, Twentieth Century-Fox cameramen strapped in rigging to shoot scene on ship's deck

hundreds of tons of water cascading down sixty-five-foot inclines, dense clouds of swirling sulphur smoke, and flying debris that was thrown in front of the wind machines at just the right times, combined to make a hurricane far more impressive than

(Continued to page 124A)

Man Faster Than Prize Horse in 120-Yard Hurdles Contest

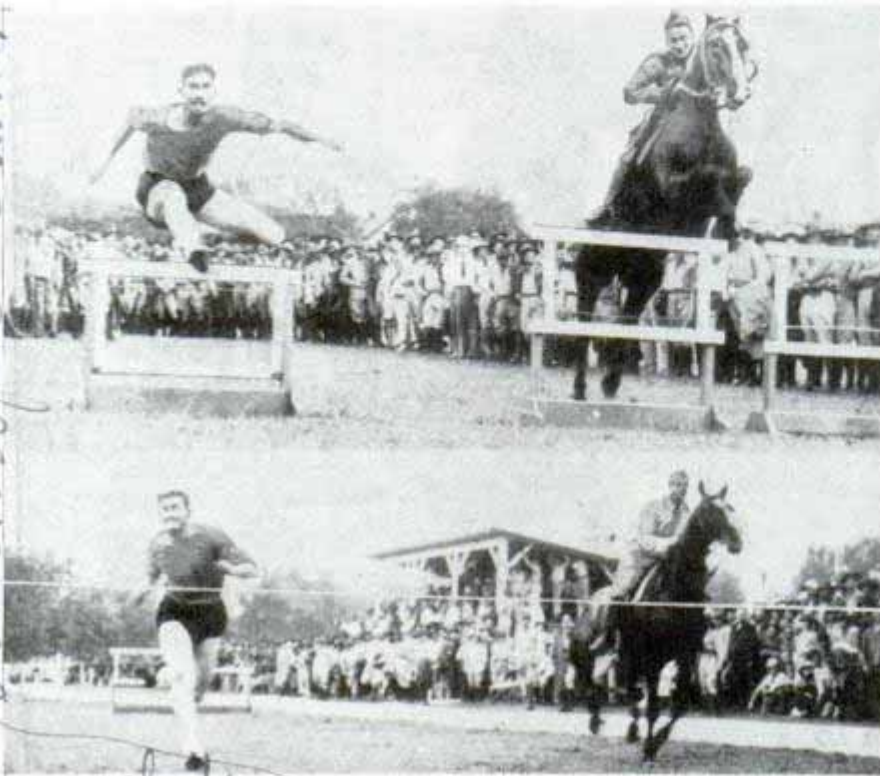

Top, start of the unusual race, with the man and the horse going over the first hurdle. Bottom, the finish—and the man wins

In an odd race between a man and a horse recently, the man won. He was Forest Towns, Olympic hurdle champion, and he outran a prize jumping cavalry horse in a 120-yard hurdles race. Towns covered the distance in thirteen seconds, getting a big lead before the horse could get under way. Once he started, however, the horse gained rapidly and Towns' margin of victory was only about two feet.

Auto's Weight Cut Half by Modern Metals

Discovery of new metals and new alloys in the last quarter century have enabled automobile manufacturers to build cars which would have weighed twice as much if constructed of materials available in 1910. Alloyed steel began to be used by car makers about 1907 and quickly gained recognition as a material for production of better, lighter-in-weight automobiles. Today one manufacturer uses fifty kinds of steel, each treated so that it may perform a certain function in the

finished car. Typical of the modern automobiles is an American car which has about 1,900 pounds of steel in its makeup, 350 pounds of cast gray iron and thirty-five pounds of cast malleable iron. This same car has seventy pounds of rubber, fifty pounds of glass, slightly more than thirty pounds each of copper and lead, about fifteen pounds of zinc and the same of manganese. Aluminum, tin, chromium, antimony, nickel and cadmium are used in smaller amounts.

Shock from Electric Eel Makes Neon Lamp Blink

There was plenty of life in the sea-going "battery" that arrived at a Los Angeles aquarium recently. Fresh from its native South American marsh, an electric eel was harnessed to a wire circuit and promptly emitted a shock that lighted a neon night lamp.



Electric eel just in from South America sets a neon lamp winking like a harbor buoy with its intermittent shocks

Entered at Ford Agletthorpe, Inc. Forest, Spec. Jando.

Es 129

S.A. & Journal, Nov. 1937

Walter Wood
Fredrich Krause

W. A. S. P. Co. & Pittsburgh

Automatic Board Scores Baseball or Football

Convertible for keeping score in baseball or football, an automatic board erected recently in the Chicago National League park is operated by pressing buttons. By proper manipulation, the board posts umpires' decisions in letters and numbers visible from all the stands and indicates, by numbers, the player at bat, the count in balls and strikes and the number of



Top, manipulating control board which changes numbers on large scoreboard shown in bottom photo. The score keeper simply presses buttons to make the changes as game progresses

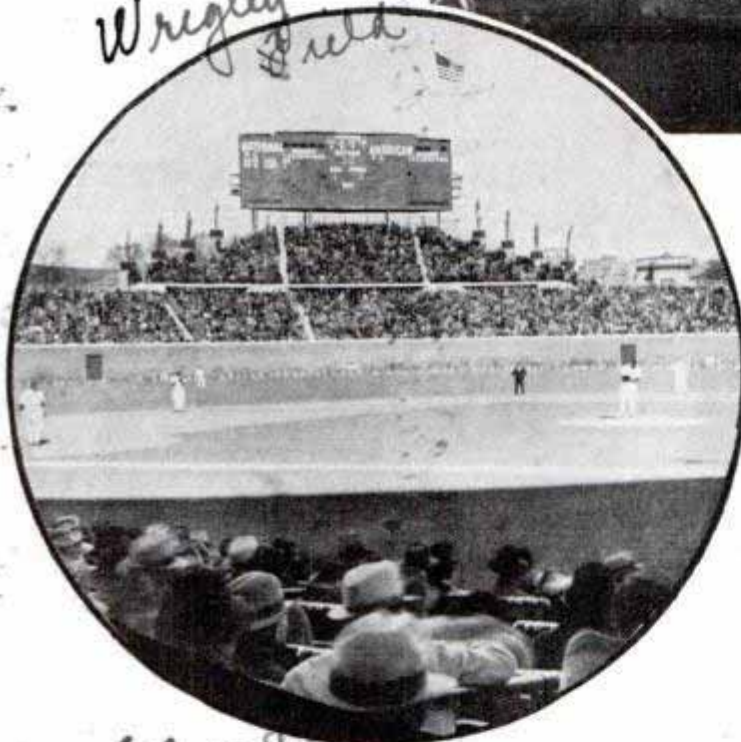

outs. An additional panel, to be used next season, will show hits and errors on each play. Changing the wording over the various panels and adding an extra panel adapts the board to football scoring. It shows the team in possession of the ball, the quarter, down and number of yards to go. Action of the board is electromechanical. The numbers are posted by solenoids, controlled by relays.

Vacuum Cleaner for Your Pipe Washes Inside of Stem

Now there is a special vacuum cleaner for pipe smokers. Not the dirt-collecting type that cleans your rugs, but a liquid cleaner that washes the crust of tar and sediment from the pipestem. It consists of a small retort into which the cleaning fluid is placed with a dropper. The retort is then connected with a rubber tube to the stem of the pipe and held over a flame until the liquid boils up into the pipe, creating a vacuum in the retort. When removed from the flame the liquid returns to the retort. The process is repeated until the liquid is black with dirt removed from the pipe.



Cleaning fluid inserted in retort with medicine dropper boils up into pipe when heated

Stern Dept. Co. 1108 S. Wetland Blvd.

Photographer's Folding Ladder Is Mounted on a Light Truck

Service on viaducts.



Two views of ladder used by photographer. Above, ladder folded for passing under viaducts. Right, taking picture of large area from ladder top

Enabling the photographer to eliminate foreground in taking pictures of large areas, a folding ladder mounted on a truck saves the work of climbing trees and the expense of going up in planes. The ladder is thirty feet long. It folds on the truck to facilitate travel under low wires and bridges.

Horn and Whistle Wake Driver Quicker Than a Red Light

Motorists listen better than they look in responding to traffic signals, it was found in a test of 700 drivers at Indiana University. An automobile horn aroused quicker reaction in applying the brake than did a red light. In the safe driving test, the motorist sat with his foot pressing the accelerator half way down, and the time required to shift the foot to the brake and push it all the way down when signaled by

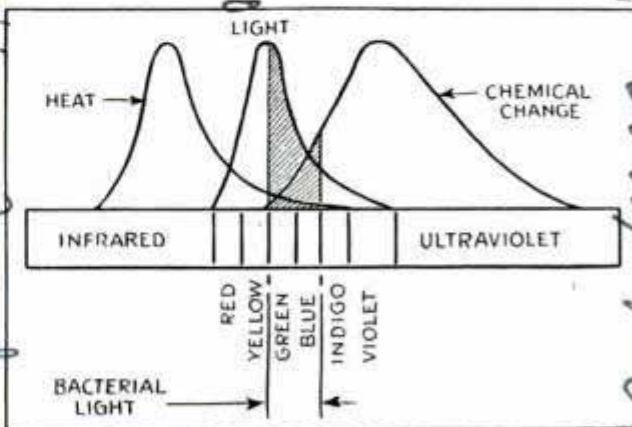

Drawing shows how greenish light rays of bacteria in decayed wood fall in "cold" section of spectrum

a red light or a horn was measured. Ears averaged one-hundredth of a second faster than eyes in reaction time for the whole group. However, for individuals, the fastest braking time with the red light was three-tenths of a second; with the horn a little more than two-fifths of a second.

Bacteria in Decayed Wood Glow with "Cold Light"

Photographs and spectrum studies of "fox fire," the weird greenish luminescence seen on fungi and decaying wood at night, show that it is the "cold light" of bacteria. These bacteria are luminous for only a short period of their life span. Some forms of life use energy in motion or in generating heat; rarer forms use energy in developing electricity or light. The light visible to the human eye falls between the red and violet of the spectrum; heat waves fall largely in the infrared section, and rays causing chemical changes are found in the ultra-

Tests made by my friend Prof. C. M. Louttit.

Chicago Star & News 1/15/37
Journal of Franklin
180:5:34 etc.
Dr. George W. Howard

Blomington

violet side. All these waves vary in their effectiveness; the human eye is most sensitive to light in the yellow-green band. Scientists have found that the bacterial light of fox fire is in the spectral area having the maximum sensitivity to the human eye, and the minimum of heat value, thus classifying it as "cold light."

Boys' Model Home Is Complete to Car, Garage

Built to one-third scale, a model house constructed by the boys of the National School of Crayford, Kent, England, is complete, even to a small garage and automobile. The car is barely large enough for one of the boys to squeeze into it. Both house and garage are complete even to small details, reflecting the boys' skill in craftsmanship.



© Planet News, Ltd.

This Lilliputian house and garage were built by schoolboys. The models are constructed to one-third scale. Note the midget car

Drummer's Job Seems Easy Until You See What He Plays

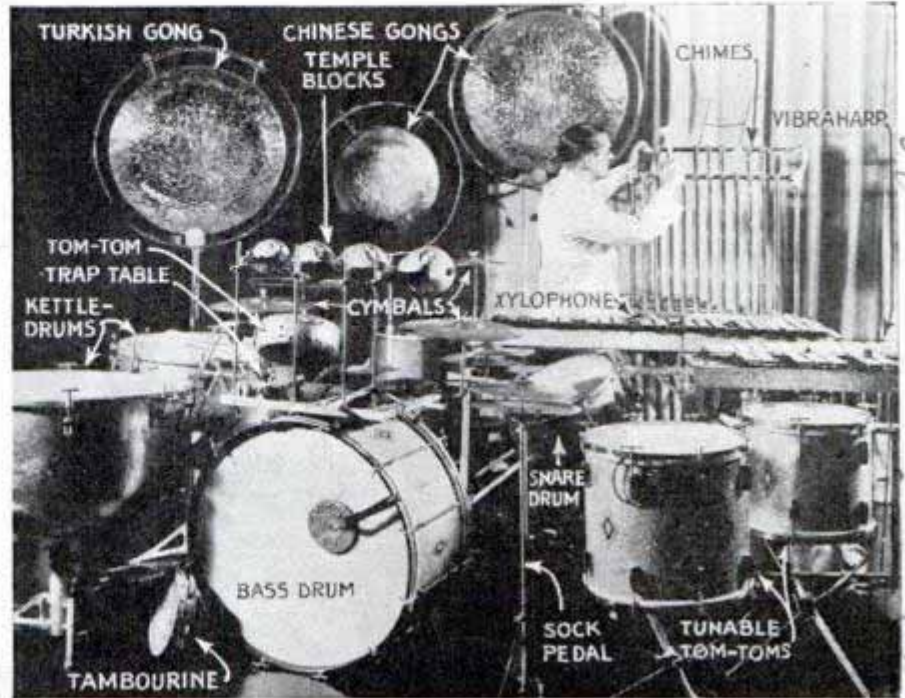

How would you like to "caddy" for the drummer in a radio orchestra? If he had to practice at home he would need a moving van

There was a time when a drummer was a drummer, and there his responsibility stopped. But consider the modern drummer of the radio orchestra and the dance band! He has branched out into sidelines so numerous that Roy Graham of the WGN concert orchestra, standing in the midst of his instruments, looks like a one-man band. His equipment

is protected by an insurance policy for \$5,000. Besides the kettle and snare and bass drums of various sizes and pitches, Graham keeps busy handling the various tomtoms and tambourines, chimes and vibraharp, Turkish gongs and Chinese gongs, xylophones and cymbals. He uses both hands and feet and needs quick eyes, too, to follow his complicated score.

Ⓢ A turbine generator is being built by the General Electric company to operate at the high pressure of 2,500 pounds and a temperature of 940 degrees Fahrenheit.

Sheriland
 1935
 Wagon and Drum
 1935

Scherlach

201144. Maxwell Reed Strawn
541 1/2 Glendale Blvd
Los Angeles, Calif

The HIT and RUN

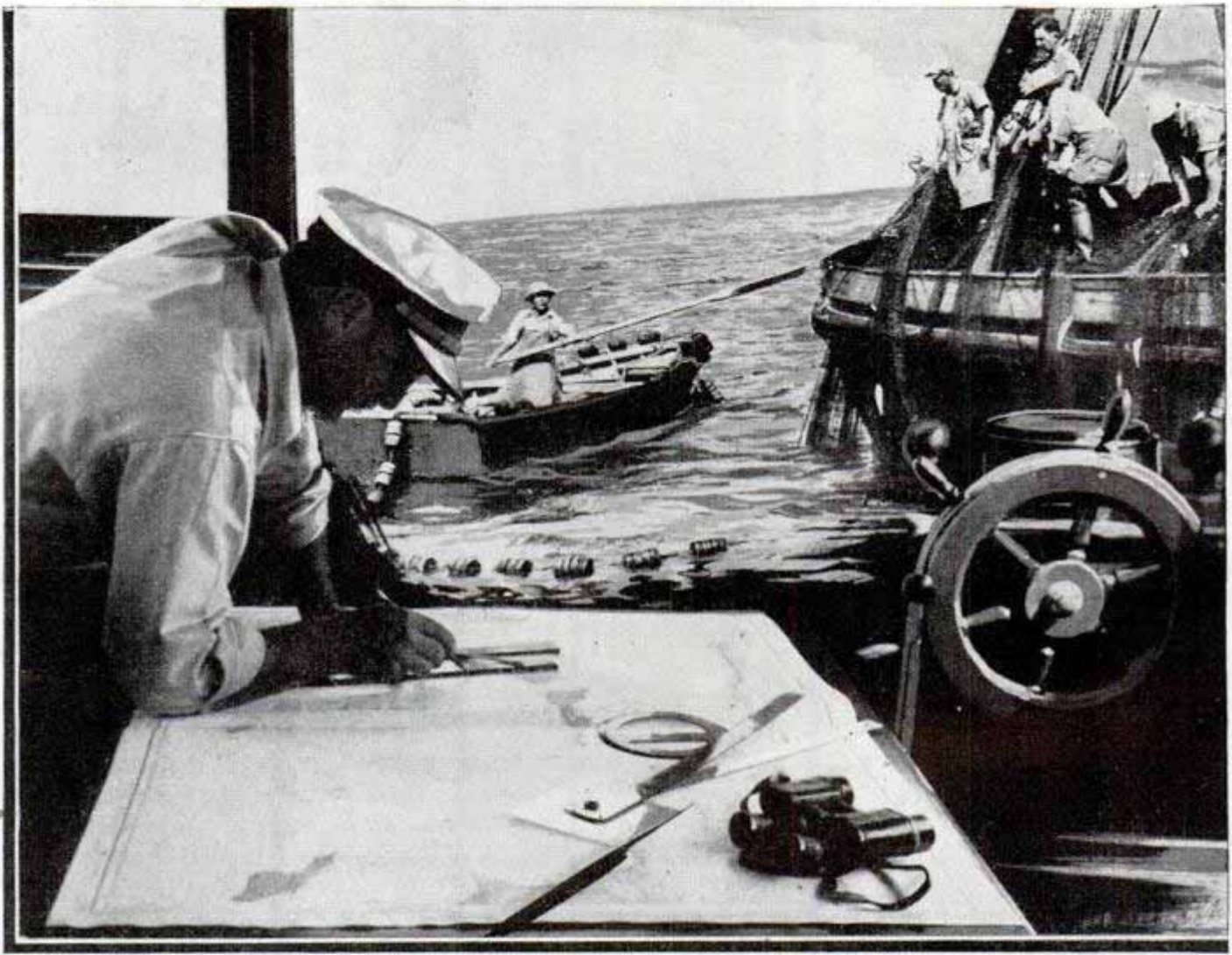

Top, closing the purse seine by drawing in lines attached to top and bottom. Bottom, planning strategy in war against the modern pirates of the Pacific

DARKNESS brings pirates to waters surrounding Santa Catalina island, off the southern California coast. By day they are ordinary fishermen, plying the open sea beyond U. S. waters. By night they are a "hit-and-run" fleet preying upon rich but forbidden fishing grounds inside the three-mile limit.

From April to November, huge schools of tuna, sardines, sea bass, yellowtail, barracuda and albacore stream along the Pacific coast on trips of a thousand miles or more. Many come into the bay between Catalina island and the mainland to rest and feed. Fishermen detect their approach several miles away by sighting a ripple roughening the surface or, at night, a bright gleam as the phosphorescence in the water

is disturbed. Immediately the big Diesel boats flock to the vicinity.

Frightened by the disturbance, the fish head for shore, as if realizing that a law protects them in the closed areas, and quietly feed until ready to resume their travels. But this tempting bait is too alluring not to bring poachers into the forbidden waters, for treasure is there—big blue-black tuna averaging thirty pounds in weight, silver shoals of sardines, small but worth fifteen dollars a ton, flashing mackerel that are heavy and quickly run into real money at a cent a pound and schools of yellowtail, sea bass and barracuda. A single night's work may easily net \$5,000.

But there's danger in the form of a fast patrol boat, the "Cobra," a forty-five-foot

FLEET



cruiser whose 195-horsepower gasoline engines drive her at twice the speed of the ordinary fishing boat.

Eight years ago, while County Fire and Forestry Warden Spence D. Turner was at Avalon, Catalina island, recuperating from an accident, he saw that thousands of tons of fish were being stolen each year by pirates. He foresaw that soon the great schools of sardines, tuna, yellowtail, and albacore would go the way of the buffalo, unless their resting grounds were protected. As a result the "Cobra" was put into service by Los Angeles county to patrol areas in which the law forbids net fishing, and there began a battle with the hit-and-run pirates.



Top, the "Cobra" on patrol. Center, "shooting the sun" to take bearings of captured fishing boat. Bottom, shouting the command to halt from the "Cobra"



Top, Capt. Smith at the helm. Center, radio keeps the "Cobra" in touch with police. Bottom, loading tear-gas gun used in war on fish pirates

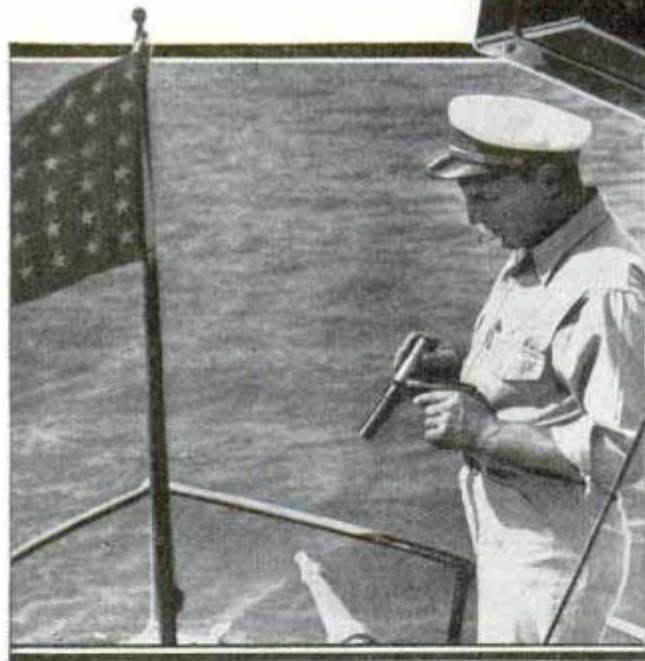

Like the rumrunners of prohibition days, these men are a hardy crew, used to matching their wits and sizable bank rolls against the law. The stakes are high. Before a pirate can operate he must outfit himself with a sturdy Diesel-driven boat, an eighty-footer that with auxiliary machinery and other gear will cost \$50,000. Then his net, a "purse seine" woven of cord the thickness of a clothesline wire, must be of the best. Stretched out it measures more than a mile from end to end;

weighs twelve to fourteen tons, and, when it lies neatly stacked on the stern of his boat, represents an investment of at least \$5,000.

Recruiting a crew isn't so hard, for the shares may be rich prizes, but it takes a knowledge of men. Besides being able seamen they must possess an uncanny sense for locating fish. Some of the old-timers have studied the movements of the schools until they know the paths they follow as an Indian knows the movements of the deer.

But Skipper Lester Smith of the "Cobra"

knows, too, when the fish are running. By night his craft quietly makes for the spot, takes its place among the pirates, drops anchor and waits. The ocean is dotted with other craft, perhaps fifty to a hundred. Some have extinguished the navigation lights required by law, others flaunt them and attempt no concealment.

Soon voices call in low tones as a lookout sights a school. Across the water comes a creak of tackle, as a skiff is lowered over the side, the purr of sliding ropes, the plop-plop of cork floats slapping on the water, the swish of the nets as they pay out, fold after fold, from the high piles on

(Continued to page 120A)

Decorating with 'Velvet' Sprayed from a Gun

see ad.

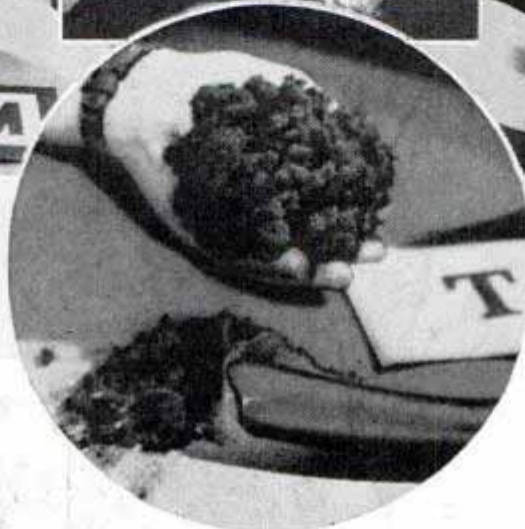

Top, candy box coated with "felt"; spraying "wig" on plaster head and applying sizing. Below, handful of ground material

Anything from a candy box to the parlor walls can be given a decorative cloth finish with a spray set just put on the market. You can pump powdered wool, silk, rayon or cotton from the hand spray gun and produce an effect of velvet, felt, suede or wool. The ground material is available in various colors, so that unusual decorative effects can be worked out on gift boxes, handbags, book ends and similar household objects; suede shoes can be recovered to look as if new; monograms and numerals can be applied in color to women's clothing and athletic jerseys; pil-

low covers can be given gay patterns, and it is even possible to spray walls and ceilings with the material. Two spray guns are furnished with the outfit, one for applying the powdered cloth and the other for spraying sizing. This sizing is first applied as a binder, then the powder is sprayed on and in fifteen minutes it is dry. Monograms and patterns are obtained by using stencils. The finished covering is washable and can be brushed. There is no waste, for the powdered material which does not adhere in the spraying can be recaptured and used again.

Slack in Wire Fence Taken Up by Hand 'Crimping' Tool

When wire fences begin to sag, the slack can be taken up by a tightening tool which puts a "crimp" in the wire. This method makes unnecessary the old system of removing staples, pulling the wire taut and tacking down again. The tightener is worked by hand, taking up an inch of slack with every crimp. The wire is not injured and the crimp is not easily pulled out.

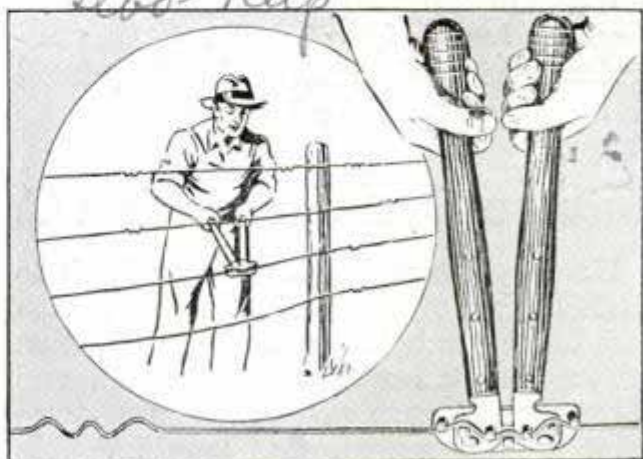

When fence wires begin to sag, take up the slack with this hand tool which puts a crimp in the wire

☞Inquiries as to makers of articles described in Popular Mechanics will be answered by our Bureau of Information upon receipt of return postage.

es 1309. Art. Carroll, 175 N Michigan Ave Chicago

modern art material Service march 19 38 - 1970

Albaine Mfg Co. Ohio

Anatomical Shirt Charts the Human Body

Several views of the anatomical shirt, used in first-aid classes to show the location of arteries, bones and organs of the human body. Bottom, right, note how the spine is outlined

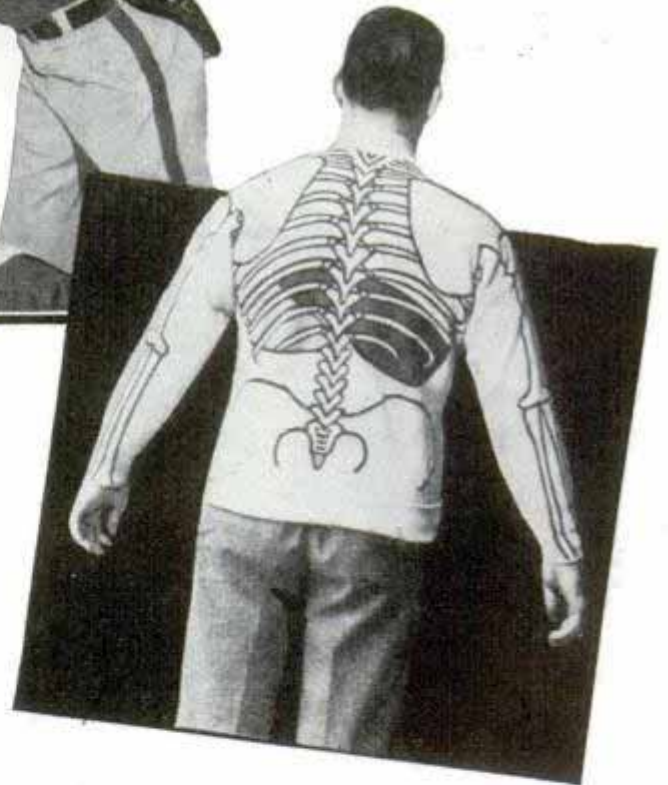

Offering graphic, dramatized instruction in the location of arteries, bones and organs of the human body and arms, an anatomical shirt is an aid in teaching first-aid classes. It charts the body, giving a vivid picture of the physical features constantly referred to in instruction and essential to a working knowledge of first aid. The arteries, bones and organs are boldly printed in black and striking colors.

Million-Cycle Television Cable Smooths Out the Flicker

Newsreels traveled from New York to Philadelphia over the ninety-mile television line recently in the first demonstration of that million-cycle coaxial cable, and already engineers are planning a two-million-cycle system that would double the size of the picture or double its clarity. The television screen was an eight-inch-

square cathode-ray receiver. The movies transmitted from New York appeared in Philadelphia as a 240-line image with very little flicker, and the audience, ten feet away, could see a tennis ball in flight. The signals are amplified every ten miles along the cable, the "multiplier" containing about as much equipment as an average radio

Waters Safety - Appliances Co
Bradford, Pa
Pittsburgh, Pa

Science Service
11/10/37
Bell Telephone Laboratories 463 West

James Mc...
431 W. 60th Street
Kansas City, Mo

receiver. Radio chains expect to begin regular television broadcasts experimentally in the New York metropolitan area very shortly. If broadcasts are made beyond this area the coaxial cable would be required, and since the short waves used for television cannot be transmitted more than fifty miles, it is expected long-distance transmission would be by cable with automatic rebroadcasting every fifty miles.

Mirror Shows Pianist's Hands to All in Concert Audience



Here is how the pianist appears to the audience when a mirror is used back of piano to make artist's hands visible to all spectators

— 1275 —
Pumpkin with Face of a Man Grows Inside a Cast

Raised inside an aluminum cast, a pumpkin with the face of a man has been grown by an Ohio farmer. Experimenting for four years with various types of casts, he finally succeeded in developing a sculptured pumpkin by placing it in an aluminum form when it was still as small as an indoor baseball. After it had grown big enough to fill the inside contours, he removed the cast and the features remained as the pumpkin grew larger. The farmer patented his invention.



This "pumpkin-head" with the face of a man grew up inside an aluminum cast until it took this shape

Because almost everyone in the audience wants to see the artist's hands in action, a mirror attached properly to a piano reflects the pianist's hands in a manner satisfactory to all admirers and students attending concerts. The solution, worked out by Dr. Thomas C. Poulter of Chicago, makes the hands visible to practically every spectator in the concert hall. Hitherto, the artist's hands were visible only from part of the left side of the hall.

— 1305 —
Porous Rubber Clothes Brush Removes Lint, Dust and Hair

Especially suitable for brushing velvet, satin or suede materials, a rubber clothes brush is now offered. It is made of porous latex rubber and can be washed with soap and water. The brush is claimed to be especially effective in removing hair, dust or lint from clothes.



Patented by John Czeski, Madison, Ohio

Hyde Park, Ohio
 10360
 name
 manufacturer's name
 John Czeski

'Granddaddy' Toes the Mark with 200-Mile-an-Hour Racer

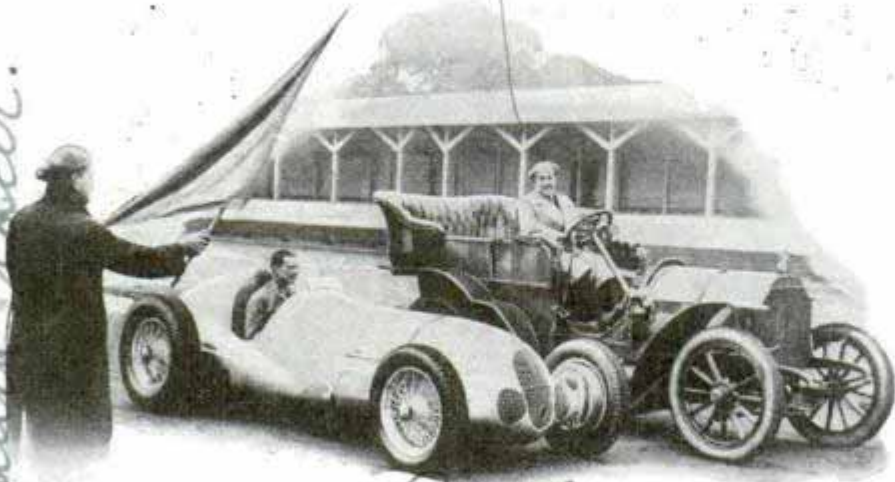

The old-timer, a 1903 Mercedes, has a one-yard lead but it won't last when the 1937 racer gets going! The younger car can do 200 miles an hour

They don't look like near relatives, but they are both Mercedes cars, "born" thirty-four years apart. The two automobiles lined up side by side recently before the start of London's first international auto race, presenting a dramatic picture of the progress from the "linen duster" days of automobiling to the streamline age. The "granddaddy" was built in 1903. The bulletlike racer is capable of 200 miles an hour.

preventing the burning out of costly equipment and the danger of under and over curing. The vulcanizer plugs into the nearest wall outlet of 110 volts, alternating current, fifty-sixty cycles. All types of repairs on auto tubes, from small punctures to large tears, and valve-stem replacements can be made.

Boat Repair Shop Specializes on Propellers

Adjusting and repairing boat propellers is the sole business of one Massachusetts firm, introducing a new line in this age of specialization. The firm has hundreds of customers in the United States, as well as in Cuba,

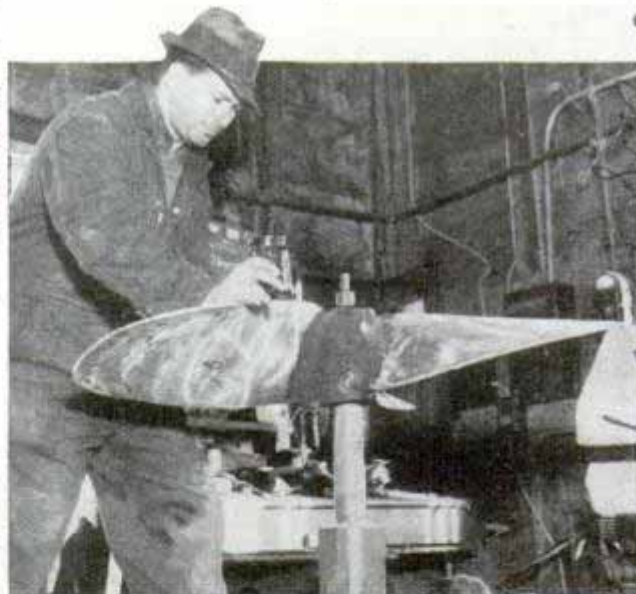

Finishing a boat propeller in shop which makes specialty of this kind of work

Mexico and Sumatra. Among the jobs calling for special attention is that of refinishing a propeller. In order that the propeller may perform its functions properly, it must be finished to an exact degree. Refinishing calls for the same exactitude in workmanship.

Inquiries as to makers of articles described in Popular Mechanics will be answered by our Bureau of Information upon receipt of return postage.

Electric Auto-Tube Vulcanizer Shuts Off Automatically

Assuring the user of a perfect job, an electric vulcanizer now on the market automatically shuts off when the time is up. A special timing device does the work.

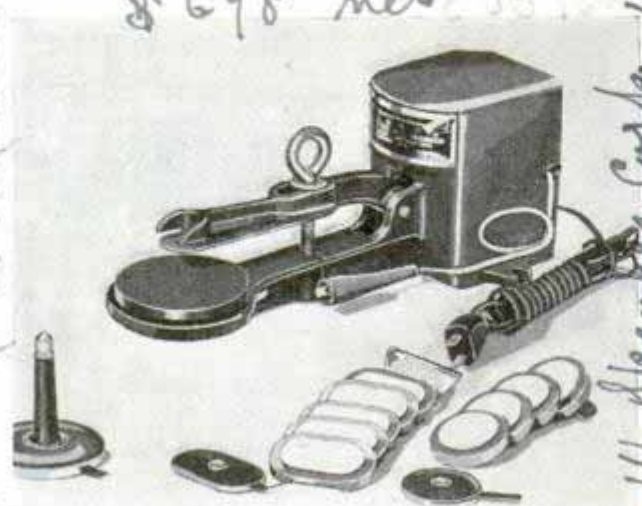

Here are the essential parts of electrical vulcanizer for auto tire tubes

J. W. Speaker Corp.

Sub. Spangui
1210
150
151
Electromatic

Heck
Eserman drive

Gene

1635 N. Water St.
W. Speaker Corp.

Milwaukee

Mass
D. Asharen



BEGINNER'S TRANSMITTER

from KIT



ANY amateur can build this 25-watt C.W. transmitter, which covers all bands with only two crystals. The complete kit of parts, less tubes, meter and crystal, costs about \$16. Most of the smaller parts are pre-mounted to avoid any possible error in assembly.

The rear-view photo of the completed unit shows the R. F. chassis above and the a.c. power supply on a separate base below. The R. F. section contains the entire oscillator circuits as well as the antenna tuning condenser. A neat black crackle-finished steel cabinet houses both chassis bases, and stand-off insulators are provided for the antenna feeders. A schematic circuit diagram is given in Fig. 1. Simplified wiring diagrams and detailed instructions are supplied with the kit.

A phone jack is provided for plugging in the key; this jack is mounted on the rear of the R. F. chassis. Forty and 160-meter crystals are recommended for beginners and the use of harmonics is not advised unless the operator has a good frequency meter to distinguish between the crystal frequency or one of the harmonics.

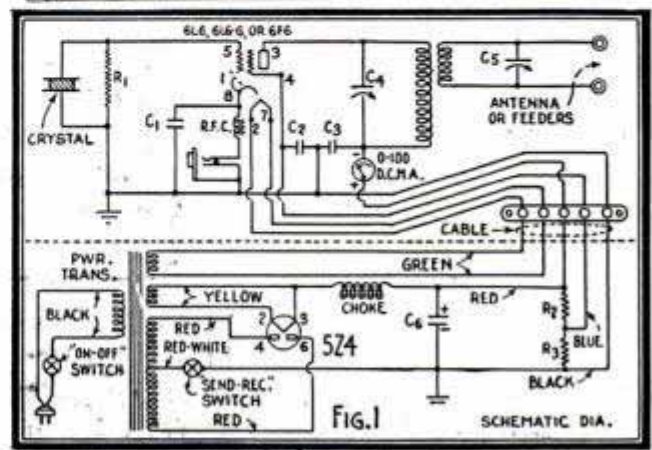
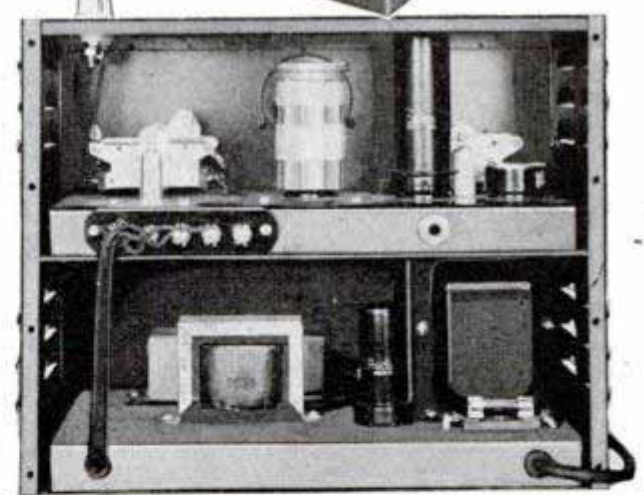

Utah Radio Products
820 N. Orleans, Cheas

How to Build

By M. N. Beitman



INSTANT, direct, two-way conversation between a master station and from one to five sub-stations is possible with this easily assembled inter-room communication system. The sub-stations can be located at any distance up to 500 ft. from the master station. This single main station operates on 110 volts, either a.c. or d.c., and the operator can call any of the outlying stations. Sub-station operators must press the push button to call the master station initially. Once the outlying station is identified, the master-station operator sets the station-selector switch to its corresponding number and all further switching is performed at the master

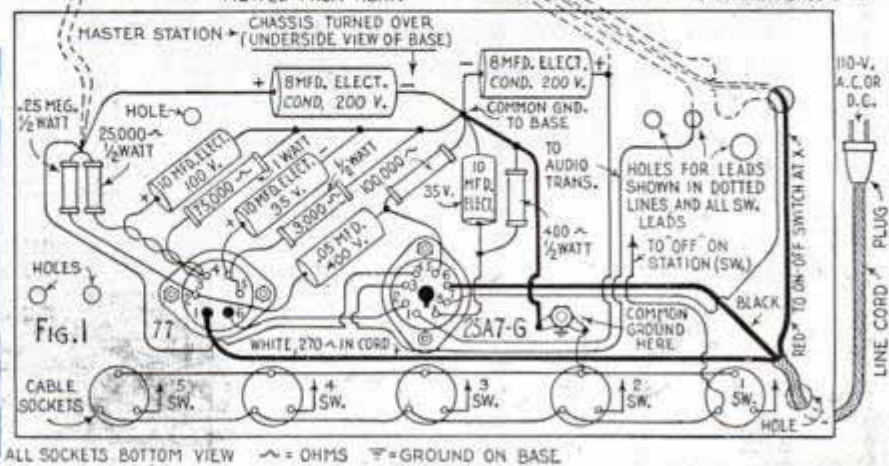
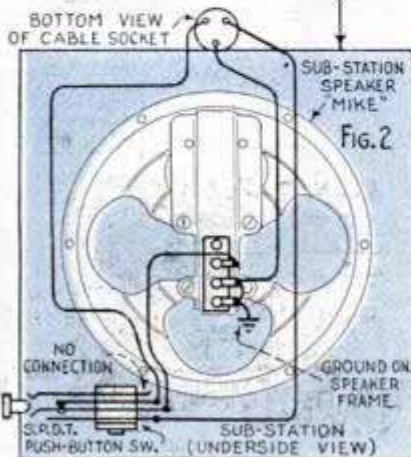
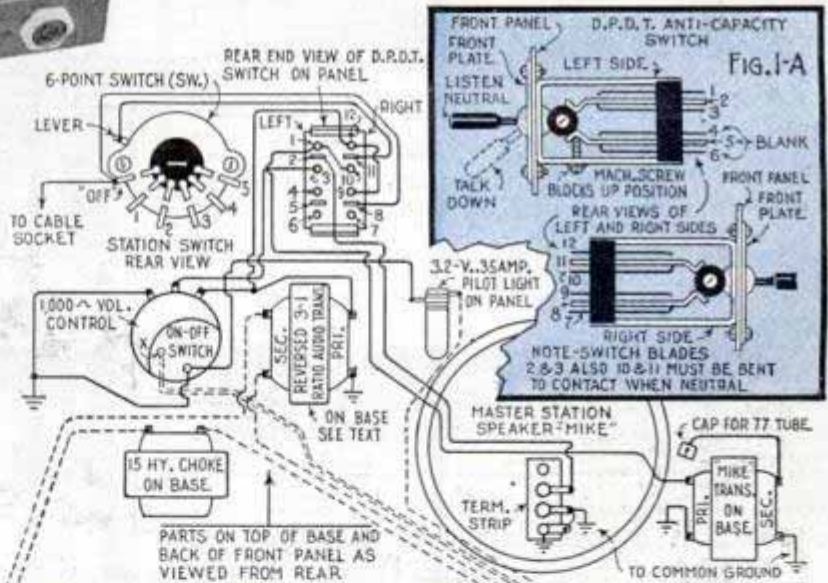
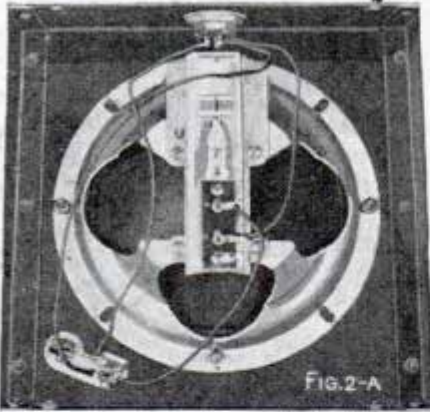

a TWO-WAY INTER-ROOM Communicator

station. He pushes the d.p.d.t. switch lever down to talk and raises it to the neutral position to listen. At the end of the conversation the station switch is reset to the "off" position and the system is ready for further calls. Messages between any two sub-stations may be relayed by the master-station operator.

The heart of the system is the amplifier in the master station; only two tubes are used for economy and simplicity. A type-77 tube is employed as a high-gain pentode and is resistance-coupled to a new type 25A7-G combination pentode-amplifier and rectifier. This results in an extremely high-gain circuit which permits the use of magnetic speakers as microphones.

As the sub-stations are directly connected to the amplifier in the master station, by means of shielded rubber-covered 2-conductor cables and

(Continued to page 136A)

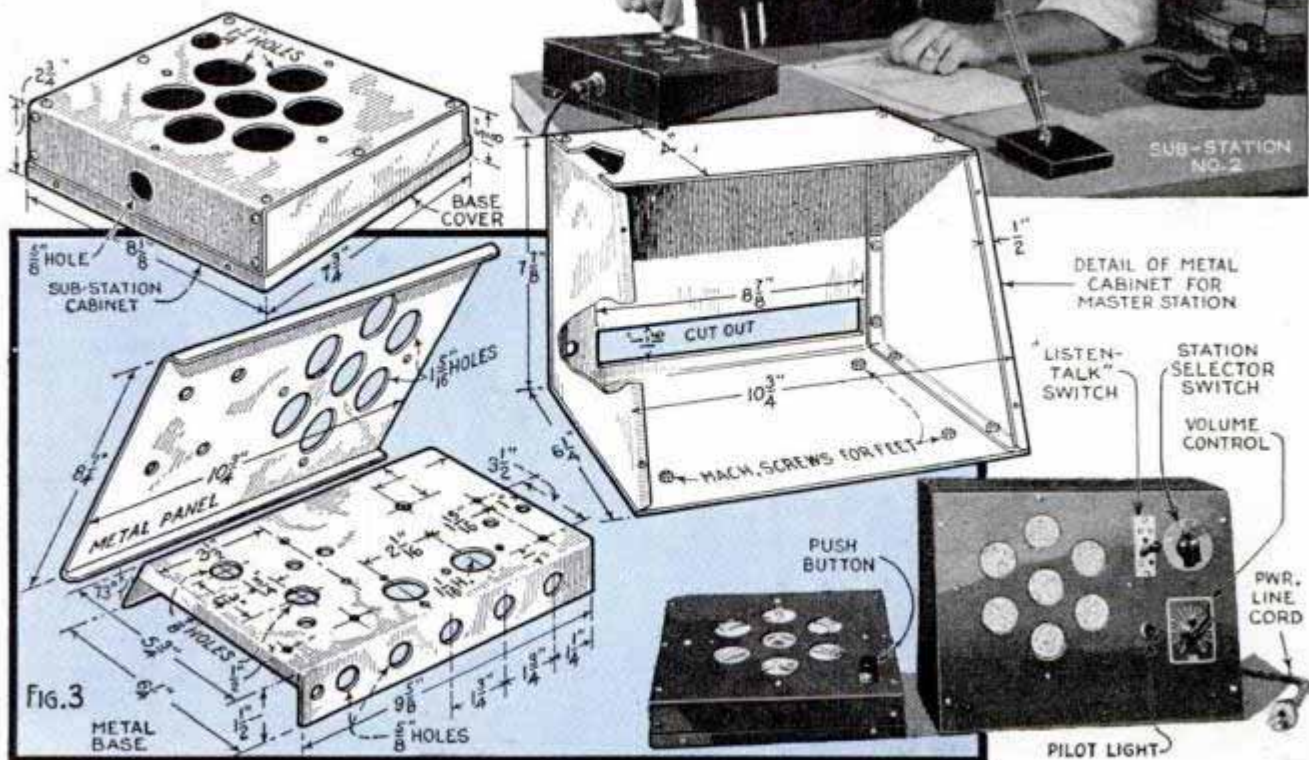
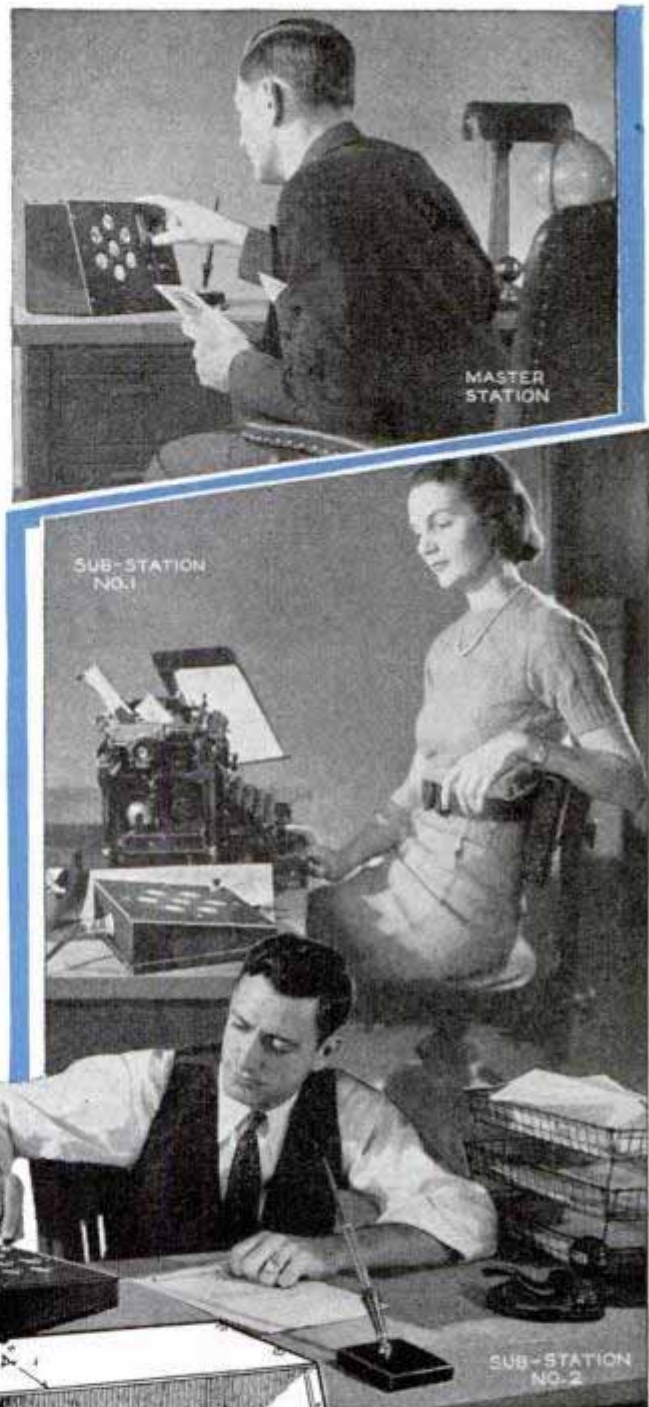

Ten-Watt High-Fidelity 2A3 Audio Amplifier

By W. C. Howe

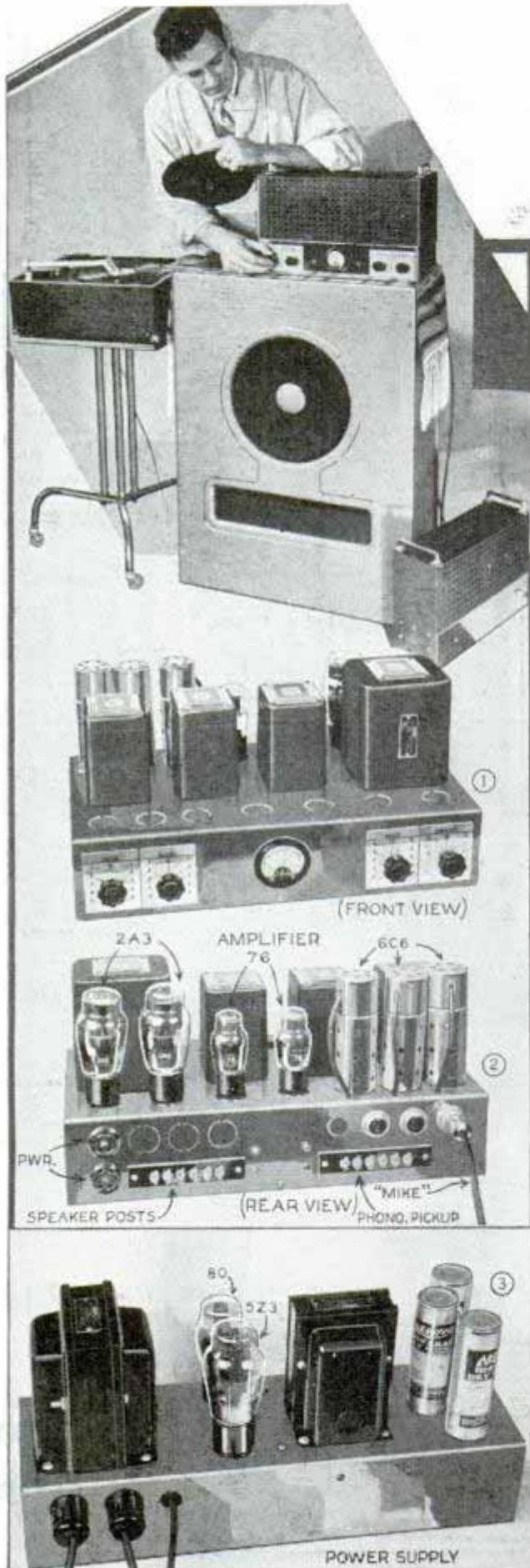

EVERY provision for perfect audio reproduction has been included in the design of this 10-watt audio amplifier that can be assembled with ordinary tools. Type-2A3 tubes and the conservative output rating were selected as being most consistent with pure, clear sound reproduction. Dependable, quality performance fits the unit for work in all fields where high fidelity is important, such as home recording and public address.

Tested in Popular Mechanics radio laboratory with a 15-in. peri-dynamic speaker and a high-impedance phonograph pickup, the results were highly satisfactory. The assembly includes a pre-amplifier and mixer with three input channels which may be faded from each other, thus enabling the builder to work out input combinations of microphone and pickup to suit different requirements. Service men will find this amplifier useful for rental purposes as the cases are provided with carrying handles mounted on the metal covers.

The meter is employed to measure the plate current of each 2A3 tube separately, and individual bias controls make possible compensation for differences in the tubes. All parts are standard and a foundation unit is available from radio supply houses. This unit consists of the chassis bases with all tube sockets mounted, terminal strips and the necessary hardware; also complete diagrams and assembly instructions.

Various views of the completed amplifier and power-supply units are shown in photos Figs. 1, 2 and 3. The schematic circuit diagram indicates all connections to the cable plugs and sockets employed for quickly connecting the power-supply unit to the amplifier.

In a high-fidelity amplifier of this description, there are a few necessary precautions to observe in wiring: volume-control cases must be grounded to the common ground wire; this also applies to all shielding. Keep the input and output leads as far away from each other as possible and make sure that all tube shields are well grounded.

(Continued to page 126A)

Technical Appliance Corp
19 E 16th New York

Hints for RADIO EXPERIMENTERS

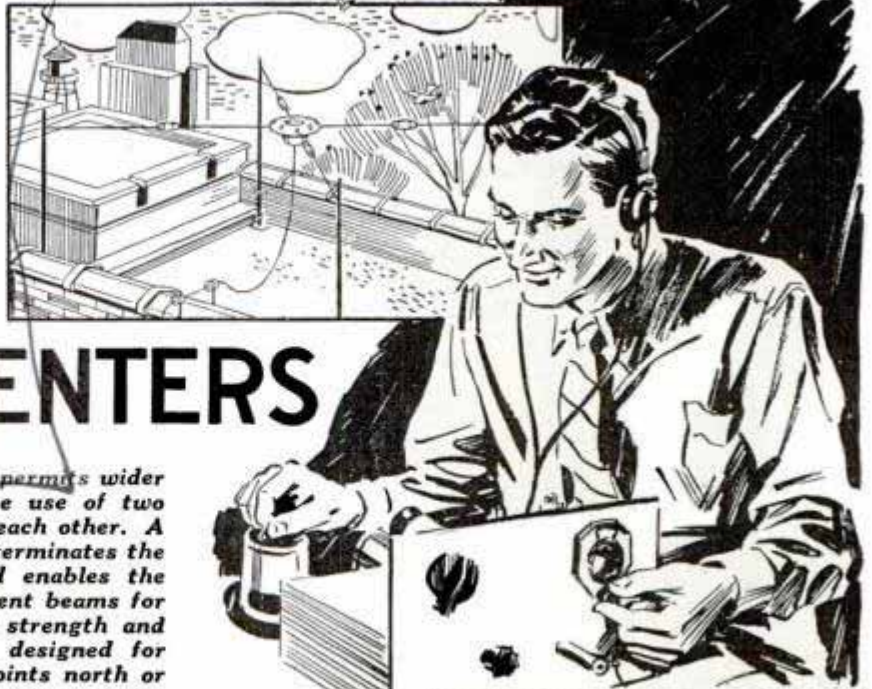

Selective-beam directional antenna permits wider and sharper reception through the use of two doublets placed at right angles to each other. A switching unit at the receiver end terminates the 4-conductor transmission line and enables the operator to pick at will nine different beams for the desired signal with maximum strength and minimum interference. Although designed for the 20, 40 and 80-meter bands, points north or east connect the system into a "T"-type antenna suitable for lower frequencies and the broadcast band. Below, tapered reamers for radio workers

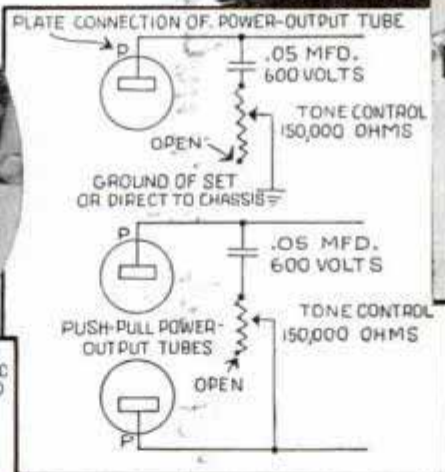
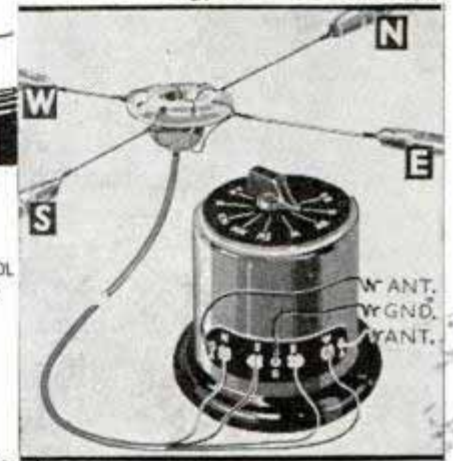
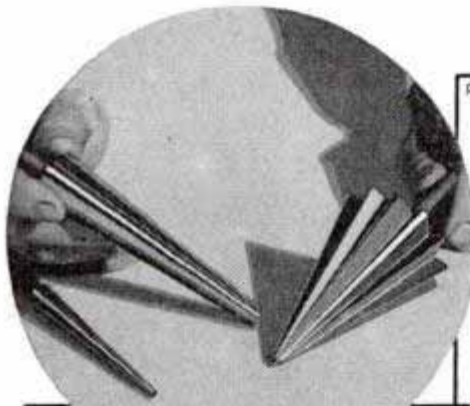

Left, tone control easily connected to any set; diagrams show variable resistor and condenser connections for either single or push-pull output tubes

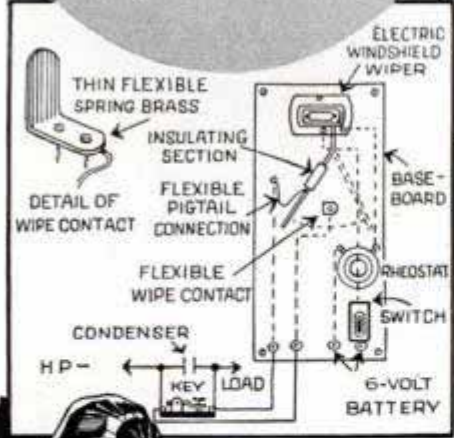

Left, automatic signal key made from electric windshield wiper. A handy method for leaving the key on "stand-by" signal if called to answer the phone when half-way through a transmission. The wiper arm is cut and insulated with a short section of fiber dowel. Below, voltage-regulator strip for operating 2-volt tubes on any 3-volt dry-cell battery

Below, cutting pliers clamped in vise provide a simple means for quickly stripping insulation from the ends of wire when numerous pieces are required for circuit connections. Separate the jaws a little more than the thickness of the wire at the hinge, pull wire down and outward to remove insulation

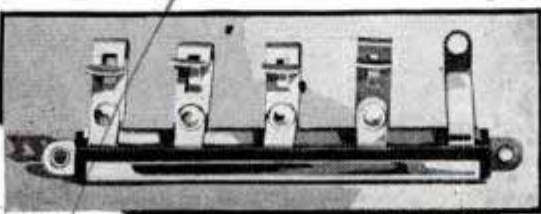

Leslie Hunter Co.
125 E 16th Ave

Receiver Has Motor-Driven Dial

Build This Oscillograph

Single control knob starts and stops electric tuning dial



A choice of electric or manual tuning is available in this 6-tube dual-band "dynatrol" receiver with 8-in. electro-dynamic speaker housed in an attractive chairside cabinet. Under complete control of the operator, a small motor quickly drives the dial pointer from one end of the mirror-type dial to the other.

Tube for Ultra-Short Waves

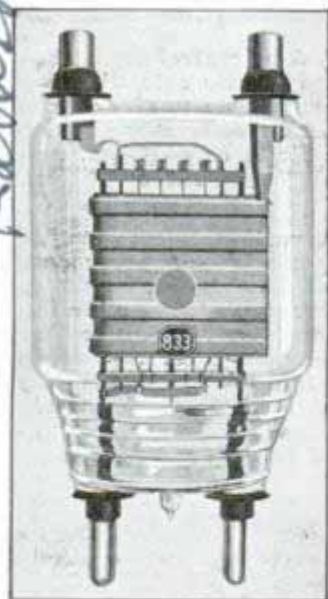

Of advanced design, this tube, for transmitting ultra-high frequencies up to 100 megacycles, employs a minimum amount of insulation within the tube, and terminal posts make a base unnecessary. This type-833 tube can be operated at high plate efficiency with low driving power.

You can assemble this oscillograph from a complete kit of parts which include the steel cabinet, sockets, transformers, condensers and necessary hardware. A 1-in. type-913 cathode-ray tube is used with built-in sweep circuit and wide range vertical amplifier. Provision is made for cutting the amplifier in and out.

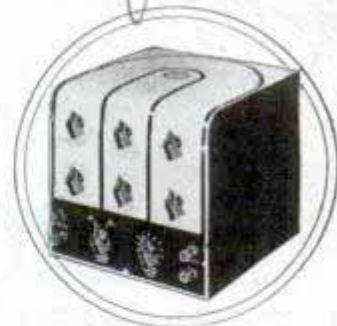

Automatic Record Changer

Seven 10-in. records are automatically changed by means of this compact unit that can be installed in your old phonograph to bring it up to date. It will play 12-in. records manually and repeats the last record of either size.

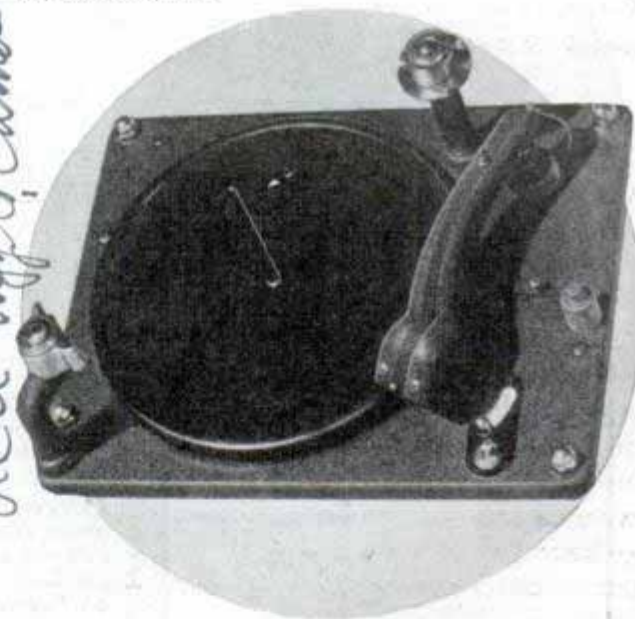

Blueprints covering radio construction articles in past issues are available for 25 cents each; original material lists and additional information can be obtained from our Radio Department without charge upon receipt of postage.

NEXT MONTH—How to Build the 1938 Little Giant Portable A.C.-D.C. Receiver. The improved model of this popular midget broadcast set has variable tone control, phonograph pick-up jacks, gets police calls, 2-watt output, works on 20-ft. antenna, and beginners can build. Also, **Three-Band 804 Radiophone**

RCA Mfg. Co. Radiotron Div. Harrison, N.J.

RCA Mfg. Co. Camden, N.J.

Crosley Radio Mfg. Co. of America. 69 W. 100th St. New York



Window CORNICES

For your home

Four styles—both wood and metal. One has the latest wire trimming and another telescopes for size

By
WAYNE C. LECKEY

POPULAR a decade ago, valance boards, now called window cornices, are again considered smart window treatment for the up-to-date home. The little cornice-shaped boxes suggested here conceal the drapery fixtures and give an attractive finish to a window. The designs shown are typical examples of what can be done. Finished in bone white or walnut, they go well with almost any modern furnishings. As window sizes vary, no dimensions are given. Measurements must be taken directly from the window so that the completed cornices extend to the edges of the window casings.

Heavily enameled in bone white, the cornice shown in Fig. 1, with its scalloped edge of wire, is formed from light sheet

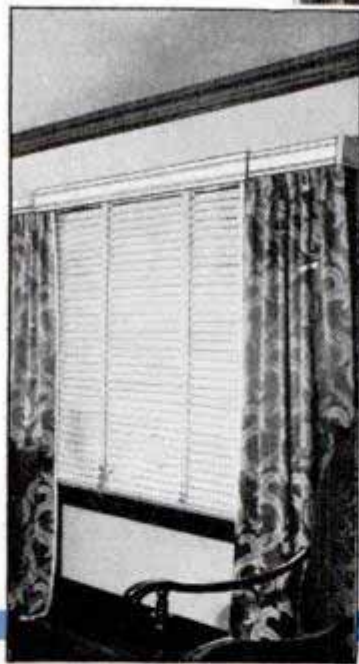

The cornice above is just the thing for families living in apartments or rented homes as the end pieces slide into the center one permitting adjustment to different windows

metal. A pattern, Fig. 2, is first laid out and then cut from No. 26-ga. galvanized metal. The edges can be bent easily in an improvised brake assembled by clamping the work between two lengths of angle iron or strips of hardwood. The gussets at the corners are then soldered together neatly.

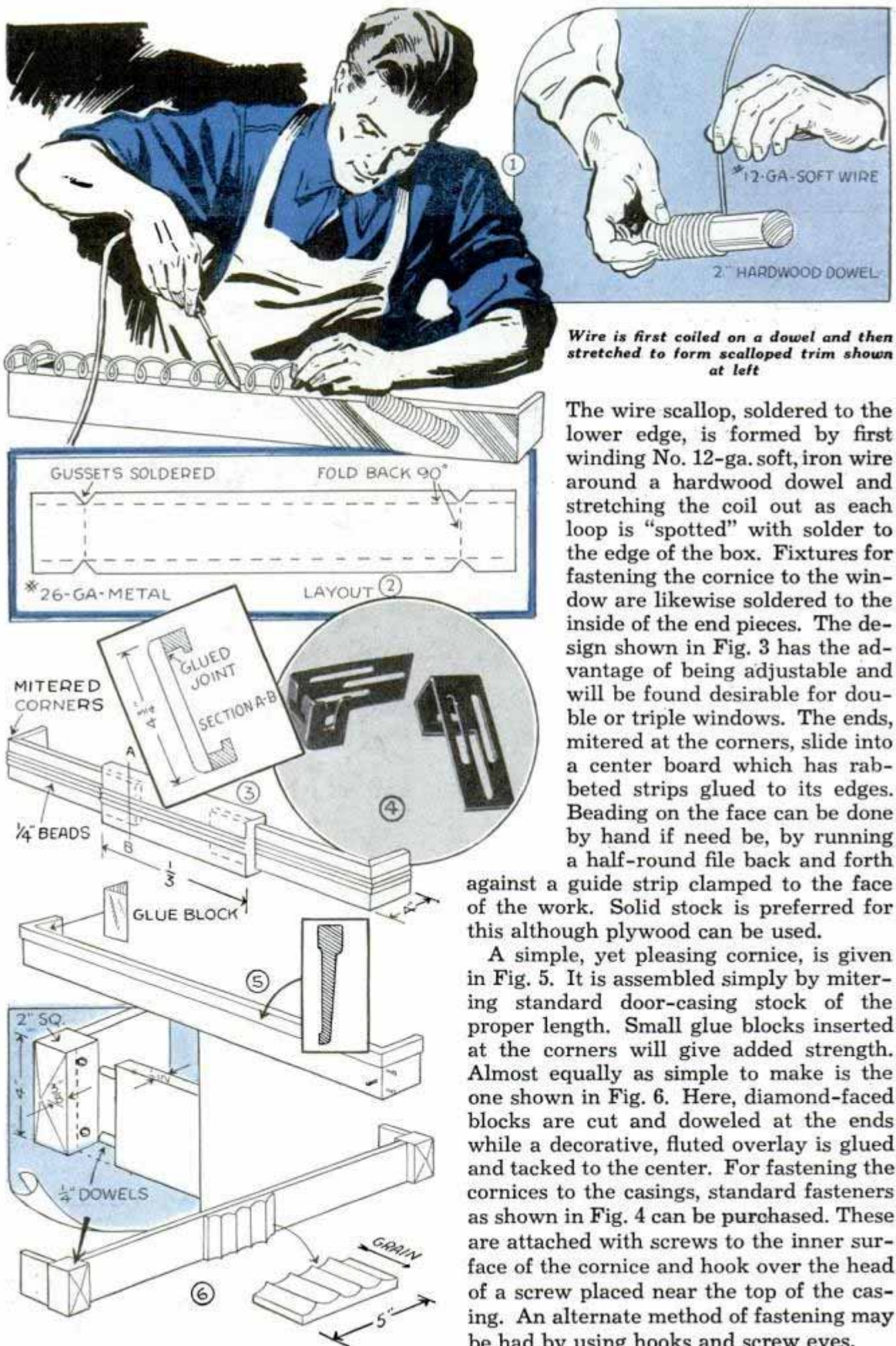

Wire is first coiled on a dowel and then stretched to form scalloped trim shown at left

The wire scallop, soldered to the lower edge, is formed by first winding No. 12-ga. soft, iron wire around a hardwood dowel and stretching the coil out as each loop is "spotted" with solder to the edge of the box. Fixtures for fastening the cornice to the window are likewise soldered to the inside of the end pieces. The design shown in Fig. 3 has the advantage of being adjustable and will be found desirable for double or triple windows. The ends, mitered at the corners, slide into a center board which has rabbeted strips glued to its edges. Beading on the face can be done by hand if need be, by running a half-round file back and forth

against a guide strip clamped to the face of the work. Solid stock is preferred for this although plywood can be used.

A simple, yet pleasing cornice, is given in Fig. 5. It is assembled simply by mitering standard door-casing stock of the proper length. Small glue blocks inserted at the corners will give added strength. Almost equally as simple to make is the one shown in Fig. 6. Here, diamond-faced blocks are cut and doweled at the ends while a decorative, fluted overlay is glued and tacked to the center. For fastening the cornices to the casings, standard fasteners as shown in Fig. 4 can be purchased. These are attached with screws to the inner surface of the cornice and hook over the head of a screw placed near the top of the casing. An alternate method of fastening may be had by using hooks and screw eyes.

Mirror Imitates Water Reflection in Photos

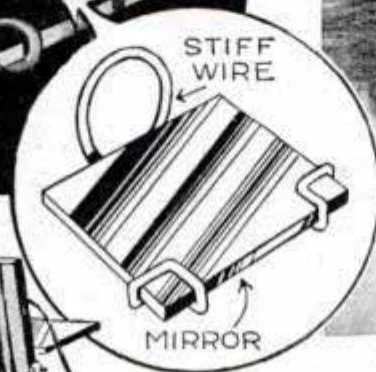
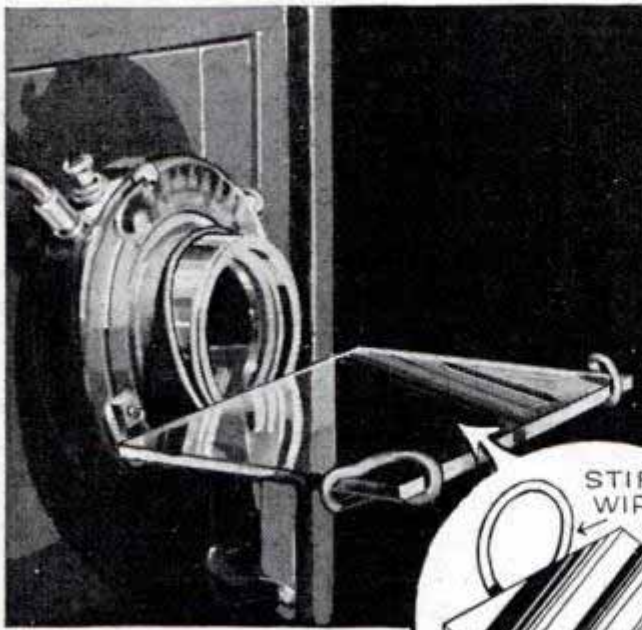

By attaching a mirror to your camera lens as shown in the upper left-hand detail, you can take photos of objects that appear to be reflected by water in the foreground. An example is shown in the photo above. The mirror should be 3 or 4 in. square, and can be attached with stiff wire bent to hold it as indicated in the circular detail. If you keep the attachment a secret from your friends, and take photos of their homes or other familiar objects not near water, you'll have a lot of fun when they see photos of their homes and a body of water in the foreground. It is necessary to have the glass free of dust when taking a picture.

—Paul Hadley, Piggott, Ark.

Speed of Photographic Film Increased by Mercury Vapor

Photographers who want still greater speed than modern emulsions can provide, will be interested in a method of dry hypersensitizing with mercury vapor, which gives from 50 to 150 per cent increase in emulsion sensitivity. The film is placed in a tight container with a small amount of liquid mercury (0.5 gram), or silver amalgam containing a high percentage of mercury and is allowed to stand at room temperature. About 36 hrs. is long enough for loose or unwrapped material but a week is required for wrapped or tightly

spooled film. The sensitizing action of the mercury vapor is reported to be slow and so uniform that streaks or spots will not occur. Actual contact with the film is prevented by placing the mercury in an open glass or metal container, or by wrapping the amalgam loosely in porous blotting paper. It was found that films showed greater sensitivity when hypersensitized after exposure instead of before exposure. The stability of the film is not permanently affected, although the increase in speed is gradually lost over a period of four weeks.

Typist's Copy Holder Spaces the Same as Your Typewriter

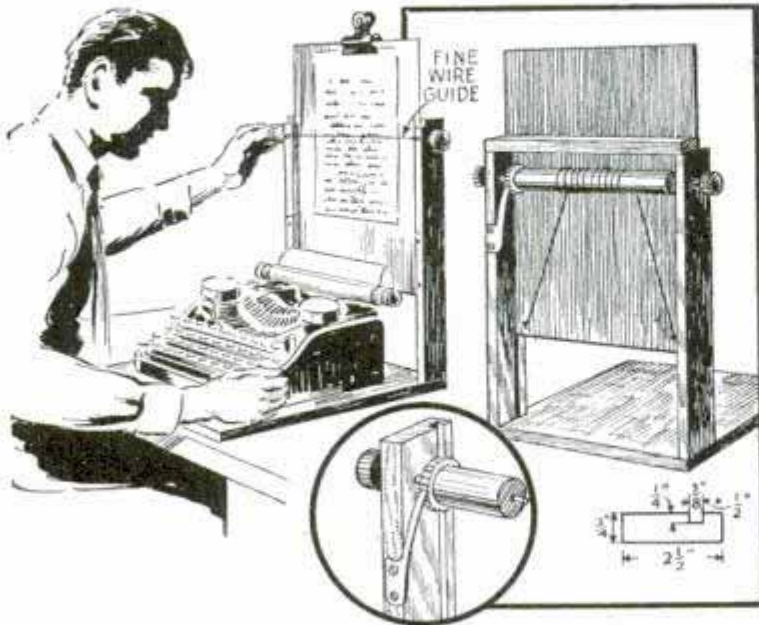

Your typewriter sets on the base of this copy holder and keeps it steady when raising or lowering the copy

Here's a holder that keeps your copy at the correct eye level for easy reading and it raises the copy one typewriter space at the turn of a knob. The frame of the holder is made of wood as indicated at the right, the copy board operating in grooves cut in the two standards. The board is suspended from an old typewriter platen mounted at the top of the standards, a piece of spring brass or steel being shaped and screwed to one of them to engage the ratchet on the platen as shown in the circular detail. A piece of fine wire is used as a line finder, although a piece of cardboard or thin plywood across the front will serve the same purpose.

—W. W. Wheatly, Lakeside, Calif.

Emergency Shoelaces Are Made from Electrician's Tape

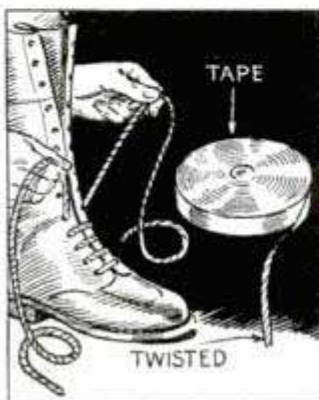

When laces on your high-top shoes break, and there are no new ones at hand, emergency laces can be made in a jiffy from strips of electrician's tape. It is twisted as shown, with the gummed surface

inside to help prevent the tape from unrolling and also to allow the lace to pass easily through the shoe eyes. The strong cords made in this manner are also useful for other purposes.

Mounting Bicycle Tires

Bicycle tires may be mounted upon either wood or steel rims with a cement made by mixing the following together, rubber (crude), 2 lbs., rosin, 2 lbs., and carbon disulphide, 1 gal. Carbon disulphide should never be handled near an open flame or while smoking, as it is highly inflammable. The cement will keep if stored in screw-cap bottles or sealed cans. To use it, clean the rim of old cement and dirt and apply with a brush. A light coat of the cement should also be applied to the rim surface of the tire. The tire is placed on the rim quickly and the cement allowed to set for from 1 to 2 hours.

This Tap and Die Rack Rotates for Quick Selection

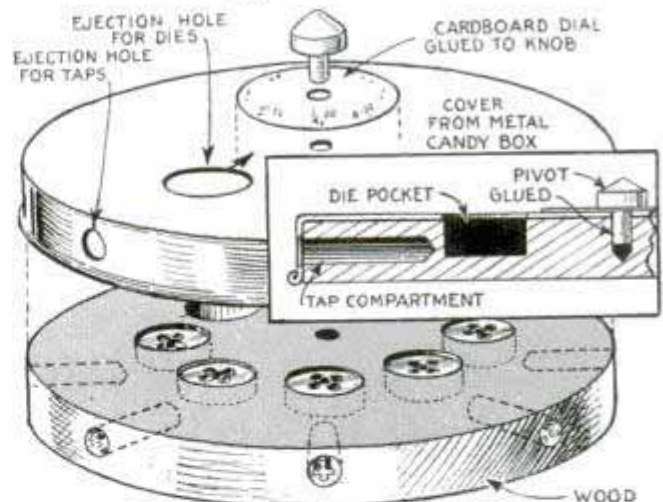

Taps and dies are selected as to size by turning cover until arrow points to correct figure on dial

Any size tap and its corresponding size die can be selected instantly from this holder which consists of a plywood disk fitting freely inside of a metal cover as shown. A hole through the center of both permits the location of a wood peg, which should fit the disk snugly but the cover loosely so the latter can be rotated. Ra-

dial lines are drawn on the disk—as many lines as there are taps—and two sets of holes are bored; one set in the edge of the disk to take the taps and the other on the top surface to take the dies. The result is that a tap and die of the same size are located in line so that when the tin or cardboard cover having a pair of similar holes cut in it, is swung around, both tap and die are accessible. As a guide to indicate sizes of the taps and dies, a tin or cardboard disk having the sizes marked on its edge, is fastened to the head of the peg so that it will remain stationary in relation to the wooden disk while the tin cover can be rotated freely.

Gasoline Drum Is Pivoted on Rigid Support

Quickly improvised from odds and ends, this oil or gasoline drum support is tipped to a horizontal position in order to pour out the contents. The drum stands almost vertically when not in use, which prevents the contents from being accidentally lost through a leaky cock. A sturdy wooden framework of 2-in. stock braces two up-rights between which a cradle is pivoted. This cradle consists of a half of an old automobile-tire rim and some flat iron, assembled as shown.

—O. L. Conaway, Long Beach, Calif.

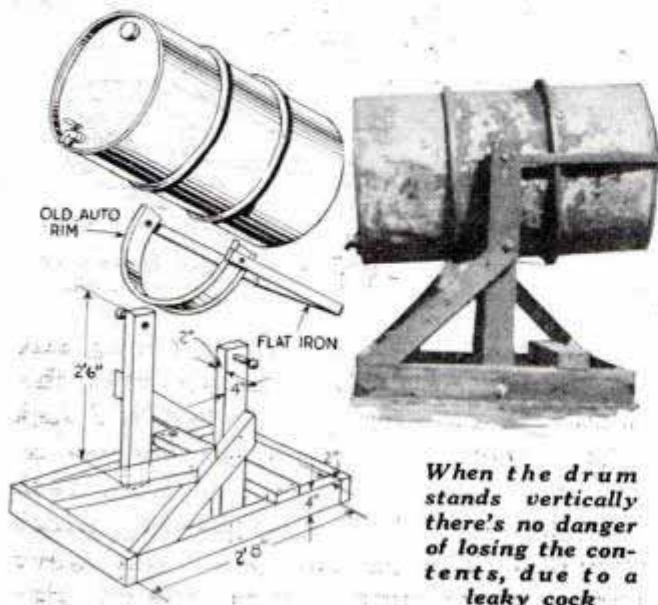

When the drum stands vertically there's no danger of losing the contents, due to a leaky cock.

Darkroom Temperature Reduced by Evaporation of Water

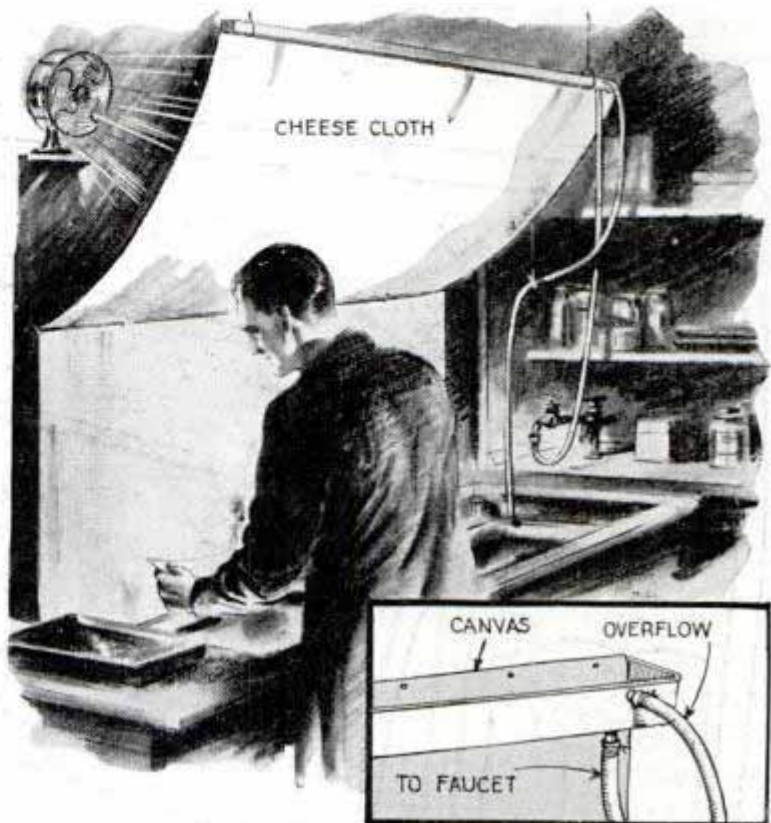

Cloth stretched above darkroom sink keeps room cool by evaporating water rapidly when fan blows air across it

Based on the fact that evaporation of water from any surface cools it and the adjacent air, this darkroom cooler helps considerably to keep the temperature down on hot summer days. On dry days the cooler works better than it does on humid days because when the humidity is high, the evaporation of water is very slow and the consequent cooling effect is minimized. The cooler illustrated consists of a large piece of cheesecloth suspended from a shallow trough over the sink. The detail shows how the water from the faucet is brought up into the trough through a rubber tube and how another tube leads the overflow back to the sink. An electric fan keeps the air in motion and hastens evaporation. In the darkroom where the cooler was installed, the initial room temperature of 85° was reduced to 70° in a short time.

—Merle Terrill, Portland, Ore.

Painted bathroom walls often can be cleaned by filling the tub with very hot water and letting the room steam for about 5 min., after which the walls and ceiling can be wiped clean with a dry cloth.

HANGING BOOK SHELF

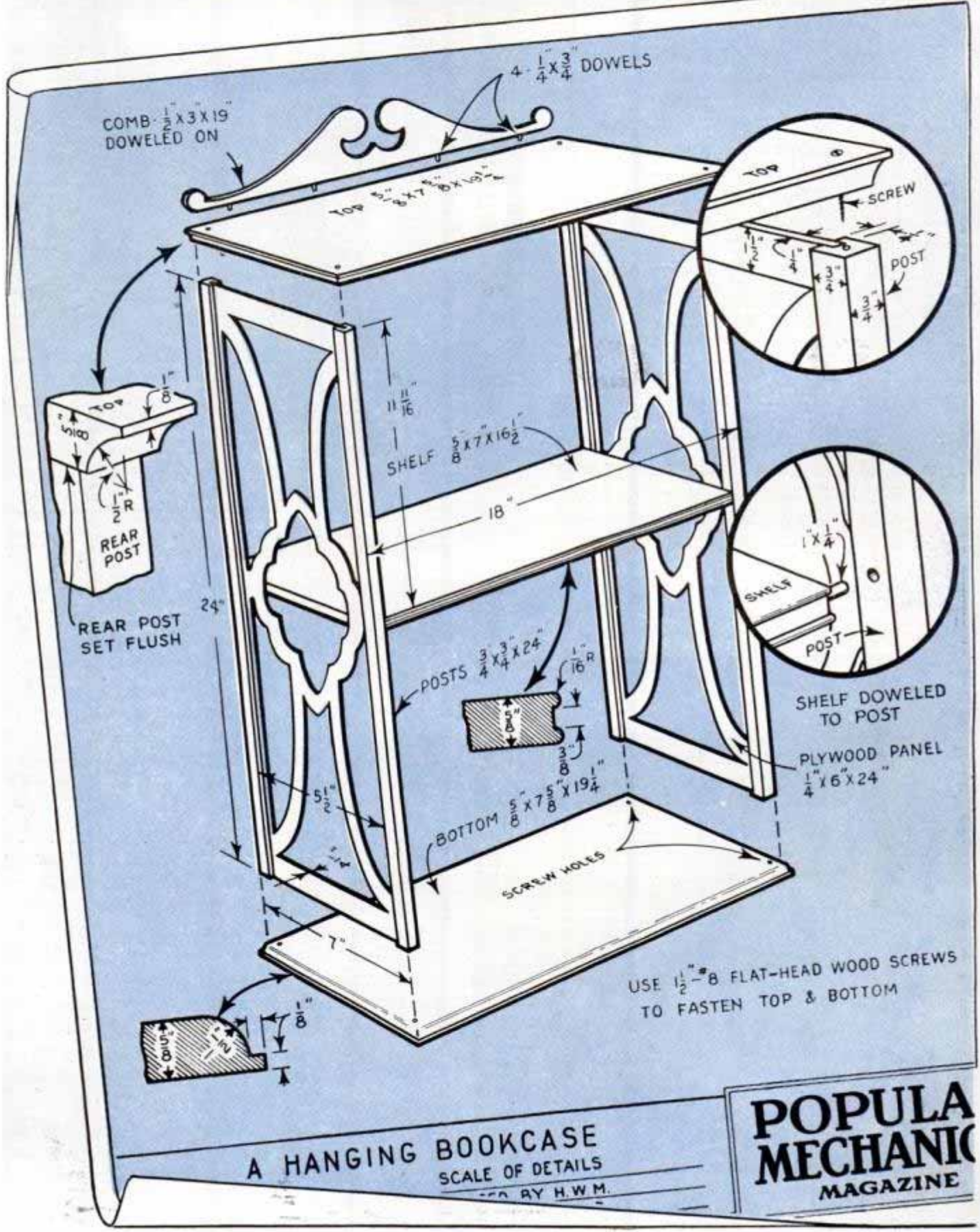

has scroll-sawed panels

TOP, BOTTOM AND SHELF - GUMWOOD
PANELS - FIR PLYWOOD

FINISH WITH TWO COATS OF UNDER-COAT AND ONE OF COLORED ENAMEL

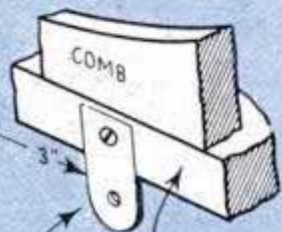

BACK EDGE OF TOP SHELF

$\frac{1}{16} \times \frac{3}{4} \times 1\frac{1}{2}$ METAL HANGERS
2 REQUIRED

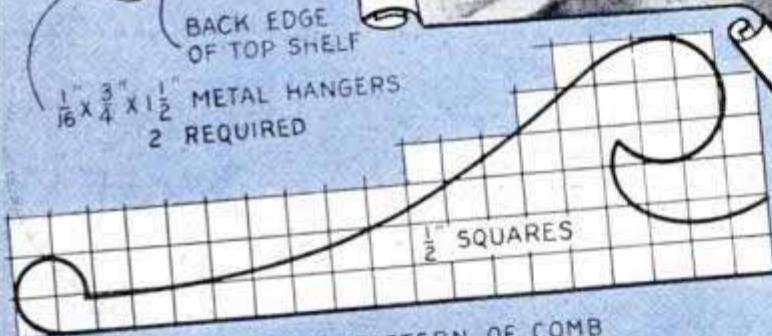

HALF PATTERN OF COMB

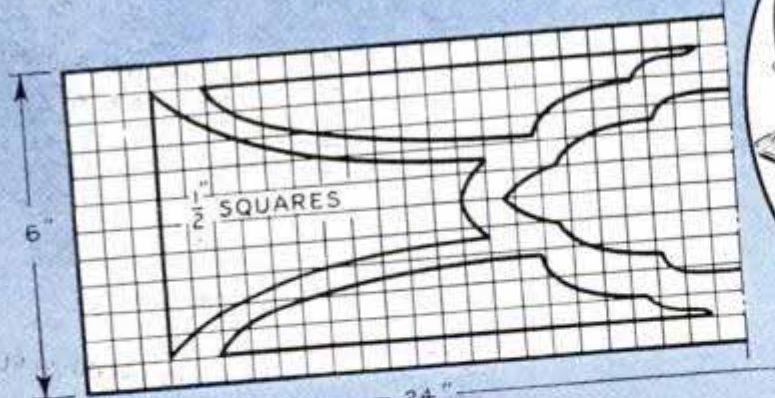

HALF PATTERN OF PANELS

Reminiscent of colonial days, this shelf is especially suited to a small room where floor space doesn't permit use of a regular bookcase. It is light in weight and inexpensive to build, yet the simple, pleasing design is well suited to colored enamel or bone-white finish. The end pieces are dadoed into the corner posts to cover the laminations of the plywood edges

971

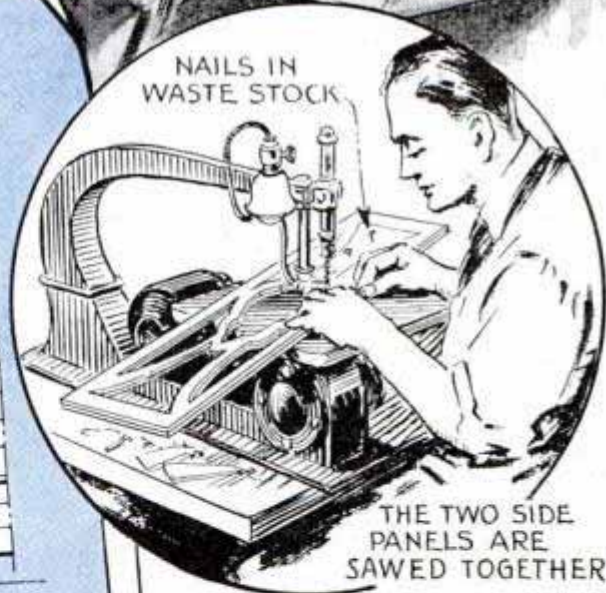
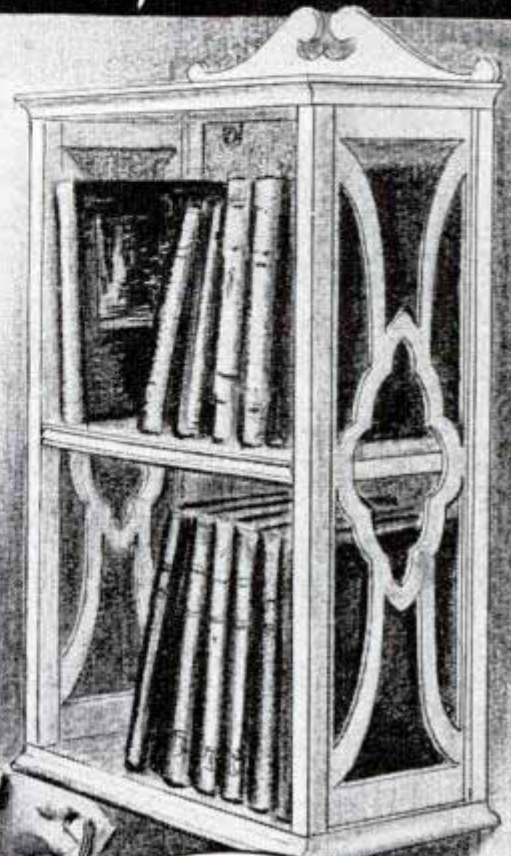

BILL OF MATERIAL

- 1 COMB — $\frac{1}{2} \times 3 \times 19$ "
- 1 TOP — $\frac{5}{8} \times 7\frac{5}{8} \times 19\frac{1}{4}$ "
- 1 SHELF — $\frac{5}{8} \times 7 \times 16\frac{1}{2}$ "
- 1 BOTTOM — $\frac{5}{8} \times 7\frac{5}{8} \times 19\frac{1}{4}$ "
- 4 POSTS — $\frac{3}{4} \times \frac{3}{4} \times 24$ "
- 2 PANELS — $\frac{1}{4} \times 6 \times 24$ "

This Improved Drawing Curve Is Quickly Adjusted



Adjustable drawing curve made from wood block fitted with a handle and a length of clock spring

A piece of wood, a length of rod, an old clock spring and a handle comprise this adjustable curve, which is a timesaver for artists. It is necessary, of course, that the spring be fairly stiff. Holes in the spring, where it is mounted on the rod, should be slightly oval-shaped, but not enough to give the spring a tendency to slip. If it does, however, the trouble may be prevented by using a small collar and set screw. A strip of fairly heavy sheet fiber or celluloid can be substituted for the clock spring, if desired.

Darkened Notarial Seals Show Clearly on Photostat



Notarial seals on legal papers will show clearly on photostatic copies if the impressions of the seals are rubbed lightly with carbon paper before photographing them. The carbon darkens the raised por-

tion of the seal so that it shows on the negative and finished copy. The carbon will not damage the original and it saves time of retouching the negative by hand.

Hunter Carries "Stove" and Fuel in His Pocket

When you go on a hunting or hiking trip, get a couple of cans and fill them with sand. Then pour in enough alcohol to saturate the sand thoroughly and put on the lids, which should fit tightly. Then you will have a tiny "stove" already filled with fuel and ready to ignite.

—Charles B. Kramer, Michigan City, Ind.

Both Sides of Coin Are Visible in This Holder

Both sides of your coin collection are visible in this holder without any danger of the pieces being scratched or thumb-stained. A frame of 1 by $\frac{3}{4}$ -in. walnut takes a core of hard-pressed board and two pieces of glass as indicated. Holes are bored in the core to take the coins, which should fit tightly so that they will not fall out.—Don. W. Sigler, Lincoln, Nebr.

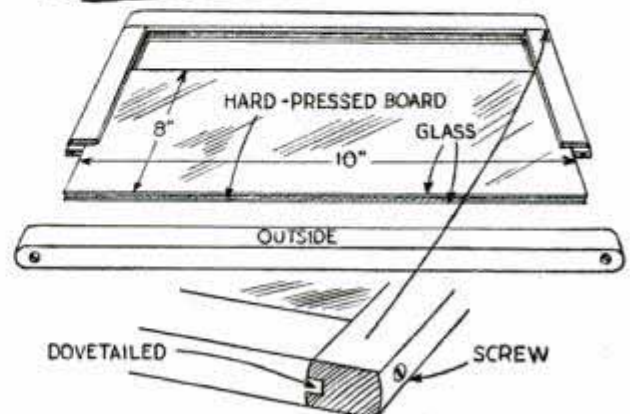
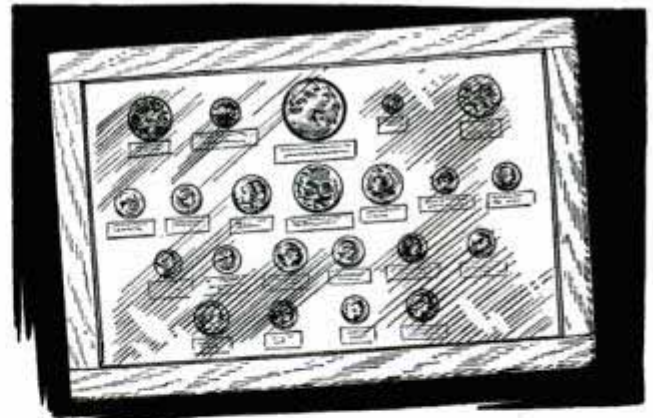

This holder permits showing both sides of coin collection yet avoids danger of the coins being damaged

Table LAMP

has . . .
mirror
sides

Blue-glass mirrors on the sides and a cylindrical shade lend a touch of distinction to this lamp. You can enhance it still more by letting the mirrors serve as frames for pet photos. Scraping off some of the silvering with a razor blade after scribing a circle is a simple matter. Plastic buttons or large-head ornamental upholstery tacks hold the mirrors in place on the wood core, the edges of which may be colorfully enameled. Or, if desired, the core may be maple or walnut, shellacked to retain its natural effect. Knob feet are turned from plastic or dowel stock. Assembly is accomplished by means of a pin concealed behind the mirror and a locknut in the base.

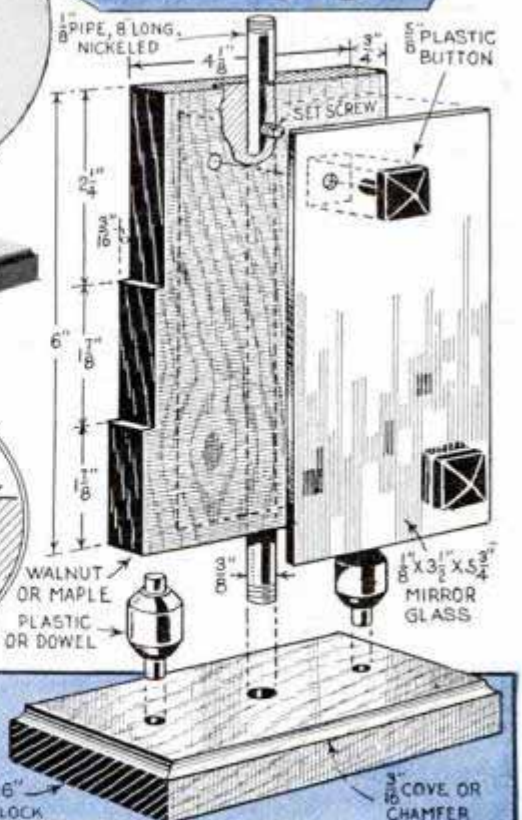
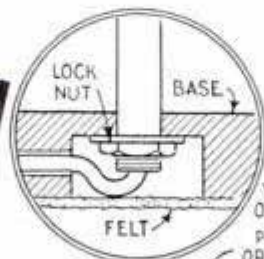
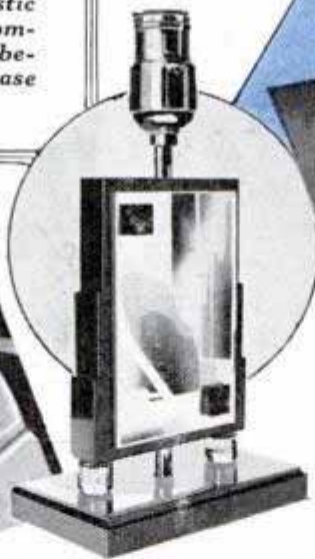

Movie Film Is Cleaned of Dust While Rewinding It

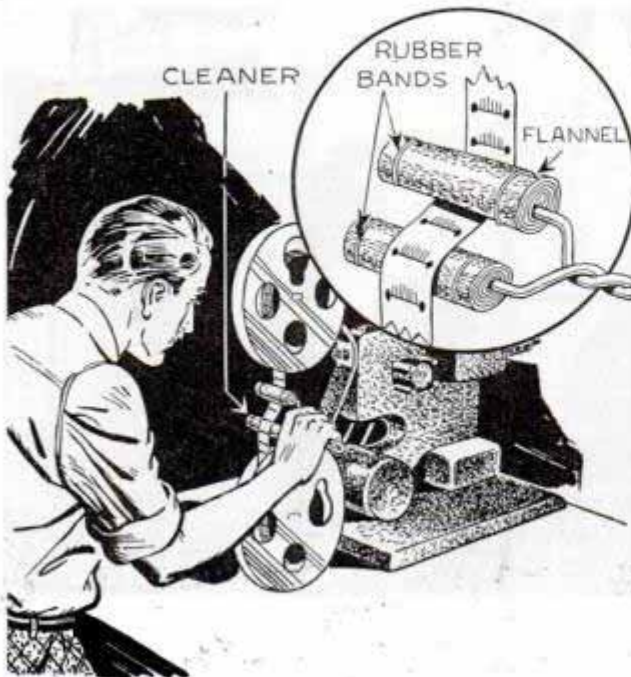

Flannel pads on wire prongs straddle movie film and clean both sides while it is being rewound

Here is a simple device with which you can clean both sides of your movie film when rewinding it on a reel. The cleaner consists of a length of wire looped in the center and twisted to leave two prongs at the end, which are wrapped with flannel in several layers and bound with rubber bands. It is best to dampen the pads with a good film-cleaning fluid before using them. When the pads become soiled on one side, the film is shifted so that it runs on the other side. When both sides are soiled, the cloth is unwound one turn and the soiled piece is cut off.

—Martin G. Winterton, Fort Lewis, Wash.

Designs on Mimeograph Stencils Made with Sandpaper Cutouts

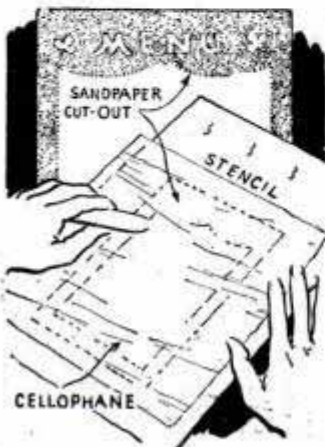

In making mimeograph stencils for duplicating menus and similar work they can be given decorative borders with sandpaper cutouts, as shown. The border design is first sketched on the back of a sheet of

medium-grain sandpaper and then cut out with a sharp knife. The cutout is placed, rough side up, under the stencil after which the latter is covered with a sheet of Cellophane to prevent scratching. The design is then transferred to the stencil by rubbing over the cutout with regular stylus or a blunt-end instrument.

Tripod Legs Are Held Together by Wide Rubber Band

Stretched over the legs of a camera tripod near the top, a rubber band 2 or 3 in. wide cut from an old inner tube will keep the legs from spreading when carrying it. Also, the band tends to keep the legs from slipping when the camera is in use.

—Jos. C. Coyle, Yuma, Ariz.



Microscope Slides Held Safely in Coiled Pipe Cleaner



Using this holder you can keep microscope slides at hand right on your worktable without damaging the specimens. A pipe cleaner is coiled and the ends are fastened to the

table or shelf with tacks or small screws, after which the glass slides can be set edge-wise between the coils.

Defrosting Refrigerator Quickly

If you have an electric refrigerator that does not defrost automatically, the job can be done in a few minutes by merely filling the ice trays with hot water and setting an electric fan in or near the refrigerator to blow warm air from the kitchen onto the freezing unit. If an electric hair drier containing a heating element is available, it will melt away the ice speedily.

—Harold E. Benson, Denver, Colo.

An Easy Way to Duplicate Wood Carvings

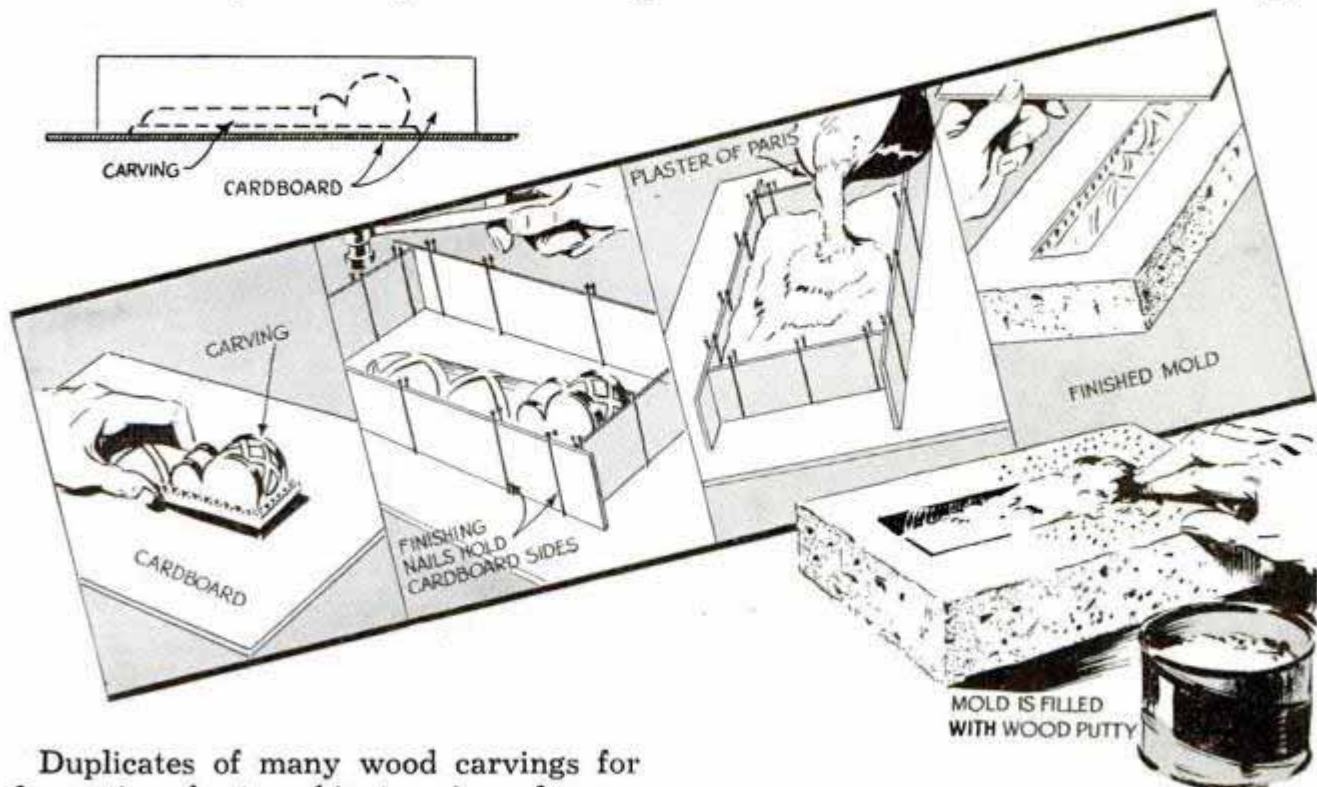

Duplicates of many wood carvings for decorating chests, cabinets, mirror frames, etc., are easily made by molding them. This is done by first forming a plaster-of-paris mold and filling this with wood putty. For one-piece molds, the carvings must be fairly simple so that they can be drawn out easily. For more intricate carvings you may have to use two or three-part molds. First apply a liberal coating of sweet oil to the carving and lay it face upward on a piece of cardboard. Then put a cardboard "fence" around the carving, supporting it

with nails. Mix equal parts of water and plaster of paris and pour the mixture over the carving. After the mixture has hardened, remove the cardboard and carving carefully. Now you proceed to fill the mold thus made with wood putty. Press in a layer and allow it to dry thoroughly before adding successive layers until the mold is filled. If the whole mold is filled at one time, a certain amount of shrinkage may cause distortion of the work.

Trunnion Made of Pipe Fittings Gives Close Adjustment

Using a heavy pipe tee and a matching close nipple, you can make a trunnion for tilting tables that gives critical adjustment through a range of 45° . The nipple is cut away to form two rockers, which are slotted for bolts. A steel plate, which supports the table, is welded to the rockers. Notice that the tee is cut away to allow the table to tilt a full 45° . The second nut on the clamping bolt is filed away so that it will ride in the slot without turning when the clamp is loosened. The second bolt at the rear is, of course, shorter, and if tension is desired, may be provided with a spring compressed between the head and the nut. Keep light oil on the threads.

—A. F. Buzdas, Stockton, Calif.

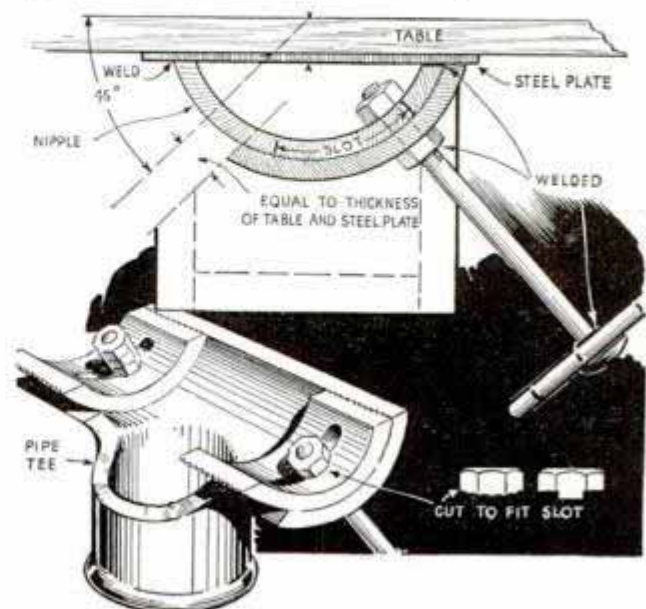

Better Pictures



the size of an ordinary 60-watt lamp although the same type bulbs are available in larger lamps. Then there are clear-glass photoflood lamps; those having opal or white, outside-spray bulbs so that they can be used in enlargers; photoflood lamps with blue-glass bulbs to give a daylight quality to the illumination.

Photoflood lamps come in several sizes. First, there's the No. 1 photoflood, the smallest of the series and an all-around lamp for the amateur. Then the No. 2 and No. 4 photofloods which are useful where progressively higher levels of illumination are required, the latter size being especially suitable for the average work of the advanced amateur. Finally, there's the movieflood lamp which is not strictly a photoflood lamp, but may be considered along with them. It is designed for motion-picture and still photography where a very high light intensity is desired. Essential characteristics of the four different types of lamps are given in the following table:

	No. 1	No. 2	No. 4	Movie-flood
Wattage (actual) at 115 volts...	250	500	1,000	2,000
Amperage ratings at 115 volts...	2.17	4.35	8.7	17.4
Maximum life in hours	2	6	10	15

INDOOR portraits, candid shots of all members of the family, unposed photos or just pictures of the home interior for record—these are now easy to take with any camera and photoflood lamps, the latter providing an inexpensive source of intense illumination. By carefully arranging the lamps, it is possible for the amateur cameraman to produce almost any lighting effect that he desires.

In general appearance, a photoflood lamp is very much like any other incandescent lamp. The filament, however, has been designed so that it is heated almost to the melting point of tungsten when an electric current passes through it. At such a high filament temperature, the light output is great, but the current consumption is relatively low. Because of the high filament temperature, a photoflood lamp has a short life when compared with ordinary service lamps. Most generally useful are the inside-frosted photofloods which are about

with PHOTOFLOODS



②

If you find that the exposure given with a certain photoflood lamp produces a well-exposed negative at one time, but results in under-exposure at another, the answer may be found either in lamp age or voltage. As a photoflood lamp burns, vaporized tungsten from the filament condenses on the inside of the bulb and blackens it. This deposit absorbs some light. Thus, when a photoflood lamp is about at the end of its useful life, its light output may be only 75 per cent of what it was when the lamp was new.

You can use photoflood lamps in photography wherever you would use ordinary incandescent lamps or, in some instances, where special types would be required. For general photographic work, two or three No. 1 photofloods, or two No. 1 and a No. 2 will produce an almost endless variety of lighting effects. If you look at the table of lamp characteristics, you will see that six No. 1 lamps can be used with safety on a line fused for 15 amperes; or that two No. 2 lamps and two No. 1 lamps, or one No. 4 and two No. 1 lamps can be used on such a line without blowing out the fuse. Of course, no other lamps

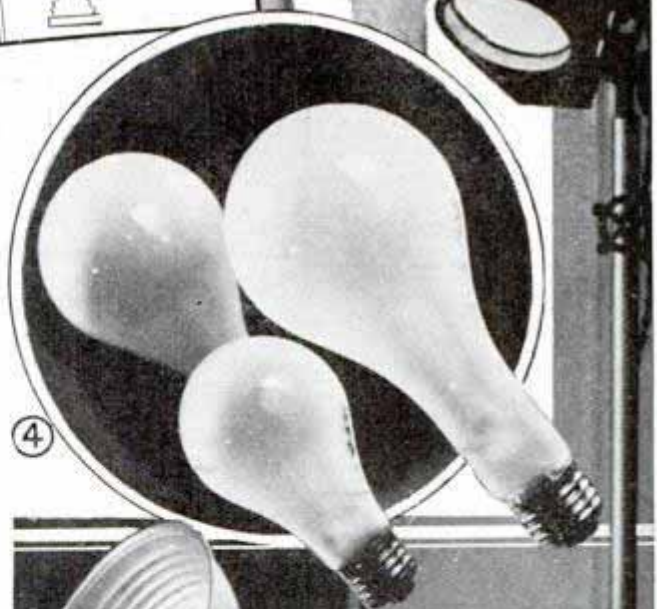
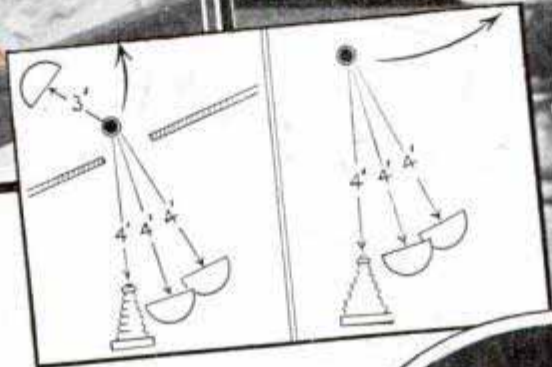

④

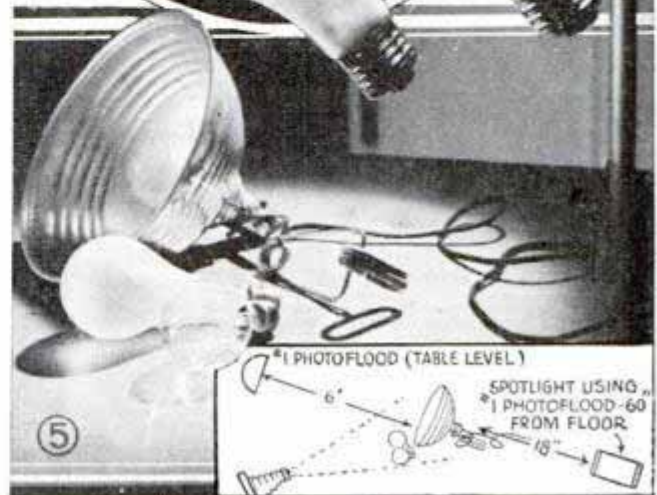

⑤

③



you will want soft shadows that bring out the modeling of the subject's face. In this case, you use a diffusing-bulb lamp in a reflector having a large area and a form that makes it act as a disk-shaped light source. You can test the effectiveness of a reflector by looking squarely at it when the lamp is burning, through a piece of smoked or colored glass to protect your eyes. Maximum diffusion is obtained by hanging a silk diffusing screen between the lamp and subject. Inside-frosted photoflood lamps are also used in spotlights because they are inexpensive, and because they produce less harsh lighting than conventional projector lamps—that is, the shadows are not as sharply defined, and the circle of illumination has a “feather-edge.”

Probably the widest use of the smaller photofloods among

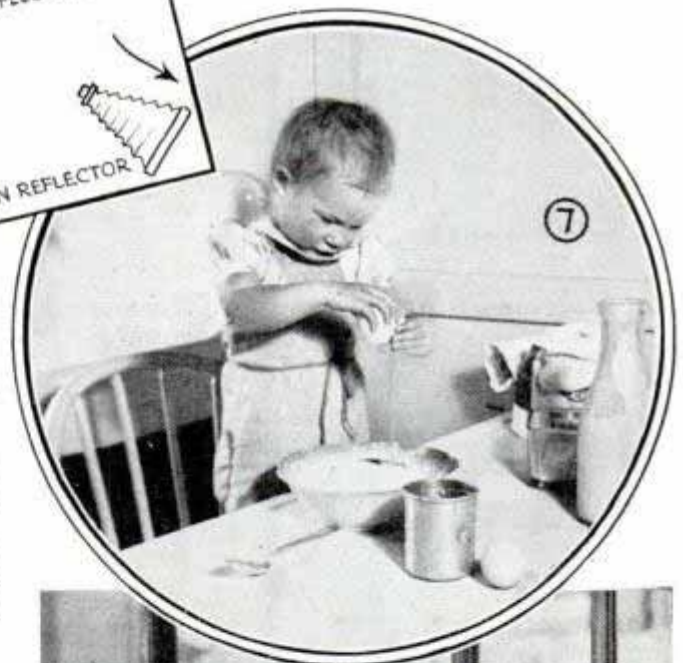
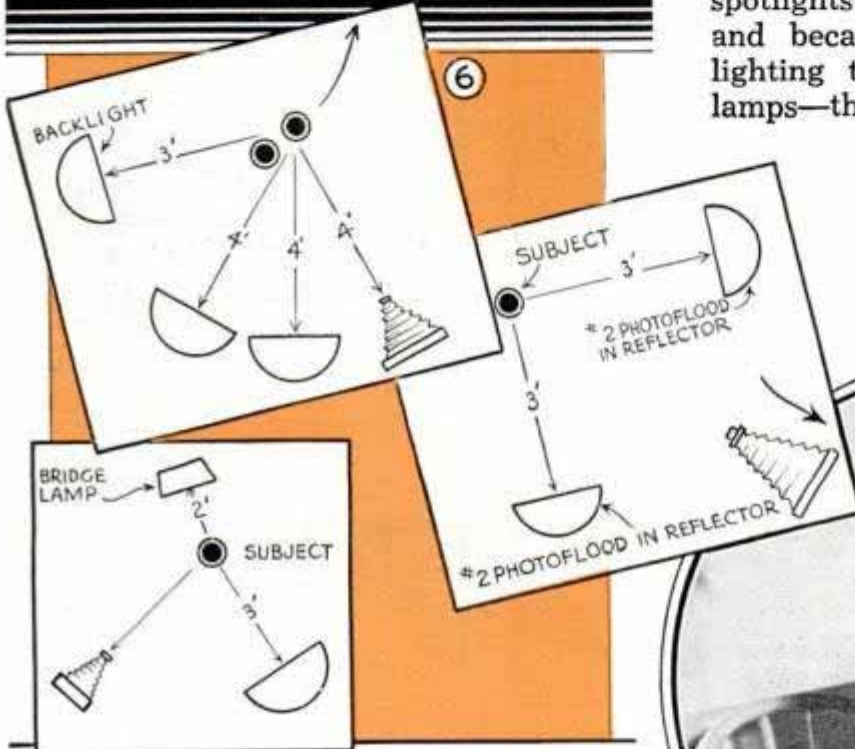

or appliances should be operated on the same circuit. To get the most out of your photofloods, always use a reflector. A well-designed reflector will increase the photographic effectiveness of a lamp three or four times.

The matter of light softness is of considerable importance in photography. Sometimes you will want to produce needle-sharp shadows, in order to obtain certain effects. Thus, if you are photographing a collection of abrasive wheels, and want to show the texture and interesting shadows, you should use a light arrangement that produces sharp shadows. A frosted-bulb photoflood lamp without a reflector might do the trick; or a lamp with a clear-glass bulb might be better. Moving the lamp farther away will sharpen shadows. If, on the other hand, you are taking a portrait,

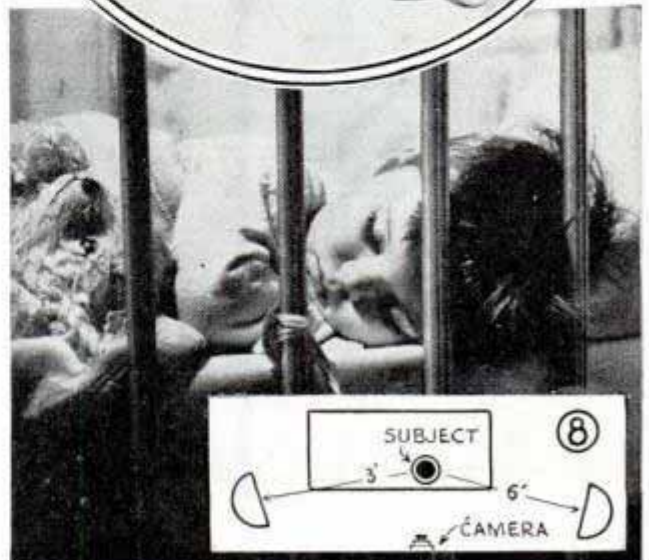

amateur photographers is for the making of indoor portraits of children and grown-ups. Two or three portable lighting units are required for best results. Simple metal reflectors with No. 1 photofloods will do in most cases; or a photoflood spotlight can be substituted for one of them, if desired. While there are many ways of arranging the various lighting units, the general arrangement for the average indoor shot is to place one photoflood lamp somewhere behind the subject's head, out of range of the camera lens, and adjust it for height and lateral position until the proper back lighting is obtained on the hair, face, shoulders, hat, etc. Then place a second unit somewhere in front of the subject, adjusting it to provide general illumination on the face in such a manner that the features are brought out boldly. This lamp generally will be to the left or right of the camera, and fairly close to the subject. Place the third photoflood lamp farther back, and on the opposite side of the camera, adjusting it so that it produces good



Exposure Table for Two No. 1 Photoflood Lamps in Good Reflectors

Distance—Lamps to Subject	Exposure Sec.	Lens Diaphragm Opening
4 ft.	1/25	F/4.5
	1/10	F/8
	1/5	F/11
	1/2	F/16
6 ft.	1/10	F/4.5
	1/5	F/6.3
	1/2	F/11
	1	F/16
10 ft.	1/5	F/4.5
	1/2	F/6.3
	1	F/8
	1-1/2	F/11
	3	F/16

modeling of features by illuminating the harsh shadows cast on the face by the second lamp, but does not obliterate them entirely. See Figs. 1 to 10.

The matter of exposure can be determined by means of a table, if you have no exposure meter. The exposure table on this page, based on the use of fast panchromatic film, has been worked out and will be of some use in calculating exposures.

To decrease exposure time for a given distance and lens opening, increase the number of lamps. Thus, doubling the number will cut the exposure in half. Another way is to employ larger lamps. The No. 2

gives twice as much light as the No. 1, and the No. 4 gives four times as much. If you use No. 2 lamps instead of No. 1 give 1/2 the exposure; for No. 4 lamps, give 1/4 the exposure.

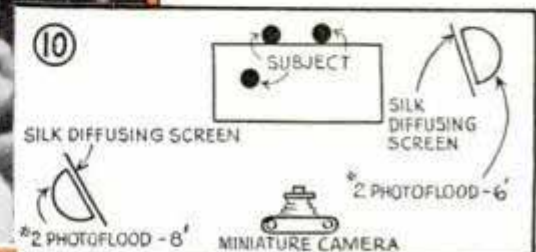

Carrying Rack on Child's Scooter for School Books

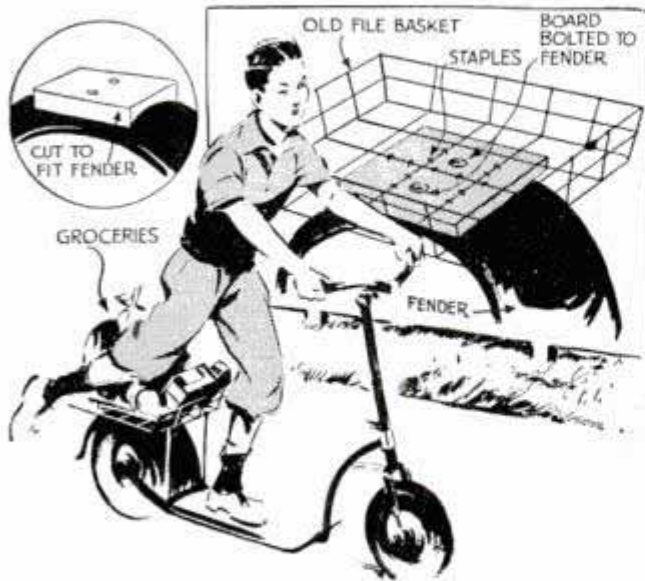

Child's scooter fitted with rack to carry school books, or groceries from the store

Besides making it convenient for the child to carry books and parcels, a rack on his scooter allows him to have both hands free to handle the scooter when crossing streets. A wire file basket such as used in offices will serve as a rack; it is mounted on a wood block, which is curved on the underside to the contour of the fender and bolted in place. When the rack is not needed, it can be removed by merely taking out the two bolts.

—Opie Read, Jr., Chicago.

Glass Disks Cut Accurately on Drill Press

A number of glass disks are cut quickly and accurately on your drill press with the jig shown. It consists of a hardwood block

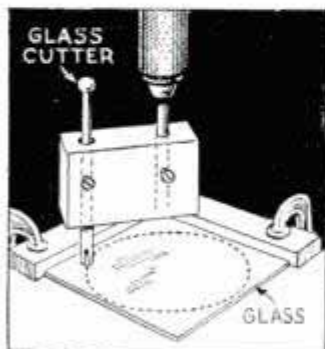

drilled to take a glass cutter and a small rod, with which it is chucked in the drill press. The glass to be cut is held in place on the table by two blocks clamped in position. In use, the cutter is rotated slowly by pulling

on the belt with one hand. After a circle has been scored on the glass, scored lines radiating from the circle to the edges

of the glass will have to be made by hand so that the waste can be broken away without damaging the disk.

Canvas Pockets to Hold Brads and Small Parts

Fitted with eye-lets and suspended from L-hooks on the wall above a workbench, canvas pockets are handy to hold screws, brads and other small parts within easy reach. In use, a pocket is removed from the supporting hooks,



laid on the bench and the contents poured out on the flap. Raising the flap returns the unused parts to the pocket without waste of time.

Turret Stand Keeps Your Drills Within Easy Reach

Here's a drill holder that you can mount on the wall above your workbench or any other place where it is within convenient reach, and it can be rotated to make selec-

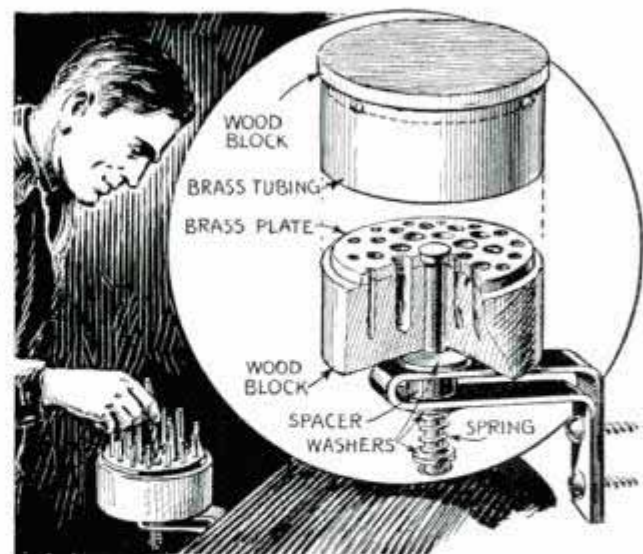

This holder is mounted within easy reach and rotates so that you can select a drill in a jiffy

tion of the drills easy. It consists of two parts—a body and cover—which are pivoted to a flat-iron bracket. The body consists of a circular wood block of suitable

thickness and a brass plate slightly smaller in diameter, which is screwed to the top of the block. Holes for the drills are bored in circular rows, the holes being staggered in each row so that they do not line up across the top of the plate. A center hole in the block is fitted tightly with a piece of tubing to serve as a bearing for the pivot, which is a bolt or stud extended downward through the bracket with a coil spring on the lower end, a spacer washer between the two arms of the bracket, and a washer under the block to serve as a bearing. The cover consists of a short piece of tubing of a diameter to slip snugly over the brass plate on the body and a wood disk in the top. The edge of the disk is recessed on the underside to fit into the tubing, where it is held with wood screws as indicated in the drawing.

Occasional Wood-Turning Job Done Quickly on Drill Press

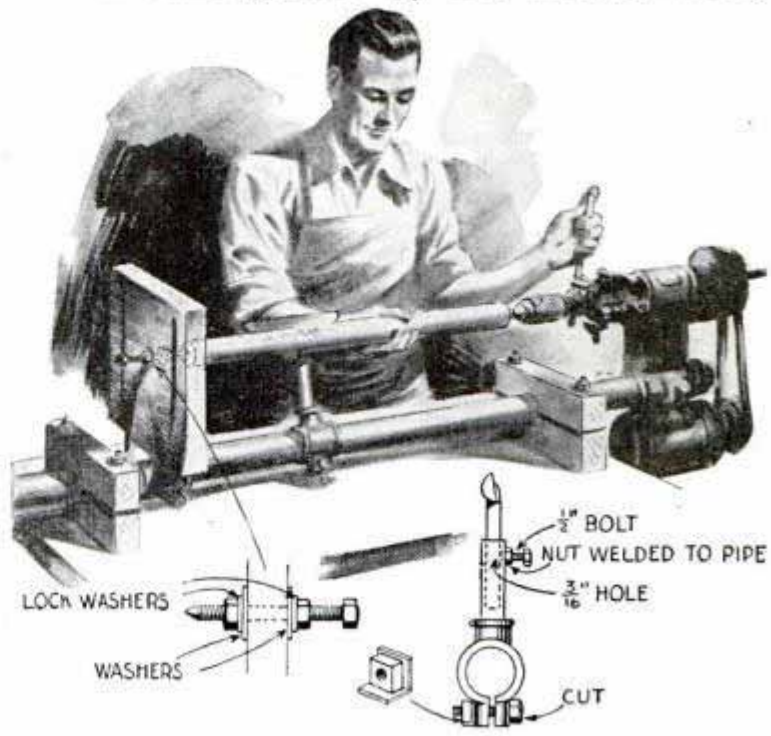

Floor-type drill press used as a wood-turning lathe by placing it horizontally on bench and clamping it with bolts and blocks

Emergency Play Pen for Baby Improvised from Table

When a play pen is needed for a baby and none is at hand, just take a kitchen or other small table, turn it upside down and stretch cloth around the outside of the legs as indicated. A bed sheet folded to make it narrow will do the trick. An old comforter can be placed in the bottom of the unturned table to pad it.

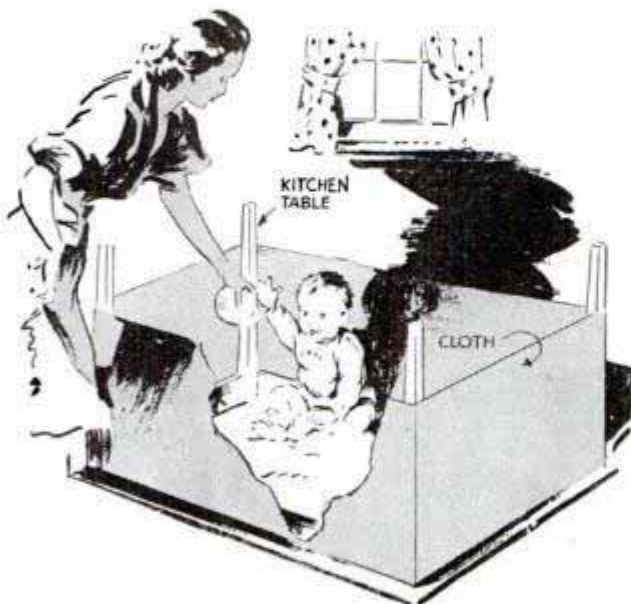

Table turned upside down with cloth stretched around legs provides emergency play pen

In the absence of a wood-turning lathe, a drill press can be used as a substitute to turn out an occasional job. The drill press is placed horizontally on a bench or table and is clamped in place with bolts and blocks as indicated, the drill spindles serving as a headstock and the table, which is fitted with an adjustable center made from a bolt, serves as a tailstock. The tailstock center is a pointed bolt, which is threaded its entire length and fitted in the hole in the table with two nuts and lock washers as indicated. The tool-rest support consists of a four-way pipe fitting large enough to slide over the drill-press standard and a nipple assembled as shown in the lower right-hand detail. The lower end of the fitting is split and fitted with a bolt to clamp it around the standard as indicated.

—A. M. Dremin, Toronto, Ont., Can.

Whitewashing Furnace Pipe to Prevent Rusting

It is claimed that the inside surface of a new smoke pipe can be prevented from rusting by giving it a coat of whitewash. The lime in the whitewash neutralizes the acid in the soot, which causes rusting of the pipes.—J. Milota, Cleveland, Ohio.

Ship modelers, try this one!

The
**Grecian
Trireme**

WAR GALLEY

600 B.C.

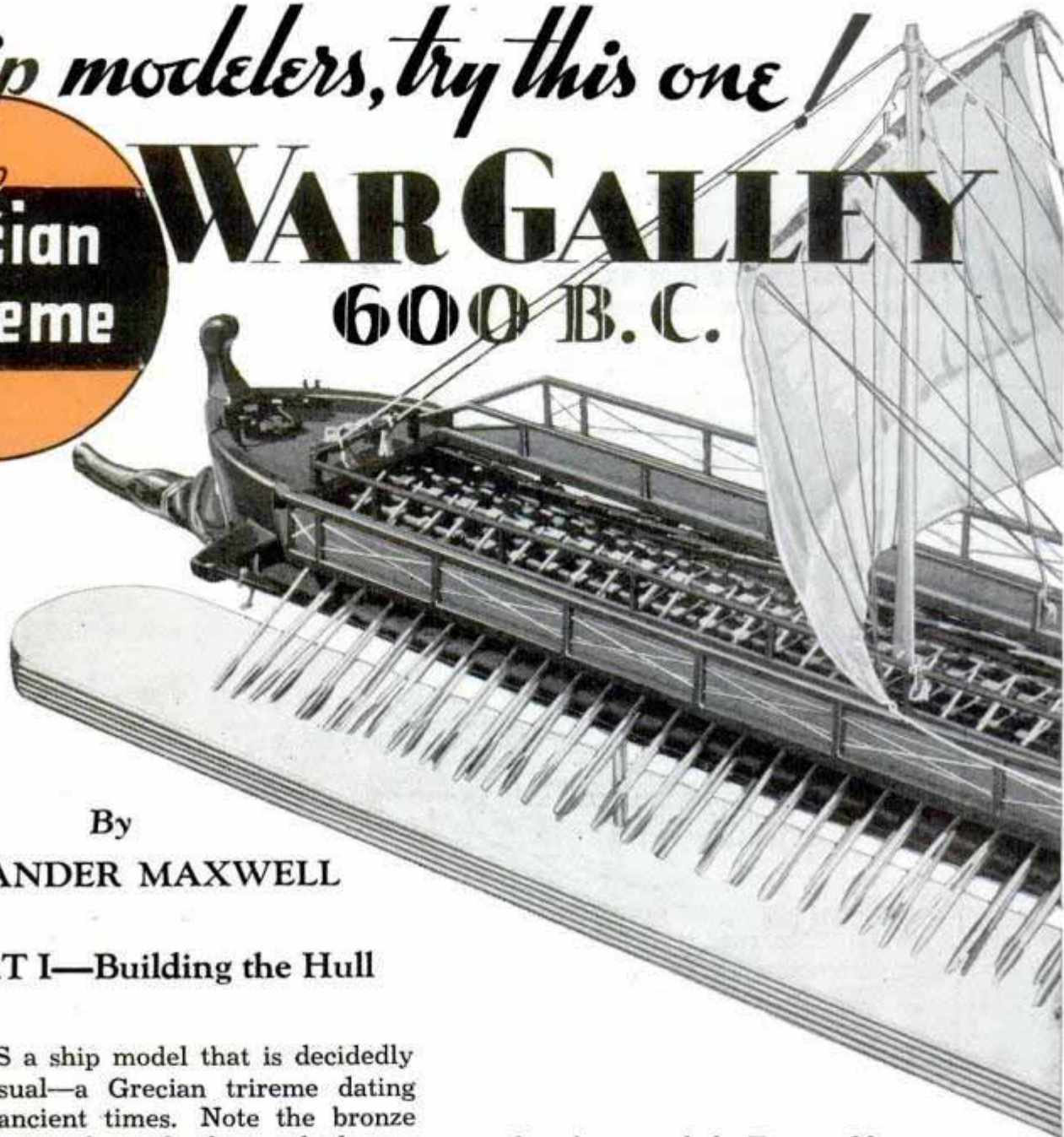

By
ALEXANDER MAXWELL

PART I—Building the Hull

HERE'S a ship model that is decidedly unusual—a Grecian trireme dating back to ancient times. Note the bronze ram projecting from the bow, which was driven into the hull of an adversary at a speed of fifteen to eighteen miles per hour, 172 crack oarsmen furnishing the motive power, the oars biting into the water in perfect synchronism with the beating of the gong. Unlike later Roman galleys in which slaves were employed as oarsmen, the Grecian ships had crews of highly paid professional oarsmen. The oars were arranged in three banks; hence the name trireme as distinguished from bireme, a ship having two banks of oars. A sturdy cathead on either side of the bow was designed to brush against the adversary's ships and break off whole banks of oars. The cruel eyes were of inlaid marble. A small sail could be raised or lowered in-

stantly when needed. Two rudders were found better insurance than one, and two ladders were provided, these being lashed onto the stern as shown, one for scaling cliffs along the shore and the other for disembarking on beaches. Many ships of the same type formed the large navy and all replaceable parts were standardized like auto parts today, so that they could be ordered by letter from the shipyards. To my knowledge, this is the only fully equipped model of a Grecian trireme in existence. Information on constructing it as accurately as possible was gathered over a period of ten years. A Grecian bireme was built by Fred Lippold and is now on exhibition in the Deutches Museum at Munich. I selected a trireme as a still more compre-

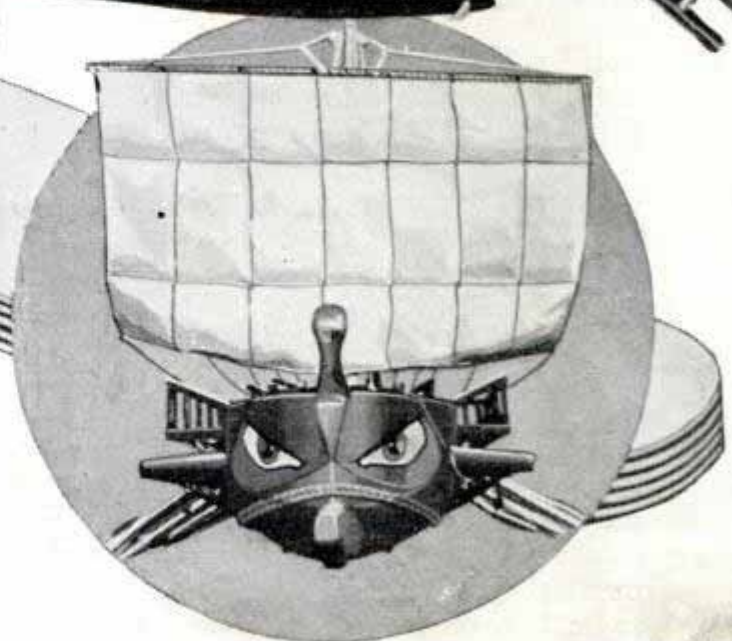
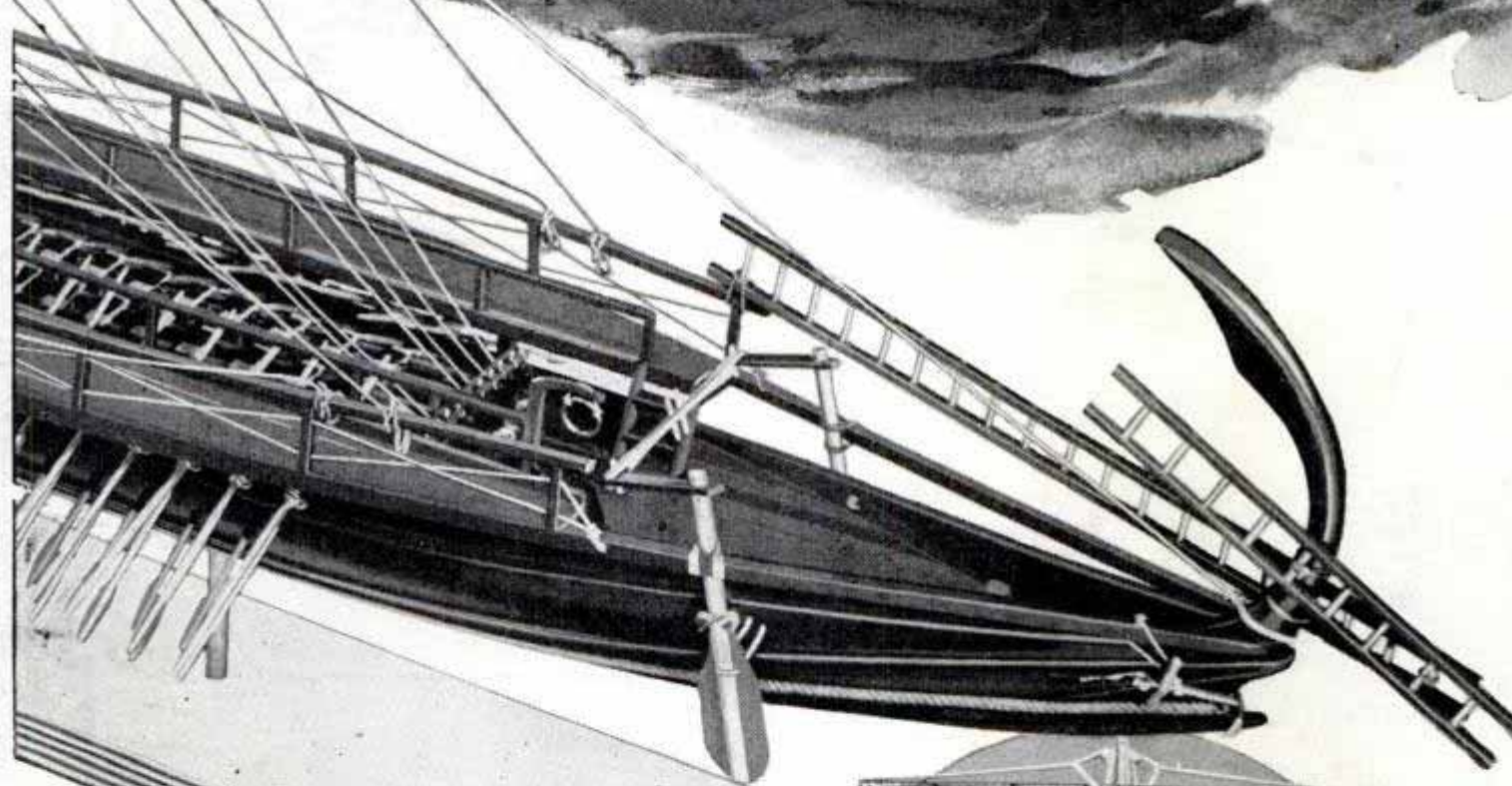
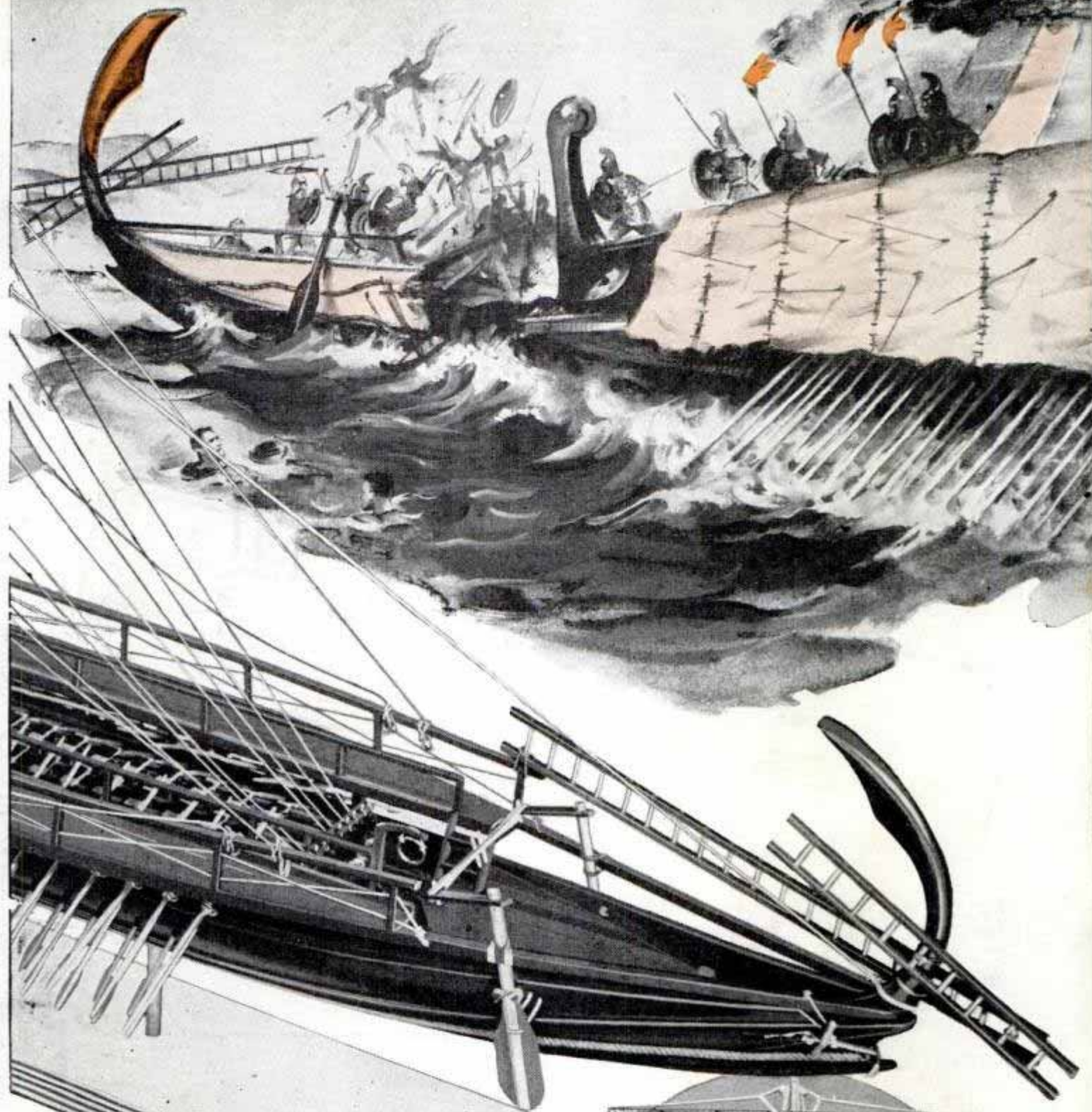

hensive model of ancient Grecian warships which were developed in the period from 1000 to 300 B.C. As early as 1000 B.C. ships of 100 oars and 300 tons capacity were plying the Mediterranean sea and by the time Greek republics had reached their supremacy, warships of 172 oars and merchantmen of 1,000 tons capacity were in use.

As the original ship was planked with

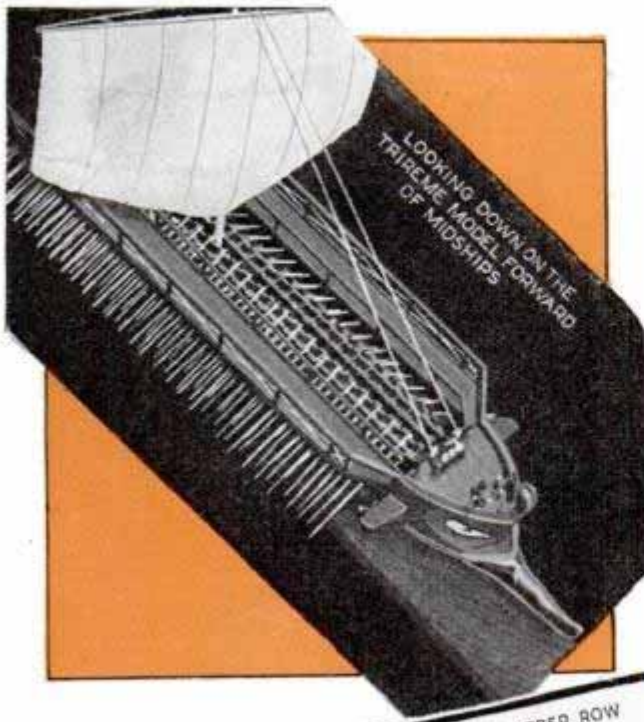

been installed. Sand the hull till the plane marks are removed, and when all templates register, finish with No. 000 garnet paper. The interior of the hull is hollowed, Fig. 1, leaving only a shell $\frac{1}{4}$ in. thick at the gunwale and $\frac{1}{2}$ in. at the keel. Although the latter dimension is not critical, it's well to keep it fairly close, as later on the structure which supports the rowers' benches is fitted inside the hollowed section. The thickness at the gunwale should be kept uniform. This stem and stern will be decked over, so they may be left solid. Tie a string around an auger bit for a

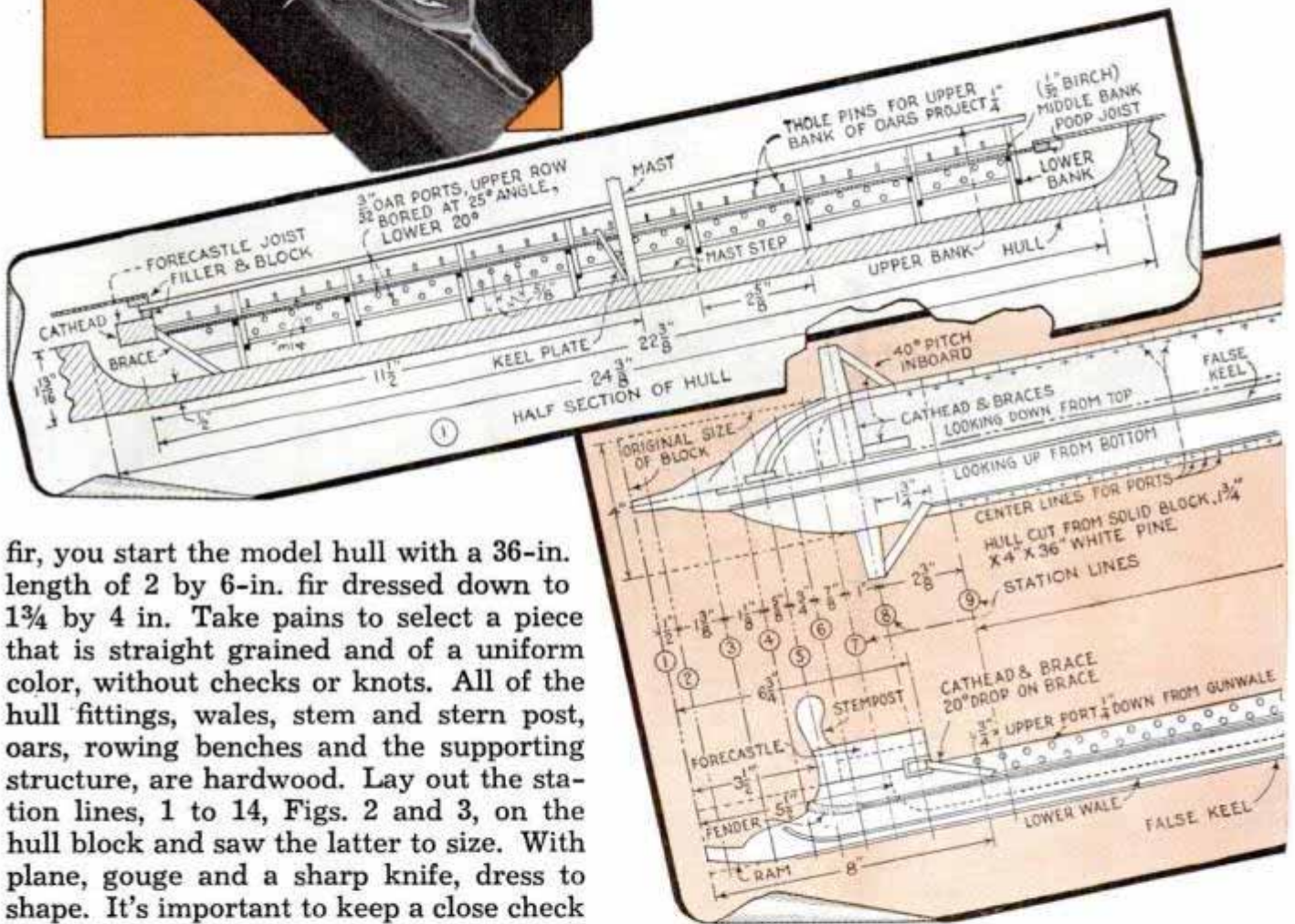

fir, you start the model hull with a 36-in. length of 2 by 6-in. fir dressed down to $1\frac{3}{4}$ by 4 in. Take pains to select a piece that is straight grained and of a uniform color, without checks or knots. All of the hull fittings, wales, stem and stern post, oars, rowing benches and the supporting structure, are hardwood. Lay out the station lines, 1 to 14, Figs. 2 and 3, on the hull block and saw the latter to size. With plane, gouge and a sharp knife, dress to shape. It's important to keep a close check with the templates even when the hull block is in the rough stage of shaping. One has to be especially careful with the gouge and chisel, for if either of these tools happens to lift a chip too deep you will have an unsightly depression which is difficult to patch, particularly on the straight section of the hull between stations 9 and 10. The block may be held steady by an improvised vise made of a C-clamp and two blocks. Rough the bow and ram to approximate dimension. They will not be carved to final shape until after the forecastle has

depth gauge and bore the waste stock full of holes as in Fig. 4. Of course, the holes will vary in depth, those at the center being deeper to remove as much waste as possible. When this is done, it is a simple matter to lift away the waste with a gouge, Fig. 8.

The two lower oar banks pass through port holes drilled in the hull, Fig. 2. Start the middle bank $\frac{1}{4}$ in. down from the gunwale and 8 in. back from the tip of the ram. Bore $\frac{3}{32}$ -in. holes, $\frac{5}{8}$ in. apart at an angle

of 25 degrees. There are 29 holes on each side in the top row, and 27 in the lower row. The lower bank is staggered, and the holes bored at an angle of 20 degrees. Of course, it's necessary that these holes be spaced equally and what is even more important, the angle of the holes must be kept uniform, otherwise the oar bank will be uneven when the individual oars are placed in position. The stempost and sternpost are next carved to shape and glued in place, Figs. 5, 6 and 9. Use airplane cement for all joints. The huge cathead comes next. In the prototype it was a massive timber used to pro-

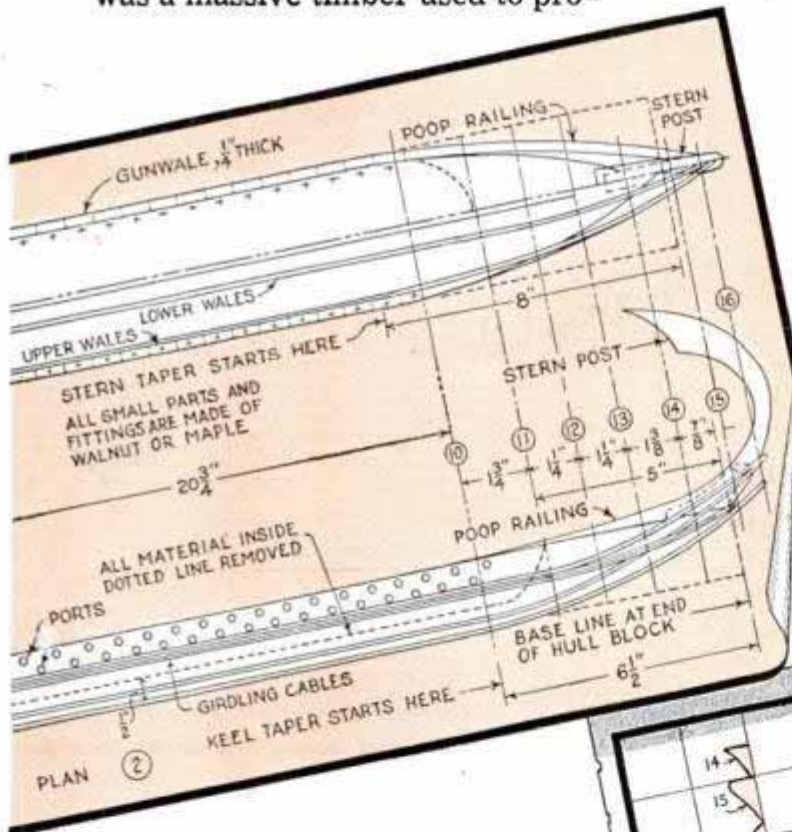
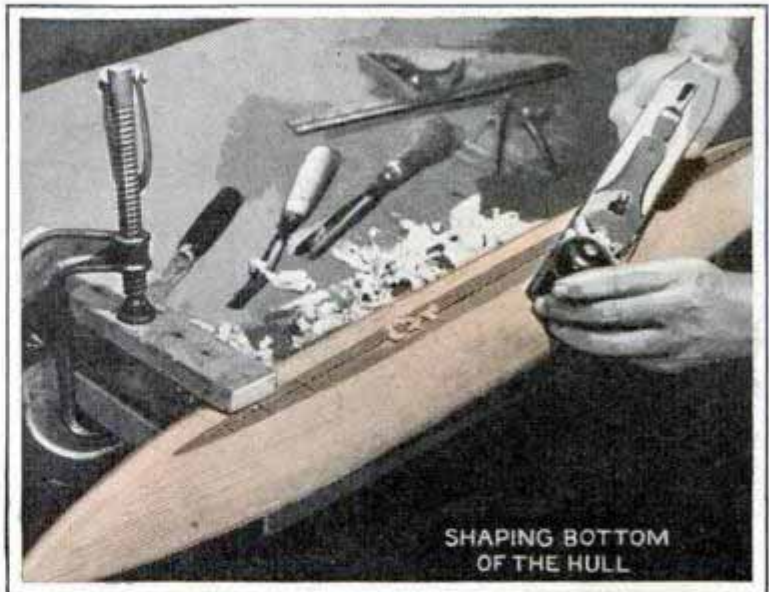

keel is broad and flat and curves up like a sled runner at the stern. Glue the straight section in place and hold with pins until dry. Don't bend the curved portion until the straight section has set. The end projects to form a horn which holds the girdling cables and the stern anchor. Two of the cathead braces go inside, the others are fitted to the hull, Figs. 6, 12 and 13. Install the outside braces first, and carve to shape when dry.

There is considerable flair at the stern, so allow plenty of waste stock on the stern rails, Fig. 11. Glue in place with the sternpost, Fig. 10, and carve to shape when dry. The four wales act as fenders and skids and help to absorb stresses when ramming or bucking a heavy sea. They are glued

tect the oars and gangways when ramming, and also as a horn to tear away the upper works of an enemy or splinter his oars. Fit the cathead into the hull slot and shape the forecastle rails to fit between it and the stempost, Figs. 5 and 6. Glue the rails in place when roughed out. When dry, the entire bow structure is carved to shape, and at the same time the ram is fashioned into a boar's head. When not in use the ship was always drawn up on the beach, stern first. Hence, the false

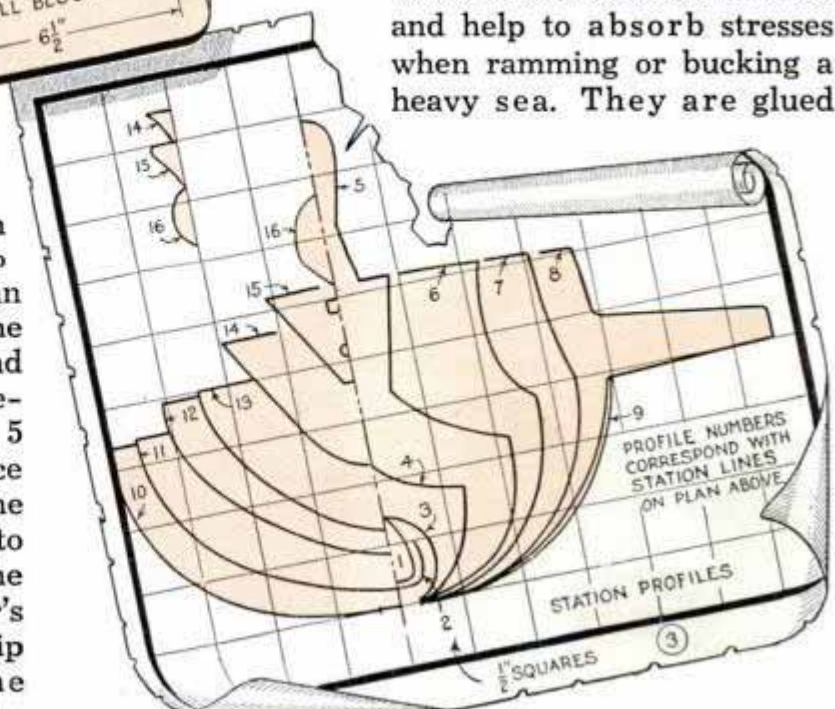

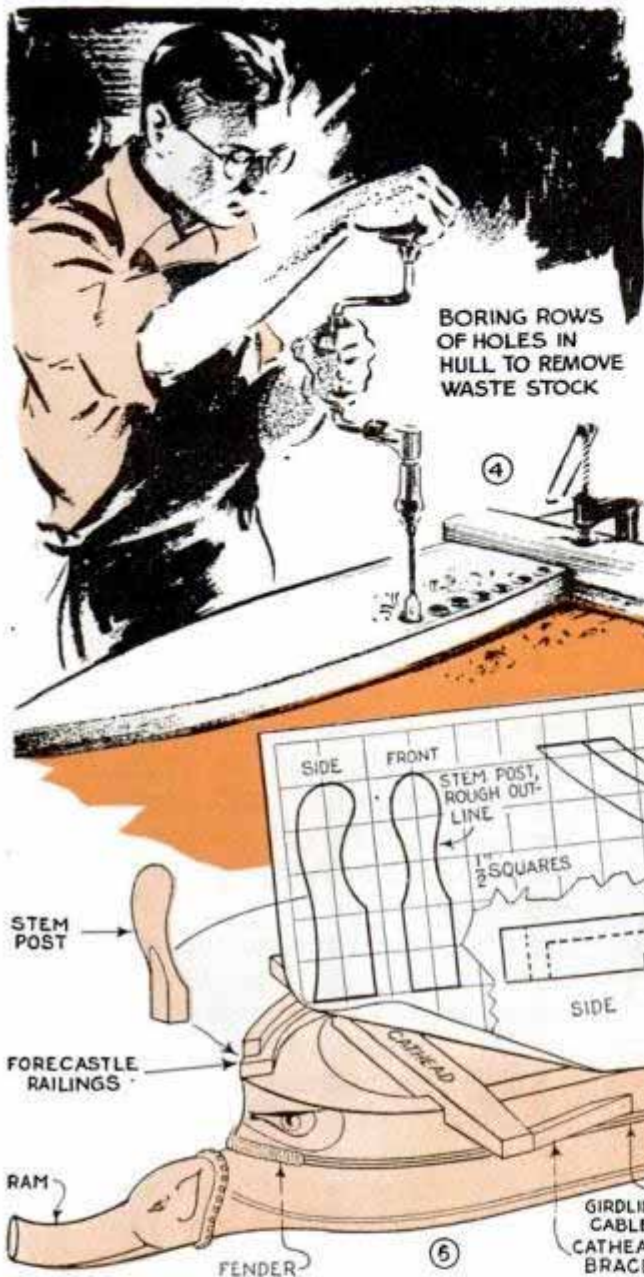

and pinned in place in the same way as the keel. The forward ends of the two lower ones must be shaved paper thin before they will bend up against the ram.

Oil paint as we know it, had not yet been invented when this ship sailed. Instead the builders used a mixture of tar, tallow and beeswax in which was mixed a crude earth pigment. This was melted and spread on the planking smoking hot. Homer states that the tallow of a thousand oxen was used to coat a single vessel. However, the original paint job can be duplicated nicely in miniature by using tube pigment mixed with flat varnish. The former is the solid coloring painters use for tinting white paint or enamel. The hull below the upper wale is black. Mix two parts black pigment with one part varnish and apply with a watercolor brush. The remainder of the

hull and sternpost is painted dark blue. Mix equal parts of cobalt and black, thin with one third varnish and apply. The upper wale, stempost, and cheeks of the forecastle are a terra-cotta red, Fig. 7. This distinguished the vessel from ships of other nations. Terra cotta is made by mixing half and half, vermilion and black, thinned with one third varnish. When dry, put a fine line of purple between the red and the blue, and also between the blue and the black forward of the cathead brace. Do not use any varnish in this. To duplicate the paint job on the original ship you would not have to be at all particular for it was necessarily crude. However, for the sake of appearance it's best to take care to get the pigment brushed out well on the model.

The predominating feature of the ship is the large and cruel eyes, Fig. 7. These were made of marble and were inlaid in the wood. Draw the eye full

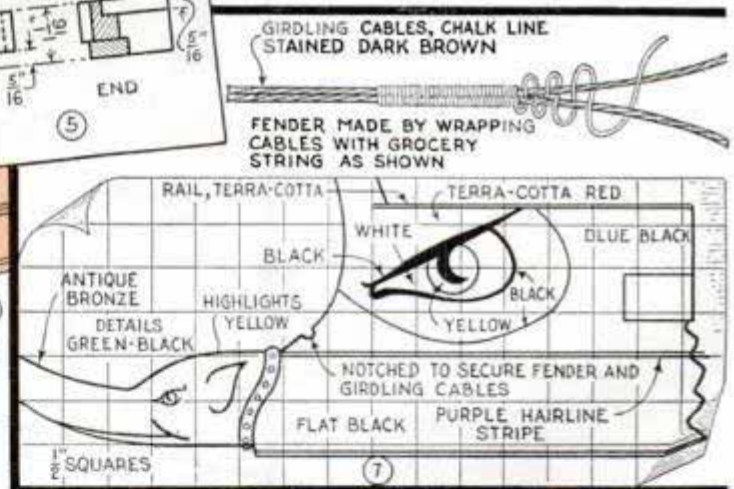

size on a piece of paper, pin in place and trace the outline with a hard pencil. This will dent the red paint enough to give an outline. Reverse and do the same to the other side. Paint the pupil black, the iris yellow and the eyeball white. Outline with black and make the brow heavy and scowling. Apply the paint directly from the tubes.

The ram is gilded with antique bronze powder mixed in varnish. The original was a rough, bronze casting, so detail the features with green-black and touch the high spots with bright yellow. Do not make any lines too distinct. The neck of the ram was hollow, and was spiked to a

protruding timber in the stem. Indicate this ring of spikes with yellow dots. Finally add the girdling cables, made as in Figs. 7 and 14, and you have the hull finished ready for the fittings.

Now, to re-emphasize certain points in the procedure: In going through these first steps in the construction you'll notice that much depends on hand work, that

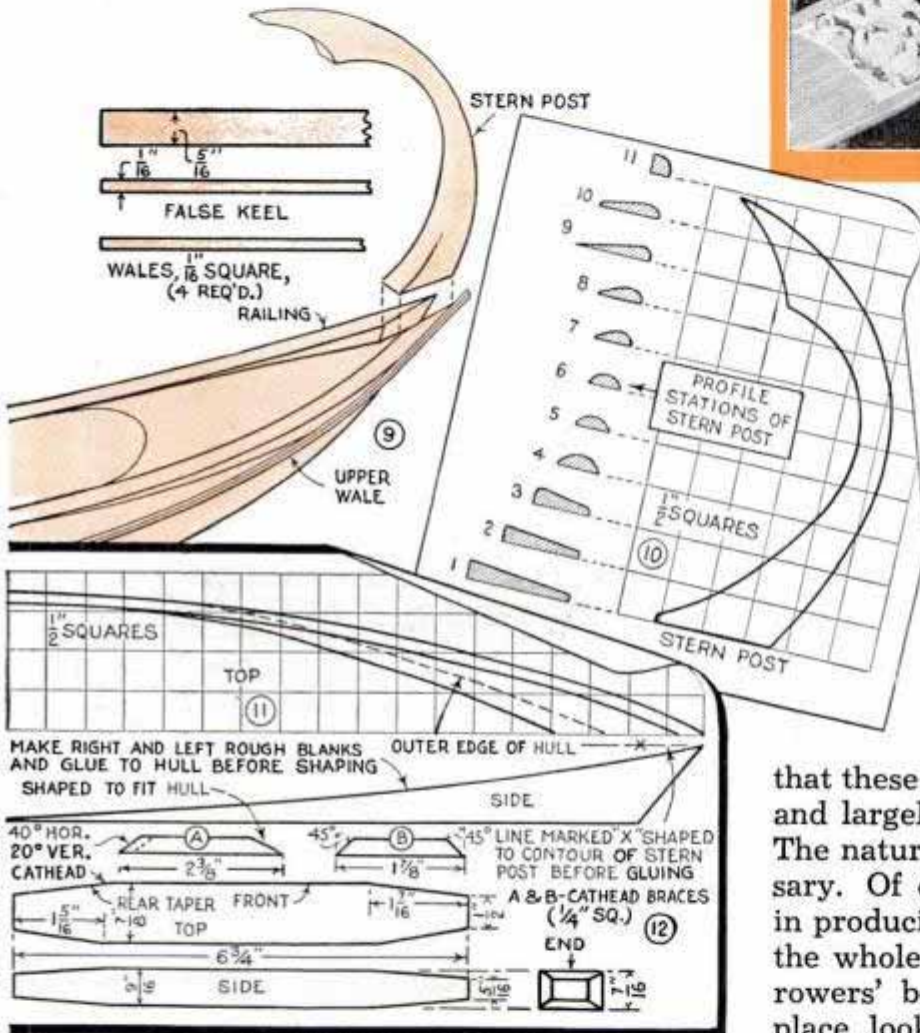
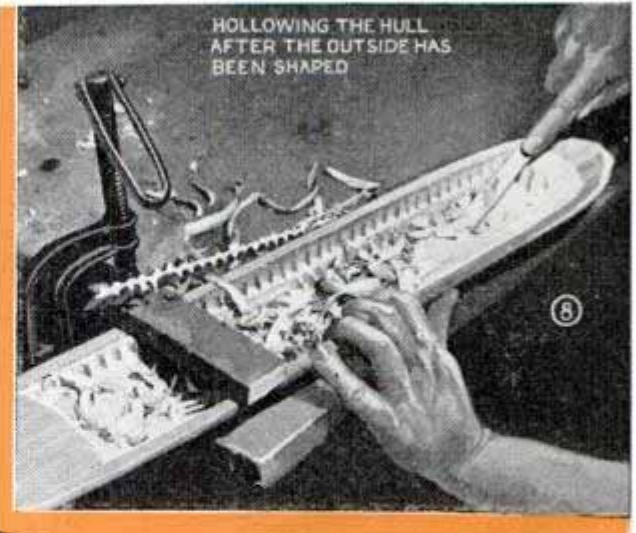

practically all parts are made and fitted in this way. Hence, the builders' capacity for taking pains with details will mean everything in the appearance of the finished work. The hull, you will see, is really a very simple job but the contours fore and aft must be watched closely when you get the curves down near the finished size. Also, the dimensions on many of the parts fitted to the hull are only approximations, which means

that these parts must be fitted individually and largely by the "cut and try" method. The nature of the work makes this necessary. Of course, sharp tools are essential in producing a crisp, clean-cut job. While the whole thing fully assembled, with the rowers' benches, oars and rigging all in place, looks as complicated as ship models of a much later date, the fact that the greater part of the fittings are duplicates simplifies matters greatly. For example, there are 172 oars to be made but these are all of the same construction, the only variation being in the length. The rowers' benches are all exactly the same size and the frame supporting the benches consists of a number of strips resting on vertical members.

(To be continued)

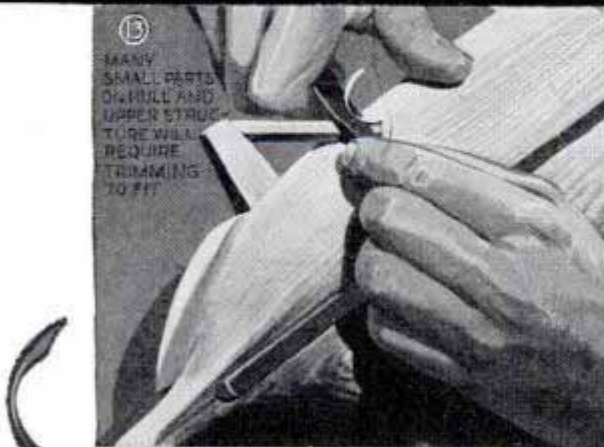

Lamp Held Above Workbench by Sheet-Metal Bracket

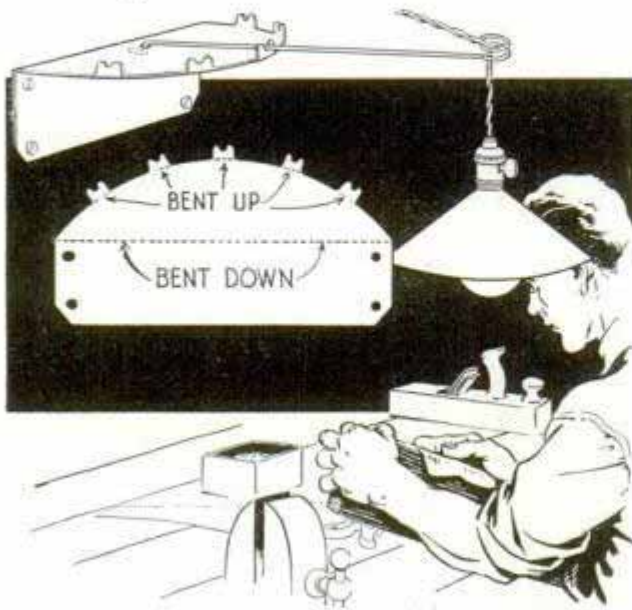

Wall bracket to support drop lamp holds the latter in any desired position above the workbench

Here is an adjustable bracket that holds a drop light over my workbench in various positions to illuminate a jig saw, lathe or drill press. It consists of a piece of heavy sheet metal cut and bent as indicated, and a length of stout wire which has a spiral loop at the outer end so that the lampcord may be inserted or removed instantly. By swinging the arm to the desired position and allowing it to rest in a notch of the bracket, the lamp is held securely.

—G. E. Hendrickson, Argyle, Wis.

Top of Drawing Table Is Tilted by Casement-Window Adjuster

I can tilt the top of my drawing table by merely turning the small crank of a casement-window adjuster on one of the standards, which is much easier than

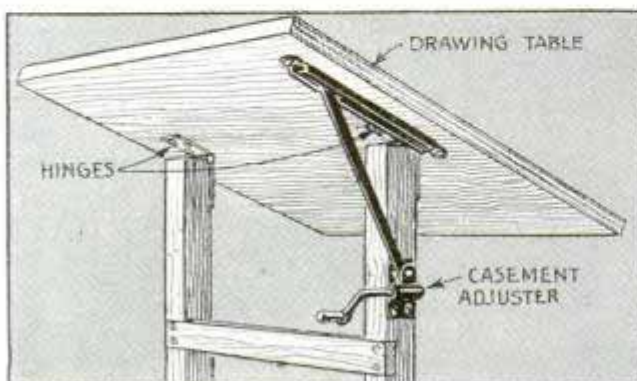

This method of tilting your drawing table is much easier than fussing with wing nuts

stooping to loosen a couple of wing nuts usually provided on drawing tables to permit tilting of the top. The drawing shows how to mount the adjuster.

—Jack Elms, Flagstaff, Ariz.

Notched Cardboard Forms Holder for Card Writer's Brushes

Showcard writers who dislike to lay their brushes into a drawer or cabinet, where the tips may come in contact with other objects, can protect and keep the brushes at hand by using this holder.

It is nothing more than a piece of cardboard notched as indicated and fastened to a glass with a rubber band.

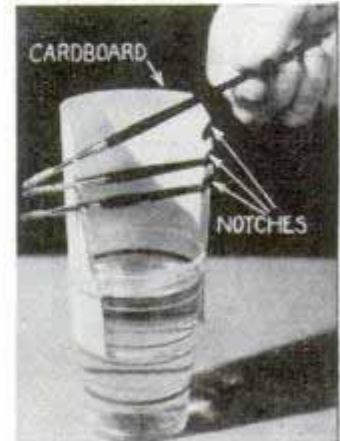

Building the Ice Glider

Sturdy, yet light in weight, the midget iceboat pictured on the opposite page has a frame of seamless steel tubing, assembled without welding. The seat gives the pilot full vision ahead and he can step off instantly in case of an emergency. As the sail is mounted low, with corresponding low center of effort, any tendency to capsize is minimized. The two main frame members are bent around a curved wooden form, or simply a curved block. By heating a short section at a time with a blowtorch, bending can be done gradually. Runners are of steel plate, sharpened to an inverted V-shape on the bottom and mounted in wooden blocks, which in turn are bolted to the frame members. A curved boom and mast-peak holds the sail out sufficiently to permit it to belly without coming into contact with the rigging, thus presenting a smooth surface to the wind. The mast swings with the boom, and by hauling on one or the other main sheet the sail can be set to catch the wind from several angles. It can be furled by unhooking the grommets at the boom ends and wrapping around the mast. The mast and boom are quickly dismantled by removing a couple wing nuts.

Light-weight

ICE GLIDER

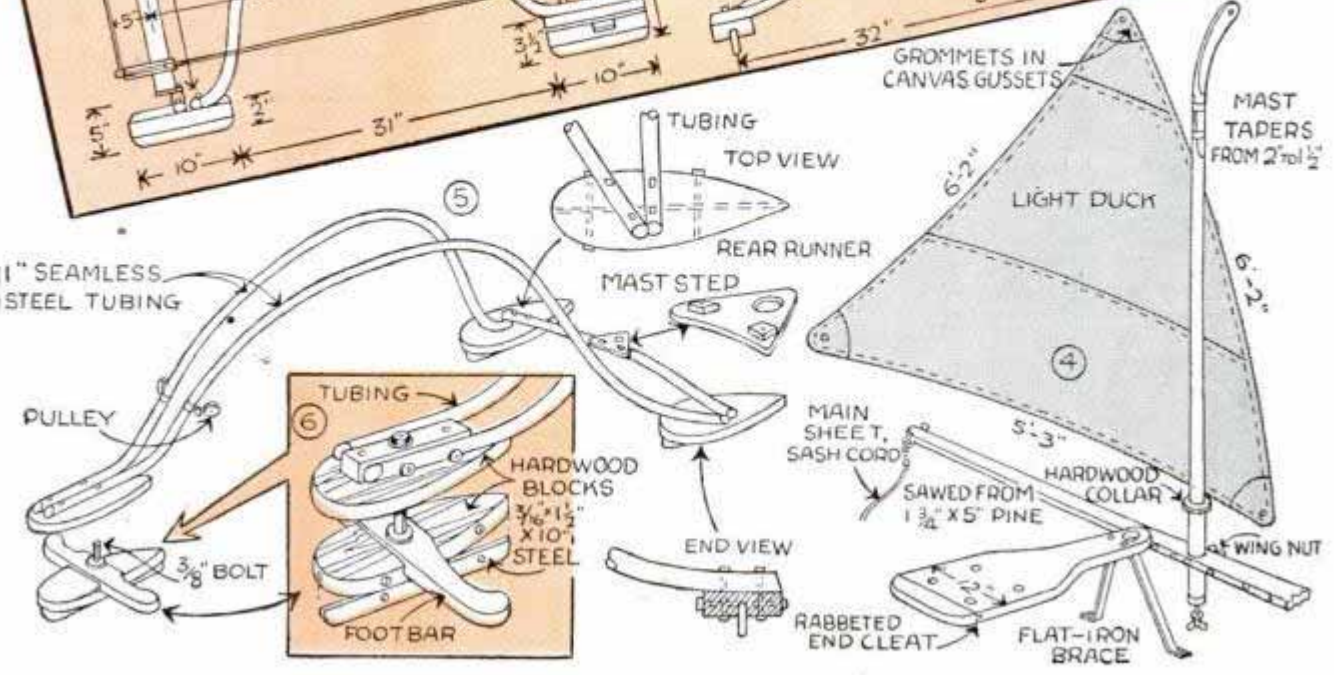
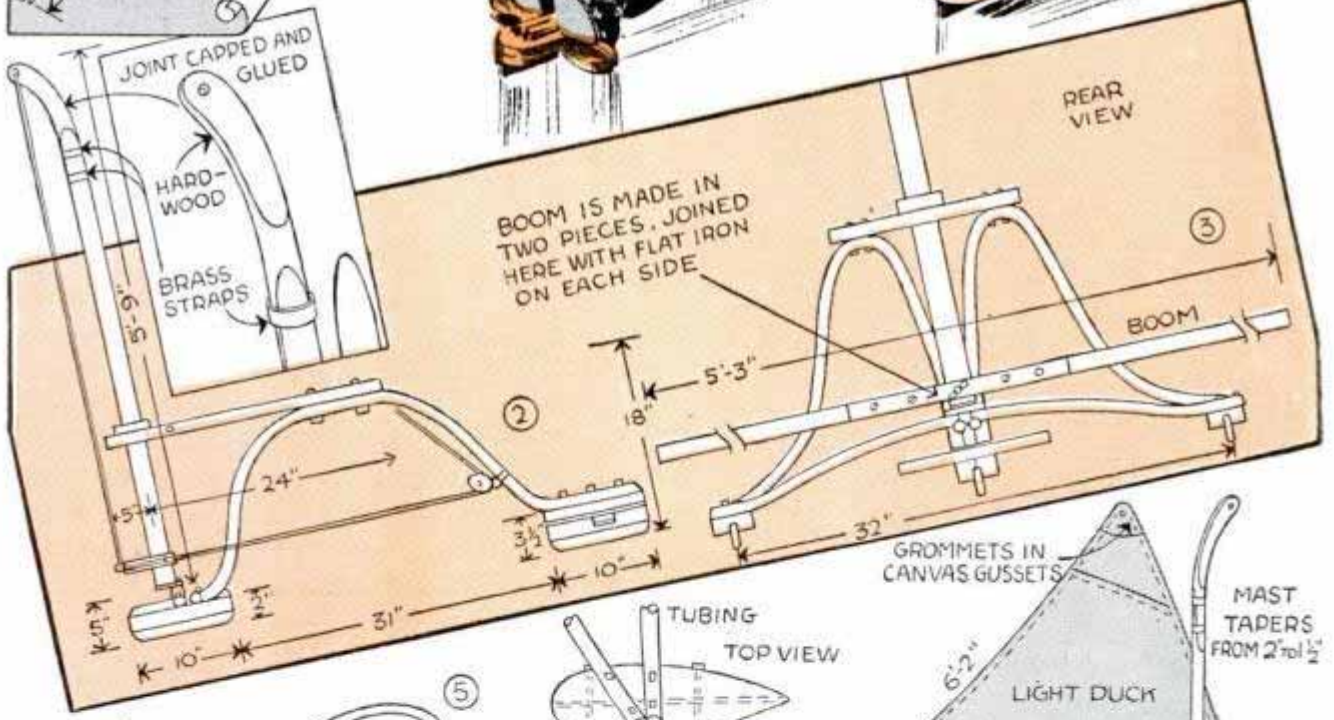
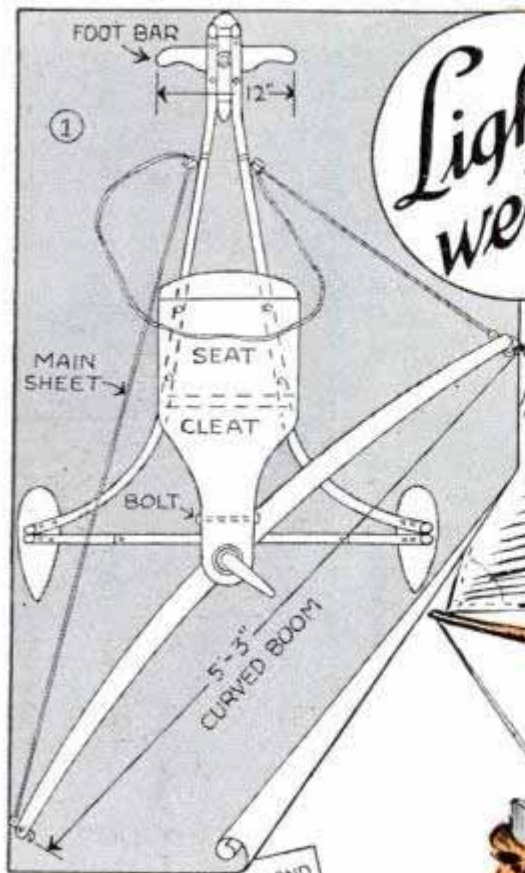

Camera Supported on Book End for Time Exposure



Stamped-metal book end supports miniature camera steady for copying or taking portraits

Owners of miniature cameras who have difficulty in holding them steady for making portraits, or for copying work, can improvise a support for the purpose from a stamped-metal book end. The camera is inserted into the central opening of the book end, after which a rubber band is used to hold the assembly together. The book end is especially convenient in copying where, facing the object, the camera must stand upright on a plane surface.

—Lytt I. Gardner, Reidsville, N. C.

Floor Scraper on Scrub Brush Made from Old Razor



from the floor. Such a scraper is easily obtained by removing the guard from an old safety razor and screwing it to the brush as indicated. It has been found the teeth of the guard give a better cutting ac-

In cleaning the floors of milk houses and similar buildings, it is a good idea to have a scraper on the scrub brush to remove packed spots of dirt and other foreign matter

tion for this purpose than a sharp-edged cutter, often improvised from a heavy piece of sheet metal.

Funnel in Electric Element to Heat Water

For heating small quantities of water quickly in a home workshop, screw a lamp socket to a board to take the cone-type heating element. A small funnel, corked at the end of the spout and fitted with a



spring-type clothespin for a handle, serves as a receptacle in which to heat the water.

Glass Cutter Scores Cardboard

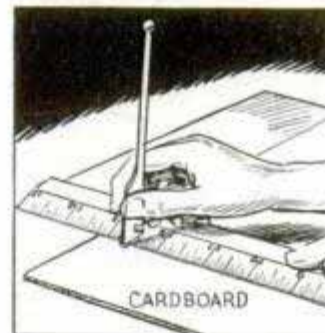

along the scored line. If a glass cutter is employed for this work, the scored mark may be made heavy enough for easy bending of the cardboard without breaking it.

When a knife is used to score cardboard, in the construction of boxes or decorations, care must be exercised that the cutting is not too deep or the cardboard will break when it is folded

Removing Corrugated Roofing

On a job of removing some metal corrugated roofing the work was done without undue damage to the material by using this tool to pull the nails. It is made from a short length of angle iron



one end of which is rounded and slotted as indicated in the detail so that it can be slipped astraddle the nail to pry it out.

Furnace Humidifier Tilts Down When Dry

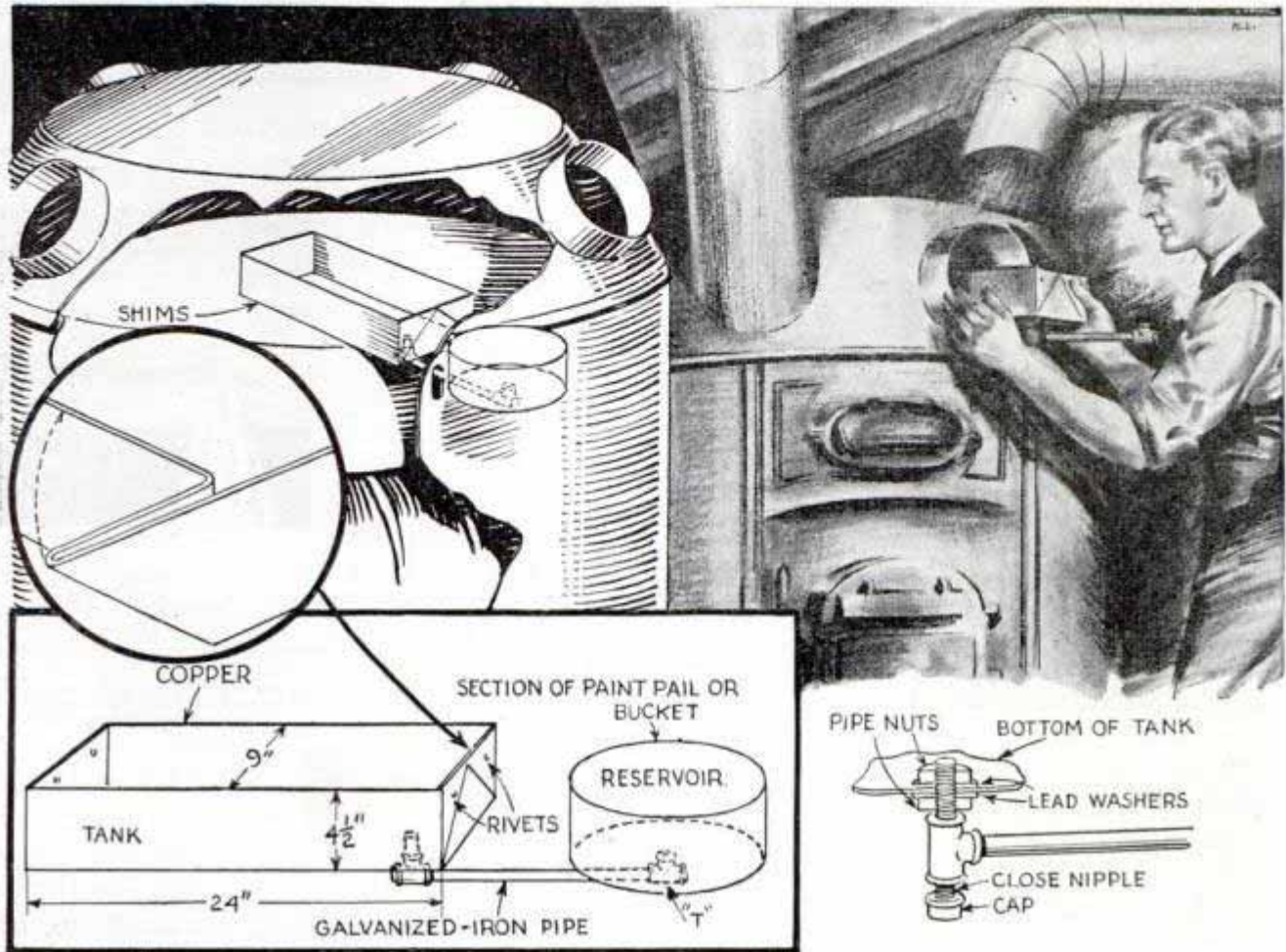

This humidifier is simply a shallow copper tank placed on the radiator dome of the furnace and connected through the casing with a $\frac{1}{2}$ -in. galvanized-iron pipe to an outside reservoir. The latter can be approximately the same depth as the tank but should be about $\frac{1}{2}$ in. lower to prevent overflow and also give ballast to tip the inner tank when dry, indicating that the supply of water needs to be replenished. You can make the tank to the dimensions indicated, from a copper sheet 18 by 33 in. As soft solder will not hold, the corners of the tank must be folded and riveted in the manner shown. Holes are drilled in the bottom of the tank and the reservoir for pipe nipples which are held in place with two pipe nuts turned down on lead washers. You can place the pipe tees in either of the two ways shown. Locate the tank over the hottest portion of the furnace dome and then drill and file a slot in the outer casing for the pipe connecting the tank and the reservoir.

—Harry A. Kotz, Syracuse, N. Y.

Felt Strips Seal Hot-Air Register Preventing Smudged Walls

Soot and dust deposits on the wall around a hot-air register can be avoided

by providing a good seal between the register and the wall to prevent escape of hot air. This can be done with felt strips of the type used for weatherstripping. Remove the register, put the strips in place on the

wall, using a few drops of shellac to hold them in position while replacing the register.—L. H. Georger, Buffalo, N. Y.

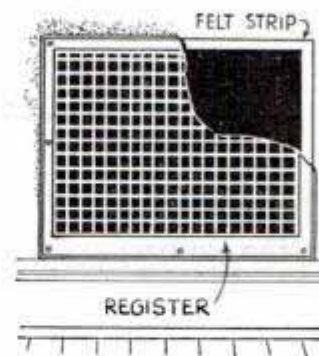

☐ If sheets of wax paper stick together when stored in a warm room, chill them in a refrigerator a few minutes and they can be separated easily.

Workman's Apron Held by Strap Can Be Removed Quickly



Workman's apron held by arrow-pointed strap is quickly put on or taken off

Workmen who are obliged to put on or remove an apron frequently, will find that a narrow leather strap, with the ends pointed like an arrow, will permit the apron to be removed in a jiffy. The strap is threaded through a wide hem in the top of the apron so that the projecting ends may be slipped through the belt loops of the trousers.

Tack Hammer Easily Improvised from Clothespin and Ruler

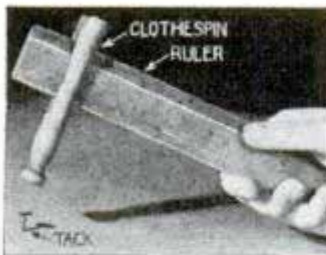

When a regular hammer isn't available to drive a small brad or tack, but you do have a ruler and clothespin at hand, it's no trick at all to improvise a tack hammer that will serve the purpose. Just push the clothespin over the ruler near one end, as indicated.

Cleaning Windows and Mirrors

Windows, mirrors and other glass surfaces may be cleaned thoroughly with a compound made by mixing precipitated chalk, 7 oz., and tripoli, 2 oz., into a strong soap solution. The latter is made by dissolving castile or other high-grade soap, 2 oz., in boiling water, 4 oz. After the soap has been dissolved completely add the

chalk and tripoli and stir until the mixture is smooth. This preparation is applied with a rag and the surplus removed after it has dried, leaving a high luster.

Dust Cloth Fastened to Wrist Saves Time

Instead of carrying a dust cloth in your hand and laying it down every time you want to move some article, why not fasten it to your wrist so that it is always at hand?



This can be done with a strong rubber band, as indicated in the drawing.

Wax Paper Protects Developer



When you must leave photo developer standing in a tray for some time, it can be kept from oxidizing by using waxed paper. Just cut the

paper to size and lay it gently on the surface of the liquid. All air will be excluded, and the solution can be preserved for several days in this manner, which is much easier than pouring it back into a bottle after each developing job.

—Kenneth Murray, Sturgis, Mich.

Removing Rust from Auger Bits

Removing rust from the flutes of auger bits is accomplished easily by using a length of small rope which is coated with glue or shellac and sprinkled with fine emery. The rope is pulled back and forth through the flute to produce a bright finish in a short time. Different sizes of rope are used for bits of various diameters.



—W. C. Wilhite, Carlinville, Ill.

Simple PARTY TRICKS

anyone can do

WHEN the spirit of the party seems to lag, and you're the host, just start things going again with a few simple tricks that can be performed with props available in any home, such as matches, coins, tumblers and paper.

There's the trick of the suspended egg, Fig. 1. Seemingly it defies natural laws by sinking halfway in a jar of water, and going no farther. The reason for this is that there are two liquids in the glass, one on top of the other, care having been taken to prevent them from being mixed. The lower liquid is saturated salt water or brine on which the egg will



PUZZLING MATCH TRICKS

float (rock salt is used as it does not leave the water milky). The upper liquid is ordinary water in which the egg will sink. After the salt water has been poured into the jar, a paper disk is placed on its surface and the water is added carefully with a spoon or siphon. Then the disk is removed, and the trick may be performed. You announce to the guests that you will cause the egg to submerge in this liquid and that it will come to rest about half way down the jar. Someone is very likely to take issue with you, but when you drop the egg in the jar that is just what happens.



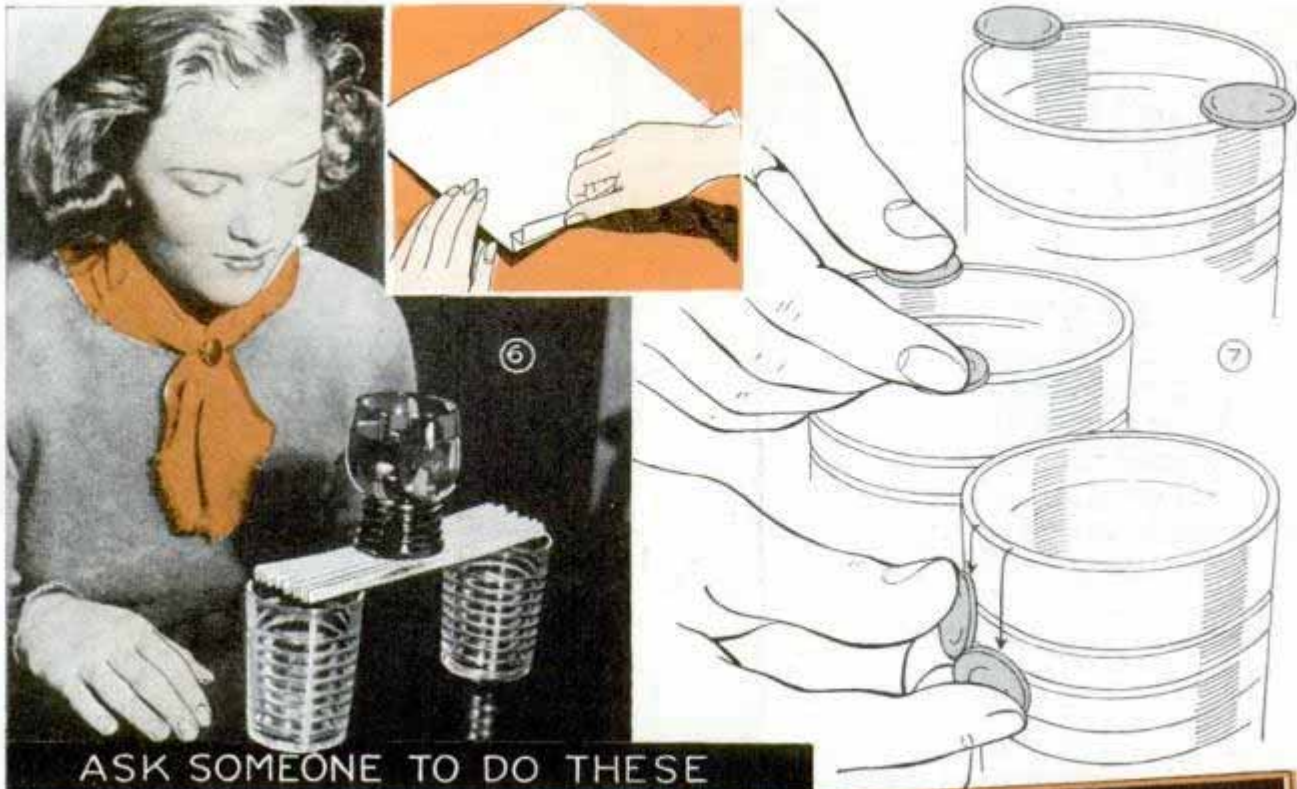

Then, a couple of match tricks: The first one involves causing a match to stand unsupported on a piece of wood. Lean the match against a cup, head down on a piece of scrap wood, as shown in Fig. 2. Ignite the head and then blow out the flame quickly. The head will "fuse" to the board sufficiently to hold it in place as in Fig. 3. In the second trick, Fig. 4, you split a match in half and ask someone to drop it in such a way that it will remain on edge. Of course, there's only one way to do it and that involves breaking the match at the center to form a vee.

Another trick, which is simply an illusion, is shown in Fig. 5. It looks as if the knife is glued to the palm of the hand, but the guests don't see the index finger of the right hand, which holds the knife. To all appearances the right hand is grasping the left wrist, and one doesn't pause to count the number of fingers visible.

Now, ask someone to lay a piece of writing paper across a couple of glass tumblers to support a third one partly filled with water, which, of course, seems impossible at first thought. The secret is to pleat the paper by folding it as in Fig. 6 and it will sustain considerable weight before buckling.

The upper detail of Fig. 7 shows two coins balanced on the edge of a tumbler opposite each other. The idea is to remove



both coins at the same time, using only one hand. This is very simple once you know how. Just slide the coins toward each other by placing your thumb and finger over them as in the center detail, and then bring both over the edge and together as indicated by the arrows in the third detail.

For another coin trick, support a tumbler of water on two nickels under the base, with a penny placed midway between them. Ask someone to remove the penny without touching the glass or nickels. The penny can't be blown out. To do the trick, the setup is arranged squarely with the weave of the tablecloth. Then by repeatedly scratching the cloth with your fingernail as in Fig. 8, the penny will be coaxed out from under the glass.

"Bottle-Phone" a Novel Musical Instrument

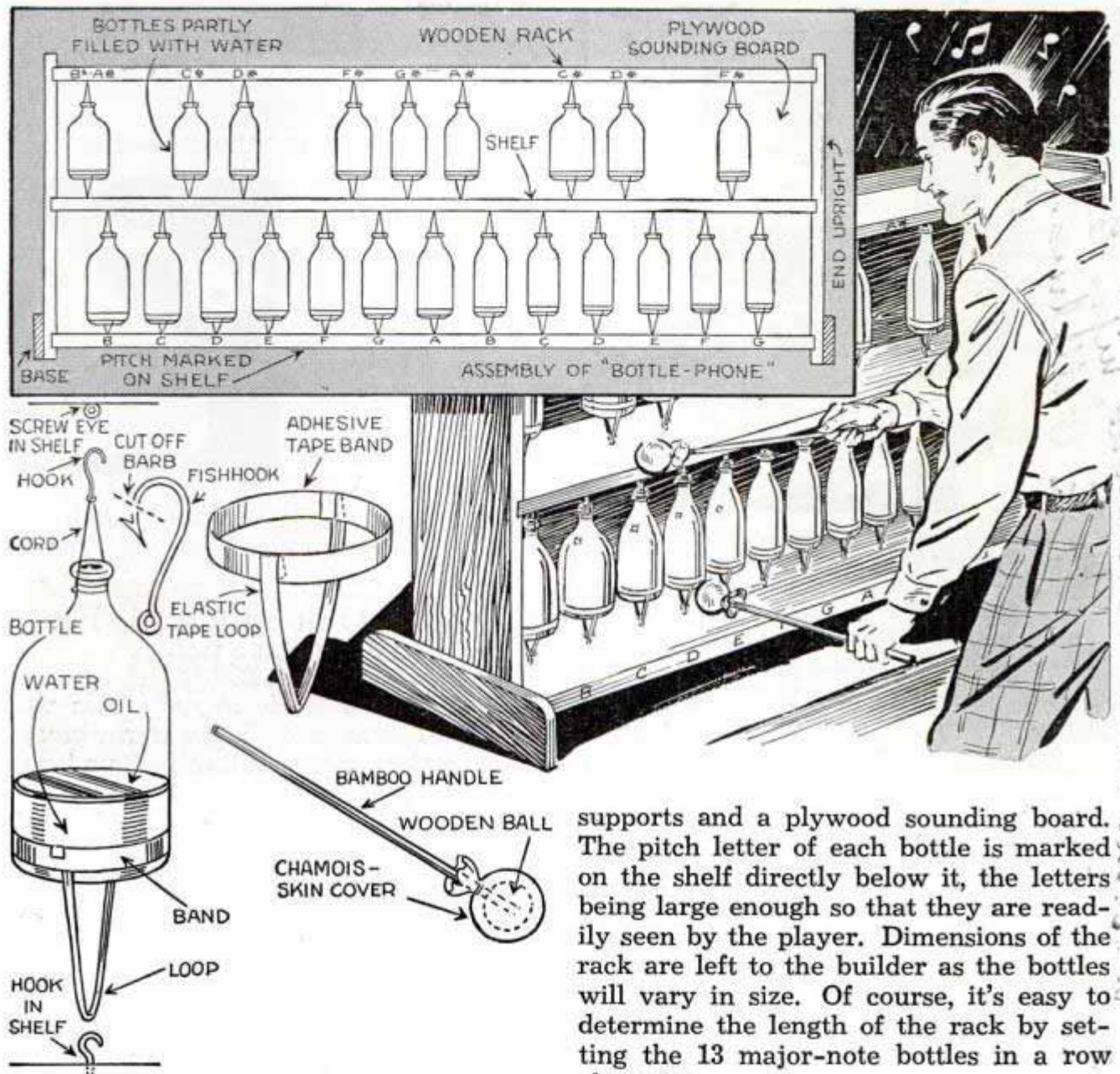

With this instrument you're "all set" to contribute your share of entertainment at the next party. You will need 22 bottles of varying size to get a range of notes from B-flat below middle C to G above high C with the intervening half tones. Each bottle is suspended on a string and the pitch is checked with a pitch pipe or a properly tuned piano, adding water as necessary. Bottles should be selected which will come to the required pitch when only about a third filled with water. As each one is tuned, mark its pitch on the glass and set it aside. The rest of the details are more or less self-explanatory. The bottles are suspended individually in a resonating rack consisting of three shelves with end

supports and a plywood sounding board. The pitch letter of each bottle is marked on the shelf directly below it, the letters being large enough so that they are readily seen by the player. Dimensions of the rack are left to the builder as the bottles will vary in size. Of course, it's easy to determine the length of the rack by setting the 13 major-note bottles in a row about 2 in. apart.

—L. B. Robbins, Harwich, Mass.

Bending Plywood Easily

If you have had difficulty in bending plywood, try the following method: First wet both sides of the wood and then go over it with a hot smoothing iron, preferably an electric one, which is hot enough to convert the moisture to steam. Go over each side of the board twice in this manner. Then, as the wood is being bent, apply the hot iron to the wet surface as the arc is formed. I have bent 1/4-in. fir plywood around a 4-in. radius without cracking by this method.

—W. N. Briggs, Pittsfield, Mass.

Circle-Cutting Jig on Scroll Saw Is Quickly Detached

General Electric Vapor Lamp Co. Westinghouse Electric and Mfg. Co. N.Y.

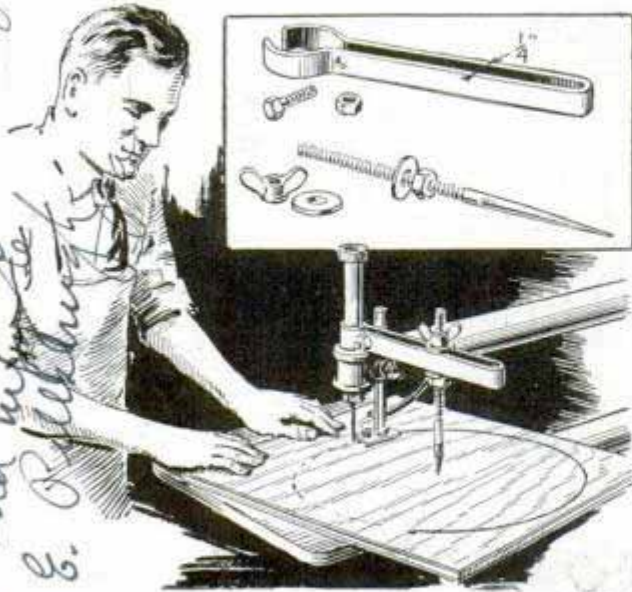

It's easy to saw disks on a jigsaw with this attachment to guide your work

In this circle-cutting attachment on a scroll saw, which has the good feature of being quickly attached and detached, a U-shaped arm of fairly heavy flat iron is clamped to the head of the saw, extending over the table. A threaded, pointed center on which the work swings, is made from 1/2-in. iron rod. This can be slid along the arm and tightened firmly at any point so that adjustment is obtained for radius and also for the thickness of the stock.

Neon Glow Lamp for Night Light

A neon glow lamp of 1/2 c.p., 2-watt size with a standard base, is an excellent night light for a home. If left on when the family retire, it gives a red glow sufficient for anyone to see the furniture and floor of a room, and at the same time, there is not the glare of a white light that might normally disturb one sleeping in the room.

Easy Repair for Pocketknife

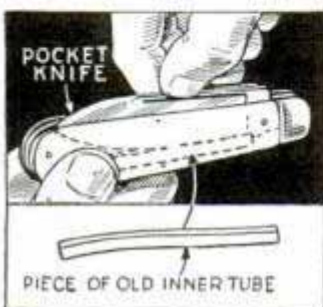

If the spring in your favorite pocketknife has become so weakened it allows the blade to drop down into the handle so that it is hard to open, it can be re-

paired quite easily with a strip of rubber. This is cut to fit into the knife, as indicated by the dotted lines, where the edge of the blade rests against it and keeps the latter from dropping too far into the handle.

Key Used as String Cutter

If you carry keys, it's a simple matter to convert one of them to a string cutter without damaging it for its regular purpose. This is done by filing out one side of a hole in the head of a key,



after which the inner edges of the hole are beveled to form a sharp cutting surface.

Heating Unit on Electric Fan Dries Photo Prints

Glossy prints on ferrotype plates will dry in a few minutes in the warm breeze from an electric fan equipped with a heating unit. A porcelain socket, into which the unit is screwed, is attached to the cen-



Electric heating unit attached to guard of electric fan heats air to dry photo prints quickly

ter of the fan guard as indicated in the photo. The unit can be unscrewed from the socket when the fan is used for other purposes.—Kenneth Murray, Sturgis, Mich.

TYPE *on* CUSHIONS

with this portable typewriter stand

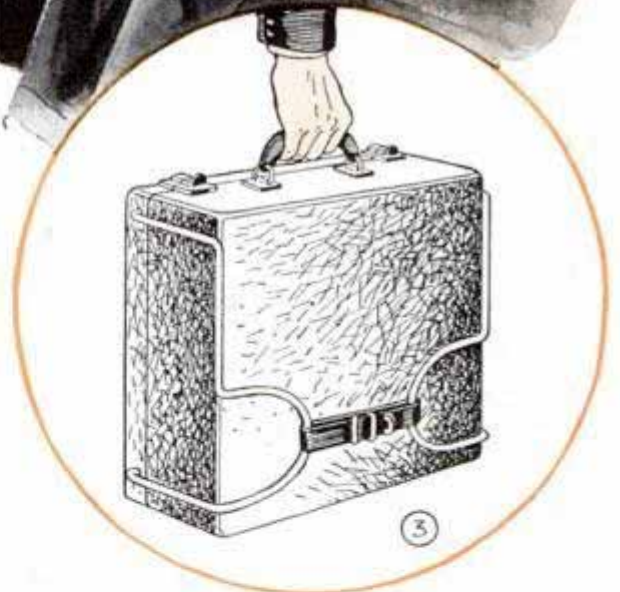
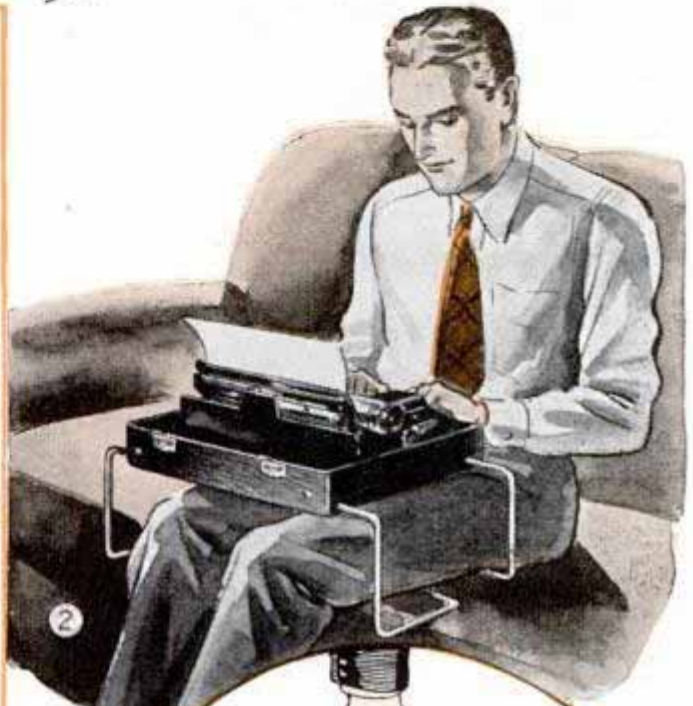
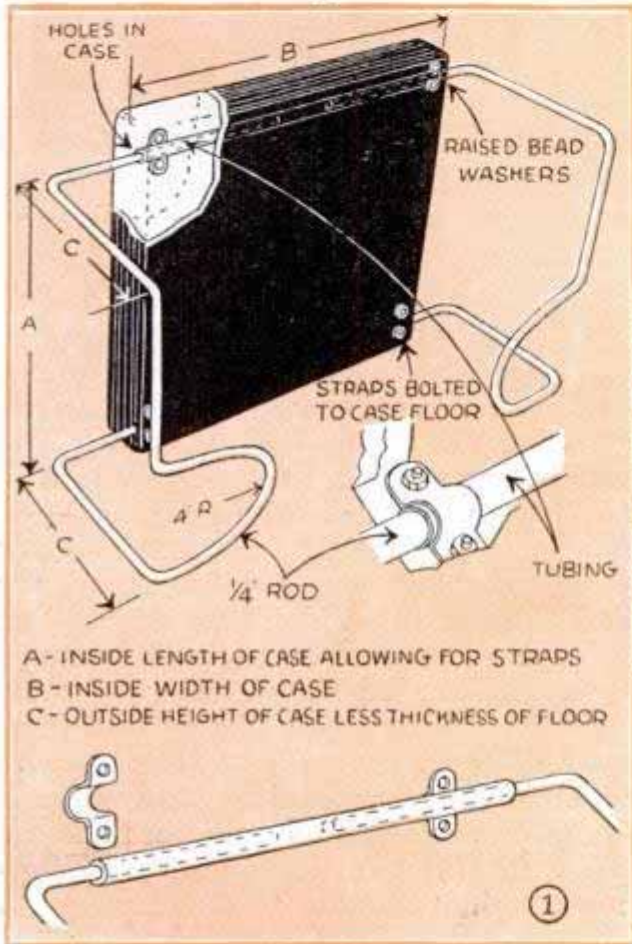

Takes the weight off your knees and supports the machine at just the right height for easy typing no matter what seat you select

By JACK MODROCH

OWNERS of portable typewriters who usually do their typing with the case resting on their knees, will find a great convenience in store for them if they spend a few hours time in fitting the case with a pair of legs as shown in Fig. 1. By doing this a simple stand is formed which raises the machine to the correct typing level above the knees and relieves them from

When the case is carried, the position of the supports is reversed to fit snugly against the sides

carrying the weight. Such a stand is handy to use whether the typing is done in a favorite easy chair or on a davenport as in Fig. 2; whether it is done while traveling in a railway coach or in an auto as in Fig. 4. When the typewriter is not in use, the legs, which are detachable as shown in Fig. 5, are pulled out of their sockets and, after the lid has been attached, they are

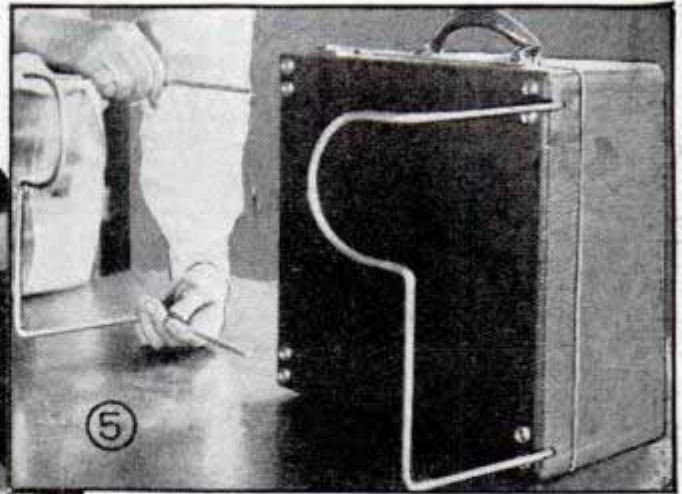

Note the neatness of the job—raised-bead washers under the exposed heads of the nickel screws add a decorative touch

re-inserted into the sockets in a reversed position so that they fit snugly against the case as shown in Fig. 3. To prevent them from possibly slipping out of place and being lost, a small strap or rubber band is placed over the looped sections.

Now for the constructional details: All the material required is some $\frac{1}{4}$ -in. iron rod, some brass or steel tubing which should be a sliding fit on the rod, and some sheet metal suitable for forming miniature "pipe straps" to fit over the tubing. From Fig. 1 you will see that the exact dimensions of the supports depend on the size of the case, the variable dimensions being in-

dicated by distances A, B and C. While corresponding dimensions of the two supports should be identical, remember that the supports must be left and right—not duplicates. The ends slip snugly into two lengths of tubing fastened to the inside of the case with the four pipe straps. Of course, before the pieces of tubing are installed, holes are bored through the side of the case to line up with the tubes. Each one of the pipe straps has two holes for attachment to the case, for which small nickel, oval-head machine screws are used. These screws, which are fitted with raised-bead washers, are pushed through both the case and the straps from the outside, and are then secured with nuts on the inside as indicated. This method of assembly adds a decided neatness to the job.

Steel Tape Measures on Lathe Save Time for the Operator

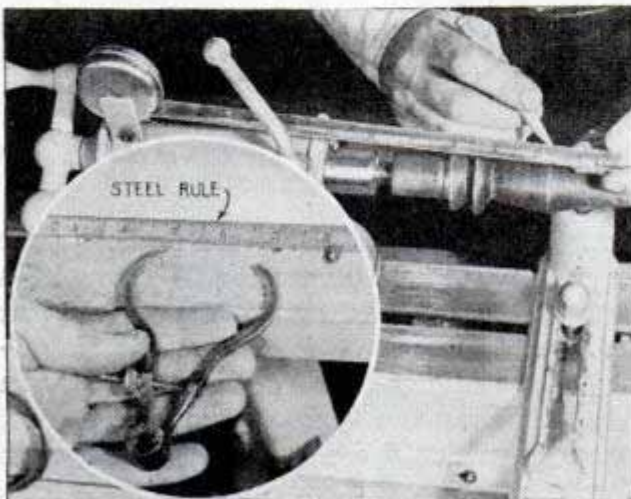

Steel tape measures mounted on woodworking lathe are always at hand when needed

To save time in setting calipers and making measurements on a woodworking lathe, steel tape measures will be found handy. For general measurements, one tape is extended the length of the bench and fastened by slipping one side under the lathe bed and fastening the other side with small wood screws and washers as shown. For making measurements along the length of the spindle, a tape can be mounted on the tailstock. A strip of metal is bent around the body of the tailstock and fastened with a small bolt, after which the case of the tape measure is soldered to this strip. The tape is never in the way, but may be pulled into position instantly.

Setting Wood in Concrete

When concrete is poured around posts or timbers it is likely to crack unless some type of resilient joint is provided between the two materials. Such a joint can be made by wrapping corrugated cardboard around the posts or timber before pouring the concrete. The cardboard is removed, after the concrete sets, and tar or asphalt poured in the opening.

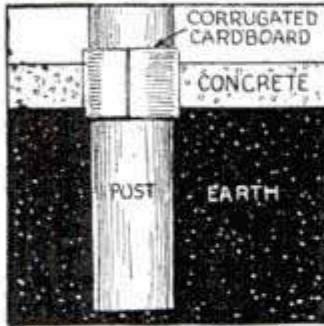

The cardboard is removed, after the concrete sets, and tar or asphalt poured in the opening.

Simple Miter Gauge Improvised by Clamping Scale to Nut

On a job where a number of boards had to be sawed at an angle of 60° , and no miter box or steel square was at hand, I used a miter gauge improvised by clamping a steel scale to a hexagon nut as shown. When one of the adjacent sides of the nut was laid against the edge of the work, the rule was used as a guide to mark off a 60° line across the surface of the board.

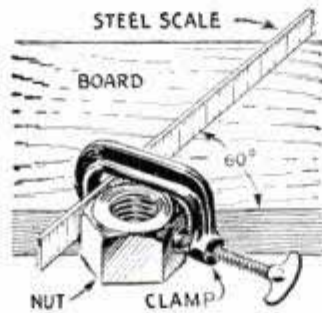

—W. C. Wilhite, Carlinville, Ill.

Straightening Table Leaves

After trying to straighten the warped top and leaves of an antique drop-leaf table by means of a vise, various clamps and heavy weights, the problem was solved by laying the leaf outside on wet grass with the warped side down. When the sun and wind struck the wood, the edges curled upward. As soon as the board

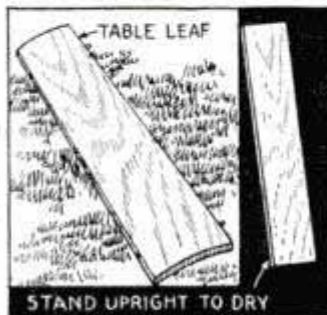

is straight, it should be set on end in a building to dry out the center slowly.

Camera Steadied on Arm Strap Instead of Using Tripod

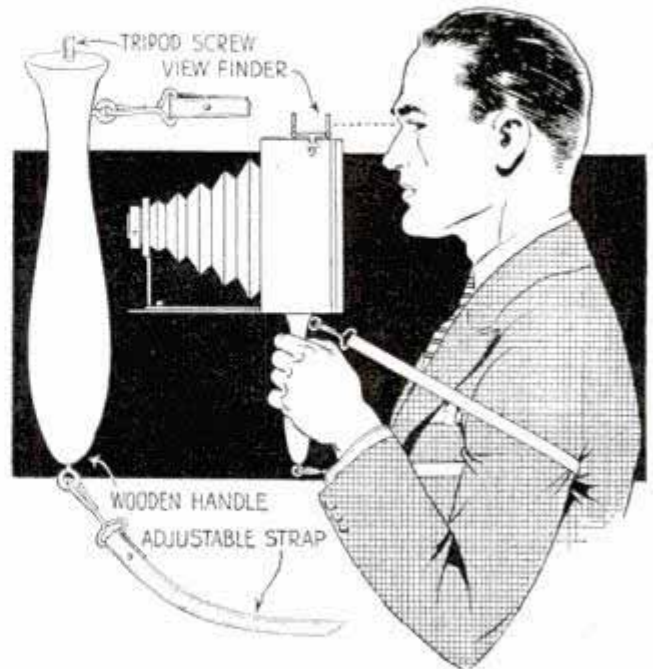

Slipped over the arm, the strap tends to steady the camera where a tripod cannot be used

Finding it almost impossible to support his camera on a tripod when taking pictures in a crowd, a Wisconsin photographer uses an arm strap and a handle to aid in holding the camera steady. The handle, which is turned from hardwood, is fitted with a tripod screw to take the camera and two screw eyes to take hooks attached to the ends of the strap. In use, the strap is slipped over the crooked arm as indicated.

Money for Your Ideas

Although the solution of many minor everyday problems around the home, in the workshop, concerning the car, or pertaining to your daily work, may seem rather insignificant to you, there are perhaps thousands of others who have the same problems. If your solution was unusual, but simple and practical, why not pass it along to others to help them? These pages are a "clearing house" for such ideas and if you have any new ones that are exceptionally outstanding, don't hesitate to tell us about them. We are always looking for such short cuts that will save time, work and money. And, of course, we will send a check in payment for anything that we use. Write to Shop Notes Editor, Popular Mechanics Magazine, 200 E. Ontario St., Chicago.

Solving

If a perforated skimmer is not at hand to remove scum, which usually accumulates on the surface of wash water that has been softened with a chemical, try using a whisk broom. The scum sticks to the broom and is easily washed off again



HOME

WHISK BROOM



You can save time in lighting a wickless kerosene stove by opening the valve and squirting kerosene on the asbestos ring before igniting



APPLE HALVED AND CORED

THIN-WALL STEEL TUBING

Apples are cored and halved in one stroke with a knife slipped into a sharpened piece of thin-wall steel tubing as above. Small children can't open or close the cocks on a gas stove when the sheet-metal shield shown below is pivoted in place

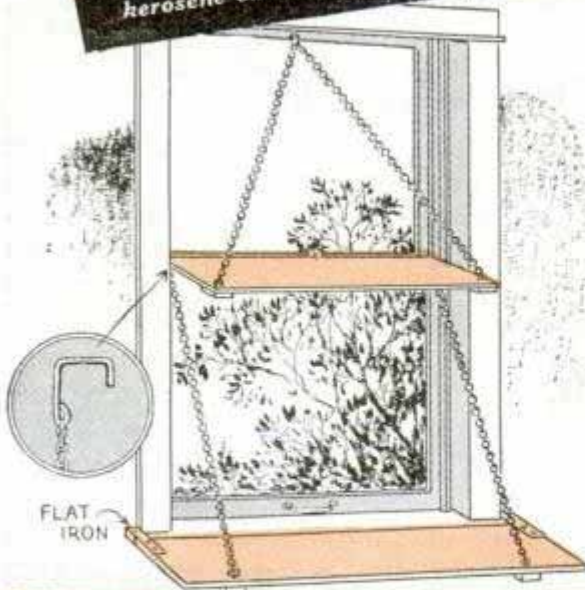

FLAT IRON

Removable flower shelves for windows are supported at the rear by wood or flat-iron cleats resting on or hooked to the sill, and at the front by chains attached to screw eyes in the shelves and to hooks, that fit into the sash-cord grooves. Chain of top shell is held by a screw hook

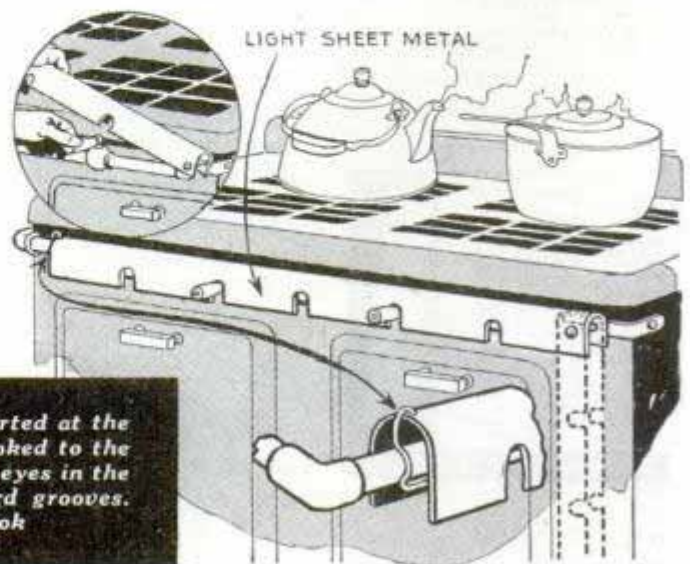

LIGHT SHEET METAL

Your

Warped storm door is kept closed tightly by a window-sash lock, the two parts of which are mounted on blocks screwed to the door and casing as indicated at the left



WINDOW LOCK



PROBLEMS

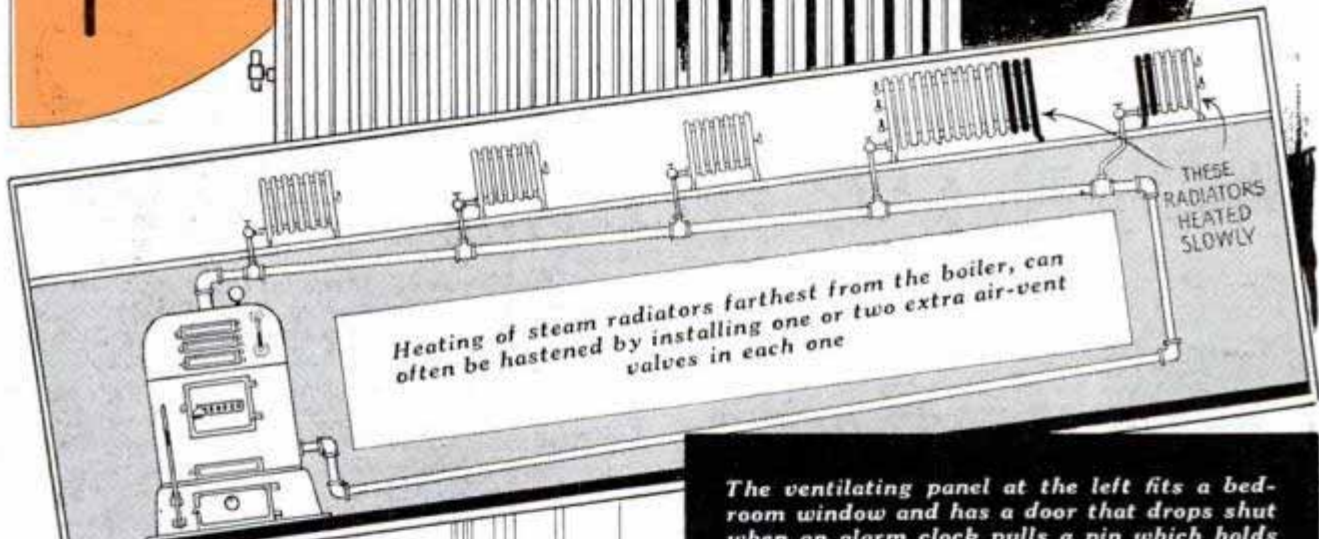

The ventilating panel at the left fits a bedroom window and has a door that drops shut when an alarm clock pulls a pin which holds it open. Made from a wide board or a piece of plywood, the panel is slipped in place by raising the lower sash. In the lower left-hand detail, a rubber band keeps a sponge from dropping out of the hand when washing windows. Instead of supporting long runs of stovepipe with wires, you can use pieces of stovepipe iron cut and bent as shown below to make a neat support. A tongue, made by slotting one edge of the support, is slipped between the two pipe sections

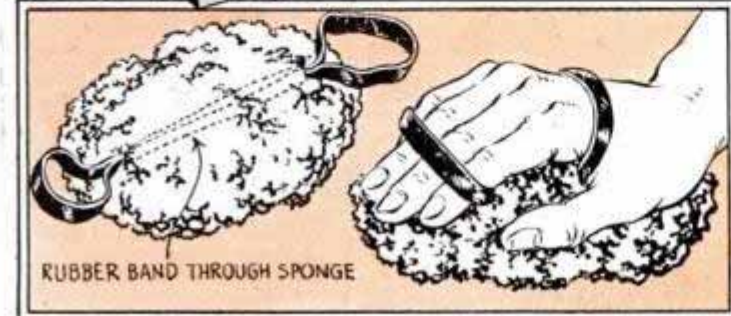
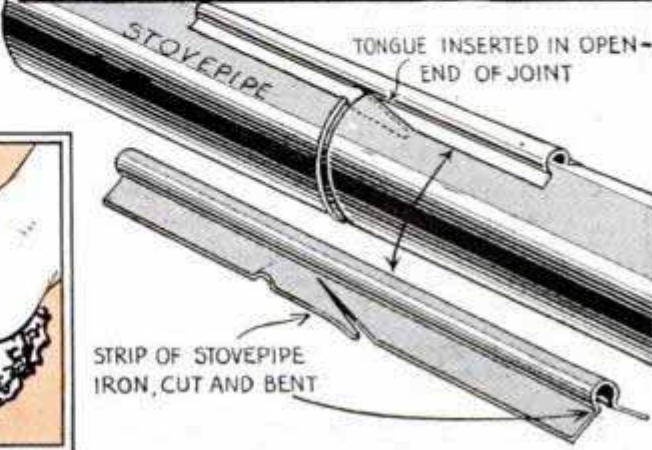
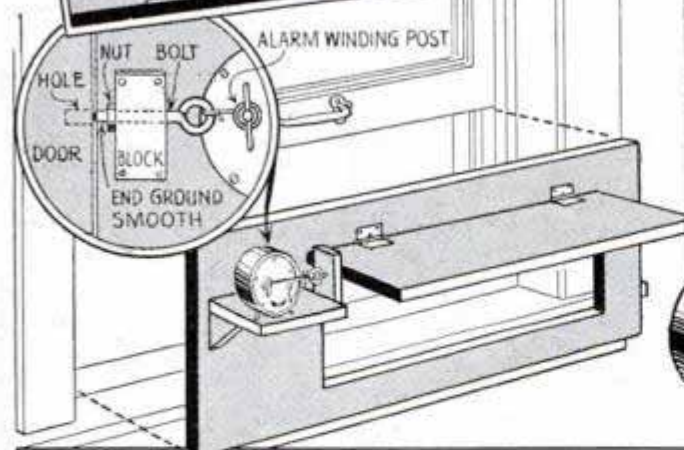

Rats Kept Out of Your Corncrib with Brake Drums on Posts



Corncribs built on wood or cement posts can be protected against entrance of rats and mice by placing auto brake drums over the tops of the posts as indicated.

Drums of the largest size available should be used so that they will project well beyond the sides of the posts to keep the rodents from climbing over them.

Repairing Camera Bellows

Instead of trying to patch a camera bellows that has pin holes, coat the surface with a flexible, opaque varnish made by mixing asphaltum varnish and rubber cement in equal amounts. You will find this method more serviceable than patching and it can be done in a jiffy.



Why Not Start a Home Workshop?

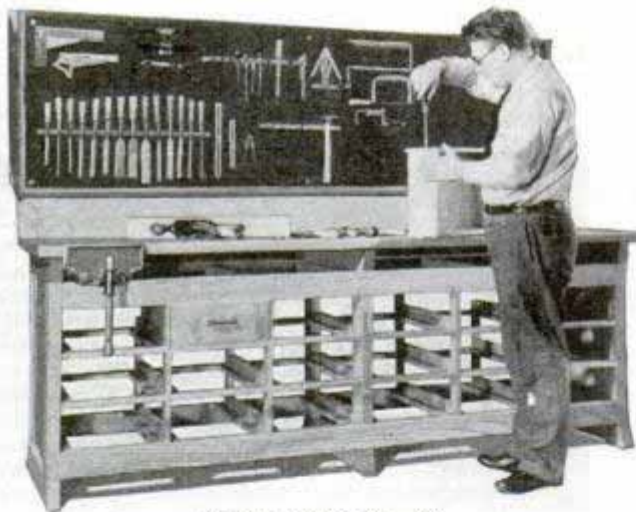

Cabinet Workbench—898

A few homemade machines will enable you to get into this interesting field. Whether you want a shop for pleasure or profit, our plans will give you all of the information you need.

CABINET BENCH—898: Nearly 8 ft. long, 27 in. wide, 35 in. high. 20 drawers—25c.

THREE EASILY MADE WORKBENCHES—896 and 897: Designs that are applicable to benches of various sizes. Two prints 50c.

22-IN. SCROLL SAW—771: Pipe fittings and hardwood. Has sewing-machine drive—25c.

12-IN. BAND SAW—836: Smooth running and sturdy. Cuts 2-in. stock easily—25c.

DRILL PRESS—895: Pipe fittings. $\frac{1}{2}$ -in. chuck and ball-bearing spindle. 28 in. high—25c.

BELT SANDER—579: Heavy-duty type. Angle-iron framework and a 5 by 46-in. belt—25c.

CIRCULAR SAW TABLE—910: Angle-iron frame. 24 by 36-in. table. 10-in. blade—25c.

CARPENTERS' TOOLBOX—824: $8\frac{1}{4}$ by $13\frac{3}{8}$ by $31\frac{1}{4}$ in. in size. Has special rack for auger bits—25c.

Any six of these blueprints (not sets of prints) will be sent postpaid upon receipt of \$1.00

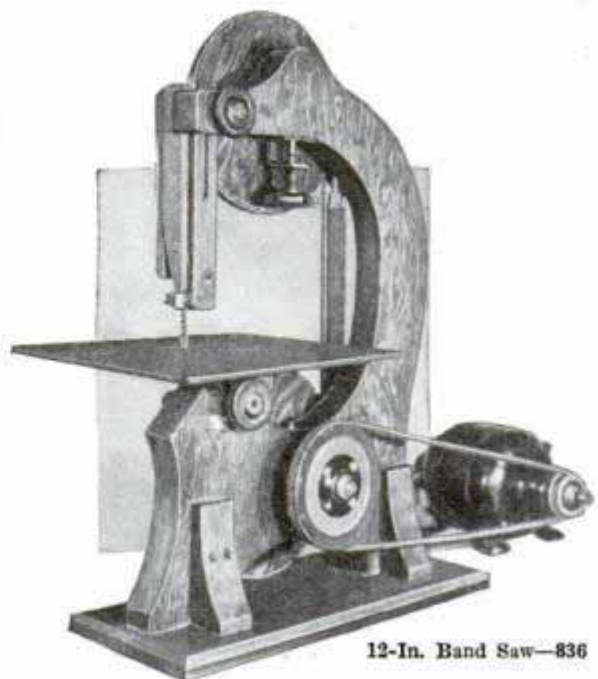

12-In. Band Saw—836

Blueprint Department, Popular Mechanics Magazine, 200 E. Ontario St., Chicago



SHOP NOTES

“SAWING” GLASS *on your lathe*

Counterweight maintains constant pressure of work against a steel disk “charged” with emery powder

By EDWIN M. LOVE

USED in combination with a lathe, this simple jig cuts glass tubing, rods, and bottles accurately to length. Not only square ends, but angles may be cut, or a tube can be split. A steel disk which is charged with emery powder and crankcase oil does the sawing, while the work is fed against it by a weight on a string as in Figs. 1 and 2. As this process is continuous, no further attention after starting is needed, except to apply a little more abrasive occasionally.

The body of the jig is in two sections. The lower part has a cleat underneath, near the front, to clasp the end of a sanding-disk table, and another placed lengthwise to clamp to the edge of the table as in Fig. 1. Slides of L-section are screwed to the top of the lower part and also to the bottom of the upper section to guide the upper part as it slides on the lower, Fig. 4. Two clamp strips attach to the top of the jig by means of a carriage bolt through each, so that they can be swiveled for angular cuts, and the wide front strip is slotted for adjusting, the bolt being shifted, as necessary, in the holes bored in the upper section. For most work the simplest clamp

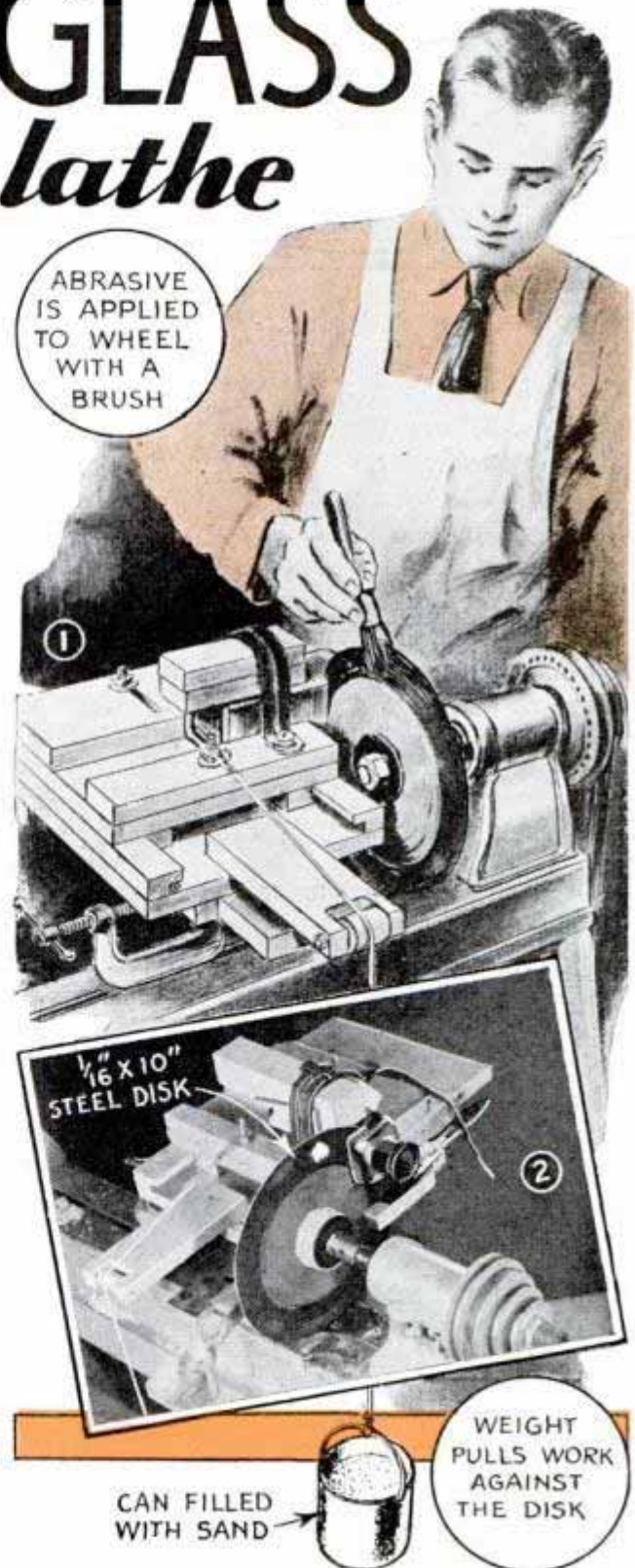

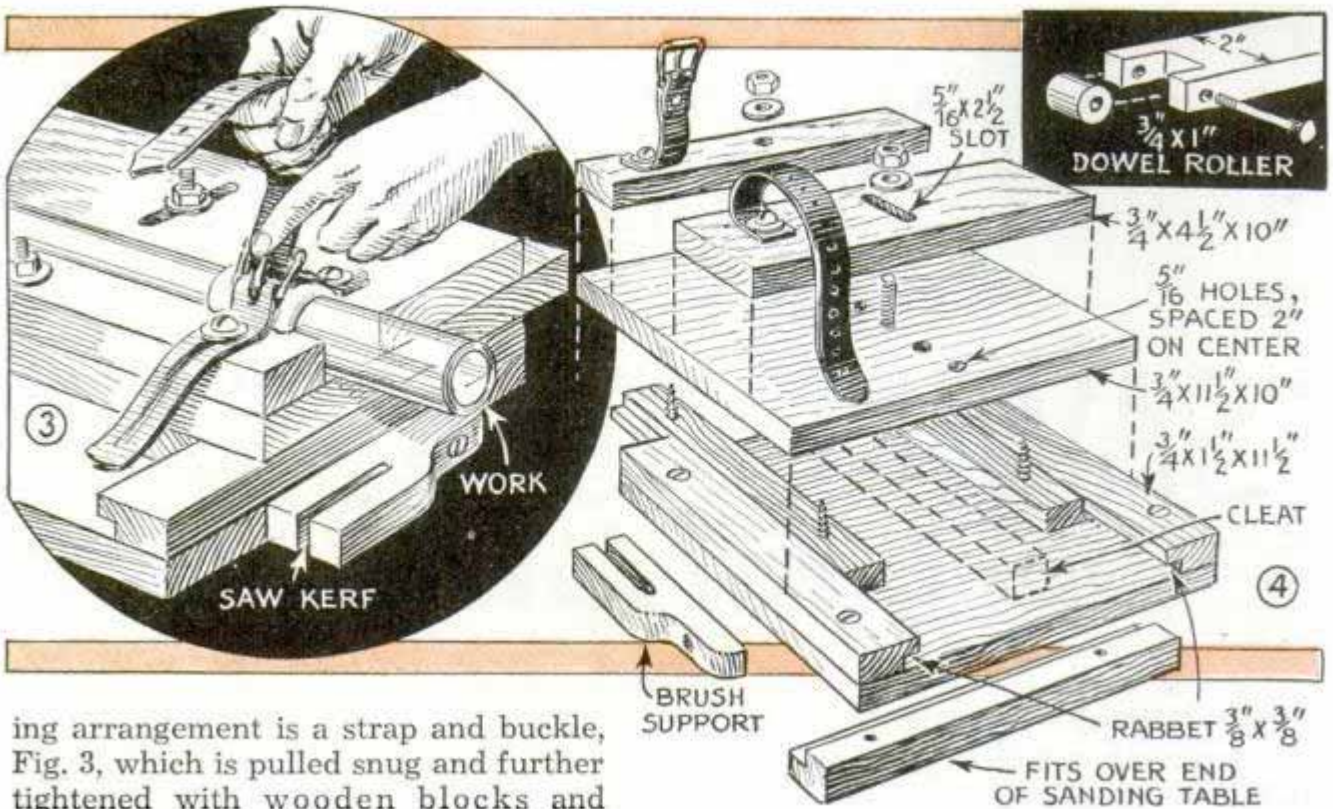

ing arrangement is a strap and buckle, Fig. 3, which is pulled snug and further tightened with wooden blocks and wedges. Where lengthwise cuts are made in a piece of glass, it should be gripped in a wooden handscrew and clamped to the base at the desired angle.

To hang the weight string sufficiently far behind the machine to clear, an extension arm is made for the roller, and screwed to the lower section of the jig. The roller is a piece of dowel rod, grooved at the center, with pivot nails driven in the ends through

small holes drilled in the sides of the notch.

Use a disk from 8 to 10 in. in diameter and about $\frac{1}{16}$ in. thick, and run the lathe at 200 r.p.m., or slower, applying a mixture of oil and emery powder of about No. 25 grit by means of a cheap paintbrush, which is afterward laid on a cleat at the side of the jig and alongside the wheel to keep the supply of abrasive replenished.

Warehouse Chute Has Wheel at Curve to Turn Cases

In a warehouse where a gravity chute for delivering cases and packages from the upper floors to the loading platform had to be constructed with a sharp curve in it, trouble of having the cases lodge at this point was eliminated with an old auto wheel and tire. The wheel was mounted in the position indicated. When the cases and packages came to the wheel, it rotated and turned them around the curve.

Covering Fresh Cement in Winter

If you have just put in a cement sidewalk and it is necessary to cover it to avoid freezing, be sure to use building paper rather than waterproof paper. Moisture condenses and collects under waterproof paper and may freeze fast to the work, but building paper absorbs moisture.

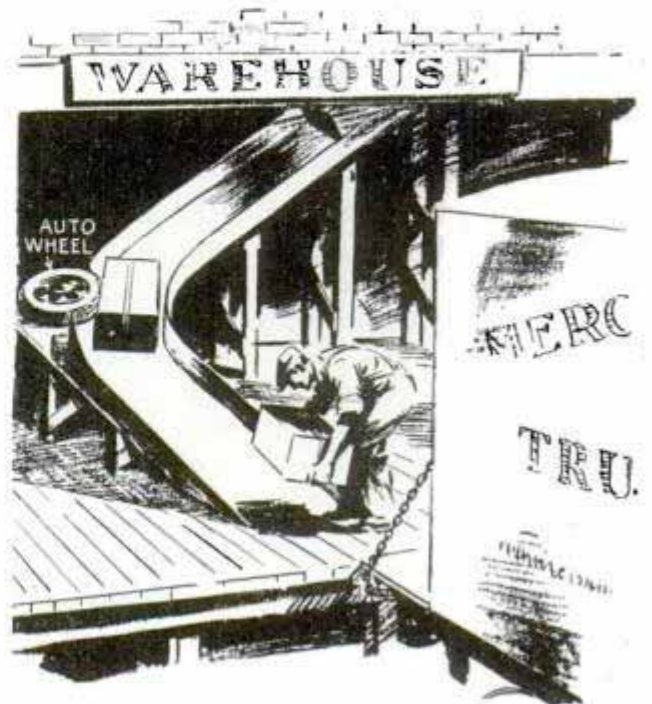
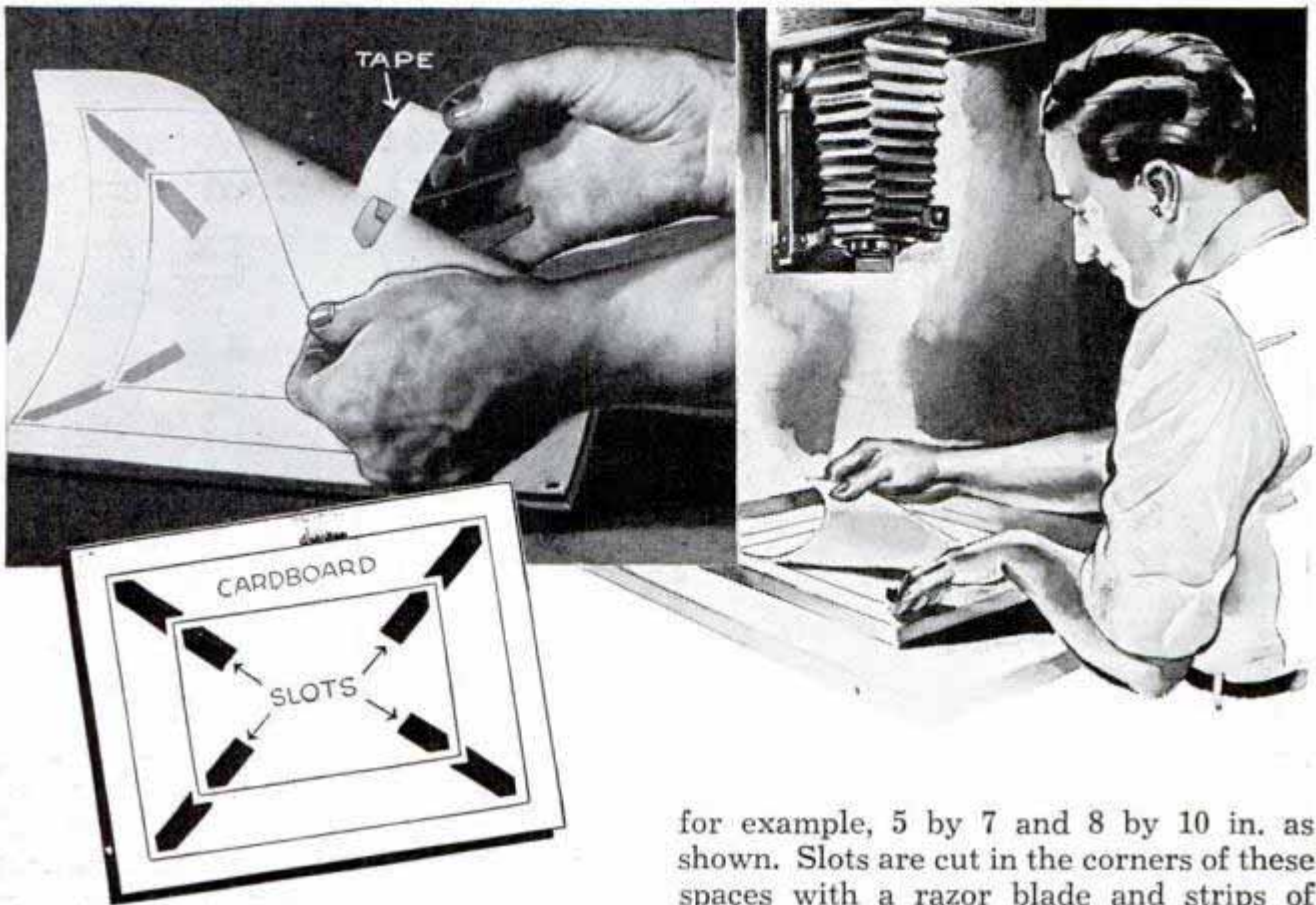

Photo Paper Sticks to This Enlarging Easel



This enlarging easel permits you to mount photo paper in position for printing and to remove it instantly without the bother of holding it flat under glass. It consists of a rectangular piece of thin cardboard or Bristol board on which the exact size of the enlarging paper is laid out with heavy lines. You can have two or more sizes indicated on the same board;

for example, 5 by 7 and 8 by 10 in. as shown. Slots are cut in the corners of these spaces with a razor blade and strips of tape are stuck to the under side over the openings. In use the easel is thumbtacked, taped side down, on a small drawing board. The enlarging paper is placed in position with the corners against the tape. After the exposure has been made, the paper is simply pulled off. A dozen or more papers can be exposed before the tape has to be renewed.

—Jacques H. Upshaw, College Park, Ga.

Prick Punch Has Guide to Space Layout Work Uniformly

When cutting heavy metal by drilling a number of holes side by side, I locate their positions accurately with this special punch. It consists of a prick punch, which slides inside a tube, and a locating punch or spacing guide assembled as indicated. Both the prick punch and the tube are drilled horizontally to take the spacing-guide holder, the hole in the punch being large enough to allow some movement. A stop pin in the guide keeps it from falling out.

—H. Moore, Hamilton, Ont., Can.

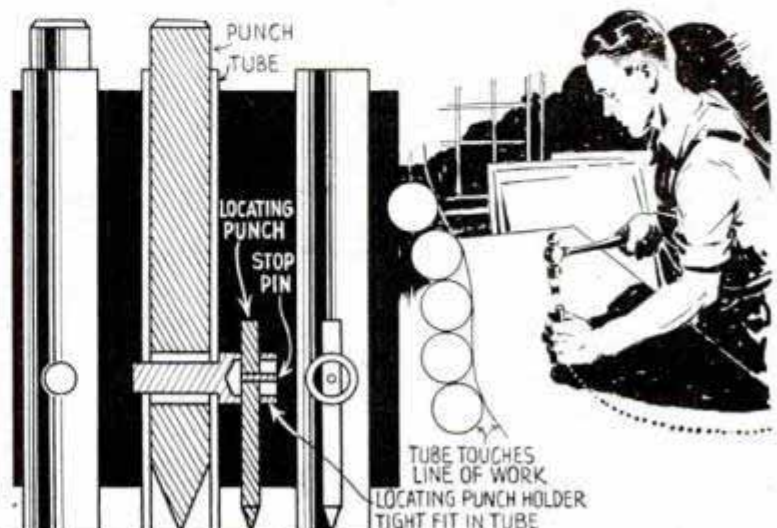

What Makes the Water Flow from This Faucet?

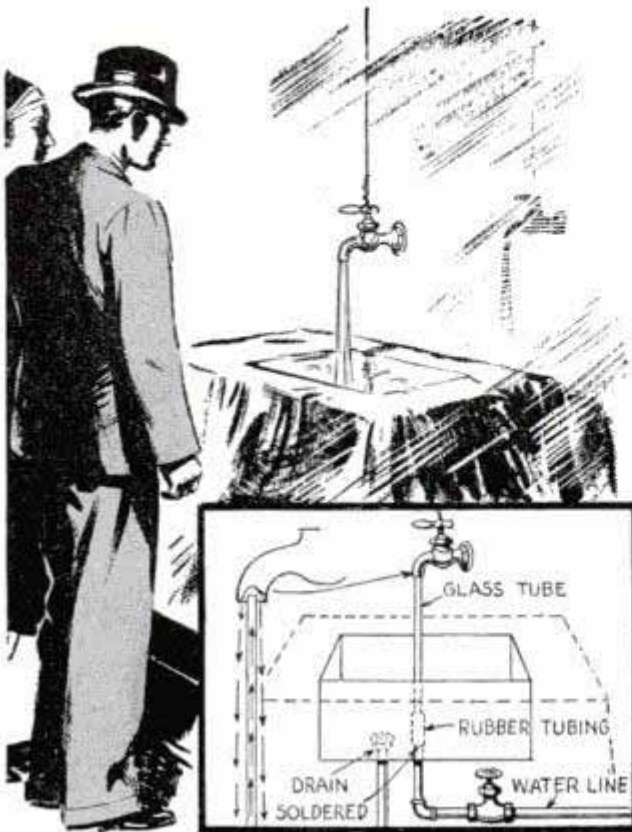

Unconnected faucet suspended in merchant's show window keeps pouring water into the pan below

This window display will keep the crowds wondering. Suspended in mid-air and apparently not connected to any water supply, an ordinary faucet keeps on pouring water into a sink or pan directly below it. While the thing looks mysterious, the simple secret is a glass tube that projects up through the sink or drain and extends into the end of the faucet. Under the sink, the tube is connected to the water supply by means of a length of rubber tubing. A shut-off cock controls the amount of water that flows up into the faucet and down again on the outside of the tube, which conceals it from the casual observer. Of course, a drain is provided in the sink or pan, and the joint where the tube passes through the pan must be sealed carefully with cement to prevent leakage.

—Stephen Petrilak, Simpson, Pa.

Aluminum Castings Are Ground on Soap-Lubricated Wheel

Before grinding a piece of cast aluminum, apply a small amount of soap to the abrasive wheel, and it will not fill with the

soft metal. Use a cake of hard laundry soap and hold it against the rotating wheel for a second. Do this about every 5 or 10 min. as the grinding work progresses.

Fowls Kept Out of Watering Pan by Funnel Set on Clothespins

To keep poultry from soiling the drinking water in his open pans, one poultryman uses an inverted funnel set on clothespins as indicated. They are of the spring type and are adjusted to support the funnel a couple of inches above the bottom of the pan.

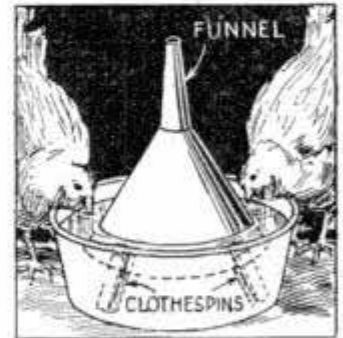

Ink Tube Suspended Above Press Is Always at Hand

To avoid leaving his work whenever it was necessary to apply ink, one job-press operator suspended his tube of ink above the machine within easy reach. With this arrangement, it takes only a moment to



Ink tube suspended from ceiling above job press by rubber bands is always at hand for inking the plate

apply additional ink to the plate, as the rubber bands allow it to be pulled down, and the tube is not likely to be mislaid or carried away by other workmen.

Diameters Measured Without Stopping Lathe

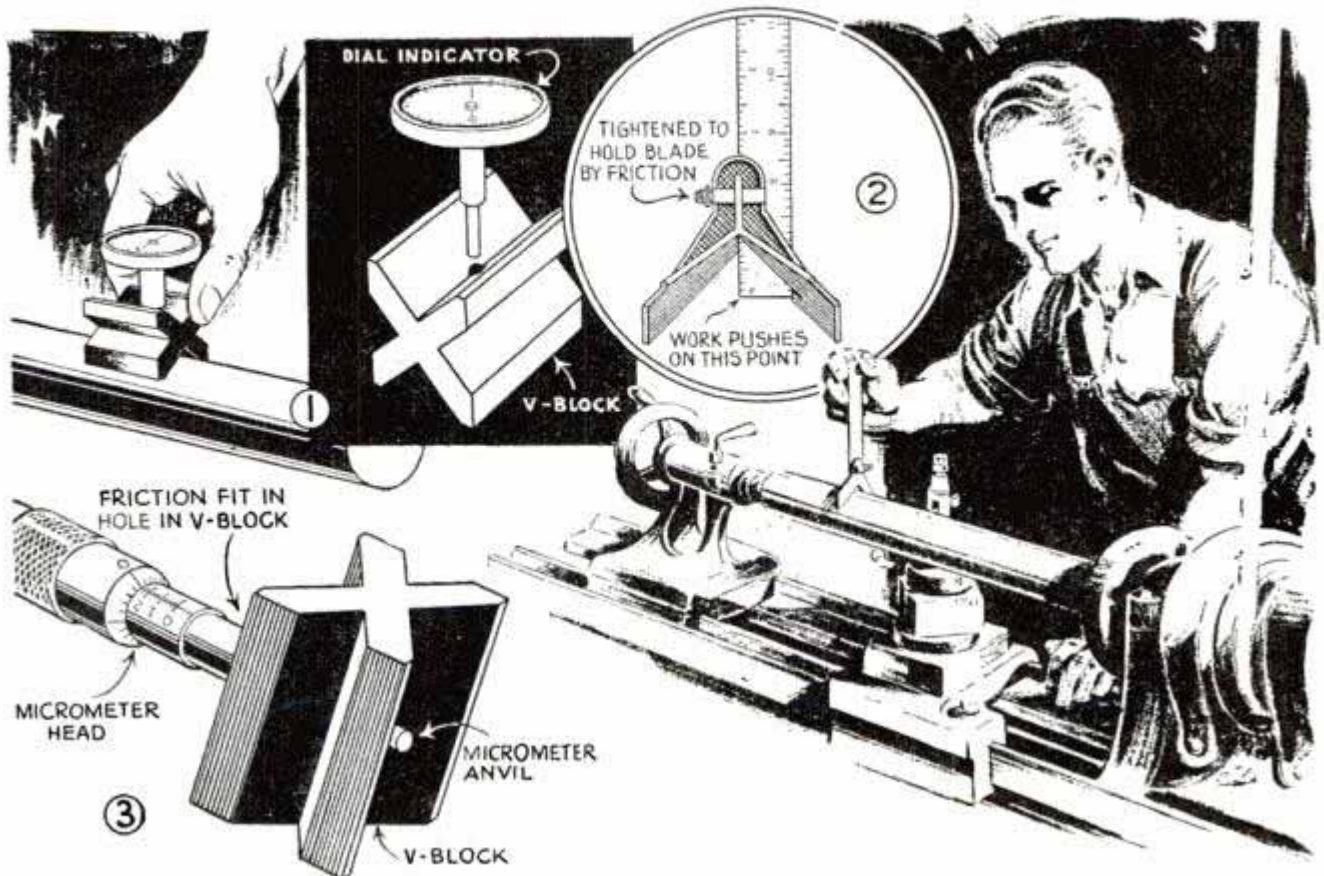

Using adaptations of standard measuring tools, you can make quick accurate checks of duplicate round work without stopping the lathe. The basis of the three devices shown is the combining of a vee with a suitable measuring tool. The first one, Fig. 1, makes use of a dial indicator fitted in a hole drilled in an ordinary V-block. Here the plunger guide of the

indicator must be a friction fit in the hole. The same is true of the micrometer head in Fig. 3. In Fig. 2 the operator simply sets the scale on his center square with enough tension so that a slight downward pressure forces the scale upward to give a comparative reading. This arrangement gives sufficient accuracy for ordinary work and can be used on wood or metal.

Imitation Steaks Help Purchaser Judge Thickness of Meat

To assist his customers in determining the thickness of steaks they desire, a butcher keeps imitation steaks setting on his refrigerated showcase. Band-sawed from wood, they vary in thickness from $\frac{1}{4}$ to 2 in., and when painted red and white, they have a realistic appearance.



Sealing Wounds in Pruned Tree

Always coat the wounds of a pruned tree with pure asphaltum instead of house paint. Asphaltum not only protects the wood from insects but, unlike house paint, it is not affected by weather. Any break in the bark should also be coated.

—L. H. Georger, Buffalo, N. Y.

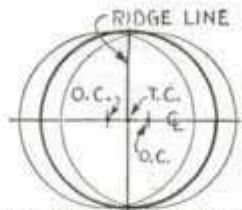

ONE TRUE CENTER AND TWO OFF CENTERS ARE USED IN TURNING OVAL WORK

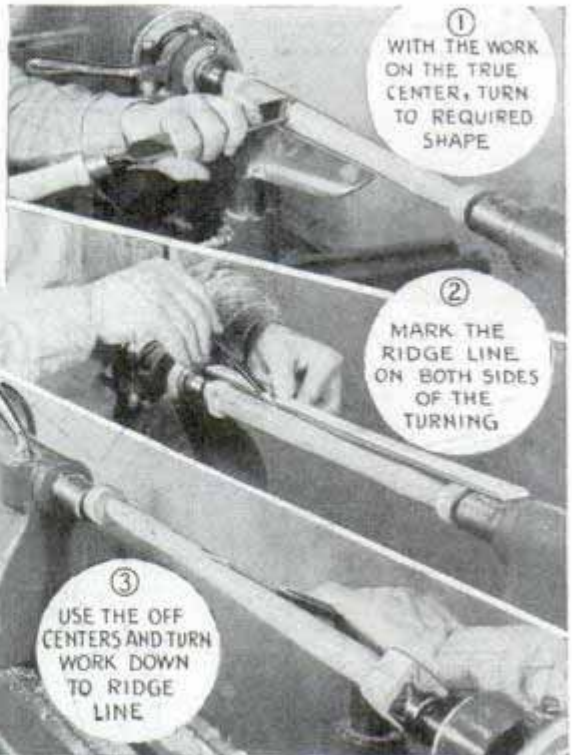

① WITH THE WORK ON THE TRUE CENTER, TURN TO REQUIRED SHAPE

② MARK THE RIDGE LINE ON BOTH SIDES OF THE TURNING

③ USE THE OFF CENTERS AND TURN WORK DOWN TO RIDGE LINE

④ SAND AT SLOW SPEED TO REMOVE SHARP EDGE AT RIDGE LINES

Turn Right!

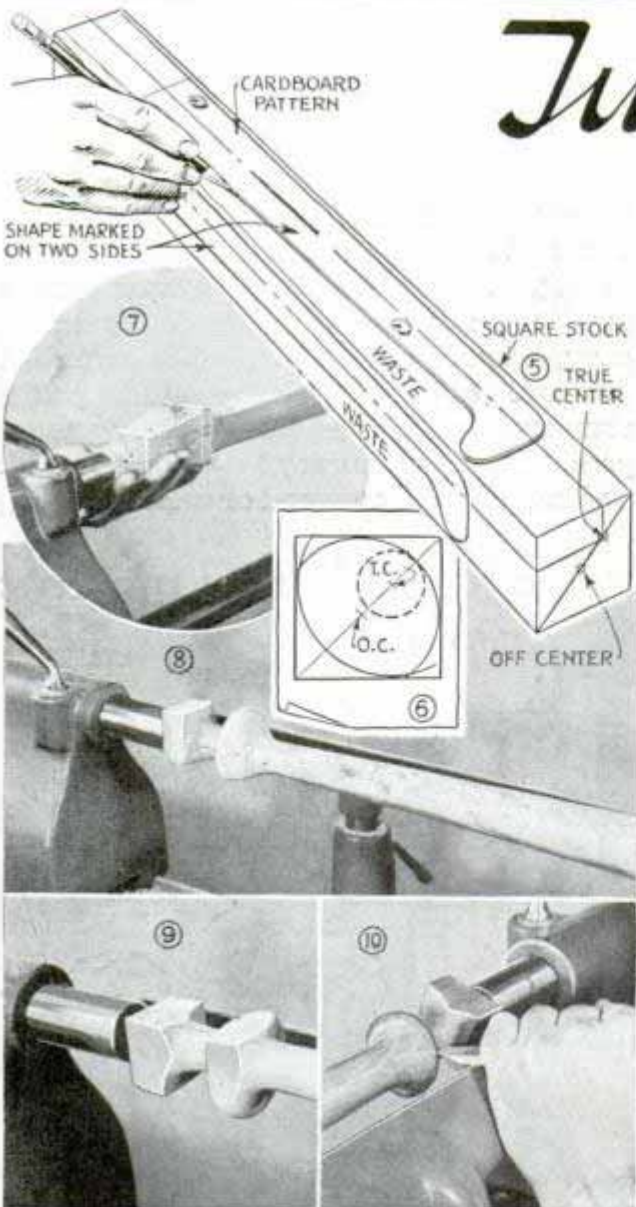

CABINET work demands the use of many kinds of special spindles, which vary in different respects from regular turnings. A typical example is the turning of an oval spindle, shown in Figs. 1, 2, 3, 4 and 11. Three centers are required. The true center is located in the usual manner, after which the off centers can be located by experiment to obtain the required shape. The work is first turned on the true centers to the contour of the project, after which the ridge line, previously marked on the end of the work, is scribed on opposite sides of the turning. The work is then recentered, using two corresponding off centers, and is turned down until the cut comes exactly to the ridge line. This is done easily by running the lathe at second lowest speed, so that the ridge line can be seen as the work rotates. The same operation is performed with the work mounted between the second pair of off centers.

Club-foot furniture legs are produced by a similar process of off-centering. A paper pattern of the leg is first made, and the shape transferred to two adjoining sides of the turning square, as shown in Fig. 5. The true center is carried out to the

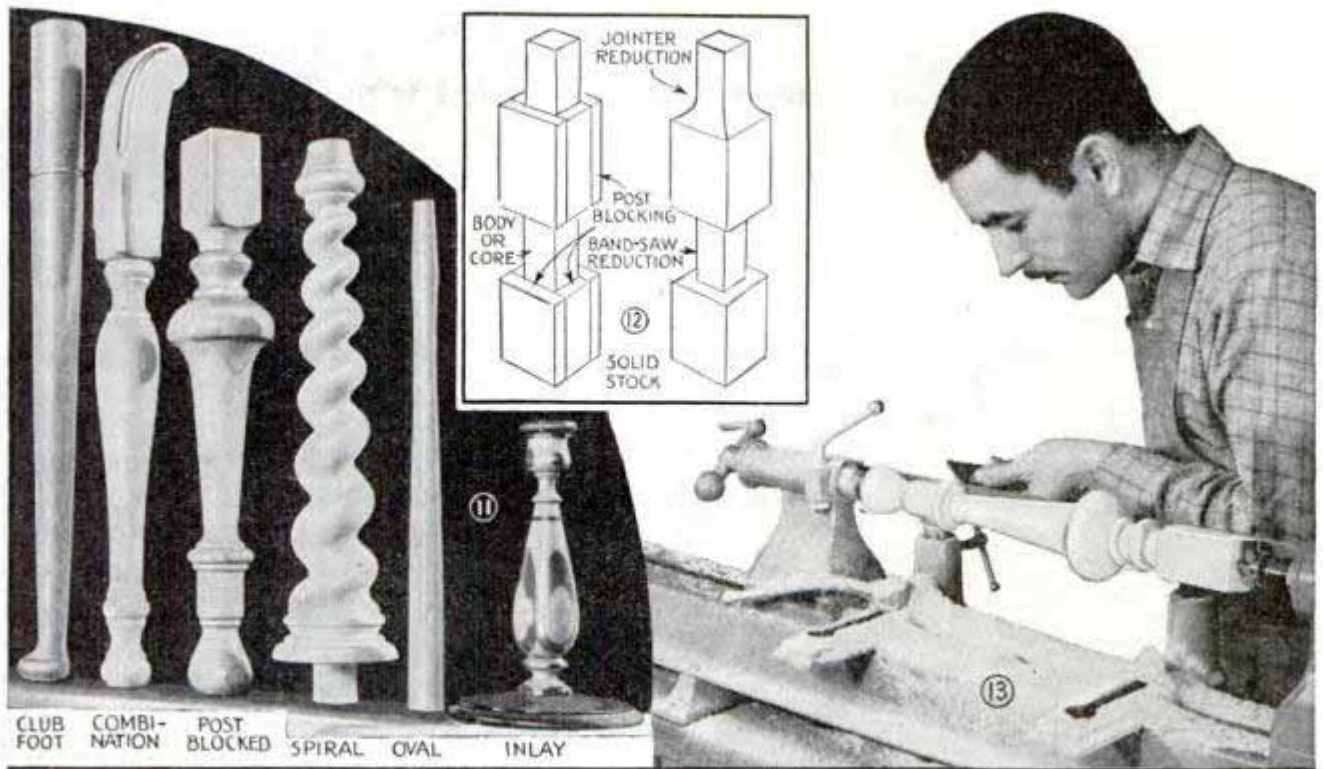

SPECIAL SPINDLES PART 3

end of the work. The off center is found by experimenting with a compass until the desired shape is obtained, as shown in Fig. 6. This end of the work goes to the tailstock; the opposite end, which is the driven end, has a true center only and is not off-centered. It can be seen in Fig. 7 a large part of the waste stock has been sawed away. Turning is then carried out the full length of the leg, including the toe portion, as in Figs. 8 and 9. If the work is now placed on the off center, the back of the toe can be finished, Fig. 10, after which the work is returned to the true center for sanding.

Some very attractive turnings have square sections which are smaller than the diameter of the largest round section. The

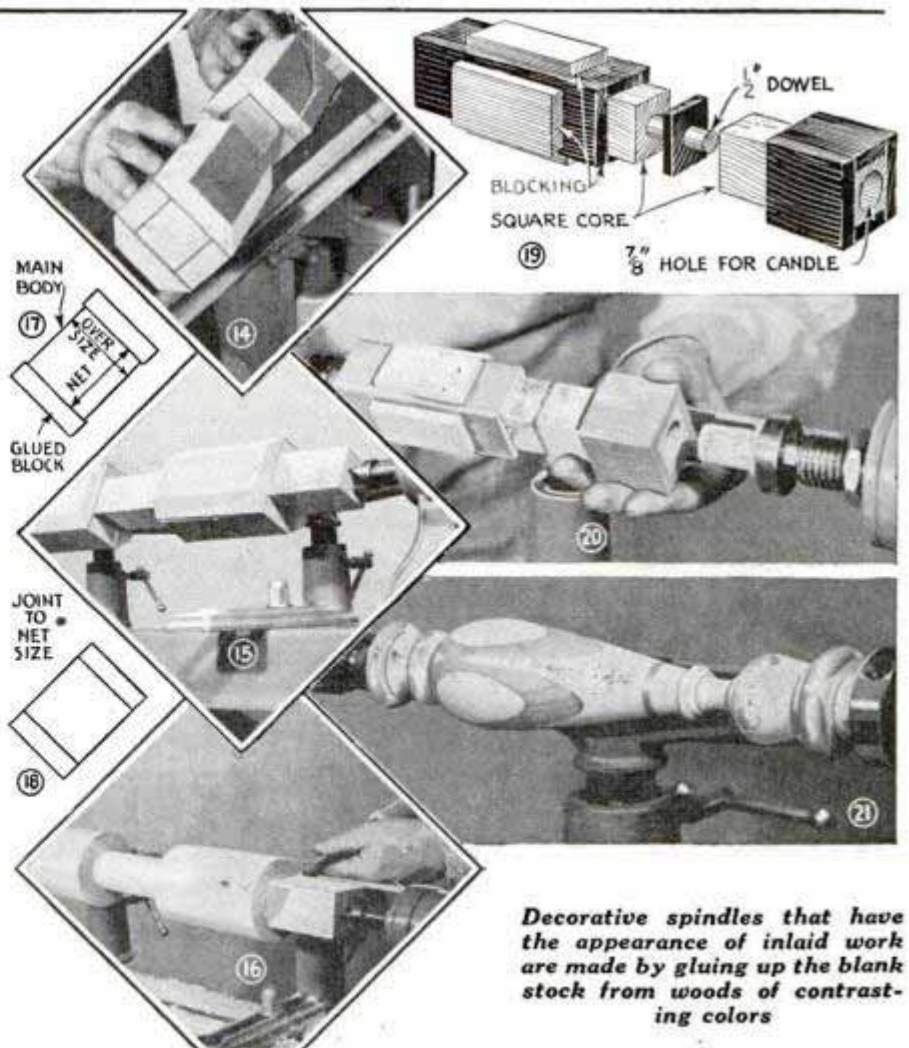

Decorative spindles that have the appearance of inlaid work are made by gluing up the blank stock from woods of contrasting colors

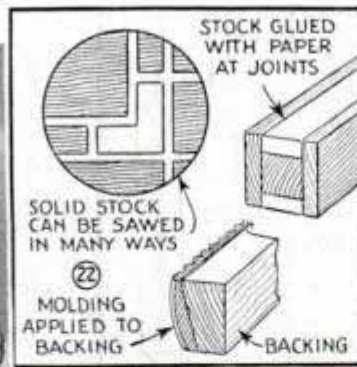
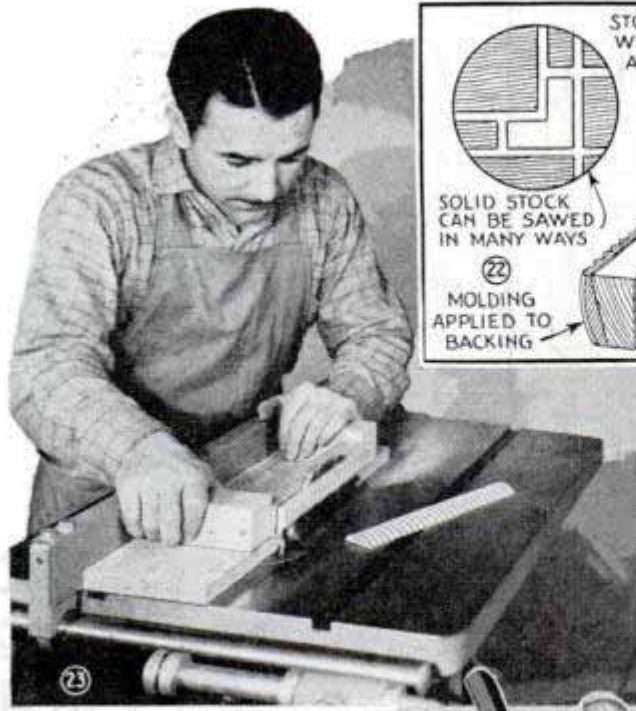

post-blocked leg in Fig. 11 is an example. Two methods of making these turnings are shown in Fig. 12. Solid stock can be used, the necessary square sections being reduced with a jointer or band saw. The second method is known as "post blocking," so called because the central square or post is blocked up to the required thickness. After the pieces have been glued on and the work allowed to dry, the edges are cut off on the band saw, Fig. 14. The work is then mounted in the lathe and turned to shape in the usual manner, as shown in Figs. 13, 15 and 16. The essential point in post blocking is good glue joints. The narrow pair of blocks are glued in place first, as shown in Fig. 17. After the glue has dried, the work is sanded or jointed flush and to net size, Fig. 18, and the second set of blocks is applied. Figs. 19, 20 and 21 show how an "inlaid" candlestick is prepared. Maple and walnut are used for contrast.

Not all turned spindles are left in the round. Many are split, quartered, and otherwise cut into lengthwise strips to form a wide

variety of split turnings and ornamental moldings as in Fig. 24. Work of this kind can be done by two different methods. In the first method, the work is turned from solid stock, after which the required molded sections are cut off, as shown in Figs. 22 and 23. The upper right sketch in Fig. 22 shows the second method, the molded sections being glued to a wood core with paper between the joints, and then split off after turning. The latter method is useful when working thin stock, and is preferable when two half-round turnings are required. The complete operation is shown in Figs. 25, 26 and 27.

Spiral turnings involve the most work of all special lathe spindles. The most common type is the single spiral, where one thread or twist spirals its way along the length of the turning. In working a turning of this kind, the stock is first turned to cylindrical shape, and the limits of the spiral portion are laid off. The full length of the spiral is now divided into an equal number of spaces, each space being about the same width or a little less than the diameter of the turning. Each main division is again subdivided into four equal parts, as shown in Fig. 28. Next, the dividing head is set to quarter the stock, and four horizontal lines are drawn along the work, as in Fig. 29. The ridge of the spiral can then be penciled in by crossing each of the small spaces, as shown in Fig. 30. Other spiral lines can be added, preferably in colored pencil to avoid confusion, to show the bottom of the groove, and the limits of the true groove portion. Some workers prefer to

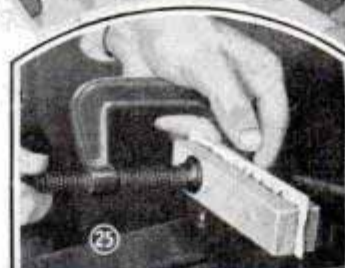

STOCK GLUED WITH PAPER JOINT



TURNED AS ONE PIECE



SPLIT APART WITH KNIFE

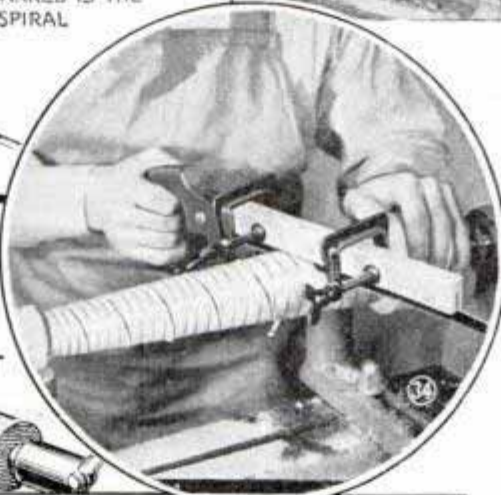
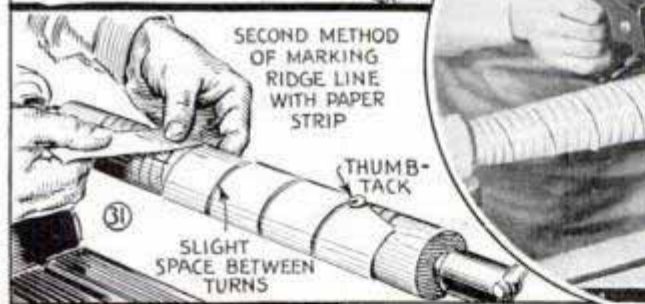
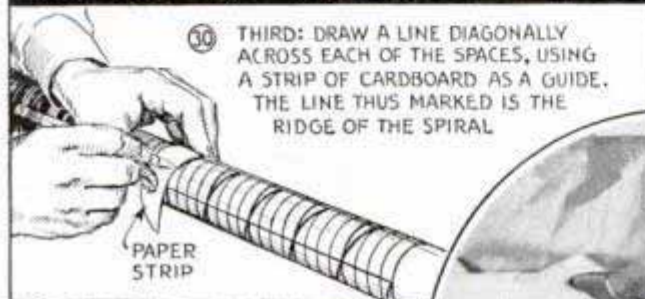
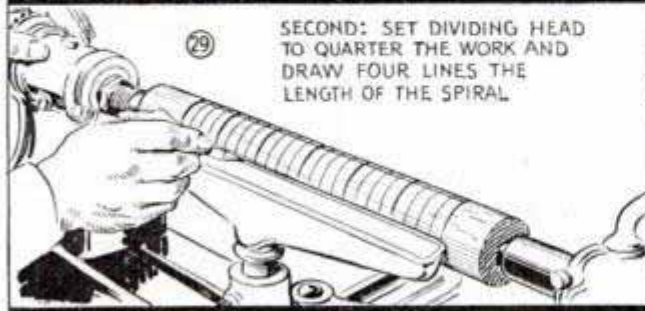
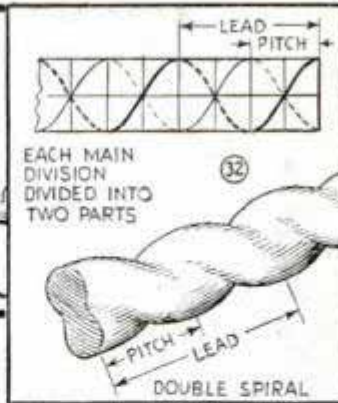
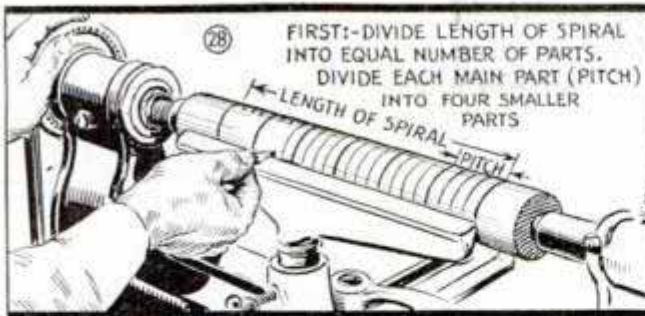

lay out the spiral with a long strip of paper, as shown in Fig. 31, wrapping this evenly along the turning so that a pencil can be inserted between the strips to mark the ridge of the spiral.

The actual work of cutting starts with the operation in Fig. 34, in which a saw cut to the required depth is made on the line which shows the bottom of the groove. The cut does not follow the line at the extreme ends of the spiral, but, starting at the center of the final main division, the cut follows more truly in a circle about the turning.

The saw can again be used to rough out the cut to a full vee-shape, after which the true groove portion of the spiral is roughed to shape with a file, as shown in Fig. 35. After the groove has been worked out, a flat file is used to dress the round of the spiral, as in Fig. 36, following which the work can be turned at slow speed and chased up with sandpaper to complete the spiral, Fig. 33. The photo illustrations are of a single spiral on a ta-

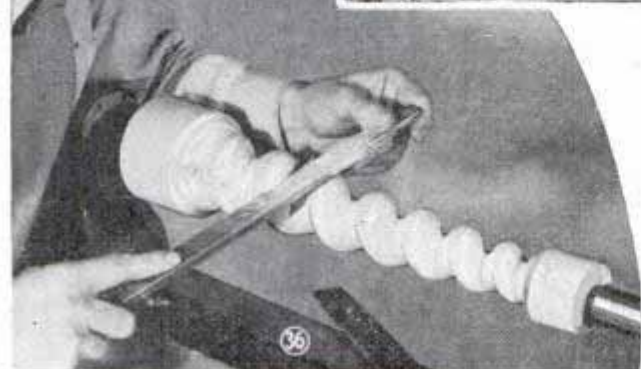
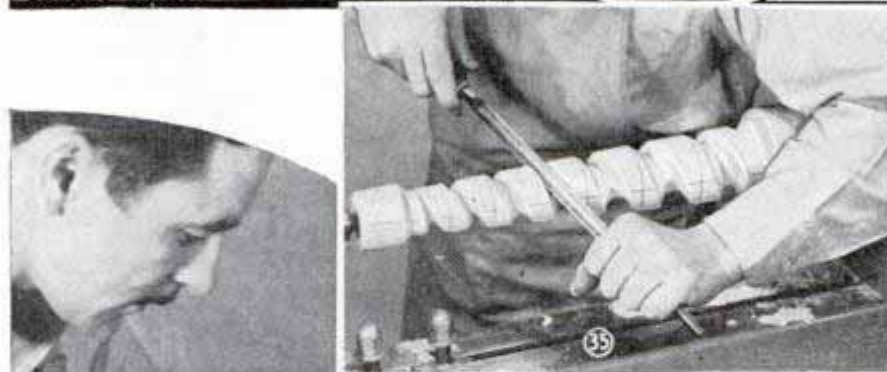

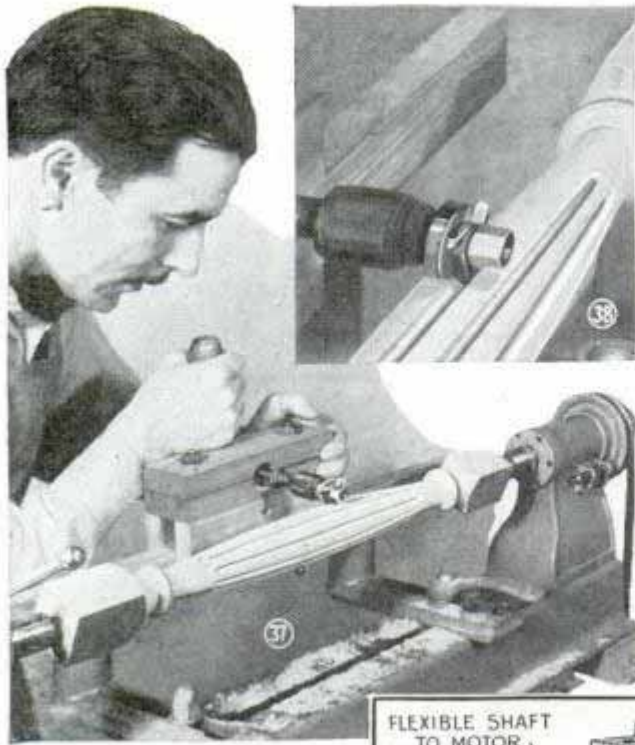

scribed for the single twist. Figs. 37 and 38 show how turned spindles can be fluted or reeded on the lathe. The setup makes use of a flexible shaft, which drives standard $\frac{5}{16}$ -in. hole shaper cutters. The manner of supporting and guiding the cutter along the work should be apparent from Fig. 39. The spacing of the various cuts is done with the standard lathe indexing head, while the depth of the cut is set by a suitable collar.

One other style of special spindle is worthy of mention. This is the combination leg, where one portion is turned to shape while the opposite end is band-sawed. Figs. 40 and 41 show how the combination leg is mounted in the lathe for turning, the upper portion being left partly

unfinished in order to furnish wood for the lathe center. In some work it is necessary or more economical to cut the shaped portion first. In this case, a suitable jig is made up to fit the curved portion of the leg, and the leg is fastened to this block with some form of clamp, as in Fig. 42.

pered shaft. This is similar to the straight single spiral except that the main divisions are graduated in width. A good rule to follow is to measure the taper at its largest diameter, then lay out this same distance to establish the second ring. Measure the diameter at the second ring and lay out this same distance to establish the third ring, and so on the full length of the spiral.

A second form of common spiral is the double spiral, in which two threads or twists wind along the turning. In this layout, each main division is divided into two parts, as shown in Fig. 32. The ridges of the spiral are the same distance apart as before, but the distance each ridge travels in one complete revolution is twice as great as the pitch. The two spirals should start on opposite sides of the turning. As there are two spirals, it is necessary to make two saw cuts—in short, do double all the operations de-

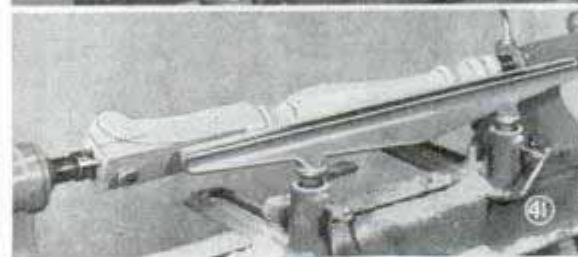
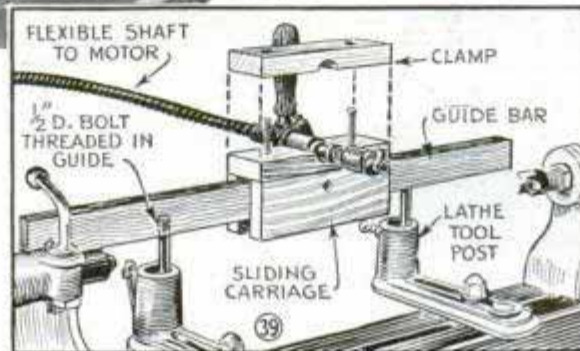

In-and-Out Fade Slides for Movie Cameras

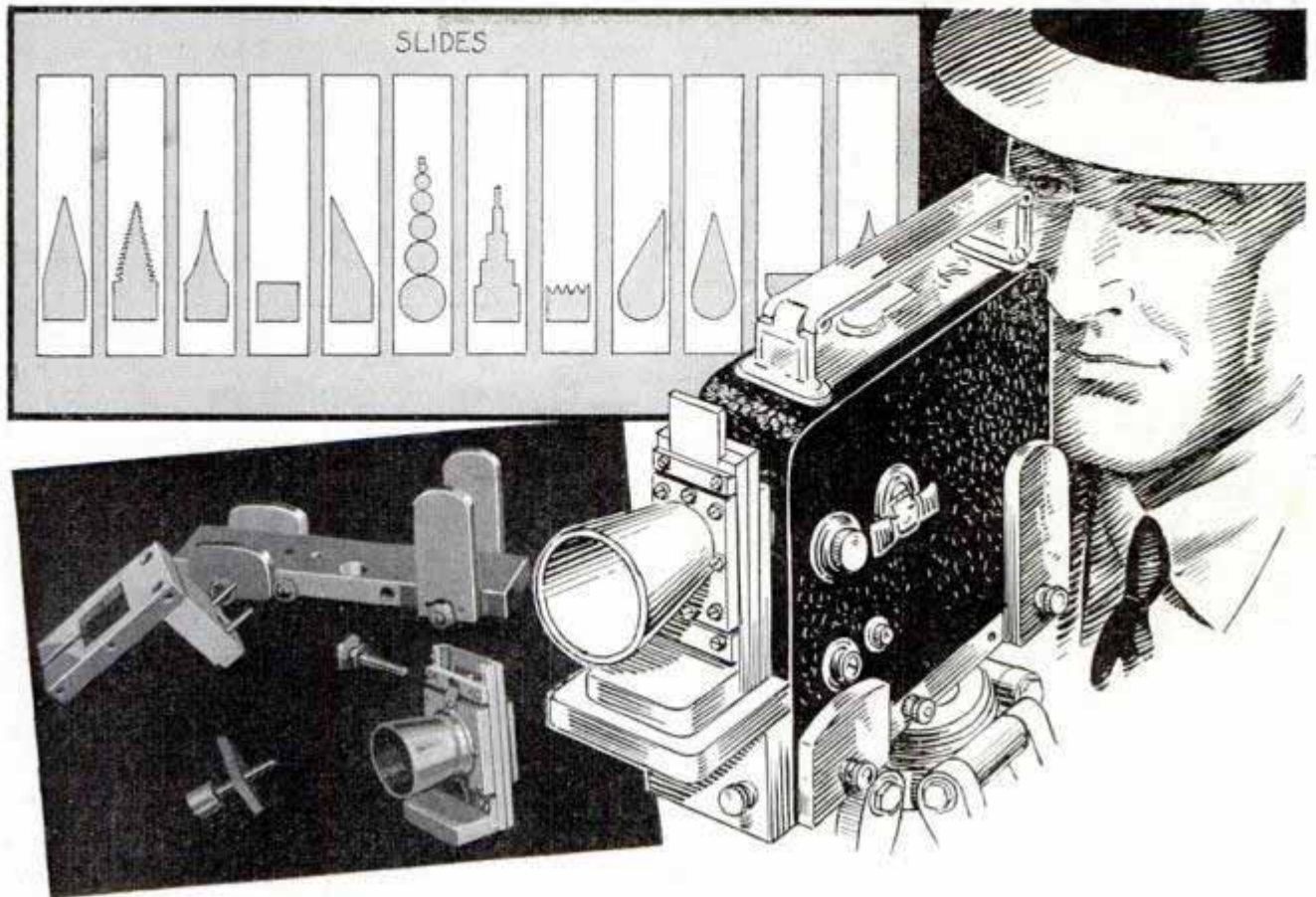

Although home movie cameras are not usually equipped to wind back the film for "lap and wipe dissolves," any amateur operator can create attractive effects with in-and-out fade slides. The fade, properly used, is an effective means of indicating to your audience a lapse of time, change of scene sequence or the tempo of the picture. As you will see from the samples shown, slides can be of almost endless variety. To handle them effectively and without loss of time when shooting a series of scenes, you need a holder like that pictured. This can be made of hardwood to such size that it will support the camera rigidly when the whole assembly is mounted on a tripod. The combination holder and sunshade must be made carefully so that the slides work smoothly. Although you can use cardboard or Bristol board for cutting slides, thin, black fiber is perhaps the best material. The slides shown are 7 in. long and $1\frac{1}{4}$ in. wide, but this size will vary with different makes of cameras.

☐ When the breaker points burn to a yellowish or whitish appearance it indicates condenser trouble.

Screen Wire Held by Clamps for Measuring and Cutting

To hold lengths of screen wire on a counter for unrolling and cutting, one dealer employs a pair of auto-hood clamps. They are attached to the end of the counter, notches of the required depth being cut so the clamps can be pulled up vertically when used.



Brakes on Wheels of Hand Truck Work Automatically

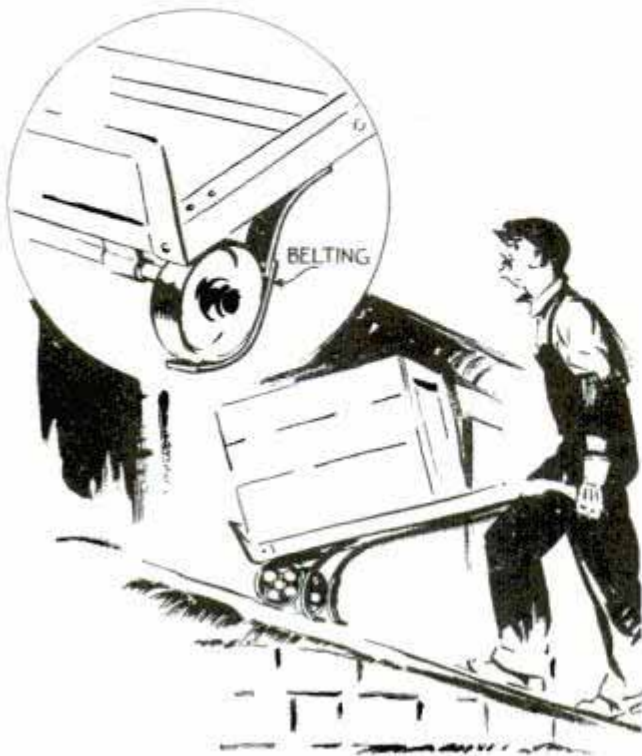

Automatic brakes keep hand truck from rolling backward when stopped on incline

Accidents to workmen pushing heavily loaded hand trucks up inclined gangplanks, can be minimized if the trucks are equipped with simple automatic brakes of the kind shown. They consist of strips of stout fabric belting attached firmly to the underside of the truck frames behind the wheels so that the ends just clear the floor when the trucks are held at the usual working angle. If the load is too great, and the workman needs to rest, he can lower the handles and allow the wheels to roll back onto the belting as shown in the detail.

"Well" Set in Top of Stepladder to Hold Small Parts

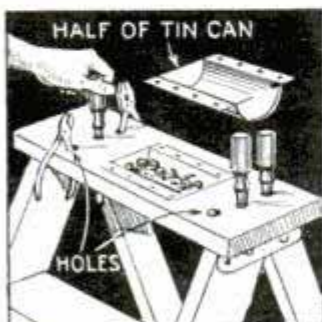

Electric wiremen and others using a stepladder while installing fixtures and appliances will find a "well" in the top step a handy place to keep screws and other small parts.

The well is made from one half of a tin can, the edges of which are bent over at

right angles to take screws which hold it in place. As a further convenience, a few holes can be drilled through the top step as shown, to hold screwdrivers, pliers and other small tools.

Type Cleaner

A cleaner that will instantly soften all types of printing inks, which have hardened on type forms, cuts, etc., is made by mixing butyl cellosolve, 8 fl. oz., and diglycol oleate, 2 fl. oz. This cleaner is also a solvent for most dyes, therefore it should not be spilled on clothing. After softening and rubbing free with a rag, the type can be washed with water as enough of the diglycol oleate will remain to give excellent soap action in removing solid matter lodged between letters or in recesses.

Uncoiling and Unreeling Cable to Avoid Kinking It

As the life of wire rope and cable is greatly reduced by kinks, careful attention should always be given to uncoiling or unreeling it. When a kink in a wire rope is straightened, the latter is weakened, and when used the wires will soon break. It is advisable never to use a rope that has been kinked. The drawing shows how rope should be handled as recommended by one large steel company.

—W. F. Schaphorst, Newark, N. J.



Life of wire rope determined largely by the way it is handled in uncoiling or unreeling

Equatorial TELESCOPE MOUNT

made from
ball-bearing
truck
casters

By D. L. AVERY

WHEN you build a vertical or equatorial mounting for either the reflecting or refracting type of telescope, there are two things you are after—rigidity and ease of adjustment. With these two points in mind, it has been found that heavy ball-bearing casters of the type used on hand trucks in manufacturing plants can be made to serve the purpose with a minimum of alteration and very little machine work. These truck casters are not expensive and can be had in various styles fitted with single and double-row ball bearings, some types having ball bearings on both axes. Figs. 3 and 5 show a caster of the single ball-bearing type made into a simple vertical mounting. The telescope tube is attached to the truck wheel by means of a saddle block of hardwood and pipe hangers. A close-fitting bolt is substituted for the wheel spindle and the wheel is fixed to the bolt with a setscrew. A wing nut

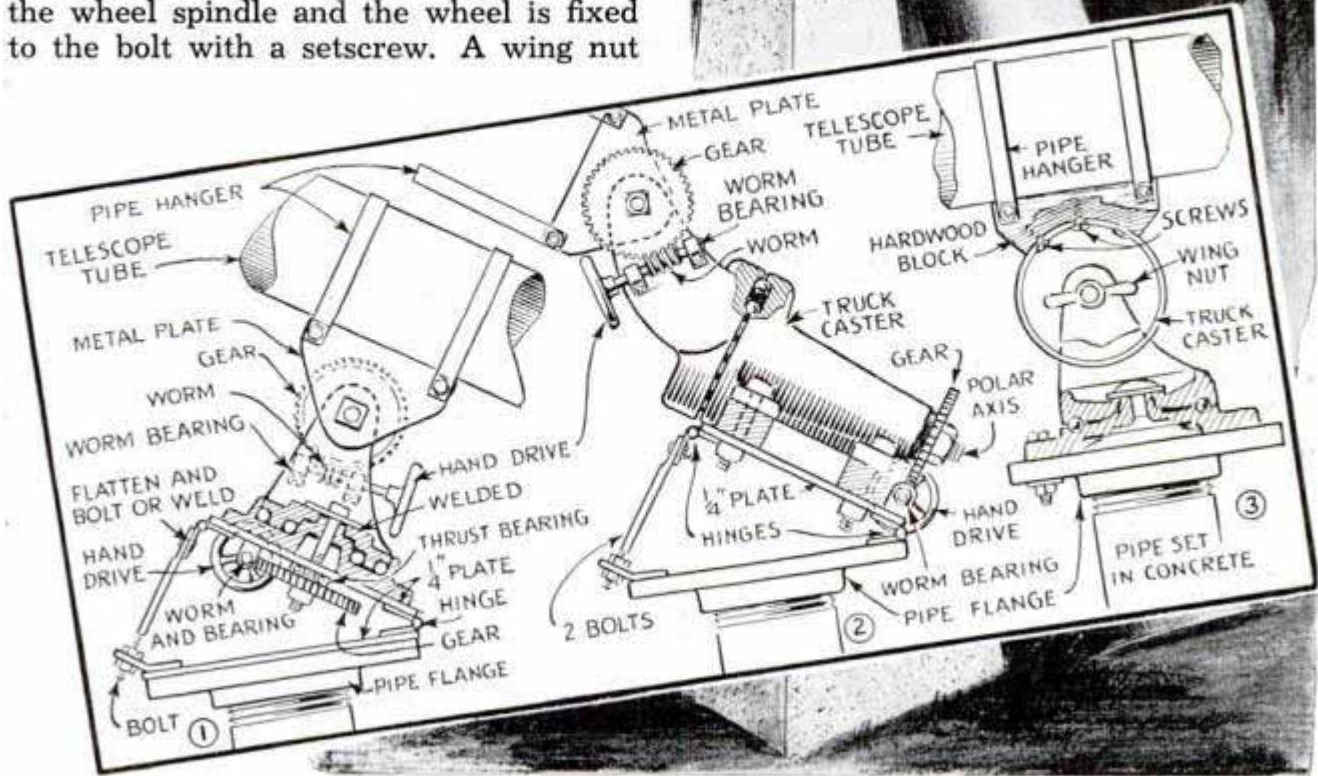
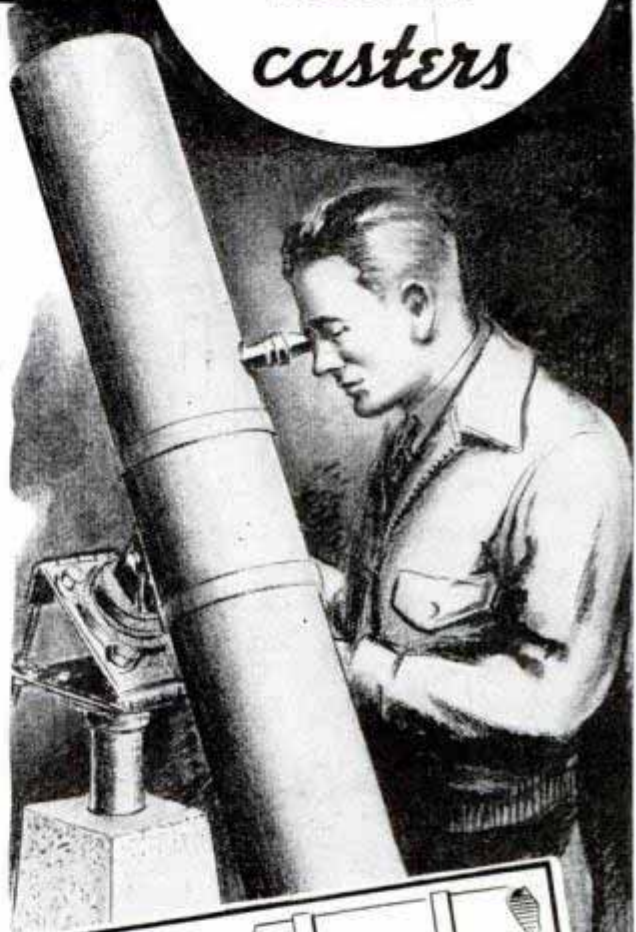



bears against the fork, giving a friction stop for declination adjustment.

Now, Figs. 1 and 2 and also Figs. 4 and 6 illustrate the method of converting casters into the equatorial-type mounting with slow-motion adjustments on both axes. Although these are somewhat more complicated affairs, you will see that the caster is readily adapted with only a few fittings. The mount shown in Fig. 1 uses a double ball-bearing caster with a flat bolster which is bolted to a steel plate hinged to a pipe flange. By welding the bolt connecting the two halves of the ball races to the lower half and fitting a fine-pitch gear and companion worm over

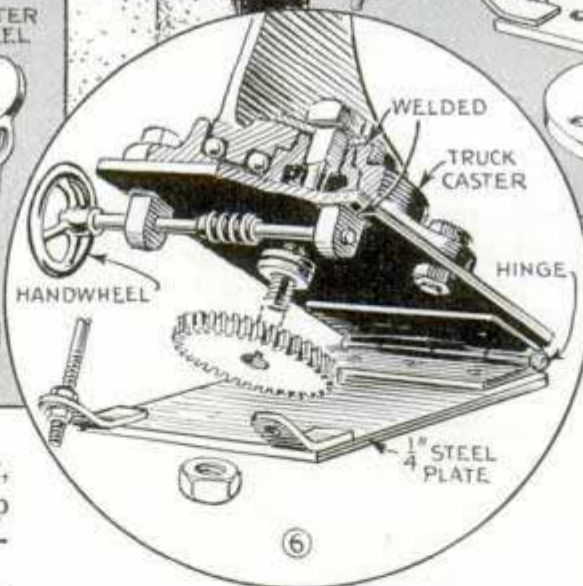
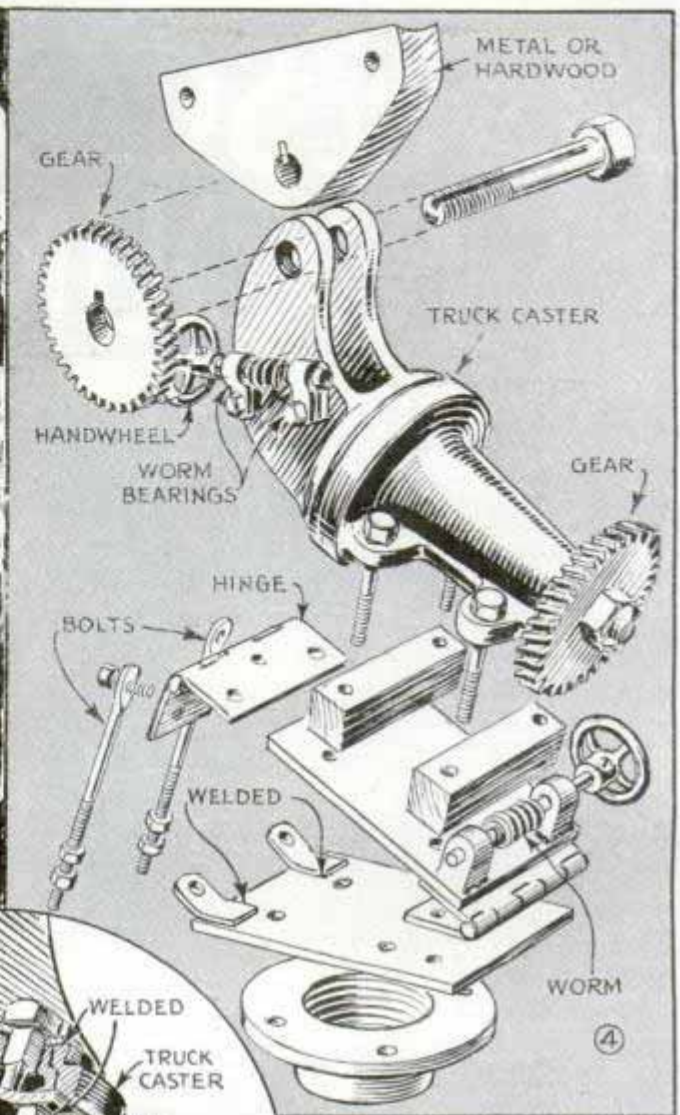

a ball thrust bearing as shown, you get a sensitive and yet positive slow-motion adjustment. The only involved operation here is slotting the bolt and gear for a key. Lacking milling equipment, you can do this job with

a hacksaw and then file out a key to fit.

The mount shown in Figs. 2 and 4 is in some respects the best of all those shown. This is largely due to the use of a spindle-type caster which permits placing hand wheels where they are more accessible. Note that the adjustable hinged base is the same as that on the mount shown in Fig. 1. Bearings for the worm spindles are made of flat steel and welded or bolted to the hinged base and to the side of the caster fork. All the mounts shown are designed to be placed on a concrete pedestal.

Armature Growler Serves as Magnetic Vise

You'll find many uses for an armature growler besides its regular testing work. Fig. 1 shows it serving as a handy magnetic "vise" or hold-down for odd-shaped parts of iron or steel while filing or other work is being done on them. In this case, a generator armature is held securely while undercutting the mica. Care should be taken to see that the work bridges the poles of the growler before turning on the current. When it is desired to reduce the voltage for controlling motor speeds, lighting a lamp circuit at reduced brilliancy, etc., the growler will come in handy as a choke coil if one of the feed wires is hooked up in series with the appliance,

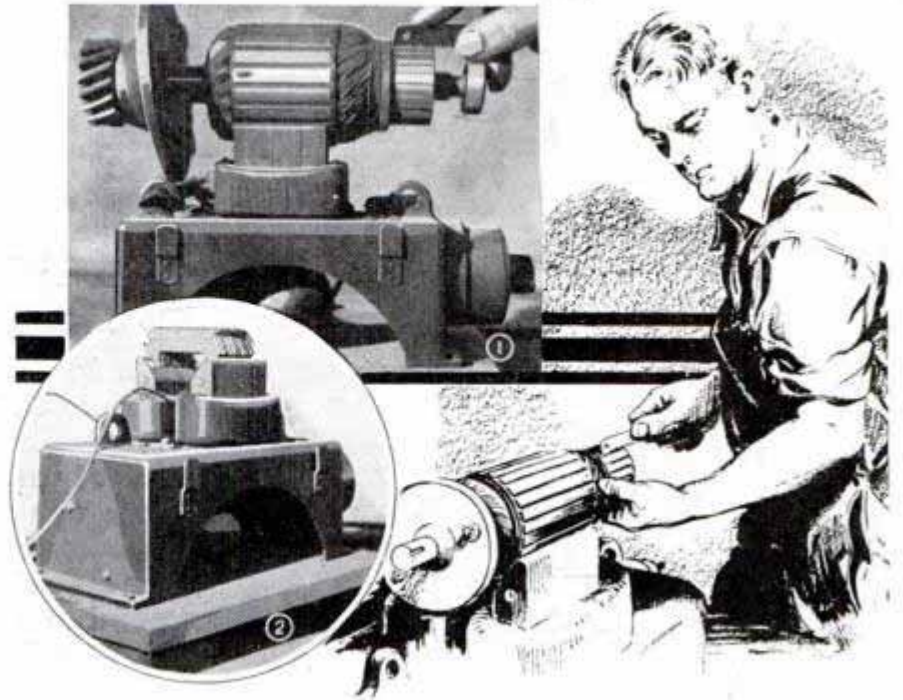
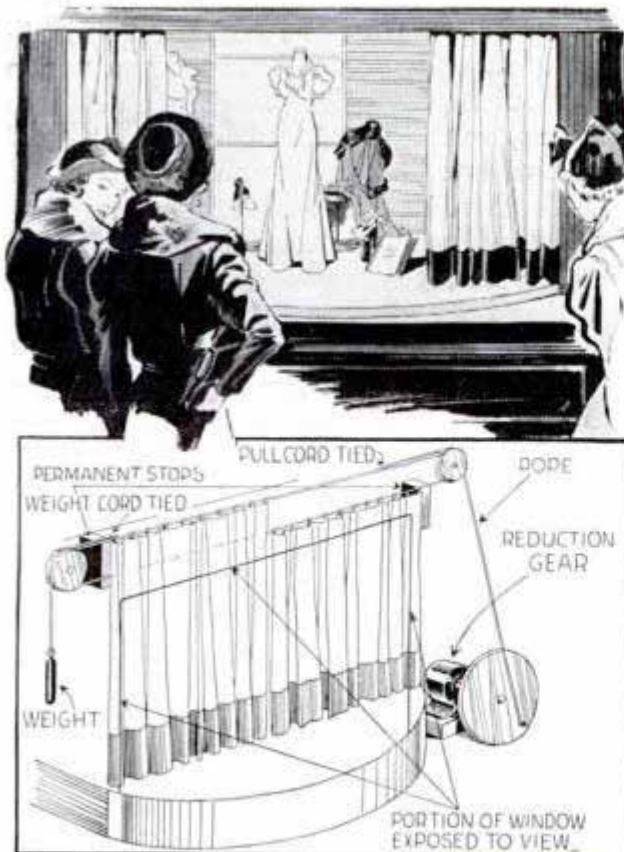

Fig. 2. With the core open, its choking effect is slight, while the presence of an iron or steel bridge increases its choking capacity.—W. C. Wilhite, Carlinville, Ill.

Moving Curtains Give Stage Effect in Store Show Window



Curtains operated by small electric motor open and close once at 90-sec. intervals

Richly colored curtains slowly sliding open at regular intervals to expose a display tastefully arranged on a stage in a show window are sure to attract attention of shoppers. A small electric motor operates the curtains, a reduction gear being used to reduce the speed so that the curtains open and close once every 90 sec. The curtains are suspended from an endless cord or belt, which runs over pulleys concealed by the stage trim. A pull cord or rope tied to the belt near one pulley and to a crank wheel on the reduction gear slowly pulls the curtains open during one-half revolution of the wheel. A weight attached to a cord, which is tied to the belt near the other pulley, slowly closes the curtains as the wheel completes the revolution.—Harold Mann, Muncie, Ind.

ⓘ When the points of a spark plug in your car have a tendency to burn away or "whisker," it indicates that the motor is too hot for that style of plug, or that the mixture is too lean.

Flat Metal Quickly Bent to Shape by Jig on Anvil

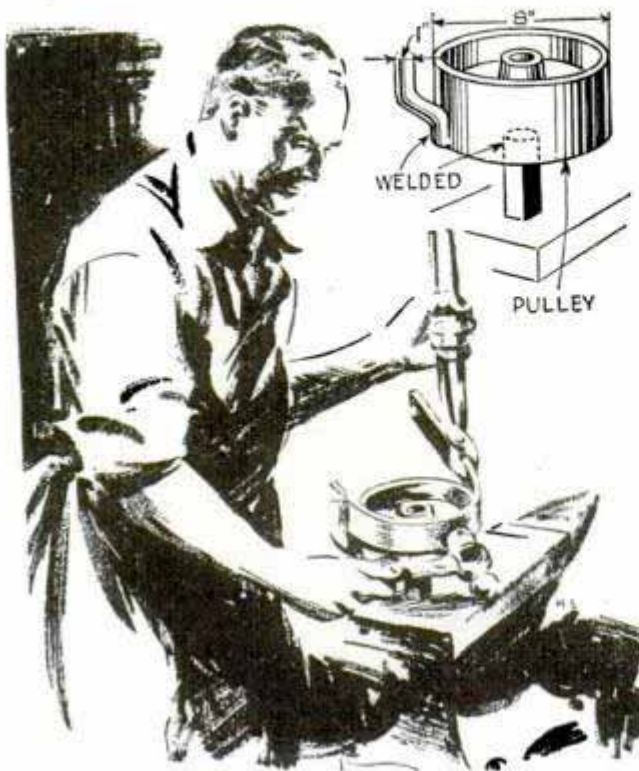

Flat metal can be formed to almost any shape desired by bending it around this anvil jig

A handy accessory for a blacksmith's anvil on which to bend light flat metal, is a short piece of 6 or 8-in. shafting with a 1-in. length of round iron bent to a lazy S-shape and welded to one side. A square pin to fit the anvil hole, is also welded to the pulley. Metal is quickly bent to different shapes by using either the shafting or the small bar, or both, as forms.

Cement for Leather Belts

Leather belts work best and with least noise when their ends are beveled and cemented together with a good belt adhesive. Although ordinary glue may be used, this special preparation is far superior. The cement is made by soaking and dissolving high-grade cabinetmakers' glue, 1 part, in water, 4 parts, with heat, taking care not to overheat the glue. A good double-boiler gluepot should be used. In a separate container dissolve tannic acid, 1 part, in water, 10 parts. A few drops of glycerin are added to help dissolve the tannic acid. This solution is heated and added to the glue and the combined solution heated in the gluepot until stringy. To use the cement, bevel the ends of the belt and rough-

en the surface with a file. The prepared belt ends should be warmed slightly and the glue applied with a brush. Immediately after applying the glue, place the splice between blocks of wood, with paper between leather and wood to prevent sticking, and apply pressure with a clamp. The belt should be left clamped for 48 hours.

Special Paper Dial on Scales Saves Time in Laboratory

In a laboratory where a certain chemical formula for a cleaning mixture was compounded frequently, the difficulty of remembering or looking up the required quantities was eliminated by pasting a special paper dial over the regular dial of the scales.



Numbers were used to indicate the different chemicals.

Locking Screw Collar on Shaft

An effective way of locking an adjustable screw collar on a threaded shaft is to cut a slot in the collar at right angles to the axis, as indicated, cutting about one-fourth or one-third through the collar. A hole is then drilled and tapped through the slotted part of the collar, parallel to the axis. A set screw or cap screw driven into this hole pinches the slotted portion together slightly, binding the threads of this portion against the threads of the shaft. A very slight tightening of the screw is sufficient to hold the collar firmly.

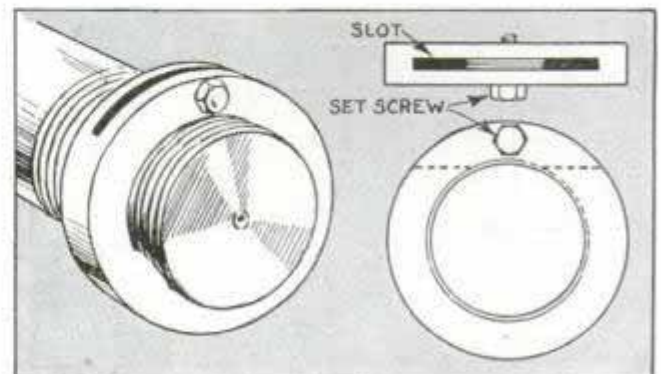

Screw collar locked on shaft by slotting side for screw, which binds the threads against the shaft

Helps for the MOTORIST

Difficulty of closing doors against the resistance of air trapped in steel-top cars is avoided by installing a flap valve in the dash to release it automatically. The valve, installed on the engine side of the dash, covers a 1-in. hole drilled through the latter and is mounted as shown in circle



SHEET BRASS
BENT ON DOTTED LINES
WATCH

NAIL
COTTER KEY
FINE STEEL WOOL

BICYCLE TIRE OR RADIATOR HOSE
HEADLIGHT BULB

RIVETS
SPRING
RUBBER DISK
HOLE DRILLED THROUGH DASH

An easily made holder that will keep your pocket watch in sight on the instrument panel in front of you

Corrosion is removed from the sunken terminals of a distributor cap with steel wool held in a cotter key

Protection for an extra headlight bulb is afforded by a piece of bicycle tire or radiator hose of the right size

#20-GA. COPPER WIRE

POINT WHERE GASKET BLOWS OUT

5-GAL. OIL CAN

CUT ON DOTTED LINES

EDGE BENT OVER

Tendency of a cylinder-head gasket to blow out is often prevented by placing a piece of copper wire over the weak spot on the new gasket before replacing the cylinder head. A pan for draining the radiator or crankcase can be made from a square oil can. It has ample capacity and is shallow enough to slide under most cars. When the starter pinion does not engage properly with the flywheel, because the teeth on the latter are worn down, the trouble often can be overcome by placing washers over one or two of the starter bolts to tilt the pinion toward the flywheel

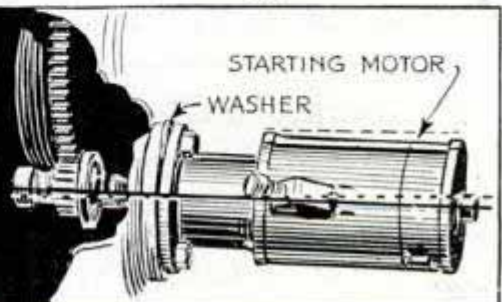

Liquid to Clean Car Windows Applied with Atomizer

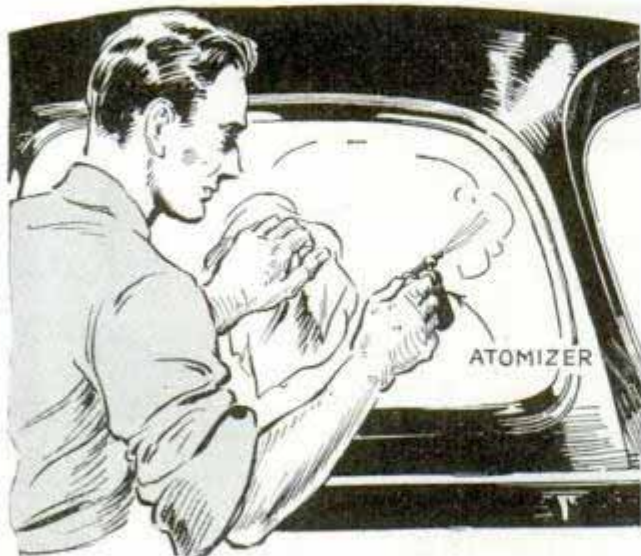

You can clean your car windows in a minute if a perfume atomizer is filled with cleaning liquid

An inexpensive perfume atomizer provides a handy container for applying window-cleaning liquids. Carried in the glove compartment or pocket of the car, the atomizer is always at hand to give the windows a quick, thorough cleaning by simply spraying the glass and then wiping it with a clean cloth.

Ice Kept Out of Air-Hose Nozzle by Rubber Hood



When an air hose is kept outside where water is likely to run down the hose and freeze in the nozzle, a rubber hood or shield slipped over the nozzle as shown will prevent this trouble. The shield is cut from a piece of inner tube and assumes a conical shape when forced over the nozzle.

Temperature Checks Oil Filter

Whether or not the oil filter is protecting your car or merely deceiving you into thinking it is reducing engine wear, can be told quickly by feeling the filter. If the engine has been driven far enough to have

the crankcase feel warm to the touch yet the filter feels cool, oil is not passing through it and it should be replaced. But if the filter is about as warm as the crankcase, then it is on the job. As sludge accumulations may clog any filter before the regular changing period, this test should be made frequently.

Driver's Knee Pad for Long Trips

Pinned to the upholstery of the left front door, a soft cushion offers a resting place for a driver who has a tendency to lean his knee against the door on a long trip. Besides resting the knee, the cushion also helps prevent marring the upholstery, and if the pinning is done carefully, there is little possibility of tearing the cloth.



—J. Stewart Borland, Hingham, Mass.

Oil Pan Rests on Rubber 'Chains' While Starting Screws

Discarding other cumbersome devices designed to hold the oil pan while starting the screws, one mechanic found that chains

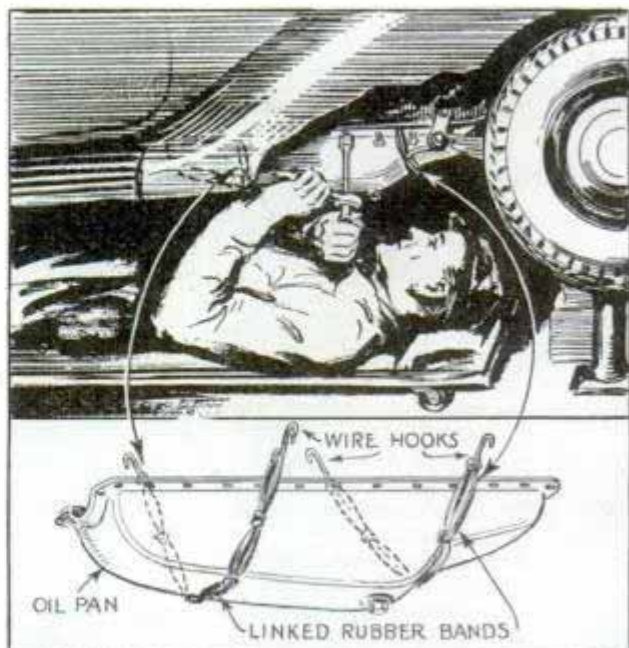

Tension of the rubber chains stretched under the pan holds it in place with screw holes in alignment

made of rubber bands served the purpose more efficiently. Hooks in the ends of the chains engage the frame of the car, stretching the rubber snugly under the pan.

Adjustable Drop Light in Trailer from Cigar-Lighter Cord



Cable-type cigar lighters, which were used just before the introduction of the present removable-element type, make excellent drop lights for house trailers. All you have to do, in most cases, is substitute a lamp and socket for the lighter element on the cord, and mount the reel box behind a panel so that the cord can be pulled through a hole in the panel.

element on the cord, and mount the reel box behind a panel so that the cord can be pulled through a hole in the panel.

Floor Truck of Auto Springs

By bolting two discarded auto springs together and inserting heavy casters into the eyes at the end of the springs, one mechanic constructed a floor truck to move heavy engines, large castings, etc.

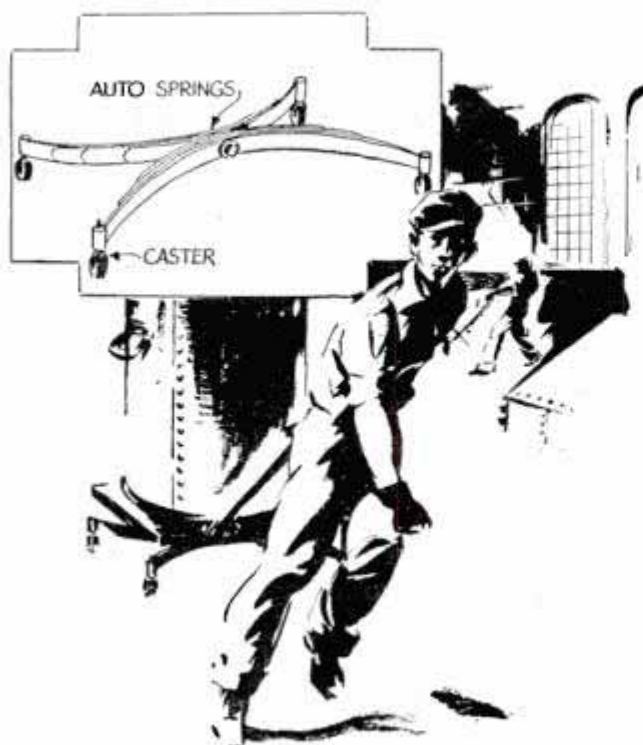

This truck is quickly improvised to haul heavy loads, which are easily lifted onto it

Snowplow Hooked on Bumper Clears Your Driveway

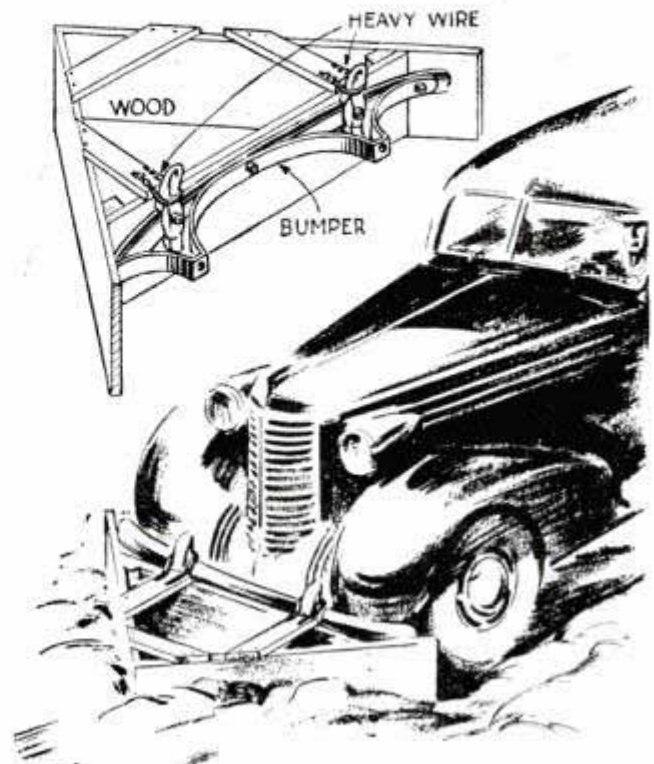

You won't have to shovel snow from your driveway if you keep this plow handy

Fitting either the front or rear bumper, this snowplow is quickly attached to help you go through shallow drifts in the driveway without shoveling. The plow, which is not intended for heavy work, is assembled from $\frac{3}{4}$ -in. stock. Shape and style of the bumpers on your car will determine the method of attaching the plow. The original was provided with heavy, wire eyes which slipped over the bumper guards as indicated in the detail.

Shielding End of Starter Cable to Prevent Short Circuits

Instead of tying up the starter cable to keep it from "shorting" against the motor or other metal part of the car, when it is removed to repair the starter, just slip a short piece of rubber hose or tubing over the terminal end. Then you can let the end of the cable drop without any possibility of running down the battery.

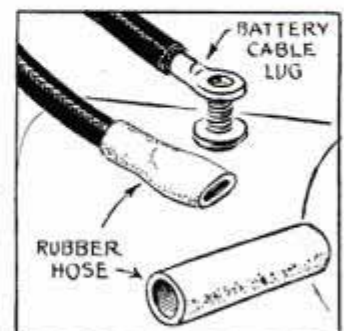

Cylinders Held for Soldering on Auto-Engine Head



Large cylindrical objects, such as milk cans, that are to be soldered are readily rotated in this holder

Workmen in a shop where they often have cylindrical objects to solder, such as milk cans, tanks, etc., use an old auto cylinder head with furniture casters inverted

in the bolt holes. The work rests on the casters, which allow it to be turned easily. The head is heavy enough to stay where it is put on a bench, and the casters are quickly spaced in the holes to accommodate work of various sizes.

Clock Springs May Be Punched on "Anvil" of Babbitt Metal

A Minnesota locksmith, of many years experience, says that clock springs or other hard and brittle metal can be perforated easily if placed on an "anvil" of babbitt metal, as shown,

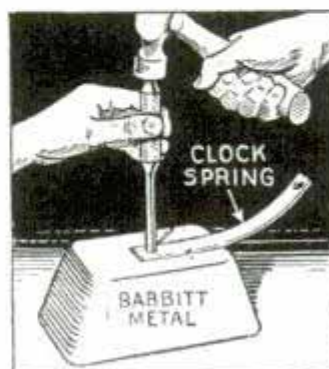

and a punch (not tapered) employed. It is a good idea to grind the shank of the punch so that it is slightly smaller in diameter than the face, as the least taper will spread the hole and crack the spring.

The Next Issue

CANADIAN-TYPE CANOE IS EASY TO BUILD

Unusually steady and easy to paddle, this 16-ft. canoe is little affected by cross winds. It has a 33-in. beam amidships, a flat bottom and low ends. Thin, wide ribs that are bent easily, simplify the construction.

"ROAD-FLEA"—AN ENGINE-POWERED SCOOTER

Rolls smoothly on pneumatic tires and runs many miles on a gallon of gas. Easily assembled on an oak-plank chassis with front-wheel support of tubing.

PHOTO-COPYING TABLE FOLDS FLAT

Compact table for copying and enlarging. Has two easels and two adjustable flood lamps. Is easily stored in any small space when legs are folded.

DUPLICATE WOODTURNING

Special jigs and set-ups for your lathe that speed up the work and help assure accuracy in duplicating parts on a production basis in your shop.

ROLLING BUFFET

Unusual in design, buffet has three glass-bottom trays, which are pivoted on a standard and swing to one side to provide additional table area.



"You Can't Beat Fun"

and the World's Greatest Fun
is Riding a

HARLEY-DAVIDSON



Harley-Davidson

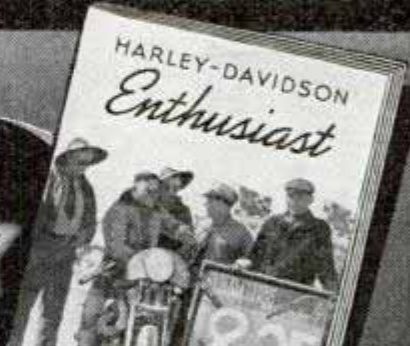

See your Harley-Davidson dealer. Get "hep" to the big times and wonderful companionship in store for you when you ride this world's champion motorcycle. Learn about the fun-packed activities of the local motorcycle club. Take a ride on a snappy new 1938 model—ask about Easy Payment Plan. **Send in the coupon now!**

HARLEY-DAVIDSON MOTOR CO., Dept. P, Milwaukee, Wis.
Motorcycling sounds like great sport to me. Send illustrated literature and FREE motorcycling magazine, "The Enthusiast." No obligation. Postage stamp is enclosed to cover mailing cost.

Name.....

Address.....

My age is () 16-19 years, () 20-30 years, () 31 years and up,
() under 16 years. Check your age group.

When writing to advertisers please mention Popular Mechanics

DO EXPERT MARKSMEN FIND THAT CAMEL'S COSTLIER TOBACCOS MAKE A DIFFERENCE?

"YES, SIR, in any bunch of expert shots—Camels are the favorite cigarette," says *Ransford Triggs*, one of the foremost marksmen in America. "Marksmen know that it takes steady nerves to make high scores. And the fact that Camels don't frazzle my nerves goes over big with me. That comes from a man who smokes plenty of Camels every day, too."

And millions of other people — the most loyal group of smokers in the world — put their "O. K." on Camels too — making Camels the largest-selling cigarette in America

"EVERY CAMEL I smoke seems tastier than the last one," says *I. Gorkun*, watchmaker. "That's honest-to-goodness natural flavor in Camels—the kind I don't get fed up on—ever. 'I'd walk a mile for a Camel!'"



ELIZABETH MAY, home economist: "There's a world of comfort in smoking Camels 'for digestion's sake,'" she says. "I smoke Camels myself at mealtimes and after."



"I'M HANDLING money by the thousands," says bank teller, *John McMahon*. "Jittery nerves just don't fit in with this work. So it's Camels for me. Camels are mild!"



FRANK EAMON, New York ambulance driver, says: "I smoke a good many Camels. I know I can count on Camels. They don't jangle my nerves. And without healthy nerves I'd never be able to hold down this job."

CAMELS

When writing to advertisers please mention *Popular Mechanics*



Copyright, 1937, R. J. Reynolds Tobacco Co., Winston-Salem, N. C.

{ABOVE}

Head-on view of Ransford Triggs on the firing line. His .22 calibre rifle is equipped with hand-made sights. He uses the sighting 'scope beside him to help get his sights set exactly for the centre of the bull's-eye.

Camel pays millions more for **COSTLIER TOBACCOS!** Camels are a matchless blend of finer, **MORE EXPENSIVE TOBACCOS**—Turkish and Domestic.

**THE LARGEST-SELLING
CIGARETTE IN AMERICA**

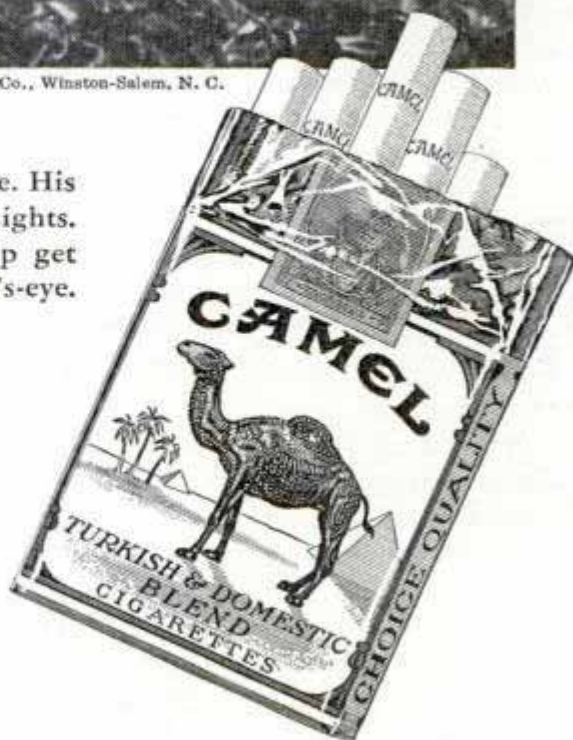

When writing to advertisers please mention Popular Mechanics

Shoot When They Don't Expect It

(Continued from page 213)

conspicuous. While the friend is looking in one direction, perhaps to divert attention, you can bring the camera into action over his shoulder and snap-shoot. The shoulder may also come in handy to rest your camera when using shutter speeds slower than 1/25. Any stationary object like a tree or a wall will suffice to steady the camera.

Camera subjects should not be hard to find. Wherever there are people, there are always possibilities for candid work. Crowded places are of course preferred. Here you become just one of the mass, and no one pays attention to you. Busy street corners and main streets are excellent for this; the traffic cop, a bootblack bending over shoes, fruit vendor making a sale, a woman window shopping.

Men at work with machinery at outdoor construction jobs and the crowds idly watching them offer possibilities for excellent pictorial as well as candid scenes. Activity on a dock, open markets, artists' fairs, beaches, passengers on streetcars, all have that human-interest angle which make a photographic study.

If the subject spots you, don't let him suspect your intention. Keep your eye on him and when his attention strays—that is your cue!

Although photos are most candid when the subject is unaware of the camera, you are by no means limited to snapping them only when they are off guard. For instance, you may be photographing a friend who knows that you are doing so. Ask him to pay no attention to you. Or ask him to sit down, to read a book, to examine a picture, at the same time engaging him in conversation. While doing this pretend to be sighting for the best angle, though really snapping one picture after another.

Next time you attend a picnic or party, try this method of picture making on your friends. Candid pictures will reveal to you a new world in photography. You will find all people are excellent camera subjects if you have the patience to wait and the alertness to snap the shutter at the psychological moment. Watch your angles and backgrounds. Keep your camera steady. But the major requirements are patience and alertness.

es 1189

Hunting Oil with Earthquakes

(Continued from page 197)

yet so sensitive that they can pick up the vibrations of a dollar watch laid near by. They are affected by earth movements of only a millionth part of an inch in amplitude and must be buried below the surface to avoid the vibrations of stray wind currents. Thirty or forty of them, laid out in a straight line a quarter of a mile long, may be used to measure the waves from one of the man-made earthquakes. Sometimes a geophysics crew runs into trouble

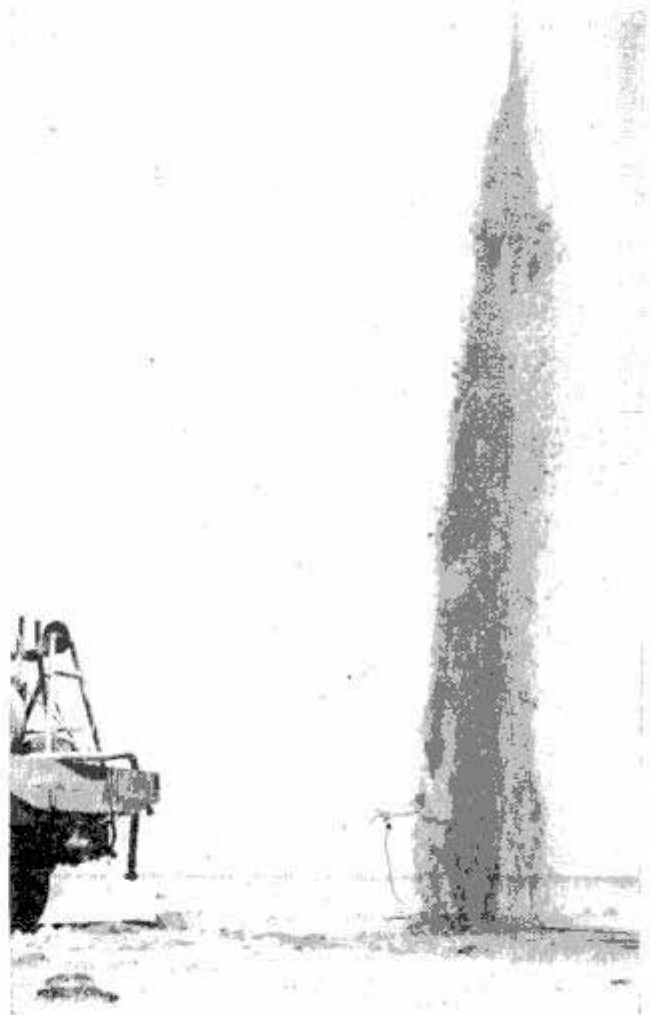

Geyser of mud and water shooting up from shot hole after explosion below

when natural earth tremors occur at inopportune times and upset their calculations. The seismometers may also pick up vibrations from other outfits working a few miles away, and when several crews find themselves exploring the same territory they usually arrange a schedule so that their shots will not disturb each other.

When everything is ready and the command is given, the powder man plunges down the handle of his blasting dynamo

(Continued to page 118A)

*You're making pictures in a
new world — when it's*

SNAPSHOTS at NIGHT



ALL YOU NEED—
Your present camera
loaded with Kodak
"SS" Film



**Two or three
Photoflood lamps
in Kodak
Handy Reflectors**



INDOORS, at night, there's a fascinating new world in which to ride your favorite hobby. Scores of exciting picture chances, and an interesting technique to learn—gauging distances, placing subjects, arranging lights.

You get good pictures, too, from the very start; snapshots at night aren't difficult—just interestingly different.

Equipment is simple. You

don't need a costly camera. Any camera that takes Kodak "SS" Film will do—even a Brownie.

With "SS" Film, you use two or three No. 2 Mazda Photoflood lamps, which last for hours, and inexpensive Kodak Handy Reflectors. If your particular camera is equipped with an *f.6.3* or faster lens, then No. 1 Photofloods are powerful enough.

FREE BOOKLET . . . Suggests a variety of picture opportunities . . . shows you how to arrange your lights . . . how to place your subject . . . tells you everything you need to know about two ways to make night pictures—*snapshots* with Photoflood lamps, *fast exposures* with Photoflash lamps. (You can use Photoflash lamps, each good for one picture, if your camera can be set for "time.") The directions are simple and easy to understand. Get a copy at your dealer's today . . . Eastman Kodak Company, Rochester, N. Y.

When writing to advertisers please mention Popular Mechanics

MORE POWER TO YOUR SHOP WITH THESE *Direct Drive* POWER TOOLS BY DRIVER

Direct drive, from motor to saw blade, without belts or pulleys—saves up to 40% of your motor's power formerly wasted by belts. Efficient, sturdy and economical to operate.

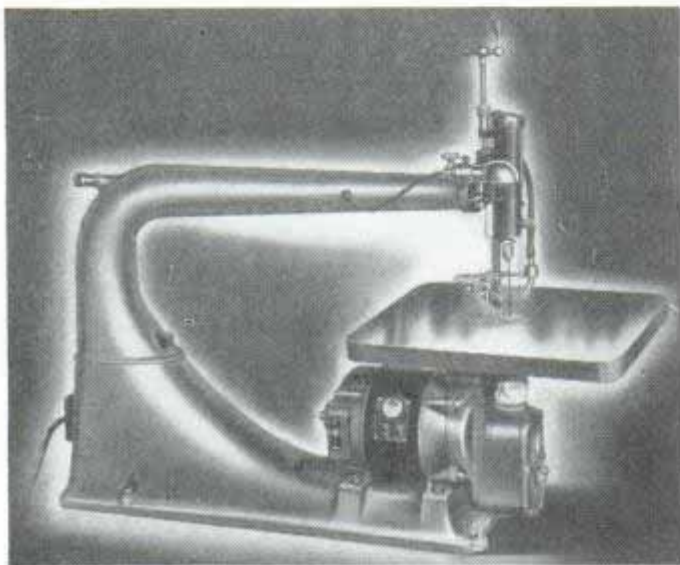

**DIRECT DRIVE
MJ917 JIG SAW**
\$48.50

The combination of the three most outstanding features since the invention of jig saws makes this machine a pleasure to operate. *Direct Drive*—built-in drive means more power, no belts to slip. *Fingertip Speed Control*—a flip of a switch from low to high speed while running. *Motion Blade Tensioner*—permits accurate tensioning of blade while in operation. Same model with single speed (774) priced at \$38.50.



**GEAR DRIVE 990 TILTING
ARBOR SAW \$72.30 (with-
out motor unit)**

The tilting 8-in. blade gives you full 2-in. depth of cut, at any angle. The big table is always level; unwieldy stock is easy to handle. And the new Geared Motor Drive assures increased power transmission to the saw blade, preventing stalling even under heavy cuts. Precision controls, sealed ball bearings, handy control switch. The 1100 series, with 10 in. blade, also available at \$107.25 (less motor unit).

Driver makes three lines of lathes, bench saws, band saws, jointers, drill presses, flexible shaft grinders, bench grinders, surfacers, and a complete line of motors and accessories. Send for your 1938 Driver Catalog and examine the many features of the year's most important tool developments. Walker-Turner Co., Inc., 128 South Ave., Plainfield, N. J.

DRIVER *Engineered* **POWER TOOLS**

(Continued from page 116A)

and the buried charge blows up. Standing near by, you can feel the ground rock under your feet in wavelike motions. The same seismic waves are traveling in all directions through the earth and weak echo waves are being reflected to the surface from the hard strata below. These echoes form the basis of reflection geophysics.

Each seismometer, which consists of a metal armature suspended above a magnet, is affected by the earthquake waves. The vibration jiggles the armature, causing it to move in the magnetic field, which sets up currents that travel along the cable to the laboratory truck. Here the current goes through several stages of amplification and then by means of a galvanometer or oscillograph is transformed into a wavy line on a strip of photo-sensitized paper mounted on a revolving drum. The arrangement is similar to the seismograph recording of a full-sized earthquake. Each buried seismometer sends in its own signal string and these are recorded as parallel lines on the paper. A few minutes after the earthquake is touched off the record has been run through developing and fixing tanks and has been hung up to dry.

The complete seismic record is merely a jumble of wavy lines on a piece of paper and it takes a trained geophysicist to interpret them. One of the men may point out to you the wavelike line that was drawn by the seismometer located closest to the laboratory truck. Occasionally the even pattern of this line is interrupted by a few waves of greater amplitude. These large waves represent the time, on the moving drum, at which vibrations were reflected back up to the seismometer from a buried stratum.

Next you notice that the records from seismometers buried at greater distances from the laboratory truck also contain the same groups of waves of greater amplitude, but that these are displaced or staggered over to the right of the echo from the first seismometer. This is because the waves have to travel farther and need more time to reach the farthest recorders. Farther over to the right on the record paper are other groups of high amplitude waves, representing echoes from formations buried even deeper than the first.

Seismic waves travel from one to three

es 1189

miles per second, depending upon the compactness of the material through which they move, and they go fastest at the greatest depths. Some of the energy is reflected back each time the wave strikes a change in formation, such as a change from sandstone to shale. By figuring the speed of the wave and the elapsed time from the record, the geophysicist is able to gauge quite accurately the depth of the formations and can measure differences in depth to within plus or minus twenty feet. The dip or angle of each stratum as well as its depth can be determined.

There are several other methods of underground exploration aside from the reflection type. Seismic refraction, used extensively a few years ago, depends upon the refraction or travel of energy waves along shallow formations before they are reflected back up again. An electrical resistivity method indicates formations below by measuring the resistance of the ground. Salt domes and buried granite ridges may sometimes be detected with a torsion balance, a kind of gravity meter that is often used in the initial reconnaissance of unexplored territory. Another instrument sometimes used in general surveys is the magnetometer, a highly refined dip needle that is influenced by the deformation of magnetic lines of force around or through large buried bodies that have slightly different magnetic properties than the surrounding material.

Unfortunately the development of scientific underground exploration has brought in its wake many fake "doodle bug" instruments that are worthless. No instruments that will detect the presence of oil directly are known to science.

There is a possibility, however, that a direct method of locating oil or gas pools will eventually be perfected from experiments being conducted in Russia. Known as "gaseous mapping," the technique consists of measuring the number of hydrocarbon molecules found in the soil just below the surface and comparing them to the amount of methane present. The basic idea is that gaseous particles slowly escape to the surface above any oil pool, and the presence of oil below can be anticipated when comparatively large amounts of such hydrocarbons are found close to the top of the ground.

BE YOUR OWN FIXER AND SAVE THE REPAIR MONEY

Typical repairs that can be made perfectly with Smooth-On:—Stopping leaks in steam, water, gas, oil or stove pipes; mending cracks, breaks or leaks in furnaces and boilers, radiators, tanks, sinks, pots and pails; making loose handles tight on umbrellas, knives, hammers, brushes, drawers, etc.; tightening loose screws, hooks, locks, door knobs, etc.

On the Automobile:—Making cracked water jackets and pumps good as new; stopping leaks in radiator, hose connections, gas tank and gas, oil and exhaust lines; making a fume-proof joint between exhaust pipe and tonneau heater; tightening loose headlight posts; keeping grease cups, hub caps, and nuts from loosening and falling off, etc.

Practically every householder spends at least \$10.00 to \$50.00 each year and many spend several times that much on the above and other simple repairs that can be made **quickly, easily and well** with Smooth-On No. 1.

With a can of Smooth-On you can save this money in your own home—and by doing similar repair work for others, you can make money.

No skill is required to make repairs and the amount of Smooth-On used on any one job seldom costs more than a few cents.

To get perfect results, write to us for and use the Smooth-On Repair Book.



SMOOTH-ON
Radiator

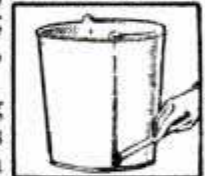

Leaky Pail



Leaky Kettle

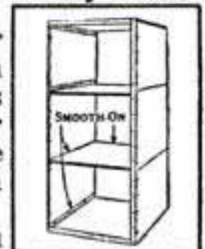

Leaky Tank



Stove Pipe



Oil Leaks



Write for
FREE BOOK



Get Smooth-On No. 1 in 7-oz., 1-lb. or 5-lb. tins at nearest hardware store or if necessary direct from us.

SMOOTH-ON MFG. CO.,
Dept. 37,
574 Communipaw Ave.,
Jersey City, N. J.

Please send the free Smooth-On Repair Book.

Name.....

Address.....

2-38.....

Do it with **SMOOTH-ON**

es 1144

The Hit and Run Fleet

(Continued from page 252)

deck. In the skiff men are holding a long rope which passes through a series of iron rings fastened at intervals around the bottom of the net. The other end is attached to the mother craft which swings widely to draw the net into a large circle. Now the two ends of the rope are pulled together like strings of a giant purse, closing the net into a huge bag.

A big dip net or "brail," five feet across, now comes into play. Working off a long boom operated by the engine, it dips into the mass of struggling fish, picks them up 500 to 1,000 pounds at a time, and dumps them into the ice-packed hold.

Now it's time for fast work, for within forty-five minutes most of the fish will be dead, stifled by their own weight. If the brail can't pick them up fast enough, the net begins to grow even heavier and pull until the boat lists far over to the side. An ordinary school of fish will weigh around ten tons, but occasionally a big one will run up to fifty or even 100 tons. If the load's too big, they must cut it loose—and lose a \$5,000 net—or follow it to Davy Jones's locker. Last year at Redondo Beach a boat was pulled under and the crew narrowly escaped by taking to the skiffs.

It takes two hours to set a big net, plus time to gather in the fish with the brail. All this time the seiners are at the mercy of the patrol boat, for the "Cobra" can run rings around any of them. Even if given a few minutes start, a seiner can't very well run away, for the wake it leaves remains a giveaway trail that can be followed for some time afterward.

Knowing this, Captain Smith is patient. He waits until sounds tell him that most of the poachers are well engaged in their business. Then he starts the engine, opens wide the throttle, and snaps on the powerful searchlights as the "Cobra" darts forward. Consternation seizes the pirates. There is a hurried bustle, a frantic rattling of winches, a feverish gathering of nets as the poachers try to get under way. As the "Cobra" bears down, the pirate fleet scatters. One by one, Captain Smith picks out the seiners, reading each craft's name through binoculars and noting the bearings of the place where it was observed. The

(Continued to page 122A)



Bewise - Alkalize

An Alka-Seltzer Tablet in a glass of water makes a sparkling alkalizing solution which quickly relieves pain and discomfort of Headaches, Upset Stomach, Cold and common everyday ailments. It also helps correct the excess acid condition so often accompanying these troubles.

TUNE IN
THE NATIONAL
BARN DANCE
SATURDAY NIGHT
NBC · NETWORK

30¢ & 60¢ PKGS.
OR BY THE GLASS
AT DRUG STORE
SODA FOUNTAINS



THOSE DAYS ARE GONE FOREVER, NOW, WE ALKA-SELTZER-IZE

OUR COLDS WERE FREQUENT AND SEVERE, TILL SOME ONE PUT US WISE

AND WHEN YOUR STOMACH GOT UP-SET, YOUR TEMPER ALSO RILED.

HEADACHES USED TO GET YOUR GOAT. THEY ALMOST DROVE YOU WILD -

Alkalize with Alka-Seltzer AT ALL DRUGGISTS



EARN MONEY MAKE COLOR-GLAZED CONCRETE PRODUCTS

New low cost method. No molds or costly tools. You build your own equipment from plans we furnish. Easy to make pottery, statuary, giftware—in home or shop—to earn money.

MEN—Send 10c TODAY for booklet, details, NATIONAL POTTERIES COMPANY Room 6, 13 W. 26th St., Minneapolis, Minn.

THIS NEW REMINGTON ..Can Be Yours!

Become a
Well Paid
User-Agent ...
**EARN YOUR
OWN FREE
TYPEWRITER!**



**MAKE
STEADY
CASH
PROFITS
In Addition!**

Remington Rand makes this sensational offer because we need more men *right now* to help us take care of the huge demand that exists for Remington Portable Typewriters! If you act quickly you can be eligible to receive a brand new, latest model Remington *absolutely without cost!* And in addition, get started toward a worthwhile, lifetime connection that will pay you *liberal cash profits* for years to come! Are you interested? *Rush the coupon below* for all the amazing facts.

Modern Families Can't Be Without A Typewriter!

Father needs it for all his "night-time figuring," business reports, memos. Mother has lots of letters to write, "household business," recipes, club matters. *And the young folks!* A typewriter simply is a **MUST** to all high school and college students! And, besides, there's a steady demand from stores, clubs, restaurants, garages, service stations, professional offices, etc. People never dreamt that genuine, brand new Remington Portables cost so little—they never imagined easy terms of 10c a day. That's why Remington Portables are selling just as fast as we can make them! That's why we publish this call for *more representatives*... why we're willing to place demonstrating machines and hand

out *unusual cash profits* for helping us serve the thousands who want to buy.

"NEW 10¢-A-DAY" Ownership Plan

When folks see your shining new Remington Portable, imagine how anxious they'll be to have one. And how pleased they'll be when you say, "YES, you *can* afford one! Prices are amazing low—and you pay only 10c a day!" People can hardly believe that only 10c a day brings them a brand new Remington, including the newest writing features like the Variable Line Spacer, Automatic Ribbon Reverse, Standard Size Keyboard, Stencil Cut-out, Paragraph Self-Starter, Two Color Ribbon, etc. **PLUS** the famous *noiseless* feature that removes every bit of typing sound and makes night-typing *quiet* and pleasant.

A Complete Typing Bargain!

There are three important "extras" that make the Remington at 10c a day a *complete* typing bargain:—1. **FREE** Carrying Case that's so cleverly designed it even doubles as an overnight bag or picnic box. 2. **FREE** Home Instruction Course that makes the speedy "touch system" simple even for beginners. 3. **FREE** Ten Day Trial that permits every customer liberal test period without one cent's obligation.

If You Want Big Profits—

Then follow our User-Agent Plan... only five sales a week net you over \$50.00 clear profits! Bonnell, New Jersey, reached 177 sales in a single month. Boland, New York, hit \$3,500 in four weeks. Hundreds are enjoying steady weekly incomes, plus the prestige that comes when you say, "I'M FROM REMINGTON RAND." No sales experience needed. *You don't have to know how to typewrite.* But you must act **AT ONCE** while there's still room for you. Fill in and *mail the coupon below.*

M. N. RAND, REMINGTON RAND INC,
Dept. 15-B Buffalo, N. Y.

MAIL COUPON FOR DETAILS!

M. N. Rand, REMINGTON RAND INC.
Dept. 15-B, Buffalo, N. Y.

I want the complete facts about your User-Agent Plan and how it can help me make steady cash profits and earn my own Remington Portable absolutely free. Please rush particulars at once, without obligation.

NAME.....
STREET.....
TOWN..... STATE.....

21144
(Continued from page 120A)

HERE'S THE DRILL FOR YOUR OWN WORKSHOP—IT'S GOT EVERYTHING!

K-M
ELECTRIC DRILL

The **K-M** Family Circle

\$9.95

It's efficient, dependable, yet light in weight—with perfectly-balanced pistol-grip handle—hence non-fatiguing. Knurled collar permits easy inserting and removing of drill bits. Sturdy chuck that won't wobble accommodates 3/4" maximum drill. For wood or metal. Drills holes 3/4" from corners. Phosphor bronze thrust bearings. Mica insulated commutator. Recessed brush-holders. Operates on low wattage—AC and DC. On-and-off thumb switch. Look for the K-M Electric Drill wherever appliances are sold.

K-M Auto Fan and Defroster. with safe flexible rubber blades, keeps windshield clear of sleet, frost, etc. \$3.95.



KNAPP-MONARCH CO., St. Louis, U.S.A.

AUTO ENGINE SPEED CONTROL GOVERNORS

To control speed of any make of auto or truck engine, regardless of load changes, when used as a stationary or portable power plant. Fully guaranteed. Plain Bearings, \$9 and \$13.50. Ball Bearings \$16.50. 30 days free trial. (No cash down) if you send name of your banker, to whom we will send Governor. Free circulars. **Mfg. Candee-Smith Governor. Dept. BD, 215 North L. A. St., Los Angeles.**

FOR FLAT BELT
FOR V BELT
TO CARBURETOR LEVER

ENGINES

A real money maker for farm or factory. Uses Cheap fuels. Pays for itself out of savings. Costs Less to Own—Less to Operate.

LOG SAWS

Make Money—Start a wood sawing business—turn spare timber into cash. Factory Prices—Cash or Terms—FREE Catalog.

WITTE ENGINE WORKS
1742 OAKLAND AVE., KANSAS CITY, MO.

rest will be easy—the boat can be picked up later and seized under the game laws.

Night after night the "Cobra" plays its game of hide-and-seek with the poachers. One night she will lurk beside the deep-water fishing grounds near the open sea. The next evening will find her gliding into an obscure cove where a poacher would feel safe, or skimming along the three-mile line with a bone in her teeth, ready to swoop down upon the first seiner that has its net spread in forbidden waters. Occasionally, too, other assignments fall to her lot. Her radio receiver tuned to police broadcasts sometimes brings the summons to join in a rescue at sea, or an appeal to help in the search for a lost yacht. Not long ago, for instance, Captain Smith rescued nine hungry fishermen who had had to take to their skiff when their boat caught fire after an explosion. Again, it may be a tip that poaching seiners have been seen at work by yachtsmen, or perhaps by an airplane pilot. Once in a while it is a warning that people aboard a pleasure boat are shooting at the cattle on Catalina island.

Now and then a poacher will show fight when trapped. One day when Captain Smith stepped upon the deck of a seiner, he heard a sudden sharp cry from the "Cobra's" mate:

"Drop that ax!"

Whirling, Smith saw one of the fishermen standing behind him with ax upraised. His assailant jumped at the sharp command and dropped his weapon.

Another seiner refused to stop at the megaphoned command. Cutting sharply across the bow, the "Cobra" made plain the command to stop, but instead of complying the fishermen opened the throttle and tried to ram their captor. Captain Smith gave four peremptory blasts on the whistle, then fired three shots across her bow, but without effect. When the pirate craft finally turned and tried to ram the "Cobra" broadside, Captain Smith lost patience. Rather than endanger the cruiser, he made for Avalon, where he commandeered a plane, followed the pirates to port and arrested the entire crew of eleven men.

Send return postage to our Bureau of Information to learn the name of the maker of any device described in this magazine.

BIG MONEY!

ASSEMBLING MEAD'S

NEW PORTABLE KI-YAK

IN A FEW DAYS AT HOME!



FACTORY-TO-YOU at Low Factory Prices!

Assemble your own beautiful, portable MEAD KI-YAK in a few days at home and save nearly half the factory assembled cost! Also—earn Big Profits building & selling to others! Mead's perfected, PATENTED, exclusive "Home Assembly" Method using Cut-To-Fit-Construction Kit GUARANTEES successful, quick assembly. Experience unnecessary. 10 and 12 year old children have done fine jobs! All Parts Numbered! ALUMINUM Ribs Come Formed Ready-to-Attach! Wooden Parts Accurately Cut-to-Shape! Then . . . take your "Mead" anywhere, by hand or car for paddling, sailing, rowing, outboard motoring, touring, fishing, camping, hunting! Safe, Seaworthy, Leakproof, Durable, INEXPENSIVE, Snappiest boat afloat.



The sensational new Double-End Cut-out "OK-2," as a motor-boat



Get started on yours now!



Here's the OK-2 as a row-boat



CK-3 with sail-rig . . . probably the fastest boat of its size ever built! Length: 16 ft. Wt.: 45 lbs.



The 50 Lb. OK-2, strong as a Giant . . . light as a Feather . . . Takes any Outboard 4 1/2 h.p. or less. Also Uses Sail and Oars.

PORTABLE OUTBOARD KI-YAK Uses Paddle, Oars, Sail or Motor!

Each model in the "CK" KI-YAK series is convertible in 10 minutes from paddle boat to SAIL-BOAT complete with rudder, tiller, lee-boards, outrigger floats! The "OK" KI-YAK is really 3 boats in one being immediately convertible into row-boat, sail-boat or motor-boat using any outboard 4 1/2 h. p. or less! They are the fastest boats for their weight whether you use wind, muscles or motor BECAUSE Mead Ki-Yaks are:

Light as a Feather—Strong as a Giant!

Our entirely new and exclusive small-boat construction principle gives astonishing strength. Ribbs can't break, rot, warp. And IMAGINE! CK-1 weighs only 20 lbs. . . . CK-2 only 30 lbs. . . . CK-3 only 45 lbs. And "OK-2" weighs only 50 lbs. Nothing else like them! MEAD KI-YAKS are unsurpassed. This is the kind of boat you have always wanted. NOW is the time to start building one—find out all the fascinating details! Send dime and coupon now!

MEAD GLIDERS

15 South Market—Dept. B-28—Chicago

MAIL COUPON NOW!

\$6 PADDLE GIVEN with your CK Ki-Yak—if you hurry!

Mail Coupon NOW!

GENTLEMEN

I enclose 10c as postage-handling charge. Please rush me your new Illustrated KI-YAK Circulars, Money-Making Plan, Low Introductory Prices, and details of your \$6 Gift Paddle Offer!

NAME

St. & Number

CITY..... State.....

RUSH ME WITH 10c TO:

MEAD GLIDERS
15 S. MARKET ST. DEPT. B-28 CHICAGO, U.S.A.

Hurry—Before Prices Go Up!
The Cost of Living is going up—and MEAD KI-YAK prices may have to be raised. Send coupon now while prices are still rock-bottom. This may be your Last Chance to buy at present low prices! Hurry!

Oh Boy! How Grand I Feel

"NOW I know there IS a difference in the way laxatives work since I used the ALL-VEGETABLE Laxative, Nature's Remedy (NR Tablets). One NR Tablet convinced me... so mild, thorough, refreshing and invigorating."

Dependable relief for sick headaches, bilious spells and that tired-out feeling, when caused by or associated with constipation.

Without Risk try NR. Geta25c box from any druggist. Use for one week, then if you are not more than pleased, return the box and we will refund the purchase price. That's fair. Try it.



NR TO-NIGHT
TOMORROW ALRIGHT

FREE: Beautiful Six-color 1938 Calendar-Thermometer. Also samples of NR and Tums. Send stamp for packing and postage to Lewis-Howe Co., Desk 130-B, St. Louis, Mo.

FOR MODERN SHAVING **Barbasol** **NO BRUSH NO LATHER NO RUB IN**



ARE YOU A **WET SMOKER?**

Did you know 97% of the moisture that forms in an old fashioned pipe is caused from condensation? Bohn-Dri and Vogel pipes eliminate moisture without the use of absorbent cartridges. Enjoy the comfort of a sweet uncontaminated smoke in these new modern pipes. Durable, cool and dry. Finest quality Briar Root. Natural or Italian finish. Small, medium and large. Patented in U. S. A., Great Britain and Canada.

BOHN-DRI hand made. First grade..... \$3.50
VOGEL PIPES hand made. Second grade..... \$1.00

Order today and get that smoking thrill you have always wanted. Please specify shape as indicated below.



VOGEL PIPE COMPANY

LOER ARCADE

MINNEAPOLIS, MINN

FREE CAMERA BOOK!

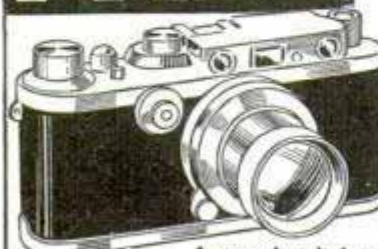

Just out! Explains latest inventions, methods in photography and Home Movie Making, for fun and profit. Offers hundreds of amazing, money-saving Bargains in new and used still, movie Cameras, Lenses, Films, Exposure Meters, Enlargers, Darkroom Supplies—everything photographic. Central offers you America's most complete, varied stock of foreign and domestic merchandise from world's leading makers: Eastman Kodak, Zeiss, Bell & Howell, Graflex, Geveart, Korona, Rausch & Lomb, etc. SAVE at Central! Satisfaction guaranteed or money back. We take your old camera and equipment in trade. Write for Free camera book!

CENTRAL CAMERA CO., 230 S. WABASH
Dept. K-2, CHICAGO, U. S. A.

PHOTOGRAPHIC HEADQUARTERS since 1899

es 1031
Adventures of Hurricane Hunters

(Continued from page 245)

any picture of a real storm could have been. The terrifying sounds of the hurricane were made in another part of the studio after technicians had invented a brand new kind of nine-piece orchestra. The instruments consisted of hollow tubes and whirling shapes that were placed in front of a variable-speed fan. The instruments emitted everything from the weird eerie scream of the wind to the rumbling roar of wind combined with a heavy surf.

These days the owner of a sailing ship at San Pedro can earn as high as \$20,000 per year by renting his vessel to the movies.



Twentieth Century-Fox camera crew on stern of tug getting pictures of square rigger

The same ship may appear in half a dozen different pictures in one year, with the hull and rigging changed to represent a new period. Muzzle-loading cannon mounted on board are usually true antiques or exact copies cast in a foundry. Vessels with steel sides are converted into wooden ships by bolting wood siding to the hulls.

Geography means little or nothing to the movie fleet. The steep cliffs of near-by Catalina island masquerade as the coast of New Zealand in one picture and the hills of Italy in another. Once some tourists who had watched a South Sea scene being filmed at Catalina rubbed their eyes in amazement when they saw the picture on the screen. "Why," one of them exclaimed. "Where did that coral reef come from that the ship is sailing around? We saw that

scene made last summer and I'll swear there wasn't a reef there."

The tourist was right but he had been watching the ship instead of the camera when the scene was made. The script called for the ship to cruise past a palm studded reef on its way into the bay and since that particular kind of scenery wasn't available the movie technicians created it. A miniature reef twelve feet long complete to a skyline of bending palms, and a fore-shore white with surf, had been placed in front of the camera. Suspended in the air the right distance away and with shades held over it to give a dull lighting, the



Scenes like this storm-at-sea close-up are made in big pool at Paramount studio

mock reef had all the appearance of reality. To the one-eyed camera it looked like a full-sized reef in the distance.

The picture crews that are sent to sea to get background and atmospheric shots are known as the second units. The men are specialists in out-of-doors photography. Some of the footage that they bring back may be worked into a film drama and other times it is used merely for reference for building duplicate sets at the studio.

Men like Robert Bruce of Paramount spend only a few months a year at their studios. Once Bruce had the job of chasing rainbows for a color picture. With a couple of assistants and his outfit loaded on a truck he drove to Utah. When the unit finally spotted a rainbow it was too far away to photograph, so the men started after it in the truck. After getting one short scene a rainstorm washed the rainbow away and they had to chase several more. On the same trip Bruce was asked to film some desert mirages, which he found in Death Valley.



IMPROVES YOUR APPEARANCE 100%

Have that healthy **TAN**
... that Men and Women Admire!

IT'S the first impression that counts! Get that healthy, vital appearance that opens the door to success! Many a man has lost his big chance because his appearance didn't "click." Social as well as business success depends on your looks... and the pale, pasty-looking chap won't get to first base. Now a daily "sun bath" in the privacy of your own home, will keep you *looking* like a Million Dollars—and *feeling* as physically fit as you *look*!

LOOK SUCCESSFUL—BE SUCCESSFUL!

■ A good, healthy coat of tan has a surprising effect on your appearance. Salesmen find their sales actually increase after they have acquired a real bronze *tan*! And you will become more popular, for women, too, admire that healthy outdoor look!

IMPROVES HEALTH AS WELL AS APPEARANCE!

■ Frequent exposure to the ultra-violet rays of the sun tones up the entire system, stimulates the body into energy and vitality, increases gland activity, builds up resistance to colds... and aids in clearing up many skin diseases.

4 TIMES AS POWERFUL AS SUMMER SUN!

■ You know what a glorious tan your skin would acquire if you could spend an hour every noon sun-bathing. The Health Ray Sun Lamp has been tested by the well known Electrical Testing Laboratories of New York. Their report indicates that this inexpensive Sun Lamp gives the same amount of beneficial ultra-violet rays in 15 minutes in your home that you would get in one hour's exposure to the mid-summer sun!

INEXPENSIVE HEALTH INSURANCE FOR EVERY MEMBER OF YOUR FAMILY



■ Build up resistance and vitality. Insure yourself against illness the sunshine way!



FULLY GUARANTEED! MAKE THIS FREE TEST!

Test this lamp at our expense NOW! Compact, easy to use, tested and approved... it is yours for 7 days FREE trial! This *genuine* carbon-arc lamp, fully guaranteed by The Health Ray Mfg. Co., Deep River, Conn., will be one of the greatest health investments, you ever made.

SEND FOR DETAILS OF OUR 7-DAY FREE TRIAL!

Let us mail you our FREE book containing valuable information on sunshine, complete details of the Health Ray Lamp and our 7-day trial offer.

OR

If You Want YOUR SUN LAMP AT ONCE...

Simply mail \$1 with the coupon. Use it for 7 days. Then either pay \$6.95 balance or return the lamp and get your dollar back.

\$1.00 DOWN PAYMENT BUYS IT!

HEALTH RAY MFG. CO., INC.

142 Elm Street, Deep River, Conn.

(Check below for free literature or Sun Lamp)

- Send full details of FREE trial offer.
 Send Health Ray Lamp at once. I enclose \$1. In 7 days I will either pay \$6.95 or return the lamp and receive my dollar back.

Name

Please write Mr., Mrs., or Miss

Address

ONE DROP OF ME AND JOINTS HOLD FOREVER

LEPAGE'S LIQUID GLUE

A DIME PACKAGE WILL SAVE DOLLARS—IN HANDY BOTTLES, TUBES AND CANS

NEW BENJAMIN AIR PISTOLS

\$7.50

Powerful—Accurate—Economical—Practical—Adjustable Shooting Force—Amazing Maximum Velocity—cal. 177 or 22 and BB—For Target and Small Game—the only Genuine Compressed Air Pistol for Shooting BB on the market—Single Shot with Bolt Action—Hammer Fire—Hair Trigger—Safety. Price \$7.50. Holster \$2.00. Also 177 and 22 Single Shot Air Rifles \$7.50—Single Shot BB Air Rifle \$6.00—22 Shot BB Repeater Air Rifle \$7.50—at Dealer or Direct—No license required—Safe for indoor use. **FULL DETAILS—TARGETS—FREE—WRITE TODAY** Benjamin Air Rifle Co., 851 Marion St., St. Louis, Mo.

STOP Backtracking

Haven't you often driven the wrong road and had to backtrack many miles? The Hull Streamline Auto Compass always shows your direction of travel, prevents backtracking, saves money and time for only \$2.95 at your dealer. Two-piece model \$1.95. Write for circular.

HULL MFG. CO., P. O. Box 246-D9, WARREN, OHIO

Empire PRESSER

KNIFE-EDGE CREASES

Now you can always be well groomed. Use an Empire. Save time, pressing bills, wear on clothes. Press pants, coat collars, sleeves, lapels, ties, etc. in a few minutes at home, office or when traveling. No wet cloth, board or boiler. Easy to use. Plug in any socket. Weighs 10 oz. Underwriters' Approved 6-ft. cord. Over 500,000 Empires now in use. Circular free.

EMPIRE ELECTRIC COMPANY
817 Main St. Dept. D. Cincinnati, O.

\$2 at stores or postpaid on Money-Back Guarantee.

High-Fidelity 2A3 Amplifier

(Continued from page 260)

The true-fidelity performance of this amplifier is due to the type of audio transformers employed. These transformers are designed for extended audio range and have many features only found in very expensive special-application types. Terminals are provided on a terminal board which connect to leads under the bottom cover. For sub-panel connections the bot-

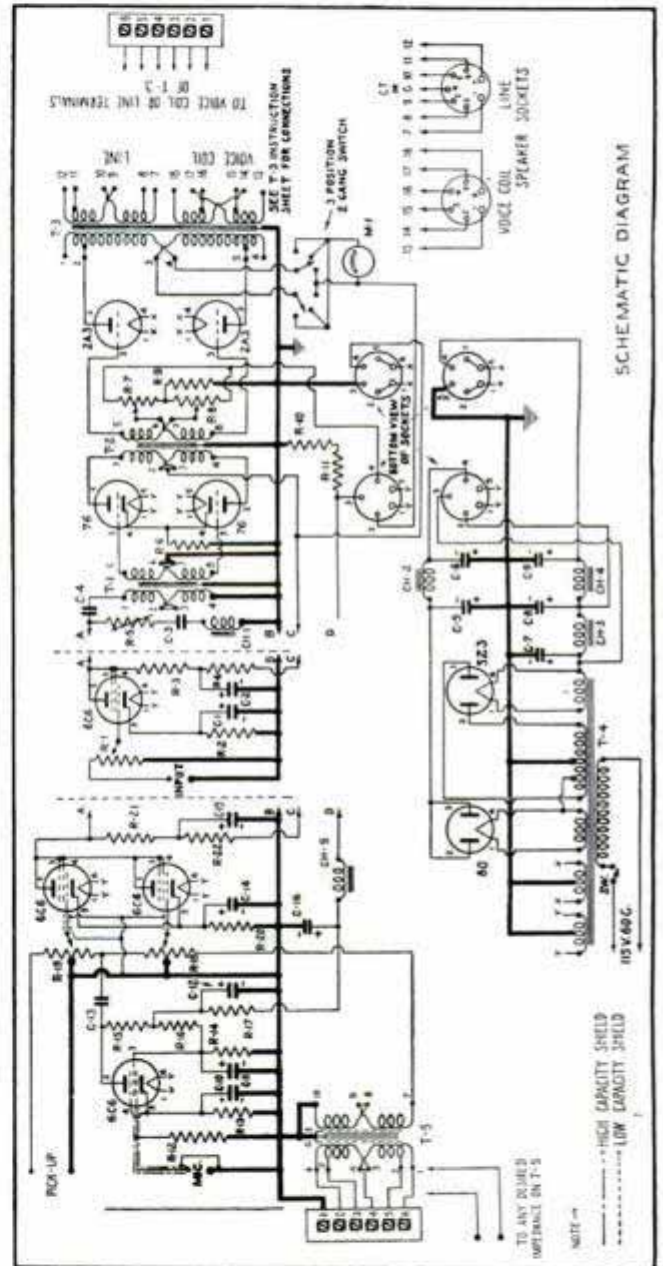

tom cover is removed and the required number of leads threaded through the bottom mounting hole. Desired connections are then bridged at the terminal board. Each transformer can be rotated about its single mounting bushing to neutralize stray magnetic fields without altering the connecting leads.

ALLIED OFFERS RADIO'S GREATEST VALUES!

Everything IN RADIO
AT LOWEST PRICES!



Kits—10,000 Parts

Radio's largest selection of Kits—from beginner's One-Tube to 14 Tube Superbet, and over 10,000 exact duplicate and replacement parts for building or repairing any circuit—all shown in ALLIED's great Catalog.



P.A. Systems

KNIGHT Integrated Sound Systems for every P. A. need—8 to 60 Watts—Portable, Mobile and Permanent—and Inter-Com Systems—2 way, Selective and Super-Selective. Also Recording Equipment, Transcription Players, etc.



Test Equipment

Testers of every type—Analyzers, Tube Checkers, Set-Testers, Meters, Signal Generators—all nationally known brands. See them at lowest prices in ALLIED's 1938 Catalog. Be sure to write for your FREE copy today—it's Radio's Leading Supply Guide.

**RADIO DEALERS! • SERVICE MEN! • SOUND MEN!
AMATEURS! • SET BUILDERS! • EXPERIMENTERS!**

You need ALLIED's Complete 1938 Radio Catalog. Everything in radio in one great book, at lowest prices—164 pages of Sets, Parts, Kits, Sound Systems, Amateur Gear, Test Equipment, Books, Tools, etc.—every Radio requirement at your finger-tips for instant reference—easy to use and profitable to order from. For ALLIED's complete stocks and fast service save you time—and ALLIED's low prices save you money. Send coupon today for ALLIED's free 1938 Catalog—Radio's Complete Supply Guide!

*Just touch a button—
THERE'S YOUR STATION!*



KNIGHT PUSH-BUTTON TUNING Models
AT STARTLING LOW PRICES!

In KNIGHT Radios, ALLIED brings you Push-Button Tuning and every other newest feature at prices that fit everybody's purse! Advanced R. C. A. and Hazeltine licensed circuits, World-Wide Range, Push-Button Tuning, Select-O-Matic Slide-Rule Dials, Electric Eye, New A. F. C. Action, Giant Electro-Dynamic Speakers, Broadcast Studio Tone Quality, Dual Tone Control—all these and more, at far less than you'd expect to pay. Only ALLIED's volume and low distribution costs make these values possible. 61 great KNIGHT models to choose from—a set for every purpose—for AC, AC-DC, 6 Volt, 32 Volt, Battery and Auto operation. See them all in ALLIED's Catalog now—just send coupon!

WRITE FOR THIS FREE CATALOG!

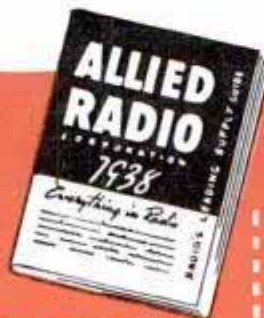

ALLIED RADIO CORP.

833 W. JACKSON BLVD., CHICAGO, ILL.

ALLIED Radio Corporation
Dept. 5-BE—833 W. Jackson Blvd.
Chicago, Ill.

Send your Free 1938 Catalog

Send Free Parts Lists for

Name.....

Address.....

City.....

State.....

FREE
Catalog

The Toy that Grew Up

(Continued from page 191)

starts an electric motor which moves the rudder to correct the deviation. Movement of the rudder is transmitted back to the gyropilot which stops the motor, leaving enough rudder applied to return the vessel to its course. As the ship responds, the gyropilot functions to return the rudder to mid-ship position.

The "metal mike" as a single unit is geared directly to the ship's wheel. A double unit is provided with an electrical transmission system for controlling the



It is easy to demonstrate the action of a gyroscope with a model such as this

steering engine, and a triple steerer has provision for steering automatically, for electrical control of rudder movements and for direct mechanical control.

Dr. Sperry's first idea, when he became intrigued by his children's toy, was to stabilize a ship with a gyroscope to prevent rolling. But an attempt had been made to do this with a spinning wheel and it was found that a gyroscope large enough to exert a stabilizing influence responded so slowly to the upward motion of a wave that the roll was well on its way before the stabilizer began to absorb it.

Today, however, the great Italian liner, "Conte di Savoia," is equipped with three

rotors, each thirteen feet in diameter and weighing 110 tons, and there are numerous other installations of gyrostabilizers on vessels large and small. To understand how a stabilizer acts, we must understand the wave motion which produces the roll.

The rolling motion is the result of fluid pressure acting on one side of a ship, then the other. Since a ship is free to rise and fall, most of each wave passes beneath it, imparting only a slight roll. Each succeeding wave adds a little impetus just as a child gets up momentum in a swing. Since each wave imparts only a little motion, a relatively small counteracting force, applied just as each roll starts, is sufficient to quench it. With this in mind, it is easy to demonstrate the action of a stabilizer with your gyro model.

Spin the rotor, set the outer ring horizontal and the rotor axle vertical. The outer ring is your ship. Simulate wave motion by applying upward pressure with your finger to one side of the outer ring. Note that the gyro strongly resists this force. Duplicate the action when the wave passes under the ship by raising the other side of the outer ring. Again the gyro resists. A gyrostabilizer acts in like fashion, moving back and forth and resisting the action of the waves from side to side.

In actual practice, the gyro is controlled by a motor which regulates its movement to conform to existing wave action. Sometimes a sensitive gyro is employed to start a motor at the very beginning of each roll. The motor then actuates the large stabilizer.

Gyroscopes were used in airplane stabilizing equipment more than twenty years ago but it was not until 1929 when the gyrohorizon and directional gyro were introduced that the full possibilities of the gyroscope in aviation were realized. Just as the natural horizon is the reference which a pilot consults in clear-weather flying, the gyrohorizon serves the same purpose when outside visibility is obscured.

By means of a miniature plane and a gyro-actuated horizon bar, this instrument shows the pilot what he would see if he could see outside the ship—whether the

(Continued to page 130A)

Toy gyroscope. L. J. Hurst mfg. Co. 708 E 16th Chas. Manafolis

LESS "PING" — MORE POWER!



BUICK SPECIAL 4-door streamline sport sedan—\$1022 delivered at Flint, Mich. Complete with standard equipment

Another reason why Buick, with the **DYNAFLASH ENGINE** and **TORQUE-FREE SPRINGING**, has the Most Modern Chassis in the world

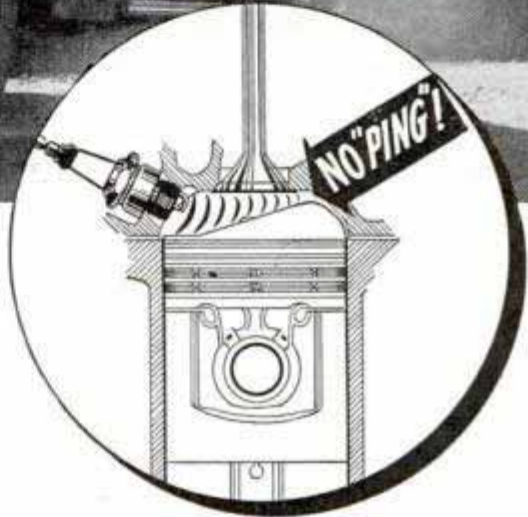

YOU know that stepping up compression gives an automobile engine more brilliance. You also know that higher compression means more "ping"—and that "ping" means power-stealing pre-ignition. Now look how the **DYNAFLASH** engine gets around that.

Pre-ignition starts at the point in the cylinder opposite the spark plug. But the special **Turbulator** built into the face of each Buick piston provides larger surface area at this point to carry away the heat that causes this pre-ignition.

So less "ping"! More power! And also — *turbulence* in the fuel charge that means better fuel combustion.

The net result is almost ten per cent more

power without increase in engine size or weight. And this flashing, brilliant, quick-responding power is made still more enjoyable by the velvet-smooth *ride* of **TORQUE-FREE SPRINGING!**

If you want to check that, just see the nearest Buick dealer for a demonstration.

MATCH THESE VALUES!

Complete with **DYNAFLASH** engine, **TORQUE-FREE SPRINGING**, and all standard equipment, these models deliver at Flint, Mich. at these prices: Buick **SPECIAL** business coupe, **\$945**; Buick **SPECIAL** 4-door touring sedan, **\$1047**; **CENTURY** 4-door touring sedan, **\$1297**; **ROADMASTER** 4-door touring sedan, **\$1645**; **LIMITED** 8-passenger sedan, **\$2350**. Special accessories, local taxes if any and transportation extra.

BETTER BUY BUICK ON EASY GENERAL MOTORS TERMS

"Better buy Buick!"

A GENERAL



MOTORS VALUE

When writing to advertisers please mention Popular Mechanics



★ Cash FOR SPARE TIME!

**MAKE \$25 TO \$30
PER WEEK AT HOME
IN YOUR SPARE TIME**



THE IDEAL LAWNMOWER SHARPENER

Like magic, the Ideal Lawnmower Sharpener makes old, dull, half worn-out mowers cut like new. Simply set the mower in the Ideal and the machine does the rest. Sharpens any lawnmower to a perfect edge in 15 to 20 minutes . . . and you make \$1.00 to \$1.50. Attach to light socket. Start in your basement or garage. Work in spare time. Attachments furnished for grinding skates, grass shears, hedge shears, sickles, scythes, axes, etc. FREE CATALOG tells complete story.

WHAT THESE MEN DID . . . YOU CAN DO

Remember, no experience is necessary. Most men sharpen lawn-mowers in spare time only. A. V. Gebhardt writes: "Have made \$1,000.00 the past 6 months." George Seitel writes: "I have sharpened over 500 mowers and every customer is well pleased." A. M. Larsen writes: "I average 9 mowers a day." Roy F. Stier says: "I live in a town of 500 and to-date have sharpened 200 mowers at \$1.25." Edward A. Myrdersso writes: "Have sharpened around 500 mowers this season." Nick Baltus says: "Last summer I sharpened 200 mowers at \$1.00 each." Bucher Battery Co. writes: "We sharpened over 600 mowers last year at \$1.50 each."

FREE BOOK Shows How!

Right now, before you forget it, send for a copy of our FREE BOOK, "How To Make \$25 to \$30 per week in SPARE TIME."

SEND POST CARD TO

THE FATE-ROOT-HEATH CO.
Box 308 Plymouth, Ohio



BURN YOUR NAME ON TOOLS

WITH THE

ARKOGRAF

PROTECT YOUR TOOLS FROM THEFT

Write with electricity any name or design on the hardest and finest tools and instruments, or any metal, like writing on paper with pen or pencil.

Complete Outfit \$3.50—Prepaid Anywhere

Introducing illustrated circular free. Write today.

Agents wanted.

ARKOGRAF PEN CO., 3927 S.E. Stark St., Portland, Ore.

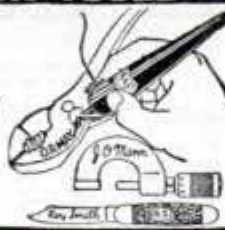

NEW BRUSH PLATING OUTFIT For AUTO PARTS

Connects to a battery with no tanks necessary. Plates on iron, steel, brass, copper, etc. Almost as simple as painting. Hundreds of car owners waiting for this low-cost plating. Improves appearance and value of the car.

Your opportunity to make good income plating auto parts, bathroom fixtures, reflectors, mirrors, etc.

FREE PROOF

Write quick—big season here. Get FREE PROOF and particulars that put you in a paying business of your own.

GUNMETAL COMPANY

AVENUE M

DECATUR, ILL.

(Continued from page 128A)

plane is banking, climbing, gliding or flying level. You can demonstrate the action with the gyro model. Spin the model with the outer ring horizontal and the axle vertical. Extend the arms to simulate the wings of a plane. Tilt them to indicate a bank and indicate a climb or glide by turning the palms. Now pick up the model, tilt it right or left, move it forward and backward for glide and climb. Note that the gyro remains horizontal, no matter how the base is moved.

In the gyrohorizon, a pointer bar is connected to the gyro to simulate the horizon. An airplane is painted in silhouette on a dial in front of it. As the plane banks, climbs or glides, the silhouette does likewise, but the pointer bar, actuated by the gyroscope, remains horizontal. Keeping the silhouette in line with and parallel to the bar thus insures level flight.

Accurate steering requires a fixed reference such as a star, the sun or objects on the ground with which the heading of the plane may be compared. The directional gyro provides a fixed directional reference within the cockpit when flying "blind." To demonstrate it with the model, hold it in front of you with the spinning axle horizontal and one end pointed away from you. Turn your body and the model just as an airplane might turn in flight. The spinning axle of the gyro continues to point in the same direction, regardless of how the base is turned.

The directional gyro has a circular card which, like the gyro, remains fixed as the airplane moves around it. This card is observed in relation to a lubber line on the front of the instrument. Both gyrohorizon and directional gyro rotors are air driven, spinning at about 12,000 revolutions per minute. They are about two inches in diameter and weigh about twelve ounces.

These two instruments made possible the next logical step—wholly automatic flying of an airplane. When the gyropilot flies a plane, the gyroscopic elements of the gyrohorizon and the directional gyro serve the added purpose of actuating the controls to keep the plane in level flight and on any predetermined course. The relative movement between the gyros and their casings is converted by an air pick-off and air relay system into movements of

(Continued to page 132A)

SWEARS HE GAINED 14 LBS. THIS QUICK EASY WAY

For some time I had been losing weight, and didn't have any pep or energy. I couldn't eat, and what I did eat didn't seem to do me any good. Then my skin began to get pimply. I looked so bad I was ashamed to go out and meet anybody. Then I saw an advertisement of Ironized Yeast and thought I would try it. Inside of 3 weeks I saw my skin clearing and began to gain weight and feel peppy again. In about 3 months I gained 14 pounds, and am now in fine shape. My new huskiness and pep has brought me lots of new friends, too. I never knew what a difference an improved appearance could make in a person's popularity.

Don Russo, Phila., Pa.

Sworn to before me
Jos. E. Smith
Notary Public

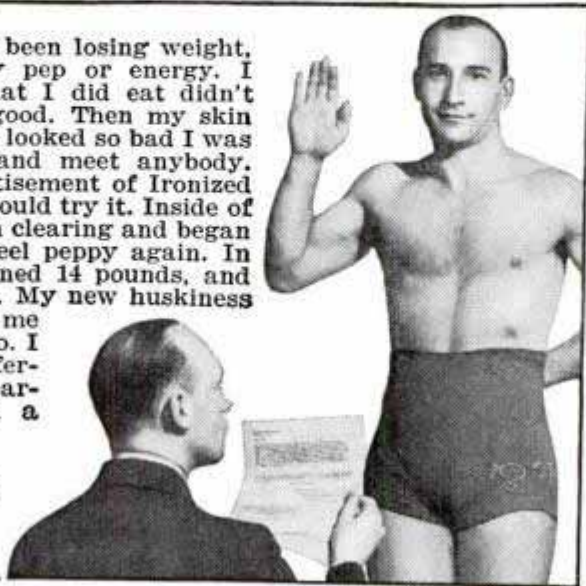

Don Russo swears to his startling statement before Notary Public Smith

Thousands Gain 10 to 25 Pounds With New Ironized Yeast Tablets

If you're skinny and puny-looking, and consequently not very popular, here's wonderful good news. You see what Don Russo swears to under oath above. Then remember he's just one of many thousands of thin rundown people who never could gain before, but who've put on 10 to 25 pounds of solid, naturally good-looking flesh—with these amazing new Ironized Yeast tablets.

Not only that, but they've also gained naturally clear skin and healthy color, new pep and energy, new friends, new good times and popularity—often in just a few weeks!

Why they build up so quick

Scientists have discovered that hosts of people are thin and rundown only because they don't get enough Vitamin B and iron in their daily food. Without these vital elements you may lack appetite and not get the most body-building good out of what you eat. Now you get these exact missing elements in these new Ironized Yeast tablets.

They're made from one of the world's richest sources of health-building Vitamin B—the special yeast used in making English ale. By a new costly process, this rich yeast is concentrated 7 times, taking 7 pounds of yeast to make just one pound of concentrate—thus making it many times more powerful in Vitamin B strength than ordinary yeast. Then 3 kinds of strength-building iron (organic, inorganic and hemoglobin iron) and pasteurized English ale yeast are added. Finally every batch of this

Ironized Yeast is tested and re-tested biologically for its Vitamin B strength. This insures its full weight-building power.

No wonder, then, that these new easy-to-take little Ironized Yeast tablets have helped thousands of the skinniest people who needed their vital elements quickly to gain new normally attractive pounds and new pep.

Make money-back test

To make it easy for you to try Ironized Yeast, we do better than offer you a small sample package. We offer you a FULL SIZE package, and you don't risk a penny. For if with this first package you don't begin to eat better and get more benefit from your food—if you don't feel better, with more strength, pep and energy—if you are not convinced that Ironized Yeast will give you the normally attractive flesh you need—the price of this first package will be promptly refunded. So get Ironized Yeast tablets from your druggist today.

Special offer

To start thousands building up their health right away, we make this valuable special offer. Purchase a package of Ironized Yeast tablets at once, cut out the seal on the box and mail it to us with a clipping of this paragraph. We will send you a fascinating new book on health, "New Facts About Your Body." Remember, results with the very first package—or money refunded. At all druggists. Ironized Yeast Co., Inc., Dept. 532, Atlanta, Ga.

**WARNING: Beware substitutes.
Get the genuine Ironized Yeast.**

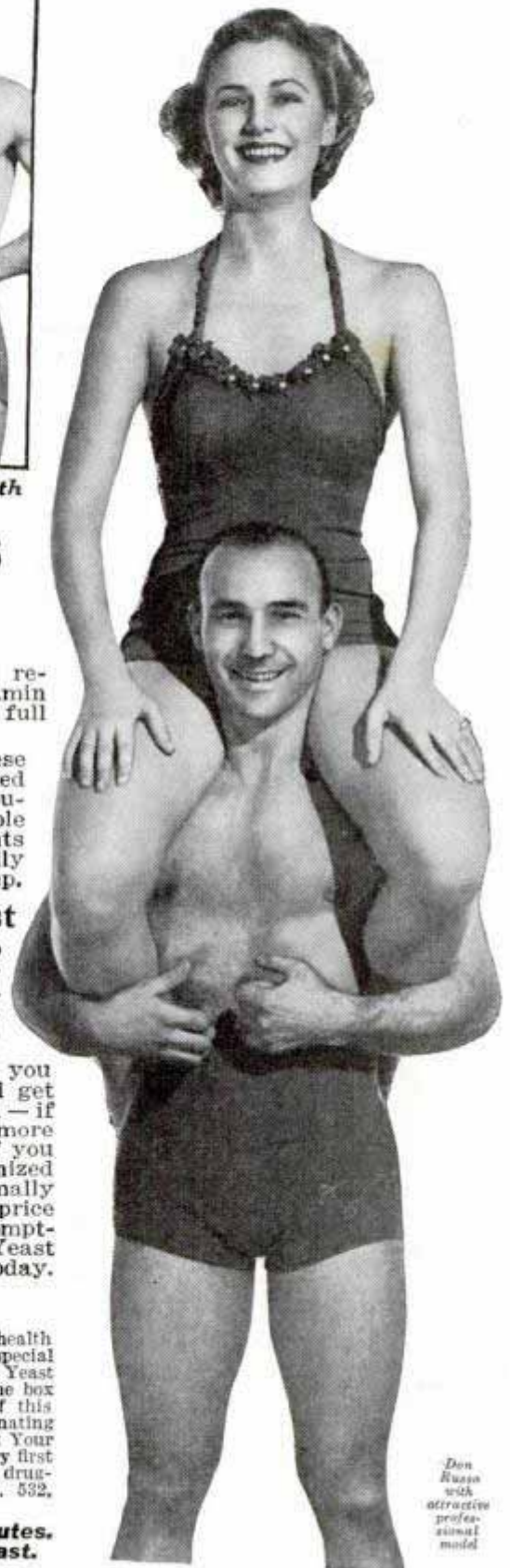

Don Russo with attractive professional model

When writing to advertisers please mention Popular Mechanics

**WHERE THERE'S SMOKE
THERE MAY BE FIRING!**



THE OLD BOY got a whiff of Joe's stinky pipe—swore that Joe was stealing ink erasers to fill it—and fired him like *that!*



THE BOSS RELENTED, saying: "Any man with sense enough to find a burley blend *that* fragrant and mild can stay on my payroll forever. Get me a two-ounce tin!"

**HOW TO
TAKE CARE
of
YOUR PIPE**

FREE BOOKLET tells how to make your old pipe taste better, sweeter; how to break in a new pipe. Write for your copy today. Brown & Williamson Tobacco Corporation, Louisville, Kentucky. Dept. P-82.

TUNE IN Tommy Dorsey and his orchestra. Every Friday, 9:30 P. M., E. S. T., coast-to-coast NBC Blue Network.

(Continued from page 130A)

a hydraulic unit which provides the power for moving the controls.

In the gyropilot, the horizontal gyro controls the operation of both the ailerons and elevator while the directional gyro controls the rudder. Maneuvers such as turns, climbs and glides are made with precision by adjusting knobs on the face of the instrument in the cockpit. The automatic pilot weighs only sixty pounds and in the United States alone, this robot is flying airplanes 1,000,000 miles per month.

One odd use of the gyroscope is in the oil industry where it penetrates thousands of feet below the surface of the earth to prevent the wasted effort and expense of boring crooked holes.

Thus in the short space of three decades has a child's toy developed into an indispensable servant of mankind in the air, on the sea, even on the earth and under the earth. And the evolution of the gyroscope from a toy to a means for changing the history of travel has been due, in no small part, to the vision and genius of one man—an inventor who saw the existence of a great human need and a means for filling it.

Chemistry and You

(Continued from Coloroto Section)

rosion resistance to welded joints without subsequent expensive heat-treating.

A radically new process known as "powder metallurgy" is responsible for our commercial use of these valuable metals that only yesterday were beyond our reach. Instead of being melted up like all metals have been for centuries, they are reduced by electrochemical methods to fine powders, which are then purified, pressed into bars and heat-treated electrically under a high vacuum. The powdered grains are thus literally welded together. A single bar of tungsten produced by this process will yield hundreds of miles of filament wires such as you find in ordinary electric-light bulbs. Applied to older metals, such as copper, the powder process has made it possible to fabricate bearings that are self-lubricating and will outlast the machine they serve. Graphite is simply mixed with the powdered metal and the mixture is heated and compressed into a hard, semi-porous body capable of

(Continued to page 134A)

Charles Hardy, Inc. See Dec. 1932, p. 935
 -herman-

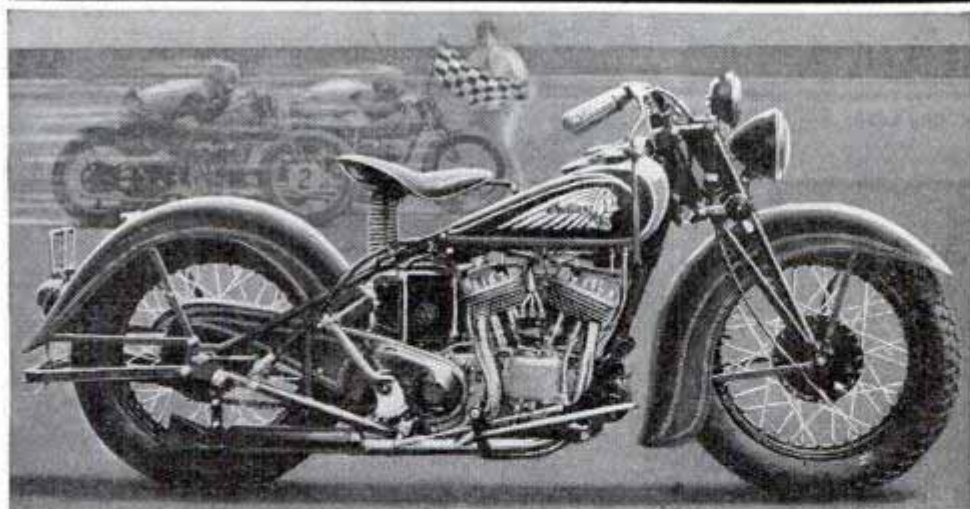

Indian

SPORT SCOUT 45

PRICES ON NEW
MODELS BEGIN AT
\$215.
F.O.B. FACTORY
FULLY EQUIPPED

THE BEST MOTORCYCLE "BUYS" FOR 1938

WHO BUT INDIAN could bring you engineering triumphs like these new 1938 motorcycles at such smashingly low prices! These great new Indians have *everything*—easy handling, power, pep, economy, and all the thrill and adventure of motorcycling.

Visit your Indian dealer today! See the whole new Indian Line—JUNIOR SCOUT, SPORT SCOUT, DE LUXE 4, and CHIEF. Find out how easy it is to own

any of these splendid machines on easy payments—and how you can get a fine RIDER'S HELMET and INDIAN PIN absolutely FREE the minute you place your order.

INDIAN MOTOCYCLE CO., Springfield, Mass.



FREE!
Get this RIDER'S
HELMET and
INDIAN PIN



MAIL COUPON TODAY!



INDIAN MOTOCYCLE CO., Springfield, Mass.

Please send me at once, without obligation, your illustrated Folder showing the new 1938 Indian Motorcycles, and CERTIFICATE of VALUE entitling me to FREE RIDER'S HELMET and INDIAN PIN, as illustrated, when I place my order.

Name.....

Address.....

Please be sure to check your age group: **PM-28**

15-19 years 20-30 years 31 years and up under 15 years



**Work Faster
Make More Money
with the**

Red E UNIVERSAL TRACTOR

With this practical machine and attachments you can do all field and belt work hours faster at the low cost of 33c per day. Many units pay for themselves the first season. Unusually easy to handle and operate. Absolutely safe. Hundreds of users. Buy direct at low factory price. Two weeks' trial—satisfaction guaranteed. Write for colorful, free catalog.

PIONEER MFG. CO. Dept. V-28 West Allis, Wis.

BUILD CLOCKS with our help

Cash in on the demand for Mantel, Banjo, GRANDFATHER'S CLOCKS. Ask about our new, low-priced Hall Clock and Special Blue Print Offer. Send dime for illustrated working drawing of Hall Clock; 25c for plans of 16 Mantel & Banjo Clocks, Catalog FREE.

AMERICAN CHIME CLOCK CO.
1676 Ruffner St. (Established 1877) Philadelphia, Pa.

MODEL AIRPLANE ENGINE

THE SYNCRO ACE is the first modern, streamlined gasoline engine designed for model airplanes. Each engine is block tested at factory. Equipped with new, high efficiency coil, developing 1/5 H.P. Bore, 7/8"; stroke 15/16"; speeds from 800 to 8000 R.P.M. Special matched steel piston; special alloy connecting rod; counter-balanced crankshaft. Improved timer.

Each engine factory tested, mounted on skids and sold ready to run. (Less batteries). Only \$15.00, from your dealer. Write for illustrated folder and full information.

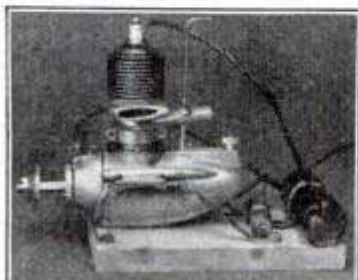

511 Boydell Bldg. Detroit, Mich.

HANDEE TOOL OF 1001 USES

A Whole Shop Full of Tools in One



For work on all metals, alloys, bone, resins, glass, stone, wood, etc. Uses 200 different accessories to grind, drill, cut, polish, carve, route, saw, sand, sharpen, engrave, etc. Saves hours of tedious hand work. Weighs 12 ounces. Speed 25,000 r. p. m. Plugs in any socket, AC or DC, 110 volts, \$18.50 postpaid, 6 Accessories Free.

STANDARD MODEL. For the man who prefers less speed, 13,000 r.p.m. Weighs 1 pound. A sturdy little helpmate for mechanic, repairman or home craftsman. \$10.75 postpaid, 3 Accessories Free.

GET A DEMONSTRATION at your Hardware, Department or Tool Dealer or Order either Model on 10-Days Money-Back Trial. Catalog Free.

CRAFTSMAN'S PROJECT BOOK. Easy working plans for making many interesting and unusual projects. 25c stamps or coin.

CHICAGO WHEEL & MFG. CO.
1101 W. Monroe St. Dept. Q Chicago, Ill.

Send Catalog Project Book **PM-2**
 \$10.75 Model De Luxe Model Send C.O.D.

Name.....
Address.....

When writing please mention Popular Mechanics

MADE \$1025.00

in 9 Months with the



FOLEY LAWN MOWER SHARPENER

"A substantial increase in grind jobs each year, proves beyond any doubt that Foley Grinders do very satisfactory work. We have ground 723 mowers since February 1 to date, November 9. Our total receipts on lawn mower service alone during that period has grossed us \$1,025.00. The prevailing price of grinding and adjusting service is \$1.00 and \$1.25—repairs and parts extra."—W. A. Tulip, Phoenix, Ariz.

You Too Can Make Big Money

Free plan tells you how to start. The Foley Lawn Mower Sharpener turns out perfect work quickly and easily, no experience needed. Simply put the mower in the machine and turn on the power. Uses same system as lawn mower factories. Sharpens all sizes and types in 15 or 20 minutes.

Special Offer: Attachment for grinding axes, hatchets, knives, etc., included FREE with Foley Lawn Mower Sharpener on our Special Offer, brings you business the year around. Send postcard today.

FOLEY MFG. CO. 207-8 Main St. N. E., Minneapolis, Minn.

es 817

The DUAL COMBINATION WOOD & METAL LATHE

12-INCH SWING 47 to 3000 R.P.M.

Larger, heavier but costs no more. TIMKEN BEARINGS

CLAUSING MFG. CO. OTTUMWA, IOWA.

es 1422

WHY PAY Fancy Prices?

1938 CATALOG FREE

Quality Radios—Save up to 50%

FREE home trial. MONEY-BACK if not satisfied. ONE YEAR GUARANTEE. 50 beautiful models. 5 to 15 tubes. AUTOMATIC tuning models. Radios that get EUROPE. New battery radios for farms. Auto radios. Send postcard for FREE catalog—just off press.

WORLD-WIDE RADIO CO.
2870 ELSTON AVE., DEPT. P-2, CHICAGO

FREE HOME TRIAL \$6.95

Order Now. Send \$1 Dep. Pay balance C. O. D.

SCALE MODEL TRAINS

"0" Gauge 17/64" Scale

MIN-I-SCALE MODELS

Perfect, die cast scale models, accurate to the smallest detail. Absolute scale accuracy. Sturdy construction. Precision workmanship. All locomotives "run-in" under power. Both kits and assembled units—Pullmans, Box Cars, Combination Baggage and Day Coaches, Tank Cars and Hoppers. Kits easily assembled without drilling or machining. Castings prime coated. Ask your dealer or send name and 3c stamp for full information.

CONGRESS TOOL & DIE CO.
9028 Lumpkin Ave., Detroit, Mich. **FREE FOLDER**

(Continued from page 132A)

absorbing oil, which is retained by the finished bearing throughout its life.

Artificial ice-making has been practiced almost fifty years, and as early as 1914 the Santa Fe railroad was trying to achieve air conditioning in passenger cars that would make travel more comfortable. Not long after the close of the World War we were becoming definitely aware of the huge market opening for mechanical refrigerators in the home. However, a serious lack worried the industry and jeopardized its whole future. It was without a refrigerant that was safe under all conditions, regardless of leakage, fire or other accident, a gas that was non-toxic, non-explosive, non-inflammable and non-corrosive.

Chemists were frankly dubious when they tackled this problem. To compound a refrigerant possessing any two of these properties was a feat in itself; to compound one possessing all four, which at the same time would be equal in effectiveness to the refrigerants in use, seemed a feat in the realm of the miraculous. Nevertheless in 1932 the prescribed new material emerged from the laboratory under the trademark of "Freon." Not only is "Freon" safe, but it is superior to the older refrigerants as such, and it requires a much lighter condensing equipment, a fact of importance in the air-conditioning of transportation units.

The paradox is that this utterly safe new refrigerant is compounded from three of the most ill-omened of gases, namely, methane, the deadly and explosive fire-damp of mines; chlorine, one of the poison gases used in the World War, and fluorine, which is highly corrosive to most metals. This chemical near-miracle is only one of many important chemical contributions to the modern revolution in refrigeration.

(Concluded next month)

Twelve Billion Tin Cans a Year Produced in U. S. Alone

Can makers in the United States produce 12,000,000,000 tin cans every year—one hundred for every person. Only sixty per cent of the cans are used by the food-packing industry. The other forty per cent are used to ship moth balls and tennis balls, neckties and aspirin, paint, tobacco, and even roller skates. In 1933 the can industry used more steel than the railroads.

Technology Renewed.

Free Book!
MAIL COUPON now

\$200 My First Week



... Now in my OWN Business.

Would you, too, like to own a business where you could take in \$200 your first week as did L. A. Eagles in Madison, Wisconsin?

We want a reputable, honest man in each county. This man need not have any special experience or more than ordinary ability, but he must be honest and courteous.

Such a man we will start in business for himself. You can make far above average profits in the rug-cleaning business—a high-grade business all your own. Many earn \$125 to \$200 per week—some considerably more.

NO SHOP NECESSARY

The rug-washer finishes rugs like new on the customer's floor. Anyone can run it. Electricity does the work. A quick, thorough and highly-efficient method that restores the natural beauty of floor coverings.

There are hundreds of customers—in your vicinity and nearby towns. The business grows steadily. Simply clean a few rugs or carpets. These customers tell others and also give you their future work. Soon you will have a prosperous year-around business. Send coupon for booklet explaining everything.

"Profits Pay for Home"

Harry Hill built and paid for a home from rug-washer profits. His first day's business was \$86. Another man writes, "Made \$70 in 13 hours." A. L. Miller says, "Have had rug-washer 6 years—have earned as high as \$92 a day." M. O. Malmin earned 3 times the cost of his machine the first two months. You, too, can enjoy a large income.

VON SCHRADER MFG. CO., 102 PL., RACINE, WIS.

VON SCHRADER MFG. CO.
102 PL., Racine, Wis.

Send at once (no obligation) your free booklet illustrating rug-washer and telling how I can own my own permanent business; how I can earn large profits at prices below other methods; how I can become financially independent in a short time; and how I can pay on easy terms.

Name.....

Address.....

City..... State.....

"Never a Complaint"

C. J. White says: "\$100 business in six days—never a complaint." That is the nicest part of this business—every customer is more than satisfied. Stains and blotches disappear and vivid colorings and freshness in faded floor coverings come back.

EVERY MACHINE GUARANTEED

You take no risk. These machines have been manufactured since 1918 and are used by the United States Government and by many of the world's largest hotels. They are fully GUARANTEED.

EASY TERMS

The complete equipment is inexpensive. A reasonable down payment brings everything to you and the balance is paid monthly. From the start, you have your own business—one that is profitable and of which you can be proud.



MAIL COUPON Today



BIG NEW WOOD LATHE AT A SENSATIONAL LOW PRICE SPECIAL OFFER



Turns 8 in. Diameter 36 in. between Centers
headstock, 3 step cone pulley for V-belt. Extra long reservoir outer bearings. Spur center and 4 inch face plate screw onto spindle. Tailstock spindle has screw movement of 1 1/4 in. Tool rest 8 in. long. Priced amazingly low. Accessories include 3 step cone motor pulley, V-belt, and set of 4 turning chisels. Shipping weight 30 lbs. Send now for new FREE catalog, low prices. Not sold through agents.
BLUE STAR PRODUCTS, 602 Palm Ave., Fairfield, Iowa.

KINKADE GARDEN TRACTOR and Power Lawnmower

A Practical Power Plow and Cultivator for Gardeners, Suburbanites, Florists, Truckers, Nurserymen, Fruit Growers.

Low Prices—Easy Terms
AMERICAN FARM MACHINE CO.
1058 33rd Ave. SE., Minneapolis, Minn.



"THE NEON LIGHT sets you RIGHT" TEST-O-LITE

At Electrical Stores or \$1.50 Postpaid
Handiest electrical tester made; quickly locates trouble in electric circuits, fuses, cut-outs, motors, radios, etc. Has 1,001 uses for electricians or home. Tests any voltage 110 to 550; tells A.C. from D.C. Excels ordinary clumsy test bulb. Fountain-pen size; with pocket clip. Lifetime guarantee.
L. S. BRACH MFG. CORP., 55 Dickerson St., Newark, N. J.

EARN MONEY Stringing TENNIS RACKETS

An opportunity to earn as much as \$3.50 for a few minutes of your spare time. String your own racket and save money. Tennis players need restringings frequently. Every stringing means profit for you. No experience needed—we teach you how. TOMGUT Equipment makes it easy. Costs practically nothing to start. Easy work. Begin NOW!



FREE Write today and we will send you FREE our Plan and special offer on strings and stringing equipment.

THOMPSON MANUFACTURING COMPANY
4535 Packers Avenue, Chicago, U. S. A.
TOMGUT "Court-Tested" Tennis & Badminton Strings

Send FREE plan and special offer.
 Send booklet, "400 YEARS OF TENNIS," for which I enclose 10c to cover mailing costs.

Name.....
Address.....
City..... State.....

MAIL THIS COUPON

FREE RADIO Catalog



BARGAINS AND FUN FOR ALL THE FAMILY

YOU'RE MISSING SOMETHING if you don't have Wholesale Radio's new catalog. Big as a magazine, handy as a calendar, the 1938 edition is now ready. Send for it. It's FREE! The family will marvel at the bargains we have packed between the covers. Lafayette Radios—a model for every purpose and every purse. Electrical appliances, experimental parts, "gadgets" and tools for workshop and kitchen. Prices? Let the Wholesale catalog show you how low they are! Get your copy now! Mail the coupon!



LAFAYETTE 5 TUBE A.C. SUPERHET WITH 2 BANDS



MODEL D21 ONLY

\$14.95

WITH TUBES

30-DAY FREE TRIAL
If, within 30 days you are not satisfied, return the set—your money will be refunded.

Everywhere people are talking about Model D-21's amazing power, about the 5 latest type sensitive tubes that "sound like seven", about this receiver's automatic volume control which overcomes blast and fade; about its rich walnut cabinet and streamlined styling. Read about Model D-21 and the 70 other brilliant new Lafayettes in the catalog.

BEFORE YOU BUY ANYTHING IN RADIO — SEND FOR THIS **FREE CATALOG**

WHOLESALE RADIO SERVICE CO. INC.
NEW YORK, N.Y. CHICAGO, ILL. ATLANTA, GA.
100 SIXTH AVENUE 901 W. JACKSON BLVD. 265 PEACHTREE STREET
BOSTON, MASS. • BRONX, N.Y. • NEWARK, N.J. • JAMAICA, L.I.

WHOLESALE RADIO SERVICE CO., INC.
100 SIXTH AVENUE, NEW YORK, N. Y.

Rush FREE 1938 Catalog No. 69-7B8

NAME _____

ADDRESS _____

CITY _____

STATE _____

MAIL THIS COUPON NOW FOR **FREE CATALOG**

PASTE COUPON ON PENNY POST CARD

Inter-Room Communicator

(Continued from page 259)

3-contact Amphenol plugs and sockets, a Federal-type d.p.d.t. switch is employed to automatically change over the correct speakers for use as speaker or microphone as the case may demand. Right and left side views of this switch are shown in Fig.

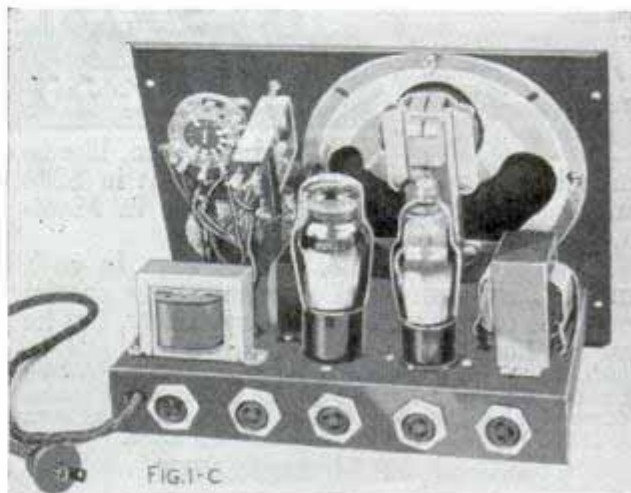

1-A. It will be noted that the frame is drilled for a 6-32 machine screw which blocks the switch in the "up" position, as only neutral and down are used. Output volume is adjustable by means of the 1,000-ohm volume control; inexpensive audio transformers match the amplifier to the line. The connections to the 3-to-1 ratio audio transformer must be made as shown in Figs. 1 and 4; these reversed

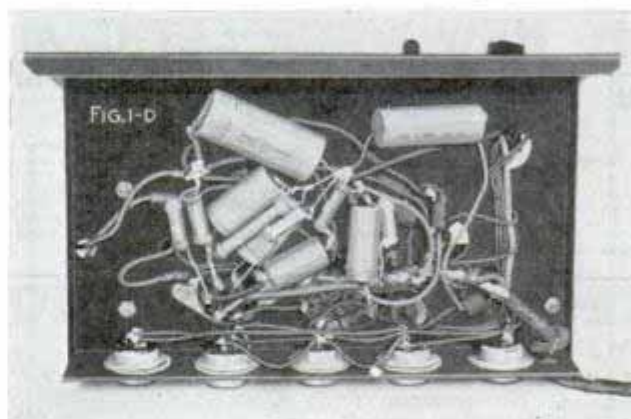

connections are made to obtain a step-down ratio necessary to match the 500-ohm sub-station line to the output tube.

All parts are available at reasonable prices. A list of the original materials used can be obtained from Popular Mechanics radio department without charge. The

(Continued to page 138A)



New 24" LATHE
\$ 490
POST PAID

"Giftmaker Sr."
(Outside U. S. A. & C. O. D. \$5.15)

A heavy duty, smooth running wood lathe at a remarkable price. 32" long, 7" high. Turns pieces 4 1/2" in diameter by 24". Fully adjustable. 2-speed. Weighs 10 lbs. Long and short tool rests. OILLESS bushings. Satisfaction guaranteed or money back.

Free Catalog describing cash prize contest and illustrating complete power tool lines: Shaper or Circular Saw with oilless bushings, \$3 each; Drill Press, \$2.50; Jig Saw, \$1.50; 9 1/2" Lathe, \$2; Sander, \$1 etc. Order today or send card for catalog.

J & H Metal Products Co. 5 Commercial St. Rochester, N. Y.

PINS FREE TREASURE BOOK!

30¢ This Class Pin, any letters, any numerals, Silver Plated 25 or more, 30¢ each; 7 to 24, 35¢ each; 1 to 6, 40¢ each. Gold Plated add 10¢ each to above prices: Sterling Silver add 20¢ each; Sterling Silver Ring as shown, 26 or more \$1.50 each; 12 to 25, \$1.75 each; 1 to 6, \$1.95 each. Write for Big FREE Treasure Book.

Metal Arts Co., Inc. Factory 44... Rochester, N.Y.

RINGS

DO YOU WANT a new business profession of your own, with all the trade you can attend to? Then become a foot correctionist, and in a few weeks earn big income in service fees,—not medical nor chiropody—easy terms for home training, no further capital needed, no goods to buy, no agency. Established 1894. Address **Stephenson Laboratory, 1 Back Bay, Boston, Mass.**

BILD-UR-OWN
COASTERS • MIDGET AUTOS • SCOOTERS • BUILT-UP TRAILERS, ETC.

DISC WHEELS equipped with 10"x2 1/2" (GOODRICH-GOODYEAR-FIRESTONE) Balloon Tires offered at LOWEST PRICES

We also carry a complete line of larger Tires and Wheels, Axles, Motors, etc.

BILD-UR-OWN DEVICES
WRITE FOR PRICES 5237 Lake St., Dept. A-2 Chicago, Ill.

BETTER TOOL CHESTS
For Machinists, tool, die and Pattern Makers. Free Catalog.
GERSTNER TOOL CHESTS
438 Columbia St. Dayton, Ohio

ONE-MAN SAWMILL
Makes lumber, shingles, lath, ties, crates, boxes, casks, all forms lumber

TURN TREES INTO MONEY WITH A BELSAW
Three capacities: 10, 14 and 20 ft. Accurate set works positive dogs. Hand or power feed. Runs on low power—Many owners use old auto engine. Pays for itself quickly—thousands in commercial service, everywhere. Write for free lumber handbook and catalog of mills, supplies, tools, saw tables, and woodworking equipment.
Belsaw Machinery Co., 8110N Davidson Bldg., Kansas City, Mo.

FARM MODEL \$49.00

BUILD CLOCKS for PLEASURE—PROFIT

Half clocks are high priced in stores—you can make good money building them or electrifying spring clocks. Dime brings drawing of easily built Grandfather Case with "HOW" Book pricing banjo, desk, mantel, spring. **ELECTRIC CHIME, BATTERY CLOCKS** from \$1.40. **Hall Clock, Brass weight chime movements** from \$16.95. **Starinos, KUENPEL CHIME CLOCK CO.**
Building 13 Guttenberg, Iowa



ONAN A. C. ELECTRIC PLANTS FOR THOSE WHO MUST PROVIDE THEIR OWN ELECTRICITY

ONAN ELECTRIC PLANTS furnish the same current as supplied by power lines—110 volt, 60 cycle, ALTERNATING CURRENT. Operate Radio, Water System, Washing Machine, Electric Iron and all Electric Appliances.

Run from gasoline or gas and generate electricity for Farms, Lake Cottages, Oil Stations, Commercial Places. A woman or child can operate it.

SIZES 350 WATTS AND UP

Each ONAN PLANT is a complete Unit, ready to run. No battery used except to start the engine. Easy to install. Available from stock. 32 volt, Direct Current Models also available. Write for details.

D. W. ONAN & SONS
1013 Royalston Ave. MINNEAPOLIS, MINN.

FUN and PROFIT

CRAFTSMAN OUTFITS
Get these fascinating big sets. Learn skilled craft work. Make money selling finished products.

- **HOT SPOT Woodburning**
Modern electric pen burns designs on wood, leather, cork, etc. Outfit includes wood, paint, patterns. Complete set making Pair of Bookends, What-Not Rack and 2 Plaques, \$2.00.
- **HAMMERED BRASS**
Plywood plaques and non-tarnishable jeweler's metals, with patterns, hammer, tools, full equipment for "raised metal work." Complete set making Pair of Bookends and 5 Plaques, \$2.00.
- **SOLDIER CASTING**
Large 3 figure mould, clamps, handles, supply of lead, paints, brushes, electric ladle for making any number of big lead soldiers. Complete \$2.00. At your dealer's or send money order to **RAPAPORT BROS.** 703 W. Ohio St., Chicago

FREE 40 PAGE BOOK

STANDARD GARDEN TRACTORS

Plow Seed Cultivate Mow Hay and Lawns

Powerful Gas Tractors for Small Farms, Gardeners, Florists, Nurseries, Fruit Growers, Poultrymen.

1 & 2 Cylinders
High Wheels. Rubber or Steel Tires. Walk or Ride.
Do Belt Work—Free Catalog

STANDARD ENGINE CO.
Minneapolis, Minn. Philadelphia, Pa. New York, N. Y.
3221 Como Ave. 2546 Market St. 290 Cedar St.

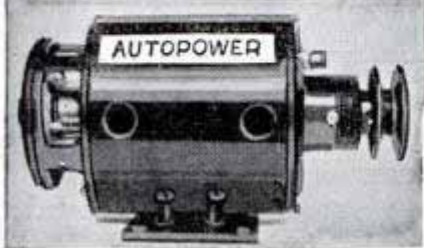

TURN SCRAP INTO MONEY

AUTOPOWER tells you how in plain, easy, simple and illustrated instructions that anyone can follow. Change auto generators into useful, practical A C and D C generators and motors with voltage from 2 to 1,000 volts, for power, light, welding, radio, sound, etc. No previous experience nor special tools needed. Generators can be driven by wind, water, fan belt, etc. **INSTRUCTIONS FOR BUILDING AN A C WELDER THAT ACTUALLY WORKS UP TO A 3/16" ROD. ALSO COMPLETE PLANS FOR WIND AND WATER POWER PLANTS.** Send for your copy of "AUTOPOWER." Already used and endorsed by thousands. Only \$1.00 postpaid.
S. W. DUNCAN, Publisher. 410 S. Hoyne Ave., Chicago

(Continued from page 136A)

blueprint number is R-249. A simplified wiring diagram of the master station appears in Figs. 1 and 1-A and a similar diagram for the sub-station is shown in Figs. 2 and 2-A. Complete construction details for the metal cabinets, panel and bases are given in Fig. 3. These units can be formed

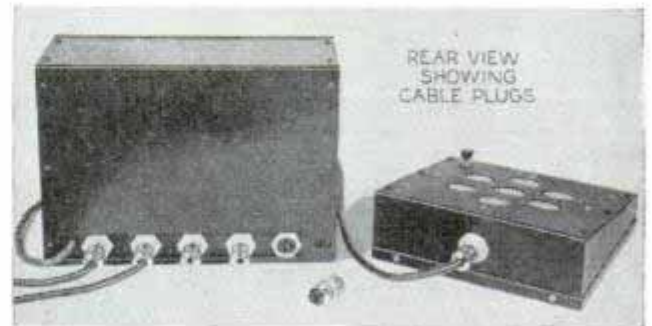

and drilled by the builder, or purchased as desired. Some readers may wish to use small wood cabinets of the type commonly employed to house midget receivers; in this case the base only need be of metal. Photos Figs. 1-B, C and D show various views of the completed master station; a schematic circuit diagram for the system appears in Fig. 4. Ordinary No. 16 or 18 hook-up wire, with push-back insulation, is used to wire all units, except for the

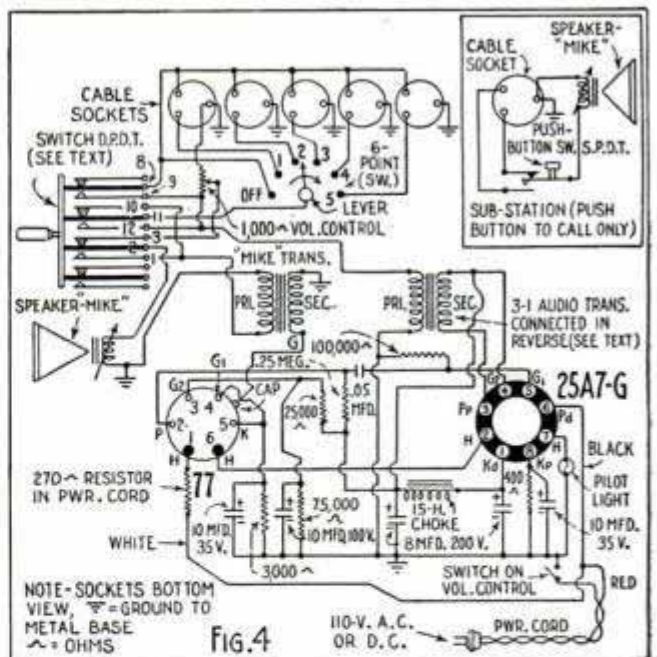

heavy common ground wire which may be No. 14 tinned copper. Each connection should be carefully soldered. When operating the system on direct current it may be necessary to reverse the power-cord plug in the wall socket for correct polarity.

TRY THIS

ALL-PURPOSE MOTO-TOOL

10 DAY MONEY BACK TRIAL

saves time and labor on all craft work

Everybody who works with his hands—at home, shop, school, or profession—can use the efficient, attractive Moto-Tool to advantage. With this practical machine you can do in seconds jobs that require hours of hard hand work. Moto-Tool handles hair-line precision work or does power jobs with equal ability. Plugs in any AC or DC socket. Absolutely safe. There are thousands in use.

Model 1 \$9.85 POSTPAID

Model 2 \$16.50 POSTPAID

20 pc-craftsman's tool set, for either model \$5.75 Post-paid

DREMEL MFG. CO.
 2826 CT., Racine, Wisconsin

Two sturdy Moto-Tools serve every purpose of the craftsman. The No. 1 machine—weighs 6 oz., 25,000 r.p.m.—is recommended for light bench jobs. Model 2—weighs 13 oz., 27,000 r.p.m.—is a more powerful, rugged machine with extra mechanical refinements that shop men want and appreciate. Order on 10-day money back trial. Send for FREE booklet.

RE-STRING RACKETS AT HOME

EARN MONEY

It's pleasant, profitable work. No experience or skill required. Easy to Learn. Full line of guaranteed stringing tools, frames, gut and silk strings for your selection. Every item highest quality. Write for complete details.

FREE

Write for our 1958 Illustrated Catalog and Instruction Book.

W. A. BICKEL, Dept. A-2, 809 W. Madison St., Chicago, Ill.

ATTENTION PLEASE

NOW YOU CAN MAKE YOUR OWN PUBLIC ADDRESS SYSTEM!

It's easy to build a Jefferson sound-amplifier for your own pleasure, and for profit, too—renting it out for games, outings, parties, public meetings, skating rinks and dances.

Jefferson offers a wide choice of circuits from which to select, each incorporates the latest in radio engineering development. Catalog 372-R and manual of Easy-to-Build Amplifiers give you complete information Decide now to enjoy the thrills of building your own sound system—rentals quickly return the original cost. Clip and mail the coupon now.

JEFFERSON ELECTRIC COMPANY,
 Bellwood (Suburb of Chicago), Illinois.
 Canadian Factory: 535 College St. Toronto, Ont.

JEFFERSON RADIO TRANSFORMERS

Jefferson Electric Co., 900 S. 25th Ave., Bellwood, Ill.
 Please mail free Catalog 372-R and Amplifier Manual to:

Name

Address

City and State

READY CUT HOMES

\$416 and Up... freight paid; save \$500 or more. Designs are all modern, practical, distinctive. Ready cut houses complete ready for quick, easy assembly. Includes lumber, insulation material, spring bronze weather stripping, built-in ironing board, medicine cabinet. Attractive 1-panel doors and latest hardware. Also, complete plans, nails, lath, paint, varnish, shingles, etc. Range of 100 homes, summer cottages, garages, etc. Full color catalog and complete descriptions sent for 25c coin or stamps to help cover costs.



FULL COLOR CATALOG FOR ONLY 25c

INTERNATIONAL MILL and TIMBER CO.
Dept. P-28
Bay City, Mich.



CAN YOU BEAT THESE POWER COSTS?

SAVE
up to
\$293⁸⁰
Per
Month
on
power
costs

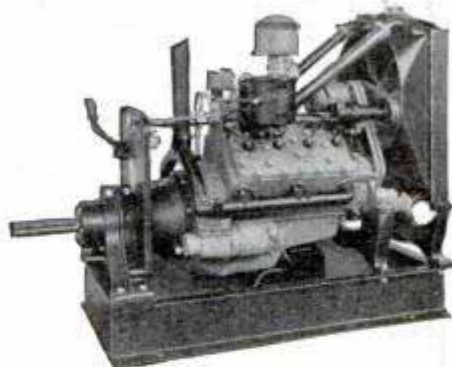

with a KRW FORD V8 Unit

50 H. P. with KRW V8 Unit using natural gas (1125 BTU) @ 30c per 1000 cu. ft. \$ 46.80 per month
50 H. P. with KRW V8 Unit using gasoline @ 10c per gal. (no tax) \$ 145.60 per month

Above figures show primary fuel costs (lubricating oil not included) for operating a KRW V8 Unit to develop 50 H. P. for 10 hours per day—26 days per month. Compare this with electricity @ 3¢ per KWH which amounts to \$340.60 per month. You can pay for a KRW Unit in a few short weeks **out of actual savings!** KRW V8 Units are daily saving money for operators of air conditioning and refrigeration equipment, mills, factories, shops, welders, compressors, pumps, well-drilling outfits, contractors' equipment, etc., etc.

For complete information, prices and data write us. You can buy through your local Ford Dealer and benefit by local service and low-cost Ford engine replacement feature.

K. R. WILSON 17 Lock St. BUFFALO, N.Y.
EXCLUSIVE BUILDER OF APPROVED FORD SHOP EQUIPMENT SINCE 1916

722 Mateo St., Los Angeles. Export Office: 90 West St., New York

EXTRA \$5 in SPARE TIME PRINT at HOME

Letterheads, Circulars, billheads, cards. Printing pays BIG. Easy, interesting, educational. **PRINTING PRESS BARGAINS** 512. Types and Supplies, lowest prices. Send stamp for catalog. **PEIFFER Co., 3-C; 6 Columbia St., Newark, N. J.**

CLAMPS

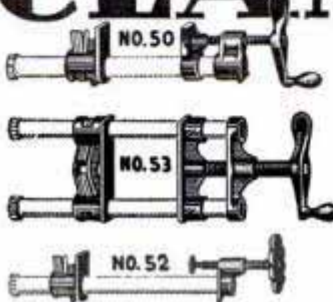

Clamping problems are solved with "Pony" Clamp Fittings for with ordinary pipe that you can pick up anywhere, anytime, for a few cents per foot. You can make clamps of any length. There's no size limit on what you can make—a cigarette box today, a davenport tomorrow. Don't confuse with makeshift devices... these are the standard (on pipe) clamps of industry with the patented Multi-Disc Clutch. Fittings for 2 No. 53 Double Bar Clamps \$4.50 plus postage (10 lbs.). Fittings for 2 No. 50 (3/4") Clamps \$3.00 plus postage (6 lbs.). Fittings for 2 No. 52 (1/2") Clamps \$1.50 plus postage (4 lbs.).

ADJUSTABLE CLAMP CO.
"The Clamp Folks"
421 N. Ashland Ave., Chicago, U.S.A.

Write for Free Catalog

Everything Sold on Time Payments



SAVE

Get the latest and finest radio equipment at rock-bottom prices! Use it while you're paying for it on convenient Monthly Terms. Send for your free copy of Wards 1938 Radio Catalog—the finest ever printed. See for yourself how much you can save and how easily you can buy the radio equipment you need. Mail the coupon NOW for your FREE copy.

MONTGOMERY WARD

MONTGOMERY WARD, DEPT. TM-1
CHICAGO, ILLINOIS

Send me my FREE copy of Wards 1938 Radio Catalog. I am interested in equipment checked at left.

- Sound Systems and Equipment
- Inter-Communication Systems
- "Ham" Transmitters and Parts
- "Ham" Receivers and Supplies
- Testing Instruments and Books
- Replacement Supplies and Parts

NAME

ADDRESS

CITY STATE

FUN

To snap Gyp's bath



... and it's *EASY* with

G-E MAZDA PHOTO LAMPS

● Put *your* camera to work recording precious indoor scenes, to give you happier, livelier memories in years to come.

It's as simple as taking pictures outdoors . . . thanks to G-E MAZDA Photoflash lamps. Their

brighter, whiter light gets you crisp, clear shots indoors or at night. And they last for dozens of pictures.

For action, use G-E MAZDA Photoflash lamps. Each lamp gets one picture. 15¢ list.

Go to your druggist or camera dealer for photo lamps, *but be sure they're marked G-E, to be sure of better pictures.*

No. 1
25c
LIST

No. 2
50c
LIST

FREE FOLDER
Suggests pictures you'll want, tells how to take them. Write for your copy today. General Electric Co., Dept. 166-PM, Nela Park, Cleveland, Ohio.

GENERAL ELECTRIC
MAZDA PHOTO LAMPS

The Rough Road to Glory

(Continued from page 183)

of the American team and we expected to see Jimmy crowned a hero. Instead, all the toasts were for the Frenchman who placed third. Not a word was said about Jimmy—up to the time we left.

The twenty-four hour races were the man killers in the early days. Each car had two drivers and two mechanics, for it was impossible for one crew to go through the entire twenty-four hours. I remember driving a total of nearly nineteen hours in one race. Toward the finish, I saw big buildings, bridges and apartment houses right in front of us, all hallucinations. In another twenty-four hour race, we drove in the rain almost continuously. Goggles were of no use, and the sand piled into our eyes. Wiping it out with a piece of waste



Billy Winn, American driver, and the car in which he competed in 1937

was not so pleasing. At times, we rubbed lemon juice in our eyes to keep awake. It was strenuous, but we loved it. If we hadn't, we couldn't have done it.

In one such race I killed a special policeman. He did just what he was there to keep others from doing. He had jumped the fence and started to cross the track in front of several cars. He stepped away from one car and right in front of mine. I hit him, his body flew over my head and I felt something warm, a liquid, running down my neck. I thought it was blood but it was water from the radiator. The whole front end of my car was smashed. I put on a new radiator, water manifold, headlights and all connections—and still won the race and set what was a world's record at that time. Freak accidents were common in the

early days, things you just could not explain. It was customary to take a newspaper reporter for a ride in those days, then let him write up his impressions. I took one newspaperman for a spin in 1910—a ride neither of us will ever forget. I went down a straightaway wide open. He didn't say a word. Then I hit a turn. He didn't say a word then either—just put both arms around my neck and held on tight. I couldn't see and went off the turn. The car rolled over on top of us, broke several ribs, fractured my backbone and tore most of my hair off. My reporter friend was thrown out—and landed on his feet. He didn't even get his derby hat dented.

One of the closest races I ever ran was on a one-mile saucer-shaped board track near Los Angeles. It was in 1910 and was to be a five-man match race between De Palma, Oldfield, Bruce Brown, Caleb Bragg and myself. We got away from a standing start but the track was banked at such an angle we had to keep moving about 115 or 120 miles an hour to keep from sliding. For the ten-mile race all five of us were so close together you could have covered us with a couple of blankets. We were going so fast our wheels kept sliding and, since the track was just about wide enough for the five of us, we had to slide in unison or hit each other. Not one of us could stop or even slow down if we had desired. If we had, we would have slid down into the next chap. I finished a half length ahead in six minutes and eleven seconds, a record then and it should still be because I don't think there ever was another track like that one built anywhere.

Tragedy and comedy were always with us. In a race at Brighton Beach, a car in front had an accident and caught fire. The mechanic staggered away, his clothing in flames. He started running down the road in front of us, a human torch. "I'll slow down," I shouted to my mechanic Glenn Ethridge, now of Philadelphia. "You jump and knock him down." I slowed to what I thought was a crawl and Glenn jumped. As he rolled over and over, I realized I was still doing forty. He got to the burning man and smothered the blaze. The chap later recovered.

Out at Crown Point, Ind., one year we had a 400-mile stock car race. It was so hot I had water blisters under my goggles

(Continued to page 142A)

MID-WINTER NEWS REEL

**NEW-TYPE BATTERY
GUARANTEED AS LONG AS
YOU OWN YOUR CAR!**



NO GAMBLE TO THIS GUARANTEE

Whether you own your passenger car one year or ten years, if the Goodrich Kathanode Electro-Pak Battery you buy fails to give satisfactory service in that car, The B. F. Goodrich Company will replace it *without charge*, as clearly stated in the written guarantee.



POWER ROBBERS ARRESTED

Special Spun Glass Retainer Mats prevent power loss from the plates. And every Goodrich Electro-Pak is built with the Power-Saving Top Cover that *keeps out* costly trouble-makers and seals in the Goodrich Electro-Pak's *super power*.



MORE POWER TO YOU

Have your Goodrich Tire and Battery Dealer or Goodrich Silvertown Store install a Goodrich Kathanode Electro-Pak in your car without delay. That's the way to get expense-free battery service *as long as you own your car*.

Goodrich
KATHANODE
Electro-Pak BATTERY

74
es 11



COOK and HEAT
without **COAL or WOOD** in Your **PRESENT STOVE**
TWICE THE HEAT AT LESS COST—No Dirt or Ashes
QUICK HEAT AT TURN OF VALVE

An Amazing New-Type Oil Burner Which Users Say BEATS ANY FOR LOW COST, PERFECT PERFORMANCE, Burns Cheap Oil a NEW WAY Without Pre-generating or Clogging Up, Cuts Fuel Bills and Pays for Itself Quickly by What It Saves. READ BELOW HOW YOU CAN TEST THIS REMARKABLE SUPER FLAME OIL BURNER in Your Own Home FREE OF RISK. Then Mail Coupon.

COOK and HEAT for LESS

Why burn coal or wood with its dirt and drudgery of building and feeding fires? Why carry ashes and get uneven, slow-starting heat? Burn cheap oil a NEW WAY and get TWICE THE HEAT at LESS COST—and have QUICK HEAT regulated by a simple turn of a valve. Positively guaranteed NOT TO CLOG, NOT TO CARBON OR STOP UP. Has a record of over 11 years constant use without ever needing any cleaning. Simple—safe—economical—no electrical connections—no moving parts to wear out—does better work at less cost. Burns 95% air and 5% cheap oil—TWICE THE HEAT OF COAL by simply turning valve.



AGENTS SALEMEN BIG MONEY

No wonder salesmen and distributors are breaking records in sales. They show how it gives QUICK HEAT, HOTTER, CHEAPER, WITHOUT DIRT AND ASHES, and how IT SAVES—then, reap BIG CASH PROFITS.

SALEMEN SAY:

Installed one when 10 degrees below zero. Kept house well heated. I can dispose of 250.—F. Silver—Canada.

I am a plumber, but never knew such a thing to get that much heat out of oil. There is money in selling them.—W. C. Nicholson—Ind.

Get YOUR OWN OIL BURNER SAMPLE AT NO COST and CASH IN BIG. Be FIRST in your locality—MAIL COUPON or 1c postcard today—NOW.

Engineer of National Reputation Says: Combustion principles are simple, efficient, excellent—assures economical oil consumption and maximum heat. Tests made on burner with one year's hard service prove no evidence of dirt or residue or any carbon on interior parts. No nozzles or tips to "coke up" or stop up.—C. W. Lovelace—K. C., Mo.

USERS SAY: Fifteen oil burners of different kinds here but Heat King is cheapest, best.—J. R. Goldthorp—Washington.

I get more heat from your burner than I ever had from coal or anything burned in my furnace.—W. C. Nicholson—Ind.

Reduced coal bill fifty percent.—W. S. Collins—Pa.

SENT ON TRIAL

SENT ON TRIAL for 30 days. If you want to SAVE MONEY in cooking and heating you may try the "HEAT KING" AT OUR RISK—prove that it ends drudgery and dirt of coal or wood, cuts fuel bills, pays for itself quickly by what it SAVES. You must be satisfied under our liberal guarantee or YOU PAY ABSOLUTELY NOTHING FOR THE BURNER.

FREE SAMPLE to Agents

and salesmen offered to one in each locality who will demonstrate and take orders. Send no money—just sign and mail coupon (or 1c postcard will do)—be first in your locality to learn how satisfactory oil heat can really be and how you can MAKE REAL MONEY spare or full time. Mail Coupon or 1c postcard today—NOW.

UNITED FACTORIES

B-751 Factory Bldg. KANSAS CITY, MO.

MAIL COUPON		UNITED FACTORIES	
Without cost or obligation rush generous TRIAL OFFER on wonderful "HEAT KING" Oil Burner sent WITHOUT RISK TO ME.		B-751 Factory Bldg., Kansas City, Mo.	
Name.....	Address.....	City.....	State.....
		<input type="checkbox"/> CHECK HERE if interested in NO COST SAMPLE and money-making offer.	

(Continued from page 141A)

and the roads were atrocious. One car hit some bales of hay at a turn and scattered them over the course. We plugged along in the heat and dust as long as I could stand it. We had worked all the night before and we were dog-tired.

Finally I said to Glenn, "Come on, let's quit and get under the car where it's shady." So we pulled off and crawled under and stayed until we cooled off. Louis Chevrolet won. He didn't stop to get cool.

All this old-time stuff probably doesn't add up to much to the young fellow who wants to break into racing today. But it should because, after all, the racing game hasn't changed much in the past thirty years. Cars have changed but it still takes the same qualities to make a driver which were required three decades ago. First of all, it takes a real love of racing. It also takes courage and an ability to act first and think afterward. And last of all, it takes a sense of humor.

es 12 79

Handy Remover for Jar Tops



Designed to facilitate the removal of all kinds of jar tops, including screw, pry-up and friction-top caps from jars, bottles and jelly glasses, a handy tool for the kitchen is available. The remover may be attached easily to the kitchen wall.

Jim Luff Co
3037 Carroll Ave.

John made \$42⁵⁰ in one day in his NEW Business



● Get into this business NOW—a business which is so new that it is practically without competition. This alone should enable you to

make really BIG MONEY. Hotels, homes, clubs, country estates offer tremendous possibilities. Our new DETERGER washes upholstered furniture, tapestries, all sorts of fabrics, electrically right in your customer's home, with a new soapless soap whipped into DRY suds. No liquid touches the fabric, therefore the furniture is ready for use soon after cleaning. We have helped hundreds of men get into business for themselves with our automatic equipment. The U. S. Government and many of the world's largest hotels use our machines.

Make Money the FIRST DAY

You are ready to go to work the minute you get the outfit, so you ought to be taking in big profits the first day. We want an honest, ambitious man in every locality. If you are that man we will help you get started for yourself in a business with tremendous possibilities.

No Rent to Pay You don't have to rent a shop. You don't have to hire a building, for you do the work right in your customer's home. You save the expense of carting furniture back and forth to a central plant; the owner's home is your workshop.

J. S. Corson says

"I cleaned seven living room sets and fourteen chairs, as well as twenty-five automobile interiors the very first month and made \$279.50." Berger Hanson wrote "My investment in your DETERGER was the wisest I have ever made. It is my most valued asset." Barrett says: "Made \$28.00 in eight hours, on another job made \$11.00 in two and one-half hours." Alex Gulkin's business expanded so fast that he already has six DETERGERS making money for him.



No liquid touches the fabric when cleaning with the DETERGER.

Pay as you Earn

Only a limited amount of money is needed for a down payment. The balance you send on easy terms. Most men find it possible to make far more than the cost of the machine before the payments come due. Every machine is fully GUARANTEED and satisfied customers send their friends to you.

Book sent FREE

Write today for copy of our booklet "Get Into Business For Yourself." Let us tell you how easy it is to get started in a year around business where you are your own Boss and can stop worrying about just a job. Write today—NOW.

VON SCHRADER MFG. CO. 552 Pl., Racine, Wis.

VON SCHRADER MFG. CO. 552 Pl., Racine, Wis.

Send me (without obligation) your free booklet telling me how I can own my own business and become financially independent and how I can pay for the DETERGER on easy terms.

Name.....
Address.....
City..... State.....

TYPEWRITER 1/2 Price

Easy Terms Only 10c a Day

Save over 1/2 Mfg.'s Original Price on all standard up-to-date office models.

SEND NO MONEY

Sensational saving on all late models completely refinished like new. FULLY GUARANTEED. Big Free Catalog shows all makes in full colors. Send post-card for lowest prices.

SPECIAL PORTABLE BARGAINS—

Brand New FEATHERWEIGHT—Latest Model Portable—up-to-date streamline features—now offered at amazing low price. Fully Guaranteed—10 day trial—only 10c a day. Full details sent free!

Free course in typing included.

International Typewriter Exch., 231 W. Monroe St. Dept. 201, Chicago



Sani-Flush

SAFE, NOT CAUSTIC

KEEPS AUTOMOBILE RADIATORS CLEAN

DEFIES WEATHER ROT. TERMITES. MOLD.

The Successor to Plywood Ordinary plywood is inadequate for any use where insects, rot, heat and moisture can attack and separate the plies. The new successor is proof against these destructive forces.



SUPER-Harbord

is hot-pressed with a resinoid bond insoluble in water; and is unconditionally guaranteed against ply separation—works easily; does not dull tools unusually; large panels save construction time; long life saves need for replacement; finishes beautifully. Buy from your lumber dealer.

NOW:

PLANS for Making Dog houses, boats, furniture, cupboards, play houses, wheelbarrows, signs, etc.

10c Each To Cover Handling Cost

WEATHER PROOF

MAIL THIS COUPON TODAY

Harbor Plywood Corp., Port Dock Hoquiam, Wash. Gentlemen: Please tell me how Super-Harbord will give me better and cheaper outdoor construction.

NAME.....
ADDRESS.....
LUMBER DEALER.....

When writing please mention Popular Mechanics

EARN MONEY Make Wind Electric Plants

WE SHOW YOU HOW! Simplified plans make old auto generator light buildings, play radio, operate washing machine and other motors. Sell friends and neighbors. Dime brings complete plans, and valuable parts catalogue.

LEJAY MFG CO., 447 LeJay Bldg., Minneapolis, Minn.

OTTAWA LOG SAW



GREATEST OFFER EVER MADE

only \$39

PUTS THIS OTTAWA TO WORK FOR YOU

Make Money! Wood is valuable. Saw 15 to 20 cords a day. Does more than 10 men. Ottawa easily operated by man or boy. Falls trees—saws limbs. Use 4-hp. engine for other work. Write today for FREE book.

OTTAWA MFG. CO., 227 Wood St., Ottawa, Kansas

do 1197
New Billion-Dollar Crop

(Continued from page 239)

was cut and allowed to lie in the fields for weeks until it "retted" enough so the fibers could be pulled off by hand. Retting is simply rotting as a result of dew, rain and bacterial action. Machines were developed to separate the fibers mechanically after retting was complete, but the cost was high, the loss of fiber great, and the quality of fiber comparatively low. With the new machine, known as a decorticator, hemp is cut with a slightly modified grain binder. It is delivered to the machine where an automatic chain conveyor feeds it to the breaking arms at the rate of two or three tons per hour. The hurds are broken into fine pieces which drop into the hopper, from where they are delivered by blower to a baler or to truck or freight car for loose shipment. The fiber comes from the other end of the machine, ready for baling.

From this point on almost anything can happen. The raw fiber can be used to produce strong twine or rope, woven into burlap, used for carpet warp or linoleum backing or it may be bleached and refined, with resinous by-products of high commercial value. It can, in fact, be used to replace the foreign fibers which now flood our markets.

Thousands of tons of hemp hurds are used every year by one large powder company for the manufacture of dynamite and TNT. A large paper company, which has been paying more than a million dollars a year in duties on foreign-made cigarette papers, now is manufacturing these papers from American hemp grown in Minnesota. A new factory in Illinois is producing fine bond papers from hemp. The natural materials in hemp make it an economical source of pulp for any grade of paper manufactured, and the high percentage of alpha cellulose promises an unlimited supply of raw material for the thousands of cellulose products our chemists have developed.

It is generally believed that all linen is produced from flax. Actually, the majority comes from hemp—authorities estimate that more than half of our imported linen fabrics are manufactured from hemp fiber. Another misconception is that burlap is made from hemp. Actually, its source is usually jute, and practically all of the burlap we use is woven by laborers in India

THE New DURO

HEAVY DUTY
Portable
FLEXIBLE SHAFT
Built to Excel
IN PERFORMANCE
CONVENIENCE
LONG LIFE



- Ball Bearing Swivel Head and Ball Bearing Casters.
- General Electric 1/3 H.P. Ball Bearing Motor.
- Heavy Duty Ball Bearing Flexible Shaft.

Ideal unit for body polishing, grinding, drilling, buffing, car-bon removing and many other operations around the garage or workshop. Speed range 690 to 4000 RPM.

3075—Complete Unit as pictured **\$43.95**
 3074—Stand only, less motor and shaft **14.75**
 Send for complete woodworking tool catalog.

DURO METAL PRODUCTS CO.
 2657 NORTH KILDARE AVE. CHICAGO, ILLINOIS
 280 BROADWAY NEW YORK

Learn to Re-seat Your Chairs



Have you a chair, stool or bench that you would like to re-seat? We will teach you how to do it. Use either Cane, Rush, Reed, Splints, Fibre Rush, Cane Webbing or Grass. **Instruction Book Only 10c**

Send 10c today for our illustrated Instruction Book and price list explaining how to do Seat Weaving.

The H. H. Perkins Co., 252 Shelton Av., New Haven, Conn.

Print Your Own

Cards, stationery, circulars, tags, labels, advertising, etc. Save money. **Print for Others; Big Profits;** easy rules sent. Will do popular Raised Printing like Engraving. Junior outfit \$2.85. Senior outfit \$12 and up. Send for free catalog and all details.

THE KELSEY COMPANY, E-37, MERIDEN, CONN.

Thompson BEATS the World on BOATS



Better Built Lower Prices

- Canoes \$64 and up
- Rowboats \$42 and up
- Outboards \$42 and up
- Very fast utility model

Only Boats With Full Length Spray Rails
 Keep passengers perfectly dry—even at high speeds. Catalog also shows today's five most popular models of sailboats. Two big factories. Prompt shipment.

CATALOG FREE
 Write for your copy. State kind of boat in which you are interested.

THOMPSON BROS. BOAT MFG. CO. (87)
 213 Ann St. PESHTIGO, Wis. (Write to either place)
 113 Elm St., CORTLAND, N. Y.

who receive only four cents a day. Binder twine is usually made from sisal which comes from Yucatan and East Africa.

All of these products, now imported, can be produced from home-grown hemp. Fish nets, bow strings, canvas, strong rope, overalls, damask tablecloths, fine linen garments, towels, bed linen and thousands of other everyday items can be grown on American farms. Our imports of foreign fabrics and fibers average about \$200,000,000 per year; in raw fibers alone we imported over \$50,000,000 in the first six months of 1937. All of this income can be made available for Americans.

The paper industry offers even greater possibilities. As an industry it amounts to over \$1,000,000,000 a year, and of that eighty per cent is imported. But hemp will produce every grade of paper, and government figures estimate that 10,000 acres devoted to hemp will produce as much paper as 40,000 acres of average pulp land.

One obstacle in the onward march of hemp is the reluctance of farmers to try new crops. The problem is complicated by the need for proper equipment a reasonable distance from the farm. The machine cannot be operated profitably unless there is enough acreage within driving range and farmers cannot find a profitable market unless there is machinery to handle the crop. Another obstacle is that the blossom of the female hemp plant contains marijuana, a narcotic, and it is impossible to grow hemp without producing the blossom. Federal regulations now being drawn up require registration of hemp growers, and tentative proposals for preventing narcotic production are rather stringent.

However, the connection of hemp as a crop and marijuana seems to be exaggerated. The drug is usually produced from wild hemp or locoweed which can be found on vacant lots and along railroad tracks in every state. If federal regulations can be drawn to protect the public without preventing the legitimate culture of hemp, this new crop can add immeasurably to American agriculture and industry.

☐ Popular Mechanics Magazine can furnish the name and address of the maker of, or dealer in, any article described in its pages. If you wish this information, write to the Bureau of Information, inclosing a stamped, self-addressed envelope.

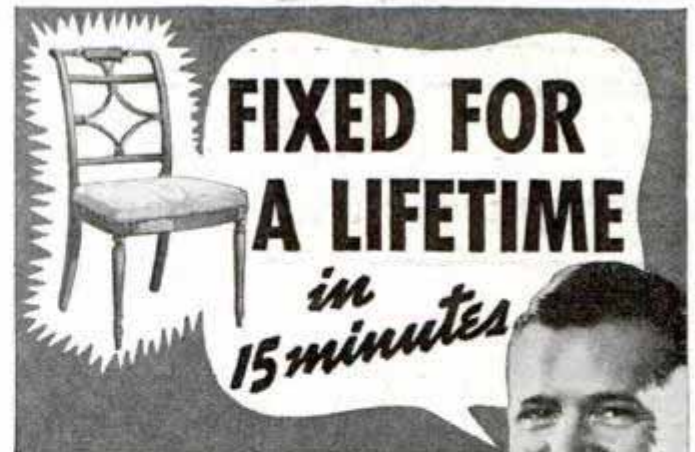

Now you can make home repairs with **CASCO**, the same glue used by **Master Woodworkers**

● No more gluing failures! Now permanently fix broken furniture, loose linoleum, toys, luggage, anything that needs gluing...and get the same weatherproof **CASCO** joints that leading manufacturers use in building custom furniture, pianos, airplanes.

EASY TO USE. Just mix one part **CASCO** powder in one part water, and it's ready to apply. No mess. No heating. And no waste...you mix it as you need it.

PERMANENT. **CASCO** sets chemically like concrete. It's not loosened by atmospheric heat and moisture like ordinary evaporation-setting glues.

ECONOMICAL. **CASCO** plus cold water makes a full-strength glue at less cost than ordinary liquid glues. More than a glue, **CASCO** has many household uses. (Send for the free book offered below.)

AMAZING EVIDENCE of CASCO'S Moistureproof Strength:

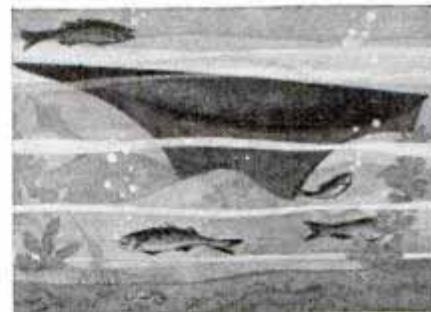

"**LOST 11 YEARS UNDER WATER**, the 84-inch hull of the model yacht 'Witch' was recovered, washed, and found to be in excellent condition. The **CASCO**-glued construction was strong as ever..." (John Black, Watertown, Mass.)

FREE! NEW 1938 CASCO GLUING GUIDE!

32 pages, 40 pictures, the book that saves dollars in repair bills:

How to repair—

Furniture
Musical Instruments
Sports Equipment
Automobile Tops
Airplanes
Giders
Trailers
Boats
Luggage
Books

How to make—

Sizing
Water-Resistant Paint
Tile Cement
Crack Filler
Swedish Putty

New ways for—

Erecting Fibreboard
Veneering
Flush Door Construction

Send for your copy now. Just write your name and address and the words "Gluing Guide" on the back of a penny postcard, and mail to—

CASEIN COMPANY OF AMERICA, INC.
Dept. P. M. 238, 350 Madison Ave., New York



CASCO

**WEATHERPROOF
POWDERED CASEIN GLUE**

4 Handy Sizes—10c to 65c—At Your Hardware Dealer's

NOW, MRS. MOUSE, FIND ANOTHER HOME... P.W. IS FILLING THIS CRACK!



MAKES HOME REPAIRS EASY

With Plastic Wood—the discovery that handles easy as putty and quickly hardens into wood—it's easy to do an expert repair job on broken chairs, loose casters, holes in floors, nicks, floor cracks, loose drawer pulls, etc. You can paint it, carve it—holds nails, screws. At paint hardware, 10¢ stores, in 10¢ and 25¢ tubes, 35¢ cans.



PLASTIC WOOD



HERE'S THE MASTER FIXER

Quickly, permanently joins and repairs china, glass, wood, celluloid, etc. Transparent—or Metal color. Get it at paint, hardware or 10¢ stores.

Old English CEMENT

ACE
LATHE TOOL SET
\$14.50



Be permanently tooled-up for every operation on your Metal Cutting Lathe

The ACE Set is complete—there's nothing more to buy. Drop forged by the manufacturers of cutting tools used by 96 per cent of the plants and shops in industry they are correctly designed, are of special steel, are finely finished, are stronger—will last a lifetime. You can cut easier, faster and more accurately with ACE TOOLS.

At your Hardware Store—Circular FREE

ARMSTRONG BROS. TOOL CO.
"The Tool Holder People"

368 N. Francisco Ave., CHICAGO, U.S.A.

3 Turning Tools, 2 Cutting Tools, Knurling Tool, Boring Tool, Threading Tool, High Speed Steel Cutters and Blades, and 2 Wrenches in Filled Steel Case.

15183

Short Waves Rule the Seas

(Continued from page 205)

another ship 100 miles to the north for its local weather conditions. During the four hours he has talked to as many as a dozen or more Radio Corporation, Mackay Radio, and Tropical Radio land stations, and possibly several naval stations and Latin American stations as well. Whenever possible he stands by on 600 meters to pick up any CQ messages. These may be hydrographic reports of menaces to navigation ranging from icebergs in the North Atlantic to floating logs off Guatemala, or calls for medical assistance.

"CQ MEDICO—" calls take precedence over everything except distress messages

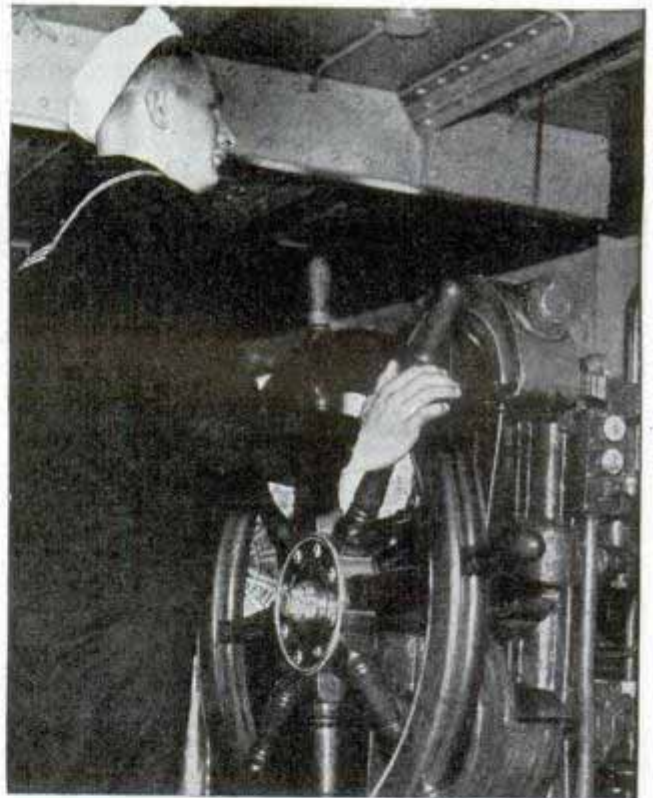

Using hand wheel, instead of electric wheel, in taking ship in and out of port

and are handled free of charge. When some near-by ship or fishing vessel without a doctor calls the "Santa Paula," describing the condition of a sick crew member, Dr. Roscoe H. Philbrick of the ship diagnoses the ailment and writes out a treatment, which is then radioed back to the vessel. If the symptoms seem extreme, as was the case when a fisherman received several broken bones and poisonous stings in a battle with a giant sting ray, the ship changes its course to meet the other boat

(Continued to page 148A)

DO YOU KNOW—

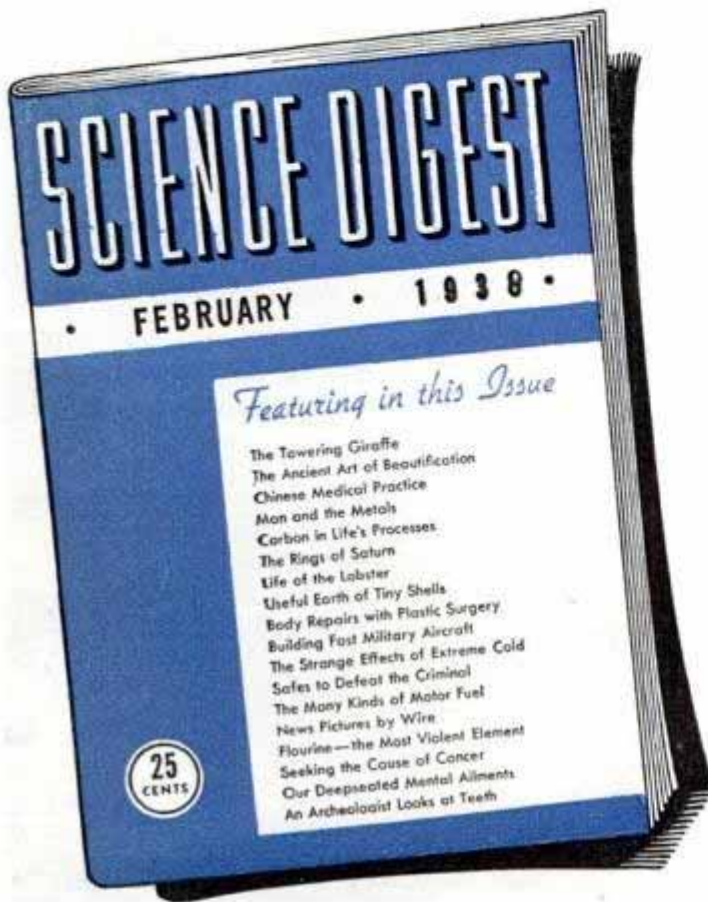

how pictures are transmitted by telephone

that you may have symptoms of a disease without the disease

how alloys add to the life of your car

what you would weigh on Saturn

how plants purify the atmosphere

that Greek gentlemen preferred blonds

how to combat dust explosions

what animal is voiceless

that anesthesia was used in the third century B. C.

that the lobster sheds his shell

why, in a combat plane, the comfort of the pilot is important

Answers to these and hundreds of other questions are in the February issue of Science Digest — on newsstands today.

YOU can have right at your fingertips an interesting monthly report of the progress of science in all its branches. For busy men and women, in the professions or business, Science Digest presents pertinent news of scientific progress, in all parts of the world, in concise, clear, easy-to-read form. Each month hundreds of scientific publications are studied for the time-saving digest that is given to you in ninety-six pages for only twenty-five cents. Buy the February issue at a newsstand today—or mail this coupon for a year's subscription.

SCIENCE DIGEST, INC.

631-643 St. Clair Street, Chicago, Ill.

Gentlemen: Please send me Science Digest for one year beginning with the February 1938 issue.

I enclose \$2.50 Please bill me
Outside United States and Possessions, Canada, Newfoundland, Labrador, and countries of the Pan-American Postal Union, including Spain, please add 50 cents to cover overseas postage

Name.....

Street.....

City..... State.....



A YEAR'S FUN 10¢. BUYS IT!

Open the door to a fascinating hobby with the Stanley Plan Book. If you have a workshop, you'll enjoy making the articles listed — if you haven't, you'll want to. Plans are complete with full directions, measurements and list of tools required. Fully illustrated and simple to follow. Send 10c in coin or stamps.

TOOL GUIDE "TELLS ALL"

All that you want to know about the use and care of tools — much of it new — is in this Guide. Your tools will last longer and work easier. 25¢ sent to-day may save dollars to-morrow.



STANLEY TOOLS

107 Elm Street, New Britain, Conn.

TRAILER PARTS AND EQUIPMENT
for building any type of trailer.

WRITE FOR FREE LITERATURE.
HAMMER BLOW TOOL COMPANY, Dept. 102

WAUSAU,

WIS.

"Handy" HAND PUMPS

for shop, garage or home — pump oils, gas, paints, etc., from drums and barrels. Easy turning — no priming — capacities up to 20 gallons per minute . . . LOW PRICED. FREE BULLETIN shows 14 Different Models by a nationally known builder of rotary pumps.



BLACKMER PUMP CO. 1801 CENTURY AVE. GRAND RAPIDS, MICH.

120 MILES PER Gallon of Gas! World's Greatest Economy in Transportation!

30 mi. per hour in comfort! Expertly engineered all through! Be first in your community with this modern sensible transportation! Ideal for parcel delivery. Write for booklet and name of dealer!



Dealers!

There's a world of profit in Moto-Scoot. Write for facts!

\$89.00
F.O.B. Chicago

Moto Scoot

219 S. WESTERN AVE., CHICAGO, ILL.

(Continued from page 146A)

in mid-ocean to pick up the patient and carry him to a hospital at the next port.

The "Santa Paula" once answered an emergency call from a school ship cruising off Guatemala and steamed 100 miles out of its way to rush aid. An epidemic of spinal meningitis had broken out on the school ship and a number of cadets and crew members were badly off. When the ships met, all of the serum on the "Santa Paula" and some extra hypodermic needles were lowered over the side and were picked up by a boat from the other ship.

The 600-meter band is also the wave length on which emergency weather reports are broadcast. Forecasting is not well

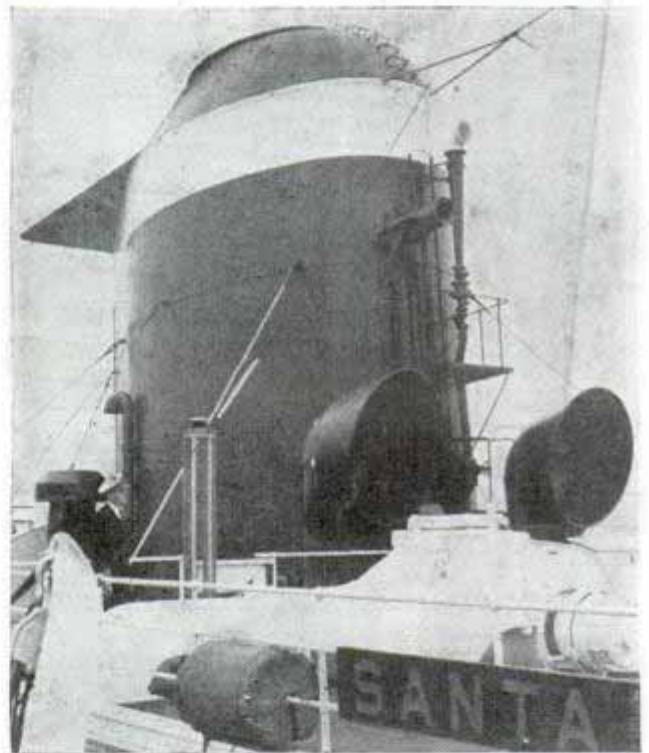

Streamline funnel and anti-smoke hood on the steamship "Santa Paula"

organized in some parts of the world and often storms arise so suddenly that advance indications are short. Then an emergency report is tapped out so that other ships can change course to stay clear of the storm area.

One of the weather sore spots is the big Gulf of Tehuantepec on the west coast of Mexico. In this region hurricanes of extreme severity are apt to blow up with hardly any notice. The storms last about twelve hours and cover comparatively small areas but their intensity is as bad as the larger hurricanes of the Caribbean.

(Continued to page 150A)



FOG-RAY

For SAFE DRIVING In FOG, RAIN, SLEET, SNOW

FOG-RAY is a waterproof, quick-drying, non-inflammable liquid—easily applied—which converts regular headlights and spotlights into brilliant, penetrating fog lights, enabling you to drive safely through fog, rain, sleet or snow. FOG-RAY gives same results as the most expensive auxiliary fog lights, saves extra drain on the battery, adds to appearance of car. Easily removed when emergency is over. Endorsed and used by fleet owners, trucking and taxi companies. Complete set for applying and removing—enough for many applications—retails for \$1.50, on money back guarantee.

AGENTS: FOG-RAY sells on demonstration. Every motorist is a prospect. Write today for territory, sending \$1.00 for complete demonstration set. Your money back if FOG-RAY does not do everything we say it will.

FOG-RAY Co. 1337 Merchants Bank Bldg., Indianapolis, Ind.

MANUFACTURING OPPORTUNITIES

18 SIZES

IN BUILDING INDUSTRY—with machine and process producing permanent construction with savings of 1/3 labor, 1/2 mortar, and 1/3 material costs—ashlar, hollow, veneer or solid walls—plain or 40 colors.

WE EQUIP YOU with Automatic Machinery—large production only one or two men. Equipment costs but fraction of other processes with equal capacity.

INVESTIGATE—let us show you why building today offers you the greatest opportunity for growth, expansion and profit in a business of your own, using raw materials available in your territory. Write today.

W. E. DUNN MFG. CO.
600 West 24th St. Holland, Michigan

MONEY!

If you know clothes and have real sales ability, here's your opportunity. Take orders for nationally-advertised custom-tailored clothes. Valuable franchise with well-known house. Write at once.

P. H. DAVIS TAILORS Dept. J Cincinnati, Ohio

ExtraMoney From Books

SEND NO MONEY • Books Sent C.O.D. Anywhere in U. S.

These famous Pay-Raising, Extra Money Books have helped thousands of others. Let them help you too. Check this list and mail with your name and address. Pay postman on delivery plus few cents postage. Send 3c stamp to cover postage and ask for catalog of other books.

SELECT FROM THIS LIST



HIGH-SPEED DIESELS
New, practical, non-technical. . . . \$2.50
1500 Needed. . . . \$2.50

LEATHER MAKING and Home Tanning. . . \$1.00

MACHINE SHOP WORK
Tools and Methods. . . \$2.50

MAGICIAN'S MANUAL
New, 100 Tricks for Amateurs. . . . \$1.39

METAL SPINNING
Practical New Book. . . \$1.00

MONEY MAKING FORMULAS
10,000 Practical. . . . \$4.00

MOTOR VEHICLE
Trouble Shooters' Handbook. . . . \$2.00

PLASTERING
Best Instruction Manual. . . . \$1.25

RADIO PHYSICS COURSE
New edition. Everything about Radio. . . \$4.00

SHEET METAL
Construction Work. . . \$2.00

STEAM ENGINEER'S LICENSE
How to Obtain. . . . \$2.00

STEEL SQUARE
Hodgson. 500 pp. 300 illustrations. . . \$2.00

TAXIDERMY, HOME
Mount Trophies Profit, Pleasure. . . \$1.50

WROUGHT IRON WORK
Practical. . . . \$1.35

ARMATURE WINDING
For A.C. and D.C. Machines. . . . \$2.00

AUTO REFINISHING
Duoco With Spray Gun. \$1.50

BLUEPRINT READING
For Machine Trades. . . \$1.50

BRICKLAYING
Plain and Fancy. . . . \$1.50

CARBURETORS (All Makes)
New, Revised Edition. . \$2.50

CHEVROLET SIX
Car, Truck, Operation Repair. . . . \$2.50

COLONIAL FURNITURE
Making, 95 Pieces. . . . \$3.50

DANCE
Learn at Home Without Music or a Partner. . . \$2.00

DIE CASTING
Machines, Dies, Alloys. \$3.00

ELEMENTS DIESEL
Engineering Questions and Answers. . . . \$4.00

FOUNDRY WORK
Molding, Casting, etc. \$2.00

FURNITURE REPAIRING
Finishing and Decoration. . . . \$3.00

HEATING, VENTILATING
Homes and Buildings. . \$2.50

POPULAR MECHANICS PRESS
Room 238A 200 E. Ontario St., Chicago

Treet Topics

WHEN SHE SAYS



AND YOU SAY



AND YOUR BANK ROLL SAYS



SAY



-AND TREET YOURSELF TO A PACK OF PERFECT SHAVES!



4 FOR 10¢

Single-Edge BLADES

FOR GEM AND EVER-READY RAZORS

Treet Safety Razor Corporation, Newark, New Jersey
When writing please mention Popular Mechanics

MODERN HOMES

at mill prices



The MAYFAIR—6 Rooms and Bath (Materials) **\$1396**

Save
\$300
AND UP

Buy Direct from Mill and Save—You buy from our 5 great mills at lowest wholesale prices. One order buys your home complete. No extras! Over 270,000 people live in Gordon-Van Tine Homes. Many save \$300 and up!

Famous Ready-Cut System—Saves you 30% in labor. 18% on lumber waste and gives you stronger, better built home. Brings the savings of modern production methods to home building.

Finest Guaranteed Materials—Complete iron-clad specifications assure you of guaranteed lumber, millwork, hardware, paint, tinwork, plumbing and heating. Best materials and strongest construction save repair costs year after year. Satisfaction Guaranteed or Money Back.

Attractive Modern Features—Skillfully arranged floor plans, sunlight kitchens planned to save time and steps, cheerful dinettes, modern bathrooms and many other features mean more comfort and less work for the housewife.

Building Material Catalog—Get free book of 5,000 Building Material bargains. Doors, windows, paint, hardware, built-in fixtures, lumber—everything for fix-up work—at amazing money-saving prices.

FREE BOOK of HOME PLANS

Contains modern home plans, specifications, valuable home building information. Send for it today!



Gordon-Van Tine Co.

World's Largest Specialists in Home Building Since 1865
1798 Case Street, Davenport, Iowa

Check free books wanted: Homes, Farm Buildings, Building Material Catalog.

Name.....

Address.....

HANDY TAP and DIES . . .
Accurate—carefully hardened and tempered. Complete range of sizes at your local five and ten cent store.
HENRY L. HANSON, WORCESTER, MASS.

Stoves AT FACTORY PRICES!



Sale Catalog — FREE

Nearly 200 Styles and Sizes of Stoves, Ranges, Furnaces at Factory Prices. Easy Terms—as little as **12c a day**. 30 Days Trial. 24 Hour Shipments. Write today for this FREE CATALOG. Over 1,200,000 Satisfied Users. 38 Years in Business.

KALAMAZOO STOVE & FURNACE CO.
391 Rochester Ave.
Kalamazoo, Michigan

FREE CATALOG **A Kalamazoo** Trade Mark **Direct to You**

(Continued from page 148A)

Hatch went through one of them a few years ago while serving on another ship. At three o'clock in the morning, in good weather, he picked up an emergency CQ weather report from a ship fifty miles away, telling of a 120-mile-an-hour wind and enormous seas. There was no time to steam away from the path of the storm and a few hours later it struck. For hours the ship, at reduced speed, was held pointed at an angle into the waves. This gave the ship an unpleasant corkscrew motion but put it on a safe course. Two other passenger vessels, a freighter and an oil tanker were caught in the same blow and on some of the ships hatches were stove in, parts of the bridges smashed, and passengers hurt.

Another thing the radio operators do is copy the daily press reports from WSC in New Jersey, taking the news down on stencil on a wide typewriter so that the stencils can be used directly for printing the "Spanish American" that is published daily on board the ship, giving a digest of the world's news as well as the latest stock market reports. One passenger, at a cost of fifty dollars in radio tolls, cleared a \$15,000 profit in stock operations during his trip.

A red signal light in the radio room warns the operator when a watch officer on the bridge wants to use the direction finder to take bearings on some radio-equipped lighthouse. By throwing an overhead switch the operator puts his transmitter out of commission and closes the circuit that operates the direction finder. Then the deck officer takes his bearings directly. He swings the wheel of the loop around until he hears minimum signals in the phones, and reads off the direction from which they are coming on a compass set under the loop. When the captain wants to learn his exact position by having radio compass stations on shore tune in on the ship, the operator requests the assistance on 800 meters and then sends long strings of dashes with his key for half a minute or so. Compass stations along the coast, grouped in twos or threes, tune in on him, get his bearings with their loops, transmit the bearings to the master compass station, and the master station tells the ship its latitude and longitude.

For the safety of souls at sea every effort is being made to make radio foolproof.

251183
One of the latest developments is the "auto-alarm" that is installed on ships having only one operator and that automatically sounds an alarm whenever a distress message comes in on the receiving set. The auto-alarm has brought about a change in the conventional "SOS" distress signal. Today such a signal is preceded by a sequence of long dashes, twelve of them being transmitted in a minute's time. It is this signal that sets off the automatic alarm. If a ship in distress sends the dashes and then the emergency call, and no one close by responds, a shore station with a more powerful transmitter taps out the dashes with full power to "wake up" the alarm on any ship that might be near by and did not respond on the first call.

There is practically no chance of a ship's radio equipment failing these days. Aside from the emergency sets and the several kinds of emergency power, the motor lifeboat carries a small transmitter and receiver that has a range of several hundred miles. A large list of spare parts, including at least one spare tube of every type used, insulators, wire, and tools, is carried on every ship. At some port of call on each trip government inspectors thoroughly test every part of the radio equipment. Finally, the radio operators themselves test and operate each part of the emergency equipment during the weekly lifeboat drills.

251349
"Funnel" Coupler for Trailers Guides Post into Its Socket



Hitching trailer to car is easy with a funnel-shaped coupling arrangement just developed. As soon as the hitching post on the trailer encounters any part of the "V" opening

on the back of the automobile, it is automatically guided directly to the locking mechanism. You can back the car up to the trailer and lock it without help.

Send return postage to our Bureau of Information to learn the name of the maker of any device described in this magazine.

251-376
MAKE MORE MONEY

GET AHEAD FASTER!



"Take advantage of this free offer. Send the coupon right now. I got a big raise—just while trying out a Royal. I sent my ideas in to the boss—typed."

START NOW!



Own a ROYAL PORTABLE ON YOUR OWN TERMS!

You've ideas—ideas that are worth real money to you. Don't waste them . . . Present them *right* to the *right* people—worked out in your spare time—*typewritten*. Easy! Even if you've never thought of typing—if you own a *Royal Portable*! For Royals are scientifically designed for *everyone* to use. With full-sized standard keyboard and such genuine office typewriter features as Royal's famous Touch Control, Finger Comfort Keys, Complete Dust Protection and many others to make writing easier!

Only a Few Cents a Day

Get the facts! Try the Royal Portable in your own home *free*! And remember you can own a Royal on your own terms . . . cash, or only a few cents a day.

FREE! Carrying Case and Instant Typing Chart



Handsome triple-purpose convertible Carrying Case; also a free Instant Typing Chart. Latest invention—it shows you, at a glance, how to type *right*.

ROYAL TYPEWRITER COMPANY, Inc.
Dept. B-83, 2 Park Avenue, New York City, N. Y.

Please tell me how I can own—for only a few cents a day—a latest model, factory-new Royal Portable—complete with free Carrying Case and Instant Typing Chart.

Name _____
Street _____
City _____ State _____
I already own a _____ Typewriter,
Serial No. _____ Tell me how much you
will allow on it as CASH payment on a new Royal Portable.

Island Avenue
Spring & Body Co.
Annes, Moine, d'ava

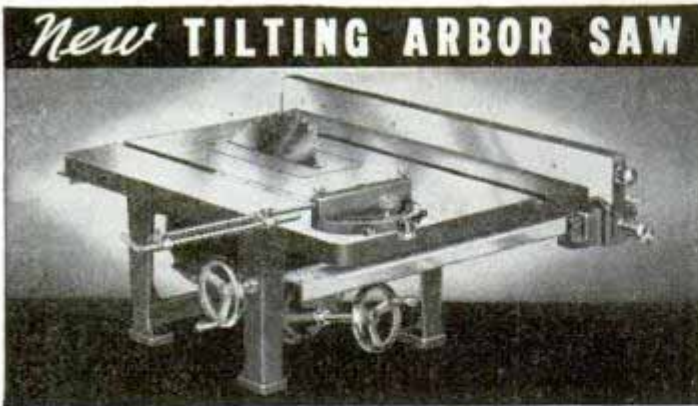

New TILTING ARBOR SAW

Strange as it may seem, the biggest and best "Tilting-Arbor" Saw actually costs you less. Boice-Crane's patented construction saves you plenty of money. A highly perfected, and exceedingly strong construction that makes for easier and better operation... and assures every user perfect performance for 10, 15 years or more. Has the most rapid and easiest tilting and lowering saw-arbor controls ever used. New large hand wheels with deluxe ROTATING HANDLES are easy on your hands... and they add new speed, new enjoyment to saw operation. Here is the REAL saw... and a stupendous value.

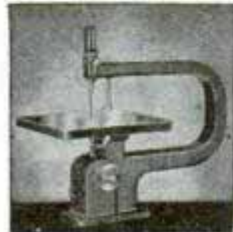

This brand new 1938 JIG SAW is a 5-DUTY machine. Does more work than expensive ones... and YOU SAVE thirty percent.

And here... the sensational Boice-Crane Shaper... a modern and complete floor model... so handsome... so completely thorough in every way... so far ahead of all others, that you should know all about it.



Write today for 1938 Boice-Crane Catalog. Sent post-paid. Include 10c for booklet "How to Do Metal-Spinning."

BOICE-CRANE COMPANY
Dept. PM-228 TOLEDO, OHIO

2400 DEGREES FAHRENHEIT!!
BRONZE FOUNDRY
for Schools and Home Workshops



Complete Foundry Outfits are available in three sizes and make it possible for you to produce beautiful bronze, silver or aluminum castings in your home workshop from scrap metal. Presents such as book ends, ash trays, dishes, paper weights, letter openers, bottle openers, statuary, etc., can be quickly made by the sand casting process. Existing objects can be used as patterns, and sand moulds made in a few minutes' time. Previous experience unnecessary. Domestic gas supply and 110 volt energy required for operation.

Size	Capacity	Wt.	Casting Complete	Price
351	6 cu.in.	25 lbs.	1 1/2 lbs.	\$13.50
352	12 cu.in.	40 lbs.	3 lbs.	19.00
353	24 cu.in.	65 lbs.	6 lbs.	27.50

Universal motor blower operates on either AC or DC. Prices f. o. b. K. C. Check or money order acceptable, express charges C. O. D. Write for circular.

KANSAS CITY SPECIALTIES CO.
P. O. Box 6022 Kansas City, Mo.



FREE! WHOLESALE CATALOG

Has: 15 selling plans; 30 money making ideas; 4000 world wide bargains; 260 pages of big values. Also shows top-notch prizes; business stimulators. All at rock bottom wholesale prices. Obtain this fascinating Book Of Opportunity, FREE. Write for it today, to

SPORS CO., 12-37 Main Le Center, Minn.

BUILD THE CUTTY SARK

2 ft. MODEL OF THE FAMOUS CLIPPER SHIP



Everything... including CARVED WOOD HULLS, Printed-Balsa Decks, Cast-Metal Life-boats, Anchors, Bits, Steering Wheel, Chains, Mast, Spars, Rigging, Cement, Colored Lacquer - Full-Size Plans and Instructions.

Send for Catalog of Ideal's new Models... 10¢ IDEAL AEROPLANE & SUPPLY COMPANY, INC. 26 West 19th Street, New York

Complete Kit makes perfect building easy. **2.50** plus 15¢ postage

PHOTO ENLARGER \$5.94

Money back guarantee

A REAL Photo Enlarger that does fine work. Focuses automatically. Also COPIES and has a Contact Printer and Retouching Table. Interesting circular free. Only \$5.94 complete, Lens included.

IDEAL-R, 122 East 25th St., New York

Ask for FREE Catalog

...ITALIAN... ACCORDIONS

Latest Models - Buy direct from factory representative at lowest WHOLESALE PRICES. Save One Half. Used musical instruments taken in trade. Write now, ITALIAN ACCORDION MFG. CO., 323 W. Polk St., Dept. M-1 Chicago

New Adding Machine Fits Vest Pocket!..

Adds, subtracts and multiplies up to one billion. Weighs only 4 ounces. Not a toy - strong guarantee. Absolutely accurate, very fast. Sells to offices, stores, homes - wherever figures are used. Write quick for FREE AGENTS sample offer and Money-Making Plan.

VE-PO-AD, Dept. 111, 303 W. Monroe St., Chicago

Costs only \$2.95

YOUR OWN MOVIES! 10¢ A DAY!

NATIONALLY ADVERTISED 8MM and 16MM Movie camera, projectors. For home, business, church, school, club. MONEY BACK 10 DAY TRIAL. Payments as low as 10¢ A DAY. Satisfied customers throughout the world. FREE details. WRITE TODAY. Dan Elder's Home Movies, Dept. A-2, 739 Baylston St., Boston, Mass.

Welding Business Earns \$150 to \$300 for You Each Month

"BUILD-YOUR-OWN"

Just couple your own engine to this unit, mount it on chassis and you have money making advantage of a portable welder at a saving of \$100 to \$500.

"Build-Your-Own" Unit

30 DAY'S TRIAL AT HOBART'S RISK AND EASY "PAYS FOR ITSELF" TERMS

New low prices make this profitable welding service available to everyone. Opens doors to big pay jobs that carry real profit. Hobart Welders are easier to operate, faster, guaranteed to bring you quality welding business... extra profits will pay for welder without expense to you.

NO INVESTMENT TERMS - PROFITS PAY FOR IT

Extra earnings and savings possible with Hobart Welders make it easy to own without expense. You can even rent a new Hobart and later purchase it without loss. Coupon brings details.

Free! VALUABLE BOOKLETS ON WELDING. CHECK YOURS AND MAIL THE COUPON TODAY.

How to "Build-Your-Own"

New Profits in Arc Welding

New Arc Welding Catalog

HOBART

Gas Engine Drive Electric Drive

THE FASTEST SELLING ARC WELDER ON THE MARKET TODAY

HOBART BROS., BOX M-28, TROY, OHIO

Gentlemen: Send me information on () Build Your Own Welder () Electric Drive Welder () 30 Days Trial, Easy Terms () Rental Plan. Also send me free books I've checked.

Name.....

Address.....

Game Wardens with Wings

(Continued from page 229)

up the opening. Next day they would come back and take out the entire beaver family, all dead from the anesthetic.

The beaver locations were many miles from the nearest game wardens' camp. In attempting foot patrol the resident warden had put in weeks of snowshoe tramping without avail. So the air warden took over the job. First Ned Hutchinson cruised above the beaver ponds until he had located the snowshoe trails of the poachers. Then he followed the trail until he caught the two poachers. He made a ski landing, arrested them, loaded them into his plane and flew them back to justice.

Commissioner Stobie believes that this one accomplishment suggests future pos-



Lieut. Earl Crabb and Supervisor George Faulkner on pontoon of plane

sibilities of backwoods and rural crime prevention and detection by aviation. Today the business of poaching in the big woods is far less safe than it was before game wardens sprouted wings.

So far as Maine is concerned, the plane warden is now a definite fixture. Conservation experts realize that the great breeding grounds of big game and native game fish would be damaged by opening modern roads into them. So the plane becomes necessary for patrol of Maine's big woods. Plane patrol includes numerous errands of mercy. Travel in the big woods by land or riverways involves considerable danger.

(Continued to page 154A)



NIGHT SHIFT!

● "I work the night shift week in and week out," says Paul Whiteman, King of Jazz. "My face has to be clean shaven. I can't take a chance on misfit blades or faulty shaving methods. So I always use a Gillette Blade in a Gillette Razor. This combination gives the closest, longest-lasting shaves money can buy!"

● Why make your face a proving ground for shaving experiments! Demand Gillette Blades. They're precision-made to fit your Gillette Razor accurately!

Try Gillette's new Brushless Shaving Cream, made with peanut oil. It speeds shaving, tones the skin. You'll like it! Big money-saving tube 25 cents.



I SAID
GILLETTE!

REMEMBER IT'S YOUR FACE

LESS
THAN IF A DAY
buys the world's
finest blades



PRECISION - MADE
FOR EACH OTHER

Gillette Blades

MORE SHAVING COMFORT FOR YOUR MONEY

PATENTED!

WE KNEW THESE NICHOLSON FILES WERE
Different . . . Exclusive

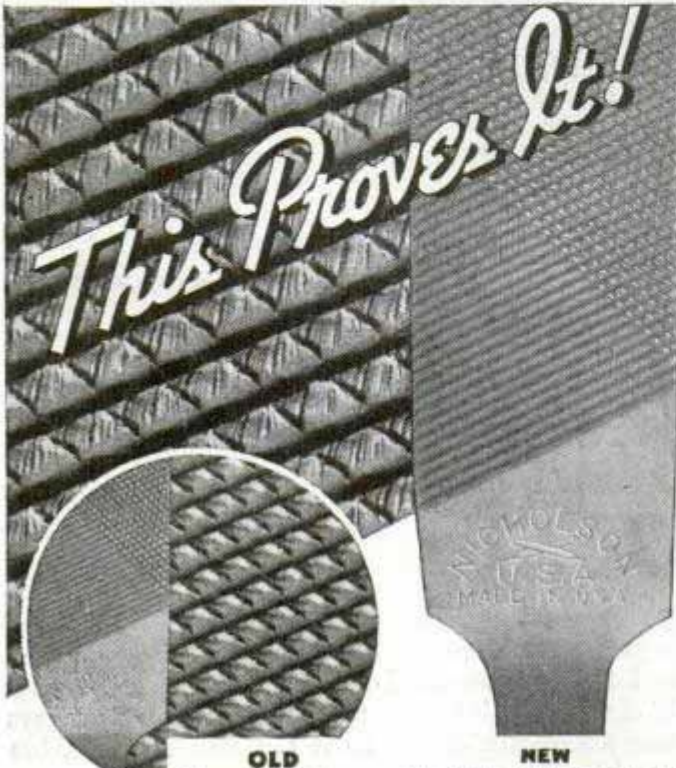

OLD
Close-up of the
old style tooth
construction.

NEW
Close-up of the new tooth
construction. Notice the
irregularity of the top edges
of the tooth points. That
is the patented principle
of controlled serrations.

The Patent means files that are really new and different. These files cut faster, cleaner, last longer and are easier to use. Files with up to three times as many cutting edges per square inch. The reserve cutting edges go to work as old ones wear down.

Nicholson Files with the new Patented tooth construction are on sale at your hardware store. Also, look for the new Nicholson No. 66 Display Unit—a popular assortment of files—each one wrapped in cellophane.

Step into the nearest hardware store and get acquainted with the new Nicholson Files. Nicholson File Company, Providence, R. I., U. S. A.



A FILE FOR EVERY PURPOSE

(Continued from page 153A)

Recently a boy who had traveled with a party by canoe far up a big woods river became stricken with appendicitis. One of his pals tramped through the woods to the nearest warden's post. The resident game warden telephoned to the pilot warden the approximate location of the sufferer. Pilot-warden Hutchinson took off from his home port near Augusta, arrived at the location within a few minutes, made a quick pontoon landing on a small pond, and in less than two hours after the distress call was entered, the sick boy was in a hospital.

Restocking back-country trout streams is another mission of the warden plane. Scattered through the big woods areas are hundreds of rivers and small lakes. These inland waters are actually the last haven for native game fishes. When once fished out, it has been impossible to successfully



Some of the wooded area, inaccessible by road, patrolled by means of planes

restock them. Hatchery-raised fish are extremely delicate and must be "planted" under ideal circumstances. Where roads are available hatchery fish are transported in special trucks.

In attempting to carry hatchery stock to the back-country lakes and streams, game wardens heretofore have made the transport by canoes, spending several days getting to the desired location. During this time the fish die or become too weakened to be of much good. Last summer Maine's warden plane took over this mission. Trout are placed in ten-gallon milk cans, loaded into the plane, whisked quickly to the desired location. The warden-pilot makes a pontoon landing and with the help of his assistants plants the fish in ideal condition.

Atlas Modern Engineering Technique for Modern Precision Equipment

The latest knowledge of skilled metallurgy, the latest discoveries of modern functional design, the savings of today's precision production methods—all have been combined here at Atlas to give you the finest in modern machine tools at sensible prices. Send for the new 1938 Catalog today. See the sensational small deluxe lathe, the amazing new bench shaper, and all the newest lathe and drill press attachments.

SEND FOR NEW 1938 CATALOG



NEW SMALL LATHE

Sensation of the season. Back-gearred, screw-cutting, 16 speeds. Timken bearings, V-belt drive. 12" and 18" between centers, 6" swing. \$59.50 and \$64.50.

DRILL PRESSES

Four sizes and prices to fit every need. New Atlas ball bearing spindle construction assures greater accuracy and longer life. \$17.75 to \$45.75.



NEW 7" BENCH SHAPER

All the precision and power of larger machines built down to scale, 4 speeds, 5 feeds. \$215 with guards.



Atlas 9" and 10" lathes are well known for their precision workmanship and versatile performance. Here's everything you want and need in a dependable bench lathe, with many extra exclusive features. \$59.50 to \$122.50.

ATLAS PRESS COMPANY

243 N. Pitcher St., Kalamazoo, Mich.

FACTORY DISPLAYS AT:

CHICAGO—35 E. Wacker at Wabash

NEW YORK—130 W. 42nd St.

PHILADELPHIA—113 N. 3rd St.



ATLAS PRESS CO., 243 N. Pitcher St., Kalamazoo, Mich.

Kindly send me your 1938 Catalog. I am interested in:

- New Small Lathe
- Metal Lathes
- Arbor Presses
- New Shaper
- Drill Presses
- Wood Lathes

Name.....

Address.....

City and State.....

LATHES · DRILL PRESSES · ARBOR PRESSES · SHAPERS

WHIZ ELECTRIC TOOL

DRILLS—GRINDS—POLISHES—SANDS
SHARPENS—SAWS—CARVES

A whole shopful of tools in one. Most useful power tool for home owners, hobby workers, mechanics, etc. Works on: Metals, Woods, Alloys, Plastics, Glass, Steel, etc. Powerful 110 volt, AC-DC motor. Full size chuck 3/4" capacity. Pistol grip with thumb switch. Uses 50 different accessories, instantly interchangeable. **FREE!** Accessory outfit includes set of drills, mounted 1 1/4" grinder, sanding discs, cutting wheels, mounted brush, etc. (Regular value \$2) **FREE** with each outfit ordered **NOW**. Everything sent postpaid for \$6.95 on 10 Day Money Back Trial.



ONLY \$6.95 POSTPAID

PARAMOUNT PRODUCTS CO., Dept. 2-A, 245 Broadway, New York



GET THIS HANDY METAL PUNCH!

For punching holes up to 3/4" in metal up to 16 gauge thickness. Forged steel handles. Clean-cutting. Will punch in center of 3" disc. Height of gap 3/4". Weight only 2 1/2 lbs. Furnished complete in metal box with magazine and 7 sets of punches and dies. Standard set 3/16" to 3/8" by 32nds—or your choice any 7 from 1/8" to 3/8" by 64ths. Cash with order or \$5.75 C.O.D. only. We pay postage.

WHITNEY METAL TOOL CO., 80 Forbes St., Rockford, Ill.

Radio-Electrical EXPERIMENT KIT

Only \$3.99

6 Books FREE

25 pieces genuine commercial apparatus with illustrated manual! Build radio circuits, 110-volt motor, extension phone, thief detector, arc light, arc furnace, electric stove, generate ultra-violet rays, scores more! Used by leading schools! **SAVE 60%**. Send only \$3.99 for kit and 6 Radio-Electrical books (value over \$10.) Or, sent C. O. D. Money back if not 100% pleased. 3c stamp brings Bargain Catalog! **ELECTRICAL SALVAGE CO.**, Box 524-61, Lincoln, Nebr.



Saw-Filing

Pays Up to \$2 or \$3 an Hour — Start in Spare time

NO EXPERIENCE NEEDED to file hand, band and circular saws with **FOLEY Automatic Saw Filer**. J. W. Anderson, Texas, writes: "My fourth year with Saw Filer and third with **FOLEY Lawn Mower Sharpener** as side line. Business has increased until it is about full time."

Used by Leading Saw Makers
Atkins, Disston, Simonds and by industrial plants and repair shops all over U. S. Cash work. No canvassing. No eye strain. Postcard brings **FREE PLAN** and special offer of **Foley Saw Setter** free. No obligation.
FOLEY MFG. CO. 216-8 Foley Bldg.
11 Main St., N. E., Minneapolis, Minn.



In answering advertisements always write name and full address clearly.

RADIOS.. SAVE UP TO 50%



DEAL DIRECT...FACTORY PRICES! Many models to select from: AC-DC; All-Wave; armchair models; automatic tuning; car radios; Farmsets that operate like city radios! Send postcard for **NEW Bargain Catalog FREE**. 30-DAY TRIAL plan and agent-user proposition! **GOLDENTONE RADIO CO.** DEPT. E2, DEARBORN, MICHIGAN

Free Catalog

STOPS FIRE Instantly SCIENTIFIC WAY



WE NEED MORE COUNTY MEN

THOUSANDS BEING SOLD WEEKLY! Call on Business Concerns; Auto, Truck and Bus Owners; Schools, Public Buildings, Factories, Farms. All season seller. Excellent year round profit opportunity. **Nationally Advertised Products** We help you close sales with Direct Mail Adver-

tising. 360,000 sold to U. S. Government. Approved by Underwriters' Laboratories, also Good Housekeeping Institute. Used by 10,000 large Corporations. Write today with details of age, past experience, etc., for inside information. **The Fyr-Fyter Co., Dept. 90-26, Dayton, O.**

201132

The Puzzle of the Ice Ages

(Continued from page 223)

called the "year without a summer" and "eighteen hundred and froze to death," followed the great explosion of Tambora that killed 56,000 people. Observations in 1912 showed that dust from the Katmai explosion reduced solar radiation reaching the earth by twenty per cent, far more than necessary to have brought on the beginning of another ice age if a series of comparable explosions a year or two apart had followed.

The amount of dust necessary to turn the blue sky white and create the "dry fogs" that shut out sunshine is compara-

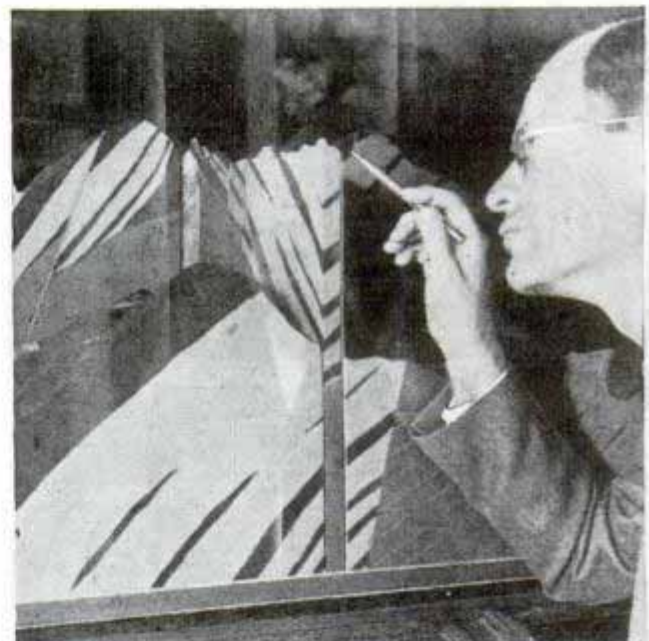

Model of earth's cross section with segments raised to illustrate typical actions in mountain building by tremendous earthquakes

tively small. It is estimated that the 1,500th part of a cubic mile of earth, blown into the sky every year or so for a number of years, would be enough to start an ice age. Volcanic dust is much more effective than ordinary dust in shutting out radiation because it takes the form of thin-shelled bubbles that float in the air for a long time.

Earth temperatures are so sensitive to extra-terrestrial influences that investigators have found that even the slight reduction in radiation from the sun that occurs during sunspot periods has a measurable effect. During a sunspot cycle such as is now occurring, average temperatures on the earth may be lowered by as much as one degree, shifting isotherm lines as

(Continued to page 158A)

Unusual Bargains IN POWER TOOLS

SQUARE TABLE JIG SAW

\$2.20

Sturdy cast iron frame, 8" square table, 10" throat, adjustable blade guide, 2" step pulley, 5" blade.



POWER DRILL PRESS

\$2.75

Height 16", max. clearance 7 1/2" x 3 1/4", adjustable swing Table, spindle travel 1 3/4", 1/2" chuck.



WOOD TURNING LATHE \$2.75



Cast iron bed, ground ways, bronze bushed, includes face plate, pulley and spur center, size 5x12.

6" CIRCULAR SAW TABLE

\$3.75

Heavy cast iron throughout, bronze bushed, table tilts, includes 6" saw blade, mitre and fence.



BALL BEARINGS SAW MANDREL

\$1.95

Make your own saw table or grinder, includes 6" saw blade.



Send cash, check or Money order. Prices F. O. B. Phila.

PHILADELPHIA MACHINERY CO., 118 N. Sixth St. Phila., Pa.

NEW MODEL DRAW-O-MATIC DRAWING BOARD

ATTACHED, SLIDING, SELF-ALIGNING, PARALLEL-BAR
 With Set of Triangles
 A SELF-CONTAINED UNIT BUILT TO A STANDARD OF QUALITY. Thousands in use by Draftsmen, Students, Architects, Artists, Engineers, Designers and Executives. Hard composition board stays flat. Bar slides accurately and easily. Patent CROSS-STRUNG bronze cable and pulley gives positive action. Adhesive Drafting Tape furnished; eliminates thumb tacks. Water, oil and acid proof. ENABLES ANYONE TO DRAW WITH ACCURACY AND SPEED. THREE SIZES: 12"x16" \$3.00, 16"x20" \$4.00, 20"x25" \$5.00 plus postage. Add 25% if Transparent Straight-Edge and Triangles are desired. FREE CIRCULAR.
 ROLLIN PRODUCTS CO., Dept. PM7, 212 W. Hubbard St., Chicago, Illinois

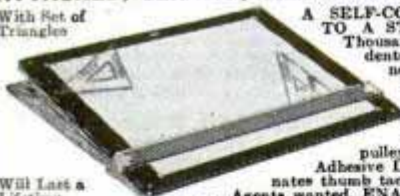

RADIO SENSATIONS! SAVE UP TO HALF

FREE Wholesale CATALOG
\$4.95
 Sensational New 2-Tube Loud Speaker Battery Radio—gets distance on only 45-v of B battery. Complete, less batteries \$4.95.
POCKET RADIO Amazing tubeless, battery-less midset radio, gets stations loud and clear. Complete with full instructions—\$1.95.
FREE! Order direct from this ad or send today for Marco's most complete wholesale Radio Catalog. Special Dealer-Agents Offer. Choice territory open.
MARCO RADIO CO., 1264 McGee, KANSAS CITY, MO.

SPARE TIME MONEY . . .

There's a big demand for the many hand-tooled articles you can make with the Easco Leathercraft Set. Easily learn to make good money in your spare time. Complete outfit including tools, leathers, patterns, etc., and full instructions, only \$2.00—on sale at leading Department Stores or order direct and pay postman on arrival.

LEATHERCRAFT

Free When ordering direct, clip name of your Department Store to this ad, and we will include with your ret. one extra free project. Illustrated catalogue 10c.
E. A. SWEET CO., Dept. A-9 Binghamton, N. Y.



CONDON'S GIANT TOMATO
EVERBEARING
 "Queen of the Market." Big Money Maker. Large Solid Fruit—Excellent Canner. To introduce to you our Vigorous Northern Grown "Pure Breed" Garden Farm and Flower Seeds, Bulbs, Strawberry Plants, Fruits and Nursery Items we will mail you 125 Seeds of Condon's Giant EVERBEARING Tomato and our big 1938 Catalog **FREE** Most Complete Seed and Nursery Book—180 pages—600 pictures. Bargain Prices. Write Today. Send 3c Stamp to cover Postage.
CONDON BROS. SEEDSMEN Box 144 Rockford, Illinois

do-it-with-squabs

Ready for market **ONLY 25 DAYS OLD**. Write a post-card, get **FREE EYE-OPENING Picture Book**. Why breed for ordinary trade when these great luxury national markets are wide open for all the **SQUABS** you can ship, every day in the year? We give a large bonus in stock for promptness.
RICE FARM, 636 H St., Melrose, Mass.

52 BREEDS BERRY'S New POULTRY BOOK
BERRY'S Hand-Picked **CHICKS**, also **SEXED, STARTED, 52 Breeds, 5 HYBRIDS**, World-Famous Money Makers. All Iowa Inspected, Pullorum Tested, **Fowls, Turkey Poults**, 40 years' Service, **LOW PRICES, Beautiful POULTRY BOOK FREE**, stamps appreciated.
BERRY'S POULTRY FARM, Bx. 29, CLARINDA, IOWA

OLDEST BEST POULTRY JOURNAL NINE ISSUES 25c
 Helps increase Poultry Profits. Send coin or stamps. Only \$1.00 for 3 years or 25 cents for 9 months trial. Agents wanted. **American Poultry Journal** 532 So. Clark Street, Chicago, Illinois

CREDIT Given on FRUIT TREES, SHRUBS VINES, BULBS, Etc....
 Small down payment books order. Easy terms on balance. Apple & Peach trees, low as 5c. Grapevines 3c. Ornamental shrubs 10c, Evergreens 25c. Garden Seed and Vegetable Plants. Write for **FREE Catalog** and bargain prices. **Benton County Nursery Co., Box 621, Rogers Ark.**

CATCH 'em ALIVE! **MINK, MUSKRAT, SKUNK, etc.,** also **FISH**, with our Folding Galvanized **STEEL WIRE TRAPS**. Made strong and durable. Sent Parcel Post. Write for Free Trap Offer and descriptive Catalog. \$1 Box of **FISH or ANIMAL BAIT** Free to introduce our traps. **WALTON SUPPLY CO.** 3507-Junata St., Dept. 5, St. Louis, Mo.

A AND N SUPPLY CO.
 Bargains—Military, Sport Goods, Firearms, Clothes, Shoes, etc. Send 10¢ for new catalog, to be redeemed on first order.
EST. 1868 A & N Supply Co., 4773 Lester St., Richmond, Va.

Men & Women Earn Cash at Home!
 Raise giant **Patented Mushrooms!** We supply materials, instruct with pictures, & our 25 branches buy all crops. Big **FREE** book, photos, tell if your cellar, shed, barn, etc., suitable. Write today.
 Est. 1908. **UNITED CO., 3848 Lincoln Ave., Dept. 307, CHICAGO**

A REAL MICROMETER
 The best little tool you've ever seen at this price. Accurate and dependable. Send 5 cts, coin or stamps, for our complete tool catalog. (Send for yours today.) **50c**
REAL MANUFACTURING CO., Dept. K-1, FINDLAY, OHIO

Monuments \$11. Up WE PAY FREIGHT
 Best Marble or Granite. Big Saving. Lettered. Guaranteed. Send Today for our **FREE** Catalog and samples.
U. S. MARBLE & GRANITE CO., A-18, Oneco, Fla.

RAISE GIANT FROGS
FREE BOOK
GOOD PRICES YEAR ROUND! Nation-wide markets waiting for all you can ship. Sell to us also. Get ready now for next spawn. Breeder lays 20,000 eggs yearly. Start with small pond, creek, lowland. **Free book** shows sketch. **Men & Women** starting in every state and Canada. See what others are doing. **Send no money!** Just write your name-address on postcard and get our special offer to beginners. **American Frog Canning Co. (Dept. 133-BB), New Orleans, La.**

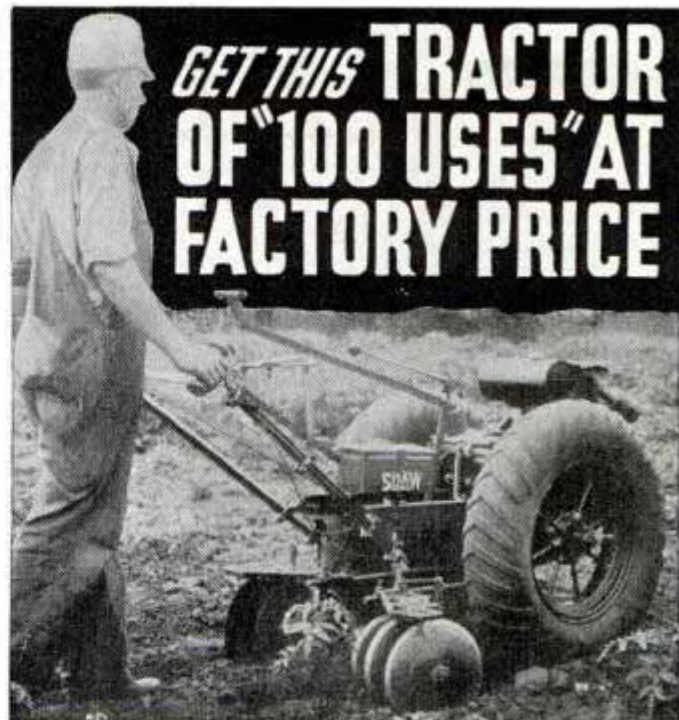

GET THIS TRACTOR OF "100 USES" AT FACTORY PRICE

DOES WORK OF MANY MEN OR 2 HORSES!

Here's untiring speed and power—that gets field and belt work done on time! Smallest size does work of many men—saving wages. Larger sizes do work of 2 horses or mules—quicker, cheaper, more efficiently—saving costly animal keep. **Runs all day for 33c.** Greatest time, labor and money-saver made!
"Tractor of 100 Uses"—Does all field, road, belt work. Plows, discs, harrows, furrows, seeds, cultivates, harvests, mows, rakes, cuts tall weeds, hauls. Runs washing machines, feed grinders, corn shellers, light plants, saws, concrete mixers, water pumps, lathes, other belt machinery. Does deep mold-board plowing, other heavy work. **Amazing money-maker** for farms, truck gardens, nurseries, orchards, suburban homes, golf courses, parks, etc.



SHAW GARDEN TRACTOR

New 1938 Model Has 3 Speeds Forward, and Reverse. Special to Order, 6 Speeds Forward—runs from 1/4 mile to 15 miles per hour. New Power Turn enables Shaw to turn in its tracks with no lifting or pushing. **Reverse Gear** makes it easy to work among rocks, roots, in close quarters. **Tool Attachments** for different uses. Convenient Jiffy Hitches. **Improved Tool Control** gives tools a wider range of movement. . . increases tractor's usefulness. **Briggs & Stratton air-cooled, 4-cycle engine. 4 Models, 2 to 5 H. P., Walking and Riding Types.**
Available With Air or Steel Tires. Air tires save 25% fuel. Enable Shaw to do more work in a day. Provide better traction.
LOW FACTORY PRICE!! Mail Coupon for details of price and terms today!



10-DAY TRIAL OFFER! FREE BOOK! Use on your own work for 10 days. Know how Shaw makes you much more money—with less work and trouble! Mail Coupon for details **10-DAY TRIAL OFFER** today!
 Explains everything about Shaw. Tells what enthusiastic owners say. Shows photos of tractors in use. Gives **LOW** Factory Prices on 4 different size models—with different attachments. Mail Coupon today!

FREE BOOK COUPON

THE SHAW MFG. CO. (Address Nearest Office)
 4502 Front St., Galesburg, Kans.; 5812-G Magnolia Street, Chicago, Ill.; 130-G West 42 St., New York, N. Y.; 668-G No. Fourth St., Columbus, Ohio.
 Send me **FREE** information at once about the Shaw "Du-All" Garden Tractor as checked below:
 FREE Book and Low Factory Prices **10-Day Trial Offer** **Liberal Agent's Proposition**

Name

Address

Town.....State.....

SAVE
ON HAMILTON, ELGIN AND BULOVA
WATCHES
★ AND HIGH GRADE ★
DIAMOND RINGS

Thousands have taken advantage of the easy Santa Fe way to own America's finest diamond rings, watches, silverware, or jewelry.

BY USING OUR LOW MONTHLY PAYMENT PLAN AT NO EXTRA COST!

**TURN
PIN MONEY
INTO DIAMONDS**

Gifts for Every Occasion

Don't pay extra for credit—at the Santa Fe you pay only the low nationally advertised cash price, in small monthly payments.

Send for FREE Catalog

Get this Beautiful Book of Values—sent FREE to adults. Leading brands of watches, diamond rings, silverware, and jewelry are shown—prices and low payments plainly marked. Don't miss this opportunity by delaying—WRITE NOW!—We Buy Old Gold.

SANTA FE WATCH COMPANY
Dept. 26 Thomas Bldg., Topeka, Kans.

free! -SEND FOR THIS
CATALOG

Bass Bargaingram

Save Money on hundreds of Camera and Photo Supplies.
WRITE DEPT P

Bass CAMERA CO.
179 W. MADISON ST.
CHICAGO, ILL.

TRAILER BUILDERS · BUYERS · OWNERS
TRAILER Send 25c for this Big Book Today

Over 100 pages! Beautifully Printed and Illustrated! Trailer Suggestions and Ideas galore! Catalog shows America's greatest line of Trailer Parts and Equipment at lowest prices. Everything from wheels to tops. Rush 25c today. Satisfaction positively guaranteed!

TRAILER SUPPLY CO. Box 438-A WAUSAU, WIS.

BUILD IT YOURSELF
The Jim Dandy Cabin Cruiser

The Trailer that has everything. Classy! Roomy! Easy to build in any size with my simplified Plans and Instructions—Price \$1.00. Rush dollar bill today to

JIM DANDY Box 125-A WAUSAU, WIS.

Net wt.—10 1/4 lbs. Ship. wt.—12 lbs.

Motor Speed Reducer

Ratio 144 to 1; Ball bearing; white metal housing; rating up to 3/4 H. P. Equipped with friction Clutch for overload protection. Originally sold for \$25.00. 12" long, 6" wide, 5 1/2" high. Close out price

\$3.95

NATIONAL ELECTRIC TOOL CO.
560 W. Washington Blvd., Dept. 10, Chicago, Ill.

**WOODSTOCK
TYPEWRITERS**

es 1132

(Continued from page 156A)

far as 100 miles and having a slight effect on the growth of plants.

Before the last ice age the United States had an animal population that in richness and diversity of types compared with the animal life of Africa today. Most of the North American animals were giants of their breed and were much larger than their present counterparts. Imperial mammoths thirteen feet high at the shoulders, "dire" wolves and saber-tooth tigers, camels, horses, sloths, and bears roamed the country. An interesting part of the study of the ice ages is the checking over of the early animal populations and determining when such a breed as the prehistoric horse, for example, died out.

One way by which the appearance and disappearance of the different types is checked is by comparing the bones found in tar deposits and by studying fossil bones found in the earth strata of different periods. Two of the early animal traps, the La Brea tar pits of Los Angeles and the McKittrick tar seeps of the San Joaquin Valley, are receiving special study because of the difference in their ages. The La Brea pits existed about 25,000 years ago and the McKittrick deposits are a burying ground for animals that existed 15,000 years ago, at about the end of the last ice age and about at the time that man first appeared on the continent.

Paleontologists are convinced that the "age of animals" in which the large mammals were kings of the earth is over. Even when the world is cooled off in the next ice age, they think, there is little chance that prehistoric animal types will develop again. They point out that the disappearance of the big breeds just about coincided with the appearance of man, and suggest that man with his crudely developed weapons was a major reason for the disappearance of the big animals. Instead, they think that man will be able to penetrate farther north as the present interglacial stage proceeds, and will continue to exist even if he has to move back toward the equator when the next ice age comes.

Names and addresses of manufacturers and dealers in articles described in this magazine will be furnished by our Bureau of Information upon request accompanied by stamped, self-addressed envelope.

Revolutionary New *SCROLL SAW* of a *THOUSAND SPEEDS*

ANY SPEED FROM
790 TO 1700 R.P.M.
AT THE TIP OF
YOUR FINGERS!

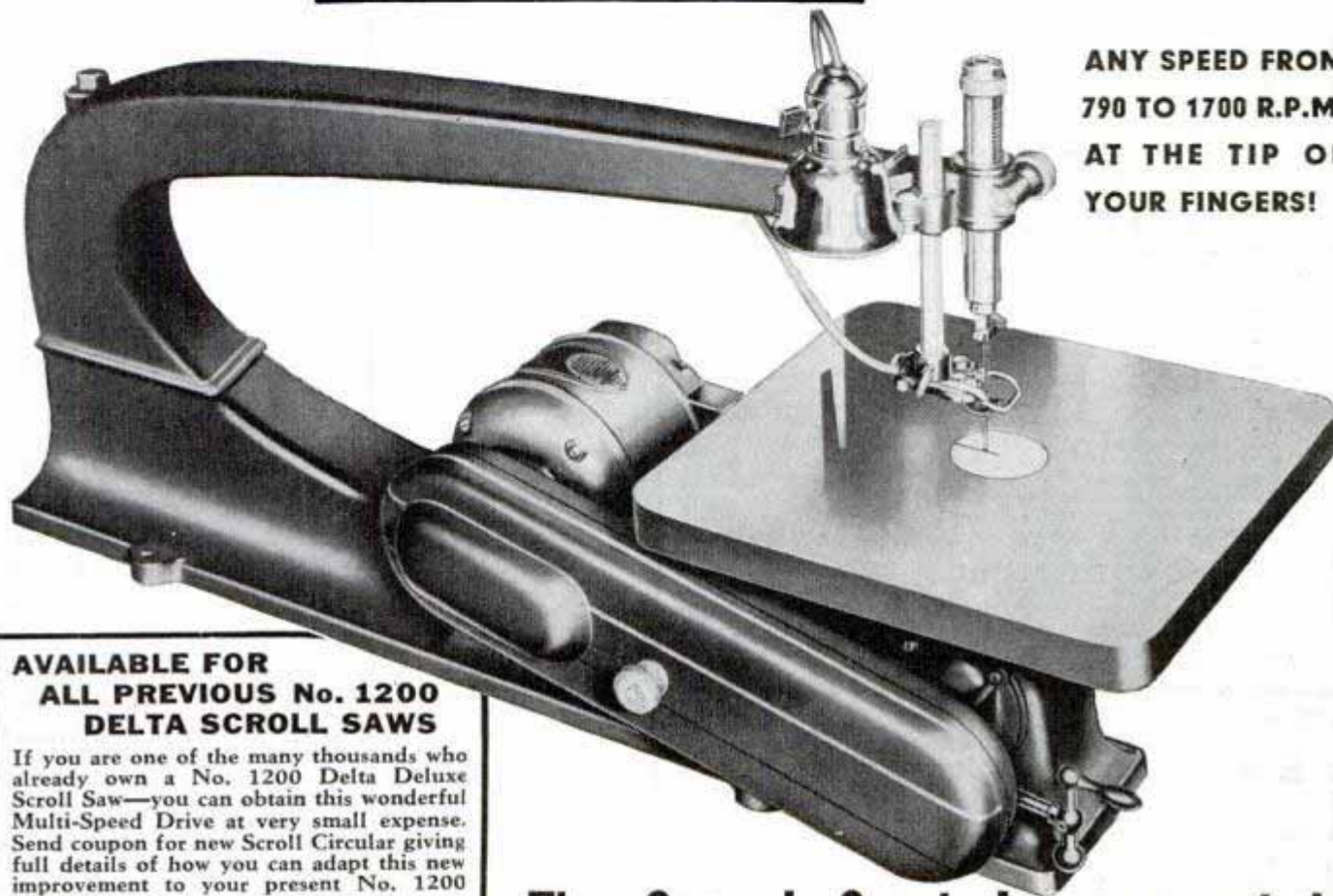

AVAILABLE FOR ALL PREVIOUS No. 1200 DELTA SCROLL SAWS

If you are one of the many thousands who already own a No. 1200 Delta Deluxe Scroll Saw—you can obtain this wonderful Multi-Speed Drive at very small expense. Send coupon for new Scroll Circular giving full details of how you can adapt this new improvement to your present No. 1200 Scroll Saw.

ONLY DELTA CAN OFFER ALL THESE FEATURES—

1. Any Speed You Want—from 790 to 1700 R.P.M.;
2. High Speed for Light Work;
3. Slow Speeds for Heavy Materials;
4. All Intermediate Speeds;
5. Timken-Bearing Crankshaft;
6. Shaft-Driven Blower Pump;
7. Universal Tilting Table;
8. Tilting Spring Hold-Down;
9. Completely Universal Guide;
10. High-Speed Blade Support;
11. Adjustable Blade Tension;
12. Patented Sanding Attachment;
13. Minimum Blade Breakage;
14. High Speed with Minimum Vibration;
15. Splash Lubricated Drive.

The Second Great Improvement in Modern High-Speed Scroll Saws

In 1932 Delta scored an engineering triumph by introducing the first practical High Speed Scroll Saw—permitting the running of the saw at full motor speed without troublesome vibration. Now—Delta is happy to announce a *second* great step forward in Scroll Saw design—the perfected *Multi-Speed Drive*. Through this remarkable development you can select *any speed you want* from 790 to 1700 R.P.M. regulating the speed within 1 or 2 R.P.M. if you wish. You can cut any material within the range of the scroll saw with full assurance that you have the best speed for your purpose. Furthermore, scientific design has made this improvement simple, foolproof and trouble-free. Every user of motor-driven tools should get the full story of this unusual engineering achievement.

Send For *CIRCULAR*

Check the proper square in the coupon below and you will be sent the special circular giving full details and prices on the new Multi-Speed Scroll Saw. If you have not received the 1938 Catalog showing the complete line of latest Delta motor-driven tools—send the coupon for your copy as well as special circular on new Multi-Speed Scroll Saw—and the latest Delta Project Book No. 4—packed full of new and different things to make, with many photographs, working drawings, and complete instructions. Enclose 10c for Project Book. Catalog will be mailed postpaid.

DELTA MANUFACTURING CO.

600-634 E. Vienna Ave.

Milwaukee, Wis.

DELTA MANUFACTURING CO., Dept. A238
600-634 E. Vienna Ave., Milwaukee, Wis.

I enclose 10c (stamps or coin) for which please send me one copy of the new 1938 Book No. 4 of "Practical Delta Projects." Also place me on your mailing list to receive 1938 Delta catalog of quality motor-driven woodworking tools.

Send me special circular on new Multi-Speed Scroll Saw.

Name

Address

City..... State.....



SKOOT-MOBILE

America's Smart New Fad

Everyone gets a big thrill out of Skoot-Mobile . . . youngsters and oldsters use it for pleasure and profit. Small merchants now have motorized delivery service at 1/10 of a cent per mile with the Economy Car . . . side car with 500 lb. pay load. Skoot-Mobile, designed and built like an automobile, averages 120 M.P.G. with speeds up to 30 M.P.H. . . . provides comfort with knee action shock absorbers on front wheel . . . has 2 speed transmission—low gear for power and hill climbing—high gear for speed and economy . . . Simple . . . fool-proof . . . economical . . . durable. FREE descriptive literature, write today.

SKOOT-MOBILE, INC.

Manufactured by

QUALITY HARDWARE AND MACHINE CORPORATION
5835 RAVENSWOOD AVENUE, CHICAGO, ILLINOIS

60 POWER TELESCOPE . . . \$219

VARIABLE EYEPIECE 20X—40X—60X

NEW! Three telescopes in one. 3 different magnifications. 20 extra long range. Guaranteed to bring distant objects, people, sports events, ships, moon, stars, etc., 60 times as close.



Most powerful made anywhere near the money. Can be collapsed to less than a foot in length. Multiple lens systems. 30 mm. objective in heavy brass mount. Directions included for using as a compound 4 lens microscope, American made. 10 day money-back guarantee. We pay the postage. Only \$2.19. BROWNSCOPE CO., Dept. 42, 5 W. 27th St., New York, N. Y.

WET BASEMENTS!

Amazing new Seal-Seep method, anyone can use. Applied to inner masonry wall and floor surfaces; no digging. Guaranteed permanently effective. Agents write for unusual earnings opportunity. Details FREE.

National Seal-Seep Co., Dept. 292, Cincinnati, O.

Waterproof
Your Own
Save up to
\$100 to \$150

GOVERNS SPEED OF ANY GAS ENGINE

It's easy and economical to supply your own power for operating all types of machinery, and do more work for less money. Simply remove the engine from a used automobile or truck, set it up where you like, attach a PIERCE UNIVERSAL GOVERNOR, start the engine and you have constantly controlled power for the operation of electric lighting plants, are welders, refrigerating units, air compressors, feed grinders, hoists, saw mills and innumerable other applications.

The load may change but the PIERCE UNIVERSAL GOVERNOR will maintain a uniform engine speed. For close regulation of speed and dependable performance PIERCE GOVERNORS are never equalled. Installation is simple. Either V or flat belts can be used. Complete Governor outfits are also available for nearly all makes and models of industrial engines.

Write for illustrated literature and prices.

THE PIERCE GOVERNOR COMPANY
1601 Ohio Avenue, Anderson, Indiana



PIERCE GOVERNORS
THE BRAINS OF ANY GAS ENGINE

New Giants for the Air Lines

(Continued from page 164)

With partial load they are able to cruise and maintain altitude on only two of their four engines. Nine men, including crews for manning five different machine-gun nests are required to operate the plane and its equipment. Each bomber can carry several tons of bombs.

Late in 1937 Boeing tested out its latest secret development, a thirty-ton big brother of the flying fortress, having a wing spread of 150 feet. This super-bomber contains heated living and sleeping quarters for the crew, a galley, and even two auxiliary gasoline engines inside the fuselage for driving 110-volt alternating-current generators that supply current over the more than seven miles of wiring which the plane contains. This plane, instead of ordinary landing gear, has double truck landing gear consisting of four huge tires as well as the usual tail wheel.

Huge as it is, not even this latest plane compares with the six "clipper" flying boats that Boeing is building for Pan American. These ocean-flying giants will weigh forty-one tons. Each boat will be powered with four 1,500-horsepower twin-row radial engines that so far have been used only in secret military operations. They will be able to carry seventy-two passengers in daylight flights, or provide berths for forty passengers. Two and a half tons of air mail and freight will form part of the cargo and with full load each boat will have a cruising radius of 5,000 miles. The engines will consume one gallon of fuel per mile and fifteen tons of gasoline will be carried in the wings and the small hydro-stabilizer stubs that help to balance the boat in the water.

These flying boats are so large that they are being constructed just like regular steamships. Engine nacelles stand thirty-five feet above the factory floor and the hull is surrounded by a half mile of construction platforms, on which workmen assemble the boat while working on five different levels. Three and a half carloads of lumber were required for scaffolding and jigs. The wing of one of these monsters is 152 feet long. The airfoil tail surface is forty-eight feet long, large enough to be used as the wing for a ten-passenger

(Continued to page 162A)

STRIPE YOUR OWN CAR

Anyone can stripe a car with an automatic ROLL-A-STRIPE. You can save the price of your striping job and earn money doing others. Specially knurled roller and dependable gauge. Paint, lacquer, enamel or varnish may be used. Stripe signs, furniture, models, etc. See any Duco Dealer today or send direct. Postpaid \$1.50.

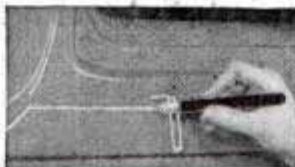

MODCRAFT INDUSTRIES, Dept. P-51, 2908 N. Nordica Ave., CHICAGO, ILL.

7 for a Penny

STREAMLINED IDEAS!

Streamline for quick action—better jobs—bigger pay—in 1938. Cut down the resistance that holds back success. Get Shop Notes with 318 money-making, time-saving ideas and helps for mechanics and handymen. If you use tools you need it. 224 pages. 645 illustrations. Order now. Only 50 cents. Two books—Shop Notes for 1937 and 1938 Postpaid for \$1.

SHOP NOTES FOR 1938

Popular Mechanics Press, Room 238-D, 200 East Ontario St., Chicago

Whether you design for welding, build by welding, or use welding in any way **YOU NEED THIS BOOK**

PROCEDURE HANDBOOK OF ARC WELDING DESIGN AND PRACTICE

819 pages, 990 illustrations

Long recognized throughout the world as the authority on the art of electric welding. Standard welding reference guide in thousands of industrial plants in U.S.A. and foreign countries. New Handbook makes all others obsolete. Contains complete, authentic, up-to-date data on all latest arc welding applications and design procedure. Order your copy now.

Fourth edition gives you, at no extra cost, 223 pages of new welding data, 289 new illustrations

POPULAR MECHANICS PRESS
Room 238B, 200 East Ontario Street, Chicago



ONLY \$1.50

IN U.S.A.

\$2.00 elsewhere.

Prices are postpaid.

\$ MONEY-MAKING \$ OPPORTUNITIES

For those who need larger incomes or must seek new occupations. The following workable, tested plans are adaptable both to the needs of the country or city dweller either for part time development or principal income source.

Every idea set forth in these books has been used by others for profit. They are well worth your consideration.

Plan No. 1—1000 Ways to Make \$1,000. Practical new book of tried, tested methods that work that you too, can use. Price \$2.65.

Plan No. 2—Radio Servicing. Let an expert teach you how to engage in this money making business. Price \$4.15.

Plan No. 3—Refrigeration Service. Official manual covers all makes. Good service men are needed. Price \$5.00.

Plan No. 4—Automobile Refinishing. Start a lucrative business of your own. Fine possibilities here. Excellent new instruction book. Price \$1.50.

Plan No. 5—Outdoor Opportunities. The raising of small animals, birds and plants for profit. Price \$2.00.

Plan No. 6—10,000 Money-Making Formulas. Complete instructions for the making of commodities at small cost that may be sold at a handsome profit. Price \$4.00.

Plan No. 7—1000 Spare Time Money Making Ideas. A job for everybody. 146 page book tells how. Price \$1.00.

Plan No. 8—100 Civil Service Examinations. Covering steady Government jobs. All types of positions. Better business means thousands of new jobs. Prepare now by studying this new book. Price \$2.50.

Plan No. 9—Making Poultry Pay. The proper breeding and management of fowls for higher egg production. Price \$2.00.

Plan No. 10—A Living from the Land. Answers the question "How can I successfully get established in the country?" Price \$1.50.

Plan No. 11—Rabbits for Food and Fur. A complete guide to the successful rearing and breeding of rabbits. Price \$2.00.

Plan No. 12—The Frog Industry. Should be considered more as a side line than as a major means of income. Price \$1.00.

Plan No. 13—Is There Money in Welding? Factual information shows welding is a growing field offering opportunity to anyone looking for a trade. Price \$1.00.

Plan No. 14—Auto Service Shop Management. Money-saving and business-producing ideas by two men who know just what is essential to a profitable service shop business. Price \$1.50.

Any of the above mailed postpaid upon receipt of price or sent C.O.D. anywhere in U. S. Pay postman price and few cents postage.

POPULAR MECHANICS PRESS

Room 238

200 E. Ontario St.

Chicago, Illinois



Then Get This FREE BOOK!

Tell us how, when, and where to fish—how to bait and fly cast, tie knots, etc. Special advice by Tony Accetta on how to balance your tackle for greater skill and more thrill.

SPECIAL OFFER

- SPORT POUCH—transparent, waterproof all silk pouch for reel or tobacco — \$.15 postpaid. (limited supply)
- FREE 100 pg. Fishing Guide and Catalog. Write today.



SHAKESPEARE COMPANY
486 N. PITCHER ST., KALAMAZOO, MICH.

QUICK CASH with a SECURE FUTURE for MEN OVER 40!

Nationally Known Company Offers Steady Good-Paying Work for Ambitious Men!

Are you 40 years of age, or older? Do you feel that the best part of life is still AHEAD of you? Would you like to be associated with a big 51-year old Company, selling a product every man NEEDS at low prices that instantly appeal to those who know real VALUE? If this sounds interesting, write to us today. Start in spare time, if you wish. We furnish all sample equipment FREE. No experience necessary. If you're honest and ambitious we'll show you how to make a good year-around income, to qualify quickly for a New Tailored Suit without cost, as a bonus, and build a SECURE FUTURE for yourself. Send no money, but mail letter or postcard today.

FAIRBANKS TAILORING CO., 2218 Wabansia, Chicago, Ill.

Neon Truck Signs

-- NOW Possible with Amazing New TRANSFORMER and Novel Method of Tube Installation!

DISTRIBUTORS WANTED

Old, established factory wants financially responsible business executives—to handle distribution in exclusive territories. Signs fill long-felt Advertising need! Enable any advertiser to have brilliant, colorful, attention-getting Neon Advertising message on trucks, both day and night. Expected to quickly sweep country! Easily installed on top driver's cab. Amazing NEW TRANSFORMER enables Sign to operate on any truck's standard 6-volt auto storage battery—using only about same amount current as an extra tail light. Novel method tubing installation protects against breakage. Reasonable capital handles exclusive Distributorship Contract. Big Profits. No sign experience necessary. We furnish entire product. FREE LITERATURE gives details, explains liberal proposition. Write today!

E. E. SOUTHERN IRON CO. - - 1952-A-42 Kienlen Ave., St. Louis, Mo.

Amazing TYPEWRITER BARGAINS



SAVE ONE-HALF—10c A DAY! Nationally makes. Recent standard models reconditioned, re-finished. Fully guaranteed! Look and operate like new! ALSO PORTABLES. FREE SHORTHAND AND TYPING COURSE. Easy terms or as low as \$10 cash. FREE TRIAL! MONEY BACK GUARANTEE. Send for illustrated circular and details TODAY. FRUIT CO., 774 FRUIT BLDG., CHICAGO

Midget Portable Electric or Battery Radios

WORLD'S SMALLEST RADIOS
Just a handful—Wt. only 2 lbs. Size 3 1/2x5 1/2—4 tube performance! Midget BUILT IN LOUD-SPEAKER and AERIAL—Requires no ground—Hi efficiency circuit and quality parts. Has Broadcast, Short Wave and Foreign bands! Simple to operate—durable—troublefree. Ideal Radio for office, Apts., bedrooms, college, camps, trailers, tourists etc. Battery model has batteries inside case for use on farms, boats, autos, etc. Electric model uses 110 volts A.C.D.C. Either model—kit of parts for \$6.49—Wired and checked 50c extra or \$6.99, complete ready to listen! Beautiful breakfast cabinets, State Color. Send only \$1. and pay postman balance on delivery. Batteries for Battery Model \$1.49 extra. Free catalogue listing 100 other radios at factory price. ORDER NOW! GUARANTEED. TINYTONE RADIO CORPORATION, Dept. P-2, Kearney, Nebr.

SEND ONLY \$1.00

es 1311

(Continued from page 160A)

FACTORY TO YOU

NEW REMINGTON NOISELESS PORTABLE



10¢ A DAY

FAMOUS Remington Noiseless Portable that speaks in a whisper, only

10c a day, direct from factory. Standard Keyboard, Automatic ribbon reverse, Variable line spacer and all the conveniences of the finest portable ever built, PLUS the NOISELESS feature. Act now. Send coupon TODAY for details.

You don't RISK a Penny. We send you a Remington Noiseless Portable for 10 days' free trial. If not satisfied, send it back. We pay all shipping charges.

FREE typing course and carrying case. You will receive FREE a complete simplified home course in Touch Typing. Also FREE, a handsome, sturdy carrying case. No obligation. Mail coupon for full details—NOW.

Remington Rand Inc., Dept. 152-2
315 Fourth Ave., New York, N. Y.

Tell me, without obligation, how to get a new Remington Noiseless Portable, plus Free Typing Course and Carrying Case, for 10c a day. Send Catalogue.

Name

Address

City.....State

AUTOMATIC TYPELESS PRINTER

Amazing new Print-O-Press Stenell Dupli-cator. Automatic feeding, Automatic inking. Full 8 1/4 x 14 legal size. Other models also, at world's lowest prices. Details free. Also free samples of work done. User-Agents write.

\$13.95
Complete



Professional Products
Dept. 210, Silverton, O.

Order direct

BABY CALCULATOR
CHICAGO U.S.A.
PATENT APPLIED FOR

VEST POCKET ADDING MACHINE

IDEAL FOR INCOME TAX! Adds, subtracts, multiplies, divides. Does work of more costly machines. Counts up to million, made of steel—weighs 8 ounces. Simple, accurate. Not a toy. Guaranteed 5 years.

— FREE TRIAL —
SEND NO MONEY!

\$2.50
Total Cost

Order from ad, not sold in stores. Just send name and address. On delivery pay postman \$2.50 (plus few cents postage). (If outside U. S. send cash.) 10c additional in Leatherette Case. If not satisfied after 10 days' trial you get your money back. Thousands of satisfied users. Write for Agent's proposition. CALCULATOR MACHINE CO. (Mfrs.) Dept. 162, P. O. Box 1118, Chicago, Illinois.

NEW Grinding Attachment

For 9" to 13" Metal Lathes

The new Huron Grinding Attachment doubles the usefulness of your lathe. Enables you to machine accurately to 1/4 of one-thousandth of an inch. Grinds hard or soft stock; eliminates tool marks; produces mirror finish. For both internal and external grinding. Grinds valves, pistons, bushings. Sharpens reamers and cutters. Grinds lathe centers, spindles, flats on shafts. Does eccentric drilling; laps; polishes. Scores of other uses. Invaluable to every home workshop owner, model builder, garage man and machinist. SEMI-MACHINED CASTINGS, only \$5.95. Finish on your lathe and save real money. Write for FREE illustrated folder and full information.



BUILD IT YOURSELF.

SAVE TWO-THIRDS.

Huron Machine & Tool Co., Yale, Michigan

plane. More steel than ever before is being used in the structural parts. When completed each of the boats will be launched down ways into the water from the Seattle factory.

The hull will contain two complete decks, with passenger accommodations on the lower deck and operating quarters, crews quarters, and cargo compartments on the upper deck. To reduce glare the two-man cockpit bridge is painted dull black inside, as are the reflecting surfaces of the two inboard engine nacelles. Sun visors similar to those used on automobiles swing down from overhead in the cockpit. Behind the cockpit is a navigating and chart room as large as an ordinary kitchen, containing a large chart table, the radio operator and his equipment, the flight engineer and his control and instrument panels, and the captain's office. A door beside the engineer's desk leads out into the wings so that the engines can be serviced in flight. There is plenty of space inside the engine room behind each engine for a mechanic to stand comfortably. A navigation turret in the roof of the compartment behind the chart room will enable the navigator to make observations during flight. The cargo hold is located in and below the center section of the wing, with crews' quarters and baggage compartments farther toward the stern.

On the lower deck, reached by a spiral staircase, are various passenger compartments, a full-sized galley, a special dining lounge, and a de luxe "bridal suite" apartment at the stern. The bow of the boat is taken up by an anchor and gear room in which lines, anchors and sea anchors, and other gear are carried.

Passengers will have hot and cold running water at their disposal and will use dressing rooms just as large and comfortable as those on sleeping cars. Furniture is made of light duralumin metal and cabin walls are covered with removable tapestries especially selected for their sound-deadening qualities.

The first boat of this fleet is to be test flown early in 1938. It is the largest airplane ever built in the United States and is one and a half times the size of the present China Clippers. Pan American may use them either on the Atlantic or the Pacific or both.

es 12 15
**Welded Spider Web of Steel
Helps Cool Gas Producer**

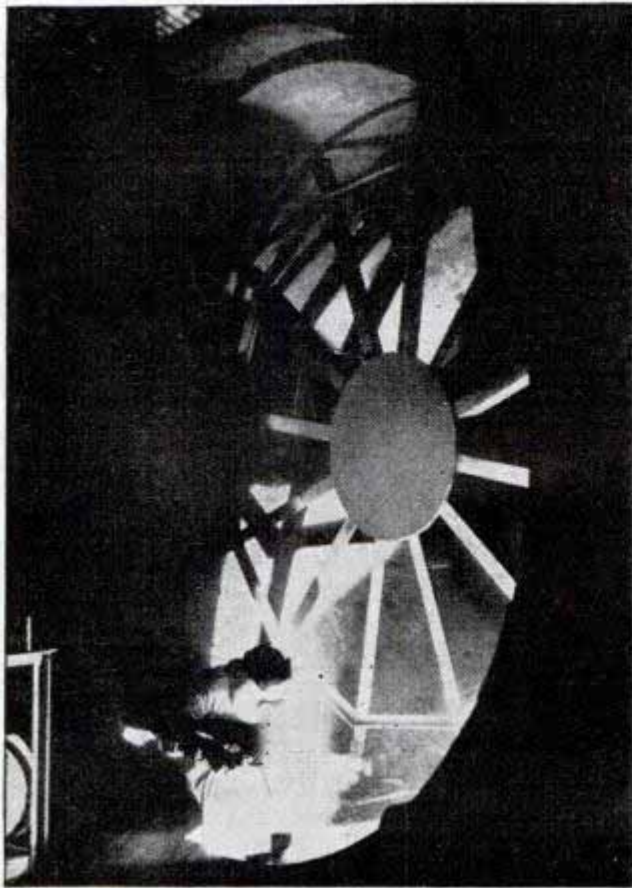

Welding the big water jacket for gas producer.
Note resemblance to spider web

Resembling a giant spider web, a big water-cooling jacket for an automatic gas producer recently was completed by the arc-welding process. The company in charge of the work is engaged in a scientific study of arc welding.

es 1402
**Self-Wringing Household Mop
Cleans Floor and Wallpaper**

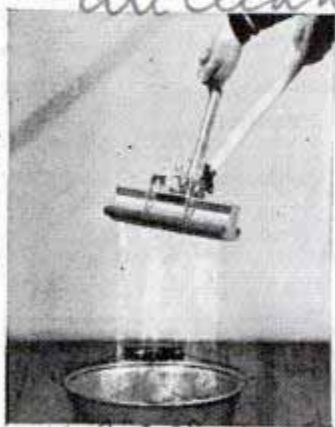

Any household task that calls for a duster, mop or broom is handled neatly by an all-purpose mop that is self-wringing. It is cleaned simply by dipping in soap and water, then pulling the lever of the wringer. It is used to

dust floors, to pick up lint, hair and ashes from carpets and even for cleaning painted or papered walls.

*Artmoore Co, Inc
108 N Water St*

**"THAT'S
AN
EDGE"**



You can give lathe tool bits that extra keen, extra smooth edge by touching them up with an Aloxite Brand Abrasive Stick.

**SHARP TOOLS IN A JIFFY
WITH CARBORUNDUM BRAND
ABRASIVE PRODUCTS**



Use a Carborundum-made grinding wheel to sharpen gouges, drill bits and the like. Your hardware dealer has the right wheel for the job. Ask for Carborundum Brand Products.

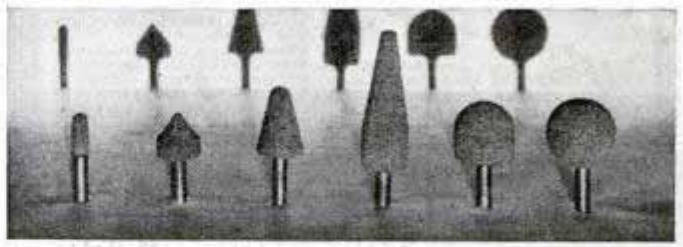

Removing projecting ends of screws, taking sharp edges from glass are only two of many jobs you can do with Carborundum Brand Silicon Carbide Mounted Wheels. Your dealer has them.

THE CARBORUNDUM COMPANY, Niagara Falls, N.Y.

CARBORUNDUM

ABRASIVE PRODUCTS



Thrilling NEW
EVINRUDE
"Ranger"
ONLY \$47.50



A brand new Evinrude . . . amazingly light, handy and powerful. Literally packed with big-value features including famed Hooded Power — Evinrude Co-Pilot — Underwater Silencing. Starts instantly! — spins into action with a flick of the starting cord. Runs three hours on a single fill—and costs less than 3¢ an hour to operate. Send for catalog!

ELTO PAL only \$37.50
 Elto PAL (built by Evinrude) weighs only 14 pounds, and drives boats at twice the speed of oars. Elto ACE, \$47.50—the husky Handitwin, only \$67.50. Each a stand-out value in its class!

FREE CATALOGS! Write for 1938 Evinrude and Elto catalogs, Boat Directory and Boat-and-Motor Selector. All free. Address **EVINRUDE MOTORS** 5286 N. 27th St., Milwaukee. **PRICES F. O. B. FACTORY**

WEIGHS ONLY 16 LBS.
CRUISES 3 HRS.
ON A SINGLE FILL!

EVINRUDE OUTBOARD MOTORS



BUILD WITH DOENUTS

Build with the original patented low pressure Musselman Doenut cord tires and wheels. They absorb surface obstructions, eliminate jolts and reduce pushing and pulling effort approximately 50%. Tire requires as low as 12 to 15 lbs. air pressure for loads up to 225 lbs. per wheel. Size 10" x 2 1/2". Cadmium plated steel disc wheel with adjustable ball bearings. Doenuts are ideal for building hand trucks, midget autos, wheelbarrows, lawn mowers, lawn furniture, portable painting, spraying and greasing equipment or any portable unit under 900 lbs. Buy: send 50c for full set blue prints for building wagons, wheelbarrows, bicycle trailers, scooters and midget autos, with free literature.

MUSSELMAN PRODUCTS CO.
 6247-X ST. CLAIR AVE. CLEVELAND, OHIO

HOLD-E-ZEE

FINE SCREWDRIVERS

Hold, start and set up any size screw in unhandy places. Gripper slides up out of way when not in use. All models of finest materials thruout with chrome vanadium blades; many have transparent, unbreakable handles. No more expensive than ordinary screwdrivers. Patented. At auto supply, hardware and electrical stores.



UPSON BROS., INC.
 85 Exchange St., Rochester, N. Y.



NEED MONEY? Men or Women

Part time or full time to sell

GENUINE LEATHER TIES

Sell on sight—they are neat, novel and practical. Big profits for you. No sales ability needed. Everybody wants them. Your first hour will be a pleasant, profitable surprise. Young man made \$6 one night after school. Send 50c for samples of 4-in-Hand and Bow.

CENTURY TIE CO., 2345-L, W. Grand Blvd., Detroit, Mich.

BUILD ARC WELDER FROM OLD DODGE GENERATOR

35c brings complete plans for building economical and efficient 75 to 125 amp. arc welder, and 1938 catalog listing over 500 electrical items. 50 other generator changes.

LEJAY MFG. CO.
 347 LeJay Bldg., Minneapolis, Minn.



HOME AUTOMATIC CIGARETTE MACHINE
 Have YOUR OWN Monogrammed Cigarettes
 Put tobacco and block of papers on machine, TURN THE CRANK —PRESTO—CIGARETTES. Easy—simple. All metal construction. Guaranteed. No cloth ribbons; no special tube or gummed papers required. **ASK FOR FREE ILLUSTRATED FOLDER.**
A. C. MACHINE WKS., P.M.-2, 1055-57 Devon Ave., Chicago, Ill.

OVER 120 STYLES. SELL THE WHOLE FAMILY

Illustration shows shoe in process of construction. Los Angeles to New York on original pair of soles and heels.

"BEARDED"
SAMPLE MAKES ORDERS COME THICK AND FAST

Cords hanging from sample show how soles and heels are made. Greatest sample in direct selling field.

Several good territories still open will be protected when agents are appointed.

CAMP MOCCASINS
 For Camp or Home Use. Work Shoes, Hunting Boots, Men's Fine Street Shoes, Women's Shoes. Write TODAY for Our Line, Dept. P-2

J. C. MOENCH SHOE CO., BOSTON, MASS.

SHOES OF EVERY DESCRIPTION
 FIVE MONTHS GUARANTEE

Are Some of Your Rooms Cold?
Here's What to Do!

Equip your hot-air furnace with a New Deal Air Circulator and Draft Control. Provides forced air circulation, guaranteeing heat in every room, regardless of wind or weather. Automatically keeps temperature of your home at any point desired. Keeps rooms warm with a much lower fire. Ends costly fuel wastes. Pays for itself in fuel saved. More than a thermostat. Regulates both furnace fire and air circulation automatically. Easy to install. Takes only a few minutes. Very low priced. Sold under a guarantee of satisfaction or your money back. Send today for FREE circular. **AGENTS:** Write for sales proposition.

NEW DEAL APPLIANCES
 2262 Gratiot Ave. Detroit, Mich.

WRITE for CIRCULAR

TECHNICAL BULLETINS
Technical Data Simplified for the Practical Man

A New and Valuable Popular Mechanics Service • \$1.00 Each

Here is a valuable, inexpensive service for mechanics, inventors, technical specialists and practical craftsmen of all kinds. Popular Mechanics Technical Bulletins give the needed basic and practical information on a wide variety of subjects — briefly, concisely and simply presented—yet complete in every detail. No advanced mathematics, chemistry or physics needed to understand them. Material never before in print, now specially prepared in bulletin form. Postpaid \$1 each or sent C.O.D. in United States. Ask for list of complete bulletin service.

- D-101—Using Nichrome Resistance Wire.—Features electrical appliance repairs.
- D-102—Cleaning Products for all Purposes.—Includes ten formulae for making.
- D-103—Automobile Specialty Chemical Products.—Complete instructions for making wide-selling products.
- D-104—Silver Soldering and Brazing.—Includes data, methods and materials needed.
- D-105—Latest Gas-Welding Practice.
- D-106—Rewinding Electric Motors.—A difficult subject made simple and easy.
- D-107—Electro-Plating with Copper, Nickel and Chromium.
- D-108—Electro-Plating with Gold and Silver.
- D-109—Electro-Plating with Zinc and Cadmium.
- D-110—Electro-Plating Non-Metallic Objects and Electro-Forming.
- D-111—Designing and Building Transformers.
- D-112—Designing Electro-Magnets.
- D-113—How to Design Solenoids and Plunger Magnets.
- D-114—Designing Thermostats for Air Conditioning and Heat Control Purposes.
- D-115—Flexible Molds for Casting Small Objects.
- D-116—Printing Photos on Cloth, Paper, Etc.
- D-117—The A B C of Air Conditioning.

POPULAR MECHANICS PRESS
 Room 238B 200 East Ontario Street Chicago
 When writing please mention Popular Mechanics

SEND FOR IT TODAY



Every Wood Craftsman Should Have This 100 Page Book No. 10 It is full of beautiful things that you can easily make—hard to find material such as foreign woods—lovely crotch, butt, burl, fiddle back, etc. Veneers, Panels and Solid Woods. Lists and illustrates 76 Blue Print Designs for Scroll Patterns, Inlay Table Tops, etc.

How to make your own Venetian Blinds at 1/2 store prices.

Make Beautiful Period Furniture at a fraction of store cost. If you are handy with tools you will value this book. It will save you money and make available exactly the kind of material you want.

CRAFTSMAN WOOD SERVICE CO.

We Ship All Over the World

2715 SOUTH MARY STREET CHICAGO

It's full of Bargains like these

Rare and Fancy Wood for Inlaying

DEAL No. 16

- 3 square feet, 3/8 inch Walnut, 5 1/2 inches and wider
- 3 square feet, 3/8 inch Mahogany, 5 1/2 inches and wider
- 3 square feet, 3/8 inch Satinwood, 3 1/2 inches and wider
- 3 square feet, 3/8 inch Benin, 5 1/2 inches and wider
- 3 square feet, 3/8 inch Holly, 4 inches and wider
- 3 square feet, 3/8 inch Plain Maple, 6 inches and wider

We will ship about 36 inches long

Deal No. 56

100 square feet 1/28" Veneer A-Grade Sheets About 10" x 36"

- | | |
|-----------------------------|-------------------------------|
| 20 sq. ft. Striped Walnut | 8 sq. ft. Walnut Butt |
| 20 sq. ft. Striped Mahogany | 3 sq. ft. Brazilian Rosewood |
| 20 sq. ft. Huya | 2 sq. ft. Cuban Mahogany |
| 4 sq. ft. Huya Crotch | 6 sq. ft. Myrtle Cluster Burl |
| 5 sq. ft. Maple Burl | 6 sq. ft. California Walnut |
| 3 sq. ft. Walnut Crotch | 3 sq. ft. Ash Butt |

Special \$.75 Veneer cutting knife included Free with No. 56 Veneer deal.

Shipping weight 18 lbs. Special at, F. O. B. Chicago...

\$5.00

Deal No. 61

8 pieces absolutely clear rough American Black Walnut 2"x2"x24". Shipping weight 22 pounds. F. O. B. Chicago.....\$2.15

Deal No. 61A

American Black Walnut clear squares, 8 pieces 1 1/2"x1 1/2"x24". Shipping weight 13 pounds not planed. F. O. B. Chicago. Only.....\$1.65

Books Every Wood Worker Should Have—217 Pages Each

Wonderful books for men or boys handy with tools. Make articles at home. 7 Big Books.



- 1—Carpentry for beginners
 - 2—Fretwork, inlaying and overlaying
 - 3—Details cabinet construction
 - 4—Wood carving
 - 5—Wood turning
 - 6—Staining and polishing
 - 7—Woodwork joints
- Beautiful cloth binding
Set Postpaid only..\$11.25
Single Copies Post-paid 1.75



ONLY
\$3.00

F. O. B. Chicago

SHIPPING WEIGHT 10 POUNDS

New Process of Inlaying

No tools or clamps necessary—this beautiful wall plaque No. 260 in striped Mahogany—Walnut—Lacewood, etc. Complete kit including intricate border all ready to fit together. Makes a lovely 6 1/2"x9" Wall ornament. Will sell for \$3.00 or more and only takes 1 hour to completely finish.



No. 260

Sent Postpaid Only \$1.00.

Kit No. 120. Matched striped Mahogany with colored inlay center, inlay colored band borders. All cut exact size to fit perfectly in solid Walnut frame, all glued up complete with base board—felt bottom—Garnet sand paper, etc. Size 15 1/4" x 21 1/2". Easily worth \$15.00 when completed. Price Postpaid Only \$5.50.

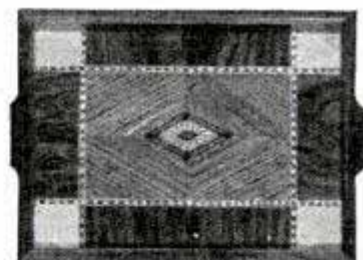

No. 121. Without diamond color inlay center. Postpaid\$4.65 Many other plaques, trays, boxes, etc., shown in big book.



Set Dowel Centers 1/4 in. to 5/8 in. 7 sizes. Indispensable to cabinet makers. Special Postpaid 40c—2 sets 75c.

Craftsman Wood Service Co.

2715 South Mary St. CHICAGO

Please send me No. No.
 I accept your offer of Catalog No. 10 free with order,
 I am enclosing 10c (stamp or coin) for Catalog No. 10.
 NAME
 STREET AND NO.....
 TOWN..... STATE.....

If your hardware dealer cannot supply you, send your order direct to us

Everything we sell carries a money back guarantee

When writing to advertisers please mention Popular Mechanics



BIG OPPORTUNITY STUCCO SPRAYING

Make new or old buildings more attractive and waterproof. Plastic COLORCRETE fuses with any masonry surface. It fills all cracks. It can be sprayed in any thickness and in 30 colors. Fully proven by over twelve years actual use under all conditions and every climate.

Owners everywhere want to enhance values. You can supply this big waiting market with permanent COLORCRETE at amazingly low cost.

Offers big earnings. Operators report costs of 2c and up per sq. ft. and sell up to 7c. Some have paid for their equipment from first few jobs. Machine capacity up to 1,000 sq. ft. per hour.

Get the facts. Send for book "Proven Business Opportunity". Write today. It offers big extra income.

With this machine



COLORCRETE INDUSTRIES, INC.
570 Ottawa Ave. Holland, Mich.



CAPE COD CHAIRS

Style "B", "C", "A". Blueprint 50c. All 3 for \$1.00.

M10 - Martin

House 8 family Beautiful Castle Style. Blueprint only 65c. For catalog illustrating over 75 practical projects, send 10c. Free with order. "Over 35,000 Satisfied Customers."

CRAFTSMAN'S MODEL CO.

Dept. P-14, 2030 N. 41st Street Milwaukee, Wisconsin

120 Miles PER Gallon 30 Miles per Hour!

Auto-Glide

For the ride-thrill of your life, try Auto-Glide! Swift, safe, comfortable. Amazingly Economical! Operating

cost, less than 1/3c a mile—15 miles on a cup of gasoline—cheaper than shoe leather! None other so ruggedly built. Proved by year's use in the hands of thousands of owners, every state in the Union! Available with or without carrier. 1 or 1 1/2 H. P. genuine Cushman engine. Starter, clutch, brake, light, lock, etc.



FREE See your dealer or write for free illustrated book and full details.

\$125 and up F.O.B. Factory.

DEALERS: Write for Special Offer!

THE CUSHMAN MOTOR WORKS, Dept. H-2, Lincoln, Nebr.

FACTORY TO YOU

NEW SUPER-QUALITY KITSELMAN FENCE

Heavier, tougher pure zinc galvanizing. Stronger, tougher Copper-Bearing Steel. Same low Factory Prices. WE PAY FREIGHT. 160 styles and heights Farm, Poultry and Lawn Fence; Steel Posts, Gates, Barb Wire, Paints, Roofing. Write today.

KITSELMAN BROTHERS
Box 94 Muncie, Indiana

SHAMED BY PIMPLES AT 17?

Keep your blood free of pimple-making adolescent poisons

Don't let your face be blotched with ugly hickies! Stop being shunned and laughed at! Learn the cause of your trouble and start correcting it now!

Between the ages of 13 and 25, vital glands are developing, helping you gain full manhood or womanhood. These gland changes upset the system. Poisons are thrown into your blood . . . and bubble out of your skin in hated pimples.

Resolve to rid your skin of these adolescent pimples. Thousands have succeeded by eating Fleischmann's Yeast, three cakes a day. Each cake is made up of millions of tiny, active, living yeast plants that fight pimple-making poisons at their source in the intestines and help heal your skin, making it smooth and attractive. Many get amazing results in 30 days or less. Start eating Fleischmann's Yeast today!

Copyright, 1937, Standard Brands Incorporated

450 Miles a Gallon of Gas!

Potential Gasoline Mileage

ACCORDING to an article by the president of the world's largest motor research corporation, there is enough energy in a gallon of gasoline if it were converted 100% in mechanical energy to run a four cylinder car 450 miles.

NEW GAS SAVING AND TOP-OILING INVENTION Astonishes CAR OWNERS

A Marvelous Device has accomplished wonders in utilizing a portion of this waste energy. It saves gasoline, gives better mileage, reduces carbon formation, creates more power, gives quicker starting, snappy pick-up and a smoother running motor. Saves many repair bills.

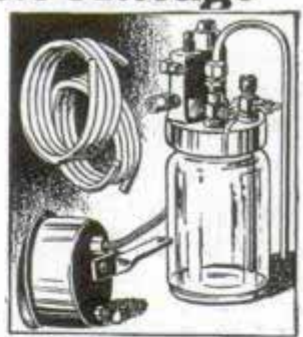

Big Profits and Free Offer! . . . To obtain national distribution quickly, men are being appointed everywhere to help supply the tremendous demand. Free samples furnished to workers. Write today for this free sample and big money-making offer.

Diamond Fuelizer, Dept. 154, 600 High St., Akron, Ohio

FREE ELECTRICITY

Build Windchargers
Used car generator plus 98c material cost. Send 25c for guaranteed plan book. Get in Windcharger business.

WESCO, 8 Terminal, Minneapolis, Minn.

98c

S

AGENTS

500% Profit

SIGN LETTERS

For Store Fronts and Office Windows. Anyone can put them on. Free samples. Liberal Offer to general agents.
METALLIC LETTER CO., 438 N. Clark St., Chicago

FREE

Send for your copy of 80 page catalog

BALKO ELECTRIC MOTOR & SUPPLY CO., Dept. A24, 10 S. Clinton Street, Chicago, Illinois

When writing to advertisers please mention Popular Mechanics

NEW Sensational "POWER SCOOTER" \$69.50 and up
ELECTRIC
 Goes 5 miles for 1c. No gasoline, oil, noise, or bother to start! Instant action—anyone can ride it—even a 6 year old child the **FIRST TRIAL**. Variable speeds—perfect control—brakes, lights, horn, etc. **PLENTY OF POWER!** Hi-speed model goes 35 m.p.h.—any speed available! Entirely self-contained power unit and charger. Simply plug into light socket (patented). Unusual range—Heavy duty tires and spring frame give smoothest ride! **ULTRA STREAMLINED**—available with airfoil parcel carrier. Write for literature on complete line including gas models. **EXCLUSIVE DEALERS WANTED.**
MIDGET MOTORS CORP. Dept. P-2 Kearney, Nebr.



MAKE MONEY IN PAINTING BUSINESS

Paint walls, ceilings, screens, furniture, radiators, machinery faster, better! 3/4 H. P. motor 110 Volt 60 Cycle AC, complete with Spray Gun, 15 ft. hose. Weighs only 44 lbs. Carry anywhere. **FULLY GUARANTEED.** Only \$31.15 f. o. b. Chicago. \$5 Deposit, Balance COD, or SEE YOUR DEALER. Circular FREE. Get started making money NOW!
\$31.15 Complete
 Ideal Pump Co., Dept. PM2, 801 Washington, Chicago



MODEL SE-2 with denatured alcohol burner and wire-mesh fire screen. A two-cylinder steam engine for small boat models. Bore 3/4", Stroke 3/2". Price complete as illustrated \$2.70 postpaid. Propeller rig for above engine 30c extra.
SHAWNEE ENGINE CO.
 Box 162, Station D, Cincinnati, Ohio



Balance as above with 1-50; 1-20; 2-10; 1-5 and 2-2 gram weights base 6 3/4" x 3 3/4" \$4.75. Catalog with 3000 illustrations of laboratory apparatus sent for 50c. Catalog listing 10,000 chemicals, drugs, flavors, etc., and 1700 scientific books sent for 25c; Wholesale Price List 1900 ill. 10c.
Laboratory Materials Company, 639 E. 71st St., Chicago, Ill.



THAT UNUSUAL SNAP SHOT

may be worth **HUNDREDS OF DOLLARS to YOU**
 This is not a contest. For particulars send self addressed and stamped envelope to **UNUSUAL SNAP SHOT DISTRIBUTING CO., 423 Euclid Ave., Cleveland, Ohio.**

When You Build the "SOVEREIGN" You Can Build Them All
 Complete book on building Popular Mechanics Famous Museum Ship Model "Sovereign of the Seas." Price \$1.00 postpaid.
Popular Mechanics Press 200 E. Ontario St., Chicago

900 WORK SHOP IDEAS!

How to Make Articles of Beauty and Utility that Sell
 Get the most out of your hobby. Turn your Work Shop hours into profit. The "Make It Yourself" book shows you what to make and how to make it, with that "professional touch"—models—toys—useful decorative articles of all kinds. Newest edition—480 pages, 823 pictures, 7 x 10 inches. Sent postpaid for \$3.00 or in U. S. and possessions C. O. D.—you pay postman. Order Now.
POPULAR MECHANICS PRESS, Room 2388, 200 E. Ontario St., CHICAGO

"MAKE IT YOURSELF" INCLUDES:
 Toys—Models—Furniture—Garden Equipment—Home Repairs—Sports Equipment—Auto Kinks—Radio Equipment—Workshop Tools and Machinery. Articles on Working: Wood, Metal, Leather, Glass, Etc., Etc., Etc.



In answering advertisements always write name and full address clearly.

Trindl ELECTRIC ARC WELDER
 Works Off Any Storage Battery or Ordinary Light Socket... **3.75**
 This New Electric Arc Welder is made possible by the invention of a low voltage carbon. Auto batteries may be used without removing from car. Uses about same current as four headlight bulbs. Can be used on 110 Volt electric light socket or 32 Volt electric light plant by using a Trindl Converter in place of battery. Broken parts are **SIMPLY MELTED TOGETHER** by the white HOT electric arc, in just a few seconds. Produces about 7,000 degrees heat.
HOTTEST FLAME KNOWN
 Melts iron and steel instantly. Welds fenders; radiators, holes in bodies and milk cans, tanks and brazes broken castings.
WORKS on ANYTHING iron, steel, copper, brass, tin or galvanized metal. Permanent repairs made for almost nothing. Used by factories in many operations. Positive money back guarantee.
AGENTS Men with cars to sell mechanics, repairmen and farmers, factories, radio and battery shops. Five minute demonstration makes sales. Up to 150% profit! Write TODAY.
TRINDL PRODUCTS, 2229-ZD Calumet Ave., Chicago, Ill.



AMAZING GROFLEX SHOES! NEED NO BREAKING IN
YOUR OWN SHOES FREE AND BIG, QUICK CASH PROFITS
 Steady income all year showing outstanding new Spring line Men's, Women's, Children's shoes. Over 150 styles. Also Sensational New Cushion Sole Shoes \$10.00 Gold Bond women's satisfaction. Free shirts, ties, hosiery offers to customers. Wonderful self-adjusting inbuilt arch. We pay postage. No experience needed. **Big \$30. Sample Case Of Shoes Free!** Write TODAY for full information, money-making plan and Free Selling Kit.
TANNERS SHOE CO. 703 C STREET BOSTON, MASS.



NEW! DIFFERENT Wrist Action CORD SET MONEY MAKER
Women ARE GOING WILD ABOUT THIS NEW WRIST-ACTION CORD!
 Here is no ordinary new product. This new Wrist-Action Plug is one of the most remarkable new devices ever offered in the Direct Selling Field! You never saw anything like it. Housewives are fascinated—held spellbound by the instant demonstration you can give with this new electric iron cord that swings freely in any direction. Ends kinking and twisting—prevents broken wires, burned fuses. Swivel action plug spins round and round—swings from side to side—keeps cord out of the way—no wonder housewives say, "Just what I want," as soon as they lay eyes on it!
FREE Sales are instant—sure! Nothing like it ever before. Here is the self selling big money maker you can clean up with. Get the story at once. Learn how you can **GET YOUR DEMONSTRATOR FREE.** All **WRITE** territories virgin—wide open. **NOW!** Write immediately for sensational money making plan.
NO-TRO ELECTRIC APPLIANCE CORPORATION
 820 W. Erie St. Dept. P-2 Chicago, Ill.



"I WANT TO TAKE THIS OPPORTUNITY TO THANK YOU FOR DOING ME A FAVOR BY SELLING ME MY HOBART WELDER. I CERTAINLY AM WELL PLEASED WITH IT AND IT HAS HELPED ME BUILD MY BUSINESS MORE THAN I CAN SAY"
DANBURY, CONN.

SIMPLIFIED ARC WELDING BRINGS BIG PROFITS EVERY MONTH
 New low prices make this profitable welding service available to everyone. Opens doors to big pay jobs that carry real profit. Hobart welders are easier to operate, faster, guaranteed to bring you quality welding business... extra profits will pay for welder without expense to you.
NO INVESTMENT TERMS—PROFITS PAY FOR IT
 Extra earnings and savings possible with Hobart Welders make it easy to own without expense. Write for details.
HOBART BROS., Box M-284, TROY, OHIO



New 9" x 3' Genuine SOUTH BEND WORKSHOP LATHE

TERMS AS LOW AS \$6 A MONTH

\$85⁰⁰

Less Motor Drive

No. 415-YA, 9 1/4" swing by 3' bed Workshop Bench Lathe with Horizontal Motor Drive, 1/2 H.P. Reversing Motor, Switch and Adjustable Belt Tension Countershaft... **\$117.00**

(\$15.00 down, \$6.00 a month for 18 months.)



THE new 9-inch Workshop Precision Lathe is a back-geared, Screw Cutting Lathe, and has the same workmanship and materials as our larger, more expensive models.

It is designed to handle the finest, most accurate jobs in manufacturing—in the tool room, in home workshops and automotive machine shops. This lathe at \$85 and up represents the greatest value we have ever offered in 31 years of fine lathe building.

Features include Twin Gear Reverse to lead screw, Ball Thrust Bearing on Spindle, Automatic Longitudinal Screw Feed to Carriage, Precision Lead Screw for Cutting screw threads from 4 to 40 per inch, 3/4-inch hole through spindle taking collets up to 1/2-inch capacity. Takes 38 attachments

Lathes Stocked in Principal Cities

Chicago, Ill.—C. B. Burns Mchry. Co., 541 W. Wash. Blvd.
New York, N. Y.—A. C. Colby Mchry. Co., 183 Centre St.
Philadelphia, Pa.—W. B. Rapp Mchry., 132 No. Third St.
Los Angeles, Cal.—Eccles & Davies Mchry., 1910 Santa Fe
Detroit, Michigan—Lee Mchry. Co., 6318 E. Jefferson Ave.
Milwaukee, Wisconsin—Voell Mchry. Co., 1533 No. 16th St.
Boston, Mass.—The MacKenzie Mchry. Co., 36 Oliver St.
Cleveland, O.—Reynolds Mchry. Co., 2034 E. 22nd Street.

Write FOR THESE BOOKS

"How to Run a Lathe" has 160 pages with over 300 illustrations of work on a lathe. Over 1,500,000 copies sold. 25c each. Catalog No. 15-Y describes and prices the 9" Workshop Lathe in 8 drives and 4 bed lengths. Copy sent free, postpaid.

South Bend Lathe Works
626 E. Madison St., So. Bend, Ind., U.S.A.

South Bend Lathe Works,
626 E. Madison St., South Bend, Ind., U. S. A.
Please send me the following:

- No. 33LB "How to Run a Lathe," 25c
- No. 15Y 9" Workshop Catalog, Free
- Easy Payment Purchase Plan

Class of Work

Name

Address

City State

for milling, grinding, draw-in Collet chuck work, and many other lathe operations. In 3', 3 1/2', 4', and 4 1/2' bed lengths.

Write for information on this lathe and larger sizes in motor drive and countershaft drive. Get the bulletins we offer—with instruction about Manufacturing work, Automotive jobs, Home shop projects, etc. Use coupon below.

5 OTHER SIZES: 9", 11", 13", 15" and 16" SWING IN ALL BED LENGTHS—PRICED \$102 to \$1500.

Lathe shown below is No. 117-C, 16" x 6' Quick Change Gear Underneath Belt Motor Driven Lathe with 1 H.P. motor. Complete as shown, Wt. 2300 lbs. **\$969**

(\$97 down, \$43.50 monthly for 22 months.)

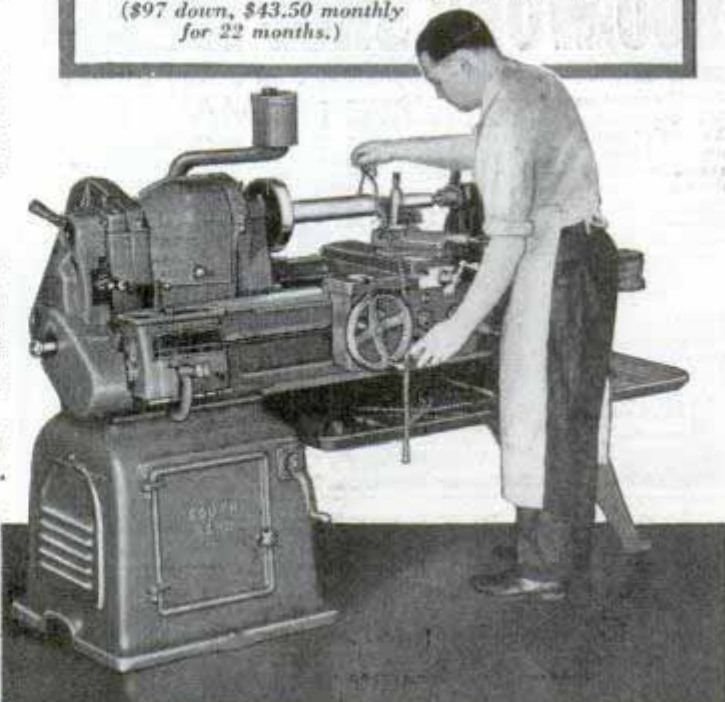

SOUTH BEND Precision LATHES

F I S H E R F A C T S

WEATHERPROOFING COMFORT

in the UNISTEEL BODY by FISHER

IT takes a lot more than meets your eye to make a motor car body completely comfortable — a lot more, for instance, than wider, easier-riding seats and spacious interiors.

You have to consider weather conditions, noise and air circulation, too. All of these affect comfort. So, naturally, when Fisher engineers set out to glorify the steel body they had to master each of them—and did.

They fused the steel panels in the Unisteel Turret Top Body into one integral steel unit. Then, they insulated all panels as well as the Turret Top and the Saftiseal steel floor—to muffle outside noise and shut out heat and cold.

With all these advantages added to the plus of Fisher No Draft Ventilation, they achieved the first *completely comfortable* steel body!

You'll find the Unisteel Body more weave-proof, shock-proof, and secure, as well. And you'll more than likely agree that the style leaders this year are all General Motors cars — the only cars with the Unisteel Turret Top Body by Fisher.

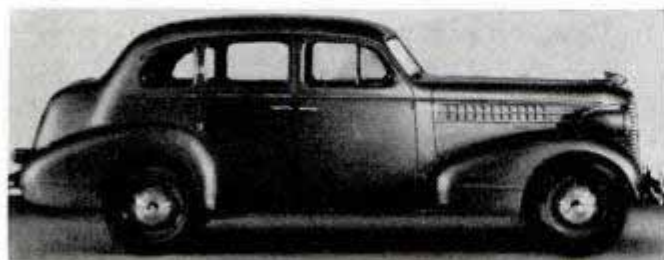

IT'S PONTIAC, with its Unisteel Body by Fisher. That's the car they mean when they say, "The Most Beautiful Thing On Wheels Again Outvalues Them All."

LET IT SNOW OR SLEET—Fisher No Draft Ventilation supplies fresh air yet shuts out bad weather—drip shields help to keep rain, snow and sleet from trickling in. You ride in comfort.

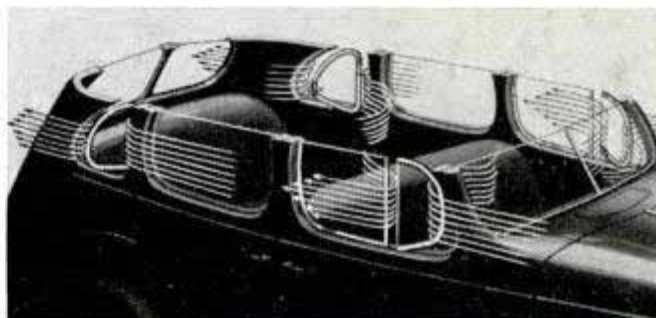

The Inside Facts About Fisher No Draft Ventilation

1. Note how air circulates about each Ventipane—in at the front, out the back.
2. It promotes air circulation, but prevents cross drafts.
3. It permits unlimited circulation, varying in degree with the extent to which the Ventipane is opened. Note: In cold weather you use only the Ventipanes to secure fresh air. The windows are kept closed.
4. It is individually controlled, so that each person is virtually his own weather man.
5. Front Ventipanes when opened slightly keep the inside of the windshield from fogging.



Body by Fisher

ON GENERAL MOTORS CARS ONLY:

CHEVROLET • PONTIAC • OLDSMOBILE
BUICK • LA SALLE • CADILLAC

Chesterfield

Let me wish you
MORE
PLEASURE
for '38

