

SCIENTISTS OF THE AIR

POPULAR MECHANICS

★

MAGAZINE

WRITTEN SO YOU CAN UNDERSTAND IT

BEST TRADE MARK GREAT BRITAIN No. 40426

REG. U.S. PAT. OFF.

JAN.
25 CENTS

SEE PAGE 79



"If you want my number—"

Get Yourself a Barbasol Face"

It does not take many weeks to get a full-fledged Barbasol Face and then you're a prize package for the women folk.

Your jowls and cheeks look and feel softer and firmer and fresher. Roughness and irritations tend to vanish. Even wrinkles seem to smooth away.

The whole effect, of course, is a more attractive, younger-looking Barbasol Face—gained in a very short time after you discard old shaving methods and switch to modern Barbasol.

That's because Barbasol is a cream. It contains none of those harsh alkalis that dry and tighten the skin, resulting in roughness and wrinkles.



First time you shave with Barbasol, you can tell by the way it cools and soothes how wonderful it is for the skin. Its good ingredients hasten the work of your razor, and then they leave your face soft and supple and youthful looking.

Start with Barbasol today for the finest shave you ever had, and in about two weeks you'll cheer at the wonderful improvement in your face. At all drug stores, large tube, 25¢; giant size, 50¢; family jar, 75¢. Five Barbasol Blades, 15¢.

For modern shaving



No Brush—No Lather—No Rub in

How Movies of Noise Gave Cars a "Hushed" Ride

REMEMBER the clatter of old-time "gas-buggies"? In today's Plymouth you can hear a watch tick! And it's priced with the lowest...with the Commercial Credit Company's easy terms offered by Dodge, De Soto and Chrysler dealers.



1 This is One Way to plug out noise. But Plymouth contains special insulating materials which effectively keep noise out...give a "hushed" ride!



2 Different Parts of a Car have different vibrations. So Plymouth engineers put microphones everywhere inside... to ferret out the slightest noise.



3 They Used Television tubes to photograph noise and transform it into light-rays. Throw these light-rays on a movie-film — and noise will paint its own picture for you.



4 This is a Movie of Noise. Look at the wavering sound-track on the film. Plymouth engineers studied hundreds of these "movies." They worked out 5 different ways to stop noise.



5 Dampens Hum, Rumble. When you grab an alarm-clock bell, the vibration is "dampened." A special material dampens vibration in various Plymouth parts.

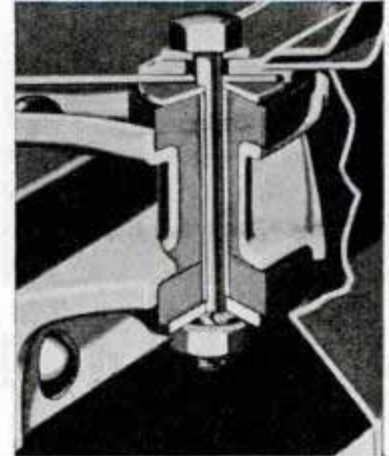

6 Blocking Road Vibration. Spools of rubber "float" Plymouth's body on the frame...efficiently block out road vibration.



7 Soaking Up Noise from the Air. Insulating materials are tested in this tunnel. Noise must be actually "soaked up" by these materials.

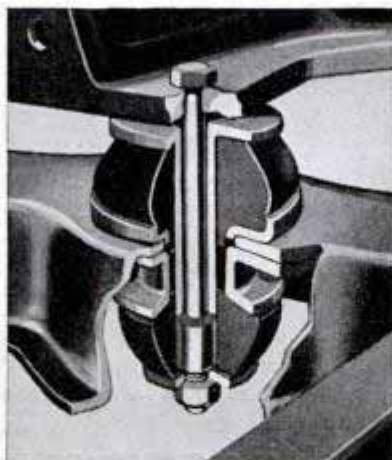

8 Patented Floating Power engine mountings keep power vibration from being telegraphed through the car's frame to the body.



9 The Big 1938 Plymouth! See it today — and learn the whole great story! PLYMOUTH DIVISION OF CHRYSLER CORPORATION, Detroit, Michigan. Major Bowes' Amateur Hour, C.B.S. Network, Thurs., 9-10 p.m., E.S.T.

IT'S "THE CAR THAT STANDS UP BEST!"

Plymouth Builds Great Cars

When writing to advertisers please mention Popular Mechanics



Bread, Butter, and Jam for 13,000,000 People

ARE you one of these 13,000,000 people? Does the income which supports you come from making or selling automobiles, radios, electric refrigerators, or movie films? If so, you are one of them. You are one if that income comes from the rayon or aluminum industry, or any of the other industries which have grown up in a single generation.

Automobiles, radios, gasoline, aluminum—these and many other products exist today because industry sought new products and better ways of building old ones. And after unearthing these new products, industry developed them, found

ways to build them better, means to sell them at lower prices.

Today, these industries not only employ millions but—through demands for steel, coal, cotton, transportation—they help support millions more.

Some of the greatest advances in this work have been made through the use of electricity. Through it new products have been developed, and the efficiency of all industries has been increased. In most of these modern electrical developments, General Electric research and engineering have pioneered.

G-E research has saved the public from ten to one hundred dollars for every dollar it has earned for General Electric

GENERAL ELECTRIC

90-8E2

LISTEN TO THE G-E HOUR OF CHARM, MONDAYS, 9:30 P.M., E.S.T., NBC RED NETWORK

Popular Mechanics Magazine

H. H. WINDSOR, Founder

H. H. WINDSOR, Jr., Editor and Publisher

January, 1938

Vol. 69, No. 1

Special Features

New Wealth from the Sea	1
Chemistry and You—Part II	Coloroto
How to Make Good Home Movies	18
Two Miles Down for Oil	26
Dare-Devil Scientists of the Air	34
Red and Black Magic	42
A New Breed of Racing Cars	50
Putting the World on Skids	58
Sled Thrills by Slide Rule	66
Packing Drama in the Films	72
Dispatching the Corn Poppers	82
Broadcast Gives "Sight" to Ears	90

(Continued on next page)

The Rough Road to Glory

THE road to fame and fortune can be covered quickest in a racing car—that's the conviction of hundreds of enthusiastic young men today. Wherever there's an old car on which to tinker, you'll find one of them at work. One and all, they dream of roaring to glory on the race track. And some of them will! Among these ambitious young men are the winners of future Indianapolis and Roosevelt Raceway speed classics. But for each one who makes the grade, many will fail. Racing is a truly great sport but, unfortunately, there is no royal road to a speed king's crown. It's a hard, tough climb from the bottom up. After reading Major George H. Robertson's article about racing cars in this issue, your appetite will be whetted for his February article telling what it takes to make a race driver. It's filled with yarns of the track by the first American driver to win a Vanderbilt Cup race.

Next Month

AIR wardens this winter are patrolling the roadless woods of Maine and the airplane is helping to protect wild life and prevent forest fires. It is being used to stock backwoods waters with game fish and to carry food to winter-starved deer and moose. Naturally, when game wardens sprout wings, it's news and the story is in the February issue.

A Toy That Grew Up

CHILDREN were amused thirty years ago by a strange spinning toy which seemingly defied the laws of gravity. The kids called it a magic top. Their scientific elders termed it a gyroscope. And because one man of vision was intrigued by the possibilities of this toy, its uncanny balancing properties are harnessed to the controls of ocean liners and airplanes. Watch for "The Toy That Grew Up" next month.

The Ice Age Riddle

IF THE average temperature of this country should drop eight or nine degrees, Chicago would be buried under half a mile of ice. So say scientists studying the last great ice age. And a future ice age is a very real possibility, an ice age which some believe might be set in motion by the heat and fire of volcanoes! And thereby hangs a tale which you'll find in the February issue.



Pyroil won't actually make your car fly. But it does add a thrill to automobile performance that's sensational! As one user of Pyroil says, "My engine sounds as though it is running on velvet!"

Ask your service station attendant to add 15 cents worth of Pyroil to the gas tank of your car every 200 to 250 miles. Also, add a dime's worth each time a quart of oil goes into the crankcase. Then, enjoy new pep, power, smoothness!

New cars need Pyroil from the start. It safeguards all engine parts against excessive wear. Against corrosion (acid attack). Against carbon, gum and sludge accumulations. Older cars get these same benefits—plus marvelous stepped up performance.

In cold weather, Pyroil gives you LUBRICATION at the first turn of the engine—stays on the cold metal when regular lubrication drains away!

Try Pyroil today! Mail coupon for interesting facts. Manufactured and Guaranteed by Pyroil Company, W. V. Kidder, Founder, 51 Pyroil Bldg., La Crosse, Wisconsin, U. S. A.



DISTRIBUTORS:

Check and mail coupon for facts of our unusual Sales Opportunity for you. Start now!

SIMPLY ADD TO GAS & OIL

PYROIL COMPANY
 51 Pyroil Bldg., LaCrosse, Wis., U.S.A.
 Please send complete Pyroil facts.
 Also send details of your plan for Distributors.

Name.....
 Address.....
 City..... County..... State.....

When writing please mention Popular Mechanics

(Contents—Continued)

AUTOMOTIVE	
House on wheels has bed in upper deck	46
Auto parts tester "feels," "sees" and "hears"	48
Glider motor drives tiny sports model car	56
Home on wheels looks like brick house	57
Wheel tester winks neon eye as warning	76
Army tank takes to air in leaping embankment	77
Tractor hoisted atop building aids wrecking crew	79
Roadside figure of Death warns drivers	80
AVIATION	
Flaws in airplane parts found by magnetizer	24
Scouting warplane hangs report on wire	33
Quick-release crash belt helps pilot escape	38
Water tank to serve as wind tunnel	56
Giant press for plane parts	78
Private plane has comforts of yacht	79
Plane drops food to mountain peak climbers	81
Four-miles-a-minute sleeper plane seats forty	93
CONSTRUCTION	
Super-highway traffic circle covers big garage	17
Modern tower replaces old building's dome	21
Steel for elevated highways demands increased output	21
West Virginia dam to challenge floods	41
FARMS AND GARDENS	
Inexpensive barn built from old freight cars	40
Mechanical corn picker handles two rows	71
Cows wear rubbers to prevent foot infection	77
Folding bars form stalls for cows	80
HOUSEHOLD	
Vegetable shredder saves hands from injury	23
Sliding thermostat checks gas when water is hot	30
Ventilator in stove pipe removes cooking odors	38
Gas-heated clothes drier	48
Hot-or-cold pack handy to use	63
Venetian clip-on tape is detachable	87
Homemade snowplow ends labor with shovel	96
MOVIES AND PHOTOGRAPHY	
Fast camera catches stone striking water	25
Electric eye stops "ground noise" of sound film	31
Prize photo of Rockies snapped from air liner	31
Projector of moving words latest in advertising	39
Secret pocket for films in latest album	40
Horse-drawn fire engines do double duty	48
Extra lens increases camera's depth and speed	88
Paintings guide film workers in big scenes	95
RADIO AND ELECTRICITY	
718-foot steel antenna reduces signal fading	22
Television transmitted from movie studio	32
Microphone like machine gun aimed at sound	46
Electric shock makes cat try forepaw stand	48
Swivel base socket for light	71
Phone message is "parked" on magnetized tape	76
Arc-welding shop in arctic	80
Radio directs fire fighters speeding to blaze	87
Weatherproof electric outlet for house exterior	88
Radio guides tunnel borers in straight line	89
Automatic code reader operates on any receiver	97
How to build a four-tube midget receiver	98
Simple 5-meter transmitter for beginners	100
Practical radio suggestions	101
Compact capacity-operated relay	102
German receiver has shift control	102
Radio set with phone system	102
RAILWAYS	
Railway wrecking crew rescues a mired cow	33
Diesel railroad track shifter speeds up work	46
Small mover for freight cars eliminates pinchbar	49
Railway cars given crash test	64
SCIENCE AND INDUSTRY	
Glass-faceted grinder shapes big mirror	39
"Dust magnet" cleans air of dirt	62
Shatterproof glass for light fixture	70
Motor on back speeds boat scraping	88
Truck has grab arms to move barrels	94
Scale has a dial that locks	96
SHIPS	
Quick-diving submarine	40
Million-dollar ships await torch in graveyard	54
U. S. fleet seen in battle array from plane	57
"Yorktown" is navy's largest aircraft carrier	86
SPORTS	
Motor sled carries passengers up ski run	17
Bowling-shuffle board combined in game	30
Bicycle scooter steered by feet	63
Teletype board for football helps radio announcer	64
Hill-climbing tractor hauls skiers on sled	65
Two-speed unit for bicycle	86

(Continued to page 6A)



Indian JUNIOR SCOUT

F.O.B. FACTORY
\$215.
 FULLY
 EQUIPPED

THE TWIN CYLINDER MOTORCYCLE MARVEL

THE NEW 1938 INDIANS ARE READY to flash you over the open road to fun and adventure! New Indian triumphs, all of them—great motorcycles built as only Indian can build them.

Heading the parade is the new Indian Junior Scout—the greatest twin cylinder "buy" in all motorcycle-dom! It's a great machine—an engineering marvel easy to handle, easy to start, with plenty of power and pep to flash you along with the leaders. And it costs so little to run—you'll get 70 miles to the gallon easily!

NOW OWN AN INDIAN ON EASY PAYMENTS

The Junior Scout is still the lowest priced "twin" in America! So why wait? Visit your Indian dealer today and let him tell you how easy it is to own any Indian model on easy payments.

BOY—HOW THEY TRAVEL!



Don't forget
 our great
FREE OFFER



Get this fine RIDER'S HELMET and INDIAN PIN absolutely FREE when you place your order.

MAIL COUPON TODAY!

INDIAN MOTORCYCLE CO. Springfield, Mass.

This One



36T4-CZE-L4J1

INDIAN MOTORCYCLE CO., Springfield, Mass.



LIFETIME MOVIE CAMERA

EVERYBODY wants a movie camera . . . and few people have one! No other gift can match the thrill that comes with preserving forever life's happiest moments . . . of bringing back to life precious memories on one's own movie screen—again and again.

USES .60¢ FILM

And no other movie camera can match UniveX value! Because it's the only one in the world that takes theatre quality movies *at less cost than snapshots!* But not price alone has sold more UniveX movie cameras than those of all other makes combined! Its dependable performance . . . ease of loading and operation . . . its compactness . . . have made the UniveX Cine "8" America's No. 1 movie camera!



DON'T DELAY!

Because of the unprecedented demand, dealers may not be able to accommodate you if you wait 'til the last minute. So see your dealer for demonstration *today*.

\$9⁹⁵

AMERICA'S No. 1
MOVIE CAMERA!

CINE "8"
UniveX

(Contents—Continued)

TOOLS

Insulation stripped off wiring by electrical pliers . . .	40
Belt lacing tool used with hammer or vise	65
Pocket soldering lamp	78
Staple remover	95

MISCELLANEOUS

Ninety eggs graded in second by machine	23
Tube of gas in safe prevents robbery	23
Baby buggy slides down stair on frame	24
Low upkeep of steel house offsets price	24
Pedal car made of two bikes and hood	24
Electric map has names in Braille	30
Anti-aircraft gun operated by one man	32
Cornea of eye tattooed to improve vision	32
Potato cleaner and sorter has rubber fingers	38
Lincoln's head on mountain nearing completion	49
Stiffness tester for cloth eliminates guessing	54
Model shows preview of California fair pyramids	55
"Merry-go-round" roadside advertising sign	56
Shoe fit for a giant's foot	56
Firemen race to ladder top in drill	62
Deer is a family pet	63
Speaker sees own voice in test tube	64
Cylinder clock tells time by sliding on incline	70
Inkwell saves ink from drying up	70
Safety cuffs for pressman	70
Pump sucks smoke out of burning building	71
Gas masks guard firemen from smoke	77
Plant growth speeded by low-wattage lamps	80
Odd puzzles created by secret process	81
Swordsmen duel at gate of medieval castle	87
Outside mirrors reflect sun's rays into room	88
Paper harness feeds envelopes to typewriter	89
Smoke gun shows direction of air currents	93
Deaf hear through fingers on vibration instrument	94
Eleven-pound outboard motor cooled by immersion	94
Room-size "lung" for infantile paralysis	96

Craftsman and Shop Notes

ARTISTS

Artist's paintbrushes cleaned on clothespin	110
Fuller ball makes handle for compass	134
Brush holders on mixing tray	138
Cartridge shells hold artist's crayons	156

AUTOMOTIVE

Auto short cuts	157
Hand wiper cleans "foggy" windshield	158
Keeping inner tubes submerged in test tank	158
Name of gasoline on driveway helps motorist	158
Strong lamp for motor trouble at night	158
Hinged tail board facilitates unloading boxes	159
Holder to keep cable wires in order	159
Installing headlight lamps	159
Spark plugs tested with radio tube	159
Piston-ring compressor from door spring	160

CONSTRUCTION

Fasteners to attach articles to brick walls	130
Casting imitation marble	147
Sand heated with oil-soaked bricks	150
Twisted iron stakes hold concrete forms rigidly	150

ELECTRICAL

Figuring operating cost of electrical appliance	113
Thimble to pull wires through conduit	130
Jig aids in wiring electrical sockets	155

FARM

Pipe removed from well with special hook	118
Improvised post-hole digger	135
Stove-wood racks held by woven wire	142

FURNITURE

Pivot-top end table	103
Hamper combined with vanity	108
Shoe-shining chairs have magazine racks	146

HAND TOOLS

C-clamps from old turnbuckles	106
Spring tool to remove battens	106
Abrasive pencils have many uses	110
Coping saw shielded to prevent marring work	117
Simple guide to start taps	118
Wing nut wrench made from pipe fittings	118
Coping saw has pressure foot	120
How to mount a bench vise	129
Jig spots center in end of small rod	133
Hose aids in bending copper tubing	134
Small soldering-iron tip that holds heat	134
Clamp for brazing broken band-saw blades	146
Tiny socket wrenches from hollow set screws	149

(Continued to page 8A)

Are You STILL in the DEPRESSION??

TIMES are better. Business is out of the rut—well ahead of a year ago. Millions of men have gone back to work. There's more money in lots of pay envelopes. But what good is that to you, if your pay check is still written in depression figures?

You weren't so discontented a year ago. In fact, you considered yourself lucky to have a job. But now—you have begun to wonder and worry why the oncoming tide of prosperity hasn't reached you yet. The situation is getting desperate. Bills continue to pile up. You can't get along forever on a "shoe string" budget. You *must* win back those pay cuts. Other men are doing it—how can you?

Certainly, you can't work any harder than you have been. And it isn't a question of your intelligence, honesty or ambition. Those virtues do not solve today's problem—they are often insufficient to hold down a job, as millions unemployed sadly testify.

But there *is* a way to get back to the prosperity pay check. A way that's probably far easier than you have dreamed. A *plan* that has been "depression-tested."

During the worst period of the depression, this plan was helping thousands of men and women forge ahead. Today, during recovery, these same men and women—their ranks swelled by thousands more—are being picked for top positions. They are escaping years of monotonous, routine service—achieving their dreams while they are young enough to enjoy success in its fullest measure.

Since this plan brings results in bad times as well as

LASALLE EXTENSION, Dept. 164-R, Chicago

I would like to know about your Success-Building Plan and service in the business field I have checked.

- | | |
|--|--|
| <input type="checkbox"/> Business Management | <input type="checkbox"/> Industrial Management |
| <input type="checkbox"/> Higher Accountancy | <input type="checkbox"/> Modern Foremanship |
| <input type="checkbox"/> Traffic Management | <input type="checkbox"/> Business Correspondence |
| <input type="checkbox"/> Modern Salesmanship | <input type="checkbox"/> Business English |
| <input type="checkbox"/> Commercial Law | <input type="checkbox"/> Effective Speaking |
| <input type="checkbox"/> Law: Degree of LL. B. | <input type="checkbox"/> Office Management |
| <input type="checkbox"/> Expert Bookkeeping | <input type="checkbox"/> Stenotypy |
| <input type="checkbox"/> C. P. A. Coaching | |



good, it obviously works independently of business conditions. As unbelievable as that may sound, remember that success is largely up to the individual. Most men struggle through a depression all their lives. The few who forge ahead ride to success the same business tides that sweep the majority to failure.

The LaSalle Success-Building Plan is made for men like you—men with courage, ambition, persistence, who need expert guidance to make the most of their efforts. But LaSalle supplies even *more* than that. Not only individualized training and coaching to help you meet today's crying needs . . . but also the very steps you need to take to fill the job ahead, and force that pay raise *quickly*. Any

synopsis of this plan, which we might include here, could give you only a vague idea of this service. We suggest you mail the coupon for complete details on your own line of work.

Today's Danger

There's a real danger to accepting "depression pay" these days. A danger that lower wages will continue to dog you—for no employer will pay more until he is convinced you are worth more. Some day, some way, you've got to convince him. There's no time to lose. The sooner you begin, the better.

If the LaSalle Plan has fulfilled this aim for thousands, isn't it logical to expect it can do as much for you? This coupon can easily become your passport to better times. Mail it today.

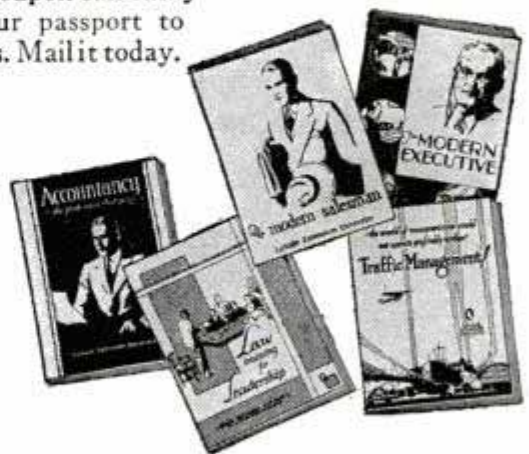

Name..... Age.....

Address.....

LaSalle Extension

When writing to advertisers please mention Popular Mechanics



THE OLD WAY You bought a file like your wife buys a hat . . . the clerk hunted through five or ten boxes, unwrapped yards of brown paper . . . and wondered whether you actually knew what you wanted . . . it took lots of time and patience . . .



THE NEW WAY You step up to a self-service display, find popular types and sizes clearly divided, marked, and priced . . . cellophane wrapping lets you examine each file closely and quickly choose the one you want at the price you want to pay.

Alert hardware dealers in your community are featuring this new display with the new, faster-cutting Nicholson or Black Diamond Files. The Nicholson File Company, Providence, R. I., U. S. A.

PATENTED

(Contents—Continued)

HOME IMPROVEMENTS

Chimney repairing table straddles roof	107
Modern linen closet encloses wash stand	111
Wetting plaster crack to patch it	133

HOUSEHOLD

Circulating fan in furnace operated by thermostat	105
Scroll-sawed wall shelves can fold flat	105
Scale on sewing-machine cabinet saves time	110
Black cloth helps thread machine needle	118
Medicine tray made from soap holder	118
Fuel corrodes pipes in coal bin	120
Card table serves as bed table	129
Chair height increased for child	130
Rubber ball makes finger shield for knife	130
Easy ways to solve your home problems	136
Straightening smoke pipe with metal bands	138
Correcting balky electric clocks	140

PHOTOGRAPHY

Enlarger iris ring illuminated by view finder	106
Camera window protected when using film	112
Shadow box, moving pictures in Yuletide	126
Miniature contact printer	133
Photos held in loose-leaf binder by clips	134

POWER MACHINE

Chamfering tool for lathe operators	134
Accurate spiral fluting with homemade jig	139
Faceplate and chuck turning—Part 2	151

SPORTS

Ringer game played on table	107
Skate sails go like the wind	114
Steel front on toboggan simplifies construction	117
Homemade ski carrier fits on running board	129

STORE AND SHOP

Watch crystals handled with vacuum lifter	110
Glass cutter held in lathe tool post	141
Caricatures for holiday shoppers	142
Sliding tray under vise catches small parts	142
Clothespins support window cards	144
Color chart in millinery store	144
Machinist's goggles cleaned with wash-basin stopper	144
Flowerpots make pouring holes for molds	146
Baker motorizes hand pastry-filling pump	148
Rubber-handled market baskets	148
New shoes tested on improvised walk	149
Spring device holds sack mouth open	149
Blower system prevents condensation on windows	150
Lamp rheostat to control small motors	155
Small gutter keeps dirty water off sidewalk	155
Barrel carrier fitted with bicycle wheels	156
Jeweler keeps small parts in rubber rings	156
Novel method of displaying pastries neatly	156
Tag on pencil protects wall chart	160

WOODWORKING

Dowel screws join wood turnings	112
"Lazy-peon" book ends	113
Turned candy box has "snap-up" lid	135

MISCELLANEOUS

Make your own luminous paint	106
Yarn-ball holder on knitting bag	107
Easy way to adjust wing nut	110
Kinked wire straightened with garden rake	112
Sandblasting with scratch brush	112
Clothing made fire resistant	117
"Stage" your Christmas gifts	119
Anchoring end of tape measure	120
Glass annealed in electric heater unit	120
Crepe-paper novelties	121
Loose-leaf book markers from shipping tags	125
Newsboy's paper bag leaves both hands free	125
Taking ring measurement	125
Toothpick holder for your pocket	125
"Bowl-O," a table-top bowling game	131
"Sewer mole" does work of many men	141
Bolt heads flanged to prevent splitting grommets	144
Baggage counter has rollers to slide suitcases on	146
Tool chest serves as workbench	149
Movers use rubber "bumpers" to protect woodwork	150

IMPORTANT NOTICE

It is the intention of this magazine to provide its readers with information regarding the latest developments in the mechanical arts. We take no responsibility as to whether the disclosures contained in our articles are covered by patents and advise readers to investigate this subject before making, using, or selling any of the products, machines, or processes described, in order to avoid possible liability for patent infringement.

A FILE FOR EVERY PURPOSE

*What will you
be doing - ONE
YEAR FROM TODAY*



THREE hundred and sixty-five days from now — what?

Will you still be struggling along in the same old job at the same old salary — worried about the future — never able to make both ends meet?

One year from today will you still be putting off your start toward success — thrilled with ambition one moment and then cold the next — delaying, waiting, fiddling away the precious hours that will never come again?

Don't do it, man — don't do it.

There is no greater tragedy in the world than that of a man who stays in the rut all his life, when with just a little effort he could advance.

Make up your mind today that you're going to train yourself to do some one thing well. Choose the work you like best in the list below, mark an X beside it, and, without cost or obligation, at least get the full story of what the I. C. S. can do for you.

INTERNATIONAL CORRESPONDENCE SCHOOLS

BOX 5695-H, SCRANTON, PENNA.

★ Without cost or obligation, please send me a copy of your booklet, "Who Wins and Why," and full particulars about the subject *before* which I have marked X: ★

TECHNICAL AND INDUSTRIAL COURSES

- | | | | | |
|--|---|--|--|--|
| <input type="checkbox"/> Architect | <input type="checkbox"/> Sheet Metal Worker | <input type="checkbox"/> Plumbing | <input type="checkbox"/> Steam Fitting | <input type="checkbox"/> Bridge Engineer |
| <input type="checkbox"/> Architectural Draftsman | <input type="checkbox"/> Boilermaker | <input type="checkbox"/> Heating | <input type="checkbox"/> Ventilation | <input type="checkbox"/> Bridge and Building Foreman |
| <input type="checkbox"/> Building Estimating | <input type="checkbox"/> Telegraph Engineer | <input type="checkbox"/> Air Conditioning | | <input type="checkbox"/> Chemistry |
| <input type="checkbox"/> Contractor and Builder | <input type="checkbox"/> Telephone Work | <input type="checkbox"/> Steam Engineer | | <input type="checkbox"/> Pharmacy |
| <input type="checkbox"/> Structural Draftsman | <input type="checkbox"/> Mechanical Engineering | <input type="checkbox"/> Steam Electric Engineer | | <input type="checkbox"/> Coal Mining |
| <input type="checkbox"/> Structural Engineer | <input type="checkbox"/> Mechanical Draftsman | <input type="checkbox"/> Marine Engineer | | <input type="checkbox"/> Mine Foreman |
| <input type="checkbox"/> Management of Inventions | <input type="checkbox"/> Machinist | <input type="checkbox"/> R. R. Locomotives | | <input type="checkbox"/> Navigation |
| <input type="checkbox"/> Electrical Engineer | <input type="checkbox"/> Patternmaker | <input type="checkbox"/> R. R. Section Foreman | | <input type="checkbox"/> Cotton Manufacturing |
| <input type="checkbox"/> Electric Lighting | <input type="checkbox"/> Diesel Engines | <input type="checkbox"/> Air Brakes | <input type="checkbox"/> R. R. Signalmen | <input type="checkbox"/> Woolen Manufacturing |
| <input type="checkbox"/> Welding, Electric and Gas | <input type="checkbox"/> Aviation Engines | <input type="checkbox"/> Highway Engineering | | <input type="checkbox"/> Agriculture |
| <input type="checkbox"/> Reading Shop Blueprints | <input type="checkbox"/> Automobile Mechanic | <input type="checkbox"/> Civil Engineering | | <input type="checkbox"/> Fruit Growing |
| <input type="checkbox"/> Heat Treatment of Metals | <input type="checkbox"/> Refrigeration | <input type="checkbox"/> Surveying and Mapping | | <input type="checkbox"/> Poultry Farming |

BUSINESS TRAINING COURSES

- | | | | |
|--|---|---|--|
| <input type="checkbox"/> Business-Management | <input type="checkbox"/> Bookkeeping | <input type="checkbox"/> Service Station Salesmanship | <input type="checkbox"/> Grade School Subjects |
| <input type="checkbox"/> Industrial Management | <input type="checkbox"/> Secretarial Work | <input type="checkbox"/> First Year College Subjects | <input type="checkbox"/> High School Subjects |
| <input type="checkbox"/> Traffic Management | <input type="checkbox"/> Spanish | <input type="checkbox"/> Business Correspondence | <input type="checkbox"/> College Preparatory |
| <input type="checkbox"/> Accountancy | <input type="checkbox"/> French | <input type="checkbox"/> Stenography and Typing | <input type="checkbox"/> Illustrating |
| <input type="checkbox"/> Cost Accountant | <input type="checkbox"/> Salesmanship | <input type="checkbox"/> Civil Service | <input type="checkbox"/> Cartooning |
| <input type="checkbox"/> C. P. Accountant | <input type="checkbox"/> Advertising | <input type="checkbox"/> Railway Mail Clerk | <input type="checkbox"/> Lettering Show Cards |

DOMESTIC SCIENCE COURSES

- | | | | |
|---|---|--|--|
| <input type="checkbox"/> Home Dressmaking | <input type="checkbox"/> Advanced Dressmaking | <input type="checkbox"/> Millinery | <input type="checkbox"/> Foods and Cookery |
| <input type="checkbox"/> Professional Dressmaking and Designing | | <input type="checkbox"/> Tea Room and Cafeteria Management, Catering | |

Name.....Age.....Address.....

City.....State.....Present Position.....

If you reside in Canada, send this coupon to the International Correspondence Schools Canadian, Limited, Montreal, Canada

When writing to advertisers please mention Popular Mechanics



Seized With the Swag

A "smart" crook! Gloves to cover his finger tips! A clean getaway; a good haul. So he bragged, only to see his petty pride crushed by a fatal slip he had made—a palm print on the wall!



Finger Prints Free the Maid

A luxurious home . . . glittering gems . . . a rich haul. An inside job? Maybe. But it took a smart finger print expert to squelch suspicion of a blameless girl and send sly thief Gordon up for a two-year stretch.

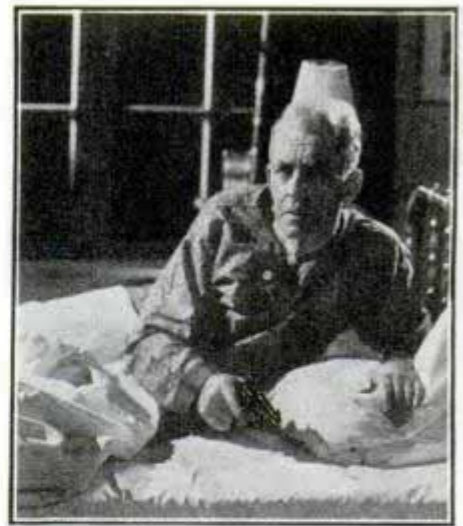

Stealthy Footsteps . . . a Crash!

Tragedy—raw-stark—casts its heavy shadow over this household. Dread-foreboding. Unknown, a madman with a grudge moves silently, persistently, on his errand of death. Finger prints, made in the nick of time, balk an atrocious crime.



The Tell-Tale Steering Wheel

Its secret revealed! Youth and gaiety at the dance; crime and greed stalking their prey. A finger print—a silent stain—shouts its guilt and sentences George Brandon for life. So ends the ghost-mystery of Death's Gap.



"This Man Is Innocent"

A deserted hospital pharmacy—tempting shelves of drugs—a prowling fiend fired by a mad desire for dope. And a pretty nurse involved in a case of double identity. Finger prints alone save an innocent man from prison bars.



With Nerves of Steel

Cold, bold, speedy—he criss-crossed the country with mystifying burglaries. A cool crook but he left a hot trail—finger prints on window-putty that led straight to Bassili and headed a fast worker to the pen.

Be a Finger Print Expert!

Solve fascinating crime problems like those pictured above! Become a well-paid Finger Print and Crime Detection Expert and enjoy the thrill of tracking down mysteries—of getting your man—with no personal danger—PLUS a regular monthly salary and the opportunity to share in rewards. Learn at home in your spare time—and at low cost—the exciting secrets of this young, fascinating and fast growing profession. **Our graduates are at the head of 47% of ALL Identification Bureaus in America.** Write for list of over 600 institutions in each of which from ONE TO FIFTEEN of our graduates earn regular monthly salaries. Then write the nearest grad-

uate to tell you all about us! Any man of average intelligence can quickly master this profession that combines thrills with personal safety AND the security of a steady income.

Wonderful Opportunity for Trained Men In This Young, Fast-Growing Profession

Of the many thousands of cities in America, more than three-fourths are STILL without identification bureaus. The last two years saw more than 300 new identification bureaus established. Many more are bound to come! That spells OPPORTUNITY! But you must make yourself READY for it. We show you HOW—as we have **already** shown the hundreds of graduates who now hold good-pay positions.

FREE! The Confidential Reports No. 38 Made to His Chief

Rush coupon for YOUR free copy of these reports! Follow Operator No. 38 on his exciting hunt for a murderous gang. BETTER than Fiction, because TRUE. ALSO, get free, "The Blue Book of Crime."—illustrated in colors. Take TODAY your first step toward a steady income and success! Mail the coupon AT ONCE.

INSTITUTE OF APPLIED SCIENCE
1920 Sunnyside Ave. Dept. 1351 Chicago

Institute of Applied Science,
1920 Sunnyside Ave., Dept. 1351, Chicago.

Without obligation to me, send me the Confidential Reports of Operator No. 38, also illustrated "Blue Book of Crime," complete list of over 600 bureaus employing your graduates, together with your low prices and Easy Terms offer. (Literature will be sent ONLY to persons stating their age.)

Name

Address

Age

PREPARE NOW FOR A BETTER JOB IN ELECTRICITY

BY 12 WEEKS TRAINING IN THE BIG COYNE SHOPS

Get into a real live, money making field where thousands of men make \$30, \$40, \$50 and up a week in the fascinating field of electricity. Prepare today for your start in a field that is full of opportunities for the trained man.

Learn by Doing — in 12 Weeks

on real motors, generators, engines, etc. The remarkable "Learn by Doing" method used in the great Coyne Shops trains you in Electricity and its many branches in 12 weeks. Actual shop work—not a correspondence course—you don't have to recite. Instead you are trained by actual work in wonderful, modern daylight shops on the finest kind of Electrical equipment, under personal supervision of expert instructors. That's why Coyne Training prepares you for your start in this field, in a short time.

You Don't Need Previous Experience or a Lot of Book Learning

Many of our successful graduates have not even completed common school. At Coyne you learn by actual experience on a wide variety of up-to-date generators, motors, dynamos, batteries, automotive and aviation engines, electric signs, etc.

On Jobs Like These—No Correspondence
Real Work on Modern Electrical Equipment

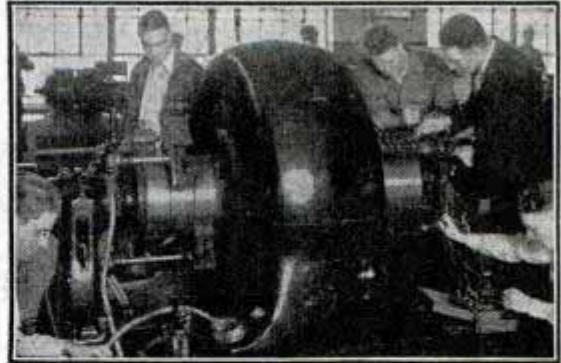

Working on Real Electrical Equipment at Coyne

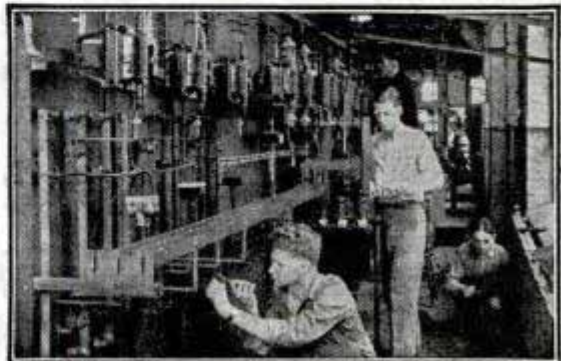

A Real Switchboard in the Coyne Shops

Astounding Offer! PAY COST OF TRAINING AFTER YOU GRADUATE Over a Year to Pay in Small Monthly Payments

Get your training first—then pay back tuition in easy monthly payments starting 5 months from the date you start school, or 2 months after the required training period is over. And

you'll have 18 months to complete your payments. Mail the coupon now and I will send you, without obligation, full details of this astounding offer!

EARN LIVING Expenses While You're Training!

Many of my students work part time to help pay their living expenses while they are training.

EMPLOYMENT Help For You After Graduation

My Graduate Employment Service will give you employment help after graduation. You are also entitled as a graduate to free consultation service any time you need it.

DIESEL, ELECTRIC REFRIGERATION AND AIR CONDITIONING

Mail Coupon Today and I'll tell you about this additional training I am including without extra cost. These fast growing branches offer many opportunities for a better job and a real future. Here at COYNE



you will get training to prepare you to fill a job in these well paid branches of the Electrical Industry . . . You will do actual work on equipment by the famous COYNE Learn by Doing method which quickly and easily gives you the PRACTICAL KNOWLEDGE you will need for your start towards a job or a business of your own in these gigantic branches of Electricity. This additional training is all included at no extra cost.

MAIL Coupon NOW!

GET THIS FREE BOOK

Get the new "Coyne Opportunity Book," giving all facts about Coyne Training. Photographs of Shops showing students at work on modern electric equipment under the personal supervision of Coyne Expert Instructors. Also details of my Spare Time Employment Offer, Pay After Graduation Plan and Graduate Employment Service. Yours without cost. Simply Mail the coupon.



H. C. LEWIS, Pres.

Founded 1899

COYNE ELECTRICAL SCHOOL
500 S. Paulina St., Dept. 18-72, Chicago, Ill.

H. C. Lewis, President
Coyne Electrical School, Dept. 18-72
500 S. Paulina St., Chicago, Ill.

Send me your big FREE Book about Coyne Training and give me all details regarding your "Spare Time Employment Offer" and "Pay After Graduation Plan" of easy, monthly payments.

NAME.....AGE.....

ADDRESS.....

CITY.....STATE.....

LEARN TO DRAW AT HOME!

IT'S FUN TO LEARN THIS WAY-AT HOME - IN YOUR SPARE TIME



LEARN TO BE AN ARTIST and become your "own boss." There's a big future in this fascinating, profitable field for men and women who are well-trained Artists. You can learn at home in your spare time this helpful, practical way.

COMMERCIAL ART CARTOONING AND DESIGN All in ONE Practical Course

For 23 years our method of instruction has proven successful. Today it is even more complete and strictly up-to-date. You start by drawing straight lines, and in advancing from lesson to lesson your drawings are given the correction and criticism of an experienced Art instructor. A few pleasant hours a week should give you the ability to earn good money later on.

ENJOY THE BETTER THINGS IN LIFE

Set a Goal for Yourself!



GET MARRIED



OWN YOUR HOME



TRAVEL

Many of our graduates are enjoying a "new life" thanks to W. S. A. training. Margaret Kessell of New York earned \$125 in one week doing free lance Artwork. Mr. L. Haymond of Florida says, "Course paid for before completed." There's big money waiting for YOU—and sending for our FREE BOOK will help toward your career as a successful Artist.



ARTIST OUTFITS GIVEN!

Two full-sized Outfits given with the course. Including everything you need to get started—drawing board, pens, brushes, paints, paper, etc. Mail coupon today for complete details.



FREE BOOK shows how

WASHINGTON SCHOOL OF ART Est. 1914
 Studio 121E, 1115-15th Street, N. W.
 Washington, D. C.

Yes! I am interested in learning to draw. Please send me a FREE copy of your Book, "Art for Pleasure and Profit."

Name..... Age.....

Address

City State.....

(No salesman will call)

EASY

SOPRANI AMPLIPHONIC Simplifies Playing

Lighter, easier to play, less bellows-ing, plus more beautiful tone and volume,—that's how Soprani's exclusive Ampliphonic feature has simplified this accordion. Assures rapid progress. Home trial. Easy terms. See your music dealer or send for beautiful free book. Write today.



Nunzio, New York, with his Soprani 182

SOPRANI, INC. Dept. 129, 630 S. Wabash Ave. Chicago, Illinois

Learn Public Speaking At home—in spare time. Many overcome "stage-fright," gain self-confidence and increase earning power, this easy way. Write for free booklet, *How to Work Workers With Words* and requirements. North American Institute, Dept. 1351, 3601 Michigan Ave., Chicago, Illinois

LE'S Correspondence Courses in **RADIO and ELECTRICAL ENGINEERING** SPECIAL Only \$25

ELECTRICAL ENGINEERING Get good grasp of wide electrical field. Prepare yourself, at Low Cost, for secure future. Modern course. So simplified anyone can understand quickly.
RADIO ENGINEERING Extra fine course in radio, public address, super-service man, real vacuum tube technician. Experimental kits furnished. Diploma given on completion. Tuition, ONLY \$25, either course. Deferred payment plan available.
FREE! Send name quick for free copies of school catalogs, student magazines, complete details. SEND NOW. LINCOLN ENGINEERING SCHOOL, Box 931-56, Lincoln, Nebr.



Want to be an EXPERT PHOTOGRAPHER?

Write for booklet about N.Y.I. method of individual training. Commercial, News, Portrait, Advertising, Candid and Motion Picture photography. Big money-making opportunities! Fascinating hobby. Personal Attendance and Home Study courses. 28th year.

NEW YORK INSTITUTE OF PHOTOGRAPHY
 10 West 33 St. (Dept. 49) New York City

ELECTRICAL ENGINEERING

For those who can't afford the time and expense of a 4-year college course, Bliss offers a condensed ONE YEAR residence training, combining essential Theory and Practice. 45th year. CATALOG ON REQUEST!

BLISS ELECTRICAL SCHOOL
 131 Takoma Ave., Washington, D. C.

FLY WITH THE DAWN PATROL

Government Approved. Unsurpassed advantages in location, equipment, type training, for obtaining License Transport, Limited Commercial, Private Flying, Sheet Metal, Radio, Mechanical. For Complete Illustrated catalog. Write the: SPARTAN SCHOOL OF AVIATION, J.D. Green, Director, Dept. PM3, Tulsa, Okla.

GOV'T. JOBS

Thousands of openings yearly. Men-Women, age 18-50 Start \$105-\$175 month. Get ready now for next entrance test. Get our new plan—mailed FREE. Write, OZMENT INSTRUCTION SERVICE, Dept. 111, St. Louis, Mo.

Become a Draftsman



Enjoy a Real Job in Industry

Steady Work

As nearly all manufacturing—construction—building starts on the drafting table, the draftsman is one of the first to be hired and one of the last to be laid off. It is his blueprints, his specifications, that give the last word in what the workmen are to do. No article—building or construction job is started before the plans drawn by the draftsman have been officially approved.

Good Pay

The draftsman has been called the Junior Engineer which title just about describes his work—position and pay. He combines his knowledge of principles, mechanism and construction details with the ability to draw and reproduce motions and methods on paper. On the average, his salary is considerably above the wages of the mechanic and, of course, less than that of the engineer.

Chance for Promotion

Working on plans, helping design new machines or new methods of construction, the draftsman is working directly with the important men of the organization. Consequently he knows what is being considered and planned. It may be the superintendent—the engineer—or even the prospective buyer with whom he consults. Because of these contacts, his experience and knowledge of the business in general he is in an excellent position to be promoted when next there is a good opening.

Young at 40

Athletes—farmers—and factory and shop workers who rely on muscle start growing old even before they reach 40 while office workers—executives—teachers—professional men, in fact, all kinds of brain-workers are just approaching their prime at 40 to 50. Training increases your value at once and continues to help boost your earning power as you mature and as you increase your experience and background for forming judgments of the firm's policies and methods.

Don't grow old at 40. Train now for the job you want at 50. Training helps you to be independent—self-supporting. It helps you to enjoy associations that are denied the untrained man. Training helps you to increase your earning power and by so doing to offer members of your family advantages far in excess of what you could give them as an untrained man. Train and enjoy **PROGRESS—CONTENTMENT—INDEPENDENCE.**

American School, Drexel at 58th, Chicago



Mail Coupon for 2 Lessons Free

American School, Dept. DD-145
Drexel Ave. at 58th St., Chicago

Without the slightest obligation, send 2 beginning Drafting Lessons and free Bulletin.

Name..... Age.....

Address.....

City..... State.....

2 Lessons Free

Test yourself — see how readily ★
you, too, can learn Drafting

HOW A "TIP" GOT TOM A GOOD JOB

I HAVEN'T HAD A RAISE IN YEARS -- GUESS I NEVER WILL -- I'M READY TO GIVE UP

BUCK UP, TOM, WHY NOT TRY AN INDUSTRY THAT'S GROWING -- WHERE THERE'S MORE OPPORTUNITY



I'M DOING SWELL IN RADIO. MARY AND I ARE TO BE MARRIED NEXT MONTH. RADIO IS A BIG BUSINESS AND GROWING FAST. TAKE MY TIP AND GET INTO RADIO NOW, TOM!



IF BILL SUCCEEDED I CAN TOO!

THEN I CAN MAKE REAL MONEY SERVICING RADIO SETS



OR GET A JOB IN A BROADCASTING STATION

OR INSTALL AND SERVICE LOUD SPEAKER SYSTEMS



J. E. Smith, President,
National Radio Institute
Established 1914
He has directed the home study training of more men for the Radio Industry than any other man in America.

I will train **YOU** too at Home in Spare Time for Good Jobs in Radio

HERE'S PROOF THAT MY TRAINING PAYS



\$80 Monthly in Spare Time

"I work on Radio part time, still holding my regular job. Since enrolling five years ago, I have averaged around \$80 every month." JOHN B. MORISSETTE, 809 Valley Street, Manchester, N. H.



Makes \$50 to \$60 a Week

"I am making between \$50 and \$60 a week after all expenses are paid and I am getting all the Radio work I can take care of, thanks to N. R. I." H. W. SPANGLER, 126½ S. Gay St., Knoxville, Tenn.



Operates Public Address System

"I have a position with the Los Angeles Civil Service, operating the Public Address System in the City Hall Council. My salary is \$170 a month." R. H. ROOD, R. 136, City Hall, Los Angeles, Calif.



Do you want to make more money? Radio offers you many opportunities for well-paying spare time and full time jobs. You don't have to give up your present job, leave home or spend a lot of money to become a Radio Expert.

Many Radio Experts Make \$30, \$50, \$75 a Week

Radio broadcasting stations employ engineers, operators, station managers and pay up to \$5,000 a year. Spare time Radio set servicing pays as much as \$200 to \$500 a year—full time jobs with Radio jobbers, manufacturers and dealers as much as \$30, \$50, \$75 a week. Many Radio Experts operate their own full time or part time Radio sales and service businesses. Radio manufacturers and jobbers employ testers, inspectors, foremen, engineers, servicemen, paying up to \$6,000 a year. Radio operators on ships get good pay, see the world besides. Automobile, police, aviation, commercial Radio, and loud speaker systems are newer fields offering good opportunities now and for the future. Television promises to open many good jobs soon. Men I trained have good jobs in these branches of Radio. Read their statements. Mail the coupon.

There's a Real Future in Radio for Well Trained Men

Radio already gives good jobs to more than 300,000 people. In 1936, Radio enjoyed one of its most prosperous years. More than \$500,000,000 worth of sets, tubes and parts were sold—an increase of more than 60% over 1935. Over a million Auto Radios were sold, a big increase over 1935. 24,000,000 homes now have one or more Radio sets, and more than 4,000,000 autos are Radio equipped. Every year millions

Get Facts about **THE TESTED**

When writing to advertisers please mention Popular Mechanics



2 TOM! HEY! HOW ARE YOU, OLD BOY?

BILL! GOSH, I DIDN'T KNOW YOU, IN THOSE SWELL CLOTHES AND THAT SNAPPY CAR. SOMEBODY LEAVE YOU A MILLION?



3 ONLY A FEW MONTHS AGO YOU WERE SLIVING AWAY AT THE SAME JOB AS THE REST OF US. NOW LOOK AT YOU. HOW COME?

WELL, TOM, I DECIDED I'D NEVER GET ANYWHERE UNLESS I PICKED OUT A BUSINESS WITH LOTS OF OPPORTUNITIES AND TRAINED MYSELF FOR IT -- SO I PICKED RADIO!



4 YOU HAVE THE SAME CHANCE TOM. ABOUT A YEAR AGO I SHOWED YOU A BOOK FROM NATIONAL RADIO INSTITUTE TELLING ABOUT THE OPPORTUNITIES AND FUTURE IN RADIO, AND HOW OTHERS HAD SUCCEEDED THROUGH THEIR HOME TRAINING. WELL -- I ENROLLED.



OR MAKE GOOD MONEY IN ANYONE OF THE MANY OTHER NEW AND GROWING BRANCHES OF RADIO. I'M GOING TO SEND FOR THAT FREE BOOK RIGHT NOW!



7 YOU CERTAINLY KNOW RADIO. MINE NEVER SOUNDED BETTER

THANKS!

N. R. I. TRAINING CERTAINLY PAYS. I JUST STARTED A FEW MONTHS AGO AND I'M ALREADY MAKING GOOD MONEY IN MY SPARE TIME.



8 OH, TOM, IT'S WONDERFUL HOW FAST YOU'VE GONE AHEAD IN RADIO. WE NEVER COULD HAVE GOTTEN MARRIED ON WHAT YOU WERE GETTING BEFORE.

OUR WORRIES ARE OVER. I'M MAKING GOOD MONEY NOW, AND THERES A REAL FUTURE AHEAD FOR US IN RADIO.

of these sets go out of date and are replaced with newer models. More millions need servicing, new tubes, repairs, etc. A few hundred \$30, \$50, \$75 a week jobs have grown to thousands in 20 years. And Radio is still a new industry—growing fast!

Many Make \$5, \$10, \$15 a Week Extra in Spare Time While Learning

Almost every neighborhood needs a good spare time serviceman. The day you enroll I start sending Extra Money Job Sheets showing how to do Radio repair jobs. Throughout your training I send plans and ideas that made good spare time money for hundreds. I send Special Equipment to conduct experiments, build circuits, get practical experience. I GIVE YOU A COMPLETE, MODERN, PROFESSIONAL ALL WAVE, ALL PURPOSE RADIO SET SERVICING INSTRUMENT TO HELP SERVICE SETS QUICKER—SAVE TIME, MAKE MORE MONEY.

I Give You Practical Experience

My Course is not all book training. I send you special Radio equipment; show you how to conduct experiments, build circuits illustrating important principles used in modern Radio receivers, broadcast stations and loud speaker installations. I show you how to build testing apparatus

for use in spare time work from this equipment. Read about this 50-50 method of training—how it makes learning at home interesting, quick, fascinating, practical. Mail coupon.

Money Back Agreement Protects You

I am sure I can train you successfully. I will agree in writing to refund every penny you pay me if you are not satisfied with my Lessons and Instruction Service when you finish. I'll send a copy of this agreement with my Free Book.

Find Out What Radio Offers You

Act Today. Mail the coupon now for "Rich Rewards in Radio." It's free to any fellow over 16 years old. It points out Radio's spare time and full time opportunities and those coming in Television; tells about my training in Radio and Television; shows you letters from men I trained, telling what they are doing and earning. Find out what Radio offers YOU! MAIL THE COUPON in an envelope, or paste it on a penny post card NOW!

**J. E. SMITH, President
Dept. 8AP
National Radio Institute
Washington, D. C.**

GET THE FACTS.
MAIL THIS COUPON
NOW!

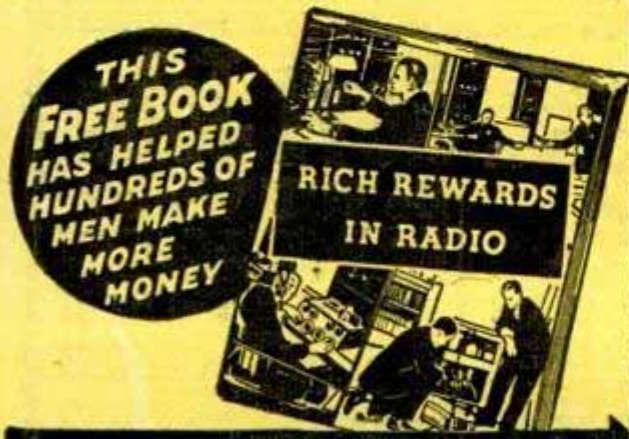

THIS FREE BOOK HAS HELPED HUNDREDS OF MEN MAKE MORE MONEY

This Coupon is Good for One FREE Copy of My Book

J. E. SMITH, President, Dept. 8AP, National Radio Institute, Washington, D. C.

Dear Mr. Smith: Without obligating me, send "Rich Rewards in Radio," which points out the spare time and full time opportunities in Radio and explains your 50-50 method of training men at home in spare time to become Radio Experts. (Please Write Plainly.)

NAME..... AGE.....

ADDRESS.....

CITY..... STATE.....

WAY TO BETTER PAY

NOW FIX ANY MAKE OF AUTO



SIX BIG AUTO BOOKS ALL SHIPPED FREE

on approval; whether you want to qualify as garage owner, auto repair expert or merely wish to know how to keep your own car 100% efficient, look at these books—they are sent to you for free examination. This brand new edition has been prepared by a large group of America's greatest automotive engineers. Anybody who can read will understand them, for this great automobile encyclopedia is a veritable gold mine of valuable facts. Take advantage of this offer now: send in the Coupon for FREE examination. You don't pay us a penny, you don't obligate yourself to pay us anything unless you decide to keep the books. Just tell us you want to see them and the full set of 6 great volumes, just off the press, will be sent to you! Read them, look them over and prove to your own satisfaction that one fact alone, which you will find in them, may save you an expensive repair or help you to a better job.

Diesel Engines, Aviation Motors, Outboard Motors, Motorcycles, Tractors, Wiring Diagrams, Equipment Charts, Superchargers, Knee Action and other up-to-date features all included.

Brand New Edition

Imagine books which are so new that every page is right up to date—wiring diagrams, construction details, service problems—are all right up to the minute. Over a million dollars of resources have enabled us to give you the most authoritative books on the subject ever published. Everybody interested in automobiles in any way will welcome these books published by the world's largest publishers of Technical Cyclopedias (est. 1897) with agencies all over the world.

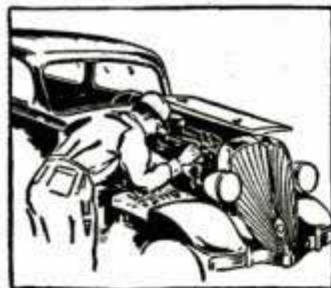

Can You Fix It?

Can you take out "play" in differential? Can you kill the "shimmy" in steering? Can you reset TIMING? Can you put your finger on engine trouble without guessing or tinkering? Can you pull the starter off and fix it? Can you adjust and repair transmission, engine, rear axle?

These Books Tell How and tell you how to do any and every auto job right, the first time, and in addition cover Service Shop Management.

6 Big Volumes, Beautifully Bound

Nearly 3,000 pages, over 2,000 illustrations, wiring diagrams, equipment charts, etc. De Luxe edition with gold-stamped flexible binding. Sent FREE for 10 days' use. If not wanted return express collect. If kept, send only \$2.00 after 10 days, then \$3.00 a month until advertising price, \$24.80, is paid.

A Year's Consulting Membership Included

Privilege of consulting engineers of million-dollar American Technical Society on any automotive problem for one year without charge, if you mail coupon immediately. AMERICAN TECHNICAL SOCIETY, Drexel at 58th St., Dept. A119, Chicago.

SEND NO MONEY

American Technical Society, Dept. A119
Drexel Ave. at 58th St.
Chicago, Illinois.

I would like to see the brand new 6-volume edition of your automobile books but without any obligation to buy. I will pay the few cents delivery charges only and will examine the books and return them at your expense in 10 days unless I like them. In which case I will send you \$2.00 then and only \$3.00 per month until the total price of only \$24.80 is paid. You are to include consulting membership certificate in the American Technical Society. Send Brand New Edition.

Name.....

Street.....

City..... State.....

Attach letter stating age, occupation and name and address of employer and that of at least one business man as reference.

When writing please mention Popular Mechanics

I'LL SAY IT'S EASY!



You'll learn more quickly and easily to play a P-A Sax, Trumpet, Clarinet, or Trombone, because P-As are easier to blow and have such beautiful tone. Strongest factory guarantee. Moderate prices. Home trial. Easy terms. See your music dealer or write for beautiful free book. 1235

PAN-AMERICAN
103 P-A Bldg., Elkhart, Ind.

You Can Regain Perfect Speech, if you

STAMMER

Send today for beautifully illustrated book entitled "DON'T STAMMER," which describes the Bogue Unit Method for the scientific correction of stammering and stuttering. Method successfully used at Bogue Institute for 37 years—since 1901. Endorsed by physicians. Full information concerning correction of stammering sent free. No obligation. Benjamin N. Bogue, Dept. 185 Circle Tower, Indianapolis, Indiana.

AVIATION CAREER OFFERS YOU GREAT FUTURE!



Demand for trained aircraftmen in Southern California plants is increasing and already exceeds supply. Curtiss-Wright Technical Institute, Aviation's foremost and oldest school, is located in heart of this activity and specializes in Sheet Metal, Master Mechanics and Aero Engineering. (No flying involved.) Graduates are obtaining immediate employment. Write for details NOW! Curtiss-Wright Technical Institute, Glendale, (Los Angeles) Cal., Dept. PM - 1

ENGINEERING

DEGREE
IN TWO
YEARS

TECHNICAL AND APPLIED COURSES. Nonessentials omitted. TIME AND MONEY SAVED. Degree 2 yrs., diploma 1 yr. Electrical, Mechanical, Architectural, Structural, Civil, Aeronautical, Highway. All courses include Air Conditioning, Electric Refrigeration and Diesel. Short intensive courses 3 and 4 months in Electricity, Power Plant, Diesel-Electric, Air Conditioning, Electric Refrigeration, Drafting. Extensive modern equipment. LOW TUITION. Part-time work for room and board. Thousands of successful graduates in U. S. and foreign lands. Approved by Industry, endorsed by educators, recommended by alumni. One and two-year courses open in Sept., short courses open year round 35th YEAR. Catalog free.

FINLAY ENGINEERING COLLEGE

1001 Indiana Avenue

Kansas City, Mo.

CARTOONING PAYS WELL

Develop your ability with personal instruction from an internationally-known cartoonist. His exclusive, successful method of drawing and creating ideas makes it easy to attain success. Write for details of this exceptional home-study course.

National School of Cartooning, 437 Penton Building, Cleveland, Ohio

Which
of These

Gov't Jobs

Do YOU Want?

No special education or experience usually required. Steady work. Short hours. Vacations. PENSIONS! Age 18 to 50. Extra Social Security Jobs expected soon. Send coupon for FREE Book. Tested Method will help you pass Civil Service Examination for earliest possible appointment.

Arthur R. Patterson, (Former Govt. Examiner) **FREE BOOK**
Principal, PATTERSON SCHOOL.

81 Mercantile Building, Rochester, N. Y.
Send FREE Book, "How to Secure a Government Position."

Name.....

Address.....

MEN--WOMEN

START \$1,260 to
\$2,100 a YEAR

Liquor-Gauger
Stenographer
Meat Inspector
Custom House
Office Clerk—Typist
Accountant
File Clerk
Income Tax Auditor



MORE MONEY and a BETTER JOB!

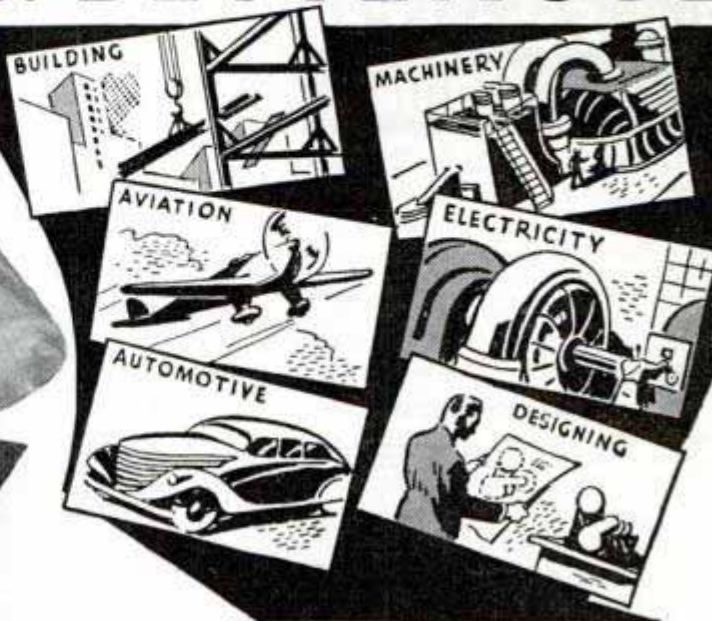

Learn **DRAFTING** At Home Let *Engineer Dobe* Show You How!

If you want to learn drafting as a profession—or if you want to learn drafting to advance in your present work—Engineer Dobe can train you at home in your spare time by his long established, proven-practical "Work-Job" Method. A knowledge of drafting is a vital aid to your success—for all modern industry *begins* with the draftsman. The drafting room is the *nerve center* of manufacturing, building and transportation. New inventions, new designs, new plans, basic improvements must begin with the draftsman. He is the *key man* of our industrial system—with rich opportunities for advancement and better pay in scores of fields.

JOBS NOW OPEN . . .

In Machinery, Building, Aviation, Electricity, Transportation, Automotives—draftsmen must be used. Many trained draftsmen will be needed on better jobs at better pay and shorter hours.

Engineer Dobe can prepare you just as he has trained thousands of successful students, aged 16 to 18 to past 50. His practical "Work-Job" method requires no previous experience. High school education not needed. He offers you a real opportunity to get a complete training in drafting right in your home in a surprisingly few months. Trained draftsmen enjoy good salaries. Engineer Dobe teaches his students until thoroughly trained and until holding a good paying job. That's Engineer Dobe's guarantee.

Send for FREE BOOK

Mail the coupon today for FREE illustrated book "Successful Draftsmanship" and full details of Engineer Dobe's remarkable trial offer that includes all necessary tools and equipment. Learn just how you can be trained successfully at home in your spare time. Time is money. Now is the time to prepare. Don't wait another day. Send the coupon Now for Engineer Dobe's FREE Book.

ENGINEER DOBE Div. 3371 Libertyville, Ill.

You'll be amazed at the speed with which you can learn in your spare time by Engineer Dobe's Practical Method. Send coupon TODAY for free book entitled "Success in Draftsmanship."

All Working Tools Furnished

Here's a draftsman's set of tools—sent at once (also a drawing table) — all without extra charge the day you enroll.

Complete Outfit, size 20x25", furnished to you.

These TOOLS and Other EQUIPMENT Given When You Start

Free Book!

ENGINEER DOBE, Div. 3371 Libertyville, Ill.

Send me your free book "Successful Draftsmanship". Please explain how you assist your graduates to good positions as draftsmen.

Name

Address

Town

State..... Age



High School Course at Home

Many Finish in 2 Years

You can complete this simplified High School Course as rapidly as your time and abilities permit. Equivalent to resident school work—prepares you for entrance to college. Standard H. S. texts supplied—Diploma. Credit for H. S. subjects already completed. Single subjects if desired. High School education is very important for advancement in business and industry and socially.

College Entrance

During the past 14 years, our High School graduates have been admitted to 531 different Universities, Colleges, Junior Colleges and Normal Schools—80% of them without entrance examination. Course also prepares for teachers' certificate and pre-professional examinations.

Business—Industry

To get and hold a good position in Business today you must be able to write clear, accurate letters and reports—do figuring involving Algebra and Geometry—talk intelligently on matters requiring a knowledge of Geography, History, and Economics.

In Industry—Mechanical and Engineering lines—you must have at least an elementary knowledge of Physics and Chemistry—be able to figure quickly and accurately—know something of Mechanical Drawing and blueprints—and be able to talk and write accurately and clearly on both your work and ordinary topics of conversation.

Our High School course meets the preparatory educational requirements for Business and Industry.

An Educational Institution

The American School was chartered in 1897 as an educational institution, not for profit—and is exempt from paying Federal income tax, like the best resident colleges and universities.

Don't Be Handicapped—Complete Your Training Now

Be a High School Graduate! Prepare yourself for promotion in Business and Industry—for the Professions, College Entrance and social success. No matter what line you may select, High School training will prove invaluable to you! Our moderate fees cover all instruction, standard textbooks and Diploma. Easy monthly terms. Get ahead in life. Start your training NOW!

20 Other Courses

Over 150 noted Educators, Engineers, and Business Men helped prepare our special instruction material, which is used by many resident schools and colleges, U. S. Navy, and Province of Manitoba, Canada. We offer you quality training at home for the best-paying lines of Industry and Business, as listed in the coupon.

Prepare yourself for promotion in Business and Industry—for the Professions, College Entrance and social success. No matter what line you may select, High School training will prove invaluable to you! Our moderate fees cover all instruction, standard textbooks and Diploma. Easy monthly terms. Get ahead in life. Start your training NOW!

Mail coupon for information about line that interests you
American School, Drexel at 58th, Chicago

American School, Dept. H145, Drexel at 58th, Chicago
 Tell me how to train for success in line checked. No obligation.

- | | |
|--|--|
| <input type="checkbox"/> Accounting & Auditing | <input type="checkbox"/> Diesel Engineering |
| <input type="checkbox"/> Architecture & B'ldg | <input type="checkbox"/> Drafting & Design |
| <input type="checkbox"/> Automotive Engin'g | <input type="checkbox"/> Liberal Arts |
| <input type="checkbox"/> Business Management | <input type="checkbox"/> Private Secretary |
| <input type="checkbox"/> Com'ercial Aeronautics | <input type="checkbox"/> Hi'er Ac't'g (C.P.A.) |
| <input type="checkbox"/> Electrical Engineering | <input type="checkbox"/> Highway Engin'g |
| <input type="checkbox"/> Electrical Refrigerat'n | <input type="checkbox"/> Mechanical Engin'g |
| <input type="checkbox"/> Air Conditioning | <input type="checkbox"/> Radio & Television |
| <input type="checkbox"/> Civil Engineering | <input type="checkbox"/> Salesmanship |
| <input type="checkbox"/> Complete Law | <input type="checkbox"/> Steam Engineering |

Name.....
 Address.....

PARKS AIR COLLEGE

PARKS AIRPORT EAST ST. LOUIS, ILL.

Offers COLLEGE and PROFESSIONAL TRAINING Majoring in AVIATION

FOUR courses lead to B.S. degrees in Professional Piloting, Aviation Operations, Aviation Mechanics, Aeronautical Engineering.

TWELVE TRAINING PLANES are used in professional flight training which prepares graduates for airline flight operations. 74% of graduates enter air transportation in North and South America. 64,000 hours flight training given, 650 hours being flown monthly.

FACULTY of 33 specialists in various fields of aviation. 1477 graduates. Capacity enrollment of 302 for Fall term. 100-acre airport, 14 buildings devoted to school purposes exclusively. Dormitories and dining hall on the Field.

Accredited by the Illinois Superintendent of Public Instruction. Government approved as a Transport Ground and Flying School and Mechanics' School. Open to high school graduates.

Winter term January 4. Send postcard for new 60-page catalog.

11th YEAR **REGISTRAR, DEPT. PM-1**
PARKS AIR COLLEGE, East St. Louis, Ill.

LEARN MECHANICAL DENTISTRY

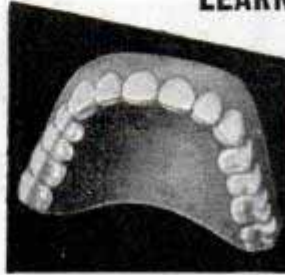

A profession offering unlimited opportunities. Most modern and complete course embracing every branch from Plate to Porcelain Work, which prepares you to work for Dentists or start your own business. Individual instruction—practical training in day or night school. No books—no classes. Catalog upon request.

Dept. 729
McCARRIE SCHOOL OF MECHANICAL DENTISTRY
 207 N. Broad St. Phila., Pa.

BE A PASSENGER TRAFFIC INSPECTOR



Your Opportunity—Get the Facts NOW
 Good Positions are ready for active men—19 to 50—trained as Railway and Bus Passenger Traffic Inspectors. Simple, home-study course qualifies you quickly and upon completion we help place you at up to \$135 per month, plus expenses to start or refund tuition. Free Booklet. **STANDARD BUSINESS TRAINING INSTITUTE, Div. 201, Buffalo, N. Y.**

VOICE

100% Improvement Guaranteed
 We build, strengthen the vocal organs—not with stinging lessons—but by fundamentally sound and scientifically correct silent exercises... and absolutely guarantee to improve any singing or speaking voice at least 100%... Write for wonderful voice book—sent free. Learn WHY you can now have the voice you want. No literature sent to anyone under 17 years unless signed by parent.
PERFECT VOICE INSTITUTE, Studio 1351
 64 E. Lake St., Chicago

AUTOMOTIVE ENGINEERING

Bachelor of Science Degrees—in Automotive, Aeronautical, Architectural, Chemical, Electrical, Industrial and Mechanical engineering! Modern equipment. All college activities. Low tuition. Write today for Catalog.
LAWRENCE INSTITUTE OF TECHNOLOGY
 15102 Woodward Ave. DETROIT, MICH. **CATALOG ON REQUEST**

LEARN CARTOONING

by the method that has developed hundreds successfully. Send name, address and age for free chart to test your ability.
THE LANDON SCHOOL, 1737 National Bldg., Cleveland, Ohio

CRIME DETECTION SECRET SERVICE AND FINGER PRINTS

SECRET SERVICE BOOK FREE

For 30 Days Reading
 No Money Down—Actual Crime Cases—
 If You Act Quick! We will send you this stirring book on Crime Detection, Secret Service and Identification Work for 30 days free reading. Send no money. If you decide to keep it, then send me only \$1. If not, return it. **WRITE TODAY.** Literature will be sent only to persons stating their age.

T. G. COOKE, Dept. 1351, 1920 Sunnyside Ave., Chicago, Ill.

THE TRUTH ABOUT DIESEL

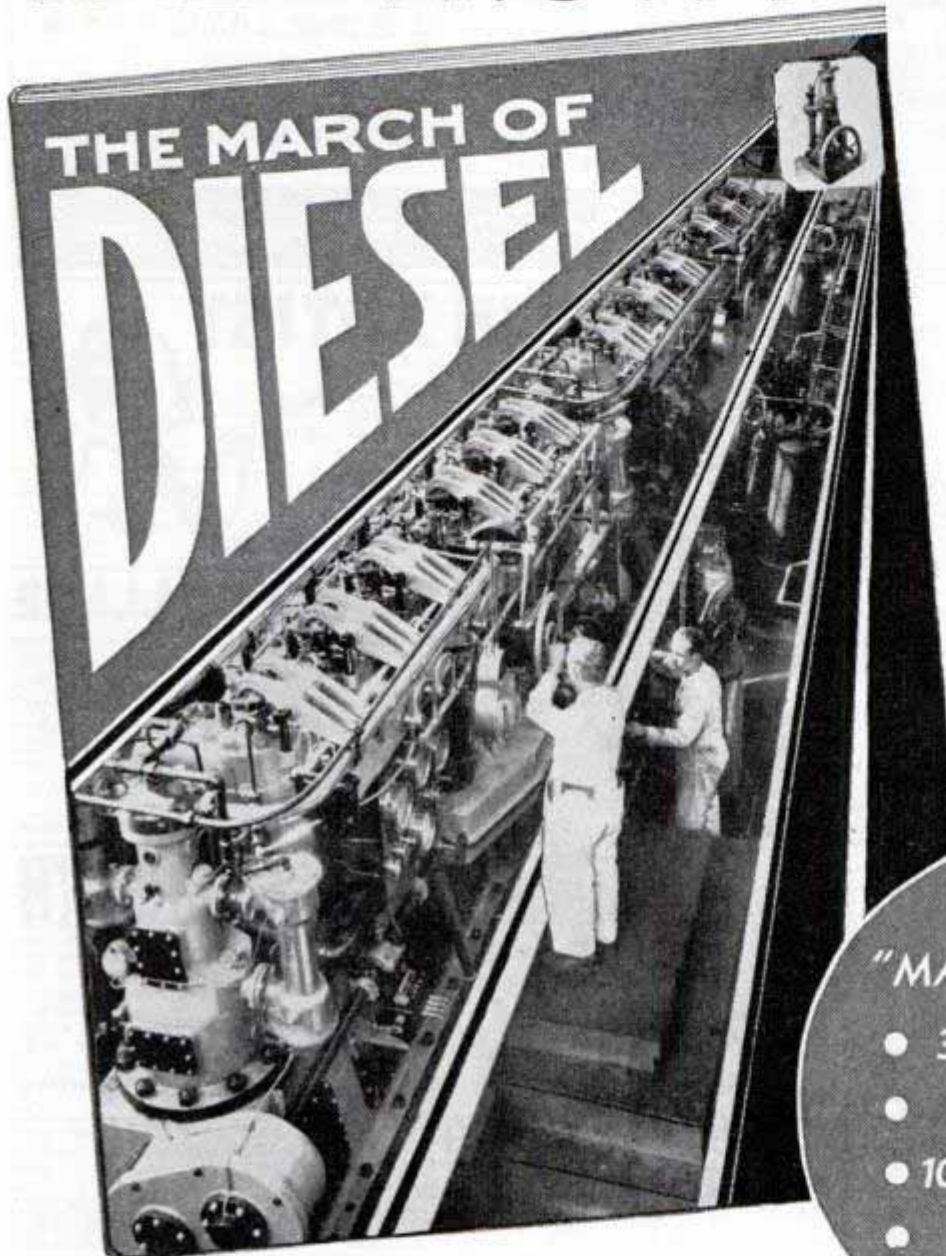

- Clearly Told.
- Profusely Illustrated.
- Authoritatively Written.
- A Standard by which **YOU CAN JUDGE** the importance and significance of this field to the world today. . . .

THE "MARCH of DIESEL"

- 32 Pages
- 2 Colors throughout
- 104 Illustrations
- 8 Graphs

A FREE COPY

of the "March of Diesel" will be sent without cost or obligation (while supply lasts) to those men who are interested in the history, the growth, the magnitude and the future of the Diesel.

Send Coupon
for your copy
TODAY

USE NEAREST ADDRESS

BOSTON, 114 Brookline Avenue
NEW YORK, 31-26 Queens Blvd., L.I. City
DETROIT, 2341 West Lafayette Blvd.
CHICAGO, 2014 Larrabee Street
MEMPHIS, 417 Monroe Avenue
LOS ANGELES, 2120 San Fernando Road
SEATTLE, 501 Westlake North
VANCOUVER, B.C., 1363 Granville St.

HEMPHILL DIESEL SCHOOLS

(Addresses at left)

I am interested in Diesel. Please send me free copy of "March of Diesel", and information on your training.

Name _____ Age _____

Street _____ City _____ State _____

M-16-B

AIRCRAFT CAREERS

in the making

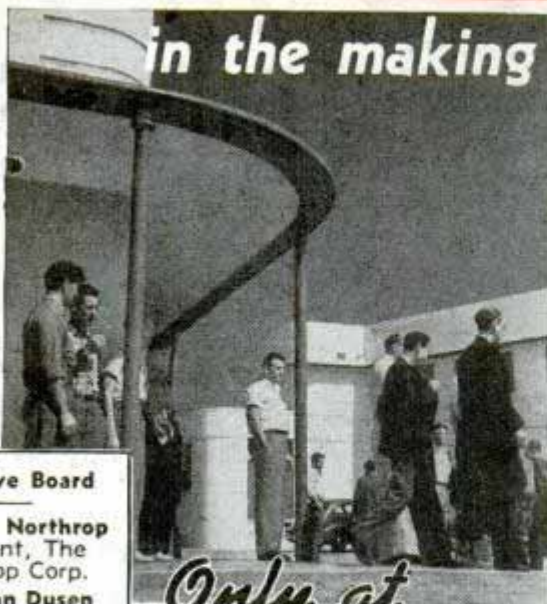

Executive Board

John K. Northrop
President, The Northrop Corp.

C. A. Van Dusen
Vice-President, Consolidated Aircraft Corp.

Robert E. Gross
President, Lockheed Aircraft Corporation

Only at



These Advantages

- **Industry supervision**
Executive Board members are internationally known aircraft engineers and executives. They supervised courses, layout of buildings, shop equipment—and are active in Institute's operation.
- **Exclusive courses**
the lessons contain material never before released by the industry. Exactly what is required of an aircraft employee is provided.
- **The vast shop equipment**
is the most extensive standard and advanced production equipment ever provided for student instruction. The 20,000 square foot shop building is virtually a modern aircraft plant.
- **Nationally recognized**
Aero I.T.I. has received nation-wide editorial comment because of the unusual opportunity it offers men wanting to enter the rapidly expanding aircraft industry.
- **Four New Buildings**
each expressly designed to serve a specific purpose in the training program

If you are interested in an AIRCRAFT CAREER

if you want to enter the industry equipped to be of real service to your employer—get full details on what Aero I.T.I. offers. Send coupon for new booklet "MORE PLANES." Offer limited to those 18 years old or over.

AERO INDUSTRIES TECHNICAL INSTITUTE
5253 W. San Fernando Road, Los Angeles, California

PLEASE SEND ME INFORMATION ON YOUR COURSES, AND FREE COPY OF BOOKLET "MORE PLANES." My age is _____.

Name _____

Street _____

City _____ State _____ a-5-p



Learn to Write.

BEGIN TODAY! Write for our Free Book, "HOW TO BECOME A GOOD PENMAN"

It contains specimens and tells how others learned to write in spare time. Your name beautifully written on a card if you enclose stamp for postage. Over 40 years' experience teaching by mail. **WRITE TODAY**

THE TAMBLYN SCHOOL OF PENMANSHIP
418 Ridge Bldg. Kansas City, Mo.

The Tamblyn School

BE AN ARTIST

WE CAN TEACH YOU DRAWING in your own home during your spare time. Thirty-five years of successful teaching proves our ability. Artists receive large salaries.

Write today for Art Year Book

SCHOOL OF APPLIED ART

Dept. 118 10 E. Huron St., Chicago, Ill.



TRI-STATE COLLEGE

B. S. Degree in 2 years. World famous for technical 2-year courses in Civil, Electrical, Mechanical, Chemical, Radio, Aeronautical Engineering; Business Administration and Accounting. Those who lack high school may make up work. Low tuition. Low living costs. Located in picturesque hill and lake region. Students from every state and many foreign countries. 54th year. Enter September, January, March, June. Write for catalog.

418 College Ave. ANGOLA, IND.

LEARN WATCH REPAIRING



AT HOME You can learn by our modern and original system of instruction every part of the Watch Repairing Trade at home. You can earn money while learning and prepare yourself for a well paying position or start in business after completing our course of instruction. Good watch repairers are in demand and generally earn very good salaries. For particulars apply to the Wisconsin School of Watch Repairing

524 E. Mason St., MILWAUKEE, WIS.



WHY NOT spend spring, summer, fall, gathering butterflies, insects. I buy hundreds of kinds for collections. Some worth \$1 to \$7 each. Simple outdoor work with my instructions, pictures, price list. Profit or pleasure. Send 10c (not stamp) for Illustrated Prospectus, terms, before sending butterflies.

MR. SINCLAIR, DEALER IN INSECTS
Dept. 6, Box 1424 San Diego, Calif.

HOME STUDY COURSES

Home Study Courses leading to Degrees in Arts and Sciences; Philosophy; Education; Writing; Psychology; Chemistry; Theology; Law; Agriculture; Business; Accounting; Sales; Advertising; Public Speaking; Electrical, Civil, Mechanical, Diesel, Architectural, Aeronautical, Automotive, Drafting, Radio and Chemical Engineering. Standard Text. McKinley-Roosevelt College of Arts and Sciences, 4228 Clarendon Ave., Chicago

NEW YORK SCHOOL OF MECHANICAL DENTISTRY

Earn big money in a few months. We show you how. Real Laboratory Training. OLDEST school. Day, Evn. Easy terms. Ask for free Catalog P and tool offer.

N. Y. SCHOOL of MECHANICAL DENTISTRY, 125 W. 31 St., N. Y. C.

MAKE MONEY AT HOME

RUBBER MOLDS Low as 6¢ EA.

Amazing rubber mold-making outfit makes perfect flexible molds of plaques, ash trays, book-ends, etc. Molds cost from 6c to 25c each. Each mold makes hundreds of novelties and gifts to sell up to \$1.00 apiece! No experience necessary. Everything furnished. Start profitable business in your home... sell to stores, friends, resorts, road stands or by mail—NOW! Make BIG MONEY full or spare time. Write for complete FREE details and easy instructions.

50-LO GO-MA MOLD CO., Dept. A-827, Cincinnati, O.



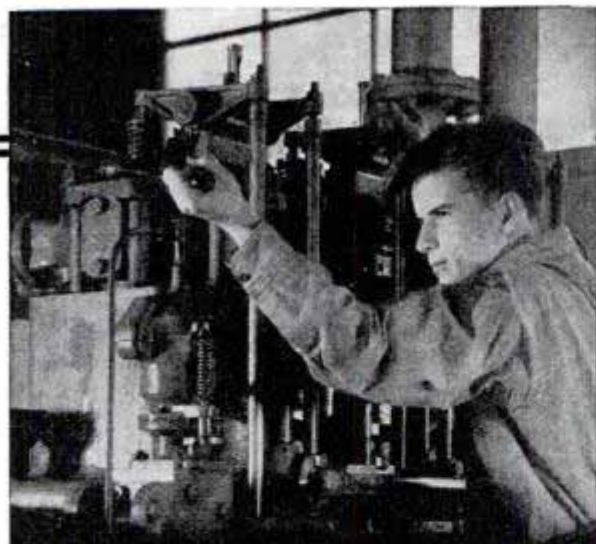

HERE'S THE WAY TO
BECOME AN EXPERT
ON
**DIESEL
ENGINES**



● If you work in industrial power and lighting plants; in small community power and light plants; in municipal pumping stations for water supply; in construction work, including trucks, tractors, hoists, graders and power shovels; in transportation, with special reference to buses, rail buses, locomotives; in marine service, including ocean liners, freighters, river and lake vessels, yachts and small cabin cruisers—

You should become an expert on Diesel Engines!

Your future depends on it. And the time to insure your future is—to-day. In your spare time, by study of the I.C.S. Diesel Power Course, you can become an expert. Mail the coupon for free information.

INTERNATIONAL CORRESPONDENCE SCHOOLS

BOX 5696-H, SCRANTON, PENNA.



Without cost or obligation, please send me a copy of your booklet, "Who Wins and Why," and full particulars about the subject *before* which I have marked X:



TECHNICAL AND INDUSTRIAL COURSES

DIESEL POWER

- Architect
- Architectural Draftsman
- Building Estimating
- Contractor and Builder
- Structural Draftsman
- Structural Engineer
- Management of Inventions
- Electrical Engineer
- Electric Lighting
- Welding, Electric and Gas
- Reading Shop Blueprints

- Boilermaker
- Heat Treatment of Metals
- Sheet Metal Worker
- Telegraph Engineer
- Telephone Work Radio
- Mechanical Engineering
- Mechanical Draftsman
- Machinist Toolmaker
- Patternmaker
- Aviation Engines
- Automobile Mechanic

- Refrigeration
- Plumbing Steam Fitting
- Heating Ventilation
- Air Conditioning
- Steam Engineer
- Steam Electric Engineer
- Marine Engineer
- R. R. Locomotives
- R. R. Section Foreman
- Air Brakes R. R. Signalmen
- Highway Engineering

- Civil Engineering
- Surveying and Mapping
- Bridge Engineer
- Bridge and Building Foreman
- Chemistry Pharmacy
- Coal Mining
- Mine Foreman Navigation
- Cotton Manufacturing
- Woolen Manufacturing
- Agriculture Fruit Growing
- Poultry Farming

BUSINESS TRAINING COURSES

- Business Management
- Office Management
- Industrial Management
- Traffic Management
- Accountancy
- Cost Accountant

- C. P. Accountant
- Bookkeeping
- Secretarial Work
- Spanish French
- Salesmanship Advertising
- Service Station Salesmanship

- First Year College
- Business Correspondence
- Stenography and Typing
- Civil Service
- Mail Carrier
- Railway Mail Clerk

- Grade School Subjects
- High School Subjects
- College Preparatory
- Illustrating Cartooning
- Lettering Show Cards Signs
- Apartment House Management

Name..... Age..... Address.....

City..... State..... Present Position.....

If you reside in Canada, send this coupon to the International Correspondence Schools Canadian, Limited, Montreal, Canada

TO ★ INVENTORS

THIS is a message to inventors, for inventors, about inventors. If you yourself have an invention—even though it's only a crude idea in the back of your mind—**READ ON.** Read what other inventors have done—what steps they took—what steps you can take.

First remember this: that to be practical, useful, salable, and profitable, neither an invention nor the inventor need become *famous*. Most inventions and inventors are not. You know that Morse invented the telegraph; Edison the electric light; Bell the telephone. But who invented the eyelets in your shoes, the tips on the laces, the hook where you hang your coat, the hundreds of things you use from early

morning until you go to bed at night?

In fact, the benefits you derive from the inventor do not even stop at night. You brush your teeth with a patented brush; with paste or powder from a patented tube or container; you wash in a patented basin; bathe in a patented tub; go to bed on a patented mattress, which in turn rests on patented springs.

Yet there is—always will be—room for improvement, progress, **INVENTION.** And for more **INVENTORS!** Today's "pipe dream" may become tomorrow's necessity. Most of the things people used even five years ago have been changed, improved, by new inventions. That is because inventors have been busy. Maybe it will pay you to get busy, too. Who can tell?

Double Stitch Sewing Machine

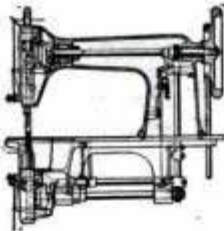

The Double Stitch Sewing Machine shown in diagram form at the left, is one of the patented inventions of Miss Beulah Louise Henry, famous as the leading woman inventor and generally known as "Lady Edison." With more than fifty patents to her credit, "Lady Edison" is still going ahead. The Double Stitch

Sewing Machine shown here eliminates the bobbin, practically doubles speed of the average machine, permits use of smaller thread, and is less expensive to manufacture. Among her other inventions are a hair curler, vanity case, rubber sponge soap holder, dolls, toys and typewriter attachment.

Shaving Cream and Toothpaste Dispenser



Apparently Paul F. Roache, the inventor of this dispenser for shaving cream or toothpaste, was tired of having his shaving cream misplaced or of failing to find toothpaste ready for use at a busy moment. So he invented this dispenser to be attached to the wall of the bathroom. Patented certain features of same during 1937. The device first opens the collapsible tube and then discharges a desired

amount of paste and automatically closes the container when released. Handy, indeed, especially when you are in a hurry.

New Type Clothes Hanger

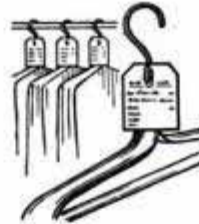

It is to be supposed that Richard D. Moore, who patented this new type clothes hanger in 1937, didn't like the ordinary wire or wooden hanger and decided to do something about it. So he developed and patented a new type hanger which can be made out of compressed paper and which also provides for an identification tag. The tag can be used for advertising purposes or for quickly locating a suit or dress of any patron in a dry cleaning establishment.

Lipstick Spreader and Remover



Another lady takes a hand at invention. Miss Esther M. Buttschau patented this little device to be carried in a woman's purse. The container holds small absorbent pads, to be used in place of handkerchiefs or tissue paper, for spreading and removing lipstick. Remove lid of container, push up the little feeder or knob at the bottom and up comes a pad. Lift off pad, use it on the lips and then discard.

Illuminated Sinker



The fact that fish are attracted to light is no recent discovery. Illuminated fishing lures are not new. But James D. Watts decided he had a new and improved method of construction. The sinker contains a dry cell and small light bulb. When fish come "arunning" to the light, they're supposed to smell the bait and presto, they're hooked. There's just no telling where an inventor's mind will turn.

ABOUT INVENTORS



New Type Garter

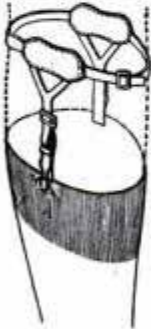

Dr. Jeremiah Day, another inventor, believes in keeping his socks up evenly all around. The Y support for the garter attachment is designed to distribute pressure on the garter band evenly instead of at one or two points, thus preventing the sock from being up in front and down behind. The garter is also intended to insure greater comfort, and to prevent the possibility of interference with blood circulation. Why wear garters and then keep pulling up your socks?—so reasons this inventor.

Carbureter

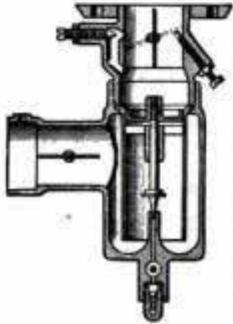

Literally thousands of inventions relate to the operation of a gasoline motor. Here you see in phantom another idea for carburetor construction. The inventor's object is to provide a device to be employed either as an up-draft type or a down-draft carburetor and a means to simultaneously control the air and fuel in accordance with the increased or decreased speed of the motor. The inventor in this case is Eugene H. Rustin.

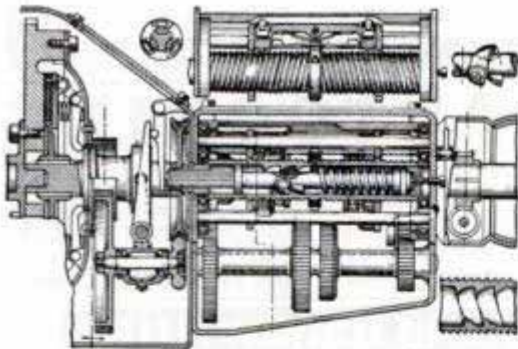

Automatic Transmission

And here we illustrate what is commonly known as a complicated invention. This cross section showing the multiplicity of gears, drives, levers and shafts, serves to give only a crude idea of the mechanism involved in George L. Brown's conception of an automatic transmission. In cases of this character, the patent application frequently taxes the skill and knowledge of the patent attorney to the utmost. The cross section shown here is but one of several views embodied in the actual patent itself, granted by the Patent Office in 1937. It is said that today's automobile embodies the work of thousands of inventors. Certain it is that because of the spirit of inventive progress, the world has traveled a long way from the stage coach stage.

38 Years of Service to Inventors

It has been the privilege of this organization to serve inventors for 38 years. Today here in Washington we maintain a large staff of Registered Patent Attorneys, skilled draftsmen and experienced searchers to adequately represent our clients. Our fees are reasonable; deferred payments frequently arranged. If you have an invention, or have one in mind, your first step should be to secure information regarding Patent procedure. We have therefore in the booklets shown below, set forth many interesting facts and suggestions which other inventors have found helpful.

68 Pages of Facts for Inventors

Send today for your copies of the two Free booklets "Patent Protection" and "When and How to Sell an Invention." These booklets will answer many questions regarding the simplest and most direct steps to take to apply for a U. S. Patent and likewise supply facts you should know before you attempt to sell or commercialize an invention. With the booklets comes an "Evidence of Invention" form on which you can quickly prepare a dated disclosure of your invention, a step which may prove valuable to you later on. No need to delay. Know the facts. Every inventor owes himself that much. Sign and mail the coupon now.

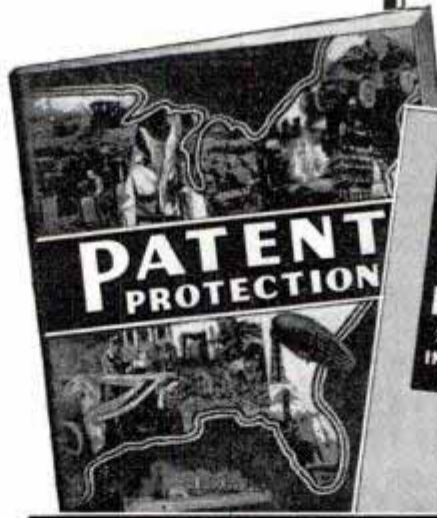

Now Mail Coupon for these FREE BOOKS

VICTOR J. EVANS & Co.

REGISTERED PATENT ATTORNEYS

Main Office: 20-A, Victor Building, Washington, D. C.
Other Offices: 2610-N, Singer Bldg., New York
 1445-N, Monadnock Bldg., Chicago
 1010-N, Hobart Bldg., San Francisco
 405-N, Garfield Bldg., Los Angeles

Send me FREE copies of your books, "Patent Protection" and "When and How to Sell an Invention." (Note: Same books supplied by any of branch offices listed above.)

Name.....
 Street and No.....
 City or Town..... State.....



Learn a TRADE in 8 weeks



Many Good-Pay Jobs Are Available Trained men are in demand and earn good money in these fascinating well-paying trades. This is not a correspondence school—no books—no lessons. Don't look for a job—TRAIN FOR IT. Read below how a McSweeney-trained man made good.

- **AUTO MECHANICS**
- **AVIATION MECHANICS**
- **DIESEL MECHANICS**
- **Collision Repair (Complete)**
- **Body and Fender Repair**
- **Auto Painting**
- **WELDING—Arc and Gas**

You Get Actual Shop Training

Work on real equipment with real tools. In a few weeks you should be trained by actual work to hold down a Good Pay Job.

We get many letters like this

1801 E. 65th St., Cleveland, O. Dear Mac—Immediately after leaving school I went to work for United Motors and am now located in Cleveland where I hold a good position. I have been able to take care of the most complicated electrical jobs. I think I have done fine considering I had no experience before coming to your school. —Hubert Todd

LEARN NOW—PAY LATER!

We will give you complete information on how to get your training now and pay for it later out of your earnings.

FREE Write today for Big Free Book. Get the facts about jobs; and low Tuition Offers. Mailing the coupon does NOT obligate you. It obligates ME to tell YOU how you can train for Big Money in a few short weeks. Address Dept. 10-49

McSWEENEY SCHOOLS

DETROIT, MICH. and KANSAS CITY, MO.

Write Our School Nearest You



DETROIT

In Big New McSweeney Buildings

The finest of their kind. Every modern facility for thorough instruction.



KANSAS CITY

McSWEENEY TRADE SCHOOL

Dept. 10-49, Detroit, Mich., or Kansas City, Mo.

Without cost or obligation send me your big FREE Book.

I am interested in the course on _____

Name _____

Street _____

Town _____ State _____ Age _____

Air Become An Conditioning Engineer

Rich, fast-growing field for men thoroughly trained in design, manufacture, estimating and installing. In 1936, Air Conditioning did a 49 million dollar business—while in the first 5 months of '37 it skyrocketed to 50 million—14 TIMES as many installations as in 1933. FREE booklet on home study points out YOUR opportunities in Air Conditioning. Tells WHY this new industry promises steady work, good pay, promotion, and jobs where you are still young at 40. No obligation. Write TODAY.

American School, Dept. AC-145, Drexel at 58th, Chicago

A billion dollar industry in the making!

Cheap Heat—No Coal

Remarkable, Cheap Invention, Burns Cheap Grade Diesel Oil Once Thrown Away as Useless—Converts any Stove or Range to Fast, Clean Heat—Hotter, More Economical Than Coal or Wood—Banishes Wood Chopping and Ashes. Sent on 30 Days' Free Trial.

Over 10,000 already in use. No more Coal and Wood drudgery. No more getting up freezing winter mornings to coax stubborn fires. Safe. Temperature controlled. Many wonderful automatic features. Runs on pennies. Sent on 30 days' trial at our risk. Agents Wanted—we will select parties in each locality to receive one FREE for installing in their own homes to demonstrate. Make up to \$60 weekly and more booking orders. Selling fast. Write at once—peak of season now—no time to lose. Name and address on one cent postcard will do. Brigham Oil Burner Co., Dept. 2927-A, St. Louis, Mo. Approved by National Board Fire Underwriters.

ENGINEERING DEGREE IN TWO YEARS

B.S. DEGREE courses in engineering: Electrical, Civil, Chem., Mechanical, Mech. Drafting, Radio and Television or Aeronautical. Intense, practical, thorough program. No extras for prep. or review. Earn while you learn in this industrial center. Low tuition. Enter March, June, Sept., Dec. Write for catalog. 229 E. Washington Blvd., Fort Wayne, Ind.

INDIANA TECHNICAL COLLEGE



CARTOONING

You can now get personal instruction in this fascinating and well paid profession by one of America's leading cartoonists. Why be satisfied with less? It costs no more to get the best. Write for details about this "easy to learn" home study course.

DORMAN H. SMITH, 597C, San Rafael, California

Improves Handwriting In 3 Hours

Marvelous invention. Corrects poor writing in few days. Amazing results guaranteed. No failures. Positive proof and complete outline mailed FREE. Write quickly.

OZMENT INSTRUCTION SERVICE, Dept. 34, St. Louis, Mo.

Learn ADVERTISING at Home

Greater opportunities now in advertising. Learn easily and quickly in spare time. Practical work. No text books. Old established school. Low tuition—Easy terms. Send for free booklet and requirements. Page-Davis School of Advertising Dept. 135L, 3601 Mich. Av., Chicago

STUDY ENGINEERING AT HOME

BIG STEADY JOBS—BIG PAY for skilled Engineers. Courses prepared by 64 Noted Engineers and Professors. Degrees conferred in Electrical, Mechanical, Diesel, Civil, Automotive, Aeronautical, Radio, Architectural, Drafting and Chemical Engineering. Only standard text-books used. Become a Real Engineer.

McKINLEY COLLEGE OF ENGINEERING, 4246 Clarendon Ave., Chicago

MONEY-MAKING OPPORTUNITY

for men of character. Over \$1,600 per month earned by California man. Over \$400 a week by Georgia man. \$1,000 in a month by Delaware man. Exclusive franchises available for an invention expected to replace a multi-million dollar industry. Install on free trial. Sells itself. Repeats. Exclusive proposition. Write F. E. Armstrong, Dept. 1112-A, Mobile, Alabama.

NEW ELECTRIC LIBRARY

\$ 1.50 A VOLUME

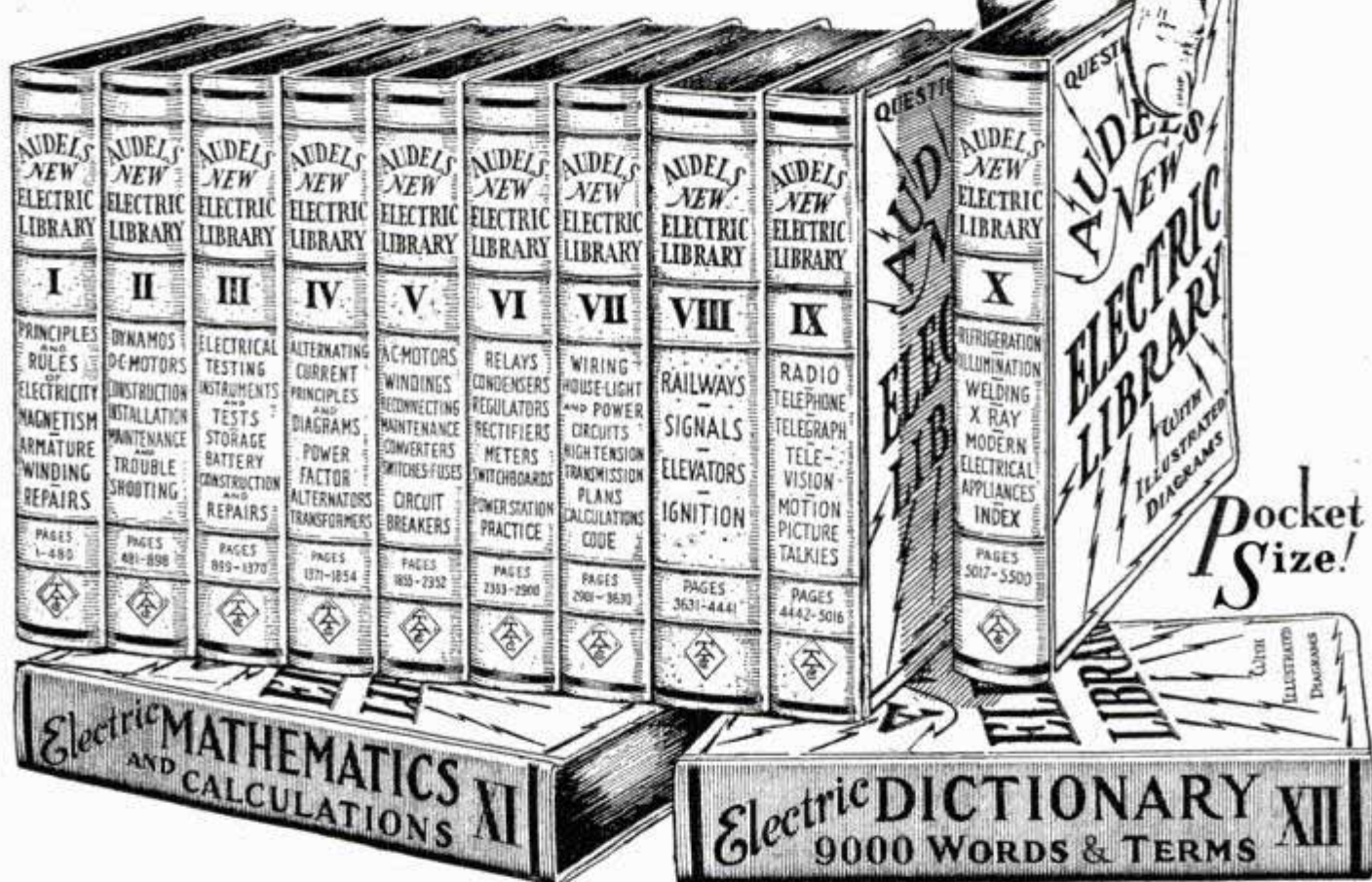

AUDEL'S NEW ELECTRIC LIBRARY

THE 12 volumes are now complete with 7,200 pages—9,500 illustrations—gold titles and edges—red, flexible covers—pocket size—5½x6 inches—sold separately at \$1.50 a volume postpaid—money back if not pleased.

THIS IS YOUR OPPORTUNITY

EVERY electrician, every engineer, every mechanic, every student, should know about these new helpful books which give in plain words, including questions and answers, a complete working knowledge of electrical engineering in all phases.

HOME STUDY BOOKS

AUDEL'S New Electric Library is arranged as a progressive home study course in Electricity. It will give anyone who will devote 15 to 30 minutes a day to its study, a scientific and working knowledge of Electricity in all branches. Written in plain language, the clear illustrations are easy to understand. They make study and learning a pleasure.

VALUABLE REFERENCE BOOKS

YOU ask the questions—Audel's New Electric Library will give you the answer. You

THEO. AUDEL & CO., 49 W. 23RD ST., NEW YORK CITY

will be surprised how easy it is to learn Electricity the Audel way. The 9,500 simplified outline cuts and graphic pictures are concise explanations of the theories and applications of applied Electricity with useful information relating to the construction, operation and maintenance of machines.

EASY TO READ FOR PROFIT

THESE books are helping thousands of men by giving them a broader view of the whole field of Electricity, without which a man is often handicapped. Send for a single volume, any one of the Series, at our risk.

AUDEL'S BOOK A MONTH PLAN

THE first book is sent to you on 7 days' free trial. If you find it will help, send the price; if not mail it back. The second book is sent on receipt of payment for first book and we allow you 30 days to pay for each following book. Following numbers are mailed after payments have been received until you have completed the Series. If not satisfied, you may cancel your subscription at any time. Mail order to-day and you will have taken your first step on the Road to Success. Start subscription with any volume.

MAIL EXAMINATION COUPON

Theo. Audel & Co., 49 W. 23rd St.
New York City, N. Y.

Please enter my subscription for Audel's New Electric Library, Price \$1.50 a volume. Mail one volume each month, for which I will remit \$1.50 promptly after arrival. Start my subscription with Volume _____

Name _____

Address _____

Occupation _____

Employed by _____

When writing to advertisers please mention Popular Mechanics

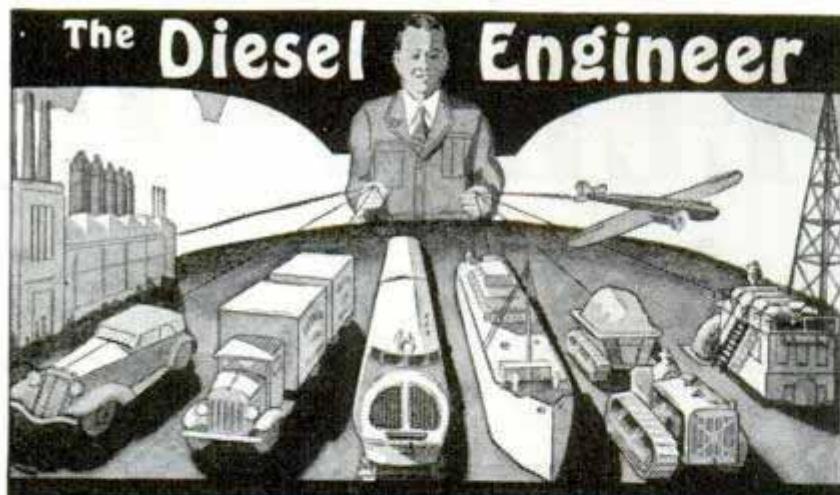

The Diesel Engineer

Is Your Job Safe?

Just as the gasoline engine changed the jobs of thousands who depended on horse-drawn vehicles for their living—so now the Diesel engine is fast invading both the power and transportation fields, and threatening the present jobs of thousands.

What This Field Offers You

Diesel engines are replacing steam and gasoline engines in power plants, motor trucks and busses, locomotives and ships, aircraft, tractors, dredges, pumps, etc.—opening up well-paid jobs for Diesel-trained men. You get all the latest Diesel developments in our course. Special diagrams for quick understanding of this new power.

2 Diesel Lessons Free

Men Over 18—Under 40

This opportunity is NOT open to boys under 18 or men over 40. But if you are WITHIN these ages, you owe it to yourself to investigate this opportunity of acquainting yourself with Diesel—the new, fast-growing field.

In your own home, learn about Diesel

No experience necessary. At our expense, see how plain every point is made—how thoroughly you grasp it—how greatly you will enjoy the work. If you are over 18 and under 40, send postcard, state age, and get 2 beginning lessons FREE. No obligation. This may be the turning point in your life, so write TODAY!

AMERICAN SCHOOL, Dept. D 145, Drexel Avenue at 58th Street, Chicago, Illinois

Test Yourself for a Good Pay Job—Steady Work

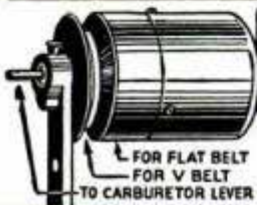

AUTO ENGINE SPEED CONTROL GOVERNORS

To control speed of any make of auto or truck engine, regardless of load changes, when used as a stationary or portable power plant. See Adv., Page 132A.

MAN IN EACH TOWN To Plate Auto Parts

Reflectors, Bicycles, Fixtures, Mirrors, by late method. Simple plan of manufacturing at home starts you IN GOOD PAYING BUSINESS. Write today for FREE particulars and proofs.

Ave. M GUNMETAL CO. Decatur, Ill.

No Joke To Be Deaf

—Every deaf person knows that—Mr. Way made himself hear his watch tick after being deaf for twenty-five years, with his Artificial Ear Drums. He wore them day and night. They stopped his head noises. They are invisible and comfortable, no wires or batteries. Write for TRUE STORY. Also booklet on Deafness.



Artificial Ear Drum

THE WAY COMPANY

729 McKerchey Bldg. Detroit, Michigan

Know Electricity as Experts Know It—and Get an Expert's Pay!

Recovery has begun! The months ahead are charged with significance and expectation. What will you do to get the jump on the other fellow? Thousands of men have used

The Croft Library of Practical Electricity

The Croft Library is a complete electrical educator. It is founded on practice—on 20 years of shirt-sleeve experience—on work as it is actually done. It is jammed from cover to cover with the kind of hard-headed facts you want. Written so that the beginner can easily understand it, yet so sound, so thorough, that it is the daily guide of 50,000 highly paid electrical workers and engineers. Croft tells you the things you need to know about motors, generators, armatures, commutators, transformers, circuits, switchboards, distribution systems—electrical machinery of every type—wiring for light and power—wiring of finished buildings—underwriters' and municipal requirements—illumination in its every phase—the most improved methods of lighting—lamps and lamp effects, etc.—how to do a complete job, from estimating it, to completion.

No money down—easy payments

Fill in and mail the coupon attached and we will send you the entire set of seven volumes for ten days' Free Examination. We take all the risk—you assume no obligation. If you decide to keep the books, send \$1.50 in ten days and the balance at the rate of \$2.00 a month. Send the coupon NOW and see the books for yourself.

FREE EXAMINATION COUPON

McGRAW-HILL BOOK CO., 330 W. 42nd St., New York

Send me for ten days' free examination the Croft Library of Practical Electricity. If satisfactory I will send you \$1.50 in 10 days and \$2.00 monthly until the price of \$19.50 is paid. If not wanted, I will return the books postpaid. (To insure prompt shipment write plainly and fill in all lines.)

Name.....

Home Address.....

City and State.....

Position.....

Name of Company..... PM-1-38

BUCHSTEIN'S FIBRE LIMB is soothing to your stump—strong, cool, neat, light. Easy payments. Braces for all deformities. Agents wanted.

D. BUCHSTEIN CO.
610 3rd Ave., So., MINNEAPOLIS, MINN.

Send for Catalog Today

CRIME DETECTION Prepare for a Thrilling Career in Fingerprinting and Secret Service. Write for Free Publications and Particulars if age 17 or over.

NATIONAL INSTITUTE, 340-G Electric Bldg., Omaha, Nebr.

SONG POEMS WANTED AT ONCE! Mother, Home, Love, Patriotic, Sacred, Comic or any subject. Don't delay—send best poem today for our offer.

RICHARD BROS., 62 Woods Bldg., CHICAGO, ILLINOIS

AGENTS UP TO \$50.00

Big cash profits! Full or spare time. Over 250 household necessities—things people must buy. Proven fast sellers: NEW FORD SEDAN OR \$500 CASH BONUS BESIDES YOUR WEEKLY EARNINGS. I'll show you how to start earning very first day; send you everything—Big Display Outfit and quick cash plans—no money risk. Details FREE. Just mail postcard.

ALBERT MILLS, 4938 Monmouth Ave., Cincinnati, Ohio

THOUSANDS NOW PLAY

who never thought they could!



Learned Quickly at Home

I am delighted with the U. S. School of Music course of instruction for the piano. It is clear and thorough. I have made wonderful progress.

*L. M. C., N. Y. C.



Makes Extra Money

I have completed your wonderful method for Guitar. For the past year I have been teaching and I have earned \$200 thanks to the U. S. School of Music.

*C. C., New Jersey



Wouldn't Take \$1000 for Course

The lessons are so simple that anyone can understand them. I have learned to play by note in a little more than a month. I wouldn't take a thousand dollars for my course.

*S. E. A., Kansas City, Mo.



Surprised Friends

I want to say that my friends are greatly surprised at the different pieces I can already play. I am very happy to have chosen your method of learning.

*B. F., Bronx, N. Y.



Best Method by Far

Enclosed is my last examination sheet for my course in Tenor Banjo. This completes my course. I have taken lessons before under teachers, but my instructions with you were by far the best.

*A. O., Minn.

*Actual pupils' names on request. Pictures by professional models.

You, too, can play any instrument By this EASY A-B-C Method

YOU think it's difficult to learn music? That's what thousands of others have thought! Just like you, they longed to play some instrument—the piano, violin, guitar, saxophone or other favorites. But they denied themselves the pleasure—because they thought it took months and years of tedious study and practice to learn.

And then they made an amazing discovery! They learned about a wonderful way to learn music at home—without a private teacher—without tedious study—and in a surprisingly short time. They wrote to the U. S. School of Music for the facts about this remarkable short-cut method. And the facts opened their eyes! To cap the climax, a free Demonstration lesson actually showed them how easy it was to learn.

The result? Over 700,000 men and women have studied music at home this

simple, A-B-C way. Now, all over the world, enthusiastic music-lovers are enjoying the thrilling satisfaction of creating their own music. They have found the key to good times, popularity and profit.

And that's what *you* can do, right now. Simply mail the coupon below. Get the proof that you, too, can learn to play your favorite instrument—quickly, easily, in spare time at home. Never mind if you have no musical knowledge, training or talent. Just read the fascinating illustrated booklet that answers all your questions—examine the demonstration lesson. Both will be mailed to you without the slightest cost or obligation. Tear out the coupon now, before you turn the page. (Instruments supplied when needed, cash or credit.) U. S. School of Music, 71 Brunswick Bldg., New York City. *Fortieth year, Established (1898).*

FREE DEMONSTRATION LESSON AND BOOKLET

U. S. SCHOOL OF MUSIC

71 Brunswick Bldg., New York City

Without cost or obligation to me, please send me your free illustrated booklet and demonstration lesson. I am interested in the instrument checked below:

PIANO
VIOLIN
GUITAR
ACCORDION
SAXOPHONE
CELLO
HAWAIIAN GUITAR

BANJO
MANDOLIN
UKULELE
CORNET
TRUMPET
HARP
CLARINET

TROMBONE
FLUTE
PICCOLO
ORGAN
DRUMS AND TRAPS
HARMONY AND COMPOSITION
VOICE CULTURE

Name..... Have You This Instru.?.....
Address.....
City..... State.....

When writing to advertisers please mention Popular Mechanics

**ARE YOU
ONE OF THESE**
4 *Types of*

WIN

WHAT OUR PATENT SERVICE DOES

THE first important step in securing a patent is to obtain the services of a Registered Patent Attorney. The U. S. Patent Office advises that you secure the aid of a Registered Patent Attorney to prepare your application and counsel you.

We have secured patents for inventors located in every state in the Union. Our organization is a large and efficient one. Our practice is confined entirely to Patents, Trade-Marks, and Copyrights. We have had years of experience in Patent Matters. When you place your invention in our hands, we are in position to proceed at once to secure protection for you.

Don't worry about finances. Our fees are very reasonable—we can arrange convenient terms of payment. It is our custom to permit clients to pay for our services in installments as the application progresses in our office.

1 IF YOU ARE THINKING OF INVENTION AS A CAREER

There are many people today who are making a good living from inventions. If you have inventive originality and the ability to recognize human needs, you should go far in the commercial world. If you are considering Invention as a career, write for our FREE BOOK at once.

2 IF YOU HAVE A MECHANICAL INVENTION

There is probably a bigger demand for mechanical inventions today than any other type. If your invention is of a mechanical nature, the first step is to have a search made at the U. S. Patent Office to ascertain that no one has gotten ahead of you. You will find this FIRST STEP fully covered in our FREE BOOK, "Patent Guide for the Inventor."

THE ANSWER TO YOUR QUESTION "HAVE I A SALEABLE INVENTION?"

Some of the most successful commercial inventors—men who amassed large fortunes—reaped their rewards on simple everyday creations; the kind of things that make thousands ask themselves the question: "why didn't I think of that myself?" If you can beat the other fellow to the little gadgets always cropping up that make life more comfortable, easier, or exciting, you may succeed as a successful inventor. Are you convinced that you have "something?" Then don't flounder around trying to make up your mind to start; ascertain right now if you have hit upon an original idea by having us institute a Search of the U. S. Patent Office Records to determine if your invention has been anticipated.

IMPORTANCE OF ACTION

The greatest curse of the average inventor is delay in making practical use of his invention. The day-dreaming inventor may have wonderful ideas but unless he gets a Patent on his invention he is likely to remain a dreamer all his life.

Your invention of a practical article or an improvement upon an old one should be patented NOW. Frequently many of the thousands of applications filed in the U. S. Patent Office each year are for the same or almost the same invention. In such case, the burden of proof rests with the last applicant to file. Sometimes a delay of even a few days in filing the application means the total loss of the patent. LOSE NO TIME.

CLARENCE A. O'BRIEN & HYMAN BERMAN

70-C ADAMS BUILDING, WASHINGTON, D. C.
Registered Patent Attorneys before U. S. Patent Office

When writing to advertisers please mention Popular Mechanics

ENTORS

3

IF YOU HAVE A NOVELTY INVENTION

Go through the 10c stores and see the millions of articles offered for sale. The majority of these simple gadgets are patented, manufactured in big quantities at a substantial profit. If you have a novelty invention, get information on direct steps necessary to obtain Patent. Send for our FREE BOOK.

4

IF YOU HAVE A GENERAL UTILITY INVENTION

Have you an invention that makes home life easier and more attractive or serves a general purpose of utility? Some of the simplest inventions have found a quick market and earned immediate incomes for the inventor. Learn all about the possibilities of General Utility inventions. Write today for our FREE BOOK.

OUR OFFICES IN THE HEART OF THE NATION'S CAPITAL

Located in Washington, D. C., within a few blocks of the U. S. Patent Office, we are able to give you immediate advice and accurate, authentic information on all matters concerning Patents and Trade-Marks, particularly if it is necessary to examine the records in U. S. Patent Office.



This FREE BOOK

TELLS HOW

There are certain definite facts the inventor must know to Patent and market his invention. Our FREE BOOK gives complete information: How Patent Application is made, what kind of drawings and sketches are necessary, what papers must be filled out, the value of action in applying for patent, how the patent laws protect you, why it is necessary to secure patent to protect your invention, etc. Don't be discouraged or disheartened about the future until you get our FREE BOOK and learn how other inventors succeeded despite lack of funds, remoteness from market, lack of mechanical skill, education, and other handicaps. Send coupon for this FREE BOOK today!



FREE RECORD OF INVENTION FORM

This FREE Record of Invention Form enables you to make in convenient form a sketch of your invention and have it witnessed in a manner of value to you should the occasion for evidence arise. MAIL THE COUPON TODAY and obtain our FREE BOOK and Record of Invention Form.



CLARENCE A. O'BRIEN

& HYMAN BERMAN

70-C ADAMS BUILDING

WASHINGTON, D.C.

REGISTERED PATENT ATTORNEYS
BEFORE U.S. PATENT OFFICE

Please send me at once your Big FREE 48-Page Book, "Patent Guide for the Inventor" and your Specially Prepared "Record of Invention" form. This request does not obligate me.

NAME.....

ADDRESS.....

(Please write or print plainly)

PATENTS

Booklet Free **Highest References**
Promptness Assured **Best Results**

Send drawing or model.

ALL BUSINESS GIVEN PROMPT AND PROPER ATTENTION

Listed Patent Lawyer in the latest editions of the Rand-McNally Directory of Bankers and Bank-Recommended Attorneys, published by Rand-McNally & Co., Chicago, Ill.; The Baggott & Ryall Directory of Guaranteed Attorneys, published by Legal Directory Corporation, Boston, Mass.; American Lawyers Annual, Cleveland, Ohio; Bankers Service Legal Directory, published by Bankers Service Co., Boston, Mass.; Eyre's Law List, 9 Park Place, New York City; Snow-Church Directory Co. Lawyers List, published in New York City, and the Central Guarantee Co., Bankers and Lawyers Directories, 630 Fifth Avenue, New York City.

WATSON E. COLEMAN, Victor Building, 724 Ninth Street, N. W.
 REGISTERED PATENT LAWYER **WASHINGTON, D. C.**

INVENTORS PATENT YOUR IDEAS SEND FOR FREE BOOK



HOW TO OBTAIN A PATENT

Written by a Former Member of the Examining Corps (1922-24) of the U.S. Patent Office. If you want to profit by your idea, you should take steps to apply for a U. S. Patent at once. Your first step is to get this Free Book. This interesting illustrated book contains valuable information you should have. It tells you fully how to obtain a patent on your idea in the quickest way. With this Free Book you will also receive a "Record of Invention" form on which you can easily record your idea. Personal and Confidential Service: Your case will be personally handled only by a Registered Patent Attorney who is also a Former Member of the Examining Corps of the U. S. Patent Office. All communications confidential.

MAIL COUPON TODAY for FREE PATENT BOOK and RECORD OF INVENTION Form.

CARL MILLER
 REGISTERED PATENT ATTORNEY
 FORMER MEMBER EXAMINING CORPS U. S. PATENT OFFICE

3503 Woolworth Bldg., Dept. 18A, New York City
 MILLER BUILDING, Dept. 18A, WASHINGTON, D. C.
 Please send me your Free Book, "How to Obtain a Patent," and your "Record of Invention" form.

NAME.....

ADDRESS.....

PATENTS—TRADE MARKS

All inventions submitted held confidential and given personal attention by members of the firm. Form, "Evidence of Conception" and instructions, "How to Establish Your Rights"—FREE!

LANCASTER, ALLWINE & ROMMEL

Patent Law Offices
 412 Bowen Bldg. Washington, D. C.

New Ideas now Salable Before Patenting

Practical, useful inventions may now be safely marketed without patenting expense. Write for proof that we successfully sell both patented and unpatented inventions.

Chartered Institute of American Inventors
 Dept. 4, Barrister Building, Washington, D. C.



G E A R S

In Stock—Immediate Delivery

Gears, speed reducers, sprockets, thrust bearings, flexible couplings, pulleys, etc. A complete line is carried in our Chicago stock. Can also quote on special gears of any kind. Send us your blueprints and inquiries.

Write for Catalog No. 10

CHICAGO GEAR WORKS
 769-773 W. Jackson Blvd. CHICAGO, ILL.

NEW BENJAMIN AIR PISTOLS \$7.50

Powerful—Accurate—Economical—Practical—Adjustable Shooting Force—Amazing Maximum Velocity—enl. 177 or 22 and BB—For Target and Small Game—the only Genuine Compressed Air Pistol for Shooting BB on the market—Single Shot with Bolt Action—Hammer Fire—Hair Trigger—Safety. Price \$7.50. Holster \$2.00. Also 177 and 22 Single Shot Air Rifle \$7.50—Single Shot BB Air Rifle \$6.00—25 Shot BB Repeater Air Rifle \$7.50—at Dealer or Direct—No license required—Safe for indoor use. **FULL DETAILS—TARGETS—FREE—WRITE TODAY**
 Benjamin Air Rifle Co., 849 Marion St., St. Louis, Mo.

STOP Your Rupture Worries!

Why suffer with that rupture? Learn about my Appliance for reducible rupture. Automatic air cushion assists Nature to close the opening—has relieved thousands of men, women and children. No obnoxious springs or hard pads. No salves or plasters. Sent on trial to prove it. Beware of imitations. Never sold in stores. Write today for confidential information sent free in plain envelope. **Brooks Company, 111-K State Street, Marshall, Michigan**

ALBERT E. DIETERICH
THEODORE H. RUTLEY
 REGISTERED PATENT LAWYERS
 512 B Colorado Bldg. WASHINGTON, D. C.
Booklet on Patents sent free

FLASH! FLASH! FLASH!

READ INVENTION FINANCE MAGAZINE. Year subscription 60c, entered on promise to pay on receipt of first copy. Place your order by cutting out and mailing this advertisement.

INVENTION & FINANCE MAGAZINE
 80-G Wall Street New York, N. Y.

INVENTORS who derive largest profits know and heed certain simple but vital facts before applying for patents. Our book, Patent-Sense, gives those facts; sent free. Trade Marks—Copyrights. **LACEY & LACEY, Est. 1869, 635 F St., N. W., Dept. 5, WASHINGTON, D. C.**

In answering advertisements always write name and full address clearly.

To PROTECT YOUR INVENTION—Use this coupon, NOW

Delays are dangerous and may be very costly. My personal service assures prompt action, strict confidence, and a minimum of expense. I suggest that you send me a model or drawing, or sketch and description of your invention, and \$5.00. I will make a search and report

promptly as to its patentability and send you a copy of my 72-page booklet. Or, if you prefer to read my booklet first, mail the attached coupon at once. I will also send my "Record of Invention" form. (Over 38 years experience as a Registered Patent Attorney.)

L. F. Randolph, 302-D Victor Bldg., Washington, D. C.

Please send me at once, free of charge, your 72-page booklet and "Record of Invention" form.

Name.....

Address.....

A PERSONAL CONFIDENTIAL PATENT SERVICE

PRACTICAL ENGINEERING IN ONE YEAR

Choose Air Conditioning & Refrigeration; Radio-Television; Electric Arc Welding or Commercial Electrical Engineering and be prepared for success in the industrial world.

ELECTRICAL ENGINEERING IN 3 ADDITIONAL YEARS

By our special system you may EARN WHILE YOU LEARN. Free employment service. Student loans. Pioneers for 34 years. Write for illustrated catalog—mention course desired.



MILWAUKEE SCHOOL OF ENGINEERING

B. S. Degree 1020-R North Broadway Milwaukee, Wis.

GAG-CARTOON!



AND MAKE BIG MONEY—AT HOME—BY MAIL! Magazines pay up to \$200.00 per cartoon. Get in this NEW FIELD and be your own boss! My 50 lesson—1000 illustration course shows you how. **FREE CARTOON MARKETS INCLUDED—\$280**

All for..... Send for FREE details. FREE drawing set with course. **MOON GAG-CARTOON SCHOOL** Paramount Bldg. Dept. A-5, Fall Creek, Wis.

LEARN WATCHMAKING AND ENGRAVING
BY OUR PROFIT-SHARING PLAN
OUR GRADUATES SUCCEED
 One of our Iowa students started in a very small way—now doing over \$30,000 a year. Another in Wisconsin, over \$10,000 the first year. Day or night classes. Call or write for FREE BOOK. **Chicago School of Watchmaking, Dept. 5901, 155 N. Clark St., CHICAGO.**

Minstrels Comedy Stunts Plays Songs
 Unique First Parts for complete show with special songs and choruses. Make-up. Catalog Free.
T. S. Denison & Co. 203 N. Wabash, Dept. 19, Chicago

DIESEL
 Get BETTER training. Realize Adcox advantages. Located in Pacific Northwest, a Diesel center. Established 28 years. Modern equipment, expert instructors. Close cooperation for YOUR success. Earn room and board while learning. Send for FREE big 40-page Diesel School Catalog No. 18. Home Study and Resident Courses.
L. L. ADCOX TRADE SCHOOL Portland Oregon

A AND N SUPPLY CO.
 Bargains—Military, Sport Goods, Firearms, Clothes, Shoes, etc. Send 10¢ for new catalog, to be redeemed on first order.
A & N Supply Co., 4772 Lester St., Richmond, Va.

WILL YOU WEAR THIS SUIT
and Make up to \$12 in a Day!
 Let me send you this fine all-wool Union tailored suit **FREE OF COST**. Just follow my easy plan and show the suit to your friends. Make up to \$12 in a day easily. No experience—no canvassing necessary. Send for Samples—**FREE OF COST**. Write today for FREE details. **ACTUAL SAMPLES** and "sure-fire" money getting plans. Send no money.
H. J. Collin, Progress Tailoring Co., Dept. A-216
 500 S. Throop St. Chicago, Ill.

MAIL FOR FREE INFORMATION
BEDFORD YMCA TRADE SCHOOL
 1117 Bedford Ave., Dept. PM-56 Brooklyn, New York City, N. Y.
 Diesel Engines Oil Burner
 Diesel Engineering Welding
 Aviation Mechanic Machine Shop
 Aeronautical Engineering Talking Pictures
 Auto Mechanic Refrigeration Sign Painting
 Radio and Television Mechanic
 Air Conditioning Architectural-Mechanical Drafting
 Electrical Window Display
 Armature Winding
 Name.....
 Address.....

Inventors
TAKE THIS FIRST STEP TO PROTECT YOUR INVENTION
 Find Out Now If Your Invention Is Patentable
 It is not necessary to make an expensive model or finished drawings. A description and sketch is all we need to help you. The important thing is to get started NOW, just as quickly and as economically as possible. But FIRST, send for our free Patent and Selling Guides. Know where you stand NOW in regard to Patent Protection.
Our Free Books Tell You What Every Inventor Wants to Know
 They tell you why delay can prevent you from securing Patent Protection. How to avoid costly mistakes. How to get your invention saleable as quickly as possible. Whom to sell it to. How patent laws protect you. What a Patent costs. What kind of Patents are granted. The importance of secrecy in Patent matters. How a skilled Patent Attorney can secure you better Patent Protection. The difference between a good patent and a worthless one.
C. A. Snow's 62 Years of Experience Can Be of Real Value to You
 We have served inventors in every state in the Union . . . In every field of invention. In fact, we have secured Patents for inventors in every civilized nation in the world. To help inventors get started without delay, we offer a convenient **DEFERRED PAYMENT PLAN**. By this plan, the cost of your patent is spread over several months.
Your Patent Application Personally Prepared By a U. S. Registered Patent Attorney
 Every member of our firm is a U. S. Registered Patent Attorney. Therefore, your patent application will be carefully prepared **IN STRICT CONFIDENCE** by a skilled specialist. A specialist who will secure for you the broadest possible patent protection, because, as a member of our firm, he has a personal pride in your patent.
Send for These FREE Patent Guides Today

C. A. SNOW & CO.
 Registered Patent Attorneys Since 1875
 1000 Snow Building, Washington, D. C.
 Gentlemen: Send me your free handbooks for inventors by return mail. No obligation on my part.
 NAME
 ADDRESS
 CITY STATE.....
 When writing please mention Popular Mechanics

Do you like RADIO? Does the future of TELEVISION

Interest You?

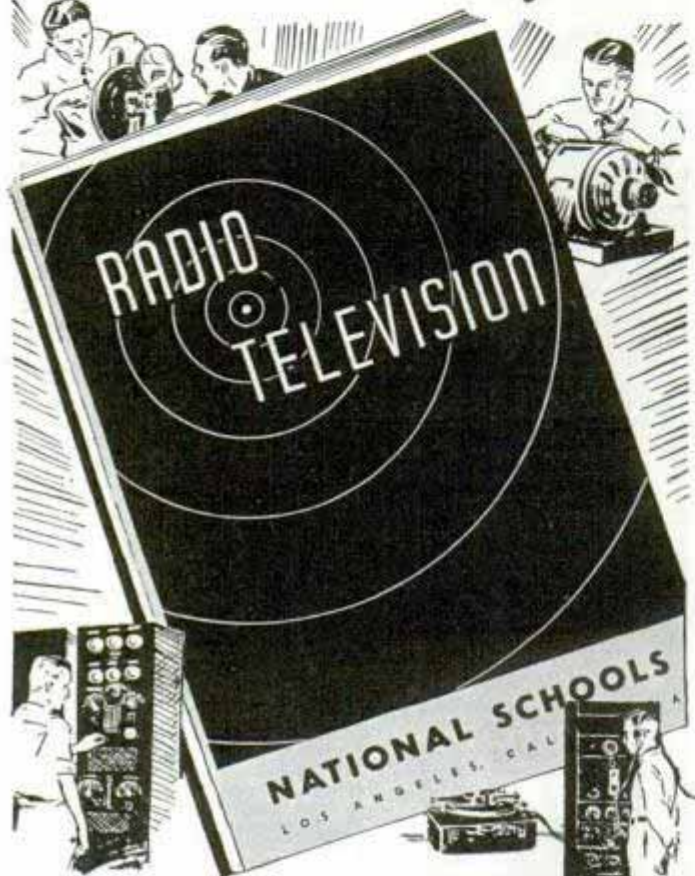

**Send for your FREE COPY
of this book of FACTS**

**Full of Instructive Information on
Employment Opportunities and
Requirements**

You men who are sincerely ambitious to make good in radio and related industries will want a copy of this new book about employment opportunities and requirements. Written in plain, understandable language with no exaggerations and no mis-statements, this free book gives you facts you want to know about these profitable trades. 95 illustrations. Major subjects include Television Theory and Construction, Pick-up Systems, Amplifiers, Transmitters, Receivers, Cathode Tubes, Sound-Recording on disc, Loud Speakers, Talking Picture Projection and Radio Communication.

NATIONAL SCHOOLS is the oldest trade institution in the West. Established in 1905. Occupies its own modern three-story building, exclusively devoted to training ambitious men. Latest equipment. Selected, experienced staff of engineers and instructors. Many students can earn room and board while learning. National students are allowed coach railroad fare from any point in the United States.

NATIONAL SCHOOLS

Los Angeles

Request for FREE BOOK of Details

NATIONAL SCHOOLS

Dept. PMR-1 4000 So. Figueroa Street, Los Angeles, Calif.

NAME AGE

ADDRESS

CITY STATE

**Don't
Buy
Mandolin
Guitar or
Drums**



*Gene Krupa World's
Greatest Swing
Drummer Uses
Slingerland Drums
with Benny Good-
man's orchestra.*

Don't buy
Guitar
Mandolin,
Banjo, Electric
Guitars, Ukule-
les, or Drums,
until you have
seen and tried
the Slingerland
May-Bells, Guar-
anteed More for
your Money.
Wonderful, snap-
py, powerful, pleas-
ing tone. No equal in
price. Sold on easy pay-
ments and 5 days free trial
by all leading music deal-
ers.

Cut this Adv. Out—
Good for \$1.00 Credit.
Send for free catalog.
Mention instrument
wanted.

Write today:

Slingerland Musical Instrument Mfg. Co.
1325 Belden Ave., Chicago, Illinois



Learn CHALK TALKING

Entertain for all occasions. Send \$1.00 for Laugh
Producing Program of 23 Trick Drawings with In-
structions. Catalog of Chalk Talk Supplies 10c.
BALDA ART SERVICE, Dept. K, Oshkosh, Wis.

Save Your Feet



Thousands get relief from pain-
ful feet and walk freely with
HEEFNER ARCH SUPPORTS
Write
for
**FOOT
FACTS**
Tells how to
aid nature in strengthening weak feet. It's FREE

HEEFNER ARCH SUPPORT CO. ... 660 Lewis Bldg., Salem, Va.

Photography



for

PLEASURE or PROFIT

Prepare for profitable business or fascinating
hobby, at home under guidance of qualified
instructors. No previous experience necessary,
common school education sufficient. Many earn while
learning. Our practical studio methods also qualify
for well-paying positions upon graduation. Send coupon
below at once for free booklet "Opportunities in
Modern Photography", particulars and requirements.

AMERICAN SCHOOL OF PHOTOGRAPHY

3601 Michigan Avenue
Send booklet, "Opportunities in Modern Photography", full particulars and
requirements.

Dept. 1151

Chicago, Illinois

Name Age

Address

City State



Will You Give Me 7 Days to PROVE I Can Make YOU a New Man?

LET ME START SHOWING YOU RESULTS LIKE THESE

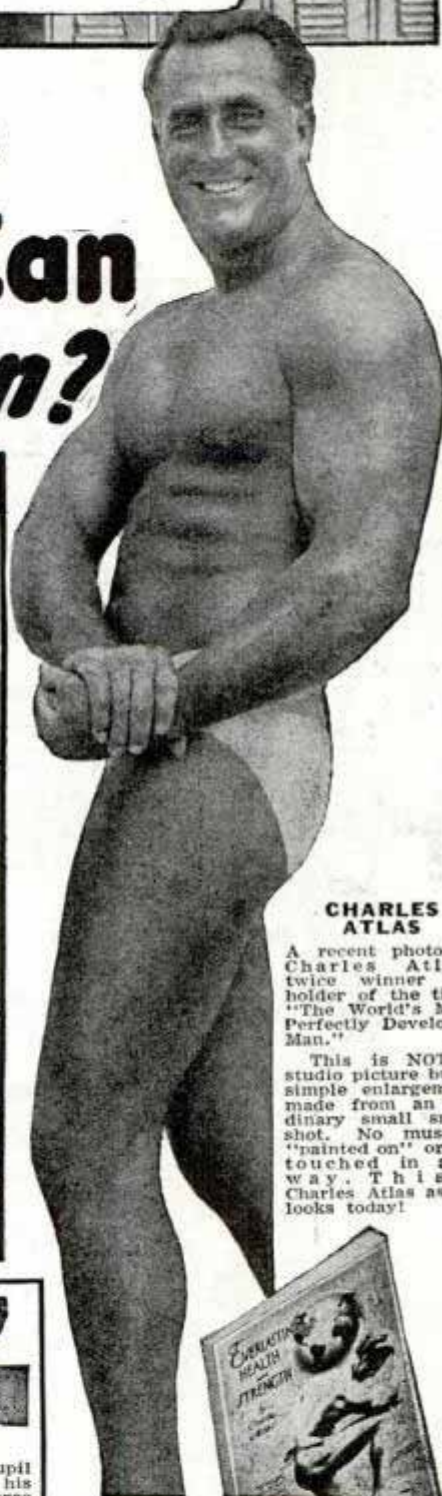
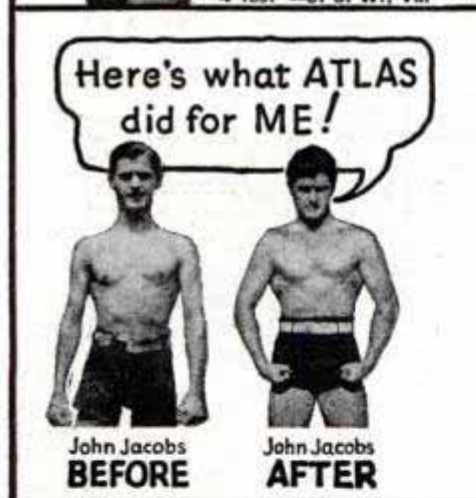

CHARLES ATLAS

A recent photo of Charles Atlas, twice winner and holder of the title, "The World's Most Perfectly Developed Man."

This is NOT a studio picture but a simple enlargement made from an ordinary small snapshot. No muscles "painted on" or retouched in any way. This is Charles Atlas as he looks today!

7-Day TRIAL OFFER

I could fill this whole magazine with enthusiastic reports from OTHERS. But what you want to know is—"What can Charles Atlas do for ME?"

Find out—at my risk! Right in first 7 days I'll start to PROVE I can turn YOU into a man of might and muscle. And it will be the kind of PROOF you (and anyone else) can SEE, FEEL, MEASURE with a tape!

My FREE BOOK tells about my amazing 7-DAY TRIAL OFFER—an offer no other instructor has ever DARED make! If YOU want smashing strength, big muscles, glowing health—I'll show you results QUICK!

FREE BOOK

I myself was once a 97-pound weakling—sickly, half-alive. Then I discovered "Dynamic Tension." And I twice won—against all comers—the title, "The World's Most Perfectly Developed Man!"

I have no use for apparatus. "Dynamic Tension" ALONE (right in your own home) will start new inches of massive power pushing out your chest—build up your shoulders to champion huskiness—put regular mountains of muscle on your biceps—free you of constipation, pimples—make those stomach muscles of yours hard ridges!

Make me PROVE it! Gamble a postage stamp. Send coupon for my FREE BOOK AT ONCE! Address me personally: Charles Atlas, Dept. 81, 115 East 23rd Street, New York, N. Y.

Sterling Silver Cup Being Given Away

This valuable cup, of solid sterling silver, stands about 14 inches high on a black mahogany base. I will award it, engraved, to my pupil who makes the most improvement in his development within the next three months.



CHARLES ATLAS, Dept. 81

115 East 23rd Street, New York, N. Y.

I want proof that DYNAMIC TENSION will make a new man of me—give me a healthy, husky body and big muscle development. Send me your free book, "Everlasting Health and Strength."

Name
(Please print or write plainly)

Address

City..... State.....

When writing to advertisers please mention Popular Mechanics



**START
\$1260 to \$2100 YEAR**

**MANY 1938
APPOINTMENTS EXPECTED**

Railway Postal Clerks

Railway Postal Clerks get \$1,900 the first year regular, being paid on the first and fifteenth of each month. (\$79.17 each pay day.) Their pay is automatically increased yearly to \$2,450. Advance may be had to Chief Clerk at \$2,700 a year. (\$112.50 each pay day.)



3 Days On—3 Days Off—Full Pay

Railway Postal Clerks on long runs usually work 3 days and have 3 days off duty or in the same proportion. During this off-duty their pay continues just as though they were working. They travel on a pass when on business. When they grow old, they are retired with a pension.

City Mail Carriers, Post Office Clerks

Clerks and Carriers now get \$1,700 the first year on regular and automatically increase \$100 a year to \$2,100 and \$2,300.

Customs Inspector

Salary \$2,100 to start. Men 23 to 45. Work connected with examining baggage and merchandise entering the country from foreign parts covering boats, trains, roads, automobiles, etc.

Many Other Positions

Many other positions are obtainable. Those wishing these positions should qualify at once.



Get Free List of Positions

Fill out the following coupon. Tear it off and mail it today—now, at once.

This investment may result in your getting a big-paid government job.

FRANKLIN INSTITUTE, Dept. L-195, Rochester, N. Y.

Rush to me, entirely free of charge (1) a full description of U. S. Government Jobs; (2) Free copy of illustrated 32-page book, "U. S. Government Positions and How to Get Them"; (3) List of U. S. Government Jobs; (4) Tell me what to do to qualify for a U. S. Government Job.

Name.....

Address.....

Use This Coupon Before You Mislay It. Write or Print Plainly.

KNOWLEDGE
THAT HAS
ENDURED WITH
THE PYRAMIDS

A SECRET METHOD FOR THE MASTERY OF LIFE

WHENCE came the knowledge that built the Pyramids? Where did the first builders in the Nile Valley acquire their astounding wisdom that started man on his upward climb? Did their knowledge come from a race now submerged beneath the sea? From what concealed source came the wisdom that produced such characters as Amenhotep IV, Leonardo da Vinci, Isaac Newton, and a host of others?

Today it is known that they discovered and used certain *Secret Methods* for the development of their inner power of mind. They truly learned to master life. This secret art of living has been preserved and handed down throughout the ages and today is extended to those who dare use its profound principles to meet and solve the problems of life in these complex times.

This Sealed Book -- FREE

Has life brought you that personal satisfaction, the sense of achievement and happiness that you desire? If not, it is your duty to yourself to learn about this rational method of applying natural laws for the mastery of life. To the thoughtful person it is obvious that everyone cannot be entrusted with an intimate knowledge of the mysteries of life, for everyone is not capable of properly using it. But if you are one of those possessed of a true desire to forge ahead and wish to make use of the subtle influences of life, the Rosicrucians (not a religious organization) will send you A Sealed Book of explanation without obligation. This Sealed Book tells how you, in the privacy of your own home, without interference with your personal affairs or manner of living, may receive these secret teachings. Not weird or strange practices, but a rational application of the basic laws of life. Obtain your complimentary copy by addressing your inquiry to Scribe E.Z.C.

The ROSICRUCIANS
(A M O R C)
San Jose, California

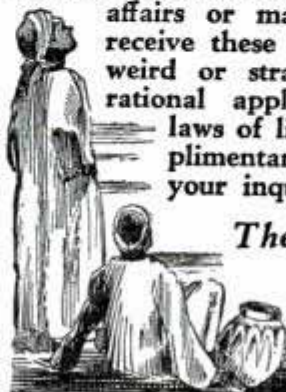

When writing to advertisers please mention Popular Mechanics



Reading the 'want-ads' in the hope of finding just any sort of a job—

Glamour and romance in Television-Broadcasting! An action scene "on stage" in the Power and Light Building, the home of Midland Television and the base of Midland's training.

A Lifetime of Fear ? -OR- A GOOD JOB, MORE MONEY, for the FUTURE ? -OR- A BRILLIANT FUTURE in—

TELEVISION

YOU CAN BE ONE OF THE VERY FIRST TO BE TRAINED ON "ULTRA-MODERN," 441-LINE ELECTRONIC TELEVISION EQUIPMENT

**BROADCASTING—
AIRLINE OPERATING
SHIP OPERATING
POLICE RADIO**

Sound advice. Based on ironclad facts! If that's what you want, read on. But if you're looking for the easy, "gambling way," of winning success, you might as well stop reading right now.

This very minute you're confronted with opportunities of such magnitude that you may be inclined to doubt their existence... Yet you know how Radio skyrocketed into a giant industry almost overnight. You know that many young men have won, and are continuing to win, success in Radio—**BECAUSE THEY TRAINED THEMSELVES FOR SUCCESS...** And now we all know that TELEVISION will be another world-wide industry, rich in rewards for those who are prepared... **WILL YOU BE READY?...** Yes—if you take immediate advantage of the outstanding features of Midland training!

Midland is the **ONLY** independent school offering complete, ultra-modern training on 441-line RCA electronic television receiving and transmitting equipment. And *that* is the type of equipment that is bringing commercial television closer every day. Already perfected to a point comparable to motion pictures, "electronic scanning" is almost ready to do its part in starting America on another era of prosperity.

To take advantage of Midland's outstanding training, you don't have to give up your present job. You complete your preliminary training *at home*—studying intensely interesting "color-coded" lessons, conducting a host of fascinating and instructive experiments, with *equipment we provide*—and then you come to Kansas City and our beautiful home in the Power & Light Building for *actual experience*. For remember, this is **NOT** a correspondence course. It is a combined extension-resident training. You study actual operation of radio and television in our resident school, in our modern laboratories—under an engineering staff of accomplished, friendly men, with years of practical experience.



Midland training includes actual experience as a Television Camera Man!

If you are sincere in desiring to enter an industry that offers immediate, substantial cash rewards and a brilliant future, we invite you to send for your **FREE** copy of "Fortunes in Foresight." Just fill out, clip, and mail us the coupon below. **DO IT TODAY AND WE WILL DO THE REST.**

FULL TRANSPORTATION ALLOWANCE TO KANSAS CITY

Gentlemen: Without obligating me, please send me your new **FREE** book on Radio-Television opportunities, "Fortunes in Foresight."

Name..... Age.....

St. or R. F. D.....

City..... State.....

Occupation.....

I am most interested in Broadcasting, Television, Ship Radio Operating, Airline Radio Operating, Police Radio.
(Mail in envelope or paste on postcard)



"... It was you who pointed out the vast possibilities of a radio career to me. It was Midland that made it possible."
Orwin Middleton, employed by Earl J. Goetze, Inc., wholesale distributors RCA-Victor products.

"... Thank you for obtaining my new position. Even though only part way through my course of study with Midland, I have already received much value for money and time invested."
Donald Welborn, employed by Radiolab, radio and public address sales, Kansas City, Mo.



"... and I want to tell you and the whole wide world that I owe it all to your incomparable training and whole-hearted help!"
Wm. Davis, Radio Operator with TWA, stationed at Amarillo, Texas.

Midland training prepares for **TWO** Government radio operator's license exams; qualifies for immediate employment in radio, and the marvelous future opportunities in television. As a Midland student, everything will be in your favor.

**MIDLAND
TELEVISION, INC.**
Power and Light Building
106-A West 14th Street,
KANSAS CITY, MISSOURI

Affiliated with
Columbia Network Basic
Broadcast Station KMBC

THE ONLY MAN



WHO COULD TALK TO THE SUPERINTENDENT

"Soon after I began studying," a student wrote to us the other day, "we had a change in management at our plant. I certainly was glad then that I had decided to study in my spare time. For, thanks to my I. C. S. Course, I was the only man in the organization who could talk to the Superintendent in his own language. As a result, I was promoted over men who had been here many years longer than I."

That's a true story of what just one I. C. S. student has done. This is proved by letters from satisfied students telling of promotions and increases in salary due directly to spare-time study.

One hour a day, spent with the I. C. S. in the quiet of your own home, will help prepare you for success in the work you like best. *Yes, it will!* Put it up to us to prove it.

INTERNATIONAL CORRESPONDENCE SCHOOLS

Box 5697-H, Scranton, Penna.

Without obligation, please send full particulars about the subject before which I have marked X:

TECHNICAL AND INDUSTRIAL COURSES

- | | |
|--|---|
| <input type="checkbox"/> Architect | <input type="checkbox"/> Diesel Engines |
| <input type="checkbox"/> Architectural Draftsman | <input type="checkbox"/> Aviation Eng. <input type="checkbox"/> Auto Mechanic |
| <input type="checkbox"/> Building Estimating | <input type="checkbox"/> Plumbing <input type="checkbox"/> Heating |
| <input type="checkbox"/> Contractor and Builder | <input type="checkbox"/> Air Conditioning <input type="checkbox"/> Refrigeration |
| <input type="checkbox"/> Structural Draftsman | <input type="checkbox"/> Steam Engineer |
| <input type="checkbox"/> Structural Engineer | <input type="checkbox"/> Steam Electric Engineer |
| <input type="checkbox"/> Electrical Engineer | <input type="checkbox"/> Marine Engineer |
| <input type="checkbox"/> Electric Lighting | <input type="checkbox"/> Civil Engineer <input type="checkbox"/> Highway Engineer |
| <input type="checkbox"/> Welding, Electric and Gas | <input type="checkbox"/> Bridge Engineer |
| <input type="checkbox"/> Reading Shop Blueprints | <input type="checkbox"/> Bridge and Building Foreman |
| <input type="checkbox"/> Telegraph Engineer | <input type="checkbox"/> Surveying and Mapping |
| <input type="checkbox"/> Telephone Work <input type="checkbox"/> Radio | <input type="checkbox"/> R. R. Locomotives <input type="checkbox"/> Air Brakes |
| <input type="checkbox"/> Mechanical Engineer | <input type="checkbox"/> R. R. Section Foreman |
| <input type="checkbox"/> Mechanical Draftsman | <input type="checkbox"/> R. R. Signalmen |
| <input type="checkbox"/> Machinist <input type="checkbox"/> Toolmaker | <input type="checkbox"/> Chemistry <input type="checkbox"/> Pharmacy |
| <input type="checkbox"/> Patternmaker | <input type="checkbox"/> Coal Mining |
| <input type="checkbox"/> Foundry Practice | <input type="checkbox"/> Navigation |
| <input type="checkbox"/> Sheet Metal Worker | <input type="checkbox"/> Cotton Manufacturing |
| <input type="checkbox"/> Boilermaker | <input type="checkbox"/> Woolen Manufacturing |
| <input type="checkbox"/> Heat Treatment of Metals | <input type="checkbox"/> Agriculture <input type="checkbox"/> Fruit Growing |
| <input type="checkbox"/> Management of Inventions | <input type="checkbox"/> Poultry Farming |

BUSINESS TRAINING COURSES

- | | |
|--|--|
| <input type="checkbox"/> Business Management | <input type="checkbox"/> Lettering Show Cards <input type="checkbox"/> Signs |
| <input type="checkbox"/> Industrial Management | <input type="checkbox"/> Stenography and Typing |
| <input type="checkbox"/> Traffic Management | <input type="checkbox"/> Civil Service <input type="checkbox"/> Mail Carrier |
| <input type="checkbox"/> C.P. Accountancy | <input type="checkbox"/> Railway Mail Clerk |
| <input type="checkbox"/> Bookkeeping | <input type="checkbox"/> Grade School Subjects |
| <input type="checkbox"/> Secretarial Work | <input type="checkbox"/> High School Subjects |
| <input type="checkbox"/> Cost Accountant | <input type="checkbox"/> College Preparatory |
| <input type="checkbox"/> Salesmanship <input type="checkbox"/> Advertising | <input type="checkbox"/> First Year College Subjects |
| <input type="checkbox"/> Service Station Salesmanship | <input type="checkbox"/> Illustrating <input type="checkbox"/> Spanish |
| <input type="checkbox"/> Business Correspondence | <input type="checkbox"/> Cartooning <input type="checkbox"/> French |

DOMESTIC SCIENCE COURSES

- | | |
|---|--|
| <input type="checkbox"/> Professional Dressmaking and Designing | <input type="checkbox"/> Millinery |
| <input type="checkbox"/> Home Dressmaking | <input type="checkbox"/> Foods and Cookery |
| <input type="checkbox"/> Advanced Dressmaking | <input type="checkbox"/> Tea Room and Cafeteria Management, Catering |

Name.....Age.....
 Address.....
 City.....State.....
 Present Position.....

If you reside in Canada, send this coupon to the International Correspondence Schools Canadian, Limited, Montreal, Canada

When writing please mention Popular Mechanics

Give Helpful Books for Xmas!

RADIO · ELECTRICITY

Books At Sensationally LOW PRICES

LATEST technical information by nationally known authorities. New popular size books. Crystal clear. Profusely illustrated. Most outstanding book values in America!

HOW TO BUILD Exp. Lab. Work Bench. 20c
 EXPERIMENTS with 110-V Electrical Area. 23c
 MOTOR TRANSFORMER EXPERIMENTS. 25c
 RADIO EXPERIMENTAL MANUAL. 30c
 ELECTRICAL EXPERIMENT MANUAL. 35c
 STARTING AN ELECTRIC REPAIR SHOP. 35c
 ELECTRICAL-RADIO DICTIONARY, condensed electrical education. Explains 676 terms. 217 Ills. 48c
 FAULT LOCATION, Adjustment and Alignment of Radio Electronic Apparatus. Equips you to service your own or others. 65c
 CHARACTERISTICS AND TROUBLE ANALYSIS OF RADIO APPARATUS. You need this book. 75c
 RADIO SERVICING INSTRUMENTS. Two vols. 22c Ills. Circuits, data, operating instructions, etc. Both for. 38c
 SHORT COURSE in MATHEMATICS. Two vols., fractions to logarithms, clear, amazingly complete. Both for \$1.05
 SHORT COURSE in ELECTRICITY and RADIO. Two volumes. 332 Ills. Newest, most complete. Both for \$1.45
 Complete Radio-Electrical Library, all 15 books. \$3.98
 See Xmas gift postpaid, only.....



MAILED POSTPAID!
 Send cash, check or stamps. Or, books mailed C. O. D.
 ORDER NOW or send card for Free Folder describing full line of Low Priced Books!

ELECTRONIC PUB. CO., Box 323-K, Lincoln, Nebr.

New Way to Improve YOUR ENGLISH



A command of effective English gives you added advantages and better opportunities. Poor English handicaps you more than you will ever realize. You can improve your English through Sherwin Cody's 100% self-correcting invention.

If you are ever embarrassed by mistakes in grammar, spelling, punctuation or pronunciation, this new free book "How You Can Master Good English in 15 Minutes a Day" will prove a revelation to you. Send for it now. It is free. Address

SHERWIN CODY SCHOOL OF ENGLISH
 51 Searle Building Rochester, N. Y.



BE A CARTOONIST

AT HOME IN YOUR SPARE TIME under personal supervision of the famous cartoonist NORMAN MARSH creator of "DAN DUNN" appearing every day in big papers. Success—Fame—Real Money may be Yours when you learn Marsh's easy simple methods and secrets. Send name and address for free details of MARSH'S Personal course. ACT TODAY!

MARSH CARTOON SCHOOL
 Chicago Daily News Bldg., Dept. I-A, Chicago, Ill.

AVIATION APPRENTICES



BIG PAY GOOD FUTURE
 IF YOU ARE INTERESTED IN WORKING YOURSELF INTO A HIGHLY PAID POSITION IN AVIATION—Write, immediately, enclosing stamp—

MECHANIX UNIVERSAL AVIATION SERVICE CO.
 Strathmoor Station Dept. E Detroit, Mich.

Refrigeration



Text-Book for Home Study

This complete, up-to-the-minute, practical book will teach you quickly how to service all types of refrigerators. Page after page of useful, easy to understand facts. Refrigeration is the big money field and you can get into it after studying this textbook. Size 8 1/2 x 11 in. Priced at only \$1.00, postpaid. Send for this book today.

SUPREME PUBLICATIONS 3727 W. 13th St. Dept. B, Chicago, Ill.

TELEGRAPHY

both Morse and radio taught thoroly. R. R. retirement act creating splendid demand for Operators. Recognized outstanding school; estab. 1874. All expenses low. Catalog free.
 DODGE'S INSTITUTE, Morse Street, Valparaiso, Ind.

HOW TO MAKE MONEY

Thousands of magazines and newspapers buy MILLIONS of photos from free-lance camera owners every year. We show you what to photograph, how to do it, where to sell for biggest profits. Learn at home in spare time. No special camera needed. Write for FREE BOOK telling about this fascinating new field. UNIVERSAL PHOTOGRAPHERS, Inc., Studio 71, 10 West 33rd Street, New York City.



**FOR MEN
WHO WANT
TO LEARN A
PROFITABLE
TRADE**



Complete DIESEL Training!

**with all types INTERNAL COMBUSTION ENGINES,
ELECTRIC POWER GENERATION, etc.**

YOU MEN who are sincerely ambitious to make good in the Diesel and related industries, want to know the true facts—you want to know about employment opportunities and employment requirements. For 33 years, National Schools, a recognized leader in the field of trade education, has played a vital part in helping wide-awake men to qualify for success in industry. National Schools—a million-dollar trade school—will supply you with a sincere, honest statement of facts on what you should do to get into the profitable Diesel Industry. No exaggerations—no mis-statements.

nearest point of entry.) Student social life includes inspection trips, excursions, athletic activities, etc. Special doctor service. Personality coaching. **Many students are helped with spare-time jobs to earn room and board while learning.** (Canadians excepted.) Graduate employment cooperation.

YOU NEED REAL SHOP EXPERIENCE WITH TIME-TESTED TRAINING

Mail the coupon below. In the literature you will be sent, you will see exactly how other men like you are preparing themselves for success in National's modern training shops. You learn on the latest, finest equipment. You do real job work. You learn by time-tested, shop practice methods. Your training is fascinating in every detail. You are taught how to make good, and helped to make good after you graduate. All of this and much more is clearly pictured for you in the Free Book of Facts we will send to you.

TRANSPORTATION ALLOWED TO LOS ANGELES

National Students are allowed coach railroad fare from any point in U. S. (Canadian students from

National Training is so thorough and all-inclusive, that no ambitious man can afford to consider Diesel Training without first knowing all of the facts regarding the many advantages available to him as a National Student. INVESTIGATE.



HOME OF NATIONAL SCHOOLS

A million-dollar trade school, occupying its own modern three-story building, exclusively devoted to training ambitious men. Latest equipment; selected, experienced staff of engineers and instructors; practical, thorough training.

PUBLIC SCHOOL SUPERINTENDENT PROFITS BY NATIONAL TRAINING

"I have attended two state universities and two state normal schools and I want you to know that I feel I have received more for my money at National than at any other school I have attended. One cannot be too high in praise of the instructors—of their determination to see that each student received complete instruction and thorough understanding of each assignment."

J. Stover, Jr.,
Sup't., Palouse Public Schools,
State of Washington.

NATIONAL SCHOOLS *Los Angeles*

SEND FOR YOUR COPY TODAY

—Real Facts on Diesel
Employment Requirements

Free
NEW BOOK
OF
TRAINING FACTS

Request for Free Book

NATIONAL SCHOOLS
(established 1905) Dept. PMA-1
4000 S. Figueroa St., Los Angeles

Please send me, without obligation, your FREE BOOK and information regarding Diesel Employment Opportunities and Requirements.

NAME _____

ADDRESS _____ AGE _____

CITY _____ STATE _____

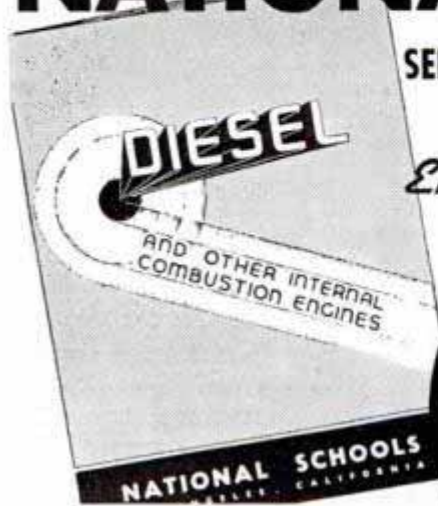



NEW

INVENTIONS

es 114 **UNORTHODOX** propulsion of a motorboat is provided under a patented design revealed recently. The design calls for a motorboat with a hull having a recess. An endless propeller belt, connected to the motor, is equipped with means for expelling the water from the recess in the hull, thus giving the boat a forward motion.



WALKING on ice or wet, slippery pavement would be easy if your shoes were equipped with a non-skid attachment for which a patent has been issued. It is a flat sandal wire frame forming the outline of the sole of the foot, with wire braces running crosswise. Spikes extending downward from the braces give a firm footing. The frame is attached to the shoe by means of straps and buckles at the toe and instep.



MORE space for the traveler's clothing is provided by a patented bag which is attached to the top of the automobile. The boxlike bag conforms to the general dimensions of the top. It has narrow, collapsible side-walls and a rigid front wall. At the



rear end is a full opening. A pulley, operated by flexible cable, controls movement of a chain inside the bag. This chain has connections or hooks for wearing apparel, such as suits and dresses. When the garments have been attached to the chain, they are pulled into the bag by means of the pulley and the opening is closed.

IMPROVED lighting is the purpose of a lamp just patented. It consists of the electric bulb and a shade supported for adjustment about the bulb axis. An opening is provided in the shade at one side. Between this opening and the bulb is a lens which collects and projects an intense beam of light in the direction determined by the adjustment of the shade frame. Thus, the light might be adjusted to cast a powerful beam on a book, table, workbench or other point.

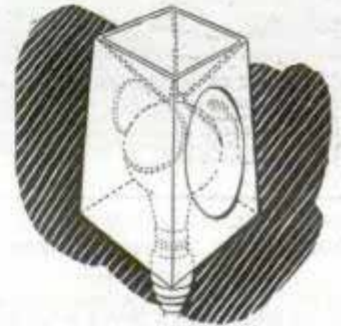

DANGEROUS deflation of tires on heavily loaded trucks could be detected instantly by means of a device now protected by patent. One part of the device, which would be attached to the chassis, extends downward to within an inch or two of the ground. When that detector touches the pavement, it closes electrical contacts which flash a warning to the driv-

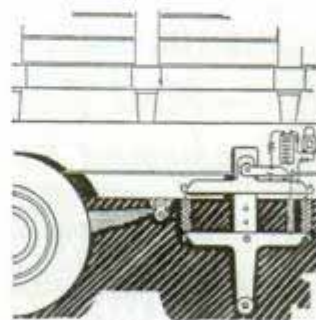

(Continued to page 40A)

VACU-MATIC SCORES AGAIN!

BOB McKENZIE

TRANSCONTINENTAL AUTOMOBILE CHAMPION
COAST TO COAST

WESTERN UNION
TIMED

NEW YORK
TO
LOS ANGELES
24 hrs. 45 min.

LOS ANGELES
TO
NEW YORK
27 hrs. 28 min.

CANADA
18,000 MILES
12 DAYS

LOS ANGELES
TO
NEW YORK
AND RETURN
121 hrs. 52 min.

WASHINGTON, D.C.
TO
MEXICO CITY
62 hrs. 27 min.

LOS ANGELES
TO
PHOENIX
8 hrs. 16 min.

MURDOCK DRYLAKE
1927 M. IN 1 DAY

LOS ANGELES
TO
SAN ANTONIO, TX.
4 hrs. 37 min.

ALPAX, NB.
TO
DOVER, N. C.
4 hrs. 51 min.

Vacu-matic Carburetor Co.
7617 W. State St.
Wauwatosa, Wisconsin

Dear Sirs:

Having just completed a new speed record between Los Angeles and Chicago, driving a 1936 Chevrolet equipped with a Vacu-matic carburetor control, I thought you might be interested in knowing some of the facts and the important part Vacu-matic played in the success of the run.

The distance covered was 2322 miles in thirty nine hours and forty-two minutes, officially timed by Western Union, which gave me an average speed of 59.7 M.P.H. based on elapsed time and with the Vacu-matic averaged 18 1/2 miles per gallon on gas-line.

Before leaving Los Angeles, we made several test runs both with and without the Vacu-matic, and the tests proved that Vacu-matic increased my gas mileage 3 1/2 miles per gallon at the driving speed of 80 M.P.H. and also very noticeable increase in both acceleration and power.

After this experience with Vacu-matic, you can depend that on my future speed runs across country that I will be depending on Vacu-matic to give me the same added performance it has proven on this last record breaking drive.

Yours very truly,



Sets New
Coast-to-Chicago
Record

New Supercharge
Principle
SAVES GAS

MORE POWER - MORE SPEED
FASTER PICK-UP - NEW LIFE



ESTABLISHING new mileage records on cars in all sections of the country, the Vacu-matic again scores in a new speed record established by Bob McKenzie transcontinental automobile champion. Los Angeles to Chicago—2,322 miles in 39 hours and 42 minutes—driving 75 and 80 to maintain a speed average of 59.7 miles per hour!

Here is speed—a gruelling grind—where quick acceleration, greater top speed — and less stops for gasoline mean those precious moments saved that make new speed records possible. The same Vacu-matic that helped Bob McKenzie establish this speed record and gave him such fine gas savings is now available for all car owners. It is positively automatic—simple to install—inexpensive—and pays for itself many times over in gas savings.

Automatic - - Nothing Like It!

Vacu-matic is *entirely different!* It operates on the supercharge principle by automatically adding a charge of extra oxygen, drawn free from the outer air, into the heart of the gas mixture. It is entirely AUTOMATIC and allows the motor to "breathe" at the correct time, opening and closing automatically as required. No idling troubles—no carburetor adjustments necessary. It is so simple it will amaze you—so practical it will save you many dollars on gas costs.

Fits All Cars

VACU-MATIC is constructed of six parts, assembled and fused into one unit, correctly adjusted and *sealed at the factory*. Nothing to regulate. Easily attached in ten minutes.

Agents and Salesmen

VACU-MATIC offers a splendid opportunity for unusual sales and profits. Valuable territories now being assigned. Check and mail coupon.

The VACU-MATIC Co. Wauwatosa, Wis.

Guaranteed Gas Savings

VACU-MATIC must prove itself on every car. It is guaranteed to give worthwhile gas savings, quicker pick-up and more power, or it costs you nothing. "On my V-8 Ford it works miracles", says Ralph Fields. James Seeley—"On an International Truck on a round trip to Cleveland, 385 miles, it saved 19 gallons of gas." A. V. Grove—"On the Buick it showed 5 miles more per gallon." F. S. Peck—"I average 22 miles per gal. on my Plymouth, an increase of 7 miles, for a saving of \$15.00 a month, or \$180.00 a year." Wm. Lyons—"Averaged 25 miles on a gal. with a Model A Ford at 40 miles per hour."

Free Details

You owe it to yourself to know all about this remarkable discovery. Mail the coupon below. Start saving gas with VACU-MATIC and enjoy a new driving thrill! There's no obligation—so get the facts now! Write today!

--- FREE OFFER COUPON ---

THE VACU-MATIC COMPANY
7617-356 W. State St., Wauwatosa, Wis.

Gentlemen: Please send me full particulars concerning the Vacu-matic and details of your Free Offer. This of course does not obligate me in any way.

Name

Address

City State.....

Check here if interested in selling proposition.

When writing to advertisers please mention Popular Mechanics

Learn this Profitable Profession



in 90 Days at Home

Hundreds of men and women of all ages 18-50 make \$10.00 to \$20.00 in a single day giving scientific Swedish Massage and Hydro-Therapy treatments. There is a big demand from Hospitals, Sanitariums, Clubs, Doctors and private patients as well as opportunities for establishing your own office. Learn this interesting money-making profession in your own home by mail, through our home study course. Same instructors as in our NATIONALLY KNOWN resident school. A diploma is awarded upon completion of the course. Course can be completed in 3 to 4 months. High School training is not necessary. Many earn big money while learning.



Anatomy Charts & Sample Lessons FREE

Enroll now and we will include uniform coat, medical dictionary, patented reducing roller and Hydro-Therapy supplies without extra cost. The reducing course alone may be worth many times the modest tuition fee. Send coupon now for booklet containing photographs and letters from successful graduates, illustrated sample lesson sheets and Anatomy Charts. These will all be sent postpaid—FREE.

THE College of Swedish Massage (Successor to National College of Massage)
Dept. 164—1601 Warren Boulevard, Chicago
You may send me FREE and postpaid, Anatomy Charts, illustrated sample lesson sheets and booklet containing photographs and letters from graduates.

Name

Address

City..... State.....

Train for RADIO IN 12 WEEKS AT COYNE ON REAL EQUIPMENT

The great Coyne Shops in Chicago have a world-wide reputation for training ambitious fellows for their start in this well paid field in only 12 weeks. Then they help you by giving you life-time employment service. By my new plan YOU can take advantage of their wonderful method of learning-by-doing NOW.

SEND TODAY FOR DETAILS OF MY "PAY AFTER GRADUATION" PLAN

Get training in 90 days on Real Radio, Television and Talking Picture Equipment. Send the coupon today. If you are short of money I'll send you all details of my finance plan which tells how you can get training first and you won't have to start paying tuition until five months from the date you start school and then you'll have 18 months to complete your payments. Big Free illustrated Book telling all about COYNE and how many earn while learning, and training you can get without book study or useless theory.

H. C. Lewis



COYNE RADIO & ELECTRICAL SCHOOL

500 S. Paulina Street, Dept. 18-3H, Chicago, Illinois

MR. H. C. LEWIS, President

500 S. Paulina St., Dept. 18-3H, Chicago, Ill.

Send me the Big FREE Illustrated Book on RADIO, and details of your "Pay After Graduation" Plan.

Name

Address

State..... City.....

NEW INVENTIONS

(Continued from page 38A)

er by means of an alarm located on the instrument panel. Thus, the driver would be able to halt the truck before complete deflation took place and save his tires.

INSTRUCTING and testing the automobile driver is made easy by apparatus

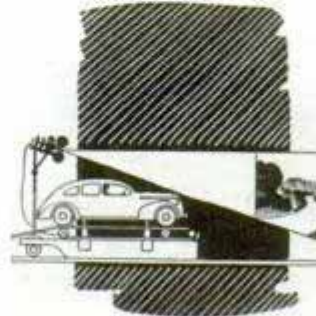

patented not long ago. It consists of a moving-picture projector with means for its operation at a predetermined speed by the driving mechanism of an automobile. Thus,

the car placed on the treadmill of the device would cause the projector to operate at a speed proportional to the speed of the car's rear wheels. The projector flashes moving pictures of traffic hazards, thus testing driver's reactions to emergencies.

FOR convenience of the carpenter is a handy tool protected by a recent patent.

It consists of a parallelogram frame with pivotally connected sides and having one of the longitudinally extending sides flanged for engagement with the edge of

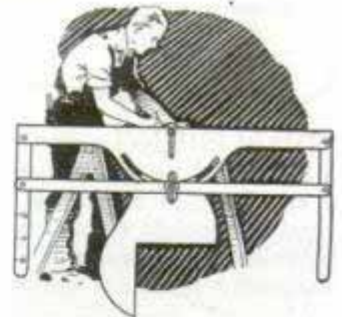

timber to be marked. The transversely extending sides constitute rules for marking opposite ends of the timber. A protractor is provided for setting the frame with the rules at the desired angle.

BBETTER health is the purpose of a patented humidifier which may make its

appearance soon. It consists of a series of pan units and connecting means between the pans comprising a conduit connecting the interior of the pans. A portion of the con-

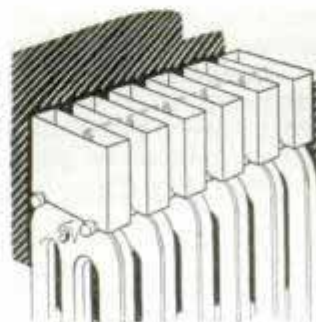

(Continued to page 42A)

Here I Am At WORK

Making
GOOD MONEY
thanks to this



DRAFTING

Yes, this free lesson **proved** that drafting is easy, mighty interesting work . . . convinced me I didn't need special talent to get into this well-paid profession . . . **proved** beyond a doubt that Drafting by the fascinating C. T. C. method can be mastered easily **AT HOME** in SPARE TIME.

So I enrolled. Today I know my job is secure. For draftsmen are always needed in construction,

YOU GET THIS COMPLETE DRAWING OUTFIT



without a penny extra. These are quality instruments—the kind that professional draftsmen use. With them you can put your ideas on paper quickly and with accuracy. With this outfit and C. T. C. training, you're all set to master draftsmanship **in months**—not years—at home, and you can use these very same instruments some day soon in a good paying job as draftsman.

CHICAGO TECHNICAL COLLEGE

A209 Tech Bldg., 118 E. 26th Street, Chicago, Illinois

manufacturing and industry . . . and in those new Diesel and Air Conditioning plants. Draftsmen can't be replaced with machines! What's more, I'm slated for promotion—but if I wish, I can be independent . . . go into business.

Here's a tip: Mail the coupon or drop a card for the free trial lesson. **Do this today**—and drafting will take care of you tomorrow.

LEARN AT HOME IN SPARE TIME

A few hours of pleasant home study every week—that's all! No interference with your present job. You train yourself step by step. This tested method—developed over 35 years of C. T. C. progress—will fit you for a job in months—a job we'll help you get. Get this: Terms are low. You can't honestly say, "I can't afford it." There isn't a reason why you shouldn't mail us the coupon **today**. When you get your **FREE TRIAL LESSON**, you'll say, "I never knew learning could be so easy and enjoyable."

MAIL THIS COUPON

CHICAGO TECHNICAL COLLEGE

A209 Tech Bldg., 118 E. 26th Street, Chicago, Illinois

Please send me **FREE Trial Lesson** in **DRAFTING** and show me how I can prepare for a good position in **spare time AT HOME**.

Name _____ Age _____

Address _____

P. O. _____ State _____

THOUSANDS of MEN WANTED

for **AIR CONDITIONING JOBS**

60,000 JOBS will open up in the skyrocketing air conditioning and refrigeration industry during the next few years, state employment authorities. Thousands of those jobs are open NOW. Manufacturers and distributors are clamoring for trained men. Get your training NOW . . . in time to qualify for air conditioning payrolls at the start of the big spring rush.



BIG FREE BOOK tells about the unlimited opportunities in air conditioning and refrigeration . . . and about how you can qualify for a job through Thermo Institute resident or "home-and-shop" training.

THERMO AIR CONDITIONING INSTITUTE, INC.
 Resident Schools — 1755-A Broadway, New York
 125-A West Hubbard St., Chicago
 182 S. Alvarado St., Los Angeles

Please send **FREE** book and complete information on Thermo Institute training.

Name _____ Age _____

Address _____

City _____ State _____ t-6-p



There's Quicker, Bigger MONEY for YOU-in POULTRY

Earn \$1,000 to \$2,500 a Year or Have a Business of Your Own!



Whether you want a job at good pay or a highly profitable business of your own—Poultry Raising offers you more than any other easily-learned trade or profession. Poultry meat and eggs are always in demand—and there is a shortage of trained poultrymen. My Home Study Course trains you quickly to fill a good job in poultry—and my Personal Employment Assistance will help you get one!

Spare Time or Full Time YOU CAN Cash-in BIG
 No matter where you live—city, town or country—or what you do now, my proved methods will assure your success right from the start. I'll help you make from \$1,000 to \$2,500 a year and UP! And, if you choose to start your own business, I'll show you how to make your tiny investment multiply itself automatically. What I've done for thousands of others—I can do for you.

FREE Book Shows the Way to Big Pay and BIG Profits
 Mail coupon below TODAY—for my Big NEW FREE Book, "How to Raise Poultry for Profit." My forty years of experience are yours. The Poultry Industry needs YOU. You need my book. Get it—and get in line for the BIG Money that's waiting for you in POULTRY.



Mail NOW for FREE Book

NATIONAL POULTRY INSTITUTE, Dept. 37-C, Adams Center, N. Y., Att'n: Harry M. Lamon, Pres.

Dear Mr. Lamon: Send me your FREE Book, "How to Raise Poultry for Profit." I want to know more about my opportunity to make \$1,000 to \$2,500 a year, spare or full time.

Name

Address

esll4/ **NEW INVENTIONS**

(Continued from page 40A)

duit is constructed in a lower plane than the bottom of the pans. The humidifier would be connected to the radiator by fitting the conduit over the tops of the radiator's sections.

OF INTEREST to the building contractor and the home owner is the multiple sash window patented recently.



It consists of a frame with two or three sashes which may be swung outward individually or collectively. A clutch mechanism, which can be disengaged when independent operation of one sash is desired, controls movement of the sashes.

UNUSUAL illumination of the dining table in public restaurant or in the home is provided in a patented table which has a glass top and means for lighting it from below.



The top is supported by an opaque pedestal which contains the electric socket and lamp with connecting wire and plug for attachment to a wall outlet. A reflector beneath the glass top illuminates a circular portion, creating a novel effect.

HANDY for the small apartment is a combined drying and cooking device for which a patent has been issued recently.



It consists of a boxlike structure with a chamber at one end for an electric heating element. The other part of the device forms the drying compartment with room for several garments. It may be inverted to change its function from drying to cooking.

(Continued to page 62A)

DIRECT FACTORY-TO-YOU

SALE

SAVE 50% ON THIS

16-TUBE TOUCH BUTTON WORLD-WIDE MIDWEST!

Only
\$ **39** ⁹⁵

**ABSOLUTELY COMPLETE
WITH TUBES IN RICHLY FINISHED
CONSOLE—NOTHING ELSE TO BUY!**

JUST imagine a radio so big, so powerful, so luxurious—in a big, beautiful, richly-finished walnut console—selling at such an amazingly low factory-to-you price! While it costs no more than an ordinary 6 or 8-tube set, its advanced circuit and improved design result in great current economy. In addition its tremendous range (550 KC to 18,000 KC) and great reserve of power enable you to drive across the world and bring in weak, distant, foreign stations (10,000 and more miles away) like "locals." That's why careful buyers say: "Midwest gives you twice as much for your money."

GLORIOUS NEW TONE

Midwest gives you glorious, crystal-clear concert realism, brilliant world-wide reception and scores of advanced features, including Dial-A-Matic Tuning—at a sensationally low factory-to-you price! Zip! ...Zip!...stations come in instantly, automatically, perfectly... as fast as you can push buttons. The famous Midwest factory-to-you plan, proven by 18 years of success, is just as exciting. It enables you to buy at wholesale prices... to save up to 50%... to make your radio dollar go twice as far... and to pay as little as 50 cents a week on the Midwest Easy Pay Plan. You get 30 days FREE home trial!

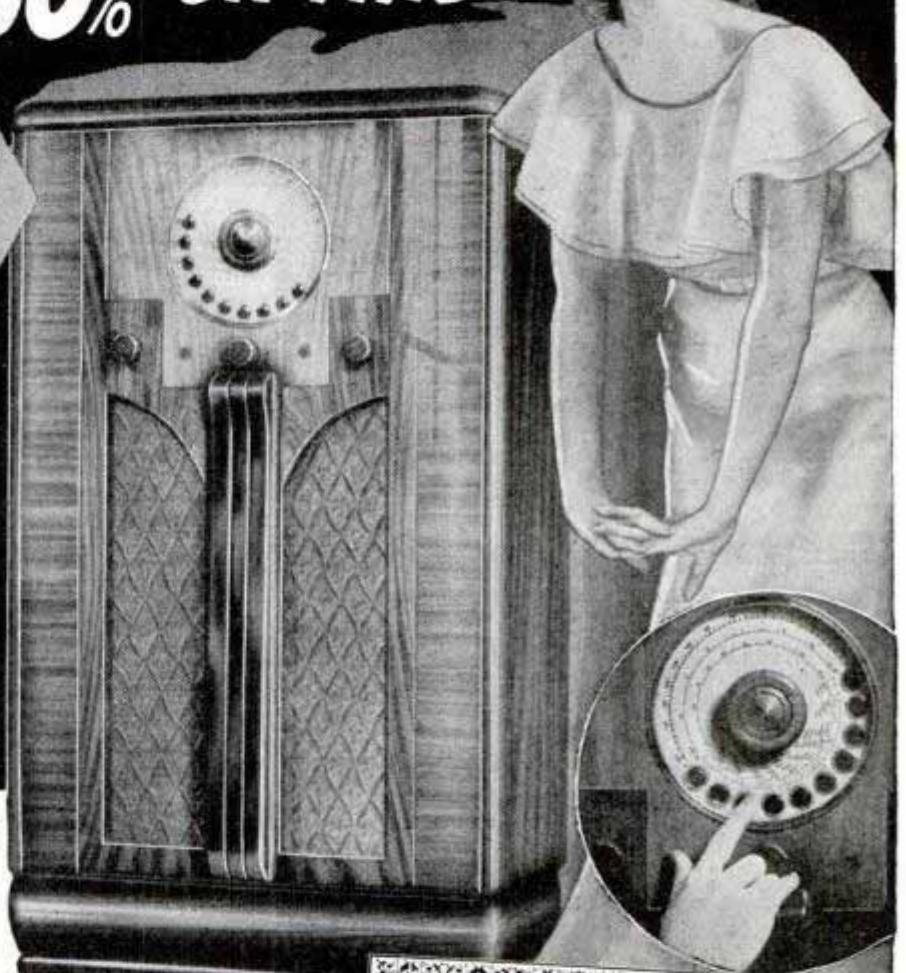

Not a cut-price set, but a bigger, more powerful, super performing COMPLETE radio in a big exquisitely designed cabinet of matched walnut.

**TERMS
AS LOW AS
50¢
A WEEK**



MIDWEST 30-Day Free Home-Trial Plan

TAKE advantage of the popular Midwest 30-day FREE Home Trial which enables you to try out this Midwest radio or any other Midwest for 30 full days... in the privacy of your own home. You are the final judge. If you decide not to keep it—just send it back to us!

PASTE COUPON ON 1¢ POSTCARD... OR

MIDWEST RADIO CORPORATION
Dept. KK-15 Cincinnati, O.

Send me your new FREE catalog and complete details of your liberal 30-day FREE trial offer. (Special offer and prices prevail only when dealing direct with factory by mail.)

Write Today!

Name _____

Address _____

Town _____ State _____

User-Agents Make Easy Extra Money. Check Here for details
 Check Here for 1938 BATTERY catalog

MIDWEST *Factory-to-You* RADIOS

DEPT. KK-15 MIDWEST RADIO CORPORATION... CINCINNATI, OHIO, U.S.A.
Manufacturers of Quality Radios Since 1920

When writing to advertisers please mention Popular Mechanics

Be Somebody—



**Get more money; prestige; a better career
You can do it. Read this**

- "YOU KNOW, MARY, I DREAMED OF BETTER THINGS FOR US— BUT SOMEHOW I'VE FAILED TO GET WHAT WE HOPED FOR—"
- "I KNOW, JIM—WE'VE WORKED HARD, TOO. BUT YOU DO WORK ANYONE COULD DO. THERE MUST BE SOMETHING—"

AND there is something. Here it is: Become an Accountant; train at home in your spare time—with LaSalle! Fit yourself to get bigger pay in a modern respected profession. Prepare yourself to get what you want from life—a home, money for education, a car, luxury for your family—everything you've hoped for!

Accountancy through home study opens two fields for you. First, it can put you in line for higher bracket jobs in your present company. It can give you the drop on untrained men—can lift you out of their class. Your increased value will quickly be apparent in your work and noticed by your superiors. Accountancy training can give you ability and experience for which business is looking—for which it is glad to pay.

The second opportunity LaSalle Home Study Accountancy offers is a profitable profession of your own! Right now the professional accountant faces a greater demand than ever before. It is not uncommon for trained accountants to earn \$3,000, \$5,000 and more.

Three Men Who Proved It Can Be Done

Read the actual experience of three men who started accountancy training with us in 1936:

After a short period of intensive study, the first man started bookkeeping jobs on the side. Soon he got

enough of them so he opened his own business. Today he is his own boss, a successful business man with a splendid income. All in one year!

Another member—five months after starting his study—was called into the office and given a more responsible position paying \$40 a month more. His employer told him anyone studying a LaSalle home-study course was obviously more alert than most men and therefore capable of a bigger job.

To the employer of the third member we sent information about the member's study. The letter resulted in his being chosen—above five other candidates—for a better position with shorter hours and more pay.

Just three of thousands who tell us that LaSalle home study was the turning point in their lives. Their cases, which may seem extraordinary to you, are not uncommon to us. Many others have done as well. Perhaps you can, too. At least, it's worth investigating.

Send for This Free Book

The facts about LaSalle training in Accountancy and the opportunities in this growing field are clearly outlined in a 64-page book which LaSalle will send you free. If you have the urge and the will to increase your income, clip and mail the coupon for it—NOW.

LASALLE EXTENSION, Adult Business Training, Dept. 164-H, Chicago, Ill.

I'd like to see whether I should take up Accountancy. Send me—without obligation or cost to me—your booklet *Accountancy, the Profession That Pays*, and full information about your Accountancy training program.

Other LaSalle Opportunities:

Higher Accountancy

If more interested in one of the fields indicated below, check and mail now.

- Business Management
- Modern Salesmanship
- Law—Degree of LL.B.
- Commercial Law

- Railway Accounting
- Practical Accounting and Office Management
- Expert Bookkeeping

- C. P. A. Coaching
- Business Correspondence
- Business English
- Stenotypy

Name.....

Present Position.....

Address.....

When writing to advertisers please mention Popular Mechanics

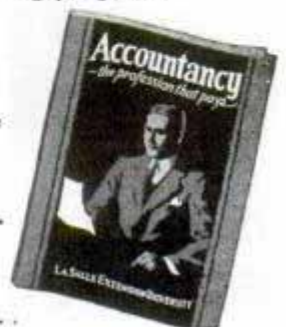



CLASSIFIED

Advertisements



Advertisements in this section, 35 cents per word, each insertion, minimum 10 words, payable in advance

To be inserted under proper classification in February issue, copy should be in our office December 8th

February issue on sale January 1st

Popular Mechanics Magazine, 200 East Ontario Street, Chicago, Illinois

YOU'LL PROFIT

By reading and answering the classified ads in this section. Hundreds of opportunities to make and save money.

Popular Mechanics Magazine, Chicago, Ill.

Gentlemen: We are writing this letter to tell you of the wonderful results we have had by placing an ad in your classified section. Last April we started to advertise in your magazine for Photo Finishing. From the very start Popular Mechanics had more pulling power than all the rest of our ads put together. The results have been so much better than we expected that at the present time we are making enlargements on our plant and equipment to take care of this business. We are expecting to have even better results in the future, and Popular Mechanics is the magazine that will do the trick. We thank you, and wish you all the success in the world.

Very truly yours,
THE FILM CAPITOL SERVICE.

(Original letter on file in our office)

AUTOMOBILES

CAR Owners—Eliminate "ping" and "buck" in acceleration. Smooth out pickup and add 5% to 15% in fuel economy with Osco Fuel Flow Regulator. Agents wanted. This is no "gadget." Write Osmitson, 3103 O Street, Philadelphia.

NEW Era wheel design weather vane for garage. Complete with staff and brackets. Price \$10.00. Get circular. John Schweers, 134 Sheridan Ave., Roselle Park, New Jersey.

FORD V-8's, 1935-36-37; gasoline saver, \$1. Walert Co., 3429 No. 10th St., Milwaukee, Wis.

ENGINES, Propellers, for sleds, midget cars. Circulars dime. Storms, 199 Broadway, Asheville, N. C.

ECONOMY! Performance! Mileage! Semi-Diesel conversions for gasoline motors, \$5.00 up. Manufacturers written guarantee. Learn basic facts from free literature. Houston & Logan Conversions, 1719 Addison, Berkeley, California.

MIDGETS! Motors! Parts! Used, new; sport, racing. Over 20 midgets, 60 motors, \$6.00 up. Latest lists, 20c. Shipps Midgets, Box 543-H, Zanesville, Ohio.

BUILD Pedal power streamlined racer, six to sixteen year sizes. Picture free. Plans \$1.00. Ray F. Kuns, Dept. R, Madisonville, Cincinnati, Ohio.

MIDGET Racing car. 100 m.p.h. Build with our plans, parts. Details for stamp. Shipps, Box 543-H, Zanesville, Ohio.

AUTOMOBILES, Trucks, tractors, burn distillate successfully now. We teach you the coming business free. Start now. Co-operative Conversion Service, Sullivan Bldg., Oakland, Calif.

CONVERT Automobile engine into fast pumping air compressor. Instructions \$1.00. Particulars free. Tuck Garage, 73 Shirley, Pontiac, Michigan.

R & R Mfg. Co., Anderson, Indiana. Racing cars and midgets. Catalogue 25c.

MIDGET Racer—Sell or exchange for car. Cash speaks. Leonard Tieszen, Mountain Lake, Minn.

REFINISH Your car. Instruction book treats all phases of painting and refinishing autos and trucks. Written for the man who wants to renew his own car, but covers also the business end of refinishing for the professional. \$1.65 postpaid. Popular Mechanics Press, Room (C37), 200 E. Ontario St., Chicago.

1937 IGNITION Supercharger. Quick starting, wet or cold. Mileage, pep, power, less carbon, \$1.25. E. G. Sales Co., 321 Broadway, New York.

DESOGAS Fuel oil converters \$4 up. Pretti Desogas, 1618 6th, Berkeley, Calif.

(POWERFUL) Leaky radiator sealer. (Harmless.) 40c coin. Agents wanted. E. O. K., Porterville, Calif.

MIDGET Cars, parts, plans. Catalog dime. Derby Midget Cars, Woodstock, Ill.

AUTO SUPPLIES AND EQUIPMENT

DEMONSTRATORS. Compressor, test bench, 8-hour battery charger, arc welder. Guaranteed. Trial and terms. Hobart Welder Exchange, Box M-181, Troy, Ohio.

DIESEL Engine Digest \$2.50 year, Diesel Power \$3.00 year, Diesel Progress \$3.00 year, Pacific Marine Review \$1.50 year, Welding Engineer \$3.00 year—subscription without foreign. John Rodakowski, Hayden Bridge Road, Springfield, Oregon.

MOTORISTS—Automatic reverse light \$1.12 prepaid. Give make, year. Century Products, Box 127, Racine, Wis.

"MOTO-HEATER" Keeps engine warm, battery charged, coldest weather. Automatically starts, stops motor with car locked. No outside connections. Sensational. Agents wanted. Summerheat Company, South Bend, Indiana.

ZEROL Anti-freeze, prevents frozen radiators to 40 degrees below zero. No alcohol. Won't rust. Complies with government standards. Manufacturing costs 15c gallon. Formula \$1.00 postpaid. Keystone Service, Topeka, Kans.

NEON Ignition timing stroboscope. Shows flywheel marks while running. Cuts job quarter time. Simple construction. Plans 50c M. O. General Physical Laboratory, 509 - 5th Ave., New York.

AUTO Horn operating ring. \$2.50. 1938 Buick, Chrysler, LaSalle have them. Fits all cars. Nil Mellor, Waldorf Astoria, New York.

ATTENTION Automobile owners. Save money. Do things yourself. Complete information 25c postpaid. F. Hutchko, 314 N. 4th St., Camden, N. J.

TURN Scrap into money. Convert old auto generators into A.C. generators for auto radio, camp and home lighting, power and other uses. Complete book \$1 postpaid. Popular Mechanics Press, Room (C37), 200 E. Ontario St., Chicago.

CONVERT Your car to burn Diesel oil. Save up to 70% fuel costs. Cheap installation. Wonderful performance. Proven factory method. Different and better. Costs nothing to investigate. Write for free circular No. 4. Harrington Company, 201-204 Manchester Building, Portland, Oregon.

CURE Oil pumping. Restore pep, power. Increase gas, oil mileage. Easily installed segment rings, piston expanders. Guaranteed. Agents wanted. Haling, 4750A Sheridan, Chicago.

PLATING Outfits for auto parts. Connect to a battery. No tanks used. Free particulars and proofs. Gunmetal Co., Ave. J, Decatur, Ill.

AUTO TRAILERS

BUILDERS—A big 68 page book, tells all about trailers. How to plan and build the latest modern designs. Complete instructions, how to select and where to get dependable material and supplies. 350 illustrations, over 500 new and improved parts and accessories. Every phase of trailer construction is dealt with. The book is compiled by engineers engaged in trailer building. Send 25 cents, coin or stamps to cover postage and mailing. A. J. Stephens & Co., 2807B E. 14th St., Kansas City, Mo.

PARTS For the Popular Mechanics "Family Trailer" featured in the February, March and April, 1936 issues. Everything you need—Axle, hitch, wheel housings, water tank, pump, toilet, sink, stove, wood parts, windows, screens, lights, cushions, etc. Send for price list. Include 25c for our big catalog and Trailer Builders' Manual. Trailer Supply Co., 411 Jackson St., Wausau, Wis.

25 PIECE Beetleware service for four \$5.49 postpaid. State color. 600x16 Budd wheels, \$7.00 pair. Gem Trailer, North Bergen, N. J.

BUILD The beautiful Parlor Cabin trailer and land cruiser. Complete working details, 50c silver. Parlor Corporation, Greenwood Lake, New York.

BUILD The famous Jim Dandy cabin trailer—thousands on the road! A roomy, good looking trailer easy to build at low cost by anyone handy with tools. Complete plans and instructions—only 50c—give every detail of chassis, body, top, beds, cabinets, refrigerator, electric light and water systems and where to buy all parts. Can be built in any size to accommodate 2 to 4 people. Send 50c for these practical plans. Rush your order today to Jim Dandy, Box 1125, Wausau, Wis.

A. C. GENERATORS

PRACTICAL Changes for automobile generators. See our advertisement at bottom of page 127A. Autopower.

MOTORCYCLES, BICYCLES AND SUPPLIES

SEND 10c For Handbook of Information, listing new and used parts, for Indian, Harley, Excelsior, Henderson; accessories, batteries. Bootz, 622 East Grand, Des Moines, Iowa.

INSIDE Dealer prices. Overstocked, all models, Indians and Harleys. Rebuilt, guaranteed. Dime brings latest list. Crandall-Hicks, Boston, Mass.

RECONDITIONED Motorcycles. New-used parts for all makes. Authorized Harley-Davidson dealer. Whitman Motorcycle & Supply Co., 405-9 Southwest Blvd., Kansas City, Mo.

SEND 15c For illustrated used motorcycle catalog. Bargains. Largest stock genuine Indian parts and motorcycles. Indian Motorcycle Sales, Kansas City, Mo.

REBUILT Motorcycles, all makes, new and used Harley-Davidson parts. Send 10c for bulletin. Western Harley-Davidson Distributors, 914 E. 15, Kansas City, Mo.

MOTORCYCLE Bargains, lowest prices, bargain sheets for stamp. Motorcycle accessories. Rochester Harley Davidson Corp., 129 W. Main St., Rochester, N. Y.

ALLOY Pistons—Harley, Indian, Henderson, Excelsior, new or used parts, cylinder grinding. Catalogue and wings pin 10c. Ballak, 1115 Chestnut, St. Louis, Mo.

AVIATION

AERO-SLEDS For ice or snow transportation, supplies. Details dime. Adastik Bros., Grand Rapids, Mich.

HEATH Motor Manual invaluable operation, overhaul, conversion. Installation data Heath and Henderson motors \$1.00 or C.O.D. Cabin iced blueprint instructions \$1.00. Heath, Benton Harbor, Mich.

S-B PROPELLERS For airplane, sleds and boats, we sell only the best. Rejected airplane propellers cheap. Send dime or equal in stamps for circular. Sensenich Brothers, Lititz, Penna.

PROPELLERS — Genuine mahogany. Stainless steel tips. 4 ft. \$9.00, 4½ ft. \$12.60, 5 ft. \$14.85, 6 ft. \$18.00. Literature free. Universal Aircraft, Fort Worth, Tex.

73" CURTISROBIN Airplane kit \$1.50 postpaid. Gonsalves Airplanes, Woburn, Mass.

SLED Propellers—Harley \$2.98, Henderson \$4.50, Ford, Chev. \$7.50. Catalog free. Standard Propeller Co., Fort Worth, Tex.

HOW to organize a flying club. Tells how you can learn to fly. Send 10c today. Bennett Air Service, Hightstown, N. J.

YOUNG Men interested in entering aviation under apprentice plan see ad on page 36A.

SKY Flyer. Four foot model sailplane. Rises 2000 feet. Circles, dives for hours. Assemblies in twenty minutes. 50c. No stamps. Hare Products, Whitinsville, Mass.

BOOK: 500 Aviation questions correctly answered. \$1.00. George Tuck, 73 Shirley, Pontiac, Michigan.

AERODRIVE Sled. Detailed blueprint, 25c. Propellers. Ostergaard Aircraft, Dunning, Chicago.

PROPELLERS For airplanes, sleds. Also ice sled blueprints. Catalog dime. Lorenzen Propellers, Niles, Mich.

AIRPLANES \$50 Up. Motors, crackups, salvage. Complete directory 25c postpaid. Used Aircraft Directory, Athens, Ohio.

GET into aviation. Air transport pilots get up to \$7,000 per year; mechanics \$2,500. Learn at this government approved school. Write for complete information. State age. Lincoln Flying School, 2004 Aircraft Bldg., Lincoln, Nebr.

BATTERIES, GENERATORS, ETC.

32 VOLT Light plants, parts for all makes, batteries, radios, appliances. M. J. Fitzgerald Co., Madison, Wis.

BUILD Wind light plant. We show you how. Complete plans and valuable catalog 10c. Wind plant parts, welders, electric fences. LeJay Mfg., 447 Lake, Minneapolis, Minn.

FACTORY Rewound 110 volt a.c. generators for lights, power, 1500 watts \$15.00; 300 watts \$5.00. Guaranteed. Monroe Mfg. Co., Box 3343, St. Paul, Minn.

REWOUND Auto generators give 110 volts a.c. for lighting outfit. Complete instructions in Shop Notes for 1937 only 50 cents postpaid. Popular Mechanics Press, Room (C37), 200 E. Ontario St., Chicago.

EDISON Lifetime storage batteries for light and power. Eliminates acid battery diseases. Long guarantee. All kinds rebuilt generating plants, motors, and miscellaneous articles at bargain prices. Free interesting literature. T. Hawley Smith Co., Croton Falls, N. Y.

EDISON Storage batteries for light-power systems. Non-acid. Odorless, fifteen year life. Five year unconditional guarantee. Bargains in complete lighting systems. Low prices. Free illustrated literature. "See-Jay" Battery Co., 82 Sterling Ave., Yonkers, N. Y.

ELECTRICAL SUPPLIES—EQUIPMENT

ELECTRICAL Kit, \$1.69! Make arc light mile range. Arc furnace. Melt glass, metal. Weld iron, brass. Sun-tan rays. Dozens others. Complete with goggles, instructions. Works from house light current. Electrical Salvage Co., Box 524-H, Lincoln, Nebr.

ELECTRICIANS: Send for our free list of blue prints. H. Henriksen, 140 West 42nd Street, New York, N. Y.

HUNDREDS Of new, unusual, hard-to-get electrical items, replacement parts and supplies. Send for free wholesale catalog. Autopower, 410 S. Hoyne Ave., Chicago.

MAGNET Lifts 50 times own weight. Recover lost articles. \$1.00 postpaid. Particulars stamp. Amfadco, 861, Minneapolis, Minn.

ELECTRIC Pen engraves all metals, dollar prepaid. Hudson Bros., East Syracuse, N. Y.

WELDING AND SOLDERING

DEMONSTRATORS, Electric arc welders. Money-saving prices. Used by the government. Trial and terms guaranteed. Hobart Welders, M-182, Troy, Ohio.

ARC Welding outfit \$1.50. Heavy duty, weld fenders, braze, solder. Lavrow, 4368-W Warren, Detroit.

DODGE Arc-welder. Build your own, 40 volts, 25-200 amperes, direct current from old Northeast Dodge 12 volt automobile generators, 120 amperes from one generator, using ½ electrodes. 200 amperes, 3/16 electrodes from two generators, etc. Low cost and upkeep. Results guaranteed. Certified instructive plans \$1.00 COD. \$1.12 airmail 12c extra. Welders Club of America-A, Box 3432, Merchandise Mart, Chicago.

75-125 AMPERE Arc welder from Dodge generator. Complete plans and catalog 35c. 50 other generator changes. LeJay Manufacturing, 347 Lake, Minneapolis, Minn.

ELECTRIC Welders, 110-220 volt, fan-cooled, can be used for hours, \$75.00. Box 331, Hamilton, Ohio.

WELDER Shortage. Big pay. Finest training and employment help. Wonderful climate. Folder. Dunn Welding School, 1308 N. E. Union, Portland, Oregon.

ELECTRIC Arc welder, only 22c a day! Sensational Commonwealth all-purpose, heavy duty, continuous operation arc welder, only \$5.75 down—balance payable over 10 months from profits. Handles all welding—lightest sheet metal to heaviest castings. Operates from any electric socket. Complete, nothing else to buy. 10-day trial. Details free. Commonwealth, Dept. D-55, Cincinnati, Ohio.

A. C. Arc-welder. Build your own. Results guaranteed. Instructive plans \$1.50. COD. Box 48, Fairview, N. J.

SOMETHING New—110 volt electric brazing torch. Produces a 3 inch flame similar to an acetylene welder. Requires no gas or upkeep. Ready to use at the turn of a switch. Will last for years. Complete with all accessories—\$12.50. Dept. B, Apollo Mfg. Co., 319 Union Ave., Memphis, Tenn.

GENUINE Dodge arcwelder economically built without rewinding. Plans \$1. Particulars free. Pulis, Booker, Texas.

WANTED, Plans and instructions for building arc-welders from farm light plants, automobile battery chargers, electric car motors, etc. Must be original. Send photographs of welders built and prices wanted for plans. Welders Club of America, Box 3432, Chicago.

REBUILT 100 Ampere Dodge arc welder generator \$15.00. Neal Brown, Richland Springs, Texas.

REBUILT Electric arc welders, all sizes, a.c.—d.c. Service Co., 3732 Cedar Ave., Cleveland, Ohio.

ENGINES, MOTORS, DYNAMOS

A.C. ELECTRIC Motors, ¼ h.p., \$3.50. Send M.O. Larger sizes, list 10c. 3008 Bailey St., Philadelphia, Penna.

CLOSE Out. Slightly used ½ horse, 110 volt, alternating motors, \$8.50. Wilmut Auto Supply, 2247 St. Paul Ave., Chicago.

"PEPY" Gasoline engine governors: automobile engines made power units for electric welders, saw rigs, generators, etc. Order one on trial guarantee. \$7.50 postpaid. Harris Machinery, Minneapolis, Minnesota.

BARGAIN—½ Hp. motors, 60 cycle, 1 phase, 110 volt, like new, guaranteed, \$8.25. Send check to Erie Electric Motor Co., 120 Church, Buffalo, N. Y.

SMALL Elect. motors, high speed, 1/10 h.p., 110 volts, universal, rebuilt, \$2.00 postpaid. McConnell, 1619 Edgewood, Racine, Wis.

GUARANTEED Rebuilt and new motors, generators, fans. All kinds and sizes. Very reasonable prices. Tell us your needs. Queen City Electric, 519 S. California, Chicago.

WINDING Data, 225 motors, single and three phase. Price \$1. Motor Data Co., Box 7631, Kansas City, Mo.

GOVERNORS For auto engines. Read our ad on page 132A. Mfg. Candee-Smith Governors.

MACHINERY, TOOLS AND SUPPLIES

CONCRETE Building block machines and molds. Easy payments. Catalog free. Concrete Machine Co., 5 North Main St., St. Louis, Mo.

7" BOYNTON Metal shaper with ball bearing self-contained counter shaft, excellent condition. Sensenich Brothers, Lititz, Penna.

BARGAINS, Demonstrators, electric arc welders, guaranteed, 30 days trial and terms. Write Hobart Welder Exchange, Box M-183, Troy, Ohio.

GEAR Cutting with lathe, 90% quicker, very simple. No cutters, etc., needed. Instructions \$2.00. Melic Research, 7340 Chestnut, Kansas City, Mo.

HOME Shop machinery. Paint sprays. Used lathes. Circular. Burk Machinery, 1314 Prospect Ave., Toledo, Ohio.

12" x 6" SEBASTIAN Geared head motor drive Gold Seal lathe. Excellent condition. Write for bargain price. Cincinnati Machinery & Supply Co., 219 E. Second St., Cincinnati, Ohio.

WHO Makes it? Address of manufacturer 25c. Stern, 7401 Sangamon, Chicago.

BALLBEARING Grinders \$3.80. Willers Mfg. Co., 1945 N. California Ave., Chicago, Ill.

BENT Iron craft and 460 other useful subjects in Shop Notes, Vol. 28, only 50c postpaid. Popular Mechanics Press, Room (C37), 200 E. Ontario St., Chicago.

FREE—Bargain catalog, handy electrical tools, drills, motors, machinery, accessories; for mechanics, craftsmen. Paramount Products, 245A Broadway, New York.

PLASTICS, Brass, aluminum, Dowmetal, monel, stainless steel, gears, etc. New catalog now ready 10c coin. Hobby Supply House, Box 2014, Pittsburgh, Penna.

BOATS, OUTBOARD MOTORS, ETC.

KAYAK Construction kits \$10.45 up. Catalogue free. Jamestown Specialty Co., 377P, Titusville, Penna.

BUILD Electric outboard motor from automobile generator. Operates with car battery. Complete plans and catalog 10c. LeJay Mfg., 547 Lake, Minneapolis, Minn.

FORD And Zephyr marine engines. Send 10c coin. Lehman Engineering Company, Newark, N. J.

15 FT. Canoe \$39.50. Ready to ride. Catalogue free. Jamestown Specialty Co., 377PX, Titusville, Penna.

INBOARD Power for your row boat or canoe. Any part or complete kits. Sturdy Craft, 2404 Bridge St., Philadelphia.

"NEW Front steering," motor sleds, using outboard or motorcycle engine, snowmobiles, blue-prints, kits and supplies. Propellers, counter-shaft. Bargain prices! Rush dime for details. Mead Gliders, Dept. 18-BC, 15 So. Market St., Chicago.

MAKE 12' Kayak, new easy way. Full size patterns \$1.50. Henry Bakewell, 44 Billings St., Lowell, Mass.

AUTOMOBILE Transmission conversions. Marine use. High reverse. Complete line Ford model A and B conversion parts. Walter Machine Company, 75 South Street, Jersey City, New Jersey.

BUILD A boat by the Welch System. Use Welch ready cut parts. Send 10c for large catalog showing boats of many types. Welch Boat & Supply Company, Station K-1, Milwaukee, Wisconsin.

ICEBOAT Parts \$24.75. Skate sails \$7 up. Try-Sail Co., Patterson, N. Y.

BUILD Your boat and save; using our knock down frames. Muller Boats, 4920 Seventh Ave., Brooklyn, N. Y.

ASSEMBLE Your own boat. Our finished knock-down frames save you 2/3 builder's cost. All types and sizes. Send 25c for big catalog. Brooks Boat Co., Inc., D4, Saginaw, Mich.

OUTBOARDS—Save 1/2. Good used parts, all makes and models. Bargains rebuilt motors. Crandall Hicks Co., 780 Commonwealth, Boston, Mass.

FORD Marine conversion parts and kits. Models A, B, V8 (domestic or foreign). Catalogue 25c (coin). Osmithson, 3101 C St., Philadelphia, Penna.

12-FOOT Flat bottom rowboat—complete plans 25c. Free boatbuilding catalog. The Rudder, 15 Murray St., New York.

BOAT Designers are highly paid professionals. Complete course by mail. Catalog. Westlawn, Montville, N. J.

BUILD Your own boat—New book gives plans, methods, etc. 312 pages \$3. Popular Mechanics Press, Room (C37), 200 E. Ontario St., Chicago.

SPORTING GOODS, GUNS, FISHING TACKLE, ARCHERY

FOR A "Punch" new heavy fast training bags, pat. pen. Circular 10c. J. Andre, 3520 Mt. Elliott (rear), Detroit, Mich.

FENCING Equipment. Foils, swords, masks, etc. Low prices. Free catalog. Industrial Products, 274 Madison Ave., New York.

KNIFE Throwing instructions, ten cents. Throwing knife one dollar postpaid. Frank Dean, 1294 E. San Fernando St., San Jose, Calif.

SUBSCRIBE Now to the leading archery magazine of America. Covers all phases of archery. \$1.00 the year. Send ten cents for sample copy. American Bowman Review, Albany, Oregon.

SNOWSHOE Troubles eliminated. New tie. Copyrighted blueprint 25c. Antoine Gagnon, North East, Pennsylvania.

SPORTSMEN! Free bargain gun catalog. Skiers! Free bargain ski catalog. J. Warshal & Sons, First & Madison-I, Seattle, Wash.

HUDSON Bay blankets, Indian pack baskets, camp stoves, knives, compasses, outdoor equipment. Free catalog. Howe Fur Co., Box P, Coopers Mills, Maine.

ARCHERY. Most delightful sport for young and old. Instruction book 10c. Catalogue free. Archery Sales, 617 S. State St., Chicago.

NATIONALLY Known and advertised guns delivered at bargain prices. Catalogue free. Hoyt's Store, Sac City, Iowa.

OUTDOOR Sports for everyone—Enjoy them all your round with aid of book published by Popular Mechanics. Hundreds of ideas for new and popular sports for every season; complete instructions for making necessary equipment at small cost. 350 pages and 650 illustrations. \$2 postpaid. Popular Mechanics Press, Room (C37), 200 E. Ontario St., Chicago.

FIELD GLASSES, TELESCOPES AND MICROSCOPES

8 POWER 32mm. Prism monocular \$7.95. New government lenses for \$45 binocular used. Results of \$60 binocular but one eye. 150 yard field, great light, 8 ounces. Fraction original cost. With leather case \$7.95 prepaid. Catalog: binoculars, field glasses, telescopes, etc., 10c (credited). Largest assortment. Lowest prices. DuMaurier Co., Dept. 201-A, Elmira, N. Y.

GRIND Powerful telescope worth \$50.00 finished. 4" mirror kit \$3.00 postpaid. J. Loepfe, 2135 South 57th St., Milwaukee, Wis.

BOYS! Fine field glasses given free. Nothing to buy. Emery, 118 Lincoln St., Pittsfield, Mass.

LENSES And instructions for giant powerful telescope \$2.00. Atemsco, Box 213p, Flushing, N. Y.

BUILD Powerful astronomical telescope. Complete plans, diagrams, etc. 25c. Teeko Optical, Evanston, Illinois.

TELESCOPES, Microscopes, binoculars. Lowest prices. Optical catalog free. Brownscope Co., 234 Fifth Ave., New York.

FREE Catalog listing microscopes, telescopes, field glasses, chemical and scientific supplies. Send 3c for postage. Kemkit, 397M Bridge St., Brooklyn, N. Y.

BUILD Reflecting telescopes: catalog free. Instruction 10c. Optical Laboratories, Larchmont, N. Y.

TELESCOPES, Microscopes, binoculars, mineralogy, chemistry. Catalog free. Teeko, Evanston, Ill.

USED Microscopes, binoculars, astronomical telescopes, surveying instruments—Bought, sold, repaired. Send 10c for list. Rasmussen, P. O. Box 294, Amsterdam, N. Y.

ANTIQUES, RELICS, INDIAN GOODS

100 GOOD Arrowheads \$3. Catalog 5c. H. Daniel, Hot Springs, Ark.

100 GOOD Arrowheads, \$3.00. Satisfaction guaranteed. George Holder, Glenwood, Ark.

INDIAN Relics, beadwork, coins, curios, minerals. Catalog 6c. Indian Museum, Northbranch, Kansas.

TAXIDERMISTRY

GLASS Eyes, Taxidermists', furriers' supplies. Lowest prices. Forty page catalogue, free. Write today. Elwood Supply Co., 222 Smith Bldg., Omaha, Nebr.

TAXIDERMISTRY Supplies—Quality artificial eyes, teeth, genuine Jonas head forms. Tools, materials, etc. Everything for the progressive taxidermist. Send 10c for big illustrated catalogue. Jonas Bros., 1049 Broadway, Denver, Colo.

DOGS, PETS, BIRDS

PUPPIES—All breeds. Sons and daughters of famous \$5000 champions. Sold on approval. \$50-\$100. By mail only. McFarlin Breeders Service, Delavan, Wisconsin.

COLLIES, Shepherds, bull pups. Ship any where. R. Tonn, Dallas, Texas.

SPORTSMEN: 200 Pointers, Straight Cooners, combination Hunters, Rabbit and Fox Hounds. Cheap. List free. Ramsey Creek Kennels, Ramsey, Ill.

PUPPIES! Saint Bernards! Purebreds! Satisfaction guaranteed. Dime brings delightful photographic prospectus. Royal Kennels, No. 8, Chazy, N. Y.

PAL; Shooting dogs. Stupendous bargains. Jack Y. Flocker, Sharpsburg, Penna.

BIRDS? Get American Canary Magazine monthly. Year, \$1; six months, 50c. 2839-P N. Halsted, Chicago.

BEAUTIFUL Pure white police dogs. Ansonia Kennels, Mose, N. Dak.

POULTRY AND FARM SUPPLIES

MAKE Money with poultry. Read Poultry Tribune, a monthly magazine that tells how leading poultry raisers succeed. Only poultry magazine operating its own experimental farm. One year 50c, three years \$1.00. Poultry Tribune, Dept. E-93, Mount Morris, Ill.

"NEVER-FREEZE" Hog Fountain. Best waterer made. No valves, floats. Priced low. Illustrated folders. Wettschurack's, Montmorenci, Indiana.

BUY Seymour Chicks and see more profits this year. Barred, Buff, White Rocks, Reds, Wyandottes \$8.25. Leghorns \$7.25. Free catalog. Seymour Hatchery, Box 36, Seymour, Ind.

DEMAND Davis Chicks for broilers, layers. High priced broilers, low priced feed mean greater profits. Write for new catalogue and advance order discount. Turkeys, sexed chicks. Davis Poultry Farm, Route 34, Ramsey, Indiana.

MAKE More profits with Salem's AA Chicks. Write for prices and free catalogue. We pay postage and ship C.O.D. Salem Hatchery, Rt. 19, Salem, Ind.

FARMS AND FARM LANDS

THE Great Northern Railway serves an agricultural empire of fertile productive farms where rents, prices and operating costs are low in Minnesota, North Dakota, Montana, Idaho, Washington and Oregon. Write for free book and full information. E. C. Leedy, Dept. 157, G. N. Ry., St. Paul, Minn.

BARGAINS In land! Where crops are dependable. Washington, Minnesota, Montana, Idaho, Oregon and North Dakota. Literature. Impartial advice. Specify state. J. W. Haw, 119 Northern Pacific Ry., St. Paul, Minn.

EQUIPPED Farm, site for cabins and gas station, roadstand; 50 acres on state highway, 40 min. drive to 3 cities; fishing stream and swim pool, 30 acres tillage, some timber, fruit; good 5-room house, basement barn 30x40, 2 hen houses; splendid bargain at \$2300, part down, including horses, 8 cattle, hens, implements; page 32 free bargain catalog. Strout Ag'y, 255-P 4th Ave., New York City.

CANADIAN Tax sale lands for a dollar an acre and up. Small monthly payments. Farms, timber, hunting and fishing camps, minerals. Limited number of properties. Write at once for free illustrated booklet. Tax Sale Service, Room 613, 72 Queen St. W., Toronto, Canada.

WANT To hear from owner of property for sale or trade. Details free. Real Estate Salesman, Desk B, Lincoln, Nebr.

40 ACRES, Near White River, unimproved; poultry land. \$175, \$5 down, \$5 monthly. Free list and literature. Hubbard, 216 Grossman Bldg., Kansas City, Kans.

PROFITABLE OCCUPATIONS

MUSHROOMS: Grown at home with newly patented tobacco stem spawn. Book, pictures free. Tells all about this profitable business. Write Home Growers Service, Box 62, Dept. D-3, West Chester, Pa.

WANT Money? Quickly, surely, easily, steadily and honestly. 101 practical ways for husbands and wives, students, boys, girls, only 49c. Your money back, if not pleased. Julius, Amarillo, 15, Texas.

"RAISE Frogs!" We buy! Good prices year round. Start small pond. Free book shows sketch. American Frog Canning, (153-A) New Orleans, Louisiana.

BE An independent producer. We pay for equipment. California Earthworm Farms, La Canada, California.

"HOW to Grow Pearls in Bedrooms, in Shellfish." Postal brings information. Pearl Culturists, Woodland, New York.

MRS. M. earned \$267, three weeks raising mushrooms in cellar! Exceptional, but your cellar, shed perhaps suitable. We buy crops. Book free. United, 3848 Lincoln Ave., Dept. 68, Chicago.

RAISE Rabbits and cavies for us. We buy at top prices. Complete details in catalog, contract and magazine. 10 cents. Stahl, Box 1, Holmes Park, Mo.

RAISE Fur rabbits. We pay to \$7.00 each for young. Catalogue free. Rabbitries, Bowling Green, Kentucky.

INVESTIGATE Frog raising—a profitable side line. Valuable book explains and illustrates every phase of subject. Covers very latest developments. \$1 postpaid. Popular Mechanics Press, Room (C37), 200 E. Ontario St., Chicago.

"FOUR Years With Frogs." Experience arranged in questions and answers describing ponds, vegetation, sex and marketing. Twenty-five cents coin. Lafayette Frog Farm, Lafayette, Louisiana.

DRIVE To country, movies afternoons! Work mornings home. No canvassing! Folio-H, Station D, Los Angeles.

FREE Booklet describes 107 plans for making \$20-\$100 weekly, in home or office, business of your own. Elite Co., 214 Grand St., New York.

RAISING Jumbo frogs. Interesting. Big future. Females lay 10,000 eggs. Free literature. American Frog Industries, Box 336, Rayne, La.

TREES, SHRUBS, ROOTS, HERBS

JUST Out! World's greatest "Herbalist Almanac." Beautifully illustrated in natural colors. Contains over 200 old-fashioned herb medicine recipes for home use. 10c postpaid. Worth dollars! Botanics, 145 W. 112th St., Chicago.

OLD BOOKS WANTED

WE Pay up to \$5000 each for old books, also high cash prices for old magazines, letters, newspapers. A single story book, school book, old Bible, travel book, almanac, etc., that looks worthless may bring you \$50, \$100 or \$500 in cash. Thousands wanted. Send 10c now for latest price list. American Book Mart, 140 S. Dearborn, Dept. 2013, Chicago.

BOOKS, PERIODICALS, PICTURES, POSTCARDS

NEWEST Radio, electrical books, 20c to \$1. Amazing values. Catalog free. Electronic Publishing Co., Box 323-L, Lincoln, Nebr.

LIBERTY Magazine \$1.50, year. True Story—20 issues, \$2.00. Getz's, 129 Brick, Dickson, Penna.

"A Physician in the House." 1937 edition, 8 volumes in one, 960 pages, illustrated. Cloth bound. Special price \$2.50. Wallace & Co., Box 1485, St. Petersburg, Fla.

MAGAZINE Back numbers, all kinds. Charles, 506 b. Jones, Detroit, Michigan.

BOY Mechanic—Famous library of 3 volumes covers the building of almost everything a boy might want to make. Actually covers 3,000 different articles. Each volume 460 pages, fully illustrated. Cloth. Price \$2 each or set of 3 vols.—\$5 postpaid. Popular Mechanics Press, Room (C37), 200 E. Ontario St., Chicago.

RARE Antique books. Some two hundred years old. List, ten cents. Friday, Streator, Ill.

MAGAZINES Bought, sold, exchanged. Lists 10c. Seeley Service, Jennings, La.

BAPTISM, Immersion arguments answered. Pamphlet 10c. Church Press, Greenwood, Wisconsin.

GAMES—ENTERTAINMENT

PLAYS, Operettas, musical comedies, complete minstrel first-parts with song programs, blackface skits, vaudeville acts, monologs, dialogs, recitations, juvenile plays and songs, musical readings, entertainments, make-up goods. Catalog free. T. S. Denison & Co., 203 N. Wabash, Dept. 11, Chicago.

"**TEE-UP**" Parlor golf game. Dollar. Pippel, Publisher, Grand Haven, Michigan.

GAMBLER'S DREAM! Intriguing, fascinating card game, with secret instructions "how to win." 50c. Unique Studio, 33 Fullerton, Albany, N. Y.

PLAY Electric games for excitement and fun! Baseball, football, basketball. Particulars free. Electric Games, Holyoke, Mass.

MAGIC TRICKS, PUZZLES, JOKER NOVELTIES

VENTRILOQUIST Figures, instruction and 24 page illustrated catalog 25c. Frank Marshall, 837 No. State Street, Chicago, Ill.

BE A magician. Large professional magic catalogue of latest tricks 25c. Cash paid for complete Tarbell magic courses. Write, Ireland, 109 N. Dearborn, Chicago.

LEARN Ventriloquist art. Easy. Low cost. Free details. Apex, 221 E. 31, New York.

LEARN To entertain with magic. Catalog 10c coin. Gem, D-16, Wollaston, Mass.

SAMPLES Catalog, novelties, photos, 25c. P. O. Box 468-P, New Haven, Conn.

PASTIME For the whole family. Boys and girls puzzle, 1000 problems. 25 cents, no stamps accepted. Watchmans Puzzle, 105 Brookview Ave., Troy, N. Y.

SNAPPY Ventriloquist acts, cross fire dialogues, monologues, comedy bits, hilarious sketches. Specially written, reasonable. Tizzard, 17 Suydam Street, Brooklyn, N. Y.

FREE Tricks! Join Magicians' Fraternity! Monthly magazine, sample 10c. International Magicians, Mt. Morris, Illinois.

EARN \$25 A night with magic. Make professional equipment at home for almost nothing. Stamp brings list and information. Merlini, 400 Linwood, Buffalo, N. Y.

JUST Off the press! Our large catalog of magic for everyone. From the beginner to the professional magician. Send 25c for your copy. Chicago Magic Co., 2300 N. Mason Ave., Chicago.

35 CARD Tricks, 3 magic catalogs, 10c. Lonergan, 55-E Wacker, Chicago.

LARGE Illustrated magic catalogue 20c. Lynn, Midland Ave., Paramus, N. J.

EARN Money in any crowd. Call names of strangers, tell unspoken questions. Professional course mind reading, spirit writing, etc., \$1. Henderson, Box 341, San Bernardino, Calif.

LEARN Ventriloquism, 3c stamp brings particulars. Smith, 125 N. Jefferson, Peoria, Ill.

LARGE Professional magic catalogue, 25c. Holden, 220 W. 42nd St., New York.

MAGIC Catalogue, latest tricks, 10c. Frank Lane, Little Bldg., Boston, Mass.

RARE COINS

GET Profit and pleasure in collecting old coins. Send 10c for 48-page illustrated coin catalog. You'll be delighted with it. Send for it now. B. Max Mehl, 370 Mehl Bldg., Fort Worth, Texas. Largest rare coin establishment in U. S. Established 38 years.

INDIAN Head cent, and list 10c. Charles Banker, Salina, Kansas.

OLD Money wanted. Will pay fifty dollars for nickel of 1913 with Liberty head (no buffalo). We pay cash premiums for all rare coins. Send 4c for large coin folder. May mean much profit to you. Numismatic Co., Dept. 20, Fort Worth, Texas.

CALIFORNIA Gold quarter size 25c. 20 different coins classified 25c; 60 different \$1.00. Bishoff, 739 Locust St., Kansas City, Mo.

100 COINS, Bills, tokens 75c. 33 for 25c. Otto Qdehon, 106E8, Kansas City, Mo.

SILVER Coin and lists 10c. Maurice Gould, Box 73, Brighton, Mass.

ILLUSTRATED Buying and selling coin lists. 10c. Chester Brooks, 624 Cameron, Dallas, Texas.

LINCOLN Commemorative \$1's, \$1 each. Five different commemoratives \$5.75. Complete set Lincoln cents including album, 80 different, fine to uncirculated \$5.75. Postpaid. S. M. Koeppel, Merritt Building, Los Angeles, California.

COINS And stamps, curios sold, bought, exchanged. Free 1938 list. Hussman, 211 South 7th Street, St. Louis, Mo.

SOME Specimens 1909 cent worth \$10. We buy certain coins, common and rare. Others worth to \$6000; certain 1864-1865 Indian head cents \$100 each; dimes before 1895, \$450; Liberty head nickels before 1914, \$300; large pennies \$2000; encased postage stamps, \$13; half cents, \$275; half dimes, \$175; quarters, \$390; fractional currencies; paper money; gold dollars, \$1,500; colonial coins, \$300; silver dollars, \$4,000; 1933, 50c, \$4.00; foreign coins \$165, etc. Only certain coins worth top prices, but others have premium value too. Send 15c today for illustrated 1937 coin book, before sending coins. National Coin Corp., (80), Springfield, Mass.

1803 JAVA Copper, latest bargain coin list, dime. W. Webb, Westminster Rd., Rochester, N. Y.

\$5.00 TO \$2500.00 Each paid for rare coins. Send 15c for newest 38 page illustrated buying book. Bob Cohen, Box 3507-R, Cleveland, Ohio.

\$5 TO \$500 Each paid for hundreds of old or odd coins. Keep all until posted. Many very valuable. Send 10 cents for illustrated Coin Value Book, 4x6. Guaranteed buying and selling prices. 31 years in business. Coin Exchange, Box 5, Le Roy, N. Y.

UNITED States coins at bargain prices. 2c piece and newest 1937 selling price list 10c. Em. Cohen, Box 3507, Cleveland, Ohio.

FREE! Foreign coin, banknote, and large illustrated coin catalogue. Send 4c postage. Coin approvals sent. Tatham Coinco, Springfield-125, Mass.

RARE U. S., foreign coins, war medals. Catalogue 10c. Mengelle, Colorado Springs, Colo.

UNITED States. Large cent, 2c bronze, 3c nickel and bargain list, 25c. Eleven dates large cents, \$1. George P. Coffin Co., Augusta, Maine.

COMMEMORATIVE \$1's. Illinois, Oregon, Stone Mountain, San Diego, Texas, Long Island, \$1.50 each. Illustrated catalogue 10c. Norman Shultz, Salt Lake, Utah.

STAMP COLLECTING

WONDERFUL Bargain: British coronations, St. Lucia, Sierra Leone, Nigeria, New Mozambique, and 100 different others. Everything 10c to approval applicants. Dusenberry, Box 799, Fresno, California.

SUPER-WONDER Packet offered containing 60 different stamps from Afghanistan, Transjordan, North Borneo, Manchukuo, Sudan, Macao, Iraq, Guadeloupe, French and British Colonies, including natives, beasts, ships, etc., all for 5c to approval applicants. Big illustrated lists free. Kent Stamp Company, Box 87 (9), Brooklyn, N. Y.

FREE! 5 Revenues, 10 commemoratives. Approvals. Postage 3 cts. Hutter, Cumberland, Maryland.

200 VARIETIES United States \$1.03; 100—28c. Wright, Dover, Mass.

25 DIFFERENT Canada, 4c, with approvals. Sweet, PB165, Winsted, Conn.

U. S. Approvals to responsible collectors. Lundgren, 1751 Eustis, St. Paul, Minn.

TWENTY Airmails dime, with approvals. Notro Stampco, 4909 North Seeley, Chicago.

CANADA 50 Different 20c with approvals. Chas. Chase, Newcastle, N. H.

WORLD'S Largest triangle! Spain triangle, and N. Guinea bird of paradise airmail; \$5 U. S.; big pkt. 25 diff. Russia (cat. nearly \$1.00); pkt. Br. Coils. including abdicated Edward, Silver Jubilee, coronation, Egypt, Travancore, Ireland, Malay, etc. All for only 5c to approval appl. Fidelity Stamp Co., (20) Barrister Bldg., Washington, D. C. Free: Unusual U. S. and foreign list.

FREE, A beautiful pictorial set to serious approval applicants. No postcards answered. Henry Dowst, Box 16-W, Short Falls, N. H.

PRODIGIOUS Gift! German state, Selangor, Perak, Trinidad, Negri Sembilan, foreign revenue, bicolored Banana airmail, Siberia—absolutely free with approvals! Postage 3c. Saxon Company, Dept. 65, Albee Bldg., Brooklyn, N. Y.

GIGANTIC Bhopal triangle, Turks Caicos, \$5 U. S., Cayman Islands, rare genuine Baden. Everything free to approval applicants enclosing 3c postage. Viking, 1-Z, Hanson Place., Brooklyn, N. Y.

DENMARK. Kings jubilee 12c. Hans Andersen commemoratives, 12c. Ancient ships complete (14) 12c. Sweden, Gustavus Adolphus commemoratives (6) 25c. American, 600 mixed 25c. Foreign, 440, 100 different 25c. Jackland, 1129 Blaine, Racine, Wis.

SEVEN Pretty mint blocks of the French Colonial stamps, and beautiful Queen Astrid mint blocks. All 10c to approval applicants. Harry Hansmeier, Forest City, Iowa.

BOY Scout Jamboree stamp and United States catalog, dime to approval applicants. Clough, Frankestown, New Hampshire.

HISTORIC Art covers from original drawings for commemorative issues. Virgin Islands next. Envelopes four for 30c. Two designs. First days single 20c. Harry Allen, Inc., 22 North 9th Street, Richmond, Virginia.

DIAMOND Shaped air mail—Big packet 105 all different, including air mail, commemoratives, Congo, Epirus, Manchukuo, etc.; set of two ex-King Edwards and Costa Rica diamond shaped air mail; scarce U. S. telegraph, cat. 30c; pkt. British Colonies—Gwallor, Hyderabad, Silver Jubilee; big lists. Everything for 5c to approval applicants. Send today! Mystic Stamp Co., Dept. 80, Camden, New York.

FINLAND—25 Different, 10c; 15 China 10c; 10 Ecuador, 10c; 6 Palestine, 10c; 15 Philippines, 10c; 25 Canada, 10c; 30 Belgium, 10c; 25 Switzerland, 10c. Stamps accepted. Eisea, Bowling Green, Ohio.

BIG Bargain! Triangle, coronations, Mongolia, Epirus, Albania and 100 diff. others cataloging up to 50c each. Everything only 10c to approval applicants. References. Pauly, Bad Axe, Michigan.

AIR Mails free! Fine packet 60 different stamps, (no trash) for 5c to approval applicants. Set of three airmails free with each order. W. H. Watson, Dept. M, Havre, Mont.

NEW Gauge. Sensational! Indispensable! Over ten different philatelic uses. Send quarter. Dennis, Osgood St., Pittsburgh, Penna.

SOMETHING Really good. Three dimes (securely wrapped) or dollar bill brings you beautiful introductory lot stamps worth ten times more. Lists free. Bileski Station B, Winnipeg, Canada.

50 DIFFERENT Beauties: China's Great Wall, coronations, Edward Morocco, commemoratives 10c. Approvals included. Seekaye, 2459 Station St., Chicago.

SOUTHERN Rhodesia coronation! 1d, 2d values of this scarce set with 25 valuable jubilees, coronations and bi-colored commemoratives, 10c to approval applicants. Frederick Day, 3938 Broadway, Indianapolis, Indiana.

A BIG Bargain—All for only 55c. Stamp album, providing spaces for 2300 stamps with 700 illustrations, packet of 500 different stamps, 500 hinges, and millimetre measure. Free with each order our pamphlet which tells "How To Make A Stamp Collection Properly," and our price list of albums, supplies and hundreds of bargains in sets and packets. Queen City Stamp Co., Room 36, 604 Race St., Cincinnati, Ohio.

33 DIFFERENT United States 10c. Approvals. Utecht, 1143 North Keeler, Chicago.

100 LATIN America with approvals 25c. Thurman Bailey, Pierson, Florida.

FREE! Surprise packet! Approval applicants. Van Ormer, 2369 Cottage Grove Ave., Atlanta, Georgia.

"GOYA Nude" stamp 10c to approval applicants. "Jewells," Tamaqua, Penna.

BEST One cent approvals in America. Elvin Stanton, Niantic, Conn.

50 DIFFERENT, Fine U. S. including perforation gauge, 10c with approvals. The Stamp Shop, 809 Holland Bldg., St. Louis, Mo.

AIRMAILS, Commemoratives, etc., 201, 10c. Wehrell, 49 Broadway, Passaic, N. J.

FREE 25 Different, dandy foreign approvals. Bargains! Vallette, Declo, Idaho.

1936 SPAIN Airstamp (4), also 25 different stamps 10c to approval applicants. Simpson, 11 Copeland, Roxbury, Mass.

SPA Stamp. Quarter, McCaddon, 3659 Thirteenth Northwest, Washington, D. C.

BRITISH Colonial air mails. Virgil Springer, 1805 Roosevelt Ave., Los Angeles, Calif.

ZANZIBAR Jubilee, 25 commemoratives, pictorials, etc. 10c with approvals. "Stacee," 18 Park Road, Toronto, Canada.

PANAMA Stamps, 5 different, dime. Leo Marchosky, David, Panama.

25 DIFFERENT South American 10c. No approvals. Burkhart Stamps, Sandwich, Ill.

1000 DIFFERENT Mixed stamps 25 cents. Lizzie Sebastian, Marine, Illinois.

EXCHANGE Your duplicates without cost. Particulars free. Gage, Arcade Building, Pasadena, California.

LOOK—Countries at war, grand collection 5 cts. with approvals. Lek Stamp Supply, Box 6, Station B, Hamilton, Canada.

10c EACH: 200 World, 25 commemoratives, 4 triangles, 6 coronation. Ransom, 1333 Pontiac, Ann Arbor, Mich.

BEAUTIFUL Lot coronations! Pictorials! Commemoratives! 5c with approvals. Valley Stampco, Little Valley, New York.

FREE! Samples cellophane envelopes for stamps, coins, covers. Wetzel Bros., Ridgefield Park, N. J.

JUBILEES! 10 Different used 10c. Specialty Import Service, 2308 Harvey, Berwyn, Ill.

UNCOMMON Set free with first selection new Rainbow approvals. 3c postage. McGruder, 123 Oxford Place, Louisville, Kentucky.

400 DIFFERENT Mounted in album \$3.00. Hirz Co., Ryerson Ave., Paterson, N. J.

12 MEXICO 5c. Approvals. Reidenbach, Lexington Ave., Troy, New York.

3 CEYLON Pictorials 3c to approval applicants. CoOperative Stamp Co., 130 Bates, St. Paul, Minn.

WAR! Spain-Franco's Moroccan soldiers (4) 6c; 66 from 66 countries, 6c. Approvals included. Franklin Shultes, Berne, New York.

100 STAMPS, Approval applicants, five cents. References required. South Texas, 314 Gunter Building, San Antonio, Texas.

BETTER Approvals for less. Let's get acquainted. Premiums with purchases. L. W. Fick, 1929 1/2 Broadway, Denver, Colo.

BARGAIN: 75 Different Canada, \$1.00. Newberry, 946 Fort, Victoria, B. C.

25,000 UNPICKED Cheap foreign, \$5.00, postpaid. Lee Beal, 451 Perry, Oakland, California.

50 DIFFERENT Canada or United States 20c. Security, 310 Erie, Toledo, Ohio.

COLLECTION, Value \$7.00! 35c. Eureka Approvals, 4E Northgate, Scarsdale, N. Y.

200 DIFFERENT 10c. Big 50% approvals. Covert Stamp, 39 State, Rochester, N. Y.

WORLDWIDE Penny approvals. Amazing values. L. D. Gibson, B-203, Bandana, North Carolina.

UNITED States approvals on request. Welker, 1320 Liverpool, Pittsburgh, Penna.

MIXTURES—Reg. 10c, 20 for \$1.00 bill. Ammidown, 8 Walnut, Medford, Mass.

SOMETHING Different, historical first day air mail cover with 50 selected stamps, 25 cents. Dale, Box 714, Havana, Cuba.

SELECTED Penny approvals. Leader Stamp Co., 1550 Seward, Detroit, Mich.

PENNY Approvals are my specialty. Chas. Creek, San Gabriel, Calif.

CHOICE Stamps on approval, penny up. Hanslick, 180 South Ogden, Buffalo, New York.

FREE! 10 Diff. Siam, 3c postage. Approvals. Gordon Davison, 756 Hanover, Manchester, New Hampshire.

CHINATOWN Souvenir and 125 different 10c. R. & M. Harris, 560 27th Ave., San Francisco.

150 UNITED States commemoratives, etc., 13c. 500—28c. (Approvals.) Paradise Stamps, Blawnox, Penna.

FIJI, Borneo, 23 other British colonials 3c. Approvals. Porter, Box 863, Springfield, Ohio.

TRAVEL On stamps! Visit 15 ports on 5 continents. High spots—Mt. Pijana, pyramids, Mt. St. Michel, Paris, Niagara Falls. "Excursion" only 10c approval applicants. Bennett, 27 Washington Square, New York.

NEWFOUNDLAND, 15 Different 5c with approvals. Frederick Brown, Plainfield, N. J.

CORONATIONS! Jubilees, airmails, Edwards, fine lot, 5c with approvals. Lew Ward & Sons, 116 Nassau, New York City.

\$1, \$2, \$4, \$5, \$10 REVENUES. Also Civil War revenues, 19th century postage and commemoratives, battleships, a total of 30 stamps for only 15c to U. S. approval applicants. Metropolitan Stamps, 198 Broadway, New York.

KING Edward and coronation stamps are best and most popular stamps this year and will prove to be immensely valuable. Set of 3 King Edwards, 2 coronations, Queen Victoria stamps over 56 years old, beautiful submarine telephone stamp and South Australia commemorative. All for only 5c to serious approval applicants. Potomac Stamp Co., Dept. 101B, Washington, D. C.

FREE—100 Different 3c to approval applicants. Evanston Stamp Shop, Box 200, Evanston, Ill.

UNPICKED! 100 U. S. revenues on documents, 10c! 1,000, 60c. Vanvoorhis, Hyndman, Pennsylvania.

BRITISH Coronations including Newfoundland, Bahamas, etc. Also Ex-King Edward, King George jubilees and 20 stamps from Azerbaijan, China, Uralia, etc. All, 5c to approval applicants. Clipper Stamp Co., Dept. 6, Gloucester, Mass.

FREE! New King George set. Postage 3c. Roberts, 901F Fourth, Bay City, Mich.

200 VARS. 10c. With approvals. C. Ritchie, Box 743, Watertown, So. Dak.

FINEST U. S. list free. Best prices and quality. Brookman, 500 Plymouth Bldg., Minneapolis, Minn.

UNPICKED! 100 U. S. revenues on documents, 10c. Free copy Airline. McKay, 7200 Yale, Chicago.

500 FINE Mixed United States with rare cover from Civil War period 25c. Approvals. Wright, 201 Mealey, Hagerstown, Maryland.

BIG Bargains, approvals 1/4c up. Josiah Babcock, St. Joseph, Michigan.

ATTRACTIVE Approvals by country, mostly 1/3d catalogue. Also 1c, 2c stamps. Leinert, 851 Marcy Ave., Brooklyn, N. Y.

MALTA, Mongolia, Hyderabad, 125 others. 10 cents. Lufbery, Middletown, Conn.

63 COUNTRIES! Triangle airmail; Coronation! Pictorials! British Colonies! Special 5c to approval applicants. Bargain, Box 39P, Times Square Station, New York.

TWO Old Samoos, thirty pictorials, new triangle—10c, with attractive approvals. Economystamps, Box P1543, Hartford, (6) Connecticut.

\$1.00 PACKET Free! Enclose postage, request approvals. C. Secrist, Muscatine, Iowa.

110 DIFFERENT Scandinavia 15c to approval applicants. Sandles, 1967 Summit Street, Columbus, Ohio.

LIBERIA Packet free to approval applicants. Welsh, Elsmere, N. Y.

ELUSIVE United States on approval. Huber, 3 South 8th, Minneapolis.

SURPRISE Packet, dime with approvals. Newell Stamp Company, 29a Lafayette Street, Arlington, Massachusetts.

SNAP This offer! 25 stamps (includes 20 commemoratives), value \$2.75! Special with approvals 15c. Brady, Cheswick, Penna.

WORLD'S Smallest airmail, free stamp magazine, \$2.00 U. S., animals, bird, train, Indian, airplane, commemoratives, scarce stamps 25 countries, 5c with approvals. Capital Stamps, Dept. 2, Little Rock, Arkansas.

PANAMA Triangle and 50 others free to approval applicants sending 3c postage. Tatham Stampco, Springfield-30, Mass.

FREE Surprise packet to approval applicants. Large and pictorial penny approvals. Special selections by countries. Alfred C. Johns, Sidney, Montana.

AMAZING Offer! Smoky Mountain souvenir sheet. Most popular U. S. stamp issued and 23 North American stamps from Canada, Mexico, Newfoundland, U. S., catalog over 65c. Only 10c to approval applicants. Illustrated pricelist free. Curhan Stamp Co., Dept. P, Gloucester, Mass.

MIXTURES. Foreign \$1; Japan \$1.50; U. S. 50c pound. Mission, 4512 N. Racine, Chicago.

FREE! Liberia triangle, coronation stamps, United States commemoratives, Mozambique triangle, large colonial pictorials and 25 different given free to approval applicants sending 3c postage. Sierra Stamp Co., Box 973, San Bernardino, Calif.

LARGE Spanish ship stamp. Azerbaijan, Cameroons, Chad, Dahomey, Gabon, Ubangi in packet of 57 stamps. All for 5 cts. with approvals. Swedell, 3129 Garfield Ave., Minneapolis, Minn.

TREASURE-PARCELS—U. S. or worldwide—\$1.00. "Bargain!" (Sample: 25c.) Guaranteed. Ray Evans, Brookfield, Mass.

U. S. Commemoratives—40 different 25c. Approvals included. Crystal Stamp Co., Racine, Wis.

FINE United States or foreign approvals. Premiums included. Dealing, Mound, Minnesota.

ATTENTION—World's largest diamond shaped airmail, new rare King Edwards, Canadian Niagara Falls, Cartier, others. All 10c provided you desire approvals. Fair-Play Stamp Service, 1215 Browning Blvd., Los Angeles, Calif.

MIXTURE, Unpicked United States, contains commemoratives, precancelled, etc., pound 60c postpaid. Ellis, Box 86, Orono, Maine.

FREE! 110 Different stamps to approval applicants, 3c postage. Zephyr, 5124 George, Chicago.

FREE—\$2 And 15 other U. S. Foreign approvals. Postage 3c. Wm. Clatworthy, Upland, Calif.

STAMP Catalogue free: Special gift edition. Giant forty-page quarterly listing albums, supplies, coronations, British Colonials, Canadians, United States, sets and airmails. Illustrations galore! Empire Stamp Co., Dept. P.M., Toronto, Canada.

NEW, Beautiful—A loose leaf stamp collection system. 10c brings you postpaid 5 double sheets, all different designs. S. J. Jorgensen, 91 Maritime Bldg., Seattle, Wash.

50 U. S. Different commemoratives 30c. 60 different U. S., air mail, etc. 15c. U. S. \$5.00—\$1.00, 50c. 30c dues 15c. U. S. unused-mint 28 diff. commems. \$1.00. Steger, Box 154, Crown Point, Ind.

REIMERS New packet! Kenya lion; Nayasaland leopard; British jubilee; Paraguay airmail; Morocco; Tanganyika, and many other scarce countries in our packet of new, recent issues—stamps many have never seen! Get this packet today—5c to approval applicants. Reimers, 212 Flatiron Bldg., Forth Worth, Tex.

300 MIXED. Many countries, 15c. Approvals. Harvey Teeple, Decatur, Ind.

15 AIRMAILS Free to approval applicants. Globetrotter, Hotel LaSalle, South Bend, Ind.

EARLY U. S. Send for list. M. Place, Harding, Mass.

LOWEST Wholesale price. Directory and fifty different rare stamps for \$1. No approvals. Patek's, PMC882 Spuzzum, B. C., Canada.

CORONATION Jubilee air, etc., 55 different 55 countries 10c, approvals. Keilen Stamp Co., 112 Bailey Ave., Pittsburgh, Penna.

DIAMOND Airpost commemorative issue complete, proletariat portraits complete, dragon stamp, with 117 additional, cataloging \$3.00, only 10c. Friendly Philatelists, Box 4428P, Philadelphia, Penna.

STAMPS. A superb selection sent on approval. Quality at low prices. Fred Herzberg, Box 91-P, Elmhurst, Ill.

RARE Airmail, scarce camel stamps. Chance to join big stamp club. Mammoth stamp packet. All for only 5c. Approvals. Atlas Stamps, Little Rock, Arkansas.

44 DIFFERENT U. S. including \$5 stamp, or complete set U. S. bicentennials, or 30 different obsolete Canada, 13c postpaid with approvals. C. A. Lennan Co., Box 322, Church Street Annex, New York, N. Y.

U. S. Commemoratives, coronations, Jubilees, British Colonies. Bargain lot, 5c with approvals. Hudson Co., 116 Nassau, New York City.

THE Gold and silver coronation set of Persia is one of the most beautiful issues of stamps in the world. Printed in actual gold and silver, the stamps show the glories of mystic Persia. We'll send the complete set of 17 varieties, all unused, at the special price of only 25c to approval applicants. The first hundred to answer this ad will be sent their stamps in a cover bearing the new S. P. A. 10c Smoky Mountain souvenir sheet without any extra charge! Rush your order for the most outstanding offer of 1937! Frasek Company, Dept. 55, White Plains, New York.

PACKET Bargains (non-duplicating): 10 Africa 2c; 15 China 3c; 25 Japan 3c; 1000 foreign 89c. Wright Company, 2527 Guilford, Baltimore, Md.

OVER \$2.00 Catalog value including coronation, Edwards, jubilees, 5c with approvals. Approval Co., 2846 Harrison Street, San Francisco, Calif.

175 U. S. Commemoratives, etc., 10c.; 500—25c. Box 457, Newark, N. J.

STAMP Dealers, your ad here will bring wonderful returns. Ask me for proof. P. W. Johnson, Manager, Classified Advertising, Popular Mechanics Magazine, 200 E. Ontario St., Chicago.

DISGUSTED? Try my approvals. 1/2c up. Bargains galore. Viscusi, 4, Scotia, N. Y.

FREE. U. S. \$1, \$2, \$4 and \$5 stamps. Unbeatable U. S. approvals. Nelson, 78 E. 5th St., St. Paul, Minn.

U. S. Approvals only. Send post card for selection of U. S. stamps on approval: 19th century, commemoratives, air mails, revenues. John C. Daub, Dept. E, Wabash Bldg., Pittsburgh, Penna.

CANNON! Set of stamps showing cannon, firing squad, cavalry charge and 200 other different stamps, only 10c to approval applicants. L. H. Reich Stamp Co., 4225 Broadway, Chicago.

NEW Rivera nude stamp! World's largest triangle! Congo, Sudan, South Seas, bicolors, pictorials, and many others. Only 3c with approvals. Cactus Junior Approvals, Box 1870, Tucson, Ariz.

GIANT-SIZED Russian Zeppelin stamp, cat. val. 20c! and beautiful Lithuania airmail triangle; also big packet of 53 dif. stamps including Azerbaijan, Epirus, new Martinique, etc., and illustrated lists, all for 5c to approval applicants! World-Wide Stamp Co., Box 600, Camden, New York.

FREE—The Stamp Finder! Our new 24 page edition, fully illustrated, which will enable you to instantly identify all difficult stamps. Also fine packet of odd and unusual stamps from Bosnia-Herzegovina, Monaco, Patiala, Eritrea, etc., including maps, ships, animals and strange scenes. All free to approval applicants inclosing 3c postage. Garcelon Stamp Co., Box 900, Calais, Maine.

DIAMOND-SHAPED Stamp, Liberia gunboat triangle, two other triangles, silver jubilee, 27 others, 5c. Crowder Co., 127E North, Baltimore, Md.

FREE! 107 Different, 30 countries. Extra 25 U. S. including \$1 value, with approvals. Send 6c for packing, mailing. Ace Stamp, Colonial Arcade, Cleveland, Ohio.

300 DIFFERENT 20c; 1,000, \$1; 2,000, \$3; 3,000, \$7; 5,000, \$17. Fred Onken, 630 79th St., Brooklyn.

FREE! "United States, British Colonies and Better-Grade Foreign Stamps"—our valuable illustrated 96-page catalog. Money-saving prices! Send today. H. E. Harris & Co., 137 Transit Bldg., Boston, Mass.

50 DIFFERENT British Empire including jubilee, Edwards, 50 different new, recent and pictorial world issues, 15 different airmails, 500 hinges, perforation gauge, all for 25c. Approvals sent. Lists free. Victoria Stamp Co., London, 4, Canada.

BRAZIL, 50 Different 10c with bargain approvals. Davis, Silver Lake, Ind.

ASK For our wonderful one cent approvals. Prospect Stamp Co., 225 Broadview, Toronto, Canada.

WHOLESALE Catalog for dealers. Illustrated. Postage 5c. Frank Co., 4900 Chalmers, Baltimore, Md.

PENNY Approvals, that satisfy. Neil Gronberg, Box 5441-P, Philadelphia, Penna.

WEEKLY Stamp magazine, thirteen weeks, 10c. Stamp Journal, Kalamazoo, Mich.

U. S.—45 Different 10c. Free 25 different with approvals. Enclose 3c. Seidenberg, Baroda, Mich.

30 DIFFERENT Angola, Cape Verde, Guinea, Portugal, Mozambique, St. Thomas and Prince 5c. Approvals. Depraw, Ocean Park, Calif.

FREE, 50 Stamps, Manchukuo, etc. Postage 1c. Album 3c. U. S. bargains. Bullard, 268 Northampton, Boston, Mass.

ILLUSTRATED U. S. list, price 50c, large complete U. S. price list free. Send postage. Stanley Gibbons, 38P Park Row, New York.

QUEEREST Stamp packet. Receive world's smallest stamp; Vatican City; scarce Liberia triangle; 1935 Greek Red Cross picturing coiled snake in Garden of Eden; Australian Bushman; new Spanish Morocco; Japan 'quake stamp; Manchukuo; many others. Only 5c to approval applicants. R. M. Stamp Co., P. O. Box 230P, Port Chester, N. Y.

APPROVAL Sheets. One to three cents. Frederick B. Driver, 2009 Finance Bldg., Philadelphia, Penna.

4 1/2 TRIANGLES! Guatemala bisect (diagonal half-stamp), beautiful Liberia, three additional triangles, 27 other stamps, 5c. Abell Co., 1818 St. Paul, Baltimore, Md.

25 UNITED States, including 4 and \$5 stamps free to approval applicants. 3c postage. Brownie Stamp Shop, Flint, Mich.

PHOTO FINISHING

THREE 5x7 Enlargements, 25c, colored 50c. Fifteen Christmas cards \$1.00. Send negatives. Midwest Studio, Humboldt, Iowa.

SENSATIONAL Photo ring—Any snapshot can be mounted in chromium ring or tie holder. 41c postpaid. The Hobby Man, Jefferson, Iowa.

PROFESSIONAL Quality service. Rolls developed, 8 prints and 2 enlargements 25c. The Film Capital Service, Box 504, Rochester, N. Y.

CHRISTMAS Photographic greeting cards, twenty for 95c. Send for particulars; 10c for sample. Twenty reprints 25c. Roll developed and two prints each negative, 25c. Star Photos, 109 N. Dearborn, Chicago.

20 REPRINTS 25c. Films developed, 16 prints 25c. Enlargements 8x10, 25c; 5x7, 10c. Low Photo. M-2657 Neva, Chicago.

NEW Beautiful "Dated Border Prints" of Aristo quality. Roll developed, eight prints, free album, enlargement coupon, 25c. Aristo Photos, Dept. P, Box 5037, Chicago.

AT Last! All your prints in natural color. Amazingly beautiful. Roll developed, 8 natural color prints, 25c. Reprints, 3c. Fast service. Natural Color Photo, C-54, Janesville, Wis.

COLOR Photos, snapshots, enlargements, maps. Complete tinting outfit 10c. Photo Lab., (R-8), Yakima, Wash.

FILMS Developed 2 prints of each 25c; 20 reprints 25c. Pine Photo, M-5134 Nevada, Chicago.

COLORING, Copying, enlarging. Professional work. Moderate prices. Write Grant, South Windham, Conn.

GUARANTEED. Roll developed, 16 prints 25c. 20 reprints 25c. Quality Photo, Hutchinson, Kansas.

AT Willard's, Box 3535-A, Cleveland Heights, Ohio, you'll get quicker service, beautiful quality. Roll developed, 2 prints each negative 25c. Enlargement coupon. (Trial offer.)

ROLLS Developed, remarkable quality, two master enlargements, eight gloss prints 25c. Reprints 3c. World Famous Johnson Studio, Eau Claire, Wis.

IF You want the best! Send films here, eight border prints, one enlargement, 30c. Hulls Photo Service, Anderson, Ind.

MAIL Your rolls to film center of the world. Any size roll developed and printed 25c coin. DeLuxe enlargement coupon free! Photo Finishing Shop, Est. 23 yrs., 411-Q Genesee Valley Trust Bldg., Rochester, N. Y. "The Camera City."

100 STAMP Size copies any photo 20c. Representatives wanted. Photo Lab. (R-8), Yakima, Wash.

FREE—4 Enlargements every roll 25c. 20 reprints 25c. 100—\$1. Filmco, Albany, Wis.

KODAK Enlargement 5x7, 10c; 3 for 25c coin. Send best negatives (film). Dept. 5, Kint Photo Lab., Cedar Rapids, Iowa.

MINIATURE Film processing. Spotless, stainless, 35c; press grain, 25c. Prints 1c. Tintinger, Hardin, Montana.

PRINT Photos on cloth, paper, wood, leather, etc. Guaranteed process \$1.00. Ideal, 179PM, Park Ridge, Ill.

CONFIDENTIAL Developing, two prints each negative 25c. Royal Photos, 3902 N. Sixth, Harrisburg, Penna.

OIL Painting from photograph. \$5. Portature, 826 Noble, Chicago.

IMMEDIATE Service! Better pictures. Two beautiful heavy-weight professional enlargements and eight guaranteed Perfectone prints 25c coin. Sixteen pictures from roll 25c. Eight beautiful enlargements from roll only 25c. Candid rolls developed free—prints enlarged to 3x4, only 4c each. Pictures sent back same day film is received. American Studios, Box B, LaCrosse, Wis.

TWO Enlargements or one colored with each film developed, 25c. LaCrosse Film Company, LaCrosse, Wis.

BEAUTIFUL Photographic Christmas cards 75c dozen. Send negative for sample. 10c. Hensch Studios, 1814 Chestnut, Harrisburg, Penna.

TWO Prints each with every roll developed, 25c. Very finest quality. Reprints 2c each. Brown Photo Company, 2209-34 Lowry, Minneapolis, Minnesota.

LATEST in photo finishing. Miniature films developed, printed 3x4—4c each. Two enlargements free each roll. Radio Film, LaCrosse, Wis.

ENLARGEMENTS 4x6, Five for 25c. 5x7 three for 25c. 8x10 three for 35c. Hand colored and framed each 4x6, 30c. 5x7, 35c. 8x10, 45c. Send film negatives. Enlargers, Maywood, Ill.

LARJARGRAPH Reprints, five (5x7 enlargements) 29c. Cardinal Photoers, Summit, N. J.

FINER Photos guaranteed. Rolls developed professionally. 8 Velox prints, 2 bromide enlargements, 25c coin. Finerfotos, Box D-898, Minneapolis, Minn.

ROLLS Developed, 2 prints each and 2 free enlargement coupons, 25c; reprints, 2c each; 100 or more, 1c. Summer's Studio, Unionville, Mo.

21 REPRINTS 25c. Rolls developed, 2 prints each negative, 25c. Fred Weick, 2840 Zenobia, Denver, Colo.

ROLL Developed, 8 brilliant fadeproof Velox prints and two professional enlargements 25c. Overnight service. Young Photo Service, 405-C, Albany, N. Y.

20 REPRINTS 25c. 100 Reprints \$1. Roll developed with 16 prints 25c. Nordskog, 4, Maywood, Ill.

ROLL Developed and 8 beautiful Velox glossy prints 25c coin or stamps. Reprints 3c each. Fotoprint Service, Box E, Roanoke, Va.

ROLL Developed, 2 prints each negative, 25c. Reprints 2c. Photoshop, Ogden, Utah.

ROLLS Developed. Two beautiful double-weight professional enlargements and 8 guaranteed Never Fade Perfect Tone prints. 25c coin. Rays Photo Service, LaCrosse, Wis.

FINER Finishing. Rolls developed and printed, with one colored enlargement, or two professional enlargements. All for 25c (coin). Genuine, nationally known, Moentone superior quality. Moen Photo Service, La Crosse, Wis.

ROLL Developed 16 guaranteed prints, 25c. Smart Photo, Winona, Minn.

ROLLS Developed—Two new Beautitone Dublwater professional enlargements, 8 guaranteed fadeless Beautitone prints, 25c. Giant Snapshots, Inc., 667A, Green Bay, Wis.

ROLL Developed and 8 guaranteed prints including two enlargements, 25c coin. Super Snapshot, Winona, Minn.

BEAUTIFUL 5x7 Enlargements from your favorite negatives 17c each; three for 50c. Eight exposure roll developed and printed 25c. Work guaranteed. Jeems Service, Box 137, Ann Arbor, Mich.

FOR The discriminating amateur, roll developed and carefully printed 25c, reprints 3c. Superior workmanship, same day service. Paramount Co., 327 E. 92nd St., New York.

TWO Glossy enlargements, 1 colored with roll 25c. Arbor Service, 10, Joliet, Ill.

GET The best. Roll developed, beautiful hand colored enlargement, 8 neverfade border prints, 25c coin. Prompt service. Sun Photo Service, Drawer T, St. Paul, Minn.

COMPARE The difference! Roll developed, two professional double weight enlargements, 8 guaranteed prints, 25c coin. Excellent service. Nationwide Photo Service, Box 3333, St. Paul, Minn.

BE Modern! Get Modern service. Modern quality. Modern prices. Our modern methods give quick service and bright guaranteed neverfade pictures. Roll developed 16 prints, 25c coin. 16 reprints, 25c. Enlargement coupon. Send next roll or reprint order to Modern Finishers, 3537-C, St. Paul, Minn.

CAMERAS—PHOTO FINISHING

DUPONT Superior Panchromatic 35 millimeter film, 25 ft. \$1.00. Optical Laboratories, Larchmont, N. Y.

CAMERAS And supplies. Free illustrated catalog listing everything photographic—still and movie cameras, films, lenses—at tremendous savings. Hundreds of bargains, new and used. All guaranteed. We take your old camera or equipment in trade. Write now for your free copy of our newest money-saving bargain book—just out! Limited edition. Hurry! Central Camera Co., (Photographic Headquarters since 1899), 230 S. Wabash, Dept. 1-K, Chicago.

BIG Camera set; take real photographs and develop them yourself; set includes good lens camera, 2 lots film, developing and finishing chemicals, glass printer, printing paper, full easy instructions. Postpaid 69c. (This outfit sells everywhere for \$1.00.) The Hobby Man, Jefferson, Iowa.

WHY Pay \$15.00. Correct exposure every shot. Optical Photometer \$1.00. McMurry, 4133 Kenmore, Chicago.

MAKE Money in photography. Learn quickly at home. Spare or full time. Easy plan. Previous experience unnecessary. Common school education sufficient. Interesting booklet and requirements free. American School of Photography, 3601 Michigan Ave., Dept. 3432, Chicago.

PROJECTORS, Cameras, accessories. Substantial discounts. Stans Home Movies, South River, New Jersey.

MOVIE Film. Develop yourself, all kinds. Information, chemical samples, 15c. Lake Camera Exchange, Gary, Ind.

\$50 A WEEK With a kodak. Booklet describes 100 magazine markets. 25 cents. S. George, 285 E. Queen, Philadelphia, Penna.

RICH, Heavy cowhide Eveready cases. Duo 620, Retina, Vollenda, Foth, Wirgin \$4.50 postpaid. Quentin Products, West Salem, Illinois.

BEST Developing, printing, enlarging. Views and post cards of Mexico. Finest German cameras, field glasses, movie cameras and projectors. Ask for prices and catalogues. Foto Mantel Sucr. Rudolf Rudiger, V. Carranza 11.—Postbox 1459, Mexico, D. F.—105, Branch 3, No. 169½ First Street, Tijuana, Baja California.

PHOTO Enlarger plans with specifications, takes negatives to 5 by 7 inches, requiring no castings, cloth bellows, or machining. Plans \$1.00 set postpaid. Toellen Mfg. Co., Box 4, Strathmoor Station, Detroit, Mich.

12 KODAK Snapshots American Legion parade \$1.00. Forman, 882 Lorimer, Brooklyn.

FREE Introductory offer—remarkable new photographic exposure meter to those interested in improving their photography. Send 10c postage. Carlyllian Co., 10 E. Huron, Chicago.

FREE Photoflash calculator (value 50c) with trial six month subscription at \$1.50. Photographic Digest, 1666 Linden Street, Brooklyn, N. Y.

MODERNIZE Your 9x12 camera with Kalart equipment. The New Kalart Synchronized Range Finder lets your 9x12 with 13.5 lens go candid, gives it hair trigger action and automatic focus, plus "Man-size" negatives. New Kalart Micromatic Speed Flash with micrometer adjustment for all flashbulbs and shutter characteristics. Adaptable to practically all cameras. See dealer or write: Kalart, Room 501, 58 Warren St., New York, N. Y.

PHOTOGRAPHIC Chemicals, developers, etc. Catalog 10c. McBee Chemical Company, 1624P Boren, Seattle.

CAMERAS And shutters repaired. Leather bellows installed in folding and view cameras. Bellows made to order. United Camera Company, Inc., 1515 Belmont Avenue, Chicago, Illinois.

MAKE Money with your camera. New book tells how. 46 pages, 50c. Popular Mechanics Press, Room (C37), 200 E. Ontario St., Chicago.

BASS—Camera crossroads of the world has ready for you a new 48 page Still Camera Bargaingram and that's news because Bass values are proverbial. Just think, a half No. 120 reinforced bakelite DeFranne roll film camera with F:2.9 Anastigmat lens in Compur shutter at \$27.75. A 9x12 cm. DeFranne Norfolk double extension plate and film pack camera, with F:6.3 lens in shutter, with film adapter and holder, new at \$16.75. Midget Marvel candid camera with F:4.5 lens at \$19.50. Dollina II coupled range finder 35 mm. candid camera with Radionar F:2.9 lens, Compur rapid shutter at \$49.75. Voigtlander Brilliant Reflex with F:7.7 lens at only \$7.50. Your money back at all times if any apparatus is not satisfactory. It is our policy for almost thirty years. Write for this latest Bass Bargaingram No. 233 and know what value and service really means. Bass Camera Co., Dept. AG, 179 W. Madison St., Chicago, Ill.

XMAS Bargains cameras, projectors. Block, 154 East 47th, New York.

INCOME From your camera instead of expense. Low cost home course teaches you to make photographs for magazines, newspapers, advertisers. Tremendous demand. Earn good money wherever you live. Free book. Universal Photographers, Dept. 104, 10 W. 33rd St., New York.

HAVE You a camera? Send ten cents for recent number of our big magazine, showing how to make better pictures and earn money. American Photography, 116 Camera House, Boston, 17, Mass.

WE Purchase and accept in trade used photographic equipment. Send for bargain list. Fotoshop, 134R W. 32nd, New York City.

35% DISCOUNT On films. Write Paramount Photo Division, 327 E. 92nd St., New York.

MOTION PICTURES AND SOUND EQUIPMENT

BARGAINS! 8mm., 16mm. Free literature. Elder, B-739 Boylston, Boston, Mass.

16 AND 35 MM. silent films for toy projectors. Lewis Films, 105 East First, Wichita, Kansas.

FREE List and sample; 8mm. 16mm. Goodwill Company, Jackson, Tennessee.

NEW! 16MM. equipment. 35mm. films, 10c. Superior, 126 Fourth, Paterson, N. J.

NEW Complete 8mm. popular star movies 60c. 16mm. color film sample 50c. Free 16mm., 8mm. bargain lists. Home Movies, Box 216, Easton, Penna.

FILM—8MM., 50 feet, \$1.21. 16mm., 100 feet, \$1.73, postpaid. Goodwill Company, Jackson, Tennessee.

16MM. FILMS, Silent and sound, rent, sale, exchange. American Legion parade, war in China, Hindenburg disaster, Dionne quintuplets, major football games, others. Films rented everywhere. Bargains in new and used equipment. Trades accepted. Free illustrated catalogue, (with sample film 10c). Garden Exchange, 317 West 50th, New York.

AMAZING 16mm., 8mm. Movie bargains. Cine, 151 Broadway, Paterson, N. J.

TRIPOD Silver movie screens, 22x30, worth \$10.00. Limited quantity at \$4.00. Hornstein, 29 E. Madison, Chicago.

35MM FILMS Rented, 50c weekly. Lists 3c. Hoffman Film Service, 57 Broad, Albany, N. Y.

CENTRAL'S Free, new, money-saving bargain book explains latest movie developments, offers money-saving bargains in cameras, lenses, projectors, films. Used equipment taken in trade. Write for free copy. Central Camera Co., (Photographic Headquarters since 1899), 230 S. Wabash, Dept. 21-K, Chicago.

LEARN Motion picture theatre business. Home-study training; management, advertising, projection. Free catalog. Theatre Institute, Elmira, N. Y.

SPECIAL—8MM., 50c feet, \$1.27; 25 feet, 77c. Goodwill Company, Jackson, Tenn.

TITLES—Make your own black and white or Kodachrome—solid metal letters—8mm.-16mm., complete \$5.75. Free samples. Paramount Title Co., 19 West 44 Street, New York.

GUARANTEED 35mm. Silver jubilee bargains! Silent, shorts, features, complete with title, ending, \$1.00 per 1000'. DeVry portable silent projector, 500 watt, motor-driven (suitcase) \$29.50. DeVry 1000' capacity, 1000 watt sound-on-film projector, amplifier, speaker, tubes, complete, ready for show, \$198.50, fully guaranteed. Simplex-Holmes, silent, sound outfits at big savings. We convert 35mm. silent into sound machines. 8x10 screen \$10.00. Griswold splicer \$12.75. Simplex double rewind \$5.50 set. 16mm. silent, sound shorts, features for sale, 8mm. library, Leica F3.5 camera \$45.00, Zeiss high power binoculars \$29.00. House of Satisfaction, Mogull's 1944-J Boston Road, New York.

"THE World's greatest of all Passion Plays," 16mm. 7½ reels. Sound with dialogue or silent. Rent or purchase. Superior than Oberammergau stage play. Write Hemenway Film Co., 37 Church St., Boston, Mass.

1000 ITEMS Offered, some below cost. Complete catalog free! Passion Play, 16 and 35mm., silent, sound for rental, sale. We are specialists 8, 9½, 16 and 35mm. equipment, film, for home, church, school, road shows. Universal library. Mogull's, New York.

8MM. FILMS. Send for lists. Spring Films, Westboro, Mass.

CLOSEOUT Specials! Irwin 16mm. cartridge loading camera, and standard 16mm. projector, both for \$12.95. Cartoon film free with each set. New candid camera sensation "Baby Chrome," f6.3 lens, \$9.95 postpaid. Hollywood Cine Film Distributors, Dept. P-1, 1431 No. Highland Ave., Hollywood, Calif.

GUARANTEED Mogull's 100', fresh, 16mm. film for camera, \$2.39 including processing. Tripod or screen carrying case, 98c. 100% safety cement 25c. Humidifier 25c. RCA Victor soundfilm 16mm., complete outfit \$149.50. Keystone motor driven, 400' capacity projector \$11.89; Ampro 400 watt projector \$61.50; Eastman 8 or 16mm. projectors \$18.00; Eastman 16mm. movie camera \$14.75; projector floor stand \$7.49; 1600' reel \$1.45. Save by buying direct from Mogull's, New York.

BARGAINS! 8-mm16. Illustrated catalog free. G. Taylor, Bx-234, Corning, N. Y.

8-16MM. RENTAL—Sale. Films, projectors, large discounts. Xmas story, comedies, cartoons. Enclose stamp for catalog. Abbe Films, 3 West 29th St., New York.

MOVIE Camera free! Details 10c. Echo Stamp Co., PMC-1765 Ivar, Hollywood, California.

WESTERNS, Comedies, 500 feet 75c. Jersey Films, 2075 Richland, Lakewood, Ohio.

BASS Invites you to drop in when you are in Chicago and see for yourself the largest stock of cine equipment in America, silent or sound. On sale a lot of brand new RCA Victor Model PG 71 16 mm. sound on film projectors, 750 watt bulb, 10 watt amplifier, a \$500 value at \$225. RCA 16 mm. sound on film camera, newsreel model, \$250. New Keystone 8 mm., 200 watt, motor drive projector, special at \$29.25. Moviematic still or movie camera, 16 mm., \$3.75. 8 mm. Kodascope projector, motor driven, 100 watt bulb, \$16.50. Bass Cine Bargaingram No. 230 is yours for the asking. Settles your movie problems—8 mm., 16 mm., 35 mm. sound or silent. Write to Camera Crossroads of the World. Bass Camera Co., Dept. A, 179 W. Madison St., Chicago, Ill.

8-16MM. TITLES, 2c Word. Catalogue. Cineshop, 1812 Piedmont, Charleston, West Virginia.

WORLD'S Best passion play, seven reels, new version all talking sound and silent 16 and 35 mm. rent or sale. All-Sacred Film Co., 50 Melrose Street, Boston, Mass.

FREE—Send 25c for three art end titles, 16mm or 8mm, film lists and sample copy 32 page Home Movie Magazine and how to obtain free subscription. Pacific Cine Films, 1454-A N. Gardner, Hollywood, Calif.

15% TO 25% Discount on still or movie cameras. Free circular. Paramount Co., 327 E. 92nd St., New York City.

RADIOS, SUPPLIES, INSTRUCTION

SAVE Money on radios and parts. Send for our money saving catalog. United Radio Company, N-Newark, N. J.

35 RADIO Lessons 40c. Electrical Compendium 55c. Colonial Company, Billerica St., Chelmsford, Mass.

FARM-CITY Radios \$7.95 complete. Save half. Agents free offer. Amazing prices windchargers, power plants, accessories. Marco, 1244 McGee, Kansas City, Mo.

PLANS 18 Distance record crystal sets, with "Radiobuilder"—year. 25c. Laboratories, 151-C Liberty, San Francisco.

LEARN Radio, \$1 lesson. Missouri Tech, 3907 North 25, St. Louis.

PHILCOS, Zeniths. All makes. Agents cut prices. Radioman, Lake, New York.

PARTS And kits of parts for Popular Mechanics Improved Little Giant, R235, 6 Tube, R233, Preamplifier R238, Pup R240, and Knockabout R244. Only specified parts used. Lund Manufacturing Company, 43 E. Ohio St., Chicago.

SOCKET Punches. Round or amphenol. Six sizes. \$1.00 to \$1.50 each. Write factory for list. Gerett Corp., 2947 No. 30, Milwaukee.

CODE Machines \$1. Codagraph, 4016 Avenue H, Brooklyn, New York.

QUALITY Radios at wholesale prices. Catalog free. Capitol Radio Company, 43 E. Ohio St., Chicago.

RADIO Engineering, broadcasting, aviation and police radio, servicing, marine and Morse telegraphy taught thoroughly. All expenses low. Catalog free. Dodge's Institute, Ames St., Valparaiso, Ind.

MUSIC AND MUSICAL INSTRUMENTS

VIOLINS—Handmade masterpieces, best since Stradivarius. Free trial. John Lehto, San Pedro, Calif.

PIANISTS: Free booklet describes method improving your technique, accuracy, sight reading, memorizing. Write Dept. 423-A Broadwell Studios, Bendix Bldg., Los Angeles.

REBUILT Band and orchestra instruments. Honestly rebuilt, fully guaranteed. Catalog on request. Specify instrument interested in. Weymann Co., Dept. M-1, 1613 Chestnut St., Philadelphia.

LATE Phonograph records, some new, some slightly used. Fifty—\$2.50. Davis Sales Company, Syracuse, New York.

ACCORDIONS. Famous P. Del Principe accordions. Est. 1890. Liberal allowance on your old accordion. All musical instruments repaired. Write for particulars. Oakley Music House, Dept. P, 2244 Harrison St., Chicago, Ill.

SONGWRITERS! Amazing convincing opportunity. Hibbeler, C-5, 2157 N. Avers, Chicago.

SONGS Composed, arranged, printed \$5—100. Auto-Litho Co., Box 765, Jensen, Fla.

SONGWRITERS Wanted, write for free book. Indiana Song Bureau, Salem, Ind.

SONGWRITERS. Real opportunity. Details. Edward Madden, 1017 Danforth, Syracuse, N. Y.

SONGS Arranged, revised by arranger—"Cherry Blossom Lane," "Gypsy Tea-room," others. Send for details. Harold Potter, 1619(P) Broadway, New York.

LYRICWRITERS, Composers publication guaranteed. Sid Small, 647 Howard Avenue, Brooklyn, N. Y.

WE Pay cash for songs, poems or music. Earle & Arace, Station F, New York.

LEARN Swing piano! Home study. Booklet free. Christensen, 717P Kimball Hall, Chicago.

WANTED—Hillbilly, cowboy, popular songpoems for phonograph records. Submit for examination. Futuristic Music, 1695 Broadway, New York.

ORIGINAL Music composed to your words: \$5. Song printed. Reginald Belcher, Chatham, N. J. 30 years church organist.

ORCHESTRATIONS, Saxophone reeds, sheet music, unbelievable prices. Silverman, 3303 Lawrence, Chicago.

PLAYS, Comedies, with music. Full evening's program. \$1. Reginald Belcher, Chatham, New Jersey.

MUSIC Composed to song-poems. Orchestration arranged. Frank Wildt, Lancaster, Pennsylvania.

SONG Writers. Send for publishing agreement. McKinley Music Publishers, 1501 E. 55th St., Chicago.

SONGWRITERS—Get "How to Write Songs" by famous Broadway composer and free rhyming dictionary. Songwriters Institute, 1234-C Broadway, New York City.

MUSIC Composed to words. Wonderful proposition. Bauer Bros., Oshkosh, Wis.

WANTED Original poems, songs, for immediate consideration. Send poems to Columbian Music Publishers, Ltd., Dept. 42, Toronto, Canada.

POEM Writers, songwriters. Send for free rhyming dictionary, writers guide. Submit best poems, melodies today for bonafide, superior offer. MMM Publishers, Portland, Ore.

SONG Poems wanted to be set to music. Free examination. Send poems to McNeil, Bachelor of Music, 4153-PM S. Van Ness, Los Angeles, Calif.

DUO-FLEX Reeds for clarinets, and saxophones eliminate your reed troubles. Write for circular. Duo-Flex Reeds, 1204 1st Ave., Evansville, Ind.

WRITE Songs. Big money and reputation. Write for information. J. Gordon Pub. Co., 201 N. Hoyne Ave., Chicago.

SONG Poems wanted—Home, love, sacred, any subject. Send best poem today for offer. Richard Bros., 24 Woods Bldg., Chicago.

WANTED! Lyrics, melodies for songs. We arrange, publish, sell. Superior Song Studios, Passaic, N. J.

BUSINESS OPPORTUNITIES

DOLLAR Brings material, models making three rubber molds. Express charges collect. Colonial Art, Derry, N. H.

SELL "Breniser" dollar mail order treatise. 84c profit. Particulars 3c. Green, 15788 Parkside, Detroit, Mich.

COLOR Concrete surface with chemical solutions. Beautiful pottery without moulds. Garden wishing wells. Concrete glazing. Sample 10c. Hollywood Cement Craft, 8527 Wonderland, Hollywood, Calif.

FASCINATING Business. Repair, adjust typewriters, adding machines. Learn easily at home from factory expert. Earn up to \$15 daily. Complete instructions covering all makes \$3 postpaid or sent C.O.D. Adding Machine Equipment Service, 3601 Michigan, Dept. 3431, Chicago.

"MAKE Mirrors at home." Big profits. Little outlay. Also emboss, grind—foil, gold leaf, frost, chip and make imitation stained glass. Instruction course \$1.00. Bestovall, 4047 N. Whipple, Chicago.

OPERATE A collection-credit agency. Quickly learned. Big income assured. Write Cole Associates, Syracuse, N. Y.

WANTED—Representatives for commercial printing in every town. Roe Printing Co., Weldman, Mich.

MORE Money for your spare time. Honest, pleasant, profitable—local or mail order. Details for stamp. Heimroth, 323 E. 35, Union City, N. J.

AT Last! Book of moneymaking plans. Start at home, full or spare time. Send for descriptive folder free. Paramount Sales Service, Box 1784 Wilshire-LaBrea Sta., Los Angeles, Calif.

FORMULAS—Fast selling products. Guaranteed. Laboratory tested. Lowest prices. Catalog free. Kemico, 55N, Park Ridge, Ill.

MONEY in dry cleaning. We furnish machinery and instructions. Ship from St. Louis. Potterf, 1723 W. 38 St., Los Angeles, Calif.

WHERE To buy anything! Wholesalers, manufacturers. 25c (coin). Kings, 115 Liberty, Jamestown, N. Y.

101 WAYS To make money and 700 money making secrets, both complete 50c. Lerner, G. P. O. Box 238, Brooklyn, N. Y.

BOOKS, Chock-full of moneymaking ideas, formulas, plans, information. Literature free. Patek's, PMB883, S. Puzum, B. C., Canada.

VALUABLE Home mail business. Experience unnecessary. No canvassing, peddling. Free particulars. Thompson, Box 241, Duluth, Minn.

CASH In on a sound mail order business. Modest capital. Send for letter-foler "The Question That Has Tormented Thousands." Steinger, 706 West North, Pittsburgh, Penna.

OPERATE A money-making business in your own home. Write: Bohn Supply, Box 4352, Portland, Oregon.

HOME Industries, 44 pages, year, 10c. Melotz Publisher, Benson, Nebr.

CHIPPING Glass signs. Booklet free. Beveridge, 160-22P Locust, Jamaica, N. Y.

EARN \$25.00 Weekly working two hours daily. No canvassing or manufacturing. Business opportunities. Box 5005, Dept. 44, Saint Paul, Minnesota.

YOU'LL Like resilvering mirrors, auto-parts, reflectors, making chipped glass signs. Write, Sprinkle, Plater, 127, Marion, Indiana.

1001 WAYS To Use Concrete. Send for large free illustrated folder describing new Popular Mechanics book covering every known use of concrete for the home, farm, building, business and industry. Popular Mechanics Press, Room (C37), 200 E. Ontario St., Chicago.

WHERE To buy at lowest wholesale prices. Information free. Yorena, Box 312-P, Bayonne, N. J.

PROFIT With new products. Make, sell, repeat. Analysis. Research. Guaranteed formulas. Biggest catalog free. Special prices, leads. Gibson Laboratory, Chemists. BD-1142 Sunnyside, Chicago.

BUILD Your own food products business. All or part time. Established merchants sell for you. Hardly any capital. Easy, permanent, profitable. You control. Booklet free. Imperial Food Products Service, 2841 Firard Ave., Philadelphia.

PROFITS And pleasure making shell jewelry, novelties—newest field! Stamp appreciated. Challenge, A-10, St. Petersburg, Fla.

OPERATE Electric Simonizing station, full or part time. Cash in on national advertising with proved labor-saving invention for your car and business. Only \$29.50. Should net you approximately \$300-\$400 month. Write Bissell's Mfg. Co., 3320 Archer Ave., Chicago. Dealers wanted.

"SUCCESS Beacon," 52 pages! Money-making schemes, ideas, plans. Dime. Jay, Publishers, 6054-p Kenwood, Chicago.

STEADY Income easy! Home business. No peddling. Free details. Century, 1261-PK Broadway, New York.

ORDERS Waiting! Start home industry—help us fill tremendous demand for new, fascinating, simply-cast, china-like, artware. Nothing like it. Amazing profits. Your start to independence. Artware, 9 Indian Church Road, Buffalo, N. Y.

START Mail order business at home with "Coin Coaxers." Plan, samples, big magazine. Dime. Thomasson's, Minneapolis, Minn.

WORK At home. Carve, paint and decorate gourds. Instruction, information and 250 varieties of gourd seeds \$1.00. John Ciesla, World's Largest Gourd Grower, Pomona, California.

AMAZING Profits in mail order business from your home! Mailservice, 2231 McKinley, Berkeley, Calif.

ENTER The mail order field. Operate in your own home. I handle the best, only. Write. L. F. Newlin, 1110 N. Euclid, Indianapolis.

MAKE Up to \$300 month in a business of your own. No investment necessary. Details free. Thayer Company, Gassaway, West Virginia.

NEW "Co-op plan," sells anything, your product or ours. Easy, simple; no personal contacts. Free particulars. Lewis, Box 243, Minneapolis.

MAKE Artificial marble, glazed tiles, un-canny. Tabletops, plaques, floors, hones, novelties. Hard, fireproof, inexpensive, cement secrets. Brilliant tile and liquid rubber samples 3c. John A. Payn, 945 Grande Vista Avenue, Los Angeles, Calif.

DIME Brings sample merchandise and imprint circular paying 10c to \$80.00 profit on single orders. Lorrac Company, Albany, N. Y.

MAKE More money. Profitable particulars free. Ralph Underhill, Beebe, Ark.

MRS. M. earned \$267, three weeks, raising mushrooms in cellar! Exceptional, but your cellar, shed perhaps suitable. We buy crops. Book free. United, 3848 Lincoln Ave., Dept. 67, Chicago.

\$100 STARTS "Chain" of chewing gum and confection vending machines. Steady cash income. Details free. Robbins Co., 1141P DeKalb Ave., Brooklyn, N. Y.

SEE New marbleizing cement; makes building slabs, all sizes, shapes, for walls, halls, ceilings, etc.. Snow-white or colored. Can be sawed, drilled, cut to fit perfectly, waterproof. Dime brings surprising samples. Also we carry the best liquid rubber, and teach mold making. We have hundreds novelty models, cut rate prices. Address, Cowell Institute, Grayling, Mich.

ANYONE With small garden can earn up to \$500.00 two months. Stamp brings particulars. Lightning Speed, Streator, Illinois.

MAKE Flexible molds for casting novelties, statuary, clock cases, other objects. Easy method. Complete formulas and working instructions, \$1.00. Bestoval, 4047-P North Whipple St., Chicago.

PLANS, Ideas, tips, particulars. Wm. F. Sullivan, 60 Mountain, Rockville, Conn.

OTHERS Make big money, why not you? Free particulars. Vocational Service, Box 1902, Houston, Texas.

EARN Marvelous profits spare time. Pleasant business. Details free. Streamline, R. 3, Pleasantville, N. J.

BRANCH Managers, new national magazine. Profitable subscription business plan, all magazines, 25c. Courier, Box 1178, Washington, D. C.

AMAZING Method. Gold plating process. Easily worked at home. Experience unnecessary. No battery, electricity, dipping necessary. Simple, reliable, satisfactory results. Stand acid test. Send \$1.00 for secret process. Progressive Laboratories, Box 74, Sta. A, New Haven, Conn.

DRIFTING? Future unsettled. 1,000 counselling reports published for all trades, businesses, professions. Write Marshall Greenburgh, Publisher, 521 Fifth Avenue, New York.

BUY Any article wholesale. Supply source 25c. What's the item? Globe Reference, 11 Pemberton Square, Boston.

START 1938 Right! Making newest staple products to sell, repeat, with Miller's Famous Certified Formulas. Investment small—profits great! Valuable literature free! Miller, Chemist, 1706-M Tampa, Florida.

FREE! Big money making secrets. Flescher, 6 No. Clark, Chicago.

NEED Money? Write for free particulars describing 13 easy steps to riches. Century Service Co., 217 E. Ontario, Chicago, Ill.

FREE Circulars describing hundreds of moneymaking opportunities by mail. Newest methods. Pleasant surprise. Write now. Progress Publishing Co., 2513A N. 9th St., Milwaukee, Wis.

TEN Successful mail order plans 10c. Williams Co., 766, Wilmington, Delaware.

INVENTION Finance Magazine, 80-G Wall Street, New York. Two year subscription (\$1.00) entered upon promise pay receipt of first copy.

LISTEN: If it's dollars you can't make, write B. F. Spencer, 447 Central Ave., Batesville, Ark.

RESTAURANT Owners, want more profits? Management suggestions, recipes, etc., explained. What is your problem? Write Master Chef, 580 Market St., San Francisco.

FIVE Modern money making secrets \$1.00. Arlington Co., 875 Thornhill, Cleveland, Ohio.

START Home business resilvering mirrors, plating autoparts, tableware, etc. Easy methods. No electricity. Literature free. Ideal, 100, Park Ridge, Ill.

INCREASE Your prestige and business. Just 1c daily for personal or 2c for business purposes, maintains permanent New York office. Co-Operative Mail Service, 126P Lexington Ave.

WORK At home, carve, paint and decorate gourds. Make radios, lamps, vases, charm strings, and hundreds other useful and ornamental articles from gourds. Book with 95 illustrations \$1. Gourd Studio, 1409 W. Holt, Pomona, Calif.

MONEY Making home propositions. Free particulars. Leslie, 3415 Fort Independence St., New York City.

GET Dollar bills in your mail daily. Nearly all profit. Particulars free. Homecraft Arts, PM, Lakeside, Calif.

SELL By mail. Big profit. Write Sweeper, 101 Monmouth, Newark, N. J.

AFTERNOONS Free for outdoors, movies, \$340 month home. Unique plans. No canvassing. Prepare for surprise. Folio-P, Station D, Los Angeles.

MAKE Money re-silvering mirrors. Formula only 15c. Boltach & Co., 5007 - 28th St., Detroit, Mich.

WE Are establishing associate manufacturers. 500% profit. Something new. Troughton, Aurora, Missouri.

OPPORTUNITY For man to get into something for himself—be own boss. No soliciting. Start with as little as \$75.00—a tried and proven money-maker. No previous experience required. Write H. H. Wing, Box R, Central Station, Toledo, Ohio.

POPCORN, Crispette, carmelcrisp, potato chip, salted nut machines. Long Eakins, 1960 High St., Springfield, Ohio.

PLASTEX Industries offer industrious men an opportunity to start a business of their own, manufacturing art goods, novelties and utility products in Plastex and marble imitation. 1/2c materials makes regular 10c store sellers. Rubber moulds furnished for speed production. Small investment brings big returns. Nationwide demand in these low priced goods for coming X-mas holidays. Ambitious men have chance for real prosperity. Plastex Industries, Dept. A, 1085 Washington Ave., New York.

WE Start you in business, furnishing outfits and instructions, operating Specialty Candy Factory home. Men and women, earn \$25 up to \$60 weekly, all or spare time. (Our 29th year.) Booklet free. W. Hillyer Ragsdale, Inc., Drawer 4, East Orange, N. J.

LIQUID Marble—anyone can make! Colorful, glazed! Moulded, brushed, sprayed. Rubberlastic moulds. Composition flooring. Big money in these! Particulars free. Marbleizing Service, Edwardsville, Ill.

SUCCEED With your products. Make-sell them. Formulas, Processes. Accurate analyses. Catalog free. B. Thaxly Co., Washington, D. C.

DONUT, Potato chip, cheezed pop corn. Home made. Big profits. Vanderpol, Springfield, Ohio.

PROFITABLE Home business. Legitimate. No canvassing. Maywood Publishers, P-923 Broadway, New York.

MAKE Your own products. Employ agents yourself. Toilet articles, soap, extracts. We furnish everything. Valuable book free. National Scientific Laboratories, 1950W Broad, Richmond, Va.

SELL By mail. Books, novelties. Bargains! Big profits! Particulars free. B. Elfco, 438 N. Wells, Chicago.

FREE Booklet describes 107 plans for making \$20-\$100 weekly, in home or office, business of your own. Elite Co., 214 Grand St., New York.

I WANT To send you proof of the wonderful pulling power of Popular Mechanics Magazine's classified pages. What's your proposition? Write me today. F. W. Johnson, Manager Classified Advertising, 200 E. Ontario St., Chicago, Ill.

CHARTERS: Delaware: best, cheapest; free forms. Colonial Charter Co., Wilmington, Del.

CASH Every week clipping and preparing news items for publishers. Simple, fascinating work. Experience unnecessary. Stamp brings information. Division 55, National Press, 3923 W. Sixth, Los Angeles, Calif.

HOW And where to obtain capital fully explained, free particulars. Star Service, Wapakoneta, Ohio.

DELAWARE Charters: Complete service \$35. Submitted forms. Chas. G. Guyer, Inc., Wilmington, Del.

ARTIFICIAL Marble sanitary flooring, instruction covering wood or cement flooring 1/2 inch thick, fireproof, all colors, low cost, ornamental casting, concrete, plaster, papier-mache, garden furniture, statuary, flexible molds, particulars free. Chris Mahler, Elmont, N. Y.

MAIL Order business is your opportunity. Many began small, now earn thousands yearly. No personal contact. Boundless opportunities. Have had over 30 years experience; will help you succeed. Send 25c for valuable booklets, none free. B. Brenner, 257 S. 21st, Philadelphia.

100 PROFITABLE Mail order and local plans. Gilbert Supply, 1107 Broadway, New York.

ZERPID, Fertilizer, 25c. Necessity for thousands. Sanquist Co., Pomeroy, Iowa.

MONEYMAKING OPPORTUNITIES

JUST Out! "Opportunities Hidden in Subscription Agency." New sales methods show how to build mail and phone business from home. \$1 postpaid. Money refunded if dissatisfied. Julius, Amarillo, 16, Texas.

WANT Extra income? Free folder describes 100 helpful plans. Dixon Co., 776P, Springfield, Mass.

EASY Work, all profit, coloring photographs, miniatures. Talent unnecessary. Inexpensive instructions, outfit. (Circular.) Hughes, 815-R4 So. Hill, Los Angeles.

WONDERFUL Moneymaking opportunities explained. Particulars free. Lewis Co., 828-P Carpenter, Oak Park, Ill.

AMAZING Plans, formulas, ideas, all money makers. Rowell, 240 Illinois, Rochester, N. Y.

WHERE To buy anything. 3 addresses 25c. Grout, San Bruno, Calif.

MAKE Low-cost expensive perfumes. Sample 25c. Belle Mead, (N. J.) Laboratories.

YOU'LL Like resilvering mirrors, autoparts, reflectors, making chipped glass signs. Write, Sprinkle, Plater, 287, Marion, Indiana.

GET Cash quickly, steadily! Home business. Spare or full time. Free details. Century, 1261-P Broadway, New York.

FREE! Extraordinary ideas, nationwide propositions. Evers, Box 66PM, Elmhurst, N. Y.

PRINCE Warren, Grant Hotel, Chicago, buys cancelled stamps. Particulars free.

QUIT Playing at the mail order business! Make real money—others are! "6000 word folio," 3c stamp. Dr. Swearingen, Station "S," Los Angeles.

FREE! Hundreds of moneymaking opportunities! Schumacher, 3503 Hirsch, Chicago, Ill.

TURN Spare time into cash with typewriter! Addressing envelopes, mailing circulars, typing! 25c (coin) brings information. Ace, TPM-7, 322 Empire, Birmingham, Ala.

PROFIT With your own business. Unusual opportunities. Learn how. Gordon Publications, Box 1137, North Adams, Mass.

IMMEDIATE Home cash! Starting outfit free! Tell Service, Gold, 1451 Broadway, New York.

MAKE Money. Easy electrical course. Complete 50c. Schrico Service, Cashton, Wis.

PROFITABLE Business. Free typewriter. Complete outfit 25c. Details free. Drawer A, Oil City, Pennsylvania.

1,000,000 ARTICLES Wholesale. Latest directory, 10c. Jelsmith, 163 Myrtle, Waltham, Mass.

START Mailorder business. Details free. Pederson, 1609 1/2 East Fifth, Duluth, Minn.

BIG Paying mail order business quickly developed. Working details 25c silver. Parlor Co., Greenwood Lake, New York.

MAKE It Yourself—Hundreds of practical and useful devices described in our big book. Plain instructions and illustrations show you how. Save money on things for yourself or make profit selling to others. 900 articles, 480 pages, 823 illustrations. \$3 postpaid. Popular Mechanics Press, Room (C37), 200 E. Ontario St., Chicago.

BE Independent. No canvassing. Write Leslie, 3415 Fort Independence St., New York City.

"SCHEMER" Magazine, Alliance, Ohio, supplies schemes, tips, ideas, formulas; winners! \$10,000 to \$25,000 reported. 39th year, \$1. Special: trial six months only 30c, year, 50c.

MAKE honest money at home. Free details. John Grady, Cosman Apts., Iliion, N. Y.

PROFIT In vegetables, flowers, using chemicals. Remarkable yields. Quick growth. Experiment now. Proven formulas. Enough chemicals for 40 gallons solution and instructions \$1.00 postpaid. Quick Growth Solutions, Hollywood Sta., Box 648, California.

SENSATIONAL Opportunities! Particulars free. Sine, 323 South Eighth East, Salt Lake City, Utah.

OVER 100 Ways to make money. Home or office. Literature 25c. Texas Sales Office, Weslaco, Texas.

STOP Squealing—Start crowing! Work mornings home—drive to country—"movies"—afternoons! No canvassing! Folio-A, Station "D," Los Angeles.

START Profitable mail order business at home. Stamp brings details. Success Publishers, 5623 So. Flores, San Antonio, Texas.

MAN In each town to plate auto parts, reflectors, bicycles, fixtures, mirrors, by late method. Simple plan of manufacturing at home starts you in good paying business. Free particulars and proofs. Gunmetal Co., Ave. N. Decatur, Ill.

NEW All profit plans. Kurtz, 3541 94th St., Jackson Heights, N. Y.

RAISE Earthworms for profit. Information free, stamp appreciated. Bureau Zoological Research, 106A Broadway, Peoria, Ill.

MILLIONS Jobs! Get dollars in mail daily, like we do, for amazing employment information. Keep money; we fill your orders free. Stamp brings details. Co-Operative Service, 77 Swan, Buffalo, N. Y.

MOULDS. Guaranteed, for casting toy soldiers, Indians, trappers, warships, sinker moulds, 244 kinds. Send 5c for illustrated catalogue. Henry C. Schiercke, 645 Spencer, Ghent, N. Y.

WHOLESALE Sources, 500,000 articles. Free directory. Maywoode, 925 Broadway, New York.

107 PLANS For making \$20-\$100 weekly in home or office business of your own. Descriptive booklet free. Elite Co., 214 Grand St., New York.

LIKE To draw? Earn steady income tracing and duplicating advertising cartoons. Ad-Service, Argyle, Wis.

FORMULAS, PLANS, ETC.

MAKE Liquid floor wax. Formula 50c. Money maker. Western Formula Co., Box 23, York, Nebraska.

EASY Money. Formula for making best penetrating oil on the market. 300% profit. Directions for making and selling 50c. W. A. Farnsworth, 801 W. Main St., Bellevue, Ohio.

GUARANTEED Formulas—New fast sellers. None better. Lowest prices. Catalog free. Kemico, 49N, Park Ridge, Ill.

DOLLARS And days perfecting our formulas. They work! Box 822, Los Angeles, Calif.

1938 BEST Sellers: Circular free. Catalog 25c. Grinstead, 505 Fifth Avenue, New York.

ANALYSIS. Research. Newest guaranteed formulas. Biggest catalog free. Special prices, leads. Gibson Laboratory, Chemists, BD-1142 Sunnyside, Chicago.

NEWEST Formulas. Everything. Specials! Catalogue free. Manufacturers' Service, 489 Arcade, St. Louis, Mo.

WE Give formula, instructions and quotation on ingredients, any product, \$1.00. Federal Laboratories, Box 200, Jersey City, N. J.

\$1.00 BRINGS Formula for North Pole Anti-Freeze and Rex-battery Charging Powder; guaranteed. Nu-Way Sales Co., Hornell, New York.

"TWO Dimes" brings plan, formula, sample, that's sweeping country like tornado! Satisfaction guaranteed! Davis, Box 1484-P, Clarksburg, W. Va.

ANY Formula 30c or money back. 1938 catalog free. Ogg Laboratories, Tampa, Florida.

MAKE, Sell—Brushless shaving cream, anti-freeze solution, mechanic's hand soap, glass cleaner, magic dishwasher. Guaranteed formulas. 50c each, any three \$1.00. Progressive Laboratories, Box 74, Sta. A, New Haven, Conn.

GUARANTEED Formulas, 100 for 20c coin. Edwards, 1700 Locust, Quincy, Ill.

100 MONEYMAKING Formulas 25c. Descriptive literature free. Harvey Teeple, Decatur, Ind.

THAXLY Formulas for perfect products. Accurate analysis assured. Resultful research. Catalog free. B. Thaxly Co., Washington, D. C.

MAKE Your own products. Employ agents yourself. Toilet articles, soap, extracts. We furnish everything. Valuable book free. National Scientific Laboratories, 1950W Broad, Richmond, Va.

FORMULAS. Latest money makers. Literature free. Belfort, 4042 N. Keeler, Chicago.

CHEMISTRY

CHEMICALS In 5c quantities. Catalog 5c. Fleischer's Laboratories, Everett, Mass.

RUBBER Latex sample twenty experiments for quarter. Eastern Latex Labs., Box 53, Canton, Mass.

ANALYSIS. Research. Newest guaranteed formulas. Biggest catalog free. Special prices leads. Gibson Laboratory, Chemists, CT-1142 Sunnyside, Chicago.

CHEMISTRY Magazine—research, experiments—three months subscription 15c. Spanner, 100 Forsyth, New York.

MAGIC Chemical Submarine, chemistry magazine, book experiments, new chemical catalog; all for 10c. Clinton Chemical Company, Swedesboro, New Jersey.

HANDBOOK For chemical experimenters, hundreds of experiments, illustrated, 50c. Experiment booklet, 15c. Chemical catalogue, 10c. Reading Scientific Co., Reading, Penna.

FREE Chemistry catalog. Supplies at 5c! Equip complete laboratory. Send 3c for postage. Kemkit Scientific Corp., 397P Bridge St., Brooklyn, N. Y.

CHEMICALS. Laboratory glassware, apparatus. Send 5c for catalog CP-1. Biological Supply Co., 1176 Mt. Hope Ave., Rochester, N. Y.

CHEMICALS For all purposes. Equip your laboratory. Catalog 10c. McBee Chemical Co., 1624 Boren, Seattle.

AGENTS WANTED

MEXICAN Finest feather pictures: 4x9" costs 25c including duty, retails \$1.00. (Sample 20c stamps.) Embroidered tablecloths: 36x36" with napkins costs \$1.18. Retails \$2.50. (Sample \$1.00.) Free particulars. Marquez, Apartado 1176-P, Mexico City.

SALES Agents—To sell direct to the automobile and truck owners, an absolute safety device on large commission basis. No Skid Company, Liberty Bank Building, Wilkes-Barre, Penna.

100% PROFIT In new perfected (1938) quick-action self-starting cigar lighter. No flint or friction. No wind can blow it out. Retails 25c. Costs you \$1.75 dozen. Sample and can fluid 25c. New Method Co., Box PM-61, Bradford, Penna.

AGENTS For pipe. Patent rights covered. Every smoker a prospect. Big profits. Permanent business. Samples carried in pocket. Good side line. Write Al. H. Hoffman, 776 E. Alosta Ave., Glendora, Calif.

AGENTS: Smash go prices! Santos coffee 12c lb., 4 oz. vanilla 8½c. Razor blades 10 for 8½c. 100 sticks chewing gum 12c. 150 other bargains. Premiums. Experience unnecessary. Carnation Co., PO, St. Louis, Mo.

NEW Soapless cleaning discovery! Amazing repeater. Enormous profits. Sales guaranteed. Free sample. Chicago Products, AF-3968 Avondale, Chicago.

COAL And oil burners save 15% on your fuel bill—automatic dampers \$6.95 easily installed. Guaranteed. Free literature. Agents wanted. "X" Coal Co., 2924 East Lake Street, Minneapolis, Minn.

STRANGE Ironing cord. Prevents scorching. Saves electricity. Abolishes kinks and snarls. For telephones also. 150% profit. Sales guaranteed. Samples furnished. Neverknot, Dept. 1-A, 4525 Ravenswood, Chicago.

500% PROFIT Selling new 20-in-1 kitchen utensil. Retails 25c. Costs you \$1 a dozen or \$6 a gross. Sample 10c. New Method Co., PMM-61, Bradford, Penna.

LOCAL Agents wanted to wear and demonstrate free suits to friends. No canvassing. Up to \$12 in a day easy. Experience unnecessary. Valuable demonstrating equipment, actual samples free. H. J. Graves, Pres., 1300 Harrison, Dept. A-817, Chicago.

SELL Tinselled Christian mottoes to homes, big profits. Novelty Signs, Stryker, Ohio.

SWEETEST 25c Seller out! Gold embossing ink, decorate Xmas cards, Easter eggs, etc. Sample 15c, catalog free. Hell Co., Gaylord, Minn.

LIQUID Typewriter type cleaner. B. Omoto, 2819 Hyperion, Hollywood, Calif.

BE Your own boss! Operate used-new clothing business from store, home, auto. Over 100% profit. Everything furnished. Catalog free! Roosevelt Mercantile, 550-F Roosevelt, Chicago.

MAGIC Clothes brush. Revolutionary invention. "Erases" dirt like magic. Saves drycleaning. Sensational seller. Samples sent on trial. Rush name. Kristee, 128, Akron, Ohio.

YOU'LL Like resilvering mirrors, auto-parts, reflectors, making chipped glass signs. Write, Sprinkle, Plater, 128, Marion, Indiana.

NEW Deal giving away shoes. Spare or full time. Outfit free. Reed Sales Co., Brockton, Mass.

HOLDS-UM Dry powder cement. Holds anything, anywhere. Fireproof, waterproof, never shrinks. Five ounces 25c; pound 65c delivered. Holds-Um, Royal Oak, Mich.

5c WILL Make you \$1 profit. Free sample product. Free literature. Fastest winter seller. M. A. Baske, 507 W. Barnes Ave., Lansing, Mich.

450% PROFIT Quick-Action automatic gas lighter. No flint. 25c seller to every home, office and restaurant. Free sample. New Method Co., Box PMG-61, Bradford, Penna.

\$200.00 A MONTH! Only 10 \$1.00 sales daily pays \$50.00 a week. An auto product. Thermo-Power Works, Peoria, Ill.

PROFIT With new products. Make, sell, repeat. Analysis. Research. Guaranteed formulas. Biggest catalog free. Special prices, leads. Gibson Laboratory, Chemists, BD-1142 Sunnyside, Chicago.

500% PROFIT! Gold reflecting letters for store windows. Large sizes 1c. Free samples. Modernistic Sign, B-3004 Lincoln Ave., Chicago.

NO Peddling. Start home business. Little or no investment. Free booklet tells how. Century, 1261-PM Broadway, New York.

VALUABLE Samples medicated bandages 10c, plans, proof, money back. "Gaypads," 190 Dwight, Holyoke, Mass.

AMAZING New scientific discovery cuts coal bills 40% to 60%. 75c package treats a ton. Every home and building a prospect. Agents cleaning up. Write for free sample. WCS Products Co., Beverly, Mass.

WHOLESALE Price list free, razor blades, notions, hosiery. Bulger, 147B Pemberton, Cambridge, Mass.

AGENTS. "National Opportunity Catalog" 10c. 4101 S. 38 Avenue, Minneapolis, Minn.

YOUR Opportunity for permanent income. Quality uniforms for quality buyers! Exclusive styles and models. Large profits. Restricted territory! Free outfit. Write today. Lion Uniform Co., Dept. M-18, Dayton, Ohio.

STARTLING Invention—Pocket adding machine. Nationally advertised \$2.50. Whirlwind seller. Big profits. Calculator Mfg. Co., Box 1118, Chicago.

MONEYMAKER. Proven proposition. Stamp brings information. Johnston, 1051 S. Central, Lodi, Calif.

MONEY In butterflies, moths. See Sinclair Display Advertisement on page 20A.

START 1938 Right! Making newest staple products to sell, repeat, with Miller's Famous Certified Formulas. Investment small—profits great! Valuable literature free! Miller, Chemist, 1706-M, Tampa, Florida.

JAY-WAY Door holder, sensational moneymaking. Jay-Way, One E. 42nd, New York.

GUARANTEED Gold leaf letters for store and office windows. 500% profit. Free samples. Metallic Co., 438-B N. Clark, Chicago.

ATLAS For best gold reflecting window sign letters. Large sizes ¾ cent each. Free samples. Atlas, 7941 Halsted, Chicago.

BIG Money applying initials on automobiles; \$1.45 profit on each sale. Write for particulars and free samples. American Monogram Co., Dept. 40, Dunellen, N. J.

MAKE Full strength, non-explosive, non-inflammatory, odorless cleaning fluid from benzyne crystals, 1c gallon. Sample 25c. Literature free. Western Reserve Laboratories, 6615 Denison Ave., Cleveland, Ohio.

SELL Novelty fun cards, novelties, etc. Samples 10c. National, Box 500M, Cincinnati.

MAN In each town to plate auto parts, reflectors, bicycles, fixtures, mirrors, by late method. Simple plan of manufacturing at home starts you in good paying business. Free particulars and proofs. Gunmetal Co., Ave. H, Decatur, Ill.

BIG, Steady weekly profits for men and women with cut price food route. More than 300 fast selling household and farm necessities. Sensational premium deals get quick cash and build profitable routes quickly. Write Bleecker, 259 E. 4th St., St. Paul, Minn.

AGENTS—To mail our literature. Good profits. Home business. Maywood, 149 Fifth Ave., New York.

SUCCEED With your products. Make-sell them. Formulas. Processes. Accurate analyses. Catalog free. B. Thaxly Co., Washington, D. C.

MAKE Your own products. Employ agents yourself. Toilet articles, soap, extracts. We furnish everything. Valuable book free. National Scientific Laboratories, 1950W Broad, Richmond, Va.

AGENTS—Opportunity to make money; book containing 107 successful business plans; home or office; send for free introductory booklet. Elite Co., 214 Grand St., New York.

FREE Sample—Amazing cleaner; sells homes, taverns, everywhere. Big profit—fast repeater. Betco, 5007 Irving Park, Chicago.

WANTED—District purchasing agents. No experience or money required. Write Purchasing Manager, 174 N. Halsted, Chicago.

DO You want agents for your proposition? Your ad in this space will place your message before hundreds of men seeking fast-selling products. My folder "How to Secure Agents," is filled with proof. I'll gladly send you a copy free. F. W. Johnson, Manager Classified Advertising, Popular Mechanics Magazine, 200 E. Ontario St., Chicago.

MANUFACTURE Specialties, hire agents yourself. Big money. Free literature. Gilbert Supply, 1107-P Broadway, New York.

ENGRAVED Name plates, numbers, signs, etc., easily sold, profits large. Brett Bros., Winthrop, Mass.

AGENTS: Stamping names on pocket-key protectors. Sample check with your name, address, 25c. Stamping outfits. Emblem checks, check-fobs, name plates. Hart Mfg. Co., 303 Degraw St., Brooklyn, N. Y.

HIGH-GRADE SALESMEN

INTRODUCE New advertising idea to retailers. Show them how to give away free chewing gum and increase profits! Send for big-commission plan, free sample outfit. National Adgum, Dept. K-20, Cincinnati, Ohio.

NATIONALLY Known chemical corporation considering applications from salesmen experienced in selling disinfectants, insecticides, cleaning compounds, floor maintenance products, deodorants, etc., to factories, schools, institutions, municipal and county buildings, and other direct bulk users. References required, own automobile, protective contract given, drawing account considered. The Federal Sanitation Co., Inc., 2340 Euclid Avenue, Cleveland, Ohio.

NO Selling! Steady work—Big pay daily. Be my local buyer. Money furnished. Details free. Pruitt Co., 1180 Pruitt Bldg., Chicago.

SHIRT Salesmen. Sell Johnstonian fine shirts direct to wearer. Self-selling sample kit free. Daily commission. Johnston Shirt Co., Union City, Tenn.

ADVERTISING Book match factory offers you amazing opportunity. We are largest in world selling direct. Big cash commissions, bonuses. Full-part time. Big repeats. Samples and kit free. Match Corp. of America, Dept. E-1, 6041 Grand, Chicago.

MAN Wanted to supply Rawleigh's household products to consumers. Sales way up this year. We train and help you. Good profits for hustlers. No experience necessary. Pleasant, profitable, dignified work. Write today. Rawleigh's, Dept. A-53-PPM, Freeport, Ill.

SELL Grooved felt back changeable signs with double prong celluloid letters to all stores. Big commissions. P. Pricing Press, 124 White St., New York.

SELL Nothing. \$95 weekly. \$500,000 punchboard firm announces new, no investment plan. Season starting. K&S, Dept. C121, 6227 Broadway, Chicago.

NEW Specialty—Sells every business and professional man. Pour \$15 sales daily pay \$280 weekly. Farrell cleared over \$1,000.00 monthly. Write, F. E. Armstrong, President, Dept. PM, Mobile, Ala.

WANTED County distributors. Excellent opportunity for earnings. Nationally advertised product. Large company. Dept. 252, Fry-Fyter Company, Dayton, Ohio.

\$100 WEEKLY. Installing new automatic fire-detector-burglar alarm system. Homes, farms, warehouses. Complete \$6.50. Territory. Fyre De-Tector Co., Thorp, Wisconsin.

JUST Out. Big sensation. New hand cleaner, big profits. Money back guarantee. Full size box 25c. McArthur Products Company, 13332 Compass, Detroit, Mich.

GREATER Commissions. Increase your income selling \$10,000 accident and health policy; \$25-\$50 weekly benefits, \$10.00 yearly. Other amounts proportionate. Guaranteed renewal income. \$1,045,318.19 securities deposited. Universal Policy, Dept. O, 11 Commerce St., Newark, N. J.

BE Your own boss. Make the largest commissions selling our complete line of brushes. Write for sales plan. Wire Grip Sanitary Brush Corp., 2300 5th Ave., New York.

NEW Power Air Auto Vac, no bag or hose, quick sale on demonstration to garages, gas stations. Big profits. Sales-manager, 2417 N. Ashland, Chicago.

PERMANENT. Exclusive agency. Our unusual products still used steadily in the homes after 37 years. Rayburn Sons, Chemical Specialties, 5946 Eggleston, Chicago.

WANTED—District managers, distributors—age 25-55—to investigate and interview dealers for sensational merchandising plan. (Requires no selling.) 100% credit insurance on merchandise. Profits up to \$300.00-\$600.00 month. New scientific method conditions automobile motors few minutes, while motorists wait. (No graphite—no mica.) Easy to use. Saves time, money, gasoline, oil. Lloyds of London insurance to \$5000.00 protects users. Method and proposition alone in field. Guaranteed results. Your profits up to 233%. Write today for details free of risk test and "profits-or-money-back" plan. Territories going fast. Rush. Craver and Jay Company, Dept. 101, 21 West 10th, Kansas City, Mo.

TIRE Accessories. Guaranteed 10,000 mile Tiger Grip Tire Patch, and complete fast-selling line auto accessories. Salesmen-distributors easily make up to \$75 weekly, and over. Protected territory. Economy Rubber Products Co., 839 Burkhardt, Dayton, Ohio.

WANTED Representatives. Sensational burglar and fire alarm. Real money maker. Exclusive territory. Be independent. Automatic Alarm Co., Cadillac Square Building, Detroit, Mich.

SALESMEN—Sell business stationery, book matches, calendars, Xmas cards, advertising pencils, shelf moulding, labels, salesbooks, pricing sets, tags, office supplies. Business cards \$1.50 thousand. 35% comm. daily. Free deals. Sales portfolio free. Willens, 2130 Gladys, Dept. WK, Chicago.

SALESMEN, Distributors. New deal, higher commission; exclusive territory. 125 varieties brushes, mops, specialties. Neway Brush Co., Hartford, Conn.

GUARANTEED Gold leaf letters for store windows. Free samples. Liberal offer to car owners. Metallic Co., 438-A N. Clark, Chicago.

ATLAS For best gold reflecting window sign letters. Large sizes 3/4 cent each. Free samples, Atlas, 7941 Halsted, Chicago.

SALARY Or commissions. Permanent. National Salesmen's Bureau, Taylor Bldg., Rochester, N. Y.

MAKE More money with Red Comet Automatic Fire Extinguishers. Low price. Proved seven years. Splendid sales outfit free. Some good territory open. Exclusive. Write quick. 704 Red Comet Bldg., Littleton, Colo.

BRUSH Salesman—If you ever sold brushes write for our money making proposition. Donald Brush Co., Camden, N. J.

FREE Booklet describes 107 plans for making \$20-\$100 weekly, in home or office, business of your own. Elite Co., 214 Grand St., New York.

SPARKLING Glo-Brite signs sell fast to stores, restaurants, taverns. Lasting gold finish. Plenty profit. J. A. Baxter, Cambridge, Ohio.

"1,000 WAYS To Make \$1,000." You can do it—others have. This amazing book will startle you. 475 pages, only \$2.50. Popular Mechanics Press, Room (C37), 200 E. Ontario St., Chicago.

HELP WANTED

MEN Wanted for coffee routes. Earnings up to \$45 in a week. Automobile given producers as bonus. Write Albert Mills, 8835 Monmouth, Cincinnati, Ohio.

"WEAR-EVER" Aluminum has sales opening in Chicago territory. Future for man selected. Not canvassing. Car essential. Average earnings \$60 weekly. Write Mr. Ogden, 1313 Conway Building, Chicago.

MONEY In butterflies, moths. See Sinclair Display Advertisement on page 20A.

STOP Job-hunting. Be your own boss. Start profitable mail order business of your own. No selling. Write Hant Service, 516-Y Federal, Pittsburgh, Penna.

MODERN Refrigeration. New industry needs trained men for installing, servicing, repairing. If you seek a new field with larger opportunities get latest book by Alt-house and Turnquist. \$5 postpaid. Popular Mechanics Press, Room (C37), 200 E. Ontario St., Chicago.

EDUCATIONAL AND INSTRUCTION

AIR Conditioning, electric refrigeration industries demand trained men for installation, service, maintenance and sales. Qualify in 3 months. Free employment service. Established 34 years. Get new book "Step Up to Success" free. Write O. Werwath, President, 1020-S N. Broadway, Milwaukee, Wis.

"SHORTHAND Simplified" complete \$1.00. Folder-less dime. Simmons, Rocky Hill, Conn.

KNOCK-EM-COLD! Learn police Jiu Jitsu! 36 secret knockout blows without fists, many one-fingered, headlock breaks, etc. New complete illustrated course by world-famous instructor, only 15c today. S. J. Jorgensen, Maritime Bldg., Seattle, Wash.

BECOME An investigator—Secret service agent. New "Test Problem Method." Develops your ability. Particulars free. International Secret Service Institute, (PM18), Hoboken, N. J.

MAKE More money. Get a U. S. government job. Get our new plan for obtaining one—no obligations. Age 18-50. Write, Instruction Service, 101, St. Louis, Mo., immediately.

1938 GOVERNMENT Jobs. Start \$105-\$175 month. Dependable. Prepare immediately for next examinations. List positions, free. Write today. Franklin Institute, Dept. L3, Rochester, N. Y.

BECOME Business investigator. Earn good fees in pleasant spare-time work. Write! Business Detective System, 1009 Oak, Elmira, N. Y.

ASTROLOGY Taught—weekly lessons, help, corrections, 50c. Albert Byron, 162 Holden St., Providence, R. I.

LEARN Air conditioning—America's next big industry. Thousands of opportunities. Get your start with complete book by E. W. Riesbeck, \$3.50 postpaid. Popular Mechanics Press, Room (C37), 200 E. Ontario St., Chicago.

GOV'T Jobs start \$1260-\$2100 year. Men-women age 18-50. Former examiner's tested method helps qualify you. Particulars, list jobs free. Write today. Patterson School, 8C Mercantile Bldg., Rochester, N. Y.

DEGREES Earned by home study in arts, sciences, philosophy, education, psychology, theology, law, chemistry, engineering, business, agriculture. McKinley-Roosevelt College, Chicago.

HIGHER Arithmetic solves problems quickly. Frederick A. Smith, 2410 Bernard St., Chicago.

SECRET Investigations. Excellent opportunity. Particulars free. Write George Wagner, M-2640 Broadway, New York.

EARN Extra money! Clipping and preparing newspaper articles for publishers. Simple; fascinating; profitable. Send stamp. Division 55A, National Press, 3923 W. Sixth, Los Angeles, Calif.

LEARN Machinist trade, tool, die making. Automatic and hand screw machines. Modern shop methods. Actual work. Jobs open for trained men. Employment help. Illustrated booklet free. Allied Screw Machine Co., 601 Lake St., Chicago.

LEARN Auto mechanics, body, repairing, welding, electricity, refrigeration. Diesel. Stevinson's, 2008A Main, Kansas City, Mo.

PLAYS, STORIES, MANUSCRIPTS

WRITERS: Studios pay \$2500 to unknown writers for screen stories or ideas. "Screenwriters Handbook" tells how to construct and sell your story or idea. Endorsed by studio story editors. Used by successful professional and amateur screenwriters. Send \$2 (total cost) or order COD. today. Address Broadwell Studios, Dept. 342-A, Bendix Bldg., Los Angeles, Calif.

POEM Writers, songwriters—Send for free Rhyming Dictionary, Writers Guide. Submit best poems, melodies today for bonafide, superior offer. MMM Publishers, Portland, Oregon.

WRITER'S Service. Particulars free. A. M. Seymour, 126 Lexington Avenue, New York, N. Y.

MARKETING. Advisory service for writers. Free bulletin 5A. Don Wimmer, Route 7, Huntington, Ind.

WANTED. Original poems, songs, for immediate consideration. Send poems to Columbian Music Publishers, Ltd., Dept. 209, Toronto, Can.

CARTOONING, COMMERCIAL ART, SHOWCARD WRITING, SIGN PAINTING

DRAFTSMEN, Students, showcard writers save time with patented Universal Drawing Instrument. Does wonders. Descriptive circular free. Box 451, Leominster, Mass.

ONEDAY Sho-card system. 21 lessons cartooning. Both \$1.00. Straley, 28 Spring, Springfield, Ohio.

SIGN And showcard lettering. Complete illustrated course \$1.00. Showing every stroke of brush. Lawler & Vernon, 858 E. 63rd St., Chicago, Ill.

CARTOONING Course \$1.00. Simplified home study course, 30 illustrated lessons, over 500 drawings, pens and pencils, \$1.00 complete, postpaid. Scovell Studios, Box 748-P, Hollywood, Calif.

SELL Drawings. Read Art Advisor Monthly. Parkville, Missouri. Samples 20c.

ART Magazine. Helps you sketch, paint, model, carve, cartoon, draw human figure, sell drawings, exhibit, form clubs. Regular 25c copy for 10c while samples last. Artist, 18 E. 48, New York City.

CARTOONING, Sketching, etc.—46 lessons, 600 illustrations, including drawing paper, pens, pencils. \$1.00 complete. Fraba Service, Cashton, Wisconsin.

EARN cash income, copying and duplicating simple cartoons for advertisers. 3-M Service, Argyle, Wis.

BUSINESS SERVICE

\$2.00 MONTHLY Maintains Los Angeles address. Dickey, 628 W. 9th.

DETROIT, Michigan, address. Personal or business, \$1.00 monthly. Letters forwarded daily. Charles, 506a Jones.

SAVE. Use experienced credit, collection counsel. Producing letter and collection tip \$1. Arthur Kelley, Church, Montclair, New Jersey.

BUSINESS Problems answered, send 50c with details. Confidential. Counsel Associates, Douglas, Georgia.

FLORIDA Mailing address. \$3.00 per month. Universal, Box 546, Jacksonville.

WASHINGTON, D. C., mail address. For business or personal purposes. \$2 monthly. Hawkins Mail Service, 817 Fourteenth.

ADVERTISING AGENCIES—FOR ADVERTISERS

CALIFORNIA Names, per 500; laborers, women \$1.00; pharmacists, mechanics \$2.00; department stores, executives, premium users \$3.00; wealthy women, millionaires \$4.00. Bestwest Service, 1252 Ruberta, Glendale, California.

LEARN Advertising quickly at home. Easy practical plan. No text books. Common school education sufficient. Interesting booklet and requirements free. Page-Davis School of Advertising, 3601 Michigan Avenue, Dept. 3432, Chicago.

ADVERTISE Profitably: \$15 reaches 6,000,000 Sunday newspaper readers with 24 word ad. Newspaper, magazine, rate-guide, free. Chicago Union Agency, 20 W. Jackson, Chicago.

ADVERTISING Placed; any publication, anywhere. Copy written. No service charge. Free rate guide. LeGrand Agency, 34 West 33rd Street, New York City.

33 WORDS, 25 Magazines, three months, \$2.00. Goodall, 742 Market, San Francisco.

FREE—New Advertisers Rate Guide, 44 pages. Includes everything. Lowest rates. E. H. Brown Advertising Agency, 140 S. Dearborn, Chicago.

ADVERTISING Placed anywhere. Helpful, free service. Rate guide book free. Baker Advertising Agency, 189 W. Madison, Chicago. Successors to Ankrum Advertising Agency. Established 27 years.

ADVERTISE: 5 Lines 100 national mail order publications \$4. Lists free. Advertising Bureau, 4515-C Cottage Grove, Chicago.

TYPEWRITERS, DUPLICATORS, OFFICE DEVICES

TYPEWRITER And mimeograph supplies. We undersell. Address Box 135, Gillespie, Illinois.

NEW \$3.75 Automatic adding machine. Fully guaranteed. Bassett, Box 302D, Altadena, Calif.

TYPEWRITERS, Duplicators, multi-graphs. Write for free list office machine bargains. Save half. Pruitt, 518 Pruitt Bldg., Chicago.

INCREASE Business now. "Excellograph" Rotary Stencil Printer reprints thousands everything you typewrite, hand-write, draw or trace. Colors. \$19.75 to \$44. Terms. Illustrated literature free to business or professional men. Pittsburgh Typewriter Supply, Department K-2, Pittsburgh, Penna.

OFFICE Machines, typewriters, adding machines, duplicators, etc., 29 different makes, care and operation of. Only book on subject. 384 pp. illus. \$2.50 postpaid. Popular Mechanics Press, Room (C37), 200 E. Ontario St., Chicago.

RUBBER STAMPS AND OFFICE SUPPLIES

GUARANTEED Frozen staples for Ace, Star, Boston, Bostitch, Hercules, Hotchkiss, Dennison, Speed, etc., 25,000 \$3.25; 50,000 \$6.25 postpaid. Staples for all machines—get our prices. Armstrong West, Statesboro, Georgia.

NAME, Address, 2 lines 25c; 3 lines 35c. Stamp Works, Auburn, Nebr.

CUSHION Mounted, one-two lines 25c, three 35c; facsimile signatures \$1.50. Stamp Works, 814 Bradley, Peoria, Ill.

2 LINES 25c, 3 Lines 35c. Stamp Works, Centertown, N. Y.

PRINTING, MULTIGRAPHING, MIMEOGRAPHING, GUMMED LABELS

LETTERHEADS, Envelopes, cards, blotters, circulars, statements, etc. 1938 price-list free. McCall Printing Company, 1326 So. 27th, Omaha, Nebr.

BUSINESS Concerns and individuals have sufficient consideration for you to justify quality printed letterheads for their correspondence. Why not reciprocate? Our special postage saving letterheads are excellent quality, printed in modern plant under favorable labor conditions. Ten dollars thousand postpaid. Holiday or birthday card inclosed when requested. Electron Prints, New Orleans, La.

ENVELOPES, Letterheads—1000, \$2 postpaid. Marcus, 1627 S. Hamlin, Chicago.

BETTER Printing, lower prices. Send for samples. Moore Brothers, Alstead, New Hampshire.

250 8½x11 LETTERHEADS, 250 6¾ Envelopes, \$1.00. Victor's Printery, Exeter, New Hampshire.

1000 LETTERHEADS, Envelopes, statements, business cards, \$1.50. Shore, 9429 80th, Ozone Park, L. I., New York.

HAMMERMILL 8½x11 Letterheads, statements, etc., 6¾ envelopes: 1000 \$3.75, 500 \$2.00, 250 \$1.25 postpaid. Price list free. Commercial Press, Britton, So. Dak.

BUSINESS Cards, tickets, 69c 1000. Canary's Press, East Moline, Ill.

125 LETTERHEADS, 8½x11, and 125 Envelopes, \$1.00 postpaid. Benneville, 907 West Roosevelt, Philadelphia.

250 ENVELOPES Or letterheads, \$1.00 postpaid. Samples. Ranneger Press, B134, Pittsburg, Kansas.

SAMPLES—Attractive assortment free. Lowest prices! Sanderson's Printing, Ottawa, Illinois.

BUSINESS Cards, \$1.00 1000 post paid. McBride Printery, 912 Towne Ave., Los Angeles, Calif.

BETTER Business cards, 1000—\$1.19, postpaid. Norp Shinn, Bellflower, Calif.

500 GUMMED Stickers, four lines, 25c. Cott's Press, Spickard, Missouri.

PRINTING—Lowest prices! Envelope, letterhead specials! Rapid Service, Edwardsville, Illinois.

100 EACH 5½x8½ Atlanta bond letterheads, envelopes, \$1.00 postpaid 4th zone. Universal Supply, Orange, Mass.

250 LETTERHEADS, 250 Envelopes, both \$2.00 prepaidd. Evans Print, Reading, Penna.

500 MOST Anything printed \$1.00. Samples for stamp. Springer Print, Miami, Oklahoma.

ARTISTIC Printing. Cash, terms, trade, commission. Ozark Press, Romance, Ark.

250 LETTERHEADS Or envelopes, fine colored bonds and inks, \$1.50 postpaid. Samples. Becker, Printer, Altoona, Penna.

HARVEY Labels are verified better values. 6618-R Quimby, Cleveland, Ohio.

LABELS, Printed name, address, 2¼x3¾ gummed, \$1.00 thousand, two thousand lots. Free samples. Samnick, 305 E. 45, New York.

THOUSAND Books advertising matches \$4.50. Sanderson's, Ottawa, Illinois. (Salesmen wanted.)

PARTICULAR? Neagravure-Embossed stationery! Distinctive. Unique samples. Sollidays, Knox, Indiana.

1000 6¾ ENVELOPES \$1.75; 5,000, \$7.00. Hunt, Printer, Morrisville, Penna.

LABELS: All kinds. Write, samples. JBSCO, Box 93, Holyoke, Mass.

250 BOND Letterheads or envelopes \$1.00. Moyer, B-241-P, Milton, Penna.

LINE Work—Ten inch—\$1.00. Richardson, 705 Longfellow, Washington, D. C.

EXTRA Special—500 envelopes and 500 letterheads \$2.50 postpaid. Bond paper. Guaranteed. Hustler, Advance, Indiana.

1000 UNIQUE Advertising cards \$1.50. Rolland Marsh, Harbor Springs, Mich.

1000 RULED Statements, envelopes, \$2.00. Ruled billheads, letterheads, \$2.35. KPress, Box 103, Station W, Brooklyn, N. Y.

1000 6x9 CIRCULARS, Letterheads, envelopes, postcards, \$2.95; 5000, \$8.99. All printing reasonable. Samples. Cuts. Goodprint, Harrisonburg, Va.

PHOTO Engravings—Zinc line cuts made, 10 square inches, \$1 up; halftones; electros; artist; speedy; free price list. Riteway Engraving, 1457P Broadway, New York.

1,000 3½x5½ PRINTED Adcards \$2.39. Sample for stamp. Comstock, Charlestown, N. H.

BETTER Grade printing, reasonable priced. Free samples. Economic Press, Leonia, N. J.

500 ¾x2¼ FOUR Line gummed stickers, 25c. Moritz Printery, Saginaw, Mich.

QUALITY Printing. Lowest prices. Samples. Tucker Press, Box 63, Indianapolis.

PRINTING OUTFITS AND SUPPLIES

HAND Press, type and complete printers' supplies. Advise equipment you need and we quote prices; or send stamp for catalog. P. Peiffer, 2-C; 6 Columbia St., Newark, N. J.

NEW Type. List 3c. George Fister, 52 Spring, Hartford, Conn.

BUY Your printing equipment from one who started a large printing business with a hand press. Presses, type and supplies. Catalog free. Globe Press Co., Dept. A, 2608 Lawrence Ave., Chicago.

HAND Presses, type, supplies. Big lists 3c. Landis, Richland, Penna.

GOOD Used complete equipment bargain catalog free. Bradshaw, 3214-P Huron, Chicago.

PRINT Your own cards, stationery, circulars, advertising. Save money. Easy rules furnished. Print for others, big profits. Junior outfit \$8.85; job presses \$11. Details free. Kelsey Co., B-11, Meriden, Conn.

NEW Type 29c font. Catalog dime. National Type Co., Jackson, Mich.

BARGAINS, Presses, type. List 3c. Exchange D-15, 22 Orient, Meriden, Conn.

BARGAINS—Presses, type, supplies. Send stamp. 159 Harvard, Cambridge, Mass.

HAND Presses, Outfits, Christmas specials. Catalogue for stamp. Printers Sales, 114 S. Howard St., Baltimore, Md.

PATENT ATTORNEYS

INVENTORS: Send immediately for your copies of our new free books, "Patent Protection" and "Suggestions on Selling an Invention." Sixty-eight pages of interesting facts. They tell how patent laws protect you; kind of sketch or model needed; simple steps to take without cost; how successful inventors have secured financial assistance; show interesting inventions; illustrate important mechanical movements. With books we also send free Evidence of Invention form to help establish date of disclosure. Prompt service, reasonable fees, special deferred payment plan. Strictest secrecy. Thirty-six years experience. Highest references. Write us today. The facts in our books are worth money to the man with a good invention. Address: Victor J. Evans & Co., Registered Patent Attorneys, 12A Victor Bldg., Washington, D. C.

PATENTS—Before too heavy an outlay of time or money is made on an invention, a search of the Patent Office records should be made to determine as nearly as possible whether or not the same idea has been patented before. The cost of this search is small, while the value of the facts it uncovers is often considerable. We offer inventors and manufacturers a thorough prompt, confidential search service—plus experienced counsel and assistance in every phase of Patent and Trade-Mark practice. Write for our new free book containing valuable information relating to patent procedure. Clarence A. O'Brien and Hyman Berman, Registered Patent Attorneys, 587 Adams Bldg., Washington, D. C.

PATENT Your invention with this responsible firm of Registered Patent Attorneys. Deferred payment plan. Over 62 years' experience. Write for two free books and "Certification of Invention." C. A. Snow & Co., Inquiries Division, Snow Bldg., Washington, D. C.

WE Successfully sell inventions, patented and unpatented. Write for proof, and tell us what you have for sale. Chartered Institute of American Inventors, Dept. 4-C, Washington, D. C.

DIETRICH & Rutley, Registered Patent Lawyers, 512 Colorado Bldg., Washington, D. C.

PATENTS—Personal, confidential services for protection of your invention at reasonable cost. Preliminary information and approximate cost of patent furnished without obligation. John B. Thomas & Co., 902 F St., N. W., Washington, D. C.

"INVENTOR'S Guide," 100 mechanical movements, free; advises on patenting, selling inventions. Frank Ledermann, Tribune Bldg., New York.

PATENTS, Instructions "How to Establish Your Rights" and form, "Evidence of Conception"—sent free! Lancaster, Allwine & Rommel, 411 Bowen Bldg., Washington, D. C.

PATENTS, Booklet free. Highest references. Best results. Promptness assured. Watson E. Coleman, Patent Lawyer, 724 Ninth St., Washington, D. C.

L. F. RANDOLPH, 302-B Victor Bldg., Washington, D. C. Low cost. Book and information free.

INVENTORS—Send for free booklet "Patent-Sense." Information based on 64 years experience. Lacey & Lacey, Dept. 5A, 635 F St., Washington, D. C.

PATENTS—Trade marks. Preliminary advice, book and disclosure form free. Personal service. Irving L. McCathran, 1060 International Bldg., Washington, D. C. Registered Patent Attorney.

PATENTS, Protect your idea by securing free "Proof of Invention" folder. Exceptional personal service. Established 1906. E. E. Vrooman, 871 Woodard Bldg., Washington, D. C.

FOR INVENTORS

SHOE Findings ideas—Suitable for 10c store counters. Royalty or outright purchase of accepted ideas, patents. Address Savasole Company, 3317 Madison Road, Cincinnati, Ohio.

INVENTIONS Wanted. Patented—unpatented—"applied for." Northlake Products, Peoria, Ill.

WE Make working models, tools, dies for stamping and special machinery. Send 3 cents for catalog of gears and supplies. Pierce Model Works, 20 N. Clinton, Chicago.

MODELS: Light manufacturing, any quantity, any material. Modern equipped shop. Free confidential advice. M. C. Suttle, Mt. Vernon, Ill.

HAVE You hit a snag? Let our technical experts help you to success. Any scientific question answered or your money promptly refunded. Enclose \$2.00 with each question. Technical Information Bureau, Box 511, Chicago, Illinois.

NEW! Profitable inventors' information. How to prove priority, finance, patent, sell. Counselor, Cantil, Calif.

INVENTORS Ideas developed or will make tools and manufacture your articles in the most efficient manner. Inventors Laboratory, 1821 Farrington St., Memphis, Tenn.

MERITORIOUS Inventions financed, promoted. Jennings Butts, One E. 42nd, New York.

WE Locate buyers meritorious patented, unpatented inventions. If will sell, write immediately to Invention Reporter, Dept. 20, 11236 So. Fairfield, Chicago. Copyrighted booklet on request.

INVENTORS—Send for 72-page book on patents. Reasonable terms. Conscientious treatment to inventors. L. F. Randolph, Registered Patent Attorney, 302-E Victor Bldg., Washington, D. C.

INVENTORS: "Making Inventions Pay," our 32-page illustrated book, mailed upon receipt of 3c postage. Crescent Tool Co., Dept. Z, Cincinnati, Ohio.

SELL Your patent through a small classified ad in Popular Mechanics. Many inventors have found buyers in this way. Ask me for proof—I'll gladly send it to you. F. W. Johnson, Manager Classified Advertising, 200 E. Ontario St., Chicago.

TO Inventors: We are in the market to purchase a good patent, preferably a small item made of metal. Will purchase outright or royalty. Purchasing Agent, 241 Front St., New York, N. Y.

I SELL Patents. Established in 1900. Charles A. Scott, 773PM Garson Ave., Rochester, N. Y.

INVENTOR'S Universal Educator: contains 900 mechanical movements; 50 perpetual motions; instruction on procuring and selling patents and selecting an attorney, etc. Suggests new ideas. Price \$1 postpaid in U.S.A. Address Albert E. Dietrich, 511-B Colorado Bldg., Washington, D. C.

HAVE You a sound, practical invention for sale, patented or unpatented? If so, write Chartered Institute of American Inventors, Dept. 4-A, Washington, D. C.

PATENTS—Before too heavy an outlay of time or money is made on an invention, a search of the Patent Office records should be made to determine as nearly as possible whether or not the same idea has been patented before. The cost of this search is small, while the value of the facts it uncovers is often considerable. We offer inventors and manufacturers a thorough prompt, confidential search service—plus experienced counsel and assistance in every phase of Patent and Trade-Mark practice. Write for our new free book containing valuable information relating to patent procedure. Clarence A. O'Brien and Hyman Berman, Registered Patent Attorneys, 587 Adams Bldg., Washington, D. C.

INVENTORS: Send immediately for your copies of our new free books, "Patent Protection" and "Suggestions on Selling an Invention." Sixty-eight pages of interesting facts. They tell how patent laws protect you; kind of sketch or model needed; simple steps to take without cost; how successful inventors have secured financial assistance; show interesting inventions; illustrate important mechanical movements. With books we also send free Evidence of Invention form to help establish date of disclosure. Prompt service, reasonable fees, special deferred payment plan. Strictest secrecy. Thirty-six years experience. Highest references. Write us today. The facts in our books are worth money to the man with a good invention. Address: Victor J. Evans & Co., Registered Patent Attorneys, 13A Victor Bldg., Washington, D. C.

INVENTIONS WANTED

SMALL Inventions wanted by manufacturers. I'll help you sell your invention. Write for free circular. Stanley Hull, K-7829 Euclid Ave., Cleveland, Ohio.

PATENTS, Inventions commercialized. Plans to suit inventors. Details free. Inventors Service Agency, Box 15, Penns-grove, N. J.

CASH For unpatented ideas. Stamp for particulars. Mr. Ball, 9441-A Pleasant, Chicago.

SIMPLE, Practical inventions wanted by manufacturers, patented or unpatented. For information write Chartered Institute of American Inventors, Dept. 4-D, Washington, D. C.

PATENTS FOR SALE

FOR Sale. Patented double duty clothes line. Pulley usable for full line. No leaning out of windows. Charles Haberstroh, Warren Ave., North Port, L. I., New York.

NOD-ALARM—Keeps sleepy auto drivers awake. Royalty. Patentee, 35 North Ninth St., Columbus, Ohio.

AEROPLANES—2054610—Triplice Streamcraft Wingparachute. Volpicelli, 1260 Reynolds, Scranton, Penna.

NEW Improved ham rack for delicatessen use. Reasonable. N. Robinowitz, 2312 Hutchins St., Houston, Texas.

BARBWIRE Unreeler, lease, outright. Information free. Michael Juranic, Red Hook, New York.

POSITIVE Burglar proof ventilating window sash lock, locks with key, royalty preferred. Albin Swanson, Mount Jewett, Penna.

PATENTED Cover cap with transparent disc, for milk bottles. R. J. Lemke, 2610 N. 24 Place, Milwaukee, Wis.

MANUFACTURING

MACHINE Work wanted for precision bench lathes. Automatic screw machine products—short runs. Small stampings, blanking dies. Fisher Model Shop, 1002 Etowah Ave., Royal Oak, Mich.

ANALYSIS. Research. Newest guaranteed formulas. Biggest catalog free. Special prices, leads. Gibson Laboratory, Chemists, DS-1142 Sunnyside, Chicago.

DIES With 1000 stampings \$20 up. Manufacturing. Wire forming. Precision parts. Southern Products, P 138, Independence, Mo.

INVENTIONS Manufactured in any quantity at low cost. Stampings, dies, models, etc. Estimates and free catalog. Crescent Tool Co., Dept. X, Cincinnati, Ohio.

MANUFACTURING, Dies, machinery, models, brasswork, white metal casting moulds. Catalog 3c. Baum's Metal Specialties, Kansas City.

LEARN To do wood turning on the lathe. Fascinating, profitable. 200 page book with 141 plates provides complete mastery of this art. \$1.50 postpaid. Popular Mechanics Press, Room (C37), 200 E. Ontario St., Chicago.

MODELS AND MODEL SUPPLIES

BUILD A model railroad! Send 10c for new 24 page 1938 catalog. Railroad models, kits, track, signals. Model Railroad Shop, Dept. P M, Dunellen, New Jersey.

SHIPS—16" Flying Cloud, Constitution, Galleons. Materials include easy plans, only \$1.50. Catalog 15c. Hancock, 323 Douglas Ave., Portsmouth, Va.

SHIP Models—fittings. Airplanes—engines. 10c both catalogs. Polks Model-craft, 421 Seventh Ave., New York City.

LATEST Catalogue. Locomotives. Gas, steam engines, castings, etc., 25c. Usual refund. Howardco, A-2417 N. Ashland, Chicago.

MODEL Supplies for the inventor. Send 3c stamp for catalog. Pierce Model Works, Tinley Park, Ill.

SHIP Model supplies and fittings. Catalog dime. Welcher, Fulton, N. Y.

$\frac{3}{4}$ " **SCALE** Steam locomotive easily built by "Step" method. Catalog of castings, instructions, boiler fittings, track material, etc. 25c coin (returned first order.) Little Engines, Box B15, Wilmington, Calif.

ENGINE Catalog 20c. Particulars free. Evraymesco, 28 N. Clinton, Chicago.

HEADQUARTERS For yacht fittings—Marblehead (50-800) and Class A. List free. Illustrated catalog of ship fittings and construction sets 15c. A. J. Fisher, 1002-1 Etowah Ave., Royal Oak, Mich.

MODELS—Your ideas developed into practical working models. 30 years' successful experience; thousands of satisfied customers. Confidential service guaranteed. Bank references. Send 3c postage for 32-page book—"Making Inventions Pay." Crescent Tool Co., Dept. Y, Cincinnati, Ohio.

RAILWAY Models. Catalog handbook 25c. Walthers, 247 E. Erie, Milwaukee.

WRIGHT "Whirlwind" engine. Model lithographed in colors, size 13x22 in. Shows and names every part. Invaluable for aviation students. \$1 postpaid. Popular Mechanics Press, Room (C37), 200 E. Ontario St., Chicago.

BLUEPRINTS AND PLANS

NOVELTY Shelves that are different. Small graceful designs. Very attractive. 12 prints \$1.00. Walter Kohlenberger, 14412 E. Vernor, Detroit, Mich.

HOW To make jointers, shapers, millers and sanders for home shop and 290 other valuable articles in Shop Notes, Vol. 27, only 50 cents postpaid. Popular Mechanics Press, Room (C37), 200 E. Ontario St., Chicago.

HOME CRAFTSMEN

CHEST Of drawers. Plywood. Finish in oak, mahogany or walnut. 19 drawers. A handy and neezy part for every workshop. \$5.00 F.O.B. or write for details. Craftco, Box 92, West Springfield, Massachusetts.

20 FULL-SIZED Novelty patterns of door stops and book ends, etc., 25c. Modern Woodcraft, Saginaw, Mich.

EARN Money, no canvassing, make, paint, sell beautiful gifts, toys, novelties. No expensive equipment, materials required. Send dime for instructions and particulars. Craftsman Art Service, Room 602, 15 William St., New York City.

BUILD Your own practical inexpensive drills, shapers, lathes, etc., using standard pipe, fittings and accessories. Complete plans and instructions. Seven tools easily assembled. \$1.00. The Pipe Craft Company, Box 402, Minneapolis, Minnesota.

KNOCKDOWN Furniture, novelties. Ideal Christmas gifts. Send 10c for catalog. Giles Kendall Co., Decatur, Ala.

POPULAR Turning squares, 2", 10c foot postpaid. Craftwood, 6641 Bramble, Cincinnati, Ohio.

"MODERN Wood sculpture." Complete instruction book on carving statues \$1.00. Lee, Wood Art Studio, Centerville, Ia.

HOMEMADE Drill press, belt sander, forge and 328 other practical shop articles in Shop Notes, Vol. 31, only 50c postpaid. Popular Mechanics Press, Room (C37), 200 E. Ontario St., Chicago.

LEATHERCRAFTSMEN—Write for free instructions and price list of leather, tools, etc. Sample cards 5c. Wilder & Co., Dept. F, 1038 Crosby St., Chicago, Ill.

DESIGN Your own furniture. Our complete course shows you how. Only \$8.50. Invaluable to home craftsmen. Write for descriptive folder. Klok Institute, 430 Lyon, Grand Rapids, Mich.

HOMEMADE Band saw, saw table, jointer, grinder and 350 other practical shop subjects in Shop Notes, Vol. 32, only 50c postpaid. Popular Mechanics Press, 200 E. Ontario St., Chicago.

OLD GOLD, WATCHES, JEWELRY, PRECIOUS STONES

GOLD \$35 Ounce. Ship old gold teeth, crowns, jewelry, watches—receive cash by return mail. Satisfaction guaranteed. Free information. Dr. Weisberg's Gold Refining Co., 1500-Q Hennepin, Minneapolis, Minn.

HOW To identify and determine value of old precious metals. Where to buy. To whom to sell. Reliable and up-to-date information. Complete instructions only \$1 postpaid. Popular Mechanics Press, Room (C37), 200 E. Ontario St., Chicago.

TRADE Watch repairing. Mainsprings 50c. Paul Jewelry Co., LaCrosse, Wis.

AUSTRALIA'S Lovely opals. Illustrated catalogue free. Good selection \$5. Norman Seward, Melbourne, Australia.

5000 REBUILT Open face Waltham, Elgin watches. New chromium open face cases. Make big money! 12 size, 7 jewel, \$4.75; 16 size, 17 jewel, \$7.50. Send 3c stamp for free catalog. The New York Jobbers, Dept. M, 74 Bowery, New York, N. Y.

CASH For old gold, teeth, watches, jewelry. Full cash value mailed day shipment received. Satisfaction guaranteed or articles cheerfully returned. Information free, or ship today. Chicago Gold Smelting Co., 300-P Champlain Bldg., Chicago.

FOR THE HOME

AUTOMATIC Humidifiers for furnaces. \$14.75-complete. High capacity evaporator. Save fuel. Be comfortable, healthy. Free circular. Airmister Company, Omaha, Nebraska.

AIR-CONDITION Your steam heated home with Ace humidifying valves, \$1 per set. Ace Agency, 905 S. 16 St., Newark, N. J.

METAL Furniture in modified modern design, how to make, described in Shop Notes for 1937 only 50 cents postpaid. Popular Mechanics Press, Room (C37), 200 E. Ontario St., Chicago.

TOBACCO

GUARANTEED: Cigarette, pipe or chewing, 5 lbs., \$1.00; ten, \$1.75. Pay when received. Pipe and box cigars free. Rives Tobacco Co., Paducah, Ky.

FREE Smokes—Tell me your favorite brands of tobacco, cigars, cigarettes. I'll send free samples and show you better smokes for less money. Pete Moberly, Box 1044, Owensboro, Kentucky.

CHEWING, 4 Pounds, \$1.25. Subac smoking Gold Leaf burley, Turkish tobacco, 3 pounds \$1.10 postpaid. Belmont Farms, Chatham, Va.

LOOK! Higher quality! Golden yellow smoking or rich ripe chewing, four pounds, guaranteed and postpaid, \$1. Riverside Ranch, Hazel, Ky.

RAZOR BLADES—SHARPENING

100 FINEST Double edge razor blades, \$1.00. Franal, Box 214, Pittsfield, Mass.

100 RAZOR Blades, Double or single edge. \$1.50 postpaid anywhere USA. Razor free. Jackson, Box 858, Fayetteville, N. C.

SURVEYING INSTRUMENTS

GUARANTEED Factory rebuilt transits and levels for rent (with purchase option) or sale (cash or terms). Order now before prices advance. We will repair, trade in, or buy your old instruments. Ship prepaid for estimate and valuation. Write for List M-31 and complete information to Warren-Knight Co., 136 N. 12th St., Philadelphia, Penna.

WANTED—MISCELLANEOUS

WANTED: Used diving suit. Harstad, 915 Vine, Eau Claire, Wis.

CASH For used microscopes, binoculars, slide rules, drawing sets, cameras, surveying, medical and scientific instruments, tools, marine equipment. Highest prices paid day shipment received. Satisfaction guaranteed or shipment promptly returned. Elman's, 2302 Van Buren, Chicago.

PERSONAL

BUSINESS Men, collect past due accounts. 25 friendly reminders 50c. Davis Oil Co., Ridgeway, Wis.

POEMS Written on any subject. Rates reasonable. Earle Campman, 631 Superior Street, New Castle, Penna.

NERVOUSNESS, Nervous fear! Afflicted? Free, interesting information. Investigate! John Englund, Ontonagon, Mich.

HAIR Thinning? Want results? Write Healthway, 60 Weldon, Rochester, N. Y.

ULTRA Violet—Infra red. Dual ray health lamp. Two separate units in one. Promotes sun tan—vitamin "D." Automatic control. AC-DC current. \$3.90 postpaid. Details free. Beyer Mfg. Co., 4515-P Cottage Grove, Chicago.

SHOOTING High in life? Seeking greater personal power? Particulars free! Johnston, 257pm North Washington, Tiffin, Ohio.

WIN Prize money! New booklet—"Successful Contesting"—shows how. 10c postpaid. Bulletin listing \$200,000.00 prizes included free! World Publishers, 4515-B Cottage Grove, Chicago.

WANTED, Original poems, songs, for immediate consideration. Send poems to Columbian Music Publishers, Ltd., Dept. 33, Toronto, Can.

BEAR Oil—Best treatment for baldness. You never saw a bald headed Indian. They use it. We can supply you with the genuine product. One dollar prepaid. Swastika Drug Co., Limited, Swastika, Ontario.

STUTTERING And stammering corrected at home. Descriptive booklet free. Paul J. Wolfe, Box 52, Pittsburgh, Penna.

MISCELLANEOUS

BABY'S First shoes preserved in bronze. Circular. Radio Press, Monroe, N. C.

ALASKA Is enjoying prosperity. Business conditions are better in Alaska than they have been for many years. If you wish to know or receive any information about Alaska, write The Alaskan, a newspaper published in Alaska. Subscription rates \$1.00 per year. Advertising rates 35c per inch. Address The Alaskan, Box 332, Juneau, Alaska.

FREE Illustrated catalog, sports equipment, games, stamp accessories, coin boards. C. Otto, 1418-CM Leonard, Evanston, Illinois.

YOU'LL Like resilvering mirrors, autographs, reflectors, making chipped glass signs. Write, Sprinkle, Plater, 288, Marion, Indiana.

PHYSICAL Perfection course \$1. Sid's System, 8421 Evergreen, Southgate, Calif.

SWAPPERS, Collectors, investigate free trading service. Exchange, Box 425, Detroit.

MEXICAN Finest feather pictures: 4x9" costs 25c including duty, retails \$1.00. (Sample 20c stamps.) Embroidered tablecloths: 36x36" with napkins costs \$1.18, retails \$2.50. (Sample \$1.00.) Agents wanted. Free particulars. Marquez, Apartado 1176-X, Mexico City.

NOVELTIES: 12 Assorted samples 10c. Novelties, 1525 Grove, Lafayette, Ind.

SWAP Or sell: Articles you don't need for those you want. Send dime for Swapper's Guide, listing articles from over U. S. Dept. PM, Swapper's Guide, Delphos, Ohio.

MARVELOUS, New, pocket cash box, six compartments; neat, durable. 90c, postpaid. Unique Products, Waynesfield, Ohio.

FACTORY Sacrifice—1938 furnace oil burners. Underwriter's approval. Were \$285; \$75 complete, guaranteed. Hoover Oil Burners, Bridgeport, Conn.

CONVERT Any hot water tank to automatic electric at very low cost. Plans \$2.00 postpaid. Z and Z, 1877 Penthley Ave., Akron, Ohio.

MONEY In butterflies, moths. See Sinclair Display Advertisement on page 20A.

TWO Profitable shop books—Lathe and Drilling and Thread Cutting—filled with hundreds of valuable "kinks" discovered by successful mechanics all over the world. Both postpaid for \$1.15. Popular Mechanics Press, Room (C37), 200 E. Ontario St., Chicago.

GOLD Specimen \$1. Rocks. Minerals. Swallow, 849 Flora, Winnipeg, Can.

LIKE To draw? Earn steady income tracing and duplicating advertising cartoons. Ad-Service, Argyle, Wis.

WATERPROOF Basement walls, floors. Inexpensive. Easy. F. Gerwin, Meeker, Oklahoma.

67 PENMANSHIP Copies \$1.00. 6 cards and samples 10c. Bert Rich, Wizard of the Pen, Ocala, Florida.

CHRISTMAS Gift pencils. 144 \$2.75. Samples 5c. Ad-Craft, LaCrosse, Wis.

TATTOOING Outfits, supplies, illustrated lists free. Waters, 965 Put-nam, Detroit.

SWAPPER'S Friend, R4, Saline, Mich. Interests swappers, collectors, sportsmen. 50c year, sample 10c.

AMATEUR Tattooing outfits, illustrated catalog 6c. "Tatuo," 651A S. State, Chicago.

10,000 MONEY-MAKING Formulas. Tells you how to make and sell almost everything under the sun; cosmetics, muclage, anti-freeze solutions, battery solution, beverages, cheese, chewing gum, cleaning preparations, extracts, hair preparations, inks, bluing, leather polish, mirrors, perfumes, polishes, typewriter ribbons, carbon paper, washing powders, liquid soap, and hundreds of other profitable articles. \$4 postpaid. Popular Mechanics Press, Room (C37), 200 E. Ontario St., Chicago.

NOW I KNOW WHAT FRED MEANT WHEN HE SAID HE GOT HIS PAY BOOST OUT OF A TWO DOLLAR BOOK.



PAY RAISING EXTRA MONEY BOOKS THAT WILL HELP YOU WIN SUCCESS

You, too, will find the selected list of practical books below just what you need to help you improve your job, prepare for a better one, or add to your income through spare time earnings. Thousands give these books credit for their success.

SEND NO MONEY! Use this advertisement as an order blank. Check books wanted. Add name and address and mail. Just pay postman price plus few cents postage. (In U. S. and possessions.) Or remit with order and add 10 cents per book for postage.

POPULAR MECHANICS PRESS

Room 138B 200 East Ontario Street Chicago

- AIR CONDITIONING**
Live Field; Great Future.....\$3.50
- AUTO ENCYCLOPEDIA**
The Famous Dyke's Latest Edition.....\$6.00
- 110-V. GENERATORS**
Made From Old Auto Units.....\$1.00
- BIRD HOUSES**
Build to Sell; Easy Designs.....\$1.00
- BLUEPRINT READING**
for the Building Trades.....\$1.25
- BOAT BOOK**
Power, Sail, Rowing, Paddle Plans.....\$3.00
- BOY MECHANIC**
Hundreds Things Boys Can Make.....\$2.00
- CARPENTRY, PRACTICAL**
Complete 436 pages. 1936 Edition.....\$2.00
- CHEMISTRY, PRACTICAL**
Make Hundreds Things Daily Use..\$2.00
- CIVIL SERVICE**
Home Study Courses Federal, State, City Positions.....\$1.00
- CONCRETE**
1001 Ideas for Using. New Popular Mechanics Book...\$5.00
- DIESEL HANDBOOK**
New! Latest Information.....\$5.00
- ELECTROPLATING**
With Copper, Nickel and Chromium Technical bulletin.....\$1.00
- FORD V-8 CARS, TRUCKS**
New, 700 Pages. Includes Details 1937 Cars.....\$2.50
- FORMULAS**
1059 Money Making. Start a Business...\$1.25
- FROG INDUSTRY**
New! Raise and Sell Profits!.....\$1.00
- FURNITURE MAKING**
Tools, Materials, Design.....\$2.50
- HOUSES, SMALL**
Book of, for Home Builders.....\$2.00
- HYPNOTISM**
How to Become an Expert.....\$2.00
- LATHE WORK (Metal)**
Drilling, Threading..\$1.00
- LOCOMOTIVE**
Folding Chart Shows all Parts.....\$1.00

- LOG CABINS**
Easy Plans; Build for Profit, Value!.....\$2.50
- MATHEMATICS**
Easy Guide for the Practical Man.....\$1.50
- MECHANICAL DRAWING**
Learn Drafting; Good Salaries.....\$1.00
- MONEY MAKING IDEAS**
1000 Ways to Make \$1000.....\$2.50
- OFFICE MACHINES**
All Makes. Care and Operation.....\$2.50
- PLUMBING**
500 Facts Every Homeowner Should Know.....\$1.50
- TEST GOLD—PLATINUM**
Identify—Buy—Sell. By C. M. Hoke....\$1.00
- POWER TOOLS**
For Home Workshop..\$1.75
- PROSPECTORS' HANDBOOK**
How to Mine, Appraise, Equip.....\$3.00
- RADIO SERVICING**
Profit by Knowing Costs, Kinks, Etc..\$4.00
- REFRIGERATION**
Electric. Gas. Be a Service Expert.....\$5.00
- REWINDING ELECTRIC MOTORS**
Fractional Sizes. Value!.....\$2.50
- SHIP MODEL**
Entire Text, Famous "Sovereign" of 1637\$1.00
- SHOP NOTES LIBRARY**
5 Vol. 2000 Wonderful Shop Ideas.....\$2.50
- STAMP ALBUM**
Modern, 400 Pages...\$1.00
- STEEL SQUARE**
How to Figure Angles of Rafters, Roofs, Etc.....\$1.00
- TOYS**
For Amusement or Profit. Saleable Designs.....\$1.50
- TRAILER BUILDING**
New Book.....\$1.00
- UPHOLSTERY**
Always a Big Market. Start Own Business..\$2.00
- WOOD FINISHING**
Methods, Tools, Materials.....\$2.00



SECRETARIES STENOGRAPHERS TYPISTS



STENOTYPY wins the better jobs

Machine-typed shorthand is the modern way in convention, office, courtroom and conference

THOUSANDS are now earning bigger salaries, winning promotions, preparing for further advancement with Stenotypy—the new way to better positions for office-trained men and women.

Enables you to keep pace easily with fastest talkers—150 to 200 words (or more) a minute. Easier to learn, to write, to read. Types plain capital letters. Accurate and unforgettable. No "cold" notes.

Small, lightweight machine goes with you anywhere, is instantly ready for silent, efficient, streamlined speed, accuracy and ease.

Stenotypist-secretaries head for executive jobs on an inside track, because executives welcome this new, better method. Nine out of ten conventions are reported by Stenotypists.

You can now learn Stenotypy right in your own home, in spare time, at low cost, on easy terms. Get full details in our newest book: "Stenotypy for Better Business Careers," describing the exceptional opportunities for ambitious men and women in this growing field.

Join the thousands who are really going places! Send the coupon NOW!



LASALLE EXTENSION

Dept. 164-ST
Chicago, Illinois

I'd like to know about your Stenotype training and to have a free copy of your 32 page booklet, "Stenotypy for Better Business Careers."

Name.....

Address.....

Age..... Position.....

When writing please mention Popular Mechanics



DRAFTING

BOOKS SENT FREE!

ON APPROVAL
5 VOLUMES BRAND NEW EDITION

Only 15 minutes a day with these WONDER BOOKS can prepare you for a good drafting job in less than a year. Mechanical and architectural drafting from simple straight lines to important complex plans. *A step at a time!* Built especially for beginners, for men with only grammar schooling. Drafting room practice. PLUS ENGINEERING, made easy and clear. Includes complete course in blueprint reading.

Big Field Big Demand Big Pay

Competent draftsmen are urgently needed right now in all building and manufacturing lines at \$30.00 to \$75.00 a week. That's just the beginning—FOR DRAFTSMEN HAVE THE BEST CHANCES FOR ADVANCEMENT. Pleasant, fascinating work, easy to learn and do. Learn quickly with these books—send coupon for a set and see for yourself.

A year's consulting membership in the American Technical Society now given to subscribers of this famous cyclopedia of drafting. Many say that it is worth more than the cost of the books.

Complete set of drawing instruments if you send for these drafting books NOW.

These instruments are made of the finest of German silver, are absolutely accurate and are packed in velvet lined leatherette pocket case. Real \$10 value, but included with these books.

AMERICAN TECHNICAL SOCIETY
Dept. D119, Drexel at 58th St., Chicago, Ill.

American Technical Society, Dept. D119, Drexel at 58th St., Chicago, Ill.
Send for 10 days' trial New 5 volume set of drafting. I will pay the few cents delivery charges. If I wish, I may return books in 10 days and owe you nothing but if I decide to keep them, I will send \$2.00 after 10 days, then only \$3.00 a month until \$24.80, the advertising price, is paid. Send latest edition and include drawing instruments and Membership Certificate.

Name.....
Address.....
Attach letter stating age, occupation, employer's name and address and that of at least one business man as a reference.

AUTO-MECHANICS & WELDERS

GOOD JOBS and MIGHTY GOOD PAY

Do you want to earn big money? If so let us know which of the following trades you prefer. You learn by doing. Practical work. Expert teachers. Low tuition. Personal attention. It will pay you to investigate AT ONCE. Just check the courses you'd like to take and mail today. You will receive full information, absolutely without cost or obligation. But don't delay.

Check the Trade You'd Like to Learn

- | | |
|--|--|
| <input type="checkbox"/> Auto Mechanics | <input type="checkbox"/> Welding |
| <input type="checkbox"/> Auto Collision | <input type="checkbox"/> Spray Painting |
| <input type="checkbox"/> Metal Finishing | <input type="checkbox"/> Torch Soldering |

Ask about our "Pay After Graduation Plan"

Name

Address

Mail the above to

MICHIGAN TRADE SCHOOL

Write for FREE CIRCULAR

3758 Woodward Avenue DETROIT, MICH.

Increase Your Earning Power

Apply time and labor-saving kinks to your work. Your efficiency will soon be recognized and you will be in line for advancement.

If you do machine shop work of any kind, sheet-metal work, painting, carpentry, auto repairing, farming, concrete work, plumbing, electrical work, welding, building-glass work, general repairing, tool-making, poultry raising, masonry or home repair work, get this

LIBRARY OF 2400 TIME AND LABOR SAVING IDEAS FOR SHOPMEN AND HANDYMEN

JUST OUT

SHOP NOTES for 1938

318 Articles
645 Illustrations
224 Pages
Price 50c
See partial list of contents below

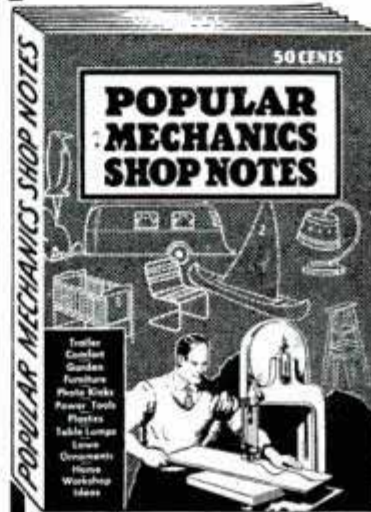

Including the new 1938 issue illustrated above, there are six volumes in the Shop Notes Library of 2400 easily understood short cuts to every-day jobs. Here are just a few of the subjects taken from the latest issue:

- | | | |
|--|---|---|
| Are Welder, Auto Motor Runs | Garden Furniture, Metal Gas Engine, Midget Hacksaw, Electrically Driven | Plastic Ornaments |
| Bits, Wood-boring Cabinet Humidifier over Radiator | Hydraulic Rams for Country Homes | Sail Rig, Airstream Sander, Oscillating Saw, Power-Driven Table |
| Carpenter's Hints for Child's Crib | Jigs for Belt Sander | Shaper Projects |
| Corrosion, Guarding Against | Jigs for the Shaper | Snow Plow, Small Rotary Table Lamps from Plastics and Metal |
| Drilling, Safe Drills, Using Driveways, Durable Electroplating | Kinks for Photographers Ladder Chair Laundry Cart | Temperature Indicator, Electric |
| Frozen Water Pipes, Thawing Electrically | Lawn Ornaments Movie Film, Power Reel for Developing | Trailer Brakes, Vacuum Trailer Comfort Torch, Electric Arc Wood Turning Kinks |
| Garage, Profit Makers for | Photographic Equipment | |

Each volume contains approximately 400 articles and 600 illustrations and has 200 or more pages. This unrivaled library of shop helps may be secured for a limited time only. After the present supply of books is exhausted the offer must be withdrawn.

Send No Money

POPULAR MECHANICS PRESS,
200 E. Ontario St., Room 138, Chicago, Ill.

Send me, as per your offer, the following books. I will pay postman price and small amount of postage. My money will be refunded if I am not satisfied. (Check what you want.)

- 1938 Shop Notes and Lathe Handbook (Metal Working), both for 98c.
 Shop Notes Library (6 vols.) \$3.00.

Name.....

Street and No.....

City..... State.....

*C. O. D. applies to U. S. and possessions only. If you reside elsewhere, remittance must accompany order.

When writing please mention Popular Mechanics

AIR CONDITIONING AND ELECTRIC REFRIGERATION INDUSTRY NEEDS TRAINED MEN

34-year-old organization now receiving applications of men to prepare for positions in Air Conditioning and Electric Refrigeration. Qualify in 3 months for Estimating, Installation, Service, Maintenance and Sales positions. No experience needed —we train you under actual working conditions in our own air conditioned laboratories. Free employment service. Get free book "Step Up to Success" —just off the press. Write

MILWAUKEE SCHOOL OF ENGINEERING

1020-Q North Broadway, Milwaukee, Wis.



Auto-Diesel

Master a real trade. Auto Mechanics, Diesel Mechanics, Arc Welding, Acetylene Welding, etc. Let us train you to be an expert Auto-Diesel Mechanic and help you get a good job. The cost to you is reasonable. Learn on modern equipment with tools under experienced instructors. Real shop work. Steam heated buildings. Room and board in our steam heated dormitory. We pay your fare to Nashville. For free catalog write

Nashville Auto-Diesel School, Dept. 75, Nashville, Tenn.

CARTOON YOUR WAY TO SUCCESS!



DON'T COPY—LEARN TO ORIGINATE!

RAYE BURNS will teach you HOW to CREATE ORIGINAL CARTOONS at home that you can SELL! Course contains 26 lessons and over 600 illustrations. All for Only... **\$3.85**

Send name and address for free details.

RAYE BURNS SCHOOL, Dept. 10, BOX 2194, Cleveland, Ohio

FENCING World's Finest Sport



Boys! Become the best swordsmen in your neighborhood. Develops both body and mind. Harmless, because the spring-steel 3 ft. long foils are equipped with rubber buttons. Cup shaped hand guards. Complete set of two foils (swords) and free instruction booklet only \$1.58 postpaid. Order Now.

INDUSTRIAL PROD. CO., Dept. 13M, 274 Madison Ave., NEW YORK, N. Y.

EARN THE DEGREE

Doctor of Psychology (Ph.D.), Philosophy, Science, General Courses—Arts, Law, Business, etc. "CHARTERED BY STATE OF MONTANA." Send for FREE Bulletin at once. No Obligation. Temple Bar College, Dept. 2-R, 213 East Main Street Missoula, Montana, U. S. A.

do-it-with-squabs



Markets UP. Supply scarce, demand big. Write a post-card, get FREE EYE-OPENING Picture Book. Why breed for ordinary trade when these great luxury national markets are wide open for all the SQUABS you can ship, every day in the year? We give a large bonus in stock for promptness.

RICE FARM, 636 H St., Melrose, Mass.

OLDEST POULTRY JOURNAL NINE ISSUES 25¢



Helps increase Poultry Profits. Send coin or stamps. Only \$1.00 for 3 years or 25 cents for 9 months trial. Agents wanted. American Poultry Journal 532 So. Clark Street, Chicago, Illinois

LOOK! Baby Chicks THOUSANDS WEEKLY ALL YEAR



Finest quality & Layers in 40 breeds. Hybrid Baby Pullets and Cockerels, B. W. D. Tested. Ducklings, Goslings, Baby Turkeys, Guineas. Mature Breeders priced right. In business 28 years. Catalog free. Nabob Hatcheries, Box M, Gambier, Ohio.

RAISE GIANT FROGS

FREE BOOK



BIG DEMAND! Good prices year round. Nation-wide markets waiting for all you can ship. **WE BUY!** Sell to us also. Breeder lays 20,000 eggs yearly. Get ready now for next spawn. Start with small pond, creek, lowland. Free book shows sketch. Men & Women starting in every state and Canada. See what others are doing with our methods. Send no money! Just your name and address on postcard brings special offer to beginners. Write, AMERICAN FROG CANNING CO. (Dept. 133-A) New Orleans, La.



U.S. GOVERNMENT JOBS

START

\$1260 to \$2100 YEAR

MANY 1938

APPOINTMENTS EXPECTED

Railway Postal Clerks

Railway Postal Clerks get \$1,900 the first year regular, being paid on the first and fifteenth of each month. (\$79.17 each pay day.) Their pay is automatically increased yearly to \$2,450. Advance may be had to Chief Clerk at \$2,700 a year. (\$112.50 each pay day.)

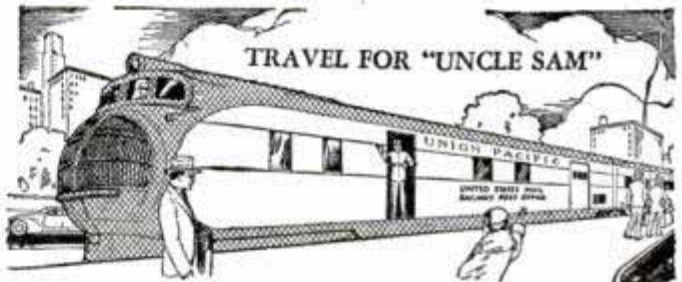

3 Days On—3 Days Off—Full Pay

Railway Postal Clerks on long runs usually work 3 days and have 3 days off duty or in the same proportion. During this off duty their pay continues just as though they were working. They travel on a pass when on business. When they grow old, they are retired with a pension.

City Mail Carriers, Post Office Clerks

Clerks and Carriers now get \$1,700 the first year on regular and automatically increase \$100 a year to \$2,100 and \$2,300.

Customs Inspector



Salary \$2,100 to start. Men 23 to 45. Work connected with examining baggage and merchandise entering the country from foreign parts covering boats, trains, roads, automobiles, etc.

Many Other Positions

Many other positions are obtainable. Those wishing these positions should qualify at once.

Get Free List of Positions

Fill out the following coupon. Tear it off and mail it today—now, at once.

This investment may result in your getting a big-paid government job.

FRANKLIN INSTITUTE, Dept. L-173, Rochester, N. Y.

Rush to me, entirely free of charge (1) a full description of U. S. Government Jobs, (2) Free copy of illustrated 32-page book, "U. S. Government Positions and How to Get Them"; (3) List of U. S. Government Jobs; (4) Tell me what to do to qualify for one of these.

Name.....

Address.....

Use This Coupon Before You Mislay it. Write or Print Plainly

STEP INTO THE Spotlight

FREE LESSONS... A YEAR TO PAY

Banish Boredom . . . Earn Extra Money START TO PLAY VERY FIRST DAY

Picture the joy of playing a snappy foxtrot, dreamy waltz or mellow old favorite on the Xylorimba. No reason why you shouldn't! Xylorimba is **easiest** of instruments to play and yet the most spectacular. In constant demand by orchestras, radio stations, at lodge meetings and parties. Marvelous opportunity to increase popularity, make big spare-time money. No bothersome practice or exercises. With Free easy lessons you actually **Start to Play Very First Day.**

BIG FREE BOOK tells all about Deagan line, liberal trial offer and easy payments. Send coupon today for your free copy.

J. C. Deagan, Inc., Dept. 2451, 1770 Berceau Ave., Chicago

Send me, without obligation, full details of Free Trial offer and easy-payment plan on the Deagan Xylorimba.

Name.....

Address.....

AUDELS Carpenters and Builders Guides 4 vols. \$6



Inside Trade Information for Carpenters, Builders, Joiners, Building Mechanics and all Woodworkers. These Guides give you the short-cut instructions that you want—including new methods, ideas, solutions, plans, systems and money saving suggestions. An easy progressive course for the apprentice and student. A practical daily helper and Quick Reference for the master worker. Carpenters everywhere are using these Guides as a **Helping Hand to Easier Work, Better Work and Better Pay.** To get this assistance for yourself, simply fill in and mail the **FREE COUPON** below.

Inside Trade Information On:
 How to use the steel square—How to file and set saws—How to build furniture—How to use a mitre box—How to use the chalk line—How to use rules and scales—How to make joints—Carpenters arithmetic—Solving mensuration problems—Estimating strength of timbers—How to set girders and sills—How to frame houses and roofs—How to estimate costs—How to build houses, barns, garages, bungalows, etc.—How to read and draw plans—Drawing up specifications—How to excavate—How to use settings 12, 13 and 17 on the steel square—How to build hoists and scaffolds—skylights—How to build stairs—How to put on interior trim—How to hang doors—How to lath—lay floors—How to paint.



THEO. AUDEL & CO., 49 W. 23rd St., New York City
 Mail Audels Carpenters and Builders Guides, 4 vols., on 7 days' free trial. If O.K. I will remit \$1 in 7 days, and \$1 monthly until \$6 is paid. Otherwise I will return them. No obligation unless I am satisfied.

Name.....

Address.....

Occupation.....

Reference..... P.M.

NEW INVENTIONS

(Continued from page 42A)

LAUNCHING lifeboats would be made safer under a recent patent covering

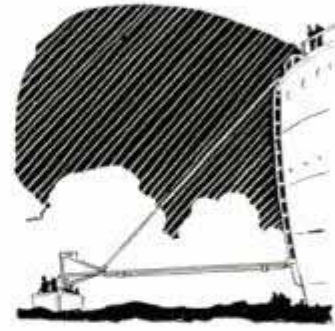

apparatus designed for installation on ships. This equipment would swing the lifeboat from its inverted position aboard ship and lower it to the water by a semi-circular motion. An automatic release frees the lifeboat from the apparatus when it touches the water. A windlass and cable raise and lower the launching arm.

BBETTER vision for the winter driver is the object of a patented combination

sun visor and windshield heater. The visor could be swung out of place when not in use. Means for conducting heat from the car heater is provided. When the visor is swung



downward for use, it connects with the heating means in such a manner as to direct the warm air over a predetermined area of the windshield, thus preventing frosting. The visor has a translucent portion so that the driver may see the road.

AMATEUR and professional gardeners would find a recently patented shrub-



bbery trimmer an aid in their work, particularly in keeping the hedge neat. The trimmer consists of a handle with a housing containing an internal combustion motor. The motor

has the thrust lines of its pistons lying in the plane of the axis of the handle. The cutters are connected to the motor. A guard mounted on the housing in a manner to surround the cutters protects the user, and prevents damage to the machine.

You are Invited to Come to
LINCOLN
for Complete Training for a
GOOD PAY JOB in AVIATION

Learn Aviation at Lincoln. Prepare Yourself now for a Big Pay Job in Aviation. Exceptional opportunities for trained men. Airline Pilots earn up to \$700 a month; Mechanics up to \$200 a month. Airlines adding millions of miles to flight schedules—hundred million dollars being spent on new airplanes. Lincoln Training prepares you for your Government Rating. 14 MODERN TRAINING PLANES. 12 practical shops and laboratories. You get experience on wide variety of airplanes and engines. Instructors hold Government Rating. Lincoln Graduates in demand. We assist graduates in locating positions. Write today for complete information. State age.

LINCOLN AIRPLANE & FLYING SCHOOL
 204-H Aircraft Bldg. Lincoln, Nebr.

THERMOSCHOOL

Home study course for men interested in steam or Diesel power plants, internal combustion engines, refrigeration, or air conditioning. Entertaining, recreational, instructive, and profitable. Get greater satisfaction from your work. Prepare for advancement. Continued education is the best insurance for job security. If your work is in any way related to these fields, send name and address now for further details.

THERMOSCHOOL Box 302 LEXINGTON, KY.

Free AIR CONDITIONING AND REFRIGERATION TRIAL LESSON

Trained men needed. Good pay. Opportunities. Learn easily AT HOME in spare time. Write today for **FREE TRIAL LESSON**.

CHICAGO TECHNICAL COLLEGE
 A302 Tech Bldg., 118 E. 26th St., Chicago, Ill.
 If you can go away to college to learn Air Conditioning, Engineering Architecture, Drafting, Electricity, or Radio, send for Free Blue Book

ARTISTS MAKE MONEY

Find out your ability. Send name, age, occupation and address for Free Vocational Art Test.

Federal Schools, Inc., 1138 Federal Schools Bldg., Minneapolis, Minn.

RADIO ENGINEERING, broadcasting, aviation and police radio, servicing, marine and Morse telegraphy taught thoroughly. Nine months' engineering course equivalent to three years' college radio work. School established 1874. All expenses low. Catalog free.

Dodge's Institute, Ada St., Valparaiso, Ind.

S AGENTS 500% Profit SIGN LETTERS

For Store Fronts and Office Windows. Anyone can put them on. Free samples. Liberal Offer to general agents.

METALLIC LETTER CO., 438 N. Clark St., Chicago

GROW NEW HAIR OR MONEY BACK!

with **SENSATIONAL Vacuum Helmet**

Same Principle as used in machines costing \$150.00 now available for your use in new Low Price Home Unit. Complete equipment only \$21.50. AND—your money back if it doesn't grow hair on your head! Send check or send name for further information, guarantee, FREE Trial Offer, etc.

Hydro-Vac, Inc., Dept. 161, Walnut Bldg., Des Moines, Iowa

NEW SCIENTIFIC WONDER

"X-RAY" CURIO

10c 3 for 25c

Reg. U.S. Pat. Off.

BOYS BIG FUN. You apparently see thru cloth. Wood, Stone, any object. See Bones in Flesh. **FREE PACKAGE** radio picture film, take pictures without camera. "You'll like 'em." 1 package with each 25c order.

MARVEL MFG. CO., Dept. 80 NEW HAVEN, CONN.

There's MONEY IN ARC WELDING!



"No more tiresome work for me. I get a real thrill out of being an arc welder—and don't forget it, I'm getting more money than I ever earned on hit or miss jobs."

You, too, can become part of this great new industry! There's almost no limit to what welders can accomplish—they cut manufacturing costs way down. Because they know the "How and Why" of Welding, Metallurgy, Drawing, Blueprint Reading, Set-Up Work and Fabrication.

No wonder manufacturers all over the country are demanding practically trained School of Engineering Welding Operators, Welding Technicians, and Welding Engineers!

Don't be content with ordinary work at low pay—when in a short time you can become a thoroughly Trained Specialist in Welding.

MILWAUKEE SCHOOL of ENGINEERING
 Institute of Electrotechnics

1020P-N. Broadway and E. State, Milwaukee, Wis.

Send Free Booklet "The Dawn of Gigantic Industry and its Outstanding Opportunity." Also tell me how I can become an

Arc Welding Operator in 3 months..... Gas Welding Operator (6 weeks).....
 Welding Technician (6 months)..... Welding Engineer (1 year).....

Send details of Student Loan Plan..... Earn Part Expense Plan.....

Name..... Age.....
 City..... State.....

If interested in other courses, check here: Refrigeration and Air Conditioning Technician (3 mo.)..... Radio and Television Service Man (6 Mo.).....
 Commercial Radio Engineer (1 Yr.)..... Electrical Engineer B.S. Degree (4 Yrs.).....

This MACHINISTS' Home-Study Course helps men get ahead



Newly assembled—specially priced—these five recent books give you the practical facts on modern machines, up-to-date methods, you need to advance in machine shop work. Take advantage of the other man's experience as found in books, to solve your problems, increase your efficiency, with the new

Library of MODERN MACHINE SHOP PRACTICE

5 volumes—2000 pages—1600 Illustrations
 (A combined home-study course and reference library)

This library of machine shop practice was written for practical men. It gives you the best methods for every kind of machine shop work. It fully explains lathes, drills, and other machine tools and their operation, automatic screw machines, speeds and feeds, gear design and production, punch and die work, metal finishing, etc., etc. Plainly written—completely illustrated—the best kind of help to the machine-shop man who wants to advance himself.

No money down—special price—easy payments.

FREE EXAMINATION COUPON

McGRAW-HILL BOOK CO., 330 W. 42nd St., New York

Send me for ten days' free examination the Library of Modern Machine Shop Practice. If satisfactory I will send you \$1.50 in 10 days and \$3.00 monthly until the price of \$16.50 is paid. If not wanted, I will return the books postpaid. (To insure prompt shipment write plainly and fill in all lines.)

Name.....
 Home Address.....
 City and State.....
 Position.....
 Name of Company..... PM-1-38

When writing please mention Popular Mechanics

Learn to MOUNT Birds and Animals



FUN • PROFITS

Send Today for Free Book

Old reliable school (250,000 students) will teach you **AT HOME** to Mount **BIRDS, ANIMAL HEADS, FISH and TAN SKINS and FURS.** Write now—at once.

SPORTSMEN: Save your trophies. Game is growing scarcer—every **Specimen** is valuable. Keep them—save them—mount them. Decorate your den. Fun and fascination. Profits, too.

TAN heavy and light skins and furs. Make real **HARNESSE LEATHER, BUCK SOLE LACE, ETC.** Best method known, but easy and simple. Don't sell those hides cheap. Tan them for your own use. Make leather vests, belts, gloves, etc. **TAN FOR OTHERS.**

FUR-WORK for men and women. Tan and make up scarfs, capes, coats, muffs, mitts, trimmings. Quickly, easily learned.

EXTRA MONEY \$40 to \$80 a month, even more some students report. Big demand for **TAXIDERMY, TANNING AND FUR-WORK.** A real spare-time business—good in every community. If you need extra money, **WRITE!**

FREE BOOK

48 pages, 100 beautiful pictures, tells **ALL** about Taxidermy, Tanning, Fur-Work. Write **Today**—this minute for this **STRANGE, MARVELOUS FREE BOOK.** A postal will do. State **AGE.**

N. W. School of Taxidermy, 3371 Elwood Bldg., Omaha, Neb.



BIG Free BOOK ON CRIME CASES

Send NOW for this fascinating book on Scientifically Solved True, Sensational Crime Cases. It is absolutely **FREE** and will be sent to you postpaid if you are 17 years of age or over and are interested in following a career of thrills and steady pay.

This amazing book also tells **YOU** how **YOU** can get into Scientific Crime Detection by studying at home just a few hours each week during your spare time. Learn about our extra easy terms policy making it easy for **YOU** to get this training. Learn about the new opportunities for travel, adventure, regular pay checks, steady employment, and how you can establish your own detective agency. **EXPERIENCE NOT NECESSARY.**

Course includes Finger Prints, Bertillon Portrait Parle', Criminal and Private Investigation, Police Photography, Handwriting and Secrets of Defense and Attack. Fill in Coupon below—Mail today **SURE.**

SCIENTIFIC CRIME DETECTION Dept. 2A8
INSTITUTE OF AMERICA, INC. J. T. Burdette, Pres.
Chesapeake & Ohio Bldg.
Huntington, West Virginia

Gentlemen: Without obligation, send big book including 14 famous cases, telling how I can get into Scientific Crime Detection.

NAME.....
ADDRESS..... AGE.....

HE WAS ASHAMED OF HIS SKINNY BODY!

But He Gained 30lbs. Quickly on Kelpamalt . . Now Feels Great!

Read This Actual Letter:

The Kelpamalt Co.
Gentlemen:

I had been skinny since childhood. Last September was my 19th birthday, so you see how long I had been skinny.

Most every Sunday the kids in the neighborhood would go swimming. I did not go with them. I suppose they knew why. I was ashamed of my skinny body. I was nervous too. Even when I went to town or to picnics in summer. I was ashamed to have my sleeves rolled up like the other fellows did. A few months ago when I was up town I stepped on a pair of scales. I weighed about 120 lbs. and me a young man going on twenty. I thought of the future—would I always be skinny? I had seen Kelpamalt advertised in the papers and magazines so I bought a bottle. I was sure amazed at how much I gained and how much better I felt. I bought four more bottles. Over two months have passed. I have gained better than 30 pounds. You don't know how much better I feel and look and how thankful I am for what Kelpamalt has done for me. I would not take a hundred dollars for what Kelpamalt has done for me, if I could not get any more.

So I am going to thank Kelpamalt and the Kelpamalt Company for what their sea minerals have done for me.

Lester D. Curless, Astoria, Ill.

Kelpamalt has proven itself so effective as a weight and strength builder because it helps supply the iron, iodine and vitamins vitally necessary for you to get the real good out of your food. Your own doctor will approve this way. Costs but little to use and is sold at all good drug stores.



Posed by Professional Model.

Seedol Kelpamalt Tablets



PLAY A SAW!

Produce wonderful music in 5 days...quickly play popular and classical numbers. No notes to read, no dreary practice—success guaranteed. Since 1924 thousands of my students have amazed friends, starred in shows and broadcasting orchestras. Without obligation, write for 5 DAY TRIAL OFFER now.

MUSSEHL & WESTPHAL
125 W. Water St., Fort Atkinson, Wis.

New York Electrical School

Established 1902

Ask for free booklet
44 West 17th St., N. Y. C.

LETTERING ARTISTS MAKE Big MONEY



BE A SUCCESS—LEARN SHOW CARD PROFESSION "THE ACME STUDIO WAY"—Spend 2 full weeks our Big Chicago Studios—finish training spare time at home. Hundreds taught this way now receive Big Pay. Free Employment service. Positions waiting. Earn while learning. E Z low terms within reach of all. **MONEY BACK GUARANTEE—NO RISK—PROVED PLAN.** Name, address and present occupation brings **FREE ABILITY TEST AND BOOKLET.**

ACME STUDIOS, Dept. PM-1, 24 W. Hubbard St., Chicago, Ill.

JOBS for PHOTO-ENGRAVERS!!

EARN WHILE LEARNING PHOTO-ENGRAVING IN SPARE TIME—Photo-Engravers are needed to operate Tasope' Photo-Engraving Equipment we sell to publishers everywhere . . . Start training at home in spare time. We furnish all equipment including photo-engraving camera with lamps, lens and screen. Earn while learning by making engravings for local advertisers, newspapers, printers, etc. Copper plate for picture shown here, size 8x10 inches sells for \$15.37. **SEND TODAY** for job plan details and catalog illustrated with pictures engraved by equipment we furnish. No cost! No obligation.

THE AURORA SCHOOL OF PHOTO-ENGRAVING
Dept. 117
Aurora, Missouri



Sensational New Kind of LACO OIL HEAT

\$50 to \$100 UNDER OTHERS

Here is positively the greatest improvement ever made in Automatic Oil Heating! A remarkable new 1938 model of the famous LACO, priced \$50 to \$100 under others, actually cuts fuel cost 25%! Needs no attention. Saves usual furnace dirt and work. Amazingly quiet. Only 1 moving part. Approved by Underwriter's Laboratories. Built by one of the world's largest manufacturers. Over 65,000 in use!

WRITE See your LACO dealer. Or, write us for special Direct Price!
DEALERS: Get Free Sample Burner Offer!
Laco Oil Burner Co., 118 Union Ave., Griswold, Ia.



LACO HEATER

Clean, automatic oil heat without a basement. Inner heating unit saves fuel. Handsome as finest furniture. **WRITE!**

Learn to be a LANDSCAPE ARCHITECT



FREE Full information on how to be a Landscape Architect by easy home study. Uncrowded profession open to men, women. Healthful outdoor work. Opportunities for employment assured. Big fees—up to \$100 a week. Write today for book giving opportunities.
American Landscape School, 718 Plymouth Bldg., Des Moines, Ia.

NEW MODEL DRAW-O-MATIC A BETTER DRAWING BOARD

TRANSPARENT TRIANGLES AND STRAIGHT-EDGE. ATTACHED, SELF-ALIGNING, SLIDING PARALLEL BAR. Eliminates old fashioned T square. Thousands now in use by Draftsmen, Artist, Engineers, Students, Architects and Designers. BUILT TO A STANDARD OF QUALITY. Hard composition board; stays flat. No thumb tacks necessary. Rubber Feet, no slipping or marring. Plated metal parts. FOOLPROOF. Bar slides easily and accurately. A SELF-CONTAINED UNIT EASY TO CARRY. Triangles held on back. ENABLES ANYONE TO DRAW WITH ACCURACY AND SPEED. Prices start at \$1.85. THREE HANDY SIZES—12"x16", 16"x20", 20"x25". Light in weight. A perfect gift. SEND FOR FREE CIRCULAR. **AGENTS WANTED.**
ROLLIN PRODUCTS CO., Dept. PM6, 212 W. Hubbard St., Chicago, Ill.

Men & Women Earn Cash at Home!
Raise giant Patented Mushrooms! We supply materials, instruct with pictures, & our 25 branches buy all crops. Big FREE book, photos, tell if your cellar, shed, barn, etc., suitable. Write today.
Est. 1908. UNIT ED CO., 3848 Lincoln Ave., Dept. 305, CHICAGO

5c TIRE MAKES \$2.00 MAT
Make springy, long-wearing Rubber Mats out of old auto tires. Any length or width. BIG sale to schools, factories, stores, homes. Think of the profit. Brand new business, fully patented. Field untouched. Reasonable investment and simple hand machine starts your local plant. Write quick for free information. Don't lose a minute—this is BIG!
FABRIX, INC. Dept. 71 325 W. Huron St., Chicago, Ill.

5¢ EACH LITTLE BLUE BOOKS
Send postcard for our free catalogue. Thousands of bargains. Address: HALDEMAN-JULIUS CO., Catalogue Dept. Desk X-14, GIRARD, KANSAS

Government Jobs

EXAMINATIONS SOON INFORMATION FREE
COLUMBIAN CORRESPONDENCE COLLEGE, WASHINGTON, D.C.

BUILD a BOAT AT HOME

FOR PLEASURE OR PROFIT

Now you can have just the boat you've always wanted—power, sail, or rowboat—and at rock bottom cost, plus the fun of building. Make a nice profit if you want to. Get the

BOAT BOOK—New Edition

This famous book with 6 new boats added, shows exactly how to build 15 different popular boats. Step-by-step instructions with hundreds of pictures. Gives all plans, methods and materials. Includes racing, hydroplane, inboards, outboards, sailing and sectional boat to carry on car. Also old Ford motor for marine use and all boating terms, pilot rules, boat kinks, navigation rules, etc. You can't go wrong. Specially prepared for those with limited tools and skill. Price only \$3. Write for descriptive folder or order now and pay postman on delivery.

Popular Mechanics Press
Room 135B
200 East Ontario Street,
CHICAGO

Have Your Own Boat This Year or Build Them to Sell

POPULAR FLYER

Big Profits! IN NEW PROFESSION Start Earning At Home



No soliciting! No canvassing! We show you how to make big money decorating fast-selling Giftwares. We start you with a big \$10 Artist's Outfit. We supply you with \$150 worth of Giftwares free of extra charge and show you how to dispose of them without leaving your home. We give you 29 Tested Plans for making money. One Fireside Member says, "I made \$100 on furniture in one week." Another writes, "My sales were \$500 for 5 weeks. This is my first year." R. M. P., of Ill., says, "I did \$3,500 worth of business last year and over \$12,000 this year." D. W., New Mexico, reports, "I would not take \$1000 for my Course."

No Experience Needed
You too may have a splendid income opportunity with Fireside. No tiresome study. You learn by doing. No artistic ability necessary. Our easy 3-Step Method makes the work easy to learn and easy to do and fits you to make good money practically from the start.

Quick Sales in Your Home
No need to leave the house to dispose of everything you make. Our new automatic salesman does all the selling for you. Designed to quickly find cash buyers for all the Giftwares you can turn out.

No Cost Plan
Send coupon for details of new plan that pays for your Fireside Course besides putting big cash profits in your pocket. Mail coupon now while openings for new members are still being offered.

FIRESIDE INDUSTRIES
Dept. 66-A
Adrian Mich.

FREE!
Book on decorating at home for big money. Tells how to get big associates for beautiful Giftwares free of extra charge...

Fireside Industries
Dept. 66-A, Adrian, Mich.
Send me FREE Book on Home Decorating for a big steady income. Also details of plan that will pay for my Course and give me big profits besides.

NAME _____
ADDRESS _____
CITY _____ STATE _____

FREE New! Sensational!

"SUCCESS PLAN" for Distributors of Justrite COMBINATION SOLDERING IRON AND BLOW TORCH

Big Seller
TO MECHANICS, CRAFTS, HOBBY, TRADES, ETC.

Amazing. New "Success Plan" banishes guesswork for Distributors of the famous Justrite Combination Soldering Iron and Blow Torch. Questions answered on major points of selling!
BIG MONEY—full or part time for men who will call on Mechanics, Engineers, Plumbers, Sheet Metal Workers, Garage Men, Battery Shops, etc., to demonstrate this **MARVELOUS TOOL!** Operates with 100% satisfaction on less than 1/4 cent per hour—with NO stoves, NO charcoal, NO air pumps, NO electricity. Fully portable. For hundreds of uses in shops, plants, homes.
ACT NOW! Distributorships open for men of ability. Write for Complete Information TODAY!
JUSTRITE MANUFACTURING CO.
Dept. 151, 2061-81 Southport Ave., Chicago, Ill.

CARTOONISTS

WRITE FOR FREE BOOK

FREE WIN \$25.00



Everyone who likes to draw should have this valuable book. Contains money-making tips, drawing instructions, ways of getting ideas, and list of cartoon buyers. Sent free. You also will be given the opportunity to win \$25.00 or one of 25 other cash prizes, with a simple cartoon. Entry blank included with book. Big money in cartooning. We show you how to draw cartoons by the Marionette Method. All particulars free. Send no money. Just send name on penny postcard. Hurry. Our supply of free books limited.

CARTOONISTS EXCHANGE DEPT. 91 PLEASANT HILL, OHIO

MOUNT YOUR OWN TROPHIES—

ALL

\$1

No Other Cost



COMPLETE TAXIDERMIC COURSE
DIPLOMA FREE OF OTHER COST

Due to tremendous sales volume, Schmidt's Original \$15.00 Professional Training in Taxidermy NOW ONLY \$1 COMPLETE. 7 great books; 218 subjects; 62 lessons. Has taught thousands to mount birds, animals, game heads, fish; make novelties. All seven books—whole course—only \$1. Nothing more to pay. All comes at once! Starts you mounting first day. Send \$1, or pay postman \$1 plus postage. (Foreign orders \$1 cash.) If not 100 per cent satisfied, money refunded at once.

Schmidt School of Taxidermy, Dept. J-1, Memphis, Tenn.

EASY to play

With an easy playing Conn band instrument, you can be ready for band or orchestra in 4 to 6 weeks. A sure road to popularity if you start on a Conn. Choice of the world's greatest artists. Magnificent tone. Many exclusive features—yet they cost no more.

Ask to see the marvelous new models now being displayed by Conn dealers.

WRITE FOR THIS NEW FREE BOOK

Home trial. Easy payments. Write us for free book on whichever instrument interests you most. Mention instrument.

C. G. CONN, LTD., 131 CONN. BLDG. ELKHART, IND.

CONN

BAND INSTRUMENTS

WELDERS WANTED!

ELECTRIC ARC—OXY-ACETYLENE
Skilled Welders earn \$8 to \$15 a day. The demand now greater than the supply. Learn this highly paid trade in 4 weeks by actual shop work. One of America's leading schools. Established 1902. 7 floors of shops. Endorsed by welding industry. Limited number of students. 4 weeks course in Electric Arc or Acetylene Welding, including room and board, only \$159. Write or wire for reservation. Ask for "Welding Facts." State age.

GREER COLLEGE, Dept. 118, 2025 S. Wabash Ave., Chicago

LAW

STUDY AT HOME for Personal Success and Larger Earnings. 28 years of successful student guidance assures expert instruction. LL.B. Degree awarded. All text material furnished. Easy payment plan. Send for FREE BOOK—"Law and Executive Guidance," at ONCE.

AMERICAN EXTENSION SCHOOL OF LAW
Dept. 1-A, 737 N. Michigan Ave., Chicago, Ill.

PLAY GUITAR!

We guarantee to teach you for less than 2c per day. You'll enjoy learning to play this fascinating instrument by our easy, illustrated lessons. FREE Guitar Tuner when you enroll. Ask for full details—no obligations. Write TODAY—Sure.

HAMANN INSTITUTE, 3015 N. 24th Place, R-1, Milwaukee, Wis.

Only 22¢ a Day
Puts This All-Purpose ELECTRIC ARC WELDER IN YOUR SHOP

TEN-DAY TRIAL
Guaranteed: 10 Months To Pay

Details FREE

Now, for first time, it is EASY for every inventor, laboratory, home workshop owner, garage, repair shop, and factory to afford a complete welding service for manufacturing, maintenance, experimental, or repair work. Full size, heavy-duty Electric Arc Welder—Commonwealth Model 120-FS—yours for only 22c a day! Has efficiency of machines costing \$250.00 to \$1,000.00. Welds all metals and alloys. Six heats handle everything from fenders and light sheet metal to motor blocks and heavy castings. Also fine for soldering and brazing.

WORKS ON 110 OR 220-VOLT A. C.
Simply plug into 110 or 220-volt, 60-cycle A. C. electric socket. Costs only few pennies an hour to operate. Anyone can use easily. Comes complete with helmet, electrode holder, welding rods, full instructions, etc. Nothing else to buy. Fully guaranteed.

WRITE FOR 22c A DAY PLAN
Stop throwing away profits! Do your own welding. Get sensational facts about Model 120-FS and 22c-a-day plan. Write today!

COMMONWEALTH MFG. CORP.
Dept. D-51. 4208 Davis Lane, Cincinnati, O.

NOW YOU CAN GET A... HEAVY DUTY INDUSTRIAL WELDER

WORKS ON 110-VOLT
Electric Light CIRCUIT

At this unheard of price, you can get this marvelous DYNAMIC Super-Charged Welder—this welder is a radical departure from accepted welding practices. It will do the work of much higher priced types—efficiently cooled—light of weight—easily portable. Will solder and braze on the lightest material. Works on iron, steel, tin, brass, copper and all other metals.

WELDS Cylinder Blocks, Bumpers, Fenders, Tanks, Farm Machinery...

AGENTS

Make big profits selling to garages, factories, janitors and machine shops. Write TODAY and ask for our 10-DAY TRIAL OFFER.

With this Dynamic Super-Charged WELDER, a man without previous experience can make as much as \$5.00 on a repair job that can be done in less than one hour. Many welding operators make as much as \$15.00-\$20.00 a day—Go into business—Open a Welding Shop NOW.

DYNAMIC WELDER COMPANY
2225-BE Silverton Road, Chicago, Illinois

for Only
\$195
RETAIL



Midget Portable

ELECTRIC OR BATTERY
Radios

WORLD'S SMALLEST RADIOS

Just a handful—Wt. only 2 lbs. Size 3 1/2" x 5" — 4 tube performance! Midget BUILT IN LOUD-SPEAKER and AERIAL—Requires no ground—Hi-efficiency circuit and quality parts. Has Broadcast, Short Wave and Foreign bands! Simple to operate—durable—troublefree. Ideal Radio for office, Apts., bedrooms, college, camps, trailers, tourists etc. Battery model has batteries inside case for use on farms, boats, autos, etc. Electric model uses 110 volts A.C.D.C. Either model—kit of parts for \$8.49—Wired and checked 50c extra or \$6.99, complete ready to listen! Beautiful breakproof cabinets—State Color. Send only \$1. and pay postman balance on delivery. (Batteries for Battery Model \$1.25 extra). Free catalogue listing 100 other radios at factory price. ORDER NOW! GUARANTEED.

SEND ONLY
\$1.00

TINYTONE RADIO CORPORATION, Dept. P-1, Kearney, Nebr.

MONUMENT \$11.00 Freight Paid or UP Erected.

Genuine Marble, also Granite. Lettered Free. Freight paid. Erected if desired. Thousands satisfied customers. FREE Catalog and samples.

U.S. MARBLE & GRANITE CO. A-18 Oneco, Fla.

YOU'LL LIKE RESILVERING MIRRORS, REFINISHING

Plated articles, Autoparts, Reflectors, Tableware. Making Chipped Glass Name Plates, Signs. Experience Unnecessary. Write, SPRINKLE, Plater, 129, Marion, Indiana

SELLEY SHIP MODEL FITTINGS

SEND FOR CATALOG 5c. Largest and most complete range of QUALITY FITTINGS. DIE CAST—BOXWOOD—BRASS PARTS at NEW LOW PRICES

SELLEY MFG. CO., Dept. 801 1377 Gates, Brooklyn, N.Y.

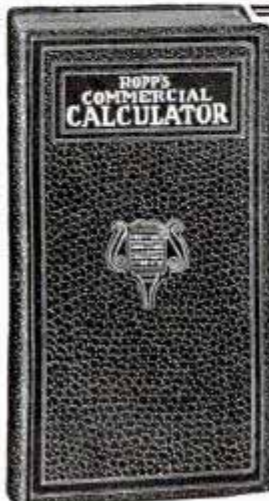

Mathematics Made Easy by ROPP'S CALCULATOR AND SHORT-CUT ARITHMETIC

Shows the Answer as Quickly as a Watch shows the Time to all Problems likely to occur in the Office, Store, Shop, Bank, Farm, or Factory.

Over 2,000,000 Sold Explains and simplifies every principle in Arithmetic, Mechanics, and Mensuration.

PRICES POSTPAID

Desk Size, Flexible Keratol Binding... \$2.00
Pocket Size, Art Leather Binding... \$1.00
Pocket Size, Cloth Binding... \$0.50

POPULAR MECHANICS PRESS
Room P-1 200 E. Ontario St. CHICAGO



Young men wanted

for the interesting outdoor profession
of caring for shade trees

Expansion creates future openings for permanent positions and advancement on merit to men who qualify. Selections are now being made. Consideration given only to sturdy, clean-cut Americans, not afraid of strenuous work. Must be single, between 18 and 26 years of age, free to travel, with good practical education. Must have good references and be able to pass a thorough physical examination. Write for qualification blank to serve in place of personal interview. Davey Tree Expert Co., 138 City Bank Bldg., Kent, Ohio.

FREE BOOK Tells How to Earn Up to \$30-\$50 WEEKLY

ELECTRIC REFRIGERATION and AIR CONDITIONING



RIGHT NOW there are jobs for thousands in Electric Refrigeration and Air Conditioning. Prepare for your opportunity at home in spare time by U.E.I.'s low-cost, easy-pay plan. Learn Engineering, Estimating, Installation, Servicing under a system that has brought outstanding results for TEN years. Get practical experience in our large, completely equipped Laboratories. We'll help you get Big Pay Jobs. Hundreds of U.E.I. trained men now employed by leading manufacturers, distributors and service organizations. Employment Service offered FREE of extra cost. Get Book of Facts.

UTILITIES ENGINEERING INST., Est. 1927
400-410 N. Wells St., Dept. 118, Chicago, Ill.

MASTER CHEMISTRY AT HOME

BIG JOBS IN CHEMISTRY. BIG PAY. Become a Chemical Engineer. Home Study Courses leading to Degrees in Chemistry and Chemical Engineering; also Electrical, Mechanical, Civil, Diesel, Automotive, Aeronautical, Architectural, Drafting, Air Conditioning, Refrigeration and Radio Engineering.

McKinley-Roosevelt College of Engineering, 4242-C Clarendon Ave., Chicago

FREE "Why Diesel Means Dollars to You!" BOOKLET

TELLS HOW YOU CAN EASILY LEARN DIESEL AT HOME... OR AT JOURDEN SCHOOLS in Philadelphia, Pittsburgh, Cincinnati or Baltimore.

WRITE TODAY for your copy of our Free Illustrated Booklet—"WHY DIESEL MEANS DOLLARS TO YOU!" Learn about the Big Opportunities for trained men. See how Jourden courses are helping men to get BIGGER PAY. They will help you, too. WRITE TODAY!

JOURDEN DIESEL SCHOOLS
2839A N. Broad St., Philadelphia, Pa.

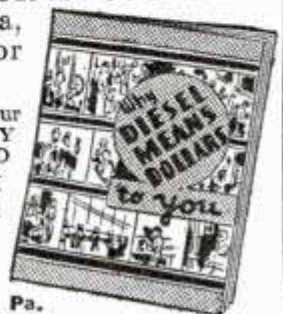

LEAN BACK, BROTHER, AND LEARN SOMETHING!

**That Easy Chair of Yours can Show You
One Reason why the 1938 Buick has the
Most Modern Chassis in the World**

WHEN an easy-chair maker wants to build in comfort, what kind of springs does he use?

Right the first time — *coil* springs! Because coil springs are softer—last longer — keep their temper and springiness.

For such good reasons the 1938 Buick now has big, stout springs of *coiled* steel on all four wheels.

And by replacing the usual type of rear springing with **TORQUE-FREE SPRINGING** we not only gain a far smoother ride, but more constant traction, less wheel slip, lighter unsprung weight

and surer car handling.

Buick is the only car that has such rear springing, and here's why.

Coil springs are not easily applied to any car that drives through the springs. Only a car like Buick, transmitting power through a torque-tube can get full benefit of this new and better suspension.

With your interest in mechanical things, you'll want to inspect this new springing carefully and see how much simpler, safer and better it really is. You'll also find a lot to interest you in the *principle* of Buick's new **DYNAFLASH** engine.

Why don't you drop in on the nearest Buick dealer? You'll find the 1938 Buick has as many important new features as a red-headed kid has freckles.



"Better buy Buick!"

A GENERAL  MOTORS VALUE

When writing to advertisers please mention Popular Mechanics

Popular Mechanics Magazine

REGISTERED IN U. S. PATENT OFFICE AND CANADA

WRITTEN SO YOU CAN UNDERSTAND IT

Vol. 69

JANUARY, 1938

No. 1

NEW WEALTH *es 115 7* from the SEA

By Charles Morrow Wilson

new land 'W.
PROGRESS in ocean industries is taking two directions, marine farming and better processing of sea products.

The French government instituted ocean experiment farms as early as 1910, but the work was halted by the world war. Today the United States is leading the world in salt-water agriculture with a sea-food catch worth about \$100,000,000 a year at the docks and about four times that when completely manufactured.

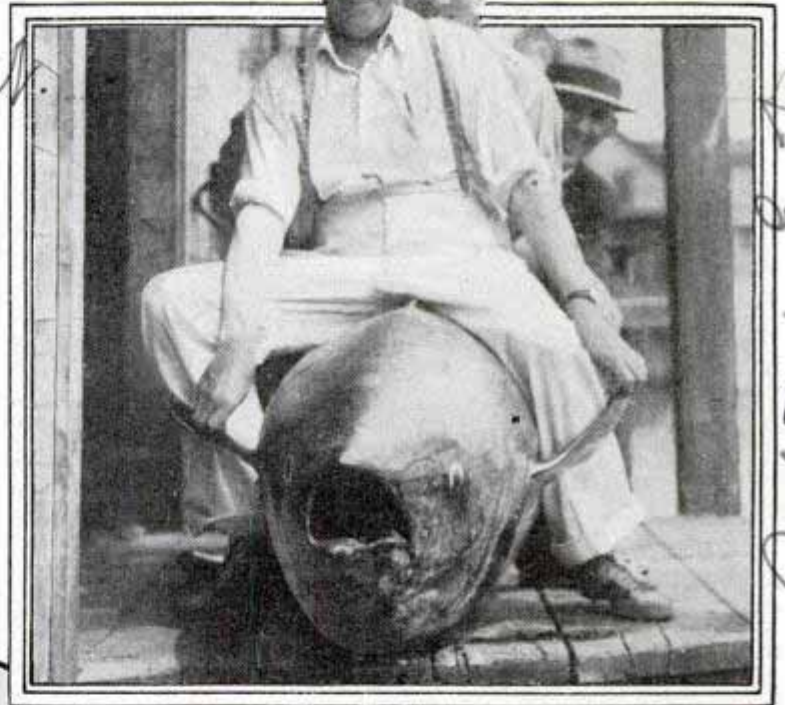

Rodney & Tyler. Sea and...
Top, riding a record catch weighing 700 pounds. Bottom, hoisting a catch of ground fish. This is a typical two-man fishing vessel

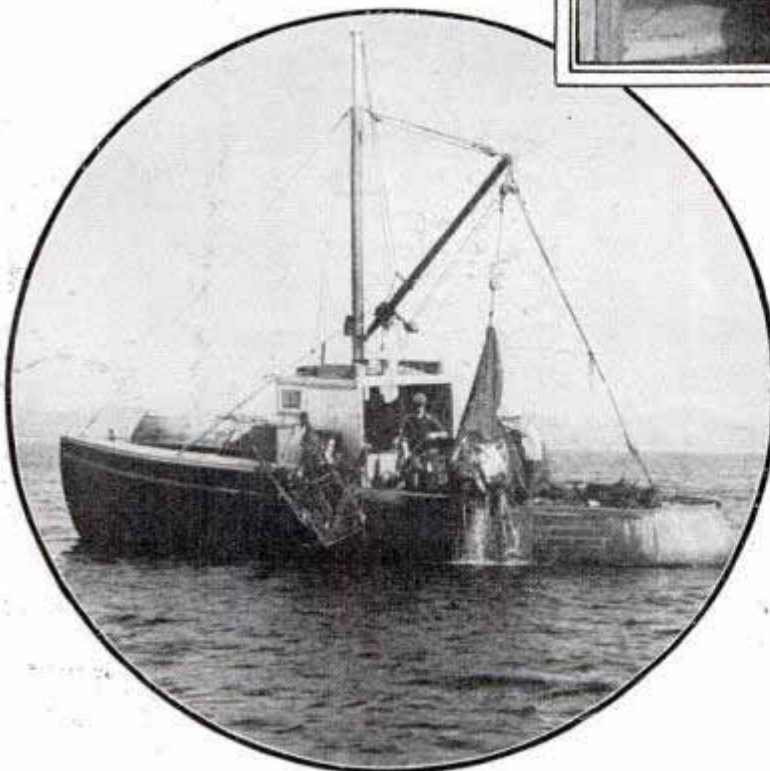

Marine farming begins at the shore line with field cultivation of clams, one of the four greatest ocean foods. The state of Maine, with about 500,000 acres of tidal flats capable of growing clams, has opened a clam experiment farm at Friendship. Mud between high and low water marks is plowed by tractors and small "seed-size" clams are sown as one would sow a grain crop. The crop requires two to three years to mature and in good locations yields from 800 to 1,200 bushels to the acre, worth



fifty from an average brood may reach market size or a minimum of one pound.

The growth period for market size, usually stated by law as a minimum body length of three inches, is about five years. In the hatchery, baby-lobster diet is actually more fussy than that of the human baby. The best fare seems to be ground hog's liver, which is fed through strainers into the brooder trays. Another important step in lobster farming is the lobster pound, or ocean barnyard. Feeding pounds are usually corrals built of seine-covered pickets at the tips of inlets. Live-lobsters are taken from the

traps, placed into the pounds and fed two or three times a week. In this way they are kept in good flesh to meet market demands.

Oysters are another sea crop now being planted in submarine fields. But the newest ocean "field crop" is

from \$400 to \$750. The most valuable popular sea food is lobster, which thrives in a twenty-mile strip of the Atlantic coast line from the Carolina capes to Labrador. For some years the lobster industry has been threatened by failing supply. In Maine, greatest of lobstering states, the yearly catch has fallen from twenty million pounds to five million. This is leading to the establishment of a new style of lobster farming. The newest feature is the modern rearing station. The largest of these hatcheries is maintained cooperatively by Maine and the U. S. bureau of fisheries at Boothbay Harbor.

Though the adult female lobster sheds from 8,000 to 12,000 eggs each year, natural survival is only about two lobsters out of that number. The eggs and newly hatched lobsters float at the surface for about twenty days. During this period the mortality from gulls and fish is tremendous. With modern hatchery methods lobster experts believe that as many as

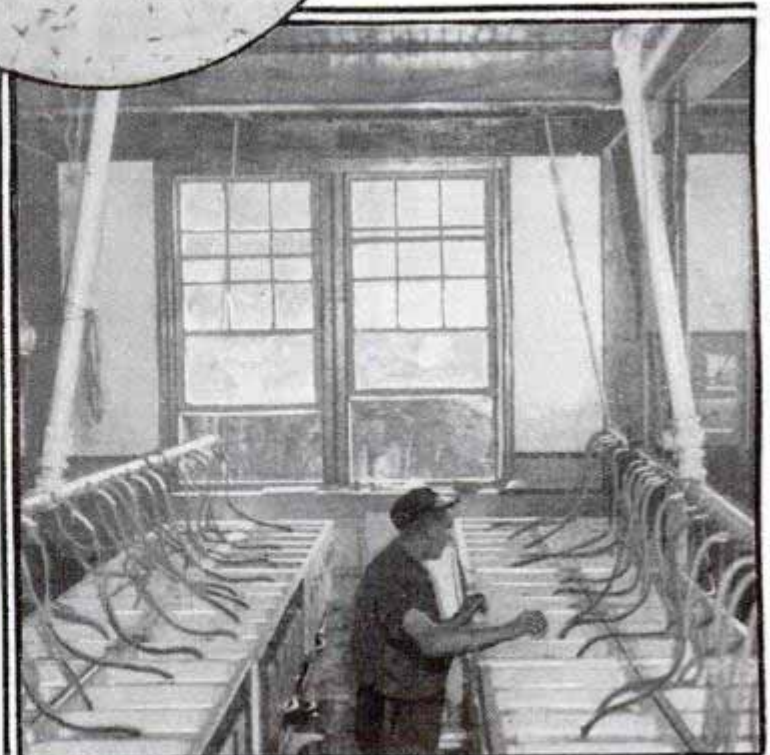
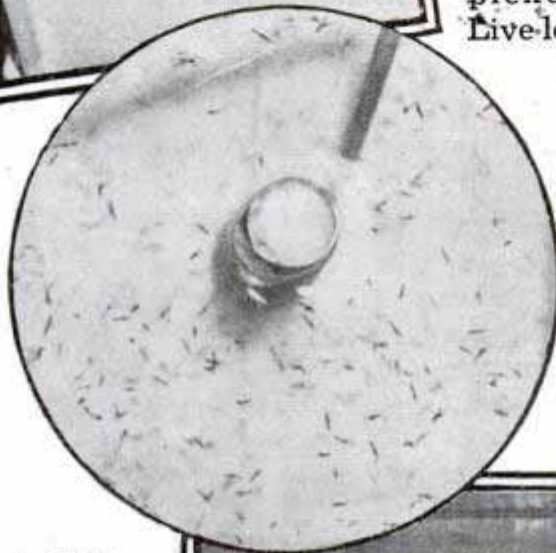

Top, feeding young lobsters in hatchery. Center, fourth-stage lobsters ready to be released. Bottom, hatchery tanks in which young lobsters are raised

the scallop, whose edible portion is the "eye" or abductor muscle. The crop usually flourishes on flat sandy bottoms under sixty feet or more of water. The scallop industry began to gain importance upon the Maine coast about fifteen years ago and now has grown to such importance on the Atlantic fishing front that interested states and the U. S. government are beginning to replant the more productive shoals which are becoming exhausted. This is done by purchasing small live scallops and transporting them to the desired location where the seed are scattered overboard. Then the area is closed to dragging for a period of a year or more.

A scallop boat is usually a stout Diesel-driven craft costing from \$5,000 to \$30,000. The crop is harvested by means of twin drags, towed from either side of the vessel. The drag is an iron framework from six to twelve feet long and about two feet deep, with a netting bag attached. The framework is pulled by means of a steel cable about 1,000 feet long, and is hoisted by Diesel power about twice an hour for a take of from six to twenty bushels to the drag. The scallops are dumped on deck, culled and placed on shucking benches. Crew workers pry open the shells, recover the abductor muscles, wash the meat, pack it in iced canvas bags, throwing the waste portions overboard. The product is packed in airtight tins to improve flavor and shipping qualities.

On a tonnage basis school fish are still the greatest ocean harvest. These are divided into ground fish, such as cod and haddock, which ply only a few feet above the ocean bed, and surface fish, such as mackerel and herring, which swim only a few feet beneath the surface. Herring is the most numerous of all ocean fish though commercially mackerel is the most valuable surface fish and haddock is the most valuable ground type. The great bulk of all sea-fish catch is made offshore on the fishing "banks," which are underwater ledges protruding from twenty to 600 feet below the surface, with 240 feet the most common fishing depth. Most of the food fishes ply in schools, ranging from a few dozen to millions. Ground fish are caught with hand lines and hooks, trawl lines, or deep drag nets. Surface fish are scooped

(Continued to page 158A)

Electric Exercise for Eyes
Helps to Correct Squint



Peering through eyepiece at lighted figures of this instrument, patient is given eye muscle exercises

Like every other organ, the eye needs exercise to strengthen it. An electrically operated instrument was invented recently for the purpose of correcting squint and giving the eye muscles exercise. The subject looks through an eyepiece at lighted figures on the front of the machine.

Rocking Chair Propels Odd Boat
by Turning Paddle Wheel

Propulsion of an unusual water craft placed in operation recently is accomplished by rocking in a chair. The chair is attached to large driving arms which cause a paddle wheel to revolve at the rear of the boat. A large steering wheel controls directional movements.



Rocking the chair propels this unusual craft

no further information

Shew at National Inventors Meeting

Perelosed

At Mt. St. Albert, Perre, 35 2 129 S. Cleveland Ave., Los Angeles

Brown Photos

Watchmaker's Home and Shop Built in Truck

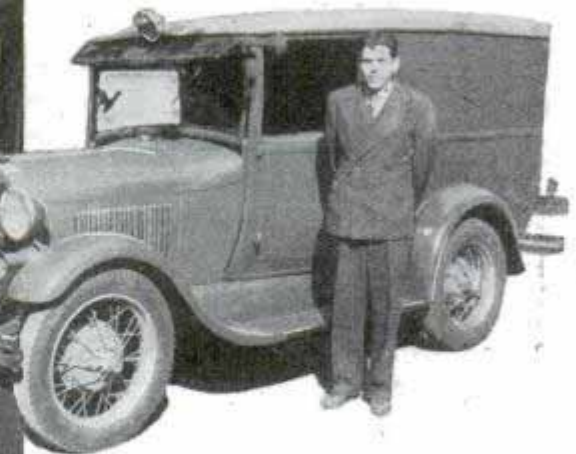

Top, right, watchmaker standing beside his home-and-shop. Left, ready for sleep. Center, folding bunk. Bottom, preparing meal on the gasoline stove



neath the bunk is a clothes compartment with space for ten pairs of pants, a dozen shirts, underwear, socks and towels. Back of the bunk, against the wall, is space for two suits in zipper bags. A folding basin with rubber drain hose extending through the floor fits into a separate compartment in the bunk. Just above is another compartment for toilet articles. A folding gasoline stove with two burners and a hood to carry away vapors makes it possible for the occupant to cook his own meals. A tourist refrigerator, a pantry box and a dish-pan fitted into friction-tight grooves are other features. In addition, a completely equipped watchmaker's cabinet and tool shelf have been built into the truck. Other equipment includes a two-gallon Thermos jug for drinking water, large collapsible easy chair, hot-water heater, camera and first-aid box.

Built into an old model truck are home conveniences and a workshop for the watchmaker-owner who takes his business to the customer. Among the features is a folding bunk which is six feet long when ready for sleeping, five feet long when ready for traveling. At one side is a bookcase holding twenty volumes and a radio. A fixed light provides illumination. Be-

Snow Trails Tell Census Taker Wild Life Population

Taking the census of wild life, particularly the fur-bearing animals, calls for experts who can read snow tracks. Following fresh trails, the census taker can locate dens or burrows and then from a careful study of the various footprints around can

187 Baldwin St. Portland, Me.
 Baldwin St. Portland, Me.
 Edwin Harrison, 187 Baldwin St. Portland, Me.

es 1298

High-Speed Super-Locomotive Built to Haul Crack Train

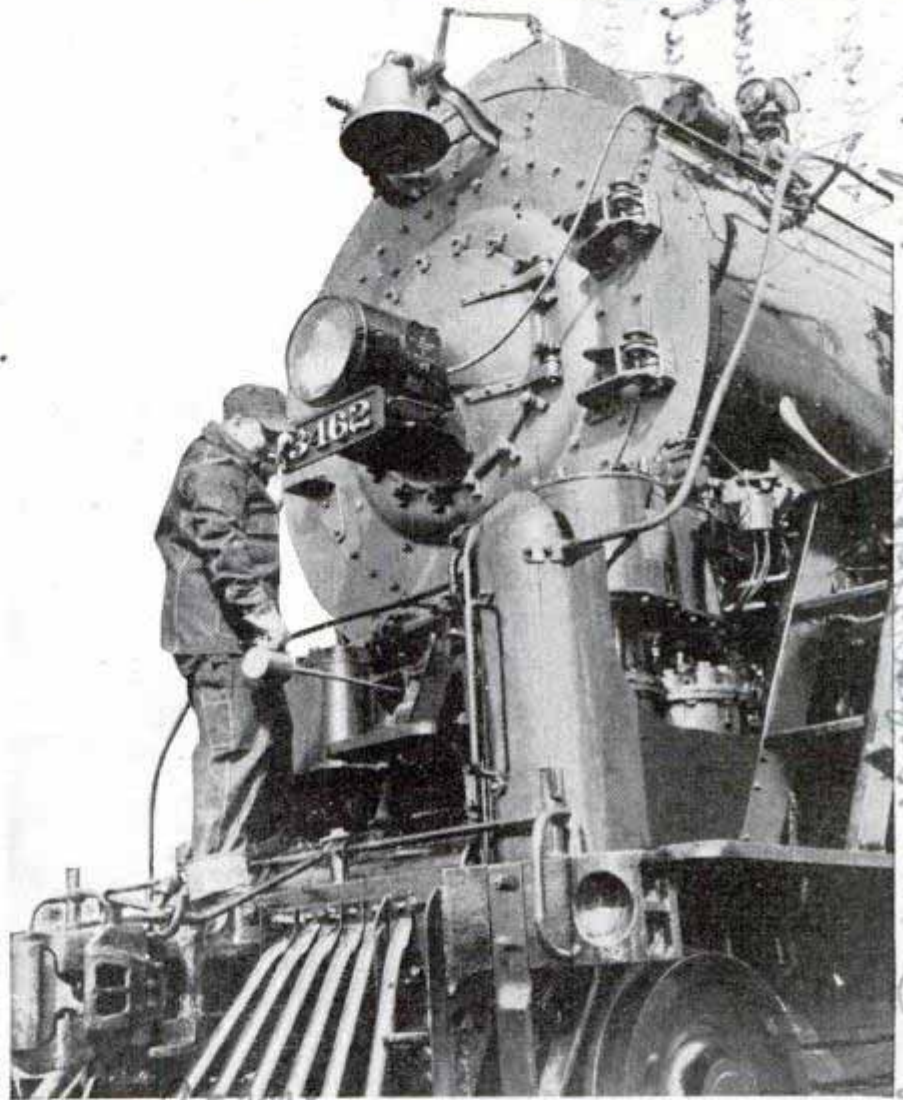

Here is the front of the giant steam locomotive which will pull a long string of passenger coaches at 100 miles per hour

Constructed to haul the Super-Chief, crack Chicago-Los Angeles train, a giant locomotive was completed recently at the Eddystone, Pa., plant of the Baldwin Locomotive works. It is one of six super locomotives being built for the same railroad to haul long passenger trains at 100 miles per hour.

Grounded Ship Causes "Quake" Rattling Houses along Shore

When a 5,630-ton freighter ran aground in a dense fog at Seattle recently the crew was scarcely aware of the beaching but it caused a minor "earthquake" on shore. As the steamer "Charles Christenson" struck the gravel beach the shock was transmitted through the earth to houses nearly a block away, shaking windows and rattling dishes violently

tell how many animals live there, and the approximate age groups. The Bureau of Biological Survey has found it quicker, more economical and reliable to count deer and elk by spotting them from airplanes. Airplane counts have also been found helpful in estimating the number of waterfowl in lake regions.

Sliding Top Car Gives Amazing Gas Mileage

Designed to run more than forty-five miles on one gallon of gasoline, a small Italian-made car was introduced in the American market at the New York auto show. The cabriolet model has a one-finger sliding top, a new development in convertible top adjustment, which is waterproof and rattleproof. The car has an all-metal body, independent front-wheel suspension, hydraulic brakes and synchromesh transmission. It will compete with American autos in the low-price field.



Converting Italian car by sliding back the top. This car gives exceptional gas mileage

Dep. of Agriculture. She
10100
11/7/28

Feb. 12th and 14th
Washington, D.C. 20540

U. S. Agent - The Advance Corp. Butler
228 Healey Bldg
Chicago, Ill.

Phobee
1123 B. Blvd. St. Philadelphia
No. 10. 200

4
1294
Fiat 500
me. 225

Fiat 500
at Perkins Lane

Truck Adapted to Railroad Hauls Big Loads



Three views of the new rail truck. Top and bottom, left, the truck on test run. Bottom, right, at the controls in the truck. Note that controls are locomotive type

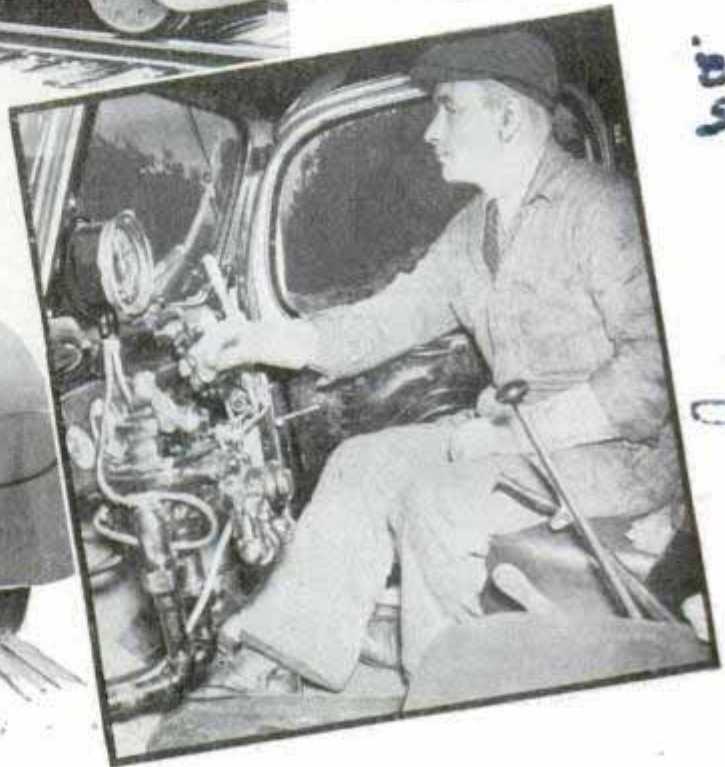
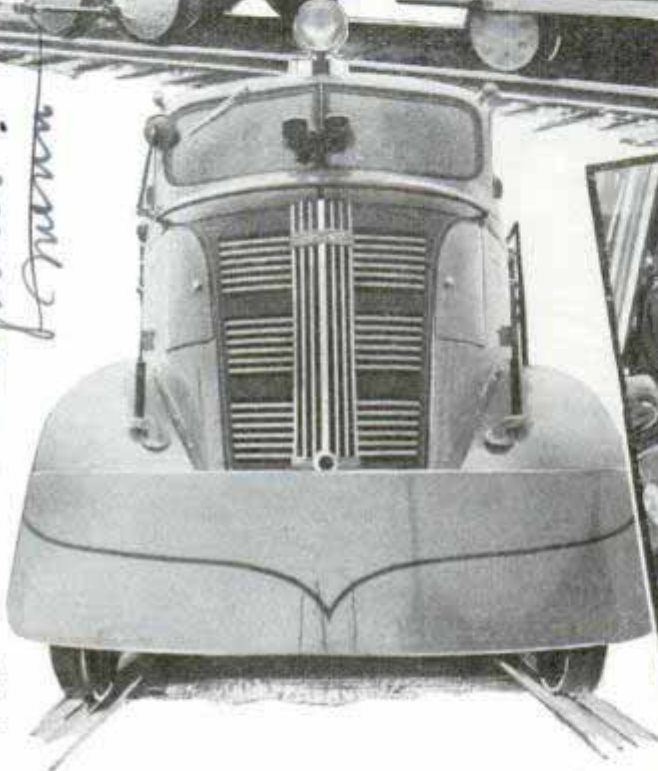

Designed to meet the need for a cheaply operating locomotive on secondary railroads, a standard truck has been adapted for use on rails. It is capable of hauling two loaded freight cars. Higher-powered models capable of pulling eight to ten cars loaded with freight or passengers are possible. For converting the truck to railroad use, a new differential employing a four-wheel drive was substituted for the standard drive. One set of gears is used and the two sets of drive wheels are linked by tie rods. The wheels are rubber cushioned, insuring quiet operation, and air brakes are used, with standard railroad couplings. Throttle and other controls, except for the reverse gear, are of locomotive type. A special transmission permits the same number of speeds in reverse as forward, so that

the rail truck may run at full speed in either direction. Lights are mounted like those on a locomotive and a dual horn and bell are provided.

Original Bell Phonograph Plays After Half Century in Vault

Sealed away in a metal-covered wooden box fifty-six years ago, the original Bell phonograph was recently taken from its vault in the Smithsonian Institution and its first wax record played again through a modern loudspeaker. Thomas A. Edison had invented a method of recording on tin foil four years before Alexander Graham Bell and his co-inventors developed the wax cylinder, but the tin-foil system was

es 126
 2875
 Coordinated transportation
 Minneapolis
 222
 Highland
 Parkway
 St. Paul
 Minn

es 1291
 Original Bell Phonograph
 Smithsonian Institution
 Washington D.C.
 The original Bell
 phonograph
 played again
 through a
 modern
 loudspeaker
 Thomas A. Edison
 had invented
 a method of
 recording on
 tin foil four
 years before
 Alexander
 Graham Bell
 and his co-
 inventors
 developed the
 wax cylinder
 but the tin-
 foil system
 was

unsuccessful. Bell, Charles Sumner Tainter and Chichester Bell had their "graphophone" and the original record sealed away with instructions that the box should not be opened without permission of two of the inventors. The Bells are now dead, but Tainter, 84 years old, invalid at San Diego, and the descendants of Bell gave permission to open the box. The rubber speaking tube for making records had hardened with age, and the electrotype matrix for an early record had turned green. When the original record was played the voice fifty-six years old said clearly: "There are more things in heaven and earth, Horatio, than are dreamed of."

es 1222

Crowd Sees Parade in Mirrors Held Overhead on Canes

Everyone can't have a "front seat" at the curb when the parade marches by, but



Mirrors mounted on poles overcome the handicap of a "back seat" on the sidewalk when parade goes by

those in back can see the show with mirrors. Hand mirrors will do, but it's easier on the neck and arms to use a mirror fastened to the end of a cane or stick.

Inquiries as to makers of articles described in Popular Mechanics will be answered by our Bureau of Information upon receipt of return postage.

es 1252.

Rubber Strip in Pavement Takes Up Expansion

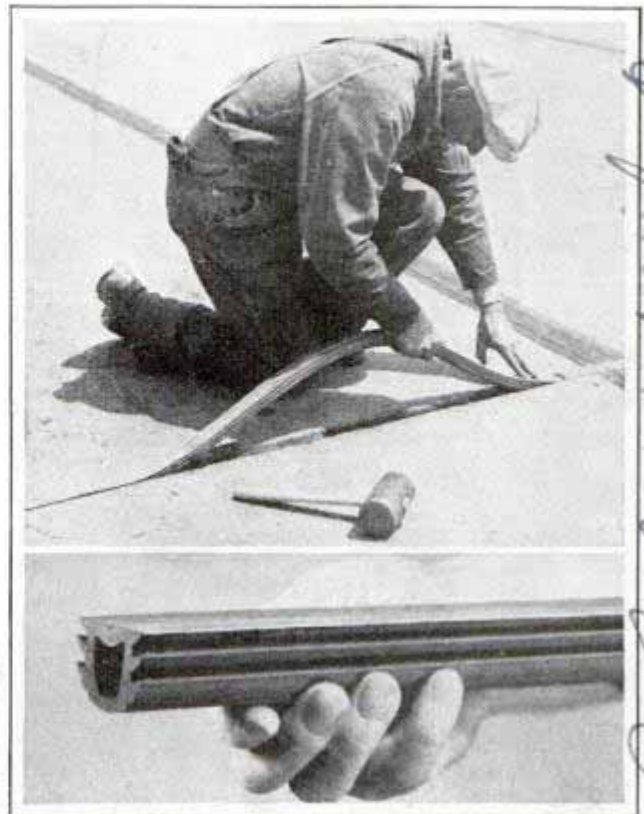

Laying the rubber expansion strip in joint of pavement, and closeup showing its moisture-proof design

Rubber strips are now being used to seal joints in street and highway pavements. They allow for expansion and contraction due to temperature changes, and keep moisture from penetrating the joints. The strips are easily applied and economical.

es 1258

Transparent Music-Sheet Clip Makes All Notes Visible

Made of transparent material so that all notes may be visible, a new clip may be attached anywhere on the music sheet

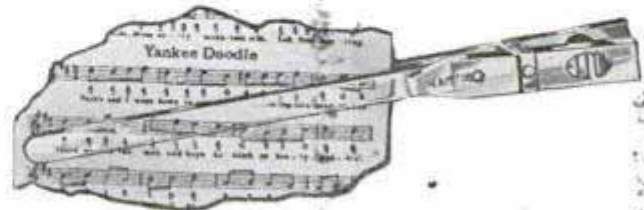

All notes on the sheet are visible through this handy transparent clip

without interfering with the musician's vision. Heretofore music clips were made of wood or metal, necessitating care in attaching to avoid covering some notes.

ref. L. A. Elvington, 322 E 34th St. New York

Dr. J. S. Woodruff, City of Akron, Ohio

Giant Shorthand Characters Are Latest Aid in Teaching



Flashing the shorthand characters, in enlarged form, before outdoor class. This method is said to speed up school work

Helping to teach outdoor shorthand classes, giant characters are displayed to classes for a few seconds in a novel visual education method. The demonstration involves a simplified shorthand which some educators believe may become a universal writing method. The simplified writing is based upon the corresponding longhand letters but utilizes only sufficient characters to serve as a memory guide.

Rubber Cap for Impact Tools Reduces Danger and Wear



Protection against flying chips is provided by molded rubber caps for the heads of sledges, mauls, chisels and other impact tools. In addition to the safety feature, the caps reduce re-dressing and replacement costs.

One test by a railroad showed that the capped tools could be struck three to ten times more blows than those not so equipped. The caps are made in a variety of sizes for precision fitting.

Curve Meter Aids Engineers in Road Survey

Engineers surveying California's highways have designed special instruments to speed up the task. These instruments, mounted in lightweight automobiles, gather data as the cars are driven along the roads. One of the instruments, called the curvometer, measures the radii of horizontal curves. A half circle of plywood, with calibrations to show degree of curves, the curvometer

has the same diameter as the car's steering wheel. Another instrument is the superometer and gradometer for determining the superelevation on curves and measuring the rate of per cent of grades. Information gathered with the instruments will be used in planning new roads.

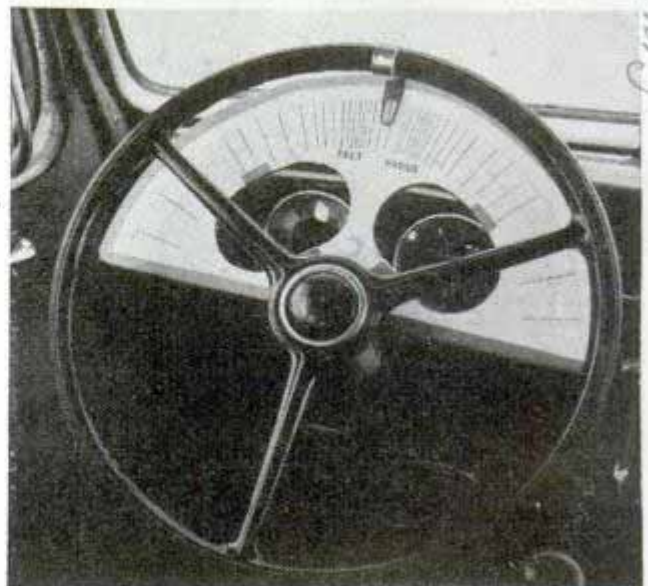

Curve meter mounted on dash aids engineers in surveying California highways

es 1287
Educational Research Association
Pasadena Calif
Chicago
Standard Safety Equipment Co
es 1277
Chicago

es 1235
Curve Meter Aids Engineers in Road Survey
731 Kansas City
Allen
Cub.

es
811

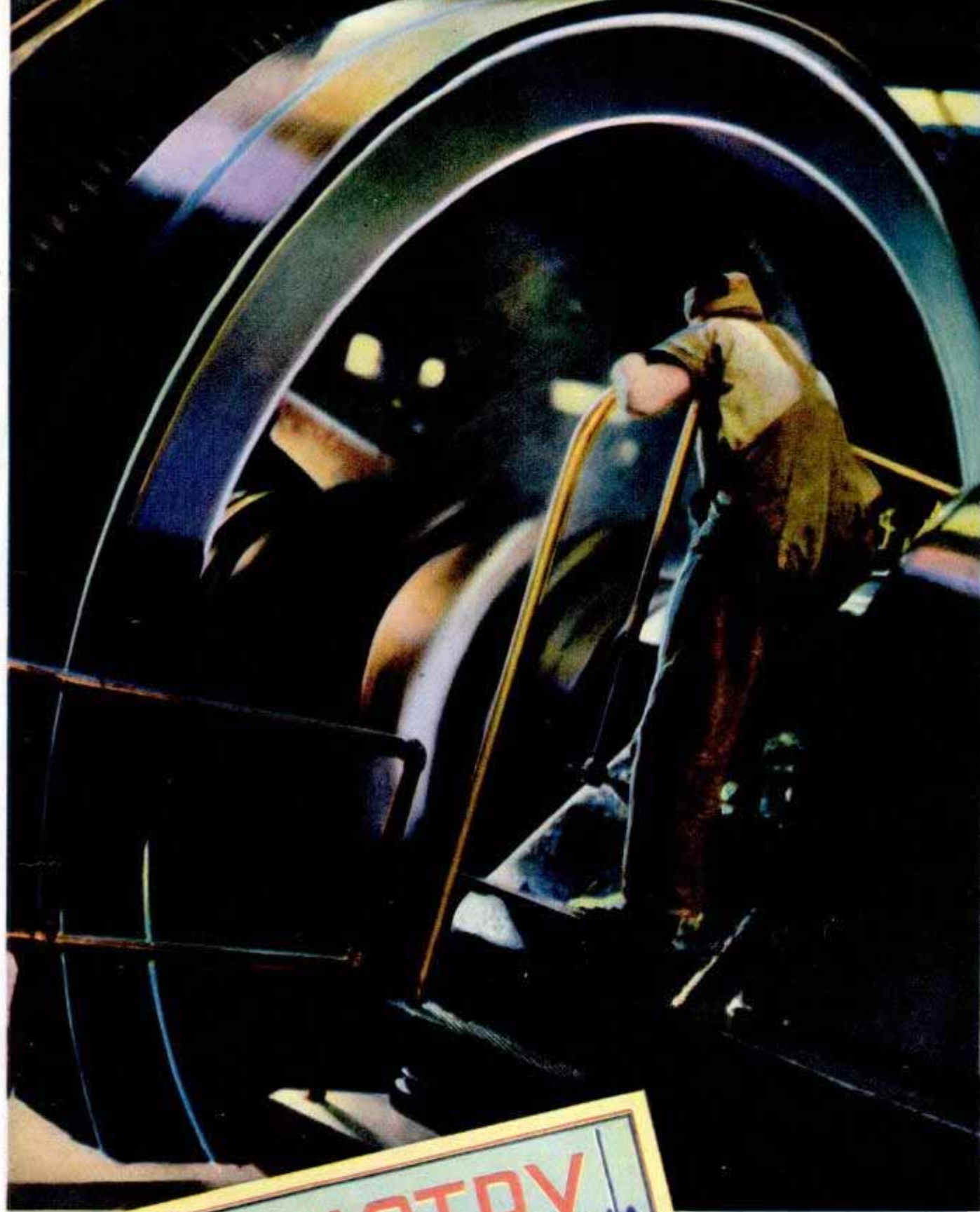

9

CHEMISTRY and YOU

PART 2

ONE of a battery of huge gas compressors in an ammonia plant. Today nitrogen is extracted from the air and fixed directly with hydrogen to form ammonia.

es 811



DEMONSTRATING the durability of a synthetic resin finish by subjecting it to temperature of "Dry Ice" and then to boiling water.

By Dr. C. M. A. Stine

Vice-President E. I. du Pont de Nemours and Company

Wilmington, Del.

THE textile industry is literally being made over with the aid of chemistry. Its sensation, of course, has been rayon. As late as 1910 no rayon was made in this country. As late as 1925 it was looked upon as a poor imitation of silk and its faults were many. Today rayon stands on its own legs as a unique new fiber, with a yearly consumption more than four times that of silk and more than half that of wool. Most of its Cinderella-like transformation dates from 1930.

The chief fault of all natural fibers is that their quality varies with climate, season and state of health of the producing animal, insect or plant. Then, too, man has practically no control over the length, strength and size of fibers grown on a sheep's back, or produced from the soil or spun by a worm. These two facts limit the range of fabrics that can be fashioned from natural fibers. On the

other hand, rayon is mechanically produced under rigidly exact scientific control. Its quality may be maintained uniformly year in and year out. Its filaments may be made even finer than those of silk, or as fine, or heavier; they can be made of any desired degree of luster or dullness, can be short or long, rough or smooth, or even alternately thick and thin. No other fiber has such versatility or can be changed so readily, with the result that rayon's possible range in fabric-making is almost unlimited.

The smart modern woman little realizes her dependence on rayon. It has become a dominant material in textiles, indeed is setting new higher standards for all dress, drapery and upholstery fabrics. The finest of transparent velvets are made of rayon. It may be found in the costliest creations of Paris, because in no other fabric can designers achieve such a wealth of original effects. Two



years ago a survey of gowns worn at one of the most famous of New York City's balls revealed that ninety per cent were of rayon, wholly or in part. Rayon is being used in men's lightweight suits and widely for men's coat linings. In this unique material man has mastered many of the most important elements required for the perfect yarn, and rayon's future is limited only in so far as the field of scientific research is limited.

However, chemistry's contribution to the textile industry is going far beyond rayon. The sheerest of dresses may now be rendered water-repellent and spotproof, and so may hosiery, hats, suits, sports

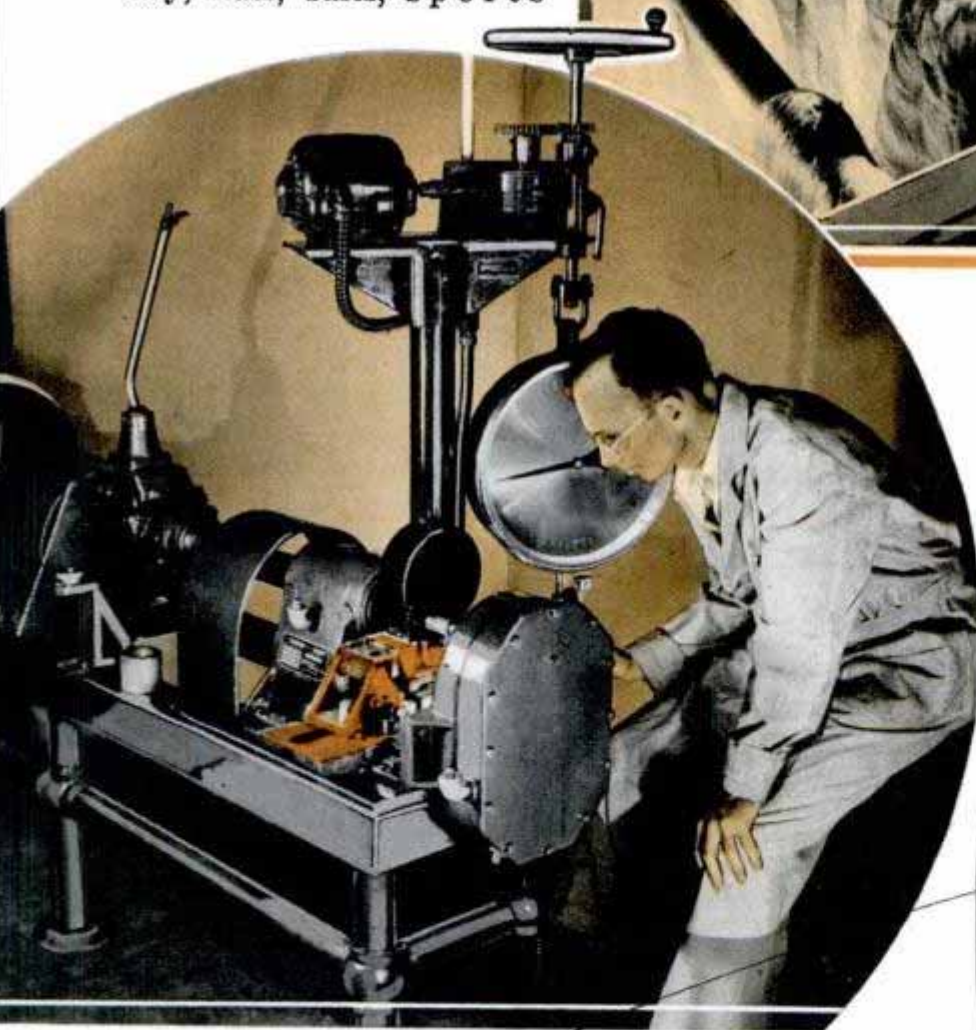

RUNNING test on extreme-pressure lubricants, developed through the wizardry of the chemist. Above, inspecting rayon, a man-made fabric produced by chemistry.

clothing, and in fact most fabrics of silk, wool, rayon, linen or cotton wherever used, as in awnings, tents, the outer covering of mattresses and in window drapes. The waterproofing chemical is applied to the fabric in a single operation, whereupon it becomes an invisible and odorless part of the fabric itself, shutting out water but not air. Raindrops run off without wetting the fabric.

Wrinkleproof fabrics for shirts and dresses, fabrics that stay "starched" without restarching in the laundry, others that will "hold a crease" in daily wear, and still others for use in home furnishings that are fire-retardant are already on the market or soon to be

Soldaire - Everfast Fabrics, Inc. de Nemours & Co. Fine, Under - E. du Pont

See Dec 1937-815



A RESEARCH worker in the General Motors plant intent on solving a chemical problem. The work of such men results in the year-by-year improvement of the many kinds of metal, the fabric, the glass and the other materials which make up an automobile.



12 introduced. A wealth of new dyes, wetting agents, detergents and kindred textile assistants has been evolved, the general purpose of which is improvement of quality, and new comfort, beauty and new utility, all at less cost both to producer and consumer.

It is well to emphasize the all-prevalent creed of the new chemistry, which is to give more for less. You see it at work in the shoe industry, in textiles, in motor cars, wherever the science is applied. The practical result is a steadily growing distribution of wealth in terms of usable things; not alone the production of two blades of grass where one grew before, or perhaps where none grew at all, but production of two at the cost of one, a feat in economics that chemistry is fast making a commonplace.

Business depressions lower prices temporarily, usually at the cost of employment and profits and often of quality as well. Chemical science aims to lower prices permanently, and to keep on low-

ering them, even as it creates more opportunities for work and insures a fair return to the labor and capital concerned. In every store in the land today you find manufactured goods that are superior to those of five or seven years ago, or that did not exist five or seven years ago, and if you will compare prices, you will find that in most cases those of today are substantially less than you once paid for inferior articles of the same kind, if you could buy them at all.

Fluctuations in the costs of raw materials affect retail prices, of course, but the present phenomenon in retail prices is not a mere passing phase of our economy brought about by low raw material costs; nor is it the result of sweating labor. It is a fundamental change, fostered by man's own ingenuity in creation, that points a way to an ever better and more

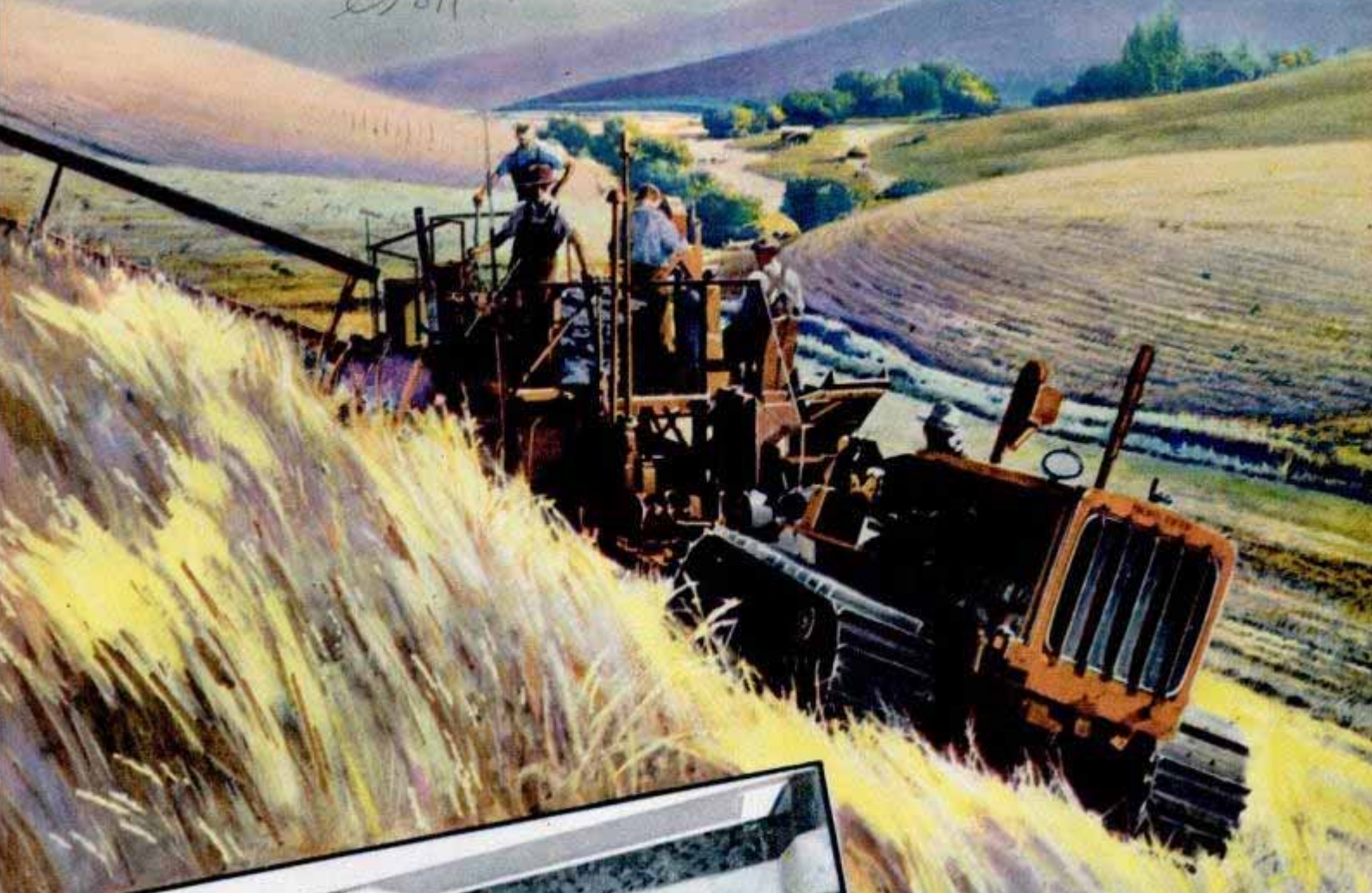

13

HARVESTS such as this would be impossible today, except for the fertilizers supplied by chemistry. Below, pigments developed by the chemist give this bathroom its colorful appearance. Note the hand-cut inset of the seahorse in the linoleum floor covering to give a marine atmosphere.

Lower photo courtesy Congoleum-Nairn, Inc.

Kearny, M J



DYESTUFFS made from coal tar and some of the uses for the dyes are shown in this exhibit at the New York Museum of Science and Industry.



A RUBBER "tree" made of metal, part of the du Pont plant which produces "Neoprene," a substance with many of the physical properties of rubber.

14
abundant life. And it is change that has come to stay, for it is rooted in a scientific creed that does not admit the word retreat.

No less than shoes and textiles, the rubber industry has been revolutionized by chemistry. Indeed in no other industry is the influence of chemistry more marked. Recent tests of automobile tires made by a governmental agency and published by the Consumers' Union show the useful life of the best-made tires to be well in excess of 25,000 miles. When these mileages are compared with the three-to-five thousand miles of haphazard travel furnished by the tires of wartime, which cost from two to three times more and were only about half the size of modern tires, we can appreciate the extent to which tires have been improved. And rubber in all of its more than 30,000 uses has been similarly improved, with the chemist leading its amazing advance.

One of the several shortcomings of rubber is its susceptibility to oxidation. In

its natural form it rapidly deteriorates on exposure to air, particularly in the sunlight, and loses its elasticity. Nature did not put latex in the rubber tree for us to use in making rubber boots, hot-water bottles, tires and garden hose. The latex is in the tree to provide it with a means of healing wounds inflicted by insects and other enemies. As such it is a perfect material, but like so many materials satisfactory for nature's purposes, rubber must be altered to suit it to the artificial purposes of man.

Goodyear's process of vulcanizing rubber improved its strength and elasticity,

and enabled it to resist wear within limits, but the process consumed from three to four hours. The chemist set out to reduce this time by the use of chemical agents known as accelerators. Finally he found ultra-accelerators that made vulcanization possible in three minutes or less, and which simultaneously increased the strength, elasticity and abrasive resistance of the finished rubber.

Anti-oxidants were introduced that further extended the life of rubber by inhibiting oxidation and cracking caused by flexing.



ONE of steps in manufacture of "Pyralin," a plastic. Below, research chemist at work in laboratory. 15



PLASTIC materials used in Hudson car, including wheel, ignition parts, timing gear and washers, interior fittings and radiator ornament.

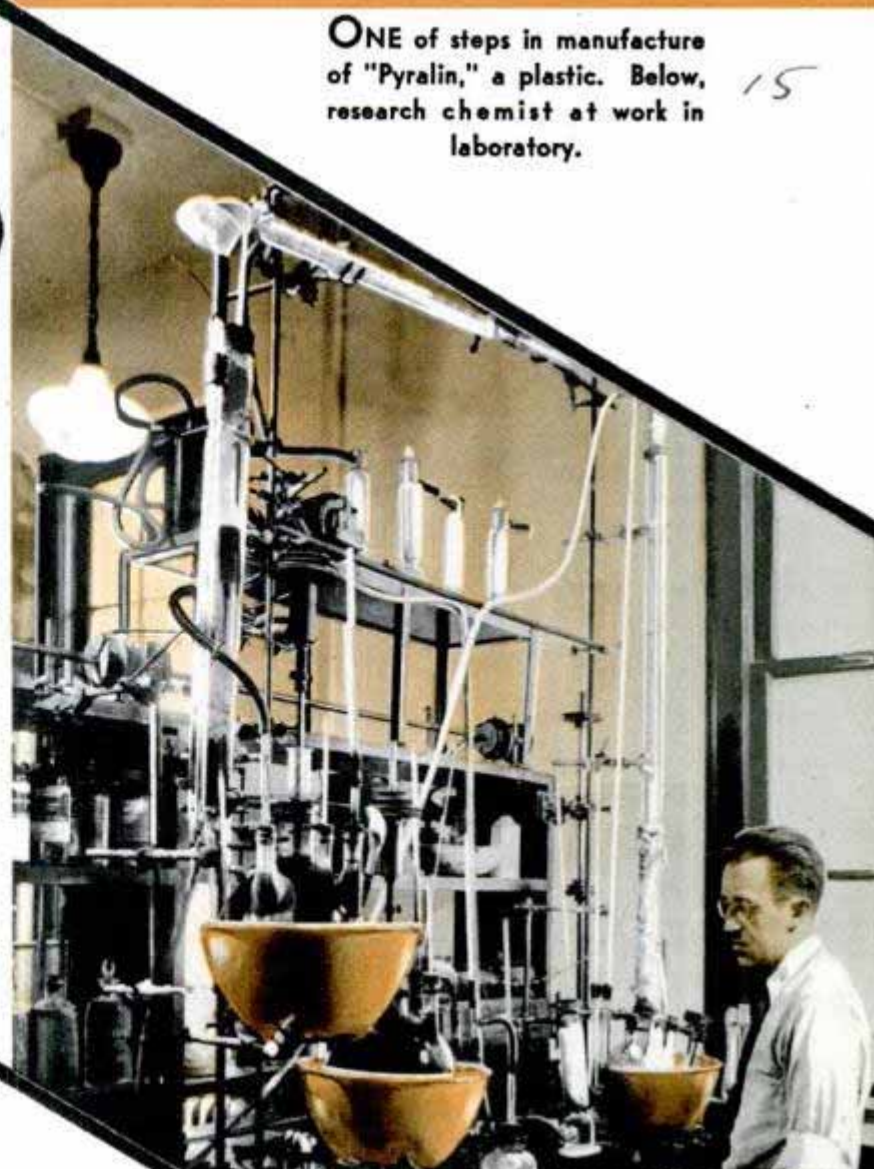



SPRAYING to reduce the damage of codling moths in a Pennsylvania apple orchard. Chemists are constantly searching for better controls for insect pests.

The cotton fabric used in tires was improved. So tough was crude rubber when it reached the manufacturer from the plantations that it had to be masticated in heavy machines until it was plastic enough to be compounded. Chemical plasticizers were developed, a very recent contribution that is another step toward more economical production.

The rubber in common use today is a much superior rubber to that of five years ago, and incomparably superior to the rubber of twenty years ago, but it still has certain deficiencies. It disintegrates when in contact with oil, grease and gasoline. It still falls victim in time to oxidation. In the automobile, where it is most extensively used, it falls short of the ideal of all earnest engineers, which is a motor car wherein every part, as in the deacon's one-horse shay, will serve throughout the car's life without need of replacement.

(Cont. to page 132-A)

Cloverleaf Traffic Circle Covers Big Garage

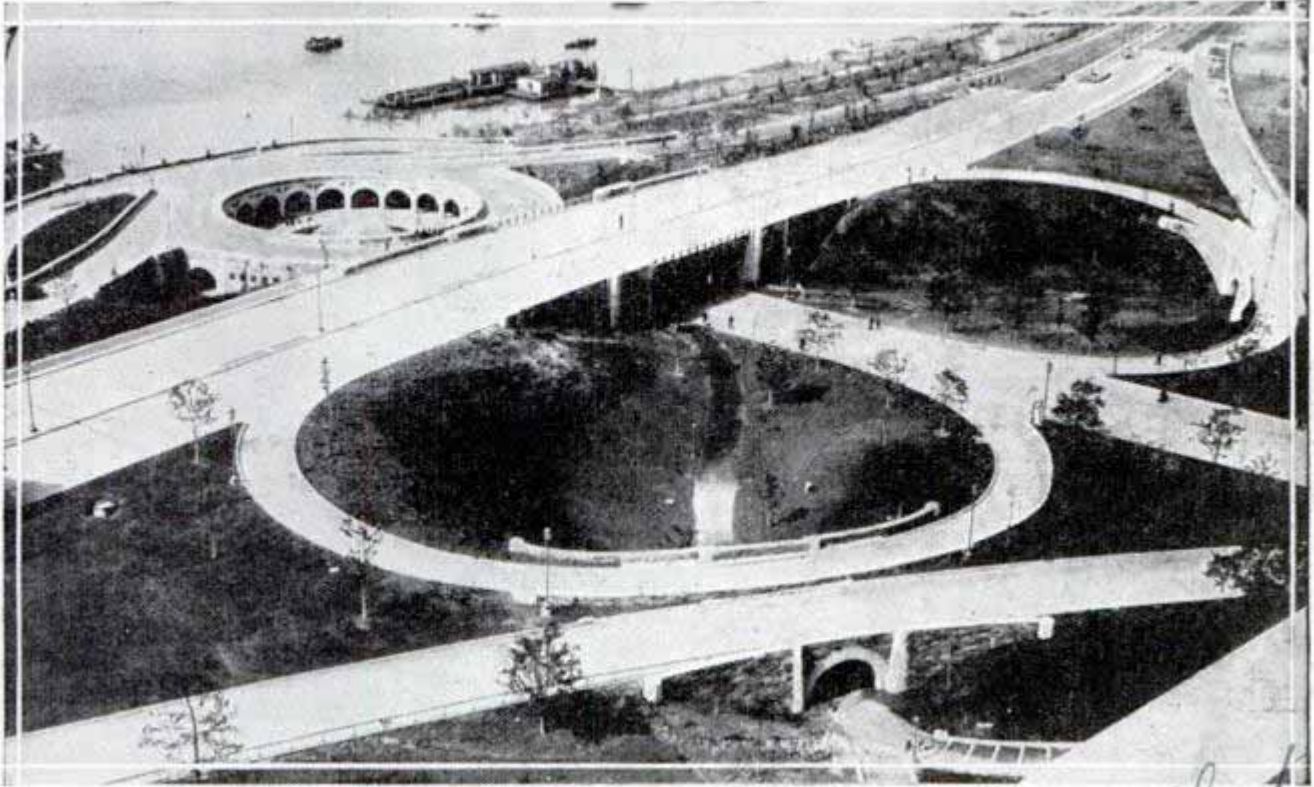

Under traffic circle at left of the superhighway, is a garage with accommodations for 250 automobiles. Cloverleaf intersection at Seventy-ninth street is part of Manhattan's \$24,000,000 water-front project

Beauty, utility and safety are combined in New York's new superhighway, part of a \$24,000,000 improvement project on the Manhattan west side water front. The clo-

verleaf traffic intersection at Seventy-ninth street includes a huge fountain, and a yacht basin and promenade are yet to be built. Beneath the traffic circle is a garage.

Motor Sled Hauls Ski Party by Cables to Peak of Slide

Tobogganing uphill makes skiing downhill more pleasant for winter sportsmen in

Yosemite National Park. A motorized sled—they call it an "upski"—takes ski parties



Double sled with motor at center hauls ski parties in Yosemite Park

up the 3,000-foot slope to the top of the ski run. The upski is really two passenger-carrying sleds, mounted ahead of and behind the ninety-five horsepower truck motor which is on a center section. Traction is furnished by two fixed cables counterweighted at the bottom, and the sled is protected by safety devices which would go into operation if a cable broke or the motor stopped. The sled, fifty feet long and weighing two tons, carries thirty-two, and makes the uphill run in five minutes.

Badger Pass Ski Area

*ent. 1148
Chinquapin
Yosemite
National Park, Calif.
ent. Log cabin
ranger station
National Park, Calif.*

Es 1105 Eastman Kodak Co,
Rochester, N.Y.

How To MAKE

Here are some clips from home-movie reels. They should remind you to keep your lens focused on the center of action—and if you must “panoram,” do it to follow a moving object such as a football run. Then your audience watches the player and doesn’t mind the blurred background

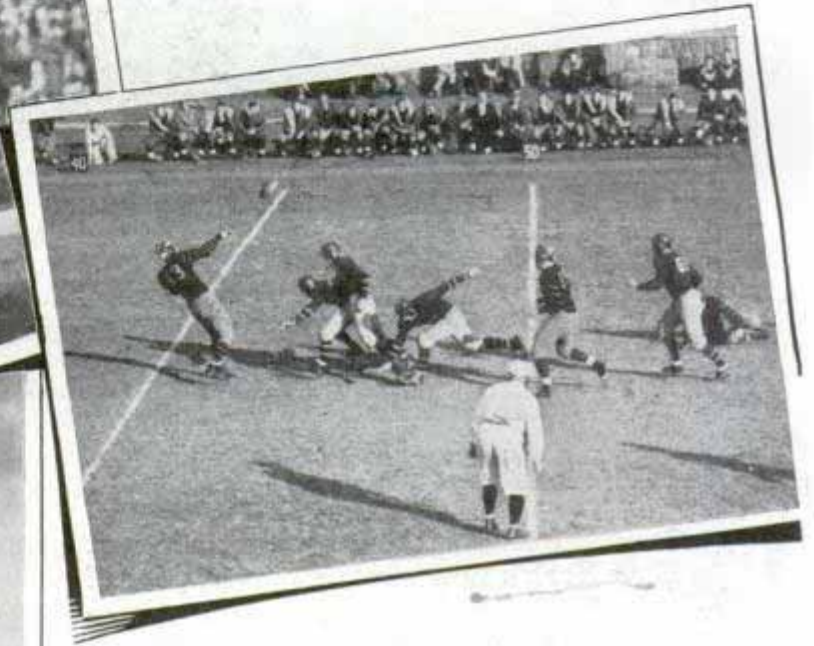

Learn the difference between mere animated snapshots and a movie.

When you start taking motion pictures you are a step ahead of the old snapshot days when you merely pushed a button and “took down” a scene to be pasted in a book. Later you would show the pictures

IN HOME movies it’s change of pace, or what the professionals refer to as “tempo,” that wins.

Ten seconds is the rule for a scene, but learn when to break the rule.

Steal the stunt of the candid cameraman—catch your actors off guard.

“Panoram” almost never—but when there’s action to follow, forget the background.

Mix things up. Mix action with calm, mix landscapes with personalities, mix close-ups with distant shots.

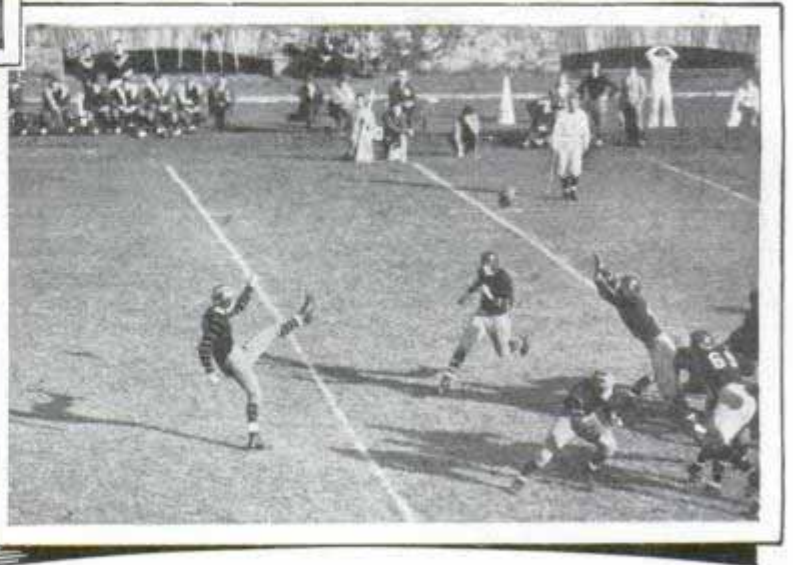

Good HOME MOVIES

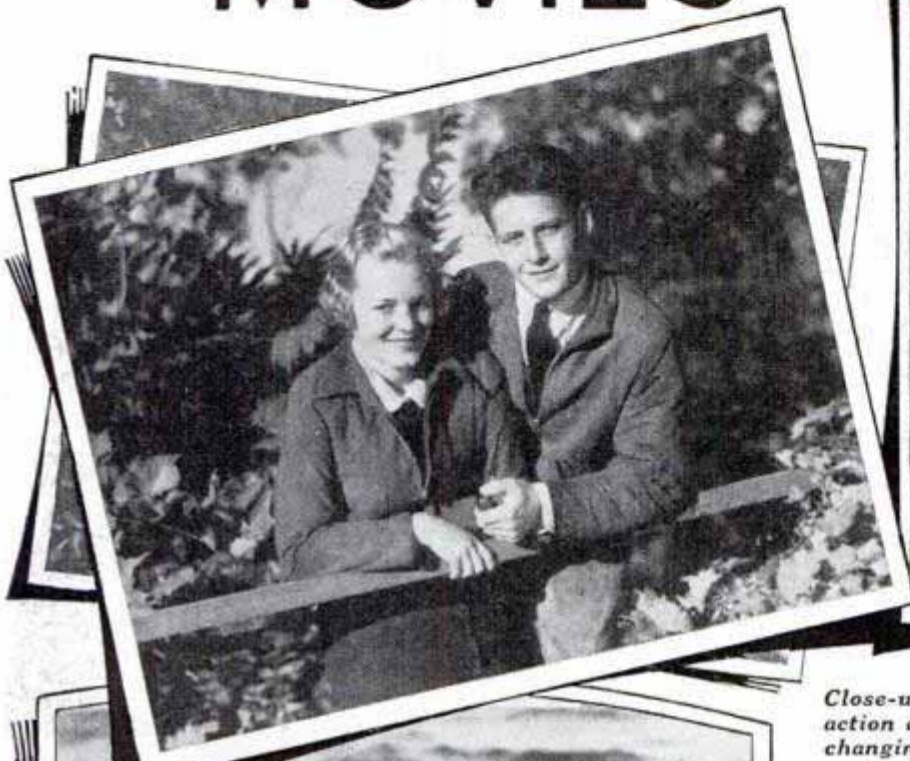

Close-ups count in movie making—close-ups of action and people. Nothing can catch the quick-changing expressions on a child's face so well as a movie. Let the figures fill the view finder

Let's use for example a simple and popular picture subject such as a boy and a new bike. A snapshot record of the prideful youth and his shining steed would, perhaps, be merely a shot of him about to shove off for his first ride—and probably very conscious that he is being filmed in the act. Maybe several snapshots, until you feel you've gotten the "right" expression.

A movie, however, need not and should not be posed. It should not be one, two, or a dozen shots of a "boy with bike"—it should tell the story of the boy and that new bicycle. Each new shot should logically elaborate upon its predecessors so that your movie audiences will see, among other things, the pride of the lad in his new acquisition; cautionings from his father on its care; adjustment of seat and handle bars; demonstration of the use of the brake; learning the importance and location of oil caps; the first careful ride; growing skill; daring acrobatics; inevitable spills. It should be composed of shots made at many different distances, different camera angles—up-

to your friends and explain the Who, What, Where and When of each snap. Movies tell their own story. Of course you can title them—but that is incidental. Every "take" of a parlor movie should be part of a continued story. Even silent movies can "talk."

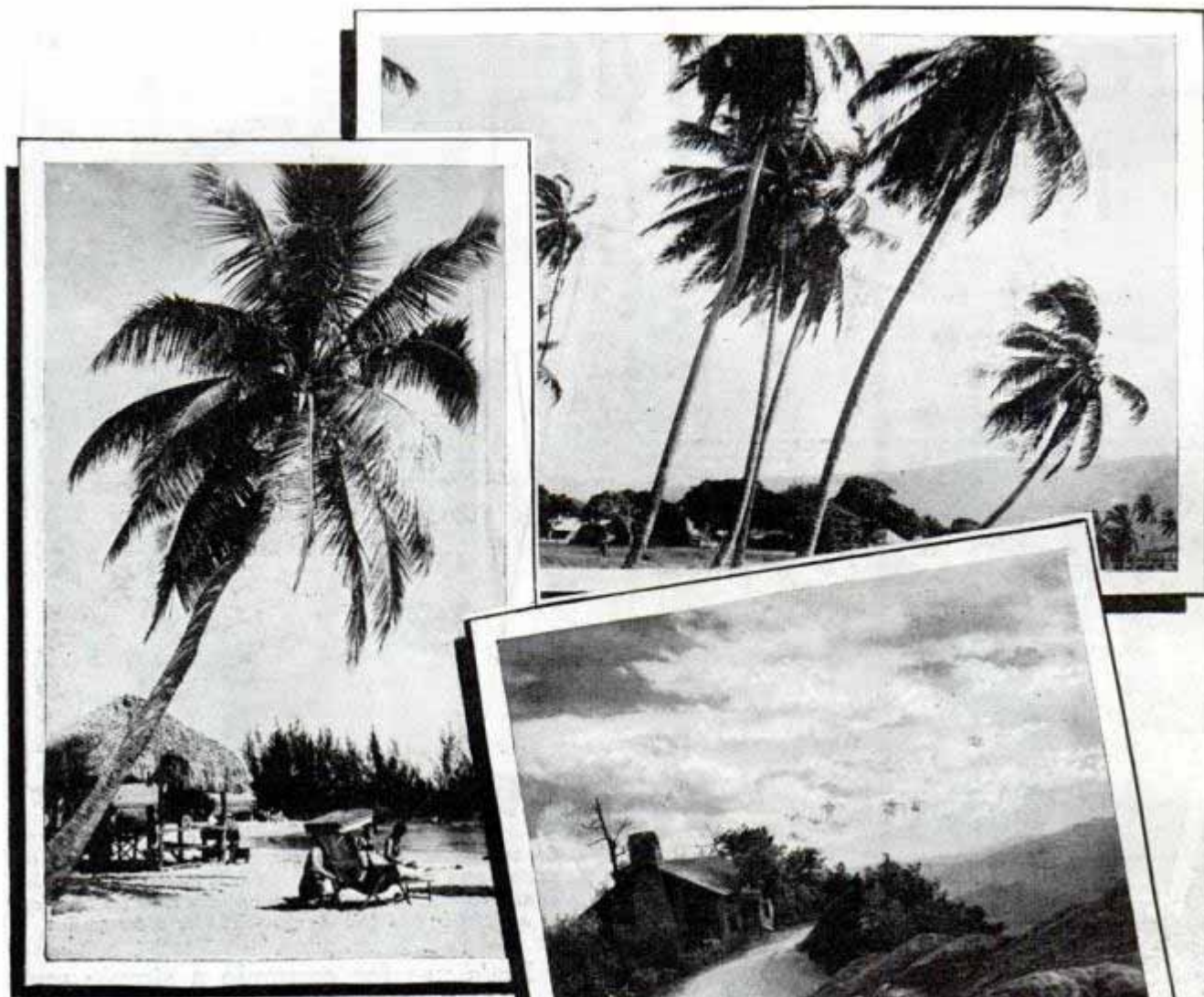

Dreamy tropical scenes and quiet landscapes call for longer exposures. Your audience wants time to take in details. Hold the camera steady—let swaying palms or drifting clouds furnish action in pictures like these

wards, downwards. It should be filmed in sequences with continuity. For, although both movie shots and snapshots are made singly, the former are shown successively. Which, alone, implies that they will tell a story, a story with a logical beginning and a logical ending. There need be no acting, no posing, no props, no staging or make-up. Yet it's every bit as much a movie as the most colossal "Colossal" ever born of Hollywood. It's just as easy to make as a collection of animated snapshots. And its simple, obvious technique is equally applicable to the filming of every subject.

Many movie beginners, yet to grasp the fact that movies should be taken with their projection possibilities in mind, seek to "needle" their animated snapshots with camera tricks to stimulate interest.

The most popular and unnecessary is the panoram. While it is true that panorams are possible with any movie camera and clearly beyond the realm of snapshot making, wherein lies their chief charm, they should be studiously avoided. If for no other reason than that they prove distracting on the screen. A lovely garden; a charming landscape; an imposing structure—the desire is to "get it all" in one shot. Hence, a panoram, generally a fast, unsteady panoram, and the desirable subject matter, projected on the screen, whizzes groggily past the eyes. Its beauty is lost in distracting jumpiness.

(Continued to page 116A)

Modern Tower Replaces Old Building's Dome

Restyling of an old fourteen-story building in San Francisco has resulted in replacement of a large dome with a setback tower which increases the height to twenty-one stories and adds almost 100 offices to the rental space. Since lightweight steel was used, the tower's weight was held to that of the dome, making it un-

Claus Spreckels



Top, the old building in process of remodeling. Bottom, architect's sketch of same building after it had its "face lifted"

necessary to reinforce the foundations or original framework. Specifications called for replacing the old elevators with modern high-speed cars, each equipped with automatic door-closing and floor-leveling devices and latest safety features.

Use of Steel for Elevated Highways Calls for Increased Production

Increasing use of steel for building elevated automobile highways throughout the country will call for heavily increased steel production a decade from now, engineers predict. Other cities are expected to follow New York in solving traffic problems by constructing express highways on steel stilts with cloverleaf underpass systems to

make intersections safe. Production of steel is forecast at four and one-half billion tons by 1947, a billion tons more than at present. Much of that steel will be going into skyscrapers and railroads, bridges, homes and ships, machinery and automobiles as in the past, but the future will see more steel used in double-deck roads.

Scene Source 10/26/37

at convention of American Institute of Steel Construction. 200

Cont. William W. Wier 576 G' James St. San Francisco, Calif

718-Foot Antenna Improves Radio Programs

Vastly improving broadcast service, a 718-foot steel spire antenna is being used by KDKA, the Westinghouse station, to reduce signal fading. The spire, operating inside a circle of eight ninety-foot antennas, gives primary broadcasting service over an area ten times greater than that previously provided with strong, clear signals by the old equipment. Vertical antennas, of the type used in the new system, radiate both ground and sky waves. When the two waves meet in areas of varying distances from the station they interfere with each other, causing

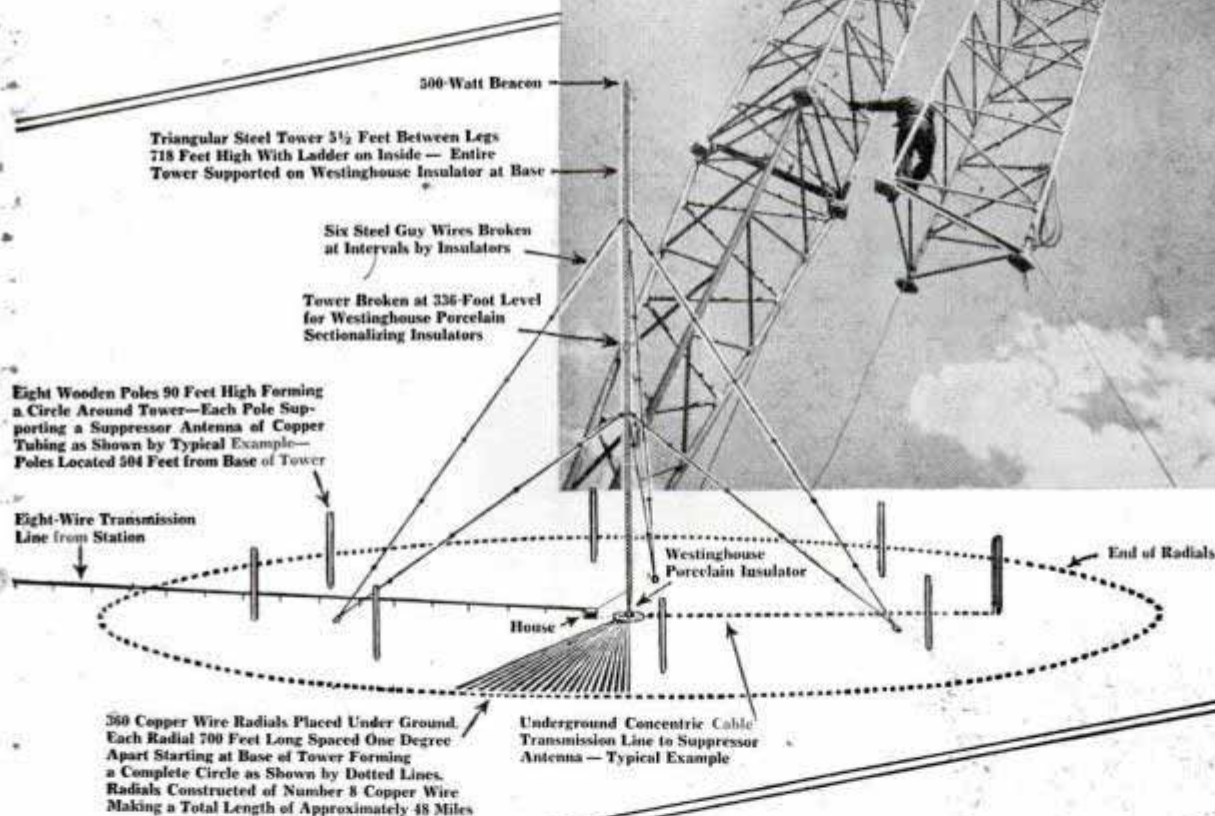
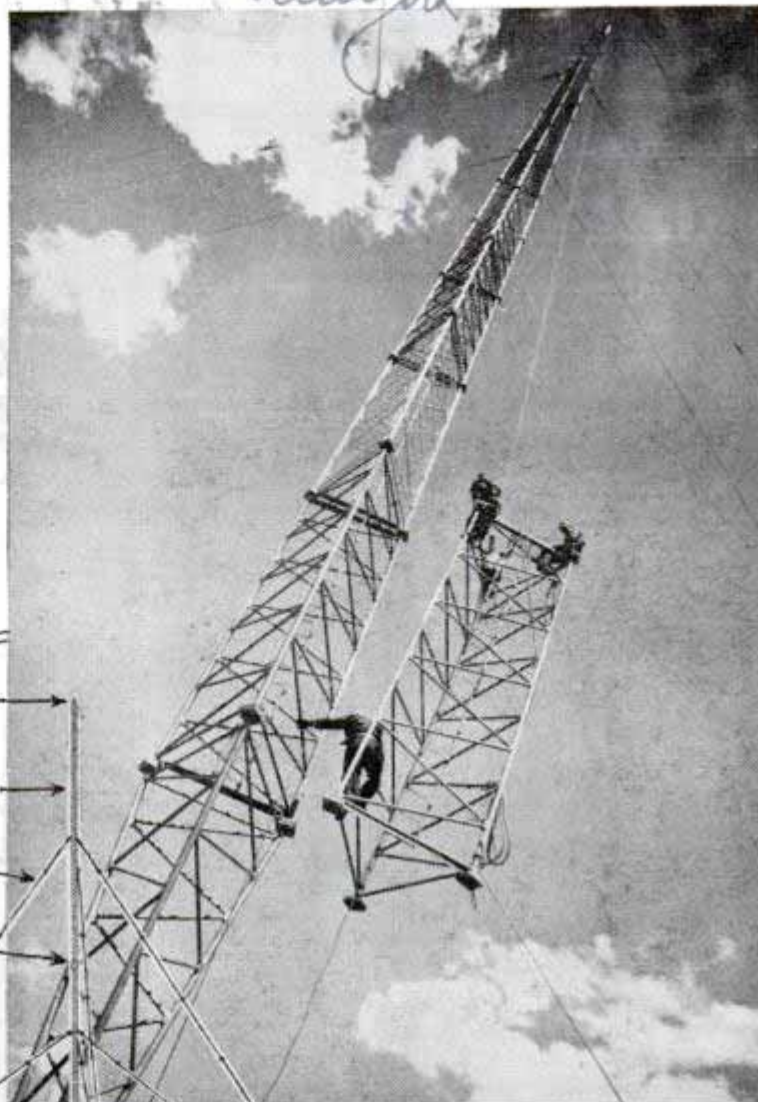

Top, section of lofty antenna being hoisted. Bottom, sketch of antenna system designed to improve radio broadcast service

fading or "mushy" program reception. The shorter antennas also radiate sky waves but in opposite directions to nullify the effect of the sky wave emitted by the main antenna. So high that its top half frequently is obscured by clouds, the spire is composed of thirty-two three-cornered welded steel sections. Only five feet wide, these sections are bolted together. Two

sets of long guy wires hold the antenna upright. The sixty-ton structure rests in the ball-and-socket joint of a single large porcelain insulator strong enough to support the weight of the steel and the twenty-ton additional load imposed by the pull of the guys. About halfway up the spire, three smaller sectionalizing insulators have been inserted to break the antenna,

electrically, at a height of 336 feet. Insulators inserted in the guy wires eliminate radiations from this source and the conducting of current to the ground. Thus, completely insulated from the ground, the spire becomes charged with static during storms, then crackles and sparks continuously, but its broadcasting efficiency is not affected. To improve the conductivity of the ground around the antenna, fifty miles of copper wire have been buried one foot under the surface, radiating out, one degree apart, for 700 feet. Data included in the design of the antenna were obtained by tests with small blimps, sent aloft to extend transmitting wires up to 1,500 feet. It took a crew of nine expert steel riggers seventy-two working days to erect the tower. *Es 1042.*

Ninety Eggs Graded in Minute by Latest Automatic Machine

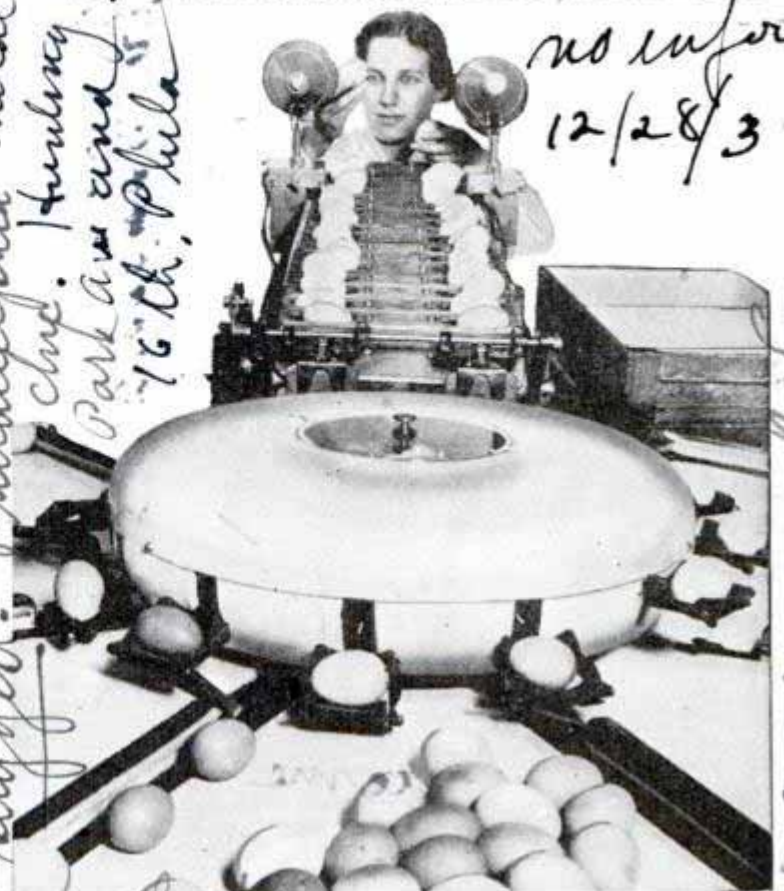

This woman operator finds it easy to grade eggs with the aid of this machine which turns out ninety per minute

Vegetable Shredder Saves the Hands

Designed to eliminate injury to the user's hands, a vegetable shredder and slicer has a trough in which the vegetable is inserted and pushed toward the cutter. A metal feeder makes it possible to use all of the vegetable. Various sizes of shredders and cutters may be used with the kitchen tool.



Feeding vegetable into shredder. Note that danger of injury is reduced

More than ninety eggs per minute can be graded in a machine exhibited recently in London. Almost as fast as the eggs can be placed on the machine, they are graded, so that more than 5,400 per hour can be handled at the machine's top speed.

Tube in Safe Prevents Robbery by Giving Off Strong Gas

Protection of a safe against robbers is afforded by a sealed tube containing a liquid that turns into a powerful gas when the container is broken. The gas affects the eyes and other parts of the body. Concealed in the safe, the tube is broken by anyone attempting to force the safe by breaking off the combination or using explosives. It is claimed the device can be marketed inexpensively.

Whenever you find that you wish to know more about any article in this magazine, write our Bureau of Information, inclosing return postage

*St. Wendale Caly
C. B. Morain, 536 Vice*

*suggested Philadelphia Metal Works
Chas. Furlong
Park Ave and
16th, Phila.*

*no info
12/28/37*

*at Agric. Hall
Ed. M. Hedges, 75 Park*

Es 1135. Dallas, Texas

Flaws in Airplane Parts Found by Magnetizer

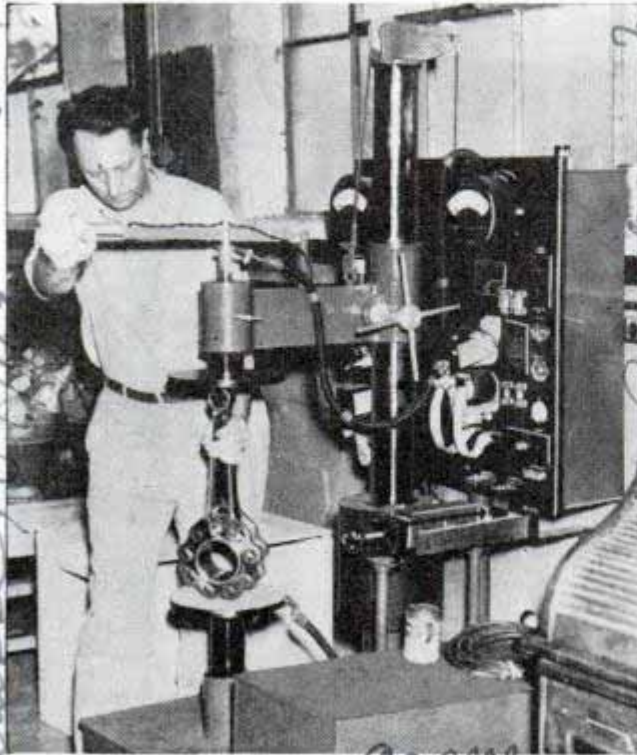

Part of plane being subjected to flaw-finder in air line's repair shop

Flaws in the metal structure of an airplane can be revealed through use of the Magnaflux, a device now in use at the operations base of one air line. The Magnaflux magnetizes the metal to be used, after which the part is dusted with metal filings. Any flaw is revealed by the line of lesion in the metal not covered by the filings.

Baby Buggy Slides Down Stair on Folding Glider Frame

Attached to the undercarriage, a folding glider frame enables mother or nurse to

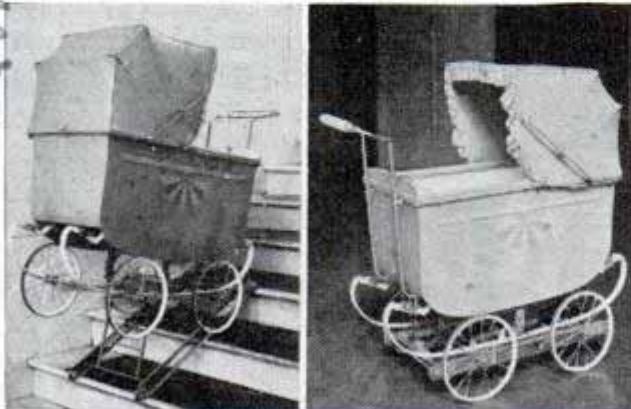

Two views of carriage. Left, glider in use. Right, glider folded against axles

slide the baby buggy down stairs without permitting the wheels to bump on the steps. Unfolding the glider into operating position at downward angle lifts the wheels clear and the buggy remains on a level during the trip. This eliminates dangerous tipping. When the glider is not in use, it folds neatly against the axles.

Low Upkeep of Steel House Offsets High Price

Steel houses cost more than other houses but the high initial price is offset by low maintenance charges, according to F. T. Llewellyn, U. S. Steel research engineer. More than 1,400 steel houses already have been built in the United States. Envisioning a potential market of 300,000 homes using 1,500,000 tons of steel each year, the research engineer pictures homes without basements and with increased number of corner windows and larger areas of glass made possible by the use of steel construction. He points out that non-shrinkability of steel gives a more efficient structure which requires lower maintenance costs than houses constructed of other materials.

Pedal Car Made of Two Bikes and Streamline Hood



Here is the cyclomobile and the family which makes short trips in it

Consisting of two bicycles joined together and covered with a streamline canvas hood, an odd pedal car carries the whole family in Massachusetts. While husband and wife work both sets of pedals, the baby rides in a small berth. There also is space for luggage. The waterproof hood has isinglass windows. Dry-cell batteries furnish current for front and rear lights

Leopold Trade Fair 108 40 New York

Built and owned by Mr. and Mrs. Aime

Paula Steiner, Berlin Germany Mercedes-Dastasse, 11 Broadway, N.Y.C.

Es 1270 Es 1224 Es 1224

Fast Camera Catches Stone Striking Water

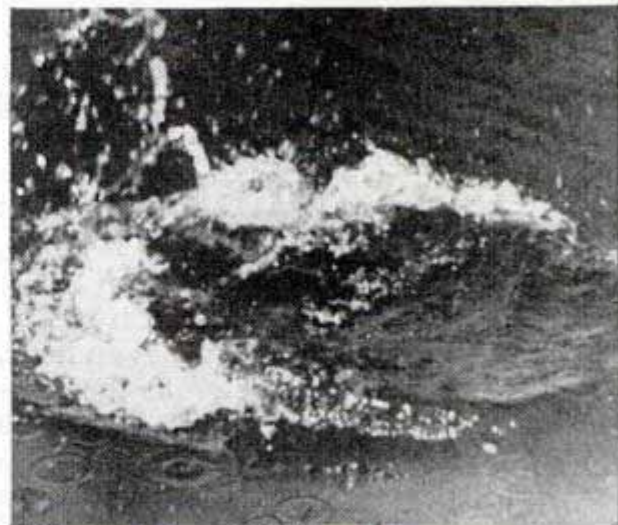
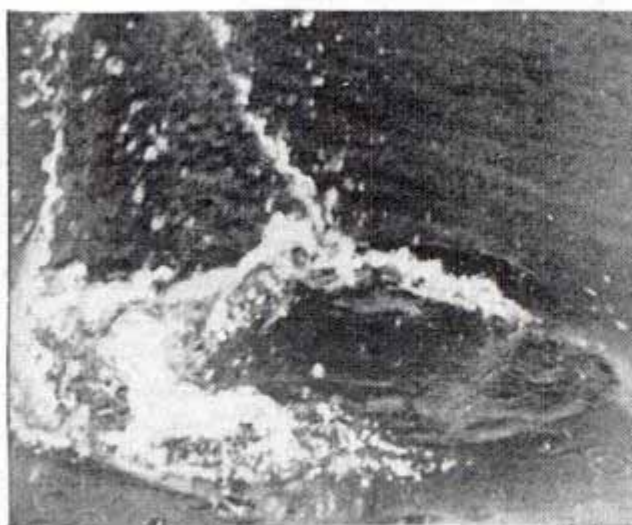
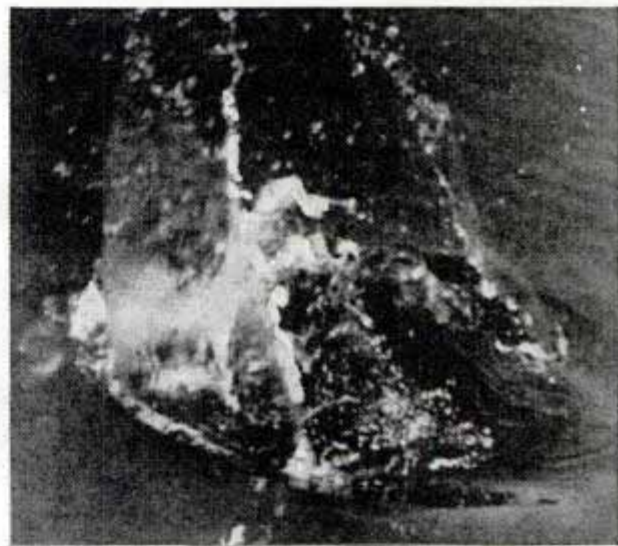
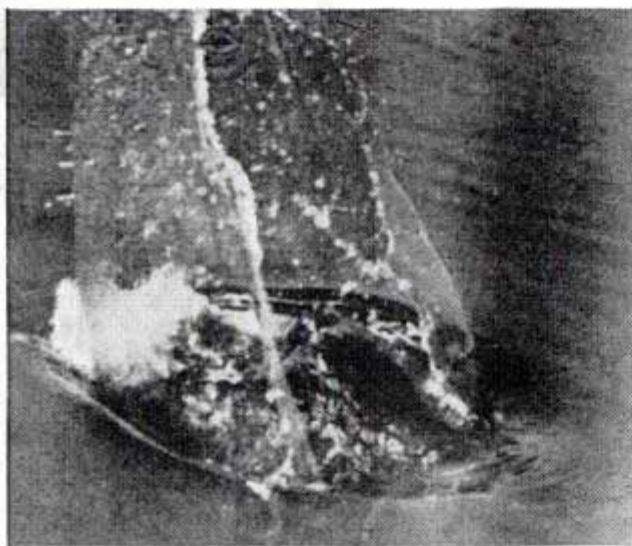

Wide World Photos.

What happens when a stone is thrown into the water at an angle of seventy-five degrees is revealed by a fast camera in a set of six photos taken recently. The action, all taking place in one-fiftieth of a second, is too fast for the human eye. In the photos above, reading from left to right and top to bottom, as the stone hits the water, it makes a crater-like depression and throws up a veil of water on both sides. Then the water rushes into the depression and sets up a small wave that is the forerunner of the familiar succession of circles. The pictures were made with a high-speed continuity camera

Es 1160 Cont Thomas G. D. Umick, Jr
105 55 Holman Ave
Los Angeles, Calif

TWO MILES

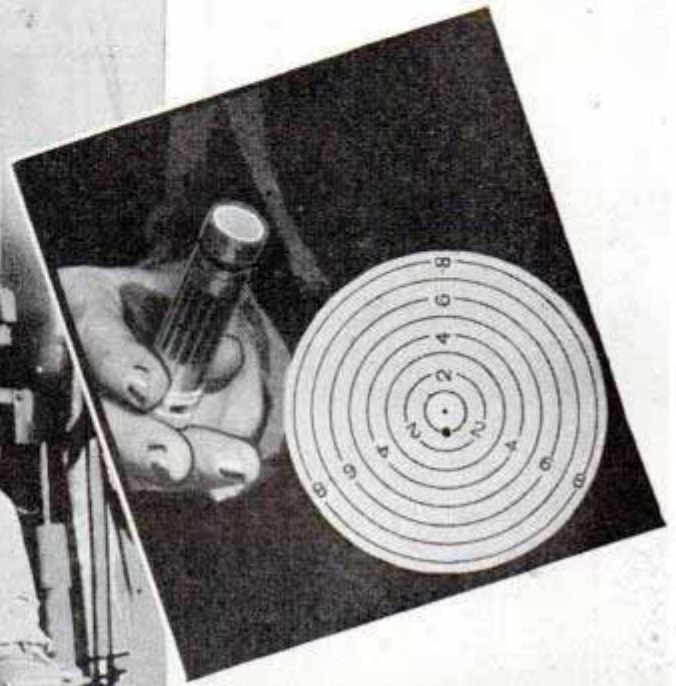
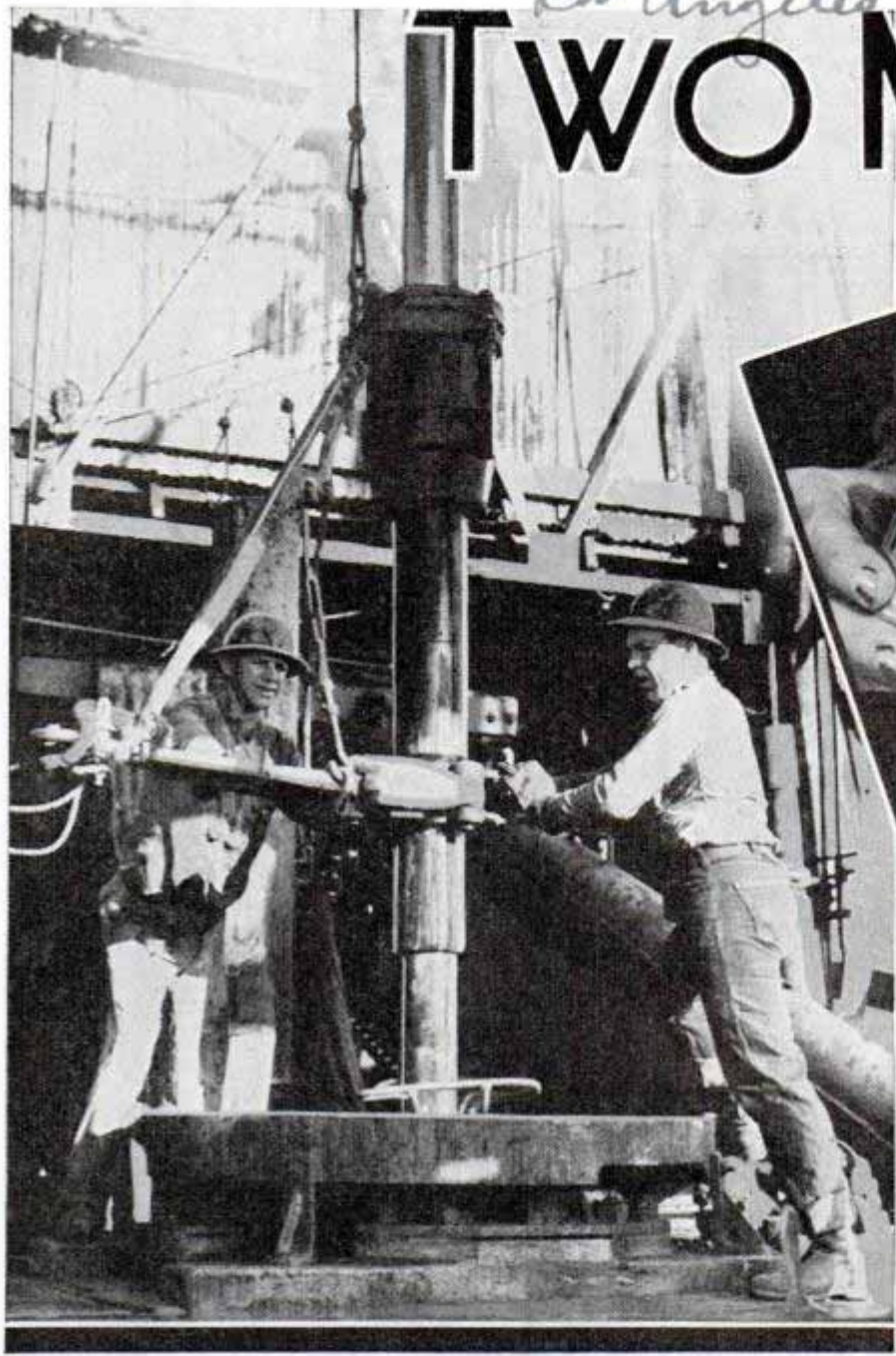

Left, drilling crew threads pipe. Right, examining paper target brought up from bottom of well. Tiny hole near center shows mile-deep well is comparatively straight

they pull out the slips that hold the pipe string and another eighty-eight feet of pipe goes down into the hole.

At any stage a single mistake by one of the men would cause a serious accident or do damage

PERCHED high in the steel framework of the oil derrick, the derrickman leans out against the pull of his safety belt. Up from the floor of the well ninety feet below the steel cables whisk a two-ton traveling block and elevator at thirty miles an hour.

As the block arrives, he grabs the dangling elevator link and sways it over to the top of a length of drill pipe in the corner of the derrick. In another second the elevator gate slams around the pipe and with a jerk the cables lift it into the air. Looking down, the derrickman can see the two helpers push their end of the pipe over to the rotary table, stab it into the top of the pipe sticking out of the well, and spin in the threads with the big tongs. Then

costing a small fortune. Yet the well-trained drilling crew, working with tools that weigh from 100 pounds to several tons, moves at high speed with the sureness of a championship football team.

Five or six years ago oil operators thought they had gone as deep as they could when they drilled not much more than a mile. Today a good crew is able to push pipe farther than two miles below the surface. Stronger flexible metals for the drill pipe, taller derricks and more powerful pumps for circulating mud down the well and back are playing their parts, but more than half of the credit goes to the husky driller who stands at the engine controls. With good luck a two-mile well

Reference: ...
Associated Oil Co.
Pacific Electric Bldg.
Los Angeles.
Calif

DOWN for OIL

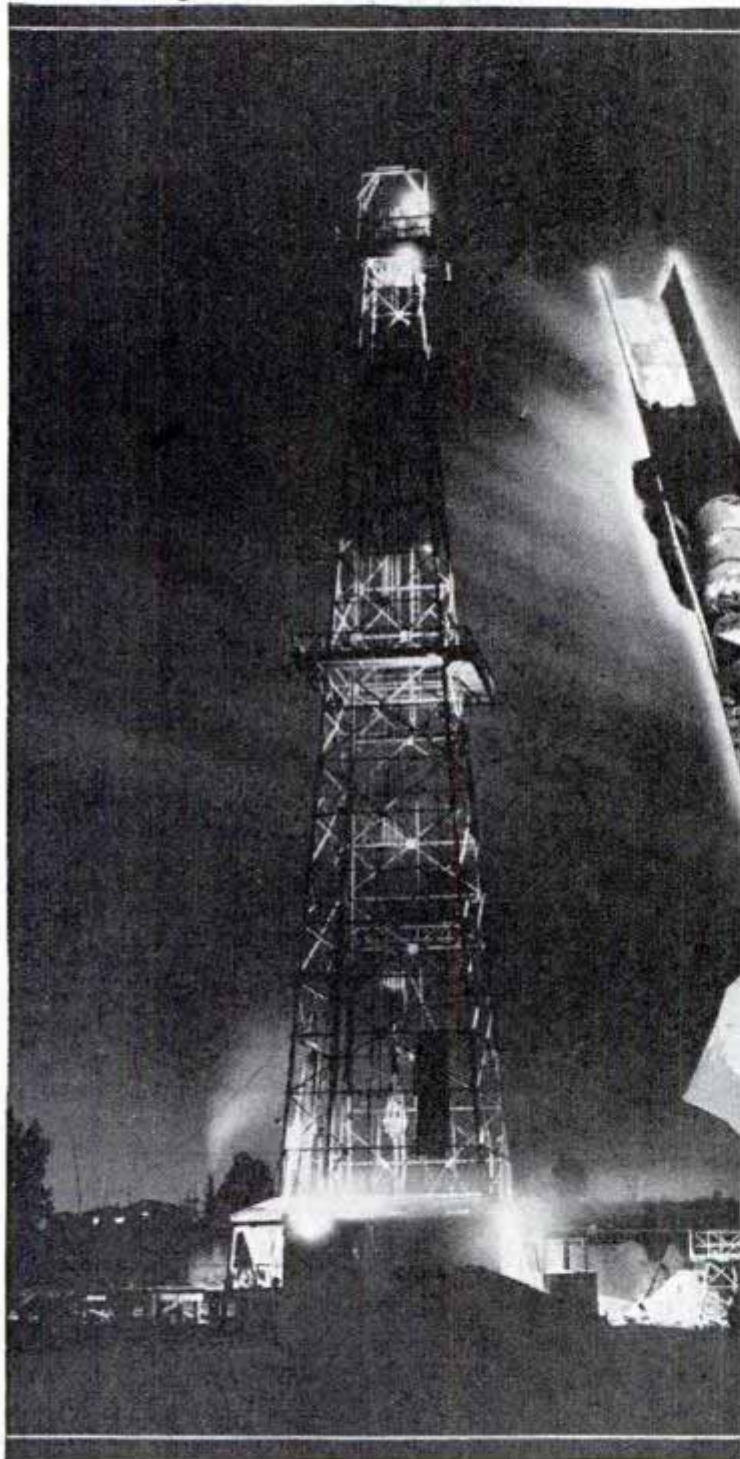

Left, night drilling scene. Right, samples of rock cut from bottom of well and brought to surface by coring machine that drops down inside drill pipe

takes nearly a year to drill. The three chief drillers, spelling each other in eight-hour shifts, never leave their post. The revolving column of drill pipe and its bit

at the bottom may weigh 100 tons but instead of being slam-bang mechanics the drillers are chosen for their great skill in handling the tools. Drilling a deep oil well is one of the most delicate jobs in the world.

If you made a model one foot high of a deep oil well the 10,000 feet or more of three and four-inch drill pipe would be about four-thousandths of an inch in diameter. That is literally the tool with which the driller works. His drill pipe bends just as easily and will go crooked



Top, driller at the controls. Bottom, derrick floor, showing traveling block and swivels that support part of drill pipe's weight

bit he supports the pipe partly by the cables so that the crunching teeth at the bottom of the hole will not bite too deeply. With a flip of his right hand he can raise the bit from the bottom or by spinning in the throttle wheel keep the bit from turning. Big dials in front of him show the weight on the bit, torque of the drilling table and the pressure under which the mud is going down the well.

Drilling a deep well is slow work and often the bit will cut through only fifteen or sixteen feet of rock per day. In hard formations the bit has to be pulled out of the well and changed once a day. It took 338 days to drill the McGonigle No. 12, an Associated Oil company well in California that held the record for deep production at 10,569 feet for a long time in 1937. The first 800 feet of that well is wide enough to stand in, and after that depth had been drilled and lined with steel casing a thirteen-inch casing was placed down to 6,000 feet, after which the well was reduced in diameter again, with the last few hundred feet of the well only four inches wide. Down at the bottom the temperature is just at the point of boiling. The steel liner casing that went into the hole weighs 528 tons. The pipe with which the hole was drilled is hollow so that a continuous stream of mud could be pumped down inside it under pressure to pick up chips and broken rock at the bottom and flow back to the surface outside of the drill pipe.

just as easily as the microscopic wire and it will twist off and break with the same ease. To control his fragile brace and bit the driller keeps one hand constantly on the lever that controls the cables supporting the 100-ton weight of the pipe string, and his other on a throttle wheel that keeps the drill pipe turning. Instead of permitting all the weight to rest on the

Technicians watch every step of drilling. They keep track of the well's straightness by various means of "taking a picture," one of which consists of lowering a tiny paper target inside a heavy steel rod down to the bottom of the well. After an interval, a time clock operates a plunger

that pierces the target. The degree that the punch mark is off center on the target indicates how far from true vertical the well happens to be.

Instead of taking time to pull the string of drill pipe out of the hole to lower a special coring tool to the bottom in order to take a sample of the rock, a small coring device is dropped down inside the drill pipe and through a hole in the center of the bit so that it can



Top, derrickman descends from lofty perch in emergency cage. Left, split section of pipe recovered at great depth by means of wall hook. Bottom, bits used in drilling deep well



cut new rock and bring up the sample.

As a final checkup on the formations through which the drill has cut, an "electric log" draws a geoanalytical record of the kinds of rock encountered on the way down and the presence of water-bearing and oil-bearing strata. Sometimes a crew keeps on drilling after it has pierced three or four different oil sands, one below the other. When drilling is fin-

(Continued to page 146A)



Bowling and Shuffle Board Combined in Game on Lawn

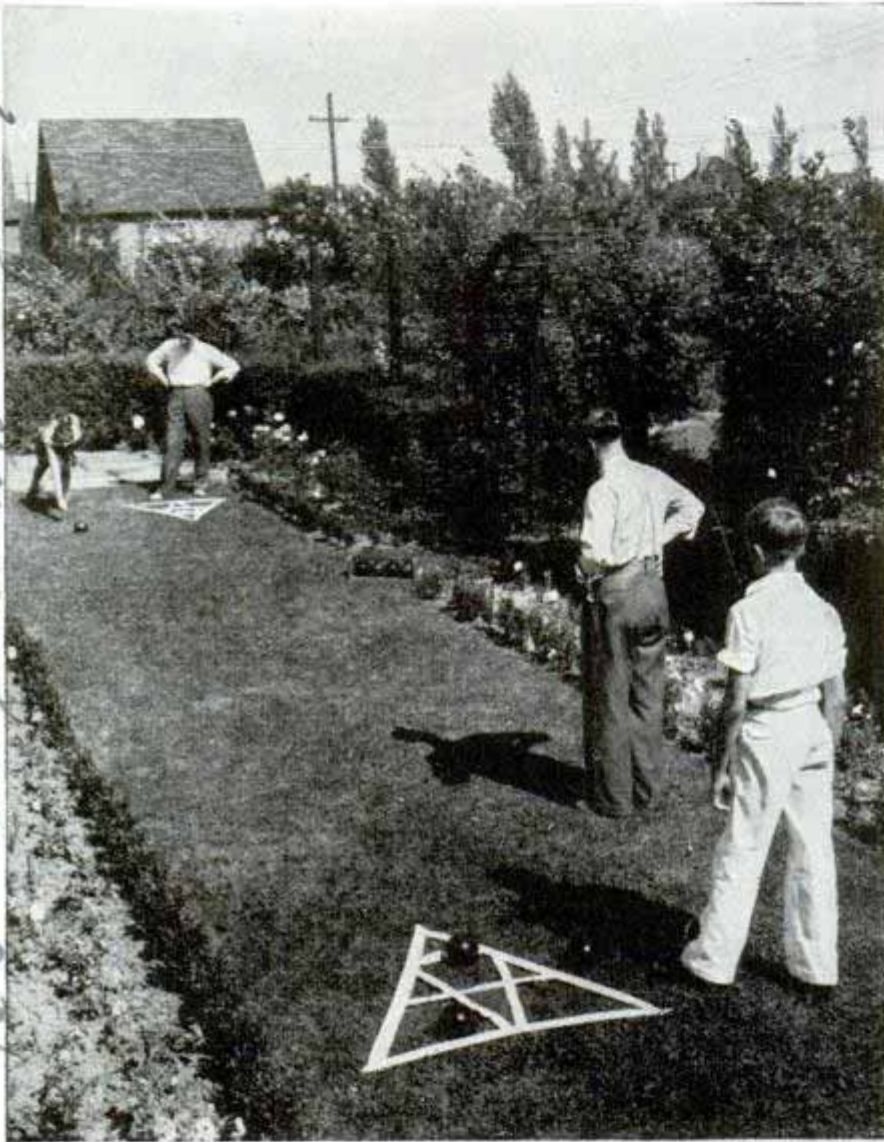

Playing the new lawn game. The idea is knock opponent's ball out of target with the bowling ball which is rolled along the grass

Combining the features of bowling and shuffle board, a new game is played on the lawn. Regulation bowling balls are rolled toward a target divided into several scoring areas. The idea is to knock your opponent's scoring ball out of the target ring and leave your own in the scoring area. Each side has a target, the two being thirty to forty-five feet apart.

Sliding Thermostat Checks Gas after Enough Water Is Hot

If you want to heat only a part of a tankful of water, there is a sliding thermostat which can be adjusted to shut off the gas when the hot water reaches the level desired. It slides up and down the

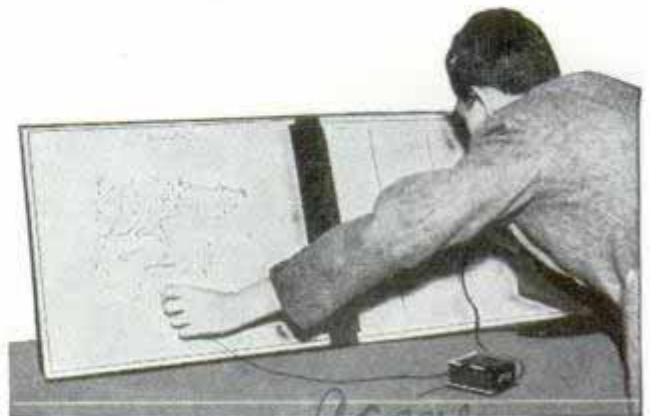

Showing how the electric map works. It rings when the proper contacts are made

tank on a cable. This method economizes on the use of gas, and also promotes safety, making certain the gas will be turned off if you forget. You can also install switches in the bathroom, laundry and kitchen to start the hot-water heater by remote control.

Electrified Map for Blind Has Braille Names

Constructed so that a blind person may feel and read the name of any town on which he puts his finger, an electric map rings to give a double check on the name. It is a relief map with the towns marked by copper tacks and the rivers by copper wire. Beside the map is a list of the names of towns and rivers in Braille, each with a copper tack in front of it. To find the name of the town on which he has his finger, the blind person attaches one contact of an electric circuit to the copper tack at that point, then runs the other contact down the tacks in front of the names. When it touches the tack opposite the right name, a bell rings.

Used in Norway

Beau-Lon Products Co
125 Bayard St. Dayton, Ohio

Ed. Kedzie 2744

es 1248

U.S. Patent
4244 W. Taylor
Chicago

es 1208

es 1195

Stephane

Acme

Prize Photo of Rockies Taken from Air Liner

Taken aboard an air liner traveling more than two miles a minute at an altitude of 8,000 feet, an unusual photograph of the Rocky mountains recently won a high award from the Photographers' Association of America. Snapped through a celluloid-covered window and with a "sky-view" aerial camera "stop 5.6 at $\frac{1}{125}$ of a second exposure," the photo shows a vast expanse of snow and fir-clad sweep of distant mountain range. The curved cowling of one of the transport's motors occupies the foreground. The prize photograph was made by Herman R. Wenner, who has made aerial photography a hobby.

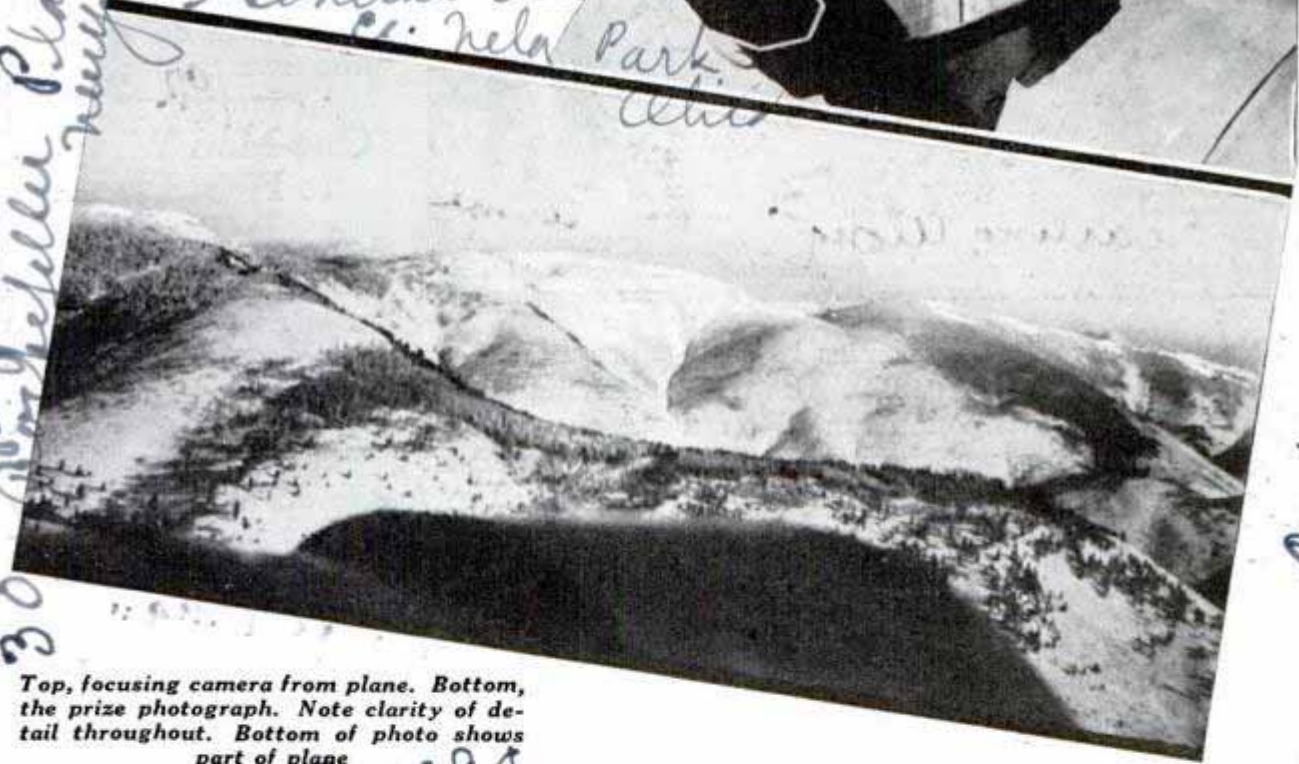

Top, focusing camera from plane. Bottom, the prize photograph. Note clarity of detail throughout. Bottom of photo shows part of plane

Electric Eye Stops Ground Noise in Sound Track of Talking Pictures

That buzzing "ground noise" that has accompanied talking pictures to the great annoyance of sound engineers is being curbed by the "electric eye." An inventor has discovered a way to make the silent portion of the sound track really silent, using a set-up of three photoelectric cells. Sound is recorded on film by picking it up with a microphone, which converts it into varying electric current; this current op-

erates a lamp which makes a record on the sound track. When the films are projected the process is reversed. The entire sound track is not filled with sound at all times, and the black portions should be silent. But sometimes diffusing light leaks onto the silent portion and causes a low tone. The inventor arranged electric eyes to operate a shutter covering the "silent" portion of the sound track, preventing leakage of light.

Patented by Edward W. Kellogg
 Worcester, Mass. 99

Assigned to Radio Corp. of America
 30 West 42nd Street, New York
 1280

Service 10/26/37

same server
10/26/37

Television Breaks into Films with Broadcast from Studio



Sarling Along

© Planet News, Ltd.

Cast of musical show being filmed at English studio gathers around television camera which broadcast "preview" while movie was in production

Television invaded the movies in England for the first time recently. The television camera, its tripod mounted on a rubber-tired truck, was brought into a film studio in Buckinghamshire during the making of a new musical picture, and a view of the studio action was broadcast on an afternoon television program.

Cornea of Eye Is Tattooed to Improve Vision

Tattooing the cornea of the eye with gold and platinum to improve vision is one of the recent additions to surgery which have proved valuable, according to Dr. Ramon Castroviejo of Columbia Presbyterian Medical Center. This form of eye surgery dates to the second century A. D. when Galen used a hot iron rod, powdered pomegranate bark and copper salts to make indelible coverings for opaque spots on the cornea, which is the transparent layer that forms the outer layer of the eyeball. When superficial opaque spots de-

velop on the cornea, especially near the pupil, they greatly interfere with vision, Dr. Castroviejo says, by dispersing the light that passes through the translucent area. Tattooing closes up the spaces between the opaque spots and allows light to pass through a concentrated area. Gold was first used in 1911 and platinum in 1928. The metals, in the form of chlorides, are used in a solution which is placed on the opaque spot for two or three minutes. Then adrenalin chloride is added and the gold changes chemically so that a dark brown, almost black, coloring is produced.

One-Man Weapon to Fight Planes Is Tested

Secret tests of a mysterious anti-aircraft gun are being conducted by foreign officers serving with the Spanish insurgent forces. A one-man weapon, the gun can be operated at almost any angle, elevation being controlled by foot levers and direction by hand. It is regarded as an important development in defense against airplanes.

German

Officer inspecting and operating the one-man anti-aircraft gun. It is controlled by hand and foot levers



Pinewood Studios

Brooklyn and 168th St. New York

described at meeting of American College

of German

Scouting Warplane Hangs Report on Wire

When Japanese warplanes operating in North China return from a scouting flight, they report by hanging a cylinder on a cross-wire in front of headquarters. The plane flies low, the cylinder dangling at the end of a wire, and the pilot hooks the cylinder wire across the ground wire. Then he flies on, making it unnecessary to report after bringing the ship to the hangar. The cylinder contains a report of observations on the flight, enabling headquarters to speed up operations against the enemy.

Japanese warplane preparing to fly over cross-wire on which it will hang scouting report

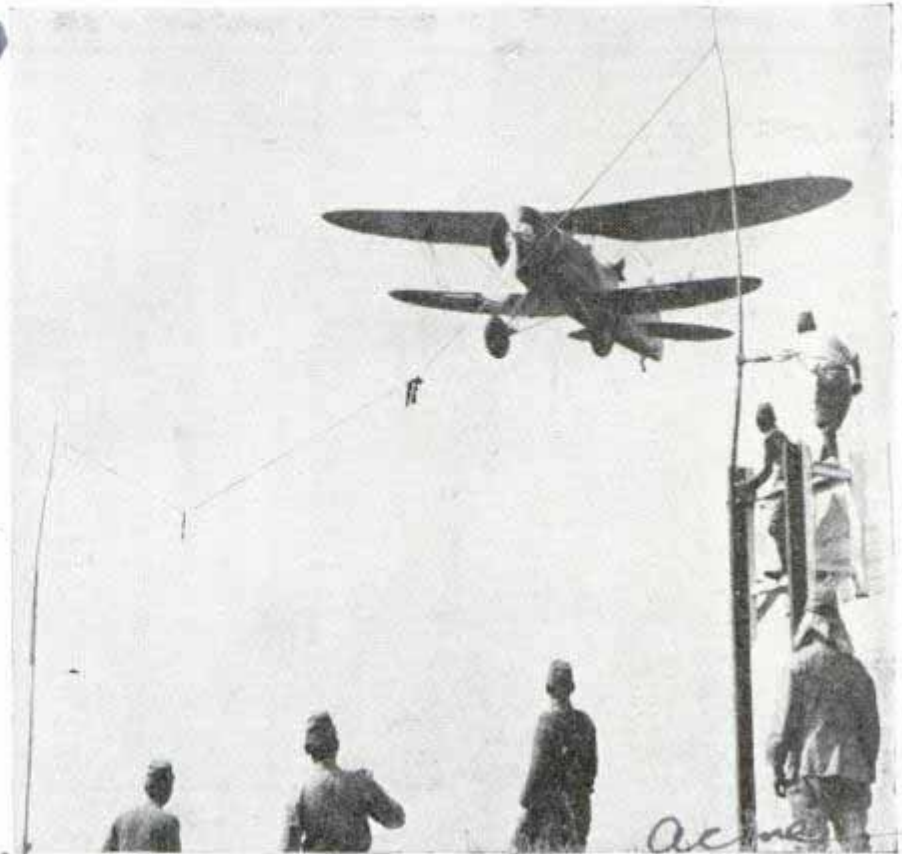

Railway Crew Called to Rescue Cow from Quicksand

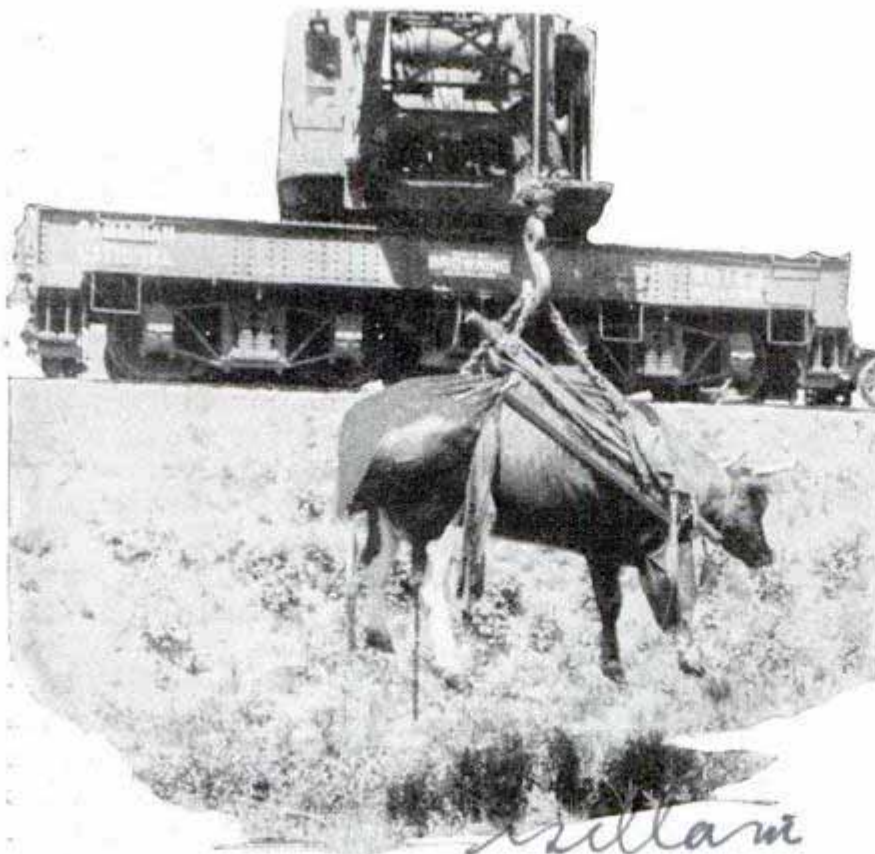

Suzanne, the farthest north cow in Manitoba Province, got in too deep one day and it took a railway wrecking car to hoist her out of quicksand

Rescuing cows is scarcely the regular line of duty for railway wrecking crews, but Suzanne, the farthest-north cow in the province of Manitoba, Canada, is very grateful to a Canadian National Railway crew. Suzanne supplies milk for some of the residents of Gillam, Man., a small town on the Hudson Bay railway. She went for a stroll one day along the right of way, slipped and got stuck in quicksand surrounded by muskeg. Pulling her free was too big a job for men. Suzanne was in too deep and nothing could save her but the power hoist of the wrecker. The railroad sent it out promptly and the big hook lifted her to safety.

Canadian National Railway

es 1081

Mr. Thomas G. Bennett, Jr.
16555 Holman Av
Los Angeles, Calif

DARE-DEVIL

Reference: Vance, Byers, Bennett, Aufplane
San Fernando, Calif



THE strangest scientist in the world sits tipped over in a padded chair diving toward the earth at 500 miles per hour. Instead of watching test tubes he glances at rows of flickering instrument needles. Instead of a desk he uses a writing pad strapped to his knee. His laboratory is one of the latest experiments in fast fighting planes.

His 1,150-horsepower engine is heard miles away and spectators hold their breath. But instead of wondering whether he should jump while there still is time the scientist calmly goes on with his work. Starting his dive four miles above the earth, he has less than twenty seconds in which to note and remember readings of more than a dozen instruments.

Then, at the bottom of the dive, with a tremendous yell to constrict his stomach against the strain, he tilts up the nose of the plane for a crushing pull-out. His body begins to prickle as if it were going to sleep. Right now his weight is more than half a ton and

Top, seven and one-half ton Lockheed leaving for test. Bottom, leaving cockpit after 19,000-foot dive in fighting plane

es 1007

SCIENTISTS *of the* AIR

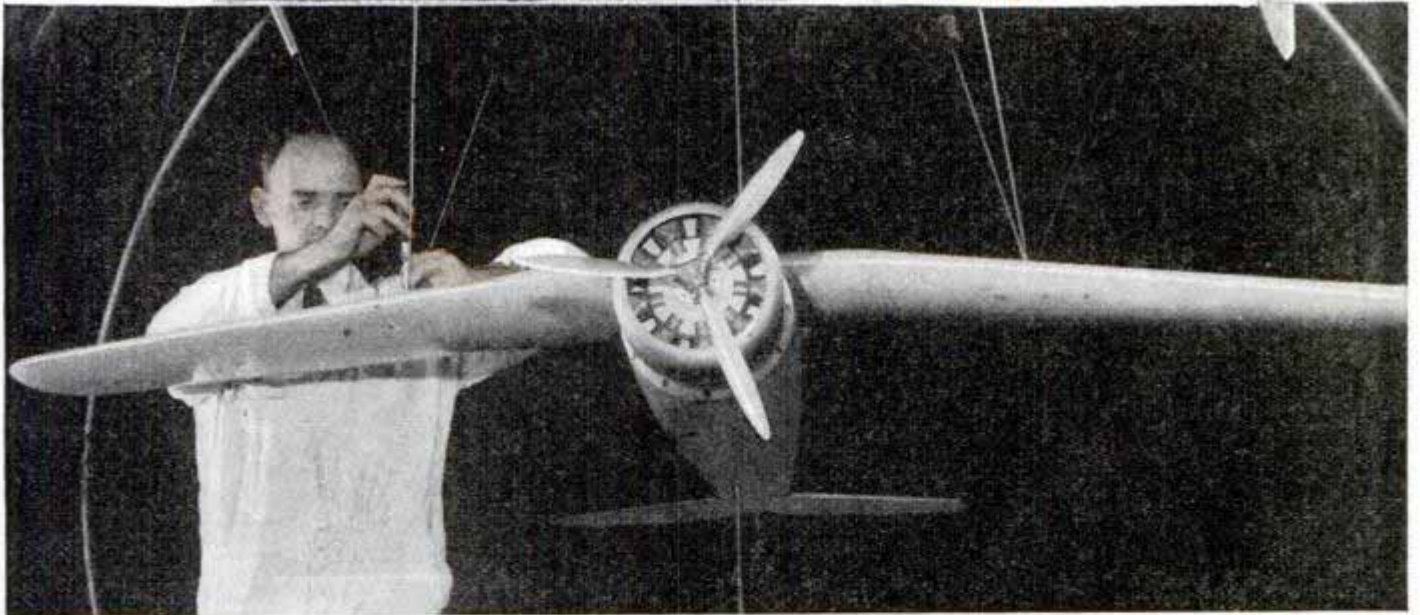
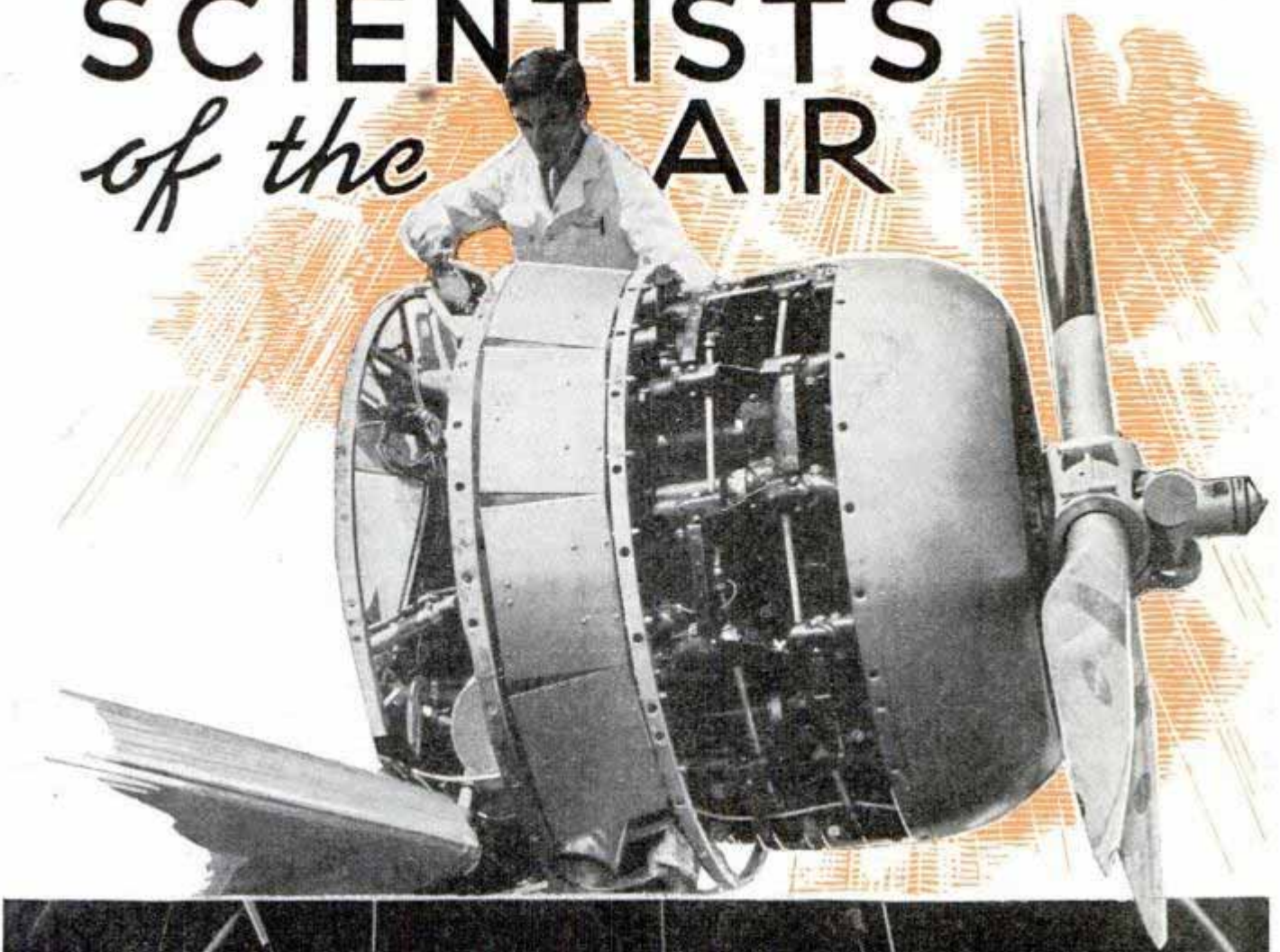

Top, mechanic giving twin-row engine final inspection before test flight. Bottom, preparing for wind-tunnel test of a new model plane

his leaden fingers can barely operate the stick. But he still has to watch and remember the stories that the accelerometer, the thermometers, and the other instruments tell.

Aviation has replaced the dare-devil test pilot of ten years ago with a scientist who takes up a new fighting plane and finds out

exactly what it will do. Even death-defying terminal velocity dives, spins, and flat pull-outs are reduced to cold, mathematical performances.

A pilot rarely allows an airplane to work up to its full velocity in a dive because of the strain on the engine. To slow down he opens the throttle wider. He actually puts



struggle out against the air blast, and fall up," one test pilot says. "A pilot who is able to leave a diving plane receives the sensation of falling up because the plane drops away from him the instant he lets go. He starts to lose speed at once but the plane flashes on. Right then the best way to commit suicide would be for him to open his life-saving parachute. He must wait long seconds until the cushioning air slows him down to half his original speed. Otherwise the terrific slam of the air against the opening parachute might shred it to rags."

Abandoning his ship is the last thing a test pilot wants to do. Sometimes he must, but a new design often represents an investment of a quarter or a third of a million dollars. If anything happens he tries to get it down safely. The cause of a failure would be hard to find if the plane is wrecked.

Often a competent pilot is able to observe a threatening failure before it actually disables the plane. A vibrating wing panel, a tendency toward aileron flutter, or a slight jerking of the controls will make him ground the plane until changes are made and it is ready for tests at higher speeds.

The half dozen top-flight test pilots in the

IN FLIGHT (Check following items thoroughly and record full details)
 ENGINES:—Climb at rated horsepower at optimum indicated air speed to engines critical altitude. 14 deg. C.
 Outside air temperature at critical altitude

	LEFT ENGINE	RIGHT ENGINE
Gasoline Pressure	4.2	4.4
Oil Pressure	80 lbs.	82 lbs.
Oil Temperature	60 deg. C	63 deg. C
Manifold Pressure	32" at 8000 ft	32" at 8000 ft
R.P.M. at Full Power	2250 at 8000 ft	2260 at 8000 ft
Carburetor Air Temperature	35 deg. C	35 deg. C
Head Temperatures	210 on #1 cyl.	215 on #1 cyl.
Engine Vibration	smooth	smooth
Propeller Smoothness	smooth	smooth
Indicated air speed level flight full power at critical altitude	210 m.p.h.	

SHIP'S BALANCE
 Lateral 1 degree right tab Directional 3 degrees right tab Longitudinal 0 degrees tab

Top, test pilot with pad strapped to knee for recording instrument readings. Center, typical report on test flight in two-engined airplane

on the brakes with the throttle. A pursuit plane moves so fast in a dive that air resistance alone against the propeller spins the propeller and pistons faster than they normally move. The way to slow them down is to admit more air with the throttle, thus increasing engine pressures and slowing down the propeller rotation. Then the propeller acts as a brake against the air.

There is always a chance that something will happen in a high-speed dive. "If something goes wrong the flyer has only a few seconds in which to flip off his safety belt, slam back the hatch of his canopy, try to



Transparent canopy slides forward and protects pilot from air blast in tests

United States who try out the very latest fighters and light bombers have traveled faster in diving airplanes than any other men in the world. The speeds they have made in secret trials are far higher than present official world records. What they are learning in the air, the smoothness of flight at 500 miles per hour, the lack of unusual reactions from high speed alone, convinces them that man is physically and psychologically able to handle two or three times such speeds when he builds machines that will fly them.

Different pilots get different sensations from terminal velocity dives and "high G" pull-outs. A pilot who has to swallow like any one else to accustom his ears to altitude changes in a slow trans-



Center, double tail group of new midwing transport being prepared for test

port can dive straight down for 10,000 feet in a fast plane and not be affected at all. One explanation is that the rapidly increasing density of the air during a dive forces air mechanically into the ear passages, though some pilots think that the tight transparent canopies of the fighting planes prevent dense air from leaking in too fast and the ears are able to accustom themselves to the slow change.

Pilots are learning that in most cases the effects of a flat pull-out

(Continued to page 122A)



Top, canopy gives plane a humpbacked appearance. Bottom, cockpit of modern air liner shows numerous control instruments

es 1087

John Dean nyc to Lansing Mich

Potato Cleaner and Sorter Has Set of Rubber "Fingers"



Here is the potato cleaner and sorter in operation. Electric motor at rear end drives the rubber-finger mechanism

Designed with rubber "fingers," a new machine cleans and sorts potatoes automatically. The rubber fingers are mounted on pairs of disks which are set farther apart as the potatoes travel along the assembly, causing the potatoes to fall into different hoppers, according to size. The fingers, of special rubber, clean the tubers without injury.

es 1203

Ventilator Built in Stovepipe Removes Cooking Odors

Ventilator Sales Corp
1715 Euclid Av.
Cleveland Ohio



Odors and fumes may be removed from the kitchen by a ventilator that is an integral part of a twenty-four inch length of stovepipe. An electrically operated fan in the ventilator runs quietly and at low cost. For stoves

Tested at Wright Field

lacking pipes there is a model that fits into the flue opening in the hood. Installed where odors and smoke prevail, the ventilator removes about as much air in one minute as other types remove in a considerable longer time.

es 1161

Quick-Release Crash Belt Helps Pilot Escape

Army pilots are testing a new type crash belt with an instantaneous-release catch which may save lives of fliers caught in wrecked planes. The belt is a combination of the usual waist belt and suspenders, which are secured in front by a single metal hook. The pilot can free himself from the straps on landing by flicking a lever that releases the hook. During normal flying conditions the straps would be left loose for comfort and easy operation of the controls; in an emergency the straps are tightened by pulling a chain between the knees. This

Rayton New Rayton Ohio



Capt. Charles J. Warner

Quick pull on chain tightens belt in emergency and pilot can free himself by flicking lever in buckle

Designer J. S. Manson Army

chain passes through a tube under the seat to the suspender straps in back, and is held taut by a snubber. Use of the belt would prevent head injuries against the instrument panel, cause of a large percentage of crash fatalities. The belt is adaptable to passengers as well as pilot.

Huge Glass-Faceted Grinder Shapes 200-Inch Lens

Ready to shape the 200-inch star mirror at California Institute of Technology is a huge glass-faceted grinding tool. Whenever it is not on the grinding machine the big glass disk is kept in a protective sling-frame to prevent any shock. The mirror is made of borosilicate glass, which expands and contracts very little in changes in temperature.

Projector of Moving Words Latest in Advertising Devices

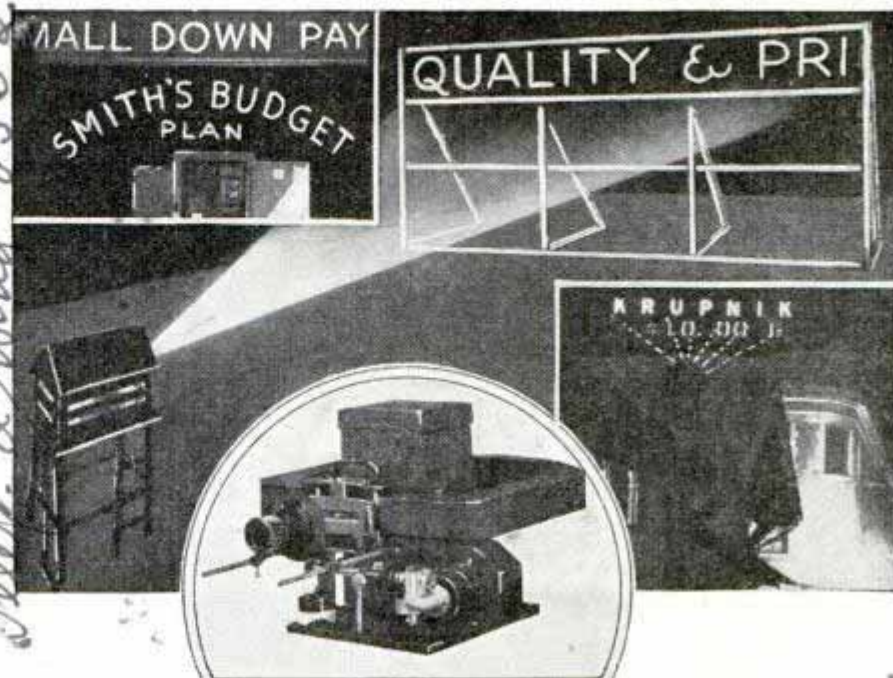

Projector and some examples of advertising signs it produces. The machine, which operates automatically, weighs thirty pounds

One of the latest means of carrying a sales message to the public is a projector which flashes moving words on walls of buildings, on top of buildings, inside of entrances, around borders of canopies extending over walks, and elsewhere. Film or stencil belts may be used. The number of words can be unlimited. Letters from one-half inch to three feet high,

with a spread of thirty-five feet, in any color, may be produced, with the reading matter appearing on a straight, curved or angular line. Continuous and automatic, the machine weighs only thirty pounds. It requires no more attention than an electric fan. It operates on the principle of a projection machine using one 500 or 1,000-watt lamp. Power is furnished by one motor.

☐Inquiries as to makers of articles described in Popular Mechanics, will be answered by our Bureau of Information upon receipt of return postage.

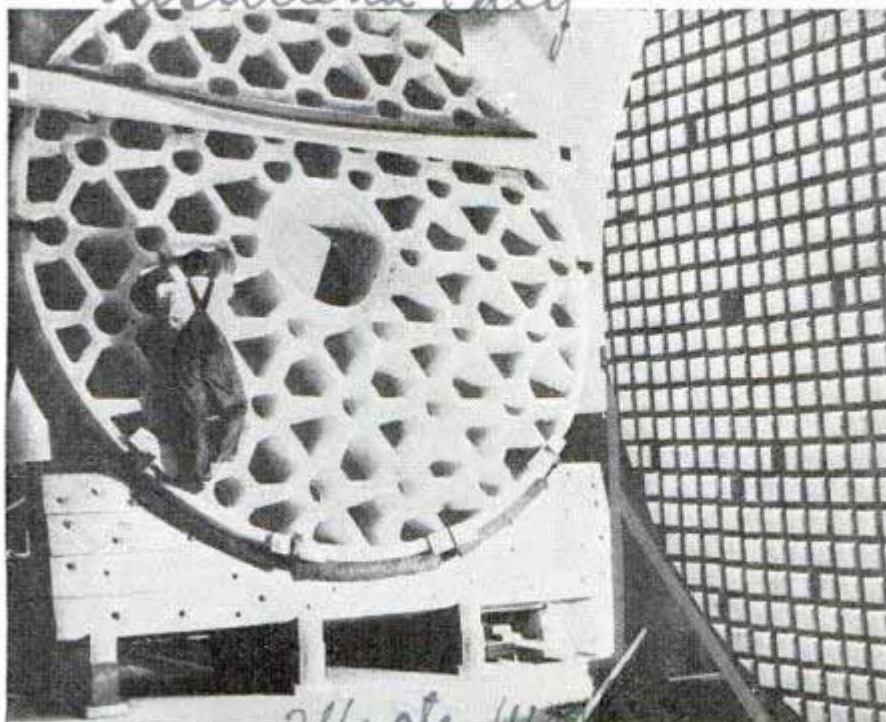

Checkerboard disk at right is big glass-faceted tool used to grind telescope lens. At left is the 200-inch mirror resting in protective sling

Handwritten notes:
 20116
 201169
 4505
 Projecting Moving Words
 P. Krupnik
 n. Redgie, Cheas

Quick-Diving Submarine Launched in British Yard

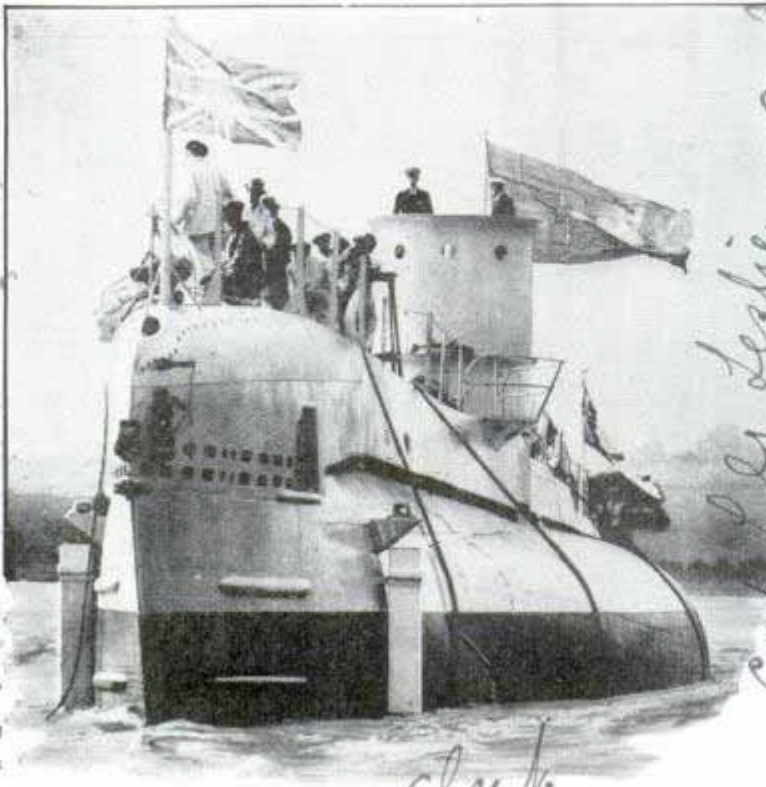

British submarine "Sterlet," last of a group of twelve quick-diving boats, immediately after its recent launching at Chatham

Ability to dive quickly when threatened is an essential feature of modern submarines, and the latest addition to the British navy was planned for speedy submersion. Last of a group of twelve submarines built since 1930, H.M.S. "Sterlet" was launched recently at Chatham dockyards.

Insulation Stripped off Wiring by Electrical Pliers

Operated like pliers, a new device for electrical workers strips wiring of its insulation. The tool cuts and strips the insulation in one movement. Crushing

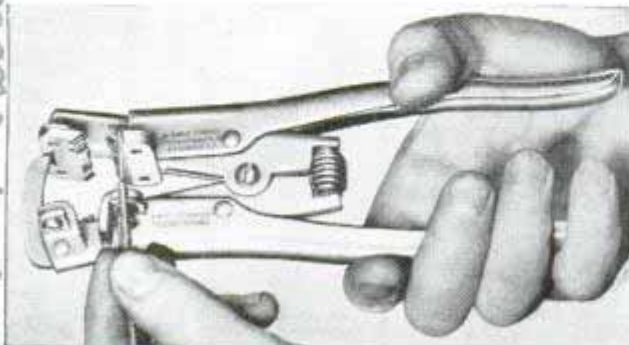

Stripping the insulation off electrical wiring with tool that works like pliers

stranded wiring is avoided by providing for the jaws of the tool to remain open until the wire is removed. The stripper accommodates wiring of various sizes.

Inexpensive Barn Is Built from Old Freight Cars

When a California farmer found that he needed a new barn, but lacked the money for building one, he purchased, at a low price, two old refrigerator cars discarded by a railroad. The cars were set about twenty feet apart and a roof built over the intervening space. In one car the farmer now stores grain, in the other he stores fertilizer. The space between is fenced and used as a feeding lot.

Secret Pocket for Films in Latest Album

Filing negatives of photographic film is made easy for the ama-

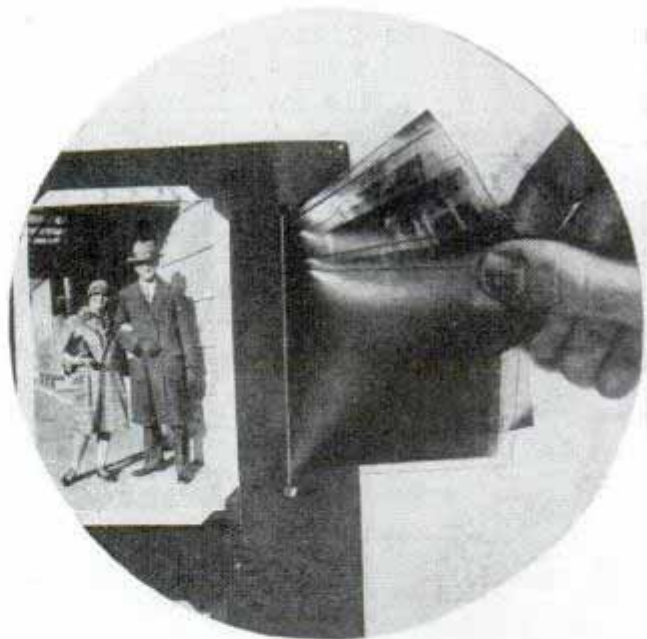

Slipped into pocket in album leaf, these negatives are identified by photo

teur by a patented album whose leaves contain secret pockets. The negatives are filed in the pocket of the leaf on which the prints are mounted, thus making identification easier. The pocket is formed by two pages of the album being pasted together, with a Cellophane enclosure for negatives.

J. W. Nelson Edwards,
111 W. Lexington St.

Pyramid Products Co
2209 S. State, Chicago

251150
near
Wasco, Calif
20/257
Crawley teaching on cars
1920
dis 1182

West Virginia Dam Rises to Challenge Floods

First of a series of dams planned to end the flood menace in the Allegheny and Monongahela river valleys, the Tygart river dam spans a Monongahela tributary two miles south of Grafton, W. Va. Started in December, 1934, it now rises 265 feet from its bed in the river and reaches 1,900 from bank to bank, with a thickness of 207 feet at the base. Its dual purpose is to regulate floodwaters and to provide storage for sufficient water to insure

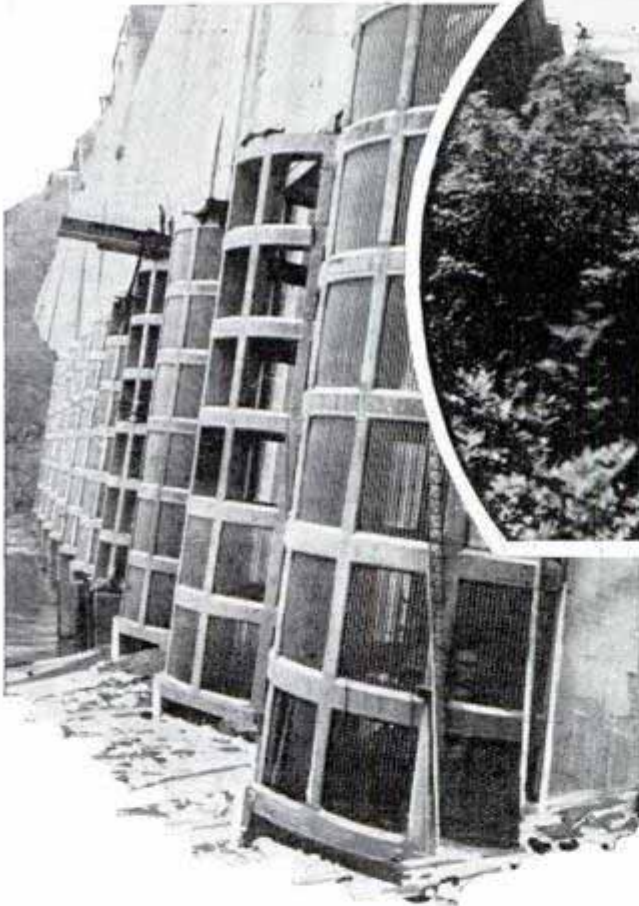
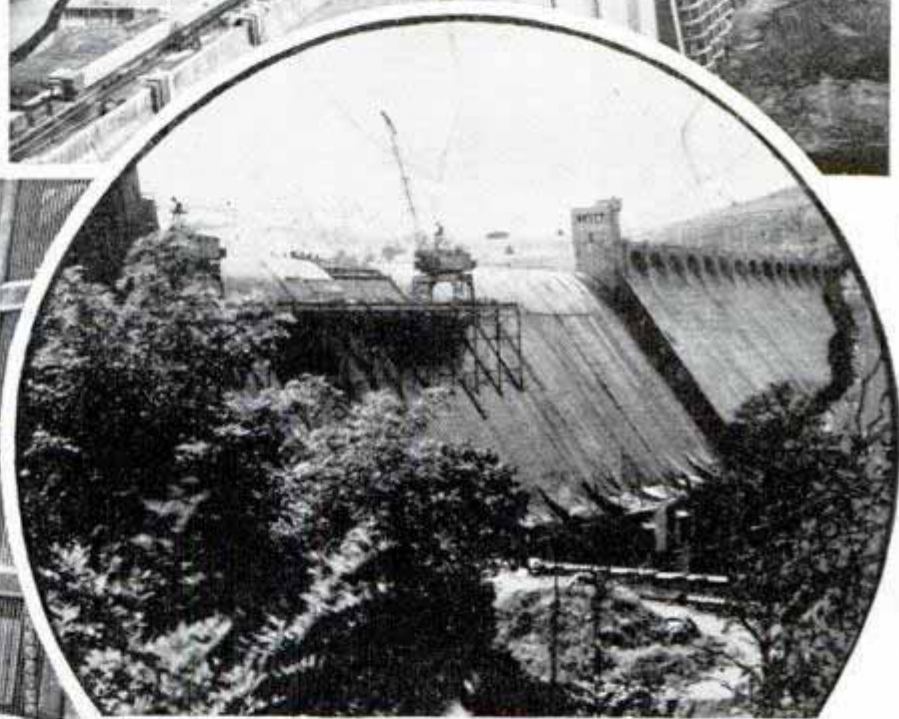
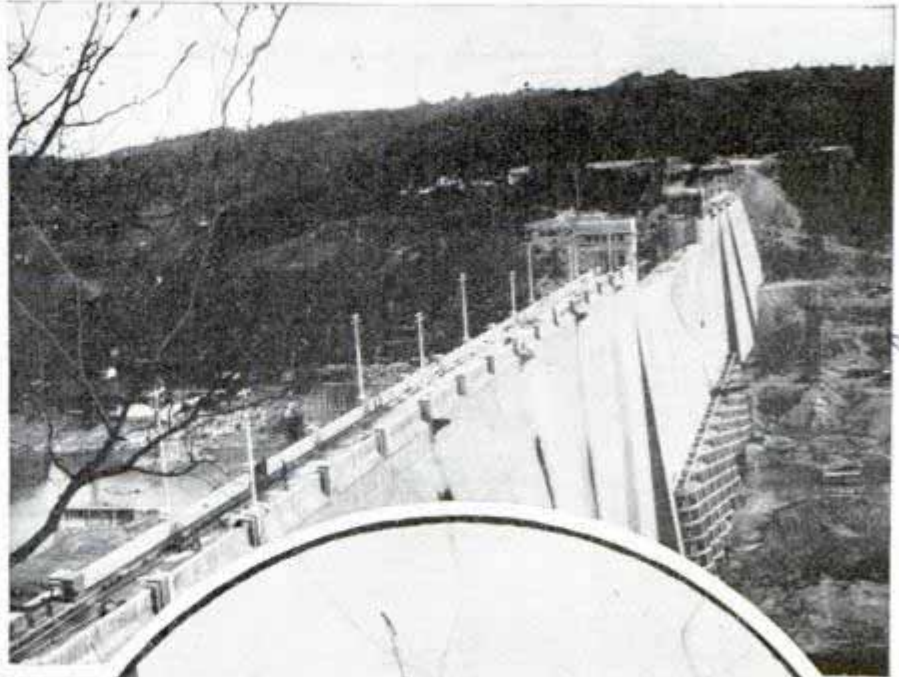

Top, upstream side of Tygart river dam near Grafton, W. Va., 1,900 feet from bank to bank. In circle, a view of downstream face as last concrete was poured recently. Left, close-up of the big trash racks, visible in top picture, which protect the water gates from clogging with debris. The dam is 265 feet high

a navigable stage during the dry season. Its drainage area covers 1,220 square miles with a sixty-eight mile shore line. The dam contains 1,247,060 cubic yards of concrete, 3,200,000 pounds of reinforcing steel and 4,390,705 pounds of steel valve and linings. On the upstream side is a series of trash racks, huge semicircular cages over

the water conduits to prevent debris from clogging the gates or outlets. Construction of the dam entailed also the rebuilding of twelve miles of the Baltimore and Ohio railroad branch which follows the Tygart valley, to place it above the new high water level. The entire project cost more than \$18,000,000.

Emb. A. O. Aldrich, Mayor, W. Va.

251067

Cont. Wizard

Red and Black



YOU'D like to stand ace high as an entertainer in your crowd? Just brush up on these card tricks and spring them when there's a lull in the party.

Draw a pack of cards from your pocket, divide it into two parts and hand someone the bottom part, nonchalantly asking him to take any number of cards up to ten from his half of the deck and you will undertake to tell him how many he removed. It's simple, to you, but baffling to the other fellow.

You turn your back while he chooses



① DEMONSTRATOR HOLDS 13 CARDS KING DOWN TO ACE (MIXED SUITS)

② FRIEND SELECTS ANY NUMBER OF CARDS (1-10) FROM REMAINING DECK AND PLACES THEM FACE DOWN ON DEMONSTRATOR'S CARDS

④ DEMONSTRATOR COUNTS OFF 14

② PLACE JACKS ON DECK (FACE DOWN)

2 QUEENS CONCEALED BEHIND THIRD JACK

③ TOP JACK PLACED ON BOTTOM

NEXT 2 CARDS (QUEENS) INSERTED IN DIFFERENT PARTS OF DECK



①

Above, guessing number of cards removed. Below, hidden queens make the jacks inseparable

his cards—let us say seven—and at your direction lays them on top of your half of the deck, which you have left face down on the table. Then you face the audience, pick up the cards, knit your brows as if deeply concentrating on your problem; thumb over the cards still face down, and finally pick up the fourteenth card from the top and flip it over. To the amazement of the crowd, the card is a seven spot, and you an-

*U. S. Playing cards
Park Ave, Hollywood, Connecticut, Conn. 06106*

MAGIC

nounce that your friend has transferred seven cards from his hand to yours!

This trick depends on a "stacked" deck. You have arranged it in advance so the top thirteen cards are in order from king down to ace of mixed suits. Keep this upper part of the deck as yours, and let your friend select his one to ten cards from the other part. The number of cards



Is called "Card Trick" for Amateurs magicians



ASSUMING THAT THE 3 AND 6 ARE PICKED

$$x(2) + (5) \times (5) + (6) = 61$$

THE OTHER CARD

SUBTRACT 25 FROM TOTAL AND GET 36
ONE CARD IS 7 THE OTHER

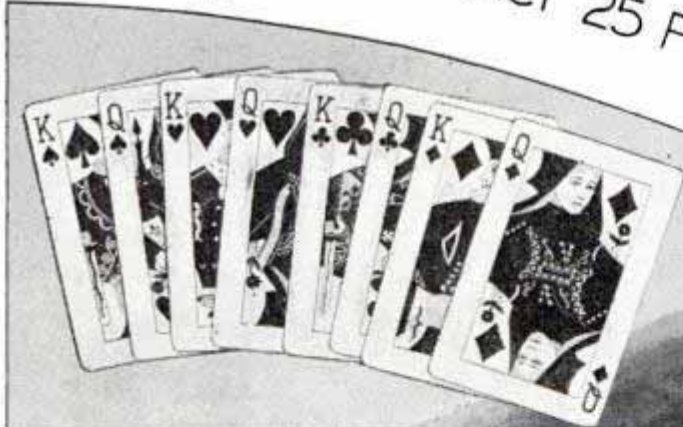

Above, formula for discovering value of two cards. Below, pairing kings and queens by "touch"

he adds on top of yours will always equal the number of spots on the fourteenth card down.

Here is a trick that looks like sleight of hand, and by making a few mystic passes you can throw off detection of the method.

Spread out four jacks and two queens in your hand so the audience can see only the jacks, hiding the pair of queens behind one jack. Then, careful not to





Top, reading the minds of five persons in the five-card, five-row trick. At right, the clock-dial stunt

expose the queens, place all six cards face down on top of the deck; first two of the jacks, then the jack and its two hidden queens, and lastly the fourth jack. Now tell your audience you will split the jacks up in various parts of the deck and bring them together again by a simple cut of the cards. First you place the top jack on the bottom of the deck; then, slip the next two cards—the queens, which the spectators think are two jacks—into two different places in the deck; cut the cards once, and hand them to anyone in the crowd. He will find all the jacks together, for the cut has replaced the bottom jack with the three left on top.

An easy stunt to remember is that of "divining" the numbers on two cards chosen at random by the audience. You prepare a pack consisting of the aces, deuces, threes, fours, fives, sixes, sevens, eights and nines of all four suits and let someone shuffle it as he pleases. Then one of the spectators picks two cards which are concealed from you. Ask him to take either one of those cards and mul-

tiply its number of spots by two, add five, multiply this sum by five, and then add the number of spots on his second card.

"What is your result?" you ask him. Quickly you deduct twenty-five from the figure he gives you, leaving a two-digit number of which each digit represents the spots on the cards he drew. Assume for example that he picked a three and a six. Taking the three and doubling it, he had six; adding five made eleven, multiplied by five made it fifty-five, to which he added the six for a total of sixty-one. Mentally you subtract twenty-five, leaving thirty-six—and you announce that his cards were a three and a six.

It is a good idea never to repeat tricks for the audience. Don't give the other fellow a chance to "catch on." A bit of stagecraft, mysterious action with the hands, chatter that distracts attention, all these throw your audience off the trail and make the simplest mathematical or sleight-of-hand trick seem a feat of magic.

Have one of your friends pick out



the kings and queens from a deck and examine them to satisfy the entire audience that the royal pairs are not marked. Then toss them down in a pile as carelessly as you can, without calling attention to the fact that you are laying them down in order—first a king, then the queen of its suit, another king and its mate, and so on. Now ask someone to cut the cards, face down, with a simple cut, as often as they like. Apparently the cards have been well mixed.

“My sense of touch,” you say, “is so delicate I can tell a queen’s complexion by my fingertips. Without looking, I shall separate kings from queens.”

As you talk, you hold the cards behind your back and deftly pick out the first, third, fifth and seventh card with one hand, and produce the other four cards in the other hand. Dramatically you disclose four queens in one hand,



• Above, producing the unknown card by cutting deck.
Left, discovering two cards by separating colors



four kings in the other! You can just as easily produce them in pairs, by picking up first the four kings and then the four queens, taking care the queens are in the same order of suit—for example, diamonds, spades, clubs and hearts. Allowing any number of simple cuts, take the cards behind your back and divide them into two hands of four. Pairing the top card of each hand one after another you produce a mated king and queen.

The ten-hour clock dial trick is one that your audience seldom can solve. You arrange ten cards of any suit in a circle from one to ten and ask a spectator to point to any card and to think of some other card in the circle. Tell him you are a mind reader and that you can make him point to the card he is concentrating upon. Secretly you add ten to the number at which he is pointing, and, if he has indicated the five spot, have him count backward around the circle until he reaches fifteen, starting with the five spot but calling it by the number of his secret card.

(Continued to page 142A)

'Mike' Like a Machine Gun Is Aimed at Sound



Aiming the machine-gun microphone at source of sound, a passing parade

Shaped something like a machine gun, the latest microphone is aimed at the sound source to pick up the maximum volume for broadcast purposes. Thus may be eliminated, to a great degree, sounds from other sources. The microphone may be trained on a passing band to pick up the musical sounds during parades.

Diesel Railroad Track Shifter Speeds Up Work

Less expensive than the usual equipment employed for the purpose, a one-man railroad track shifter speeds up work along



Track shifter being used to move rails and cross-ties into a new position

the right of way. It is Diesel-powered. The machine is firmly bolted to the track and a ram inserted on a slant between the two sleepers. Then the traveling mechanism is switched on and the ram forces the track to move sideways. The machine is moved farther up the track and the process is repeated. For building embankments without tearing up the track, the ram is fitted to lift the rails and cross-ties vertically. Workmen may then fill in between the old track bed and the rails.

Two-Story House on Wheels Has Bed in Upper Deck

There is room for two double beds in the streamline touring sedan built by a Californian for his vacation home on wheels. He spent seven years developing it. On the "first floor" are four upholstered chairs which readily convert into a comfortable double bed. When the top is

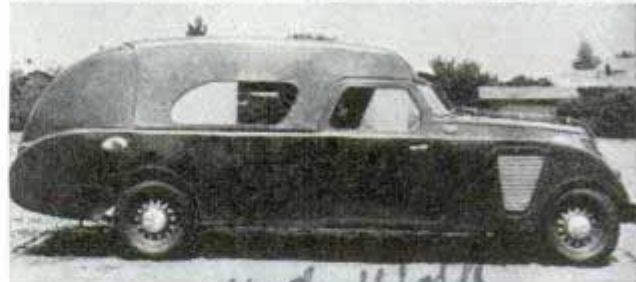

There's an extra double bed on second floor of this touring home when its roof is elevated at night

raised, it forms an "upstairs" room containing a magazine bed. Fresh air is supplied by a specially built ventilating system. In the roomy rear end of the car is a refrigerator and sink with running water, and storage space. The car is of standard width and has a 138-inch wheelbase.

Wesley Hemlock. Mark
Sole leather of good lasting qualities can be obtained by tanning with a blend including tannin extracted from the bark of the western hemlock.

Bureau of Chemistry
and Sale, 10/20/37

J. A. Lorington, American Legion
Empire State Bldg
Quincy, Illinois
Emil Weger machine works
Madison, Wis.
No U.S. agent.

California
Thompson
Berber

Horse-Drawn Fire Engines Do Double Duty

Mr. James M. Sweeney
 431 W. 60th Terrace
 Kansas City, Mo.

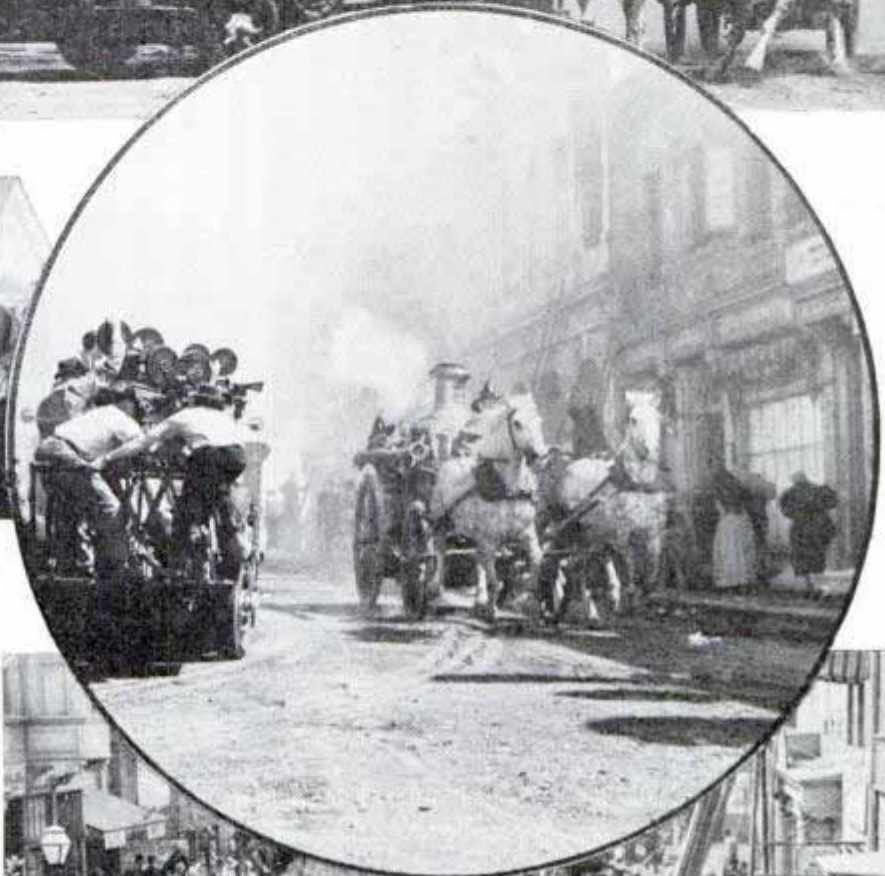
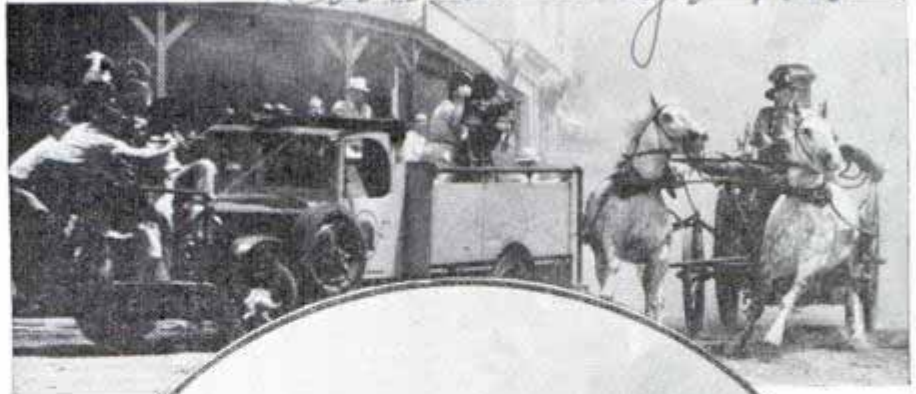

Several views of camera crews getting spectacular shots for movie dealing with Chicago's great fire. Note the part played by the old fire engines in their dash to different parts of the city and in fighting the flames

Fire-fighting equipment that once was used in Los Angeles is doing double duty in Hollywood, being photographed in historical films and generating steam for power on the motion-picture lots. Although some of the horse-drawn engines are more than forty years old, their pumps still function. During a flood at one studio, the machinery of one old engine turned over under steam developed in the original boiler to pump water out of a film vault. For movies such as "In Old Chicago," which



has the city's great fire of 1871 as one of its highlights, the old engines come into their own. To give theater audiences a new thrill, the camera crews mount their equipment on a truck and grind out spec-

tacular shots of the old engines, drawn by big fast horses, dashing to a fire in the awe-inspiring manner which was so familiar to Chicago's residents of more than sixty years ago.

made by...

...

Gas-Heated Clothes Drier Holds Entire Wash



Gas clothes drier for home laundry packs in a small space the equivalent of ninety-six feet of line

There is room for an entire household washing in a gas-heated clothes drier just placed on the market. Occupying less floor space than a kitchen table, it has twenty-four drying rods mounted in two tiers providing the equivalent of ninety-six feet of clothesline. The gas consumption of the heating unit is said to be low, and the washing can be dried in two hours or less.

Electric Shock to Brain of Cat Makes It Stand on Forepaws

Sam L. Clark

By administering a very slight electric shock to the brain of a cat, it can be made to perform strange acrobatics. In laboratory experiments at Vanderbilt University, hairlike electrodes were placed on the brain surface and harmless shocks given. If the electrode touched the left side of the brain, the cat would slowly lift its left foreleg, then the right foreleg, left hind leg and right hind leg, the movements covering six or seven minutes. A shock to the right side of the brain had a similar effect, but starting with the right foreleg. If the

electrode touched a spot in the middle, the cat would lift both forelegs and sit on its haunches, then lift both hind legs and try to stand on its forepaws.

Auto Parts Tester "Feels," "Sees" and "Hears"

Inspection of auto-engine valve lifters is speeded up and made more accurate by a machine which "feels," "sees" and "hears." A weight bounces off each valve lifter and intercepts a light beam if the part has been hardened properly. If the part is too soft, the rebound does not intercept the light beam and a rejector kicks the part into a bin. Thus the machine "sees." Then a hammer strikes a valve lifter that has passed the first test. A crystal microphone sends the sound through an amplifier fitted with a frequency filter. If there is a crack in the valve lifter, it doesn't resound properly and is rejected. In this check the machine "hears." Other tests are performed by electrical gauges which automatically pass all parts machined within the limits allowed. This is the function of "feeling." The parts are placed on a mesh-chain conveyor one at a time for the tests. They are in upright position during part of the inspection trip and in horizontal position for the remainder. The machine makes sixteen tests.

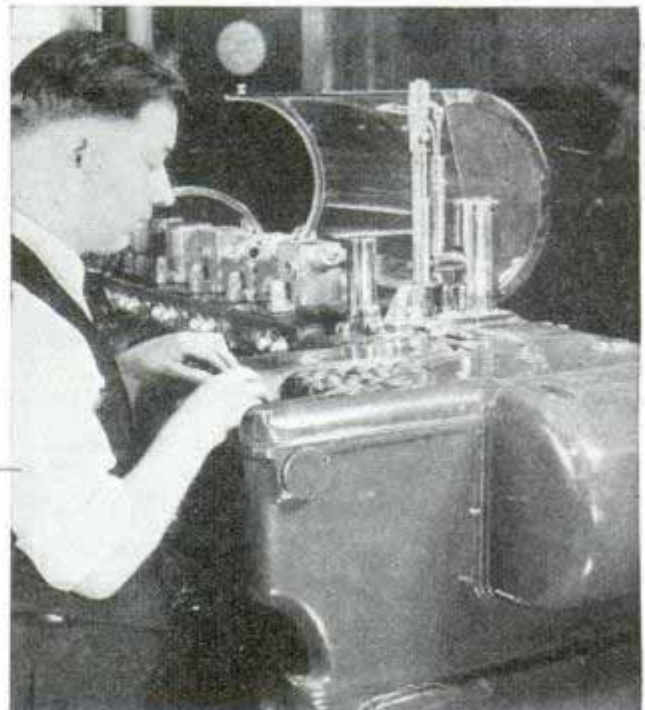

Feeding valve lifters into machine that inspects auto parts with super-accuracy

at Ford plant

es 1194
Hurley machine drier. Cermak
Roeder and 54th Ave. Chicago
es 1249
Chicago Tribune. 10/22/37
Nashville

es 1221

Lincoln's Head on Mountainside Is Unveiled

Right, general view of the Mt. Rushmore memorial near Rapid City, S. D. Below, close-up of workmen, under the direction of Gutzon Borglum, carving the head of Abraham Lincoln

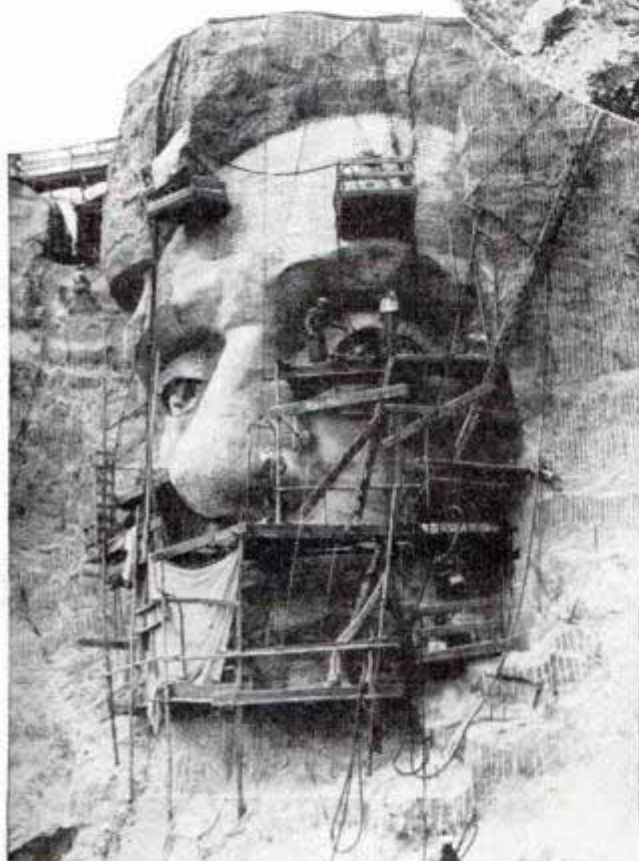

acme
Sixty-six feet from chin to crown, the giant head of Abraham Lincoln being carved on the granite face of Mount Rushmore is nearing completion. Recently it was unveiled, another step in the work of carving the heads of George Washington, Thomas Jefferson, Theodore Roosevelt and Lincoln on the mountainside in a national memorial. Upon completion the head recently unveiled will show a bearded Lincoln. Faces of Washington and Jefferson already are well-formed and the features of Roosevelt will be cut in the granite between Jefferson and Lincoln. Sculptor Gutzon Borglum expects to complete Roosevelt's head within three years, marking completion of the entire project. The memorial is located in the Black Hills near Rapid City, South Dakota.

es 1231

Small Mover for Big Freight Cars Eliminates Pinchbar

Shifting loaded freight cars for short distances is made easy by a small electric mover which eliminates use of the pinchbar. The mover is operated by a one-quarter horsepower motor. It slides along the rail, keeping its sturdy nose rooting under the car wheel. An arm swinging around the rim of the car wheel pulls the mover as the wheel revolves. A set of wheels and a looped handle make the mover easy to trundle around the yards.

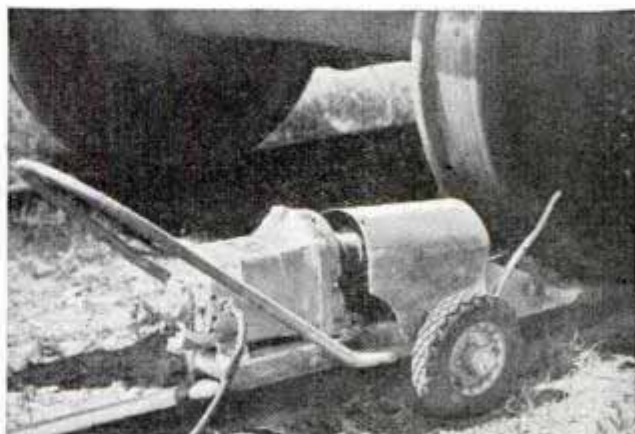

Small one-quarter horsepower device which easily shifts loaded freight cars in railroad yards by rooting under the wheel

Our Bureau of Information will answer questions regarding articles in this magazine, if accompanied by return postage.

H. W. Pierce & Son, Anaheim, Calif. 756 N. Olive

es. 1140

A NEW BREED

Com. Hans J. Rietebach,

*Moltkestrasse 2
Berlin, Slegel
Germany*

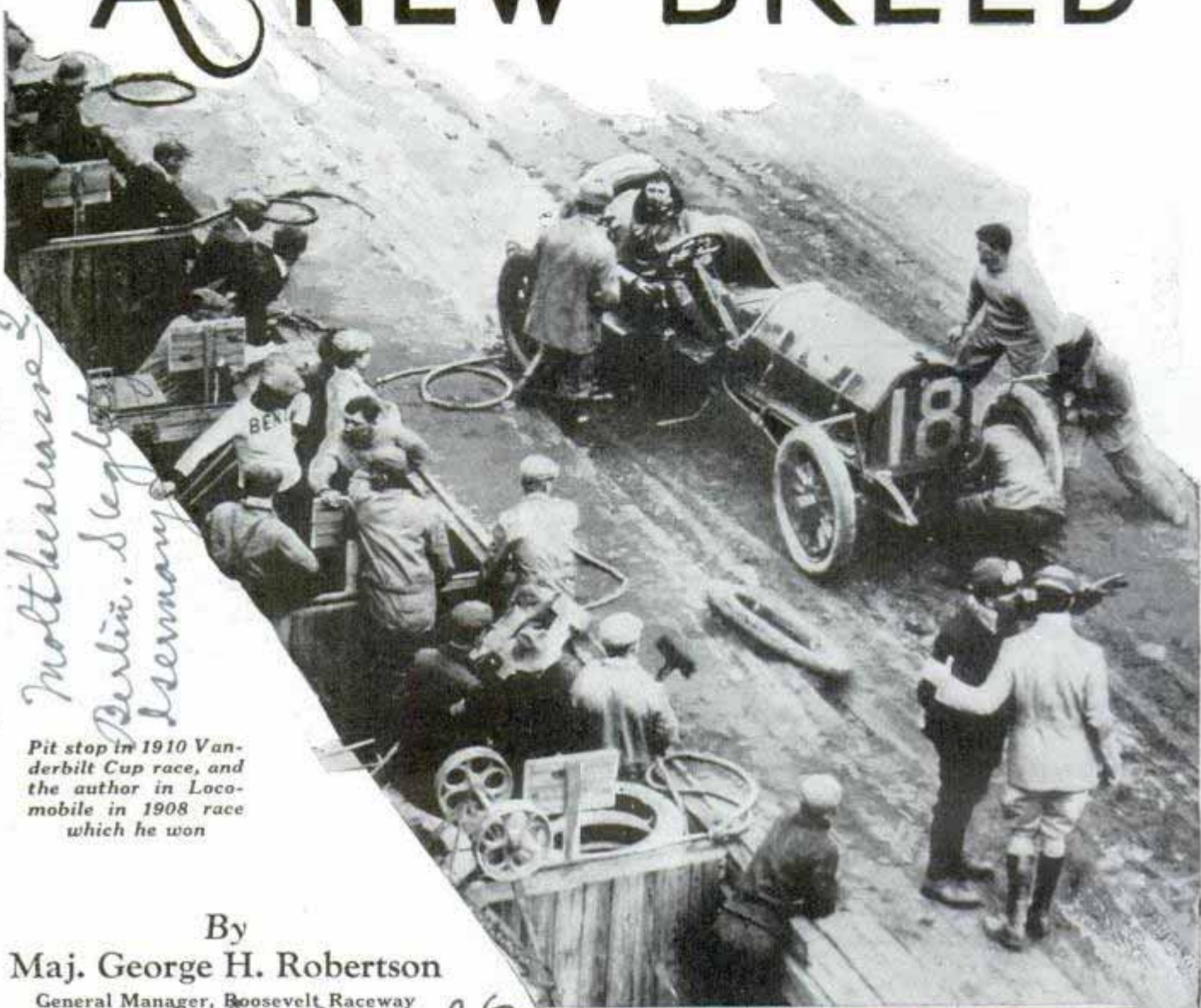

Pit stop in 1910 Vanderbilt Cup race, and the author in Locomobile in 1908 race which he won

By
Maj. George H. Robertson
General Manager, Roosevelt Raceway

see July 1937 - 26

ARE European racing drivers better than the Americans?

Ever since I became the first American driver to win a Vanderbilt Cup race thirty years ago, I have been asked that question hundreds of times each year. I couldn't answer it. No one else could.

The reason no one knew is that racing cars in international competition have rarely been evenly matched. As a result, the best cars—rather than the best drivers—often won because the best driver in the world has a slim chance to come in first if he pilots the slowest car.

Now we are about to learn the



mauer block, A. A. Champion, 1936

Bernard Rosemeyer
Auto Union Car

of RACING CARS

Auto Union, a. s. Berlin. es 1140

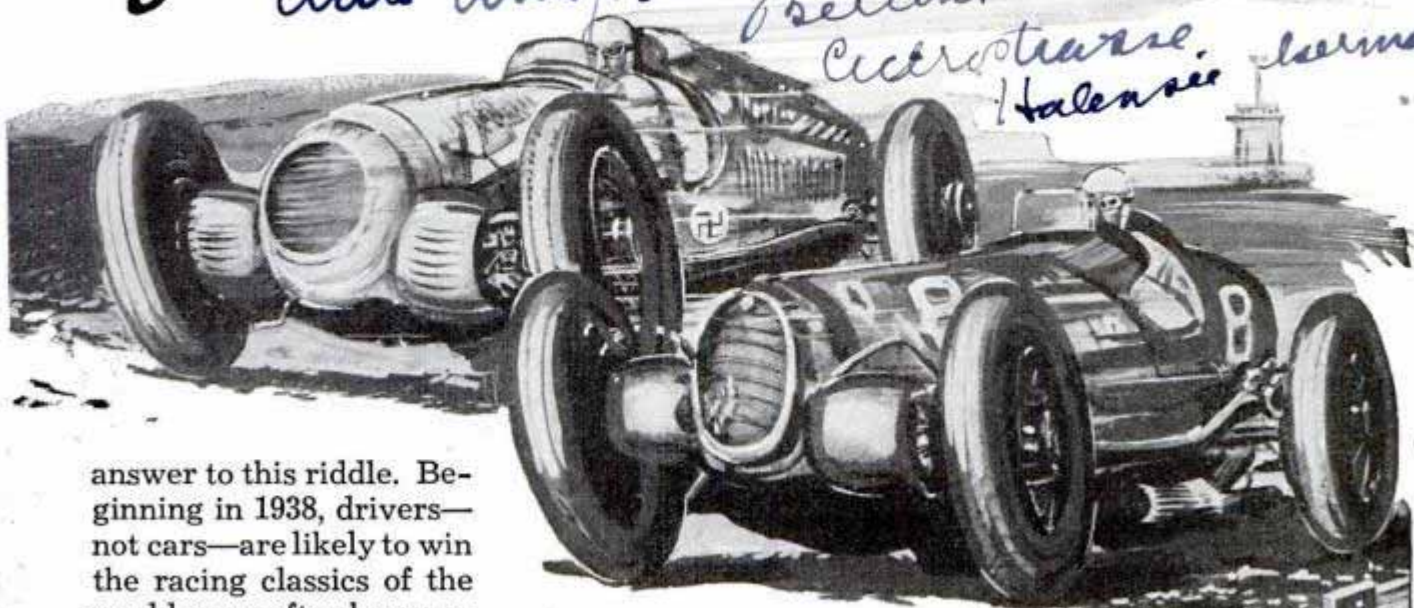

Carracciolo, Germany
Haleassi

Tazio Nuvolari

Cars which won 1936 and 1937 Vanderbilt Cup races. Below, an early Grand Prix winner

answer to this riddle. Beginning in 1938, drivers—not cars—are likely to win the racing classics of the world more often because, for the first time in years, all cars—American and European alike—must conform to the same specifications for piston displacement and weight.

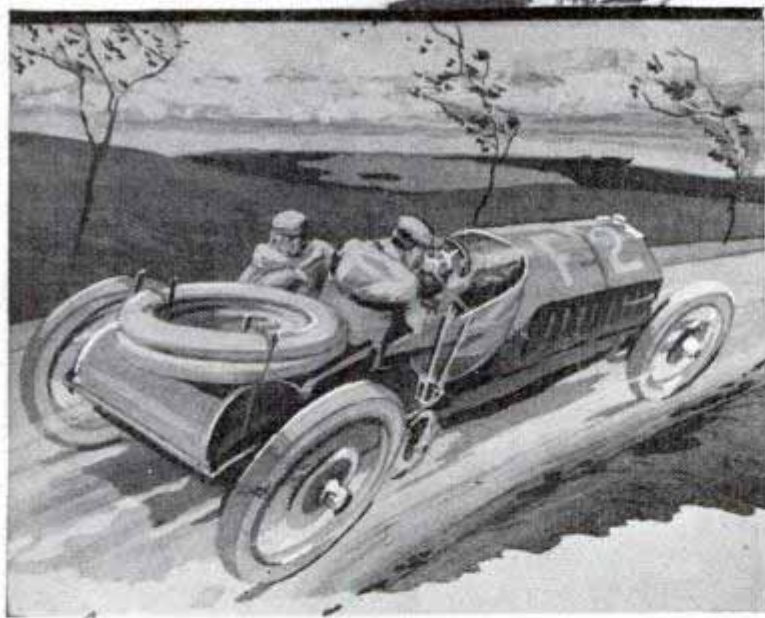

for three years, beginning in 1938, fixes piston displacement and minimum weight restrictions which will necessitate the building of new cars or the complete redesigning of old ones to come within the limits of the formula.

As a result, race fans will see a brand new breed of cars competing in 1938 because the formula applies to the 500-mile track classic at Indianapolis, and the 300-mile road race for the Vanderbilt Cup at Roosevelt Raceway and to most of the major races in Europe as well.

Adoption of the formula means a new deal for American automobile racing, a revival of the once keen competition between American and European cars and drivers. This competition had virtually ceased until the Vanderbilt Cup races were revived a couple of years ago. Why?

Because Europe was intrigued by road racing and specialized in cars with big

With the cars thus evenly matched, it then will be up to the drivers to show their stuff.

Both American and foreign cars have been placed on a more even competitive basis by the adoption by America this year of what is called the "international racing formula." This formula, which is to apply

Nagard - Herminie
Touring Car

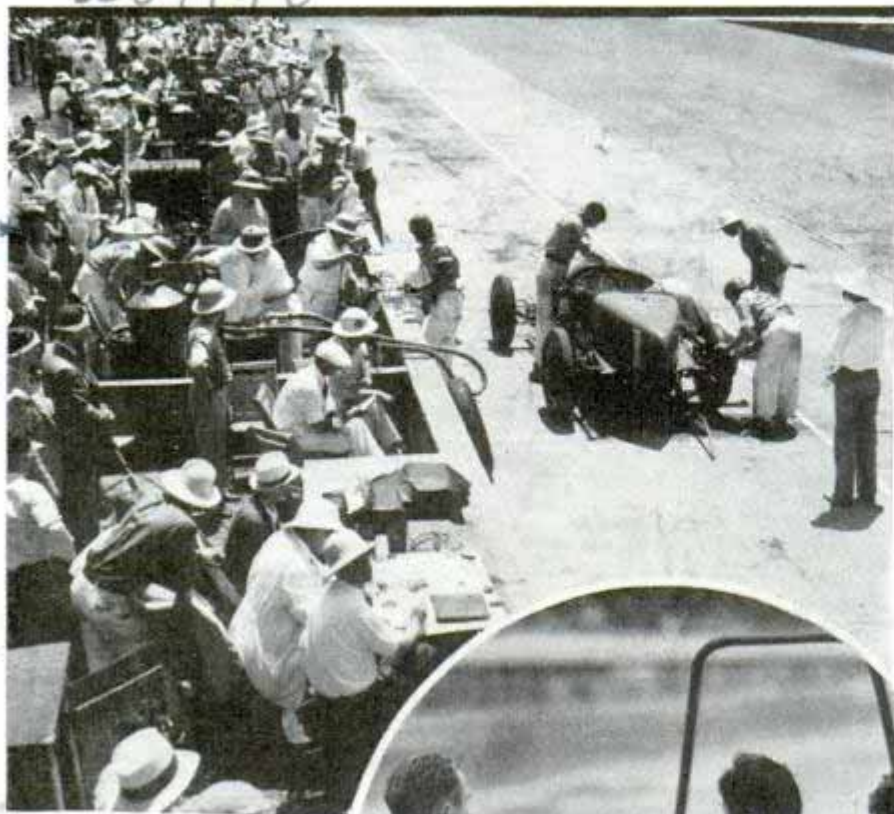

Efficient pit crews save precious seconds, above and right. Below, unusual type of race car built by Lee Oldfield

clutches, powerful brakes, superchargers, efficient transmissions and special fuels all designed for this sort of contest. America, on the other hand, has been building cars for track races—light jobs with no brakes or transmissions worthy of the name, cars intended to run wide open more than ninety per cent of the time. America's track cars and track drivers have been no match for European cars and pilots in a road contest; Europe's heavier cars and road drivers were not well adapted to track competition.

Now both the Europeans and Americans must change their designs to comply with the new specifications. When the changes have been made, American and foreign cars will be on an even footing as far as these specifications are concerned. This means we may see American cars and drivers competing on foreign courses again and foreign cars and drivers entered in an

Indianapolis race. An American winner on a European course would be a novel experience for the foreigners and a foreign winner now at Indianapolis would undoubtedly jolt American car designers and drivers. Only once, in 1921, has an American car and driver won a European classic, when Jimmy Murphy won the French Grand Prix in a Duesenberg. The foreigners, however, won the Indianapolis race three times, Jules Goux winning with a Peugeot in 1913, Rene Thomas in a Delage in 1914, and Dario Resta in a Peugeot in 1916.

The formula fixes minimum weights for various piston

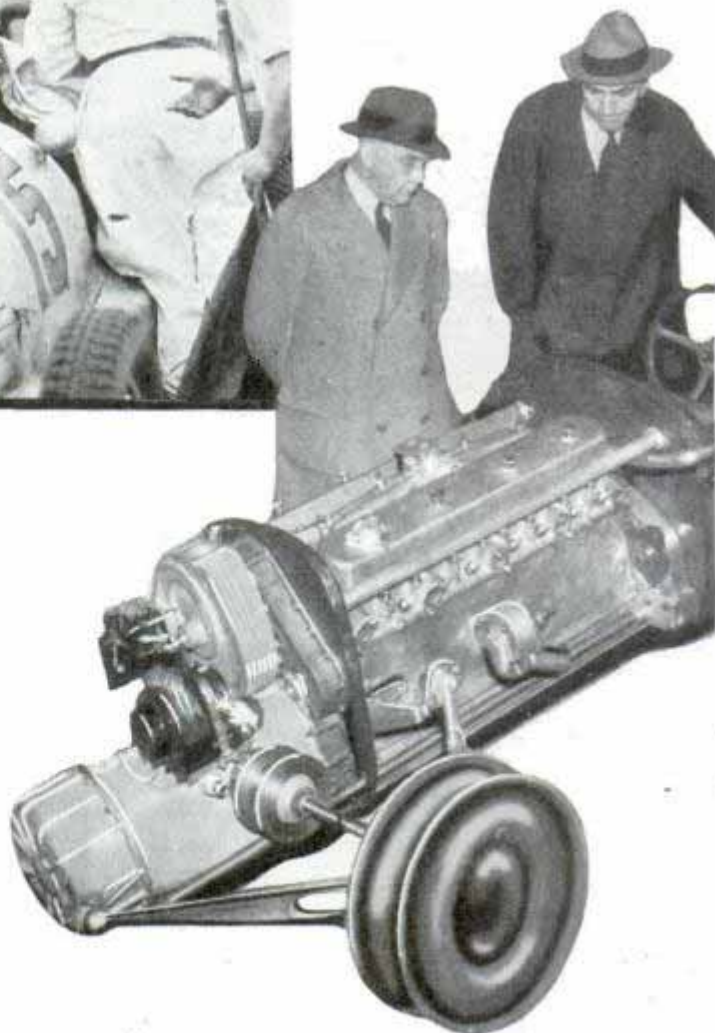
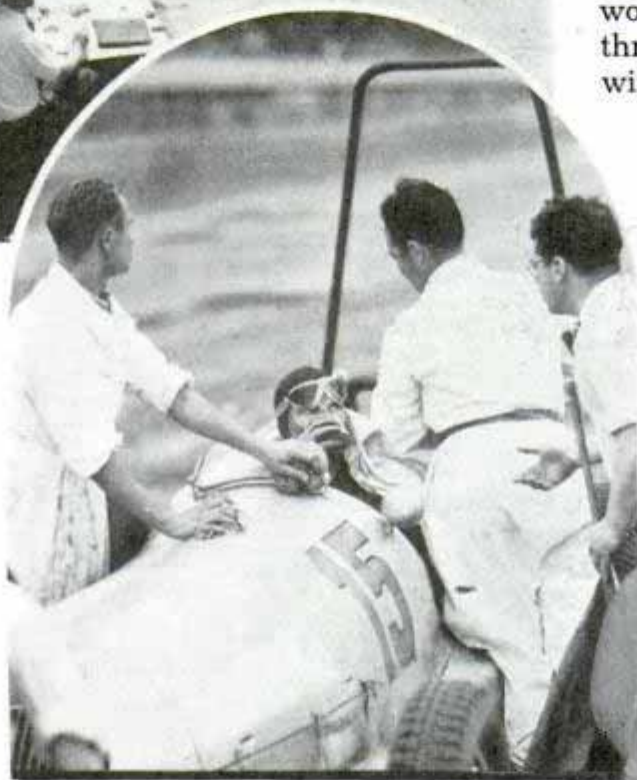

displacements, the figures varying for supercharged and unsupercharged cars. For superchargers, piston displacement starts at 40.6 cubic inches. For this displacement the car must have a minimum weight of 881.8 pounds. Weight increases four and one-quarter pounds for each increase of 0.61 cubic inch of displacement. The maximum displacement for superchargers is 183 cubic inches and the minimum weight for this displacement is 1,873 pounds.

For non-supercharged cars, piston displacement starts at sixty-one cubic inches and minimum weight at 881.8 pounds. Weight increases 2.8 pounds for each increase of 0.61 cubic inch of displacement, the maximum

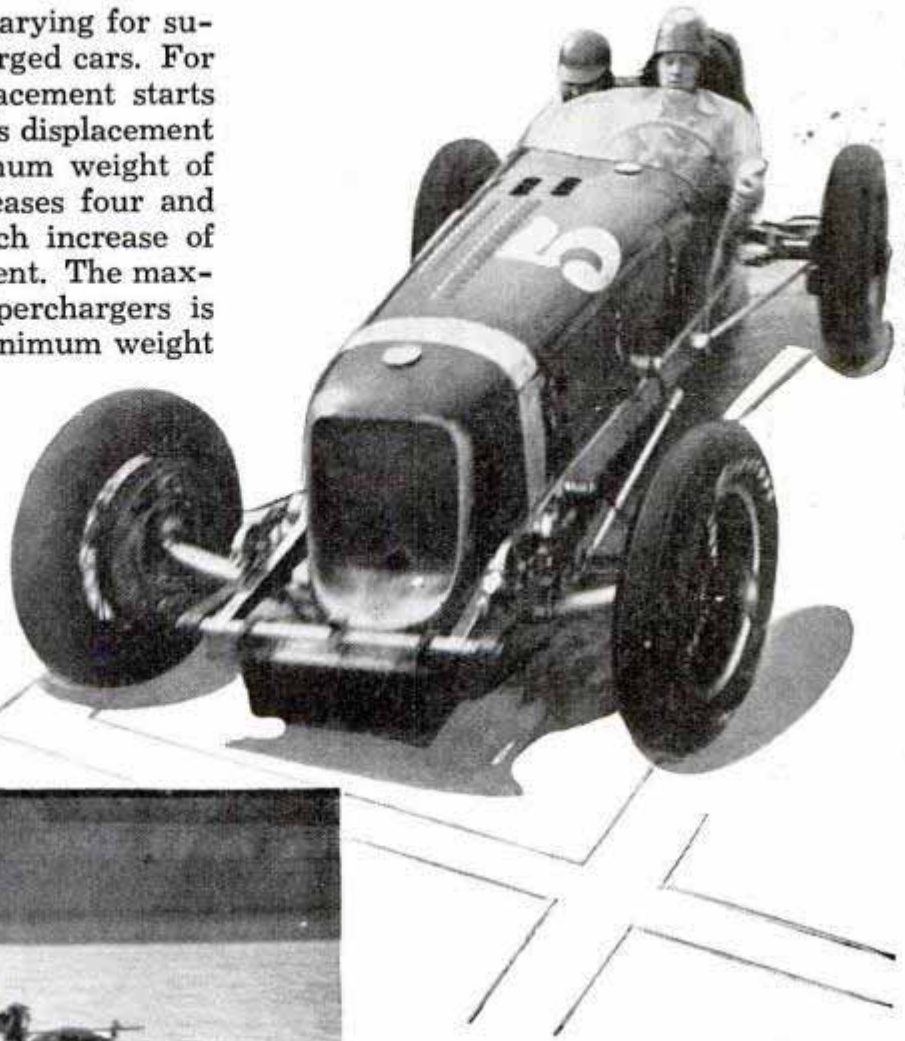

Lee Oldfield in his rear-motored car on Indianapolis' speedway, left. Above, Jimmy Snyder in car which broke lap record

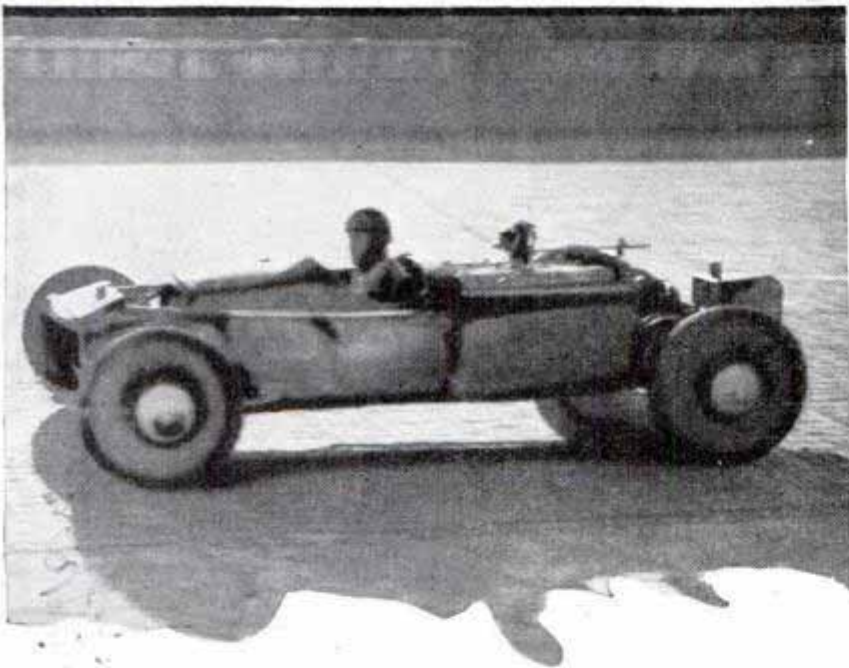

may not immediately produce cars to match the most advanced European jobs. The European race cars are built by the car manufacturers, are well financed, and have the advantage of highly skilled engineering staffs. In some instances, these cars have received government subsidy. So they can

afford to go into highly experimental stuff. Our racing car designers and drivers can't afford to spend a fortune trying out something which might prove wholly impractical after all.

All told, there are, perhaps, fifteen American cars now being built for Indianapolis and Roosevelt Raceway in 1938. These new cars, naturally, are experimental. But so are the foreign cars. We hope that money will be forthcoming from various interests for experimental work which will produce more cars for 1938, in addition to the fifteen already scheduled.

(Continued to page 134A)

displacement permitted being 274.5 cubic inches. The minimum weight for this displacement is also 1,873 pounds. The first formula cars may be slower than their predecessors because of the minimum weight and smaller motor provisions, but as the racing experience with these new types of cars continues, speeds will mount.

While the formula places everyone on an even footing so far as displacement and weight are concerned, designers and engineers are not restricted otherwise. All are free to exercise their own ingenuity in design—if they have the money to do it. And that's why, despite the formula, America

Doomed Ships in Graveyard Wait for Torch of Wrecker

no further information

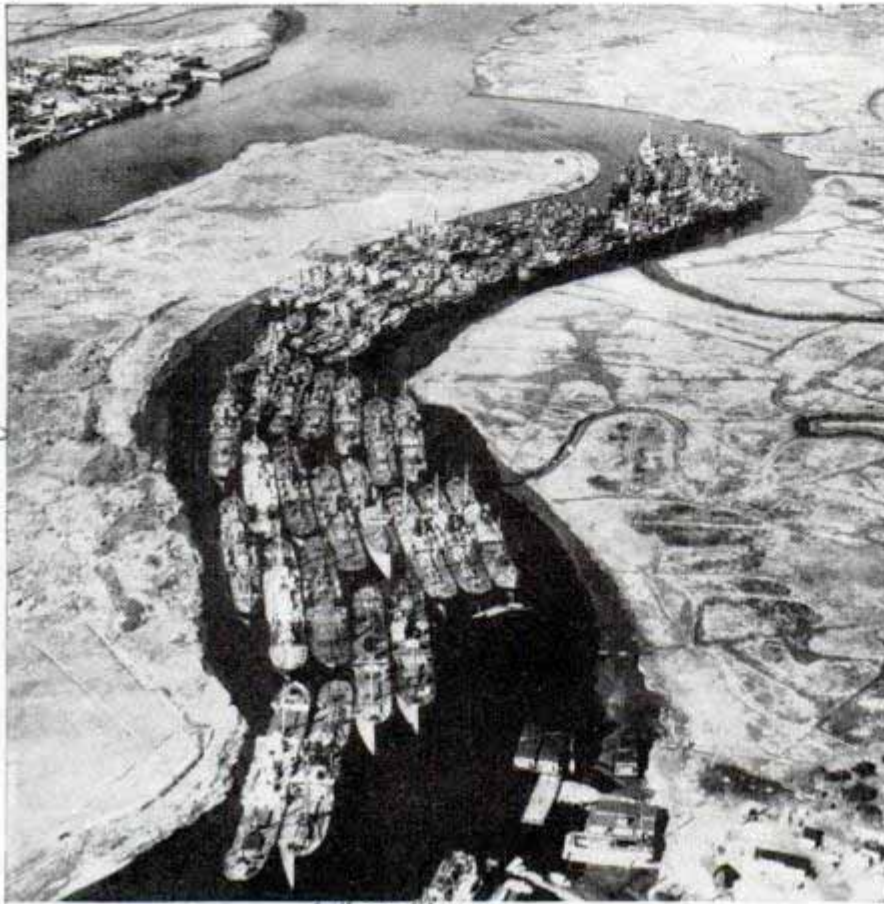

Clogging channel of the Kill van Kull on Staten Island are these discarded ships once worth \$1,000,000 each, now for sale as junk metal

In the Kill van Kull on Staten Island, graveyard of ships, a fleet of more than fifty once-proud vessels floats idly, awaiting the wrecker's torch. Discarded now as worthless and uneconomical, they cost \$1,000,000 or more apiece to build. Part of the fleet of old government boats has been destroyed by fire and some of them have been sold for scrap, selling for \$14,000 to \$50,000 each for the metal that can be salvaged.

es 1247

Steel Coated with Aluminum Resistant to Corrosion

Konos feel
Coppermen 1937

Highly resistant to corrosion, abrasion and acids, steel coated with aluminum lends itself to production of wire, rod, sheet and other forms in a continuous manner. Machine parts subject to corrosion may be made of this aluminum-coated steel in smaller and lighter sections than formerly, since it has the great tensile strength of steel, as well as the high corrosion resistance of aluminum. The coated

Process developed by
Prof. Colin G. Fink

steel is capable of being heated to 1,000 degrees centigrade for 1,000 hours without destruction and of being subjected to metal working processes without cracking or detachment of the coating. The coating process was developed by Professor Colin G. Fink of Columbia university.

Tester for Cloth Shows Degree of Stiffness

No longer is it necessary for the buyer to depend upon the human element in choosing cloth. A mechanical tester now determines the stiffness of cloth. It also shows resiliency, elastic recovery, plastic deformation and the efficiency of softening and stiffening agents. The instrument is operated by fastening one end of a strip of cloth in the device and turning the other end. This exerts a pressure which is weighed on a sensitive balance.

new York
es 1227

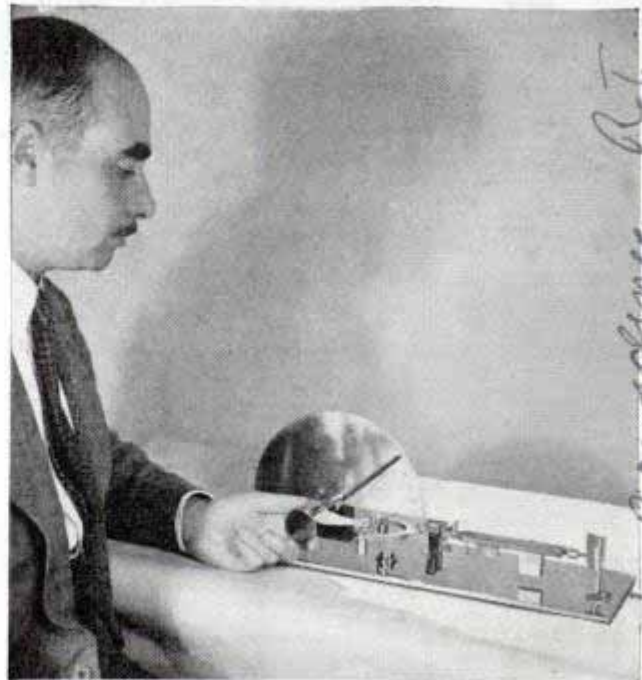

Testing cloth for stiffness with new machine

Proceedings
Industrial Trust Bldg.

Mr. Irving
Saml. Campbell

Model Shows Giant Towers of California Fair

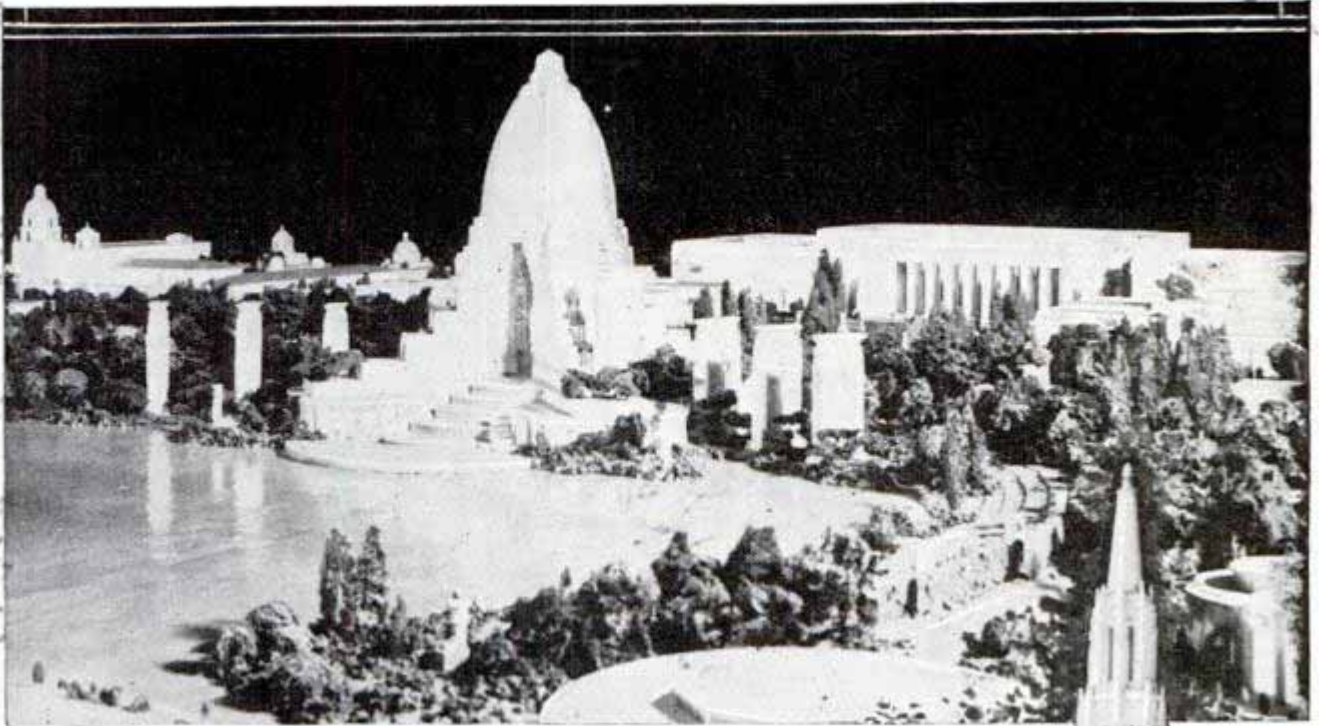

Top, model of Temple of Music to be built on site of Golden Gate exposition, with federal building in background. Below, how main entrance will appear, flanked by "elephant towers"

Treasure Island's great pyramids and towers, blending oriental with modern architecture, are seen in the plaster models that give a preview of the Golden Gate exposition of 1939. On the brink of the Lake of All Nations rises the domelike tower of the Temple of Music on whose water-level stage symphony orchestras and choral groups will perform during the fair. Six pylons that become torches at

night flank the building. Surrounding the temple and the lake is a park planted with pines and cypress, flowering trees and shrubs, while beyond the musical center are the broad, colonnaded federal building and the Spanish California group. Reminiscent of Mayan architecture are the modern pyramids of the "Elephant Towers" that flank the main gate. Beyond the gate is the 400-foot central tower of the fair.

2012 3/37

Shoe Fit for a Giant's Foot Weighs 100 Pounds

201207



201259
Built by Mr. Arnold
Mr. Pabst

Visitor to the London shoe and leather fair tries on a large size shoe. The shoe weighs 100 pounds at agricultural Hall. It looks like a misfit, and it is! This is no trick photography—the shoe was made for exhibition at a shoe and leather fair in London. It weighs 100 pounds and is almost as big as the young lady trying it on.

201225

Glider Motor Drives Tiny Car Built in Home Workshop

In the special sport model car built for her by her father, this nine-year-old Long Beach, Calif., girl drives all the way to Yosemite National Park, 400 miles from her home. She is the youngest licensed



Forty miles an hour is the speed of this sport model car owned by a nine-year-old girl

Beverly Lancaster
Calif

driver in her state. The tiny car, which has a rumble seat, is powered by a glider motor and can travel forty miles an hour.

Water Tank for Airship Models to Serve as Wind Tunnel

Tests of airship models will be made in a water tank instead of a wind tunnel at the Guggenheim Airship Institute. A tank measuring five by eight feet and equipped with apparatus to simulate wind gusts by means of a water jet is being built at the Institute. A water tank and a submersible model must be used in the tests because the model and the medium in which it moves must have nearly the same density. A small lighter-than-air model would be too difficult to construct and handle. Studies of what happens to an airship when a gust hits it will be carried out.

201259
Aeromobile
Designed by Guggenheim
Aeromobile

Roadside Merry-Go-Round "Ad" Turns Slowly in the Wind



Getting attention from motorists, this roadside sign revolves slowly no matter how high the wind

Anything from a four-miles-an-hour breeze to a sixty-seven-mile gale will turn a "merry-go-round" sign developed for roadside advertising. It revolves very slowly regardless of the power of the wind, being adjustable to any desired speed of rotation. The sign is twelve feet in diameter and ten feet high. A versatile windmill, it can be made to generate electricity or pump water.

201259
L.B. Frye,
merry go round
designed by north
Platte, Neb.

Mighty Pacific Fleet Cruises in Battle Array



Parading the ocean in practice maneuvers, the United States battle fleet of dreadnaughts, cruisers and destroyers presented this beautiful sight from an airplane flying high above the clouds

Cruising in columns as far as the eye can see, the United States fleet presented a mighty spectacle from the air during recent maneuvers. An aerial photographer

flying far above the water caught this view of the battleships, cruisers and destroyers deploying in battle formation. Fleecy clouds added to the pictorial effect.

Attractive Home on Wheels Looks Like a Brick House

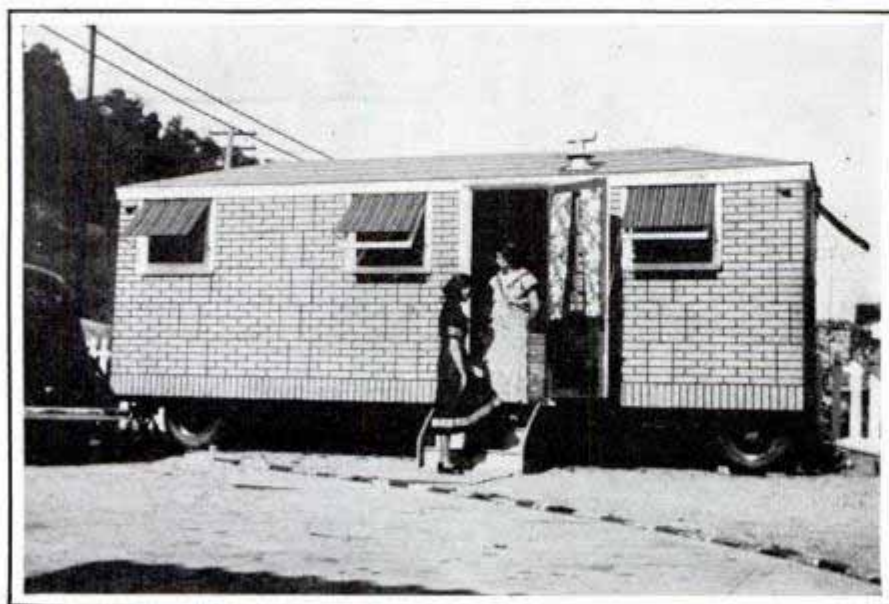

Its finish resembling brick, this four-wheel trailer makes a trim home

Its exterior finish closely resembling that of a brick house, the latest home on wheels is complete in every detail. It has four wheels, instead of the usual two on the trailer, hence there is no necessity for supporting one end of the house when the day's run is over. The home has shower bath, running water and electric lights, as well as many other conveniences. A neat flight of steps gives it the air of permanency.

*Home Trailer and Mfg Co
Aurora, Ind.*

es 1151

PUTTING *the* WORLD

From sleeping sheeted sleep 1934
B. P. 7/86
Iceboat

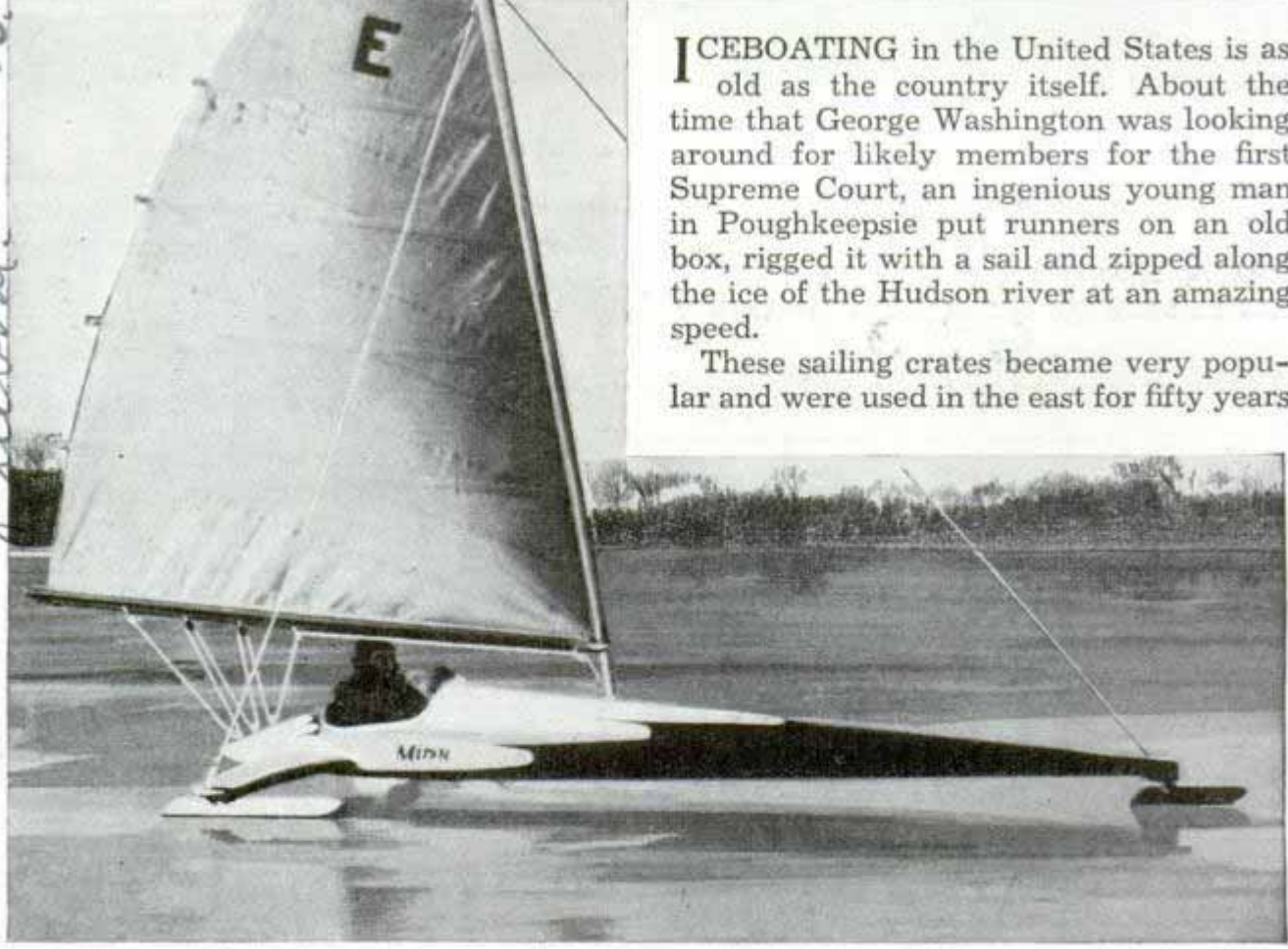

ICEBOATING in the United States is as old as the country itself. About the time that George Washington was looking around for likely members for the first Supreme Court, an ingenious young man in Poughkeepsie put runners on an old box, rigged it with a sail and zipped along the ice of the Hudson river at an amazing speed.

These sailing crates became very popular and were used in the east for fifty years

Top, snugly seated in the tiny cockpit, ready for a thrilling spin along the ice. Bottom, the 1937 "Skeeter" with twenty-foot backbone and galvanized airplane wire shroud lines. Note the "E" which is its official classification

Com. Mrs. Margaret
Richard Freshey 2756 Reese Ave
25 1181

on SKIDS

Evolution 22

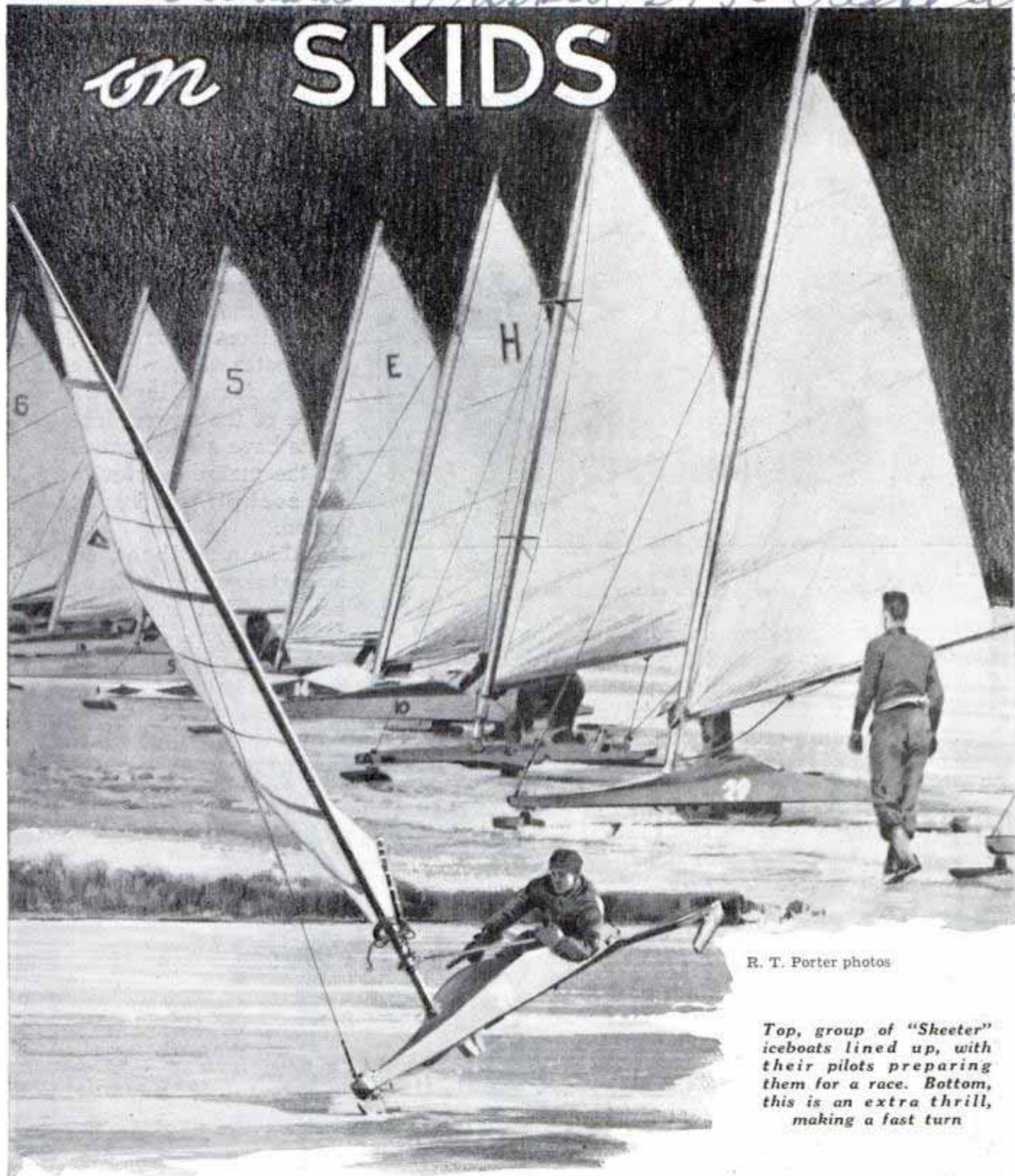

R. T. Porter photos

Top, group of "Skeeter" iceboats lined up, with their pilots preparing them for a race. Bottom, this is an extra thrill, making a fast turn

with very little change in design. Then came a boat built on a triangular frame with two runners forward and a third aft, on the apex of the triangle, which was used as a rudder. These boats attained terrific speed in the gay nineties. One of them is said to have been clocked going 107 miles an hour. For sportsmen who had never known anything faster than a tandem bike, iceboating offered exciting possibilities.

Some of these boats carried 200 to 300 square feet of sail. The rider sat aft over the rudder to help hold it to the ice, but there was a tendency for the bow to lift and cause spinning on the turns, which often sent the rider off across the ice like a hockey puck. They also had a tendency to tip up on two runners in a high wind. So the boats were heavily built and often carried sandbags or weights on the bow to

Reference: - Ted Meade,
17 S. Market. Chicago

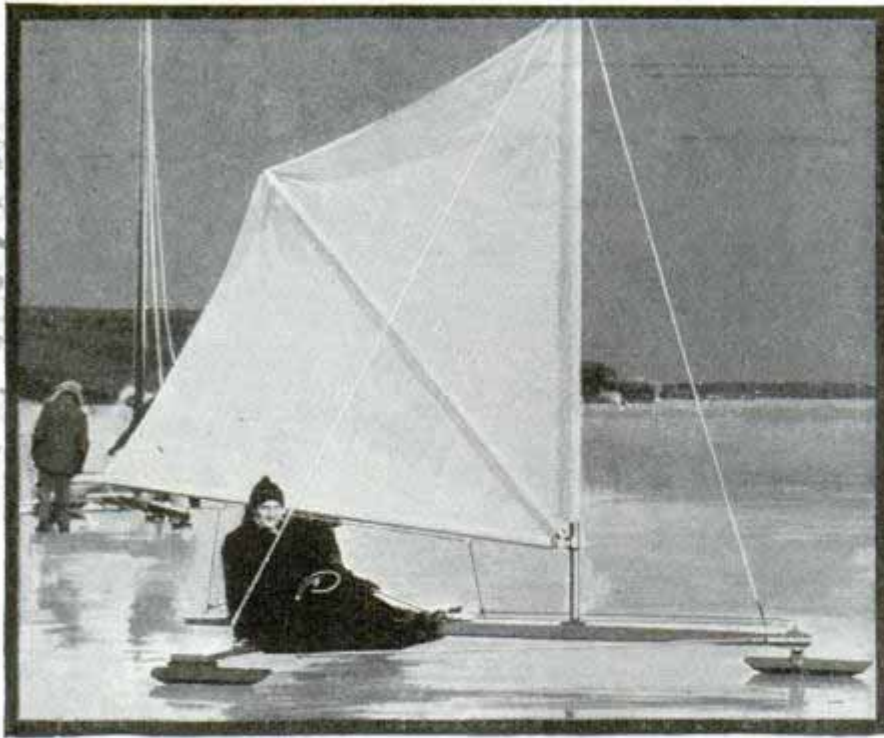

Here is another kind of iceboat, with a small batwing sail rigged on a front-steering frame. It can attain high speed, too

hold them down. This slowed them up and made them cumbersome and expensive.

The sudden rise of iceboating as a sport in this country and Canada in the last four years has been due to the development in the middle west of an entirely new type of boat; a small boat, comparatively inexpensive, easy to transport, and one that can hold its own with any of the bigger jobs.

This new boat is classified as an "E" boat for racing and is popularly known as a "Skeeter." The only two definite qualifications of an "E" boat are that it carry seventy-five square feet of sail and that the frame be built of wood. This boat has discarded all the old principles of iceboating. It carries the rudder on the front end of the backbone, and the runner plank is near the stern. This front steering offsets the tendency to spin, as the thrust of the sail holds the runner to its groove in the ice. The weight of the crew, aft, stabilizes the boat. Built with the precision and the balance of a racing airplane, the ice yacht has streamlining and strength, without an extra ounce of weight. Many of them are built with a fuselage made of lightweight wood with a canvased deck, to protect the rider from icy blasts.

Among the things that contribute to the speed of these little boats are: a twenty-foot backbone, a thirteen-foot runner plank, with some spring in it, a nineteen-

foot mast with a sharp rake aft, a main sheet rigged for multiple pressure on the sail and trimmed down through the deck near the mast, full-length battens in the sail which give a stiffer sail and a controlled draft, and straight steel runners instead of rockers. Contrary to the requirements of a sailboat in the water, the flatter the sail the better for an iceboat. Some of the newest iceboats have a foot control on the mainsheet, inside the cockpit, for instant action.

Unlike a sailboat, an iceboat always sails close-hauled. That is, it sails

with the boom laced in close over the cockpit. It never slacks off its sail to run down wind, but tacks down wind, close-hauled, just as it tacks to windward. To stop or slow down, it heads into the wind. Tacking to windward an iceboat attains its highest speed, often going four times as fast as the wind itself. For instance, in a



Here is another view of the front-steered boat rigged with batwing sail

25 1151

light ten-mile wind it is entirely possible to go forty miles an hour. The reasons for this speed are the vacuum that is formed back of the sail which tends to pull the boat forward, and the ease with which polished steel passes over ice. Resistance is very small.

"Skeeter" sailors claim that they go 100 miles an hour and more in their little boats, but the only official record of speed is eighty miles an hour clocked last season over a measured mile on Lake Geneva, Wis.

The Interstate Ice Regat-
(Continued to page 156A)



Top, heeling over a bit as he makes a turn. Bottom, view of "Skeeter" showing springy type of runner plank most satisfactory for attaining high speed on the ice



es 1204

Firemen Race to Ladder Top in Rescue Drill

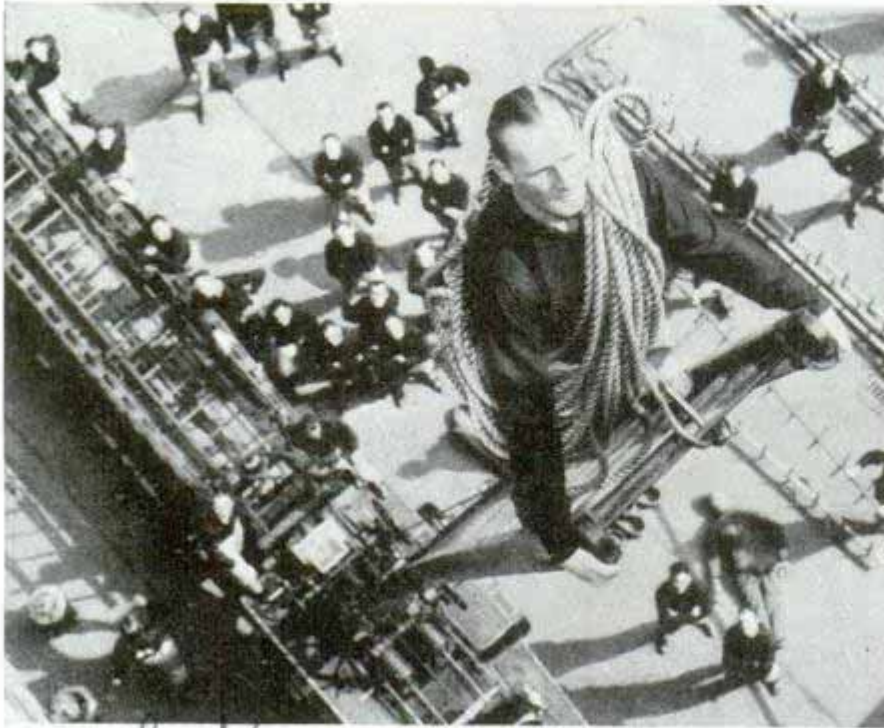

It's a long way to solid earth when you're at the top of a fireman's ladder, anchored to nothing but the fire truck eighty-five feet below! Racing up the ladder with full equipment to rescue a dummy victim in a skyscraper is just one of the daily thrills at the New York firemen's school. It looks dangerous, and it is if you're not trained. But the firemen's school teaches future fire fighters to make their risky business as safe as rescue work will permit.

Racing to top of the ladder is daily routine at firemen's school

dnt

'Dust Magnet' Cleans the Air of Pollen, Smoke and Dirt

Dust-free air, purged of ninety-nine per cent of the microscopic dirt and bacteria floating in it, is promised the homes and factories, hospitals and offices of the not distant future by a "dust magnet" developed by Westinghouse Electric and Manufacturing company engineers. Dust particles too tiny to be stopped by a mechanical filter are pulled out of the air by the high-voltage plates of this electrostatic air cleaner. Already the first units of this system are purifying the air circulating through lower floors of one of Chicago's newest skyscrapers, and engineers are now at work developing units for the home. As the air begins the cleaning process it passes between hairlike wires carrying a charge of 12,000 volts. These wires bombard the air with ions, minute electrical charges, and the ions attach themselves to the tiny bits of dust and give them a negative electrical charge. Then the air passes through a series of cells made of alternate grounded and 5,000-volt plates. The negatively charged dust is attracted to the high-potential plates, adheres to them, and the cleansed air passes on through the building. In the Chicago installation, 272,000 cubic feet of air per minute are cleaned, and it is expected that 600 bushels

Field Bldg.

Precipitation
of impurities will be collected from the air in a year. The plates themselves are cleaned every month or six weeks, and analysis of the dust shows ash and soot, volatile oils and greases, sulphur, bacteria and pollen. In the dustless home of tomorrow it is anticipated that annual cleaning of wallpaper and frequent washing of curtains and rugs will be eliminated. In a test of the electrostatic system at Pittsburgh, curtains remained clean for months. It is expected to aid patients suffering from asthma and hay fever, for pollen is elimi-

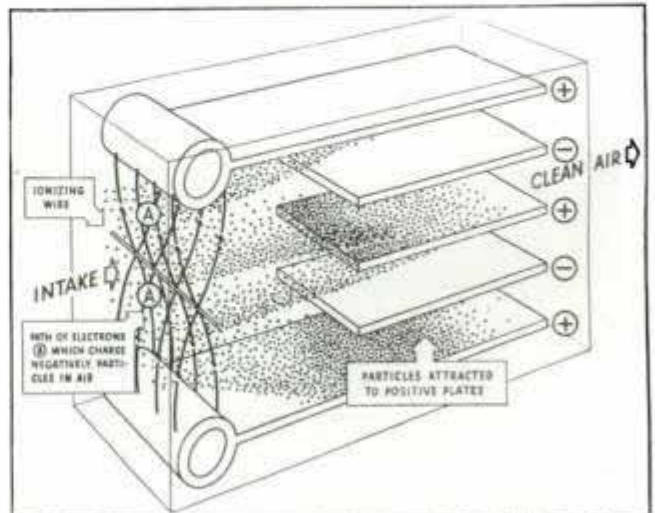

Diagram shows how dust entering at left is ionized by electric wires then caught on high-voltage plates

207 Wacker Drive Chicago

Mr. Becker
Barnegat, N.J. Dec 12 30

nated, and even bacteria. In one experiment, two types of bacteria were sprayed into the air, averaging 650,000,000 to the quart of air; after passing through the air cleaner a test showed only one micro-organism to the quart of air. The current cost of operation is low, a unit for the average home requiring about as much current as a sixty-watt lamp. A particle of cigarette smoke is about four millionths of an inch in diameter. Billions of them are blown into the air with every puff. But they are not too small or too numerous for the electric dust magnet to tackle!

par. of Preg-dk Pack

Hot-or-Cold Pack Holds Water for Making Ice



Ice pack in use. Note how ice is frozen in separate compartments in pack

Made of rubber sealed to hold the water to make ice cubes, the latest ice pack is handier to use than many of its predecessors. The ice is made by putting the pack into the freezing compartment of a refrigerator for about forty-five minutes. Placing the pack in hot water prepares it for use as a hot pack. No refilling of the water compartment is required.

es 12/2

Tame Deer Lives in the House With Family's Pet Dog

Raised by the family since it was found near by two years ago, a deer lives in a New Jersey home, as much a pet as the



Tame deer eating out of a dish placed on shelf of the kitchen cabinet

dog. Each afternoon the deer and the dog take a nap together. But at mealtime, the deer either eats from the table or rears on its hind legs to reach a saucer of orange marmalade placed on a high shelf.

Popular Mechanics Magazine does not publish the name of the maker of, or dealer in, any device described in its pages, but this information will be furnished by our Bureau of Information upon request, accompanied by stamped envelope.

es 12 2 2

Hand-Pushed Bicycle Scooter Is Steered by Foot

There's room for one passenger and a pup on this two-wheeled scooter. The youngster, seen on a beach in Belgium, steers her "bike" with her feet and propels it with the sticks held in her hands.



© Planet News, Ltd.

Selected objects & words

Speaker Sees Own Voice in 'Test Tube' Mirrors



Both teacher, at left, and speaker can "see" latter's voice through tube containing maze of mirrors

You can not only hear yourself talk, but also see your own voice. A "test tube" invented by an Italian makes it possible to test the speaking voice by watching it in action. The long, slender metal tube contains an intricate maze of mirrors. It is inserted far back in the speaker's throat to "focus" on the vocal chords. On its under side is a pinhead opening, and at the tip are two tiny electric bulbs furnishing a strong light. A vocal student can peer into one "finder" to watch his voice, while the teacher observes through another eyepiece.

Railway Cars Sent into Collision for "Crash Test" of Strength

Crash tests for fully loaded railway cars are giving engineers a practical demonstration of the strength or weakness of rail equipment. Both passenger and freight cars, loaded to a weight of eighty-four tons on the rails, are sent into collision while instruments installed at 120 points on the tops and sides measure the strains

developed by the crash. The new type lightweight running gear is also given a breakdown test on a special axle-testing machine. A speed equivalent to eighty miles an hour on the rails is maintained until the axle breaks, and good axles stand up for 200,000,000 revolutions, or the equal of a half million miles of travel.

Teletype Board for Football Aids in Announcing Game

Keeping up with the football game is made easy for the radio announcer by a teletype machine which flashes the names of players as they carry and pass the ball or make tackles. The machine consists of a sending and a receiving unit linked by flexible cable. The sending unit, in front of an observer, has twenty-two push buttons for the names of players on the two teams. As the observer presses a button on his board, a light flashing on the announcer's receiving unit indicates the name of the player handling the ball or making a tackle at that particular moment. Thus the announcer may concentrate on the play as the names of players are flashed before him. The observer's job consists of memorizing the players' names and numbers and following the ball on the sending board by touch system as he picks up the numbers on the field through field glasses. The machine was constructed by engineers of WBBM, Chicago.



Observer following ball with aid of glasses and pressing buttons on teletype board

Con. Hal Burnett Columbia Broadcasting

*Professor Angelica B. White
6075 Franklin Ave Hollywood, Calif.
Sweeney Service
101 27th St
es 1261*

Thompson's vacuum

W. H. W.

es 1176.

North Pacific Region.

Portland Oregon

Hill-Climbing Tractor Pulls Skiers on Big Sled



Ski party boarding twenty-five-passenger sled for ride up mountainside behind tractor. In front view at right, notice single track made of angle irons which grip snow

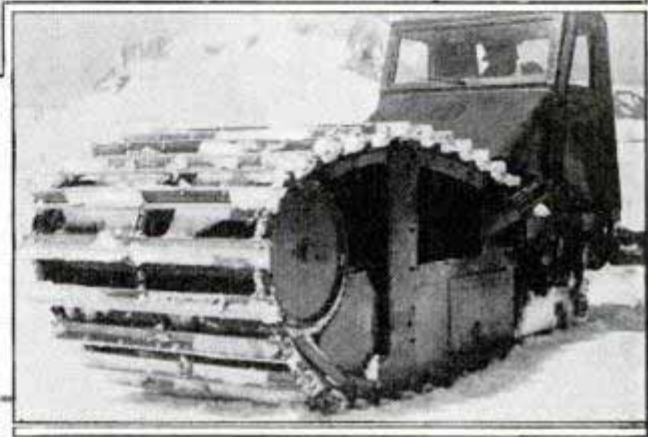

Modern counterpart of the old-time hay-rack ride is the motorized snow sled for skiers. A single-track tractor was developed by the U. S. Forest Service to haul parties of skiers up the slopes of Mt. Hood in Oregon, and a similar "Sno-motor" and sled is being built for winter sports at Sun Valley, Idaho. The power unit is a four-cylinder heavy-duty gasoline engine mounted on a track consisting of angle irons with one side projecting to bite into the snow. A flat steel plate over the track spreads the weight uniformly so that pressure on the snow is only twelve ounces per square inch, about the weight of a man on snowshoes. The tractor has several forward

speeds ranging from one to twenty-five miles an hour; it can climb forty-degree mountain slopes and turn in a thirty-foot radius. The flat-bottomed sled carrying twenty-five passengers has guiding runners on each side and in the center extending several inches down into the snow. These furnish resistance to permit the operator to steer the tractor.

es 1177
In Way 754

Belt-Lacing Tool Inserts Hooks with Hammer or Vise

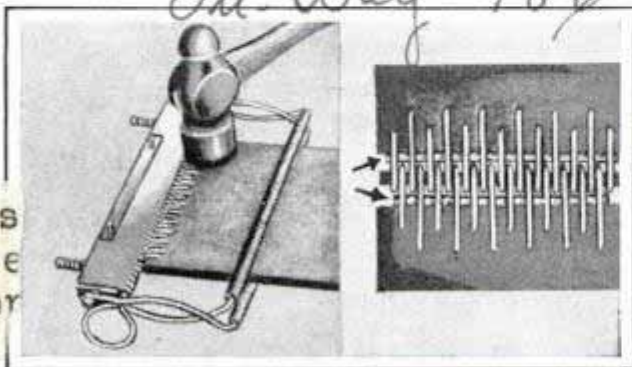

While jaws hold belt in position, hammer drives hooks in to form the laced joint seen at right

Either a hammer or a vise can be used to apply hooks in lacing belts with a tool now available. The hooks are supplied in strips and cut to the required width to fit the belt, then inserted in a magazine. The belt is placed between spiral spring-pressure jaws and pushed firmly against the magazine. The hooks can then be driven into the belt either with hammer or by tightening a vise. The tool is particularly useful when a belt must be laced away from a shop.

Safety Bell. Lacer Co., Toledo, Ohio

at s
ence
tion

es 1177
In Way 754
Safety Bell Lacer Co. Toledo, Ohio

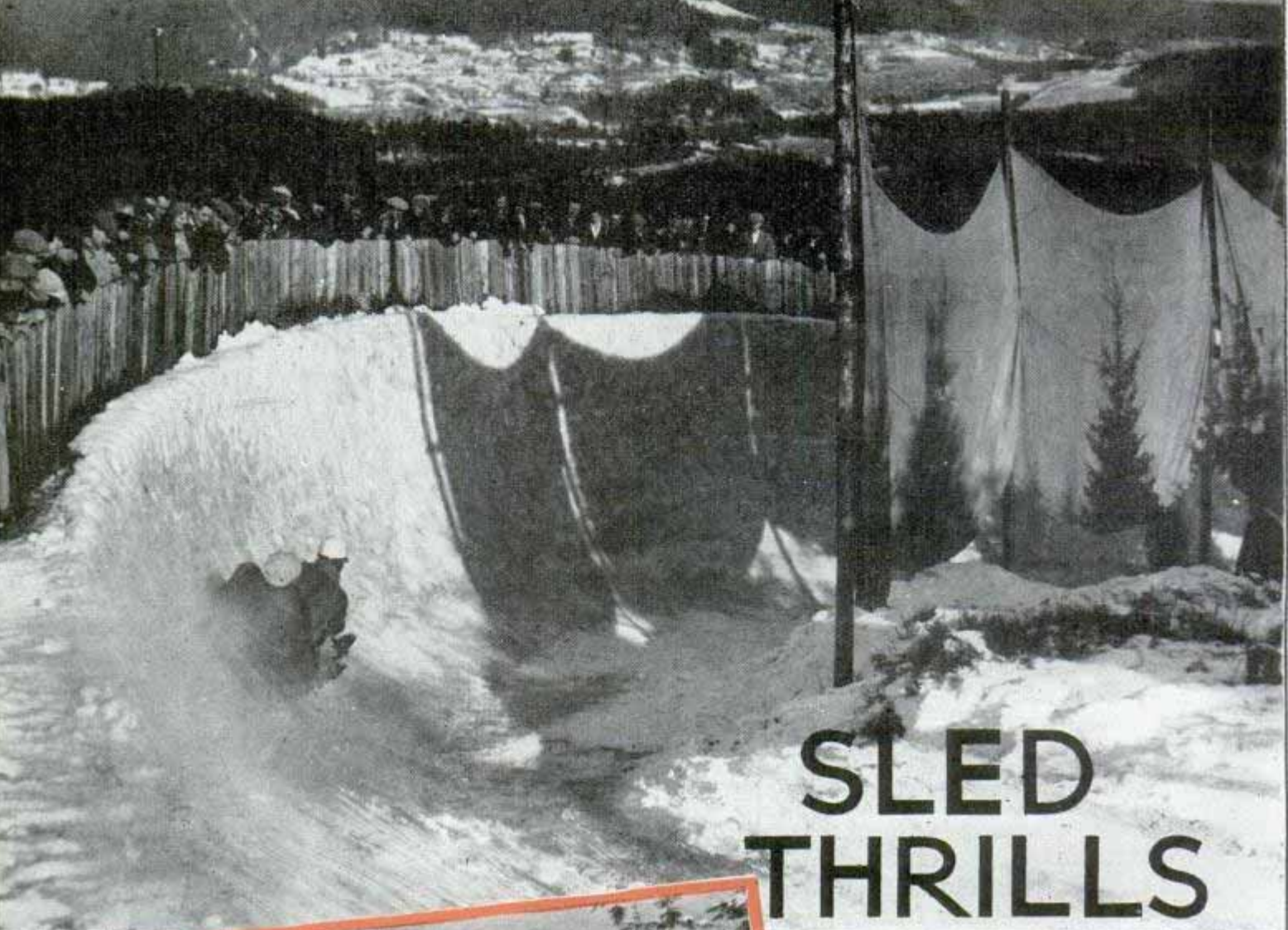

SLED THRILLS

Top, spectators line the curves to watch the bobsled whiz by. Bottom, four-man bob taking a sharp turn



and timber and must weigh close to 500 pounds. The driver examines the steering wheel while the man in the No. 4 position tests the saw-tooth brake. The place directly behind the driver is assigned to you. It is the safest spot and besides, your weight can be used to advantage there. As you place your feet on the footrests and your hands in the straps at the sides, the steersman announces that, owing to your inexperience, the running start is to be precluded. Then the man in the control tower gives the starting signal.

"Track clear,"
"Ready——go!"

Slide attendants push, and down the snow and ice-packed runway streaks the bobsled like a meteor. As Eyrie, the first

YOU are ready to take your first bobsled ride down the Mount Van Hoevenberg run at Lake Placid. A sinking sensation wells up within you as you gaze down the mile-and-a-half course with its twenty-six turns.

You adjust your crash helmet and goggles as the sled is placed at the starting line. It is a massive contraption of steel

es
264
Emb James Mc Greeny
334. J. Arnold
Carmichael Calif

...in 1900s. Best photo.

Schreiberhaus in Schantz
mountain 1964.

major turn, nears you realize that you are experiencing the most thrilling form of rapid transit known. The proximity of the earth and the blurry scenery intensify the sense of speed. The bob hurtles on to Whiteface, fashioned in the shape of a hairpin and named after majestic Whiteface mountain. Here the sled climbs a wall of ice, almost at a right angle to the ground, to take the course beyond at a beautifully accurate pitch.

At Cliffside, the next turn, you feel your neck snap backward and your heart do a flip-flap. Diving out of Cliffside onto the straight-away, the brakeman on a signal from the driver barks:



By SLIDE RULE



Top, up a wall of ice on a run in Germany. Bottom, building a run by laying ice squares on the turns. Course is watered to freeze the squares uniformly

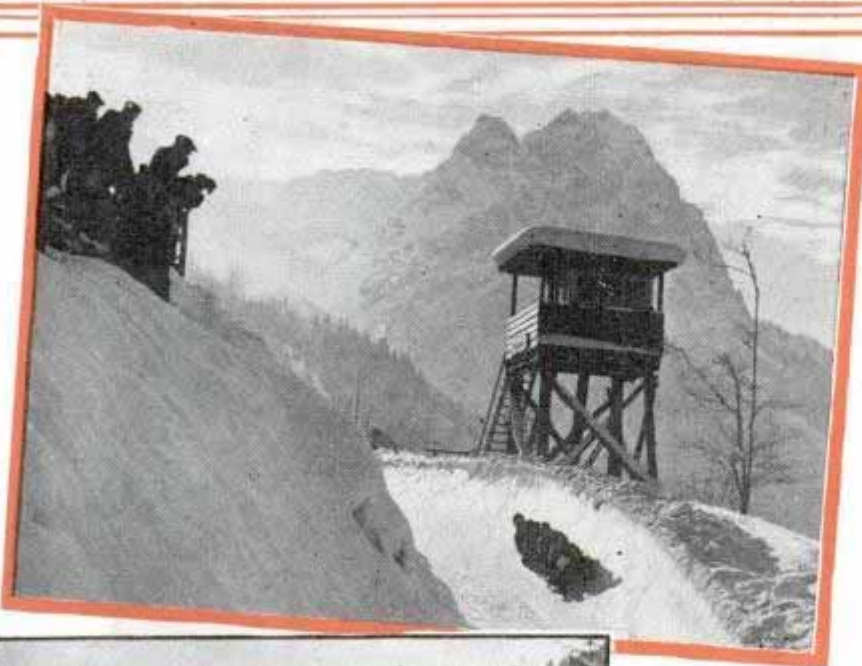

other speed spurt. Now the bob is traveling at a terrific clip; the wind is knifing your leather jacket and the snow is hot sand against your face. The sled's progress is reported from the control towers to the crowd over loud speakers. Famed Zig-Zag is the final breath-catcher. It is a double reverse bend, the supreme thrill. From the straightaway the bob hits Zig, the right bank, and from here skims on through two more curves

before passing the finish line in a miniature blizzard as the brakes are applied.

The ride of a lifetime!

Physical science, mathematics and construction engineering have contributed to the development and safety of this pulsating sport. So perfectly designed are the great slides that a riderless bob can negotiate them without upsetting. By no stretch of the imagination is bobsledding a juvenile sport. Mature individuals of sound physique and steel nerves are required to pilot the bobs. When the German four-man team lost control on the Lake Placid run a few years back, its sled jumped com-



"One—Two—Bob." This, you remember, is your cue to ease back with the two crew members behind you and then sit up forcefully, thus giving the sled extra momentum.

Shady Corner looms ahead. It is a twenty-two-foot turn that angles to the right. The driver enters it high and comes down the bank fairly early. Again the command is given to bob. An-

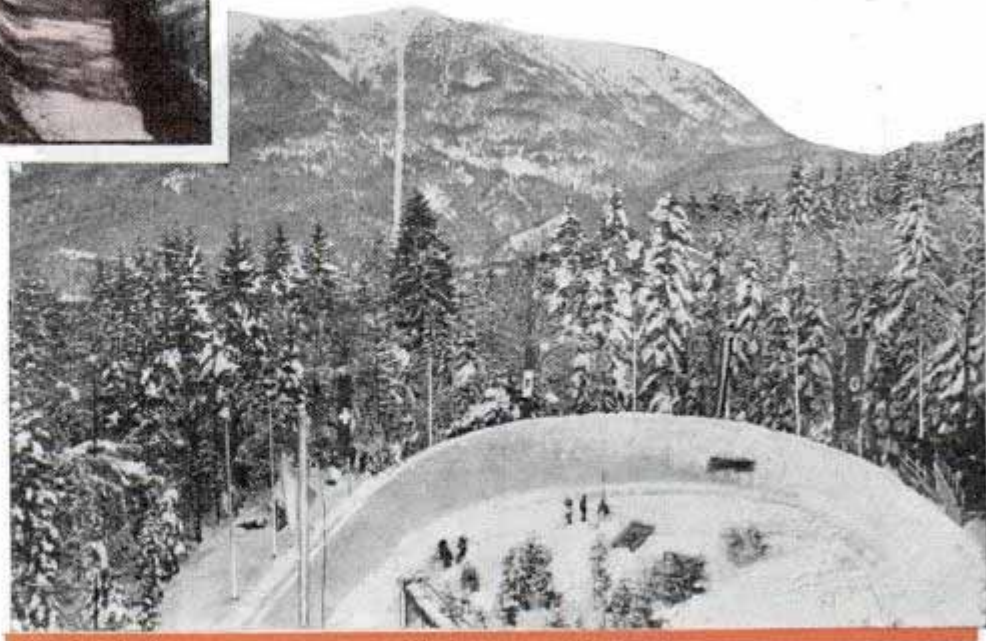

Top, whizzing around a turn. Center, run in summer, devoid of ice. Bottom, hairpin turn tests skill of the championship bobsledders



Courtesy German Railroads

pletely off the course, flew 110 feet in the air and landed in a forest. Three members of the team suffered assorted fractures, the fourth a serious back injury.

Such accidents are a rarity, however. Approximately 10,000 enthusiasts taste of the thrills of

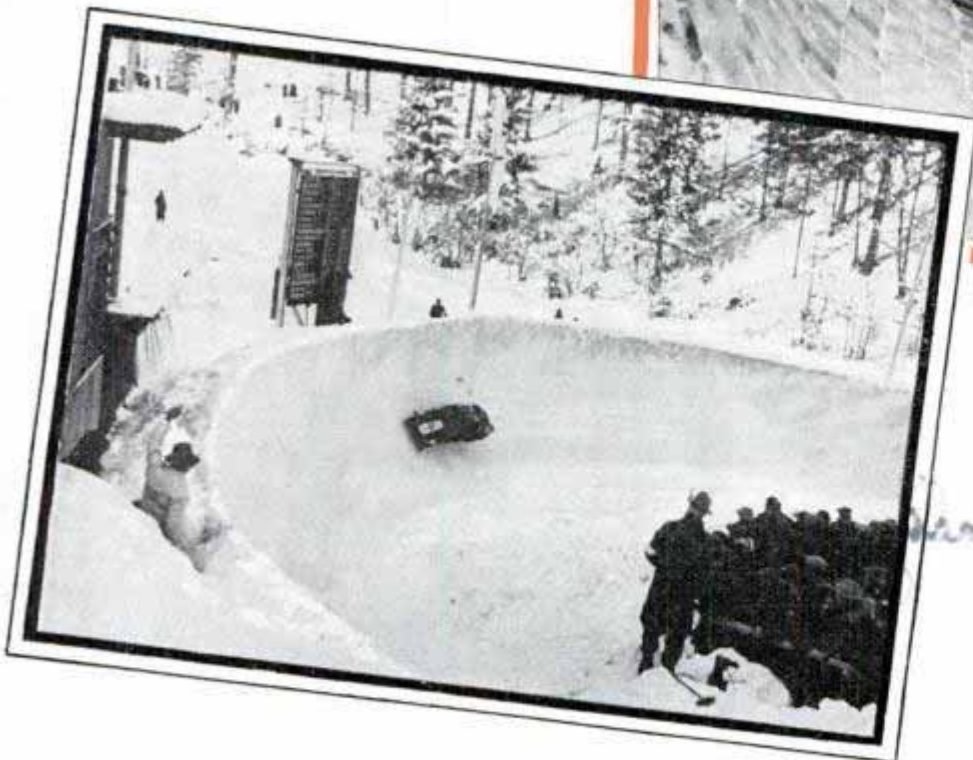

Top, watching sled take a curve. Center, putting final touches on bob run. Bottom, engineering skill makes possible the thrill of high speed on the big runs

bobsledding yearly at Lake Placid and only minor spills have occurred during the time the run has been operated by the Conservation Department of the State of New York. Manned by competent drivers and brakemen, the sleds are equipped with saw-tooth brakes, capable of bringing a sled to a complete stop within seventy feet even at top speed.

There are approximately

(Continued to page 120A)

POPULAR MECHANICS
Shatterproof Glass for a Light
Withstands Blows and Heat

es 115 3



Hammer strikes blow after blow against glass of industrial lighting fixture to prove it won't shatter

To demonstrate its ability to withstand heavy blows, a shatterproof glass developed for industrial lighting fixtures was struck time after time by a hammer at a recent business show. The glass not only endured this punishment without shattering, but stood up under a heat-resistance test in which Dry Ice was applied to one side of the glass while molten solder was splattered on the other.

commentary of asen. demand
of led engineers 435-b. much
chica

es No 4.

Cylinder Clock Sliding on Incline
Tells Day of Week and Hour

Popular more than a century ago because of its mysterious working, a cylinder clock moving down an inclined plane told the time and the day of the week. The hours and days were marked along the edge of the incline, and a needle attached to the metal cylinder indicated the time.

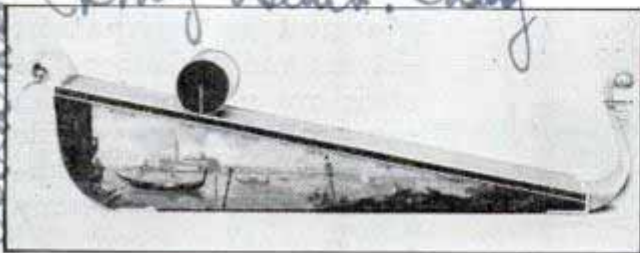

Seven-day clock tells time as the cylinder rolls down incline. Days and hours are ruled along side

Emb. Mrs. Ethel R
Adams Box 705
Long Beach, Calif

Swiss watchmaker's
window.

Gregory Ink Co
2652 Pasadena
P. Angeles, Calif

The actuating mechanism was a watch movement inside the cylinder, with a weighted lever driven by a main spring. The principle of the weighted lever used in timepieces was patented by a French inventor in 1593.

es 114 3

Latest Inkwell Saves Ink
from Drying Up

Made of acid-resisting plastic to withstand the action of ink, a new inkwell prevents ink from drying so rapidly. A special feed bottle is inverted in the well, feeding into the pen as required.



Essential Plastic
Chas. J. Archer
57 W. Jackson

es 110 6a

Safety Cuffs for Operator of Press
Pull Hands Out of Danger

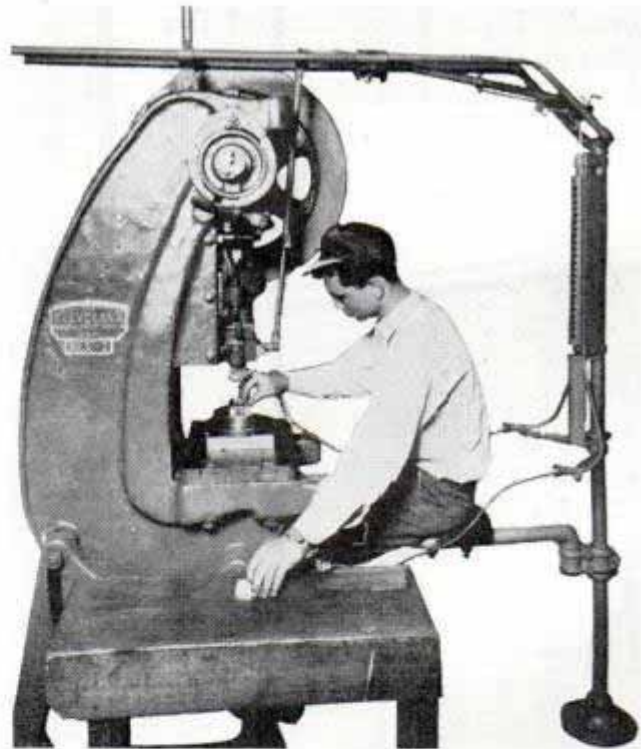

Cuffs with attached cables snatch away operator's hands before press closes

Handcuffs of leather which snatch away the worker's hands as the press starts downward make it impossible for the operator to get his fingers caught. A visit to almost any large industrial plant, where many of the workmen exhibit hands with scars and perhaps a finger missing, dem-

E.A. Whitacre
14408 Pershing Ave

Mechanical Corn Harvester Picks Ears from Two Rows

onstrates the value of the safety cuffs. Forcible withdrawal of the pressman's hands from the danger zone is accomplished by cables attached to the handcuffs. Speed of the apparatus is adjustable to that of any press. The cuffs have broad leather bands that fit around the wrists and small straps that fit between thumb and forefinger to prevent the wristbands from slipping up the forearm. When a new job is placed on the press, the foreman adjusts the speed of the handcuff cables and the distance of the withdrawal.



Working on two rows at a time, this mechanical corn picker harvests 800 bushels a day, squeezing ears from stalk and loading them into wagon

ls 1128

Pump Sucks Smoke Out of Burning Building

Clearing the way for firemen to combat flames, a vacuum pump sucks smoke out of burning buildings. The machine, with long hose attached, is lowered into a



"Vacuum cleaner" sucking smoke out of burning building is shown in demonstration

smoke-filled basement, or other part of a building, and the pump is started. Quickly the smoke is withdrawn from the basement, enabling the firemen to approach the flames without the risk of being overcome by smoke and fumes.

Cleaning up a cornfield is a fast job with the latest mechanical corn pickers, which handle two rows at once. The corn is forced between two rollers which squeeze off the ears and drop them on an elevator which loads a wagon. The average farm hand can pick sixty bushels a day. This mechanical picker harvests 800 bushels a day.

ls 1102

Swivel Base Socket for Light Permits Change in Focus

Electric lights used in a new swivel base socket may be focused in any direction at a touch of the hand. The socket has a bellow-like base, permitting the light to be turned in the direction desired. The manufacturer claims the socket is built to last throughout the normal burning life of approximately twenty lamps.



Seidseye Electric Co.
100 E 42nd St New York

Dr. J. J. Caldwell, Caldwell, Chicago

es 97
Cmbr. Philip Darley.
12. 21. - 5th Ave
Rio Angeles Calif



Thrilling scene from the Twentieth Century-Fox production "Ali Baba Goes to Town"

PACKING DRAMA

THRILLS always have been the backbone of motion pictures. A pioneer director tells of how his company once heard of a big fire raging on a near-by street. They rushed to the scene. Somehow the performers managed to get past the police lines. As the cameramen ground away, the players hustled in and out of the burning building. The director viewed these scenes in the projection room and set his writers to work weaving a story around them. After taking a few additional scenes on their lot they had a movie. Thus many early movies were made.

Adding thrills to pictures is still an important business, but it is now done with careful planning. Dangers to life and property are cut to a minimum. Stunts have been worked out with miniatures and

camera tricks that would have bewildered the old timers. For an effective background for "In Old Chicago," Twentieth Century-Fox built a prop city of six square blocks. The set was isolated because setting many of the buildings ablaze to represent Chicago's fire created a fire hazard.

Ten truck loads of steers were hauled to the studio for a sequence in which they broke out of the stockyards. The fence was weakened where modern cowboys, working out of the camera's range, chased them through. To get close-up shots of the steers Cameraman Jack Young hid in a pit with two cameras. Toward the end of the stampede the boards began to crack and had him worried for a few minutes. As in many stunt scenes the cameraman often takes a greater risk than the players.

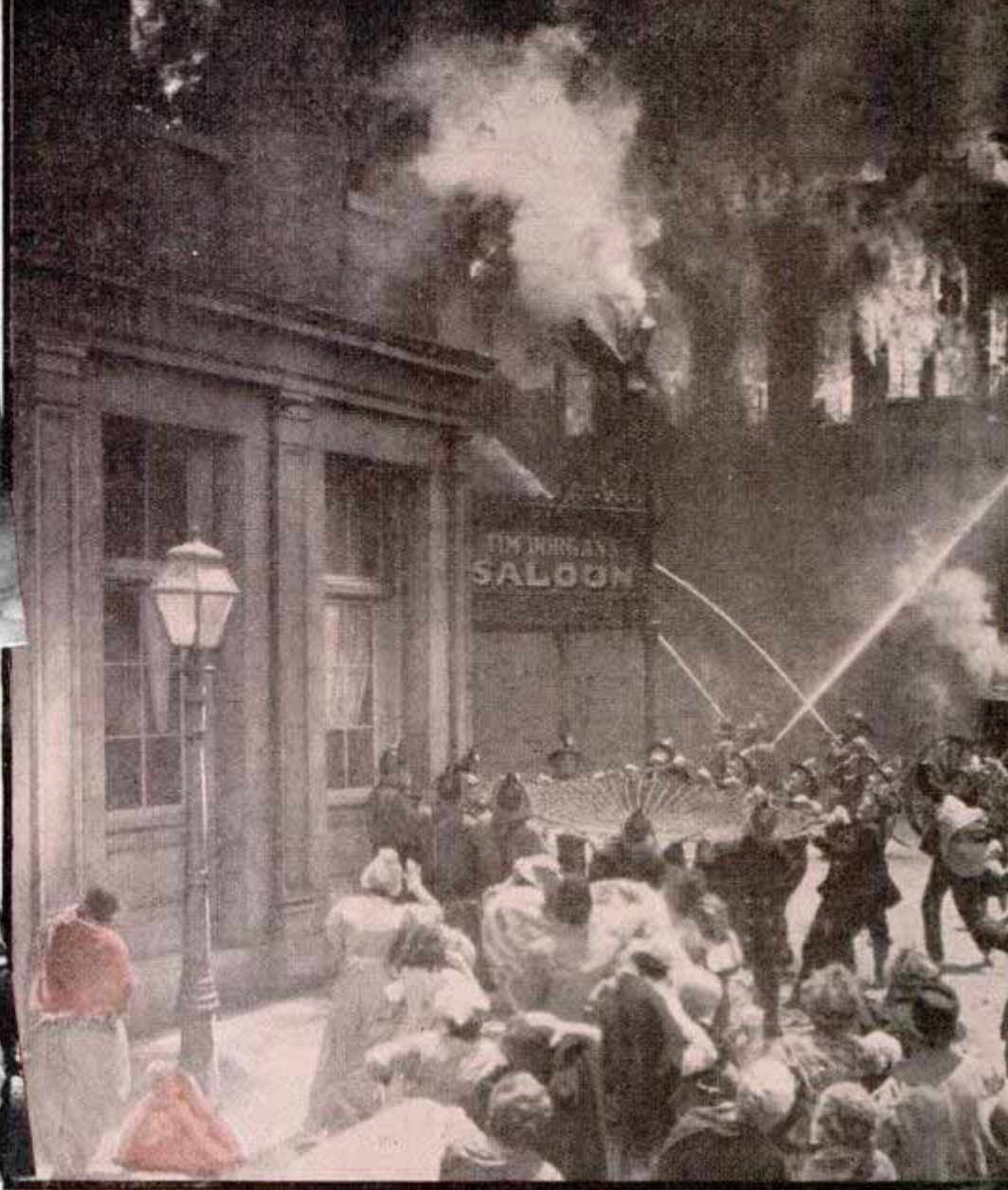
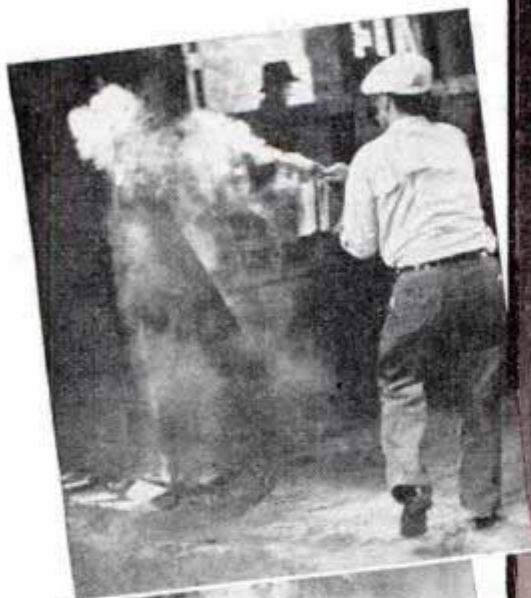

in the FILMS

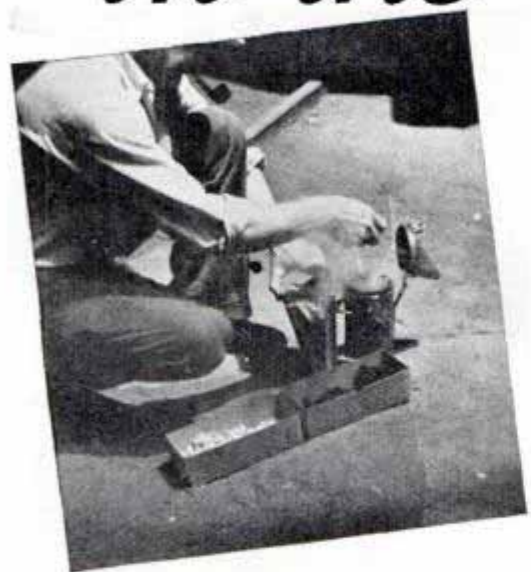

Right, fighting fire in "In Old Chicago." Left, top and center, spraying liquid smoke around prop mill and over vat of "molten metal." Bottom, mixing liquid smoke

Fire-fighting scenes usually make the movie audience's hearts go pit-a-pat, but they are dangerous to film, although every major studio maintains its own fire department. To reduce the fire hazard, men in the special effects department have worked out tricks in producing artificial fires. Liquid smoke, like that used by navy fliers to hide a battlefleet, is the basis of many modern movie fires. Lights out of the camera's view play on the rising smoke and this photographs like real flames. Electric fans are used to move the thick smoke rapidly.

A Bessemer converter belches sparks high in the air. A great vat of molten metal boils over with a roar. Flames shoot out of a furnace door at a fireman. It looks like a real steel mill, yet it is only a prop setting for Universal's "Radio Patrol." The special effects and property departments spent weeks planning and building it. Wood was the principal material used. To obtain the effect of boiling metal a mixture of lye, water and aluminum was placed in the vat. Before every scene a property man

W. V. Scribner, June 1917
"She Asked for It."

C. E. Brown, 'Special Effects man'

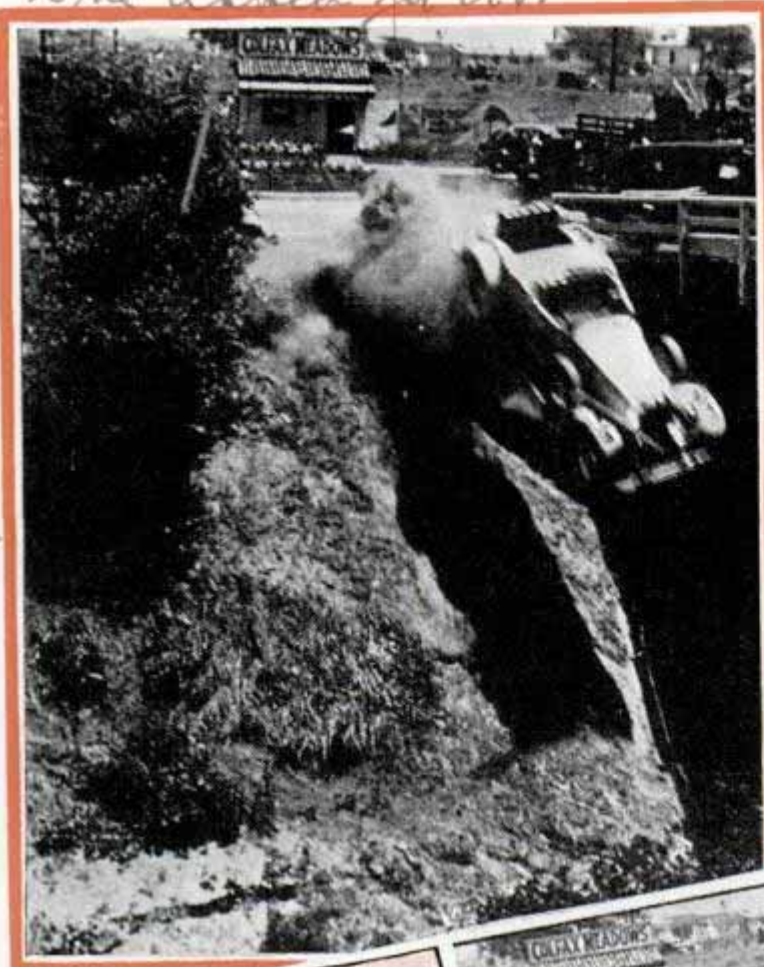

catches a stunt man toppling backward, but he only goes back so far and there the film is cut. Next a dummy of the policeman is dropped from the top of the sound stage and the camera catches its fall. Then these pieces of film are connected with a view of the real player, acting as if he were nearly dead, on the railway tracks below.

Most dummies are made from soft rubber. They fall more realistically than those stuffed with sawdust, used in the old days. An actual life cast of the player whom the dummy is to represent is made from rubber.

For a scene in "Love Under Fire," twenty stunt men were asked to jump off a freighter into

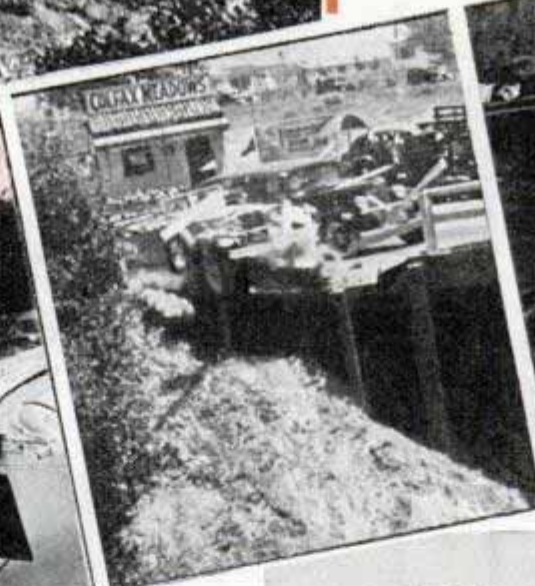

*Stuntman
 Jack Woody*

Top, roadster flying through the air. Center strip, left, wiring and priming car to explode and burn. Center, sedan crowding roadster off road. Right, camera catches roadster's crash and then the fire

sprayed smoke around the furnaces with a liquid smoke can, which looks like a big coffeepot with bellows attached.

Fights on the edges of cliffs and on skyscraper roofs are popular. A policeman is seen toppling backward off a girder, then falling through space and finally trying to move his crumpled body from a railroad track. How is it done? First the camera



Another camera view of the sedan after it crowded roadster off bridge

Los Angeles harbor and stage a battle for the possession of a lifeboat. Stunt men usually fight with open fists to avoid injury to opponents. Fist fights between movie stars are rather slow, but the camera is raced to make them look exciting.

The secret of taking a fall with minimum injury, according to stunt men, is the ability to keep the body relaxed until the impact. This applies to falling off boats as well as off horses. If one lands in the sea on his back after a thirty-foot fall he may break his back.

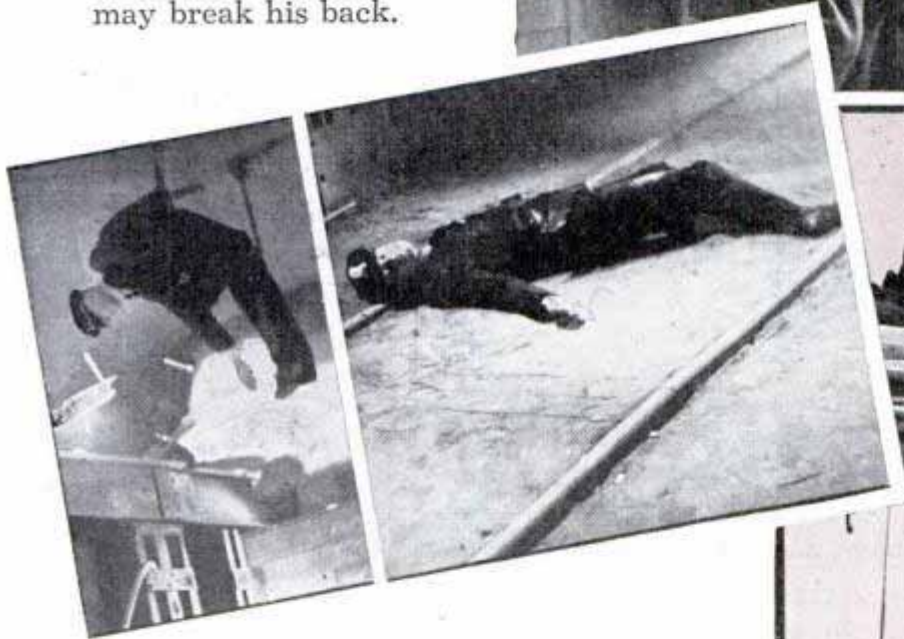

Top, stunt man toppling off ship after fight before the camera. Center, left, rubber dummy of policeman hanging from top of sound stage. It will be dropped when cameras are ready. Right, actor crumpled on rails after apparent fall

Horses don't like the idea of falling any better than humans. Cameramen would have a long wait to catch a horse stumbling. But movie directors have tricks that will make a horse fall. One of these is the "running W." They hobble the horse's front feet. A thin wire cable connects the hobble and a stake some distance away. When the horse runs the cable's length he automatically falls, throwing his rider. This stunt is usually done on the desert sands or on soft, grassy earth to save the

(Continued to page 144A)

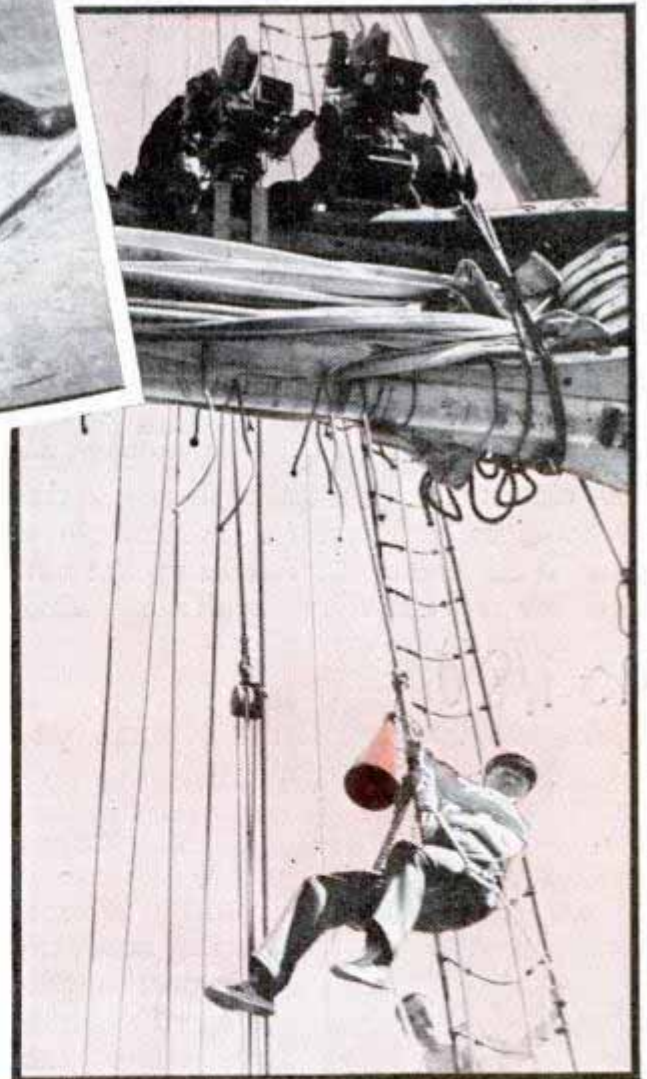

Bottom, cameramen and director in perilous positions high in rigging of ship, ready for filming another thriller of the sea

Radio Patrol
Harvey Perry

'Bird Cage' Walnut Picker Makes Harvesting Easy



Picking up nuts with "bird-cage" harvester. Inset shows triangular springs that grasp walnuts

Gathering walnuts without inflicting a lame back is the purpose of a special walnut picker designed for the small orchard man. It is a cage made of galvanized wire and mounted on the end of a pole so that stooping is unnecessary. A triangle of three small coil springs picks up the nuts and they are removed through a small door in the side of the cage.

Wheel Tester Blinks Neon Eye If Wheel Is Off Balance

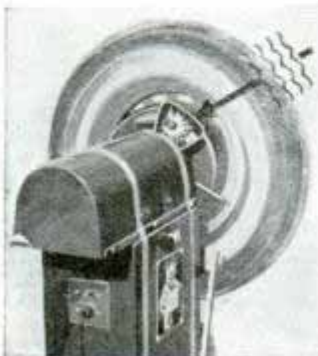

Winking its neon eye as a warning signal, a wheel-testing machine gives precise indication of any unbalanced condition in the wheel. A motor drive puts the wheel in mo-

tion and accelerates it to the vibration point, then releases it and the neon light is switched on. As the wheel revolves, the eye flashes, indicating at what position the wheel is dynamically out of balance. After the wheel is completely balanced both statically and dynamically, it can be run at the highest speed obtainable without making the neon eye blink.

Phone Message Parked on Tape Is Repeated After Delay

It may soon be possible to "park" your telephone message on a magnetized steel ribbon until the proper party arrives to receive it. In the Bell Telephone laboratories, engineers have succeeded in parking messages for a short time on a thin steel tape which is passed between the poles of two small electromagnets at a speed of one foot per second. The speech current, flowing through the magnet windings, produces varying magnetization in the tape, and as the ribbon passes between the poles of a second similar pair of mag-



Magnetized steel ribbon on which telephone message is parked until repeated on loudspeaker

nets several feet away, it induces in their windings currents corresponding to the magnetic pattern and thus to the original voice current. The words are repeated five seconds later by a loudspeaker. The tape can be used again after the magnetic pat-

Dear Wm Co Rock Island, Ill

Cape Electric Co.
111 N. Summer St
Santa Ana Calif

\$2.00

es 1165

463 West St
New York

1935

tern is removed by passing it through a strong and varying magnetic field. During experiments made thus far it has been possible to delay delivery of messages only a brief period, and no attempt has been made to put the method to actual use.

es 116
Army Tank Takes to the Air in Jumping an Embankment



Wido Wido
Quick eye of camera catches fifty-mile-an-hour army tank in the air as it hurtles over embankment during maneuvers in Pennsylvania

es 1136
Gas Mask Guards Fireman from Smoke

Protection of firemen against their nemesis, smoke, is afforded by gas masks. Now used as standard equipment by some fire departments, the mask enables the fireman to reach the source of the flames. Smoke has claimed the lives of many firemen attempting to get into strategic position to combat fire, in addition to overcoming many others.



Fireman wearing mask for protection against smoke is shown entering burning building

One of the army's new light tanks was caught "on the fly" by an alert cameraman as it leaped an embankment at high speed during maneuvers at Indiantown Gap, Pa. These tanks, just adopted by the U. S. army, can travel at fifty miles an hour. They carry three machine guns and two-way short-wave radio equipment.

es 1155
Cows Are Now Wearing Rubbers to Avoid Spread of Infection

Rubber galoshes are now the thing for cows. It's a matter of health, not style. The rubbers were developed to prevent the spread of infection among cattle suffering from hoof diseases. Similar foot coverings had previously been tried on sheep and had resulted in a considerable saving of losses to farmers.



Our Bureau of Information will answer questions regarding articles in this magazine, if accompanied by return postage.

Widow's Tale and Rubber Co. River Road, N.Y. Sheridan

Giant Press for Plane Parts Speeds Up Aircraft Building

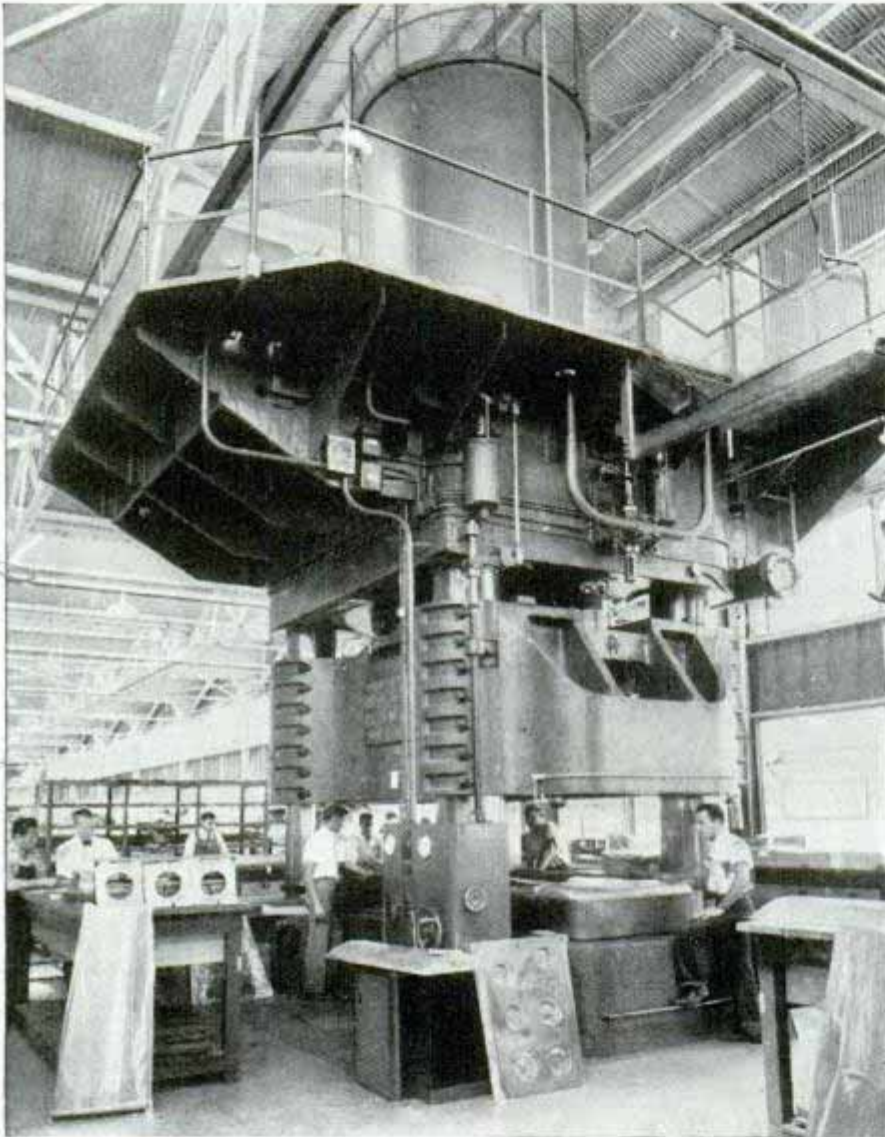

Here is the giant press in place, ready to stamp out airplane parts quickly to speed up production of air liners. It is four stories high

For increasing production of airplanes, the Douglas Aircraft company has installed a four-story, 420-ton hydraulic press which will shape several thousand kinds of parts. Completely self-contained, the press has a pressure capacity of 5,000 tons created by a single hydraulic ram six feet in diameter actuated by oil under a pressure of 2,500 pounds per square inch. The hydraulic pressure is generated by four giant radial pumps driven by two 150-horsepower electric motors. Covering as much floor space as the average home, the press is set into a special foundation of reinforced concrete. In order to move the press into the Douglas plant, it was necessary to tear away the front of the building and disman-

tle part of the roof. Shaping of the parts on this big press, and a smaller one installed sometime ago, has resulted in a reduction in tool costs, as much as twenty-five to one, over conventional requirements. The parts are all of aluminum alloy.

65-1166

Fountain Pen Lamp for Soldering Gives Quick Heat

Blue flame hot enough to melt brass or copper is obtainable with a pocket soldering lamp invented recently. Burning methylated spirit, available anywhere, it reaches a maximum heat of about 2,650 degrees Fahrenheit within fifteen seconds. The little lamp consists of two cylinders, the "heater" and "carburetor," containing wicks and a supply of spirit to last nearly an hour. A few seconds after lighting the "heater," a gas flash blows at great speed and pressure from the side of the "carburetor" cylinder nozzle, becoming a torch of blue flame.

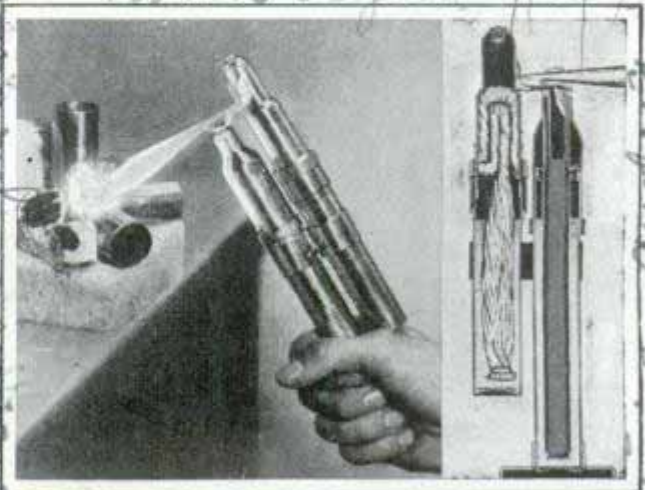

Pocket soldering lamp produces blue flame under high pressure, hot enough to melt copper or brass. Upper cylinder is "carburetor," lower is "heater"

Mr. Josef Suschany, High School

Handwritten notes:
- Top: "mount ahead" (written vertically)
- Right: "American agents wanted" (written vertically)
- Right: "Vernon, Australia" (written vertically)
- Right: "Invention" (written vertically)
- Right: "7/29/34" (written horizontally)

Tractor Helps Raze Building from Top Down

Top, tractor pushing debris over the side. Center, building in process of being wrecked. Bottom, lowering tractor to another floor



C. Peoria, Ill.
 Among the novel jobs on which Caterpillar tractors have been used is that of wrecking a building from the top down. A Diesel-powered tractor was hoisted to the top of a seven-story building in San Francisco and used to push debris over the side after the walls had been knocked to pieces by a crane swinging a heavy ball. As each story of the building was wrecked, the tractor was lowered to the next until the entire structure had been demolished. The work was done to make way for a new building.

Our Bureau of Information will answer questions regarding articles in this magazine, if accompanied by return postage.

Es 1228.
Private Plane Has Shower Bath and Comfort of Yacht

Furnished like a commodious yacht, with luxurious accommodations for thirteen passengers and a crew of three, a four-motored flying club plane is to be built for a California sportsman. It will cost slightly less than \$300,000. There will be a shower bath, a dining room and galley with a refrigerator, a lounge, a master bedroom with hot and cold running water, and bedrooms for four guests. The giant land plane is being designed

after the pattern of the new four-engined transport ships which carry thirty-three passengers, but its special interior design reduces its accommodations to thirteen daytime passengers and beds for seven, besides the crew. Its wings measure 107 feet from tip to tip, and the plane will have a speed of 250 miles an hour.

Garrett Co. Boeing Seattle, Wash. County Calif.

Capt. George Whittell San Mateo

Roadside Figure of Death Warns Fast Drivers



This grim warning of Death the Hitchhiker may be used in road safety campaign

While a photographer sought to get a roadside picture symbolic of the Grim Reaper waiting to be given a lift by a passing motorist, he noticed that the figure of Death in hitchhiking pose had a sobering effect on drivers operating their cars above safe speeds. Now it has been suggested that a man in the same costume tour the state as a warning against careless driving.

Plant Growth Aided by Light from Low-Wattage Lamps

Using lamps of low wattage, Dr. R. B. Withrow of Purdue University has found a method of forcing the growth of plants in greenhouses. The Smithsonian Institution reports the lamps were employed as supplementary lighting sources for a number of plants and the results apparently were out of all proportion to the treatment applied. With the intensities varying from less than one foot-candle to more than 100 foot-candles, the lamps illuminated the

plants for several hours each night. This light supplemented the natural light of day. Surprisingly, an aster receiving 100 foot-candles and another receiving three-tenths foot-candle showed little difference in flowering.

Arc-Welding Shop in the Arctic Saves Mine from Shutdown

Even in the arctic, far from commercial electric-power lines, electric arc-welding has become a necessity. It came to the rescue recently when a mine in a remote section of Alaska was threatened with a shutdown because of a broken gear wheel. Eskimos loaded the broken wheel into a skin boat and paddled for five days to reach the settlement of Candle, where a gasoline-driven arc-welding outfit was available. In three hours the repairs were completed and the Eskimos started back.

Folding Bars Form Stalls for Cows in Dairy

Designed to prevent cows from trampling each other, a folding guardrail partition forms an individual stall for each animal in the dairy barn. While the cows are being milked all the bars are raised out of the way. Then the bars are lowered by one movement, giving each cow the protection of a stall.

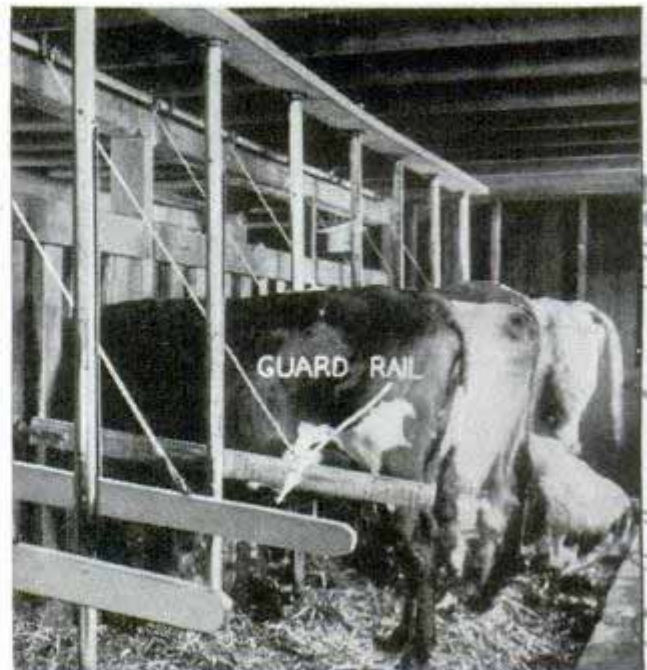

Guard rail in place after milking. It reduces the danger of cows trampling each other

es 1216

Department of Agriculture
Washington, D.C.
1936

General Electric Co. Schenectady, N.Y.

es 1250

es 1104

acme

Arkansas

Westinghouse Lamp Co.
Cleveland, Ohio

West Lafayette

Albert Jeter

man
Ceylon

Albert Jeter

es1101

Los Angeles Calif.

Odd Puzzles Are Created by Secret Process

Puzzle maker, right, with several examples of his mystifying work. Note size of puzzles in comparison with that of the small-necked bottles and electric-light globes

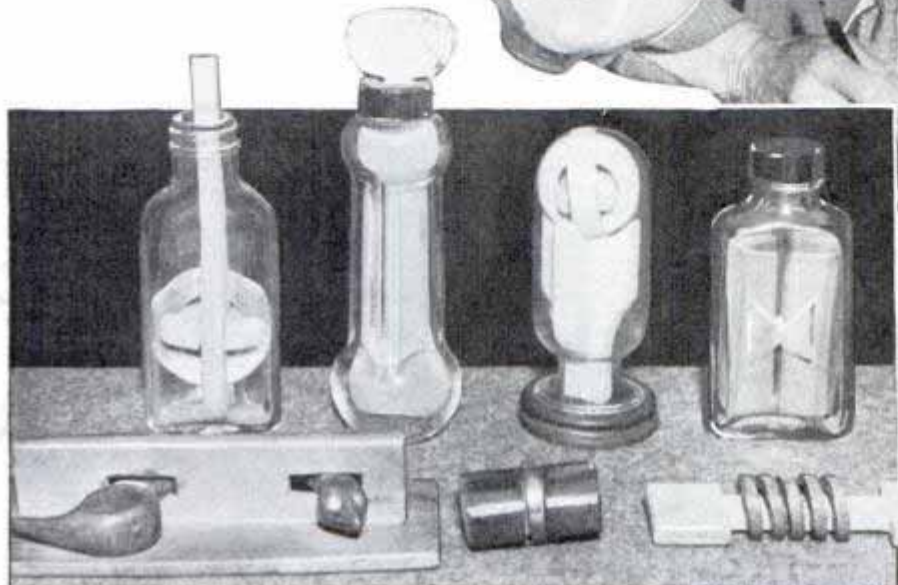

Wooden and metal objects in bottles with necks too small for them to be removed are among the puzzles prepared by a western puzzle maker. Calling them "engineers' problems," the puzzles are made by a secret process. The bottles are ordinary glass picked up at random, the bottoms have not been removed and melted back and the usual "ship in a bottle" method of assembly has not been used. One of the pieces is a large power base electric-light globe from which the base is removed and that contains three solid circles of wood that almost completely fill the interior of the globe. A pickle jar, in addition to a bulbous wooden shape inside, also contains a large metal washer far too large to have been inserted through the neck. In a third bottle a wooden dumbbell appears to have grown inside. It has one end projecting through a small hole cut in the metal cap. Another puzzle is a solid seamless metal ring placed on the crossbar of an "H"-shaped piece of wood, seemingly impossible to accomplish without welding

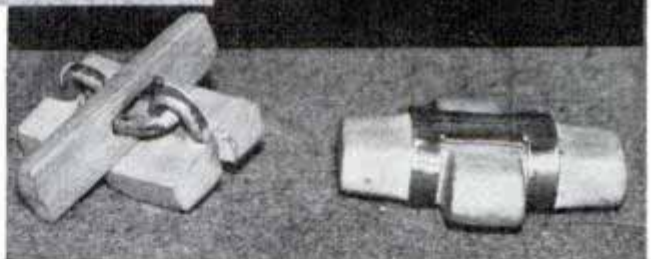

on the ring or joining the wood. There also are wooden dumbbells encircled at the middle with small rings made from other kinds of wood. Closest inspection of the objects fails to reveal the manner in which they were made.

es1124.

Plane Drops Food to Climbers Scaling Mountain Peak

Airplanes dropping food and supplies replaced the long string of laboring porters during the conquest of Lenin peak, in the Pamir range of Asia, whose 23,700-foot peak was scaled recently by eight Russian mountain climbers. Radio kept the climbers in communication with their base.

Science Service
9/17/37

Cent. Thomas G. Higgins
Jan. 1935
Los Angeles, Calif.

DISPATCHING

Dispatcher Mason on the job, keeping 1,200 tractor-and-trailer units moving. Below, driver signing maintenance card after checkup at the terminal



ONLY a few short years ago the trucking industry was considered the puny step-child of other forms of transportation, a sort of poor relation which existed on the short-haul crumbs which the more prosperous carriers contemptuously refused.

Today motor transports handle one-tenth of the nation's tonnage and trucking has become big business, a wide-awake competitor for every pound of freight to be hauled, a lusty, tough youngster in the transportation field with a rich lingo of its own, a language as picturesque as the sailor's or railroad brakeman's.

In the argot of the trucker, explains Jimmy Mason, chief dispatcher at one of the world's largest trucking terminals, a tractor is a horse; a refrigerated trailer a reefer, and perishables are hot stuff. To the cross-country driver a mechanic is a knuckle-buster; a magneto a jolt box; any trucking unit a corn popper, and a tourist camp a curfew park.

Although a wealth of trucking expressions reach his ears nightly, Mason never gives them a second thought. He's too busy

keeping 1,200 Keeshin tractor-and-trailer units moving over the highways of eighteen states, six nights in every week. Competition in the transportation field is tough. Apart from the railroads, there are between 3,000 and 4,000 trucking companies bidding for business, and rigid schedules must be maintained by both big and little operators in order to survive.

It takes brains and courage to herd the behemoths over the concrete on schedule. Through snow and dust storms, sleet and washouts the truck drivers battle to deliver their freight. They must cope with fatigue and the perils of the highway, the drunken or careless motorist, an occasional high jacker, and sometimes cattle from unfenced lands. The truck driver has a philosophy all his own. He's too smart to laugh at the dangers connected with his

es 1159

Reichstall equipped trucks

Quinnell River in
Washington



The

CORN POPPERS

job but his alertness and bravery make him equal to them at all times. The safety of others is his first consideration—no chance is too great for him to take in avoiding a highway crash. And whenever a driver goes the limit he either escapes without injury or else he's sent home in a wicker basket.

The experience of a California driver on the Sacramento-Reno run is characteristic. Traveling down a steep, winding road from Donner Summit to Truckee in the High Sierras, a United Freight driver, after negotiating a blind turn, came upon an ice-sheeted stretch of highway. An old model touring car was stalled broadside across his path. Seeing five persons in the car, the driver, with a quick turn of the steering wheel, sent the twenty-ton truck hurtling off the road into a canyon. Down a 150-foot ravine, the truck toppled. Motorists hurried to the spot a few minutes later and found the unit a wreck. But the driver

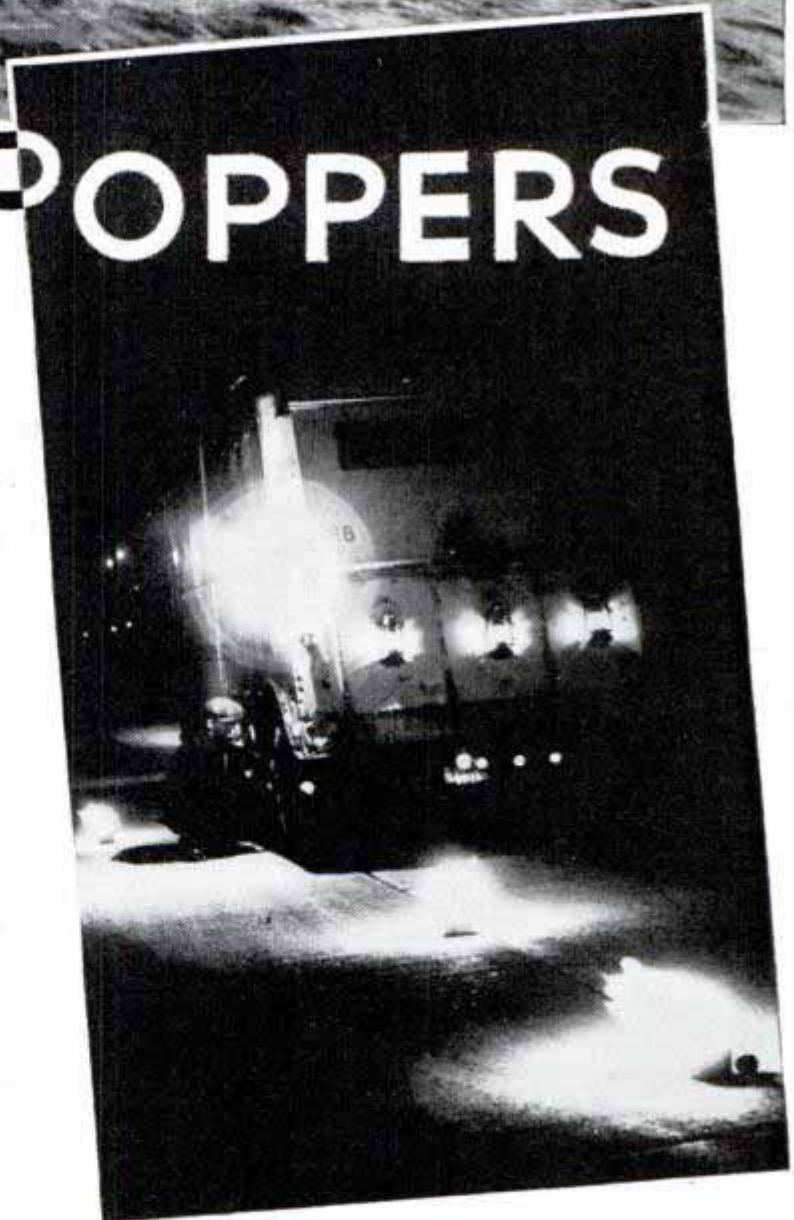

Top, big truck crossing river with 5,000-board-foot log. Bottom, flares and bomb pots warn other drivers when truck halts at night for repairs



Top, these assistant dispatchers handle fleet of city trucks that deliver freight to terminal. Bottom, sometimes loaded trucks are put on flatcars and shipped by rail because no better service can be offered by highway

was still behind the wheel with only an ashen complexion and a small bump on the head to show for his experience.

No less thrilling was an episode in the life of a Sacramento driver engaged in transporting gasoline from a storage depot to a town near by. The highway in front of the loading depot sloped downward with a small stream running parallel to it. His truck loaded, the driver started down the road at a snail's pace as he had agreed to wait for the two drivers behind him at a coffee station at the foot of the hill. The truck had gone but a short distance when the driver noticed things were growing blacker. He looked back and saw the sky a bright red. The gasoline depot had caught fire and the flames were rushing down the highway toward his truck with alarming swiftness. He pressed the accelerator to the floorboards. When the flames were outdistanced, he learned there had been an explosion and the burning gasoline from the storage tanks had spilled into the creek running alongside the highway, making it a roaring stream of fire.

Highway maintenance departments have taken the sting out of snowstorms in most sections. In the mountain regions, the heavy snows are still productive of freak

accidents and grief for the motor carriers. A noteworthy one happened on Donner Summit last year. Between ninety and 100 inches of snow within a week's time is not uncommon in this section and that means man-sized drifts. The highway workers had battled half the night in a

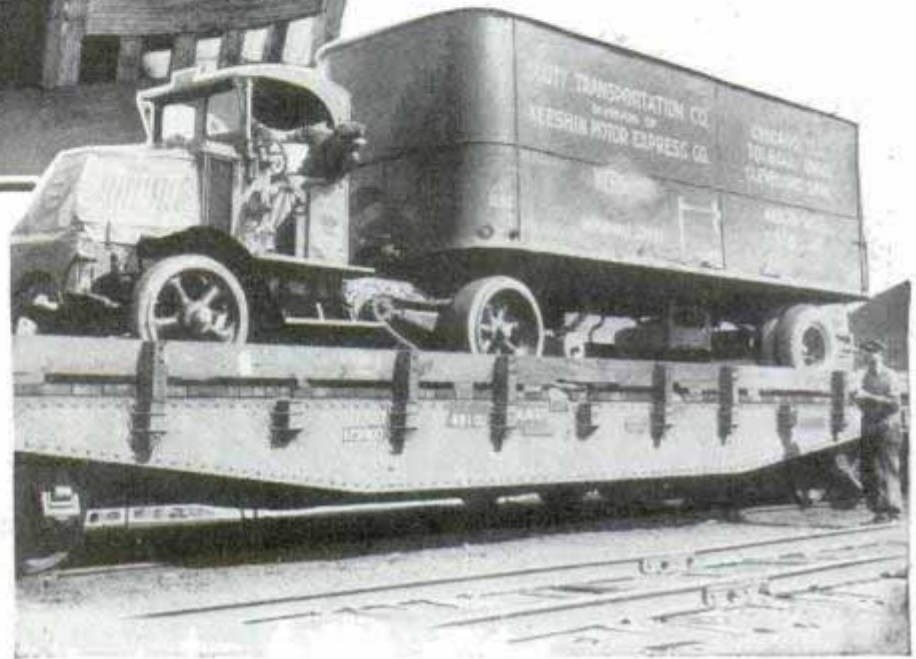

raging blizzard with the temperature at thirty degrees below zero trying to carve a roadway through the expanse of snow. Even the snow poles that served as guides for normal drifts were blanketed and the workers were cutting it from memory. On a winding curve, the plow had cut beyond the shoulder of the road but nothing happened. The hard-packed snow beneath it held.

The first truck through—a 60,000-pound Diesel—wasn't so fortunate, however. As soon as it hit the snow part, it went sliding down the mountain in toboggan fashion. The unit came to a halt in the valley and the driver and his "swamper" got out to inspect the damage. It was negligible, considering the distance the truck had traveled, but it was three weeks before the unit could be extricated because the storm continued and the drifts covered it.

Storms that bring the greatest grief to the truckers are those which occur in sections that are not prepared to handle them.



A heavy storm in the vicinity of Cedar City, in southern Utah, caused a five-day tie-up of the trucks along the Utah Hill. Many of the drivers left their motors running for five days straight while they helped battle the drifts.

In the early evening hours, the big motor-freight terminals present a vivid picture of the magnitude of this baby among industries. At one of the large ones, between 3,000 and 5,000 shipments—a million and a half pounds of freight—are placed on the docks to be loaded into the trailers that will make deliveries in 300 cities the following day. Everything from pretzels to steel hoists is handled. Running orders and the freight manifest are handed to each driver by the chief dispatcher. When going into a new territory, the driver must acquaint himself with the special regulations peculiar to that section before leaving the terminal. For example, in Michigan, a driver must keep an accurate mileage book showing how many miles the trailer has gone. Likewise, state laws differ in regard to clearance lights. To expedite matters, an ingenious lighting board has been developed in the Keeshin shops. If a driver turns a switch on the panel marked "Ohio," the board flashes a green light for the left front; red lights for each

(Continued to page 140A)

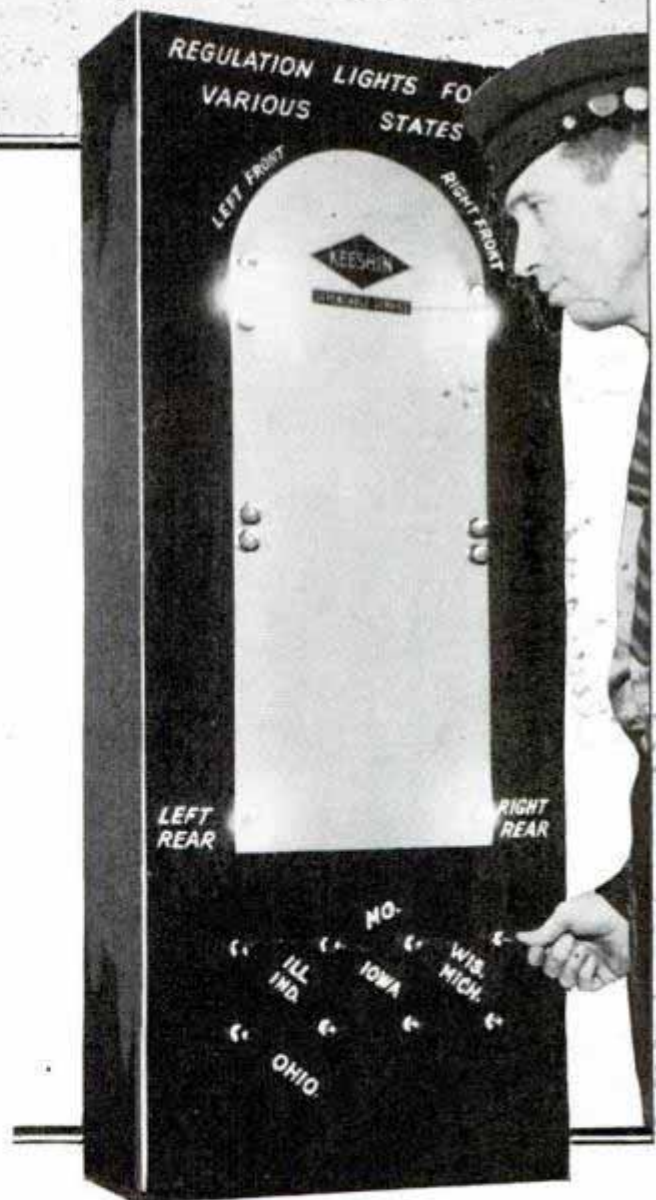

Top, driver gets final checkup on tires, brakes and lights before leaving the Chicago terminal. Bottom, by turning switch a driver can tell what clearance lights are required for various states

Keeshin

es 1163

Giant Aircraft Carrier Mothers 140 Planes

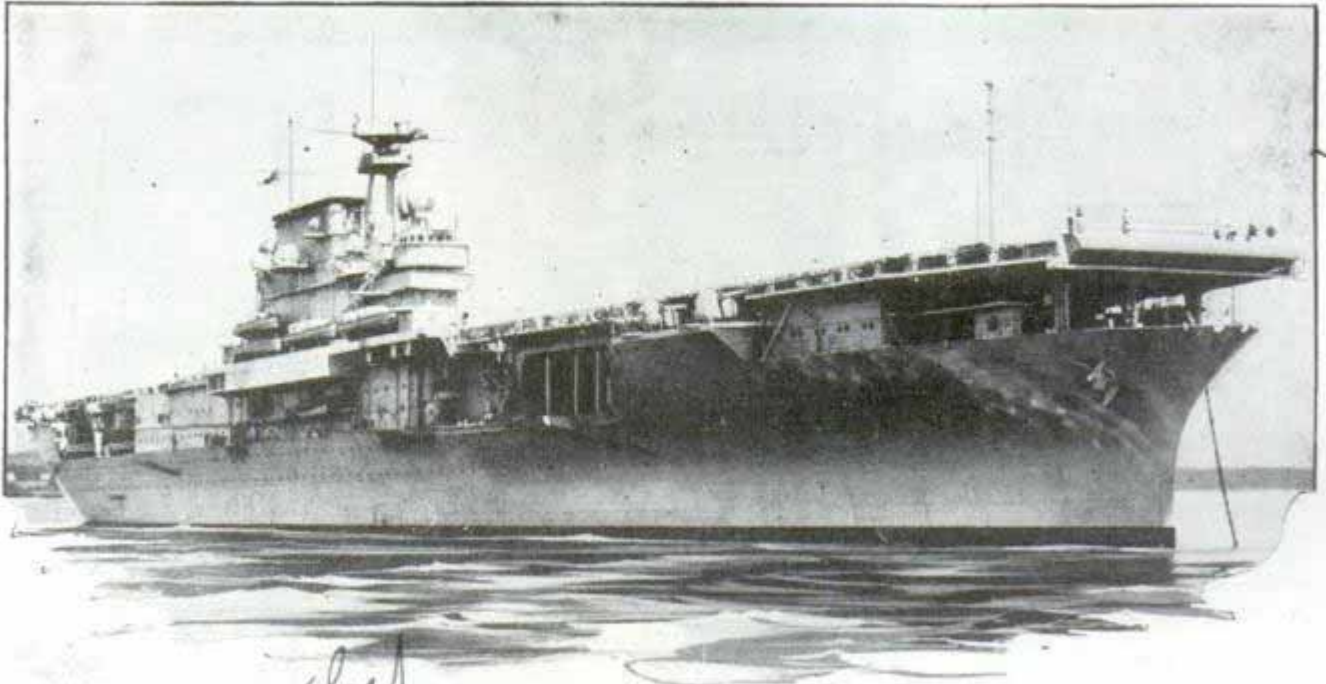

sub.
"Mother" to a brood of 140 or more warplanes, the U. S. S. "Yorktown" is the navy's biggest aircraft carrier and cost \$20,000,000. Notice its long sweep of unobstructed deck, a flying field 800 feet long

First of twin giants destined to be the largest aircraft carriers in the U. S. navy, the "Yorktown" has been turned over to the navy for tests at Newport News. The two ships were authorized in 1933. The

"Yorktown" is a 20,000-ton vessel, with a flying deck 809½ feet long and 109½ feet wide, and will carry at least 140 planes and a personnel of 2,072 officers and men. Its cost was \$20,000,000.

es 1114.

Two-Speed Brake Unit Makes Bicycle Easier to Ride

Operated with gear shift lever like that of the automobile, a simplified two-speed coast brake unit invented by A. J. Musselman makes the bicycle easier to ride. In high gear, the unit operates like any plain coaster brake. But when the gear lever is shifted the gear ratio for pedaling is lowered twenty-eight per cent, increasing the rider's power for hill-climbing by twenty-eight per cent. In either high or low gear the coaster brake serves the usual purposes of coasting and braking. The two-speed arrangement is accomplished by replacing the worm driver of a standard Musselman coaster brake with a driver fitted with planetary gear. The shift lever is attached to the rear forks of the bicycle and has no connection with the coaster brake until the lever is pulled forward. This causes two steel fingers to contact the two-speed unit, setting in motion the reduction speed gears. The gears consist of a sun gear surrounded by three carrier

The. Musselman Sub-Brake Co.
6227 N. Clair Ave.
Cleveland Ohio



Showing how two-speed unit works. Bottom, new and old in bicycle coaster brakes

es 1059.

Giant Swordsmen Fight Duel at Gates of Medieval Castle

gears, with the group encircled by a driving gear. Since these gears always are in mesh, there is no danger of a stripping. In high speed the whole mechanism is locked together by three steel pins. When these pins are released, by pushing the shift lever forward, the sun gear is locked and the wheel is in low gear. By shifting the lever back the three pins, under spring pressure, return to their normal position and the wheel is in high. There is no slippage in pedaling while shifting gears.

es 1168.

Radio Directs Fire Fighters Speeding to Scene of Blaze

Even while they race to a distant blaze, London firemen keep in touch with headquarters by radio. Sets have been installed on the fire trucks and a radio operator is an im-



Visitors to a Long Island estate modeled after medieval castle at Seville must pass between these swordsmen. They are statues dressed in armor

Keystone

Two armored knights brandish swords as if dueling at the gates of an estate at Westhampton, Long Island. The tall statues add a bit of realistic "atmosphere" at the entrance to Casa Basso, copied after a medieval castle at old Seville.

es 1137

Venetian Blind Clip-On Tape Is Detached for Cleaning

Detachable for cleaning, a new clip-on facing tape for venetian blinds eliminates the eyesore of soiled tapes. The facing tape can be removed and cleaned without taking down the blind. One-eighth of an inch wider than the regular tape, the new product is equipped with clips which hook around the regular blind tape.

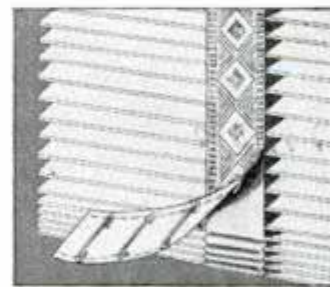

Radio operator on fire truck takes down message from headquarters while rushing to fire

portant member of the company. The two way system has proved to be especially helpful in calling for additional equipment to fight isolated fires.

Chicago 657 N. 25th St.

At top and bottom the facing tape is attached with pins or small tacks. Both cotton and silk facing tapes, made in several different designs and colors, are on the market.

E. L. Mansure Co.
1605. Indiana Ave

Extra Lens Increases Depth and Speed of Camera



Note clarity in strip, left, taken with auxiliary lens compared to strip, right, taken with ordinary lens



Depth of the focus and speed of the camera lens are increased through the use of an auxiliary lens now on the market. This extra lens fits squarely in front of the regular lens by means of three set screws. Ground by a new process providing continuous focus over the entire lens, instead of over about half of the surface, the lens extends one-plane sharpness of focus into all planes and produces excellent definition throughout the picture. Distortion of perspective is avoided and stereoscopic roundness and depth are added.

Outside Mirrors Light Room by Reflecting Sun's Rays

Normal illumination was so poor in an executive office of a London company that some other means of lighting it were sought. Finally a motor-driven heliostat, which reflected the sun's rays into the room so well that no other illumination was necessary, was installed. The helio-

stat consists of one large mirror, twelve feet wide and six feet high, and other smaller mirrors. The motor turns the large mirror in accordance with the sun's position. A photoelectric cell arrangement switches on electric lamps adjacent to the mirrors when the sunlight is insufficient.

Electric "Spigot" for Outside Use Has Weatherproof Hood

Electric outlets in the garden and on the exterior of the house and garage are made possible by a weatherproof hood and hinged cover that protect the outlet. They keep out rain, snow and ice, but the flick of a finger can lift the spring-operated hood when you want to plug in.

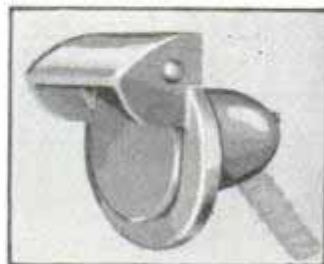

Motor of Sander Worn on Back to Speed Boat Scraping

When a boat owner found it difficult to scrape the old paint off his boat, he hooked his sander to a secondhand quarter-horsepower motor with a flexible connection and did the job easily and quickly. The motor was fastened to a board which he strapped on his back. Electrical connections were made by cable to a lighting circuit near by.



Sanding boat with aid of electric motor, strapped to back, and flexible cable

Edw. Howard, D. Beach, Buffalo, N.Y. #69 Virginia St.

Ed. Milton Bldg. Pittsburgh

Normal Electric Products Corp.

The Engineer London

Mr. James Washford, 3416 N. 7th St. Tacoma, Wash.

Designed by Sir Howard Crosby Parsons and Co.

Radio Guides Tunnel Borers in Straight Line

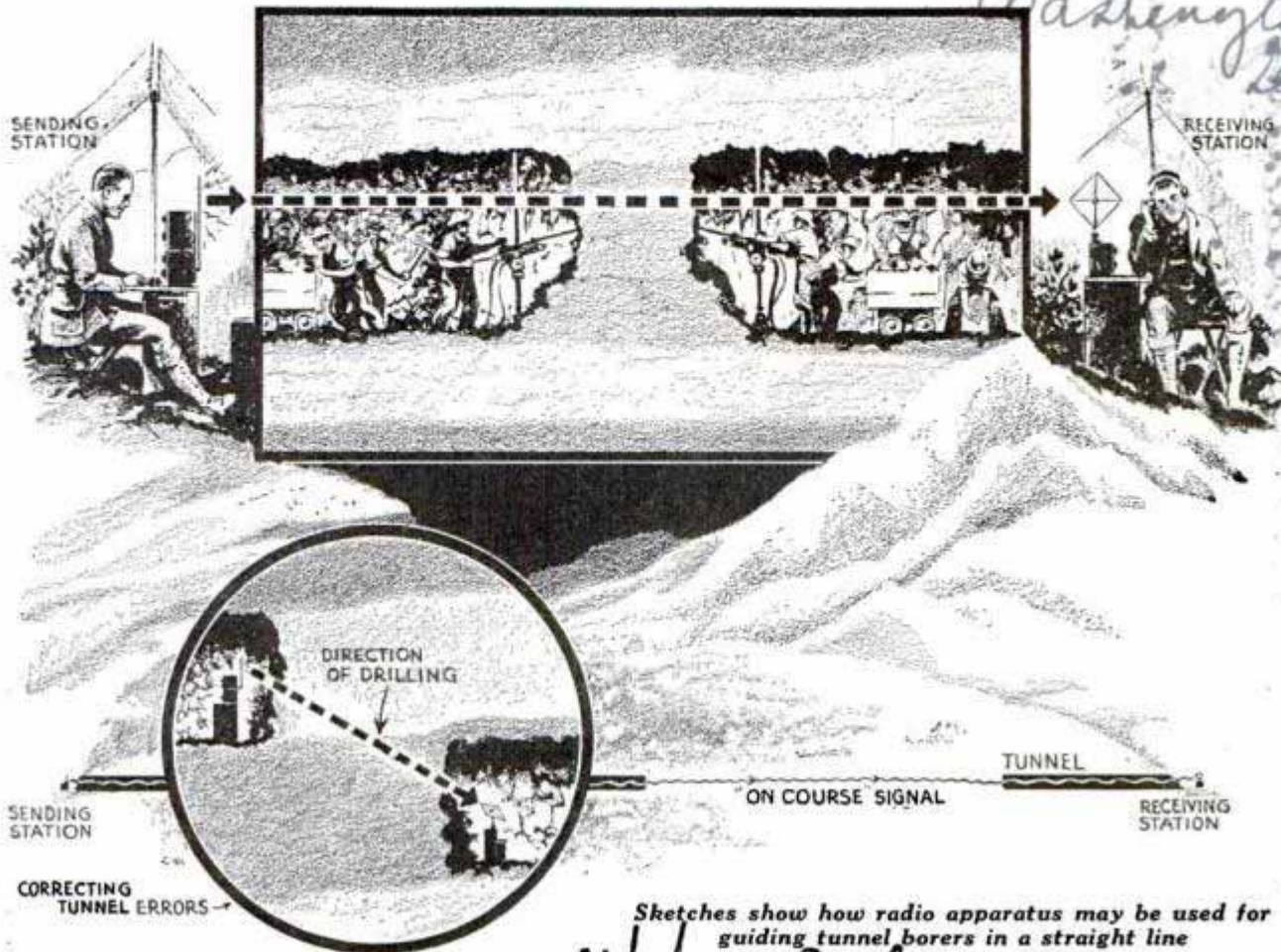

Sketches show how radio apparatus may be used for guiding tunnel borers in a straight line

Preventing boring crews from making mistakes in tunneling through a mountain, radio direction finders are being used to keep the bore from one side on a straight line with one from the other side. The boring crews simply follow the radio beam right through the mountain. Getting tunnels to meet inside a mountain always has

been a great engineering feat. While the project may be checked from every possible angle and the utmost care employed to keep the bore straight, few tunnels have met exactly. A variation of only one inch at the start may mean that the two bores will miss each other entirely. The new method will eliminate much surveying.

Envelope "Harness" Saves Time in Feeding Typewriter

Faster work in addressing envelopes can be done with a patented paper harness which feeds the envelopes into the typewriter. The harness slips inside each envelope in the pile, and as fast as one envelope is addressed another is lifted into line ready for typing. The continuous strip passes into a basket or box as it leaves the typewriter. Finally it is drawn back over the desk and the envelope is stuffed and paper harness withdrawn in one operation.

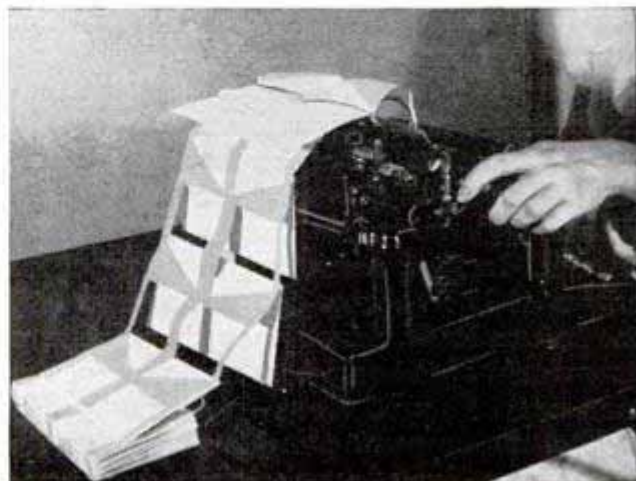

Envelopes being fed into typewriter for addressing

Our Bureau of Information will answer questions regarding articles in this magazine, if accompanied by return postage.

Abner Schmidt
5357 - 44th Ave. S.

es 10 7 0

BROADCAST Gives

Cml. Edvard de S. Amnis, Magazine and syndicate, Ltd. Publicity Dept. Columbia Broadcasting System, 485 Madison Ave. N.Y.C.



on the twenty-first floor of the Columbia Broadcasting System building in New York City, the "Columbia Workshop" goes on the air every Sunday from 7:00 to 7:30 p.m. You may find Director Reis, shirt sleeves rolled up, lowering a microphone through a hole in the top of an empty elevator, or up on the roof, directing a frozen cast while the wind and snow whistle around the microphone, or in a Broadway subway, or even in the Seventh Regiment Armory surrounded by a cast of 200 people.

If you ask the director what radio engineering has done for radio drama, he'll tell you first about scene acoustics. For the principle of scene

A YEAR ago a new kind of theater was started over the air with a radio engineer as its sole director. A young man named Irving Reis, had risen from the control panels of the "March of Time" and "Hollywood Hotel." His experimental drama venture, called the "Columbia Workshop," was dedicated to the hope that radio engineering might blaze a new trail for the radio drama of the future.

After a year's work, the "Columbia Workshop" has more than accomplished its aim. In fact, according to many of its critics, it has become the radio drama of the future itself. For it has shown that a new world of art might be made out of the materials of sound alone—that the "gadgets" of the control panel and the studio might be utilized for effects of drama never known until today. Up in Studio No. 3



Top, testing the pitch qualities of an actor's voice with the resonoscope. Bottom, cast rehearsing for "The Fall of the City" in which 200 voices were made to sound like 10,000

7th Regiment Armory

es 70 70

"SIGHT" to the EARS

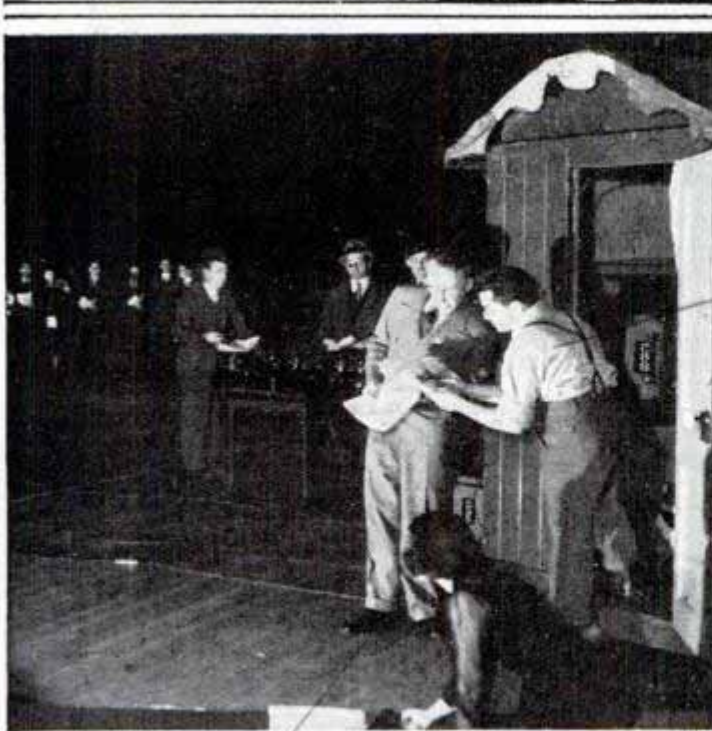

Top, sparring prize fighters supply background for radio drama, "Fifty Grand"

Irving Reis

acoustics would be the reason he was in such a picturesque place as an elevator or a Broadway subway.

"In early radio," he tells you, "every scene, regardless of where it was laid, was played in the same studio, of the same dimensions and acoustical properties. Sound effects supplied the only change in locale and atmosphere. But today, we have learned that the human ear, without actually viewing a scene, can hear space. It can tell whether the voices it is listening to over the loudspeaker seem to be coming from the confined space of an airplane fuselage or the hard resonance of a mine

Archibald McLeish



shaft—merely by the amount of echo surrounding them.

"Therefore, to paint a scene in radio drama accurately, we must play it either in the actual place the script calls for, or in a place which acoustically approximates it."

For a scene in an airplane fuselage, for instance, Reis would utilize a tight, small, rather live studio; for an airplane fuselage is small, and made of metal which has an echo. For a scene in a normal room, he would use another studio, of the approximate size mentioned by the script. For a scene in a clothes closet he would place his actors inside a heavily absorbent, soundproofed booth. And for a scene in a mine shaft Reis uses an echo chamber. To make voices sound as though they were talking at the bottom of a mine shaft, he sets up a microphone in an ordinary studio. Sound from this microphone travels to the control panel in perfectly normal fashion, where it comes through one loudspeaker. At the same time, a second wire carries the same voices down to an echo chamber on another floor of the building. This echo chamber is nothing more than a long reverberating room, with a loudspeaker at one end, and a microphone at the other. The sound comes out through the loudspeaker down here, where it is bounced across the room, and picked up by the second microphone. From there it is returned to the control panel, where

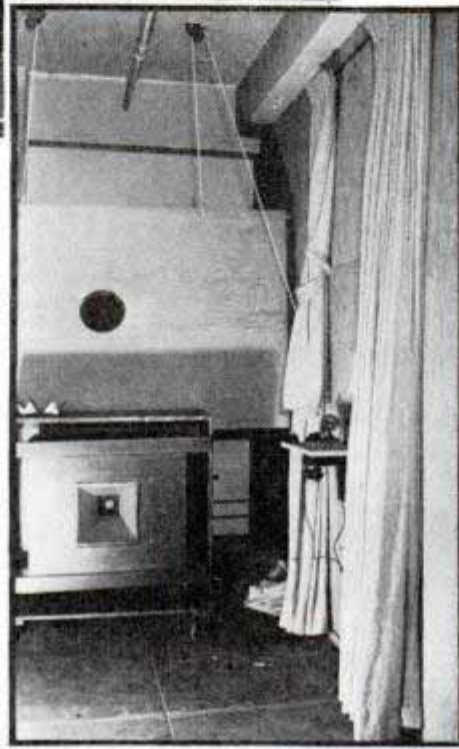

it comes out over a second loudspeaker, and is mixed with the direct sound from the first loudspeaker in a ratio of twenty-five per cent direct to seventy-five per cent indirect sound.

Reis finds that the most difficult room to reproduce acoustically in radio is the courtroom. Just a little bigger than a normal studio, a courtroom is not large enough to need the reverberating effect of the echo chamber. The answer is to have one central microphone in the ordinary studio picking up twenty-five per cent direct sound, and a second microphone on the ceiling of the same studio, twenty or thirty feet away from the voices, picking up seventy-five per cent indirect sound. Blending the two produces courtroom effects.

When Reis produced

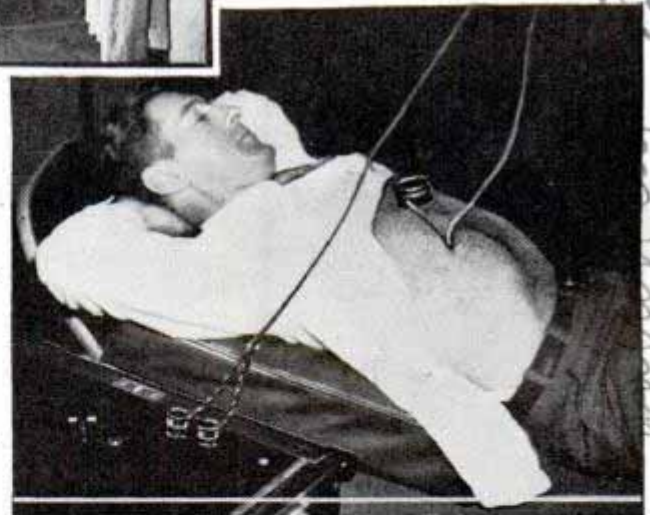

Top, determining proper tone of frequency oscillator. Center, echo chamber for giving illusion of voices in vast space. Bottom, human heartbeat going on the air as sound effect for "The Tell-Tale Heart"

Archibald MacLeish's "The Fall of the City" this spring, he had the problem of a great scene outdoors, a scene laid in a vast city, with 10,000 people gathered on the public square, a timeless city, empty of the roar of subways or the shriek of factory whistles. Besides this, he had the problem

(Continued to page 128A)

Four-Miles-a-Minute Sky Sleeper Seats Forty

The Great Messau

at Messau Germany

Germany's largest passenger airplane is the four-motored craft seen below and at right, just finished at Junkers' plant. One of twin tail rudders and wing flaps can be seen below. Notice roomy seats in cabin, which accommodates forty passengers. Seats are converted into berths at night

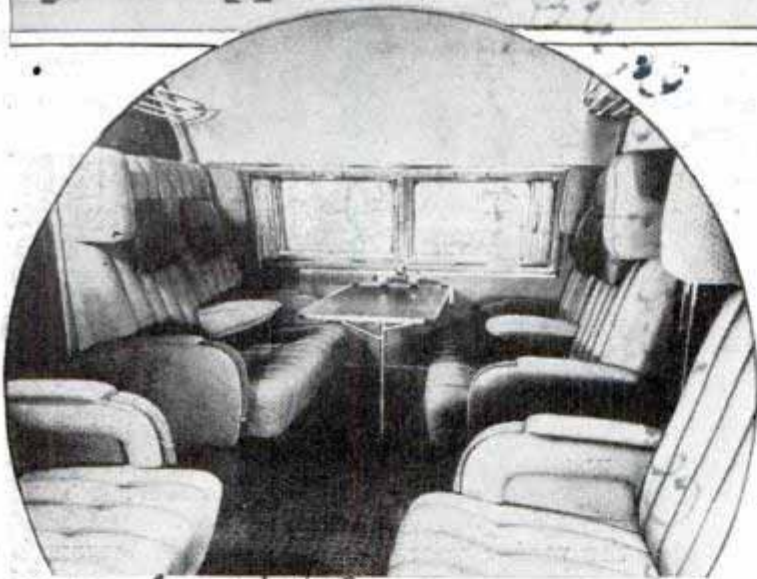
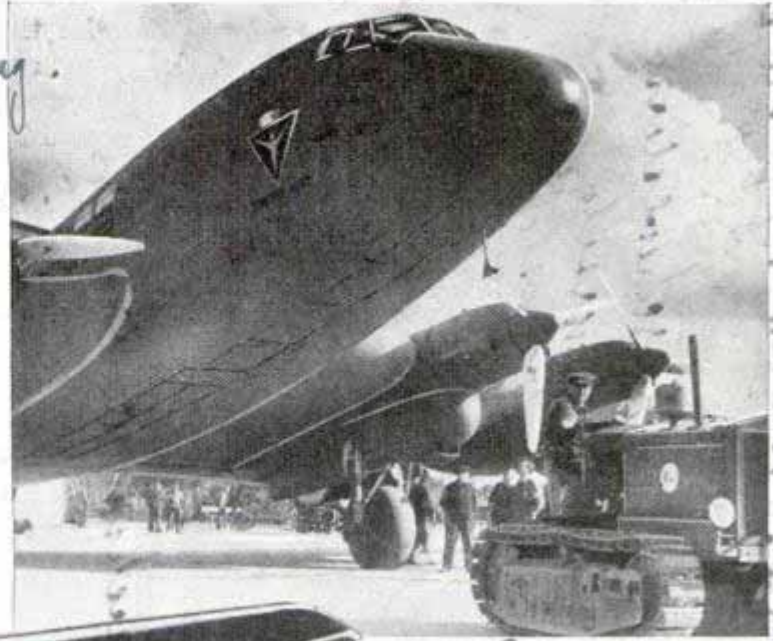

In the huge cabin of Germany's mightiest transport plane, completed recently at the Junkers' works, are five compartments accommodating forty passengers. Each compartment has four seats on either side of a central aisle, made into berths for night travel. Four motors can drive the low-winged monoplane at a top speed of 255 miles an hour. It has twin tail rudders, and its two forward landing wheels retract into the engine nacelles nearest the cabin while the plane is in flight. In the lower deck of the huge ship are located the pantry, baggage and freight rooms and lavatories.

Acme

Smoke from Chemical Gun Shows Flow of Air Currents

Heating and air-conditioning engineers have borrowed an idea from aerial skywriters. To determine the direction of air currents in a building they shoot a smoke gun loaded with the same chemicals that produce a smoke screen or write white letters against the blue sky.

Our Bureau of Information will answer questions regarding articles in this magazine, if accompanied by return postage.

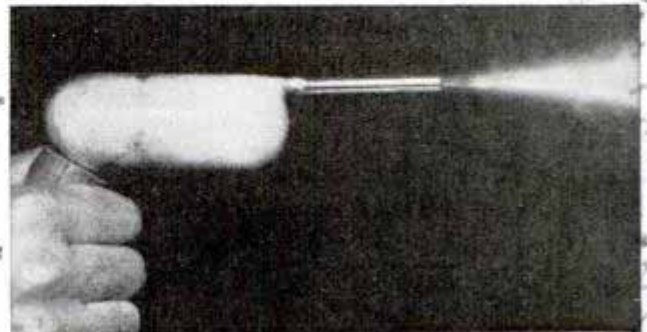

Engineer presses bulb of chemical gun and watches drift of smoke to chart air currents in building

*E. Vernon Hall
Aerologist and*

Washing...

51149

es 1150

437 W. 60th Terrace
Kansas City, Mo

Paintings Guide Film Workers in Big Scenes

Top and left, two paintings used to guide movie makers. Right, artist working on another painting which will depict spectacular scene



© Paramount Pictures, Inc.

In an effort to bring greater artistry and realism to the screen, Hollywood's directors have adopted a technique which utilizes the talents of famous artists. Before a big film goes into production the artist paints spectacular scenes on huge canvases for use as guides by art directors, cameramen and other technical workers. Dan Sayre Groesbeck, one of the artists engaged in the work, says he is convinced that in every shot seen on the screen there should be as many square inches of dark as there are of light, and that the light should be focused in the proper places to prevent tiring the eyes of the audience. As a consequence, he prepares his paintings along that line and production experts carry out the lighting plan indicated. Caricature is essential in designing for the movies. The artist is needed to counteract the deadening and diminishing effect of the camera, by emphasizing where emphasis is required. For example, if a belt or buckle were scaled to those actually worn

by pirates, the picture would look as though the studio were trying to save on costuming, due to the diminishing effect of the camera. The artist scales certain details to counteract this effect. Although players may look overdressed on the set, that look vanishes on the screen.

es 105 3

Staples Removed from Paper by Teeth of Handy Tool

Removing staples from papers is made easy by a handy little tool designed for that purpose. Slipping its teeth under the staple, you press lightly with thumb and finger and the jaws close, lifting the staple out.

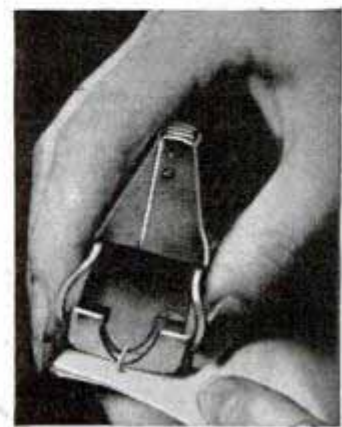

Academy of Sciences Corp
3415 North Ashland Ave

Vertical text on the right edge of the page, possibly a page number or reference code.

Scale with a Dial That Locks Permits Recheck of Weight

469 E. Chicago
Chicago



When needle is steady, lever is thrown and weight of parcel is "locked" for re-reading

When two persons must check the weight of a parcel, a scale with a locking dial is handy. A flip of a finger throws a lever that locks the dial in position so that the weight can be read after the package is removed. This scale is also useful in weighing parcels so large they cover the dial. The cost of mailing parcels up to fifty pounds in various postal zones is shown on the dial.

Room-Size "Lung" Aids Fight on Infantile Paralysis

Constructed as a new weapon in the nation's battle against infantile paralysis, a four-patient room which serves the same purpose as the one-patient "iron lung" is in use at a Boston hospital. Its designer, Professor Philip Drinker, predicts still larger treatment chambers. Professor Drinker, who with L. A. Shaw invented the iron lung eight years ago, points out that room-size lungs, with space for eight patients, would be easier on the patient than lying tied to one spot by the narrow metal barrel employed today. More important, it would permit the physician to enter and administer to the patient's body, in addition to making faster progress in learning how to combat the effects of the disease. The lung is used in treating paral-

ysis cases in which breathing of the patient is affected. At the Boston hospital, doctors and nurses enter the four-patient lung through a double door. They notice no sensation except a slight pressure on their ears, as the air of the room alternately becomes a vacuum and then returns to ordinary air pressure. Room-size lungs for eight patients will be cheaper in the end, Professor Drinker says, than separate iron lungs, which cost nearly \$1,000 each. The present type of iron lung induces breathing where muscles are too weak to expand the chest. The pressure changes come from blowers driven by electric motors. The pressure changes can induce breathing at any rate from ten to forty breaths a second. A scarcity of such equipment has handicapped doctors in their fight against the disease.

1038

Small Homemade Snowplow Ends Labor with Shovel

Tired of digging through deep snowdrifts with a hand shovel, a Minneapolis householder constructed a motor-driven plow which cleans sidewalk and driveway quickly. The plow is mounted on metal runners, making it easy to push. A switch on the plow handle controls a one-sixth horsepower electric motor which drives a four-bladed fan. As the plow is pushed forward, the snow is forced up into an apron and into the whirling blades of the fan where it is cut into powder and blown out of a funnel. The funnel is reversible and will carry snow at least ten feet away.

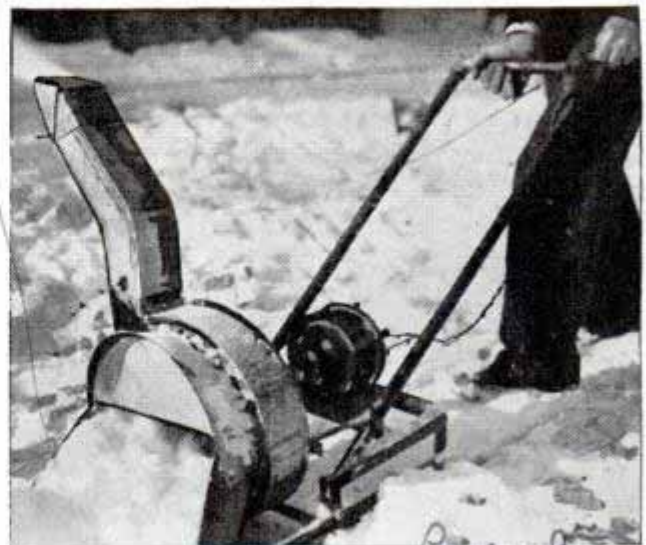

Cleaning snow off walk. Note how plow scoops up snow and blows it out funnel

Lewis Larsh
5109-29th Ave. S.

Harvard School
Public Health Cambridge Mass
1127

Chicago Tribune
4/20/38

American Communications Corp
1650 Broadway New York



CODE on a TAPE

CHEMICALLY treated paper, that immediately changes color upon the application of an electric current, is employed in this inexpensive device for automatically recording a visual record of radio code received on any receiver. The actual dots and dashes may be received at high speed on the tape, after which they can be deciphered at leisure by all-wave listeners who only need to refer to the standard radio code table.

The instrument is connected directly to the voice coil leads on the loud-speaker transformer in the radio receiver as shown in Fig. 1. Signals fed into the recorder are passed through a vacuum-tube rectifier, converted into direct-current impulses, and then sent to the recording stylus through a variable potentiometer. This variable control permits the making of permanent or temporary recordings at will, by either light or dark printing.

Another application of the instrument is illustrated in Fig. 2. A standard telegraph key is connected in series with a 4½-volt dry battery and hooked to the terminal strip so that a beginner learning code can make his own tape recordings. By this method he can watch his progress in proper letter and word spacing. An additional audio oscillator enables the student to hear the practice transmissions as well as see them. Licensed amateurs can use the instrument for making permanent records to supplement the usual station log, also for checking their own transmitting skill, and that of others. As recordings are electrochemically produced there is no blotting or smudging.

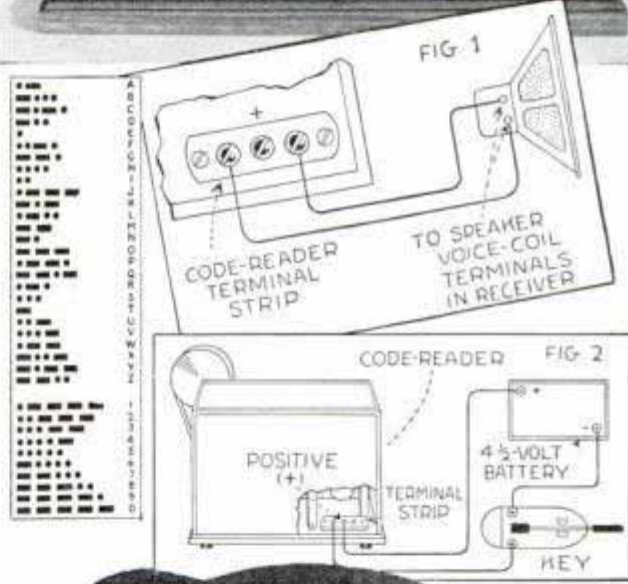
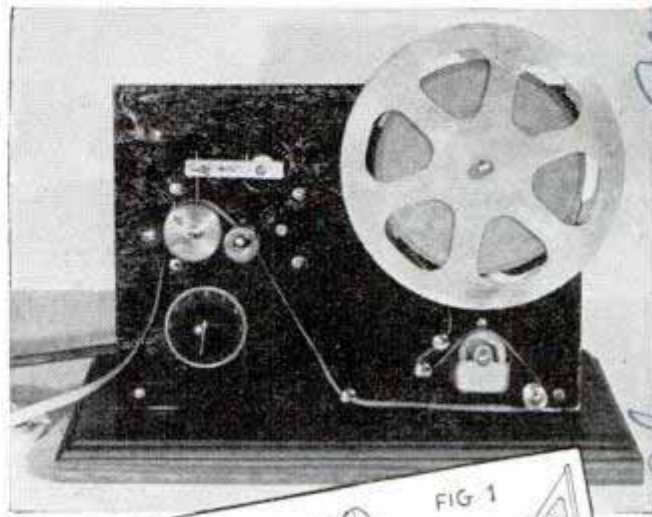

Chicago 833 W. Jackson

How to Build

By M. N. Beitman

INEXPENSIVE and easy to build, this small up-to-date a.c.-d.c. broadcast receiver is suitable for installing in a bookcase, end table or smoking stand. No external ground connection is used and the antenna may be of the indoor variety run around behind the picture molding in the room, for local stations. Where greater

distance is required a regular outside antenna is employed.

The circuit is an improved standard type using the latest tubes and a 3-in. dynamic speaker capable of handling 2.1 watts of the output. The unusual efficiency of this compact midget set is largely due to the use of a 25L6-G beam-power amplifier tube. This tube is for the output stage of "transformerless" a.c.-d.c. receivers, especially those designed to have ample reserve of power-delivering ability. It provides high power output at the relatively low plate and screen voltages available for transformerless sets. The letter "G" indicates glass-bulb type instead of the all-metal variety.

Details for the metal base and plywood



BOOKCASE INSTALLATION

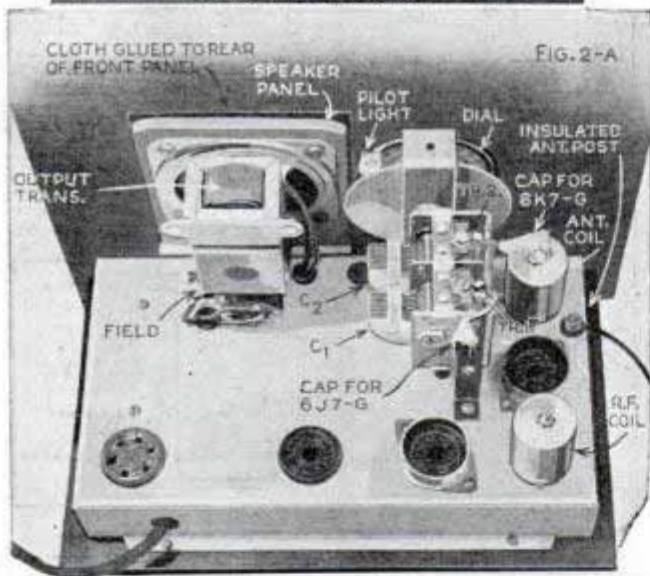

FIG. 2-A



FIG. 2-B

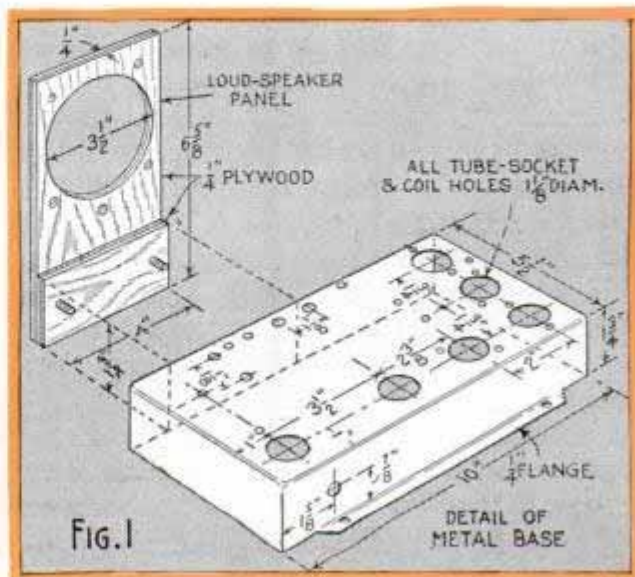
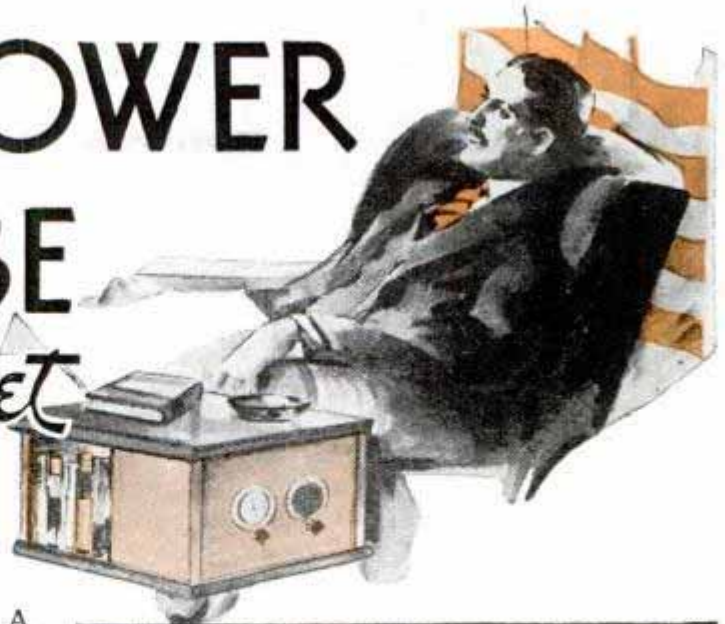

FIG. 1

a BEAM-POWER FOUR-TUBE *Bookcase Midget*



speaker-supporting panel are given in Fig. 1; the sheet-metal base is quite simple and may be formed by bending between wood blocks clamped in a vise. A keyhole saw was used to cut the 3½-in. hole in the speaker-supporting panel; all tube-socket and coil-mounting holes in the base were first drilled with a large centering hole and then enlarged with a tapered reamer to the diameter specified.

A simplified wiring diagram appears in Fig. 2. This diagram shows an underside view of the metal base with all parts in

(Continued to page 150A)

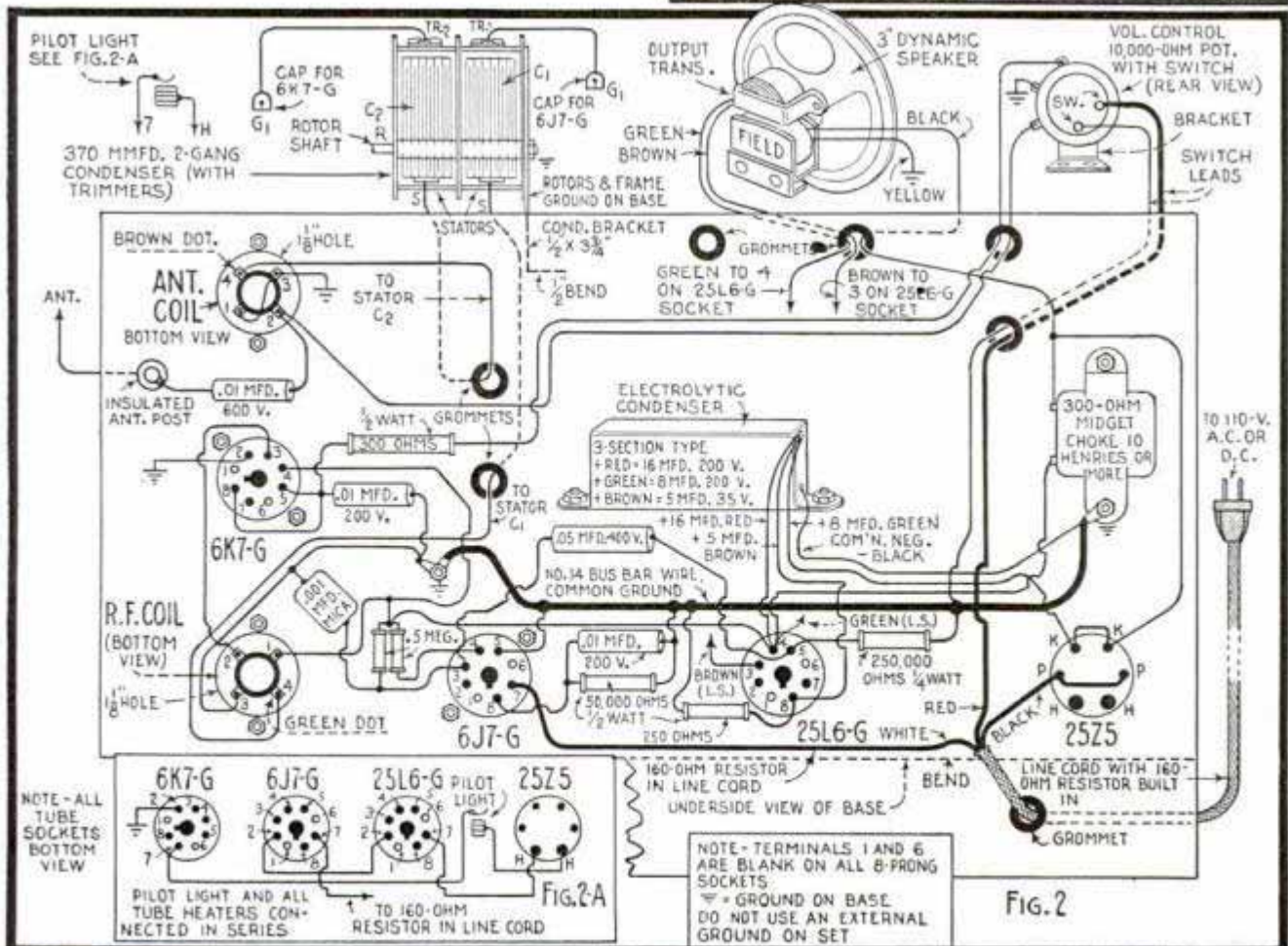
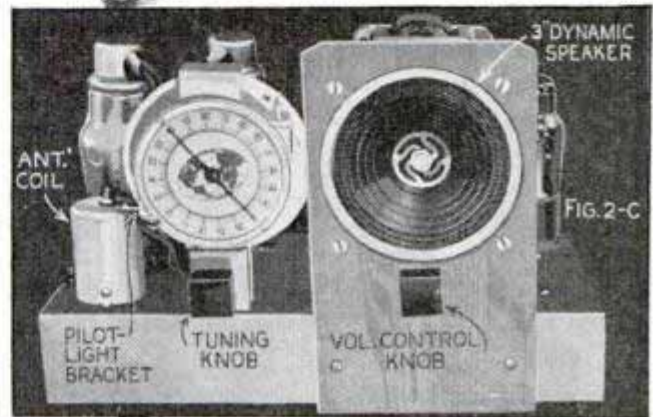

Simple 5-Meter Transmitter for Beginners

By Calvin F. Hadlock

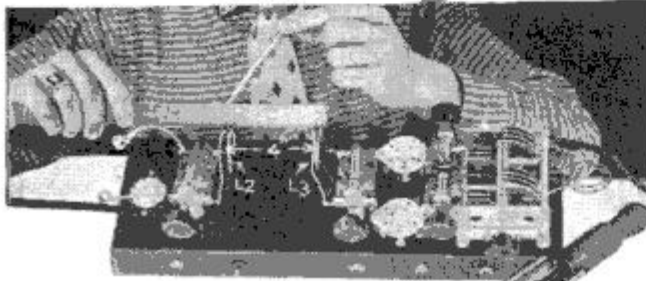
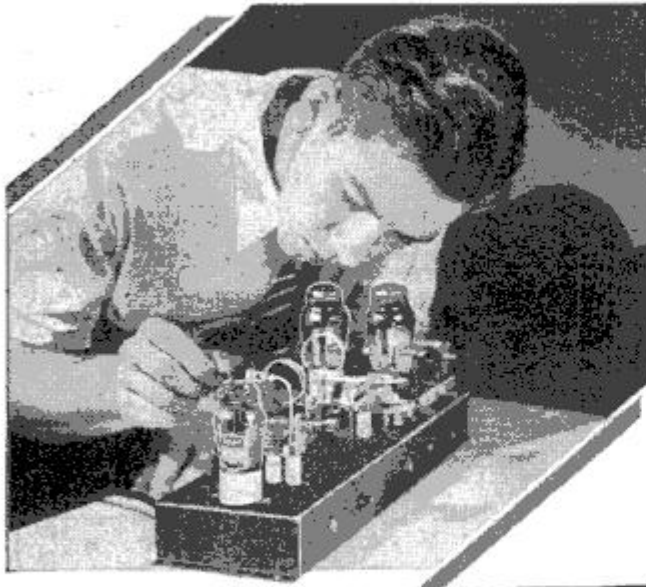

Note—Coils *L2* and *L3* should be spaced at least 4 in. apart, as loose coupling is important for stability

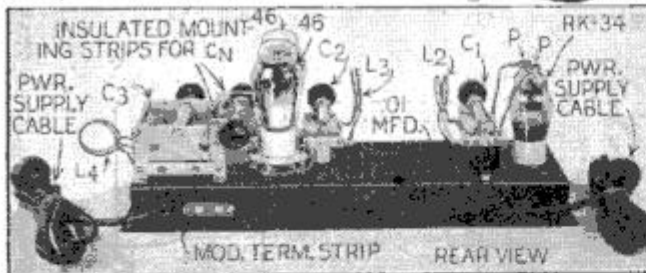
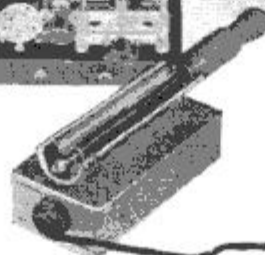

IN BUILDING the 5-meter M.O.P.A. transmitter to be described, several objectives were kept in view. It had to be simple, inexpensive, easy for beginners to construct, adjust and operate; yet it must have maximum frequency stability and give a reasonable amount of power output at good efficiency.

The circuit diagram shows an RK-34 tube as the master oscillator. This tube is especially designed for ultra-high frequency use. Both plate leads are brought out the top of the tube as will be noted in the upper photo. A pair of type-46 tubes are used in the power amplifier circuit. These tubes are easy to excite and have several features that make them desirable in this circuit.

Please notice that cathode bias is employed; do not use grid bias with this transmitter. A suggested power-supply unit is given in diagram Fig. 2. This furnishes all required voltages for both the oscillator and amplifier. However, if possible it is better to use a separate power unit for the oscillator. This unit must deliver about 45 ma. at 275 to 300 volts.

All parts should be arranged as shown in the photos and mounted as rigidly as

(Continued to page 154A)

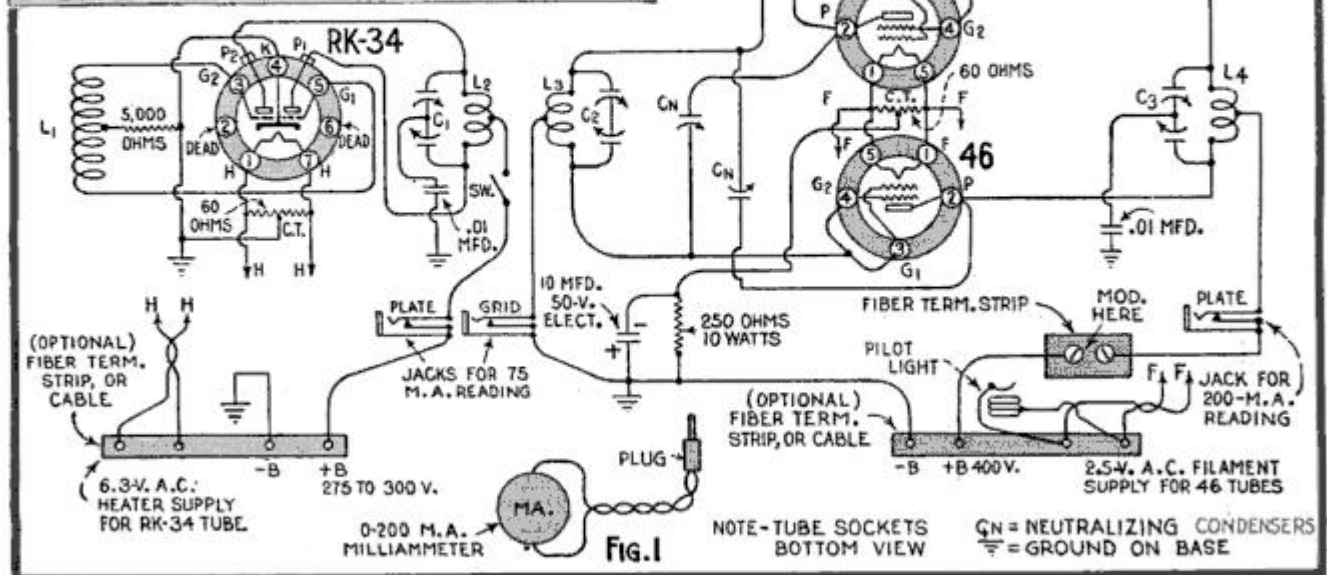

General Electric
Radio Div., Bridgeport Conn

Practical RADIO SUGGESTIONS

Extra speaker added to any receiver using either single or push-pull output tubes. Refer to socket diagram for your type of output tube, locate plate prong on tube base, slip terminal lug over prong. Do not permit lug to touch set chassis, connect as shown in either Fig. 1 or 2. Switch cuts remote speaker in or out

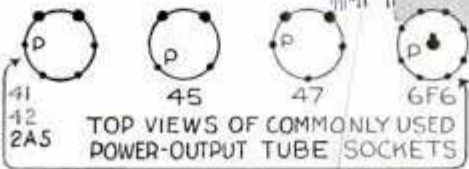
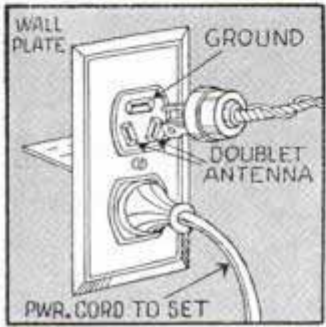

Left, wall-outlet plate provides handy doublet antenna connections, also usual power receptacle, below

Below, flexible shaft coupling made from odds and ends, for use when dial or knob does not line up with condenser or variable resistor shaft. Extension shafts are held with set screws

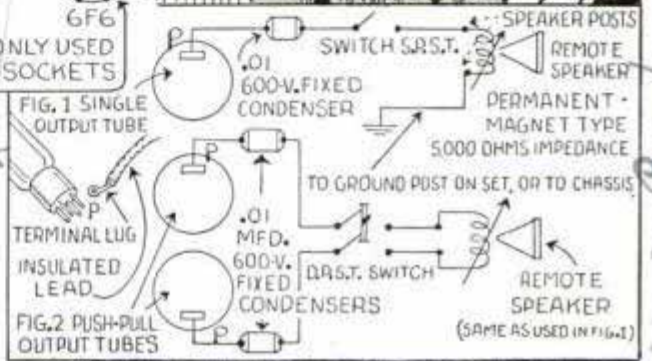
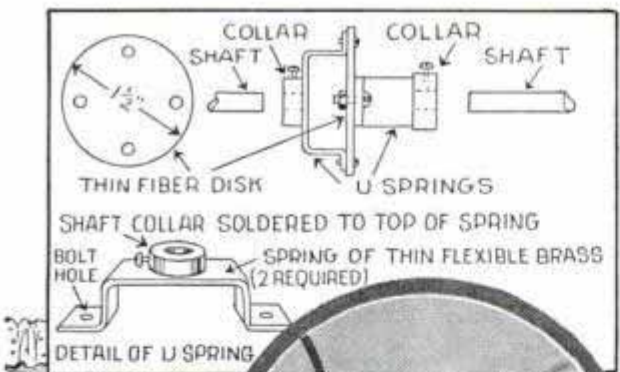

Above, isolantite sockets designed to grip tube prongs firmly. No metal extends through face of socket. Below, white paint provides a simple method for quickly locating the proper position for inserting tubes in dark corners of your receiver

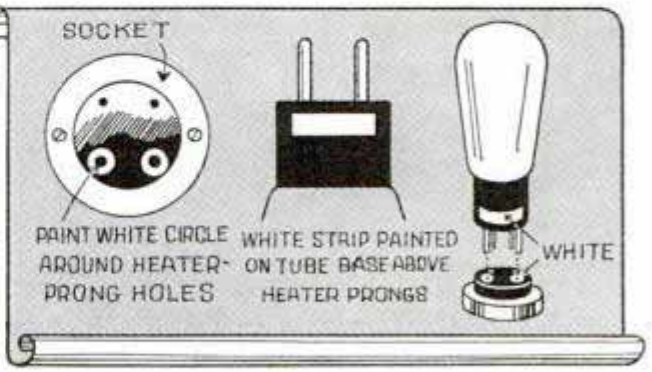
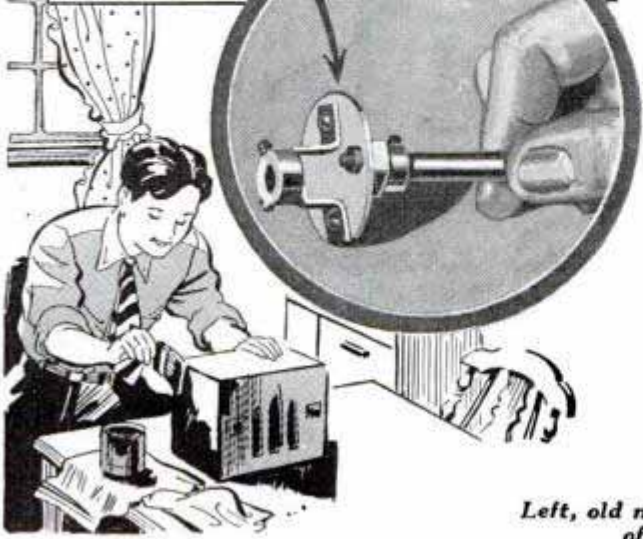

Left, old midget cabinets can be given a coat of enamel or lacquer of shade required to fit in with room color scheme

National Company, etc. make...

Radio Set with Phone System

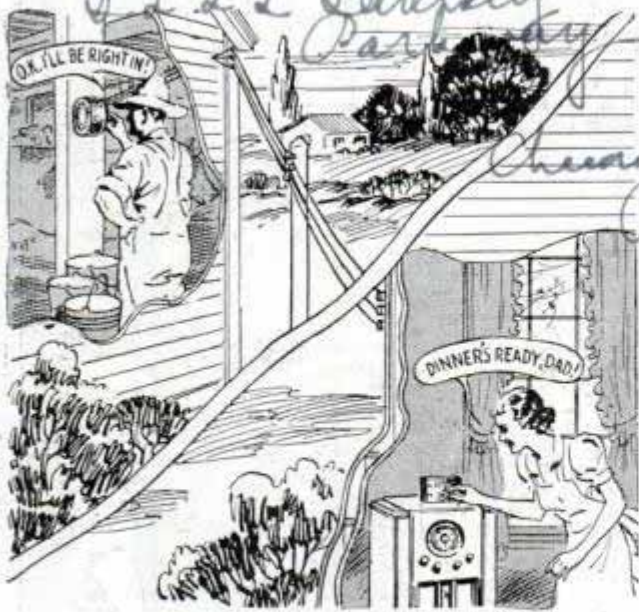

A two-way communication system is an interesting feature available with a recently announced line of farm and a.c. receivers. The kit includes a remote speaker and a control box which is located at the set; push-button signaling is provided and two-way conversations are possible, the second station also acting as an extension speaker for radio programs if desired.

Shift Control on German Set

Employing the ball-joint principle, German engineers have perfected a centralized radio control for this receiver which ap-

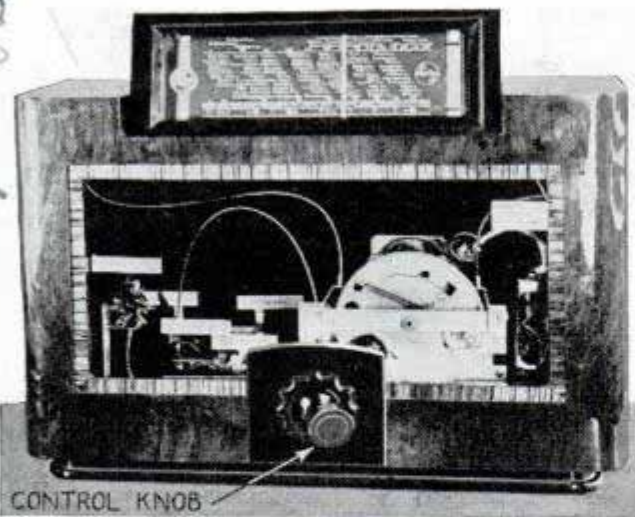

peared at a recent radio exhibition in Berlin. By moving the control knob horizontally and vertically, the operator can adjust volume, and change from one wave band to another. Stations are tuned in by rotating the large dial knob in the usual manner. The multiple scale dial is the full-vision type listing European stations.

Capacity-Operated Relay Unit

This capacity-operated relay will close a circuit when anyone approaches the antenna, which may be a wire, metal plate, screen or other metal object. It affords a

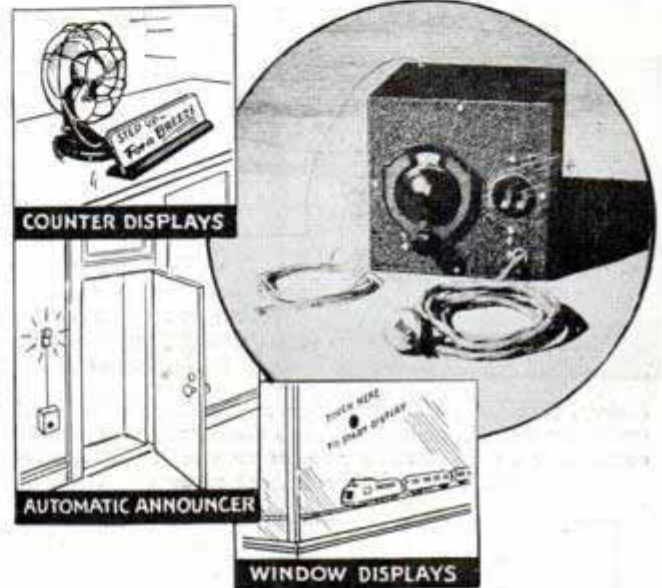

novel means for actuating advertising displays, announcing callers by ringing a bell, protecting valuables, and generally controlling electrically operated devices without actual contact. An adjustment is provided on the front panel to permit control of the sensitivity to suit individual applications. The unit works on any 110-volt a.c. or d.c. supply line.

Blueprints covering radio construction articles in past issues are available for 25 cents each; original material lists and additional information can be obtained from our Radio Department without charge upon receipt of postage.

NEXT MONTH—How to Build a Two-Way Inter-Room Communicator. A simple a.c.-d.c. master station and from one to five remote stations, for direct two-way communication between points up to 500 feet apart. Also—**A High-Fidelity Amplifier for Home Recording and Public Address.** 2A3 tubes and 10-watt output.

August Scherb, Zimmerman, 35, Berlin, Germany

Alcmena Research Laboratories, Inc. 205 W. 14th St. New York, N.Y.



Pivot-Top END TABLE

INSTEAD of having the conventional drawer, this attractive end table has a top that swings aside to reveal a spacious storage compartment. Making of the four legs comes first, and is an interesting job

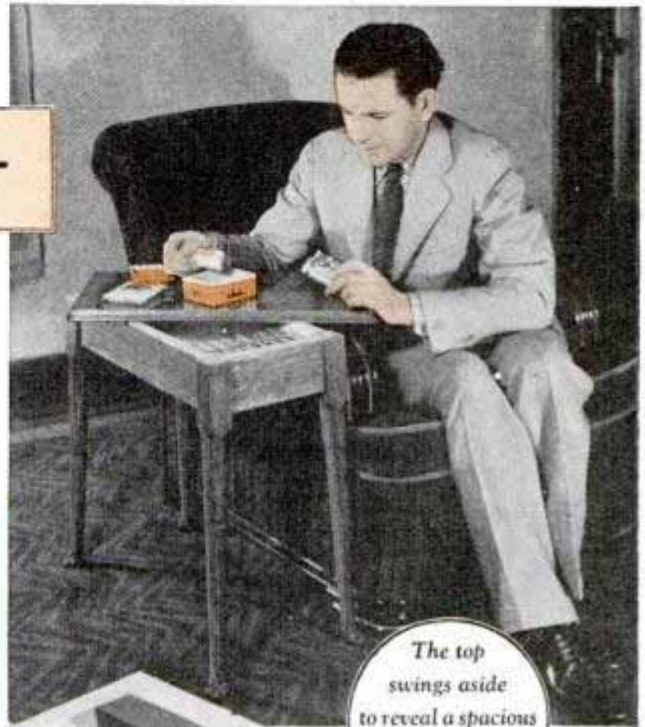

The top swings aside to reveal a spacious storage compartment

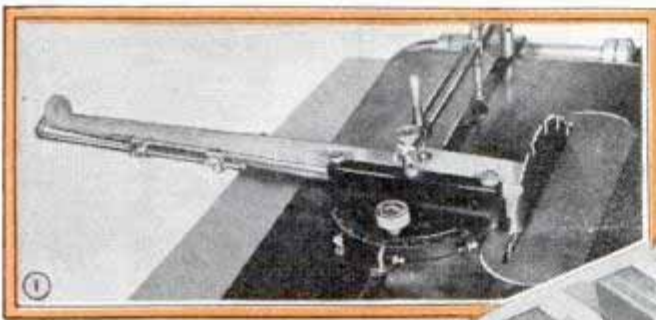

Miter gauge is set and table is tilted 2° for cutting upper end of leg

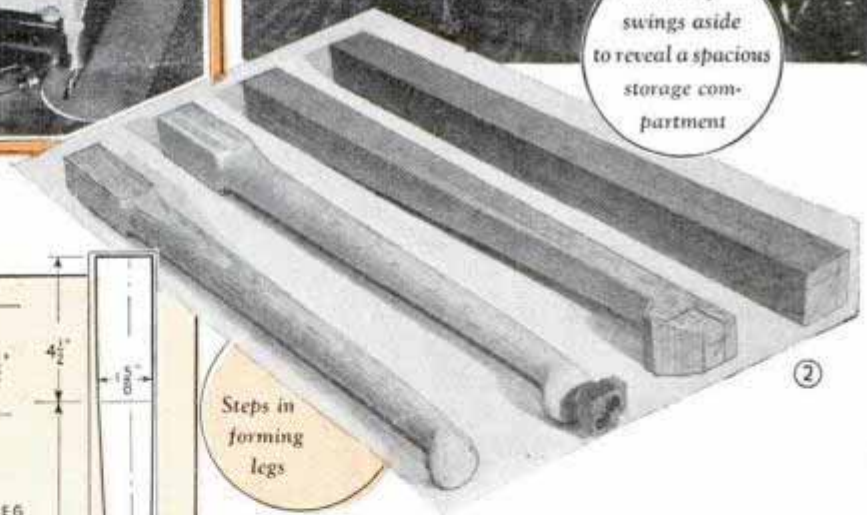

Steps in forming legs

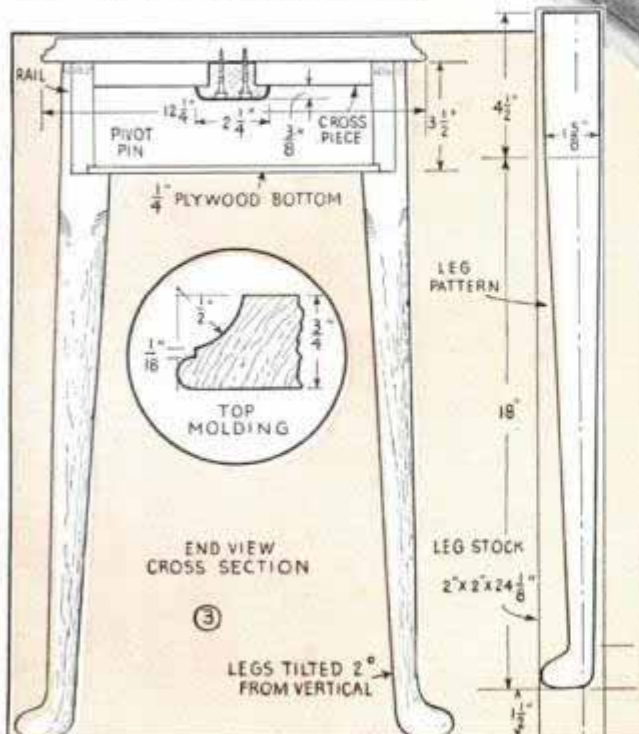

in off-center turning on a lathe. Start by making a paper pattern of the leg shape, as shown at the right in Fig. 3. Then square up the four pieces of stock, and lay out the leg design on two adjoining sides of each piece, carrying out the centerline to the ends. Fig. 2 shows the steps in making the legs. The square end, which is not to be turned, is placed at the headstock end of the lathe. This end of the work has but one center; the tailstock end has two centers, the off center being located 1/2 in. from

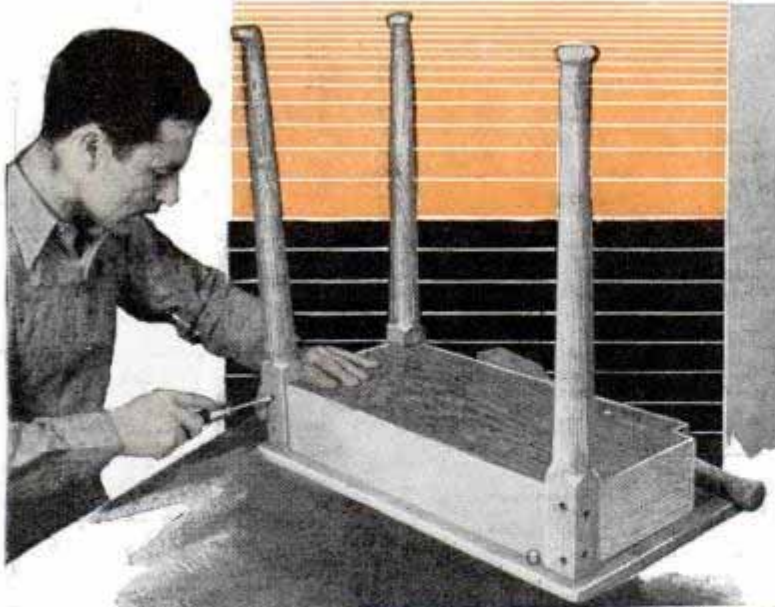

④

the true center on a diagonal from the latter. In turning, the work is first placed on the true centers and the complete shape is turned, including

the foot. The work is then off-centered at the tailstock end and carefully turned to finish the back of the foot, after which it is filed lightly to remove the ridge lines formed by off-centering.

In the table assembly, the legs are tilted out both ways at an angle of 92° . This will not affect the bottom of the legs, which can be cut off square on a band saw, but it does affect the top ends. A compound cut on the circular saw is necessary, the table being tilted 2° and the miter gauge turned 2° , Fig. 1. The gauge is in the left-hand table groove and is turned 2° in a clockwise direction, as viewed by the operator, as indicated in Fig. 1.

Make the top and mold the edges according to the plan shown in Fig. 3. On the underside of the top, lay out the complete plan of the table, as shown in Fig. 5. Make the rails and crosspieces to the required lengths. The ends of the four rails are cut with the table level, but with the miter gauge set over 2° . Assemble the two crosspieces together and fasten them to the underside of the table by means of the pivot pin, as shown in Fig. 6. Nail the side rails to the crosspiece, and set the end rails

in position. Saw a plywood bottom to fit exactly the rabbet on the under edge of the rails, cutting away at each corner to accommodate the legs. Finally, assemble the legs to the completed top, as shown in Fig. 4, using four screws to each leg, plugging the holes. While quite simple, this makes a neat and stiff assembly, and offers no difficulties about angles such as would be encountered if the legs were fitted by tenoning or doweling. The finish can be either bright or painted. Note, in Fig.

4, that a stop pin is provided on the underside of the top adjacent to one of the legs. This pin is necessary to stop the top square when it is swung back into position.

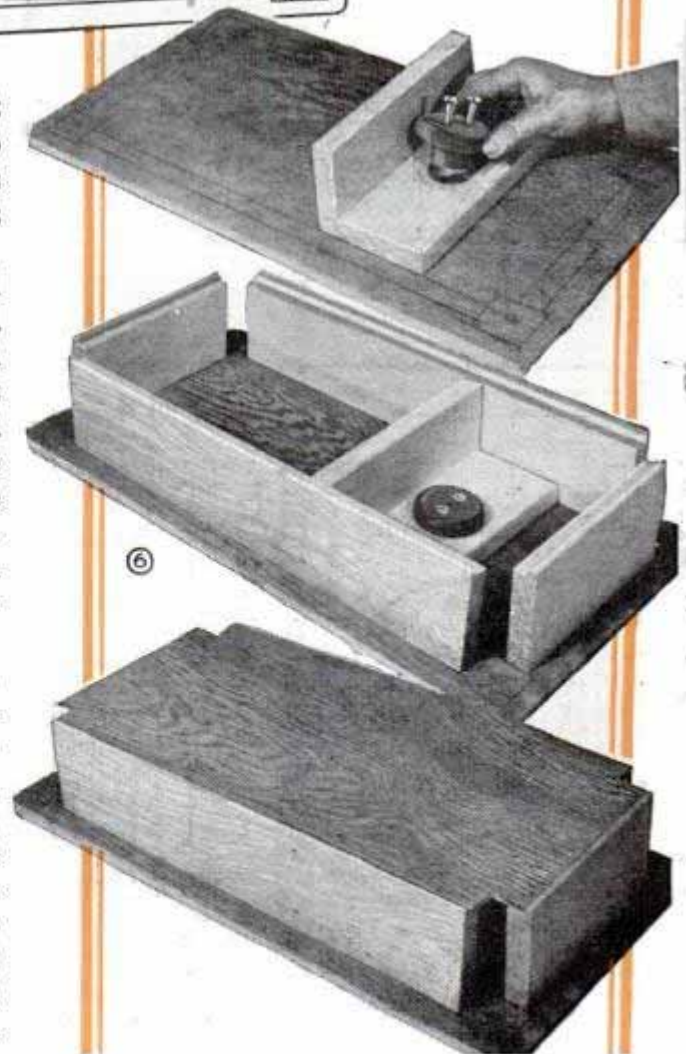
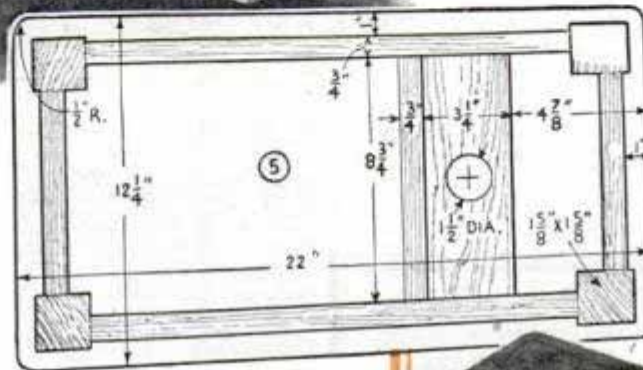

⑥

These Scroll-Sawed Wall Shelves Can Fold Flat

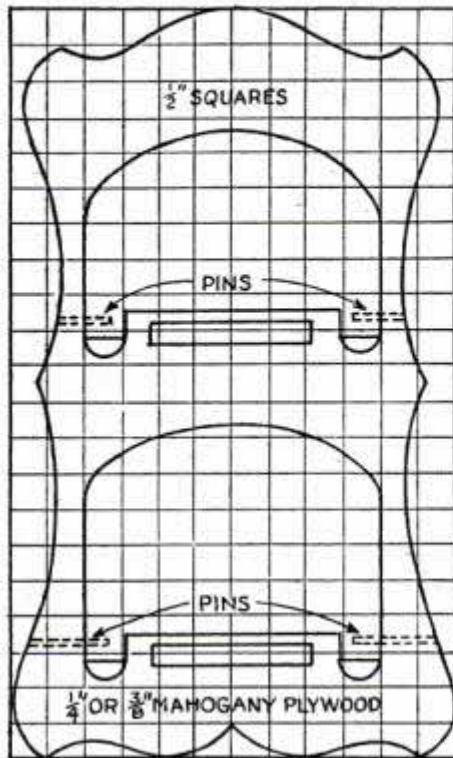

Here's something different in the construction of a bric-a-brac shelf. A piece of plywood is scroll-sawed as shown, and the cutout sections are hinged so that they can project horizontally or can be folded flush with the back. The folding feature is primarily a novelty but proves useful when the shelves are packed or stored. A short length of molding supports each shelf. As the cutout section exposes the wall behind,

The folding feature of these shelves is especially handy when storing or packing them

pleasing contrasts are possible between the objects set on the shelves and the background.—D. R. Van Horn, Lincoln, Nebr.

Circulating Fan in Furnace Is Operated by Thermostat

If you would like a circulating fan in the cold-air returns of a hot-air furnace, but object to the cost of operating a motor almost continuously, you can put a thermostat in the bonnet to control the fan. The thermostat can be set to stop the fan when the furnace castings reach a given temperature, letting circulation of air progress in the natural manner. When the castings cool to a certain temperature, the thermostat will start the fan, thus increasing the distribution of warm air. This arrangement permits intermittent running of the fan when it is most needed and reduces the cost of operation considerably. The wiring diagram shows how the thermostat is installed in the fan circuit.

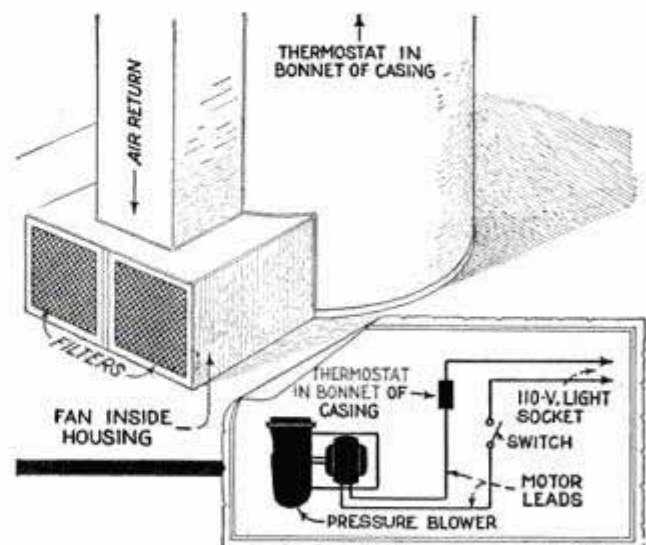

Thermostat installed in bonnet of hot-air furnace operates circulating fan only when most needed, reducing cost of current

C-Clamps from Old Turnbuckles Have Many Uses

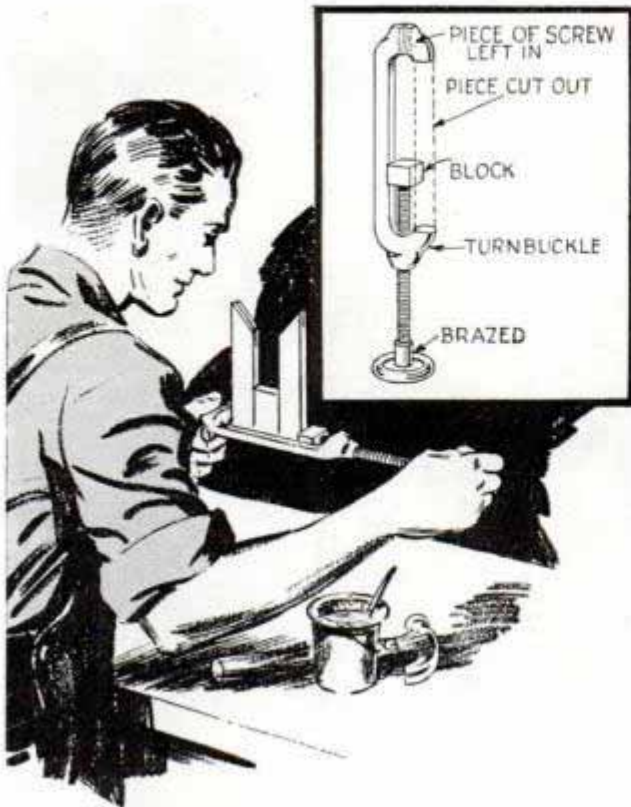

Narrow C-clamps made from turnbuckles can be used in places where regular clamps are too large

C-clamps that will serve for many odd jobs, and can be used in restricted places where it would be difficult to use regular clamps, can be made easily from discarded turnbuckles. Cut away one side of the body as shown, and file or grind square faces at each end. The right-hand threaded screw is used to clamp the work, and is fitted with a suitable grip. A small hardwood or iron block with a hole bored partly through it may be used between the end of the screw and work to prevent marring.

—W. C. Wilhite, Carlinville, Ill.

Handy Tool Removes Battens without Splitting Them

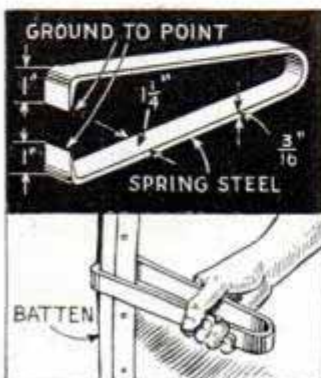

In tearing down a building on which were several battens that the workmen wished to salvage intact, the tool shown was used to do the work. It is made from a piece of $\frac{3}{16}$ -in. spring

steel bent to the shape indicated, the ends being beveled to a sharp edge. In use, the wedge-shaped ends are forced behind the batten, after which the tool is used as a pry to loosen it.

Camera View Finder Illuminates Iris on Photo Enlarger

Illumination for the iris adjustment on the lens of an enlarger can be arranged by mounting a camera view finder above the lens, as indicated in the photo. Remove the view finder from any small hand camera and mount it by drilling a hole through the board



near the lens. Scattered light from inside the enlarger will pass through the view finder and will be reflected directly onto the iris ring.

—Weldon H. Whisler, Davenport, Iowa.

Make Your Own Luminous Paint

Luminous paints may be made by mixing varnish, precipitated barium sulphate and dry color with luminous calcium sulphide. When you purchase the latter chemical be sure it is labeled "luminous" as the chemically pure and the ordinary commercial calcium sulphides are useless for this purpose. To prepare a luminous paint that emits a blue light, grind together in a mortar, barium sulphate, $1\frac{1}{4}$ oz., ultramarine blue, $\frac{3}{4}$ oz., cobalt blue, $\frac{1}{2}$ oz., and luminous calcium sulphide, $5\frac{3}{4}$ oz. These chemicals should be ground finely. To the mixed powders add varnish, $5\frac{1}{4}$ oz., and continue the grinding until the whole is perfectly mixed. The quality of the paint produced depends on how well the grinding and mixing are done. The finished paint may be applied in the same manner as any other paint. After an object covered with this preparation has been exposed to light, it will continue to glow when placed in a dark room. The brilliance and length of time it will glow depend on

the length of exposure and intensity of light. Luminous paints may be made to emit other colors by mixing the following ingredients in the same way. Green luminous paint consists of barium sulphate, $1\frac{1}{4}$ oz., chrome green, 1 oz., luminous calcium sulphide, $4\frac{1}{2}$ oz. and varnish, 6 oz. A yellow paint can be made by substituting chrome yellow for the chrome green in the last formula. An orange paint is made from barium sulphate, $2\frac{1}{4}$ oz., Indian yellow, $1\frac{1}{4}$ oz., madder lake, $1\frac{1}{2}$ oz., luminous calcium sulphide, $4\frac{3}{4}$ oz. and varnish, $5\frac{3}{4}$ oz. A brilliant red may be had by mixing barium sulphate, 1 oz., madder lake, $1\frac{1}{2}$ oz., luminous calcium sulphide, 4 oz. and varnish, $5\frac{1}{2}$ oz. By experimenting with other dry colors and varying the proportions to suit, it is possible to produce still other colors.

Ringer Game Played on Table Is Enjoyed by Everyone



Here's a game that affords lots of fun for long winter evenings and one that can be played right on your dining table

This Worktable Straddles Roof While Repairing Chimney

To provide a worktable for holding bricks and mortar, and to eliminate the usual trouble of building one on the roof each time, one workman carries a light, folding sawbuck and a table top with cleats

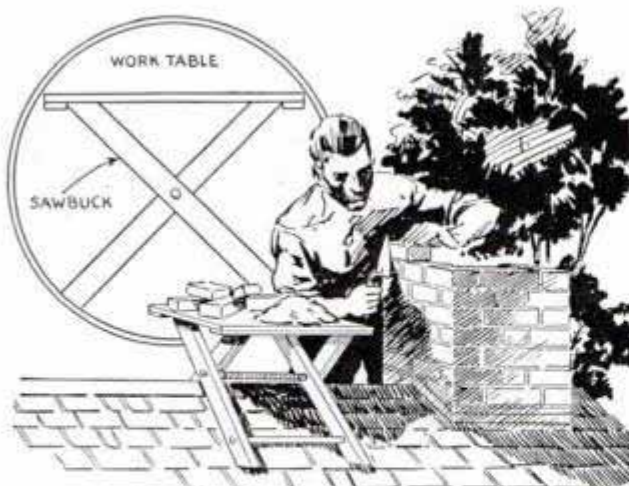

The workman carries this worktable from job to job, and it is ready for instant use by unfolding it

across the underside. In use, the buck is opened to straddle the ridge of the roof and the top is placed so that the cleats keep the buck from spreading.

—G. E. Hendrickson, Argyle, Wis.

Played similar to a miniature horseshoe game, this ringer game is enjoyed by everyone and will provide entertainment for long winter evenings. The ringers are made from heavy cardboard, as indicated in the lower detail, and the two stands are made by driving nails into wood disks, the nails projecting about 2 in. The game is played on a table and the score is counted as follows: The three outer openings of the ringer count five points each. The next three openings count ten points and the center opening counts twenty-five.

—Elmer A. Kellerman, Milwaukee, Wis.

Yarn-Ball Holder on Knitting Bag

Women who are in the habit of knitting in a car or on a train will find that a cloth or leather pocket sewed onto one side of their knitting bag is handy for carrying a yarn ball. In use, the flap of the pocket is opened and the yarn pulled out as needed, the ball remaining in the pocket at all times.



HAMPER *combined*

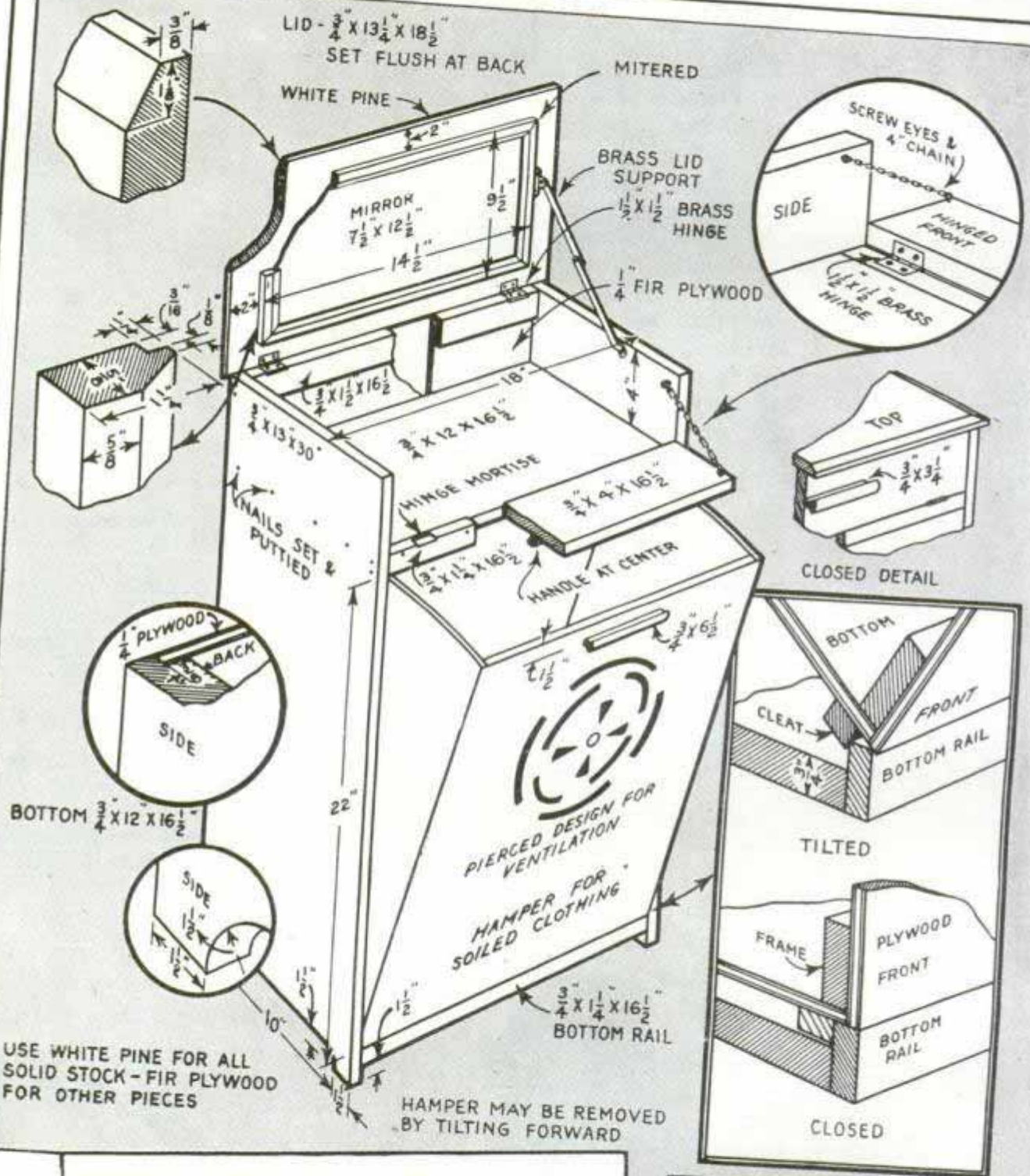

SCALE
DESIGN
DRAWN

Requiring only the floor space of a hamper, this combination unit is ideal for a small bathroom where all space must be utilized. The lid swings up exposing a mirror and space where cosmetic articles are kept. It's an easy matter to remove the clothes hamper by merely tipping it forward and lifting it out

**POPULAR
MECHANICS
MAGAZINE**

with VANITY

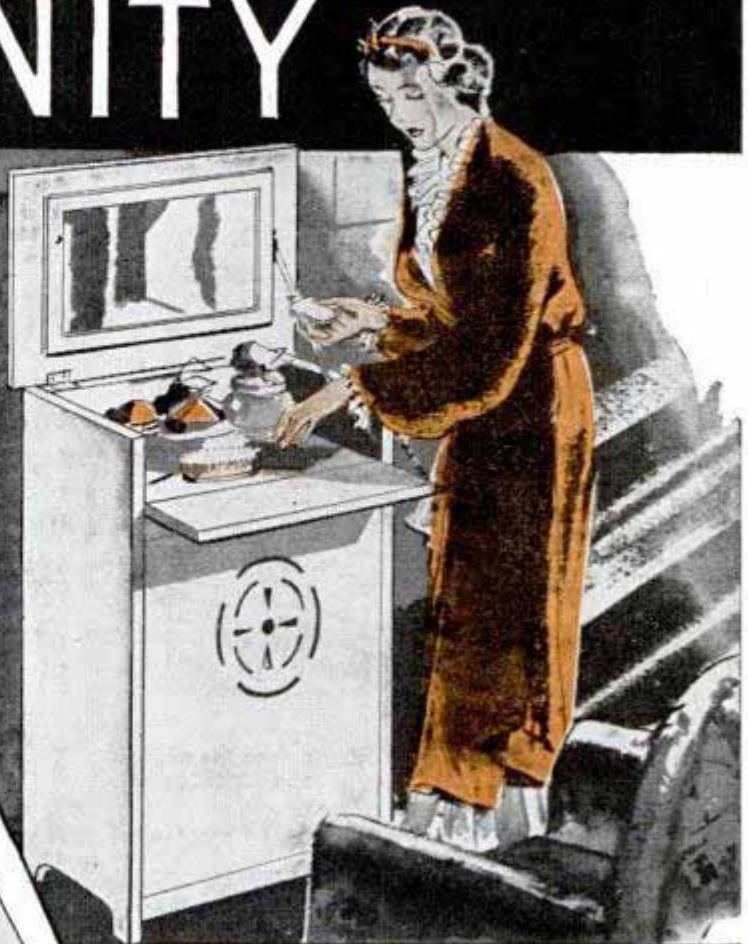

ENAMELED TO HARMONIZE WITH BATHROOM

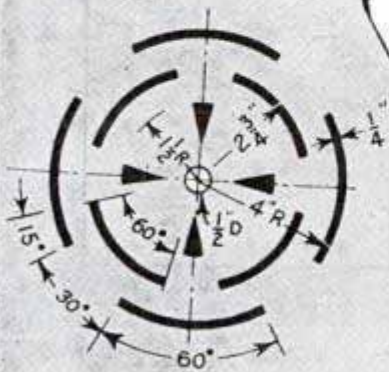

DIVIDE INTO 15° SEGMENTS

DETAIL OF PIERCED DESIGN ON FRONT OF HAMPER

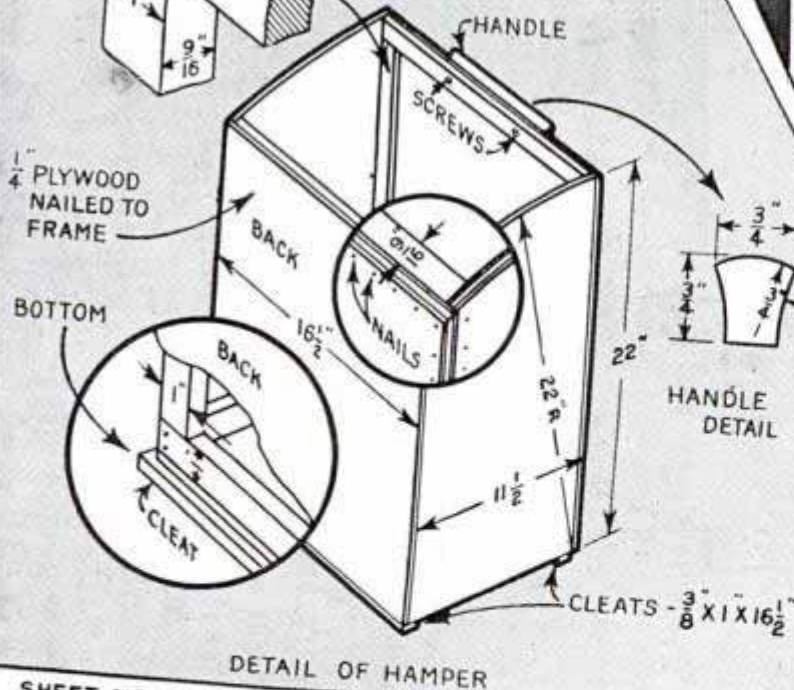
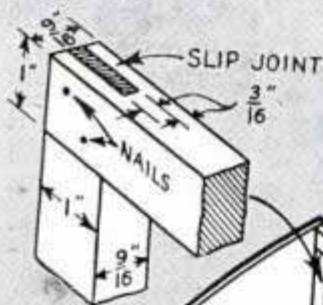

DETAIL OF HAMPER

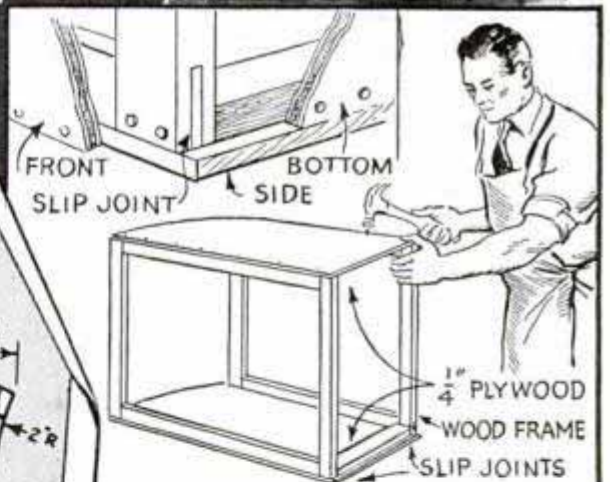

THE PLYWOOD HAMPER IS BUILT ON A FRAME

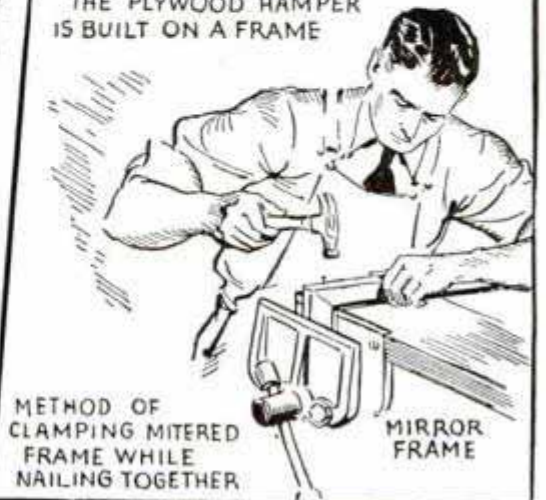

SHEET NO. 1

ISSUE

POPULAR MECHANICS MAGAZINE
200 E. ONTARIO ST. CHICAGO

BLUEPRINT No. SN 972

Scale on Sewing-Machine Cabinet Saves Time for Seamstress



Scale along edge of sewing-machine cabinet is always at hand for quickly taking measurements

Cemented along the front and left-hand end of a sewing machine, a tape measure provides a handy means of measuring cloth quickly. If you object to a tape measure applied on the wood, the scale can be scribed in the wood. Or, if you want a real good job, the edge of the cabinet can be rabbeted and a hardwood scale inlaid.

Making Abrasive "Pencils"

Modelmakers, die sinkers, experimenters and home workshop owners will find many uses for abrasive pencils, which can be made from pieces of emery cloth or sandpaper. The abrasive material is cut to a diagonal shape and then rolled tightly to form a pencil with a tapered end, as indicated. Such pencils are handy for smoothing up rough edges of glass, scratching initials, monograms, etc., on metal, smoothing up scroll work, and dozens of similar jobs. They are also an aid in smoothing out rough places

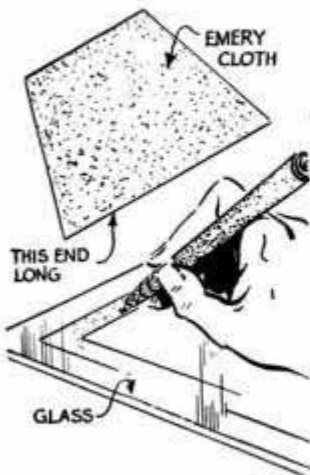

in dies or on small machines and for cleaning and polishing all sorts of cavities in either wood or metal. Modelmakers will find them especially valuable for getting into cramped places where they cannot use abrasive paper strips or squares.

Watch Crystals Handled Easily with Small Vacuum Cup

Jewelers and others who have to handle watch crystals will find that a small vacuum cup fitted with a handle, such as a lead pencil, is ideal for picking them up from flat surfaces.

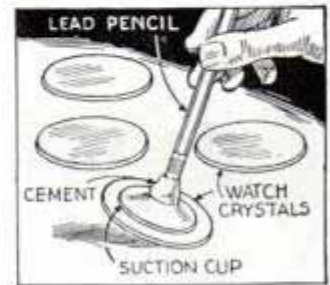

This lifter is especially handy when picking up several different crystals and trying them in the watch to find one that will fit.

Ball Thrust Washer on Wing Nut Makes It Easy to Adjust



When a wing nut is used in a place where it must be adjusted frequently, a ball thrust washer behind it will make it easy to loosen or tighten. Small thrust washers of this type usually can be picked up at any junk yard inexpensively.—A. H. Waychoff, Tempe, Ariz.

Cleaning Small Brushes

Artists will find that they can clean a brush quickly on the roughened surface of a clothespin, which is slipped over the edge of a tumbler. One leg of the pin is roughened with a coarse wood rasp and is submerged in the water.—Opie Read, Jr., Chicago.



Modern LINEN CHEST

encloses wash stand

This cabinet makes good use of the space under the bathroom lavatory for convenient storage of towels, wash cloths, etc. A mirrored door swings out from the center compartment, which serves a two-fold purpose—that of concealing the plumbing and receiving the soiled linens. Fitting the cabinet to the lavatory must be done in successive steps to assure a neat job. The whole thing sets on a base of $\frac{3}{4}$ by 3-in. stock, saw-kerfed and bent at the outer corners as shown. The frame is covered with $\frac{3}{8}$ -in. plywood, fastened in place with small screws. To assure close fit with the lavatory, build the base first, then the frame of the center compartment and finally fit the plywood sides and end shelves. Drawers, mirror, and the glass on the top shelves are optional. The wood is finished with several coats of enamel to match the lavatory

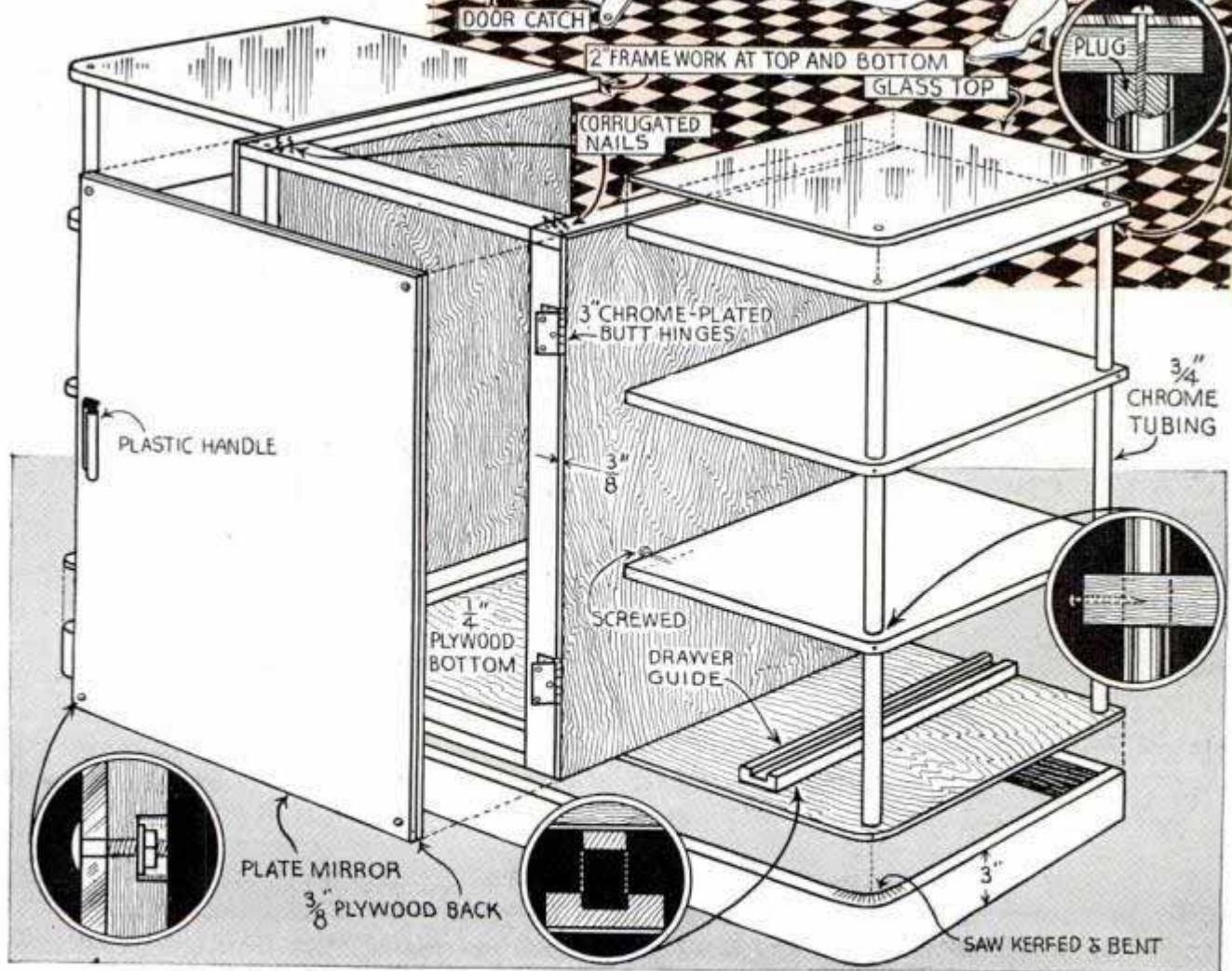

Sandblasting with Scratch Brush on Tool Grinder



Any home mechanic who has a grinder and wire scratch brush can do a good job of sandblasting

If a regular sandblasting outfit is not available but you do have access to a motor-driven grinder, sandblasting can be done by dropping sand on a rotating wire scratch brush, which throws the sand against the work with considerable force. A flat-iron bracket carrying a celluloid eye shield and a funnel to direct the sand onto the brush is screwed to one of the grinder-wheel shields, and the work is set on a box or other support in front of the brush. Adjusting of both the work and the funnel will enable you to make the sand hit the work where desired.

Window in Camera Protected by Paper Disk

When you purchase a roll of panchromatic film, you will find inclosed a small square of gummed fabric, which is used to cover the red window in the camera back while winding the film for the next exposure. The gummed strip, however, often sticks to the window as well as to the camera case, and the act of pulling it away causes the red insert to loosen and pull out of place. After nearly losing the



insert in my camera, I attached a small disk of thin paper to the inside of the gummed fabric so that when the strip is pressed over the window, the insert is protected from contact with the adhesive.

—W. C. Wilhite, Carlinville, Ill.

Wood Turnings Neatly Joined with Dowel Screws

Instead of using ordinary wood dowels in joining wood turnings, I use dowel screws, which not only make the use of clamps unnecessary, but provide a joint that is tight and invisible even at close scrutiny. The joints are made by drilling pilot holes in the ends of the turnings to take the screws. The screw is driven into one hole with a small pipe wrench, after which the other turning is screwed onto the projecting end.

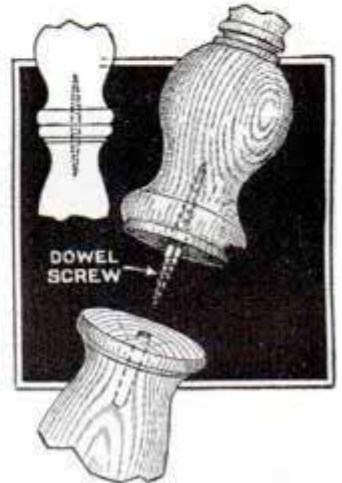

—Clyde Utz, Bangor, Pa.

Kinked Wire Is Straightened in Garden Hose

Clamped in a vise with the teeth projecting upward, an ordinary garden rake makes a good tool to take the kinks out of a length of iron or copper wire of small or

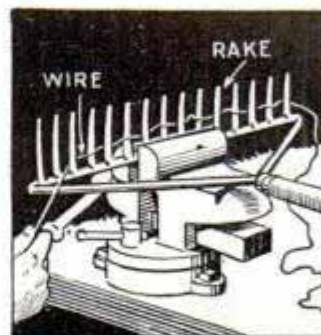

medium size. The handle of the rake is blocked up so that the head and ferrule are not strained. The wire is woven between a number of the teeth, depending on the size and the resistance needed to straighten it. A pair of pliers is used to pull the wire through the teeth.

☐ Ordinary paper plates about 10 in. in diameter make excellent bases for bird cages and save cutting paper or buying gravelled paper for the purpose.

'Lazy-Peon' Book Ends Made in One Evening

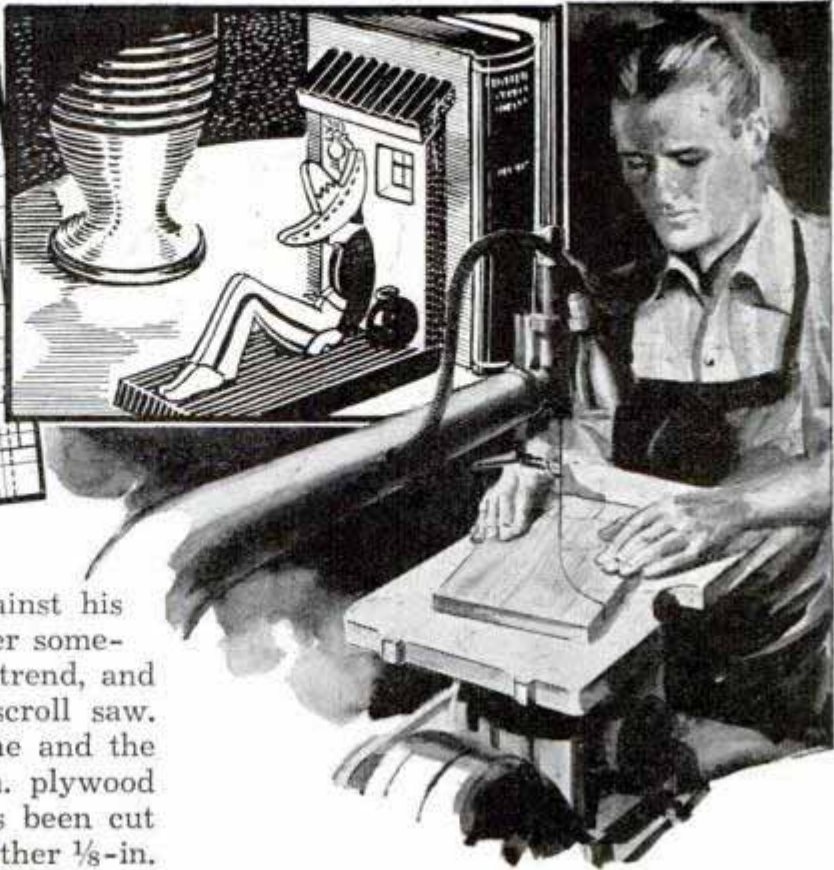
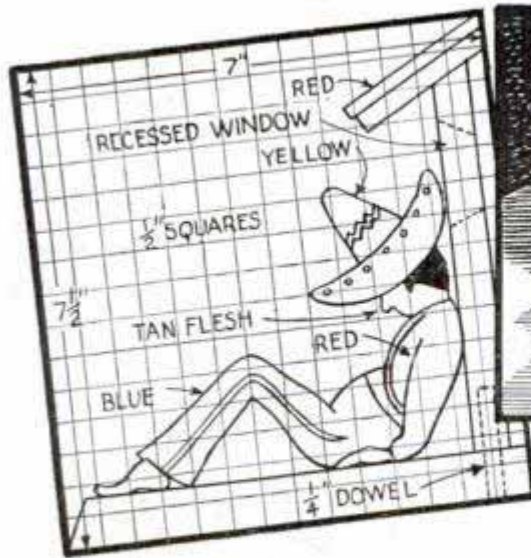

Depicting a peon dozing against his adobe hut, these book ends offer something different from the usual trend, and are easily duplicated with a scroll saw. The base is made of $\frac{3}{4}$ -in. pine and the back of $\frac{1}{2}$ -in. pine with $\frac{1}{4}$ -in. plywood glued to it after a window has been cut out. The figure is sawed from either $\frac{1}{8}$ -in. plywood or hard-pressed board. Sheet rubber is glued to the underside to provide friction against the table top to keep the book ends from spreading. A realistic

painting job is necessary to get the full effect, and bright colors should rule. Brads and casein glue are used in assembling.

How to Figure Operating Cost of Electrical Appliances

Have you ever wondered what it cost to operate certain electrical appliances, especially those that did not have the current rating stamped on the nameplate? To find



It's easy to figure current consumption of electrical appliance that does not have wattage on nameplate

out easily turn off all appliances and turn on a few lamps of known wattage. Then count the number of revolutions that the disk in your electric meter makes in two minutes. Now turn off the lights and turn on the appliance for the same length of time and count the revolutions of the meter disk. For example, say the wattage of the lamps was 700 and the disk made 70 revolutions in 2 min., and for the appliance, it made 15 revolutions. Multiply 700 by 15 and divide by 70, which gives you 150, the wattage of the appliance. Next, multiply this by the number of hours that the appliance operates per month, which gives watts consumed. Dividing this by 1,000 gives the kilowatts. Multiply this figure by the rate charged per kilowatt by your electric company.

☐ A soft cloth wound around a stick is handy for dusting under low furniture.

Go like the wind!

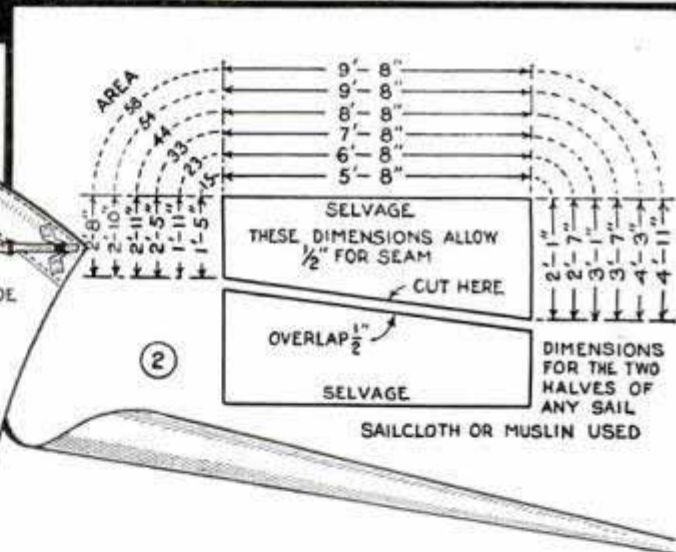
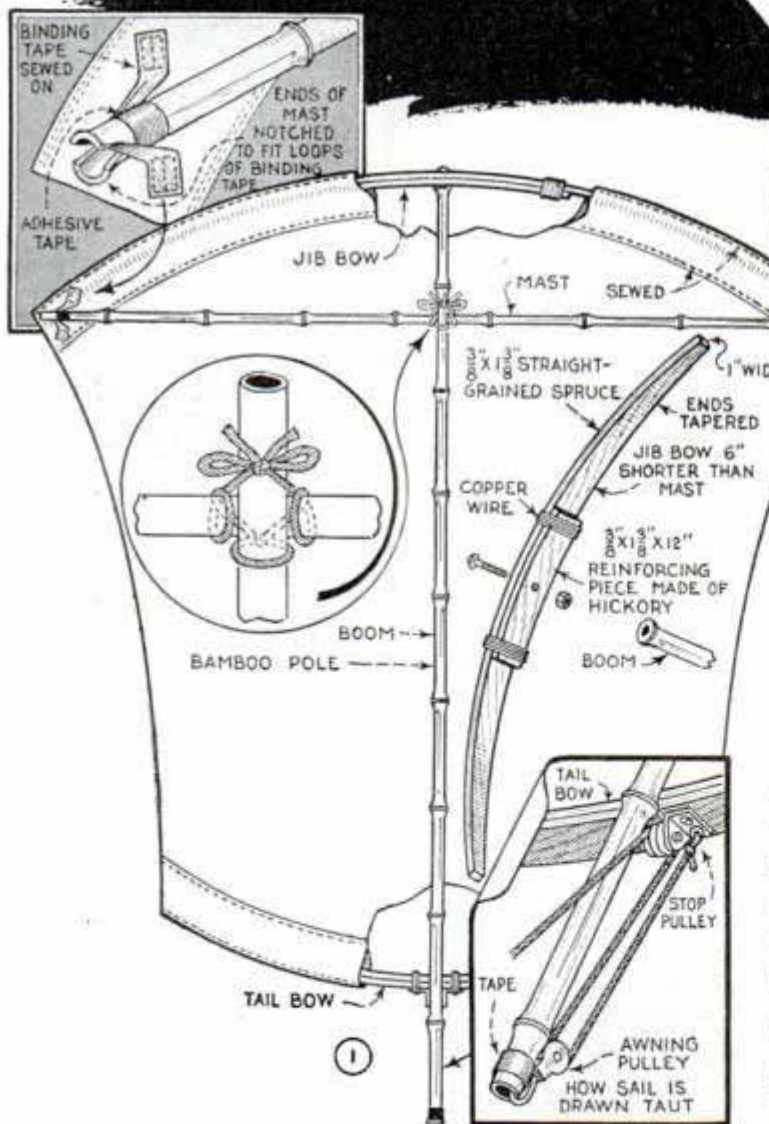

By E. O. LIEGHLEY

A GLASS-SMOOTH, unbroken expanse of blue ice, the snap of frost in the wintry air, a breeze that you can lean into—there's your setting for skate sails. In all the field of winter sports there are few pleasures that quite compare with the smooth, effortless speed attainable with a skate sail skillfully handled. Of course, there are pretty definite limits as to just how much sail a skater can carry safely, but the various sail areas indicated in the details give a selection that will suit the majority of both beginners and old hands

This sail is one of the latest types and can be taken down and rolled into a compact bundle for carrying

with these SKATE SAILS

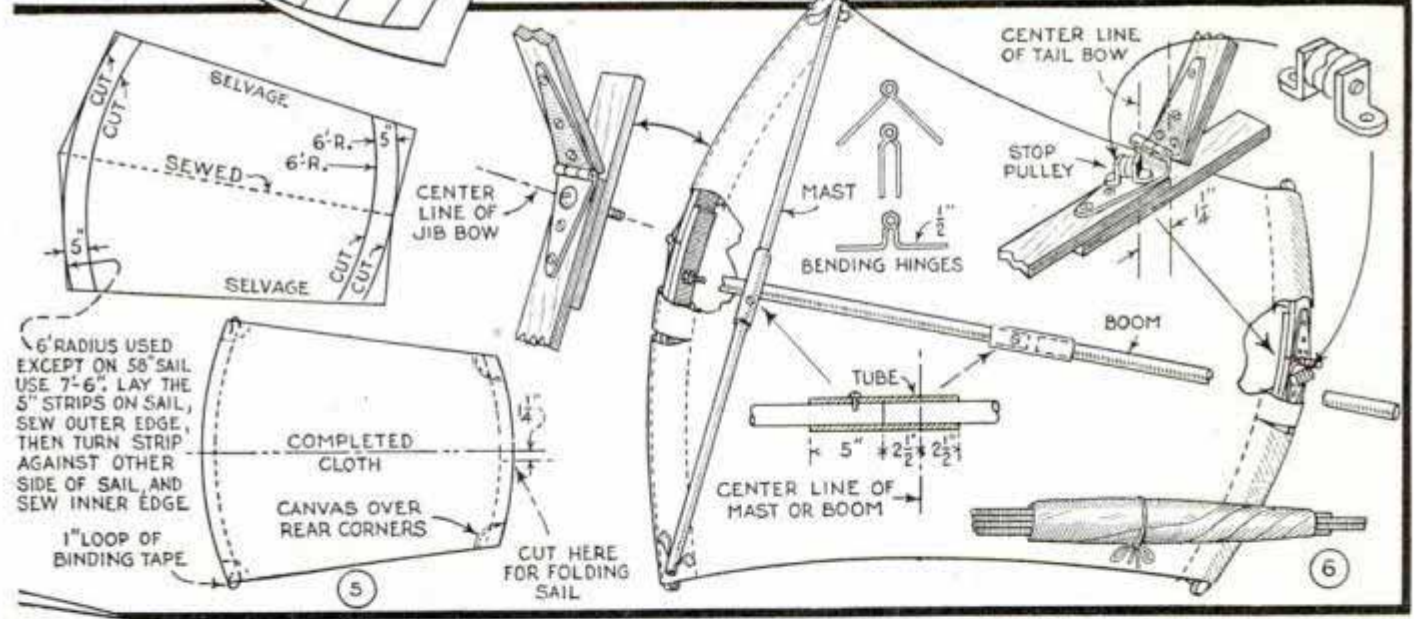
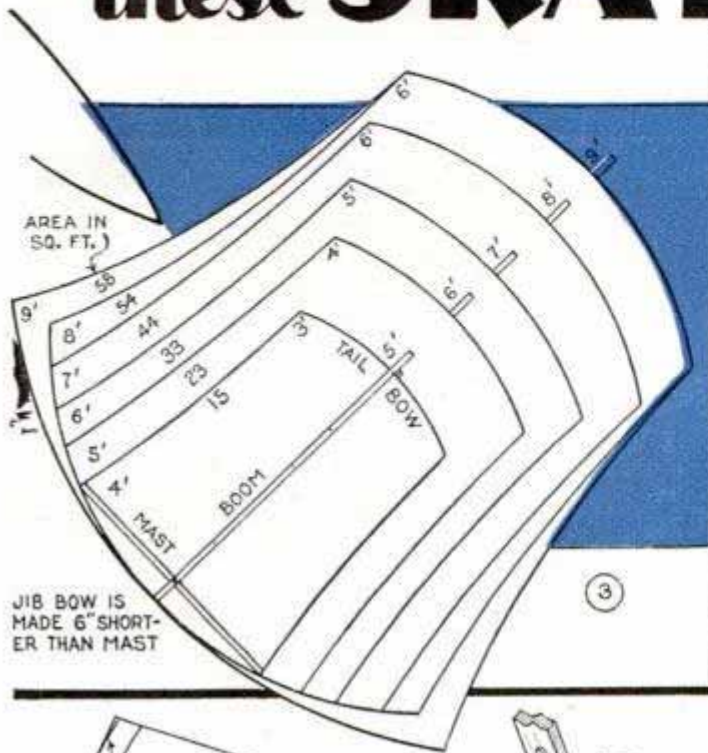

at the sport. Practiced skaters can handle the larger sails close to the wind with possibly a noticeable increase in speed and greater latitude of direction, but the more common practice is tacking across the wind. Although this imposes certain limitations, it is perhaps all in all the safest and best, particularly if you are on an unfamiliar stretch of ice. Cross-wind sailing gives you definite control, for by simply coming up into the wind you can stop easily. And, when headed into the wind, one can reverse his direction by grasping the mast with both hands, one on each side of

the boom, then duck, roll the sail over the shoulders to the other side and swing across the wind for the second tack.

Materials for building skate sails are easy to get most anywhere. Sailcloth can be used, but the best unbleached muslin will serve the purpose. For a simple sail rig that can be taken down, bamboo poles which are used to roll rugs on will be just the thing for the mast and boom, but for a folding sail straight-grained spruce should be used for these parts and the bows, Fig. 1. As a substitute for spruce you can use $\frac{3}{8}$ by $1\frac{3}{8}$ -in. straight-grained yellow pine

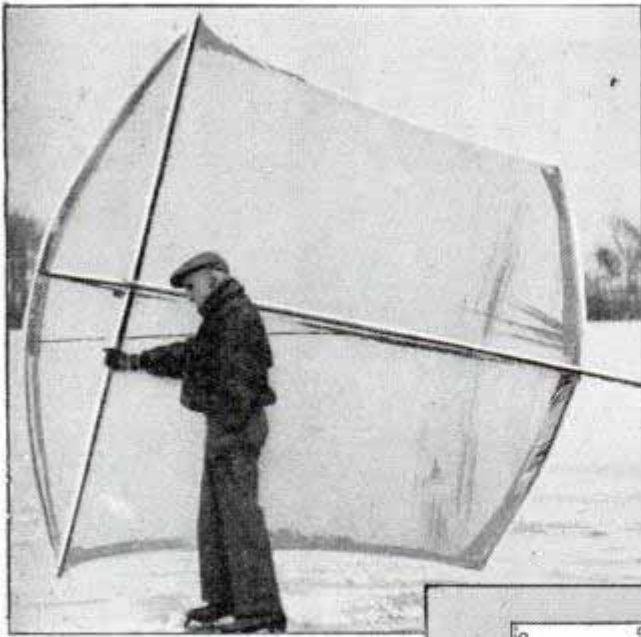

for the bow pieces. Fig. 2 gives dimensions for cutting the various sail sizes from the cloth. Fig. 3 gives the over-all dimensions and areas, and Fig. 5 shows how the sail is cut. Now, going back to Fig. 1, notice how the bows are reinforced with a hardwood strip at the center and also that they fit in pockets in the ends of the sail. A stove bolt, passing through the jib bow, is inserted in a hole in the end of the boom when the rig is set up.

Inexpensive, double-purchase, self-locking tackle for stretching the sail is shown in Figs. 1 and 4. The "stop" or locking pulley is of the type often used on large shades in store windows. To lock the cord when the desired tension has been applied, you simply feed it into one side of the pulley. The stop pulley, as you see, is screwed to the tail bow while the other is hooked into the open end of the boom. Fig. 6 shows what is necessary if you want the sail and rig to fold into a smaller bundle. Brass hinges and sleeves add some weight, of course. Bow pockets at the ends of the sail are cut through as shown and the bows are hinged

so that they will fold. The boom and mast are in two pieces held at the center with sleeves made of brass tubing. With these fittings the whole rig can be collapsed and then folded into a compact bundle for convenient carrying.

Fig. 7 gives the constructional details for the triangular sail and rig, a type still preferred by many skaters. Here the rig consists of two spars, a mast and handle. All these parts can be made of bamboo or light, straight-grained wood. The tackle for stretching the sail is essentially the same as that previously described. The size of the sail given in Fig. 7 is a good

average size. One of the details suggests an economical method of cutting a number of these sails from a single piece of cloth.

This sail, when fully rigged, will average only about $5\frac{1}{2}$ lbs. in weight and will suit a skater of most any height. Although its performance hardly equals that of the sail and rig described in the beginning, it holds plenty of thrills for the skater skillful enough to handle it in a strong breeze. The procedure in getting away and in tacking across the wind is much the same as that used with the other type of sail and rig.

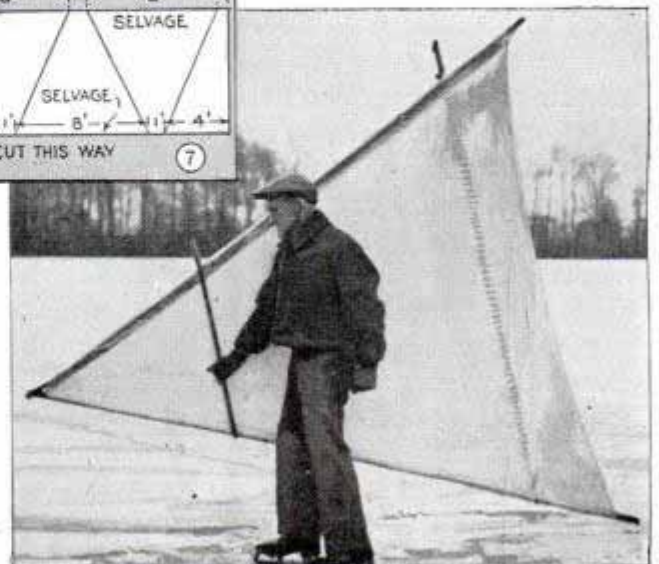
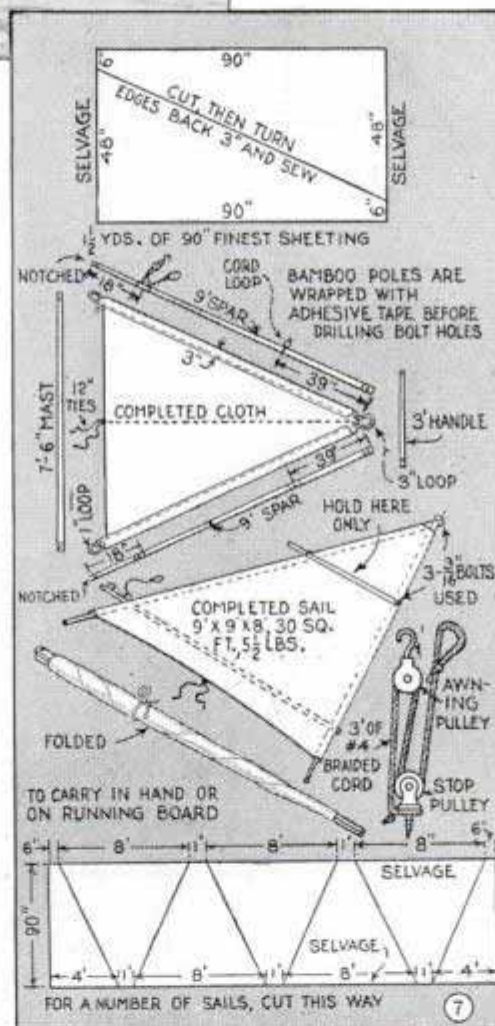

Steel Front Simplifies Building a Toboggan

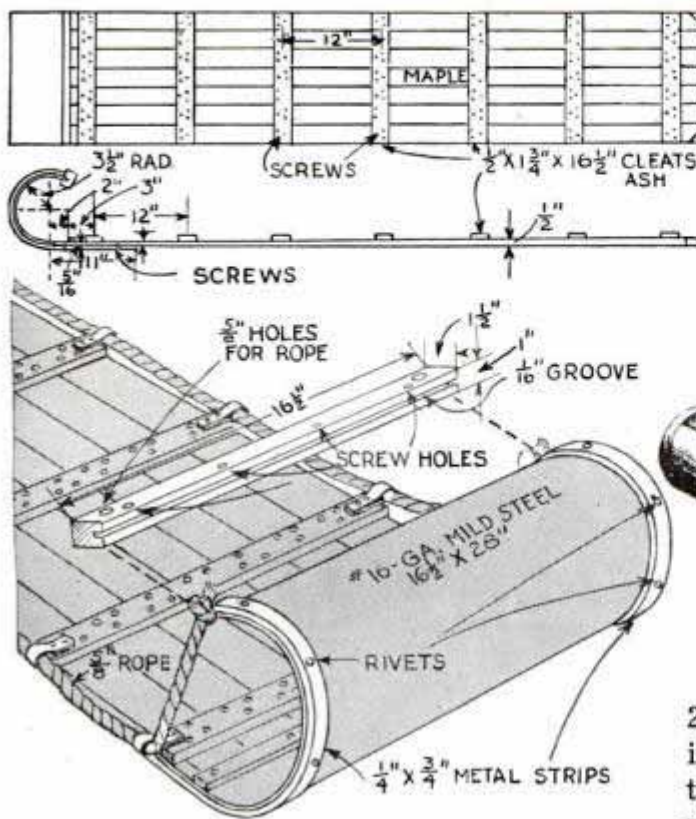

Simplicity in the construction of a toboggan is the object of this rolled-steel front as it eliminates steaming and bending of wood. Strips of straight-grained maple, 1/2 in. thick, are held together by white-ash cleats with glue and screws. The outside and center strips, which are

2 1/2 in. wide, are tapered from 1/2 to 5/16 in. in thickness, starting 27 in. from the front, to provide runners. In making the front, you first bend the steel reinforcing pieces to the desired radius. They must be identical in shape and the metal front must also be the same curvature, except the 11-in. straight portion that is screwed to the wood part. The metal should be enameled in an attractive color.

—Ambrose B. Charette, Milwaukee, Wis.

Coping-Saw Frame Shielded to Prevent Marring Work

To avoid accidentally marring work with the ends of a hand coping saw, by taking too long strokes, one workman provides a sponge-rubber ball at one or both ends of the saw as indicated. The balls, about 1 in. in diameter, are slit through the center and slipped over the blade.

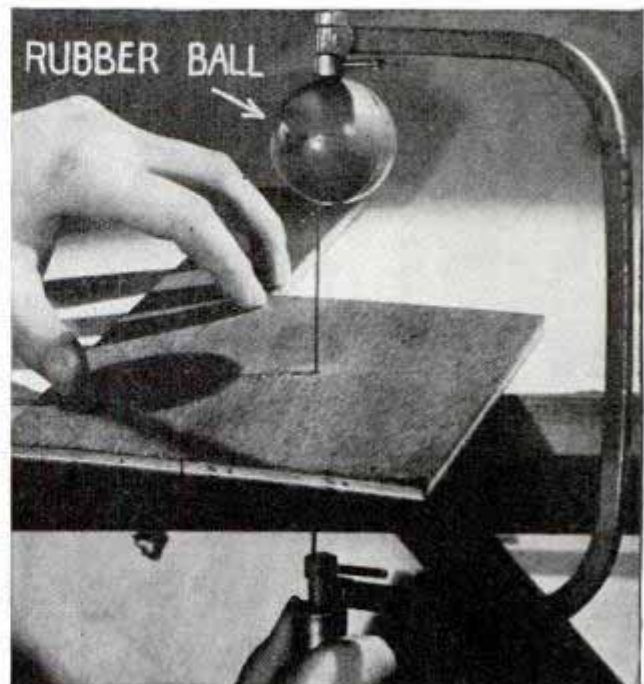

Clothing Made Fire Resistant

Anyone who works where there is possibility of clothes catching fire, can make them resistant to fire by the following treatment: First dip the clothing in a solution made by dissolving sodium stannate, 3 lbs., in water, 1 gal. Wring dry and dip them in a solution consisting of ammonium sulphate, 1/4 lb., and water, 1 gal. After the last dipping, wring them dry again.

'Fishing' Pipe from Shallow Well with Iron Hook

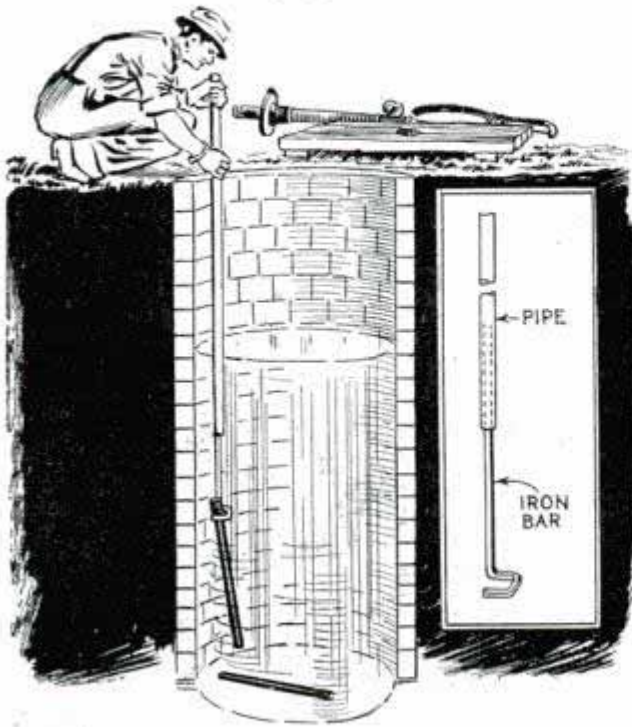

The usual difficult job of "fishing" a piece of pipe from a well is done in a jiffy with this tool

When a piece of pump pipe becomes detached and falls into a shallow well, it can be "fished" out easily with the tool shown. It is a length of iron bar bent as indicated and slipped tightly into the end of a long pipe, which serves as a handle. In use, the bar is lowered into the well and then moved around to slip the hooked end of the tool over the pipe, after which the tendency of the pipe to tip downward at one end binds it in the hook so that it can be lifted out.

—Carrol Baxter, Beecher Island, Colo.

Wrench to Turn Wing Nuts from Pipe Fittings

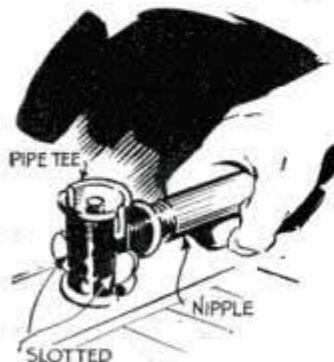

Here's a handy little wrench that will turn tight wing nuts easily. It consists of a pipe tee with a short nipple turned into one of the openings to serve as a handle. The open ends of the tee are slotted to slip over the wings of the nut as indicated in the drawing. The slots in the

two openings should be of different sizes so one side can be used for small wing nuts and the other for large ones.

Black Background Helps in Threading Needle

Difficulty in seeing the eye of your sewing-machine needle when threading it, may be overcome by holding a piece of black cloth or paper behind it as indicated. This provides a black background against which the needle will stand out clearly in contrast so that the eye can be seen.

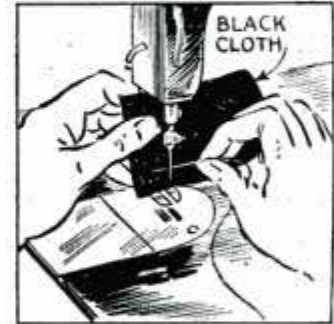

Medicine Tray for Sick-Room Bed Made from Soap Holder



A metal soap holder of the type shown may be used to hold a glass of water or bottles of medicine on the bed of a sick room. The hook can be bent to fit any size of bed rail.

Jig Aids in Tapping Blind Holes

Starting a tap straight to thread a blind hole is made quite easy by using a guide like the one shown. It's a piece of flat iron in which holes of different sizes have been drilled and tapped. In use, the guide is clamped over the work as indicated, and the tap is started into one of the holes of the right size, which guides it accurately into the hole which is to be threaded.

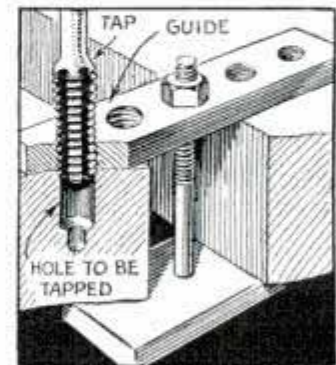

—F. Doughty, Yorks, England.

"Stage" your

CHRISTMAS GIFTS

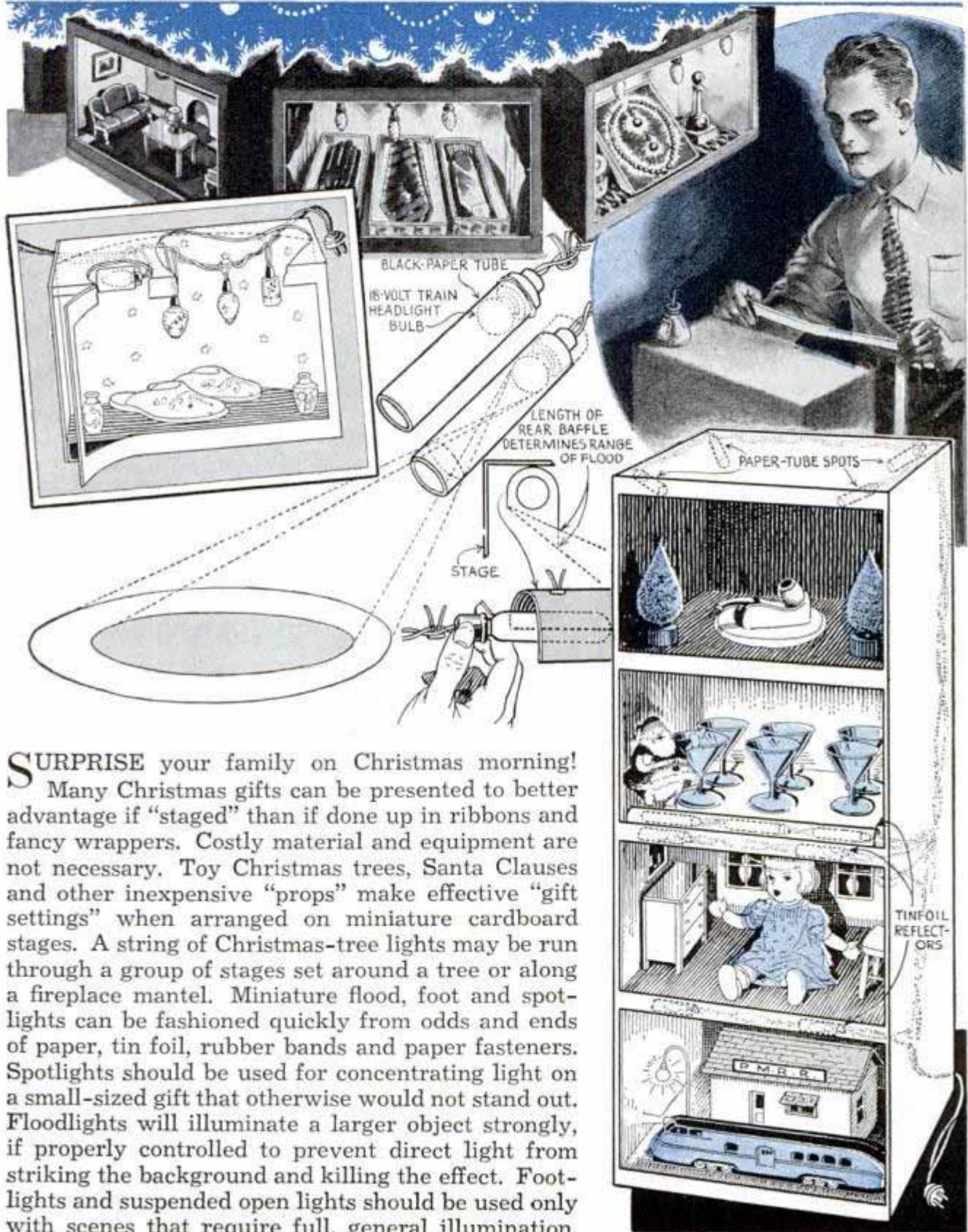

SURPRISE your family on Christmas morning! Many Christmas gifts can be presented to better advantage if "staged" than if done up in ribbons and fancy wrappers. Costly material and equipment are not necessary. Toy Christmas trees, Santa Clauses and other inexpensive "props" make effective "gift settings" when arranged on miniature cardboard stages. A string of Christmas-tree lights may be run through a group of stages set around a tree or along a fireplace mantel. Miniature flood, foot and spotlights can be fashioned quickly from odds and ends of paper, tin foil, rubber bands and paper fasteners. Spotlights should be used for concentrating light on a small-sized gift that otherwise would not stand out. Floodlights will illuminate a larger object strongly, if properly controlled to prevent direct light from striking the background and killing the effect. Footlights and suspended open lights should be used only with scenes that require full, general illumination.

Pressure Foot on Coping Saw Holds Down Work



This pressure foot will keep small or thin work from moving up and down while cutting it with coping saw

Fastened to the frame of your coping saw as indicated, a pressure foot will help keep small or thin work from moving up and down while cutting it. The foot is cut from spring brass or steel and is riveted to the saw frame. If desired to have the foot adjustable, it can be fitted with small bolts and wing nuts so that it can be clamped in place.

Glass Rods Quickly Softened in Electric Heater

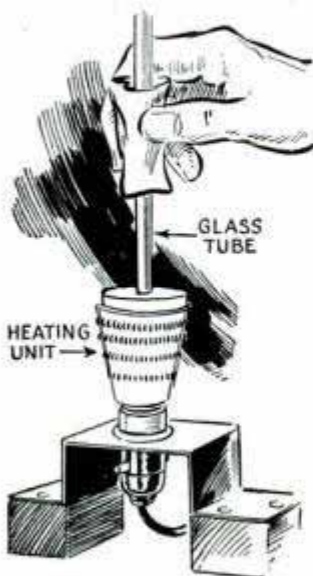

When fitted with a cover of asbestos, an ordinary electric heating unit of the cone-shaped type can be used for softening and annealing the ends of glass rods. The cover can be cut to simply rest on top of the unit, or the edge can be tapered slightly so that it will fit into the top of the clay cone. A hole is

made in the cover large enough to admit the glass to be worked. If tubes of differ-

ent sizes are to be used, it is a good idea to make a cover to fit each one. If desired, the temperature inside of the unit can be increased considerably by removing a 10 or 12-in. length of the coil-resistance wire from the outside.

—Dale R. Van Horn, Lincoln, Nebr.

Water Pipes under Coal Pile Corrode Rapidly

Corrosion of gas and water pipes where coal is stacked against them may soon result in serious leaks. The pipe shown in the photograph was corroded halfway through after coke had been piled against the pipe for a few months. It had but little farther to go to release gas into the basement, when discovered. Any pipes against which coal or coke may be piled in a coal bin should be painted and taped or covered with wood strips.—C. E. Packer, Chicago.

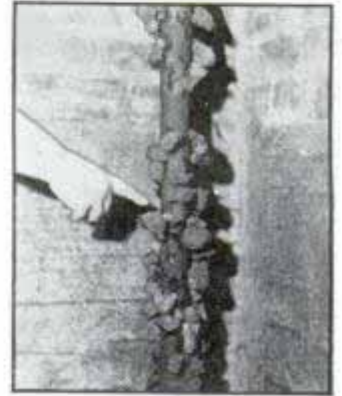

Anchoring End of Tape Measure

When using a long tape measure single-handed, an ordinary mousetrap makes a good holder for anchoring one end of it. The base of the trap is drilled to take a nail, the end of which is ground to a sharp point. In use, the end of the tape measure is clipped under the trap jaw and the nail used to anchor it securely to the ground or other surface which is being measured.

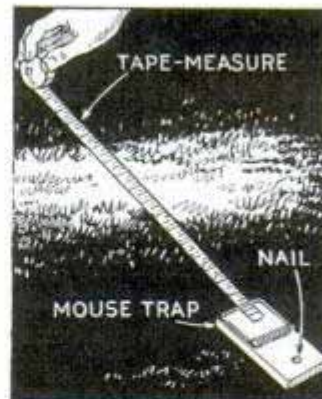

—Charles Latour, Albany, N. Y.

☞ You can dice sliced pineapple easily before emptying it from an opened can by inserting a sharp knife into the center and cutting outward.

Crepe-Paper NOVELTIES

by

E. Vogt

THERE'S no end to the number of things you can make from colored crepe paper. The work is interesting and instructive for young and old alike, and there are possibilities of making this hobby a profitable spare-time business as there is always a demand for clever novelties.

Crepe paper lends itself especially to the forming of pulled "raffia," which can be wrapped over articles or it can be woven and braided. Among the things decorated with crepe-paper raffia are picture frames, lamp bases and shades, wastepaper baskets, fancy flowerpot covers, and all sorts of square, rectangular and round containers to the surface of which the raffia is glued. A group of such items is shown in Fig. 2. Figs. 1 and 3 indicate the method of applying the raffia, while Fig. 4 shows a basket consisting of an old phonograph record which was bent while softened in hot water, and covered with raffia strips after it had hardened in the shape it was formed. The raffia strips radiate out from the center and the wire handles are wrapped. Two other items, in the making of which somewhat similar technique is used, are the tie racks shown in Fig. 6. The upper one consists of heavy cardboard or light plywood, two spools and a piece of heavy wire, all neatly wrapped with raffia. The lower tie rack—or towel rack if you wish—is cardboard

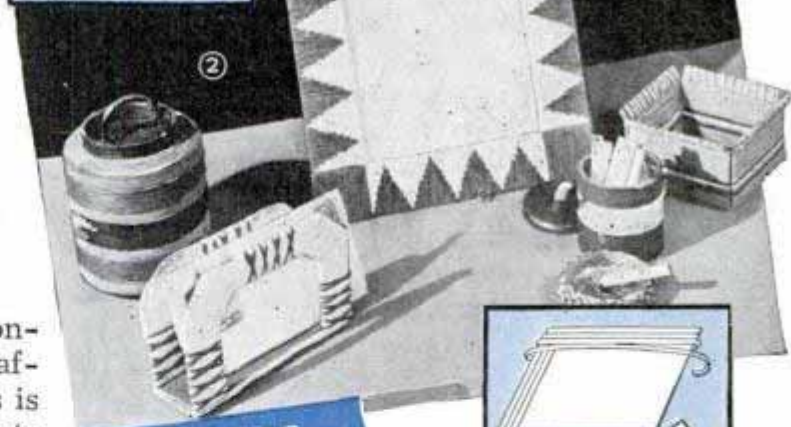
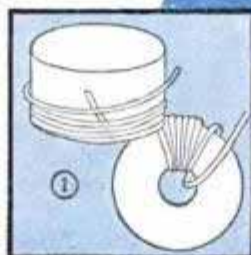

NOVELTIES
DECORATED WITH
SINGLE STRIPS OF
CREPE "RAFFIA"



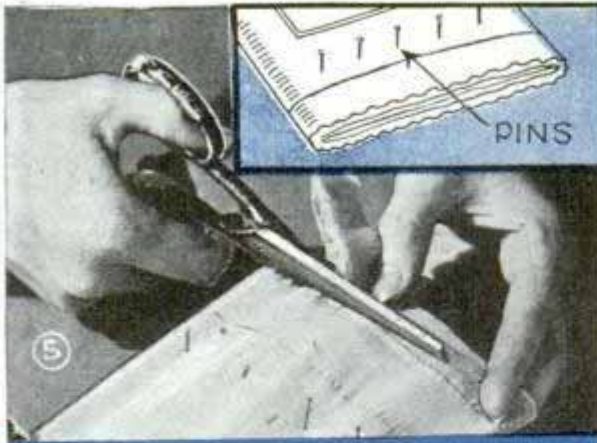

CUTTING CREPE -
PAPER INTO STRIPS

on which three wrapped fruit-jar rings are mounted. Of course, different colors are used to obtain pleasing contrast.

In making the raffia it is essential to get the best grade of crepe paper which will not break easily when pulled through the "twister." The latter is a small block of wood having two holes of different sizes, through which strips of the crepe paper are pulled. The twister can be purchased for a few cents at almost any department or variety store. You can cut the $\frac{1}{2}$ or 1-in. strips directly from a 10-ft. "fold" of the crepe paper, as you buy it at the store. Pins are used to hold the fold from shifting while you are cutting the end with a pair of sharp scissors. As the cut strip will be 10 ft. long, the pulled raffia will be about twice as long. Children who are cutting the crepe paper into strips may have to unfold it in case they cannot cut through several thicknesses of the paper as just described and shown in Fig. 5. The small hole in the twister takes the $\frac{1}{2}$ -in. strips and the large hole takes the 1-in. strips. To start the paper strip through the twister, you cut off one end diagonally so that it tapers to a point. This you roll tightly to form a "needle" which will pass through the hole in the twister. Holding it in the left hand, let the paper pass between your thumb and finger as shown in Fig. 7, so you can apply a slight pressure while pulling the paper through with your right hand.

The object of holding the paper between your thumb and finger is to stretch it. However, children often find it convenient to stretch the paper as a separate operation before pulling it through the twister. If desired, the strands can be given additional twisting after being pulled through. The paper must not be jerked at any time—an even, gentle pull will produce the desired results.

While many objects can be suitably decorated by wrapping them with the single strips of raffia, another class of work involves braided raffia. In this, gay color combinations can be used for artistic effects. The completed braids may be glued to the surface of articles or the braided lengths may be glued together, depending on the purpose of the finished article and the strain to which it is subjected. In this group are mats for hot dishes, shal-



TWISTING CREPE-PAPER STRIPS

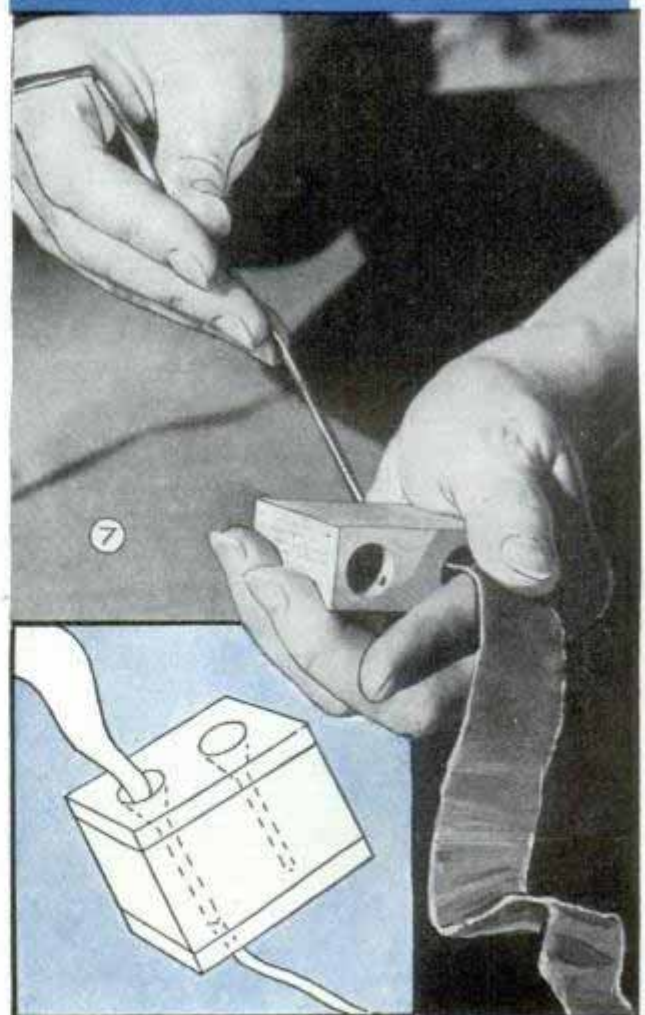

low trays or deeper containers, bowls, candlesticks and ornamental match boxes, examples of which are shown in Fig. 11. Among possibilities not shown here are fancy cigar boxes, candy or cookie jars from ordinary tin coffee cans. Likewise, baking-powder cans are converted into cigarette containers; mailing tubes into knitting-needle cases, and odd-shaped bottles into vases and lamp bases. The process of forming such items consists first of all in braiding the strips of pulled raffia as shown in Fig. 8, after which paste is carefully applied under each layer while the winding progresses, Fig. 9. When thoroughly dry, the finished article is given a few coats of shellac as in Fig. 10. Shellacking keeps the braid in place more effectively than paste only, adds durability and makes the braid moisture resistant.

Another purpose to which the pulled crepe-paper raffia lends itself is weaving, which enables you to make colorful as well as durable pillow covers, knitting bags, purses, belts and numerous other items. For pillow covers and knitting bags, you get ordinary five-cent dish cloths. The cloth may be dyed a contrasting color to the paper to be used for weaving. For pillow covers, two wash cloths, woven separately with the raffia, are sewed together at the edges. The same process is used in making knitting bags but in this case two edges of the woven cloths are attached to wooden handles. The finished "fabric" is flexible, yet it has sufficient body so that it will keep its shape.

Besides the various types of work already mentioned, the making of small dolls is a pop-



BRAIDING CREPE
"RAFFIA" STRIPS



PASTE IS APPLIED UNDER
EACH LAYER OF BRAID

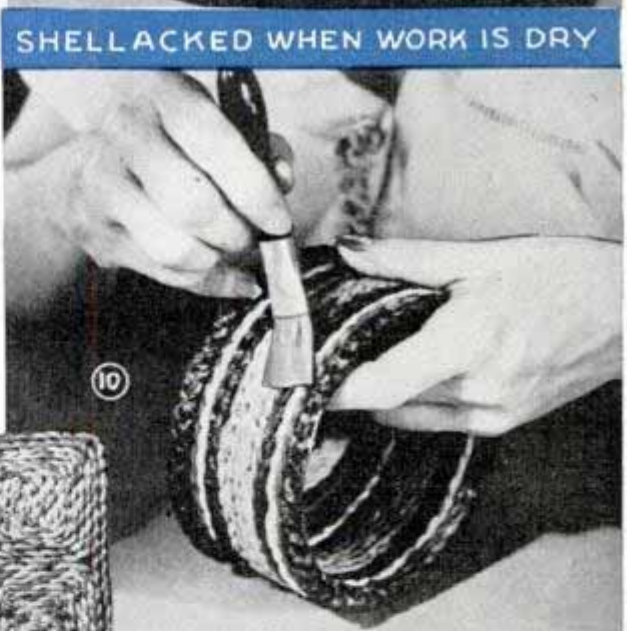

SHELLACKED WHEN WORK IS DRY

USEFUL ARTICLES
IN BRAIDED CREPE





ular and fascinating pastime for the enterprising crepe-paper crafter. You can make the dolls simply for the purpose of ornament, to be given away as party favors, or they may be designed for some definite useful purpose, which will, of course, determine the exact method followed in constructing them. They make attractive lamp and curtain pulls, or they can be used as decorative doorstops, the roomy dress covering a suitable weight. Another interesting job is the making of crepe-paper animals. You start with the skeleton, a framework of wire. This is covered with padding on which the raffia is wound.

Or, you may prefer working with crepe-paper "clay," to form various pieces of pottery. To make the clay, cut off a 1-in. sec-

tion from a fold of crepe paper, stretch it and soak it in water, $\frac{1}{2}$ cupful. While the paper is wet, cut it into "confetti." Then gradually add flour, $\frac{1}{2}$ cupful, and water, $\frac{1}{2}$ cupful. Mix thoroughly with a wire potato masher until the mass assumes the consistency of bread dough. One fold of crepe paper will make 4 cupfuls of finished "clay." A tablespoonful of salt or powdered alum added to this will prevent the formation of mold on the clay, which may happen when it does not dry quickly. Crepe clay can be applied as a permanent covering to vases, bowls and other objects. If the clay is to be removed from the foundation, cover the latter with wax paper to make removal easy. A coat of white shellac will add gloss and durability.

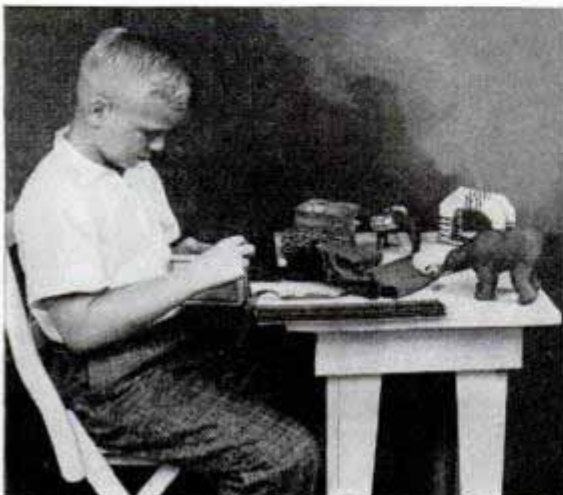

Toothpick Holder for Pocket

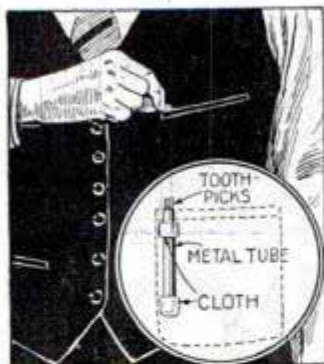

Those who are in the habit of carrying toothpicks in their pockets will find that a metal-tube holder not only helps to keep them clean, but also avoids breakage. A metal handle from an old mucilage brush

makes a good tube when cleaned, and is attached inside the pocket by cloth strips sewed to the lining as shown.

Ring Measurement Taken with Wooden Spoon

When you want to give a ring to some member of your family, and there is nothing at hand with which to take the measurement, try using a wooden spoon or a paddle whittled out to similar shape. In use, just take a ring that the person is already wearing and force the end of the spoon into it tightly. This will leave small indentations on the edge of the wood from which the jeweler can take his measurement.—F. Bentley, Jr., Missouri Valley, Ia.



Passing It On to Others

Although the solution of many minor everyday problems around the home, in the workshop, concerning the car, or pertaining to your daily work, may seem rather insignificant to you, there are perhaps thousands of others who have the same problems. If your solution was unusual, but simple and practical, why not pass it along to others to help them? These pages are a "clearing house" for such ideas and if you have any new ones that are exceptionally outstanding, don't hesitate to tell us about them. We are always looking for such short cuts that will save time, work and money. And, of course, we will send a check in payment for anything that we use.

Write to Shop Notes Editor

POPULAR MECHANICS MAGAZINE
200 E. Ontario St. Chicago

Newspaper Carrier of Stiff Wire Leaves Both Hands Free



A paper is removed from this bag with one hand while making change with the other one

Instead of using both hands to remove a paper from his shoulder bag, one to hold the bag open and one to lift the paper, this newsboy uses a wire frame from which a paper can be removed with one hand, while making change with the other one. The frame is made of fairly heavy wire, and all joints are soldered, a strap being attached to go over one shoulder.

Markers for Loose-Leaf Books Made from Shipping Tags

Markers for loose-leaf books are quickly made from shipping tags as indicated. The eyelet of the tag makes it easy to attach over one of the metal rings of the book, and the projecting portion of the tag provides a surface on which to write data which serve as an index.

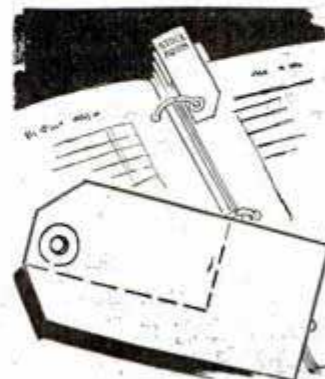

Moving Pictures in Yuletide

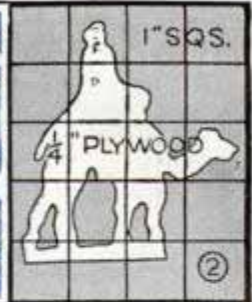

SHADOW BOX

by
FLOYD
MIX

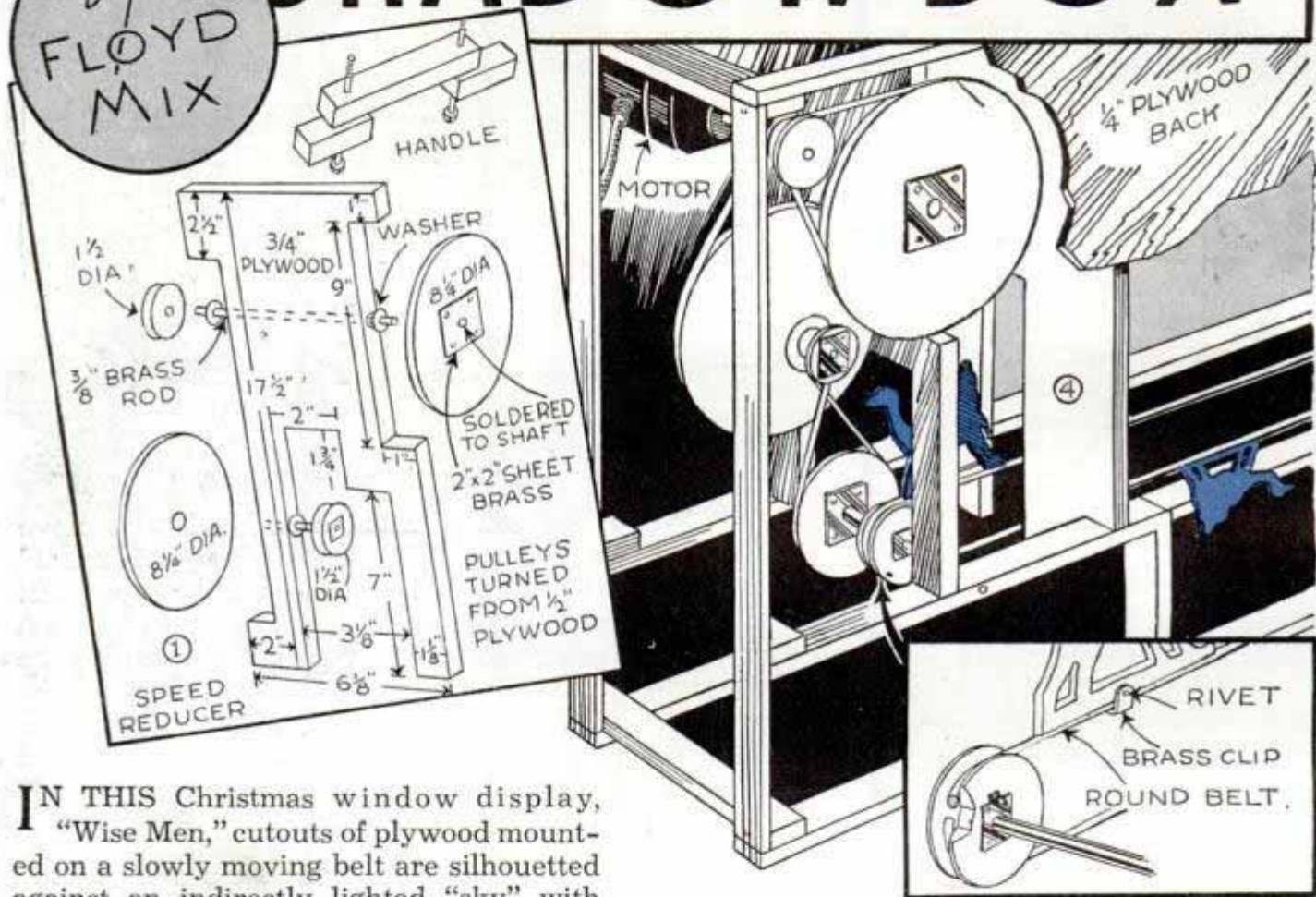

IN THIS Christmas window display, "Wise Men," cutouts of plywood mounted on a slowly moving belt are silhouetted against an indirectly lighted "sky" with prominent stars, to create a typical Eastern desert scene.

Essentially, the display consists of a plywood-covered box with an opening in one side for a miniature stage, small electric motor, speed-reducing unit, and means for controlling the light from three showcase lamps. Construction begins with the frame, Fig. 8. The required parts are ripped from $\frac{1}{2}$ and $\frac{3}{4}$ -in. stock, almost any kind of wood being suitable, and assembled with flat-head screws. The heads must all be countersunk flush with the surface. Fig. 11 shows a cutaway view of the operating mechanism and bristol-board sky. The

belt trough, which also serves as a guide to keep the figures in a vertical position on their trips across the stage, consists of a wood core, $\frac{3}{8}$ by $1\frac{1}{4}$ in., onto which strips of sheet metal are nailed as indicated in the cross-sectional view. Upright pieces which support the sky are next sawed out and nailed to the frame cross-pieces. When these are finished, cleats to hold the bristol-board sky are cut and fitted in place, and the board trimmed to fit. Before tacking it down, make a cutout of a large five-pointed star in the upper right-hand corner and glue a piece of yel-

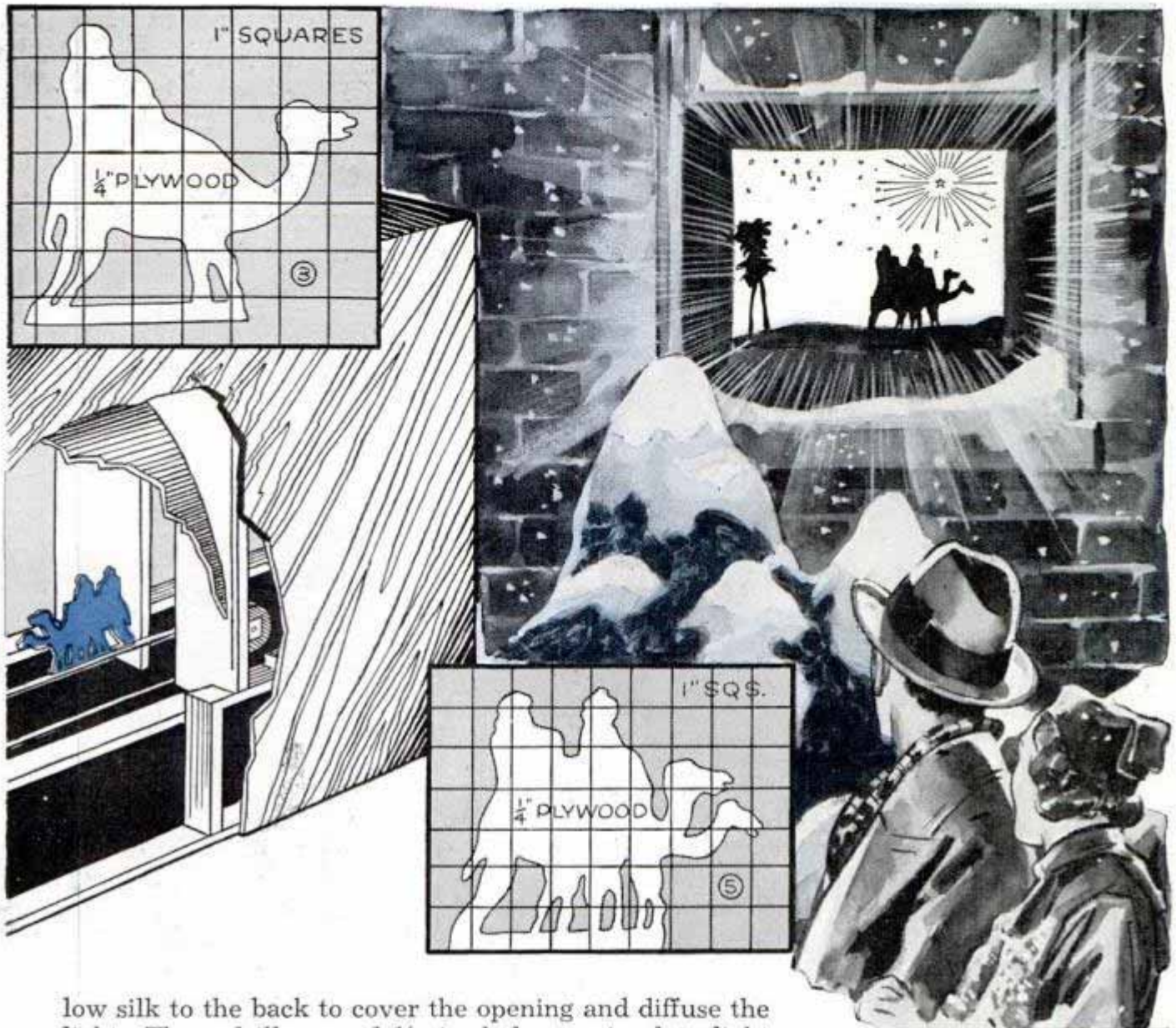

low silk to the back to cover the opening and diffuse the light. Then, drill several $\frac{1}{16}$ -in. holes to simulate light rays and small stars.

Fig. 1 gives dimensions of the various parts required for the speed reducer. Jigsaw the pulleys to the approximate shape and true them up on a wood-turning lathe. The surface of each should be recessed approximately $\frac{1}{4}$ in. to take a belt composed of several strands of stout cord. Also turn the pulleys for the trough belt. Use $\frac{3}{4}$ -in. plywood for these pulleys, turning two to the dimensions shown in one of the details, Fig. 11, and the other to a diameter of 6 in. The manner in which all the pulleys are mounted is illustrated in Fig. 9. Fig. 10 shows the motor in place, and Fig. 7, a wiring diagram. Whether or not you will need a rheostat to help control the speed of the motor depends on the one you have at hand, and can best be determined by experimenting. Now for the plywood cutouts, Figs. 2, 3, 5 and 6. Lay off 1-in. squares on a piece of wrapping paper, sketch the design given in the small squares into the large ones freehand, trace them onto $\frac{1}{4}$ -in. plywood and saw out one of each. The camel cutouts are mounted on a $\frac{1}{4}$ -in. leather belt of the sewing-machine type, using brass clips as illustrated in the detail, Fig. 4.

Illumination for the display is provided by three lamps, as

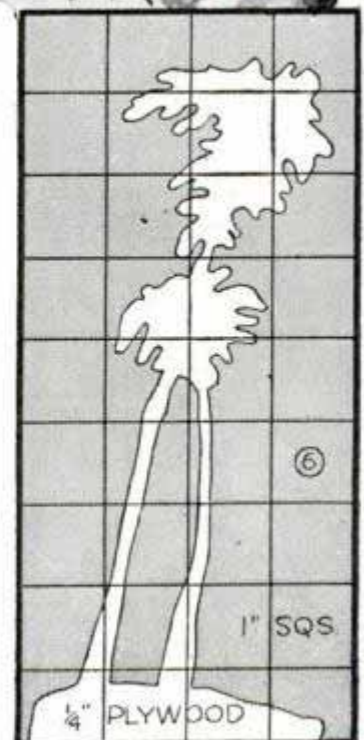

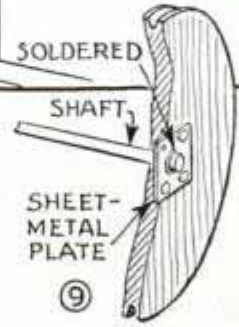
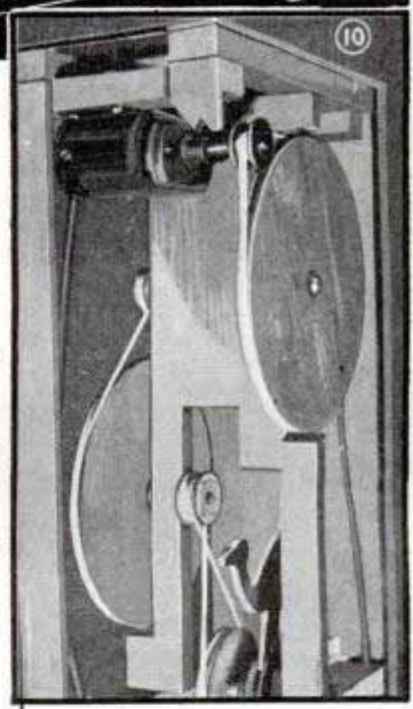
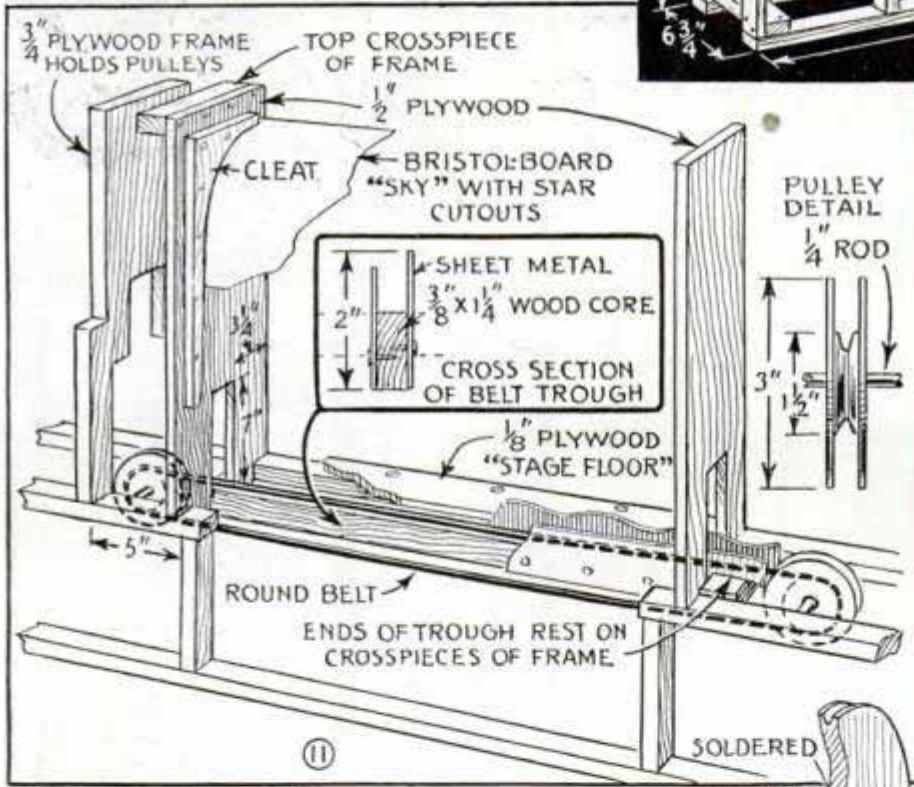
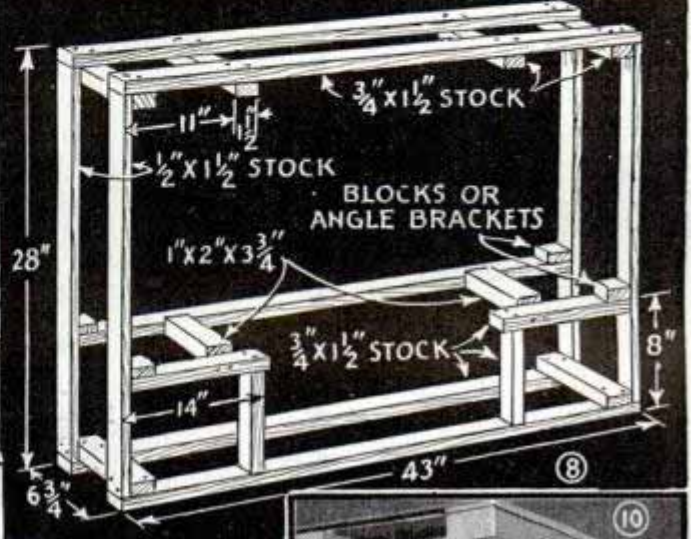
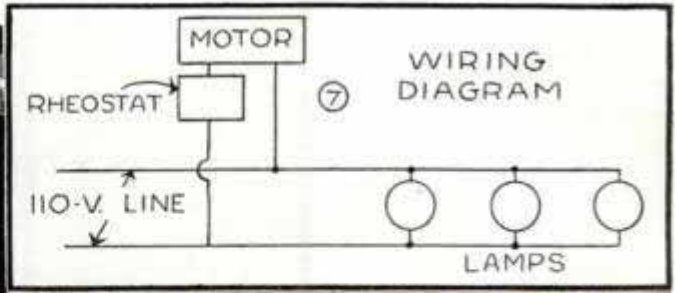
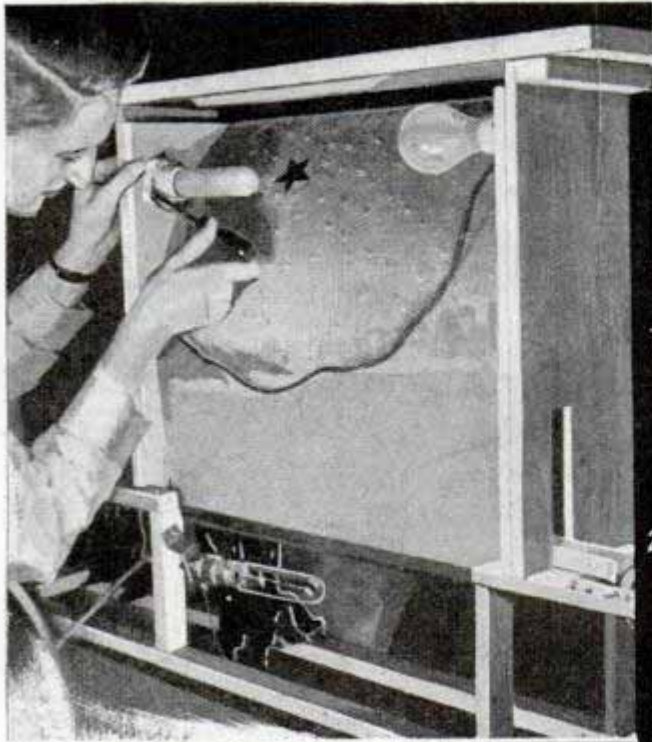

shown in the photo at the left of Fig. 7. Two of the lamps keep the stars glowing and light from the other shines up through a gap between the bristol board and belt trough. After the wiring of the lamps is completed, the frame work is boxed in with 1/4-in. plywood. A layer of adhesive tape is used in all joints to make them lightproof. Nails can be used in fastening the front panel, but the side and back panels should be screwed in place so they can be removed readily to make minor adjust-

ments. Following this the various parts are stained and painted. The sides of the moving figures and palm-tree cut-outs are painted black, the edges being left unfinished. Bright blue water color is used on the bristol-board sky. The exposed surface of the plywood is given a coat of walnut oil stain, and if the display is to be used outdoors, a couple coats of shellac.

Homemade Ski Carrier Fits on Running Board

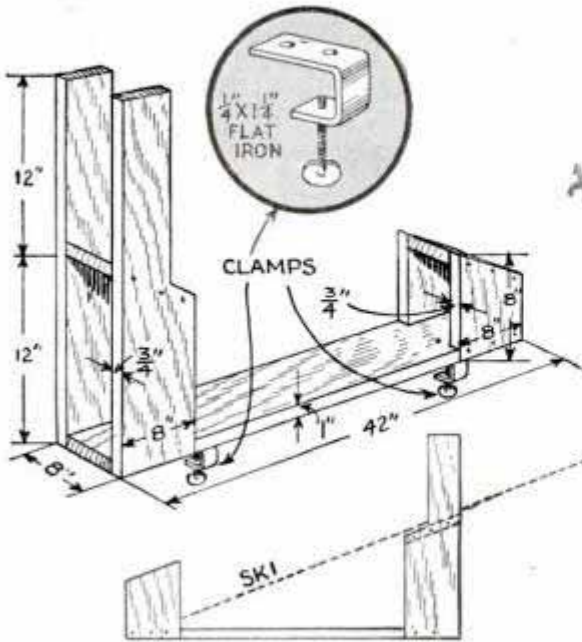

Overcoming the difficulties of transporting bulky skis and poles on a car, this carrier, made from scrap lumber, is securely clamped to the running board. There's a "heel box" at one end, which keeps the skis and poles nested together snugly. A crosspiece nailed between two uprights

serves to hold the skis above the front fender. Clamps from an old luggage carrier can be used to hold the ski carrier on the running board. Five pairs of skis can be carried conveniently and they do not extend beyond the limits of the car. Of course, it's a good idea to keep some burlap handy for wrapping the skis in order to avoid marring the finish of the car.

Bed Table for Sick Room Improvised from Card Table

When some member of your family must stay in bed for a while, and desires a "desk" on which to read or write, take your folding card table, open two legs and set it on the bed as indicated. Card tables are usually light so that the end of the table resting on the patient's body is not uncomfortable. If it is, however, pillows or books can be placed on each side of the

patient to carry the weight. A small desk lamp can be clamped to the upper edge of the table to provide illumination.

—Robert M. Eadie, Granum, Alberta, Can.



It takes only a minute to improvise this reading or writing table for a bed patient

Vise Jaw Should Clear Bench

Before mounting a vise permanently on a bench, clamp two wood blocks in the jaws, one on each side of the screw and extending several inches below the base of the vise. Then place the latter on the bench at the desired location, being sure that the blocks clear the bench edge a little, and that both blocks clear the same distance. This mounting assures that long pieces of work can be clamped vertically in the vise without striking the bench.

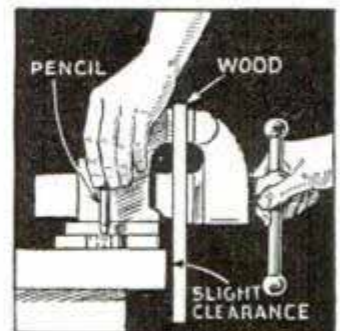

Extra Chair Seat Raises Child at the Table



Placed on a regular chair, this extra seat raises a child so that it can reach the table comfortably

After your child has outgrown the high chair, but is still too short to reach the table comfortably when sitting on a regular chair, this extra seat will solve the problem. It is cut from a piece of plywood to approximately the same shape as the chair seat and rubber-tipped doorstops are screwed to the underside at each corner.

—Axel E. Ogren, Chicago.

Fasteners to Attach Articles to Brick Walls

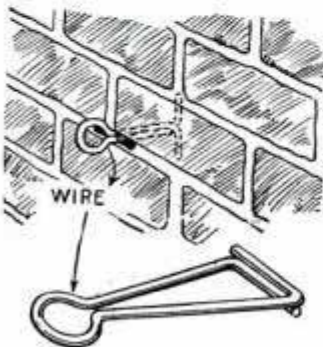

in the detail. To anchor it in the wall, mortar is removed from between two bricks,

Here's a good fastener to put in a brick veneer wall when it is desired to hang or secure something to it. The fastener is made by bending a length of fairly strong wire to the shape shown

making an opening wide enough to insert the fastener, which is then twisted at right angles to bring the edges of the fastener into the position indicated by the dotted lines in the drawing. The space between the bricks is then filled with mortar to hold the fastener securely in place.

Pocketknife Has Finger Shield for Carving and Whittling

When using a pocketknife to carve or whittle wood, slip a small sponge-rubber ball over the blade, as indicated, on which to rest the tip of your index finger. You'll find that this keeps the blunt edge of the blade from "cutting" into the finger,

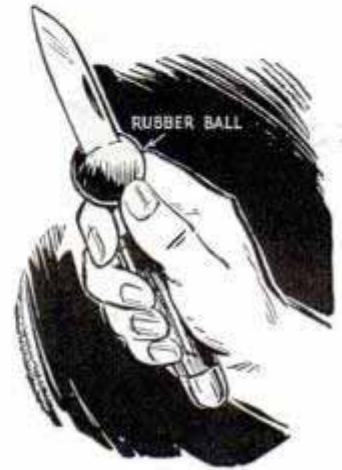

which is rather painful when the knife is used for long periods. Once a slot is made in the ball it slips on or off easily.

Pulling Wires through Conduit

The next time you have a number of wires to pull through a conduit, try using a piece of radio shielding over the ends, as shown in the photo. This provides a thim-

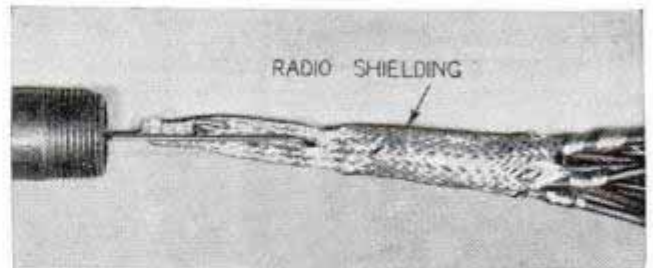

Radio shielding slipped over ends of wires so that they can be pulled through conduit easily

ble to keep the wires together and prevent them from catching against the side of the conduit. The pulling strap or wire is hooked into the shielding and the pull applied at the other end of the conduit.

—Ivan Grosvenor, Richmond, Ind.

☞ Tar spots may be removed from the hands or face by rubbing them with olive oil, or a piece of freshly cut lemon.

"BOWL-O"

*a table-top
bowling
game*



NOW you can enjoy bowling right in your own home. The mechanical features of this table-top alley are much like the familiar pin-ball game, but with this important difference: Quick, accurate judgment and manual skill are what it takes to win. The nature of the construction practically rules out the element of pure luck.

Essentially, as you will see, it's a miniature bowling alley complete with gutters, pin spots and pit. Only one ball is used, however. This is shot up a trough and follows a guide rail which ends in an adjustable tangent spring, the arc of which can be changed by turning a graduated knob at the end of the game cabinet, Fig. 1, thus directing the course of the ball to any point at the lower end of the alley. Now you cannot set the tangent spring by trial and thus guide the ball consistently for a strike, for there is another factor: The force with which the ball is shot up the trough must be gauged very carefully, as the slightest distortion of the tangent spring will deflect the ball from its course; hence that nicety of control which is the problem of each player individually. Otherwise the game is the same as conventional bowling.

The cabinet is built first, Figs. 4, 5 and 11. A 4-in. handhole is cut near the upper end of the bottom to give access to the mechanism operating the tangent spring. Then get out the cross members, from $\frac{3}{4}$ -in. stock, Fig. 5, boring a hole in all but

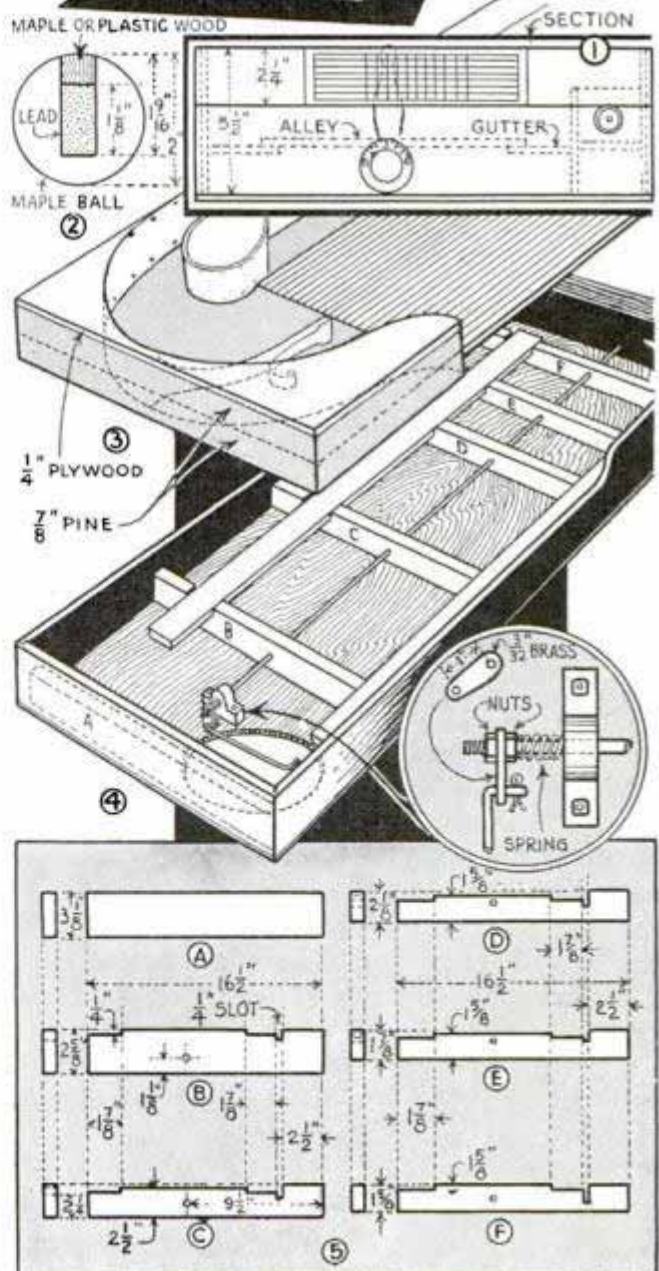

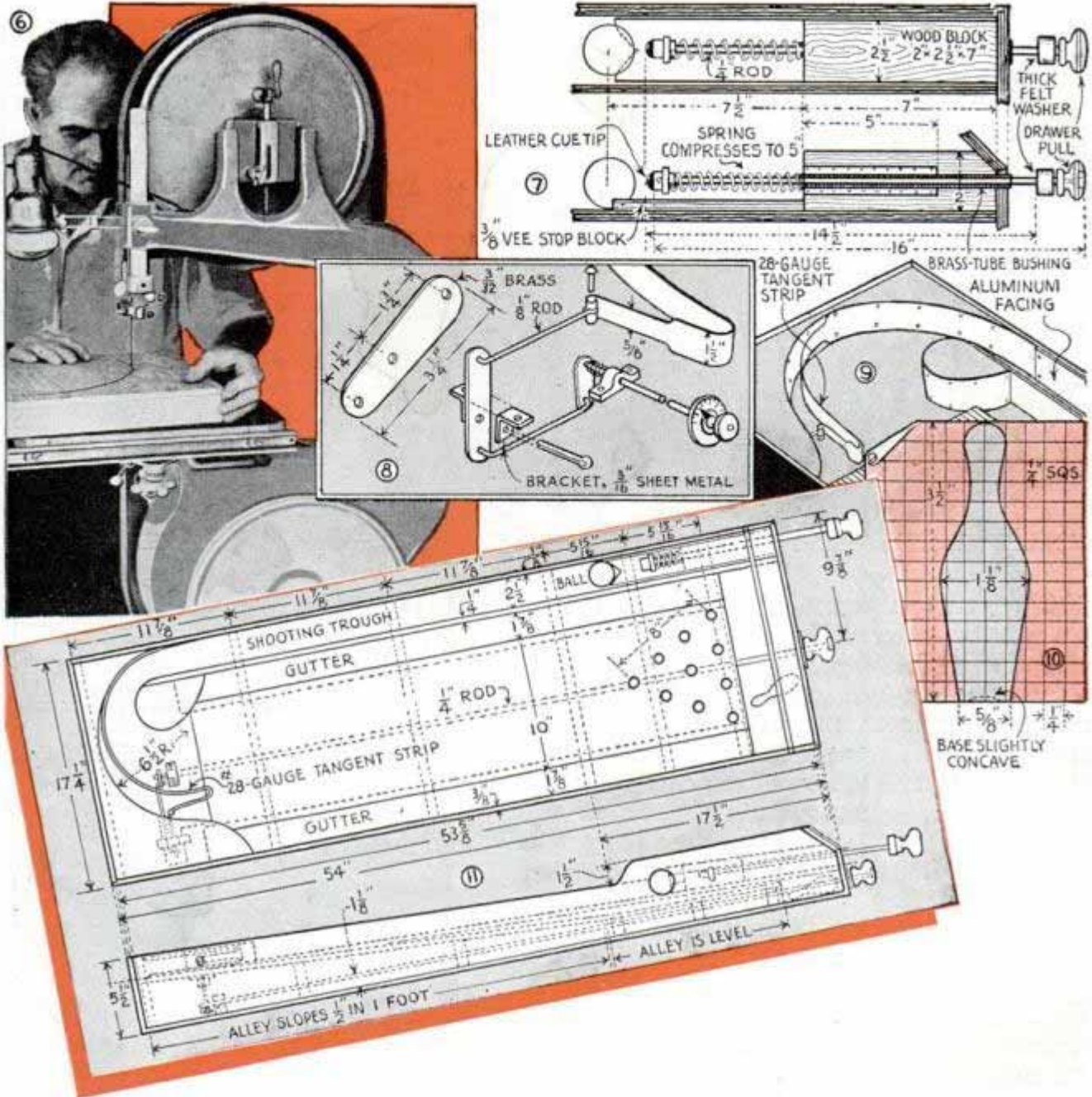

one for the tangent spring control rod. One end of the latter is fitted with a large wooden drawer pull. The alley can be made of $\frac{3}{8}$ -in. fir plywood or birch of the same thickness. Before you cut this to the finished length, it's best to get out the curved blocks which form the guide for the ball at the top of the alley, Figs. 3, 6 and 9. Some fitting will be necessary when assembling these parts. The gutters fit into notches in the cross members A to F in Figs. 4 and 5, also, the inner side of the ball trough fits in a vertical position against the edge of the gutter.

Figs. 7 and 8 detail the mechanism which controls the movement of the ball, the latter being turned from a block of maple and loaded with lead as in Fig. 2.

The plunger which propels the ball up the trough is actuated by a compression spring and is bushed through a wood block with a piece of brass tubing as shown in Fig. 7. The ball trough is lined with sheet aluminum up to the point where the curve begins, as in Fig. 9. From this point on, the facing is merely a continuation of the tangent strip, which can be made of brass or duralumin. About all that's left to do is turn out the pins, Fig. 10, from hard maple, draw the parallel lines on the alley with India ink and then finish up with shellac and varnish.

☞ When rush photos are required, you can print from a wet negative, if both sides of the negative are covered with Cellophane.

Film Slides Through This Miniature Printer

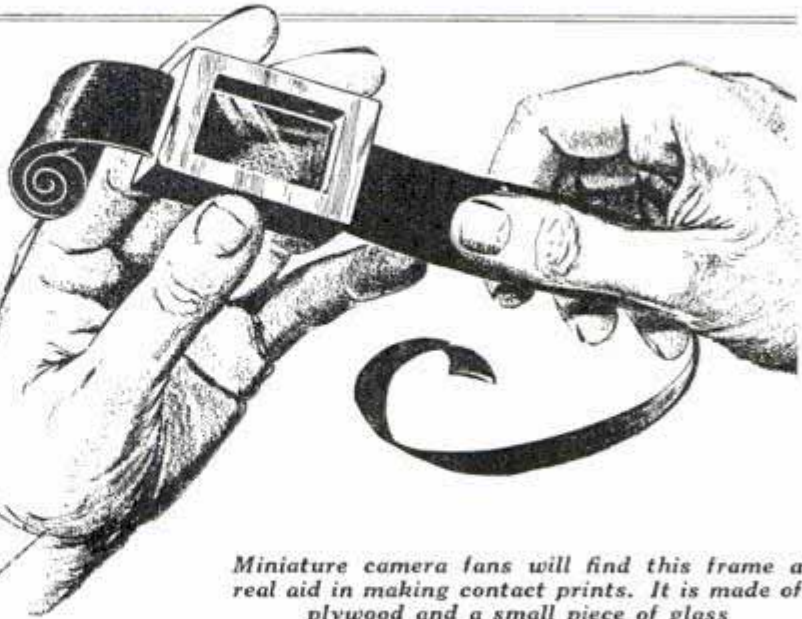
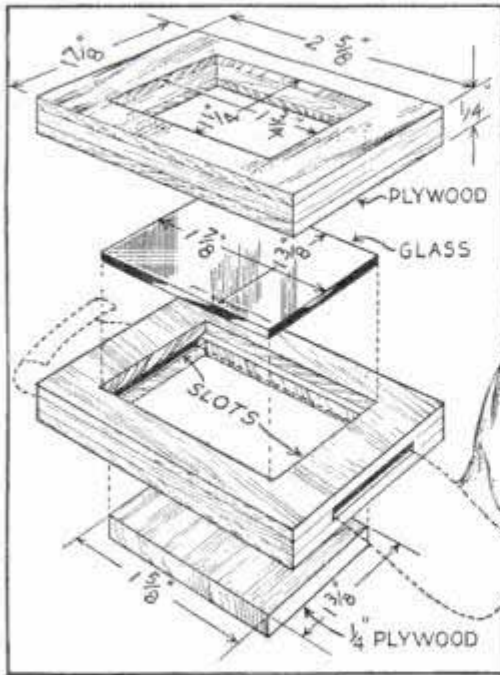

Miniature camera lens will find this frame a real aid in making contact prints. It is made of plywood and a small piece of glass

There's no need to cut your miniature film into various short lengths for contact printing as this small frame enables you to slide the film along to any exposure. Two pieces of light plywood with cutouts of different sizes are glued together. The lower one has the larger cutout and also a slot at each end to take the film. A piece

of glass is cut to fit rather snugly inside the slotted piece and a frame backing piece, a little smaller than the glass, is also provided. The glass is inserted and then the film is pushed through, after which a piece of printing paper is held against the negative by the backing piece, which can be hinged to the frame with a strip of tape.

Jig for Spotting Center Holes in Round Rods on Drill Press

This simple jig solves the problem of spotting a hole on center in the end of a small rod. In effect, the drilling is done upside down as the drill bit is held in a clamp on the machine table while the work is gripped in the chuck. As an example, assume that the rod to be centered is $\frac{1}{4}$ in. in diameter. Drill a $\frac{7}{32}$ -in. hole through a square of cold-rolled steel. Then ream the hole to $\frac{1}{4}$ in. and set up as shown. With a properly ground drill, the hole in the end of the rod will be spotted on center.

—R. F. Lindenmuth, Barnesville, Pa.

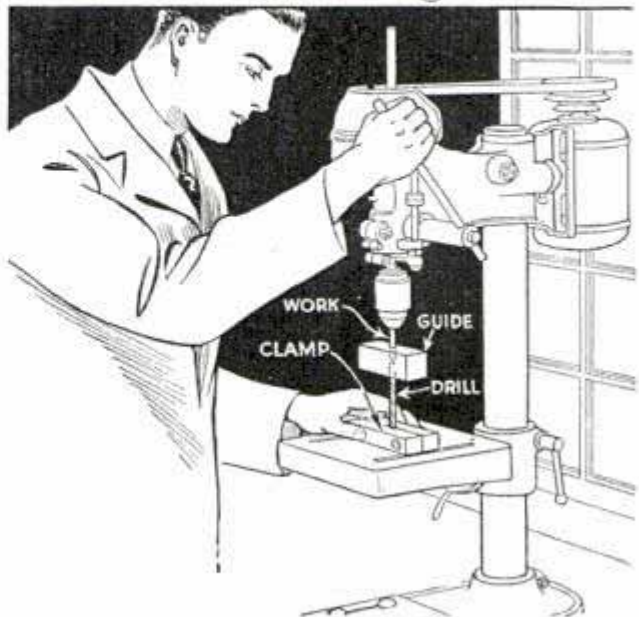
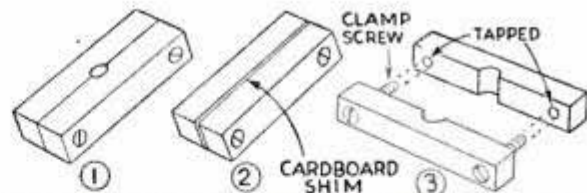

Wetting Plaster Crack to Patch It

Instead of wetting the edges of a plaster crack with a cloth, sponge or brush before patching it, use a small household insect sprayer. It concentrates the water where directed and tends to force it into the plaster, causing the patch to bond firmly with the wall.

Self-Supporting Chamfering Tool for Lathe Operators

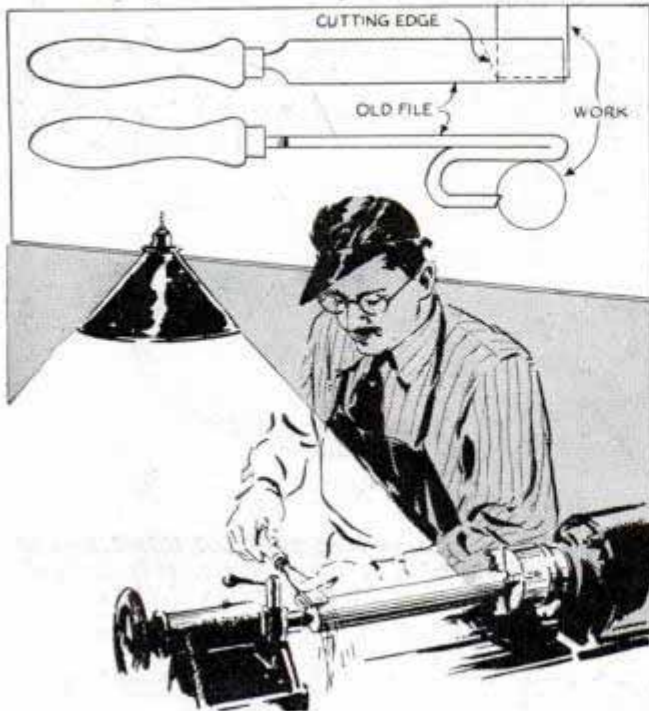

You'll find this easily made tool much faster for chamfering the edge of work than a file

Workmen who often use a file to chamfer the edges of work in a lathe, will find this tool a timesaver. It is made from an old file heated and bent to the shape shown. The tool is held on the work as indicated in the detail so that the sharpened end bears against the edge of the work.

—H. Moore, Hamilton, Ont., Can.

Small Soldering-Iron Tip Holds Heat

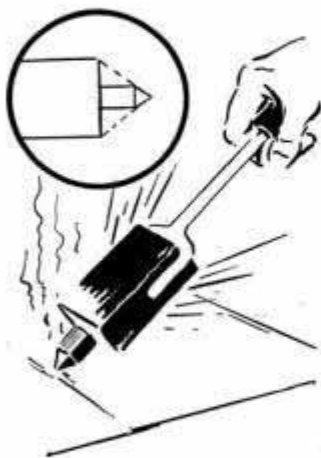

Here is a soldering-iron tip that can be used on delicate work with the added advantage of holding heat for a longer period than the usual light tip required for this work. To make the tip, take a large one that is old and pitted so that it is

unfit for further use and cut down the end with a saw or file to the shape indicated in the drawing. This gives you a small tip or working surface which can be used on del-

icate jobs, but is backed by a large piece to hold heat and transmit it to the tip.

—Joseph Petr, Omaha, Nebr.

Fuller Ball Is Convenient Handle for Drawing Instruments

Drawing tools, especially compasses and dividers, may be made much more convenient for use if a fuller ball, about $\frac{1}{2}$ in. in diameter, is forced over the handle of each. This gives a large, non-slip grip.



Photos Held in Loose-Leaf Binder by Means of Paper Clips

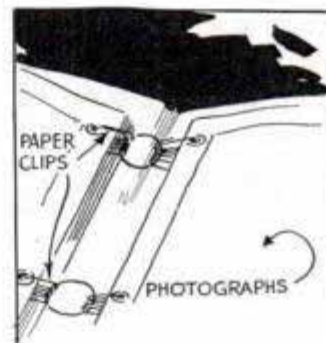

When you want to keep photos filed in a loose-leaf binder, you can use paper clips, as shown, instead of punching holes in the photos. The required number of

clips are slipped over the rings and then over the photographs, thus holding them securely without marring the paper, and photos are easily removed or replaced.

Rubber Hose Aids in Bending Copper Tubing

Small copper tubing, such as is commonly used for gas lines in automobiles, may be bent at almost any angle without kinking if a length of rubber hose is fitted rather



snugly on the tube to cover the portion to be bent. With the hose in position, the tube may be grasped with the hands, as indicated, and bent slowly without damage.

Turned Candy Box Has Hinged 'Snap-Up' Lid

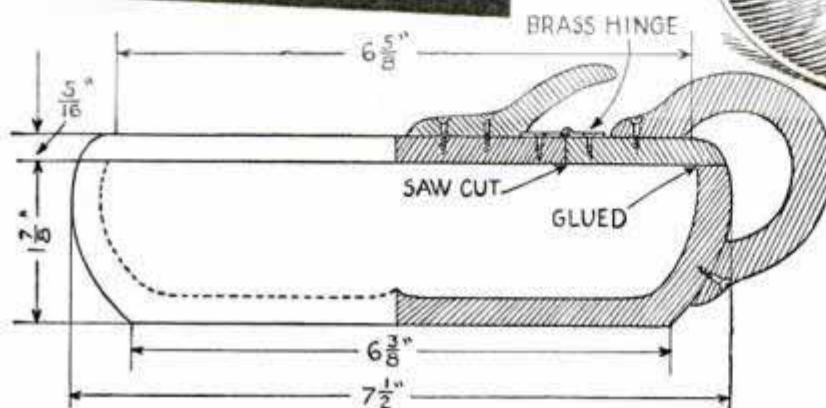
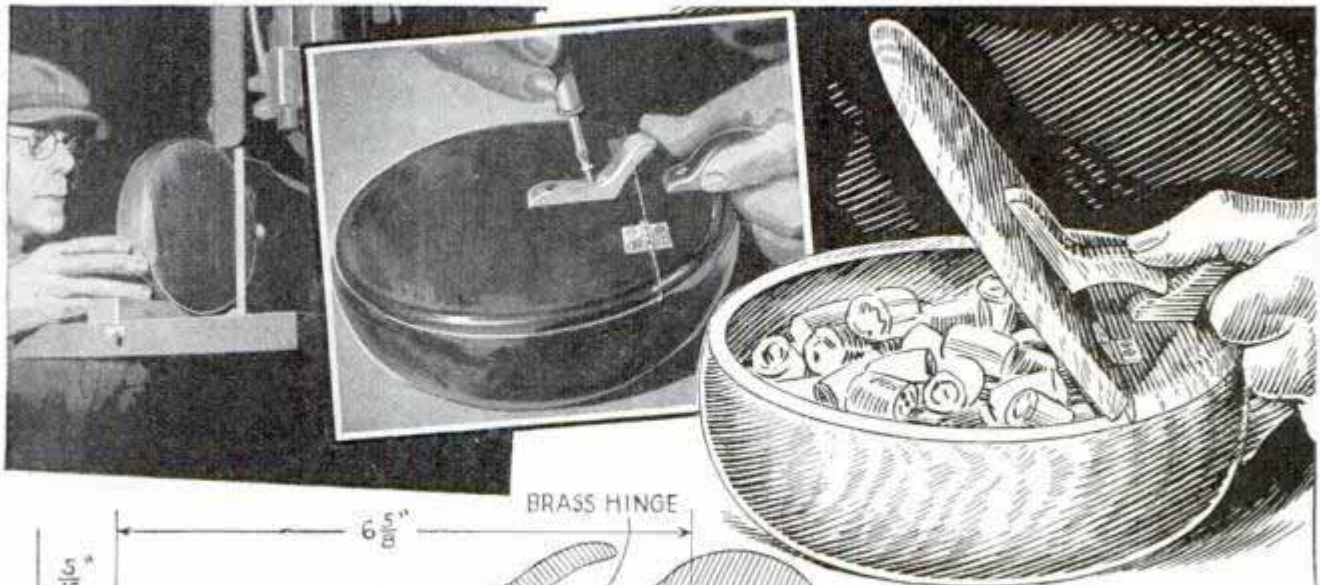

There's one unusual detail in the turning of this attractive wooden candy box, that is, the lid and box proper are turned and finished as one piece. First, you turn and recess the box to near the finished dimensions, making the sides and bottom about $\frac{3}{8}$ in. thick. Then saw the lid slightly over size and locate the approximate point where it is to be cut to get the hinged section. Slip a piece of wax paper under

this latter portion and spread glue between the fixed section and the box. Clamp in the lathe until the glue is dry. Then set the work up on the band saw as shown and cut the hinged section of the lid free. Set it back in place with spacers the width of the saw cut between the two parts and re-mount in the lathe with a block of wood over the lid to prevent marring. True up with light finishing cuts. Then install the hinges, handle and "trigger." The latter parts are fitted to the contour of the box by removing waste with a rasp until the fit is uniform. Then they are attached with screws and a spot of glue.

—Dale R. Van Horn, Lincoln, Nebr.

Shovel and Spade Tied Together to Make Post-Hole Digger

The town or city resident who occasionally wants to set a post and does not have a regular post-hole digger at hand, can improvise one from a spade and a coal scoop. These are tied together near the top of the handles, as shown in the detail. When connected together, the spade and shovel can be operated in much the same manner as a post-hole digger.

—W. Mack Angas, Winchester, Mass.

☐ To keep the inside surfaces of bread boxes and other tin containers from rusting, coat them with melted paraffin, especially the joints and cracks.

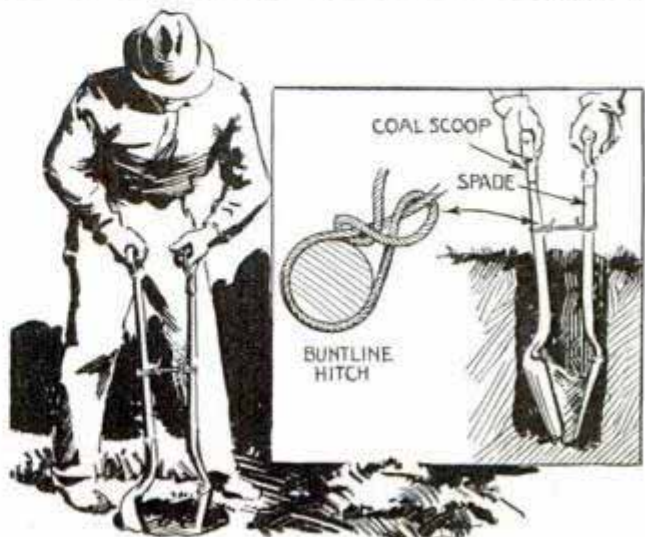



Easy Ways to Solve Your HOME

SMALL WOOLEN ARTICLES STORED IN FRUIT JARS ARE SAFE FROM MOTHS IF MOTH BALLS ARE ADDED AND JAR IS TIGHTLY CLOSED

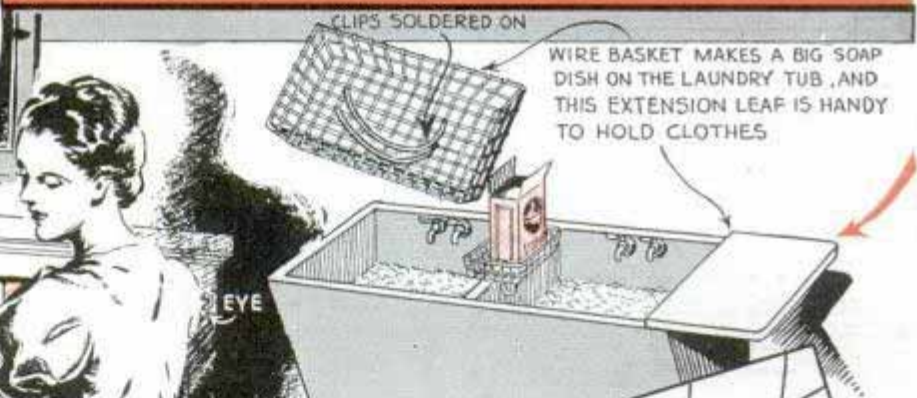

HOOK →
WINDOW SHADE
PROTECTING BOOKS FROM DUST WHEN SWEEPING

Rubber bands hold pail firmly on platform of stepladder
RUBBER BANDS
SCREW HOOK

SPOOL
Spool screwed to scrubbing brush eases hand strain

Looking through frosty window to read thermometer
GLASS OR CELLULOID DISK
FRUIT-JAR RING

FOOT SCRAPER
NOTCH
Extended stair tread notched to pull off muddy rubbers

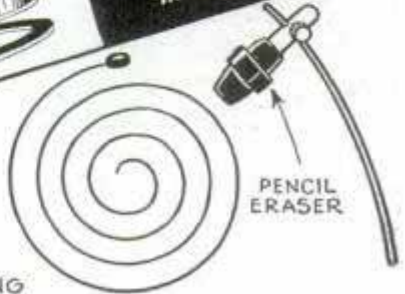

PENCIL ERASER ON CLOCK HAMMER SOFTENS LOUD STRIKING

To protect wallpaper from being soiled by fingermarks or by splashing you can use sheets of Cellophane, which are glued to the wall by means of transparent cement

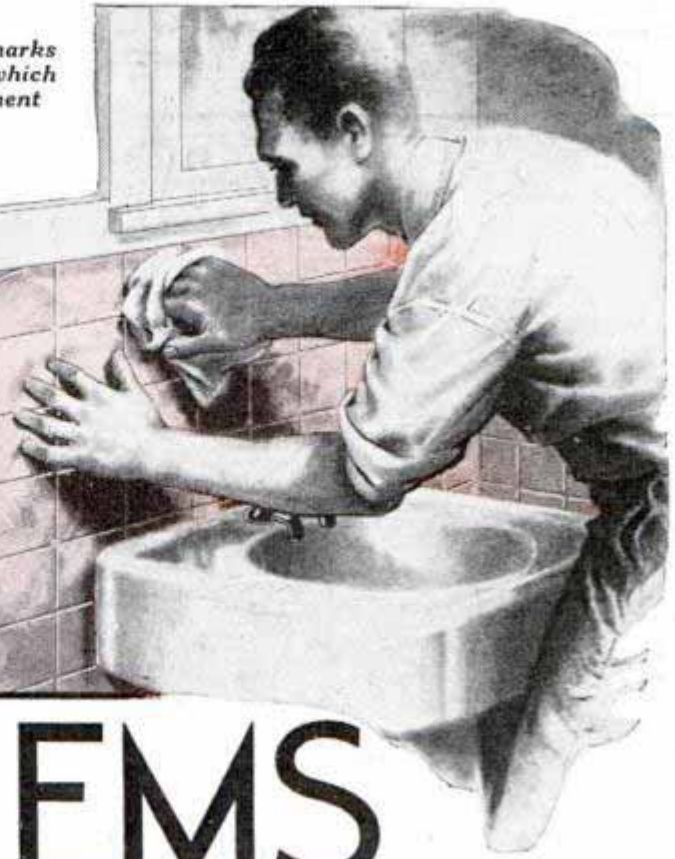
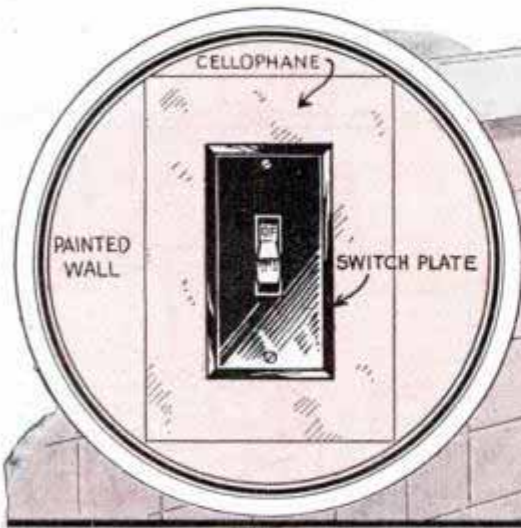

PROBLEMS

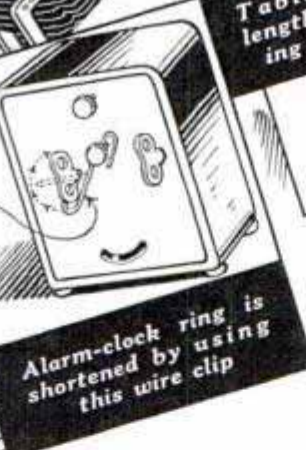
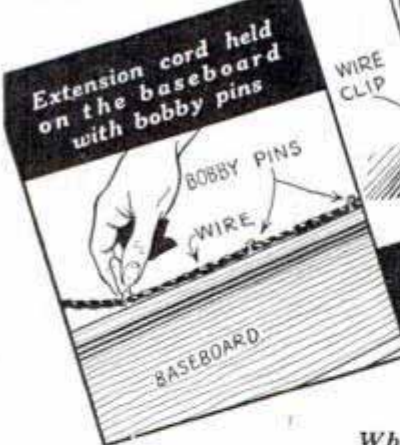
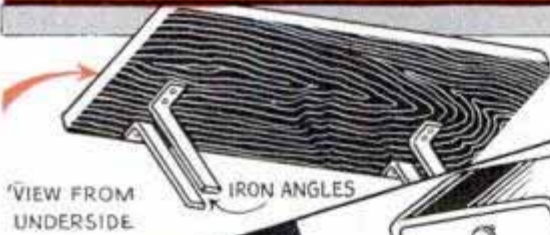
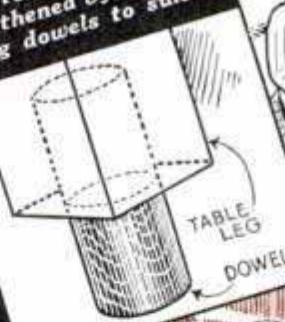
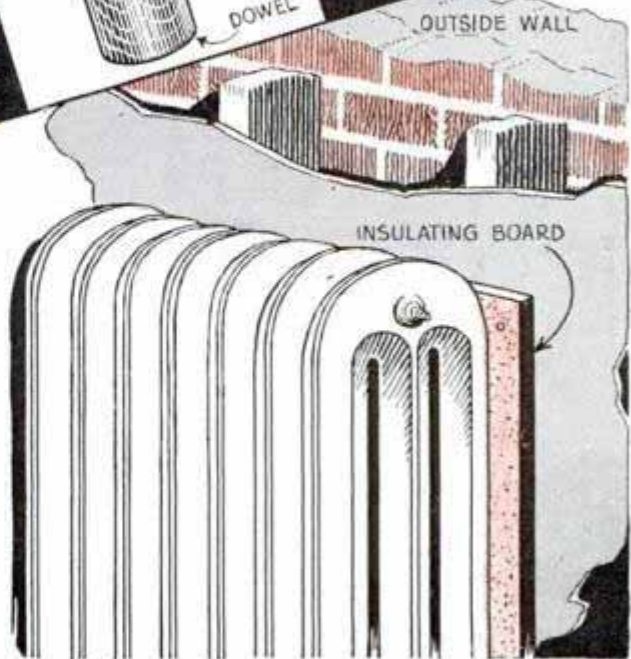

Table legs can be lengthened by inserting dowels to suit



Where a radiator is located against an outside wall, loss of heat through the wall can be minimized by the simple expedient of nailing a piece of suitable insulating board behind the radiator as shown at the right. Left, safety razor, with blade removed, is effective for scraping shavings from a bar of soap or a piece of ice



Bent Smoke Pipe Is Trued Up with Adjustable Iron Bands

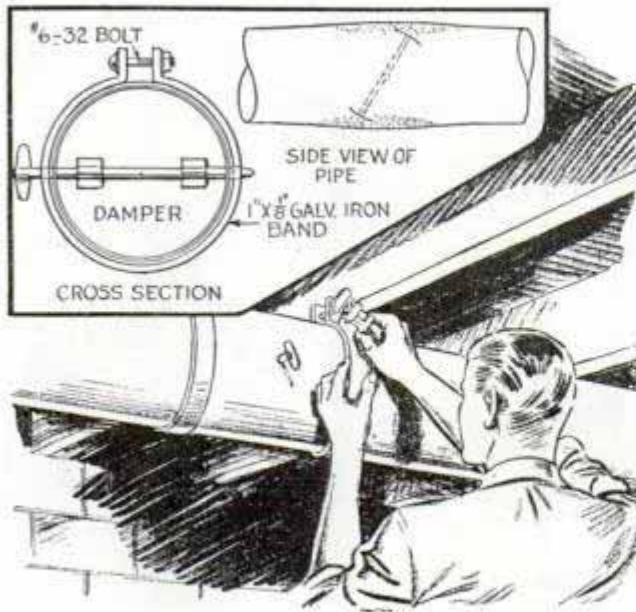

Bringing bent smoke pipe to its original contour by clamping it tightly with metal bands

If you have installed a damper in a smoke pipe and have bent it out of shape slightly in doing the job, the pipe can be brought back to its original contour by

clamping iron bands around it as indicated. The bands are cut from heavy sheet metal and are drilled and bent at right angles at the ends to take bolts with which they are turned up snugly around the pipe.

—L. H. Georger, Buffalo, N. Y.

Brush Holders on Mixing Tray

Instead of using one brush when retouching photos, which often calls for various tints and necessitates washing the brush several times, one artist attached a brush holder to the back of each section of the mixing

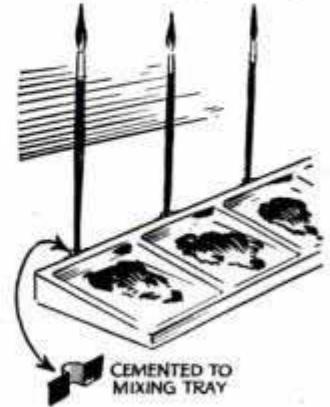

tray so that he could use a brush for each tint. The holders are small brackets bent from thin sheet metal to the shape shown. This arrangement allows the artist to work fast and with positive assurance that he will have the exact tints each time.

Venetian Blinds to Dress Up Your Windows



Tilted slats let in air and light without glare. Quickly adjusted at any desired angle for shade on sunny days or privacy at night. Our blueprints 926 and 927 cover the construction of three different types of Venetian blinds and will be sent postpaid upon receipt of a 50c remittance.

BLUEPRINTS ON WINTER SPORTCRAFT

18-FT. ICE BOAT—774: Roomy cockpit seats four people. 14-ft. mast, main sail and jib. 25c.

FRONT STEERING ICE BOAT—786: 13-ft. cockpit. Single sail on 18-ft. mast. Safe. 25c.

COASTING TOBOGGAN—657: 7½ ft. long by 16 in. wide. Includes data on bending slats. 25c.

8-FT. BOBSLED—632: Auto-type steering gear. Runner supports made from pipe fittings. 25c.

HOMEMADE SNOWSHOES—796 and 797: Prints show how to bend frames, and string rawhide. Two prints 50c.

AIR-PROPELLED ICE BOAT—785: Motorcycle engine drives a 52-in. airplane propeller. Has canvas-covered fuselage 8 ft. long. 25c.

Any six of these blueprints will be sent postpaid upon receipt of \$1.00

Blueprint Department, Popular Mechanics Magazine, 200 E. Ontario St., Chicago



Accurate SPIRAL FLUTING with this homemade jig

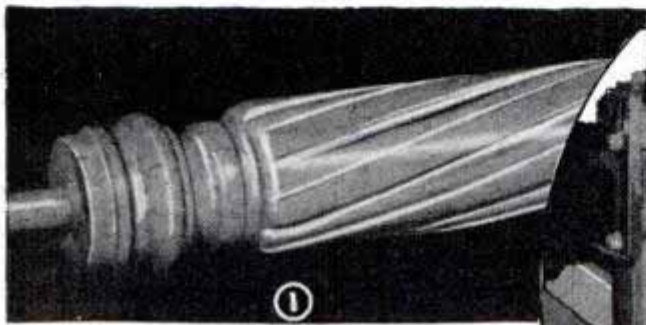

By EDWIN M. LOVE

USUALLY spiral reeding and fluting on a turned column means a tedious job of hand carving. However, if you take time out to build this simple jig, your shaper, drill press or lathe will do the hard work, and the variety of patterns will depend only on the assortment of shaper cutters at hand. Once set up, it takes but a few minutes to do the most intricate job, for the jig mounts the column on bearings and rotates it against the cutters as the assembly is pushed along the fence.

The ends of the jig are cut from scraps of 2 by 4-in. stock. Two ball bearings are obtained, not less than $\frac{3}{4}$ in. in diameter, and preferably larger. These are mortised into the jig ends by counterboring with an expansive bit as in Fig. 3, the smaller hole being large enough to clear the inner ball races. Side pieces are 36 in. long, to accommodate a 30-in. spindle. One bearing end is nailed rigidly in place, the other being screwed or nailed where needed when a column is mounted. Equidistant holes are drilled near the circumference of the index disks, the number being a matter of

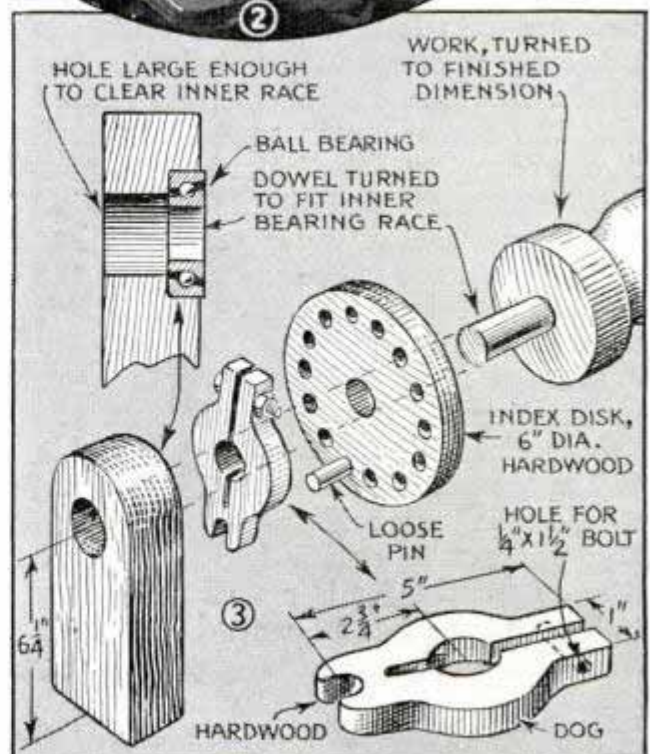

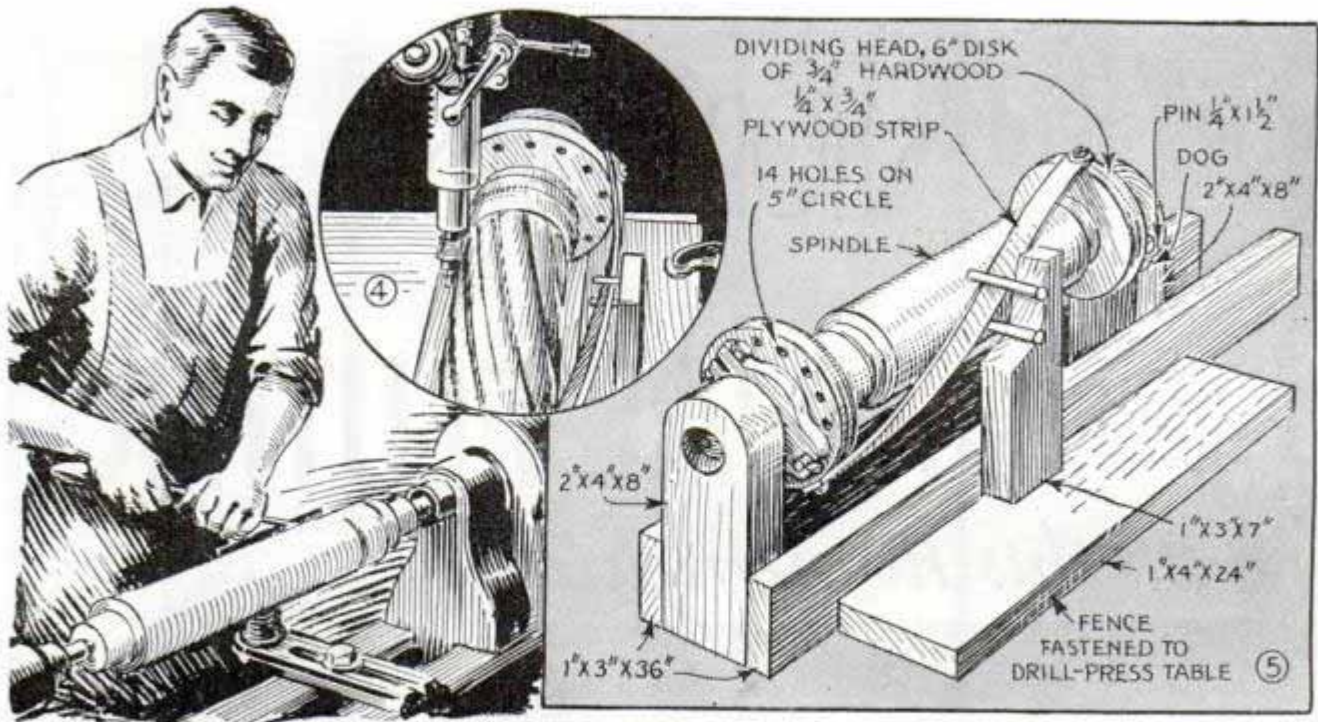

choice, although seven, or some multiple of seven, is usually sufficient for average work. Each hole is numbered with a lead pencil. The work is turned with dowels on both ends long enough to take the index disks, dogs and washers, leaving about $\frac{3}{4}$ in. to enter the bearings, Figs. 3 and 5. The spindle is mounted in the jig with an index disk, dog and washer on each end. For the spiral guide, a strip of plywood cut with the outer plies running crosswise is used. The ends are screwed to the disks as in Fig. 5. After one end has been fastened, the index pins are inserted in the holes numbered 1 to lock the disks. Then the guide strip is flexed to the desired spiral and the free end fastened to the second disk. The fence has an upright notched into one edge, Fig. 5, the latter being pieced out if necessary with a $\frac{3}{4}$ -in. strip, so that the upright will clear the spiral guide. For the upper pin use a $\frac{1}{4}$ -in. dowel; for the lower, a headless nail, bearing lightly against the guide strip.

When setting up the jig on a drill press, depth-stop parts are removed from the machine, the cutters put on and the table tilted to the angle of the spiral by resting the jig on the table and shifting it until the spiral appears to be level alongside the cutter. Then the jig is placed in cutting position and the fence clamped against it. After checking for easy movement, the jig is shifted until the cutter clears at the starting end. Then the machine is started

and the jig pushed slowly forward against the fence and table, Fig. 2. When the cut is finished the jig is removed, the index pins withdrawn and the disks shifted to holes numbered 3, and the process repeated until all seven cuts are made. If intermediate spirals of different pattern are desired, the shaper cutters are changed and the index pins inserted in the even-numbered holes as in Fig. 4.

The jig is used on a spindle shaper by laying it on its side, suitably blocked up from the table, and running the bottom against a fence, the cutters working at the top of the jig. Here the guide pins are mounted on the shaper table. A similar arrangement is used on a lathe, the cutter working on the upper side. When designing the column to be fluted, leave coves or small-diameter cylindrical sections at the starting end, Fig. 1, to clear the cutters. Tapered columns are fluted by using a dividing disk at the small end proportionally smaller than that at the larger end.

Correcting Balky Electric Clocks

If your electric clock has the motor sealed in a case packed with lubricant, and it suddenly stops, the trouble is often caused by the lubricant settling to the bottom. This can be corrected usually by turning the clock upside down for a few days, in which time the lubricant will re-distribute itself.

"Sewer Mole" Does the Work of Many Men



For cleaning out clogged drains and sewers at greatly reduced labor cost, an electric "sewer mole" was recently put in operation by a California contractor. Consisting of a powerful electric motor mounted on a movable carriage with several feet of flexible metal tubing inclosing the power drive wire, and the working unit at the end of the tubing, the machine is a compact laborsaving aid to cities and property

owners. The "teeth" are two sharp, adjustable steel blades, which rotate faster than the eye can follow. "Boring" into the sewer or pipe, they reduce any hard-packed mass of rubbish to loose material that can be flushed out with a hose. Only two men are required to use the machine, which can be operated several hundred feet from the obstruction in the pipe.

—Bob McLean, Oakland, Calif.

Glass Cutter Held in Lathe Tool Post Scores Any Size Disk

Those who have a lathe may use it for cutting glass disks if they have no circle cutter at hand. A block of wood is chucked in the lathe headstock and is faced up

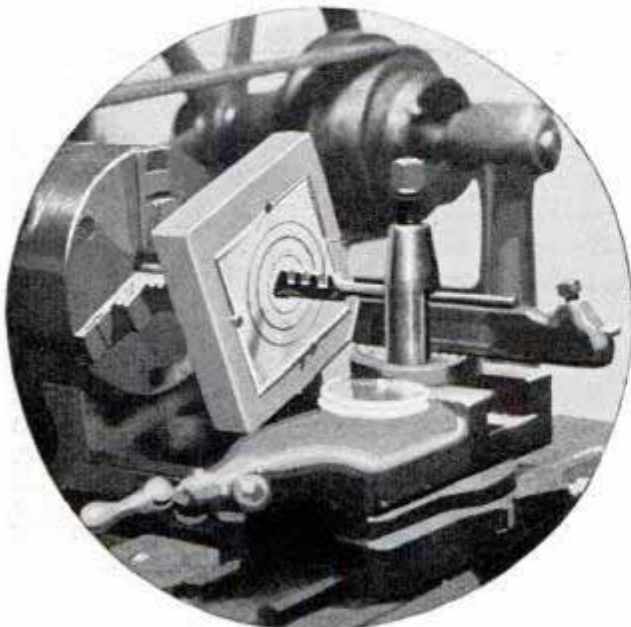

square, after which a piece of glass slightly larger than the disk required is fastened to the block by means of carpet tacks. Three of the tacks are driven into the block so that their heads just clear the thickness of the glass, while the fourth is pressed in with the fingers. This facilitates changing pieces of glass of identical size if you wish to cut a number of disks, as only the fourth tack has to be removed and replaced. Penciled circles may be scribed on the wood block for convenience in locating the glass cutter. This is gripped in the tool post and is lightly pressed against the glass, the chuck being rotated by hand. After the circle has been scored, the glass is removed from the block and several radial scores are made from the circle to the edge of the glass. This facilitates the removal of the disk from the square with little risk of breaking it when tapping the glass on the reverse side.

—J. L. Phelps, Lincoln, Nebr.

Stove-Wood Ricks Held Together by Woven Wire



Why have your ricked stove wood scatter when strips of woven wire will prevent the trouble?

When you rick up your stove wood or kindling, it's a good idea to lay strips of woven wire on the rick as you pile it so that the wood will not roll down as it is used. Place the strips of wire about 1 ft. apart. Any scrap or old rusty wire that you have lying around will do the trick.

Sliding Tray Under Bench Vise Catches Small Parts

Workmen and shop mechanics will find that a sliding tray underneath their vise is handy for catching small parts, which often fall to the floor when dismantling or assembling various kinds of work. The tray is a shallow sheet-metal pan with flanges projecting at right angles from the sides to slide in improvised grooves un-

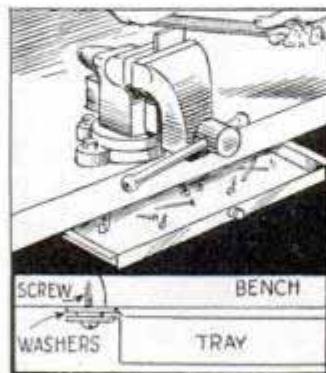

derneath the bench top. These grooves are made by screwing two strips of thin flat iron to the bench with washer spacers between them, as shown in the detail.

—Chas. H. Willey, Concord, N. H.

Novel Store-Window Caricatures from Merchant's Wares

Last season these clever little caricatures made from stock taken right off the merchant's shelves, proved highly effective in getting the attention of the holiday shoppers. Little Miss Muffet in Fig. 1, frightened by a large spider, makes an outstanding display with her cauliflower body, grapefruit head, and eyes of potato slices dotted with pea pupils. Carrot legs, and asparagus-stalk arms with a tomato spider pierced with green-bean legs complete the picture. Associated with Miss Muffet is jolly Santa, Fig. 4, directing attention to holiday foods. The Santa has a cheese face dotted with onion eyes having olive pupils, red-tomato cheeks, a parsnip nose and split-pea pod mouth surrounded by a mustache of peeled bananas and a cooked spaghetti beard. Carrots form fingers which hold a spoon. Santa threading a needle, in Fig. 5, centers interest on fancy work in a notions store. Buttons form amusing eyes, which are mounted on a cardboard face covered with silk. Silk-thread skeins serve as eyebrows and mustache. Wool yarn wound around a cardboard cutout comprises the beard and the hands are cut from heavy felt. Strips of fel. and fabric form the cap. The robot tennis match in Fig. 2 is the subject of an interesting display for hardware stores. Tea balls serve as the players' heads. The figure at the left consists of a potato masher, funnel, small cake pan, measuring spoons and a smaller funnel all held together with toothpicks and bits of adhesive tape. A potato masher, tube, spoon and a percolator cup comprise the other player. In Fig. 3, style comes to the kitchen in a novel utensil display. An inverted coffee pot, resting on a percolator stem, forms the head, with a twisted door spring serving as a coiffure. A pan cover with a cookie mold and an egg beater perched at a jaunty angle, form the bonnet. Numerous other figures can be assembled in the same way.



Eye-stopping

WINDOW DISPLAYS

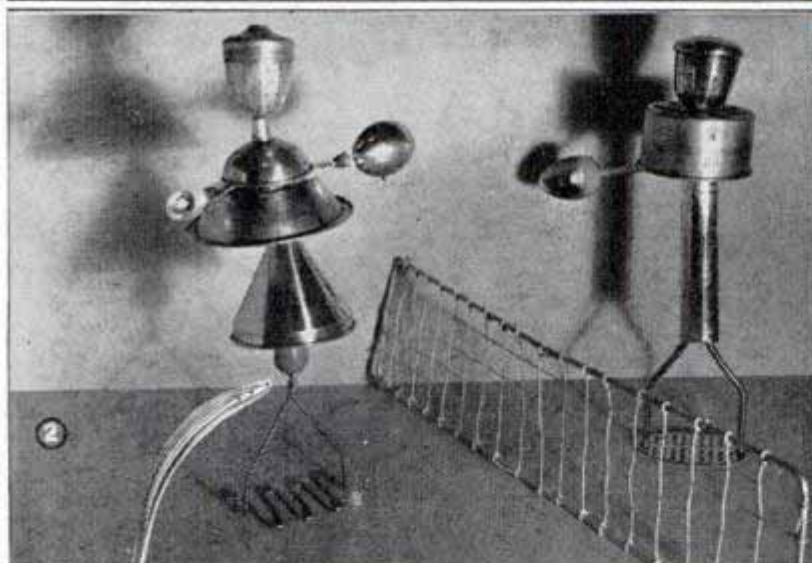

These suggestions closely tie up your merchandise with the display as all the figures are assembled from materials on your shelves. Figs. 1 and 4 are suggestive of fresh vegetables for the holiday season, while Santa in Fig. 5 reminds the shopper of yarns and fabrics for Christmas gifts. The robot tennis game in Fig. 2 and the stylish bonnet in Fig. 3 are appropriate for the hardware store, suggesting kitchen gifts and cooking utensils for the holidays.



Color Chart in Millinery Store Helps Customer Select Hat



Changeable color-chart support close to lady's hat enables her quickly to select color of new hat desired

Instead of having a customer try on several hats of different colors, the saleslady in a millinery store uses this color chart which enables a customer quickly to pick out a color to harmonize with the rest of her garments. The chart consists of a wire holder soldered or bolted to an adjustable standard, such as a music rack, and several pieces of cardboard of different colors which can be slipped in and out of the wire holder. In use, the standard is placed close to the customer as she looks into a mirror and the cards inserted until the color desired is found.

Machinists' Goggles Easy to Clean with Wash-Basin Stopper

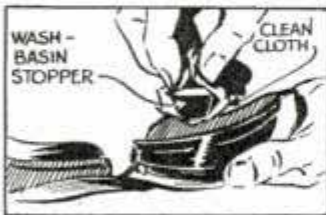

Those who have occasion to wear safety goggles at work, will find that a piece of cloth wrapped around a wash-basin stopper is ideal for cleaning the lens on the inside. When the metal ring is removed from the stopper, the boss projecting from its upper surface makes a handy finger grip for holding both the stopper and the cloth,

and the smooth bottom surface provides a good resilient backing for the cloth. The stopper allows a firm twisting motion which thoroughly cleans and polishes both inside and outside the lens.

—Frank Bentley, Clinton, Iowa.

Bolt Heads Flanged to Prevent Splitting Lead Grommets

When a job requires using lead grommets under bolt heads, they are likely to be split by the sharp edges of the head when tightened down on them, unless some precaution is taken to avoid this trouble. A good precaution is to turn a small shoulder on the underside of the bolt head, as shown in the drawing. It takes only a few minutes to do this, and is well worth the time required, especially when lead grommets are used only occasionally on certain jobs.

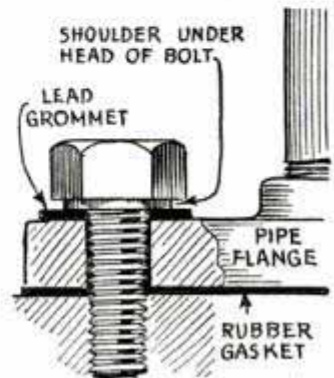

Clothespins Hold Window Cards

By whittling off the inside surfaces of the jaws of spring-type clothespins, as indicated by the dotted lines in the detail, so that the other ends form a wide angle, you can make inexpensive supports for window display cards. The spring in the clothespins is strong enough to allow the wood to be cut away from the edges to increase the spread of the other ends more than 1 in. and still retain a good grip on the cards. When painted a bright color, the pins are attractive and can be snapped on or off in a jiffy.



Castings will part easily from plaster molds if the latter have been smoked by holding them over a lump of burning rosin.

Baker Motorizes Hand Pastry-Filling Pump

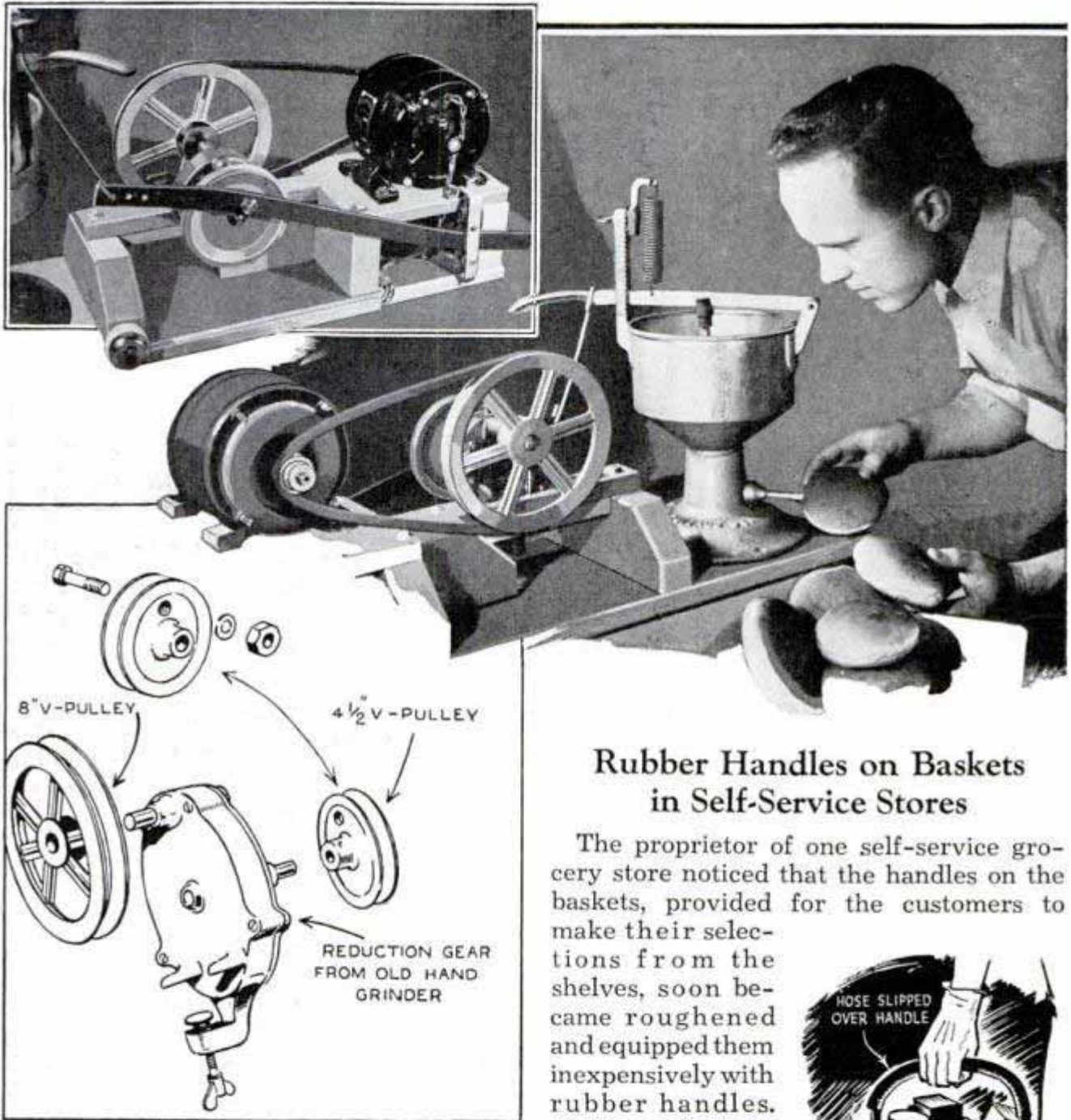

Rubber Handles on Baskets in Self-Service Stores

The proprietor of one self-service grocery store noticed that the handles on the baskets, provided for the customers to make their selections from the shelves, soon became roughened and equipped them inexpensively with rubber handles.

These are nothing more than short lengths of large-size garden hose, and were installed by removing the rivets from one side of the handle, slipping the hose in place and then replacing the rivets. Besides providing a smooth surface for the hands, the hose was found to be more sanitary than wood as the smooth surface is cleaned easily at intervals with a coarsely woven cloth and warm, soapy water.



Here's a simple method used by one baker to convert his hand-operated jelly pump to a power-driven outfit, which he claims works fast and uniformly in filling bismarcks, eclairs, etc. Speed reduction is obtained by using a hand grinder, V-pulleys being substituted for the handle and grinding wheel. The pulley on the handle shaft is fitted with a crankpin, which actuates an arm to operate the pump handle, the latter being connected by a heavy wire link. The other end of the arm is attached to the base of the outfit by means of a bracket through which it slides freely.

Baggage Counter Has Rollers to Slide Suitcases Easily

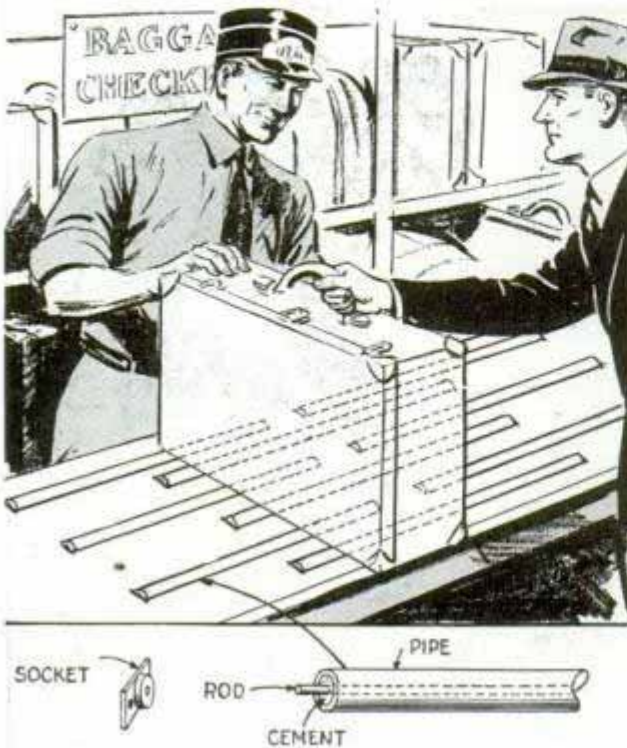

This baggage clerk rolls suitcases across the counter with little effort

To ease his job of sliding heavy suitcases and packages over the counter of a check room, one clerk fitted a number of rollers into the counter, as indicated. These were made by centering iron rods in lengths of pipe and then filling them with cement, the rods projecting slightly from the ends to fit in iron sockets screwed to the ends of the roller slots cut in the counter. The rollers should be staggered so the baggage rests on one or more rollers at all times.

Clamp Grips Band-Saw Blade While Brazing It



In one small shop where broken band-saw blades were brazed frequently, a workman made a clamp from a hinge to hold the broken ends of the blades together. The clamp consists of an ordinary strap hinge in which a large opening is

drilled to expose the ends of the blade to the torch flame. In use, the ends of the blade are butted together in alignment under the opening, after which a bolt through one of the screw holes in the hinge is tightened to hold the blade securely.

Small Clay Flowerpots in Molds Form Smooth Pouring Holes

In a foundry specializing in small brass and aluminum castings, clay flowerpots about 2 in. in diameter were found to provide good pouring holes in the molds. The bottoms are knocked out of the pots, which are then set in the sand as indicated. The pots also provide a hard lining that the metal will not cut or wash away as it does sand.

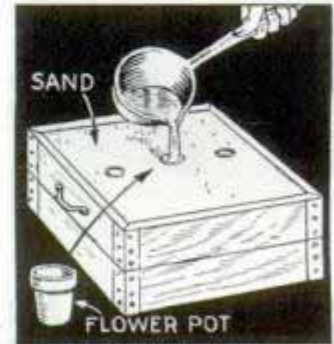

Chairs in Shoe-Shining Parlor Have Magazine Racks

To provide his customers with reading matter while having their shoes shined, the owner of one shoe-shining parlor fitted the chairs with magazine racks. These were made of thin plywood, painted and then screwed to the legs of the chairs.



Magazine racks on chairs of shoe-shining parlor keep reading matter at hand for waiting customers

IMITATION MARBLE

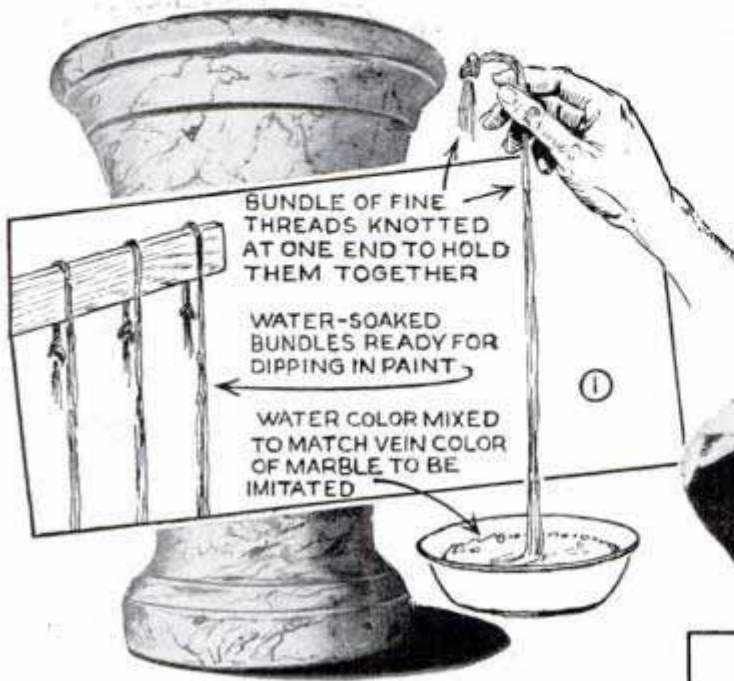

After webs are dipped in colors the bundles are spread and arranged in the greased mold

By J. MODROCH

*Conn
R F L 2 Hanbury*

"SCAG" is the shop term usually applied to imitation marble cast by this process. The trick is simple once you have seen it done. Webs of extra-fine silk thread saturated with water color serve as a vein pattern. Superfine plaster-cement, which sets with a smooth, hard, glassy surface is used as the casting aggregate. Veins are embedded in the cast by laying paint-soaked webs in empty mold sections, Figs. 1 and 2, covering them with a thin layer of aggregate and then lifting them out as in Figs. 3 and 4. Thus, color patterns of the webs are left imprinted in what becomes the surface layer of the finished casting, since the inner bulk of the aggregate is not poured into the mold until after the "scagging" operation has been completed. The result, when polished and waxed, is a realistic likeness of marble that even an expert might not detect as being imitation.

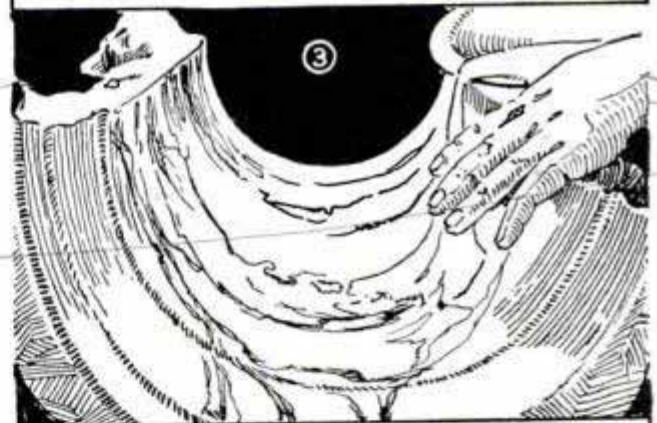

"Scag" layer is built up by sprinkling thin layers of dry and wet aggregate over webs



Before the aggregate sets, the webs are lifted out of the molds

In preparing webs, the threads are divided into bundles, about the diameter of a pencil, and each is knotted at one end, Fig. 1. After cutting to convenient lengths, the latter depending on the size of the job, bundles are thoroughly soaked in water before being dipped in the paint. Dark-blue water color was used in casting the

*260 W. Broadway
New York
Cement - imported by
Whittaker, Clark and Landis*

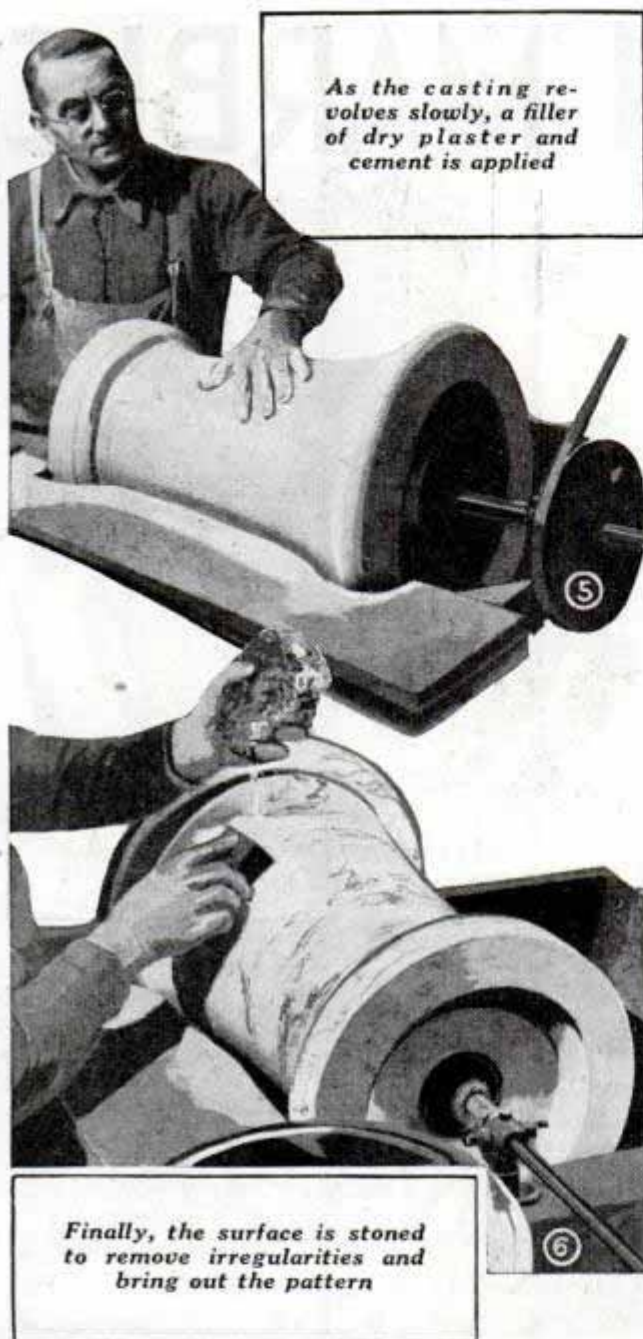

vase shown. Many kinds of marble can be imitated since it is only a matter of mixing paint to match the color of the original.

Spreading paint-soaked bundles requires four hands. The bundles are simply pulled apart, allowing the threads to separate and clot however they will. The webs thus made are then laid in greased mold sections, Fig. 2, being placed so that they overlap slightly where more than one web is required to cover the mold completely.

The scag layer is built up by sprinkling succeeding thin blankets of dry and wet aggregate over the webs, Fig. 3, until the layer not only covers threads but also reaches a sufficient depth to allow for stoning down later on. Fig. 4 shows the

web being lifted out, which completes the scagging operation. However, as further protection against disturbing delicate veins of embedded color, additional layers of aggregate are carefully troweled on over the scag layer before the mold is assembled and the rest of the aggregate poured.

After castings have been removed from the mold, mold seams and other irregularities are leveled off with a medium-surfaced water stone and a filler of dry plaster-cement is applied with the hands, Fig. 5. Allowing time for the filler to set, the surfaces are polished with a fine-surfaced stone, Fig. 6, then washed with water and given a final finish of wax.

Dead-Center Gauge for Cutting Accurate Threads

On thread-chasing jobs where accuracy in centering a threading tool is very important I use the gauge shown. To make, use a good grade of steel or machine-steel deeply case-hardened. First turn it to within .020 in. of the diameters given after squaring the ends, and milling the flat, bearing in mind that you must leave enough for grinding, as stock must be removed from two sides when the .250-in. dimension is considered. After hardening, lap the two centers and rough grind to .5005 in. This one-half thousandth allows for lapping. Then grind on centers to .25075 in. on the flat, which allows .00025 or $2\frac{1}{2}$ tenths for lapping the flat. When lapping to

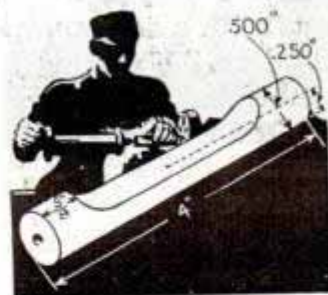

.500 diameter use a lap that is at least 3 in. long to take care of the open part of the gauge. The flat part of the latter is lapped last. To use the gauge, set it between the lathe centers with enough tension to permit it to be turned with the fingers. Set your threading tool as near dead center as you can see with your eye and move the threading tool to the center of the gauge. You can rock the gauge against the threading tool point if it is below dead center. If it is above, you will not be able to get the tool point on the flat of the gauge.

—James MacIntyre, Hartford, Conn.

Spring Band Holds Sack Open

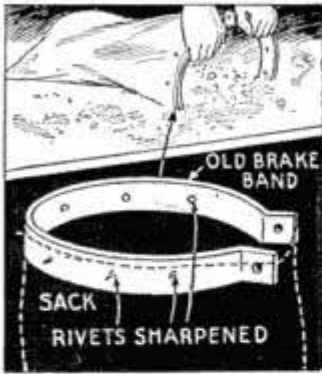

Made from an old auto brake band of the external type, this simple device will be found useful for holding open the mouths of sacks and bags. It is especially handy when removing

the contents from a bag or when using it to dip up material from a pile. Pointed prongs to puncture the upper edges of the sack are made by inserting rivets through holes in the band and pointing the projecting ends with a file.

Tool Chest Serves as Light Bench on Outside Jobs

To avoid stooping to get tools from a chest, and to provide a handy little bench for light assembly work, a plumber mounts his chest on detachable pipe legs. Floor



Plumbers and others will find this tool-chest bench handy on jobs away from the shop

flanges are screwed to the bottom corners of the chest to take the legs. Long threads on the legs allow for adjustment to level the bench on uneven floors.

☐ For mailing film packs of certain sizes, you will find a flat cigarette tin satisfactory.

Customers Can Test New Shoes on Improved Walk



RUBBER MATTING

Customer tests new shoes under regular walking conditions with this novel platform

Simulating almost any walking conditions the wearer may encounter, this test walk in a shoe store enables a customer to test out a new pair of shoes before leaving the store. The walk consists of a narrow platform about 1 ft. high in the center with both sides sloping to the floor as indicated. The top surfaces of the walk are covered with rubber mats to prevent slipping.

Tiny Socket Wrenches Are Made from Set Screws

Needing some socket wrenches smaller than could be obtained from the usual sources, I made up a set from hollow-head set screws, which are often used for fastening collars or pulleys to rotating shafts. The wrenches are made by merely brazing the set screws to handles shaped from small drill rod, and have been found ideal for work on radios, electric meters, clocks, and other small work.

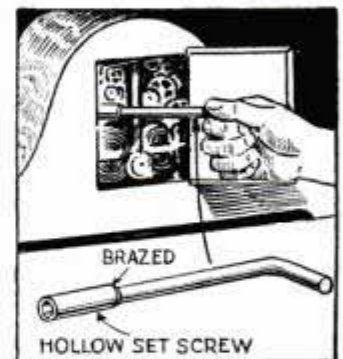

—J. R. Coursey, Dallas, Tex.

Movers Use Rubber "Bumpers" to Protect Door Casings

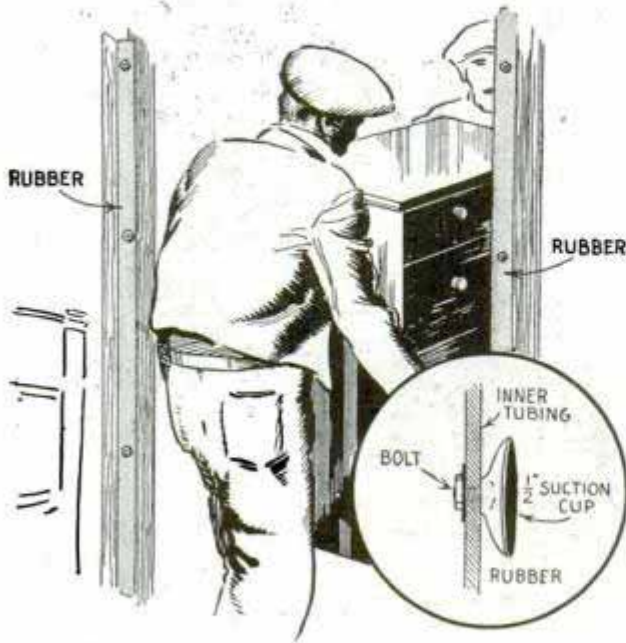

Strips of heavy rubber on door casing prevent woodwork from being marred

To avoid marring woodwork in a house when carrying out furniture, one moving man uses heavy rubber strips which he fastens to the edges of the door casings with suction cups. These are the type that come fitted with small anchoring bolts, the latter being inserted through holes made in the rubber and the nuts covered with layers of electricians' rubber tape. When the workmen go into a home, it takes only a minute to install the rubber "bumpers."

—Earl Wellersdick, Torrington, Conn.

Spiral Iron Stakes to Hold Concrete Forms



In setting up his concrete forms on the ground, one contractor uses twisted iron stakes, which he claims are easier to drive and will hold better than straight ones. They are made from heavy flat iron which is heated, clamped in a vise and twisted, about three turns being made in each running foot of metal. When

taking up the forms, the stakes are removed by merely screwing them out of the ground with a long-handled wrench.

Oil-Soaked Bricks Make Fuel for Heating Sand

Instead of using coal or wood to heat sand and other materials on a construction job during cold weather, one foreman substituted oil-soaked bricks. These burn steadily for some time, require no poking or other attention to keep them burning, and there are no ashes



to accumulate and clog the draft. A number of the bricks may be kept in a pail of oil drained from auto crankcases.

Dampness under Show Window Avoided with Blower

The problem of keeping the area under a show window dry during summer and preventing condensation on the glass during winter is solved with the simple installation shown. This consists of a small motor-driven blower which forces air through 4-in. slots along the edge of the window to prevent condensation. The slots are covered with a metal grille so that air from the blower can pass through them. During summer the slots are covered with pieces of glass to admit sunlight.

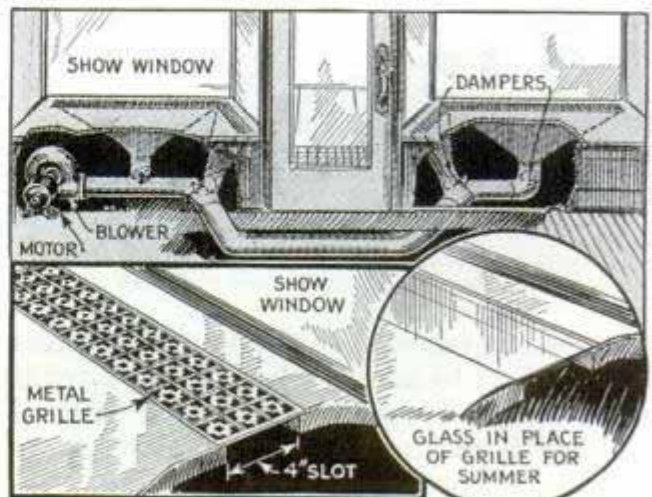

Glass-covered slots let sun dry out area under show window in summer and emit air from blower in winter

Turn Right!

PART 2

FACEPLATE and CHUCK TURNING



AS ALL lathe work cannot be turned between centers, but must be mounted on a faceplate or chuck, the correct method of working is far more important than skill in the handling of the turning tools. The turning of a ball is a typical example. Where the ball is over 2 in. in diameter, the method shown in Figs. 1 to 7 inclusive should be used. Stock for the job is first squared up, and is then marked on two adjacent sides with a circle slightly larger than the size of the required ball. The shape thus marked is cut out on a band saw, the pieces from the first cut being bradded back in position to permit making the second cut. The resulting shape is roughly blackened with a soft pencil along the center area of each of the four sides, after which the work is mounted in the lathe between centers. Using first a gouge and then a skew, the wood is turned down until the pencil mark shows as a

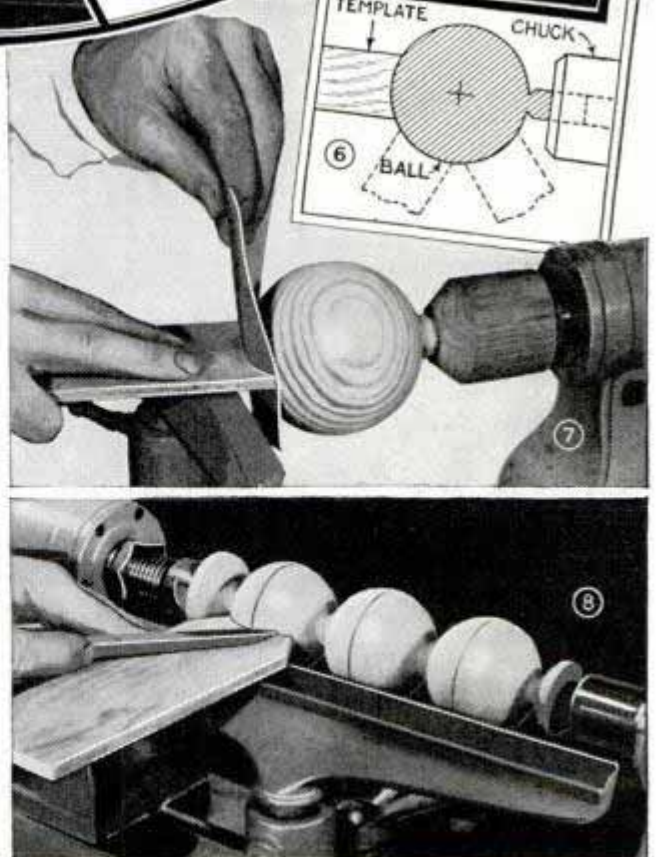

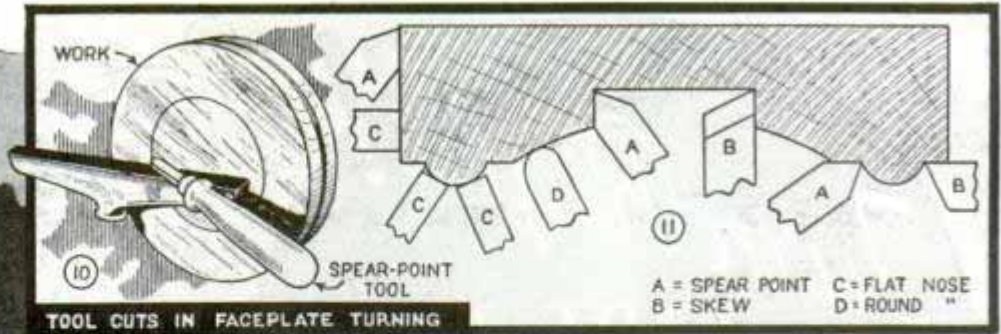
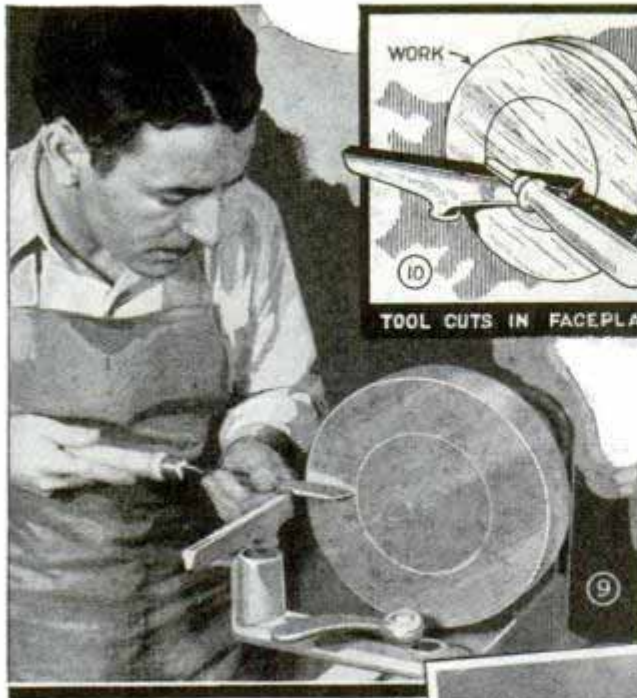

faint line, as in Fig. 4. Next, carefully caliper and turn the narrow neck at the dead-center end to $\frac{3}{4}$ -in. diameter. The ball can now be cut off at the live end, as in Fig. 5. A wood chuck is made up, and is mounted on the single-screw center, or, better, fitted by means of a set screw to the end of

the lathe spindle. The chuck has a $\frac{3}{4}$ -in. hole in it to take the stub of the ball, as can be seen in Fig. 6. Sanding with a piece of paper held between the ball and a $\frac{1}{4}$ -in. plywood template of the same diameter as the ball, as shown in Fig. 7, will bring it to

an exact round, after which it is cut off carefully. Where several balls are to be made, they can be turned in line, as shown in Fig. 8. Notice that a spear-point tool is worked directly over a wooden template to obtain the proper shape at the center of each ball. After the center is perfect, the balls can be cut apart and finished in a cup chuck, shown in Figs. 33, 35 and 36.

Figs. 9 to 11 show various cuts used in faceplate turning. Differing from spindle turning, practically all cutting on faceplate work is done by scraping. The chisel must be in line with the center of the work, especially when the face of the disk is being worked. Fig. 9 shows one of the most common

methods of surfacing, in which a skew chisel is advanced across the face of the work. Surfacing is also done with the edge of a spear-point chisel, as shown in Fig. 10,

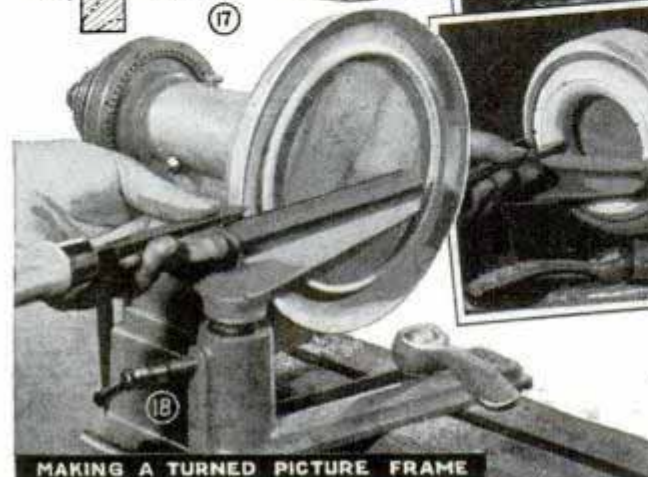
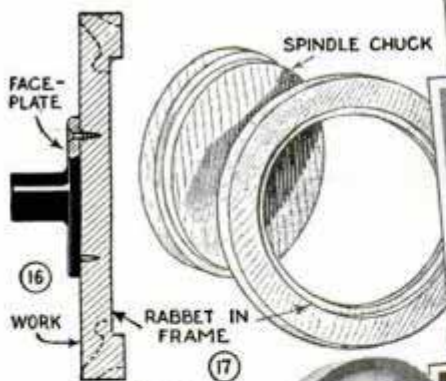
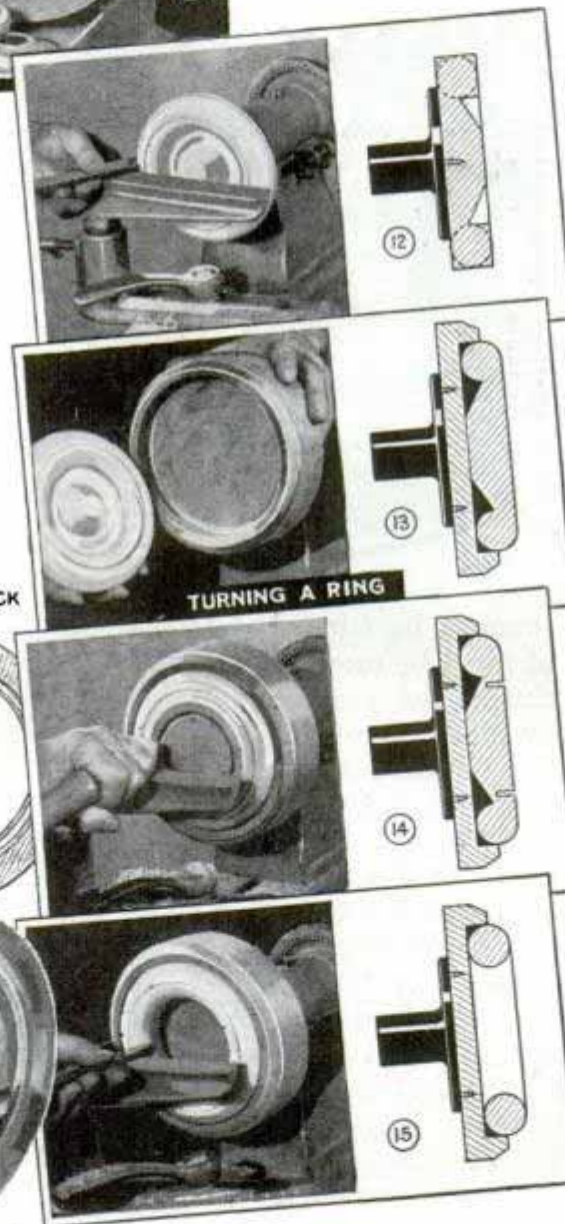

MAKING A TURNED PICTURE FRAME



TURNING A NAPKIN RING ON A SPINDLE CHUCK

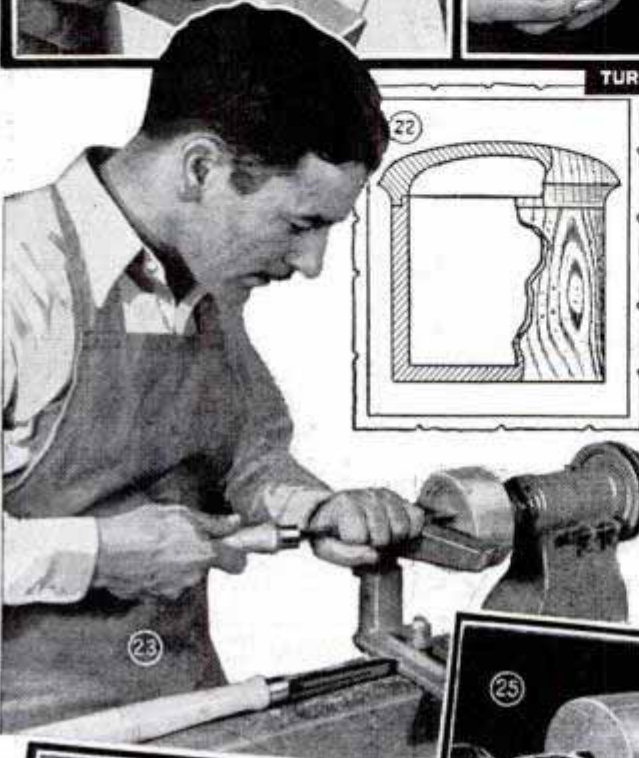

back of the frame is cut first, this being done while the work is mounted on a faceplate, as shown in Fig. 16. The rim is then used to hold the work on a spindle chuck, as shown in Figs. 17 and 18.

The turning of napkin rings and similar hollow cylinders offers another example in the use of the spindle chuck. As shown in Fig. 19, the napkin ring is first finished on the outside and bored halfway through, this being done while the work is mounted on the single-screw center. A suitable spindle chuck is then made up to fit tightly inside the ring, as shown in Fig. 20. Mounted on this spindle chuck, the opposite end of the ring can be turned out, Fig. 21.

Boxes and similar turnings whose bottoms are too thin to take screws must be mounted on backing blocks. In the example, shown in

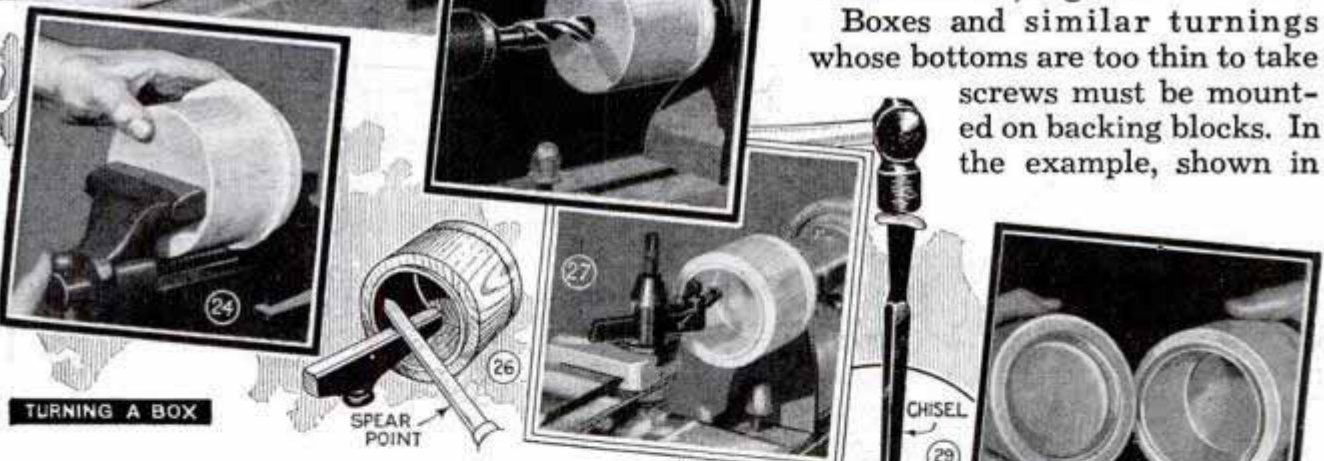

TURNING A BOX

and also can be done with a flat-nose chisel. A job that involves both faceplate and chuck work is the turning of a ring, as shown in Figs. 12 to 15. The work is first fastened to a suitable faceplate to permit the outer portion of the ring to be turned, after which the partly finished ring is put in a recessed chuck. This must be turned carefully so that the ring will be a "press fit." A parting tool now is used to cut away the center of the ring. Templates should be used frequently to check the progress of the work. Turned picture frames and trays are worked in much the same manner as a ring. The recess in the

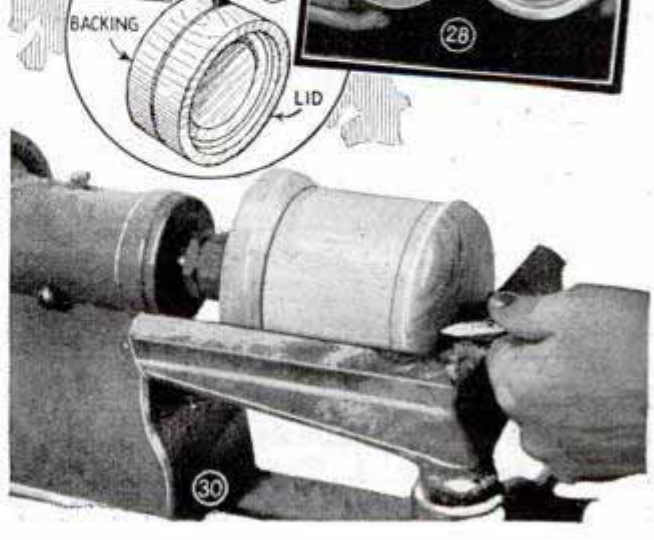

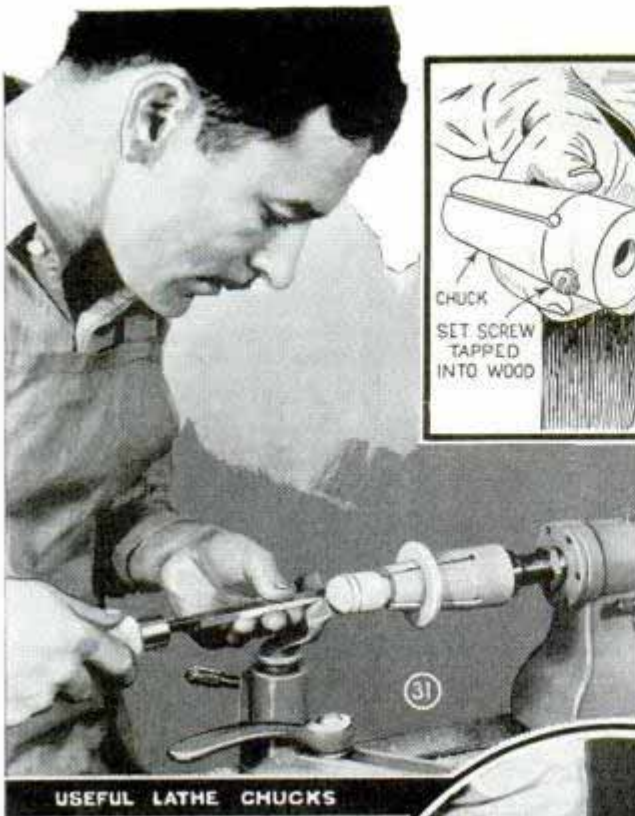

best done with a flat-nose chisel by inserting it into the backing block about $\frac{1}{8}$ in. away from the joint and in the end grain, as shown in Fig. 29. The lid is now mounted on the box and the outside of both lid and box turned, Fig. 30. Keep the work on the faceplate until it is polished or otherwise finished, then sand the joint between the box and the lid lightly for a good working fit, and remove from the backing block.

Chucks, other than those already mentioned, are frequently useful in lathe work. A common type is shown in Fig. 31 and in 32. This chuck can be made any suitable size to accommodate the work. In use, the work is first turned between centers to

form a plug which can be gripped tightly in the chuck by means of plywood ring. Fig. 34 shows a similar chuck, but without the expansive feature. The hole can be tapered or straight as de-

USEFUL LATHE CHUCKS

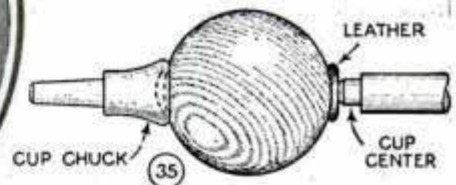
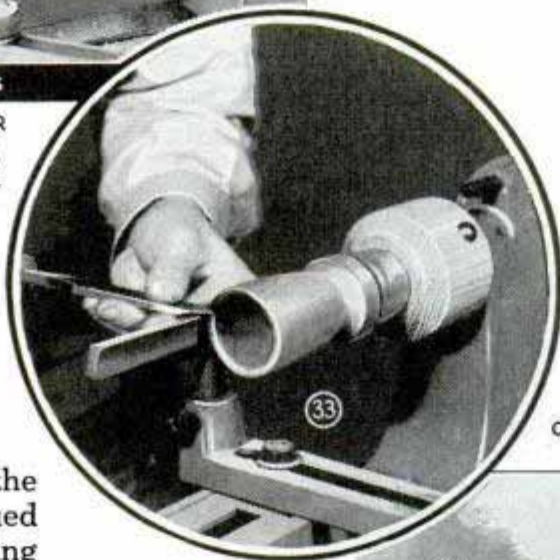
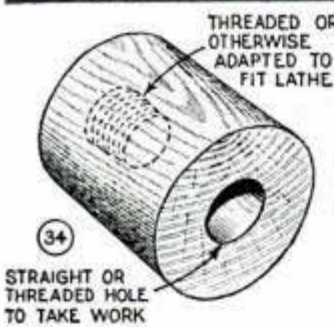
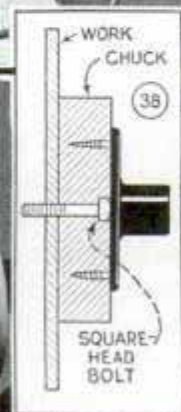
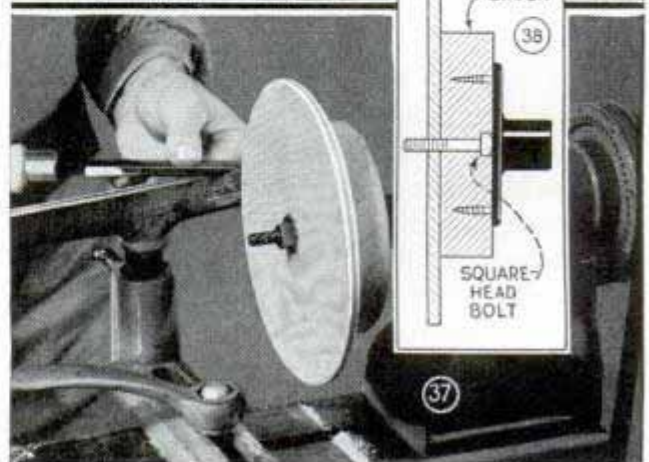
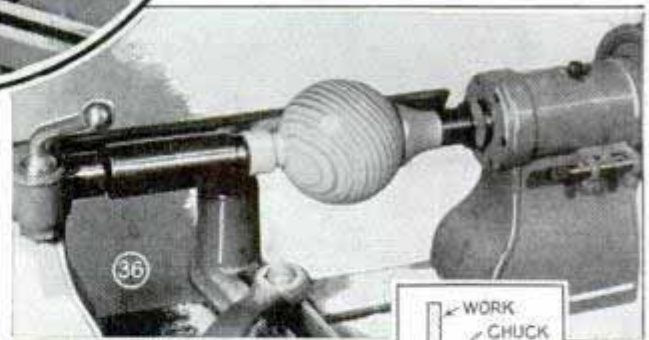

Fig. 22, the stock for the body of the box is glued to a soft-wood backing block, Fig. 24. A piece of paper must be placed between the joints so that the work can be separated easily from the block. The lid for the box is mounted in the same manner on a second block, this, in turn, being fastened to a suitable lathe faceplate.

The inside of the lid is turned first, Fig. 23, after which the inside of the box is turned out, Fig. 27. If you have a slide rest, by all means use it for deep boring like this. The center can be turned out equally well, however, with a spear-point chisel or skew, as shown in Fig. 26. In either case, it is usually simpler to start the hole by drilling, as in Fig. 25. The inside of both lid and box completed, the lid can be tested on the box, as indicated in Fig. 28. A tight fit is essential. The lid can now be separated from its backing block. This is



sired. This kind of chuck is ideal for turning wood goblets and similar work, as shown in Fig. 33.

Figs. 35 and 36 show a cup chuck, which is frequently used in turning balls. The use of the cup chuck for such work involves two important points: The portion of the ball which is seated against the chuck must be finish-turned; if it is not correctly shaped, the work will be out-of-center. The tailstock support for the ball must turn with the work in order to prevent burning. A spinning center, as shown in Fig. 36, solves this problem perfectly, but good results can be obtained by simply inserting a piece of leather between the ball and the cup center, as shown in Fig. 35. Figs. 37 and 38 show a useful chuck for turning disks and other work having a central hole. Its construction and use are apparent from the sketch and photo.

Lamp Rheostat Controls Speed of Electric Motor

To control the speed of a motor driving a mixing machine in a bakery, this simple lamp rheostat has been used successfully.

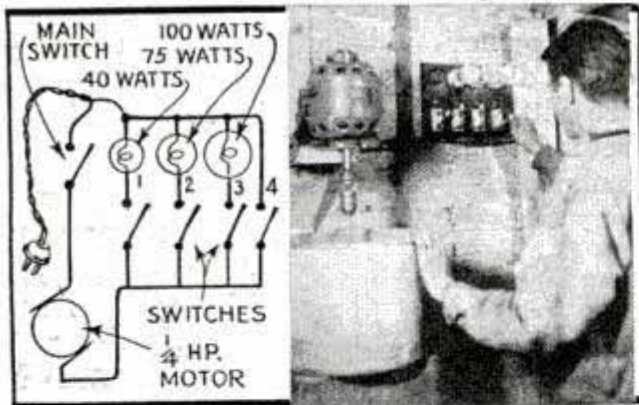

Rheostat consisting of three electric lamps used successfully to control speed of $\frac{1}{4}$ -hp. motor

As shown in the detail, the rheostat consists of a 40, a 75 and a 100-watt lamp, each provided with a switch so that any one of them can be cut in. Also, there is a fourth switch to operate the motor on full amperage and a main switch to cut off the current entirely.

—Pat Fairmont, Cleveland, O.

When placing a dish on ice, put a fruit-jar rubber under it. The ring will adhere to both the ice and dish and tend to prevent slipping

Small Gutter on Show Window Keeps Water Off Sidewalk



Gutter at bottom of show window drains dirty water into a bucket and keeps it off sidewalk

Getting dirty water on sidewalks in front of stores, which often results when washing the windows, can be prevented by using a small gutter or trough at the bottom of the glass as indicated. The gutter is a permanent fixture and is attached at a slight angle so water running into it will drain into a bucket placed at one end.

Jig for Wiring Light Sockets

Used to speed up the work of wiring light sockets, this jig consists of a $\frac{1}{2}$ by 4-in. pipe nipple screwed into a floor flange, which is bolted to a bench top. The brass base of a standard light bulb is cleaned out and soldered to the top of the pipe. In use, a socket is screwed into the base, the cap removed and the shell allowed to slip down out of the way while connecting the cord to the binding terminals.—W. C. Wilhite, Carlinville, Ill.

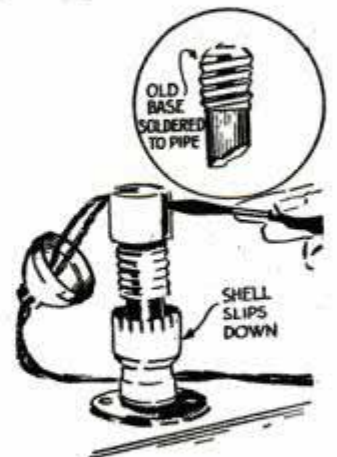

Barrel Carrier on Bicycle Wheels Is Easy to Push

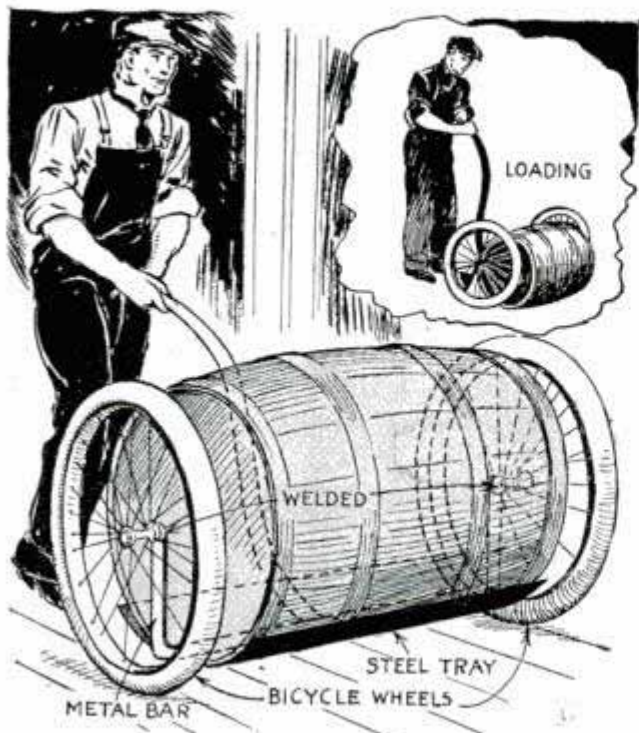

Heavy barrels are easily loaded onto this carrier as it only clears the floor by about 2 inches

This simple carrier will be found handy in factories, warehouses, etc., where the workmen often have to move heavy barrels. It consists of a curved sheet-steel tray, which is riveted to a metal-bar axle. This is bent to a U-shape so that it reaches almost to the floor when the bicycle-wheel spindles are welded to its ends. A long curved handle is also welded or bolted to the axle. The tray must be of strong metal that will not bend easily.

Cartridges Hold Artist's Crayons

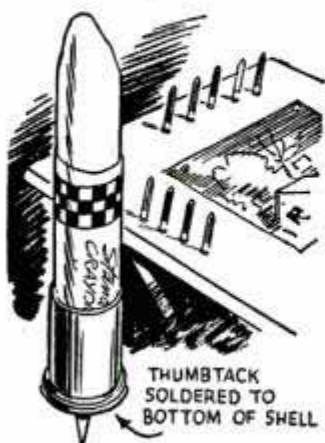

bottom of the shells so that they could be placed on the drawing board in any convenient position. If necessary, the ends of

To keep his crayons neatly arranged on the drawing board where they would be within easy reach, one artist made a number of holders from large cartridge shells that had been fired. Thumbtacks were soldered to the

the crayons can be shaved down to slip into the cartridges easily. Or, the ends of the cartridges can be flared with a hardwood stick tapered sharply at one end.

Jeweler Keeps Tiny Watch Parts in Rubber Rings

To keep small screws, wheels and other parts of a watch or clock from being scattered over the table when taking it apart for repairing, one jeweler uses rubber rings $\frac{1}{4}$ in. wide, which he cuts from the end of a large garden hose. He finds the rings especially useful in keeping the parts of individual watches or clocks separated, and, being quite shallow, the rings allow the tiny parts to be picked up easily.



Pastry Displayed by Mirrors Set at 45-Degree Angle

The owner of a bakery has a novel method of displaying his pastries. The goods are set on a shelf and a mirror is placed behind them at an angle of 45° . Strips of molding at the top and bottom of the display shelves hold the mirrors in place.

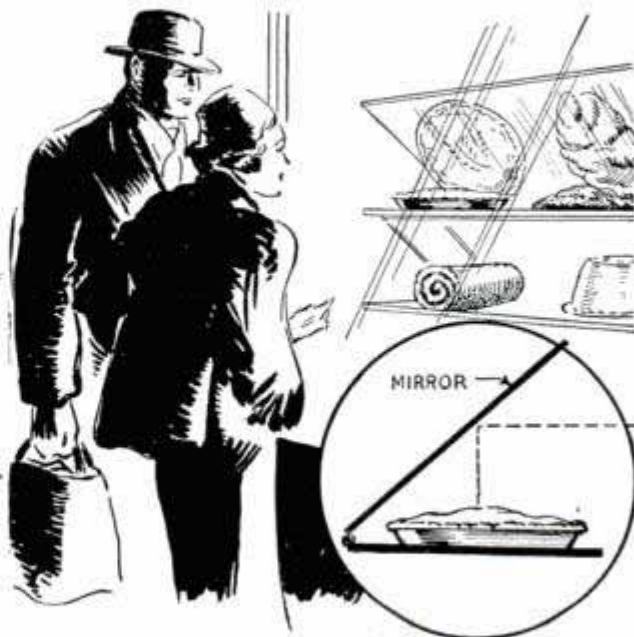

Mirror displays pastries set on shelf so customers can get a top view

AUTO

Short Cuts

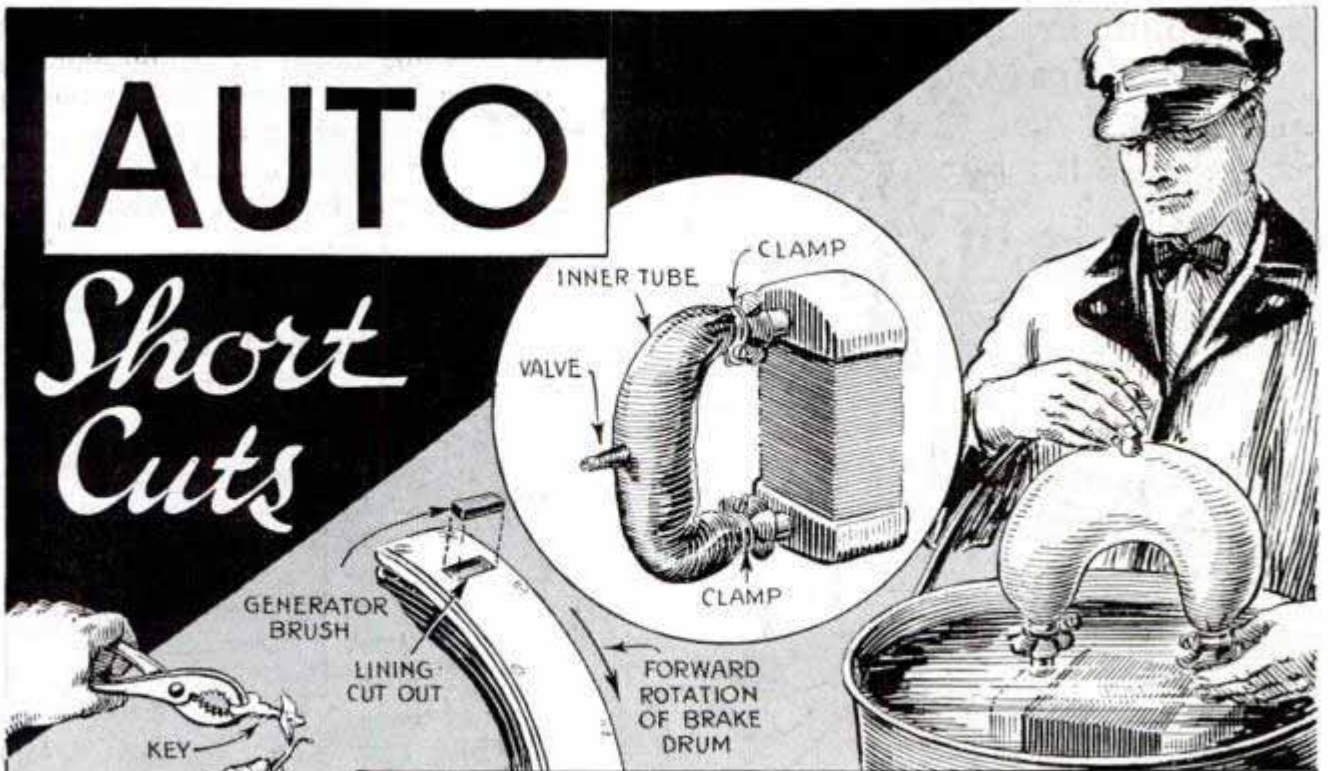

Above, leaks in hot-water heater indicated by bubbles when heater is submerged in tub of water and air pumped into the section of inner tube

Mortised into the brake lining about 1 in. from the end, a small insert shaped from an old generator brush will often "cure" groaning of brakes

A frozen door lock is thawed by preheating the key before inserting it

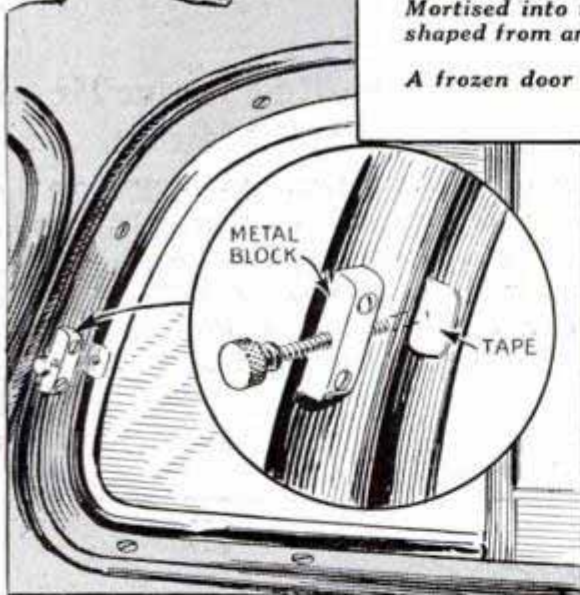

Entering a car by prying out the trailing edge of a no-draft wing is prevented by use of a metal block fitted with a long thumbscrew and fastened to the window frame as above. The screw is turned to bear against the wing frame

Insulating your oil pan as above keeps the oil at a uniform temperature in cold weather. A sheet-metal pan holds the insulation in place

Clogged grease holes in shackle bolts can be opened by directing the flame of a blowtorch on them for a minute to melt the hardened grease

Right, if the armature of a starting motor is rubbing, a feeler gauge held close to the housing will be attracted to it when motor rotates

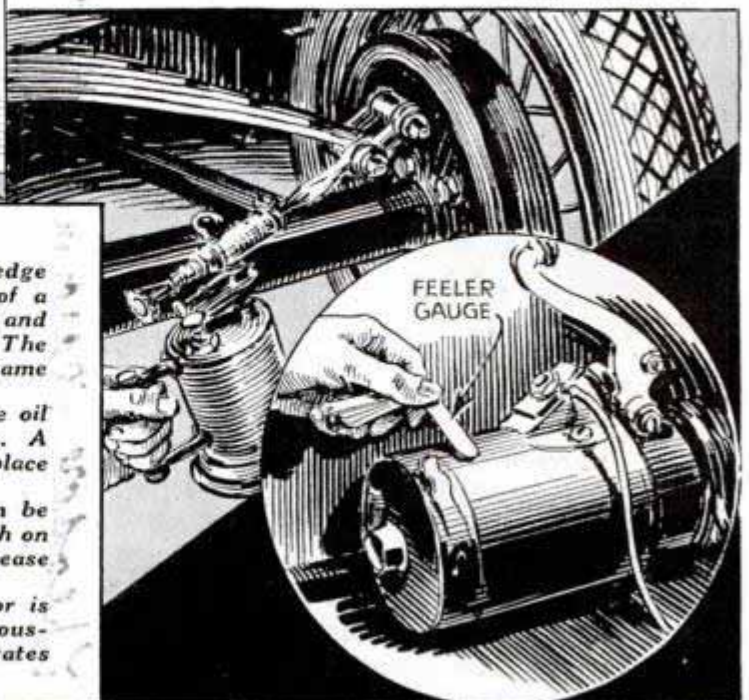
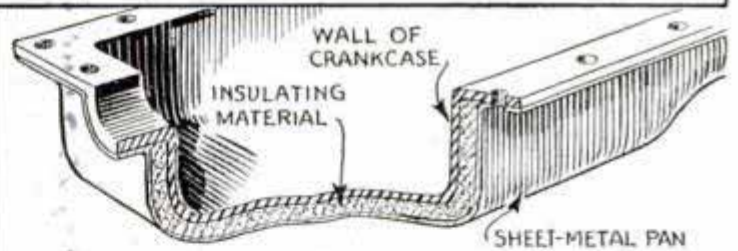

Gasoline Price on Driveway Helps Motorists

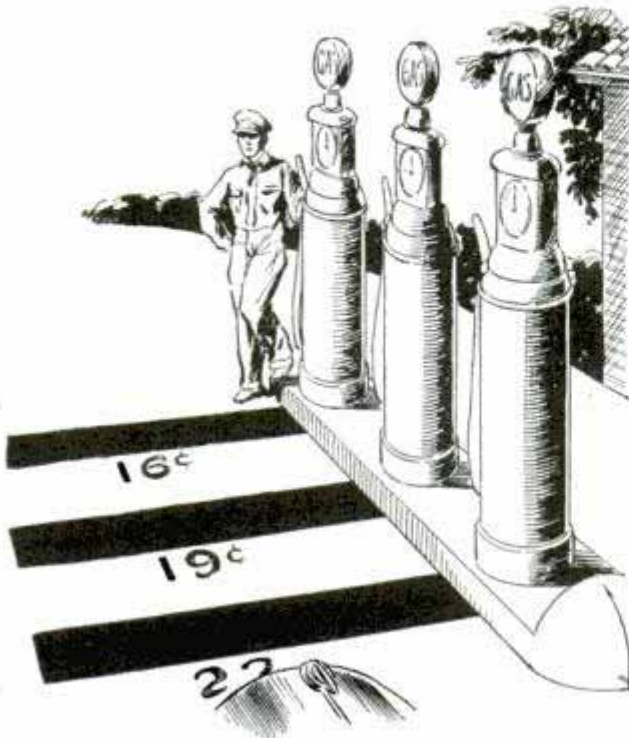

Printing the price of gasoline on the driveway aids motorist to stop in front of right pump

By printing the price of his gasoline on the driveway in front of the pumps, customers could see at a glance the pump from which they wanted gas. If desired, the name or grade of gasoline can be printed on the concrete in front of each pump. Large, white letters painted on a black background are easily seen, and will last a long time.

Keeping Inner Tubes Submerged in Test Tank

The difficulty of keeping large inner tubes submerged in a test tank while inspecting them for leaks, led one repairman to make the device shown. A length of $\frac{3}{4}$ -in. pipe with a floor flange fitted to one end, was soldered in a vertical position in the center of the test tank. A shorter length of $1\frac{1}{4}$ -in. pipe was fitted with a coupling, which was drilled at four equidistant points and tapped to receive lengths of $\frac{3}{8}$ -in. rod. When a tube is placed in the tank, the

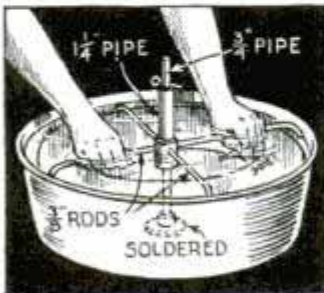

of the test tank. A shorter length of $1\frac{1}{4}$ -in. pipe was fitted with a coupling, which was drilled at four equidistant points and tapped to receive lengths of $\frac{3}{8}$ -in. rod. When a tube is placed in the tank, the

wheel piece is dropped over the upright pipe and forced down to submerge the tube, after which a key is inserted in a hole drilled through the vertical pipe, holding the inner tube under water while it is rotated slowly to detect the leaks.

Hand Wiper to Clean Windshield Inside the Car

When the windshield "fogs up" on the inside during cold weather, I find that it can be kept clean with a windshield-wiper blade screwed to the end of a short dowel rod or penholder, which serves as a handle. A clip can be provided on the instrument panel to carry the wiper, or it can be kept in the glove compartment.

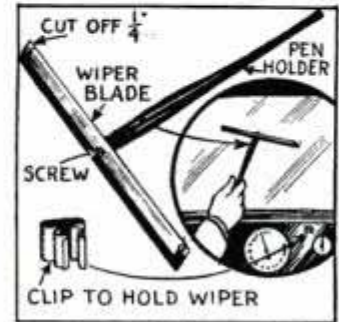

—Tom Robertson, Long View, Wash.

Large Lamp on Reel under Hood Illuminates Motor

To get a strong lamp that will brightly illuminate his entire motor in case of trouble at night, one motorist uses a 6-volt, 25-watt lamp on an improvised reel, which is suspended from one of the radiator tie rods underneath the hood. The reel is made from heavy wire and is suspended by a couple of battery clips. The lamp is

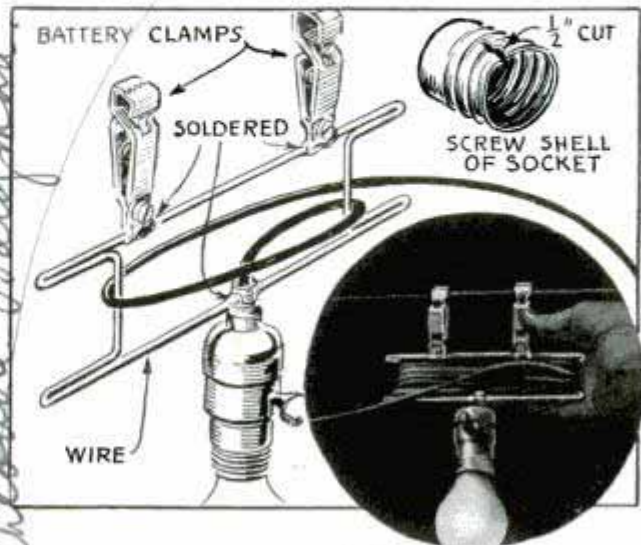

New type lamp of 6 volts, 25 watts, hung on reel under car hood gives plenty of light when needed

Trailer Supply Co.

5209 Main Street, Madison, Wis.

of the new type which looks like a regular 110-volt house lamp, and it can be obtained at most large accessory stores or mail-order houses. To keep the lamp from being loosened by vibration, a slit is made in the screw shell of the socket and one edge is bent inward slightly to press firmly against the screw base of the lamp as indicated.—C. E. Packer, Chicago.

Spark Plug Tested by Radio Tube

Fitted with a socket and attached to a suitable handle, an old radio tube of the 201A or 171 type makes a good tester for spark plugs. Saw off the two filament prongs and attach a 3 or 4-in. length of wire solder to the plate prong. Now push the solder and the two prongs into the socket. To test a plug, start the motor and then rest the tube grid prong on the top terminal of the plug and let the solder make contact with the motor block.

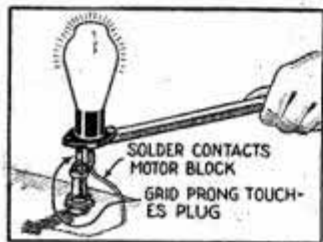

If the plug is firing regularly, a distinct glow will be seen in the tube. If the plug is not up to standard, the glow will be spas-

modic and of varying intensity. Or, if the plug is not firing at all, there will be no glow. A clear glass tube should be used, but if one is not at hand, hold the opaque type horizontally over an alcohol flame for a moment, and a circle of clear glass will appear as the inside coating of the tube is driven away by the heat.

Installing Headlight Lamps

Trouble often experienced in installing headlight lamps that have flanges around the bases with holes to slip over pins in the socket can usually be prevented by flattening the contact points of the lamp with a file. This permits the points to slip by the spring plungers in the socket easily so that there is less danger of twisting the bulb loose from its base.

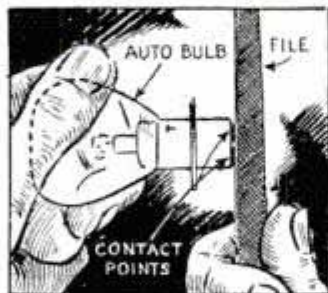

Part of Truck Tailboard Drops When Unloading Boxes



Boxes extended onto a lowered tailboard easily unloaded if upper part is hinged to drop down

When a truck is loaded with boxes and crates so that they come about flush with the edge of a lowered tailboard, the difficulty of getting the hands under the crates on the bottom to lift them can be eliminated by hinging the upper part of the tailboard as shown. When the tailboard is lowered, the hinged part is held horizontally by lengths of iron bars slipped through brackets.

Holder Keeps Terminal Ends of Cables in Order

Auto mechanics and others who often work with electric cables will find this holder handy for keeping the terminal ends of the cable wires separated for easy identification. The

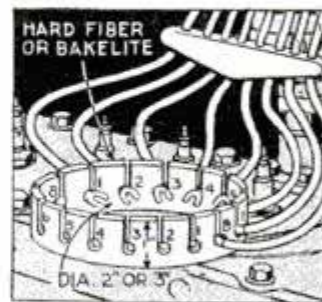

holder is a narrow section of fiber or Bakelite tubing with slots formed by first drilling and then cutting with a hack saw. The holes are numbered so that the wires can be located in order.

Tag on Pencil Protects Chart from Greasy Hands

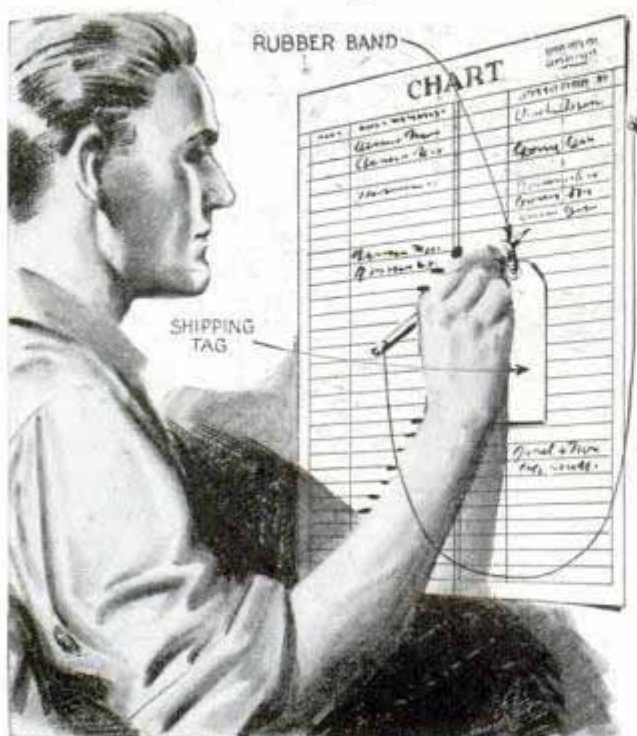

In shops where mechanics are required to write certain records on a wall chart from time to time, the difficulty of keeping

the chart unsoiled by grimy hands can be overcome with a shipping tag. This is tied to the pencil and is held between the chart and the hand of the writer, as shown, while the notations are being made.

Door Spring Used as Compressor for Piston Rings

A screen-door spring shortened to fit tightly around a piston provides a good piston-ring compressor. The spring, aided by the mechanic's fingers, will keep the ring compressed. As the piston is pressed into the cylinder bore, the compressor rolls up to the next ring.



For extremely narrow rings, a spring of small diameter is desirable so that it will stay on the ring until the latter has entered the cylinder.—C. E. Packer, Chicago.

The Next Issue

MODELING A WARSHIP OF CLASSIC GREECE

An authentic model of a Greek trireme of the pre-Christian era. Armed with a bronze ram and propelled by 172 oars ranged in three banks, the trireme represented the ultimate development of ancient war craft. Unlike most historic models, you'll find this one surprisingly easy to build.

BETTER PICTURES WITH PHOTOFLOOD LAMPS

How to use the different types and sizes of photoflood lamps to get the best results as well as how to arrange and set them up for correct lighting effects.

TURNING SPINDLES FOR CABINET WORK

Takes you through the tricky processes of turning special spindles such as the oval, spiral, inlaid, club-foot, post-blocked and combination types.

WINDOW CORNICES IN LATEST STYLES

Distinctive designs of little cornice-shaped boxes that conceal drapery fixtures and give an attractive finish to windows. Can be made with ordinary tools

PARTY TRICKS ANYONE CAN DO

Some easily performed tricks that mystify and seem to defy natural laws, and always come in handy to eliminate dull, quiet moments at a party.

Two-Purpose TOOLS

for Industrial and Home Shops

Modern low-cost motor-driven tools such as produced by Delta really possess more than double utility. They are designed and priced to be within the reach of the home shop. Yet they are engineered and built so well that industrial users everywhere welcome them as standard production equipment. For either purpose—home shop or industrial—Delta tools have *proven* in thousands of instances that they have what it takes to give long satisfactory service.

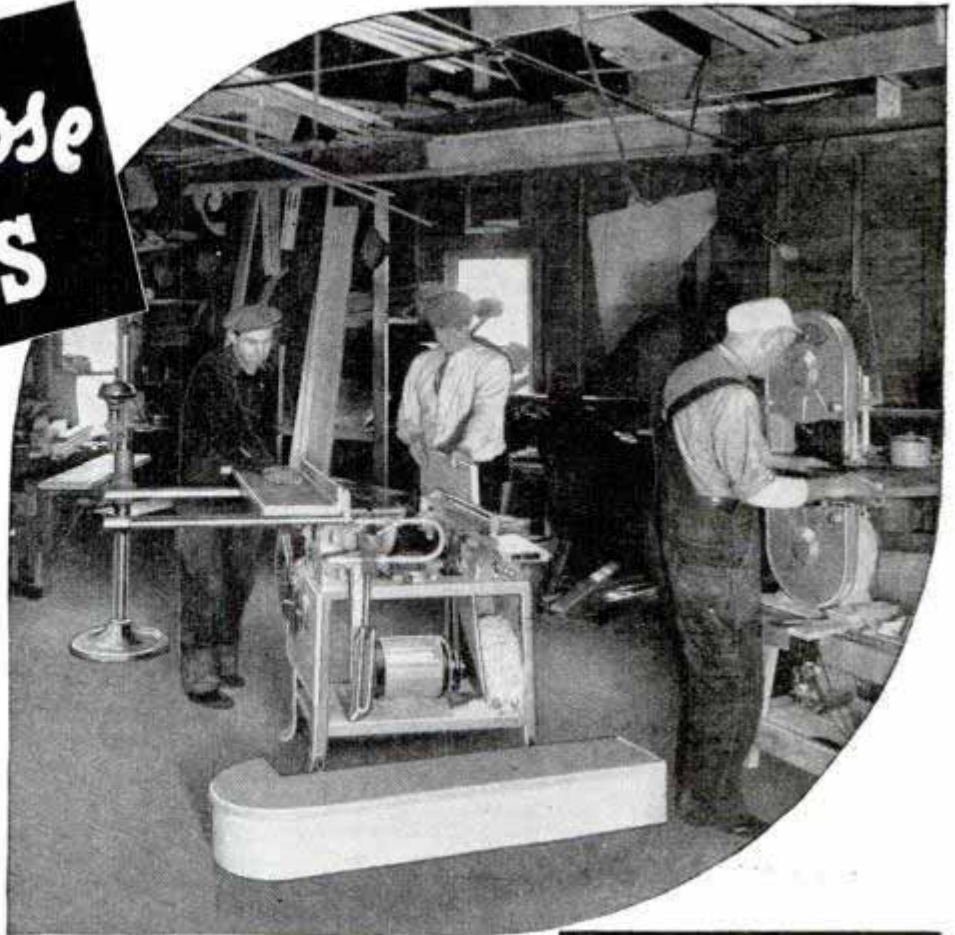

What Industrial Users Say

Just read the partial list of nationally known concerns using Delta tools. Add to these the thousands of professional cabinet shops, millwork shops, pattern shops, furniture factories, contractors using Delta Quality Tools. "The most useful tools in our shop" says one factory superintendent. "We are astonished at the machine value and precision you offer in your drill presses." "We are setting up complete production lines of your tools." "Our sample-making costs have been cut in half."—These are but a few of the thousands of favorable comments made on Delta tools—and they are saying it with repeat orders. The low cost of Delta "precision tools" spells economy and flexibility to the industrial user—skillful design and rugged construction mean greater satisfaction to the home shop owner. Send the coupon for the latest Delta catalog and check Delta values for yourself.



New Metal-cutting Band Saw

It takes the place of a power hacksaw in cutting off bars and shapes; it is used in the toolroom for sawing off tool, die and fixture stock; it will cut uniform strips from sheets; it saves hours of time in cutting templates and similar tools, and will cut almost any material, such as asbestos, mica, vulcanite, fiber, etc. Four low metal-cutting speeds and one high speed for wood sawing.

The 1938 Delta Catalog is the guide book to modern motor-driven tools. Send coupon for your copy—and the latest Delta Project Book No. 4—packed full of new and different things to make, with many photographs, working drawings, and complete instructions. Enclose 10c for Project Book. Catalog will be mailed postpaid.

DELTA MANUFACTURING COMPANY
600-634 E. Vienna Ave. Milwaukee, Wis.

Delta

QUALITY TOOLS

A Partial Roll Call

Below are listed a few of the thousands of industrial plants using Delta "Quality" Motor-Driven Tools.

The Owens-Illinois Glass Co.
Sikorsky Aircraft Corporation
General Electric Company
Underwood Elliott Fisher Co.
AC Spark Plug Company
Eastman Kodak Company
United States Bureau of Mines
Afga Anso
Frankford Arsenal
General Motors
Dodge Brothers
Hudson Motor
Chevrolet Motor Company
Fisher Body
Continental Motors
Packard Motor Car Co.
Chrysler Corporation
U. S. Rubber Products, Inc.
Fairbanks-Morse Company
Ramsey Accessories Mfg. Co.
Republic Steel Corporation
Graybar Electric Company
Truscon Steel Company
Firestone Tire & Rubber Co.
Mallinckrodt Chemical Co.
International Shoe Company
Caterpillar Tractor Company
The B. F. Goodrich Company
Goodyear Tire & Rubber Co.
Pittsburgh Plate Glass Co.
United Air Lines Trans. Corp.
Burd Piston Ring Company
Allis Chalmers Company
Kimberly-Clark Corporation

DELTA MANUFACTURING CO., Dept. A138
600-634 E. Vienna Ave., Milwaukee, Wis.

I enclose 10c (stamps or coin) for which please send me one copy of the new 1938 Book No. 4 of "Practical Delta Projects." Also place me on your mailing list to receive 1938 Delta catalog of quality motor-driven woodworking tools.

Name

Address

City..... State.....

Check here if you are a Delta user now.



HERE'S WISHING
YOU ALL THE
HAPPIEST
HOLIDAY SEASON
EVER —

(below) The famous Christmas package, the Camel carton—10 packs of "20's"—200 cigarettes. You'll find it at your dealer's.

Camels

**MADE FROM FINER,
MORE EXPENSIVE TOBACCOS**

Give Camels for Christmas! There's no doubt about how much people appreciate Camels—the cigarette that's made from finer, MORE EXPENSIVE TOBACCOS. A gift of Camels says: "Happy Holidays *and* Happy Smoking!"



(above) Another Christmas special—4 boxes of Camels in "flat fifties"—wrapped in gay holiday dress.



Prince Albert

(right) A pound of Prince Albert, in a glass humidor that keeps the tobacco in prime condition and becomes a welcome possession.

THE NATIONAL JOY SMOKE

If you know a man owns a pipe — you're practically certain to be right if you give him PRINCE ALBERT — The National Joy Smoke. Beginners like P. A. because it doesn't bite. Occasional pipe-smokers find it's extra cool. And the regulars think it's tops for mellow taste.

(right) One pound of Prince Albert — the "biteless" tobacco — placed in an attractive Christmas gift package.



Copyright, 1937,
R. J. Reynolds
Tobacco Company,
Winston-Salem, N.C.

When writing to advertisers please mention Popular Mechanics

How to Make Home Movies

(Continued from page 20)

1105
An occasional panoram, however, provides a helpful and interest-promoting change of pace when, and only when, it is properly executed. Such a panoram should be used only on distant objects. It should be executed slowly and evenly. It should always conclude, not start, with the most interesting objects within view. And it should begin with a steady shot, then a short panoram to the piece de resistance, which should likewise be held steady for several seconds.

When you take your camera to a football game you will certainly want to follow the play as it surges up and down the field. Much of the time the ball carrier will not run beyond the limits of your camera's finder, and when he doesn't, there's certainly no reason to blur the scene by moving the camera. But when one of the backs breaks loose for a long run, stay with him. By doing so you will probably blur the background of field and opposing rooters. But who cares? It's the action you're after. This is equally true when you are filming any moving objects which cannot be filmed at an acute angle and must therefore pass you and your camera at right angles. If you keep them in the center of the finder, the magic of movies causes them to "stand still" for your movie audiences, and the stationary background to move. This type of camera motion is thoroughly justified.

Panorams, oddly enough, are an unnatural presentation of subjects. The human eye does not panoram; it darts here and there, pausing upon interesting points, hurrying across the uninteresting. And right here, incidentally, is where the movie maker has the edge. For he can entirely eliminate these uninteresting areas by merely filming the interesting—in steady shots of several seconds' duration.

At about this point the alert reader will say, "Fine, panorams are out. But how about that continuity idea? Where does that fit into the picture of filming a building, for example?"

In this way: Make a long shot of the building, showing all of it and much of its surroundings. Then one a bit closer. Then a series of close-ups of interesting aspects of the building, grillwork, plaques, orna-

(Continued to page 118A)

PREVIEW of

Miniature Kodaks

KODAK DUO SIX-20, SERIES II (right) New, improved—the "miniature" that takes album-size pictures (1½x2¼). Kodak Anastigmat f.3.5 lens; 1/500-second Compur-Rapid shutter. Shutter release on camera body. Bracket for range finder. Single-finger bed release. Die-cast metal body. Price remains

\$5750

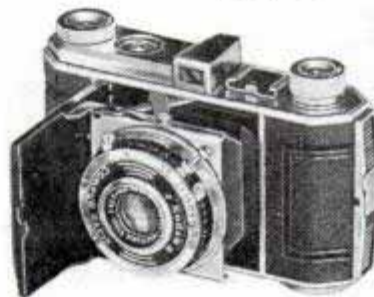

KODAK BANTAM SPECIAL (below) Performs brilliantly under all conditions. Lens, Kodak Anastigmat EKTAR f.2.0. 1/500 Compur-Rapid shutter. Coupled range finder, military-type, split-field. Negatives are needle-sharp, yield superb enlargements. Also makes full-color transparencies on Kodachrome Film. Price **\$110**

KODAK RETINA

(above) Lens, Kodak Anastigmat EKTAR f.3.5. 1/500 Compur-Rapid shutter. For black-and-white pictures: Kodak "SS," Panatomic, Super X, Infra-Red Film. For full-color transparencies: Kodachrome Film. (Negatives approximately 1 x 1½ inches.) Film-measuring device. Exposure counter. Price **\$5750**



KODACHROME FILM FOR FULL-COLOR "STILLS"

Load with Kodachrome and get full-color transparencies to be viewed as they are, or mounted for large-size projection. Easy as black-and-white. No. K828 or K828A (8 exp.) for Kodak Bantam Special, \$1.35; No. K135 or K135A (18 exp.) for Kodak Retina and similar cameras, \$2.50. Prices include processing.

Brownies from \$1; Kodaks from \$5. See them at your dealer's . . . Eastman Kodak Company, Rochester, N. Y.

ONLY EASTMAN MAKES THE KODAK

your Kodak dealer's Christmas suggestions...

Precision Kodaks

Ciné-Kodaks



KODAK SENIOR SIX-20 (f.4.5)

Kodak Anastigmat f.4.5 lens; 1/200 Kodamatic shutter. Body shutter release minimizes camera movement. Optical, direct-view finder helps you get the picture when it's exactly right. 2 1/4 x 3 1/4-inch pictures. Price **\$2950**



KODAK RECOMAR 18

Kodak Anastigmat f.4.5 lens, 1/250-second Compur shutter. Built-in self timer. Double-extension bellows and bed. Ground-glass focusing back. Utilizes the almost limitless emulsions available in film packs, cut film and plates. Pictures, 2 1/4 x 3 1/4 inches. Price **\$54**

KODACHROME FILM

FOR FULL-COLOR MOVIES

Loaded with Kodachrome Film, all Ciné-Kodaks make gorgeous full-color movies. They are easy to make as black-and-white. No extra equipment; the color is in the film. Here are beauty and realism impossible to describe. The projection of Kodachrome is thoroughly trouble-free. You can splice color sequences right in with black-and-white. See a Kodachrome reel at your dealer's. 16 mm. cameras load with 100-foot rolls at \$9, 50-foot rolls at \$4.75, 50-foot magazines at \$5. Rolls for Ciné-Kodak Eight cost \$3.75. Prices include processing.

CINÉ-KODAK EIGHT

(right) Movies at only "10 cents a shot." Ciné-Kodak Eight makes it possible. A roll of Ciné-Kodak Eight Panchromatic Film costs you only \$2.25, finished, ready to show. Good for from 20 to 30 black-and-white movie "shots," each of newsreel length. Price **\$3450**

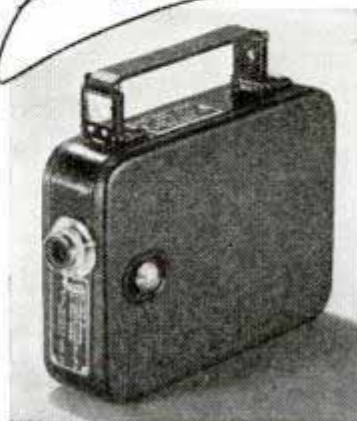

CINÉ-KODAK "E"

(left) An Fastman 16 mm. movie camera at the lowest price ever. Kodak Anastigmat f.3.5 lens. Fixed focus. Triple-speed device. Simplified gate enormously facilitates loading. Takes all 50- or 100-foot 16 mm. Ciné-Kodak Films. Price, \$48.50.



\$4850

CINÉ-KODAK "K"

(right) World's most widely used 16 mm. home movie camera. Makes clear, brilliant movies at the touch of a lever. Performs beautifully for the beginner, and as his skill increases, responds to every exacting demand. Loads with full 100 feet of 16 mm. film. With f.1.9 lens. **\$8850**

Including carrying case, \$100.



\$125

MAGAZINE CINÉ-KODAK

(left) Loads in three seconds. You don't touch the film at all—it comes in a magazine. Just slip the magazine into place, close the camera cover and you're ready to shoot. To switch from one film to another, you merely take out a partly used magazine, slip in one of the others. Effortless loading is only one of the six new features in this remarkable pocket-size movie camera. Equipped with fast f.1.9 lens, \$125; including combination carrying case, \$137.50.

How to Make Home Movies

(Continued from page 116A)

mental doors, towers, foundations, archway-framed views from within the building, all of the little bits you notice and admire. Then wind up your sequence with another distant shot. That returns your audiences to the initial scene, and logically concludes the sequence.

Another way to take better home movies is to avoid making all-inclusive shots of every subject—backing up until the scenes appear in the camera finder in their entirety. Here, again, is a heritage of snapshot making, trying to get as much as possible into one shot because it will probably be the only shot made of the subject. Yet, because movie subjects are to be filmed in

voice destroys all the color of a verbal story. Mix 'em up. Start off slowly. Speed up toward the end. Conclude with another prolonged shot.

Some subjects, themselves, suggest the scene length. Fast-moving action recommends terse, brisk shots. Dreamy tropical subjects call for extended exposures. Close-ups generally demand brevity; scenics, that you stay with them for a while.

Frankly, isn't this all ridiculously manifest—now that it's been called to your attention? You sense these things in a screened movie. You know when they are there. And you are equally conscious of their absence.

How to make better movies is, after all, to make pictures that are really movies. Remember every second that yours is a movie camera; that, although you may take but one scene at a time, they are immutably joined in succession by movie projection. Think how your shots are going to appear when screened. Think of what you've already filmed, and of what you will film next. Think of your camera finder as being a screen. What you see there when you press the exposure button is just what you'll see later in your living room. In movie making, it's finders keepers.

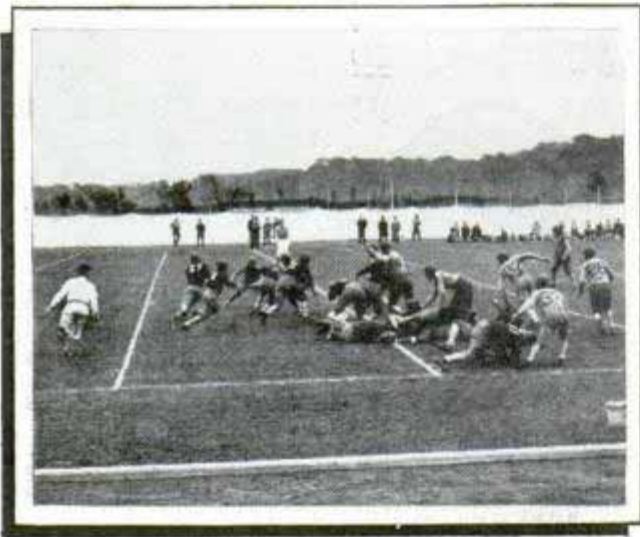

Try "slow motion" when you film a football game. You can analyze the play afterward

sequences, you obviously desire to achieve just the opposite effect. You don't want to tell all at once. But you do want to present the complete story, and should, therefore, make your shots at varying distances, with emphasis upon close-ups.

Close-ups tell the story. In life you grasp the hands of people, look them in the eyes. You don't back up for a full-length. So forget the feet. Get the features.

One sure-fire method of spoiling good movies is to make all scenes of equal duration. Movie camera manuals harp upon shots of ten seconds' length. It's a good idea—but only as a guide. For the duration of scenes establishes the tempo of a movie sequence. Equal duration makes movies drag, just as effectively as a monotonous

Side Lights Protect Bicyclist

Bicyclists can have added protection from traffic at night by installing a headlamp which throws warning beams on each side. There are two small side windows in arms protruding into the cone of light from the headlight, diverting beams to the side without interfering with the light thrown forward.



Whenever you find that you wish to know more about any article in this magazine, write our Bureau of Information, inclosing return postage.

Dynamic
W.H. Lee
 Kutschbach's Engineering Service, Molthedress

*Each tin
proves it
over and
over again..*



Better



Smoking



Tobacco

*..and here's
WHY*

- aged-in-wood
Burley tobacco*
- extra good taste*
- for pipe or
cigarette*

*2 full ounces
in every tin*



New Remington NOISELESS PORTABLE

Now you can own a brand new, latest model Remington de luxe Noiseless Portable for only 10¢ a day. This amazing typewriter has all the modern features of the big office machines. Standard keyboard, handset tabulator, composition keys, automatic ribbon reverse, two color ribbon shift, etc., PLUS the NOISELESS ACTION that types in a hushed whisper!

ONLY
10¢
A DAY!

ENJOY 10 FULL DAYS TRIAL...FREE

Try this great new Remington in your own home for 10 days. Use it as much as you like. See how convenient it is to type letters, memos, reports; how much pleasure you get from putting your spare time to profitable use. Earn extra money—develop your ideas—enter contests. You can *write better—think better—spell better* when you use your Remington. If you're not 100% delighted, return it AT OUR EXPENSE at the end of ten days. We pay transportation charges BOTH WAYS.

EXTRA!

HERE'S WHAT
YOU GET
FREE!

1. Typewriter Course. Anyone can learn to typewrite with this FREE 19 page course.
2. 10-DAY FREE TRIAL in your own home. Convince yourself without risking a cent.

HURRY! RUSH COUPON FOR "FACTORY" OFFER

Write for big Free illustrated catalog describing all of the famous Portable models; *special 10¢ a day plan; 10-day free trial offer*, free typing course that makes it easy for anyone to typewrite, and Double Duty Carrying Case that can be used as an overnight bag. *Don't send any money—just mail coupon and get all the facts WITHOUT OBLIGATION.*

REMINGTON RAND INC.
Dept. 152-1 Buffalo, New York

**REMINGTON RAND INC., Dept. 152-1
Buffalo, New York**

Rush FREE Catalog and full information about the "10¢ a day" plan, Free Trial Offer, Free typing course, etc., entirely without obligation. *This is not an order.*

Name.....

Address.....

Town.....State.....

es 964

Sled Thrills by Slide Rule

(Continued from page 69)

150 recognized bobsledders in America and scarcely half of these are licensed drivers. In Europe, where there are over forty standardized runs in contrast to America's one, participation in championship events is not so restricted.

The bobs used on the big slides are engineered to a fraction of an inch and are as carefully and stoutly constructed as any racing car. The four-man bob is eleven feet seven and one-half inches long and weighs 485 pounds. The seat rests ten and one-half inches off the ground. The two-man bob is nine feet long and weighs 352



Courtesy German Railroads

*Constant practice teaches the drivers the tricks
of each perilous turn*

pounds. American sleds, which cost between \$500 and \$600, are steered like a motor car while the European models employ tiller ropes.

A German engineer, Stanislaus Zentzytzki, has designed the leading bob runs of the world, including those at Lake Placid and Garmisch-Partenkirchen in the Bavarian Alps. The American run is his masterpiece, however. It cost \$200,000 to build. The average drop is ten per cent with a minimum grade of eight and one-half and a maximum of fifteen per cent.

The surface of a bob run is of glare ice, made of a mixture of snow and water, and is covered in the straightaways with a thin frosting of snow so the sled runners may

15964
bite in and hold the track. The turns are built on a foundation of crushed rock, padded by turf. Some are twenty-two feet high, their towering banks running up almost at right angles to the bottom. They are built with geometric precision so as to hold the giant steel sleds, which with cargo weigh up to 1,200 pounds, as they go spinning around at fifty miles an hour. On the straightaway, a run is six and one-half feet wide while on the curves the width varies from ten to twenty-two feet. Eight thousand feet of pipe running from top to bottom expedite the spraying of the course, more than 20,000 gallons of water being used daily for this purpose.

When a bob starts its downward dash, the run must be clear of all obstructions,



Another step in the construction of the run, which is carefully engineered

sleds or loose ice. The slide is patrolled constantly and as an added safeguard the seven telephone control booths can observe every foot of the run. No bob leaves the starting line until "Clear Track" is reported from each station to the other and final word is relayed back to the starter at the top. Only one sled is permitted on the track at a time. Three telephone circuits run from the top to the bottom. The first is a direct circuit, the second is a one way connecting the intermediate control booths, and the third is for operating the electric

(Continued to page 123A)

NOW—A 7-Inch Genuine BLACK & DECKER ELECTRIC SANDER



FOR ONLY \$39.50

THE NEW 7-INCH JUNIOR SANDER saves hours of slow, hard work with sandpaper, emery, files, etc. Makes quick work of such jobs as cleaning and smoothing wood or metal surfaces; removing paint and rust; grinding and smoothing welds and casting ridges; rubbing down new lacquer with felt rubbing pad; polishing metal, etc. Universal motor operates on A. C. or D. C. A great tool. A great value. Only \$39.50.

LOW-PRICED B. & D. DRILLS, TOO

1/2-INCH JUNIOR DRILL: (Illustrated). Drives twist drills for drilling up to 1/2" holes in steel; augers for drilling up to 1" holes in wood. Also drives Black & Decker Hole Saws for cutting clean, round holes from 3/4" to 3 1/2" diameter in any material a hacksaw will cut. Universal motor. Only \$35.00.



1/4-INCH JUNIOR DRILL: Drives twist drills for drilling up to 1/4" holes in metal; augers for drilling up to 1/2" holes in wood. Also drives light wheels for grinding, buffing, polishing, etc. Universal motor. ONLY \$19.95.

MAIL THE COUPON TODAY for complete information and name of nearest dealer where you can see the Junior Sander, Drills and other Black & Decker Tools.

BLACK & DECKER

World's Largest Manufacturer of
PORTABLE ELECTRIC TOOLS

MAIL THIS COUPON NOW

The Black & Decker Mfg. Co.,
601 Pennsylvania Ave., Towson, Md.

Please send me Free Literature describing new low-priced Black & Decker Tools and the address of my nearest B. & D. dealer.

Name

Occupation

Address

City State

FUN

to snap Christmas pictures



.. and easy to get them

WITH G-E MAZDA PHOTO LAMPS

• What a Christmas picture Sally makes sitting proudly by her new doll . . . and Junior beating on his new drum! Catch such happy, delighted faces around *your* Christmas tree, and keep them forever . . . with indoor snapshots.



**SPECIAL LIGHTING KIT \$1.00
FOR INDOOR PICTURES**

2 G-E MAZDA Photoflash lamps No. 2; • 2 handy paper reflectors to concentrate the light on subjects; • Folder that tells where, and how, to take pictures at night.

Just put a few G-E MAZDA Photoflood lamps in sockets around the room, load up your camera with supersensitive film, and take snapshots as easily as outdoors in the sunlight.

The brighter, whiter light of these amazing bulbs gets you crisp, clear pictures indoors, or at night. And they last for dozens of shots.

For action, use G-E MAZDA Photoflash lamps. Each lamp gets one picture. 15 cents list.

Go to your druggist or camera dealer for photo lamps . . . but be sure they're marked G-E, to be sure of better pictures.

**GENERAL  ELECTRIC
MAZDA PHOTO LAMPS**

Dare-Devil Scientists of the Air

(Continued from page 37)

at the bottom of a dive depend greatly upon their own physical condition. Fighting planes are often tested up to nine "G's," which means that they are pulled out of a dive so rapidly that inertia alone tends to make them keep traveling toward the earth with a force nine times normal gravity. The same tremendous pull is exerted against the pilot. He slumps down in his seat, blood tends to drain away from his brain, and in some cases blood vessels have burst and the men lapse into momentary unconsciousness. Easing forward on the stick reduces the sharpness of the strain.

Once a pilot who pulled back too sharply on the stick built up the tremendous load of twelve times normal gravity. The strain bent the airplane into a mass of junk. The fuselage buckled, the wings bent back, cracks opened in the windshield and the gasoline tanks caved in. The pilot was barely able to land the wreck. After that he went to the hospital.

Fighting planes have to be put through barrel rolls, inside and outside loops, and many other stunts, but a test pilot does eighty-five per cent of his work on the ground instead of in the air. Men like Vance Breese and Eddie Allen, who are paid as much as \$5,000 for test flying a single ship, earn their money not because they risk their necks but because years of thorough training in aeronautics, engineering and design enable them to diagnose and correct faults in a plane still on the ground, to understand exactly what the trouble is when a ship responds improperly in the air, and to advise in design and construction. Wind-tunnel tests take many of the bugs out of a new airplane even before it is built, but in spite of careful preliminary work trouble may be encountered when the finished airplane is first flown.

Once the ailerons broke on an airplane Breese was flying for the first time and he was left practically helpless in the air. He came down toward the field with the prayer that speed alone would keep the wings level. Instead of trying to make a normal landing he skimmed along the runway at 125 miles per hour, getting his

(Continued to page 124A)

Sled Thrills by Slide Rule

(Continued from page 121A)

timing device that records the speed of the bobs to hundredths of a second.

In the event of a spill, the operator who has had word a sled left the telephone station above his, notes it has not passed his station and instantly calls the starter. The track is closed and the operator goes down into the slide to investigate the trouble. The dangers of bobsledding may be measured in direct ratio to the driver's skill and the discretion of the brakeman. The captain, seated in front, steers the sled and directs operations at the turns. It is his job to signal the brakeman in the rear when to apply the three-pronged metal rake that digs into the ice. A brakeman never acts on his own initiative and braking on a curve is regarded as the unpardonable sin. If the speed is excessive he applies the brake just before the turn is reached. The secret of taking a turn correctly, explains J. Hubert Stevens, famous pilot, is to enter high and come down the bank fairly early. If a sled enters the curve too low it is apt to hurtle over the rim during the final stage of the turn.

Correct bobbing can increase a sled's speed. A smartly synchronized crew can be a big help to gravity with this movement, which is, in effect, a rowing stroke in reverse. The shock of raising the body must be transmitted through the legs, so the whole force is applied with the feet on the footrests. The crew lift slightly out of their seats when the pressure is greatest.

Allan Washbond is perhaps the greatest bobber in the world. He is only five feet nine inches tall and weighs 235 pounds. By a judicious use of his weight, which is centralized around his hips, he has lowered marks in the two-man division as much as a full minute in this sport, which deals in hundredths of a second. His technique differs from most riders in that he bobs with his hips instead of his body.

Popular Mechanics Magazine does not publish the name of the maker of, or dealer in, any device described in its pages, but this information is kept on file and will be furnished by our Bureau of Information upon request, accompanied by stamped, self-addressed envelope.



-just a DOLLAR
"Fine for Gifts"







Famous "Yankee" Ratchet

DRIVES SCREWS
RIGID DRIVER
DRAWS SCREWS
JUST PUSH on handle

"YANKEE" Handyman SPIRAL SCREWDRIVER

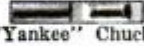
Greatest improvement!
Wanted by man, woman or boy who likes to tinker around home. Ask dealer for "Yankee" No. 33H. Price \$1 with one blade. ALSO "Yankee" Handyman Attachments to bore small holes for screws or other purposes.

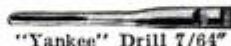
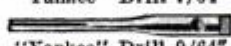
"YANKEE" CHUCK & 3 DRILLS... Fit in Place of Blade
Set 39c

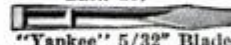
-  "Yankee" Chuck
-  "Yankee" Drill 5/64"
-  "Yankee" Drill 7/64"
-  "Yankee" Drill 9/64"
-  "Yankee" Countersink
Each 25c
-  "Yankee" 5/32" Blade
for small screws, each 12c

— — — INTRODUCTORY OFFER — — —
North Bros. Mfg. Co., Philadelphia, U. S. A.



NEW TOOL! If not at dealer's, send \$1.00 for delivery postpaid of "Yankee" Handyman that drives or draws screws at a push on handle. "Yankee" Tool Book, included FREE.

Name.....

Address..... (PM - 1)

es/08

Dare-Devil Scientists of the Air

(Continued from page 122A)

wheels within inches of the ground before closing the throttle. That saved the plane. It was down safely on the ground before a wing had a chance to drop.

Another time the propeller of a fighting plane stuck in low pitch after the take-off and the motor literally blew up 500 feet in the air. Breese couldn't land straight ahead because the airport was surrounded by water. The easiest thing to do was jump, but there was \$250,000 tied up in the new plane he was flying. He had twenty seconds in which to make his decision, cut the

NO UPSET STOMACH TROUBLES ME,
NO "MORNING-AFTER" WOE,
NO HEADACHES STAY TO MAR MY DAY,
THEY SIMPLY HAVE TO GO.
TO NIP A COLD BEFORE IT'S OLD
I ALKALIZE IT WELL, SIR.
I DODGE THE GRIEF AND GET RELIEF
BY TAKING ALKA-SELTZER

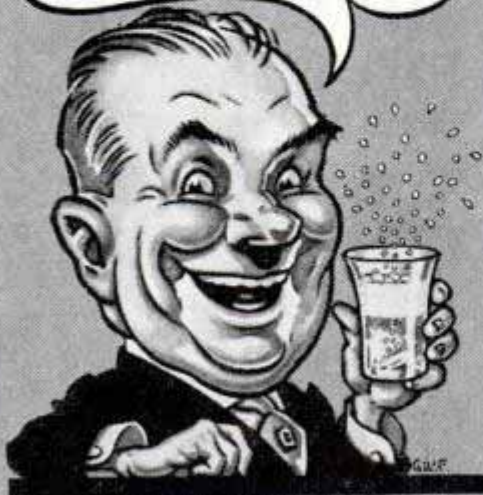

When a Headache, Upset Stomach, Cold or some other common everyday ache or pain threatens to spoil your good time—be wise—Alkalize with Alka-Seltzer. A tablet in a glass of water makes a pleasant tasting, effervescent solution, which brings quick relief in TWO ways. Because it contains an analgesic (sodium acetyl salicylate) it first relieves the pain and then because of its alkalizing properties, it corrects the cause of the trouble when associated with an excess acid condition.

ALKALIZE WITH

Alka-Seltzer

AT ALL DRUGGISTS 30¢-60¢ Pkgs.

Also sold by the glass at
Drug Store Soda Fountains



Scientist of the air climbing into cockpit for test flight in a new airplane

switch, get his wheels and flaps down, turn the plane around and make a down-wind landing. It took plenty of luck as well as skill and the landing was successful.

Once a pilot in a normal dive delayed his pull-out until he was within fifty feet of the ground. As he started to flatten out an aileron gave way and the plane started to fly to pieces. Without hesitation the pilot pulled way back on the stick, pointing the nose of the plane toward the sky, and depending upon his tremendous speed

(Continued to page 126A)

MAKE MONEY IN PAINTING BUSINESS



Paint walls, ceilings, screens, furniture, radiators, machinery faster, better! $\frac{1}{4}$ H. P. motor 110 Volt 60 Cycle AC, complete with Spray Gun, 15 ft. hose. Weighs only 44 lbs. Carry anywhere. FULLY GUARANTEED. Only \$31.15 f. o. b. Chicago. \$5 Deposit, Balance COD, or SEE YOUR DEALER. Circular FREE. Get started making money NOW!

Ideal Pump Co., Dept. PM1, 801 Washington, Chicago **\$31.15** Complete

"OH BOY-AM I KEEN!"

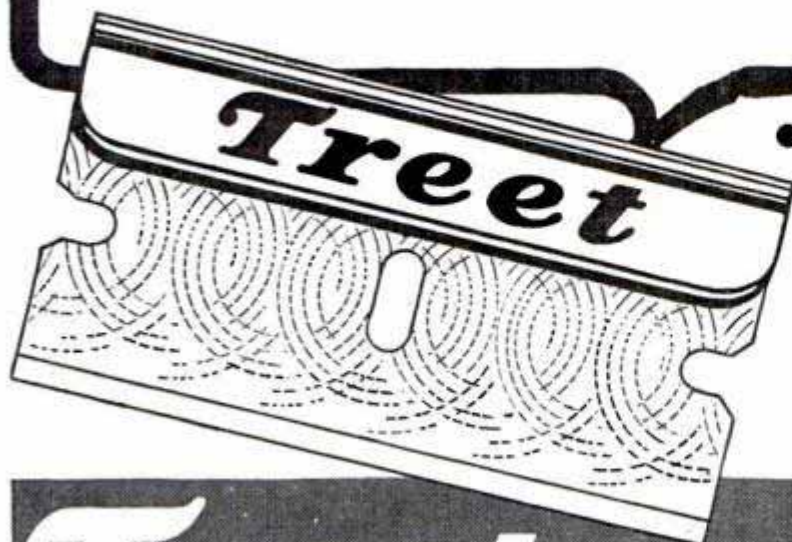

• It costs only a dime to discover a world of shaving comfort! Ask for Treet Blades and let their super-keen edges rid you of shaving troubles! 4 for 10¢. Treet Safety Razor Corp., Newark, N. J.

Treet BLADES
FIT GEM AND EVER-READY RAZORS

4 FOR 10¢

HOLD-E-ZEE
FINE SCREWDRIVERS
Hold, start and set up any size screw in unhandy places. Gripper slides up out of way when not in use. All models of finest materials thruout with chrome vanadium blades; many have transparent, unbreakable handles. No more expensive than ordinary screwdrivers. Patented. At auto supply, hardware and electrical stores.

Plus

UPSON BROS., INC.
86 Exchange St., Rochester, N. Y.

BURN YOUR NAME ON TOOLS WITH THE ARKOGRAF

PROTECT YOUR TOOLS FROM THEFT Write with electricity any name or design on the hardest and finest tools and instruments, or any metal, like writing on paper with pen or pencil. Complete Outfit \$3.50—Prepaid Anywhere. Interesting illustrated circular free. Write today. Agents wanted. ARKOGRAF PEN CO., 3927 S.E. Stark St., Portland, Ore.

AN IDEAL GIFT FOR XMAS 9-INCH WORKSHOP SOUTH BEND LATHE

New Low Terms
ONLY \$6.99 A MONTH

Give him a lathe for Xmas—The 9"x3" Workshop Precision Lathe—Back-Geared, screw-cutting. Made in 4 bed lengths. Takes 38 attachments. Wt. 320 lbs. Prompt deliveries for Xmas.

Write for Catalog 15-Y

\$90 LESS MOTOR DRIVE

SOUTH BEND LATHE WORKS
359 E. MADISON ST., SOUTH BEND, IND., U. S. A.

BUILD THE CUTTY SARK
2 FT. MODEL OF THE FAMOUS CLIPPER SHIP

Everything...including CARVED WOOD HULLS, Printed-Balsa Decks, Cast-Metal Life-boats, Anchors, Bits, Steering Wheel, Chains, Masts, Spars, Rigging, Cement, Colored Lacquer—Full-Size Plans and Instructions.

Send for Catalog all Ideal's new Models - 10¢ IDEAL AEROPLANE & SUPPLY COMPANY, INC. 28 West 19th Street, New York

Complete Kit makes perfect building easy. **2.50** plus 15¢ postage

Guaranteed WEATHERPROOF!!
FOR SALE *...the NEW Successor to Plywood*

Make your own road signs with this better building material. Rain, snow, sun or wind cannot separate the plies. The binder is proof against termites, rot, mold and fungi, too.

PLANS for making SUPER-Harbord

Boats, outdoor furniture, cabinets, toys, ornaments, etc. Send for full list.

10¢ TO COVER HANDLING COST

is impervious to moisture because hot-pressed with a resinoid binder absolutely insoluble in water. Ideal for boats, trailers, garages, greenhouses, etc. Takes finish beautifully—saves money. Buy from your lumber dealer.

----- **MAIL COUPON TODAY** -----
HARBOR PLYWOOD CORP., Port Dock, Hoquiam, Wash.
Gentlemen: Please tell me how Super-Harbord will give me better and cheaper outdoor construction.

NAME.....
ADDRESS.....
LUMBER DEALER.....

When writing please mention Popular Mechanics

25¢

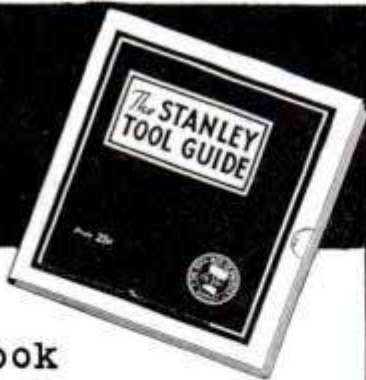

"Finest Book On Tools I've Ever Seen!"

Says one expert carpenter, "When I was young I hunted through every available book for information on tools. Just received your *Tool Guide*—wish something like it had been available then. It's the finest book on tools I've ever seen!"

Today, send a quarter for this big 32-page workbench handbook—contains hundreds of illustrations—tells how to adjust, sharpen and care for tools—and how to use them. Add a dime, if you wish, and get 16 complete plans—"Things To Make In Your Home Workshop." Send coin or stamps for one or both of these helpful, profusely illustrated books—NOW.

STANLEY TOOLS

105 Elm Street New Britain, Conn.

NEW! POCKET SKATE SHARPENER

No more dull ice skates! You can keep your skates sharp as a champion's with the **Johnson Pocket Sharpener**. Restores sharp keen edge in a jiffy. Just run it up and down the blades. So handy, you can carry it in your pocket. Touch up your skates while you're out skating; remove burrs, feather edges. Help yourself skate like a champion by keeping your skates always sharp, with the **Johnson Pocket Skate Sharpener**. Only 25¢ at hardware, sporting goods, and department stores.



25¢

For girls and women—Nestor Johnson offers the new *Sonja Hente Pleasure Skates*, recommended by *Sonja Hente*. Be sure to look for the full name **NESTOR JOHNSON** when buying skates.

NEW Grinding Attachment

For 9" to 13" Metal Lathes

The new Huron Grinding Attachment doubles the usefulness of your lathe. Enables you to machine accurately to $\frac{1}{4}$ of one-thousandth of an inch. Grinds hard or soft stock; eliminates tool marks; produces mirror finish. For both internal and external grinding. Grinds valves, pistons, bushings. Sharpens reamers and cutters. Grinds lathe centers, spindles, flats on shafts. Does eccentric drilling; laps; polishes. **Scores of other uses.** Invaluable to every home workshop owner, model builder, garage man and machinist.

SEMI-MACHINED CASTINGS, only \$5.95. Finish on your lathe and save real money. Write for FREE illustrated folder and full information.



**BUILD IT
YOURSELF.**

SAVE TWO-THIRDS.

Huron Machine & Tool Co., Yale, Michigan

Gules Racine
20 W. 47 St
New York

(Continued from page 124A)

to carry him back up to a safe altitude. He rode the wreck up to 500 feet where he had room to step off and get his chute open.

Test pilots are always encountering new problems and hazards. With design tending toward smaller, heavier fighting planes, spins are harder to control and correct than before. Another new thing is the "tip stall" that makes a plane unmanageable at normal landing speeds. The wing roots are still supported by air but the wing tips are stalling, causing loss of aileron control. Some kinds of control surface and wing flutter that occur only at certain critical speeds can be studied only in the air. It may take scores of flights to study and correct such a vibration.

Attempts are being made to make the pilot's job easier by developing automatic

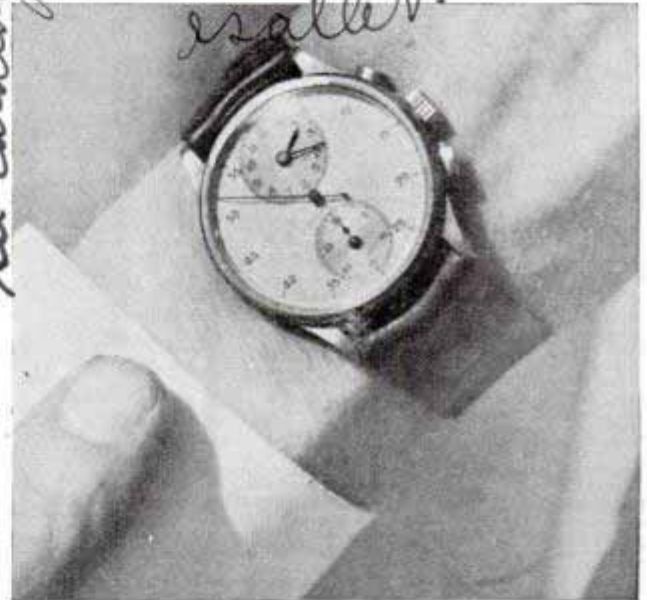

Chronometer stop watch by which pilot checks performance of plane during test

cameras that photograph all the instruments on the board at short intervals. Sometimes, instead of jotting down the readings on his leg pad in flight, a pilot reads them aloud into his radio microphone and they are recorded by a stenographer listening in on the ground. It usually takes several months and hundreds of routine flights, testing the plane and engine at every attitude and altitude, before the trial flights are finished.

Whenever you find that you wish to know more about any article in this magazine, write our Bureau of Information, inclosing return postage.

\$200 My First Week



... Now in my OWN Business.

Would you, too, like to own a business where you could take in \$200 your first week as did L. A. Eagles in Madison, Wisconsin?

We want a reputable, honest man in each county. This man need not have any special experience or more than ordinary ability, but he must be honest and courteous.

Such a man we will start in business for himself. You can make far above average profits in the rug-cleaning business—a high-grade business all your own. Many earn \$125 to \$200 per week—some considerably more.

NO SHOP NECESSARY

The rug-washer finishes rugs like new on the customer's floor. Anyone can run it. Electricity does the work. A quick, thorough and highly-efficient method that restores the natural beauty of floor coverings.

There are hundreds of customers—in your vicinity and nearby towns. The business grows steadily. Simply clean a few rugs or carpets. These customers tell others and also give you their future work. Soon you will have a prosperous year-around business. Send coupon for booklet explaining everything.

"Profits Pay for Home"

Harry Hill built and paid for a home from rug-washer profits. His first day's business was \$86. Another man writes, "Made \$70 in 13 hours." A. L. Miller says, "Have had rug-washer 6 years—have earned as high as \$92 a day." M. O. Malmin earned 3 times the cost of his machine the first two months. You, too, can enjoy a large income.

VON SCHRADER MFG. CO., 101 PL., RACINE, WIS.

Free Book!
MAIL COUPON now

VON SCHRADER MFG. CO.
101 Pl., Racine, Wis.

Send at once (no obligation) your free booklet illustrating rug-washer and telling how I can own my own permanent business; how I can earn large profits at prices below other methods; how I can become financially independent in a short time; and how I can pay on easy terms.

Name.....

Address.....

City..... State.....



"Never a Complaint"

C. J. White says: "\$100 business in six days—never a complaint." That is the nicest part of this business—every customer is more than satisfied. Stains and blotches disappear and vivid colorings and freshness in faded floor coverings come back.

EVERY MACHINE GUARANTEED

You take no risk. These machines have been manufactured since 1918 and are used by the United States Government and by Statler and other leading hotels. They are fully GUARANTEED.

EASY TERMS

The complete equipment is inexpensive. A reasonable down payment brings everything to you and the balance is paid monthly. From the start, you have your own business—one that is profitable and of which you can be proud.

MAIL COUPON Today



"THE NEON LIGHT sets you RIGHT" ★ TEST-O-LITE

At Electrical Stores or \$1.50 Postpaid
Handiest electrical tester made: quickly locates trouble in electric circuits, fuses, cut-outs, motors, radios, etc. Has 1,001 uses for electricians or home. Tests any voltage 110 to 550; tells A.C. from D.C. Excels ordinary clumsy test bulb. Fountain-pen size; with pocket clip. Lifetime guarantee.
L. S. BRACH MFG. CORP., 55 Dickerson St., Newark, N. J.

DO YOU

WANT a new business profession of your own, with all the trade you can attend to? Then become a foot correctionist, and in a few weeks earn big income in service fees,—not medical nor chiropody—easy terms for home training, no further capital needed, no goods to buy, no agency. Established 1894. Address Stephenson Laboratory, 1 Back Bay, Boston, Mass.

CHEAP FARM POWER PULLFORD MAKES ANY FORD CAR INTO A TRACTOR



Powerful... Economical

Plows 5 acres a day. Discs, cultivates, harvests. Does the work of 3 or 4 horses, faster and better. The PULLFORD unit is quickly attached to Model T or A Ford. It's simple, strong, built to last. Use your old Ford or buy one cheap, and get the advantages of power farming.

WRITE for FREE Catalog Pictures... letters from users... details and LOW FACTORY PRICES.

PULLFORD CO., 2948 Cherry St., Quincy, Illinois

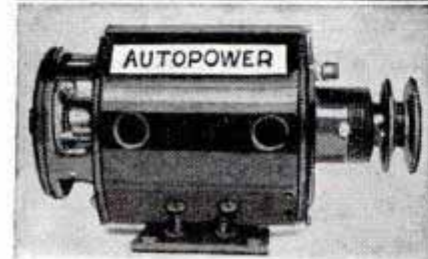

TURN SCRAP INTO MONEY

AUTOPOWER tells you how in plain, easy, simple and illustrated instructions that anyone can follow. Change auto generators into useful, practical A C and D C generators and motors with voltage from 2 to 1,000 volts, for power, light, welding, radio, sound, etc. No previous experience nor special tools needed. Generators can be driven by wind, water, fan belt, etc. INSTRUCTIONS FOR BUILDING AN A C WELDER THAT ACTUALLY WORKS UP TO A 3/16" ROD. ALSO COMPLETE PLANS FOR WIND AND WATER POWER PLANTS. Send for your copy of "AUTOPOWER." Already used and endorsed by thousands. Only \$1.00 postpaid.
S. W. DUNCAN, Publisher. 410 S. Hoyne Ave., Chicago



20,070.

YOU NEED THIS FREE HOME REPAIR BOOKLET

Contains diagrams and simple instructions for emergency and routine repairs that every home and auto owner can and should make himself. Revised



edition, greatly enlarged and completely rewritten. Get a copy for your workshop.

Be thrifty—do your own work—and keep the money otherwise paid to plumbers, repair men and for new parts.

With Smooth-On No. 1, you can stop leaks at joints, seams and cracks in pipes, boilers, heating systems, tanks, pails, auto radiators, water jackets and crank cases, tighten loose parts, reset stripped screws, bolts and nuts, and make dozens of other equally practical repairs—all at almost no cost, and in emergencies without the delay of waiting for outside help.

Smooth-On No. 1 is applied without heat or special tools, hardens into metallic iron and holds permanently under any pressure and on any metal, masonry, wood and tile. Leading power and industrial plants have used it for 35 years, and with this new booklet, as a guide, you can make equally successful applications.

When you know where and how to apply Smooth-On No. 1, you will make constant savings. Be prepared. Ask us for the booklet and buy Smooth-On No. 1 in 7-oz., 1-lb. or 5-lb. can from your hardware store.



SMOOTH-ON

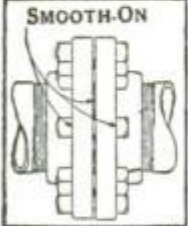

SMOOTH-ON



SMOOTH-ON

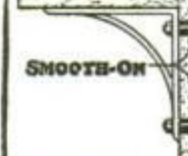

SMOOTH-ON



SMOOTH-ON



Do it with SMOOTH-ON

SMOOTH-ON MFG. CO., Dept. 37
574 Communipaw Ave., Jersey City, N. J.

Please send the free Smooth-On Repair Book.

Name.....
Address.....
1-38.....

Broadcast Gives "Sight" to Ears

(Continued from page 92)

of a super-imposed scene that was entirely different—an announcer, modern, up to date, describing this timeless city.

Reis would have preferred going outdoors to some mighty stadium. But he couldn't on account of that timeless angle—New York's most isolated stadium would necessarily catch familiar city sounds—and on account of his cast. Obviously he couldn't have an actual cast of 10,000. Two hundred men, women and children were the most permitted. He had to devise some

Charles Dickens "The Signal man"



Actor reading his lines inside acoustical screen to get effect of small place

means of amplifying or adding to those 200 voices mechanically, to make them sound like the entire population of a city.

So he chose the Seventh Regiment Armory in New York, a huge block-long edifice. It was big enough so that an actor, standing at one end, could speak into a microphone and his voice would "decay" into the distance, in much the same way that it might disappear into the great space of outdoors. Yet it was at the same time capable of being used for the trick of making 10,000 voices out of 200. Reis did this by recording the shouts and cries of his 200 people at rehearsal. He then had four different copies made of the recording, which he gave to four different assistants stationed at strategic positions around the

Summit, New Jersey

armory. At a given signal, these assistants played the records over loudspeakers, which projected the shouts into the armory at the same time that the live cast of 200 was also shouting over the microphone. As each record was played on a turntable of varying speed, the result was that of a confused human rumbling. But the modern announcer couldn't speak in the same kind of acoustical space as that of the city shouters. So Reis built a special box, a complete little shack of acoustic panels, similar to those used for broadcasts of races and football games. Sound-proofed, with a separate microphone of his own, and in communication with Reis only by headphones, the announcer sounded really in a "world apart."

Reis isn't content with ordinary auditions of actors or ordinary casting of his radio dramas. Instead he tests his actors' voices by means of the resonoscope, a device uncannily accurate in showing the exact pitch, tone color, intonation and balance of a voice. Merely by speaking into the small microphone attachment of this instrument, the actor is enabled to see the colored visual pattern of his own pitch quality thrown upon a portable screen. After finding pitch and tone qualities which suit him, Reis often proceeds to change them entirely, to suit the peculiar need of some scene.

For instance, in an adaptation of Charles Dickens' "The Signal Man," he needed a voice for the signal man that was abnormally dull and dead. No actor, fine though he might be, quite filled the bill. So Reis "deaden" a normal voice by placing the actor inside a heavily absorbent, acoustically dead booth. In "Downbeat on Murder," where he needed to overemphasize the rasping, nasal tone of a nagging wife, he passed a normal woman's voice through an electrical filter, and by eliminating some of the lower frequencies, obtained a high-pitched, thin, unpleasant quality.

Often he uses the filter to represent a voice which in the drama is supposed to be speaking over a telephone wire or a radio set. One of Reis' new effects are sounds he calls "sound abstractions." These are sounds which everybody thinks he has heard, but which in reality do not exist. Such things include the "ringing of silence," in an empty house, the "crying"

(Continued to page 131A)

BIG MONEY

Assembling Mead's New

50 lb. Portable OUTBOARD BOAT!

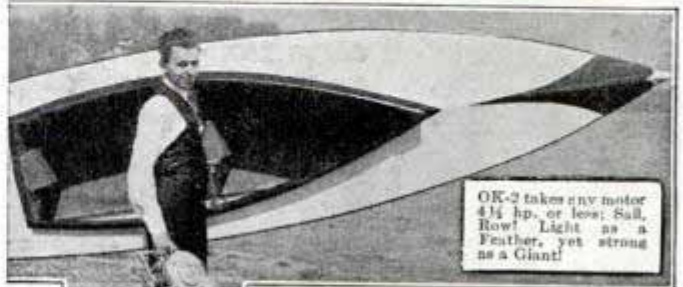

OK-2 takes any motor 4 1/2 hp. or less: Sail, Row! Light as a Feather, yet strong as a Giant!

FACTORY-TO-YOU AT LOW FACTORY PRICE!



PRICED LOW — and PAY as You BUILD!

A sensation! Build this 50-lb. tough, durable, seaworthy, portable Outboard Ki-Yak in 2 days at home! Then it's always ready to go anywhere by hand or car. Safe, leakproof. More speed per horsepower. More miles per gallon! Mead's perfected aluminum-ribbed, Cut-to-Fit Construction Kit guarantees successful assembly, easily, quickly—and profitably (if you build to sell to others). Amazing LOW Factory-To-You Introductory Prices, and if you wish you can even Pay as You Build! Mead Ki-Yaks and Ki-Yak its sold Direct from Factory ONLY. So rush dime and Coupon below, for details!



DEAR, THAT'S THE FIRST THING YOU EVER BUILT—IT LOOKS GREAT!

YOU BET EASY WORK AND EDUCATIONAL, TOO!

SEE THIS IS FUN, DAD!

9 HOURS TO BUILD NEW SPORTSMAN'S BOAT!

"CK-2"

Paddle Boat Is

Quickly Converted Into Speedy Sailboat!

Assemble Mead's "CK" Sportsman's Ki-Yak in 2/3 LESS time with new construction principle. "Home Assembly" eases you nearly HALF factory-built cost! Most sensational boat development in years! Weighs only 30 lbs. Portable by hand or car! Thousands in use! Sold Factory-To-You ONLY. So rush dime (covering handling, postage) and Coupon for giant new Colored Circular, low Introductory Factory Prices, \$6.00 Gift Paddle Offer. Hurry!

\$6 PADDLE GIVEN with your Ki-Yak — if you hurry!



MAIL COUPON RIGHT NOW!

Gentlemen: I am enclosing 10c postage handling charge. Please rush me your New Boat Catalog, Low Introductory, "Factory-To-You" Prices and \$6 Gift Paddle Offer.

NAME.....
STREET & NO.....
CITY..... STATE.....

RUSH ME WITH 10c TO MEAD GLIDERS 15 So. Market, Dept. B-15 CHICAGO

TRY THIS for a Merry Christmas and **A HOBBY NEW YEAR** 10-DAY money-back TRIAL

ALL PURPOSE MOTO-TOOL

saves time and labor on all craft work

An attractive, appreciated gift for every craftsman who works at home, shop, school or profession. Grinds, drills, carves, polishes, etc. on all materials. Takes 10 seconds to do 10 minutes hand work. Absolutely safe—thousands in use. Weighs 6 oz., handles easily as a pencil. Powerful—about 25,000 r.p.m., AC or DC current. Chuck handles a large variety of tools.

MODEL 1
\$9.85
Postpaid



NEW MODEL 2 MOTO-TOOL
Faster — More Powerful

Designed for heavier shop work, this rugged machine is recommended where precision and accuracy are demanded. It has many refinements—unit finger grip—chuck lock—snap switch—air cleaner—better cooling—convenient hanger, etc. Weighs 13 oz., develops about 27,000 r. p. m. Price \$16.50, postpaid.

20 pc. craftsman's tool set, for either model **\$5.75** Post-paid

Ask your dealer for a demonstration or order by mail on 10-day money-back trial. Send for FREE booklet.

DREMEL MFG. CO.
2825 Ct., Racine, Wisconsin

UNIVERSAL SHAPING TABLE \$2.50 (stand extra)
STAND \$4.50





MEN—MAKE MONEY

Get into something for yourself, where your income is practically unlimited—The American Electric method of floor surfacing gives you that opportunity. Large profits—Work easy to get—No previous experience necessary—As little as \$75. starts you—Write quick—No obligation.

The American Floor Surfacing Machine Co.
323 So. St. Clair St. Toledo, Ohio



BUILD CLOCKS for PLEASURE—PROFIT

Hall clocks are high priced in stores—you can make good money building them or electrifying spring clocks. Dime brings drawing of easily built Grandfather Case with "HOW" Book pricing banjo, desk, mantel, spring. **ELECTRIC CHIME BATTERY CLOCKS** from \$1.40. Hall Clock, Brass weight chime movements from \$16.95. Starinus. **KUEMPEL CHIME CLOCK CO.**
Building 12 Guttenberg, Iowa



DIESELECTRIC PLANTS

MAKE YOUR ELECTRICITY FOR 1c PER KILOWATT

Make your own electric light and power the "Diesel Way" with **WITTE Dieselectric Plants**, 1600, 3000 or 6000 watts, for Less Than ONE CENT per KILOWATT on cheap non-explosive fuel. 110 volt A. C. or D. C. for direct lighting, 32 volt for battery operation. Charging costs lowered 75%. Easily installed in small space. Also stationary Diesel Engines 3, 5 and 10 H. P. Use a Diesel for Economy and Safety.

4741 Oakland Ave. Kansas City, Mo.

WITTE ENGINE WORKS

\$650 and up F. O. B. K. C., Mo. Easy Payment Plan



Can You Equal This Home for \$895

Shipped Direct from Our Mill

Save 30% to 40% on Your New Home.. **WE PAY FREIGHT**

Don't pay several hundred dollars more than necessary when you build a home! Buy it direct from our mill at our low factory price. We ship you the materials—lumber cut-to-fit, ready to erect. Paint, glass, hardware, nails, etc., all included in the price—no extra charges. We pay the freight. Plans furnished—also complete building instructions. No wonder our customers write us that we saved them 30% to 40%, compared with builder's prices. Easy terms—monthly payments.

Handsome Big CATALOGUE FREE

Pictures wonderful homes in colors at money-saving prices. Designs to suit everyone. Write for your catalogue today

LEWIS MANUFACTURING CO.
Dept. 1281 Bay City, Michigan

Send for FREE BOOK of Liberty Homes



ONE-MAN SAWMILL

Makes lumber, shingles, lath, ties, crates, boxes, cases, all forms lumber

TURN TREES INTO MONEY WITH A BELSAW **\$49.00** FARM MODEL

Three capacities: 10, 14 and 20 ft. Accurate set works positive dogs. Hand or power feed. Runs on low power—Many owners use old auto engine. Pays for itself quickly—thousands in commercial service, everywhere. Write for free lumber handbook and catalog of mills, supplies, tools, saw tables, and woodworking equipment.

Belsaw Machinery Co., 8110M Davidson Bldg., Kansas City, Mo.



RADIOS.. SAVE UP TO 50%

DEAL DIRECT...FACTORY PRICES! Many models to select from: AC-DC; All Wave; armchair models; automatic tuning; car radios; Farmsets that operate like city radios! Send postcard for NEW Bargain Catalog FREE. 30-DAY TRIAL plan and agent-user proposition!

GOLDENTONE RADIO CO.
DEPT. EL DEARBORN, MICHIGAN

30 DAY TRIAL \$6.98 UP

Free Catalog



Sani-Flush SAFE, NOT CAUSTIC

KEEPS AUTOMOBILE RADIATORS CLEAN



TRAILER BUILDERS TRAVELERS TRAILER PLANS

SEND 25c TODAY FOR this big 68 page Trailer Manual printed in color. It is chock full of builders' information—Over 350 illustrations, 500 exclusive Trailer supplies, equipment and accessories needed to build the most modern Trailer. **BUILDERS' GUIDE** with complete plans, instructions, designs, specifications, listing practical material. Trailer cabinets, stoves, refrigerators, sink, water tanks, cushions, table, drawers, bathtub, toilet, etc. Also a complete Trailer shell built into 10 sections ready to set up and bolt together. Takes low freight rate. Send 25c, coins or stamps today

A. J. Stephens & Co., 2805 E. 14th St., Kansas City, Mo.



MARVEL LONG RANGE TELESCOPE

All distant objects, stars, ships, sports, airplanes, etc., closely seen through powerful lenses. Opens nearly 3 feet. Brass trimmings.

SPECIAL INTRODUCTORY OFFER. This wonderful value telescope will be sent postpaid for only \$1

For lowest prices on telescopes, microscopes and binoculars—send for FREE catalog.

The HOBBY MAN, 703 W. State St., (Dept. P.M.) Jefferson, Ia.



1070
(Continued from page 129A)

of fog, the weird throbbings and whistlings supposedly heard by patients going under ether. Reis uses a lot of these sounds as backgrounds in the subconscious dramas, in plays where men slowly go mad, drown or suffocate. Sometimes he employs a pulsating oscillator, held far back from the microphone, so that there is just a kind of eerie whistling going on.

Besides these queer "background" sound effects, Reis has added immensely to the resources of radio sound effects by introducing hitherto unheard sounds.

One of these was the beating of a human heart. To secure this sound effect, which beat steadily throughout the drama, becoming louder and louder until it resembled the pound of an orchestral timpani, Reis employed an athlete who lay upon a couch in a separate studio with a stethoscope strapped to his chest. The sound of his heartbeat was picked up by a microphone attached to the stethoscope, and sent over a controlled loudspeaker near by.

Recently, in Ernest Hemingway's "Fifty Grand" which was about a prize fight, Reis employed two prize fighters from a New York boxing establishment, and had them spar in front of the microphone.

In putting sound effects into a radio drama, Reis works under a principle he calls key sound effects. That is, he feels that for artistic drama, only a few significant sounds should be heard, rather than all the sounds actually there in life.

He learned this principle while experimenting with a drama called "Broadway Evening." Designed to show a composite picture of Broadway, the drama called for a scene in a restaurant, Times Square and other famous spots in the city. Reis therefore took his microphone out to the real restaurants, the real streets of New York City, and picked up everything. But the microphone gathered in too much, and the background was chaotic.

Therefore, Reis has decided on a few simple and suggestive noises. In a restaurant scene these days, he'll have only the clinking of forks or the clatter of dishes. In a scene outdoors, he may merely use a single cricket chirping over and over again.

Our Bureau of Information will answer questions regarding articles in this magazine, if accompanied by return postage.



Low Operating Cost as Well as Low Initial Cost

If you want to get into aviation at low cost, get a Cub airplane. Here's a ship that is as economical to fly as it is to buy. Records reveal that Cub owners obtain 25 miles to a gallon of gas and 350 miles to a quart of oil. And the New Silver Cub is only \$1270 F.A.F. factory—\$425 down—easy monthly payments. Wherever you go, COUNT THE CUBS.

FREE!



Get Your Wings Now!

Send today for free new Cub folder and name of your Cub dealer. Use coupon below, if you wish. Enclose 10c in stamps or coins and we'll send you a handsome "wings" insignia pin.

TAYLOR AIRCRAFT COMPANY

18 M Street, Lock Haven, Pa., U.S.A.

Please send me your free illustrated Cub folder and name of my Cub dealer. Enclosed find 10c for my "wings" insignia pin.

NAME _____

ADDRESS _____

CITY _____

STATE _____

The New Silver CUB



SAW TABLE \$1.75

A fine bargain, heavy cast iron saw table. For the home or shop, size 9 1/4 x 7 x 6 1/2 inches; 1/2" shaft; weighs 7 1/2 lbs. Has side guide and tilt adjustment; pulley included. Belts or 4" saw blades 35c each, requires 1/4 h.p. motor. All prices F.O.B. Phila.

Send \$1.00 with order, balance C. O. D. Canadian orders \$1.00 extra.

Send 10c for illustrated catalog showing screw cutting lathes, drill presses, motors and other tools.

MARTIN ELECTRIC T & S CO. 604 Arch Street, Philadelphia, Pa.

NEVERSLIP PULLEY

Transmits more power with less belt wear; unaffected by weather. No pulley covering, no belt dressing required. Replace troublesome pulleys with NEVERSLIPS. All sizes. Money-back guarantee. Ask for NEVERSLIP Pulleys on ALL power machinery you buy. Write for folder and prices.

ROSENTHAL CORN HUSKER CO.
Box 16 Milwaukee, Wisconsin



AGENTS PICK UP DOLLAR BILLS



● Make up to \$20.00 a day showing women how to keep doors from slamming. New JAY-WAY door holder SNAPS into place—no screws, no attachments. Homes, offices, hotels, hospitals—all prospects. Only 50c. You should sell two in every home. Write for special offer to agents.

JAY-WAY Company, Dept. 15
350 Madison Ave., New York, N. Y.



HERE'S PROVED RELIEF FROM ACID INDIGESTION

YES—TUMS, a remarkable discovery brings amazing quick relief from indigestion, heartburn, sour stomach, gas, and constant burning caused by excess acid. For TUMS work on the true basic principle. Act unbelievably fast to neutralize excess acid conditions. Acid pains are relieved almost at once. TUMS contain no laxatives; no harmful drugs. **Guaranteed to contain no soda.** Over 1½ billion TUMS already used—proving their amazing benefit. Try TUMS today. Only 10c for 12 TUMS at all druggists. Most economical relief. Chew like candy mints. Get a handy 10c roll today, or the three roll economy package with metal container for only 25c.



FREE Beautiful Six-color 1938 Calendar-Thermometer. Also samples of TUMS and NR. Send stamp for packing and postage to Lewis-Howe Company, Dept. 31-A-10, St. Louis, Mo.



ELECTRICAL KIT ONLY \$1.69

Make Dozens of Fascinating Experiments!

Fun! Educational! Weld iron, brass. Melt glass, metal. Make arc light, 1-mi. range. Arc furnace. Ultra violet sun-tan rays. Dozens interesting experiments. Works from house light current. (List \$4.75.) Yours now for only \$1.69!

COMPLETE with carbon resistor compensator, cord, plug, special goggles, Instr. Book, etc.

ELECTRICAL SALVAGE CO., Box 524-K, Lincoln, Nebraska

NEW BENJAMIN AIR PISTOLS

Powerful - Accurate - Economical - Practical - Adjustable Shooting Force - Amazing Maximum Velocity—cal. 177 or 22 and BB—For Target and Small Game—the only Genuine Compressed Air Pistol for Shooting BB on the market—Single Shot with Bolt Action—Hammer Fire—Hair Trigger—Safety. Price \$7.50. Holster \$2.00. Also 177 and 22 Single Shot Air Rifles \$7.50—Single Shot BB Air Rifle \$6.00—25 Shot BB Repeater Air Rifle \$7.50—at Dealer or Direct—No license required—Safe for indoor use. FULL DETAILS—TARGETS—FREE—WRITE TODAY Benjamin Air Rifle Co., 891 Marion St., St. Louis, Mo.



AUTO ENGINE SPEED CONTROL GOVERNORS

To control speed of any make of auto or truck engine, regardless of load changes, when used as a stationary or portable power plant. Fully guaranteed. Plain Bearings, \$9 and \$13.50. Ball Bearings \$16.50. 30 days free trial. (No cash down) if you send name of your banker, to whom we will send Governor. Free circulars. Mfg. Candee-Smith Governor. Dept. BC, 215 North L. A. St., Los Angeles.

Chemistry and You

(Continued from Coloroto Section)

For years chemists sought to create rubber independently of the rubber tree. Governments and men, including Edison, tried to produce it from plants and weeds, such as the common goldenrod. One reason for these feverish efforts was that rubber production is practically a monopoly of the Far East—the United States, user of more than half the world's rubber, gets ninety-nine per cent of its supply from that source. Another reason was rubber's inherent shortcomings which science had mitigated but not removed.

Finally, in 1931, the world-sought material was successfully synthesized by du Pont chemists. Fortunately, however, the product was not true rubber—chemically it was not rubber at all! If it had been, it follows that the synthetic substance would have had all of natural rubber's weaknesses. This new material, built up by intricate processes from coal, limestone and salt, looks like rubber, acts like rubber, serves wherever rubber serves, but it is many times more resistant to oil, grease and gasoline, and to alkalis and acids; it offers far superior resistance to sunlight, oxygen, heat and age, and it is less permeable to gases.

This material has been named neoprene. It is produced in quantity and is being used in a wide variety of products—for gaskets, washers, and packings in all industries, for printing rollers, gasoline hose lines, for pistons and cups in oil slush pumps, in covers of transmission belts operating under greasy and oily conditions, in hospital sheeting, balloon fabrics, and on through an ever-growing list. Much mechanical progress that was retarded because of the lack of a rubberlike material without rubber's faults, is now under way, thanks to the synthesis of neoprene.

The price of neoprene is three and one-half times that of the present price of rubber, but on the basis of utility it is cheaper than rubber for many purposes even now, and, although nature may be able to grow rubber at a lower cost than we can make neoprene, if history should repeat itself we may yet see the day when neoprene costs no more per pound than rubber. In the meantime the price of neoprene stands as a limit beyond which the price of planta-

(Continued to page 134A)

\$7.50 EACH POSTPAID

Most Unusual MOVIE OFFER EVER MADE

GET BOTH CAMERA & PROJECTOR for Only \$13.50 Complete and Postpaid

\$7 EACH POSTPAID



Everything to take and show **real 16 mm. movies** at less cost than taking snapshots.

CAMERA — Spring Motor drive — Automatic Release Button — Footage Indicator — 50 foot capacity. No adjustments necessary.

PROJECTOR — Quiet, smooth and flickerless — Motor driven — sturdily built. Uses any standard 16 mm. film.

FREE 50 FOOT PROJECTOR FILM with each \$13.50 COMBINATION.

Write NOW for Big **FREE** Catalogue of Movie Supplies and Film Subjects. **We are never undersold.**

PARAMOUNT MFG. CO., DEPT. G-92 BOX 224, BACK BAY, BOSTON, MASS.

A Gift in the Right Direction



Every driver needs this handsome, dependable **Hull Auto Compass** to be sure of directions and travel anywhere by the shortest routes without confusion or backtracking. Saves precious time and money. Quickly attached. Guaranteed for any car. In a beautiful gift package, only \$2.95 at your dealer. Write for circular.

HULL MFG. CO., P. O. Box 246-D7., WARREN, OHIO

HULL STREAMLINE AUTO COMPASS

JIG SAW \$1.50

COD or outside U.S.A. \$1.75

POST PAID



Including 12 assorted blades, Adapters, Illustrated Manual, and roller Saw Guide formerly found on expensive machines only. All metal, 15" long, 8" high, 6 1/2" table. A swift and easy cutter—best ever made for the money.

"The Jigmaker" cuts wood up to 2" thick

FREE CATALOG describing cash prize contest and illustrating complete power tool line: Shaper, Circular Saw with oilless bearings, \$3 each; Drill Press, \$2.50; completely equipped Lathes, \$2 and \$4.90; Sander, \$1 etc. Order today or send card for Catalog.

J & H Metal Products Co. 5 Commercial St. Rochester, N. Y.

PRINTING offers BIG PROFITS



Cards, Stationery, Circulars, etc. Easy rules. Sold direct from factory only. Does raised printing like engraving. **Junior outfit, \$8.85.** Senior outfits \$12 and up. **Do Your Own Printing: Save Money.** Pays for itself in short time. Write for full details. **THE KELSEY Company, Y-37, MERIDEN, CONN.**

EXCELSIOR

New Adding Machine Fits Vest Pocket!



Adds, subtracts and multiplies up to one billion. Weighs only 4 ounces. Not a toy—strong guarantee. Absolutely accurate, very fast. Sells to offices, stores, homes—wherever figures are used. Write quick for **FREE** AGENTS sample offer and Money-Making Plan.

VE-PO-AD, Dept. 110, 303 W. Monroe St., Chicago

Costs only **\$2.95**

BUILD WITH DOENUTS



Build with the original patented low pressure **Musselman Doenut** cord tires and wheels. They absorb surface obstructions, eliminate jolts and reduce pushing and pulling effort approximately 50%. Tire requires as low as 12 to 15 lbs. air pressure for loads up to 225 lbs. per wheel. Size 10" x 2 3/4". Cadmium plated steel disc wheel with adjustable ball bearings. Doenuts are ideal for building hand trucks, midget autos, wheelbarrows, lawn mowers, lawn furniture, portable painting, spraying and erasing equipment or any portable unit under 900 lbs. Boys: send 50c for full set blue prints for building wagons, wheelbarrows, bicycle trailers, scooters and midget autos, with free literature.

MUSSELMAN PRODUCTS CO. 6247-W ST. CLEVELAND, OHIO

Sensational BARGAINS

Guaranteed \$102.50 Model NOW Only \$44.90 Cash

On Easy Terms SMALL CARRYING CHARGE

10 Day Trial No Money Down



Positively the greatest bargain ever offered. A genuine full sized \$102.50 office model re-finished Underwood No. 5 for only \$44.90 (cash) or on easy terms. Has up-to-date improvements including standard 4-row keyboard, backspacer, automatic ribbon reverse, shift-lock key, 2 color ribbon, etc. The perfect all purpose typewriter. Completely rebuilt and **FULLY GUARANTEED.**

Learn Touch Typewriting

Complete (Home Study) Course of the famous **Van Sant Speed Typewriting System** — fully illustrated, easily learned, given during this offer.

INTERNATIONAL TYPEWRITER EXCHANGE
231 West Monroe St., Chicago, Ill., Dept. 101
Send Underwood No. 5 (F. O. B. Chicago) at once for 10-days' trial. If I am not perfectly satisfied I can return it express collect. If I keep it I will pay \$3.00 a month until I have paid \$49.90 (term price) in full.
For quick shipment give references and occupation.
Name.....Age.....
Address.....
Town.....State.....

Money Back Guarantee

Send coupon for 10-day Trial — if you decide to keep it pay only \$3.00 a month until \$49.90 (term price) is paid. Limited offer — act at once.

HANDEE TOOL OF 1001 USES

A Nifty GIFT FOR BOYS FROM 7 TO 70



A whole shop full of tools in one — for work on all metals, alloys, bone, resins, glass, stone, wood, etc. Uses 200 different accessories to grind, drill, cut, polish, carve, rout, saw, sand, sharpen, engrave, etc. Saves hours of tedious hand work. Weighs 12 ounces. Speed 25,000 r.p.m. Plugs in any socket, AC or DC, 110 volts. \$18.50 postpaid, 6 Accessories Free.

STANDARD MODEL. For the man who prefers less speed, 13,000 r.p.m. Weighs 1 pound. A sturdy little helpmate for mechanic, repairman or home craftsman. \$10.75 postpaid, 3 Accessories Free.

GET A DEMONSTRATION at your Hardware, Department or Tool Dealer or Order either Model on 10-Days Money-Back Trial. Catalog Free.

CRAFTSMAN'S PROJECT BOOK Easy working plans for making many interesting and unusual projects. 25c stamps or coin.

CHICAGO WHEEL & MFG. CO.
1101 W. Monroe St. Dept. Q Chicago, Ill.

Send Catalog Project Book PM-1
 \$10.75 Model De Luxe Model Send C.O.D.

Name.....
Address.....



ABSOLUTELY EQUAL BLADE TENSION... Eliminating "WHIP" the chief cause of all blade breakage

It's an engineering fact—right now there is no other saw which maintains the same blade tension throughout the entire blade stroke—Two scientifically designed adjustable compensating spring mechanisms are used, a cantilever type on the upper operating shaft and an adjustable spring tension on the lower mechanism that are synchronized to eliminate blade whip and reduce vibration to a minimum. A great improvement over all other scroll saws.

DURO METAL PRODUCTS COMPANY
2649 N. KILDARE AVE. • 258 BROADWAY
CHICAGO NEW YORK

FOR HIS CHRISTMAS

Bartlett DROP-FORGED Compound Lever Snips \$2.70 to \$9.50
Made of high-grade Crucible Tool Steel, accurately tempered. Cuts metal up to 18 gauge easily. A special snip for repair work about the house or shop. Cuts screen, stove pipe, picture wire, paper, wallboard, tin, cloth, and sheet metals. 7-inch, aluminum, \$2.70; 8-inch, forged, \$4.00; 10-inch, \$6.00; 12-inch, \$8.00; 14-inch, \$9.50. Every tool guaranteed. Postpaid. Sold by dealers or direct.
FOLDER ON REQUEST
Bartlett Mfg. Co., 3020 E. Grand Blvd., Detroit, Mich.

MIDGET GAS MOTORS
for SPEED BOATS and AIRPLANES

MIGHTY MARINE
• The famous Mighty-Midget and Mighty Marine gas engines are the latest development of America's leading model manufacturer. Individually tested, with Bunch piston rings, aluminum alloy piston, sandcast crankcase, machined and polished steel cylinder, foolproof timer and carburetor for easy starting, these engines have no equal for quality, stamina and performance. • The newly developed **Mighty Marine**, with flywheel furnished, is the only simplified air-cooled speedboat engine today. • The unexcelled **Mighty-Midget** will propel your gas job for reliable, extra high-climb, super-endurance flights. • Specifications: 3/8" bore, 13/16" stroke, 1/5 h.p. at 5200 R.P.M., 1/4 h.p. 8500. Bare engine wt., 6 1/4 oz. Assembled and block-tested; attach batteries and run. **Mighty Marine**, \$17.75 (for Speedboats) **Mighty-Midget**, \$14.00 (for Airplanes).

• **Save money**, Build Your Midget Engine at Home. Spend a pleasant evening setting up an engine kit. All parts machine finished and fitted as illustrated. Factory performance guaranteed. **Mighty Marine Kit**, \$11.40, **Mighty-Midget Kit**, \$9.85. For Speedboat and Airplane circular, send 10c.

MOTOR KIT

BUNCH MODEL AIRPLANE CO.
5007 SO. HOOVER ST., LOS ANGELES, CALIF.

WOODSTOCK TYPEWRITERS

es 811

Chemistry and You

(Continued from page 132A)

tion rubber cannot go. Neoprene has an enormous immediate value in industry, but compared to its potential value its present status is relatively trivial.

Other new rubberlike materials also have been developed here and abroad. Each of them has one or more special properties that make it valuable, and a broad new field in the use of such materials, as well as in the wider use of rubber itself, is opening. Rubber-tired railway and subway trains are now a subject of experiment. In view of the rising opposition to the continuous din of noise that makes our large cities like so many bedlams, it is highly probable that all vehicles such as milk wagons and streetcars will be fitted at no distant date with rubber tires. Carriages were rubber-tired forty years or more ago when rubber was costlier and far less durable than it is now. Developments are pending that may double and even treble the life of motor-bus and truck tires at enormous savings in the aggregate to operators.

(Continued next month)

A New Breed of Racing Cars

(Continued from page 53)

The formula gives the designer with a limited bank roll a better chance than before. It continues for three years, so when he builds a car and gets the "kinks" ironed out, he knows he has something that can be used for three years instead of one. Thus he can afford to put a little more money into the experimental work. Heretofore rules in America were changed annually and designers spent most of their time not in building new cars but in changing old ones to conform to new rules.

For many years, Europe has built the best race cars. In Germany they have the Mercedes and also the Auto Union, an organization involving several motorcar companies. They get their engineering forces together and build a race car. That car is not known by any trade name. It's an Auto Union car. Into it have gone the best engineering brains in the country. When it wins, Germany benefits and German car prestige is advanced.

Why can't our manufacturers do that? For some time, American car makers have

Auto Union Club's

201140

hesitated to put their names on race cars because they feared a loss of prestige if the car lost, and usually a new car doesn't win the first time up. But if our manufacturers would consolidate their engineering facilities, as the Germans have done, they could build American race cars without this disadvantage—and better cars, probably, than any one of them could turn out individually. We are dependent on export to take care of our surplus car production, and if American race cars could win European races, that fact would be reflected in our foreign market.

America stands an excellent chance—although perhaps not an even chance—to win the Vanderbilt Cup race at Roosevelt Raceway in 1938. When road racing was renewed in this country in 1936 with revival of the Vanderbilt Cup races at Roosevelt, American racing interests were unprepared. They had no new cars and built none. In fact, if they had had time to build, they would not have known what to construct. In Europe the three-year rule already was in effect and foreign cars in the 1936 race had been raced for two years on the roads in Europe.

There were no combination men among the present-day American drivers, because our men were fundamentally track men. That was no discredit to them. They just never had an opportunity in track racing to take right-hand turns and to do the braking, accelerating and gear shifting necessary to win a road race. Our drivers were accustomed to a circular or oval track where all turns were to the left and where the throttle was kept virtually wide open all the way. By this, I do not mean that track racing is not a he-man's game. Every track race is tough, just as tough as many road races, but different entirely in driving technique.

Foreign cars had superchargers, big brakes, sturdy transmissions, formula fuel. Our fellows had no adequate brakes, few had superchargers, transmissions were inferior to the foreigners' and we used the fuel mixtures available for gasoline instead of the alcohol mixtures in foreign cars which gave a quicker and colder explosion and extra power.

Our drivers, with their cars, entered the 1936 Vanderbilt under a great disadvantage. They knew the great handicap they

(Continued to page 136A)

MAKE BIG MONEY QUICKLY, EASILY, WITH FLEXARC MIDGET MARVEL WELDING



NEW, SENSATIONAL...
**ONLY \$123.50
COMPLETE**

**GUARANTEED BY
WESTINGHOUSE**

Built in the largest works in the world devoted exclusively to the manufacture of transformer apparatus, the Midget Marvel Welder has back of it 51 years of Westinghouse transformer experience.

**START
YOUR OWN
BIG-PAY
BUSINESS**

Never before has welding offered the profit-making possibilities of today! Far-seeing men everywhere are seizing this opportunity to lift themselves out of the rut of financial uncertainty. What they are doing, YOU, TOO, can do.

Only \$123.50 buys the complete Midget Marvel Welder. You can start to weld IMMEDIATELY. It is common experience that one month's profits will pay for the completely-equipped welder.

Little Experience Required... One or two hours practice following a few simple instructions starts you making neat, solid welds.

Welds all metals from heavy motor blocks, castings and truck frames to fenders and light sheet metal down to 22-gauge.

Weights just 112 pounds. Measures only 11" by 14" by 18". The Midget Marvel can be carried easily in the back seat of your car, ready for instant service wherever 110 or 220-volt a-c. power is available.

Westinghouse *The name that means everything in electricity*

Westinghouse Electric and Manufacturing Company
Room 7-N, East Pittsburgh, Pa.

Without obligation, have your representative call with complete information on the New FlexArc Midget Marvel Welder.

Name.....

Address.....

FREE!

**LABORATORY APPARATUS
BIOLOGICAL SUPPLIES
MICROSCOPES
TELESCOPES
CHEMICALS**

New complete 32 page catalog lists hundreds of items of interest to amateur and professional experimenters. Save Money—Buy Direct. Send now! It's FREE and crammed full of bargains and valuable information.



J. H. WINN MFG. CO., Dept. 401, 124 W. 23 St., New York

NEW! DIFFERENT

Wrist Action CORD SET MONEY MAKER.

**Women ARE GOING
WILD ABOUT THIS
New WRIST-ACTION CORD!**



Here is no ordinary new product. This new Wrist-Action Plug is one of the most remarkable new devices ever offered in the Direct Selling Field! You never saw anything like it. Housewives are fascinated—held spellbound by the instant demonstration you can give with this new electric iron cord that swings freely in any direction. Ends kinking and twisting—prevents broken wires, burned fuses. Swivel action plug spins round and round—swings from side to side—keeps cord out of the way—no wonder housewives say, "Just what I want," as soon as they lay eyes on it!

FREE

Sales are instant—sure! Nothing like it ever before. Here is the self selling big money maker you can clean up with. Get the story at once. Learn how you can GET YOUR DEMONSTRATOR FREE. All territories virgin—wide open. **WRITE NOW!** Write immediately for sensational money making plan.

NO-TRO ELECTRIC APPLIANCE CORPORATION

820 W. Erie St. Dept. P-1 Chicago, Ill.

(Continued from page 135A)



I'M READY TO USE... INSTANTLY

LEPAGE'S
strength
LIQUID GLUE

You get the same uniform strength in bottle, tube or can of LePage's—standard throughout the world.

The economical fixer.



FREE!

HAMMARLUND
NEW '38'
RADIO CATALOG

A new attractive catalog, with complete details, illustrations, mechanical drawings, and curves on the new extensive group of Hammarlund precision products. Address Dept. PM-1-38 for your free copy!

HAMMARLUND MFG. CO., INC.
424-438 West 33rd Street, New York City

AMAZING NEW LOW COST ELECTRIC MOTOR

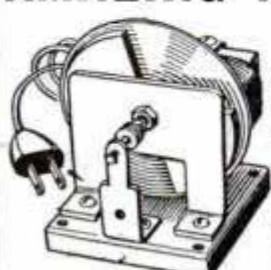

SELF-STARTING! REVERSIBLE! RUNS AT VARIABLE SPEEDS!

NO commutator, brushes, reversing switches or rheostats. Ideal for laboratory tests and experiments. Can be adapted to run small models, toys, regulate display signs, electric relays, photo electric apparatus, timing devices, self-winding clocks, many small devices. Alternating current! Precision built, carefully tested for real service.

STOPPED, STARTED, REVERSED, speeded up or slowed down by manually adjusting segment which locks in any position. Uniform speed, either direction, regardless of fluctuations in voltage and frequency. 12 Volt A.C. for operation on your transformer \$1.10 postpaid. 110 Volt A.C. operates from light socket, no transformer necessary, \$1.45 postpaid. Order now or send for literature.

JAMES RESEARCH LABORATORIES
DEPT. A-1, 1120 ADDISON ST. CHICAGO, ILL.

were under, but they made up their minds that, beaten or not beaten, they would gain important experience—find out what conditions were and what they were up against. The first American to finish landed in sixth place but our boys drove a good race considering their equipment.

The 1937 Vanderbilt found the Americans better—but not fully—prepared. Some had foreign cars, others had built new cars. They had increased brake sizes, they had better transmissions, they had been experimenting with superchargers and fuel mixtures. And they made the best of what they had found out. Our drivers proved they could pilot cars in a road race. Rex Mays, who finished third in an old Alfa Romeo, outran two new Alfas and gave Seaman, the Britisher in a Mercedes, a swell run for second place. Seaman had a faster car and passed Mays on the straightaways—but Mays was passing Seaman regularly in the turns. That's road driving!

In the past two races American drivers have proved that they've got what it takes to win road races. Give them cars that are right and they are going somewhere. One thing, however, the Europeans excel in is pit control and pit operations. That's something our drivers need and need badly. The foreigners have pit forces which are practical, military and automatic. When Rosemeyer, Germany's blond champion who won the 1937 race, stopped at the pits, each man did one job and one job only—and he did it with military precision. As a result, Rosemeyer was out in forty-six seconds after refueling and changing right and left rear tires. Some of our men spent too long in the pits. The records show an American car stopped six minutes for fuel only!

When you are running five seconds apart, pit stops make or break you. In the 1937 race, Rosemeyer beat Seaman by fifty-one seconds. If Rosemeyer's pit work had not been phenomenal—if he had spent a minute and forty-six seconds in the pit instead of forty-six seconds—it is conceivable, even probable, that Seaman would have won.

Over here we do not give enough serious consideration to pit operations. Some of our fellows come down to the track, ap-

(Continued to page 139A)

IDEAL XMAS GIFT!

MAKE HUNDREDS OF FASCINATING Radio-Electrical EXPERIMENTS

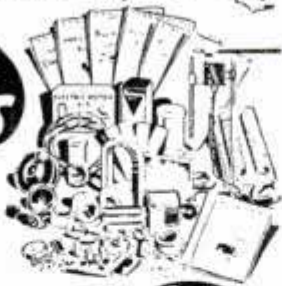

25-Piece Kit! Genuine Commercial Apparatus—Not Toys!

Dozens Experiments Wire up thief-detector, extension phone, electric welder, radio code set, electroplating, arc-furnace, circuit tester, rectifier, 110-volt motor, arc light, 4,000-ft. range, secret service phone, generate sun tan health rays, make electric stove, etc.

Contains 110-volt A. C. motor, microphones, transformer, polarized test receiver, arc carbons, electromagnet, test compass, plating chemicals, condenser, 110-volt inductances, magnet, anodes, test socket, 110-volt power reducer, test cords, slips, etc. **Our kits used by leading schools!**

6 BOOKS Free with Kit! Instruction manuals, Theory of Electricity—Radio, Full plans for Exp. Bench, etc. **SAVE 60%** Send only \$3.99 for complete kit and books (actual value over \$10.) Or, sent C.O.D. Shipped same day order received. 3c stamp brings Bargain Catalog!

ELECTRICAL SALVAGE CO., Box 524-57, Lincoln, Nebr.

Only **\$3.99**
6 Books FREE

Stoves AT FACTORY PRICES!



Sale Catalog — FREE

Nearly 200 Styles and Sizes of Stoves, Ranges, Furnaces at Factory Prices. Easy Terms—as little as **12c a day**. 30 Days Trial. 24 Hour Shipments. Write today for this **FREE CATALOG**. Over 1,200,000 Satisfied Users. 38 Years in Business.

KALAMAZOO STOVE & FURNACE CO.
391 Rochester Ave.
Kalamazoo, Michigan

"A Kalamazoo Direct to You"

FREE CATALOG

FREE ELECTRICITY FROM WIND POWER



For Lights, Power, Radio, from Auto Generators New Copyright Book with over 100 Facts about Wind Chargers. Wind-Propellers—Generators—Plants—Batteries. Answers all questions you should know. Including plans for 6 or 32 V. Plant. Send 25c for plans, facts and catalog. Agents Wanted.

CURRIER MFG. CO. 422 Terminal, Minneapolis, Minn.

EARN MONEY MAKE COLOR-GLAZED CONCRETE PRODUCTS



New low cost method. No molds or costly tools. **You build your own equipment** from plans we furnish. Easy to make pottery, statuary, giftware—in home or shop—to earn money.

MEN—Send 10c TODAY for booklet, details.
NATIONAL POTTERIES COMPANY
Room 6, 13 W. 26th St., Minneapolis, Minn.

HANDY TAP and DIES . . .

Accurate—carefully hardened and tempered. Complete range of sizes at your local five and ten cent store.

HENRY L. HANSON, WORCESTER, MASS.

VENETIAN BLIND MATERIALS

You can make fine blinds for your own home at low cost, also go into the business. All parts supplied. Send 10c for circular and samples of ladder tape, cord, slats and rails.
Venetian Blind Mfg. & Supply Co., Dept 2, 1760 Lunt Ave., Chicago, Ill.

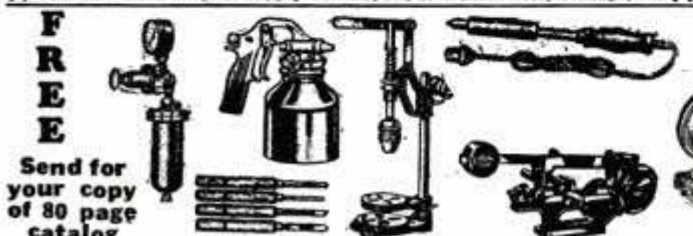

BALKO ELECTRIC MOTOR & SUPPLY CO., Dept. A 23, 10 S. Clinton St., CHICAGO, ILL.

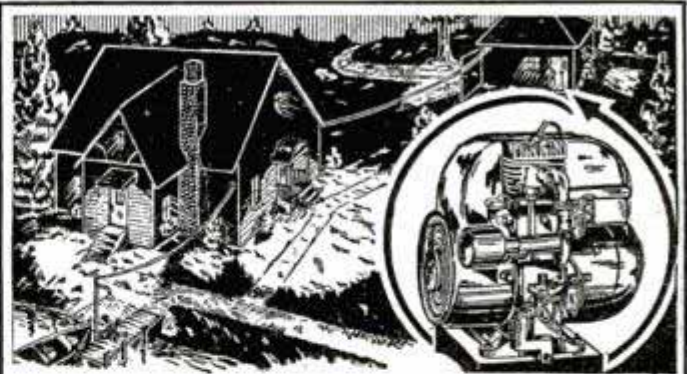

ONAN A. C. ELECTRIC PLANTS

FOR THOSE WHO MUST PROVIDE THEIR OWN ELECTRICITY

ONAN ELECTRIC PLANTS furnish the same current as supplied by power lines—110 volt, 60 cycle, **ALTERNATING CURRENT**. Operate Radio, Water System, Washing Machine, Electric Iron and all Electric Appliances.

Run from gasoline or gas and generate electricity for Farms, Lake Cottages, Oil Stations, Commercial Places. A woman or child can operate it.

SIZES 350 WATTS AND UP

Each ONAN PLANT is a complete Unit, ready to run. No battery used except to start the engine. Easy to install. Available from stock. 32 volt, Direct Current Models also available. Write for details.

D. W. ONAN & SONS

1012 Royalston Ave. MINNEAPOLIS, MINN.

FUN and PROFIT

CRAFTSMAN OUTFITS

Get these fascinating big sets. Learn skilled craft work. Make money selling finished products.

● HOT SPOT Woodburning

Modern electric pen burns designs on wood, leather, cork, etc. Outfit includes wood, paint, patterns. Complete set making Pair of Bookends, What-Not Rack and 2 Plaques, \$2.00.

● HAMMERED BRASS

Plywood plaques and non-tarnishable jeweler's metals, with patterns, hammer, tools, full equipment for "raised metal work." Complete set making Pair of Bookends and 5 Plaques, \$2.00.

● SOLDIER CASTING

Large 3 figure mould, clamps, handles, supply of lead, paints, brushes, electric ladle for making any number of big lead soldiers. Complete \$2.00.

RAPAPORT BROS.

703 W. Ohio St., Chicago

FREE 40 PAGE BOOK

ENGINES

A real money maker for farm or factory. Uses Cheap fuels. Pays for itself out of savings. Costs Less to Own—Less to Operate.



LOG SAWS

Make Money—Start a wood sawing business—turn spare timber into cash. Factory Prices—Cash or Terms—FREE Catalog.

WITTE ENGINE WORKS
1741 OAKLAND AVE., KANSAS CITY, MO.

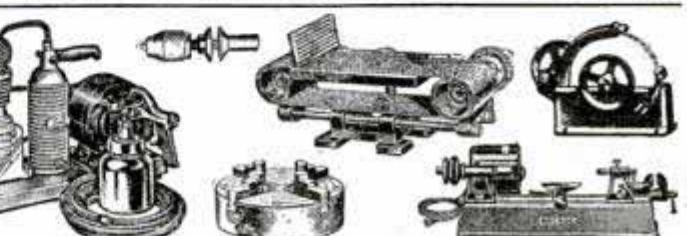

STUCCO SPRAYING MASONRY SURFACES NOW OFFERS BIG EARNINGS



This new machine and process fuses a waterproofed plastic mixture on any masonry. It beautifies and weatherproofs both old or new buildings, walls, etc., at low cost. It fills all cracks and can be applied in any thickness desired and in 30 colors and shades. Fully proven by over twelve years actual use under all conditions and every climate.

LARGE WAITING MARKET

Owners everywhere want to enhance present values and make their buildings more attractive and livable. The better builders are striving for greater permanence, beauty and salability in their new construction. With Colorcrete stucco spraying you can supply this waiting market and can offer permanent colorful surfacing at amazingly low cost. Many operators report costs of 2c to 4c per sq. ft. and sell at from 4 1/2 to 7c. Some have paid for their equipment from first couple of jobs. Machine capacity up to 1000 sq. ft. per hour.

Get the facts. The new Colorcrete books tell the whole story. Write today. It may mean business independence for you.

COLORCRETE INDUSTRIES, Inc., 570 Ottawa Ave., Holland, Mich.

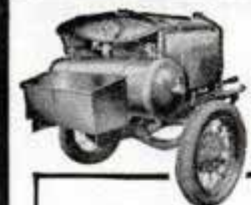

The Famous Smith MOTOR COMPRESSOR made from FORD PARTS

Top Efficiency at a Low Price

Internationally used for drilling rock, breaking pavement, riveting, sand blasting, spray painting, metallizing and general use with pneumatic tools. Replaces inefficient, cumbersome compressors.

Address Inquiries to Desk D

GORDON SMITH & CO., INC.
Bowling Green, Ky.

MODEL AIRPLANE ENGINE

THE SYNCRO ACE is the first modern, streamlined gasoline engine designed for model airplanes. Each engine is block tested at factory. Equipped with new, high efficiency coil, developed by Delco-Remy, oilite Champion spark plugs. Develops 1 1/3 H.P. Bore, 7/8"; stroke 15/16"; speeds from 800 to 8000 R.P.M. Special matched steel piston; special alloy connecting rod; counter-balanced crankshaft. Improved timer.

Each engine factory tested, mounted on skids and sold ready to run. (Less batteries).

Only \$15.00, from your dealer. Write for illustrated folder and full information.

SYNCRO DEVICES, INC. 511 Boydell Bldg. Detroit, Mich.

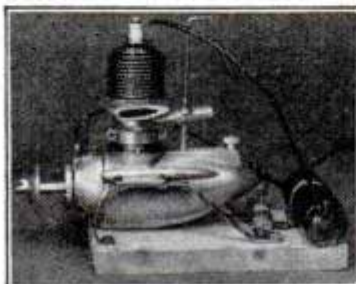

Christmas for CRAFTSMEN



\$1. POST PAID

272 PAGES - 325 ILLUSTRATIONS
LEATHERETTE COVER - WIRE-O-BINDING

It shows real thoughtfulness to give this new up-to-date Atlas Lathe Manual to your "craftsmen" friends. Pictures clearly all metal and wood operations—gives latest technical data for machining new metal alloys, plastics, etc. Each manual comes in individual box with Christmas wrap and card, postpaid for \$1. We'll do the mailing if you wish. Please print names. Order now for prompt delivery.

ATLAS PRESS COMPANY

143 N. Pitcher St., Kalamazoo, Mich.

WORLD'S GREATEST all around ELECTRIC TOOL

SENT ON 30 DAYS APPROVE The new **WHIZ ELECTRIC TOOL** is the handiest, most useful power tool ever made. Not a delicate instrument but a real rugged tool, equally effective for both power and precision work. Drills through 3/4 inch iron plate in 42 seconds or engraves intricate designs on jewelry. Uses 50 different accessories, instantly interchangeable. Handles any material: Metals—Woods—Alloys—Plastics—Glass—Steel, etc. Saves time. Eliminates tedious labor. PERFORMS JOBS IMPOSSIBLE WITH OTHER TOOLS. Plug into any socket AC or DC, 110 volts. Chuck 1/2" capacity. Ball bearing thrust. Powerful, triple-gear motor. **Ideal Xmas Gift.** **SEND NO MONEY:** Pay postman on delivery only \$6.95. Try 30 days at our risk. If not 100% satisfied, your full money returned. **PARAMOUNT PROD. Co., Dept. 1-A, 245 Broadway, New York**

ONLY \$6.95 POSTPAID

FREE! Accessory outfit including set of drills, mounted 1 1/2" grinder, cutting wheels, sanding discs, mandrel, mounted brush, etc. (REGULAR VALUE \$2.00) FREE with each outfit ordered.

TRAILER PARTS AND EQUIPMENT for building any type of trailer.

WRITE FOR FREE LITERATURE.
HAMMER BLOW TOOL COMPANY, Dept. 101

WAUSAU, WIS.

120 Miles PER Gallon 30 Miles per Hour!

For the riding thrill of your life, try Auto-Gliding! Swift, safe, comfortable, amazingly economical! Less than 1-3c a mile operating cost. Cheaper than shoe leather! Easy to park. Ideal for getting to work, school, making deliveries, pleasure spins, etc.

FREE BOOK! See your dealer or write for free book, full details.

DEALERS: Write quick for Special Offer!
THE CUSHMAN MOTOR WORKS, Dept. G-12, Lincoln, Nebr.

\$125 and up
f.o.b. Factory

VEST POCKET ADDING MACHINE

IDEAL XMAS GIFT! Adds, subtracts, multiplies, divides. Does work of more costly machine. Counts up to million, made of steel—weighs 8 ounces. Simple, accurate. Not a toy. Guaranteed 5 years.

— FREE TRIAL —
SEND NO MONEY! **\$2.50 Total Cost**

Order from ad, not sold in stores. Just send name and address. On delivery pay postman \$2.50 (plus few cents postage). (If outside U. S. send cash.) 10c additional in Leatherette Case. If not satisfied after 10 days' trial you get your money back. Thousands of satisfied users. Write for Agent's proposition. **CALCULATOR MACHINE CO. (Mrs.) Dept. 161, P. O. Box 1118, Chicago, Illinois**

(Continued from page 136A)

point one well-wisher to take care of tires and some other man, with good intentions, to refuel. The first inkling the tire man has of his duties is when the car rolls into the pits. Then all is confusion and precious seconds are wasted. Efficient pit control doesn't cost so much but it helps win a great many races.

I am not afraid of how American drivers will fare against foreign competition if they have comparable equipment. Despite lack of finances—for he usually bears the entire expense of his racing—the American driver produces astonishing results, results often comparable to those of European drivers who usually are on regular salaries and whose cars are engineered and maintained by the manufacturers abroad. It would help a great deal if our manufacturers would give our drivers a greater measure of support in their problems.

The engineering ability developed by many of our leading drivers has been the wonder of the automobile industry and this experience, coupled with a highly developed driving ability, has placed them on a competitive basis with the leading drivers of the world. Given cars of equal performance and reliability, American drivers will come into their own in international competition and place the American automobile industry where it should be in racing—at the top.

And, it seems to me, the American automobile industry owes more to racing than it has contributed to it in the past decade. Except for racing, we might never have had demountable rims. Superchargers, high-speed motors, aluminum alloys, efficient brakes, new types of carburetion and new tire formulas, all were born on the race track. A dozen other developments have been lifted off racing cars and applied to commercial cars.

Many future developments may be expected to come from racing—more, perhaps, than racing has contributed in the past. Only by contributing its own share of research and experiment can our own automotive industry reap its shares of the reward from these future developments. And the laboratory for this research and experiment is—as it has always been since the first horseless carriage frightened the first horse—the race track.

ONCE IS ENOUGH

It's some trouble to get set to do a gluing job—so—why not use a glue that really sticks permanently?

CASCO — that's the glue!

It's different, it sets *chemically*...like concrete...moisture, heat and hard use do not affect it.

EASY TO USE—Casco comes in convenient dry powder form—mixed in cold water in a moment—no cooking.

NO WASTE—You mix it as needed—always fresh and up to the full strength.

ECONOMICAL—A pound of Casco glue powder makes 1½ quarts of liquid glue—half the cost of most glues.

CONVENIENT—Comes in handy 10c and 25c packages, also in ½ lb., 1 lb., 5 and 10 lb. sizes at your Hardware, Paint and Lumber Dealers.

Preferred by homecrafters for all wood gluing...Casco is also the ideal easy-to-use glue for all household jobs. Makes *permanent* repairs on furniture, linoleum, piano keys, umbrella handles, books, luggage—everything that's "glue-able."



FREE BOOK SHOWS HOW!

32 pages—50 illustrations—full of gluing and repair information. Just ask for "Free Gluing Guide" on a penny post card.

CASEIN COMPANY OF AMERICA, INC.
Dept. P.M.138 350 Madison Avenue New York, N. Y.



PHOTO ENLARGEMENTS

Is Photography your hobby? Do you want a profitable easy business at home? Make **PHOTO ENLARGEMENTS** for yourself and others. Your cost 5c each and less. The Ideal Photo Enlarger is **AUTOMATIC**. No experience required. Also **COPIES** any picture. **\$5.94 COMPLETE**. Interesting circular **FREE**.

IDEAL-O, 122 East 25th Street, New York City

5¢
ANY
SIZE

Cash Daily Making Do-Nuts!

Here's a steady, fine-paying business that earns big profits. Hundreds of men and women in many parts of the country earning good steady incomes—a product that everybody likes, that sells on sight—delicious, greaseless donuts baked by electricity with the Ringer Electric Do-Nut Baker.

FREE PLAN shows you how to start this fine-paying repeat business. No experience needed. \$25 starts you. Total investment less than \$60. Begin at home in your spare time. Send a postcard today for full information. No obligation, no salesman will call.



RINGER DO-NUT COMPANY
146 Main St. N. E. Minneapolis, Minn.

The Radio Miracle for 1938!
AUTOMATIC TUNING



Silver
GUARANTEED
QUALITY
RADIO

The Robot of Radio

PUSH the BUTTON Zip There's Your Station!

FREE HOME TRIAL, Money Back if not Satisfied

Everybody is talking about automatic tuning—the modern robot that increases the pleasure of radio a thousand times. Silver Radio enables you to meet the demand of the public for this amazing development—at prices that will result in quick sales. Cash in now with this quality line of RCA licensed radios. Every set guaranteed for ONE FULL YEAR.

SALESMEN!
GIVE-AWAY
RADIOS FREE

The quickest money-making deal you ever saw. Give away radios free yet make from \$15 to \$20 on every deal. Send 10c for sample push-card, picture and plan.

FREE NEW 1938 CATALOG
Just off the press! Radios that get EUROPE. New battery radios for farms. Car radios, 5 to 15 tubes. 50 beautiful table models and magnificent consoles. Priced as low as \$6.70
Automatic Tuning Models \$11.95
Priced as low as \$11.95
Send post-card to
SILVER MFG. CO.
2868 ELSTON AVE., Dept. 101
CHICAGO, ILL.

BILD-UR-OWN
COASTERS • MIDGET AUTOS • SCOOTERS •
DISC WHEELS equipped with 10"x2 3/4"
(GOODRICH-GOODYEAR-FIRESTONE)
Balloon Tires offered at LOWEST PRICES



We also carry a complete line of larger Tires and Wheels, Axles, Motors, etc.
BILD-UR-OWN DEVICES
WRITE FOR PRICES 5237 Lake St., Dept. A-1 Chicago, Ill.

AN IDEAL XMAS GIFT
BIKE TRAILERS, ETC.

AUTOMATIC TYPELESS PRINTER

Amazing new Print-O-Press Stencil Dupli-cator. Automatic feeding. Automatic inking. Full 8 1/4 x 14 legal size. Other models also, at world's lowest prices. Details free, also free samples of work done. User-Agents write.

Professional Products
Dept. 110, Silverton, O.



PROLONGS Life of Batteries — PREVENTS Corrosion and Short Circuits — Send 25c

Affords quicker starting, brighter lights, better radio reception. This remarkable Velco Cream applied to batteries (externally only) crystallizes and seals the battery against corrosion, creeping current & loss of power. Guaranteed. Lasts indefinitely. For automobile, tractor, radio, or any batteries—old or new—prolongs life. Auto service stations send \$1 for can good for 300 applications. Ask for dealer proposition. Big Profits. Territories open for Distributors and Salesmen.
VELCO SALES, 4500 Malden St., CHICAGO, ILL.

for
**Full-size
Tube
Velco
Battery
Cream**

DO YOUR OWN SOLDERING!



**BLOW TORCH
SOLDERING IRON
WIRE BRUSH
SOLDER, ALL FOR**
\$1.39
in U.S.A.
Postpaid

Not a toy! Practical utility soldering set for all light work. Includes genuine Turner Self-Energizing Solid Brass Blow Torch, special End-Stand Soldering Iron, Wire Brush, and supply of solder. Saves its cost in a short time on repair of kitchen utensils; indispensable for radio work. You can now buy complete set for less than usual price of blow torch. Order today!
Dealers . . . Write for Catalog.

THE TURNER BRASS WORKS
Sycamore, Ill. U.S.A.

Dispatching the Corn Poppers

(Continued from page 85)

side in the middle and the same for the left and right rear. Thus, in a glance the lighting requirements for eight states can be shown.

Transportation companies have learned through experience that good maintenance is an important factor in safe driving. So while his trailer is being loaded, the driver checks every point of his "horse" carefully. When the unit is ready to leave the terminal, it is rechecked by supervisors. This completed, he is given a chart to sign and is on his way. On the highway, the driver is expected to observe all regulations, and some of the larger companies employ cruising cars to see that he does. Habitual offenders are penalized.

The big companies have facilities for keeping tab on the movements of their trucks. By means of a contract telephone wire out of Chicago, Dispatcher Mason checks with Keeshin's northern terminals at Eau Claire, Madison, Milwaukee, Minneapolis and St. Paul each night between 8:30 and 9:00 in order to get a report on the incoming transports and to advise the dispatchers at these points of the trailers headed for their terminals. A half hour later, South Bend, Detroit, Cleveland and Toledo are contacted. He then calls the western division—Sterling, Peoria, Bloomington, Decatur, Springfield and Indianapolis. Direct calls to Fort Wayne and Indianapolis complete his routine.

Special stops along the route are designated as registering depots. If a truck is delayed, the driver must report to the nearest dispatcher.

The unpardonable sin of the highway is to fall asleep at the wheel. No driver likes to think about it but occasionally it happens with unusual, sometimes tragic results.

What does a driver think about while he's on the road? Asked that question, one driver looked over his instrument board with its tachometer; air, fuel-oil, heat and pressure gauges; two ammeters, speedometer; levers to control engine heat; air brakes, levers for controlling the three sets of gears in the transmission, which make possible twelve forward and three reverse speeds, and then replied: "Nothing, except what a whale of a responsibility it is to drive one of these corn-poppers!"

SCALE MODEL TRAINS

"O"
Gauge
17/64"
Scale

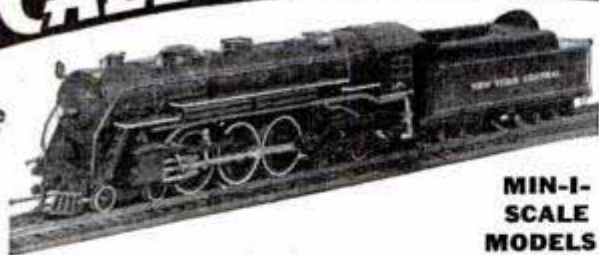

MIN-I-
SCALE
MODELS

Perfect, die cast scale models, accurate to the smallest detail. Absolute accuracy. Sturdy construction. Precision workmanship. All locomotives "run-in" under power. Both kits and assembled units—Pullmans, Box Cars, Combination Baggage and Day Coaches, Tank Cars and Hoppers. Kits easily assembled without drilling or machining. Castings prime coated. Ask your dealer or send name and 3c stamp for full information.

CONGRESS TOOL & DIE CO.
9028 Lumpkin Ave., Detroit, Mich. **FREE FOLDER**

HIGH POWERED TELESCOPE

GENUINE AMERICAN MADE BROWNSCOPIES

Most powerful made for the money!
15 power long range telescope. Can see moon's craters or time on pocket watch a block away. 5 sections. Approx. 3 ft. long. Fine lenses. Brass bound. Can be used as powerful microscope. Vol. magn. 512X. Only \$1.69 postpaid. C. O. D. 24c extra.

\$1.69 Special Super-Power 30X Telescope
Similar to above but more powerful. Guaranteed to see 900 times larger in surface and 30 times closer. 31 mm. objective 4 powerful lenses. Large field. Includes powerful microscope features. 10 day money back guarantee. Only \$1.98 postpaid.

500 POWER MICROSCOPE \$3.95
New 500X Super-Power Brownscope

Ultra high power at low cost. 75X to 500X in 5 steps. Each microscope is carefully tested to give clear images. All refinements including rack and pinion focusing, tilting stand, etc. 10 day money-back guarantee. Complete with prepared and plain slides and instruction booklet, only \$3.95 postpaid. SPECIAL 1600X objective with high resolving power for above microscope giving it the amazingly high magnification of 1600 power. Only \$1.95.

BROWNSCOPE CO., Dept. 41, 234 Fifth Av., New York, N.Y.

CLAMPS

"Good clamps and plenty of them" is a basic rule of fine cabinet work. It's the secret of firm joints, of rigid set-ups for gluing, drilling, sawing or welding, of accurately matched parts and perfectly aligned holes, etc. Standardize on "Jorgensen", "Pony" and "Mark" clamps, the clamps used in industry. If your dealer hasn't them, order direct.

Pony "50" Fittings go on ordinary 3/4" pipe. Any length. Send \$3.00 plus postage (6 lb.) for fittings for two Pony "50" Clamps. Also Fittings for "32" Pony—pipe —2 sets for \$1.50 plus postage.

Catalog **ADJUSTABLE CLAMP CO.**
FREE "The Clamp Folks"
421 N. Ashland Ave., Chicago, U. S. A.



PINS FREE TREASURE BOOK!

This Class Pin, any letters, any numerals, Silver Plated 25¢ or more, 30¢ each; 7 to 24, 35¢ each; 1 to 6, 40¢ each. Gold Plated add 10¢ each to above prices; Sterling Silver add 20¢ each; Sterling Silver Ring as shown, 26¢ or more \$1.50 each; 12 to 25, \$1.75 each; 1 to 6, \$1.95 each. Write for Big FREE Treasure Book.

Metal Arts Co., Inc. Factory 44, Rochester, N.Y.

XMAS GIFT for the model boat maker. A twin-cylinder steam engine. Bore 17/64". Stroke 1/2". Length 5-5/8". Width 2-5/8". Height 3-3/8". Price complete as illustrated \$2.98 postpaid. Propeller rig for above engine 30c extra. Shawnee Engine Co., Box 162, Station D, Cincinnati, O.

CASH IN QUICK ON THIS BIG CHRISTMAS SELLER
Thousands of These Beautiful **GENUINE LEATHER TIES** that look like silk will be sold as gifts. Write immediately for information and get started at once. Reap the big profits that Century salesmen, both men and women, enjoy every Christmas season. Send 50c for samples, 4-In-Hand and Bow, as well as swatches of numerous patterns and colors. No experience needed. Century Ties, known from coast to coast, sell on sight.
CENTURY TIE CO., 2345-L, W. Grand Blvd., Detroit, Mich.

When writing please mention Popular Mechanics



The New Simplified
40 Volt Arc Welding

Earns
\$150 to \$300
Extra Profit
Monthly
Pays for itself

START BIG PAYING BUSINESS

"Simplified" 40 VOLT ARC WELDING
New low prices on modern 40 Volt "Simplified" Arc Welders make this big pay business available to shops that never before could afford it. It opens the doors to the bigger profit jobs. The new Hobart is easier to operate, much faster. This is today's opportunity. Don't miss it.

Build Your Own
Portable Welder with Hobart Generator unit and auto engine or chassis. Lets you operate any place, especially on the profitable outside jobs. Easily saves you \$300 to \$500.

Portable Electric
New low cost on small sizes as well as large. The most profitable arc welder your shop can own. Welds faster, better, easier, saves current.

Easy to Operate
Hobart Welders have "Simplified" operation. This means faster welding—with the right current for every job. Hobart is simplified, so any of your men can weld easily and successfully. The mystery and uncertainty of obtaining correct welding current settings are removed.

60% Extra Capacity
Over old style 25 Volt Welders—necessary for welding with the new coated rods. Automatic reactance lets you handle light welding work without losing the arc. Users don't understand how they got along with the old style welders after using this new Hobart.

Remote Control
At no extra cost with Hobart. Think of being able to control your welder from any working point. Saves time, temper, and eliminates the need for a helper on overhead or concealed work.

"Pays-For-Itself" Terms
Extra earnings and savings make it easy for you to own a Hobart without expense to you. You can even rent a new Hobart—and later purchase it without loss of rent. Check Rental Purchase Plan.

GET THIS VALUABLE MANUAL
Sent Free if you will tell us the welding you plan doing.

WITHOUT COST TO YOU
Hobart pays its own way out of profits in a short time, without a cent of cost to you. The Hobart payment plan is the most liberal offer ever made.



30 DAYS TRIAL
at Our Risk
to Prove it Pays
Mail Coupon for further Details

HOBART BROS.,
Box M-18, Troy, Ohio

Tell me more about—
() Building My Own Portable Welder
() Electric Drive Welder
() Rental Plan Privilege of Purchase.
() Send FREE Manual on Welding. Attached letter tells about the work we want to do.

Name.....
Address.....
Interested in 30 DAYS TRIAL EASY TERMS



HOBART ONE OF THE WORLD'S LARGEST BUILDERS OF ARC WELDERS

BIG WOOD LATHE



Imagine! This extra heavy WOOD LATHE, steel bed, 48 in. long, at an amazing low price. Heavy duty head stock, 3-step cone pulley for V-belt. Extra long reservoir, oil bearings. Spur center and 4 in. face plate screw into spindle. Tail stock spindle has screw of 1 1/4 in. Tool rest 8 in. long. Accessories include 3-step cone motor pulley, V-belt and set of four turning chisels. Shipping weight 30 lbs. Send now for new free illustrated literature and startling low price. Write.

SENSATIONAL NEW SAW TABLE
Now, a real heavy duty SAW TABLE which is practical, accurate and dependable at a remarkable direct FACTORY TO YOU PRICE. Large 20 x 26 table. Blade raises and lowers. Also tilts 45 degrees. Price includes 8 in. blade, fence, miter gage, guard, splitter knife, motor base and V-belt on arbor. Net weight without motor 100 lbs. Write today for new Free catalog, shows complete line heavy duty wood-working equipment.

BLUE STAR PRODUCTS CO., 601 Palm Ave., Fairfield, Iowa

es 1067

Red and Black Magic

(Continued from page 45)

Perhaps he thought of the nine and pointed to five. Then he would, mentally, call the five spot nine, the four spot ten, the three spot eleven, the deuce twelve, the ace thirteen, the ten fourteen and his finger rests on the chosen nine when he counts—to himself, of course—fifteen.

Here is a fooler that takes in five of your crowd at once. Spread out a deck and let each of the five draw five cards, think of one of those five and then lay them face down in a separate pile in front of you. When each person has done this, pick up the five cards from the man at your left, then place the next five on top, and so on until you have the twenty-five cards in order in your hand. Then deal them out again face up in five rows horizontally. The first five cards you deal across the board will be the five chosen by the man at your right, the bottom horizontal row will be the five picked by the man at your left, etc. Ask the man at the right, for example, which vertical row contains the card he is thinking of. When he indicates the row, you can point to the card, for you know the top horizontal row is his.

One of the easiest stunts is to let one of the party pick a card from a deck and tell him you can discover it. While he is looking at his card, glance at the bottom card of the deck. When he replaces his card on top of the deck give it a false shuffle without disturbing top or bottom card. Then give the deck a simple cut. This brings the chosen card directly under the card you know was on the bottom. Then, feigning wizardry, thumb through the pack and dramatically produce the card.

There is another way of discovering two cards drawn by the audience. For this trick you use a prepared deck, privately separated into two parts—one half the red cards, the other half all black. Extend the halves in your hands and let two persons draw a card, one from each half. As they look at the cards you switch the cards in your hands unnoticed. When the two cards are returned they go into the wrong half deck—the red card is slipped into the black half, the black card into the reds. All you need do then is make a few mystic passes and thumb through the deck to pick out the misplaced red and black cards.

It's simple enough to you, but it's red and black magic to the fellows out in front!

John made \$42⁵⁰
in one day
in his NEW
Business



Get into this business NOW—a business which is so new that it is practically without competition. This alone should enable you to make really BIG MONEY. Hotels, homes,

clubs, country estates offer tremendous possibilities. Our new DETERGER washes upholstered furniture, drapes, tapestry, all sorts of fabrics electrically right in your customer's home, with a new soapless soap whipped into dry suds. We have helped hundreds of men get into business for themselves with our automatic equipment. The U. S. Government and many of the world's largest hotels use our machines.

Make Money the FIRST DAY

You are ready to go to work the minute you get the outfit, so you ought to be taking in big profits the first day. We want an honest, ambitious man in every locality. If you are that man we will help you get started for yourself in a business with tremendous possibilities. Only a limited amount of money is needed for a down payment—the balance you send on easy terms. Most men find it possible to make far more than the cost of the machine before the payments come due. You don't need to rent a shop—you don't have to hire a building, for the work is done in your customer's home.

Write Today for FREE

copy of our "Get Into Business For Yourself" ideas. Let us tell you how easy it is to get started in a year around business where you are your own boss and can stop worrying about just a job. Write today—NOW.

VON SCHRADER MFG. CO.
Dept. D-101 Pl. Racine, Wisconsin



free! - SEND FOR THIS CATALOG

Bass Bargaingram

LISTS HUNDREDS OF STILL, CANDID AND CINE BARGAINS
WRITE DEPT P

Bass CAMERA CO.
179 W. MADISON ST.
CHICAGO, ILL.

WET BASEMENTS!

Amazing new Seal-Seep method, anyone can use. Applied to inner masonry wall and floor surfaces; no digging. Guaranteed permanently effective. Agents write for unusual earnings opportunity. Details FREE.

Waterproof Your Own Save up to \$100 to \$150

National Seal-Seep Co., Dept. 192, Cincinnati, O.

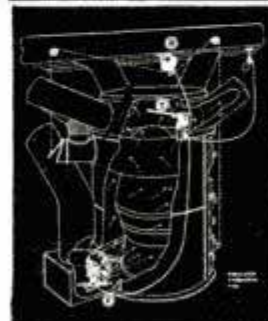

Are Some of Your Rooms Cold?

Here's What to Do!

Equip your hot-air furnace with a New Deal Air Circulator and Draft Control. Provides forced air circulation, guaranteeing heat in every room, regardless of wind or weather. Automatically keeps temperature of your home at any point desired. Keeps rooms warm with a much lower fire. Ends costly fuel wastes.

Pays for itself in fuel saved. More than a thermostat. Regulates both furnace fire and air circulation automatically. Easy to install. Takes only a few minutes. Very low priced. Sold under a guarantee of satisfaction or your money back. Send today for FREE circular. AGENTS: Write for sales proposition.

NEW DEAL APPLIANCES
2262 Gratiot Ave. Detroit, Mich.

WRITE for CIRCULAR

Sweeping the Country!
NEW-TYPE CHEAP OIL BURNER INVENTED!

COOK and HEAT
without **COAL or WOOD** in Your **PRESENT STOVE**

TWICE THE HEAT AT LESS COST—No Dirt or Ashes
QUICK HEAT AT TURN OF VALVE

An Amazing New-Type Oil Burner Which Users Say **BEATS ANY FOR LOW COST, PERFECT PERFORMANCE, Burns Cheap Oil a NEW WAY Without Pre-generating or Clogging Up, Cuts Fuel Bills and Pays for Itself Quickly by What It Saves. READ BELOW HOW YOU CAN TEST THIS REMARKABLE SUPER FLAME OIL BURNER in Your Own Home FREE OF RISK. Then Mail Coupon.**

COOK and HEAT for LESS

Why burn coal or wood with its dirt and drudgery of building and feeding fires? Why carry ashes and get uneven, slow-starting heat? Burn cheap oil a **NEW WAY** and get **TWICE THE HEAT AT LESS COST**—and have **QUICK HEAT** regulated by a simple turn of a valve. Positively guaranteed **NOT TO CLOG, NOT TO CARBON OR STOP UP.** Has a record of over 11 years constant use without ever needing any cleaning. Simple—safe—economical—no electrical connections—no moving parts to wear out—does better work at less cost. Burns 95% air and 5% cheap oil—**TWICE THE HEAT OF COAL** by simply turning valve.



Slips into Any STOVE RANGE or FURNACE

Engineer of National Reputation Says: Combustion principles are simple, efficient, excellent—assures economical oil consumption and maximum heat. Tests made on burner with one year's hard service prove no evidence of dirt or residue or any carbon on interior parts. No nozzles or tips to "coke up" or stop up.—C. W. Lovelace—K. C., Mo.

USERS SAY: Fifteen oil burners of different kinds here but Heat King is cheapest, best.—J. R. Goldthorp—Washington.

I get more heat from your burner than I ever had from coal or anything burned in my furnace.—W. C. Nicholson—Ind.

Reduced coal bill fifty percent.—W. S. Collins—Pa.

SENT ON TRIAL

SENT ON TRIAL for 30 days. If you want to **SAVE MONEY** in cooking and heating you may try the "HEAT KING" **AT OUR RISK**—prove that it ends drudgery and dirt of coal or wood, cuts fuel bills, pays for itself quickly by what it **SAVES.** You must be satisfied under our liberal guarantee or **YOU PAY ABSOLUTELY NOTHING FOR THE BURNER.**

FREE SAMPLE to Agents

and salesmen offered to one in each locality who will demonstrate and take orders. Send no money—just sign and mail coupon (or 1c postcard will do)—be first in your locality to learn how satisfactory oil heat can really be and how you can **MAKE REAL MONEY** spare or full time. Mail Coupon or 1c postcard today—**NOW.**

UNITED FACTORIES

A-751 Factory Bldg. KANSAS CITY, MO.

AGENTS SALESMEN BIG MONEY

No wonder salesmen and distributors are breaking records in sales. They show how it gives **QUICK HEAT, HOTTER, CHEAPER, WITHOUT DIRT AND ASHES,** and how it **SAVES**—then, reap **BIG CASH PROFITS.**

SALESMEN SAY:

Installed one when 10 degrees below zero. Kept house well heated. I can dispose of 250.—F. Silver—Canada.

I am a plumber, but never knew such a thing to get that much heat out of oil. There is money in selling them.—W. C. Nicholson—Ind.

Get **YOUR OWN OIL BURNER SAMPLE AT NO COST** and **CASH IN BIG.** Be **FIRST** in your locality—**MAIL COUPON** or 1c postcard today—**NOW.**

MAIL COUPON

UNITED FACTORIES

A-751 Factory Bldg., Kansas City, Mo.

Without cost or obligation rush generous **TRIAL OFFER** on wonderful "HEAT KING" Oil Burner sent **WITHOUT RISK TO ME.**

CHECK HERE

Name.....

if interested in **NO COST SAMPLE** and money-making offer.

Address.....

City..... State.....

OTTAWA LOG SAW



only \$39
PUTS THIS OTTAWA TO WORK FOR YOU

GREATEST OFFER EVER MADE

Make Money! Wood is valuable. Saw 15 to 20 cords a day. Does more than 10 men. Ottawa easily operated by man or boy. Falls trees—saws limbs. Use 4-hp. engine for other work. Write today for **FREE** book.

OTTAWA MFG. CO., 127 Wood St., Ottawa, Kansas

GET HEP TO FUN!



Don't be lonely! Make 1938 your big fun year. Pal with right guys. Join your local motorcycle club. Go places and do things with the bunch! See your Harley-Davidson dealer—he'll tell you how to join. Send for full particulars of the new 1938 models. Harley-Davidson Motor Co., Dept. P, Milwaukee, Wis.

HARLEY-DAVIDSON Motorcycles

EXTRA \$5 in SPARE TIME PRINT at HOME

Letterheads, Circulars, billheads, cards. Printing pays **BIG.** Easy, interesting, educational. **PRINTING PRESS BARGAINS** \$12. Types and Supplies, lowest prices. Send stamp for catalog. **PEIFFER Co., 1-C; 6 Columbia St., Newark, N. J.**



The DUAL COMBINATION
WOOD & METAL LATHE

12-INCH SWING 47 to 3000 R.P.M.

free catalogue TIMKEN BEARINGS

CLAUSING MFG. CO. OTTUMWA, IOWA.

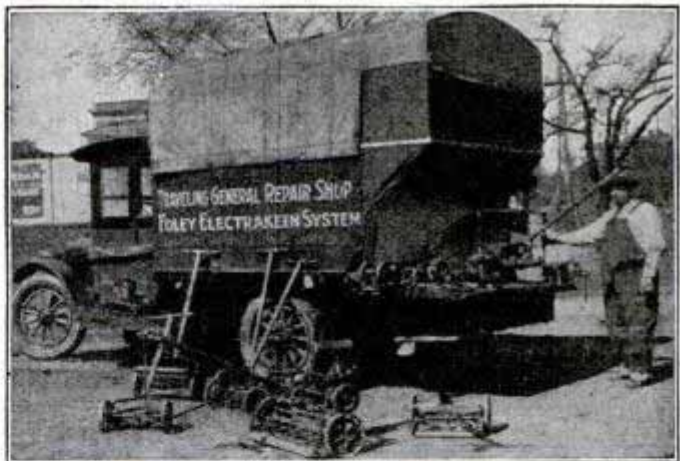

This Man Makes BIG MONEY!

"Six years ago I bought a Foley Electrakeen Lawn Mower Sharpener and mounted it on a small truck for a portable shop. First day I took in \$13.00 in the afternoon. From then on I earned from \$25 to \$30 a day for the balance of the season. The Foley turns out a perfect job and I have the same customers year after year."

IL. N. WOODMANCY, Minnesota

Free Plan Starts You

A **BIG OPPORTUNITY** is waiting for wide-awake men who want **BIG PROFITS** and an **INDEPENDENT INCOME.** Plenty of business. We tell you how to get started. No experience necessary—very little capital needed. Build a steady, permanent business sharpening Lawn mowers by the Foley Electrakeen System.

Special Offer: Attachment for grinding axes, hatchets, knives, etc., included **FREE** with Foley Lawn Mower Sharpener on our Special Offer, brings you business the year around. Send postcard today—no salesman will call.

FOLEY MANUFACTURING CO.
107-8 Foley Bldg., 11 Main St., N. E., Minneapolis, Minn.

When writing please mention Popular Mechanics

CAN YOU BEAT THESE POWER COSTS?

SAVE
up to
\$293⁸⁰
Per
Month
on
power
costs

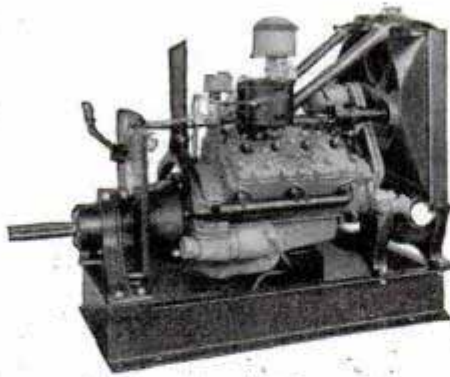

with a KRW FORD V8 Unit

- 50 H. P. with KRW V8 Unit using natural gas (1125 BTU) @ 30c per 1000 cu. ft. \$ 46.80 per month
- 50 H. P. with KRW V8 Unit using gasoline @ 10c per gal. (no tax) \$ 145.60 per month

Above figures show primary fuel costs (lubricating oil not included) for operating a KRW V8 Unit to develop 50 H.P. for 10 hours per day—26 days per month. Compare this with electricity @ 3¢ per KWH which amounts to \$340.60 per month. You can pay for a KRW Unit in a few short weeks **out of actual savings!**

KRW V8 Units are daily saving money for operators of air conditioning and refrigeration equipment, mills, factories, shops, welders, compressors, pumps, well-drilling outfits, contractors' equipment, etc., etc.

For complete information, prices and data write us. You can buy through your local Ford Dealer and benefit by local service and low-cost Ford engine replacement feature.

K. R. WILSON 17 Lock St. BUFFALO, N.Y.
EXCLUSIVE BUILDER OF APPROVED FORD SHOP EQUIPMENT SINCE 1916

722 Mateo St., Los Angeles. Export Office: 90 West St., New York

FREE

CAMERA BOOK!

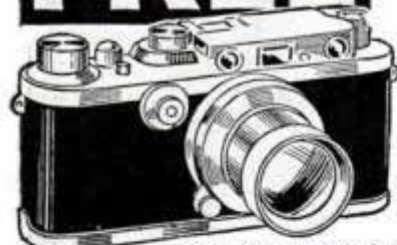

Offers hundreds of money-saving bargains in Still and Movie Cameras, Lenses, Films, Enlargers, Exposure Meters, Dark-room Supplies — everything photographic.



Choose from America's most complete, varied stock—from world's leading makers: Eastman, Zeiss, Bell & Howell, Graflex, Korona, Bausch & Lomb, etc. 10 Days Trial—Satisfaction Guaranteed. (Your camera, equipment taken in trade.) Write for Free Camera Catalog NOW!

CENTRAL Camera Co. (EST. 1899)
230 S. Wabash, Dept. K-1, CHICAGO

GOVERNS SPEED OF ANY GAS ENGINE

It's easy and economical to supply your own power for operating all types of machinery, and do more work for less money. Simply remove the engine from a used automobile or truck, set it up where you like, attach a PIERCE UNIVERSAL GOVERNOR, start the engine and you have constantly controlled power for the operation of electric lighting plants, are welders, refrigerating units, air compressors, feed grinders, hoists, saw mills and innumerable other applications.

The load may change but the PIERCE UNIVERSAL GOVERNOR will maintain a uniform engine speed. For close regulation of speed and dependable performance PIERCE GOVERNORS are never equalled. Installation is simple. Either V or flat belts can be used. Complete Governor outfits are also available for nearly all makes and models of industrial engines.

Write for illustrated literature and prices.

THE PIERCE GOVERNOR COMPANY
1601 Ohio Avenue, Anderson, Indiana



PIERCE GOVERNORS
THE BRAINS OF ANY GAS ENGINE

Packing Drama in the Films

(Continued from page 75)

rider and horse from serious injury. Here again the camera travels faster than the horse for the effect of speedy action.

When the story called for a man to fight a man-killing shark in a recent South Sea island picture the studio property department sent an order to a rubber company to make them a shark. The rubber shark performed quite realistically in the studio tank.

You can't rehearse a complete movie wreck. It would be too costly and too dangerous. In B. P. Schulberg's film, "She Asked For It," a stunt man sends an expensive roadster plunging through a bridge railing. It ends up in a blazing mass of

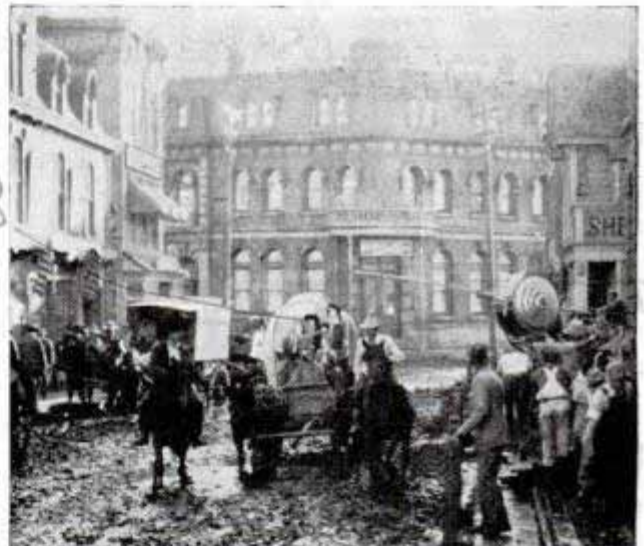

Cameramen pull camera on track to film covered wagon moving along Old Chicago's streets

wreckage some thirty feet below. The script called for a big sedan to crowd the roadster through the wooden railing. The studio was prepared for anything to happen. A doctor was on hand, dozens of policemen kept curious onlookers off the road, a fire truck stood by and saved the wooden bridge that caught fire from the blazing machine and there was a wrecking truck. Director Erle Kenton coached his stunt men, Jack Woody and Billy Jones, just how and where they were to wreck the machine. The special effects department had explosives planted in the back of the machine so it would explode when it hit the canyon floor. Woody had to pull the explosion switch and jump onto the bridge the instant the machine left the

20.9.79
road. He received only minor scratches in performance of the stunt.

All glass is removed from the windows of automobiles you see wrecked on the screen. The bodies are reinforced with steel and there are steel supports placed under the hood. This keeps the body from collapsing. A fake license plate is used because people might sue the studio if the license was the same as theirs. Usually nearly all the gas is removed from the tank to avoid fire. A stunt man gets about \$150 for a movie wreck.

You would think that stunt men would pad their bodies heavily, but they don't. Safety belts are worn for a head-on collision, particularly if the car is to take a roll. Football helmets protect their heads. And they usually pad their shins, as the

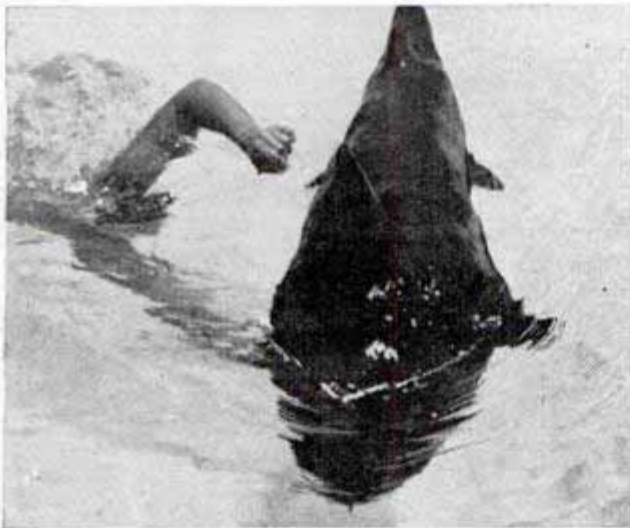

This shark looks real, but it is made of rubber. Swimmer battled it in studio tank

feet always fly forward. One driver wears a mask of heavy Cellophane over his face.

Running wild, after the driver has jumped off, a large gasoline truck crashes into a store. On the screen, when you see the driver jump off, you never guess that a stunt driver is hidden on the truck. A black hood over his head and face and a black robe over his body keep the camera from photographing him. At all times he has the truck under control and the camera supplies the illusion of speed to make it melodramatic.

Names and addresses of manufacturers and dealers in articles described in this magazine will be furnished by our Bureau of Information upon request accompanied by stamped, self-addressed envelope.

*Twins...at
a glance*

BUT SO DIFFERENT BENEATH THE SURFACE



They're both nail hammers. General appearance from a distance is the same. But one is a Plumb!

You'll realize that all hammers are not alike the minute you inspect the Plumb Nail Hammer...Streamlined beauty. Appearance of perfect balance. Heft this hammer. "Feel" the balance that makes it swing in rhythm with your arm.

See its work-saving features: claws, with split at high point of curve, catch closely driven nails; beveled edges grip slim brads, draw nails through wood...slightly crowned face protects your work—Patented Take-Up Wedge keeps head on tight.

Try the comfort of its tapered handle...flared end prevents slipping; slim, supple neck absorbs shock.

Look especially for the Red Handle and Black Head at your hardware dealer's. Fayette R. Plumb, Inc., Phila., U. S. A.

es 7160.



MAKES WORKSHOPS HUM

A few drops of 3-In-One Oil add smoothness and speed to lathes, motors, light electric tools, action points of braces. Always use 3-In-One Oil because it is specially blended to give "triple action"—it cleans, oils, prevents rust and tarnish.

LUBRICATES • CLEANS • PREVENTS RUST

Ride it for **FUN**—or for **PROFIT**



1938 MODEL
SERVI-CYCLE

Light Weight Motorcycle
Safer Than Bicycle

SAVE MONEY
Ride Servi-Cycle
To Work or Play
100 mi. per gal.
400 mi. per qt. oil
Cuts delivery cost for gro-
cers, druggists, service
stations.

Sit on the Servi-Cycle—take 2 steps—you're away! Big motor, 4 years proved, gives smooth power. Absolute safety—finger tip control. Dual brakes, dynamo lighting system. Servi-Cycle sets endurance records. New low price \$140.00, delivered complete. Free photo brochure shows all. Write today.

SIMPLEX MFG. CORP.
Suite 604, Southern Bldg., New Orleans, La.

Neon Truck Signs

-- NOW Possible with Amazing New TRANSFORMER and Novel Method of Tube Installation!

Old, established factory wants financially responsible business executives—to handle distribution in exclusive territories. Signs fill long-felt Advertising need! Enable any advertiser to have brilliant, colorful, attention-getting Neon Advertising message on trucks, both day and night. Expected to quickly sweep country! Easily installed on top driver's cab. Amazing NEW TRANSFORMER enables Sign to operate on any truck's standard 6-volt auto storage battery—using only about same amount current as an extra tail light. Novel method tubing installation protects against breakage. Reasonable capital handles exclusive Distributorship Contract. Big Profits. No sign experience necessary. We furnish entire product. **FREE LITERATURE** gives details, explains liberal proposition. Write today!
E. E. SOUTHER IRON CO. • • 1952-A-39 Kienlen Ave., St. Louis, Mo.

DISTRIBUTORS WANTED

READY CUT HOMES

\$416 and Up. . . freight paid; save \$500 or more. Designs are all modern, practical, distinctive. Ready-cut houses complete ready for quick, easy assembly. Includes lumber, insulation material, spring bronze weather stripping, built-in ironing board, medicine cabinet. Attractive 1-panel doors and latest hardware. Also, complete plans, nails, lath, paint, varnish, shingles, etc. Range of 100 homes, summer cottages, garages, etc. Full color catalog and complete descriptions sent for 25c coin or stamps to help cover costs.



FULL COLOR CATALOG FOR ONLY 25c

INTERNATIONAL MILL and TIMBER CO.
Dept. P-18
Bay City, Mich.



Two Miles Down for Oil

(Continued from page 29)

ished and the casing set in place, a special oil-well gun is lowered into the hole opposite the formations and is fired electrically, its slugs penetrating through the casing and allowing oil to seep into the pipe.

One of the big troubles in the past was that drillers usually dug crooked holes. Some of them descend in corkscrew spirals while others wander off after they have gone down a few thousand feet. When a drilling tool cuts into slanting formations, some hard and some soft, the tool is often deflected to one side. In the last few years



Milling tools used for curving well to reach oil pool at one side of derrick site

drillers have learned to drill into new formations slowly in order to cut straighter holes, and they also have a wider variety of bits for the purpose. Drilling straight holes allows them to drill deeper. Also, drillers can deflect the drill pipe into regions far from directly under the derrick, a maneuver that enables them to needle into oil pools that lie off shore under the ocean or under improved property.

When a tool is lost in the hole or when the drill pipe breaks off far below the surface, the drilling crew has a "fishing" job

(Continued to page 149A)

SCIENCE RULES YOU



determines your food, furnishes transportation, provides your entertainment, governs your work, treats your ills—and Science Digest covers all fields of science as they affect you. Read it.

Whether you are interested in metals or medicine, in mind or digestion, in plant life or planets, you'll be interested in the January issue of Science Digest—on newsstands now. On the illustration above read the partial list of January articles—every one written concisely, clearly, entertainingly. From the scientific journals of the world are selected the ideas given you in just one publication—

Science Digest. Are you reading it? In United States and possessions, Canada, Newfoundland, Labrador and countries of the Pan-American Postal Union, including Spain, a year's subscription is \$2.50. Additional gift subscriptions are only \$2.00 each. Elsewhere 50 cents more to cover overseas postage. Start with January. Mail your subscription or buy at a newsstand, today.

SCIENCE DIGEST, INC.

633 St. Clair Street

Chicago, Illinois

When writing to advertisers please mention Popular Mechanics



Now, ultra-modern design in complete floor-type Shaper. Investigate this outstanding value of the year. Now!

NEW *shop tested* BOICE-CRANE POWER TOOLS

TWO SHAPERS in ONE. Our quickly invertible spindle-housing brings either end of solid, 2-duty spindle into working position. A most valuable feature. Gives you two shaping ranges. Now, no job is too small, nor too large. Heavy-duty-end frees light-duty-end from overloads. Light-duty-end lets you use low-cost cutters . . . and that saves you money. Either way you use shaper, you get the unsurpassed speed and accuracy, and the total safety that ONLY a SOLID-SPINDLE can possibly guarantee! Purchase Boice-Crane for greatest value, and for lowest cost and economy in long run.

Write today for catalog of Boice-Crane's complete line. Include 10c for booklet "How to Spin Metal Projects" on your lathe. Now!



New 16" Jig Saw



New Tilting-Arbor Saw

BOICE-CRANE COMPANY

Dept. PM. 18

TOLEDO • OHIO

Trindl **ELECTRIC ARC WELDER**

Works Off Any Storage Battery or Ordinary Light Socket . . .

This New Electric Arc Welder is made possible by the invention of a low voltage carbon. Auto batteries may be used without removing from car. Uses about same current as four headlight bulbs. Can be used on 110 Volt electric light socket or 32 Volt electric light plant by using a Trindl Converter in place of battery. Broken parts are **SIMPLY MELTED TOGETHER** by the white HOT electric arc, in just a few seconds. Produces about 7,000 degrees heat.

3⁷⁵

HOTTEST FLAME KNOWN

Melts iron and steel instantly. Welds fenders, repairs radiators, holes in bodies, milk cans, tanks and brazes broken castings.

WORKS ON ANYTHING iron, steel, copper, brass, tin or galvanized metal. Permanent repairs made for almost nothing. Used by factories in many operations. Positive money back guarantee.

AGENTS
Men with cars to sell mechanics, repairs and farmers, factories, radio and battery shops. Five minute demonstration makes sales. Up to 150% profit! Write TODAY.

Send for it Today!

TRINDL PRODUCTS, 2229-YU Calumet Ave., Chicago, Ill.

FEDERAL ENLARGER \$9.95

PHOTOGRAPHIC SENSATION OF 1938

A precision photo enlarger with all latest improvements. Uses photo-flood or 125 w. bulb. Book-type negative holder takes all sizes film, plates up to 4 in. by 5 in. F.8 Lens with 3.5 in. focal length, BUILT-IN RED FILTER, MICROMETER FOCUS, INTER-CHANGEABLE LENS, HARDWOOD BASEBOARD takes enlargements up to 12 ins. by 15 ins. Can be used horizontally to project extreme enlargements. All features of expensive enlargers. Order now, only \$9.95 with lens postpaid or C. O. D. plus postage.

CANDID CAMERA SUPPLY CO.
303 W. 42nd St., Dept. P. M. New York, N. Y.



MADE IN U. S. A.

NEW Sensational "POWER SCOOTER" \$69.50 and up

ELECTRIC Goes 5 miles for 1c. No gasoline, oil, noise, or bother to start! Instant action—anyone can ride it—even a 6 year old child the FIRST TRIAL. Variable speeds—perfect control—brakes, lights, horn, etc. PLENTY OF POWER! H-speed model goes 35 m.p.h.—any speed available! Entirely self-contained power unit and charger. Simply plug into light socket (patented). Unusual range—Heavy duty tires and spring frame give smoothest ride! **ULTRA STREAMLINED**—available with airfoiled carrier. Write for literature on complete line including gas models. **EXCLUSIVE DEALERS WANTED.**
MIDGET MOTORS CORP. Dept. P-1 Kearney, Nebr.



PEN SETS COST YOU 39¢ SELL FOR 95¢

No. R315. Pen set. Pen is fitted with a size 6, smooth writing durium point; pump filler which cleans and fills in one operation; transparent barrel.

Mechanical pencil to match, has impel and repel movement. Comes in pearl-effect colors. Money back if not pleased. If pen set is desired in gift box—add 4c to prices below.

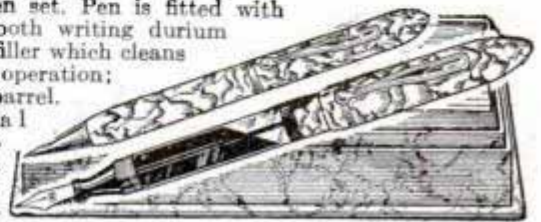

Sample Set 39c

Dozen \$3.95

FREE! Wholesale Catalog of 4000 World Wide Bargains. Write for It.

SPORS CO. 11-37 Main St., Le Center, Minn.

STANDARD GARDEN TRACTORS

Plow Seed Cultivate Mow Hay and Lawns

Powerful Gas Tractors for Small Farms. Gardeners, Florists, Nurseries, Fruit Growers, Poultrymen.

1 & 2 Cylinders

High Wheels. Rubber or Steel Tires. Walk or Ride.

Do Belt Work—Free Catalog

STANDARD ENGINE CO.

Minneapolis, Minn. Philadelphia, Pa. New York, N. Y.
3221 Como Ave. 2546 Market St. 290 Cedar St.



OLD FACES MADE YOUNG



MEN you can look 10 to 15 years younger. **5 Minutes a Day Keeps Wrinkles Away** and erases age lines. This new sensational home method **Sent on Trial—You Risk Nothing.** Lifts sagging muscles, fills up hollows. **No Cosmetics.**

Men, Women, all ages write for thrilling book and **Facial Analysis Chart**—both sent **FREE** in plain wrapper.

PAULINE PALMER, 1461-D Armour Blvd., Kansas City, Mo.

How Thousands Are Gaining 10 to 25 Lbs.

Now thousands of skinny fellows can say goodbye to "scarecrow" bones, pimples and lack of pep. For with the new, easy-to-take **Ironized Yeast** tablets many have put on 10 to 25 lbs., cleared their skin and gained new pep—quick. If you too need Vitamin B and Iron to build you up, get **Ironized Yeast** tablets from druggist today.

STOPS FIRE Instantly SCIENTIFIC WAY

WE NEED MORE COUNTY MEN
THOUSANDS BEING SOLD WEEKLY! Call on Business Concerns; Auto, Truck and Bus Owners; Schools, Public Buildings, Factories, Farms. All season seller. Excellent year round profit opportunity.
Nationally Advertised Products
We help you close sales with Direct Mail Adver-

tising. 360,000 sold to U. S. Government. Approved by Underwriters' Laboratories, also Good Housekeeping Institute. Used by 10,000 large Corporations. Write today with details of age, past experience, etc., for inside information.
The Fyr-Fyter Co., Dept. 90-25, Dayton, O.

201160
(Continued from page 146A)

that may take weeks or months to finish. Usually the first thing to do is to run a soft lead plug down the hole to get an imprint so the driller may know "what's looking up at him." Wall hooks, automatic clamps, grappling devices and even especially shaped tools for the particular job are lowered into the hole to fish for the lost part. Sometimes when a broken pipe becomes stuck far below, a cutting tool is lowered down inside of it. A long section of the pipe is cut off and brought up, then another long section, until the rest of the pipe becomes free.

Even though oil men are able to penetrate twice as far into the earth as they could in the past there is no wild rush toward deep drilling, mainly because oil that is recovered from such depths is pretty expensive. It costs something like a third of a million dollars to dig such a hole, with no certainty that oil will be found at the bottom. Aside from exploration, deep drilling is being used mainly to extend the depth of existing wells after the oil sands they have been tapping become exhausted.

One thing that has temporarily suspended the need for drilling deeper is the new process of acidizing by which existing wells are made to increase their flow. Acidizing also helps to "bring in" new wells. Such a treatment consists of pouring thousands of gallons of inhibitive acids down the well, where it washes away drilling mud that clings to the walls and opens up the pores of the rock in the vicinity of the hole, permitting oil to flow into the well more easily.

Today 92.5 of the oil produced in the United States is coming from depths of between 1,000 and 7,000 feet, of which the section between 3,000 and 4,000 feet is the most prolific. Only three or four per cent of production is coming from below 7,000 feet, although very deep production is considered extremely important because of its future possibilities.

"No one knows how far down into the earth oil will be found," says H. J. Steiny, Associated geologist. "The chances are that productive zones will be found down to depths of 20,000 feet. There would be nothing startling or out of the ordinary about a four-mile-deep well, aside from its price. Such a hole would cost at least half a million dollars."

WIRE-HAIRED TERROR



● Tough, wire-like beard absolutely *requires* Gillette Blades. That's because these super-keen blades are made for heavy duty work. No imitation—no substitute—takes stubborn stubble off so clean, close and comfortably. And remember, Gillette Blades, precision-made for your Gillette Razor, cost less than one cent a day.



● More Gillette-made Blades were sold during the past 12 months than ever before in a similar period. Thank you men, for Gillette's greatest year! Why make a proving ground of your face? Demand Gillette Blades. Reputable merchants give you what you ask for!

**LESS
THAN 1¢ A DAY**
buys the world's
finest blades

REMEMBER IT'S YOUR FACE

Precision-made
for each other

Gillette Blades

MORE SHAVING COMFORT FOR YOUR MONEY

ALLIED presents RADIO'S NEWEST FEATURES AT LOWEST PRICES

IN 61 NEW KNIGHT RADIOS

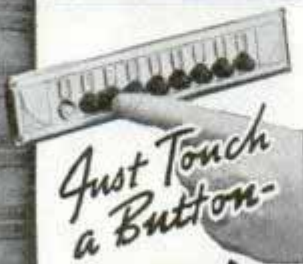
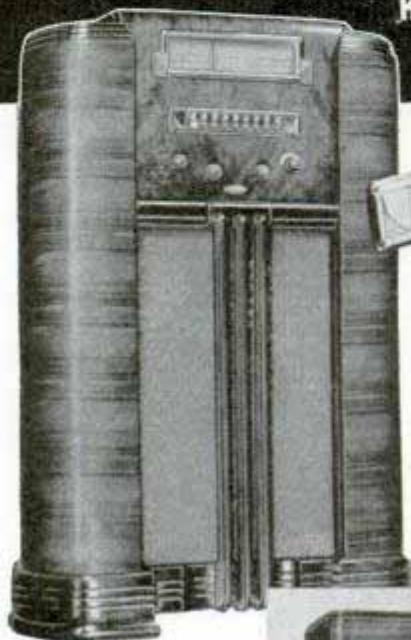

Just Touch a Button—
THERE'S YOUR STATION!

KNIGHT 11-TUBE
Push-Button Tuning
—All-wave

KNIGHT 6-TUBE
Push-Button Tuning
—3 Bands



ALLIED leads again in value with 1938 Knights combining radio's newest features at sensational low prices. Advanced R. C. A. and Hazeltine licensed circuits, with Electric Push-Button Tuning, Slide-Rule Select-O-Matic Dials, Electric Eye, Full Voice speakers, A. F. C.—world-wide range—all these at prices that challenge the industry! 5 to 16 tubes, for AC, AC-DC, 6 volt, 32 volt, battery and auto. Radio's greatest values! Choose from 61 Knight models in ALLIED's great Catalog—send coupon.

EVERYTHING IN RADIO AT LOWEST PRICES!

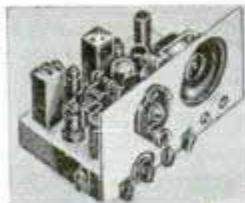

Dealers! Service Men! Sound Specialists! Amateur-Experimenters! Get ALLIED's 1938 Catalog. Everything you need at lowest prices—over 12,000 Parts, Kits, Sound, Amateur, Test Equipment, books, tools, tool-kits—every radio requirement. Complete stocks, fastest service, lowest prices. save you time and money at ALLIED. Send coupon today for Free 1938 Catalog—radio's complete supply guide!

KITS—All types, for any set in any Radio publication. Write for Free Parts Lists.



ALLIED RADIO CORPORATION
Dept. 5-A8, 833 W. Jackson Blvd.
Chicago, Ill.

- Send your Free 1938 Catalog.
- Send Free Parts Lists for.....

Name.....

Address.....

City..... State.....

Beam-Power Four-Tube Midget

(Continued from page 99)

their relative positions. The variable condenser, speaker and other parts mounted on top of the base are sketched in above so that all connecting wires are clearly shown. All wiring is done with No. 16 stranded

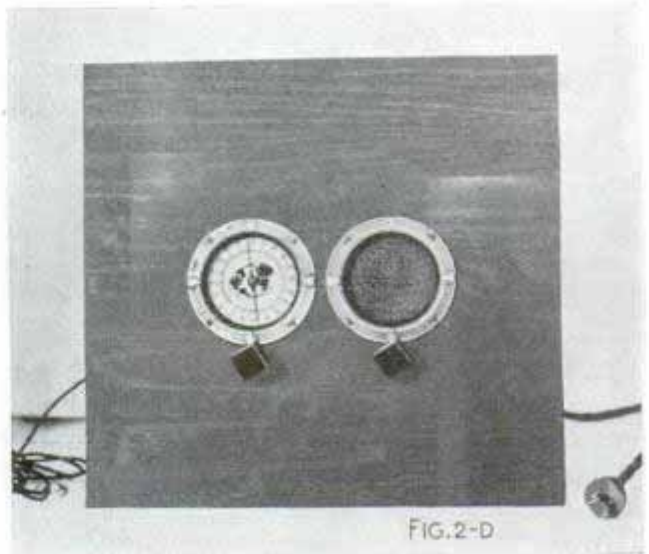

FIG. 2-D

hookup wire with push-back insulation. It will be noted that a length of No. 14 tinned-copper bus-bar wire is used for common ground connections. This is a handy and efficient way to insure well-soldered grounds to the metal base. Rosin-core solder is employed for all connections. The schematic circuit diagram is given in Fig. 3. A list of the original parts used can be obtained from Popular Mechanics radio de-

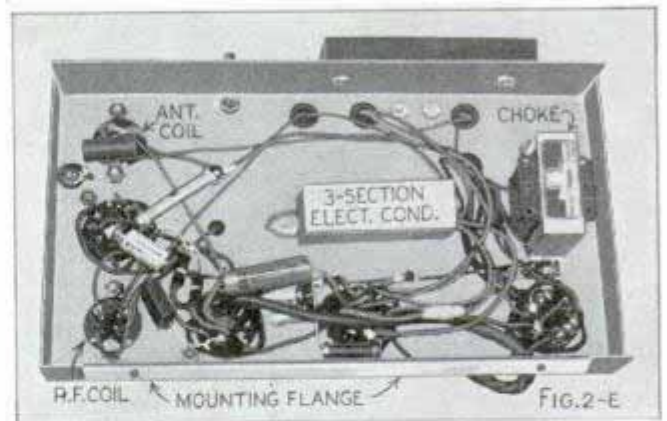

FIG. 2-E

partment without charge. The blueprint number is R-247.

Photos Figs. 2-A, 2-B and 2-C show various top and front views of the completed set; photos 2-A and 2-D illustrate the method employed in mounting the receiver on a plywood front panel of any required

(Continued to page 152A)

**PRECISION-
BUILT**
By Specialists

Driver has concentrated all its engineering research, years of experience, and complete plant facilities on small power tools. Only because Driver manufactures small power tools *exclusively* are values like these possible.

Whether you're buying for industrial production or home workshop use, compare these four Driver tools with others in any price class. Compare them for precision features. For ruggedness. Then compare them for low price. You, too, will decide on Driver—for the work they do—and the way they do it. You can get the big new 1938 catalog, right away, free, by mailing the coupon below. Have the complete Driver line to refer to—now or whenever you want faster, finer work with a power tool!

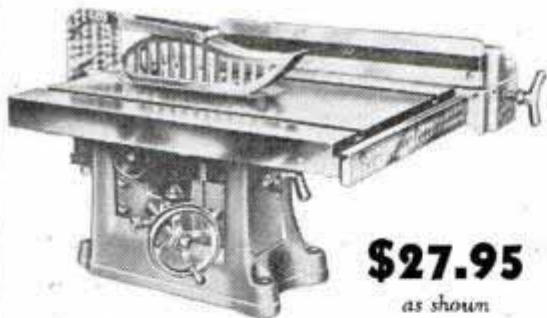

\$27.95

as shown

**8" BENCH SAW
MORE TOOL FOR THE MONEY**

Driver B737 8" Bench Saw has a 20" x 15" table surface—the biggest ever offered in the 700 Series price range. And the width can be increased to 31" with available extensions. Saw cuts to a full 2 1/4" depth without vibration; lowers by a worm gear for other depths. Table tilts to 45° accurately measured by indicator for angle cuts. Ripping fence is adjustable. See this value at your Driver dealer's.



**DRIVER Engineered
POWER TOOLS**

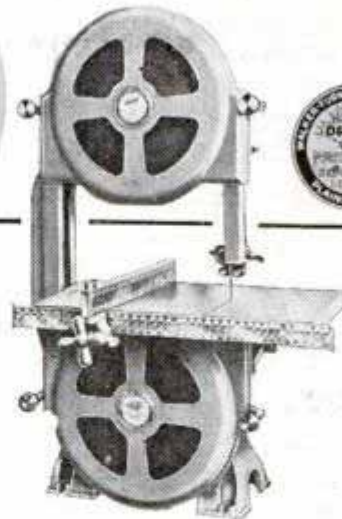

\$34.95

as shown

**12" BAND SAW SAWS
LUMBER 6" THICK!**

Driver BN730 12" Band Saw has six precision ball bearings to give permanent smoothness to wheels and guide rollers. Wheels are carefully balanced and rubber faced. Table tilts to 45°. Wheel guards, back guard, and telescoping front guard provide complete safety. Everything to make it the finest 12" band saw on the market!

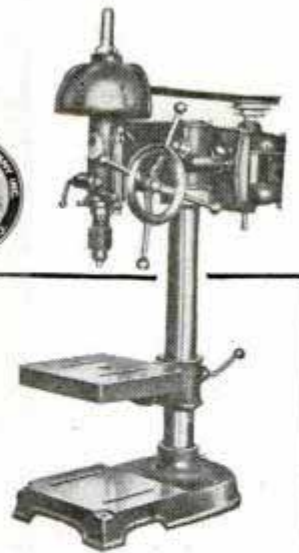

\$39.95

as shown, less motor, including belt and motor pulley.

**HEAVY SPLINE
SPINDLE
DRILL PRESS**

Driver D925 Drill Press does precision drilling, heavy or light, and carves, dovetails and mortises. Six-spline spindle reduces vibration to minimum. Pilot wheel with calibrated depth stop for lowering spindle; positive spring action returns it. Heavy smooth ground table raises and lowers, swings to any position, tilts to any angle. Shaft supported by high grade ball bearings at four points. These and other features make this Driver tool an outstanding drill press value.

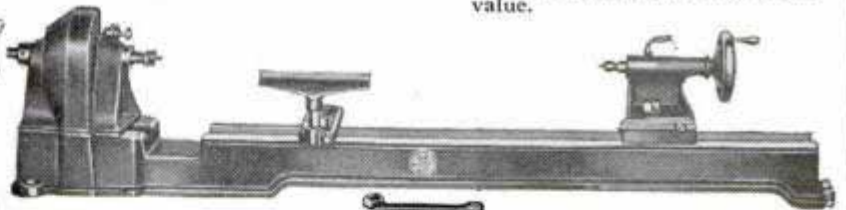

\$34.65 as shown, plus heavy duty V-belt and box wrench

700 SERIES LATHE TURNS WORK A YARD LONG

Driver L751 Lathe has 37" capacity between centers, 10" swing over bed, and 13 1/2" swing over gap. Built rugged enough to take Driver attachments for metal turning and spinning. Hollow head spindle is 1" in diameter and supported by two deep grooved ball bearings of ample thrust capacity, one double for added precision and long wear. Morse Taper centers, four speeds, extra strong gap bed and other features which make this lathe an extraordinary value!

FREE! OUR CATALOG FOR THIS COUPON!

Walker-Turner Co., Inc.
118 South Ave., Plainfield, N. J.

Send me, without charge, your new 1938 catalog describing the complete line of Driver Engineered Power Tools.

Name.....

Address.....

Try a Vegetable Laxative

See the difference



I TOOK ONE NR TABLET LAST NIGHT AND THIS MORNING I FEEL GRAND

WHETHER your constipation is chronic or occasional—one trial of Nature's

Remedy (NR Tablets) will show why millions prefer this ALL-VEGETABLE Laxative. One NR Tablet convinced me... so mild, thorough, refreshing and invigorating.

Dependable relief for sick headaches, bilious spells and that tired-out feeling, when caused by or associated with constipation.

Without Risk get a 25c box of NRs from any druggist. Use for one week, then if you are not more than pleased, return the box and we will refund the purchase price. That's fair. Try it—NR Tonight—Tomorrow Alright.



FREE: Beautiful Six-color 1938 Calendar-Thermometer. Also samples of NR and Tums. Send stamp for packing and postage to Lewis-Howe Co., Desk 130-A, St. Louis, Mo.

MAKE YOUR XMAS PRESENTS WITH A BRONZE FOUNDRY

for Schools and Home Workshops



Complete Foundry Outfits are available in three sizes and make it possible for you to produce beautiful bronze, silver or aluminum castings in your home workshop from scrap metal. Presents such as book ends, ash trays, dishes, paper weights, letter openers, bottle openers, statuary, etc., can be quickly made by the sand casting process. Existing objects can be used as patterns, and sand moulds made in a few minutes' time. Previous experience unnecessary. Domestic gas supply and 110 volt energy required for operation.

Capacity	Crucible	Shipping Wt.	Price Complete
351	6 cu.in.	25 lbs.	1 1/2 lbs. \$13.50
352	12 cu.in.	40 lbs.	3 lbs. 19.00
353	24 cu.in.	65 lbs.	6 lbs. 27.50

Universal motor blower operates on either AC or DC. Prices f. o. b. K. C. Check or money order acceptable, express charges C. O. D. Write for circular.

KANSAS CITY SPECIALTIES CO. P. O. Box 6022 Kansas City, Mo.

The NEW UNIVERSAL GRINDER

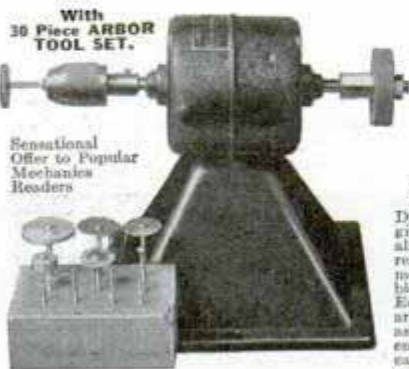

\$395

The grinder that is truly universal in its application to jobs impossible with other power tools. This versatile tool is indispensable to jeweler, optician, dentist, model maker and home craftsman.

LOOK AT THESE AMAZING FEATURES

Dynamically balanced hi-speed motor gives you vibrationless power. Self-aligning bearing semi-oilless and oil reservoir in each bearing. Tool steel motor shafts. Compact design enables you to work on delicate jobs. Equipped with a three jaw universal arbor chuck, adjustable to take drills as fine as a hair. Arbor tool set enables you to grind, drill, route, carve, sand or polish. Operates on 110 volt A. C. or D. C. current. Variable Speeds from 10,000 R. P. M. to 500 R. P. M.

R. P. M. Can be obtained with use of rheostat \$2.50 additional. INCLUDES 30 PIECE ARBOR TOOL SET: 9—Grind stones with brass centers assorted sizes. 2—Bakelite cut off wheels. 3—Assorted engraving or carving burrs. 2—Polishing buffs. 1—Mounted point. 1—Bristle polishing brush. 10—Assorted sanding discs emery, sand, garnet, fine, coarse and medium. 2—Screw mandrels. 1—Large grind stone.

Rush \$1.00—Balance C. O. D. PHILADELPHIA MACHINERY CO. 118 N. 6th St., Philadelphia, Pa.

(Continued from page 150A)

size or shape for the bookcase or other cabinet that the builder may have in mind. Two 3-in. holes are cut in the center of the front panel for the airplane-type dial, and speaker; the same type of escutcheon is used for both. A plywood base panel, or shelf, 3/8 by 6 3/4 by 11 in., is fastened to the rear of the front panel by means of small shelf brackets, to support the set chassis at the correct height. Referring to the underside photo of the chassis base, Fig. 2-E, it will be noted that two holes are provided in the rear mounting flange for short wood screws. This type of mounting lends itself to practically any installation such as in

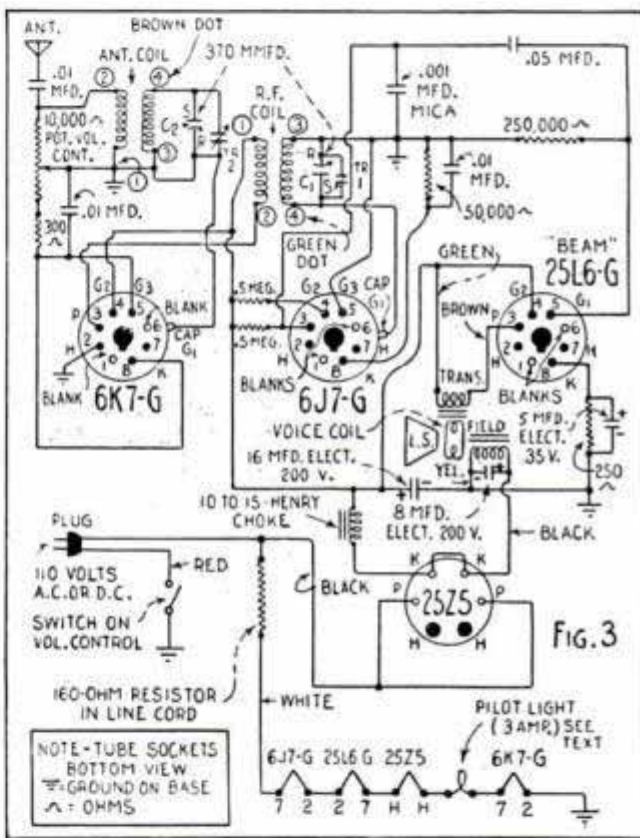

open book shelves, wall cabinets, magazine racks, or wherever convenience and economy of space are desired.

To balance the set, connect the antenna to the insulated antenna post, plug in the line cord and permit the tubes to warm up. If used on a d.c. line it may be necessary to reverse the plug in the wall socket for correct polarity. Tune in a fairly weak station and vary trimmer (Tr.2) with a small screwdriver, for the loudest signal. Next adjust trimmer (Tr.1) for still louder signal. These balancing steps are in the rotation given, and, after once done seldom require readjusting unless the set is subjected to rough handling.



HANDY Taps and Dies

Electrically heat treated for long, accurate service. Every tool guaranteed to give complete satisfaction. Handy to own (10 cents each).



Made by HENRY L. HANSON
Worcester, Massachusetts
At Your Local 5 and 10 Cent Store

ACE LATHE TOOL SET

\$14.50



Be permanently tooled-up for every operation on your Metal Cutting Lathe

The ACE Set is complete—there's nothing more to buy. Drop forged by the manufacturers of cutting tools used by 96 per cent of the plants and shops in industry they are correctly designed, are of special steel, are finely finished, are stronger—will last a lifetime. You can cut metal, faster and more accurately with ACE TOOLS. At your Hardware Store—Circular FREE.

3 Turning Tools, 2 Cutting Tools, Boring Tool, Threading Tool, High Speed Steel Cutters and Blades, and 2 Wrenches in Filled Steel Case.

ARMSTRONG BROS. TOOL CO.
"The Tool Holder People"
368 N. Francisco Ave., CHICAGO, U.S.A.

STRIPE YOUR OWN CAR

Anyone can stripe a car with an automatic ROLL-A-STRIPE. You can save the price of your striping job and earn money doing others. Specially knurled roller and dependable gauge. Paint, lacquer, enamel or varnish may be used. Stripe signs, furniture, models, etc. See any Duro Dealer today or send direct. Postpaid \$1.50.

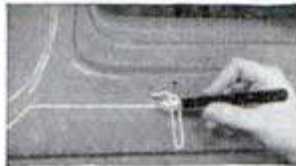

MODCRAFT INDUSTRIES, Dept. P-41, 2908 N. Nordica Ave., CHICAGO, ILL.

Catch Fish!



Eels, Mink, Muskrats, with our new folding galvanized STEEL WIRE TRAP. Write for our FREE TRAP OFFER and Bargain Catalog. \$1 Box of our famous Fish Bait FREE to introduce our traps. WALTON SUPPLY CO., 3501 JUNIATA AVE., ST. LOUIS, MO.

WESTINGHOUSE UNIVERSAL MOTOR 1/30 H.P. operates on 110 volt, AC or DC, 5000 RPM. \$2.55 plus 25c Postage. Arbor and 1/4" Chuck \$1.00 Extra; 3/4" Pulley—25c. Send Check or Money Order. Money back guarantee.



NATIONAL ELECTRIC TOOL CO. Dept. 12, 560 Washington Chicago, Ill. Hgt. 3 3/4", Leth. 3 3/4" Wdth. 1 1/2", Shft. 1 1/2"

OFFICE MACHINES—Care

and operation of 29 different makes. Typewriters, adding machines, duplicators, etc. Only book on subject. 384 pages, illustrated. \$2.50 postpaid.

POPULAR MECHANICS PRESS
200 East Ontario Street Chicago



Get this
Book Now!

MONEY MAKING FORMULAS

1059 PRICELESS FORMULAS ALL IN ONE BOOK FOR \$1.25

FORTUNES MADE WITH FORMULAS LIKE THESE

- Cosmetics
- Remedies
- Beverages
- Paints
- Glues
- Polishes
- Inks
- Soaps
- Fertilizers
- Preservatives
- Lubricants
- Auto Products
- Food Products
- Metal Products,
- Etc.

Hundreds of big selling products—earning millions in profits—grew from a simple formula. Your own product may bring you fame and fortune. Get this big 200 page book with 1059 formulas, and start a spare or full time business of your own. Everything explained—what to make—how to make it—where to get materials. This is the book that lifts the veil of secrecy from a profitable and fascinating business. Get your copy now. Only \$1.25 postpaid.

Popular Mechanics Press, Dept. 138-B, 200 East Ontario St., Chicago

SAVE ON HAMILTON, ELGIN AND BULOVA WATCHES ★ AND HIGH GRADE ★ DIAMOND RINGS

Thousands have taken advantage of the easy Santa Fe way to own America's finest diamond rings, watches, silverware, or jewelry.

BY USING OUR LOW MONTHLY PAYMENT PLAN AT NO EXTRA COST!



Gifts for Every Occasion

TURN PIN MONEY INTO DIAMONDS

Don't pay extra for credit—at the Santa Fe you pay only the low nationally advertised cash price, in small monthly payments.

Send for FREE Catalog

Get this Beautiful Book of Values—sent FREE to adults. Leading brands of watches, diamond rings, silverware, and jewelry are shown—prices and low payments plainly marked. Don't miss this opportunity by delaying—WRITE NOW!—We Buy Old Gold.

SANTA FE WATCH COMPANY
Dept. 16 Thomas Bldg., Topeka, Kans.

YOUR OWN TYPEWRITER



FOR ONLY 10c A DAY!

SAVE 50% on Nationally Known typewriters. Late models re-conditioned, refinished. Fully guaranteed! Standard 4-row keyboard, automatic ribbon reverse, 2-color ribbon, back spacer, etc. Look, operate like new! 10c a day terms or as low as \$10 cash. Also PORTABLES!

FREE TRIAL! Money back guarantee! Free typing and short-hand course. Send for illustrated circular and details. No obligation! Write TODAY!

PRUITT CORP. 766 Pruitt Bldg., Chicago, Ill.

TEMPLE SPORT GLASSES



Permit free use of hands while viewing distant objects. Just the thing for sport events, inside or out. As comfortable as spectacles, and slip on or off as easily. Fine quality 30 mm. objective lens mounted in individually focusing calibrated eye-pieces with width adjustment. Magnify 2 1/4 X with clear, sharp, and bright definition. Complete with leatherette case, ONLY \$1.95 POSTPAID, or sent C. O. D. plus postage.

DELMACO PRODUCTS, BOX 1123C, Wilmington, Del.

XMAS MONEY FOR YOU...

There's a big demand for the many hand-tooled articles you can make with the Easco Leathercraft Set. Easily learn to make good money in your spare time. Complete outfit including tools, leathers, patterns, etc., and full instructions, only \$2.00—on sale at leading Department stores, or order direct and pay postman on arrival.

LEATHERCRAFT

Free When ordering direct, ell name of your Department Store to this ad, and we will include with your set, one extra free project. Illustrated catalogue 10c

E. A. SWEET CO. Dept. A-8 Binghamton, N. Y.

When writing please mention Popular Mechanics

FREE RADIO CATALOG

ASTOUNDING VALUES IN LAFAYETTE RADIOS LIKE THIS 6 TUBE, 2 BAND A.C.

The coupon below has brought new radio thrills to thousands. Mail it today for your FREE copy of the big 1938 180 page Wholesale Radio catalog containing the full line of Lafayette Radios. Illustrated is Model D-35—featuring sensational tuning "eye" which gets stations with pin-point accuracy plus tone that is unequalled. Designed with rounded walnut front and modernistic dial. One of 70 outstanding LAFAYETTES described in the catalog. 30 DAY FREE TRIAL—Easy Time Payments. Send the Coupon NOW.



FREE XMAS CATALOG \$17.75
 Get this Special 40 page Xmas catalog! Nationally advertised electric trains, toys, home appliances, etc. Gifts for every member of the family. **IT'S FREE. COMPLETE**

WHOLESALE RADIO SERVICE CO. INC.
 NEW YORK, N.Y. • CHICAGO, ILL. • ATLANTA, GA.
 100 SIXTH AVENUE • 901 W. JACKSON BLVD. • 430 W. PEACHTREE ST., N.W.
 BOSTON, MASS. • BRONX, N.Y. • NEWARK, N.J. • JAMAICA, L.I.

WHOLESALE RADIO SERVICE CO., INC.
 100 SIXTH AVENUE, NEW YORK, N. Y.
 Rush FREE 1938 Catalog No. 69-7A8
 Rush FREE XMAS Catalog No. 70-7A8

TWO GREAT FREE CATALOGS

Name.....
 Address.....
 City..... State.....

PASTE COUPON ON PENNY POST CARD

PHYSICS CHEMISTRY
FREE BOOK
 LIGHT

HOME SCIENCE EXPERIMENTS

Interesting and unusual things you can do with materials found at home; also a CHRISTMAS PRESENT MYSTERY for you to solve. Send for this FREE Book and learn the keen fun and valuable information you can get from Home Experimenting with CHEM-CRAFT Chemistry Outfits and SCIENCE-CRAFT Science Sets. Write today to **THE PORTER CHEMICAL CO., 4901 Prospect Ave., Hagerstown, Md.**

MINERALOGY • SPECTROSCOPY

EARN MONEY Make Wind Electric Plants
WE SHOW YOU HOW! Simplified plans make old auto generator light buildings, play radio, operate washing machine and other motors. Sell friends and neighbors. Dime brings complete plans, and 1938 parts catalog.
LEJAY MFG CO., 447 LeJay Bldg., Minneapolis, Minn.

NO SELLING BE MY LOCAL BUYER!
 Steady Work. Big Pay Daily! I furnish the money. Run this highly profitable business from your home—spare room—spare or full time. No experience. Full instructions furnished. Write for money-making details today!
PRUITT SALES CORP., Dept. E-1, 10 N. Clark St., Chicago, Ill.

AMAZING LOW PRICED FOG-LITE INVENTION

Strange New Material SNAPS-ON HEADLAMPS

KNOCKOUT SELLER. Turns headlamps into AMBER FOG-LITES. Pierces Fog, Snow, Sleet and Rain. Prevents "blind driving." Cuts glare. Helps save life, property. Low priced. Gripping demonstration. Agents wanted everywhere. Phenomenal profits.

SAMPLE OFFER Samples sent on trial to first person in each locality who writes. No obligation. Get details. Be First—send in your name **TODA !!**
KRISTEE CO., 671 Bar St., Akron, O.

Simple 5-Meter Transmitter for Beginners

(Continued from page 100)

possible. The metal base is 17 in. long, 5 1/2 in. wide and 2 in. high. Both neutralizing condensers (CN) are mounted on rectangular pieces of Victron, which are fas-

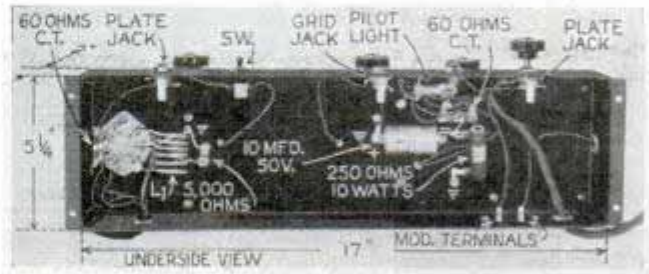

tened directly on the side of the National plate tuning condenser (C₃). This gives a compact arrangement with short, direct leads. A list of the original parts used, together with complete tuning and operating instructions, can be obtained from

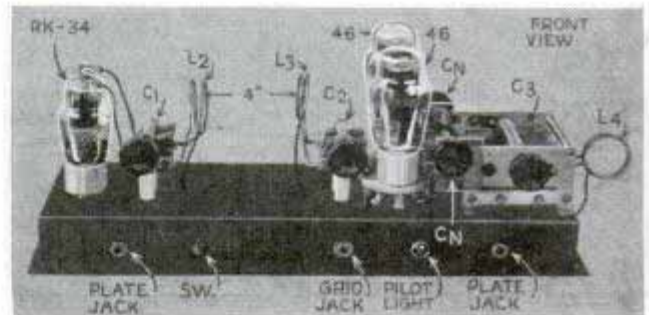

Popular Mechanics radio department, without charge. The blueprint number is R-248.

If carefully adjusted, this transmitter has a frequency modulation of around 20 kilocycles at 100 per cent modulation and

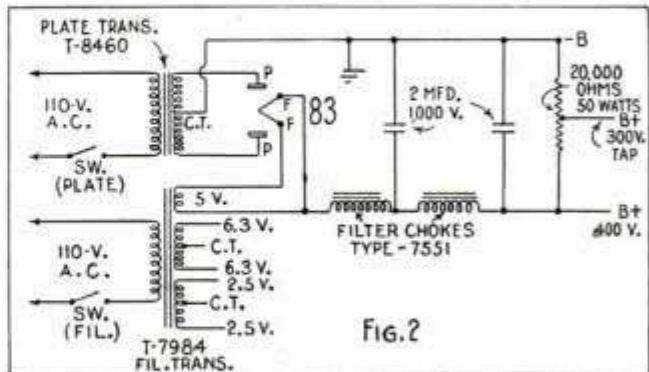

has a carrier output of about 35 watts; the frequency drift is very low. A suitable modulator can be any speech amplifier delivering 20 to 35 watts of audio. The modulation transformer is coupled in the rear of the chassis by means of the terminal strip.

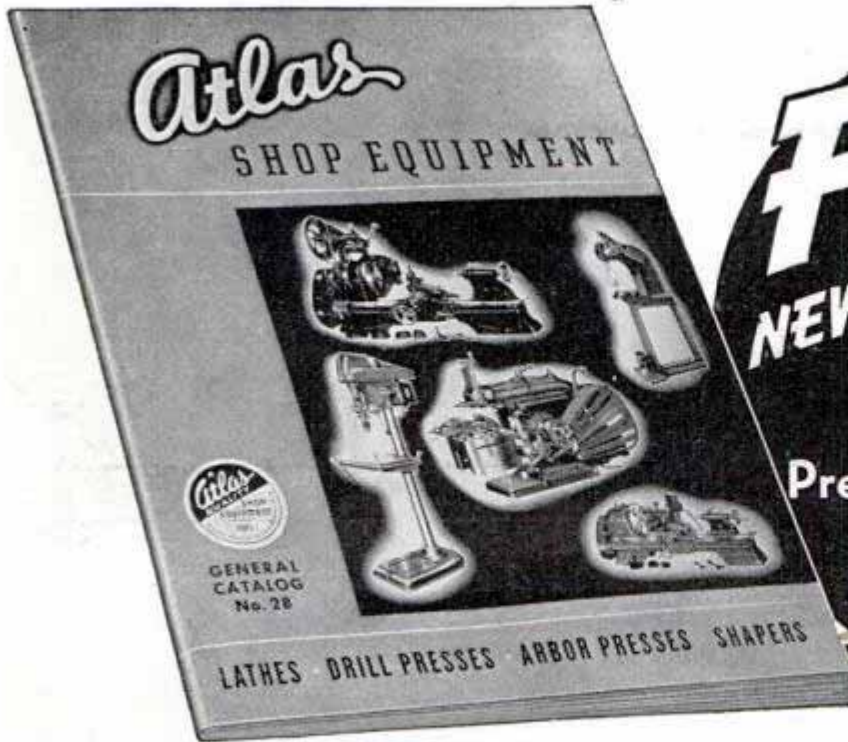

FREE!
NEW 1938 Atlas CATALOG
 ... Presenting
**The Finest Modern
 Precision Machine Tools
 You've Ever Seen!**
**WRITE
 TODAY**

See the sensational new Atlas machine tools—the new small metal lathe, the amazing new bench shaper! See all the latest lathe and drill press attachments for special operations. Every man who has a workshop or hopes to have one this year should have this interesting catalog.

ATLAS PRESS COMPANY

143 N. Pitcher St., Kalamazoo, Mich.

FACTORY DISPLAYS AT
CHICAGO—35 E. Wacker at Wabash
NEW YORK—130 W. 42nd St.
PHILADELPHIA—113 N. 3rd St.



ATLAS PRESS CO., 143 N. Pitcher St., Kalamazoo, Mich.
 Kindly send me your 1938 Catalog. I am interested in:
 New Small Lathe Metal Lathes Arbor Presses
 New Shaper Drill Presses Wood Lathes
 Name.....
 Address.....
 City and State.....

LATHES · DRILL PRESSES · ARBOR PRESSES · SHAPERS

BUILD CLOCKS with our help
 Cash in on the demand for Mantel, Banjo, GRANDFATHER'S CLOCKS. Ask about our new, low-priced Mantel Clock and Special Blue Print Offer. Send dime for illustrated working drawing of Mantel Clock; 25c for plans of 15 Mantel & Banjo Clocks. Catalog FREE.
AMERICAN CHIME CLOCK CO.
 1675 Ruffner St. (Established 1877) Philadelphia, Pa.

BUILD THESE PROJECTS
 For garden or lawn. Easy to build. Easy to sell. Detailed Blueprints Model B-25 Dutch Windmill 50c; Model OM-60 Old Mill, \$1.00. Lawn Figure Patterns—Sunbonnet Girl, Dutch Boy, Tulip Girl, Holland Girl, 35c each, 4—\$1.00. Catalog illustrating over 25 models, send 10c, today.
CRAFTSMAN'S MODEL CO. Dept. P-13, 2030 N. 41st St., Milwaukee, Wis.

NEW TRAILER PARTS CATALOG
 New catalog of trailer parts at bargain prices. Axles, straight, \$8. Drop center axle, \$7.50. Drop center axle undercarriage, \$19.50, complete less tires. Cable-controlled brakes on axle, \$15 extra. Electric brakes—prices on request. Send for FREE Catalog today.
SHAMROCK TRAILER PARTS, 12321 Turner, DETROIT, MICH.

FREE — 7 sq. ft. Poster of spectacular scientific pictures. Shows new Speed Erector and exciting models it builds. Mail 1c post card.
A. C. Gilbert Company (31) Erector Sq., New Haven, Conn.

RAISE GIANT FROGS
FREE BOOK
BIG DEMAND! Good prices year round. Nation-wide markets waiting for all you can ship.
WE BUY! Sell to us also. Breeder lays 20,000 eggs yearly. Get ready now for next spawn. Start with small pond, creek, lowland. **Free book shows sketch, Men & Women starting in every state and Canada.** See what others are doing with our methods. **Send no money!** Just your name and address on postcard brings special offer to beginners. Write **AMERICAN FROG CANNING CO.** (Dept. 133-AA) New Orleans, La.

KINKADE GARDEN TRACTOR
 and Power Lawnmower
 A Practical Power Plow and Cultivator for Gardeners, Suburbanites, Florists, Truckers, Nurserymen, Fruit Growers.
Low Prices—Easy Terms
AMERICAN FARM MACHINE CO.
 1058 33rd Ave. SE., Minneapolis, Minn.

100 PAGE BOOK No. 10
 Full of beautiful things easily made—hard to find foreign woods—lovely crotch, butt, burl, fiddle back, etc. Veneers, panels and solid woods—hard to find hardware. How to make your own Venetian Blinds at 1/3 store prices. Scroll patterns. Inlay table tops, etc.
CRAFTSMAN WOOD SERVICE CO.
 2722 Mary Street Chicago
 We Ship All Over the World

3-Minute Spring Motor for Model Boats
 Propels boats up to 20 in. at the rate of 100 ft. a minute. High grade, rigidly constructed, easy to install. Complete with clutch, shaft and propeller. Postpaid, complete.....\$1.25
SEATTLE MODEL BOAT CO.
 Dept. P, Box 333 Seattle, Wash.

Manheim POCKET SLIDE RULE
 With A-B-C-D Scales. Multiplies, divides, squares, takes square root, finds circumference and area of circles. 6 inches long—thin construction. **NO WOOD OR CELLULOID.** Fits in vest pocket. Send \$1 in cash, money order or check (\$1.25 Canada and foreign countries) and receive slide rule with genuine leather case and instructions. Box M-15.
M. MANHEIM COMPANY, Inc. 15 E. 26th St. New York, N. Y.



Build Your Own ICE YACHT

Enjoy old Man Winter in a Mead Ice Yacht—"Skeeter" type or Batwing—a available in construction kit or factory-built. Or build your own Motor Sled. Rush dime for complete details on Mead Winter Sportcraft.



BATWING

(Above) MEAD SKEETER

Build Your Own MOTOR SLED

Mead

MEAD GLIDERS, 15 S. Market, Dept. 18-BS, CHICAGO



Masons—Look

Pin dollar bill to this ad and receive this genuine morocco billfold-card case. **MADE TO FIT YOUR LODGE CARD.** Holds 5 cards. Masonic emblem stamped in gold FREE. Your name stamped 35c extra. Oldest Masonic supply house in U. S.

The REDDING MASONIC SUPPLY CO., Inc.
17 W. 23rd Street, New York, N. Y.



YOUR OWN MOVIES! 10¢ A DAY!

NATIONALLY ADVERTISED 8MM and 16MM Movie cameras, projectors. For home, business, church, school, club. **MONEY BACK 10 DAY TRIAL.** Payments as low as 10¢ A DAY. Satisfied customers throughout the world. FREE details. WRITE TODAY. Den Elder's Home Movies, Dept. A-1, 739 Boylston St., Boston, Mass.



TOOL CHESTS

That always Please
Toolmakers and Machinists. Free Catalog.
GERSTNER TOOL CHESTS
438 Columbia St. Dayton, Ohio

FREE VIOLIN-MAKING CATALOG

The perfect adult hobby! The perfect hobby gift! Build instruments with real tone! Send for free 1938 illustrated catalog of seasoned old tone-woods, tools, supplies, complete Kits and Instructions. Drop a card today to Dept. P. VOIT & GEIGER, INC., 14 E. Jackson Blvd., Chicago, Ill.



Ship or Coach Model, \$1

Make money building these beautiful ornaments. Hulls of Calif. Redwood, fully shaped and all parts cut exactly to fit, including sails. Full instructions and drawings. Also 27 in. Queen Mary, \$2.50, and many others \$1.00 to \$6.00. Send 3c stamp for illustrated catalog.

MINIATURE SHIP MODELS, Dept. RT, Parkside, Pa.



NEW 5 in 1 & 2 in 1 SHEET METAL PUNCH

Radio Tinsmith & Sheet Metal Workers—it cuts those holes quickly and efficiently and punches its own guide hole (using only a hammer). 5 in 1 hole sizes 1 7/16, 1 3/16, 1 5/16, 1 1/2, 1 3/8, 1 1/4, 1 1/8, 1 1/16, 1/8, 1/16, 1/32. Price \$4.25. 2 in 1 hole sizes, 1 3/16, 7/8, Price \$2.50.

LIVERMORE PUNCH CO., 119 S. Broom St., Madison, Wis.

20715

Putting the World on Skids

(Continued from page 61)

ta which was held at Fox Lake, Ill., in 1936, had thirty-eight "Skeeters" start. Melvin Jones and Ted Meade took first and second places. The biggest event in the middle west is the regatta held each year in Wisconsin by the North American Ice Yachting Association, which attracts hundreds of boats of all types.

The rules for ice-yacht racing are very similar to those of the International Yacht Racing Association, with a few modifications. The iceboats are lined up at the start, an equal number on each side of the starting mark. When the gun cracks, they start off on opposite tacks, with the crews

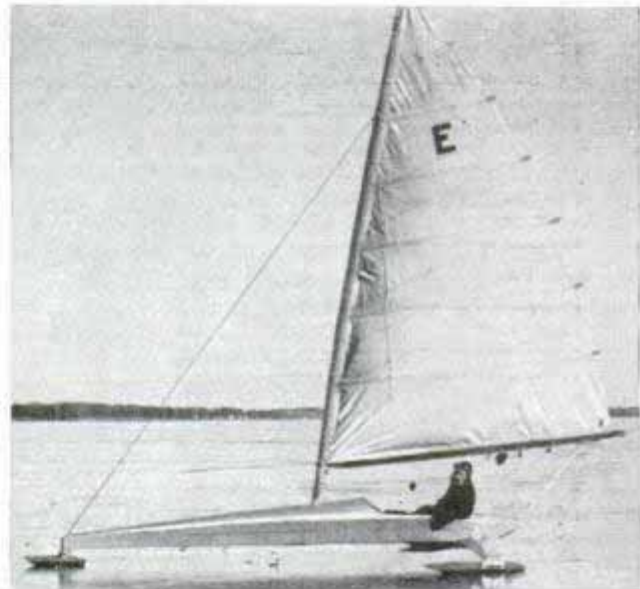

Those who have tried it say there's nothing like an iceboat for a real thrill

pushing the boats to get them under way. If there is no wind it is entirely permissible to push a boat all the way around the course. You can get out at any time it seems advisable and give it a shove. The boat on starboard tack has the right of way over the boat on port tack. The boat going down wind must keep clear of the boat going up wind. The windward boat must keep clear when two boats converge on the same tack. Starboard tack means that you are sailing with the wind coming over the right hand, or starboard side of the bow. Port tack, the wind is coming over the left or port side.

Our Bureau of Information will answer questions regarding articles in this magazine, if accompanied by return postage.

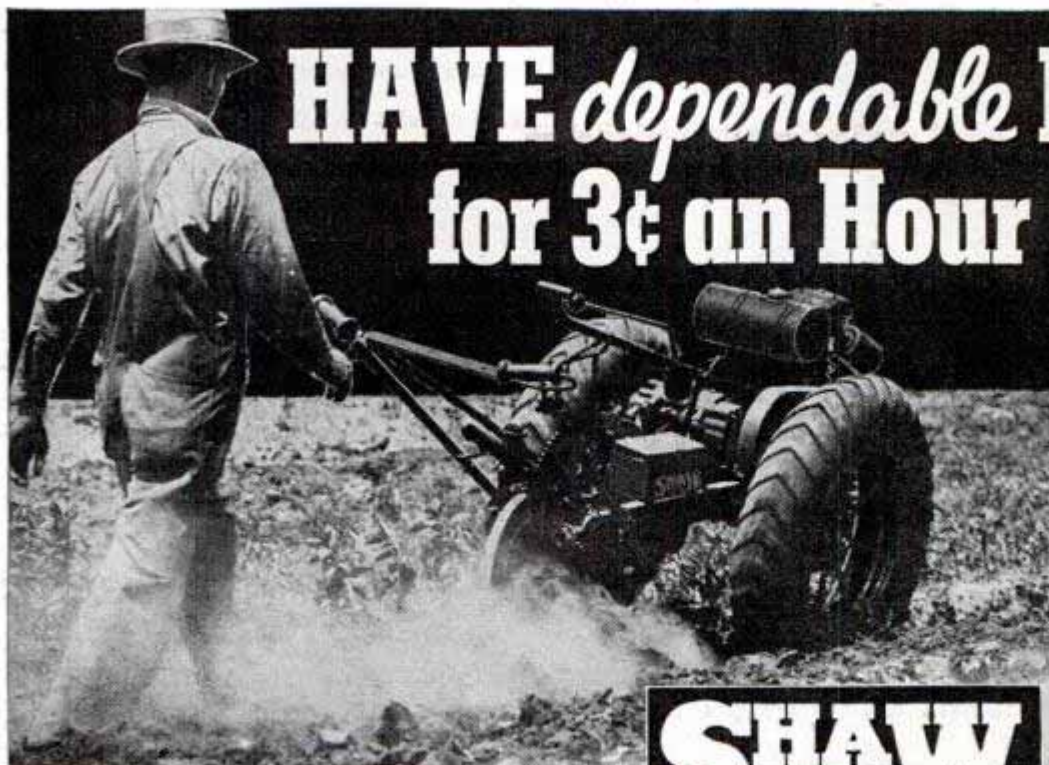

HAVE *dependable* POWER for 3¢ an Hour

**Get Your SHAW At
LOW FACTORY PRICE!**

**SHAW
'DU-ALL'
TRACTOR OF '100 USES'**

GET untiring speed and power with a Shaw DU-ALL at an amazingly low FACTORY-TO-YOU price—so low it will surprise you. DU-ALL does work of many men and two or three mules for only 3¢ an hour. Soon pays for itself in money saved. Greatest time, labor and money saver made. Can be run by woman or 10-year-old boy.

DU-ALL DOES ALL—Does all field, road, belt work. Plows, discs, harrows, furrows, seeds, cultivates, harvests, digs potatoes, mows, rakes, sprays, cuts weeds and hauls. It runs washing machines, feed grinders, corn shellers, buzz saws, concrete mixers, onion graders, water pumps, lathes and other belt machinery. Does deep mold-board plowing and other heavy work. **AMAZING MONEY MAKER** for farms, ranches, truck gardens, nurseries, orchards, poultry ranches, estates, suburban homes, golf courses and parks.

SPECTACULAR NEW FEATURES—New 1938 DU-ALL has 3 speeds forward (6 when ordered special) and reverse. Runs from 1/8 mile to 15 miles per hour. Reverse gear eases work among rocks, roots and in small areas. New power turn enables DU-ALL to be turned in its tracks. Powerful Briggs &

Stratton 4-cycle air-cooled engine. Air cleaner. Patented tool control makes possible the shifting of cultivating tools from side to side. Gauge wheel regulates cultivating depth. Tool and riding attachments available for all uses. Convenient jiffy hitches speed tool and attachment hook-ups. Air tires save 25% fuel costs; allow greater traction in field; fast travel on highway. Power take-off pulley converts DU-ALL into portable power plant for belt machinery. 4 models, 2 to 5 H. P.

LOW FACTORY PRICE—Mail coupon for details of price and terms today! You'll be astounded.

10-DAY TRIAL OFFER—Use DU-ALL for 10 days on your own work. See what amazing time, labor and money saver it is. Mail coupon for details. No obligation.



Agents and Dealers Wanted!

—Liberal proposition for qualified men. Mail coupon for low prices, discounts and terms.

ADDRESS OFFICE NEAREST YOU

THE SHAW MFG. CO., 4501 FRONT STREET, GALESBURG, KANSAS

5812 G Magnolia St., Chicago, Ill.

130 G West 42nd St., New York, N. Y.

668 G North 4th St., Columbus, Ohio



**Get This
BIG
FREE BOOK!**

Contains action photos of DU-ALL on the job. Pictures and describes various models, attachments and tools. Quotes low factory price. Tells what users say. 56 colorful pages. Mail coupon now! See how you can increase profits, save money, time and labor. Read about real 10-day trial offer. Be surprised at unusually **LOW FACTORY PRICE**. Mail coupon immediately.

RUSH COUPON TODAY!

THE SHAW MFG. CO., (Address nearest office)

4501 Front St., Galesburg, Kans.; 130-G West 42nd St., New York, N. Y.; 5812-G Magnolia St., Chicago, Ill.; 668-G No. Fourth St., Columbus, Ohio.

Send **FREE** information at once about the Shaw DU-ALL Tractor as checked below.

- FREE** book, **LOW FACTORY PRICE** and **10-DAY TRIAL OFFER.** Liberal proposition for agents and dealers.

NAME

ADDRESS

TOWN STATE

When writing to advertisers please mention Popular Mechanics



● For those qualities in a saw which cause it to run for long periods between filings, to do more work by keeping steadily at it ... buy an Atkins. Circular, hand, hack and all other types of saws used in your workshop are in the complete Atkins line. Be sure you get this reliable performance the next time you buy a saw. Your local hardware dealer can tell you about them.

E. C. ATKINS & COMPANY, Indianapolis, Ind.

Ask for an

ATKINS
Certified Saw



NEW! 1938 BOUCHER JUNIOR

CARVED HULL SETS

Complete with Fittings—Drawings—Instructions

\$5.00 to \$9.50

Buy from America's oldest and best known SHIP MODEL House. Get the New 64 Page Book. Send 25c in Stamps or Coin.

BOUCHER

126 Lafayette St. (Dept. PM-1, New York

From **INDIANAPOLIS**
to **LOUISVILLE . . .**

ON ONE GALLON OF GAS!

It's true! Over 120 miles on a gallon of gas! Startling economy of operation. High speed. True comfort. Be first in your neighborhood to own the new improved Moto-Scout at greatly reduced price. Write for literature and name of closest distributor. See it! Drive it! No obligation!

Dealers:

Many valuable territories still open. Write today for FREE booklet.



Now Reduced To ONLY \$89.00

See the New Improved Moto-Clutch—Smooth starting—Simple operation.

and up F.O.B. Chicago

Moto-Scout

219 S. WESTERN AVENUE, CHICAGO, ILL.

es 115
New Wealth from the Sea

(Continued from page 3)

in with finer seines, usually operated from vessels of from fifty to 100 tons and crews of from ten to fifteen men.

The various types of fishing vessels feature a great number of new mechanical accessories such as electric hoists and draw lines which do much of the work done formerly by manpower. All hatches are loaded with chipped ice or refrigerator coils, and the catch is instantly "put on ice."

There are now about 2,700 fishing vessels in operation off U. S. shores and more than 17,000 smaller boats. The more modern fishing boats are heavier crafts costing from \$100,000 to \$250,000 each.

Heretofore more than fifty per cent of the live weight of sea fish has been wasted. The modern fishing plant seeks to make more use of by-products. For this reason fish packing is now one of the most rapid manufactures known. The fish are weighed and run through an automatic scaler, then delivered by endless-chain carriers to expert butchers who cut off the fillets or side meat. Fillets are then wrapped in Cellophane, packed in paper cases, and frozen at sub-zero temperatures, to remain frozen until they reach the frying pan.

The remainder of the fish, about sixty per cent of original weight, is then dispatched for by-products. In some instances the bone is extracted to be ground into bone meal. Livers are extracted, cooked, and placed in power presses where the oil is taken from them. The rest of the fish is cooked for glue. The dry portion of the waste is re-cooked and ground into meal, an important feed for livestock.

Sea-food canning is now a \$100,000,000-a-year industry. Salmon remains the most important canned sea product with tuna second. The Alaska salmon pack alone returns to the United States about \$40,000,000 a year. Perhaps the most promising of all the new uses for fish is that of fertilizers. The material is rich in phosphorus and potassium.

From kelps or seaweeds modern industry is making iodine, dyes, anti-rust solutions, spray materials, imitation hemp, and composition roofing. One of the most bizarre of the new ocean products is manufacture of artificial pearls and other imitation gems from herring scales.

New Amazing INVENTION! ELECTROPLATES WITH BRUSH AS EASY AS PAINTING!



No Tanks, Liquid Generators—Does Same Work As Big Outfits *Only* **\$350**

Sensational news! Marvelous new discovery actually electroplates with small hand brush as easy as painting. Deposits heavy layer of actual metal—gold, silver, nickel, cadmium, copper, etc.—by electrolysis. Does same beautiful, PERMANENT work as big costly tank outfits. Non-liquid. Anyone can use from dry cells, storage battery or household current. Complete outfit weighs only 1 lb.—take it anywhere.

FREE SAMPLE! Send today for amazing details and FREE Sample that proves all claims.

Agents Wanted: Write for Big-Money Proposition
RAPID ELECTROPLATING PRODUCTS
Dept. PM-11, 854 N. Clark St., Chicago

900 WORK SHOP IDEAS!

How to Make Articles of Beauty and Utility that Sell

Get the most out of your hobby. Turn your Work Shop hours into profit. The "Make It Yourself" book shows you what to make and how to make it, with that "professional touch"—models—toys—useful decorative articles of all kinds. Newest edition—480 pages, 823 pictures, 7 x 10 inches. Sent postpaid for \$3.00 or in U. S. and possessions C. O. D.—you pay postman. Order Now.

"MAKE IT YOURSELF" INCLUDES:

- Toys—Models—Furniture—Garden Equipment—Home Repairs—Sports Equipment—Auto Kinks—Radio Equipment—Workshop Tools and Machinery. Articles on Working: Wood, Metal, Leather, Glass, Etc., Etc., Etc.



POPULAR MECHANICS PRESS, Room 137B

200 E. Ontario St., CHICAGO

Tells How to Use—

Concrete About the Home; Concrete in the Garden and Yard; Concrete About the Farm; Concrete Homes and Buildings; Making Recreation Devices; Concrete in the Workshop; Concrete Products for Manufacture; Concrete in Business and Industry, etc. Gives 146 Concrete Kinks.



The Book of the hour for the workshop fan, handy man and home owner.

NEW Concrete BOOK
Makes Cement Work of All Kinds Easy

Money Making Facts - Best Methods - Materials - New Colored Concrete - 146 Kinks

"1001 Ways to Use Concrete" strips the mystery from the fascinating work of making useful articles and permanent improvements with concrete. This book, just published covers every known use of concrete for the home, farm, building, business and industry, plus newer uses in decoration and arts. Includes new fast setting and gloriously colored concrete and 146 valuable usable kinks. 1001 uses of concrete including homes, garden furniture, pools, statuary, etc., recreation devices, farm improvements, driveways, walks, etc. Describes all methods and materials. Shows how to do real professional type jobs.

256 Pages — 16 Colored Plates, Hundreds of Pictures

Large book 7 x 10 inches. Handsome cloth binding. Sent postpaid for only \$5. Sent COD in U. S. if preferred. Order today. Make concrete work a fascinating hobby or a profitable business.

POPULAR MECHANICS PRESS - 200 East Ontario St., Dept. 138C - CHICAGO

PICTURE NEWS OF AN AMAZING BATTERY

THAT'S GUARANTEED AS LONG AS YOU OWN YOUR CAR!



DRIVE FROM MAINE TO CALIFORNIA AS OFTEN AS YOU WANT

Think of it! Here is a battery that's guaranteed not for just a few months, a few years or a few thousand miles—it's guaranteed as long as you own your passenger car. Once you equip your car with the new Goodrich Kathanode Electro-Pak, Goodrich guarantees you'll never have to buy another battery for it or spend a penny for repairs.



ADDS TO LIFE OF BATTERY

Specially designed flexible Spun Glass Retainer Mats not only prevent the loss of active power-producing materials from the plates but also assure a free, steady flow of power.



SUPER-POWER CAN'T ESCAPE

Goodrich Electro-Pak Batteries are the only batteries with the Power-Saving Top Cover. This exclusive feature locks out dirt, acid spray and corrosion and seals in the Electro-Pak's super-power. See your Goodrich Tire and Battery Dealer or Goodrich Silvertown Store today.

Goodrich
KATHANODE
Electro-Pak BATTERY

When writing please mention Popular Mechanics

New 9" x 3' Genuine SOUTH BEND WORKSHOP LATHE

\$85⁰⁰

Less Motor Drive
AN IDEAL XMAS GIFT
Immediate
Deliveries

No. 415-YA, 9 $\frac{1}{4}$ " swing by 3'
bed Workshop Bench Lathe
with Horizontal Motor Drive,
 $\frac{1}{4}$ H.P. Reversing Motor,
Switch and Adjustable Belt
Tension
Countershaft . . . **\$117.00**

(\$15.00 down, \$6.00 a
month for 18 months.)

TERMS AS LOW AS \$6 A MONTH



A Back-Geared Screw-
Cutting Precision Lathe
Weight 320 lbs.

THE new 9-inch Workshop Precision Lathe is a back-geared, Screw Cutting Lathe, and has the same workmanship and materials as our larger, more expensive models.

It is designed to handle the finest, most accurate jobs in manufacturing—in the tool room, in home workshops and automotive machine shops. This lathe at \$85 and up represents the greatest value we have ever offered in 31 years of fine lathe building.

Features include Twin Gear Reverse to lead screw, Ball Thrust Bearing on Spindle, Automatic Longitudinal Screw Feed to Carriage, Precision Lead Screw for Cutting screw threads from 4 to 40 per inch, $\frac{3}{4}$ -inch hole through spindle taking collets up to $\frac{1}{2}$ -inch capacity. Takes 38 attachments

Lathes Stocked in Principal Cities

Chicago, Ill.—C. B. Burns Mehry, Co., 541 W. Wash. Blvd.
New York, N. Y.—A. C. Colby Mehry, Co., 183 Centre St.
Philadelphia, Pa.—W. B. Rapp Mehry, 132 No. Third St.
Los Angeles, Cal.—Eccles & Davies Mehry, 1910 Santa Fe
Detroit, Michigan—Lee Mehry, Co., 6318 E. Jefferson Ave.
Milwaukee, Wisconsin—Voell Mehry, Co., 1533 No. 16th St.
Boston, Mass.—The MacKenzie Mehry, Co., 36 Oliver St.
Cleveland, O.—Reynolds Mehry, Co., 2034 E. 22nd Street.

Write FOR THESE BOOKS

"How to Run a Lathe" has 160 pages with over 300 illustrations of work on a lathe. Over 1,500,000 copies sold. 25c each. Catalog No. 15-Y describes and prices the 9" Workshop Lathe in 8 drives and 4 bed lengths. Copy sent free, postpaid.

South Bend Lathe Works

625 E. Madison St., So. Bend, Ind., U.S.A.

South Bend Lathe Works,
625 E. Madison St., South Bend, Ind., U. S. A.

Please send me the following:

- No. 33LB "How to Run a Lathe," 25c
 No. 15Y 9" Workshop Catalog, Free
 Easy Payment Purchase Plan

Class of Work.....

Name.....

Address.....

City..... State.....

for milling, grinding, draw-in Collet chuck work, and many other lathe operations. In 3', 3 $\frac{1}{2}$ ', 4', and 4 $\frac{1}{2}$ ' bed lengths.

Write for information on this lathe and larger sizes in motor drive and countershaft drive. Get the bulletins we offer—with instruction about Manufacturing work, Automotive jobs, Home shop projects, etc. Use coupon below.

5 OTHER SIZES: 9", 11", 13", 15" and 16" SWING IN ALL BED LENGTHS—PRICED \$102 to \$1500.

Lathe shown below is No. 117-C, 16" x 6' Quick Change Gear Underneath Belt Motor Driven Lathe with 1 H.P. motor. Complete as shown, Wt. 2300 lbs. **\$969**

(\$97 down, \$43.50 monthly
for 22 months.)

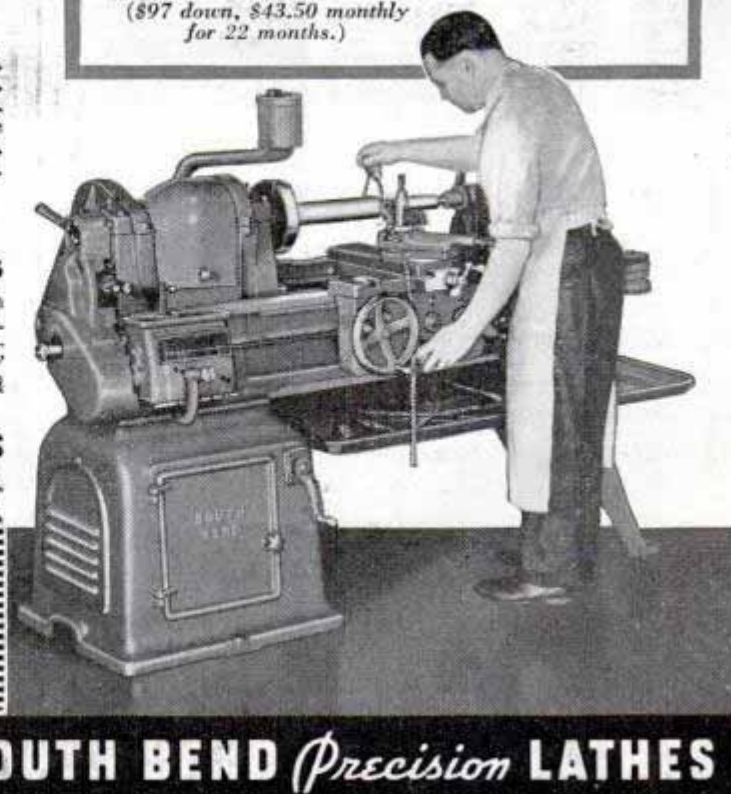

SOUTH BEND Precision LATHES



Get **MOBILOIL ARCTIC**—For 30 winters
Millions of Motorists have proved it's America's

BEST



WINTER OIL

WINTER-PROOF TODAY

START QUICK with Mobiloil Arctic—world's largest-selling winter oil.

SHIFT EASY with Mobiloil Gear Oil. No more fighting with your gears.

RIDE QUIET. Winter Mobilgreases end nerve-racking squeaks.

PREVENT FREEZE-UPS. Protect radiator with Mobil Freezezone.

"BETTER ONE WEEK EARLY... THAN ONE DAY LATE!"

TIME: 8 a.m.! TEMPERATURE: Freezing!
TOUCH THE STARTER... and YOU'RE OFF!

Mobiloil Arctic starts cars quick... easy!
Gives double protection—when your motor's cold or running hot. That's why...

More people buy Mobiloil Arctic than any other winter oil in the world!

Isn't that a great testimonial? It's the finest proof you could ask—that Mobiloil Arctic is the oil for your car this winter!

MOBILOIL AND MOBILGAS

SOCONY-VACUUM OIL COMPANY, INC.





Joan Crawford

takes time out from her part in M-G-M's "Mannequin" to play the part of Mrs. Santa Claus. Joan Crawford has smoked Luckies for eight years, has been kind enough to tell us: "They always stay on good terms with my throat."

Tobaccoland's Finest Gift

When you offer friends the welcome gift of cigarettes, remember two facts:

1. Among independent tobacco men, Luckies have twice as many exclusive smokers as all other brands combined.
2. Luckies not only offer you the finest tobacco but also the throat protection of the process "It's Toasted".

With men who know tobacco best...

It's Luckies 2 to 1



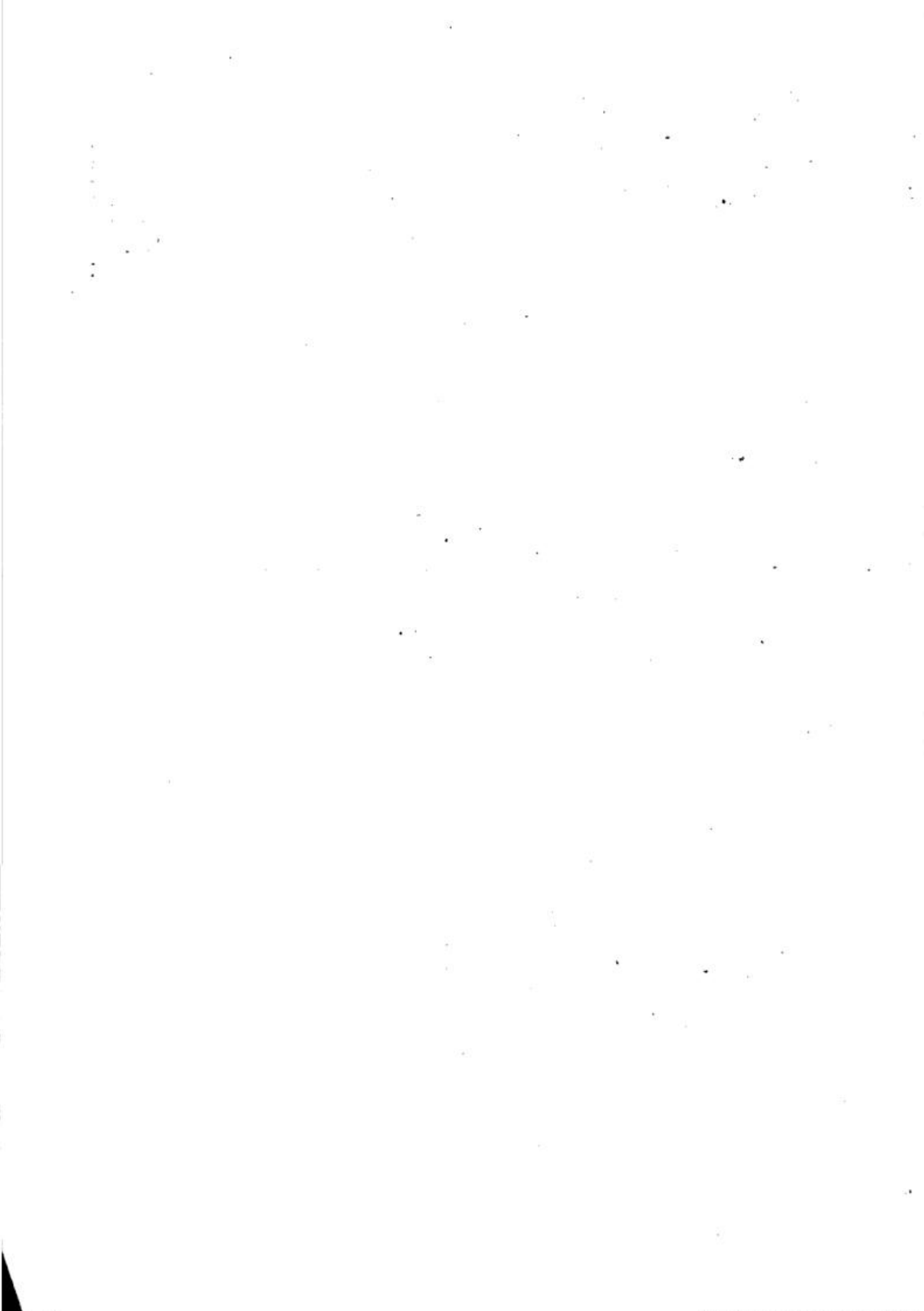

January 1938

DEC 8 - 1937

OFFICE OF IMMIGRATION

