

THRILLS OF THE NAVY TEST PILOTS

POPULAR MECHANICS



REG. U.S. PAT. OFF.

REG. U.S. PAT. OFF.

**AUG.
25 CENTS**

**SEE PAGE
186**



AUTO-LITE SPARK PLUGS

*complete the
Ignition System*

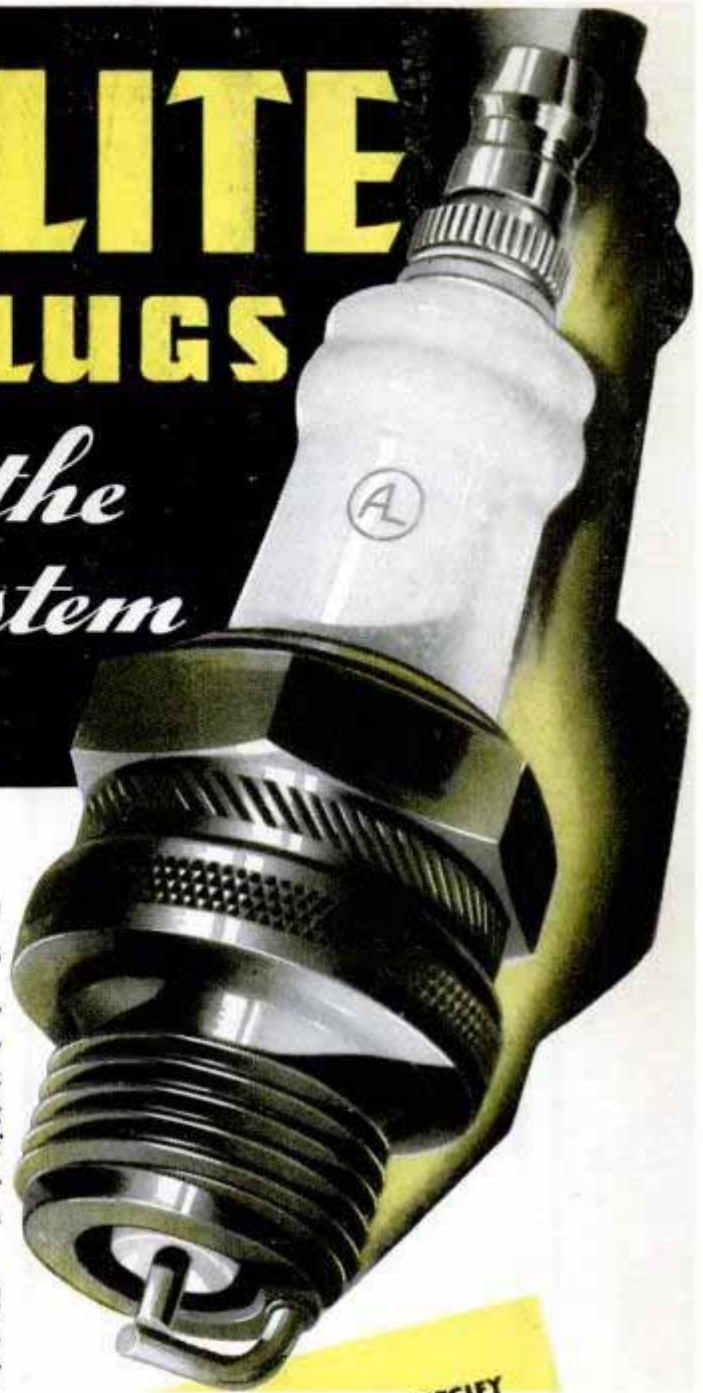

With the FIRST Spark Plug ... Ignition Engineered by Ignition Engineers

● Auto-Lite Ignition Engineers, after a quarter-century of research and experience, have developed the Auto-Lite Spark Plug as a component part of the Ignition System, the first spark plug built to work in perfect harmony with the rest of the ignition system—and as a result, produce perfect performance. The FIRST Spark Plug Ignition Engineered by Ignition Engineers.

To accomplish this, Auto-Lite engineers developed new materials and greatly improved features. Konium, for example, is a new electrode superior in vital properties to anything heretofore available. Ziramic is a new insulator material developed and made by Auto-Lite. These features insure longer life and better ignition performance.

AUTO-LITE

"BALANCED IGNITION" PERFORMANCE

Auto-Lite Spark Plugs are built to work in perfect harmony with the rest of the Ignition System, and as a result, produce "Balanced Ignition"—more power in your motor—a spark of the right characteristic, delivered in the right place at the right time. Your motor will prove these facts to you as soon as you install a set of Auto-Lite Spark Plugs.

Merchandising Division

THE ELECTRIC AUTO-LITE COMPANY, TOLEDO, OHIO.

THESE MANUFACTURERS SPECIFY AUTO-LITE EQUIPMENT

The Electric Auto-Lite Company is the world's largest independent manufacturer of automotive electrical and other automotive equipment. Today, Auto-Lite supplies one or more products to this outstanding list of car, truck and engine manufacturers.

ALLIS-CHALMERS... AUBURN... BROCK-
WAY... CHRIS-CRAFT... CHRYSLER...
DE SOTO... DIAMOND T... DODGE...
FEDERAL... FORD... GRAHAM... GRAY
MARINE... HUDSON... HUPMOBILE...
INTERNATIONAL HARVESTER... KER-
MATH... LINCOLN... LYCOMING... NASH
... PLYMOUTH... PACKARD... REO...
STUDEBAKER... WHITE... WILLYS.

"SECRET OF LONG LIFE"

EXTRA YEARS
SKILLFULLY ENGINEERED
INTO TODAY'S CARS

Things to Look for in Judging a Car's Stamina

HERE are some of Plymouth's engineering improvements. Others not pictured here, include Plymouth's all-rustproofed sheet metal...super-hard valve seat inserts...anodic-coated pistons.

Check these things in your next car. They make Plymouth "the car that stands up best!"—PLYMOUTH DIVISION OF CHRYSLER CORPORATION, Detroit, Michigan.

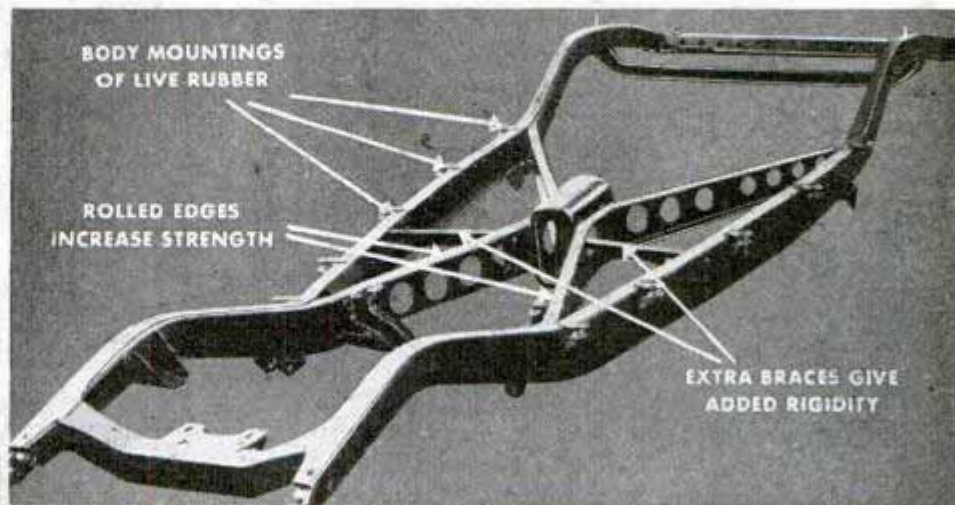

GREATER STRENGTH and ruggedness in the big, rigid, X-type frame. New rubber body mountings absorb vibration...make the body quiet!

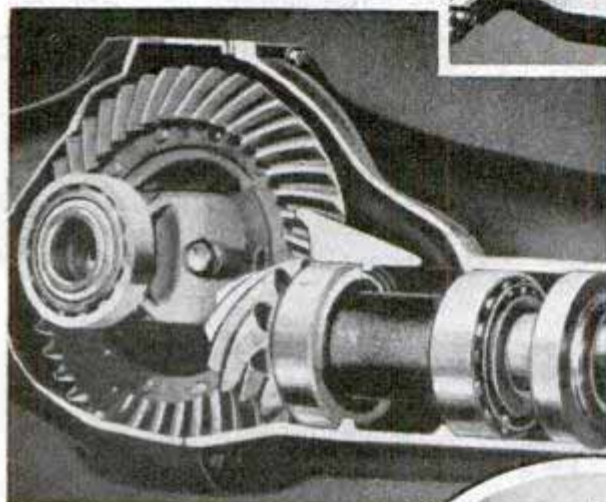

HYPOID rear axle has a much longer life than the spiral bevel type.. bigger and longer-lived gear teeth. It also lowers the propeller shaft...removing "hump" from rear compartment floor.

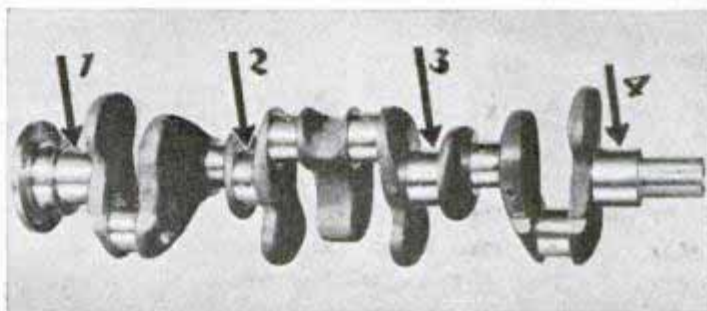

CRANKSHAFT with four main bearings, instead of the usual three...smoother operation, longer life.

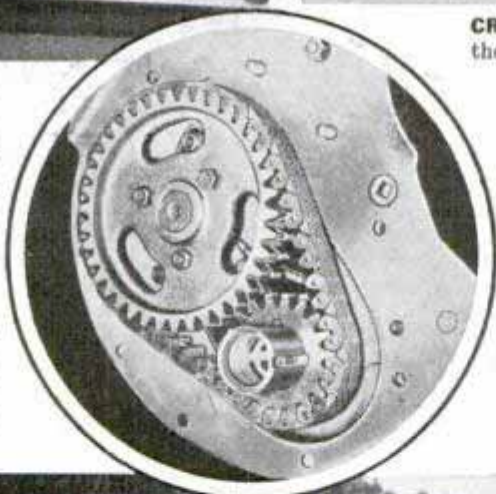

CHAIN-DRIVEN camshaft is far superior to gear drive. With a chain drive, there is a much greater contact area...which makes it run more quietly and stand up better.

OTHER VITAL, LONG-LIFE AND ECONOMY FEATURES

- 1 Smooth, double-acting hydraulic brakes...trouble-free, safe.
- 2 All-steel body...steel above, below, all around you...new quiet construction.
- 3 Semi-elliptic springs of special "Amola" steel.
- 4 Floating Power engine mountings dissipate vibration.
- 5 New, Aero-Hydraulic shock-absorbers.
- 6 Tubular front axle...stronger though lighter, than any other.

PRICED WITH THE LOWEST

The Commercial Credit Company offers very easy payment terms through all Chrysler, De Soto and Dodge dealers.

TUNE IN MAJOR BOWES' Amateur Hour—Columbia Network, Thurs., 9 to 10 p. m., E. D. S. T.



When writing to advertisers please mention Popular Mechanics



SHE MUST HAVE GOOD TELEPHONE APPARATUS TO GIVE YOU GOOD SERVICE . . . BELL SYSTEM SERVICE IS BASED ON *Western Electric** QUALITY.

* Makers of Bell telephone apparatus for more than 50 years.



Popular Mechanics Magazine

H. H. WINDSOR, Founder

H. H. WINDSOR, Jr., Editor and Publisher

August, 1937

Vol. 68, No. 2

Special Features

<u>The New Gold Rush</u>	161
<u>At Home Afloat—Part I</u>	Coloroto
<u>Celluloid Models</u>	180
<u>Torture Chambers for Safety</u>	188
<u>Caution! Danger Ahead!</u>	194
<u>Hunting Treasure with Magic Light</u>	202
<u>Forecasting Weather a Year Ahead</u>	210
<u>Salvage Squad to the Rescue</u>	218
<u>Thrills of the Navy Test Pilots</u>	226
<u>Scenic Highway Built in Clouds</u>	232
<u>Super-Steam—Part II</u>	236
<u>Snapshots from New Angles</u>	242
<u>New Progress in Fireproofing</u>	252

(Continued on next page)

Get That Picture!

WHEN you open your favorite newspaper, you find the news of the day told in pictures as well as type—pictures, perhaps, of a disaster only a few hours old or a great sports event 1,000 miles away. Daring news photographers made the photographs but making the pictures was only half the job. The other half was delivering the pictures to the paper. A few years ago graphic photographs of any except a local event trailed hours or even days behind the news story. Today the word story and the picture story both travel by wire and news pictures are handled as expeditiously as news articles. There's an interesting story in the development of processes for transmitting pictures by wire and you'll find it in September.

Next Month

AN eight-page Coloroto article in this issue describes the delights of living afloat in a modern cruising motorboat. Perhaps, after reading it, you'll observe, "That's all very well—but a yacht costs a lot of money." A yacht runs into money, but a little cruiser isn't a yacht. The second part of this article next month reveals just how little it costs to spend a vacation or an entire summer on the open water.

Hot News on the Air

WHEN big news breaks, radio reporters with portable transmitters whirl into action. And so fast do they move that your receiver often brings you eye-witness accounts of a tragic disaster or other big news event while the story is still in the making. There's plenty of excitement in the life of a radio reporter as you'll discover by reading about their experiences next month.

Liquid Gold

A FEW years ago gasoline, kerosene and lubricating oils were about the only products manufactured from petroleum. Today petroleum derivatives are numbered by the hundreds and range all the way from fly spray to T.N.T. and from lip sticks to golf-ball cores. An article next month discusses the new wealth being extracted from petroleum.

Published monthly by POPULAR MECHANICS CO., 260 East Ontario Street, Chicago, U. S. A. Single copy in United States, 25 cents; \$2.50 a year, \$4.00 for two years, \$5.00 for three years in United States and possessions, Canada, Newfoundland, Labrador and countries of the Pan-American Postal Union including Spain. To all other countries add \$1.00 a year extra for overseas postage. Changes in address must be reported to us immediately to eliminate delay. Entered as Second Class Matter, Sept. 15, 1903, at the Post Office at Chicago, Illinois, under Act of March 3, 1879. Entered as Second Class Matter at the Post Office Department, Canada. Copyright 1937, by Popular Mechanics Co. in the United States, Australia and France.

This One



5N1D-P2S-Y2Q5

(Contents—Continued)

AUTOMOTIVE

Electrically locked gas cap controlled from dash.....	177
Small dolly for moving trailer.....	179
Freight trailer helps truck on grades.....	186
Streamline study by image of air flow.....	187
Hilltop prism shows motorist road beyond.....	201
Sixty-five ton anvil in auto plant.....	207
Motorized bicycle hub.....	208
Streamline rear-engine car furnished like trailer....	224
Stop light at curve operated by autos.....	231
Gasoline hose has nozzle of synthetic rubber.....	234
Sheepskin mitten cleans car and protects hands....	239
Therapeutic lamps bake paint on autos.....	240
"Straphanging" firemen ride behind a windshield...247	
Truck body tilts three ways for unloading.....	251
Car headlamp tested with photocell meter.....	136A

AVIATION

Workshop on stilts services clipper planes.....	177
Airplane X-ray finds flaws in ship.....	178
Plane to fly stratosphere in army tests.....	184
Plane guided to landing by radio compass.....	200
Chart shows aviation's progress in speed.....	206
Streamline car tests model plane on water.....	207
Dirt on plane wings reduces speed.....	209
Fan forces parachute to ascend with jumper.....	209
Bump recorder on plane shows roughness of trip...222	
Two-blade offset propeller reduces vibration.....	240
Three-deck clipper has aisle in wing.....	241
Shadow shading camouflages war planes.....	250
Chemicals cool plane engine adopted by army.....	256

CONSTRUCTION

Small house "framed" of lightweight concrete.....	199
Plastic and synthetic houses promise lower costs...200	
House is built inside a church.....	234
Glass roof, sliding cover for future homes.....	239
Radiant dual walls heat or cool home.....	247
Paint for use on damp surfaces.....	251

HOUSEHOLD

Telescope awnings of metal.....	178
Furnace air control saves fuel.....	184
Water heater needs no pipe nor tank.....	216
Electric cord molded with plug lies flat.....	224
Sirup server pours from the bottom.....	224
Reel rewinds clothesline and prevents kinking....129A	

MOVIES AND PHOTOGRAPHY

Movie camera dolly travels on wooden rails.....	192
"Reading glass" for microfilm.....	222
Photo flash with longer flash.....	231
Three-dimension magnifier fitted to wearer.....	256
Twin sponges for drying photo film.....	256

RADIO AND ELECTRICITY

Invisible electric trap guards area from intruders..178	
More light produced by improved filaments.....	179
Vast lake starts river of power.....	186
"Ignitron gun" stops bullet in flight.....	192
Super-high voltage built up by artificial raindrops..223	
Television projected on large-size screen.....	223
Radio links window washers miles apart.....	251
"Doorknob" tube for one-half meter operation.....	257
Self-powered audio amplifier.....	258
Homemade "cold oven" piezo crystal holders.....	260
Practical radio suggestions.....	261
Audio amplifier circuit seen and heard.....	262
Heat-control unit for soldering iron.....	262
Improved punch for socket holes.....	262

RAILWAYS

Bay windows replace cupola on caboose.....	185
Gyrating headlight sweeps track in front of train...201	
Miniature trains run on garden railroad.....	249

SCIENCE AND INDUSTRY

Energy tester finds women harder than men.....	187
Auto made of farm products.....	208
Soap in oil well stops flow of water.....	217
Portable stroboscope stops engine for inspectors...222	
Insulin made more effective by adding zinc.....	234
Reduction in pneumonia toll promised by chemical..246	
Flares on balloon show night wind direction.....	248
No drought until 1975 is forecast.....	248

(Continued to page 6A)

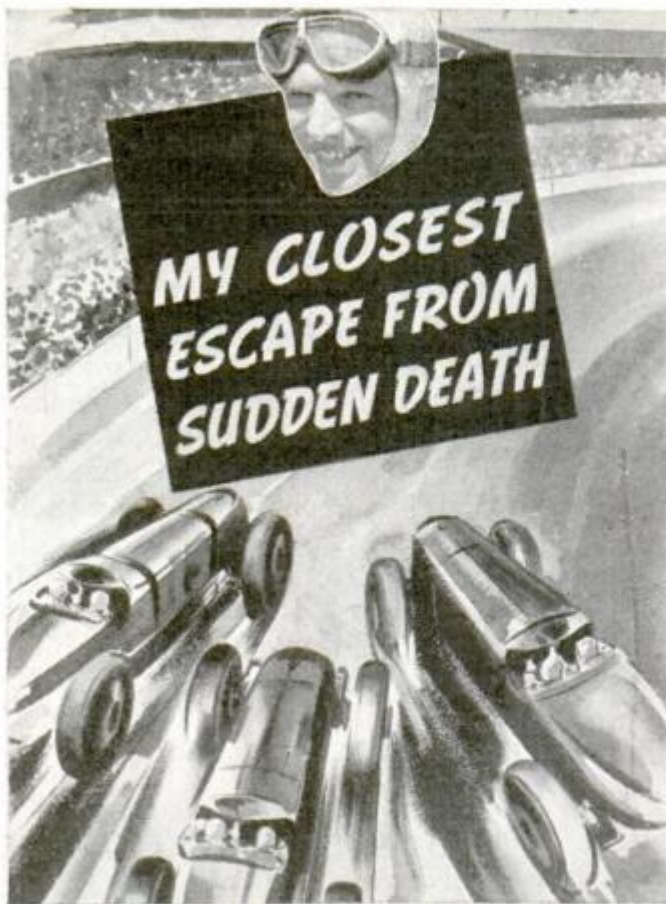

FAMOUS AUTO RACE DRIVERS TELL YOU OF THEIR NARROWEST ESCAPES, IN A NEW BOOKLET MAILED TO YOU FREE.

Roaring down the Indianapolis Speedway at 125 miles an hour, two cars abreast suddenly go into a crazy skid. Another, scarcely ten yards behind, bears down upon them. Destruction for all seems imminent. Then, the miracle happens! Radiator to radiator, the two cars in front shy from each other. And through this opening the third one sweeps. Close! But death is cheated. And all roar on to greater speed than ever!

What is it like in the driver's seat when death snatches at your racing mount? How does it feel to hurdle the wall? How can a car tumble end over end and yet spew out its pilot unharmed?

Frank Brisko tells you. So do Wilbur Shaw, Deacon Litz and a score more of the world's most famous automobile race drivers—all in an exciting booklet now being mailed Free on request to Pyroil Company. Mail coupon below for your Free Copy.

Famous race drivers the world over use Pyroil. Do you? Pyroil reduces friction, banishes hard carbon, gums and sludges, prevents corrosion damage—one of today's greatest engine and bearing problems. Insist on Pyroil every time you buy gas and oil. Only an ounce or two are needed, at only a few pennies cost! Manufactured and Guaranteed by Pyroil Company, W. V. Kidder, Founder, 58 Pyroil Bldg., LaCrosse, Wisconsin, U.S.A.

PYROIL HAS BEEN TESTED BY POPULAR MECHANICS AND IS USED BY POPULAR MECHANICS' PRESSES AND EQUIPMENT.

DISTRIBUTORS:

Check and mail coupon for facts of our unusual Sales Opportunity for you. Start now!



SIMPLY ADD TO GAS & OIL

This 12-ounce can treats 7 Quarts of Lubricating Oil.

PYROIL COMPANY
58 Pyroil Bldg., LaCrosse, Wis., U.S.A.

Please send me (entirely Free) a copy of your new booklet giving the true and exciting escapes from death of famous auto racers.

Also, send details of your Plan for Distributors.

Name.....

Address.....

City..... County..... State.....

80 MILES PER HOUR TO DEAD STOP IN A FEW SECONDS!

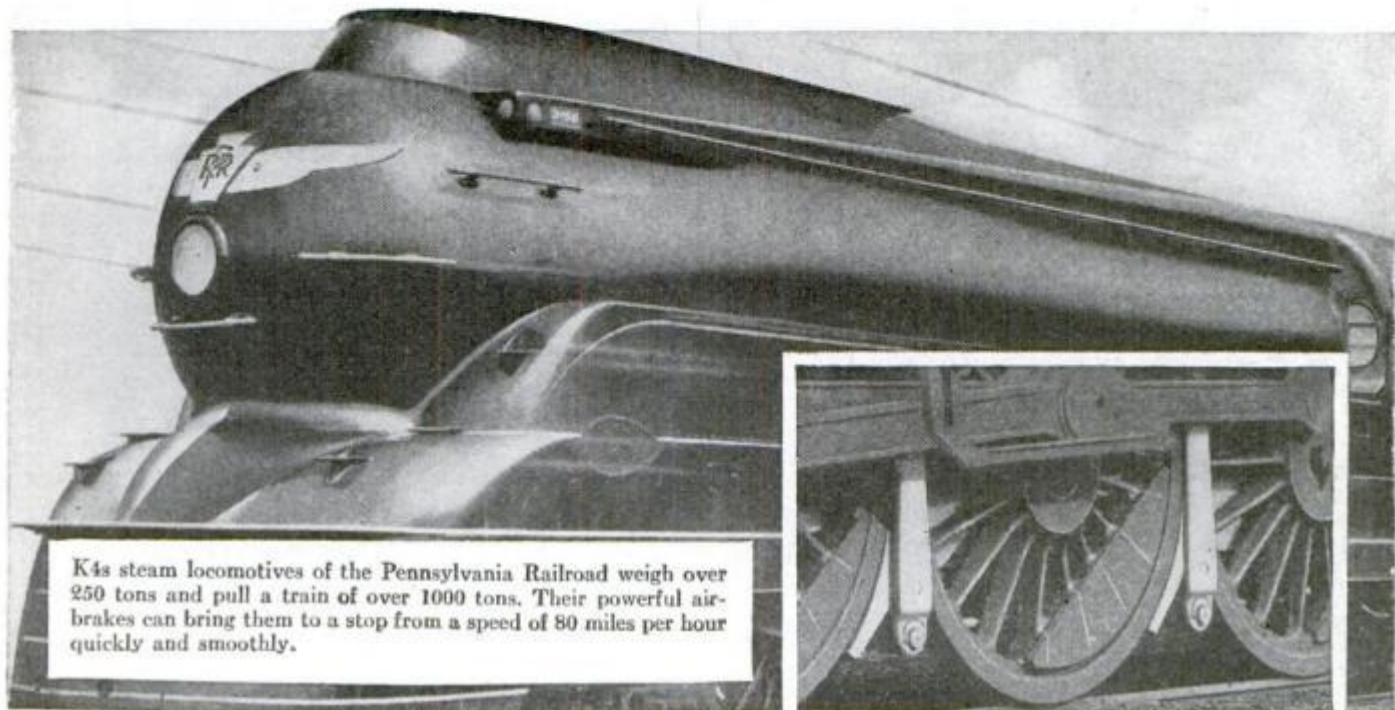

K4s steam locomotives of the Pennsylvania Railroad weigh over 250 tons and pull a train of over 1000 tons. Their powerful air-brakes can bring them to a stop from a speed of 80 miles per hour quickly and smoothly.

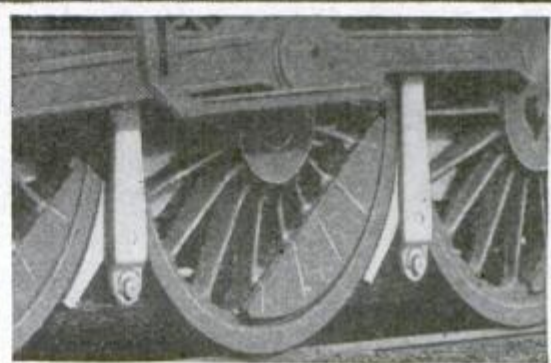

BRAKE SHOES are jammed against racing drivers by compressed air power for smooth, safe stops.

Powerful air-brake of locomotive illustrates **HIGH COMPRESSION** principle of modern auto engine

THE higher the air-pressure in the locomotive brake cylinders, the more stopping power Casey Jones gets. The higher the compression in the cylinders of your automobile, the more driving power you get.

That's why automobile manufacturers are using high compression engines in even the lowest priced cars. These cars squeeze more power, more mileage, more get-up-and-go from every drop of gasoline.

To get these advantages, set the spark for maximum performance *and use a fuel made for high compression!* Stop at pumps marked "Ethyl." There you will get more anti-knock

**GIVES YOU A BETTER
RUN FOR YOUR MONEY**

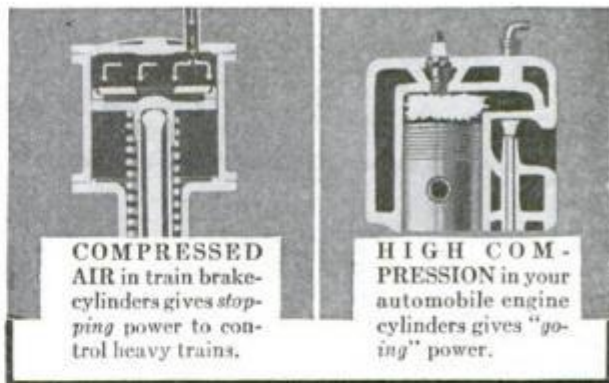

COMPRESSED AIR in train brake-cylinders gives *stopping* power to control heavy trains.

HIGH COMPRESSION in your automobile engine cylinders gives *"going"* power.

fluid (containing lead tetraethyl) than you get in the best regular-grade gasoline. By preventing harmful knock and overheating, you make sure of 100% performance from your high compression engine and save on gas and oil.

And at these Ethyl pumps you get all-round quality that is *double-tested*—by the oil company and by the Ethyl Gasoline Corporation.

ETHYL GETS FULL POWER FROM HIGH COMPRESSION

When writing to advertisers please mention Popular Mechanics

"Misfit Blades Nicked My Face Scraped My Skin

—says Illinois man

Now I'm back to Gillette Blades
in my Gillette Razor."



MISFIT BLADES NICKED
MY FACE AND SCRAPED MY
SKIN. NOW I'M BACK TO
GENUINE GILLETTE BLADES
IN MY GILLETTE RAZOR
FOR COMFORTABLE SHAVES

W. R. Corbett, Quintens Road, Palatine, Ill.

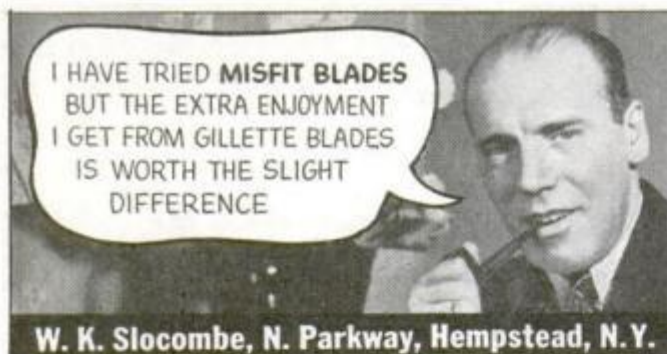

I HAVE TRIED MISFIT BLADES
BUT THE EXTRA ENJOYMENT
I GET FROM GILLETTE BLADES
IS WORTH THE SLIGHT
DIFFERENCE

W. K. Slocombe, N. Parkway, Hempstead, N. Y.

THE shaving edges of MISFIT blades have either too much shaving edge which scrapes the skin—or not enough shaving edge which leaves your face half shaved. Avoid these discomforts by always using *genuine* Gillette Blades. They FIT your Gillette Razor because they were made for it! Buy a package today.



Gillette Blades
Precision-made for the Gillette Razor

(Contents—Continued)

SHIPS

Diesel fire boat shoots seventeen streams	193
Stop-and-go lights for ship	225
Midget Diesel tugs do work of big craft	250

TOOLS

Arc welder built in streamline trailer	184
Pedal controls solder flow leaving hands free	206
Hole digger enlarges bottom of concrete work	234
Latest scientific tools aid crime detection	235

MISCELLANEOUS

Holder for books attaches to table	187
Police prowls carry fire extinguishers	192
Non-heating microscope lamp gives bright light	193
Aerial horse rides flying platform in circus	198
Freezing cleans raw wool of burs and dirt	198
Music typewriter prints staff and all characters	198
Spray gun with tank on top	199
Weed cutter squirts gasoline on root	200
Wheeled dummy trains dog to lead blind	206
Spectacles in mask aid short-sighted	208
Giant tube to supply water for millions	214
Eighty-five mile tunnel taps vast watershed	215
Detection of old bloodstains may solve crimes	216
Flame-throwing army tank practices for war	216
One-piece helmet protects the welder	217
Tractor driven like Dobbin responds to reins	217
Bottle feeding rig for puppies	222
Doughnut loader fills transparent bag	224
Self-cleaning white paint latest for homes	230
Epsom salt poison for grasshoppers	241
Flexible track for toy electric railroad	241
Flutelike instrument helps beginner learn music	246
Golf putter with adjustable weight	246
Automatic target shows where bullet hits	248
Fourteen-mile horn calls in squad cars	250
Artist "paints" picture with pieces of type	255
Tractors haul big artillery units	255

Craftsman and Shop Notes

AUTOMOTIVE

Vacuum trailer brakes give smooth stops	315
Copper tubing flared with acorn nut	318
Die ornaments for control knobs	318
Truck tailboard held level with floor	318
Vulcanizing auto tires	318
Cleaning sleeve wire connectors	319
Glare shield slides across windshield	319
Hole in pail to fill radiator	319
Insulating horn wire in steering column	319
Sun visor directs breeze on driver	320
Tool drills holes in radiator hose	320

BOATS AND BOATING

Hinged boat seat is weatherproof	266
Splash shield for outboard motors	267
Pail and rope stabilize canoe	278
"Sea-Bee"—a gas-driven model speedboat	281
"Sea-Hiker," a foot-powered catamaran	295
Homemade boat anchor holds tightly	297

CAMPING, HUNTING, FISHING

Pack "saddle" that fits your back	271
Sponge-rubber bait for catfish	280
Holes cut in paper plates to hold cups	296

FARM

Watering tank from engine wheel	304
Hydraulic rams furnish water to country homes	306
Shock absorber saves horses shoulders	312

FURNITURE

Twin-top table in walnut or maple	268
Armrest relieves strain on artist's muscles	286
Glass-top table of iron	297

HAND TOOLS

Pivoted "spikes" hold toolbox level on roof	266
Emergency setter for tubular rivets	286
Toolbox swings on ladder	294

(Continued to page 8A)

Why Trained Accountants Command

—and how ambitious men are qualifying
by the LaSalle Problem Method

High Salaries

GET this straight.

By "accountancy" we do not mean "bookkeeping." For accountancy begins where bookkeeping leaves off.

The skilled accountant takes the figures handed him by the bookkeeper, and *analyzes* and *interprets* them.

He knows how much the costs in the various departments should amount to, how they may be lowered.

He knows what profits should be expected from a given enterprise, how they may be increased.

He knows, in a given business, what per cent of one's working capital can safely be tied up in merchandise on hand, what per cent is safe and adequate for sales promotion. And these, by the way, are but two of *scores* of percentage-figures where-with he points the way to successful operation.

He knows the intricacies of government taxation.

He knows how to *survey* the transactions of a business over a given period; how to show in cold, hard figures the progress it has made and where it is going. He knows how to *use* these findings as a basis for constructive policies.

In short, the trained accountant is the *controlling engineer* of business—one man business cannot do without.

Small wonder that he commands a salary two to ten times as great as that of the bookkeeper. Indeed, as an independent operator (head of his own accounting firm) he may earn as much as the president of the big and influential bank in his community, or the operating manager of a great railroad.

Some Examples

Small wonder that accountancy offers the trained man such fine opportunities—opportunities well illustrated by the success of thousands of

LaSalle accountancy students.* For example—one man was a plumber, 32 years old, with only an eleventh grade education. Today he is auditor for a large bank and his income is 325 per cent larger.

Another was a drug clerk at \$30 a week. Now he heads his own very successful accounting firm with an income many times as large.

A woman bookkeeper—buried in details of a small job—is now auditor of an apartment hotel, and her salary mounted in proportion to her work.

A credit manager—earning \$200 a month—moved up quickly to \$3000, to \$5000, and then to a highly profitable accounting business of his own which nets him better than \$10,000 a year.

And What It Means to You

Why let the other fellow walk away with the better job, when right in your own home you can equip yourself for a splendid future in this profitable profession?

Are you really *determined* to get ahead? If so, you can start at once to acquire—by the LaSalle Problem Method—a thorough understanding of Higher Accountancy, master its fundamental principles, become expert in the practical application of those principles—this without losing an hour from work or a dollar of pay.

Preliminary knowledge of bookkeeping is unnecessary. You will be given whatever training, instruction or review on the subject of bookkeeping you may personally need—and without any extra expense to you.

If you are dissatisfied with your present equipment—if you recognize the opportunities that lie ahead of you through home-study training—you will do well to send at once for full particulars. The coupon will bring them to you without any obligation, also details of LaSalle's convenient payment plan.

Check, sign and mail the coupon NOW.

Business Control Through Accountancy



LaSalle Extension University

DEPT. 864-HR CHICAGO

Opportunities in Accountancy—Check below and we will send you a copy of "Accountancy, the Profession that Pays," without obligation.

Higher Accountancy:

Other LaSalle Opportunities: If more interested in one of the other fields of business indicated below, check here:

- | | |
|---|---|
| <input type="checkbox"/> Business Management | <input type="checkbox"/> Modern Foremanship |
| <input type="checkbox"/> Modern Salesmanship | <input type="checkbox"/> Personnel Management |
| <input type="checkbox"/> Traffic Management | <input type="checkbox"/> Expert Bookkeeping |
| <input type="checkbox"/> Law: Degree of LL. B. | <input type="checkbox"/> C. P. A. Coaching |
| <input type="checkbox"/> Commercial Law | <input type="checkbox"/> Business English |
| <input type="checkbox"/> Industrial Management | <input type="checkbox"/> Stenotypy |
| <input type="checkbox"/> Business Correspondence | <input type="checkbox"/> Effective Speaking |
| <input type="checkbox"/> Credit and Collection Correspondence | <input type="checkbox"/> Railway Accounting |

Name

Present Position

Address

*Names available on request.

When writing to advertisers please mention Popular Mechanics

(Contents—Continued)

Work in vise protected with auto casing	296
Perforator from hack-saw blade	300
Holder for hack-saw blades	311
Stud-bolt setter from hexagon steel	318

HOME IMPROVEMENTS

Hip boots dried on coat hanger	270
Out with the moths	274
Opening in garbage can lid admits refuse	280
Bug-proofing French windows	288
Cooling electric-lighting plants	294
Solving your home problems	298

LAWNS AND GARDENS

Garden pool and waterfall	287
Celery bleached with inner tube	294
Plants in box protected against rain	296

PHOTOGRAPHY

Removing organic stain from photo prints	278
Better photos with diffused light	301
Using mirror to cut photo costs	311

POWER TOOLS

Taking up play in shaper sticker block	294
Electrical outlet for your lathe	305
"Wrench" to turn grease cups	305

STORE AND SHOP

Paper bags "tied" without string	267
Window ventilator from curtain rod	270
Paper tape applied with brush	304
Shop workers wear towels on arms	305
Powdered rosin in sack handy around workshop	312
Sturdy tank for welding tank	312
Work rest for welding table	314

WOODWORKING

Novelties in wood	263
Jig holds work for molding cutter	266
Cutting sharp angles on a miter box	273
"Standpipe" pressure steamer for light jobs	278

MISCELLANEOUS

Five-point star drawn accurately	266
Tool to plug watermelons	267
Hooks tip bucket when bailing out cistern	270
Sink stoppers provide covers for chemists' jars	270
Coat rack hangs from picture molding	273
Flame shield from chemist's burner	273
Locking bottle stopper	273
Sidewalk locomotive easy to build	279
Boy's bicycle locked against side of house	280
Cleaning dirty threads in nuts or bolts	280
Water faucet operated with clothespin	280
Plant retractor for aquarium	286
Sliding nail bins from tin cans	286
Whitewashing porous surfaces	286
Block to hold flooring tight while nailing	288
Celluloid shield for compass leg	288
Thumbtacks kept in drawing-board pocket	288
Doll carriage for winter and summer	289
Wallboard supported against ceiling by standard	289
Flower stands in bent metal	290
Heavy barrels loaded on truck with parbuckle	296
Oilstone kept on sliding shelf	296
Disk over glasses to use microscope	300
Driving small iron rods without buckling	304
Warning flag carried in pocket	304
Nozzle to clean drums	305
Salesman carries papers in false pocket	312
Helps for the machinist	313
Micrometer extension for places hard to reach	314
Show cards displayed on embroidery hoops	314
Turnbutton improves square for marking boards	314

IMPORTANT NOTICE

It is the intention of this magazine to provide its readers with information regarding the latest developments in the mechanical arts. We take no responsibility as to whether the disclosures contained in our articles are covered by patents and advise readers to investigate this subject before making, using, or selling any of the products, machines, or processes described, in order to avoid possible liability for patent infringement.

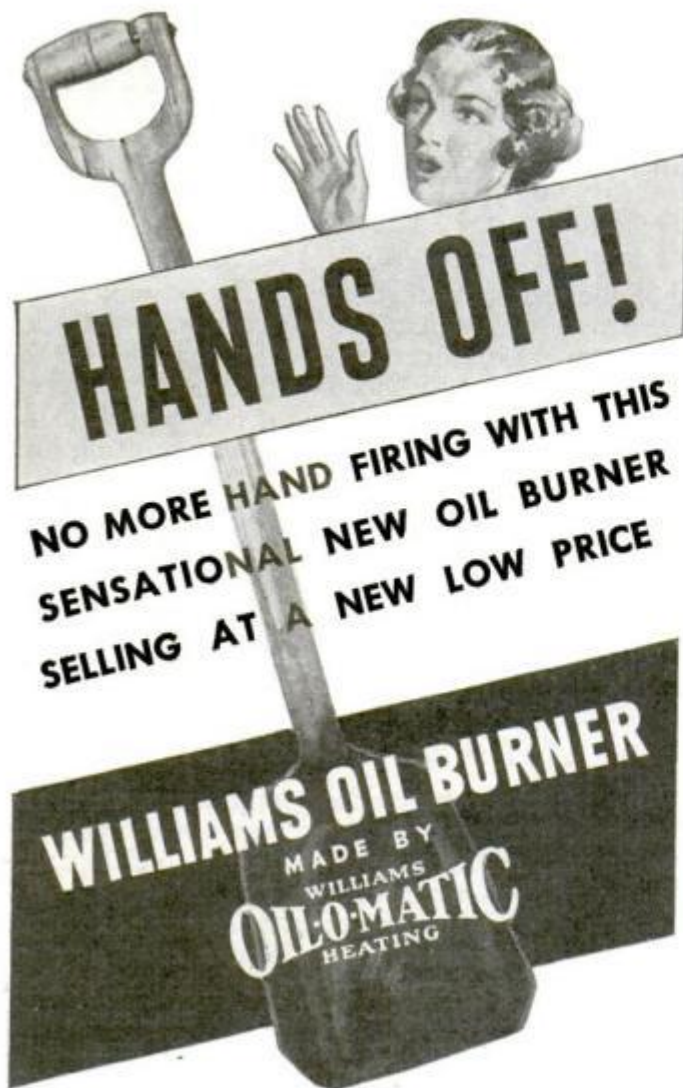

DO YOU want automatic oil heat in your home? Here's the answer . . . the sensational new Williams Oil Burner! Engineers say it is a marvel . . . and it delivers you for all time from the back breaking, callous making drudgery of furnace tending!

Why wait? Here's oil heat at a price you can afford!

BUILDERS ATTENTION! *It will pay you to investigate this great new oil burner. See it!*

STUDY THESE GREAT FEATURES!

- ★ Fully Automatic
- ★ High Pressure continuous spark—no radio interference
- ★ 1/10 h.p. motor—very low current consumption
- ★ Two-stage pump with automatic safety shut-off—uniform pressure—constant flame
- ★ Exclusive anti-carbon nozzle
- ★ Burns low cost No. 3 fuel oil
- ★ Silent as a whisper
- ★ Williams engineered throughout
- ★ Easy payments—12 to 36 months to pay

WILLIAMS OIL-O-MATIC HEATING CORP.
Dept. 398, Bloomington, Ill.
Please send full facts about your amazingly low priced Williams Oil Burner.

Name.....
Address.....
City.....State.....

THIS EMPTY

MEANS

IT takes brain to earn money—trained brain!
 The man without training is usually the man without cash. You can train your brain! Thousands of men have done it through spare-time study of I. C. S. Courses. Be a cash man—be a trained man—mail this coupon!



THIS EMPTY

INTERNATIONAL CORRESPONDENCE SCHOOLS

BOX 5679-H, SCRANTON, PENNA.

★ Without cost or obligation, please send me a copy of your booklet, "Who Wins and Why," and full particulars about the subject *before* which I have marked X: ★

TECHNICAL AND INDUSTRIAL COURSES

- | | | | | |
|--|---|--|--|--|
| <input type="checkbox"/> Architect | <input type="checkbox"/> Sheet Metal Worker | <input type="checkbox"/> Plumbing | <input type="checkbox"/> Steam Fitting | <input type="checkbox"/> Bridge Engineer |
| <input type="checkbox"/> Architectural Draftsman | <input type="checkbox"/> Boilermaker | <input type="checkbox"/> Heating | <input type="checkbox"/> Ventilation | <input type="checkbox"/> Bridge and Building Foreman |
| <input type="checkbox"/> Building Estimating | <input type="checkbox"/> Telegraph Engineer | <input type="checkbox"/> Air Conditioning | | <input type="checkbox"/> Chemistry |
| <input type="checkbox"/> Contractor and Builder | <input type="checkbox"/> Telephone Work | <input type="checkbox"/> Steam Engineer | | <input type="checkbox"/> Pharmacy |
| <input type="checkbox"/> Structural Draftsman | <input type="checkbox"/> Mechanical Engineering | <input type="checkbox"/> Steam Electric Engineer | | <input type="checkbox"/> Coal Mining |
| <input type="checkbox"/> Structural Engineer | <input type="checkbox"/> Mechanical Draftsman | <input type="checkbox"/> Marine Engineer | | <input type="checkbox"/> Mine Foreman |
| <input type="checkbox"/> Management of Inventions | <input type="checkbox"/> Machinist | <input type="checkbox"/> R. R. Locomotives | | <input type="checkbox"/> Navigation |
| <input type="checkbox"/> Electrical Engineer | <input type="checkbox"/> Toolmaker | <input type="checkbox"/> R. R. Section Foreman | | <input type="checkbox"/> Cotton Manufacturing |
| <input type="checkbox"/> Electric Lighting | <input type="checkbox"/> Patternmaker | <input type="checkbox"/> Air Brakes | <input type="checkbox"/> R. R. Signalmen | <input type="checkbox"/> Woolen Manufacturing |
| <input type="checkbox"/> Welding, Electric and Gas | <input type="checkbox"/> Diesel Engines | <input type="checkbox"/> Highway Engineering | | <input type="checkbox"/> Agriculture |
| <input type="checkbox"/> Reading Shop Blueprints | <input type="checkbox"/> Aviation Engines | <input type="checkbox"/> Civil Engineering | | <input type="checkbox"/> Fruit Growing |
| <input type="checkbox"/> Heat Treatment of Metals | <input type="checkbox"/> Automobile Mechanic | <input type="checkbox"/> Surveying and Mapping | | <input type="checkbox"/> Poultry Farming |
| | <input type="checkbox"/> Refrigeration | | | |

BUSINESS TRAINING COURSES

- | | | | |
|--|---|---|--|
| <input type="checkbox"/> Business Management | <input type="checkbox"/> Bookkeeping | <input type="checkbox"/> Service Station Salesmanship | <input type="checkbox"/> Grade School Subjects |
| <input type="checkbox"/> Industrial Management | <input type="checkbox"/> Secretarial Work | <input type="checkbox"/> First Year College Subjects | <input type="checkbox"/> High School Subjects |
| <input type="checkbox"/> Traffic Management | <input type="checkbox"/> Spanish | <input type="checkbox"/> Business Correspondence | <input type="checkbox"/> College Preparatory |
| <input type="checkbox"/> Accountancy | <input type="checkbox"/> French | <input type="checkbox"/> Stenography and Typing | <input type="checkbox"/> Illustrating |
| <input type="checkbox"/> Cost Accountant | <input type="checkbox"/> Salesmanship | <input type="checkbox"/> Civil Service | <input type="checkbox"/> Cartooning |
| <input type="checkbox"/> C. P. Accountant | <input type="checkbox"/> Advertising | <input type="checkbox"/> Railway Mail Clerk | <input type="checkbox"/> Lettering Show Cards |
| | | | <input type="checkbox"/> Signs |

DOMESTIC SCIENCE COURSES

- | | | | |
|---|---|--|--|
| <input type="checkbox"/> Home Dressmaking | <input type="checkbox"/> Advanced Dressmaking | <input type="checkbox"/> Millinery | <input type="checkbox"/> Foods and Cookery |
| <input type="checkbox"/> Professional Dressmaking and Designing | | <input type="checkbox"/> Tea Room and Cafeteria Management, Catering | |

Name.....Age.....Address.....

City.....State.....Present Position.....

If you reside in Canada, send this coupon to the International Correspondence Schools Canadian, Limited, Montreal, Canada

When writing to advertisers please mention Popular Mechanics

CAUTION-

TO ALL PROSPECTIVE DIESEL STUDENTS . . .

- If YOU are fully convinced that Diesel offers YOU a real opportunity, then you want the best training available. Naturally you would expect us to tell you that we have the best. Others may make the same claim for their institutions.
- Remember this fact — that in whatever school you enroll you are spending YOUR time, effort and money to prepare yourself for opportunities in the Diesel field, and the value of your training will depend on what you LEARN, and also on the STANDING OF THE SCHOOL OF YOUR CHOICE, and the RECOGNITION IT ENJOYS WITH THE DIESEL INDUSTRY AND EMPLOYERS THROUGHOUT THE NATION.
- The Hemphill Diesel Schools are the original and exclusive Diesel Schools in the United States and Canada. Our Schools and employment services are located in strategic Diesel centers and are recognized from one end of the country to the other, not only for the quality of equipment and the training, but for the care used in the selection of students.
- We do not accept students without references as to qualifications and character. We will not even tell you that you should consider Diesel. IF YOU ARE THE TYPE OF MAN WHO IS SWEEPED OFF HIS FEET BY IMPOSSIBLE CLAIMS AND PROMISES, YOU ARE NOT THE TYPE WE DESIRE. Analyze yourself, first, — then observe the tremendous growth and development of the Diesel field. If you then believe it offers you opportunities, get a Diesel training. Investigate other Diesel schools — investigate Hemphill Diesel Schools — by all means make a thorough investigation — then use your own judgment.

Ralph Hemphill
President Hemphill Diesel Schools

HEMPHILL DIESEL SCHOOLS (use nearest address)

• A NATION-WIDE INSTITUTION •

Please send me full details on your system of Diesel training and a free copy of the 32 page book "MARCH OF DIESEL".

Name Age

Street

City State MS-25-p

HEMPHILL DIESEL SCHOOLS

are located only in the cities and at the addresses listed below. In no way connected with other schools.

BOSTON, 114 Brookline Avenue

NEW YORK, 31-26 Queens Blvd., L.I.C.

DETROIT, 2341 W. Lafayette Blvd.

CHICAGO, 2014 Larrabee Street

MEMPHIS, 417 Monroe Avenue

LOS ANGELES, 2120 San Fernando Rd.

SEATTLE, 501 Westlake North

VANCOUVER, B.C., 1363 Granville St.



To help you answer these **3** questions:



1 - What are today's opportunities in Drafting?

2 - Will I like the work?

3 - Can I learn Drafting readily?

[To Men Over 18 and Under 40
This offer is NOT open to boys under 18 or men over 40. But if you are WITHIN these age limits, you owe it to yourself to investigate this unusual opportunity.]

2 Beginning Lessons in Drafting Free

Drafting Opportunities Growing Daily

Before anything can be made or built, the Draftsman *first* must draw it. Building trades, transportation, manufacturing — ALL depend on him. That is why *any* pickup in *any* line means *first call for the Draftsman!*

Fit Yourself for a Job with a Future

Drafting welcomes ambitious men — offers good pay to start, with splendid opportunities for promotion. One of the *stadiest* of all lines. Right from the start, the beginner works side by side with experienced men — inking in their drawings, making tracings, constantly profiting by his contact with seasoned engineers. The "higher ups" see his work. If it is good, advancement is sure and steady.

Pleasant, well-lighted offices are the Draftsman's workroom. He keeps regular hours, with congenial, high grade fellow workers. The work is fascinating — embraces not just *one* line, but *hundreds*.

Drafting Experience NOT Necessary

You can master Drafting readily by home study because you learn and advance *exactly* as professional Draftsmen work — with T-square, dividers and drawing board. *Actual* working conditions are duplicated to the final detail. *Thousands* of successful graduates enthusiastically endorse American School methods, nowhere better exemplified than in our Drafting course.

We want you to see for yourself — before you come to ANY decision — exactly what Drafting is like. We want you to judge your own interest in the work — and our ability to teach you. So we make this 2 Free Lesson Offer.

American School, Drexel Ave. at 58th St., Chicago, Ill.

Prove That You Can Qualify

If you are over 18 and under 40 years of age, the 2 lessons will be sent FREE. In the privacy of your own room, look them over. See how simply you start — how gradually you are led step by step — how, as time goes on, you can pass from a raw beginning to complete *mastery* of Drafting — able to get and hold a pleasant, profitable, steady job. Such a future is well worth looking into RIGHT NOW, so... just mail the coupon!



Mail Coupon for 2 Lessons FREE

American School, Dept. DDC45

Drexel Ave. at 58th St., Chicago

Without the slightest obligation, send 2 beginning Drafting Lessons and free Bulletin. I am over 18, under 40.

Name..... Age.....

Address.....

City..... State.....

When writing to advertisers please mention Popular Mechanics

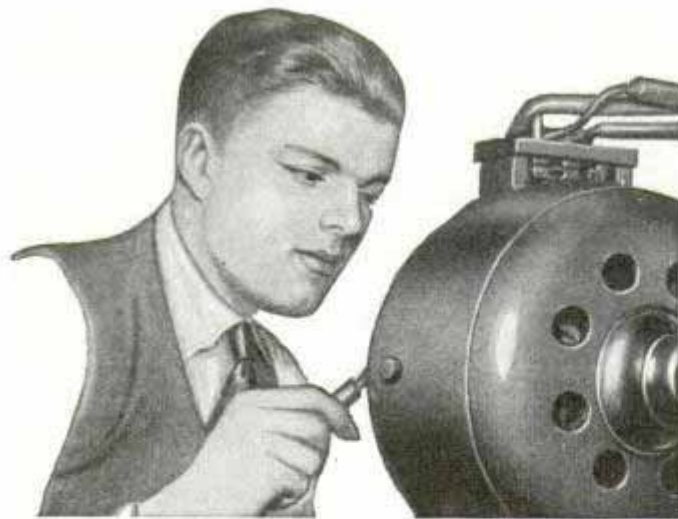

AMAZINGLY EASY WAY TO GET INTO ELECTRICITY

Send Today for Details of My
"PAY-AFTER-GRADUATION" PLAN

Don't spend your life never sure of a job. Let us prepare you for your start in a good paying field. Let us teach you how to prepare for positions that lead to good salaries in Electricity—NOT by correspondence, but by an amazing way we teach right here in the great Coyne Shops. You get a practical training in 90 days. Mail the coupon below. If you are short of money I'll send you all details of my "pay-after-graduation plan" where many get my training first and start paying for it 5 months after they start school and then have 18 months to complete their payments.

LEARN BY DOING—IN 90 DAYS BY ACTUAL WORK—IN COYNE SHOPS

I don't care if you don't know an armature from an air brake—I don't expect you to! Coyne training is practical "learn-by-doing" training. Don't let lack of money hold you back from getting all details of my amazing plan.

MANY EARN WHILE LEARNING

If you need part time work to help pay your expenses, we may be able to help you as we have hundreds of others. When you graduate we'll give you lifetime employment service. And, in 12 brief weeks, in the great shops of Coyne, we train you as you never dreamed you could be trained . . . on one of the greatest outlays of electrical apparatus ever assembled . . . real dynamos, engines, power plants, autos, switchboards, housewiring, armature winding and many other branches of Electricity.

ELECTRIC REFRIGERATION AIR CONDITIONING

Right now we are including additional instruction in Electric Refrigeration and Air Conditioning without extra cost so that your training will be complete and you can get into this marvelous, rapidly expanding field.

GET THE FACTS Coyne is your great chance to get into Electricity. This school is 38 years old—Coyne training is tested. You can find out everything absolutely free. Simply mail the coupon and let us send you the big, free Coyne book with photographs . . . facts . . . opportunities. Tells you how many earn expenses while training and how we assist our graduates in the field. No obligation to you. So act at once. Just mail coupon.

BIG FREE BOOK! Send for my big book containing photographs and telling the complete story—absolutely FREE.

COYNE ELECTRICAL SCHOOL

500 S. PAULINA ST., Dept. C7-72, CHICAGO, ILL.

H. C. LEWIS, Pres., COYNE ELECTRICAL SCHOOL
Dept. C7-72, 500 S. Paulina St., Chicago, Ill.

Dear Mr. Lewis: Without obligation send me your big, free catalog with facts about Coyne Training and details of your "Pay-Tuition-After-Graduation" Plan.

Name..... Age.....
Address.....
City..... State.....



DON'T BUY

Until you have
seen and tried
out these
wonderful
instruments
at your
dealer



Don't buy
Guitar,
Mandolin,
Banjo, Electric
Guitars, Uku-
leles, or Drums,
until you have
tried the Slinger-
land May-Bells,
Guaranteed
More for your
Money. Wonder-
ful, snappy, power-
ful, pleasing tone. No
equal in price. Sold on
easy payments and 5
days free trial by all
leading music dealers.

Send for free cata-
log. Mention instru-
ment wanted.

Write today:

Slingerland Musical Instrument Mfg. Co.,
1325 Belden Ave., Chicago, Illinois

Cut This Adv.
Out — Good
for \$1.00
Credit



AVIATION



APPRENTICES

Ambitious, air-minded young men, interested in entering the well paid field of Aviation, write immediately, enclosing stamp, to

Mechanix Universal Aviation Service, Incorporated
Dept. E
Strathmoor Station
Detroit, Mich.



WHY NOT spend spring, summer, fall, gathering butterflies, insects. Profit or Pleasure. I buy hundreds of kinds for collections. Some worth \$1 to \$7 each. Simple outdoor work with my Instructions, pictures, price list. Write today! Send 10c (not stamps) for Illustrated Prospectus, before sending butterflies. Mr. Sinclair, Dealer in Insects, Dept. 6, Box 1424, San Diego, Calif.



Print Your Own

Cards, stationery, circulars, tags, labels, advertising, etc. Save money. **Print for Others; Big Profits;** easy rules sent. Will do popular Raised Printing like Engraving. Junior press \$5.99, job press, \$11 up, power \$147. Send for free catalog and all details. **THE KELSEY COMPANY, F-37, MERIDEN, CONN.**

MAIL FOR FREE INFORMATION

BEDFORD

1117 Bedford Ave., Dept. PM-51
Brooklyn, New York City, N. Y.

YMCA

**TRADE
SCHOOL**

- Diesel Engines
- Diesel Engineering
- Aviation Mechanic
- Aeronautical Engineering
- Auto Mechanic
- Refrigeration
- Radio and Television Mechanic
- Air Conditioning
- Architectural-Mechanical Drafting
- Electrical
- Oil Burner
- Welding
- Talking Pictures
- Machine Shop
- Sign Painting
- Window Display
- Armature Winding

Name.....
Address.....



THE AIR YOU BREATHE

..... is today's challenge to science and to you

DO YOU KNOW THAT...

- man can live thirty days without food, three days without water, but not three minutes without air?
- the average person eats three pounds of food, drinks four pounds of water, but breathes thirty-four pounds of air each day?



You, young man, are standing at the threshold of a new and expanding world development — a new industry designed to make a better and healthier people through air conditioning and refrigeration. What part will YOU have in it? This new forward movement will not come to you. You must go to it — prepared to serve. If you are properly trained your rewards should be great.

The Thermo Air Conditioning Institute is dedicated exclusively to training men for the responsible and profitable opportunities now opening. Courses offered meet the needs of the student and the demands of the manufacturers. All include practical training on modern equipment.

"THE AIR YOU BREATHE" is our new booklet that will help you decide whether or not you can make a place for yourself and grow with this industry. It is full of enlightening facts and illustrations. Free for the asking. Send postcard, or use coupon below, for your copy.

Investigate, also, railroad transportation allowance to the Institute.

This ultra modern and especially equipped training institution is located at 182 S. Alvarado Street Los Angeles, Calif.

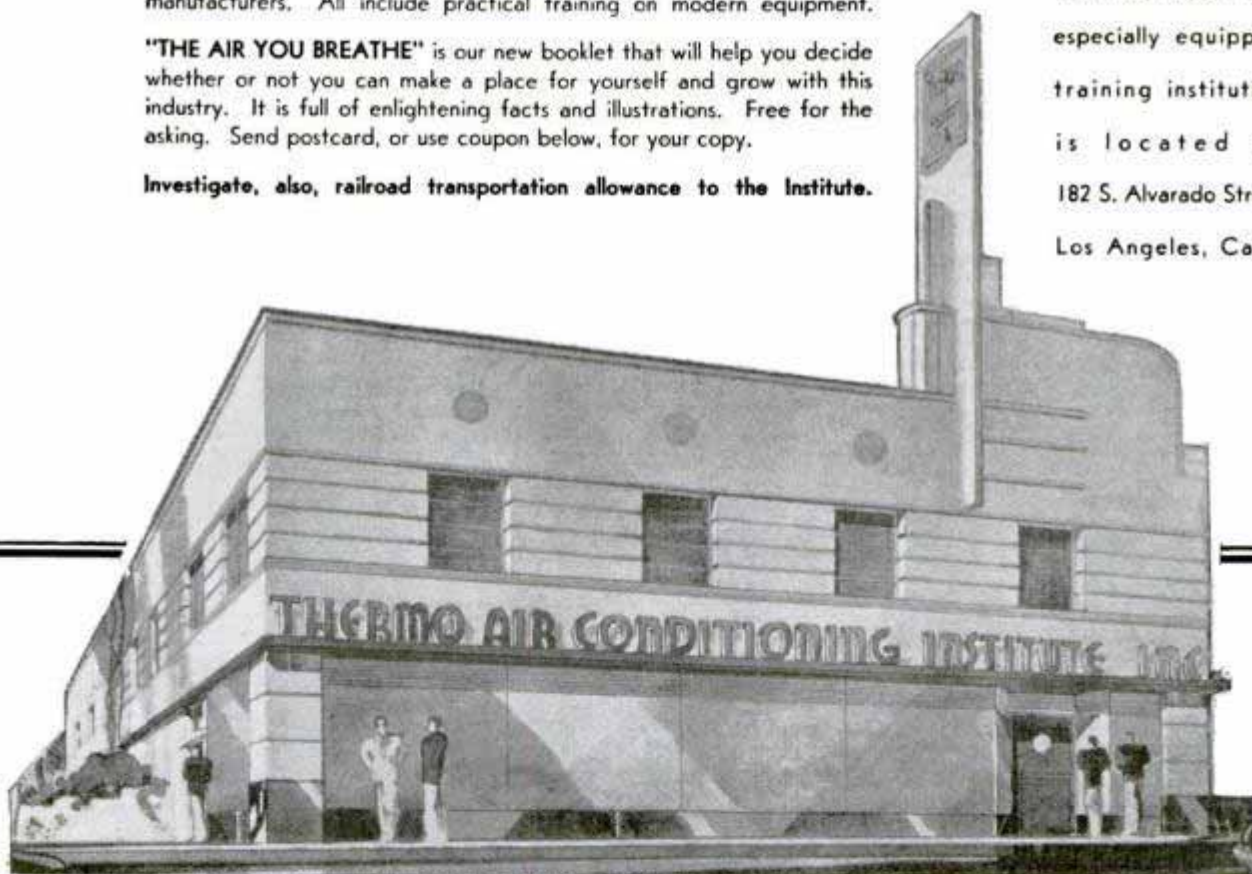

THERMO AIR CONDITIONING INSTITUTE, INC.

"TRAINING WORTHY OF THE INDUSTRY"

182 SOUTH ALVARADO STREET, LOS ANGELES, CALIF.

Please send me your new booklet and information on your courses.

Name..... Street.....
 City..... State..... AGE..... t-1-p

When writing to advertisers please mention Popular Mechanics

Are You TIED TO YOUR JOB?



Are you in a rut, tied to a factory job, with little or no prospect for advancement? Will you be doing the same thing 20 years from now?



Or..

will you train for a better job, more pay and prosperity? Prepare now, to enjoy everything that bigger earnings make possible.

The Road to Advancement DRAFTING

In every walk of life practical training in DRAFTSMANSHIP will prove valuable. Even if you don't accept a job as a DRAFTSMAN, you will be money ahead by taking Engineer Dobe's Course. You will be amazed at the speed with which you can learn in your own home in your spare time by Engineer Dobe's PRACTICAL METHOD.

JOBS NOW OPEN

In all industries, Drafting leads the way. In Aviation, Electricity, Building, Machinery, Automobile, Draftsmen must be used, and their work comes first. Recovery in industry and building is definitely on the way. Many trained Draftsmen will be needed on better jobs at better pay and shorter hours. Prepare NOW!

Learn at Home From an Engineer

I will teach you my practical method that has been successful with thousands since 1900. I will furnish you with all tools and a drawing table. I will teach you in a very short time by mail in your spare time until you actually have a desirable Draftsman's job, or prepare you for better pay in the job you now have. No High School or previous experience needed. You must be entirely satisfied with my personal training UNTIL COMPETENT and until assisted to a position. OR YOU GET ALL YOUR MONEY BACK. Start NOW and get the training. Prepare for more pay and a better job. Send the coupon below TODAY! Time is money! Don't delay! No obligations!

Complete Outfit
Size 20 x 25 inches
FURNISHED

Free Book!

ENGINEER DOBE, Div. C337, Libertyville, Ill.
Send me your free book, "Successful Draftsmanship" and explain how you will assist me to a good position as a draftsman.

Name _____ Age _____
Address _____
Post Office _____ State _____

When writing please mention Popular Mechanics

AMAZING NEW ELECTRIC ARC WELDER

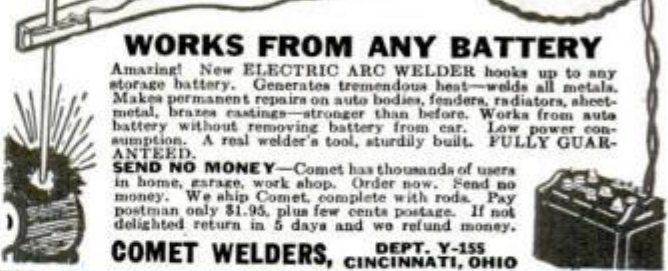

RETAILS ONLY
\$1.95
COMPLETE

WORKS FROM ANY BATTERY

Amazing! New ELECTRIC ARC WELDER hooks up to any storage battery. Generates tremendous heat—welds all metals. Makes permanent repairs on auto bodies, fenders, radiators, sheet-metal, brazes castings—stronger than before. Works from auto battery without removing battery from car. Low power consumption. A real welder's tool, sturdily built. FULLY GUARANTEED.

SEND NO MONEY—Comet has thousands of users in home, garage, work shop. Order now. Send no money. We ship Comet, complete with rods. Pay postman only \$1.95, plus few cents postage. If not delighted return in 5 days and we refund money.

COMET WELDERS, DEPT. Y-155 CINCINNATI, OHIO

WILL YOU WEAR THIS SUIT

and Make up to \$12 in a Day!
Let me send you this fine all-wool Union tailored suit FREE OF COST. Just follow my easy plan and show the suit to your friends. Make up to \$12 in a day easily. No experience—no canvassing necessary. Send for Samples—FREE OF COST. Write today for FREE details, ACTUAL SAMPLES and "sure-fire" money getting plans. Send no money. H. J. Collin, Progress Tailoring Co., Dept. W-216 500 S. Throop St. Chicago, Ill.

AGENTS UP TO \$50.00

Big cash profits for you; full or spare time. Over 250 household necessities—things people must buy. Proven fast sellers; earnings very fast day. \$500.00 CASH BONUS BESIDES YOUR WEEKLY EARNINGS. I'll show you how to start at once; send you everything—Big Display Outfit and quick cash plans—no money risk. Details FREE. Just send name on postcard. ALBERT MILLS, 4060 Monmouth Ave., Cincinnati, Ohio



VOICE

100% Improvement Guaranteed
We build, strengthen the vocal organs—not with singing lessons—but by fundamentally sound and scientifically correct silent exercises... and absolutely guarantee to improve any singing or speaking voice at least 100%... Write for wonderful voice book—sent free. Learn WHY you can now have the voice you want. No literature sent to anyone under 17 years unless signed by parent. PERFECT VOICE INSTITUTE, Studio C-135 64 E. Lake St., Chicago

LEARN WATCHMAKING AND ENGRAVING

BY OUR PROFIT-SHARING PLAN
OUR GRADUATES SUCCEED
One of our Iowa students started in a very small way—now doing over \$30,000 a year. Another in Wisconsin, over \$10,000 the first year. Day or night classes. Call or write for FREE BOOK. Chicago School of Watchmaking, Dept. 5401, 155 N. Clark St., CHICAGO.

Photography

for **PLEASURE or PROFIT**

Prepare for profitable business or fascinating hobby, at home under guidance of qualified instructors. No previous experience necessary; common school education sufficient. Many earn while learning. Our practical studio methods also qualify for well-paying positions upon graduation. Send coupon below at once for free booklet "Opportunities in Modern Photography", particulars and requirements.

AMERICAN SCHOOL OF PHOTOGRAPHY Dept. 135-C Chicago, Illinois
3601 Michigan Avenue
Send booklet, "Opportunities in Modern Photography", full particulars and requirements.
Name _____ Age _____
Address _____
City _____ State _____

2 Beginning Lessons in Diesel Engineering Free

To Men Over 18 and Under 40

This offer is NOT open to boys under 18 or men over 40. But if you are WITHIN these age limits, you owe it to yourself to investigate this unusual opportunity.

Test Yourself Without Cost

See how readily you, too, can

Learn Diesel

At your leisure in your own home, read these 2 Diesel lessons carefully. Judge for yourself our ability to teach—and your ability to learn—this fast-growing new line of work. No experience needed.



Diesel — the New, Fast-Growing Power

Is Your Job Safe?

Just as the gasoline engine changed or wiped out the jobs of thousands who depended on horse-drawn vehicles for their living—just as electricity changed the entire set-up in the fields of light and power—so now the Diesel engine is fast invading both the power and transportation fields, and threatening the present jobs of thousands of workers.

If jobs in your line are steadily growing scarcer, you owe it to yourself to investigate this new, progressive, uncrowded line, that in our opinion will offer good openings for the next 25 years.

Diesel engines—because of their high efficiency, dependability, and economy of operation—are fast replacing steam and gasoline engines in power plants, motor trucks and busses, locomotives and ships, aircraft, dredges, drills, pumps, etc.—opening up an increasing number of well-paid jobs for Diesel-trained men. The field of Diesel Engineering is on the upgrade and continually expanding. It will provide steady employment, advancement and good pay for those properly trained in this new industry.

What This New Field Offers You

Now is your chance to get into a big new industry and grow up with it to an important position. Today there is practically no competition in the Diesel field, but the increasing use of Diesel engines will result in keen competition for jobs in the near future. By starting your training now, you

can keep ahead of such competition.

You get complete information on all the latest Diesel developments—two- and four-stroke cycles; low- and high-speed and heavy duty types; Diesel-electric generating systems, etc.—in our course. Includes all text material—with special diagrams for quick understanding of this new power.

Real Opportunities for Trained Men

Get our Free Diesel Booklet and learn all about this new, fast-growing line—its opportunities and requirements. Find out what the Diesel field offers you—how rapidly the Diesel industry has developed during the last three years—the large number of Diesel engines and accessories being manufactured today—how quickly you can obtain a complete understanding of Diesel engine principles and operation by home study during your spare time! ... at your own pace—without interfering with your regular work.

American School, Dept. DC45, Drexel Avenue at 58th Street, Chicago

The Diesel Engineer

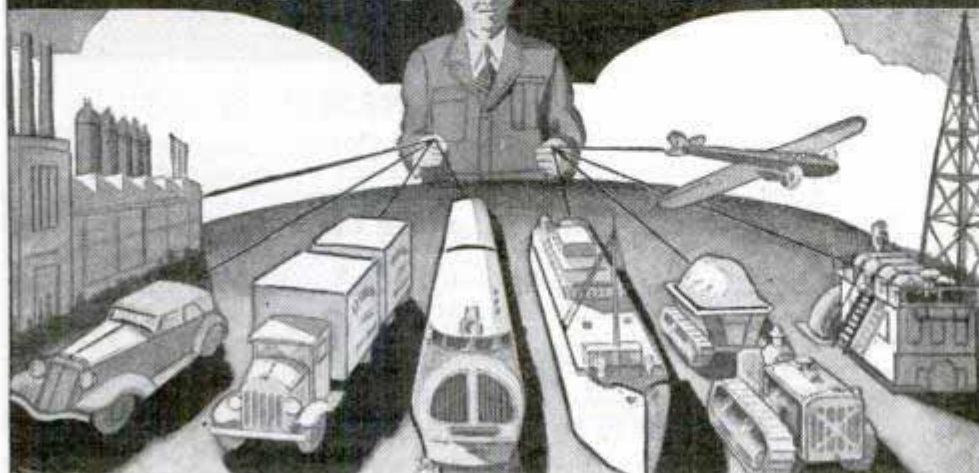

Get These 2 Diesel Lessons

When you learn what worthwhile opportunities Diesel offers and how readily you can cash in on them through American School training, it may mark the turning point in your life. If you are over 18 and under 40, write TODAY for FREE lessons and FULL information. No obligation.

Free Lesson Coupon

American School, Dept. DC-45
Drexel Ave. at 58th St., Chicago

I am over 18 and under 40 years of age. Without obligation, please send me 2 Diesel lessons and Diesel booklet FREE.

Name.....

Address.....

THOUSANDS HAVE LEARNED TO PLAY THIS EASY WAY..



Everything was so plain and easy. I began actual music in less than two months! My friends were astonished—they wondered when and where I had ever taken music lessons.

* Miss R. P.
Southmont, N. C.



I enjoy practicing your lessons and am making great headway. I play in a church as second violinist and have also signed up with the M—Band of Ohio, getting \$2 per playing hour.

* Mr. E. C. R., Pemberville, Ohio.

* Actual pupils' names on request
Pictures by Professional Models

FREE BOOKLET.. and demonstration lesson

SEE for yourself how simple and easy it is to learn to play your favorite instrument through this famous short cut method. The U. S. School of Music will gladly send you a Free Demonstration Lesson and explanatory booklet which describes the amazingly simple principles on which this method is built. No needless exercises. No expensive teacher. You learn at home in your spare time—and much faster than by old-fashioned tedious methods.

More than 700,000 people have studied music this easy way—and what they have done you, too, can do. . . . The cost is surprisingly low, averaging only a few cents a day. If you really *do* want to play your favorite instrument—fill out and mail the coupon NOW! The Free Booklet and Demonstration Lesson will be sent you at once. Instruments supplied when needed, cash or credit. Address U. S. School of Music, 78 Brunswick Bldg., New York City.

Pick Your Course

Piano	Guitar
Violin	Saxophone
Organ	Mandolin
Cornet	Ukulele
Trombone	Harp
Piccolo	Clarinet
Flute	Cello
Hawaiian Steel	
Trumpet	
Piano Accordion	
Italian and German	
Accordion	
Voice and Speech	
Culture	
Harmony and	
Composition	
Drums and Traps	

U. S. SCHOOL OF MUSIC,
78 Brunswick Bldg., New York City

Send me your amazing free book, "How You Can Learn Music in Your Own Home," with inspiring message by Dr. Frank Crane; also Free Demonstration Lesson and particulars of your easy payment plan.

Instrument Have you
..... Instrument?
Name
Address

Get this new CONCRETE BOOK Just Published!

Now, ready! A new and practical book on the amazing new art of concrete work. Things are being done with concrete that will amaze and thrill you. And "1001 Ways to Use Concrete," by Harold Hayes, covers it all with the exception of big engineering projects.

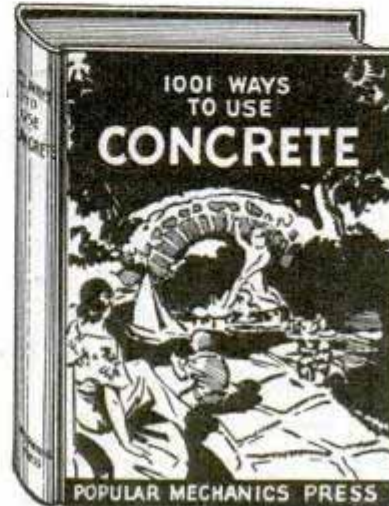

Nothing like it ever published before. It covers every known use of concrete for the home, farm, building, business and industry, plus newer uses in decoration and arts, including new quick-setting type and recent developments in glorious colored concrete that you can make. It's the book of the hour for contractors, handymen, hobby seekers, farmers, home builders, fac-

ories, shops and home work shop owners. It is filled with plans, methods and formulae. Shows how to make money, build your own business and improve your property. Gives 146 "Concrete Kinks," alone, easily worth cost of entire book. See chapter headings and description. Order your copy today. Sent postpaid for \$5.00 with order, or pay the postman.

Tells how to make concrete pools, statuary, garden walks, walls, buildings, etc. 146 Concrete Kinks in one section alone.

Gives Money-Making Plans. Describes Interesting Hobby. Covers New Concrete Arts. Facts on Colored Concrete. Applications and Methods.

Size 7x10 Inches. 256 Pages. 16 Colored Plates and Hundreds of Beautiful Half-tone Illustrations and Working Drawings. Cloth Binding. \$5.00

"1001 WAYS TO USE Concrete" BY HAROLD O. HAYES

SOME CHAPTER HEADS

Concrete About the Home
Concrete in the Garden
Concrete About the Farm
Concrete Homes and Buildings
Recreation
Concrete in the Workshop
Concrete Products for Plant Manufacture
Concrete in Business and Industry
Concrete Kinks
Varied Uses of Concrete

POPULAR MECHANICS PRESS
Dept. 837, 200 East Ontario Street, CHICAGO

When writing to advertisers please mention Popular Mechanics

WANTED: TRAINED PILOTS and MECHANICS -for BIG PAY JOBS IN AVIATION

Aviation Needs and Must Have Thousands of Newly Trained Men for new positions as Pilots and Airplane Mechanics. Airlines adding millions of miles to their flight schedules. Factories crowded with huge private and Government orders for new airplanes.

This Lincoln Government Approved School trains you for good pay positions as Pilot or Government Licensed Airplane and Engine Mechanic. School now in 27th year; 17th year teaching Aviation.

Good Salaries paid to properly trained men. Airline Pilots get up to \$700 a month; Co-Pilots \$250 a month. Licensed Mechanics get up to \$200 a month—wonderful opportunities for promotion.

Make Aviation YOUR Career. Supervised by U. S. Government, Aviation offers you unlimited opportunities for promotion. Prepare yourself at this Lincoln Government Approved School. Graduates now employed by leading Airlines, Factories and Foreign Governments. We assist Graduates in locating positions when qualified. **Write for Catalog.** Please state age

LINCOLN AIRPLANE & FLYING SCHOOL, 200-J Aircraft Bldg., Lincoln, Nebr.

Be a DENTICIAN

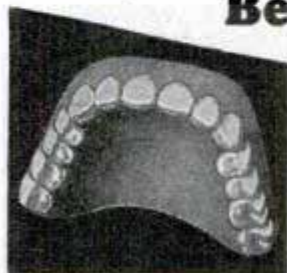

Learn at home to make Crowns, Plates, Bridgework, etc., for Dentists. Easy, practical way to learn mechanical dentistry at home in spare time. Full Equipment of Tools and Materials Included with Course. Low tuition. Easy terms. Write for FREE BOOK about this money-making profession that is not affected by "machine age."

McCARRIE SCHOOL OF MECHANICAL DENTISTRY
207 No. Broad St., Dept. 724, Philadelphia, Pa.



FOLLOW THIS MAN

Secret Service Operator No. 38 is on the job! Running down dangerous Counterfeit Gang. Tell-tale finger prints in murdered girl's room.

Free
The Confidential Report Operator No. 38 made to his chief. Write for it.

Earn a Regular Monthly Salary
YOU can become a Finger Print Expert at home, in your spare time, at small cost. Write for confidential full report and details. Write! Literature will be sent only to persons stating their age.

INSTITUTE OF APPLIED SCIENCE
1920 Sunnyside Ave. Chicago, Ill.
Dept. C-135

WE BUY HIGH SCHOOL AND COLLEGE BOOKS

copyrights beginning 1933 to 1937 in good condition. Not less than four books accepted. Until July 31, premiums given everyone sending books. Address MODERN BOOK SHOP, 1412 Great Northern Bldg., Chicago, Ill.

RADIO

ENGINEERING, broadcasting, aviation and police radio, servicing, magine and Morse telegraphy taught thoroughly. Nine months' engineering course equivalent to three years' college radio work. School established 1874. All expenses low. Catalog free.

Dodge's Institute, Ada St., Valparaiso, Ind.

Learn CHALK TALKING

Entertain for all occasions. Send \$1.00 for Laugh Producing Program of 23 Trick Drawings with Instructions. Catalog of Chalk Talk Supplies 10c. BALDA ART SERVICE, Dept. K, Oshkosh, Wis.

Which of These **Gov't Jobs** Do YOU Want?

No special education or experience usually required. Steady work. Short hours. Vacations. PENSIONS! Age 18-50. Extra Social Security jobs expected soon. Send coupon below for FREE book. Tells how you can pass Civil Service Examination.

FREE BOOK

Arthur R. Patterson, (Former Govt. Examiner) Principal, PATTERSON SCHOOL, 88 Mercantile Building, Rochester N. Y. Send FREE Book, "How to Secure a Government Position."

Name.....
Address.....

MEN--WOMEN
START \$1,260 to \$2,100 a YEAR
Liquor-Gauger
Stenographer
Meat Inspector
Custom House
Office Clerk—Typist
Accountant
File Clerk
Income Tax Auditor

Be a RADIO EXPERT



Learn at Home to Make \$30, \$50, \$75 a WEEK

Chief Operator Broadcasting Station
"When I completed 20 lessons, I obtained my Radio Broadcast Operator's license and immediately joined Station WMPC, where I am now Chief Operator."—HOLLIS F. HAYES, 85 Madison St., LaPeer, Mich.

Own Business Pays \$300 a Month
"I now have my own Radio business which shows three hundred dollars a month profit—thanks again to National Radio."—FRANK T. REESE, 39 N. Felton St., Philadelphia, Penna.

Earned \$50 First Month in Spare Time
"I knew nothing about Radio. After four lessons, I began servicing Radios, earning \$50 the first month. Last winter I made as high as \$100 a month in spare time."—G. F. WALTON, 808 West Olney Road, Norfolk, Va.

Do you want to make more money? Broadcasting stations employ engineers, operators, station managers and pay up to \$5,000 a year. Spare time Radio set servicing pays as much as \$200 to \$500 a year—full time servicing jobs pay as much as \$30, \$50, \$75 a week. Many Radio Experts own their own full or part time Radio businesses. Radio manufacturers and jobbers employ testers, inspectors, foremen, engineers, servicemen, paying up to \$6,000 a year. Radio operators on ships get good pay and see the world. Automobile, police, aviation, commercial Radio, and loud speaker systems offer many good opportunities. Television promises many good jobs soon. Men I trained have good jobs in these branches of Radio.

Many Make \$5, \$10, \$15 a Week Extra in Spare Time While Learning

The day you enroll I start sending you Extra Money Job Sheets. They show you how to do Radio repair jobs that you can cash in on quickly. Throughout your training I send plans and ideas that have made good spare time money for hundreds of fellows. I send special equipment which gives you practical experience—shows you how to conduct experiments and build circuits which illustrate important Radio principles.

Find Out What Radio Offers You

Mail the coupon now for "Rich Rewards in Radio." It's free to any fellow over 16 years old. It describes Radio's spare and full time opportunities, also those coming in Television; tells about my Training in Radio and Television; shows you actual letters from men I have trained, telling what they are doing and earning; tells about my Money Back Agreement. MAIL COUPON NOW!

J. E. SMITH, President
Dept. 7HP
National Radio Institute
Washington, D. C.

MAIL NOW for FREE PROOF

J. E. SMITH, President, Dept. 7HP, National Radio Institute, Washington, D. C.

Dear Mr. Smith: Without obligating me, send "Rich Rewards in Radio," which points out the spare time and full time opportunities in Radio and explains your 50-50 method of training men at home in spare time to become Radio Experts. (Please Write Plainly.)

NAME..... AGE.....

ADDRESS.....

CITY..... STATE.....

When writing please mention Popular Mechanics

STAMPS

and *Collecting*

By Richard McP. Cabeen

P. 900 33379 Buchanan Chicago



Courtesy De Soto Stamp and Coin Co., and Garden City Stamp Agency, Chicago

Top row, coronation issues. Center, Czechoslovakian child welfare issue, George VI stamp, two triangular Liberian stamps, Nauru coronation and Pushkin memorial. Bottom, Polish pictorial, Greek issue, Ecuador's airmail, Mermoz memorial and Austrian Mother's Day stamp

ALTHOUGH Great Britain has the distinction of introducing the adhesive postage stamp she never has attempted to gain further honor, or dishonor among philatelists, by finding new reasons for special stamps. From 1840 to 1914 one set of stamps was sufficient for both postage and revenue. In the latter year she brought out her first postage due stamps, and ten years later, her first commemorative issue.

Other countries seem to be looking for excuses to issue new purpose stamps. The first of the special purpose stamps was the Newspaper stamp issued by Austria in 1851. Now there are at least twenty-five groups of these stamps, not including any of a fiscal nature such as Newspaper Tax, or War Tax stamps required on certain mail matter.

The Special Delivery stamps were first

used in the United States, having been introduced in 1885, but even today few countries have felt the need of this special-service stamp. Canada was second in 1898, and in 1899 and 1901, overprinted United States Special Delivery stamps were placed in use in Cuba and the Philippines respectively. The inscriptions on the stamps mentioned above are, of course, in the English language. When Cuba became self-governing she issued special delivery stamps with inscriptions in Spanish. This reads *Intrega Inmediata* and the same form appears on the stamps of Mexico and Panama, although some of the latter show the word *Expreso*, as do all of the special delivery stamps of Peru. The same form, or the inscription *Entrega Especial*, marks the stamps of the Dominican Republic. Va-

(Continued to page 22A)

STOP THAT SLAM!

AMAZING INVENTION STOPS SLAMMING DOORS

PAYS BIG PROFITS DAILY!

KANT-SLAM closes heaviest doors silently, positively, automatically. Prevents slamming or leaving doors open. Works in oil. Lasts lifetime. Easily installed. **LOW PRICED.** We supply actual **Real Demonstrator** miniature door. You make big money on quick sales to stores, offices, factories—every building can use 1 to 20. Free Demonstrator to workers. Write! Get free details.

KANT-SLAM CO., Dept. U-53, Bloomfield, Ind.



MAKE MONEY AT HOME

RUBBER MOLDS *Low as 6¢ EA.*

Amazing rubber mold-making outfit makes perfect flexible molds of plaques, ash trays, book-ends, etc. Molds cost from 6¢ to 25¢ each. Each mold makes hundreds of novelties and gifts to sell up to \$1.00 apiece! No experience necessary. Everything furnished. Start profitable business in your home... sell to stores, friends, resorts, road stands or by mail—NOW! Make BIG MONEY full or spare time. Write for complete FREE details and easy instructions.

SO-LO GO-MA MOLD CO., Dept. U-827, Cincinnati, O.



BE A POULTRY EXPERT

Make \$40, \$50, \$60 a Week

Free book shows how to get started quickly. You'll be surprised at the amazing profit opportunities in the poultry business. Wherever you live—whatever you do—it is easy to start on a spare or full time basis. Free book tells all. Send for "How to Raise Poultry for Profit." You learn right at home in spare time by methods endorsed by colleges and leading poultrymen. Know how to get the maximum profits from interesting, healthy work. Iron-clad agreement protects you. We have prepared hundreds for good jobs and businesses of their own. Write now for free book. No obligation. **National Poultry Institute, Inc., Dept. 32-C, Adams Center, New York**

ENGINEERING

Get a Bachelor of Science Degree! Complete courses and fully accredited degrees in Aeronautical, Architectural, Chemical, Electrical, Industrial and Mechanical engineering. Modern equipment. All college activities. Low tuition. Write Registrar today for full information and catalog.

LAWRENCE INSTITUTE OF TECHNOLOGY
15102 Woodward, Detroit, Mich.

CATALOG ON REQUEST

A NON-PROFIT COLLEGE



X STAMMER Learn to speak clearly. New mental diversionary method working wonders. Prof. John A. Meyers tells you before you enroll if he can help you. No obligation for pre-enrollment analysis. Acquire normal speech this easy way. For booklet on cause and cure of stammering send 10¢. **MEYERS SCHOOL OF SPEECH, Dept. P-2, 709 No. 11th Street, Milwaukee, Wis.**

BE A RAILWAY TRAFFIC INSPECTOR

A Field Where Pay Advances Are Rapid

ACTIVE, RELIABLE MEN—19 to 50—trained as Railway and Bus Passenger Traffic Inspectors earn up to \$135 per month to start, plus expenses. Experience brings rapid advancement. Our record: 18 yrs. success in placing our graduates or we refund your tuition. Write for Free Booklet.

Standard Business Training Institute
Div. 298 Buffalo, N. Y.



Would You WEAR this All-Wool SUIT

If We Send It Without Cost?

Here's an amazing opportunity to get a guaranteed all-wool suit, tailored-to-measure without cost. No experience—no money necessary. Just call on a few friends during your spare time—we show you how to get your suit quickly. EASILY! Also how you can turn spare time into BIG MONEY. Samples sent FREE. Write: **FAIRBANKS TAILORING CO., 2315 Wabansia, Chicago, Ill.**



Go to High School at Home

You can secure a high school education in your spare time by studying the new courses prepared by the International Correspondence Schools.

These courses are equivalent to the courses given in resident high schools. They have been specially arranged for men and women who wish to meet college entrance examinations, to qualify for a business position, or to make up the education they missed in past years.

The lessons are easy to understand and you will make rapid progress because you will be *in a class by yourself* and you will study under the guidance of instructors who are sincerely interested in you.

Just mark and mail the coupon and we will gladly send you interesting free booklets describing the High School Courses of the I. C. S. or any other subject in which you are interested.

INTERNATIONAL CORRESPONDENCE SCHOOLS

Box 5680-H, Scranton, Penna.

Without cost or obligation, please send me a copy of your booklet, "Who Wins and Why," and full particulars about the subject before which I have marked X in the list below:

- College Preparatory Course
- High School Commercial Course
- High School English Course
- High School Vocational Course
- High School Agricultural Course

BUSINESS TRAINING COURSES

- | | |
|--|---|
| <input type="checkbox"/> Business Management | <input type="checkbox"/> Service Station Salesmanship |
| <input type="checkbox"/> Office Management | <input type="checkbox"/> Business Correspondence |
| <input type="checkbox"/> Industrial Management | <input type="checkbox"/> Lettering Show Cards |
| <input type="checkbox"/> Traffic Management | <input type="checkbox"/> Stenography and Typing |
| <input type="checkbox"/> Accountancy and C.P.A. Coaching | <input type="checkbox"/> Civil Service |
| <input type="checkbox"/> Bookkeeping | <input type="checkbox"/> Mail Carrier |
| <input type="checkbox"/> Secretarial Work | <input type="checkbox"/> Railway Mail Clerk |
| <input type="checkbox"/> Cost Accountant | <input type="checkbox"/> Grade School Subjects |
| <input type="checkbox"/> Salesmanship | <input type="checkbox"/> First Year College |
| <input type="checkbox"/> Wallpaper Decorating | <input type="checkbox"/> Illustrating |
| <input type="checkbox"/> Salesmanship | <input type="checkbox"/> Cartooning |
| | <input type="checkbox"/> Lumber Dealer |

TECHNICAL AND INDUSTRIAL COURSES

- | | | |
|---|--|---|
| <input type="checkbox"/> Architect | <input type="checkbox"/> Plumbing | <input type="checkbox"/> Heating |
| <input type="checkbox"/> Contractor and Builder | <input type="checkbox"/> Air Conditioning | |
| <input type="checkbox"/> Structural Draftsman | <input type="checkbox"/> Sheet Metal Worker | |
| <input type="checkbox"/> Structural Engineer | <input type="checkbox"/> Steam Engineer | |
| <input type="checkbox"/> Electrical Engineer | <input type="checkbox"/> Civil Engineer | |
| <input type="checkbox"/> Reading Shop Blueprints | <input type="checkbox"/> Surveying and Mapping | |
| <input type="checkbox"/> Telegraph Engineer | <input type="checkbox"/> Refrigeration | |
| <input type="checkbox"/> Telephone Work | <input type="checkbox"/> R. R. Locomotives | <input type="checkbox"/> Air Brakes |
| <input type="checkbox"/> Mechanical Engineer | <input type="checkbox"/> R. R. Signaller | |
| <input type="checkbox"/> Mechanical Draftsman | <input type="checkbox"/> Highway Engineering | |
| <input type="checkbox"/> Machinist | <input type="checkbox"/> Chemistry | <input type="checkbox"/> Pharmacy |
| <input type="checkbox"/> Inventing and Patenting | <input type="checkbox"/> Coal Mining Engineer | |
| <input type="checkbox"/> Patternmaker | <input type="checkbox"/> Navigation | <input type="checkbox"/> Boilermaker |
| <input type="checkbox"/> Heat Treatment of Metals | <input type="checkbox"/> Textile Overseer or Supt. | |
| <input type="checkbox"/> Bridge Engineer | <input type="checkbox"/> Cotton Manufacturing | |
| <input type="checkbox"/> Gas Engines | <input type="checkbox"/> Diesel Engines | <input type="checkbox"/> Woolen Manufacturing |
| <input type="checkbox"/> Aviation Engines | <input type="checkbox"/> Agriculture | <input type="checkbox"/> Fruit Growing |
| <input type="checkbox"/> Automobile Mechanic | <input type="checkbox"/> Marine Engineer | <input type="checkbox"/> Radio |

Name.....Age.....
Address.....
City.....State.....
Occupation.....

If you reside in Canada, send this coupon to the International Correspondence Schools Canadian, Limited, Montreal, Canada

Concealed from the Eyes of Man

A Secret Sought For 3000 Years!

- An elixir to prolong life!
- A strange process to change the composition of metals!
- A weird device for communication with distant planets!

Did the ancients accomplish these things? Were they masters of a lost wisdom? Down through the ages these rumors persisted. Was it possible that a vast knowledge accumulated by forgotten civilizations still existed? Tales of strange phenomena gave support to the belief that there was hidden from the world stupendous secrets of nature, possessed by a chosen few.

To the far corners of the earth journeyed men in search of these gems of wisdom. To the finder would come fame, power, wealth. Tyrant and peasant alike strove to find this, the greatest of all treasures—a mastery of nature. One man had the key. He alone seemed to know the answer.

To Roger Bacon, medieval monk and scholar, man of mystery, the eyes of the world turned. He accomplished feats at which the peoples of the eleventh century gasped. They begged and implored him to divulge his formulas, to reveal his source of wisdom. To these and their threats his lips were sealed. He knew the wisdom was too powerful, too dangerous to be in the hands of those who might locally use them.

For generations his manuscripts were a hopeless confusion of strange hieroglyphs and symbols. Then in recent years came their decipherment, and the world learned of many of his great experiments and the source of his tremendous knowledge. He was one of a secret brotherhood which had carefully guarded in code the great knowledge of the ancients.

OBTAIN THIS FREE SEALED BOOK

Today this great brotherhood, known as the Rosicrucians, still flourishes. It still keeps from the eyes of the curious, as in Bacon's time, the profound truths of nature, which give man mastery of self and happiness in life. Its keys of universal wisdom are extended to all who are sincere in their desire to unlock the hidden truths of the universe and find freedom, power, and success in such knowledge. A fascinating free book, "The Secret Heritage," will explain how you may receive these helpful facts. Direct a letter to the address below, asking for it.

SCRIBE I. S. S.

The **ROSICRUCIANS**

« A M O R C »

SAN JOSE, CALIFORNIA, U. S. A.



of

Saxth

Δ∇8C32

cꝛꝛꝛ

40flaw

Wit3

90ϕεπιο

ηεωο



ϕκϕ
S44Δ3ϕ

49ϕϕ

JREF

ofth

oꝛ3e

YES, BOB, MOUNTING BIRDS and ANIMALS IS A GRAND HOBBY! I'VE DOUBLED MY FUN FROM HUNTING—AND AVERAGE \$14 PER WEEK, SPARE TIME, MOUNTING FOR HUNTERS—WHY DON'T YOU WRITE TO THE N.W. SCHOOL FOR THEIR FREE BOOK?

FREE BOOK!

Learn Taxidermy at home. Write today for Free Book. State age.
N. W. School of Taxidermy
C-337 Elwood Bldg., Omaha, Nebr.



Aviation Career
OFFERS YOU GREAT FUTURE

Demand for trained aircraftmen in Southern California plants is increasing and already exceeds supply. Curtiss-Wright Technical Institute, Aviation's foremost and oldest school, is located in heart of this activity and specializes in Sheet Metal, Master Mechanics and Aero Engineering. (No flying involved.) Graduates are obtaining immediate employment. Write for details NOW. Curtiss-Wright Technical Institute, Glendale, Los Angeles, Cal. Dept. PM-8.

MAKE MONEY WITH YOUR CAMERA

BIG DEMAND FOR PHOTOS YOU CAN TAKE

No matter where you live, what you do, or what kind of camera you own—if you like to take snapshots, you can turn your hobby into a profitable spare-time or full-time profession as journalistic or press photographer. 16,000 publications and advertisers buy millions of photos each year from free-lance amateur photographers.

FREE BOOK—tells how we train you at home to cash-in on this demand. No canvassing. Pay for course in easy monthly installments. And you earn as you learn. Write at once.

UNIVERSAL PHOTOGRAPHERS
Studio 78, 10 W. 33rd St., New York City.

BIG Free BOOK ON CRIME CASES

Fascinating book on Scientifically solved true crime cases sent absolutely free to those over 17. Also tells how to get into Scientific Crime Detection, Home Study. New opportunities. Travel. Steady Employment. Experience not necessary. Very easy terms.

SCIENTIFIC CRIME DETECTION INSTITUTE OF AMERICA, INC.
C & O Bldg., J. T. Burdette, Pres. Dept. 2H7 Huntington, West Virginia

CARTOONING PAYS WELL

Develop your ability with personal instruction from an internationally-known cartoonist. His exclusive, successful method of drawing and creating ideas makes it easy to attain success. Write for details of this exceptional home-study course.

National School of Cartooning, 437 Penton Building, Cleveland, Ohio

LE'S Correspondence Courses in RADIO and ELECTRICAL ENGINEERING

SPECIAL Only \$25

ELECTRICAL ENGINEERING. Get good grasp of wide electrical field. Modern. Very understandable.

RADIO ENGINEERING. Extra fine course in radio, public address, photo-electric work. Trains you to be super-service man, real vacuum tube technician. Tuition ONLY \$25, either course. Deferred payment plan. Experiment kits furnished.

WRITE TODAY for free copies of school catalogs, student magazines, etc.

LINCOLN ENGINEERING SCHOOL Box 931-32 Lincoln, Nebr.

STAMMERERS

Write for our Free List of ethical schools that correct stammering.

STAMMERERS' GUILD
Maccabees Bldg., Suite 1236, DETROIT, MICH.

Learn ADVERTISING at Home

Greater opportunities now in advertising. Learn easily and quickly in spare time. Practical work. No text books. Old established school. Low tuition—Easy terms. Send for free booklet and requirements.

Page-Davis School of Advertising
Dept. 135-C, 3601 Mich. Av., Chicago

CAMPION JESUIT HIGH SCHOOL FOR BOYS

Highest academic standing. Prepares for all colleges and universities—and for Life. Finest, most healthful location in middle west. Beautiful large campus. Complete modern equipment. All sports including Golf and Ice Hockey. R.O.T.C. Catalog FREE.

Campion, Box 20, Prairie du Chien, Wisconsin.

Amazingly Different

DIESEL GAS ENGINE & AUTO TRAINING

START at home
FINISH in California



NOT Ordinary Home-Study Course

Be a trained Diesel and Gas Engine Man. Excellent opportunities for men who can qualify. Train for good-pay jobs, such as Diesel Operator, Trouble Shooter, Master Mechanic, Ignition Expert, Auto Repairing, etc. You don't have to leave home to start training.

COMBINED HOME TRAINING AND ACTUAL SHOP EXPERIENCE

"How can I get actual shop practice with home training?" you ask. National points the way. National Schools has made revolutionary progress in bringing to ambitious men a most complete and practical training course. It is an Extension of residential training, enabling you to master preliminary training while you are at home working, thereby saving time and money. Then you come to School for final intensive SHOP-PRACTICE instruction which qualifies you for bigger pay jobs.

SHOP-TESTED, QUICK-TO-LEARN COURSE perfected in million-dollar Institution

Only a residential School such as National can offer this kind of training. This "start-at-home" plan has been developed as a result of 32 years of continuous testing and use in the shops and laboratories of National Schools. Easy and fascinating. No dull text books. All instruction is shop-tested. We actually bring the School's facilities to you, and you to the School.

USE SPARE TIME AT HOME—preliminary work

FINAL SHOP TRAINING IN CALIFORNIA

You can start right now. Money no problem. For 32 years National Schools has specialized in practical training. Round-trip transportation to Los Angeles allowed from any point in U. S.

Lose no time—investigate—request details

NATIONAL SCHOOLS

(HOME TRAINING DIVISION) *Los Angeles*

MAIL COUPON FOR FREE BOOK AND DETAILS

National Schools (Home Training Division)
Dept. 8-PME, 4000 So. Figueroa St., Los Angeles, Calif.
Without obligation send full details and Book.

NAME..... AGE.....
ADDRESS.....
CITY..... STATE.....

AUDELS Carpenters and Builders Guides

4 vols. \$6



Inside Trade Information for Carpenters, Builders, Joiners, Building Mechanics and all Woodworkers. These Guides give you the short-cut instructions that you want—including new methods, ideas, solutions, plans, systems and money saving suggestions. An easy progressive course for the apprentice and student. A practical daily helper and Quick Reference for the master worker. Carpenters everywhere are using these Guides as a Helping Hand to Easier Work, Better Work and Better Pay. To get this assistance for yourself, simply fill in and mail the FREE COUPON below.

Inside Trade Information On:

How to use the steel square—How to file and set saws—How to build furniture—How to use a mitre box—How to use the chalk line—How to use rules and scales—How to make joints—Carpenters arithmetic—Solving mensuration problems—Estimating strength of timbers—How to set girders and sills—How to frame houses and roofs—How to estimate costs—How to build houses, barns, garages, bungalows, etc.—How to read and draw plans—Drawing up specifications—How to excavate—How to use settings 12, 13 and 17 on the steel square—How to build hoists and scaffolds—skylights—How to build stairs—How to put on interior trim—How to hang doors—How to lath—lay floors—How to paint.



THEO. AUDEL & CO., 49 W. 23rd St., New York City

Mail Audels Carpenters and Builders Guides, 4 vols., on 7 days' free trial. If O.K. I will remit \$1 in 7 days, and \$1 monthly until \$6 is paid. Otherwise I will return them. No obligation unless I am satisfied.

Name.....

Address.....

Occupation.....

Reference..... P.M.



DRAFTING

BOOKS SENT FREE!

ON APPROVAL
5 VOLUMES BRAND NEW EDITION
Only 15 minutes a day with these WONDER BOOKS can prepare you for a good drafting job in less than a year. Mechanical and architectural drafting from simple straight lines to important complex plans. *A step at a time!* Built especially for beginners, for men with only grammar schooling. Drafting room practice. PLUS ENGINEERING, made easy and clear. Includes complete course in blue-print reading.

Big Field Big Demand Big Pay
Competent draftsmen are urgently needed right now in all building and manufacturing lines at \$30.00 to \$75.00 a week. That's just the beginning—FOR DRAFTSMEN HAVE THE BEST CHANCES FOR ADVANCEMENT. Pleasant, fascinating work, easy to learn and do. Learn quickly with these books—send coupon for a set and see for yourself.

A year's consulting membership in the American Technical Society now given to all readers of this famous cyclopedia of drafting. Many say that it is worth more than the cost of the books.

Complete set of drawing instruments if you send for these drafting books NOW. These instruments are made of the finest of German silver, are absolutely accurate and are packed in velvet lined leatherette pocket case. Real \$10 value, but included with these books.

AMERICAN TECHNICAL SOCIETY
Dept. DC19, Drexel at 58th St., Chicago, Ill.

American Technical Society, Dept. DC19, Drexel at 58th St., Chicago, Ill.
Send for 10 days' trial New 5 volume set of drafting. I will pay the few cents delivery charges. If I wish, I may return books in 10 days and owe you nothing but if I decide to keep them, I will send \$2.00 after 10 days, then only \$3.00 a month until \$24.80, the advertising price, is paid. Send latest edition and include drawing instruments and Membership Certificate.

Name.....

Address.....
Attach letter stating age, occupation, employer's name and address and that of at least one business man as a reference.

(Continued from page 18A)

rious forms of the word express are used to denote the special service and in the case of New Zealand alone it appears in English as Express Delivery. Egypt uses Expres, Italy and colonies have one issue in that form but generally prefer Espresso, as do Fiume and Vatican City. Russia uses Expres and the Russian characters for special. In Brazil the word becomes Exprespresso. Spain uses the term Urgente or Urgencia and the Colombian Republic is similar with Correo Urgente Urbano. Mensajerias is the form used by Uruguay, Surgos, by Hungary, and Eilmarke by Bosnia. The special delivery stamps of China, Austria, Czechoslovakia and Eastern Silesia do not have inscriptions stating the purpose of the stamps.

Air Post special delivery stamps have been issued by Spain, Italy and Italian colonies, and by the United States, and Semi-Postal special delivery stamps by San Marino, Spain and some Italian colonies.

Another form of special delivery stamp which is limited to parcel post packages is the Special Handling stamp which the United States began to issue in 1925. The service contemplated by this stamp included quick dispatch from the office of origin as well as speedy delivery to the addressee.

The Too Late or Late Fee stamps may be classed as special delivery stamps of a peculiar nature. These represent an extra fee paid to the postoffice in order to have a letter placed on board a ship after the mails for that vessel have been sent aboard. Such stamps were issued by Victoria in 1855, by the Colombian Republic and states, between 1886 and 1903, and by Denmark in 1923. In the United States this service is handled under the head of supplementary mail without special stamps, but double the normal rate of postage must be paid.

New Stamp Issues

The stamps of Great Britain and colonies and dominions will hold the interest of collectors and dealers for the coming season. It is rather fortunate for collectors that the change in rulers took place when it did and not after the various sets of Ed-

(Continued to page 25A)

A Simple Recipe for Inventive Success

PROBABLY the simplest recipe for inventive success would be this: First, a practical, useful invention; second, a good, strong Patent; third, a buyer or a market. The inventor needs all three to get anywhere. Lacking any one, he is likely to get nowhere. The recipe is simple. Working it out isn't so simple. That is why inventors—and others inventively inclined—have found the two books shown here so helpful. We've gone into each part of the recipe carefully. *Exactly what is an invention? We tell you. What is a strong Patent? We tell you. How can I go about finding a buyer? We tell you.*

But there's much more. For example, just how an Application for a Patent is made; how an inventor can safeguard himself with dated sketches as he goes along; how the pertinent Patent Office records are checked to see what other inventors may have done along the same line; how some successful inventors have secured financial backing; simple ways to contact manufacturers; and many other points.

37 Years in the Business of Helping Inventors

The world needs, can use and will pay for practical, useful, inventions. Manufacturers are on the alert for new articles, or improvements that will help them increase sales. Maybe you have one. Maybe not. These books will help you in deciding that. *From that standpoint alone, they are valuable.*

For more than 37 years, it has been our business to help inventors. We answer your questions and supply complete information about Patent procedure, costs, steps to take, kind of sketch or model needed, and much more. Our staff is made up of experienced Registered Patent Attorneys, Draftsmen, Searchers. Fees are reasonable—deferred payments arranged. Whether your idea is large or small, finished or still in a rough stage, you should have the facts both about Patenting and Selling. The information which we give you—based on long experience with thousands of inventors—is yours for the asking. No need to delay. These two books of facts may save you time, trouble, money, even later disappointment. **Return the coupon—or write us a confidential letter—today.**

PATENT and SELL your INVENTION

Suggestions
on
WHEN
and
HOW
to Sell an
INVENTION

Here
TWO BOOKS
tell you how to go
about it — **Both**
SENT FREE

115 Mechanical Movements

The mechanical movements shown below are taken from 115 such movements illustrated in our book, "Patent Protection." Maybe you'll find just what you need to work out some of your own ideas. Many other interesting pictures are shown in this book. **Both books and an "Evidence of Invention" form sent to you FREE, the same day we hear from you.**

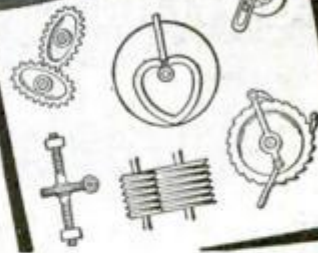

**VICTOR J.
EVANS & Co.**

REGISTERED PATENT ATTORNEYS

Main Office: 200-J, Victor Building,
Washington, D. C.

Other Offices: 2610-N, Singer Bldg., New York

1445-N, Monadnock Bldg., Chicago

514-N, Empire Bldg., Pittsburgh

1010-N, Hobart Bldg., San Francisco

736-N, Security Bldg., Los Angeles

Send me FREE copies of your books, "Patent Protection" and "When and How to Sell an Invention." (Note: Same books supplied by any of the branch offices listed above.)

Name.....

Street and No.....

City or Town.....



Know Electricity as Experts Know It—and Get an Expert's Pay!

Recovery has begun! The months ahead are charged with significance and expectation. What will you do to get the jump on the other fellow?
Thousands of men have used

The Croft Library of Practical Electricity

The Croft Library is a complete electrical educator. It is founded on practice—on 20 years of shirt-sleeve experience—on work as it is actually done. It is jammed from cover to cover with the kind of hard-headed facts you want. Written so that the beginner can easily understand it, yet so sound, so thorough, that it is the daily guide of 50,000 highly paid electrical workers and engineers. Croft tells you the things you need to know about motors, generators, armatures, commutators, transformers, circuits, switchboards, distribution systems—electrical machinery of every type—wiring for light and power—wiring of finished buildings—underwriters' and municipal requirements—illumination in its every phase—the most improved methods of lighting—lamps and lamp effects, etc.—how to do a complete job, from estimating it, to completion.

No money down—easy payments

Fill in and mail the coupon attached and we will send you the entire set of seven volumes for ten days' free examination. We take all the risk—you assume no obligation. If you decide to keep the books, send \$1.50 in ten days and the balance at the rate of \$2.00 a month. Send the coupon NOW and see the books for yourself.

FREE EXAMINATION COUPON

McGRAW-HILL BOOK CO., 330 W. 42nd St., New York

Send me for ten days' free examination the Croft Library of Practical Electricity. If satisfactory I will send you \$1.50 in 10 days and \$2.00 monthly until the price of \$19.50 is paid. If not wanted, I will return the books postpaid. (To insure prompt shipment write plainly and fill in all lines.)

Name.....
Home Address.....
City and State.....
Position.....
Name of Company..... P.M. #37



**U.S.
GOVERNMENT
JOBS**

START

\$1260 to \$2100 YEAR

GET READY
Immediately

Common Education
Usually Sufficient.

Many appointments
every year.

Mail Coupon
Today—
SURE

Franklin Institute
Dept. F196
Rochester, N. Y.

Gentlemen: Rush to me, FREE of charge, list of U. S. Government big pay jobs. Send me FREE 32-page book describing salaries, vacations, hours, work and free sample coaching tests. Tell me how to get one of these jobs.

Name.....

Address.....



STEP UP TO BETTER JOBS AND BIGGER PAY WITH GOOD PRACTICAL BOOKS

Thousands of others have found extra cash between the pages of the selected, practical books listed below. Make these books your guides too—guides to better jobs—bigger pay—extra money.

- AIR CONDITIONING**
Live Field; Great Future..... \$3.50
- AUTO ENCYCLOPEDIA**
The Famous Dyke's Latest Edition..... \$6.00
- 110-V. GENERATORS**
Made From Old Auto Units..... \$1.00
- BIRD HOUSES**
Build to Sell; Easy Designs..... \$1.00
- BLUEPRINT READING**
For Building Trades.. \$1.25
- BOAT BOOK**
Power, Sail, Rowing, Paddle Plans..... \$3.00
- BOY MECHANIC**
Hundreds Things Boys Can Make..... \$2.00
- CARPENTRY, PRACTICAL**
Complete 436 pages. 1936 Edition..... \$2.00
- CHEMISTRY, PRACTICAL**
Make Hundreds Things Daily Use.. \$2.00
- CIVIL SERVICE**
Home Study Courses Federal, State, City Positions..... \$1.00
- CONCRETE**
1001 Ideas for Using. New Popular Mechanics Book... \$5.00
- DIESEL HANDBOOK**
New! Latest Information..... \$5.00
- ELECTROPLATING**
Modern Practice Including Nickel, Zinc, Cadmium and Chromium..... \$2.25
- FORD V-8 CARS, TRUCKS**
New, 700 Pages. Includes Details 1937 Cars..... \$2.50
- FORMULAS**
1059 Money Making. Start a Business... \$1.25
- FROG INDUSTRY**
New! Raise and Sell. Profits!..... \$1.00
- FURNITURE MAKING**
Tools, Materials, Designs..... \$2.50
- HOUSES, SMALL**
Book of, for Home Builders..... \$2.00
- HYPNOTISM**
How to Become an Expert..... \$2.00
- LATHE WORK (Metal)**
Drilling, Threading.. \$1.00
- LOCOMOTIVE**
Folding Chart Shows all Parts..... \$1.00
- LOG CABINS**
Easy Plans; Build for Profit. Value!..... \$2.50
- MATHEMATICS**
Easy Guide for the Practical Man..... \$1.50
- MECHANICAL DRAWING**
Learn Drafting; Good Salaries..... \$1.00
- MONEY MAKING IDEAS**
1000 Ways to Make \$1000..... \$2.50
- OFFICE MACHINES**
All Makes. Care and Operation..... \$2.50
- PLUMBING**
500 Facts Every Homeowner Should Know..... \$1.50
- TEST GOLD—PLATINUM**
Identify—Buy—Sell. By C. M. Hoke.... \$1.00
- POWER TOOLS**
For Home Workshop.. \$1.75
- PROSPECTORS' HANDBOOK**
How to Mine, Appraise, Equip..... \$3.00
- RADIO SERVICING**
Profit by Knowing Costs, Kinks, Etc.. \$4.00
- REFRIGERATION**
Electric. Gas. Be a Service Expert..... \$5.00
- REWINDING ELECTRIC MOTORS**
Fractional Sizes. Value!..... \$2.50
- SHIP MODEL**
Entire Text, Famous "Sovereign" of 1637 \$1.00
- SHOP NOTES LIBRARY**
5 Vol. 2000 Wonderful Shop Ideas..... \$2.50
- STAMP ALBUM**
Modern, 400 Pages... \$1.00
- STEEL SQUARE**
How to Figure Angles of Rafters, Roofs, Etc..... \$1.00
- TOYS**
For Amusement or Profit. Saleable Designs..... \$1.50
- TRAILER BUILDING**
New Book..... \$1.00
- UPHOLSTERY**
Always a Big Market. Start Own Business.. \$2.00
- WIRING**
Approved Economy Methods for Homes, Buildings..... \$2.50
- WOOD FINISHING**
Methods, Tools, Materials..... \$2.00
- WOOD TURNING**
Woods, Tools, Methods; Practical Teacher..... \$1.50
- WRIGHT ENGINE**
Chart of "Whirlwind"; All Parts..... \$1.00

SEND NO MONEY! Check the books wanted on the above list. Tear out and mail with your name and address.

When postman hands you the books pay him price and a few cents postage. (In U. S. and possessions only.) If remittance is sent with order add 10 cents per book extra for postage. Send 3c stamp for postage and ask for catalog of other books.

POPULAR MECHANICS PRESS
Room 837A 200 East Ontario Street Chicago

When writing to advertisers please mention Popular Mechanics

(Continued from page 22A)

ward VIII stamps had been issued. The coronation stamps are only an appetizer, compared to what is to follow when the complete list of dominions, colonies and dependencies begin to issue definitive sets showing the portrait or attributes of George VI.

In the top row of this illustration are shown four examples of the coronation stamps. At the left is one value of a set of four bicolored stamps issued by the dominion of Southern Rhodesia, and next to it is the single value issued by Great Britain. Then follows a Newfoundland coronation stamp which is typical of the sets of three stamps issued by each of the forty-five colonies, and at the right is the single value issued by the dominion of Canada. Newfoundland has not forgotten the fact that she enjoyed dominion status for a long time, and has issued a set of eleven coronation stamps in addition to the colonial set of three. These eleven stamps combine designs used on previous issues with a portrait of George VI. Below these four and just left of the center is one value of three issued by Great Britain on May 10, as the forerunner of the new definitive set showing George VI, while at the right is one example of a set issued by the mandated province of Nauru to celebrate the coronation. The central pair of triangular stamps are a part of a new definitive issue of Liberia, of which six values were placed on sale April 10, 1937. The pair will show how triangular stamps are arranged in a sheet to avoid waste. At the extreme left of the middle row is a sample of the Czechoslovakian Child Welfare issue. The design shows a mother placing her babe in a cradle. At the right of the same row is one of the Russian stamps issued to commemorate the 100th anniversary of the death of the poet, Alexander Pushkin. Two values of the set were issued "se tenant," in a wide-margined souvenir sheet. Beginning at the left the bottom row shows one example of four new pictorial stamps issued by Poland. Next is the Greek stamp commemorating the centenary of the University of Athens. The design is based on an archaic statue of the goddess Athene, patron saint of Athens, and so of the University. In the center is an Ecuador air-mail stamp, one of a series issued in con-

(Continued to page 32A)

LEARN AUTO MECHANICS

in 8 weeks!

IN BIG, NEW McSWEENEY BUILDINGS

The finest of their kind. Every modern facility for thorough instruction.

Prepare For These Good-Paying Jobs

Trained men are in demand and earn good money in these fascinating well-paying trades. This is not a correspondence school—no books—no lessons. Don't look for a job—TRAIN FOR IT. Read what two McSweeney-trained men have done.

AUTO MECHANICS
AVIATION MECHANICS
DIESEL MECHANICS
BODY AND FENDER REPAIR
METAL FINISHING
TORCH SOLDERING
AUTO PAINTING
COLLISION REPAIR (Complete)
WELDING—Arc and Gas

Belton, Texas
 Dear Mac—I really enjoyed the eight weeks of schooling and received a great benefit. I am working in Temple with the Chevrolet people. I had as you remember some mechanical experience before coming to school and was surely surprised at how much I did not know about motors. Will always be glad to recommend your school.—W. F. Jones.

1801 E. 65th St., Cleveland, O.
 Dear Mac—Immediately after leaving school I went to work for United Motors and am now located in Cleveland where I hold a good position. I have been able to take care of the most complicated electrical jobs. I think I have done fine considering I had no experience before coming to your school.

—Hubert Todd.

A FEW WEEKS OF INTERESTING SHOP TRAINING

Work on real equipment with real tools. In a few weeks you should be trained by actual work to hold down a Good Pay Job.

Learn Now — Pay Later!

We will give you complete information on how to get your training now and pay for it later out of your earnings.

FREE Write today for Big Free Book. Get the facts about jobs; and Low Tuition Offers. Mailing the coupon does NOT obligate you. It obligates ME to tell YOU how you can train for Big Money in a few short weeks. Address Dept. 10-44.

McSWEENEY SCHOOLS

DETROIT, MICH. and KANSAS CITY, MO.
 Write Our School Nearest You

McSweeney Auto and Aviation School,
 Dept. 10-44, Detroit, Mich., or Kansas City, Mo.

Without cost or obligation send me your Big FREE Book on Autos; also full information about your Low Tuition Offer.

Name

Street

Town.....State.....Age.....



AUTO BOOKS SENT FREE



on approval. Just mail the coupon and we'll send you a set of these remarkable auto books, just off the press. Whether you are a mechanic or helper, expert or apprentice, auto owner or driver, if you're interested in knowing all about automobile mechanics, take advantage of this FREE OFFER.

Nearly 100 pages on DIESEL Engines

A better job—in the gigantic auto industry. BIGGER PAY—a chance to go into business for yourself and get a share of the huge profits, are waiting for any man who ev-n half tries to improve himself. Learn auto engineering with these wonder books a new way—without studying or memorizing. Simply use the JIFFY INDEX to look up the answer to any auto problem. Built by eleven of America's greatest automobile engineers, and written in simple language so you can understand it. Very newest cars, all covered.

CAN YOU FIX IT?

These wonder books tell step by step HOW to take out "play" in differential—to kill the shimmy in steering—to set TIMING—how to put your finger instantly on engine trouble and then the quick expert way to FIX it. Newest improvements fully covered. Equal to a complete trade course at less than a fourth the cost.

6 Big Volumes 1937 Edition

2500 pages, 2000 illustrations, wiring diagrams, etc., including Marine Engines, Aviation Motors, Diesel engines, etc. DeLuxe edition, gold-stamped flexible binding.

FREE Privilege of consulting Automobile Engineers of American Technical Society for one year without cost if you mail coupon immediately.

AMERICAN TECHNICAL SOCIETY
Drexel Avenue & 58th St., Dept. AC19, Chicago, Ill.

AMERICAN TECHNICAL SOCIETY:
Drexel Ave. & 58th St., Dept. AC19, Chicago, Ill.

I would like to see the new 6-volume edition of your AUTO BOOKS. I will pay the few cents delivery charges only, but if I choose to, I may return them express collect. If after 10 days use I prefer to keep them, I will send you \$2 and pay the balance at the rate of only \$3 a month, until \$24.80 is paid. Please include free consulting membership as per your offer above.

Name.....
Address.....
City..... State.....
Attach letter, stating age, occupation and name and address of employer and that of at least one business man as reference.

NEW ELECTRIC LIBRARY

\$ 1.50 A VOLUME

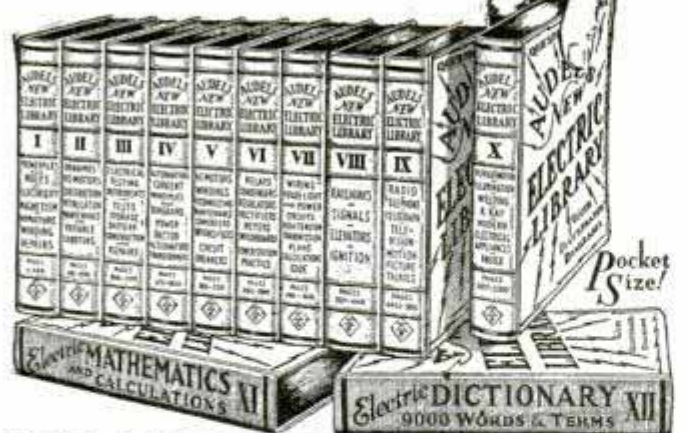

WHAT EVERY ELECTRICIAN WANTS TO KNOW!

Is easily found in AUDEL'S NEW ELECTRIC LIBRARY. Electricity made simple as ABC. Up-to-date, trade dope for the expert and ALL electrical workers. Questions, answers, diagrams, calculations, underwriter's code; design, construction, operation and maintenance of modern electrical machines and appliances FULLY COVERED. All available at small cost, easy terms. BOOK-A-MONTH service puts this NEW information in your hands for 6c a day. You can start your subscription with any volume. Write TODAY for electric Folder and FREE TRIAL offer.

THEO. AUDEL & CO., 49 W. 23rd St., New York City

Mail Vol. I Electric Library on 7 days' free trial. If O. K. I will remit \$1.50, otherwise I will return it. I also request you to mail one book each month on same terms. No obligation unless I am satisfied.

Name.....
Address.....
Occupation.....PM

When writing please mention Popular Mechanics

AERONAUTICAL UNIVERSITY



**ENGINEERING - LICENSED MECHANIC
ADMINISTRATION - RADIO - SHEET
METAL - WELDING**

A real technical university education in less time at less cost. B.S. Degree. Graduates with all leading aviation companies and air lines. Day and eve. classes. State Accredited. Government approved. Write for "Aviation as a Career." Address Curtiss Wright Bldg. Dept. A, 1342 S. Michigan Ave., CHICAGO, ILL.

GAG-CARTOON!



AND MAKE BIG MONEY—AT HOME—BY MAIL! Magazines pay up to \$200.00 per cartoon. Get in this NEW FIELD and be your own boss! My 50 lesson—1000 illustration course shows you how. FREE CARTOON MARKETS INCLUDED—only course of its kind. All for..... **\$280**
Free Drawing Set if you act at once. WRITE TODAY—Stamp brings FREE details. MOON GAG-CARTOON SCHOOL. Paramount Bldg. Dept. A-2, Fall Creek, Wis.

You Can Regain Perfect Speech, if you STAMMER

Send today for beautifully illustrated book entitled "DON'T STAMMER," which describes the Bogue Unit Method for the scientific correction of stammering and stuttering. Method successfully used at Bogue Institute for 36 years—since 1901. Endorsed by physicians. Full information concerning correction of stammering sent free. No obligation. Benjamin N. Bogue, Dept. 151, Circle Tower, Indianapolis, Indiana.

Learn ELECTRICITY



IN YOUR HOME—by Practical Shop Training
NEW EASY WAY TO BETTER JOBS—GOOD PAY! We furnish dozens of items of Electrical Equipment to train you by practical shop methods doing actual jobs right in your home. Amazing new plan gets results. Write for Free Book and details.
ELECTRIC INSTITUTE, Inc.
Dept. 67K
Minsdale, Illinois

INVESTIGATE WORK FOR U.S. GOVERNMENT

Thousands of openings yearly. Men-Women, age 18-50. Start \$105-\$175 month. Get ready now for next entrance test. Details Free. Write OZMENT INSTRUCTION SERVICE, Dept. 111, Saint Louis, Mo.

NEW YORK SCHOOL OF MECHANICAL DENTISTRY

Make more money as a DENTICIAN. We show you how! Oldest school. Real Laboratory Training. Day, Eve. Easy terms. Tools FREE. Ask for Catalog P. N. Y. SCHOOL OF MECHANICAL DENTISTRY, 125 W. 31 St., N. Y. C.

WANTED HIGH GRADE MEN

Money making opportunity. Over \$400 a week earned by Georgia man. \$1,000 a month by Delaware man. \$300 week by Texas man. New specialty. Sells every business, professional man—used by America's leading firms. Exclusive territory. Write, F. E. Armstrong, Dept. 1112-H, Mobile, Ala.

Learn Public Speaking

At home—in spare time. Many overcome "stage-fright," gain self-confidence and increase earning power, this easy way. Write for free booklet, *How to Work Wonders With Words* and requirements. North American Institute, Dept. 135-C 3601 Michigan Ave. Chicago, Illinois

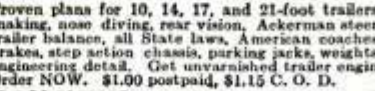

TRAILER ENGINEERING BRAND NEW BOOK

To Help You Buy or Build. 14 chapters, 130 illustrations. Tells you about bob, roll, weave, making, nose diving, rear vision, Ackerman steering, tandem wheels, tow bar balance, trailer balance, all State laws, American coaches, English coaches, plumbing, wiring, brakes, step action chassis, parking jacks, weights, furniture, ironing the tow car, every engineering detail. Get unvarnished trailer engineering facts before you buy or build. Order NOW. \$1.00 postpaid, \$1.15 C. O. D.

RAY KUNS, Dept. 8, 6 Eastwood Circle, Cincinnati, Ohio



Full Size Professional ARC WELDER

Full size, heavy duty Aladdin Electric ARC WELDER only \$39.25 with De Luxe Accessories! Has efficiency of machines costing \$145.00 to \$800.00. Welds all metals and alloys from heavy motor block and castings to fenders and light sheet metal. Also fine for soldering and brazing. Fully gas anteed. Easily portable on casters.

WORKS FROM 110-V SOCKET. Simply plug into 110 Volt or 220 Volt electric socket—costs only few pennies an hour to use. Has complete heat controls. Anyone can use easily. Full instructions included. **AMAZING DETAILS FREE!** Write today for sensational facts about Aladdin Arc Welder for \$39.25 including De Luxe Accessories!

Only \$39.25 With Deluxe ACCESSORIES

COMMONWEALTH MFG. CO.
4208 Davis Lane
Cincinnati, Ohio

Dept. Y-51

RADIO ENGINEERING

RCA Institutes offer an intensive course of high standard embracing all phases of Radio. Practical training with modern equipment at New York and Chicago schools. Also specialized courses and Home Study Courses under "No obligation" plan. Catalog Dept. PC-37.

RCA INSTITUTES, Inc.
75 Varick St., New York 1154 Merchandise Mart, Chicago
Recognized Standard in Radio Instruction Since 1909.

ENGINEERING DEGREE IN TWO YEARS

B.S. DEGREE courses in engineering: Electrical, Civil, Chem., Mechanical, Mech. Drafting, Radio and Television or Aeronautical. Intense, practical, thorough program. No extras for prep. or review. Earn while you learn in this industrial center. Low tuition. Enter March, June, Sept., Dec. Write for catalog. 229 E. Washington Blvd., Fort Wayne, Ind.

INDIANA TECHNICAL COLLEGE

BARBERING OR BEAUTY CULTURE OLDEST, LARGEST SCHOOLS. Est. 1893. **EARN** while **LEARNING.** Day, Night classes. Free National employment bureau. Prize winning teachers. Big pay. Professions. Low rates. Easy terms. Free booklet "B."

MOLER SYSTEM, NEW YORK, N. Y., 303 Fourth Ave.

LEARN WATCH REPAIRING

AT HOME You can learn by our modern and original system of instruction every part of the Watch Repairing Trade at home. You can earn money while learning and prepare yourself for a well paying position or start in business after completing our course of instruction. Good watch repairers are in demand and generally earn very good salaries. For particulars apply to the **Wisconsin School of Watch Repairing** 524 E. Mason St., MILWAUKEE, WIS.

Learn to Write

Begin Today. Write for our Free Book, "How to Become a Good Penman." It contains specimens and tells how others learned to write in spare time. Your name elegantly written on a card if you enclose stamp for postage. Write today. F. W. TAMBLYN, 418 Ridge Bldg., Kansas City, Mo.

REFINISHES AUTOS Like NEW!

PAYS UP TO \$7.00 AN HOUR!

KAR-NU refinishes any color automobile easily, quickly and economically without polishing, waxing, rubbing or painting. **JUST WIPE IT ON WITH A CLOTH!** Magic-like fluid covers old paint with tough, elastic coat. Absolutely transparent, self-leveling, self-polishing. **Guaranteed.** Lasts 8 to 12 months. Equal in beauty to repaint job costing \$10 to \$35. Write for Free Sample to prove our claims and Territory offer. **KAR-NU CO.** Dept. U-30, Oakley Sta. Cincinnati, O.

Learn

DIESEL and GAS ENGINEERING

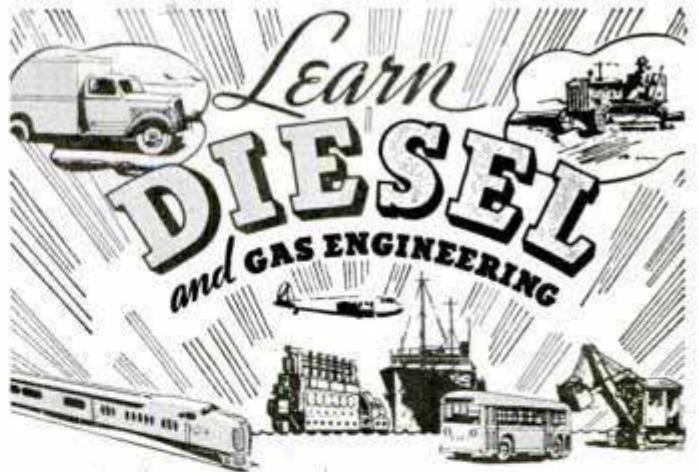

TESTED SYSTEM OF DIESEL AND GAS ENGINE TRAINING

To qualify for a good Diesel job you must receive training in an institution that can offer you **practical** instruction. At National Schools you actually work on the latest equipment, including practically every approved make of Diesel engine. You get the kind of instruction that serves your every day needs in the Diesel field after you have graduated. It's the type of training you can "cash in" on. You are trained under the direct, personal supervision of licensed Diesel Engineers.

DIESEL ELECTRIC POWER GENERATION

A new feature essential to the complete training of Diesel experts. Completely covers power generation. This extra course is now presented to all Diesel students without extra tuition.

EAST-TO-LEARN MASTER TRAINING

National Schools' training is complete in every respect. It includes all phases of Diesel engines, fuel injection, gasoline, butane, propane and natural gas engines, also Auto-Diesel electrics, machine shop practice, batteries and other essentials that must be learned in order to give you well rounded-out training.

LEARN IN LOS ANGELES

The most delightful place to learn—Los Angeles—the playground of America. Fascinating surroundings. Your coach railroad fare will be allowed to Los Angeles from any point in the U. S.

EARN ROOM AND BOARD

We help students obtain part-time jobs to earn room and board while learning. This service only for residents of U. S.



Partial Room, Diesel Engine Dept.



Student Servicing Diesel Electric Unit

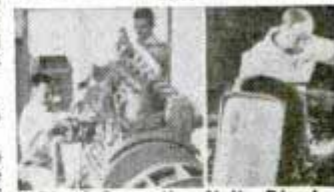

Diesel Generating Unit. Diesel Converted Ford Auto

DIESEL and GAS ENGINEERING

NATIONAL SCHOOLS

FREE BOOK

Los Angeles

MAIL THIS COUPON

NATIONAL SCHOOLS, Dept. 8-PMA,
4000 So. Figueroa St., Los Angeles

NAME AGE

ADDRESS

CITY STATE

When writing please mention Popular Mechanics



*Small
Inventions*
**THAT HAVE
BUILT BIG
BUSINESSES**

INVENTIONS do not have to be complicated to be profitable when Patented. The 5c and 10c stores flourish on simple Patented products which are commercially successful. The zipper, safety pin, thumb tack, paper clip, collar button—all simple, yet familiar inventions—brought their inventors rich rewards. If you have a Patentable invention—act to protect it. Many of the most useful, widely popular, greatly profitable, and ex-

tremely successful inventions have been very simple ones. You have only to look at the devices we have pictured here to realize how a simple invention may become a utility bought by a hundred thousand or a million people soon after it is produced. Don't be afraid that the simplicity of your invention makes it valueless. The thing that you find so simple that you wonder why a thousand other people haven't already done it is often the invention worthwhile.

HOW OTHER INVENTORS GOT STARTED



The list of men who succeeded in invention with only a poor boy's start is a very long and noble one. Poverty, hardships, lack of friends, distance from the market—these could not hold back Bell, Edison, Eastman, McCormick, Whitney and others. Everyone cannot succeed. But every man can try. Courage, sacrifice, and hard work may bring you a measure of the success these men had. Lack of mechanical ability is not a serious drawback. You can always get someone able to build a model, draw a detailed design, or otherwise materialize your invention for you. The big draw-back is discouragement.

Your invention of a practical article or an improvement upon an old one should

be patented NOW. Frequently many of the thousands of applications filed in the U. S. Patent Office each year are for the same or almost the same invention. In such a case, the burden of proof rests with the last application filed. Sometimes a delay of even a few days in filing the application means the total loss of the patent. **LOSE NO TIME.**

The entire time of this large and experienced organization is devoted exclusively to patent and trade-mark cases. We know the rules and requirements of the Patent Office. We understand the technicalities of Patent Law. We can proceed in the quickest and safest ways in preparing an application for a patent covering your invention.

FREE **THE BIOGRAPHY OF GEORGE EASTMAN**
Views of the man who used Patent Protection to amass millions and give perfection to a new art—*Photography*—itself one of the greatest inventions.

CLARENCE A. O'BRIEN & HYMAN BERMAN

707 ADAMS BUILDING

WASHINGTON, D. C.

Registered Patent Attorneys Before U. S. Patent Office

When writing to advertisers please mention Popular Mechanics

Send For This
FREE BOOK

TORS

PROTECT YOUR
INVENTIONS
WITH U.S.
PATENTS

If you have an invention that is patentable—and want to secure for yourself your inventor's sole right to profit from the invention—you can't afford to lose time in securing the protection of a U. S. Patent. Other inventors may be working on the same invention right now. Should they develop this invention and file patent application before you do—the burden of establishing priority will be upon you. Our Big Book—"Patent Guide for the Inventor"—will tell you the quickest possible way to secure Patent Protection for your invention. **SEND FOR IT TODAY!**

The **FIRST IMPORTANT STEP** in **SECURING A PATENT**—is to obtain the services of a Registered Patent Attorney. The U. S. Patent Office advises that you secure the aid of an experienced Registered Patent Attorney to prepare your statements. Establish the date of your invention as explained in our book and disclose your invention to him in correct form. He then makes a **SEARCH** of the Patent Office Records and reports to you on existing U. S. Patents which might bear on your invention, giving his opinion on the advisability of proceeding and filing formal application.

REASONABLE FEES—CONVENIENT TERMS. Don't worry about finances. Our fees are very reasonable—we can arrange convenient terms of payment. It is our custom to permit clients to pay for our services in installments as the application progresses in our office. See our Big Book for fees in obtaining Patent. It explains our arrangements clearly. Send for it **NOW!**

FREE RECORD OF INVENTION FORM—Use our FREE "Record of Invention" form to assist you in recording the descriptive outline of your invention and to establish the date of your invention. With it you can make a rough sketch of your invention and have it witnessed in a manner of value to you as evidence should occasion arise.

TEAR OFF AND MAIL NOW!

**CLARENCE A. O'BRIEN
& HYMAN BERMAN**

707 Adams Building

WASHINGTON, D.C.

**REGISTERED PATENT ATTORNEYS
BEFORE U.S. PATENT OFFICE**

Please send me at once your Big Free 48-Page Book, "Patent Guide for the Inventor" and your Specially Prepared "Record of Invention" form. Also George Eastman Biography, "Inventor and Business Man." This request does not obligate me. (Please write or print plainly.)

NAME.....

ADDRESS.....

PATENTS

Booklet Free Highest References
Promptness Assured Best Results

Send drawing or model.

ALL BUSINESS GIVEN PROMPT AND PROPER ATTENTION

Listed Patent Lawyer in the latest editions of the Rand-McNally Directory of Bankers and Bank-Recommended Attorneys, published by Rand-McNally & Co., Chicago, Ill.; The Baggott & Ryall Directory of Guaranteed Attorneys, published by Legal Directory Corporation, Boston, Mass.; American Lawyers Annual, Cleveland, Ohio; Bankers Service Legal Directory, published by Bankers Service Co., Boston, Mass.; Eyre's Law List, 9 Park Place, New York City; Snow-Church Directory Co. Lawyers List, published in New York City, and the Central Guarantee Co., Bankers and Lawyers Directories, 630 Fifth Avenue, New York City.

WATSON E. COLEMAN,
REGISTERED PATENT LAWYER

Victor Building, 724 Ninth Street, N. W.
WASHINGTON, D. C.

INVENTORS PATENT YOUR IDEAS SEND FOR FREE BOOK



HOW TO OBTAIN A PATENT

Written by a Former Member of the Examining Corps (1922-24) of the U.S. Patent Office. If you want to profit by your idea, you should take steps to apply for a U. S. Patent at once. Your first step is to get this Free Book. This interesting illustrated book contains valuable information you should have. It tells you fully how to obtain a patent on your idea in the quickest way. With this Free Book you will also receive a "Record of Invention" form on which you can easily record your idea. Personal and Confidential Service: Your case will be personally handled only by a Registered Patent Attorney who is also a Former Member of the Examining Corps of the U. S. Patent Office. All communications confidential.

MAIL COUPON TODAY for FREE PATENT BOOK and RECORD OF INVENTION Form.

CARL MILLER

REGISTERED PATENT ATTORNEY
FORMER MEMBER EXAMINING CORPS U. S. PATENT OFFICE

1638 Woolworth Bldg., Dept. 87A, New York City
MILLER BUILDING, Dept. 87A, WASHINGTON, D. C.

Please send me your Free Book, "How to Obtain a Patent," and your "Record of Invention" form.

NAME.....

ADDRESS.....

ALBERT E. DIETERICH

REGISTERED PATENT ATTORNEY
512 B Colorado Building, WASHINGTON, D. C.

Booklet on Patents sent free

STOP Scratching

RELIEVE Itching of Insect Bites

Even the most stubborn itching of insect bites, athlete's foot, hives, scales, eczema, and other externally caused skin afflictions quickly yields to cooling, antiseptic, liquid **D. D. D. PRESCRIPTION**. Greaseless and stainless. Soothes the irritation and quickly stops the most intense itching. A 35c trial bottle, at drug stores, proves it—or your money back. Ask for **D. D. D. PRESCRIPTION**.

PATENTS—TRADE MARKS

Form "Evidence of Conception" and instructions,
"How to Establish Your Rights"—FREE!

LANCASTER, ALLWINE & ROMMEL
412 Bowen Bldg. Washington, D. C.

Inventions Wanted Patented or Unpatented

We have been successfully selling inventions, patented and unpatented, since 1924. Write for proof, and tell us what you have for sale.

Chartered Institute of American Inventors
Dept. 4, Barrister Building, Washington, D. C.

INVENTORS

who derive largest profits know and heed certain simple but vital facts before applying for patents. Our book, Patent-Sense, gives those facts; sent free. Trade Marks—Copyrights.

LACEY & LACEY, Est. 1869, 635 F St., N. W., Dept. 5, WASHINGTON, D. C.

No JOKE TO BE DEAF

—Every deaf person knows that—



Mr. Way made himself hear his watch tick after being deaf for twenty-five years, with his Artificial Ear Drums. He wore them day and night. They stopped his head noises. They are invisible and comfortable, no wires or batteries. Write for TRUE STORY. Also booklet on Deafness.



Artificial Ear Drum

THE WAY COMPANY

729 McKeheey Bldg.

Detroit, Michigan

NEURITIS

Relieve Pain In Few Minutes

To relieve the torturing pain of Neuritis, Rheumatism, Neuralgia, Lumbago in few minutes, get **NURITO**, the Doctor's formula. No opiates, no narcotics. Does the work quickly—must relieve worst pain to your satisfaction in few minutes—or money back at Druggist's. Don't suffer. Get trustworthy **NURITO** on this guarantee. Don't wait.



BUCHSTEIN'S FIBRE LIMB

is soothing to your stump—strong, cool, neat, light. Easy payments. Braces for all deformities. Agents wanted.

D. BUCHSTEIN CO.
610 3rd Ave., So., MINNEAPOLIS, MINN.

Send for Catalog Today

To PROTECT YOUR INVENTION—Use this coupon, NOW

Delays are dangerous and may be very costly. My personal service assures prompt action, strict confidence, and a minimum of expense. I suggest that you send me a model or drawing, or sketch and description of your invention, and \$5.00. I will make a search and report

promptly as to its patentability and send you a copy of my 72-page booklet. Or, if you prefer to read my booklet first, mail the attached coupon at once. I will also send my "Record of Invention" form. (Over 38 years experience as a Registered Patent Attorney.)

L. F. Randolph, 302-D Victor Bldg., Washington, D. C.

Please send me at once, free of charge, your 72-page booklet and "Record of Invention" form.

Name.....

Address.....

A PERSONAL CONFIDENTIAL PATENT SERVICE—

ENGINEERING ELECTRICAL—MECHANICAL— ARCHITECTURAL—STRUCTURAL— CIVIL—AERONAUTICAL—HIGHWAY

Technical and applied courses—nonessentials omitted—fundamentals stressed.

Chartered by the State. Recommended by graduates, endorsed by industry, approved by engineers and educators. Courses include Air Conditioning, Electric Refrigeration and Diesel. Extensive modern equipment. Low tuition. Part-time work for room and board. Degree in two years, diploma in one year. Also short intensive courses of

three and four months in Electricity, Diesel-Electric, Power Plant, Refrigeration, Air Conditioning and Drafting. One and two-year courses open in September, short courses open the year round. Thousands of successful graduates in U. S. and foreign lands. Write for catalog.

**38th
YEAR**

FINLAY ENGINEERING COLLEGE
1001 Indiana Avenue
Kansas City, Missouri

AUDELS MATHEMATICS AND CALCULATIONS FOR Mechanics

\$2

**A
HANDY
BOOK**

Good News!

MATHEMATICS AND CALCULATIONS FOR HOME STUDY AND REFERENCE

PRACTICAL MATHEMATICS ILLUSTRATED. How to figure correctly. EVERY MECHANIC can use the new, correct, easy methods, covering a complete review of practical arithmetic—with examples including mensuration—plane and solid geometry—trigonometry—algebra—calculus—ELECTRICAL and MECHANICAL SHOP CALCULATIONS—practical tests—reference tables and data—how to use the slide rule—700 pages—550 illustrations—pocket size.

Highly endorsed. Let us mail you copy for free trial. Price \$2, postpaid.



**FREE
EXAMINATION
COUPON**

THEO. AUDEL & CO.
49 W. 23rd St., N. Y. C.

Mail Audel's Mathematics on 7 days' free trial. If O. K. I will remit \$2, otherwise I will return it.

Name

Address

Occupation P. M.



TRI-STATE COLLEGE

ENGINEERING DEGREE IN 2 YEARS

Courses in Civil, Electrical, Mechanical, Chemical, Aeronautical, Radio Engineering. Essentials of engineering training included and non-essentials eliminated. B. S. Degree granted upon completion of course. Also short diploma courses in Surveying (36 weeks), Drafting (36 weeks). For ambitious, earnest students. Those who lack high school training may make up required work. Graduates compete successfully with those of 4-year schools. Technical in-

struction at lowest cost and in least time consistent with thorough training. Intensive instruction in accord with individual ability. Courses also in Business Administration and Accounting. Students from all parts of the world. Tri-State graduates make good. Located in picturesque hill and lake region. Tuition, living expenses low. 54th year. Enter September, January, March, June. Write for catalog. 487 College Ave., Angola, Ind.

PARKS AIR COLLEGE

Offers COLLEGE AND PROFESSIONAL TRAINING Majoring in Aviation

FOUR two-year courses (96 weeks) lead to Bachelor of Science degrees in Professional Piloting, Aviation Operations, Aviation Mechanics and Aeronautical Engineering.

THIRTEEN TRAINING PLANES are on the flight line. They are used in giving a systematic course of professional flight training which prepares graduates for airline flight operations. Requests from airlines for flight graduates are exceeding the number available.

Accredited by the Illinois Superintendent of Public Instruction. Government approved as a Transport Ground and Flying School and Mechanics' School.

58,000 hours flight instruction have been given, 650 hours now being flown monthly.

THE FACULTY of 33 is composed of specialists in the various fields of aviation.

AN ENROLLMENT of 241 resident students for the 1937 Spring term.

On its 100-acre airport, Parks has 14 buildings with a total floor area of 2 3/4 acres, devoted to school purposes exclusively.

DORMITORIES and DINING HALL ON THE FIELD.

1434 graduates.

Graduates are being placed prior to graduation.

74 per cent of graduates enter air transport operations in North and South America.

At Parks you train for aviation in aviation. Parks is recognized as the training division of the industry. Ask any one who is in aviation. You can expect more at Parks and still be agreeably surprised when you come.

The new 60-page catalog gives complete information. Send for it. It is FREE. It is packed full of valuable information. A letter or post card will bring it to you.

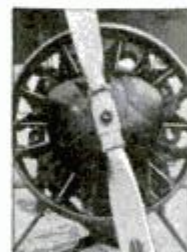

PARKS AIR COLLEGE

837-M Cahokia Rd.

East St. Louis, Illinois

When writing to advertisers please mention Popular Mechanics

(Continued from page 25A)



**Electric
Arc Welding
Revolutionizes modern Industry**

U.S. Manufacturers desire men to learn Electric Arc Welding and get practical experience under actual production conditions in the laboratories of the School of Engineering. Moderate training Fee. Accepted applicants will be fully trained until ready to pass rigid test and assisted in securing employment.

ARC WELDING presents one of the outstanding opportunities for steady income and future success. Welding is growing rapidly, replacing large and intricate castings, rivets, nuts, bolts, screws. It is commonly used in assembling cranes, hoists, bridges, structural steel work, etc. No limit to the application of welding to industry, increasing durability and reducing manufacturing costs. There is a decided shortage of properly trained Welding Operators, Technicians, and Welding Engineers. Why be content with ordinary work, hit and miss jobs and low pay when in a short time you can become a trained Specialist in Welding?

MILWAUKEE
SCHOOL of ENGINEERING
Institute of Electrotechnics

Dept. PM-8-A, Broadway & E. State, Milwaukee, Wis.

Without obligation send Free Booklet "The Dawn of a Gigantic Industry and its Outstanding Opportunity." Also tell me How to Become an
Arc Welding Operator (3 mo.)..... Air Conditioning & Refrig. Tech. (3mo.)
Gas Welding Operator..... Radio Serviceman (6 mo.)
Welding Engineer (1 yr.)..... Commercial Electrical Engineer (1 yr.)
Electrical Engineer..... Commercial Radio Engineer (1 yr.)
B.S. Degree (4 yrs.)..... Student Loan Plan
 Earn Part Expense Plan.

Name..... Age.....
 City..... State..... (PM-8-A)



DRAW

Your own check

Be an artist and be your "own boss"! Many of our graduates are making \$35, \$50, \$75 a week in the profitable field of Commercial Art, Cartooning and Designing. Learn AT HOME, in your spare time, this simple, practical way. Start now on your art career, and gain the ability to make big money.

Artists' Outfits Given

As soon as you enroll, we send you a big full-size professional artists' outfit containing everything you need to get started, later on you receive a second big outfit. Since 1914 our graduates have been making good—YOU CAN TOO!

SOLD FIRST COVER DESIGN — to national magazine. Extra income paid for course, says D. PECKHAM, of Nevada.

This FREE BOOK shows how

Washington School of Art, Studio 128A
 1115—15th St., N. W., Washington, D. C.
 Please send me without obligation your Free Book, "Art for Pleasure and Profit."

Name..... Age.....
 Address.....
 City..... State.....
 (No salesman will call)

nection with the First International Philatelic exposition held at Quito, Ecuador. At the right is the 3fr value of a set of two stamps issued by France to honor the memory of Jean Mermoz, an airplane pilot who lost his life last year while in the South Atlantic service, and finally the new Austrian Mothers' Day stamp.

Stamp Notes

A new edition of the official booklet containing a description of all United States postage stamps issued from 1847 to Dec. 31, 1936, has been issued, and for the first time shows illustrations of the stamps. The booklet may be obtained from the Superintendent of Documents, Government Printing Office, Washington, D. C. The price is twenty-five cents for booklets with paper binding, or seventy-five cents for those with cloth binding.

—O—

Postmaster General James A. Farley has announced a new five-cent stamp to honor Virginia Dare, first child to be born to English parents in America. This stamp will be placed on sale on Aug. 18, 1937, the 350th anniversary of the event. It is believed this stamp will be used also for the souvenir sheet promised for the convention of the Society of Philatelic Americans, at Asheville, N. C., on August 26. Middle west collectors will be pleased to learn that a three-cent stamp to commemorate organization of the "Northwest Territory" has been approved for early issuance.

—O—

Complete information has been received on the Czechoslovakian triangular stamps shown in the July number of Popular Mechanics. One of these stamps is red and bears the letter "D" in each corner, the other is blue and has "V" similarly placed. These stamps are used on registered mail. The blue stamp is sold to the public and when affixed to a letter assures the sender that the letter will be delivered to the addressee only. When instructions are left at the post office for registered mail to be delivered to the addressee only, one of the red stamps is affixed to the letter and fifty haleru is collected on delivery. The letter "V" stands for Vyplatni (prepayment), while the "D" stands for Doplatni (postage due.)

Home-Study Business Training

Your opportunity will never be bigger than your preparation. Prepare now and reap the rewards of early success. Free 64-Page Books Tell How. Write NOW for book you want, or mail coupon with your name, present position and address in margin today.

- | | |
|---|---|
| <input type="checkbox"/> Higher Accountancy | <input type="checkbox"/> Credit and Collection Correspondence |
| <input type="checkbox"/> Mod. Salesmanship | <input type="checkbox"/> Modern Foremanship |
| <input type="checkbox"/> Traffic Management | <input type="checkbox"/> Expert Bookkeeping |
| <input type="checkbox"/> Law: Degree of LL.B. | <input type="checkbox"/> C. P. A. Coaching |
| <input type="checkbox"/> Commercial Law | <input type="checkbox"/> Business English |
| <input type="checkbox"/> Industrial Mgm't | <input type="checkbox"/> Effective Speaking |
| <input type="checkbox"/> Business Mgm't | <input type="checkbox"/> Stenotypy |
| <input type="checkbox"/> Business Corres. | |

LA SALLE EXTENSION UNIVERSITY
Dept. 864-R Chicago

BE AN ARTIST

WE CAN TEACH YOU DRAWING in your own home during your spare time. Thirty-five years of successful teaching proves our ability. Artists receive large salaries.

Write today for Art Year Book
SCHOOL OF APPLIED ART
Dept. 107-C, 10 E. Huron St., Chicago, Ill.



EARN WHILE LEARNING AT HOME!

Television, Photo Electric Cells, Public Address Many R-T-1 Trained Men make up to \$75 a week and more in full-time radio jobs—\$5-\$15 in spare time alone. More trained men are needed. Learn at home by quick, easy, R-T-1-WAY. Endorsed by 50 big concerns. Write for big Opportunity Book FREE.

PHILCO CROSLY ZENITH GRUNOW and 46 other mfgs. endorse R-T-1

RADIO and TELEVISION INSTITUTE, Inc.
2130 LAWRENCE AVE., Dept. 1-C CHICAGO, ILL.

NEW Industry NEEDS MEN NOW!

AIR CONDITIONING ELECTRIC REFRIGERATION

Large Air Conditioning and Electric Refrigeration Training Organization now selecting men who would like to prepare for positions as local Service and Installation Experts. Many make \$30.00-\$50.00 a week. No experience needed. We will train you in your spare time for this interesting work. For further facts, without obligation, send your name and address, age, occupation. Utilities Engineering Institute, 400-420 N. Wells St., Dept. 187, Chicago, Ill.



GUITAR

You'll enjoy learning for less than 2c a day. Full particulars Free. Write today.

Hamann Institute of Music, 3016 N. 24th Pl., P-8, Milwaukee, Wis.

AGENTS 500% Profit GOLD LETTERS

For Store Fronts and Office Windows. Anyone can put them on. Free samples. Liberal Offer to general agents. METALLIC LETTER CO., 438 N. Clark St., Chicago

NEW BRUSH PLATING OUTFIT For AUTO PARTS



Connects to a battery with no tanks necessary. Plates on iron, steel, brass, copper, etc. Almost as simple as painting. Hundreds of car owners waiting for this low-cost plating. Improves appearance and value of the car.

Your opportunity to make good income plating auto parts, bathroom fixtures, reflectors, mirrors, etc.

FREE PROOF

Write quick—big season here. Get FREE PROOF and particulars that put you in a paying business of your own.

GUNMETAL COMPANY

AVENUE M DECATUR, ILL.

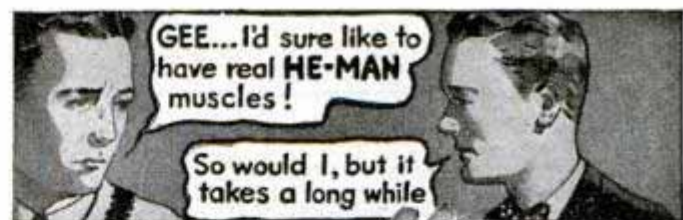

—says Charles Atlas Holder of title, "World's Most Perfectly Developed Man" won in National and International Contests.

"Bunk!"

I'll Prove in the first 7 days YOU can have a Body like Mine!

DON'T get the idea that it takes a lot of time and hard work for you to get smashing strength and powerful muscles! Don't think you need dumb-bells, springs or other contraptions! Both these ideas are all bunk—and I have PROVED it. All I need is 7 days to prove what I can do for you! And I don't need any apparatus either. In fact, I don't believe in artificial methods that may strain your vital organs for life!

NATURAL Methods Are All I Need

Here you see an actual photo of how I look today. No muscles have been "painted on." This is the camera's honest proof of what I did for MY body. Now I'm ready to prove what my secret of Dynamic Tension can do for YOURS!

A few years ago I was a physical wreck, a 97-pound weakling—flat chested, arms and legs like pipestems. I was worried. I studied myself. Then I found a new way to build myself up. A way that was simple, natural, quick and sure! "Dynamic Tension" is what I called it. In a short time I had the body that has twice won the title of "The World's Most Perfectly Developed Man."

Get My FREE Book

Thousands of others now know from their own personal experience what Dynamic Tension has done for them.

This little coupon brings you my free book, which tells all about it. No cost or obligation.

I just want to give you proof that I can do for you what I have done for so many others; give you broad, powerful shoulders, biceps that bulge with smashing strength, a chest which stands out solid and muscular, and an evenly developed body that will make others look like dwarfs next to you. Mail this coupon TODAY! CHARLES ATLAS, Dept. 8X, 115 E. 23rd St., New York, N. Y.

CHARLES ATLAS, Dept. 8X, 115 East 23rd Street, New York, N. Y.

I want the proof that your system of Dynamic Tension will make a New Man of me—give me a healthy, husky body and big muscle development. Send me your free book, "Everlasting Health and Strength."

Name (Please print or write plainly)
Address
City..... State.....

THIS STERLING SILVER CUP BEING GIVEN AWAY

This valuable cup stands about 14 inches high on a black mahogany base. I will award it to my pupil who makes the most improvement in his development within the next three months.

ELECTRICAL TRAINING

APPROVED BY
EDUCATORS

ENDORSED BY
INDUSTRY

For 44 years Bliss Electrical School has been equipping men in one school year for technical positions in the electrical field. Bliss residence training is today's answer to the increased demands of Public Utilities and Private Industries for men with a fundamental knowledge of Electrical Engineering. Suburban campus. Modern shop and laboratory equipment. Excellent faculty. Wholesome, friendly atmosphere. 45th year begins September 29th. CATALOG ON REQUEST!

CONDENSED COURSE
COMPLETE IN
ONE SCHOOL YEAR



118 Takoma Ave., Washington, D. C.

BLISS Electrical School

NEW 1/4-inch
JUNIOR DRILL \$19.95

Write for Details

BLACK & DECKER

608 Penna. Ave., Towson, Maryland

COOK WITH CHEAP OIL Why Burn COAL?

Cool Kitchen in Summer

AT LESS COST
NO WORK - NO
DIRT - NO
ASHES

Revolutionary
New-Type OIL
Burner Slips Into Any Cook Stove

Cooks a Meal for Less ON OR OFF AT
TURN OF VALVE

Beats any oil burner for low cost, perfect performance - burns cheap oil new way without pre-generating or clogging up - Quick heat by Simple Turn of Valve.

TRY AT OUR RISK

30 Days' TRIAL Prove it ends drudgery and dirt of coal or wood; cuts fuel bills in half, pays for itself quickly by what IT SAVES.

FREE SAMPLE offered to one energetic man or woman in each locality who will demonstrate and take orders. **WRITE QUICK.** Be first to learn how to make REAL MONEY spare or full time - mail to postcard today. **UNITED FACTORIES**
K-751 Factory Bldg., Kansas City, Mo.



**AGENTS
SALESMEN
BIG MONEY**

Get YOUR OWN oil burner FREE and make REAL Money. Write now.

GO TO COLLEGE AT HOME!

Courses leading to Degrees in Philosophy, Psychology, Theology, Law, Business, Engineering. Many others. LOW cost; terms. "Chartered by State of Montana." Write for FREE Bulletin.
Temple Bar College, Dept. 2-R, 213 East Main Street, Missoula, Montana, U. S. A.

PATENTS

More than 62 years' successful experience securing good Patents for inventors. Write for FREE booklets explaining Patent procedure, selling inventions, etc.

C.A. SNOW & CO.

Dept. A Snow Building
WASHINGTON, D. C.

RAISE GIANT FROGS

MUFOND GIANTS WEIGH
UP TO 3 LBS. EACH



MARKETS WAITING!

Frog legs in big demand at good prices the year 'round. Millions used yearly!

WE BUY We have one of the largest frog markets in the world. Sell to us in addition to other waiting markets.

Men & Women starting in every state and Canada! Now's the time to begin. Small pond starts you. **FREE BOOK** explains unusual offer to beginners. Get this year's eggs. Write today!

AMERICAN FROG CANNING CO.
(Dept. 133-R) New Orleans, Louisiana

**FREE
BOOK**



Law!

LEARN AT HOME

Are you adult, alert, ambitious, willing to study? Investigate LAW! We guide you step by step—furnish all texts, including 14-volume Law Library. Training prepared by leading law professors and given by members of bar. Degree of LL. B. conferred. Low cost, easy terms. Send NOW for Free, 64-page "Law Training for Leadership." LaSalle Extension University, Dept. 864-L, Chicago

CARTOON YOUR WAY TO SUCCESS!



DON'T COPY—LEARN TO ORIGINATE!

RAYE BURNS will teach you HOW to CREATE ORIGINAL CARTOONS at home that you can SELL! Course contains 26 lessons and over 600 Illustrations. All for Only **\$2.85**. Send name and address for free details. RAYE BURNS SCHOOL, Dept. M-X, BOX 2194, Cleveland, Ohio

LEARN Midland's RADIO TELEVISION

Color-Coded Extension Training fits you for better radio jobs—prepares for future television opportunities. Backed by 5000-watt Columbia basic network broadcasting station, KMBC. Graduates qualified to take Government operator's license exams. Lifetime employment service. All necessary equipment for "home laboratory" experiments furnished; 90 illustrated lessons, 10 laboratory manuals. After "home training," bus ticket to Kansas City for 4 weeks' intensive training in laboratories. Get facts—write for free catalog. MIDLAND TELEVISION, Inc., Power & Light Bldg., 106 W. 14th St., Kansas City, Mo.

HOME STUDY COURSES

Home Study Courses, leading to Degrees in Arts and Sciences; Education; Writing; Psychology; Chemistry; Business and Commerce; Law; Theology; Agriculture; Engineering; also courses in Business Training; Accounting; Advertising; Sales Management; Public Speaking; Radio. Many others. Low Cost; Easy Terms. McKinley-Roosevelt College of Arts and Sciences, 4247 Clarendon Ave., Chicago



DUAL RAY HEALTH LAMP Two Separate Lamps in ONE
ULTRA VIOLET—INFRA RED RAY

Gives SUN-TAN. Promotes Vitamin "D". SIMPLE—easy to operate. Automatic control. 110 Volt AC-DC current. Also Experimental work. Sold with money back agreement. FREE DETAILS. **\$3.90**

Complete with Goggles Ready for Use. Only **\$3.90**

Beyer Mfg. Co. 4515-D Cottage Grove, CHICAGO, ILL. AGENTS WANTED



Earn Cash at Home!

Raise giant Patented Mushrooms! We supply materials, instruct with pictures, & our 25 branches buy all crops. Big FREE book, photos, tell if your cellar, shed, barn, etc., suitable. Write today. Est. 1908. UNITED CO., 3848 Lincoln Ave., Dept. 300, CHICAGO

MIDGET BATTERY OR ELECTRIC RADIOS

World's smallest Loudspeaker Radios Self contained Battery set for farms, etc. All electric for any house lighting current just a handful—Wt. only 1 1/2 lbs. (2 1/4 lbs. for battery model). Size only 3 1/2 x 2 1/2" both models. Has two multi-purpose hi-gain tubes. Hi-efficiency coils and precision p. te.—BUILT IN AERIAL. Midget BUILT IN speaker operates with beautiful tone and clarity on any station including POLICE calls. ACTUAL four tube performance with real distance and punch for so tiny a radio. Easily carried in any large pocket or tucked in knapsack or suitcase. Ideal second or personal radio. Colors to match any room—beautifully finished break-proof cabinets. Only hi-grade parts used—a truly trouble proof midget. Late improvements. Users report wonderful reception in ALL PARTS OF THE WORLD. Electric model uses 110 volts A.C.D.C. (220 volt adapters for foreign use extra.) Battery model has midget batteries inside case. Kit of parts with tubes and diagram \$7.45 either model. WIRED AND FACTORY CHECKED 50c extra or \$7.98 as shown. Send only \$1.00 — pay postman balance on delivery. Guaranteed to operate. Colors Black, Brown, White, Green, Blue (State yours). Set of batteries for battery set \$1.25 extra. (These will last 4 to 6 weeks average.) Order your set now and be pleasantly surprised!

TINYTONE RADIO CO. P-8 KEARNEY, NEBRASKA



fascinating, profitable PROFESSION



NOW OPEN to More Men and Women

If you are looking for a NEW and BETTER way to make a living, take up Swedish Massage. This interesting, big pay profession was for years available only to a few. Its secrets were guarded jealously and fabulous prices were paid for instruction. This same instruction is now available to you at a mere fraction of the former price and you need not leave your present work until you have qualified as an expert and can command an expert's pay. The demand for both men and women has shown a steady increase and few, if any, have lacked employment.

You Can Learn at Home

Turn spare hours into money. Use spare time at home to master a profession which has made thousands of dollars for ambitious men and women. Many graduates have completed this training in three months but take your own time, it need not interfere with other work or pleasure. All instruction prepared by teachers in our famous resident school—the same material is used and a diploma is awarded upon graduation.

Swedish Massage Pays Big A few years ago treatments were given for health only, but NOW seekers of body beauty have learned that here is the best way to secure youthful grace as well as health. Hollywood's stars pay enormous fees to men and women in this profession. Swedish Massage has been credited with almost miraculous results in reducing weight and halting the results of passing years. Magazines and newspapers are full of such stories—you can profit by this publicity.

Reducing Course Alone of Great Value

Many of our students become specialists in reducing. Thousands of men and women pay huge sums to take off fat. This course includes lessons in Dietetics, Reducing Diets, Hydro-Therapy, Anatomy, Medical Gymnastics, in fact everything you need to know to qualify for a Diploma. Everything is written in simple language easy to understand.



Anatomy Charts and Sample Lesson Sheets FREE

Write Now for our amazing offer of Anatomy Charts and Free lesson sheets including illustrations of massage technique. Medical Dictionary, Patented Reducing Roller and Hydro-Therapy supplies are all included in our course without one cent of extra cost. Send the coupon now—there is no cost or obligation.

THE College of Swedish Massage
(Successor to National College of Massage)
1601-1613 Warren Blvd., Dept. C-64, Chicago

THE College of Swedish Massage
Dept. C-64—1601-1613 Warren Blvd., Chicago

You may send me FREE and postpaid, Anatomy Charts, illustrated sample lesson sheets and booklet containing photographs and letters from graduates.

Name.....

Address.....

City..... State.....

**This
MACHINISTS'
Home-Study
Course**



helps men get ahead

Newly assembled—specially priced—these five recent books give you the practical facts on modern machines, up-to-date methods, you need to advance in machine shop work. Take advantage of the other man's experience as found in books, to solve your problems, increase your efficiency, with the new

**Library of MODERN
MACHINE SHOP PRACTICE**

5 volumes—2000 pages—1600 Illustrations
(A combined home-study course and reference library)

This library of machine shop practice was written for practical men. It gives you the best methods for every kind of machine shop work. It fully explains lathes, drills, and other machine tools and their operation, automatic screw machines, speeds and feeds, gear design and production, punch and die work, metal finishing, etc., etc. Plainly written—completely illustrated—the best kind of help to the machine-shop man who wants to advance himself.

No money down—special price—easy payments.

FREE EXAMINATION COUPON

McGraw-Hill Book Co., 330 W. 42nd St., New York

Send me for ten days' free examination the Library of Modern Machine Shop Practice. If satisfactory I will send you \$1.50 in 10 days and \$3.00 monthly until the price of \$16.50 is paid. If not wanted, I will return the books postpaid. (To insure prompt shipment write plainly and fill in all lines.)

Name

Home Address.....

City and State.....

Position

Name of Company..... PM-8-37



**GOVERNMENT
JOBS
START**

**\$1260 to \$2100 Year
MEN — WOMEN**

File Clerks
Statistical Clerks
Postoffice Clerks-Carriers
Railway Postal Clerks
Customs Inspectors
Stenographers-Clerks
Many Other Jobs

**GET READY
IMMEDIATELY**
Common Education
Usually Sufficient

Mail
Coupon
TODAY—
SURE

Franklin Institute
Dept. F-173
ROCHESTER, N. Y.

Gentlemen: Rush to me, FREE of charge, list of U. S. Government big pay jobs. Send FREE 32-page book describing salaries, vacations, hours, work, etc. Tell me how to get one of these jobs.

Name.....

Address.....

**Now—Clean Automatic
LACO Oil Heat**

LOW AS \$49.50
F.O.B. FACTORY

More, Clean, Uniform, "No-Work" Heat—CHEAPER THAN COAL

*No basement needed. *Abundant heat from low priced oil. *Clean. *Automatic. *Uniform temperature. *Beautiful design. *With or without electricity.

Two marvelous new features—nothing else like them:
1. Famous LACO Burner. Most efficient known. Same principle as used in LACO oil burners so successfully for more than 11 years—now improved!

2. Special Inner Heating Unit. Adds large extra heating surface. Increases heat, reduces fuel cost, up to 40 per cent.

LACO'S new Gun-Type marvel of low cost heating. Uses less fuel. Only 1 moving part. Factory-tested. GUARANTEED.

FREE Books Such amazing oil burner values never before offered! Get full details. Send postcard TODAY!

DEALERS: I need more dealers to help make deliveries and installations. WRITE!

LACO OIL BURNER CO.
187 Union Ave., Griswold, Iowa



**SAVE \$100 on
New Pressure Type
LACO**

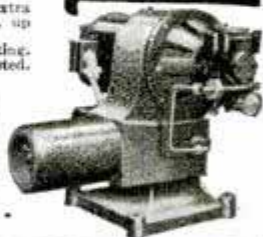

**AMATEUR CARTOONISTS
WIN \$25.00**

Wanted—Amateurs with humorous ideas. No drawing ability necessary. The amateurs of today are the professional cartoonists of tomorrow. Ideas judged and prizes awarded by Applause-O-Meter test before movie audiences.

Everyone has an equal chance. 26 cash prizes in all. Rush name on penny post card for "Valuable Tips on How to Make Money With Simple Cartoons and Humorous Ideas". Cash Prize Entry Blank and Rules—SEND NO MONEY.



CARTOONISTS' EXCHANGE, Dept. 98, Pleasant Hill, Ohio

JOBS for PHOTO-ENGRAVERS!!

EARN WHILE LEARNING PHOTO-ENGRAVING IN SPARE TIME—Photo-Engravers are needed to operate Tasope' Photo-Engraving Equipment we sell to publishers everywhere... Start training at home in spare time. We furnish all equipment including photo-engraving camera with lamps, lens and screen. Earn while learning by making engravings for local advertisers, newspapers, printers, etc. Copper plate for picture shown here, size 8x10 inches sells for \$15.37. SEND TODAY for job plan details and catalog illustrated with pictures engraved by equipment we furnish. No cost! No obligation.

THE AURORA SCHOOL OF PHOTO-ENGRAVING
Dept. 187
Aurora, Missouri



A AND N SUPPLY CO.
Bargains—Military, Sport Goods, Firearms, Clothes, Shoes, etc. Send 10¢ for new catalog, to be redeemed on first order.
EST. 1868 A & N Supply Co., 4772 Lester St., Richmond, Va.

**YOU'LL LIKE RESILVERING MIRRORS,
REFINISHING PLATED**

Articles, Autoparts, Reflectors, Tableware. Making Chipped Glass Name Plates, Signs. Experience unnecessary. Write,

SPRINKLE, Plater, 129, Marion, Indiana

NEW SCIENTIFIC WONDER



10c
3 for
25c

BOYS BIG FUN. You apparently see thru cloth, Wood, Stone, any object. See Bones in Flesh. FREE PACKAGE radio picture films, take pictures without camera. "You'll like 'em." 1 package with each 25c order.
MARVEL MFG. CO., Dept. 80 — **NEW HAVEN, CONN.**



CLASSIFIED

Advertisements

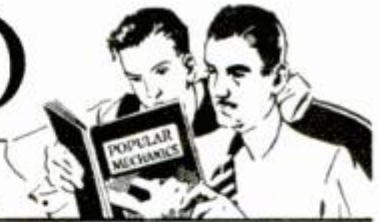

Advertisements in this section, 35 cents per word, each insertion, minimum 10 words, payable in advance

To be inserted under proper classification in September issue, copy should be in our office July 8th

September issue on sale August 1st

Popular Mechanics Magazine, 200 East Ontario Street, Chicago, Illinois

YOU'LL PROFIT

By reading and answering the classified ads in this section. Hundreds of opportunities to make and save money.

Popular Mechanics Magazine,
Chicago, Illinois

Gentlemen:—Your Classified Column tops them all in results! A bit skeptical, we placed an ad during the summer lull. Three hundred replies during the first 30 days and months later still pulling one or two daily!

You can bet the Popular Mechanics Classified Column heads our list of essential advertising mediums.

Very truly yours,

PEEGEE STAMP CO.

(Original letter on
file in our office)

AUTOMOBILES

MIDGET Auto motors! Used, all types. For sport midgets, \$5.00 up; racers, \$10.00 up. List of 65, with illustrated motor information, 20c. Shipps Midgets, Box 543-E, Zanesville, Ohio.

DIESEL—Karp system. Diagrams \$1.00. Newest German invention. Semi-Diesel conversion plans for gasoline motors. More mileage for less money. Parts obtained locally, approximately \$4.50. Box 6384, Los Angeles, California.

MIDGET Cars, plans, parts. Catalog dime. Derby Midget Car, Woodstock, Illinois.

CONVERT Automobile motor into fast pumping air compressor. Instructions \$1.00. Tuck's Garage, 73 Shirley, Pontiac, Mich.

R & R MFG. CO., Anderson, Ind. Racing cars and midgets. Catalogue 25c.

MOTORIST'S "Komic Kards," 25c. (Novel surprise.) David Sanderson, Ottawa, Ill.

SEMI-DIESEL Conversions! Build your own. Flash-chamber system. Blueprint, detailed construction sheets, operation secrets \$1.10. Chute Publishing Company, 163 Sutter St., San Francisco, Calif.

DIESEL Engine "Hi-Lites" illustrations, valuable questions, answers, 25c. Nanesh Mailings, Box 147, Racine, Wisconsin.

LIFE Time oil filters for cars, trucks, tractors, make yourself for less than \$1.50. Plan \$1.00. Parts to be made free with plan. Ben Lehman, Garfield, Wash.

FORD V-8's, 1935-36-37; increases mileage. \$1.00. Walert Co., 3429 No. 10th St., Milwaukee, Wis.

MIDGET Car plans, parts, engines. Circulars dime. Storms, 199 Broadway, Asheville, N. C.

ECONOMY! Performance! Mileage! Semi-diesel conversions for all gasoline motors. \$5.00 up. Deal direct with the manufacturers. Unconditional written guarantee. Special complete units for Ford and Chevrolet. Learn basic facts, illustrated literature free. Des-A-Gas, 1719 Addison, Berkeley, California.

1937 IGNITION Supercharger. Quick starting, wet or cold. Mileage, pep, power, less carbon, \$1.25. E. G. Sales Co., 321 Broadway, New York.

BOOKS Covering hundreds of subjects. Big catalog for 3c postage. Popular Mechanics Press, Room (C37), 200 E. Ontario St., Chicago.

AUTO SUPPLIES AND EQUIPMENT

ALL Parts needed to convert your sedan or tudor into a bed with full plain instructions. \$5. Descriptive literature free. Dealers proposition. Convertible Car Seat Company, 2114 Ames St., Saginaw, Mich.

SILENT Auto burglar alarm. Better, safer, inexpensive. Circular free. Najder Mfg. Co., 1437 So. First Street, Milwaukee, Wis.

CONVERT Your car to burn Diesel oil. Save up to 70% fuel costs. Cheap installation. Wonderful performance. Proven factory method. Different and better. Costs nothing to investigate. Write for free circular No. 4. Harrington Company, 201-204 Manchester Building, Portland, Oregon.

NEW Patented fluid added to gasoline gives more mileage, power, eliminates carbon, guaranteed. Free particulars. Kubelka, 58 East 106th, New York.

DEMONSTRATORS. Compressor, test bench, 8-hour battery charger—are welder. Guaranteed. Trial and terms. Ken's Equipment Exchange, Box M-871, Troy, Ohio.

CURE Oil pumping. Restore pep, power. Increase gas, oil mileage. Easily installed segment rings, piston expanders. Guaranteed. Agents wanted. Haling, 4750A Sheridan, Chicago.

AUTO Body files—Superflex. Send for circular and price list. N. L. Rhyneason Products Co., Anderson, Ind.

NEW Brush plating outfits for automobile parts. Connect to battery. No tanks used. Free particulars and proofs. Gunmetal Co., Ave. J, Decatur, Ill.

CHAMPION Automobile air cooled radio generators. Distributors wanted. List and literature. Wilt Electric Co., 7829 South Racine Avenue, Chicago.

TURN Scrap into money. Convert old auto generators into A.C. generators for auto radio, camp and home lighting, power and other uses. Complete instructions \$1.00 postpaid. Popular Mechanics Press, Room (C37), 200 E. Ontario St., Chicago.

AUTO TRAILERS

GET Going on that house trailer now. Our latest, fully detailed plans with instructions only 10c. Ask for the new parts catalog. It's packed with bargains and it's free to you. Write now. National Trailer Equipment Co., Welsh Building, Milwaukee, Wis.

TRAILER Coupler, adjustable, safe, with lock. \$2.50 postpaid. The Hobby Man, Jefferson, Iowa.

PARTS For the Popular Mechanics "Family Trailer" featured in the February, March and April, 1936 issues. Everything you need—Axle, hitch, wheel housings, water tank, pump, toilet, sink, stove, wood parts, windows, screens, lights, cushions, etc. Send for price list. Include 25c for our big catalog and Trailer Builders' Manual. Trailer Supply Co., 411 Jackson St., Wausau, Wis.

BUILD The famous Jim Dandy cabin trailer—thousands on the road! A roomy, good looking trailer easy to build at low cost by anyone handy with tools. Complete plans and instructions—only 50c—give every detail of chassis, body, top, beds, cabinets, refrigerator, electric light and water systems and where to buy all parts. Can be built in any size to accommodate 2 to 4 people. Send 50c for these practical plans. Rush your order today to Jim Dandy, Box 1125, Wausau, Wis.

WE invite you to submit your trailer requirements. Conventional or folding. Fold-A-Way Trailer Co., Box 642, Davenport, Iowa.

POPULAR Mechanics "Family Trailer," complete illustrated plans for building in Shop Notes for 1937 only 50 cents postpaid. Popular Mechanics Press, Dept. (C37), 200 E. Ontario St., Chicago.

A. C. GENERATORS

PRACTICAL Changes for automobile generators. See our advertisement at bottom of page 135A. Autopower.

MOTORCYCLES, BICYCLES AND SUPPLIES

SEND 10c For Handbook of Information, listing new and used parts, for Indian, Harley, Excelsior, Henderson; accessories, batteries. Bootz, 622 East Grand, Des Moines, Iowa.

REBUILT Motorcycles, all makes, new and used Harley-Davidson parts. Send 10c for bulletin. Western Harley-Davidson Distributors, 914 E. 15, Kansas City, Mo.

SEND Dime for sample racing magazine, catalog Indian and English motorcycles, speed books, racing crash helmets, supplies all motorcycle. New and used motor scooters, great fun. Clymers, 434 W. Pico, Los Angeles, Calif.

ALLOY Pistons—Harley, Indian, Henderson, Excelsior, new or used parts, cylinder grinding. Catalogue and wings pln 10c. Ballak, 1115 Chestnut, St. Louis, Mo.

SEND 15c For illustrated used motorcycle catalog. Bargains. Largest stock genuine Indian parts and motorcycles. Indian Motorcycle Sales, Kansas City, Mo.

RECONDITIONED Motorcycles. New—used parts for all makes. Authorized Harley-Davidson dealer. Whitman Motorcycle & Supply Co., 405-9 Southwest Blvd., Kansas City, Mo.

MOTORCYCLE Bargains, lowest prices, bargain sheets for stamp. Motorcycle accessories. Rochester Harley Davidson Corp., 129 West Main St., Rochester, N. Y.

AVIATION

PROPELLERS For airplanes, fans, sleds. Catalog dime. Lorenzen Propellers, Niles, Michigan.

GET into aviation. Air transport pilots get up to \$7,000 per year; mechanics, \$2,500. Learn at this government approved school. Write for complete information. State age. Lincoln Flying School, 2004 Aircraft Building, Lincoln, Nebr.

YOUNG Men interested in entering aviation under apprentice plan see ad on page 12A.

PROPELLERS For airplanes, generators, fans. Airplanes, motors, supplies. Save 50%. List free. Universal Aircraft, Ft. Worth, Texas.

AIRPLANES \$50 Up. Terms. Motors, crackups, salvage. Complete directory 25c. Used Aircraft Directory, Athens, Ohio.

MODEL Of Wright "Whirlwind" 300 radial engine. Size 13x22 inches, lithographed in colors. By means of an ingenious arrangement of flaps, this model can be practically disassembled and put together again. Shows and names every part. Of great value to aviation students, mechanics and air-minded men and boys. \$1.00 postpaid. Popular Mechanics Press, Room (C37), 200 E. Ontario St., Chicago.

BATTERIES, GENERATORS, ETC.

EDISON Storage batteries for light-power plants. Non-acid, non-sulphating. Long life. Fully guaranteed. Low priced. Also attractive bargains in power-light plants, generators, motors, etc. T. Hawley Smith Company, Croton Falls, N. Y.

ELECTRIC Light plants, 350 watts and up. AC or DC. For use with or without batteries. Priced as low as \$95. Ideal for cottages, camps, trailers, etc. Write for bulletin "G." Universal Motor Company, Oshkosh, Wisconsin.

WIND Generators, propellers, lowest prices. Woodcraft Propellers, Hillside Station, Wichita, Kans.

BUILD Wind light plant from automobile generator. Plans 10c. 50 other generator changes. LeJay Manufacturing, 1647 Lake, Minneapolis, Minn.

EDISON Storage batteries for light-power systems. Non-acid. Odorless, fifteen year life. Five year unconditional guarantee. Bargains in complete lighting systems. Low prices. Free illustrated literature. "See-Jay" Battery Company, 82 Sterling Avenue, Yonkers, New York.

REWOUND Auto generators give 110 volts a.c. for lighting outfit. Complete instructions in Shop Notes for 1937 only 50 cents, postpaid. Popular Mechanics Press, Dept. (C37), 200 E. Ontario St., Chicago.

ELECTRICAL SUPPLIES—EQUIPMENT

MAGNET Lifts 50 times own weight. Recover lost articles. \$1.00 postpaid. Particular stamp. Amfado, 861, Minneapolis, Minn.

HUNDREDS Of new and rare items, replacement parts and supplies. Send 10c for new, 60-page wholesale catalog. Autopower, 410 S. Hoyne Avenue, Chicago.

AT Last! A piece of neon tube for your experiments and testing. One foot, electrodes inclusive, postpaid on receipt of dollar bill. Beacon Neon, Box 693, Daytona Beach, Fla.

ELECTRICIANS: Send for our free list of blue prints. H. Henriksen, A-11, 140 W. 42nd Street, New York City.

REPAIRING Electrical appliances and 330 other money making shop kinks in Vol. 31. Shop Notes, only 50c postpaid. Popular Mechanics Press, 200 E. Ontario St., Chicago.

WELDING AND SOLDERING

ARC-WELDER—40 Volts, 25-200 amperes, direct current. Build it yourself from old North-East, Dodge automobile generators. Low cost and upkeep. Results guaranteed. Certified instructive plans \$1.00, COD. \$1.12. Includes free consultation service for one year. Materials and parts furnished at cost. Welders Club of America, Box 3432-A, Merchandise Mart, Chicago.

ARC Welder only \$39.25. Professional type—110-220 volt. Delivers 110 amperes. Easy to use. Details free. Commonwealth, Dept. Y-55, Cincinnati, Ohio.

ARC Welder; no batteries, generators, transformers. Instructions 25c. 1313 Avalon, Waterloo, Iowa.

DEMONSTRATORS. Electric arc welders. Money-saving prices. Used by the government. Trial and terms guaranteed. Hobart Welders, M-872, Troy, Ohio.

ACETYLENE And electric welding equipment. Box 331, Hamilton, Ohio.

REBUILT Electric arc welders, all sizes, a.c.—d.c. Service Co., 3732 Cedar Ave., Cleveland, Ohio.

DODGE Arc welder plans 35c. 50 other generator changes. LeJay Manufacturing, 1347 Lake, Minneapolis, Minn.

HOW To make efficient small electric spot welder, hundreds other useful devices in Shop Notes, Vol. 29, only 50 cents postpaid. Popular Mechanics Press, Room (C37), 200 E. Ontario St., Chicago.

ENGINES, MOTORS, DYNAMOS

"PEPY" Gasoline engine governor \$7.50 postpaid. Automobile engines made into controlled power plants. Guaranteed. Agents wanted. Harris Machinery, Minneapolis, Minn.

BARGAIN Prices—Small elect. motors, rheostats. Photo and particulars free. McConnell, 1619 Edgewood, Racine, Wis.

SMALL Motor fan unit, \$1.50. For home air conditioning. Arthur Pohl, 2123 Hubbard, Detroit, Mich.

CLOSE Out. Slightly used $\frac{1}{2}$ horse, 110 volt, alternating motors, \$8.50. Wilnot Auto Supply, 2247 St. Paul Ave., Chicago.

GOVERNORS Control speed of any make of auto engine, regardless of load changes, when used for stationary or portable power production. Candee-Smith Governor, 213 N. Los Angeles St., Los Angeles.

ALTERNATING Current bargains. Motors, grinders, fans, clocks, appliances. Bargain price list free. Mailorder Electric Company, 1718 So. Michigan, Chicago.

BARGAIN— $\frac{1}{2}$ HP. a.c. motors, 60 cycle, 1 phase, 110 volt, like new, guaranteed, \$9.50. Send check to Erie Electric Motor Co., 120 Church St., Buffalo, N. Y.

THREE To ten KVA alternating generators. Motors, converters. Queen City Electric, 1730 Grand Avenue, Chicago.

WINDING Data, 225 motors, single and three phase. Price \$1.00. Motor Data Co., Box 7631, Kansas City, Mo.

BOOKS Covering hundreds of subjects. Big catalog for 3c postage. Popular Mechanics Press, Room (C37), 200 E. Ontario St., Chicago.

MACHINERY, TOOLS AND SUPPLIES

SPRINGS? Make your own with our winder. Write for details. Describe unusual spring problems. We make special machines. Myers Spring Winder Company, 109 Jefferson St., Burlington, Iowa.

KELLOGG Air compressors, \$6. Electric refrigerators, \$25. Taylor, 105 East 102nd St., New York.

BARGAINS. Demonstrators, electric arc welders, guaranteed, 30 days trial and terms. Write Ken's Equipment, Box M-873, Troy, Ohio.

LATHE. Bench type, \$39.50. Metal turning. New, Burk Machine, 1314 Prospect Ave., Toledo, Ohio.

EVERY Tractor owner needs Irving's 84 page 1937 tractor replacement parts catalog. Absolutely free. Thousands parts, all makes; tremendous price savings. Irving's Tractor Lug Co., 134 Knoxville Road, Galesburg, Illinois.

FREE Catalog all shapes brass, copper, steel, aluminum, Dowmetal, monel, stainless steel, gears. Hobby Supply House, Box 2014, Pittsburgh, Penna.

15" x 6' SOUTH Bend screw cutting engine lathe, \$175.00. 14" Steptoe crank shaper \$125.00. All sizes of machine tools. Cincinnati Machinery & Supply Company, 27 West Second St., Cincinnati, Ohio.

HOME MADE Band saw, saw table, jointer, grinder and 256 other practical shop subjects in Shop Notes for 1936, only 50c postpaid. Popular Mechanics Press, 200 E. Ontario St., Chicago.

KELLOGG Air compressors, complete with pulley, \$5.95. Send \$3. balance COD. Dealers, agents, distributors, send stamps for wholesale electrical, mechanical catalog. Cmco, 1111 Wash. Blvd., Chicago.

BUILD Self-powered air compressor using Ford model A motor. Detailed instructions three dollar bill. Tritt Electric, Niles, Mich.

BOATS, OUTBOARD MOTORS, ETC.

KAYAKS. Kits. New designs. Maximum stability. Speediest. Safest. Simplified assembly. Catalogue dime. Dedham Kayaks, Dedham, Mass.

PROPELLERS. Gear pumps, stuffing boxes, bearings, etc. Wm. Baker, Pond St., Quincy, Mass.

ASSEMBLE Your own boat. Our finished knock-down frames save you $\frac{2}{3}$ builder's cost. All types and sizes. Send 25c for big catalog. Brooks Boat Company, Inc., D4, Saginaw, Michigan.

15 FT. Canoe \$32.50. Ready to ride. Catalogue free. Jamestown Specialty Company, 377PX, Titusville, Pa.

12-FOOT Flat bottom rowboat—complete plans 25c. Free boatbuilding catalog. The Rudder, 15 Murray Street, New York.

FORD Marine conversion parts and kits. Models A, B, V8 (domestic or foreign). Catalogue 25c (coin). Osmithson, 3101 C St., Philadelphia, Pa.

BOAT Designers are highly paid professionals. Complete course by mail. Catalog. Westlawn, Montville, N. J.

OUTBOARDS—Save $\frac{1}{2}$. Good used parts, all makes and models. Bargains rebuilt motors. Crandall Hicks Co., 780 Commonwealth, Boston, Mass.

KAYAK Construction kits \$9.45 up. Catalogue free. Jamestown Specialty Company, 377P, Titusville, Pa.

BUILD A boat by the Welch system. Ready cut parts, plans and instructions for boats of many types. 10c for complete catalog. Welch Boat & Supply Company, Station K-1, Milwaukee, Wisconsin.

FREE—Boat supply catalog. Sag Harbor Shipyard, Sag Harbor, New York.

BOATS. Camps, motor camping, trailers, outdoor sports, etc. Send for list of special books on. It's free. Popular Mechanics Press, Room (C37), 200 E. Ontario St., Chicago.

SPORTING GOODS, GUNS, FISHING TACKLE, ARCHERY

EXERCISE Equipment, courses. Special offers! Free literature. Good Barbell Co., 947 Elm, Reading, Pa.

FENCING Equipment. Foils, swords, masks, etc. Low prices. Free catalog. Industrial Products, 274 Madison Ave., New York.

GOLF Clubs, bankrupt stock, 4000, new, regulation size and weight, hickory shafts, chromium plated. Right hand irons, \$40.00 per 100. Sample five club matched set \$2.50. No woods. Used on every popular golf course U. S. Lincoln Surplus Co., 516 Chestnut, Freeport, Ill.

KNIFE Throwing instructions, ten cents. Throwing knife one dollar postpaid. Frank Dean, 1294 E. San Fernando St., San Jose, Calif.

"RAISE Earthworms for Profit," practical culture methods, \$1.00. Bureau Zoological Research, 106 Broadway, Peoria, Illinois.

BUCKTAILS. Flytied material. Hofmann Studio, 992 Gates Avenue, Brooklyn, N. Y.

OUTDOOR Sports for everyone—Enjoy them all year round with aid of book published by Popular Mechanics. Hundreds of ideas for new and popular sports for every season; complete instruction for making necessary equipment at small cost. 350 pages and 650 illustrations. \$2 postpaid. Popular Mechanics Press, Room (C37), 200 E. Ontario St., Chicago.

FIELD GLASSES, TELESCOPES AND MICROSCOPES

FREE Literature, price lists and interesting facts for amateur telescope makers. Jamer, Box 4, Bayside, N. Y.

TELESCOPES. Microscopes, binoculars. Lowest prices. Optical catalog free. Brownscope Company, 234 Fifth Avenue, New York.

TELESCOPE. 31 inches extended. Brass trimmed 75c. M. Phillips, Box 48, Chanute, Kans.

USED Microscopes, binoculars, astronomical telescopes, surveying instruments—Bought, sold repaired. Send 10c for list. Rasmussen, P. O. Box 294, Amsterdam, N. Y.

BUILD Reflecting telescopes; catalog free. Instructions 10c. Optical Laboratories, Larchmont, N. Y.

TELESCOPES. Microscopes, binoculars, chemistry, mineralogy. Catalog free. Teeko Optical, 1126 Elmwood, Evanston, Illinois.

FREE Catalog listing microscopes, telescopes, field glasses, chemical and scientific supplies. Send 3c for postage and handling. Kemkit, 397M Bridge Street, Brooklyn, New York City.

BOOKS Covering hundreds of subjects. Big catalog for 3c postage. Popular Mechanics Press, Room (C37), 200 E. Ontario St., Chicago.

ANTIQUES, RELICS, INDIAN GOODS

INDIAN Arrowheads, 5 for 25c. Stone tomahawk, 50c. Send for list. Tom Jevan, 125 W. Center, Marion, Ohio.

OLD Rare Chinese snuff bottles of fine beautiful carved jade, amethyst, carnelian, amber, ivory, turquoise, malachite, agate, porcelain, rock crystal, etc. Many choice pieces. Sales at \$12.50 to \$24.50. Honcan Bough, 1313 Sixth Avenue, New York.

INDIAN Relics, Chippewa and Potawatomie—Write Floyd Schultz, Clay Center, Kansas.

5 **ARROWHEADS** 20c. 3 Birdpoints 18c. Knife, birdpoint, scraper, spearhead 45c. Catalogue, Coins, Minerals, Curios, Lemley Curlo Store, Northbranch, Kansas.

100 **GOOD** Arrowheads \$3.00. Catalog 5c. H. Daniel, Dardanelle, Ark.

TAXIDERMISTRY

MOUNTED Specimens. Glass eyes, supplies. Hofmann Studio, 992 Gates Avenue, Brooklyn, N. Y.

TAXIDERMISTRY Supplies—Quality artificial eyes, teeth, genuine Jonas head forms. Tools, materials, etc. Everything for the progressive taxidermist. Send 10c for big illustrated catalogue. Jonas Bros., 1049 Broadway, Denver, Colorado.

PROFIT And pleasure in taxidermy. Complete guide for the preparing and mounting of animals, birds, fish, reptiles, etc., for home, den, or office. \$1.65 postpaid. Popular Mechanics Press, Room (C37), 200 E. Ontario St., Chicago.

DOGS, BIRDS, PETS

PEDIGREED Puppies. Bought, sold, \$2 monthly. Darwin McFarlin, Delavan, Wis.

LOVE Birds (Parrakeets) are profitable to raise. We supply breeding at reasonable prices and marketing plan for young you raise. Particulars free. J. Sheehan, Box 104, Lemoyne, Penna.

SAINT Bernards—Summer puppies, prices reduced! Dime brings interesting photographic particulars. Royal Kennels, Napierville, Que.

BEAUTIFUL Pure white police dogs. Ansonia Kennels, Mose, N. Dak.

POULTRY AND SUPPLIES

WRITE For new low prices on Salem's "Profit" Chicks. Only one grade. Catalogue free. Salem Hatchery, Box 19, Salem, Ind.

800 **BIRDS** Wormed for 15c! Send \$2.00 for my prescription and instructions. Results guaranteed. Dr. Ramsey, Great Northern Bldg., Chicago.

POULTRY Tribune—America's leading poultry magazine. Five years \$1.00; one year trial 25c. Poultry Tribune, Dept. 93-C, Mount Morris, Illinois.

FARMS AND FARM LANDS

FARMS That pay in the Great Northern Railway agricultural empire, Minnesota, North Dakota, Montana, Idaho, Washington, Oregon. Fertile black soil, high producing crops, grain, fruit, vegetables, feed and livestock. Many kinds of farms for selection. Write for lists and Zone of Plenty book. E. C. Leedy, Dept. 857 Great Northern St. Paul, Minn.

MODERNIZED Farmstead \$900, beauty spot within few steps of mile-long lake; 15 acres, woodlot, good 7-room house, wired for electricity and private plant, furnace, basement barn 38x42; excellent for poultry and vegetables, or summer home; part down, picture page 8 free catalog 1000 bargains. Strout Ag'y, 255-P 4th Ave., New York City.

NEW Farm opportunities! Washington, Minnesota, Idaho, Oregon, North Dakota and Montana. Farm income advancing but land prices still low. Literature. Specify state. J. W. Haw, 119 Northern Pacific Ry., St. Paul, Minn.

40 **ACRES**, Near White River, unimproved; poultry land. \$175, \$5 down, \$5 monthly. Free list and literature. Hubbard, 216 Grossman Bldg., Kansas City, Kansas.

TREES, SHRUBS, ROOTS, HERBS

JUST Out! World's greatest "Herballist Almanac." Beautifully illustrated in natural colors. Contains over 200 old-fashioned herb medicine recipes for home use. 10c postpaid. Worth dollars! Botanica, 145 West 112th Street, Chicago.

PROFITABLE OCCUPATIONS

RAISE Giant mushrooms! We buy! Start cellar, shed, Book, pictures free. United, 3848 Lincoln Ave., Dept. 70, Chicago.

NEW Profession. Plenty business anywhere. Box 12, Madison, Tenn.

"RAISE Giant frogs!" We buy! Unusual offer to beginners. Free book, American Frog Canning, (153-R), New Orleans, La.

FROG Raising. New method publication, American Frog Raising. Introductory price only one dollar prepaid. NuAmerikan Giants (registered), American Frog Publishing Co., 167 South Maple Ave., Ridgewood, N. J.

BOOKS Covering hundreds of subjects. Big catalog for 3c postage. Popular Mechanics Press, Room (C37), 200 E. Ontario St., Chicago.

AGENTS—To mail our literature. Good profits. Home business. Maywood, 149 Fifth Ave., New York.

FREE Booklet describes 107 plans for making \$20-\$100 weekly, in home or office, business of your own. Elite Co., 214 Grand St., New York.

RAISING Jumbo frogs. Interesting. Big future. Females lay 10,000 eggs. Free literature. American Frog Industries, Box 336, Rayne, Louisiana.

BOOKS, PERIODICALS, PICTURES, POSTCARDS

SEND Ten cents for post marked original humorous Old Man Alaska post card showing map and statistics. F. Menager, Kotzebue, Alaska.

BOOKS, Wholesale catalog free. 10c postage. Stephens Bros., 1411 Patricia, Detroit.

EXCHANGE—Postcard views. Addresses 150 exchangers for dime. Dean Fox, Argos, Indiana.

FREE—Beautifully illustrated folder describing new book "Plastics in the School and Home Workshop," first and only text on this interesting new subject, authoritative, complete, 150 illustrations, 100 designs, how to make new homecraft tools, describes professional methods, full of money-saving ideas and designs. Governor Publishing Corp., 30 West 27 Street, New York.

GREATEST Health magazine in its class. 10 big issues \$1; currency, stamps. Thousands satisfied! No postals—Foreign orders. R. 2. B. 87, Alpha, Minn.

YOUR Favorite magazines—Half price. Catalog, 10c. Magazine Exchange, Baseline, San Bernardino, Calif.

THOUSANDS Of old magazines. List 10c. Seeley Service, Jennings, La.

BOY Mechanic—Famous library of 4 volumes covers the building of almost everything a boy might want to make. A great boon to parents and teachers. Actually covers 4,000 different articles. Each volume 460 pages, fully illustrated. Cloth. Price \$2.00 each or set of 4 vols.—\$7.00 postpaid. Popular Mechanics Press, Room (C37), 200 E. Ontario St., Chicago.

GAMES—ENTERTAINMENT

MATCH Book cover collecting is great fun. Albums for mounting without paste, postpaid 60c east, 70c west of Mississippi river. Matchless Album, Grand Central P. O., Box 120, New York.

BE "Different." "Original." Clever ideas for home entertainment. 12—10c, 36—20c. Victor Co., Box 521, Vancouver, Wash.

ILLUSTRATED "Graphology" chart, wholesale directory \$1, currency. Postals ignored! Thousands pleased! Suchan, Alpha, Minnesota.

CARNIVAL Games make you money. Outfits supplied, catalog 10c. "MooreMade," LaPeer, Michigan.

PLAYS, Operettas, musical comedies, complete minstrel first-parts with song programs, blackface skits, vaudeville acts, monologs, dialogs, recitations, juvenile plays and songs, musical readings, entertainments, make-up goods. Catalog free. T. S. Denison & Co., 623 So. Wabash, Dept. 11, Chicago.

MAGIC TRICKS, PUZZLES, JOKER NOVELTIES

SPECIAL—50 Cigarette tricks, 320 page catalogue—Magic, illusions, mind reading spiritualism, ventriloquism—Living and dead experiment, Magic Magazine. All 4, \$1.00. Abbott's, Colon, Michigan.

BE A magician. Send 20c mailing fee for our large catalog. Chicago Magic Co., 2300 N. Mason Ave., Chicago.

LARGE Illustrated magic catalogue 20c. Lynn, Midland Ave., Paramus, N. J.

MAGIC Tricks at lower prices. South's largest line. My famous "Book 1000 Wonders" and "50 Magic Mysteries" postpaid 10c. Write today. You will be surprised. Lyle Douglas, Station A-5, Dallas, Texas.

EARN Money in any crowd. Call names of strangers, tell unspoken questions. Professional course mind reading, spirit writing, etc., \$1. Henderson, Box 341, San Bernardino, Calif.

LARGE Professional magic catalogue, 25c. Holden, 220 W. 42nd St., New York.

LEARN Ventriloquism, 3c stamp brings particulars. Smith, 125 North Jefferson, Peoria, Ill.

TRICK Catalogue, illustrated, 10c. Oaks Magical, Dept. 548, Oshkosh, Wis.

MAGIC Catalogue, illustrated. All the latest tricks, 10c. Frank Lane Co., Little Bldg., Boston, Mass.

200 **TRICKS** You can do—Mystify your friends; have loads of fun. This collection of tricks has been selected by Thurston for the average person. Neither unusual skill nor elaborate apparatus required. 200-page illustrated book. \$1 postpaid. Popular Mechanics Press, Room (C37), 200 E. Ontario St., Chicago.

RARE COINS

\$5.00 TO \$2500.00 Each paid for rare coins. Send 15c for new and interesting 28 page complete buying book. American Coin Company, Box 3507-A, Cleveland, Ohio.

OLD Money wanted. Do you know coin collectors pay up to \$100.00 for certain U. S. cents? High premiums for all rare coins? I buy all kinds. Send 4c for large coin folder. May mean much profit to you. B. Max Mehl, H Mehl Bldg., Fort Worth, Texas.

COIN Collectors—Read "The Numismatist." Monthly news on coins, medals and paper money. Published by the American Numismatic Association. Annual dues, \$3.00. Dues and subscription for last half of 1937, \$1.50. Write for descriptive circular. Suite P, 159 Washington Street, Mount Vernon, N. Y.

COIN Sales list and Indian penny for dime. Acorn Stamp & Coin Co., South Norwalk, Conn.

SOME Specimens 1909 cent worth \$10—We buy certain coins, common and rare—Others worth to \$6000; certain 1864-1865 Indian head cents \$100 each; dimes before 1895, \$450; Liberty head nickels before 1914, \$300; large pennies \$2000; encased postage stamps, \$13; half cents, \$275; half dimes, \$175; quarters, \$300; fractional currencies; paper money; gold dollars, \$1,500; colonial coins, \$300; silver dollars, \$1,000; 1933, 50c, \$4.00; foreign coins \$165, etc. Only certain coins worth top prices, but others have premium value too. Send 15c today for illustrated 1937 coin book, before sending coins. National Coin Corporation (82), Springfield, Mass.

COMMEMORATIVE 3/8s, Illinois, Stone Mountain, Oregon, Texas, Long Island, \$1.50 each. California gold quarter size and illustrated catalogue 25c. Auction catalogue 50c. Norman Shultz, Salt Lake, Utah.

UNITED States. Large cent, 2c bronze, 3c nickel and bargain list, 25c. Eleven dates large cents, \$1.00. George P. Coffin Company, Augusta, Maine.

U. S. COIN Book—Guide to values, just issued. Many special features. Order Burt's, the leader among American coin books, only 50 cents postpaid. Popular Mechanics Press, Room (C37), 200 E. Ontario St., Chicago.

\$5.00 TO \$500.00 Each paid for old coins. Keep all old money. Send 10 cents for illustrated coin value book. 416. Guaranteed prices. Buying and selling. Coin Exchange, Box 5, Le Roy, N. Y.

FREE! Foreign coin, banknote, and large illustrated coin catalogue. Send 4c postage. Coin approvals sent. Tatham Coinco, Springfield-125, Mass.

RARE United States, foreign coins, war medals. Catalogue 10c. Mengelle, Colorado Springs, Colorado.

STAMP COLLECTING

PRODIGIOUS Gift! Scarce Perak, Negri Sembilan, bicolored airmail, cheery French Colonies, picturesque Trinidad, Siberia, Selangor. Absolutely free with approvals! Postage 3c. Saxon Stamp Co., Dept. 65, Albee Bldg., Brooklyn, N. Y.

FREE—New issue service, 100% complete. You are advised of new issues by mail. "No approvals." Frederick A. Newman, Miami, Fla.

CANNON! Set of stamps showing cannon, firing squad, cavalry charge and 200 other different stamps, only 10c to approval applicants. L. H. Reich Stamp Co., 4225 Broadway, Chicago.

15 AIRMAILS Free to approval applicants. Globetrotter, Hotel LaSalle, South Bend, Indiana.

SCARCE Airmail and triangle. Beautiful Uruguay "flying horse" airmail and scarce Guatemala triangle (smallest in the world) are included in our big packet of 60 different stamps from Alouites, Grand Liban, Venezuela, British and French Colonies, etc. All for 5c to approval applicants. Big illustrated lists free with each order. Write today! Mystic Stamp Co., (Dept. 80), Camden, New York.

CORONATION Mint sets. Newzealand 30c, Niue 35c, Cook Islands 35c. Newzealand airmails 25c. Stampco, Box 81, Ashburton, Newzealand.

CANADA Catalogue. Stamp appreciated. No approvals. Rosenbaum, 4119 Decarie, Montreal, Canada.

COSTA Rica diamond airmails, only five cents to general approval applicants. Albany Stamp Exchange, 61 Columbia St., Albany, N. Y.

FREE Set to approval applicants. August Fischer, 235 Citizens Bldg., Louisville, Ky.

BRITISH Coronations, 10c. The best way to acquire "British Coronations" in the easiest manner and at lowest prices is to get them "on approval" from "Approval Headquarters." For only 10c we shall send you five different Coronation stamps from five different countries and then keep on sending you "on approval" both single stamps and complete sets of all 45 Crown Colonies as well as all Dominions and dependencies. Our prices are so low on individual sets and single stamps that no saving is effected if the entire series is bought at once. This astounding service is extended only to regular approval buyers. Do not miss the best issue in many years, get in on the ground floor. You will pay much more later. Get on our mailing list now by sending 10c for your first five Coronations today. Approval Headquarters, Globus Stamp Company, 268 Fourth Avenue, New York City, N. Y. Dept. 50.

COMMEMORATIVE United States, 35 different 25c. Approvals, Leduc, St. Petersburg, Florida.

100 DIFFERENT Stamps 5c, includes Abyssinia, Spain. Catalogue about \$3.00. With approvals. Majestic Stamp Co., Box 72, Sylvania Sta., Fort Worth, Texas.

MAURITIUS, 7 Different, 10c with approvals. Federal, Box 112, Station A, Brooklyn, New York.

APPROVAL Sheets. One to three cents. Frederick B. Driver, 2009 Finance Building, Philadelphia, Pa.

FREE, Free, penny approvals. For every 5 purchased 1 free. Extra premiums, pictorials, airmails, triangles. Scotty Stamp Co., 707 Palisade Ave., Yonkers, N. Y.

SET Of twelve Newzealand pictorials, used 45c, unused \$1. Stampco, Box 81, Ashburton, Newzealand.

PENNY Approvals our specialty. Doty, 315 1/2 No. Atlantic, Alhambra, Calif.

BUYING List of U. S. stamps. Aldrich, Box 744, St. Joseph, Mo.

EXCHANGE Stamps, postcards by "Exchangers," 51 Passage Bureau, Paris 126, France. Particulars free.

HIGHEST Prices for stamp accumulations. Satisfaction guaranteed. Doak, Fresno, Ohio.

LIBERIA And India triangles; Costa Rica airmail diamond; Egypt; Lebanon airmails. Also big packet with many leaders. 6c with approvals. Eureka, No. 602, Burbank, Calif.

20 DIFF. Airmails 15c. Approvals. Oscar Parsons, No. 2, Federalburg, Md.

CORONATION Packet 3c to approval applicants. References, please. J. D. Howard, Box 153, Berkley, Norfolk, Virginia.

"CORONATION Stamps." 45 different mint for \$2.00. "Jewells," Tamaqua, Penna.

FREE! Rare airmail! Jubilee! Pictorials! Extraordinary packet 65 different stamps from strange countries (no Europe). 5c postage to approval applicants. Bargain Co., Box 39P, Station H, New York.

FREE, 50 Stamps, Manchukuo, etc; postage 1c. Album 3c. U. S. bargains! Bullard, 268 Northampton, Boston, Mass.

SURPRISE Offer! Assortment each triangles, airmails, old United States, jubilees, etc. All only 10c to approval applicants. DeVoe, Nichol Ave., New Brunswick, N. J.

LIBERIA Triangles free to approval applicants. Stephen Link, Box 397, Union, N. J.

UNPICKED! 100 U. S. revenues on documents—10c. Vanvorhils, Hyndman, Penna.

STAMP Wallet, etc., three cents to approval applicants. Waldo Stamp Co., 24 Grove Street, Bangor, Maine.

TWENTY Different commemoratives dime, with approvals. Notre Stampco, 4909 North Seeley, Chicago.

PRECANCELS, 50 Different 10c with approvals. W. R. Franson, 3022 N. Kenneth Ave., Chicago.

(FIRST) Stamps, 15 countries 10c. Approvals. Zegel Stampco, Windham, N. Y.

SENSATIONAL Offer! 50 different including airmail, triangle, octagon, jubilee, Edward, only 5c with approvals. Calumet Stamps, 5613 Hohman, Hammond, Ind.

DON Kosack bidding farewell to his sweetheart, the Russian Hero Ilya Murometz included in our special offer with the famous Spanish airmail, Vatican, Venezuela, Persia, Liberian airmail, triangle, rare old 19th century Serbian stamp, Queen Astrid mourning stamp, King Albert and King Leopold, Ex-King Edward of England and a fine lot of French Colonials. The entire collection of 35 different, all good and genuine stamps for only 5c to approval applicants. Frasek Company, Dept. 55, White Plains, N. Y.

\$5.00 U. S. Postage Red Blue Liberty catalog \$1.25, one Coronation stamp, attractive magnifying glass, dictionary telling nationality any stamp, all for 20c with unusual approvals including Coronation. Above dictionary only, free for 3c postage. French American, 1637 Superior, Cleveland.

SUPER-WONDER Packet offered, containing 60 different stamps from Afghanistan, Transjordan, North Borneo, Manchukuo, Sudan, Macao, Iraq, Guadeloupe, French and British Colonies, including natives, beasts, ships, etc., all for 5c to approval applicants. Big illustrated lists free. Kent Stamp Company, G. P. O. Box 87 (8), Brooklyn, N. Y.

BARGAIN! 50 Different British Empire including jubilee, Edwards, 50 different new, recent and pictorial world issues, 15 different airmails, 500 hinges, perforation gauge—all for 25c. Approvals sent. Lists free. Victoria Stamp Co., London 4, Canada.

150 AUSTRIA 1918-24 Issues 25c with approvals. Sompeco, St. Louis, Missouri.

ATTENTION—World's largest diamond shaped airmail, new rare King Edward set, Canadian Niagara Falls, Cartier and others. All 10c provided you desire our approvals. Fair-Play Stamp Service, 1215 Browning Blvd., Los Angeles, Calif.

CORONATIONS, Jubilees, etc. 10c coin. Approvals. Nathaniel Thompson, Ocean Grove, N. J.

"GOLD Nugget" penny approvals. Roald Witmer, Pineapple Ave., Sarasota, Florida.

AIRMAILS—15 Different 5c with approvals. Wollaston Stamps, Wollaston, Mass.

85 STAMP Free to serious approval applicants. State whether beginner, medium, advanced. Twin City Stamp, Kitchener, Can.

APPROVALS Sent. References required. Oulmette's, 1007A Water, New Bedford, Mass.

1000 WORLDWIDE Stamp mixture 25c. Monjar, 1542 Waverly, Cincinnati, Ohio.

88 DIFFERENT United States 25c. Reittar-Imhoff, 111 Jackson, Chicago.

100 DIFFERENT Stamps from many countries 3c with approvals. Badger Stamp Company, 747 North Plankinton, Milwaukee, Wis.

10 VATICAN City, 22c; 25 Cyprus, 38c. Rosenberg, Miller, Indiana.

BIG Bargain! 107 stamps including Peru, Patalia, Swaziland. Dime. Hutter, Cumberland, Md.

EXTRAORDINARY Free offer—Turks Caicos, \$5 U. S., Caymans, Western Samoa (native girl) genuine Baden. Everything free to approval applicants enclosing 3c postage. Viking Stamp Company, 1-Z Hanson Place, Brooklyn, N. Y.

\$1.00 CANADA King George 8c. 15 Irish Free-State 20c. Sompeco, St. Louis, Mo.

QUEEREST Stamp packet. Receive world's smallest stamp; Vatican City; scarce Liberia triangle; 1935 Greek Red Cross picturing coiled snake in Garden of Eden; Australian Bushman; new Spanish Morocco; Japan 'quake stamp; Manchukuo; many others. Only 5c to approval applicants. R. M. Stamp Co., P. O. Box 230P, Port Chester, N. Y.

SUPERIOR Approvals of used United States. Attractive prices. Richards, 229 Mulberry, Newark, N. J.

50 DIFFERENT Angola, Cape Verde, Guinea, Portugal, Mozambique, St. Thomas and Prince—5c. Approvals. Depraw, Ocean Park, Calif.

U. S.—45 Different 10c. Free 25 different with approvals. Enclose 3c. Seidenberg, Baroda, Mich.

WHOLESALE Catalog for dealers. Illustrated. Postage 5c. Frank Co., 4900 Chai-grove, Baltimore, Md.

FREE, 50 Stamps, Manchukuo, etc. Postage 1c. Album 3c. U. S. bargains. Bullard, 268 Northampton, Boston, Mass.

COLLECTORS Illustrated catalogue free—28 pages featuring United States, Canadians, Newfoundland, British Colonials, jubilees, Edwards. Sent for postage or entirely free. Empire Stampco, Dept. P.M., Toronto, Canada.

BRAZIL, 50 Different 10c with bargain approvals. Davis, Silver Lake, Ind.

UNITED States approvals! Reasonable! Serious collectors only! Box 822, Minneapolis, Minn.

FREE!! New King George VI set. Postage 3c. Roberts, 901F Fourth, Baycity, Michigan.

FREE—U. S. \$1, \$2, \$4 and \$5 stamps. Unbeatable U. S. approvals. Nelson, 658 Laurel, St. Paul, Minn.

FREE! "United States, British Colonies and Better-Grade Foreign Stamps"—our valuable illustrated 96-page catalog. Money-saving prices! Send today. H. E. Harris & Co., 137 Transit Building, Boston, Mass.

NEW Rivera nude stamp! World's largest triangle! Congo, Sudan, South Seas, bicolors, pictorials, and many others. Only 3c with approvals. Cactus Junior Approvals, Box 1870, Tucson, Arizona.

MIXTURES—United States 50c lb., 5 lbs. \$2.00; Canada 75c; Belgium \$1.10; France \$1.00; Netherlands \$1.25; foreign \$1.00; Japan \$2.00; postpaid. Mission, 4512 North Racine, Chicago.

LIBERIA Snake triangle, giant Spanish triangle, 50 other stamps, 5c. Wright Company, 2527 Guilford, Baltimore, Md.

4 1/2 TRIANGLES! Guatemala bisect (diagonal half-stamp), beautiful Liberia, three additional triangles, 27 other stamps, 5c. Abell Company, 1818 St. Paul, Baltimore, Md.

MONTHLY Stamp and coin magazine, six months and 25 foreign stamps, 25c. American Stamp Journal, Cedar Rapids, Iowa.

NEWFOUNDLAND, 15 Different 5c with approvals. Frederick Brown, Plainfield, N. J.

FREE—Dollar packet to approval applicants. Harlan, 5307 S. Marshfield, Chicago.

AMAZING Offer! Army and navy commemoratives, imperforate Chicago, packet of 23 North American stamps from U. S., Canada, Mexico, Newfoundland. Catalogue value over 65c—all for 5c to approval applicants. Illustrated pricelist free. Curhan Stamp Co., Dept. P, Gloucester, Mass.

SCARCE New giant sized, diamond-shaped Russian "sports" stamp; Nyassaland "leopard"; Morocco; Tanganyika, and other scarce countries included in our big packet of new and recent issues—stamps most collectors have never seen! Get this valuable packet today. 5c to approval applicants. Reimers, 115 Flatiron, Fort Worth, Texas.

\$5.00 U. S. Postage due, No. 2284, fine copy 5c with general approvals. Hudson Company, 116 Nassau St., New York City.

ILLUSTRATED U. S. list, price 50c, large complete U. S. price list free. Send postage. Stanley Gibbons, 38P Park Row, N. Y.

PENNY Approvals that please. Haywood, 395 Adams St., Pomona, Calif.

AIRMAIL Triangles from Liberia and Mozambique, 3 British silver jubilees, new King Edward stamp and packet 25 different stamps from Azerbaijan, China, Ukrainia, etc. All for 5c to approval applicants. Clipper Stamp Co., Dept. 7, Gloucester, Mass.

ASK For our wonderful one cent approvals. Prospect Stamp Co., 225 Broadview, Toronto, Canada.

FREE—\$1.00 U. S. stamp with request for 52 page list of United States and foreign stamps. Stamps on approval. References necessary. 1 lb. U. S. mixed 40c. New Hussman Stamp Co., 1122 Pine St., St. Louis, Mo.

STAMPS: A splendid selection sent on approval. Quality at low prices. Scarce and high value stamps are included in our approval books. Fred Herzberg, Box 91-P, Elmhurst, Ill.

GIANT-SIZED Russian Zeppelin stamp (cat. val. 20c!) and beautiful Lithuania airmail triangle; also big packet of 53 dif. stamps including Azerbaijan, Epirus, new Martinique, etc. and illustrated lists—all for 5c to approval applicants! World-Wide Stamp Co., Box 600, Camden, New York.

WEEKLY Stamp magazine, thirteen weeks, 10c. Stamp Journal, Kalamazoo, Mich.

PENNY Approvals, that satisfy. Nell Gronberg, Box 5441-P, Philadelphia, Pa.

44 DIFFERENT United States including \$5 stamp, or complete set United States bi-centennials, or 30 different obsolete Canada, 13c postpaid with approvals. C. A. Lennan Co., Box 322, City Hall Annex, New York, N. Y.

\$5.00 U. S. Red and blue liberty, present postage value, Scott No. 573 cat. \$1.25 (retails as high as \$1.00 net by some dealers) only 5c to approval applicants. Giant U. S. pricelist free! Tatham Stamp Company, Springfield-5, Mass.

25 UNITED States, including \$4 and \$5 stamps free to approval applicants. 3c postage. Brownie Stamp Shop, Flint, Michigan.

DIAMOND-SHAPED Stamp, Liberia gunboat triangle, two other triangles, silver jubilee, 27 others, 5c. Crowder Company, 127E North, Baltimore, Md.

PHOTO FINISHING

HIGHEST Class photo finishing in America. Any size roll developed and printed and two enlargements 25c. One dozen reprints and two enlargements 36c. Helen Art Photo Service, Albany, New York.

OIL Colored enlargement with each roll developed, including Acme Gloss prints, 25c (coin). Badger Film Service, LaCrosse, Wis.

DEVELOPING And 8 beautiful double deckle Velox prints, 5x7 enlargement 25c, 3x4 Argus prints 3c. Elkhart Photo Service, Elkhart, Ind.

"LARGER-Prints" from Argus negatives 7c, 127, 129, 116 negatives 10c coin. Williams' Photo, Boise, Idaho.

FILMS Finished with two enlargements 20c. Marvel, 644 Genesee, Morrison, Ill.

FREE Enlargement coupon with every order. Rolls developed, 2 brilliant professional prints of each 25c. New deep-view process. Barclay Studios, 5520 South Shore Drive, Chicago.

SPECIAL Offer: Roll developed and eight Panel Art Deckle Edge dated and certified prints, 35c. Camera book of bargains free. Roanoke Photo Finishing Co., Box N, Roanoke, Va.

BEAUTIFUL 5x7 Enlargements from your favorite negatives 17c each; three for 50c. Eight exposure roll developed and printed 25c. Work guaranteed. Jeems Service, Box 137, Ann Arbor, Mich.

35MM. ARGUS Film, fine grain developing, every picture printed, 25c complete. Witmer Photolab, Sarasota, Florida.

ROLLS Developed and printed 20c. Send names of two other kodackers. Sterling, Box 5556-C, Cleveland, O.

FILMS Developed 2 prints of each 25c; 20 reprints 25c. Pine Photo, M-5134 Nevada, Chicago.

PHOTOGRAPHY For pleasure and profit. Prepare for profitable business or fascinating hobby at home. Previous experience unnecessary. Common school education sufficient. Write for information and requirements. American School of Photography, 3601 Michigan Ave., Dept. 345-C, Chicago.

IMMEDIATE Service. Better pictures. Two beautiful heavy-weight professional enlargements and eight guaranteed Perfectone prints 25c coin. Sixteen pictures from roll 25c. Pictures sent back same day film is received. American Studios, Service Dept., LaCrosse, Wisconsin.

"HOLLYTINTS Mean better prints." Two Hollywood professional enlargements with trial roll—25c. Valuable premium coupons free. Unequaled service. Hollytints, P-1350, Hollywood, California.

20 REPRINTS 25c. 100 Reprints \$1.00. Roll developed with 16 prints 25c. Nordskog, 4, Maywood, Ill.

MAIL Your rolls to film center of the world. Any size roll developed and printed 25c coin. Deluxe enlargement coupon free! Photo Finishing Shop, Est. 23 yrs., 411-L Genesee Valley Trust Bldg., Rochester, N. Y. "The Camera City."

IMMEDIATE Service! No delay! Roll developed, carefully printed and two beautiful 5x7 double weight professional enlargements or one tinted enlargement or six reprints—all for 25c coin. The expert's choice. Reprints 3c each. The Photo Mill, Box 629-Z, Minneapolis, Minn.

BEAUTIFUL Colored enlargement with each film, 25c. LaCrosse Film Company, LaCrosse, Wis.

ROLL Developed, two sets dated Velox prints 25c. Hench Studios, 1814 Chestnut, Harrisburg, Pa.

20 REPRINTS 25c—Films developed, 16 prints 25c. Enlargements 8x10—25c; 5x7—10c. Low Photo, M-2657 Neva, Chicago.

ROLL Developed, 16 guaranteed prints, 25c. Smart Photo, Winona, Minnesota.

MINIATURE Camera owners: Get our prices for fine grain developing and 3x4 Magni prints from your miniature rolls. Work guaranteed and certified. Camera book of bargains free. Roanoke Photo Finishing Co., Box O, Roanoke, Va.

ROLLS Developed—One print and one enlargement of each exposure 25c. Trial. Reprints 20 for 25c. Skrudland, 6968-8 George, Chicago.

ROLLS Developed with choice of three offers for 25c—(1) one print each including two beautiful "Masterprint" enlargements. (2) Two prints each negative (no enlargements). (3) One print each including "oil-colored" enlargement. Order by number. Brown Photo Company, 2209-12 Lowry, Minneapolis, Minnesota.

ROLLS Developed, remarkable quality two master enlargements, eight gloss prints 25c. Reprints 3c. World Famous Johnson Studio, Eau Claire, Wisconsin.

ROLLS Developed, 8 prints, two beautiful glossy enlargements 25c coin. 6 hour service. The Picture Folks, Box 911, Lincoln, Nebraska, Dept. X.

ROLLS Developed, printed, reprints coupon 25c. Hitone, Box 134, Hagerstown, Md.

DEVELOP And print your own pictures. Save time, money with our complete \$1.95 outfit postpaid, or pay postman \$1.95 COD. Includes electric ruby lamp, printing frame, photo paper, chemicals and equipment. One of hundreds of amazing bargains in our free, newest, money-saving bargain book. Send for it today! Central Camera Co., 230 So. Wabash, Dept. 18-K, Chicago.

CONFIDENTIAL Developing, two prints each negative 25c. Royal Photos, 3902 North Sixth, Harrisburg, Pa.

FREE Enlargement. Send negative, 6c postage. Rolls developed, 16 sparkling double-clear neverfade prints and 2 big 5x7 enlargements—25c. Overnight service. Truefoto, 408-3, Des Moines, Iowa.

20 REPRINTS 25c. Rolls developed and 16 prints 25c. Crotty Photos, D1, Menlo Park, Calif.

ROLL Developed and printed. Two enlargements, one of them in colors, all for 25c coin. The Photo Finisher, Station E, Box 42, Columbus, Ohio.

20 REPRINTS 25c; 100—\$1.00. Free—4 enlargements with every roll developed, 25c. Filmco, 679, Albany, Wis.

8 FINE Enlargements per roll. Charge 25 cents. Beat this for a bargain! Hilo, Yale, Okla.

TWENTY Reprints 25c. Roll developed and two prints each negative, 25c. Star Photos, 189 N. Clark, Chicago.

WIN Prize, \$100.00 value offer. Roll developed, 8 guaranteed prints, 2 enlargements, coupon on 8x10 painted enlargement, 25c. Daily service. Midwest Photo, B-54, Janesville, Wis.

\$100.00 VALUE Prize offer. Roll developed, 8 guaranteed prints, oil painted enlargement, coupon on 8x10 painted enlargement, 25c. Immediate service. Janesville Film, A-54, Janesville, Wis.

PROMPT Service—Quality work. Two beautiful double weight gloss enlargements, eight guaranteed neverfade prints each roll, 25c. Excel Photo Service, Dubuque, Iowa.

ROLLS Developed, one print and one enlargement of each exposure 25c. Photoshop, Dunning Station, Chicago.

21 REPRINTS 25c. Rolls developed, two prints each negative 25c. Weick's, 2840 Zenobia, Denver, Colo.

AT Last! All your prints in natural color. Their lifelikeness is outstanding; their beauty amazing. Roll developed, 8 natural color prints, 25c. Fast service. Natural Color Photo, C-54, Janesville, Wis.

GUARANTEED. Film developed, 16 prints 25c; 20 reprints 25c. Introductory offer. Quality Photo, Hutchinson, Kansas.

COMPARE The difference! Roll developed, two professional double weight enlargements, 8 guaranteed prints, 25c coin. Excellent service. Nationwide Photo Service, Box 3333, St. Paul, Minnesota.

GET The best. Roll developed, beautiful hand colored enlargement, 8 neverfade border prints, 25c coin. Prompt service. Sun Photo Service, Drawer T, St. Paul, Minn.

ROLL Developed and 8 guaranteed prints including two enlargements, 25c coin. Super Snapshot, Winona, Minnesota.

BE Modern!—Get Modern service. Modern quality. Modern prices. Our modern methods give quick service and bright guaranteed neverfade pictures. Roll developed 16 prints, 25c coin. 16 reprints, 25c. Enlargement coupon. Send next roll or reprint order to Modern Finishers, 3537-C, St. Paul, Minn.

ROLL Film developed and printed, including two beautiful double weight olive tone enlargements free. 25c coin. Nu-Art Photo Shop, LaCrosse, Wis.

ROLLS Developed. Two professional double weight enlargements, 8 Nu Tone prints 25c. Herman Studio, Ft. Wayne, Ind., 105 Main.

RADIO Film Company, LaCrosse, Wisconsin. Latest in photo finishing. Eight guaranteed prints—two enlargements 25c.

TWO Beautiful portrait type double weight enlargements, eight guaranteed neverfade prints each roll 25c. Dubuque Film Service, Dubuque, Iowa.

ROLLS Developed—Two new Beautitone Duhlwate professional enlargements, 8 guaranteed fadeless Beautitone prints, 25c. Giant Snapshots, Inc., 667A, Green Bay, Wisconsin.

FOR The discriminating amateur—roll developed and carefully printed 25c, reprints 3c. Superior workmanship, same day service. Paramount Co., 327 E. 92nd Street, New York.

IMMEDIATE Service! No delay! Roll developed, carefully printed and two beautiful 5x7 double weight professional enlargements or one tinted enlargement or six reprints—all for 25c coin. The expert's choice. Reprints 3c each. The Photo Mill, Box 629-12, Minneapolis, Minn.

ROLL Developed with 16 prints and two professional enlargements 30c. 100 reprints \$1.00. 16 reprints and 2 enlargements 30c. Dependable, RiverGrove, Illinois.

HAND Colored enlargement with each roll 25c. 40 reprints 50c. Colorgraph, Dunning Station, Chicago.

PROFESSIONAL Quality service. Rolls developed, 8 prints and 2 enlargements 25c. The Film Capital Service, Box 504, Rochester, N. Y.

BOOKS Covering hundreds of subjects. Big catalog for 3c postage. Popular Mechanics Press, Room (C37), 200 E. Ontario St., Chicago.

IDEAL Finishing. Your roll developed and printed 25c. Snapshot folder and enlargement coupon with each order. Ideal Photo Service, Box 2255, Paterson, N. J.

QUICKER Service, sparkling double-clear never-fade prints. Roll developed, two prints each negative, enlargement coupon 25c. Willard's, Box 3535-A, Cleveland Heights, Ohio.

ROLL Developed, 2 prints each negative, 25c. Reprints 2c. Photoshop, Ogden, Utah.

FILMS Developed and printed, also two double weight enlargements 25c, 8 reprints and one enlargement 25c. Photoart Shop, Box 3406 P, St. Paul, Minnesota.

ROLL Developed, two prints each, two enlargement coupons 25c. Summers' Studio, Unionville, Mo.

TWO Glossy enlargements, 1 colored, with roll 25c. Arbor Service, 10 Joliet, Ill.

FINER Finishing. Rolls developed and printed, with one colored enlargement, or two professional enlargements. All for 25c (coin). Genuine, nationally known. Moentone superior quality. Moen Photo Service, La Crosse, Wis.

ROLLS Developed. Two beautiful double-weight professional enlargements and 8 guaranteed Never Fade Perfect Tone prints, 25c coin. Rays Photo Service, LaCrosse, Wisconsin.

ROLL Developed and 8 beautiful Velox glossy prints 25c coin or stamps. Reprints 3c each. Fotoprint Service, Box E, Roanoke, Virginia.

24-HOUR Service, roll Filmachine developed and your choice (1) 8 Finerfotos and 2 professional bromide enlargements; (2) 16 guaranteed Velox Finerfotos or (3) 8 Finerfotos and one beautiful colored (in oil) enlargement, all for 25c coin. Order by number. Finerfotos, Box D-898, Minneapolis, Minn.

CAMERAS, PHOTO SUPPLIES

FREE! Just out! Big new, illustrated catalog of nationally advertised cameras and photographic supplies by Marks & Fuller (in the heart of the photographic industry since 1860). Read about extra liberal trade-in allowance on your present camera. Send for it today. Marks & Fuller, Inc., Dept. PM-11, Rochester, New York, U. S. A.

BASS Is the camera cross roads of the world. Saves you money on the highest-grade cameras. Goldi candid camera F:2.9 lens, Compur shutter, only \$34.50. Voigtlander streamlined convertible miniature takes 16 V. P. or 8 2 1/4 x 3 1/4. F:4.5 Anastigmat, only \$24.75. Voigtlander Superb Reflex, twin lens, Skopar F:3.5 Anastigmat, only \$67.50. Brilliant Reflex F:7.7 lens. A knockout at \$7.50. The famous Argus candid camera, F:4.5 lens, post-paid \$12.50. The above just a few from the hundreds of items from the latest and greatest Bass Bargaingram No. 231. Write for your copy or order direct from the ad. Money-back guarantee. Department A-G, Bass Camera Company, 179 West Madison Street, Chicago.

MAKE Money in photography. Learn quickly at home. Spare or full time. Easy plan. Previous experience unnecessary. Common school education sufficient. Write for full information and requirements. American School of Photography, 3601 Michigan Avenue, Dept. 3431, Chicago.

CAMERAS And supplies. Free illustrated catalog listing everything photographic—still and movie cameras, films, lenses—at tremendous savings. Hundreds of bargains, new and used. All guaranteed. We take your old camera or equipment in trade. Write now for your free copy of our newest money-saving bargain book—just out! Limited edition. Hurry! Central Camera Co., (Photographic Headquarters since 1899), 230 So. Wabash, Dept. 8-K, Chicago.

MINICAM Storage case, holds 40, 35mm rolls. \$5.00 value. \$1.75 and this ad. Mirox, 6241 Southwood, St. Louis, Mo.

PHOTO Enlarger, Automatic, \$5.94. Free circular. Ideal-N, 122 East 25th Street, New York.

CANDID Camera with case, \$4.00 postpaid. The Hobby Man, Jefferson, Iowa.

MAKE Photography a profitable hobby. The Photographic Digest tells how. Send 10c for sample to 1666 Linden Street, Brooklyn, New York.

MAKE Money selling snapshots. Complete instructions, 1800 markets, 10c. Photo Markets, 405-P Evans Bldg., Washington, D. C.

GET Inside! Fire lines; parade lanes; courts. Photographer's Press Card (like reporters) 25c each. Emery Service, Adam St., Pittsfield, Mass.

35% DISCOUNT On films. Write Paramount Photo Division, 327 E. 92nd St., New York.

HAVE You a camera? Send ten cents for recent number of our big magazine, showing how to make better pictures and earn money. American Photography, 116 Camera House, Boston, 17, Mass.

INCOME From your camera instead of expense. Low cost home course teaches you to make photographs for magazines, newspapers, advertisers. Tremendous demand. Earn good money wherever you live. Free book. Universal Photographers, Dept. 104, 10 West 33rd St., New York.

MAKE Money with your camera. New book tells how. 46 pages, 50c. Popular Mechanics Press, 200 E. Ontario St., Chicago.

MOTION PICTURES AND SOUND EQUIPMENT

CLEARANCE Sale—8mm, 16mm listings. Cine, 151 Broadway, Paterson, N. J.

A SQUARE Deal in 16mm films and supplies, new and used. Rentals and exchanges in some lines. List free. Bald Mountain Exchange, Somers, Conn.

CENTRAL'S Free, new, money-saving bargain book explains latest movie developments, offers money-saving bargains in cameras, lenses, projectors, films. Used equipment taken in trade. Write for free copy. Central Camera Company, (Photographic Headquarters since 1899), 230 So. Wabash, Dept. 28-K, Chicago.

16MM EXCEL Motor driven projector, 100-ft. reel, \$3.95. 8 and 16mm. Pop-Eye, Betty Boop, "Our Gang" comedies and others, 3c stamp for catalogue. Excel Home Movies, 622 Madison, Toledo, Ohio.

LOW Rate 8mm-16mm, rental, sale library. Films shipped anywhere. Silent, SOF equipment. Free lists. National Cinema Service, 3 West 29th Street, New York.

"THE World's Greatest Passion Play," 16mm. Seven reels. Sound and dialogue or silent. Superior than Oberammergau play. Write Hemenway Film Co., Church St., Boston, Mass.

CLEARANCE Sale—16mm, 8mm listings. Cine, 151 Broadway, Paterson, N. J.

BARGAINS! 8mm, 16mm. Literature free. Elder, Dept. B-38, Chelsea, Massachusetts.

8-16MM. TITLES, 2c Word. Catalogue. Cineshop, 1560 Jackson, Charleston, West Virginia.

FILMS—8-16MM. List 10c. Spring Films, Westboro, Mass.

35MM. BARGAINS. Shorts, features. Lists. Floyds, 36 Franklin St., Sloan, N. Y.

16MM. MOVIE Titles to order. 1c per word. Wolf, 6858 Stony Island Avenue, Chicago.

16MM. FILMS For sale, rent, exchange. Bargains in equipment. Free catalogue (with sample film 10c.) Parkway Exchange, 1040 Eastern Parkway, Brooklyn, New York.

TALKIE Specials rented, sold. Projectors. Simpson, 1275 South Broadway, Dayton, O.

JUST Released! 8mm-16mm films Donald Duck, Clarabelle Cow, Westerns, Tarzan, comedies, features. Special 8mm titling board for Univex cameras \$3.75. Free catalogue. Hollywood Cine Film Distributors, Dept. C, 1431-33 No. Highland Ave., Hollywood, Calif.

8MM-16MM MOVIE Cameras \$9.95. Film 54c up. Free circular. Bytom, Dept. C, Park Ridge, Ill.

DEVRY Soundfilm 35 projector, amplifier, speaker, complete \$189.50; Leica camera "G" F2 \$150; RCA soundfilm 16mm projector \$198; Victor soundfilm, complete outfit \$159.50; Filmo No. 75 camera \$39.50; professional Eyemo with 4 lenses \$350; Cine Kodak special \$275; 100 ft. 16mm camera film \$1.98 with processing; Kodak 8mm camera projector both \$43.25; Newsreel 16mm automatic \$12.49; Hometaikie converter \$9.95 complete; Coronation, Hindenburg disaster movies; 8mm, 9 1/2, 16, 35 silent, soundisc, soundfilm. America's largest film library. Rentals sent anywhere. Bargaingram; new, used equipment. Trades accepted, bought. Mogull's, 1944-J Boston Road, New York.

READY, Bargaingram 230 of Cine values. Shrewd buyers, send for your copy. Unquestionable quality of merchandise sold on money back basis. Stewart-Warner 16mm, camera 3.5 lens \$18.50. Keystone 16mm, spring-driven 3.5 lens \$16.50. Kodascope Model A projector motor-driven \$22.50. Practically new Victor 24A sound on film projector, 750 watt, \$25.00 value \$275.00. Write to the "Camera Crossroads of the World," Bass Camera Company, 179 West Madison Street, Department A, Chicago.

LEARN Motion picture theatre business. Home-study training; management, advertising, projection. Free catalog. Theatre Institute, Elmira, N. Y.

1001 BARGAINS, Films, cameras, projector. Block, 154 East 47th, New York.

TALKING Films. Sale or rent. Reasonable. Box 155, Virginia, Illinois.

35MM TALKIES—Shorts 75c, features \$7.50. Shermco Film Exchange, 6101 Orchard Grove, Cleveland, Ohio.

16MM CAMERAS, Projectors, all makes and models, new and used, big discounts, trades accepted, films for rent, sale and exchange. Free illustrated catalog with sample film 10c. Garden Exchange, 317 W. 50th St., New York.

16-MM-8 EQUIPMENT. Real bargains. Catalog. G. Taylor, Bx-234, Corning, N. Y.

MOVIE Titles on 8 or 16mm film, 2c per word. These are sharp, printed titles, professionally made. Minimum order \$1.00. Cinema Service, Western Springs, Ill.

CORONATION 16mm. And 8mm. movies 75c up. Popular stars 19c up. Free bargain lists. Home Movies, Box 32, Easton, Penna.

25c FOR Postage and handling brings free 3 art end titles, sample copy big 32 page Home Movies Magazine, lists 8mm-16mm cameras, projectors, films, etc. Pacific 1454 North Gardner, Hollywood, California.

35MM. FILMS Rented, 50c weekly. Lists 3c. Hoffman Film Service, 57 Broad, Albany, N. Y.

15% TO 25% Discount on still or movie cameras. Free circular. Paramount Co., 327 E. 92nd Street, New York City.

RADIOS, SUPPLIES, INSTRUCTION

PLANS 18 Distance record crystal sets; copy "Radio Workbench"—25c. Laboratories, 151-C Liberty, San Francisco.

FORMULA For Galena radio crystals, dime. Tillotson's, Drayton, South Carolina.

RADIO Engineering, broadcasting, aviation and police radio, servicing, marine and Morse telegraphy taught thoroughly. All expenses low. Catalog free. Dodge's Institute, Ames St., Valparaiso, Ind.

MUSIC AND MUSICAL INSTRUMENTS

LEARN "Swing" piano playing. New self-instruction book. Descriptive folder sent free. Axel Christensen, 751 Kimball Hall, Chicago, Ill.

PLAY Guitar quickly. Fascinating new system only 50c. Guaranteed. Century Studios, 813 South Oak Park, Oak Park, Illinois.

MUSIC Arranged for songbooks; orchestra. Address: Frank Wildt, Lancaster, Pennsylvania.

POEMS Wanted. Work guaranteed. We publish. Great Eastern, Thomaston, Maine.

MUSIC Composed to your words. Song published. Reginald Belcher, Chatham, New Jersey. 30 years church organist.

LEARN Banjo, guitar, etc., by easy method. Details free. Neil Duggan, Middleboro, Mass.

COMPOSERS-LYRICISTS, Songs arranged, words or melodies, written or revised by arranger of "Cherry Blossom Lane," "Carolina Moon," "Treasure Island," "Having Wonderful Time," many others. Send for details. Harold Potter, 1619(P) Broadway, New York.

LYRICWRITERS! Composers! Get genuine fifty-fifty partner to work with. "Collaborator," Suite 102, 729 Yonge St., Toronto, Canada.

PIANO! Learn to play quickly. \$1.00. Fair view Music, Houston, Texas.

PIANISTS! Free booklet describes method improving your technique, accuracy, sight reading, memorizing. Write Dept. 422-H, Broadwell Studios, Bendix Bldg., Los Angeles.

SONGWRITERS—Get "Inside Facts" and remarkable special offer. Songwriters Institute, 1234-C Broadway, New York.

SONGWRITERS Professional service. Investigate. Edw. Madden, 1017 Danforth, Syracuse, N. Y.

SONGWRITERS! For best offer and immediate consideration send your songpoem today to Standard Song Service, 1412 Great Northern Bldg., Chicago.

BIG Money in popular music. Details free. National Music Distributors, Garfield Bldg., San Francisco.

SONG Poets, 50-50 plan. Instruction book free. Song Bureau, Salem, Indiana.

SONGWRITERS! Send for free Rhyming Dictionary and Writers' Guide. MMM Publishers, 637 Studio Bldg., Portland, Ore.

SONGS Published, arranged and composed. Royalty basis. West Coast Music Publishing Company, 942 Market Street, San Francisco, California.

SONG Writers. Send for our "Publishing Agreement and Arranging Plan." McKinley Music Publishers, 1501 E. 53th St., Chicago.

PIANO Jazz guaranteed by mail in 20 lessons. Erskine Studios, 810 East 14th St., Oakland, Calif.

WANTED! Lyrics, melodies for songs. We arrange, publish, sell. Superior Song Studios, Passaic, N. J.

SONG Poets wanted—Home, love, sacred, any subject. Send best poem today for offer. Richard Bros., 24 Woods Bldg., Chicago.

VIOLINS—Handmade. Best since Stradivarius days. (Curious don't bother.) John Lehto, San Pedro, Cal.

MUSIC Composed to words. Wonderful proposition. Bauer Bros., Oshkosh, Wis.

WRITE Songs. Big money and reputation. Write for information. J. Gordon Pub. Co., 201 N. Hoyne Ave., Chicago.

BUSINESS OPPORTUNITIES

MAKE Beautiful concrete pottery without moulds. Color concrete surface with chemical solutions. Sample 10c. Hollywood Cement-craft, 8527 Wonderland, Hollywood, Calif.

START Your own business. New profitable field. Men or women. Send postcard for free details. L & A Publishing Co., 321 North Center, Bloomington, Ill.

SMALL Inventions wanted by manufacturers. I'll help you sell your invention. Stanley Hull, M-7829 Euclid Avenue, Cleveland, Ohio.

FORMULAS—Fast selling products. Guaranteed. Laboratory tested. Lowest prices. Catalog free. Kemico, 55H, Park Ridge, Ill.

WHERE To buy almost anything manufactured in U. S. 25c coin. Murray, Box 110, Aberdeen, S. D.

SELL Fried pies to cafes, grocers. Formula in detail \$1. Box 2131, Amarillo, Tex.

SELL Zerpilid, new plant fertilizer. 25c. Sanguist Co., Pomeroy, Iowa.

WANTED—Inventions, ideas, metal stampings, manufacturing, consider anything profitable. Fraizer, 2937 Walnut, Kansas City, Mo.

START Little business anywhere. Make money. No canvassing. Dunn, Box 74, Ionia, Michigan.

SIGNS, Name plates, mottoes easily made. Samples, instructions 10c. Clark, Ellwood City, Pa.

INVENTORS—Small ideas may have large commercial possibilities. Write us for free book, "Patent Guide for the Inventor" and "Record of Invention" form. Delays are dangerous in patent matters. Free information on how to proceed. Clarence A. O'Brien & Hyman Berman, 582 Adams Building, Washington, D. C.

PUBLISH A magazine of your own. Start a mail order business on small capital. Instructions and sample of magazine 10c (coin). Dickson Bureau, 2221 Mahon St., Pittsburgh, Penna.

\$100 STARTS "Chain" of chewing gum and confection vending machines. Steady cash income. Details free. Robbins Co., 1141P DeKalb Ave., Brooklyn, New York.

OPPORTUNITIES, Ideas, plans, secrets. Book 50c. Kulish, Box 806, Mason City, Washington.

HAVE A fine business-profession. Quickly become a collection expert. Very profitable. Free details. Cole Associates, Syracuse, New York.

BOOKS, Check full of money making ideas, formulas, plans, information. Free literature. Sealect Sales, 1144 St. Lawrence Ave., Bronx, New York.

WHY Not be your own boss? Operate collection agency by mail at home. Circular free. Hant Publishing Service, 516 Federal, Pittsburgh, Pa.

PROFITABLE Opportunities. Operating mailorder! Local! Home business! Write, Service Malls, Grand Marais, Mich.

YOU'LL Like resilvering mirrors, auto-parts, reflectors. Making chipped glass signs. Write, Sprinkle, Plater, 127, Marion, Ind.

HOW And where to obtain capital fully explained, free particulars. Star Service, Wapakoneta, Ohio.

I MADE Over \$50,000. Started with \$1.00. You have the same opportunity. I will show you how it was done. Details for stamp. Peris, Box 53, East Rochester, N. Y.

100 PROFITABLE Mail order and local plans. Gilbert Supply, 1107 Broadway, New York.

DOLLARS-BY-MAIL! To win—"You must do something different"—New! Honest! Safe! 6000 word folio—"A Paying vs. a Playing Mail Business"—3c. Dr. Swearingen, Station "S," Los Angeles, California.

REAL Estate offers industrious people wonderful opportunity. Complete course \$2.00. New sales ideas. Folder free. International Research Bureau, 1650 South Sherman, Denver, Colorado.

KEY Tags and dog collar plates. America's finest. 25c coin. Sensational photograph free. Satisfaction or moneyback. J. D. Irwin, P. O. Box 262, Portsmouth, Va.

POSTAL Brings Mail Order Dealer's magazine. Sunflower Mailers, 1202 Mathewson, Wichita, Kansas.

MANUFACTURE Polish pads. Big profits. Instructions 25 cents. Guilford Specialties, Aurora, Nebr.

MAKE Artificial marble, glossy tiles, uncanny. Tabletops, plaques, floors, whetstones, novelties. Hard, fireproof, inexpensive, cement secrets. Brilliant tile and liquid rubber samples 3c. John A. Payn, 945 Grande Vista Avenue, Los Angeles, Calif.

FREE—Sample big moneymakers. No canvassing. Stamp appreciated. Chic-Craft Industries, 557 Mithoff, Columbus, Ohio.

BIG Paying business at home, no canvassing. Free particulars. "Kernish," Ashley, Pa.

RAISE Giant mushrooms! We buy! Start cellar, shed. Book, pictures free. United, 3848 Lincoln Ave., Dept. 69, Chicago.

STOP Squealing—Start crowing!! Work mornings home—drive to country—"movies"—afternoons!! Unusual "plans." No canvassing! Prepare for surprise! Folio-A, Station "D," Los Angeles.

PROFITABLE Mail or local business. Repeats. Sample product, full details 25c. Beauty Glow, Sorento, Illinois.

FREE Booklet 1937 plans. \$100 weekly spare or full time. Wyman, 912 Charlotte, Mishawaka, Indiana.

"4-IN-1" Household necessity. Everybody buys! One piece metal. Homemade. Wonderful moneymaker. Thousands sold Europe. Blueprint, pattern \$1 money order. Satisfaction guaranteed! Jonckheere, 52 Mellery Str., Brussel 2, (Belgium).

BIG Pay, clipping newspapers; investigate. McArthur, Drawer 339-5, Butte, Mont.

DO You want money and a business? Send 25c for a copy of Folio S-4 "Selected Notes and Formulas From the Handbook of a Successful 'Mixer'." You receive in addition other material of interest and value. W. O. Birchfield, Mayo, Florida.

FREE! Our new book describing many money-making plans. Write to Continental Service, 291 McLean Avenue, Yonkers, New York.

WE Start you in business, furnishing outfits and instructions, operating "Specialty Candy Factory" home. Men and women, earn \$25.00 up to \$60.00 weekly, all or spare time. Booklet free. W. Hillyer Ragsdale, Inc., Drawer 4, East Orange, N. J.

BUILD Your own business—Janitor's supplies. Apartment houses, mills, big offices, schools—everywhere there are many people. Steady, permanent. All or part time. New ideas and preparations you control. Learn how for dollar. Milton Manufacturing, Desk P, Drexel Bldg., Philadelphia.

FUN And profit making new household specialty out of wood. Skill easily acquired. Painting and preparing principal job. Sells from your home or work shop. Big demand. We supply plans for making and for profit-making. Stamp for circular. Craft Service Co., 120 Central, Athol, Mass.

MAKE Money! Casting bookends, novelties. Special beginners offering set rubber molds, instructions, \$5.00. Colonial Art Products, Derry, New Hampshire.

PROFIT With new products. Make, sell, repeat. Analysis. Research. Guaranteed formulas. Biggest catalog free. Special prices, leads. Gibson Laboratory, Chemists, BD-1142 Sunnyside, Chicago.

CAN You drive? Make \$70 up, weekly. No selling. Complete details \$1.00. ABN, 1600 Denison, Cleveland, Ohio.

WORLD'S Champion mail order plan. Pays big anywhere. Try it. Write. Madison, 2535 Burling, Chicago.

LIQUID Marble—anyone can make! Colorful, glazed! Moulded, brushed, sprayed. Rubberlastic moulds. Composition flooring. Big money in these! Particulars free. Marbleizing Service, Edwardsville, Illinois.

OPERATE Chain world's finest money making vending machine. Sells four products—same time. Instant success! Small capital—profits immediately. No curiosity seekers. Penny King, 1233 Chouteau, St. Louis.

TAKIGRAFIC—Shorthand complete \$1.00. Folder-lesson 10c. Simmons, Rocky Hill, Conn.

MONEY Making chances offered in the Key to Business Opportunities. Free. F. Spindler, 4628 McPherson, St. Louis, Mo.

CANNED Oysters containing valuable pearls. Details stamp. Ralph Brooks, Arkansas, Wis.

LEARN Marbleizing; crystal cement mixed with water, sets solid in 30 minutes. Novelties, yard ornaments, tables. Interior, exterior decorations. Strictly waterproofed, stainproof. Learn mold making, liquid rubber, sets solid any thickness, in four hours. Free samples. Cowell Institute, Grayling, Mich.

WANTED—500 Journalists, advertising people. Substantial earnings possible. Seltz, 236 North Clark, Chicago.

MANUFACTURE Ten fast sellers from Benzene Crystals. Sample 14c stamps. Western Reserve Laboratories, 6615 Denison Ave., Cleveland, O.

WHERE To buy at lowest wholesale prices. Information free. Yorena, Box M-312, Bayonne, N. J.

MOST Sensational money makers in years. New plans that are hot off the fire! Start mailorder! Home business! Sure big profit makers. Particulars free. Rico Service, Dept. 67, Box 744, Charleston, W. Va.

START Your own neon shop. Write about our training school. Neon Glo-Sign Manufacturing Co., Moose Lake, Minnesota.

WORK With plastics. Experimental kit with generous quantity of material \$1. Plaskit, Box 108, Toledo, Ohio.

REPRESENT New adjustable window sash balance. Two million sold in California. Immense possibilities anywhere. Become factory representative in protected territory. Must have building experience and furnish references. Invest in a small stock. Big returns. P. O. Box 742, West Branch, Los Angeles, Calif.

MAKE Your own products. Employ agents yourself. Toilet articles, soap, extracts. We furnish everything. Valuable book free. National Scientific Laboratories, 1950W Broad, Richmond, Va.

RAISE Needed business capital. We show you how. Write fully. Enterprise Bureau, Syracuse, N. Y.

DELAWARE Charters: Complete service \$35. Submitted forms. Chas. G. Guyer, Inc., Wilmington, Delaware.

\$12,184. PROOF How was made nine months. Legitimate. "Extra Money" Magazine, dime. Long Industries, Elkhart, Ind.

START Little business anywhere. Everything furnished. No canvassing. Maywood, PM-923 Broadway, New York.

CASH Every week clipping and preparing news items for publishers. Simple, fascinating work. Experience unnecessary. Stamp brings information. Division 55, National Press, 3923 West Sixth, Los Angeles, California.

"SCHEMER," Monthly Magazine, Alliance, Ohio, prints schemes, tips, ideas, formulas—big winners—\$10,000 to \$25,000 reported. 39th year; \$1.00. Special: Trial six months only 30c.

MANUFACTURE Newest profit-making specialties from guaranteed formulas, trade secrets, analyses. Complete chemical service. Charges most reasonable. Interesting literature free! Miller, Manufacturers' Chemist, Tampa, Florida.

INVENTION Finance Magazine, 80-G Wall Street, New York. Year subscription 60c entered upon promise to pay on receipt of first copy.

SUCCEED With your products. Make-sell them. Formulas. Processes. Accurate analyses. Catalog free. B. Thaxly Company, Washington, D. C.

PLASTEX Industries offer industrious men an opportunity to start a business of their own, manufacturing art goods, novelties and utility products in Plastex and marble imitation. 1/2c material makes regular 10c store sellers. Rubber moulds furnished for speed production. Small investment brings big returns. Since the crash, low priced goods are needed and this line meets the demand. Interesting booklet mailed free. Plastex Industries, Dept. A, 1085 Washington Avenue, New York.

SELL By mail. Books, novelties. Bargains! Big profits! Particulars free. B. Elco, 438 North Wells, Chicago.

CHARTERS: Delaware; best, cheapest; free forms. Colonial Charter Co., Wilmington, Del.

POPCORN, Crispette, caramels, potato chip, salted nut machines. Long Eakins, 1960 High St., Springfield, Ohio.

ARTIFICIAL Marble sanitary flooring, instructions covering wood or cement flooring 1/2 inch thick, fireproof, all colors, low cost, ornamental casting, concrete, plaster, papier-mache, garden furniture, statuary, flexible molds, particulars free. Chris Mahler, Elmont, N. Y.

FREE Booklet describes 107 plans for making \$20-\$100 weekly, in home or office, business of your own. Elite Co., 214 Grand St., New York.

MAIL Order business is your opportunity. Many began small, now earn thousands yearly. No personal contact. Boundless opportunities. Have had over 30 years experience; will help you succeed. Send 25c for valuable booklets, none free. B. Breniser, 257 South 21st, Philadelphia.

I WANT To send you proof of the wonderful pulling power of Popular Mechanics Magazine's classified pages. What's your proposition? Write me today. F. W. Johnson, Manager Classified Advertising, 200 E. Ontario St., Chicago, Ill.

MONEYMAKING OPPORTUNITIES

PHOTOGRAPHY For pleasure and profit. Prepare for profitable business or fascinating hobby at home. Previous experience unnecessary. Common school education sufficient. Write for information and requirements. American School of Photography, 3601 Michigan Ave., Dept. 344-C, Chicago.

IMPORTED Wall hangings. Profitable home business. Complete \$1. Shrlco, Cash-ton, Wisconsin.

AMATEUR Cartoonists—Win \$25.00. No drawing ability necessary to win 26 prizes in all. Rush name on postcard for valuable tips on "How to Make Money With Simple Cartoons," cash prize entry blank and rules. Send no money. Cartoonists' Exchange, Dept. C-98-B, Pleasant Hill, Ohio.

AFTERNOONS Free! Work mornings home—drive to country—"movies"—after-noon! No canvassing! Prepare for surprise! Folto-B. Station "D," Los Angeles.

MONEYMAKING. Profitable, home work, spare time work offers. Write today. Katz, 4254 N. Kimball, Chicago.

START Home manufacturing business. Big formula catalog 3c. Kemico, 198, Park Ridge, Ill.

LIKE To draw? Earn up to \$35 week, spare time, copying cartoons for advertisers. Ad-Service, Argyle, Wis.

EARN Money mailing circulars. Propositions 10 cents. Lapage, 412 Pine, St. Louis, Mo.

BOOKS Covering hundreds of subjects. Big catalog for 3c postage. Popular Mechanics Press, Room (C37), 200 E. Ontario St., Chicago.

BUILD Profitable business. Latest guaranteed formulas. Expert research, analysis. Write for information. Industrial Institute, Box 3660-AZ, Midse, Mart Station, Chicago.

BIG Profit, make homemade candles. Anybody, anywhere. Recipes and proven selling methods \$1.00. The Candy Jar, Box 107, Corsicana, Texas.

ANALYSIS. Research. Newest guaranteed formulas. Biggest catalog free. Special prices, leads. Gibson Laboratory, Chemists, CS-1142 Sunnyside, Chicago.

EARN \$100.00 Monthly. In spare time, at home. California Earthworm Farms, La Canada, California.

MAIL Trade Guide—Other money-making propositions, 10c. Sanvoy, Arlington, Ky.

MAIL Sale Advertiser 3 months 10c. Devine, MS20 Wrightwood Ave., Chicago, Ill.

HUNDREDS Amazing big moneymaking secrets. No canvassing. Folder free. Herman System, 4518, Massillon, Ohio.

MONEY For you—A legitimate, honest idea that will make you a comfortable living. Plan and full particulars by mail on receipt of one dollar bill. Grant, 277 Broadway, New York.

MAKE \$25-\$75 Weekly with your own business. Details free. Texas Sales Office, Weslaco, Texas.

TURN Spare time into cash with typewriter! 3c stamp brings details. Ace, TPM-3, 322 Empire Bldg., Birmingham, Ala.

VALUABLE Moneymaking opportunities, book 25c. Literature free. Harvey Teepie, Decatur, Ind.

10,000 MONEY-MAKING Formulas. Tells you how to make and sell almost everything under the sun; cosmetics, maulage, anti-freeze solutions, battery solution, beverages, cheese, chewing gum, cleaning preparations, extracts, hair preparations, inks, bluing, leather polish, mirrors, perfumes, polishes, typewriter ribbons, carbon paper, washing powders, liquid soap, and hundreds of other profitable articles. \$4 postpaid. Popular Mechanics Press, Room (C37), 200 E. Ontario St., Chicago.

MOULDS — Guaranteed — for casting toy soldiers, Indians, trappers, warships, sinker moulds, 244 kinds. Send 5c for illustrated catalogue. Henry C. Schiercke, Spencer Road, Ghent, N. Y.

10c BRINGS Copy National Mail Order News, Box 1773PM16, Roanoke, Virginia.

NEW Brush plating outfits for auto parts, reflectors, etc., connect to a battery, no tanks used. Almost as simple as painting. Good income plating and silvering mirrors, low cost. Free proof. Gunmetal Co., Ave. N, Decatur, Ill.

NEW Mailorder and local opportunities. Merchants Sales, 617M North Second, Milwaukee, Wis.

107 PLANS For making \$20-\$100 weekly in home or office business of your own. Descriptive booklet free. Elite Co., 214 Grand Street, New York.

FORMULAS, PLANS, ETC.

SELECTED Formulas. Cosmetics, insecticides, inks—anything. \$1 each. Gordon, 21601 Fenkell, Detroit, Mich.

GUARANTEED Formulas—New fast sellers. None better. Lowest prices. Catalog free. Kemico, 49H, Park Ridge, Ill.

MAKE Bleach water. Formula 50c. Capotosto, 1707 Cranston St., Cranston, R. I.

MONEY Making formulas 2c each. Send for list. Ben Buller, P. O. Box 211, Henderson, N. C.

1938 MONEYMAKERS. 25 Formulas 50c. Fay Smith, 319 Utica St., Waterloo, Ia.

ICELESS Ice! Colder! Cleaner! Cheaper! Instructions, 25c. Duffy, Covington, Ky.

ANALYSIS. Research. Newest guaranteed formulas. Biggest catalog free. Special prices, leads. Gibson Laboratory, Chemists, BD-1142 Sunnyside, Chicago.

THREE Mirror formulas, \$10.00. Silver, gold, gunmetal. Write for information and samples. Nashville Mirror and Sign Co., 179 3rd Ave. N, Nashville, Tenn.

500 MONEYMAKING Formulas 25c. Descriptive literature free. Harvey Teepie, Decatur, Indiana.

SOILLESS Agriculture, raise tomatoes, potatoes, flowers, etc., in shallow tank of water containing 21 chemicals. Tomato vines 20 feet, bear for year, 20 pounds per vine, quality better than soil grown. Instructions, formula \$1.00. Purdy's Chemicals, 1852 E. Slauson Ave., Los Angeles.

MAKE Your own products. Employ agents yourself. Toilet articles, soap, extracts. We furnish everything. Valuable book free. National Scientific Laboratories, 1950W Broad, Richmond, Va.

MOTOR Oil 2c per gallon. You can reclaim used oil, no machinery required. One cheap chemical used. Formula 25c. George, 285 E. Queen, Philadelphia, Pa.

NO More ice bills. Ice Ola keeps food cool. Formula 25c. George, 285 East Queen, Philadelphia, Pa.

CERTIFIED Formulas, best science can produce for making popular, biggest-selling specialties. All lines. Before buying formulas, get my valuable "Eye-Opening" literature, including free subscription to Miller's Monthly Messenger. Miller, Chemist, 1706-A, Tampa, Fla.

SUCCESS With your products. Make-sell them. Formulas. Processes. Accurate analyses. Catalog free. B. Thaxly Company, Washington, D. C.

FORMULAS—Latest money makers. Literature free. Belfort, 4042 N. Keeler, Chicago.

BOOKS Covering hundreds of subjects. Big catalog for 3c postage. Popular Mechanics Press, Room (C37), 200 E. Ontario St., Chicago.

CHEMISTRY

3 RESEARCH Experiments—25c. Keystone Laboratories, 149 Gladstone St., Philadelphia, Pa.

FREE Chemistry catalog. Supplies at 5c! Equip complete laboratory. Send 3c for postage and handling. Kemkit Scientific Corp., 397P Bridge Street, Brooklyn, New York.

ANALYSIS. Research. Newest guaranteed formulas. Biggest catalog free. Special prices, leads. Gibson Laboratory, Chemists, CT-1142 Sunnyside, Chicago.

CHEMICAL Units for experimental chemistry. 40 assorted units in a durable aluminum cabinet for \$2.00. Send for list of contents. Pales Units, Inc., 72 Gold Street, New York City.

RUBBER Latex. Dime brings literature, twenty experiments. Eastern Latex Labs., Box 53, Canton, Mass.

CHEMICALS. Laboratory glassware, apparatus. Send 3c for catalog CP. Biological Supply Company, 1176 Mt. Hope Avenue, Rochester, New York.

AGENTS WANTED

AGENTS Make 200% profit selling "Push." New product. Amazing possibilities. Sample, 25c. Details free. T. R. Gibbs Co., 207 B St. N. E., Washington, D. C.

CHRISTMAS Cards! Absolutely finest assortment. Big profits. Write for samples. Robinson Cards, 338 Orange, Clinton, Mass.

300% PROFIT In new perfected (1937) quick action self-starting cigar lighter. No flint or friction. What makes it light? No wind can blow it out. Retail 50c. Costs you \$2 a dozen. Sample and sales plan 25c. New Method Co., New Method Bldg., Box PM-56, Bradford, Pa.

GENUINE Remington portable typewriter for 10c a day! Men wanted to take orders for this remarkable bargain. M. N. Rand, Remington Rand, Inc., 313 Fourth Ave., Dept. H-50B, New York.

STRANGE Ironing cord and stand! Save electricity. Abolish scorching and lifting. Can't kink or snarl. For telephones also. Big free offer. Sales guaranteed. Samples furnished. Neverknot, Dept. 8-A, 4525 Ravenswood, Chicago.

SENSATIONAL Summer seller. Sells for \$3.00 every home—you make \$2.00 each sale. Good for \$20.00 a day until September 27th. Send name quick for facts and free sample offer. L. B. Patterson, 510 Tenth St., Des Moines, Iowa.

CANVAASERS Buy household products cheaper. Your own literature. Latest deals. Paty Co., Dept. B, Somerville, Mass.

SELL Only (3) wool reversible Chenille rugs to get yours free. No limit to number you may sell. Sample 27x50 inch \$2.55, delivery paid 3 parcel post zone. Return in five days for any reason, money refunded. Extra large and odd sizes made to order, forty color selections. Write for full details. The Oriental Rug Company, Lima, Ohio.

PORTRAIT Agents including foreign countries. Lowest prices portraits, frames. Catalog free. Picture-Man Friedman, Dept. 9, 328 Cornelia, Chicago, Ill.

BIG Money. Fast sales. Your own business. Dunn, Box 74, Ionia, Michigan.

MONEY In butterflies, moths. See Sinclair Display Advertisement on page 12A.

AGENTS Make flavors, lotions, shampoos, medicines—68 products. Your name on labels, materials supplied. Quality Company, F-29030 Russell, Detroit, Michigan.

STARTLING Gas saving device, fastest selling automobile sensation. Splendid moneymaker. Write now. Donneberg's, 820 N. Corinthian, Philadelphia, Pa.

YOU'LL Like resilvering mirrors, autographs, reflectors. Making chipped glass signs. Write. Sprinkle, Plater, 128, Marion, Ind.

TRANSPARENT Neon-like signs, 4c—retails 25c. Celluloid pricing sets, 50% commission. Sample free! Lowy, Department 726, 8 W. Broadway, N. Y.

LOCAL Agents wanted to wear and demonstrate free suits to friends. No canvassing. Up to \$12 in a day easy. Experience unnecessary. Valuable demonstrating equipment, actual samples free. H. J. Graves, Pres., 1300 Harrison, Dept. W-817, Chicago.

NEW Soapless cleaning discovery! Amazing seller homes, everywhere. Sales guaranteed. Free sample. Chicago Products, D-3968 Avondale, Chicago.

450% PROFIT In perfected (1937) quick action automatic gas lighter. No flint or flame. Lights gas instantly. Retail 25c. Costs you \$1.00 for dozen or \$8 for 12 dozen postpaid. Sample 10c. New Method Co., Box PMG-56, Bradford, Pa.

EVERYONE Wearing glasses needs 25c item. Sample 10c. Box 107, Seward, Nebr.

BEST Seller of the year. Mercury Mails, Box 51, Ottumwa, Iowa.

IF You need money—Here's a genuine opportunity to make up to \$45.00 in a week. Operate grocery route business from your own home. I send everything; no money risk. Automobile given as bonus. Details free. Albert Mills, 2370 Monmouth, Cincinnati, Ohio.

DISTRIBUTORS — Welding tool, 300% profit. "Arrow," 4368-W Warren, Detroit.

NEW Items, universal appeal, steady income, investigate. Orahod Sales, West Mansfield, Ohio.

CHRISTMAS Card bargains. Sell 50 personal Christmas cards for \$1. All beautiful folders with customer's name inscribed. Liberal commission. Free samples. Also marvelous value \$1.00 box assortments. General Card, 400 S. Peoria St., Dept. F-54, Chicago.

SELL 8x10 Hand colored photographic enlargements, simulated leather framed. Sells for \$1.25. 50c cash commission. Get free particulars for sample outfit. Economy Studios, Dept. 2908, 150 Nassau Street, New York.

MEN! Women! Luminettes—Electrified real wax candles with novel flame. Brand new. No competition. Instant seller to homes, stores and shops. Liberal commissions. Protected territories. P. J. Neuman, Room 1614, 9 Rockefeller Plaza, New York.

500% PROFIT! Gold reflecting letters for store windows. Large sizes 1c. Free samples. Modernistic Sign, B-3004 Lincoln Ave., Chicago.

SEVERAL Territories open for agent-distributors. Profitable, fast-selling line. Write Sevaco Products Co., 906 Main St., Cincinnati, Ohio.

PROFIT With new products. Make, sell, repeat. Analysis. Research. Guaranteed formulas. Biggest catalog free. Special prices, leads. Gibson Laboratory, Chemists, BD-1142 Sunnyside, Chicago.

RE-NU Automobiles, woodwork like magic, samples. Other products, agents wanted. P. O. Box 768, Waco, Texas.

MAKE Extra money spare time showing my "Exclusive Selections" \$1 assortment 21 Christmas folders. You make 50c a box. Seven other Christmas bargains. Engraved holiday stationery, 50c. Gift wrappings. Write free samples. Schwer, Dept. 38, Westfield, Mass.

SENSATIONAL New zipper clothesline. Instant demonstration—sure sale. Free big money plan. Dunn Bros., Hempstead, N. Y.

\$5.00 HOURLY! Amazing electric saving invention. Free sample. Iron-So-Ezee, Mt. Washington, Ohio.

THYDRO-X (Extra miles). Fast seller! A money-maker! Up to 500% profit! Tremendous market! Year round seller! The bank account builder! Particulars free. Thermo-P Works, Peoria, Ill.

EARN Cash quick! Sell double value Christmas cards. Master creations personal cards, stationery, 7 different assortments, retail 60c up. Make up to 100%. Experience unnecessary. Samples free. Wallace Brown, 225 Fifth Ave., Dept. 110, New York.

GNORMOUS Profits selling Mexican feather pictures. Size 4x9", retails \$1.00, costs you \$2.64 dozen including duty. Free particulars. Sample 30c stamps. Marquez, Apartado 1176-P, Mexico City, Mexico.

JO BO Rubber bow ties. Excellent sideline. Jo Bo Products Co., 3402 School St., Des Moines, Iowa.

AGENTS, Sell metal Social Security plates. Send 10 cents for samples and details. G. W. Reese, 1218 English Avenue, Indianapolis, Ind.

STARTLING Invention—Liquid dispenser. Fast seller. Circulars free. Chandler, 6557 Yale, Chicago.

LEATHER Neckties—Big profits for salesmen. Look finer than silk. Cleaned with damp cloth. Always look new. All styles, colors. Sample tie and sales outfit 50c. Nu-Mode Ties, 1337-A North Twelfth, Milwaukee, Wis.

\$10.00 DAY And expenses easy, selling unique car washing device. Pocket sample. Sells by sight to service stations, fleet owners. No demonstration necessary. BB Chem. Co., Box 418, Gainesville, Tex.

BIG Money applying gold initials on automobiles. Easiest thing today. Free samples. Also, sideline salesmen for name plates and tire cover transfers. "Ralco," 1305 Washington, Boston, Mass.

MAKE Your own products. Employ agents yourself. Toilet articles, soap, extracts. We furnish everything. Valuable book free. National Scientific Laboratories, 1950W Broad, Richmond, Va.

AGENTS: Smash go prices. Santos coffee 12c lb., 4-oz. vanilla 8½c. Razor blades 10 for 8½c. 100 sticks chewing gum 12c. Christmas cards, 21 in box, 14c. 150 other bargains. Premiums. Experience unnecessary. Carnation Co., P.O., St. Louis, Mo.

90c PROFIT On \$1.00 sales. Cleaner for autos, metal and glass. Your name on labels. Free sample. Write. Instant Kleen Lab., Dept. E, Dayton, Ohio.

15,000 PROFIT Making formulas. Following and many others: Accidents and emergencies, agriculture, alloys and amalgams, artist's materials, beverages, cements, glues, pastes, muclages, bleaching, renovating, coloring metals, dyeing glass, heat treatment of metals, household formulas, ice cream, confectionery, chewing gum, lapidary work, exterminating vermin, lubricants, paints, varnishes, photography, condiments, canning formulas, rubber, soap, candles, soldering, toilet preparations, perfumes, waterproofing, fireproofing, writing materials. \$3.50 postpaid. Popular Mechanics Press, Room (C37), 200 E. Ontario St., Chicago.

CHRISTMAS Cards—50 beautiful folders, name imprinted, cost 65c, sell for \$1.00. Marvelous 21-folder assortments sell for 60c and \$1, pay you 100% profit. Be first with this great new 1937 line! Extra bonuses for early sales. Samples free. Start now! New England Art Publishers, North Abington, 256, Mass.

SELL Novelty fun cards, novelties, etc. Samples 10c. National, Box 500M, Cincinnati.

NEW Brush plating outfits for auto parts, reflectors, etc., connect to a battery, no tanks used. Almost as simple as painting. Good income plating and silvering mirrors, low cost. Free proof. Gunmetal Co., Ave. H, Decatur, Ill.

MAKE More money taking orders: Shirts, ties, hosiery, raincoats, uniforms, dresses. Sales kit free! Experience unnecessary. Nimrod Company, Department 8, 4922-28 Lincoln Avenue, Chicago.

GOLD Reflecting window sign letters. Penny each. Large sizes. Easily applied. New styles. Absolutely beautiful. Free samples. Atlas Sign Works, 7941 Halsted, Chicago, Ill.

BIG Money and fast sales. Every owner buys gold initials for his auto. You charge \$1.50, make \$1.45. Ten orders daily easy. Write for particulars and free sample. American Monogram Company, Dept. 40, Dunellen, N. J.

SUCCEED With your products. Make-sell them. Formulas. Processes. Accurate analyses. Catalog free. B. Thaxly Company, Washington, D. C.

ENGRAVED Name plates, numbers, signs, etc., easily sold, profits large. Brett Bros., Winthrop, Mass.

FREE Sample—Amazing cleaner; sells homes, taverns, everywhere. Big profit—fast repeater. Betco, 5007 Irving Park, Chicago.

GENUINE Gold letters for store windows. Easily applied. Free samples. Liberal offer to general agents. Metallic Letter Co., 438-B North Clark, Chicago.

AGENTS—Opportunity to make money; book containing 107 successful business plans; home or office; send for free introductory booklet. Elite Co., 214 Grand St., New York.

WANTED—District purchasing agents. No experience or money required. Write Purchasing Manager, 174 N. Halsted, Chicago.

DO You want agents for your proposition? Your ad in this space will place your message before hundreds of men seeking fast-selling products. My folder "How to Secure Agents" is filled with proof. I'll gladly send you a copy free. F. W. Johnson, Manager Classified Advertising, Popular Mechanics Magazine, 200 E. Ontario St., Chicago.

PROFITABLE Home business. Legitimate. No canvassing. Maywood Publishers, P-923 Broadway, New York.

HIGH-GRADE SALESMEN

NEW Type repair section for saving tires. (Patents pending). Demonstrators months ago deliberately removed test sections, used repair, still using these tires. Furnished with superior solvent. Applied almost instantly, stays permanently. Higher and higher prices crude rubber and tires make this repair more valuable. Manufactured by reliable manufacturer. Wanted, distributors and dealers. Write Western States Mfg. Co., Sioux City, Iowa.

IMMEDIATE Openings for ambitious men! Wear, introduce "Fairbanks" tailored-to-measure clothes, make up to \$10 in a day. Experience unnecessary. Bonus suit offer. Low prices. Quick sales. Free outfit. Permanent! Fairbanks Company, 2305-A Wabasha, Chicago.

REMINGTON Rand will employ local representatives for portable typewriter division. No experience or investment. Unusual opportunity for reliable man. Write M. N. Rand, 315 Fourth Ave., Dept. H-50A, New York.

BOON To pedestrians. Lev-L-Lok, "The Locked Up Lock." Non-competitive. Eliminates projecting hazards on horizontal steel door closures, easily installed. Salesmen, distributors wanted. Lovatt & Radcliffe, 937 E. 26th Street, Paterson, New Jersey.

WANTED—Men for good paying work with a large shoe company. Good pay every day. Free shoes as bonuses to "go-getters." No experience needed. Complete sales outfit sent free. Write Consolidated Shoe System, Dept. G59, Chippewa Falls, Wis.

DON'T Be a job hunter. Start your own business on our capital. No hard times; no lay-offs; always your own boss. Hundreds average \$3,000 to \$5,000 annual sales year after year. We supply stocks, equipment on credit. 200 home necessities. Selling experience unnecessary. Wonderful opportunity to own pleasant, dignified, profitable business backed by world wide industry. Write Rawleigh, Dept. H-U-PPM, Freeport, Ill.

BIG Commissions selling stores celluloid pricing tickets, metal shelf moulding, menu covers, signs, chrome changeable letters. P. Pricing Press, 124 White St., New York.

BIG Profits in your own business. Sell to stores by amazing new plan. Handle regular route. Place nationally advertised line 5c-10c counter display goods—200 products, including Laymon's aspirin—tested, approved Good Housekeeping Bureau. Advertised in Saturday Evening Post. Merchants double profits. You make up to 112%. World's Products, Dept. 8810, Spencer, Ind.

EARN Big commissions daily; cash bonuses regularly. Sell genuine Trubenzed Starchless-Collar Shirts guaranteed one full year. All season's newest styles. Ties, Sox, underwear, also. Expensive new sample outfit free. Write today. Dept. P8, Quaker, Broadway at 31st Street, New York.

SPARKLING Glo-Brite signs sell fast to stores, restaurants, taverns. Lasting gold finish. Plenty profit. J. A. Baxter, Cambridge, Ohio.

NEW Punchboard assortments. Free large colored catalog. Nothing to carry. Larger cash commissions daily. Season now! Add-will Sales Co., 180 Adams, Chicago.

JUST Out! Directory of over 1500 large responsible business firms in every section of the United States who are immediately seeking direct selling salesmen. Full information about their products given. Also names of scores who supply you with complete outfits absolutely free—and pay generous commissions. Send 25c for this large 160 page book. It can be the means of making 1937 your greatest money-making year. Direct Selling Institute, Inc., 75 East Wacker Drive, Dept. B, Chicago, Ill.

I'LL Start you in the products business on my capital. 200 home necessities. Big profits. Quick repeats. Bargain deals. Write today. Ho-Bo-Co., 2745-R Dodler St., St. Louis, Mo.

SELL Nothing! \$95.00 weekly. \$500.00 punchboard firm announces new, no investment plan. Season starting. K&S, Dept. C128, 4329 Ravenswood, Chicago.

YOUR Own business! Become a subscription representative for "Popular Mechanics." No capital needed. Liberal commissions. Monthly bonus. Write for details. Circulation Department, 200 East Ontario Street, Room 491, Chicago.

SALESMEN, Sell world's best Diesel engineering instruction books. Free particulars. Nanesh Mailings, Box 147, Racine, Wis.

GOOD Opportunity in desirable territories to distribute increasingly popular Grafo Products to automotive and industrial trades. Excellent commissions. Write today for information on your territory. Grafo Lubricants Corporation, 6 Grafo Building, Sharon, Pennsylvania.

INVENTION Sharpens scissors. Reliable salesmen needed. Trial offer. Sample 25c. Shear-Sharp, 3413 Clarendon, Cleveland, Ohio.

SALESMEN, Contacting taverns, confectioneries, etc. Send for our new novelty, premium and salesboard wholesale catalog listing thousands of new items at remarkably low prices. Real opportunity for live wires. Write today. Badger Novelty Co., 2546 North 30th Street, Milwaukee, Wis.

FREE Suits, o'coats, pants. Given as bonus besides large cash profits premiums and gifts. Sell only (4) suits to get a free suit. No limit to number of free garments you may earn. Wholesale prices \$17.99-\$21.99-\$24.99. Sample line free. No experience needed to make big money. All garments individually cut and tailored to measure. Satisfaction or money back guarantee. Square Deal Tailoring Co., Inc., 332 South Franklin St., Dept. L-1, Chicago, Ill.

\$10.00 DAY And expenses easy, selling unique car washing device. Pocket sample. Sells by sight to service stations, fleet owners. No demonstration necessary. BB Chem. Co., Box 418, Gainesville, Tex.

SALESMEN: Sell complete line Hammer-mill bond business stationery, book matches, advertising pencils, shelf-moulding, tear-off business cards, labels, salesbooks, garage forms, etc. Free deals, premiums, 35% comm. daily. Free sales portfolio. Willens, 2130 Gladys, Dept. TL, Chicago.

ADVERTISING Book match factory offers you amazing opportunity. We are largest in world selling direct. Big cash commissions, bonuses. Full-part time. Big repeats. Samples and kit free. Dept. E-8, Match Corp. of America, 6041 Grand, Chicago.

MAIL Selling at home, experience unnecessary. We guarantee no canvassing, peddling. Sample, particulars 25c. Sheal, Box 263, Duluth, Minn.

SALESMEN—Distributors for fast selling supplies to welders, auto repair shops, auto body shops. Hercules Products, 325 Roebing Street, Brooklyn, New York.

EARN Free suits as bonus and big profits. Do you know a dozen or two men to whom you can sell fine, made-to-measure suits if you show them big savings? Make easy money. Get own clothes free as a bonus. No experience needed. Work spare time. Prices \$15.95 up. Amazing values. Newest styles—fabrics. Every garment guaranteed. Beautiful outfit sent free. Jim Foster, Inc., 2252-A So. Spaulding Avenue, Chicago, Illinois.

SELL To stores. Excellent proposition. Atigo Co., St. Johnsville, N. Y.

SALESMEN, Distributors, new deal—more profit. Exclusive territory. 125 varieties brushes, mops, specialties. Neway Brush Co., Hartford, Conn.

NEW Burglar proof lock. Fast seller. Salesmen, distributors wanted. Stewart Safety Window Lock, St. Clair Shores, Mich.

MAKE More money taking orders: Shirts, ties, hosiery, raincoats, uniforms, dresses. Sales kit free! Experience unnecessary. Nimrod Company, Department 65, 4922-28 Lincoln Avenue, Chicago.

SALESMEN—Four \$15 sales to stores net you \$40 daily. Sayers Systems, Est. 1895, 2801-123 Sheffield Ave., Chicago, Ill.

SALESMEN: Sell advertising novelties, calendars, fans, thermometers, etc., for nationally known firm. Liberal commissions. Stanwood Hillson Corp., 21 Station St., Brookline, Mass.

NEW Specialty—Sells every business and professional man. Four \$15 sales daily pay \$280 weekly. Ferrell cleared over \$1,000.00 monthly. Write, F. E. Armstrong, President, Dent, PM, Mobile, Ala.

BE Your own boss. Make the largest commissions selling our complete line of brushes. Write for sales plan. Wire Grip Sanitary Brush Corp., 220 Southern Boulevard, N. Y.

BRUSH Salesman—If you ever sold brushes write for our money making proposition. Donald Brush Co., Camden, New Jersey.

FREE Booklet describes 107 plans for making \$20-\$100 weekly, in home or office, business of your own. Elite Co., 214 Grand St., New York.

SALESMEN—Sideline free pocket samples patent punchless checks and guest checks. Sells to hotels, restaurants and soda fountains. Commission on reorders. Standard Check & Menu Co., 348 N. Ashland Ave., Chicago, Ill.

MECHANIC Salesman wanted. Sell new patented inexpensive electrical trouble shooter. Every repairman buys on demonstration. Qualified men making \$75.00 weekly. 2812 Gillham, Kansas City, Mo.

HELP WANTED

IF You want to get groceries at wholesale and make up to \$45 in a week besides, send me your name immediately. No experience necessary. New Ford sedan given you as bonus. Albert Mills, 2364 Monmouth, Cincinnati, Ohio.

MONEY In butterflies, moths. See Sinclair Display Advertisement on page 12A.

STEADY Income. Home work. Experience unnecessary. Jankus, Box 103, Kenosha, Wis.

UNEMPLOYED? Desire a better job, perhaps? We can help you. Write Keith Service, Ogallala, Nebraska.

EDUCATIONAL AND INSTRUCTION

BUMPING, Welding, metal finishing, soldering, taught. Men getting jobs. Factory Trade School, 8807 Harper, Detroit, Mich.

ENGINEERING Drawing pays big. Pleasant work. Easy home study course. Free tools. Write, Morris Dunn, Ionia, Michigan.

WATCHMAKING. Lessons, practice movement \$1.00. Catalogue 5c. Tools, material. Stewart's, 721 Olive, St. Louis, Mo.

WORK For "Uncle Sam." Start \$1260-\$2100 year. Try next held examinations. List positions and particulars telling how to get them—free. Write today. Franklin Institute, Dept. F3, Rochester, N. Y.

BECOME Business Investigator—Make money in your spare time—pleasant work—good fees. Details free. Business Detective System, 1009 Oak, Elmira, N. Y.

BECOME An Investigator—Secret service agent. New "Test Problem Method." Develops your ability. Particulars free. International Secret Service Institute, (PM87), Hoboken, N. J.

LEARN Massage, physiotherapy—Free literature. Dr. Crandalls Institute, York, Penna.

MAKE More money. Get a U. S. government job. Get our new plan for obtaining one—no obligations. Age 18-50. Write. Instruction Service, 101, St. Louis, Mo., immediately.

SECRET Investigations. Excellent opportunity. Particulars free. Write George Wagner, M-2640 Broadway, New York.

COLLEGE Courses at home. Degrees—Psychology, engineering, law, many others. Free bulletin. Temple Bar College, Missoula, Montana.

LEARN Lettering \$1 complete course. Northeastern School of Lettering, Bangor, Maine.

DOUBLE Entry bookkeeping mastered 60 hours with keys. (Diplomas.) International Bookkeeping Institute, 8, Springfield, Mo.

PHOTO-COLOR—Learn at home—Easy method. Make money. Complete course only \$1.00. W. Greener, St. Johns, Michigan.

LEARN About Alaska! Thrilling, illustrated stories, articles on game, mining, industries. Send 15c single copy; \$1.50 year. The Alaska Sportsman, Box C-142, Ketchikan, Alaska.

BIG Bargain catalogue educational matter 19c. Hanfling, Y-799 Broadway, New York.

BLUE-PRINT Reading taught by mail. Write Blueprint Reading Institute, Box 5662, Metropolitan Sta., Los Angeles.

AMBITIOUS. Alert men trained to qualify as insurance claim adjusters—Complete courses: resident school and homestudy by the author of the outstanding publications on claims in the nation. Enrollment limited to placement possibilities. Act now. American Adjusters Institute, Des Moines, Iowa.

HOMESTUDY. Trimester doctor course. Earn while learning. Collegium, S-Whitley, Ind.

HOME Study engineering courses leading to degrees. Mechanical; electrical; Diesel; civil; aeronautical; automotive; chemical; radio and others. McKinley College of Engineering, Chicago.

GET \$50 To \$87.50 every pay day on Uncle Sam's payroll. Many appointments expected soon. Our coaching helps qualify you for Social Security, liquor gauger, meat inspector, office clerk, stenographer, typist, customs, postal and many other positions. Write today for free book, list of positions, etc. Patterson School, (Arthur R. Patterson, former Government examiner, Principal), 8 Case Bldg., Rochester, N. Y.

MASSAGE, Hydrotherapy, dietetics, drugless therapeutics, chiropody, taught by Mrs. Evans Correspondence School, Montgomery, Ala.

LEARN Machinist trade, tool, die making. Automatic and hand screw machines. Modern shop methods. Actual work. Jobs open for trained men. Employment help. Illustrated booklet free. Allied Screw Machine Company, 601 Lake Street, Chicago.

LEARN Auto mechanics, body, repairing, welding, electricity, refrigeration. Diesel. Stevinson's, 2008A Main, Kansas City, Mo.

LEARN Latest methods solving arithmetical problems quickly. Frederick A. Smith, 2410 Smalley Court, Chicago.

OFFICIAL Refrigeration Service Manual. Electric. Gas. Be a service expert. Every refrigerator part explained. Diagrams shown. 400 pages. Loose leaf. Leatherette binding. \$5.00 postpaid. Popular Mechanics Press, Room (C37), 200 E. Ontario St., Chicago.

PLAYS—STORIES—MANUSCRIPTS

SCREEN Writers—Movie plot digest supplies story ideas. Sample 25c (coin). Friedman, 1146 Ogden, New York.

STORIES Wanted to sell on commission. Unusual sales plan. Crown Service, 917 Shreve Bldg., San Francisco, California.

WANTED—Unusual manuscripts for publication. Fortuny's Publishers, 45 West 45, New York.

CARTOONING AND COMMERCIAL ART, SHOWCARD WRITING, SIGN PAINTING

SIGN Painting letter patterns ready to use for quick layout. Illustrations postpaid. Headquarters for home-study showcard lettering instruction. Thompson School, 872-3, Pontiac, Michigan.

COMPLETE Cartooning course consisting of spiral bound book of lessons, drawing board, Tee-square, triangles, pens, pencils, India ink, brushes, eraser, tacks, pencil pointer, tracing paper and drawing paper. \$2.00 prepaid anywhere. Cash, check, money order or stamps. Cardinell, Montclair, N. J.

SILK Screen process. See our ad under Printing Outfits. Artset Company.

AMATEUR Cartoonists—Win \$25.00. No drawing ability necessary to win. 26 prizes in all. Rush name on postcard for valuable tips on "How to Make Money With Simple Cartoons," cash prize entry blank and rules. Send no money. Cartoonists' Exchange, Dept. C-98-A, Pleasant Hill, Ohio.

CARTOONING, Sketching, etc., by Alexander Murray. 46 lessons, 600 illustrations, including practice sheets, pens, pencils, drawings criticized. \$1.00 complete. Singer Service, 1782 E. 190th, Cleveland, Ohio.

CARTOONING, Sketching, etc., by Alexander Murray. 46 lessons, 600 illustrations, including practice sheets. Special price: 50c. Fraba Service, Cashton, Wisconsin.

DRAWING Course by Alexander Murray 50 cents. Ancasco, Box 271, Rochester, New York.

CARTOONING Course: Thirty illustrated lessons, over 500 drawings, pens and pencils, \$1.00 complete, postpaid. Scovell Studios, Box 748-P, Hollywood, Calif.

AMATEUR Cartoonists, earn up to \$35.00 weekly, copying cartoons for advertisers. 3-M Service, Argyle, Wisconsin.

ADVERTISING AGENCIES—FOR ADVERTISERS

LEARN Advertising quickly at home. Easy practical plan. No text books. Common school education sufficient. Interesting booklet and requirements free. Page-Davis School of Advertising, 3601 Michigan Avenue, Dept. 3431, Chicago.

ADVERTISE. Sell by mail. Booklet free. Goodall, 742 Market, San Francisco.

WEATHER Forecasters. Excellent advertisers or premiums. Six, 25 cents; hundred, \$2.75. Lorraine, 307 Pearl Street, New York.

MATCHES—2,500 Books \$8.95. Quick cash sales. Rush printing instructions. Sanderson's Book Matches, Ottawa, Illinois.

ADVERTISE: 5 Lines 100 national mail order publications \$4.00. Lists free. Advertising Bureau, 4515-C Cottage Grove, Chicago.

INCH Display advertisement 30 magazines year \$24. Wood's Popular Services, Atlantic City, (N. J.)

ADVERTISING Placed anywhere. Helpful, free service. Rate guide book free. Baker Advertising Agency, 189 W. Madison, Chicago. Successors to Ankrum Advertising Agency. Established 27 years.

ADVERTISE Profitably: \$15 reaches 6,000,000 Sunday newspaper readers with 24 word ad. Newspaper, magazine rate-guide, free. Chicago Union Agency, 20 West Jackson, Chicago.

FREE—New Advertisers Rate Guide, 44 pages. Includes everything. Lowest rates. E. H. Brown Advertising Agency, 140 S. Dearborn, Chicago.

BUSINESS SERVICE

CHICAGO: Branch office service. Business, personal, smartest address in Chicago. Commission accounts given consideration. Personal representation. Investigate. Telephone Mail Secretariat, Pittsfield Bldg.

WASHINGTON, D. C., mail address. For business or personal purpose. Hawkins Mail Service, 817 Fourteenth.

MANUFACTURER'S Addresses, any line, 25 for \$1. National Service, 35 N. Ninth, Columbus, Ohio.

"1,000 WAYS To Make \$1,000.00." You can do it—others have. This new amazing book will startle you. 475 pages only \$2.50. Popular Mechanics Press, Room (C37), 200 E. Ontario St., Chicago.

MAIL SERVICE

\$1.00 MONTHLY Maintains New York office. Co-operative Mail Service, 126-P Lexington Ave.

RUBBER STAMPS AND OFFICE SUPPLIES

CUSHION Mounted, one-two lines 25c, three 35c. Signatures \$1.50. Office printing outfits. Stamp Works, 814 Bradley, Peoria, Ill.

QUALITY Rubber stamps, two lines, 35c. Frank Landis, Auburn, Nebr.

NAME, Address, 2 lines 25c; 3 lines 35c. Stamp Works, Auburn, Nebr.

2 LINES 25c, 3 Lines 35c. Stamprite, FP43, Springfield, Mass.

2 LINES 25c, 3 Lines 35c. Stamp Works, Centerport, N. Y.

TYPEWRITERS, DUPLICATORS, OFFICE DEVICES

OFFICE Machines, new, used. Reasonable prices. Mitchell's, 10407 Lexington, Kansas City, Mo.

TYPEWRITER Ribbons 50c. Worth \$1. Guaranteed. Lee Gooch, Hernando, Miss.

UNIQUE Pocket calculating machine with instructions. Adds, subtracts. \$1.00 postpaid. McGovern, Box 255, Station A, East Liverpool, Ohio.

NEW \$3.75 Automatic adding machine. Fully guaranteed. Bassett, Box 302A, Altadena, California.

INCREASE Business now. "Excellograph" Rotary Stencil Printer reprints thousands everything you typewrite, handwrite, draw or trace. Colors. \$19.75 to \$44.00. Terms. Illustrated literature free to business or professional men. Pittsburgh Typewriter Supply, Department K-2, Pittsburgh, Pa.

TYPEWRITERS, Duplicators, multi-graphs. Write for free list office machine bargains. Save half. Pruitt, 518 Pruitt Bldg., Chicago.

PRINTING, MULTIGRAPHING, MIMEOGRAPHING, GUMMED LABELS

\$1.00—200 LETTERHEADS With 150 envelopes; 500 statements; etc. Benneville, 907 West Roosevelt Blvd., Philadelphia.

MIMEOGRAPHING. 1,000, \$2.85. Samples. Bur-Wil Enterprises, 24 Louisa, Binghamton, N. Y.

FREE Pricelist! Mimeographing! Printing! Popular prices! Sylco, Downers Grove, Ill.

PRINTING—Envelopes, ledgers, catalogs. Free estimates. Mitchell's, 10407 Lexington, Kansas City, Mo.

1000 BUSINESS Cards \$1.75; 2,000, \$2.95; 5,000, \$6.95. National Sales Agency, Box 446, Gainesville, Florida.

MIMEOGRAPHING. 250, \$1.50; 500, \$2.00; 1,000, \$2.85. Cop-Y-Cat, 3459 S. Howell, Milwaukee, Wisconsin.

LETTERHEADS, 20 Pound bond, 8 1/2 x 11 and 6 1/2 white envelopes. 500 each \$2.80. Press Printery, Rockford, Ohio.

500 TWO-COLOR Gummed stickers, four lines, 40c. Cott's, Spickard, Mo.

MODERN Printing—500 letterheads, envelopes and cards or billheads. Kohler Press, 358 Ashburton, Yonkers, N. Y.

ENVELOPES, Plain, printed. Specify size, quantity. Samples, estimates. Universal Envelope Supply, Orange, Mass.

1,000 BUSINESS Cards \$1.00. The Ben Franklin Printery, Ashland, Ohio.

BUSINESS Cards, 1,000, \$1.00, post free. McBride Printery, 646 McBride Avenue, Los Angeles, Calif. Agents wanted.

STATIONERY, Circulars, blotters, cards, advertising specialties. Samples. Gaylord, Greenwood, Wisconsin.

BLOTTERS Make customers. 500, \$2.00. 300 cards 50c. Sirocan, 2038 Ohear, St. Louis.

1000 BUSINESS Cards \$1.00. Cycle Press, Box 325, Lawndale, Calif.

1,000 BLOTTERS \$2.95—3 1/2 x 6. Assorted colors. Sanderson's Printing, Ottawa, Ill.

500 LETTERHEADS, Envelopes, statements \$1.10; 1,000, \$2.00. Samples. Raymond's, Newport, New York.

PRINTING Prices slashed. 1000 business cards 95c; 1000 statements \$1.95; 1000 letterheads \$1.95; 1000 envelopes \$1.95. We print everything from a business card to a newspaper. Edward-Howard Corporation, 16909 Livernois, Detroit, Mich.

6x9 CIRCULARS, Letterheads, envelopes, postcards, \$2.95 1000; 5000, \$8.99. All printing low prices. Samples. Goodprint, Harrisonburg, Va.

100 EACH 8 1/2 x 11 Letterheads, 6 1/2 envelopes, \$1.00 postpaid. Tucker, Box 63, Indianapolis, Ind.

LABELS—All kinds. Write, samples. JBSCO, Box 93, Holyoke, Mass.

500 1/2 x 2 1/4 FOUR Line gummed stickers, 25c. Moritz Printery, Saginaw, Mich.

1000 BUSINESS Cards, card case, \$1.50. Miller, Printer, Ambler, Pa.

PRINTING OUTFITS AND SUPPLIES

PRINT Your own cards, stationery, circulars, advertising. Save money. Easy rules furnished. Print for others, big profits. Junior outfit \$8.85; job presses \$11 up. Details free. Kelsey Co., B-11, Meriden, Conn.

PRINTING Presses, type, supplies. Big lists 3c. Landis, Richland, Pa.

6x9 PRESS \$5.00. Bargain lists 3c. Novelty Shop, Downsville, Louisiana.

HAND Press, type and complete printers' supplies. Advise equipment you need and we quote prices; or send stamp for catalog. P. Peiffer, 18-B; 6 Columbia St., Newark, N. J.

SILK Screen process. For showcards, signs, displays, etc. Decorating toys, furniture, novelties. On paper, cardboard, wood, metal, other products. Easily learned. Complete instruction. Particulars free. Artset Company, 637 Case Building, Rochester, N. Y.

PRESSES, Type equipment bargain list free. Bradshaw, 3214-PM Huron, Chicago.

BARGAINS—Presses, type, supplies. Send stamp. 159 Harvard, Cambridge, Mass.

BARGAINS, Presses, type. List 3c. Exchange D-15, 22 Orient, Meriden, Conn.

PATENT ATTORNEYS

INVENTORS: Send immediately for your copies of our new free books, "Patent Protection" and "Suggestions on Selling an Invention." Sixty-eight pages of interesting facts. They tell how patent laws protect you; kind of sketch or model needed; simple steps to take without cost; how successful inventors have secured financial assistance; show interesting inventions; illustrate important mechanical movements. With books we also send free Evidence of Invention form to help establish date of disclosure. Prompt service, reasonable fees, special deferred payment plan. Strictest secrecy. Thirty-six years' experience. Highest references. Write us today. The facts in our books are worth money to the man with a good invention. Address: Victor J. Evans & Co., Registered Patent Attorneys, 900-J Victor Building, Washington, D. C.

PERSONAL Attention. Moderate charges. Six years, member "examining corps" U. S. Patent Office. Over 15 years' experience including patent work for leading manufacturers. Master patent law. Washington associate. Write for free "Proof of Invention." Address Benjamin Webster, Registered Patent Attorney, 38 Park Row, New York City.

INVENTORS—Small ideas may have large commercial possibilities. Write us for free book, "Patent Guide for the Inventor" and "Record of Invention" form. Delays are dangerous in patent matters. Free information on how to proceed. Clarence A. O'Brien & Hyman Berman, 582 Adams Building, Washington, D. C.

PATENTS—Trade marks—Personal service, reasonable charges. Preliminary advice, book and disclosure form free. Irving L. McCathran, 1060 International Bldg., Washington, D. C. Registered Patent Attorney.

"INVENTOR'S Guide," 100 mechanical movements, free; advises on patenting, selling inventions. Frank Ledermann, Tribune Bldg., New York.

PRACTICAL Inventions now salable before patenting. What have you? Write Chartered Institute of American Inventors, Dept. 4B, Washington, D. C.

PATENTS—Proper service for manufacturers and individual inventors. Established 1895. Reasonable charges. Consult Chandler & Chandler, Patent Attorneys, 902 F. Street, Washington, D. C.

INVENTORS—Send for free booklet "Patent-Sense." Information based on 64 years experience. Lacey & Lacey, Dept. 5A, 635 F. St., Washington, D. C.

L. F. RANDOLPH, 302-B Victor Building, Washington, D. C. Low cost. Book and information free.

PATENTS. Protect your idea by securing free "Proof of Invention" folder. Exceptional personal service. Established 1906. E. E. Vrooman, 871 Woodward Building, Washington, D. C.

PATENTS. Instructions "How to Establish Your Rights" and form. "Evidence of Conception"—sent free! Lancaster, Albine & Rommel, 411 Bowen Building, Washington, D. C.

PATENTS. Booklet free. Highest references. Best results. Promptness assured. Watson E. Coleman, Patent Lawyer, 724 Ninth St., Washington, D. C.

FOR INVENTORS

MODEL Supplies for the inventor. Send 3c stamp for catalog. Pierce Model Works, Tinley Park, Ill.

"HOW To Sell an Invention." Booklet of practical information, compiled by Registered Patent Attorney. Postpaid \$1. C. L. Drew, Hobart Bldg., San Francisco, California.

INVENTORS: Send immediately for your copies of our new free books, "Patent Protection" and "Suggestions on Selling an Invention." Sixty-eight pages of interesting facts. They tell how patent laws protect you; kind of sketch or model needed; simple steps to take without cost; how successful inventors have secured financial assistance; show interesting inventions; illustrate important mechanical movements. With books we also send free Evidence of Invention form to help establish date of disclosure. Prompt service, reasonable fees, special deferred payment plan. Strictest secrecy. Thirty-six years' experience. Highest references. Write us today. The facts in our books are worth money to the man with a good invention. Address: Victor J. Evans & Co., Registered Patent Attorneys, 900-J Victor Building, Washington, D. C.

PERSONAL Attention. Moderate charges. Six years, member "examining corps" U. S. Patent Office. Over 15 years' experience including patent work for leading manufacturers. Master patent law. Washington associate. Write for free "Proof of Invention." Address Benjamin Webster, Registered Patent Attorney, 38 Park Row, New York City.

INVENTORS—Small ideas may have large commercial possibilities. Write us for free book, "Patent Guide for the Inventor" and "Record of Invention" form. Delays are dangerous in patent matters. Free information on how to proceed. Clarence A. O'Brien & Hyman Berman, 582 Adams Building, Washington, D. C.

SEND 25 Cts. for Bulletin A listing inventions wanted today by manufacturers. Address Invention Market, Post Office Box 55, City Hall Annex, New York City.

WE Display your invention, patented or unpatented. Models or drawings. Inventors Display Institute, 3529 Grand River Ave., Detroit, Mich.

INVENTORS—Cash in on your inventive ability, patent unnecessary. International Inventors Service, 503 F Street, Washington, D. C.

PATENTS, Trade marks, procured; low cost; consider exchange services. Saunders, 6430 Evans, Chicago.

EXPERTS Will guide you. Solve your inventive problems yourself—patenting—selling—financing, etc. Inventors' Counselor, Cantil, Calif.

WE Successfully sell inventions, patented and unpatented. Write for proof, and tell us what you have for sale. Chartered Institute of American Inventors, Dept. 4-C, Washington, D. C.

TO Inventors: We are in the market to purchase a good patent, preferably a small item made of metal. Will purchase outright or royalty. Purchasing Agent, 241 Front St., New York, N. Y.

INVENTORS: "Making Inventions Pay." Our 32-page illustrated book, mailed upon receipt of 3c postage. Crescent Tool Company, Dept. Z, Cincinnati, Ohio.

INVENTORS—Send for 72-page book on patents. Reasonable terms. Conscientious treatment to inventors. L. F. Randolph, Registered Patent Attorney, 302-E Victor Bldg., Washington, D. C.

I SELL Patents. Established in 1900. Charles A. Scott, 773PM Garson Ave., Rochester, N. Y.

45 YEARS Successful inventing and marketing inventions on royalty basis. Your fortune lies in my methods. How to Invent and Market. Send 35c to Jiffy Specialty Co., Marietta, Ohio, for details.

SELL Your patent through a small classified ad in Popular Mechanics. Many inventors have found buyers in this way. Ask me for proof—I'll gladly send it to you. F. W. Johnson, Manager, Classified Advertising, 200 E. Ontario St., Chicago.

INVENTIONS WANTED

SMALL Inventions wanted by manufacturers. I'll help you sell your invention. Stanley Hull, K-7829 Euclid Avenue, Cleveland, Ohio.

INVENTIONS Wanted by many responsible concerns. Write, Box 374, Vicksburg, Mich.

MANUFACTURER Wants new ideas and designs car radio antennas, also automotive items. Box 1055, St. Joseph, Missouri.

HAVE You a sound, practical invention for sale, patented or unpatented? If so, write Chartered Institute of American Inventors, Dept. 4A, Washington, D. C.

INVENTIONS Wanted—Patented, unpatented. If you have an idea for sale, write Hartley's, Inc., Box 928-E, Bangor, Maine.

PATENTS FOR SALE

OUTRIGHT—U. S.-Canadian rights on garment-holder device that absolutely prevents removal of garments by other than authorized persons. D. W. York, 31 Harvard St., Brockton, Mass.

PATENTED Automatic music sheet turning device. Will fit any music rack. Musicians hands free at all times. Herbert Hysmith, 5847 Indiana Ave., Chicago, Ill.

PATENTED Automatic electric switch. Operate any fire extinguisher, or alarm. Multiplies efficiency. Operates without heat from fire. Entirely new. F. Bahlmann, 320 McKinley, San Antonio, Texas.

METAL Pocket dispenser for tablet or candy ring. Sell outright. A. Pearson, 5012 Toga Street, Duluth, Minnesota.

ADJUSTABLE. Two in one dough cutter, just allowed, inexpensive, practical, bakers, chefs, housewives. Outright or royalty. Hans Dohring, Irwin, Nebraska.

SELL Your patent through a small classified ad in Popular Mechanics. Many inventors have found buyers in this way. Ask me for proof—I'll gladly send it to you. F. W. Johnson, Manager, Classified Advertising, 200 E. Ontario St., Chicago.

MANUFACTURING

WILL Build die and stamp 1000 flat blanks. Any shape. Sizes up to 5 square inches—\$25.00. Production lathe jobs. Manufacturing. Wire forming. Southern Products, P87, Independence, Missouri.

ANALYSIS. Research. Newest guaranteed formulas. Biggest catalog free. Special prices, leads. Gibson Laboratory, Chemists, DS-1142 Sunnyside, Chicago.

DIES. Manufacturing, stamping. Free estimates. Presto Mfg., 4044 Twentieth Avenue, South Minneapolis, Minn.

MANUFACTURING. Dies, machinery, models, brasswork, white metal casting moulds. Catalog 3c. Baum's Metal Specialties, Kansas City.

INVENTIONS Manufactured in any quantity at low cost. Stampings, dies, models, etc. Estimates and free catalog. Crescent Tool Co., Dept. X, Cincinnati, Ohio.

TWO Profitable shop books—Lathe and Drilling and Thread Cutting—filled with hundreds of valuable "kinks" discovered by successful mechanics all over the world. To do regular jobs more quickly, easier and better send for these low cost books. Both postpaid for \$1.15. Popular Mechanics Press, Room (C37), 200 E. Ontario St., Chicago.

MODELS AND MODEL SUPPLIES

NEWEST Kit of R. M. S. Queen Mary luxury liner. Materials and parts to build 24 inch model of this famous vessel. Shaped hull and new method of building the superstructure allowing the model to be electrically lighted, only the pleasant work left for you to do. Assortment includes hull, plywood for cabins, metal life boats, cut davits, propellers, paint, railings, etc. \$6.00 postpaid. Gundersen, 3403 W. Flournoy, Chicago.

COMPRESSED Air model airplane motors \$4.85. S. H. Dobrusin, 3310 Roosevelt Rd., Chicago, Ill.

SHIP. Airplane models. List free. Gilmore, Box 1086, Butte, Montana.

INVENTIONS—Small ideas may have large commercial possibilities. Write us for free book, "Patent Guide for the Inventor," and "Record of Invention" form. Delays are dangerous in patent matters. Free information on how to proceed. Clarence A. O'Brien & Hyman Berman, 582 Adams Building, Washington, D. C.

MODEL Makers lathe, photographs for die. Depoy Model Shop, Muncie, Ind.

ENGINES. Models, supplies. Particulars free. Evrasmesco, 28 N. Clinton, Chicago.

RAILWAY Models. Catalog handbook 25c. Walthers, 247 East Erie, Milwaukee.

MODELS—Your ideas developed into practical working models. 30 years' successful experience; thousands of satisfied customers. Confidential service guaranteed. Bank references. Send 3c postage for 32-page book—"Making Inventions Pay." Crescent Tool Company, Dept. Y, Cincinnati, Ohio.

MODEL Of modern passenger locomotive—size, unfolded 10x46 in. Here, accurately shown in colors, are all the intricate parts of a modern giant of the rails, complete with tender. Invaluable for study. Of great interest and fascination to boys and others interested in railroads. \$1.00 postpaid. Popular Mechanics Press, Room (C37), 200 E. Ontario St., Chicago.

HEADQUARTERS For yacht fittings—Marblehead (50-800) and Class A. List free. Illustrated catalog of ship fittings and construction sets 15c. A. J. Fisher, 1002-1 Etowah Ave., Royal Oak, Mich.

BLUEPRINTS AND PLANS

BLUEPRINTS For homemade unit air conditioner \$2.00. Information free. Gress Blueprint Service, Box 1233, Paterson, N. J.

HOME CRAFTSMEN

COLORED Tile-like new plastic. Brush-applied, beautifies any material. For walls or home craft articles; waterproof, flexible, brilliant lustre. Sample carton 10 lbs. with four colors covers 100 feet. \$2. American Ceramo, 30 Church, New York.

SQUAREKNOTTERS! Make belts, handbags, etc. Quality cord samples with catalog, free. Beginners book, catalog and samples, 10c. Special! Regular \$1.00 book with 50c beginners outfit, all for \$1.00. P. C. Herwig Co., Dept. J8, 121 Sands St., Brooklyn, N. Y.

BUILD Your own lathe, drillpress. Complete plans only \$2.00. National Designing, 23 West 38th, New York.

LAWN Ornaments, ready cut and sanded. 25c brings two and blueprints of other designs. A. Barker, Mount Kisco, N. Y.

WOODCRAFTSMEN: Knockdown projects, lumber, panels, plywood, cedar chest. Send 10c for catalog. Giles Kendall Co., Decatur, Alabama.

HOMEMADE Drill press, belt sander, forge and 328 other practical shop articles in Shop Notes, Vol. 31, only 50c postpaid. Popular Mechanics Press, 200 E. Ontario St., Chicago.

LEATHERCRAFTSMEN—Write for free instructions and price list of leather, tools and beginners' kits. Send 5c for sample cards. Address Wilder & Company, Dept. F, 1038 Crosby St., Chicago, Ill.

OLD GOLD, WATCHES, JEWELRY, PRECIOUS STONES

CASH For old gold, teeth, watches, jewelry. Full cash value mailed day shipment received. Satisfaction guaranteed or articles cheerfully returned. Information free, or ship today. Chicago Gold Smelting Company, 300-P Champlain Bldg., Chicago.

ANY Watch repaired \$1.00 (plus parts). Holmes Watch Co., Washington, Kansas.

5000 REBUILT Hunting Waltham, Elgin watches. New chromium engraved open face cases. Make big money! 16 size, 7 jewel, \$3.75; 16 size, 17 jewel, \$6.25. Send 3c stamp for free catalog. New plan. The New York Jobbers, Dept. M, 74 Bowery, New York, N. Y.

HOW To identify and determine value of old precious metals. Where to buy. To whom to sell. Reliable and up-to-date information. Complete instructions only \$1.00 postpaid. Popular Mechanics Press, Room (C37), 200 E. Ontario St., Chicago.

FOR THE HOME

KILL Insect pests with electric death lamp, also gives light. \$1.75 postpaid. The Hobby Man, Jefferson, Iowa.

BOOKS Covering hundreds of subjects. Big catalog for 3c postage. Popular Mechanics Press, Room (C37), 200 E. Ontario St., Chicago.

TOBACCO

TENNESSEE'S Favorite Red Leaf or Air-Cured chewing or smoking; 10 pounds \$1.00. Shoffner Farms, Martin, Tenn.

GUARANTEED: Cigarette, pipe or chewing, 5 lbs. \$1.00; ten \$1.75. Pay when received. Pipe and box cigars free. Rives Tobacco Co., Paducah, Ky.

LOOK! Higher quality! Golden yellow smoking or rich ripe chewing, four pounds, guaranteed and postpaid, \$1.00. Riverside Ranch, Hazel, Kentucky.

SURVEYING INSTRUMENTS

GUARANTEED Factory rebuilt transits and levels for rent (with purchase option) or sale (cash or terms). Order now before prices advance. We will repair, trade in, or buy your old instruments. Ship prepaid for estimate and valuation. Write for List M-28 and complete information to Warren-Knight Co., 156 N. 12th St., Philadelphia, Pa.

RAZOR BLADES—SHARPENING

YOUR Old razor blades sharpened like new for 1c each. G. Mitrovich, 2215 So. Springfield Ave., Chicago, Ill.

WANTED—MISCELLANEOUS

CASH For used microscopes, binoculars, slide rules, drawing sets, cameras, surveying, medical and scientific instruments, tools, marine equipment. Highest prices paid day shipment received. Satisfaction guaranteed or shipment promptly returned. Elman's, 2302 Van Buren, Chicago.

PERSONAL

DOCTOR'S Ringworm prescription used successfully 14 years. Send money order \$1.00. Crafts Co., Box 255, Hammond, Ind.

NICKEL-SILVER Keyring tag 9/16"x2". Name, address, social security, phone numbers. Machine lettered 25c. Identifi Tag Co., 312 West Olympic, Los Angeles.

HOUSE Trainers, automobiles, radios! Largest contesters magazine 5 months \$1.20; currency coin. No postals! R. 2, B. 87, Alpha, Minnesota.

VENTRILOQUISM—Complete \$2.50 course 25c. Lonk Institute, D-1613, Palatine, Ill.

WANTED—Original poems, songs, for immediate consideration. Send poems to Columbian Music Publishers, Dept. 33, Toronto, Can.

STUTTERING And stammering corrected at home. Descriptive booklet free. Paul J. Wolfe, Box 52, Pittsburgh, Penna.

MISCELLANEOUS

STANDARD Electric lamp insect killer, \$2.00 up. Literature free. Sauer Bros., East Oakland, Calif.

KNOCK 'Em cold. Learn police Jiu Jitsu. 13 secret knockout blows without fists. Illustrated course by world famous instructor. Price 15 cents. S. J. Jorgensen, 406 Maritime Bldg., Seattle, Wash.

WEATHER Forecasting chart based on barometer and wind direction. Scientific. 35c. Ogen Company, 47 Cambridge Place, Brooklyn, N. Y.

COLLECTORS! 75 Assorted tin buttons, 25c. Janson, 1637 W. 105 Pl., Chicago.

POLAR-AID Soft drink powders, six different flavors 55c. Both Products, Box 535, Kiefer, Okla.

COMBINATION Pen and pencil, hand painted, lifetime guarantee. 59c. Box 794, March Field, Calif.

FREE. Spare time profits guide. Just out. Stamp appreciated. C. Moore, 160 Broad St., Newark, N. J.

YOU'LL Like resilvering mirrors, auto-parts, reflectors. Making chipped glass signs. Write, Sprinkle, Plater, 288, Marion, Ind.

MONUMENTS \$11.00 Up delivered. Erected. Guaranteed. Thousands sold. Catalog free. Marble-Granite Co., A-17, Oneco, Fla.

AMAZING New paste puts razor edge on knives and scissors. Simple to use. Fully guaranteed. 30c per tube—no stamps. R. J. Stine, Dept. B, Osceola Mills, Pa.

FEET Hurt? Rest scientific relief methods known. Box 12, Madison, Tenn.

MONEY In butterflies, moths. See Sinclair Display Advertisement on page 12A.

NOVELTY Flowers made with used postage stamps. Sample and details 25c. Ford Mailing Service, Cresson, Penna.

WOLF'S Penetrating oil quickly relieves aching and abscessed teeth. Postpaid 35c. Wolf Laboratories, Orange City, Florida.

BRONZE Tablets, desk plates, wall plates, memorials, grave markers. Bronze, brass and aluminum casting. Wandkey Pattern & Foundry Co., Anderson, Ind.

AMATEUR Tattooing outfits, illustrated catalog 6c. "Tatuco," 651A South State, Chicago.

SWAPPER'S Friend, R4, Saline, Michigan. Interests swappers, collectors, sportsmen. 50c year, sample 10c.

\$1.50 AUTHENTIC, Igoroi, Bolo. Suitable for weapon, or collection. B. P. Northrup, Box 294, Manila, P. I.

MAKE It Yourself. Hundreds of practical and useful devices described in our big book. Plain instructions and illustrations show you how to make them. Save money on things for yourself or make profit selling to others. 900 articles of great variety, 480 pages, 823 illustrations. \$3 postpaid. Popular Mechanics Press, Room (C37), 200 E. Ontario St., Chicago.



Easy

YOU'LL advance faster with an easy playing Conn. Choice of world's greatest artists. Many exclusive features yet they cost no more. Home trial. Easy payments. See your dealer or write for freebook. Mention instrument. C. G. CONN, Ltd. 831 Conn Bldg. ELKHART, IND.



CONN

BAND INSTRUMENTS

Be a TELEVISION EXPERT



Here's opportunity! Get ready for the best paid jobs in Radio as Television sweeps the country. Train at big-time broadcasting station. Get actual experience over our Television Station W9XAL and commercial station KXBY. Write today for free folder and literature showing actual photos of Television broadcasting, opportunities, etc.

FIRST NATIONAL TELEVISION, INC.
Dept. AA-8 Fidelity Building, Kansas City, Mo.

Free AIR CONDITIONING AND REFRIGERATION TRIAL LESSON



Trained men needed. Good pay. Opportunities. Learn easily AT HOME in spare time. Write today for FREE TRIAL LESSON.

CHICAGO TECHNICAL COLLEGE
K301 Tech Bldg., 118 E. 26th St., Chicago, Ill.
If you can go away to college to learn Air Conditioning, Refrigeration, Architecture, Drafting, Electricity, or Radio, send for Free Blue Book.

MONEY MAKING

Formulas

NOW ONLY \$1.25



Millions from Formulas Like These

Cosmetics
Remedies
Auto Products
Beverages
Food Products
Paints
Glues
Polishes
Inks
Fertilizers
Preservatives
Soaps
Lubricants
Metal Products,
Etc.

1059 Priceless Recipes. The kind that have made Fortunes for others. Now in Book Form.

Do you want to make extra money—establish a part-time or full-time business of your own? Then get MONEY-MAKING FORMULAS now. It tells you how to make hundreds of saleable products. Tells you what to use, where to get materials and how to turn

simple, inexpensive ingredients into real profits. No experience required. Practically no capital needed. Order this amazing 200-page book and get started on an interesting and profitable career.

Big fortunes have been made from a simple formula. Hundreds of well known, advertised articles you see in the stores were started on a "shoestring"—with a good formula and just a few dollars. The hit of this year might easily be yours—even bring you fame and fortune.

Complete in one book—1059 priceless formulas—all instructions and manufacturing processes—where to get the raw materials—everything you need to know. Send for your copy now.

Get the book that lifts the veil of secrecy from an interesting, fascinating and money-making business opportunity. Complete—Only \$1.25 postpaid. Write today.



High School Course at Home

Many Finish in 2 Years

You can complete this simplified High School Course as rapidly as your time and abilities permit. Equivalent to resident school work—prepares you for entrance to college. Standard H. S. texts supplied—Diploma. Credit for H. S. subjects already completed. Single subjects if desired. High School education is very important for advancement in business and industry and socially.

College Entrance

During the past 14 years, our High School graduates have been admitted to 531 different Universities, Colleges, Junior Colleges and Normal Schools—80% of them without entrance examination. Course also prepares for teachers' certificate and pre-professional examinations.

Business—Industry

To get and hold a good position in Business today you must be able to write clear, accurate letters and reports—do figuring involving Algebra and Geometry—talk intelligently on matters requiring a knowledge of Geography, History, and Economics.

In Industry—Mechanical and Engineering lines—you must have at least an elementary knowledge of Physics and Chemistry—be able to figure quickly and accurately—know something of Mechanical Drawing and blueprints—and be able to talk and write accurately and clearly on both your work and ordinary topics of conversation.

Our High School course meets the preparatory educational requirements for Business and Industry.

An Educational Institution

The American School was chartered in 1897 as an educational institution, not for profit—and is exempt from paying Federal income tax, like the best resident colleges and universities.

Don't Be Handicapped—Complete Your Training Now

Be a High School Graduate! Prepare yourself for promotion in Business and Industry—for the Professions, College Entrance and social success. No matter what line you may select, High School training will prove invaluable to you! Our moderate fees cover all instruction, standard textbooks and Diploma. Easy monthly terms. Get ahead in life. Start your training NOW!

20 Other Courses

Over 150 noted Educators, Engineers, and Business Men helped prepare our special instruction material, which is used by many resident schools and colleges, U. S. Navy, and Province of Manitoba, Canada. We offer you quality training at home for the best-paying lines of Industry and Business, as listed in the coupon.

Mail coupon for information about line that interests you
American School, Drexel at 58th, Chicago

American School, Dept. HC-45, Drexel at 58th, Chicago

Tell me how to train for success in line checked. No obligation.

- | | |
|--|--|
| <input type="checkbox"/> High School Course | <input type="checkbox"/> Diesel Engineering |
| <input type="checkbox"/> Accounting & Auditing | <input type="checkbox"/> Drafting & Design |
| <input type="checkbox"/> Architecture & B'lding | <input type="checkbox"/> Liberal Arts |
| <input type="checkbox"/> Automotive Engin'ring | <input type="checkbox"/> Private Secretary |
| <input type="checkbox"/> Business Management | <input type="checkbox"/> Hi'er Ac't'g (C.P.A.) |
| <input type="checkbox"/> Com'rcial Aeronautics | <input type="checkbox"/> Highway Engin'ring |
| <input type="checkbox"/> Electrical Engineering | <input type="checkbox"/> Mechanical Eng'ring |
| <input type="checkbox"/> Electrical Refrigerat'n | <input type="checkbox"/> Radio & Television |
| <input type="checkbox"/> Air Conditioning | <input type="checkbox"/> Salesmanship |
| <input type="checkbox"/> Civil Engineering | <input type="checkbox"/> Steam Engineering |
| <input type="checkbox"/> Complete Law | |

Name.....

Address.....

Popular Mechanics Press, Dept. 837C 200 E. Ontario St., Chicago

When writing please mention Popular Mechanics

JUST OUT!



If you are interested in the construction, operation and maintenance of modern Diesel engines, you will want this new timely book of practical, useful information.

"AUDEL'S DIESEL ENGINE MANUAL" with Questions and Answers explains in simple, concise language the Fundamental Diesel Principles—Operating Principles—Engine Starting—Air Starting Valves—Fuel Spray Valves—Inlet and Exhaust Valves—Valve Timing—Fuel Pumps—Fuel Injection Compressors—Starting Air Compressors—Scavenging Air Compressors—Pistons and Piston Rings—Cylinders—Lubrication—Cooling Systems—Fuel Oil—The Engine Indicator—Governors—Engine Reversing—Semi-Diesel Engines—High Speed Diesel Engines—Answers on Operation—Horse Power Calculations.

The illustrations and texts are clear and easy to understand. All details are plainly brought out. This book is of extreme value to engineers, operators, students and all who desire a knowledge of the Diesel engine. A handsome book, flexible, with gilt edges. 300 pages—illustrated.

Send for free Diesel folder today.

FREE EXAMINATION COUPON

THEO. AUDEL & CO., 49 W. 23rd St., New York
Please mail a copy of AUDEL'S DIESEL ENGINE MANUAL. If satisfactory, I will remit \$2 on its safe arrival, otherwise I will return the book.

Name

Address

Occupation PM

AUTO-MECHANICS & WELDERS

GOOD JOBS and Mighty GOOD PAY

Do you want to earn big money? If so let us know which of the following trades you prefer. You learn by doing. Practical work. Expert teachers. Low tuition. Personal attention. It will pay you to investigate AT ONCE. Just check the courses you'd like to take and mail today. You will receive full information, absolutely without cost or obligation. But don't delay.

Check the Trade You'd Like to Learn

- Auto Mechanics
- Welding
- Auto Collision
- Spray Painting
- Metal Finishing
- Torch Soldering

Ask about our "Pay After Graduation Plan"

Name

Address

Mail the above to

MICHIGAN TRADE SCHOOL
3758 Woodward Avenue DETROIT, MICH.

Write for FREE CIRCULAR

TO YOUNG MEN— STENOTYPY THE WAY TO SUCCESS!

Stenotypy, the new profession, offers unusual opportunities to ambitious young men. It's a man's way of recording speech in this machine age—a silent little machine that types plain print letters faster than any one can talk. It opens up preferred jobs now—leads to executive careers later. One of the surest, quickest ways to get into Business on the right basis.

Now you can learn Stenotypy at home in your spare time. Low cost—easy terms. Get full details. Write for valuable, free booklet, "Stenotypy, the New Profession," describing the unusual opportunities for young men in this growing field and telling how you may enter it successfully. Write Dept. 8648T THE STENOTYPE COMPANY, 4101 S. Michigan Ave., Chicago, Ill.



New York Electrical School Established 1902
Ask for free booklet
44 West 17th St., N. Y. C.

KNOCK-EM-COLD!

THE BIGGER THEY ARE, THE HARDER THEY FALL. LEARN JIU JITSU!
13 secret knock-out blows without lists by world famous Police Jiu Jitsu instructor 15c

A little jab with tip of fingers or strike with edge of hand to right spot and tough guys go out like a light. Northwest "Mounties" use Jorgensen's system. G-Men must be Jiu Jitsu experts. He has taught many in U. S. Army, Navy, Marines, National Guard, Coast Guard, Police, etc. Send for illustrated course. Full Price 15c. Also learn how you may defend yourself against any man regardless of size or strength whether he is armed with gun, knife or club. S. J. JORGENSEN, 794 Maritime Bldg., Seattle, Wash.



DO IT WITH SQUABS

Easily, steadily raised in only 25 days. Write us a postcard, ask for eye-opening picture book telling how, why, where. Why cater to ordinary trade when these great luxury national markets are wide open for all the SQUABS you can ship, every day in the year, at profitable prices. We give bonus WHITE KINGS for promptness. Write ELMER RICE, 633 How, St., Melrose, Mass.

MONUMENT BIG FREE CATALOG
Best Genuine Marble or Granite \$10.95 up. Direct by Mail Low Prices. U. S. MARBLE & GRANITE CO., Dept. A-18, ONECO, FLA.,

PENNY EACH !! WINDOW SIGNS
Large sized! Beautiful Gold Reflecting Window Signs. Letters. Finest Quality. 1 Year Guaranteed. New Styles. Tremendous Demand. Amazing Profits. Easily applied. Write for FREE SAMPLES and starting equipment. HURRY!
Atlas Sign Works, 7943 Halsted, Chicago, Ill.

Ob Last! A WIRELESS Pocket TUBELESS BATTERYLESS Radio
WORLD'S SMALLEST REAL PERFORMING RADIO
Amazing Midget radio weighs only 3 ozs. complete. Receives all stations with clear beautiful tone. Very little static and interference. Nothing to adjust or cause trouble—should last for years. USES PATENTED FIXED CRYSTAL DETECTOR. ENTIRELY NEW DESIGN! Patent No. 2074887. Not to be confused with cheaply made imitations or unlawful copies. Music and programs come DIRECTLY FROM GRILL OF RADIO! New patented "Speakophone" gives more volume and stations! NOT A TOY. Tunes broadcast band. The Newest radio sensation of the year. Absolutely complete with picture instructions for use in hotels, offices, boats, autos, bed, etc. TAKES ONLY A SECOND TO CONNECT—no messy hookups to any current or extra wires. SATISFIED OWNERS report wonderful service in ALL PARTS OF THE WORLD. THESE ARE FACTS! Beautiful two color cabinet.
SEND NO MONEY Pay postman only \$2.99 plus charges or send \$2.99 (check, M. O. cash) and yours will be sent postpaid. GUARANTEED. Can be used by anyone. ORDER NOW! DEALERS. TINYTONE RADIO CO. Dept. P-8 KEARNEY, NEBR.

ExtraMoney From Books

SEND NO MONEY • Books Sent C.O.D. Anywhere in U. S.
These famous Pay-Raising, Extra Money Books have helped thousands of others. Let them help you too. Check this list and mail with your name and address. Pay postman on delivery plus few cents postage. Send 3c stamp to cover postage and ask for catalog of other books.



SELECT FROM THIS LIST

ARMATURE WINDING
For A.C. and D.C. Machines.....\$2.00

AUTO REFINISHING
Duco With Spray Gun. \$1.50

BLUEPRINT READING
For Machine Trades...\$1.50

BRICKLAYING
Plain and Fancy.....\$1.50

CARBURETORS (All Makes)
New, Revised Edition...\$2.50

CHEVROLET SIX
Car, Truck, Operation Repair.....\$2.50

COLONIAL FURNITURE
Making, 95 Pieces.....\$3.50

DANCE
Learn at Home Without Music or a Partner...\$2.00

DIE CASTING
Machines, Dies, Alloys. \$3.00

ELEMENTS DIESEL
Engineering Questions and Answers.....\$4.00

FOUNDRY WORK
Molding, Casting, etc. \$2.00

FURNITURE REPAIRING
Finishing and Decoration.....\$3.00

HEATING, VENTILATING
Homes and Buildings. \$2.50

HIGH-SPEED DIESELS
New, practical, non-technical.....\$2.50

INVENTIONS
1500 Needed.....\$2.50

LEATHER MAKING
and Home Tanning...\$1.00

MACHINE SHOP WORK
Tools and Methods...\$2.50

MAGICIAN'S MANUAL
New, 100 Tricks for Amateurs.....\$1.39

METAL SPINNING
Practical New Book....\$1.00

MONEY MAKING FORMULAS
10,000 Practical.....\$4.00

MOTOR VEHICLE
'Trouble Shooters' Handbook.....\$2.00

PLASTERING
Best Instruction Manual.....\$1.25

RADIO PHYSICS COURSE
New edition. Everything about Radio...\$4.00

SHEET METAL
Construction Work....\$2.00

STEAM ENGINEER'S LICENSE
How to Obtain.....\$2.00

STEEL SQUARE
Hodgson, 500 pp. 300 Illustrations....\$2.00

TAXIDERMY, HOME
Mount Trophies Profit, Pleasure.....\$1.50

WROUGHT IRON WORK
Practical.....\$1.35

POPULAR MECHANICS PRESS

Room 937A

200 E. Ontario St., Chicago



Build a BOAT FOR PLEASURE OR PROFIT



Shows
EXACTLY HOW TO BUILD 15 DIFFERENT BOATS

This is the new edition with 42 added pages, 6 new boats, and conversion of Ford motor for marine use. Full directions and details for cabin cruiser, racing, hydroplane, outboard runabout, sail boats, kayak, sled type—15 boats in all. Also sectional boat to carry on car.

SEND NO MONEY

Write for new edition of Boat Book today! Sent anywhere. Pay postman \$3.00 plus few cents postage. Outside U. S. and possessions remit with order. Money refunded if not satisfied.

POPULAR MECHANICS PRESS—Room 937A
200 East Ontario St., Chicago

EASY—LOW COST with POPULAR MECHANICS BOAT BOOK

Build a boat at home! You can do it. Just the kind you've wanted—power, sail, or row boat. The "Boat Book" shows you how in simple step-by-step directions. Specially prepared for those with limited tools, little skill and money. Build boats to sell for profit too. Book tells how.

GIVES PLANS, METHODS AND MATERIALS

Actual working plans and photos of real boats under construction makes building easy. Shows materials needed and rock-bottom costs. Hundreds of pictures. No chance for mistake. Includes also, navigation and pilot rules, handling sailing craft, boat kinks, boating terms. Everything a boat enthusiast should know. Size 7x10 inches. 312 pages. Fine cloth binding.

SKINNY WATCH OUT! DON'T BE A BEACH SCARECROW IN A BATHING SUIT!

NO EXCUSE NOW FOR SCRAWNY FELLOWS NOT TRYING THE NEW WAY THOUSANDS HAVE FOUND ADDS 5 TO 15 POUNDS QUICK!

ADD WEIGHT — FEEL GREAT! WITH KELPAMALT say Thousands Results Guaranteed or No Cost

Don't resign yourself to being a skinny, scrawny physical wreck — a sight in a bathing suit. Kelpamalt, the new mineral concentrate from the sea, has put husky flattering pounds on thousands who never before could gain an ounce. That's because it contributes to the supply of natural minerals, often deficient in the daily diet, and needed for the body's chemical processes which change food into flesh, strength and energy. Kelpamalt's assimilable iron, copper, phosphorus, calcium and other minerals, together with its natural plant iodine, help your system get the real good out of food. Try it. Thousands are amazed at quick gains of 5 to 15 lbs. often in a few weeks. They look better, sleep better, feel better, too. Results guaranteed, or it doesn't cost you a penny. Kelpamalt costs but little to use. Sold at all good drug stores. Send for fascinating instructive 50 page booklet on Your Strength and Weight FREE to Kelpamalt Co., Dept. 1253, 27 West 20th St., N.Y.C.

SEEDOL

Kelpamalt Tablets

When writing please mention Popular Mechanics



Do You Want a WATCH or DIAMOND?

Thousands have found it easy to own America's finest diamond rings, watches, silverware or jewelry by the Santa Fe Plan. Bulova, Hamilton, or Elgin watches—brilliant blue-white diamonds—silverware from world-famous companies, and the great Santa Fe Specials—offered to you at startling cash prices on confidential liberal credit terms.

A Few Cents a Day is the Santa Fe Way

That watch or diamond you've always wanted, longed for—you needn't wait any longer for it. The Santa Fe will trust you—let you wear the watch or diamond you want while you pay only a few cents a day.



TURN PIN MONEY INTO DIAMONDS

Gifts for Every Occasion

Don't Pay Extra For Credit!

No honest person should pay extra to have someone trust him. The Santa Fe trusts you the way you want to be trusted—straight from the shoulder without any extra charges, extra fees, or taxes. You pay only the low advertised cash price in small monthly payments. Send for 1937 Catalog NOW!

FREE to Adults—Send for this beautiful book today. Sent ABSOLUTELY FREE to adults. Send your name and address, and the beautiful catalog will come to you by return mail. Do it now while you think of it.

SANTA FE WATCH COMPANY
Dept. 86, Thomas Bldg., Topeka, Kans.

THE INGENUOUS MARKWELL "RX45"

1⁷⁵ - WITH 100 STAPLES!

Indispensable for fastening paper, drawings, etc., to drafting boards instead of thumb tacks. The thin wire staple also very handy for assembly of small models instead of brads.

A simple adjustment converts the "RX45" from a tacker to a pinning and stapling machine: IN A SPLIT SECOND.

MARKWELL MFG. CO., Inc.
200 Hudson St. Dept. P, N. Y.



STAPLES PINS TACKS

FREE TRIAL LESSON IN DRAFTING

More good jobs now in Drafting. Learn AT HOME in spare time (or at our Chicago School). Send post card for **FREE TRIAL LESSON** and see how easy to learn and get a good job.

CHICAGO TECHNICAL COLLEGE
K208 Tech. Bldg., 118 E. 26th St., Chicago, Ill.

If you can go away to college to learn Drafting, Engineering, Architecture, Electricity, Air Conditioning or Radio—send for **FREE Blue Book**.



FREE TRIAL LESSON

Cheap Heat—No Coal

Remarkable, Cheap Invention, Burns Cheap Grade Diesel Oil Once Thrown Away as Useless—Converts any Stove or Range to Fast, Clean Heat—Hotter, More Economical Than Coal or Wood—Banishes Wood Chopping and Ashes. Sent on 30 Days' Free Trial.

Over 10,000 already in use; No more Coal and Wood drudgery. No more getting up freezing winter mornings to coax stubborn fires. Safe. Temperature controlled. Many wonderful automatic features. Runs on pennies. Sent on 30 days' trial at our risk. Agents Wanted—we will select parties in each locality to receive one FREE for installing in their own homes to demonstrate. Make up to \$60 weekly and more booking orders. Selling fast. Write at once—peak of season now—no time to lose. Name and address on one cent postcard will do. Brigham Oil Burner Co., Dept. 2927, St. Louis, Mo. Approved by Nat'l Bd. Fire Underwriters.

Potato Chip Business

Greaseless Potato Chips

Here's your opportunity to get into business for yourself. Turn potatoes into cash by making potato chips. I'll show you how with my improved outfit. Makes delicious crispy, tasty, superior, "greaseless" chips at a surprisingly low cost. Also Doughnuts and Salted Nuts. Very little cash needed. No previous experience required if you follow the instructions and selling plans I furnish. Begin in any location, village, city or suburb. An opportunity is waiting. Steady year 'round business. Groceries, delicatessens, restaurants, taverns do the retailing for you. Merely keep them supplied.



WE HELP START YOU IN BUSINESS

Raw material plentiful and low priced. Simplified process and confidential plans. Profit large—unusually so. Enormous quantities of Potato Chips are bought daily.

We Have a Credit Plan

Find out how you can buy equipment on a monthly payment plan. Let us tell you what others say about the Potato Chip business. Get all the facts. Get into this dignified, year 'round business with its money-making opportunity. Send for **FREE** booklet entitled, "How to Start a Factory." Do this **AT ONCE**.

LONG-EAKINS COMPANY

828-S High St., Springfield, Ohio

Complete 16-unit Outfit includes new type white vitreous enamel ROUND Cooking Vat; Direct-to-fat high speed slicer; centrifugal Grease Extractor; Thermometer—Positively everything necessary to start—all at new low price.

LEARN CARTOONING

by the method that has developed hundreds successfully. Send name, address and age for free chart to test your ability.

THE LONDON SCHOOL, 1404 E. 9th Street, Cleveland, Ohio

In answering an advertisement with a coupon, be sure to write name and complete address clearly. Sometimes advertisers are unable to respond to inquiries due to lack of complete information.

A BILLION IDEAS FOR ONLY A 3¢ STAMP

Send today for the big Popular Mechanics Illustrated Book Catalogue—"A BILLION IDEAS." An interesting helpful guide to thousands of practical informative and money-making books. It describes many books of the kind you want to know about. Limited edition just published. Send three cent stamp to cover postage.

POPULAR MECHANICS PRESS 200 East Ontario Street, CHICAGO



All About DIESEL Power



Diesel Power is no passing fad. It's the coming world power. In the air—on land and sea—thousands of men who know about Diesel Engines will be in demand. Plan ahead. Get the most timely book of the day—**ELEMENTS OF DIESEL ENGINEERING** by Orville Adams. The ideal book for beginners, students, mechanics of all kinds and the only book you need. Large size 6 x 9 inches. 450 Pages. 284 Illustrations. 22 Fact Filled Chapters. Send for your copy today and get out in front in Diesel Power. Sent postpaid only \$4.00. Order today.

POPULAR MECHANICS PRESS
200 EAST ONTARIO ST. ROOM 837-B CHICAGO, ILL.

472 PAGE BOOK Complete \$4 Only

When writing please mention Popular Mechanics

FOR Real FUN Play. A Soprani



AMPLIPHONIC ACCORDION

● Music, popularity, and romance surround you when you play your Soprani Ampliphonic accordion, a complete band in itself. Easier playing, reduced size and weight, more beautiful tone, greater volume with a third less bellowsing. Exclusive ampliphonic feature assures rapid progress. Home trial. Easy terms. See your music dealer or send postal for beautiful free book. No obligation. Act now. Write today. 153

SOPRANI, INC. DEPT. 529
630 South Wabash Avenue, Chicago, Illinois

Get the FREE Book of opportunity

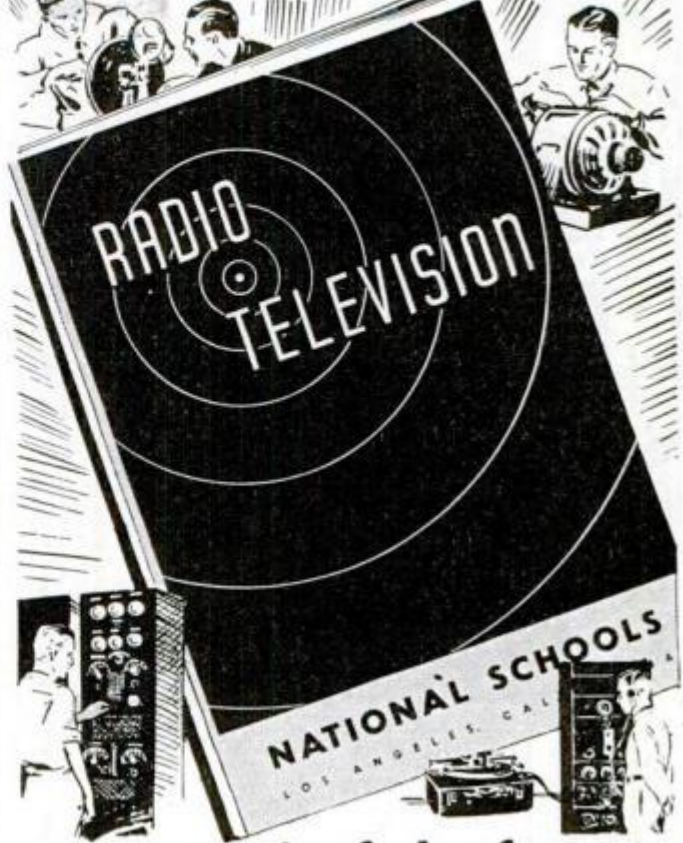

Brimful of terse instructive facts about **TELEVISION RADIO** **SOUND RECORDING** **ELECTRICITY**

Note These Interesting Contents
Written in plain, understandable language, this free Book gives facts you want to know about the best-paying trades and opportunities. 95 illustrations. Major subjects include Television Theory and Construction, Pick-up Systems, Amplifiers, Transmitters, Receivers, Cathode Tubes; Radio in all its branches, Receiving, Broadcasting, Trouble-shooting, Construction and Theory; Sound-recording on Disc; Loud Speakers, Talking Picture Projection, Radio Communication, Laws, etc. This book also tells how you can qualify for these good pay trades by training at NATIONAL SCHOOLS. Send coupon now for free book.

National Schools is the oldest trade Institution in the West. Established 1905. You can earn room and board while learning. Coach railroad fare allowed to Los Angeles. This service only for residents of U.S.

NATIONAL SCHOOLS

LOS ANGELES

NATIONAL SCHOOLS, Dept. 8-PMR.
4000 So. Figueroa St., Los Angeles, Calif.
Without obligation send your free book.

Name Age

Address

City State



Government Jobs

EXAMINATIONS SOON INFORMATION FREE
COLUMBIAN CORRESPONDENCE COLLEGE, WASHINGTON, D. C.

ARTISTS MAKE MONEY

Find out your ability. Send name, age, occupation and address for Free Vocational Art Test.
Federal Schools, Inc., 8137 Federal Schools Bldg., Minneapolis, Minn.

5c TIRE MAKES \$2.00 MAT

Make springy, long-wearing Rubber Mats out of old auto tires. Any length or width. BIG sale to schools, factories, stores, homes. Think of the profit. Brand new business, fully patented. Field untouched. Reasonable investment and simple hand machine starts your local plant. Write quick for free information. Don't lose a minute—this is BIG!
FABRIX, INC. Dept. 78 325 W. Huron St., Chicago, Ill.



LETTERING ARTISTS MAKE Big MONEY . .

Learn in LARGEST COMMERCIAL STUDIOS OF KIND IN MIDDLE WEST under master craftsmen. Few weeks prepares you for job. No talent needed. Positions waiting. Free employment service. Show Cards, Posters, Sign Painting, Window Displays, Silk Screen Process. Send name, address, present occupation for FREE ability test chart.

ACME POSTER STUDIOS • 22-24 W. Hubbard St., Chicago

WANTED ORIGINAL POEMS, SONGS

For Immediate Consideration • • • • • Send Poems to
COLUMBIAN MUSIC PUBLISHERS LTD., Dept. 43, TORONTO, CAN.

In answering advertisements always write name and full address clearly.

FREE WHOLESALE CATALOG of 4000 FAST SELLERS

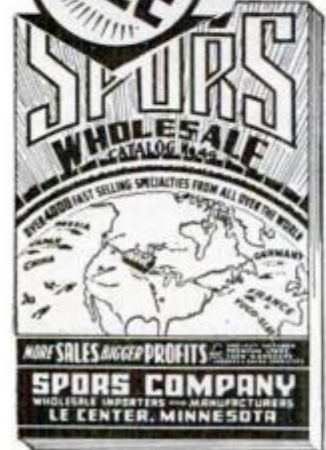

HAS
260 Pages of World Wide Bargains
4000 Salesmen's Specialties
15 New Selling Plans
30 Money Making Ideas

Shows fast sellers of every description from many parts of the world, at rock bottom wholesale prices. Hundreds of selling sensations, new creations, outstanding values—one source of supply, all in our latest, revised catalog. It's free. Send for it today.

SPORS CO.
6-37 Main St., Le Center, Minn.

For
FUN
and
PROFIT
learn
to
MOUNT BIRDS



AND ALL KINDS OF ANIMALS

SPORTSMEN, SAVE YOUR TROPHIES! Learn at home in spare time to mount all kinds of birds and animals. Decorate your den with trophies of field and stream. We teach you this **FASCINATING SPORTSMEN'S HOBBY**. Quickly, easily learned. Wild game is growing **scarcer**. Trophies now more valuable than ever! Shoot **FEWER** and **MOUNT** them true to life. **IT'S PROFITABLE!** Many report earning \$25 to \$75 a month mounting specimens for hunters. Why not **YOU?** Learn to make **USEFUL** articles from mounted specimens such as book ends, lamps, etc., etc. (See squirrel lighter to left.)

WILD GAME NOT NEEDED. If you don't hunt you can mount **COMMON** specimens: Owls, crows, pigeons, hawks, rabbits, even frogs. **Real FUN.**

LEARN TANNING We also teach you to tan furs soft and pliable and new method to **TAN GENUINE LEATHER** from all kinds of hides. Great spare time money maker.

FREE BOOK Send right now for beautiful free 48-page booklet, illustrated, telling how easily **YOU** can learn to be a Taxidermy Artist. Contains many fine pictures. Intensely interesting. Get **YOUR** copy today. No cost or obligation. **Send now!** State **AGE**. N. W. SCHOOL OF TAXIDERMY, 9337 Elwood Bldg., Omaha, Neb.



JOBS FOR THOUSANDS



in the technical fields if trained. Save time on B. S. Degree in **Engineering . . . Architecture Electricity, Construction, or Radio Engineering.**

Shorter courses in **Air Conditioning, Drafting, Building, Radio, etc.**

No time to lose. Start training *now*, days or evenings. Opportunities to earn part living expenses in Chicago. Job help when ready. 34th year. *Accredited*. Send post card for **FREE 80 Page BLUE BOOK**.

CHICAGO TECHNICAL COLLEGE
K75 Tech Bldg., 118 E. 26th St., Chicago, Ill.

SERVICE 12000 RADIOS!

WITH THE MALLORY-YAXLEY
RADIO ENCYCLOPEDIA

Here's all the dope you need to service any radio set ever made! Over 200 pages packed with complete data on schematics, condensers, I.F. peak frequencies, vibrators, tubes, volume controls, transformer circuits, etc.—**ALL** for the first time under one cover! Easy to use, detailed, practical, this "All-in-One" book is invaluable for Experimenters, Servicemen, and Amateurs—it *always* gives you the correct answer! Costs only \$1.47. Get your copy from any Radio Dealer or order direct from P. R. Mallory & Co., Inc.



P. R. MALLORY & CO., Inc.
INDIANAPOLIS, INDIANA

Increase Your Earning Power

Apply time and labor-saving kinks to your work. Your efficiency will soon be recognized and you will be in line for advancement.

If you do machine shop work of any kind, sheet-metal work, painting, carpentry, auto repairing, farming, concrete work, plumbing, electrical work, welding, building-glass work, general repairing, tool-making, poultry raising, masonry or home repair work, get this

LIBRARY OF 2000 TIME AND LABOR SAVING IDEAS FOR SHOPMEN AND HANDYMEN

JUST OUT

SHOP NOTES for 1937

357 Articles
703 Illustrations
224 Pages
Price 50c
See partial list
of
contents below

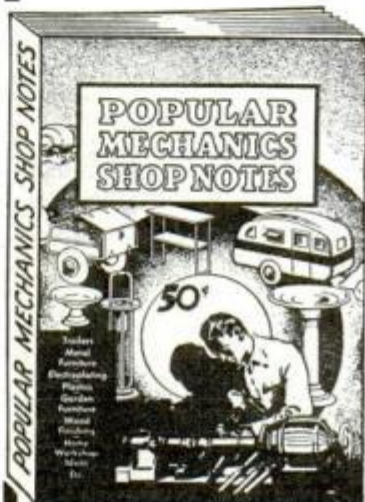

Including the new 1937 issue illustrated above, there are five volumes in the Shop Notes Library of 2000 easily understood short cuts to every-day jobs. Here are just a few of the subjects taken from the latest issue:

Alloys, Electroplating With
Belt Sander
Cesspools, Repairing
Concrete Garden Furniture
Dovetails, Making
Dowel Making
Efficient Farm Weeder
Electric Motors, Servicing
Electrical Test Board
Electroplating Non-Conductors
Family Auto Trailer
Fence Posts, Pulling

Fly Chaser for Door
Folding Bed in Auto
Fruit-Picker's Ladder
Go'd, Finding
Humidifier for Furnace
Magnet Recharger
Metal Awning
Metal Furniture
Oil Finishing
Photo Enlarger
Photo "Spot" Light
Plastics, Working With
Pottery, Concrete
Resilvering Mirrors
Rewinding Auto Generators

Sawhorse for Uneven Floors
Shop Heating Unit
Soldering Aluminum
Thermostat, Designing
Tools from Drill Rod
Trailer, Contractor's
Truck Lift, 3 Speed
Universal Tripod for Cameras
Window Displays, Novel
Window Sign "Flasher"
Winter Starting Aids
Wood Lathe Used for Metal Turning
Wooden Bowl Forming

Each volume contains approximately 400 articles and 700 illustrations and has 200 or more pages. This unrivaled library of shop helps may be secured for a limited time only. After the present supply of books is exhausted the offer must be withdrawn.

* **Send No Money**

POPULAR MECHANICS PRESS,
200 E. Ontario St., Room 837, Chicago, Ill.

Send me, as per your offer, the following books. I will pay postman price and small amount of postage. My money will be refunded if I am not satisfied. (Check what you want.)

- 1937 Shop Notes and Lathe Handbook (Metal Working), both for 98c.
 Shop Notes Library (5 vols.) \$2.50.

Name.....

Street and No.....

City.....State.....

* C. O. D. applies to U. S. and possessions only. If you reside elsewhere, remittance must accompany order.

LATEST 20-TUBE MIDWEST TUNES ITSELF BY ELECTRIC MOTOR..... JUST TOUCH A BUTTON!

ONLY MIDWEST'S DIRECT-FROM-FACTORY POLICY MAKES THIS AND OTHER SENSATIONAL FEATURES POSSIBLE AT AMAZINGLY LOW PRICES!

SAVE UP TO 50% DIRECT FROM MIDWEST FACTORY

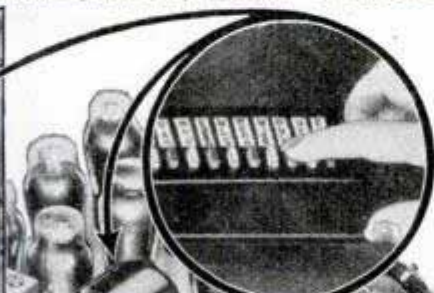
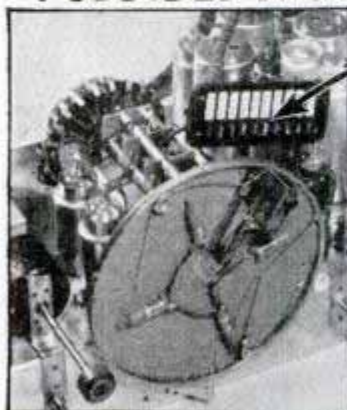

20 TUBES
6 BANDS
SUPER POWERED
TO BRING IN WEAK OVERSEAS STATIONS

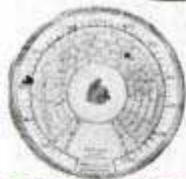

MAGIC MOVIE DIAL

Now, Midwest gives you today's finest world-wide overseas reception. Note that the dial on the chassis shows only the broadcast band. Then, flip 6-wave-band-switch, and, instantly, 5 additional bands are projected on the dial.



MAGIC MYSTIC BRAIN

"Mystic Brain" interprets your touch button signals and controls electric motor. Ten contact fingers can be easily set to any ten stations you desire.

A VITAL

engineering advancement, Midwest's Electric Touch-Button Tuning is entirely automatic and the sensation of the radio world! Ten touch buttons completely control the set. Touching any button turns set "on" and tunes in desired station. Nine other favorite stations are automatically and perfectly brought in... Zip... Zip... Zip... as fast as you can touch buttons. No more dial twiddling! Why be content with an ordinary 10, 12 or 14-tube set, when you can buy a 20-tube Super DeLuxe Motorized Midwest for the same money. It will surprise and delight you with its brilliant world-wide reception on 6 bands. You save 50%—and get 30 days free trial in your own home—when you buy direct from the factory at wholesale prices. You are triply protected with Foreign Reception Guarantee, One-Year Warranty and Money-Back Guarantees.

TERMS AS LOW AS \$1.00 A WEEK

You have a whole year to pay for your Midwest on the easiest and most convenient of credit terms. Send for the FREE 40-page catalog today—and begin to enjoy motorized radio at its best, right now!

Send for **FREE 40-PAGE CATALOG!**

See for yourself that Midwest offers today's greatest radio values! Write for new 1938 Factory-To-You Catalog showing 40 pages of radios, chassis and features—in their natural colors. Select the one you like on 30 days FREE TRIAL in your own home.

Service Men! Join nation-wide Midwest service organization. Write for free details.

only \$**49**⁹⁵

FACTORY-TO-YOU NEW LOW BASE PRICE CHASSIS

The new 1938 Midwest consoles are triumphs of the furniture art. The Trio-Sonic Reproducers (3 speakers), installed in this 20-tube console were especially developed for use with Double Power Beam Output Tubes.

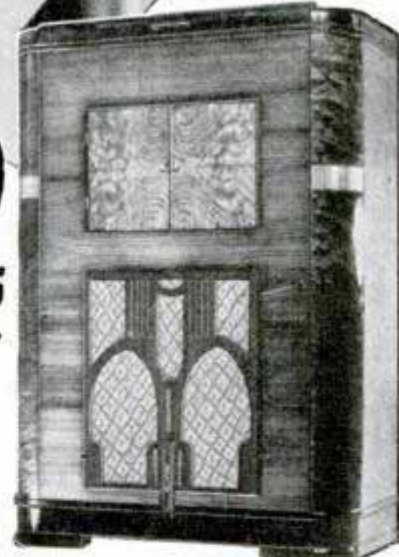

30 DAYS FREE TRIAL

PASTE COUPON ON 1¢ POSTCARD...OR WRITE TODAY.

MIDWEST RADIO CORPORATION
Dept. AA15 Cincinnati, O.

Name.....

Address.....

Town..... State.....

Send me your new FREE catalog and complete details of your liberal 30-day FREE trial offer (Special offer and prices prevail only when dealer direct with factory by mail.)

User-Agents Make Easy Extra Money. Check Here for details.

MIDWEST RADIO CORP.
DEPT. AA-15 CINCINNATI, OHIO, U.S.A.
Established 1920 Cable Address MIRACO...All Codes



SEALED POWER PISTON RINGS

Best in New Cars! Best in Old Cars!

LIGHTNING-FAST get-away . . . robust speed and power . . . thrifty on oil . . . stingy on gas! That's the 1937 Nash LaFayette-"400".

Under its hood, of course, you'll find Sealed Power Piston Rings—put there after engineers' tests had proved they mean greater speed, greater power, and maximum oil economy. Just like the engineers of Buick, Cord, Hudson, Oldsmobile, Pontiac and other splendid 1937 cars—Nash engineers know Sealed Power Rings are designed right! That they *seal* power!

New Ring for Old Cars

Now, Sealed Power offers a special expander ring for cars that have gone 10,000, 20,000, 30,000 miles or more. The experience of hundreds of thousands of motorists proves that this great new-type ring ends "between meal oil hunger." Without excess pressure

an inner spring of Swedish steel holds the cast iron outer ring firmly against the cylinder wall. If your car is using too much oil, has no pep or power, try it. You'll be amazed by results!

Warning! Read Carefully!

But let a Sealed Power ace mechanic check your car first. Perhaps new valve guides, new bearings or new pistons are needed. Depend upon your Sealed Power mechanic for straight-from-the-shoulder facts. Usually Sealed Power Rings alone will restore new car oil economy. Meanwhile, write for our booklet, "New Low Cost Way to Save Oil and Gas and Increase Pep". It's free! You'll like it!

SEALED POWER CORPORATION

Dept. 278, Muskegon, Mich. • Canadian Factory at Walkerville, Ont.

Manufacturers of Piston Rings, Pistons, Piston Expanders, Piston Pins, Valves and Cylinder Sleeves

When writing to advertisers please mention Popular Mechanics



Popular Mechanics Magazine

REGISTERED IN U. S. PATENT OFFICE AND CANADA

WRITTEN SO YOU CAN UNDERSTAND IT

Vol. 68

AUGUST, 1937

No. 2

5570
230 Redwood Ave
Sacramento Calif.

GOLD RUSH of the EXPERTS

geophysical engineers

GOLD is luring a new army of searchers into abandoned mining fields of the far west. Engineers, chemists and devotees of that newer science, geophysics, are in the vanguard, carrying newly created contrivances which make two ounces appear where an ounce or less would have been produced with older apparatus.

The thirty-five dollar per ounce price tag on gold is a contributing factor in the re-

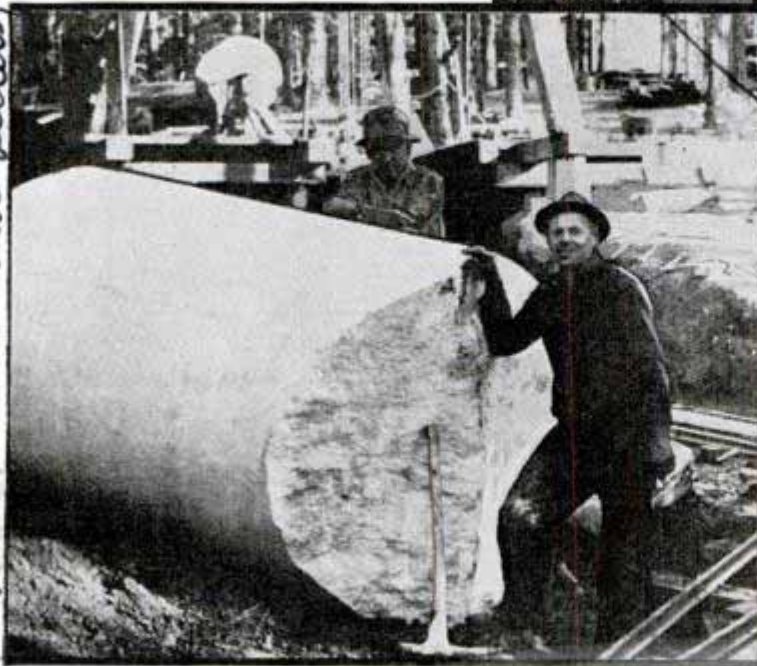
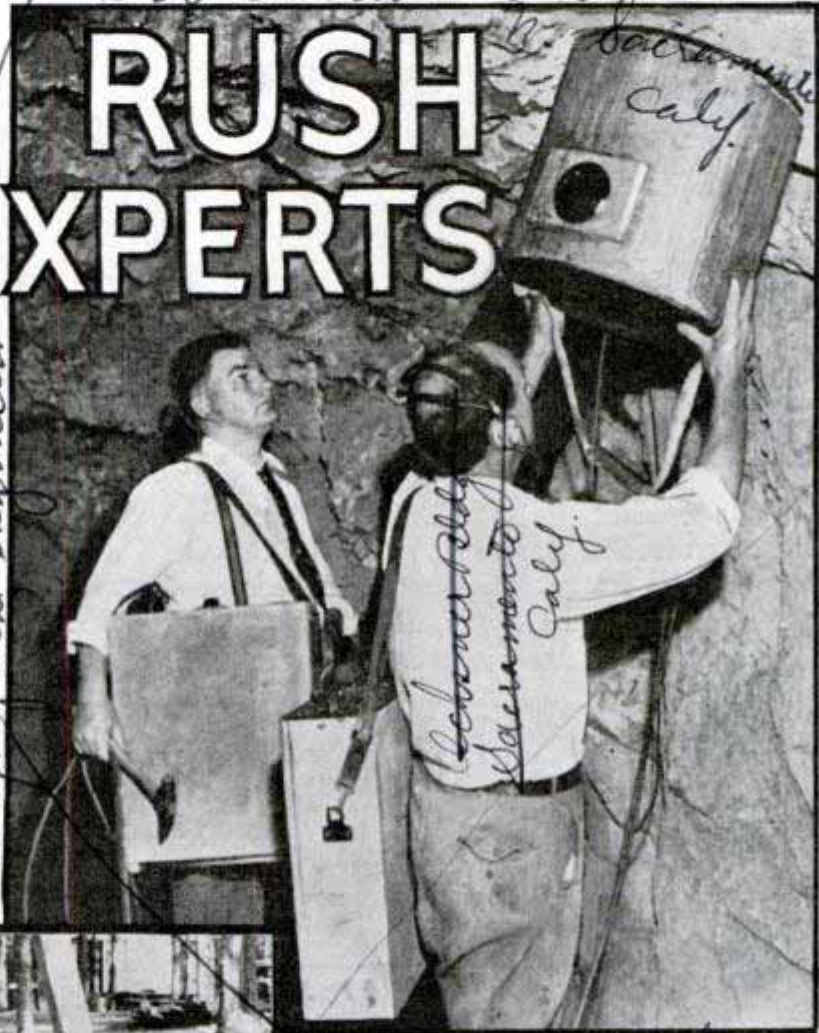

Top, hunting lost vein of ore with metal-locating device. Bottom, solid rock core taken out with Newsom driller

Sham and Sham

surgence of the gold fever, but experts say that even at the old price of \$20.67 an ounce and with the new methods of mining, some of the old abandoned mining properties might have been revived. The all-time top for gold production in the United States was attained in 1915 with 4,887,604 ounces produced. Gold then sold at the \$20.67 figure. In 1935 the United States Bureau of Mines reported production of 3,546,169 ounces and at thirty-five dollars an ounce that represented an all-time dollar high of \$124,115,915.

*J. B. Newsom Co. Idaho
Manufactured near Coeur d'Alene, Idaho. Box 923*

From Lens and Letters, 474 Chaminé Bldg. New York

*Buford d sham (left), Charles d sham, California
Tullis mines, near Steamboat Springs, Colo
Nevada City, Calif.*

County
Sacramento
570
Road from
Sacramento
California
see Feb. 1936

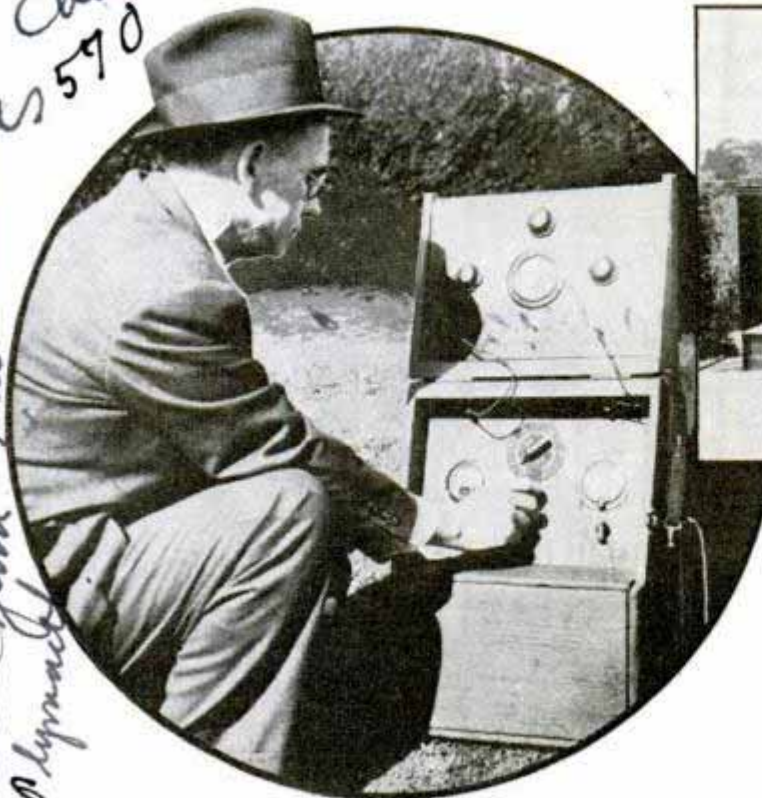

Fig Tree Mine

Experts predict that the 1915 production will be exceeded within a very short time, and point to some of the new methods of mining as basis of their belief.

An ultra-modern plant is that of the New Method Mining and Milling company at the Fig Tree Mine in California. The Fig Tree mine is said to have caused the failure of several companies which had to depend on the free gold that it produced. With the gasoline storage-tank plant of the New Method company the Fig Tree is now expected to become a money-maker,

yielding from twenty to \$100 a ton. Gold is produced by the New Method outfit by grinding the ore, and placing it in tanks to be mixed with a chemical formula. Leaching takes place in the tanks, and flour gold is crystallized ready for the mercury to pick it up. When it finally comes out it is in the solid piece and ready to go to the mint.

The plant consists of an ore hopper, a grinding mill, and four large leaching tanks. Processing of the ore at this plant costs about two dollars a ton. The plant represents seven years of experimentation with methods for mining flour gold.

Another aid to quicker and cheaper mining is the contribution of one J. B. Newsom, of Palo Alto, Calif. Mr. Newsom's contrivance is a circular bore that digs shafts at the unbelievable speed of ten feet per day. The driller was completed after eighteen months of experimentation at the Idaho-Maryland Mine at Grass Valley, Calif.

There it was used to drill a shaft, even while it was being perfected, and there its weaknesses were discovered and corrected to produce the finished product. The essential difference between the Newsom drill and other core drills, aside from its larger size, is that the entire machine goes into the hole. Thus time is saved in the handling of drill rods, and no rod tower or rod handling tackle is required, and, as the operator goes into the hole with the machine, he always can control its operation closely. It gouges out a core five feet in diameter, and in

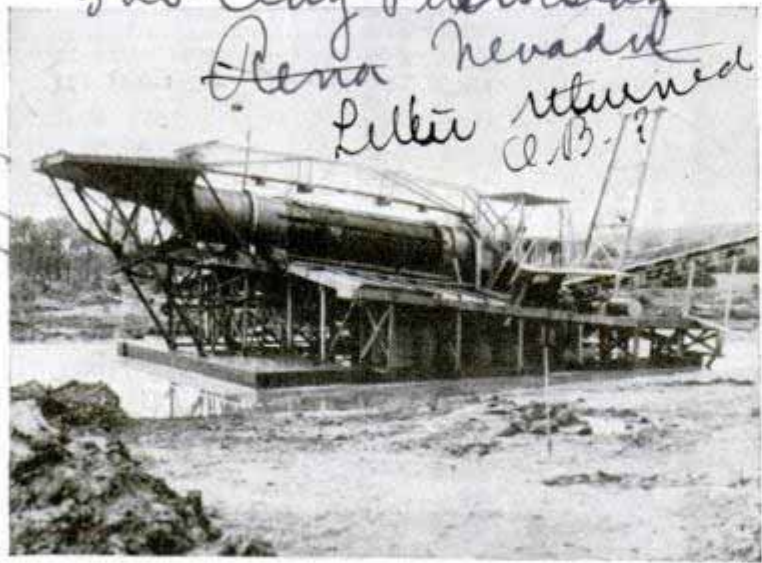

Clay Petersley Reno Nevada Little returned

Top, left, control board of earth resistivity instrument. Right, latest gold-producing plant. Bottom, "doodle-bug" dredge for placer mining is another new machine in the low-field field

Charles DeSham Sacramento, Calif
Chester Aldy Sacramento, Calif

Sacramento
California
North
Sacramento
see Feb. 1936

es 570

Idaho mountains mine.

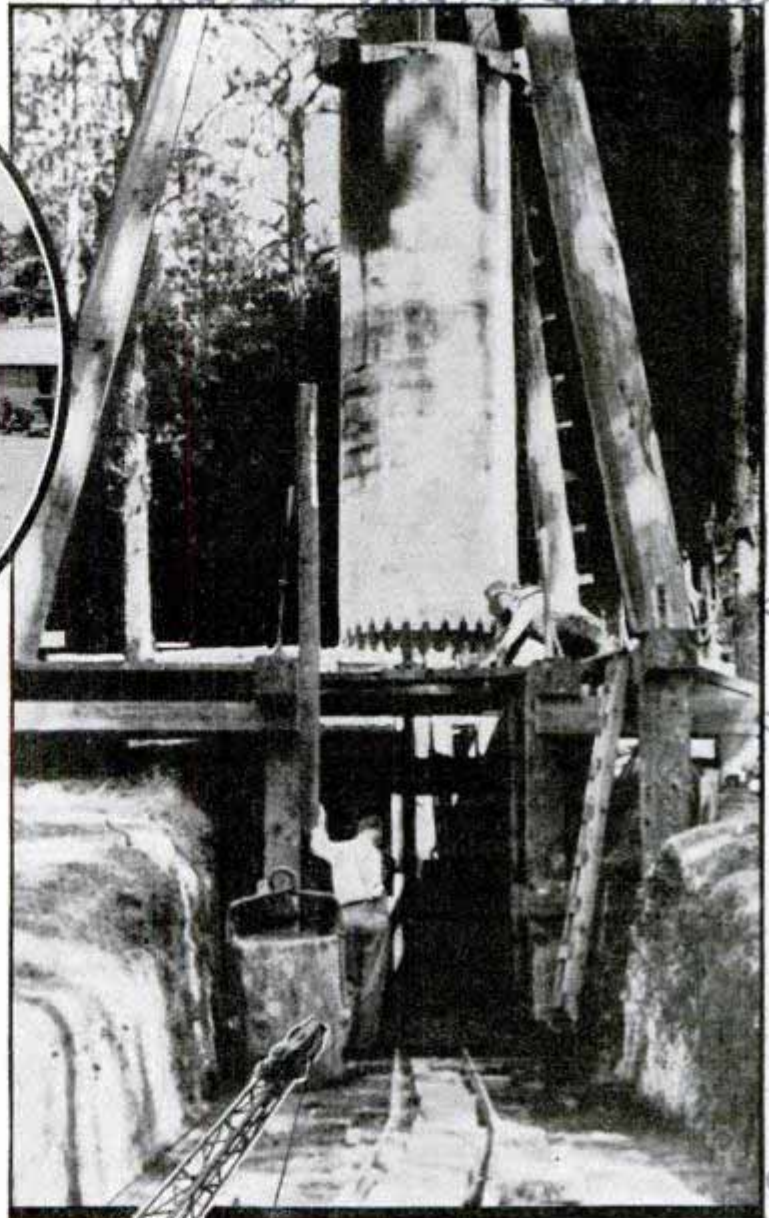
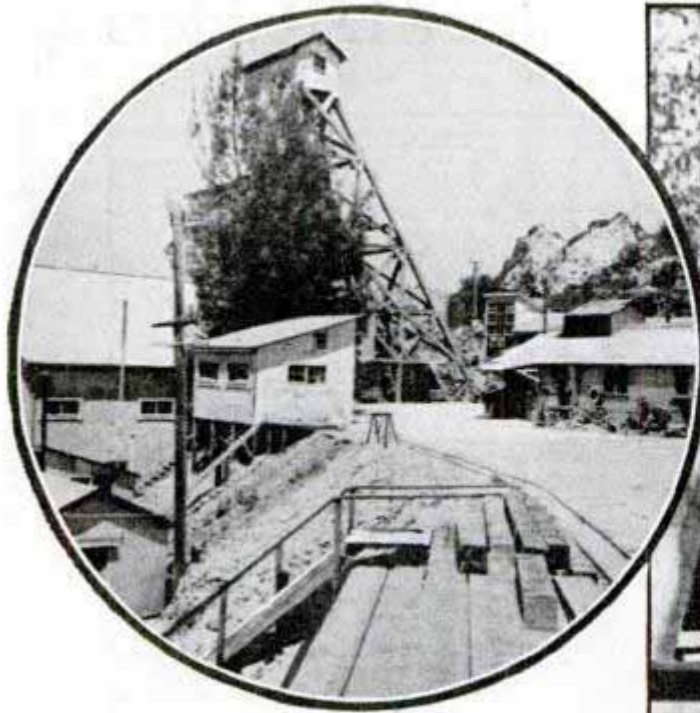

the Idaho mine test the cost of drilling was lower that it would have been with other core drills, despite the fact that the drill itself was being developed as the shaft progressed. Mining men will understand the advance represented by the Newsom drill, as against old-type core drills which bit into the ground at the rate of about four feet a day.

The greatest contribution to modern gold mining, however, comes from the comparatively new science of geophysics. In times past many devices for ore detecting, such as divining rods, treasure

(Continued to page 147A)

Idaho earth residents of Louisa

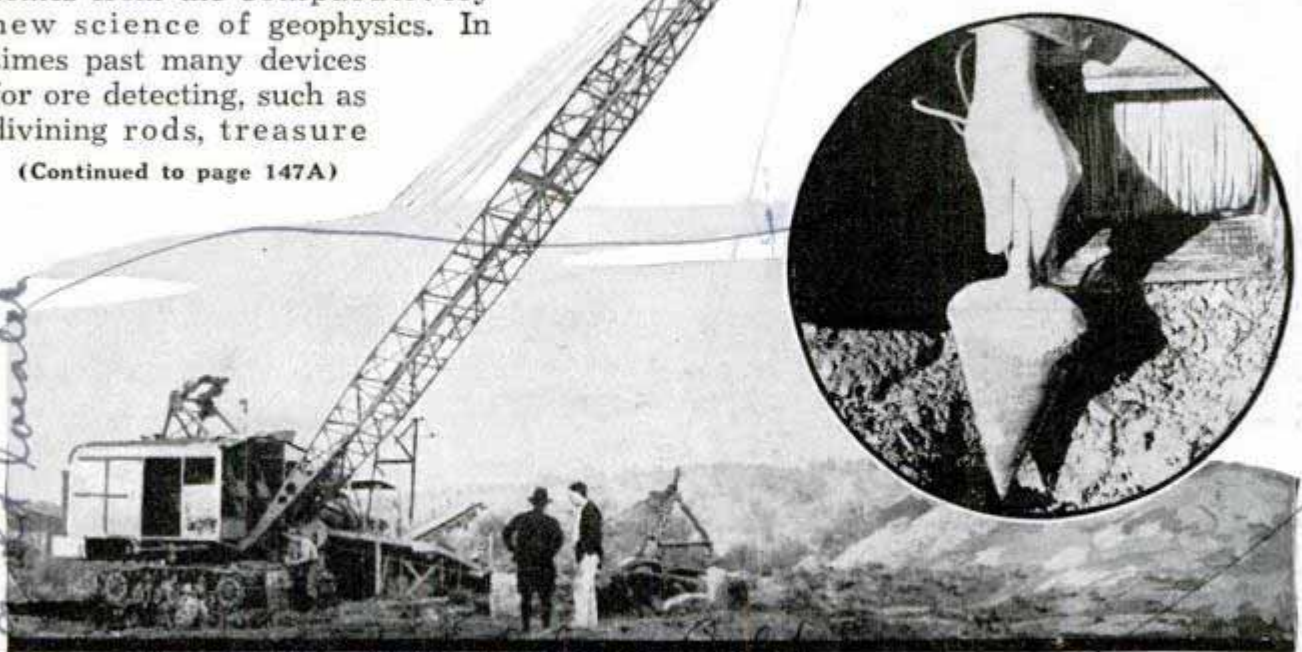

Discovery of A. E. Vandercreek Sacramento, Calif. Patd

4 miles from Coalinga, Calif

Circle, Gold Reserve mine which is being mined by a new process. Top, right, Newsom's core drill. Bottom, power shovel in open mine. Inset, bottom, setting electrode of gold locator in ground

Developed by J. B. Newsom

es 5 70

Defense Guns and Planes Combat Air Raiders

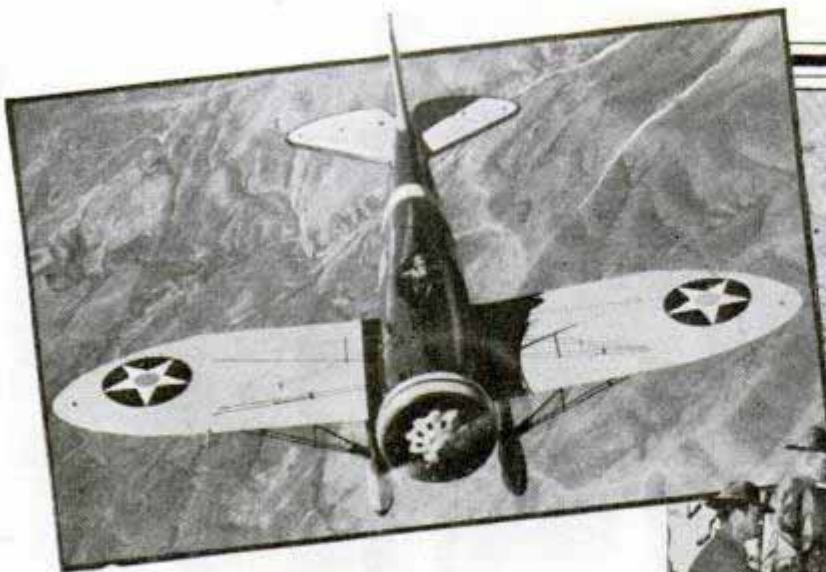

Above, latest Boeing single-seater pursuit plane, used for attacking enemy bombing planes, has high-speed and super-efficient guns. Right, one of the 63d Coast Artillery's three-inch anti-aircraft guns concealed by camouflage and ready to "fire" at attacking planes in recent U. S. maneuvers near Muroc, Calif.

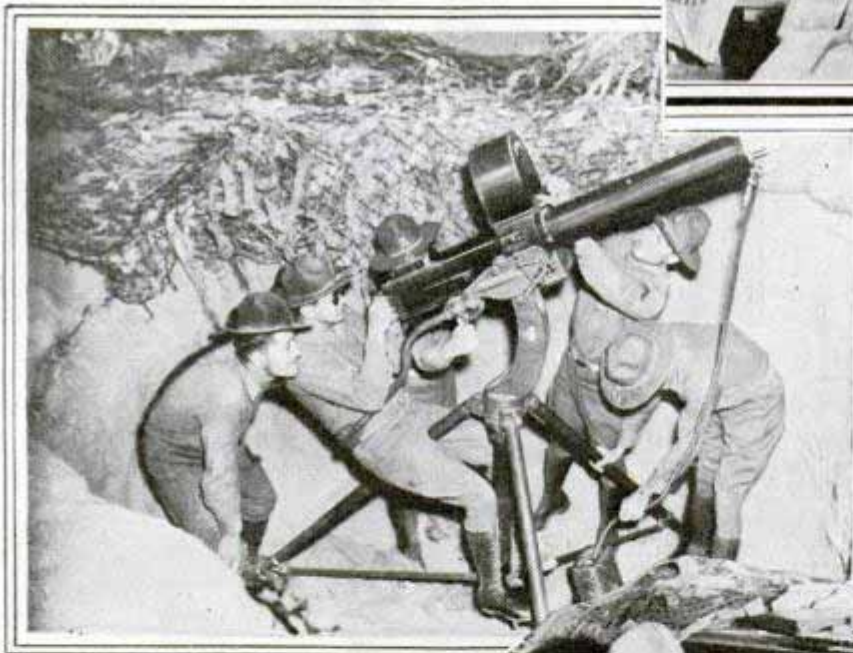

Wickie Wolk

Left, machine gunners of the 63d Coast Artillery training their anti-aircraft weapon on "enemy" air raiders attacking "targets" outlined on the dry lake near Muroc. Remarkable accuracy is a feature of the latest guns produced for defense against air raids. Note the camouflage net over the machine gun's "nest"

Right, soldiers of the 63d Coast Artillery operating an anti-aircraft range finder on the lake bed at Muroc. This apparatus locates and registers the range and angle of fire for the anti-aircraft batteries so that a deadly defensive shower of shells and bullets may be directed at approaching "enemy" planes. Even the range-finding equipment is partially protected by camouflage from the eyes of observers in raiding planes. This photo was snapped during the recent maneuvers in California



Photo by Sgt. J. J. ...

Diesel Streamliners Now Link Coast to Coast

With the assignment of two new streamline Diesel-electric locomotives to the Capitol Limited of the Baltimore and Ohio railroad, Diesel trains for the first time span the continent. These two powerful locomotives, running daily in each direction between Chicago and Washington, are the first of their kind on any trunk line from Chicago eastward. Three years ago the first Diesel-electric streamliner streaked across the coun-

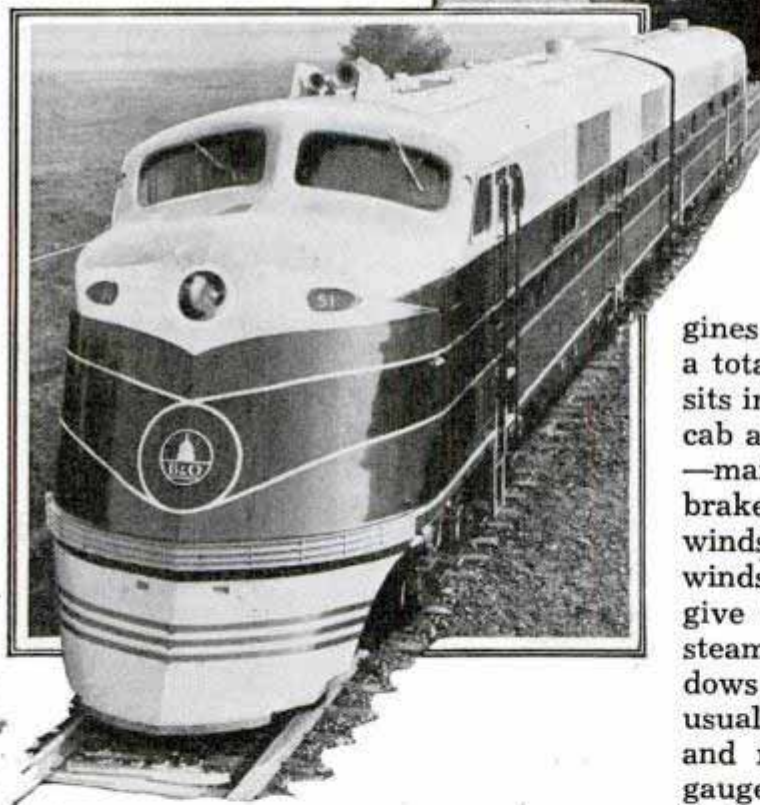

Streamline dual power car at left, built to haul Baltimore and Ohio railroad's Capitol Limited, completes eastern link of Diesel-electric passenger service from coast to coast. Officials are shown in locomotive's control cab above

try to pioneer a new type of railway passenger service, and today a score of these trains are in service, covering a total of 13,000 miles daily. Four trains operate between the Pacific cities and Chicago on thirty-nine and three-quarter hour schedules, and with the Baltimore and Ohio streamliners connecting at Chicago you can ride from San Francisco to Washington in fifty-four hours and ten minutes running time by Diesel. These newest en-

gines are twin-unit power cars delivering a total of 3,600 horsepower. The operator sits in a comfortable adjustable seat in the cab and drives the train with three levers—main throttle, reverse lever and air brake handle. Slanting, automotive-type windshields of thick safety glass, with windshield wipers and hot-air defrosters, give the driver good vision. The cab is steam-heated, with adjustable side windows and no-draft ventilators. To the usual instruments such as the indicating and recording speedometer, air brake gauges and motor dials has been added a "wheel slip" indicator which flashes a red light when any driving wheels slip because of poor track conditions. In the engine room the attendant is warned by four colored lights and an electric gong whenever the engine overheats, oil pressure is low or a boiler is failing.

Whenever you find that you wish to know more about any article in this magazine, write our Bureau of Information, inclosing return postage.

Automatic Transmission Saves Gas and Power

Providing four forward gears which are selected automatically through a device actuated by oil pressure and engine speed, a new automatic transmission for the automobile saves gas, improves acceleration and reduces engine wear. It eliminates the gear-shift lever from the floor of the driving compartment, employing a small control lever located on the

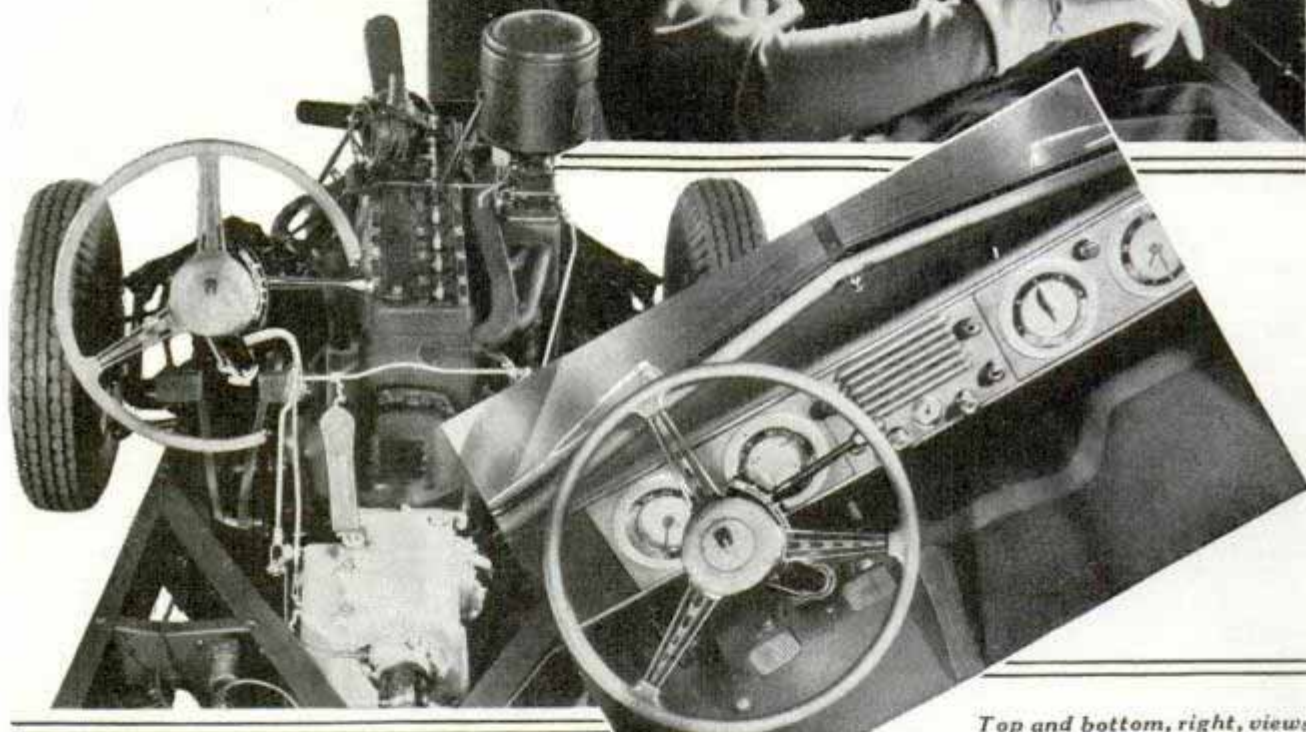

Top and bottom, right, views of control lever on Oldsmobile steering column. Left, showing means of controlling transmission

steering column. This lever has four positions, reverse, off and two forward speeds. The first forward position consists of a first and second gear designed for starting when the engine is cold, when the car is on hills or when maximum power is desired. The car is started as usual, by using the clutch, after the control lever is in first forward position. At six miles per hour the gears automatically shift from first to second. Then the driver moves the lever into second forward position, without using the clutch, and the transmission automatically shifts into higher gears until it reaches "super drive" at a speed of twenty-three miles per hour or greater. Extremely fast acceleration or increased

power for hill climbing may be obtained while the car is operating in fourth forward gear, or super drive, by depressing the accelerator pedal to the floorboard. This causes the transmission to shift into third or "pickup" gear, which operates as long as the accelerator pedal is depressed or until the car attains a speed of approximately sixty-five miles per hour. Then the shift back into super drive occurs automatically. At speeds below fifty the control lever may be shifted back into first forward position, causing the lower gears to retard the speed of the car on down-

causing much
es 57

Road to Span Lake Michigan Is Plan to Speed Traffic East

grades. The shift to reverse also is made manually, but may be accomplished only by pressing a lock button at the end of the control lever. This prevents accidental shifting into reverse. The super drive has the effect of the "overdrive" and "cruising gear" featured by other manufacturers in that it provides a low axle ratio, permitting the engine to work slower without reducing the speed of the car. A ten to fifteen per cent increase in gasoline mileage is claimed, compared to fuel consumption of a car equipped with conventional transmission. The automatic transmission, designed by Olds Motor Works engineers, consists primarily of two planetary gear sets which replace the conventional forward speed gears. These gears are placed one in front of the other, so that the power from the engine may be transmitted through either or both gear sets. The automatic selection of the most efficient gear for each speed is controlled by a centrifugal governor incorporated into the transmission which controls the shifting mechanism. The shift from one gear to the other is accomplished through hydraulically operated pistons that control brake bands on the planetary gear sets and clutches within the planetary units. Thus, when the transmission is in low gear the brake bands of both gear sets are held tightly against the drums and the power is transmitted through the two sets of gears. In second gear the brake band of the forward gear set is released and power transmitted through the rear gear set. In third, the brake band on the rear gear set is released and the drive is through the forward gear. In super drive, the bands on both gear sets are released and power is transmitted directly from engine to rear axle. Oil pressure for operating the transmission is generated by a built-in pump.

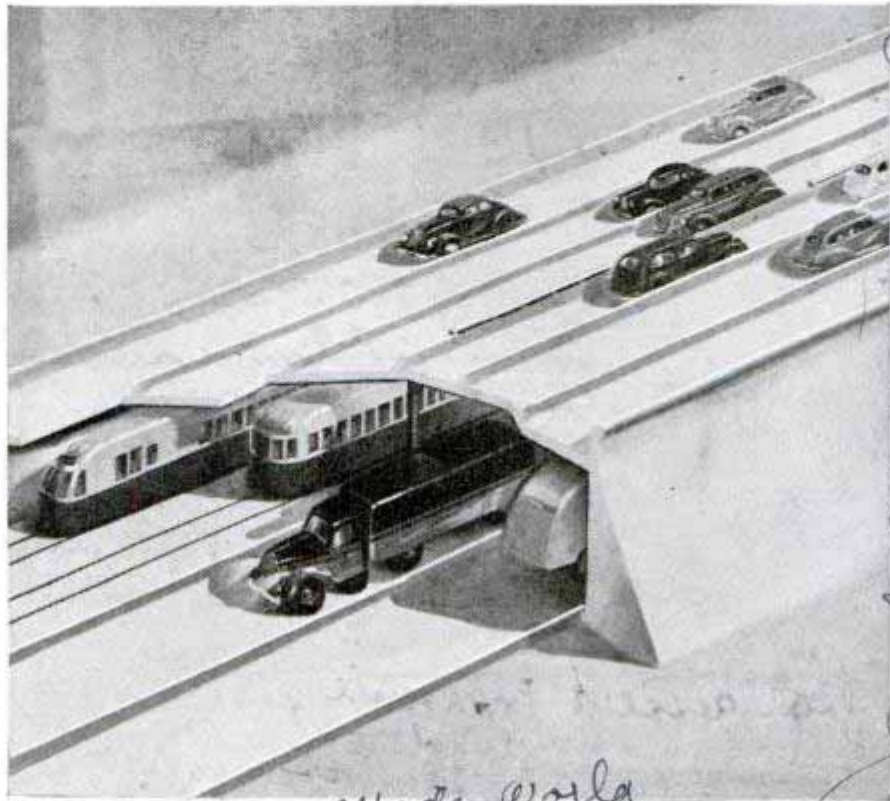

Wide world
Drawing of twin-decked super-highway for automobiles, trucks and electric lines, which engineers suggest building across Lake Michigan

To link Chicago with the east by an express highway, Chicago men propose a double-deck super-highway that would span Lake Michigan. Their plan calls for an island at the mid-point of the road between Chicago and the Indiana shore. A six-lane upper deck would carry automobile traffic, and below it would be four lanes for trucks and interurban lines.

Rope Clamp Gives More Tension When Line Is Pulled

es 56
Made so that a pull on the rope will increase tension, a simplified clamp is available for use on clotheslines, tennis nets, tents and awnings. Regardless of tension, the clamp maintains a non-slip grip which can be loosened only by pulling the trigger. Round leather or cord rope may be used in the device.

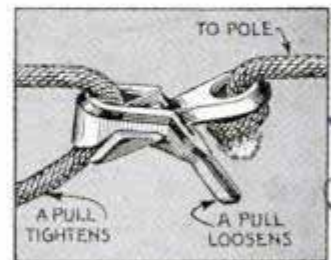

Paul H. Anderson, Raymond
Feen and Raymond Hough
Stel Rope Clamp Co. 98 Magazine St., Newark, N.J.

A FORTY-FOOT twin-screw craft capable of taking the family for a week-end vacation or an all-summer cruise.

*Baltzer Boat Co.
Massachusetts
Medford, Mass.*

*Cont. Eric G. Snelgrove,
c/o Geneva Realty Firm
Geneva, N.Y.*

169



169

Owner Robert E. Todd
Syosset, L.I., New York

Lawn Cruisers, Inc.
Clason Point NY

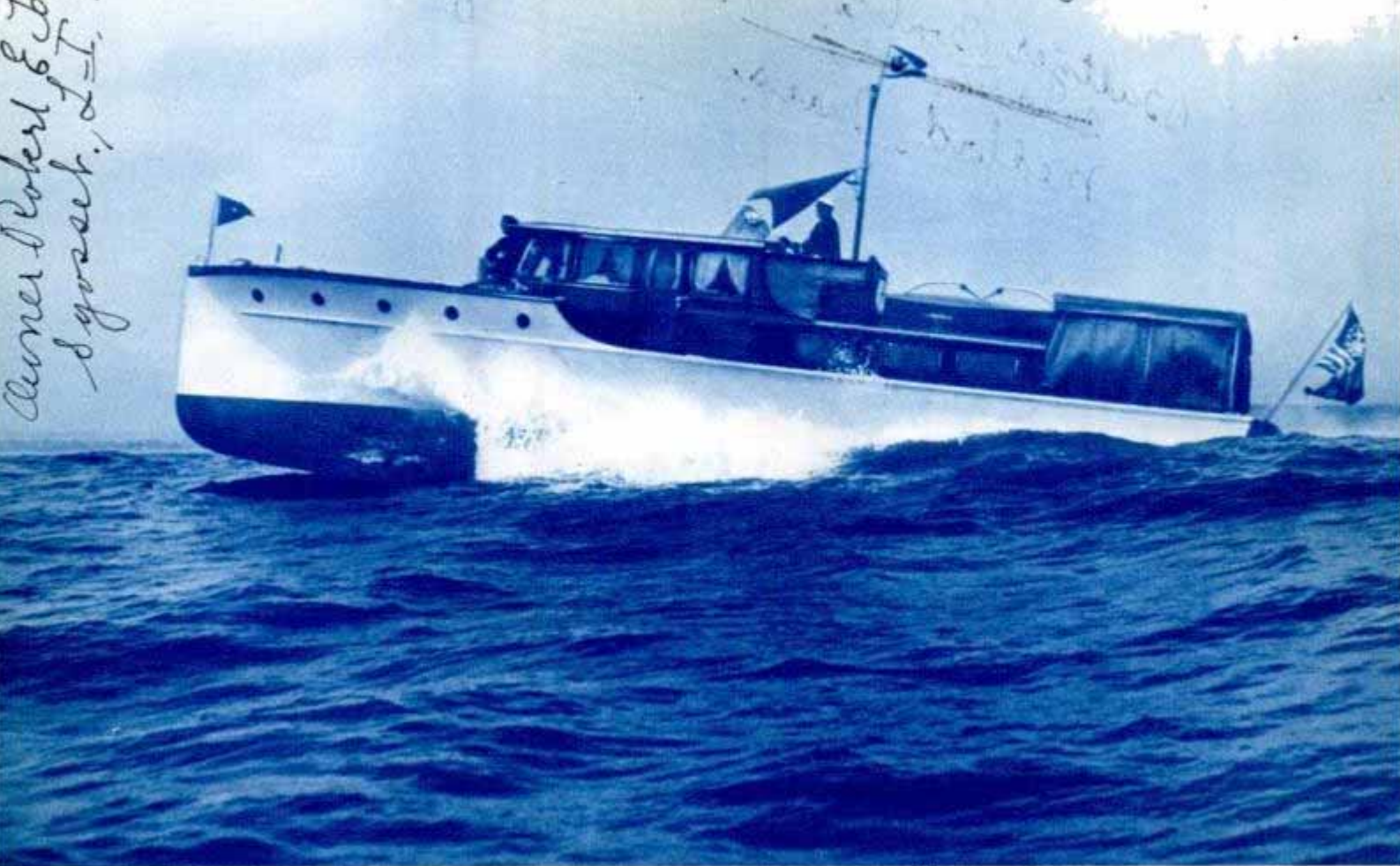

190

Karina

453

A SEAWORTHY floating home powered by two 150-horsepower Diesel engines and capable of taking you almost anywhere you want to go.

PART I

HUNDREDS of American families have discovered a new way to live. They are closing up homes or deserting city apartments during the summer for life aboard that marvel of comfort, compactness and seaworthiness—the modern small cruising motorboat. Naval architects and boat builders have created a home afloat that is within the reach of thousands.

The trend to the water has become increasingly evident the last few years. There were 319,404 motorboats numbered at the forty-four federal customs houses, according to a recent survey made by the National Association of Engine and Boat Manufacturers for war department engineers. Numbered motorboats in use on federal waterways throughout the country more than doubled in the nine-year period covered, the survey disclosed. From 208,037

motorboats in 1926, the fleet was increased by 111,367 craft.

Nowhere is mechanical progress better exemplified than in the motorboat of today. Gone are the days of steam and naphtha launches with their gingerbread and scalloped awnings overhead. Gone, too, are their successors, the slim and wet toothpick type of hull that sliced through the water and rolled perilously in even a moderate sea. Relegated with them to the limbo of forgotten things of the sea in Davy Jones's locker, are the huge, cold hunks of balky iron that were the early two-cycle marine engines with make and break, or jump spark ignition.

The modern motorboat is a thing of comfort and luxury. Those gleaming mahogany runabouts that dash across the water at speeds from twenty-five to more than sixty miles an hour have ultra-soft leather cushions, usually filled

6

41 foot cruiser
 Elec Work?
 Port Elec. N.Y.

COMFORTABLE berths,
 right, in forward cabin of
 forty-one foot cruiser. Be-
 low, roomy cabin of a sixty-
 foot sailing boat with an
 auxiliary power plant.

gas or diesel
 engine.

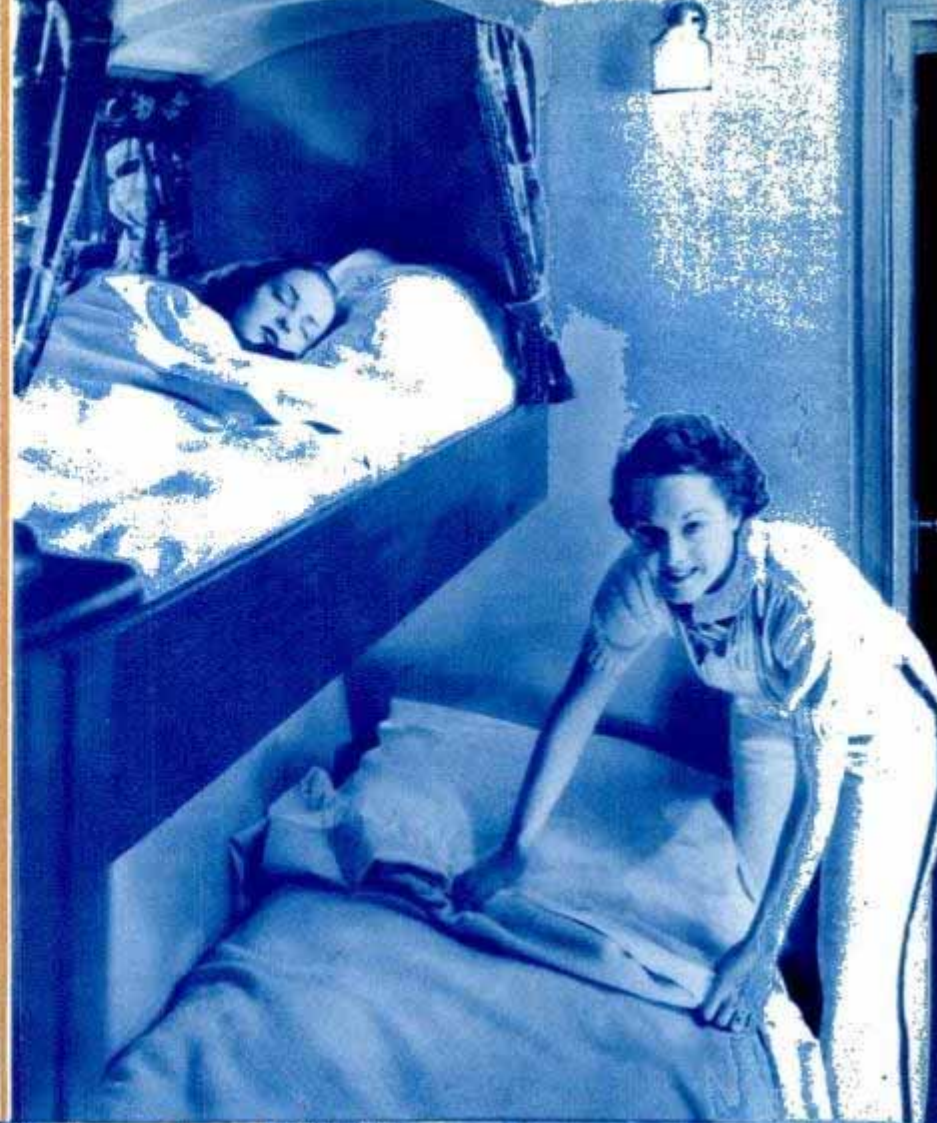

Owner: Langhorne Brown

Designed by Sparkman and Stephens
 11 E. 44th St. New York
 in the Davis and Sons, Solomoni
 engine

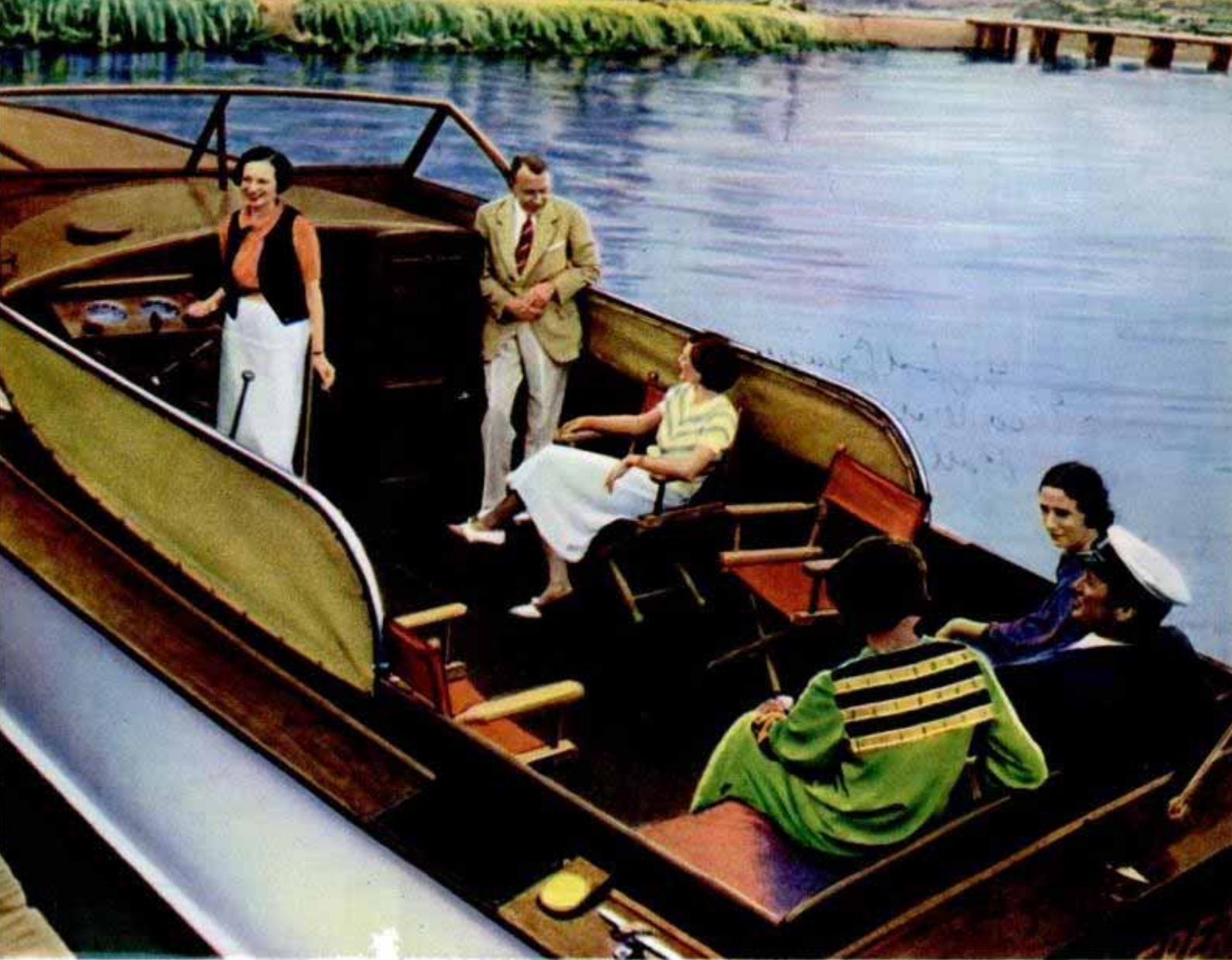

192
 THERE'S plenty of room for all the family and a guest or two in the wide and roomy after cockpit of this thirty-two foot craft.

2553

'Wanderer'
 American Car and Foundry Co. 36 Church St. New York

with kapok to act as life preservers. The trim cruisers, some with speeds up to thirty miles an hour, but mostly in the twelve to eighteen mile class, are literally floating homes with everything from dining nooks to shower baths.

Living afloat is an experience, once tried under proper conditions, that has few equals from the standpoint of health, happiness, comfort and freedom.

Within the comparatively small space of thirty feet in length, by nine to ten feet of beam, about average specifications for a medium-priced cruiser although 1937 models show a trend toward more beam, are to be found complete living accommodations for at least four people. Such a little ship is capable of taking this family out on the water for an indefinite time—a week end, or an entire

summer, a short day cruise or a trip to Florida and return. It is poor policy, however, to crowd too many people aboard to live for any extended period. It is best to have only the immediate family aboard if you want frictionless peace and comfort.

The average landlubber has little conception of the interior of the modern small cruiser. There are comfortable berths, usually Pullman-style uppers and lowers in the single-cabin type of craft; full headroom for six-footers and a complete galley that surpasses the most compact kitchen of a modern home.

There are electric lights, toilet facilities, running water, and plenty of storage space with full-length clothes lockers. And when you grow tired of the scenery and surroundings of your an-

American Car and Foundry Co. 36 Church St. New York



Ad for
Atlantic Lumber Co 1933
mutual Lumber Co
as motorboating

253



AN OCEAN-GOING cabin boat which serves as a winter home in tropical waters, and the kitchen and dinette of a thirty-two footer.

Wanderer

American Lumber Foundry Co.
36 Church St New York

Higgins Industries, Inc.
1755 St. Charles Ave.

New Orleans
La.



es 53

194

THREE "tunnel stern" boats of very shallow draft which have no trouble navigating river shoals and are also seaworthy for the open water.

chorage it is only necessary to up anchor and away to newer and bluer waters.

Mr. and Mrs. General Public are learning about boats, and learning fast. They jammed three spacious floors of the Grand Central Palace in New York City for the entire week of the annual National Motor Boat Show. Literally thousands of interested people stood patiently in line during the week to climb the gangways and inspect the neat and comfortable interiors of the fleet of cruising motorboats displayed by the nation's boat builders.

The boat-wise dropped to hands and knees to peer underneath the smooth and gleaming hulls and cast a knowing eye at struts, shafts, bottom planking, noting hull lines, talking glibly with overwhelmed salesmen about stuffing boxes, cutless-rubber shaft bearings, engine revolutions, propeller pitch, and such mysteries to the landlubber as tachometers, binnacles, backfire traps, auto-

matic bilge pumps, exhaust blowers, and other accessories of the 1937 boat.

The steadily growing interest in the family cruiser was again one of the outstanding trends noted by show officials and boat builders. It was apparent to them that the average boatman wants a craft on which he can take his family along and on which they can live in comfort for as long as desired.

More than one interested prospect mentioned that he had read about the construction of a "marina" in his neighborhood and after investigating the meaning of this new word, had become enthused about the idea of living afloat. What is a marina? It is a modern boat basin where a small cruiser can be anchored in perfect safety, the family left aboard while the man of the "house" hies himself off to business via some means of land transportation.

A visit to the clean, supervised and safe marinas of Florida in the winter

Raymond ...
morning ...
Newport.



175

1753

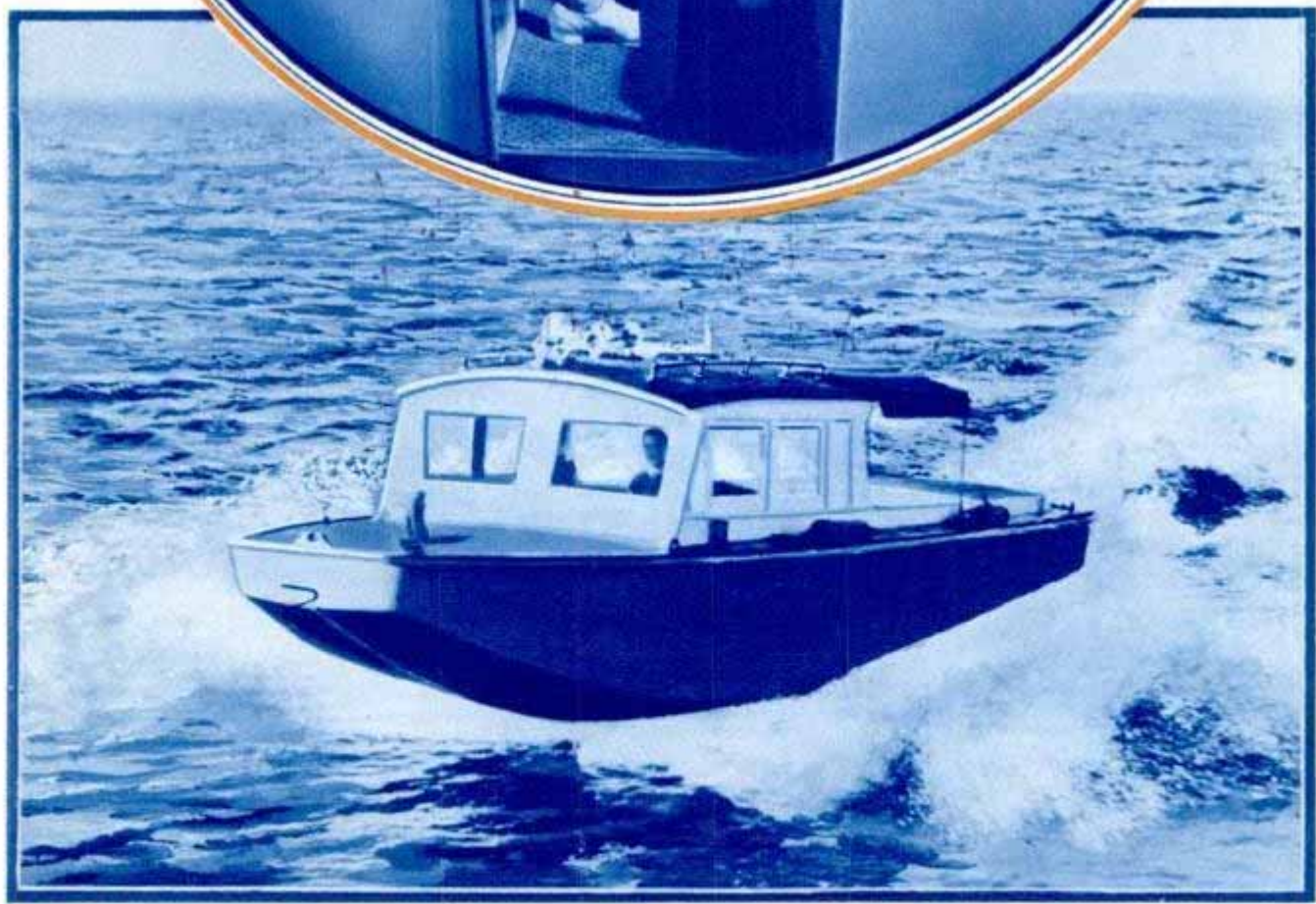

DINETTE of a forty-two foot power boat which can be transformed into a Pullman-type berth at night. Below, this boat has just run over a log, a feat made possible by its unique type of "spoonbill" bow.

Higgins Industries, 1755 St Charles Ave New Orleans, La

time tells more vividly than words the extent this living afloat is taking hold of Americans. Hundreds of cruisers ranging all the way from some in the twenty-foot class to luxurious houseboats and those floating palaces, the big yachts of the wealthy, are in Florida basins every winter.

It is surprising, too, to most casual visitors the number of smaller craft that hail from northern ports and which have come south under their own power. The federal government has provided a protected inland coastal waterway from New York to Miami, except for a twenty-five mile open ocean passage from Sandy Hook to Manasquan Inlet, N. J.

Living aboard is not only a healthful and comfortable means of escaping hotel expenses or rental of furnished flat or house but it also provides a means of seeing Florida not available to those who do not own cruising motorboats. For a small dockage fee, city water and telephone service are handy right at your slip in the marina while electricity can be hooked right into your cruiser if it is wired for city voltage.

(Concluded next month) 53

TWENTY-FIVE foot sloop for those who like sailing. It also has an auxiliary motor.

There are sleeping quarters for four.

Playboat

Consolidated Shipbuilding Corp.
Morris Heights, N.Y.

196

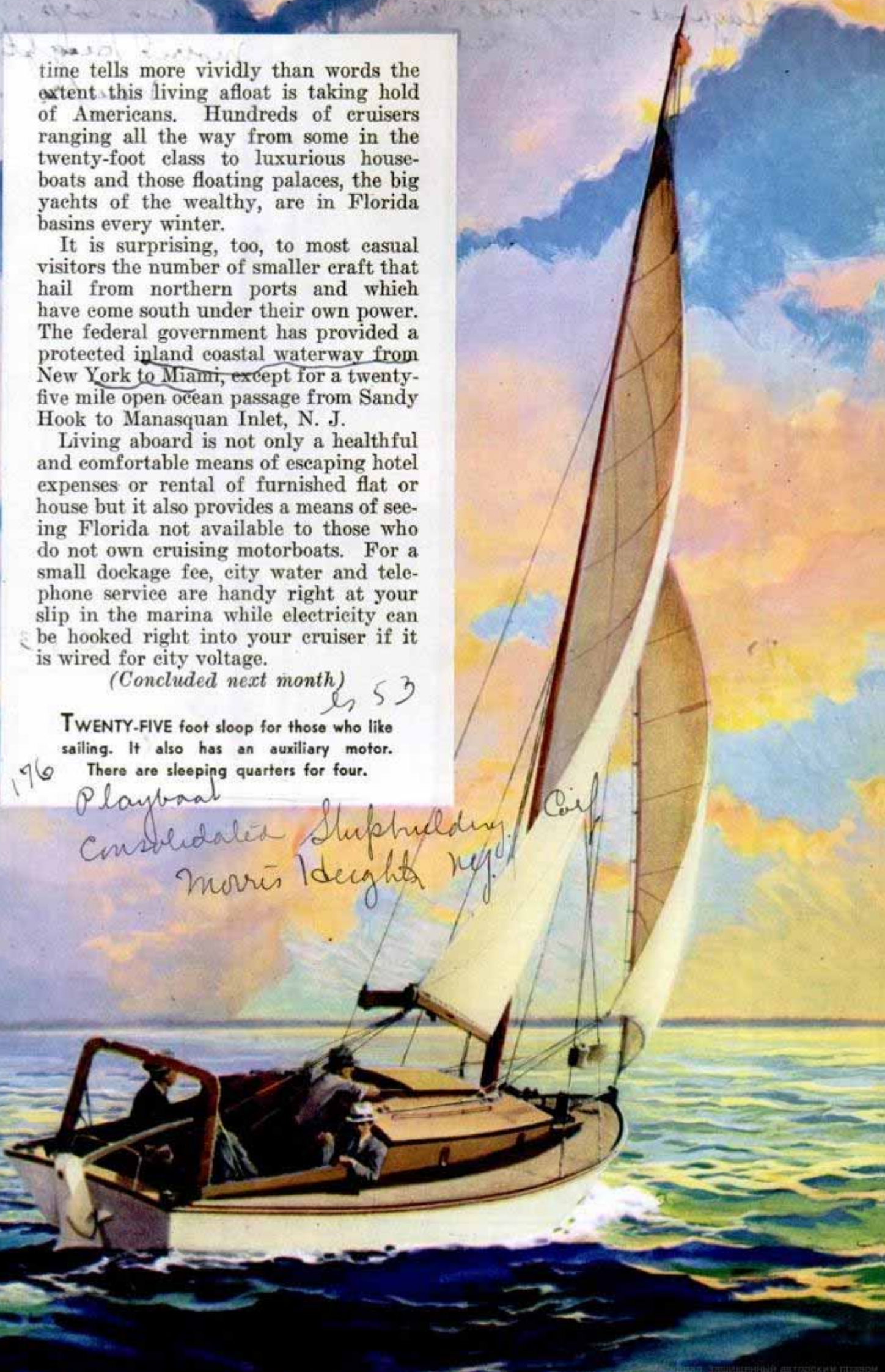

es 506

Workshop on Stilts Services Clipper Planes

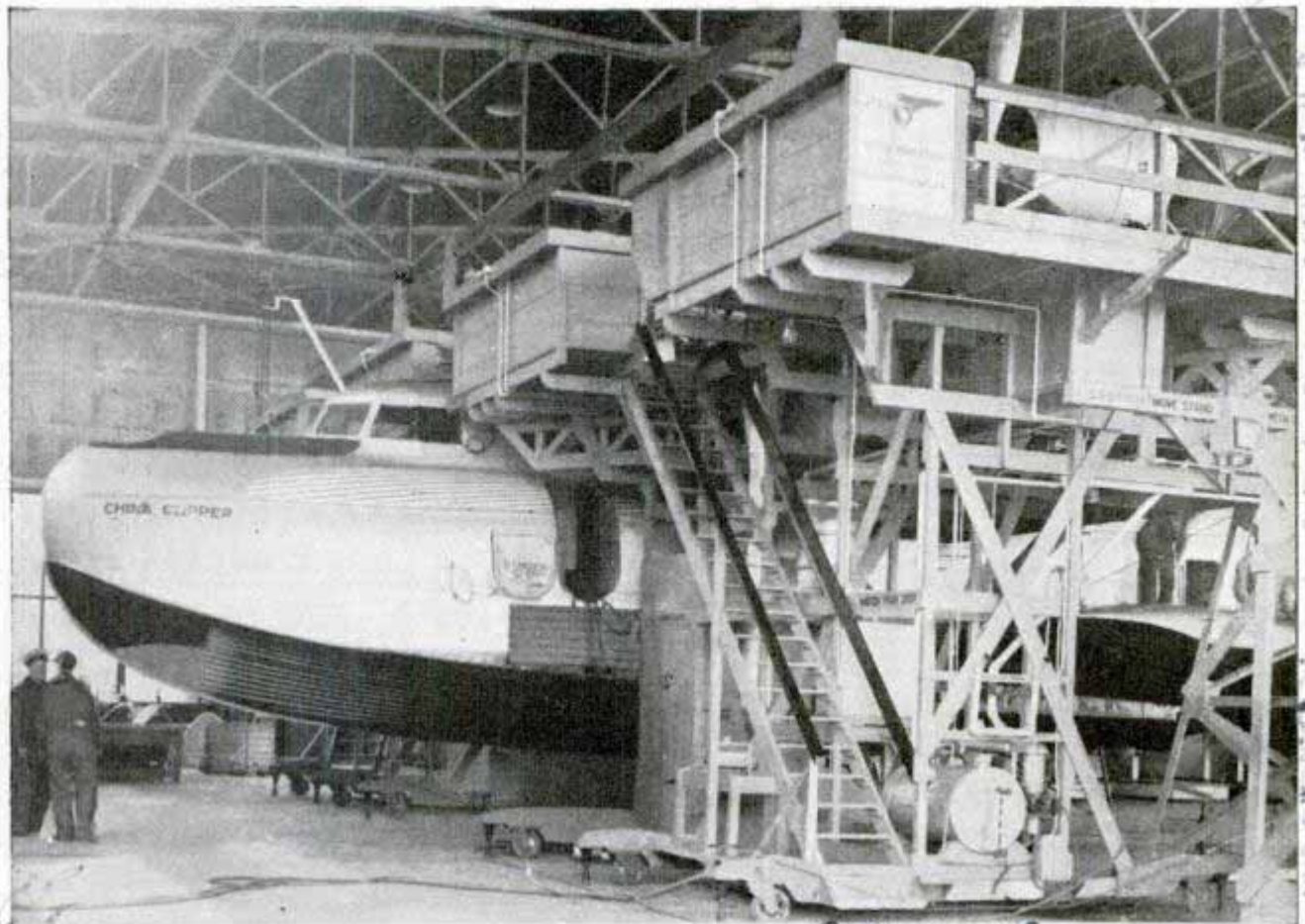

Portable workshop in place, ready for servicing big ocean-going clipper plane. Upper right, note how stand fits around motor to facilitate inspection and repairs. The workshop is moved on small wheels

Mounted on wheeled stilts, a traveling workshop facilitates servicing of the trans-pacific clipper planes at the Alameda, Calif., base of the Pan-American Airways. When the big planes are moved into the hangar, the scaffold-like stand is rolled

up in two sections to fit around the motors and the fuselage, thus making it easy for mechanics to reach any part requiring attention. The gallery for working on the motors is twenty-one feet above the floor of the hangar.

Electrically Locked Gas-Tank Cap Controlled from Dash

Operated by button on the dash, a new electrically locked gas-tank cap has been placed on the market for automobile owners. It is slightly larger than the ordinary gas-tank cap. An electric magnet, actuated by the dash button, pulls a lever to release the cap. A spring in the hinge of the cap causes it to open. The cap is closed by pressing it down. It may be wired so that it cannot be opened when the key is out of the ignition lock.



Left, control button on dash which releases gas cap, shown in photo at right

The department of agriculture estimates there are 123,000,000 rats in the United States—almost as many rats as people.

Clp. 5/2/37

Steel Bros. Co.
445 Winchester Ave

This is a portable workshop on stilts for servicing clipper planes. The workshop is moved on small wheels.

a standard key

es 518.

Airplane X-Ray Reveals Flaws in Metal

Miss. Tom G. Triplett and Victor J. Barkhead Factory of Burbank Calif



Portable X-ray equipment being used to test various metal parts of airplane

When Amelia Earhart's big plane was placed under a newly developed X-ray machine recently, several flaws were discovered which might have forced down the aviatrix at some point on her round-the-world flight if they had not been corrected. The secret of the new X-ray is a small tube which pours out rays powerful enough to penetrate eighteen inches of solid aluminum. Designed to send 280,000-volt rays through a plane's wing, the machine is said to reveal flaws as small as one-millionth of an inch.

es 565

Invisible Electric Trap Guards Area Against Intruders

How an invisible network of electric rays can be used to trap intruders and sound an alarm without their knowing it was demonstrated recently. Attempts to enter a 13,000-square foot area or to move from one zone to another were defeated at every turn in the test. Developed with the aid of General Electric engineers the de-

Signalphone Corporation are

vice relies principally on the phototube, or electric eye, to foil the intruder. The network is made up of the beam from a standard automobile headlamp from which all visible rays of the light spectrum have been filtered. By a multiple system of mirrors this single invisible beam may be reflected back and forth across a room, around corners and at different angles and levels until the guarded area is completely protected. The system is extremely flexible in that the energy released by interfering with any beam can be used for sounding an outside bell or siren, or transmitting alarms by telephone.

"Telescope" Awnings of Metal Have Long Useful Life

es 520

Metal awnings made of "telescoping" segments are available in galvanized iron, aluminum, copper or stainless steel. They are raised or lowered by cable from inside the window. Being of metal, they can be used throughout the year.

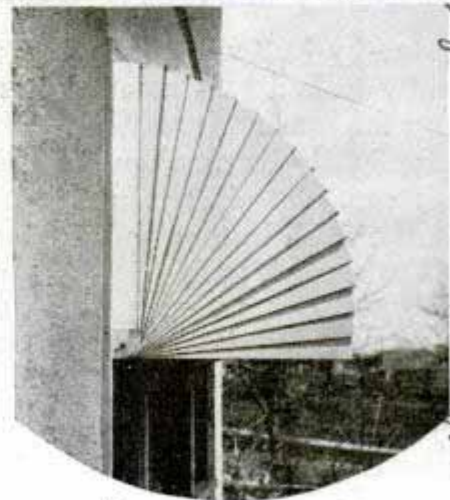
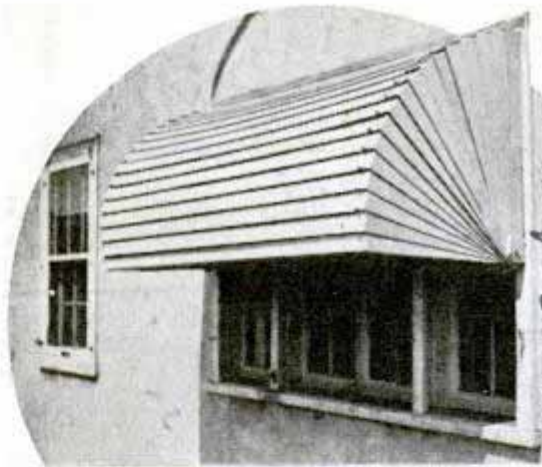

Two views of metal awning, operated from inside house. It can be used throughout the year

The Lubart Shade Corp. Inc. 276 Clingstone Ave. n.e. Charleston

More Light Produced by Improved Filaments

Increasing the light output by ten per cent without additional electricity, new high-efficiency tungsten lamp filaments soon will be saving the public millions of dollars each year. First drawn into a straight wire 19/10000 of an inch in diameter, so fine it is almost invisible, the tungsten then is wound, 335 turns to the inch, around a thin molybdenum wire or mandrel, leaving the coils 1/1000 of an inch apart. The coils must be kept close together to reduce heat loss, but must not touch because a short circuit would cause immediate lamp failure. Then the coiled wire is coiled on another mandrel, seventy turns to the inch, with a spacing of 7/1000 of an inch between the secondary coils. This process reduces the twenty-inch wire to a length of five-eighths inch. Following the second coiling the mandrel is dissolved out by means of chemicals. Use of certain gases within the bulb introduces pressure which reduces filament evaporation, with its accompanying evil of bulb blackening, and allows the lamp to operate at a higher temperature for the same life. Presence of gas, however, is conducive to cooling of the filament, reducing the temperature and also the light output. This problem

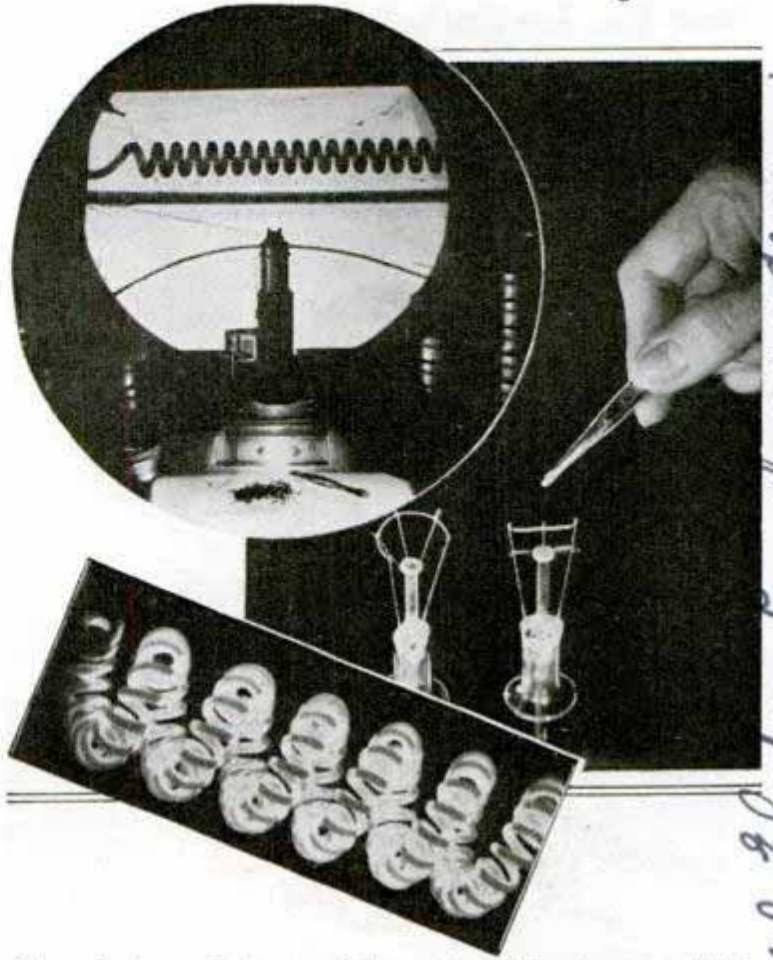

Several views of improved filaments which give more light without increasing amount of electricity used

has been solved by reducing the length of the filament, thus lowering the heat loss and permitting the lamp to give ten per cent more light for the same amount of current. Gas employed in the new lamps is a mixture of nitrogen and argon.

Small Dolly for Moving Trailer Fits into Hitching Socket



Pressing down handle of dolly lifts trailer off its parking wheel. It is easy to maneuver even a heavily loaded trailer in tight parking spaces

Even a heavily loaded trailer can be moved about and maneuvered in tight parking spaces by means of a two-wheeled dolly. Its ball tip fits into the socket of the trailer's hitching mechanism. After raising the handle to fit ball into socket, a downward push lifts the trailer off its parking wheel. The upright column is adjustable vertically from fifteen to twenty inches.

Whenever you find that you wish to know more about any article in this magazine, write our Bureau of Information, inclosing return postage.

General Electric Incandescent Lamp Dept., 2160 Park Cleveland, Ohio

Saginaw Stamping Tool Co. 68 Williams Saginaw, Mich

To 44 S. Elm. Walter & Maurion
1032 Florida Ave. Akron, Ohio

CELLULOID MODELS-



machinery design. The use of models in industry is an old story. The patternmaker who whittles a machine part from wood so that it can be cast in metal is really a model builder working on a scale of one to one. Airplanes and automobiles are modeled in wood and similar materials before they are built full size.

At the Westinghouse Electric and Manufacturing company's turbine division in Philadelphia, where research engineers now employ celluloid for building model turbines and other machines, wood was used for years as a model material. About six years ago, the engineers were working with a model boat that was to be propelled by storage batteries. No batteries small

CELLULOID is becoming a useful tool of engineering science because it can be substituted for steel in the testing of machines yet to be built. It is used in modern industry as a material for making scale models of machinery still in the blueprint stage. For this purpose, it threatens to oust wood and metal because of its transparency, ease of handling, and its steel-like behavior when welded together or subjected to various tests.

Engineers of some industrial laboratories where celluloid is now an important research necessity are wondering why no one thought of it seriously as a material for making experimental models until a little more than two years ago. Celluloid has been common and well-known for a long time, yet it still is in its infancy as a raw material for models to be used in testing deflection, efficiency, operation and other features of heavy-

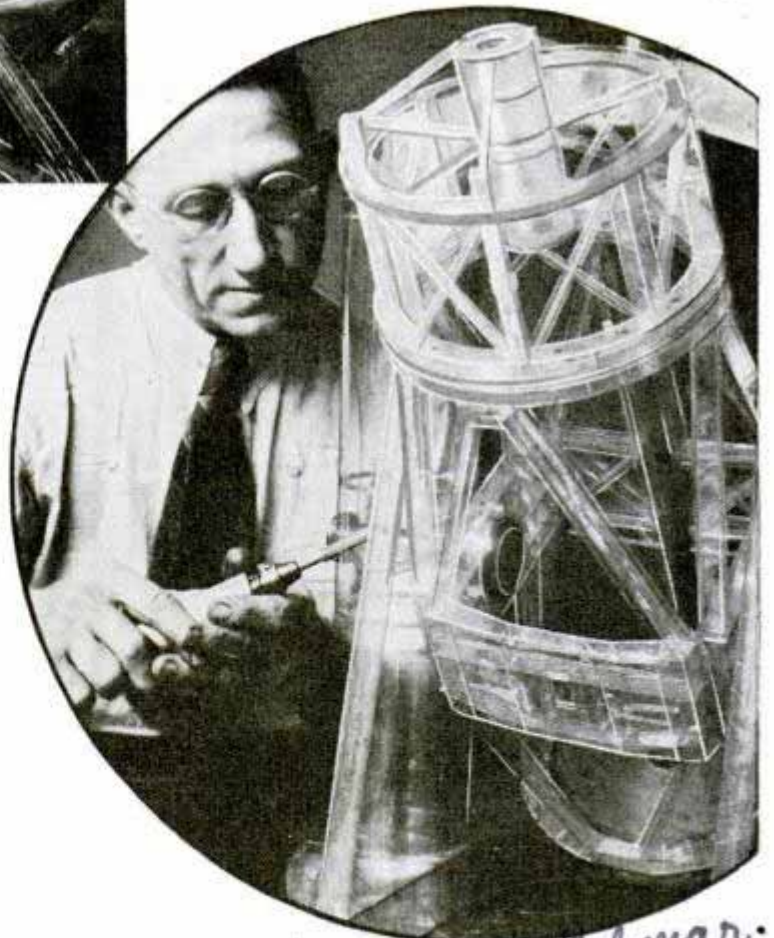

Top, working on celluloid model of giant telescope mounting. Bottom, smoothing corners of model with rotary file

Mr. Palmer.

see also sup. for makers

Walter Dill Scott
Works of Crommroyd

New Tools for Engineers

5443

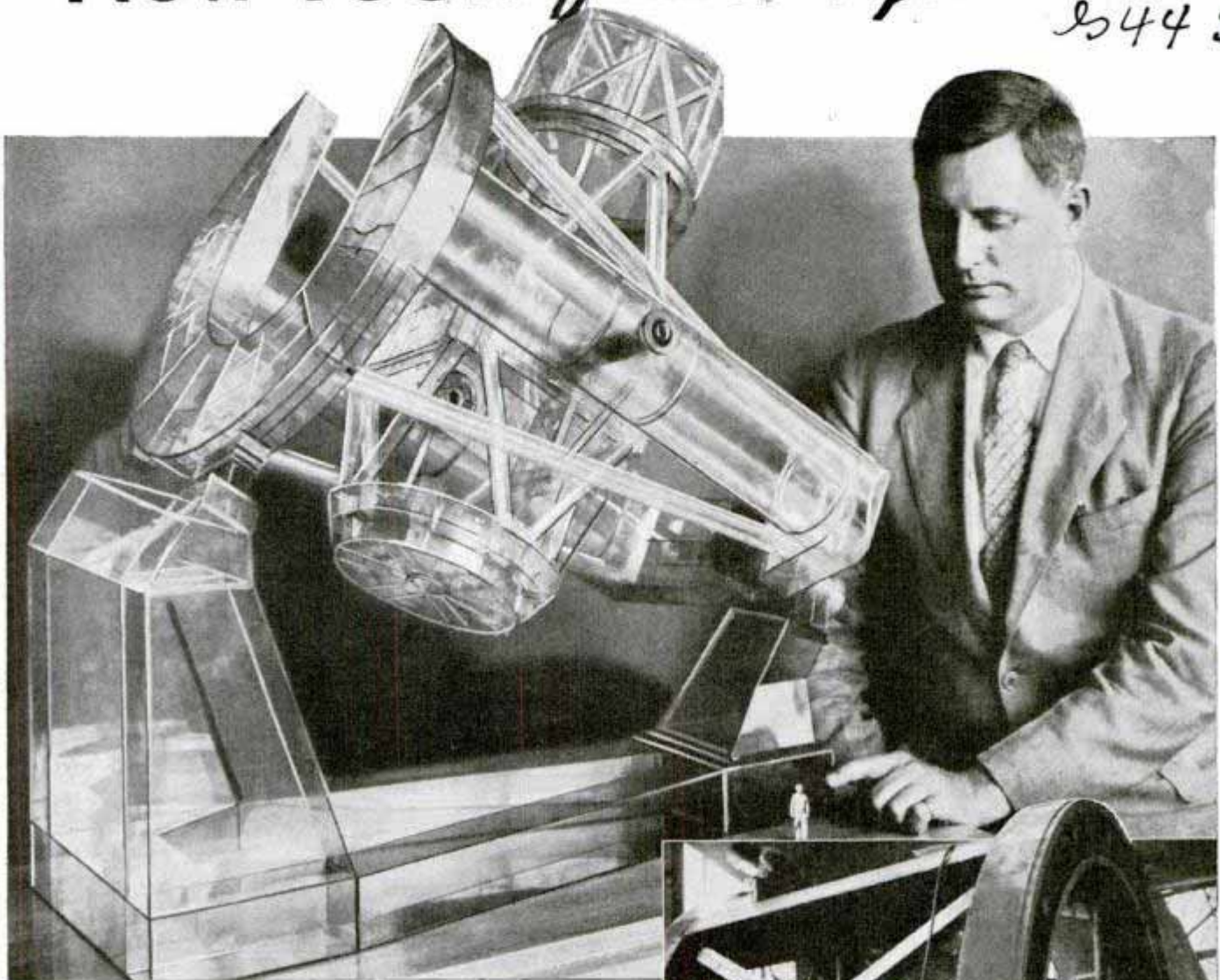

enough were obtainable, so they had to be made. Celluloid was selected as the most convenient material for the cases, because it can be cut and joined together easily. The celluloid batteries were satisfactory, but no one at that time saw in them the promise of a change that may revolutionize the model-building end of industry.

About four years later, the United Engineers and Constructors, Inc., of Philadelphia, found it necessary to build a miniature version of a giant 165,000-kilowatt turbine-driven generating unit to be installed in a Philadelphia electric-power station. The steam turbine itself, generator and various other parts were made of wood in model form to show how the completed power unit would look. Wood was satisfactory, up to a certain point. The engineers wanted to demonstrate how the foundation structure would be made but

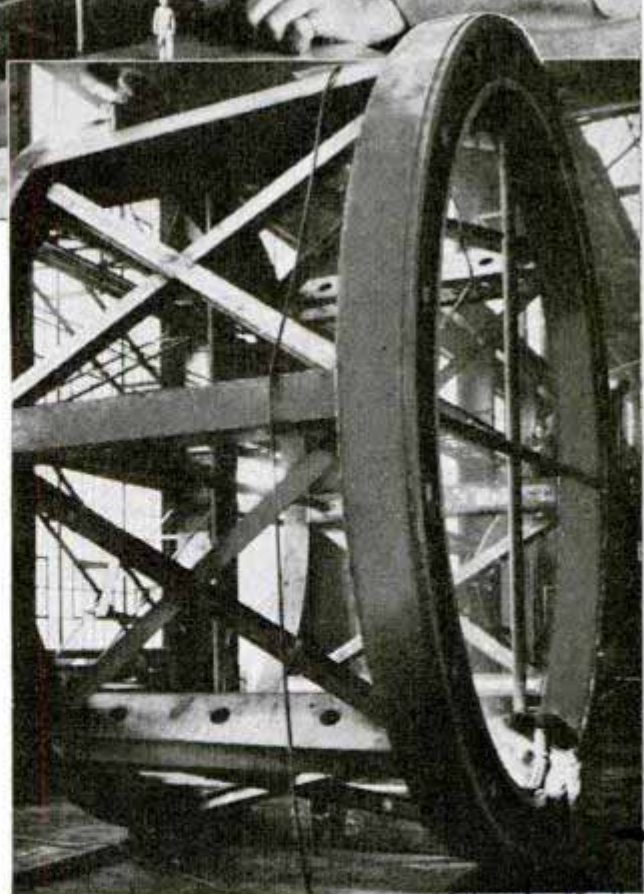

Mr. Tolmie
Top, midget figure shows relative size of telescope mounting. Bottom, welding giant prime focus ring of telescope



see through wood, and therefore the engineers cannot see, or show other people, what the inside structure looks like and how internal working parts move. There are other advantages on the side of celluloid. By properly juggling such things as the modulus of elasticity, specific gravity and strength, the behavior of celluloid when supporting a weight can be translated into the behavior of full-sized steel structures under similar conditions. In other words, celluloid can be used as a model for steel behavior as well as steel structure. The celluloid models that have replaced wood at the Westinghouse laboratory are employed largely for the measuring of deflection of parts under load. By suspending weights from various parts of a housing for a steam turbine, engineers can determine just how much deflection there will be when similar loads are imposed on the steel parts of the same turbine after it has been built, full-scale, of metal. Measurements of the tiny movements made by parts of a celluloid model as weights are attached to it are made

with "electrified micrometers," which are connected into the circuit of an electric bell or buzzer so that the experimenter knows the instant the micrometer screw touches the part being measured. This pre-

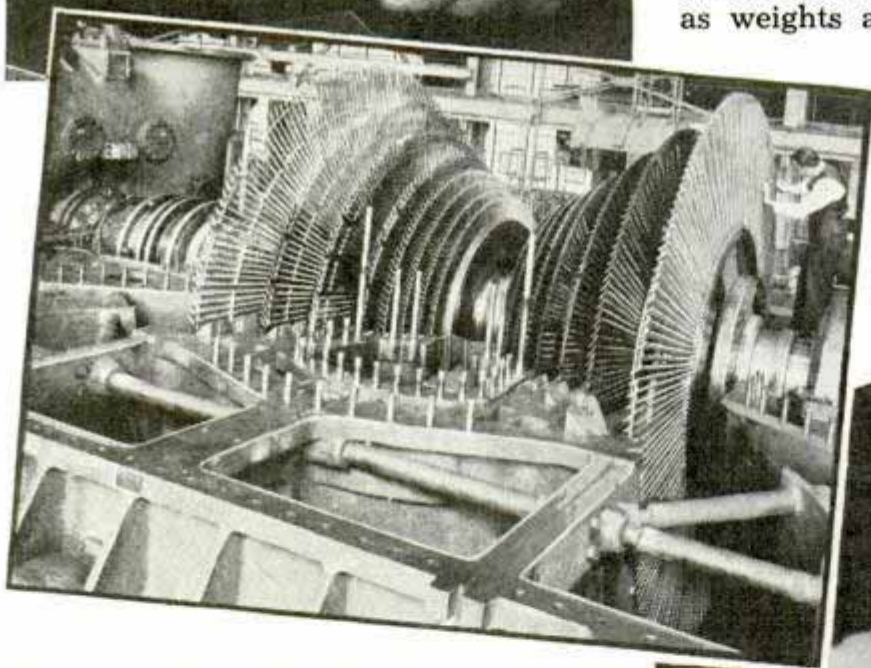

they couldn't do this if floor surfaces were of wood. Something transparent would have to be used. So they used celluloid. The generating unit built with the help of that model is turning out current today in Philadelphia.

Westinghouse engineers now realized that celluloid was a material far superior to wood for creating miniature steam turbines, blowers and other things. A wooden model of a steam turbine may be just as accurate as one of celluloid; but you can't

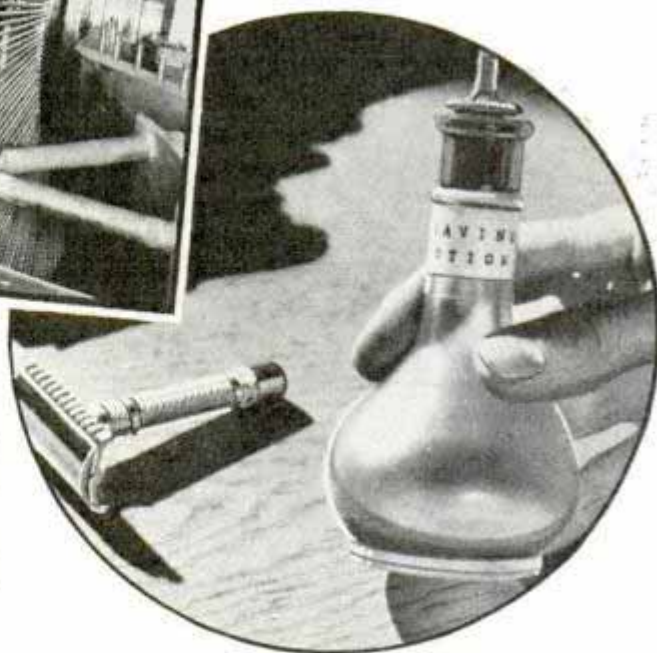

Top, celluloid is easily cut. Center, designing big machines is easier with celluloid models. Bottom, bottle label protected by celluloid

*Philadelphia
Es 443.*

*Model made of Chemwood
and was well received by
mail*

vents the setting up of false deflections by pressure from the measuring instruments.

The celluloid pieces forming a model are welded together with the aid of acetone, which softens celluloid so that it flows together and becomes one piece, just as a welding torch fuses together two pieces of metal. It was discovered that here is another way in which celluloid imitates steel, for when it is welded with acetone

cannot be sent by mail

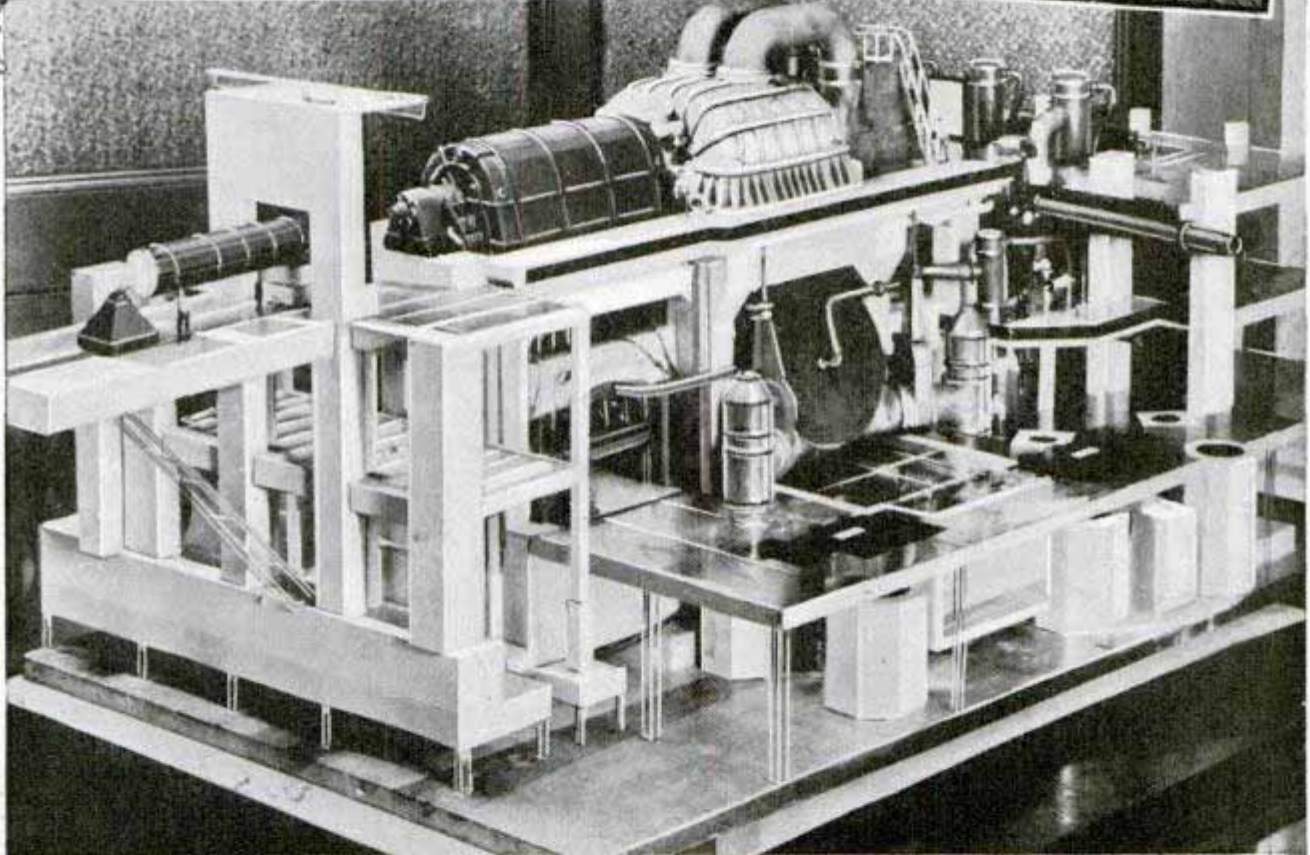
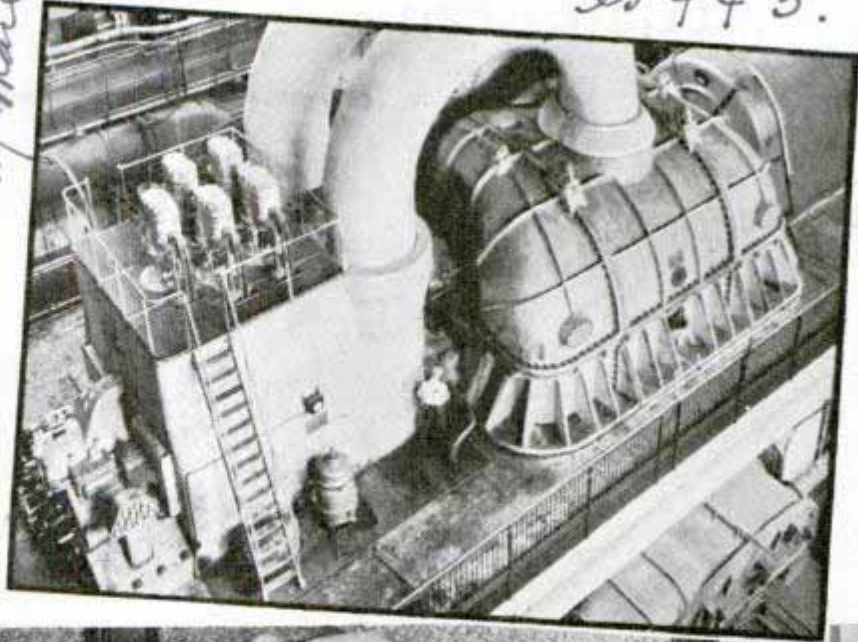

Top, turbo-electric generating plant built with aid of wood-and-celluloid model. Bottom, the model of turbo-electric generating unit, with celluloid used in floor to reveal structure of foundation

operation in Phila. Richmond Station

it warps just as welded steel pieces of the same shape warp as a result of heating and cooling. Thus engineers can find the answers to welding problems while the project still is in the model stage. Much of our modern heavy machinery, which a generation ago would have been made of heavy castings, today is built up by welding metal parts together to form the completed structure.

Celluloid models of steam turbines,

blowers, the mounting for the new 200-inch telescope to be erected on Mount Palomar in California, and of other machine units enable engineers to work out details of structure, such as the shape of bracing elements. Besides making it possible to see just how the various parts will behave when subjected to heat of the welding arc or torch, they serve as a proving ground for new ideas in welding. The

(Continued to page 138A)

... ..

... ..

... ..

es 539

New Plane Ready for Stratosphere Test Flights

Lockheed Aircraft Co
Burbank, Calif



dul

Plane ready for test flights in the stratosphere. The U. S. army designed the ship and some of the features which will make possible experimental journeys into the thin air of high altitudes

Powered by two special supercharged engines, a Lockheed-Electra experimental airplane has just been completed for tests in the stratosphere. Designed by the U. S. army, the ship has features enabling it to fly in the thin air found several miles

above the earth. Superchargers provide the powerful engines with sufficient air to operate at normal speed in the higher altitudes and a supply of air under compression protects the crew when the ship reaches a level where the air is thin.

Arc Welder Built in Trailer from Odd Automobile Parts

es 481

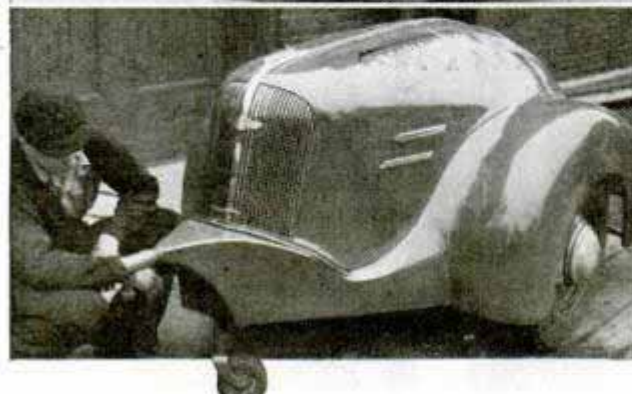

Two views of portable arc-welder built into streamline trailer easily hitched to car and hauled to job

From parts of seven different makes of automobiles a Milwaukee welder built himself a portable arc-welding outfit in a streamline trailer. Quickly coupled, it is ready for work in a hurry. The gasoline motor is in front, the generator over the axle and the control panel is at the rear.

es 531

Furnace Air Control Saves Fuel by Slow Burning

By keeping the plant from operating at full speed, the latest furnace control saves fuel and prevents overheating. A check-damper unit, entirely self-contained, is mounted on the smoke pipe to control the air at its source, the stack. No chains or pulleys are used, the motor and damper being directly connected. Air is admitted below

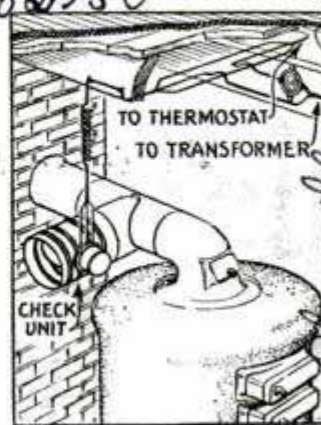

Wellington, Ohio

Clyde Locks
625 W. Beulah St. / Cleveland Steel Products Corp.

4531

447
**Caboose Gets a Bay Window
in Place of Familiar Cupola**

the grates to the fuel bed by small hooks or angles inserted under the ash-pit door to hold it open only a small amount, thus restricting the air flow. The damper control is connected to the usual room thermostat. Upon demand of the thermostat, the damper closes and the restricted draft arrangement makes it impossible for the fire to over-accelerate. As a result combustion picks up slowly, gradually producing enough heat which has ample time for transmission through the heating surfaces to the rooms. When sufficient heat has been produced to satisfy the thermostat, the check damper opens, completely by-passing the air through the stack and relieving the ash-pit draft except for a very slight amount of air which filters through the fixed opening permitted by the draft door hook. This is sufficient to support combustion at a slow rate through the deceleration period. Instead of operating on the "full speed" to "dead stop" principle, the control regulates the furnace at "slow" and "medium." The control eliminates opening and closing of the draft door.

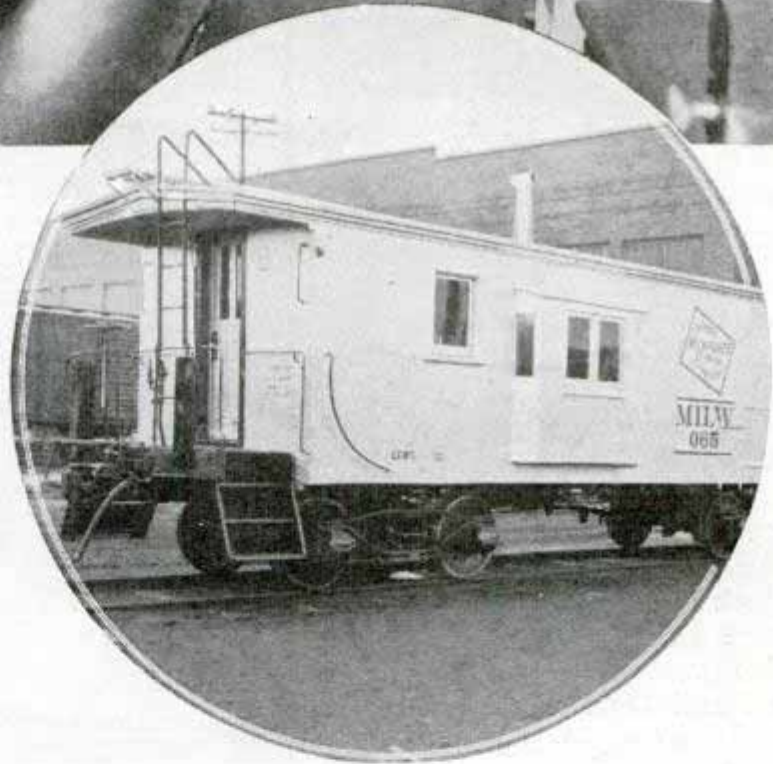
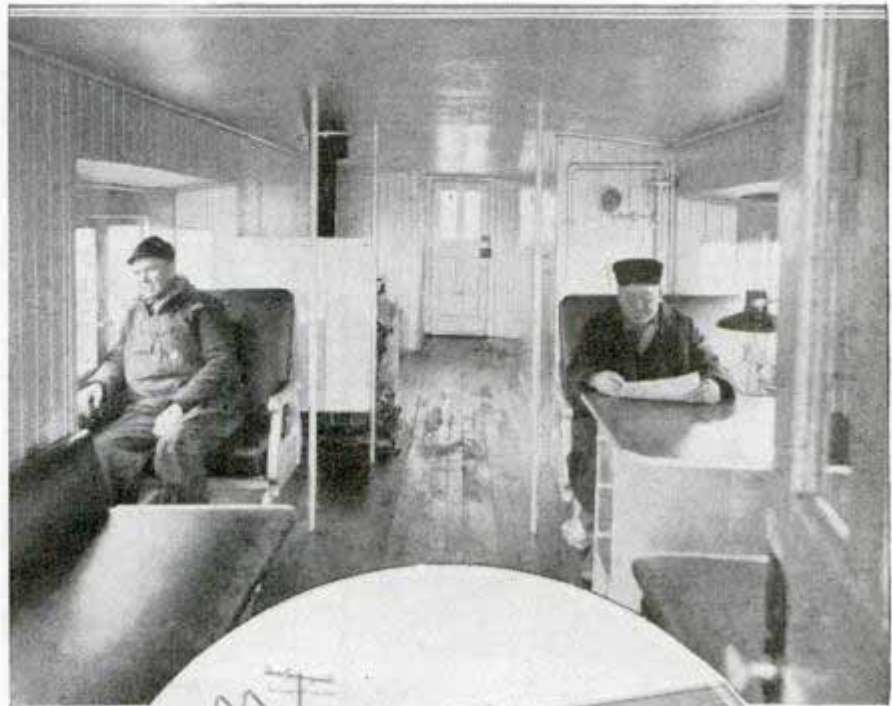

Trainmen at desk and on watch in bay window of restyled caboose. Below, note how protruding window has replaced cupola as observation post

Popular Mechanics Magazine does not publish the name of the maker of, or dealer in, any device described in its pages, but this information will be furnished by our Bureau of Information upon request, accompanied by stamped, self-addressed envelope.

Bay windows are replacing the traditional cupola on the old freight caboose. The cupola has always been an observation post from which brakemen could watch over the long line of freight cars ahead, but higher boxcars being built today sometimes obstruct the view. The Milwaukee railroad is rebuilding its fleet of 900 cabooses, removing the roof-top cupola and installing bay windows on each side. From the bay, a brakeman can watch the full length of the train. The cabooses are being dressed with aluminum paint inside and out for coolness. Outside, black safety rails and ladders show up clearly against the aluminum paint.

Vast Lake Starts 287,000-Volt River of Power



72,200 acres of once desert land. The huge generators settled down on June 1 to continuous, routine production of energy; four 115,000-horsepower units are in operation and ultimately there will be a battery of fifteen such generators and two more of 55,000 horsepower. A high-voltage switching yard routes the power over the main line to Los Angeles at 287,000 volts. The power travels over 270 miles of mountain and desert, then at the gates of Los Angeles it is stepped down to 132,000 volts by seven gigantic transformers such as that shown on the cover. Each transformer, as large as two boxcars standing on end, can handle 80,000 kilovolt-amperes.

From the vast pool of Lake Mead, where Boulder Dam has stored water enough to supply the homes of this country for three years, a 287,000-volt river of power is flowing. This tremendous power plant can deliver 1,250,000,000 kilowatt-hours of electric energy per year. Above the dam in this world's greatest man-made lake stand 11,000,000 acre-feet of water, still rising with spring freshets. The lake extends 101 miles up the Colorado river, covering

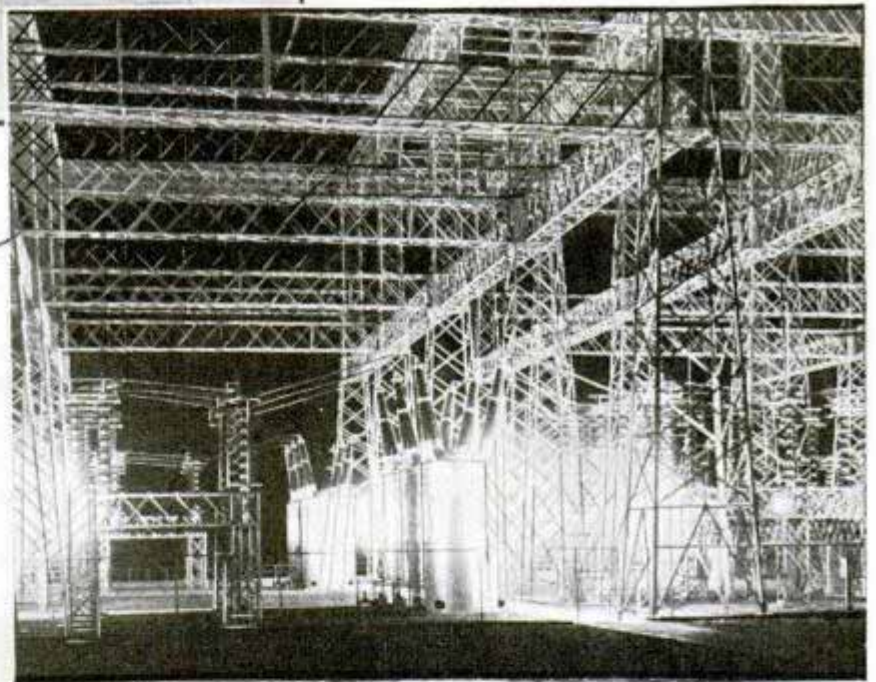

Top, four 115,000-horsepower generators at Boulder Dam. Below, high-voltage switching yard which starts power to Los Angeles

Freight Trailer with Motor Helps Truck on Hard Pulls

Equipped with motor to help the towing vehicle on hard pulls, a new freight trailer functions like the booster locomotive behind a long train. Complete synchronization of power plant in truck and in trailer is accomplished by connecting the two transmissions, throttles and clutches by a hydraulic system. Controls in the truck

cab operate both motors. The trailer's engine is installed under the frame. Air brakes operating from its own motor control the trailer on down grades. A truck with motorized trailer can attain a speed of eighteen miles per hour on grades negotiated with difficulty at eight miles per hour by a truck towing the trailer with-

Best Trailer Co. Los Angeles Calif

Chevrolet Motor Sales Corp.
General Motors
187
20548
Image of Air Flow on Model

out motor. Safety from skidding and power to pull out of muddy ground are provided by the traction on both rear wheels of the truck and the wheels of the trailer. A conventional torque tube and rear axle assembly are substituted for the front axle of the dual rear axles of the trailer. Spring suspension of the dual rear axles equalizes braking on both axles, eliminating the bouncing of the front wheels.

20509

Body Energy Tester Finds Women Are Hardier Than Men

That women are hardier than men is the conclusion reached by Dr. Jakob A. Stekol after tests with an instrument which measures the creation of body energy and the giving off of heat. His findings indicate that even after an eighteen-hour fast women consume ten per cent less of their energy reserves than men to keep going. Measurements with the instrument, which checks on the intake of oxygen, on the oxydizing of food and the creation of body energy, also show the nutritional value of different foods, pointing the way to a proper diet.

Miltabolo



Woman subject being tested for body energy. The study aids in prescribing diet

Professor of Nutrition
University of Wisconsin

Aids in Study of Streamlining

420 W. Milwaukee Street
Chicago



Demonstrating the way air flows around model. Engineers find this projection makes easier the study of streamlining

Projecting the image of an object while air is flowing around it enables engineers to study visually the effect of streamlining. This method of facilitating the study of streamlining is called the Schlieren effect. The image of any scale model object may be projected, together with air flowing around it, demonstrating wind resistance at any point.

20543

Holder to Help Mark Books Attached to Table

Adjustable to books of any size, a handy holder is an aid in marking of books. It may be attached to table or similar surface and adjusted up or down, in or out. The book is held in natural position for marking the back.

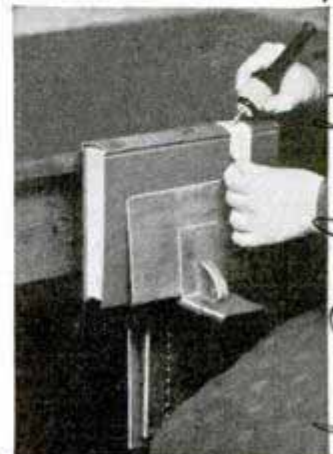

The Book Specialty
Paris, France
Parsons

Es 36

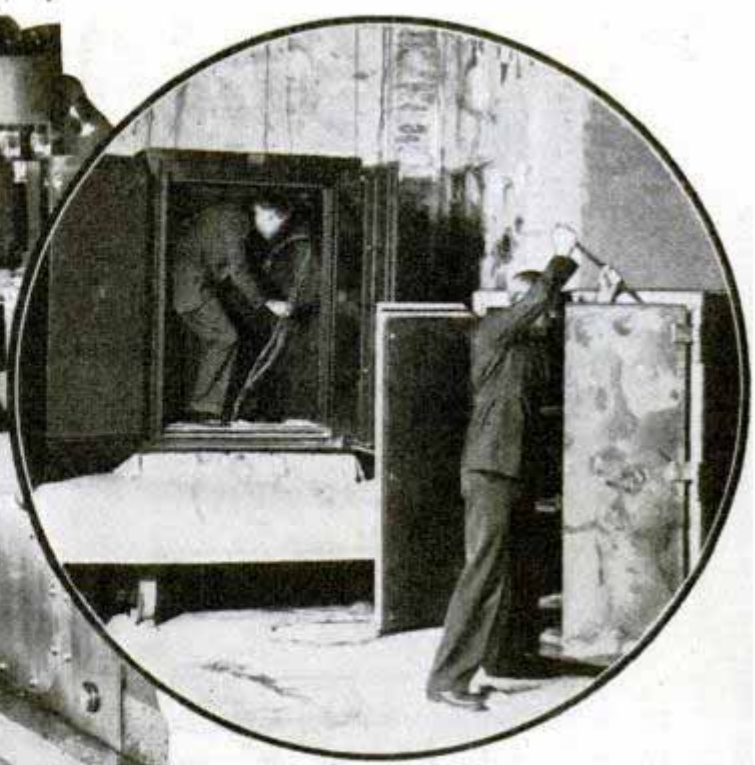
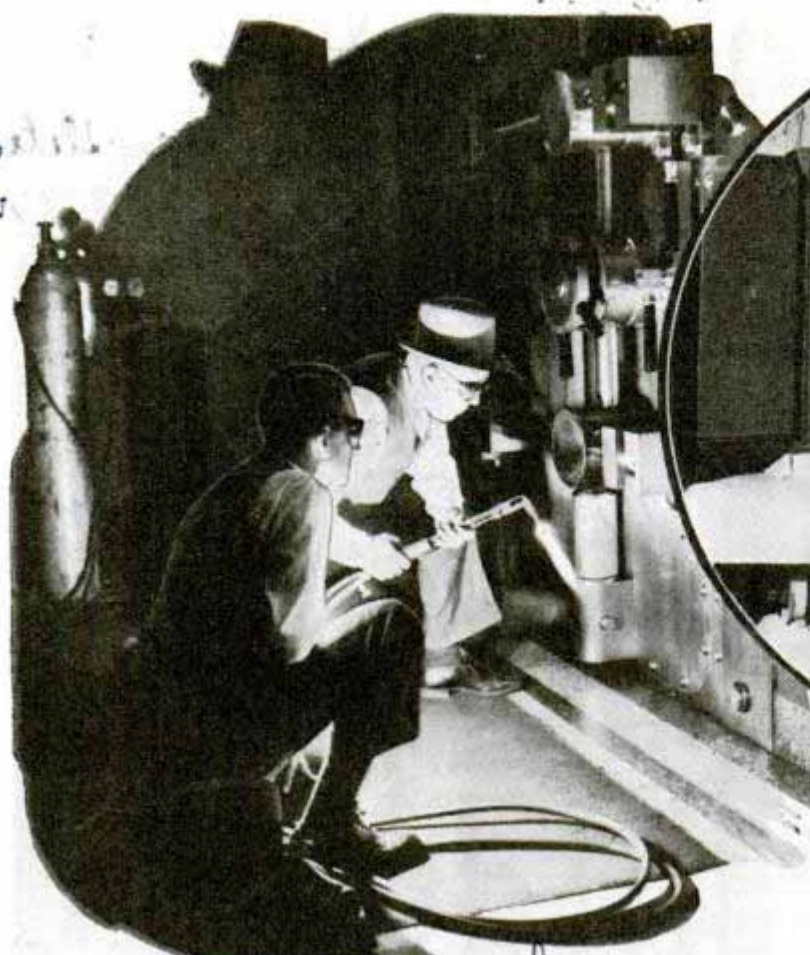

Top, determining how long a vault will resist attack by burglars, and preparing "fireproof" safe for test in gas furnace. Below, torch sets off sprinkler and resultant spray is measured on walls and in buckets

Wide Walls

Torture CHAMBERS

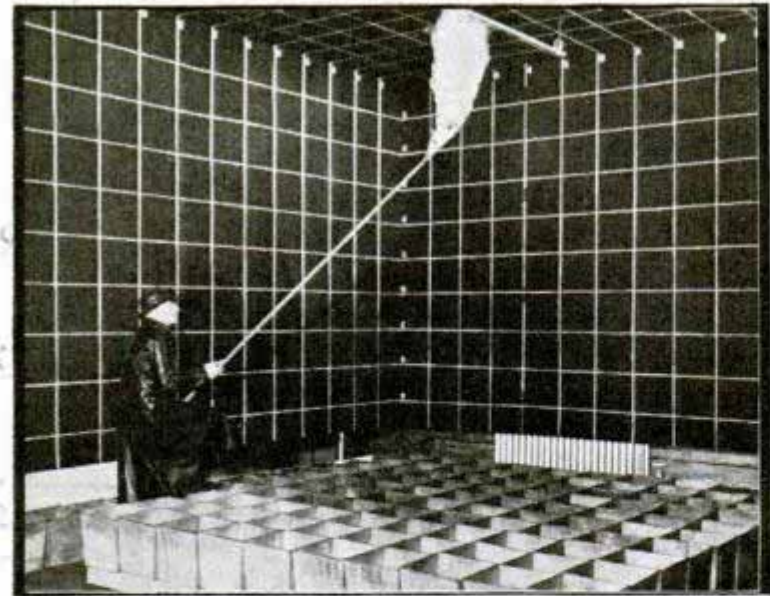

to turn off the oven or disconnect the iron will you come home to find the house a heap of ashes?

A Kalamazoo, Mich., woman boarded a train for Chicago the other day and, thirty miles on her way, remembered the curling iron. Aghast, she knew it was connected and supposed her home was by now a mass of flames. As the train roared through a town fifty miles out she tossed a note to the station agent. He rushed to the wire and dispatched a telegram to Kalamazoo. Firemen broke into her house, found a hot iron, smoke, but no flames.

also in San Francisco.

PICKING up a microphone recently, an announcer touched it to his lips and dropped dead. Leaking current had killed him.

How do you know your home is not full of such perils? Can you tinker with that radio set in perfect safety? If you forget

Maybe it was just luck; but if that curling iron wore the "approved" label of the Underwriters' Laboratories, she might have known it would be all right. Before they approve an iron, the Underwriters' men try every trick they know to make it start a fire. They set it on cloth, rest it on

161-6th Ave New York
207 E 43rd St

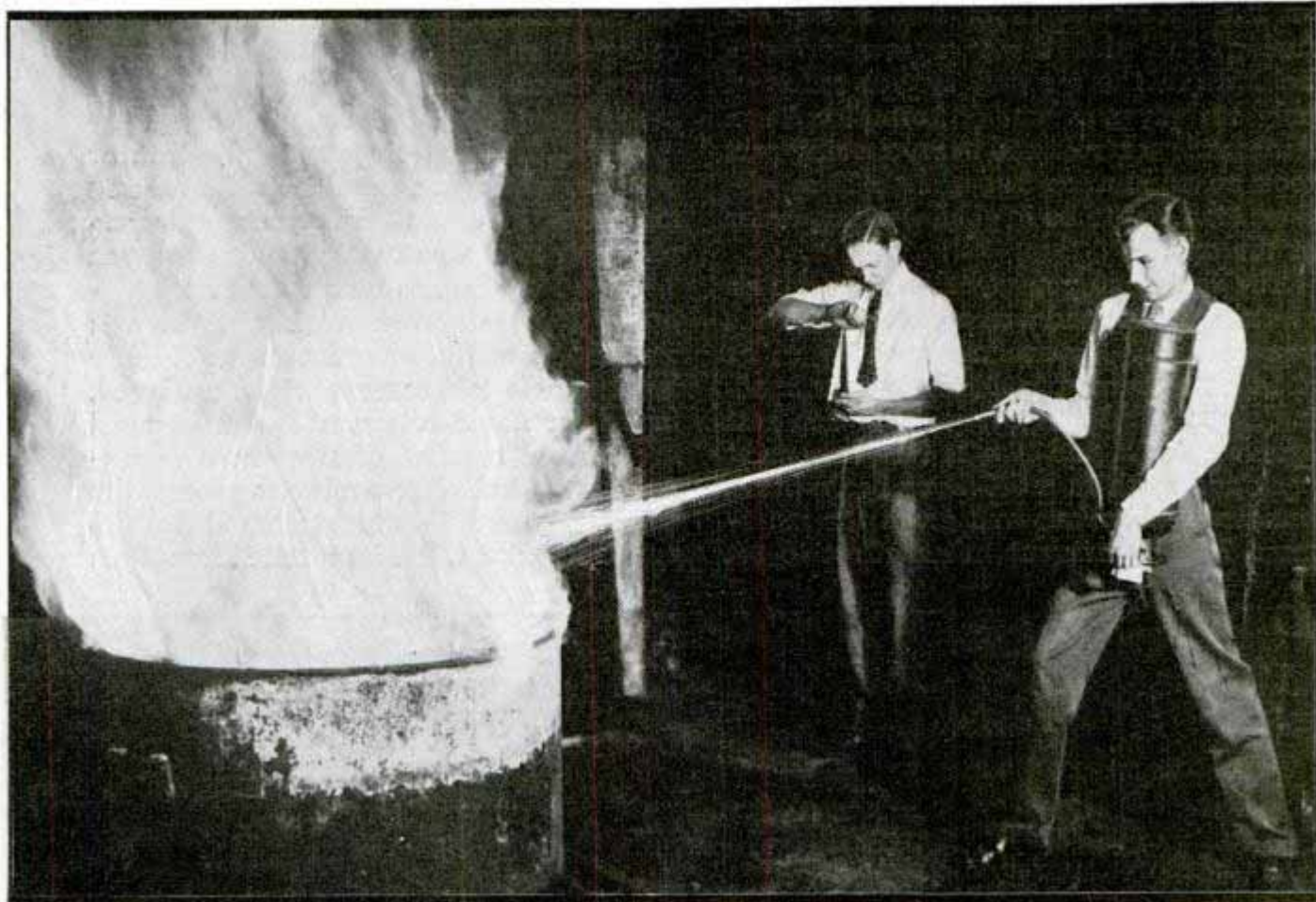

for SAFETY

a pine board, and let it get plenty hot. It may burn its way right through the board. That's permissible. But it can only char. It must not start a flame. For more than forty years these engineers have been inventing ingenious tortures to protect you, your car, your home, your valuables from fire, shock, accident and theft. Take your oil burner. If you were to come home from a winter vacation and start a fire, would it be likely to blow up? Not if it has gone unscathed through the Underwriters' torture chamber for oil burners. In earlier days, faulty ignition systems were a hazard. Your furnace might become choked with an explosive mixture of oil vapor and air, and then a tardy spark would touch it off. Today ninety-one per cent of the oil burners on the market are approved, and here is what they went through first: for 180 hours the burner was operated intermittently in the laboratory, ten minutes on and ten minutes off; then it burned continuously for seven hours

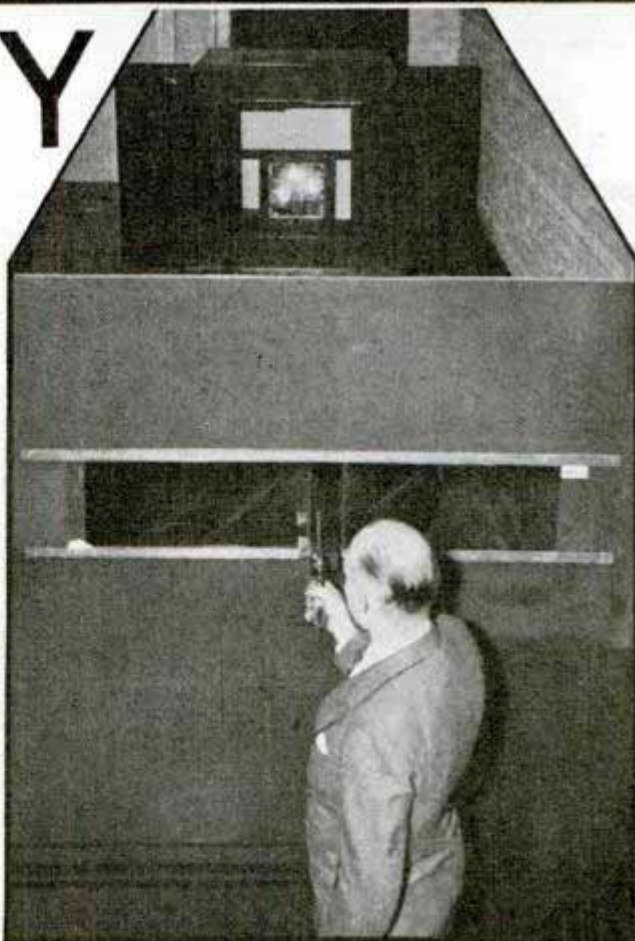

Stop watch checks up the efficiency of fire extinguisher in quenching tubful of blazing gasoline. Below, bullet-resistant glass is tested in target range

on five successive days; then it was fed fuel oil chilled to thirty degrees Fahrenheit, while the ignition system received only seventy per cent of normal voltage. Automatic controls and every moving part took an endurance test of 100,000 operations, and had to be in good working order at the end.

The first time you went to bed with an electric heating pad under your ailing back you probably lay awake expecting to be shocked or burned to death. If your heating pad is "U.L." approved you can rest assured, for a pad like it has been bent back and forth in a 500-hour flexing test, bundled in blankets and given the maximum heating current in an effort to set

the blankets afire, its thermostat has been operated on and off 100,000 times, and plugs, switches, cords, heating element and fabric have been inspected.

Before the cord on your waffle iron or electric heater was rated safe, it endured ingenious abuse. Carrying normal current, the cord was twisted and untwisted 3,000 to 10,000 times by a mechanical torturer. If wire or insulation gave way, it went back to the manufacturer. Rubber insulation is taken from wires, analyzed, tested for flame-retardant qualities, aged in oxygen "bombs" of steel in a bomb-proof room built like a maze to protect the engineers, and finally stretched to the breaking point while its tensile strength is

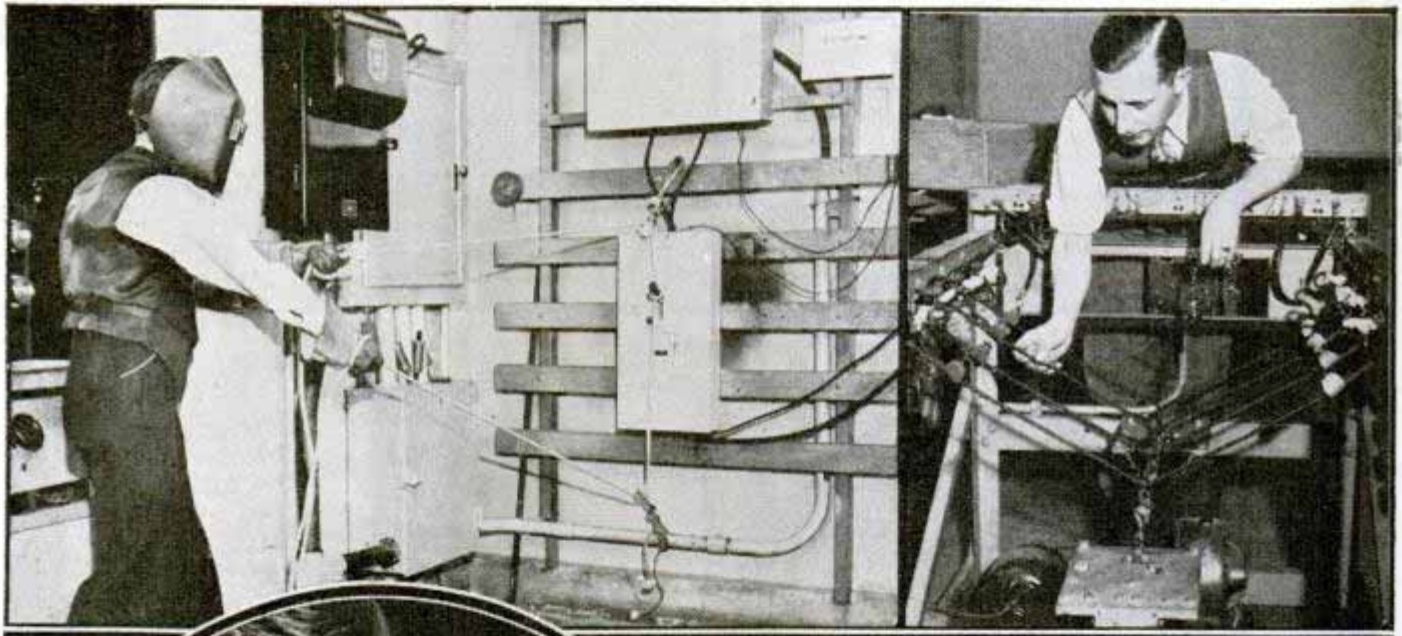

Left, above, engineer takes no chances in testing high-voltage switch. Right, electric-heater cord is twisted thousands of times by this machine to prove it safe. Below, charring cloth with electric heater

measured. One versatile machine pulls light cords, punches and twists a half dozen different types of electric switch buttons simultaneously for 6,000 operations.

The other day a manufacturer wanted to know how a glass brick wall would stand up in a fire. Would it explode, melt, or collapse? They built a ten-by-twelve foot glass wall in the Chicago laboratories, let the mortar age for a month and rolled the wall up to a gas furnace. Torches lighted the gas ports. In five min-

utes the inside of the glass bricks was heated to 1,000 degrees Fahrenheit. The glass crackled merrily with sudden expansion. They turned on more gas. Thermocouples at five points of the outer wall gave continuous readings of the temperature. Engineers measured the wall's sag every few minutes. The outer wall became red hot, molten plaster oozed out and plopped on the floor; still the wall stood. Through mica windows in the furnace the engineers saw the inner surface of the glass wall bulging like a toasting marshmallow,

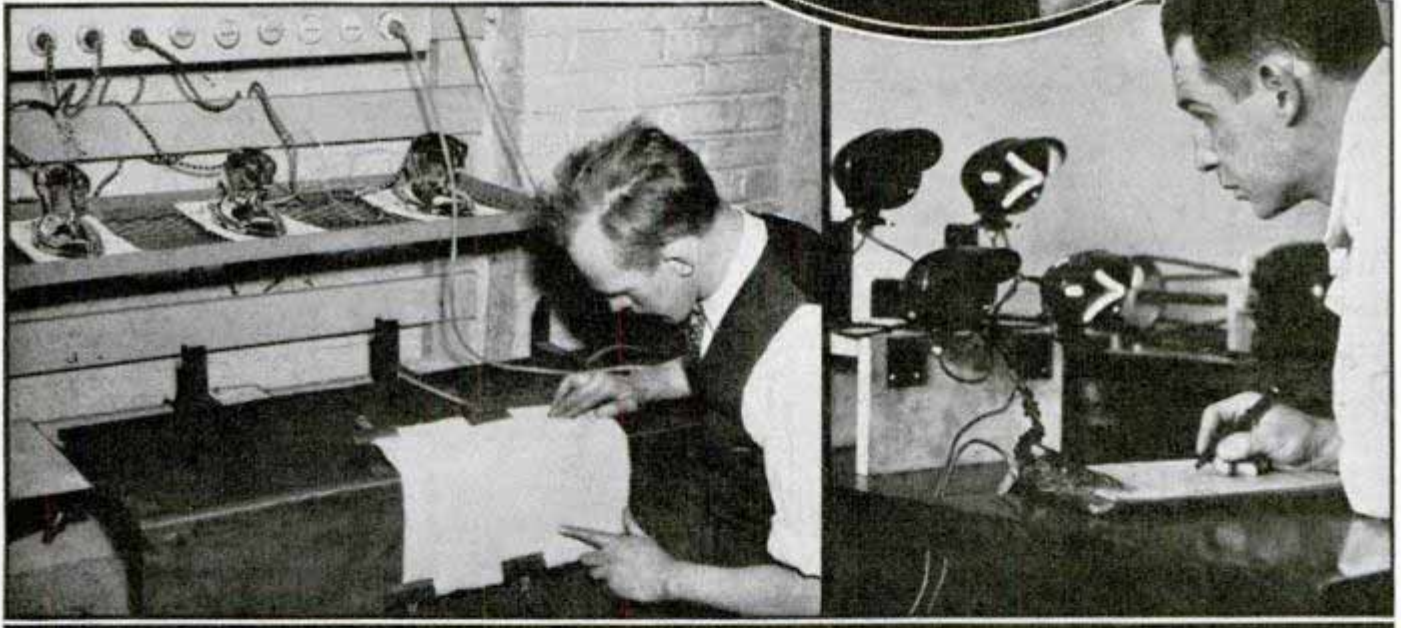

Engineer at top is examining electric refrigerator. Below, administering flexing ordeal to heating pad and giving auto tail-light endurance test

finally dripping like molasses. After forty-five minutes the gas ports were closed and the glass wall, now at 1,640 degrees, was rolled out and immediately drenched with a fire hose. Sizzling, crackling, that wall took its punishment standing. When the hose was withdrawn after playing over the red-hot glass for a full minute, the wall was still erect, about one-fourth of its bricks punctured by the powerful stream. The manufacturer was satisfied the wall would be an effective barrier to fire.

That was but one of the everyday "stunts" performed in the Underwriters' Laboratories to make life safer. They devise standard tests for fire-fighting equipment, inspect building materials for fire resistance, examine anything a manufacturer submits for its hazards to life, and provide inspection service for protection against burglary, theft or robbery.

In that same gas furnace, pre-heated to 2,000 degrees, the engineers thrust a 3,000-

(Continued to page 116A)

Chicago Fire Dept
Diesel Fire Boat Shoots Seventeen Streams

Equipped with five main Diesel engines, the latest fire-fighting boat can throw seventeen streams of water. Three engines drive the craft, but only one can propel the boat while the other two are used for pumping. Two other engines are only for pumping. Four ten-inch centrifugal pumps supply water to the various connections. The boat has a fire tower which is raised and low-

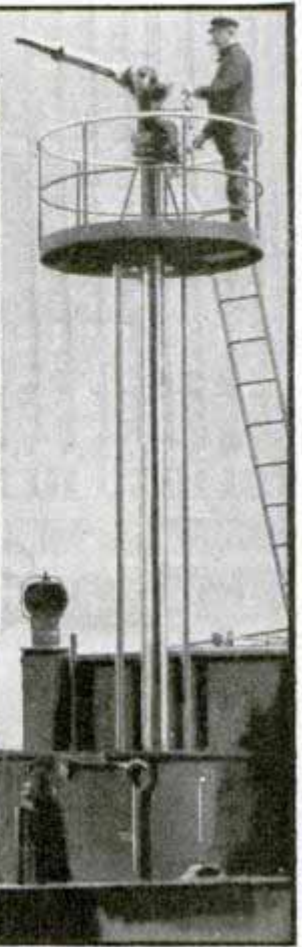
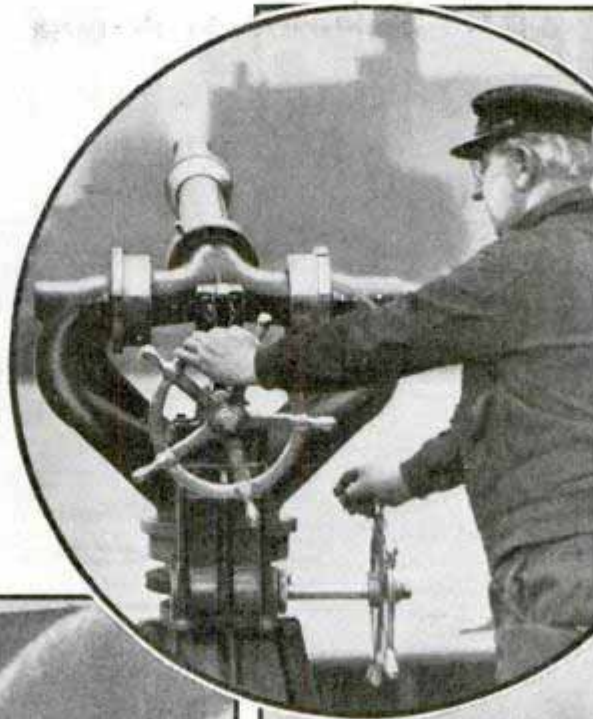

Three views of new fire-fighting boat. Left, more than a dozen streams of water at once. Center, controls for one of the nozzles. Right, tower which may be raised or lowered hydraulically in a few seconds

ered hydraulically in a few seconds. In raised position, with a three-inch nozzle the tower produces 4,600 gallons of water per minute at a pressure of 300 pounds. Four deck turrets, twelve hose valves and the tower supply the seventeen streams at the same time, totaling 10,000 gallons per minute. Deck turrets, fitted with three-inch nozzles, throw a stream 450 feet. The fire boat is all steel. It has little superstructure and can pass under low bridges.

532
Non-Heating Microscope Lamp Gives Bright Light

Heat is scarcely perceptible when a new low-wattage microscope lamp is used for laboratory work. A pair of matched reflectors give the lamp its efficiency. The reflectors are combined in such a manner that a very clear, brilliant spot of light is cast upon any object seven and five-eighths inches from the large reflector, giving ample working space. Light for transmission through a compound microscope is taken from a disk of celluloid with ground surface on which the spot of light is thrown. Intensity is sufficient for high magnification with oil immersion objectives. The lamp uses a standard bulb and operates on 110 volts, alternating current, through a self-contained transformer.

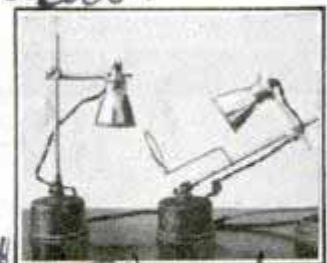

Calab.

\$12.50 prepaid

California Laboratory Supply Co. 928

CAUTION!

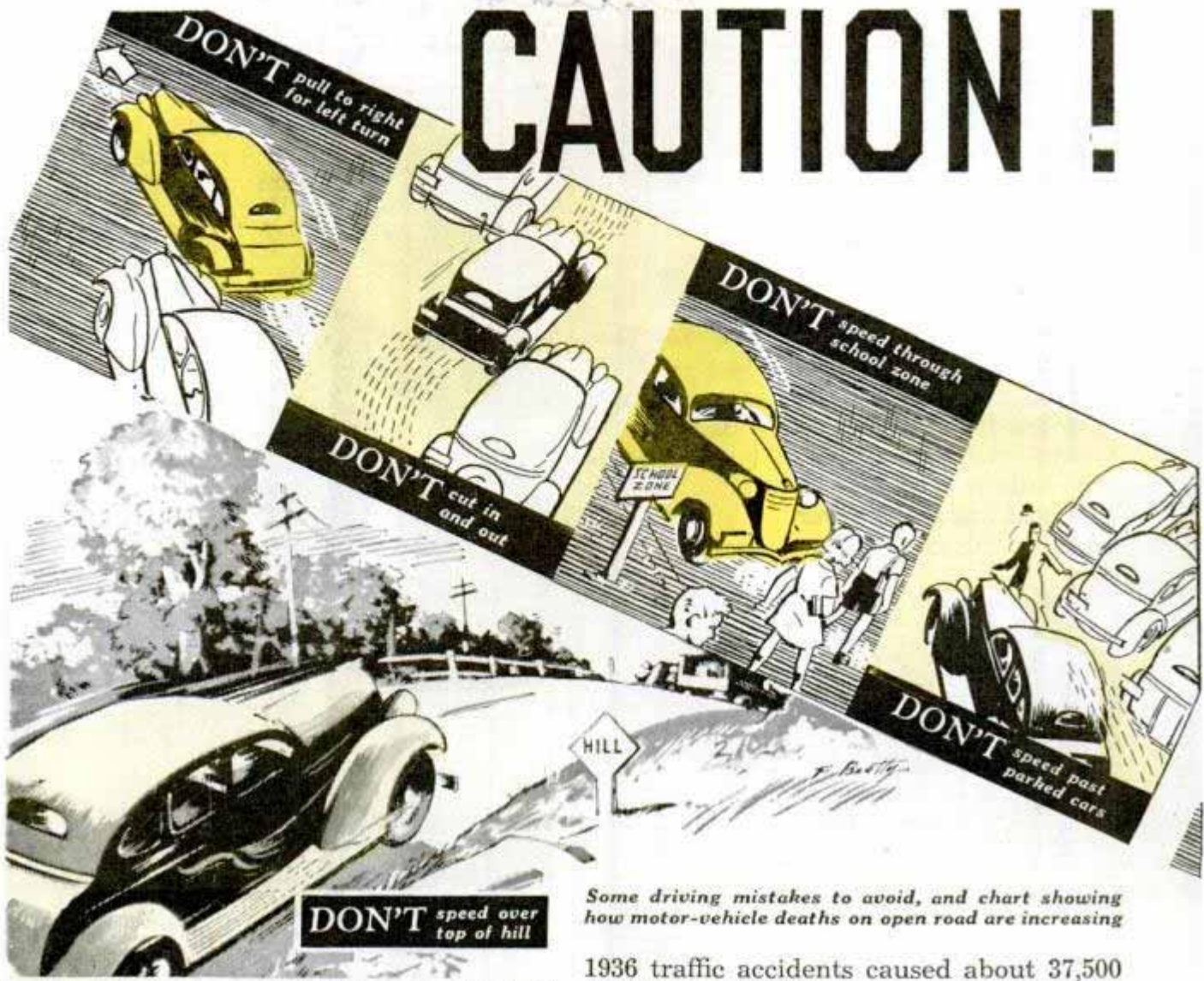

Some driving mistakes to avoid, and chart showing how motor-vehicle deaths on open road are increasing

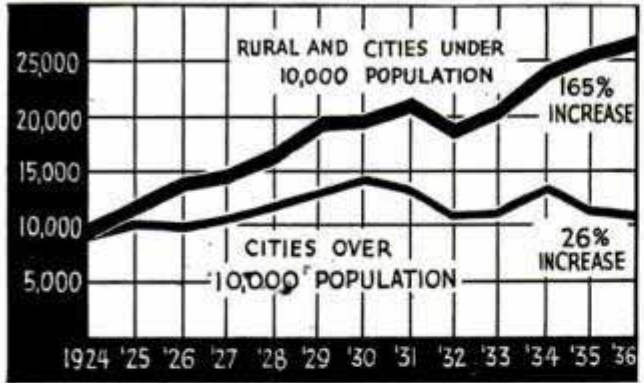

1936 traffic accidents caused about 37,500 fatalities, 110,000 permanently disabling injuries, 1,230,000 temporary disabilities and an economic loss estimated at \$1,660,000,000. Each year the figures are growing bigger but if, by some miracle, they can be held stationary through 1951, it's easy to compute the terrifying totals. And here they are:—

More than half a million fatalities—including thousands yet unborn—1,650,000 disabled for life, 18,450,000 temporarily disabled! That's like wiping out the population of Wyoming, Nevada and Delaware, injuring for life all the people of Vermont, New Mexico, Idaho and Arizona, and temporarily disabling everyone in New York and California.

That's more than six deaths and injuries per mile of highway, one death or injury for each two drivers, almost one for each car on the road today! Virtually one person out of six marked for death or injury by 1951 or before! Plus an economic loss of \$24,900,000,000!

By H. W. Magee

THERE'S danger ahead if you drive a car carelessly and here's why. Traffic accidents will kill or injure more than 20,000,000 persons in this country and cause an economic loss of about \$25,000,000,000 within the next fifteen years unless we do more to promote highway safety than we have yet done. Simple arithmetic proves the tragic truth of this seemingly incredible statement. In

DANGER AHEAD!

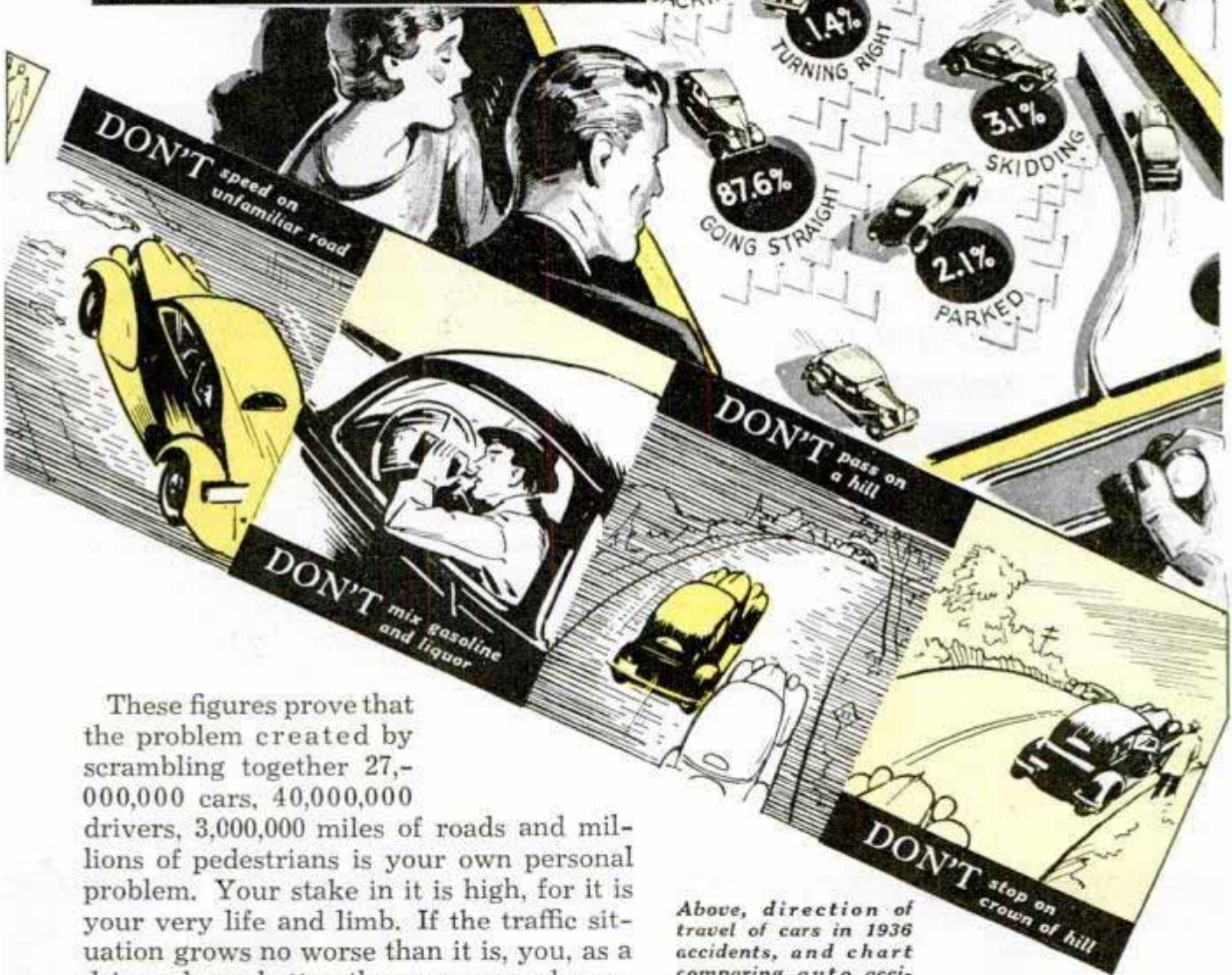
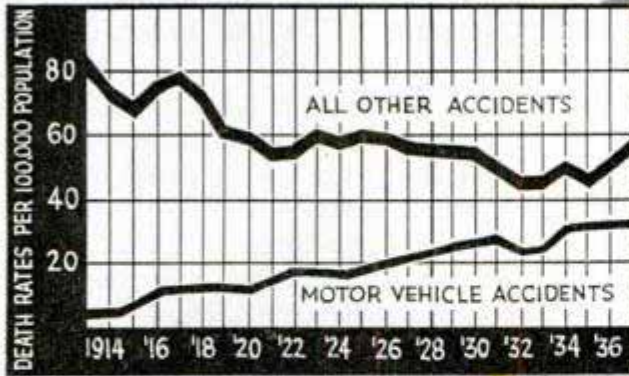

These figures prove that the problem created by scrambling together 27,000,000 cars, 40,000,000 drivers, 3,000,000 miles of roads and millions of pedestrians is your own personal problem. Your stake in it is high, for it is your very life and limb. If the traffic situation grows no worse than it is, you, as a driver, have better than an even chance, under the law of averages, of killing or injuring yourself or someone else within the next few years.

While organized traffic safety efforts have accomplished much, the fact that the highway toll still increases indicates that this problem does not yield readily to wholesale solution. Keeping yourself from killing or being killed in a traffic accident today is pretty much an individual prob-

Above, direction of travel of cars in 1936 accidents, and chart comparing auto accidents and other types

lem. The best way to avoid driving into a tragedy is to make your own driving "accident proof," rather than rely on a law or some other safety measure to protect you.

Five or six mistakes account for most accidents and a study of the common errors which landed most 1936 traffic accident victims in the hospital or morgue is an excellent way to avoid making the same



DON'T gamble the rest of your life to win one minute

DISTANCE REQUIRED FOR STOPPING

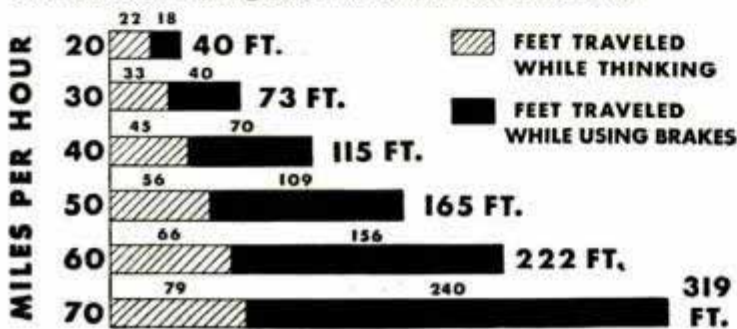

mistakes yourself. In the first place, every accident is the result of a mistake by someone. Perhaps the pedestrian is at fault, or the man who planned the road, or the engineer who designed the car. But the statistics show that in about three cases out of five, it's the man behind the wheel who makes the blunder.

And too much speed was blunder No. 1 among drivers who had accidents resulting in deaths or injuries in 1936. Not

speeds of seventy or eighty miles an hour, either, for most cars involved in accidents were traveling less than fifty. This brings up the question: How fast is too fast?

That depends on the condition of the road, the weather, the time of day, the amount of other traffic. But here's a tip from the accident statistics that ought to help. Nearly one-third of those killed last year and more than one-fifth of those injured were killed or hurt by cars which were exceeding the speed limit. Almost nine out of each ten cars involved in accidents were going straight ahead when disaster overtook them—and that's the only direction in which drivers can really step on the gas.

Would you dare top the crest of a hill and go down the other side at fifty miles an hour—with your eyes shut? Certainly not. But you might as well have them shut if you can't see over the crest. Probably there won't be anything there, but suppose there's a steer or a stalled truck?

So you're driving too fast—speeding—when you can't stop within the distance you can see ahead because then you're driving "blind." And this brings up the problem of night driving. Only one-fifth or one-fourth of all traffic is at night, but more than half of all fatal accidents occur after dark. Deaths from night accidents increased more than one-third from 1930 to 1935, while deaths from daylight crashes decreased. And in nearly every report of



Chart above shows how distance required for stopping increases as the speed mounts. Note difference between sixty and seventy miles an hour

es 338

a night accident, there is evidence that someone drove faster than his eyes could see. Fifteen miles an hour may be too fast on a foggy night; fifty is likely to be too fast most any night unless your headlights can penetrate the darkness for 250 feet or more.

Courtesy, consideration for the other fellow, observing the rules of the road—all these pay you big dividends by keeping you out of accidents. To prove it, consider the inconsiderate drivers who disregarded such things and came to grief in 1936. When you decide to take a chance—cross the center line, steal the right of way, crowd in, pass a standing streetcar, pass on a curve or hill or on the wrong side or neglect to signal—just remember that more than 250,000 accidents causing deaths and injuries in 1936 resulted from exactly such practices.

If you know what you are most likely to hit, you ought to be able to exercise extra care in the presence of such objects. Cars and pedestrians are your big hazards. Of accidents resulting in deaths and injuries in 1936, nearly one-half involved collisions with au-

(Continued to page 127A)

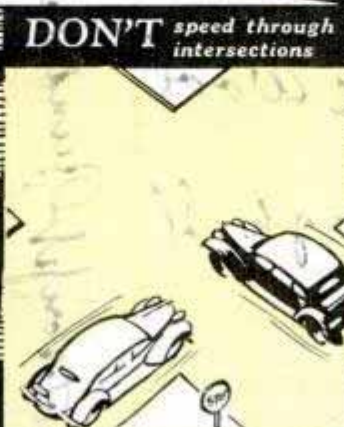
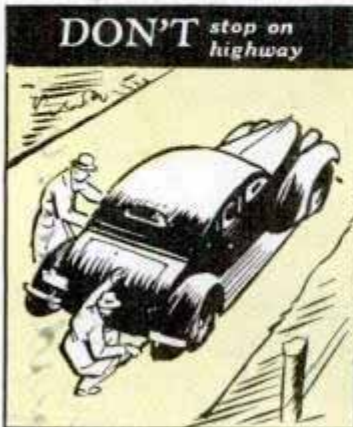
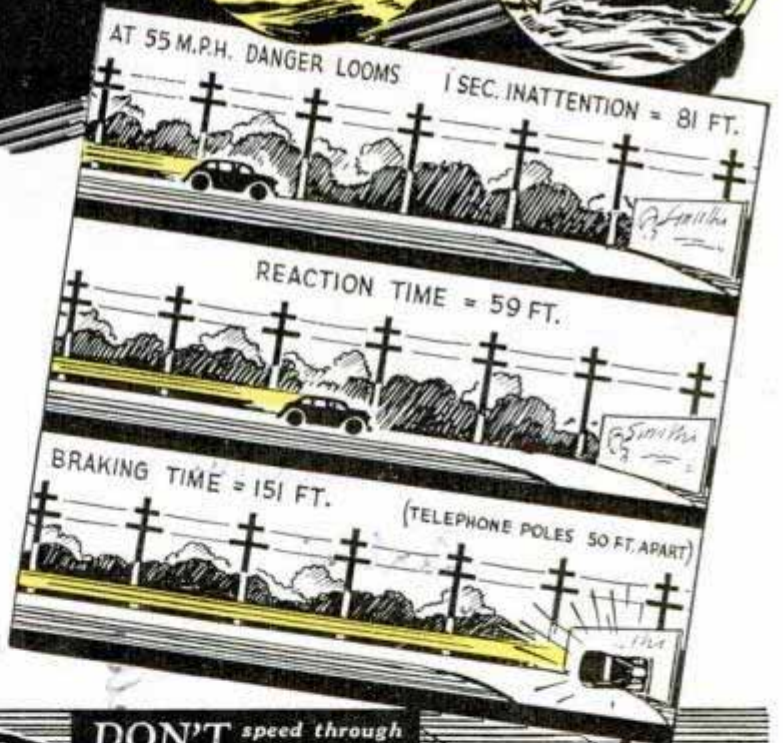

At fifty-five miles an hour, above, you travel more than eighty feet a second, almost sixty feet while you react, and you need 150 feet more to stop

Horse Rides Flying Platform in Thrilling Circus Feature

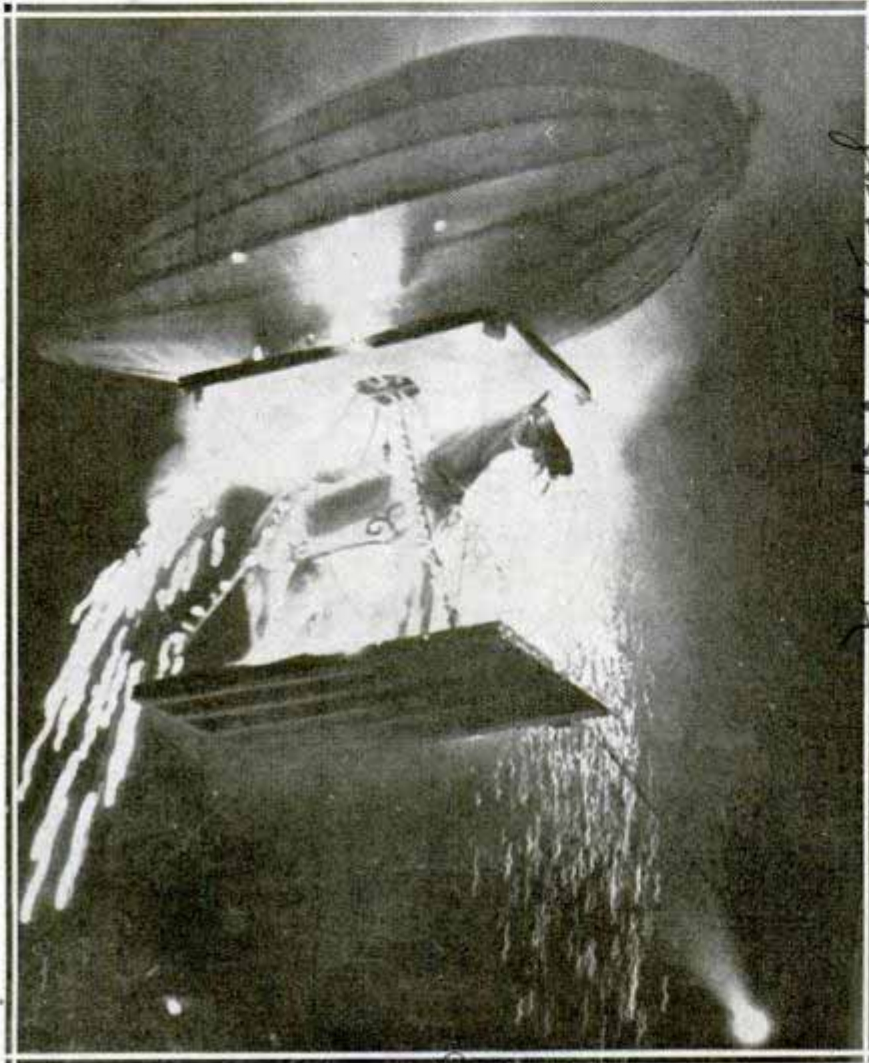

Trained horse stands quietly amid the flash and crack of fireworks while a captive balloon lifts his platform to roof of circus arena

Standing quietly amid popping fire-crackers and a glare of spotlights, a circus horse rides a flying platform in a feature act of a show in Germany. A balloon lifts the aerial horse to the ceiling of the arena while guy ropes steady the platform.

Freezing Cleans Raw Wool of Burs, Dirt, Grease

Burs, thistles, grease and vegetable matter are literally frozen out of raw wool by passing it through a cold room in which the temperature is thirty to fifty degrees below zero. The low temperature freezes solid the burs and grease on the wool. When the frozen wool is beaten or shaken, the dirt and impurities drop away. About

Perfected by Lowell Textile Institute

1,500 pounds of wool an hour can be cleaned by this process, which is being used by some wool mills. Discovery of the process, which leaves the wool whiter, fluffier, stronger and more receptive to dye than that cleaned by more expensive methods, was made at a picnic. Dry Ice, in which ice cream for the picnic had been packed, was thrown accidentally on a wool blanket spread on the grass. When the discoverer shook the blanket later, vegetable matter frozen to it dropped off like icicles. Wool can be cleaned in this manner at a cost of about four-tenths of a cent per pound.

Music Typewriter Prints Staff and Notes

On blank paper the latest music typewriter prints the five-line staff according to requirements, then notes, clefs, signatures, rests, straight and slanting bars and other characters. Pressing a key rotates the roller, eliminating hand operation.



Latest music writing machine types the staff and all characters necessary

Notokyn Windstatter, Laub-H. Lutnowstr.

Science Service 6/8/37

notokyn Windstatter

Science Service 6/8/37

es 49 3

Los Angeles Calif

High Voltage Co. D

es 430

Science Service 6/8/37

Small House Is "Framed" in Light Concrete

Small houses framed in lightweight concrete much as a wood-frame house is built are the latest development in home construction. Light, durable, proof against fire and termites, and free from expansion and contraction, these houses are built of a new type of concrete made of "baked" clay and shale pellets. Instead of the heavier

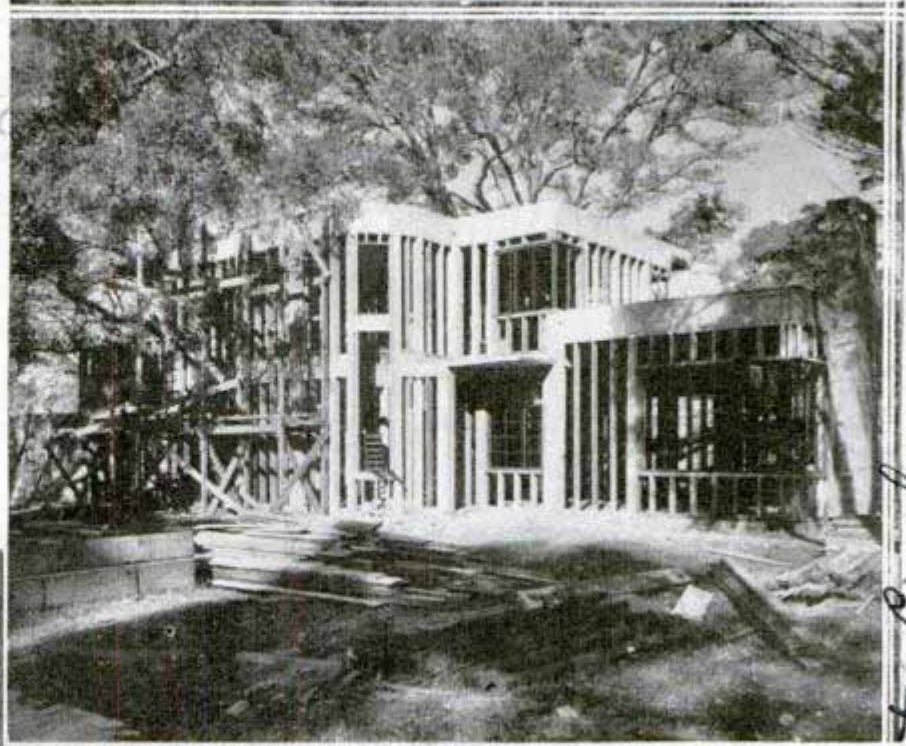

Above, house of lightweight concrete under construction, showing beams and posts of concrete instead of traditional wood framing. At the left is architect's drawing of the completed house. This light concrete is made of cylindrical pellets of clay and shale fired in a kiln

Paravelite Co. Inc. 111 Sutter St. San Francisco, Calif.

aggregates from sand and gravel beds, the builder mixes clay and shale, slightly moistened, presses it into cylindrical pellets and fires them in a kiln at 2,000 degrees Fahrenheit. The sand is also baked, reducing the grains in weight and expanding them to twice normal. A cubic foot of finished concrete from these materials weighs 100 pounds against 150 pounds for concrete of heavy aggregates. In the small house, supporting beams and posts are of concrete instead of timber, and between them are placed nailing studs to which the outside sheathing, usually stucco, and the inside backing and plaster are attached. Floors, roofs and decks are poured as integral parts of the structure. The upper deck of the San Francisco-Oakland bay bridge is paved with this light concrete.

Spray Gun with Tank on Top Feeds Heavy Materials

With its tank mounted on top, a new spray gun duplicates gravity feed conditions and makes possible the use of spraying materials which cannot pass through the ordinary siphon gun. The equipment has been found adapted to the use of ceramic materials, as well as hammered silver, bronze, and gold-type finishes. The tank holds a pint.

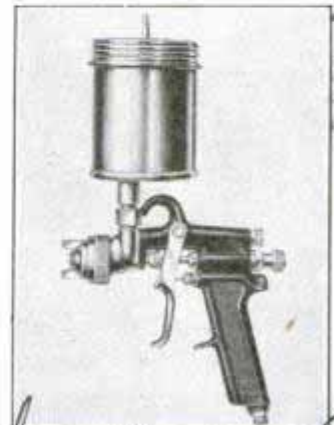

The Binks Mfg Co
 2114 Carroll Ave

5/8.

Plane Is Guided to Exact Landing by Radio Compass System

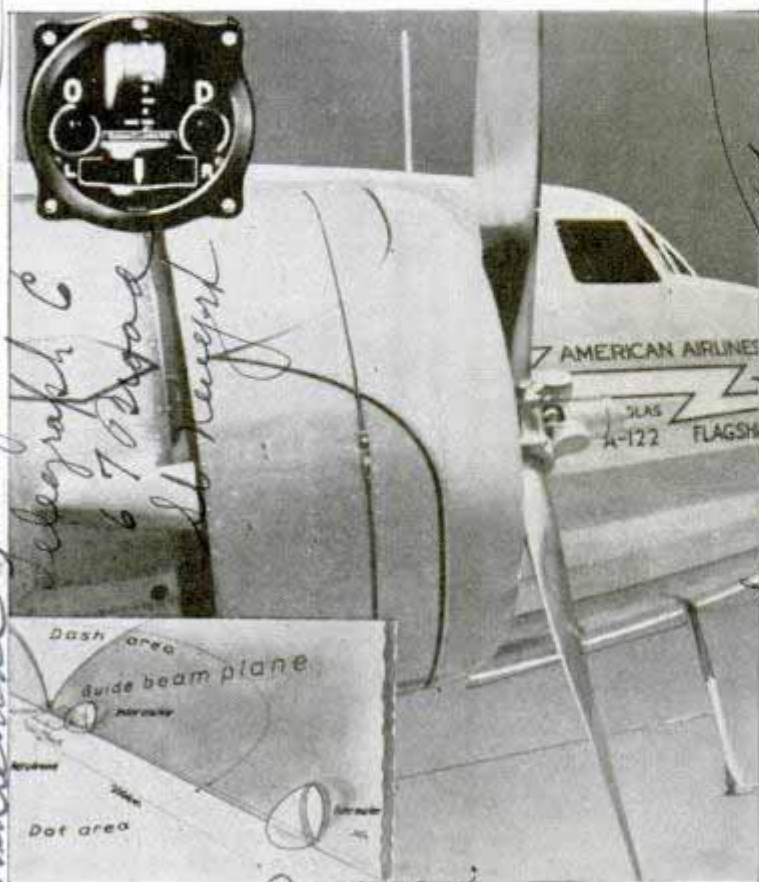

Plane with antenna above and below cockpit. Inset, top, indicator on dash. Bottom, area covered by the guide beams

Already in use in Europe, the Lorenz radio compass has just been introduced in the United States as a means of guiding airplanes to exact landings. The first plane equipped with the compass in this country has a staff antenna on its cabin and a horizontal antenna under the cockpit. The first is used when the pilot prepares to land, the other when he desires to pick up signals while approaching the field. As a pilot, who has been guided throughout his flight by an ordinary radio compass, reaches a point where he should begin descending to land, he watches a dial on his instrument panel. The dial has circles marked "O" and "D," which have points of light in them. As the plane passes into the range of the landing guide, the point of light in "D" circle breaks into a series of dashes. When the range of an inner marker beacon is reached the circle "O" shows a series of dots. An indicator between the two shows whether the pilot is descending at the proper angle, and an arrow below it shows whether he is veering

plant poison to kill the root. The handle of this weeder carries a pint of gasoline. Merely pressing it into the ground opens



Closeup of weed cutter shows small hole from which gasoline drops when blade cuts root

a valve and lets gasoline drip on the root. Farmers use it to attack Canada thistles, and gardeners fight dandelions with it.

Our Bureau of Information will answer questions regarding articles in this magazine, if accompanied by return postage.

Carbide and Carbon Chemicals Corp

to right or left. With the aid of this equipment the pilot flying "blind" is enabled to set his plane down on the rear end and center of the runway he is to use.

Homes Built of Plastics Promise Lower Costs

Houses of the future will be built of plastic and synthetic materials that should outlast materials used today, industrial chemists predict. From new applications of plastic materials, lacquers and synthetic fibers, new types of homes will emerge, with building costs much lower. Such houses would be noiseless, sanitary and proof against fire, vermin and weather.

Weed Cutter Sheds Poison on Root of Plant

Double death for weeds is dealt out by a farm and garden tool just invented. As the cutting blade is thrust at the root of a weed, it not only cuts the stem but sheds a few drops of gasoline or other

Es 511
W. C. Lorenz, Berlin, Germany
Telegraph Co
670 Broadway
St. Neuyart
Acme

Es 529
Acme Service 5153

Es 516

Es 519
Acme Service, 1119 E. 91st. Neuyart
Peatore, 1119 E. 91st. Neuyart
W. A. M. Schroeder

Hilltop Prism Shows Driver the Road Beyond

Trafficscope

Minneapolis, Minn.

Home address - Ralph Cooley, 1633 Thomas, St. Paul, Minn.

R. R. Rand, Jr. 26th floor Rand Bldg

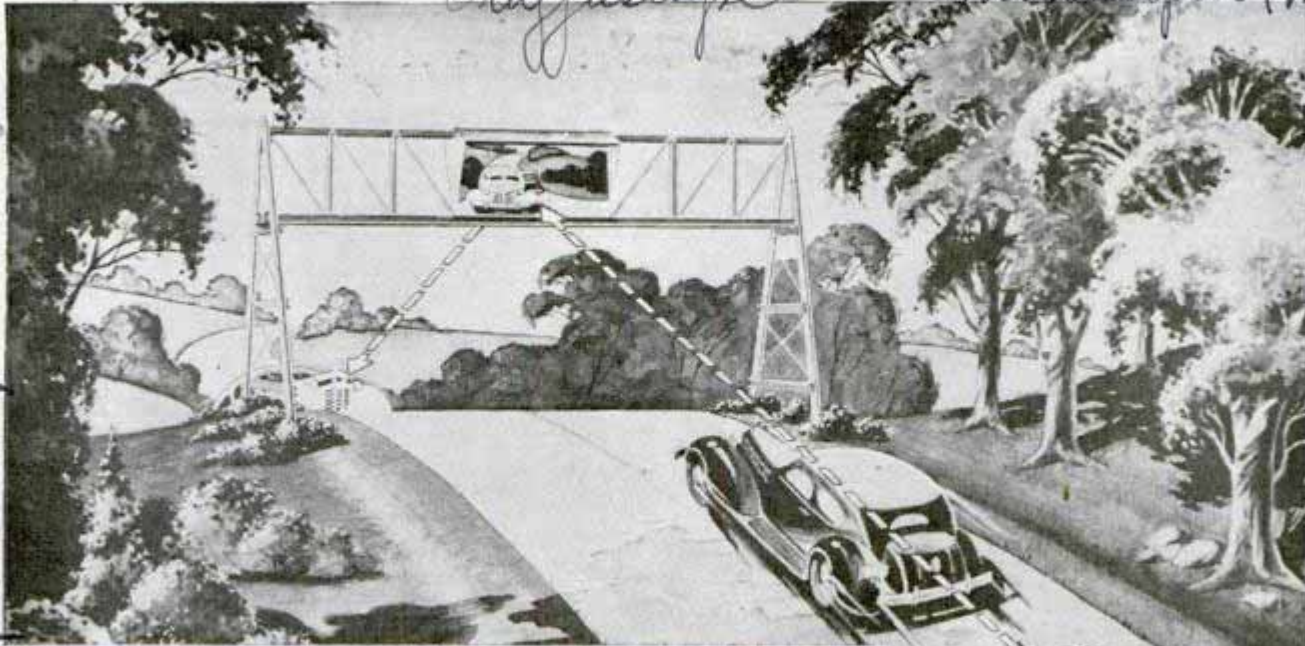

Left, prism installed above dangerous hilltop. Drawing shows how motorist watching prism can see cars approaching beyond the crest of hill

torist's vision would be less expensive in many cases than regrading roads to meet the federal government's requirement of 800 feet "sight distance" on federal-aid highways.

To prevent hilltop traffic collisions, a highway engineer has invented an overhead prism which gives the motorist a clear view of the road beyond the crest. The prism is made of glass, mounted like an inverted V in a trestle spanning the highway, fifteen to twenty feet above the ground at the top of the hill. The glass frame is filled with glycerin or some similar transparent non-evaporating liquid. A motorist approaching the crest can watch the prism from 2,000 feet away and see cars approaching a half mile on the other side. This method of extending the mo-

Waving Spotlight Sweeps Track in Front of Fast Train

Gyrating in a spectacular figure "8," a powerful headlight installed on a fast train between Chicago and Minneapolis sweeps the track to give distinctive and unmistakable warning of the speed train approaching. Its 3,000,000 candlepower light throws a canary yellow beam which attracts attention three miles away. A motor oscillates the reflector, swinging the beam in wide arcs and striking automobiles approaching the grade crossings.

comb. J. F. Schmitter, Chicago and N.W. A.R.

Vertical handwritten notes on the right margin, including "26th floor Rand Bldg" and "Minneapolis, Minn."

HUNTING TREASURE

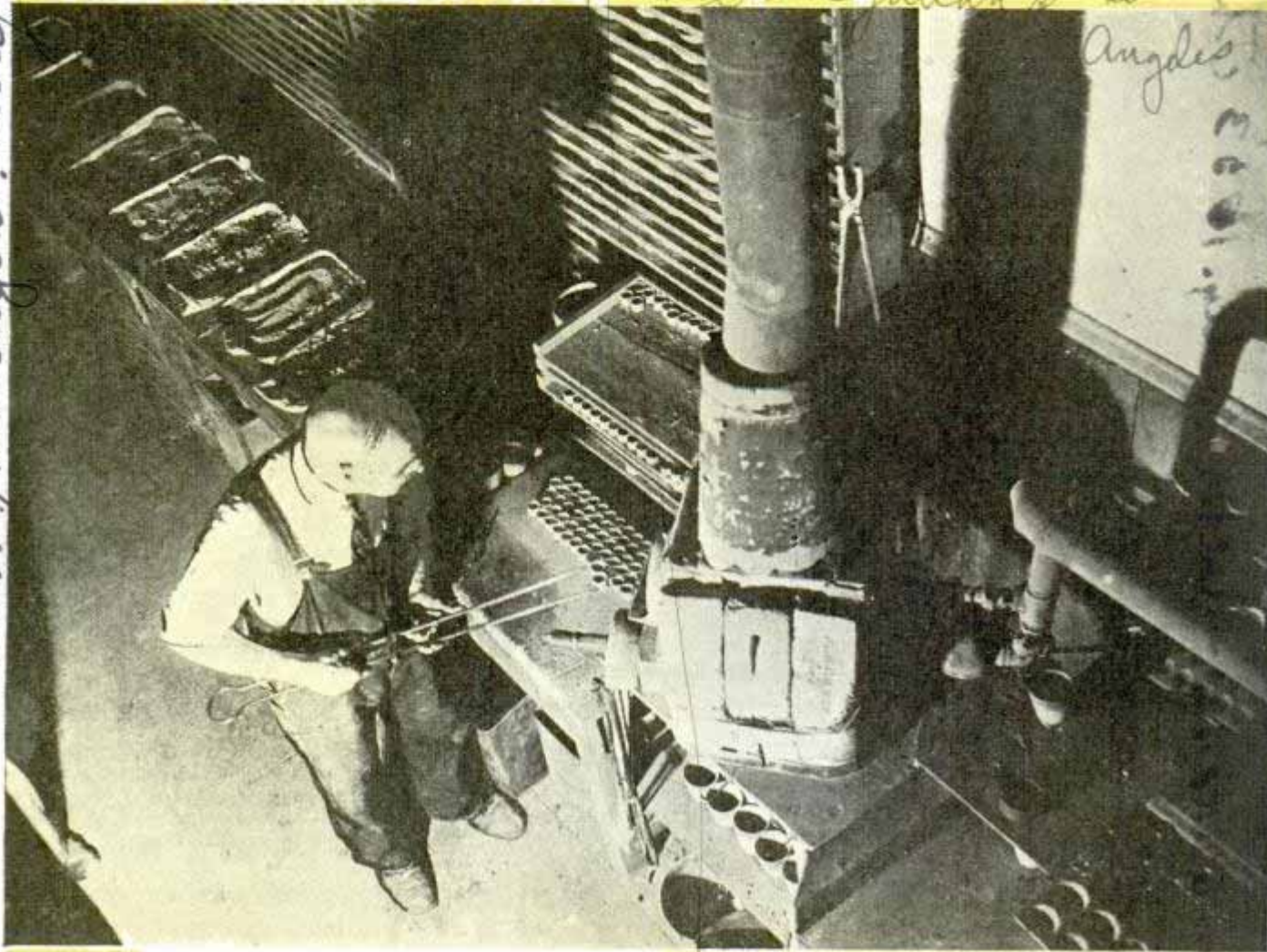

Assayer making tests on sample of ore by firing in furnace. Tests are made quickly with the aid of the spectrograph which "fingerprints" all minerals present in the ore

IF YOU'RE planning to explore abandoned mines of the West for overlooked treasures, take science's newest "magic eyes" along. Two or three black boxes about the size of portable typewriters will hold your "black-light" argon bulb, your iron arc, willemite screen, blowtorch, goggles, geologist's hammer, and minor tools for prospecting.

You won't need the old-fashioned burro train piled high with sample bags—a tablespoonful of powdered rock, sealed in an envelope, is enough. Your assayer will use the spectrograph to analyze your findings. Cramming a small pinch of the sample into a cupped crater in an electric arc's carbon electrode, he will start the current flaming across and snap a photograph. Every mineral present will leave its "fin-

gerprints" on the film. The rest is a matter of measuring the position of thin vertical stripes on the negative, made easy by comparison with a master film which has all the minerals showing on it.

An assay used to take days of painstaking work, a big bagful of samples, and cost the customer \$150. Now the job can be done in a few minutes for only six dollars.

A bronzed man in a wide-brimmed hat walked into a western assayer's office the other day, pulled from his pocket a bunch of sealed envelopes, and requested spectrographic analyses of their contents. On his return, he leafed through the assayer's reports and picked out one with a grunt of satisfaction. "Just what I was looking for!" he announced.

The assayer registered surprise.

with expanded scale Applied Research Laboratory

Cont. Maxwell Reid Bryant, 541 1/2 Scendale Blvd., Los Angeles, Calif.

Praven Corp 2260 E 15th Los Angeles

impure spectrographs assays - \$6.00 each Mr. John Hermann 971 San Julian St Los Angeles

with MAGIC LIGHT

"Why, I thought you were going to be disappointed. There's no gold in those rocks, nor anything else of commercial value."

The man smiled. "Cadmium's what I'm looking for, and here it is."

The assayer looked at the report. "Why, the test shows only .0003 per cent—you wouldn't get a dime's worth of cadmium in a ton of ore," he protested.

"No," retorted the other, "but gold in our mine runs in a formation streaked with very faint traces of cadmium. Last week we lost the vein and tunneled eighteen feet without finding it. So I took samples along the drift and brought them in for testing. The cadmium showings will lead us straight to the ore body."

Tracing precious ores by such "markers" is now possible because

Right, mercury-vapor lamp tests ore sample with ultraviolet light as goggles protect the eyes. Bottom, left, pulverizing ore samples to be assayed. Right, placing tiny bit of ore in electric arc crater for spectrographic analysis

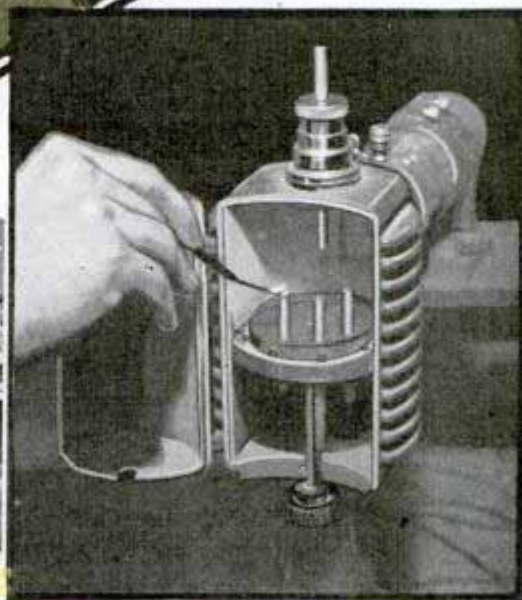
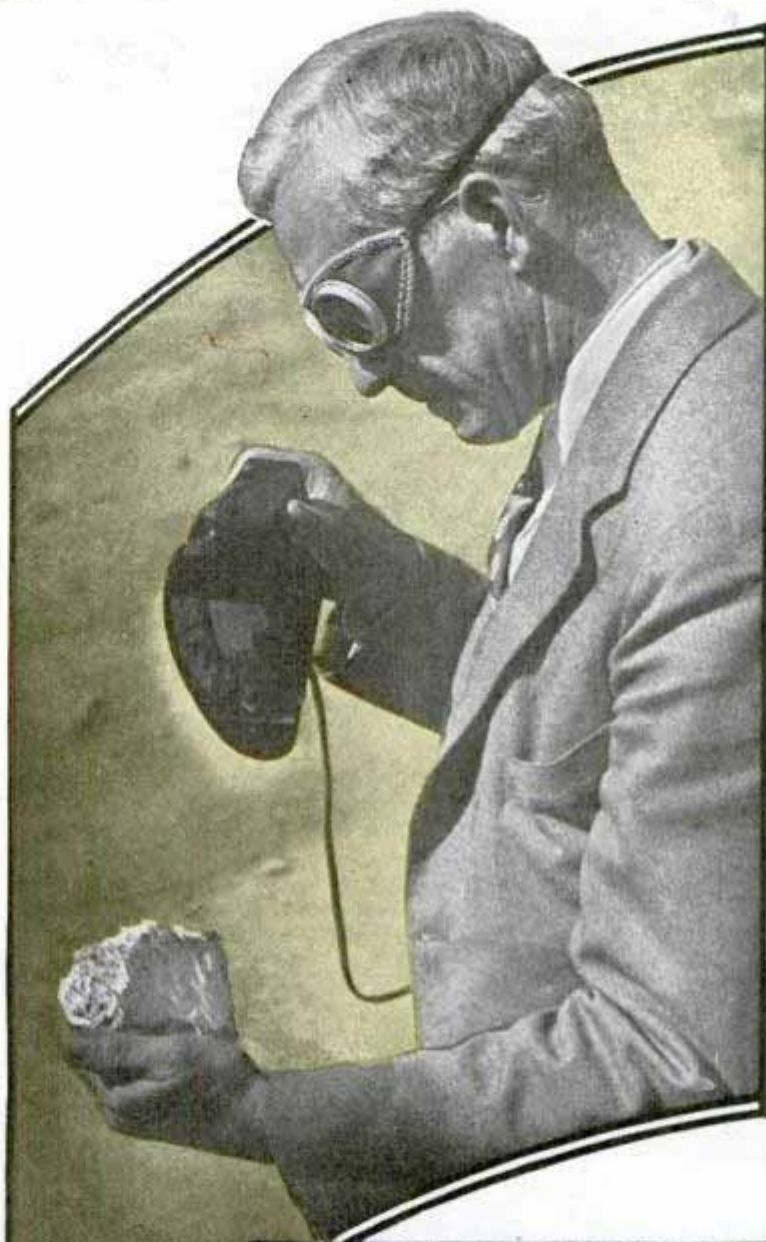

Dr. Hermann Los Angeles

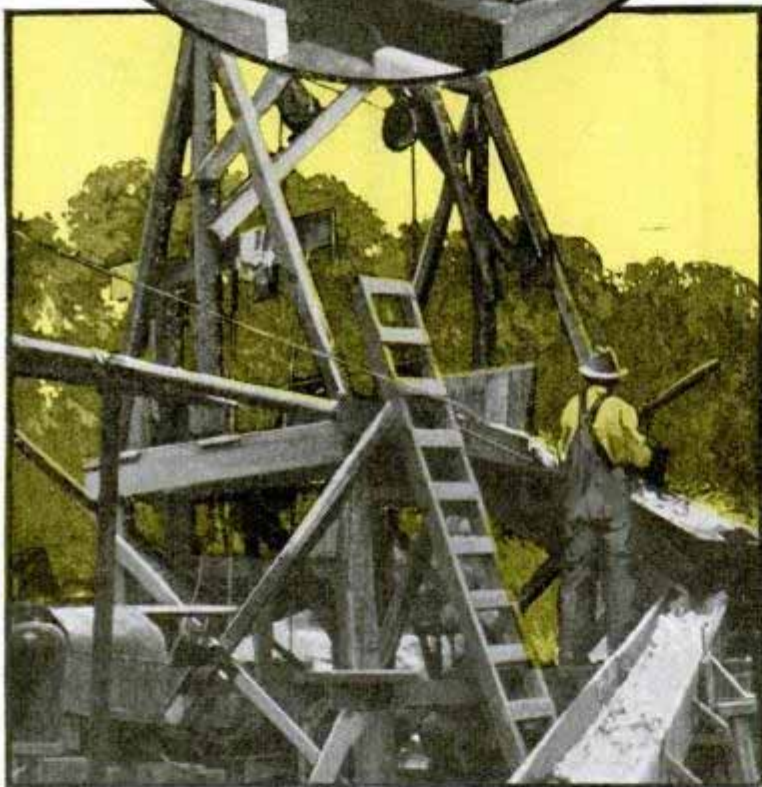
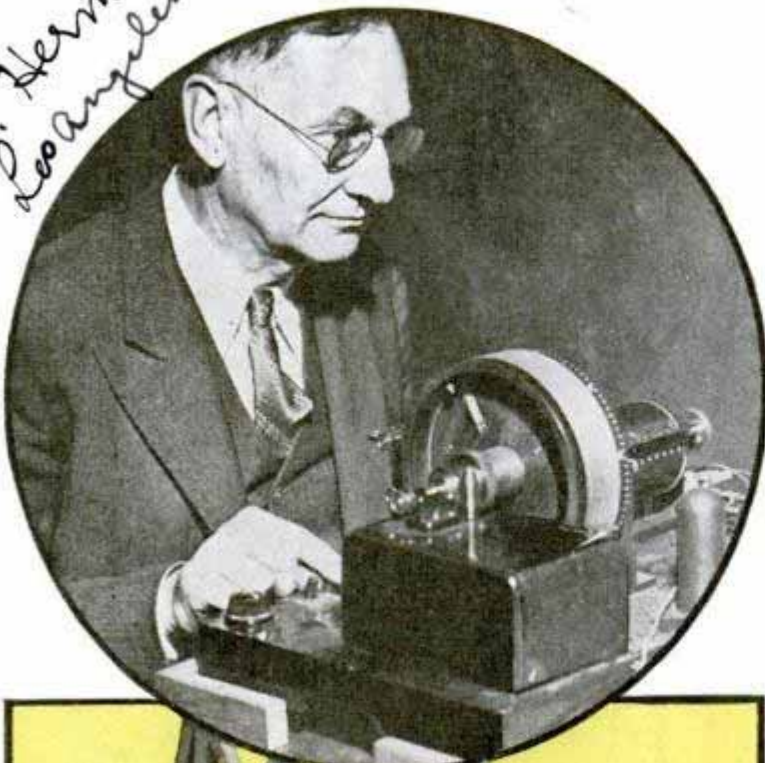

predictable. A big company drove a tunnel 1,800 feet and found no ore, but later a sharpshooter drifted twenty-six feet farther and hit the bottom of a pocket of ore worth \$40,000. Another miner stopped six inches too soon, and the next man drove his pick straight into a young fortune.

But now magic-light prospecting is enabling a few shrewd prospectors to steal a march on the others. Wise in mining lore and fortified with a few hundred dollars that they are prepared to stake on a long chance, these men are going over the tunnel walls of abandoned, water-filled mines with an eagle eye. It's picking over dry bones, but they take plenty of samples, knowing that the spectrograph will tell them things that the old-fashioned assay never mentioned. A prospector used to rush into the assayer's and demand to be told whether his ore contained any gold. Now his spectrographic report shows not only gold, but twenty-five or thirty other minerals as well, and

the spectrograph can detect tiny amounts of elements that elude delicate chemical tests. A glance at the spectrographic film will show whether the pay ore contains any uncommon material not found in the barren country rock, and from then on, the prospector knows that any sample containing this marker mineral will point the way to the lost vein.

In recent years old diggings have been combed by "sharpshooters" seeking overlooked fortunes. Now and then they struck it rich, for "pockety" formations are un-

Top, polarograph for detecting minerals in liquids. Center, bringing up pay dirt from old mine. Bottom, adjusting iron arc beam to detect minerals

*Dr. Otto Muller
Dept. of Physiology, Stanford*

nowadays in the mining camps you often hear of men who went out looking for gold and found tungsten, or molybdenum, or even carnotite, mother ore of priceless radium.

One miner was electrified when his sample showed a brilliant green line in the spectrum indicating the rare metal thallium, used in special glass and certain alloys. Another found osmium, far more precious than gold.

It's an old saying of mining that erosion does more for prospectors than a million holes dug in the ground. Here is another field being explored by a few prospectors. Running water that eats into a mountainside and exposes hidden veins of ore carries away microscopic traces of the ore. Near the huge copper mines at Bisbee, Ariz., you'll find the run-off waters after each rain betraying tiny quantities of copper salts. Maybe the trace would be as small as one part in a million—but nearer the ore body, this percentage might jump to ten or even a hundred.

A glassful of water, taken from each of a number of likely locations, is the starting point for general search of a region. Turned

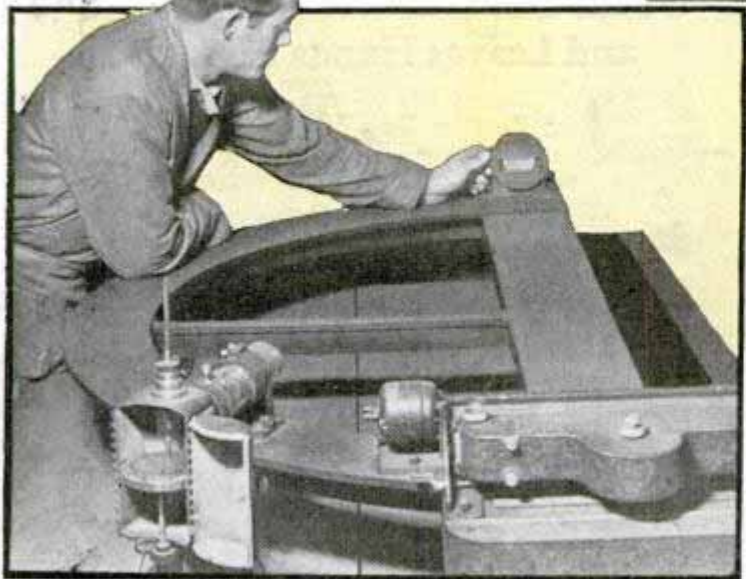
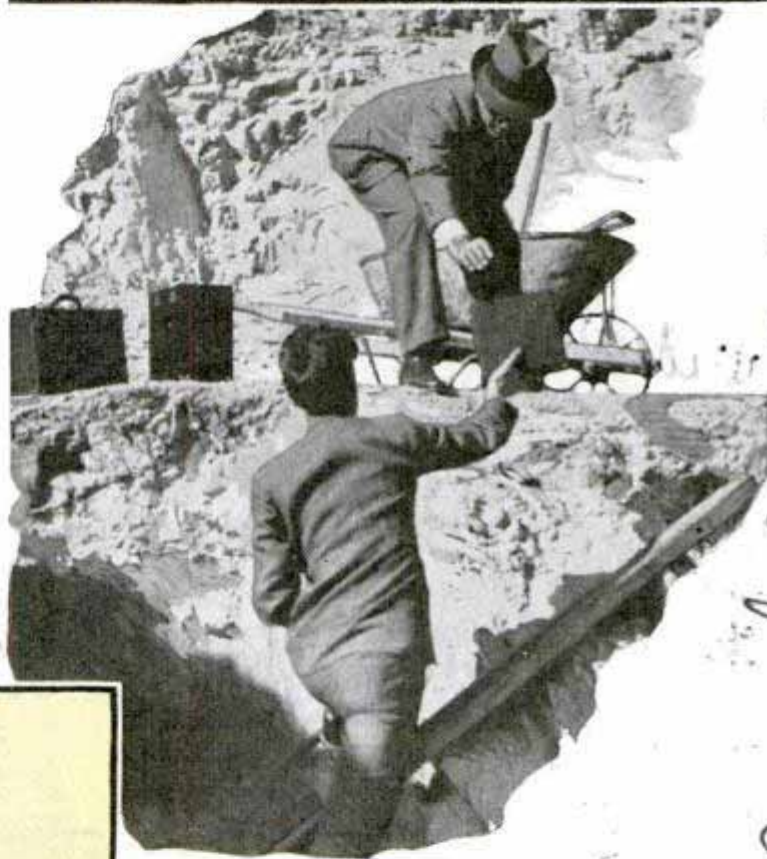
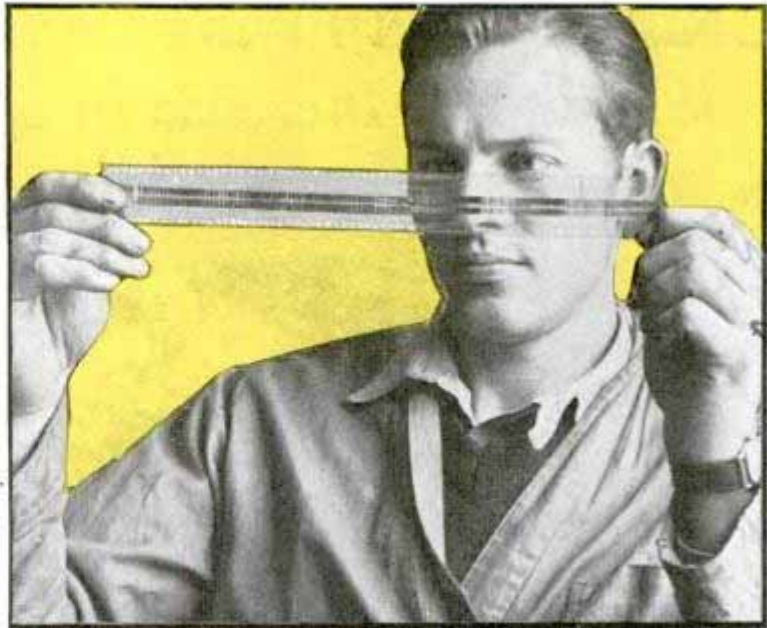

Top, strip of film showing elements in ore sample. Center, modern prospectors with magic-light kit. Bottom, adjusting reflecting mirror of spectrograph

over to the polarograph, a supersensitive instrument which uses weak electric currents and galvanometers to analyze liquids, these samples quickly reveal mineral traces and narrow the search to a particular valley or hillside.

Another tool used by the modern prospector is the "black-light" argon bulb, whose invisible ultraviolet rays make certain ores glow like phosphorescent fish or glowworms. By flashing the rays from one of these bulbs, or from a port-

(Continued to page 124A)

George A. M... 568 N. ... Los Angeles

Handwritten notes and signatures at the bottom of the page, including 'George A. M...' and other illegible scribbles.

Coast-to-Coast Flying Chart Shows Big Increase in Speed



COAST TO COAST BY AIR	
1911	54 DAYS
1920	78 HRS.
1924	33 HRS.
1927	31 HRS.
1936	16 1/4 HRS.
1937	15 1/2 HRS.
1938	?

How coast-to-coast flying has been speeded. In twenty-six years the trip has been cut from fifty-four days to less than sixteen hours

How aviation has advanced in the last twenty-six years is revealed on a chart showing the flying time required for crossing the United States. Weeks, days and hours have been clipped from coast-to-coast journeys year by year, starting from Capt. Galbraith P. Rodgers' fifty-four-day trip in 1911. Today passengers are carried from the Atlantic to the Pacific ocean in slightly more than one-half day. Just recently United Air Lines inaugurated a new Chicago-to-California schedule of eleven hours and fifty-nine minutes, cutting two and one-fourth hours off the old schedule. United's schedule for the east-bound coast-to-coast flight is fifteen and one-third hours. West-bound planes require slightly more than seventeen hours.

Wheeled Dummy Trains Dogs to Lead the Blind

Dogs are being trained to lead the blind by means of an "artificial man," consisting of a light frame about the height and

width of a man, mounted on a pair of wheels. The object is to get the dog accustomed to avoiding obstacles of his own size and also of a man's size. First the dog is given the task of pulling the pair of wheels, to teach him to avoid steps, street-railway tracks and excavations and to choose a path that will not let one of the wheels, representing the blind man's foot, slip into the gutter or strike against walls or posts. Then the full-size dummy is added to teach the dog to pay attention to overhead obstacles, such as low-hanging tree branches, awning poles, wires, ropes and the like. After several collisions affecting the upper framework of the dummy the dog learns to go around, rather than under, obstacles seven feet or less above the ground.

When the dog has mastered the job of leading the dummy, he is allowed to guide a man who can see. Later he is transferred to his blind master.

Pedal Controls Solder Flow and Leaves Hands Free



Hands are left free to handle the work when the craftsman uses a new soldering machine equipped with pedal for controlling the flow of solder. The iron is heated by electricity and the feed rollers are adjustable to feed

strip or wire solder from one-sixteenth to three-sixteenths inch. The supply holder carries a roll of wire solder up to twenty-five pounds. A funnel takes away fumes.

American Solder & Files Co.

Capt. Jack Knight

Gene Stone 5/8/37

Wide World

58 E. 42nd Street New York

is 540

Mr. E. L. Davis, Director for Environment Research, Hamburg, N.Y.

W. Payne and Berkeley, Cal.

Streamline Car Tests Model Plane on Water

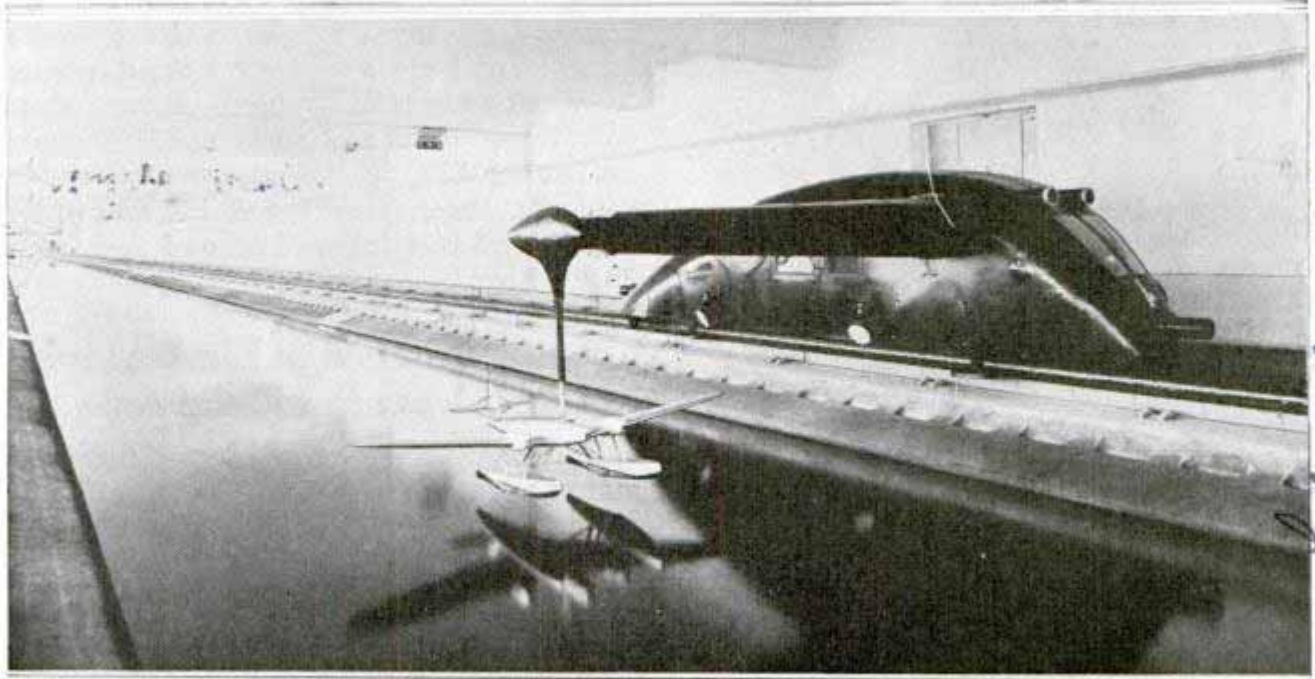

High-speed streamline car tows model seaplane in 500-yard test basin near Rome while instruments and observers check its performance in the water. Car is capable of eighty-five miles an hour

Streaming along a track flanking a 500-yard test basin near Rome, Italy, a fast streamline car tows model seaplanes and ship hulls while cameras, dynamometers and other instruments record the performance. To smooth the waves set up during the test, terminal buffers and water-shock absorbers are installed at the tank ends, and these are so effective that testing time can be shortened from an

hour to five minutes. One tow car, capable of traveling eighty-five miles an hour, carries the model on a projecting arm. In another section of the basin the models are linked with an overbridge structure on four wheels attached to a testing car capable of forty-four miles an hour and driven by four electric motors. Every five yards, the force acting on the model in the water is registered in the towing car.

Sixty-Five Ton Anvil Reveals Progress Made in Tools

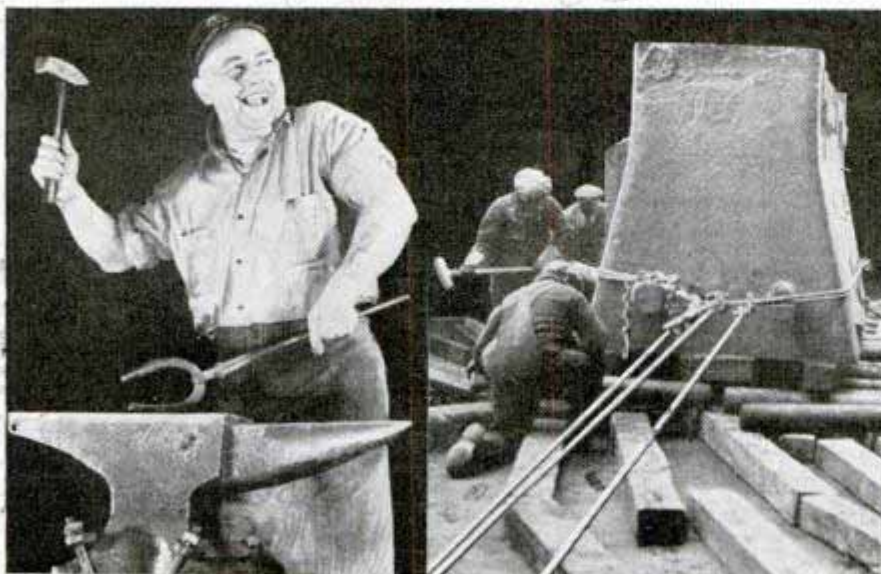

The old and the new in anvils. Right, sixty-five ton hammer base which is used in the forging of crankshafts for automobiles

In contrast to the old-fashioned hand anvil on which one workman forges small parts is the sixty-five ton hammer base or anvil installed recently in the Chevrolet plant for the forging of automobile crankshafts. A steam hammer replaces the workman's brawny arm in operation of the giant anvil. The small anvil is located in the gear and axle plant and is used for making conveyor hooks and other small parts.

Es 521
29 Bean Road
Desley Heath ne London Eng
Aeronautica Laboratory - St. Albans
Air Ministry Rome, Italy

are Detroit Mich

Motor Division
General Motors Sales
Dept # 20

Magazine, May 1937
P. 110.

Spectacles for Gas Mask Aid Short-Sighted

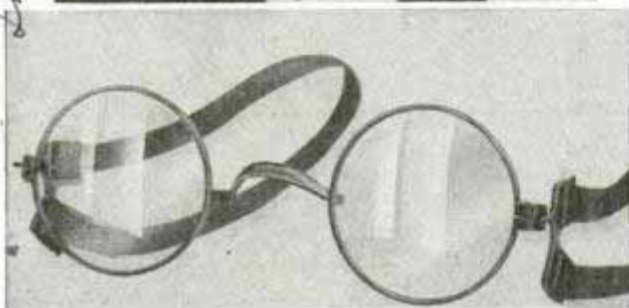

Bottom, spectacles for use in gas mask. Top, demonstration showing how they fit

Designed especially for use in gas masks, a new type of spectacles eliminates the hazard of having the mask displaced by the frames of the glasses. The new spectacles have soft tapes that lie close to the head instead of rigid side pieces. An anti-fogging fluid keeps the glasses clear when worn with the mask. Thus short-sighted persons may work in comfort and safety, certain that gas cannot enter the mask during peace-time drills or actual warfare.

Auto Is Made of Farm Products from Thousands of Acres

Farm crops from thousands of acres every year go into the manufacture of automobiles which, at first glance, appear to be mostly metal. One manufacturer alone, to build a million cars, requires 2,400,000 pounds of linseed oil, from 17,500 acres of flax, for paints, oil, soap and glycerin; a half-million bushels of corn for rubber substitutes, alcohol and solvents; 3,200,000 pounds of wool for upholstery, gaskets,

carpeting and lubricants; 1,500,000 square feet of leather from 30,000 cattle for upholstery and glue; 89,000 pounds of cotton from 558,000 acres for safety glass, brake linings, upholstery and timing gears; 2,000,000 pounds of soybean oil for paint; 350,000 pounds of mohair from 87,500 goats for fabric; 2,500,000 gallons of molasses for solvents, shock-absorber fluids and anti-freeze; and bristles, lard oil and acid from 20,000 hogs.

Motor Installed in Bicycle Hub Revolves around the Axle

Extremely economical in gasoline consumption, a motorized hub for bicycles has been introduced in Germany. The motor itself is stationary. The maximum speed is about twenty miles an hour and it can climb a grade as great as nine per cent without help from the pedals. The single-cylinder, two-stroke motor develops one-half horsepower and is fed by a gravity tank installed over the rear wheel. A metal disk clutch is set up on the hub housing.

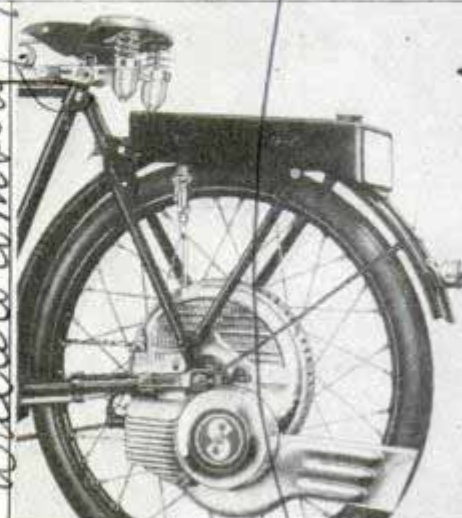
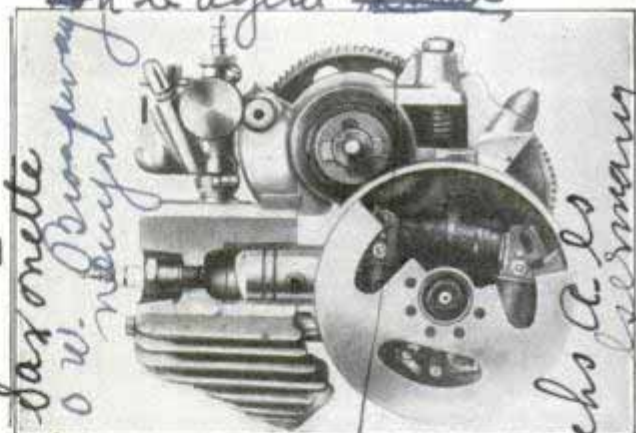

Top, one-cylinder bicycle motor. Below, motor installed on rear hub with gas tank over wheel

U.S. agent. Walter
Reinberg, 9408-34th

U.S. agent Reinberg, 47 Wignmore St London, W.1. England

U.S. agent Reinberg
Daxonnelle
90 W. Broadway
New York
Dichtel and Sachs A.G.
D. Chwenfurf 110. Germany

U.S. agent Reinberg

Fan Forces Parachute to Ascend with Jumper

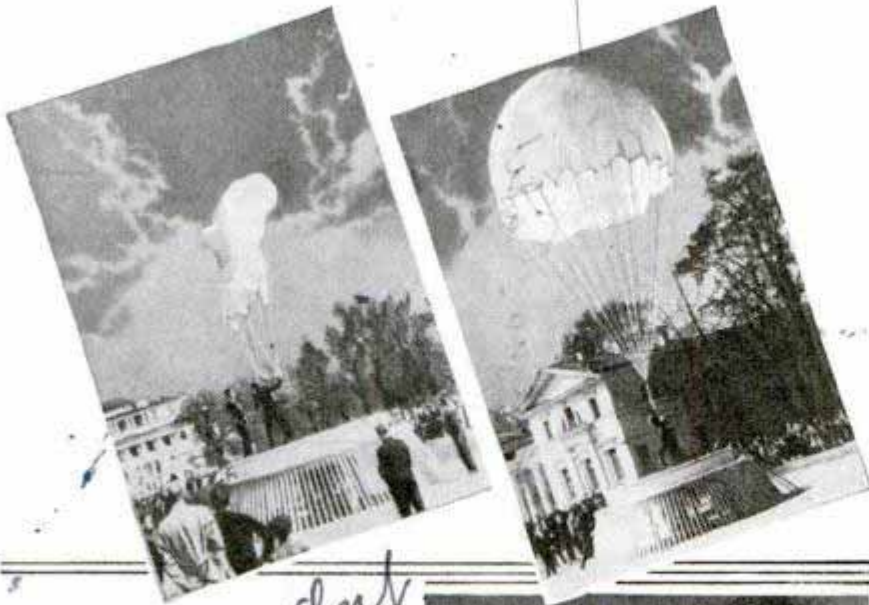

Several views of parachute ascension. Top, left, 'chute beginning to fill with air from blower. Right, ready for the take-off. Bottom, left, soaring into the air with aid of blast from blower. Right, starting descent

Used in training parachute jumpers in Russia, a blower device forces the parachute upward until the student's weight counteracts the air current. Then the "jumper" descends in the usual manner, working the shroud lines to jockey for a perfect landing. At the beginning of the lesson, the student stands on a grilled platform, his chute attached. A powerful motor-driven fan generates a strong upward current of air, filling the parachute, tightening the harness and lifting the parachutist off his feet. Steadily the 'chute rises toward "ceiling," the point at which the student's weight overcomes the air current's force, and then comes the descent, which is



made as though the student had dropped from an airplane. By eliminating that perilous interval between an actual jump and the opening of the 'chute, the blower reduces the hazard.

Dirt on Plane's Wings Costs Money by Reducing Speed

In operating high-performance airplanes the importance of smooth surface on the wings, as well as other parts, is so great that experts suggest it may be found economical to have the wing surfaces wiped clean of dirt and dust at every stop. Even a small amount of dirt on the wings increases resistance to the air and thus reduces speed, causing the engines to work

harder to maintain the same rate of travel. Reducing the size of rivets in an airplane wing by one thirty-second of an inch makes it possible to reduce the power necessary for operation by 100 horsepower.

Alligators and reptiles in Chicago's Brookfield zoo keep their feet warm by means of heating cables laid in the sand.

National Advisory Committee for Aeronautics

General Electric Review

Science Service 6/18/37

579

ACB, low

Lo 438

Comr. Wm. H. Thompson 6. Stinson Jr

10555

Holman Ave
Los Angeles, Calif

Forecasting the WEATHER



Pasadena, Calif

It is too early in the year to predict next winter's weather, although the forces that will control it are being studied already. But the conditions that brought on last winter's floods and unusual conditions were scrutinized as early as last summer. Last October Dr. Irving P. Krick of the California Institute of Technology warned citrus growers that they could expect unusually cold weather and heavy frosts during the winter season. He based his forecast upon a queer shift in what he calls the semi-permanent atmospheric boundaries that control the general climate in the United States.

Normally one of these boundaries lies just east of the Rockies and the other hovers over the Atlantic a few hundred miles at sea. The boundaries mark the limit of the fairly stable cold continental air mass and separate it on both

EVERYONE wants to know what the weather will be like tomorrow. Weather wizards who are developing the science of air-mass analysis can tell you not only that but they can make predictions for the next two or three days that are correct nine times out of ten. Air-mass analysis is contributing amazingly to the accuracy of weather forecasts.

Now there is a possibility that the same science may help to foretell the general climate a whole season in advance. That means that late in the summer, for instance, forecasters will be able to say whether a cold wet winter or a comparatively mild one may be expected. Advance information like that has been a major goal of meteorology for a long time. Such a head start on the weather would mean tremendous savings to industry.

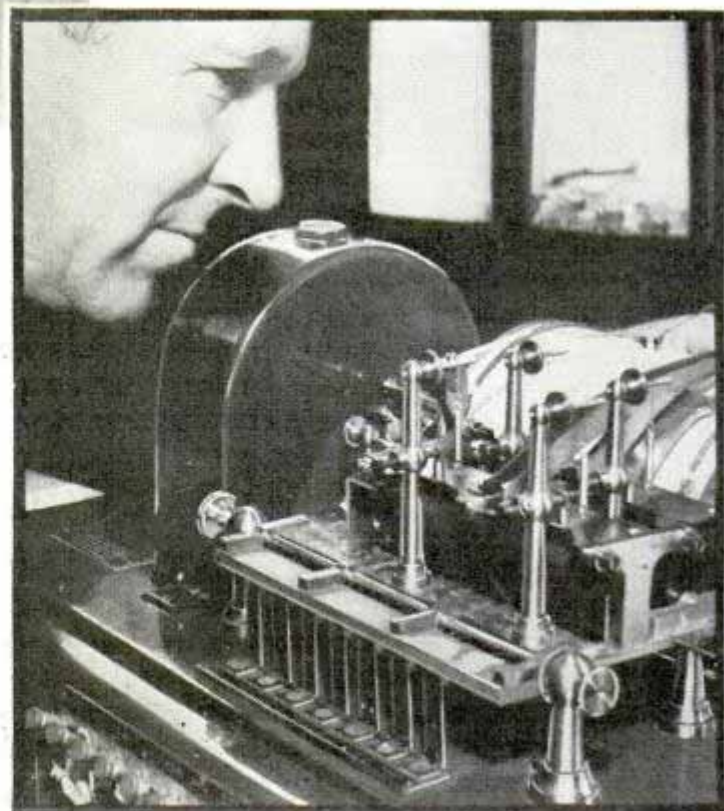

Top, wind vane and air-speed indicator. Bottom, automatic weather recorder

20438

a YEAR AHEAD

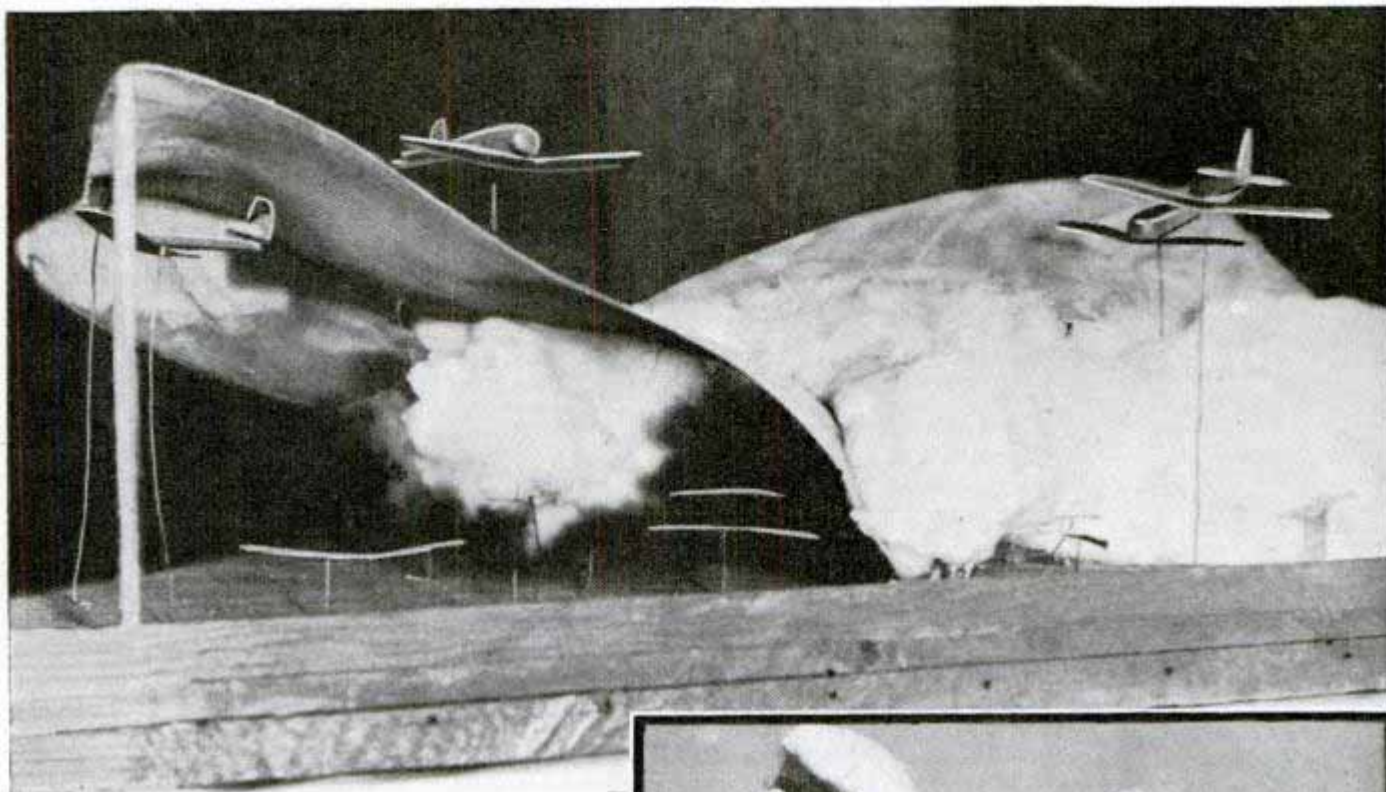

sides from warmer and more moist air masses over the oceans. Frequently these boundaries shift back and forth several hundred miles in a few days but their average geographical positions seem to be pretty well fixed. Ordinarily, oncoming Pacific air provides a mild winter along the west coast, and the cold continental air in the middle west and in the east provides a cold winter climate.

What Dr. Krick noticed was that the cold continental air mass had shifted to the west something like 500 miles and for a time it remained more or less fixed in its new position. The western boundary had moved out over the Pacific. This would prevent warm ocean air from reaching the west coast and led to the forecast of a cold winter for the citrus growers. At the same time, the eastern boundary of the continental air mass had moved inland as far as the west slope of the Appalachians. Put in simple words, this suggested that the forces influencing weather had shifted west

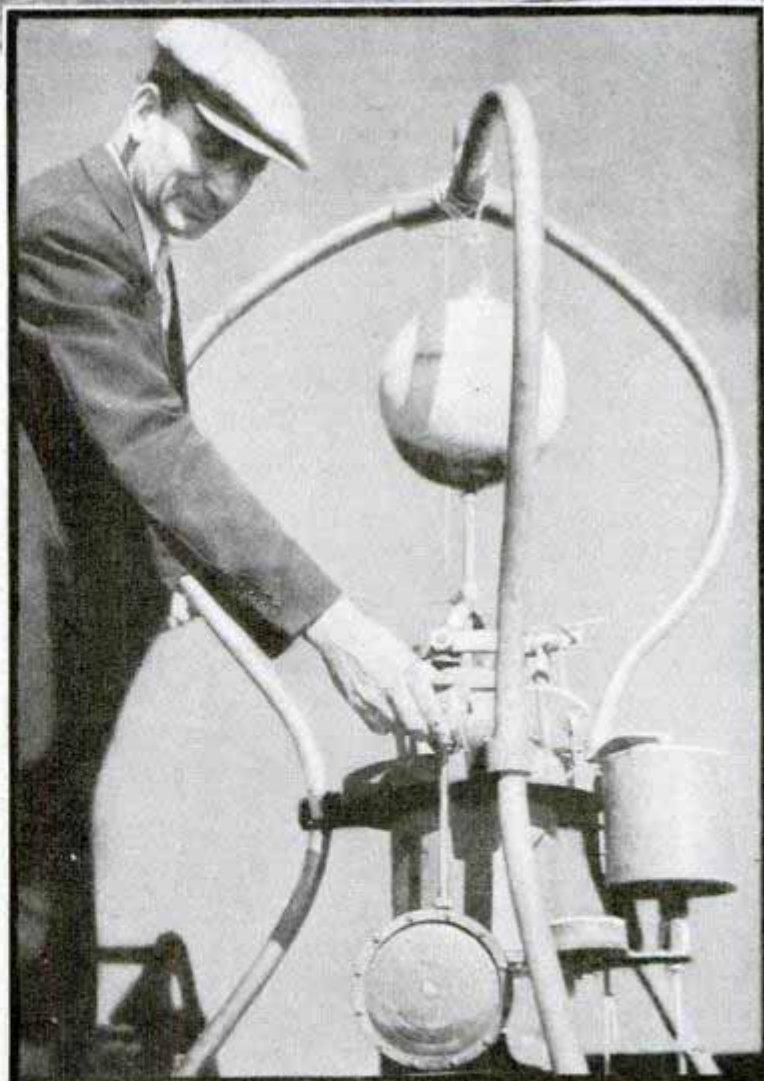

Top, demonstrating how cold-air masses flow under and lift warm air. Bottom, adjusting device which registers data concerning currents at bottom of ocean

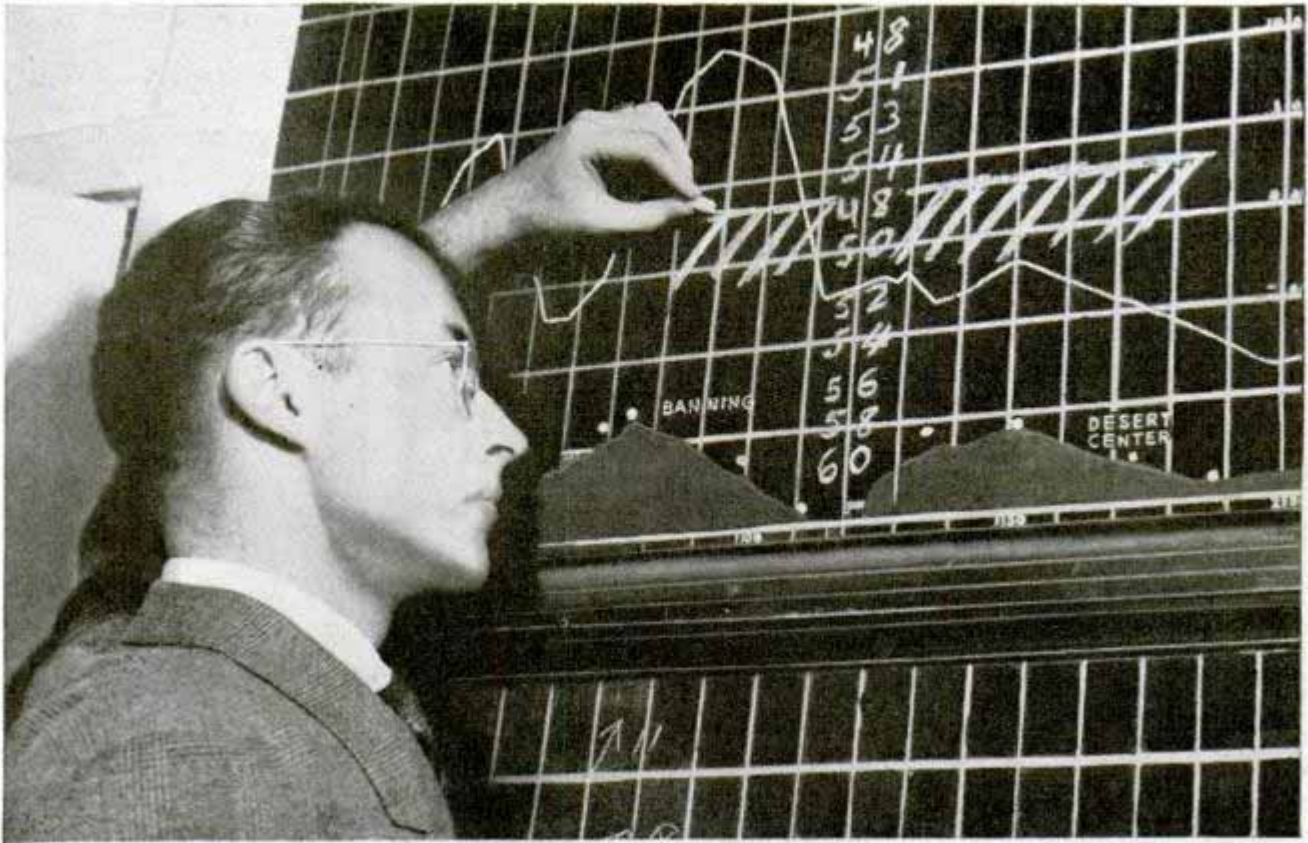

Air-line meteorologist plotting top of cloud bank expected six hours in the future. Temperature information radioed by transport pilots is used in this work

for the time being and that in any one place the weather conditions that normally occurred a few hundred miles to the east might be expected, modified by local conditions.

That meant unusual weather everywhere. In the east, exposure to the warm Atlantic air indicated a relatively warm winter with thaws and floods. That is precisely what happened.

The displacement of the continental air mass also seems to account for the devastating floods along the Ohio and Mississippi rivers. The thaws west of the Appalachians contributed their share and the same displacement of the continental air mass that caused them also re-routed the storms that normally travel from west to east along the northern border of the country. Starting out over the Pacific, the storms encountered the cold continental air sooner than usual and were shunted far to the south where they described circular tracks across Mexico and the Gulf and finally made their way up the Mississippi valley. In crossing the Gulf the storm centers picked up tremendous quantities of moisture that were later precipitated in the flood area.

The same westward shift also provides

a reason for the drought in the middle-western dust bowl last summer. Ordinarily heavy showers occur east of the Rockies along the zone of activity that marks the western boundary of the continental air mass. When the boundary moved to the west the showers fell as usual, but last summer the boundary happened to lie over Utah and Arizona instead of the states more to the east. Those states were robbed of their normal summer rains, resulting in the drought.

Even if this extension of air-mass analysis is going to provide the key to accurate long-range forecasts, Dr. Krick won't be ready to depend upon it until the reasons for the behavior of the air masses can be found. One explanation may be found in the fact that last summer unusually high temperatures were recorded by seawater thermometers in the north Pacific. This suggests that the warm sea water in turn warmed the air above it, allowing the air to pick up more moisture than usual. In turn, this made the air lighter than it is ordinarily. Humid air is always lighter than dry air. The result was that the cold dense air of the continental air mass was able to flow in under the warm air, shouldering it upward and extending its own

Giant Tube to Supply Water for Ten Millions

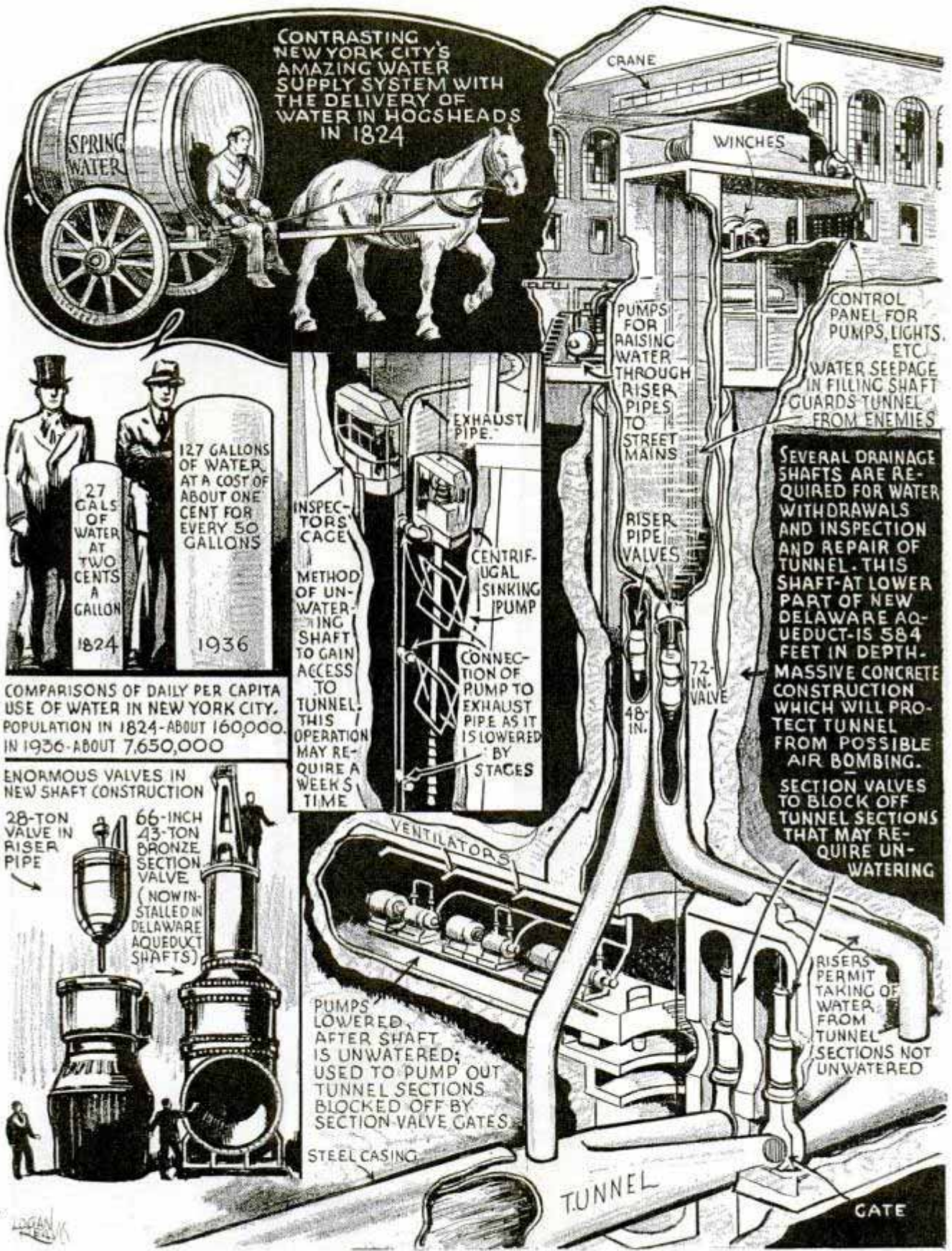

CONTRASTING NEW YORK CITY'S AMAZING WATER SUPPLY SYSTEM WITH THE DELIVERY OF WATER IN HOGSHEADS IN 1824

27 GALS OF WATER AT TWO CENTS A GALLON 1824

127 GALLONS OF WATER, AT A COST OF ABOUT ONE CENT FOR EVERY 50 GALLONS 1936

COMPARISONS OF DAILY PER CAPITA USE OF WATER IN NEW YORK CITY. POPULATION IN 1824-ABOUT 160,000. IN 1936-ABOUT 7,650,000

ENORMOUS VALVES IN NEW SHAFT CONSTRUCTION

28-TON VALVE IN RISER PIPE

66-INCH 43-TON BRONZE SECTION VALVE (NOW INSTALLED IN DELAWARE AQUEDUCT SHAFTS)

EXHAUST PIPE

INSPECTOR'S CAGE

METHOD OF UNWATERING SHAFT TO GAIN ACCESS TO TUNNEL. THIS OPERATION MAY REQUIRE A WEEK'S TIME

CENTRIFUGAL SINKING PUMP

CONNECTION OF PUMP TO EXHAUST PIPE AS IT IS LOWERED BY STAGES

VENTILATORS

PUMPS LOWERED AFTER SHAFT IS UNWATERED; USED TO PUMP OUT TUNNEL SECTIONS BLOCKED OFF BY SECTION VALVE GATES

STEEL CASING

TUNNEL

GATE

CRANE

WINCHES

PUMPS FOR RAISING WATER THROUGH RISER PIPES TO STREET MAINS

RISER PIPE VALVES

48-IN.

72-IN. VALVE

CONTROL PANEL FOR PUMPS, LIGHTS, ETC.

WATER SEEPAGE IN FILLING SHAFT GUARDS TUNNEL FROM ENEMIES

SEVERAL DRAINAGE SHAFTS ARE REQUIRED FOR WATER WITHDRAWALS AND INSPECTION AND REPAIR OF TUNNEL. THIS SHAFT AT LOWER PART OF NEW DELAWARE AQUEDUCT IS 584 FEET IN DEPTH. MASSIVE CONCRETE CONSTRUCTION WHICH WILL PROTECT TUNNEL FROM POSSIBLE AIR BOMBING.

SECTION VALVES TO BLOCK OFF TUNNEL SECTIONS THAT MAY REQUIRE UNWATERING

RISERS PERMIT TAKING OF WATER FROM TUNNEL SECTIONS NOT UNWATERED

New York's \$272,587,000 Delaware aqueduct, designed to supply ten million persons with water within ten years, is begun with driving of a shaft, fourteen feet in diameter, which pierces a mountain. Upper left, note how use of water increased as price dropped. Other drawings show features of the shaft which will tap the water supply in a giant tunnel. Massive concrete construction will protect water system from bombs dropped by enemy planes

Eighty-Five Mile Tunnel Taps Vast Watershed

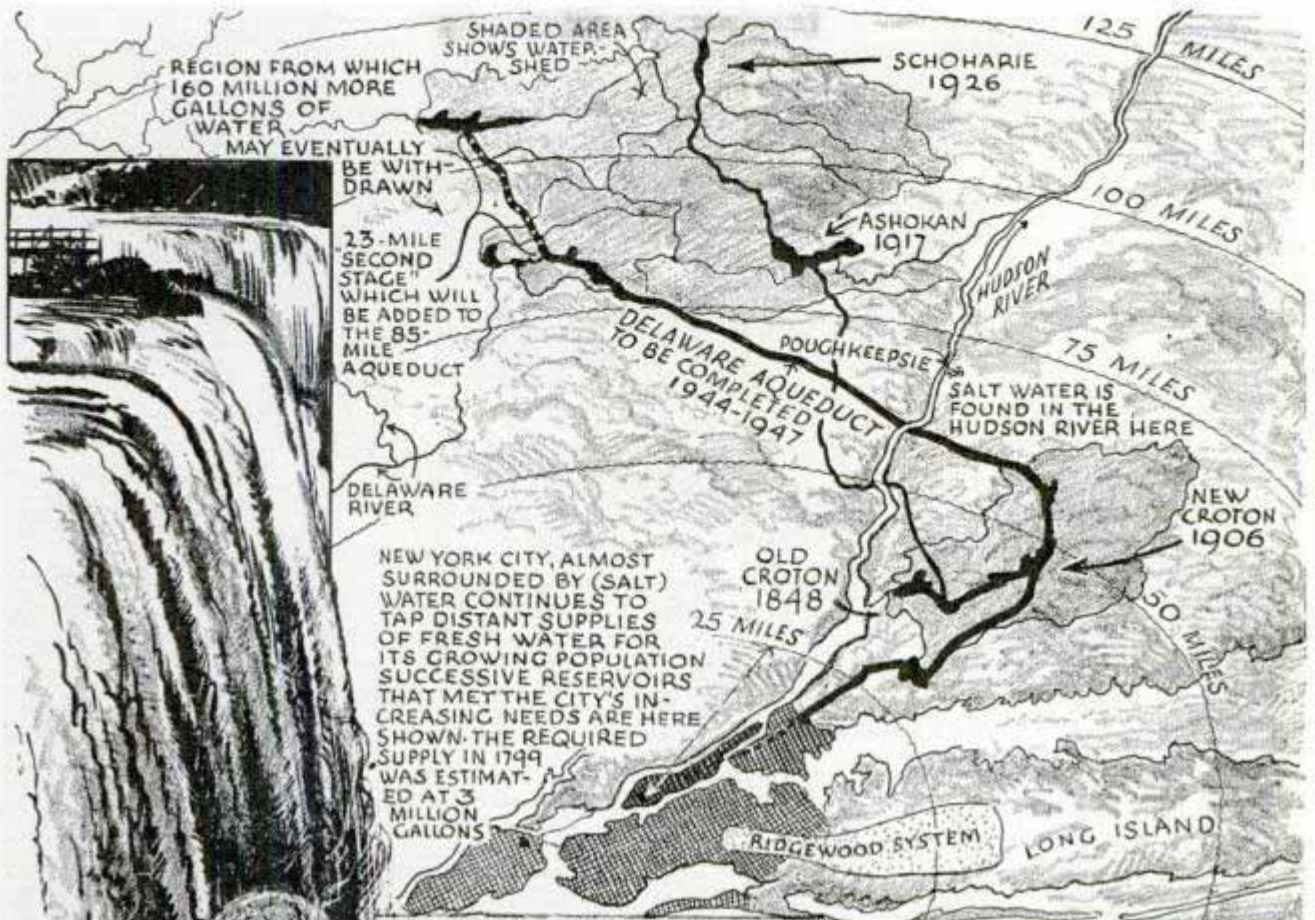

NIAGARA RIVER: 1 MILLION, 500 THOUSAND GALLONS PER SECOND

NEARLY 17 HOURS WOULD BE REQUIRED FOR THE PASSAGE, OVER THE PRECIPICE OF NIAGARA, OF THE 1 BILLION, 500 MILLION GALLONS OF WATER TO BE SUPPLIED DAILY TO NEW YORK CITY WHEN THE DELAWARE AQUEDUCT IS COMPLETED

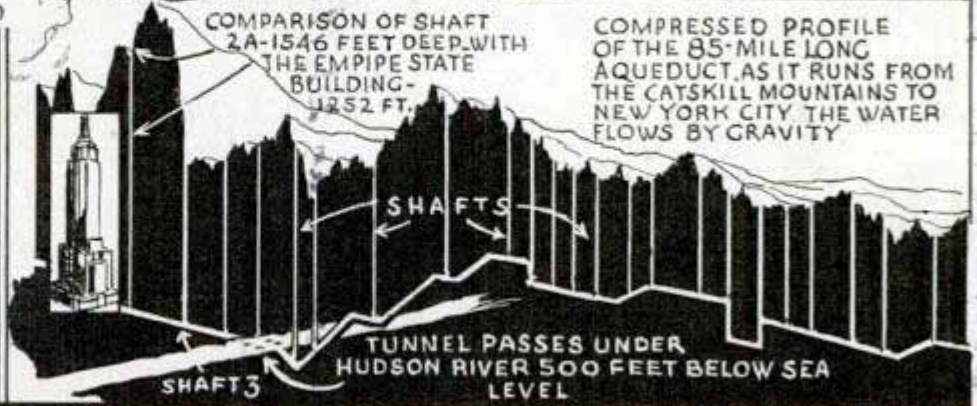
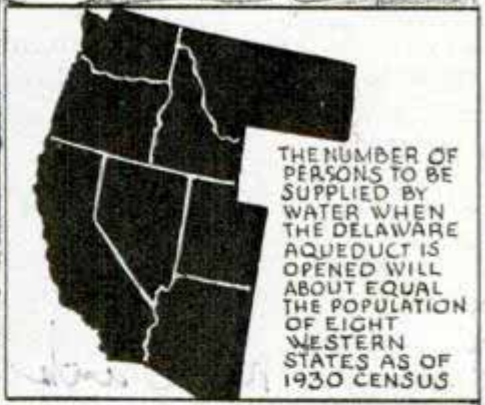
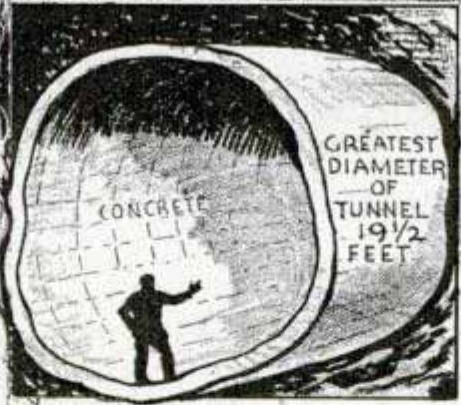

Tapping a vast watershed, the huge tunnel will convey by gravity one and one-half billion gallons of water each day from the Catskill mountains to New York, a distance of eighty-five miles. The greatest diameter of the tunnel will be nineteen and one-half feet. In map at top, note various sources which have been tapped and spot from which 160 million gallons more per day may be drawn when the population warrants such an extension

Ventube flexible ventilating tubing used in heronment shafts with pumps & tunnel

20.560

Flame-Throwing Tank Practices for War

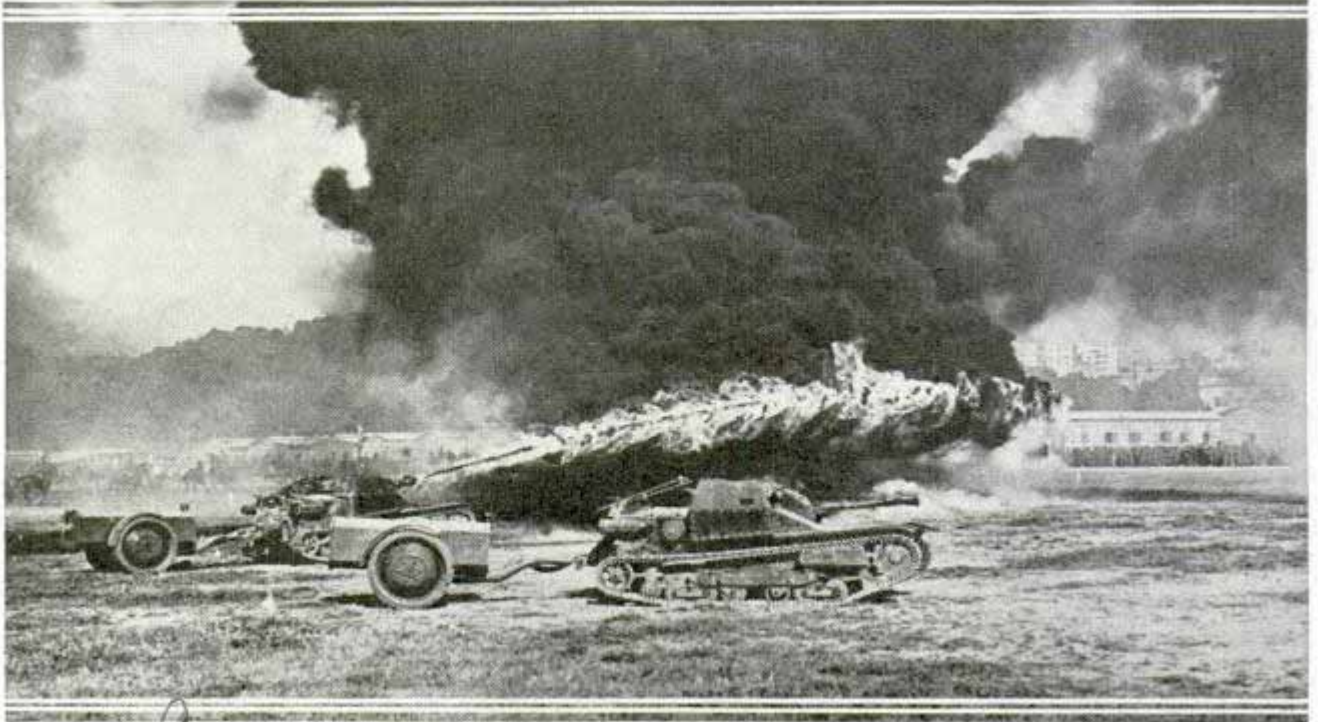

Acme
 Fire-shooting tanks in action. Note the trailer pulled by each of these war monsters. Crowd in distance at right witnessed this awe-inspiring spectacle at recent army maneuvers at Rome, Italy

Shooting a solid column of flame far in front as it traveled, the latest Italian army tank was put through its paces recently at a war demonstration in Rome. Flame-throwing was used to some extent in the world war, but the method of producing

and projecting the column of fire was far from efficient. The modern tank, towing a small two-wheeled trailer, performs its destructive job in an awe-inspiring manner as a result of improvements on the method employed two decades ago.

Es 552
Instant Heater on Water Faucet Needs No Extra Pipes

Eliminating the added expense of installing hot-water pipes and tank, the latest type of hot-water heater is installed

over the sink and connected with the regular cold-water pipe. When the hot-water faucet is turned on, gas is automatically lighted in the heater and hot water is supplied instantly. The burner shuts off when the faucet is closed. The temperature can be adjusted by mixing the two faucets.

United American Bosch Corp. Springfield Mass.



no. Tank
 Instant hot-water heater over sink saves cost of installing usual dual pipes for hot and cold water

Es 592
Detection of Old Bloodstains May Aid Crime Fighters

Detection of bloodstains several weeks old, even though they have been wiped off and exposed to the rain, is claimed to be possible with the aid of chemicals which react with the hemin in the blood to create a brilliant blue luminescence. A solution of peroxide and a derivative of phthalic acid are employed. Hemin is a constituent of all blood, but is found in higher proportion in old than in new blood. The meth-

Acme May 24, 1937

Acme 5126/41
needed ventilating
removed & is available at back

od, reported in Germany, appears to have importance in crime detection because the chemical reaction is very specific and does not occur with other substances. It is especially useful since large objects can be submitted for examination and the spots thus found further investigated by other methods.

530

One-Piece Helmet Cut to Protect the Welder

Formed of one-piece vulcanized fiber and cut deeply for extra protection, a new welding helmet now on the market is said to have exceptional ruggedness to withstand hard shop use. Riveted, lapped-over seams or joints are eliminated. A smooth, rounded interior promotes air circulation and results in a cool, comfortable helmet. The deep-cut design gives protection on the sides of the head to a point well back of the ears.



Welder on the job, protected by the one-piece helmet that fits closely about head

Wilson Products
Inc., 200 Thoin St

Tractor Driven Like Dobbin Responds to Farmer's Reins



It's just like driving a horse to handle this tractor. The farmer steers and controls it by manipulating the reins leading to a control box

Although it can't answer to "Giddap" or "Whoa," the latest farm tractor responds to the reins just like old Dobbin. The controls of this gasoline-eating draft horse, invented by two brothers during eight years of experiment, are located in a small iron box behind the motor. When the farmer pulls in the reins, the tractor halts. When he releases them, the machine moves forward. It backs up in response to a hard pull on the lines, and is turned by jerking one rein.

Mr. Bert Bonham
Layton, Utah

593

Soap Is Pumped into Oil Well to Stop Flow of Water

From the ring around the bathtub engineers have learned how to prevent the "drowning" of oil wells with water. A Texas oil company has patented a method of pumping ordinary soap solution into the bore holes of oil wells to plug the pores of underground sands and stop the flow of water into the oil. The soap reacts with magnesium and calcium salts in the water to form a tough soap curd, just as salts in hard water react with soap to form the ring around the tub. Soap does not affect the flow of oil.

assigned to Standard Oil
By photographing the sound wave in the core of an electric welding arc its temperature has been computed around 10,300 degrees F., hotter than the sun's surface.

Patent 2,099,431

General Electric Review
May 1937

Mr. Bert Bonham
Layton, Utah
N. C. Bonham
Houston Texas
Development Co.

10555 Hollywood Ave.
Los Angeles

FIRE and water don't mix and that simple rule makes water the best all-around weapon that fire fighters have. But it is far from perfect because it can cause a lot of damage. Sometimes the water poured into a burning building does far more harm to the contents than the flames themselves.

"One classic example of that is the time that firemen dashed up to a smoking house, threw open the front door, and sprayed water into the interior," recalls Capt. C. B. Lesinsky of the Los Angeles fire department. "When they thought they had flooded the fire they cranked their nozzles shut and walked inside. Instead of the remnants of a big blaze they found only a large bundle of rags smoking in an open oven. The fire had done no damage at all but the water had ruined the walls and furnishings of three rooms."

Fire fighters know better than that now. These days they rarely turn on their water until they have real flames for a target. They use less water than ever before and try to make every drop count. When they roll up to a fire they

SALVAGE SQUAD



Top, pulling protective covers from salvage truck. Bottom, left, salvage men unloading equipment from truck. Right, protecting office records against damage from water

W.C. Salvage Co. # 24.
217 N. 14th St.

TO THE RESCUE

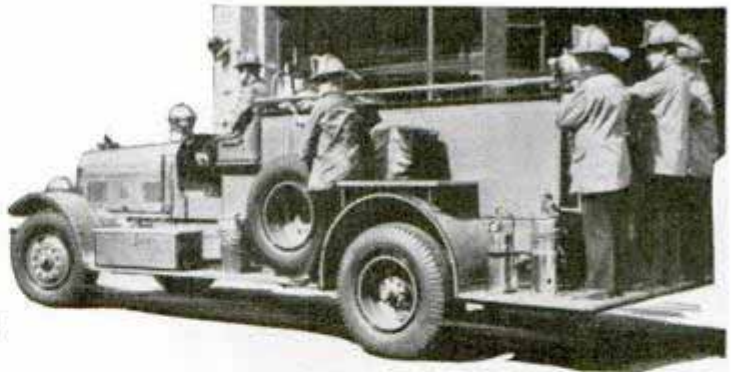

are accompanied by a salvage corps whose methods also have been revolutionized to keep pace with modern fire fighting. It is the job of these men to protect the contents of the building, to minimize damage by water and chemicals from the fire hose.

Last month a residence in Los Angeles caught fire and was almost totally destroyed. But not one cent of damage was done to the furnishings. Books, rugs, and even delicate curtains were unharmed by fire or water. The salvage squad of the fire department, working shoulder to shoulder with the fire fighters, saved every article in the house. That was an unusual record, but salvage nearly 100 per cent complete is becoming common at fires.



Top, rigging up hydraulic siphon to suck water out of basement. Bottom, left, water pouring out of house on salvage covers. Right, salvage squad on way to a fire

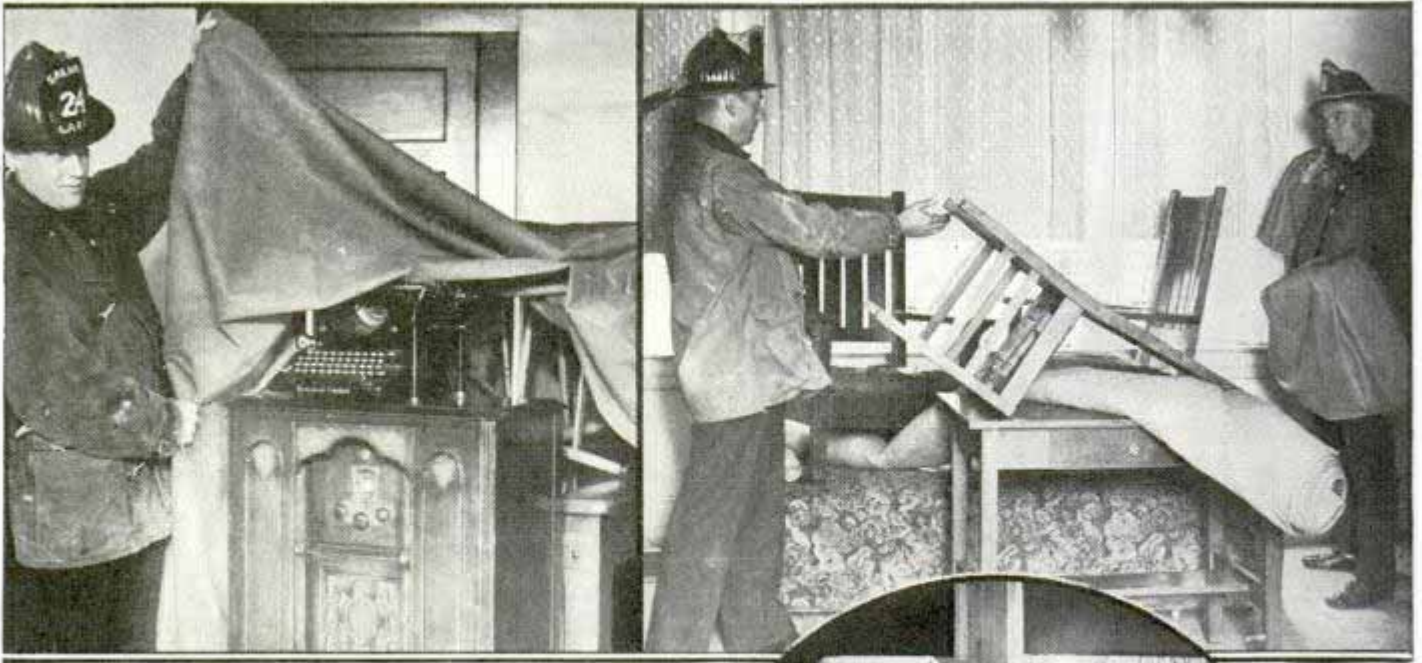

Modern salvage got its start when fire fighters began to realize that sometimes ninety per cent of the damage is caused by water. A few shingles may cover the damage of a roof fire but the water used to put it out can ruin ceilings and furnishings. In a commercial building a little water flowing down a stairway can spoil thousands of dollars worth of goods that were never threatened by the flames. In some cities, such as Los Angeles, salvage squads are part of the fire department. In other communities private patrols turn out when the property of subscribers is threatened.

When salvage men plunge into a burning house they go through the rooms like whirling dervishes. Working in pairs, the men protect the furnishings apt to be harmed by water. The front room comes first in a residence because its contents are the most valuable. Radio plugs and other electrical connections are pulled free. Chairs, tables, and sofas go into a big pile in the center of the room. Pictures are laid face down on a sofa. Flower vases are emptied of water before being placed on upholstered furniture. Curtains and drapes go into the pile.

The men work fast but they are in no haphazard hurry. They may be moving around in dense smoke only a few yards from the fire, still they get their work done rapidly and without damage. The place for rugs is on top of a piano or table where they will protect the finish. Every-

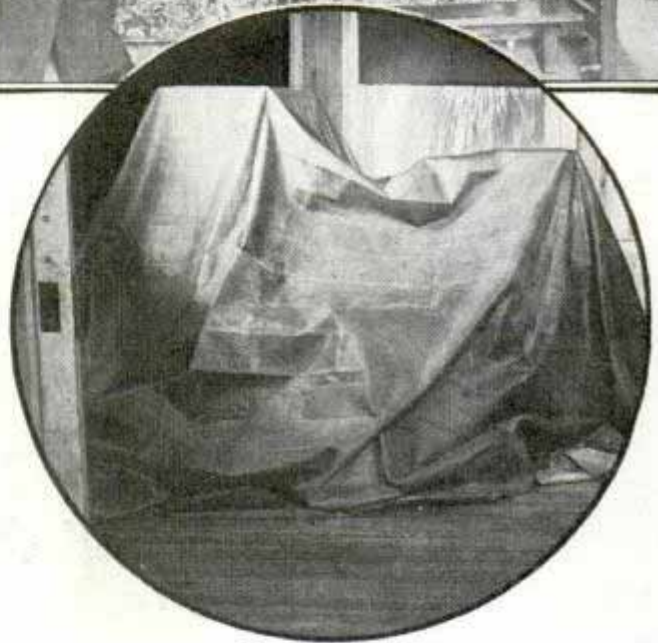

Top, left, laying covers over stack of furniture. Right, stacking furniture. Bottom, covers in place, protecting furniture from water

thing in the room goes into the pile. Finally the salvage men flip huge rubberized tarpaulins over the heap. If the fire is on an upper floor and if the room has a central chandelier one of the men climbs to the top of the heap and pushes down the tarpaulin to form a basin.

"Water seeping through a ceiling first starts to come down the chandelier hole," Capt. Lesinsky explains. "The idea is to catch this water in the top of the salvage cover and drain it down to a bucket at one side instead of letting it spread over the floor. In the bedrooms we pile everything on a bed and move it to the center of the room before covering the heap with tarpaulins. Sometimes when a lot of water is coming through a ceiling we hook sal-

vage covers to the picture molding on the walls to catch the water and chute it through an open window. As the last resort we move the furniture outside. It has to be carried out, not tossed through a window or door."

In the meantime other salvage men lay tarpaulins on the stairways to act as flumes for carrying off water. Down below other salvage covers with rolled-up edges to make a trough are laid to form a channel from the stairs to a door. Getting rid of the water is just as important as protecting furnishings from it.

In a big commercial fire getting rid of the water becomes more important than ever. An average hand line can deliver a ton of water per minute and sometimes the

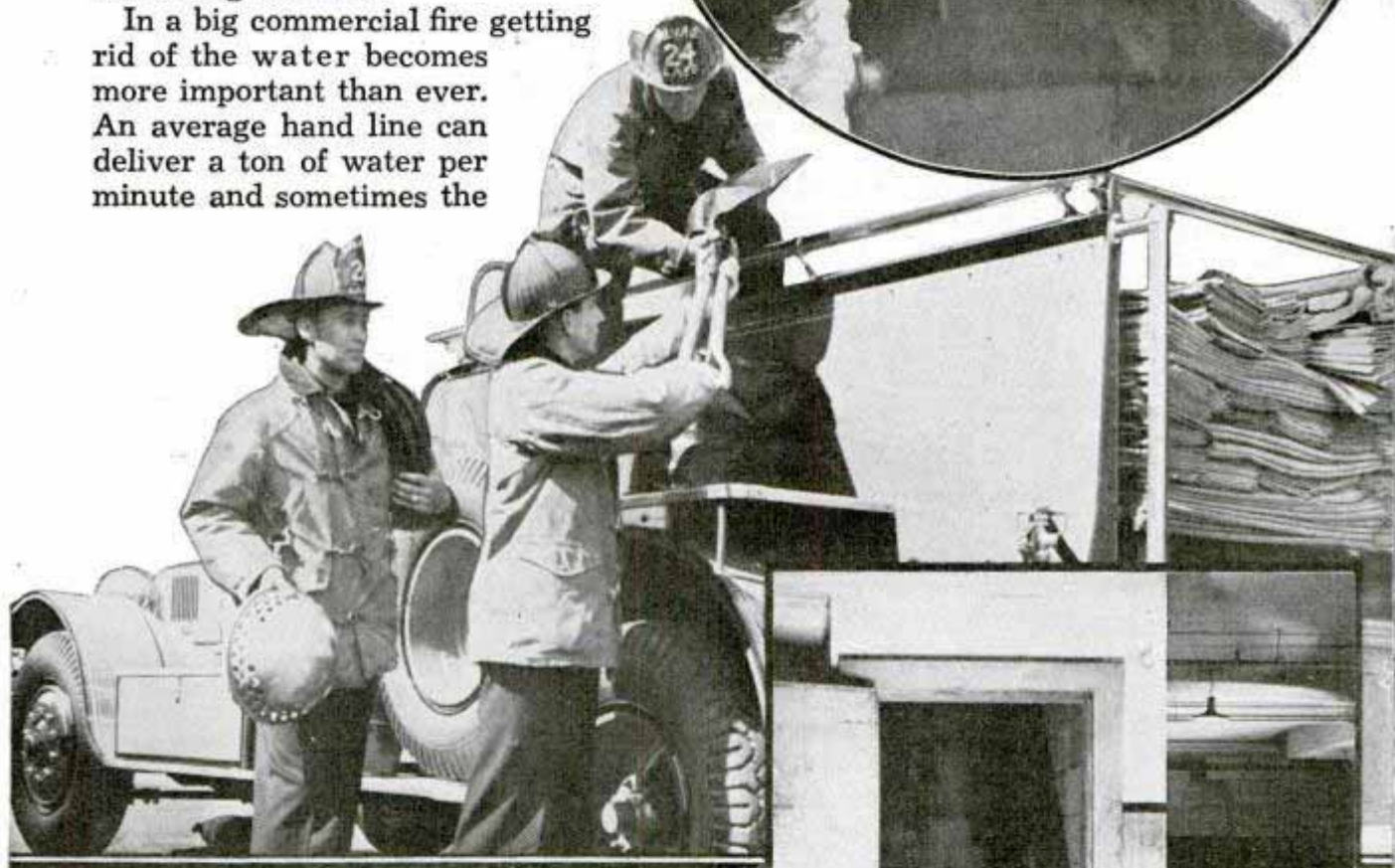
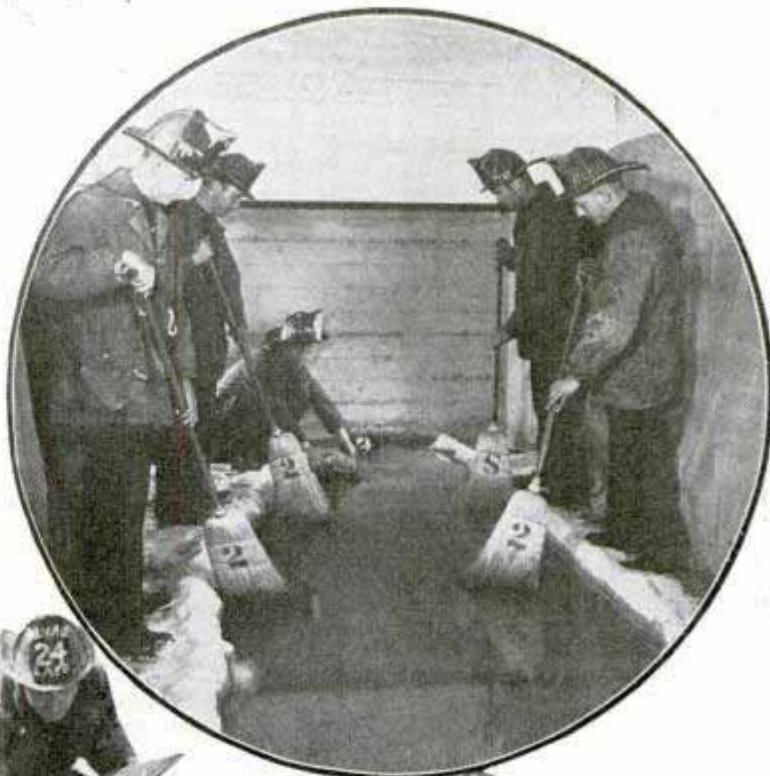

fire fighters have to pour tremendous quantities of water into the upper stories of a building. The sheer weight of the water might be enough to cause collapse of some structures. It's up to the salvage squad to get the water out of the building almost as fast as it goes in. In big fires an elevator shaft is a convenient channel for waste water and salvage men have even punched holes in the side of a burning building when they had to get the water outside as fast as they could. If water drains into the basement the next step is

(Continued to page 144A)



Top, sweeping out water. Center, unloading salvage apparatus. Bottom, emptying water from building

Committee for Aeronautics
Langley Field, Va

Bottle-Feeding Rig Solves Problem of Orphan Puppies

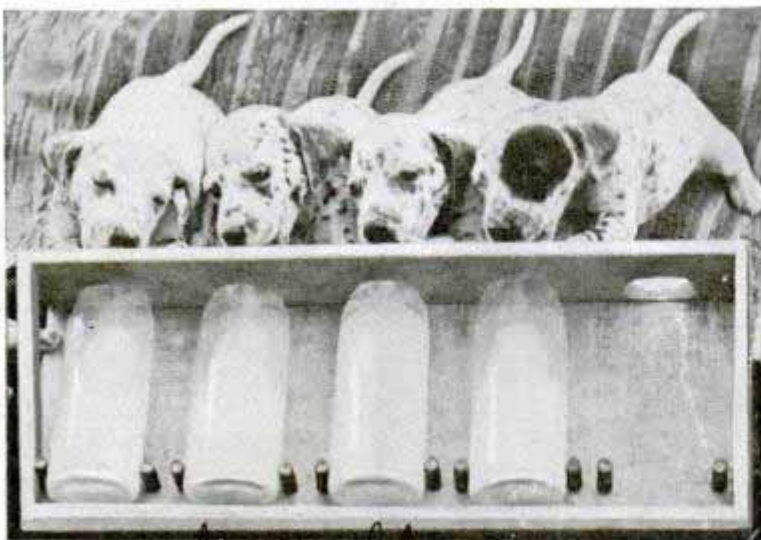

It's feeding time for this family of orphan coach puppies. This rack apparently is a good substitute for their mother

Solving the problem of how to feed a family of motherless coach dogs, the owner rigged up a rack with bottles, one for each puppy. So well does the rig meet the need that the puppies seem to be thriving as well as if being fed by their mother.

"Reading Glass" for Microfilm Magnifies Tiny Image

To make it easy to inspect microphotographs on thirty-five millimeter film, a "reading glass" has been developed. Libraries are copying newspaper and textbook pages on motion-picture size film to save storage space, but to read such tiny print requires either a projector or

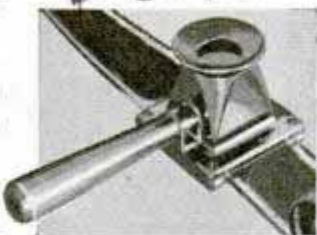

the new microfilm reader, which has a magnification of seven and one-half to eight times. The film enters at either side, sliding into reading position easily.

Bump Recorder Aboard Plane Shows Roughness of Trip

Gusts of wind are being measured and studied with the aid of two new devices. One is a "bump" recording instrument small enough to fit into the pocket. Car-

ried on airplane journeys, the instrument traces a curve which enables engineers to reconstruct every roughness of the voyage and to tell what stresses the plane withstood. A new wind tunnel also aids in the same line of study. Gusts are made to order in the tunnel and model planes are catapulted into them. As fast as an arrow is shot from a bow, the tiny planes are accelerated to fifty miles per hour in a few feet of travel. A motion-picture camera makes a record of the reaction of the model when it strikes the artificial gust of wind.

Portable Stroboscope Light Sees Motor in Slow Motion

High-speed motors can be inspected in "slow motion" under the fast-winking eye of a portable, low-priced stroboscope just developed. Plugged into an alternating-current outlet, its neon spotlight throws an intermittent beam which is adjustable in its flashing rate so that the action of

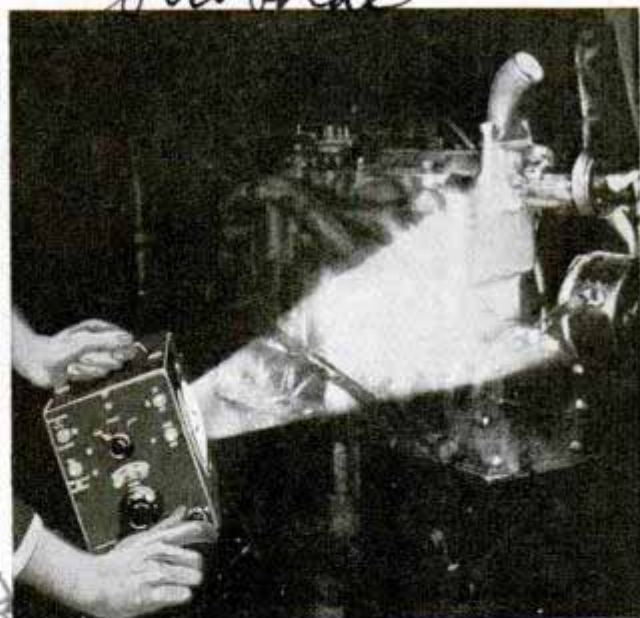

Portable stroboscope slows motion of engine fan for inspection while it really runs at full speed

valve springs, gears, fan or any moving part can be slowed down or stopped. Similarly, the engine speed can be checked by adjusting the light until the engine appears motionless and then reading the speed rate on the stroboscope dial.

550
Helen Meyer,
North Adams, Mass.
Mrs. Helen Meyer,
North Adams, Mass.
Bausch & Lomb Optical Co.,
26 St. Paul, Rochester, N.Y.
Scene Service
6/18/37

536
Stroboscope
General Radio Co.
Cambridge, Mass

5588

Camden, N.J.

Television Projected on Large-Size Screen

Television on a screen, with images eighteen by twenty-four inches, has been made possible by the invention of a new cathode-ray tube. The pictures have a brightness equal to that of home movies. By increasing the distance from the screen it is possible to obtain pictures as large as three by four feet, clear enough to be viewed by an audience of several hundred. Enlargement is obtained through a simple optical system placed before the fluorescent end of the new tube, where the original picture appears. The tube is the outgrowth of the kine-



Left, pointing to the tube which is key to instrument which enlarges and projects television images like that shown above

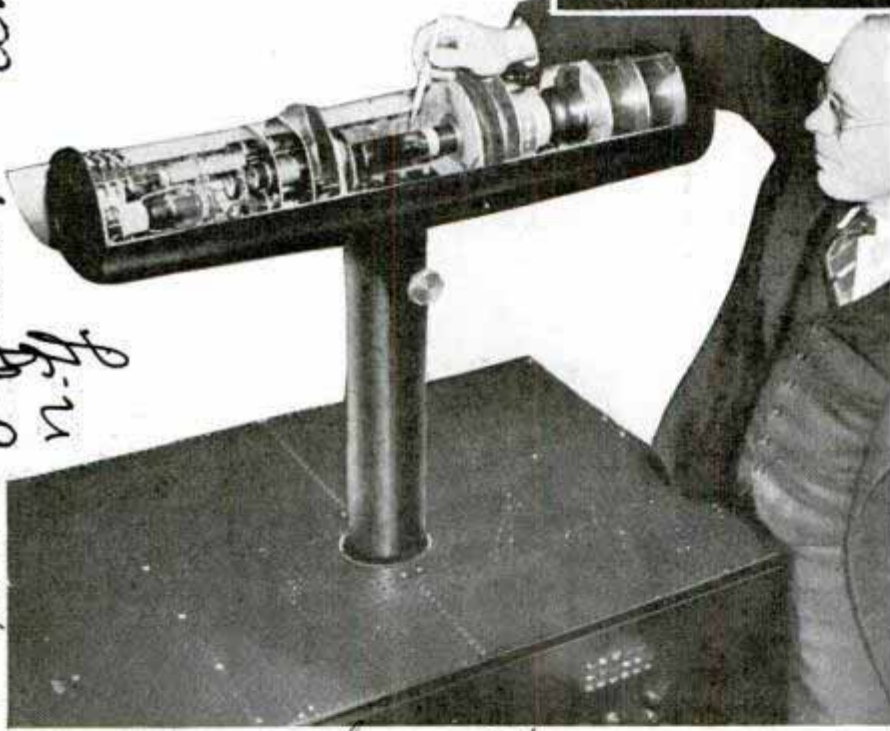

scope, the television receiving tube that paints images on its flat end but does not project them. The largest kinescope with a viewing end fifteen inches in diameter produces pictures nine by twelve inches. The tube, which was invented by Dr. R. R. Law of R.C.A. laboratories, was demonstrated at a recent convention of the Institute of Radio Engineers.

Super-High Voltage Built Up by Artificial Raindrops

Showers of electrically charged artificial raindrops are the basic factor in the latest high-voltage electrostatic generator designed for bombarding the nucleus of the atom or for X-ray treatment of disease. The high voltage is built up in the same way in which nature generates the enormous voltage of lightning. The artificial rain consists of a spray of semi-conducting liquid which falls through an intense electrical field. Electrical charges are thus carried to the "ground" below, which is a container attached to the high-voltage

generator. The small electrical charges are conducted to great storage spheres. The new generator is remarkable for its absence of moving parts. The raindrops replace silk or paper belts employed in other generators to carry the electrical charges into storage spheres. One type of belt generator is capable of attaining a potential of 5,000,000 volts.

Gas diffusing through solid metal at a rate of one cubic inch in 100,000 years can be measured with a metal vacuum tube.

Dr. R. R. Law

Jefferson N.J.

Patd. by Clarence W. Hainseley, Port

Assigned to The Radio Corp. N.Y.C.

General Electric Review May 1937

Scene June May 24, 1937

es 578

Doughnut Loader Fills Bag by Means of Ramrod



Ramming home an order of doughnuts with a transparent bag fitted over end of special doughnut loader

Doughnuts being an awkward product to package, a special doughnut loader has been developed. A transparent bag is held open at one end of a channel which is loaded with doughnuts, and a hand ramrod shoves the doughnuts into the bag.

Rear-Engine Auto Seating Eight Is Furnished Like Trailer

Combining features of both automobile and trailer, an eight-passenger streamline car just designed is driven by a rear engine. Noise, heat and odor of the motor are left behind. Inside, this car has a table, icebox and studio couch for two. The chassis and body form an integral unit entirely of steel, able to stand the shock of



Eight-passenger teardrop car with rear engine. It has an icebox, table and studio couch for two.

1285 Boston Ave
Burlington Conn

collision. Large windows offer good visibility, and the driver's seat is mounted further to the front than in the conventional automobile.

es 562

Angle Plug Will Not Dislodge When Cord Is Pulled

Rubber electric plugs molded with the cord at right angles are being introduced. This design permits the cord to lie flat against the wall or baseboard, and the plug does not become dislodged by a direct pull on the cord, making it neat and safe.

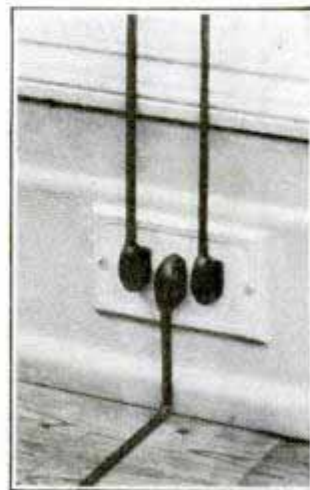

es 583

Non-Drip Server for Sirups Pours from the Bottom



This sirup server has no dripping spout. It pours from bottom and spring-operated spigot seals it

Honey, sirup and salad dressings can be served neatly and without dripping, from a table dispenser with an opening in the bottom. The glass dispenser rests in a glass bowl on the table, and both parts are easy to clean. Pressing the lever raises the spigot rod and the honey pours from the base; when the lever is released, the spring-operated spigot seals the opening, keeping the contents sanitary.

551 Fifth Ave
New York

The Singer Company, 9th St.
1273 W. Cleveland Ohio

Saginaw Stampery, 500 E. Saginaw Mich
68 W. Belmont St. Saginaw Mich

Whitehall Club Co. 400 1/2 E. 10th St. Saginaw Mich

25970

Stop-and-Go Lights Control Big Liners in Port

Right, pressing button to change dock signal. Circle, tugs maneuvering big liner toward its pier. Left, traffic signals at top of photo aid in handling the ocean-going craft. The system also is a safety measure, reducing the chance of collisions.

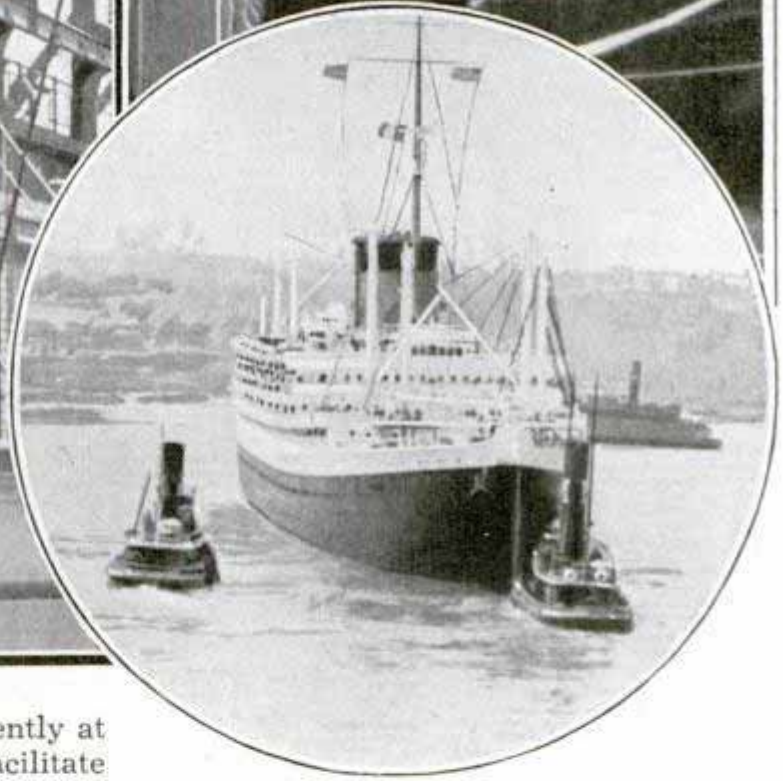

Traffic signal lights installed recently at the French Line pier, New York, facilitate arrival and departure of ocean liners. In order that ports for passengers and freight will not be interfered with by pier girders, a big ship must lie within a few inches of the same position each time it docks. An engineer sights along one of the girders toward a marked plate on the ship's side. With a switch on a flexible cable he signals, a green light for "go forward," a red one for "go aft" and a blinking yellow light instructing the captain how to inch the ship to exact position. For departure of the "Normandie," "Ile de France" and other big craft there are two units of two

lights each, one at the end of the pier to warn river traffic and the other close to the bridge of the ship. These are operated by the marine superintendent who surveys the river from the tip of the pier. Just before starting time a red light is flashed, warning river boats that the liner is soon to back out. At the moment of scheduled departure a yellow light is flashed, telling the captain the river is clear. If it is not clear, a siren is sounded and the yellow light is delayed until it is safe for the liner to leave.

610 Fifth Ave. New York

23
368.

THRILLS

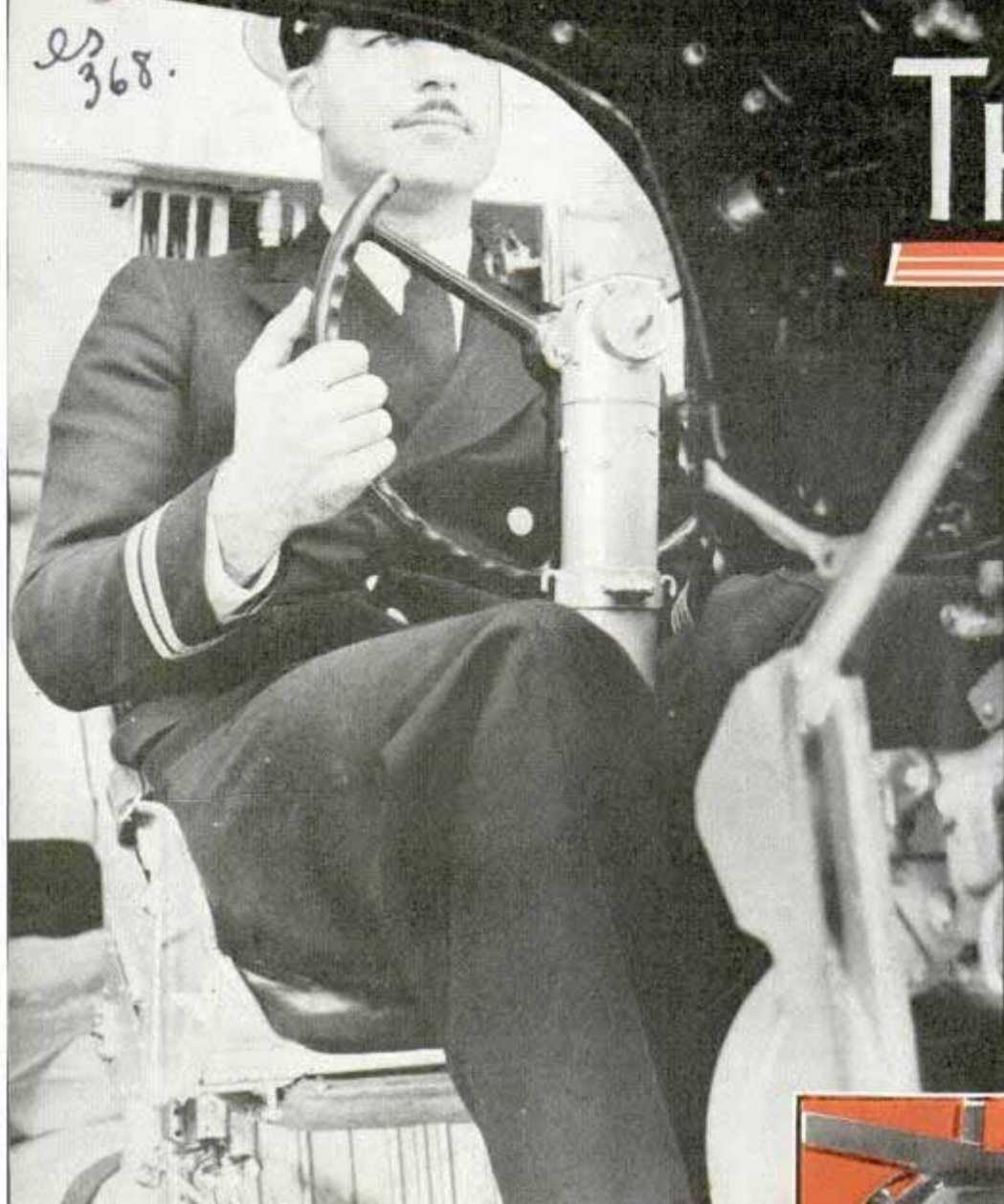

ideal. Smacking into the hills of solid water will rip the bottom out if the hull is poorly built. The crash of landing may bend the wings down in a permanent curve or even tear the motors loose from their mountings. If something goes wrong the pilot may be able to taxi back home on the surface, or he may have to send out a radio plea for help.

What's it like to crash one of the big boats on purpose? For one thing, your safety belt must be around you and tightly fastened. The boat hits with a smash and throw-

WHAT happens to a twenty-ton flying boat if it is slammed into mountainous waves while going seventy miles per hour?

Nothing, if the boat is as sturdy as her designers think and the pilot is one of the best in the world.

Tumbling a big transport around in the sky is just routine to a test pilot, but taking a big flying boat out for her rough-water landings is something that always packs a thrill. This supreme test is part of the Navy's requirements because when one of the big "ducks" goes to the rescue of a plane or ship in distress it is usually in bad weather. The pilot has to know that his boat can take a terrific beating and get back up into the air again safely. That's why the pilot picks rough water for his proving ground. Waves twenty or thirty feet high are

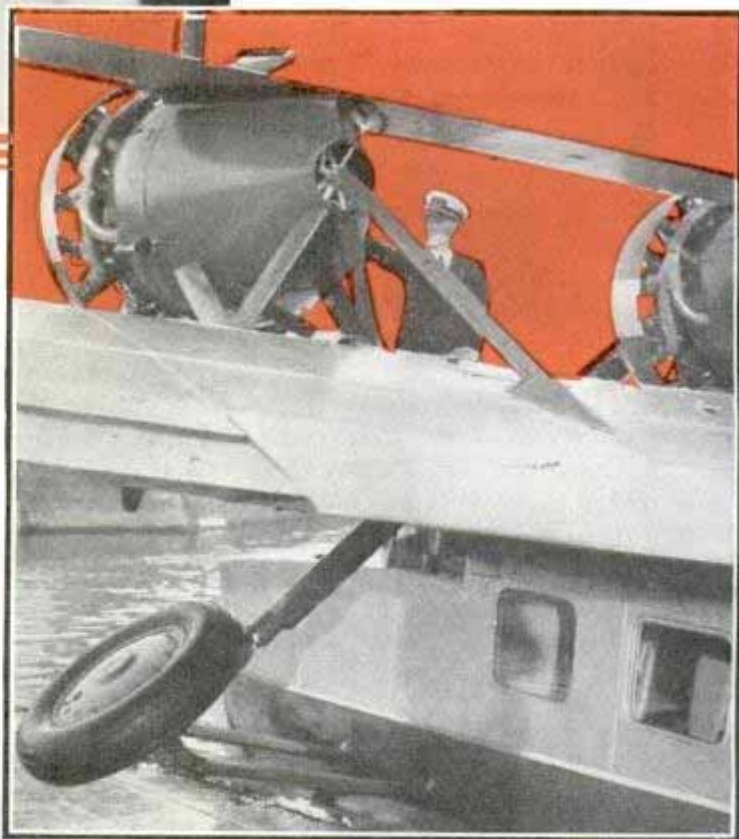

Top, pilot at controls of flying boat. Bottom, engines of flying boats and amphibians are mounted high above water to avoid spray

Handwritten notes at the bottom of the page, including the number '226' and some illegible scribbles.

Capt. Thomas E. Stinson, Es 268
18555 Hollywood Ave
Los Angeles Calif

of the NAVY Test PILOTS



ing motion that tosses everything around. Men who have tried to stand up during a rough landing have broken their ankles. Mingled with the thunder of the impact is the screech of metal as it strains under the shock. The jar of landing imposes the same terrific strains that a terminal velocity pull-out gives to a fighting plane. In test pilot lingo, the impact may amount to eight or nine "Gs," which means that the boat and crew are subjected to a pull of eight or nine times normal gravity.

"Getting down safely is a touch-and-go maneuver that you can't plan out ahead of time," one pilot says. "It all depends on the directions the wind and waves are running. Sometimes it is best to land into



Top, big flying boat getting up speed for the take-off. Bottom, pilot confers with engine inspector after completing tests on plane

the wind and take your chances with the waves. But if they are running too high you have to land parallel with them and fight the cross wind. If you catch the bow in a wave it may cave in like an eggshell. A stray wave crest may flick a wing pontoon off cleanly.

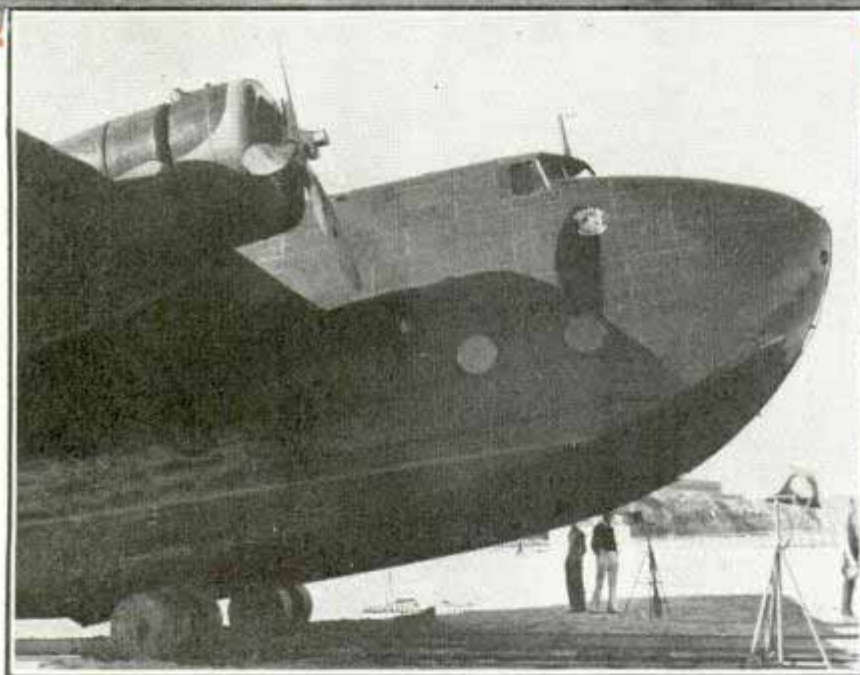

Top, seaplane landing in a cloud of spray in rough sea. Bottom, big flying boat on its beaching gear

heaving surface with too much speed or at the wrong angle the huge boat slams through the water like a skipping stone. It may bounce back up into the air time after time.

Once the fuel line of a single-engined boat broke while the boat was flying off Haiti. The pilot came down into the water at fifty miles per hour.

"The best way to land is between the crests and you try to drop the boat in solidly. A good landing is a two-point landing and the pilot can pick out the 'slap slap' of the hull as it touches first on the heel and then on the toe. One minute you are flying a big airplane and the next you are struggling with the controls of a bouncing boat, trying to kill its speed and face around into the waves without getting a wing under."

Pilots find that the best way is to drop the boat into the water from a three or four-foot height so that the water can get a good grip on the hull and slow it down. If the pilot makes a bad guess and hits the

There was a heavy sea running and the boat hit hard, bouncing thirty feet into the air. The pilot fought to keep the wings level and down the ship went again, this time bouncing ten feet. On the next drop the boat stayed down. The three crashes buckled the motor struts and the boat was in no condition to fly, so the radio operator got off an emergency message and the rest of the crew broke out a sea anchor. They rode it out until they were rescued next day. That was several years ago. Today the big boats must be able to take even worse beatings without damage.

"Even more exciting than a landing is a rough-water take-off," one of the pilots

JWA Douglas

says. "Just how you do it all depends on the wind and waves. In a heavy storm you may have to ride it until things calm down a bit. Usually you try to take off into the wind although sometimes you make a downwind take-off. Other times the boat may lift easiest in a cross wind and then you guide the plane to follow along a wave crest while you get up flying speed.

"In a take-off directly into the wind and waves you get what amounts to a high-speed roller-coaster ride. One minute you are on a crest looking down into a deep valley right under the boat and the next you are down in the hollow climbing the next wave. The motors are on full and the high scream of the propellers seems to go right through your head. As you get up flying speed the boat begins to skip across the hollows and land on the other slopes. You hit a wave crest and the crash of the water against the hull below and behind the cockpit sounds like the boom of a cannon. The



plane staggers. Sheets of spray explode upward over the wings. You can't see through the flying water but you have already pulled the nose of the boat up to prevent crushing it and now you nose down again to regain speed. You have to remember to keep the wings level because getting a wing under just now would mean the end of the trip. You smash into a few more wave crests and then begin to pull up over them. Finally you are safely in the air."

Each kind of plane requires a different technique to get off the water. A small

(Continued to page 120A)

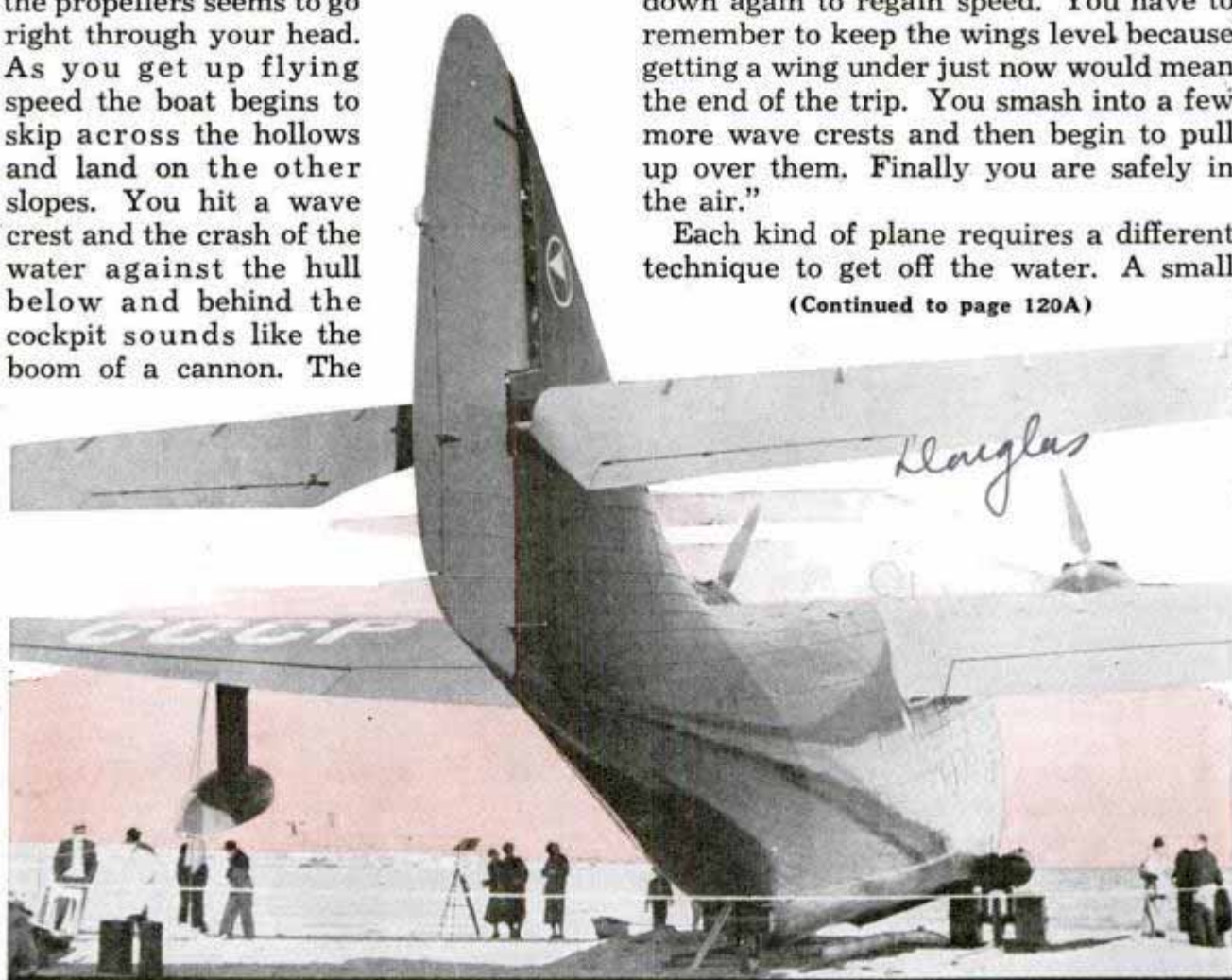

Top, temporary interior finish of air liner while undergoing government tests.
Bottom, tail group of giant Douglas flying boat on the beach

Self-Cleaning White Paint Latest for Homes

Right, painting house with self-cleaning white. Center, comparing ordinary white paint with self-cleaning type after weathering. Note how much whiter is the self-cleaning paint, shown below. In bottom photo, house remains white after long periods of weathering



particles of the pigment separate themselves from the surface and carry with them accumulated dirt and dust. This chalking goes on so slowly that the reduction in thickness of the paint film is hardly noticeable. After years of weathering the chalking process leaves the surface in excellent condition for repainting. A new material, titanium oxide, which

Prepared for outside surfaces of homes or other buildings, a self-cleaning white paint now on the market preserves appearance by remaining clean and white after years of weathering. Dirt and dust are washed away by rain. Gradual wearing away of the topmost film of the paint, a process known as "chalking," is responsible for the self-cleaning feature. Tiny

is noted for its opaqueness, is used in the self-cleaning paint. This property of super-whiteness makes it possible for the painter to get desired results from fewer coats and in less time. The self-cleaning paint gives full protection to surfaces. Unpainted wood, exposed to the weather, will crack and check and warp so that the tightness of the house against heat and

*E. I. du Pont de Nemours & Co.
2100 Elston Ave Chicago*

*Krebs, Pigment and Color Corp., Newark, N.J.
Thomas and Vanderpool, Sts.*

*Chicago - W. 21st
and S. Peoria*

cold will be affected. Nails will rust and boards will pull away from the side of the house, all contributing to rapid deterioration. Early white house paints consisted of white lead in linseed oil. Then paint manufacturers discovered that addition of other pigments, notably zinc oxide, greatly reduced tendency of the paint to collect dirt. Continued experiments brought the titanium paint.

es489

Stop Light at Dangerous Curve Is Operated by Autos

Baltimore, Md.

Safe speeds in rounding a dangerous curve in one American city are attained by regulation of traffic by a stop-and-go light. The overhead traffic signal displays a red light as a vehicle approaches the corner. One hundred feet from the light is an illuminated sign warning the driver to reduce speed to fifteen miles per hour. As the auto passes the sign it goes over a metal box embedded in the right-hand traffic lane. A microphone within the metal box picks up the car's sound waves and converts them into electric impulses which actuate a timing mechanism. If the car is traveling at safe speed the timer switches off the red light and turns on an amber light soon enough for the car to round the curve without stopping. A car moving outside the right-hand lane will not operate the signal and the red light will remain burning. At each end of the curve is a sign which lights up when a car is approaching from the opposite direction.



Switch set in roadway operates traffic signals at dangerous corner ahead

Cmt. N.C. McLeod
2720 Maryland Ave

Longer Flash Photo Bulb Makes Candid Pictures

Superflash



Camera with wire-filled flashlamp and synchronizer snaps action pictures like the one above

Filled with a measured length of hydro-lanium wire instead of aluminum foil, a new type photo-flash bulb has a peak illumination characteristic considerably longer than the foil-filled bulb. Thus the slit in the camera shutter curtain is given ample time to cross the film focal plane before the light begins to diminish, solving the problem of unevenly exposed negatives. The bulb is designed for synchronized flash work with Leica and Contax cameras. Another new development in the same field is a speed flash adapter, an inexpensive device consisting of a special release fitting and a plunger spring matched to the tension of Contax and Leica shutter releases. Tests with the new bulb and a speed flash synchronizer show that satisfactory results can be obtained at all shutter speeds from 1/50 to 1/1250 second.

Our Bureau of Information will answer questions regarding articles in this magazine, if accompanied by return postage.

The Kalan Co, 58 Waverly St.

es 401 *Com. James McLaughlin*
517 *Harbour Commissioner B.C.*

Towns of Canada Spectacular **SCENIC**

A LONG passes between snowcapped mountains 11,000 feet high, Canada is building what is considered North America's most spectacular scenic highway connecting Banff and Jasper on the Alberta-British Columbia boundary. The road builders have completed nearly half the route using the latest equipment and engineering developments. No settlement of any kind is on this road, built through a mountainous area seen by few people since the white man came.

Surveyors went in with pack ponies, fording icy mountain streams to find a scenic route which would safely skirt the Columbia ice field, the source of one-fourth of the waters of North America. Clearing crews followed and are still operating to make a right of way through virgin forest in mountain valleys, to blast a road along narrow mountain ledges.

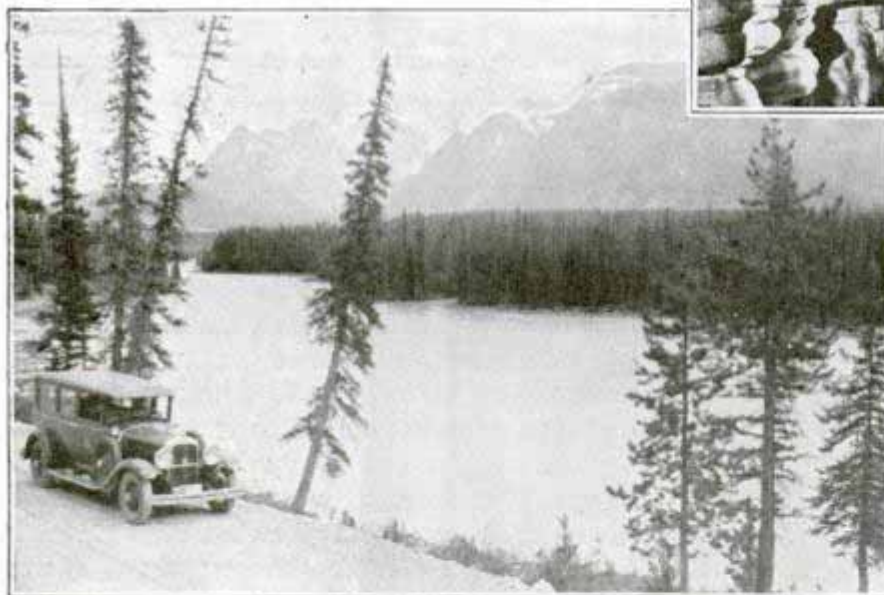
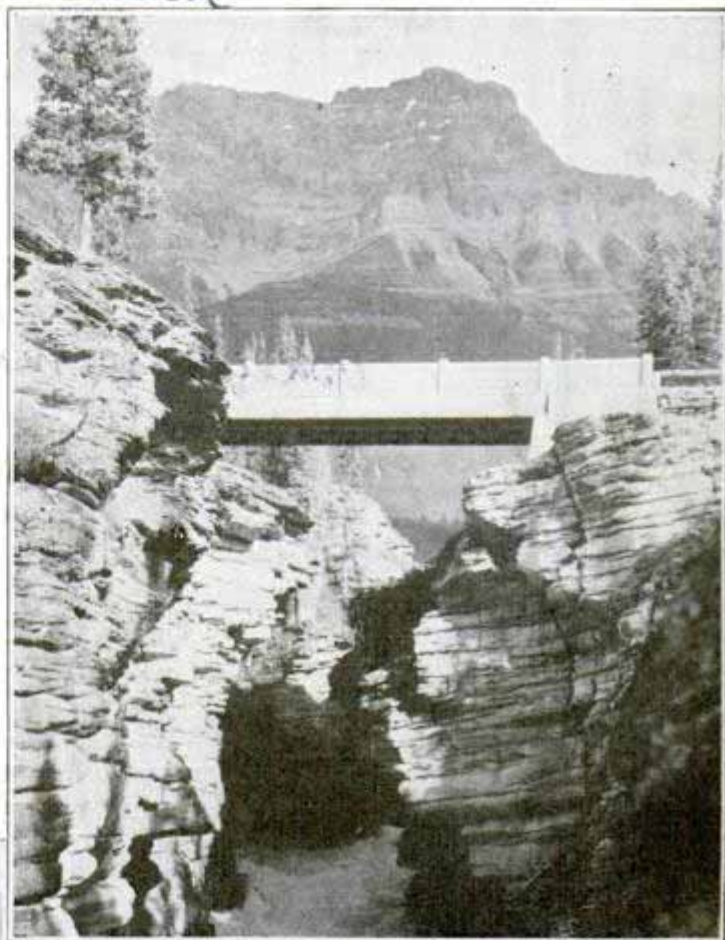

*Top, modern bridge across Athabasca Falls on Banff-Jasper highway.
Bottom, section of completed road skirting Athabasca river*

Tractors pulling in supplies, grading machines and trucks followed. So remote is the district that building operations can be carried on only in summer.

The 185-mile highway, starting northward at Banff where United States roads connect, follows the great inter-mountain trench in the Canadian Rocky Mountains between peaks which form the backbone

of the North American continent. It crosses the Bow Pass, 6,878 feet above sea level, spans foaming mountain rivers, and goes gradually down to the mother of glaciers, the Columbia ice field. Then the road climbs again to cross Sunwapta Pass, 6,675 feet above sea level. Here deep canyons cross the route, and to avoid these engineers have designed a series of switch-back roads, blasted out of rock walls, making a gentle twisting grade to the valley below, where the road crosses spectacular Athabasca Falls by a concrete and steel bridge, and starts climbing again to reach the town of Jasper. The road connects Banff National Park, 2,600 square miles in area, with Jasper National Park, 4,200 square miles in area.

*Com. J. B. Macdonald
517 B.C.*

HIGHWAY

Built in Clouds



Above, map of territory traversed by new road. Right, Athabasca Falls viewed from highway across canyon. Bottom, graders working on scenic road

Eighteen feet wide, the highway will have an all-weather graveled surface. The most difficult stretch to construct was the series of switchbacks. For seven miles the road builders had to hang onto sheer rock walls to dynamite the right of way. While work has been going on from both ends not more than seventeen miles can be graded and surfaced each year. Typical of problems faced by engineers was one stretch over so many mountain streams that six bridges and 215 culverts had to be installed. Completed sections are to be opened to motorists this summer. This road forms the first section of a northern Canadian transcontinental feeder route to Prince George and Prince Rupert on the north Pacific coast.

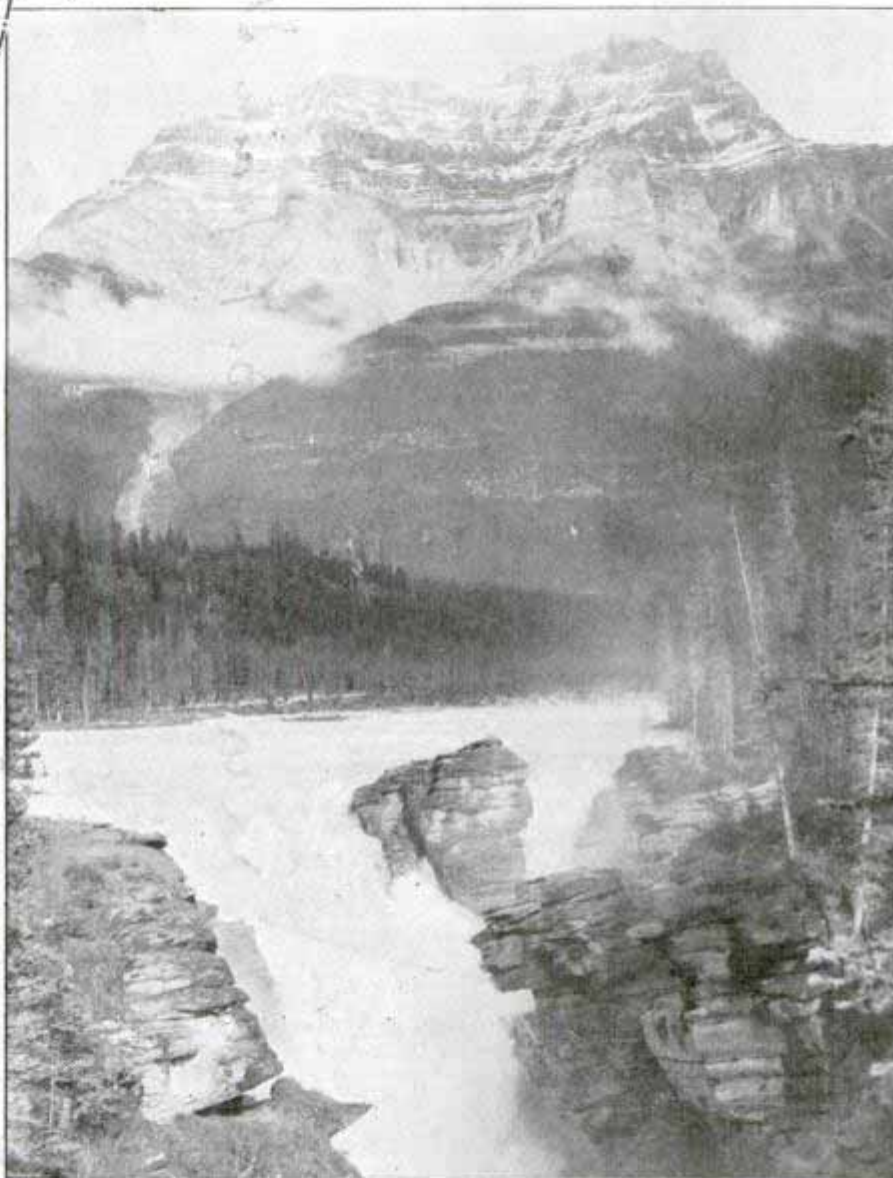

Es 512.

Bungalow Built in a Church as Wreckers Dismantle It



Church in Aurora, Mo., before, during, and after it was transformed into a six-room bungalow

It was winter when a man in Aurora, Mo., was ready to build a home, so he built it indoors. He bought a frame church which was being abandoned, and while the wreckers dismantled it they used the same building materials to construct a six-room house which grew inside as the church came down. The church roof provided protection from the weather until it was needed to roof the bungalow.

Insulin Dose Made More Potent by Addition of Zinc

Insulin may be given vastly increased power in the treatment of diabetes by adding zinc to ordinary insulin. Sir Frederick Banting, Canadian scientist who dis-

Serene Serna 5/6/39

covered insulin, says the new zinc insulin, in tests on dogs, proved effective in lowering the dangerous blood sugar for a prolonged period. It has not yet been adequately tested on human patients.

Es 436

Hole Digger Enlarges Bottom for Concrete Work

Designed to facilitate preparation of post or pier holes for concrete foundations, a new tool enlarges the bottom of the hole, making it flat with slanting sides in bell shape. It operates automatically, with no triggers, trips or ratchets. Dropped into the hole, it reams the bottom to about four times its original area. The tool may be obtained for any size hole and the handle adjusted to any depth.

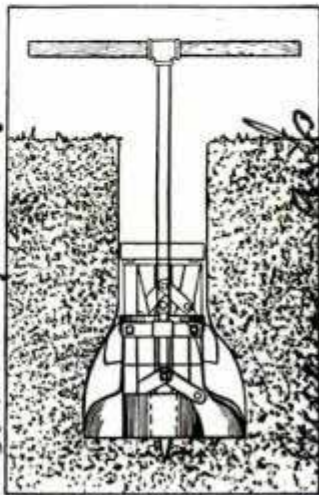

Flexible Nozzle of Gas Hose Made of Synthetic Rubber

Nozzles for gasoline hose are being made of synthetic rubber to eliminate the hazard of scratching fenders and cut down the drip loss. Tanks can be filled quicker, too, since the flexible nozzle adapts itself to the curves of the tank spout and can be thrust far down.



Synthetic rubber nozzle for gasoline hose adapts itself to spout of tank and avoids scratching car

Esates Rubber Co
999 S. Broadway

H. E. Price. 39 W. 4th Louis St.

Insulate
Call Street P.
Cramer Co 4319 Main St. Dallas, Tex.
6 ft. hole - 8 ft. 00.
wire
"The hole I get with it is 4 inches wide"

Mr. Thomas J. Meyer
7826 S. Honore St.
Chicago

Latest Scientific Tools Aid Crime Detection

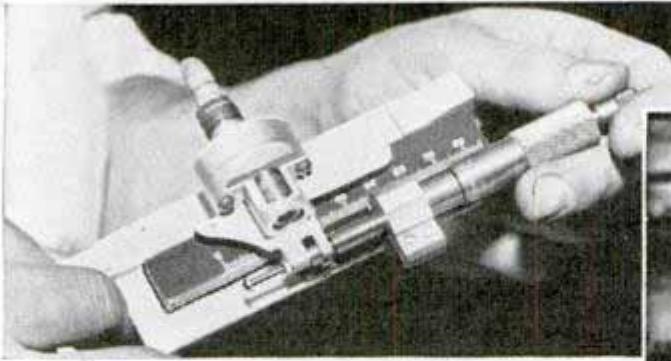

Science's latest tools for crime detection include the variable stage micrometer (above), used for measuring bullets and for other purposes. It is accurate to .001 inch

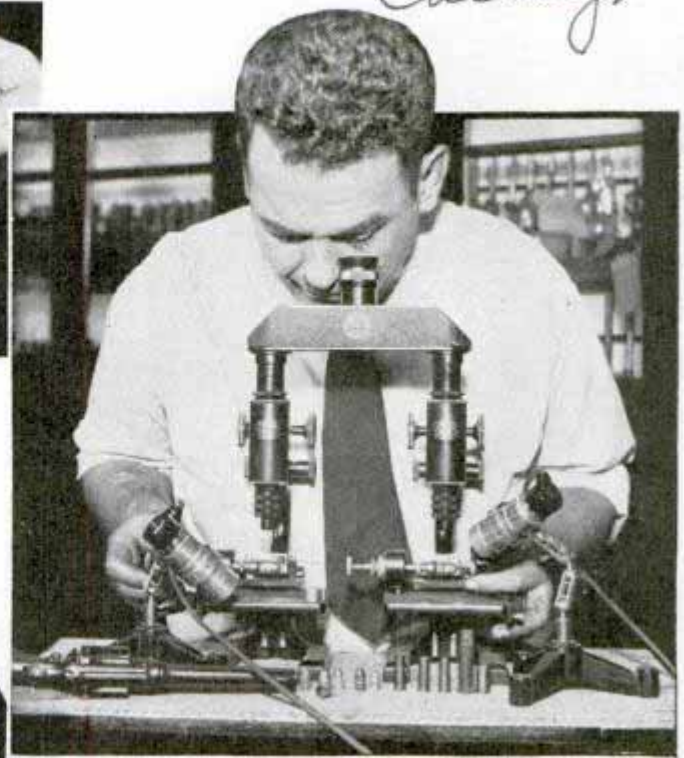

Above, new microscope for comparing bullets, shells, cloth and plaster. Also equipped for examination of blood and bloodstains, it aids crime detection by means of comparative photomicrographs

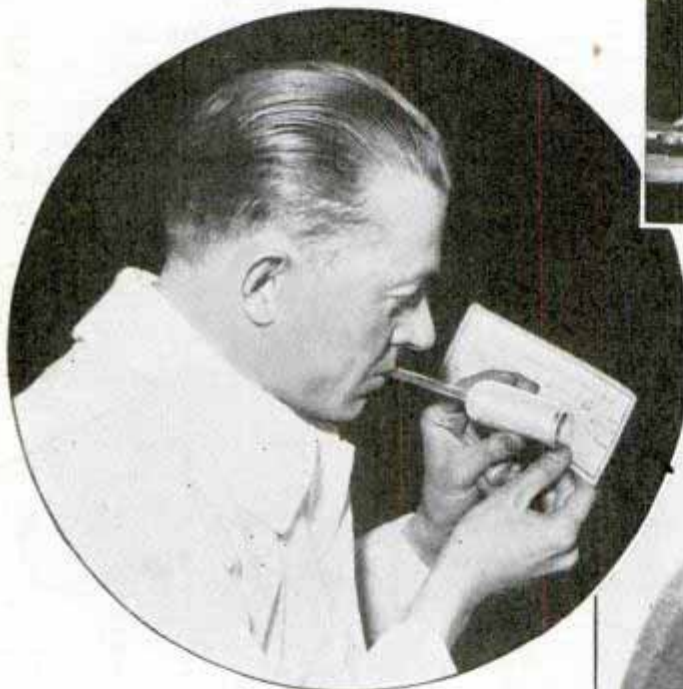

Above, fuming document with sulphocyanic-acid vapor to restore erased writing. The erasure shows as blood-red coloration after vapor treatment



Left, photomicrograph of matched bullets. Note line of demarcation down center where two photos were fitted together, showing that the bullets match, therefore were fired from same weapon. Above, comparative photo of two shell heads, taken through the comparison microscope and camera. This shows similarity after shells have been fired

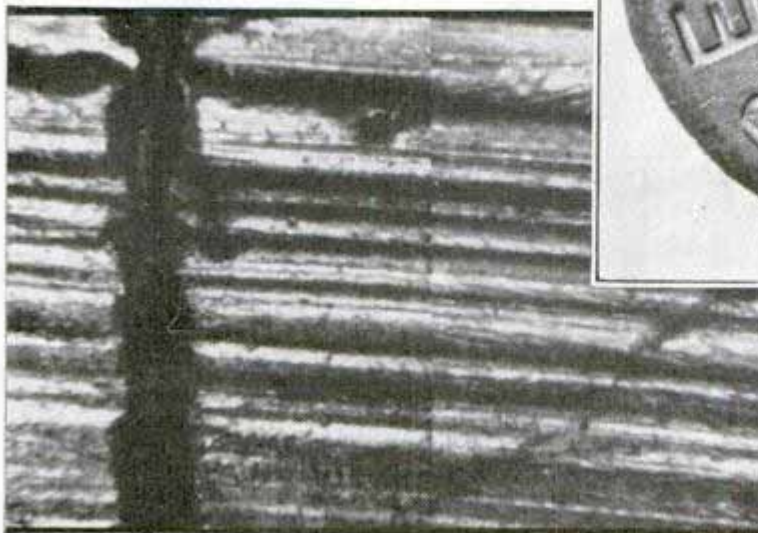

Scientific Crime Detection Laboratory
Northwestern University
Chicago

469 E. Ohio, Chicago

General Electric Co. Schenectady, N.Y.

SUPER-

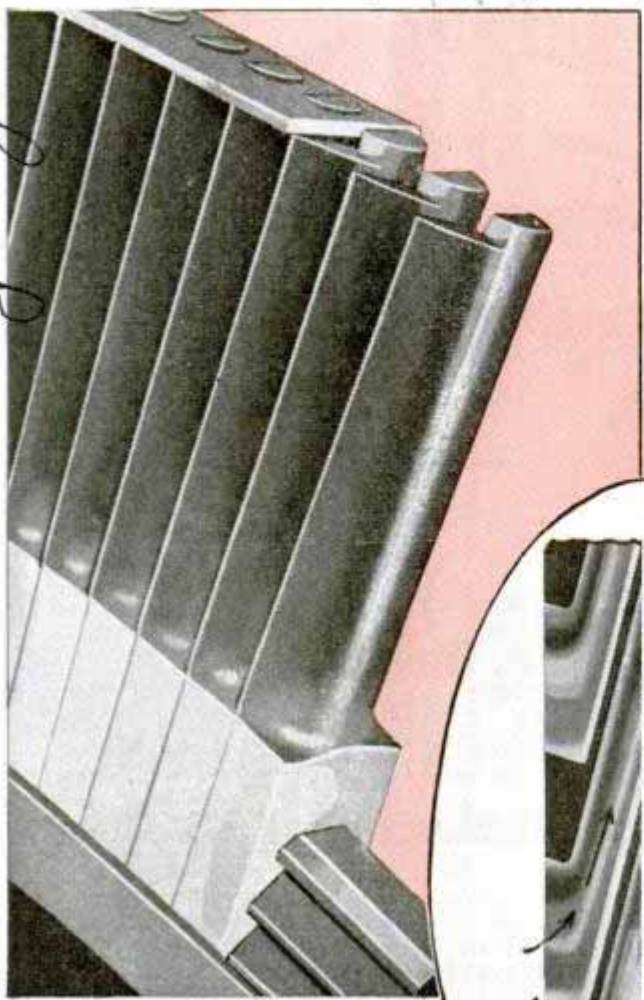

steel. But the stretch of turbine steel must be held to the merest "creep." A turbine may change size as time goes on, provided such changes are symmetrical and uniform, but the changes must not exceed about one part in a thousand. And this must apply not only to the shell and blades, but in the same degree to pipes, flanges, bolts and nuts—all parts reached by the hot steam and hence under stress.

In the turbine factory of the General Electric company, for example, are automatic electric furnaces held at temperatures higher than those which occur

By
Charles M. Ripley
Electrical Engineer

Part II

A MODERN turbine run by superheated steam is subjected to pressures equal to those half a mile down in the ocean and to temperatures which would melt tin, zinc, lead and tellurium. And inside its almost red-hot shell, spinning at whirlwind speed like a huge top, is a rotor weighing perhaps twenty tons.

But the top spins true and the shell does not leak, despite the enormous pressure and terrific heat, because man has developed metals which can withstand the grueling punishment meted out by super-steam. Turbine materials are tested for years at a time and changes of even one part in a million are recorded and studied to be sure the metal can "take it."

Heat softens metal just as it softens molasses candy. And just as the candy stretches when it is pulled, so does the

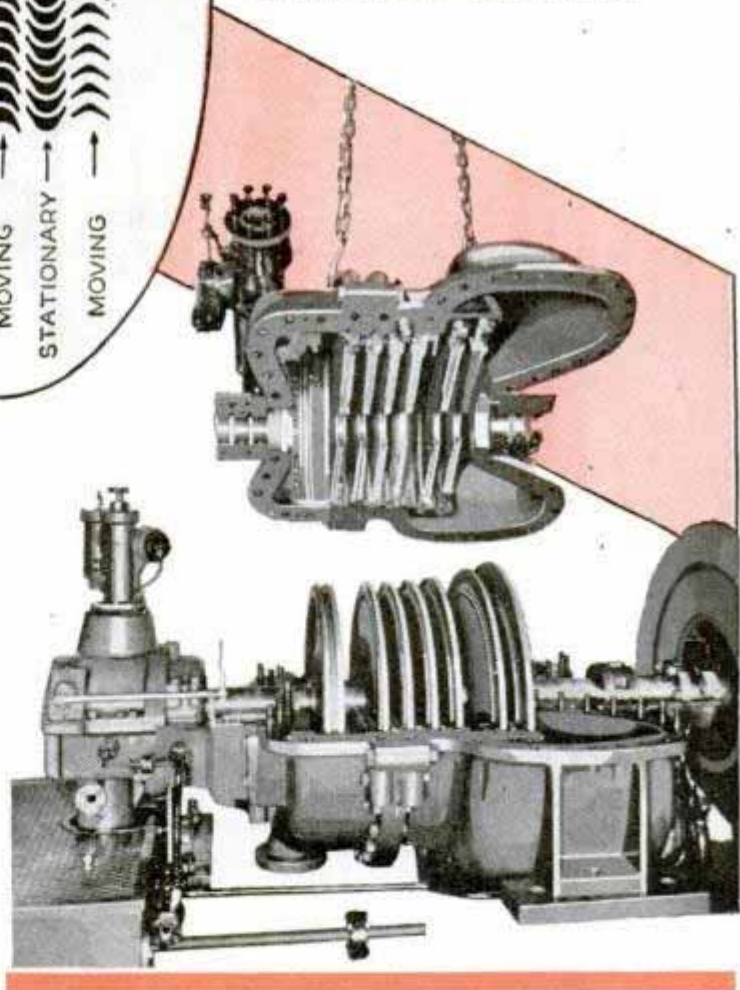
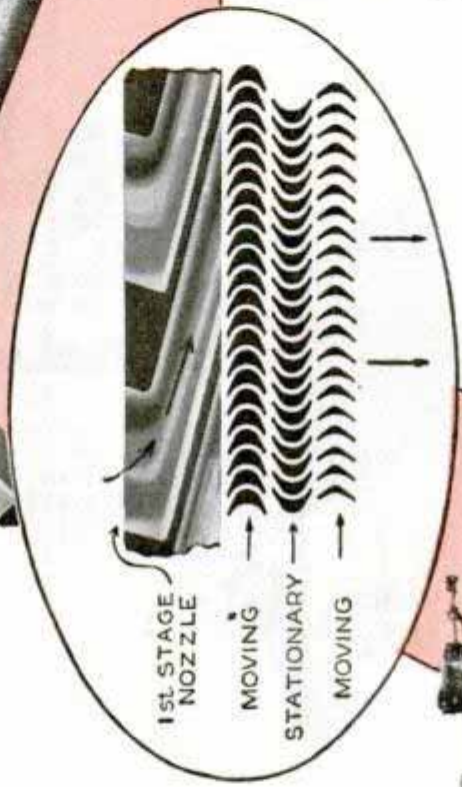

Photos Courtesy General Electric Co.
Top, buckets attached to rim of steam-turbine wheel. Center, diagram showing steam path in turbine. Bottom, condensing steam turbine with upper half of casing raised to show the wheels turned by the steam under pressure

STEAM... An Amazing STORY of ACHIEVEMENT

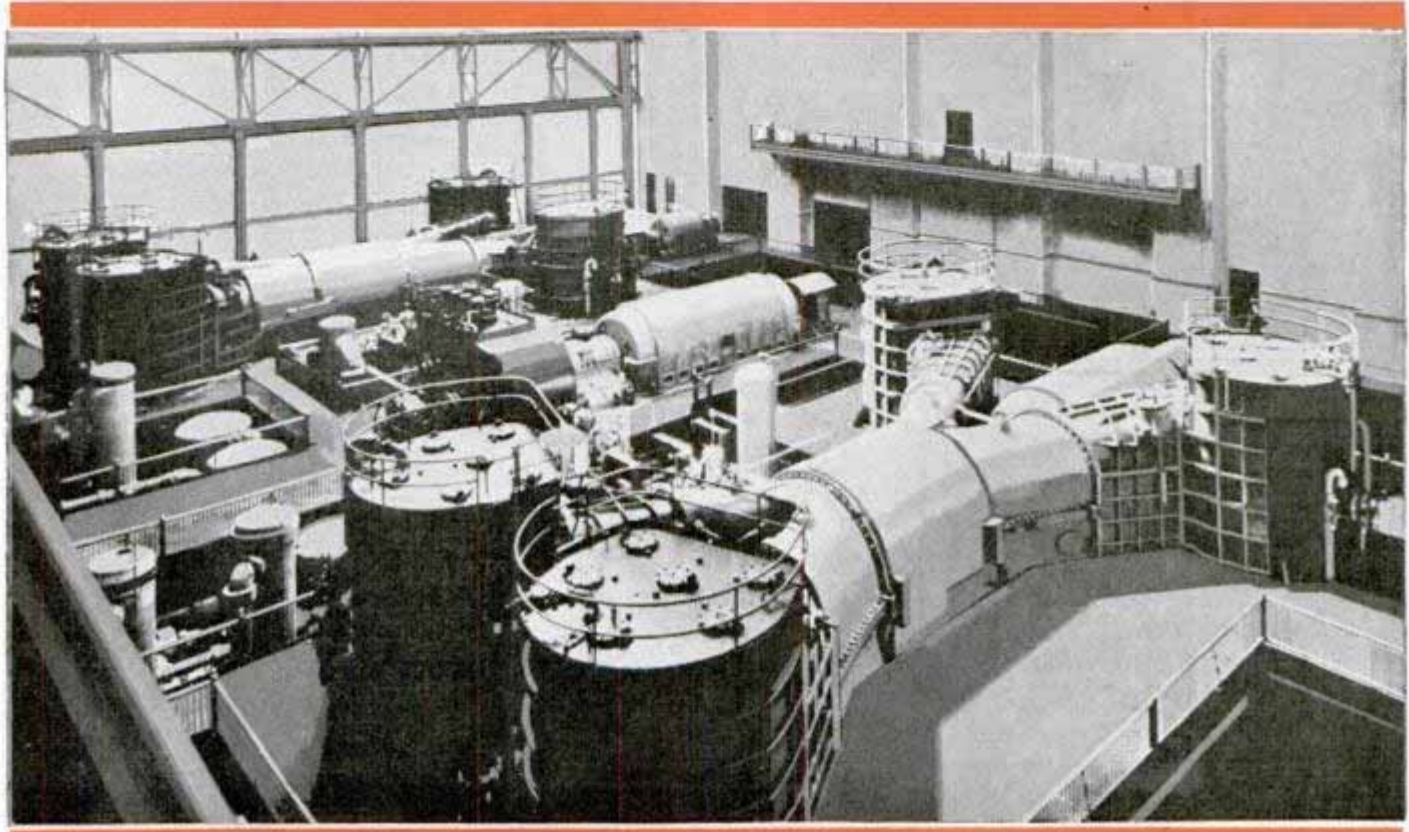

in turbines. In them rods of turbine materials, under constant tension, are tested for years at a time and gauges indicate changes in rod length of one part in a million. Thus, watching the "creep" of these heated and stressed rods day after day and week after week, test men determine surely in a short time what may happen in a long time and are able to select only steels certain to maintain their shapes and dimensions within allowable limits during the lifetime of the turbine. And some designers fix the allowable rate of "creep" at one one-hundredth of one per cent a year—very little stretch indeed.

There's plenty of reason for all this meticulous testing because there's just as much difference between ordinary steam and super-steam as there is between low voltage and high voltage. A construction gang once heard a squealing noise and found it was invisible super-heated steam escaping from a leak in a pipe joint. The

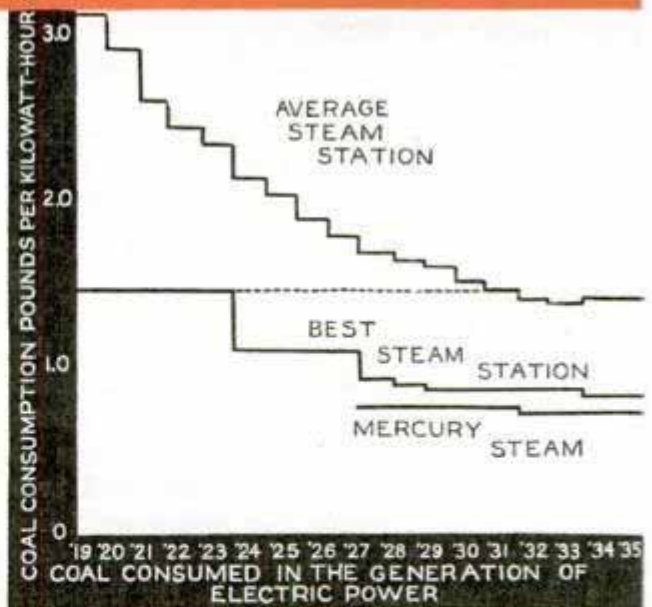

The 208,000-kilowatt, three-unit turbine-generator set of the "State Line" station at Hammond, Ind., and chart showing how coal consumption per kilowatt-hour is decreasing

men placed an oak plank four inches thick against the leak to divert the steam from a switchboard in the same room. When

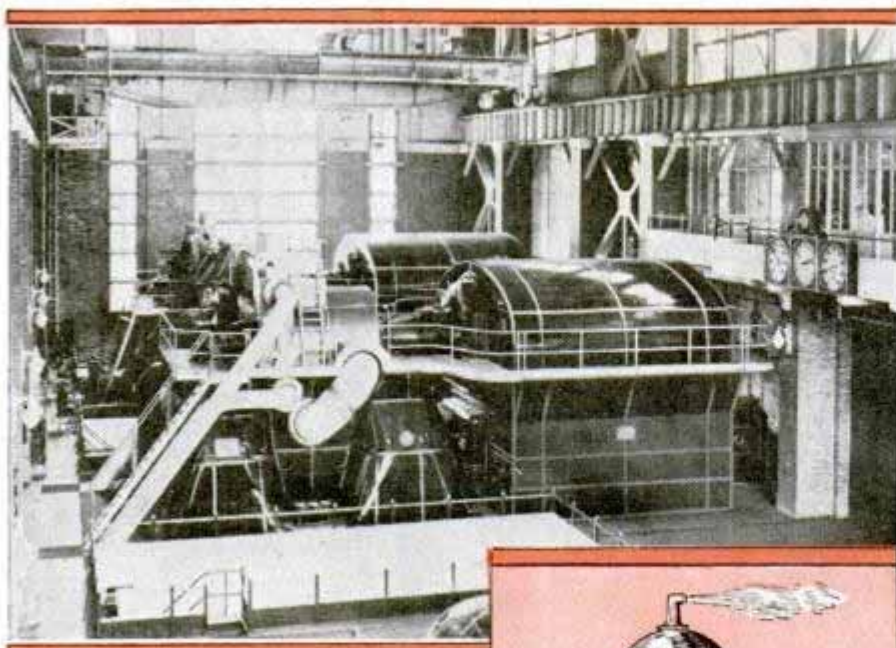

The Ford Motor Company's 110,000-kilowatt, vertical-compound steam turbine generator sets

they returned next morning, they found a hole burned clear through the plank—a hole burned by invisible steam. You can't take chances with steam like that.

When engineers discovered super-steam enabled them to extract twice as much electricity from each ton of coal, they began building super-turbines—literally piling one turbine atop another. This is known as "superposing" and an example is the latest 110,000-kilowatt turbine at the Ford plant. It occupies a floor space of twenty-two by sixty-two feet and is about twenty-five feet high—just about the size of a six-room house. It is really a double turbine for one is set on top of another. The exhaust steam, after making power in the top turbine, goes into the lower one without reheating, and there it makes more electricity, then passes to the condenser. So two turbines and two generators both make electricity with the same steam, producing a kilowatt-hour for less than one pound of coal. By this superposing, one plant doubled its power output with only two per cent more coal.

One of the biggest turbines in the world is in the Chicago district, the State Line plant on the shore of Lake Michigan. It has a capacity of 208,000 kilowatts or 277,000 horsepower. It would require



HERO'S TURBINE

more than 3,200 automobile engines of eighty-five horsepower each, running at full capacity, to equal the power of this one turbine and these cars, placed end to end, would extend almost ten miles. This turbine can't think but it can do the muscle work of more than 2,700,000 men. But the turbine works twenty-four hours a day and men can't. So it can do the muscle work of more than 8,000,000 men working in three eight-hour shifts.

In 1936 more than 68,000,000,000 kilowatt-hours were produced by steam in the United States. This represents the muscle work of more than 300,000,000 strong men—more than twice the population of this

(Continued to page 130A)

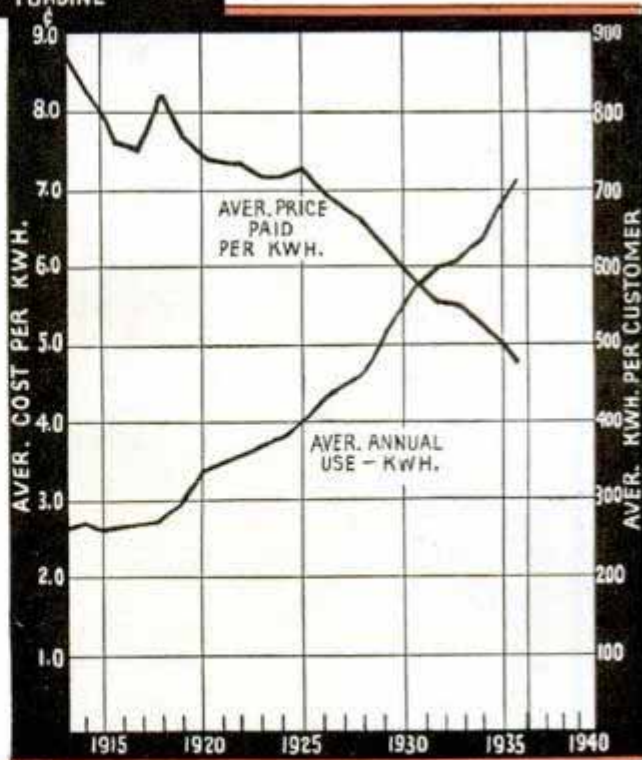

USE OF DOMESTIC ELECTRIC SERVICE AND ITS PRICE AS COMPARED WITH COST OF LIVING TO SEPT. 1936

Hero's turbine of 120 B.C. Chart shows how cost of electricity has declined as consumption increased

As 499 American Radiator Co.
40 W. 40th St.
New York City
Glass Roof, Sliding Cover for Future Homes

Admission of more light to the home, office building and factory is being achieved through the increasingly liberal use of glass. Many industrial structures, as well as residences, now have entire walls of glass. Materials are on the market for erecting buildings almost wholly of glass, either in the form of brick or double panes. Such buildings would have supporting members of steel, therefore would be substantial. Not far in the future are homes like the one presented recently in sketch form. The design calls for glass walls and roof, to admit light and radiant heat from the sun, and for a sliding cover. In winter the cover would be rolled back to let in the sunlight; in summer it would be rolled forward to shield the glass roof from the sun. Operated by motor, the roof cover is re-

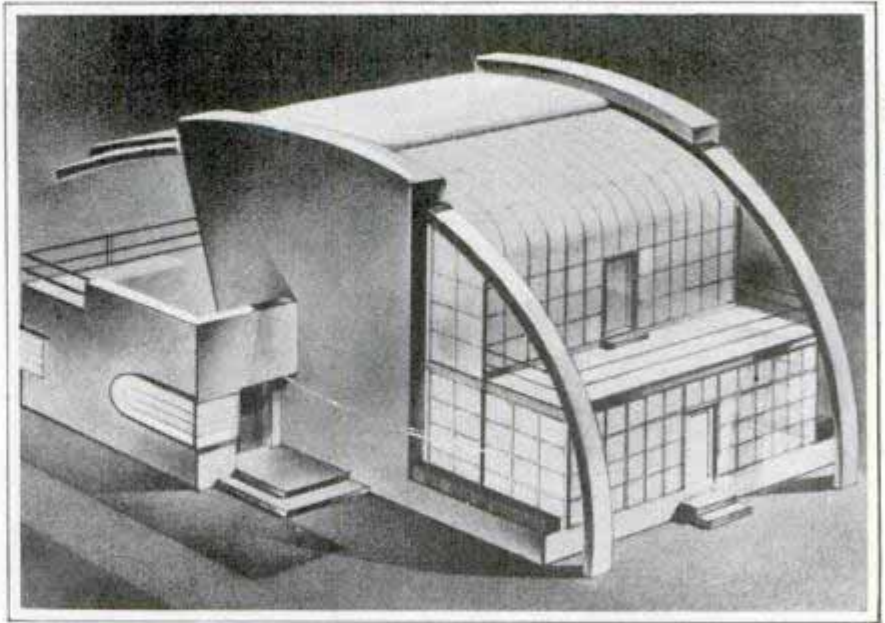

Courtesy American Radiator Co.

Sketch for a "Home of the Future" into which radiant heat from sun would be introduced by means of glass roof and walls

garded as practical. It would be moved by rollers, or other means, in two channels, one at either side of the house, running over the roof in a graceful curve. The movement would be similar to that of a roll-top desk. When rolled back, the roof would serve as a cover for a porch in rear.

483
\$2.00
Sheepskin Mitten Does Double Duty in Cleaning Auto



Here is sheepskin mitten being used in cleaning car. Its size speeds up work

Doing the work of sponge and chamois in washing automobile or truck, a sheepskin mitten now on the market protects the hands from dirt and dust and from scratches. It does a thorough cleaning job when used as sponge in washing the car. After the mitten has dried it may be used as a duster. The mitten is chemically treated to eliminate use of a chamois after washing and is process tanned to withstand water. It will not injure paint and will not hold sand, gravel, grit and dirt during a wash job. The mitten also may be used for dusting venetian blinds, furniture, floors, painted walls and woodwork and for waxing and polishing.

Motorists will soon be able to drive from the English Channel to Istanbul on a paved highway 1,940 miles long; it is already completed as far east as the Hungary-Jugoslavian border.

Winchester Products
Co. Joplin, Mo

Compressed Air Magazine.
April 1927

Therapeutic Lamps Bake Paint on Modern Autos

see April 1938



Battery of paint-baking lamps trained on hood of car in factory. This system permits accurate control of the temperature

In the same way that therapeutic lamps bake parts of the human body to relieve pain, so does a new drying lamp device bake paint on the modern automobile to assure a uniform finish. The lights are installed in a "hot house" at the end of the assembly line. Mounted on flexible standards to permit focusing the beams on any part of the auto's top or sides, the lights are installed in units, each containing two banks of lamps set in reflectors resembling the photoflood banks on motion-picture sets. Unlike the movie lights, however, these lamps throw heat instead of light. The twin banks contain twenty therapeutic bulbs, of 260 watts each, to produce heat up to 250 degrees, the same intensity employed in body-plant baking ovens. Twenty-five minutes under the lamps is the usual treatment for each car. The system, now in use

at the Plymouth factory, permits perfect control of baking temperatures. It also makes possible the baking of certain portions of the surface when special color combinations are ordered. Thus, it becomes unnecessary to send the automobile through the big baking ovens to harden a small area painted or striped an individual shade.

5517

Offset Propeller Reduces Wear by Vibration

Two-blade propellers offset at the hub, acting as a flywheel and thus eliminating much vibration, are being introduced to the aviation industry. The blades, with a decided arc, take a larger

"bite" of air and direct the air stream at a sharp bias under the body of the plane, giving it added buoyancy. It is claimed for this type propeller that it offers ten per cent better air speed and climb, quicker take-off, and lowers the engine temperature thirty to forty degrees, with a consequent reduction in lubrication costs.

Inu Perino di Cesare

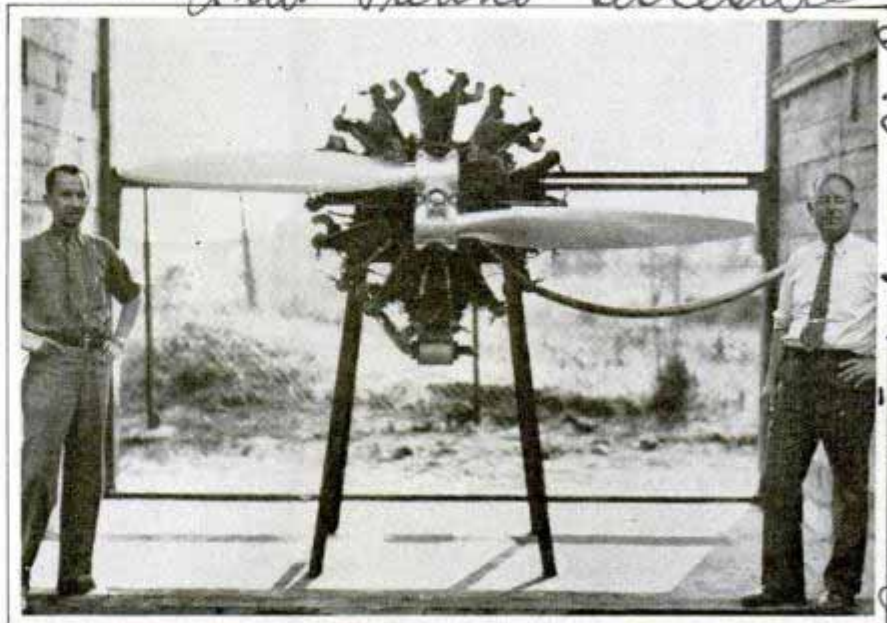

Quicker take-off and greater speed and climbing power are claimed for this new type of airplane propeller with two blades offset at hub

341 Massachusetts Ave. Detroit, Mi.

Propeller Corp. Milwaukee Wis
Maynard Eli Cesare at W. Dakota
27

Handwritten notes and signatures at the bottom of the page.

Three-Deck Sky Clipper Has Aisle in Wings

*200 W. Michigan.
Seattle Wash.*

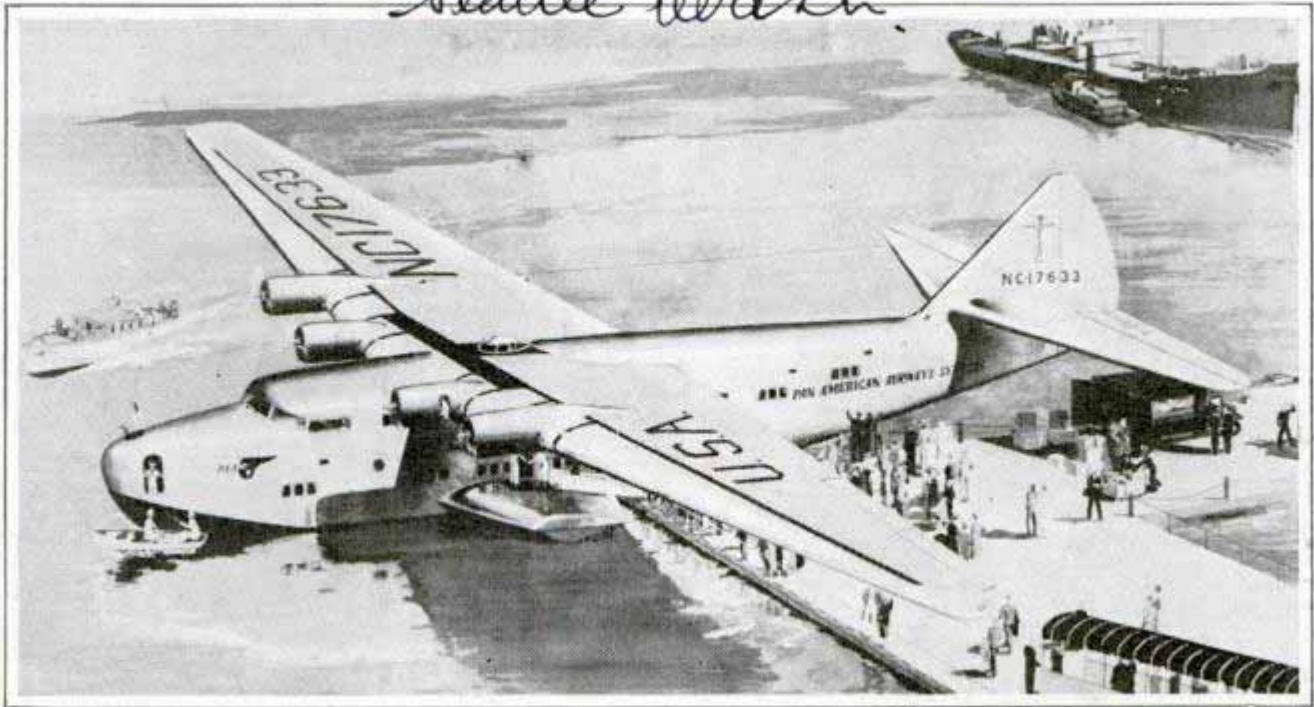

Destined for non-stop transatlantic service, this four-engined flying boat has cabins on three levels for passengers, crew and cargo. A companionway in wings gives access to the motors

Three-deck flying clippers with seats for seventy-two passengers and a crew of eight or nine are being built to span the Atlantic, non-stop between New York and London. So vast are the wings that there is a full-length companionway giving mechanics access to the four engines during flight. The ships will weigh 85,000 pounds and be capable of cruising 5,000 miles at

150 miles an hour, with 200-mile top speed. The fuel capacity is 12,000 pounds, but with a full gasoline load the clipper will not carry its top capacity of seventy-two passengers. The hull, 110 feet long, is being divided into three decks, the upper deck for crew, the middle for passengers, and the lower one for heavy cargo. Each motor develops 1,500 horsepower.

Can American Airways

Flexible Track for Toy Trains Curves in Any Direction

Miniature railroads can be laid out with great freedom by using a flexible track that curves in any direction. Available in rolls consisting of a four-foot and a six-foot section, this "third rail" electric track snakes and climbs around the mountains

and valleys of the toy railway system, adapting itself readily to any contour. It is of standard size and connects with switches and crossovers, as well as with the conventional type track. Natural wood ties give it a realistic appearance.



Flexible track for toy electric railroad comes in rolls and can be curved in any direction

*Parfait Products
1500 N. Ogden Ave*

Epsom Salt Kills Grasshoppers When Mixed with Bran Bait

Epsom salt is bitter medicine for man, but it is deadly poison to grasshoppers. Two University of Oklahoma scientists discovered this recently, and found that a bran bait prepared with bran, molasses, Epsom salt and water was more effective in killing grasshoppers than the standard arsenic bran bait.

\$5.08

2 Greenberry St

*Hubert W. and Mabel
J. J. rings*

*Not main
see article
Dec 1939 p. 241*

SNAPSHOTS



Camera pointed downward catches most of boat crew at left, while girl in canoe is seen from an unusual and interesting angle

PPOINT your camera straight ahead, push the button, and you get—just another picture. Take that same scene, but play the angles—and you may have a prize-winning shot.

Did you see that fellow crouching down behind the streetcar, squinting up at the conductor as he leaned from the back window to pull the trolley? He wasn't playing a game. He was after an angle shot with his camera.

It's too easy to get into the head-on habit, to take a picture that is a record, but nothing more. Don't fall into that rut. Camera fans are learning that there are interesting pictures in the most common-

place objects, if they play the angles. You wouldn't pick the broad side of a streetcar as a worthy object for snapshotting. But look down on that car from a skyscraper window just as it turns a downtown corner, boring a hole through a solid mass of shoppers, and you may catch a distinctive picture. The fellow who snapped the conductor silhouetted against the sky as he hauled in the trolley rope turned a commonplace event into a story-telling scene.

Look right in your own back yard. Wash day may seem quite unexciting, but get your camera down on the ground and turn it skyward as they hang the clothes on the line. If there's a parade in town, pick out a vantage point along the line of march and film it from curb level. Men seem like giants to the low-placed eye. Tramping feet march right into the camera. Go to the racetrack and shoot from the level of those pounding hoofs. The low angle magnifies the exciting action.

Eastman Kodak Co. 343 State St. Rochester, N.Y.

Magell

25 978

from NEW ANGLES

One of the commonest angle shots is the skyscraper, taken straight up from the sidewalk. You have seen those pictures. The tall buildings appear to be leaning backward, toppling from their foundations. Such pictures are either striking patterns or merely bizarre distortions. If you like them, fire away.

Sports photographs are lifted from drab to dynamic by the right slant. Swimming pictures are better if the camera is at a high level and you focus down on the subject. From there you catch the light playing on ripples of water, and the swimmer's form is less distorted than from the side. Stoop below the pole

Dramatic view from below the 746-foot main tower of Golden Gate suspension bridge, and a street-paving gang from a high window. (Photo at right by Orville Logan Snider)

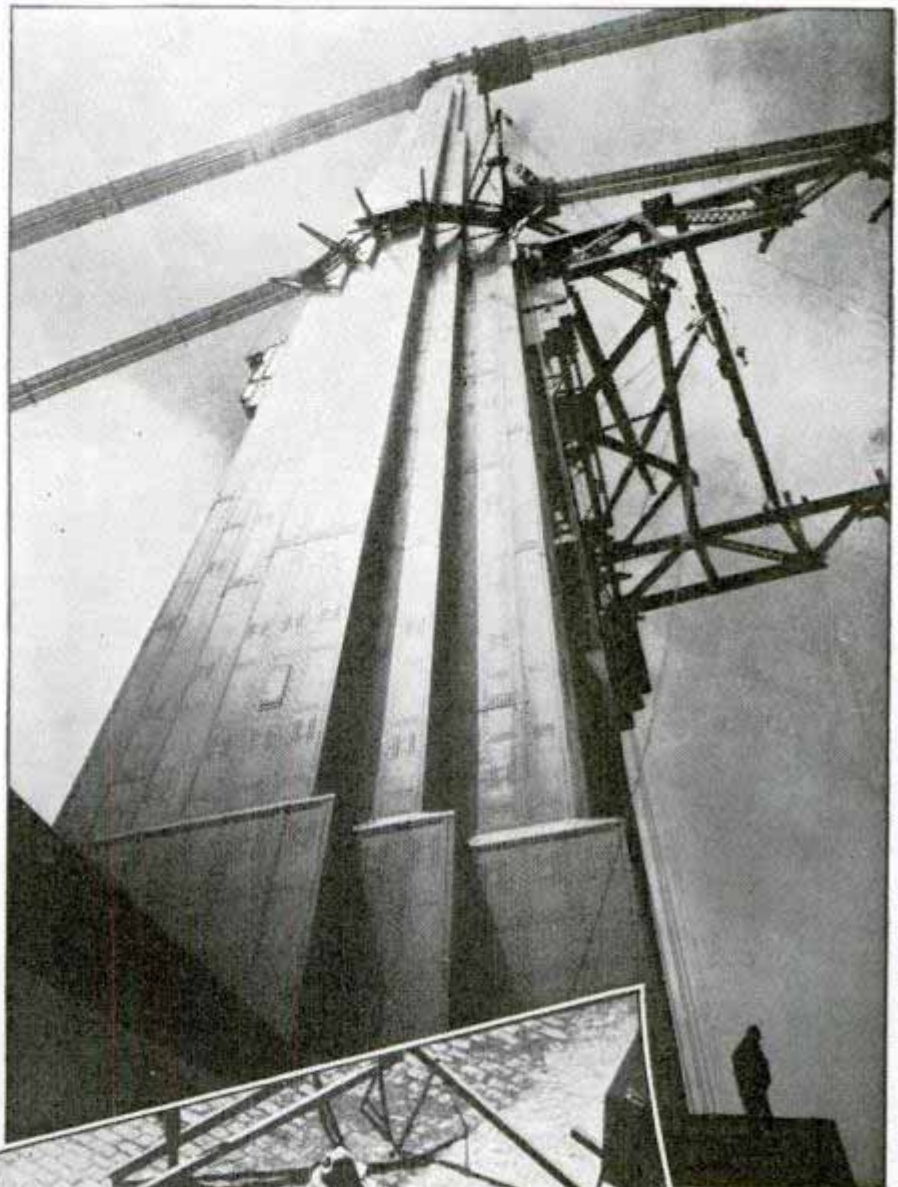

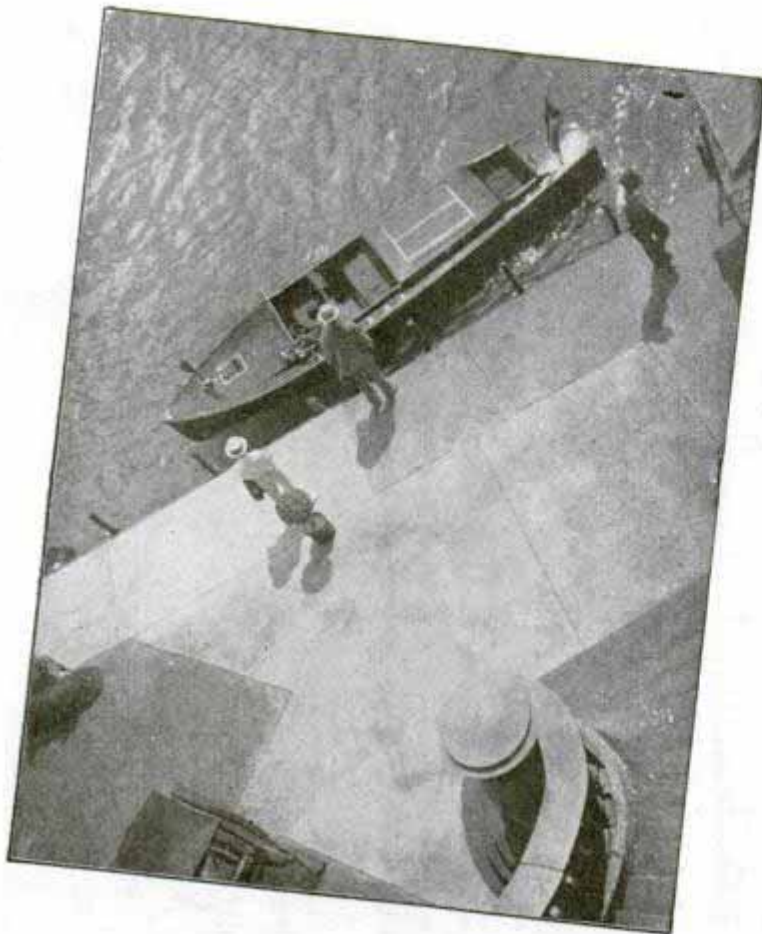

vault standards and catch the athlete against the sky. Snap the hurdler from ground level. Drop behind a tennis net and click the shutter as a fast drive comes at you. Aim downward at figure skaters whirling around the ice. Two good angles for football pictures are the "aerial" view, with the camera pointed downward so that each player is a dot on the field, and the shot from low at the end of the line as the teams face each other ready for action.

There is no particular trick about angle photography. Camera mechanism has little to do with it. True, you must remember to shut the lens down a stop or more if your aim happens to be against a bright sky or water reflecting light. But the real trick is in you—your ability to see the fresh slant on the ordinary scene.

Machinery lends itself to extraordinary angle shots. Focus on the wheels of a locomotive from track level and observe how the power of those giant wheels is intensified! Stand close to a great flywheel, look up from the foot of a lofty dam, peer down into the engine room as the fireman shovels coal into a furnace.

Realistic pictures of table-top models depend largely upon the point of view.

Aim down at a model city or contour map from the proper distance above it and your picture may appear to be an aerial photograph. On the other hand, for a lifelike photograph of a doll house or an architect's building model, set the lens at "doll's eye" level.

Street scenes—hurrying crowds, the repair gang at work, the traffic jam, patterns in pavement and streetcar tracks—are usually most striking from a high vantage point. Bridges offer rich opportunities for angling. Train the eye on the structural steel work for an effect of massive strength, or use that steel work to frame a river scene. The steel web of a suspension bridge is interesting from many angles. Stand on a bridge and catch a downward glimpse of a steamer gliding beneath, or fishermen in small boats, or a girl paddling a canoe. Climb into a switch tower or a viaduct for a different view of a busy freight yard or a speeding train.

Instead of asking friends to pose



Above, the boat would be lost if this scene had been taken from dock level. Below, note impression of height gained by looking upward at men on girder

for you in the conventional, stiff way, catch them off guard from an upstairs window as they come up the walk. Point upward at a balcony or a dormer window; watch for unnoticed beauty in the pattern of a stairway and balustrade seen from above. At the seashore, snap that flock of gulls lined up on a roof top; in the country, swallows in dress parade on a telegraph wire. Lie down in a hay field with the camera close to the earth and "fire" through the big wheel as the farmer drives his rake abreast of you. At the airport, catch a grotesque upward view of the nose of a sky liner, its two lights like eyes of a giant bug.

You'll find yourself in ridiculous pictures now and then, but the results should pay! You need not always climb to a skyscraper roof or an upstairs balcony. You can perch on a chair, a fence, or the top of an automobile, to gain perspectives that will make your pictures attractive and distinctive. All pic-

(Continued to page 116A)

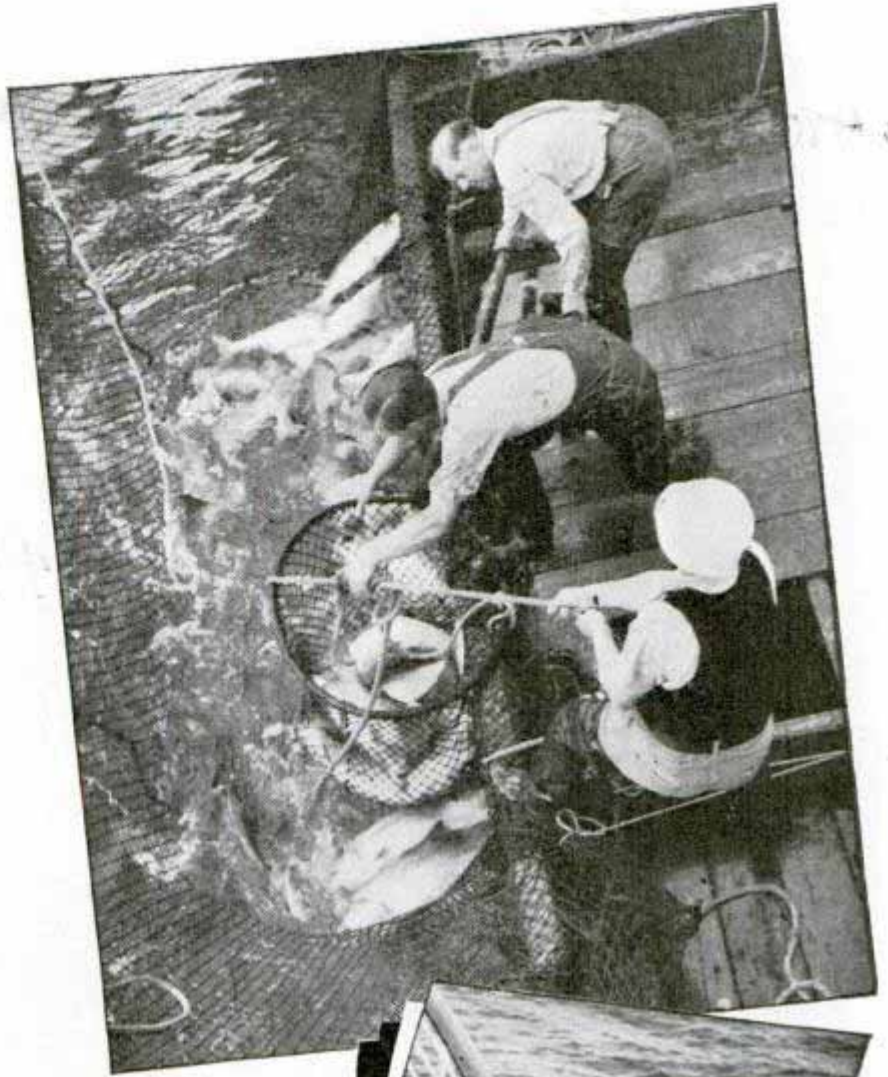

Scenes on shipboard offer excellent opportunities for angle photography. Fishermen hauling in nets, crew loading naval gun and couple at rail of steamer all were caught advantageously from above

Ann Arbor, Mich Adjustable-Weight Putter Helps Line Up Stroke

So 410

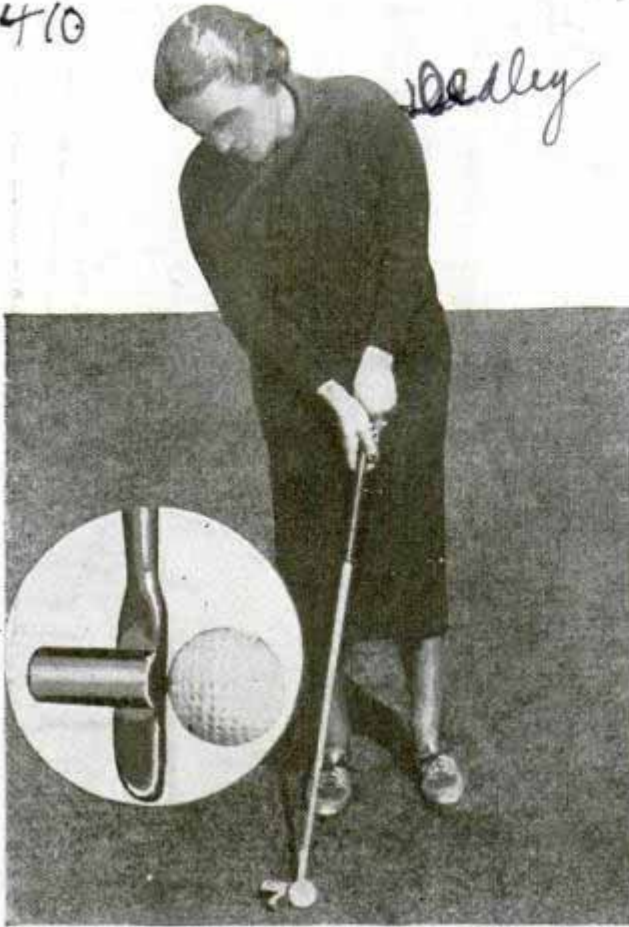

Bedley

Putting with adjustable-weight club, which helps line up stroke. Lead slugs fit in cylindrical housing

Designed to improve accuracy on the green, a golf putter with adjustable weight is offered. The weight is varied by adding from one to ten lead slugs which fit in a cylindrical housing directly behind the point of contact with the ball. The cylinder, being at right angles to the club face, helps in lining up the putt.

So 526

Reduction in Pneumonia Toll Promised by Chemical

Successful warfare against pneumonia is being waged with the aid of a chemical called hydroxyethylapocupreine. It is one of the seventy-six chemical preparations based on quinine which were synthesized by a Mellon Institute laboratory staff and then tested on mice, rabbits and dogs to determine whether they should be tried on human cases. In 100 pneumonia cases treated last winter the mortality was twenty-seven per cent, compared to a

*announced by Dr. William
S. MacLachlan, M.D.,
Hospital, Pottsville, Pa.*

normal mortality of about forty-five per cent for 100 non-specifically treated cases. Apparently the preparation may reduce the number of deaths by half. The chemical is swallowed in capsule form, as though it were quinine. The doses are unusually large, 400 to 800 grains or even higher during a week's time. In cases of pneumonia for which there is no serum the chemical is effective. Hydroxyethylapocupreine also is useful in treating empyema, one of the common complications of severe pneumonia infections. Doctors who have used the remedy warn, however, that the chemical has no beneficial action on influenza and streptococcus infection.

So 490

Flutelike Instrument Helps Beginner Learn Music

Resembling the end-blown flute of Shakespeare's day, a simplified instrument is aiding in the teaching of music. Easy to blow and to finger, it provides elementary training in reading music without the technical complications of standard instruments. It is equipped with a mouth-piece fashioned from a new thermoplastic material by means of a hydraulic injection process. The instrument has a clear flute-like tone and covers a range of nearly two octaves upward from middle C, controlled by only six finger holes.

And J. E. Patch horn



Teaching elementary music with aid of instrument resembling the flute

*Saxette Co,
Delaware*

Es 397 New American Homes. Inc.

228 N La Salle Chicago. Steel Housing Corp

Radiant Dual Walls Heat Home or Cool It

Abandoning the traditional method of heating, a construction company is building homes with dual walls that are radiators in winter and cooling areas in summer. There are no conventional radiators or warm-air registers. Instead of heating the air, the walls and ceiling are heated, and it is claimed that the house heated by radiation to sixty-five degrees Fahrenheit is as comfortable as the house heated to seventy-five degrees by warming the air. The engineers say, too, that radiant walls retain their warmth longer thus saving fuel. From the basement heating plant, warm air rises between the inner walls to the ceiling, flows across the heating space above the ceiling and is drawn down the outer walls and beneath the floor to a return duct for reheating. Outside walls are insulated against heat loss. Between outer and inner walls is a three or four inch

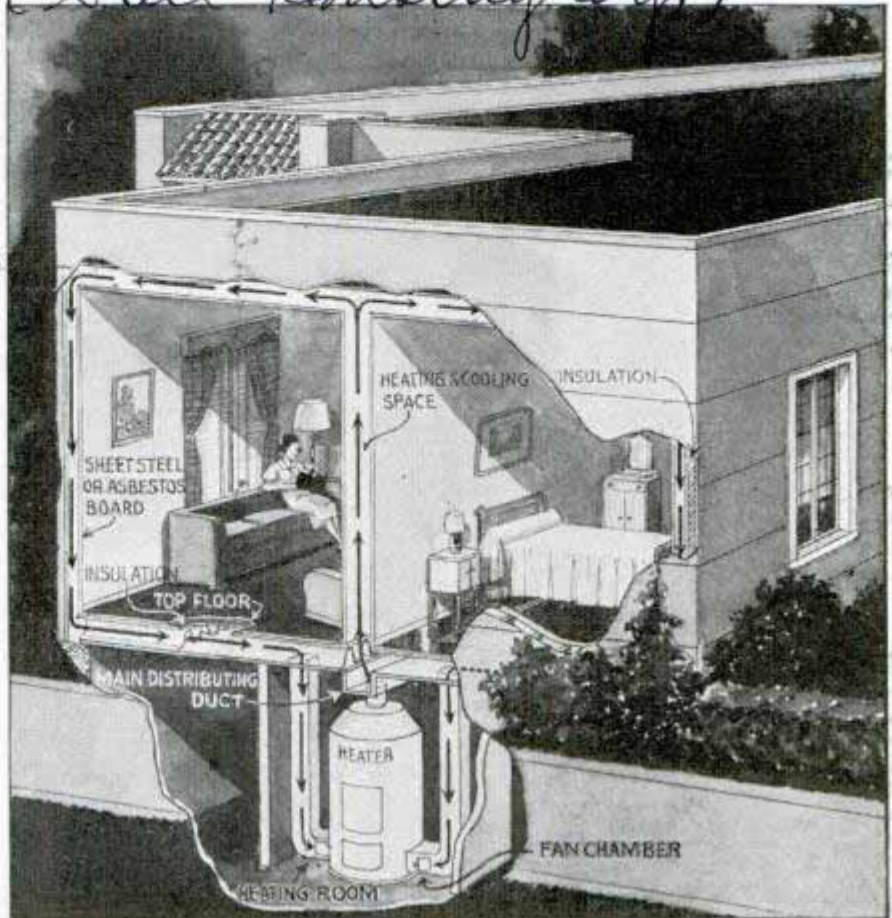

Arrows trace movement of warm air up through dual inner walls, across ceiling and down outer walls, returning to furnace for reheating

space for the sealed air circulation. Inner walls are radiating surfaces of steel or asbestos board. The same air passages are used for circulating cool air in hot weather.

“Straphanging” Firemen Ride Behind a Windshield

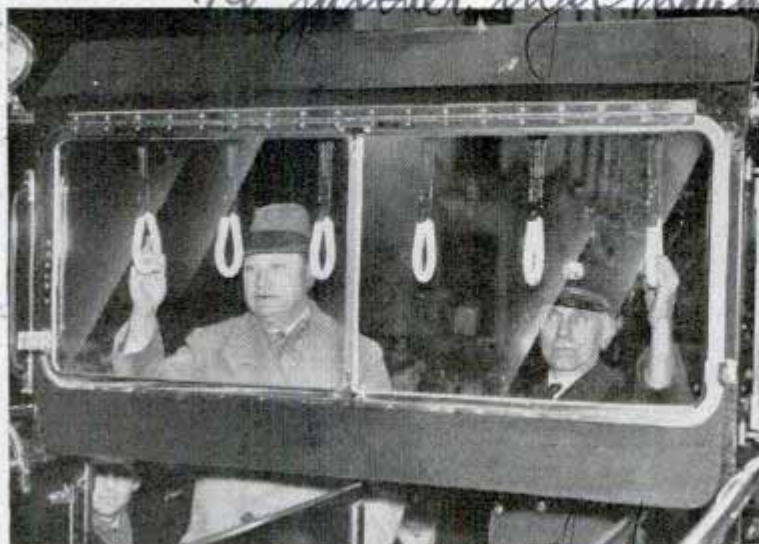

Trying out the latest fire engine. Note straps to which firemen cling. Windshield gives protection from weather

Equipped with a windshield to protect firemen holding to hand straps like those in subway or trolley cars, the latest New York fire engine has all the features for efficient fire fighting. The firemen are protected from cold and wind by the windshield, and the straps give them more security as the engine speeds through the streets. Each fire truck of the new design cost \$11,765.

When you wish to know more about any article in this magazine, write our Bureau of Information, inclosing return postage.

Fire Commissioner, Mc Elégolt
Capt. Herman J. Rice

Target Tells Which Ring Bullet Has Struck

American connection wanted



Target showing bullet hit the eighth ring from outer rim. Inset shows oscillating rings behind target

Throwing out a large metal plate bearing the score, an automatic target tells instantly which ring the bullet has struck. The rings around the target disk are numbered from one to ten toward the bull's-eye. Each ring is divided into four segments. If a bullet hits the fourth ring in the upper left quadrant, a metal plate showing the figure "4" is ejected at the upper left corner. A bull's-eye is indicated by the number ten at the top center. Oscillating steel rings behind the cardboard disk actuate the number plates when struck. The shooter replaces the score plate by throwing a lever.

No More Drought Until 1975 Is Long-Range Forecast

Drought years in the United States will end soon, not to return until 1975. This is the long-range weather prediction made by Dr. Charles G. Abbot, secretary of the Smithsonian Institution, and based on a

Washington, D.C.

study of the twenty-three year cycles in solar activities and earthly weather. He expects recovery from drought conditions in the northwest within a year or two, but severe recurrence of them after 1975, the end of a double cycle that began about 1929. Regular occurrence of twenty-three year cycles has been noted in tree rings and similar cycles occur in variations of Great Lakes levels.

Flares Carried by Pilot Balloon Show Drift of Night Winds

To chart the direction and velocity of night winds above the earth, a method of photographing the weather balloon by means of magnesium flares has been developed at Massachusetts Institute of Technology. From an observation point on the earth, a special 180-degree camera lens is pointed upward, taking the entire sky into its vision. As the sounding balloon rises and drifts, the flashes of magnesium flares attached to it and lighted at known intervals are registered on the photographic plate. By measuring the angles between the camera and the various positions of the flashes, the winds can be accurately charted. Tests of this method have recorded the flashes of light seven miles away and more than 13,000 feet high.



String of lights near bottom of this night sky photo shows position of drifting weather balloon

*Harv Johansen Metal Works
Battenberg-Eber Germany*

Meteorological Laboratory

Es 496

Swen Senné - 4/26/37

*Es 497
Reviewed by Atchoblanco, W. mas...
Oceanographic Institute, W. mas...*

Miniature Trains Run on Garden Railroad



Courtesy Canadian National Railways

Here are several views of Canada's smallest railway system, complete with right of way, rolling stock, board of directors and executive headquarters



Located in garden of Prof. William Rowan's summer home in Jasper National Park, the Lake Edith Railway company operates miniature trains. Top, left, double locomotives pulling train over "Athabasca viaduct." Right, executives supervising chief signal engineer on job

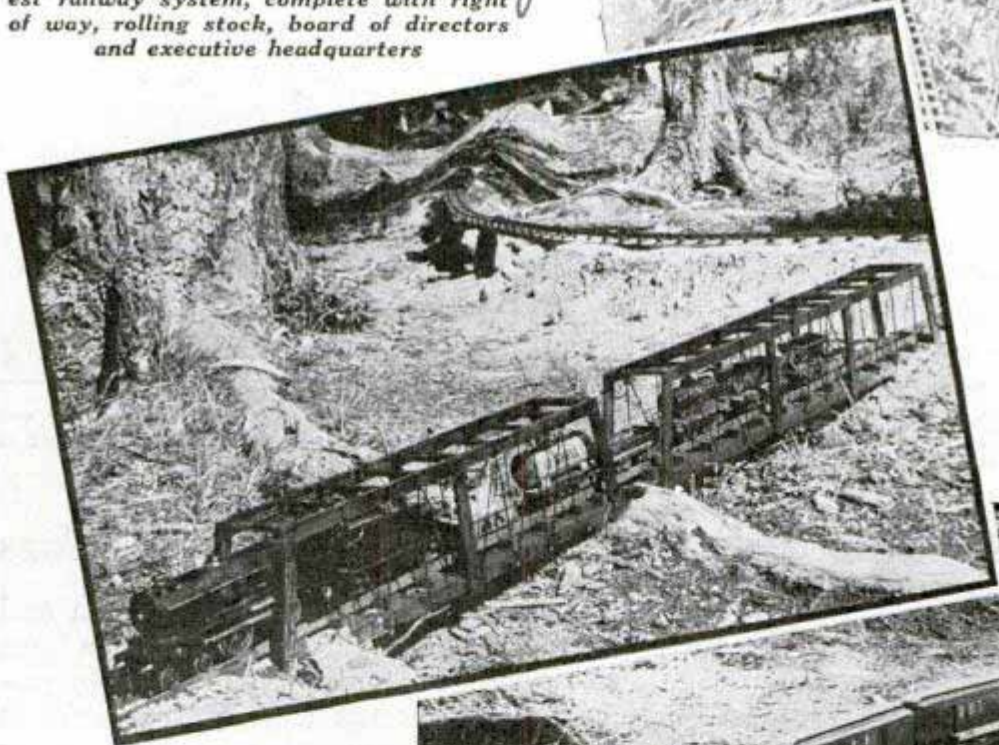

Center, how engineering staff solved problem of protruding tree root by spanning it with bridge over which midget train is passing. Bottom, "Tonquin Limited" passing over Maligne gorge trestle before ascending steep grade. Note that two locomotives are being used. The locomotives are built on English style and the system is equipped with both passenger and freight cars



well built

es 460

410 Camp St

Small Diesel Tugs Do Work of Big Steam Craft

new Orleans La.



and of providing the helmsman with control over the power and the direction of the craft. The simplicity of the Diesel makes possible a pilot-house control on the engine, which aids materially in fast handling of the boat. The result is a highly maneuverable tug, shorn of all unnecessary weight. Thus the new tugs, with only 100 to 125 horsepower, can out-perform more powerful, but much heavier craft.

Small Diesel-powered tugs, capable of doing the work of steam tugs twice their size, are making their appearance on American waterways. The steam craft, because of their greater size, are harder to maneuver and their fuel costs are much higher. One of the midgets is the "Jeanne," said to be the smallest welded steel Diesel tug ever built. Her length is twenty-nine feet and her power plant is a lightweight Cummins engine developing eighty-five to 125 horsepower. Harbor and inland waterway tugs seldom require crew accommodations, which gives the hull only the functions of supporting the power plant



One of the midget Diesel-powered tugs which are beginning to appear on inland waters. The craft is of welded steel construction

Fourteen-Mile Police Horn Is Used to Call in Squad Cars



Wine glass at the moment it was shattered by sound waves of powerful horn

Designed for calling in patrolmen and squad cars not equipped with radio, a horn with a fourteen-mile range is used by police in a California city. So powerful is the horn that its sound waves will shatter a wine glass held in front. Mounted on top of police station or automobile, the horn is operated by compressed air.

"Shadow Shading" Hides Planes from Foe Above or Below

British bombing planes are being "shadow shaded" to protect them from enemy eyes above or below them. This is a new

Chicago Daily News

5/8/37

Cutrimino Engine Co. Columbus, Ind
Es 437
Lorver Products Co.
1221
Los Angeles Calif

method of camouflage. The under surfaces are painted a dull black called "night," a color that absorbs light and will not reflect the searchlights hunting for them from the ground. The upper surfaces will be green and "earth" brown, to blend with the landscape when seen from pursuit planes overhead.

5/4.

Truck Dump Body May Be Tilted Three Ways

Lending itself to being tilted to the rear, right or left, a new three-way dump body for trucks speeds up road building and similar work. Any of the three sides drops down when the body is tilted, or if the body is level all three sides can be laid flat, though road-clearance regulations prevent its use that way for hauling. It is not necessary to back up the truck to dump the load, the operator merely driv-

Window Washers on Radio While Working Far Apart



Wide World
Window washer perched high on side of building in Chicago is photographed as he talks to another washer on building in New York

Two window washers, one in New York and the other in Chicago, were interviewed and talked to each other by radio recently while perched on the sides of buildings in the two respective cities. Portable radio transmitters, attached to the back of each man, made possible the unusual meeting. One window washer was working on the side of New York's Empire State building, the world's tallest, and the other on the side of Chicago's Merchandise Mart, one of the world's largest buildings. The interview and exchange of comments by the two workmen were broadcast over a national radio hookup.

5 00

Paint for Use on Damp Surfaces Absorbs and Sheds Water

Paint, lacquer and varnish can be applied directly on wet surfaces by adding to it a special compound. The effect is to deposit the paint firmly on the surface, for the compound absorbs the moisture and then forces its way outside the film of paint, decomposes and evaporates.

Our Bureau of Information will answer questions regarding articles in this magazine, if accompanied by return postage.

*Web X-1 Hale Paint Compound
C. 5 72. Greenack, New York*

*For White Motor Co 842 E
Cleveland Ohio
99 st*



Unloading three-way dump body by tilting to left. Hydraulic hoist tilts the body

ing up to where he wishes to unload and pulling the proper lever in the cab, causing the body to lift at the side desired. The dumping mechanism is actuated by a hydraulic telescopic hoist.

*Commercial Shearing
and Stamping Co.*

25255

Mr. Charles Morrow Wilson

114 W. 11 St. N. Y. N. Y.

NEW PROGRESS

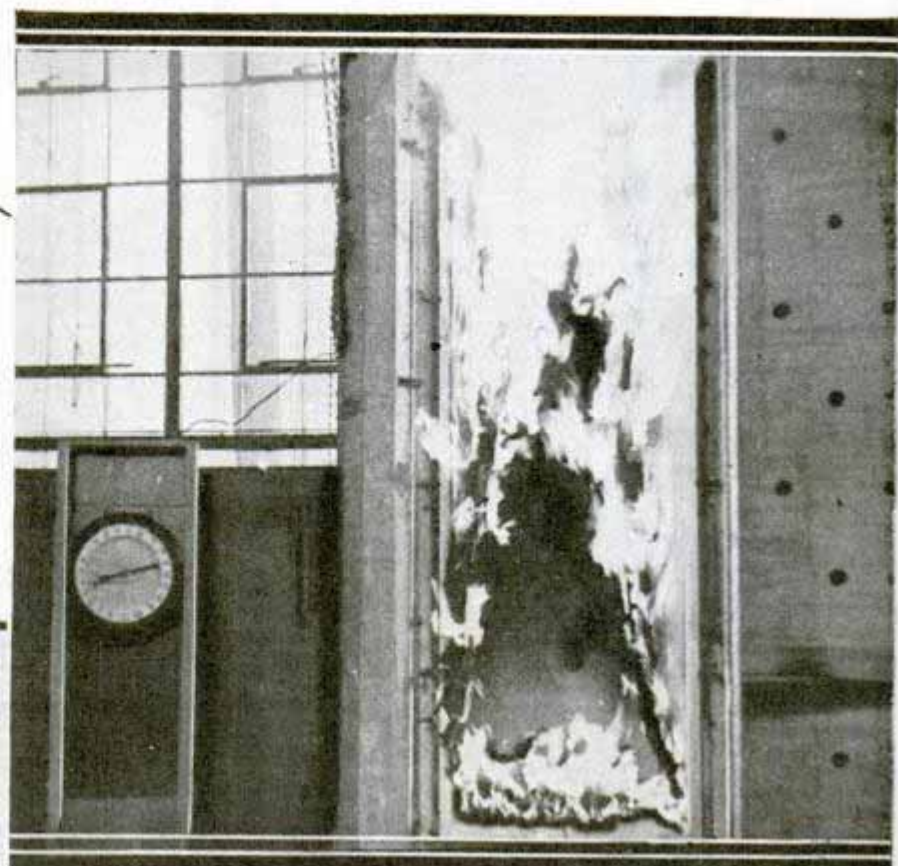
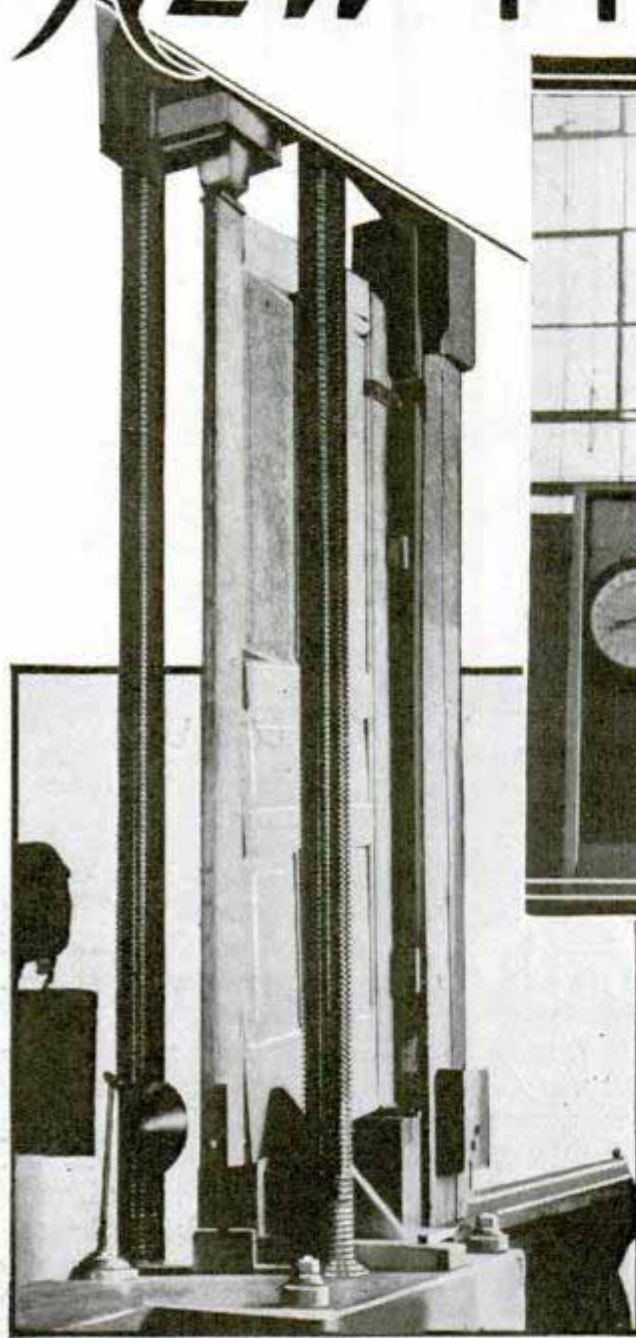

Left, testing door treated with fire-resistant chemicals. Ability of timber to withstand strain is important because intense heat exaggerates faults. Right, fire-treated wall panel fails in oven test

By Charles Morrow Wilson

AS a building material wood has three great faults—it swells and shrinks, it decays and it burns. A method of sealing wood against the passage of moisture into or out of its pores virtually eliminates swelling and shrinkage, and modern paints, lacquers, varnishes and creosote materials reduce decay, leaving the third problem to be solved through some process for protecting wood against fire.

Wood chemists, technicians and amateurs are working on the problem and fire-resistant lumber, doors, casements

and other building materials already are on the market. Several American cities are requiring use of these materials in fire-restricted areas.

Scientifically, there is no such thing as a 100-per cent fireproof building material. Steel and iron buckle, twist, or break under fire. Cement, brick and stone expand and crack. Wood has the advantage of being a better nonconductor of heat and, as a rule, does not give way until actually destroyed.

T. R. Truax, chief wood technologist of the U. S. Forest Products Laboratory, Madison, Wis., lists about 160 different chemicals which help to make wood fire-resistant. Some are too expensive and many lose their fireproofing value when exposed to air and weather. In commercial fire-treating some of the proven chemicals are ammonium phosphate, ammonium sulphate and ammonium chloride, borax and boric acid. Many types of fireproofing treatments also protect wood against ter-

25255
 3 1939
 6433 26
 Wilson Morrow C

in

FIREPROOFING

ls 2534 ne

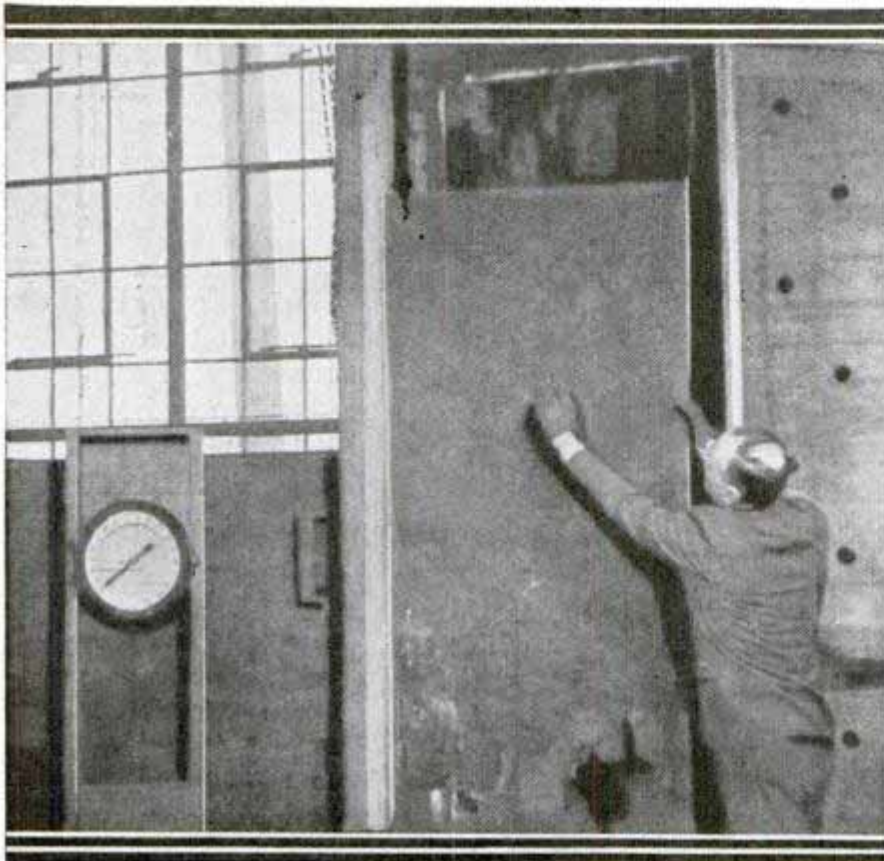

The purpose of fire-resistant coatings is to retard spread of flame and to raise combustion temperatures so that fires cannot start from ordinary causes. The best use of fire-retardant chemicals increases ignition temperature by about 200 degrees Fahrenheit. Insurance experts estimate that such a raise in ignition temperatures might eliminate as much as seventy-five per cent of fire hazards in ordinary wooden dwellings, which regularly represent from thirty-three to fifty per cent of the total fire loss of the nation.

Fireproofing requires exact knowledge of how wood burns, and demands standard, accurate tests for fire-retardant

mites, other insects and fungi. This is particularly true of ammonium phosphate and ammonium arsenates. Zinc chloride, aluminum chloride, manganese chloride, nickel sulphate, calcium acetate, oxalic acid, and four sodiums, bicarbonate, silicate, chloride and sulphate, are others of the thirty-three chemicals commonly used.

Early experiments depended largely upon surface coatings. The new style of treatment recognizes that although some types of surface coating serve to retard flame, saturation is the most effective; that is by soaking dry wood in a soluble which totals from one to eight pounds of chemical to the cubic foot of wood. Some students of fireproofing believe it soon will be possible to perfect a paint, which in addition to ordinary values may also serve to prevent flame spread. Several manufacturers are making final tests of such a paint.



Top, removing wall panel from oven. Bottom, electrical tester determines water content of wood. If wood is air-dry it can absorb satisfactory weight of fire-resistant chemicals

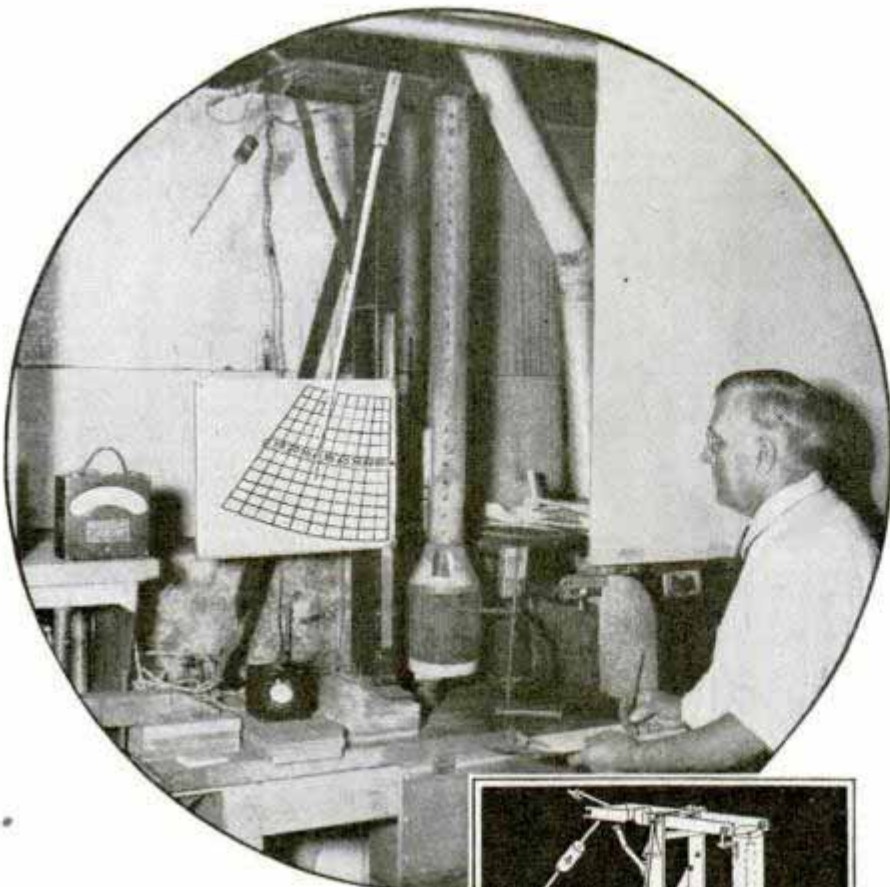

Top, fire-tube tester. Center, sketch of same apparatus showing outline of wood sample suspended in tube. Bottom, oven used to test fire-resistant qualities of wood

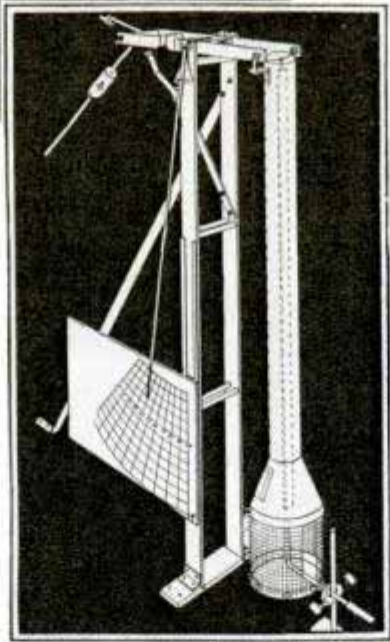

qualities. When subjected to high temperatures wood decomposes and gives off inflammable gases. Up to 212 degrees vaporization of wood moisture occurs. Scorching and slow production of inflammable gases take place between 300 and 400 degrees. Charring, with more rapid evolution of inflammable gases, glowing and then flaming occur between 400 and 700 degrees and quick ignition of inflammable gases and glowing of charcoal between 700 and 950 degrees.

Actual fire temperatures sometimes go as high as 2,000 degrees, but students of fireproofing are principally interested in the lower brackets of combustion. Suitable chemicals injected into or absorbed by the wood interfere with the process of combustion and may prevent it entirely. At present, no fire-retardants which can prohibit charring at extreme temperature have been perfected but fire-resistant

woods which will lose as little as fifteen per cent of original weight after long exposures to temperatures as high as 2,300 degrees have been developed. For all practical purposes such wood is fireproof. Fire-retardant treatments add to natural fire advantages of wood by increasing insulation properties, opposing flame spread and reducing its tendency to support combustion or build up high temperatures.

Many attempts have been made to measure fire-resistance of wood in terms of one or more of these properties. Some investigators have measured the volume and character of gases resulting from heating wood, or the temperatures of

(Continued to page 122A)

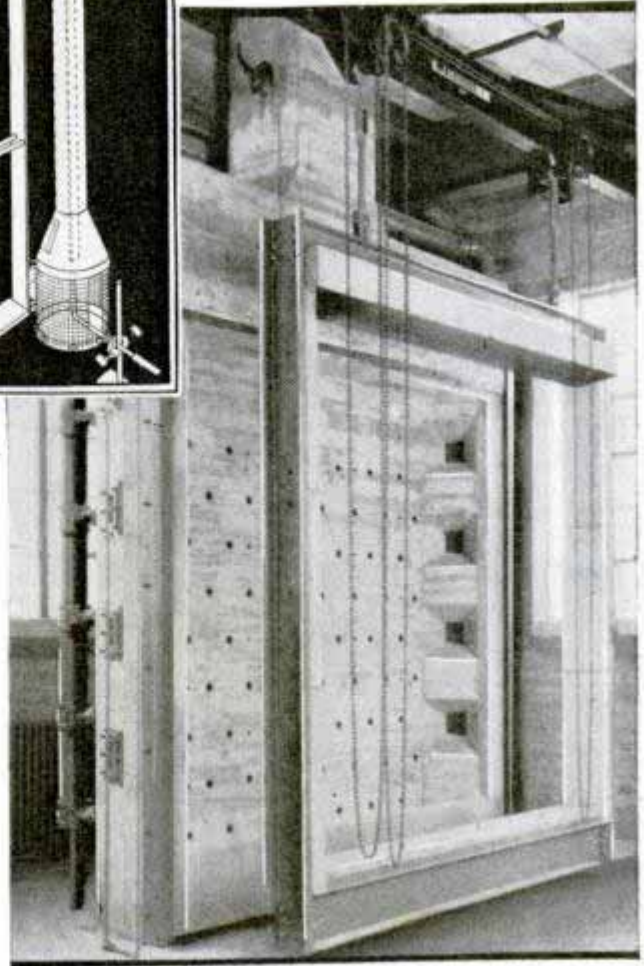

es494

Tractors Haul Artillery in Mechanized Army

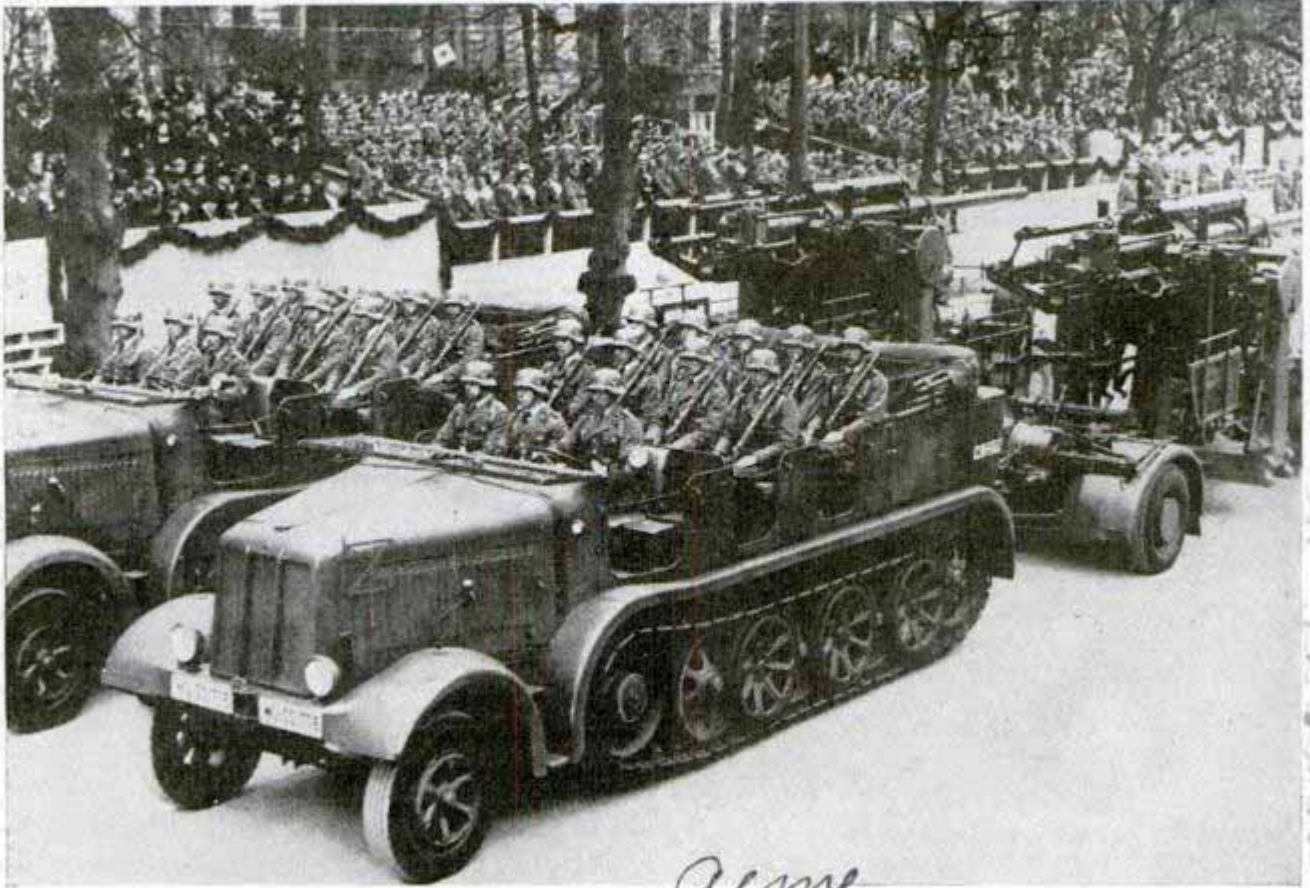

acme.

In a military parade in Berlin, these huge tractors carrying artillery troops and hauling big guns are seen passing the reviewing stand. Six hundred mechanized artillery units participated in the display

Giant tractors that carry twelve soldiers and haul big guns behind them are replacing horse-drawn field pieces in Germany's mechanized army. Formidable

weapons can be transported with great speed by these tractors. Six hundred motorized units participated in a recent military display in Berlin.

Artist "Paints" a Picture with Pieces of Printers' Type

es464

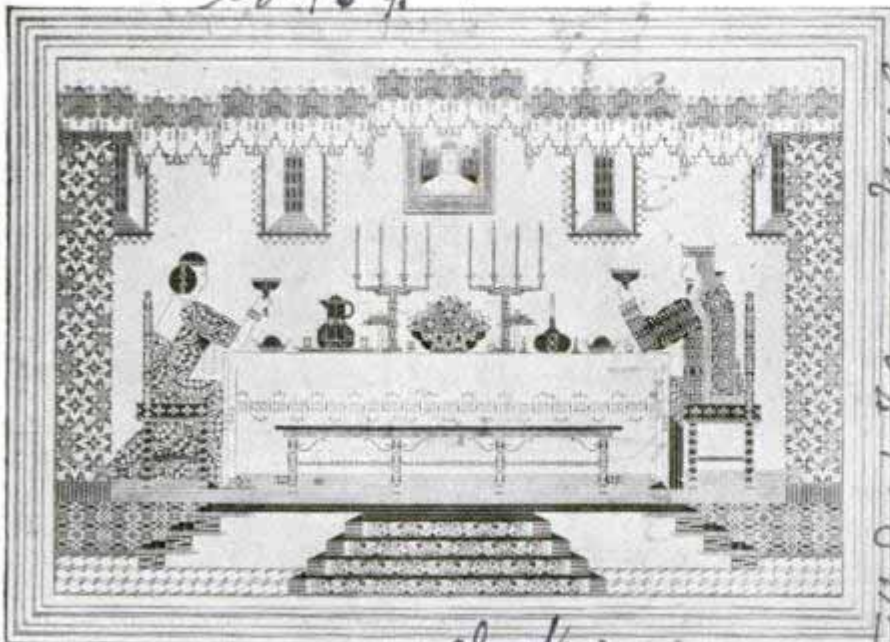

748 a. 12 nd page

One of the costliest forms of art is that of creating pictures with printers' type. Decorative scenes can be "painted" by cleverly arranging the ornamental type units found in any printing shop. Type pictures call for endless patience and time. A pencil sketch serves as a guide for the typographical layout.

Our Bureau of Information will answer questions regarding articles in this magazine, if accompanied by return postage.

This picture was made by cleverly arranging decorative printers' type

alut.

Albert Schiller, artist.
at es hebdom - Society of Independent Artists

Three-Dimension Magnifier Fitted to Wearer



Examining patient with aid of adjustable three-dimension magnifier

Designed so that it may be fitted to the individual, a new binocular loupe is equipped with three-power magnifying lenses providing stereoscopic vision. The lenses are mounted on the end of a bar extending from the specially designed frame and bridge. A flip of the finger throws the magnifier upward, out of line of vision, when desired. The loupe is essentially a spectacle frame with an ingenious aluminum block in place of a bridge. Round eyewires are mounted on slotted bars and held to the bridge block by set screw. By loosening the screw each eyewire may be adjusted separately to get the proper interpupillary distance for the wearer. The loupe is useful in surgery, dentistry, ophthalmology and other branches of medicine. Laboratory workers, artists, etchers, engravers, locksmiths, clock and watch makers and jewelers also will find it an aid to vision in their work.

Chemical Cools Plane Engine Approved by Army

Rated at 1,000 horsepower, the Allison aircraft engine, recently approved by the

U. S. Army, is cooled by chemical. Ethylene glycol is used instead of water. It has a boiling point of 387 degrees Fahrenheit, thus permitting more effective cooling radiators to handle heat transfer from cylinders to atmosphere than water, which boils at 212 degrees. Water-cooled motors require large radiator area. The frontal area of the Allison engine is only six and one-fourth square feet, compared to sixteen and three-fourths for air-cooled engines of less power. The Allison is fitted with a turbo supercharger driven by waste exhaust gases. It delivers to the carburetor at sea-level pressure the rarefied atmosphere at high altitudes to provide air necessary for proper combustion. Thus the engine develops its full 1,000 horsepower up to an altitude of 25,000 feet, permitting very rapid climbing and high speeds. Weighing 1,275 pounds, the engine again gives America the lead for the most powerful lightest weight power plant for aircraft, answering the complaint of many aviation technicians that England, and other European nations, had superior aircraft motors, particularly for military purposes.

Twin Sponges Dry Photo Film on Both Sides at Once

Two sponges mounted with triple hinges offer photographers a quick method of drying negatives or paper. With the sponges pressed together, film can be

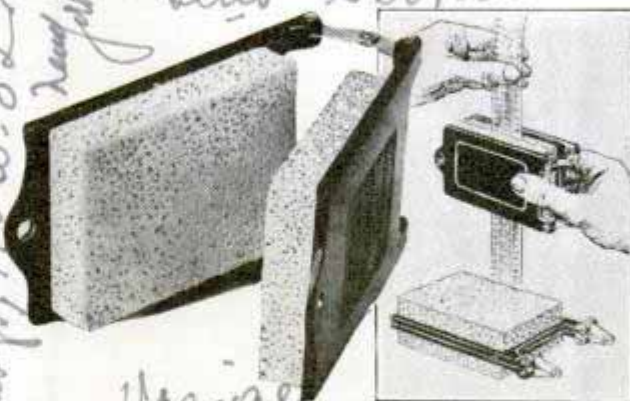

Reversible sponge-pack used to blot photo paper and to dry negatives by drawing between sponges

drawn between them to be dried on both sides in one operation. The sponge-pack can also be opened flat for double-width drying, or folded back to back.

Bausch & Lomb Optical Co. 626 St Paul
Mr. Rochester, N.Y.

more and to the...
indianapolis, ind
\$425
\$501
Willoughby, 100-82nd St.
Lynch Div. Service
Vintage



Radio

“DOORKNOB” Tube for One-Half Meter Operation

NEW limits in the development of radio communication at ultrahigh-frequencies have been reached by means of specially designed tubes recently introduced by the Western Electric company.

Heretofore, the only sources of real power available to experimenters for high frequencies corresponding to wave lengths of less than a meter, were tubes of the electron-oscillation or magnetron types. These tubes required critical adjustment that was difficult to maintain. To avoid this difficulty, the so-called “doorknob” 316-A tube of ordinary negative-grid type has been developed.

The conventional base has been eliminated com-

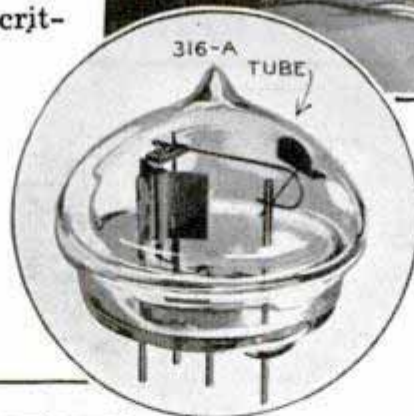
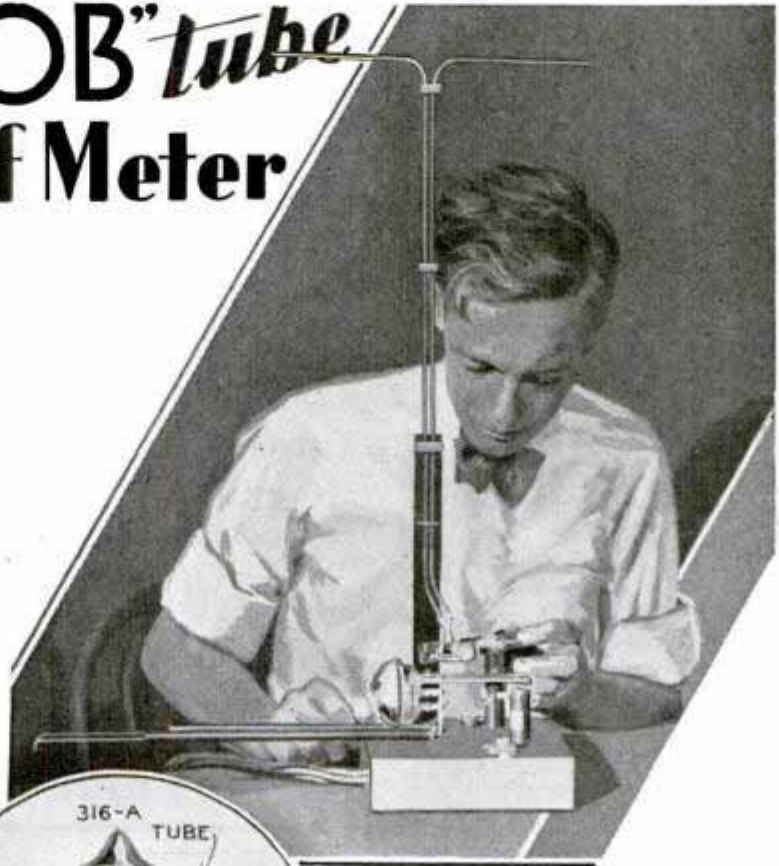

pletely, each lead being brought out through a molded glass end plate which is part of the tube envelope. Circuit connections are made by means of brass sleeves that slip over the rods where they are held firmly by set

screws; soldering is not recommended because of the high operating temperatures. The filament supply is 2 volts, either a.c. or d.c., with a current requirement of 3.65 amperes.

An experimental half-wave transmitter is shown in the upper photo and the schematic circuit diagram appears in Fig. 1. It is said that 6 watts can be radiated from this transmitter. Suitable receivers may be made with tubes already available to radio experimenters.

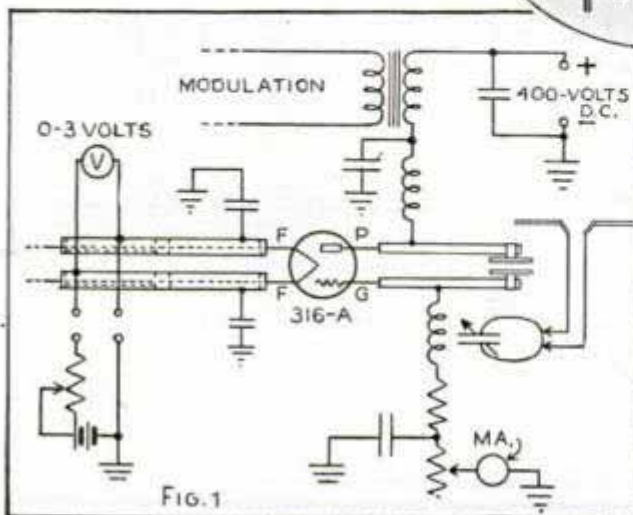

*Western Electric Co.
195. Broadway New York*

Self-Powered

By
R. C. Hitchcock



ANYONE can build this 6-tube a.c.-d.c. audio amplifier and use it to bring an old phonograph up to date. The only additional parts necessary

will be a magnetic pickup arm for your phonograph and a suitable permanent-magnet type dynamic speaker.

The unit consists of a 3-stage amplifier employing two new beam-power tubes that have real power-delivering ability. The undistorted high-quality audio output is $3\frac{1}{2}$ watts at a very low hum level.

Complete with built-in power supply, all parts are assembled on an 8 by 12-in. wood baseboard; the maximum height is $4\frac{1}{2}$ in. It can be operated on any 115-volt, 50 or 60-cycle a.c. line or on a 115-volt d.c. line if desired. This choice of operating current is unusual in an audio amplifier. There are no interstage transformers, power transformers or chokes in the unit.

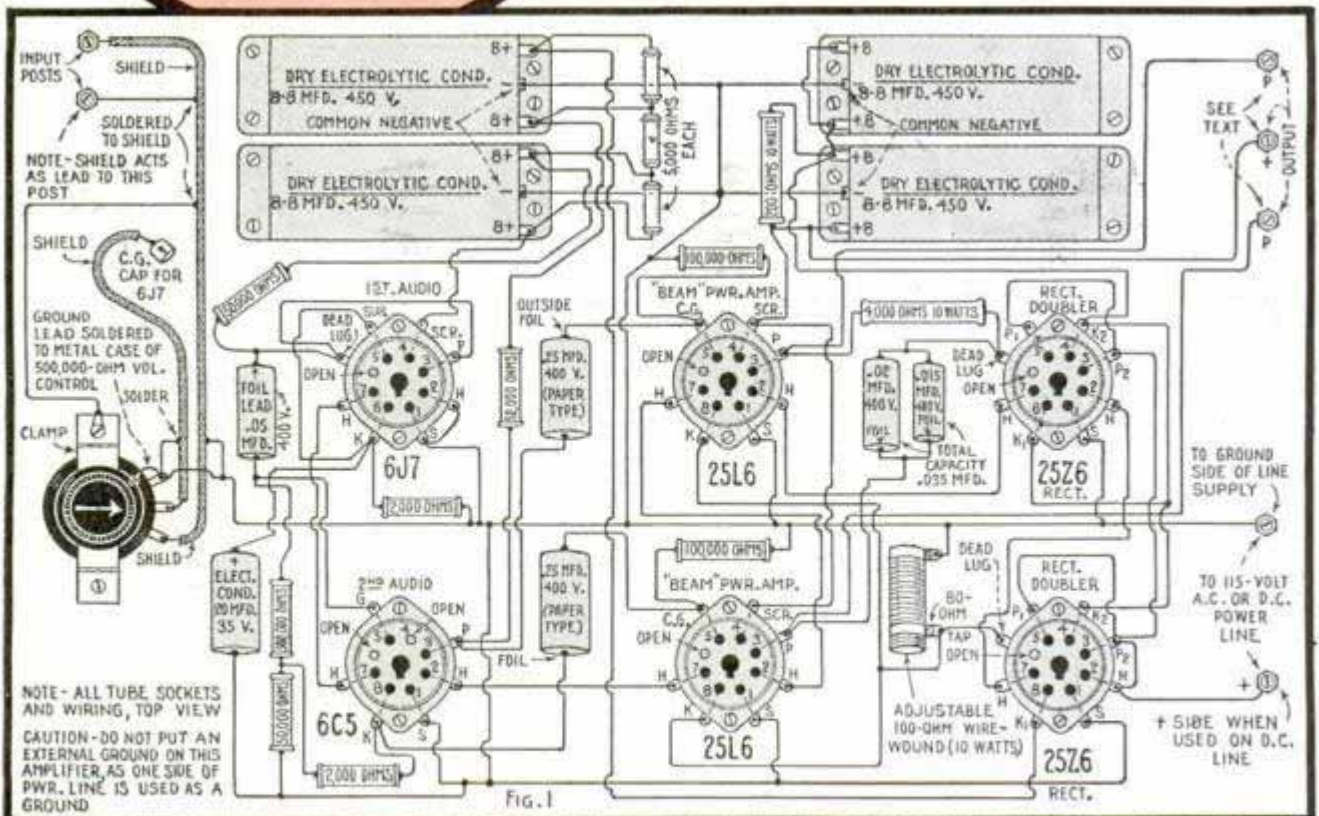
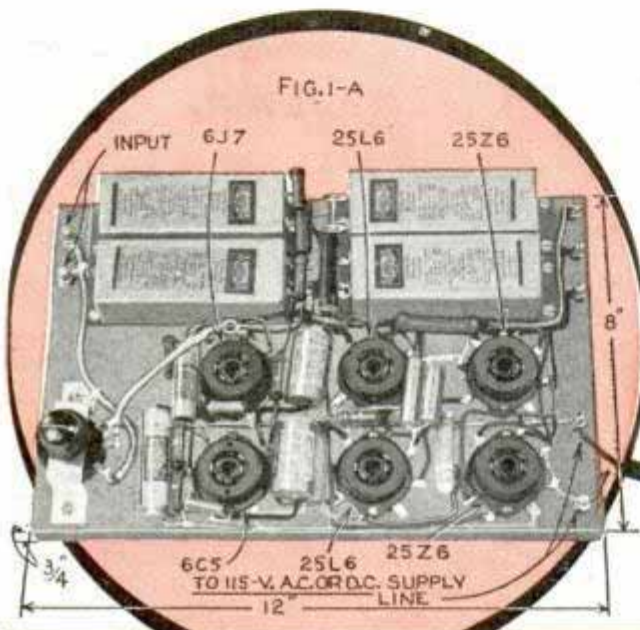

AUDIO AMPLIFIER

requires no transformers or chokes

The speaker, of course, comes with an output transformer on it, and this should have a center-tapped push-pull tube winding of from 2,500 to 3,000 ohms, capable of carrying 50 ma. of direct current each side of the center tap. Speakers of this type are available from all-parts houses at reasonable prices.

To install the amplifier in a phonograph console, it is only necessary to remove two of the record shelves as illustrated in the sketch. In some cases the speaker can be mounted on a small baffle board and installed in the horn opening. If this is not practical, remove the phonograph sound chamber and mount the speaker baffle on a shelf by means of angle brackets. A 2-conductor shielded cable should be used to connect the pickup arm to the input posts on the amplifier unit, the cable shield being connected to the common ground input terminal. It is important that no external ground of any description be used, since with a transformerless circuit the line voltage is one terminal.

A simplified wiring diagram of the complete amplifier unit is given in Fig. 1 and the schematic circuit diagram appears in Fig. 2. It will be noted that there are socket terminals for each tube which do not connect with any of the elements of the tubes. Such blank terminals make convenient places to solder wires which otherwise would be unsupported. Shielded leads must be used both for the volume control and the cap lead to the 6J7

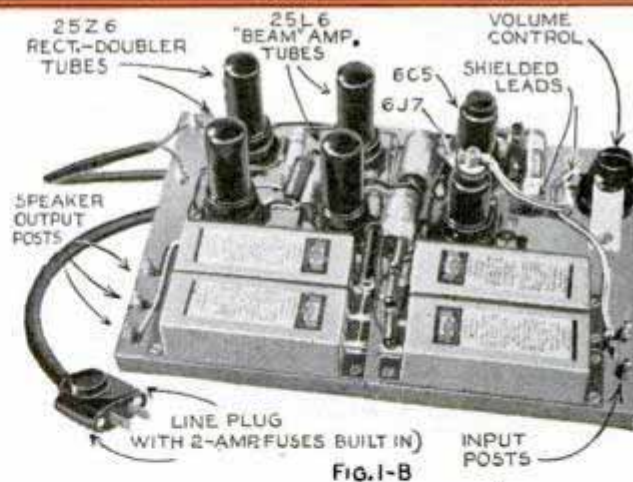

tube. In addition, the metal case and shaft of the volume-control potentiometer must be connected to the wire shields, and all connected to the common wire which runs to the ground side of the line supply. All tube heaters are in series.

Please note that one of the fixed resistors is 52,000 ohms; this unusual value is found by testing the three 50,000-ohm resistors specified in the material list. An ohmmeter will usually show one of these

(Continued to page 142A)

Homemade 'Cold Oven' Piezo Crystal Holders

By Calvin F. Hadlock

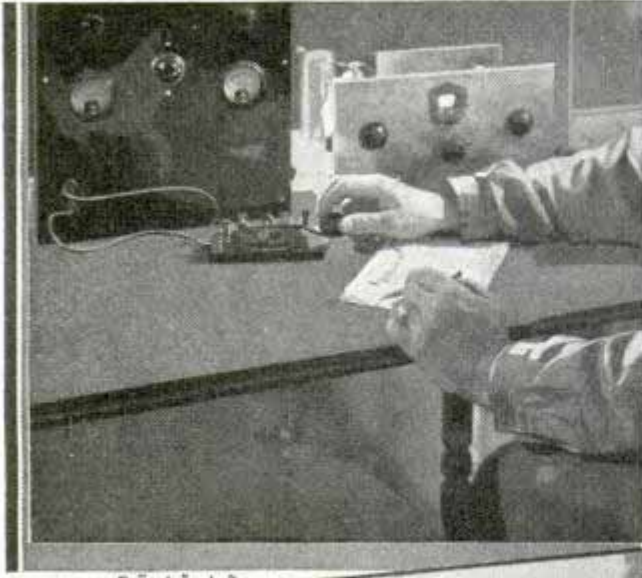

IN THE amateur transmitter of today, piezo crystal control is, without question, the best way to insure a perfect carrier that will not wander out of the band limits specified for amateur radio operation. Accurately ground quartz crystals are not expensive. However, most experimenters like to operate on several different bands and even at different points on the same band; in this case the problem of providing a suitable holder for each crystal often places a severe strain on the pocketbook.

The homemade crystal holders shown in photos Figs. 1 and 3, are not difficult to make and they include features not found in holders available to amateurs. As crystals operate on the calibrated frequency at normal specified temperatures, temperature-control ovens are employed in some climates to keep the crystals at the proper working point. Ordinarily this is not necessary in the amateur bands; however, when

operating on the 20 and 10-meter high-frequency bands a different condition is encountered which calls for some means of stabilizing the crystal frequency.

During a transmission of normal length on 20 meters, using a crystal in an ordinary holder, the carrier frequency will sometimes drift as much as 10 kilocycles; at 10 meters this drift is, of course, about 20 kilocycles. These holders are known as "cold ovens" because they stabilize the frequency and eliminate this drift without the use of a heater. The bases of the holders are solid blocks of copper $\frac{1}{2}$ in. thick. Copper being an excellent conductor of heat, this large slab "soaks it up" as fast as it is generated, thereby maintaining the crystal at practically a constant temperature.

Details for a single-crystal holder appear in Figs. 1 and 1-A; the multiple-type, Fig. 3, enables the operator to change quickly from one crystal to another. The single unit closely follows ordinary construction, with the exception of the copper

(Continued to page 146A)

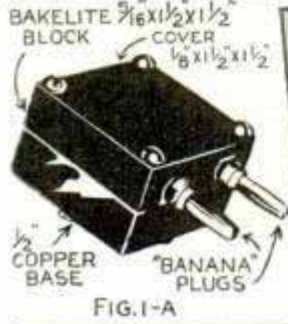

FIG. 1-A

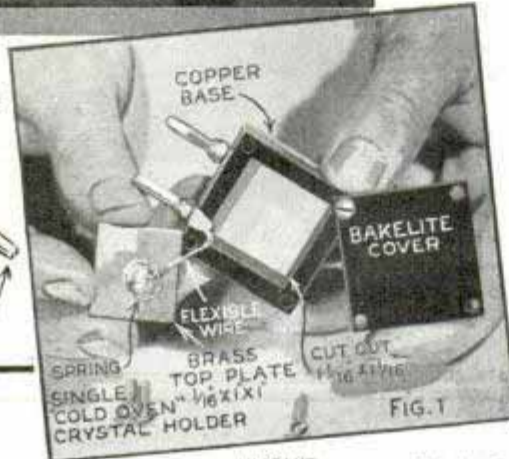

FIG. 1

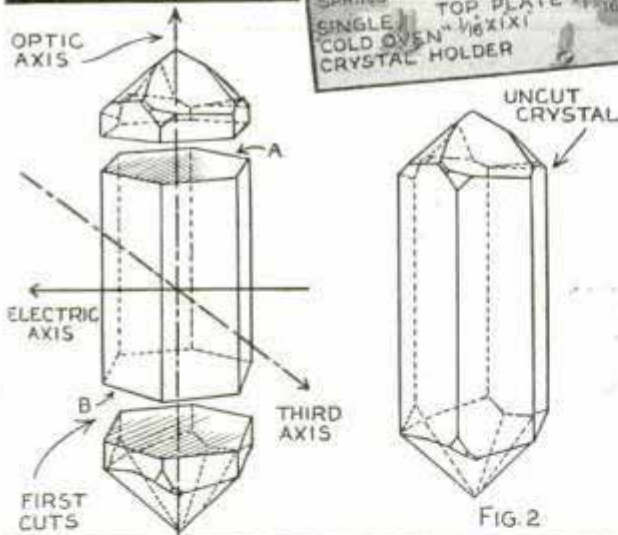

FIG. 2

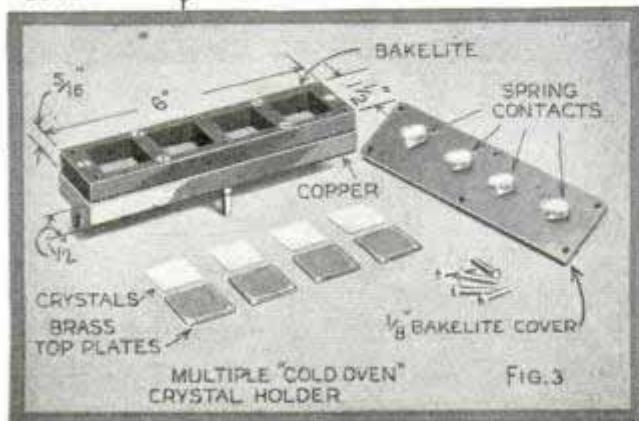
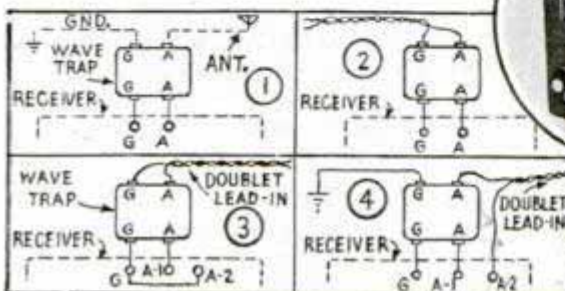

FIG. 3

Practical RADIO SUGGESTIONS

Any radio set owner can use this dual universal wave trap to suppress code and noise interference entering the receiver at intermediate frequencies between 400 and 475 KC.; at the same time, owing to dual control, it may be adjusted to eliminate interference from powerful near-by broadcasting stations. It is connected between the antenna and ground or doublet feeders, and the posts on your receiver, as shown below in Figs. 1, 2, 3 and 4



Right, sensitive circuit breaker protects costly tubes and condensers from accidental overloads. Below, extension shaft for tuning a short-wave receiver when body-capacity effects are troublesome

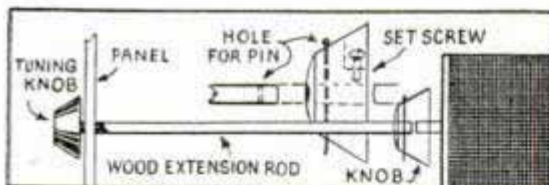

Below, neon tuning wand indicates current in r.f. circuits without any connection to the circuit; it provides an easy inexpensive method for adjusting any transmitter or receiver

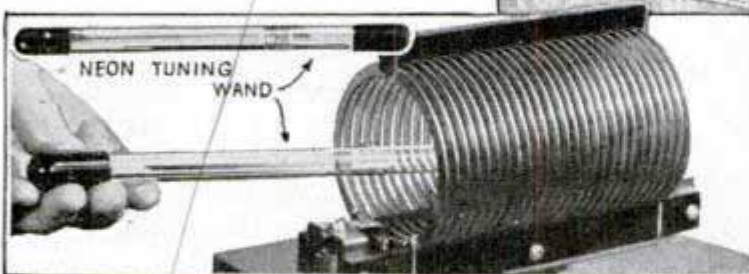

Right, receiver and large separate speaker installation suggested where space is at a premium. This compact set is placed in a wall niche at a suitable height for easy tuning; note speaker mounted in ceiling on small baffleboard which was backed with rock wool



Below, a simple method of safeguarding batteries in portable test equipment, transceivers or battery-operated receivers. A small block of wood is screwed to the cover of the portable case at a point that will prevent closing of cover until the toggle-type battery switch is in the "up" or "off" position. This little block of wood will prevent many cases of "run-down" batteries when such equipment is needed

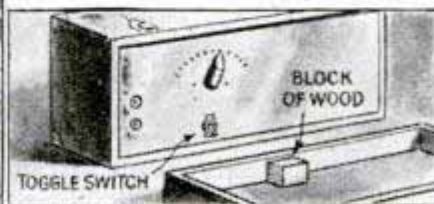

Toggle switch shown in the "down" or "on" position

Littlefuse Laboratories,
4507 Ravenswood Ave

Hemminger Electric Co. Trenton, N.J.

Radio Circuit Seen and Heard

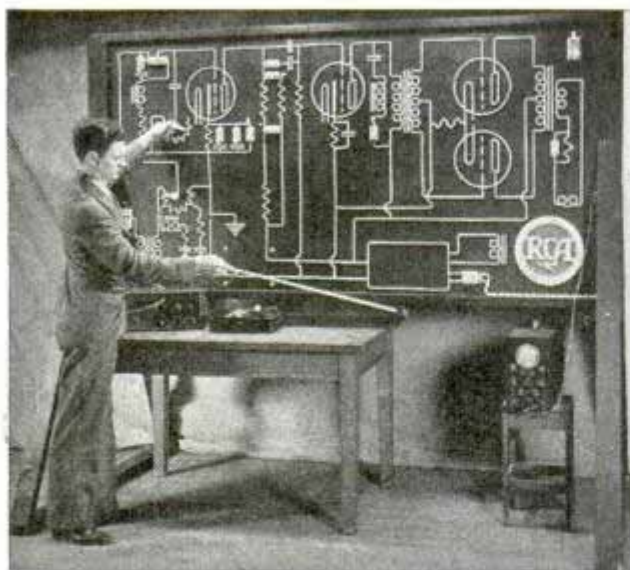

Demonstrating to students and servicemen, visually and audibly, the effect of different circuit conditions upon the output of an audio amplifier, this apparatus traces a continuous response curve on the screen of the cathode-ray oscilloscope shown below the loudspeaker which is mounted on the board at lower right. Knife switches and controls inserted in this schematic diagram make and break similar connections in the actual amplifier located on the rear of the board.

Heat Control for Soldering Iron

Now you can regulate the heat of your electric soldering iron to meet individual requirements. This heat-control unit pro-

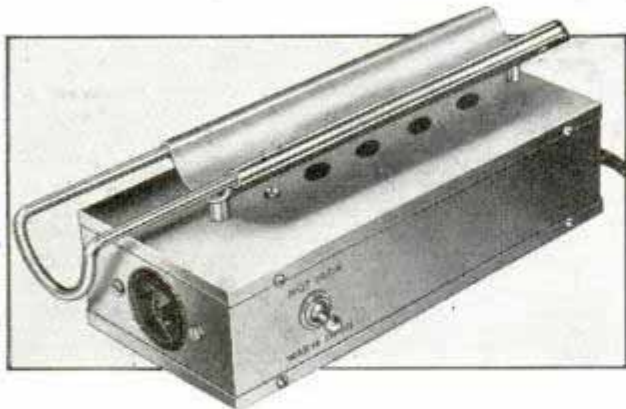

vides a rest, keeps the tip properly tinned and the iron at the right temperature. In the "down" position, the toggle switch enables the operator to maintain a warm iron at low cost; with switch "up" it is quickly heated and ready for use in a few moments. Claimed to double the life of an electric soldering iron, it is designed for use with any standard iron not exceeding 150 watts input, operating on 115 volts either a.c. or d.c.

Improved Punch for Socket Holes

No drilling of center holes is required to use this self-centering punch for making large holes in metal chassis bases to mount tube sockets and electrolytic filter condensers. The tool makes a clean round hole, as the cutting edges center them-

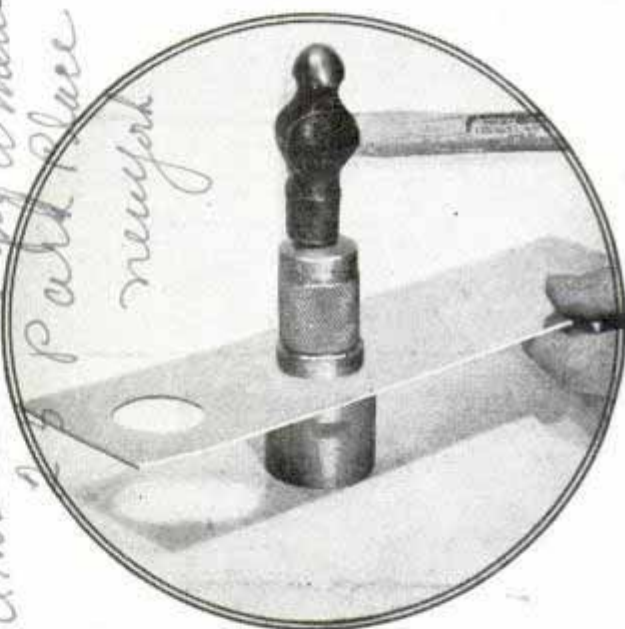

selves automatically when the head is struck with a hammer. It solves a troublesome problem for radio experimenters.

Blueprints covering radio construction articles in past issues are available for 25 cents each; original material lists and additional information can be obtained from our Radio Department without charge upon receipt of postage.

NEXT MONTH—How to Build a Low-Cost Call System. A small quick-heating a.c. unit with an output of 2½ watts; suitable for operating one or more magnetic speakers at remote locations. Handy between house and garage or for general paging purposes. Also, construction details for a **High-Fidelity Speaker Cabinet**

Make Electric Works 2656 Lincoln Av. Chicago

*Disinfective Carbide
Punch Place
new York*



NOVELTIES *in* WOOD

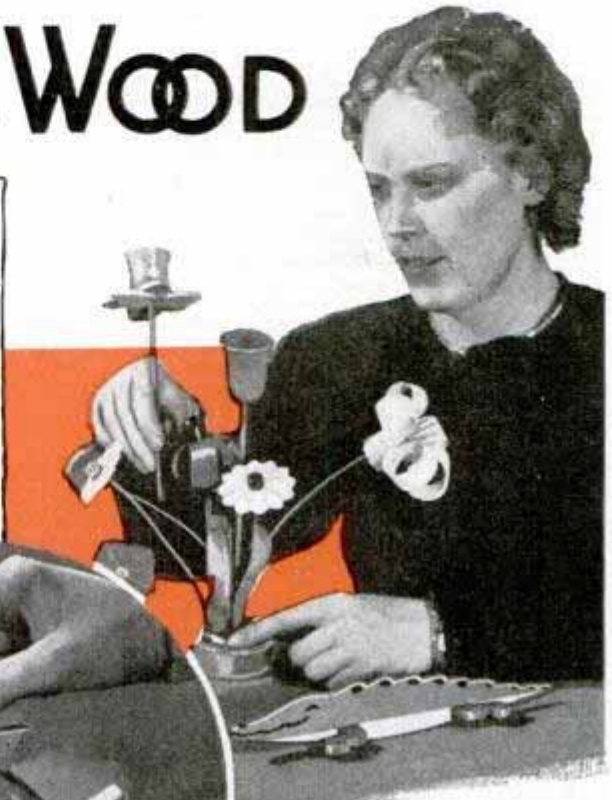
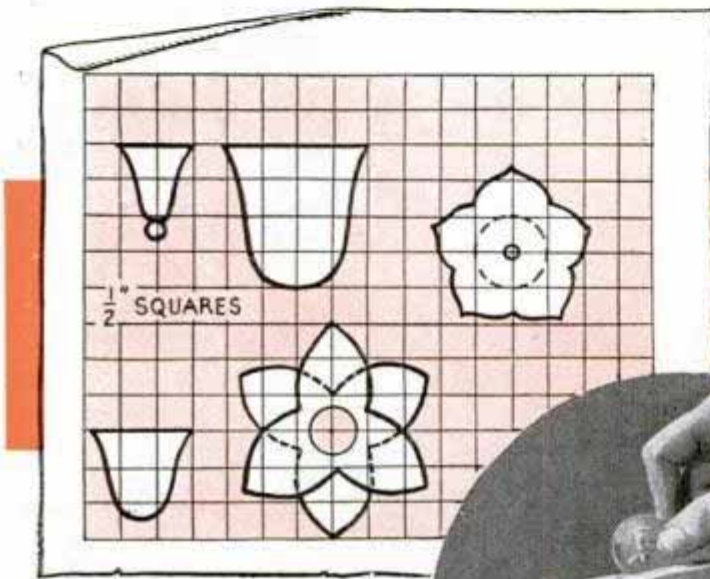

Each one has some useful purpose, is fun to make and profitable to sell

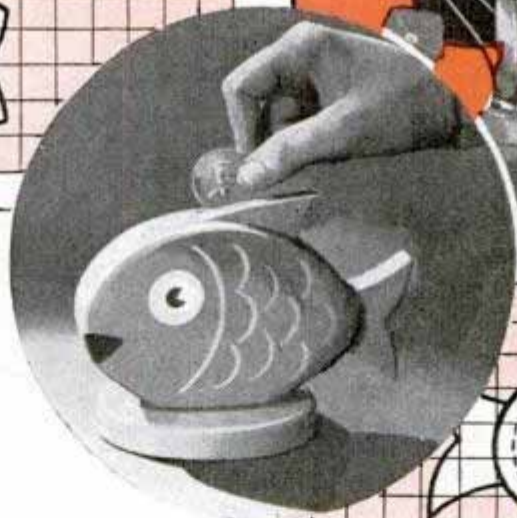

MADE from inexpensive woods and enameled or stained in bright colors, these novelties should prove profitable sales items. To form the flowers shown above, cup-shaped parts are turned in the wood lathe, and petals, imitative of many varieties, are sawed out of thin stock. Curved petals can be shaped from damp wood shavings stained to match the natural colors. Brads, nails, or tacks make realistic stamens, while stems can be made of dowel or stiff wire.

There's plenty of room between the scaly sides of the goldfish to hold nickels and dimes. Softwood, $\frac{1}{4}$ in. thick, is used for the sides, and $\frac{5}{8}$ -in. stock for the mid-

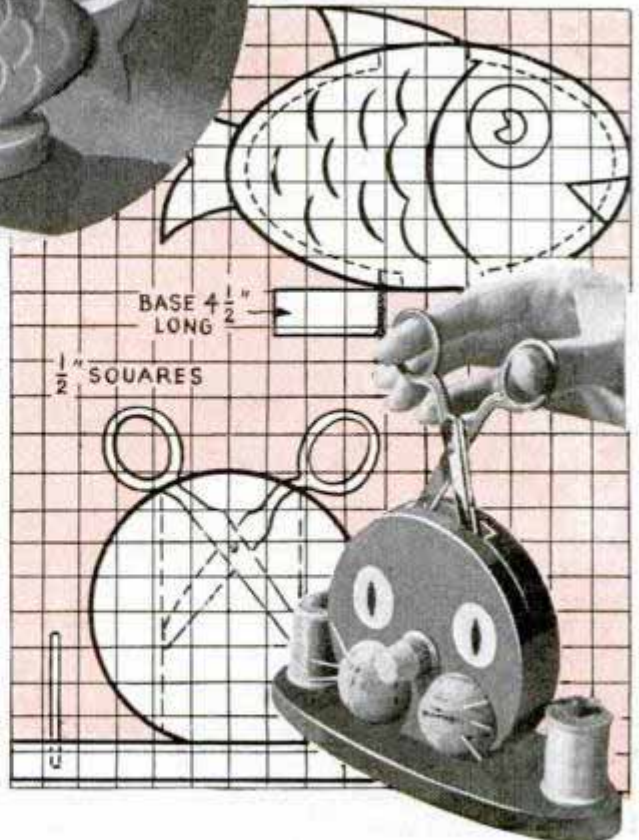



on $\frac{3}{8}$ and $\frac{1}{2}$ -in. stock, that is, all except the hands of the peasant girl which hold the candles. These are turned with an offset and recessed at the center to hold the lower ends of the candles firmly. The chef's "hands" are small hooks by means of which he patiently holds mixing spoons, ladles, saucepans and the like. His nose is a round bead. A small screw eye turned into the top of his cap provides a means of hanging him onto the wall. His white coat is kept buttoned with thumbtacks.

A rare species of cactus which thrives on the closet shelf, or in any nook or corner, makes an excellent hat rack and, without any damage to the "plant" you can also use it as a

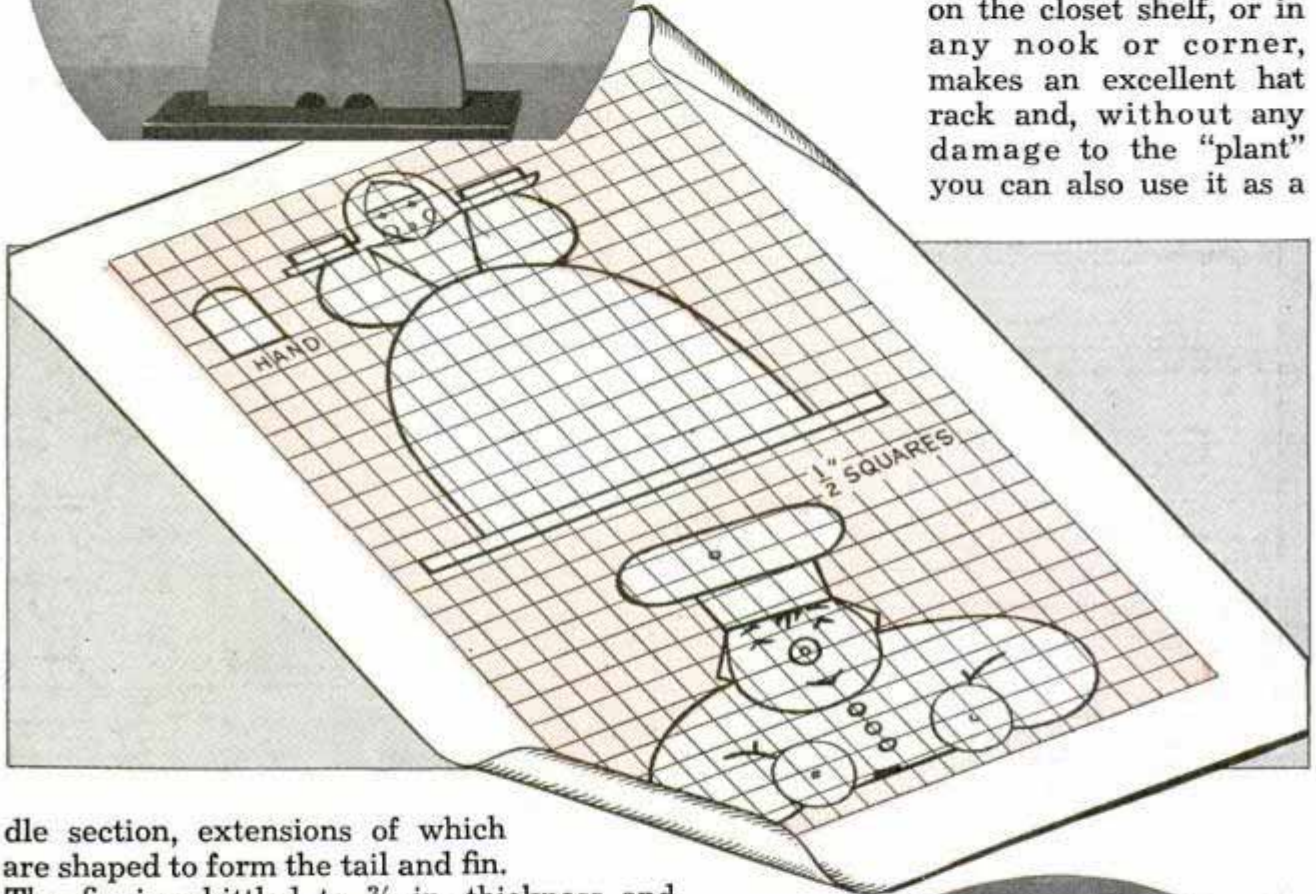

dle section, extensions of which are shaped to form the tail and fin. The fin is whittled to $\frac{3}{8}$ -in. thickness and slots 1 in. long are cut on each side for inserting the coins. The base is sawed and sanded from $\frac{5}{8}$ -in. stock and the fish is fastened to it with two screws driven up from the underside. Only by removing the two screws can you reclaim the coins. The sewing kit is the same type of construction, except that $\frac{3}{8}$ -in. stock is used for both the head and base. A $\frac{5}{8}$ -in. dowel tapered and glued to the face where the nose ought to be, holds the thimble and the halves of a round cork fishing float glued to the face on each side of the nose provide pincushions, the pins representing the whiskers. A $\frac{1}{4}$ -in. dowel in each end of the base holds spools of thread.

The peasant girl holding the candles and the jovial chef are just simple scroll-saw jobs

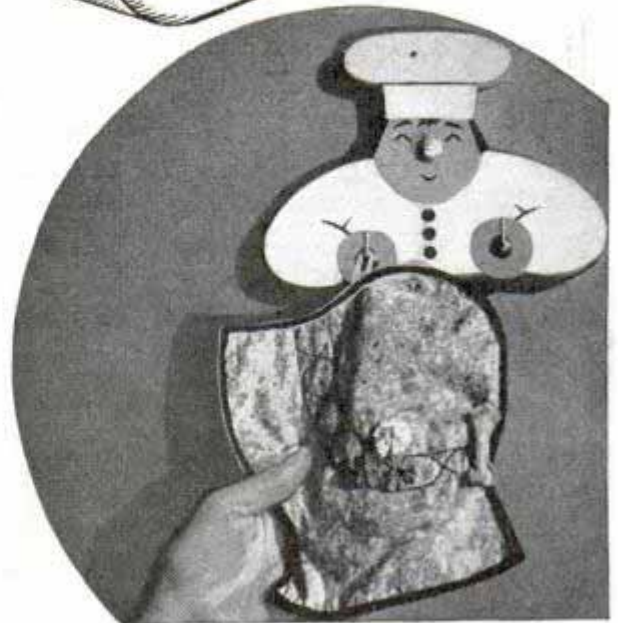

rack for necklaces, bracelets, or even pretzels in the proper setting. It's made of wood, of course, the pot and base being turned in one piece. The "watch dog" is handy for holding your watch in an upright position, making it easy to see the time. The morning-glory "blossom" is just another version of the same idea. And lastly, the fat pig finds himself growing thinner each time you use cord from the ball that forms his body. However, there is nothing he can do about it until you fit him out with a new ball of twine. Two round pieces of wood make up his face, while a twisted wire provides a tail.

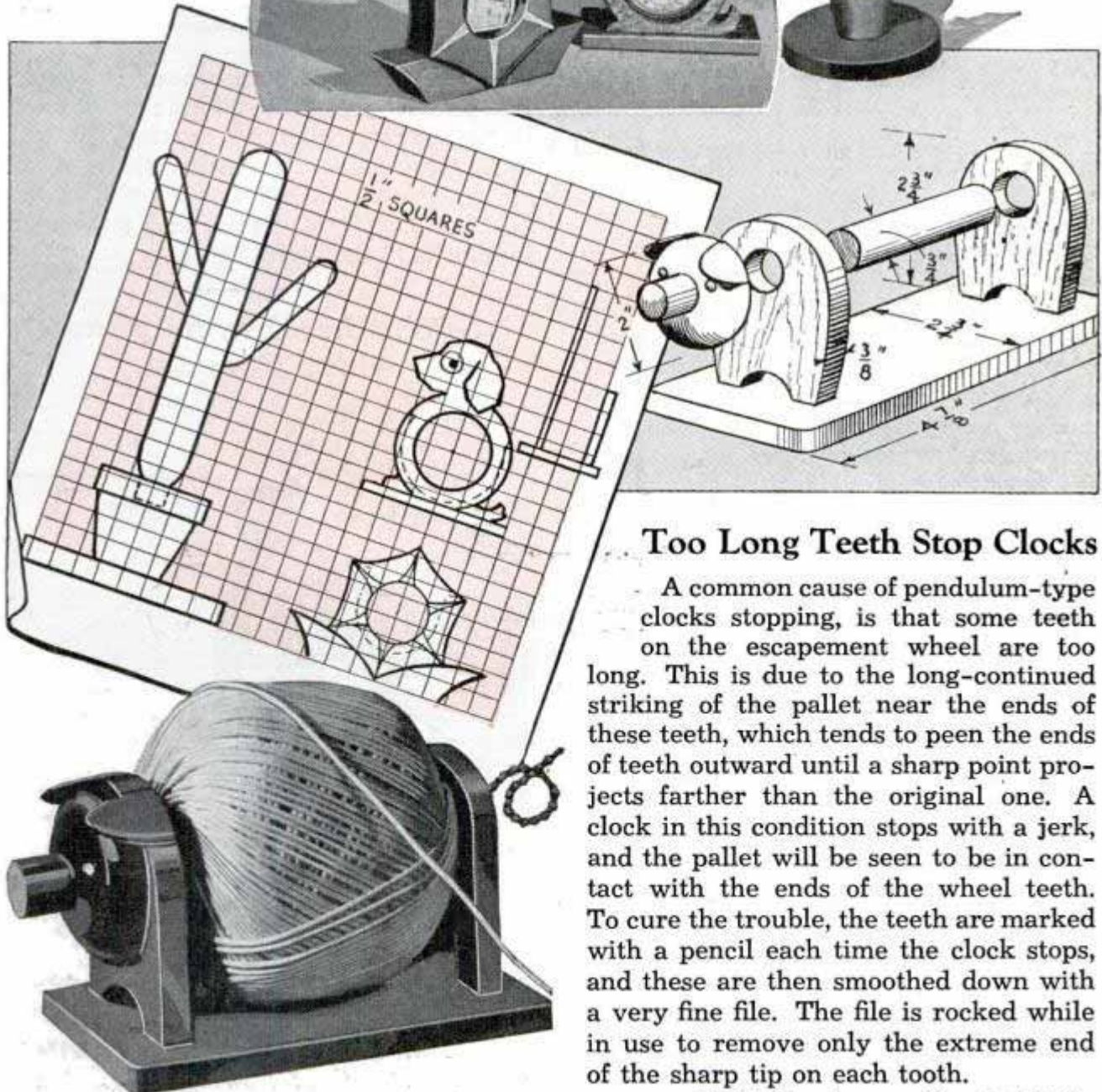
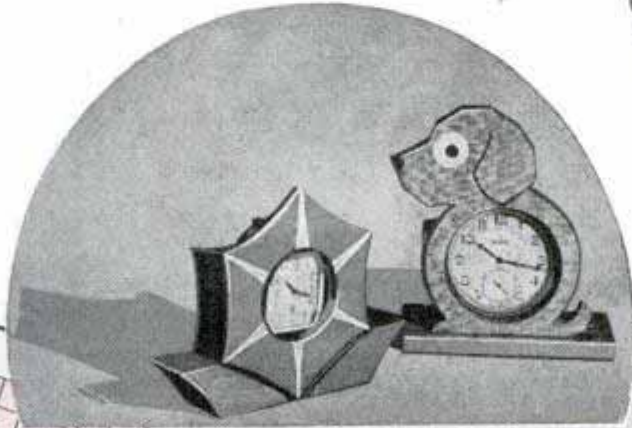

Too Long Teeth Stop Clocks

A common cause of pendulum-type clocks stopping, is that some teeth on the escapement wheel are too long. This is due to the long-continued striking of the pallet near the ends of these teeth, which tends to peen the ends of teeth outward until a sharp point projects farther than the original one. A clock in this condition stops with a jerk, and the pallet will be seen to be in contact with the ends of the wheel teeth. To cure the trouble, the teeth are marked with a pencil each time the clock stops, and these are then smoothed down with a very fine file. The file is rocked while in use to remove only the extreme end of the sharp tip on each tooth.

—E. T. Gunderson, Humboldt, Ia.

Pivoted "Spikes" Hold Toolbox Level on Sloping Roof



This toolbox rests level on a roof when the pointed legs are swung down

By pivoting a pair of spikes, made from small iron rod, to the side of the toolbox, it can be set on sloping surfaces. The spikes, when not in use, rest out of the way on a screw hook driven into the side of the box. When swung into position to support the box horizontally on a sloping surface, they snap into notched metal clips which are screwed onto the underside of the box at each end.

Jig Fitted with Friction Catch Speeds Production Work

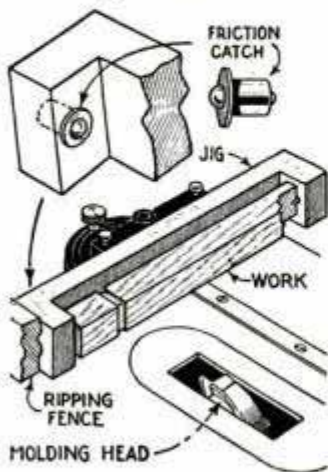

When finishing duplicate pieces of work on a circular-saw molding cutter, this jig, screwed to the miter gauge, will enable you to remove or insert the work rapidly. The jig is made of wood as shown, and is fitted with a pointed screw at one end and a friction catch at the other, which serve as centers to support the work. The spring-contained catch bears against the

end of the work with sufficient pressure to hold it firmly. Aside from saving time, the jig is positive, resulting in accurate duplication of identical pieces.

Hinged Boat Seat Is Turned Over to Protect Cushion

Although a little upholstering would make the rowing seat of most boats much more comfortable, padding of any kind is discouraged on account of the weather, as the rain and sun would soon make it anything but pleasant to use. However,

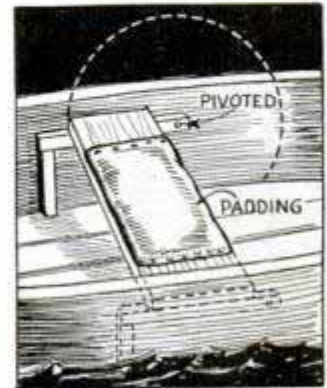

it is practical to use a padded seat if it can be turned over when not in use. The seat is merely mounted on stringers, or wood strips, which are hinged to the side of the boat at the forward ends and supported by blocks at the other.

Five-Point Star Drawn Accurately with a Compass



You can draw a perfect five-point star of almost any size desired by using this method

The next time you want to make a five-point star, try the following easy method: Draw a vertical line on the paper and, be-

ginning at the top, make five dots on the line, spacing them a distance equal to about $\frac{1}{8}$ of the dimensions of the star desired. Then draw a horizontal line at right angles to the vertical one, crossing it at the intersection of the third dot from the top. Now, using the next dot below as a center for a compass, make a circle having a radius to intersect the dot at the top of the line. Next draw the straight lines from the intersections of the horizontal line and edge of the circle across the lower dot to the lower edge of the circle. The star is completed by drawing two lines from these points to the upper dot.

Sheet-Metal Guard on Outboard Motor Shields Against Splashing Water

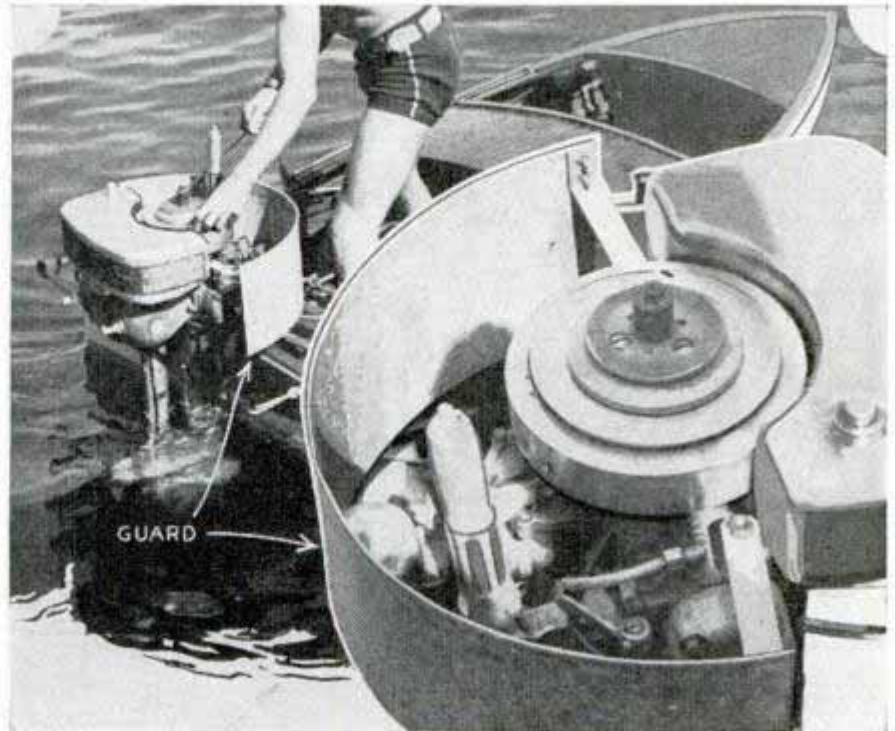

This splash shield is bent around the front of an outboard motor and is fastened to the cylinder-head bolts

Paper Bags "Tied" without String by Folding Top

Three folds will close the mouth of a paper bag and provide a good grip without using any string. The first fold is made at a 45° angle at one corner, after which the other two are made by bending down the corner of the bag and turning it under the first fold.



By making the three simple folds shown above, the mouth of a paper bag can be closed tightly

If you have ever been bothered by water splashing up and "drowning" your outboard motor, here is a guard that will help stop the trouble. Made from a strip of galvanized sheet iron 10 in. wide, the guard is bent to a half circle and is fastened to the motor by means of short pieces of flat iron riveted to the metal and slipped under nuts of the cylinder-head bolts. A third piece of flat iron in the center of the guard slips under a nut on the carburetor.

—John Thomson, Hollywood, Calif.

Watermelons "Plugged" Neatly with Altered Trowel

To "plug" watermelons quickly and neatly, just take a small hand trowel and bend the sides downward at right angles. Then grind the edges of the blade sharp, bringing them to a point at the end.



in walnut or maple

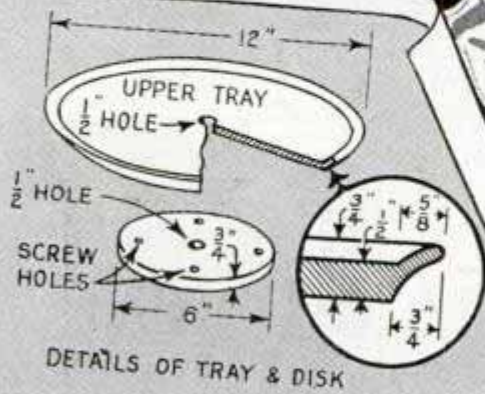

WALNUT, LINSEED-OIL FINISH

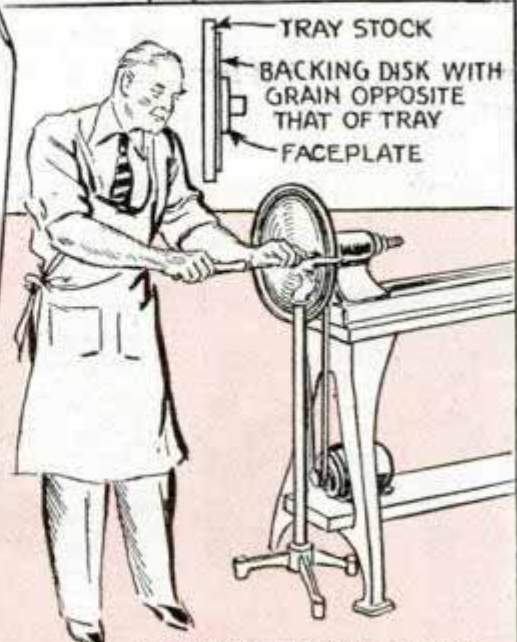
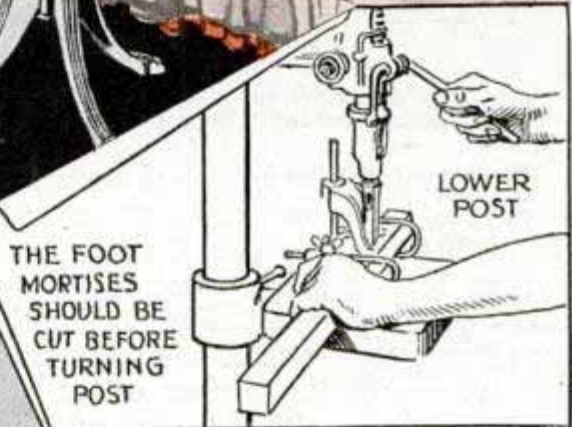
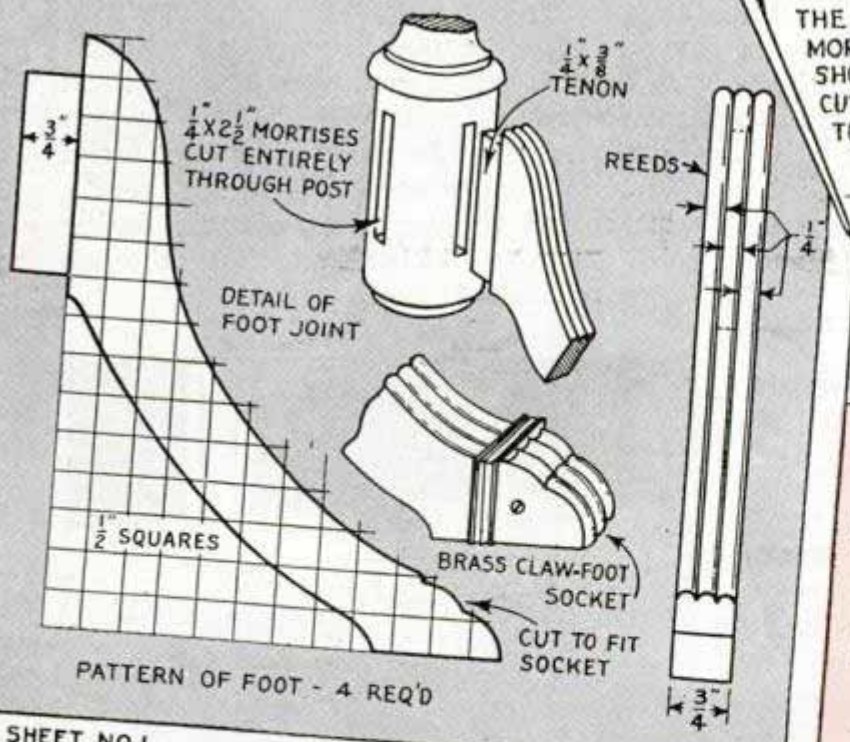
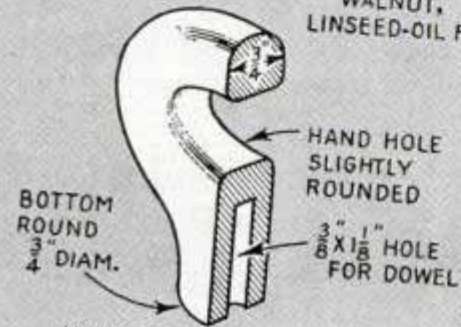

SHEET NO. 1
POPULAR MECHANICS MAGAZINE
200 E. ONTARIO ST. CHICAGO

BLUEPRINT No. SN 964

Bucket Tipped by Hook on Rope When Bailing Cisterns

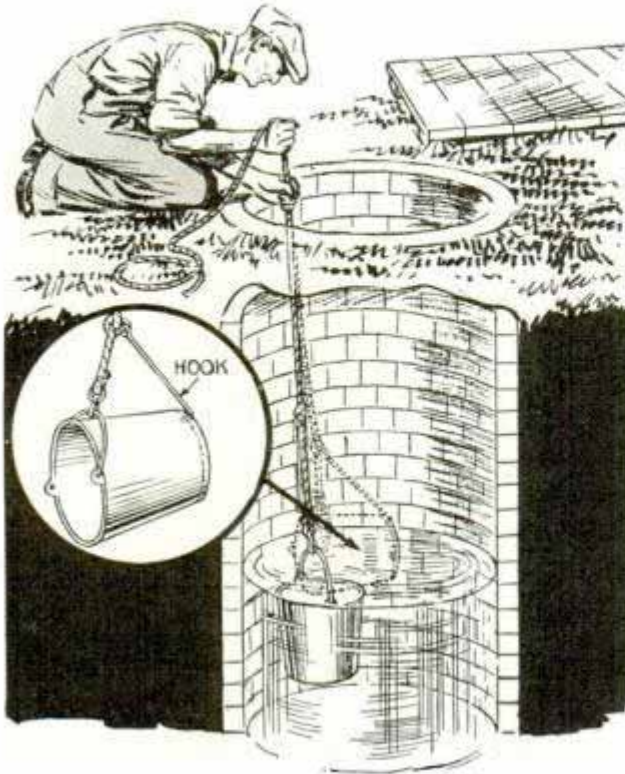

This hook holds bucket horizontal for quick filling, after which slackening the rope releases it

When water is to be bailed from a tank or cistern, it will not be necessary to jerk the bucket about to fill it if a long hook is knotted loosely in the rope at the point indicated in the detail. The hook will engage the bottom rim of the bucket when it is lowered to the surface of the water, holding it in position to be submerged quickly. A slackening of the rope from above releases the hook so that the bucket can be lifted.

Sink Stoppers Provide Covers for Chemist's Jars



Instead of employing large corks or screw caps to seal many of the jars in his laboratory, one experimenter uses rubber sink stoppers. These are of size suitable for jars of various

kinds and are heavy enough to seal ordinary dry chemicals, as well as some liq-

uids, against air or dust. Besides, they are easily removed so that little time is wasted in giving access to the contents.

Coat Hanger Suspends Hip Boots for Drying Quickly

Although usually stored right side up and folded over, hip boots should be kept inverted at full length to prevent rotting and cracking of the rubber at the fold creases. This can be done easily by bending a wire coat hanger to the shape shown so that the cross bar will engage the boot heels. The hanger is suspended from a hook in a storeroom.



Ventilator for Shop Window Made from Curtain Rod

To allow fresh air to enter a shop or garage window in small and easily controlled amounts, why not install a three-hole sliding ventilator which is cut from two pieces of telescoping curtain rod? Punch these with corresponding holes and bend the narrower one to provide a finger grip by which it may be pushed back and forth. When the wider section is tacked over a slot cut in the window sash, the inside piece may be slid back and forth to open or close the vent as desired.

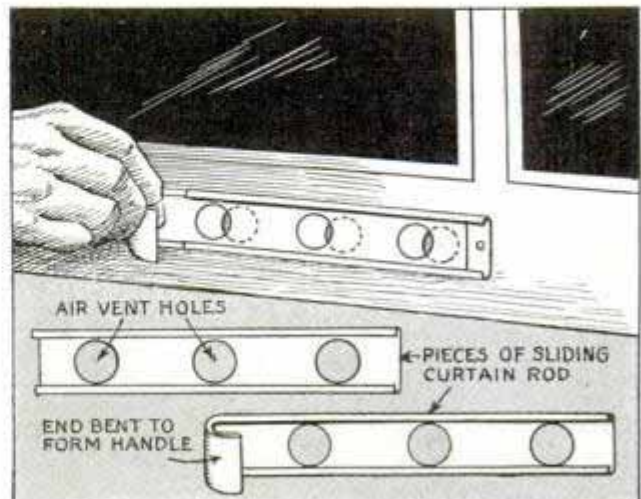

A short piece of flat, telescoping curtain rod is all you need to make this window ventilator

This PACK "SADDLE" fits your back

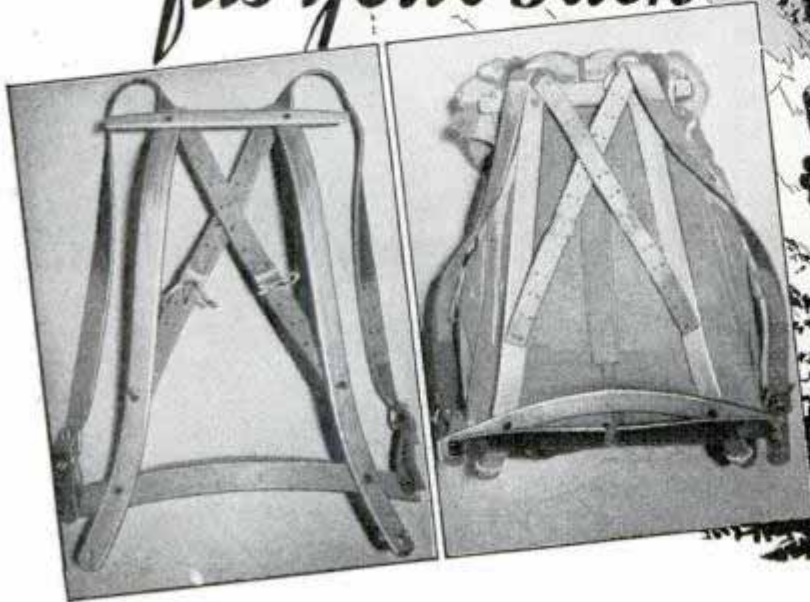

The pack sack is supported on a wood frame that you can easily "tailor" to suit your own individual build

HERE'S a pack saddle that can be made to fit just like a glove, and it's designed to give an equal distribution of weight from the shoulders down. The back, from shoulders to hips, carries the load, as you'll see from Figs. 1 and 2, all of which means relief from binding and chafing at the shoulders. You can walk naturally—no "leaning into the harness" to carry a heavy load.

The frame, a four-piece affair, is made from white ash of the general dimensions given in Fig. 5. These can be varied, of course. If you cannot get selected white ash for the frame, white oak will do. The side pieces of the frame have an "S"-shaped curve combined with a slight twist. The exact shape of this curve depends on the individual build and cannot be given exactly. However, you can get a pattern of your own back easily by simply bending a piece of heavy wire to fit, allowing about 1 in. clearance over the shoulder blades and exaggerating the flare at the hips. Measure the distance from the top of the shoulder blades to the belt and cut the side pieces about 8 in. longer. Now, using the wire as a pattern, you make bending cauls for the side pieces and the cross piece at the hip, as in Fig. 4.

Bend the wood as in Fig. 3, wrapping it in a piece of cloth and then pouring water on it in a continuous stream. In a short time the wood will be flexible enough to bend readily.

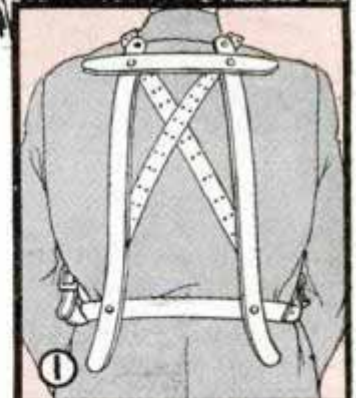

Vertical members of the saddle are curved and joined to cross members in such a way as to distribute the weight of the sack uniformly from the shoulders down

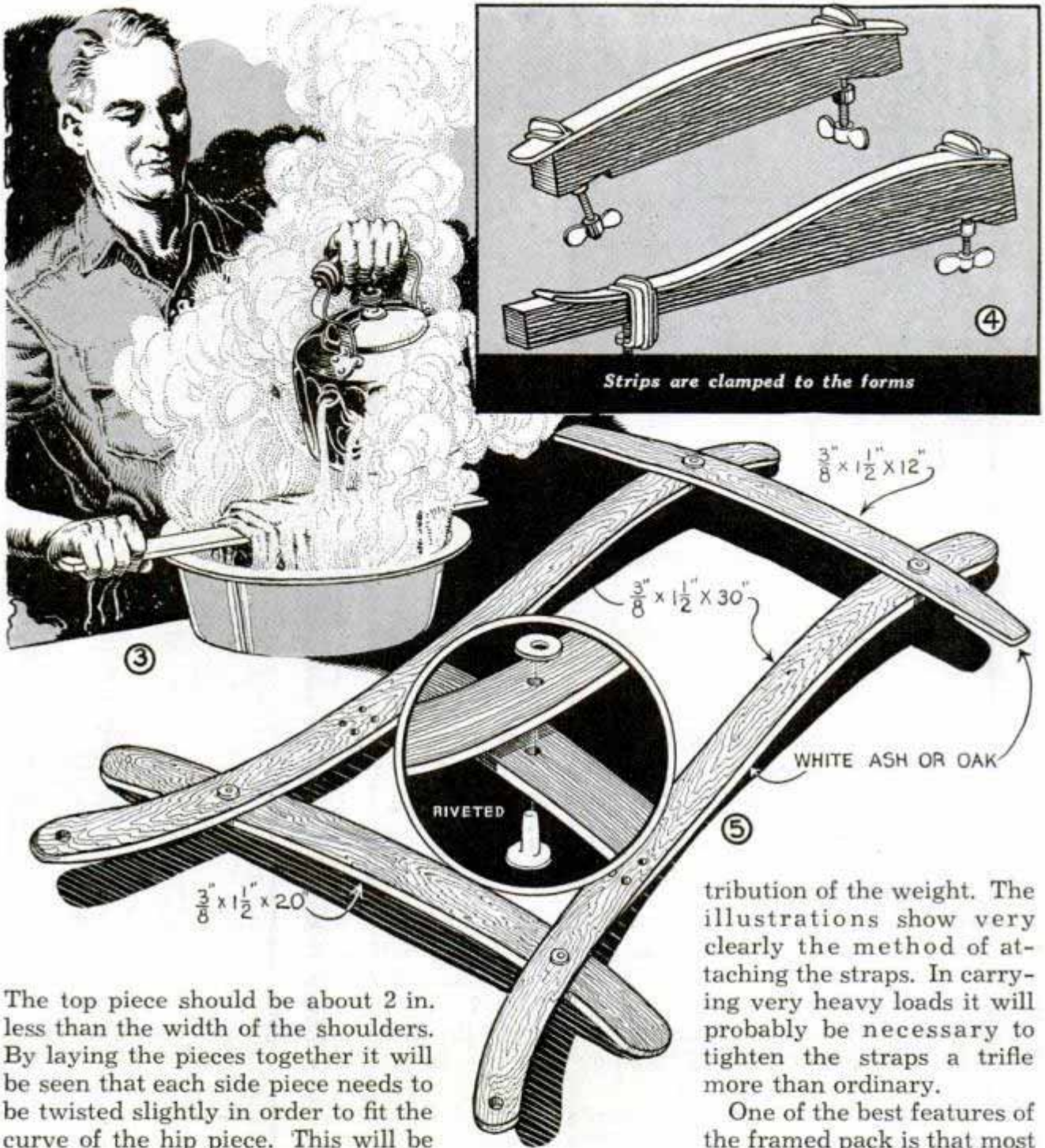

The top piece should be about 2 in. less than the width of the shoulders. By laying the pieces together it will be seen that each side piece needs to be twisted slightly in order to fit the curve of the hip piece. This will be taken care of when the parts are riveted together. After bending, give all pieces a thorough sanding and apply a coat of shellac or linseed oil. Follow this with spar varnish, and rub smooth with fine steel wool. Now assemble the parts with copper rivets. The tops of the side pieces are separated about 4 or 5 in., the shoulder piece being fastened on about 2 in. below the top ends. The side pieces are then steamed lightly and riveted to the hip piece, which must be placed low enough to be tipped downward by the flare of the side pieces. The position is important as it is this piece that effects an equal dis-

tribution of the weight. The illustrations show very clearly the method of attaching the straps. In carrying very heavy loads it will probably be necessary to tighten the straps a trifle more than ordinary.

One of the best features of the framed pack is that most any kind of a sack can be lashed to it. The sack shown is one that has been found practical for average use. The bottom is about 6 by 16 in. but the sack is cut so that the top is 16 in. square. A drawstring threaded through grommets closes the top of the sack. The back is made of one piece and has a large pocket with flap, while the front, sides, and bottom are cut from one piece and sewed to the back. For fastening to the frame, loops of webbing are sewed to the sack and these are in turn lashed to the frame by thongs. All leather parts should be softened with neat's-foot oil.

Bottle Stopper Locks with Key

Bottles of poison, acids, corrosive liquids, etc., can be locked safely with this stopper so that the contents will not be



accidentally used by children or adults. Just take a combination rubber and metal stopper of the plunger type, which is often used in opened bottles of carbonated beverages,

and slip a tiny butt hinge under the head of the plunger, first drilling holes in the hinge for the shackle of a small padlock.

This Folding Coat Rack Hangs from Picture Molding

Folded flat into little space, a number of these coat racks may be kept on hand either in homes or offices to accommodate garments of social gatherings or business meetings. Salesmen and tourists who travel "heavy" will find it convenient to carry a couple in their trunks. The rack can be hung from any picture molding. For use on average walls, it should be from 2 ft. to 2½ ft. long, with an arm 1 ft. long.

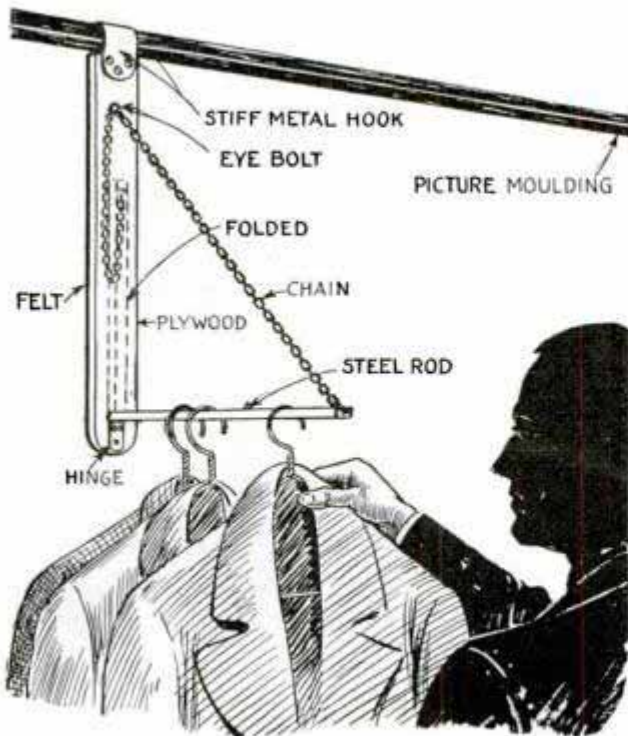

A few of these racks kept on hand will accommodate many garments at large gatherings

Try Square Serves as Miter-Box Stop to Cut Sharp Angles

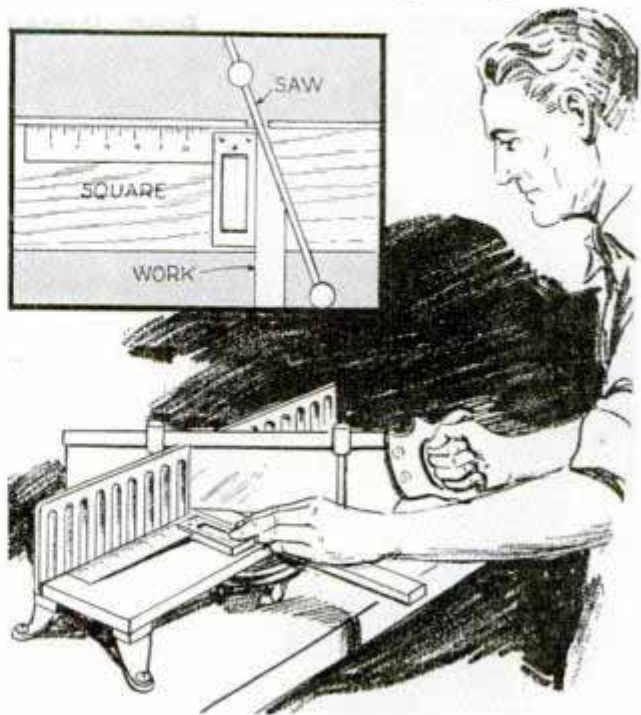

By using a try square to aline work at right angles to a miter box, cuts of almost any angle are made

When it is necessary to cut work in a miter box at a greater angle than 45°, the following method will be helpful. Place the work in the box at right angles to the bed and hold it in alinement with the aid of a try square as shown. With the work held in this way, the saw can be swung to cut almost any desired angle.

—Wayne C. Leckey, Aurora, Ill.

Flame Shield for Bunsen Burner Made from Flowerpot

I have found that a medium-size flowerpot provides a dandy flame shield for a bunsen burner in my chemical laboratory. Besides protecting the flame against drafts, the pot affords a rigid and convenient support for dishes, crucibles, triangles, etc. The bottom of the pot, which is turned upside down over the burner, is removed and a notch is cut in the rim of the top to straddle the burner hose.

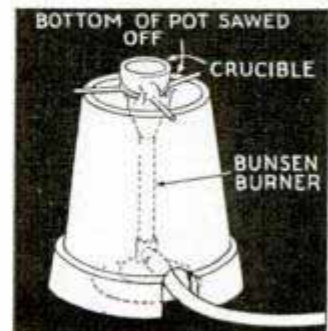

—Geo. Vias, Chicago.

Out with the



①

OVER two hundred million dollars of damage to clothing, bedding, carpets and furniture, is the annual moth toll. Of the three common kinds of moths generally seen, the most harmful one is the webbing clothes moth—a little buff-colored one having a wingspread of about $\frac{1}{2}$ inch. It is not attracted to light like the others but flits around in the darker parts of the room, just beyond the range of lamp illumination.

In houses kept scrupulously clean, there are still numerous places where moths can

conceal themselves and live for several months. They readily get in tiny floor cracks, under and behind baseboards and similar places where they can feed on lint and hair from pet animals. Later, while you're sleeping perhaps, they will find their way into clothes or upholstered furniture where considerable damage may be done before it is detected. An adult moth at the flying stage is practically harmless and rarely lives longer than a month. But the eggs—averaging about 100 per moth—are laid right in the folds of a fine woolen dress, suit or other material (See Fig. 2) and these hatch into tiny worms or larvae, which do the damage. Larvae feed upon wool, hair, fur, feathers and materials manufactured from them until they are large enough to form cocoons, from which more moths emerge. So every moth killed helps to reduce infestation.

The best method of preventing the hatching of eggs is to brush thoroughly, air and sun at monthly intervals, all arti-

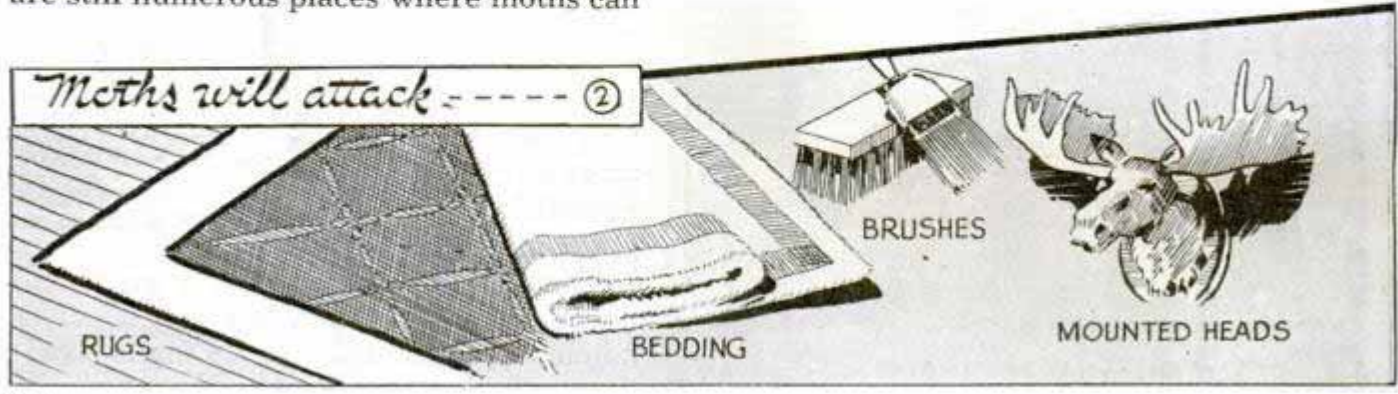

MOTHS!

cles that are subject to attack, as in Fig. 1. Fortunately the eggs are extremely fragile and that's why a thorough brushing and rubbing will generally destroy them. This is also the reason why clothing that is worn frequently is not infested. The brushing of articles should be thorough, especially at the seams and folds and places subject to perspiration. Dry-cleaning and washing garments and blankets thoroughly will remove all traces of moth eggs and larvae, except the tell-tale holes in case damage has been done.

For garments that are to be stored away for a season, something more than brushing is required to be reasonably safe. Should any of the tiny eggs remain undestroyed, damage may result. There are three common and inexpensive materials on the market, available to everybody and any one of these, under proper conditions, will destroy moths in any of the stages. They are naphthalene flakes or balls, (moth balls) paradichlorobenzene flakes and gum-camphor chips. Paradichlorobenzene has a more pleasing odor and is less persistent than naphthalene so that traces of it are soon gone. Its cost is a little more than that of naphthalene. The odor of none of these preparations is a deterrent to moths, as commonly believed, but the fumes which are slowly given off, will, in sufficient concentration, destroy them. A quantity of about 1 lb. of any of the materials referred to must be used for each 6 to 8 cu. ft. of space, which must be sealed to prevent the escape of the fumes. However, protection

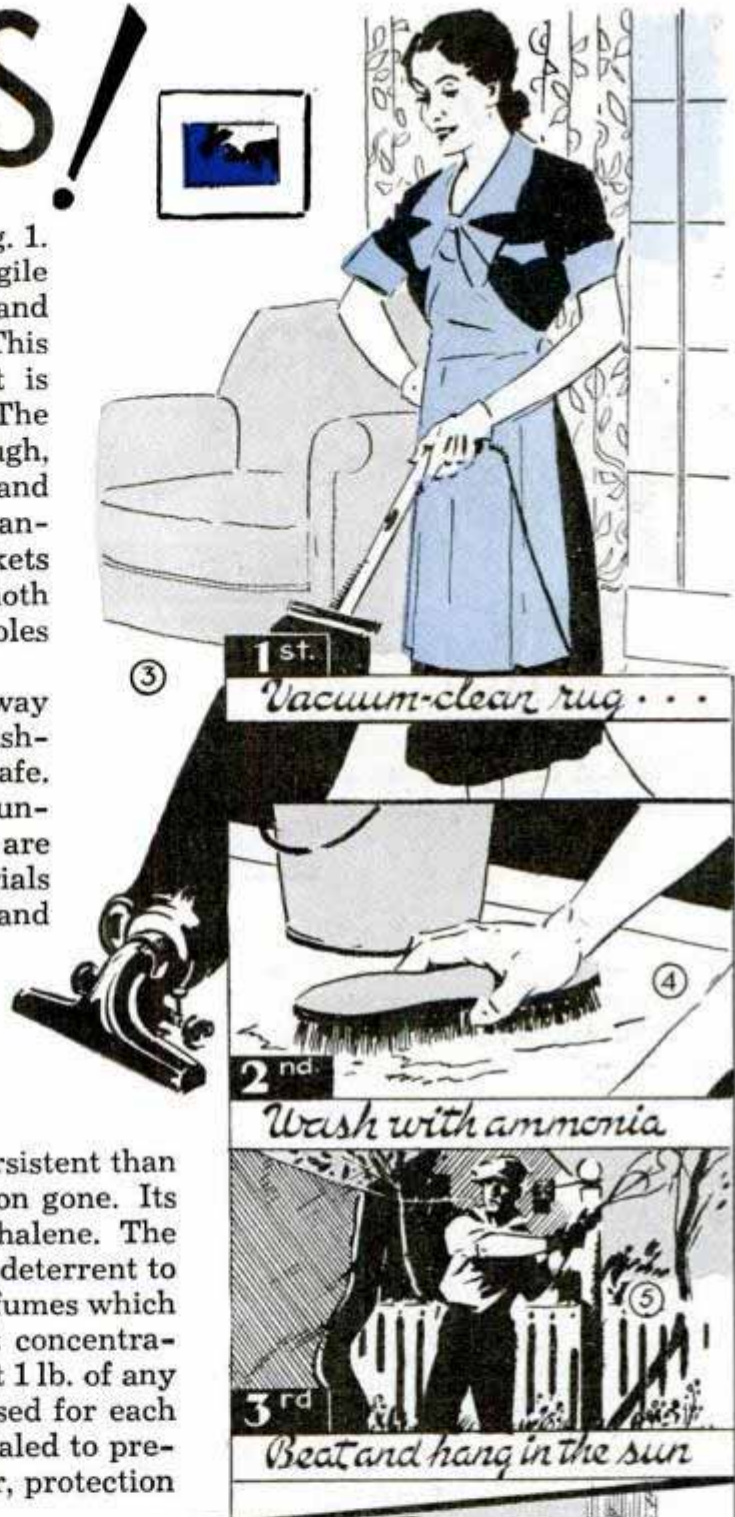

PIANO FELT



CLOTHING

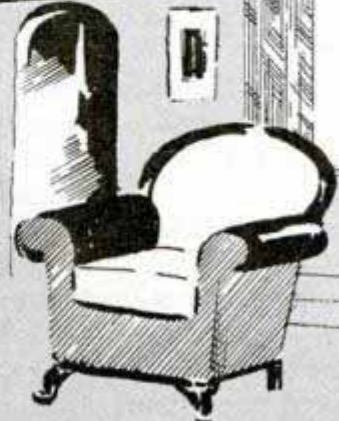

UPHOLSTERED FURNITURE



Storage compartment built in clothes closet



is assured only as long as the preparation emits fumes, unless the container is sealed tightly so moths cannot get inside. Small articles, such as fur-lined gloves, caps, etc., may be stored conveniently in glass or metal containers as suggested in Fig. 10. For larger garments heavy paper bags which are completely sealed with gummed tape generally prevent the entrance of egg-laying moths and retain the fumes for a time. Wrapping with heavy paper, taking care to fold and seal all edges, is equally valuable. The beliefs that newspapers have special virtue because of the ink and that tobacco keeps moths away, are apparently unfounded. Clothing stored in a closet may be protected by partitioning the closet, as in Fig. 6, and sealing all crevices and cracks in the wall, baseboard and floor with plastic wood putty. Before sealing garments in the closet, as in Fig. 9, they should be brushed thoroughly and hung in the sun. As an added precaution, a pad soaked in carbon tetrachloride, as shown in Figs. 7 and 8, should be hung at the top of the storage compartment. The fumes of this chemical are heavier than air and therefore settle to the bottom.

"Mothproof" paper bags of various types, which are on the market, are often impregnated with tar or pine and cedar oils.

According to the U. S. Department of Agriculture, (Farmers' Bulletin No. 1353) such bags are just as effective as ordinary bags made of plain paper, but only if properly sealed. The value of any bag as protection against moth infestation ceases as soon as it is torn, even slightly, or if it is left unsealed. For sealing, gummed tape is best.

Cedar chests are only effective when they are tight and contain volatile oil in the heartwood, the fumes of which destroy moths in all stages. The cedar should be at least $\frac{3}{4}$ in. thick. Thin linings such as are sometimes used in chests and closets, and

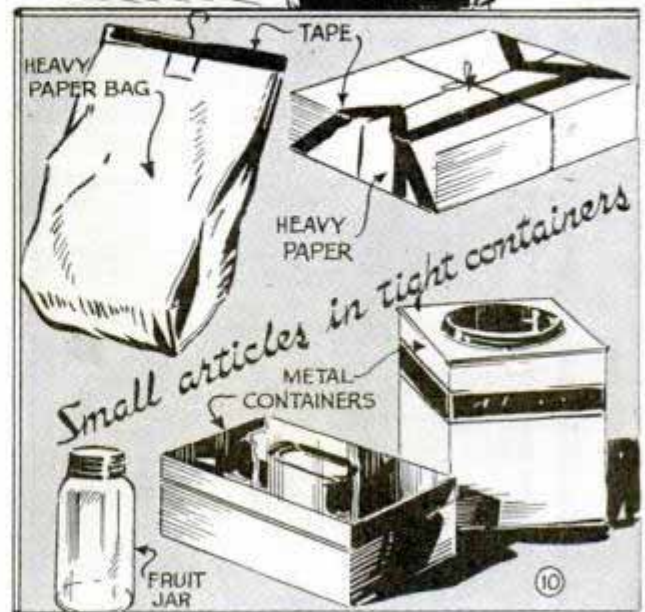

even the thicker stock, loses its strength in time, so that the chest is no better than a tight box. Any tight chest can be made mothproof by cementing a strip of sponge rubber around the top, under the lid, as shown in Fig. 14, and applying some method to hold the lid down tight. Garments or bedding placed in the chest should be packed with flakes as an added precaution. As both naphthalene and paradichlorobenzene discolor some fabrics, if placed directly on them, the flakes or balls should be wrapped loosely in tissue paper before folding into garments. Fig. 14 also shows a practical method for partitioning off a chest so that certain articles, which may be required, can be removed without exposing the balance of the contents.

If rugs or upholstered furniture have become infested, moths, eggs and larvae must be eliminated completely to prevent further damage. Rugs in daily use are seldom attacked but when the room is undisturbed for several weeks, damage may be done. Should this happen, send the rugs to a professional cleaner at once or give them the treatment suggested in Figs. 3, 4 and 5. Upholstered furniture usually becomes infested from within so you may be unaware of it until some damage is evident. The space around

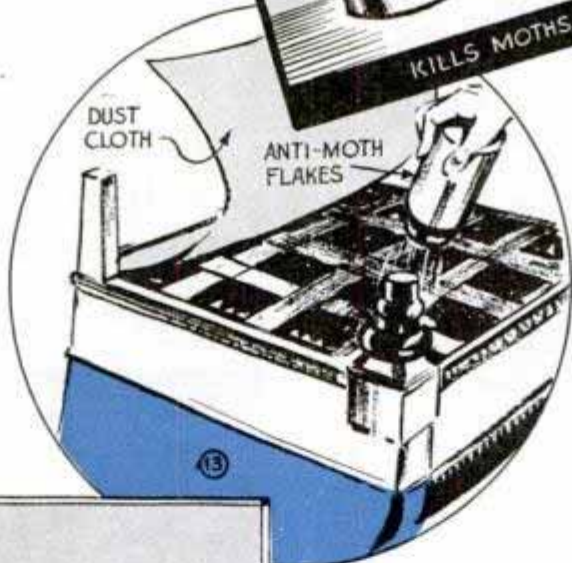

the springs makes an ideal place where the moths may live for many generations without leaving the article. If fumes from some of the flakes can be confined inside of a piece of furniture for several hours, by covering it with blankets or a rubberized cover as shown in Fig. 11, all stages of the moth will be killed. To accom-

plish this the flakes must be scattered liberally throughout the interior, as shown in Fig. 13, as well as in all external folds. Spraying with some fluoride, or cinchona alkaloid solution, is also effective provided the fabric is thoroughly saturated with the solution so that the fibers will be impregnated. This can be accomplished with a power sprayer but hand sprayers are of doubtful value. In using any spray, make sure that it will not stain the particular fabric to be treated. The solution suggested in Fig. 12 is effective, non-inflammable, but as it is slightly toxic, be sure to provide sufficient ventilation.

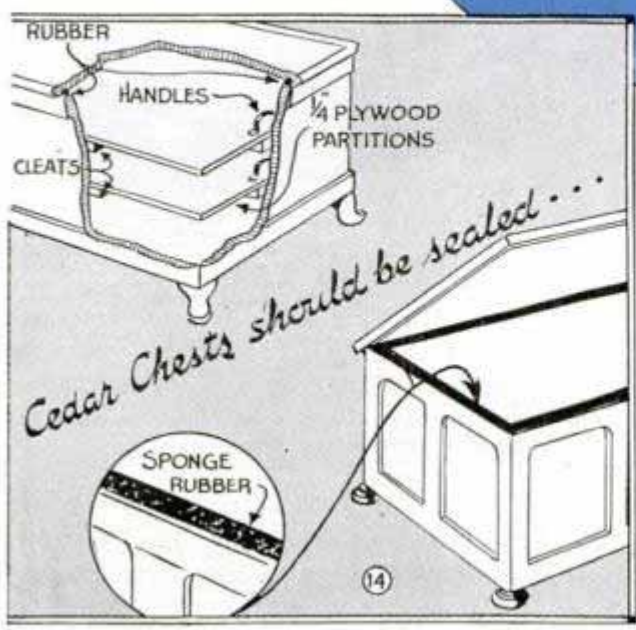

'Standpipe' Pressure Steamer Handles Wood Strips Quickly

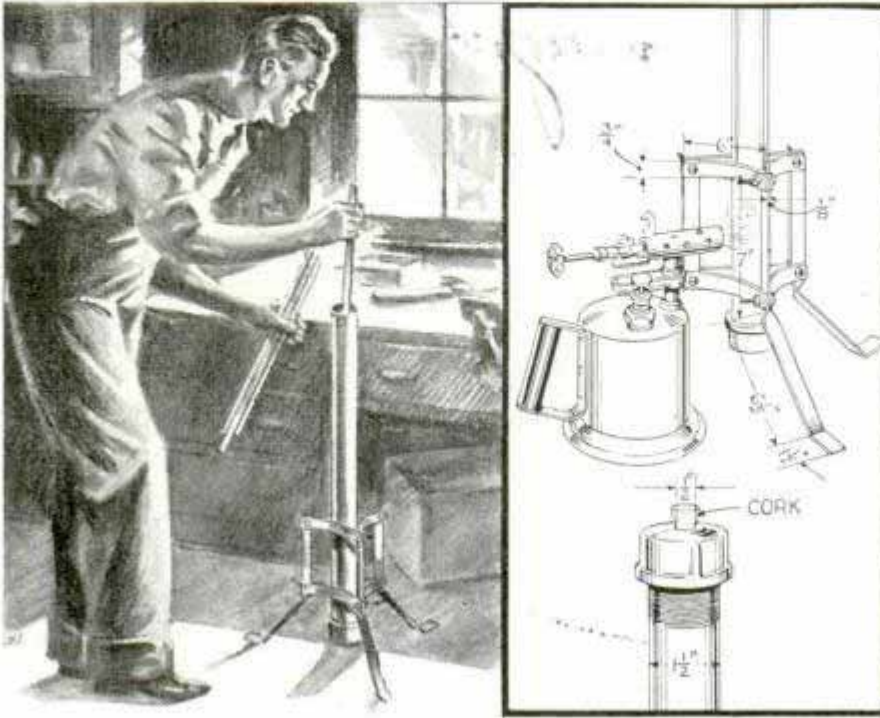

A simple steamer that will soften light strips of wood in 10 to 20 min. so that they can be bent

Having need of a steamer for light wood-bending jobs, I made the one shown which takes flat strips up to $1\frac{3}{8}$ in. wide and 3 ft. long. The steamer consists of a length of $1\frac{1}{2}$ -in. pipe capped at both ends and supported by a flat-iron stand. The upper cap is drilled for a cork, which serves as a safety valve against too high a steam pressure. In use, the pipe is filled with water to a depth of about 15 in., the wood strips inserted and a blowtorch flame directed against it as indicated. Most wood strips will be sufficiently pliable for bending in 10 to 20 min. When bending small strips, they can be held in position on an improvised form, set in the stove oven and dried in almost the same time, thus speeding up the job considerably.

—Dale R. Van Horn, Lincoln, Nebr.

Removing Stain from Photo Prints

Amateur photographers who do not have running water for washing prints often find a slight yellow stain on their dried prints. A cure for this staining—when caused by an organic condition of the wash water—is to dissolve potassium oxa-

late, 1 oz., in water, 20 oz. After the prints have been washed for about three-quarters of the washing time, remove them from the water and soak them in this solution for about 5 min. or longer if the stain is bad. Then finish by washing about a half hour, and drying in the usual manner. This solution will not remove stains caused by contamination or exhausted solutions. After repeated use, the solution sludges and turns yellow. However, this condition appears to have no effect on its action. I have used 2 gal. to treat the equivalent of one thousand 8 by 10-in. prints, and its action is still as rapid as when mixed.—Melvin Kennard, Gasport, N. Y.

Pail and Rope Stabilize Canoe for Fisherman to Cast

By suspending an open pail with ropes under the center of a canoe it may be balanced safely against tipping when the oc-

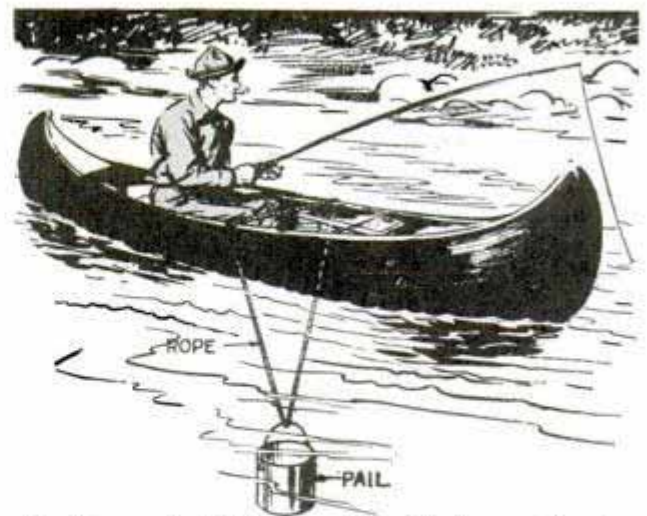

Tendency of a light canoe to roll when casting is greatly reduced by this stabilizer

cupant moves quickly to cast or reel his line. Just run the rope through the bail, tie the ends together and then slip it over one end of the canoe.



SIDEWALK LOCOMOTIVE

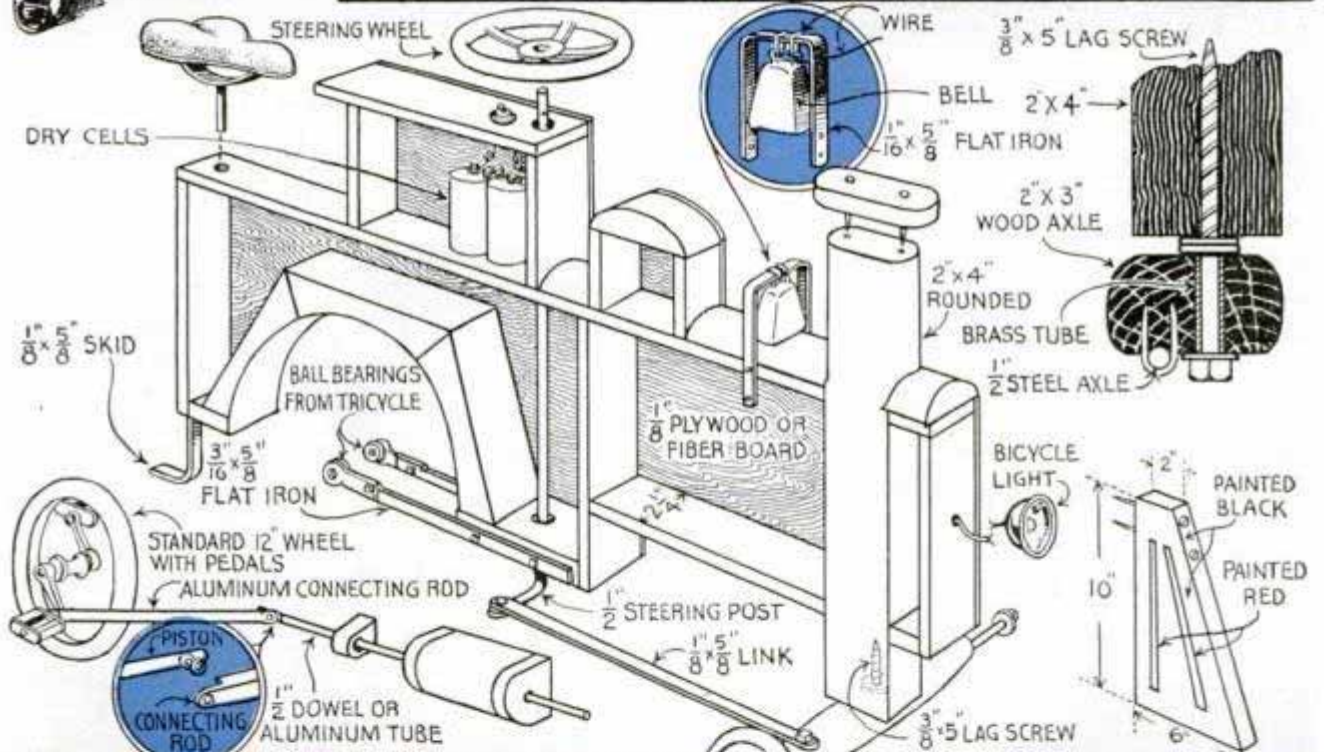

Using parts of a tricycle, an old coaster wagon and some thin plywood or hard-pressed board, you can build this sidewalk locomotive at very little cost, and when finished in a glossy black lacquer with red trim and brass bands, it will be the envy of all your friends. White pine or other light wood is used for the framework, which is covered with panels cut as shown in the squared detail. The original ball bearings for the drive wheel are removed from the tricycle and are installed on the ends of iron bars. Dry cells, a bicycle lamp and a bell add to the completeness of the little mogul. The saddle should be set up on a block



Bicycle Locked Against House with Iron-Rod Holder



Simple holder keeps bicycle against building and permits locking to discourage theft

To hold his bicycle upright against the side of a house, and also to provide a means of locking it, one boy used the simple holder shown. It is made from a length of steel rod bent to a U-shape with opened eyes formed on the ends to be closed over screw eyes driven into the side of the house. The closed end of the holder is bent to fit over the bicycle frame so a short chain and padlock can be used.

Sponge-Rubber Bait for Catfish

Anglers who know the lure of chicken blood for catfish and bullheads, but have difficulty in keeping the bait on a hook,

will find this idea an improvement. Cut a small piece of sponge rubber, the size depending upon the hook to be used. Run the hook through most of the rubber and tie the upper tip to the shank of the hook with silk thread. Several hooks are prepared in this manner and each provided with a 2 or 3-ft. length of line. Each bit of rubber is then immersed in the blood and worked with a stick until the rubber is filled, after which the hooks are laid in the sun to dry.



Several hooks are prepared in this manner and each provided with a 2 or 3-ft. length of line. Each bit of rubber is then immersed in the blood and worked with a stick until the rubber is filled, after which the hooks are laid in the sun to dry.

Once dry, considerable water action is required to remove much of the bait. Before putting it away, the sponge should be washed out and then dipped in a strong brine solution.

Slits in Threaded Part of Bolt Clean Nut Threads

If the nut on a bolt is too tight because of dirt in the threads, and there is no tap available, file slits in the threaded portion of the bolt. The edges of the slits will tend to clean the nut threads as it is driven onto the bolt. The same idea can be carried out to clean bolt threads by filing slits in the threads of a nut.

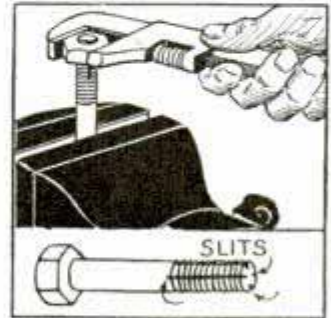

The edges of the slits will tend to clean the nut threads as it is driven onto the bolt. The same idea can be carried out to clean bolt threads by filing slits in the threads of a nut.

Opening in Garbage-Can Lid Admits Light Refuse



Instead of removing the lid from your garbage can every time you want to drop in a little rubbish, cut a round opening 5 or 6 in. in diameter in the lid

as shown, and hinge a metal flap to cover it. Use a spring hinge so that the flap will stay closed, and fasten the hinge on the underside of the lid with small stove bolts.

Key-Operated Faucet Opened with Clothespin

If you happen to lose or misplace the key to a water faucet, try using a clothespin to open or close it. If the faucet valve does not operate too hard, the pin will usually do the trick.

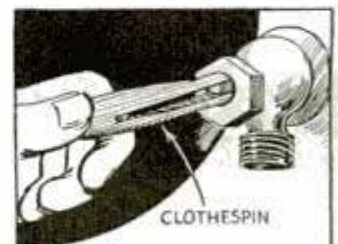

Just push the legs of the pin over the squared shoulder of the valve and twist it.

"Sea-Bee"

a gas-driven

Model Speedboat



FIG. 1

By Floyd M. Mix

THIS 32-in. motorboat, designed by F. E. Ludolph, of Chicago, is powered by a 22-oz. midget gas engine that develops approximately $\frac{1}{8}$ hp. at 5,000 r.p.m., and drives the boat on a circular course at a speed of 30 to 35 m.p.h. The job of building the boat is not difficult, and by starting now, you can get one finished in plenty of time to use this summer, and compete in the National races this fall.

Assuming that all of the items specified in the material list at the end of this article are at hand, let's get right into the constructional details. The frames dimensioned on print No. 965 are made from birch plywood, Nos. 1, 3, 5 and transom from $\frac{3}{8}$ -in. stock and Nos. 2 and 6 from $\frac{1}{4}$ -in. stock. To obtain full-size patterns of the frames, rule sheets of kraft paper into 1-in. squares, then sketch the patterns of the half frames given in the small squares into the large ones freehand. Fold the paper along the center line with the pattern on the outside and cut along this line with a pair of scissors to make both sides symmetrical. Then you fasten the patterns on the plywood, using rubber ce-

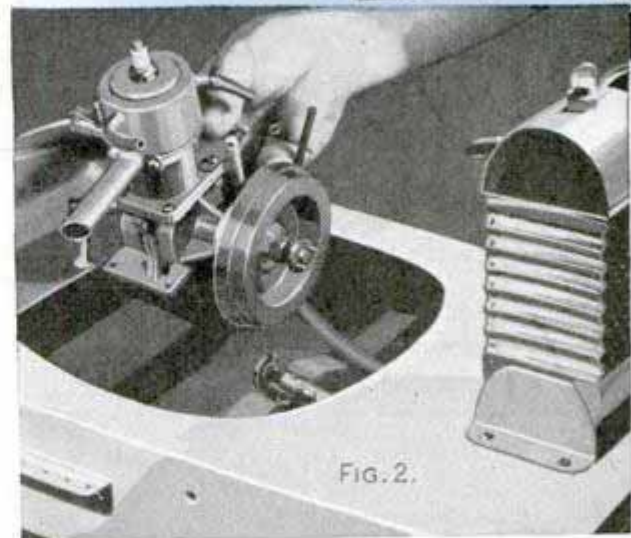
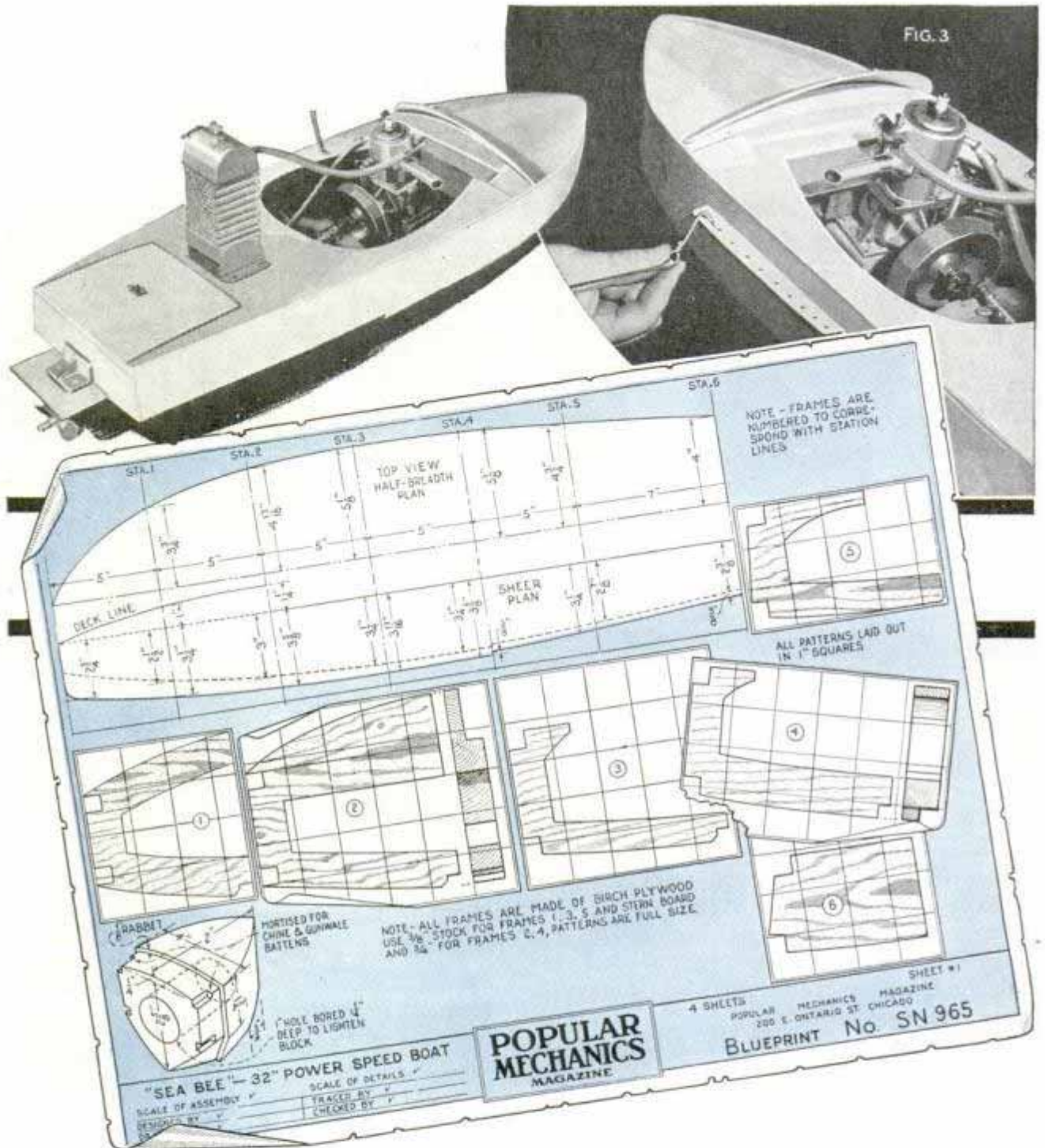

FIG. 2.

ment, and scroll-saw the frames to shape, Fig. 7. Cut the nose block from a piece of birch or white pine 2 by 3 by 6 in. in size. Carve the block to approximate shape and

Refer Letters to Mix.



rabbit it $\frac{1}{8}$ in. as indicated. Also, rabbit frames 2 and 4 as shown in the end view of these pieces.

The framework, Fig. 10, is assembled on a building board or form, the upper side of which is cut to the contour indicated in Fig. 4. Aside from temporary nailing required to fasten the frame pieces to the form, all parts of the model are fastened in place with flat-head brass screws and waterproof casein or marine glue. Also, all of the wood surface must be shellacked and given a couple coats of marine paint of the desired shade to protect it from the mois-

ture. Naturally this must be done as the work progresses otherwise part of the inner works would be inaccessible.

Now to get started with the assembling: The keel is fastened to the nose block and then to the building form as shown in Fig. 5. The frames are placed in their respective positions as indicated in the half-breadth plan, print No. 965, and toenailed in place with 1-in. wire brads. Both chine and deck beams are $\frac{3}{8}$ in. square, being ripped from a piece of clear white pine about 36 in. long. These pieces are heated thoroughly over a gas burner so they will

bend without breaking, then fastened to the frames with glue and No. 4 f. h. brass screws, $\frac{5}{8}$ in. long. The heads are countersunk to allow for evening up the frames in preparation for the planking. All planking is $\frac{1}{8}$ -in. birch plywood, and it is glued and screwed to the frame pieces with No. 0, $\frac{3}{8}$ -in. f. h. brass screws. To avoid waste of material and to aid in getting the plywood shaped properly, it is a good idea to make up cardboard patterns of the various pieces required. Where necessary, the

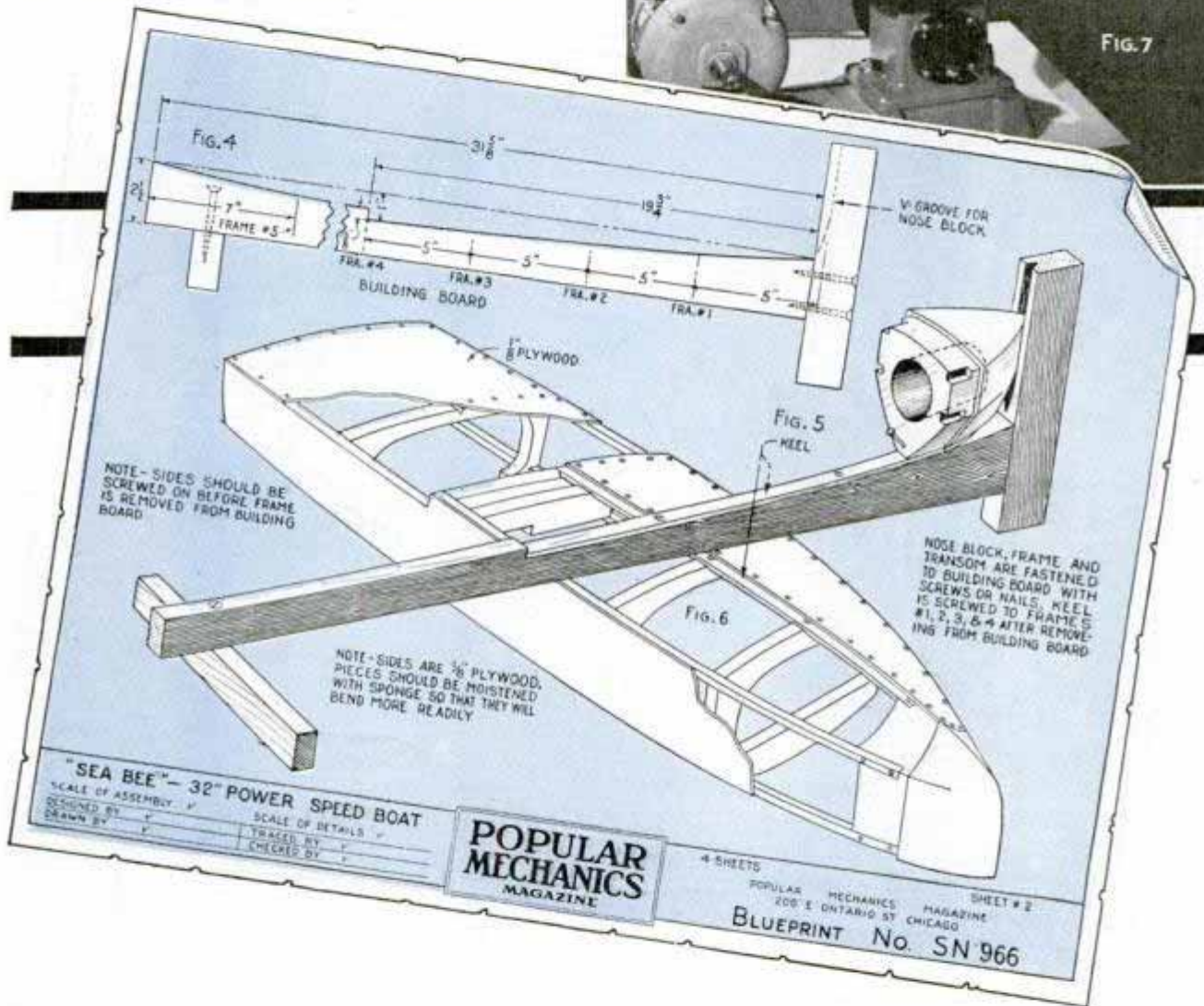
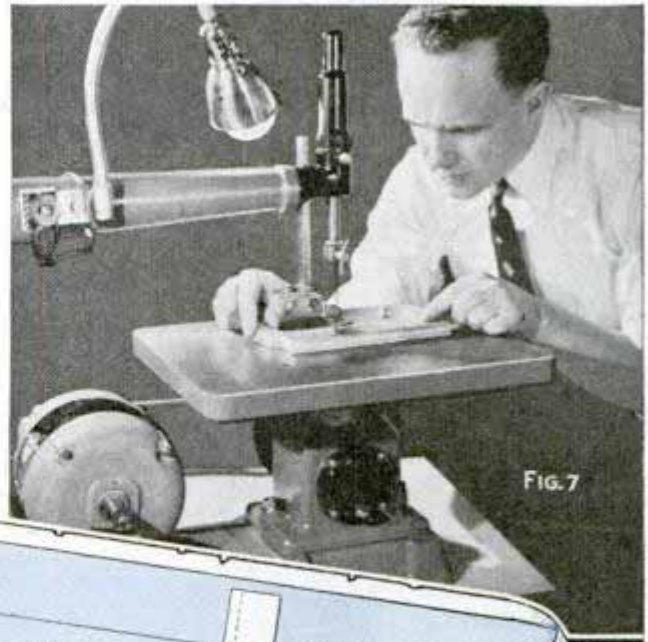

frames are dressed down with a rasp to insure a good fit at all joints. After all the frames have been attached, the side planks are put on. Contacting surfaces are smeared with glue and C-clamps used to hold the wood in place until the screws are driven in. About four screws, staggered to prevent splitting, will be required for each frame piece. After both side planks are in place, the model is removed from the form and the keel is fastened to frames 1, 2, 3, and 4. Fig. 6 shows details

on the bottom planking. By sponging the pieces with warm water, they can be bent readily to the contour of the framework.

Now build a cradle for the model from $\frac{3}{4}$ -in. plywood, as shown in Fig. 18. The motor base, Fig. 9, and the drive-shaft support just ahead of frame No. 4, come next. A battery compartment, which accommodates the four flashlight cells required to operate the engine, is illustrated in Fig. 16. When the battery compartment is in place and a cover made for it, as dimensioned in

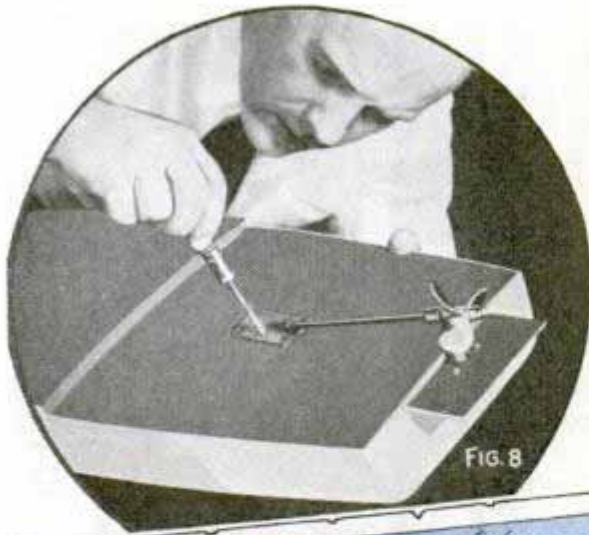

FIG. 8

As soon as all of the drive-shaft mechanism is lined up, you can go ahead with the deck planking, Fig. 11. Start with the forward deck, covering it with $\frac{1}{2}$ -in. strips of $\frac{1}{8}$ -in. plywood. Put on the middle plank first, then gradually work toward the sides. The aft deck is covered with a piece of the same material, openings being cut in it as shown in Fig. 13. On print No. 967, Fig. 12, you will find dimensions for the windshield and mold-

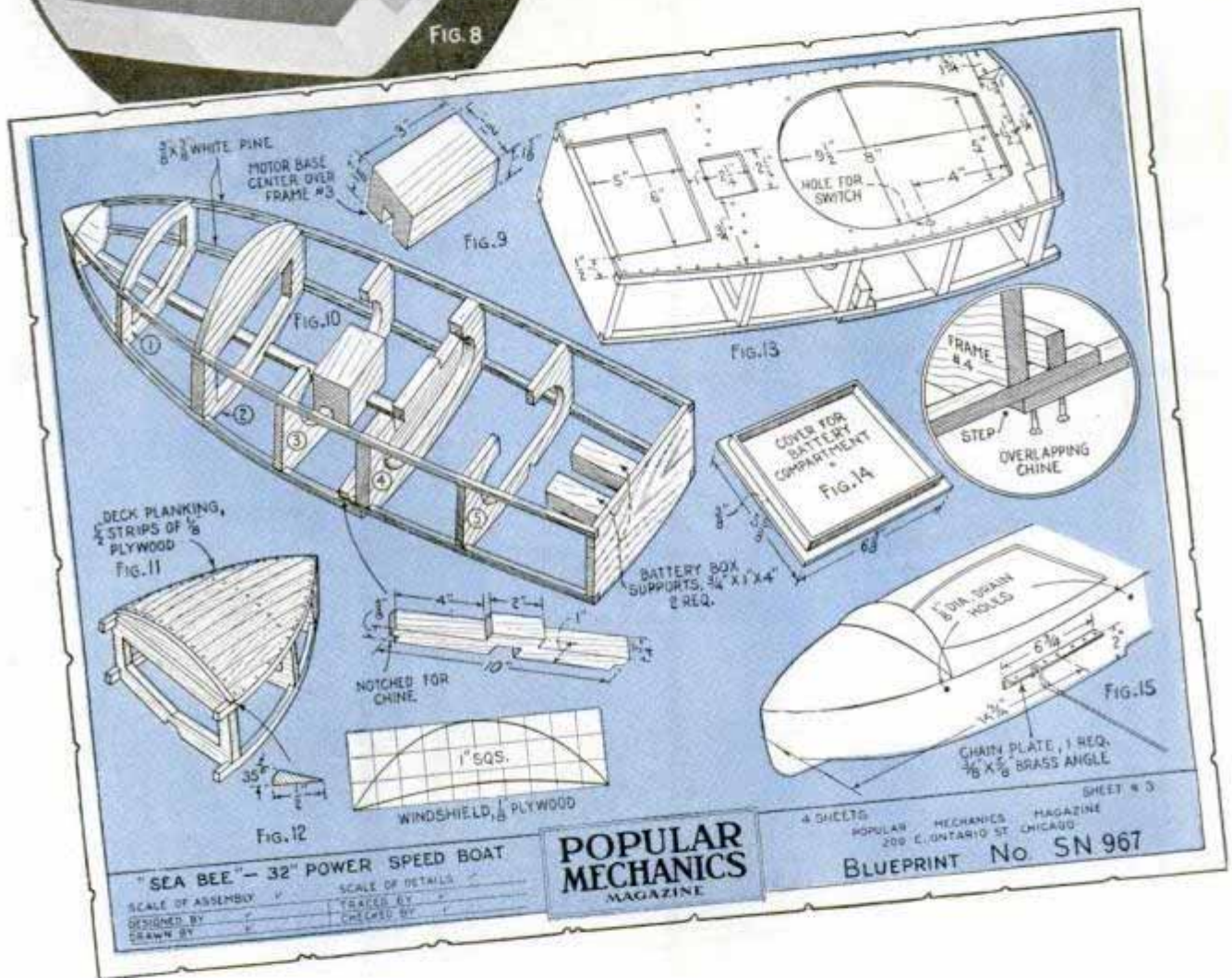
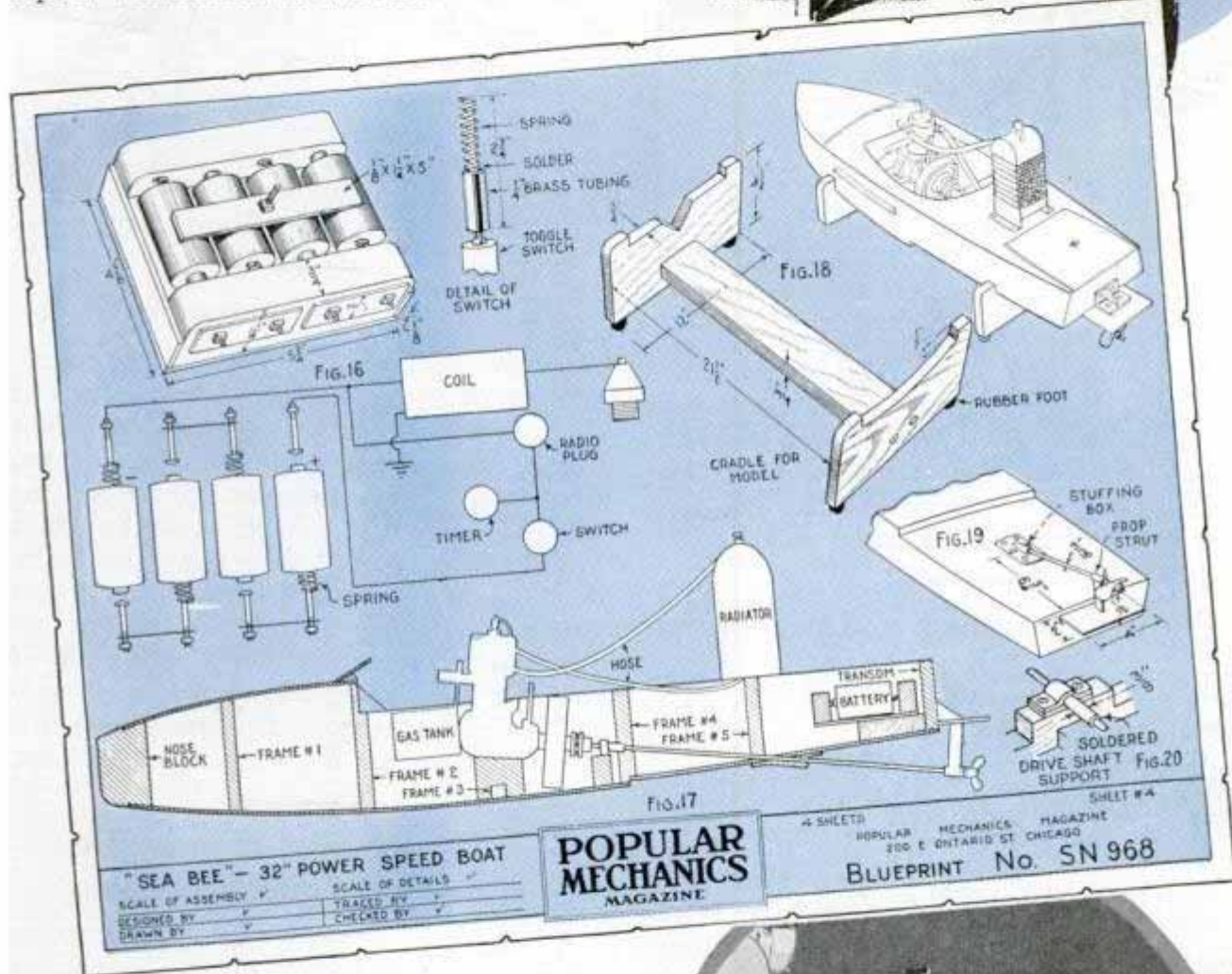
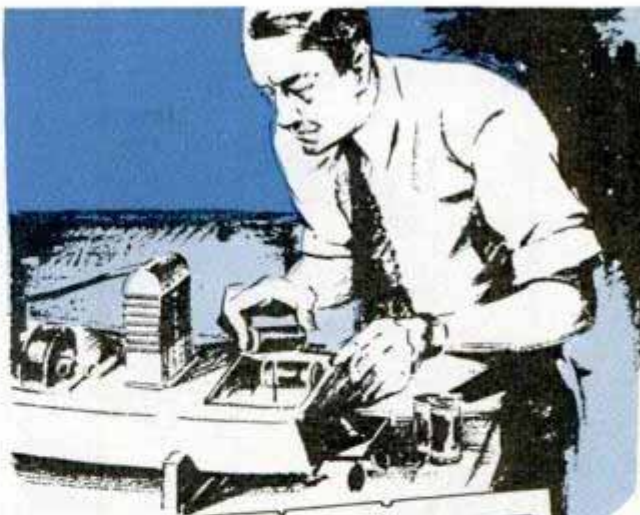

Fig. 14, you can go ahead with the preliminary wiring, using small staples to anchor the wires to the side of one of the deck beams. Notch the top edge of the frames where necessary. Be sure the wires are left long enough to make all the necessary connections after the engine has been installed and the top decking applied. Refer to Figs. 8, 17, 19 and 20 for data on the drive-shaft and propeller installation. To provide a thrust bearing for the propeller shaft, slip a $\frac{3}{4}$ -in. length of $\frac{1}{4}$ -in. brass tubing over it and solder it in place just back of the bearing.

ing to which it is attached. With the windshield on, the main construction is finished, but there's still several odd jobs to clear up. A radio plug must be installed in the forward deck, Fig. 1, so you can use an auxiliary battery for starting, and a switch, detailed in Fig. 16, mounted on the aft deck, to stop the engine at the close of a race. Then there's the chain plate, Figs. 3 and 15, and the installation of the motor, Fig. 2, radiator, and $1\frac{1}{2}$ -in. propeller. For the outside finish on the boat use a coat of thin shellac, and a couple coats of marine paint of the desired shade, sanding

lightly between coats. When ready for a trial run, the model is placed on the cradle and the engine started by twisting the propeller as in Fig. 21. Speed is controlled by adjusting the carburetor needle valve, spark and choke valve before placing the model in the water. A tank of fuel will run the motor from 15 to 20 min.

For a circular race course the boat is attached to a 50-ft. line which pivots on a pole not over 4 ft. above the water level. The model making the best time in a race of not less than three consecutive circular laps is considered the winner.



MATERIAL LIST

- 1 pc. 3/4x24x36-in. birch plywood—frames
- 1 pc. 3/4x12x12-in. birch plywood—frames
- 1 pc. 3/4x18x24-in. birch plywood—cradle, battery box
- 1 pc. 2x3x4-in. birch—nose block
- 1 pc. 3/8x3x36-in. white pine—chines, deck beams
- 2 pc. 1/2x24x36-in. birch plywood—planking, windshield
- 1 pc. 2x4x12-in. white pine—motor base, miscellaneous
- 1 pc. brass angle 3/8x3/8x6 3/4 in.—chain plate
- 1 pc. 3/16-in. steel rod approx. 20 in. long—drive shaft
- 1 1/2 lbs. No. 0, f. h. brass screws 3/8 in. long
- Universal joint, prop strut, stuffing box, shaft bearing, propeller
- Marine glue, several sizes of wire brads and screws

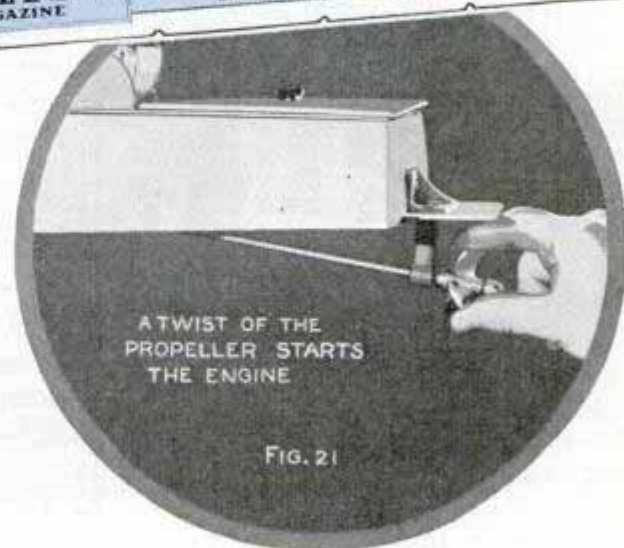

Pivoted Armrest Relieves Strain When Lettering Show Cards

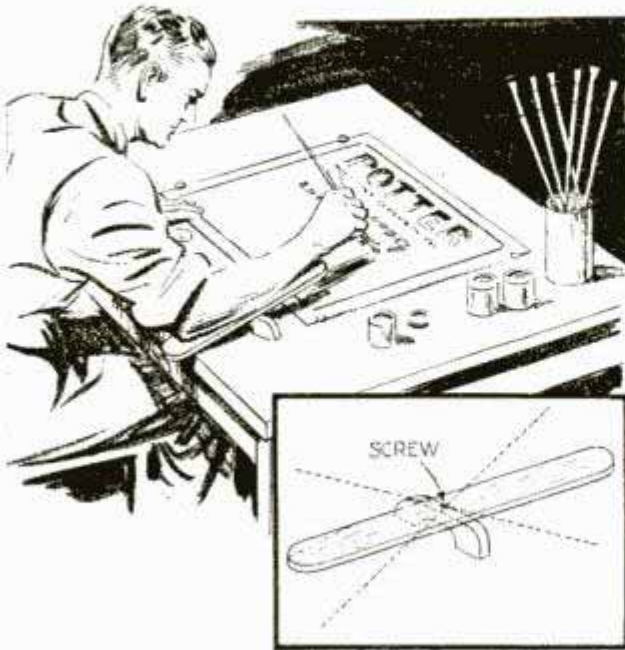

When producing show cards in quantities this armrest will relieve muscle strain considerably

An armrest for show card writers, that relieves muscle strain when producing cards in quantities, can be made easily from two pieces of wood as indicated. The rest pivots on a supporting cleat so that the arm can move back and forth.

Plant Retractor for Aquariums



Surface plants and other floating vegetation, which often interfere with the proper feeding and rearing of pond and aquarium fish, may be confined to any desired area by using a light woven cord, supported at intervals of about 14 to 18 in. by small wooden or cork floats. This method of segregating the plants in one section does not cause any interference with the feeding or breeding habits, and can in no way injure the most delicate plant or fish. The line can be fastened by means of wire or

small hooks imbedded in the walls of the tank. Some may prefer to paint the floats to harmonize with the scheme of the plant life of their pond.

—W. J. Schroll, Garwood, N. J.

Emergency Setter for Rivets

If you have a repair job that requires the use of tubular rivets and there is no tool at hand for splitting and clinching the ends, try using a countersink. Just set it on the projecting ends of the rivets and strike it lightly with a hammer.

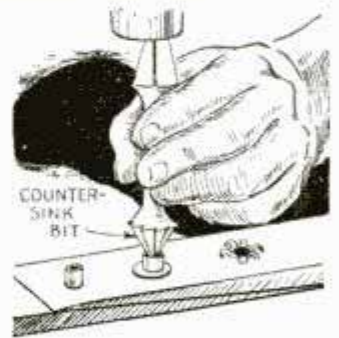

—Andrew Vena, New York.

Whitewashing Porous Surfaces

Before whitewashing a brick or terracotta wall or other porous surfaces, wet them lightly with water thrown on with a brush. This reduces the suction of a too dry surface and permits spreading the whitewash evenly and thinly, as the water in the mixture is not absorbed too rapidly. A given quantity of whitewash will also cover more surface and require far less labor to apply it neatly on a wet wall. If the wall is very dry and warm, such as a boiler room, it may be necessary to wet it generously—possibly with a garden hose.

Tin Cans Make Handy Bins for Nails and Screws

Small nail and screw bins which will slip under tack or nail heads driven into the underside of a shelf or bench top can be made in a jiffy from tin cans.

Just slit the cans lengthwise on one side, and bend the severed edges outward. Taper the edges toward the rear end with a pair of tinner's snips and solder a handle to the front end.

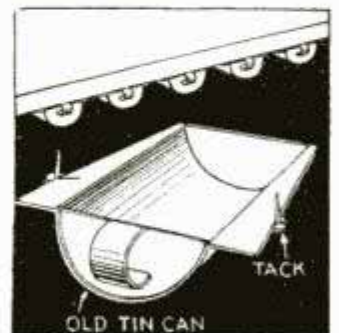

Your own POOL and Waterfall

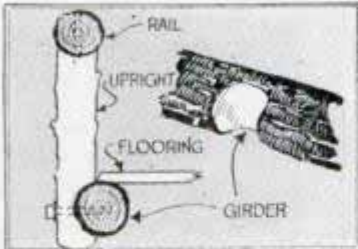
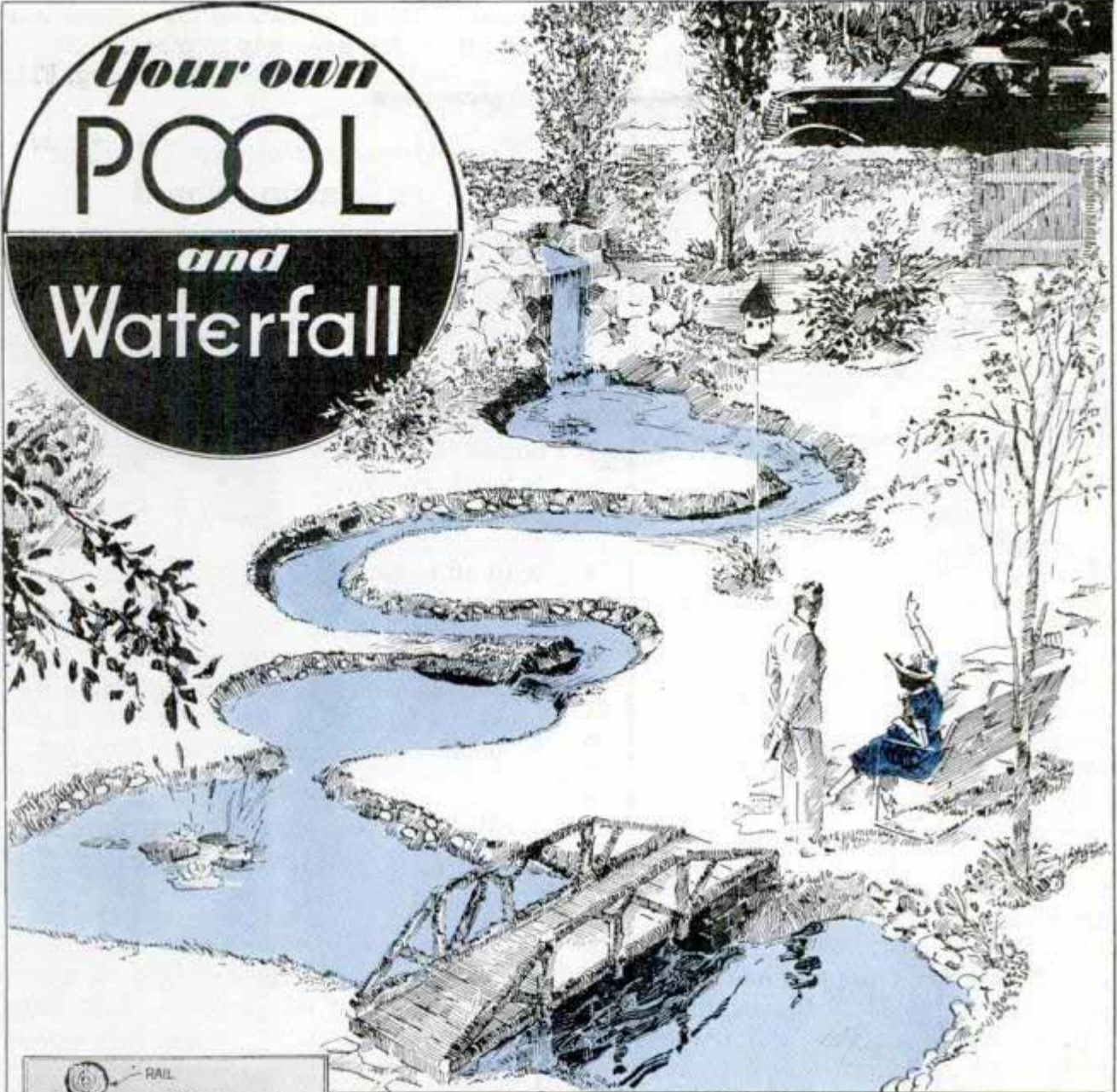

Using the same water over and over again, by means of a small centrifugal pump, such as an old auto pump, this garden pool and waterfall plan can be applied to the small back yard or expanded to suit a small estate. Bottom and sides of the pool should be of concrete on well-compacted earth and the concrete should be reinforced with heavy wire mesh. All piping should be concealed and both motor and pump should be housed to protect them against the weather. Additional attractiveness is possible by building up the banks with layers of limestone

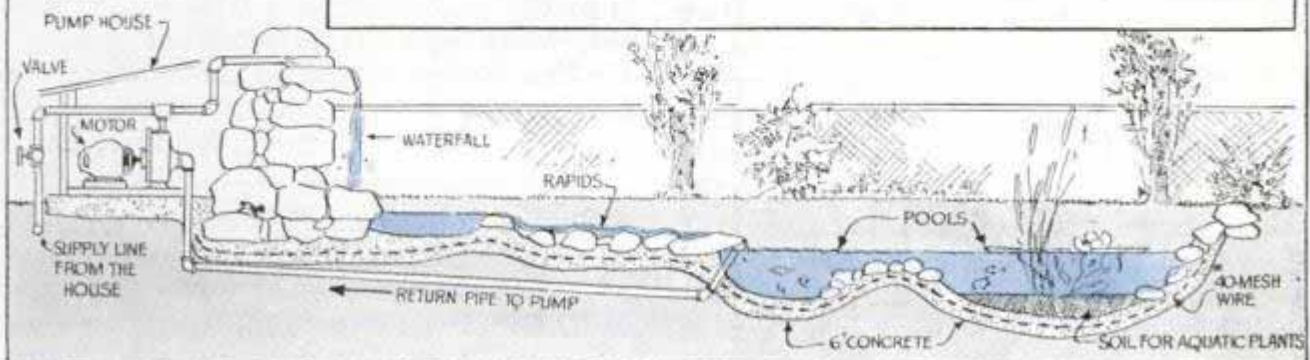

Block to Hold Flooring Tight While Nailing It to Joists

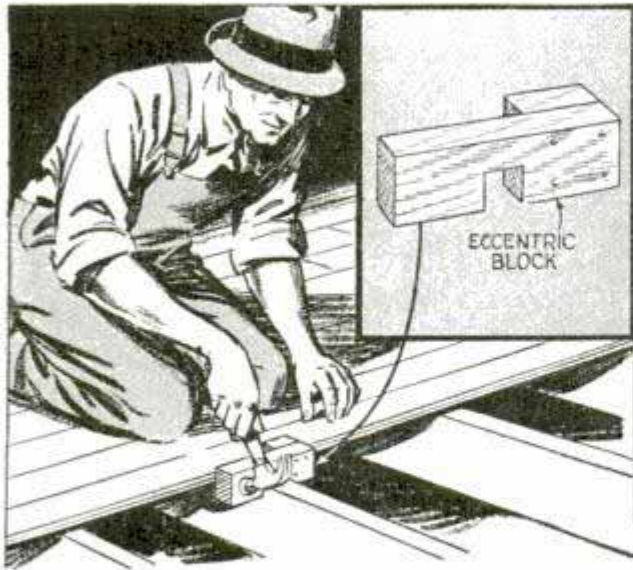

With this block, you can drive flooring boards in place and hold them for nailing

Here's a block that not only allows warped flooring to be driven into place without damage to the tongue or groove, but holds it in place while being nailed. A 4 by 4-in. block is slotted to slide easily upon a 2-in. joist, and a 2 by 4-in. block is nailed onto this at one end. In use, the block is slid against the flooring strip and struck with the hammer at the thick end. When the flooring is fitted firmly together, a light blow with the hammer at the opposite end of the block imparts a twist or lock to the device that will prevent the board from springing out of place while it is being nailed to the joist.

Bug-Proofing Casement Windows

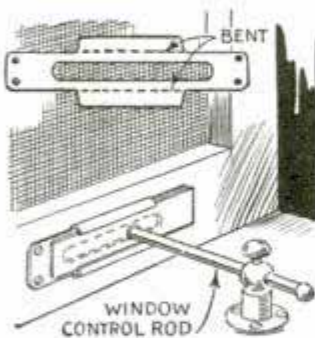

Here is an easy way to keep insects from entering a house through the control-rod opening in the screens of casement windows. Cut a strip of copper or galvanized iron to the

shape shown, making it sufficiently large to overlap the entire opening. Then bend over the ears, indicated by the dotted lines, and cut another strip to serve as a slide between them. Drill a hole through the

center of the slide to take the control rod and mount the assembly in place.

—K. F. Keith, St. Petersburg, Fla.

Thumbtacks Kept in "Pocket" in Drawing Board

To avoid pricking his fingers on thumbtacks, when picking them out of a box or dish, one artist made a pocket with a swinging bottom at one corner of his drawing board. The pocket is made by boring a large hole through the board with an expansive bit and fitting a sheet-metal disk

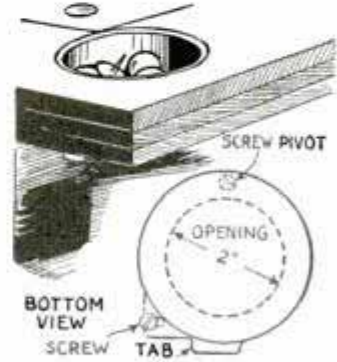

over the bottom with one small wood screw. The disk has a tab extending beyond the edge of the board so that it can be pushed over to let the tacks drop out.

Celluloid Shield for Compass Leg Protects Drawing Board

To avoid marring a drawing with perforations made by the leg of a compass, use a $\frac{5}{8}$ -in. clear celluloid disk on which to set the leg of the compass. Two lines

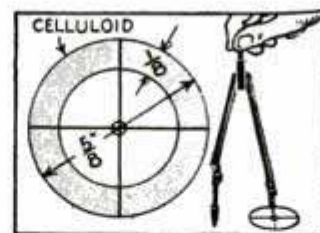

are drawn across the disk at right angles with their intersecting points in the center of the disk, after which a thin coat of rubber cement about $\frac{1}{8}$ in. wide

is applied to the reverse side. This is allowed to dry thoroughly. In use, the disk is placed on the drawing with the cement side down and the intersecting point of the lines directly over the place where the compass leg is to be set.

—Robt. E. Davy, Represa, Calif.

Picture frames should have thumbtacks at each lower corner and on the bottom edge to hold the picture away from the wall. Otherwise a dirty line usually shows when a picture is taken down.

Plywood Doll Carriage for Winter or Summer

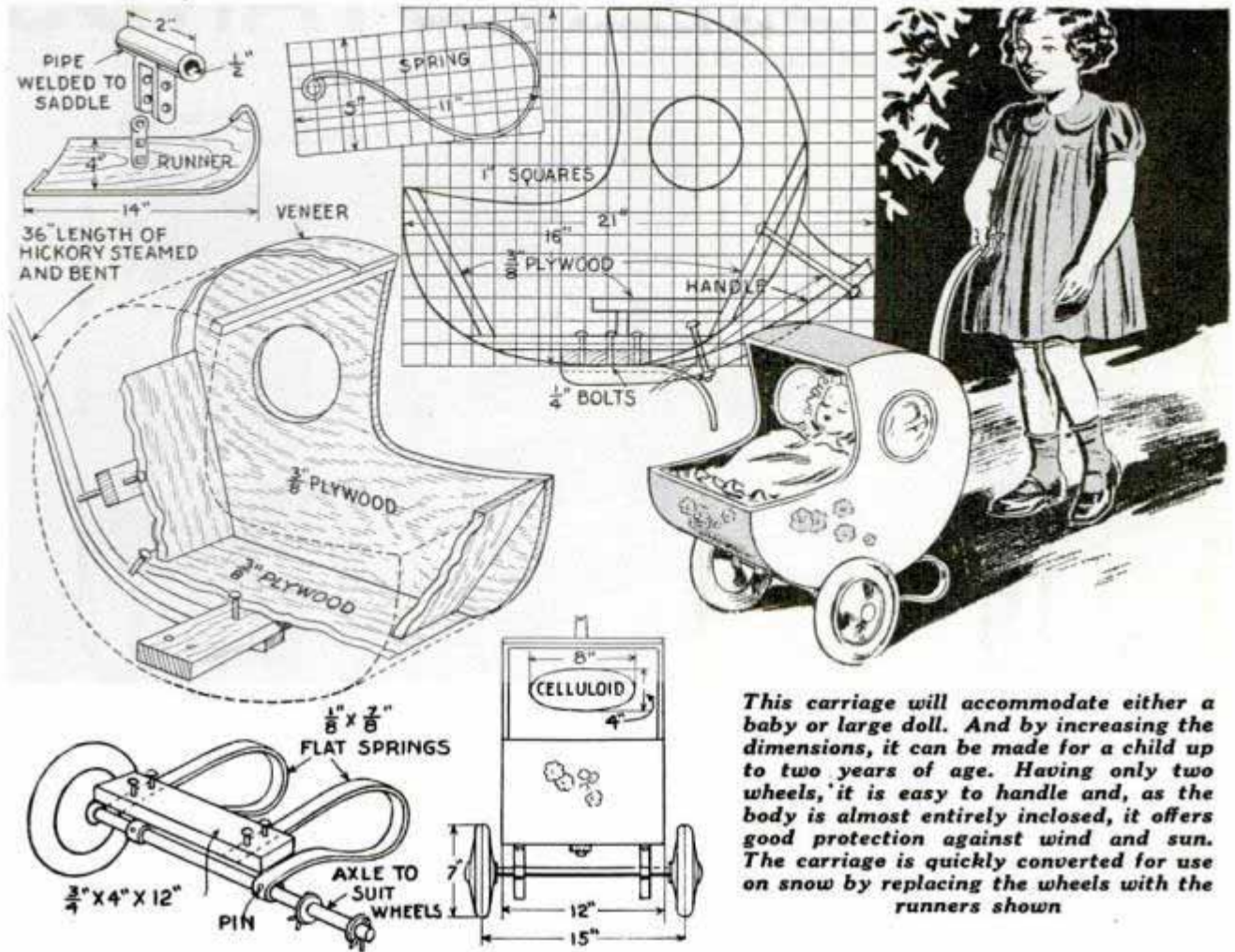

This carriage will accommodate either a baby or large doll. And by increasing the dimensions, it can be made for a child up to two years of age. Having only two wheels, it is easy to handle and, as the body is almost entirely inclosed, it offers good protection against wind and sun. The carriage is quickly converted for use on snow by replacing the wheels with the runners shown.

Wallboard Supported by Standard While Nailing to Ceiling

The problem of applying large sheets of wallboard to ceilings single-handed is solved with this standard, which can be adjusted to support the sheet while nailing it in place. The standard consists of three lengths of 1 by 3-in. stock, two of which are nailed to a cross of 1 by 3-in. stock at the top and telescope over the third length which is nailed to a second cross to serve as a base. The 1 by 3-in. members are slotted lengthwise to take bolts with which the adjustment of the standard is locked.

☐ When electric-light switch plates become dark and discolored, they can be restored to their original brightness by washing them with vinegar, after which transparent metal lacquer is applied to preserve the finish. Of course, the plates must be removed from the wall while this is being done.

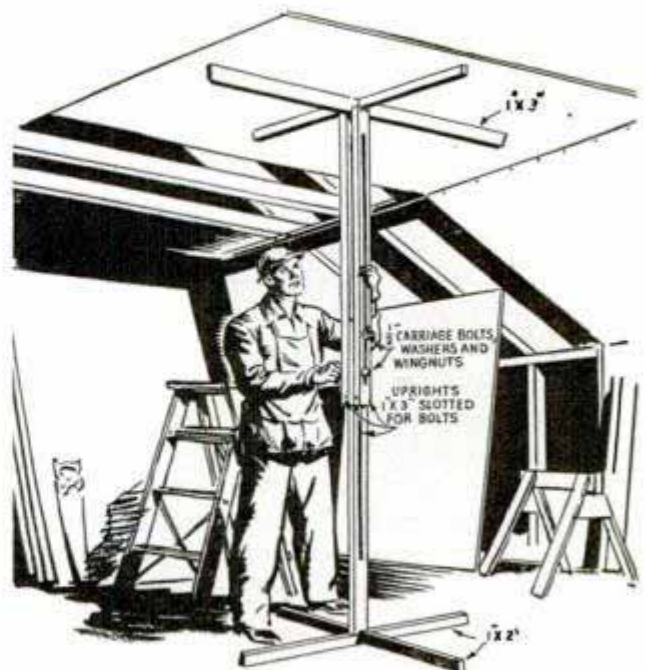

The difficult job of holding a sheet of wallboard in place on a ceiling is made easy with this standard

New FLOWER STANDS

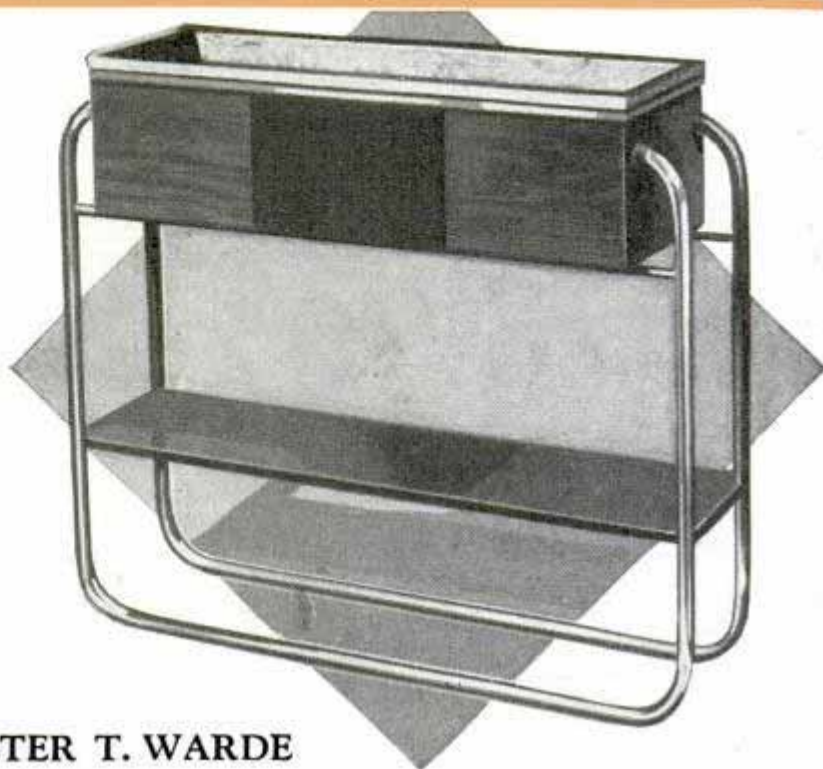

By WALTER T. WARDE

Familiar pieces of household furniture given new color and styling by the use of gleaming metal, polished wood and brilliant plastics

THESE variations in fern or flower stands, a large one to accommodate several plants, and two individual ones, all done in modern styling, are interesting jobs for the craftsman who likes something in metal, wood and plastics combined. Details on one individual stand are given in Figs. 1 and 3, while those concerning the second one are shown in Fig. 5. In both instances you first make the bowl. This can be made by two methods. If you have metal-spinning equipment the bowl can be spun from aluminum sheet thus making a very beautiful job; if not, it can be made as the one shown in Fig. 3. The base of the bowl is turned from a wood disk as in the detail, and the outside enameled black, the upper part being of No. 20-ga. sheet aluminum rolled to shape and screwed in position or held by crimping the edges. The top rim of $\frac{1}{8}$ by $\frac{1}{4}$ -in. aluminum bar is bent to the correct diameter, enameled black and screwed to the

top edge of the bowl at the joint and some "liquid solder" applied inside the rim to hold it in place. The inside of the bowl is painted with acid-proof paint. The bending of the legs is a simple operation if the method shown in Fig. 1 is followed. Don't forget to polish before bending. The legs, of $\frac{3}{16}$ by $\frac{3}{4}$ -in. rectangular bar, are held together at the center column with two 1-in. rings cut from a 3-in. o.d. tube with a .065-in. wall. At the top the legs are held in position with a bar of $\frac{1}{8}$ by $\frac{1}{2}$ -in. aluminum bent to the required diameter and fastened with screws as in Fig. 7. The legs are held at the base with a 1 by 3-in. disk of wood overlaid on top and edge with $\frac{1}{32}$ -in. black Bakelite. You will find that casein glue is quite effective to hold the Bakelite provided the surface of the latter is roughened.

The procedure for the second individual stand is much the same. Start with the bowl, cutting the base from wood and

in Bent Metal

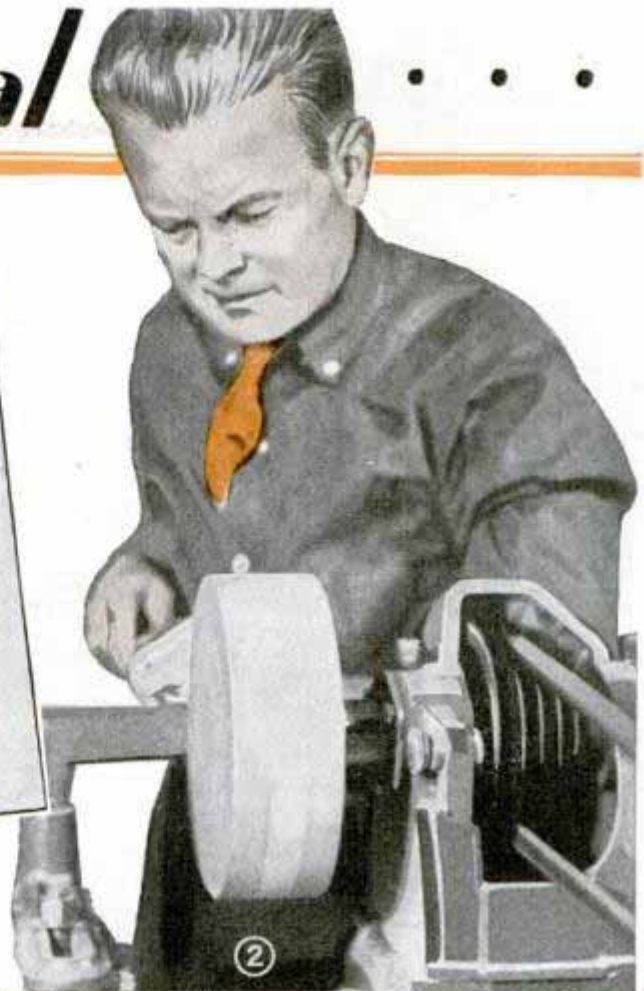
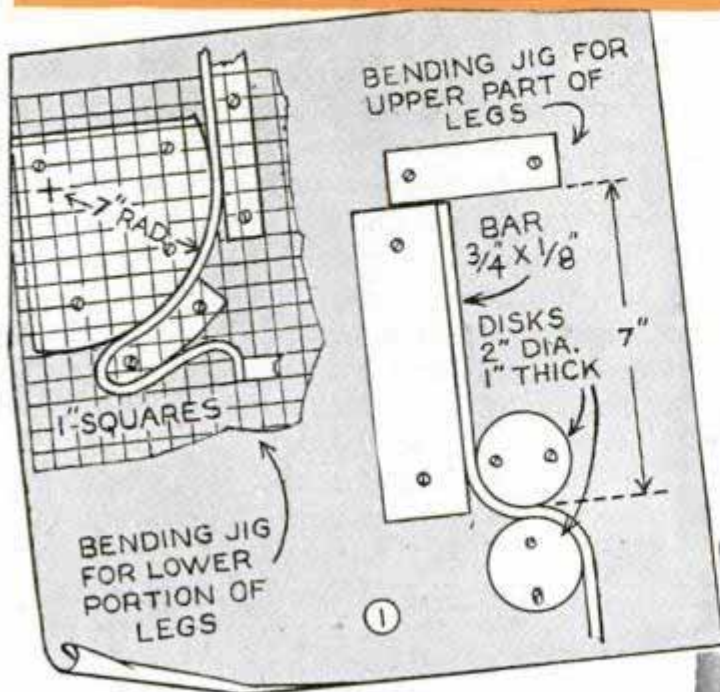

turning it as shown in Fig. 2. Dimensions of the turning are given in Fig. 5. The two lower rims of the bowl base are overlaid with No. 20-ga. sheet aluminum, using casein glue and one screw in each rim. The upper portion of bowl is a sheet of the same material bent to the required diameter and held in position by screws, or by crimping the joint. The upper rim is of $\frac{1}{32}$ -in. plastic of the same color as used on the base, glued to the bowl, or the rim may be a $\frac{1}{8}$ by $\frac{1}{2}$ -in. rectangular aluminum bar, enameled the same color as the base and screwed in position. The inside is painted with acid-proof paint. This design differs from the previous one in that tubes instead of rectangular bars are used for the legs, and there are four legs instead of three. The method of bending the tubes is shown in Fig. 4 and is described in detail in the last paragraph of this article. Inasmuch as the legs take all the weight of the bowl, great care should be taken to get a firm, tight fit on the plugs which are inserted at the top of each leg. The base of the stand consists of two disks cut from $\frac{3}{4}$ -in. wood and overlaid with $\frac{1}{16}$ -in. laminated plastic on the top and $\frac{1}{32}$ -in. plastic on the rim. The legs are held in place with screws driven from the underside of the base and up into plugs in

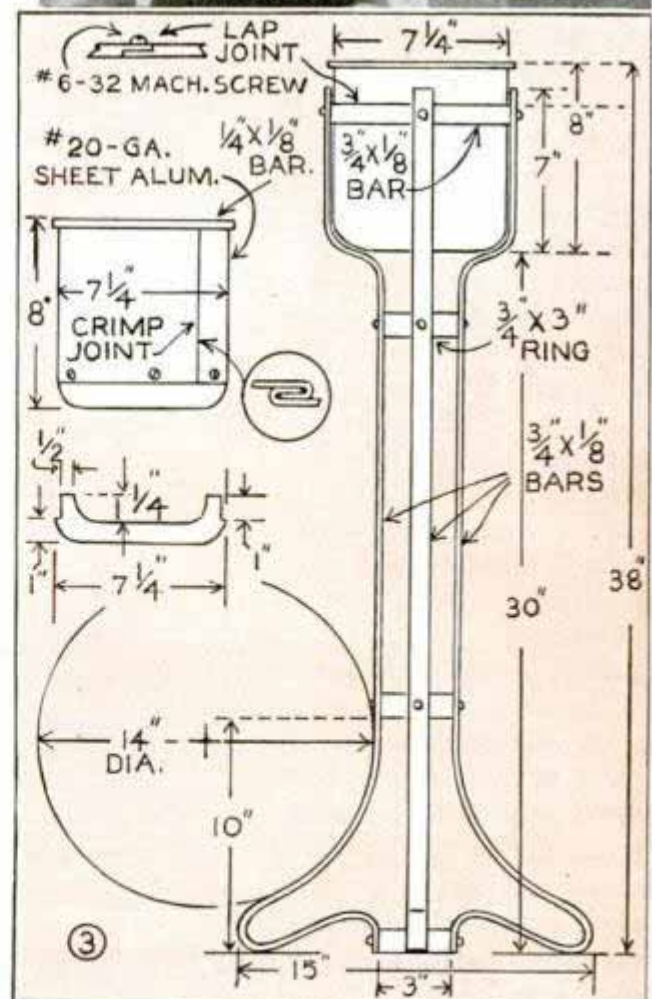

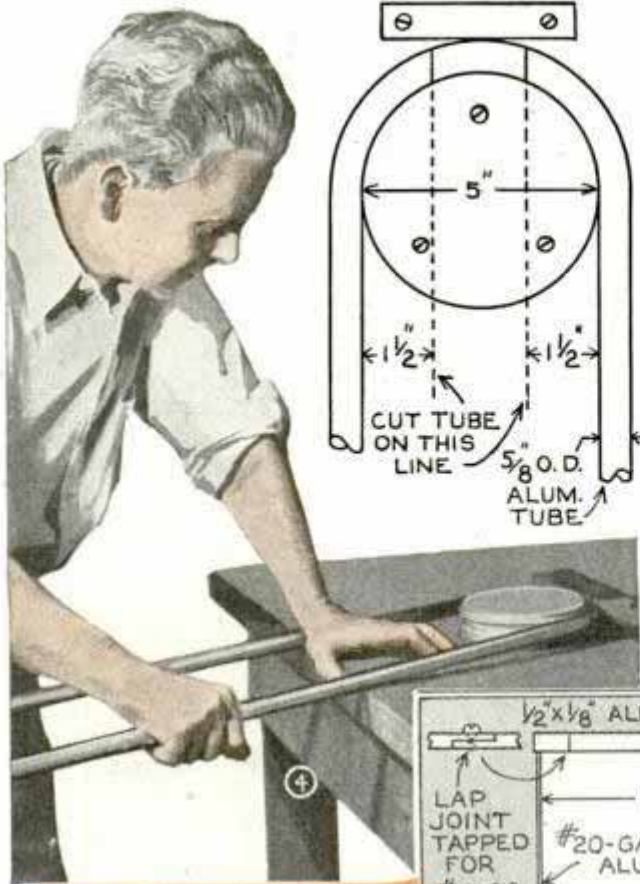

the legs. The underside of the base is covered with a piece of felt. The band inside the legs is of $\frac{3}{4}$ by $\frac{1}{8}$ -in. rectangular bar bent to the correct diameter and screwed to each leg.

Now for the roomy stand in which several plants or flowers can be grouped. This one is rectangular in shape and its dimensions may be varied somewhat to suit the size of a zinc tray, should you happen to have one from an older type of flower stand. Or, perhaps you can pick up such a tray in a secondhand store, although it's really not much of a job to make one that is watertight, if you are handy at metal working. And, in case you build the tray yourself, follow the dimensions given in Fig. 9.

Then comes the box. This is made of $\frac{3}{8}$ -in. wood for the sides and bottom, the corners of the box being mitered and glued, and the bottom rabbeted into the sides. Having assembled the box, the wood should be stained a suitable color, the one shown being finished in walnut stain and varnished. The $\frac{1}{2}$ by $\frac{1}{4}$ -in. strips of aluminum that decorate the outside of the box are polished and attached with small nickel-plated, round-head screws. With the aluminum strips in place, the plastic overlays are glued to the box. These overlays can be of any color to suit the individual taste as a wide range of color is to be had in such laminated plastics. The overlays on the box are $\frac{1}{16}$ in. thick. In the stand shown in the photograph the material for overlays was black Bakelite.

The legs are of $\frac{3}{4}$ -in. o.d. aluminum tubing with .065-in. wall. The bending process entails the plugging of the tubes and filling with dry sand

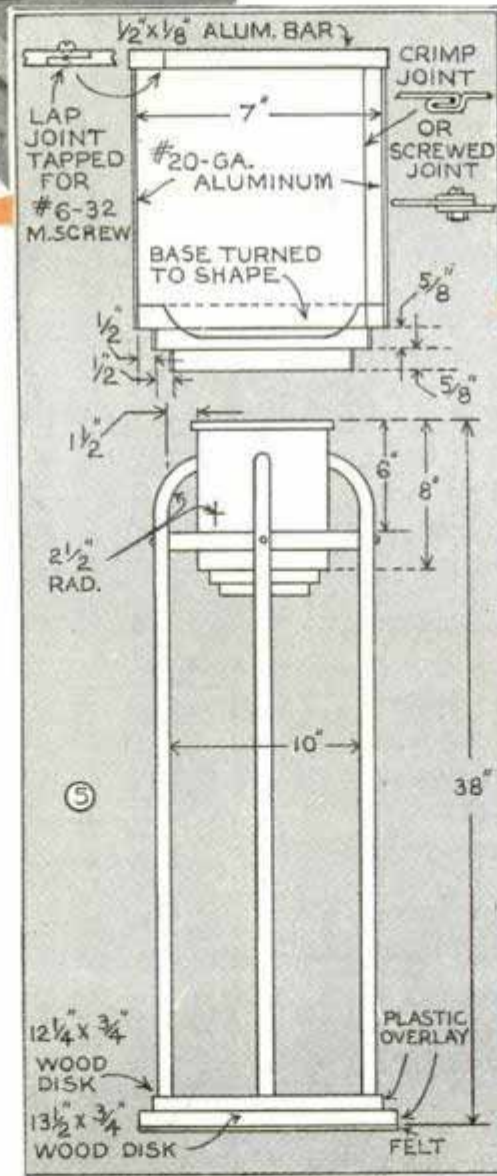

All the metal parts should be buffed carefully and polished before assembly. In this way you will be able to get a uniform finish on parts that become inaccessible as soon as the job is set up



to assure a clean bend, the sand being emptied from the tube on the completion of the bend. The method of bending is shown in Fig. 4. Before bending, however, all metal pieces should be polished on a buffer so that only hand polishing is necessary after assembly. The joining of the legs at the base is accomplished by plugging and pinning as shown in Fig. 10. The ends of the legs which fit against the box are very tightly plugged with hardwood, as it is this plug which holds the screw from the inside of the box and takes most of the strain. The crossbars are of $\frac{1}{2}$ -in. o.d. aluminum tubing having a .049-in. wall, the ends of these being filed out to fit against the legs. Dowel rods $\frac{3}{8}$ in. thick

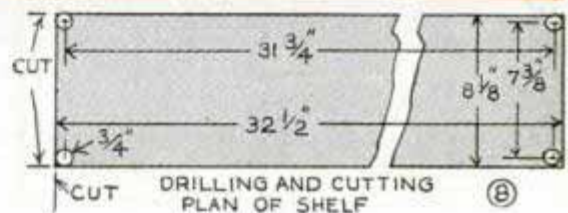
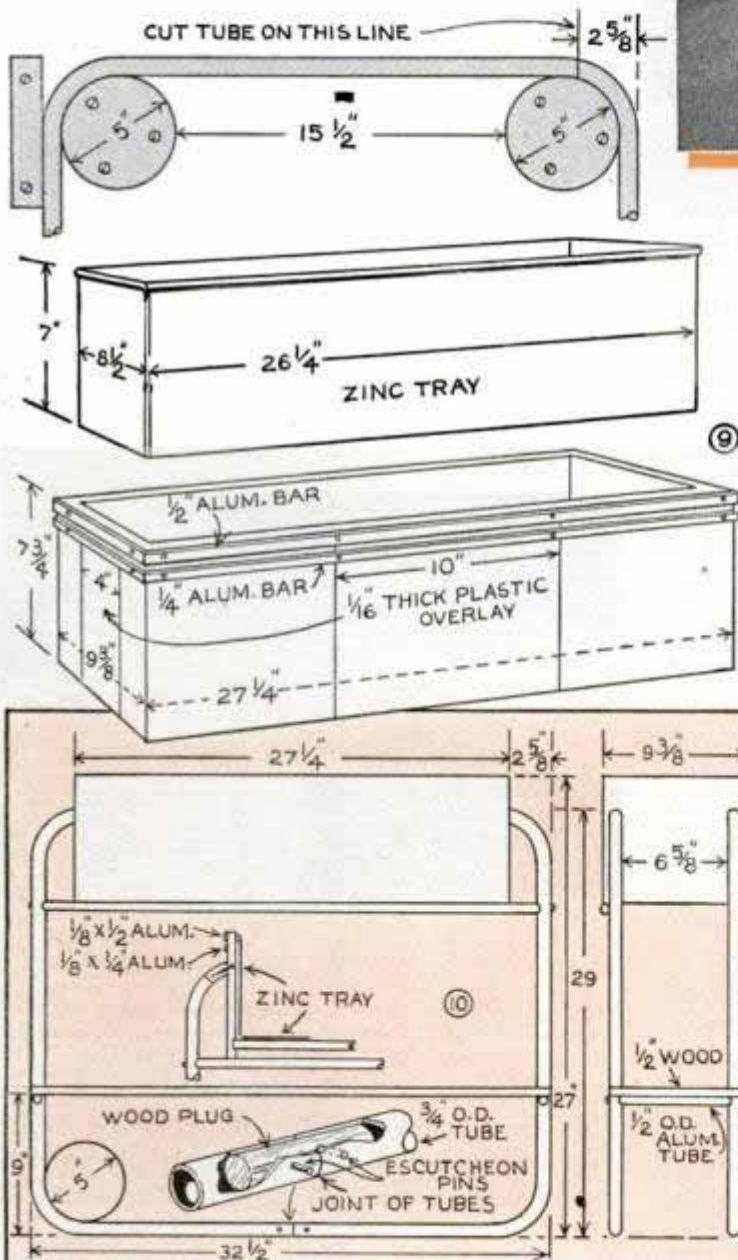
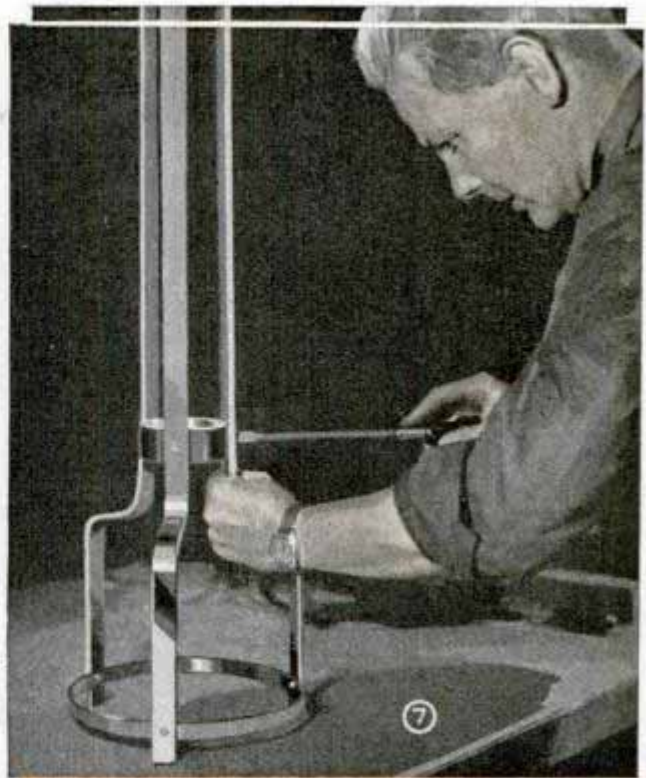

are inserted into the crossbars to take the screws, the dowel rods being continuous through the length of the tube to tighten up snugly with no chance of coming loose, as might happen in the case of a plug. See Fig. 6. With the legs and crossbars in position, centers are marked and drilled in the box for the screws holding the legs, and the box is fastened in position. Next, the top crossbars are screwed to the underside of the box to avoid slippage. The last step in the building of this stand is the cutting, staining, varnishing and overlaying of the lower shelf. The shelf, of $\frac{1}{2}$ -in. wood, is first cut oversize and $\frac{3}{4}$ -in. holes are drilled at the corners to make a snug fit against the legs. The shelf is then cut to size and finished, and the plastic overlay glued in place. This overlay is of $\frac{1}{32}$ -in. plastic.

If you're handy at metal working it's no job at all to make the watertight metal tray. It is possible, too, that you could use one taken from an old discarded stand

Lighting Plant Cooled by Air Piped to Motor

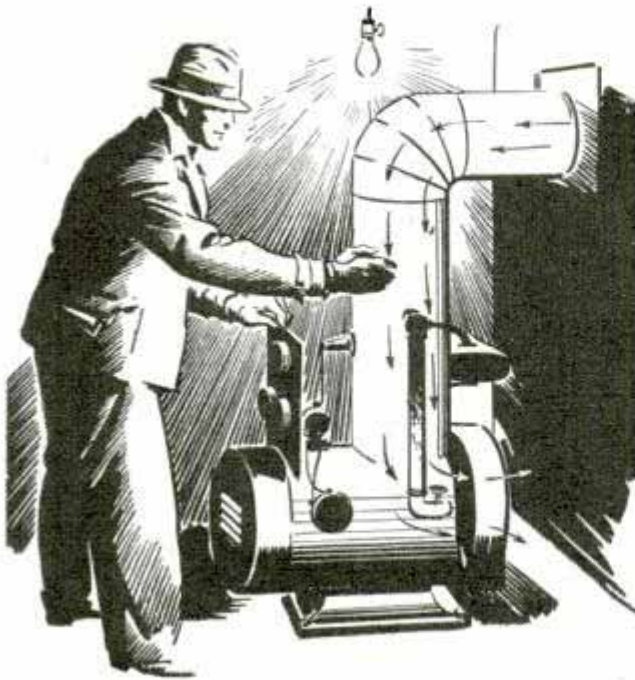

Motors of electric-lighting plants located in poorly ventilated rooms cooled by drawing air from outside

Here's an efficient method of bringing in outside air to cool the motor of an electric-lighting plant of the type having a fan incorporated in the flywheel. The small hood over the head of the motor is lifted off and lengths of stovepipe necessary to reach to a window or other opening in the wall are slipped over the sheet-metal sleeve surrounding the cylinder. The flywheel fan will draw the air down the pipe and around the cylinder.

—G. W. White, Severn Park, Ont., Can.

Celery Encased in Inner Tube Bleaches Uniformly



BANKED WITH EARTH OR TIED WITH RUBBER BANDS

For the home gardener who raises a little celery for his own use, the method shown for bleaching it will be found easier and better than the usual one of wrapping each bunch with paper. Lengths of old inner tube are

slipped down over the stalks and tied around the top with a rubber band or

banked with dirt. Celery bleached in this way is usually crisp and, as the rubber is unaffected by moisture, the stalks are not stained.—A. H. Waychoff, Tempe, Ariz.

Toolbox Swings on Rungs of Ladder

Besides having a broomstick carrying handle, this toolbox is fitted with two large screw hooks so that it can be hung on the rung of a ladder where small tools will be handy to the worker. As the ends of the toolbox extend above the sides, it always hangs level.



Play in Shaper Sticker Block Avoided by Friction Catch

To prevent play in the sticker block of his shaper, caused by varying thicknesses of stock while running several hundred feet of screen molding, one craftsman fit-

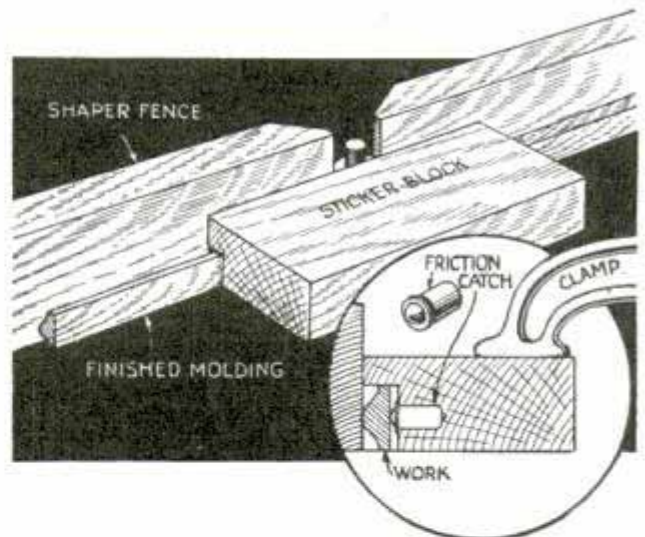

Friction catch in shaper sticker block takes up play caused by slight variation of thickness in stock

ted a friction catch in the block as shown. This permitted a uniform pressure to be exerted against the molding strips, yet allowed easy passage through the block.

Wayne C. Leckey, Aurora, Ill.

☐ Kerosene lamp burners can be cleaned with wood ashes and water.

Heavy Barrels Loaded on Truck Easy with Parbuckle



You can roll a heavy barrel into a truck with ease by using a parbuckle

Why strain your body to the limit to load a heavy barrel or other cylindrical object when you can do the job as indicated with much less energy than would be required to roll or lift it into the truck body? Just take a stout rope, double it and place the looped end over an anchor on the truck floor. Then pass the loose ends of the rope under the barrel and roll it up the lowered tailgate or an inclined platform made for the purpose.

Detachable Screen Shelters Plants in Window Box



Small flowering plants, when first set out in a window box, need to be protected from beating rains. To do this, fasten a narrow strip of screen wire over a frame of stout wire, which is bent at the ends to fit

into screw eyes driven into the window frame. The screen may be removed after the flowers have grown sufficiently.

Auto Casing Protects Wood Clamped in Vise

To avoid vise marks on lumber when it is gripped in a small vise for sawing or planing, cut a section of old auto casing with a hack saw and insert it between the vise jaws.



Paper Holds Beverage Cups Safely at Picnic Dinner

The problem of serving cups or tumblers of beverages without danger of spilling the contents on a picnic lunch cloth is solved by cutting holes in the bottom of a paper plate to receive the containers. Cut the holes to take the cups and tumblers snugly and turn the plates upside down before inserting them.

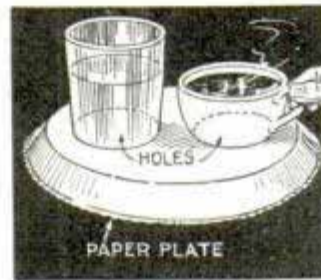

Oilstone Kept in Sliding Shelf Is Handy and Safe

This convenient sliding shelf for your oilstone not only provides a place for safe-keeping, but is always at hand for immediate use. To make the shelf, trace the outline of the stone on a $\frac{3}{4}$ -in. block about 4 in. wide, and cut this out with the coping saw. Then nail a thin strip over the bottom of the opening to hold the stone, and slide the assembly under the bench.

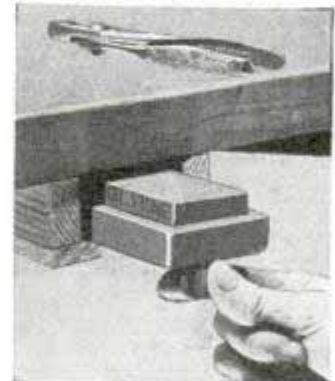

Glass-Top Table of Iron for Porch or Garden

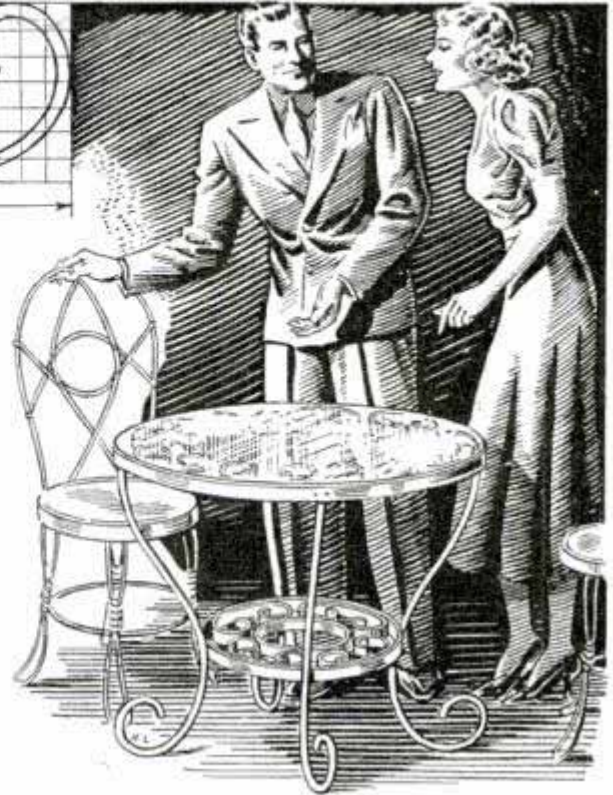
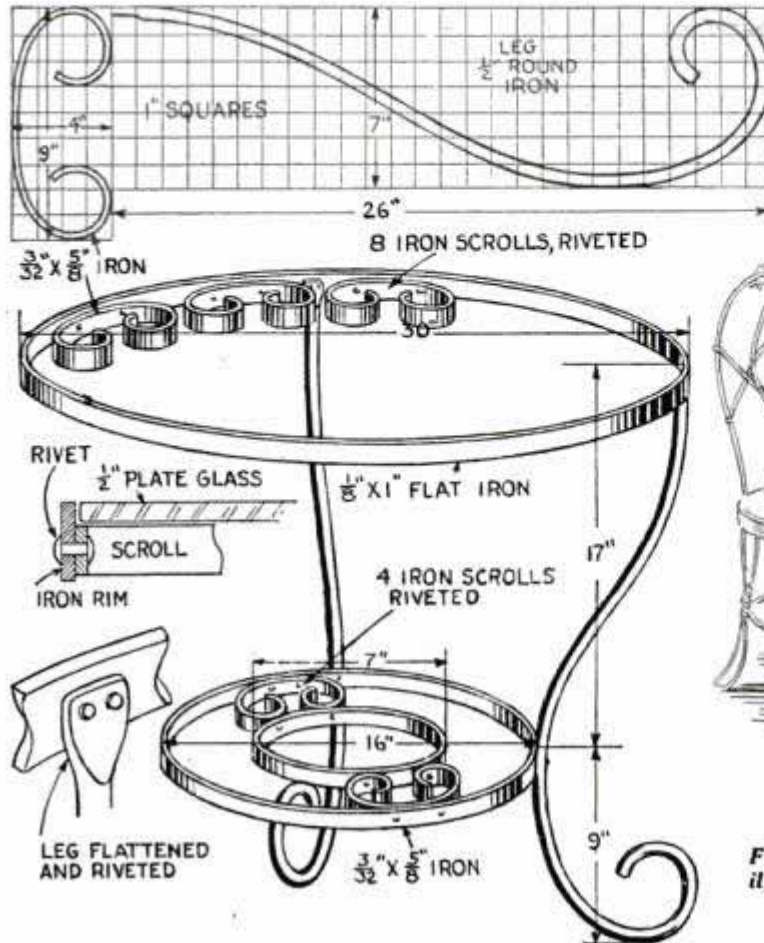

For use indoors or outdoors, this table is easily made as its construction consists of a simple iron-bending job

A striking piece of furniture for use either indoors or outdoors, this glass-top table, with its delicate scrollwork, is an excellent project for the amateur ironworker. Finished in white enamel, it is in keeping with the modern trend in graceful iron furniture. Construction is simple as there are only four curved legs, three iron rings and twelve iron scrolls all riveted together. The rings can be lapped at the joints and riveted, although lap-welded joints will look better. The legs should be made of $\frac{1}{2}$ -in. iron rods bent as shown in the squared detail, with the upper ends flattened and riveted to the table-top rim. The scrolls are of lighter iron than the rim, and support the glass top, which fits just inside, and flush with the rim. About $\frac{1}{8}$ in. clearance should be allowed between the rim and glass so that contraction of the latter in cold weather will not cause it to bind and crack.

☐ Transparent photographs can be made by printing negatives on sensitized Cellophane.

A Homemade Boat Anchor

Cast in a $\frac{1}{2}$ -gal. pail, this boat anchor is made of cement and iron prongs, the latter being taken from old ice tongs or shaped from flat iron. First prepare the pail by inserting a large eye bolt through a hole drilled in the bottom. It is best to drive a large nut part way on the thread-

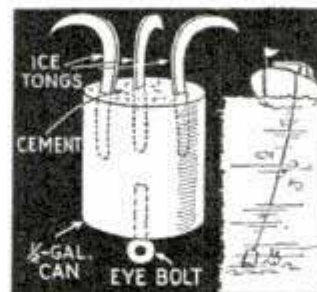

ed end of the bolt to be imbedded in the cement. Then fill the pail with a rich mixture of cement and sand. When this has been done, insert the prongs, spacing them evenly and setting them

an inch or two away from the sides of the pail. It is best to bend the upper ends of the prongs at right angles before inserting them into the cement so that they will not come out under heavy strain.

—Bob Poulson, Los Angeles, Calif.

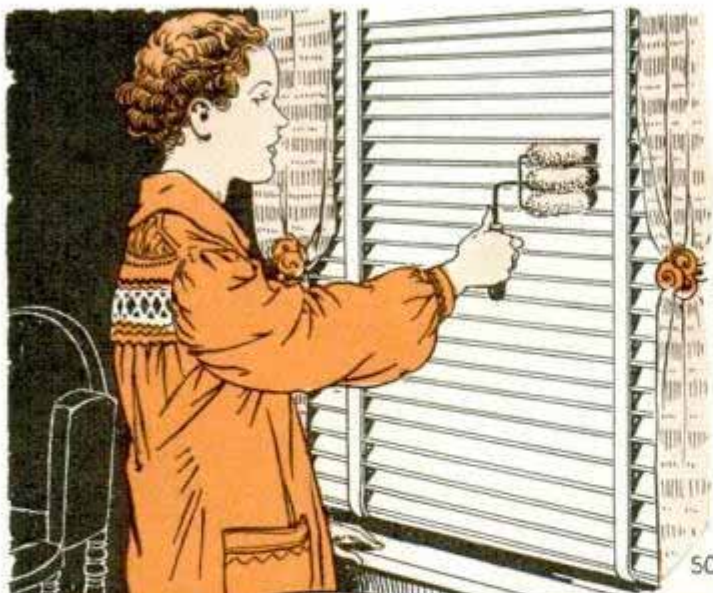

Venetian-blind cleaning is easy with this brush. It consists of three bottle brushes assembled and soldered to a handle. An opening in your porch floor to take the drop shelf in the detail will keep early-delivered milk cool and away from dogs

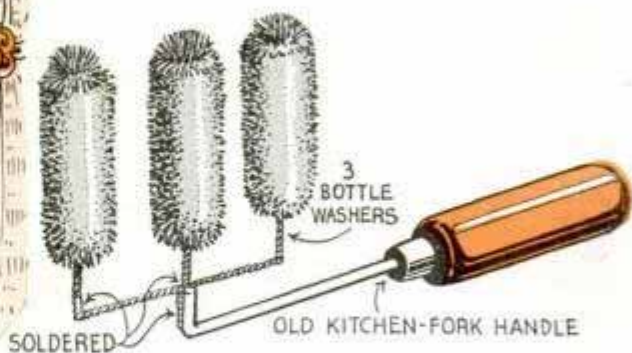

Solving Your

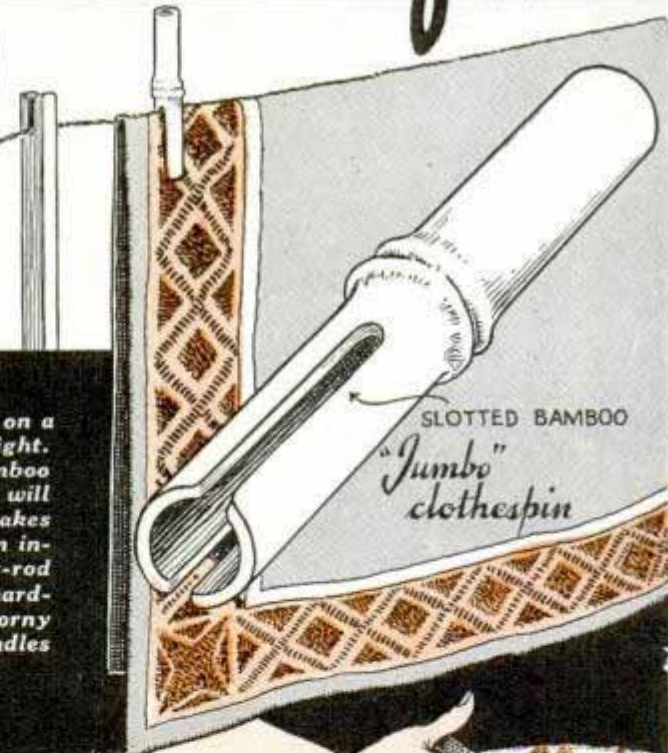

Rugs and other heavy articles are readily kept on a line with large clothespins like the one at the right. It is nothing more than a short length of bamboo slotted at one end. Your old automatic pencil will make a dandy pastry gun for "writing" on cakes with frosting. Just remove the mechanism from inside the pencil and provide it with a clean brass-rod plunger, or even a length of highly polished hardwood dowel. Next time you cut roses or other thorny flowers, tie a length of inner tube over the handles of the scissors as a hand shield

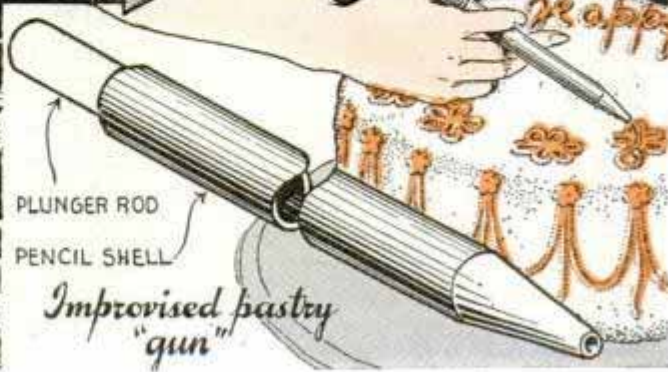
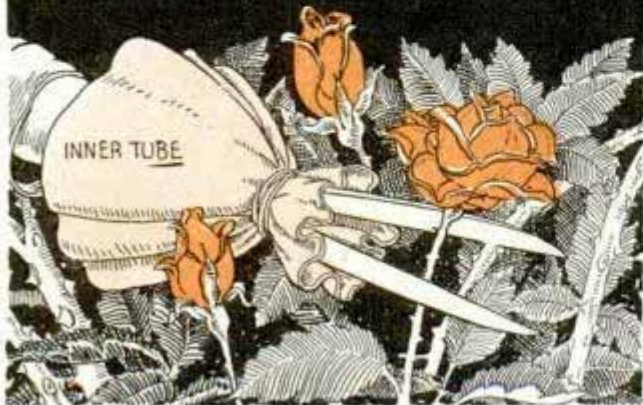

To aid in driving glaziers' points, a square nut is placed on the glass with the flat side down. You can "point" a sash in a fraction of the usual time, and the points are driven uniformly, which is necessary for a good glazing job. At the left you have an improvement on the action of a door-stop. A rubber wedge is fastened to the door with a screw and another screw, driven only part way, acts as a stop when the wedge is tilted upward to clear the floor

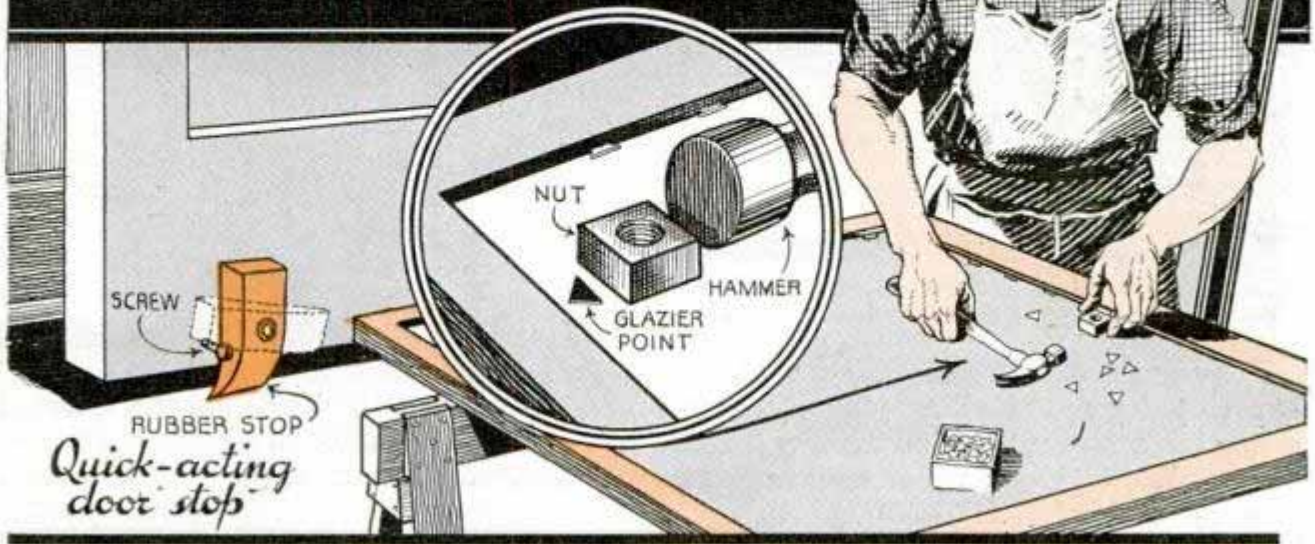

HOME PROBLEMS

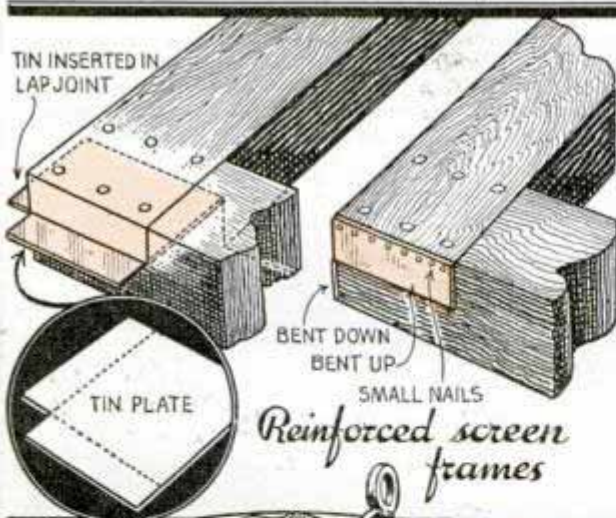

Readily adjusted to three positions, the hinged mirror above is a handy addition to the mirrorless dressing table, and it looks well when finished to match the furniture on which it sets. Screen frames are made exceptionally rigid when tin splines are used in the half-lapped corner joints. The splines are shaped as shown in the circular inset, and the projecting edges are bent in opposite directions. The problem of keeping a lid on a garbage can is solved by riveting two auto-hood clamps to the sides of the can as indicated at the left.

Black Disk over Eyeglasses to Use Microscope



Paper disk covering one side of eyeglass frame enables user of microscope to keep both eyes open

Persons who find it tiresome to keep one eye closed when working with a microscope for a long period of time, will find that a disk of black paper covering one

lens of their glasses will enable them to keep both eyes open. If the microscopist does not wear eyeglasses, the lenses can be removed from a cheap pair of sun glasses and the paper disk cemented over one of the frame openings.

Emergency Paper Perforator

A hacksaw blade with sixteen to eighteen teeth per inch makes an excellent perforator for small home work. Place the teeth along a line laid out for the perforation and tap the back of the blade sharply several times. This should be done on a very easily penetrated surface, such as linoleum.

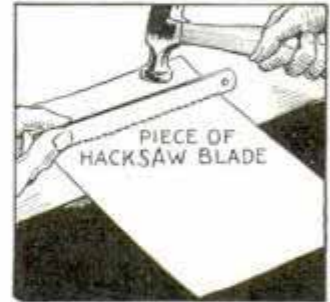

Plenty of Fun at a Safe Speed



MORE BLUEPRINTS ON GOOD SUMMER PROJECTS

"ROAMER"—765 to 770: Outboard cabin cruiser. 16 ft. long, 66 in. beam. Requires outboard motor of 20 to 36 hp. Set of six prints \$1.00.

12-FT. ROWBOAT—707: Flat bottom. Can be used with small outboard motor. 25c.

"ZIP," MODEL RACING YACHT—880 to 883: 50 in. long. Four prints \$1.00.

TRELLIS SUGGESTIONS—639: Six types that will help beautify your home. 25c.

LAWN CHAIR—529: Plain sawed from 3/4-in. stock. Easily made with hand tools. 25c.

ORNAMENTAL WOOD FENCES—640: Five artistic designs for standard wood stock. 25c.

VENETIAN BLINDS—926 and 927: Three different styles covered on two prints. 50c.

This small car, having a 58-in. wheelbase and 28-in. tread, is very easy to operate and may be powered by a 1/2 to 3/4-hp. gas engine of the washing-machine type. It is equipped with effective brakes and pneumatic tires. Plans show three alternate methods of body construction. Easy to build. Our blueprints Nos. 906 to 909 incl. give you all the information necessary. This set will be sent postpaid on receipt of \$1.00.



LAWN AND GARDEN FURNITURE—920 to 922: Collection of designs for arbor-and-seat combinations and swings. (3 prints.) 75c.

METAL WEATHER VANES—520: Scroll-sawed from sheet aluminum. Complete assembly details. 25c.

Any six of these blueprints will be sent postpaid upon receipt of \$1.00

Blueprint Department, Popular Mechanics Magazine, 200 E. Ontario St., Chicago



SHOP NOTES

BETTER PHOTOS *with diffused light*

Dime-store aluminum ware and music stands used to make these photo lamps

BUILT at a cost of about three dollars each, these two photo lamps will help you in getting good portraits and close-ups on "still" subjects, shot indoors. The lamp in Fig. 1 is the diffusing type, designed especially to light the face of the subject, while the lamp shown in Fig. 2 gives indirect illumination free from "hard spots" and "rings." When completed, each lamp is mounted on a folding music stand to which an extra length is added.

In assembling the diffusing type of lamp you get an aluminum drinking cup $3\frac{1}{2}$ in. in diameter and 3 in. deep; a hot-cake cover, $6\frac{1}{2}$ in. in diameter and $2\frac{3}{8}$ in. deep; a metal embroidery hoop 7 in. in diameter; a telescoping curtain rod of which the solid rod is about $\frac{3}{16}$ in. in diameter, and a porcelain socket. The method of assembly is shown in Fig. 3. Set the hot-cake cover on a smooth wood surface, find the exact center of the inside bottom and scribe a circle



A diffusing screen or indirect light





and connect it to the socket, and attach the socket inside the cup. Hold the cup against the reflector and screw a No. 1 photoflood lamp into the socket, moving the cup until the lamp is located in the exact center of the hole in the reflector. Then mark the positions for the four screws, drill the holes and fasten the cup on permanently. The supporting arm to hold the diffusing screen is flattened at one end as in Fig. 4. Of the two holes that remain from the cup handle, the one nearest the top of the cup may be used in mounting the supporting arm. Then only one hole need be drilled in the cup for the arm. The other end of the arm is bent to form an eye for attachment to the lamp standard, and another length of curtain

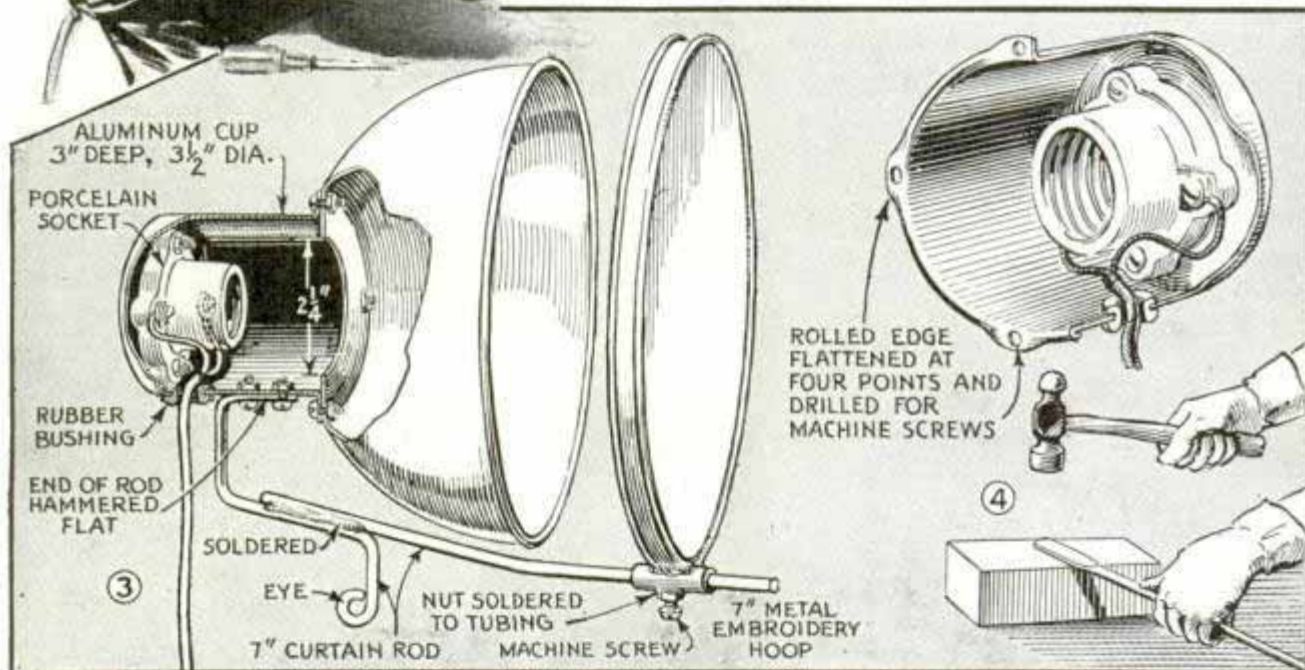

2 1/4 in. in diameter. Cut this out with a hammer and a narrow chisel, after which you smooth up the ragged edge. Now remove the handle of the drinking cup by drilling out the rivets. In line with the holes remaining from the cup handle, drill a 1/4-in. hole about 5/8 in. from the bottom of the cup and ream the hole to take a rubber "doughnut" bushing. Next, set the cup, bottom down, on a smooth surface and place the flat-base porcelain socket in the exact center. Mark the positions for the machine screws to hold it, and drill the holes. Then stand the cup, bottom up, on a smooth surface and flatten the rolled edge at four places for 1/16-in. screw holes. Pass the light cord through the insulator

rod is soldered onto the supporting arm to hold the diffusing screen. The outer frame of the embroidery hoop is soldered to a 1-in. length of tubing, which is drilled and has a nut soldered on to take a screw for tightening.

The indirect lamp shown in Figs. 2 and 5 is of similar construction in that the same size of drinking cup is used to house the socket. But the reflector is a 10-in. mixing bowl and a deflector is suspended inside by means of three small coil springs. Also, a No. 2 photoflood lamp is used. A 1 1/2-in. circle is cut in the bottom of the bowl after which you attach the cup, which holds the socket. The supporting arm is made and attached and then the de-

flector is mounted. This is a 4-in. water dipper from which the handle has been removed. The rolled edge is divided into three equal portions, marked with a pencil and flattened at the rim for holes to which the springs are attached. These are $\frac{1}{8}$ in. in diameter and 2 in. long. Next, the rolled edge of the bowl is divided into three equal portions and marked with a pencil. To find the positions for the screw eyes, you measure $1\frac{3}{8}$ in. into the bowl. Very small holes are punched so that the screw eyes can be driven through the shell of the bowl. The ends of the springs are fastened to the eyes. Be sure to close the loops in the springs so they will not pull off. As there are variations in porcelain sockets, some will project the lamp farther

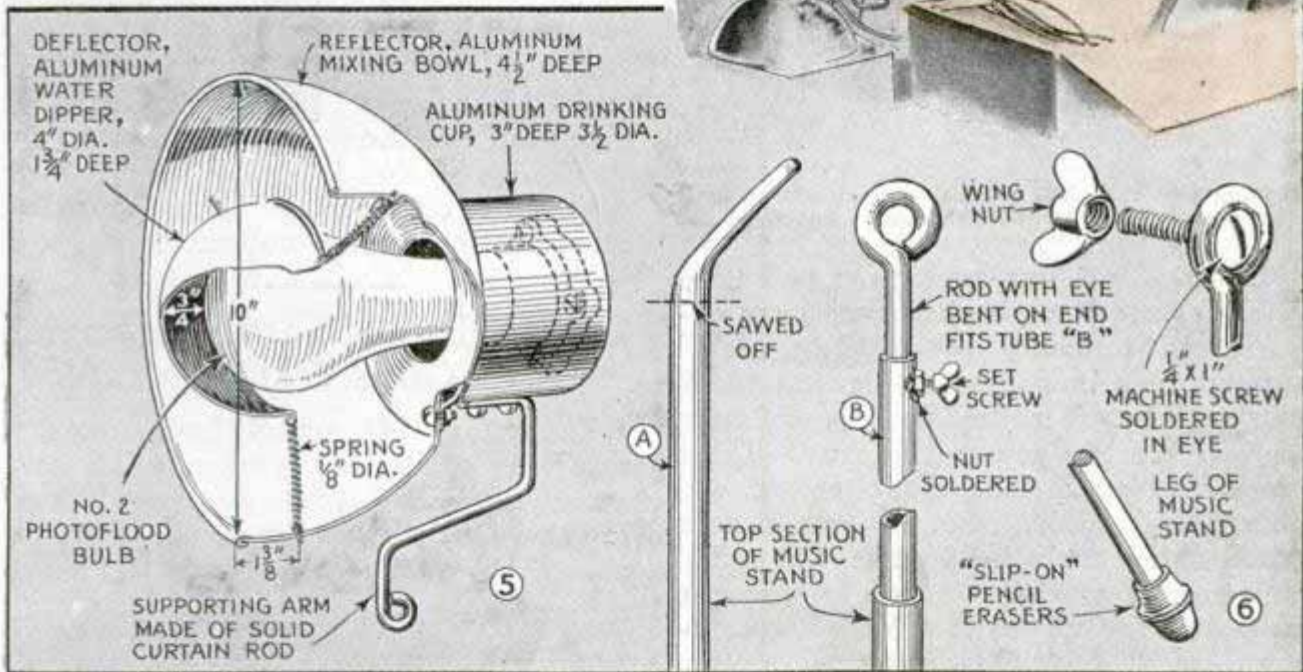

into the bowl than others. This will have to be taken into consideration before fastening the screw eyes into the bowl as the deflector should be spaced about $\frac{3}{4}$ in. from the lamp.

Folding music stands make good standards for these lamps. The only alteration necessary is at the top of the standard. The bent portion designed to fit the rack is cut off as indicated in detail A of Fig. 6. Then a hole is drilled near the top of part A and a nut is soldered over the hole to take a thumbscrew, which is made by soldering half of a washer in the slot of a machine screw. This detail is shown incorrectly as being attached to the curtain-rod sleeve B. The sleeve is pushed inside

of the top section of the music stand, the rolled end of the sleeve keeping it from sliding down too far. The thumbscrew forces the sleeve tightly against the solid rod inside of it after the latter has been pulled out to the desired height. The upper end of the rod is bent to form an eye into which a $\frac{1}{4}$ -in. brass machine screw is soldered, this fitting the eye on the lamp supporting arm. A wing nut holds the two securely together after the lamp has been adjusted to the angle desired. It is also a good idea to provide the feet of the music stand with pencil erasers of the slip-on type, in order to prevent marring varnished floors and also to make the light stand firmly where it is placed.

Driving Small Rods with Weight to Avoid Buckling



Driving iron rods into ground with weight on ends prevents vibration which causes buckling

Electric-light line repairmen and telephone or radio servicemen, who have experienced difficulty by having small ground rods buckle when driving them, can profit by the method used by workmen of one electric-power company. These workmen found that the buckling was caused by vibration set up in the rods when struck with the driving sledge, and the trouble was eliminated by using a weight on the ends of the rods when driving them. The weight was merely a piece of iron or steel shafting drilled part way through to slip over the ends of the rods.

Gummed-Paper Tape Applied with Paintbrush

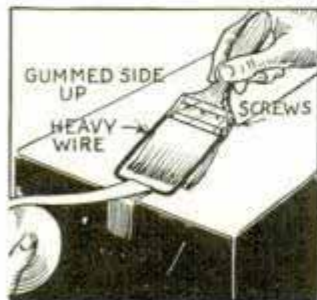

are smoothed in place. To eliminate this possibility, bend a length of heavy wire to

When gummed paper tape is employed in sealing large paper cartons, the long strips torn from the moistener usually become too dry to adhere firmly before they

a U-shape and screw it to the sides of a discarded paintbrush. Strips of tape are removed from the roll without moistening and applied to the cartons in the following manner: First dip the brush in water to moisten the bristles. Then, insert the tape through the wire guard, gum side up, and draw the brush along the surface to be sealed so that the brush moistens the carton and the wire guard pulls the tape in place.

Warning Flag Carried in Pocket

When working on road construction projects, where a warning flag is often needed, a workman carries it in his pocket. The flag is hemmed at the wide edge so that it can be slipped over the handle of a pick or sledge and displayed in the manner indicated.



Large Wheel of Threshing Engine Forms Good Watering Tank

Finding a 6-ft. wheel from a steam threshing engine in a junk pile, an Iowa farmer converted it into a stock-watering tank, which will last for years. The hub and spokes were removed from the wheel,

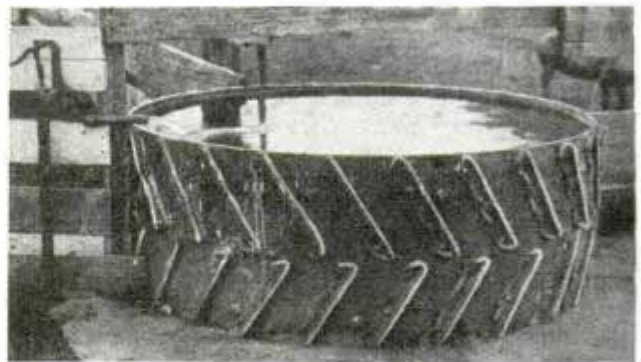

This old threshing-engine wheel has solved an Iowa farmer's watering-tank problem for years to come

after which the rim was laid on a strong, reinforced foundation of concrete. Then a rich mixture of cement and sand was applied to the foundation surface, both inside and outside the rim to a depth of 2 or 3 in., to make a watertight bottom for the tank.—R. F. Fryklund, Audubon, Iowa.

Worker Wears Towel on Arm



In shops and factories where workers must handle materials which keep their hands soiled, the problem of wiping perspiration from their faces on hot days is solved by

wearing towels on their arms. The towels are sewed up in the form of sleeves, which are large enough to slip over the hands.

Electrical Outlet on Lathe Is Handy for Attachments

If you have a metal-working lathe that has a forward-reverse switch with the line current carried directly to it, it's an easy matter to attach an electrical outlet at this point for plugging in an extra light, tool-post grinder, mica undercutter, etc. The outlet is of the double type used in house wiring, and is attached to the out-

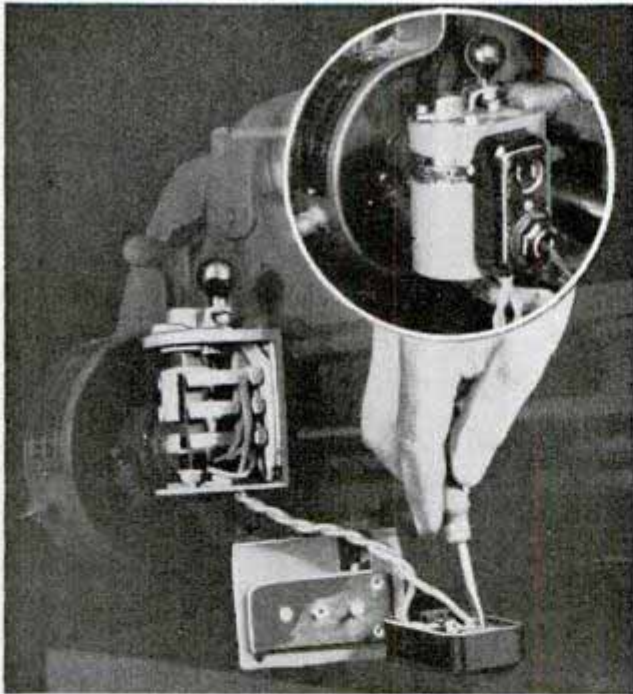

An integral part of the lathe, this outlet is handy for attaching an extra light, tool-post grinder, etc.

side of the switch housing with small stove bolts. If possible, put the bolt heads inside the housing. Run the wires down the side of the switch and up through the extra wiring hole in the bottom of the housing.

Special Nozzle to Clean Drums in a Factory



Homemade nozzle directs hot water inside of drums to clean them quickly

In one factory where there were a number of drums to clean every day, the job was done quickly with the aid of steam, hot water and this simple nozzle. The nozzle is merely a length of pipe with a cap having several small holes drilled in it. The nozzle is attached to the hot-water line with a length of hose.

—A. H. Waychoff, Tempe, Ariz.

Grease-Cup "Wrench" Is Made from Rubber Hose

A short section of rubber hose, split at one side, may be carried easily in one's pocket for turning grease cups on any machine. The rubber not only gives a firmer grip

for twisting the cup but also protects the fingers when a cup is so located that it may be too hot to turn with bare hands.



☐ Pieces of Cellophane cloth of the basket-weave pattern hung over photo lights make good diffusing screens.

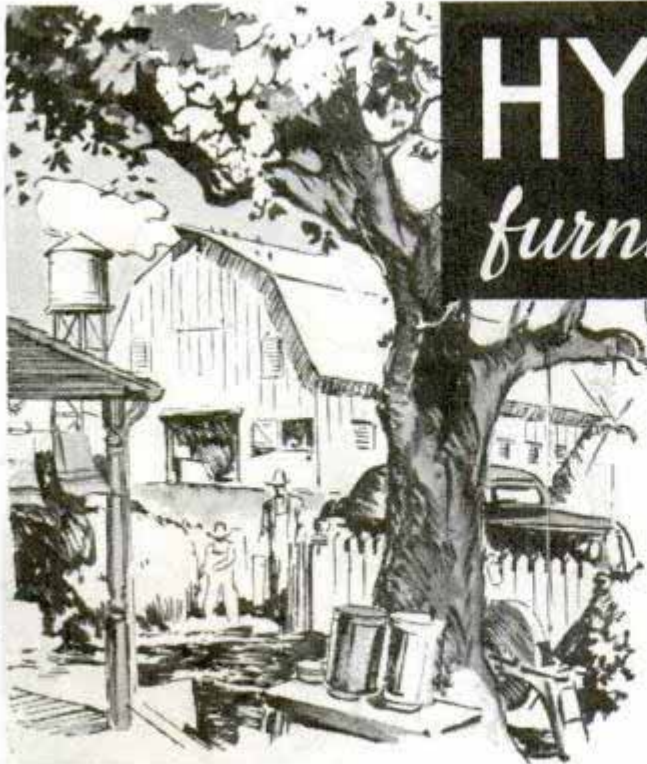

HYDRAULIC

furnish water supply

PART I

MANY rural homes and summer cottages can be furnished with running water from a near-by spring or stream even though its daily flow is modest, by installing a hydraulic ram. This is a pump which takes advantage of a small water fall to lift a portion of the water to a considerable height. Theoretically, a hydraulic ram should lift one-half of the water available twice the height of the fall or $\frac{1}{20}$ of it twenty times the height of the fall. But the actual efficiency of rams is less and varies considerably. Fig. 1 shows the working parts. Under normal conditions, the ram valve is open, thus allowing water to flow through the ram. As water flows, its velocity increases until the valve is lifted and quickly closed. Since water in motion possesses energy, a considerable pressure is developed. This pressure opens the check valve, thus admitting a quantity of water to the pressure chamber. When enough water has entered to relieve the excess pressure, the check valve automatically closes, thus preventing water from flowing back. At this instant a small volume of air enters through the

breather hole to replenish the air dissolved and carried away by the water. Upon the next stroke of the ram this air will be forced into the pressure chamber. The addition of water to the pressure chamber compresses the air which in turn forces water through the delivery pipe to the reservoir. When the check valve closes, the weight of the ram valve overcomes the pressure against it and drops, thus allowing water to again flow through the tail or discharge pipe, and so the cycle is repeated. Where the water is to be used for drinking it is best to obtain it from a spring,

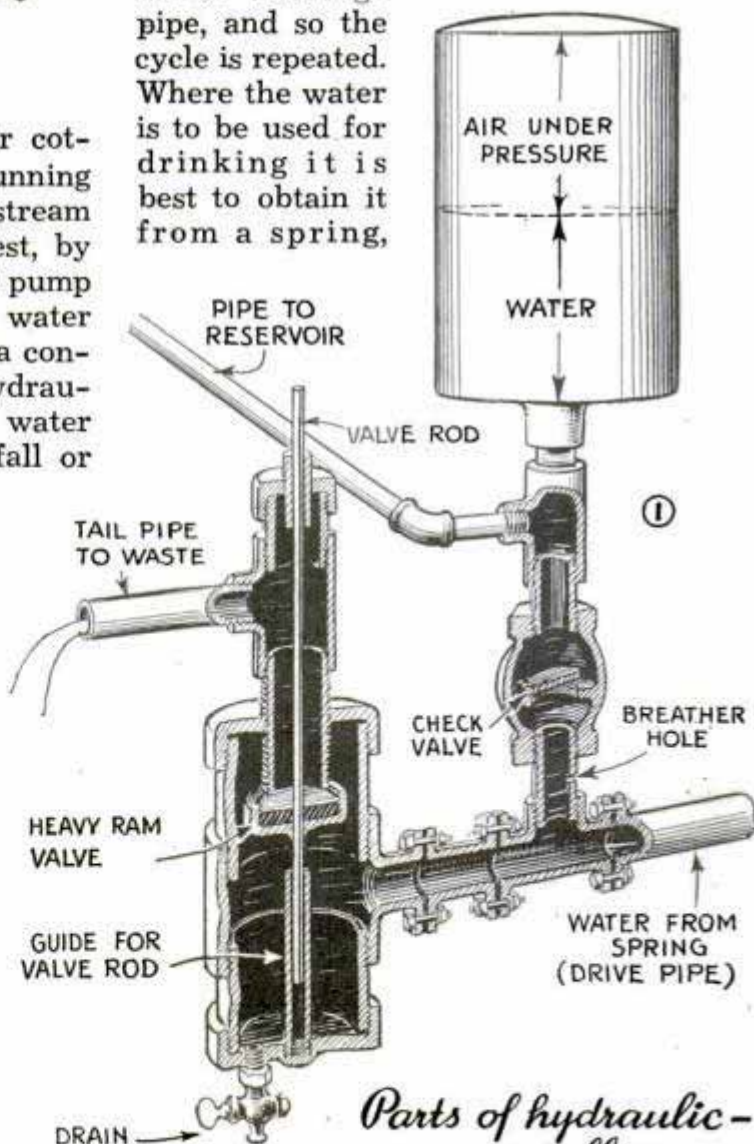

Parts of hydraulic-ram installation

RAMS

to country homes

but if it is to be used for washing, stock watering and other purposes, the supply can be obtained from a small stream.

We shall first explain simplified methods which will enable anyone to determine how much water can be lifted from a spring to the location where it is to be used, and then illustrate methods of surveying the spring and determining the other necessary values.

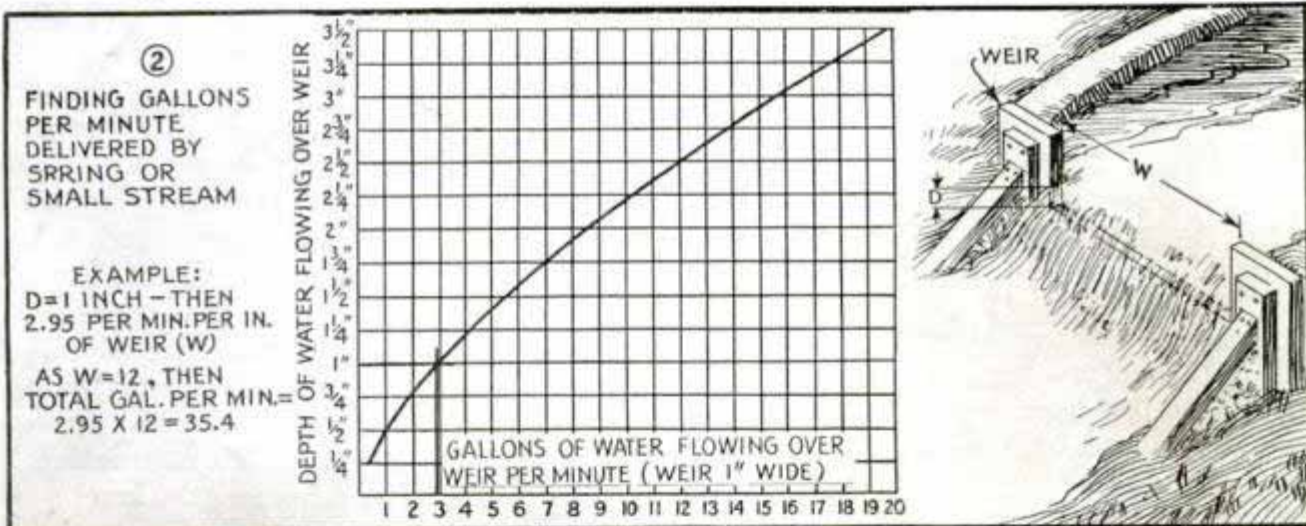

First measure distance D, which is the depth of water flowing over the weir, by the method shown in Fig. 3. Locate this value at the left-hand side of the chart, follow across to the curve, and then drop down where the amount of water in gallons per minute for each inch of weir length is given. Multiplying this number by the length of the weir in inches gives the total amount of water passing over the weir per minute

The spring must be surveyed first to find whether it will deliver enough water. To do this it is dammed as shown in Fig. 2, so that all of the water flows over the edge of the board or "weir." The weir must be perfectly level and so arranged that no water can flow under or around it. The flow should be slow and free from turbulence. The depth of the water flowing over it is measured as shown in Fig. 3. First drive a stake a couple of feet above the weir, the top of both stake and weir being level, which can be determined by the method shown in detail A. Then the

distance from the top of the stake to the surface of the water is measured as in detail B. We can now determine the amount of water in number of gals. per min., by referring to Fig. 2. To illustrate the method we will assume that the depth of water flowing over the weir is one inch. We locate one inch on the left-hand side, following across to where this line meets the curve, and drop down to read a trifle below 3, say 2.95, as the gals. per min. for each inch of weir. Next we multiply this by the length of the weir which we will assume to be 25 in., giving a total of 73.75

Finding depth of water over weir

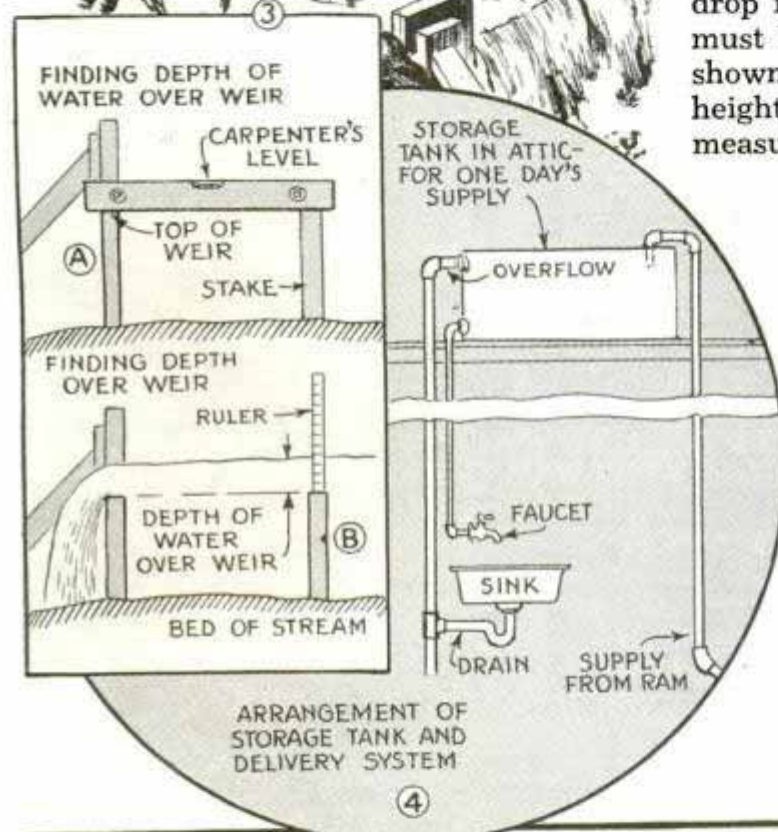

Next, it is necessary to determine how high the ram will have to pump water to fill the supply reservoir, which may be located in the attic or other convenient place. Some use an outside tank. Fig. 4 shows a practical arrangement for the water-supply system. The reservoir or supply tank should be large enough to hold an entire day's supply. With the location of the reservoir tank determined, the distance between the top of the tank and the ground level beside the house should be measured. This is indicated by distance T in Fig. 5. Then the vertical drop from the ground level to the spring must be measured in a series of steps as shown in Fig. 5, in order to determine the height that the water must be raised. The measurements of vertical drop are made

with the use of a surveyor's level and stick. If a surveyor's level is not available you can improvise something that will work with reasonable accuracy from a carpenter's level fitted with sights so that the line of sight will be parallel to the top of the level. For the stick you can use a long pole graduated with numbered markings spaced 6 in. apart. The upper detail of Fig. 6 illustrates how level and stick are used, the level being mounted on a suitable tripod which is fitted with a plumb bob. Set the stick at location X and after adjusting the level sight

⑤ Finding height ram must lift water

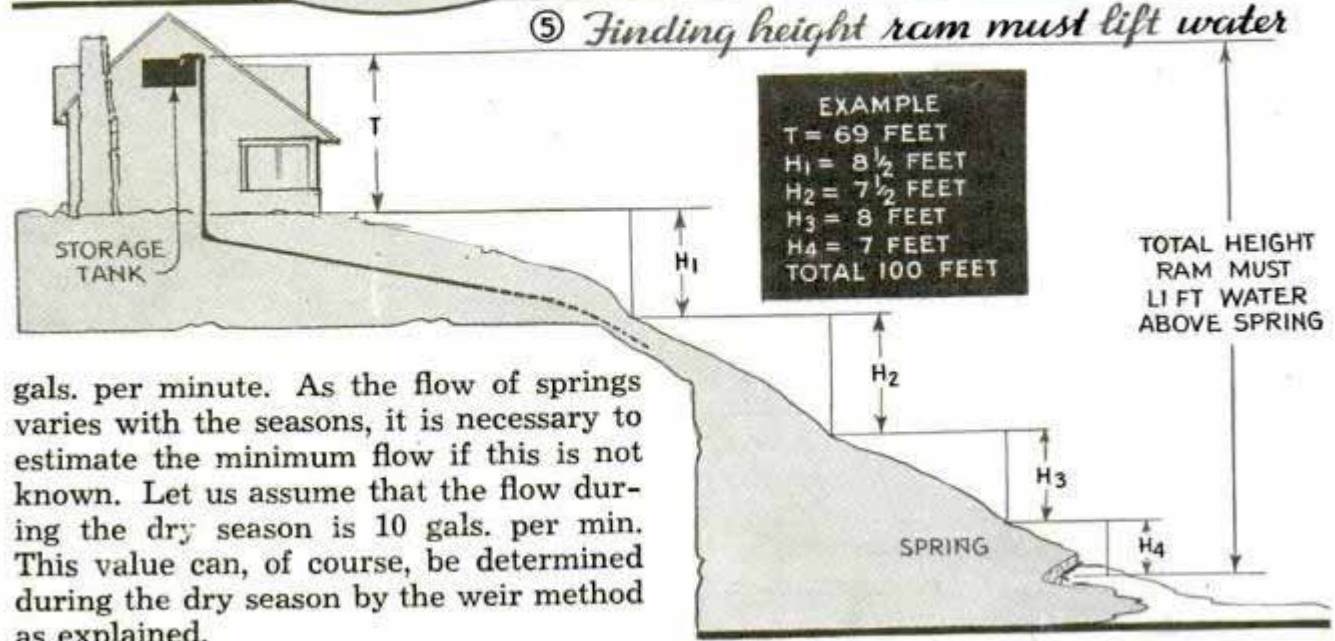

gals. per minute. As the flow of springs varies with the seasons, it is necessary to estimate the minimum flow if this is not known. Let us assume that the flow during the dry season is 10 gals. per min. This value can, of course, be determined during the dry season by the weir method as explained.

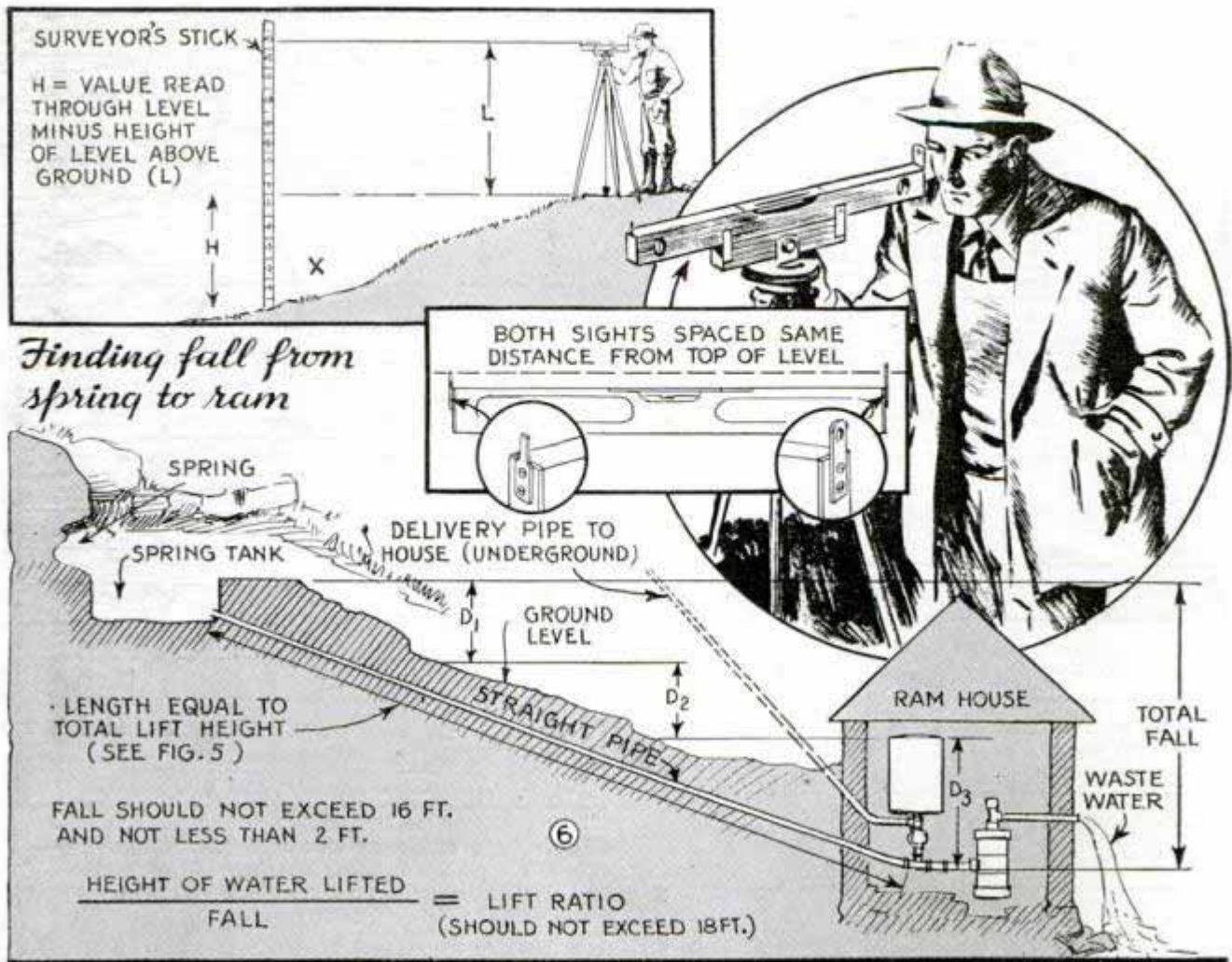

Besides measuring the vertical drop from the top of the reservoir tank to the spring, the additional drop from the spring to the ram, located not over 16 ft. below the spring, should be measured in the same way, using the level system shown in the upper details

over it, noting the height where the line of sight crosses the stick. From this height you subtract L , which is the distance from the level to the ground, and the remainder is distance H . Then set the level with the plumb bob at point X and repeat the process. In this way distances H_1 , H_2 , H_3 and H_4 of Fig. 5 are measured. Adding all of these to distance T gives the height that water must be lifted from the spring to the top of the tank. It is not necessary that the path taken between the house and the spring be straight.

It must then be determined how great a fall of water is available for operating the ram. To do this, locate a point below the level of the spring from which the waste water from the ram can easily drain away. The straight pipe-line distance between the spring and the ram should be about the same as the vertical height to which the ram must lift the water. To continue with the example, we will assume that the top of the supply tank was found

to be 100 ft. from the spring. This means that a pipe at least 100 ft. long will have to be run from the spring, straight but sloping downward, to a place below the spring where the ram will be located. Having determined the ram location, which should not be less than 2 ft. nor more than about 16 ft. below spring level and 100 ft. or more from the spring as shown in Fig. 6, we are ready to find the fall or head available for pumping water. This is the vertical height of the spring above the ram location and is found with a surveyor's level and stick as previously explained. We will assume our survey shows that the total fall (Fig. 6.) is 14 ft. Then from Fig. 7 it is easy to determine whether a spring will pump as much water as is required. Assuming that the ram will be located 14 ft. vertically below the spring, Fig. 6, we deduct 2 ft. to allow for frictional loss in the drive pipe. This leaves 12 ft. as the fall available for pumping water. We will also assume that the requirements are 550

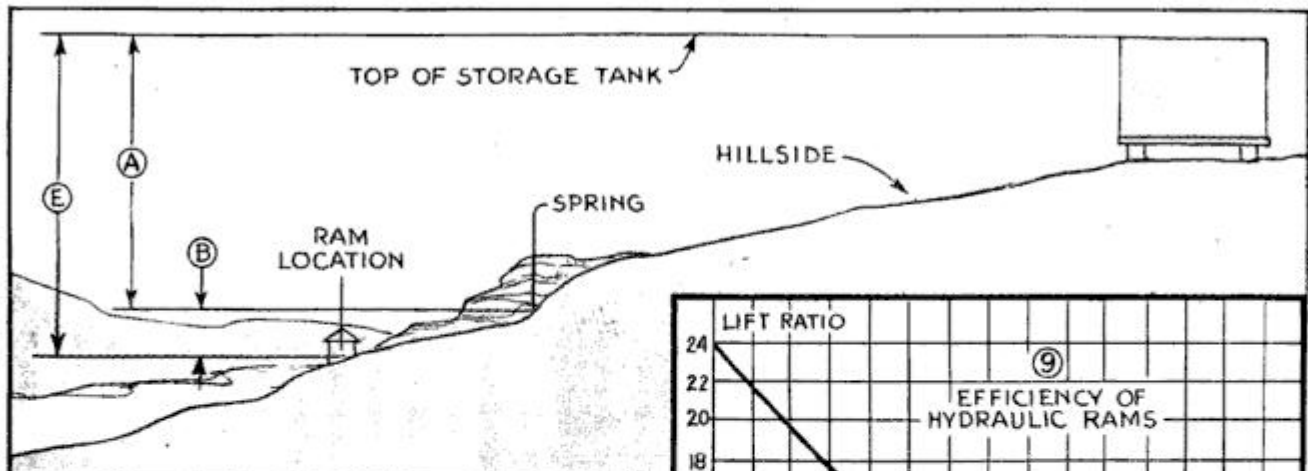

⑦ FINDING SPRING FLOW REQUIRED TO OPERATE RAM

Method	Example
A—Find vertical height to lift water (Call this A)	A = 100 feet (found by surveying—(Fig. 5))
B—Find vertical fall from spring to ram (Call this B)	B = 14 feet (found by surveying—(Fig. 6))
C—Subtract 2 from B to allow for losses in ram (Call the answer C)	C = 14 - 2 = 12 feet
D—Estimate gallons of water per day required (Call this D)	D = 550 gallons per day (estimated)
E—Add A and B to find total lift (Call this sum E)	E = 100 + 14 = 114 feet
F—Multiply D by E (Call this product F)	F = 550 × 114 = 62,700 foot gallons per day
G—Multiply C by 14.4 and this product by efficiency of ram (Fig. 9) (Call this G)	Since efficiency = 45% (Fig. 9) G = 14.4 × 12 × 45 = 7776
H—Divide F by G to find gallons per minute required of spring	H = 62,700 ÷ 7776 = 8 gallons per minute required from spring

⑧ FINDING GALLONS OF WATER PER DAY AVAILABLE FROM SPRING

Method	Example
I—Multiply 14.4 by gallons per minute from spring (Call this product I)	Spring delivers 10 gallons per minute and the fall is 14 feet. Water must be lifted 100 feet above spring. I = 14.4 × 10 = 144
J—Multiply I by C (See Fig. 7) and by the efficiency (See Fig. 9 for C) (Call this product J)	Since C = 14 - 2 = 12 and efficiency 45% J = 144 × 12 × 45 = 77,760
K—Divide J by E to get gallons pumped per day (See Fig. 7 for E)	K = 77,760 ÷ 114 = 682 gallons per day

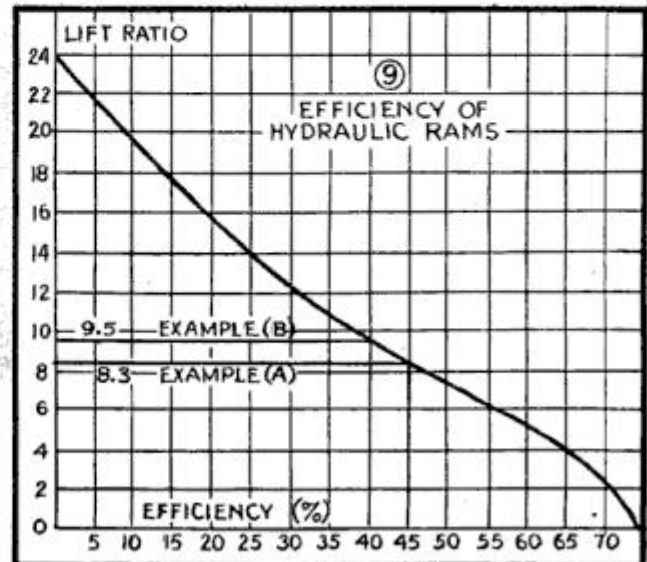

To find the efficiency of a ram, you first determine the lift ratio by dividing the height that water is to be lifted above the ram, by the fall from the spring to the ram

gals. of water per day. Referring to Fig. 6, we add the lift to the fall and multiply this by the number of gals. per day, that is, 550 multiplied by 114 or 62,700. Next, according to G of Fig. 7, the fall available for operating the ram, which is 12 ft., is multiplied by 14.4 which equals 172.8. We must next determine the efficiency of the ram by referring to Fig. 9. To do this we divide the height the water is to be lifted above the ram, or 114 ft., by the fall from the spring to the ram, or 14 ft., to get the lift ratio. In this case 114 divided by 14 equals 8. We locate this at the left side of Fig. 9, example A, follow across to the curve and down to the bottom and read 45 per cent as the efficiency. Multiplying this by 172.8, as shown in Fig. 7, we get 7,776 as the answer. The next step is to divide the first product, or F, by the second product G, or 62,700 divided by 7,776, which equals 8 gals. per min. as the amount of water which the spring will have to supply in order to furnish the required amount of water.

If the spring supplies 12 gals. of water per min. during the dry season, we will be safe in installing the ram. But if, after

making these determinations, it should be found that the spring will not deliver sufficient water, the next thing to do would be to figure how much water could be pumped per day during the dry season. Fig. 8 illustrates the method of making this calculation. Then, after you have found that there is sufficient fall available to operate a ram, the job of figuring the exact size required, and how to install it, comes next. This will be thoroughly covered in the next installment, which will also contain workable methods of making parts cheaply from pipe fittings in case you prefer to make these parts yourself. Hydraulic rams are also manufactured in a number of sizes and varieties, and they have the advantage over simple homemade ones in that they have been developed for long service and minimum trouble.

(To be continued)

Greeting Cards Are Displayed in Holder of Wire

To avoid having his stock of sample greeting cards thrown about in heaps upon the counter or showcase, one dealer holds them in this novel rack. It consists



Sample greeting and view cards displayed in coils of brass spring are kept in neat order

merely of a length of coiled brass wire, soldered together to form a large hoop. The sample cards are inserted between the spring coils. Customers seldom fail to replace them after making their selections.

Two Views on One Negative Taken with Aid of Mirror

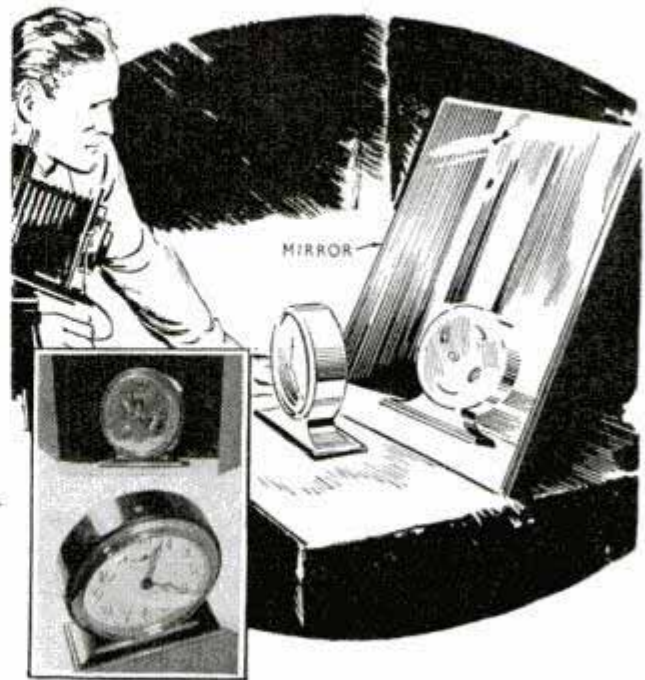

By reflecting one side of an object in a mirror, you can photograph front and back views in one "shot"

For advertising purposes, where front and rear views of an object must be shown photographically, both views may be taken at once on one negative if a mirror is placed behind the object. The camera is set so that the front of the object is clearly shown and also the reflected image of the back. A sample of this method is shown at the lower left. The finished print may have both views or each view can be enlarged on a separate print. In studios where considerable work of this type is done, quite a saving in negative cost can be made.—J. Modroch, Detroit, Mich.

Hack-Saw Blades Are Stored in Pipe Nipple

Instead of keeping your hack-saw blades hanging on a nail or lying in a drawer, where they are likely to be scattered around, why not



make this simple holder to store them? It is a long pipe nipple fitted with a pipe cap at each end. This idea can be applied to scroll-saw blades by using a shorter nipple.—Ralph R. Spain, Festus, Mo.

Sturdy Cart for Welding Tanks from Pipe and Brake Drums



This welding-tank cart is an easy job for a mechanic, costs practically nothing and rolls easily

Needing a strong two-wheel cart on which to move his welding tanks about the shop, a mechanic made a sturdy one from pipe and a couple of rear-brake drums taken from an old Ford car. The drums are mounted on an axle 34 in. long, and the frame, which consists of a length of pipe bent to a large U-shape, is attached to the axle by means of steel brackets welded in place, the brackets being just long enough to raise the frame above the top of the drums. Two or three cross members welded to the frame help cradle the tanks, which set on a platform made from a wide piece of flat iron welded to the ends of the frame. Two short lengths of angle iron projecting forward from the platform keep the cart from tipping when set upright.

False Pocket Keeps Agent's Papers in Order

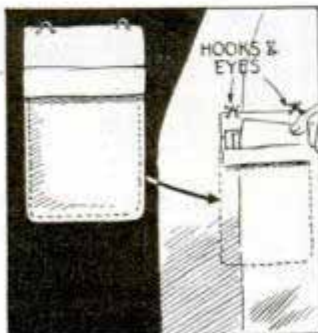

Insurance agents and salesmen who have experienced loss of some of their papers, when they were removed from their pockets and laid aside temporarily, will find this false

pocket handy. It is made to fit inside their regular coat pockets where it is held with hooks and eyes. All papers and memorandum books are kept in the false pocket, which is removed when a paper is wanted.

Powdered Rosin in Small Sack Handy around Workshop

An empty tobacco sack containing some powdered rosin comes in handy around a workshop or in a car. When tool handles become slick and hard to hold, rub the little sack of rosin over them. Enough of the powder comes through to make the handles easy to hold to. The steering wheel of a car also becomes slick. This can be fixed easily with the rosin bag.

—Fred Cornelius, El Paso, Tex.

Auto-Casing Shock Absorber in Hay Rope

When a single horse is hitched to the carrier rope to lift hay from the load into the mow of the barn, the animal frequently suffers much discomfort from the jar or shock imparted to the harness when the pull begins. To avoid this, one farmer hitches an old auto casing to the single-tree and attaches the carrier rope to this. The sudden jerk on the rope is then taken up by the elasticity of the tire and the horse may begin the pull more naturally and easily.

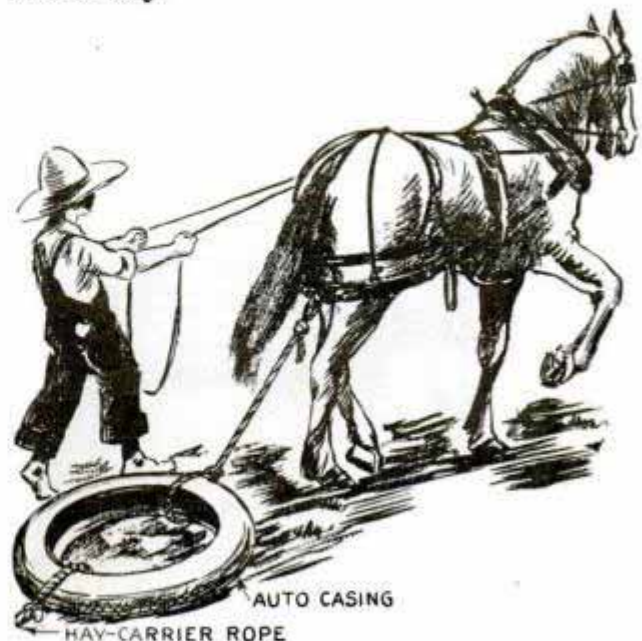

Jerking on a horse's shoulders, when starting a loaded hay fork, is avoided with this shock absorber

HELPS *for the* MACHINIST

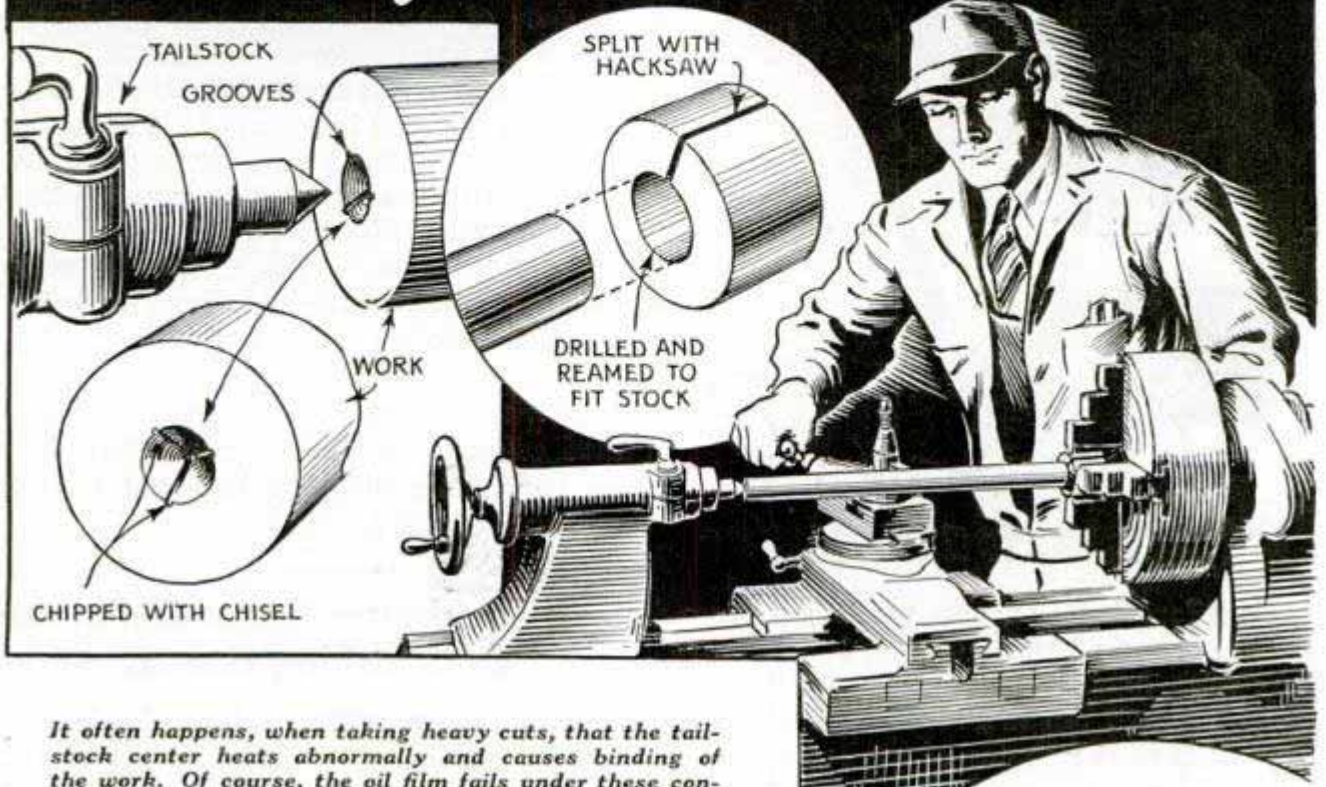

It often happens, when taking heavy cuts, that the tailstock center heats abnormally and causes binding of the work. Of course, the oil film fails under these conditions. One remedy that nearly always corrects the trouble is chipping the tapered center hole in the work with a sharp cold chisel as shown above at the left. When you have to machine rods so small that the chuck does not grip them firmly, a split collar solves the problem as shown at the right above. It takes but a few minutes to make up an assortment of these collars for various sizes of small rods

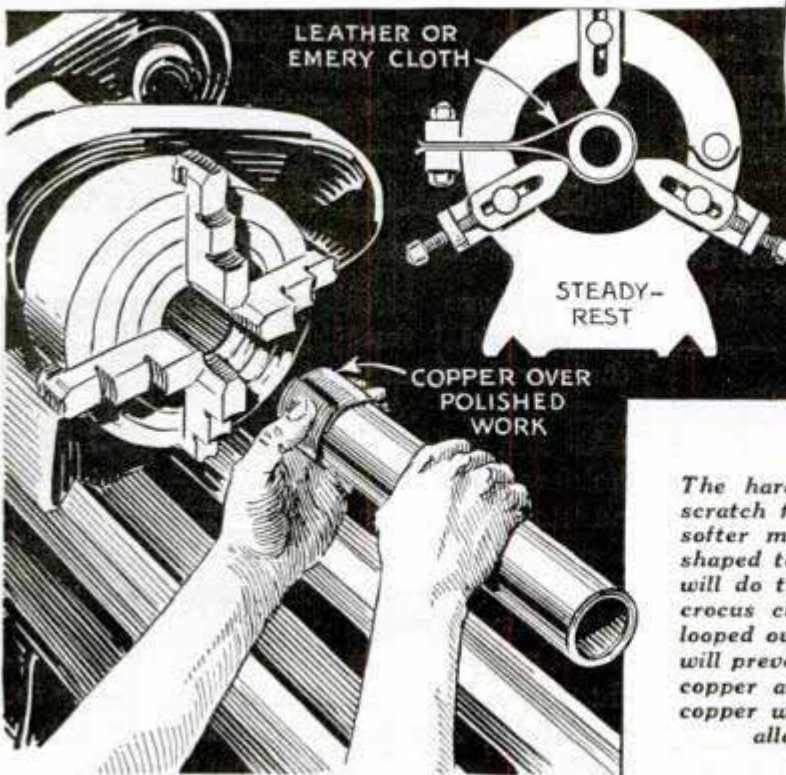
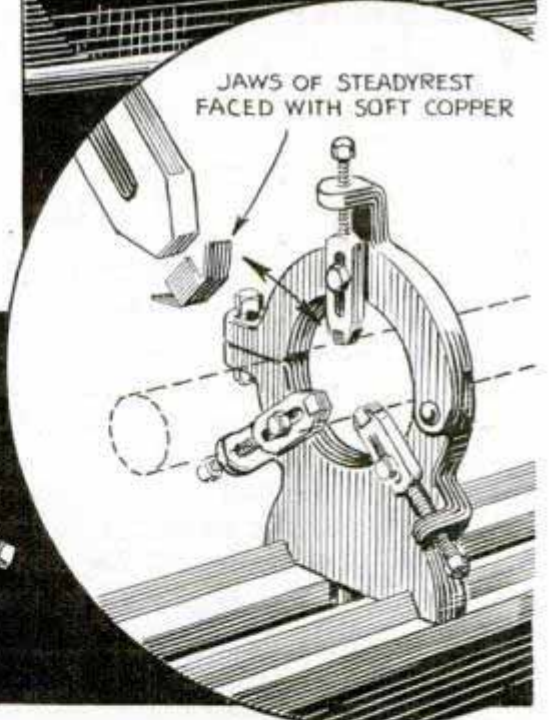

The hardened jaws of a steadyrest will mar or scratch finished work unless they are faced with a softer metal. Facings cut from soft copper and shaped to fit the point of each jaw as shown above will do the trick. Center, a piece of fine emery or crocus cloth or even a length of leather belting looped over the work and clamped in the steadyrest will prevent scratching of such soft metals as brass, copper and aluminum. Left, a strip of thin sheet copper wound about the end of polished work will allow it to be chucked without marring

Work Rest on Welding Table Saves Time



Work supported at angle against rod projecting from welder's table is easy to get at

To afford better access to certain types of work, one welder supports it at almost any angle against an iron rod, which projects through the table top. A small hole is drilled in the center of the top and the rod is inserted through it into the hollow table standard, which supports it. When not in use, the rod is removed.

Micrometer Extension for Places Hard to Reach

You will find many jobs on which to use this micrometer extension as it permits work to be "miked" where ordinarily the frame of the micrometer would not permit its use. The extension consists of a body turned and drilled transversely through the center to take a sliding collar on the outside and a sliding rod on the inside. The collar is pinned to the lower

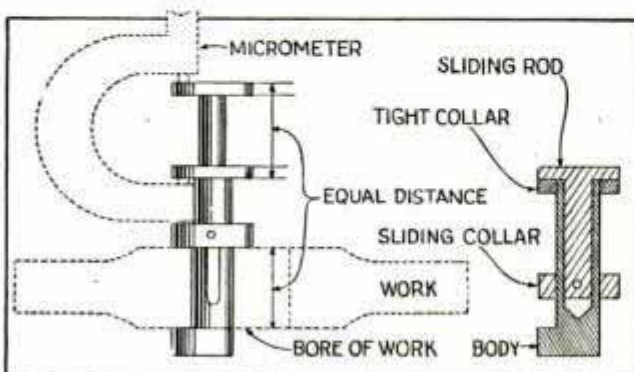

Tight places that cannot be reached with a micrometer are easily taken care of with this extension

end of the rod, and a slot through the body enables this assembly to slide up and down. A fixed collar is pinned or sweated at the upper end of the body to complete the extension. When the distance from the top face of the sliding rod to the lower face of the fixed collar is one inch, the distance between the lower face of the sliding collar and the top face of the shoulder on the body is the same, these distances being equal in any position. In use, place the extension on the work with the shoulder projecting over the underside of it and push the sliding rod down to bring the sliding collar into close contact with the upper side of the work. Then "mike" the distance from the underside of the fixed collar to the top surface of the sliding rod. This distance is equal to the thickness of the work.

Steel Turnbutton Improves Square for Marking Boards

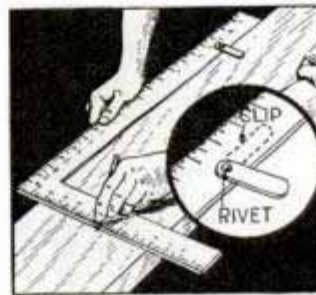

Squaring boards and timbers with a large, steel square is made easier if a small strip of steel is riveted snugly onto the long blade of the tool as shown. When turned to the position indicated, the strip will support the square against the edge of the board to be marked.

Show Cards Displayed Neatly on Embroidery Hoops

Jewelers and others will find that embroidery hoops make very neat and practical holders for display cards, either in the window or on the showcases. The hoops support

the display card and contain the merchandise upon which it is desired to center the attention. The hoops may be used also to support the cards in reverse position.



Vacuum TRAILER BRAKES *give smooth stops*

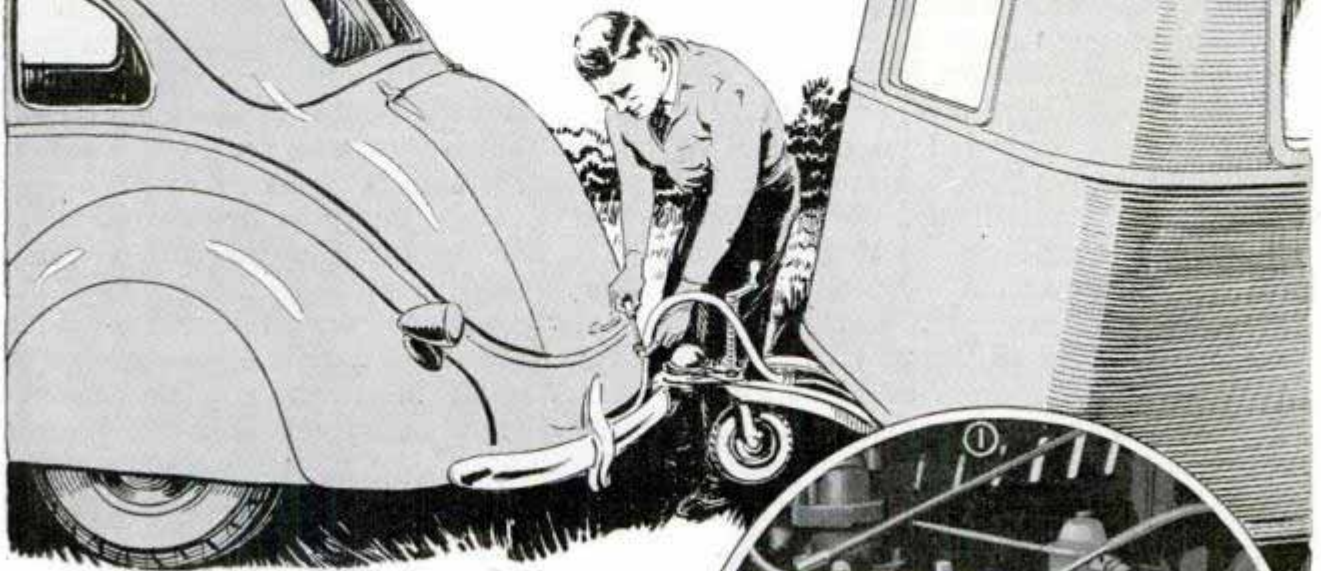

GIVEN severe tests for several months in the Adirondack country, these trailer brakes have proved satisfactory. Similar ones can be installed inexpensively by anyone. As shown in Fig. 5, vacuum in the car motor is utilized to work the brakes, and is carried through rubber hose, copper tubing and a vacuum valve to a vacuum cylinder, which actuates the brake-rod or cable assembly. The valve and cylinder are the type used to operate an automatic clutch of a 1932-33 or '34 Plymouth car.

After obtaining the valve and cylinder from a junk yard, wash them thoroughly with gasoline. You'll notice that there are three sets of valves in the assembly, Fig. 4. One of these is a pendulum valve, which is not used. The other valve is really two slide valves in one assembly, which makes up the vacuum control. The cap on the end of the valves is removed and the valve slide with the two keyways is changed as shown in Fig. 6, the end of the slots being filled with solder or brazed. If you resort to soldering, chloride of zinc will have to be used in place of regular soldering paste or acid. The ends of the keyways and the end slot should be filled above the outside surface of the slide and then smoothed with a file and emery to a snug, sliding fit, after which a by-pass $\frac{1}{2}$ in. wide is

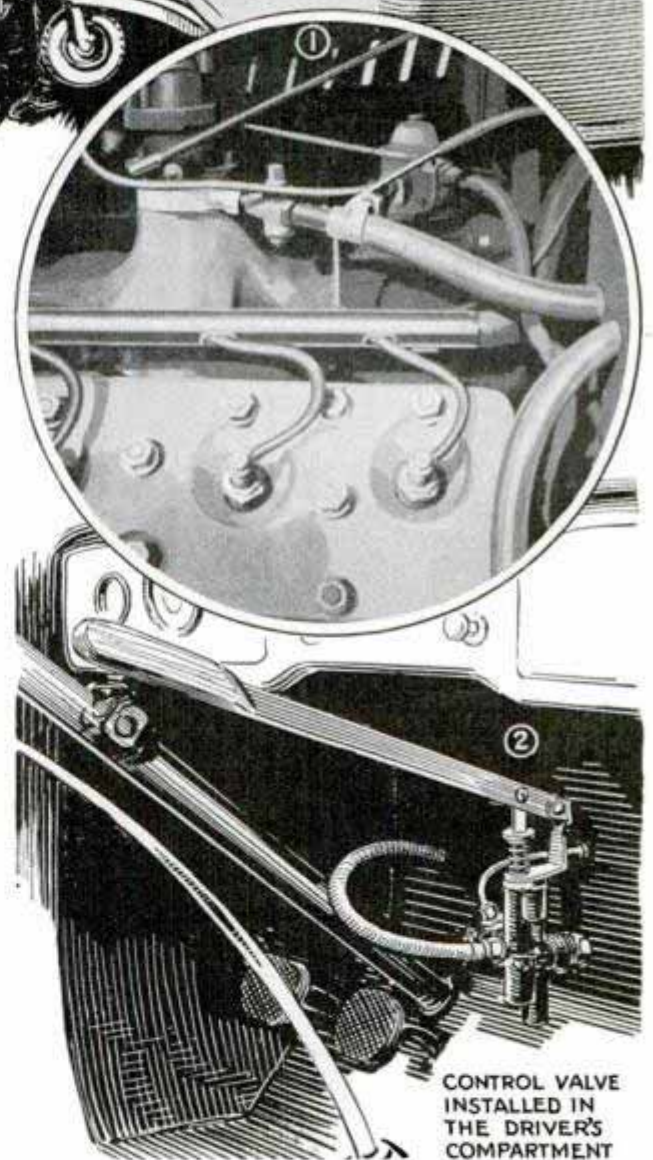

CONTROL VALVE
INSTALLED IN
THE DRIVER'S
COMPARTMENT

cut in the wall separating the keyways. In the other end of the slide, two holes are drilled to allow air to return to the vacuum cylinder and release the brakes

after the control arm has been released.

Before assembling the valve, port No. 1, Fig. 4, is carefully drilled and tapped for a short length of $\frac{3}{8}$ -in. pipe threaded at one end and fitted with a lock nut. One of the copper-tube fittings taken from the pendulum valve is screwed into port No. 2. A short piece of copper tubing from the pendulum valve can be used here for a hose connector. Port No. 3 is used to hold the mounting stud, which is a short piece of $\frac{3}{8}$ -in. pipe, threaded on one end to screw into the port, and on the other end to take two standard nuts. Be sure that the slides are returned to their original positions. If they are misplaced, the valve will not function properly. The inner slide should be pushed all the way in to close port No. 3. A few drops of oil should be put on the slide before replacing it. Also,

the air hole should be enlarged slightly. The altered slide is now pulled out of the top as far as possible and a coil compression spring, about 2 in long, is placed on it, and held slightly compressed with a washer and a steel pin. The spring closes the valve when the control arm is released.

The control valve was designed for hand operation as manual control permits synchronization of the trailer and car brakes. It is also more flexible in operation than a valve that works in conjunction with the car foot brake; it allows independent action of the car or trailer brakes and automatically shuts off the vacuum line when the brakes are not in use.

Having altered the valve and provided it with a control handle as in Fig. 4, it is mounted on the car dash within convenient reach of the driver, as in Fig. 2, after

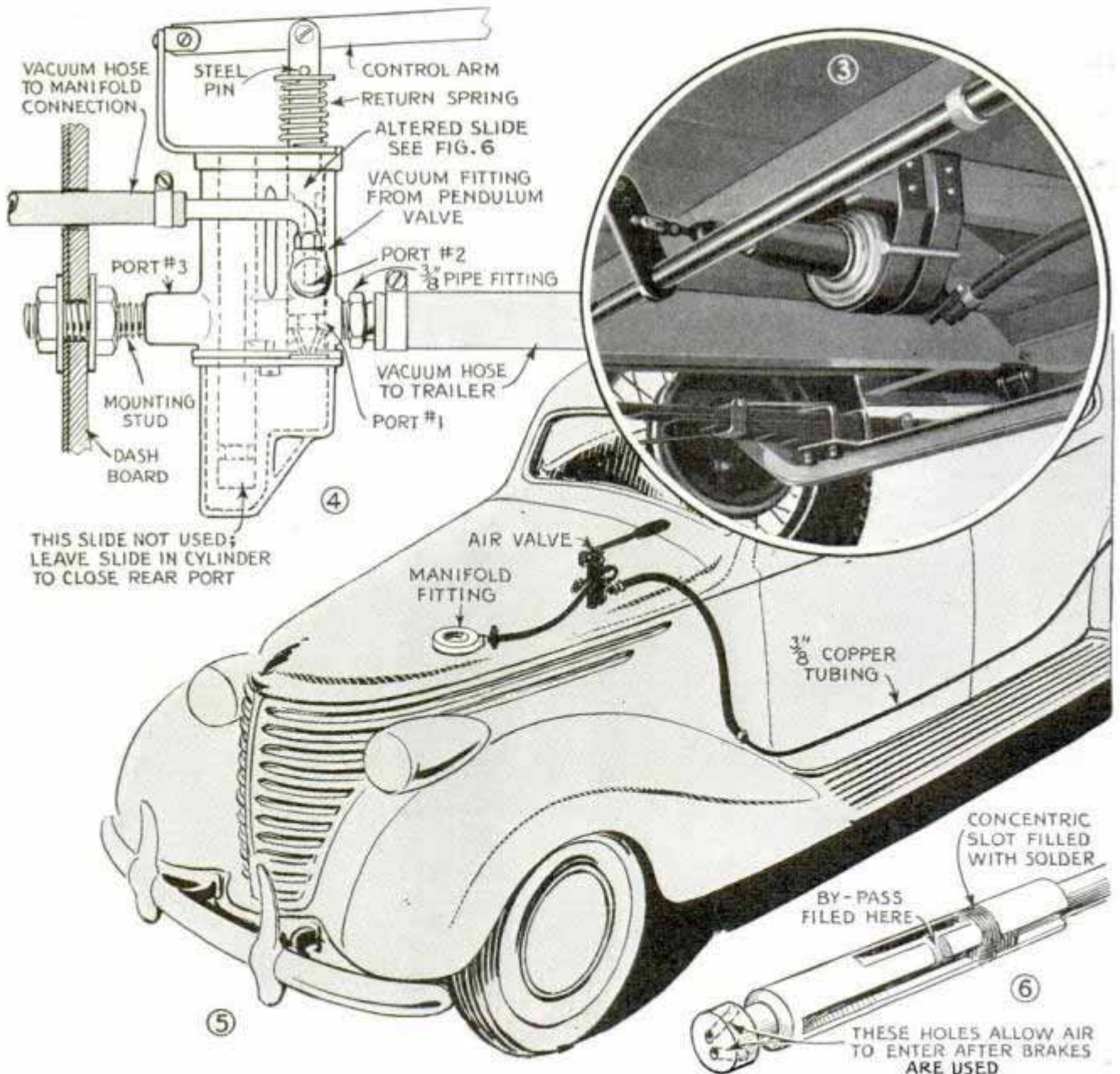

which port No. 2 is connected to the motor vacuum supply with a rubber hose. If your car has a single intake manifold, you first remove it, then drill and tap it as near the carburetor as possible for a $\frac{3}{8}$ -in. pipe fitting. Or, you can use a special fitting under the carburetor as shown in Fig. 1. On Ford cars and others having dual intake manifold, it is best to use only the fitting under the carburetor to get full benefit of the vacuum from all cylinders. The fitting can be obtained from most brake service stations. It's a good idea to install a cock in the line here so that the entire system can be shut off when the trailer is not being used.

Now's a good time to test the valve. Connect it to the vacuum cylinder with a short piece of hose, start the car motor and press down on the control arm. If everything is functioning properly, the piston in the cylinder should draw in suddenly with a powerful pull, in fact so

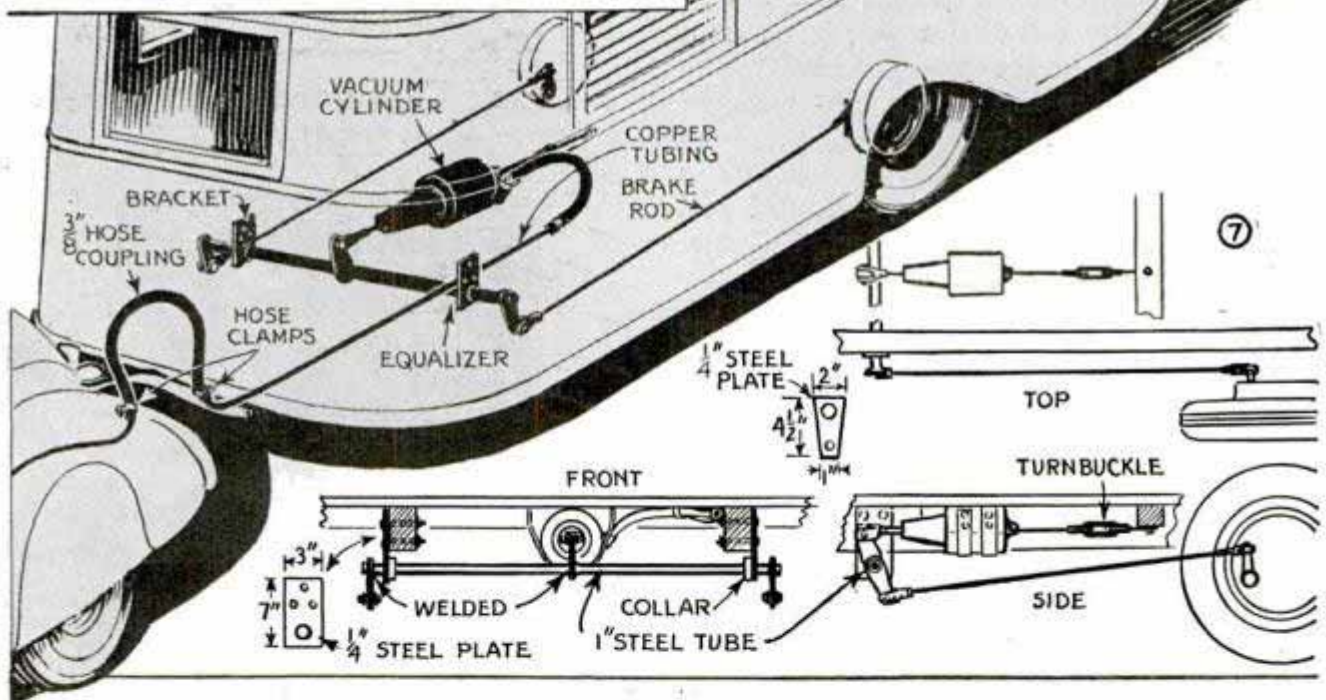

powerful that you can't hold it with your hands. If it does not, check up on your fittings. Do not worry about the hissing sound when the control valve is released. It is merely air returning to the evacuated lines and cylinder.

Next mount the cylinder under the trailer as in Fig. 3, and connect it to the valve, using rubber hose and copper tubing where indicated. Shellac all the joints carefully to avoid leaks. Fig. 7 gives details for the cross-rod equalizer, mount-

ing brackets, etc. Note that the rear end of the cylinder is connected to a cross member of the trailer body with a rod and turnbuckle so that the cylinder can be adjusted for stroke. Hook up the brake rods or cables to the equalizer and you are ready for a try-out. Go out on a road where you will not interfere with traffic. Adjustments are made by taking up on the brake rods the same as is done when taking up the rods on mechanical auto brakes.

Piston Rings Easily Compressed with Fine Wire

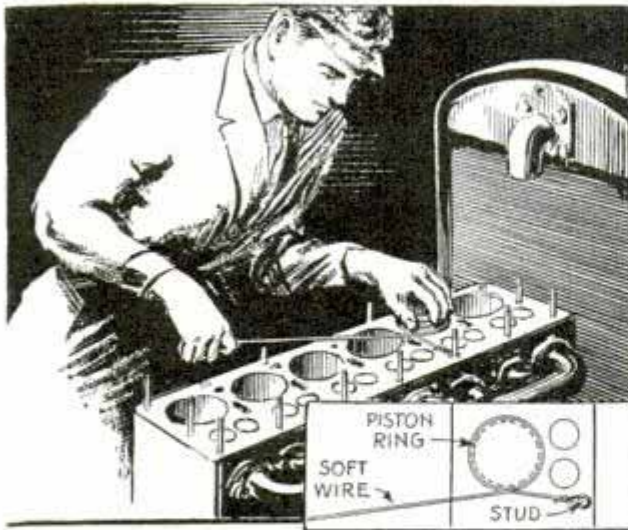

In an emergency, a length of wire can be used to compress rings to slip a piston into the cylinder

If you have no piston-ring compressor at hand when installing pistons in a motor, try using a length of soft, strong wire as shown. One end of the wire is fastened to one of the cylinder-head stud bolts projecting from the top of the motor block, after which the wire is given one turn around the ring as it rests on top of the block. Then merely pulling the wire will compress the ring.—W. Hockert, Chicago.

Die Ornaments for Control Knobs of Car Radio and Dash

If you have a die-shape ornament on your gear-shift lever, radio and dash-control knobs to match can be made from white or colored dice. File or grind one corner of each die flat and then drill it to fit tightly over the shaft of the control.

Stud-Bolt Setter Protects Threads

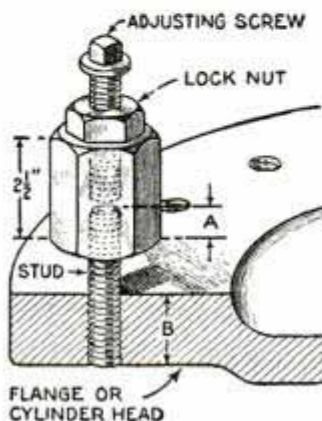

An efficient tool to remove or drive stud bolts is easily made from a 2-in. length of hexagon-shaped steel. The steel is drilled transversely through the center and is tapped to screw onto the stud bolt.

In use, one end of the tool is driven onto the projecting end of the stud bolt, and an adjusting screw, made from a piece of iron rod the same size as the stud, and fitted with a lock nut, is driven into the other end, after which a wrench is used to turn out the stud bolt.

Small Copper Tubing Flared with Acorn Nut on Bolt

Mechanics who frequently have to flare the end of a copper or brass tube can make up a set of tools to do the job from a few carriage bolts and acorn nuts. Drill holes through the shoulders of the bolts to take steel pins, which serve as handles, and drive the nuts tightly on the threaded ends.

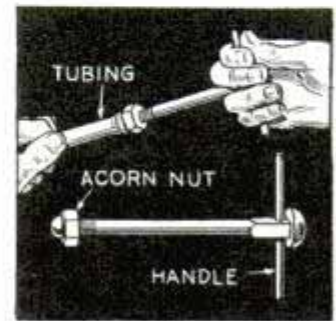

Truck Tailboard Held Level with Sliding Bars

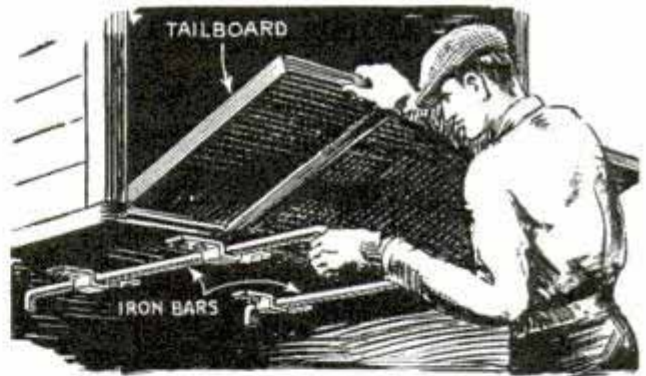

Heavy iron bars pull out from under truck body to support tailboard level with the floor

Truck drivers who want the tailboards held level with the floors of the body, will find that a couple of heavy iron bars, which slide in brackets under the body, will do the trick. The brackets are made of heavy flat iron, and the bars are bent downward at right angles at the ends, the bends at the rear ends serving as stops and those at the front as hand grips.

Vulcanizing Auto Tires

Heat used in vulcanizing automobile tires has a tendency to stiffen the tire and

cause a noticeable difference in the riding quality of the car. This trouble can be overcome to a certain extent by using the tire immediately after a repair has been completed. The flexing of the rubber will soften the repaired spot and tend to prevent permanent hardening.

Insulating Horn Wire in Column of Steering Gear

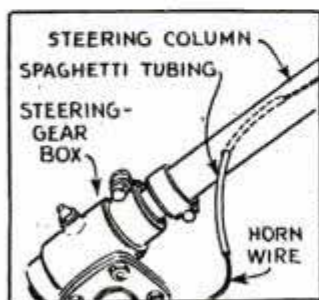

If you have trouble with the horn and other wires short-circuiting where they pass through the steering column, try insulating them with "spaghetti" tubing. This can be obtained at almost any radio repair shop. Do not use rubber tubing, as oil and grease in the column will soon cause it to rot.

—C. Pettrich, Bronx, New York, N. Y.

Hole in Side of Pail to Pour into Small Opening

When it is necessary to fill a radiator or gas tank with a can or pail, and no funnel is available, punch a small hole in the side of the pail near the top. Then you can pour out the liquid in a small stream without spilling.

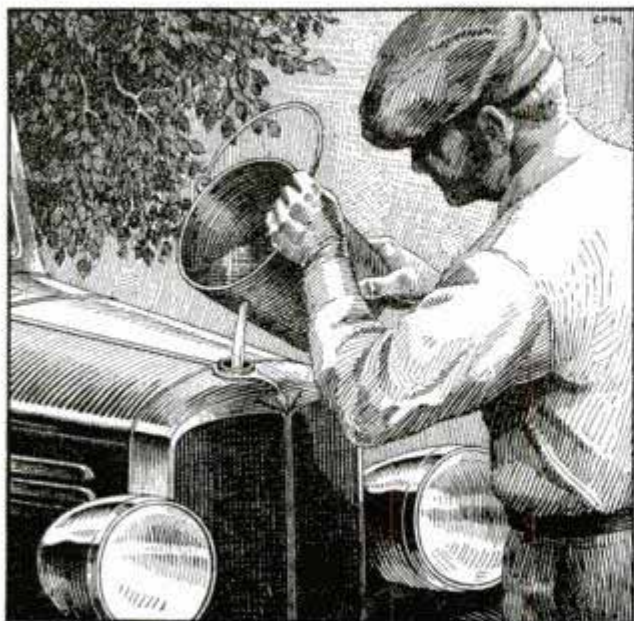

It's easy to fill a radiator with a pail if you drill a small hole in one side

This Glare Shield Is Adjusted Across Entire Windshield

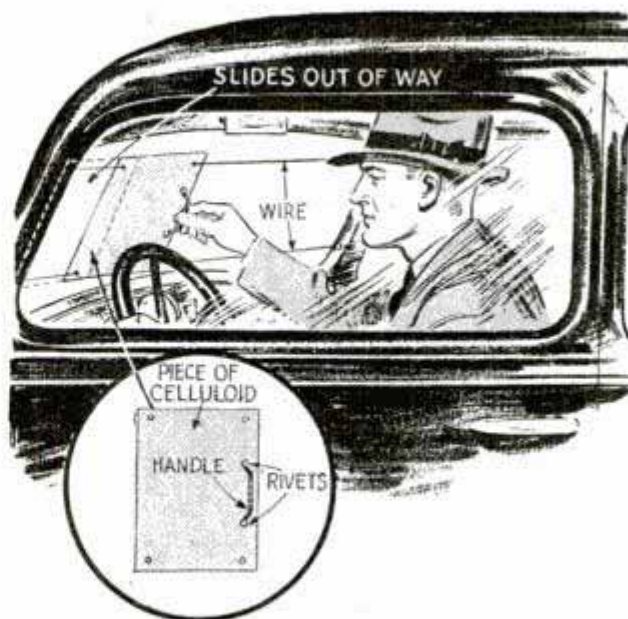

When you meet a car with glaring headlights, just pull this shield in front of your eyes

Sliding on two lengths of fine wire stretched across the inside of the windshield, a rectangular piece of colored celluloid provides the motorist with a glare shield that can be moved quickly to any position desired. The wires are fastened under screw heads holding the corner molding on the body posts. Each wire is run through two holes drilled in the shield as indicated. The shield can be fitted with a small drawer pull or knob.

Cleaning Sleeve Connectors of Tail-Lamp Wires

Here's a tool for cleaning sleeve connectors used on stop and tail-lamp wires of Ford cars, which often become corroded or blackened inside so that current cannot pass freely. The tool is nothing more than a flat-wire hairpin or bobby pin. A short section at one end is turned upward at right angles, and is twisted slightly. This causes the flat end to cover a wider area when turned inside the sleeve.

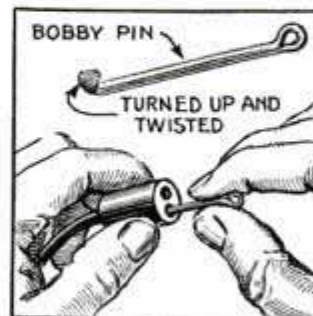

—E. T. Gunderson, Jr., Humboldt, Ia.

Hose Cutter "Drills" Holes to Attach Heater Fittings



You can quickly cut clean holes in radiator hose and other rubber accessories with this tool

For cutting holes in radiator hose and other rubber accessories, a tool made from a piece of flat steel and screwed to a short length of broomstick or a dowel, will save time and do a neat job. After grinding one end of the blade to a curved cutting edge and drilling it for wood screws, a long

wood screw is driven part way into the end of the broomstick and is then ground to a point to serve as a center or pilot. Of course, the diameter of the stick or dowel determines the diameter of the hole cut.—M. J. Schram, Sayville, L. I., N. Y.

Sun Visor Controls Ventilation

On hot days when a direct draft of air is wanted while motoring, it may be had by proper adjustment of the inside sun visor. In cars with windshields that open, the visor



can be swung down so that the air, instead of sweeping along the ceiling, is directed downward on the driver. If the car is ventilated by pivoting forward halves of the windows, the visor can be swung around parallel with the side of the window opening and adjusted to direct some of the air down toward the car floor.

—C. E. Packer, Chicago.

The Next Issue

WEAVING FOR FUN AND PROFIT ON HAND LOOMS

Fun and spare-time money are yours after a little practice on any one of the several kinds of hand looms described in this story. Ranging from a simple one made on a board to a fairly elaborate table model, the looms are home-made, and you'll be surprised at the weaving speed you can attain.

ARE YOU AN ADMIRER OF TOOLED LEATHER?

It's no trick to tool artistic designs in beautifully colored leather pillows, belts, purses, etc., once you have learned a few secrets of the process.

TURNING ALABASTER IN YOUR LATHE

Beautiful vases, lamps, clock cases, ash trays and other things are turned from alabaster in your woodworking lathe with regular turning chisels.

CAN YOU TAKE SPEED PHOTOS?

Racing cars, trains and other speed thrillers are easy to photograph if you know the tricks and fit your camera with a few inexpensive gadgets.

"DRY-ICE" CABIN CRUISER

A 17-in. model propelled over the water by means of gas escaping from an immersed jet. Gas is generated by Dry Ice melting in its four "boilers."



Stretch out vacation trails

Yes, siree—you s-t-r-e-t-c-h out your vacation when you ride a 1937 Harley-Davidson. First—it widens your cruising range—takes you to more distant places. Second—its marvelous economy makes your vacation budget last longer. Third—it gets you to more places in less time. And fourth—you have your Harley-Davidson for evening and week-end fun. You stretch your vacation joys over the entire year!

So own a new 1937 Harley-Davidson—and thrill to its zooming speed and surging power! Enjoy its gliding ride and flashing style—its carefree operation—and most important of all the low-cost mileage made possible by its many advanced motor improvements.

See your Harley-Davidson dealer—take a thrilling ride FREE—then ask about his Easy Pay Plans. And send in the coupon—TODAY!

HARLEY-DAVIDSON MOTOR CO., Dept. P, MILWAUKEE, WIS.

Ride a

HARLEY- DAVIDSON

MAIL THIS COUPON

HARLEY-DAVIDSON MOTOR CO.,
Dept. P, Milwaukee, Wis.
Interested in motorcycling. Send illustrated literature. Postage stamp is enclosed to cover mailing cost.

Name _____

Address _____

My age is 16-19 years, 20-30 years,
 31 years and up, under 16 years.
Check your age group.



FLOYD STIMSON (*above*), between puffs of his Camel describes a typical parachute jump. "I ease out of the cockpit, holding onto the edge as I stand on the wing hooking one foot behind a



strut wire. Then I crouch down and dive over, headfirst. I watch out for getting cracked by the tail. I crouch down so if the tail should hit me, it would only strike my foot. I usually make 2 or 3



FLOYD STIMSON
OFFICIAL PARACHUTE
TESTER—BAILS OUT
FOR THE 1060th TIME!

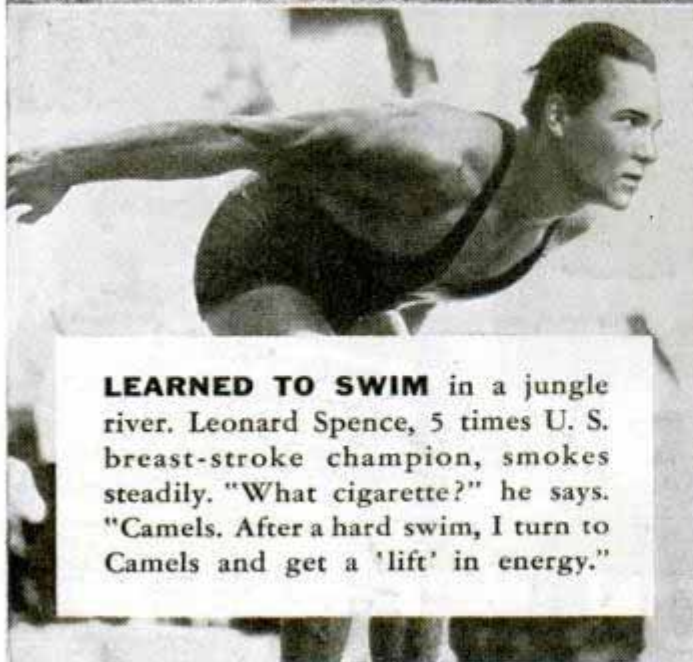

LEARNED TO SWIM in a jungle river. Leonard Spence, 5 times U. S. breast-stroke champion, smokes steadily. "What cigarette?" he says. "Camels. After a hard swim, I turn to Camels and get a 'lift' in energy."



FENCING BOUTS are won mainly on quick response. In the words of Joanna de Tuscan, U. S. Women's Foils Champion: "Being alert counts in fencing. One reason I prefer Camels is they never jangle my nerves."



turns. (In the next picture Floyd has completed a turn and straightened up.) When I'm facing the sky, I pull the

rip cord. It's a sweet feeling when she blooms open. It's like having a seat in the clouds—with the earth rushing up to you." Floyd's

work is no job for a nervous man. His cigarette is Camel—has been for 10 years. He says: "They don't frazzle my nerves."

Dangerous work — yes — but Floyd Stimson has the healthy nerves that the job requires!

HE'S stepped out into empty air well over 1000 times—yet landed right side up every time. "My order is Camels," Floyd says. "They're so mild I can smoke all I want to, knowing that Camels never frazzle my nerves. It seems as though there's no bottom in sight when I bail out—and my stomach knows it, too," Floyd Stimson continues (right). "However, a Camel helps me ease off. *Camels set me right!*"



BENNY GOODMAN SWINGS IT EVERY TUESDAY NIGHT!

Tune in! Hear the trio — the quartette — and all of Benny's boys swing the popular favorites. Tuesdays—8:30 pm E.S.T. (9:30 pm E. D. S.T.), 7:30 pm C. S.T., 6:30 pm M. S.T., 5:30 pm P. S.T., over WABC-CBS.

MILD!

• Camels are made from finer, **MORE EXPENSIVE TOBACCOS** — Turkish and Domestic — than any other popular brand

Copyright, 1937, R. J. Reynolds Tob. Co., Winston-Salem, N. C.



COSTLIER TOBACCOS

Camels never get on your Nerves!

When writing to advertisers please mention Popular Mechanics

498

Snapshots

(Continued from page 245)



This pair of skaters was snapped by a photographer in the audience at an ice carnival

tures do not lend themselves to angle photography, of course. Never get into a rut. Just as a good newspaper reporter develops a "nose for news," the successful amateur photographer must develop an "eye

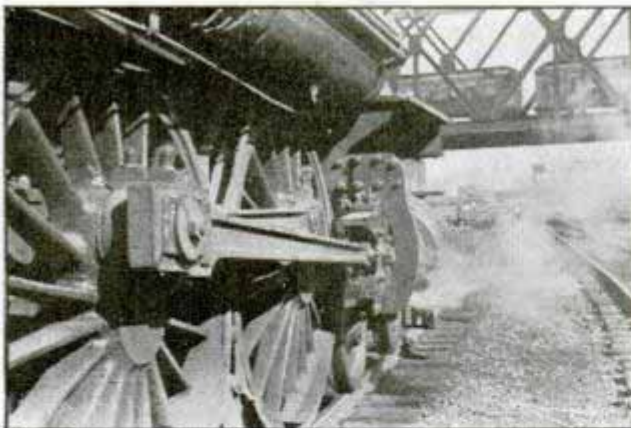

Stand close to a locomotive and focus on its giant wheels for an angle picture giving a sense of power

for pictures." His eye must tell him which subjects make good angle shots, and which should be photographed in the conventional way. It's all in the point of view.

Names and addresses of manufacturers and dealers in articles described in this magazine will be furnished by our Bureau of Information upon request accompanied by stamped, self-addressed envelope.

2036

Torture Chambers

(Continued from page 191)

pound safe to see whether the papers inside it will be protected from fire. If the safe doesn't explode in the sudden heat, they leave it a full hour. Then, red hot, they hoist it to the top of a three-story tower and dump it into a pile of bricks. If that fails to wrench the door open and expose the contents to fire, they tip the safe over and give it another hour in the furnace. If the papers are burned, or thermocouples show a temperature inside exceeding 300 degrees, the safe has "flunked."

When you step on the starter of your automobile, "U.L." is protecting you. In factory or laboratory its engineers give a terrific drubbing to fuel lines, ignition system and exhaust of every domestic make of car. The gasoline line is shaken for seventy-two solid hours in a machine vibrating 600 to 1,500 times per minute. An explosive mixture is piped into the muffler and set off by a spark plug, simulating a violent backfire. The muffler has to take twenty-five terrific wallops and still be safe and sound. And if your car doesn't burst into flame tomorrow it is partly because of the test they give your air cleaner. It is only incidentally an air cleaner, you know; its real purpose is to prevent a flare-back into the carburetor. In the laboratory they pack it with cotton, and set off a flare-back by means of a spark plug in the manifold. If the cotton is burned, the air cleaner is not properly guarding the carburetor.

The Underwriters' Laboratories are even interested in your safety matches. They put a sample match on an anvil and drop a metal block like a trip hammer on its head. The match must not be ignited by shock. Another machine tries to break the wooden stem, for safety matches must not split when you strike them. A dozen matches are placed side by side in a vise and lighted; if they sputter or spit flaming bits, they go back to the manufacturer unapproved. And finally, so that you'll feel safe in leaving safety matches on stove or radiator, there is a heat ignition test. A match and a thermometer are dropped into a test tube which is inserted in an oil bath and heated until the match ignites. If the match flares up below the safe limit of

(Continued to page 118A)

Full-range "miniature" at a remarkably low price

...\$44⁵⁰

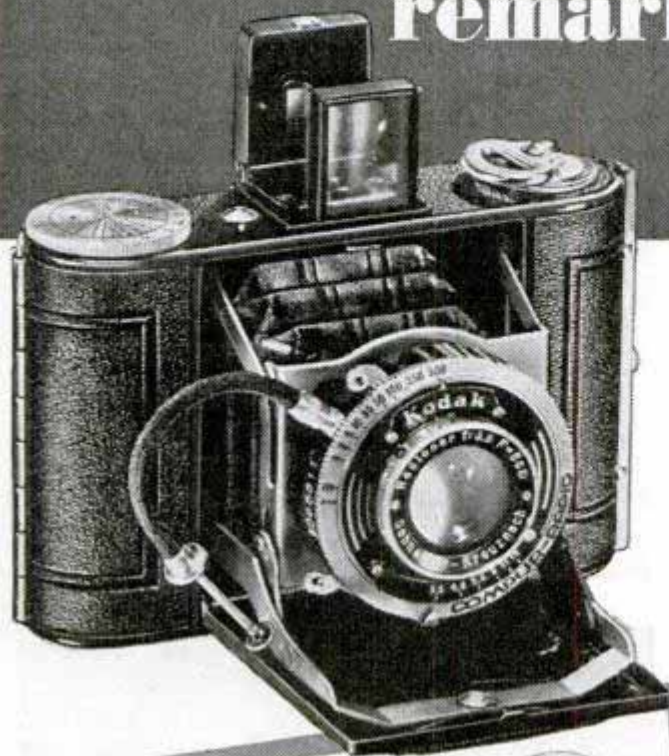

KODAK VOLLENDIA in hand, you're ready for every picture that comes along—off-guard snaps, lightning-fast sport shots, landscapes, close-ups, rainy-day pictures, indoor snapshots under Photofloods . . .

Brilliant *f.3.5* anastigmat lens; 1/500-second Compur-Rapid shutter. Negatives are sharp, capable of extreme enlargement—especially when Kodak Panatomic Film is used.

See Kodak Vollenda at your dealer's. Weigh range and refinements against price, \$44.50—you'll say it's the buy among "miniatures" . . . Eastman Kodak Company, Rochester, N. Y.

ONLY EASTMAN MAKES THE KODAK

LENS . . .

Anastigmat *f.3.5*. You get sharp negatives from dawn to dusk; in clear, cloudy or rainy weather. Also makes snapshots indoors at night under Photofloods.



SHUTTER . . .

Rim-set Compur-Rapid gives you nine speeds up to 1/500 second for fast action—down to a full second for difficult light conditions.

REVOLVING LENS MOUNT . . . For quick, easy, accurate focusing from 3½ feet to infinity.

YOU GET 16 PICTURES ON AN 8-EXPOSURE ROLL



Kodak Vollenda gives you 16 pictures, each 1 3/16 x 1 9/16 inches, on a roll of Kodak Film No. 127: Verichrome, 25¢; "SS" or Panatomic, 30¢.

Your negatives are critically sharp, and capable of extreme enlargement—especially when Kodak Panatomic Film has been used.

DEPTH-OF-FOCUS SCALE (A) Rotating outer ring shows sharp-focus range for any stop-and-distance combination. **FINDER (B)** . . . Direct-view, eye-level type; folds flat when not in use.

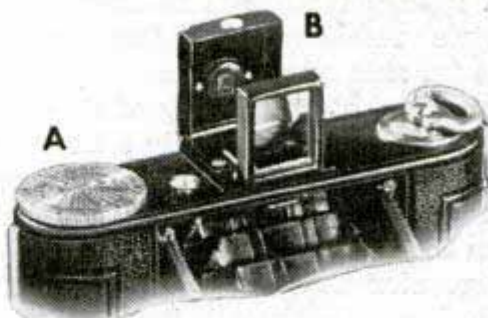

ACTION FRONT

Actuated by push button, automatically opens camera, extends bellows, erects lens, and locks front firmly in correct picture-making position.

KODAK VOLLENDIA

When writing to advertisers please mention Popular Mechanics

(Continued from page 116A)

340 degrees, it's not safe to leave around in hot places. To guarantee that your kitchen stove is foolproof, they set it against a corner built of black pine boards

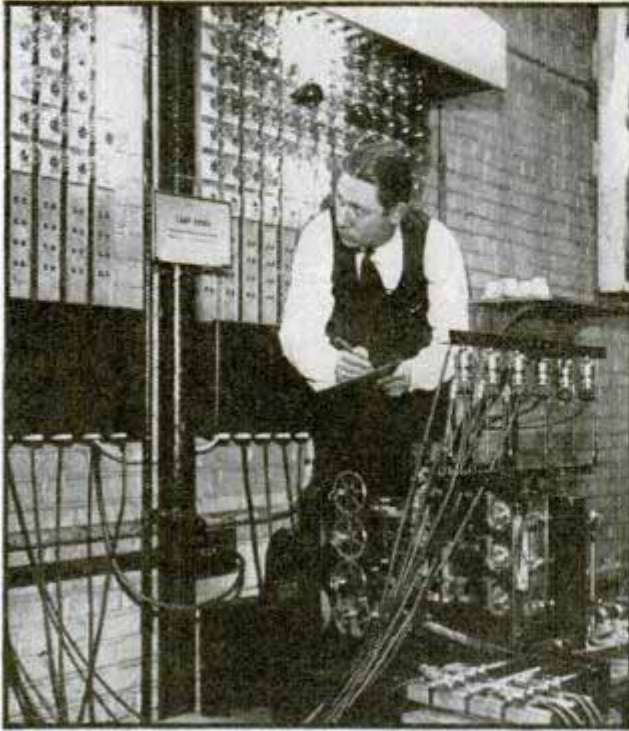

This machine "tortures" lamp sockets and switches by turning them on and off thousands of times

which will absorb heat; then they turn on all the burners. If those boards warm up beyond 194 degrees, the stove is not properly insulated and might set the house afire.

A special torture is reserved for your electric refrigerator. After undergoing tests for shock and fire hazard, toxicity of its refrigerant and safety of its compressor, it is allowed to rest in a hot chamber until the entire box and mechanism have reached a temperature of 104 degrees. Then the freezer is turned on, putting the refrigerator to work at a punishing pace, while inspectors watch its reaction.

Electric current as low as seventy-five hundredths of an ampere can kill you. The Underwriters' Laboratories play safe. They permit no more than one-hundredth ampere leakage from any electrical appliance. They take your radio, juggle the tubes around as you would never think of juggling them, give the circuit a 500-volt shock and insist that under the very worst conditions the radio must not overheat or catch fire, its insulation must be adequate and all hazardous current-carrying parts must be inaccessible. If you'd

rather feel safe from shock in using your electric washing machine, see that it has the "U.L." tag. Then you will know, too, that the wringer is not likely to scalp you or crush a hand. The Underwriters require automatic release of the wringer under pressure. Recently they put a rotary ironer through its paces and saw it perform acceptably until, in a last attempt to break it down, they locked the heater arm to the roller a few moments with the current on. Suddenly the cloth pad burst into flame. That ironer went back to the factory for some changes. The heater control should have prevented any fire.

So if you're going to leave town and forget that the oil burner and refrigerator and kitchen stove and movie projector, the toy railroad and electric fan and iron are all connected, better make certain they all bear the safety label of the Underwriters'



Ability of "air cleaner" to prevent flames reaching carburetor of auto is tested by inducing a backfire

Laboratories. The safety engineers don't recommend that you take those risks. But if the household appliances are "U.L." approved you know they've been tested under pretty rough abuse.

☞ Whenever you find that you wish to know more about any article in this magazine, write our Bureau of Information, inclosing return postage.

Half & Half Makes
ONE Swell Smoke!



Half & Half doesn't bite, even when the fish do. Cool as the sign: "No Fishing Allowed." Smooth as a permit that gives you the right. Fragrant, friendly, full-bodied tobacco that won't bite the tongue—in a tin that won't bite the fingers. Made by our exclusive modern process including patent No. 1,770,920. Cool and smooth. Smells good. Makes your pipe welcome anywhere. Tastes good. Your password to pleasure!

Copyright 1937, The American Tobacco Co.



No Bite!



No Bite!



Still no Bite!

Not a bit of bite in the tobacco or the Telescope Tin, which gets smaller and smaller as you use-up the tobacco. No bitten fingers as you reach for a load, even the last one.

HALF ^{AND} HALF
The Safe Pipe-Tobacco
FOR PIPE OR CIGARETTE

es 368

Thrills of the Navy Test Pilots

(Continued from page 229)

10¢ WORTH OF
SANI-FLUSH
WOULD MAKE IT
SO MUCH COOLER!



WHEN a radiator gets hot you lose power and you endanger your motor. Costly repair bills may result. Don't take a chance. Sani-Flush cleans out automobile radiators in a few minutes. You can do it yourself!

Just pour in a little Sani-Flush. (Directions on the can.) Run the motor. Drain, flush and refill with clean water. Lime and scale are carried away. Rust and sediment are removed thoroughly. Sani-Flush cannot hurt aluminum cylinder heads or motor fittings. You'll find Sani-Flush in most bathrooms for cleaning toilets. Sold by grocery, drug, hardware, and five-and-ten-cent stores—25 and 10 cent sizes. The Hygienic Products Company, Canton, Ohio.

Sani-Flush **Safe**
KEEPS RADIATORS CLEAN NOT CAUSTIC

AIRO MATTRESS

Supreme Sleeping Comfort
ANYWHERE!

At home or in camp—in beds and bunks, or on the ground—this famous air mattress with the double-tufted cells gives comfort supreme. Full resilience without springs. Easy to inflate; lasts for years; moderately priced. Also air cushions for autos, boats, chairs, etc. Catalog free. TRAILER OWNERS: Ask for special booklet describing "Dual-AIRO," the marvelous new trailer mattress. Don't wait; write TODAY.

K & W RUBBER CORP., Delaware, Ohio
Dept. PM-81



single-float seaplane is different from a big boat and the pilot makes a "stall" take-off, pulling the stick back at the right moment and bouncing up into the air. An inexperienced pilot may try for hours to get a flying boat up into the air if the water is rough. He has to be told at just which angle to cut across the waves in order to get off. The big boat pilots haven't any convenient wind socks to tell them which way the wind is blowing. The smoke from a steamer may be a guide and otherwise they have to read wind direction by hunting for streaks of foam on the surface or by watching the spray pulled off wave crests. A dead calm in which the water is glassy still calls for a "hot" landing that takes nearly as much skill as sitting down on rough water. The surface looks like a mirror to the pilot and he can't tell whether he is two or fifty feet in the air. If he levels off too soon his bad guess would wreck the boat, so he flies downhill as slowly as he can with power on until he hits. The shape of the hull helps absorb the shock.

In a dead calm, also, a pilot may have a hard time getting off again. When the water is flat a boat sometimes can't break itself loose from the surface. In that case the pilot taxis around in fast tight circles to stir up the water, then makes a fast take-off run across the circles.

Being a surface craft as well as an airplane, a flying boat gets all sorts of tests that no land plane is ever given. When a new Douglas flying boat is launched for its tests the first routine is to find out how it handles on the water. A full crew of pilots and engineers climb on board. At the controls may be Glen Moser, chief pilot, and alongside him Al Reid, co-pilot and engineer. Mike Hunt and another mechanic stand by in the cabin, while Schuyler Kleinhan, project engineer, and several observers strap themselves into the seats.

A good duck should handle just like a boat on the surface. First of all Moser simply taxis around on the water and makes left and right turns across the wind. He wants to know how much rudder control is needed to swing the boat. Then he

2368

tries turns using one engine as well as the rudder to turn the plane. From the cabin windows the engineers watch the wing pontoons, which are retractable into the wings these days, to find out whether they are large enough and strong enough to keep a wing from dipping under.

No airplane has a reverse on it but the big boats can sail backward down wind by allowing the engines to idle. Another test is to turn tail to the breeze and taxi slowly down wind. The big control surfaces of the tail are apt to catch the wind and make the plane yaw around, and the pilot has to know how much control is necessary to hold a straight course. Next come the high-speed taxi tests with the plane churning along through the water on its step just under fifty miles per hour. No turns are made at these high speeds and the courses are straight runs into the wind and out of it. With unlimited water in front of him a pilot can take off with the wind behind, something not recommended for land planes.

The first few flights are made with no other load but the crew, merely to learn how the boat handles in the air and to check the instruments and controls. Usually small details have to be adjusted and after that whole groups of tests are made while the boat carries increasingly larger loads of lead bars. The engineers want to know the safe minimum flying speeds for all loads, rates of climb and descent, take-off time, ceiling and maximum speeds. To check and calibrate the air-speed indicators the pilot races along a speed course marked out on the beach with a stop watch in his hand to mark his elapsed time. With a full load of 28,500 pounds on board, one of the new twin-engined Douglas boats climbs 600 feet per minute and has a high speed of 185 miles per hour. Flying boats can lift heavier loads into the air then land planes because they have all the take-off room in the world.

Just like other large surface boats, flying boats have watertight doors in their hulls. On the Douglas the six different compartments are sealed with light strong doors that can be closed or opened in a few seconds. A lightweight collapsible anchor, a bilge pump, life belts, boat hook, and signaling flares are included in the marine equipment.

State inspections show that:



3 out of 4 cars

NEED SAFER LIGHTING

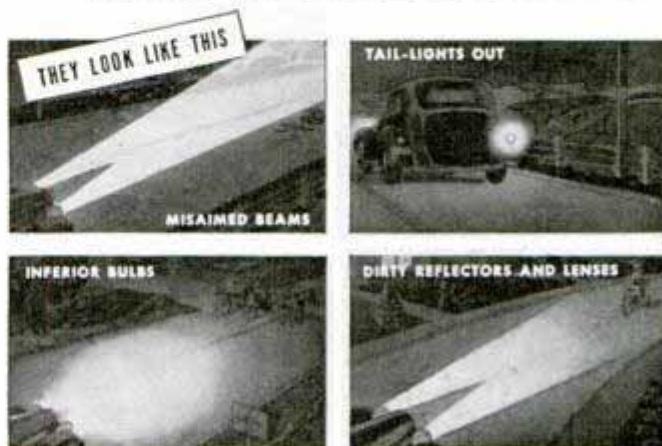

RECENT figures indicate that the nighttime auto accident rate is still going up, while the daytime rate is going down.

No wonder... when 3 out of 4 cars need safer lighting! When 3 out of 4 motorists are not getting as good lighting as they could get from the amazingly precise and efficient optical system provided by their headlights!



It pays to look for the G-E trade mark when you buy auto lamps.

TAKE THIS EASY STEP for safer driving at night

Drive your car to a G-E MAZDA Auto lamp dealer and ask him for "Safety Lighting Service." This means:

1. Cleaning lenses and reflectors... which will bring you from 25 to 150% more light.
2. Checking and aiming headlight beams... to put light on the road where you need it.

3. Replacing blackened or burned-out bulbs with new G-E MAZDA Auto lamps, to give you better light for night driving.

Remember, G-E MAZDA Auto lamps are approved by all car manufacturers and are in most new cars when you get them. General Electric Company, Nela Park, Cleveland, Ohio.

GENERAL ELECTRIC
MAZDA AUTO LAMPS

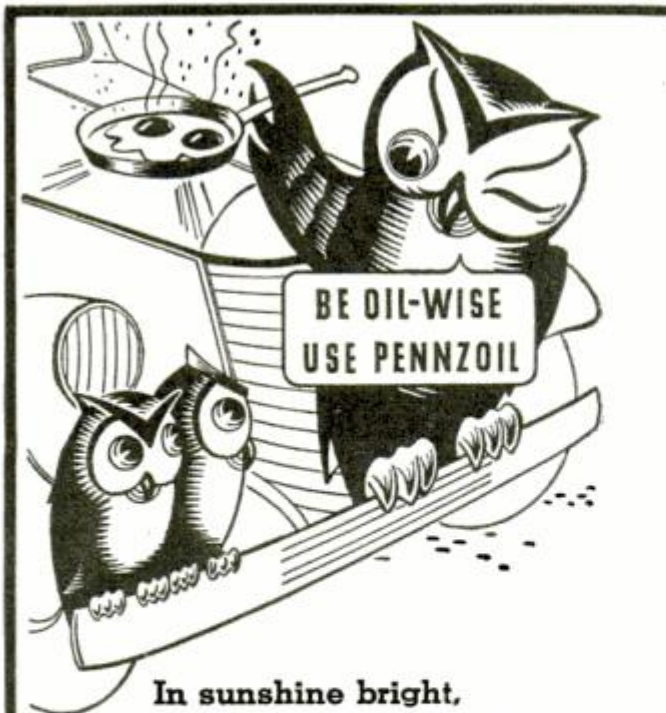

In sunshine bright,
When roads are hot,
Your lubrication's
On the spot.
So play it safe . . .
Be well advised!
Insist your car
Be Pennzoil-ized!

FREE—Attractive, reflector-type safety signal for your car! Just print your name and address on a post card and send to Dept. J, The Pennzoil Co., Oil City, Pa.



NEW Light Weight Paint Sprayer—Only \$31.15

1/4 H.P. Motor AC110 Volts. 60 Cycles- COMPLETE



Quick, easy way to paint screens, furniture, radiators, machinery—anything—in homes, Factories, Stores, Schools, Hospitals, Office Buildings, etc. Small, compact. Carry anywhere. Weight 44 lbs. Complete with Spray Gun; 15 ft. Hose. FULLY GUARANTEED. Only \$31.15 f.o.b. Chicago. \$5.00 Deposit, Balance C.O.D., or see your dealer. Free

Circular. Ideal Pump Co., Dept. P-8, 801 Washington St., Chicago, Ill.



PHOTO ENLARGEMENTS

Is Photography your hobby? Do you want a profitable easy business at home? Make PHOTO ENLARGEMENTS for yourself and others. Your cost 5c each and less. The Ideal Photo Enlarger is AUTOMATIC. No experience required. Also COPIES any picture. \$5.94 COMPLETE. Interesting circular FREE.

IDEAL-O, 122 East 25th Street, New York City

5¢
ANY
SIZE

New Progress in Fireproofing

(Continued from page 254)

gas ignition. Several tests are based upon the probability of ignition from a given heat source within a specified time, or upon persistence of flames or glowing of the wood after removal from the source of heat. Measuring the time required for a flame to penetrate a piece of wood has been another common test. In other tests the height of flame from the burning wood is taken as the measure of inflammability. Heat insulation, which is closely related to flame penetration, is another test. The depth of flame penetration in a board and the time required for a loaded timber to fail when subjected to flame also have been used for fireproofing tests.

All of these tests show differences in fire resistance of common wood and fireproofed wood, but because of so many uncontrolled conditions the tests lack definite units of fireproof measure. Lack of standard tests has been the greatest barrier to progress in fire-treating wood.

Technicians of the U. S. Forest Products Laboratory recently developed a test which has won the acceptance of the American Underwriters' Association and fire-department experts throughout the nation. It is a simple fire-tube apparatus, consisting of an open galvanized-iron tube in which a specimen of wood is burned while suspended from a balance arm. The fire tube is about fifty inches long; the wood specimen about forty inches long, three-fourths inch wide and three-eighths inch thick. A gas flame is applied to the lower quarter of the wood specimen for four minutes. To the balance arm is attached a pointer which indicates on a scale the percentage loss in weight as the burning proceeds. The temperature at the top of the tube is measured by a thermocouple type of pyrometer. As the wood is decomposed by the flame the coals that drop are caught in the bottom of the tube and their tendency to continue to glow is noted. A burning temperature of about 1,832 degrees at the base of the tube is obtained with a bunsen or gas burner, adjusted to give a blue flame about eleven inches in height. The wood specimen is suspended vertically with its lower end

about one inch above the top of the burner. A little more than ten inches or one-fourth of the wood specimen is subjected to temperatures of between 1,700 and 1,850 degrees and the upper half to temperatures of 375 to 500 degrees.

The wood specimen is thus exposed to temperatures ranging from those existing under severe fire conditions down to the approximate ignition temperature of wood. Under these conditions untreated wood ignites quickly, flames spread along the entire length of the stick which loses weight rapidly, and temperatures of 1,350 to 1,500 degrees are built up at the top of the tube within three or four minutes. But a specimen of fire-treated wood ignites with great difficulty, if at all, its lower end chars slowly, it does not spread flame or burn beyond the igniting point and causes little increase of temperature at the top of the tube.

The test shows that by means of proper impregnation by fire-resistant chemicals wood can be used widely in fireproof construction. The fire-tube test is being supplemented by fire performance tests upon built-up assemblies. For the build-up test technicians of the Forest Products Laboratory have developed iron-enclosed air-ventilated gas burners equipped with thermocouples placed at intervals of six inches to three feet throughout the structure being tested. An entire door, window sill, or wall or floor panel is placed in the oven, and maximum ignition temperatures are applied to its various parts for long intervals, sometimes as much as four hours at a time. Records are kept of loss of weight, flame-spread, conductivity, and areas of combustion. Entire doors or structural panels can be fire-treated to a point where there is no flame spread and where loss in original weight is as low as eighteen per cent.

From a building standpoint it is now possible to make a building largely fireproof by using as little as ten per cent of fire-treated timbers at various points where fire is most likely to break out, sills, eaves, inner walls, stove or furnace bases, electrical connectors, etc. Plywoods and fiberboarding are being manufactured which are more fireproof than asbestos. A great deal of study is being given to fireproof roofing.



A new sponge made (like rayon) of Cellulose. Soft, durable, sanitary, absorbent.

Get this
AMAZING SPONGE
FREE

*with every
pint can of*

**No. 7
POLISH**



WE make this generous offer so that new thousands of car owners will try No. 7 Duco Polish immediately, and see how greatly it improves the appearance of the car. You should use No. 7 Polish on new cars as well as old. It keeps new cars beautiful and restores the color and lustre of old finishes dulled by grime and Traffic Film.

Now we offer a Du Pont Cellulose Sponge (25c size) FREE to everyone who buys a pint can of No. 7 Polish. (Offer good in U. S. only.) This sponge, created by du Pont chemists, is ideal for bath and household cleaning, as well as for the car. See your dealer WHILE THEY LAST!

GRIME DOES NOT PAY
... USE No. 7

WORM YOUR DOG



AT HOME

**EASY HOME
METHOD
RIDES DOGS
OF TAPE,
ROUND
AND HOOK
WORMS**

With the "No Guess" Pulvex Capsules, you need know nothing about worms, yet you can easily worm your dog at home . . . positively free him of tape, round and hook worms . . . without gassing, gagging or harmful effects.

Protect your dog against incomplete worming or your unfamiliarity with worms; use Pulvex Capsules, the only complete treatment in one package that expels all three types of worms. In puppy or adult size, 75c. At all pet, drug and dept. stores.

PULVEX *Combination Treatment*
WORM CAPSULES



BALL JOINT \$1.95

AUTO TRAILER COUPLER

Rocky Mt. States West, \$2.25. Postpaid

ADJUSTABLE BUMPER HITCH \$1.35

This hitch can be put on, taken off, or adjusted to 6 different positions with a wrench. Postpaid, \$1.35 without ball. (Rocky Mt. States West \$1.50.) Write for catalog on trailer hardware and camping trailers.

**We Specialize in Trailer Axles—
Either with or without Brakes**

ZAGELMEYER AUTO CAMP CO.

1478 S. Henry St.

Bay City, Mich.

EARN MONEY Stringing TENNIS RACKETS



An opportunity to earn as much as \$3.50 for a few minutes of your spare time. String your own racket and save money. Tennis players need restringing frequently. Every stringing means profit for you. No experience needed—we teach you how. TOMGUT Equipment makes it easy. Costs practically nothing to start. Easy work. Begin NOW!

FREE Write today and we will send you Free our new low prices of TOMGUT "Court-Tested" Tennis and Badminton Strings, Restringing Equipment and a complete line of Racket Frames.

THOMPSON MANUFACTURING CO.

4535 Packers Ave., Chicago, U. S. A.
TOMGUT "Court-Tested" Tennis & Badminton Strings

Please send, without charge or obligation, the new price list of TOMGUT Tennis and Badminton Strings, Racket Frames, and Restringing Equipment.

Name

Address

City..... State.....

MAIL THIS
COUPON

Hunting Treasure

(Continued from page 205)

able mercury-vapor lamp like the ones used for artificial "sun" baths, or even from an electric arc flaming between iron electrodes, you can detect instantly any of the hundred or more minerals possessing this property. Under the black-light radiation, livid streaks on the rocky walls will betray pay ore. Miners in several



Putting spectrum film into analyzing device for microscopic study

tungsten mines near Randsburg, Calif., use the argon bulb or the iron arc to outline the veins, since the ore looks no different from barren rock to the human eye. They also find it a help in sorting broken rock and picking ore from worthless rock. It's a quick method of prospecting for certain metals, and makes it worth while to stroll through abandoned shafts and flash the black light upon the walls.

Another trick is to turn a blowtorch upon the rock and examine rising vapors by shining the black light through it. A fluoroscope like that your doctor uses when he studies your chest with the X-ray, gleams a weird green under the black light; but if cinnabar is present, mercury vaporized out of the rock will cast a dark shadow on the screen.

Our Bureau of Information will answer questions regarding articles in this magazine, if accompanied by return postage.

Forecasting the Weather

(Continued from page 213)

whether the forecasts are for fair or dull weather.

Air-mass analysis got its start when it was learned that large portions of the earth's atmosphere, covering as much as several million square miles and extending to heights of six or seven miles, have rather uniform characteristics. Usually an air mass from the polar regions is extremely cold and dry while an air mass moving up from the tropics is warm and humid. These air masses frequently collide and the dissimilarity of the air in the two masses results in atmospheric disturbances along the boundaries that separate them. Cold air is heavier than warm moist air, so the polar air mass begins to slope in under the warm mass, pushing its outer fringe upward. This slope between the cold and warm air is usually at the ratio of one to 100, so that if one were standing in cold air 100 miles from the line where cold air is meeting warm air at the surface, he would find warm air one mile above him.

There is a continual struggle going on between these polar and tropical air masses or currents. The usual result of each meeting of two different masses is clouds of precipitation, caused by the boosting upward of the warm air to altitudes where the moisture starts to condense.

This is a rough rule-of-thumb outline of the air-mass system. To accurately gauge the weather by it, forecasters have to assemble on charts, hundreds of reports coming in by radio and telegraph from airplanes, ships and ground weather stations. Each air mass is different, but on the charts the migrations of the masses may be plotted several days ahead of the time that they reach a district, and in that way the probable weather disturbances and their probable times of arrival are anticipated.

"Climate is merely a summation of weather, and weather from day to day results from disturbances along the atmospheric fronts," says Dr. Krick. "This gives us a start in attempting seasonal weather forecasts, for if the semi-permanent atmospheric fronts during the seasons of

(Continued to page 126A)

HAVE YOU TRIED THESE PRACTICAL HOME USES OF GENUINE MASONITE?

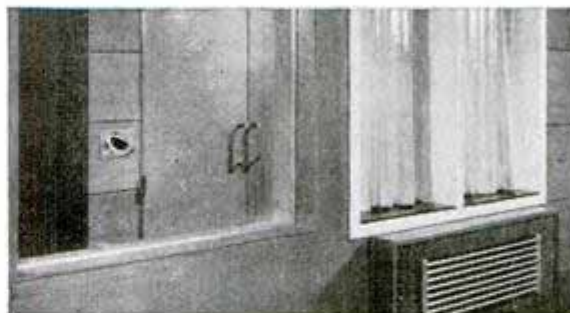

● Homecraftsmen find hundreds of ways to achieve beautiful, unusual effects in the home—with Genuine MASONITE. In the hallway shown above, the neat mirror frame is MASONITE TEMPERED PRESWOOD with sanded edges. The radiator cover, impervious to temperature changes, is MASONITE TEMPERED PRESWOOD.



● The bathroom walls are MASONITE TEMPERED PRESWOOD. Two are enameled, and two are clear-varnished to produce a smart two-tone color scheme.

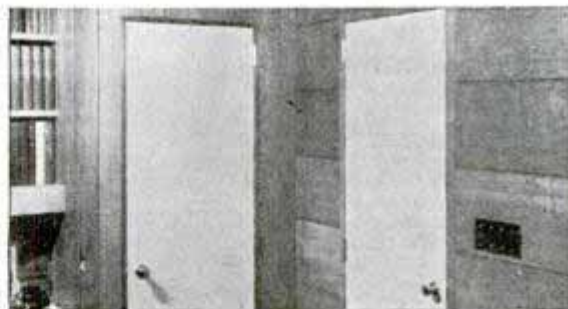

● These "flush" doors are regular doors with MASONITE TEMPERED PRESWOOD glued to each side. They not only offer a neat, modern appearance, but also provide surfaces which can easily be kept spotlessly clean.

● Why not discover the many improvements you can make in your home with Genuine MASONITE? Mail the coupon for FREE samples and details about MASONITE—THE WONDER WOOD OF A THOUSAND USES.



MASONITE CORPORATION
Department PM-8

111 W. Washington St., Chicago, Ill.

Please send me FREE samples of Genuine MASONITE and more information about THE WONDER WOOD OF A THOUSAND USES.

Name _____

Address _____

City _____ State _____

es 4 38

(Continued from page 125A)



MEAD'S NEW RANGER

CHAMPION!

FREE CATALOG

of America's largest assortment of bicycles sent free on request. Write now!

\$1 Per Week - BUT FIRST IT'S YOURS TO TRY FOR 30 DAYS!

Here it is!—The swiftest bicycle Mead has ever offered. **CHAMPION!** Built-in speedometer. Jump into the saddle—try it a whole month at our risk. Then, if not perfectly satisfied, return at OUR expense! Latest features. Save 1/2 buying direct from Mead. Send postal for free catalog, easy terms and special offers!

MEAD CYCLE CO., 15 So. Market, Dept. H-116, CHICAGO, U.S.A.

the year can be anticipated the kinds of weather associated with them may be determined, and thus the climate of the region.

"Although the climate of the earth is not changing appreciably over long periods of time, certain departures from the so-called normal weather occur from year to year, such as the floods in the Ohio valley and the frosts in southern California that happened last winter. These developments are explained and in fact were anticipated by a shift in the semi-permanent fronts that were observed in the spring of 1936.

"When the causes of such shifts in the principal atmospheric boundaries can be determined we shall be able to anticipate long in advance the abnormalities that result in seasonal weather. Then these predictions should be just as accurate as the present forecasts of the day-to-day changes in the weather."

es 551

Big Terrestrial Globe Clock Has Lighted Numerals

Lights in the dial around a large terrestrial globe clock in a Boston building indicate the hours by large Roman numerals, and minutes by smaller Arabic numerals around the edge. Hanging in the foyer of the building, the clock is controlled by a Telechron motor, causing it to keep time in synchronization with alternating electric current. A twin celestial globe at the other end of the foyer indicates the day of the month.

Master Collection



Christian Science Monitor Bldg



SAXOPHONISTS YOUR MOUTHPIECE WORRIES ARE OVER

With our new double tone chamber saxophone mouthpiece. Two separate tone chambers instead of one. (See Cut.) What a wonderful difference this makes, none other like it. Beautifully made from finest hard rubber rod. Velvet smooth precision machine facings.

PRICED SO LOW ALL CAN PLAY THIS NEW MARVELOUS MOUTHPIECE

Alto Sax. \$3.00, Tenor Sax. \$3.50. Wonderful clarinet mouthpieces \$3.00. End your worries, order now, shipped C.O.D. anywhere plus postage. Give make of Inst., close, medium or open lay. (90% play open facings.)

MONEY BACK GUARANTEE

Play it for three days, if not the most marvelous mouthpiece you ever put a reed on, gives you a bigger and more beautiful tone from top to bottom, return it, we'll refund.

HARRY E. O'BRIEN & SON

Dept. P6, P. O. Box 5924, Indianapolis, Ind. A maker of over 100,000 mpcs. 25th Year.

HOME BUILT WINDCHARGERS



Wind power Electricity for Lights, Radio, Motors and Battery Charging. Send 25c for copyrighted booklet "Over 100 Facts and Plans" gathered after three years research. Wind Power is Free. Use it.

CURRIER MFG. CO.

422 Terminal Minneapolis, Minn.

Catch Fish!

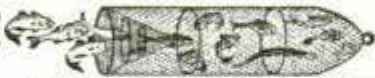

Eels, Mink, Muskrats, with our new folding galvanized **STEEL WIRE TRAP**. Write for our **FREE TRAP OFFER** and Bargain Catalog. \$1 Box of our famous Fish Bait **FREE** to introduce our traps. **WALTON SUPPLY CO., 3501 JUNIATA AVE., ST. LOUIS, MO.**

Saw-Filing

Pays Up to \$2 or \$3 an Hour — Start in Spare time

NO EXPERIENCE NEEDED to file hand, hand and circular saws with **FOLEY Automatic Saw Filer**. J. W. Anderson, Texas, writes, "My fourth year with Saw Filer and third with **FOLEY Lawn Mower Sharpener** as side line. Business has increased until it is about full time."

Used by Leading Saw Makers

Atkins, Disston, Simonds and by industrial plants and repair shops all over U. S. Cash work. No canvassing. No eye strain. Postcard brings **FREE PLAN** and special offer of **Foley Saw Filer** free. No obligation.

FOLEY MFG. CO. 816-7 Foley Bldg. 11 Main St., N. E., Minneapolis, Minn.

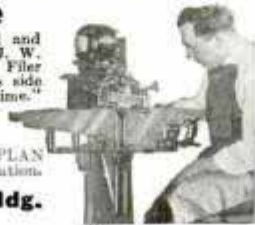

20 3 38
Caution! Danger Ahead!

(Continued from page 197)

tomobiles and more than one-third involved striking pedestrians. But don't pick off a pedestrian instead of a car if you must hit something. Hitting pedestrians caused nearly twice as many deaths last year as hitting other automobiles.

Since you're a pedestrian the minute you park your car, perhaps you can profit from the mistakes of last year's pedestrian victims. About twenty-eight per cent of them met death or injury while crossing between intersections, more than ten per cent while crossing at an intersection without a signal, and more than six per cent of those killed and thirteen per cent of those hurt were crossing at a corner



against the light. And nearly twenty per cent of those killed were walking on a rural highway. The lives of another eight per cent were snuffed out as they came from behind parked cars, and this foolish practice also accounted for more than eleven per cent of the pedestrians injured by automobiles.

"Something was wrong with my car," says the driver after a smash-up. Perhaps, but the 1936 accident figures indicate that the chances are that something was wrong with the driver. More than ninety per cent of cars involved in accidents last year were in apparently good condition. But poor brakes, glaring headlights and punctures or blowouts were the defects which resulted in the most deaths due to faulty cars. The lesson here is obvious—keep brakes, tires and lights in good condition.

Here's something else to ponder over. About eighty-five per cent of fatal and non-fatal accidents last year occurred in

(Continued to page 128A)

LOOSE HANDLES QUICKLY MADE TIGHT

MIX a little Smooth-On No. 1 into a putty, put this into the opening, force the parts together, and in a few minutes the metallizing of the Smooth-On produces *lasting* tightness. Such repairs cost only several cents each and save many dollars otherwise spent for renewals that are no better.

In addition to quick, effective replacement of loose handles and knobs as suggested in the sketches, Smooth-On No. 1 enables you to stop leaks at cracks and joints in steam pipes, radiators and boilers, in water pipes and tanks, in gas pipes, in automobile radiators, engine water jackets, hose connections and in gasoline and oil lines, to make loose bolts, nuts, screws, etc., permanently tight.

Smooth-On No. 1 after set and metallized holds water, steam, gasoline, oil, etc., under any pressure, and may be applied with equal success to any metal. It is also used for anchoring and taking up looseness, and holds in masonry, tiled walls, slate, wood, etc.

By doing your own household and automobile repairing with Smooth-On No. 1, all the Smooth-On repairs you make in a year will probably cost you less than any one of them made by a professional mechanic—and you will be surprised at the ease of application and the number of places where Smooth-On can save money.

Keep a can of Smooth-On No. 1 in your tool box and be ready for emergencies. Do your own repairing and at the end of the year you will find that your efforts have been handsomely rewarded.

The free Smooth-On Repair Book gives full instructions.

Get Smooth-On No. 1 in 7-oz., 1-lb. or 5-lb. tins at nearest hardware store or if necessary direct from us.

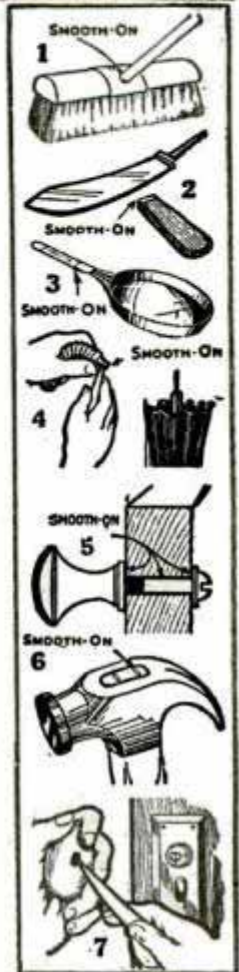

Write for FREE BOOK



Do it with SMOOTH-ON

SMOOTH-ON MFG. CO., Dept. 37
 574 Communipaw Ave., Jersey City, N. J.
 Please send the free Smooth-On Repair Book.

Name.....
 Address.....
 8-37.....

es 338

DIESELECTRIC PLANTS

MAKE YOUR ELECTRICITY FOR 1c PER KILOWATT

Make your own electric light and power the "Diesel Way" with WITTE Dieselelectric Plants, 1600, 3000 or 6000 watts, for Less Than ONE CENT per KILOWATT on cheap non-explosive fuel. 110 volt A. C. or D. C. for direct lighting, 32 volt for battery operation. Charging costs lowered 75%. Easily installed in small space. Also stationary Diesel Engines 3, 5 and 10 H. P. Use a Diesel for Economy and Safety.

174C Oakland Ave.

\$565
and up
F. O. B.
K. C., Mo.



1600
Watts

Kansas City, Mo.

WITTE ENGINE WORKS

Governs Speed OF ANY GAS ENGINE

Take any car motor out of the chassis, equip it with a Pierce Universal Governor, and you have a stationary power unit that runs steadily enough to operate even an electric welder. And that's some test for close speed regulation.

Pierce Universal Governors are standard controls on gasoline engines for commercial purposes—for electric lighting plants, refrigerating units, air compressors, feed grinders, hoists, saw mills, welders, etc.

Pierce Universal Governors are the time-tested flyball type and respond instantly to each change in engine load, maintaining uniform speed. Belt driven, either V or flat. Easily installed and never equalled for close regulation of speed and for dependable performance.

Write for illustrated literature and prices, whether you want to equip one used motor or a thousand new ones.

The Pierce Governor Company
1600 Ohio Avenue, Anderson, Indiana



A Pierce Governor puts "brains" into any gas motor.

Syncro JIG SAW

FASTER—SAFER—CLEANER

Astounding performance! Cuts up to 1" or more, with smooth, clean edges. No sanding required. Accurate, sturdy, efficient—a revelation to skilled craftsmen in handling both intricate designs and heavy work. Ideal for cutting light metals, veneers and plastics. Operates on 60 cycle, 110 volt AC, without motor or any reciprocating parts. Requires no oiling. 10" square table; 13 1/2" throat; adjustable guide; variable stroke. Complete with underwriters approved cable and rubber plug. Built for years of continuous service.

Electric Operation



7200 Strokes per Minute

No Motor Required

FREE FOLDER

GET FREE LITERATURE TODAY
Ask your dealer to show you the models now available. Or send your name for full information and illustrated literature, FREE.
SYNCRO DEVICES, INC.
511 Boydell Building Detroit, Mich.



Every Toolmaker Dreams of It!

A Better, Finer chest for his good tools.
Free Catalog.

GERSTNER TOOL CHESTS
468 Columbia St. Dayton, Ohio

ALL-PURPOSE MOTO-TOOL

Does many jobs speedily, easily—grinds, drills, engraves, sharpens, routs, carves, polishes, etc. Universal motor—about 20,000 R.P.M.—plugs in any light socket A. C. or D. C. Handles as lightly as a pencil. Weighs 6 oz. and is amazingly powerful. Oilless—self aligning—ball thrust bearings.

TEN DAY TRIAL, satisfaction guaranteed or money back. 20 pc. general utility tool set \$5.75 extra. Send for Free Booklet.

DREMEL MFG. CO., 2820-Ct., Racine, Wis.

only \$9.85

(Continued from page 127A)

clear weather—no fog, rain or snow to blame the accidents on—and about seventy-five per cent of the fatalities and injuries occurred on dry roads. A clear day and a dry road spell speed. But for more than 25,000 people last year, the combination spelled death, partly because too many drivers went too fast for conditions—even on a good road and a clear day.

And here's something else to think about next time you decide to let 'er out on a straight stretch. Since 1924 fatal accidents in cities of over 10,000 population have increased twenty-six per cent. That's bad

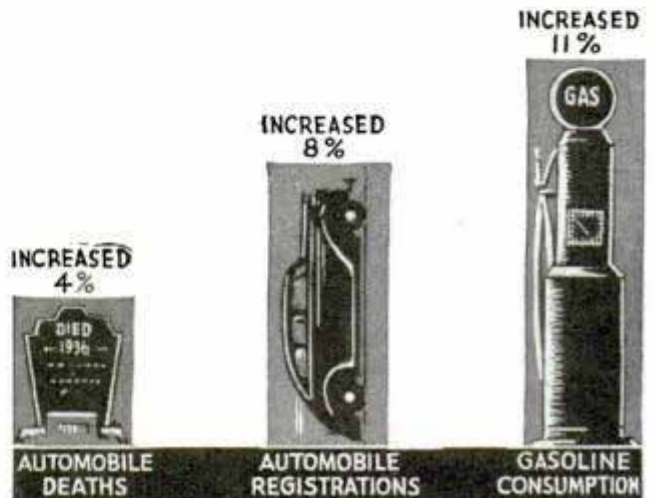

This chart shows how motor-vehicle deaths, registrations and fuel consumption increased in 1936 over 1935

enough but here's the rub. Deaths on the open road, including towns under 10,000, have increased 165 per cent in the same period. Here again, speed is an important factor—too fast for conditions. At sixty you're going almost ninety feet a second—and it takes part of that second for you to move your foot from accelerator to brake after you decide to do so.

All these figures scream just one grim warning—be careful or be killed. To err is human, and every driver occasionally does the wrong thing at the wrong time. But if you make good driving practices a habit, your mistakes will be fewer—and the figures indicate that you'll probably live longer.

The traffic picture for the future is not all black, fortunately. On a basis of gasoline consumption, fewer persons were killed in 1936 than in 1935. Also eighteen states and many large cities actually reduced traffic fatalities last year. And

twenty states with drivers' license laws had only a one-per-cent increase in traffic deaths, while states without such laws had an increase of about seven per cent. Modern highway illumination also has decreased night accidents virtually everywhere it has been attempted.

But all this has not been enough. More cars are being driven more miles each year and more people are being killed and injured despite everything that has been accomplished through advanced highway engineering, legislation, education, enforcement and other safety measures. The ultimate solution of this problem rests with you—you and 40,000,000 other drivers, some a little worse, some a little better, but most of them surprisingly like you.

And you, the figures show, are gambling your life and the lives of others when you take a chance in traffic today. If you buy a sweepstakes ticket, you hardly expect to win. But you might. When you take a chance in traffic, you never expect to lose. But you might—for you are eleven times as likely to be killed or injured in an automobile accident this year as the holder of a sweepstakes ticket is to win even a small prize. In one case, you're gambling a few dollars, in the other you're gambling your life—or the life of your victim.

Is the gamble worth the risk?

Reel Rewinds Clothesline and Prevents Kinking

Automatically winding and unwinding the clothesline, a compact reel now on the market prevents kinking and keeps the line off the ground. Weighing less than three pounds the reel is easily operated and conveniently carried. The line may be put up or taken down quickly.

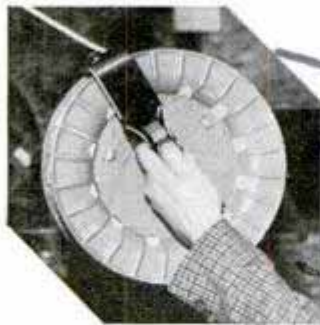

Whenever you find that you wish to know more about any article in this magazine, write our Bureau of Information, inclosing return postage.

HERE'S HOW—

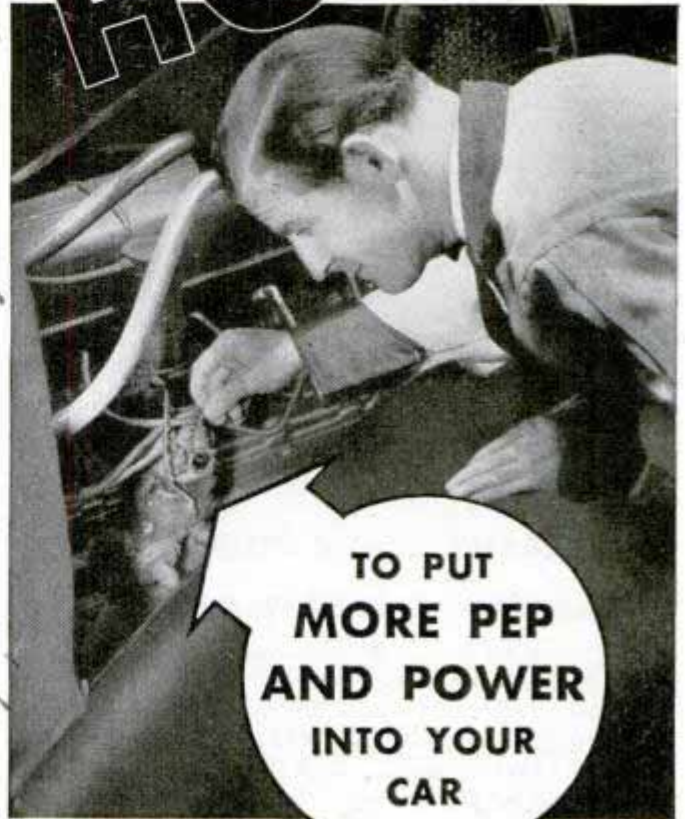

TO PUT MORE PEP AND POWER INTO YOUR CAR

Any car will keep on running for thousands of miles after the wires should be replaced. But every mile you drive on those worn-out wires you're wasting gas and losing a lot of pep and power. The current leaks away instead of delivering fat, hot sparks in the combustion chambers. Prove this yourself by rewiring with Packard Four-Forty—the long-life ignition cable with the inorganic "man-made rubber" sheath. You can't miss the difference.

NOTICE TO DEALERS

Clip the coupon for the Packard Cable specification chart and wiring guide.



Packard

Packard Electric Div. General Motors Corp. Warren, Ohio.

Send me specification chart and wiring guide.

Name _____
Firm _____
Street _____
City _____ State _____

Reel Rewind
e/o Mrs. ...

6104 N. Tolman

Sold by - John H. Leadstone Room 1482 Merchandise Bldg. - 1482 Delaware

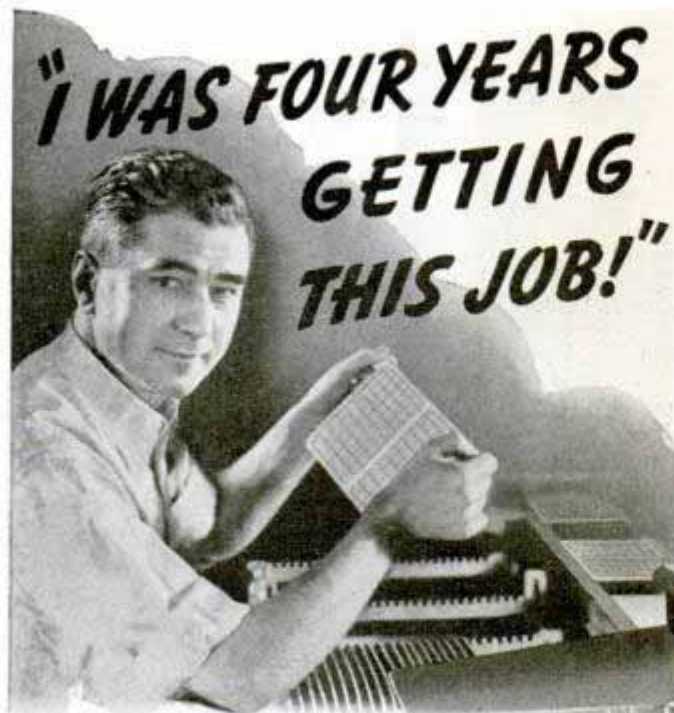

And that means YOU get a better battery

"You have to PROVE that you have the eyes of an eagle before you can sit in this chair. It took me four years to work through every step of Willard's plate-pasting process to the point where I could immediately spot the slightest flaw. Because every plate-inspector here at the Willard plant has had the same kind of training, you'll get no defective plates in a Willard whether you buy it in Seattle or Miami."

★ ★ ★

This is just an indication of the care Willard uses in this important battery-building operation. Even the temperature and humidity are scientifically controlled in this plate-pasting room... to make sure that *all* the plates in *every* Willard will deliver the long life—the quick starts—and the dependable performance for which Willard Batteries are famous.

Experienced motorists, the world over, will tell you that "Willards Cost Less to Own because they last longer—crank faster—don't let you down"—AND ACTUAL SERVICE RECORDS PROVE IT.

If You Want To Save Money—
Buy a Willard

WILLARD STORAGE BATTERY CO.
Cleveland • Los Angeles • Toronto, Can.



Willards

COST LESS TO OWN!

Because they last longer...
crank faster... don't let you down

20 402
Super-Steam

(Continued from page 238)

country—laboring eight hours a day every day in the year.

Super-steam has made it cheaper, in general, to buy coal to produce a kilowatt near the place where the power is to be used than to produce that kilowatt by distant water power and then transport it. It is even cheaper to burn coal and get clean steam than to use free steam if the free steam is dirty. North of San Francisco it is possible to get steam under pressure from the earth by sinking pipes about seventy-five feet. But this steam contains chemicals, necessitating the construction of special turbines. So, even with free steam, in this case, it has been found more practical to burn fuel to obtain steam than to use what nature offered.

But there's more to making electricity from steam than just fuel. For every ton of coal that goes in the furnace, about ten tons of water must be supplied to the boiler, twelve tons of air must be sucked into the combustion chamber and up the stack go thirteen tons of combustion gases. In addition, a tremendous amount of water must be used to cool the steam in the condenser. One New York power station daily pumps 3,600,000 tons of river water through its condensers, more than the daily water supply of New York City. And ten power stations along the East river use so much water for cooling that the average temperature of the river has been raised sixteen degrees in thirty-six years. That's one river that will never freeze again.

The turbine plant utilizes even the heat in the tons of flue gases. Air intended for the combustion chamber is passed through pipes in the flue and thus preheated and water going to the boiler also is preheated by these same gases because, the hotter the air and water, the quicker the generation of steam.

No one knows the life of a steam turbine because they haven't been making them long enough to wear them out. Since it has only rotary motion, wear is minimized. The expensive parts of a turbine don't wear out and the buckets or other minor parts that do need replacement are not expensive. Seldom does a good tur-

(Continued to page 133A)

A GREAT NUMBER!

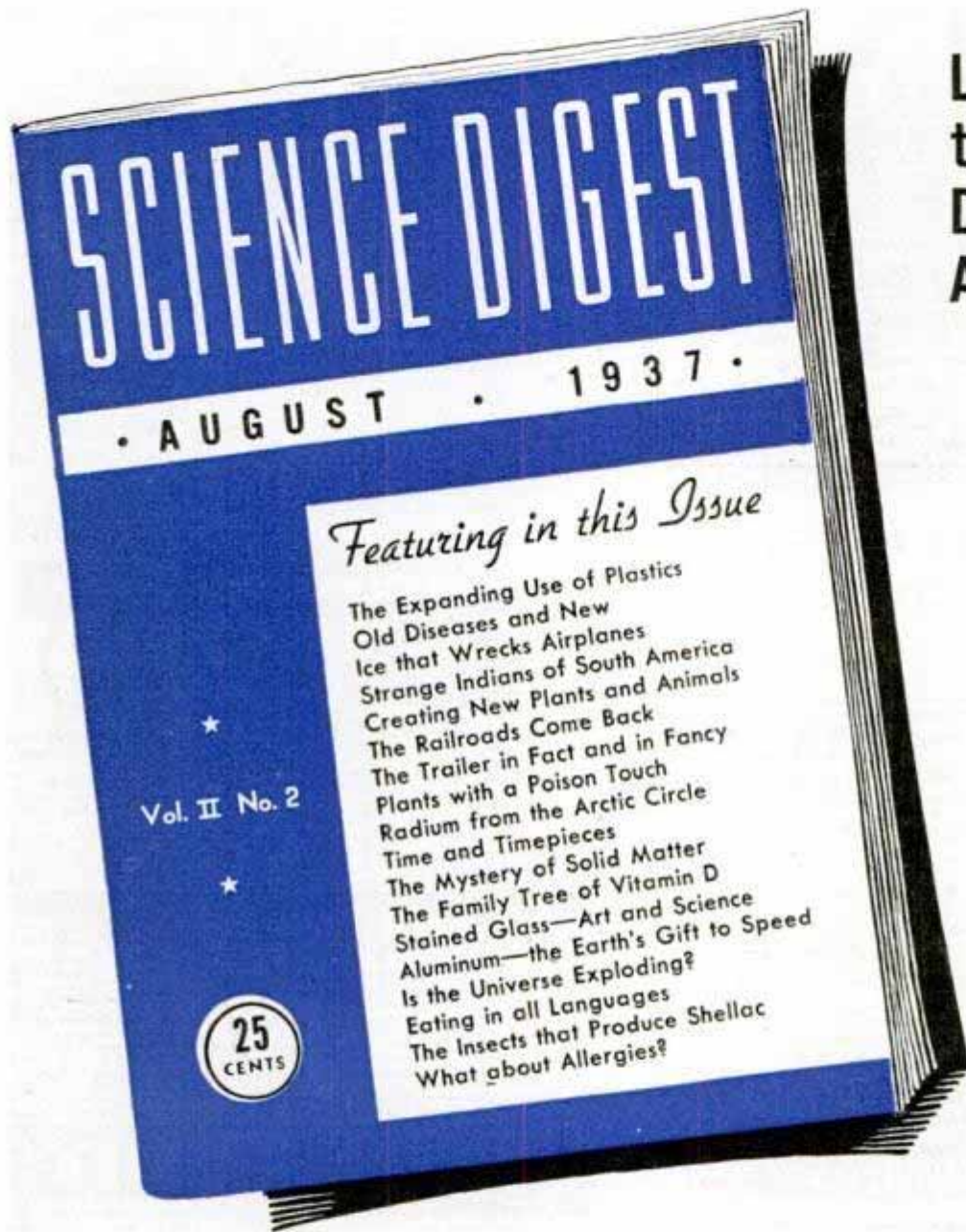

Look over
the titles.
Don't miss
August.

Featuring in this Issue

The Expanding Use of Plastics
Old Diseases and New
Ice that Wrecks Airplanes
Strange Indians of South America
Creating New Plants and Animals
The Railroads Come Back
The Trailer in Fact and in Fancy
Plants with a Poison Touch
Radium from the Arctic Circle
Time and Timepieces
The Mystery of Solid Matter
The Family Tree of Vitamin D
Stained Glass—Art and Science
Aluminum—the Earth's Gift to Speed
Is the Universe Exploding?
Eating in all Languages
The Insects that Produce Shellac
What about Allergies?

The fifty articles of varying lengths for this fine August issue were selected from over two hundred fifty scientific publications. Here's news in concise, clear, readable form from all branches of science the world over. Notice that manufacturing, medicine, transportation, natural history, astronomy are only a few of the subjects covered. Something for everyone interested in progress is

the reason each new issue of Science Digest has more readers than the last. Are you reading it? In United States and possessions, Canada, Newfoundland, Labrador and countries of the Pan-American Postal Union including Spain, a year's subscription is \$2.50. Elsewhere 50 cents more for overseas postage. Start with August. Buy at your news stand or mail your subscription today.

SCIENCE DIGEST, INC.

633 St. Clair Street

Chicago, Illinois

When writing to advertisers please mention Popular Mechanics

FACTORY TO YOU

NEW REMINGTON NOISELESS PORTABLE



10¢ A DAY

FAMOUS Remington Noiseless Portable that speaks in a whisper, only

10c a day, direct from factory. Standard Keyboard. Automatic ribbon reverse. Variable line spacer and all the conveniences of the finest portable ever built. **PLUS** the **NOISELESS** feature. Act now. Send coupon **TODAY** for details.

You don't RISK a Penny. We send you a Remington Noiseless Portable for 10 days' free trial. If not satisfied, send it back. We pay all shipping charges.

FREE typing course and carrying case. You will receive **FREE** a complete simplified home course in Touch Typing. Also **FREE**, a handsome, sturdy carrying case. No obligation. Mail coupon for full details—**NOW**.

Remington Rand Inc., Dept. 152-8
315 Fourth Ave., New York, N. Y.

Tell me, without obligation, how to get a new Remington Noiseless Portable, plus Free Typing Course and Carrying Case, for 10c a day. Send Catalogue.

Name.....
Address.....
City.....State.....

FREE CAMERA BOOK!

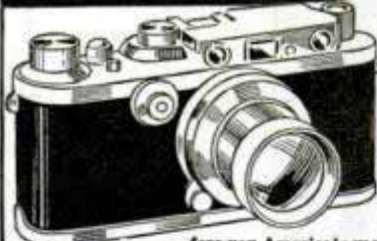

Just out! Explains latest inventions, methods in photography and Home Movie Making, for fun and profit. Offers hundreds of amazing, money-saving bargains in new and used still, movie cameras, lenses, films, exposure meters, enlargers, darkroom supplies—everything photographic. Central offers you America's most complete, varied stock of foreign and domestic merchandise from world's leading makers: Eastman Kodak, Zeiss, Bell & Howell, Graflex, Geveart, Korona, Bausch & Lomb, etc. **SAVE** at Central! Satisfaction guaranteed or money back. **We take your old camera and equipment in trade.** Write for Free camera book!

CENTRAL CAMERA CO., 230 S. WABASH
Dept. K-8, CHICAGO, U.S.A.

PHOTOGRAPHIC HEADQUARTERS since 1899

DO SANDING BY POWER—SAVE \$ \$



Belt 6" Wide—Table 36" or 60" Long

Here's a sander-finisher you can afford, exactly like mills use for finest work. Large—practical—inexpensive. Works up to 36" wide and any length stock. Sands—grinds small parts simultaneously. Pays for itself—easy to own! **We also build Saws, Jointers, Shapers, Lathes, Planers, Jig and Band Saws.**

Send 10c (stamp or coin) for complete 40 page catalog of 20 machines

BOICE-CRANE CO., Dept. PM-8M, Toledo, O.

BABY CALCULATOR
CHECKING TABLE
NATURAL APPLIED FOLIO

VEST POCKET ADDING MACHINE

IDEAL For Business or Personal Use. Adds, subtracts, multiplies, divides. Does work of more costly machine. Counts up to million, made of steel—weighs 8 ounces. Simple, accurate. Not a toy. Guaranteed 5 years.

— FREE TRIAL —
SEND NO MONEY!

\$2.50
Total Cost

Order from ad, not sold in stores. Just send name and address. On delivery pay postman \$2.50 (plus few cents postage). (If outside U. S. send cash.) 10c additional in Leatherette Case. If not satisfied after 10 days' trial you get your money back. Thousands of satisfied users. Write for Agent's proposition. **CALCULATOR MACHINE CO.** (Mrs.) Dept. 187, P. O. Box 1118, Chicago, Illinois

BIG OPPORTUNITY STUCCO SPRAYING



Renew old buildings. Make new construction more permanent and attractive. Plastic **COLORCRETE** is waterproofed. It fuses with any masonry surface. It fills all cracks. It can be applied in any thickness and in 30 colors. Fully proven by over 12 years actual use under all conditions and every climate.

OFFERS BIG EARNINGS—Owners everywhere want to enhance present values. With this machine you can supply this big waiting market with permanent **COLORCRETE** at amazingly low cost. Operators report cost of 2c and up per sq. ft. and sell up to 7c. Some have paid for their equipment from first few jobs. Machine capacity up to 1,000 sq. ft. per hour.

Get the facts. Send for book "Proven Business Opportunity." Write today. It offers you big extra income.

COLORCRETE INDUSTRIES, INC.
570 Ottawa Ave. Holland, Mich.

OTTAWA LOG SAW



only \$39
GREATEST OFFER EVER MADE
Make Money! Wood is valuable. Saw 15 to 20 cords a day. Does more than 10 men. Ottawa easily operated by man or boy. Falls trees—saws limbs. Use 4-hp. engine for other work. Write today for **FREE** book.

OTTAWA MFG. CO., 813 Wood St., Ottawa, Kansas

BIG PROFITS are Yours..

EVERY MAN YOUR PROSPECT!
Fast-selling buckle and belt made to personal order. Initials, names, lodges, commercial emblems in raised letters and colors. Genuine cowhide belt. Exclusive patented **HOOK-FAST** match. Big profits using our original sure-fire plan.
HOOK-FAST SPECIALTIES, INC.
Dept. P-52, Box 1425, Providence, R. I.

Wear This FREE SUIT GIVEN YOU AS A BONUS

AND MAKE BIG PROFITS DAILY
Easy plan gives you chance to get Made-To-Measure Suit **FREE** as Bonus right away! Wear it! Show friends how to save up to \$10 on their clothes. Take orders. Make up to \$7 every suit including Suit **FREE** of Cost plus Cash Bonus. Every suit strictly Custom Tailored—100 per cent All Wool. 6-day delivery. Satisfaction guaranteed or money back. No limit to number of Free Bonus Suits given you. Fine Traveling Case and large samples **FREE**. **O. K. TAILORING CO.**
325 S. Market St. Dept. 88 Chicago, Ill.

Print Your Own

Cards, stationery, circulars, tags, labels, advertising, etc. Save money. **Print for Others; Big Profits;** easy rules sent. Will do popular Raised Printing like Engraving. Junior press \$5.90, job presses, \$11 up, power \$147. Send for free catalog and all details. **THE KELSEY COMPANY, B-37, MERIDEN, CONN.**

FREE RADIO CATALOG 1001 BARGAINS

Remarkable values in receivers, parts, public address systems, amateur equipment. Don't buy a thing in radio until you get your **FREE** copy. **Send for it NOW!**
WHOLESALE RADIO SERVICE COMPANY, INC.
105H SIXTH AVE. NEW YORK, N. Y.

20402

(Continued from page 130A)

bine lose as much as one per cent in efficiency over a period of years.

The turbine originally was a vertical plant. Now they are horizontal. As turbines grew in size, one bearing resting on the ground was forced to support tons of rapidly rotating parts. It also was found that the structure of a big vertical turbine could not be made sufficiently rigid. Now they are laid on their sides and the shafts have more bearings.

All turbines are not put at work driving generators to produce electricity. Some are directly connected to the machines they operate. Others are geared down to drive slow-speed generators or other comparatively slow-speed machinery, such as the propellers of a ship. Nor do all turbines exhaust into condensers. In cases where heat is needed, the steam first goes to the turbine and makes electricity or mechanical power, then the exhaust steam is employed for heating purposes. In this way the steam is made to serve double duty.

The bleeder or extraction turbine is a combination of the condensing and non-condensing types. Part of the steam goes to the condenser but part is piped away for heating, baking, drying, cooking and other industrial processes. A mixed pressure turbine has a condenser but operates opposite to a bleeder turbine. Instead of extracting fairly low-pressure steam for heating purposes, low-pressure exhaust steam from engines and pumps is admitted into the turbine shell. Here again some of the steam is used twice, perhaps for operating a steam pump, after which the exhaust steam goes into the turbine at low pressure and makes more energy, mostly below atmospheric pressure.

In 1919, the average public-utility generating plant burned more than three pounds of coal per kilowatt-hour. In 1936 the average fuel consumption per kilowatt-hour was less than half that and the best turbines were producing a kilowatt-hour with three-fourths of a pound of coal. Part of this has been due to the higher pressure and temperature of the steam, part to the higher vacuum and greater capacity of the condensers. More push applied at one end, more pull exerted at the other!

(Continued to page 134A)

**"BLOW SOME
HIS WAY,
OSCAR!..**



**...and then switch to the
brand of grand aroma"**



IF ever there was a use for that foul-smelling pipe of yours—this is it! Blow some at the bull, and spare your lady-love! Then reform. Run a couple of cleaners through that soupy pipestem and load the bowl with fine-flavored Sir Walter Raleigh. Blended of choice Kentucky Burleys, Sir Walter is a smoke worth knowing. It's fresh, because it's packed in heavy gold foil. And it's only 15¢ for a full two-ounce tin.



FREE booklet tells how to make your old pipe taste better, sweeter; how to break in a new pipe. Write for copy today. Brown & Williamson Tobacco Corporation, Louisville, Kentucky, Dept. P-78.

UNION
MADE

HOW TO
TAKE CARE
of
YOUR PIPE

TUNE IN TOMMY DORSEY'S ORCHESTRA AND MORTON BOWE. NBC BLUE NETWORK, FRIDAYS 10 P. M., E. D. S. T.

es 402
(Continued from page 133A)

"GLOVER'S
*Double
Action*
FLEA POWDER
GETS 'EM
EVERY TIME!"

**POSITIVELY
KILLS
FLEAS and LICE!**



That's the guarantee you get with **GLOVER'S Double Action FLEA POWDER**—or your money back. Try it on your Dog or Cat. Safe and sure. Saves you money. Don't accept a substitute.

**ONLY
35¢**



GLOVER'S KENNEL and FLEA SOAP—thoroughly cleanses the coat and removes doggy odor; promotes normal hair growth; kills Fleas and Lice; relieves itching. 25¢

FREE DOG BOOK with Symptom Chart, write

GLOVER'S

Dept. Y 462 Fourth Avenue, New York City

FOR
MODERN
SHAVING

Barbasol

NO BRUSH
NO LATHER
NO RUB IN

**STEPS UP
FORD V-8 TO
124 H.P.**

Mc CULLOCH
Supercharger

McCulloch Engineering Co.,
Dept. C, 1327 S. 70th St., Milwaukee, Wis.



"THE NEON LIGHT sets you RIGHT"

★TEST-O-LITE

At Electrical Stores or \$1.50 Postpaid
Handiest electrical tester made; quickly locates trouble in electric circuits, fuses, cut-outs, motors, radios, etc. Has 1,001 uses for electricians or home. Tests any voltage 110 to 550; tells A.C. from D.C. Excels ordinary clumsy test bulb. Fountain-pen size; with pocket clip. Lifetime guarantee.
L. S. BRACH MFG. CORP., 55 Dickerson St., Newark, N. J.

TENEX

GLUE

THE MIRACLE CASEIN GLUE!

*Waterproof *Acidproof
*Heatproof *Weatherproof
*Fire Resistant

LESS TO BUY LESS TO APPLY
Regular 10¢-25¢ sizes everywhere. Also in one-half lb., 1 lb., and 5 lb. cans.

FREE—Ask your dealer for descriptive booklet or mail the coupon below with 10¢ (stamps or coin) for generous sample package and illustrated booklet.

TENEX MANUFACTURING CORP.
Dept. PM-8,
220 West 42nd St., New York, N. Y.

Name.....
Address.....



In 1919 there were about 10,000,000 buyers of electricity in this country and the average rate was about eight cents per kilowatt-hour. Last year there were 26,000,000 customers and their average rate was 4.7 cents per kilowatt-hour. Since 1920, the energy used by industrial plants has increased nearly two and one-half times while the price has decreased more than thirty-five per cent while domestic energy used has increased more than five times and the price has dropped more than thirty-seven per cent.

More electricity sold to more customers for less money—cheaper power. That is progress—progress with an engineering background, progress due in large measure to the development of more push and more pull in steam. George Washington could travel no faster than Alexander the Great. Cheap power enables us to outstrip both for the mass production of automobiles, for example, at a price within the means of millions would be impossible without electric power.

And we may expect greater power triumphs in the future—still cheaper power. The story of steam thus far has been primarily a story of steam from water, but today engineers are experimenting with other liquids which boil at other temperatures. In boilers at the General Electric company at Schenectady, N. Y., are 155 tons of mercury, costing about \$300,000 and used over and over again instead of water in the boiler and condenser. Mercury is boiled at 958 degrees and 125 pounds gauge pressure. The vapor first is used to turn a mercury turbine, then it exhausts into the condenser-boiler where its heat evaporates water to steam, and the steam drives still another turbine.

While man has been able to convert more and more of the energy in steam into useful power, he still is challenged by a dream—the dream of converting all the energy in a pound of steam into electricity. Today he wastes about two-thirds of that energy. But, even so, he has found it practical to buy coal and make a kilowatt with steam, rather than transport a kilowatt made by hydroelectric power plants over a long distance.

The imagination of turbine engineers visions a day when a turbine will produce

(Continued to page 136A)

"YOU'LL LIKE MY TOUCH!"

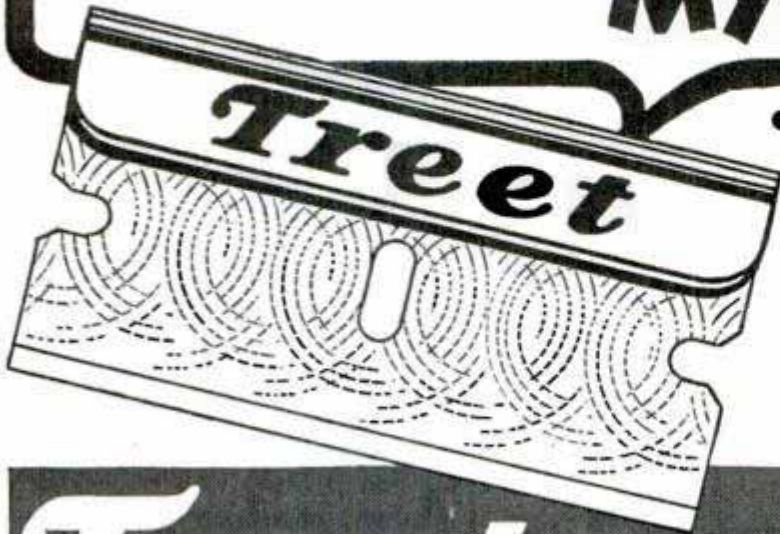

● Romp lightly through your whiskers with keen swift-shaving Treet Blades! Carefully inspected, they have true, dependable, extra-keen edges! Spare your face—spare your purse—get money-saving Treet Blades, today!

Treet Safety Razor Corp., Newark, N. J.

Treet BLADES
FIT GEM AND EVER-READY RAZORS

4 FOR 10¢

SCROLL SAW

This Balsa wood cutting saw will make your models neater, finishing them in one-fourth the time. Finest detail work easily done. Cuts out parts all at once, without the use of dangerous razors or knives. Runs easily by hand or small motor. Safe, efficient, easy to use. Do better work with a Craftsmen's Scroll Saw.

MOTOR MODEL \$2.00 HAND MODEL \$1.00

CRAFTSMEN, PM1, 4303 Cottage Grove, Chicago



Spray gun \$6.96—Wet grinder with 10 x 1 1/2" sand stone and jack shaft \$7.45—Back gear Power Hack Saw with vise \$7.95—1/4" Elec. Drill \$8.95—Spray Unit Comp. with 110 V. A.C. Motor (1/4 H.P.) and gun \$14.95. Compressor only \$3.75. Many other tools at popular prices. FREE CATALOG.

BALCO ELECTRIC MOTOR & SUPPLY COMPANY
Dept. A18 10 S. Clinton St. Chicago, Ill.

MICROMETERS

Six piece set, in velvet lined leather case. Special price, only \$11.95. Precision machined in one thousandths, up to 4" outside and 3 3/4" inside measurements. Guaranteed accurate, easy to read and adjust. Satisfaction guaranteed or money back.

This is your opportunity to get one at a Bargain Price if you act now. Shipped prepaid on receipt of remittance. On C.O.D. shipments, send deposit of \$2.00.

FREE FOLDER

MICRO PRODUCTS, 529 E. Jefferson Ave., Detroit, Mich.

NEW Moto Scoot READY!

6 Miles for 1 Cent!

EASY TERMS



ONLY \$109.00
F. O. B. Chicago

Pay While You Ride with the Money You Earn!

SCOOT so simple, so safe a child can run it YET strong enough for a heavy man! Go anywhere—at 30 miles per hour—120 miles to gallon. No other like it! Easy Terms—pay as you ride with the money you can earn from it! Shipped ready to ride. WRITE QUICK for color folder while this Special LOW PRICE. Special TERMS Offer lasts! (DEALERS! Write for available territories!)

Mead CYCLE COMPANY
DEPT. LM-116 CHICAGO

Write us today for free folder



HOME AUTOMATIC CIGARETTE MACHINE

Have YOUR OWN Monogrammed Cigarettes. Put tobacco and block of papers on machine, TURN THE CRANK—PRESTO—CIGARETTES. Easy—simple. All metal construction. Guaranteed. No cloth ribbons; no special tube or gummed papers required. ASK FOR FREE ILLUSTRATED FOLDER. A. C. MACHINE WKS., PM-8. 1055-57 Devon Ave., Chicago, Ill.

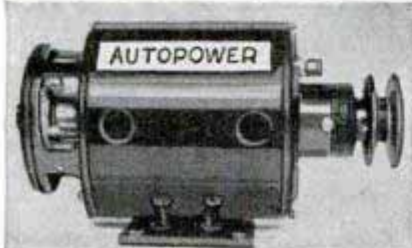

TURN SCRAP INTO MONEY

AUTOPOWER tells you how in plain, easy, simple and illustrated instructions that anyone can follow. Change auto generators into useful, practical A C and D C generators and motors with voltage from 2 to 1,000 volts, for power, light, welding, radio, sound, etc. No previous experience nor special tools needed. Generators can be driven by wind, water, fan belt, etc. Already used and endorsed by thousands. Send for your copy of "AUTOPOWER." Only \$1.00 postpaid.

S. W. Duncan, Publisher.

410 S. Hoyne Ave., Chicago



es 402



EASE LAWN MOWERS

No need to break your back. Now... you can ease the lawn mower action instantly with a few drops of 3-In-One Oil. Use it also to keep garden tools, sewing and washing machines, guns, clocks, electrical appliances, etc., rust-free.

LUBRICATES • CLEANS • PREVENTS RUST

RE-STRING RACKETS AT HOME



• EARN MONEY.

It's easy, pleasant, profitable work. No experience required. Learn in a FEW MINUTES. I supply everything needed. Earn \$50 to \$100 cash in your spare time. Act QUICK—write for details FREE.

SPECIAL 60c

Set Permatex Silk Strings with instructions, postpaid.

W. A. BICKEL, Dept. A-8, 809 W. Madison St., Chicago, Ill.

POPULAR MECHANICS FAMILY TRAILER PARTS

Available from Hammerblow Tool Company—the original.

Don't build until you get Hammerblow facts. Save money, time, wasted labor. Hammerblow guarantees a rugged, non-sway, perfect trailer! **BLUEPRINTS FREE WITH PARTS.** Hammerblow parts are world's best. Used by nationally known firms, and engineers who know. Send only 50c for 64-page Trailer Builder's Guide and Free 40-page supplement. Immense value. Or write for Free Literature. **HAMMERBLOW TOOL COMPANY, Dept. 108, Wausau, Wis.**



Learn BRASS TAPPING

FUN and PROFIT! Get this big new outfit. Learn "raised metal" work. Sell gift and art wares. Make Bookends. Complete Outfit \$2.00. What-Not Racks, Twin Plaques. Equipment includes non-tarnishable jewelers' metals, handcraft hammer, plywood backing-board, noiseless tapping tools, special nails and design patterns. Send \$2.00 money order for outfit complete. State choice Brass or Copper. ("Silver" or "Gold" \$2.50.) **FREE CATALOG** with outfit or send 3c stamps. Write today. **RAPAPORT BROS., 703 W. Ohio St., Chicago.**

BUILD YOUR OWN FANS. 20-inch aluminum propellers for aeroplane fans, \$3.50. For 1/2-inch shafts. Shipped collect. **Michael Electric Co. Fort Worth, Texas**



COOL COMFORT for Trailer, Cabin or Home

with L-B AERO-FAN

Smooth, quiet motor throws real breeze with 8-inch propeller blade. Ideal for trailers, cabins, or kitchen, bedroom and other hot spots in home or office. Stands without creeping, or hangs up anywhere. Folds compactly. Quality built throughout. Price (including cloth bag) with 110-volt A.C. or 6-volt D.C. motor (for battery) postpaid, only **\$3.95** with 12 or 32-volt D.C. motor (battery)..... **\$4.95**



Circular on request. **LYDON-BRICHER MFG. CO., 2526 University Ave., St. Paul, Minn.**

(Continued from page 134A)

a kilowatt-hour from eight ounces of coal instead of twelve ounces—half a pound instead of three-fourths of a pound. That saving of four ounces of coal would send virtually every steam turbine in use today to the scrap heap. But it would do more than make a market for more efficient steam-power machines.

It would revolutionize industry and advance civilization by offering still more electricity to still more people at still less cost—more power to lift more burdens off men's backs. And the day when we will use electricity as freely as water may not be as far ahead as most of us think.

Car Headlamp Tested Quickly with Photocell Meter

Automobile headlamps can be tested quickly by a photoelectric-cell meter to determine the amount of light output. The



Fitting tester over lens and reading dial showing condition of headlamp

test is made by placing the open end of the device to the lens of the headlamp and reading the dial to find volume and intensity.

Whenever you find that you wish to know more about any article in this magazine, write our Bureau of Information, inclosing return postage.

New Invention WITH SUPERCHARGE PRINCIPLE SAVES GAS

NEW MOTOR LIFE MORE POWER MORE PEP UP TO 30% GAS SAVINGS QUICKER STARTING

USERS REPORT
3 to 7 MILES MORE PER GALLON
MOTORIST SAVES \$100.00 a YEAR

"On my V-8 Ford it works miracles. Its added power, acceleration and top speed has sold me. The results are unbelievable."—Ralph Field, Mass.

"Very glad to say, the Buick showed an increase of 3 miles more per gallon."—A. V. Greve, Washington.

"On my Plymouth, I obtained an average of 22 miles per gallon, an increase of 7 miles. This means a saving of \$15 a month or \$180 a year."—F. S. Perck, Calif.

"It saves me one gallon a day. I had to buy 5 gallons each day—now only 4 gallons."—L. V. Sweet, Pa.

"I have twelve VACU-MATICS on taxicabs, and they all show an increase in mileage. The car owners are very well pleased."—Fred Taylor, Okla.

"I have been placing VACU-MATICS on expert mechanic's cars. All are well pleased."—J. W. Davidson, W. Va.

Guaranteed Gas Savings
 VACU-MATIC proves itself on every car. It is guaranteed to give worthwhile gas savings, quicker pick-up, and more power or it costs you nothing. You can instantly tell the difference in added power and motor performance — you quickly notice the cash savings on gasolene.

Fits All Cars
 VACU-MATIC is constructed of six parts, assembled and fused into one unit, correctly adjusted and sealed at the factory. Nothing to regulate. Any motorist can attach VACU-MATIC in ten minutes. Once in, its only reminder is the surge of instant power and speed it gives to the motor and the savings it affords your pocketbook.

Free Details
 You owe it to yourself to know all about this remarkable discovery. Mail the coupon below. Start saving gas with VACU-MATIC and enjoy a new driving thrill! There's no obligation—so get the facts now! Write today!

The VACU-MATIC Co. Wauwatosa, Wis.

AT LAST! Automotive engineers have smashed down the barriers to perfected combustion! The new VACU-MATIC solves the secret of greater power! With almost magical action, this amazing invention instantly puts new life and pep in any motor. It adds mileage to every gallon of gasoline . . . produces split-second pick-up, sensitive accelerator response, quicker starting, greater speed and smoother running.

Automatic — Nothing Like It!

The self-starter — four wheel brakes — knee action — streamlining . . . and now VACU-MATIC! The sensational money-saving invention! With it, engineers have achieved a practical means of balancing air and gasoline automatically for all speeds.

VACU-MATIC is *entirely different!* It operates on the supercharge principle by automatically adding a charge of extra oxygen, drawn free from the outer air, into the heart of the gas mixture. It is entirely **AUTOMATIC** and allows the motor to "breathe" at the correct time, opening and closing automatically as required. No idling troubles—no carburetor adjustments necessary. It is so simple it will amaze you — so practical it will save you many dollars on gas costs.

FREE OFFER COUPON

THE VACU-MATIC COMPANY
 7617-319 W. State St., Wauwatosa, Wis.

Gentlemen: Please send me full particulars concerning the VACU-MATIC and details of your Free Offer. This of course does not obligate me in any way.

Name.....

Address.....

City..... State.....

Check here if interested in selling proposition

A REAL MICROMETER

The best little tool you've ever seen at this price. Ideal for shops, homes and garages. Accurate and dependable.

Write for yours Today

ONLY 50c

Real Manufacturing Company
 321 W. Sandusky St. Findlay, Ohio

ONE-MAN SAWMILL

Makes lumber, shingles, lath, ties, crates, boxes, cases, all forms lumber

TURN TREES INTO MONEY WITH A BELSAW

Three capacities: 10, 14 and 20 ft. Accurate set works positive dogs. Full or one way type power feed runs on low power—Many owners use old auto engine. Pays for itself quickly—thousands in commercial service, everywhere. Write for free lumber handbook and catalog of mills, supplies, tools, saw tables, and woodworking equipment.

FARM MODEL \$49.00

Belsaw Machinery Co., 8110 G. Davidson Bldg., Kansas City, Mo.

Turn Your Skill Into DOLLARS

Make extra money in spare or full time with motor-driven woodworking tools. Opportunities in every community await alert craftsmen. Hundreds of men all over the country are cashing in today. Find out how they are doing it. Send only 10c for big new book, crammed with money-making plans, ideas, drawings, illustrations — showing how others have increased income and become independent. Address Dept. A837.

Delta Mfg Co. 600 E. VIENNA AVE. MILWAUKEE, WIS.

HANDEE TOOL OF 1001 USES

Grinds - Drills - Cuts - Polishes
Carves - Routs - Saws - Sands
Sharpens - Engraves

A whole shop full of tools in one for work on all metals, alloys, bone, resins, glass, stone, wood, etc. Uses 200 accessories. Saves hours of tedious work. 13,000 r.p.m. A C or D C, 110 volts. \$10.75 and up, postpaid. 3 Accessories Free.

Plug in any Socket

DE LUXE MODEL

For constant service, nothing compares with this easy-to-handle production tool. Saves time and labor. Fastest, smoothest, most powerful tool for its type and weight. 25,000 r.p.m. \$18.50 postpaid, 6 Accessories Free.

Get a Demonstration at Your Dealer's or Order Either Model on 10-Days Money-Back Trial. Catalog Free.

CRAFTSMAN'S PROJECT BOOK
 "Pleasure and Profit with a Handee"
 Easy working plans for making many interesting and unusual projects, 25c stamps or coin.

CHICAGO WHEEL & MFG. CO., 1101 W. Monroe, Dept. Q. CHICAGO

Send Catalog Project Book
 \$10.75 Model De Luxe Send C. O. D. PM-8

Name.....

Address.....

When writing please mention Popular Mechanics

BUY & BUILD THE WORLD'S OUTSTANDING MINIATURE GAS MOTOR

The Mighty-Midget Motor



Just the motor for model airplanes, seaplanes or boats. Develops 1/5 horsepower, speed range 500 to 7,500 R.P.M. Tested, perfected and manufactured by the Bunch Aeronautical Laboratories. For aircraft educational purposes—not a toy, but a real gasoline power sensation.

READ THESE AMAZING SPECIFICATIONS

WEIGHT complete, 18 oz. Every motor equipped with piston rings—Bore 7/8", stroke 13/16". Air-cooled cylinder, finned for heat and expansion control.

Sold assembled or in kit form—no special tools needed—made from finest materials. All parts machined and fitted, goes together in a jiffy. Starts instantly. Complete instructions with every kit. Order today. Every motor guaranteed.

Assembled and block-tested. Postpaid \$16.50
Kit form (Postpaid) **\$9.85**
For prompt delivery, enclose P. O. Money Order

BUNCH MODEL AIRPLANE CO.
5011 SOUTH HOOVER ST., LOS ANGELES, CALIF.

BRITISH AGTS: MODEL SUPPLY STORES, 4 STEWART ST. MANCHESTER, 3

TRAILER BUILDERS · BUYERS · OWNERS TRAILER Send 25c for this Big Book Today

Over 100 pages! Beautifully Printed and Illustrated! Trailer Suggestions and Ideas galore! Catalog shows America's greatest line of Trailer Parts and Equipment at lowest prices. Everything from wheels to top. Rush 25c today. Satisfaction positively guaranteed! **TRAILER SUPPLY CO., Box 438-A WAUSAU, WIS.**



BUILD IT YOURSELF

The Jim Dandy Cabin Cruiser

The Trailer that has everything. Classy! Roomy! Easy to build in any size with my simplified Plans and Instructions—Price \$1.00. Rush dollar bill today to **JIM DANDY Box 125-A WAUSAU, WIS.**



PARTS for the POPULAR MECHANICS FAMILY TRAILER

Everything you need! Axle, Tongue, Hitch, Wheel Housings, Wood Parts, Tank, Sink, etc. Send for price list. Include 25c (coin) for our big Catalog and Trailer Builders' Manual. Satisfaction guaranteed! **TRAILER SUPPLY CO., Box A, Wausau, Wis.**

RADIO-ELECTRICAL EXPERIMENTAL KIT

Most educational hobby any boy can have! 29 pieces genuine commercial apparatus. Illustrated manual shows how to build radio circuits, 110-volt motor, extension phone, thief detector, arc light, arc furnace, electric stove, elec. door lock, generate ultra-violet rays. AC to DC rectifier, scores more. Value \$14. ONLY **\$3.99**

6 BOOKS Value \$4.50, given with kit. Radio-Elec. Short Courses, etc. Complete value \$18.50, for only \$3.99. Price back if not pleased. Order now, or get free book! **ELECTRICAL SALVAGE CO., Box 524-A46 Lincoln, Nebr.**



BUILD THIS 24" SHIP MODEL OF CLIPPER SHIP CUTTY SARK



Complete Construction Kit containing Fully Carved Wood Hull Stamped Balsa Decks Life Boats, Anchors, Bitts, Chocks, Steering Wheel (all cast metal) Chains, Masts and Spars, Sail Cloth, Rigging, Cement, Colored Lacquer, etc., with Full Size Plans.

Ask your Dealer or Order Direct
Complete Kit—\$2.00 Plus 15c Postage
Send 10 cents for Catalog of Model Ships.
IDEAL AEROPLANE & SUPPLY CO., Inc.
26 West 19th St., New York

HIGH POWERED TELESCOPE

GENUINE AMERICAN MADE BROWNSCOPIES
Most powerful made for the money!
15 power long range telescope. Can see moon's craters or time on pocket watch a block away. 5 sections Approx. 3 ft. long. Fine lenses. Brass bound. Can be used as powerful microscope.
Vol. magn. 512X. Only \$1.69 post-paid. C. O. D. 24c extra.

\$1.69 **\$1.98**
Special Super-Power 30X Telescope
Similar to above but more powerful. Guaranteed to see 900 times larger in surface and 30 times closer. 31 mm. objective 4 powerful lenses. Large field. Includes powerful microscope feature. 5 day money back guarantee. Only \$1.98 postpaid.
BROWNSCOPE CO., Dept. 48, 234 Fifth Ave., NEW YORK, N. Y.



25443
 Electric & Mfg. Co. East-Whitney

Celluloid Models

(Continued from page 183)

models look as if they had been carved from crystal or molded in glass. This impresses the prospective customer, and enables him to grasp more details of the internal structure in an instant than he could obtain by studying drawings for hours. When, as a result of deflection studies or other tests, it is found that something is not as it should be, changes can be made in the celluloid model, or a new model can be built, and the trouble remedied at comparatively low cost.

It is this item of cost that makes the models so valuable. The money spent for a single model might buy a sixteen-cylinder automobile; but the model may save enough to pay for several hundred such cars. When an engineer can solve, with inexpensive celluloid, problems that might make it necessary to scrap an entire full-scale machine if they went unsolved, there is definitely a saving of real money.

Westinghouse engineers have used some of their models to study actual operation of parts. A celluloid replica of a propeller-type blower is a typical example. They operated it at a speed of 6,000 revolutions per minute, and made a complete set of efficiency studies. That is, they determined the capacity, rate of flow of air through it, and other characteristics as accurately as if they had been working with a full-sized machine. In a similar manner, they have studied the flow of steam in turbines.

Celluloid miniatures are, for all practical purposes, permanent. They withstand rough handling, and can be shipped about the country or stored indefinitely. Their worst enemy is an open flame.

The fascination that surrounds the construction of models in wood or metal is not lost when the builder works with celluloid. In several respects, celluloid is easier to manipulate than most other model materials. The methods employed in industrial laboratories ought to be of interest to every home mechanic, tinkerer, engineer and other person who likes to build models, or other things. There is no reason why the process of constructing a celluloid steam turbine could not be employed for a jewel box, candy jar or crumb scraper. A typical case of domestic use of

2044-3
 the celluloid method occurred when it was necessary to provide a waterproof, rugged label for a shaving-lotion bottle. The words "Shaving Lotion" were printed on a piece of typewriter paper, with india ink. The paper was cut into a strip, wrapped around the neck of a bottle originally intended for holding bitters, and a slightly larger strip of celluloid laid over it, its ends meeting in a butt joint. While rubber bands held the celluloid in place, acetone was applied to the seam. Within a few minutes the bottle was ready to use, its label protected by a tight collar of transparent celluloid.

The production of models accurate to scale requires trained fingers. In the laboratory, the most skilled mechanics usually are put to work on such projects. After a little time, the model builders acquire remarkable skill, and become capable of turning out work that is clean and precise.

Celluloid is available in a variety of forms and appearances. For machinery models, transparent sheet stock of various thicknesses is used. Some of this stock, in the thicker sizes, contains tiny air bubbles, but these usually are not objectionable. Modern celluloid is not as inflammable as many persons believe. You can touch the end of a lighted cigarette to the edge of a sheet, and the celluloid will melt and give off smokelike fumes, but it will not burst into flame. Very thin shavings might be ignited in this way. An open flame will ignite celluloid, but it burns relatively slowly, and not with explosive force.

Celluloid parts for models are cut with a knife or jig saw. With a knife and straightedge, thicknesses up to one-eighth inch can be cut easily. The celluloid first is scored with the knife, and then bent until it breaks along the line. Pieces are fastened together as soon as possible after they are cut, because celluloid absorbs moisture and changes its shape.

The "welding" of celluloid pieces is perhaps the simplest imaginable way of fastening things together. The pieces to be united are moistened with acetone, held in contact for several seconds—and the weld is complete. Acetone is a clear, volatile, waterlike liquid used widely as a solvent for organic compounds. When the model-building engineers first started us-

(Continued to page 140A)

NEW 3-WAY TREATMENT HAS PUT ON SOLID POUNDS FOR THOUSANDS OF SKINNY PEOPLE



1 Rich red blood, necessary to properly nourish and build up every part of the body, is especially promoted by this new discovery where iron is needed.

2 A healthy digestion which gets ALL the good out of your food requires an adequate supply of Vitamin B. This new discovery supplies this element.

3 Normal, regular elimination to remove poisons and thereby promote health and growth calls for adequate Vitamin B. This is the third purpose.

QUICK GAINS OF 10 TO 25 POUNDS WITH NEW IRONIZED YEAST

NOW thousands of skinny, rundown men can say goodbye to bony angles and unsightly hollows that rob them of natural attractiveness. For with this new easy 3-way treatment, thousands who never could gain before have put on pounds of solid, normally good-looking flesh—in just a few weeks!

Doctors now know that the real reason why many do not gain weight is that they don't get enough Vitamin B and iron in their daily food. Without these you may lack appetite and not get the most body-building good out of what you eat.

Now scientists have discovered that one of the richest sources of health-building Vitamin B is English ale yeast. By a new process the finest imported English ale yeast is now concentrated 7 times, making it 7 times more powerful. Then it is combined with 3 kinds of iron, pasteurized whole yeast and other valuable ingredients in little tablets called Ironized Yeast tablets.

If you, too, are one of the many "skinny" wornout persons who need these vital elements to aid in building you up, get these new Ironized Yeast tablets from your druggist at once. Day after day watch flat chest develop and skinny limbs round out to normal attractiveness. Indigestion and constipation from the same source quickly vanish, skin clears to normal beauty. Soon you feel like an entirely different person, with new charm, new personality.

Money-back guarantee

No matter how skinny and rundown you may be from lack of sufficient Vitamin B and iron, try these new "3-way" Ironized Yeast tablets just a few weeks and watch the marvelous change. See if they don't aid in building you up, as they have helped thousands. If you are not delighted with the results of the very first package, your money instantly refunded.

Special FREE offer!

To start thousands building up their health right away, we make this absolutely FREE offer. Purchase a package of Ironized Yeast tablets at once, cut out the seal on the box and mail it to us with a clipping of this paragraph. We will send you a fascinating new book on health, "New Facts About Your Body." Remember, results with the very first package—or money refunded. At all druggists. Ironized Yeast Co., Inc., Dept. 538, Atlanta, Ga.



Posed by professional models

50443

(Continued from page 139A)

Now EVERYONE CAN OWN A CROSLEY AUTO RADIO



THE CROSLEY FIVER FIVER RADIO \$19.99

YOU'RE THERE WITH A CROSLEY

MAKE MONEY - - - BE A LOCKSMITH

Here's Your Opportunity to Own a Paying Business ACT NOW!!



Make this profitable, fascinating profession yours. No experience or study required. We supply full instructions and complete equipment. You start earning immediately. May be operated right in your own home. Big returns on small investment sure. Profitable side-line for stores, too. Write now for full particulars of our startling introductory FREE offer. Be independent in your own business.

MIDWEST LOCKSMITHS, 3711-L W. Chicago Ave., Chicago

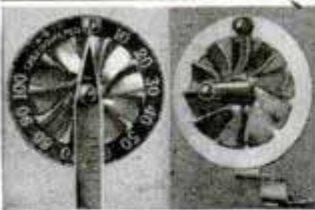

What Is Your Air Speed?

Novelty Air Speedometer for car radiator ornament, also Motorboats, Gliders and Bicycles. Chrome plated, etched aluminum dial, durable and accurate as the Speedometer on your auto, furnished with straight or bent stands. Bent stand may be mounted on radiator by sliding lower end under hood. Straight stand may be bent in desired position without damage, guaranteed. Price \$1.00 postpaid.

J. F. EISELE MFG. CO., Pinckney, Mich.

END DRIVING RISK

NEW, ingenious STOP THE GLARE spectacles a sensational contribution to night safety. Dangerous headlight glare effectively filtered out without impairing view. Relieve eye strain—insure comfort and protection. Well built, attractive. No lenses to break—will last a lifetime. Specify Regular style . . . or Clip-on style to fit over own glasses.



Satisfaction guaranteed by following directions

Send \$1.00 to

CHARLES E. BEAN CO., Optical Dept.
Box No. 816, Springfield, Mass.

STOP the GLARE

ing celluloid, they applied the acetone with medicine droppers. But they soon discovered that this produces unsightly joints because, wherever the acetone runs out over the celluloid surface, it leaves a mark. So they adopted hypodermic needles as standard acetone applicators. With such a needle, a skilled model builder can make a joint that is perfect. When two pieces of celluloid are in close contact, application of acetone at one point causes wetting of the entire joint, because it is drawn between the pieces by capillary action. The surfaces must be free of grease if perfect welds are expected.

Smoothing projecting edges, rough spots and sharp edges can be done with a fine-toothed file, a sharp knife, or a small plane having a sharp bit. Another tool that has been found useful is a rotary file, a gadget that resembles a dentist's drill but is larger. It is driven by a flexible shaft attached to a motor.

Celluloid sheets to be used for curved parts are bent after being made pliable by immersion in water at 170 degrees Fahrenheit. When they cool, they retain their shape. Tests have shown that sheet celluloid resembles wood in that it is stronger in one direction than the other, probably a result of the rolling operation during manufacture.

After a celluloid model has been assembled, it requires no further finishing.

The use of models of turbines and other machines for studies of efficiency, deflection of parts, operation, design and the like as carried out at the Westinghouse laboratory is distinguished from the use of similar material in polarized light studies of sections of beams, girders, etc. The polarized method, much older in point of the years it has been used than the celluloid model building, indicates the distribution of stresses in the model part. Thus polarized light, passed through a cut-out model of an I-beam under load and focused on the ground glass of a camera, will show the lines of stress in two of the three dimensions. Polarized light is not used by Westinghouse engineers in their tests on celluloid models.

Our Bureau of Information will answer questions regarding articles in this magazine, if accompanied by return postage.



ELECTROPLATES ANY OBJECT ON THE SPOT • NEW PATENTED INVENTION

PORTABLE—Does Same HIGH QUALITY WORK As Big Commercial Tank Outfits Costing HUNDREDS TO THOUSANDS OF DOLLARS

Remarkable Patented **NON-LIQUID Metal COMPOUND** and Patented **ELECTRIC Hair Bristle BRUSH**, especially constructed for electroplating metal objects anywhere with Gold, Silver, Nickel, Copper, Cadmium, Zinc, Brass, Tin.

WITHOUT Liquids, Vats, Tanks, Voltmeters, Ammeters, Rheostats, Scales, and other expensive equipment.

Special plating for acid resisting and rust resisting or any protective or decorative purposes. **GUARANTEED TO LAST.**

EQUALS IN QUALITY the work of any big commercial electroplating outfit according to authoritative laboratory tests.

Complete Outfit weighs Less Than a Pound. No experience necessary. Just attach the **RAPID ELECTRIC BRUSH** to dry cell, car battery or battery charger—dip brush into the Rapid Metal Compound and apply to auto parts, fixtures, ornaments, metal mountings, tools, table silver, etc. **WORKS ALSO OFF ORDINARY LIGHT SOCKET** with our Special Midget Rectifier. Used in homes, factories, stores, offices, jewelry shops, hardware stores, hospitals, schools, garage, home work shop, etc.

COMPLETE OUTFIT consisting of patented **RAPID ELECTRIC BRUSH** especially constructed with Switch, Leads and Connectors, and patented **RAPID METAL COMPOUND** for electroplating with common metals, ready for covering 1500 square inches, only \$5.75 (Gold Plating Outfit \$11.25, Silver \$6.25.) When ordering be sure to specify metal finish desired.

Only
\$5.75

SEND FOR BEAUTIFUL "RELISH SERVER" PLATED WITH 20-CARAT GOLD WITH THE RAPID ELECTROPLATING OUTFIT

Convince yourself of the high quality electroplating you can do in a jiffy with the Rapid Electroplating Outfit by getting one of these handsome gold plated "Relish Servers." Enclose 25c for cover packing, mailing and handling, or write for **FREE PARTICULARS**. Big Money Maker for salesmen and agents. Responsible Distributors wanted in Foreign Countries.

RAPID ELECTROPLATING PRODUCTS, 854 No. Clark St., Dept. PM-8, Chicago



BIG 1937 LEADER

For greater profits, steady income and repeat business, sell Century.

GENUINE LEATHER TIES

NO SALES EXPERIENCE NEEDED. Beautiful 4-in-Hands for Men and Boys, sell on sight, everybody buys. **LOOK LIKE SILK**; cleaned with a damp cloth. Famous Century Bows sell to uniform men, such as policemen, firemen, letter carriers, etc. Write today for our new **FREE DEAL OFFER**, or send 50c for samples, 4-in-Hand and Bow.

CENTURY TIE CO., 2345-L, W. Grand Blvd., Detroit, Mich.

EXTRA \$5 in SPARE TIME PRINT at HOME

Letterheads, Circulars, billheads, cards. Printing pays BIG. Easy, interesting, educational. **PRINTING PRESS BARGAINS \$12.** Types and Supplies, lowest prices. Send stamp for catalog.

PEIFFER Co., 17-B, 6 Columbia St., Newark, N. J.

PREFERRED by successful hobbyists and industrial filers. **Nicholson File Company, Providence, R. I., U. S. A.**

NICHOLSON FILES

Patents Pending—A FILE FOR EVERY PURPOSE

HANDY TAP and DIES . . .

Accurate—carefully hardened and tempered. Complete range of sizes at your local five and ten cent store.

HENRY L. HANSON, WORCESTER, MASS.

FREE TO EVERYONE interested in doing better shop work — new 48-page 1937 catalog describing and illustrating latest Driver Engineered Power Tools and accessories. Write to-day to Walker-Turner Co., Inc., 187 South Ave., Plainfield, N. J.

DRIVER Engineered POWER TOOLS

BUILD WITH DOENUTS

Build with the original patented low pressure Musselman Doenut cord tires and wheels. They absorb surface obstructions, eliminate jolts and reduce pushing and pulling effort approximately 50%. Tire requires as low as 12 to 15 lbs. air pressure for loads up to 225 lbs. per wheel. Size 10" x 2 1/2". Cadmium plated steel disc wheel with adjustable ball bearings. Doenuts are ideal for building hand trucks, midget autos, wheelbarrows, lawn mowers, lawn furniture, portable painting, spraying and greasing equipment or any portable unit under 900 lbs. Boys: send 50c for full set blue prints for building wagons, wheelbarrows, bicycle trailers, scooters and midget autos, with free literature.

MUSSELMAN PRODUCTS CO.
6247-T ST. CLAIR AVE. CLEVELAND, OHIO

MEN—WOMEN—EARN MONEY

Make colorful glazed concrete pottery without molds. New easy method. 2,500 designs. Jars, birdbaths, tiles, statuary, giftware, souvenir goods. Money-making employment. No experience needed. Send 10c TODAY for booklets, color plates, details.

NATIONAL POTTERIES CO.
13 W. 26th St., Room 21
Minneapolis, Minnesota

DRILLS, GRINDS, POLISHES, SHARPENS, SANDS, SAWS, CARVES — easily, quickly

ONLY \$6.95 POSTPAID

If you're a mechanic, carpenter or craftsman, or do any kind of shop or hobby work, you need this powerful, all-around, wonder tool. Works on steel, all metals, alloys, wood, glass, plastics, etc. Not a delicate instrument, but a real rugged tool for both power and precision work. Drills through 1/4-in. iron plate in 42 seconds. Plug into any light socket AC or DC, 110 volts. Triple geared for extra power. Universal chuck 1/4-in. capacity. Ball-bearing thrust. Self-enclosed cooling system. Die-cast metal frame. Uses 50 different accessories, instantly interchangeable. **FREE:** Accessory outfit including set of drills, mounted 1 1/2-in. grinder, sanding discs, mandrel, mounted brush, etc., sent FREE with each WHIZ ordered now. Everything sent postpaid for \$6.95 on 10 DAY MONEY BACK GUARANTEE TRIAL. ORDER NOW.

WHIZ Electric TOOL

PARAMOUNT PROD. CO., Dept. 8A, 245 Broadway, New York

Trindl ELECTRIC ARC WELDER

Works Off Any Storage Battery or Ordinary Light Socket... **375**



This New Electric Arc Welder is made possible by the invention of a low voltage carbon. Auto batteries may be used without removing from car. Uses about same current as four headlight bulbs. Can be used on electric light socket by using a Trindl Converter in place of battery. Broken parts are **SIMPLY MELTED TOGETHER** by the white HOT electric arc, in just a few seconds. Produces about 7,000 degrees heat.

Hottest Flame Known
MELTS iron and steel instantly. Welds fenders, radiators, holes in bodies and milk cans, tanks and brazes broken castings. Works on anything—iron, steel, copper, brass, tin or galvanized metal. Permanent repairs made for almost nothing. Used by factories in many operations. Positive money back guarantee by responsible firm. Send for it now.

TRINDL PRODUCTS
2229-SN CALUMET AVE., CHICAGO, ILL.

AGENTS

Men with ears to sell mechanics, repairmen and farmers, factories, radio and battery shops. Five minute demonstration makes sales. Up to 150% profit. Write TODAY.

DO YOU

WANT a new business profession of your own, with all the trade you can attend to? Then become a foot correctionist, and

in a few weeks earn big income in service fees,—not medical nor chiropody—easy terms for home training, no further capital needed, no goods to buy, no agency. Established 1894. Address **Stephenson Laboratory, 1 Back Bay, Boston, Mass.**

You BUILD IT!

TO BUILDER, BUYER AND OWNER—Easy to build this big, roomy trailer. Illustrated catalogue saves you 70% and more when building a trailer. Improve your present trailer at low cost. Catalogue "B" shows where to buy chassis, axles, brakes, hitches, pumps, body materials, cabinets, electric plants. Everything that goes into a trailer. Page after page of valuable information and ideas. This trailer is substantial yet easy for your car to pull. As deposit for catalogue "B" send 50 cents, which will be deducted from your first order. Or return catalogue and receive 55 cents from us. **New York Trailer Builders' Supply Co., 227B West 58th St., New York City, COLUMBUS 3-3833.**



GET YOUR TRACTOR AT FACTORY PRICE



Amazing money maker for farms, truck gardens, orchards, nurseries, poultry ranches, country homes, etc. Plows, discs, harrows, cultivators, mows lawns, cuts weeds. Runs belt machinery. 2 to 5 H.P. riding or walking types. Write for **FREE CATALOG**. Low **Factory Prices** and 10 day **Trial Plan**. Address **Nearest Office**.
SHAW MFG. CO., 4508 Front St., Galesburg, Kans. 130 G West 42nd St., New York, N.Y., 5812 G Magnolia Ave., Chicago, Ill., 888 G North 4th St., Columbus, O.

SHAW DU-ALL TRACTOR

Metal Castings 2400 Deg. F

Make your own castings of aluminum, copper, bronze, silver. Foundry sets are available in three sizes including 2400 Deg. F. blast Furnaces. See advertisements in April or June issues, free Circular.
KANSAS CITY SPECIALTIES CO.
P. O. Box 6022 Kansas City, Mo.

BUILD CLOCKS for PLEASURE—PROFIT



Hall clocks are high priced in stores—you can make **good money** building them or electrifying spring clocks. **Dime** brings drawing of **easily built Grandfather Case** with "HOW" Book, pricing, wiring, dial, mantel spring. **ELECTRIC chime, BATTERY CLOCKS** from \$1.40. **Hall Clock, Brass weight chime movements** from \$16.95. Start now.
KUEMPEL CHIME CLOCK CO
Building 7 Guttenberg, Iowa

THOMAS TRAILER AXLES



Wider Spring spread. Lower Center of Gravity. New of Tubular Steel. Carbon Steel Hangers. Built for vacuum, or electric brakes. For wire or steel wheels. In any wheel tread. Carrying capacity up to 3000 lbs. Fully guaranteed. Special quantity prices. Also axles using Ford Standard Brake and wheel parts. Send 10c TODAY for catalogs of axles and trailer parts.

THOMAS TRAILER AXLE CO.
2408-16 So. Pulaski Rd. Chicago

AMAZING OFFER



We Want 100 CAR OWNERS to Accept a Complete Set of

Pedrick HYDRAULIC PISTON RINGS

If your car is an "oil burner" and a glutton for gas—lacks speed and power—grab this OPPORTUNITY!

It's no fun driving a sluggish automobile that won't respond when you step on it—and it's dangerous, too! We want you and other car owners to know by actual experience that Hydraulic Piston Rings positively will restore original power and pep, even though your car is old and worn. That's why we are giving away 100 sets of Pedrick Hydraulics (cash value \$6.80 to \$17.20) in the next 30 days as part of our "Tough Job Test" campaign. If you want a set of these remarkable rings for your car, clip and mail coupon today—now—and get full information.

WE WANT "TOUGH" JOBS THE TOUGHER THE BETTER

To demonstrate the sensational results obtainable with Hydraulics—prove our claims for outstanding superiority, we are making these "Tough Job Tests." We want to show car owners that they do stop oil pumping and power loss under adverse conditions. That's why we are offering a hundred sets of rings—something no other manufacturer has ever done, to our knowledge.

Old, Worn Motors Actually Made to Perform Like New!

Almost unbelievable, the difference that Pedrick Hydraulics make. Imagine a car with 50,000 miles on it zipping away like a flash when the lights change, and climbing steep hills in high. That's what Hydraulic Reconditioning does! And, oil loss and gas waste are eliminated, too—saving from \$25.00 to \$100.00 a year in operating expense.

In All the World, No other Piston Rings Like Hydraulics

Only patented Hydraulic Action uses oil pressure, instead of stiff expander rings, to effect a positive oil and power seal. Therefore, don't expect Hydraulic results with any rings except genuine Pedrick Hydraulics—because only Hydraulics can effect a positive, yet flexible seal in tapered and out-of-round cylinders.



LASTING RESULTS

Hydraulic Rings assure new car performance for thousands of extra miles. The ring pressure varies automatically with speed of engine—light when idling—heavy when speeding—result—no abnormal wear on rings or cylinder walls.

DON'T DELAY—ACT IMMEDIATELY

You'll have to hurry if you want a set of Hydraulic Rings. This offer is good for only 30 days—write your name and address in coupon and mail today.

WILKENING MANUFACTURING CO.
Dept. 192, Philadelphia, Pa.

Piston Ring Coupon MAIL TODAY

Wilkening Manufacturing Co.
Dept. 192, Philadelphia, Pa.

My car lacks speed and power and uses far too much oil and gas. Send me full information on Hydraulic Piston Rings and tell me how to qualify for a complete set.

Name.....
Address.....
Town..... State.....

When writing please mention Popular Mechanics

Salvage Squad to the Rescue

(Continued from page 221)

to get it out of there with pumps and hydraulic siphons.

Salvage men respond to alarms in their own special trucks. In the central fire district of Los Angeles where Capt. Lesinsky and the six other men of Salvage Company No. 24 answer about seventy alarms per month and save as much as \$1,000,000 worth of property every year, the truck



Salvage man catching water from chandelier hole as it drains off tarpaulin

hauls a heavy load of special salvage equipment. Most important are the sixty-five salvage covers, each of which measures twelve by eighteen feet and weighs thirty pounds. The truck carries two roof covers to protect during rainy weather holes burned in roofs. Once this salvage squad saved \$75,000 worth of clothing from damage even though no fire occurred. During a heavy rainstorm the roof drains of a building became clogged and water started to pour down through the skylights. An alarm brought the salvage company and some of the men covered valuable stock while others went up on the roof to free the drains.

The salvage truck also carries shovels and buckets, mops, brooms, sponges and chamois, and plenty of sawdust. Sawdust

is one of the best tools that salvage men have. Sprinkled on a floor, it absorbs great quantities of water and keeps it from spreading. Two rows of sawdust make a practical channel for getting rid of waste water. The salvage squad uses sponges and pieces of chamois for wiping off furniture and walls after a fire. Gas masks, forcible entry tools, and sprinkler head replacements are other equipment.

The first thing the salvage officer does after reaching a fire is to make a fast decision as to what should be protected first. In commercial establishments office records are always first since they could not be replaced. Office furniture and equipment are next. Electrical equipment and motors always get protection as soon as possible. Once Capt. Lesinsky asked the fire fighters to let a building keep burning. "Hold the water for just a couple of minutes," he begged. "That first floor is full of expensive watches and sporting goods. A little water will ruin everything." By that time the ceiling was on fire but Lesinsky and his men dashed in and laid their covers over the stock. The slight delay reduced total damage to only a fraction of what it might have been.

One of the times of which Lesinsky is especially proud occurred when a bakery caught fire. The building looked like a total loss to the owner when Lesinsky asked him when the next shift of bakers was due to report for work. They were due in three hours, the owner replied, and Lesinsky told him to have them go to work as usual. "You are crazy," the owner retorted. But Lesinsky's men had been on the job and when the fire was put out an hour later the astonished owner walked through the plant watching the salvage men pull covers from office machinery and furniture, uncover stacks of coconut and sugar and flour, and sponge off the equipment. The roof and one end of the building were a total loss but the early morning shift of bakers went to work on time, after the salvage squad had mopped the floors for them and swept up the debris.

That's the kind of work that salvage men are proud of. Their motto is: "Keep down the loss!"

Parts Exchange Plan Saves Money and Time for Ford Owners

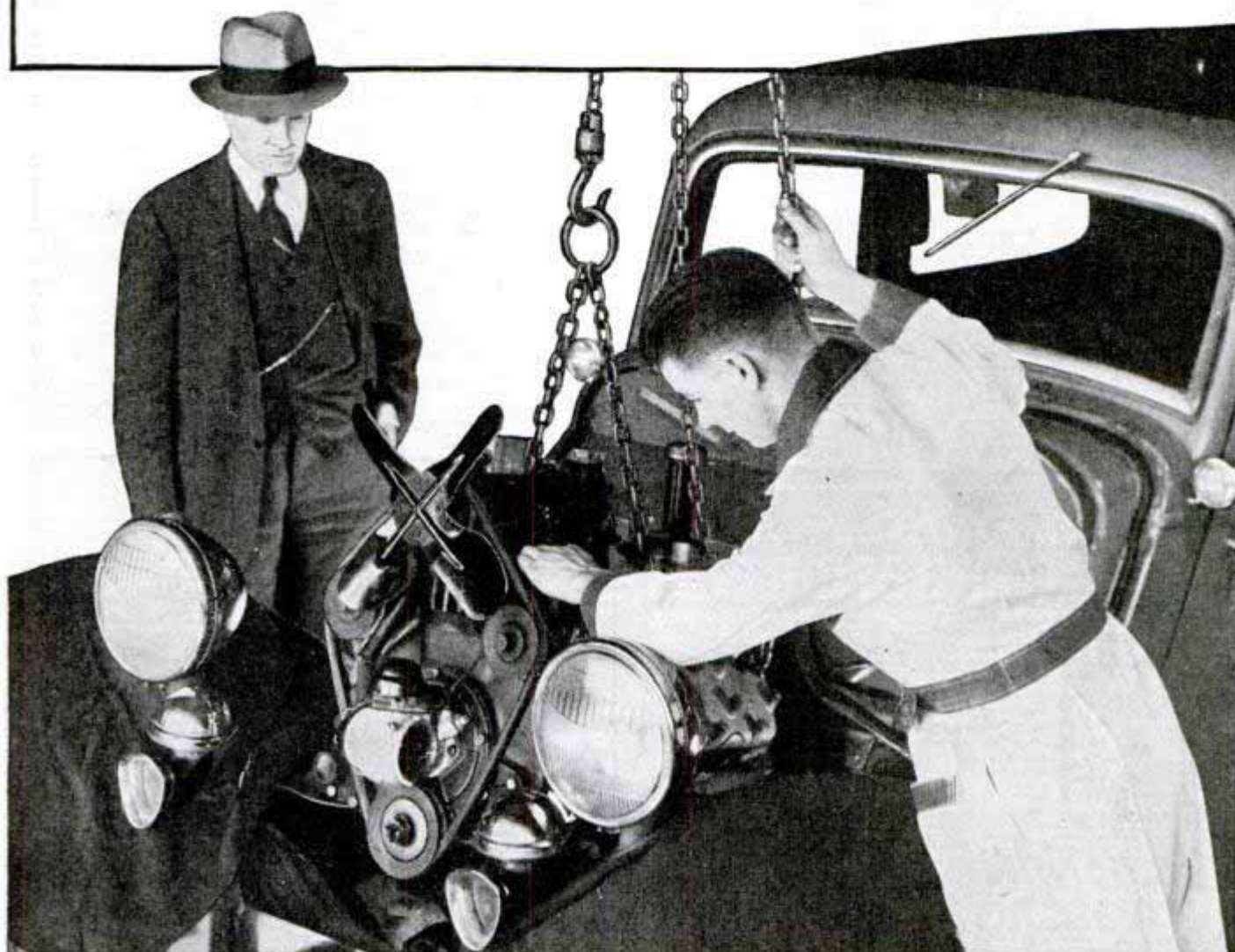

THE Ford Engine and Parts Exchange Plan offers Ford owners the modern, economical way to recondition their cars after thousands of miles of service. It eliminates old fashioned overhauls. It saves time. It saves money. And it enables Ford owners to maintain Ford quality and performance throughout the life of their cars.

The plan is simple. It substitutes a factory-rebuilt unit for the worn part. The replacement unit has been completely rebuilt at the

Ford plant—by the same men and machines that build new Ford parts. The same high-quality materials are used. The same precision manufacturing is adhered to. And the rebuilt parts pass the same rigid tests and careful inspections as new Ford parts.

The Ford Engine and Parts Exchange Plan is an exclusive Ford service. Exchange units are available through Ford dealers and garages that display the sign "Genuine Ford Parts."

Prices subject to change without notice



CLUTCH DISC ASSEMBLY—Hubs checked or replaced to insure correct fit. New clutch facings. Exchange price, \$1.75.

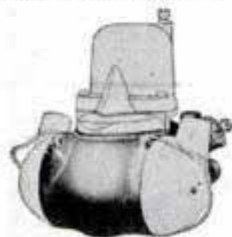

DISTRIBUTOR—Completely reconditioned. All worn parts replaced. Rotor tested for dielectric strength. Exchange price, \$2.



GENERATOR—Armature and commutator completely rebuilt. Worn or rough bearings replaced. New brushes installed. Adjusted for correct output. Exchange price, \$4.75.



BRAKE SHOE AND PLATE ASSEMBLY—For 1937 cars, completely rebuilt. Brake shoes relined. Exchange price, \$1.75. For models prior to 1937, reconditioned and relined brake shoes. Exchange price, 45c each.

FORD MOTOR COMPANY • DEARBORN • MICHIGAN

When writing to advertisers please mention Popular Mechanics

Sorry — But I Have to Scratch



Unless You Give Me This Relief

A dog doesn't like to itch, scratch, shed his coat, grow listless, dull and mopey any more than you like to have him. It may annoy you but he is suffering torment and only you can help him.

His skin isn't like yours. It's non-porous. He can't perspire. Blood impurities caused by his domestic life, prepared food, lack of natural exercise gather in his body and set up an intense irritation under his skin. They nearly drive him wild.

Won't you give him this relief—make him the happy, healthy contented dog he wants to be?

Rex Hunters Tasteless Condition Powders in sanitary capsules—for Dogs of all breeds, any age—provide the natural blood correctives his system needs. Given regularly on Saturday each week they quickly relieve the condition that causes scratching, loose coat, listlessness, poor appetite, eczema and a host of other ills. They make your pet happy, healthy and contented.

Easy to administer, safe, harmless and inexpensive. Rex Hunters Condition Powders—the famous prescription of a celebrated English Veterinary Surgeon—are for sale at leading Pet Shops and Drug Stores.

If unable to obtain locally send 25c for a package—a full month's supply for 5 pkgs. for \$1.00—direct to makers, J. Hilgers & Co., Dept. 307, Binghamton, N. Y.

Their six-fold action benefits every vital organ in your dog's body. You'll never know how fine your dog can be until you have tried them. Ask for **Rex Hunters Condition Powders—Keep Dogs Fit.**

MANUFACTURING OPPORTUNITIES

18 SIZES

IN BUILDING INDUSTRY—with machine and process producing permanent construction with savings of 1/3 labor, 1/2 mortar, and 1/3 material costs—ashlar, hollow, veneer or solid walls—plain or 40 colors.

WE EQUIP YOU with Automatic Machinery—large production only one or two men. Equipment costs but fraction of other processes with equal capacity.

INVESTIGATE—let us show you why building today offers you the greatest opportunity for growth, expansion and profit in a business of your own, using raw materials available in your territory. Write today.

W. E. DUNN MFG. CO.
600 West 24th St. Holland, Michigan

Turn North at the CROSSROADS

You are sure of your directions, anywhere, any time, any weather, with a Hull Auto Compass. It prevents confusion, lost miles and wasted expense. This high quality instrument for only \$2.95 at your dealer soon pays for itself. Two-piece model \$1.95. Write for circular.

HULL MFG. CO., P. O. Box 246-D3, Warren, Ohio

HULL STREAMLINE AUTO COMPASS

Stoves AT FACTORY PRICES!

Sale Catalog — FREE

Nearly 200 Styles and Sizes of Stoves, Ranges, Furnaces at Factory Prices. Easy Terms—as little as 12c a day. Up to 18 mos. to pay, if you wish. 30 Days Trial. 24 Hour Shipments. More Bargains than in 20 Big Stores. Over 1,200,000 Satisfied Users. 37 Years in Business.

Kalamazoo Stove & Furnace Co., Mrs. 391 Rochester Ave. Kalamazoo, Michigan

"A Kalamazoo" Direct to You

FREE CATALOG

"Cold Oven" Crystal Holders

(Continued from page 260)

base; countersunk holes are drilled and tapped in the Bakelite block to take four machine screws that are passed through holes drilled in the copper block. The Bakelite top cover is held by means of four machine screws that go down through holes drilled and tapped through each corner of the copper block.

When preparing the brass top plates for either of these holders, the surface placed next to the crystal, and the top surface of the copper where it contacts the crystal, should be ground flat and smoothed by using No. 120 carborundum on a piece of glass. Spring-brass contacts are bent to hold the crystals and brass top plates in the multiple unit; these contacts are

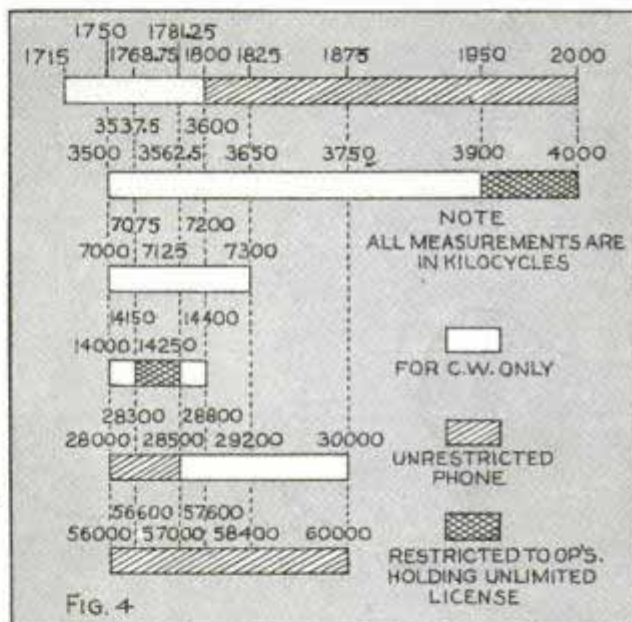

drilled for binding posts mounted on the Bakelite cover, thus completing separate electrical connections to each crystal. Mounting plugs are tapped into the copper base. One of these plugs, of course, makes the common bottom-plate circuit connection.

Some experimenters purchase crystal-plate blanks and do the final grinding and calibrating themselves, others cut original blanks from the solid piece of quartz. The plate is cut from the solid crystal in such a manner that its electrical axis is at right angles to the optical axis. The first cuts are illustrated at A and B in Fig. 2; a plate, "or slice," is then cut from the prism in a direction perpendicular to any of the parallel faces. A chart showing all amateur bands appears in Fig. 4.

205 1/2
Gold Rush of the Experts

(Continued from page 163)

finders, and willow rods, have been introduced to the world as sure-shot methods for locating gold and other precious metals. Most of these devices have been debunked by experienced mining men. However, the experts are now giving careful study and some of them have already given approval to several gold-locating instruments which have been perfected by Charles A. Isham, a mining engineer, and his son, Buford.

One of the Isham instruments, known as the earth resistivity method, forces electrical currents into the ground. Oscillating needles on the delicate mechanism point to the amount of resistance as the current enters the earth. When it strikes a mineralized zone, the zone's size and depth can be determined mathematically, as the resistance is less when it enters an ore body. Another unit is used to relocate lost veins. This set can be used in a tunnel and it can determine within a few inches how far an ore body is from the surface.

The latter apparatus operates on a set of ultra-short radio waves. Its waves are directed into the earth like a searchlight beam, or a directional antenna. Three units are used—a directional coil that shoots out the electromagnetic waves, a mixing unit that picks up the vibrations generated by the contact of the waves with the ore body, and the receiver. The extent of the ore body is determined by moving the finding coil over the surface. When it leaves the point above the ore body the sounds cease and thus the operator is able to determine almost the exact location of the pay dirt.

Still another contrivance for the modern miner is the "doodle bug" dredger. It is not as complex as some of the others, and is really a product of the depression, but it gives to the placer miner a machine costing from \$30,000 to \$40,000 to replace the bucket dredges of the old days, that required an investment of from \$300,000 to \$400,000. Rapid changing of road-building methods and the depression caught road-building contractors with a lot of obsolete road-building machinery. The gadgets were used to construct a trial dredger on a barge about thirty by forty feet in area,

(Continued to page 148A)



ONAN A. C. ELECTRIC PLANTS

FOR THOSE WHO MUST PROVIDE THEIR OWN ELECTRICITY

ONAN ELECTRIC PLANTS furnish the same current as supplied by power lines—110 volt, 60 cycle, ALTERNATING CURRENT. Operate Radio, Water System, Washing Machine, Electric Iron and all Electric Appliances.

Run from gasoline or gas and generate electricity for Farms, Lake Cottages, Oil Stations, Commercial Places. A woman or child can operate it.

SIZES 350 WATTS AND UP

Each ONAN PLANT is a complete Unit, ready to run. No battery used except to start the engine. Easy to install. Available from stock. 32 volt, Direct Current Models also available. Write for details.

D. W. ONAN & SONS

1007 Royalston Ave.

MINNEAPOLIS, MINN.

120 Miles TO THE GALLON
Auto-Glide

Investigate the original heavy-duty Auto-Glide. Learn how hundreds now enjoy its amazing economy—to and from office, factory, school—thrilling pleasure spins, 15 miles to a cup of gasoline, almost no oil! None other so ruggedly built. Extra large powerful CUSHMAN Husky engine. Kick-starter, hand-throttle, Auto-type double-face clutch, Drum-brake, 12x3 1/2" balloon air tires, Strong channel steel frame. Electric lights, horn, Anti-theft lock. Soft cushion seat. Kari-Pac model has carrier.

WRITE: Send for free illustrated book, complete description, photos, etc. Postcard will do. **\$125** F. O. B. Factory

DEALERS: Many selling 5 to 10 a week. Get SPECIAL OFFER!

THE CUSHMAN MOTOR WORKS, Dept. 66 Lincoln, Nebr.

NEW BENJAMIN AIR PISTOLS

Powerful—Accurate—Economical—Practical—Adjustable Shooting Force—Amazing Maximum Velocity—cal. 177 or 22 and BB—For Target and Small Game—the only Genuine Compressed Air Pistol on the market—Single Shot with Bolt Action—Hammer Fire—Hair Trigger—Safety. Price \$7.50. Also 177 and 22 Single Shot Air Rifle \$7.50—Single Shot BB Air Rifle \$6.00—25 Shot BB Repeater Air Rifle \$7.50—at Dealer or Direct—No license required—Safe for indoor use.

FULL DETAILS—TARGETS—FREE—WRITE TODAY.
Benjamin Air Rifle Co., 631 N. Broadway, St. Louis, Mo.

BUILD YOUR OWN ELECTRIC OUTBOARD MOTOR

from old auto generator. We show you how. Variable Speed. Light weight and Silent. Operates from 8 to 12 hours on ordinary storage battery. Dime brings complete plans and catalog. Wind Driven Cottage Light Plants, Motors, etc.

LEJAY MFG. CO. 1547 W. LAKE ST. MINNEAPOLIS, MINN.

BILD-UR-OWN

COASTERS • MIDGET AUTOS • SCOOTERS • SOAP BOX DERBY WHEELS • BIKER TRAILERS, ETC.

DISC WHEELS equipped with 10"x2 3/4" (GOODRICH-GOODYEAR-FIRESTONE) Balloon Tires offered at LOWEST PRICES

We also carry a complete line of larger Tires and Wheels, Axles, Motors, etc.

BILD-UR-OWN DEVICES
WRITE FOR PRICES 5237 Lake St., Dept. M-8 Chicago, Ill.

see Feb. 1936 177

VIBRO automatic SHAVER

The **PERFECT** Shaver **WINDS** Like a Clock

Rapid, motor-driven, pulsating action cuts beard at base of hair without pulling or scraping. Works equally well on tough and wiry, or light beards. Curved head gets into hollows; shaves upper lip perfectly. Vibratory motion gives skin a healthful, stimulating massage.

No Electricity Needed

Operates anywhere — at home, in camp, on boats, trains, trailer. No wires. Vibro is the only non-electric, automatic shaver made.



1. Detachable Head.
2. Winding Key.
3. Release Button.

Only **\$5.00**

Women Like Vibro Shaver

Prefer its light, smooth action. Ideal for removal of hair from the armpits and limbs. This shaver will amaze and delight you. Order now—while special, low, introductory price is in force. Satisfaction guaranteed.

SEAJAY COMPANY, Dept. PM-1
3302 Cottage Grove Ave., Chicago, Illinois

New! LOW COST ELECTRIC ARC WELDER ONLY \$295

10 DAY TRIAL
"HOT SPOT" PROFESSIONAL Electric Arc Welder takes carbon OR metallic electrodes. Operates from storage battery. (OR 110 V light current with adaptor). Welds, brazes, solders! Carried, used everywhere by mechanics, homeowners, farmers; in factories, body, radio, battery shops. Works on steel, brass, copper, iron, aluminum, tin, etc. Repairs broken articles stronger than before. Low current consumption. Anyone can operate. Pays for itself often in first job of welding.

SEND NO MONEY! Fully GUARANTEED! Shipped complete with instructions, weld wire, carbons, solder, ready to operate. Order now! Pay postman only \$2.95 plus few cents postage. Use 10 days. MONEY BACK if not perfectly satisfied. Send TODAY.

"HOT SPOT" PRODUCTS
Dept. 182, Osgood & Eastern Ave., Joliet, Ill.

SELLEY-TEX REARWIN SPEEDSTER

patented FLYING MODEL AIRPLANE KIT, with moulded fuselage, wheel shoes and cowling practically crashproof. Nothing else to buy, kit complete... SHIP MODEL FITTINGS—Die-cast—box-wood brass. Most complete catalogue 6c. SELLEY CO. Dept. 608, 1375 Gains Av., Brooklyn, N.Y.



Only **\$230.00**

for all parts for

THIS TRAILER

Except materials you can buy at your lumber yard — cost about \$88. Price includes tubular steel chassis, 18 ft. for 16 ft. body (can furnish longer if desired \$2.00 per ft. extra) steel coupler and jack; axle, springs, disc wheels, Bendix brakes, Goodyear G-3 tires and tubes. For roof-bent 8 ply laminated bows, canvas wadding, cement and filler, ventilators. For body-windows, screens; clearance and tail lamps; door hinge and lock; drip moulding, smoke stack.

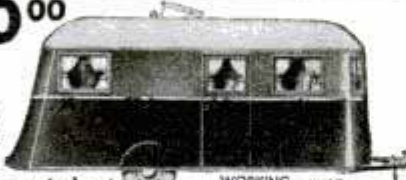

Complete parts catalogue FREE

Complete parts for inside, dome and wall lamps, heating and cooking stoves, all hardware. Two complete beds, dinette and daybed 48 in. x 74 in. — finest cushions. Everything complete for a four passenger trailer—equals any \$700 trailer.

Send 25c (coin) today for complete large size, easy to read, working blue prints. Any man handy with tools can build this trailer. Many are making big profit selling what they build — easy sales. Why not send for blue prints today. Start making money out of this new industry.

If you need any trailer parts you can save money by having our complete trailer parts catalogue — it's FREE but don't fail to order the blueprints.

KAR-A-VAN-A-INDUSTRIES, 2001 S. Michigan Ave. Chicago, Ill.

Gold Rush of the Experts

(Continued from page 147A)

and, reports say, mining men gave expression to unrestrained mirth. Miners are inclined to believe that the name "doodle bug" was applied derisively, when the mirth was at its height.

On the barge is mounted machinery for washing gravel. The equipment is somewhat similar to that used on the bucket dredges. It usually consists of a sixty-foot beam, a revolving trommel or screen, and steel riffles to catch the gold. A power shovel digs and dumps the dirt into the hopper above the trommel.

Until very recent days the quest for gold has been the haphazard undertaking of men in whom the urge for adventure and romance had been developed to extraordinary degree. Now science is taking a hand, and soon the production of the precious metal will be a precise undertaking.

Sponge-Rubber Fishing Lure Resembles Hellgrammite

Made of soft-sponge rubber, a new fishing lure for bass closely resembles the hellgrammite, which is considered excellent bait. Its construction results in lifelike action in the water and it is threaded on the hook like the genuine bait. The hellgrammite also is known as the dobson. Obtaining the live hellgrammite usually requires two persons, one to overturn rocks in the stream and the other to stretch a small mosquito net a few feet below. As the stones are rolled the current washes the hellgrammites down stream where they are caught in the netting. Care must be used in handling them because their front claws can inflict painful wounds.

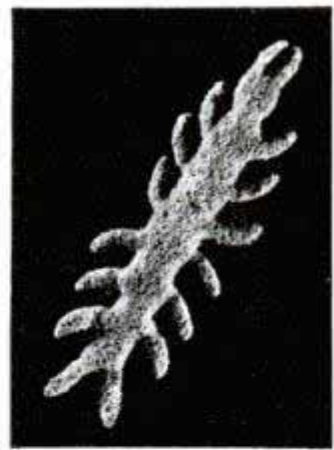

Our Bureau of Information will answer questions regarding articles in this magazine, if accompanied by return postage.

**Oil Derrick Dons Canvas Wrap
During Housecleaning Time**

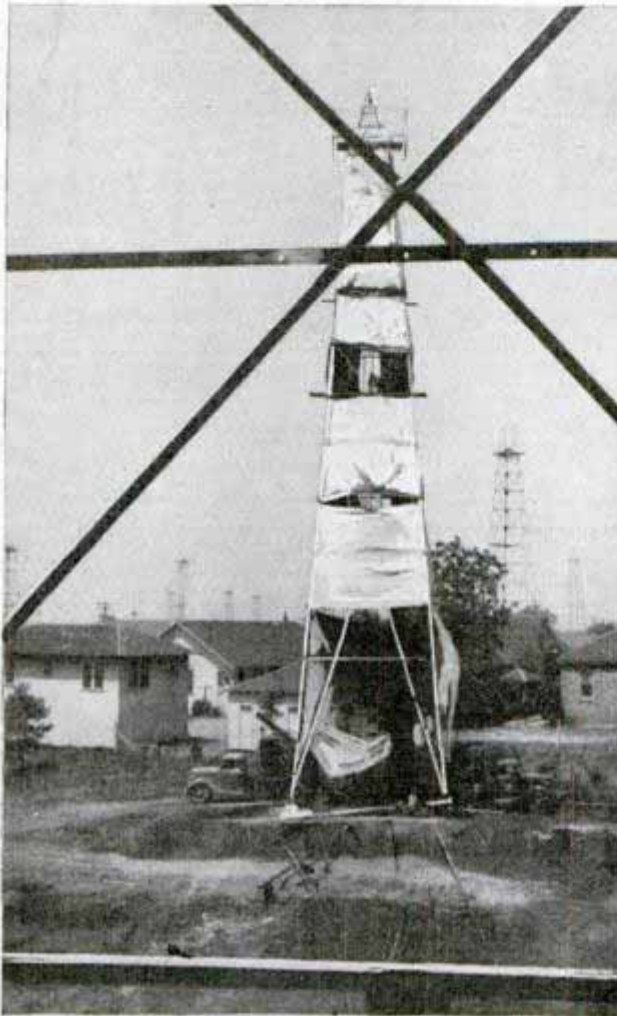

When oil wells take a bath they wear canvas aprons to protect the neighbors from a spray of oil

Even oil derricks wear "aprons" in housecleaning season. Whenever it is necessary to pull out and clean the tube through which the oil flows, the derrick is covered with a canvas wrap to protect the neighbors. The pipe, sometimes a mile or more in length, is covered with oil inside and out, and a strong wind would blow this oil throughout the neighborhood and involve the oil producer in damage bills for repainting houses and replanting lawns and shrubs. While workmen clean the piping, two strips of canvas on the windward side are furled for ventilation.

Popular Mechanics Magazine does not publish the name of the maker of, or dealer in, any device described in its pages, but this information is kept on file and will be furnished by our Bureau of Information upon request, accompanied by stamped, self-addressed envelope.

BUILD YOUR CABIN WITH



**SUPER-Harbord
Outdoor Plywood**

GUARANTEED AGAINST
PLY SEPARATION

BIG PANELS

Just what you've been needing for garages, play houses, dog kennels, barns, milk sheds, trailers, outdoor signs, boats, truck bodies, greenhouses . . . a plywood that defies all kinds of weather and weather changes. Plies of Super-Harbord are fused together under heat and pressure and can't come apart. Binder is insoluble in water and proof against insects, fungi, all forms of rot. Big panels—easy to handle—quick to put in place. Ultra-smooth surface gives better paint finish.

Harbor Plywood Corp., Port Deck Hoquiam, Washington
Gentlemen: Please tell me how Super-Harbord will give me better and cheaper outdoor construction.

Name.....
Address.....
Lumber Dealer.....

Plywood PLUS for outdoor use.

MAIL TODAY

**NEW PHOTO
ELECTRIC
AMPLIFIER**
ONLY
\$18.25
NO ADJUSTMENTS
2" x 4 1/8" x 6 3/8"

INCLUDING \$6.00 PHOTO CELL
Experimenters will get new thrills. Service men new profits. Designer will find endless uses. We invite inquiries and all orders will be filled promptly.



AUBERT CONTROLS CORP.
325 WEST HURON CHICAGO

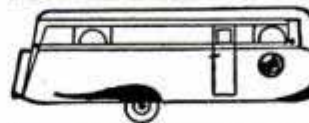

"BOB-ALONG," A PLAN FOR EVERY PURSE
Build this trailer for \$250, also four others to choose from, cost as little as \$170, to complete, accommodations for 3 to 6, all latest features, 13 to 22 ft. lengths. Send \$1.00 for drawings of five latest to **BOB-ALONG, 767 Van Buren St. Milwaukee, Wis.**

SAVE \$\$\$\$ SAVE

IS LIFE WORTHWHILE? If you have a hot-air furnace we can maintain normal relative humidity, making life worth living. COMFORT AT 68 DEG. F. Humidified air does not evaporate moisture from the skin surface, thereby causing chills. HEALTH. Humid air helps settle dust. AIRCONDITIONING helps prevent colds and bronchial diseases. Ask your doctor. SAVE. Lower comfort temperature saves fuel. Furniture doesn't dry out. Saves medical bills. Pays for itself annually.

FREE! Send for plans to determine relative humidity in your home. **HUMIDIFIER COMPLETE \$14.75 and up**
THE AIRMISTER MFG. CO.
Box No. 7, Benson Station Omaha, Nebraska

SWEEPING the CAMPS!
Thousands of boys and girls are crazy about the new EASCO LEATHERCRAFT SETS. Buy them for your camp educational projects. EASCO contains everything—tools, leathers, patterns, dyes, etc. Each set, \$2.00 complete, at Sporting Goods and Department Stores, or order direct and pay postman on arrival.

LEATHERCRAFT
Free Clip name of your department store to this ad. Send in with order for valuable leathercraft project free with your set.
E. A. SWEET CO. Dept. A-3 Binghamton, N. Y.

LOW COST POWER

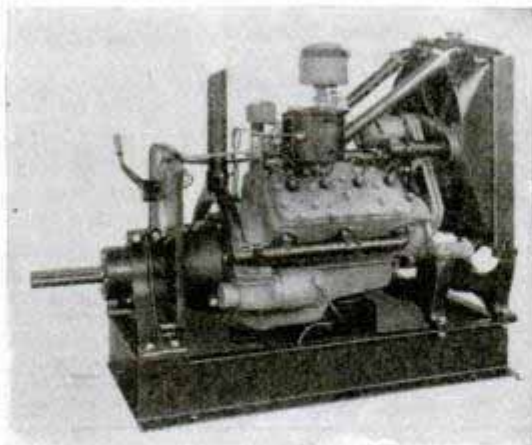

with this KRW-FORD V-8 unit

Here's dependable, low-cost power up to 60 H.P.—complete, compact, portable. Ideal for line shafts, welders, compressors, hoists, pumps, amusement devices, well drillers, agricultural, oil field and contractors' equipment, etc., etc. The most complete industrial power plant built. Uses gasoline or natural gas.

Assembled with brand new heavy duty Ford V8 Truck engine. Large capacity radiator protected by heavy screen. Engine rubber mounted—outfit complete with governor, gas tank, 17-plate battery, instruments, etc. Available also completely enclosed with sheet steel housing.

Write for complete information, price, and data showing how this unit will pay for itself out of savings in a few weeks, whether operated on gasoline or natural gas. You can buy thru your Ford Dealer and benefit by local service and low-cost Ford engine replacement feature.

K. R. WILSON 17 Lock St. BUFFALO, N. Y.
EXCLUSIVE BUILDER OF APPROVED FORD SHOP EQUIPMENT SINCE 1916

BOYS, MEN, WOMEN are building the 30" SCHODEL POWER CRUISER with a KIT now furnished with all parts Numbered and CUT to FIT.

All guess work is taken out by this method and by following the printed instructions any school boy should be able to construct this truly Marvel in Power Cruisers that will be a real Pleasure to build, easy to assemble and will Travel with SPEED.

The Schodel Power Cruiser KIT will be sent Postpaid for \$7.50. Also we can furnish Power Motor (Electric or Spring) and fittings for the completed Cruiser. Send for pamphlet. This is a SCHODEL product manufactured by the Miami Woodcrafters, 2916 S. W. 8th St., Miami, Florida.

FREE BOTH HANDS!
NEW • VERSATILE • DETACHABLE
FLASHLIGHT HOLDER

with no-scratch, no-skid wheels
ROTATES, SWIVELS ALL ANGLES
Clamps on most any type surface. Fenders, glass, pipes, on belt, over arm, etc. Folds compactly. Made for all standard two cell flashlights. Patented U.S. and Foreign. **U. S. Postpaid 50c**
KINGADGET, Woodstock, N. Y.



HOBART BROS., Box M87
Gentlemen: Send me information on () Build Your Own Welder () Electric Drive Welder () 30 Days' Trial, Easy Terms () Rental Plan. Also send me the free books I've checked.
Name.....
Address.....

For.. BIG Money-Making.. Doing ALL Work

Use **The EIFFEL-GEARED PLIERENCH KITS**

● It's 10-to-1, 1-TON, Power-Gear gives your hands 1-Ounce to 1-TON Gripping Pressures and amazing working power and skill. ● With the Universal Gear-jaw, No. 1, it is a Super Parallel Pliers, Lock-&-Ratchet Wrench, Hand-Visc . . . with 4-Way V-Grips, Wire-Cutter, Screwdriver, etc., etc.

● With PIPE Gear-jaw, No. 2, holds and Turns Pipe tight to a wall, nearly flush sink nipples; basin nuts and chwed nuts in Tight Tubing and Pipe, and places . . . Hard wrist pins, shafting, etc.!

● With WIRE Gear-jaw, No. 3, Cuts up to 1/4" wire; makes Springs; Holds Washers, Ends of Tubing and Pipe, and does 101 "odd" and amazing things.

● You Get ALL 3 . . . a \$50 Tool Service . . . at the Price of ONE Good tool in the 8 1/2" (20-Oz.) KIT; or, in the 7" (12-Oz.) KIT; and the 2 KITS give you 9 Different Super-2-Tool Combination!

● WHAT'S MORE..These "Miracle KITS" are making \$30 to \$85 WEEKLY for AGENTS and DISTRIBUTORS, and we Need More..

● MAIL this Part of Ad TODAY with your Address (on a Postcard will do). Get FREE—this 7-Edge-End-&-Angle SCREWDRIVER (It Turns Screws in ALL Positions and does many useful things) . . . and 101-PICTURE MANUAL OF MECHANICS, with . . . User Offers; or, With . . . DISTRIBUTOR, Territory and Free Kit Offer! **HPM - 4611 Ravenswood Av. AMERICAN PLIERENCH CORP N CHICAGO, ILL.**

DEVELOP & PRINT YOUR OWN SNAPSHOTS

COMPLETE OUTFIT \$1.95
Save One Half!
● Save money developing and printing your own pictures! . . . No experience needed . . . Send only \$1.95 for COMPLETE professional outfit, including electric ruby lamp, developing and fixing trays, chemical, photograph paper, directions— or sent C. O. D. \$1.95, plus postage. Satisfaction GUARANTEED or money refunded. Write for FREE BARGAIN BOOK of cameras and supplies.

CENTRAL Camera Co. (Est. 1899) 230 S. Wabash, Dept. K-18, Chicago

KWIKLOCK TRAILER HITCH

\$225 Ball & Socket Type
ALL THREE RITZY PLANS FREE WITH EACH HITCH

BUILD YOURSELF OR HAVE Carpenter or Garageman BUILD

Ritzy Standard	Ritzy Super Economy	Ritzy Air Cutter
USE AUTO HULL OR REGULAR TRAILER AXLE		
		31.00

SIMPLE PLANS AND SPEC BY REG. LENGTHS—RITZY'S WIDE 1 HIGH 11 AND 13 LONG EASY TO CHANGE LENGTH AND WIDTH MAIL 15 CENTS TODAY FOR ALL THREE PLANS TO RITZY CABIN TRAILER, BOX 291X, WAPAKONETA, OHIO

BURIED TREASURE!

Find It With the New **GOLDAK RADIOSCOPE**

Money Back Guarantee! Locates any metal including gold and silver sealed in glass. Guaranteed to detect deeper than any other device, regardless of price. Most advanced scientific design, based on original Radio Balance invented by Chilton. Write world's largest manufacturer of successful mineral locators for interesting information. (Postage stamp requested.)

THE GOLDAK COMPANY
1031 So. Broadway, Dept. PM
Los Angeles, Calif.

In answering advertisements always write name and full address clearly.

NEW PROFITS IN 40 VOLT ARC WELDING \$150 to \$300 Extra Profit Monthly

"BUILD YOUR OWN WELDER!"

New low prices make this profitable welding service available to everyone. Opens doors to big pay jobs that carry real profit. Hobart Welders are easier to operate, faster, guaranteed to bring you quality welding business . . . extra profits will pay for welder without expense to you. Special "Build-Your-Own" generator mounted on trailer with auto engine lets you operate any place. Saves \$300 to \$500 over factory built units.



No Investment Terms Profits Pay for it

Extra earnings and savings possible with Hobart Welders make it easy to own without expense. You can even rent a new Hobart and later purchase it without loss. Coupon brings details.

Free!
VALUABLE WELDING BOOKS—CHECK THEM

30 DAYS TRIAL AT OUR RISK
Pays for itself Terms



How to Build-Your-Own
New Profits in Arc Welding
New Arc Welding Catalog

HOBART
THE FASTEST SELLING WELDER ON THE MARKET TODAY

BURN YOUR NAME ON TOOLS**WITH THE
ARKOGRAF****PROTECT YOUR TOOLS FROM THEFT**

Write with electricity any name or design on the hardest and finest tools and instruments, or any metal, like writing on paper with pen or pencil.

Complete Outfit \$3.50—Prepaid Anywhere

Interesting illustrated circular free. Write today. Agents wanted.

ARKOGRAF PEN CO., 3927 S.E. Stark St., Portland, Ore.

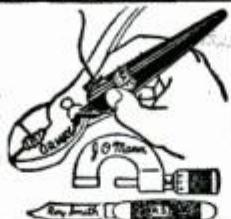

GIVEN!
\$6 Double-blade Paddle now given with your Ki-Yak—if you hurry!

**BIG MONEY Assembling
NEW BOAT!**

Make big money on each 20-lb. Mead KI-YAK, you easily assemble at home from complete "cut-to-fit" Kit at amazing **LOW COST!** Seaworthy. Fast! Snappiest thing afloat. (Complete Sailing Rig, a few dollars extra.) **Rush 10¢** for illustrated folder and \$6 Paddle Gift Offer! **MEAD GLIDERS, 15 S. Market, Dept. B-87 CHICAGO, ILL.**

100 PAGE BOOK No. 9

Full of beautiful things easily made—hard to find foreign woods—lovely crotch, butt, burl, fiddle back, etc. Veneers, panels and Solid Woods—Hard to find Hardware. Lists and illustrates 76 Blue Print Designs for Scroll Patterns, Inlay Table Tops, etc.

CRAFTSMAN WOOD SERVICE CO.

2721 MARY STREET CHICAGO

only 10¢

We Ship All Over the World

BIG QUICK CASH OPPORTUNITY

for salesmen calling on all types retailers, gas stations with startling new Sales Stimulator plan. Nationally advertised merchandise. Advance cash commission and steady repeats. Outfit **FREE!**

H. Meinhardt Co., Dept. F-12, 18 E. Kinzie, Chicago

PAINT SPRAY OUTFITS

National Paint Spray Units suitable for all purposes. 5 Sizes, \$14.50, \$22.50, \$32.50, \$47.50 and \$98.50. Best value money can buy. Send for free folder. **NATIONAL ELECTRIC TOOL COMPANY, Dept. 08, 560 West Washington Boulevard, Chicago, Illinois.**

BUILD AEROPLANE FANS

21" Aluminum propeller \$3.50
24" Circulator blade \$4.50

ELEC. EQUIP. & FDY. CO., PINE BLUFF, ARK.

MAKE \$150 TO \$300 EXTRA MONTHLY!

Get into electric welding. The New FlexArc handles all types of jobs at lowest cost. Revolutionary new design makes FlexArc easiest to use—makes welding completely safe. Easy to buy. Send for catalog today. Westinghouse Electric, Room 7N4, East Pittsburgh, Pa.

BUILD THESE PROJECTS

For garden or lawn. Easy to build. Easy to sell. Detailed Blueprints Model B-25 Dutch Windmill 50¢. Model OM-60 Old Mill \$1.00. Lawn Figure Patterns—Sunbonnet Girl, Dutch Boy, Tulip Girl, Holland Girl, 35¢ each. 4—\$1.00. Catalog illustrating over 25 models, send 10¢ today.

CRAFTSMAN'S MODEL CO., Dept. P-8, 2030 N. 41st St., Milwaukee, Wis.

FREE CATALOG OF 5000 BOOKS

on 2000 Practical Subjects. Send 3 cent stamp for postage. **POPULAR MECHANICS PRESS**
200 East Ontario Street Chicago

Whether you design for welding, build by welding, or use welding in any way **YOU NEED THIS BOOK**

**PROCEDURE HANDBOOK OF ARC
WELDING DESIGN AND PRACTICE**
\$19 pages, 990 illustrations

Long recognized throughout the world as the authority on the art of electric welding. Standard welding reference guide in thousands of industrial plants in U.S.A. and foreign countries. New Handbook makes all others obsolete. Contains complete, authentic, up-to-date data on all latest arc welding applications and design procedure. Order your copy now.

Fourth edition gives you, at no extra cost, 223 pages of new welding data, 289 new illustrations

POPULAR MECHANICS PRESS
Room 837-B, 200 East Ontario Street, Chicago



ONLY \$1.50
IN U.S.A.
\$2.00 elsewhere. Prices are postpaid.

**NOTHING
SO STRONG AS
laminated construction**

The 36" cables holding San Francisco's Golden Gate bridge are spun from 27,572 separate wires and pull 63 million pounds at each end—a form of laminated construction giving maximum strength.

NO OTHER PADLOCKS
BUT **Master**
ARE
LAMINATED



Sold by dealers everywhere
Master Lock Co., Milwaukee
World's Largest Exclusive
Padlock Manufacturers
OVER 52,800,000 IN USE

ALL STEEL TRAILER KIT**SAFE-STRONG-EASILY ASSEMBLED-COST UNDER \$320**

All steel chassis and body in knock-down kit. Complete with springs, wheels, and tires, hitch, doors and windows. Furnish to suit yourself, and you will have a custom built coach which will last a lifetime. Low freight rates throughout the U. S. Send for free illustrated circular giving specifications and prices.

STEFCO STEEL COMPANY . . MICHIGAN CITY, IND.
"Largest Exclusive Manufacturer of Sectional Steel Buildings"

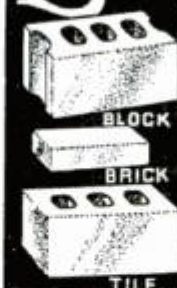
**Lower Cost
BUILDING MATERIALS**

MEN OF FORESIGHT realize the big possibilities today in the building industry. They are aware of the coming shortage. They know the trend for permanent, fireproof construction at lowest cost.

GET READY TO SUPPLY this demand in your locality. You can build up a complete modern plant from a single machine at \$190.00. **INVESTIGATE**—Now is the time to get ready. Be prepared to make this extra profit. Write today for Catalog No. 67 and easy payment plan.

CONCRETE EQUIPMENT COMPANY
512 Ottawa Ave. Holland, Michigan

WIRE CLOTH for EXPERIMENTERS

Package of assorted sizes and grades of "Buffalo" Wire Cloth. **No. 1**, Steel and Galvanized. **No. 2**, Brass and Bronze. Special to Popular Mechanics readers. Send \$1 money order or check. State which desired.
Buffalo Wire Works Co. (Est. 1869) 522 Terrace, Buffalo, N.Y.

Manheim POCKET SLIDE RULE

With A-B-C-D Scales. Multiplies, divides, squares, takes square root, finds circumference and area of circles, 6 inches long—thin construction. **NO WOOD OR CELLULOID.** Fits in vest pocket. Send \$1 in cash, money order or check (\$1.25 Canada and foreign countries) and receive slide rule with genuine leather case and instructions. Box M-10.
M. MANHEIM COMPANY, Inc. 15 E. 26th St. New York, N. Y.

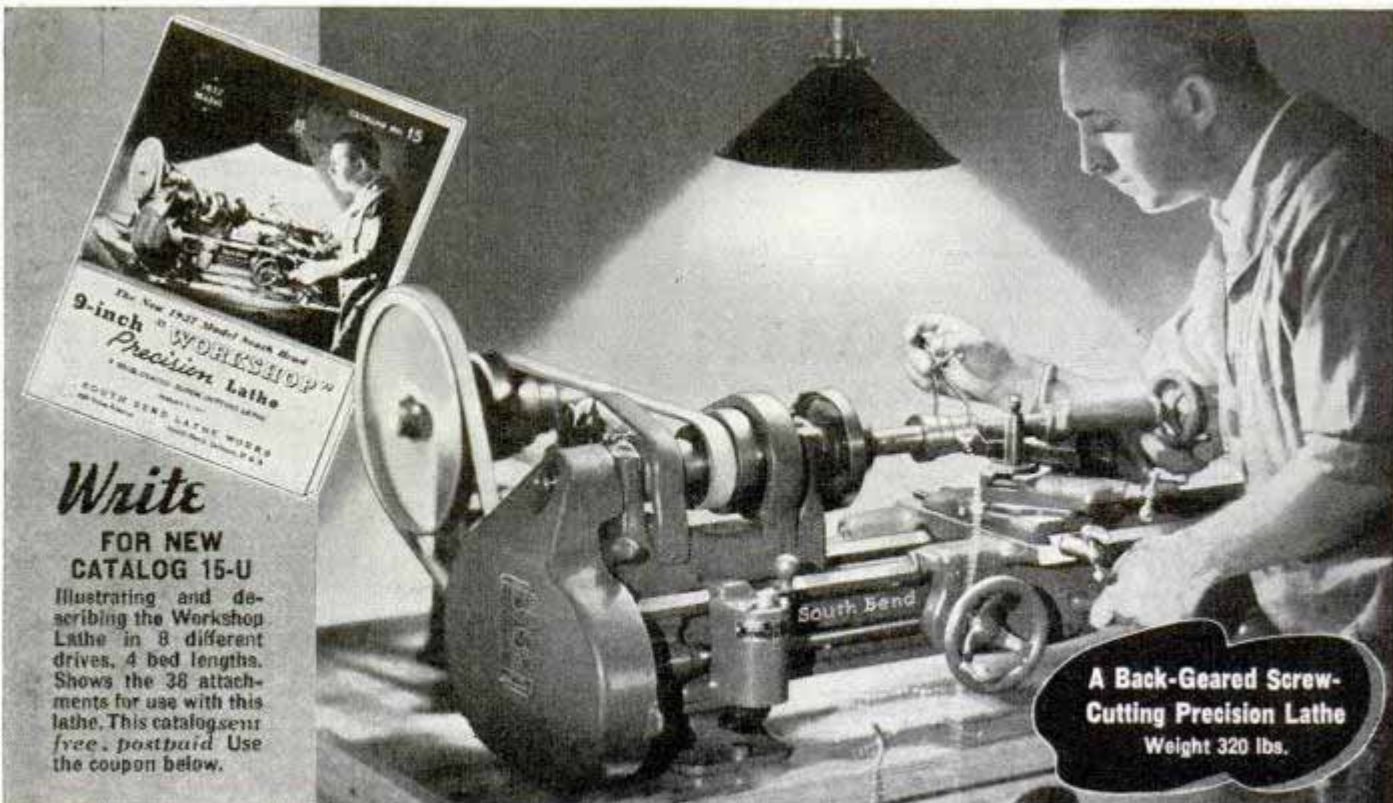

A Back-Geared Screw-Cutting Precision Lathe
Weight 320 lbs.



Write
FOR NEW CATALOG 15-U
Illustrating and describing the Workshop Lathe in 8 different drives, 4 bed lengths. Shows the 38 attachments for use with this lathe. This catalog sent free, postpaid. Use the coupon below.

\$85⁰⁰
Less Motor Drive
Terms as Low as
\$6⁰⁰
a Month

New 9" x 3' Genuine **SOUTH BEND**
WORKSHOP PRECISION LATHE...
On New Low Terms

The new 9-inch Workshop Lathe is a back-geared, screw cutting lathe designed to handle the finest, most accurate jobs in manufacturing—in the tool room, in home workshops and automotive machine shops, for all classes of fine precision work. Materials and workmanship are exactly the same as used in our more expensive models of larger size, thus representing the greatest value we have offered in more than 30 years of fine lathe manufacturing.

Features include: Twin gear reverse to leadscrew; Ball Thrust Bearing on spindle; Automatic Longitudinal screw feed to carriage; Precision leadscrew for cutting screw threads from 4 to 40 per inch; 3/4-inch hole through spindle taking collets up to 1/2 inch capacity. Operates from any ordinary lamp socket. Write for catalog.

SOUTH BEND LATHE WORKS
620 E. Madison St., South Bend, Ind., U.S.A.

No. 415-YA 9 1/4" swing by 3' bed Workshop Bench Lathe with Horizontal Motor Drive, 1/4 h.p. Reversing Motor, Switch and adjustable belt tension countershaft as shown above.

\$116⁰⁰

(\$15.00 Down, \$6.00 a month for 18 months)

5 OTHER SIZES: 9", 11", 13", 15" and 16" SWING
IN ALL BED LENGTHS PRICED FROM \$97 to \$1200
Lathe shown below is No. 117-C 16" x 6' Quick Change Gear Underneath Belt Motor Driven Lathe with 1 h.p. motor. **\$869**
Complete as shown. Weight 2300 lbs.
(\$87.00 Down, \$38.50 Monthly for 22 Months)

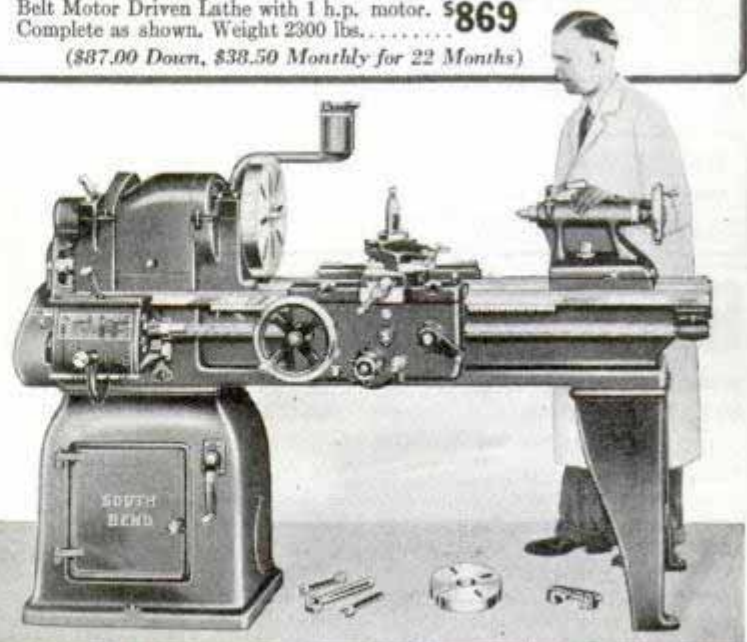

South Bend Lathe Works,
620 E. Madison St.,
South Bend, Ind., U.S.A.

Please send the following free, postpaid:

- 9" Workshop Lathe Catalog No. 15-U.
- General Catalog No. 96.
- Easy Payment Plan.

Class of work.....

Name.....

Address.....

City..... State.....

SOUTH BEND Precision LATHES