

HOW TO TAKE BETTER PICTURES

POPULAR MECHANICS

MAGAZINE



WHEN YOU UNDERSTAND IT

REG. U.S. PAT. OFF.

MAY
25 CENTS



SEE PAGE 647



NEW 1937 MOBILLOIL CHART

**OUT TODAY...
AT 79,000 DEALERS
FROM COAST TO COAST**

DO YOU know it's important to get the right grade of oil for your make and model of car?

That's why the Official Mobiloil Chart is worth money to you...

It tells the exact grade that gets utmost performance and mileage out of your motor!

Change to your car's grade of Mobiloil... today! Enjoy better driving with the world's largest-selling oil!

The Mobiloil Chart of Recommendations, 1937-33

Make and Model	1937	1936	1935	1934	1933	Make and Model	1937	1936	1935	1934	1933
AUBURN (6 Cylinder)	—	AF	AF	AF	—	LA SALLE	AF	AF	AF	AF	BB
AUBURN (8 Cylinder)	—	AF	BB	BB	BB	LINCOLN	AF	AF	BB	BB	BB
BUICK	A	A	A	AF	AF	LINCOLN ZEPHYR	AF	AF	—	—	—
CADILLAC (8 Cylinder)	AF	AF	BB	BB	BB	NASH (Models 11, 90, 12, 90)	—	—	—	BB	BB
CADILLAC (12 & 16 Cylinder)	BB	BB	BB	BB	BB	NASH (Cafayette Series 300)	A	A	A	—	—
CHEVROLET	A	A	A	A	A	NASH (All Other Models)	AF	AF	AF	AF	AF
CHRYSLER	AF	AF	AF	AF	AF	OLDSMOBILE	AF	AF	AF	AF	AF
DE SOTO	AF	AF	AF	AF	AF	PACKARD	A	A	A	AF	AF
DODGE	AF	AF	AF	AF	AF	PIERCE-ARROW	AF	AF	AF	AF	AF
FORD	AF	AF	AF	AF	AF	PLYMOUTH	AF	AF	AF	AF	AF
GRAHAM (6 Cylinder)	AF	AF	AF	—	—	PONTIAC	A	A	A	AF	AF
GRAHAM (All Other Models)	—	—	BB	BB	BB	REO	—	A	A	A	A
HUDSON	A	A	A	AF	AF	STUDEBAKER	A	A	A	AF	AF
HUPMOBILE	—	AF	AF	AF	AF	TERRAPLANE	A	A	A	AF	AF
LAFAYETTE (Series 3610)	—	A	A	—	—	WILLYS	AF	AF	AF	AF	AF
LAFAYETTE (All Other Models)	—	—	AF	AF	—						

For all of the cars listed here, Mobilil Arctic is recommended for temperatures below 32° F.

MOBILLOIL AND MOBILGAS

SOCONY-VACUUM OIL COMPANY, INC.



WAR ON "DRIVING STRAIN" IMPORTANT NEW IDEAS END DRIVING FATIGUE

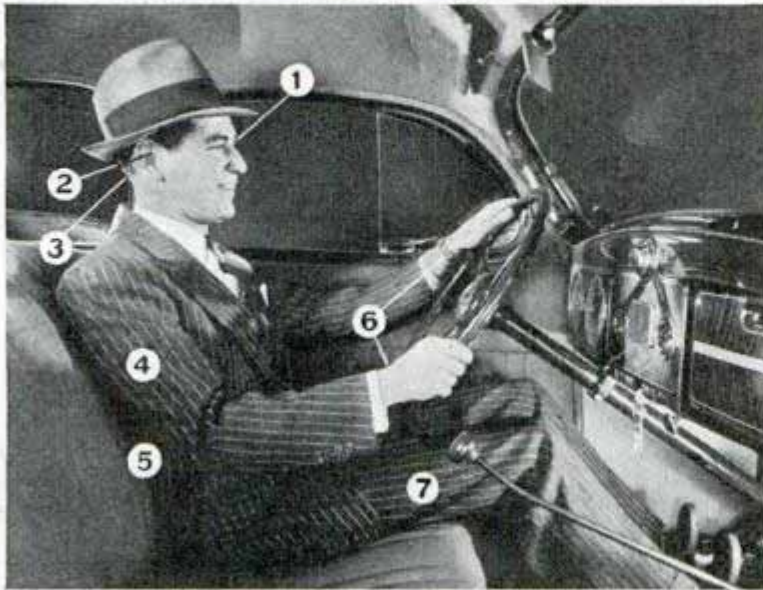

RIDE RELAXED (above) — Eye and neck strain (1 and 3) reduced by means of a wider windshield, safe-vision lighting.

Thorough, scientific insulation banishes tiring road noises that irritate ear-drums (2). Back and leg muscles (5 and 7) are rested and relaxed by comfortable, "chair-height" seats. Effortless steering plus easy, quiet shifting results in far less exertion for arms, hands and wrists (4 and 6).

Causes of Fatigue Tracked Down

"THINK of the man who drives it!" That is the first consideration of Plymouth engineers.

Eye and ear fatigue...muscular strain in neck, back and legs...no item was too small to escape their attention. They have made your Plymouth easier to handle...more restful to ride in...and therefore *safer*. PLYMOUTH DIVISION OF CHRYSLER CORPORATION, Detroit, Michigan.



MORE ROOM (above) — than ever before...for legs, shoulders, heads. Rumble and vibration are gone because the body is mounted on the frame on live rubber cushions.

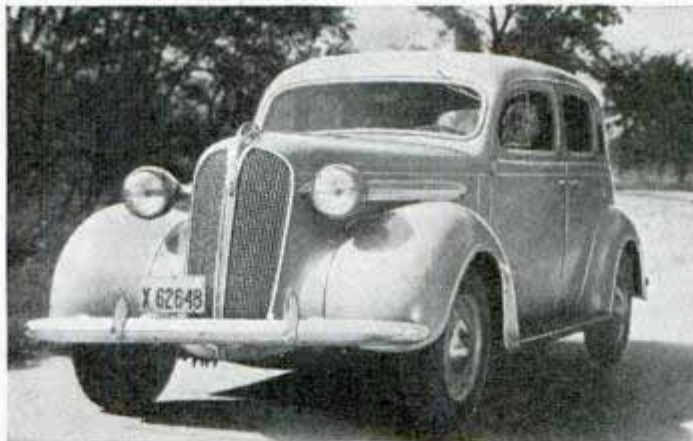

NO LEANING SWAY (left) on curves. A stabilizer bar, mounted on the frame, is connected with the front axle...it keeps the car on an even keel.

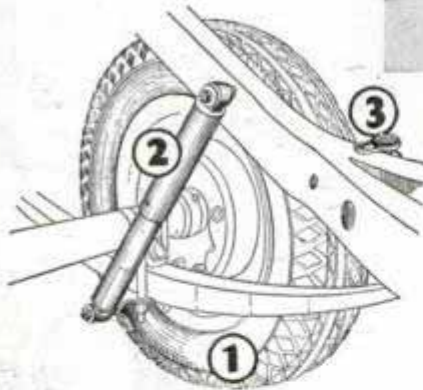

ROAD SHOCKS STOPPED (left) — large Airwheel tires (1), low-pressure shock-absorbers (2), and rubber body mountings (3) insulate the car from road vibration, bumps and jolts.

NOISE SILENCED (right) — Plymouth engineers analyzed sounds inside a car. Then they insulated the steel top, sides, doors and floor with five different materials...produced Plymouth's amazing "hushed ride."



PRICED WITH THE LOWEST

Today, you'll find Plymouth is priced with the lowest...and offers very convenient terms. You can buy a beautiful, big new Plymouth on remarkably low payments. The Commercial Credit Company has made available—through DeSoto, Chrysler and Dodge dealers—terms which you will find fit your budget...and make it exceptionally easy to purchase...and enjoy... a new Plymouth today.

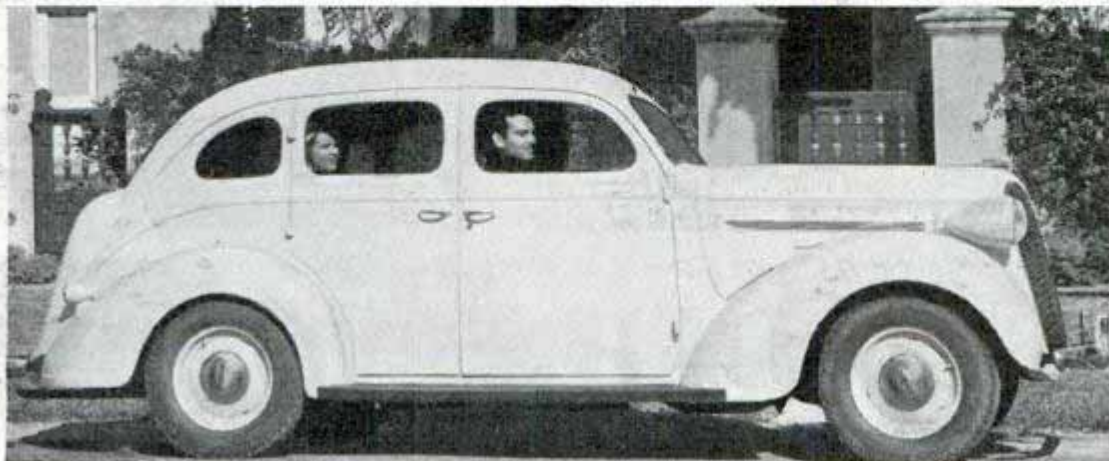

When writing to advertisers please mention Popular Mechanics

"How I Rescued Myself from a Burning Pipe"

By **SMOKY SAM**, the Fireman

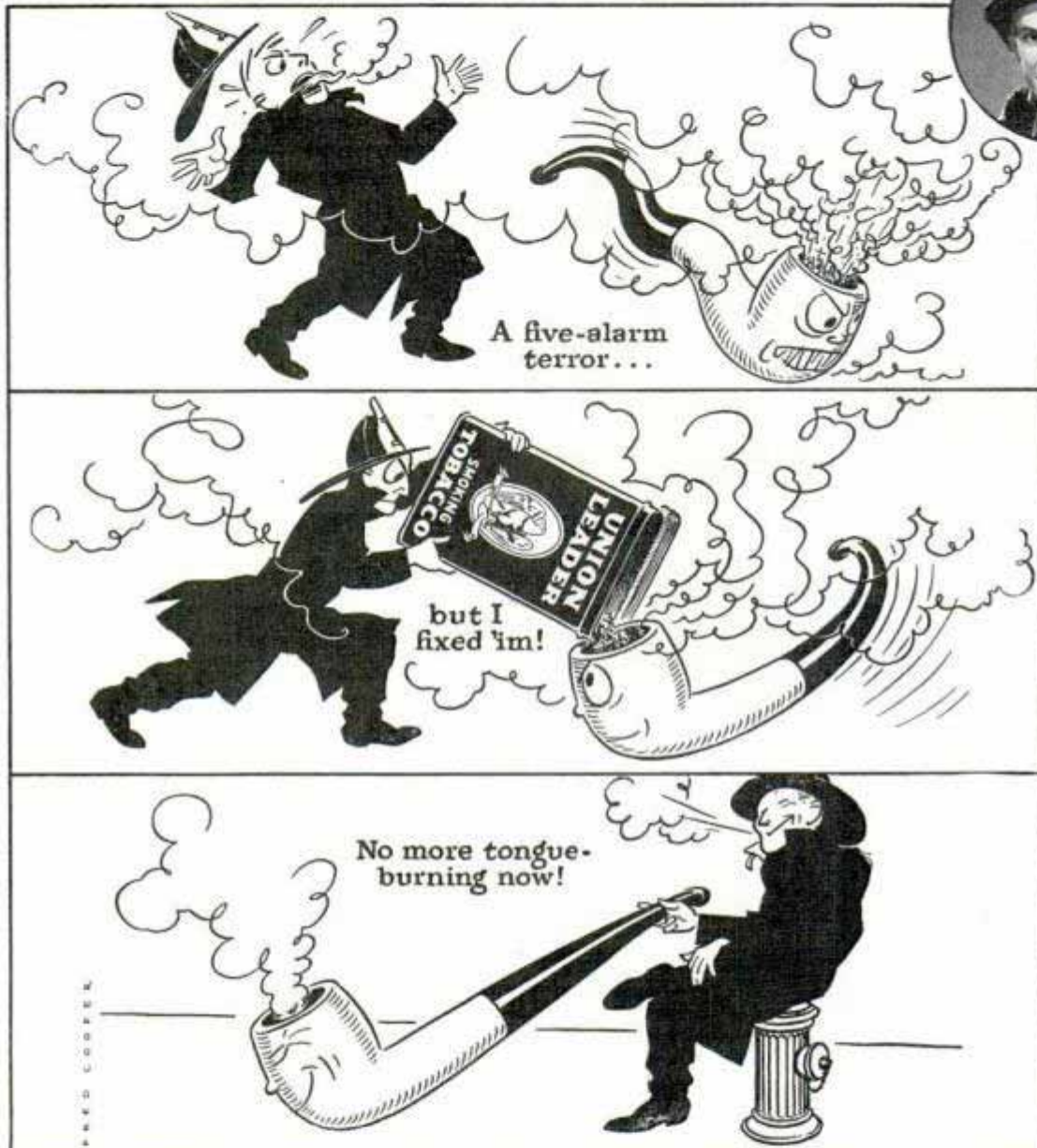

You too, can put out Tongue-Fires

THIS EASY, INEXPENSIVE WAY! Many a tongue has been saved from burning when Union Leader's big red tin answered the alarm! That fine, fragrant Burley tobacco is "bred in Old Kentucky" to mellow ripeness; cured by special processes and *aged-in-wood*—to remove every cause of bite and burn. Result: Smooth, sweet coolness with amazingly rich flavor. Union Leader is fire insurance for your tongue! (Makes fine cigarettes, too.)

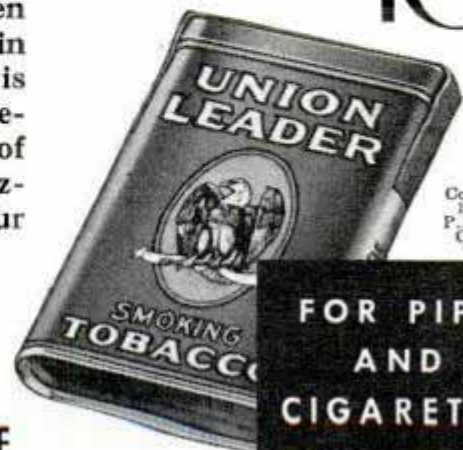

Copyright,
1937, by
P. Lorillard
Co., Inc.

FOR PIPE
AND
CIGARETTE

UNION LEADER

THE GREAT AMERICAN SMOKE

When writing to advertisers please mention *Popular Mechanics*

10¢

Popular Mechanics Magazine

H. H. WINDSOR, Founder

H. H. WINDSOR, Jr., Editor and Publisher

May, 1937

Vol. 67, No. 5

Special Features

Cross-Canada Airway Next . . .	641
"And There Was Light" . . . Coloroto	
The Bean That Made Good . . .	660
Taking the "If" Out of Farming . . .	666
You're Wrong about Elephants . . .	674
Camera Shots That Click . . .	682
Little Bugs and Big Business . . .	692
Seeing Inside a Drop of Oil . . .	696
Sound Engineers Help the Stage . . .	703
Easy Card and Rope Tricks . . .	706
Nomads of the Seven Seas . . .	714
Strange Lingo of the Movies . . .	722
Stop and Go on the Skyways . . .	730

(Continued on next page)

Things Are Not What They Seem

MOTHER Nature offered man the materials to produce almost anything his mind could conceive, but she neglected to label her gifts. So, slowly and painfully, through the centuries, man has been trying to piece together bits of the colossal jigsaw puzzle she created. Strangely enough, he succeeded in isolating rare elements before he began to realize the treasures locked in such common things as wood, air, salt, water, coal and growing plants. But, having learned the possibilities of these everyday substances, industrial chemists in the past two decades have been making over the world by transforming products of the forest, the farm and the mine into new, man-made things of beauty and utility. Watch next month for the first of two articles describing the industrial chemist's contributions to your comfort and happiness. The eight pages of Coloroto pictures will make you, too, realize that "Things Are Not What They Seem."

Next Month

FREEZING is nature's oldest way of preserving food. It is man's newest. Quick freezing seals in the freshness and flavor of fruits and vegetables but does not damage the tissues like slow freezing. The grocery store of tomorrow may deal largely in foods frozen when picked and kept frozen until you cook them. An article next month discusses the possibilities.

He Fools Your Ears

EVER hear of a rain-making machine? We know a fellow who owns one. He fills a hopper with birdseed and when the seed trickles down onto a sheet of Cellophane, he gets rain—well, anyway, he gets a sound like rain. He's a radio sound-effects expert and can make a noise like a chugging locomotive or a galloping horse. Read how he does it next month and you'll agree that "You Can't Believe Your Ears."

Believe in Signs?

THE catcher of a sandlot baseball team uses signals—two of them. When he extends two fingers in his mitt, the pitcher tries a curve. One finger means a straight ball. In professional baseball everyone in the game uses signs. In an article next month Lew Fonseca interprets some of the wigwagging you observe on the diamond. It seems there's a reason for all the funny business.

Published monthly by POPULAR MECHANICS CO., 200 East Ontario Street, Chicago, U. S. A. Single copy in United States, 25 cents; \$2.50 a year, \$4.00 for two years, \$5.00 for three years in United States and possessions, Canada, Newfoundland, Labrador and countries of the Americas and Spain. To all other countries add \$1.00 a year extra for overseas postage. Changes in address must be reported to us immediately to eliminate delay. Entered as Second Class Matter, Sept. 15, 1903, at the Post Office at Chicago, Illinois, under Act of March 3, 1879. Entered as Second Class Matter at the Post Office Department, Canada. Copyright 1937, by Popular Mechanics Co. in the United States, Australia and France.

This One



5V99-K5V-DVE3



Whenever the exceptional is accomplished by motor car or by machine, you'll generally find Pyroil helping to make it possible. Look!

Used by the winners of the 1933, 1934, 1935 and 1936 Indianapolis 500 mile auto race.

Used by Sir Malcolm Campbell in establishing world land speed record, Daytona Beach, Florida, 1935.

Used in official Flour Mill machinery test with saving of \$5,000 yearly indicated, 1933.

Used by Barney Oldfield in world record of 64 M.P.H. with a farm tractor, 1933.

Used by Jesse White, salesman, driving 18 miles of mud in 6 hours —his car undamaged while others were ruined, 1935.

Used by Art Chester in setting new world record for light planes, Miami, 1935.

Used by Cummins Diesel Engine Co., in record transcontinental run of America's first Diesel powered passenger auto, 1935.

Used by Tommy Estlick in winning many cups and world records in outboard motor boat racing.

Learn for yourself Pyroil's performance boosting ability; its extra protection against strain and damage. Save money on operation costs; cut repair expense; increase operation capacity, whether engine or equipment is brand new or very old.

Mail coupon now or ask your service station or dealer to give you full facts about Pyroil. Sold the world over. Manufactured and Guaranteed by Pyroil Company, W. V. Kidder, Founder, 55 Pyroil Bldg., LaCrosse, Wis., U.S.A.

PYROIL HAS BEEN TESTED BY POPULAR MECHANICS AND IS USED BY POPULAR MECHANICS' PRESSES AND EQUIPMENT.

DISTRIBUTORS:

Check and mail coupon for facts of our unusual Sales Opportunity for you. Big season starting now.

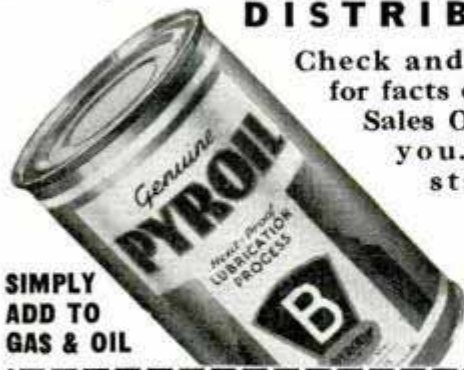

SIMPLY ADD TO GAS & OIL

This 12-ounce can treats 7 Quarts of Lubricating Oil.

PYROIL COMPANY, 55 Pyroil Bldg., LaCrosse, Wis., U. S. A.

- Please send Free facts on Pyroil's money saving features.
- Send details of Premium Plan and Business Opportunity for me.

Name.....
 Address.....
 City..... County..... State.....

(Contents—Continued)

AUTOMOTIVE

Veteran two-cylinder car spans continent..... 658
 Supercharger for light cars fits V-eight engines... 664
 White concrete is permanent road marker 670
 Electric choke on auto engine reduces stalling.... 680
 Small tractor serves one-man farm 631
 Fast drivers have the most accidents 687
 Brake lining mortar solves replacement problems.. 700
 Refrigerating unit for truck 700
 Trailer brake set by valve on steering post 704
 Torqueless axle for trailer 710
 Truck signals tell car driver when to pass 718
 Horn designed for fast country driving 720
 Seven-foot trailer towed by motorcycle 729
 Flexible rod on bridge shunts static charge 734
 Motorcycle has streamline enclosed body 734
 Tiny maps magnified on globe for driver 734
 Silo on top of auto proves strength of body 735
 Electric eye flashes warning to speeding motorist.. 736

AVIATION

Latest U. S. fighting planes built for speed 648
 Sixteen-ton plane to link U. S. and Germany 665
 Fog finder carried by balloon forewarns airmen... 670
 Fast air liner to compete in Atlantic race 672
 Propeller with single blade fast and steady 680
 Signal lamp for airport flashes messages 686
 Plane fires torpedo in defense of coast 687
 Engine builders speed up in aviation boom 689
 Flying "club car" is channel ferry de luxe 701
 Billion dollars for airplanes to be spent 704
 Flowers ice coated for air shipment 705
 Big air liners to fly British routes 711
 Latest blind landing system explained by model... 729
 Flight recorder for planes aid to safety 736

BOATS

Radio teams with foghorn to guide ship 658
 "Queen Mary" under floodlight for repairs 670
 Church arc-welded on hull of boat 686
 Cold asphalt makes deck skidproof 690
 Boat's instrument panel has dual engine controls... 718

CONSTRUCTION

Three oil tanks form garage roof 691
 Cold asphalt levels off worn stair treads 695
 "Walking pugmill" speeds highway surfacing 718
 Pressure gun injects termite poison into wood.... 721

HOUSEHOLD

Citrus fruit juicer holds a full quart 677
 Combined shredder and grater is handy 680
 Hook-rug needle makes stitch any length 690
 Beverage pours any amount without spilling 694
 Chandelier holds pipes of organ for home 694
 Folding electric iron for travel 735

MODELS

Vast diorama shows Chicago's 387,000 buildings... 677
 Model locomotive as delicate as a watch 694
 Plane rounds off hull of model boat 720

RADIO AND ELECTRICITY

Electric appliances lose heat as alloy wires grow... 673
 High definition television broadcast into city 705
 Radio "hams" join in vast "round table" 734
 Speakers built into lamps improve tone 737
 How to build farm set for windcharger operation... 738
 Code-practice oscillator built in a coffee can 740
 Hints for radio experimenters 741
 Movable-coil tuning unit in 12-tube super..... 742
 Oscilloscope for amateurs 742
 Sliding scale time converter 742
 Turret-top antenna, adjustable for all styles.... 742

RAILWAYS

Two-car streamline train driven by steam 673
 Powerful streamline engines for coast trains 681
 Boxcar has removable roof 710
 French locomotive has a streamline face 718

SCIENCE AND INDUSTRY

Sound waves rid chimney of smoke 664
 Synthetic skunk odor warns miners of fire 665
 Brain keeps growing to age of fifty or sixty 721
 Paint changes color with heat 736

(Continued to page 6A)



"HOW COME THESE PEPPY CORDS ARE SO EASY ON GAS AND OIL?"

"WELL FOR ONE THING THEY HAVE SEALED POWER PISTON RINGS."

SEALED POWER PISTON RINGS

Best in New Cars! Best in Old Cars!



SEALED POWER PISTON EXPANDERS

Control Expansion and Piston Slap

When piston skirts collapse, they must be expanded if power and economy are to be restored. Sealed Power Piston Expanders restore collapsed skirts scientifically. They have spring tension, yet are entirely adjustable to compensate for variations in piston and cylinder wear. Ask your Sealed Power ace mechanic about this great expander. And use it for best results!

THOUGH they *look* expensive—hard on oil—actually the Cord boasts an amazing record of oil economy. And, of course, it has all the speed, pep and power any motorist could ask for.

Significantly enough, Sealed Power Rings are original equipment in all Cords—just as they are in Buick, Pontiac, Nash LaFayette, Oldsmobile, Terraplane, Willys and other famous cars. For the engineers of these great cars know Sealed Power Rings are designed right. They *seal* power properly.

New Ring for Old Cars—Sealed Power now offers owners of cars that have gone 10,000, 20,000, 30,000 miles or more—a new type ring, already proved in millions of cars. It is an expander ring with springs of finest imported Swedish steel which without excess tension create a perfect seal—ending "between meal" oil hunger—saving gas—restoring pep, speed, power and performance. Engineers recommend them.

But—perhaps your car needs new valve guides, bearings or Sealed Power Lo-Ex Pistons in addition to rings in order to get 100% oil economy. Only your repairman can tell you accurately what you need. Depend on him. Meanwhile, get your copy of our new, free booklet, "New Low Cost Way to Save Oil and Gas and Increase Pep." You'll like it.

SEALED POWER CORPORATION
Dept. 275 Muskegon, Michigan

Canadian Factory at Walkerville, Ont.

Manufacturers of Piston Rings, Pistons, Piston Expanders, Piston Pins, Valves and Cylinder Sleeves



When writing to advertisers please mention Popular Mechanics



Happy Shaves Are Here Again

*when you use the blade
that was made for your razor*

HERE'S a suggestion for men who find shaving a task to be dreaded. Switch back to using Gillette Blades in your Gillette Razor. Then notice how smoothly your razor removes every trace of stubble.

You'll agree that an "All-Gillette" shave is the last word in shaving comfort. For the Gillette Razor and the Gillette Blade are made for each other. Rigidly matched in design and manufacture, they function together in perfect harmony. Buy Gillette Blades today; enjoy a real shave tomorrow.

Reputable merchants never offer substitutes for Gillette Blades. Always ask for them by name.

Tune in Gillette's "Original Community Sing" with Milton Berle and other stars Sundays 10 P. M., E. S. T., CBS Network, Coast to Coast.



Gillette Blades

Precision-made for the Gillette Razor

(Contents—Continued)

SPORTS

Propeller driven "skate-sled"	663
Winter and summer sports meet in Idaho	678
Marker imprints golf ball with owner's name	695
Fly box with transparent lid	713
Instrument board on bicycle has clock	713

TOOLS

Chuck grips broken drill ends	665
Self-feeding rotary shears for sheet metal	686
Pyrometer for molten metal easily calibrated	710
Vise removable from base for drill press	713

MISCELLANEOUS

Ring locks gasket on pail for shipping	657
Robot pen copies handwriting from disk record	657
Film washer attaches to water faucet	658
Old battleships made new by world powers	659
Handy holder keeps door at position desired	663
Human grows until late in life	664
Gathering wild roots is lonely job	671
Earphone fitted to user gives better service	672
Engine driven by liquefied air propels boat	679
Fountain envelope moistener of sponge rubber	679
Twenty thousand ice cubes cut in hour	679
Steel in year's bikes thirty million pounds	687
Guitar with tone control sounds like harp	688
Instantaneous list finder ends tedious work	688
Model of hotel on road sign	688
Rivers polluted by acid seepage from mines	689
Lightweight air-cooled engine produces high power	690
Streetcar has booth for driver	690
Tree top measured on ground to forecast growth	691
Oil drums protect shrubbery from damaging winds	694
Heater dries out muddy race track	695
Memorandum pad lighted by bulb	695
Ice cream sold by slot machines	700
Worker climbs stack on ten-foot ladders	704
Historic census rolls copied on movie film	712
Fly-eating plant traps a frog for supper	719
Funnel collar speeds filling of bottles	719
X-ray gun on wheels "sees" through pipe	719
Giant gives tailor a job	720
Ten moving stairways serve London store	727
Ether preheater mixes gas properly for patient	729
Torpedo parachuted from plane circles for enemy	735

Craftsman and Shop Notes

AUTOMOTIVE

Auto short cuts	797
Holding cream cans in partly loaded truck	798
"Police" sign on squad car illuminated	798
Repairing worn adjusting screws on valve tappets	798
Shielding spare truck tire	798
Covering glass when painting car	799
Jack attachment to raise low axle	799
Separating spot-welded joint	799
Step cut in corner of truck tailboard	799

BOATS AND BOATING

Shielding compass against motor in boat	757
Building the Biloxi dinghy	760
Safe mooring for skiff or 50 ft. cruiser	767

DRAWING

Line inked on drawing board aids in lettering	748
Artist stores supplies in steel kitchen cabinet	752
T-square from two rulers	752
T-square held by friction catches	768

ELECTRICAL

Automatic timing relay controls model trains	743
Electric arc torch	781
Electric-current indicator	788

FARM

Weighted lantern bail stays in vertical position	758
Knocker to free clogged grain chute	786
Spur guards for roosters' feet	788
Safe toolholder for farm machines	796
Tank heater from oil drum	800

FISHING, CAMPING, HUNTING

Testing for rough guide on fishing pole	752
Fish bait wired on hook	777
To prevent woolen socks from shrinking	777

(Continued to page 8A)

Accountancy Home-Study

made interesting and practical
thru problem method

YOU know as well as we do that Accountancy fits many men for positions that pay three and five and ten thousand dollars a year—gives many other men unusual opportunity to start a profitable growing business of their own.

You probably realize also that—because of the new state and federal legislation—the accounting profession faces now and for the next few years the greatest opportunity it has ever had.

The only question is—just how practical is it for you to train yourself adequately in Accountancy through home study?

And the answer lies in the LaSalle Problem Method.

For this modern plan of training not only makes Accountancy study at home thoroughly practical but makes it interesting as well.

And here's how:

You Learn by Doing

Suppose it were your privilege every day to sit in conference with the auditor of your company or the head of a successful accounting firm. Suppose every day he were to lay before you in systematic order the various problems he is compelled to solve, and were to explain to you the principles by which he solves them. Suppose that one by one you were to work those problems out—returning to him every day for counsel and assistance—

Granted that privilege, surely your advancement would be faster by far than that of the man who is compelled to pick up his knowledge by study of theory alone.

Under the LaSalle Problem Method you pursue, to all intents and purposes, that identical plan. You advance by solving problems.

Only—instead of having at your command the counsel of a single individual—one accountant—you have back of you the organized experience of the largest

business training institution in the world, the authoritative findings of scores of able accounting specialists, the actual procedure of the most successful accountants.

Thus—instead of fumbling and blundering—you are coached in the solving of the very problems you must face in the higher accounting positions or in an accounting practice of your own. Step by step, you work them out for yourself—until, at the end of your training, you have the kind of ability and experience for which business is willing and glad to pay real money—just as it was glad to pay these men.*

Five Men Who Tested and Proved It for You

For instance, there was the man who started Accountancy training with us in 1916. After a short period of study, he took a position as bookkeeper for a year, and then became accountant for a leading automobile manufacturer—with two bookkeepers under him. Today he is auditor of one of the foremost banks in his state and his salary is 325 percent larger than when he started training.

He writes, "My training is the best investment I've ever made, showing a cash value running into five figures."

And the young clerk, earning \$75 a month eleven years ago and now getting many times that as general auditor for an outstanding, nation-wide organization. Within six months after he began our training, he was earning \$125 a

month and within four years, he was earning \$250.

Do you wonder that he writes, "While LaSalle ads once seemed like fairy tales to me, now I know from personal experience that they are true."

Or let us tell you about two men—one a stenographer and the other a retail clerk—neither of whom knew more than the simplest elements of bookkeeping. One is now the comptroller and the other the assistant comptroller of a large company.

"LaSalle training in Higher Accountancy," write both, "was the important factor in our rapid climb."

And if you are thinking about the C. P. A. degree and a public accounting business of your own, read about the pharmacist who was earning \$30 a week eleven years ago when a LaSalle registrar secured his enrollment for Accountancy training. Eight months later he left the drug store to take a bookkeeping job at \$20 a week—less money but larger opportunity. Three years later he passed the C. P. A. examination and a year later yet he was earning \$5,000 a year. Now he has his own highly successful public accounting firm for which he says, "My LaSalle training has been largely responsible."

One-Tenth of All C. P. A.'s Are LaSalle Trained

If you want still more proof, remember that 1,200 C. P. A.'s—approximately one-tenth of all those in the United States who have ever passed the difficult examination for this coveted degree—are LaSalle trained.

And knowing these facts, ask yourself if there can be any further question about the practicability of this training for you—ask rather if the real question is not about the size of your own ambition and the quality of your determination.

For Accountancy is no magic wand for the lazy or the fearful or the quitter—it offers success only to the alert adult who has the courage to face the facts and the will to carry on till the job is done.

If you are that individual, the coupon below, filled out and mailed, will bring you free the information that can open up to you the future of which you have dreamed—ability and income and success.

Is it not worth getting that information?



Send for
This Book

*Names and addresses given on request.

LaSalle Extension University

LaSALLE EXTENSION UNIVERSITY, Dept. 564-HR, Chicago, Ill.

Please send me, free of all cost or obligation, your 64-page, illustrated book, "Accountancy, the Profession That Pays," telling about the profession of accountancy and your training for success in that field.

Name.....

Address.....City.....

Position.....Age.....

When writing to advertisers please mention Popular Mechanics



Restores New Car Power Saves Its Cost In Oil



**Results Proved in
Millions of Cars**

Amazing Ramco Rings Revolutionize Entire Piston Ring Industry

YOUR car—right now—can be restored to its “new car” smooth-running and economical performance for amazingly little. Probably less than half what you’d expect. It will run like new again—no oil-pumping, no piston slap, just smooth, flashing power and pep—if you give it a genuine Ramco Overhaul, the low-cost reconditioning that has revolutionized the piston ring industry.

Even motors with pistons collapsed and cylinders out of round respond like magic to a Ramco Overhaul. You stop adding oil between drains, you save gallons of gas, enjoy a quiet, responsive, powerful motor again.

Actually, you’ll probably save the entire cost in a few months. As countless others have done. For a Ramco job—unlike its many imitations—is no new, untried experiment. Millions of cars for many years have been literally reborn—given many thousands of extra miles of economical, trouble-free life. Other manufacturers have tried to duplicate this record. The market is flooded with imitations. Thus you must *insist* on Ramco if you want to play safe.

Send the coupon for an interesting **FREE** booklet that tells how other car-owners have made astonishing savings, enjoyed vastly improved performance thanks to Ramco methods. Mail the coupon—now!



Trade-Marked by Your Protection

Ramsey Accessories Mfg. Corporation
29 South Spring Ave., St. Louis, Mo.



All first class repair shops use and endorse Ramco

FREE! Ramsey Accessories Mfg. Corp.
29 South Spring Ave.,
St. Louis, Mo., U. S. A.

Please send me your free booklet which shows how Ramco Spring Piston Rings have restored new car pep, power, and oil economy in millions of cars.

Name.....
Address.....
City..... State.....

RAMCO MOTOR OVERHAUL

RAMCO PISTON RINGS
RAMCO PISTON SKIRT EXPANDERS
PATENTED IN THE UNITED STATES AND CANADA. OTHER PATENTS PENDING

(Contents—Continued)

FURNITURE

Urn-top columns add beauty to the home	745
Hanging China cabinet	750
Chair back table	753
Fastening curtains around furniture	768

HAND TOOLS

Gaskets quickly made with circular cutter	748
Mandrel for shaping sheet metal	749
Concentric micrometer adapter	786
Cement to hold tool handles	800

HOME IMPROVEMENTS

Tee in hot-water boiler helps in removing sludge ..	746
Invisible catches lock window	774
Lock cap for fuel-oil tank	774

HOUSEHOLD

Bouquets colored by water	745
Swinging cradle saves bottom of corn popper ..	758
Canopy and playthings on baby's play pen	759
Asbestos cement that will stick	774
Hot-water gauge operates electrically	775
Accurate measurements with sliding curtain rod ..	776
Padded scissors handle eases strain on fingers ..	777
Easy solutions for home problems	778
Window-cleaning fluid	780

LAWN AND GARDEN

Leaning tree straightened with windlass	744
Making uniform seed furrows	749
Spray for ornamental bushes	753
Garden row marker from rake and spools	758
Gate closer needs no lock	759
Bent shrub support saves roots	768
Keeping the birds in your garden	769
Fan-shaped trellis easily made	777

OFFICE

Cambric cloth improves worn mimeograph ink pad ..	757
Scroll-sawed letter rack for desk	767
Mail basket on filing cabinet saves time	788
Marker for filing cabinet	796

OUTDOOR SPORTS

Lettered trees aid golf players	749
Kites you will enjoy flying	770
Golf club strapped to wrist avoids accidents	774

POWER TOOLS

Small faceplates from pipe plugs	746
Drill-press handle shielded to protect face	748
Machine without vertical attachment cuts rack ..	784
Gears rough-cut in one operation	786
Half nuts meshed into lead screw easily	786
Simple jigs for the belt sander	787
The mechanics of drills	790
Flexible milling-machine fixture	796

STORE AND SHOP

Apples displayed on scales get customers' attention ..	784
Cardboard boxes in basement protected by tires ..	784
Customer tries lead pencils before buying	785
Clerk carries rubber stamps on apron	789
Welding unit easy to push with auto wheels	789

WOODWORKING

Saving wear on sanding belt	752
Sawhorse converted for ripping work	757
Template for lock mortises	774
Protractor on sanding table	780

MISCELLANEOUS

Springs hold aquarium sides while cement sets ..	745
Bearings for lawnmower roller	746
Eraser shielded with tape	746
Mounting model airplane	747
Naphtha-soluble dry-cleaning soap	748
"Dilatroscope" takes guesswork out of exposure ..	754
Serving tongs handle hot flasks in laboratory ..	758
Getting frogs out of well	768
Candle burner for boy's laboratory	777
Keeping centrifugal pump primed	784
"Poultry yard" on wheels is moved easily	785
Cutting sheet plastics neatly	788
Gas pockets eliminated in refrigerant lines	789
Wrist memo pad for policeman	789
Shavings keep fruit from freezing in cars	796

ELECTRICAL ENGINEERING

— A GREAT INDUSTRY WITH A GREAT FUTURE



The new I. C. S. Course in Electrical Engineering covers this fascinating field thoroughly. If you are just starting or are on the way to a real paying position in this industry, this course brings the knowledge necessary for advancement.

DIESEL POWER

A COMING AMERICAN INDUSTRY

The internal-combustion engine represents man's supreme triumph of machine power. Diesel engineers are in great demand. Many are acquiring necessary knowledge through spare-time study of this modern I. C. S. Course on Diesel engines. Send for free booklet!

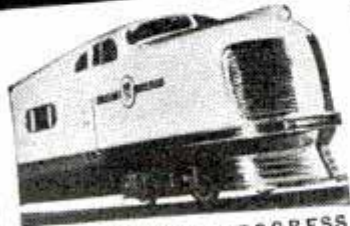

Courtesy DIESEL PROGRESS

AUTOMOBILE EXPERTS ARE ALWAYS IN DEMAND

The rapid progress in manufacture and service of the modern automobile brings new opportunities to thousands of ambitious and forward-looking men. There's always a demand for trained men. The new I. C. S. Automobile Course will make you a trained man! The time to act is now. Use coupon.



RADIO holds great rewards for trained men

Almost in a decade radio has become a giant industry. The opportunities created will be enjoyed by trained men. The I. C. S. Radio Course, prepared by leading authorities, will help make you a trained man! Write today for a fascinating, FREE book.



INTERNATIONAL CORRESPONDENCE SCHOOLS

BOX 5672-H, SCRANTON, PENNA.

★ Without cost or obligation, please send me a copy of your booklet, "Who Wins and Why," ★ and full particulars about the subject *before* which I have marked X:

- ELECTRICAL ENGINEERING DIESEL POWER
 RADIO AUTOMOBILE EXPERTS

TECHNICAL AND INDUSTRIAL COURSES

- | | | | |
|--|---|--|--|
| <input type="checkbox"/> Structural Draftsman | <input type="checkbox"/> Mechanical Draftsman | <input type="checkbox"/> Steam Electric Engineer | <input type="checkbox"/> Surveying and Mapping |
| <input type="checkbox"/> Structural Engineer | <input type="checkbox"/> Machinist | <input type="checkbox"/> Marine Engineer | <input type="checkbox"/> Coal Mining <input type="checkbox"/> Mine Foreman |
| <input type="checkbox"/> How to Invent and Patent | <input type="checkbox"/> Toolmaker | <input type="checkbox"/> R. R. Locomotives | <input type="checkbox"/> Navigation |
| <input type="checkbox"/> Mechanical Engineering | <input type="checkbox"/> Patternmaker | <input type="checkbox"/> R. R. Section Foreman | <input type="checkbox"/> Cotton Manufacturing |
| <input type="checkbox"/> Electric Lighting | <input type="checkbox"/> Gas Engines | <input type="checkbox"/> Air Brakes | <input type="checkbox"/> Woolen Manufacturing |
| <input type="checkbox"/> Welding, Electric and Gas | <input type="checkbox"/> Aviation Engines | <input type="checkbox"/> R. R. Signalmen | <input type="checkbox"/> Agriculture |
| <input type="checkbox"/> Reading Shop Blueprints | <input type="checkbox"/> Air Conditioning | <input type="checkbox"/> Highway Engineering | <input type="checkbox"/> Fruit Growing |
| <input type="checkbox"/> Boilermaker | <input type="checkbox"/> Refrigeration | <input type="checkbox"/> Civil Engineering | <input type="checkbox"/> Poultry Farming |

BUSINESS TRAINING COURSES

- | | | | |
|--|---|--|---|
| <input type="checkbox"/> Business Management | <input type="checkbox"/> C. P. Accountant | <input type="checkbox"/> Service Station Salesmanship | <input type="checkbox"/> Railway Mail Clerk |
| <input type="checkbox"/> Office Management | <input type="checkbox"/> Bookkeeping | <input type="checkbox"/> First Year College | <input type="checkbox"/> High School Subjects |
| <input type="checkbox"/> Industrial Management | <input type="checkbox"/> Secretarial Work | <input type="checkbox"/> Business Correspondence | <input type="checkbox"/> College Preparatory |
| <input type="checkbox"/> Traffic Management | <input type="checkbox"/> Spanish | <input type="checkbox"/> Lettering Show Cards <input type="checkbox"/> Signs | <input type="checkbox"/> Advertising |
| <input type="checkbox"/> Accountancy | <input type="checkbox"/> French | <input type="checkbox"/> Stenography and Typing | <input type="checkbox"/> Illustrating |
| <input type="checkbox"/> Cost Accountant | <input type="checkbox"/> Salesmanship | <input type="checkbox"/> Civil Service <input type="checkbox"/> Mail Carrier | <input type="checkbox"/> Cartooning |

Name..... Age..... Address.....

City..... State..... Present Position.....

If you reside in Canada, send this coupon to the International Correspondence Schools Canadian, Limited, Montreal, Canada

Are You TIED TO YOUR JOB?

Are you in a rut, tied to a factory job, with little or no prospect for advancement? Will you be doing the same thing 20 years from now?



Or..

will you train for a better job, more pay and prosperity? Prepare now, to enjoy everything that bigger earnings make possible.

The Road to Advancement DRAFTING

In every walk of life practical training in DRAFTSMANSHIP will prove valuable. Even if you don't accept a job as a DRAFTSMAN, you will be money ahead by taking Engineer Dobe's Course. You will be amazed at the speed with which you can learn in your own home in your spare time by Engineer Dobe's PRACTICAL METHOD.

JOBS NOW OPEN

In all industries, Drafting leads the way. In Aviation, Electricity, Building, Machinery, Automobile, Draftsmen must be used, and their work comes first. Recovery in industry and building is definitely on the way. Many trained Draftsmen will be needed on better jobs at better pay and shorter hours. Prepare NOW!

Learn at Home From an Engineer

I will teach you my practical method that has been successful with thousands since 1900. I will furnish you with all tools and a drawing table. I will teach you in a very short time by mail in your spare time until you actually have a desirable Draftsman's job, or prepare you for better pay in the job you now have. No High School or previous experience needed. You must be entirely satisfied with my personal training UNTIL COMPETENT and until assisted to a position. **OR YOU GET ALL YOUR MONEY BACK.** Start NOW and get the training. Prepare for more pay and a better job. Send the coupon below TODAY! Time is money! Don't delay! No obligations!

Complete Outfit
Size 20 x 25 inches
FURNISHED

Free Book!

ENGINEER DOBE, Div. 3375 Libertyville, Ill.
Send me your free book, "Successful Draftsmanship" and explain how you will assist me to a good position as a draftsman.

Name..... Age.....
Address.....
Post Office..... State.....

When writing please mention Popular Mechanics

TRI-STATE COLLEGE

Degree in 2 Years



B.S. Degree in Civil, Electrical, Mechanical, Chemical, Radio, Aeronautical Engineering, Business Administration and Accounting. World famous for technical two-year courses. Also short diploma courses in Surveying (36 weeks), Drafting (36 weeks). Non-essentials eliminated. Tuition and living costs low. For ambitious, earnest students. Those who lack high school training may make up required work. Students from all parts of the world. 54th year. Graduates successful. Enter June, September, January, March. Write for catalog.

SCHOOL OF ENGINEERING
54TH YEAR

457 College Ave., Angola, Ind.



BE A RAILWAY WRITE TRAFFIC INSPECTOR TODAY

RAILWAY AND BUS LINES DEMAND MEN WITH THIS SPECIAL TRAINING
CONSTANT DEMAND for active, reliable men—19 to 50—as Passenger Traffic Inspectors. Our simple, home-study course trains you quickly, and upon completion we help place you at up to \$135 per month, plus expenses, to start, or refund tuition. Fascinating work; healthful (outdoors). Travel if you like. Steady advancement with experience. Free Booklet gives our 18-yr. record.

STANDARD BUSINESS TRAINING INSTITUTE
Div. 205, Buffalo, N. Y.

AVIATION



APPRENTICES

Ambitious, air-minded young men, interested in entering the well paid field of Aviation, write immediately, enclosing stamp, to

Mechanix Universal Aviation Service, Incorporated
Strathmoor Station Dept. E Detroit, Mich.

CARTOONING

PAYS WELL

Turn your talent into dollars. Develop your ability with personal instruction from an internationally-known cartoonist. His exclusive, successful method of drawing and creating ideas makes it easy to attain success. Write for details of this exceptional home-study course. No salesman will call.

National School of Cartooning, 437 Penton Building, Cleveland, Ohio



Learn to Write

Begin Today. Write for our Free Book, "How to Become a Good Penman." It contains specimens and tells how others learned to write in spare time. Your name elegantly written on a card if you enclose stamp for postage. Write today. F. W. TAMBLYN, 418 Ridge Bldg., Kansas City, Mo.

Photography



for PLEASURE or PROFIT

Prepare for profitable business or fascinating hobby, at home under guidance of qualified instructors. No previous experience necessary, common school education sufficient. Many earn while learning. Our practical studio methods also qualify for well-paying positions upon graduation. Send coupon below at once for free booklet "Opportunities in Modern Photography", particulars and requirements.

AMERICAN SCHOOL OF PHOTOGRAPHY
3601 Michigan Avenue Dept. 1355 Chicago, Illinois

Send booklet, "Opportunities in Modern Photography", full particulars and requirements.

Name..... Age.....
Address.....
City..... State.....

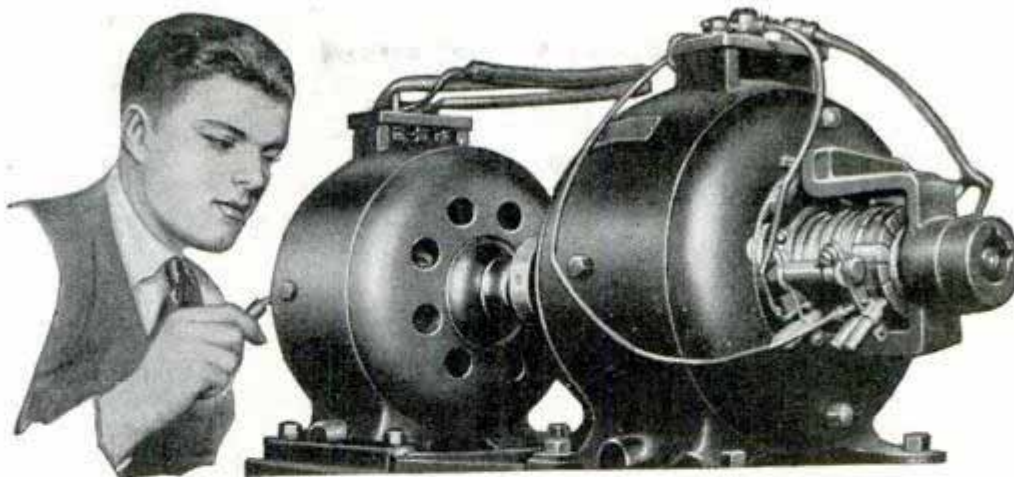

Amazingly Easy Way to train for ELECTRICITY

PAY FOR YOUR TRAINING IN EASY MONTHLY PAYMENTS

Don't spend your lifetime waiting for small raises in a dull hopeless job, or in some work that thousands of others can do. LET ME SHOW YOU HOW TO GET YOUR START IN A MONEY MAKING FIELD. THOUSANDS OF TRAINED MEN MAKE SALARIES OF \$30—\$40—\$50 WEEKLY, and MORE, IN ELECTRICITY—NOT by Book Study but by an amazing way taught RIGHT HERE IN THE COYNE SHOPS IN CHICAGO. Coyne gives you a Practical training in 90 days that should give you a real start to a better paying job in this Big Field. Getting started in Electricity is far easier than you imagine . . . For here at COYNE you can GET TRAINING FIRST, THEN PAY FOR IT IN EASY MONTHLY PAYMENTS. Send Coupon NOW for information.

"Learn By Doing" in 90 Days

Lack of advanced education or previous experience bars no one. I don't care if you don't know an armature from an air brake . . . I don't expect you to! The COYNE method of practical training teaches you on actual, full sized electrical equipment, in our own Five Story Modern Building. When you have finished a job you KNOW HOW . . . Because you did it yourself.

MANY EARN WHILE LEARNING

If you need part time work to help pay your living expenses, my Employment Department will give you this service. I will also tell you about my Low Cost Room and Board Plan. You can get, here at COYNE, the KIND of TRAINING many hundreds of Coyne Graduates have turned into actual CASH. Here at COYNE, every effort is made to make you happy and contented during your training.



PREPARE FOR JOBS LIKE THESE

Thousands of positions in the Electrical Field pay Trained Men \$30 - \$40 - \$50 weekly, and more. Get ready now for your start in this fascinating field. Our Employment Bureau for graduates gives FREE lifetime employment service.

- Armature Winder
- Sub-Station Operator
- Auto & Aviation Ignition
- Maintenance Engineer
- Service Station Owner
- And many others

HERE'S PROOF

" . . . On . . . 1936, I was made meter superintendent for this company. I do not forget that it was COYNE TRAINING that gave me the start in this large, interesting and ever growing field", writes Earl F. Ott of Ohio. . . and "I'm still Chief Electrician and getting along almost perfectly. . . I know that I can take up almost any job that might show up, because if and when I need help, the school will help me. . . . The Coyne School has sure put me where I am today", says Pete Duzenack, in a recent letter from his job in Colorado—and I could go on quoting from hundreds of letters from successful Coyne Trained Men.



COYNE H. C. LEWIS, PRESIDENT FOUNDED 1899
ELECTRICAL SCHOOL
 500 S. Paulina St., Dept. 57-72, Chicago, Ill.

TRAIN

on Actual Equipment

No dull Books, no baffling Charts, No Reciting. At COYNE you get individual training. All real actual work. You build real batteries, wind real armatures, operate real motors, dynamos and generators. You learn house wiring, electric welding, trouble shooting and many other practical phases of the industry.

Now I am including

DIESEL ENGINE, ELECTRIC REFRIG- ERATION AND AIR CONDITIONING

Instruction in these new, rapidly expanding branches of Electricity are now included without extra cost. It is all fully described in the Big FREE COYNE Illustrated Book. Send the Coupon for it Today.

Get the Facts

COYNE Training can be the foundation to the better pay jobs in Electricity. Founded in 1899, Coyne methods have been developed for 38 years. You can have complete information for the asking. Just mail coupon and let me send you the big FREE COYNE BOOK. It is filled with facts and actual pictures of the COYNE Shops in Chicago. Learn about my New Low Cost Room and Board Plan . . . Part-time Employment . . . Easy Monthly Tuition Payments Plan . . . Free Lifetime Employment Service for graduates . . . Lifetime Consulting Service, etc. Act at once . . . Mail the COUPON.

Get this FREE Book

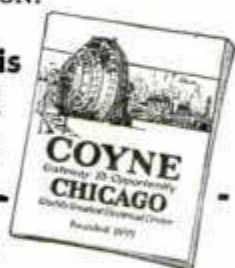

H. C. LEWIS, Pres.,
 COYNE ELECTRICAL SCHOOL
 500 S. Paulina Street,
 Dept. 57-72, Chicago, Ill.

Send me your Big FREE Book and full information on how I can get Practical Training in Electricity.

Name Age
 Address
 City State

When writing to advertisers please mention Popular Mechanics

Arrest Him, Officer!

I'LL HAVE COMPLETE FACTS ON THE OTHER FELLOW TONIGHT!



Follow This Man!

SECRET Service Operator No. 38 is on the job... follow him through all the excitement of his chase after the counterfeit gang. See how a crafty operator works. Tell-tale finger prints in the murdered girl's room that help him solve the great mystery! BETTER than fiction because every word is TRUE. No obligation. Just mail me the coupon and get—

FREE The Confidential Reports No. 38 Made to His Chief

And the best part of it all is this—it may open your eyes to the great opportunity for YOU as a well paid Finger Print Expert. This is a young, fast-growing profession. The kind of work you would like. Excitement! Thrills! Travel! A regular monthly salary. Reward money. And remember: graduates of this school HEAD 47% of all Identification Bureaus in the U. S. Quick! Mail the Coupon NOW and I'll send you these Free Confidential Reports!

INSTITUTE OF APPLIED SCIENCE
1920 Sunnyside Ave., Dept. 1355, Chicago, Illinois

Institute of Applied Science
1920 Sunnyside Ave., Dept. 1355 Chicago, Illinois

Gentlemen:—Without any obligation whatsoever, send me the Reports of Operator No. 38, also your illustrated Free Book on Finger Prints and your low prices and Easy Terms Offer. Literature will NOT be sent to boys under 17 years of age.

Name

Address

Age

When writing please mention Popular Mechanics

ELECTRICAL ENGINEERING ONE YEAR COURSE

Interesting work, interestingly taught in classrooms, laboratories and shops with modern equipment. Approved by educators, endorsed by industry. Excellent Faculty. Suburban Campus. Residence course qualifies graduates for technical positions in electrical industries. 45th year begins September 29th.

CATALOG ON REQUEST.

115 Takoma Ave., WASHINGTON, D. C.



BLISS Electrical School

LEARN MECHANICAL DENTISTRY

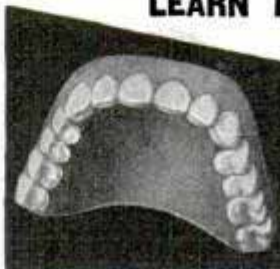

A profession offering unlimited opportunities. Most modern and complete course embracing every branch from Plate to Porcelain Work, which prepares you to work for Dentists or start your own business. Individual instruction—practical training in day or night school. No books—no classes. Catalog upon request.

Dept. 721

McCARRIE SCHOOL OF MECHANICAL DENTISTRY
207 N. Broad St. Phila., Pa.

RADIO ENGINEERING



RCA Institutes offer an intensive course of high standard embracing all phases of Radio. Practical training with modern equipment at New York and Chicago schools. Also specialized courses and Home Study Courses under "No obligation" plan. Catalog Dept. PC-37.

RCA INSTITUTES, Inc.

75 Varick St., New York 1154 Merchandise Mart, Chicago
Recognized Standard in Radio Instruction Since 1909.

LEARN WATCHMAKING AND ENGRAVING



BY OUR PROFIT-SHARING PLAN
OUR GRADUATES SUCCEED

One of our Iowa students started in a very small way—now doing over \$30,000 a year. Another in Wisconsin, over \$10,000 the first year. Day or night classes. Call or write for FREE BOOK, Chicago School of Watchmaking, Dept. 5101, 155 N. Clark St., CHICAGO.



"BECOME A LIGHTNING TRICK CARTOONIST"

Send \$1.00 for Laugh Producing Program of 23 Trick Drawings with Instructions. Catalog of Chalk Talk Supplies FREE! BALDAART SERVICE, Dept. 1. Oshkosh, Wis.

MAIL FOR FREE INFORMATION

BEDFORD YMCA TRADE SCHOOL

1117 Bedford Ave., Dept. PM-48
Brooklyn, New York City, N. Y.

- Diesel Engines
- Diesel Engineering Oil Burner
- Aviation Mechanic Welding
- Aeronautical Engineering
- Auto Mechanic Talking Pictures
- Refrigeration Machine Shop
- Radio and Television Mechanic
- Air Conditioning Sign Painting
- Architectural-Mechanical Drafting
- Electrical Window Display
- Armature Winding

Name

Address

To help you answer these **3** questions:



1 **What are today's opportunities in Drafting?**

2 **Will I like the work?**

3 **Can I learn Drafting readily?**

2 Beginning Lessons in Drafting **Free**

Drafting Opportunities Growing Daily

Before anything can be made or built, the Draftsman *first* must draw it. Building trades, transportation, manufacturing — ALL depend on him. That is why *any* pickup in *any* line means *first call for the Draftsman!*

Fit Yourself for a Job with a Future

Drafting welcomes ambitious men — offers good pay to start, with splendid opportunities for promotion. One of the *stadiest* of all lines. Right from the start, the beginner works side by side with experienced men — inking in their drawings, making tracings, constantly profiting by his contact with seasoned engineers. The "higher ups" see his work. If it is good, advancement is sure and steady.

Pleasant, well-lighted offices are the Draftsman's workroom. He keeps regular hours, with congenial, high grade fellow workers. The work is fascinating — embraces not just *one* line, but *hundreds*.

Drafting Experience NOT Necessary

You can master Drafting readily by home study because you learn and advance *exactly* as professional Draftsmen work — with T-square, dividers and drawing board. *Actual* working conditions are duplicated to the final detail. *Thousands* of successful graduates enthusiastically endorse American School methods, nowhere better exemplified than in our Drafting course.

We want you to see for yourself — before you come to ANY decision — exactly what Drafting is like. We want you to judge your own interest in the work — and our ability to teach you. So we make this 2 Free Lesson Offer.

American School, Drexel Ave. at 58th St., Chicago, Ill.

Prove That You Can Qualify

The 2 lessons will be sent absolutely without obligation. In the privacy of your own room, look them over. See how simply you start — how gradually you are led step by step — how thoroughly you master each point — how, as time goes on, you can pass from a raw beginning to complete *mastery* of Drafting — able to get and hold a pleasant, profitable, steady job. Such a future is well worth looking into **RIGHT NOW**, so . . . just mail the coupon!



Mail Coupon for 2 Lessons FREE

American School, Dept. DD-545

Drexel Ave. at 58th St., Chicago

Without the slightest obligation, send 2 beginning Drafting Lessons and free Bulletin. I am not to return them.

Name.....Age.....

Address.....

City.....State.....

When writing to advertisers please mention *Popular Mechanics*

AUTO-MECHANICS & WELDERS

GOOD JOBS and Mighty GOOD PAY

Do you want to earn big money? If so let us know which of the following trades you prefer. You learn by doing. Practical work. Expert teachers. Low tuition. Personal attention. It will pay you to investigate AT ONCE. Just check the courses you'd like to take and mail today. You will receive full information, absolutely without cost or obligation. But don't delay.

Check the Trade You'd Like to Learn

- Auto Mechanics
- Welding
- Auto Collision
- Spray Painting
- Metal Finishing
- Torch Soldering

Ask about our "Pay After Graduation Plan"

Name

Address

Mail the above to

MICHIGAN TRADE SCHOOL

Write for FREE CIRCULAR

3758 Woodward Avenue DETROIT, MICH.

DRAW

Your own check

Be an artist and be your "own boss"! Many of our graduates are making \$50 to \$100 a week in the profitable field of Commercial Art, Cartooning and Designing. Learn AT HOME, in your spare time, this simple, practical way. Start now on your art career, and gain the ability to make big money.

Artists' Outfit Given

As soon as you enroll, we send you a big full-size professional artists' outfit containing everything you need to get started. Since 1914 our graduates have been making good—YOU CAN TOO!

SOLD FIRST COVER DESIGN — to national magazine. Extra income paid for course, says D. PECKHAM, of Nevada.



This FREE BOOK shows how

Washington School of Art, Studio 125A, 1115—15th St., N. W., Washington, D. C.

Please send me without obligation your Free Book, "Art for Pleasure and Profit."

Name Age.....

Address

City State.....

When writing to advertisers please mention Popular Mechanics

JOBS for PHOTO-ENGRAVERS!!

EARN WHILE LEARNING PHOTO-ENGRAVING IN SPARE TIME—Photo-Engravers are needed to operate Tasope' Photo-Engraving Equipment we sell to publishers everywhere . . . Start training at home in spare time. We furnish all equipment including photo-engraving camera with lamps, lens and screen. Earn while learning by making engravings for local advertisers, newspapers, printers, etc. Copper plate for picture shown here, size 8x10 inches sells for \$15.87. SEND TODAY for job plan details and catalog illustrated with pictures engraved by equipment we furnish. No cost! No obligation.



THE AURORA SCHOOL OF PHOTO-ENGRAVING
Dept. 157 Aurora, Missouri

ENGINEERING

Get a Bachelor of Science Degree! Complete courses and fully accredited degrees in Aeronautical, Architectural, Chemical, Electrical, Industrial and Mechanical engineering. Modern equipment. All college activities. Low tuition. Write Registrar today for full information and catalog.

LAWRENCE INSTITUTE OF TECHNOLOGY
15102 Woodward, Detroit, Mich.

A NON-PROFIT COLLEGE

CATALOG ON REQUEST



PHOTOGRAPHY offers you big opportunities

Get into this profitable field! Cash in on the growing demand for expert photographers! Enjoy a fascinating, profitable career. We give you individual, practical training that will qualify you as an expert in Commercial, News, Portrait, Advertising or Motion Picture photography. Personal Attendance or Home Study courses. 27th year. Write for Free booklet.

NEW YORK INSTITUTE OF PHOTOGRAPHY
10 West 33 St. (Dept. 49), New York

You Can Regain Perfect Speech, if you STAMMER

Send today for beautifully illustrated book entitled "DON'T STAMMER," which describes the Bogue Unit Method for the scientific correction of stammering and stuttering. Method successfully used at Bogue Institute for 36 years—since 1901. Endorsed by physicians. Full information concerning correction of stammering sent free. No obligation. Benjamin N. Bogue, Dept. 178, Circle Tower, Indianapolis, Indiana.

KNOCK-EM-COLD!

THE BIGGER THEY ARE, THE HARDER THEY FALL. LEARN JIU JITSU!

13 secret knock-out blows without fists by 15c world famous Police Jiu Jitsu Instructor

A little jab with tip of fingers or strike with edge of hand to right spot and tough guys go out like a light. Northwest "Mounties" use Jorgensen's system. G-Men must be Jiu Jitsu experts. He has taught many in U. S. Army, Navy, Marines, National Guard, Coast Guard, Police, etc. Send for illustrated course. Price 15c. Also learn how you may defend yourself against any man regardless of size or strength whether he is armed with gun, knife or club. S. J. JORGENSEN, 712 Maritime Bldg., Seattle, Wash.



INVENTING Now Taught for the First Time!

Home study course. Send 3c stamp for free catalog TODAY.

TROFIMOV SCHOOL OF INVENTIVE PRACTICE, INC. 3859 Northampton Rd., Cleveland, Ohio



WHY NOT spend spring, summer, fall, gathering butterflies and moths. I buy hundreds of kinds for collections Some worth \$1 to \$7 each. Simple work with my low cost Instructions, pictures, price list. Profit—Pleasure. Send 10c for Illustrated Prospectus, terms, before sending any butterflies. Mr. Sinclair, Dept. 6, Box 1424, San Diego, California

INVESTIGATE WORK FOR U.S. GOVERNMENT

Thousands of openings yearly. Many Social Security jobs. Men-Women, age 18-50. Start \$105-\$175 month. Get ready now for next entrance test. Details Free. Write OZMENT INSTRUCTION SERVICE, Dept. 111, St. Louis, Mo.

Train at Home...Under Factory Engineers for **GOOD PAY** Spare-Time and Full-Time Jobs in **RADIO**



APPOINTED BY RADIO MANUFACTURERS TO SUPERVISE R-T-I TRAINING

This is the R-T-I Advisory Board—Engineers and Executives of large Radio firms—appointed by these firms to supervise and direct R-T-I Training. Put your future in their hands. 50 great radio manufacturers now endorse this Training.

LEARN TO EARN
UP TO \$75 A WEEK

(MANY R-T-I TRAINED MEN EARN MORE)
MAIL COUPON BELOW



RAY D. SMITH,
President R-T-I,
who has directed
training of 100,000
men. Read what a
few students say.

"Made my first spare time money after finishing four lessons. Over \$500 spare time money in 10 months. R-T-I is O.K."
Delmer Grote, Route 5, Greenville, Ohio

"I made \$14.25 in first 11 days of my training following your instructions."
C. E. Head, 431 Third St., Alexandria, La.

"Before finishing my training I was made Manager of a Department Store's radio section."
Howard N. Lents, 123 W. Alexander St., Buchanan, Mich.

"My job paid me \$18 a week before taking your training. Shortly after starting was averaging \$60 a week. Have made as high as \$250 in single week."
Wm. T. Ridd, 3452 Evelyn St., Verdun, P.Q., Canada

Trained Men Needed in All Branches

If you're dissatisfied with small pay—lay-offs and an uncertain future—here's an opportunity that's too good to miss. At the cost of only the time it takes you to mail the coupon, you can get my big FREE book, "RADIO'S FUTURE AND YOUR OPPORTUNITY." This book tells how you can learn at home under the supervision of factory engineers, to make more money almost at once in Radio—whether you want to make Radio your life's work, or use it to pick up an extra \$5 to \$20 a week in your spare time.

More Opportunities Than Ever Before

Radio is still forging ahead. 1936 beats all other years. Over 6 million new sets sold. Over 30 million dollars paid for service alone this year. Where only a few hundred men were employed a short time ago, thousands are employed today. And where a hundred jobs paid up to \$75 a week—there are thousands of such jobs today—many paying even more. And new jobs are being created all the time—full time jobs and spare time jobs. Get my book and see how easy it is to learn at home for this good-pay work.

"Shop Training" for the Home

R-T-I Training is different than any training you ever heard about. It comes to you right from the heart of the Radio Industry—right out of the factories where Radio sets and other vacuum-tube devices are made. It was planned and prepared and is supervised by big radio engineers IN these factories—by men appointed for the purpose. This means that trained the R-T-I way, you'll be trained as the Radio Industry wants you trained—just as the Radio Industry, itself, would train you if it was doing the job.

Television, Photo Electric Cells, Public Address Systems Included

Radio service work is only the starting point in R-T-I Training. From there it will take you through the whole field of Radio and Electronics. You will learn about every new development, including Television so you'll be ready when Television breaks. You'll also learn the big money subjects such as Aviation and Auto Radio; Public Address Systems; how to handle Photo Cells; Sound Picture Recording, Etc.

4 Working Outfits Furnished

Start almost at once doing part time radio work. I furnish 4 outfits of apparatus that you build into test equipment with which you can do actual jobs and earn extra money. My Training pays its own way and you get your money back if not satisfied.

Age or Lack of Experience No Handicap

You don't have to be a high school graduate, nor even have finished the grades. My Training is so simple, easy, and practical, that the average man, regardless of age, education, or previous experience can master it. It offers the chance you have wanted to get out of a small-pay, no-future job, into good pay work with a future, in Radio and all its branches.

Get My Free Book

INVESTIGATE! Learn why R-T-I Training is different. Find out why R-T-I Trained men get "Quick Results" and "Big Results." Send for your copy of "Radio's Future and Your Opportunity" today. It tells you about Radio's amazing opportunities. It describes my approved training. It tells what R.T.I. students are doing and making. It gives the names of my Advisory Board and 50 endorsing manufacturers. It's FREE. Clip, sign and mail coupon RIGHT NOW!



Big Money in Auto and Police Radio Work

W. H. Carr, 402 N. 16th St., Kansas City, Kansas, an R.T.I. student, has charge of 35 radio equipped cars for the Kansas City Police and Fire Departments. His salary is \$230.00 a month and he is furnished with an automobile, gas, oil, etc. He says, "If I had not taken your course I would not be able to hold this job."



Makes \$600 in One Month

Herbert B. Thomson, Gorman, Texas, formerly an oil well driller, borrowed \$170.00 to start a spare time radio business after completing 12 R-T-I lessons. He made money from the start. In two years his shop was worth \$3500. He says, "Because of my R-T-I Training I made \$450 in September and over \$600 in October 1935. It pays to be R-T-I Trained."

MAIL FOR FREE BOOK

Ray D. Smith, President,
RADIO AND TELEVISION INSTITUTE
(R-T-I),
2130 Lawrence Ave., Dept. 15, Chicago, Ill.
Without obligation, send me a copy of "Radio's Future and Your Opportunity." I am interested in your training and the opportunities in the great field of Radio for the R-T-I Trained Man.

Name.....

Address.....

City.....State.....

RAY D. SMITH, President



RADIO AND TELEVISION INSTITUTE
PRACTICAL SHOP TRAINING FOR THE HOME

Dept. 15 • 2130 Lawrence Avenue • CHICAGO

When writing to advertisers please mention Popular Mechanics



High School Course at Home

Many Finish in 2 Years

You can complete this simplified High School Course as rapidly as your time and abilities permit. Equivalent to resident school work—prepares you for entrance to college. Standard H. S. texts supplied—Diploma. Credit for H. S. subjects already completed. Single subjects if desired. High School education is very important for advancement in business and industry and socially.

College Entrance

During the past 14 years, our High School graduates have been admitted to 531 different Universities, Colleges, Junior Colleges and Normal Schools—80% of them without entrance examination. Course also prepares for teachers' certificate and pre-professional examinations.

Business—Industry

To get and hold a good position in Business today you must be able to write clear, accurate letters and reports—do figuring involving Algebra and Geometry—talk intelligently on matters requiring a knowledge of Geography, History, and Economics.

In Industry—Mechanical and Engineering lines—you must have at least an elementary knowledge of Physics and Chemistry—be able to figure quickly and accurately—know something of Mechanical Drawing and blueprints—and be able to talk and write accurately and clearly on both your work and ordinary topics of conversation.

Our High School course meets the preparatory educational requirements for Business and Industry.

An Educational Institution

The American School was chartered in 1897 as an educational institution, not for profit—and is exempt from paying Federal income tax, like the best resident colleges and universities.

Don't Be Handicapped—Complete Your Training Now

Be a High School Graduate! Prepare yourself for promotion in Business and Industry—for the Professions, College Entrance and social success. No matter what line you may select, High School training will prove invaluable to you! Our moderate fees cover all instruction, standard textbooks and Diploma. Easy monthly terms. Get ahead in life. Start your training NOW!

20 Other Courses

Over 150 noted Educators, Engineers, and Business Men helped prepare our special instruction material, which is used by many resident schools and colleges, U. S. Navy, and Province of Manitoba, Canada. We offer you quality training at home for the best-paying lines of Industry and Business, as listed in the coupon.

Mail coupon for information about line that interests you
American School, Drexel at 58th, Chicago

American School, Dept. H-645, Drexel at 58th, Chicago

Tell me how to train for success in line checked. No obligation.

- | | |
|--|--|
| <input type="checkbox"/> Accounting & Auditing | <input type="checkbox"/> Diesel Engineering |
| <input type="checkbox"/> Architecture & B'lding | <input type="checkbox"/> Drafting & Design |
| <input type="checkbox"/> Automotive Engin'ring | <input type="checkbox"/> Liberal Arts |
| <input type="checkbox"/> Business Management | <input type="checkbox"/> Private Secretary |
| <input type="checkbox"/> Commercial Aeronautics | <input type="checkbox"/> Hi'er Ac't'g (C.P.A.) |
| <input type="checkbox"/> Electrical Engineering | <input type="checkbox"/> Highway Engin'ring |
| <input type="checkbox"/> Electrical Refrigerat'n | <input type="checkbox"/> Mechanical Eng'ring |
| <input type="checkbox"/> Air Conditioning | <input type="checkbox"/> Radio & Television |
| <input type="checkbox"/> Civil Engineering | <input type="checkbox"/> Salesmanship |
| <input type="checkbox"/> Complete Law | <input type="checkbox"/> Steam Engineering |

Name.....
 Address.....

When writing please mention Popular Mechanics

FOR Real FUN Play.
 A Soprani

ACCORDION



● If you want to be really popular, have all the fun, the center of attraction everywhere, just learn to play this thrilling instrument from Italy. A complete band or orchestra in itself, and so easy to learn to play. You'll master this easier Soprani in no time, and you'll have real fun from the start. Don't delay. Big future. Send postal for beautifully illustrated literature. No obligation. Easy terms. Write today sure. 122

SOPRANI, INC.

DEPT. 529, 630 S. WABASH AVE.
 CHICAGO, ILL.

ENGINEERING DEGREE IN TWO YEARS

B.S. DEGREE courses in engineering: Electrical, Civil, Chem., Mechanical, Mech. Drafting, Radio and Television or Aeronautical. Intense, practical, thorough program. No extras for prep. or review. Earn while you learn in this industrial center. Low tuition. Enter March, June, Sept., Dec. Write for catalog. 229 E. Washington Blvd., Fort Wayne, Ind.

INDIANA TECHNICAL COLLEGE

BECOME A SUCCESSFUL FINGER PRINT EXPERT

Prepare for a Thrilling Career with a splendid, steady income. Write for Free Publication and Particulars.
NATIONAL INSTITUTE, Dept. G, Fremont, Nebraska.

LEARN WATCH REPAIRING



AT HOME You can learn by our modern and original system of instruction every part of the Watch Repairing Trade at home. You can earn money while learning and prepare yourself for a well paying position or start in business after completing our course of instruction. Good watch repairers are in demand and generally earn very good salaries. For particulars apply to the Wisconsin School of Watch Repairing 524 E. Mason St., MILWAUKEE, WIS.

NEW YORK SCHOOL OF MECHANICAL DENTISTRY

★ Make more money as a DENTIST. We show you how! Oldest school. Real Laboratory Training. Day - Eve. Easy terms. Tools FREE. Ask for Catalog P. N. Y. SCHOOL of MECHANICAL DENTISTRY, 125 W. 31 St., N. Y. C. ★

LEARN CARTOONING

by the method that has developed hundreds successfully. Send name, address and age for free chart to test your ability.

The Landon School, 1738 National Bldg., Cleveland, Ohio

Amazing Sensational Discovery REFINISHES AUTOS LIKE NEW!

NOT A WAX OR POLISH—LASTS 8 TO 12 MONTHS—SHABBY CARS GIVEN NEW LUSTER AND SHINE

Men — It's unbelievable, a miracle! KAR-NU refinishes old shabby cars in a few minutes. Gives them like-new shine. Not a polish, wax, or paint, but a real finish that lasts 8 to 12 months. Stands washing, sunning, long wear. No rubbing—no polishing—no waxing. Just apply with rag. Guaranteed.



FREE SAMPLE

What a profit-maker for agents and distributors! Millions of cars need this new LOW PRICED auto finisher. BIG PROFITS—up to \$7.00 in an hour, easy. Ten second demonstration on any man's car sells him QUICK. Hurry—get FREE SAMPLE which proves all claims. Write or wire to-day. Distributors Wanted in Foreign Countries. KAR-NU CO., Dept. R-30, Oakley, Cincinnati, Ohio

LOW PRICED GUARAN-TEED

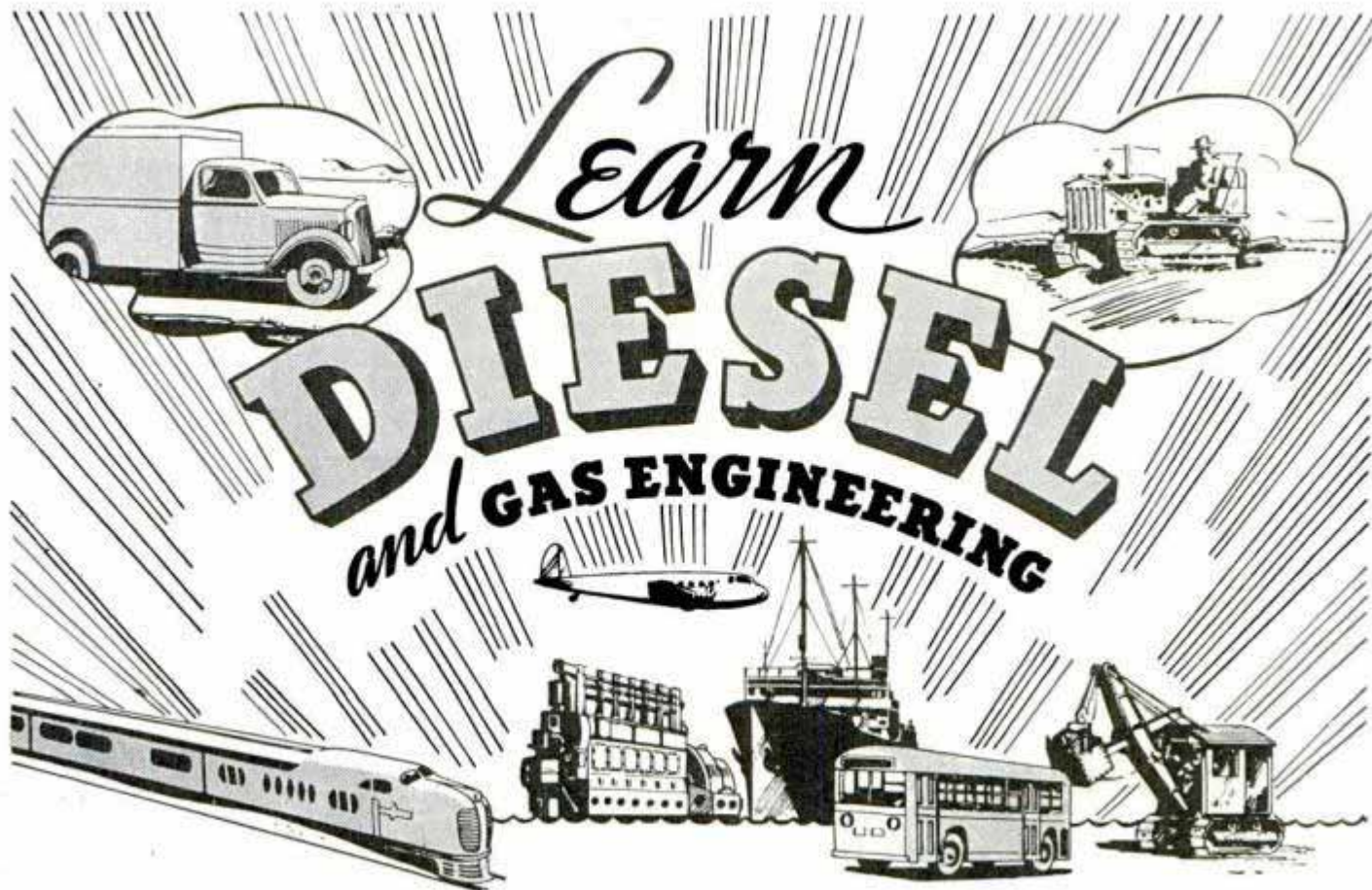

TESTED SYSTEM OF DIESEL AND GAS ENGINE TRAINING

To qualify for a good Diesel job you must receive training in an institution that can offer you practical instruction. At National Schools you actually work on the latest equipment, including practically every approved make of Diesel engine. You get the kind of instruction that serves your every day needs in the Diesel field after you have graduated. It's the type of training you can "cash in" on. You are trained under the direct, personal supervision of licensed Diesel Engineers. You learn Diesel and gas engine operation, repair, trouble-shooting, theory.

Easy-to-Learn Master Training

National Schools' training is complete in every respect. It includes all phases of Diesel engines, fuel injection, gasoline, butane, propane and natural gas engines, also Auto-Diesel electrics, machine shop practice, batteries and other essentials that must be learned in order to give you well rounded-out training.

Learn in Los Angeles

The most delightful place to learn—Los Angeles—the playground of America. Fascinating surroundings. Your coach railroad fare will be allowed to Los Angeles from any point in the U. S.

Earn Room and Board

We help students obtain part-time jobs to earn room and board while learning. This service only for residents of U. S.



Partial Room, Diesel Engine Dept.

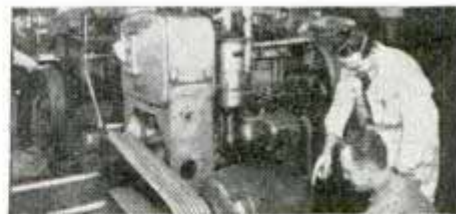

Student Servicing Diesel Electric Unit



Diesel Generating Unit, Diesel Converted Ford Auto

NATIONAL SCHOOLS

Special Added Feature DIESEL ELECTRIC POWER GENERATION

A new feature essential to the complete training of Diesel experts. Completely covers power generation. This extra course is now presented to all Diesel students without extra tuition.

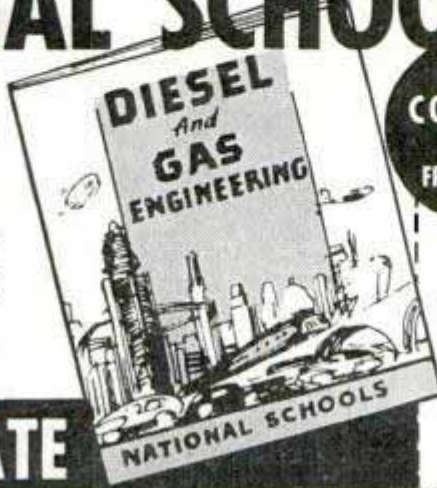

MAIL COUPON for FREE BOOK

National Schools, Dept. 5-PMA
4000 So. Figueroa St., Los Angeles
Send Free Diesel Book of Details.

Name.....Age.....
Address.....
City.....State.....

INVESTIGATE

AUDELS Carpenters and Builders Guides

4 vols. \$6



Inside Trade Information for Carpenters, Builders, Joiners, Building Mechanics and all Woodworkers. These Guides give you the short-cut instructions that you want—including new methods, ideas, solutions, plans, systems and money saving suggestions. An easy progressive course for the apprentice and student. A practical daily helper and Quick Reference for the master worker. Carpenters everywhere are using these Guides as a Helping Hand to Easier Work, Better Work and Better Pay. To get this assistance for yourself, simply fill in and mail the FREE COUPON below.

Inside Trade Information On:

How to use the steel square—How to file and set saws—How to build furniture—How to use a mitre box—How to use the chalk line—How to use rules and scales—How to make joints—Carpenters arithmetic—Solving mensuration problems—Estimating strength of timbers—How to set girders and sills—How to frame houses and roofs—How to estimate costs—How to build houses, barns, garages, bungalows, etc.—How to read and draw plans—Drawing up specifications—How to excavate—How to use settings 12, 13 and 17 on the steel square—How to build hoists and scaffolds—skylights—How to build stairs—How to put on interior trim—How to hang doors—How to lath—lay floors—How to paint.



THEO. AUDEL & CO., 49 W. 23rd St., New York City

Mail Audel's Carpenters and Builders Guides, 4 vols., on 7 days' free trial. If O.K. I will remit \$1 in 7 days, and \$1 monthly until \$6 is paid. Otherwise I will return them. No obligation unless I am satisfied.

Name.....

Address.....

Occupation.....

Reference..... P.M.

DRAFTING



BOOKS SENT FREE!

ON APPROVAL
5 VOLUMES BRAND NEW EDITION
 Only 15 minutes a day with these WONDER BOOKS can prepare you for a good drafting job in less than a year. Mechanical and architectural drafting from simple straight lines to important complex plans. *A step at a time!* Built especially for beginners, for men with only grammar schooling. Drafting room practice, PLUS ENGINEERING, made easy and clear. Includes complete course in blue-print reading.

Big Field Big Demand Big Pay
 Competent draftsmen are urgently needed right now in all building and manufacturing lines at \$30.00 to \$75.00 a week. That's just the beginning—FOR DRAFTSMEN HAVE THE BEST CHANCES FOR ADVANCEMENT. Pleasant, fascinating work, easy to learn and do. Learn quickly with these books—send coupon for a set and see for yourself.

A year's consulting membership in the American Technical Society now gives to all readers of this famous cyclopedia of drafting. Many say that it is worth more than the cost of the books.

Complete set of drawing instruments if you send for these drafting books NOW. These instruments are made of the finest of German silver, are absolutely accurate and are packed in velvet lined leatherette pocket case. Real \$10 value, but included with these books.

AMERICAN TECHNICAL SOCIETY
 Dept. D519, Drexel at 58th St., Chicago, Ill.

American Technical Society, Dept. D519, Drexel at 58th St., Chicago, Ill. Send for 10 days' trial New 5 volume set of drafting. I will pay the few cents delivery charges. If I wish, I may return books in 10 days and owe you nothing but if I decide to keep them, I will send \$2.00 after 10 days, then only \$3.00 a month until \$24.80, the advertising price, is paid. Send latest edition and include drawing instruments.

Name.....
 Address.....
 Attach letter stating age, occupation, employer's name and address and that of at least one business man as a reference.

When writing please mention Popular Mechanics

Start a POTATO CHIP BUSINESS

IN YOUR KITCHEN and MAKE MONEY!

Buy Potatoes for 2c A POUND
 Sell Them as Vita-Seald Chips for 35c A POUND

THERE'S big money in potato chips for any man or woman who wants a business capable of paying as much as \$23.50 a day in profits. Just think of it. You can install the wonderful new machine in your kitchen—just manufacture and sack a sensational new kind of "Greaseless" Potato Chip—and let the stores sell them for you. Only \$2.50 invested in raw materials brings back \$10.00 in cash.



EVERYTHING FURNISHED You don't have to have a lot of money to start this business. A small investment in the machine puts you in a big profit business of your own. I send you everything including speed-slicer, cooker, oil-extractor (for making new "GREASELESS" chip), a big supply of printed bags and free advertising material. No experience is needed as I send complete, simple instructions showing how to make a profit the first day. Prices, pictures, and complete plans will be sent free for the asking.

DON'T BUY ANYTHING Just send your name and address on a post-card for all this Free information including the "Secret of Making Greaseless Potato Chips." No obligation, but hurry, and you may become independent as so many others have done with these fast selling new "Greaseless" Chips. Address your card to

G. H. Hardt, 325 W. Huron St., Dept. C-55, Chicago, Illinois

AMATEUR CARTOONISTS WIN \$25.00

Wanted—Amateurs with humorous ideas. No drawing ability necessary. The amateurs of today are the professional cartoonists of tomorrow. Ideas judged and prizes awarded by Applause-O-Meter test before movie audiences. Everyone has an equal chance. 26 cash prizes in all. Rush name on penny post card for "Valuable Tips on How to Make Money With Simple Cartoons and Humorous Ideas", Cash Prize Entry Blank and Rules—SEND NO MONEY.



CARTOONISTS' EXCHANGE, Dept. 95, Pleasant Hill, Ohio

A AND N SUPPLY CO.
 Bargains—Military, Sport Goods, Firearms, Clothes, Shoes, etc. Send 10¢ for new catalog, to be redeemed on first order.
 A & N Supply Co., 4772 Lester St., Richmond, Va.

Details FREE!

Full Size Professional ARC WELDER

Full size, heavy duty Aladdin Electric ARC WELDER only \$39.25 with De Luxe Accessories! Has efficiency of machines costing \$145.00 to \$800.00. Welds all metals and alloys from heavy motor block and castings to fenders and light sheet metal. Also fine for soldering and brazing. Fully guaranteed. Approved by Automotive Test Laboratories. Easily portable on casters. **WORKS FROM 110-V SOCKET.** Simply plug into 110 Volt or 220 Volt light socket—costs only few pennies an hour to use. Has complete heat controls. Anyone can use easily. Full instructions included. **AMAZING DETAILS FREE!** Write today for sensational facts about Aladdin Arc Welder for \$39.25 including De Luxe Accessories!

Only \$39.25
 With Deluxe ACCESSORIES

COMMONWEALTH MFG. CORP.
 4208 Davis Lane Cincinnati, Ohio
 Dept. U-51

from

around the World

By airplane, train, boat and car — over thousands of miles — has come Diesel data. Letters, books, designs, instructions, and manuals in many foreign languages, have been gathered by a staff of Hemphill engineers seeking MORE and MORE Diesel information. This search for complete, authentic, and up-to-date Diesel engineering material started years ago — it continues month in and month out. It will never cease. That has been and continues to be the task of the Hemphill Diesel Schools corps of engineers. This continuous effort has made possible a course in Diesel engines which is so complete that an important American engine builder wanted a large quantity of the particular Hemphill lesson that described their engine for distribution among their sales and service staffs.

If you plan to enter the Diesel field, remember this: the courses offered by the Hemphill Schools are the combined efforts of many men — the time consuming experiences of practically every engine builder in America and Europe — the accumulation of years of study by many of the world's greatest engineers . . . all of which is made available to you in a manner that will qualify you for a successful career in the Diesel industry.

The shops and laboratories of the Hemphill Diesel Schools are equipped to give every student the facilities for the practical application of the most comprehensive theory training to be had anywhere.

For more complete information on our courses, and the opportunities in Diesel send coupon for FREE 32-page book "March of Diesel". There is no obligation.

HEMPHILL DIESEL SCHOOLS
are America's Original Exclusive Diesel training institution. They are located only in the cities and at the addresses listed below.

BOSTON, 114 Brookline Avenue
NEW YORK, 31-26 Queen's Boulevard, L. I. City
DETROIT, 2341 W. Lafayette Boulevard
CHICAGO, 2014 Larrabee Street
MEMPHIS, 417 Monroe Avenue
LOS ANGELES, 2120 San Fernando Road
SEATTLE, 501 Westlake North
VANCOUVER, B. C., 1363 Granville Street

HEMPHILL DIESEL SCHOOLS (use nearest address)
I am interested in Diesel and its opportunities.
Please send "March of Diesel", without obligation.

Name..... Age.....
Street..... State.....
City.....

m-20-p

When writing to advertisers please mention Popular Mechanics



Amazing New Business

PAYS UP TO \$15 in a Day!

WORK AT HOME

A SURPRISING new profit opportunity is now offered to every ambitious man and woman! A sensational new kind of food business has been invented that can be operated with no previous experience in either full or spare time—a business that brings you up to \$16.25 in a day selling production of one machine at wholesale only.

EVERYTHING SUPPLIED. We supply equipment and plans for making and selling a delicious new greaseless doughnut that is cooked in a remarkable electrical device. Easy to digest and more toothsome than old-style doughnuts ever were. This delicious new dainty—Brown Bobby—costs less to make and sells faster. No wonder so many people without one bit of experience are literally cleaning up "fortunes" with this new money-maker!

COSTS NOTHING

to learn all facts about this wonderful home business. Amazing details sent absolutely FREE—show exactly how you can start at home and make good profits from the very first day! Send your name on a post card for our special quick-starting offer. Do this at once, and this time next week you may actually be in a good business for yourself.

You manufacture—get stores to do your selling for you. You may start taking in profits the very first day. We make it simple and easy for you—absolutely no experience needed. The machine manufactures electrically—a very Brown Bobby a taste-delight.

BROWN BOBBY CO.

325 W. Huron Street
Dept. B-185 Chicago, Ill.

Learn this Profitable Profession



in 90 Days at Home

Hundreds of men and women of all ages 18-50 are making \$10.00 to \$20.00 a day giving scientific Swedish Massage and Hydro-Therapy treatments. There is a big demand from Hospitals, Sanitariums, Clubs, Doctors and private patients as well as opportunities for establishing your own office.

Learn this interesting money-making profession in your own home by mail through our college extension course. Same instructors as in our **NATIONALLY KNOWN** resident school and a diploma is awarded. Course can be completed in 3 to 4 months. No High School training necessary. Many earn big money while learning.

Anatomy Charts & Sample Lessons FREE

Enroll now and we will include anatomy charts, medical dictionary, patented reducing roller and Hydro-Therapy supplies without extra cost. The reducing course alone may be worth many times the modest tuition fee. Send coupon now for reduced price offer. Complete details with booklet containing photographs and letters from successful graduates together with illustrated sample lesson sheets and Anatomy Charts, will be sent FREE.

National College of Massage & Physio-Therapy
Dept. 564—20 N. Ashland Boulevard, Chicago

You may send me FREE and postpaid, Anatomy Charts, illustrated catalog, sample lesson sheets and details of your special offer, also booklet containing photographs and letters from graduates.

Name.....
Address.....
City..... State.....

TO YOUNG MEN— STENOTYPY

THE WAY TO SUCCESS!

Stenotypy, the new profession, offers unusual opportunities to ambitious young men. It's a man's way of recording speech in this machine age—a silent little machine that types plain print letters faster than any one can talk. It opens up preferred jobs now—leads to executive careers later. One of the surest, quickest ways to get into Business on the right basis.

Now you can learn Stenotypy at home in your spare time. Low cost—easy terms. Get full details. Write for valuable, free booklet, "Stenotypy, the New Profession," describing the unusual opportunities for young men in this growing field and telling how you may enter it successfully. Write Dept. 564-ST
THE STENOTYPE COMPANY
4101 S. Michigan Ave., Chicago, Ill.



CARICATURES

For FUN or PROFIT

Quick, easy money for those who want to be their own boss. Caricaturing is as easy as A B C when learned from the simple methods contained in "The ART OF CARICATURE." Twelve Chapters, over 100 pages, supported by over 125 illustrations showing how simple it really is. \$2.00 postpaid, five day money back guarantee.



FREE Complete catalogue of self-educational books on Commercial Art; Cartooning; Lettering; Sign Painting; Show Card Writing; and, Silk Screen Process. **WRITE TODAY.**

Drake & Co., Dept. 201, 179 N. Michigan Ave., Chicago

ENGINEERING

DEGREE IN TWO YEARS

TECHNICAL AND APPLIED COURSES. Nonessentials omitted. TIME AND MONEY SAVED. Degree 2 yrs., diploma 1 yr. Electrical, Mechanical, Architectural, Structural, Civil, Aeronautical, Highway. Short intensive courses 3 and 4 months in Electricity, Power Plant, Diesel, Air Conditioning, Electric Refrigeration, Drafting. Extensive modern equipment. **LOW TUITION.** Part-time work for room and board. Thousands of successful graduates in U. S. and foreign lands. Approved by Industry, endorsed by educators, recommended by alumni. One and two-year courses open in Sept., short courses open year round. 38th YEAR. Catalog free.

FINLAY ENGINEERING COLLEGE
1001 Indiana Avenue Kansas City, Mo.

BARBERING OR BEAUTY CULTURE OLDEST, LARGEST SCHOOLS. Est. 1893. **EARN WHILE LEARNING.** Day, Night classes. Free National employment bureau. Prize winning teachers. Big pay. Professions. Low rates. Easy terms. Free booklet "B."
MOLER SYSTEM, NEW YORK, N. Y., 303 Fourth Ave.

Learn ADVERTISING at Home

Greater opportunities now in advertising. Learn easily and quickly in spare time. Practical work. No text books. Old established school. Low tuition—Easy terms. Send for free booklet of interesting information.

Page-Davis School of Advertising
Dept. 1355, 3601 Mich. Av., Chicago

GO INTO BUSINESS MAKE 100% TO 300% PROFIT!

Sell new and used clothing direct from your home, auto or store. Undersell all competition. **EASY SALES—FAST REPEAT ORDERS!** We furnish everything and show you how. Handsome profits every day in the year. No selling experience necessary. Write at once for our Big Money Catalog—It's FREE!
Liquidation Merchandise Co., 550 E. 43rd St., Dept. D-16, Chicago, Ill.

\$ AGENTS 500% Profit GOLD LETTERS

For Store Fronts and Office Windows. Anyone can put them on. Free samples. Liberal Offer to general agents.
METALLIC LETTER CO., 438 N. Clark St., Chicago

NEW SCIENTIFIC WONDER



"X-RAY" CURIO
10c 3 for 25c
"Silver Only"
Reg. U.S. Pat. Off.

BOYS BIG FUN. You apparently see thru cloth, Wood, Stone, any object. See Bones in Flesh. **FREE PACKAGE** radio picture films, take pictures without camera. "You'll like 'em." 1 package with each 25c order.
MARVEL MFG. CO., Dept. 80 — NEW HAVEN, CONN.

Founded on an ideal

WHEN the International Correspondence Schools came into existence 46 years ago, the institution was founded on an ideal of service.

This ideal today, after more than two score years of demonstration, is equally sincere and its influence has become world-wide.

This ideal does not interpret itself as a shortcut to education. It is not a substitute for any other medium of education. It is co-operative rather than competitive. It recognizes the importance of grammar school, high school, college and university. It aims to impart technical training to ambitious men at work, adapting its courses to the needs of the individual.

The average student of the International Correspondence Schools is 27 years old. He

is married. He left school at 16 years of age, after two years of high school. He is ambitious. He wants advancement and the rewards it brings. He realizes his need for training, believes it is available through courses offered him by the International Correspondence Schools. He is told from the start that the benefits he will receive will depend upon his own effort and utilization of spare time. The fact that these courses are prepared and constantly revised by leading authorities is not assurance of his individual success. The fact that he receives personal attention from expert instructors is not the final measure of his progress. His future, after all, is in his own hands.

In 100,000 homes today, men are studying International Correspondence Schools Courses. Many of the nation's outstanding business leaders are graduates of this pioneer in the home-study field. On the record already achieved, many I. C. S. students today will be business leaders of tomorrow.

Education and training for those who were denied it at grammar school, high school, college age. And specialized training for those who need it—that is one of the missions of International Correspondence Schools.

INTERNATIONAL CORRESPONDENCE SCHOOLS

SCRANTON

PENNSYLVANIA

Member: National Home Study Council

INTERNATIONAL CORRESPONDENCE SCHOOLS

BOX 5671-H, SCRANTON, PENNA.

★ Without cost or obligation, please send me a copy of your booklet, "Who Wins and Why," and full particulars about the subject *before* which I have marked X: ★

TECHNICAL AND INDUSTRIAL COURSES

- | | | | | |
|--|---|--|--|--|
| <input type="checkbox"/> Architect | <input type="checkbox"/> Sheet Metal Worker | <input type="checkbox"/> Plumbing | <input type="checkbox"/> Steam Fitting | <input type="checkbox"/> Bridge Engineer |
| <input type="checkbox"/> Architectural Draftsman | <input type="checkbox"/> Boilermaker | <input type="checkbox"/> Heating | <input type="checkbox"/> Ventilation | <input type="checkbox"/> Bridge and Building Foreman |
| <input type="checkbox"/> Building Estimating | <input type="checkbox"/> Telegraph Engineer | <input type="checkbox"/> Air Conditioning | | <input type="checkbox"/> Chemistry |
| <input type="checkbox"/> Contractor and Builder | <input type="checkbox"/> Telephone Work | <input type="checkbox"/> Steam Engineer | <input type="checkbox"/> Radio | <input type="checkbox"/> Pharmacy |
| <input type="checkbox"/> Structural Draftsman | <input type="checkbox"/> Mechanical Engineering | <input type="checkbox"/> Steam Electric Engineer | | <input type="checkbox"/> Coal Mining |
| <input type="checkbox"/> Structural Engineer | <input type="checkbox"/> Mechanical Draftsman | <input type="checkbox"/> Marine Engineer | <input type="checkbox"/> Toolmaker | <input type="checkbox"/> Mine Foreman |
| <input type="checkbox"/> Management of Inventions | <input type="checkbox"/> Machinist | <input type="checkbox"/> R. R. Locomotives | | <input type="checkbox"/> Fire Bosses |
| <input type="checkbox"/> Electrical Engineer | <input type="checkbox"/> Patternmaker | <input type="checkbox"/> R. R. Section Foreman | | <input type="checkbox"/> Navigation |
| <input type="checkbox"/> Electric Lighting | <input type="checkbox"/> Diesel Engines | <input type="checkbox"/> R. R. Signalmen | | <input type="checkbox"/> Cotton Manufacturing |
| <input type="checkbox"/> Welding, Electric and Gas | <input type="checkbox"/> Aviation Engines | <input type="checkbox"/> Air Brakes | | <input type="checkbox"/> Woolen Manufacturing |
| <input type="checkbox"/> Reading Shop Blueprints | <input type="checkbox"/> Automobile Mechanic | <input type="checkbox"/> Highway Engineering | | <input type="checkbox"/> Agriculture |
| <input type="checkbox"/> Heat Treatment of Metals | <input type="checkbox"/> Refrigeration | <input type="checkbox"/> Civil Engineering | | <input type="checkbox"/> Fruit Growing |
| | | <input type="checkbox"/> Surveying and Mapping | | <input type="checkbox"/> Poultry Farming |

BUSINESS TRAINING COURSES

- | | | | |
|--|---|---|--|
| <input type="checkbox"/> Business Management | <input type="checkbox"/> Bookkeeping | <input type="checkbox"/> Service Station Salesmanship | <input type="checkbox"/> Grade School Subjects |
| <input type="checkbox"/> Industrial Management | <input type="checkbox"/> Secretarial Work | <input type="checkbox"/> First Year College Subjects | <input type="checkbox"/> High School Subjects |
| <input type="checkbox"/> Traffic Management | <input type="checkbox"/> Spanish | <input type="checkbox"/> Business Correspondence | <input type="checkbox"/> College Preparatory |
| <input type="checkbox"/> Accountancy | <input type="checkbox"/> French | <input type="checkbox"/> Stenography and Typing | <input type="checkbox"/> Illustrating |
| <input type="checkbox"/> Cost Accountant | <input type="checkbox"/> Salesmanship | <input type="checkbox"/> Civil Service | <input type="checkbox"/> Cartooning |
| <input type="checkbox"/> C. P. Accountant | <input type="checkbox"/> Advertising | <input type="checkbox"/> Mail Carrier | <input type="checkbox"/> Lettering Show Cards |
| | | <input type="checkbox"/> Railway Mail Clerk | <input type="checkbox"/> Signs |

DOMESTIC SCIENCE COURSES

- | | | | |
|---|---|--|--|
| <input type="checkbox"/> Home Dressmaking | <input type="checkbox"/> Advanced Dressmaking | <input type="checkbox"/> Millinery | <input type="checkbox"/> Foods and Cookery |
| <input type="checkbox"/> Professional Dressmaking and Designing | | <input type="checkbox"/> Tea Room and Cafeteria Management, Catering | |

Name..... Age..... Address.....

City..... State..... Present Position.....

If you reside in Canada, send this coupon to the International Correspondence Schools Canadian, Limited, Montreal, Canada

INVENTORS

Send for Valuable Facts *about*

David Sarnoff says:

David Sarnoff, once a poor lad and now the famous President of the Radio Corporation of America, in an article in Liberty Magazine states: "Civilization means elimination of unnecessary labor. The sewing machine and the vacuum cleaner save millions of women from backbreaking toil. The tractor makes the farmer's life bearable. The automobile lends wings to us all. The airplane is our magic carpet. It would be madness to slow up invention because our trouble is not that mechanical science moves too speedily, but that the governmental and social sciences move too slowly . . . In a world reorganized to vibrate within certain wave bands, human intelligence will be able to distribute equitably nature's bounties from above and below, and make princes of paupers."



Since the "Horseless Buggy" Days, We Have Helped Inventors

Perhaps you have already heard about our firm, because one client tells another—and we have served men in every state in the Union, and in nearly every foreign country. We have been working with inventors since 1898. If you have a good invention—or an idea for one—and don't know what Victor J. Evans & Co. can do for you, NOW is the time to find out.

How We Can Help You

Both the Patent Office and the U. S. Supreme Court have made it clear that the inventor needs the assistance of a competent patent lawyer when it comes to protecting an invention. It is one thing to think up a good invention—it is another to get effective patent protection on it.

For more than a third of a century—it has been our business to give sound advice and counsel to inventors. Our free books (described on the opposite page) tell what steps to take first, how to protect yourself, how the laws protect you, what you must do, when to offer your invention for sale, how others have succeeded, and much more. You need this information.



Simple Inventions May Have Excellent Commercial Possibilities

Frequently inventors confuse the size or the complication of a device with the question of commercial value and patentability. These two factors, of course, have no relation to each other. Most of our present-day complicated machines represent a process of evolution, a series of inventions. On the other hand, every so often some inventor comes along with a very simple "gadget" which possesses the elements of broad utility and is patentable. Some of the most profitable inventions have been of this latter class. Shown above are a few such examples. Whether a device is simple or complex, if it represents a forward step to save manufacturing costs, to save labor, or to add enjoyment to human life, it may prove patentable and profitable. This subject is more fully discussed in the booklet entitled "Patent Protection" shown on the opposite page.



What Will Be Next?

Ever since George Washington signed the first patent, America has led the world in inventions. It may be said that not a year has gone by without some important inventions being patented and commercialized. David Sarnoff, president of the Radio Corporation of America, sees a big future ahead for science and invention. Just as sure as the sunrise, 1937 will see new inventions come out—new wealth made from patents. Your idea may be one of them. You never can tell. For this reason you should send for our books today and get the facts about patents and inventions.

**Learn How Our Patent Laws
Protect You**

The U. S. has liberal patent laws, and much of our national wealth is based on patents. In fact, a Japanese commission decided that American progress was mainly due to our patent laws. These laws are made to protect you. Find out about them now. This is for your own good.



**These FREE
Books Tell You**

Get the answers to your questions: How can I protect my invention? When can I show my invention to manufacturers? When can I offer it for sale? How should I go about selling it? Can I get protection without a patent? What are my employer's rights? These and other important questions are fully answered.

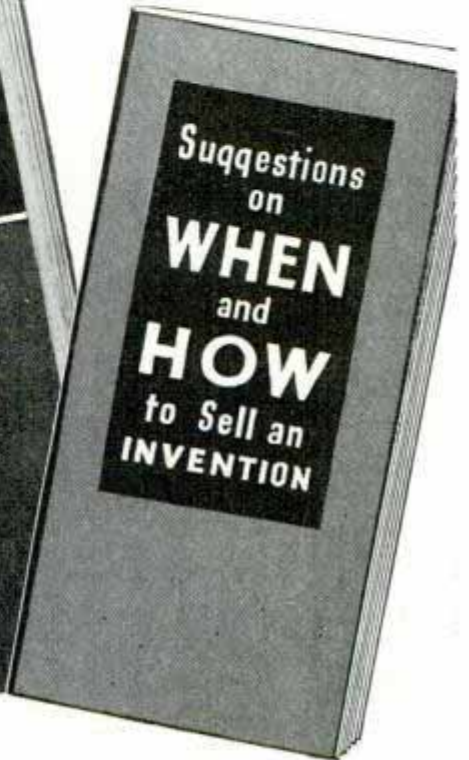

**PATENTS
and Selling
Inventions**

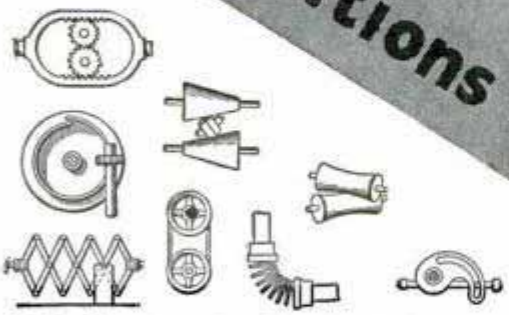

115 Mechanical Principles Shown

Request the book "Patent Protection" (sent free to inventors). Not only does it tell you what to do for protection, and how to do it—it also shows you 115 different mechanical movements that you may use in developing your own inventions. Inventors tell us they have found these useful.

Mail Coupon Today

Delays are dangerous. If you have a good invention you should get protection for it just as soon as possible. Don't turn this page until you have clipped and mailed this coupon—you will hear from us by return mail.

**VICTOR J.
EVANS & Co.**

REGISTERED PATENT ATTORNEYS
Main Offices: 200-E, Victor Building,
Washington, D. C.

Other Offices: 1007-N, Woolworth Bldg., New York
1445-N, Monadnock Bldg., Chicago
514-N, Empire Bldg., Pittsburgh
1010-N, Hobart Bldg., San Francisco
736-N, Security Bldg., Los Angeles

Send me FREE copies of your books, "Patent Protection" and
"When and How to Sell an Invention." (Note: Same books
supplied by any of branch offices listed above.)

Name.....
Street and No.....
City or Town.....

DON'T BUY

Until you have seen and tried out these wonderful instruments at your dealer



Don't buy Guitar, Mandolin, Banjo, Electric Guitars, Ukuleles, or Drums, until you have tried the Slingerland May-Bells, Guaranteed More for your Money. Wonderful, snappy, powerful, pleasing tone. No equal in price. Sold on easy payments and 5 days free trial by all leading music dealers.



Cut This Adv. Out — Good for \$1.00 Credit

Send for free catalog. Mention instrument wanted.

Write today:

Slingerland Musical Instrument Mfg. Co.,
1325 Belden Ave., Chicago, Illinois

Diesel... the NEW POWER



The amazing performance of the Diesel powered Burlington Zephyr trains has opened a new era of power efficiency. Airplanes, automobiles, great industrial plants will soon be using these marvelously efficient engines. This means a new profession, a new trade for thousands of men. Learn Diesel operation, construction and repair NOW through our brand new quick reference encyclopedia, the only complete encyclopedia on Diesel Engineering.

5 Big Books Shipped FREE

for examination. If you want to get into the most promising new field of the century, the liveliest, most up-to-date, most talked of profession, send for these books on our amazing free shipment offer. Over a thousand pages profusely illustrated and right up to the minute. Examine these books, read them, test them and if not thoroughly satisfied return them at our expense and you won't owe us one cent.

➔ Consulting Membership Included

Send now and we will include without extra charge a one year consulting membership in the American Technical Society with privilege of consultation with our engineers on any difficult problem.

AMERICAN TECHNICAL SOCIETY
Drexel at 58th Street, Dept. 0519, Chicago, Illinois.

You may send me the new 5 volumes on Diesel Engineering for ten days free examination. I will pay the few cents express only. Will examine the books and return them in ten days unless I decide to keep them, in which case I agree to send you \$2.00 in ten days and \$3.00 a month until the introductory price of only \$15.00 is paid.

Name.....
Address.....
City.....State.....

Please attach a letter giving age, occupation and the name and address of your employer and that of at least one business man as reference.

When writing to advertisers please mention Popular Mechanics

AMAZING NEW ELECTRIC ARC WELDER



HOOK UP TO ANY BATTERY!

RETAILS Only \$1.95

Just invented! Amazing new Comet ELECTRIC ARC WELDER—hooks up to any storage battery—generates tremendous heat to weld all metals. PRICE, ONLY \$1.95, complete. Repairs fenders, auto bodies, galvanized cans, radiators, castings, machinery parts, etc. Fuses broken parts permanently, stronger than before. Low power consumption. Take the Comet anywhere to the job, operate from auto battery. Sturdily built of finest materials to last years. FULLY GUARANTEED BY BIG MANUFACTURER.

SEND NO MONEY! You'll find a thousand uses for the Comet around your home, garage, and work shop. Thousands of garages need the Comet Welder. Also factories, repair shops, mechanics, farmers, inventors, tin shops, plumbers, etc. Order a Comet now. Send no money. We'll rush one to you, complete with rods. Pay postman only \$1.95 plus few cents postage. If not delighted, return Comet in 5 days from receipt and money you paid for it will be refunded instantly. Rush your order NOW. Comet Welders, Dept. U-155, Cincinnati, Ohio

GAG-CARTOON!



AND MAKE BIG MONEY—AT HOME—BY MAIL! Magazines pay up to \$200.00 per cartoon. Get in this NEW FIELD and be your own boss! My 50 lesson—1000 illustration course shows you how. FREE CARTOON MARKETS INCLUDED—only \$2.80 course of its kind. All for.....
Free Drawing Set if you act at once.
WRITE TODAY—Stamp brings FREE details.
MOON GAG-CARTOON SCHOOL
Paramount Bldg. Dept. A-1, Fall Creek, Wis.

TECHNICAL BOOKS

Over 1500 Technical books of all publishers available to you at half price or less! Chemistry, Electricity, Physics, Astronomy, Technology, Research, Engineering and other subjects. Send for handsome big new catalogue. It will save you many dollars. Just mail 10c in stamps or coin to cover shipping and mailing.

at 1/2 price or less

Chemical Publishing Co. of New York, Inc.
148 Lafayette Street, (Dept. 4) New York City

AUTOMOBILE RACING New Book

(FOURTH EDITION)

Nine Chapters—66 illustrations of dirt, midget and championship cars and drivers. How to build cars and bodies—14 plates working drawings. Converting stock cars to 135 m.p.h. racers. Answers all questions on speeding up cars, balance, speed, revs., rules, specifications, track records, etc. Postpaid \$1.00, C.O.D. \$1.12. Order NOW, Ray Kuns, Dept. B-5, Madisonville, Cincinnati, Ohio.

RADIO

ENGINEERING, broadcasting, aviation and police radio, servicing, marine and Morse telegraphy taught thoroughly. Nine months' engineering course equivalent to three years' college radio work. School established 1874. All expenses low. Catalog free.
Dodge's Institute, Ada St., Valparaiso, Ind.

Save Your Feet

When all else fails end your suffering with the flexible "no metal"

Heefner ARCH SUPPORT

Write for Free Booklet



HEEFNER ARCH SUPPORT CO., 657 Commercial Bldg., LOUISVILLE, KY.



Will You Give Me 7 Days to PROVE I Can Make YOU a *New Man*?

LET ME START SHOWING YOU RESULTS LIKE THESE

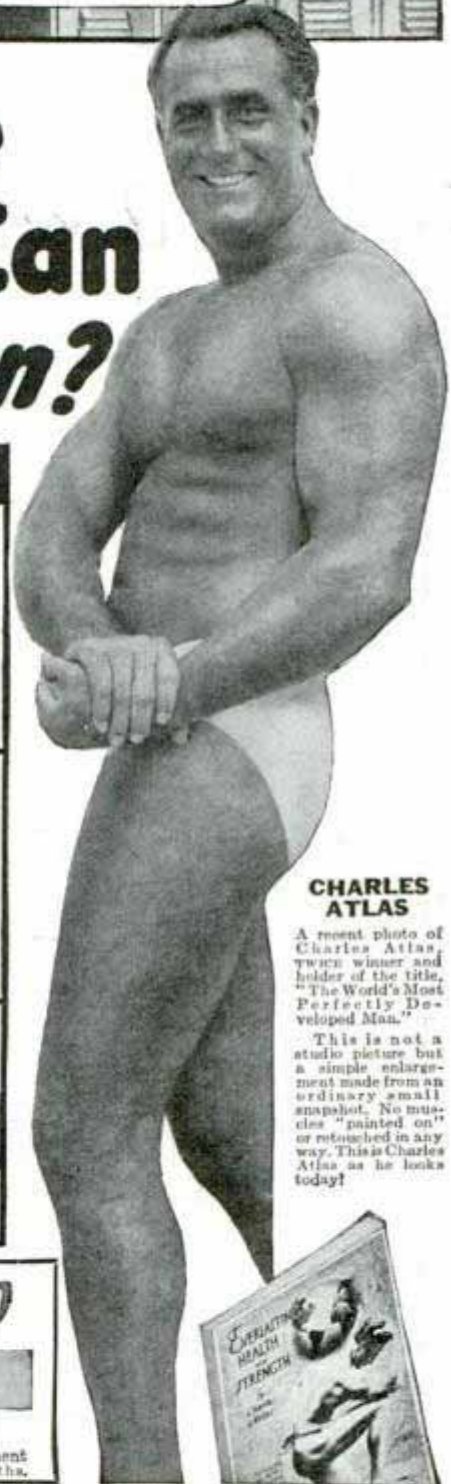
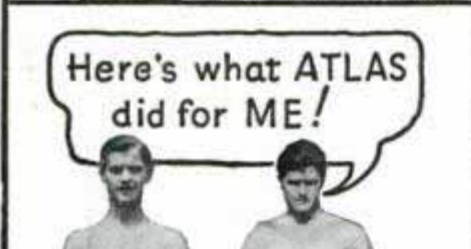

CHARLES ATLAS
A recent photo of Charles Atlas, twice winner and holder of the title, "The World's Most Perfectly Developed Man."

This is not a studio picture but a simple enlargement made from an ordinary small snapshot. No muscles "painted on" or retouched in any way. This is Charles Atlas as he looks today!

7-Day TRIAL OFFER

I could fill this whole magazine with enthusiastic reports from OTHERS. But what you want to know is—"What can Atlas do for ME?" Find out—at my risk! Right in first 7 days I'll start to PROVE I can turn YOU into a man of might and muscle. And it will be the kind of PROOF you (and anyone else) can SEE, FEEL, MEASURE with a tape!

My FREE BOOK tells about my amazing 7-DAY TRIAL OFFER—an offer no other instructor has ever DARED make! If YOU want smashing strength, big muscles, glowing health—I'll show you results QUICK!

FREE BOOK

I myself was once a 97-pound weakling—sickly, half-alive. Then I discovered "Dynamic-Tension." And I twice won—against all comers—the title, "The World's Most Perfectly Developed Man!" I have no use for apparatus. "Dynamic-Tension" ALONE (right in your own home) will start new inches of massive power pushing out your chest—build up your shoulders to champion huskiness—put regular mountains of muscle on your biceps—free you of constipation, pimples—make those stomach muscles of yours hard ridges! Make me PROVE It! Gamble a postage stamp. Send coupon for my FREE BOOK AT ONCE! Address me personally: Charles Atlas, Dept. 8T, 115 East 23rd Street, New York, N. Y.



CHARLES ATLAS, Dept. 8T, 115 East 23rd Street, New York, N. Y.

I want proof that DYNAMIC-TENSION will make a new man of me—give me a healthy, husky body and big muscle development. Send me your free book, "Everlasting Health and Strength."

Name
(Please print or write plainly)

Address

City..... State.....

When writing to advertisers please mention Popular Mechanics

STAMPS

..... *and* **Collecting**

Is 226

By Richard McP. Cabeen
A. 900 333 N. Michigan Chicago



Illustrations courtesy De Soto Stamp and Coin Co., and Garden City Stamp Agency, Chicago

Some recent stamp issues, including the semi-postal issue of Estonia, at top. The block in the center shows a recent addition to the stamps of South Africa

THREE basic forms of printing, engraving, typography and lithography, all are used in stamp manufacture. Many similar stamps have been produced by at least two of the processes, and in nearly every case one is more valuable than the other.

In Finland, the issue of 1901 showing the arms of Russia, was originally lithographed and later issued in typography. In Chile, the portrait issues of 1911 to 1913 were engraved, but in 1915 all of those in single colors were typographed, while the bicolored higher values were issued with engraved and typographed frames. In the United States stamps, designs which had been engraved originally were used for lithographed stamps in 1918-20.

These stamps are all easy to obtain and illustrate the essential differences between the various processes. Engraving provides the finest examples of stamp printing. In principle, it is exactly the reverse of type printing, for the ink which forms the design comes from the recesses in the plate rather than from the raised portions. Etchings are a simple form of engraving, and the line-engraved stamps of the United States are examples of fine engraving.

In all such cases the printing is done with ink which is retained in lines or recesses below the surface of the plate. The printing plate is a smooth and highly polished plate of copper or steel covered with

(Continued to page 34A)

VACU-MATIC SCORES AGAIN!

BOB McKENZIE
 TRANSCONTINENTAL AUTOMOBILE CHAMPION
 COAST TO COAST

Vacu-matic Carburetor Co.
 7617 W. State St.
 Wauwatosa, Wisconsin

Dear Sirs:

Having just completed a new speed record between Los Angeles and Chicago, driving a 1936 Chevrolet equipped with a Vacu-matic carburetor control, I thought you might be interested in knowing some of the facts and the important part Vacu-matic played in the success of the run.

The distance covered was 2322 miles in thirty nine hours and forty-two minutes, officially timed by Western Union, which gave me an average speed of 59.7 M.P.H. based on elapsed time and with the Vacu-matic averaged 18 1/2 miles per gallon on gasoline.

Before leaving Los Angeles, we made several test runs both with and without the Vacu-matic, and the tests proved that Vacu-matic increased my gas mileage 3 1/2 miles per gallon at the driving speed of 60 M.P.H. and also very noticeable increase in both acceleration and power.

After this experience with Vacu-matic, you can depend that on my future speed runs across country that I will be depending on Vacu-matic to give me the same added performance it has proven on this last record breaking drive.

Yours very truly,

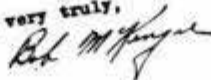

Sets New Coast-to-Chicago Record

New Supercharge Principle SAVES GAS

**MORE POWER - MORE SPEED
 FASTER PICK-UP - NEW LIFE**

WESTERN UNION
 TIMED
 NEW YORK
 TO
 LOS ANGELES
 24 hrs. 40 min.
 LOS ANGELES
 TO
 NEW YORK
 27 hrs. 26 min.
 CANADA
 15,000 miles
 18 days
 LOS ANGELES
 TO
 NEW YORK
 AND RETURN
 181 hrs. 52 min.
 WASHINGTON, D.C.
 TO
 MEXICO CITY
 82 hrs. 27 min.
 LOS ANGELES
 TO
 PHOENIX
 8 hrs. 18 min.
 MURDOCK LAKE
 1947 mi. in 24 hrs.
 LOS ANGELES
 TO
 CHARLOTTE, N.C.
 11 hrs. 27 min.
 ALPAC, W.V.
 TO
 DUNSMIRE, N.C.
 1000-21 min.



ESTABLISHING new mileage records on cars in all sections of the country, the Vacu-matic again scores in a new speed record established by Bob McKenzie transcontinental automobile champion. Los Angeles to Chicago—2,322 miles in 39 hours and 42 minutes—driving 75 and 80 to maintain a speed average of 59.7 miles per hour!

Here is speed—a grueling grind—where quick acceleration, greater top speed — and less stops for gasoline mean those precious moments saved that make new speed records possible. The same Vacu-matic that helped Bob McKenzie establish this speed record and gave him such fine gas savings is now available for all car owners. It is positively automatic—simple to install—inexpensive—and pays for itself many times over in gas savings.

Automatic - - Nothing Like It!

Vacu-matic is entirely different! It operates on the supercharge principle by automatically adding a charge of extra oxygen, drawn free from the outer air, into the heart of the gas mixture. It is entirely AUTOMATIC and allows the motor to "breathe" at the correct time, opening and closing automatically as required. No idling troubles—no carburetor adjustments necessary. It is so simple it will amaze you—so practical it will save you many dollars on gas costs.

Fits All Cars

VACU-MATIC is constructed of six parts, assembled and fused into one unit, correctly adjusted and sealed at the factory. Nothing to regulate. Easily attached in ten minutes.

Agents and Salesmen

VACU-MATIC offers a splendid opportunity for unusual sales and profits. Valuable territories now being assigned. Check and mail coupon.

The VACU-MATIC Co. Wauwatosa, Wis.

Guaranteed Gas Savings

VACU-MATIC must prove itself on every car. It is guaranteed to give worthwhile gas savings, quicker pick-up and more power, or it costs you nothing. "On my V-8 Ford it works miracles", says Ralph Fields. James Seeley—"On an International Truck on a round trip to Cleveland, 385 miles, it saved 19 gallons of gas." A. V. Grove—"On the Buick it showed 5 miles more per gallon." F. S. Peck—"I average 22 miles per gal. on my Plymouth, an increase of 7 miles, for a saving of \$15.00 a month, or \$180.00 a year." Wm. Lyons—"Averaged 25 miles on a gal. with a Model A Ford at 40 miles per hour."

Free Details

You owe it to yourself to know all about this remarkable discovery. Mail the coupon below. Start saving gas with VACU-MATIC and enjoy a new driving thrill! There's no obligation—so get the facts now! Write today!

FREE OFFER COUPON

THE VACU-MATIC COMPANY
 7617-302 W. State St., Wauwatosa, Wis.

Gentlemen: Please send me full particulars concerning the Vacu-matic and details of your Free Offer. This of course does not obligate me in any way.

Name

Address

City State

Check here if interested in selling proposition.



*Small
Inventions*
**THAT HAVE
BUILT BIG
BUSINESSES**

INVENTIONS

do not have to be complicated to be profitable when Patented. The 5c and 10c stores flourish on simple Patented products which are commercially successful. The zipper, safety pin, thumb tack, paper clip, collar button—all simple, yet familiar inventions—brought their inventors rich rewards. If you have a Patentable invention—act to protect it. Many of the most useful, widely popular, greatly profitable, and ex-

tremely successful inventions have been very simple ones. You have only to look at the devices we have pictured here to realize how a simple invention may become a utility bought by a hundred thousand or a million people soon after it is produced. Don't be afraid that the simplicity of your invention makes it valueless. The thing that you find so simple that you wonder why a thousand other people haven't already done it is often the invention worthwhile.

HOW OTHER INVENTORS GOT STARTED



The list of men who succeeded in invention with only a poor boy's start is a very long and noble one. Poverty, hardships, lack of friends, distance from the market—these could not hold back Bell, Edison, Eastman, McCormick, Whitney and others. Everyone cannot succeed. But every man can try. Courage, sacrifice, and hard work may bring you a measure of the success these men had. Lack of mechanical ability is not a serious drawback. You can always get someone able to build a model, draw a detailed design, or otherwise materialize your invention for you. The big draw-back is discouragement.

Your invention of a practical article or an improvement upon an old one should be

patented NOW. Frequently many of the thousands of applications filed in the U. S. Patent Office each year are for the same or almost the same invention. In such a case, the burden of proof rests with the last application filed. Sometimes a delay of even a few days in filing the application means the total loss of the patent. **LOSE NO TIME.**

The entire time of this large and experienced organization is devoted exclusively to patent and trade-mark cases. We know the rules and requirements of the Patent Office. We understand the technicalities of Patent Law. We can proceed in the quickest and safest ways in preparing an application for a patent covering your invention.

FREE THE BIOGRAPHY OF GEORGE EASTMAN
Views of the man who used Patent Protection to amass millions and give perfection to a new art—*Photography*—itself one of the greatest inventions.

CLARENCE A. O'BRIEN & HYMAN BERMAN

704 ADAMS BUILDING

WASHINGTON, D. C.

Registered Patent Attorneys Before U. S. Patent Office

When writing to advertisers please mention Popular Mechanics

Send For This
FREE BOOK

TORS

PROTECT YOUR
INVENTIONS
WITH U.S.
PATENTS

If you have an invention that is patentable—and want to secure for yourself your inventor's sole right to profit from the invention—you can't afford to lose time in securing the protection of a U. S. Patent. Other inventors may be working on the same invention right now. Should they develop this invention and file patent application before you do—the burden of establishing priority will be upon you. Our Big Book—"Patent Guide for the Inventor"—will tell you the quickest possible way to secure Patent Protection for your invention. **SEND FOR IT TODAY!**

The **FIRST IMPORTANT STEP** in **SECURING A PATENT**—is to obtain the services of a Registered Patent Attorney. The U. S. Patent Office advises that you secure the aid of an experienced Registered Patent Attorney to prepare your statements. Establish the date of your invention as explained in our book and disclose your invention to him in correct form. He then makes a **SEARCH** of the Patent Office Records and reports to you on existing U. S. Patents which might bear on your invention, giving his opinion on the advisability of proceeding and filing formal application.

REASONABLE FEES—CONVENIENT TERMS. Don't worry about finances. Our fees are very reasonable—we can arrange convenient terms of payment. It is our custom to permit clients to pay for our services in installments as the application progresses in our office. See our Big Book for fees in obtaining Patent. It explains our arrangements clearly. Send for it **NOW!**

FREE RECORD OF INVENTION FORM—Use our FREE "Record of Invention" form to assist you in recording the descriptive outline of your invention and to establish the date of your invention. With it you can make a rough sketch of your invention and have it witnessed in a manner of value to you as evidence should occasion arise.

**TEAR OFF AND
MAIL NOW!**

**CLARENCE A. O'BRIEN
& HYMAN BERMAN**

704 Adams Building

WASHINGTON, D.C.
REGISTERED PATENT ATTORNEYS
BEFORE U.S. PATENT OFFICE

Please send me at once your Big Free 48-Page Book, "Patent Guide for the Inventor" and your Specially Prepared "Record of Invention" form. Also George Eastman Biography, "Inventor and Business Man." This request does not obligate me. (Please write or print plainly)

NAME.....

ADDRESS.....

PATENTS

Booklet Free Highest References
Promptness Assured Best Results

Send drawing or model.

ALL BUSINESS GIVEN PROMPT AND PROPER ATTENTION

Listed Patent Lawyer in the latest editions of the Rand-McNally Directory of Bankers and Bank-Recommended Attorneys, published by Rand-McNally & Co., Chicago, Ill.; The Baggott & Ryall Directory of Guaranteed Attorneys, published by Legal Directory Corporation, Boston, Mass.; American Lawyers Annual, Cleveland, Ohio; Bankers Service Legal Directory, published by Bankers Service Co., Boston, Mass.; Eyre's Law List, 9 Park Place, New York City; Snow-Church Directory Co. Lawyers List, published in New York City, and the Central Guarantee Co., Bankers and Lawyers Directories, 630 Fifth Avenue, New York City.

WATSON E. COLEMAN, Victor Building, 724 Ninth Street, N. W.
REGISTERED PATENT LAWYER **WASHINGTON, D. C.**

INVENTORS PATENT YOUR IDEAS SEND FOR FREE BOOK



HOW TO OBTAIN A PATENT

Written by a Former Member of the Examining Corps (1922-24) of the U.S. Patent Office. If you want to profit by your idea, you should take steps to apply for a U. S. Patent at once. Your first step is to get this Free Book. This interesting illustrated book contains valuable information you should have. It tells you fully how to obtain a patent on your idea in the quickest way. With this Free Book you will also receive a "Record of Invention" form on which you can easily record your idea. Personal and Confidential Service: Your case will be personally handled only by a Registered Patent Attorney who is also a Former Member of the Examining Corps of the U. S. Patent Office. All communications confidential.

MAIL COUPON TODAY for FREE PATENT BOOK and RECORD OF INVENTION Form.

CARL MILLER
REGISTERED PATENT ATTORNEY
FORMER MEMBER EXAMINING CORPS U. S. PATENT OFFICE

1638 Woolworth Bldg., Dept. 57A, New York City
MILLER BUILDING, Dept. 57A, WASHINGTON, D. C.
Please send me your Free Book, "How to Obtain a Patent," and your "Record of Invention" form.

NAME.....

ADDRESS.....

don't WORRY

Why put up with years of needless discomfort and worry? Try a Brooks Automatic Air Cushion. This marvelous appliance permits the opening to close, yet holds reducible rupture securely, comfortably—day and night. Thousands report amazing results. Light, neat-fitting. No hard pads or stiff springs to chafe or gouge. Made for men, women and children. Durable, cheap, **Sent on trial** to prove it. Never sold in stores. Beware of imitations. Write for Free Book on Rupture, no-risk trial order plan, and proof of results. All correspondence confidential. **BROOKS COMPANY, 111-H State St., Marshall, Mich.**



PATENTS

TO THE MAN WITH AN IDEA
Personal service, reasonable charges. Preliminary advice, book and disclosure form free. Registered Patent Attorney.

IRVING L. McCATHRAN, PATENT LAWYER
Formerly with and successor to **RICHARD B. OWEN**
1020 International Bldg., Washington, D. C.

TRADE-MARKS

PATENTS—TRADE MARKS

All inventions submitted held confidential and given personal attention by members of the firm. Form, "Evidence of Conception" and instructions, "How to Establish Your Rights"—FREE!

LANCASTER, ALLWINE & ROMMEL
Patent Law Offices

412 Bowen Bldg. Washington, D. C.

New Ideas now Salable Before Patenting

Practical, useful inventions may now be safely marketed without patenting expense. Write for proof that we successfully sell both patented and unpatented inventions.

Chartered Institute of American Inventors
Dept. 4, Barrister Building, Washington, D. C.

PATENTS Protect Your Idea: By securing FREE my "PROOF OF INVENTION" folder. Exceptional Personal Service. Excellent References. Established 1906.
E. E. VROOMAN, 871 Woodward Bldg., WASH., D. C.

INVENTORS who derive largest profits know and heed certain simple but vital facts before applying for patents. Our book, Patent-Sensel gives those facts; sent free. Trade Marks—Copyrights.
LACEY & LACEY, Est. 1869, 635 F St., N. W., Dept. 5, WASHINGTON, D. C.

ALBERT E. DIETERICH
REGISTERED PATENT ATTORNEY
512 B Colorado Building, WASHINGTON, D. C.
Booklet on Patents sent free

In answering advertisements always write name and full address clearly.

To PROTECT YOUR INVENTION—Use this coupon, NOW

Delays are dangerous and may be very costly. My personal service assures prompt action, strict confidence, and a minimum of expense. I suggest that you send me a model or drawing, or sketch and description of your invention, and \$5.00. I will make a search and report

promptly as to its patentability and send you a copy of my 72-page booklet. Or, if you prefer to read my booklet first, mail the attached coupon at once. I will also send my "Record of Invention" form. (Over 38 years experience as a Registered Patent Attorney.)

L. F. Randolph, 302-D Victor Bldg., Washington, D. C.

Please send me at once, free of charge, your 72-page booklet and "Record of Invention" form.

Name.....

Address.....

A PERSONAL CONFIDENTIAL PATENT SERVICE—

MILLIONS ARE MAL-NOURISHED AND DON'T KNOW IT!

No Wonder They Are Skinny—Tired-Out— Have Weakened Resistance!

“Eating Enough” Doesn’t Prevent it. Your System Can Actually Starve at a Banquet, if it isn’t Getting the Minerals that Enable You to USE FOOD. Without Adequate Minerals for the Body’s Chemical Processes, You are living on a

“CRIPPLED DIET”!

Thousands Report Corrections of Such Deficiencies By Using Kelpamalt — Rich Mineral Concentrate From the Sea. Gains of 5 to 15 Lbs. in Few Weeks. Rugged New Health—Good Resistance.

Don't be fooled by a good appetite. If you are skinny, weak, tired-out, sickly, unable to gain an ounce of flesh or strength, no matter what you eat, you may actually be suffering from "Mal-Nourishment." Doctors now know that unless the food you eat contains certain minerals essential for the body's chemical processes, even a lot of food can fail to yield adequate nourishment. Digestion, in such cases, is incomplete, assimilation poor, and digested food isn't being changed to energy, strength and flesh.

In Kelpamalt, the new mineral concentrate from the sea, minerals essential to these body processes are available in their naturally occurring form, such as assimilable iron, copper, calcium, phosphorus, and others—all contributing to the supply of vital minerals needed for digestion and assimilation. Most important is Kelpamalt's natural iodine (not the chemical liquid kind). It is iodine, scientists say, that is vitally important to the health and proper functioning of blood, liver and glands. Kelpamalt is richer in iodine than oysters, hitherto considered the best source.

Try Kelpamalt for a single week. Thousands report they are amazed at the improvement Kelpamalt has brought them. Gains of 5 to 15 lbs. in a few weeks are not uncommon; new strength, new energy, better digestion and elimination. They eat better, sleep better, and almost invariably say they now feel fine. Your own doctor will approve this way. 100 Jumbo size Seedol Kelpamalt Tablets—four to five times the size of ordinary tablets—cost but a few cents a day to use. Get Seedol Kelpamalt today. Seedol Kelpamalt is sold at all good drug stores. If your dealer has not yet received his supply, send \$1.00 for special introductory size bottle of 65 tablets to the address at the right.

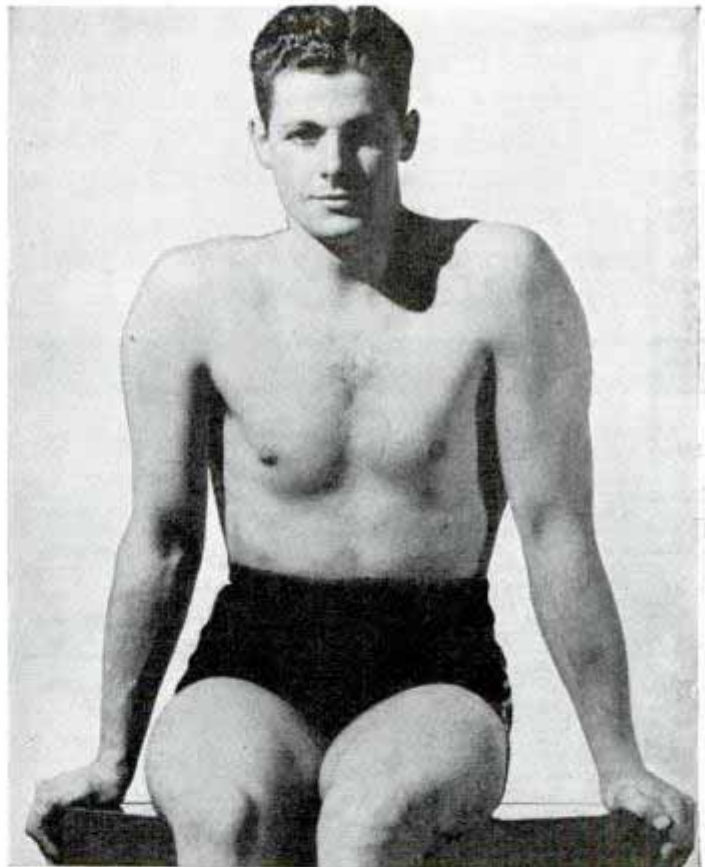

(Posed by Professional Model)

● **Manufacturer's Note:**—Inferior products imitating the genuine Seedol Kelpamalt are being offered as substitutes. Don't be fooled. Demand genuine Seedol Kelpamalt Tablets. Results guaranteed or money back.

SEEDOL Kelpamalt Tablets

SPECIAL FREE OFFER

Write today for fascinating instructive 50-page booklet on How Thousands Have Built Strength, Energy and Added Lbs. Quickly. Mineral contents of Food and their effect on the human body. New Facts about NATURAL IODINE. Standard weight and measurement charts. Daily menus for weight building. Absolutely free. No obligation. Kelpamalt Co., Dept. 1178, 27 West 20th St., N.Y.C.

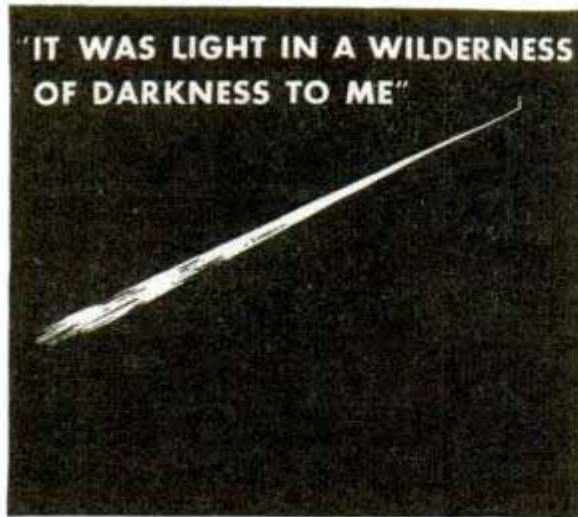

"I WAS STUCK. A wife and three kiddies — and the same old pay envelope. I couldn't see a thing ahead except the same old grind. Then one day I read an I. C. S. ad. The coupon fascinated me. A new idea struck me — it was a light in a wilderness of darkness to me! Today, because I mailed that coupon two years ago, I am a trained man — making a trained man's pay!"

Does this suggest something to you? Then mail the coupon today!

INTERNATIONAL CORRESPONDENCE SCHOOLS

Box 5673-H, Scranton, Penna.

Without obligation, please send full particulars about the subject before which I have marked X:

TECHNICAL AND INDUSTRIAL COURSES

- | | |
|--|---|
| <input type="checkbox"/> Architect | <input type="checkbox"/> Diesel Engines |
| <input type="checkbox"/> Architectural Draftsman | <input type="checkbox"/> Aviation Eng. <input type="checkbox"/> Auto Mechanic |
| <input type="checkbox"/> Building Estimating | <input type="checkbox"/> Plumbing <input type="checkbox"/> Heating |
| <input type="checkbox"/> Contractor and Builder | <input type="checkbox"/> Air Conditioning <input type="checkbox"/> Refrigeration |
| <input type="checkbox"/> Structural Draftsman | <input type="checkbox"/> Steam Engineer |
| <input type="checkbox"/> Structural Engineer | <input type="checkbox"/> Steam Electric Engineer |
| <input type="checkbox"/> Electrical Engineer | <input type="checkbox"/> Marine Engineer |
| <input type="checkbox"/> Electric Lighting | <input type="checkbox"/> Civil Engineer <input type="checkbox"/> Highway Engineer |
| <input type="checkbox"/> Welding, Electric and Gas | <input type="checkbox"/> Bridge Engineer |
| <input type="checkbox"/> Reading Shop Blueprints | <input type="checkbox"/> Bridge and Building Foreman |
| <input type="checkbox"/> Telegraph Engineer | <input type="checkbox"/> Surveying and Mapping |
| <input type="checkbox"/> Telephone Work <input type="checkbox"/> Radio | <input type="checkbox"/> R. R. Locomotives <input type="checkbox"/> Air Brakes |
| <input type="checkbox"/> Mechanical Engineer | <input type="checkbox"/> R. R. Section Foreman |
| <input type="checkbox"/> Mechanical Draftsman | <input type="checkbox"/> R. R. Signalmen |
| <input type="checkbox"/> Machinist <input type="checkbox"/> Toolmaker | <input type="checkbox"/> Chemistry <input type="checkbox"/> Pharmacy |
| <input type="checkbox"/> Patternmaker | <input type="checkbox"/> Coal Mining |
| <input type="checkbox"/> Foundry Practice | <input type="checkbox"/> Navigation |
| <input type="checkbox"/> Sheet Metal Worker | <input type="checkbox"/> Cotton Manufacturing |
| <input type="checkbox"/> Boilermaker | <input type="checkbox"/> Woolen Manufacturing |
| <input type="checkbox"/> Heat Treatment of Metals | <input type="checkbox"/> Agriculture <input type="checkbox"/> Fruit Growing |
| <input type="checkbox"/> Management of Inventions | <input type="checkbox"/> Poultry Farming |

BUSINESS TRAINING COURSES

- | | |
|--|--|
| <input type="checkbox"/> Business Management | <input type="checkbox"/> Lettering Show Cards <input type="checkbox"/> Signs |
| <input type="checkbox"/> Industrial Management | <input type="checkbox"/> Stenography and Typing |
| <input type="checkbox"/> Traffic Management | <input type="checkbox"/> Civil Service <input type="checkbox"/> Mail Carrier |
| <input type="checkbox"/> C.P. Accountancy | <input type="checkbox"/> Railway Mail Clerk |
| <input type="checkbox"/> Bookkeeping | <input type="checkbox"/> Grade School Subjects |
| <input type="checkbox"/> Secretarial Work | <input type="checkbox"/> High School Subjects |
| <input type="checkbox"/> Cost Accountant | <input type="checkbox"/> College Preparatory |
| <input type="checkbox"/> Salesmanship <input type="checkbox"/> Advertising | <input type="checkbox"/> First Year College Subjects |
| <input type="checkbox"/> Service Station Salesmanship | <input type="checkbox"/> Illustrating <input type="checkbox"/> Spanish |
| <input type="checkbox"/> Business Correspondence | <input type="checkbox"/> Cartooning <input type="checkbox"/> French |

DOMESTIC SCIENCE COURSES

- | | |
|---|--|
| <input type="checkbox"/> Professional Dressmaking and Designing | <input type="checkbox"/> Millinery |
| <input type="checkbox"/> Home Dressmaking | <input type="checkbox"/> Foods and Cookery |
| <input type="checkbox"/> Advanced Dressmaking | <input type="checkbox"/> Tea Room and Cafeteria Management, Catering |

Name.....Age.....
 Address.....
 City.....State.....
 Present Position.....
 If you reside in Canada, send this coupon to the International Correspondence Schools Canadian, Limited, Montreal, Canada

When writing to advertisers please mention Popular Mechanics

PATENT

your INVENTION through this RESPONSIBLE FIRM



... and Get PROMPT EXPERIENCED ACTION

We offer you the experience and proven responsibility of 61 years. Since 1875 we have rendered expert service and counsel to tens of thousands of inventors. Every member of C. A. Snow & Co. who works on your case is a Registered Patent Attorney. This is important, for only Registered Patent Attorneys may plead your case before the Patent Office.

The home of C. A. Snow & Co. is the largest building in Washington occupied exclusively by our Patent Attorney firm. We offer you thorough, competent work.

DEFERRED PAYMENTS ON REQUEST

Write today for our FREE "Certification Of Invention", which is of real value to you RIGHT NOW! Also two new guides, "How We Protect You" and "Suggestions On How To Commercialize Your Invention".

C. A. SNOW & CO.

Patent Attorneys Since 1875
 SNOW BLDG. Dept. A-17 WASH., D. C.

BUCHSTEIN'S FIBRE LIMB



is soothing to your stump—strong, cool, neat, light. Easy payments. Braces for all deformities. Agents wanted.

D. BUCHSTEIN CO.
 810 3rd Ave., So., MINNEAPOLIS, MINN.

Send for Catalog Today

NEURITIS Relieve Pain In Few Minutes

To relieve the torturing pain of Neuritis, Rheumatism, Neuralgia, Lumbago in few minutes, get **NURITO**, the Doctor's formula. No opiates, no narcotics. Does the work quickly—must relieve worst pain to your satisfaction in few minutes—or money back at Druggist's. Don't suffer. Get trustworthy **NURITO** on this guarantee. Don't wait.

No JOKE TO BE DEAF

—Every deaf person knows that—



Mr. Way made himself hear his watch tick after being deaf for twenty-five years, with his Artificial Ear Drums. He wore them day and night. They stopped his head noises. They are invisible and comfortable, no wires or batteries. Write for TRUE STORY. Also booklet on Deafness.



THE WAY COMPANY
 729 Hofmann Bldg., Detroit, Michigan

SKIN RASH
 RELIEVED...ITCHING STOPPED

For quick relief from itching of eczema, rashes, pimples, athlete's foot, and other externally caused skin eruptions, use cooling, anti-septic, liquid **D. D. D. PRESCRIPTION**. Greaseless, stainless, dries fast. Stops the most intense itching in a hurry. A 35c trial bottle, at all drug stores, proves it—or your money back.

D. D. D. Prescription

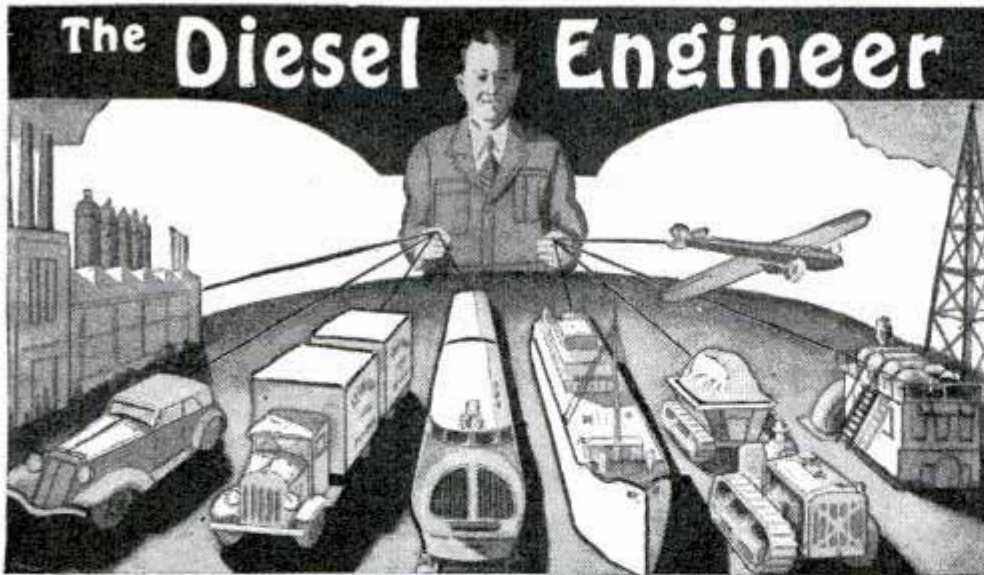

The Diesel Engineer

Is Your Job Safe?

Just as the gasoline engine changed or wiped out the jobs of thousands who depended on horse-drawn vehicles for their living—just as electricity changed the entire set-up in the fields of light and power—so now the Diesel engine is fast invading both the power and transportation fields, and threatening the present jobs of thousands of workers.

If jobs in your line are steadily growing scarcer, you owe it to yourself to investigate this new, progressive, uncrowded line, that in our opinion will offer good openings for the next 25 years.

2 Beginning Lessons in Diesel Engineering Free

Diesel—The New, Fast-Growing Power

Diesel engines—because of their high efficiency, dependability, and economy of operation—are fast replacing steam and gasoline engines in power plants, motor trucks and busses, locomotives and ships, aircraft, dredges, drills, pumps, etc.—opening up an increasing number of well-paid jobs for Diesel-trained men. The field of Diesel Engineering is on the upgrade and continually expanding. It will provide steady employment, advancement and good pay for those properly trained in this new industry.

What This New Field Offers You

Now is your chance to get into a big new industry and grow up with it to an important position. Today there is practically no competition in the Diesel field, but the increasing use of Diesel engines will result in keen competition for jobs in the near future. By starting your training now, you can keep ahead of such competition.

You get complete information on all the latest Diesel developments—two- and four-stroke cycles; low- and high-speed and heavy duty types; Diesel-electric generating systems, etc.—in our course. Includes all text material—with special diagrams for quick understanding of this new power.

Get 2 Lessons FREE to Prove Your Own Possibilities in Diesel

Can you learn Diesel? We want to give the opportunity of finding out. So, *without cost or obligation on your part*, we will send you 2 beginning lessons. In the quiet of your own home, look them over. See how clearly all is explained—how thoroughly you grasp every point—how definitely you progress step by step—so that your knowledge of Diesel grows constantly. Making this simple trial may be the turning point in your life—so write to us TODAY!

American School, Dept. D-545, Drexel at 58th Street, Chicago, Illinois

Turn Your Spare Time into Dollars

PENNY EACH!

Large sized Beautiful Gold Reflecting Window Sign Letters. Finest Quality. 5 Year Guaranteed. New Styles. Tremendous Demand. Amazing Profits. Easily applied. Write for FREE SAMPLES and starting equipment. HURRY!

Atlas Sign Works, 7943 Halsted, Chicago, Ill.



In answering advertisements always write name and full address clearly.

BECOME A VENDING MACHINE OPERATOR!

Own a "chain" of 1c peanut and chewing gum vending machines. Large, steady profits, as people eat peanuts and chew gum daily. Start with \$100. Write for details today!

D. ROBBINS & CO.
1141P DeKalb Ave. BROOKLYN, N. Y.

Be a GUNSMITH Learn this

big pay profession at home. Repair, restock, blue, check, refinish, make new parts, etc. Write for Prospectus.

GUILD SCHOOL OF GUNSMITHING, Dept. A-5, Newark, O.



Correspondence Courses in RADIO and ELECTRICAL ENGINEERING

SPECIAL Only \$25

ELECTRICAL ENGINEERING. Covers complete electrical field. Most modern course. Very understandable.
RADIO ENGINEERING. Ultra-modern course in radio, public address, photo-electric work. Trains you to be super-service man, real vacuum tube technician. Tuition ONLY \$25, either course. Deferred payment plan. Exam kit free—limited time offer. WRITE TODAY for free copies of school catalog, student magazine, etc. LINCOLN ENGINEERING SCHOOL 931-21 So. 37th St., Lincoln, Nebr.

PARKS AIR COLLEGE

Offers COLLEGE AND PROFESSIONAL TRAINING Majoring in Aviation

FOUR two-year courses (96 weeks) lead to Bachelor of Science degrees in Professional Piloting, Aviation Operations, Aviation Mechanics and Aeronautical Engineering.

THIRTEEN TRAINING PLANES are on the flight line. They range from the Kinner Sportster to the high speed twin-engined Monocoach equipped with retractable landing gear, air brakes, two-way radio, radio direction finder, and blind flight instruments.

Accredited by the Illinois Superintendent of Public Instruction. Government approved as a Transport Ground and Flying School and Mechanics' School.

58,000 hours flight instruction have been given, 650 hours now being flown monthly. THE FACULTY of 33 is composed of specialists in the various fields of aviation. AN ENROLLMENT of 260 resident students for the 1936 Fall term.

On its 100-acre airport, Parks has 14 buildings with a total floor area of 2½ acres, devoted to school purposes exclusively.

DORMITORIES AND DINING HALL ON THE FIELD.

1398 graduates.

Graduates are being placed prior to graduation.

63 per cent of graduates enter air transport operations in North and South America.

At Parks you train for aviation in aviation. Parks is recognized as the training division of the industry. Ask any one who is in aviation. You can expect more at Parks and still be agreeably surprised when you come.

The 60-page catalog gives complete information. Send for it. It is FREE. It is packed full of valuable information. A letter or post card will bring it to you.

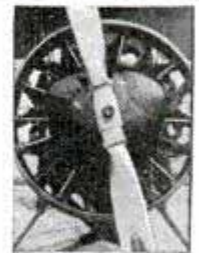

PARKS AIR COLLEGE

537-M Cahokia Rd.

East St. Louis, Illinois

When writing to advertisers please mention Popular Mechanics

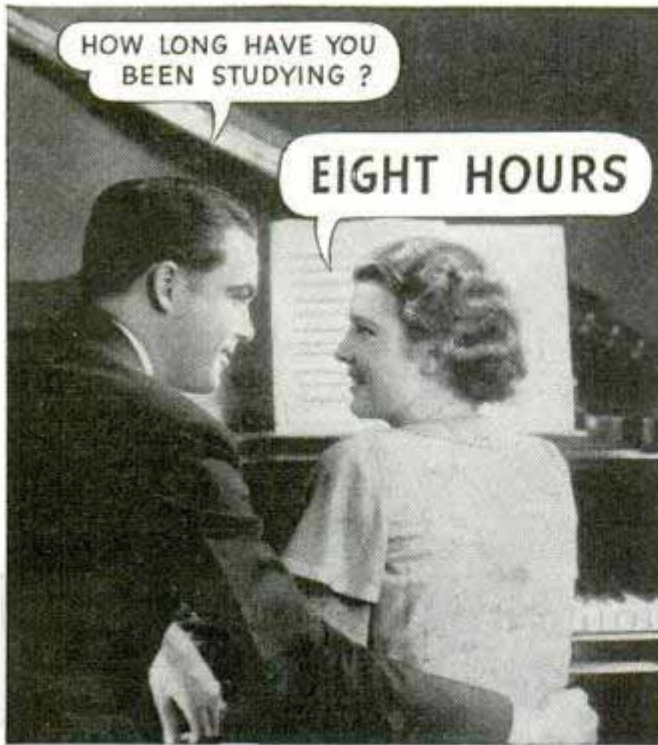

Only 8 Hours and You Start Playing by this Amazing Method!

• Does it sound too good to be true? Can you picture yourself actually playing the piano or other favorite instrument after only eight hours spent in the easiest and most pleasant way imaginable? It seems impossible—yet the amazing fact is that you start playing in your very first lesson! Before long, you'll be able to pick up almost any piece of music and play it at sight—to the astonishment of your friends and your own delight.

Easy as A-B-C

For here is a way to learn music at home that does away with the old-fashioned drudgery and tedious practice — cuts the time required to a minimum—abolishes the old scale-running exercises and instead actually starts you playing a tune. You learn to play by **playing**. You need no private teacher, no special talent or previous knowledge of music. Everything is made crystal clear in words and pictures. Even a child can understand this modern, short-cut method.

PLAY ANY INSTRUMENT

LEARN TO PLAY BY NOTE
Piano Guitar
Violin Saxophone
Organ Mandolin
Tenor Banjo
Hawaiian Guitar
Piano Accordion
Or Any Other Instrument

More than 700,000 men and women have already taken advantage of this easy way to master their favorite instruments. Send for **FREE PROOF** that you, too, can learn. Mail the coupon or write for the Demonstration Lesson that shows **how**—together with interesting, illustrated Booklet and details of the wonderful low-price offer that makes the cost only a few cents a day. Write today. Instruments supplied when needed, cash or credit. U. S. School of Music, 75 Brunswick Bldg., N. Y. C., N. Y.

U. S. School of Music, 75 Brunswick Bldg., N. Y. C., N. Y.
 Please send me **FREE** your Demonstration Lesson and illustrated Booklet showing how I can learn to play the.....
 (mention instrument).
 Name.....
 Address.....
 City..... State.....

(Continued from page 26A)

incised lines. When inking the plate a liberal supply is put on and wiped off in such a way as to fill completely all of the recessed lines. In regular plate printing the operator polishes the plate with the palms of his hands upon which he has rubbed a coating of French chalk. Other cleaner hands place the wet paper upon the plate and remove the printed sheets after the plate has passed the impression roller. This form of printing is done under pressure which forces the paper into every line of the plate to pick up the ink.

Having the paper wet aids greatly in the process, as does heating the plate, for this increases the fluidity of the stiff engraving ink at the moment of printing and does not prevent it from hardening quickly as soon as it is cool. An examination of recess printed stamps will show the ink raised above the surface of the paper and the coarser lines of the stamp indented on the back where they were forced into the recesses of the plate. Test an engraved stamp by placing a piece of smooth tinfoil over it and then a rather soft rubber eraser. If moderate pressure is applied carefully so the tinfoil is not distorted, the entire design will transfer to the foil.

Typography, or surface printing, is the name applied to all of the forms of printing in which the design is transferred to the paper from the raised parts of the printing plate. In its simplest form, the printing is done from movable type, lines of type, electros, line cuts or halftones. Before the day of photoengraving, illustrations in typography were nearly all woodcuts, entirely handmade on blocks of wood by cutting away all of the surface which was not to show.

Generally, plates for the surface printing of stamps were made up of a series of stereotypes, or electrotypes of the stamp, locked or soldered to form a rigid plate. One of the most notable methods for making cliches or printing units of a typographed stamp was used in France. In this case the master die was cut in recess at the mint, and the cliches were minted from this die in a standard coining press. In this case the compression of the metal produced a cliche superior to any which could have been cast in type metal, or built up in soft copper by electrotyping. The printed design is not raised above the surface

(Continued to page 37A)

Two Giant Industries NEED MEN NOW!

AIR CONDITIONING ELECTRIC REFRIGERATION

We supply trained men for America's two fastest-growing industries. If you can meet our requirements, we will train you in spare time at home for a good pay position as an Installation and Service Expert in the Electric Refrigeration and Air Conditioning fields. In addition we will give you **ACTUAL Shop Practice** when you graduate, and help you to qualify for profitable employment with an exceptionally bright future.

Can You Qualify?
To be acceptable for enrollment you should be mechanically inclined, between ages of 18 and 40, have fair education and be able to furnish character references.

GET FREE BOOK

Get amazing facts about actual opportunities for ambitious men in Air Conditioning and Electric Refrigeration. Our new Free Book describes these money-making opportunities and tells about our low-cost, easy-pay plan of training. Write for your copy today stating age and which industry interests you most. No obligation.

UTILITIES ENGINEERING INSTITUTE (Established 1927)
400-410 N. Wells St. Dept. 157 Chicago, Ill.



Aviation Career OFFERS YOU GREAT FUTURE

Demand for trained aircraftmen in Southern California plants is increasing and already exceeds supply. Curtiss-Wright Technical Institute, Aviation's foremost and oldest school, is located in heart of this activity and specializes in Sheet Metal, Master Mechanics and Aero Engineering. (No flying involved.) Graduates are obtaining immediate employment. Write for details NOW, Curtiss-Wright Technical Institute, Glendale, Los Angeles, Cal. Dept. PM-5.

CARTOON YOUR WAY TO SUCCESS!

DON'T COPY — LEARN TO ORIGINATE!
RAYE BURNS will teach you HOW to CREATE ORIGINAL CARTOONS at home that you can SELL! Course contains 26 lessons and over 600 illustrations. All for Only **\$2.85**
Send name and address for free details.
RAYE BURNS SCHOOL, Dept. M-X, BOX 2194, Cleveland, Ohio

STAMMERERS

Write for our Free List of ethical schools that correct stammering
STAMMERERS' GUILD
Maccabees Bldg., Suite 1236, DETROIT, MICH.

Breath-Taking! 1,000 LIGHTS From ONE match!

Amazing new breath-taking invention. Can-O-Lites banishes lighters and matches forever—gives 1,000 lights with this one mysterious new kind of match. NEVER NEEDS TO BE RE-FILLED. Sure as a match, it strikes like a match and replaces the match, yet there are no burnt out matches strewn around. Instantly you have a big giant flame that will light a pipe, cigar, cigarette, gas stove.
RETAILS FOR ONLY 25c
Can-O-Lites replaces old fashioned matches and lighters everywhere. No wicks, gears, or wheels. Nothing to get out of order. Men and women—write for amazing details.
CAN-O-LITES, Dept. H-12, Youngstown, Ohio.

AGENTS! Big Profits
Men and women! Here's big quick profits for you! Can-O-Lites wanted by millions. One man sold over 15,000 in 3 months. Ask for Money-Making Plan and territory offer. Write us today.

Be a RADIO EXPERT



Learn at Home to Make \$30, \$50, \$75 a WEEK

Chief Operator Broadcasting Station
"When I completed 29 lessons, I obtained my Radio Broadcaster's license and immediately joined Station WMPC, where I am now Chief Operator."—HOLLIS F. HAYES, 85 Madison St., Lapeer, Mich.

Own Business Pays \$300 a Month
"I now have my own Radio business which shows three hundred dollars a month profit—thanks again to National Radio."—FRANK REESE, 39 N. Felton St., Philadelphia, Penna.

Earned \$50 First Month in Spare Time
"I knew nothing about Radio. After four lessons, I began servicing Radios. Last winter I made as high as \$100 a month in spare time."—G. F. WALTON, 808 West Olney Road, Norfolk, Va.

Do you want to make more money? Broadcasting stations employ engineers, operators, station managers and pay up to \$5,000 a year. Spare time Radio set servicing pays as much as \$200 to \$500 a year—full time servicing jobs pay as much as \$30, \$50, \$75 a week. Many Radio Experts own their own full or part time Radio businesses. Radio manufacturers and jobbers employ testers, inspectors, foremen, engineers, servicemen, paying up to \$6,000 a year. Radio operators on ships get good pay and see the world. Automobile, police, aviation, commercial Radio, and loud speaker systems offer many good opportunities. Television promises many good jobs soon. Men I trained have good jobs in these branches of Radio.

Many Make \$5, \$10, \$15 a Week Extra in Spare Time While Learning

The day you enroll I start sending you Extra Money Job Sheets. They show you how to do Radio repair jobs that you can cash in on quickly. Throughout your training I send plans and ideas that have made good spare time money for hundreds of fellows. I send special equipment which gives you practical experience—shows you how to conduct experiments and build circuits which illustrate important Radio principles.

Find Out What Radio Offers You

Mail the coupon now for "Rich Rewards in Radio." It's free to any fellow over 16 years old. It describes Radio's spare and full time opportunities, also those coming in Television; tells about my Training in Radio and Television; shows you actual letters from men I have trained, telling what they are doing and earning; tells about my Money Back Agreement. MAIL COUPON NOW!

**J. E. SMITH, President
Dept. 7EP
National Radio Institute
Washington, D. C.**

MAIL NOW for FREE PROOF

**J. E. SMITH, President,
Dept. 7EP,
National Radio Institute,
Washington, D. C.**

Dear Mr. Smith: Without obligating me, send "Rich Rewards in Radio," which points out the spare time and full time opportunities in Radio and explains your 50-50 method of training men at home in spare time to become Radio Experts. (Please Write Plainly.)

NAME..... AGE.....
ADDRESS.....
CITY..... STATE.....

AVIATION *is* Calling LINCOLN Graduates to Thrilling Careers at GOOD PAY



You can be ready for YOUR big job as Pilot or Mechanic with just a few short months of Lincoln Training.

There's no mystery about getting into aviation. Men are hired every day. It's simply a question of training. But it must be the right kind of training. Lincoln Training is right. Aviation approves it—gave fine positions to 50 of our recent graduates—and is ready to give YOU a position as soon as you are properly qualified.

Do you want to be a Pilot? You can be. Under Lincoln's Government Licensed instructors you can prepare for your license as Transport, Limited Commercial, Private or Amateur Pilot. When you finish—you'll be ready for a Pilot's position.

Do you want to be a Government Licensed Mechanic? You can be. A Government Licensed instructor will train you in aircraft engine overhaul and repair, airplane design, construction, aerial radio, sheet metal, welding—everything to prepare you for your license. Licensed Mechanics are now in such demand we could place ten times as many as we can supply.

Trained men needed. Aviation's tremendous expansion program is opening up thousands of new jobs. Letters from ten leading aviation companies indicate more Lincoln Trained men are wanted in coming months. Start training now. This Government Approved School now in 27th year; 17 years teaching aviation. Mail coupon for complete information.

LINCOLN AIRPLANE & FLYING SCHOOL
 Division of Lincoln Aeronautical Institute, Inc.
 208G Aircraft Bldg., Lincoln, Nebr.

Lincoln Airplane & Flying School,
 208G Aircraft Bldg., Lincoln, Nebr.

YES! I want further facts about Lincoln's complete training and the big-pay opportunities ahead in aviation.

Name..... Age.....
 City..... State.....



Know Electricity as Experts Know It—and Get an Expert's Pay!

Recovery has begun! The months ahead are charged with significance and expectation. What will you do to get the jump on the other fellow? Thousands of men have used

The Croft Library of Practical Electricity

The Croft Library is a complete electrical educator. It is founded on practice—on 20 years of shirt-sleeve experience—on work as it is actually done. It is jammed from cover to cover with the kind of hard-headed facts you want. Written so that the beginner can easily understand it, yet so sound, so thorough, that it is the daily guide of 50,000 highly paid electrical workers and engineers. Croft tells you the things you need to know about motors, generators, armatures, commutators, transformers, circuits, switchboards, distribution systems—electrical machinery of every type—wiring for light and power—wiring of finished buildings—underwriters' and municipal requirements—illumination in its every phase—the most improved methods of lighting—lamps and lamp effects, etc.—how to do a complete job, from estimating it, to completion.

No money down—easy payments
 Fill in and mail the coupon attached and we will send you the entire set of seven volumes for ten days' Free Examination. We take all the risk—you assume no obligation. If you decide to keep the books, send \$1.50 in ten days and the balance at the rate of \$2.00 a month. Send the coupon NOW and see the books for yourself.

FREE EXAMINATION COUPON
McGraw-Hill Book Co., 330 W. 42nd St., New York

Send me for ten days' free examination the Croft Library of Practical Electricity. If satisfactory I will send you \$1.50 in 10 days and \$2.00 monthly until the price of \$19.50 is paid. If not wanted, I will return the books postpaid. (To insure prompt shipment write plainly and fill in all lines.)

Name.....
 Home Address.....
 City and State.....
 Position.....
 Name of Company..... PM-537

When writing please mention Popular Mechanics

NEW TYPE CHEAP OIL BURNER

Sweeping the Country!!

COOK and HEAT Without Coal or Wood

In Your Present Stove or Furnace—**HOTTER—CHEAPER—No Dirt or Ashes—Twice the Heat Quick at SMALL COST**



COOKS A MEAL for LESS

Beats any oil burner ever gotten out for low cost, perfect performance. Burns cheap oil a new way, without pre-generating or clogging up. Quick intense heat by Simple Turn of Valve.

Try At Our Risk 30 DAYS' TRIAL
 Prove it ends drudgery and dirt of coal or wood; cuts fuel bills in half, pays for itself quickly by what IT SAVES.

FREE SAMPLE FOR AGENTS
 offered to one energetic man or woman in each locality who will demonstrate and take orders. Write quick, be first to learn how to make REAL MONEY right now, spare or full time—mail it postcard today.

AGENTS Salesmen BIG MONEY
 Drop Everything for this Quick Seller. Get YOUR OWN oil burner FREE and make REAL Money. Write now.

Slips Into Any STOVE RANGE or FURNACE

Quick HEAT at Turn of Valve!

UNITED FACTORIES, E-751 Factory Bldg., Kansas City, Mo.

AMAZING-NEW INVENTION!

BIG EARNINGS QUICK! WITH THIS NEW MONEY MAKER

No Experience Needed. Sells easy to amazing big market. Combination **BLOW TORCH AND SOLDERING IRON**

No pressure system. No pumps. No stove. No charcoal. Operates with 100% satisfaction. Neat, complete, compact. Guaranteed by 30 year old company. Write quick for New Agents' Plan and Exclusive territory offer. Hurry!

JUSTRITE MFG. CO.
 Dept. 55, 2061 Southport, Chicago



Learn to DRAW AT HOME \$ COMPLETE ANYWHERE

OVER 150 LESSON SIGHT-CORRECTING ART COURSE

Nothing like it. Simplified, easy method, organized by former university instructor, enables you, right at home, without loss of time, to analyze your drawing and make corrections instantly. You enjoy unbelievable progress the Sight-Correcting way. You start drawing the first day. Great fun. Illustrate magazines, draw gorgeous girls, landscapes, animals, interiors, anatomy, etc. Artists make BIG MONEY. Complete 12 lessons, including 40 beautiful figure poses, drawing paper, \$1.00. Guaranteed. Nothing more to buy. Limited offer. Rush \$1.00 today!

ARTISTS AND MODELS STUDIO, Dept. PM-5 Memphis, Tenn.



TRAILER ENGINEERING (Second Edition) BRAND NEW BOOK

To Help You Buy or Build, 14 chapters, 130 illustrations. Tells you about hub, roll, weave, snaking, nose diving, rear vision, Ackerman steering, tandem wheels, tow car balance, trailer balance, all State laws, American coaches, English coaches, plumbing, wiring, brakes, step action, chassis, parking jacks, weights, furniture, ironing the tow car, every engineering detail. Get unvarnished trailer engineering facts before you buy or build.

Order NOW. \$1.00 postpaid, \$1.15 C. O. D.

RAY KUNS, Dept. 5, 6 Eastwood Circle, Cincinnati, Ohio



Which of These Gov't Jobs Do YOU Want?

No special education or experience usually required. Steady work. Short hours. Vacations. PENSIONS! Age 18-50. Extra Social Security Jobs expected soon. Send coupon below for FREE book. Tells how you can pass Civil Service Examination.

FREE BOOK
 Arthur R. Patterson, (Former Govt. Examiner) Principal, PATTERSON SCHOOL, 85 Case Building, Rochester, N. Y. Send FREE Book, "How to Secure a Government Position."

MEN--WOMEN
START \$1,260 to \$2,100 a YEAR
 Liquor-Gauger
 Stenographer
 Meat Inspector
 Custom House
 Office Clerk—Typist
 Accountant
 File Clerk
 Income Tax Auditor

Name.....
 Address.....

(Continued from page 34A)

of the stamp paper, but quite often is pressed down into it. This produces a printer's squeeze and the resultant raised effect on the back of the stamp is one of the surest checks for a typographed stamp.

Lithography, stone printing, is a form of printing which is made from a perfectly smooth plate of special stone, or zinc or aluminum. It is a chemical form of printing which depends upon the repellent force that exists between oil and water. If a design is transferred to the plate in fatty ink and the plate is then moistened, ink may be applied to the plate with a roller and will adhere upon the transferred design only and will be repelled elsewhere by the moisture on the plate. Sheets of paper now may be applied to the plate to pick up the impression of the design.

With the discovery that certain metals possess the qualities necessary for lithographic printing, it was possible to fit plates for cylinder presses, and to print on endless webs of paper. A further step came in the offset process wherein the ink is picked up from the plate by a soft rubber roller and then transferred to the paper. Lithographed stamps have a flat and lifeless appearance, are smooth, front and back, and the design is often marred by breaks and spots due to printing too many impressions from a transfer.

New Stamp Issues

New stamp issues are plentiful since the adoption by many governments of semi-postal issues, used to raise funds for charitable enterprises. The illustration shows the semi-postal issue of Estonia placed on sale in January. The surtax upon these stamps is applied to the National Relief Fund. The designs show the arms of Paide, Rakvere, Valga and Viljandi. The large stamp at the top is one of three issued by the Dominican republic to celebrate the first anniversary of the change of name of the capital from Santo Domingo to Ciudad Trujillo. The stamp pictures an obelisk erected on the occasion, a portrait of the president of the republic and a tablet with a lengthy inscription.

The block in the center shows a recent addition to the stamps of South Africa and illustrates a pit head at a gold mine. The stamp was issued last November. The

(Continued to page 57A)

More GOOD JOBS in DRAFTING NOW!

Calls for Draftsmen Are Increasing! Want-ads prove it. Steel mills—railroads—buildings—all are "on the up" . . . all are calling for Draftsmen. New fields like Air Conditioning and Diesels join in the call—"Give us more trained DRAFTSMEN." Some who read this advertisement will do nothing. Others, smart enough to realize this means Opportunity, will Send A Post Card or Mail The Coupon for Free Trial Lesson.

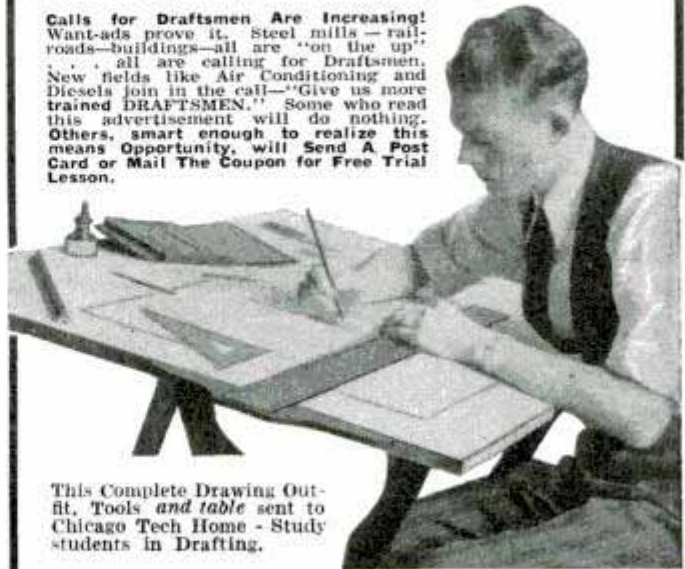

This Complete Drawing Outfit, Tools and table sent to Chicago Tech Home - Study students in Drafting.

The draftsman's work comes first. When business improves . . . and it is improving . . . there is new construction work, new buildings, new machines, repairs and reconstruction work. All these must first be laid out on paper. So the FIRST man that must be hired is the DRAFTSMAN.

Drafting is Well-Paid Work

Drafting is clean, interesting professional-type work. It pays well to start . . . offers real opportunities for promotion. You need no previous training or experience . . . no special talent—to learn Drafting. It is one of the steadiest employment fields. No machine ever did the Draftsman's work . . . and no machine can be invented. So your job is always secure.

Learn at Home in Spare Time

(or at the College in Chicago,) by the fascinating, easy, step-by-step plan originated by this 34-year old school for Draftsmen. This is the way thousands of successful men started their careers. Begin yours without delay . . . terms are low . . . and we help you to a job when ready. Send now for

FREE TRIAL LESSON in DRAFTING

Sample this easy - lesson system of learning Drafting. Send post card or this coupon. No charge now or later for this FREE LESSON. Prove to yourself how easy it is to learn Drafting by the C.T.C. Method.

CHICAGO TECHNICAL COLLEGE

CHICAGO
TECHNICAL COLLEGE

E208 Tech Bldg., 118 E. 26th St., Chicago, Ill.

Send me FREE BOOK as checked below.

- DRAFTING—in Spare Time—at Home (Trial Lesson).
 DRAFTING, at Chicago Tech—in Chicago (Blue Book).

Name Age

Address

P. O. State

Other C.T.C. money-making courses by home-study:
(Check one of these ONLY if you prefer it to Drafting.)

- AIR CONDITIONING BUILDER'S COURSE
and REFRIGERATION. for Carpenters and Builders.

JUST OUT!

AUDEL'S DIESEL ENGINE MANUAL
QUESTIONS and ANSWERS

\$2

If you are interested in the construction, operation and maintenance of modern Diesel engines, you will want this new timely book of practical, useful information.

"AUDEL'S DIESEL ENGINE MANUAL" with Questions and Answers explains in simple, concise language the Fundamental Diesel Principles—Operating Principles—Engine Starting—Air Starting Valves—Fuel Spray Valves—Inlet and Exhaust Valves—Valve Timing—Fuel Pumps—Fuel Injection Compressors—Starting Air Compressors—Scavenging Air Compressors—Pistons and Piston Rings—Cylinders—Lubrication—Cooling Systems—Fuel Oil—The Engine Indicator—Governors—Engine Reversing—Semi-Diesel Engines—High Speed Diesel Engines—Answers on Operation—Horse Power Calculations.

The illustrations and texts are clear and easy to understand. All details are plainly brought out. This book is of extreme value to engineers, operators, students and all who desire a knowledge of the Diesel engine. A handsome book, flexible, with gilt edges. 300 pages—illustrated.

Send for free Diesel folder today.

Ruptured?

Save yourself the misery of wearing leg-straps and cutting belts. Learn about the famous Cluthe Comfort Truss positively guaranteed to hold—a condition absolutely necessary for possible improvement or recovery. Water and perspiration proof; wear it in bath; Automatic Pad insures safety; hips left free. Made to your order for your individual requirements by mail on a liberal 60 days trial plan. Send for FREE 100-page Book of Advice and endorsements (publication permitted) from grateful patrons in your own neighborhood. No obligation. Write today.

Dept. 31, CLUTHE SONS, Bloomfield, New Jersey
(Serving the Ruptured Since 1871)

New York Established 1902

Electrical School

Ask for free booklet

44 West 17th St., N. Y. C.

VOICE

100% Improvement Guaranteed

We build, strengthen the vocal organs—not with singing lessons—but by fundamentally sound and scientifically correct *silent exercises* . . . and absolutely guarantee to improve any singing or speaking voice at least 100% . . . Write for wonderful voice book—sent free. Learn WHY you can now have the voice you want. No literature sent to anyone under 17 years unless signed by parent.

PERFECT VOICE INSTITUTE, Studio 1355
64 E. Lake St., Chicago

Amazing, New, Popular

PICTORIAL RING

Marvelous new secret process! Any photo or picture reproduced, permanently on exquisite gem-like ring. A priceless keepsake! Guaranteed! Sample ring from any photo you send only SEND NO MONEY—Everyone wants PICTURE RING. Show ring—take orders—make money! Just send photo with strip of paper trimmed to ends meet around finger for size. Pay postman only 5c, plus few cents postage. Photo returned with ring. Money back if not delighted. Order NOW!

PICTORIAL RING CO., Dept. Y-44, Cincinnati, O.

WANTED: NEW WRITERS!

Earn while learning! Write for magazines, books, newspapers, etc.! FREE literature! No obligation!

U. S. SCHOOL OF WRITING
Dept. 155, 20 West 60th St., N.Y.C.

Learn Public Speaking

At home—in spare time. Many overcome "stage-fright," gain self-confidence and increase earning power, this easy way. Write for free booklet, *How to Work Wonders With Words* and requirements.

North American Institute, Dept. 1355
3601 Michigan Ave. Chicago, Illinois

Forms to cast Lead Soldiers, Indians, Trappers, Hunters, Wild and Farm Animals. 239 different forms to select from. Every form guaranteed to cast perfect figures. Send 5c stamp for illustrated catalogue.

HENRY C. SCHIERCKE Spencer Rd. GHENT, N.Y.

MAN IN EACH TOWN To Plate Auto Parts, Reflectors, Mirrors, etc.; by late method. Experience unnecessary. Free particulars and proofs. Write today.

GUN METAL CO., Ave. M, Decatur, Ill.

Printing Offers BIG PROFITS

Cards, stationery, circulars, etc. Easy rules sent. Does raised printing like engraving. Do your own printing. Save money. Junior press \$5.90; job press \$11; power, \$147. Sold direct from factory only. Send for free catalog and all details.

THE KELSEY CO., P-37 MERIDEN, CONN.

FREE EXAMINATION COUPON

THEO. AUDEL & CO., 49 W. 23rd St., New York

Please mail a copy of AUDEL'S DIESEL ENGINE MANUAL. If satisfactory, I will remit \$2 on its safe arrival, otherwise I will return the book.

Name

Address

Occupation PM

★ WORK FOR UNCLE SAM ★

MANY 1937 APPOINTMENTS
\$1140 to \$2100 First Year

Most Government examinations include Mental Tests. Try yourself. Answer the following problems and mail at once. Our examiners will correct your work, rate, and return it. The result should tell you the possibility of a high rating on the U. S. Government Examination.

MENTAL TEST NO. 1

- (1) A train makes 3/5 of its trip in 54 minutes. In how many minutes will it make the entire trip?
Answer.....
- (2) MAILBAG is to LOCK as LETTER is to (1) Stamp. (2) Seal. (3) Cancellation.
Answer.....
- (3) A letter is given special protection if mailed (1) Special Delivery. (2) Registered. (3) Air Mail.
Answer.....
- (4) A clandestine meeting is one that is (1) Secret. (2) Accidental. (3) Romantic.
Answer.....
- (5) Wheeling, W. Va., is (1) North, (2) South, (3) East, (4) West, from Trenton, N. J.
Answer.....

Franklin Institute, Dept. C196,
Rochester, N. Y.

I send you my work on Mental Test No. 1. Kindly have your examiners correct this work and return to me with my rating at no cost to me. Kindly send full information regarding Government Jobs. Send list of Jobs and tell me how to get one.

Name

Address

Age.....

FREE LESSON HomeArt Crafts



Good Money for Spare Time
A new easy way. Art novelties in big demand. Get free lesson and quickly learn to decorate Gifts, Bridge Prizes, Toys, etc. No experience necessary. Anyone can succeed with simple "3-step" method, and you earn as you learn. Everything furnished including Novelties for you to decorate and Homecrafters' Outfit.

NO CANVASSING
Just sit at home and make up to \$50 a week spare time or full. Write today for big illustrated booklet and **FIRST LESSON FREE**. Absolutely not one cent to pay. Lesson is free. Openings in every locality. Write quick.

FIRESIDE INDUSTRIES
Dept. 66-E, Adrian, Mich.

MAKE MONEY AT HOME!

Learn to color photos and miniatures in oil. No previous experience needed. Good demand. Send for free booklet, "Make Money at Home" and requirements.

NATIONAL ART SCHOOL
3601 Michigan Ave. Dept. 1355 Chicago

LOOK! Baby Chicks

THOUSANDS WEEKLY ALL YEAR



Finest quality & Layers in 40 breeds. Hybrid Baby Pullena and Cockerels, B. W. D. Tested. 25 lbs. feed FREE with each 100 chicks. Ducklings, Goslings, Baby Turkeys, Guinea, Mature Breeders priced right. In business 27 years, Catalog free. Nabob Hatcheries, Box M, Gambier, Ohio.

FREE 1937 SQUAB BOOK

Squabs selling for luxury trade, more than double other poultry. Thousands wanted by best city marketmen weekly. Supply scarce. Cash for you when only 25 days old. Make money breeding them. We sell breeders at low prices. Send U. S. stamp for picture book, facts.

PR CO., 636 How St., Melrose, Mass.



ROYAL

STEP INTO THE Spotlight

FREE LESSONS... A YEAR TO PAY



Banish Boredom ... Earn Extra Money START TO PLAY VERY FIRST DAY

Picture the joy of playing a snappy foxtrot, dreamy waltz or mellow old favorite on the Xylorimba. No reason why you shouldn't! Xylorimba is easiest of instruments to play and yet the most spectacular. In constant demand by orchestras, radio stations, at lodge meetings and parties. Marvelous opportunity to increase popularity, make big spare-time money. No bothersome practice or exercises. With Free easy lessons you actually **Start to Play Very First Day**.

BIG FREE BOOK tells all about Deagan line, liberal trial offer and easy payments. Send coupon today for your free copy.

J. C. Deagan, Inc., Dept. 1455, 1770 Berneau Ave., Chicago

Send me, without obligation, full details of Free Trial offer and easy-payment plan on the Deagan Xylorimba.

Name.....

Address.....

There's Quicker, Bigger MONEY for YOU in POULTRY RAISING!



Wherever You Live—Whatever You Do Now—Extra Money Can Be Yours This Year

PROOF

Investment Will Pay Many Times Over Says Kravets

"I am perfectly satisfied with your course and wish to say that my investment will pay me over and over many times. Anyone who enrolls with you can make a success in the Poultry field." **Michael Kravets, Terre Haute, Ind.**



\$45 a Week As Poultry Manager

"Your course enabled me to secure a splendid position in charge of a Private Poultry Farm. My pay is equal to \$45 per week. I also have free house rent, water, lights, fuel and all the poultry and eggs my family can use. I secured this position after completing only the eighteenth lesson of the course." **Louis D. Baker, Reynolds, N. C.**

Spare Time or Full Time Make \$1000 to \$2500 a Year

Instead of knocking at your door, Opportunity is waiting for you in your back yard! Thousands have turned to Poultry Raising for **PART TIME EXTRA MONEY** or **FULL TIME BIG PAY**. Many start off in just a small way—with a back-yard or vacant lot flock. My profit-producing methods will make only a few hens pay. No matter what you're doing now — I will show you how to start and keep going successfully. Eggs and poultry meat are commanding high prices—prices that mean a handsome margin of profit on every egg or bird you can produce. There's not a doubt about it—**YOU CAN CASH-IN BIG**. I'll PROVE that I can put YOU among the big money makers—**QUICK**.

My Proved Methods Assure Success Right from START

All the "mystery and guess work" are taken out of poultry raising by my sure, tested, **proved** methods. My home study course, produced by thirteen famous experts and endorsed by thirty leading Agricultural Schools puts in your hands the success-secrets of leaders. Satisfaction absolutely guaranteed. If you follow our methods. Decide now to get into this fascinating, healthful, profitable business. Be your own boss—make extra money in your spare time—or qualify for a fine salary in one of the big established poultry plants. From now on, let the other fellow pay YOU the fancy prices—**Become depression-proof**.

FREE BOOK EXPLAINS

My big, new, free book, "How to Raise Poultry for Profit" will amaze you! Brings **absolute proof** of what my course and training have done for thousands of others. My 44 years' experience as Commercial Poultryman and former Senior Poultryman in the U. S. Dept. of Agriculture is yours to use and profit by. Get in line for **QUICKER, BIGGER MONEY**. Don't delay a day. Get this coupon into the **very next mail**.

32 Pages of Money-making FACTS

Get this FREE Book NOW!

Harry M. Lamon, President, The National Poultry Institute, Dept. 39-B, Adams Center, N. Y.

I want to know how to make big money raising poultry. Send me your FREE book explaining your home-study course and **PROVED** methods.

Name.....

Address.....

City..... State.....



Plan Your Future

Choose Your Field NOW For Success

Will you master fate or will fate master you? That's a question deserving your honest answer . . . right now! Actually it is all up to you. You can do with Life almost what you will. LaSalle will help you establish yourself for real success by providing you with the comprehensive, specialized training for which it is so famous. Choose your field . . . now! Check the coupon below for the free booklet you want us to send you. It can be your first step toward assured success.

Opportunities in Traffic Management

The field of Traffic Management offers real opportunity only to the man who knows. Spare time study and the will to succeed have pushed scores of Traffic employees up the ladder to financial success. Many LaSalle-trained traffic managers—both in the railroad and industrial field—now command salaries of \$3,000.00 to \$5,000.00 a year—and better. Investigate. Find out how you can qualify for these higher positions through LaSalle home-study and guidance.

Law for Business Success

And it isn't necessary to practice law to get this Success. In fact probably most of the men who study law today have no idea of taking the bar examination or becoming lawyers—they want law training to give them mastery of men and situations in business. You know that—

- (1) the man with legal training is a leader—not a follower.
- (2) legal training keeps your mind—clears away the problems that stump the ordinary fellow and makes you master instead of man.
- (3) knowledge of law simplifies the complications of executive work.
- (4) Many top executive places are filled by men who have studied law.

No matter whether you are in a big corporation or a small business—in a great city or a little town—a practical knowledge of law cannot fail to be of real and vital help to you in making a more successful career.

In every state in the union you'll find law-trained men who came up through LaSalle. What others have done, you can do.

And LaSalle offers either a full law course leading to LL. B. or a shorter business law training—whichever you prefer. All text material, including valuable 14-volume Law Library. Training comprises the most effective features of modern law instruction.

Executive Training

Executives who are efficient managers command responsible positions and good incomes. And the need for

trained executives is growing rapidly. We train you thoroughly at home in your spare time for every type of executive work—teach you the principles and practices used by our most successful business leaders and help you develop your management capacity—by a training built with the aid of outstanding executives.

Become an Expert Accountant The Profession That Pays

The demand for skilled accountants—men who really know their business—is increasing rapidly. New state and federal legislation requires much more, and more efficient accounting from business—big and small. Corporations are in constant need of expert counsel in matters relating to Auditing, Cost Accounting, Business Law, Organization, Management, Finance. Men who prove their qualifications in this important branch of business are rapidly promoted to responsible executive positions—given an opportunity to earn real salaries. The range is from \$3,000.00 to \$15,000.00 a year—even to higher income figures.

Under the LaSalle Problem Method you can at home acquire a thoro understanding of Higher Accountancy, master its fundamental principles, become expert in the practical application of these principles—this without losing an hour of work or a dollar of pay.

Your training will be under the direct supervision of a staff of legal, organization and management specialists, business efficiency engineers and Certified Public Accountants.

Preliminary knowledge of bookkeeping is unnecessary. We train you from the ground up, or from where you now are, according to your individual needs.

Mr. Salesman: What's Wrong?

Why aren't you making more sales—more money? Is it you—or your proposition? Check up first on yourself. Other men—no better than you—have found their earnings jump and stay up when they trained with LaSalle. Literally thousands of men—many of them years at the game—have increased their sales volume and earnings through home study with LaSalle guidance. Sound—practical—usable—right from field experience. Train for top-notch production with LaSalle.

LASALLE EXTENSION UNIVERSITY, Dept. 564-R, Chicago

I would like to have your special booklet—without any cost or obligation to me—about my opportunities and your success training in the business field I have checked.

- | | | |
|--|--|--|
| <input type="checkbox"/> Higher Accountancy | <input type="checkbox"/> Commercial Law | <input type="checkbox"/> Business English |
| <input type="checkbox"/> Law: Degree of LL. B. | <input type="checkbox"/> Expert Bookkeeping | <input type="checkbox"/> Business Correspondence |
| <input type="checkbox"/> Traffic Management | <input type="checkbox"/> C. P. A. Coaching | <input type="checkbox"/> Effective Speaking |
| <input type="checkbox"/> Modern Salesmanship | <input type="checkbox"/> Industrial Management | <input type="checkbox"/> Stenotypy |
| <input type="checkbox"/> Business Management | <input type="checkbox"/> Modern Foremanship | |

Name _____ Age _____

Position _____ Address _____



When writing to advertisers please mention Popular Mechanics



CLASSIFIED

Advertisements



Advertisements in this section, 35 cents per word, each insertion, minimum 10 words, payable in advance

To be inserted under proper classification in June issue, copy should be in our office April 8th

June issue on sale May 1st

Popular Mechanics Magazine, 200 East Ontario Street, Chicago, Illinois

YOU'LL PROFIT

By reading and answering the classified ads in this section. Hundreds of opportunities to make and save money.

Popular Mechanics Magazine,
200 E. Ontario St., Chicago, Ill.

Dear Mr. Johnson: We have used the classified section of your valued magazine for some years past and all that we can say is that we wish that there were a few more magazines in the country which had a "pulling" power like Popular Mechanics classified section. Have written our advertising agency repeatedly asking if there was not some other magazine that would compare favorably with yours and the answer has always been if there is such a magazine we have never heard of it or words to that effect. Thanking you for all favors and wishing you continued success we are

Yours most sincerely,

NEW METHOD MFG. CO.

(Original letter on file in our office)

1000 CLASSIFIED ADVERTISEMENTS 1000 OPPORTUNITIES FOR YOU

AUTOMOBILES

NEW Book covering every detail of auto electric system, including magneto ignition. Step by step trouble shooting. One dollar postpaid. Satisfaction or money refunded. Allen Electric Manual, Box 83, Detroit, Michigan.

"ARTISTS'-TOOL," stripes or letters, automobiles, anything. \$1. William Conner, 247 Wayne, Dayton, Ohio.

DIESEL Engine Hi-Lites. Informative. Illustrated. 25c. Scheall Research, Duluth, Minn.

DESOGAS Fuel-oil converters, two years demonstrated superiority. Pretti Desogas, 1618 8th, Berkeley, California.

DIESEL—New bulletin explaining the Diesel principle, 4c. Reader's Service, 800M No. Clark, Chicago.

FORDS! Put salvaged Lockheed hydraulic brakes on your car cheap. Plans, \$1.00. Julius Monge, North Chicago, Illinois.

ATTRACTIVE Money made putting owners' initials on automobiles. Full or part time. Easy to do. Transfer Letter Co., Maplewood, New Jersey.

R & R MFG. CO., Anderson, Ind. Racing cars and midgets catalogue 25c.

FORD V-8's, 1935-37; model A's, 1928-31; Oldsmobile 8's, 1935-36. Saves gas, oil, \$1.00. Walert Co., 3429 No. 10th St., Milwaukee, Wis.

MIDGET Car plans, parts, engines. Circulars dime. Storms, 199 Broadway, Asheville, N. C.

DIESEL Type controlled combustion chambers, easily installed, guaranteed. No smoke, carbon, dilution, pinging. Information free. Complete data, \$1. Perry Diesel Engineer, Washougal, Wash.

NEW Ford repair book for 1937 V-8 and Lincoln-Zephyr cars. Includes data taught in Ford training schools. Answers hundreds of mechanical and electrical questions in non-technical language. Used in thousands of Ford garages. Over 100 pages, many charts and diagrams. Sold on money-back guarantee. Price \$1.00, postage prepaid. Trade Press Publishing Co., Montgomery Building, Milwaukee, Wis.

ELECTRIC Welder from Dodge generator. Proven blueprints, instructions, \$1.00. Carlson, 2212 Grand, Omaha, Nebraska.

SPECIAL. Semi-Diesel, diagrams, instructions, 25c. Sovereign's Sales, Toronto, Canada.

FORD V-8s—5 to 8 more miles per gallon with "Automatic Gasaver," uses the fumes from crank-case. Automatic Gasaver Co., 126 W. Wood Str., Youngstown, Ohio.

ECONOMY! Performance! Mileage! Semi-diesel conversions for all gasoline motors. \$5.00 up. Deal direct with the manufacturers. Unconditional written guarantee. Special complete units for Ford and Chevrolet. Learn basic facts, illustrated literature free. Des-A-Gas, 1719 Addison, Berkeley, California.

TOURISTS' Cabins, attractive 10x12 ft., how to build and 359 other practical articles in Shop Notes for 1936 only 50 cents, postpaid. Popular Mechanics Press, Dept. (C37), 200 E. Ontario St., Chicago.

AUTO SUPPLIES AND EQUIPMENT

MODEL A oil filters \$1.50. Klondykes, 2605-2601 Fort W., Detroit, Michigan.

DEMONSTRATORS. Compressor, test bench, 8-hour battery charger—are welder. Guaranteed. Trial and terms. Ken's Equipment Exchange, Box M-501, Troy, Ohio.

CHAMPION Automobile air cooled radio generators. Distributors wanted. List and literature. Wilt Electric Co., 7829 South Racine Avenue, Chicago.

MICROMETER Caliper (one inch). Precision tool; adjustable; leatherette case. \$1.65. Schaap, Laurelton, New York.

TARNISH Removed, luster restored on reflectors, lamps, bumpers, etc. Guaranteed 50c coin. Marvel Products, Box 286, Fox Lake, Ill.

1937 IGNITION Supercharger. Easy starting wet or cold. More mileage, pep, less carbon. \$1.25. Improves all engines. R. G. Sales Co., 321 Broadway, New York.

USED Auto parts at half price for all cars. Century Parts Co., 1712 Lafayette Ave., St. Louis, Mo.

TIRES—Firestone's, Goodyear's, others. Cut prices. Tireman, Lake, New York.

PLATING Outfits for automobile parts. Connect to battery. No tanks used. Free particulars and proofs. Gunmetal Co., Ave. J, Deatur, Ill.

A. C. GENERATORS

PRACTICAL Changes for automobile generators. See our advertisement at bottom of page 137A. Autopower, Inc.

AUTO TRAILERS

NEW Trailer Manual—Just off the press. Big 68 page book in color. Tells all about trailers. How to plan and build them. Latest modern designs. Complete instructions—how to select and where to get dependable material and supplies. Over 350 illustrations—shows the latest improved accessories, parts and plans used in 1937 factory made trailers. Every phase of trailer construction is covered. Send 25c in coins or stamps today for this valuable book. A. J. Stephens & Company, 2809 E. 14th St., Kansas City, Mo.

HOUSE-TRAILERS: Build fourteen, sixteen foot or de luxe model in spare time. Detailed blue-prints and instructions, per model \$1.85. Parts for sale. Box 1654, Wichita, Kansas.

BUILD Trailer less \$100. Plans 50c. "Silvertop" Trailers, La Crosse, Wis.

PARTS For the Popular Mechanics "Family Trailer" featured in the February, March and April, 1936 issues. Everything you need—Axle, hitch, wheel housings, water tank, pump, toilet, sink, stove, wood parts, windows, screens, lights, cushions, etc. Send for price list. Include 25c for our big catalog and Trailer Builders' Manual. Trailer Supply Co., 411 Jackson St., Wausau, Wis.

THE New 1937 Fold-A-Way Rambler. "V" front, de luxe windows, vestibule entrance, double walls and air cell insulation throughout. And it folds away. Fold-A-Way Trailer Co., Box 642, Davenport, Iowa.

TRAILER Clocks \$3.95 postpaid. Hard to get trailer parts. Catalogue 10c. Huebl Coaches, Le Sueur, Minn.

TRAILER Wincharger plan 10c. Propeller \$1.00 postpaid. Beacon Electric, Bismarck, N. Dak.

BUILD The famous Jim Dandy cabin trailer—thousands on the road! A roomy, good looking trailer easy to build at low cost by anyone handy with tools. Complete plans and instructions—only 50c—give every detail of chassis, body, top, beds, cabinets, refrigerator, electric light and water systems and where to buy all parts. Can be built in any size to accommodate 2 to 4 people. Send 50c for these practical plans. Rush your order today to Jim Dandy, Box 1125, Wausau, Wis.

HOUSE Trailer, streamlined, blueprint and specification, fifteen or eighteen feet. \$1.00. Stewart Trailers, Box 174, Cary, Ill.

\$1.00 BLUEPRINTED Plans, instructions, streamlined trailer, materials \$100. Trailer Designers, Box 885, San Diego, Calif.

TRAILER Axles, wheels, springs, equipment. Roberts Trailers, 11429 Forest Ave., Chicago.

POPULAR Mechanics "Family Trailer," complete illustrated plans for building in Shop Notes for 1937 only 50 cents postpaid. Popular Mechanics Press, Dept. (C37), 200 E. Ontario St., Chicago.

MOTORCYCLES, BICYCLES AND SUPPLIES

MAN-SIZE Tricycle. Haul up to 180 lbs.; equip your bicycle at small cost. Write Kibler, 524 Winnebago, La Crosse, Wis.

LEARN The bicycle business and simple locksmithing. We teach you. We sell bicycle supplies wholesale and do mail order repairing. Bishop's Bicycles, Norwood, Ohio.

MOTORCYCLE Mechanical manual, 80 illustrations, 100 pages, covering carburetion, ignition, combustion, transmission, compression, electrical units, conversion tables. 175 items of upkeep and repair—Indian, H-D., Excelsior. 75c postpaid. The Motorcyclist, 333 W. Second St., Los Angeles, Calif.

SEND 10c For new 1937 Handbook of Information, listing new and used parts, for Indian, Harley, Excelsior, Henderson; accessories, batteries. Bootz, 622 East Grand, Des Moines, Iowa.

MOTORCYCLES—Direct to you at rock-bottom wholesale prices. Rebuilt, road-tested and guaranteed Indians, Harleys, etc. Send 10c today for "Bargain Bulletin 43." Crandall Hicks Co., 780 Commonwealth Avenue, Boston, Mass.

ALLOY Pistons—Harley, Indian, Henderson, Excelsior, new or used parts, cylinder grinding. Catalogue and wings pin 10c. Ballak, 1115 Chestnut, St. Louis, Mo.

RECONDITIONED Motorcycles. New—used parts for all makes. Authorized Harley-Davidson dealer. Whitman Motorcycle & Supply Co., 405-9 Southwest Blvd., Kansas City, Mo.

SEND 15c For illustrated used motorcycle catalog. Bargains. Largest stock genuine Indian parts and motorcycles. Indian Motorcycle Sales, Kansas City, Mo.

GENUINE Harley Davidson parts, accessories, repairs. Prompt service. Send 10c for used motorcycle bulletin. Bill Knuth, 2491 Fondulac Ave., Milwaukee, Wis.

MOTORCYCLE Bargains, lowest prices, bargain sheets for stamp. Motorcycle accessories. Rochester Harley Davidson Corp., 129 West Main St., Rochester, N. Y.

REBUILT Motorcycles, all makes, new and used. Harley Davidson parts. Send 10c for bulletin. Western, 914 E. 15th, Kansas City, Mo.

AVIATION

22" AIRPLANE Fan propellers, \$2.00 postpaid. Guaranteed. Fanco, 7716 South Broadway, St. Louis, Mo.

PROPELLERS For airplanes, fans, sleds. Catalog dime. Lorenzen Propellers, Niles, Michigan.

BROTHER. Can you spare a dime? If you can, send it to me and I'll send you my low-priced aviation material catalog. (Canada 20c.) Karl Ort, 635 W. Poplar, York, Pa.

YOUNG Men interested in entering aviation under apprentice plan see ad on page 10A.

AIRPLANE Wrecks!! Unusual photographs, 25c a set (coin). Lynnpeltcher, 2030 Julian, San Diego, Calif.

BOOK: 500 Aviation questions correctly answered \$1.00. George Tuck, 73 Shirley, Pontiac, Michigan.

PROPELLERS Sled-Lightplane. Literature 10c. Woodcraft Propeller Co., Hillside Station, Wichita, Kans.

GET Into aviation. Air transport pilots get up to \$7,000 per year; mechanics, \$2,500. Learn at this government approved school. Write for complete information. State age. Lincoln Flying School, 2004 Aircraft Building, Lincoln, Nebr.

AIRPLANES \$50 Up. Terms. Motors, crackups, salvage. Complete directory 25c postpaid. Aircraft Directory, Athens, Ohio.

NEW Airplanes, \$98.00. Terms. Motors, propellers, air-wheels. Send 25c for information. Hibbs, Fort Worth, Texas.

BATTERIES, GENERATORS, ETC.

ELECTRIC Light plants, 350 watts and up. AC or DC. For use with or without batteries. Priced as low as \$95. Ideal for cottages, camps, trailers, etc. Write for bulletin "G." Universal Motor Company, Oshkosh, Wisconsin.

BUILD Wind light plant from automobile generator. Complete plans and catalog 10c. 50 other generator changes. LeJay Manufacturing, 1647 Lake, Minneapolis, Minn.

EDISON Storage batteries for light-power plants. Non-acid, non-sulphating. Long life. Fully guaranteed. Low priced. Also attractive bargains in power-light plants, generators, motors, etc. T. Hawley Smith Company, Croton Falls, N. Y.

GENERATOR Propellers, expertly designed at factory prices. Hibbs, Ft. Worth, Texas.

REWOUND Auto generators give 110 volts a.c. for lighting outfit. Complete instructions in Shop Notes for 1937 only 50 cents, postpaid. Popular Mechanics Press, Dept. (C37), 200 E. Ontario St., Chicago.

ELECTRICAL SUPPLIES—EQUIPMENT

BURGLAR Alarms from closed banks. Eighteen inch gongs, housings, instruments complete. Safety, DeLance, Gamewell. Suitable wholesale houses, garages, department stores. Supplies, diagrams. Midnight Alarm System, Fenton, Michigan.

HUNDREDS Of new and rare items, replacement parts and supplies. Send 10c for new, 60-page wholesale catalog. Autopower, 410-N S. Hoyne Avenue, Chicago.

ELECTRICIANS: Send for our free list of blue prints. H. Henrichsen, Alt, 140 W. 42nd Street, New York City.

WELDING AND SOLDERING

ELECTRIC Soldering iron. Ideal for radio repair. \$1.35 post paid. Wholesale-retail. Electric Supply Service, 139 East Fourth Street, Mansfield, Ohio.

DODGE Arc welder plans 35c. 50 other generator changes. LeJay Manufacturing, 1347 Lake, Minneapolis, Minn.

ECONOMICAL Arc-welder from Dodge generator. No rewinding. Plan, dollar. Pulls, Booker, Texas.

BUILD 200-300 Ampere engine driven arc welder cheaper than converted auto generators or light plants. Parts at auto wreckers. No rewinding. Blue prints \$5.00. "Doc" Fixit's, Mount Vernon, Ohio.

ARC Welder only \$39.25. Professional type—110-220 volt. Delivers 110 amperes. Easy to use. Details free. Commonwealth, Dept. U-55, Cincinnati, Ohio.

DEMONSTRATORS. Electric arc welders. Money-saving prices. Used by the government. Trial and terms guaranteed. Hobart Welders, M-562, Troy, Ohio.

DODGE Arc-welder 25-200 amperes, \$5.00 converts old North-East automobile generators. Learn direct current welding by building it yourself. Guaranteed certified plans \$1.00. C.O.D. \$1.12. Welders' Club of America, Box 3432-A, Merchandise Mart, Chicago.

WELD, Braze, solder with new outfit. Only \$1.25 postpaid. 1450 West North Ave., Chicago, Ill.

SPECIAL Bargains on new and used welding equipment. Circulars 10c. Adastik Bros., Grand Rapids, Mich.

60 AMPERE, 110 Volt welding transformer \$8.00. 100 ampere, 110-220 volt, \$16.00. Welding supplies, literature. Address Arc-master, 4115 No. Ravenswood Ave., Chicago.

REPAIR Fenders, braze, solder. New arc-welding outfit, \$1.00. Dickerson Manufacturing, Springfield, Missouri.

ACETYLENE And electric welding equipment. Box 331, Hamilton, Ohio.

ARC Welding, procedure handbook of design and practice. Latest world standard authority. 819 pages, illus., only \$1.50 postpaid. Popular Mechanics Press, Dept. (C37), 200 E. Ontario St., Chicago.

REBUILT Electric arc welders, all sizes, a.c.—d.c. Service Co., 3732 Cedar Ave., Cleveland, Ohio.

300 AMPERE Welding generator. Fine condition \$150.00. Wilmot Auto Supply, 1970 Wilmot St., Chicago.

ARC-WELDING Outfit \$1.25. Weld fenders, braze, solder. Layrow, 4368-W, Warren, Detroit. Stamp appreciated.

WELD Electrically. Lyndale arc welder only \$27.95. Welds auto blocks, fenders, etc. Guaranteed. Agents wanted. Lyndale Laboratories, 1936 South Lyndale, Minneapolis, Minn.

MACHINERY, TOOLS AND SUPPLIES

EVERY Tractor owner needs Irving's 84 page 1937 tractor replacement parts catalog. Absolutely free. Thousands parts, all makes; tremendous price savings. Irving's Tractor Lug Co., 134 Knoxville Road, Galesburg, Illinois.

WANTED—Slightly used South Bend workshop with long bed, cheap. A. B. Conklin, 2255 Calder Avenue, Beaumont, Texas.

KELLOGG Air compressors, \$6.00. Electric refrigerators \$25.00. Taylor, 105 East 102nd Street, New York.

STEEL Files, set of 8 standard shapes, 4" to 14". Postpaid \$1.00. Filerasp Co., 2 Penn St., Brooklyn, N. Y.

REBUILD Ford T or A motor into fast pumping air compressor. Instructions \$1.00. Tuck's Garage, 73 Sherley, Pontiac, Mich.

BARGAINS. Demonstrators, electric arc welders, guaranteed, 30 days trial and terms. Write Ken's Equipment, Box M-563, Troy, Ohio.

LAWN Mower sharpening made easy, plenty business everywhere. Write Engle & Wirt, West Burlington, Iowa.

LATHE, Bench type, \$39.50. Screw cutting, new. Burk Machine, 1314 Prospect Ave., Toledo, Ohio.

FREE Catalog all shapes brass, copper, steel, aluminum, Dymetol, monel, stainless steel, gears. Hobby Supply House, Box 2014, Pittsburgh, Penna.

STOP Boiler leaks. Bolt with 800 lbs. pressure on lead washer, latest, 35c. Burke, Bedford, Ohio.

SPRING Winder, best on the market. Circular 10c. John Blauer, Box 163, Sharon, Pa.

3/4 HORSE, 110 Volt, Universal motors with 14 to 1 gear reduction \$3.50. Wilmot Auto Supply, 1970 Wilmot St., Chicago.

15" x 6" SOUTH Bend screw cutting engine lathe, \$175.00. 14" Steptoe crank shaper \$125.00. All sizes of machine tools. Cincinnati Machinery & Supply Company, 27 West Second St., Cincinnati, Ohio.

TREMENDOUS Surplus of factory tools selling out. Drills, taps, files, hacksaws, etc. Send for free lists, include six cents postage. Travers Tool Co., 264 Jackson Ave., Long Island City, N. Y.

ENGINES, MOTORS, DYNAMOS

BARGAIN—1/2 Hp. ac. motors, 60 cycle, 1 phase, 110 volt, like new, guaranteed, \$9.50. Send check to Erie Electric Motor Co., 120 Church St., Buffalo, N. Y.

THREE To ten KVA alternating generators. Motors, converters. Queen City Electric, 1736 Grand Avenue, Chicago.

GET Our book of motor end connection data covering single phase two to eight pole, three phase two to twelve pole in Star and Delta. Postpaid in United States—\$3.00. Washington Electric & Armature Works, 2211 Main Street, Vancouver, Washington.

REWIND Wash machine motors. Particulars stamp. Rewinder, Box 844, Sandusky, Ohio.

ELECTRIC Motors. New, rebuilt. All kinds. New electric appliances. Bargain price list free. Mailorder Electric Co., 1718 So. Michigan, Chicago.

GOVERNORS Control speed of any make of auto engine, regardless of load changes, when used for stationary or portable power production. Read our ad on page 126A. Man'gs Candee-Smith Governor.

SMALL Electric motors, circular free. New, 110 volt rheostats \$2.50 postpaid. L. McConnell, 1619 Edgewood, Racine, Wis.

TO Close out. Slightly used 1/2 horse, 110 volt, alternating motors \$8.50. Wilmot Auto Supply, 1970 Wilmot St., Chicago.

WINDING Data, 225 motors, single and three phase. Price \$1.00. Motor Data Co., Box 7631, Kansas City, Mo.

BOATS, OUTBOARD MOTORS, ETC.

MARINE Inboard engines, all sizes, 1 cylinder to 8 cylinders. Featuring our 1 cylinder, 8 hp. engine for \$140. Featuring our 4 cylinder 25 hp. engine complete with electric starter for \$287. Write for catalog "Department G." Universal Motor Company, Oshkosh, Wisconsin.

BUILD Electric outboard motor. Operates on 6 volt battery. Plans 10c. LeJay Manufacturing, 1547 Lake, Minneapolis, Minn.

CONVERT Your outboard motor for racing. Complete instructions; fuel formulas. \$1.00. Ferris Industries, Philmont, N. Y.

KAYAKS. Kits. Sensationally new designs. Five remarkable major improvements. Outstanding values. Catalogue dime. Dedham Kayaks, Dedham, Mass.

ASSEMBLE Your own boat. Our finished knock-down frames save you 2/3 builder's cost. All types and sizes. Send 25c for big catalog. Brooks Boat Company, Inc., D4, Saginaw, Michigan.

BUILD A boat—Everything for building, equipping or repairing a boat. Build a boat by the Welch System. Use Welch ready cut parts. Inexpensive; interesting and profitable. Send 10c for catalog showing boats of many types; boat hardware and boat materials. Welch Boat & Supply Company, Station K-1, Milwaukee, Wisconsin.

BOAT Hardware and equipment for builders and owners. Write for Skipper's Guide. 10c postage. Inland Marine Corporation, 3119 East Lake St., Minneapolis, Minn.

ALLOY Pistons, cylinder grinding, bronze bearings, machine work, aluminum and brass castings, catalogue and wings pin 10c. Ballak, 1115 Chestnut, St. Louis, Mo.

RECONDITIONED Outboard motors and parts. Johnson Motors, Columbia, S. C.

15 FT. Canoe \$32.50. Ready to ride. Catalogue free. Jamestown Specialty Company, 377PX, Titusville, Pa.

12-FOOT Flat bottom rowboat—complete plans 25c. Free boatbuilding catalog. The Rudder, 15 Murray Street, New York.

FORD Marine conversion parts and kits. Models A, B, V8 (domestic or foreign). Catalogue 25c (coin). Osmithson, 3101 C St., Philadelphia, Pa.

BOAT Designers are highly paid professionals. Complete course by mail. Catalog. Westlawn, Montville, N. J.

OUTBOARDS. All makes, bought, sold, exchanged. Used parts and accessories. Outboard Headquarters, No. 395 Atlantic Avenue, Boston, Mass.

PROPELLERS. Gear pumps, stuffing boxes, bearings, etc. Wm. Baker, Pond St., Quincy, Mass.

OUTBOARDS—Save 1/2. Good used parts, all makes and models. Bargains rebuilt motors. Crandall Hicks Co., 780 Commonwealth, Boston, Mass.

KAYAK Construction kits \$9.45 up. Catalogue free. Jamestown Specialty Company, 377P, Titusville, Pa.

SPORTING GOODS, GUNS, FISHING TACKLE, ARCHERY

FREE Circular. Electric lighted lure, other new fishing items. Seigle's, Hinton, Oklahoma.

FENCING Equipment. Foils, swords, masks, etc. Low prices. Free catalog. Industrial Products, 274 Madison Ave., New York.

FISHERMAN: Sinker molds. \$1.25 up postpaid. Free folder. Box 313-C, East Liverpool, Ohio.

FREE Catalog—Tackle, fly and rod materials. Work Fly Company, Pueblo, Colorado.

ARCHERY—Most delightful sport for young and old. Instruction book 10c. Catalogue free. Archery Sales, 617 South State Street, Chicago.

FISHERMEN—Twenty assorted spinners, one dollar. Guaranteed. E. J. Knechtz, Grafton, Ohio.

FISHERMEN! Finest stock of hooks, Spanish gut, leaders, tools and materials in America. Send 4c in stamps for list and 1937 catalog. Paul H. Young, 8065-3 Grand River Ave., Detroit, Mich.

FLY Fisherman—You can't imagine to what perfection a new Fly Box has been created. If you have not yet seen it on the market write The Daisy Fly Box, Dept. A, Fenton, Mich.

TENTS: Factory to you. Catalog free. Willis Co., Everett, Mass.

BUCKTAILS. Flytied material. Hoffmann Studio, 992 Gates Avenue, Brooklyn, N. Y.

HUDSON Bay blankets, Indian pack baskets, camp stoves, knives, compasses, outdoor equipment. Free catalog. Howe Fur Co., Box P, Coopers Mills, Maine.

BOOKS Covering hundreds of subjects. Big catalog for 3c postage. Popular Mechanics Press, Room (C37), 200 E. Ontario St., Chicago.

FIELD GLASSES, TELESCOPES AND MICROSCOPES

TELESCOPES. Microscopes, binoculars. Lowest prices. Optical catalog free. Brownscope Company, 234 Fifth Avenue, New York.

INTERESTING Free literature. Amateur Telescope Makers Supply Co., Box 213, Flushing, N. Y.

ASTRONOMICAL Telescope lenses. \$2.50 set. Jamer, Box 4, Bayside, N. Y.

WONDER Pocket microscope. 50 power, magnifies 2500 times. Mirror, slides, tweezers. Packed wooden box, special \$1.09 postpaid. Mark's, 180 E. 125 St., New York.

USED Microscopes, binoculars, astronomical telescopes, surveying instruments—bought, sold repaired. Send 10c for list. Rasmussen, P. O. Box 294, Amsterdam, N. Y.

TELESCOPES. Microscopes, binoculars, chemistry, mineralogy. Catalog free. Teeko, Evanston, Illinois.

BUILD Reflecting telescopes; catalog free. Instructions 10c. Optical Laboratories, Larchmont, N. Y.

ANTIQUES, RELICS, INDIAN GOODS

GENUINE Indian arrowheads \$2.00. Petrified wood, sample 25c. Indian relics, curious rocks, all kinds. Catalogue 10c. R. C. Norris, Kanab, Utah.

INDIAN Relics. Battleaxe, tomahawk, pistol, dagger, each \$9.99. Blunderbusses, flintlocks. Photolist 10c. Museum, Rutland, Illinois.

WANTED To buy fine gem points and arrowheads from Ark., Wash., Colo. G. Pilquist, Dardanelle, Ark.

GENUINE Sinew sewed Indian bead work. R. C. Bane, Kingfisher, Okla.

5 ARROWHEADS 20c. 3 Birdpoints 18c. Knife, birdpoint, scraper, spearhead 45c. Catalogue. Coins, Minerals, Curios. Lemley Curio Store, Northbranch, Kansas.

100 GOOD Arrowheads \$3.00. Catalog 5c. H. Daniel, Dardanelle, Ark.

TAXIDERMISTRY

MOUNTED Specimens. Glass eyes, supplies. Hoffmann Studio, 992 Gates Avenue, Brooklyn, N. Y.

TAXIDERMISTRY Supplies—Quality artificial eyes, teeth, genuine Jonas head forms. Tools, materials, etc. Everything for the progressive taxidermist. Send 10c for big illustrated catalogue. Jonas Bros., 1049 Broadway, Denver, Colorado.

GLASS Eyes. Taxidermists', furriers' supplies. Lowest prices. Forty page catalogue, free. Write today. Elwood Supply Co., 222 Smith Building, Omaha, Nebraska.

DOGS, PETS, BIRDS

CREDIT Terms! Sentries Bostons! Monthly payments. Circulars, dime. 405P Gardena, Royal Oak, Michigan.

SAINT Bernard puppies, massive beauties, lowest prices. Paramount Kennels, North Hatley, Quebec.

STANDARD Rabbit Journal, Milton, Pa. Year 50c, sample dime; propositions.

RABBIT Breeders Guide, ten cents. Judge Fehr, Woodlawn Ave., Indianapolis.

PEDIGREED Scotch collies. Beautiful, intelligent companions. Dr. Armstrong, Albert Lea, Minnesota.

ANOTHER Litter bearlike Saint Bernard puppies! Dime brings interesting photographic prospectus. Royal Kennels, Napierville, Que.

AMERICAN Canary Magazine. Monthly. \$1.00 yearly. Sample 15c. 2839-P North Halsted, Chicago.

BEAUTIFUL Pure white police dogs. Ansonia Kennels, Mose, N. Dak.

POULTRY AND SUPPLIES

DAVIS Chicks for immediate delivery. Hatched from eggs grading 23 ounces and better in all electric Smith, 65,000 egg unit incubators. Barred, White, Buff Rocks, Reds, White Wyandottes \$8.45—100, White, Buff, Brown Leghorns and Anconas \$7.95—100. Heavy mixed \$7.40. Catalogue free. Davis Poultry Farm, Rt. 34, Ramsey, Ind.

BUY Salem's tested chicks. Hatching all popular breeds weekly. Write for our prices on sexed chicks and catalog. Salem Hatchery, Box 19, Salem, Indiana.

"**POULTRY** Item by far the best," say many readers who read other poultry journals. Twelve issues 35 cents; four years \$1.00. Sample free. Poultry Item, Box 71, Sellersville, Penna.

FOR Low prices, prompt service, write Smith Chickeries, Box 90-262, Mexico, Missouri. Also selling sexed chicks.

FARMS AND FARM LANDS

FREE Book on Washington, Oregon, Idaho, Montana, Minnesota, North Dakota farms. Rents are cheaper; prices lower. Low rates. Write E. C. Leely, Dept. 557, Great Northern Railway, St. Paul, Minnesota.

40 ACRES. Near White River, unimproved; poultry land. \$175, \$5 down, \$5 monthly. Free list and literature. Hubbard, 216 Grossman Bldg., Kansas City, Kansas.

MISSISSIPPI Land suitable for tung oil trees, fruits, vegetables, poultry. 10 acres unimproved \$150, \$1 down, \$1 weekly. Free literature. Mosher, 201 North Wells, Chicago.

CANADIAN Tax sale lands in parcels at one dollar an acre up. Small monthly payments. Farms, timber, hunting and fishing camps, minerals. Limited number of properties. Write at once for free illustrated booklet. Tax Sale Service, Room 613, 72 Queen St., W. Toronto, Canada.

GOVERNMENT Lands ten cents acre up. Information all states twenty-five cents. National Tax Service, 600A Majestic Building, Detroit.

NEW Farm opportunities! Washington, Idaho, Montana, North Dakota, Oregon, Minnesota. Farm income is up. Good land still at rock bottom prices. Literature. Specify state. J. W. Haw, 119 Northern Pacific Ry., St. Paul, Minn.

TREES, SHRUBS, ROOTS, HERBS

RANCHO Verdad Boysenberry! World's largest vineberry. Taste resembles raspberry. Thrive where blackberries grow. True to name plants prepaid from original acreage or original stock 10—\$2.00; 100—\$12.00; 1000—\$100.00. Rancho Verdad, Mentone, California; Ardmore, Oklahoma; or Hampton, Virginia.

JUST Out! World's greatest "Herbalist Almanac." Beautifully illustrated in natural colors. Contains over 200 old-fashioned herb medicine recipes for home use. 10c postpaid. Worth dollars! Botanic, 145 West 112th Street, Chicago.

PROFITABLE OCCUPATIONS

"**RAISE** Giant frogs!" We buy! Start small pond. Free frog book. American Frog Canning (153-E) New Orleans, Louisiana.

IT Pays to raise "Soilife" Earthworms for orchards, gardens, poultry and fishbait. California Earthworm Farms, LaCanada, California.

MAKE Money at home. No canvassing. D. Russell, Box 335, San Diego, Calif.

MAKE Architectural models. Profitable, dignified business. Particulars free. Welder, 4589 Lexington, Hollywood, California.

FREE Circular describes 107 successful business enterprises. Home City Specialties, Box P1273M, Springfield, Massachusetts.

MONEY In rabbits, cavies, squabs. We market. Catalog free. A. Stahl's, New City, N. Y.

RAISE Giant mushrooms! We buy! Start cellar, shed. Book, pictures free. United, 3848 Lincoln Ave., Dept. 60, Chicago.

RAISE Ginseng, ginsol, 2 lb. frogs. Particulars free. Specialty Farm, Rockford, Minn.

FREE Booklet describes 107 plans for making \$20-\$100 weekly, in home or office, business of your own. Elite Co., 214 Grand St., New York.

RAISING Jumbo frogs. Interesting. Big future. Females lay 10,000 eggs. Free literature. American Frog Industries, Box 336, Rayne, Louisiana.

OLD BOOKS WANTED

WE Pay up to \$5000 each for old books, also high cash prices for old magazines, letters, newspapers. A single story book, school book, old Bible, travel book, almanac, etc., that looks worthless may bring you \$50, \$100 or \$500 in cash. Thousands wanted! Send 10c now for latest price list. American Book Mart, 140 S. Dearborn, Dept. 1613, Chicago.

BOOKS, PERIODICALS, PICTURES, POSTCARDS

OUTLOOK For Television by Orrin Dunlap, Radio Editor, New York Times. Application, contributions, opportunities, technique. Originally \$4.00. Reduced to \$2.99. Kemper Radio Book Concern, 1123 Broadway, New York.

FREE! Big catalog describing hundreds of books on various subjects. Franklin Publishing Company, 800 North Clark Street, Dept. 2219, Chicago.

FREE—Send for list of new technical books at sensational discounts. T. Winn, 124 West 23 St., New York.

LATEST Books: Health, occupations, formulas, dreams. Publisher, 149 Collingwood, Detroit.

YOUR Favorite magazines—Half price. Catalog, 10c. Magazine Exchange, Baseline, San Bernardino, Calif.

GAMES—ENTERTAINMENT

PLAYS, Operettas, musical comedies, complete minstrel first-parts with song programs, blackface skits, vaudeville acts, monologs, dialogs, recitations, juvenile plays and songs, musical readings, entertainments, make-up goods. Catalog free. T. S. Denison & Co., 623 So. Wabash, Dept. 11, Chicago.

CHESS Position-recorder. Ideal for correspondence. Manufacturer, 149 Collingwood, Detroit.

MAGIC TRICKS, PUZZLES, JOKER NOVELTIES

LARGE Illustrated magic catalogue 20c. Lynn, Midland Ave., Paramus, N. J.

SEND One dollar for marvelous pack of cards. No skill required. You can do 20 tricks within five minutes after you open them. Free magic catalog with every order. Stunts, Inc., 148 Lafayette St., New York.

STARTLING! Mysterious Hindu money vanisher. Amazes everybody. Send 5c for trick and illustrated catalog jokers, novelties, tricks, etc. Special! Included free—age guessing trick and directions for staging complete magic show. National Magicians, 220 S. State, Dept. 350, Chicago.

WHOOPIE!—Comic business cards, 25c packet. David Sanderson, Ottawa, Illinois.

81 MYSTIFYING Card tricks, 10c. Explained in simple language, illustrated. Franklin Publishing Company, 800 North Clark Street, Dept. 2218, Chicago.

BE A magician. Send 20c mailing fee for our large catalog. Chicago Magic Co., 2300 N. Mason Ave., Chicago.

LAUGHABLE, Peppy comic novelties. Big profits, 8 samples. (\$1.00 value), 25c prepaid. Price, 2463-B Kensington Ave., Philadelphia.

FREE Tricks! Join Magicians' Fraternity! Monthly magazine, sample, 10c. International Magicians, Mt. Morris, Ill.

LEARN Ventriloquist art. Easy. Low cost. Free details. Apex, 221 E. 31, New York.

AMAZE And mystify! Hundreds of tricks for home or stage require no skill. You can perform them—be popular entertainer. Learn fifty good ones by sending 10c for "50 Magic Mysteries," and receive free "Book of 1000 Wonders," America's most complete catalog of low-priced magic. Lyle Douglas, Station A-5, Dallas, Texas.

MAGICAL Apparatus, illusions, catalog 3c. McKwade, 600 Martinique, Dallas, Tex.

EARN Money in any crowd. Call names of strangers, tell unspoken questions. Professional course mind reading, spirit writing, etc., \$1. Henderson, Box 341, San Bernardino, Calif.

LARGE Professional magic catalogue, 25c. Holden, 220 W. 42nd St., New York.

LEARN Ventriloquism, 3c stamp brings particulars. Smith, 125 North Jefferson, Peoria, Ill.

RARE COINS

COMMEMORATIVES: California Jubilee, Bay Bridge \$2.50 each, San Diego, Illinois, Oregon \$1.45 each, coin catalog 15c, lists 4c. Coinshop, 2510 Chester, Alameda, Calif.

OLD Money wanted. Do you know coin collectors pay up to \$100.00 for certain U. S. cents? High premiums for all rare coins? I buy all kinds. Send 4c for large coin folder. May mean much profit to you. B. Max Mehl, II Mehl Bldg., Fort Worth, Texas.

1909 CENT \$10—We buy certain coins, common and rare—Others worth to \$6000; 1864-1865 Indian head cents \$100 each; dimes before 1893, \$450; Liberty head nickels before 1914, \$300; large pennies, \$2000; encased postage stamps, \$13; half cents, \$275; half dimes, \$175; quarters, \$300; fractional currencies; paper money; gold dollars \$1,500; colonial coins, \$300; silver dollars, \$1,000; 1933, 50c, \$4.00; foreign coins \$165, etc. Send 15c today for illustrated 1937 coin book, before sending coins. National Coin Corporation (80), Springfield, Massachusetts.

FREE!—Confederate bill with each 25c or 35c coin book. Bill, the Coin Man, Elkhart, Ind.

ALL Military medals bought. Bronze 75c, silver \$1.25. Regardless of condition. Large silver medals \$1.50 per ounce. George Studley, 115 Maryland St., Rochester, N. Y.

PENNIES—Uncirculated, 10 different—60c; tax tokens, 10 different—40c. Schmidt, 2124 31st St., Astoria, New York.

WANTED: Offering 10 Pesos Mexican gold for set 1936 3 mints: Cincinnati half-dollar, Roy Radtke, 56 Dale Street, Rochester, N. Y.

COINS, Medals, papermoney, newspapers 1768-1799, books, almanacs, deeds, documents, checks, illustrated catalogue 3c. Collectors Exchange, 1536 North Willington, Philadelphia, Pa.

20 COINS, 25c; 80, \$1.00. Coin Exchange, Kansas City, Missouri.

28 PAGE Bargain list of coins, bank notes. Send stamp. Hubert W. Careaba, St. Augustine, Fla.

COMMEMORATIVE \$½s, Illinois, Stone Mountain, Oregon, Texas, Long Island, \$1.50 each. California gold quarter size and illustrated catalogue 25c. Auction catalogue 50c. Norman Shultz, Salt Lake, Utah.

COLLECT Old coins? We have them. Send stamp for list. Frank Lenz, 50 Station L, New York City.

NEW Illustrated coin book 15c. Auction catalogue free. Entire collections wanted. Ira S. Reed, Sellersville, Penna.

U. S. TWO Cent piece in 1860's with lists 20c. Acorn Stamp & Coin Co., South Norwalk, Conn.

WE Pay \$3.00 each for 1914 Lincoln cents D or S mint in uncirculated condition. We purchase all kinds of coins and paper money. Send 15c for new and interesting 28 page buying catalog before sending coins. (No other book purchases requested.) American Coin Company, Box 3507-A, Cleveland, Ohio.

COIN Collectors—Read "The Numismatist." Monthly news on coins, medals, and paper money. Published by American Numismatic Association. \$3.00 annual dues includes subscription. Write for descriptive circular. Suite P, 159 Washington Street, Mount Vernon, N. Y.

UNITED States. Large cent, 2c bronze, 3c nickel and bargain list, 25c. Eleven dates large cents, \$1.00. George P. Coffin Company, Augusta, Maine.

\$5.00 TO \$500.00 Each paid for old coins. Keep all old money. Send 10 cents for illustrated coin value book. 4x6. Guaranteed prices. Buying and selling. Coin Exchange, Box 5, Le Roy, N. Y.

FREE! Foreign coin, banknote, and large illustrated coin catalogue. Send 4c postage. Coin approvals sent. Tatham Coinco, Springfield-125, Mass.

RARE United States, foreign coins, war medals. Catalogue 10c. Mengelle, Colorado Springs, Colorado.

STAMP COLLECTING

FREE! Mint block file, illustrated new issue album and 500 hinges. Only 10c mailing charges! Choice approvals included. Clifton English Co., Nashua, New Hampshire.

A SNAP—300 Different foreign and 60 different U. S. stamps, including \$1 value, for only 30c. Free with each order, our pamphlet telling "How To Make A Stamp Collection Properly," together with our price lists of albums, supplies and hundreds of bargains in sets, packets, etc. Queen City Stamp Co., Room 36, 604 Race St., Cincinnati, Ohio.

PRODIGIOUS Gift! Scarce Perak, Negri Sembilan, bicolorized airpost, cheery French Colonies, picturesque Trinidad, Siberia, Selangor. Absolutely free with approvals! Postage 3c. Saxon Stamp Co., Dept. 65, Albee Bldg., Brooklyn, N. Y.

DIAMOND-SHAPED Airmail! Big packet 105 all different including airmail, commemoratives, Congo, Epirus, Manchukuo, etc.; set of two ex-King Edwards and Costa Rica diamond-shaped airmail; scarce U. S. telegraph, cat. 30c; pkt. British colonies—Gwalior, Hyderabad, Silver Jubilees; big lists. Everything for 5c to approval applicants! Send today! Mystic Stamp Co., Dept. 80, Camden, New York.

COLLECTORS Illustrated catalog free:—24 pages, featuring United States, Canadians, Newfoundland, British Colonials, Jubilees, Edwards. Sent for postage or entirely free. Empire Stamp Co., Dept. P.M., Toronto, Canada.

FREE—U. S. \$1, \$2, \$4 and \$5 stamps. Unbeatable U. S. approvals. Nelson, 658 Laurel, St. Paul, Minn.

DUPLICATE Book, stamps, hinges, Netherlands triangle, 5c with approvals. Benson Stamp Exchange, Omaha, Nebr.

CANADA Pictorial packet 5c. Bargain approvals. Bay Nielsen, Cornwall, Ontario.

FREE—107 Different stamps from strange and distant lands to applicants for really fine approvals, sending 6c to cover postage and mailing. Bill Boyd, Dept. M, 3422 Tuxedo Ave., Cleveland, Ohio.

STOP—Look. Stamps from smallest Republic, abandoned prison colony, remote East Indian kingdom, all for 10c, with approvals. Square-Deal Stamp Service, Box 101, Eagle Rock, Calif.

5c-10c PACKETS—World-wide assortment. 15 Africa, 5c. 25 Italy, 5c. Elsea, Bowling Green, Ohio.

URUGUAY 100 Different one dollar, 150 two dollars, 200 four dollars. Approvals. Heriberto Meyer, Paysandu, Uruguay.

500 MIXED Containing 25 different Sweden, 10c! 840½ Perry, Defiance, Ohio.

SERIOUS Minded collectors: Free listing in first annual United States Stamp Collectors Directory. Send name, address, size of collection, years spent collecting. Rush information—forms close soon. Universal Publishing Co., 504 Victory Boulevard, Nashville, Tennessee.

EARLY United States. Send for list. M. Place, Harding, Mass.

FREE! "United States, British Colonies and Better-Grade Foreign Stamps"—our valuable illustrated 96-page catalog. Money-saving prices! Send today. H. E. Harris & Co., 137 Transit Building, Boston, Mass.

COMPLETE Set, premium for postage. Approvals. Charles Sweetzer, Dover-Foxcroft, Maine.

TUNIS 1931 Mint set of six, 5c with premium. Approvals. Dyer, Box 70, Auburn, Maine.

EXCHANGE Stamps, postcards by "Exchangers," 51 Passage Bureau, Paris 126, France. Particulars free.

7 DIFFERENT Silver jubilees 5c with approvals. Berg, 1346 Broadway, Detroit.

ALBUMS Free with approvals. Old Homestead, Box 83, Columbus, Ohio.

ANIMAL Bird stamps, 40 diff. 10c. Canada, 35 diff. 10c. Approval applicants only. "Crescent Stamps," Box 653, London, Canada.

COVERS—Future first days, first flights, 7c up. Efficiency Service, Box 661, Washington, D. C.

TRIANGLES; Jubilees 10c with approvals. Parker's, 295, Plainfield, N. J.

105 DIFFERENT, Algeria, Travencore, Estonia, etc., 3c to approval applicants. Extra—Two scarce airmails free! Hunziker, Box 225-J, Minneapolis, Minnesota.

FREE—Bi-colored Ceylon pictorial, 33 others, approvals. Enclose \$0.05 postage. Payne, 536 East 56, Kansas City, Missouri.

WORLD'S Greatest bargain! 25 British Colonies, 15 China, 10 Guatemala. 30c value for 10c and postage. Brady, Cheswick, Penna.

NEW Copyrighted loose leaf stamp collection system. Most economical yet. Most beautiful sheets ever printed. Samples 5c postpaid. S. J. Jorgensen, 90 Maritime Bldg., Seattle, Wash.

PREMIUM Of 2 Belgium railroad, 3 Belgian East Africa, mountain scene, warrior, Kraal, 6 Italy, Ferrucci leading army and being killed, flock of sheep, country scene, bust of Horace, 2 Vatican City, bells, doves, church and Bible, to reliable approval applicants for 10c. Threlfall Brothers, Box 6811, D, Philadelphia, Penna.

100 DIFFERENT For this ad and 3c to approval applicants. Evanston Stamp Shop, Box 200, Evanston, Illinois.

TWO U.S.A. \$5.00 stamps, 265 foreign, 10c! Vanvoorhis, Hyndman, Pennsylvania.

50 DENMARK, 50 Sweden, 10 cents each. Price list free. Graf, 1874 Loring Place, New York.

35c NYASSA Set, 15c, approvals. Schell, 127 Rose, Reading, Pa.

SMALLEST Airmail only 3/4 inch high, free stamp magazine, \$2.00 U. S. stamp, bird, animals, train, Indian, airplane, commemoratives, special issues, with many scarce stamps from 25 different countries, 5c with approvals. Capital Stamps, 413L Roosevelt, Little Rock, Arkansas.

WAR! 5 Spanish ships 4c with approvals. Plymouth, Bell, California.

1/2 LB. United States 25c; 1 lb. 50c. Postage 5c. Brady, Cheswick, Pa.

5 REVENUES 1 To \$5. 2 blocks foreign. Surprise packet, 10c with approvals. Coruna Stamp Exchange, Coruna, Michigan.

100 DIFFERENT 10c. Argentine, Peru, Abyssinia, Canada with approvals. Catalogue about \$3.00, 40 to 75% discount on approvals. Majestic Stamp Co., Box 72, Sylvania Sta., Fort Worth, Texas.

200 DIFFERENT 10c. Big 50% approvals. Covert Stamp, 39 State, Rochester, N. Y.

1000 HINGES 3c. Bargain approvals included. V-J Sales, 2729 N. Summit, Milwaukee, Wis.

200 DIFFERENT British Colonies, kings, queens, pictorials, jubilees. Great variety colonies cataloging \$8 for \$1. VanBenschoten, Box 16, Syracuse, N. Y.

FREE—2 Paraguay air mail, 15 different stamps, with price lists. Koeningmark, 3225 So. 53 Court, Cicero, Illinois.

SOUTH AND Central America one cent approvals. J. W. Taylor, 4764 Oak Terrace, Merchantville, New Jersey.

FREE! 12 Jubilees (used beauties) with order for 100 world-wide, cat. value up to 25c each, for only 25c. Nugents, Lake Andes, S. Dak.

FREE!! King Edward VIII packet and surprise gift. Only 10c to approval applicants. Star Stamps, 1326 1/2 Main, Kansas City, Mo.

AIRMAIL Approvals! 15 choice airmails, including stratosphere, pictorial, paradise bird, zeppelin, Liberia, Iceland triangles, 25c to applicants, Howard, 12 Willow, Hartford, Conn.

41 DIFFERENT U. S., including \$1.00 Franklin—10c. Brooks, 373C Fifth Avenue, New York.

OLD Stamps, letters bought. Philatello, Broad Street Bank, Trenton, New Jersey.

SPECIAL—New Zealand commerce issue. Very scarce stamps, 2 different 10c. Approvals, British Colonies. References please. Argosy Stamp Co., Avon, N. Y.

A DUTCH Treat! Latest complete charity set used Netherlands including price list, 15 cents. Hare & Stocking, Dutch Specialists, Box 4 P, Trinity Station, New York City.

FREE Set to approval applicants. August Fischer, 235 Citizens Bldg., Louisville, Ky.

FREE—\$2.00 And fifteen other United States with approvals. Postage 2c. Wm. Clatworthy, Upland, Calif.

VERY Scarce obsolete Labuan stamp (found in few collections) and 60 different stamps; including U. S. commemoratives, new airmail, Cape Verde, Soudan, Honduras, Hyderabad, Newfoundland, Brazil, \$2 U. S. All for only 5c to approval applicants. Lennot Stamp Company, Department 5, Claborn, Maryland.

61 BEAUTIFUL Pictorial and airmails. All mint. \$1.00. Stevenson, 1775 SW, 23rd Street, Miami, Florida.

THE Prettiest foreign stamp portraying George Washington is the famous Polish number 267. We will send this scarce beauty together with complete set of picturesque Japanese commemorative issue 1926 (3 values), complete set of Italian issue 1908 (5 values), United States \$2.00 and \$5.00 stamps as well as latest issue "Stamp Lore," most entertaining and fascinating of stamp magazines, all for only 10c to approval applicants. Globus Stamp Company, Dept. 50, 268 4th Ave., New York, N. Y.

YOU'VE Tried the rest—Now get the best!—"Challenge Collection" including Cape Goodhope, triangle, Thessaly octagonal, commemoratives, 10c with approvals. Free airmail collection, additional premiums given regular customers. Bargain Stamp Service, Box 5147, Los Angeles, California.

CHOOSE Your premiums! Jungle stamps! Animal! Bird! Airmail! Triangle and map stamps! Pick any ten from our big approval selection. Absolutely free. Stamp Importers, Akron, Ohio.

150 FOREIGN 6c, 100 Different U. S. 25c. Pillault, 528 Broadway, Oakland, Calif.

FOREIGN: 1000—\$1.50; 5000—\$17.50, 1000 Colonies; British \$12.50; French \$12.00. Bender, 4434 Second, Detroit.

STAMPS From Hong Kong, Gambia, also French Guiana (anteater), Ceylon (jubilee), Canada (Niagara Falls), Haiti (aqueduct), Congo, Jamaica, Gold Coast for only 5c to approval applicants. Maynard Sundman, M5, Bristol, Conn.

ACE Penny approvals for satisfaction. Bent, 1739-A N. Wells, Chicago.

500 MIXED United States 25c. Jocketty, Box 90, Armada, Mich.

WHOLESALE Catalog for dealers. Illustrated. Postage 5c. Frank Co., 4900 Chalmers, Baltimore, Md.

OBsolete. Scarce \$1.00 Abyssinia elephant and thirty other rare stamps totaling \$1.25 sent approval applicants for 3c. Kummer, King, Lancaster, Ohio.

1000 WORLDWIDE Stamp mixture 25c. Monjar, 1542 Waverly, Cincinnati, Ohio.

SPECIAL—25 Mexico 8c with approvals. Zenhir's, Ellicott City, Maryland.

"GOYA Nude" stamp, 5c to approval applicants. "Jewell's," Tamaqua, Penna.

FREE—40 Different to approval applicants. Arrow, 5228 South Paulina, Chicago.

100 DIFFERENT Switzerland 50c. Lists free. Approvals on request only. I.C. Trading Company, Box 38, Bellerose, N. Y.

EXTRAORDINARY Free offer—Turks Calcos, \$5 U. S., Caymans, Western Samon (native girl), genuine Baden. Everything free to approval applicants enclosing 3c postage. Viking Stamp Co., 12 Hanson Place, Brooklyn, N. Y.

GREAT Bargain! Assortment triangles, old United States, Edward issue, Congo, Newfoundland, etc. Everything only 10c to approval applicants. Mandarin Stamp Company, Box 374, Coplague, New York.

FREE—50c Gift with 100 mixed stamps—25c. Gilbert Supplies, 1107 Broadway, New York.

65 JUBILEES, Airmail, British Colonies, many others 10c with approvals. Sachse Stamps, London, Canada.

FIRST Time ever offered! Sensational Rivera nude stamp, world's largest triangle, Sudan, Congo, airmails, pictorials, and many others. Only 3c with approvals. Cactus Approvals, Tucson, Arizona.

50 LATIN America 10c. Approvals. Wholesale list. Graves, Phoenix Bldg., Holyoke, Mass.

WANTED—Precancel coil pairs, cash. Trade mint U. S. Clem Boetter, Stevens Bldg., Chicago.

SUPERIOR Approval selections foreign stamps. U. S. list free. Aldrich, Box 744, St. Joseph, Mo.

27 UNITED States given general approval applicants sending 6c postage. C. A. Newton, 810 - 15th Ave., Prospect Park, Penna.

STAMPS. Prices we pay you. Catalogue 25c. Traffic Station, Box 161, Minneapolis.

DIFFERENT: 1000 Good unsorted stamps 10c a packet. G. E. Pigeon, Meriden, Conn.

EXCEPTIONAL United States mixture—35c—1000. Schiffermuller, Bellerose, New York.

STAMPS—50 All different 5c. Gaudin, 3 Chestnut, Brockton, Mass.

UNITED States, foreign on approval. Premiums offered. Dealing, Mound, Minnesota.

MIXTURES—United States 50c lb., 5 lbs. \$2.00; Canada 75c; Belgium \$1.10; France \$1.00; Netherlands \$1.25; foreign \$1.00; Japan \$2.00; postpaid. Mission, 4512 North Racine, Chicago.

LIBERIA Snake triangle, giant Spanish triangle, 50 other stamps, 5c. Wright Company, 2527 Guilford, Baltimore, Md.

4 1/2 TRIANGLES! Guatemala bisect (diagonal half-stamp), beautiful Liberia, three additional triangles, 27 other stamps, 5c. Abell Company, 1818 St. Paul, Baltimore, Md.

UNITED States—45 different 10c; 125 different arranged on card, each with catalog number, \$1.00; 25 different free to foreign approval applicants, enclosing 3c. Seidenberg, Baroda, Mich.

NUMBERED Approvals, postpaid. This ad accepted as 25c after purchases total \$2.00. Traders Club, 16152 Snowden, Detroit, Michigan.

THE Most historic issue in existence, "The Bosnian Assassination, the Spark That Set the World Afire." We include this complete set; also a complete Denmark ancient-ship set; 2 complete Russian sets; 3 stamps over 50 years old and Italy's Mussolini stamp, all for 10c! Pearson Bros., 68 Nassau St., Dept. 19, New York.

STAMP Collectors Annual—Describes and illustrates albums, supplies, United States, British Colonial and foreign stamps, sets, collections. This 36-page catalogue free. Gray Stamp Company, Dept. P.M., Toronto, Canada.

CANADA 50 Different, 10c. Librairie Oubrad, 905 Est. Ontario, Montreal, Can.

UNBELIEVABLE—Suriname, Panama, British Honduras, Jubilees, airmail, triangle. Complete collection every country from Straits Magellan to Arctic, 10c. Approval applicants only. Mutual Stamp Service, Box 666PD, Ventura, Calif.

BOYS—1000 Packets given away. Send today for 20 packages sachet powder to sell at 15c each, and premium list. Edmondson, 815 South Hill, Suite 610, Los Angeles, Calif.

MONTHLY Stamp and coin magazine, six months and 25 foreign stamps, 25c. American Stamp Journal, Cedar Rapids, Iowa.

WORLD'S Smallest stamp with 200 all different 5c, with approvals. Franklin Shultes, Berne, New York.

BARGAIN: 50 Different British Empire including jubilee, Edwards, 50 different new, recent and pictorial world issues, 15 different airmails, 500 hinges, perforation gauge—all for 25c. Approvals sent. Lists free. Victoria Stamp Co., London 4, Canada.

FREE—25 Scandinavia to approval applicants enclosing three cents postage. Alfred C. Johns, Sidney, Montana.

UNITED States. 75 different commemoratives, etc., 20c. Steger, Box 154, Crown Point, Ind.

KING Edwards (4) mint 20c. Approvals. Hunt, 184-U Lamberville, N. J.

SET King Edwards free, approvals. Enclose postage. Ephraim, River Forest, Ill.

FROM Earth's far corners. 25 Republics, Dominions, 40 U.S. commemoratives, airs, etc., 10c with approvals. Stamp Shop, 809 Holland Bldg., St. Louis, Mo.

300 DIFFERENT 20c; 1,000, \$1; 2,000, \$3.00; 3,000, \$7.00; 5,000, \$17.00. Fred Onken, 639 79th St., Brooklyn.

JUBILEES!! Used Trinidad, Jamaica, plus 50 different, 6c with approvals. Stamcraft, Box 126, Kansas City, Kansas.

500 MIXED 18c. Animals, birds, boats, rulers, scenes. Approvals sent. Elmer's, 196A Washington St., Boston.

FREE!! Rare airmail! Jubilee! Pictorials! Extraordinary packet 65 different stamps from strange countries (no Europe), 5c postage to approval applicants. Bargain Co., Box 39P, Station H, New York.

NYASSA And New India triangles; Egypt; Lebanon airmails; giant Belgium balloon; packet Congo; SanMarino; Charkhari; China; Mexico; Brazil; many British Colonies; No. Borneo, etc. 6c to approval applicants. Eureka Stamp Co., 602, Burbank, Calif.

FREE!! Edward stamp, packet Canada 3c, approvals. Hazett Stamp Shop, 701P Fourth, Baycity, Mich.

ARGENTINE, 60 Diff. 10c with bargain approvals. Davis, Silver Lake, Ind.

FREE—\$1.00 U. S. stamp with request for 52 page list of United States and foreign stamps. Stamps on approval. References necessary. 1000 U. S. no current \$1.46. New Hussman Stamp Co., 1122 Pine St., St. Louis, Mo.

U. S. MIXTURE—3 lbs. \$1.00. Holmes Stamp Co., New Albany, Ind.

QUEEREST Stamp packet. Receive world's smallest stamp; Vatican City; scarce Liberia triangle (value 15c); 1935 Greek Red Cross picturing coiled snake in Garden of Eden; Australian Bushman; new Spanish Morocco; Japan 'quake stamp; Manchukuo; many others. Only 5c to approval applicants. R. M. Stamp Co., P. O. Box 230P, Port Chester, N. Y.

ILLUSTRATED Album. Spaces 4000 stamps; to approval applicants 20c. Swan Stamps, 604 Swan, Dunkirk, N. Y.

WHOLESALE Approvals. References. Fuld, 3155 So. Grand, St. Louis, Missouri.

AMAZING Offer! Army and navy commemoratives, imperforate Chicago, packet of 23 North American stamps from U. S., Canada, Mexico, Newfoundland. Catalogue value over 65c—all for 5c to approval applicants. Illustrated price list free. Curhan Stamp Co., Dept. P, Gloucester, Mass.

NEWFOUNDLAND, 15 Different 5c with approvals. Frederick Brown, Plainfield, N. J.

FREE—Dollar packet to approval applicants. Harlan, 5307 S. Marshfield, Chicago.

UNITED States and foreign approvals. Huber, Three South Eighth, Minneapolis.

SCARCE New giant sized, diamond-shaped Russian "sports" stamp; Nyassaland "leopard"; Morocco; Tanganyika, and other scarce countries included in our big packet of new and recent issues—stamps most collectors have never seen! Get this valuable packet today. 5c to approval applicants. Reimers, 115 Flatiron, Fort Worth, Texas.

50 STAMPS Free, Manchukuo, etc. Postage 1c. Approvals not necessary. Album 3c. Bullard, 268 Northampton, Boston.

\$5.00 U. S. Postage due, No. 2284, fine copy 5c with general approvals. Hudson Company, 116 Nassau St., New York City.

ILLUSTRATED U. S. list, price 50c, large complete U. S. price list free. Send postage. Stanley Gibbons, 38P Park Row, N. Y.

PENNY Approvals that please. Haywood, 397 Adams St., Pomona, Calif.

AIRMAIL Triangles from Liberia and Mozambique, 3 British silver jubilees, new King Edward stamp and packet 25 different stamps from Azerbaijan, China, Ukraine, etc. All for 5c to approval applicants. Clipper Stamp Co., Dept. 7, Gloucester, Mass.

ASK For our wonderful one cent approvals. Prospect Stamp Co., 225 Broadway, Toronto, Canada.

MIDGET Airmail (1/2 in. tall), Szechuen, Kouang-Tcheou, Mozambique, etc., 30 stamps—5c. Depraw, Ocean Park, California.

CANNON! Set of stamps showing cannon, firing squad, cavalry charge and 200 other different stamps only 10c to approval applicants. Paramount Stamp Co., 4225 Broadway, Chicago, Ill.

STAMPS: A splendid selection sent on approval. Quality at low prices. Scarce and high value stamps are included in our approval books. Fred Herzberg, Box 91-P, Elmhurst, Ill.

STAMP Dealers, your ad here will bring wonderful returns. Ask me for proof. F. W. Johnson, Manager, Classified Advertising, Popular Mechanics Magazine, 200 E. Ontario St., Chicago.

GIANT-SIZED Russian Zeppelin stamp (est. val. 20c!) and beautiful Lithuania airmail triangle; also big packet of 53 diff. stamps including Azerbaijan, Epirus, new Martinique, etc. and illustrated lists—all for 5c to approval applicants! World-Wide Stamp Co., Box 600, Camden, New York.

WEEKLY Stamp magazine, thirteen weeks, 10c. Stamp Journal, Kalamazoo, Mich.

PENNY Approvals that satisfy. Neil Gronberg, Box 5441-P, Philadelphia, Pa.

44 DIFFERENT United States including \$5 stamp, or complete set United States bicentennials, or 30 different obsolete Canada, 13c postpaid with approvals. C. A. Lennan Co., Box 322, City Hall Annex, New York, N. Y.

\$5.00 U. S. Red and blue liberty, present postage value, Scott No. 573 cat. \$1.25 (retails as high as \$1.00 net by some dealers) only 5c to approval applicants. Giant U. S. price list free! Tatham Stamp Company, Springfield-5, Mass.

25 UNITED States, including \$4 and \$5 stamps free to approval applicants. 3c postage. Brownie Stamp Shop, Flint, Michigan.

DIAMOND-SHAPED Stamp, Liberia gunboat triangle, two other triangles, silver jubilee, 27 others, 5c. Crowder Company, 127E North, Baltimore, Md.

FREE!!! King George memorial packet, 15 varieties. Postage 3c. Roberts 901F Fourth, Baycity, Michigan.

HOBBIES AND COLLECTORS

HOBBYISTS: Woodworkers, model builders, taxidermists. Sell your work for cash. For information, list, handling, postage send dime. (If proposition doesn't satisfy you, will return coin). National Sales, 276 Cedar St., New Haven, Connecticut.

BOOK Match collectors: One hundred attractive unfolded covers sent postpaid anywhere in U. S. for \$1.00. All different advertisers. F. David, 633 Cornelia, Chicago.

PHOTO FINISHING

BE Modern!—Get Modern service. Modern quality. Modern prices. Our modern methods give quick service and bright guaranteed neverfade pictures. Roll developed 16 prints, 25c coin. 16 reprints, 25c. Enlargement coupon. Send next roll or reprint order to Modern Finishers, 3337-C, St. Paul, Minn.

20 REPRINTS 25c—Films developed, 16 prints 25c. Enlargements 8x10—25c; 5x7—10c. Low Photo, M2657 Neva, Chicago.

ROLLS Developed, 8 prints, two beautiful glossy enlargements 25c coin. 6 hour service. The Picture Folks, Box 911, Lincoln, Nebraska, Dept. X.

FINER Photos guaranteed. 24 hour service! Rolls developed professionally—8 Velox prints, 2 bromide enlargements—25c coin. Finertotos, Box D-898, Minneapolis, Minn.

QUALITY That is permanent. Rolls developed and printed 25c, reprints 3c. Mead's, Box 811, Station H, Los Angeles, Calif.

ROLL Developed, two sets dated Velox prints 25c. Hench Studios, 1814 Chestnut, Harrisburg, Penna.

ROLL Developed with 16 prints and two professional enlargements 30c. 100 reprints \$1.00. 16 reprints and 2 enlargements 30c. Dependable, RiverGrove, Illinois.

INTRODUCTORY Offer. Films finished 10c. Marvel, 644 Genesee Ave., Morrison, Ill.

IMMEDIATE Service! No delay! Roll developed, carefully printed and two beautiful 5x7 double weight professional enlargements or one tinted enlargement or six reprints—all for 25c coin. The expert's choice. Reprints 3c each. The Photo Mill, Box 629-Z, Minneapolis, Minn.

DEVELOP And print your own pictures. Save time, money with our complete \$1.49 outfit postpaid, or pay postman \$1.55 C.O.D. Includes electric ruby lamp, printing frame, photo paper, chemicals and equipment. One of hundreds of amazing bargains in our free, newest, money-saving bargain book. Send for it today! Central Camera Co., 230 So. Wabash, Dept. 15-K, Chicago.

HAND Colored enlargement with each roll 25c. 40 reprints 50c. Colorgraph, Dunning Station, Chicago.

FILMS Developed 2 prints of each 25c; 20 reprints 25c. Pine Photo, M-5134 Nevada, Chicago.

BE Modern!—Get Modern pictures. Modern Finishers, St. Paul, Minn.

PHOTO Mirrors. Make, sell. Samples. 30c. Printerross, Perrinton, Mich.

OIL Tinted enlargement with roll 25c—refunds. One day service. Reprints 3c. Box 353, Hutchinson, Kans.

ROLL Developed, 8 fadeproof Velox prints and a photo-fle 25c. Reprints 3c. Professional 8x10 enlargement 25c. Beautiful premiums. Young Photo Service, 405-B, Albany, N. Y.

MAIL Your rolls to film center of the world. 8 guaranteed glossy Velox deckle-edged prints, 25c coin. Professional enlargement coupon free! Photo Finishing Shop, Est. 22 Yrs., 411-H Genesee Valley Trust Bldg., Rochester, N. Y. "The Camera City."

CASH For snapshots! Earn extra money. Thousands wanted immediately. Stamp brings information. Division 155, International Photos, Hohm Building, Sixth & Western, Hollywood, California.

ENLARGEMENTS Our specialty. 4x6 or smaller, 5 for 25c. 5x7, 3 for 25c. 8x10, 3 for 35c. Roll developed 16 prints 25c. 25 reprints 25c. Enlargers, Dunning Station, Chicago.

PROFESSIONAL Quality service. Rolls developed, 8 prints and 2 enlargements 25c. The Film Capital Service, Box 504, Rochester, N. Y.

QUICK Service. Rolls developed, 8 guaranteed prints, 2 enlargements, 25c coin. OK Photo Service, Ottawa, Kas.

ROLLS Developed, 2 prints, 25c. HiTone, Box 134, Hagerstown, Maryland.

FOR The discriminating amateur—roll developed and printed on super gloss Velox paper 25c, reprints 2c. Quality instead of quantity, same day service. Paramount Co., 327 E. 92nd St., New York City.

SOMETHING New! We carefully develop and print your film and send you a new roll (127 to 116 size) of a nationally known brand, all for 30c. Economy Photo Service, Box 157-A, Greensburg, Pa.

WILL Send 3 silkstone 5x7 enlargements, with prints, any roll, 25c. Photorium, Box 757M, Minneapolis.

FREE! Best snapshot on attractive photo button with 16 prints developed each roll 25c. Choice of several beautiful novelty premiums—Daily service. Novel-Ad Company, 3327 North, Chicago.

21 REPRINTS 25c; 45, 50c; 100, \$1.00. Film developed 16 pictures, 25c. 4 enlargements 25c. Million Pictures, 336, Albany, Wis.

20 REPRINTS 25c. 100 Reprints \$1.00. Rolls developed with 16 prints 25c. Nordskog, 4, Maywood, Ill.

20 REPRINTS 25c. Films developed, two prints each negative, 25c. Skrudland, 6970-8 George, Chicago.

ROLL Film developed and printed, including two beautiful double weight olive tone enlargements free. 25c coin. Nu-Art Photo Shop, LaCrosse, Wis.

LOOK! Colored enlargement and 8 Monex Art prints from every roll only 25c. Comet Photo Service, Box 266-O, Minneapolis, Minn.

FREE Contest. Your photo may win up to \$15 prize. Mail your roll of films with 25c for 8 permanent prints and magazine describing contest. Home Life, Berwyn, Ill.

IDEAL Finishing. Your roll developed and printed 25c. Snapshot folder and enlargement coupon with each order. Ideal Photo Service, Box 2255, Paterson, N. J.

ROLLS Developed 8 prints on Velox. 25c. Enlargement free. Reprints 3c. Photo Shop, Department P, Box 218, Augusta, Ga.

CLEAR, Brilliant prints; prompt service. Roll developed, 2 prints each negative 25c. Enlargement coupon. Photo Finishers, Dept. 5, Cleveland Heights, Ohio.

ROLLS Developed, 8 prints and enlargement, 25c. Reprints 3c each. U. S. Film Co., Ogden, Utah.

ROLLS Developed. Two professional double weight, enlargements, 8 Nu Tone prints 25c. Herman Studio, Ft. Wayne, Ind., 105 Main.

GUARANTEED. 20 Prints 25c. Film developed, 2 prints each, 25c. Rush service. Quality Photo, Hutchinson, Kansas.

PICTURES That compliment your skill, rolls developed and printed 35c each, the best, worth it. Casey, Leakey, Texas.

ROLLS Developed, remarkable quality, two master enlargements, eight gloss prints 25c. Reprints 3c. World Famous Johnson Studio, Eau Claire, Wisconsin.

ROLL Developed, 8 guaranteed prints and beautiful enlargement, 25 cents. Reprints 3c each. World Photo Service, Box 2154, Spokane, Wash.

TWO Beautiful Masterprint enlargements included with roll developed, printed, 25c; finest quality reprints, 2c each. Brown Photo Company, 2209-13 Lowry, Minneapolis, Minnesota.

QUICKER Service, sparkling double-clear never-fade prints. Roll developed, two prints each negative, enlargement coupon 25c. Willard's, Box 3335-A, Cleveland Heights, Ohio.

ROLL Developed, 2 prints each negative, 25c. Reprints 2c. Photoshop, Ogden, Utah.

FILMS Developed and printed, also two double weight enlargements 25c, 8 reprints and one enlargement 25c. Photoart Shop, Box 3406 P, St. Paul, Minnesota.

IMMEDIATE Service! No delay! Roll developed, carefully printed and two beautiful 5x7 double weight professional enlargements or one tinted enlargement or six reprints—all for 25c coin. The expert's choice. Reprints 3c each. The Photo Mill, Box 629-12, Minneapolis, Minn.

ROLL Developed, two prints each, two enlargement coupons 25c. Summers' Studio, Unionville, Mo.

ROLLS Developed, 16 guaranteed prints, two coupons on plain or colored enlargement 25c. Smart Photo, Winona, Minnesota.

LARJAGRAPH Reprints: (5x7), five 25c. Cardinal Photos, Berkeley Heights, N. J.

TWO Glossy enlargements, 1 colored, with roll 25c. Arbor Service, 10 Joliet, Ill.

FINER Finishing. Rolls developed and printed, with one colored enlargement, or two professional enlargements. All for 25c (coin). Genuine, nationally known, Moentone superior quality. Moen Photo Service, La Crosse, Wis.

KODAK Enlargements 5x7, 10c; 3 for 25c coin. Send best negatives (film). Dept. 5, Xint Photo Lab., Cedar Rapids, Iowa.

ROLLS Developed. Two beautiful double-weight professional enlargements and 8 guaranteed Never Fade Perfect Tone prints, 25c coin. Rays Photo Service, LaCrosse, Wisconsin.

ROLL Developed and 8 beautiful Velox glossy prints 25c coin or stamps. Reprints 3c each. Fotoprint Service, Box E, Boone, Virginia.

COMPARE The difference! Roll developed, two professional double weight enlargements, 8 guaranteed prints, 25c coin. Excellent service. Nationwide Photo Service, Box 3333, St. Paul, Minnesota.

GET The best. Roll developed, beautiful hand colored enlargement, 8 neverfade border prints, 25c coin. Prompt service. Sun Photo Service, Drawer T, St. Paul, Minn.

CAMERAS, PHOTO SUPPLIES

MAKE Money in photography. Learn quickly at home. Spare or full time. Easy plan. Previous experience unnecessary. Common school education sufficient. Write for full information and requirements. American School of Photography, 3601 Michigan Avenue, Dept. 3431, Chicago.

CAMERAS And supplies. Free illustrated catalog listing everything photographic—still and movie cameras, films, lenses—at tremendous savings. Hundreds of bargains, new and used. All guaranteed. We take your old camera or equipment in trade. Write now for your free copy of our newest money-saving bargain book—just out! Limited edition. Hurry! Central Camera Co., (Photographic Headquarters since 1899), 230 So. Wabash, Dept. 5-K, Chicago.

ENLARGE Your own photographs in five minutes. Simple, inexpensive. This amazing new enlarger makes beautiful enlarged prints from any size roll pack and plate negatives. Order this sensation today! Complete with lens, only \$2.98 postpaid. Precision Products Company, Dept. C.M., 507 Fifth Avenue, New York, N. Y.

FOR Argus. Beautiful black or tan cowhide Everready case. Similar appearance and quality as expensive miniatures \$3.75. Improved precision \$12.50 enlarger, double-wall scientifically ventilated housing, microscope focusing, special \$9.95. Both \$11.75. Guaranteed. Postpaid. Quentin Products Company, West Salem, Illinois.

BASS Will postpay to you the Argus Candid Camera with f:4.5 lens, speeds to 1/200th of a second, \$12.50. New Argus enlarger at \$12.50. Daylight Pan film, all speeds, 36 shots, 85c. Weltl Precision Candid camera with genuine Carl Zeiss Tessar f:2.8 lens in Compur shutter, \$48.50. Voigtlander Duo Bessa 2 1/2 x 3 1/4 or 16 Vest Pocket, with f:4.5 Anastigmat lens, speed shutter, \$27.50. Write for free Bargaingram 227 now ready. Largest stock of new and used apparatus in America. Dept. AG, Bass Camera Company, 179 West Madison Street, Chicago.

PANCHROMATIC Safelight, 20c. Economical. Leakproof. Lasts indefinitely. Sample, 3c. Photo Research, 202 East 44th, New York.

PHOTOMURALS. Giant enlargements. Easily and economically made. Complete illustrated instructions \$1.00. Information free. Fogarty, 1689 Capitol, Bridgeport, Conn.

\$50.00 A WEEK With a kodak. Booklet describing 100 magazine markets, 25c. Stamps or silver. Specialty Sales Co., 143A 16 Ave., Newark, N. J.

MAKE Money selling snapshots. Complete instructions, 1800 markets, 10c. Photo Markets, 201-P Barrister Bldg., Washington, D. C.

AMATEURS Photographic Manual and C.P.S. registered press card. Special \$1.00. Write Box 74, Station G, New York City.

INTERESTING Sample copy of 25c photographic magazine for 10c. Special, six months trial subscription for \$1.00. Photographic Digest, 1666 Linden Street, Brooklyn, New York.

PHOTOGRAPHIC Fun, tricks, ideas, ten cents. Parolski, Photographer, Wakefield, Mass.

VALUABLE Booklet free to camera owners. Hively Publishers, Alliance, Ohio.

PHOSPHORESCENT Screens. Make luminous pictures from your films, luminous signs, novelties, etc. Green, yellow or violet 8"x10", \$1.00 each, 3 for \$2.50. Hartson Products Co., Box No. 93, Brookings, Oregon.

35% DISCOUNT On films. Write Paramount Photo Division, 327 E. 92nd St., New York.

STEREOSCOPIC Photography. Simple device applicable ordinary camera. Easy and cheap to construct. Blueprint, instructions, \$1.00 currency. Lester, 1927 Hawthorne, Houston, Texas.

INTERESTING Photo free!! Amateur. Postfach 20, Porzellangasse, Vienna, Austria.

GET Inside! Fire lines; parade lanes; courts. Photographer's Press Card (like reporter) 25c each. Emery Service, Adam St., Pittsfield, Mass.

HAVE You a camera? Send ten cents for recent number of our big magazine, showing how to make better pictures and earn money. American Photography, 116 Camera House, Boston, 17, Mass.

INCOME From your camera instead of expense. Low cost home course teaches you to make photographs for magazines, newspapers, advertisers. Tremendous demand. Earn good money wherever you live. Free book. Universal Photographers, Dept. 104, 10 West 33rd St., New York.

MOTION PICTURES AND SOUND EQUIPMENT

CENTRAL'S Free, new, money-saving bargain book explains latest movie developments, offers money-saving bargains in cameras, lenses, projectors, films. Used equipment taken in trade. Write for free copy. Central Camera Company, (Photographic Headquarters since 1899), 230 So. Wabash, Dept. 25-K, Chicago.

16MM CAMERAS, Projectors, all makes and models, new and used, big discounts, trades accepted, films for rent, sale and exchange. Free catalogue. Garden Exchange, 800 - 8th Ave., New York.

BARGAINS—Cameras, films, projectors, accessories, lists. Shook's Photo Service, 38-40 Fort St., Forty-Fort, Pa.

BARGAINS Galore! Complete home movie line. Box 2133, Paterson, N. J.

SHORTS \$1.15. Features \$1.00. Reel. Selling out 35mm. Mutual, 6802 Racine, Chicago.

8-16MM. TITLES, 2c Word. Catalogue. Clineshop, 1560 Jackson, Charleston, West Virginia.

BARGAINS! 8mm, 16mm. Literature free. Elder, Dept. B-35, Chelsea, Mass.

LEARN Motion picture theatre business. Home-study training: management, advertising, projection. Tenth year. Free catalog. Theatre Institute, Elmira, N. Y.

SOUND FILM Devry 35mm portable projector 1000 ft., 1000-watt illumination, complete with amplifier, speaker, tubes, ready for use, fully guaranteed, \$189.50; films for above \$4.00. Portable RCA Victor 16mm soundfilm projector Model PG, complete, regularly \$500, guaranteed, special \$229.50—suitable theatre, church, school, industrial, with audience up to 1500. Odd 16mm silent films \$1.00, 400 ft. \$3.00; sound \$2.00, 100 ft.; \$6.00, 400 ft. 16mm silent-sound library, films sent anywhere. Catalog check full bargains, new, used equipment, parts, still, movie. Home talkie attachments, new, connect to any motor-driven projector—complete \$13.49. New headed 30x40" hanging screen, mounted, \$2.49. Heyde optical exposure meter, \$2.49. Trades accepted, bought. 8-9 1/2 mm Headquarters, Mogull's, 1944J Boston Road, New York City.

STILLS From movie frames, enlarged negative 35c. Send two inch strip or marked reel. Vaughan, Fletcher Rd., Belmont, Mass.

FILMS, 8mm-16mm. Popeye, Betty Boop, Mickey Mouse and others. Bargains in cameras, projectors and equipment. Send stamp for catalogs. Hollywood Cine Film Distributors, Dept. C, 1421-33 No. Highland, Hollywood, Calif.

TENTH Anniversary. 35mm, complete \$1.00. Savarese, Woodliff Lake, New Jersey.

16MM. FILMS, 25 Feet, 58c. 50 feet 88c. Lists 3c. Clifford Hoffman, 3 Thacher St., Albany, N. Y.

TALKIES \$25. Silents \$5. Projectors. Simpson, 1275 So. Broadway, Dayton, Ohio.

LOW Priced 16mm. films. Acme Cine, Box 794, Lima, Ohio.

POPULAR Star films, 16mm-8mm, 25c up. Free bargain lists. Home Movies, Box 32, Easton, Pennsylvania.

ROAD Show exhibitors. Complete, late 9 reel, 16mm, sound programs, \$20.00 week. Tremendous selection. Eastin Pictures, Davennort, Iowa.

16MM-8MM MOVIE Cameras \$9.95, 16mm film 98c, 8mm, 54c. Projectors, Screens, Circular free. Bytom, Dept. C, Park Ridge, Ill.

8MM 16MM FILMS, Equipment. Bargain bulletin. G. Taylor, Box 234, Corning, N. Y.

16MM.—8MM. SALE—Exchange—Rental—Editing, titling service. Free lists. National Cinema Service, 3 West 29th St., New York, N. Y.

MAKE Your own black and white and kodachrome movie titles with Stamp-O-Title complete titling outfit. Fluid eradicator swiftly removes lettering. Complete set with type, chemicals, cards and accessories only \$5.75. The Stamp-O-Title Co., Dept. P-5, 318 East 116th Street, New York.

READY For you—No. 224—the latest and greatest Bass Bargaingram of Cine Apparatus. Acknowledged leadership in the cinema field. A few of the fine values: Films 70A, 1" F:3.5 lens and case, \$39.50. Cine Kodak, model B, F:1.9 lens and case, \$54.50. 100 ft. DeVry 16 mm. camera, F:3.5 lens, \$22.50. Model PG 71 RCA sound projector, 750 watt lamp, regularly lists \$500.00; our price, \$245.00. Willo Cinemeter with case, \$3.75. Write today to Cine headquarters and start to save now. Bass Camera Company, Dept. A, 179 W. Madison St., Chicago, Ill.

"THE World's Greatest Passion Play." Seven reel sound with dialogue and silent (new) 16 mm. Superior than Oberammergau stage play. Rent or purchase. Write with stamp. Hemenway Film Co., 37 Church St., Boston, Mass.

FILMS, Projectors, 10c coin for lists. Capital Productions, Rosedale, Kansas.

WESTERN Thrillers, 500 feet 75c. Jersey Filmco, 2075 Richland, Lakewood, Ohio.

35MM. FILMS. Bargain lists 3c. Hoffman Film Service, 57 Broad, Albany, N. Y.

BASS Now exclusive distributor for Radio Corp. of America 16mm. R.C.A. Sound on Film Cameras. Anyone can record sound pictures. New low price. News reporter model was \$350.00, now \$210. Send for complete details. Bass Camera Co., Dept. AK, 179 W. Madison St., Chicago, Ill.

8MM FILMS: Cartoons, travel. List. Lincoln Film Service, Box 293-A, Saginaw, Mich.

CINE 8MM Movie camera, adjustable F:5.6 lens \$9.95, with F:3.5 lens extra \$7.50. Film 60c roll. Satisfactory or it's no sale. American Sporting Goods Company, St. Louis, Mo.

RADIOS, SUPPLIES, INSTRUCTIONS

AMPLIFIERS—18 Watt 6B5's high gain kits \$15.75. Super Television Labs., Oconomowoc, Wisconsin.

ANALYZER-METERS Repaired, revamped, ohm meter scales provided, lowest prices. Dungan, Forty-Fort, Penna.

SAVE Money on radios and parts. Send for our money saving catalog. United Radio Company, N-Newark, N. J.

RADIO Experimenters and set builders; parts and kits of parts for improved Little Giant R235, six tube R233, Preamplifier R228, portable battery R223, Little Giant R220 and 205 and economy three 206, described by Popular Mechanics. Guaranteed specified parts. Lund Manufacturing Co., 43 East Ohio, Chicago.

BUILD Crystal sets. Instructions 18 distance models with catalog; "Radiobuilder" year; 25c. Laboratories, 151-C Liberty, San Francisco.

\$1.50 POCKET Radio, agents sample 60c. Radio Exchange, Richland Springs, Texas.

PHILCOS, Zeniths, Majestics, others. Cut prices. Radioman, Lake, New York.

RADIO Engineering, broadcasting, aviation and police radio, servicing, marine and Morse telegraphy taught thoroughly. All expenses low. Catalog free. Dodge's Institute, Ames St., Valparaiso, Ind.

MUSIC AND MUSICAL INSTRUMENTS

PIANISTS: Free booklet describes method improving your technique, accuracy, sight reading, memorizing. Write Dept. 421-E, Broadwell Studios, Bendix Bldg., Los Angeles.

REBUILT Band and orchestra instruments. Honestly rebuilt—fully guaranteed. Catalog of new instruments on request. Weymann Company, Dept. M-5, 1813 Chestnut St., Philadelphia.

VIOLINS—Your violin can be made into a master violin through newly discovered principle in regraduation. Write Gustav F. Henning, Fischer Studio, Seattle, Wash.

"HIT"—QUALITY Music to poems. Paramount, 246 E. 2nd., New York.

SONGPOEMS Set to music. Modern marketing plan. Newald Music Co., Kitchel, Ind.

POEMS Wanted. Work guaranteed. We publish. Great Eastern, Thomaston, Maine.

SONGWRITER'S Question box. Ask us about your song problems. Each question clearly answered—25c. Hollywood Music Co., Question Dept., 6019 Hollywood Blvd., Hollywood, Calif.

CHORDS, Scales, keys, signatures, transpositions, instrumentations formed instantly. Paper musical slide rule. Send \$1.00. Paper Co., 2 Ellwood St., New York City.

MUSICIANS—Teachers. Sell popular music. New deal. National Music Dist. Co., Garfield Bldg., San Francisco.

SONGWRITERS: Send for free rhyming dictionary and writers' guide. MMM Publishers, 637 Studio Bldg., Portland, Ore.

PIANO By ear. Free explanatory booklet; no obligation. Day-V-Way, 532 Woolworth Building, Dearborn, Mich.

SONGWRITERS!! Songs arranged, prepared for publication by the arranger of "Carolina Moon," "Melancholy Baby," "Gypsy Tearoom," "Treasure Island," "Bamboo Bridge," etc. Send for details. Harold Potter, 1619(P) Broadway, New York.

PIANO Jazz guaranteed by mail in 20 lessons. Erskine Studios, 810 East 14th St., Oakland, Calif.

SONG-WRITERS. Professional phonograph record of your song. Musical arrangements. Free information. Paramount Song-Recording Studio, J-8, Box 190, Hollywood, California.

SONGPOETS. Royalty publishing. Poem lessons 50c. Songland, "PM," Thomaston, Maine.

WANTED! Lyrics, melodies for songs. We arrange, publish, sell. Superior Song Studios, Passaic, N. J.

DUO-FLEX Reeds for clarinets, and saxophones eliminate your reed troubles. Write for circular. Duo-Flex Reeds, 1204 1st Ave., Evansville, Ind.

SONG Poems wanted—Home, love, sacred, any subject. Send best poem today for offer. Richard Bros., 24 Woods Bldg., Chicago.

SONG Poems set to music. Get our phonograph recording plan. Zerse Bros., 210 Olive, St. Louis, Mo.

MUSIC Arranged for songs; orchestra. Frank S. Willit, Lancaster, Pennsylvania.

SONGWRITERS! Outstanding proposition. Inquire. Hibbeler, D1, 2157 No. Avers, Chicago.

EARN Your own musical instrument. Get free details and free attractive savings bank at your music store, or write Fred Gretsch Mfg. Co., 521½ So. Wabash, Chicago.

VIOLINS—Handmade. Best since Stradivarius days. (Curious don't bother.) John Lehto, San Pedro, Cal.

MUSIC Composed to words. Wonderful proposition. Bauer Bros., Oshkosh, Wis.

WRITE Songs. Big money and reputation. Write for information. J. Gordon Pub. Co., 201 N. Hoyne Ave., Chicago.

SONG Writers. Send for our "Publishing Agreement." McKinley Music Printers, 1501 E. 55th St., Chicago.

HAVE Phonograph record made your song. Rainbow Recording Studios, 210 Olive, St. Louis, Mo.

BUSINESS OPPORTUNITIES

SMALL Inventions wanted by manufacturers. I'll help you sell your invention. Stanley Hull, 7829 Euclid Avenue, Cleveland, Ohio.

AMAZING Opportunities. Booklet free. Publishing Service, Box 101, Aurora, Ill.

INVENTORS—Small ideas may have large commercial possibilities. Write us for free book, "Patent Guide for the Inventor" and "Record of Invention" form. Delays are dangerous in patent matters. Free information on how to proceed. Clarence A. O'Brien & Hyman Berman, 58-Y Adams Building, Washington, D. C.

REAL Money, steady business, manufacturing modern raise sign letters. Sells 1c and up. J-H-M Company, 12844 Omaha St., Detroit, Mich.

ROACHES Die quickly. Exterminated entirely, simply and cheaply. Facts free. Parker, Wetumpka, Alabama.

START Home mail order business. 400% profit. Copies 24 advertisements, details; big mail, 13c. (Refunded later.) Acme Mailers, Clarion, Mich.

FORMULAS—Fast selling products. Guaranteed. Laboratory tested. Lowest prices. Catalog free. Kemico, 55E, Park Ridge, Ill.

BIG Money for distributors. Sell through agents. Amazing new plan. Saves every housewife money daily. Send 10 cents for literature. Manual Press, Stockton, Calif.

NEW Industry manufacturing 25c—\$4 article. 1500% profit. Hycos, 1512 E. 71, Cleveland, Ohio.

OPERATE Paying mail order business from home or office. Free booklet explains. Belmont, D-127 Capitol Hill Sta., Denver, Colo.

DELAWARE Charters: Complete service \$35. Submitted forms. Chas. G. Guyer, Inc., Wilmington, Delaware.

YOU'LL Like resilvering mirrors, autographs, reflectors. Making chipped glass signs. Write. Sprinkle, Plater, 127, Marion, Ind.

INCREASE Your earnings. Unusual budget of money-making opportunities free. Smith-Dawe Company, Atmore, Alabama.

A PRACTICAL Idea you can work at home. No canvassing. 25c. Clenco, Box 17, Verdun, Quebec.

FREE! Big \$1.00 book money-making plans with our system. Details free. Box 344, Summit, N. J.

"FOOD Concentrates" offer quick mail success. Vegetable powders, tablets, vitamins (millions vitamin E already sold). Your brands, labels, samples, dime. Gardena, 128B, Station "S," Los Angeles, California.

START Your own business. Splendid opportunity. Edward Johnson, West Creek, N. J.

STOP Squealing—Start crowing!! Work mornings home—drive to country—"movies"—afternoons!! Unusual "plans." No canvassing! Prepare for surprise! National Folio-A, Station "D," Los Angeles.

COMPLETE Business for twenty dollars. New social security number specialty. Rapid, profitable seller. Your number and 25c brings samples. Key Tag Specialty Company, 91 Wall Street, New York City.

BIG Paying mail business. Write. Sawyer, 9301 Interlake Ave., Seattle, Washington.

PRACTICAL Profitable mail order plan—Dime. F. Rothe, 3949 Ontario, Chicago.

"OPPORTUNITY Offerings"—Copyrighted money-making dollar folio filled with ideas, tips, formulas—dime. Publishers, Twin Peaks, California.

WE Start you in business, furnishing outfits and instructions, operating "Specialty Candy Factory" home. Men and women, earn \$25.00 up to \$60.00 weekly, all or spare time. Louise Cary received \$62.50 first two weeks. C. M. Cobb sold 115 pounds in six days. Hundreds successful. (Our 25th year.) Booklet free. W. Hillier Ragdale, Inc., Drawer 4, East Orange, N. J.

PLAN Gets lists of names cheaply. Anytime. Anywhere. 25c coin. Midwest Specialty, Box 3, Ashton, Iowa.

POPCORN, Crispette, caramelpop, potato chip, salted nut machines. Long Eakins, 1960 High St., Springfield, Ohio.

RECEIVE Lots of mail—Magazines, samples, etc. Name on "Big Mail" list one year, 25c. The Advocate, Box 291, Houston, Texas.

NEW Sensational money maker for mail order or local business. Plan free. Phelps Laboratories, Inc., 1909 Euclid Ave., Cleveland, Ohio.

HANDY Men—Earn money home operating "Fix-It" shop. Stafford, Makanda, Ill.

ZERPID. Amazing new plant fertilizer. 25c. Sanquist Co., Pomeroy, Iowa.

MAKE Money, your own business. Information free. Fuller, Newport, Ark.

MANUFACTURE Accordion nameplates. 500 to 600 per cent profit. Send stamp. Accordion Specialties, 6713 Kazimier, Cleveland, Ohio.

RENOVATE Mattresses—\$25-\$50 weekly! Easily learned; home, shop. Clinco, Tracy City, Tenn.

BED-BUGS—Plenty people bothered. Will pay big prices for article to exterminate. We have it—give complete formula and all sales pointers for \$1. Particulars free. Rentons, 28 Buckley, Liberty, N. Y.

START Mail business. Stamp for free plans and help. General Publishing Co., Peekskill, N. Y.

WHERE To buy at lowest wholesale prices. Information free. Yorena, Box P-312, Bayonne, N. J.

DEALERS And agents. Territories now being closed for Blue Ribbon Skoot-Mo-Bile, amazing new vehicle for business and pleasure. Operates like automobile, equipped with self-starter, automotive clutch. No other vehicle in the world like it! Eliminates dangerous running start. 120 miles to a gallon of gas! 30 miles per hour! 300 lbs. pulling power! All merchants are prospects—also students, messengers, etc. Only \$119.00. Be first in your locality to cash in on this great demand. Make big profits. Write Blue Ribbon Skoot-Mo-Bile, Inc., 1712 So. Michigan Ave., Chicago, Ill.

MAKE Money at home! Grow mushrooms in cellar or shed, with AMI Selected Spore Mushroom Spawn and step-by-step, easy-to-follow manual of instructions. Very interesting. Booklet free—write today. Anglo-American Mushroom Industries, Dept. 109, Toronto, Ont.

PAPER For all purposes. Treated and untreated. Write your problems. McClellan, Littleton, Mass.

RAISE Giant mushrooms! We buy! Start cellar, shed. Book, pictures free. United, 3848 Lincoln Ave., Dept. 70, Chicago.

LIQUID Marble—anyone can make! Colorful, glazed! Moulded, brushed, sprayed. Rubberlastic moulds. Composition flooring. Big money in these! Particulars free. Marbleizing Service, Edwardsville, Illinois.

DIME Brings you the latest business tips and opportunities. Williams Publishing Co., Gatesville, Texas.

CORRESPOND For newspapers: Profitable, interesting. Easily learned. Write Publishers' Service Bureau, 4258-F Drexel, Chicago, Ill.

PROFIT With new products. Make, sell, repeat. Analysis. Research. Guaranteed formulas. Biggest catalog free. Special prices, leads. Gibbon Laboratory, Chemists, RD-1142 Sunnyside, Chicago.

BARGAINS—Paint spray outfit, gasoline engine drive. Terms—trial. Helmick Paint Spray Exchange, M-564, Troy, Ohio.

500 NEW Names of opportunity seekers, compiled Feb. 9th, 1937, 25c. Carl Edquist, Odessa, Minn.

NEW Ways to make money. Western Reserve Laboratories, 6615 Denison, Cleveland.

FORTUNES From old books, prospectus free. Fairmont, 9 Hester, New York.

CAPITAL Secured for new and established concerns. Corporations organized. James Murrow, 299 Broadway, New York.

PUBLISH Magazines \$1.00 starter. 33d year. Free books. Membership 10c. Rebate. Dolsen, 89-91 Pineapple, Brooklyn, New York.

MAKE Artificial marble, glossy tiles, unquany. Tabletops, plaques, floors, whetstones, novelties. Cement secrets, hard, fire-proof, inexpensive. Brilliant tile and liquid rubber samples 3c. John A. Payn, 945 Grande Vista Avenue, Los Angeles, Calif.

1937 OPPORTUNITY Buyers names, 50c hundred. Williams, 504 Marion, Bellefonte, Del.

LEARN The mail order business, before losing money. Illustrated lessons \$1.00. Sheall Research, Duluth, Minn.

MARBLE Imitation made on wood interior trim, table tops. Beautiful finishes produced by simple cheap process. Earn money at home. Send 10c postage for samples and information. Dept. F, Marble Cote Co., 1899 Jerome Ave., New York City.

PROFITABLE Novelty business! Write! Stewart's Industries, 2102 West 19th, Chicago.

BIG Mail offering wonderful opportunities. Stamp appreciated. Joseph Castell, 1663 Madison St., Brooklyn, N. Y.

OPERATE Chain world's finest money making vending machine. Sells four products—same time. Instant success! Small capital—profits immediately. No curiosity seekers. Penny King, 1233 Chouteau, St. Louis.

ENORMOUS Profits making specialty products. Equipment unnecessary with our tested formulas. Phillarst, Jefferson City, Missouri.

AMAZING New money making plans. Get details quick! Murray, Whitewater, Wisconsin.

LITTLE Homes sold near New York City. \$10 monthly up. Send 25c for literature. Riley Co., Greenwood Lake, New York.

COLOR Concrete with chemical solutions. Better results. Lower costs. Your own business. Fifteen formulas with directions \$1.00. Sample 10c. Hollywood Cementcraft, 8527 Wonderland, Hollywood, California.

MARBLEIZING: Porcelain enamel finish. Cement prepared, mix with water, applied to wood, wall-board, concrete, etc. Flintlike hardness, brilliant. See our 85c liquid rubber for mold making. Sets solid in four hours. Any thickness. Send dime for assorted samples, both rubber and porcelain. Cowell Institute, Grayling, Mich.

MASTER Business opportunity. Particulars—stamp. Staebler Products, 45th, Elmhurst, N. Y.

"FREE Literature"—Formulas, mailorder plans. Sockel, 734 South St., Philadelphia.

OPERATE Electric Simonizing station. Cash in on national advertising with proved labor-saving invention. \$195 starts you. Should net you approximately \$300-\$400 month. Write Bissell Co., 3320-A Archer, Chicago. Distributors wanted.

BIG Mails galore—Magazines, samples, opportunities 10c. Wyn's Service, 345-B, Lamar, Missouri.

"SCHEMER," Monthly Magazine, Alliance, Ohio, prints schemes, tips, ideas, formulas—big winners—\$10,000 to \$25,000 reported. 39th year; \$1.00. Special: Trial six months only 30c.

WE Teach you new business, then buy your product. Write Superior Specialties, Springfield, Illinois.

MANUFACTURE Newest profit-making specialties from guaranteed formulas, trade secrets, analyses. Complete chemical service. Charges most reasonable. Interesting literature free! Miller, Manufacturers' Chemist, Tampa, Florida.

MAKE \$2 To \$5 hourly operating Lord's Prayer penny engraving machine. Sample free. Midwest, 5511 Euclid, Cleveland, Ohio.

INVENTION Finance Magazine, 80-G Wall Street, New York. Year subscription 60c entered upon promise to pay on receipt of first copy.

START Your own circulating library. We furnish and exchange your books. Fireside Rental Library, 210 Crosby Bldg., Buffalo, N. Y.

HOW And where to obtain capital fully explained, free particulars. Star Service, Wapakoneta, Ohio.

SUCCEED With your products. Make-sell them. Formulas. Processes. Accurate analyses. Catalog free. B. Thaxly Company, Washington, D. C.

PLASTEX Industries offer industrious men an opportunity to start a business of their own, manufacturing art goods, novelties and utility products in Plastex and marble imitation. 1/2c material makes regular 10c store sellers. Rubber moulds furnished for speed production. Small investment brings big returns. Since the crash, low priced goods are needed and this line meets the demand. Interesting booklet mailed free. Plastex Industries, Dept. A, 1985 Washington Avenue, New York.

SELL By mail. Books, novelties. Bargains! Big profits! Particulars free. B. Eifeo, 428 North Wells, Chicago.

CHARTERS: Delaware; best, cheapest; free forms. Colonial Charter Co., Wilmington, Del.

MANUFACTURE Polishpuffs. Amazing proposition 10c. Particulars free. Hickorydell, Glenbeulah, Wisconsin.

ARTIFICIAL Marble sanitary flooring. Instructions covering wood or cement flooring 1/2 inch thick, fireproof, all colors, low cost, ornamental casting, concrete, plaster, papier-mache, garden furniture, statuary, flexible molds, particulars free. Chris Mahler, Elmont, N. Y.

START Little business anywhere. Everything furnished. No canvassing. Maywood, PM-923 Broadway, New York.

FREE Booklet describes 107 plans for making \$20-\$100 weekly, in home or office, business of your own. Elite Co., 214 Grand St., New York.

MAIL Order business is your opportunity. Many began small, now earn thousands yearly. No personal contact. Boundless opportunities. Have had over 30 years experience; will help you succeed. Send 25c for valuable booklets, none free. B. Breniser, 257 South 21st, Philadelphia.

I WANT To send you proof of the wonderful pulling power of Popular Mechanics Magazine's classified pages. What's your proposition? Write me today. F. W. Johnson, Manager Classified Advertising, 200 E. Ontario St., Chicago, Ill.

COMPLETE Chemical service, analysis, formulas, processes, trade secrets. Particulars free. W. L. Cummings, 228 Gordon Avenue, Syracuse, N. Y.

MONEYMAKING OPPORTUNITIES

AMATEUR Cartoonists—Win \$25.00. No drawing ability necessary to win. 26 prizes in all. Rush name on postcard for valuable tips on "How to Make Money With Simple Cartoons," cash prize entry blank and rules. Send no money. Cartoonists' Exchange, Dept. C-95B, Pleasant Hill, Ohio.

LOOK—Beautiful embossed slogan signs, sight sellers, sample 15c coin. Synograp Company, 1350 Margo Street, Los Angeles, California.

WHOLESALE 1937 Buying directory. Over 500,000 articles \$1. Associated Products, H-3, Box 694, Muncie, Indiana.

DON'T Worry about unemployment when proven-bona-fide method finds you a position. Mail 25c to Hesco Service, 30 N. Belvidere Ave., York, Pa.

BIG Mails. Catalogs, magazines, prosperity plans, propositions, etc. Send dime. Zimmeth's, Box 202, Mankato, Minn.

STEADY Income. Home work. Experience unnecessary. Jankus, Box 103, Kenosha, Wisconsin.

HUNDREDS Of opportunities for a business of your own. Free literature. Boening, 60 Post Street, Yonkers, New York.

10c BRINGS COPY National Mail Order News, Box 1773PM15, Roanoke, Virginia.

LIN-O-UTH!! Har-O-Uth!! Amazing money-making formulas! Davis, Box 1484-M, Clarksburg, W. Va.

SKILL By mail at home. Shoe string capital, eye opener folio \$1. Edwin Dornbush, Box 382, Waukegan, Illinois.

700 SECRETS—Book of valuable formulas and recipes for making money with small capital. Sent postpaid for 50c. Webman Brothers, 377 Fourth Avenue, New York City.

TENNIS Players—Earn money stringing rackets with the Whiteside String Tensioner. A new, modern machine which gives you faster, easier stringing with perfect results. Inexpensive! Write for particulars. F. W. Whiteside, 1534 South Avenue, Syracuse, N. Y.

LETTER Patterns for sign painting; twelve styles. Home-study showcard lettering instruction. Write. Thompson School, 872-1, Pontiac, Michigan.

MONEY By mail. Your own business! Practical, profitable propositions. Write. Specialties, 198 Harker St., Mansfield, Ohio.

BUY Wholesale, 500,000 articles. Directory, 10c (coin). Le Blanc, Box 564, Mt. Vernon, N. Y.

"PROFITABLE Ideas" Magazine, 6-M North Dearborn, Chicago. 50 money-making pages. Copy 10c.

\$30.00 PER Week with a typewriter! Earn comfortable income at home. Information mailed for 25c (coin). Ace, TPM, 322 Empire Bldg., Birmingham, Ala.

FREE! New "Self Help Bulletin" for those wanting to make more money. Self Help Opportunities, 517PM East Tenth, Amarillo, Texas.

UNUSUAL Opportunity for experienced real estate agent. Write for particulars. Box 97, Lake Placid, Florida.

OPPORTUNITY Offering, copyrighted price 50c. Money-making opportunities, formulas, now 10c. Tricity Service, Box 151, Davenport, Iowa.

ANALYSIS. Research. Newest guaranteed formulas. Biggest catalog free. Special prices, leads. Gibson Laboratory, Chemists, CS-1142 Sunnyside, Chicago.

MONEY Making deals. Particulars for stamp. Trader, 216 Degraw, Brooklyn, N. Y.

AMBITIONISTS: Let me help you acquire that spark and drive all topnotchers possess. Particulars free. Edward Johnston, 257 North Washington St., Tiffin, Ohio.

1,000,000 ARTICLES Wholesale. Latest directory 10c. Jelsmith, 163 Myrtle, Waltham, Mass.

INVESTIGATE Money-making opportunity; builds income on small investment; pays us, will pay you. Seneca Specialties, 24 Main, Geneva, N. Y.

BEDBUG Formulas and 100 labels 50c. W. Wooley, Peoria, Ill.

\$50.00 PER Week with a kodak! Sell your snapshots. Markets. Details. 25c (coin). Ace, "KPM," 322 Empire Bldg., Birmingham, Ala.

MEN Who have brains. Send dime to cover mailing. Miller Enterprises, Post Monmouth, N. J.

MAKE Big money easily and honestly right in your own home. Amazing plan that will do it, only 25c (coin). Allen, Box A, Zillah, Wash.

INFORMATION Worth many dollars to you sent postpaid for only 25c. Walter Moore, Jr., 2612 N. Fifth St., Harrisburg, Pa.

NEW Mailorder and local opportunities. Merchants Sales, 617M North Second, Milwaukee, Wis.

GOOD Income at home anywhere in U. S. Write E. Hoffnagle, Blue Island, Ill.

1000 MONEYMAKING Ideas, book 50c; literature free. Harvey Teeple, Decatur, Ind.

107 PLANS For making \$20-\$100 weekly in home or office business of your own. Descriptive booklet free. Elite Co., 214 Grand Street, New York.

TO Win success you must do something different; particulars free. Publishers Sales Company, Box A-76, Nelson, Georgia.

MILLIONS Jobless! Get dollars in mail daily, like we do, for amazing employment information (got man 76 jobs). Keep money; we fill your orders free. Stamp brings details. Co-Operative Service, 77 Swan, Buffalo.

BIG Money at home plating auto parts, reflectors, mirrors, chandeliers, by late method. Experience unnecessary. Free particulars. Gunmetal Co., Ave. N, Decatur, Ill.

FORMULAS, PLANS, ETC.

GUARANTEED Formulas—New fast sellers. None better. Lowest prices. Catalog free. Kemico, 49E, Park Ridge, Ill.

LIN-O-UTH!! Har-O-Uth!! Two amazing formulas! Davis, Box 1484-F, Clarksburg, W. Va.

MONEY Making formulas 2c each. Send for list. Ben Buller, P. O. Box 211, Henderson, N. C.

CORRECT Formulas. Samples furnished. Details free. Box 768, Waco, Texas.

MANUFACTURER'S Formulas: Samples furnished. Chemical information. Dobin Laboratory, 1746 Roscoe, Chicago.

SAWDIX Makes colored marble floors. Directions \$1.00. Universal Supply Co., 777 Boulevard, Bayonne, N. J.

PRICKLY Heat remedy. Positive results. Formula \$2.00. Heelan, R. Ph., 618 1/2 So. 31 Ave., Omaha, Nebr.

5c WILL Make you \$1 profit. Free sample of product. Stanley Products, Lansing, Mich.

ANALYSIS. Research. Newest guaranteed formulas. Biggest catalog free. Special prices, leads. Gibson Laboratory, Chemists, BD-1142 Sunnyside, Chicago.

FORMULAS 25c. Cosmetics, silver plating, floor polish, exterminators, etc. Arthur, 37-10 First Avenue, Astoria, Long Island, N. Y.

KAR-O-MEL. Ten other popcorn formulas, including cheese, directions, etc. \$1.00. Dietz, Dept. B, Toledo, Ohio.

ANY Formula 50c or money back. List free. Ogg's, Tampa, Florida.

FORMULAS—Unexcelled. High-grade, proved fast-selling, easily-manufactured products. Get unequalled special offers. Philarst Company, Jefferson City, Missouri.

ANY Formula 50c!! ("Fifty Cosmetic Formulas," \$1.00!) Thomas Galuzzo, Wilkingsburg, Pennsylvania.

SOILLESS Agriculture, raise tomatoes, potatoes, flowers, etc., in shallow tank of water containing 21 chemicals. Tomato vines 20 feet, bear for year, 20 pounds per vine, quality better than soil grown. Instructions, formula \$1.00. Purdy's Chemicals, 1852 E. Slauson Ave., Los Angeles.

RELIABLE Products spell success. Formulas, analysis, literature free. Hertstein, Chemist, 1811 Paris Ave., Grand Rapids, Mich.

500 MONEYMAKING Formulas 25c. Descriptive literature free. Harvey Teeple, Decatur, Indiana.

CERTIFIED Formulas, best science can produce for making popular, biggest-selling specialties. All lines. Before buying formulas, get my valuable "Eye-Opening" literature, including free subscription to Miller's Monthly Messenger. Miller, Chemist, 1706-A, Tampa, Fla.

SUCCEED With your products. Make-sell them. Formulas. Processes. Accurate analyses. Catalog free. B. Thaxly Company, Washington, D. C.

FORMULAS—Latest money makers. Literature free. Belfort, 4042 N. Keeler, Chicago.

CHEMISTRY

FREE Chemistry catalog. Supplies at 5¢! Equip complete laboratory. Send 10¢ (rebatable) for postage and handling. Kemkit Scientific Corp., 135P Johnson Street, Brooklyn, New York.

MYSTIFYING Chemical novelty, chemistry magazine, book twenty experiments, chemical catalog, all four, 20¢. Chemco, Swedesboro, New Jersey.

FURNACE Electric, 2550° Fahrenheit, melting half pound copper. Muffle, 30 cubic inches, metallurgical, ceramic, chemical work. Silent, clean. Uses ordinary house current, alternating or direct. Easily built. Not expensive. Heat controlled. Drawings, directions, materials list \$1.25. Circular free. Pyroelectric Company, Box 6, Trenton, N. J.

SEND 25¢ For new illustrated chemical experiment book with over 300 formulas and tests. Also receive 32 page illustrated catalog of apparatus, microscopes, telescopes and chemicals free. U. Winn, 124 West 23 St., New York.

CHEMICALS—5¢—In glass containers, apparatus. Free magazine, price lists. Nawoj Syndicate, 2124 Iowa, Chicago.

25 CHEMICALS With experiments. 50¢. Kayare Chemical, 5522 P Ft. Hamilton Parkway, Brooklyn, N. Y.

ANALYSIS. Research. Newest guaranteed formulas. Biggest catalog free. Special prices, leads. Gibson Laboratory, Chemists, CT-1142 Sunnyside, Chicago.

RUBBER Latex. Dime brings literature, twenty experiments. Eastern Latex Labs., Box 61, Norfolk Downs, Mass.

CHEMICALS From waste products! Details, sample experiments, 10¢. Oklahoma Technical, Box 742, Oklahoma City.

BIOLOGISTS — Spirostomum, ciliates. Cultures \$5. Davis Laboratory, Box 753, Fort Valley, Ga.

CHEMISTRY, Mineralogy, microscopes, telescopes, binoculars. Catalog free. B. Teeko, Evanston, Illinois.

NEW Chemistry supplies catalogue, lowest prices, 10¢. Handbook for chemical experimenters, hundreds of experiments, 50¢. Reading Scientific Company, Reading, Penna.

SEND Your chemical problems to German chemist. Twenty years experience in research work. Box 451, Leonminster, Mass.

CHEMICALS In 5¢ quantities. Catalog 5¢. Fleischer's Laboratories, Everett, Massachusetts.

CHEMICALS, Laboratory glassware, apparatus. Send 3¢ for catalog CP. Biological Supply Company, 1176 Mt. Hope Avenue, Rochester, New York.

AGENTS WANTED

JUST A minute! That's all it takes for Jiffy Mend to permanently repair glass, wood, metal. New invention turns leaks and breaks into quick ready cash. Write for free sample offer. Big catalog of fast sellers. Clyde Collins, Inc., Dept. 21-D1, Memphis, Tenn.

BE Your own agent. 500% easily made selling fast repeating face bleach by mail and through agents. Removes freckles, makes the skin three shades whiter. Retail \$1.00. Costs 15¢. Perry Maharg, 1304 E. 75th St., Chicago, Ill.

450% PROFIT In perfected (1937) quick action automatic gas lighter. No flint or flame. Lights gas instantly. Retail 25¢. Costs you \$1.00 for dozen or \$8 for 12 dozen postpaid. Sample 10¢. New Method Co., Box PMG-53, Bradford, Pa.

\$2.00 HOURLY With new, scientific cream that mends all cloth easily, quickly, invisibly, without needle and thread. Stands laundering. Free sample. Sewnomore, R-744, Cincinnati, O.

KENTOL: Cleans windows, polishes silver. Provides clear vision. Reduces headlight glare. Particulars free. Sample 25¢. Kentol Mfg. Co., Boston, Mass.

SELL Wonder herbs. Big profits. Steady income. Sample free. Dalles Ruth, Wheelersburg, Ohio.

SELL Dog, bird, fish foods. Advertised line. Sample 15¢. Write C. K. Damon Co., Division B, 673 Baltic Street, Brooklyn, New York.

AGENTS! Dresses 33¢, men's suits \$1.50-\$2.00, shirts 46¢, ties 6½¢, chiffon hose 42¢. Amazing prices. Big profits. Catalogue free. Acme, AB-558W, Roosevelt, Chicago.

\$6.85 HOURLY! Amazing No-Flatz fixes punctures without patching; makes tires puncture proof! Instantly—permanently seals holes made by nails, etc. Big seller. Free sample offer. No-Flatz, Dept. R-172, Cincinnati, Ohio.

AGENTS: "Outasite" stainless steel tooth brush clamp holds anywhere, best under cabinet shelf away from wash water, etc. Two 10¢ postpaid. Buxton, 611 Truro, Hawthorne, Calif.

MONEY in butterflies, moths. See Sinclair Display Advertisement on page 14A.

500% PROFIT Selling new "20-in-1" kitchen utensil. Retail 25¢. Costs you \$1.00 a dozen, \$7.20 a gross. Sample 10¢. New Method Co., PMM-53, Bradford, Pa.

MANUFACTURE Product yourself, chemical furnished prepaid. Quality Chemical, E-20030 Russell, Detroit, Mich.

UP To \$6.00 an hour. Amazing Karnu refinishes autos like new without rubbing, polishing, waxing or painting. Inexpensive—costs little. Wipes on with cloth. Lasts 8 to 12 months. Free sample. Karnu, Dept. R-8, Cincinnati, Ohio.

YOU'LL Like realilvering mirrors, auto-parts, reflectors. Making chipped glass signs. Write, Sprinkle, Plater, 128, Marion, Ind.

TRANSPARENT Neon-like signs, 4¢—retails 25¢. Celluloid pricing sets, 50% commission. Sample free! Lowy, Department 711, 8 W. Broadway, N. Y.

ANNOUNCEMENT—Sheen. Perfect eye-glass cleaner. Now available direct from manufacturer. Sample 25¢. Doz. \$1.35. Associated Products, PM3, Box 694, Muncie, Indiana.

400% PROFIT In new perfected (1937)—quick action self-starting no-flint cigar lighter. Retail 50¢. Sample 25¢. Get details quick on wonder seller. New Method Co., Box PM-53, Bradford, Pa.

JOIN New profit sharing Guild Salesmen Association. Canvassers buy household products cheaper. Your own literature, latest premium deals. Paty Co., Dept. B, Somerville, Mass.

STOP Squealing—Start crowing!! Drive to country—"movies"—afternoons. Work mornings—home. No canvassing! National Folio-A, Station "F", Los Angeles.

"CALIFORNIA Flower Sachet" perfume, 10¢. Sells fast. Sidella, Pottsville, Penna.

HOT Water all times. Plug in any socket. Results instantly. Hot Flash Electric Water Heater, pocket size. Agents sample prepaid \$1.25. Write for territory and special offer. Industrial Laboratories, Des Moines, Iowa.

SHAMPOO. Turns hair to golden glint. Trial 15¢. Superna Products, South Milwaukee, Wis.

OPPORTUNITY Calling experienced store demonstrators. Rams Laboratories, Brighton Station, Rochester, N. Y.

ENTIRELY New distribution plan for men's high grade clothes. Lucrative proposition. Free booklet. Western Wool Growers, 334 South Market, Chicago.

HAVE You read the Hillyer Ragsdale, Inc., advertisement under the heading of "Business Opportunities?"

WHIRLWIND Money makers! Painless eyebrow pluck cream, other specialties. Samples 25¢. Particulars. Hoffman Drug Company, Edmeston, N. Y.

NEW Kind of heat boils water instantly. Pocket size. Pays 218% profit—up to \$20 daily. Magic minute demonstration sells it. Free sample offer. Nu-Way, 509 10th, Des Moines, Iowa.

200% PROFIT Selling seeds! Send no money—write today for 30 10¢-packets of Vicks famous flower seeds. Sell them and send us \$1; keep the other \$2 for yourself! James Vicks Seeds, 878 Vick Bldg., Philadelphia.

JAPANESE Novelties—Superlative opportunity to agents. Sample and information 10¢. Maruni Co., Hideyoshi Bldg., Ginzaishi-5, Tokyo, Japan.

SELL New moth destroyer. Mother Nature's way. J. L. Lamp Co., 263, Willoughby, Ohio.

BIG Money selling old books, literature free. Fairmount, 9-11 Hester, New York.

SOAP Routes open. Apply at once. Start immediately; up to \$45 first week. Automobiles given as bonus. Write Albert Mills, 2367 Monmouth, Cincinnati, Ohio.

RAZOR Blades, neckties, shoe laces, etc., all big sellers. New bargain list. Heil Premium Co., M10, Gaylord, Minn.

MEXICAN Feather pictures. Unusual novelty. 50¢ (stamps) bring \$2.00 worth samples, details. Refunded if unsatisfied. Mexican Art, Apartado 1593, Mexico City.

100 PROFITABLE Mail order and local plans. Gilbert Supply, 1107 Broadway, New York.

AGENTS—To mail our literature. Good profits. Home business. Maywood, 149 Fifth Ave., New York.

SELL Novelty fun cards, novelties, etc. Samples 10¢. National, Box 500M, Cincinnati.

ENGRAVED Nameplates, signs, initial plates. Enamel finish, five colors, big profit. Hilton Specialty, 29 Portland, Providence, R. I.

AGENTS Get cash hourly. Thrilling new kind guaranteed silk hosiery plan. Start without experience. Full or spare time. Your hosiery free as bonus. Send size. Rush name. Wilknit, Desk 5B37, Greenfield, Ohio.

PROFIT With new products. Make, sell, repeat. Analysis. Research. Guaranteed formulas. Biggest catalog free. Special prices, leads. Gibson Laboratory, Chemists, BD-1142 Sunnyside, Chicago.

THYDRO-X (Extra miles). Fast seller! 25%-50% increases guaranteed. Tremendous profits! Automotive men—a million dollar market waiting. Particulars free. Thermo-P Works, Peoria, Ill.

MEXICAN Finest feather pictures, blankets, carved leather. Free particulars. Samples 10¢ stamps. Gampoco, Apartado 1176, Mexico City.

"UNVEILING The Universe: Where We Are—What We Are." Amazingly rapid-selling new \$1.00 book. Free circular. Research Publishers, Scranton, Pa.

AUTOMOBILE Parking mirror. New invention prevents damaging car. Installed inside. Price \$1.00. Auto Parking Mirror Co., 728 South Hill, Los Angeles, California. Sales agents wanted.

JIFFY Window burglar latch. Quick seller. Installs without tools. Sample 15¢ coin or stamps. Woods Specialty Sales, 7357 University, Chicago.

"HOLDS-UM" Cement defies the elements. Never shrinks or deteriorates. Agents pocket demonstrator advertising free. Dozen \$1.00, one can 20 cents prepaid. The Holds-um Company, 1111 Hoffman Ave., Royal Oak, Mich.

SELL The Driving Master. Shows miles per gallon when driving. Analyzes motor. Described page 369 September Popular Mechanics. Driving Master Co., Sioux City, Iowa.

MAKE, Sell own nationally advertised products. Formulas, all lines. Specials. Phillarst Company, Jefferson City, Missouri.

BE FIRST To introduce new patented Ever-Flow Salt Servers. They make salt flow freely in wettest weather. No more shattered tempers or spoiled meals because of moist salt that won't flow from server. Sells on sight to stores, restaurants, hotels, beer parlors. Home models for house canvassing. Popular priced. Large profits for agents. Write quick for complete proposition. Ever-Flow Sales Corporation, Jacksonville, Florida.

BIGGER Profits selling your own products. Supply agents, stores. Free sample. Cee-Teo Products, A-608 Evergreen Ave., Brooklyn, N. Y.

STRANGE Ironing cord. Saves electricity. Abolishes scorching and kinking. For telephones also. 150% profit. Sales guaranteed. Big free offer. Neverknot, Dept. 5-A, 4525 Ravenswood, Chicago.

AGENTS—Make \$25-\$75 weekly. No peddling. Free outline of 107 plans. C. Murray, Whitewater, Wisconsin.

PORTRAIT Agents get new hexagon portraits, frames. Lowest prices. Catalog free. Picture-Man Friedman, Dept. 9, 528 Cornelia, Chicago, Ill.

500% PROFIT: Gold reflecting letters for store windows. Large sizes 1¢. Free samples. Modernistic Sign, B-3004 Lincoln Ave., Chicago.

MAKE More money taking orders: Shirts, ties, hosiery, raincoats, uniforms, dresses. Sales kit free! Experience unnecessary. Nimrod Company, Department 8, 4922-28 Lincoln Avenue, Chicago.

AMAZING Ironing device. Saves electricity! Prevents scorching! Free offer. Iron-So-Ezee Company, Mt. Washington, Ohio.

NEW Cleaner—Amazes everybody. Cleans everything. Washes clothes snow-white quickly. Spots, stains removed like magic. Startling demonstrator. Free samples make fast sales. Quick repeater. Immense profit. Write quick for "free sample." Super-X Cleaner Co., 11, Berwyn, Illinois.

CONSIGN Stores confection product. Sample free. Lorrac Products, Albany, N. Y.

BIG Money applying gold initials on automobiles. Easiest thing today. Free samples. Also, sideline salesmen for name plates and tire cover transfers. "Ralco," 1084 Washington, Boston, Mass.

MAKE Your own products. We sell formulas for highest quality toilet preparations, extracts and household specialties. Catalog free. Scientific Laboratories, 1950-W Broad, Richmond, Va.

ATTENTION Hustlers, clean up. Costs 10c. Sells for \$1.00. For particulars write J. M. Jones, 724 W. Trade St., Charlotte, N. C.

GOLD Reflecting window sign letters. Penny each. Large sizes. Easily applied. New styles. Absolutely beautiful. Free samples. Atlas Sign Works, 7941 Halsted, Chicago, Ill.

SALESBOARD Men—New put and take jars. Details, samples free. Tom Thumb, Dept. PM, Nauroo, Ill.

BIG Money and fast sales. Every owner buys gold initials for his auto. You charge \$1.50, make \$1.45. Ten orders daily easy. Write for particulars and free sample. American Monogram Company, Dept. 40, Dunellen, N. J.

AGENTS: Smash go prices. Santos coffee 12c lb. 4-oz. vanilla 8½c. Razor blades 10 for 8½c. 100 sticks chewing gum 12c. 150 other bargains. Premiums. Experience unnecessary. Carnation Co., PO, St. Louis, Mo.

SUCCEED With your products. Make-sell them. Formulas, Processes. Accurate analyses. Catalog free. B. Thaxly Company, Washington, D. C.

ENGRAVED Name plates, numbers, signs, etc., easily sold, profits large. Brett Bros., Winthrop, Mass.

MAN in each town to plate auto parts, reflectors, bathroom fixtures, refinish beds, mirrors, chandeliers, by late method; experience unnecessary. Simple plan of manufacturing at home starts you in big money making business. Free particulars and proofs. Gunmetal Co., Ave. H, Decatur, Ill.

FREE Sample—Amazing cleaner; sells homes, taverns, everywhere. Big profit—fast repeater. Betco, 5007 Irving Park, Chicago.

GENUINE Gold letters for store windows. Easily applied. Free samples. Liberal offer to general agents. Metallic Letter Co., 438-B North Clark, Chicago.

AGENTS: Stamping names on pocket-key protectors. Sample check with your name, address, 25c. Stamping outfits. Emblem checks, check-fobs, name plates. Hart Mfg. Co., 393 Degraw St., Brooklyn, N. Y.

AGENTS—Opportunity to make money; book containing 107 successful business plans; home or office; send for free introductory booklet. Elite Co., 214 Grand St., New York.

WANTED—District purchasing agents. No experience or money required. Write Purchasing Manager, 174 N. Halsted, Chicago.

DO You want agents for your proposition? Your ad in this space will place your message before hundreds of men seeking fast-selling products. My folder "How to Secure Agents" is filled with proof. I'll gladly send you a copy free. F. W. Johnson, Manager Classified Advertising, Popular Mechanics Magazine, 200 E. Ontario St., Chicago.

PROFITABLE Home business. Legitimate. No canvassing. Maywood Publishers, P-223 Broadway, New York.

HIGH-GRADE SALESMEN

MAN Wanted—by shoe manufacturer established 34 years, for sales work. Ready cash daily and extra bonuses to producers. No experience needed. Your own shoes at factory prices. Sales outfit sent free. Write Mason Shoe Manufacturing Company, Dept. F-9, Chippewa Falls, Wis.

\$10 To \$21 Profit on every deal! This and other money making plans for all salesmen, distributors, cardmen, punch-board men and agents. 40 beautiful and exclusive RCA licensed models for home, auto and farm use. Money-back guarantee. Immediate profits and repeats. Write for free starting offers of this big money-making plan. DeLuxe Mfg., Dept. 314, 173 W. Madison Street, Chicago.

NEW Punchboard line. Free 32 page full color catalog. Nothing to carry. Larger cash commissions daily. Season now! Lea-Moore Co., 180 Adams, Chicago.

SELL Celluloid and cardboard pricing tickets, steel shell moulding, changeable signs, menu covers. Every store prospect. P. Pricing Press, 124 White St., New York.

IF You are ambitious you can make good money with a Rawleigh route. We help you get started. No capital or experience needed. Steady work for right man. Write Rawleigh's, Box E-2-PPM, Freeport, Ill.

EVERY Business and professional man needs a dignified collection service. Sells for \$7.50. Send \$1.80 for complete system and exclusive territory. Bureau of Credits, Box 863, Rockford, Illinois.

SELL Nothing! \$95.00 weekly. \$500,000 punchboard firm announces new, no investment plan. Season starting. K&S, Dept. C125, 4329 Ravenswood, Chicago.

JAY-WAY Door holder. New. Sensational. Moneymaking. Jay-Way, One East 42nd, New York.

YOU Get paid first. Take orders for 200 home necessities. Pay after you collect. Big profits. Write Ho-Ro-Co, 2777-R Dodder St., St. Louis, Mo.

"BLUMER" Develops flowers and bank-rolls. Sample 10c. Ponoco, Sparkill, New York.

"HANDS Up"—"Mystery" trouser belt defies thieves, concealers and protects money and valuables. No betraying zipper. Absolutely new. Sensational profits. Free sample offer. Write Merchandisers, Dept. B-12, Merchandise Mart, Chicago.

SALESMEN—100% Profit selling Del-Jay Upper Motor Lubricant. Get details. Almo Corporation, Newark, N. J.

SELL Rubber Renewer to garages. Liner Co., Canton, N. C.

SOMETHING New in fire extinguishers—Red Comet automatics. Proved in west five years. Exclusive territory. Low price opens pocketbooks. Write Red Comet, 404 Comet Building, Littleton, Colorado.

TIRE Accessories. Guaranteed 10,000 mile Tiger Grip Tire Patch, and complete fast-selling line auto accessories. Salesmen-distributors easily make up to \$75.00 weekly, and over. Protected territory. Economy Rubber Products Co., 821 Burkhardt, Dayton, Ohio.

SALESMEN, Here's a hit! Sell the latest, improved cleaners with biggest profits. It's the new, the different that sells. See what inventors have done for filling station, garage, and business place cleaners. Write Harper Mfg. Co., 311 Main Street, Fairfield, Iowa.

EXCLUSIVE! Big income selling merchants and manufacturers top quality advertising book matches. Represent factory direct. Full or part time. Large comm. Extra cash bonus. Fast repeats. Kit free. Match Corp. of America, Dept. E-5, 6041 Grand, Chicago.

SELL Printing. Complete low priced line. Free outfit. Cut service. Give references. Arthan Press, 15 Park Row, New York.

SALESMEN: Take orders—business stationery \$2.65 thousand, book matches, labels, salesbooks, pricing sets, business cards, 35% commission daily. Free deals. Sales portfolio free. David Lionel Press, 312 So. Hamilton, Dept. SE, Chicago.

SALESMEN, Distributors. New deal—More profit, exclusive territory. 125 varieties brushes, mops, specialties. Neway Brush Co., Hartford, Conn.

SELL To service stations \$—Auto necessities—Bulbs, fuses, valve cores, boots, repair kits, cement, fittings, etc. Large profits—Quick repeats. Distributors, Box 352, Grand Rapids, Mich.

SELL Universal basters—Fastest money making going—Spray—Cooks meats and vegetables better. Every home a good prospect. Sample \$1.95. Bordwell, 1008 Gas Building, Chicago.

NEW Counter game invention sells on sight to hotel, cigar, drug, restaurant and tavern trade. Big money maker. Advance commissions. Free details. Master Company, Dept. A-1, 173 West Madison, Chicago.

MAKE More money taking orders: Shirts, ties, hostery, raincoats, uniforms, dresses. Sales kit free! Experience unnecessary. Nimrod Company, Department 65, 4922-28 Lincoln Avenue, Chicago.

SALESMEN—Four \$15 sales to stores net you \$40 daily. Sayers Systems, Est. 1893, 2801-123 Sheffield Ave., Chicago, Ill.

GOOD Long profit side or main line. Exclusive makers radiator stop-leak and flush. Zenith, 3635-8-Lyndale, Minneapolis, Minn.

SALESMEN: Sell advertising novelties, calendars, fans, thermometers, etc., for nationally known firm. Liberal commissions. Stanwood Hillson Corp., 21 Station St., Brookline, Mass.

NEW Specialty—Sells every business and professional man. Four \$15 sales daily pay \$280 weekly. Ferrell cleared over \$1,000.00 monthly. Write, F. E. Armstrong, President, Dept. PM, Mobile, Ala.

BE Your own boss. Make the largest commissions selling our complete line of brushes. Write for sales plan. Wire Grip Sanitary Brush Corp., 220 Southern Boulevard, N. Y.

BRUSH Salesman—If you ever sold brushes write for our money making proposition. Donald Brush Co., Camden, New Jersey.

FREE Booklet describes 107 plans for making \$20-\$100 weekly, in home or office, business of your own. Elite Co., 214 Grand St., New York.

HELP WANTED

WANTED—Local buyers to purchase used office machines for us. Positively no selling. Send stamp for details! Pruitt Co., 1104 Pruitt Bldg., Chicago.

MONEY In butterflies, moths. See Sinclair Display Advertisement on page 14A.

STEADY Work—Good pay. Reliable man wanted to call on farmers. No experience or capital required. Pleasant work. Home every night. Make up to \$12 a day. Wonderful new proposition. Particulars free. Write McNess Co., Dept. 5, Freeport, Illinois.

ABLE Man to distribute samples, handle coffee route. Up to \$45 first week. Automobile given as bonus. Write Albert Mills, 2301 Monmouth, Cincinnati, Ohio.

NEW Ways to make money. Western Reserve Laboratories, 6615 Denison, Cleveland.

USE \$500.00! Raise canaries for us. Free particulars. Crimmins, 3741-B 60th Street, Woodside, New York.

EDUCATIONAL AND INSTRUCTION

MEN Wanted willing to learn landscape designing and fill big paying position as landscape architects. Free test of your natural ability and chance to win in \$750 contest. No experience needed to start. Earn while you learn. Write today for free test blank. American Landscape School, 837 Plymouth Bldg., Des Moines, Iowa.

MOTION Picture operating. Home study. Projection Institute, 128 Lexington Avenue, New York.

KNOCK 'Em cold. Learn police Jiu Jitsu. 13 secret knockout blows without fists. Illustrated course by world famous instructor. Price 15 cents. S. J. Jorgensen, 404 Maritime Bldg., Seattle, Wash.

OPERATE A collection business. Outstanding opportunity. Quickly learned. Fine income assured. Write Cole Associates, Syracuse, New York.

SHORTHAND Brings opportunities. Get details. Shorthand Institute, 6330c Clayton, St. Louis.

COLLEGE Courses at home. Degrees—Psychology, engineering, law, many others. Free bulletin. Temple Bar College, Missoula, Montana.

WORK For "Uncle Sam." Many 1937 appointments. \$1260-\$2100. Try next examinations. Full particulars free. Write immediately. Franklin Institute, Dept. C3, Rochester, N. Y.

BECOME An Investigator—Secret service agent. New "Test Problem Method." Develops your ability. Particulars free. International Secret Service Institute, (PM57), Hoboken, N. J.

WELDING, Bumping, metal finishing torch soldering taught. Days, nights. Jobs open. Men from this school getting good jobs right now. Free employment service. Licensed by state. Factory Trade School, 8807 Harper, Detroit, Michigan.

OIL Burners: Installation—Service. Practical homestudy. Write. Free lesson. National, 3943 Broad, Philadelphia.

BLUE-PRINT Reading taught by short easy home course. Prepare yourself now for boom and higher wages. Write today for details. Muffler's Blueprint Reading Institute, Box 5662 Metropolitan St., Los Angeles.

LEARN to be a tree surgeon. Interesting healthy outdoor work. Good pay. Write National School of Tree Surgery, 409 Willow St., Lombard, Ill.

COMPLETE Simplified bookkeeping system. Approved. Guaranteed. Extra sheets, free advice, when needed. \$3.15 postpaid. D. Ritchie, 723 Ada, Boise, Idaho.

AIRPLANE Mechanics trained and placed. Jobs waiting for qualified men. Warren School, Oldest in the West, 230 W. 18th, Los Angeles.

DIESEL: Air conditioning, refrigeration. Practical homestudy. Write. Free lesson. Institute, 3943 Broad, Philadelphia.

GET \$50 To \$87.50 every pay day on Uncle Sam's payroll. Many appointments expected soon. Our coaching helps qualify you for Social Security, liquor gauger, meat inspector, office clerk, stenographer, typist, customs, postal and many other positions. Write today for free book, list of positions, etc. Patterson School, (Arthur R. Patterson, former Government examiner, Principal), 8 Case Bldg., Rochester, N. Y.

GOVERNMENT Social security jobs. For men and women, age 18-50. Are you interested in obtaining one? Write immediately for full information and how to pass entrance test, etc. Instruction Service, 101, St. Louis, Mo.

BECOME Business Investigator. Earn \$1.00 hourly, upwards—spare time. Experience unnecessary; we teach you. Details free. Business Detective System, 1009 Oak, Elmira, N. Y.

HOME Study courses leading to degrees: Arts and sciences, philosophy, education, law, letters, theology, psychology, engineering, chemistry, business and commerce. Many others. McKinley-Roosevelt College of Arts and Sciences, Chicago.

SECRET Service. Particulars free. Write immediately. George Wagner, M-2640 Broadway, New York.

BIG Bargain catalogue educational matter 10c. Hanfling, Y-799 Broadway, New York.

MASSAGE, Hydrotherapy, dietetics, drugless therapeutics, chiropody, taught by mail. Evans Correspondence School, Montgomery, Ala.

LEARN Machinist trade, tool, die making. Automatic and hand screw machines. Modern shop methods. Actual work. Jobs open for trained men. Employment help. Illustrated booklet free. Allied Screw Machine Company, 601 Lake Street, Chicago.

LEARN Auto mechanics, body, repairing, welding, electricity, refrigeration, Diesel. Stevinson's, 2008A Main, Kansas City, Mo.

LEARN Latest methods solving arithmetical problems quickly. Frederick A. Smith, 2416 Smalley Court, Chicago.

TIME Study engineers are in great demand. A practical home study course will qualify you for increased pay. Employment service. National Time Study Institute, 612 N. Michigan Ave., Chicago, Ill.

PLAYS—STORIES—MANUSCRIPTS

STORIES Revised, typewritten, and placed on the market. Details free. Hursh Service, Box 1013, Harrisburg, Penna.

POETRY: Honest instruction, revision, sales suggestions. M. Romatka, 25 W. 3rd Street, New York.

SHORT Story contest \$30 monthly. Magazine for dime. Little Chronicle Assn., Inc., 163 N. Long, Chicago.

WRITERS! Public speakers! Take advantage of our distinctive services, also new, practical course in journalism. Low rates. Free circulars. Continental Writers and Speakers Bureau, 210 Fifth Ave., New York City.

CASH Paid for your legends, ballads, poetry, riddles, friendship, humorous, pets, sparetime money-making ideas and other interesting short stories. Contest prizes and up to 4c per word will be paid for acceptable material. Home Life, Berwyn, Illinois.

STORIES Needed for sales department. Commission basis. New sales plan. Crown Service, 917 Shreve Bldg., San Francisco.

CARTOONING, COMMERCIAL ART AND SHOWCARD WRITING

LAUGHS Guaranteed! Chalk talking program, \$1.00. Stewart School, 3555 Aberdeen, Alton, Illinois.

AMATEUR Cartoonists—Win \$25.00. No drawing ability necessary to win. 26 prizes in all. Rush name on postcard for valuable tips on "How to Make Money With Simple Cartoons," cash prize entry blank and rules. Send no money. Cartoonists' Exchange, Dept. C95A, Pleasant Hill, Ohio.

FREE—Copyrighted "Paramount System" of showcard writing. Enclose 12c handling and mailing charges. Complete system comes free. Paramount Systems, Montrose, California.

CARTOONING, Sketching, etc., by Alexander Murray. 46 lessons, 600 illustrations, including practice sheets, pens, pencils, drawings criticized, \$1.00 complete. Singer Service, 1782 E. 100th, Cleveland, Ohio.

CHALK Talks. Laugh producing program, \$1.00. Catalog 10c. Balda, the Cartoonist, Oshkosh, Wisconsin.

CARTOONING, Sketching, etc.—46 lessons, 600 illustrations, including drawing paper, pens, pencils, \$1.00 complete. Praba Service, Cashton, Wisconsin.

CARTOONING Course \$1.00:—30 lessons, over 500 illustrations, including drawing pens and pencils. Scovell Studios, Box 748-P, Hollywood, Calif.

LEARN Lettering, complete course. Northeastern School of Lettering, Bangor, Maine.

CASH Paid for your sketches, cartoons, illustrations and photographs. Contest prizes and up to \$10 will be paid for acceptable drawings or photos. Home Life, Berwyn, Illinois.

CARTOONISTS: Free market guide—with 25c purchase "Money Making Plans." Cartoon Studios, LaCrosse, Wisconsin.

AMATEUR Cartoonists—Sell your work. Write Smith's Service, Wenatchee, Wash.

SELL Drawings. Read Art Advisor Monthly, Parkville, Missouri. Samples 20c.

AMATEUR Cartoonists earn excellent income, spare time, duplicating cartoons for advertisers. 3-M Service, Argyle, Wisconsin.

BUSINESS SERVICE

INFORMATION Where to buy anything! Correct addresses of reliable manufacturers, wholesalers. \$1.00 per item. King Buyers' Service, 60 Day's Park, Buffalo, N. Y.

ALASKA Information, practically everything. Illustrated. \$1.00. Scheall Research, Duluth, Minn.

WE Act as a brokerage house and promote all types of business transactions. Perform any commercial service and maintain a complete information department. Cole Syndicate, Bryant Pond, Maine.

MISSING People located. Legal records traced. Investigations made in any city in the world. National Agency, 2401 Chestnut St., San Francisco, Calif.

WE Specialize in obtaining hard to get articles. Try us. Universal Salesman Research Department, Box 3, North Tarrytown, N. Y.

CHICAGO! Business-personal mail address, representation, forwarding; \$1.00 month. Established 1919. General Business Service, 56 West Washington.

WANT Branch office nation's capital? Trifling expense for prestige it gives to business or social use; letters forwarded daily. Only \$2.00 monthly. Hawkins Mail Service, 309 Burchell, 817-14th Street, Washington, D. C.

ADVERTISING AGENCIES

LEARN Advertising quickly at home. Easy practical plan. No text books. Common school education sufficient. Interesting booklet and requirements free. Page-Davis School of Advertising, 3601 Michigan Avenue, Dept. 3431, Chicago.

PUERTO Rico (1,500,000 American citizens) purchased nearly \$100,000,000 from U.S. alone in 1936. Advertise in Employment Service Bulletin, 25 words, \$1.00; 7x4 1/2" page, \$15.00; 7x2" column, \$8.00; 50,000 readers. Circulars reaching homes, merchants, etc., distributed daily—3x6" \$1 thousand, 6x9" \$2 thousand, 9x12" \$3 thousand. Box 1518, San Juan, Puerto Rico.

ADVERTISE: 24 Words in 250 newspapers \$10. Lists free. Advertising Service Bureau, 4258-C Drexel, Chicago.

ADVERTISING Placed anywhere. Helpful, free service. Rate guide book free. Baker Advertising Agency, 189 W. Madison, Chicago. Successors to Ankrum Advertising Agency. Established 27 years.

ADVERTISE Profitably: \$15 reaches 6,000,000 Sunday newspaper readers with 24 word ad. Newspaper, magazine rate-guide, free. Chicago Union Agency, 20 West Jackson, Chicago.

FREE—New Advertisers Rate Guide, 44 pages. Includes everything. Lowest rates. E. H. Brown Advertising Agency, 140 S. Dearborn, Chicago.

FOR ADVERTISERS

ADVERTISE. 30 Words, 25 magazines. \$1.00. Goodall, 742 Market, San Francisco.

RUBBER STAMPS AND OFFICE SUPPLIES

CUSHION Mounted, one-two lines 25c, three 35c. Signatures \$1.50. Pocket stamps, office printing outfits. Stamp Works, 814 Bradley, Peoria, Ill.

YOUR Own words, 150 or less, on special roller, guaranteed easyrite, \$1. Seventy words or less 60c. Corbin Stamprinter, 964 Greene Ave., Brooklyn, N. Y.

ONE Line 20c. Each additional line or inch 5c. Stamp Works, Hastings, Nebr.

NAME, Address, 2 lines 25c; 3 lines 35c. Stamp Works, Auburn, Nebr.

2 LINES 25c, 3 Lines 35c. Stamprite, FP43, Springfield, Mass.

2 LINES 25c, 3 Lines 35c. Stamp Works, Centerport, N. Y.

TYPEWRITERS, DUPLICATORS, OFFICE DSVICES

GEM Post card stencil duplicators, \$7.50 complete with supplies. Bond Equipment, 214 N. 6th, St. Louis.

STAMP PRINTER. Duplicates exactly like typewritten. See ad under Rubber Stamps.

TYPEWRITER Ribbons! Three, \$1.10; six, \$2.00! Guaranteed! Galluzzo, Wilkesburg, Pennsylvania.

GELATIN Hectograph duplicator. Size 9"x12", including necessary supplies, \$1.25. MultiPrinter Co., 220 S. State, Dept. 176, Chicago.

PRINT-O-PRESS, World's lowest priced rotary stencil letter duplicator \$9.95 complete. Details and samples of work free. Professional Products, Dept. 514, Silvertown, Ohio.

INCREASE Business now. "Excellograph" Rotary Stencil Printer reprints thousands everything you typewrite, handwrite, draw or trace. Colors, \$10.75 to \$44.00. Terms. Illustrated literature free to business or professional men. Pittsburgh Typewriter Supply, Department K-2, Pittsburgh, Pa.

NEW \$4.75 Automatic adding machine. Fully guaranteed. Bassett, Box 302A, Altadena, California.

TYPEWRITERS, Duplicators, multi-graphs. Write for free list office machine bargains. Save half. Pruitt, 518 Pruitt Bldg., Chicago.

OFFICE Machines, typewriters, adding machines, duplicators, etc., 29 different makes, care and operation of. Only book on subject. 384 pp. illus. \$2.50 postpaid. Popular Mechanics Press, Dept. (C37), 200 E. Ontario St., Chicago.

PRINTING, MULTIGRAPHING, MIMEOGRAPHING, GUMMED LABELS

PRINTING, Letterheads, statements, envelopes, \$2.65 per 1,000 delivered. Landis Printery, Auburn, Neb.

GET Acquainted bargain offer! 500 quality letterheads and envelopes \$2.95! Samples. Thrift Printers, 730-W Madison, Milwaukee, Wisconsin.

ENVELOPES, Any size, quantity, reasonably priced. Samples, estimates. Universal Envelope Supply, Orange, Mass.

GOOD Printing. Reasonable. Samples. Harmon Company, 333 South Broad, Philadelphia, Pennsylvania.

BEAUTIFUL Litho advertising blotters. 2 1/4"x4, 250—\$2.00. Pearce Print, R5, Danbury, Conn.

PRINTING! Mimeographing! Office supplies! Reasonable! Catalog! Sylico, Downers Grove, Illinois.

QUALITY Printing. 1000 envelopes, cards, billheads \$2.90. Mayflower, 227B Brookline Street, Cambridge, Massachusetts.

1000 **QUALITY** Business cards \$1.45 delivered. Quality Printery, Auburn, Nebraska.

GET Our free proposition. Superior printing. Windy City Printers, 3501 Carroll, Chicago.

SEND For our sample offer of "Fitwell" letterheads and cards. Sicoan, 2038 Obear, St. Louis.

1000 **LETTERHEADS,** Envelopes, statements, \$2.00. Hammermill bond, \$3.00. Jennings-Poble Press, Dept. A. Honesdale, Penna.

500 LETTERHEADS And 500 envelopes, three lines, \$2.75. 5-Point Printers, Box 424, Anderson, Ind.

1,000 MIMEOGRAPHED Letters, \$2.85. Samples. Bur-Wil Enterprises, 24 Louisa, Binghamton, N. Y.

QUALITY Printing: Letterheads, envelopes, statements, billheads, 500 \$1.95, 1000 \$2.95, 2000 \$4.95, 5000 \$9.95. Samples. Becker Bros., Portchester, N. Y.

500—\$1.00. ENVELOPES, Letterheads, labels, cards. Printer, Duncan, Providence, Ky.

ENGRAVURE Printing. Lowest possible prices. Samples free. Sunko, Mohawk, N. Y.

COMPLETE Reduced list printing material ready, 3c. Landis, Richland, Pa.

SATISFACTION Guaranteed. 250 letterheads and 250 envelopes \$2.00. Nixprintco, 241PM North, Chillicothe, Ohio.

250 ENVELOPES And 250 whitebond letterheads, \$2.49. Webpress, Farmland, Ind.

FOLDING, Multigraphing, mimeographing, printing. Let our low overhead save you money. Get our prices. Coleman Press, Smithboro, N. Y.

MIMEOGRAPHING—Low prices. Samples. Dougherty, 9 Wash., Phillipsburg, New Jersey.

LETTERHEADS, Envelopes, circulars, postcards, \$2.95 thousand, postpaid. Estimates low. GPress, Box 103, Station W, Brooklyn, N. Y.

HIGRADE! Envelopes, billheads, cards, tickets, postcards, \$2.00 a thousand. Lithographing. Copy writing. Box 6003, Cleveland, Ohio.

RAISED Letter printing. Letterheads—envelopes—100 of each—\$1.00. Perry Press, Albion, Maine.

1000 3/4 ENVELOPES Or 1/2x8 1/2 Billheads, \$1.95. Felton, 19 Fremont, San Francisco.

WEDDING Invitations. Salesmen's samples. Draehprint, 1619 Hogan St., St. Louis, Mo.

SAVE 50%. Cards, envelopes, letterheads. Samples. Conway Press, 2013 K-Huron, Chicago.

FREE Samples, name printed envelopes, paper. The Democrat, Somerset, Penna.

NEW Type 29c font. Catalog dime. National Type Co., Jackson, Michigan.

LETTERHEADS, Envelopes, statements, 6x9 circulars \$2.50 1,000; 5,000 \$8.40 cash with order, ledger sheets, folders low prices. Barbour Printing Co., Chatham, Va.

BETTER Printing. Reasonable prices. Valuable premiums. Write Angel, Drawer 837PM, Charleston, South Carolina.

BUSINESS Cards, 1,000, \$1.00, post free. McBride Printery, 646 McBride Avenue, Los Angeles, Calif. Agents wanted.

1,000 BUSINESS Cards \$1.00. Cycle Press, Box 325, Lawndale, Calif.

BETTER Printing—5000 circulars—6x9—\$5. Cash. Gorney, 35 Rommel, Buffalo, N. Y.

\$1.00 EACH—250 Letterheads, envelopes, statements, 1000 circulars 3x6, \$1.00. We print pamphlets and magazines. Postpaid. Try us. Hustler Publishing Company, Advance, Indiana.

FREE—250 Business cards. Write for coupon. Hudson, 24 West 20th, New York.

\$1.85—1000; LETTERHEADS, Envelopes, statements, circulars. Samples. Midwest Printing, Northfield, Minn.

CIRCULARS, Envelopes, letterheads, statements \$2.85, 1000. Business cards \$1.75, 1000. Send cash with order. Fridlund Press, 106 Milwaukee, Elgin, Illinois.

100 LETTERHEADS, 100 Envelopes, 100 business cards; your name, address, postpaid, \$1.00. Cash with order. Notice Printing Company, Columbus, O.

LETTERHEADS, 8 1/2x11, Heavy bond—envelopes. 100 each \$1.00. Evans, 44P North Tenth, Reading, Pa.

6x9 CIRCULARS, Letterheads, envelopes, postcards, \$2.95 1000, 5000, \$8.99. Booklets, folders, low prices. Goodprint, Harrisonburg, Va.

1000 6x9 CIRCULARS \$1.50; 3x6, \$1.00. Lawndalepress, Box 303-B, Franklin, N. H.

500 TWO-COLOR Howard bond letterheads, \$2.75. Press, Jamestown, Indiana.

500 3/4x2 1/4 FOUR Line gummed stickers, 25c. Moritz Printery, Saginaw, Mich.

2000 BUSINESS Cards neatly printed \$1.50. Quick service. Free samples. Atlas Distributing Co., 1814 Bedford Ave., Pittsburgh, Pa.

500 LETTERHEADS, Envelopes, statements \$1.10; 1,000, \$2.00. Samples. Raymond's, Newport, New York.

1000 BUSINESS Cards, card case, \$1.50. Miller, Printer, Ambler, Pa.

CUTS 2x3, \$1.10, from drawings and photos. Joe Bek, 118 Gazette Ave., Lexington, Ky.

PRINTING OUTFITS AND SUPPLIES

ZINC Etchings, 2x5 or smaller, \$1.00. Printwell, Box 23-P, Wyoming, Penna.

HAND Press, type and complete printers' supplies. Advise equipment you need and we quote prices; or send stamp for catalog. P. Peiffer, 12 B; 6 Columbia St., Newark, N. J.

ZINC Cuts from photo or drawing, 2x3, \$1.00. Square Deal, 2623 - 3rd St. North, St. Cloud, Minn.

PRINT Your own cards, stationery, circulars, advertising, etc. Save money. Easy rules furnished. Print for others, big profits. Junior press, \$5.99; job presses, \$11, power \$149. Write for details. Kelsey Co., A-11, Meriden, Conn.

BARGAINS—Presses, type, supplies. Send stamp. 159 Harvard, Cambridge, Mass.

PRINTING Outfits—Presses, type, supplies, type novelties. Send 20c for card case samples. Catalog free. Model Press, York, Pa.

BARGAINS, Presses, type. List 3c. Exchange D-15, 22 Orient, Meriden, Conn.

PATENT ATTORNEYS

INVENTORS: Send immediately for your copies of our new free books, "Patent Protection" and "Suggestions on Selling an Invention." Sixty-eight pages of interesting facts. They tell how patent laws protect you; kind of sketch or model needed; simple steps to take without cost; how successful inventors have secured financial assistance; show interesting inventions; illustrate important mechanical movements. With books we also send free Evidence of Invention form to help establish date of disclosure. Prompt service, reasonable fees, special deferred payment plan. Strictest secrecy. Thirty-six years' experience. Highest references. Write us today. The facts in our books are worth money to the man with a good invention. Address: Victor J. Evans & Co., Registered Patent Attorneys, 901-E Victor Building, Washington, D. C.

INVENTORS—Small ideas may have large commercial possibilities. Write us for free book, "Patent Guide for the Inventor" and "Record of Invention" form. Delays are dangerous in patent matters. Free information on how to proceed. Clarence A. O'Brien & Hyman Berman, 58-Y Adams Building, Washington, D. C.

"INVENTOR'S Guide," 100 mechanical movements, free; advises on patenting, selling inventions. Frank Ledermann, Room 2024, 154 Nassau St., New York.

WILLIAM B. Churcher, Registered U. S. Patent Office; 3208 Beverly, Beverly Hills, Baltimore, Md.

SELL Your unpatented ideas. We tell you how; help you make the sale. Particulars free. Write W. T. Greene, 976 Barrister Bldg., Washington, D. C.

PRACTICAL Inventions now salable before patenting. What have you? Write Chartered Institute of American Inventors, Dept. 4B, Washington, D. C.

PATENTS—Proper service for manufacturers and individual inventors. Established 1895. Reasonable charges. Consult Chandlee & Chandlee, Patent Attorneys, 902 F. Street, Washington, D. C.

INVENTORS—Send for free booklet "Patent-Sense." Information based on 64 years experience. Lacey & Lacey, Dept. 5A, 635 F St., Washington, D. C.

PATENTS—Personal, confidential services for protection of your invention at reasonable cost. Preliminary information and approximate cost of patent furnished without obligation. John B. Thomas & Co., 902 F Street, N. W., Washington, D. C.

PATENTS—Trade marks—Personal service, reasonable charges. Preliminary advice, book and disclosure form free. Irving L. McCathran, 1000 International Bldg., Washington, D. C. Registered Patent Attorney.

L. F. RANDOLPH, 302-B Victor Building, Washington, D. C. Low cost. Book and information free.

PATENTS. Protect your idea by securing free "Proof of Invention" folder. Exceptional personal service. Established 1906. E. E. Vrooman, 871 Woodward Building, Washington, D. C.

PATENTS. Instructions "How to Establish Your Rights" and form, "Evidence of Conception"—sent free! Lancaster, Allwine & Rommel, 411 Bowen Building, Washington, D. C.

PATENTS. Booklet free. Highest references. Best results. Promptness assured. Wat-on E. Coleman, Patent Lawyer, 724 Ninth St., Washington, D. C.

THEODORE H. Rutley, Registered Patent Attorney, 512 Colorado Bldg., Washington, D. C.

FOR INVENTORS

INVENTORS—Small ideas may have large commercial possibilities. Write us for free book, "Patent Guide for the Inventor" and "Record of Invention" form. Delays are dangerous in patent matters. Free information on how to proceed. Clarence A. O'Brien & Hyman Berman, 58-Y Adams Building, Washington, D. C.

INVENTORS: Send immediately for your copies of our new free books, "Patent Protection" and "Suggestions on Selling an Invention." Sixty-eight pages of interesting facts. They tell how patent laws protect you; kind of sketch or model needed; simple steps to take without cost; how successful inventors have secured financial assistance; show interesting inventions; illustrate important mechanical movements. With books we also send free Evidence of Invention form to help establish date of disclosure. Prompt service, reasonable fees, special deferred payment plan. Strictest secrecy. Thirty-six years' experience. Highest references. Write us today. The facts in our books are worth money to the man with a good invention. Address: Victor J. Evans & Co., Registered Patent Attorneys, 901-E Victor Building, Washington, D. C.

WE Show you how to sell your invention before or after patent. Give details for prompt advice. Patent Research, Box 628, Ben Franklin, Washington, D. C.

INVENTORS. Get finances by proving it will sell. Don't disclose. Tell us what it does. Progressive Research Corporation, Stahlman Building, Nashville, Tennessee.

LET Us help you develop and sell your ideas. We can also assist you in your designing, engineering, drafting of special machines, tools, models, dies, methods. M. R. Gerrmann, Development and Research Engineering Service, 209 South State St., Chicago, Illinois.

HAVE You invention problems? Financing, patenting, selling? Get information that offers your chance to cash in. Inventors' Counselor, Cantil, Calif.

TELEVISION Book free with radio electrical inventor's experimenter's kit \$1.00. "Ben's Radio," Boston.

GET Copies of patents similar to your ideas. L. A. Summers, 5229 7th Street, N. W., Washington, D. C.

25 YEARS Of service to inventors, developing ideas into working models, securing patents, designing machinery and devices, making shop drawings, starting production and sales. Henry, 1113 West Tioga St., Philadelphia, Pa.

WE Successfully sell inventions, patented and unpatented. Write for proof, and tell us what you have for sale. Chartered Institute of American Inventors, Dept. 4-C, Washington, D. C.

FREE Information about new magazine for inventors who want more profit from their ideas. Write "Successful Inventions," 800 Barrister Bldg., Washington, D. C.

TO Inventors: We are in the market to purchase a good patent, preferably a small item made of metal. Will purchase outright or royalty. Purchasing Agent, 241 Front St., New York, N. Y.

INVENTORS: "Making Inventions Pay," our 32-page illustrated book, mailed upon receipt of 3c postage. Crescent Tool Company, Dept. Z, Cincinnati, Ohio.

INVENTORS—Send for 72-page book on patents. Reasonable terms. Conscientious treatment to inventors. L. F. Randolph, Registered Patent Attorney, 302-E Victor Bldg., Washington, D. C.

I SELL Patents. Established in 1900. Charles A. Scott, 773PM Garson Ave., Rochester, N. Y.

UNPATENTED Ideas can be sold. We tell you how and help you make the sale. Particulars, with list of manufacturers and wanted inventions; sent free on request. Write W. T. Greene, 944 Barrister Building, Washington, D. C.

SELL Your patent through a small classified ad in Popular Mechanics. Many inventors have found buyers in this way. Ask me for proof—I'll gladly send it to you. F. W. Johnson, Manager, Classified Advertising, 200 E. Ontario St., Chicago.

INVENTOR'S Universal Educator; contains 900 mechanical movements; 50 perpetual motions; instruction on procuring and selling patents and selecting an attorney, etc. Suggests new ideas. Price \$1.00 postpaid in U.S.A. Address Albert E. Dietrich, 511-B Colorado Bldg., Washington, D. C.

INVENTIONS WANTED

SMALL Inventions wanted by manufacturers. I'll help you sell your invention. Stanley Hull, K-7829 Euclid Avenue, Cleveland, Ohio.

INVENTIONS Financed, promoted, Jennings Butts, 1 East 42nd, New York.

HAVE You a sound, practical invention for sale, patented or unpatented? If so, write Chartered Institute of American Inventors, Dept. 4A, Washington, D. C.

INVENTIONS Wanted—Patented, unpatented. If you have an idea for sale, write Hartley's, Inc., Box 928-E, Bangor, Maine.

PATENTS FOR SALE

PATENTED Gas heater. Fan forced heat. Modern design. E. L. Snyder, 1511 - 17 St. N. W., Canton, Ohio.

SECRET Invention for sale only to a government of a nation that is interested in solving depression and stop war. Communicate. Swan M. Miller, P. O. Box 123, Station G, New York City.

PATENTED Body elevating hospital device. Convenient for doctors and nurses. More comfort for patients. E. G. Clewly, Burlington, Vermont.

"TOOL Sharpening Gauge," for scissors, knives, chisels, etc. Requires only 2 operations on punch press. Just patented. P. Jarnowski, 1647 N. Paulina, Chicago.

I HAVE Patented practical attachment for hospital beds that eliminates the moving stand. Largest money making invention ever manufactured, photo on request. For sale and royalty. James R. Anderson, Kalispell, Montana.

PATENT Applied for. Trouserpresser, stretcher, creaser, hanger. For sale, reasonable. Widness, 208 Van Buren St., Brooklyn, N. Y.

PATENT 1801523 On useful novelty. Morris, 1081, Washington, D. C.

SELF-SUPPORTING Vertical antenna, thin conical, telescopic, any height, insulated base. Kent, Leemoor, Plymouth, England.

POCKET Tablet dispenser. A. Pearson, 5012 Tioga Street, Duluth, Minnesota.

FOUNTAIN Tooth brush connection. Connects brush to water faucet. Flushes mouth while cleaning teeth. Investigate this. John Mortka, 58 Hinkley Ave., Stamford, Conn.

SELL Your patent through a small classified ad in Popular Mechanics. Many inventors have found buyers in this way. Ask me for proof—I'll gladly send it to you. F. W. Johnson, Manager, Classified Advertising, 200 E. Ontario St., Chicago.

MANUFACTURING

LARGE Concern desires to manufacture your invention. Give details of your proposition. Wisco, 4220 Rosehill Avenue, Cincinnati, Ohio.

DIES, Tools, stampings, manufacturing, screw machine work. Northfield, Ohio.

ANALYSIS, Research. Newest guaranteed formulas. Biggest catalog free. Special prices, leads. Gibson Laboratory, Chemists, DS-1142 Sunnyside, Chicago.

INVENTIONS Developed, manufactured. Write, Robey Manufacturing Company, East Lansing, Michigan.

MANUFACTURING, Dies, machinery, models, brasswork, white metal casting moulds. Catalog 3c. Baum's Metal Specialties, Kansas City.

INVENTIONS Manufactured in any quantity at low cost. Stampings, dies, models, etc. Estimates and free catalog. Crescent Tool Co., Dept. X, Cincinnati, Ohio.

MODELS AND MODEL SUPPLIES

FULLY Illustrated circular. Listing 40 engines. Locomotive castings. Supplies. Stamp required. Howardo, A-2417 N. Ashland, Chicago.

INVENTIONS—Small ideas may have large commercial possibilities. Write us for free book, "Patent Guide for the Inventor," and "Record of Invention" form. Delays are dangerous in patent matters. Free information on how to proceed. Clarence A. O'Brien & Hyman Berman, 58-Y Adams Building, Washington, D. C.

POWER Models, locomotives, steam, gasoline engines, accessories. 80 page catalog 35c. Chas. Cole, Ventura, Calif.

BUILD Queen Mary, 27 in. long, all wooden model. Fully finished hull, cut to fit parts, and plans. \$2.50 complete, plus postage. Send 3c stamp for catalog. Miniature Ship Models, Perkasio, Pa.

MODEL Airplane kits, supplies; gas model supplies. Catalog 3c. Peerless Model, 3088 W. 106th, Cleveland, Ohio.

24"-32" FLYING Model kits! Cowl, wheel pants, propeller, complete! Mulligan, Waco, Monocoupe, 65c each pp. Catalogue free. Models, 4802P Clarendon, Brooklyn, New York.

RAILWAY Models. Catalog handbook 25c. Walthers, 247 East Erie, Milwaukee.

3/4" SCALE Steam locomotive easily built by "Step" method. Latest catalog of castings, boiler fittings, track materials, etc. 25c coin (returned on first order). Little Engines, Box B15, Wilmington, Calif.

HEADQUARTERS For yacht fittings—Marblehead (50-800) and Class A. List free. Illustrated catalog of ship fittings and construction sets 15c. A. J. Fisher, 1002-1 Etowah Ave., Royal Oak, Mich.

BIG 96-Page model engine catalog, postpaid 20c. Particulars free. Evraymesco, 28 No. Clinton, Chicago.

POWER Modelers—Read Modelmaker Magazine. Current sample 15c. Special big buy, 25 assorted back issues, \$1.00. Model steam locomotives, gas engines, power boats, stationary engines. Box 196-P, Wauwatosa, Wis.

MODELS, Stampings, and special machinery. Send for catalog of brass gears and model supplies. The Pierce Model Works, Tinley Park, Ill.

SHIPS—18" Flying Cloud, Constitution or Galleons. All materials including easy plans only \$1.50. Catalog 15c. Hancock, 323 Douglass Ave., Portsmouth, Virginia.

MODELS—Your ideas developed into practical working models. 30 years' successful experience; thousands of satisfied customers. Confidential service guaranteed. Bank references. Send 3c postage for 32-page book—"Making Inventions Pay." Crescent Tool Company, Dept. Y, Cincinnati, Ohio.

MAKE IT YOURSELF. Hundreds of practical and useful devices described in our big book. Plain instructions and illustrations show you how to make them. Save money on things for yourself or make profit selling to others. 900 articles of great variety. 480 pages. 823 illustrations. \$3 postpaid. Popular Mechanics Press, Room (C37), 200 E. Ontario St., Chicago.

BLUEPRINTS AND PLANS

20 **FULL-SIZED** Lawn ornament patterns, 30c. 20 full-sized silhouette patterns 30c. Modern Woodcraft, Saginaw, Mich.

HOME CRAFTSMEN

MAKE Wooden cats, dogs, birds, animals. Plans 10c each, 3 for 25c. Postpaid. Walter's Shop, 142 Summer St., Auburn, Me.

LOW-COST House plans. Quarter brings illustrated folder. Dana Co., Box 1381, Indianapolis, Ind.

BIRD Houses—Plans for building four unique types, 4c. Reader's Service, 800M No. Clark, Chicago.

20 **FULL-SIZED** Novelty patterns, 35c coin. Modern Woodcraft, Saginaw, Michigan.

"MODERN Wood sculpture." Complete instruction book on carving statues \$1.00. Lee, Wood Art Studio, Centerville, Ia.

LEATHERCRAFTSMEN—Write for free instructions and price list of leather, tools and beginners' kits. Send 5c for sample cards. Address Wilder & Company, Dept. F, 1938 Crosby St., Chicago, Ill.

METAL Furniture in modified modern design, how to make, described in Shop Notes for 1937 only 50 cents postpaid. Popular Mechanics Press, Dept. (C37), 200 E. Ontario St., Chicago.

OLD GOLD, WATCHES, JEWELRY, PRECIOUS STONES

AUSTRALIA'S Lovely opals. Beautifully illustrated opal catalogue post free. Norman Seward, Melbourne, Australia.

CLOCK Parts. F. A. Grinnell, Clockmaker, 1116 Plymouth Ave., Fall River, Mass.

DIAMONDS, Wedding rings, 25% to 50% discount. Free catalogue. Sweazey, Manufacturing Jeweler, Park Ridge, Ill.

OLD Gold, silver, platinum. Any condition or quantity for cash. Satisfaction guaranteed or goods returned. Vulcan Refining Works, Elizabeth, N. J.

5000 **HUNTING** Waltham, Elgin watches. New chromium engraved open face cases. Make big money! 16 size, 7 jewel, \$3.75; 16 size, 17 jewel, \$6.25. Send 3c stamp for free catalog. New plan. The New York Jobbers, Dept. M, 74 Bowery, New York, N. Y.

GOLD \$35.00 Ounce. Ship old gold teeth, crowns, jewelry, watches—receive cash by return mail. Satisfaction guaranteed. Free information. Dr. Weisberg's Gold Refining Company, 1593 Hennepin, Minneapolis, Minn.

CASH For old gold, teeth, watches, jewelry, 100% full cash value mailed day shipment received. Satisfaction guaranteed or articles cheerfully returned. Information free, or ship today. Chicago Gold Smelting Company, 300P Champlain Building, Chicago.

FOR THE HOME

HEALTH! 100% Softened water instantaneously. \$5.00. Guaranteed. Faucetsoft, Sausalito, California.

HEATPROOF Tablepads \$2.98. Information free. Novex, Box 1189-P, Birmingham, Ala.

BUILT-IN Furniture adds convenience, comfort and beauty to your home at very low cost. Any handy man can build a great variety of this space-saving furniture from the easily-followed instructions in our remarkable book, the only one on this subject. \$2.50 postpaid. Popular Mechanics Press, Room (C37), 200 E. Ontario St., Chicago.

TOBACCO

GUARANTEED! Cigarette, pipe or chewing, 5 lbs., \$1.00; ten, \$1.75. Pay when received. Pipe and box cigars free. Rives Tobacco Co., Paducah, Ky.

RAZORS—BLADES—SHARPENING

BLADES—Practically wholesale. 150 brands. Joseph Kowalski, Haydenville, Greensburg, Pa.

WHY Buy more blades? Re-edge them with new sharpener. \$1.25. John Deegan, 506 Liberty, Newburgh, N. Y.

SURVEYING INSTRUMENTS

GUARANTEED Factory rebuilt transits and levels for rent (with purchase option) or sale (cash or terms). Order now before prices advance. We will repair, trade in, or buy your old instruments. Ship prepaid for estimate and valuation. Write for List M-24 and complete information to Warren-Knight Co., 137 N. 12th St., Philadelphia, Pa.

WANTED—MISCELLANEOUS

WILL Pay \$250.00 Colt revolver, factory dated 1847. Other firearms wanted. Selling list 20c. Hobby Shop, 406 Clement, San Francisco.

WILL Pay \$100.00 to anyone who can reveal the formula used by the Indians to preserve their medicines. For further information write, M. Williams, 1113 East Sorin St., South Bend, Indiana.

HOW To identify and determine value of old precious metals. Where to buy. To whom to sell. Reliable and up-to-date information. Complete instructions only \$1.00 postpaid. Popular Mechanics Press, Room (C37), 200 E. Ontario St., Chicago.

CASH For used microscopes, binoculars, slide rules, drawing sets, cameras, surveying, medical and scientific instruments, tools, marine equipment. Highest prices paid day shipment received. Satisfaction guaranteed or shipment promptly returned. Elman's, 2302 Van Buren, Chicago.

PERSONAL

HAR-O-UTH!! Lin-O-Uth!! Amazing invigorating formulas! Davis, Box 1484-P, Clarksburg, W. Va.

WANTED—Original poems, songs, for immediate consideration. Send poems to Columbian Music Publishers, Dept. 33, Toronto, Can.

SURMOUNT Every obstacle. Acquire wealth, position. "You—Millionaire" tells how, 50c, no stamps. Order today, receive free "You Can Write," famous author's method. Riverside Publishers, 957 Culver Road, Rochester, N. Y.

RID Yourself of perspiring feet. Causes colds, rots shoes and hosiery. Effective remedy, \$1.00. Money refunded if it fails. Ripley, 2060 Mission, San Francisco, Calif.

HAIR Getting thin? Then investigate my "No Hair—No Pay" offer. No obligation. Paul Downing, 625 Sweetland Bldg., Portland, Oregon.

CASH'S Woven names. For marking men's, women's, children's clothing. Free sample. Oullette's, 1007A Water, New Bedford, Mass.

STUTTERING And stammering corrected at home. Descriptive booklet free. Paul J. Wolfe, Box 52, Pittsburgh, Penna.

BOOKS Covering hundreds of subjects. Big catalog for 3c postage. Popular Mechanics Press, Room (C37), 200 E. Ontario St., Chicago.

MISCELLANEOUS

DON'T Lose your keys. Metal identification tags for key rings stamped with your name and address, 25c. The Metal Tag Co., Keyville, Va.

YOU'LL Like resilvering mirrors, auto-parts, reflectors. Making chipped glass signs. Write, Sprinkle, Plater, 288, Marion, Ind.

MONEY In butterflies, moths. See Sinclair Display Advertisement on page 14A.

READ: "How to Find Ideas for Inventions." 25c. Mordaunt, 1013 E-Knapp, Milwaukee, Wis.

EXTERMINATE Bedbugs permanently. Guaranteed formula 30 cents. No gas. A. Hill, Berne, N. Y.

COIN Slugs, \$1 hundred prepaid. Baum's Specialties, Kansas City, Mo.

LAWN Ornaments, ready cut and sanded. 25c brings two and price list of other designs. A. Barker, Mount Kisco, New York.

EXCELLENT Pure toilet goods. Booklet free. Omoto, 2819 Hyperion, Hollywood, Calif.

KITT'S: The scientific football game—teaches thinking! A modern marvel. Deluxe sets at bargain prices—\$3.00. Satisfaction guaranteed. Send for free folder. Kitt's, Box 655-M, Los Angeles.

NOVELTIES Of all kinds: 12 assorted samples only 10c. Hoover's, 1525 Grove St., Lafayette, Ind.

REFINISH Your own car. New instruction book treats all phases of painting and refinishing autos and trucks. Written for the man who wants to renew his own car, but covers also the business end of refinishing for the professional. \$1.65 postpaid. Popular Mechanics Press, Room (C37), 200 E. Ontario St., Chicago.

GLASSES Are a nuisance. Why wear them? You can develop perfect eyesight without glasses or drugs. Send dime for valuable booklet. "Eye Weaknesses." Arthur Jacobson, Alexandria, Minnesota.

WEAVE Your own rag rugs. Easily made. Blueprint of simple rug loom with instructions, \$1.00. Bailey's Print, Ottawa, Ill.

HER Perfumes annoy you? "Yearning," "Full Moon" perfumes unanimously pleasing. \$1.00. Both \$1.75. Barlevy, 247 West 116th, New York, N. Y.

BULL Fight playing cards. Richest collection of oils painted by Ruano Llopiz. Limited number. Send one dollar. Anything from Mexico. Fernando Montes de Oca. Apartado 2986, Mexico City, Mexico.

BUILD Poultry house under \$5. Garages under \$10. Cabins, etc., proportionately low. Substantial. Weatherproof. Guaranteed instructions 25c (coin). Woehlk, 324 Wroughton, Winston-Salem, N. C.

TATTOOING Outfits, supplies. Illustrated list. "Waters," 965 Put-nam, Detroit.

SWAP Or sell articles you don't need. Get those you want. Send dime for Swapper's Guide, listing articles from all over United States. Dept. PM, Swapper's Guide, Delphos, Ohio.

GRANITE Monuments, markers, \$8 up. Free catalog. Mihelich Monument Co., St. Cloud, Minn.

AMATEUR Cartoonists. Sell your work. Write Smith's Service, Wenatchee, Wash.

SAFETY Razor blades sharpened free. Send four as a trial. 3c stamp to P. O. Box 672, Newark, N. J.

AMATEUR Tattooing outfits, illustrated catalog 6c. "Tatuco," 651A South State, Chicago.

CUTS Anybody can make. Zinc etching process. Specimens, particulars, testimonials for stamp. J. C. Day, Windfall, Ind.

COCOONS, Butterflies, collectors' supplies, butterfly art materials. Free lists. Maynard, 1192 Lewiston, Rochester, New York.

BRONZE Tablets, desk plates, wall plates, memorials, grave markers. Bronze, brass and aluminum casting. Wandkey Pattern & Foundry Co., Anderson, Ind.

SWAPPER'S Friend, B4, Saline, Michigan. Interests swappers, collectors, sportsmen. 50c year, sample 10c.

RESILVERING Mirrors made easy in Shop Notes for 1937 only 50 cents postpaid. Popular Mechanics Press, Dept. (C37), 200 E. Ontario St., Chicago.

OFFICE MACHINES—Care

and operation of 20 different makes. Typewriters, adding machines, duplicators, etc. Only book on subject. 384 pages, illustrated. \$2.50 postpaid.

POPULAR MECHANICS PRESS

200 East Ontario Street

Chicago

FREE CATALOG OF 5000 BOOKS

on 2000 Practical Subjects. Send 3 cent stamp for postage.

POPULAR MECHANICS PRESS

200 East Ontario Street

Chicago

Get this new CONCRETE BOOK Just Published!

Now Ready! A new and practical book on the amazing new art of concrete work. Things are being done with concrete that will amaze and thrill you. And "1001 Ideas for Using Concrete," by Harold Hayes, covers it all with the exception of big engineering projects. Nothing like it ever published before. It covers every known use of concrete for the home, farm, building, business and industry, plus newer uses in decoration and arts, including new quick-setting type and recent developments in glorious colored concrete that you can make.

It's the book of the hour for contractors, handymen, hobby seekers, farmers, home builders, factories, shops and home work shop owners. It is filled with plans, methods and formulae. Shows how to make money, build your own business and improve your property. Gives 146 "Concrete Kinks", alone, easily worth cost of entire book. See chapter headings and description. Order your copy today. Sent postpaid for \$5.00 with order, or pay the postman.

Tells how to make concrete pools, statuary, garden walks, walls, buildings, etc. 146 Concrete Kinks in one section alone.



Gives Money-Making Plans
Describes Interesting Hobby
Covers New Concrete Arts
Facts on Colored Concrete
Applications and Methods

"1001 IDEAS FOR USING Concrete" BY HAROLD A. HAYES

Size 7 x 10 Inches. About 250 Pages. 16 Colored Plates and Hundreds of Beautiful Half-tone Illustrations and Working Drawings. Cloth Binding. \$5.00

SOME CHAPTER HEADS

Concrete About the Home
Concrete in the Garden
Concrete About the Farm
Concrete Homes and Buildings
Recreation
Concrete in the Workshop
Concrete Products for Plant Manufacture
Concrete in Business and Industry
Concrete Kinks
Varied Uses of Concrete

NOW-IT'S

SCIENTIFIC CRIME DETECTION

that Pays BIG REWARDS



The nation's cry is for SCIENTIFICALLY trained Investigators. This new training not difficult. Advanced education or previous experience not necessary. Study at home during spare time. Easy terms policy. Course includes Finger Prints, Handwriting, Photography, Investigation and Defense and Attack. Big regulation outfit free to students. Instructors nationally known experts in Scientific Crime Detection. Get into SCIENTIFIC Crime Detection and prepare for BIG EARNINGS. Send for thrilling book containing full particulars. It's FREE to any young man 17 or over.

NEW—EASY TRAINING—
Endorsed by EXPERTS

SCIENTIFIC CRIME DETECTION
INSTITUTE OF AMERICA, INC.
Chesapeake & Ohio Bldg.
Huntington, West Virginia

Dept. 2E7
J. T. Burdette, Pres.

Gentlemen: Without obligation, send big book including 14 famous cases, telling how I can get it to Scientific Crime Detection.

NAME

ADDRESS..... AGE.....



AUTO

BOOKS SENT FREE

on approval. Just mail the coupon and we'll send you a set of these remarkable auto books, just off the press. Whether you are a mechanic or helper, expert or apprentice, auto owner or driver, if you're interested in knowing all about automobile mechanics, then take advantage of this FREE OFFER.

Nearly 100 pages on DIESEL Engines

A better job—in the gigantic auto industry. BIGGER PAY—a chance to go into business for yourself and get a share of the huge profits are waiting for any man who even half tries to improve himself. Learn auto engineering with these wonder books a new way—without studying or memorizing. Simply use the JIFFY INDEX to look up the answer to any auto problem. Built by eleven of America's greatest automobile engineers, and written in simple language so you can understand it. Very newest cars, all covered.

FREE! Send NOW and we will include FREE an extra loose-leaf volume No. 7 with newest cars and diagrams and also that famous book "Automobile Service Shop Management."

AMERICAN TECHNICAL SOCIETY
Drexel Avenue & 58th St., Dept. A519, Chicago, Ill.

I would like to see the new 6-volume edition of your AUTO BOOKS. I will pay the few cents delivery charges only, but if I choose to, I may return them express collect. If after 10 days use I prefer to keep them, I will send you \$2 and pay the balance at the rate of only \$3 a month, until \$24.80 is paid. Please include free consulting membership and the two extra books as per your offer above.

Name.....
Address.....
City..... State.....
Attach letter stating age, occupation and name and address of employer and that of at least one business man as reference.

Easy to Play FOR FUN OR PROFIT



SWEET OR SWING BUESCHER'S THE THING

Quickly, easily, you'll learn to play a Buescher True-Tone saxophone, cornet, trombone—any band instrument. Exclusive Buescher features mean faster progress—you join a band or orchestra in a few weeks—win pleasure and profit.

FREE TRIAL; Easy Payments. Send now for details, no obligation. Mention instrument which interests you.

Buescher Band Instrument Company
510 Buescher Bldg., Elkhart, Ind.

BUESCHER True Tone

Hal Kemp leader, and many players in his popular Radio band, use Buescher True-Tones.

NEON

Prepare yourself quickly for today's biggest opportunity—design, build, sell and service NEON or "gaseous tube" lighting—for lighted displays. Future's greatest source of illumination. Most complete, practical, low-cost, home-study course.

FREE book gives full details, student letters, Low Price! WRITE!
COMMERCIALITE LABORATORIES Box 47-P OMAHA, NEBR.

Learn to Draw

At home—by mail. Amazing easy way. No experience necessary. You study from photos of artists' models just as they pose in the life class.

FIRST LESSON Free!

Test your own ability—send name and address and 10c to cover mailing cost to

TOWERTOWN STUDIOS Dept. 536
520 North Michigan Avenue Chicago, Illinois

Get Set for Life!



Handle Big Pay Store Route. Place nationally-known Line 5c-10c Counter Goods. 200 products. Included is Laymon's Aspirin—advertised in Saturday Evening Post. All sold from Self-Help Counter Displays. Up to 112% profit. Earn up to \$65 weekly. No experience needed to start. Facts free.

WORLD'S PRODUCTS COMPANY
Dept. 5810 Spencer, Indiana

CHIPPED GLASS SIGN MAKING MIRROR RESILVERING

Metalware replating; Interesting; Profitable. Write

SPRINKLE, Plater, 129, Marion, Indiana

Signs and Show Cards

Learn at home in your spare time. 27 Big. Easy Illustrated Lessons teach you popular easy pen and brush lettering, color, layout, design, airbrush, silk screen, how to start in business, trade secrets, etc. Size 9 x 12 inches. Thoroughly Illustrated. Complete with alphabet charts. Written by D. Rogers Stewart. Money Back Guarantee.

Stewart Sign School, Dept. P5, 3555 Aberdeen, Alton, Ill.

SEE WITHOUT GLASSES



The NATURAL EYESIGHT SYSTEM Gives Your Eyes a New Deal

If you wear glasses, or think you should, our FOUR MONTHS' TRIAL OFFER—containing the inspiring story of glasses discarded for Nearsight, Farsight, Astigmatism, Old Age Sight, Eyestrain, Weak Eyes, Eye Muscle Trouble, Etc., as told by USERS AT HOME of this Revolutionary System—will be mailed FREE upon request.

NATURAL EYESIGHT INSTITUTE, INC.
Dept. 75-C Los Angeles, Calif.

When writing please mention Popular Mechanics

(Continued from page 37A)

block illustrates the regular sheet arrangement of the stamps of this country which are inscribed alternately in English and in Afrikaans. This stamp was produced by photogravure and is in blue-green and gold. At the left of the block is the newest French commemorative, bearing the portrait of Pierre Cornielle and issued to mark the three hundredth anniversary of his production of "Le Cid," called "the most epoch-making play in all literature."

At the right of the block is one of two stamps issued by Romania to mark the anniversary of the annexation of Transylvania and the formation of the "Little Entente." The stamps are overprinted with the Romanian words for Czechoslovakia and Jugoslavia and with the dates "1920-1936." At the lower left are two examples of new Lithuanian stamps. The fifteen pastas value shows the portrait of President Antanas Smetona while the five pastas shows the arms and symbols of that country. At the bottom center is a French stamp inscribed "Chamonix-Mont-Blanc," and showing a skier in midair. At the right is a Danish stamp, one of three values issued in honor of H. P. Hansen, instrumental in the return to Denmark of a part of Slesvig which had been under German rule. The design shows the Dybbol windmill. The stamp at the lower right is one of a series of six issued by the commonwealth of the Philippines in honor of the thirty-third International Eucharistic Congress held in Manila last February.

Odd Value Silver Coins

It is not easy to imagine what need there was for twenty-cent pieces. Perhaps they were depression quarters for use following the panic of 1873. They appear to be undersize quarters until a coin dealer quotes a price on a fine specimen. Then one believes they must be solid gold.

They were first coined in 1875 with Philadelphia producing about 40,000, Carson City over 130,000, and San Francisco 1,155,000. In the next year Philadelphia coined less than 16,000, and Carson City an even 10,000. In the two following years dies were made and proofs struck, but none of the coins was regularly issued to the public. The 1876 coins of Carson City are the most desirable and very fine specimens are priced at from \$300 to \$500.

Get the FREE Book of opportunity

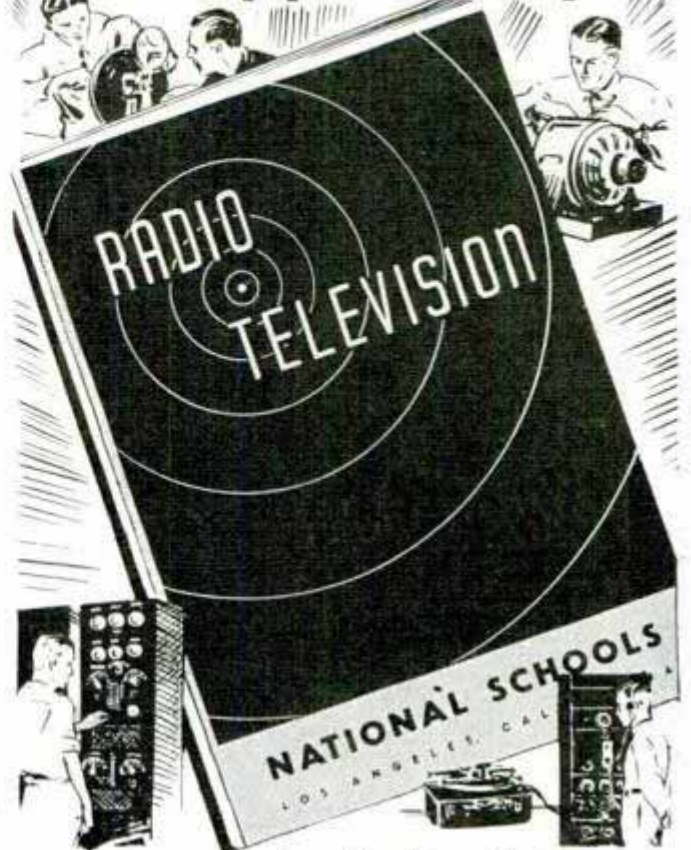

Brimful of terse instructive facts about TELEVISION RADIO SOUND RECORDING ELECTRICITY

Note These Interesting Contents

Written in plain, understandable language, this free Book gives facts you want to know about the best-paying trades and opportunities. 95 illustrations. Major subjects include Television Theory and Construction, Pick-up Systems, Amplifiers, Transmitters, Receivers, Cathode Tubes; Radio in all its branches, Receiving, Broadcasting, Trouble-shooting, Construction and Theory; Sound-recording on Disc; Loud Speakers, Talking Picture Projection, Radio Communication, Laws, etc. This book also tells how you can qualify for these good pay trades by training at NATIONAL SCHOOLS. Send coupon now for free book.

National Schools is the oldest trade Institution in the West. Est. 1905. More than 30,000 graduates. You can earn room and board while learning. Coach railroad fare allowed to Los Angeles. This service only for residents of U.S.

NATIONAL SCHOOLS

LOS ANGELES

MAIL FOR FREE BOOK

NATIONAL SCHOOLS, Dept. 5-PMR,
4000 So. Figueroa St., Los Angeles, Calif.
Without obligation send your free book.

Name..... Age.....

Address.....

City..... State.....

MIDWEST.

FACTORY TO YOU
SAVES 50%



Why be content with an ordinary 6, 8, 10, or 12-tube set when you can buy an 18-tube deluxe Midwest for the same money... direct from the factory, at half the cost! Not a cut-price set, but a more powerful super-performing radio in a big, exquisitely designed cabinet.

Only **\$39.95** AND UP
(LESS TUBES)



ZIP... and your station flashes in!

Your radio enjoyment is doubled with Dial-A-Matic Tuning* (*optional) the amazing new Midwest feature that makes this radio practically tune itself. Zip!... Zip!... Zip!... stations come in instantly, automatically, perfectly... as fast as you can push buttons.

30 DAYS FREE TRIAL

You have a year to pay... terms as low as 10c a day... you secure privilege of 30 days free trial in your own home. Other Midwest radios complete with tubes and console, \$29.95 and up! (*Base price, less tubes and console).

SEND FOR FREE 40-PAGE CATALOG

... and see why Midwest gives you so much more radio for so little money! You are triply protected with Foreign Reception Guarantee, One-Year Warranty and Money-Back Guarantee.



Dept. N-15, Midwest Radio Corp., Cin'ti, O.

MIDWEST RADIO CORPORATION
DEPT. N-15 CINCINNATI, OHIO

Send me your new FREE 40-page catalog.

Name.....
Address.....
Town..... State.....

User-Agents Make Easy Extra Money. Check Here for details.

WHOLESALE CATALOG of 4000 FAST SELLERS



Hot off the press. Opportunity to make up to \$15 a day. Shows fast sellers of every description from many parts of the world, at rock bottom wholesale prices. 256 pages chock full of the biggest bargains you ever saw, many new items just being introduced, articles for every member of the family, office necessities, etc. One of the most complete lines in America. The 15 proven money making plans are fully explained in the catalog and may increase your earnings a hundred fold. This catalog is FREE—Send for it, today.

SPORS CO.
3-37 Main St. Le Center, Minn.

WE CAN TEACH YOU TO MOUNT BIRDS

Squirrel Lighter **ANIMALS, HEADS, FISH**

Also to tan skins and FURS. Easily learned AT HOME BY MAIL. Wild game growing scarcer—big demand. Be a taxidermist. Mount for others. Big Fun, Real Hobby. Mount common specimens—no wild game needed. REAL PROFITS IN SPARE TIME.

FREE BOOK Men, Boys, get wonderful FREE BOOK—tells how YOU can learn this fine art quickly. Investigate. Send this minute. State AGE. N.W. School of Taxidermy, Dept. 3370 OMAHA, NEB.

Send Today for my Oil Burning HEATER Book—It's FREE!

Only LACO has "Inner Heating Unit" with 20% extra heating surface... doubly efficient new-type Burner that delivers ONE-THIRD more heat from low priced fuel. Cheapest, cleanest, safest heat known. Automatic uniform-temperature control. Humidifies, circulates air. Extra well built. Handsome as finest furniture. 6 sizes—for smallest homes to large buildings.



WRITE! Send for free copy of New LACO OIL-BURNING HEATER Book, Lowest Known Prices and complete details. DEALERS! I'll ship a sample Heater to new dealers. Write for details. L. A. COCKLIN, Pres., LACO OIL BURNER CO. 157 Union St., Griswold, Iowa

MONEY-MAKING CARTOON COURSE

BY THE FAMOUS CARTOONIST **Nick Nichols**

Creator of PETER PEN
This Portfolio Contains—Twenty Lessons—Hundreds of Drawings—Tells You All My Secrets—How to Draw Funny Papers—Comic Strips—Pretty Girls—etc. How and Where to Market Your Drawings. Send \$2.00. Currency or Money Order, to NICK NICHOLS SCHOOL OF CARTOONING AND NEWSPAPER SYNDICATE Times Bldg., Suite 1120-P Chicago Ill.

\$2.00 postpaid!

MASTER MUSICIANS

TEACH YOU Amazing home method—low cost—easy terms. New, quick way for beginners in Piano, Violin, Cornet, BY MAIL Trumpet, Mandolin, Guitar, Organ, Banjo, Accordion, Saxophone, Clarinet and other instruments. Wonderful results whether for pleasure, profit or both. 300,000 satisfied students. Your satisfaction guaranteed. Write for FREE CATALOG giving all details.

NATIONAL ACADEMY OF MUSIC
Dept. 802 1525 East 53rd Street, Chicago

ARTISTS MAKE MONEY

Find out your ability. Send name, age, occupation and address for Free Vocational Art Test. Federal Schools, Inc., 5137 Federal Schools Bldg., Minneapolis, Minn.

REDUCED 8 INCHES!
 "... Please send me a Weil Reducing Belt for a 38 inch waist. The first one I got was a 46—which one should be 8 inches smaller."
 W. L. McGinnis
 Livermore, Cal.

"REDUCED MY WAIST 8 INCHES"



REDUCED 50 POUNDS!
 "... This is a belt of great value and I find itsochrelief and help... It has reduced my weight from 230 to 180 pounds."
 W. Y. Anderson,
 Richmond, Va.

Why don't YOU Test the Weil Belt at Our Expense?
 Experiences of thousands of men justify us in making you this unqualified agreement:
If you do not REDUCE your WAIST 3 INCHES IN 10 DAYS . . . it will cost you nothing!

■ You will appear many inches slimmer at once and will be completely comfortable as massage-like action and gentle pressure persistently eliminate fat with every move! The Weil Belt gives an erect, athletic carriage... supports abdominal walls... keeps digestive organs in place, and with loss of fat comes increased endurance.

■ Simply write name and address on postcard and we will send you illustrated folder and full details of our 10 DAY FREE TRIAL OFFER!

THE WEIL COMPANY, 565, Hill St., New Haven, Conn.

SEND FOR 10 DAY FREE TRIAL OFFER

NEW ELECTRIC LIBRARY

\$ 1.50 A VOLUME



WHAT EVERY ELECTRICIAN WANTS TO KNOW!

is easily found in AUDEL'S NEW ELECTRIC LIBRARY. Electricity made simple as ABC. Up-to-date, trade dope for the expert and ALL electrical workers. Questions, answers, diagrams, calculations, underwriter's code; design, construction, operation and maintenance of modern electrical machines and appliances FULLY COVERED.

All available at small cost, easy terms. **BOOK-A-MONTH** service puts this NEW information in your hands for 6c a day. You can start your subscription with any volume. Write TODAY for electric folder and FREE TRIAL offer.

THEO. AUDEL & CO., 49 W. 23rd St., New York City
 Mail Vol. I, Electric Library on 7 days' free trial. If O. K. I will remit \$1.50, otherwise I will return it. I also request you to mail one book each month on same terms. No obligation unless I am satisfied.

Name.....
 Address.....
 Occupation.....PM

Want a Good JOB in AIR CONDITIONING and Refrigeration?

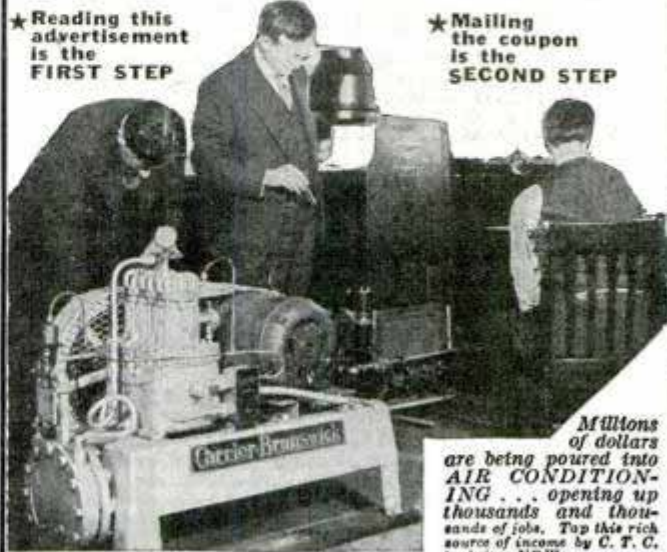

★ Reading this advertisement is the FIRST STEP

★ Mailing the coupon is the SECOND STEP

Millions of dollars are being poured into AIR CONDITIONING... opening up thousands and thousands of jobs. Tap this rich source of income by C. T. C. training NOW.

RIGHT now, today, if you knew air conditioning, you could have the pick of many jobs. It is here to stay . . . America's industry of Opportunity. Men are needed everywhere . . . to design, to build, to sell, to install, to repair and to service Air Conditioning. The cry goes out, "Where can we get TRAINED men—we haven't time to train them ourselves." That is why, if you decide NOW to get quick, easy C. T. C. training, you are in on the ground floor, way ahead of those who delay. So don't delay. Mail the coupon or postcard NOW for FREE TRIAL LESSON.

Learn AT HOME in Spare Time

by the new step-by-step plan of Chicago Technical College, the well-known 34 year old School of Engineering. Thousands of successful men have achieved success through our time-proved methods in other fields. You can, too, in AIR CONDITIONING by our fascinating plan that anybody can master. We help you to a good job when ready. Send for FREE TRIAL LESSON (Plan A—on coupon) and study at home if employed at present or lack sufficient funds to go away to college.

At the College in Chicago

If planning to attend college mark the coupon (at Plan B) for Blue Book. Start school here any Monday. Day and Evening Classes. Opportunities for spare time work to earn part of living expenses. Check coupon at Plan "A" if funds are limited. Credit given for work done at home on C. T. C. Course in Air Conditioning.

Free TRIAL LESSON

Don't ask: "What about my future?" Here it is in AIR CONDITIONING . . . the prosperity occupation . . . and the FREE TRIAL LESSON we will send you can be that FIRST step to the more abundant life. Send the coupon—or postcard NOW. You owe it to yourself. No strings attached—no charge or obligation now or later for this FREE TRIAL LESSON.

CHICAGO TECHNICAL COLLEGE



E301 Tech Bldg., 118 E. 26th St., Chicago, Ill.

Please send FREE BOOK as checked below:

Plan A AIR CONDITIONING (Free Trial Lesson)
 Learn in Spare Time at Home.

Plan B AIR CONDITIONING (Free Blue Book)
 For Study at the College—in Chicago.

Name..... Age.....

Address.....

P. O. State.....

Other C. T. C. money making Courses by home-study:
 (Check one of these ONLY if you prefer it to Air Conditioning.)

DRAFTING BUILDERS COURSE
 Calls increasing for Carpenters and Builders.

When writing please mention Popular Mechanics

This MACHINISTS' Home-Study Course



helps men get ahead

Newly assembled—specially priced—these five recent books give you the practical facts on modern machines, up-to-date methods, you need to advance in machine shop work. Take advantage of the other man's experience as found in books, to solve your problems, increase your efficiency, with the new

Library of MODERN MACHINE SHOP PRACTICE

5 volumes—2000 pages—1600 Illustrations
(A combined home-study course and reference library)

This library of machine shop practice was written for practical men. It gives you the best methods for every kind of machine shop work. It fully explains lathes, drills, and other machine tools and their operation, automatic screw machines, speeds and feeds, gear design and production, punch and die work, metal finishing, etc., etc. Plainly written—completely illustrated—the best kind of help to the machine-shop man who wants to advance himself.

No money down—special price—easy payments.

FREE EXAMINATION COUPON

McGraw-Hill Book Co., 330 W. 42nd St., New York
Send me for ten days' free examination the Library of Modern Machine Shop Practice. If satisfactory I will send you \$1.50 in 10 days and \$3.00 monthly until the price of \$16.50 is paid. If not wanted, I will return the books postpaid. (To insure prompt shipment write plainly and fill in all lines.)

Name

Home Address

City and State

Position

Name of Company



TELEVISION AND RADIO ARE YOUR OPPORTUNITY

BIG MONEY and READY JOBS AWAIT EXPERTS

Unlimited opportunities in this new expanding field await alert, aggressive, trained men...men who LEARN NOW...men with vision to get in on the ground floor when the profession is young and uncrowded. TELEVISION is already a reality awaiting development of man-power to sweep the nation.

LEARN FASTER, BETTER—"ON THE JOB"
Television Broadcasting Station W9XAL and Radio Station KXBY, owned and operated by First National Television, Inc., are your practical laboratories...your "proving ground". YOU LEARN BY DOING! Think what this means to you! Elaborate, complete broadcasting stations give you practical experience absolutely vital to rapid progress and to thorough, advanced knowledge necessary for SUCCESS.

ONLY 6 MONTHS FOR U.S. GOVT. LICENSE
Our "training on the job" qualifies you in 6 months for U.S. Govt. License (First Class). Our new, illustrated, FREE book, "Pictures on the Air" gives full facts. You owe it to yourself to investigate! Don't waste a year from now and find your friends making big money in fascinating Radio-Television careers...while you stood still! ACT NOW! Send coupon today!

FIRST NATIONAL TELEVISION, INC.
Training Division, Kansas City, Mo.

MAIL COUPON NOW!

S. O. NOEL, Pres. First National Television, Inc.
Dept. AAS, Training Division, Kansas City, Mo.
Rush me "Pictures on the Air" Free!

Name _____ Age _____

Street _____

Town _____ State _____

GET THE INSIDE STORY BOOK



When writing to advertisers please mention Popular Mechanics

NEW REMARKABLE POCKET RADIO



BEAUTIFUL CLEAR TONE DIRECT FROM POCKET RADIO
All one unit—just like the big sets, but weighs only 6 oz. Fits pocket easily. Take it with you. Nothing to adjust. No batteries, tubes, or electric socket connections required. Tuning knob is the only moving part.

Costs Nothing to Operate! Guaranteed!

Brings in stations with fine tone quality. Tunes broadcast band. Accurately made, precisely assembled, rigidly tested, assures excellent performance. Should last for years. Comes complete with built-in phone, with easy instructions for use in camps, office, picnics, home, bed, etc. Listen to music, sports, radio entertainment, etc. The "Little Giant" is guaranteed — all ready to connect and tune in. Thousands in use. An ideal gift. Order now.

Excerpts From Satisfied Users
Received radio and it works fine... Am well pleased with it in every respect. I recommend the Little Giant to any prospective purchaser who wishes just such a little radio for personal use. Cost nothing to operate... Have tried it and it works splendid. Received Midget Radio — I am pleased. Kindly mail two more... (Letters on File)

LITTLE GIANT RADIO CO., 1165 Diversy Pkwy., DEPT. 706, Chicago

WELDERS WANTED!



ELECTRIC ARC — OXY-ACETYLENE
Skilled Welders earn \$8 to \$15 a day. The demand now greater than the supply. Learn this highly paid trade in 4 weeks by actual shop work. One of America's leading schools. Established 1902. 7 floors of shops. Endorsed by welding industry. Limited number of students. 4 weeks course in Electric Arc or Acetylene Welding, including room and board, only \$159. Write or wire for reservation. Ask for "Welding Facts." State age.

GREER COLLEGE, Dept. 57, 2025 S. Wabash Ave., Chicago



PLAY GUITAR!

We guarantee to teach you for less than 2c per day. You'll enjoy learning to play this fascinating instrument by our easy, illustrated lessons. FREE Guitar Tuner when you enroll. Ask for full details — no obligations. Write TODAY — Sure.

HAMANN INSTITUTE, 3019 N. 24th Place, Milwaukee, Wis.

WIND CHARGER

FREE Genuine DUNN CHARGER for supplying 6-volt radio and house lighting current operating at less than one cent a week. Guaranteed. Be first in your community to make quick money showing world's best windcharger using the famous patented Dunn governing principle to friends and neighbors, and own yours FREE. Mail post card today.

Parris-Dunn Corp., Dept. 10, Clarinda, Iowa

The World's Biggest



Get Shop Notes for 1937! Only 50 cents. May easily be best investment of your entire lifetime. Contains 357 money-making, time-saving ideas, hints, short cuts for mechanics farmers, home workshop fans, handymen — for everyone who uses tools. 224 pages, 337 articles, 703 illustrations. Get 1936 Shop Notes too, Only 50c.

50¢ WORTH SHOP NOTES FOR 1937



All About DIESEL Power

Diesel Power is no passing fad. It's the coming world power. In the air—on land and sea—thousands of men who know about Diesel Engines will be in demand. Plan ahead. Get the most timely book of the day—ELEMENTS OF DIESEL ENGINEERING by Orville Adams. The ideal book for beginners, students, mechanics of all kinds and the only book you need. Large size 6 x 9 inches. 450 Pages. 284 Illustrations. 22 Fact Filled Chapters. Send for your copy today and get out in front in Diesel Power. Sent postpaid only \$4.00. Order today.

472 PAGE BOOK Complete \$4 Only

POPULAR MECHANICS PRESS ROOM 537-B CHICAGO, ILL.

AUDELS MATHEMATICS AND CALCULATIONS FOR Mechanics



\$2
A
HANDY
BOOK

Good News!

MATHEMATICS AND CALCULATIONS FOR HOME STUDY AND REFERENCE

PRACTICAL MATHEMATICS ILLUSTRATED. How to figure correctly. EVERY MECHANIC can use the new, correct, easy methods, covering a complete review of practical arithmetic—with examples including mensuration—plane and solid geometry—trigonometry—algebra—calculus—ELECTRICAL and MECHANICAL SHOP CALCULATIONS—practical tests—reference tables and data—how to use the slide rule—700 pages—550 illustrations—pocket size.

Highly endorsed. Let us mail you copy for free trial. Price \$2, postpaid.



FREE
EXAMINATION
COUPON

THEO. AUDEL & CO.
49 W. 23rd St., N. Y. C.

Mail Audel's Mathematics on 7 days' free trial. If O. K. I will remit \$2, otherwise I will return it.

Name

Address

Occupation P. M.



BE A CARTOONIST

AT HOME IN YOUR SPARE TIME under personal supervision of the famous cartoonist NORMAN MARSH creator of "DAN DUNN" appearing every day in big papers. Success—Fame—Real Money may be Yours when you learn Marsh's easy simple methods and secrets. Send name and address for free details of MARSH'S Personal course. ACT TODAY!

MARSH CARTOON SCHOOL
Chicago Daily News Bldg., Dept. E-1 Chicago, Ill.



BIG MONEY in MAPS

The very latest—80 pages, size 11x14 inches. Large comprehensive maps of all the 48 States and all principal cities. Also maps of Canada and Mexico. Latest census and highway data. Flashy attractive scenic cover. No price mark. WONDERFUL PROFITS. Show the book and a sale is made. Every class of business and individuals are prospects. Everyone is interested in maps. Sample copy 35c Ea. Prepaid. AGENTS write for full information. We guarantee you can sell this high-grade publication. Act Now. Write Today.

GALLUP'S, Inc., Dept. 22, Kansas City, Mo.

HOME STUDY COURSES

Home-Study Courses, leading to Degrees in Arts and Sciences; Education; Writing; psychology; Chemistry; Business and Commerce; Law; Theology; Agriculture; Engineering; also courses in Business Training; Accounting; Advertising; Sales Management; Public Speaking; Radio. Many others. Low Cost! Easy Terms.
McKinley-Roosevelt College of Arts and Sciences, 4247 Clarendon Ave., Chicago

RAISE GIANT FROGS

WUFOND GIANTS WEIGH UP TO 3 LBS. EACH



EASY TO START!

Markets Waiting. Frog legs in big demand at good prices the year 'round. Millions used yearly!

WE BUY We have one of the largest frog markets in the world! Sell to us in addition to other markets.

Men and Women starting in every state and Canada. See what others already doing. Small pond starts you. **FREE FROG BOOK** explains our unusual offer to beginners! Now's the time to begin! Write today!

AMERICAN FROG CANNING CO.
(Dept. 133-E) New Orleans, Louisiana

FREE BOOK



U. S. GOVERNMENT JOBS

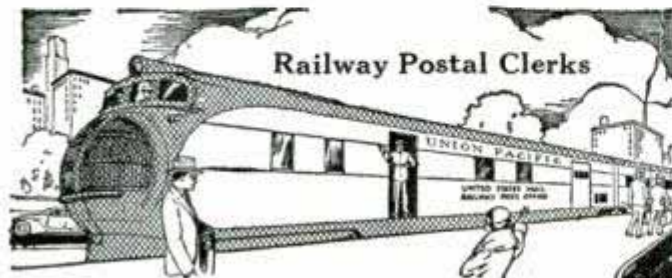

City and Rural Mail Carriers, Post Office Clerks, Clerks at Washington, Customs Inspectors, Accountants, Stenographers—Typists, etc.

Over 42,000 appointments last government year
Common education sufficient
Mail coupon at once

FRANKLIN INSTITUTE, Dept. C173,
Rochester, N. Y.

Sirs: Rush to me without charge—copy of 32-page book, "How to Get a U.S. Government Job," with list of dependable positions for men-women and full particulars telling how to get them.

Name

Address

Make Money

CONVERTING CARS TO DIESEL!

2 complete charts, easily understood directions for changing any car to Diesel. A proven method different and better. Run your car on Diesel—amaze your friends—pocket the profits they gladly pay for Dieselizing their cars. Each conversion another demonstrator. Think of it—a profitable, big business can be yours in the fascinating Diesel industry on a single dollar investment! ALSO we will send you for prompt action

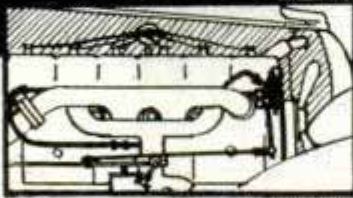

FREE!

"WHAT EVERY MAN SHOULD KNOW ABOUT DIESEL"

This FREE big book worth several dollars alone to any ambitious Diesel-minded man. Your chance to learn how to start RIGHT and make real money in Diesel. Just off the press—inside facts on countless opportunities—money-making suggestions—cram full of meaty, valuable information never before assembled under one cover—a real eye-opener and brain-widener worth plenty to those alert for short cuts to success in gigantic Diesel industry.

You can't afford to wait another day before sending for these charts and "What every man should know about DIESEL"—the biggest dollar value ever offered men ambitious for big success in Diesel. SEND FOR IT TODAY. Put a dollar bill (\$1.25 outside U. S.) in an envelope with your name and address. Address it to

HARRINGTON PUB. CO., Dept. A
515 Davis Bldg. Portland, Oregon, U. S. A.



All for \$1.00 POSTPAID IN THE U.S.

THIS GIFT IS YOURS ABSOLUTELY WITHOUT COST

If you are interested in the onward march of science and its breath-taking discoveries in Mechanics, Astronomy, Invention, Chemistry, Nature, Engineering, and other sciences, you will enjoy this fascinating booklet. "Scientific Wonders." This FREE booklet is 5½ by 8½ inches in size and is profusely illustrated with drawings, photographs and diagrams showing the marvels of the movies, power, television, wonders of biology, ingenious inventions, etc. "Scientific Wonders" also contains articles on: The Seven Wonders of the Modern World, How Chemistry Makes Food and Clothes, Behind the Scenes in Radio, Putting the Stars to Work on Earth, Touring the Wonderland of Science, Scientific Oddities, Etc. Write or send this coupon for your FREE copy of "Scientific Wonders." Also information on the monumental "Scientific Wonders of the World."



METRO PUBLICATIONS
Dept. 105, 70 Fifth Ave., New York

Name.....
Address.....

Get Lost! A WIRELESS Pocket TUBELESS BATTERYLESS Radio



World's Smallest Real Performing Radio

Amazing Midget radio weighs only 3 ozs. complete. Receives all stations with clear beautiful tone. Very little static and interference. Nothing to adjust or cause trouble—should last for years. USES PATENTED FIXED CRYSTAL DETECTOR, ENTIRELY NEW DESIGN! Not to be confused with cheaply made imitations. Music and programs come DIRECTLY FROM FRONT OF RADIO—NOT FROM REAR! New patented "Speakophone" gives more volume and stations! NOT A TOY. Tunes broadcast band. The Newest radio sensation of the year. Absolutely complete with picture instructions for use in hotels, offices, boats, autos, bed, etc. TAKES ONLY A SECOND TO CONNECT—no messy hookups to any current or extra wires. SATISFIED OWNERS report wonderful service in ALL PARTS OF THE WORLD. THESE ARE FACTS! Beautiful two color cabinets in six colors.

SEND NO MONEY. Pay postman only \$2.00 plus charges or send \$2.90 (check, M.O., cash) and yours will be sent postpaid. GUARANTEED. Can be used by anyone. ORDER NOW! DEALERS.

TINYTONE RADIO CO., Dept. P-5, KEARNEY, NEBR.



CARTOONING COURSE \$1.00

A complete, simplified, practical course in Cartooning, consisting of 30 lessons, with over 500 illustrations, including drawing pens and pencils. \$1.00 Postpaid. SCOVELL STUDIOS, Box 748, Hollywood, Calif.



Trailer Travel Magazine

If interested in trailer lore, as owner, builder, buyer or prospect, you want the only magazine devoted exclusively to trailer news, stories, features, designs and plans; touring and camping; laws, and directory. Profusely illustrated. The Trallerite's guide. 10c For 12 issues mail \$1, or for sample copy....

TRAILER TRAVEL, PMS, 35 E. Wacker Drive, Chicago, Illinois

In answering an advertisement with a coupon, be sure to write name and complete address clearly. Sometimes advertisers are unable to respond to inquiries due to lack of complete information.

MAKE MONEY

with "SHOP NOTES" Ideas, Kinks, Helps



1937 SHOP NOTES and LATHE HANDBOOK

Extra Big Book Value—ONLY 98¢ For Both

Be the man who knows the easiest and best ways of doing things—the fellow who is up-to-date—cash in on handy kinks and short cuts. Get Shop Notes for 1937 and make money. For many years the helpful, handy guide for men doing mechanical, carpentry, auto repairing, concrete, plumbing, electrical, building, masonry, farming, home repair work, etc. Now ready—1937 edition and famous Lathe Handbook—both for only 98 cents.

2000 Money Making Ideas for Shop and Handy Men

Get the Shop Notes Library. Complete set 5 books—Over 800 pages—2000 pictures—2000 money making facts, methods, processes and time saving kinks. They'll pay for themselves over and over. Whole set only \$2.50. Order now. Supply soon exhausted.

A FEW OF 357 ARTICLES IN 1937 SHOP NOTES
Shop Notes for 1937 has 224 pages—357 articles—703 illustrations. Some of the subjects are:

- Auto Owner Helps
- Auto Service Kinks
- Beit Sander
- Concrete Garden Furniture
- Drill Press Work
- Electrical Kinks
- Family Auto Trailer
- Gold Finding
- Lathe Operating Kinks
- Metal Furniture
- Plastics
- Resilvering Mirrors
- Rewinding Auto Generators
- Tool Kinks
- Workshop Kinks

SEND NO MONEY!

Combination offer above 98 cents. Shop Notes Library—5 books—\$2.50. Pay postman plus few cents delivery in U. S. and possessions. Elsewhere remit with order. Order now.

Popular Mechanics Press, Room 536A, 200 East Ontario St., Chicago

When writing please mention Popular Mechanics



Easy
 YOU'LL advance faster with an easy playing Conn. Choice of world's greatest artists. Many exclusive features yet they cost no more. Home trial. Easy payments. See your dealer or write for freebook. Mention instrument.
C. G. CONN, Ltd. 531 Conn Bldg. ELKHART, IND.



CONN
 BAND INSTRUMENTS

BE AN ARTIST

WE CAN TEACH YOU DRAWING in your own home during your spare time. Thirty-five years of successful teaching proves our ability. Artists receive large salaries.

Write today for Art Year Book
SCHOOL OF APPLIED ART
 Dept. 157, 10 E. Huron St., Chicago, Ill.



REAL JOBS OPEN

AUTO, DIESEL, AVIATION, WELDING

Step into big pay. Earn \$35.00 to \$75.00 a week. Learn in eight weeks. Practical Shop Work. Use real tools on real equipment. Write our school nearest you for big Free Book and special low tuition offer. Guaranteed training.

McSWEENEY SCHOOLS, Dept. 10-41
 Detroit, Mich., or Kansas City, Mo.



ON APPROVAL

We defy you to tell this ring from one costing \$300! To prove it to you, we'll send it at our risk. You will be delighted with its manly setting in the color and charm of natural gold. You will be thrilled with the rich beauty of the fiery, flashing, full carat facsimile diamond—looks like a million dollars of prosperity! Simply send 10 cents to cover packing, postage, etc. If delighted, continue 2 monthly \$2.50 payments (total \$5). Unconditional money back guarantee. You cannot lose! Send 10 cents TODAY. Your ring, in rich GIFT case, shipped by RETURN MAIL.

BRADLEY, DEPT. 685, NEWTON, MASS.

ROTARY TYPELESS PRINTER

Sensational PRINT-O-PRESS Stencil Duplicator. Prints post cards and up to 8 1/2 x 11 letters, circulars. Many advance features. Details free. Fully Warranted.

Professional Products
 Dept. 510, Silvertown, Ohio

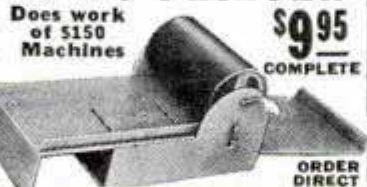

Does work of 5150 Machines
\$995
 COMPLETE

ORDER DIRECT

CIVIL SERVICE

VALUABLE INFORMATION
 COLUMBIAN CORRESPONDENCE COLLEGE
 WASHINGTON, D. C.

In answering advertisements always write name and full address clearly.



Earn Cash at Home!

We paid M. M. \$267 in 3 weeks for exceptional "cellar crop" patented mushrooms! Big free picture book tells if your cellar, shed, barn suitable. We buy all crops thru ten branches. Write today. Est. 1908 UNITED CO., 3848 Lincoln Ave., Dept. 309, CHICAGO

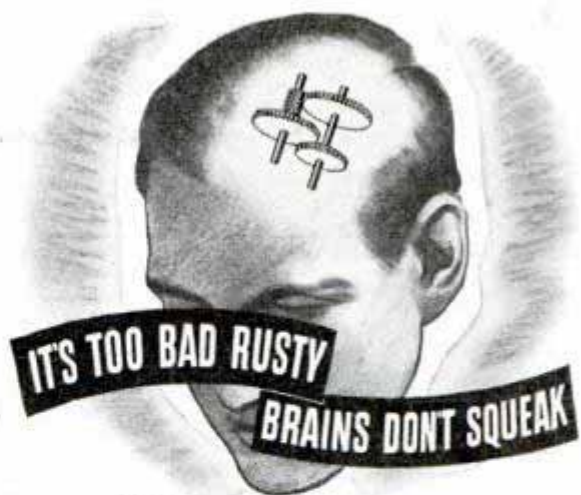

IT'S TOO BAD RUSTY BRAINS DON'T SQUEAK

IF RUSTY brains did squeak, no one would have to warn you against trying to get ahead in a modern world with antiquated training! Keeping your brain modern is just as important as keeping plant equipment modern. The best way to keep your brain up to date is to keep your training up to date. The business of modernizing men's training is the business of the International Correspondence Schools. If your pay envelope is too thin, this coupon can be the first step towards changing the whole course of your life.



INTERNATIONAL CORRESPONDENCE SCHOOLS

Box 5674-H, Scranton, Penna.

Without obligation, please send full particulars about the subject before which I have marked X:

TECHNICAL AND INDUSTRIAL COURSES

- Architect
- Architectural Draftsman
- Building Estimating
- Contractor and Builder
- Structural Draftsman
- Structural Engineer
- Electrical Engineer
- Electric Lighting
- Welding, Electric and Gas
- Reading Shop Blueprints
- Telegraph Engineer
- Telephone Work
- Mechanical Engineer
- Mechanical Draftsman
- Machinist
- Patternmaker
- Foundry Practice
- Sheet Metal Worker
- Boilermaker
- Heat Treatment of Metals
- Management of Inventions
- Diesel Engines
- Aviation Eng.
- Plumbing
- Air Conditioning
- Steam Engineer
- Steam Electric Engineer
- Marine Engineer
- Civil Engineer
- Highway Engineer
- Bridge Engineer
- Bridge and Building Foreman
- Surveying and Mapping
- R. R. Locomotives
- R. R. Section Foreman
- R. R. Signalmen
- Chemistry
- Coal Mining
- Navigation
- Cotton Manufacturing
- Woolen Manufacturing
- Agriculture
- Poultry Farming
- Auto Mechanic
- Heating
- Refrigeration
- Civil Engineer
- Highway Engineer
- Air Brakes
- Pharmacy
- Fruit Growing

BUSINESS TRAINING COURSES

- Business Management
- Industrial Management
- Traffic Management
- C.P. Accountancy
- Bookkeeping
- Secretarial Work
- Cost Accountant
- Salesmanship
- Service Station Salesmanship
- Business Correspondence
- Lettering Show Cards
- Stenography and Typing
- Civil Service
- Railway Mail Clerk
- Grade School Subjects
- High School Subjects
- College Preparatory
- First Year College Subjects
- Illustrating
- Cartooning
- Signs
- Mail Carrier
- Spanish
- French

DOMESTIC SCIENCE COURSES

- Professional Dressmaking and Designing
- Home Dressmaking
- Advanced Dressmaking
- Millinery
- Foods and Cookery
- Tea Room and Cafeteria Management, Catering

Name.....Age.....
 Address.....
 City.....State.....

Present Position.....
 If you reside in Canada, send this coupon to the International Correspondence Schools Canadian, Limited, Montreal, Canada

When writing please mention Popular Mechanics

“OL’ JUDGE ROBBINS
AIR-COOLED PIPE



SEE, THE STEM IS CURVED AND INTERTWINED IN AN INTRICATE PATTERN. STRETCHED OUT STRAIGHT, IT WOULD MEASURE TWELVE AND A HALF FEET. ITS PURPOSE WAS TO COOL THE SMOKE AND SAVE THE SMOKER'S TONGUE FROM "BITE"



PRINCE ALBERT MONEY-BACK GUARANTEE!

Smoke 20 fragrant pipefuls of Prince Albert. If you don't find it the mellowest, tastiest pipe tobacco you ever smoked, return the pocket tin with the rest of the tobacco in it to us at any time within a month from this date, and we will refund full purchase price, plus postage. (Signed) R. J. Reynolds Tobacco Company, Winston-Salem, North Carolina.



Copyright, 1937, R. J. Reynolds Tobacco Company

50 PIPEFULS OF FRAGRANT TOBACCO IN EVERY TIN OF P.A.

PRINCE ALBERT
 THE NATIONAL JOY SMOKE

PH 102

Popular Mechanics Magazine

REGISTERED IN U. S. PATENT OFFICE AND CANADA

WRITTEN SO YOU CAN UNDERSTAND IT

Vol. 67

MAY, 1937

No. 5

8147

CROSS-CANADA AIRWAY Next

FROM Halifax on the Atlantic coast to Vancouver on the Pacific, modern pioneers have blazed a 3,500-mile trail and in the summer of 1937 Canada will open her transcontinental airway.

The first regular flight will signal a victory over vast stretches of wilderness and towering mountains. Northern Ontario, a region of lakes and bush where few people live, has been bridged by the construction of nearly fifty intermediate airports.

Right, Canadian mail pilot hands the mail to northern trapper. Below, map of transcontinental airway, showing connections with United States and Arctic lines

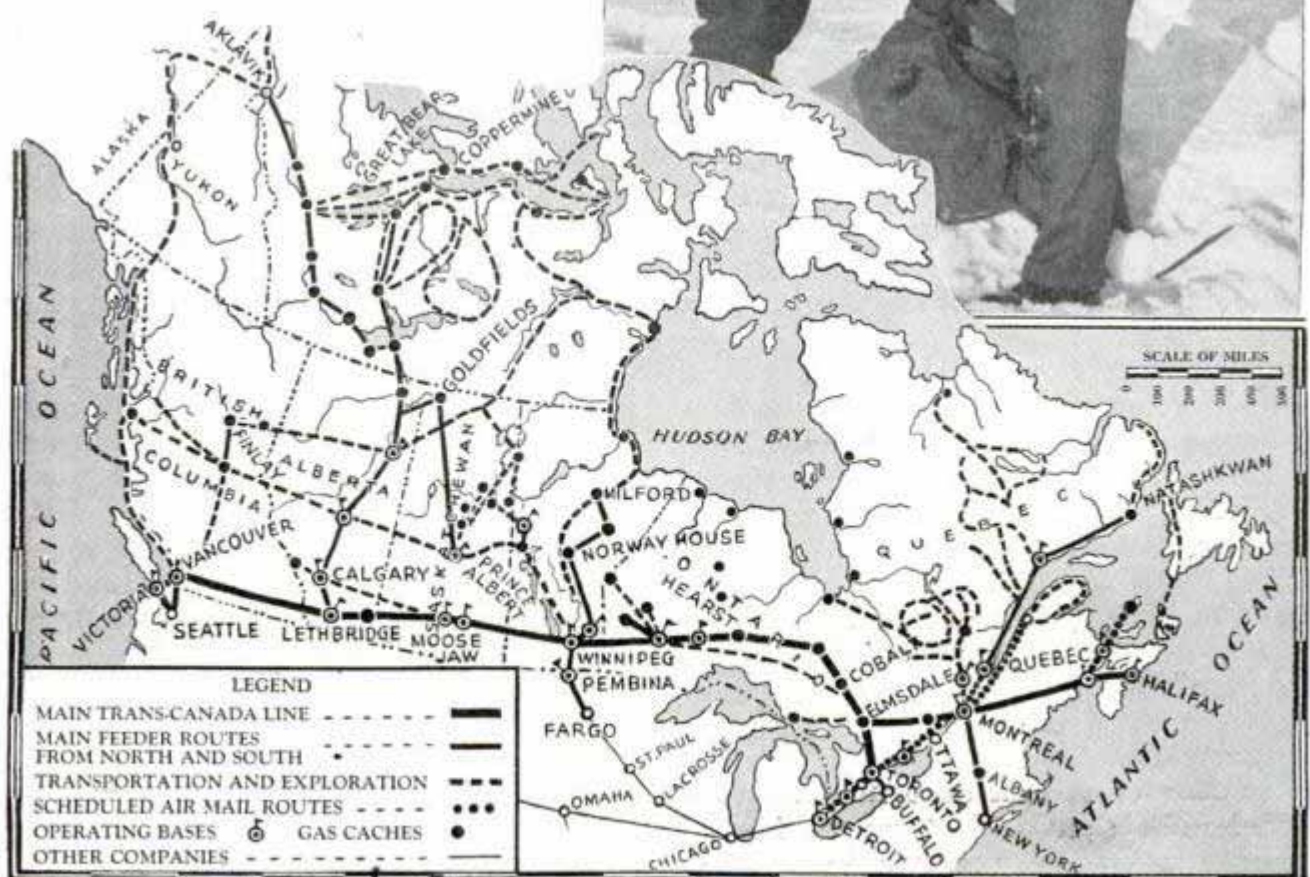

Vertical handwritten text on the right margin, possibly a page number or reference.

Cont-James Montagnes, 517 641



Photo by Royal Canadian Air Force

Top, western terminus of airway on Sea Island, Vancouver, has landing facilities for land or sea planes. Bottom, fast British plane which will be used on the Canadian line



From Quebec to Manitoba an army of workers braved wintry blasts of twenty to thirty below zero and summer's plague of big, black flies to cut down trees, level off fields, dynamite and burn stumps and fill muskeg swamps with rocks and boulders. Even after the fields had been cleared it was no small task to prevent the fast-growing bush from reclaiming the land. Thus were created small oases in the desert of forests where planes might land.

Through the Rocky Mountains, where the lowest practical pass is 4,500 feet above sea level and surrounded by peaks towering to 10,000, the trail blazers fought their way, building twenty-five airports, at twenty-five to thirty mile intervals, so that a pilot might always be within sight of one. When radio beacons for beam flying were installed it was found that the mountains caused an echo in the directional radio signals. Instruments in test planes showed "on course" when the ships were far off their path. So instead of one

beacon at each location, two or more were installed to balance the echo. More radio beacons than ordinarily required were placed in service to increase safety.

Almost all the flying in Canada has been done with planes equipped with pontoons in summer and skis in winter to take advantage of the large number of lakes scattered through the country. But twice a year, at "freeze-up" and during the spring thaw, all operations had to be halted for a period of three to six weeks because planes could not land on the lakes. Since no air line could operate under such conditions the Canadian airway will have 100 air fields, many of them built beside the lakes where planes formerly landed, so that aircraft with wheels may land the year round. The lakes still may be used by planes with suitable landing gear.

The Haviland Dragon



Top, typical stretch of sparsely inhabited country in northern Ontario over which airway planes will speed. Bottom, water end of Toronto's airport is within five minutes walk of business district

While the new line will rely on the latest antenna from the United States other radio equipment, designed and built in Canada, will be used in planes and on the ground. Four-way directional signals will be provided at all times by the radio-beam stations. Pilots will talk to and hear ground stations over efficient two-way communication systems, and weather data will be transmitted by teletype. Pilots will rely entirely on the radio beam for guidance, finding their position from information relayed by ground stations scattered

from one end of the airway to the other.

The entire chain of emergency and terminal airports from Halifax to Lethbridge will be illuminated by the latest type of lighting. The mountain route, from Lethbridge to Vancouver, will be flown only in daylight, as a safety measure. Telephones will link all emergency fields and weather service will be available instantly to pilots forced down at any intermediate field.

Close to \$10,000,000 has been spent in the construction of ground facilities for

(Continued to page 139A)

Giant X-Ray Machine Treats Five at a Time

*Columbia Presbyterian Center
Presbyterian Hospital, New York*

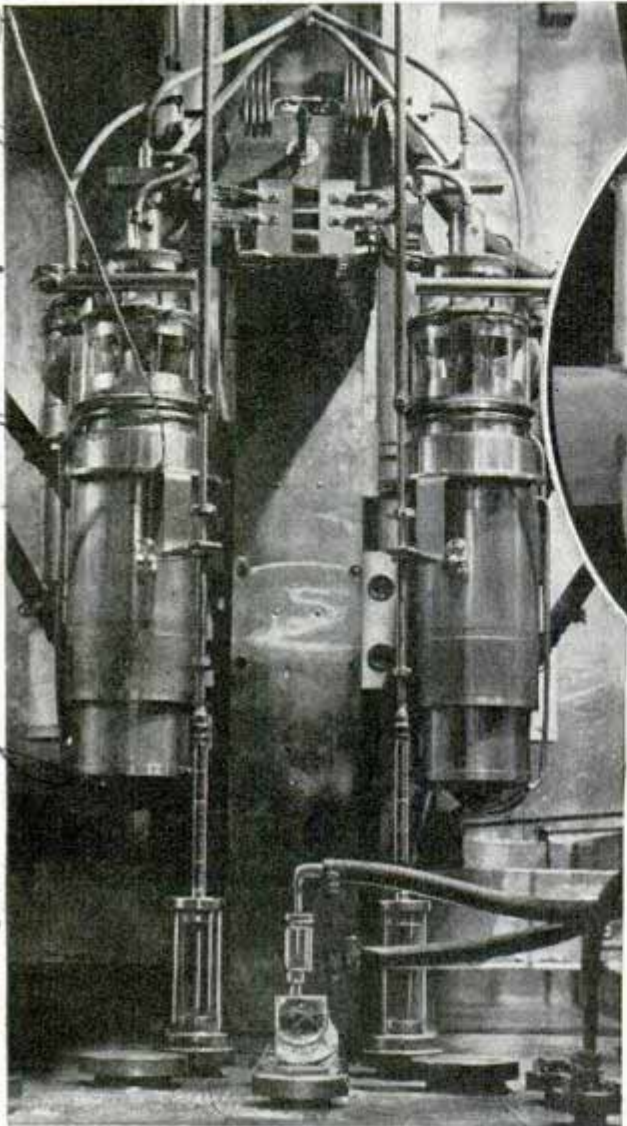

Harris and Long

Capable of generating radiation equivalent to \$100,000,000 worth of radium, a powerful X-ray machine recently installed in a New York hospital treats five patients at a time. It is intended particularly for treatment of cancer. Two large radio oscillator tubes comprise the heart of the machine, which can produce 1,250,000-volt X-rays. The powerful generator is the invention of Physicist Frank M. Exner of the Institute of Cancer Research.

1145 Amsterdam *new York* Gives Twice as Much Light

When the lamp is first turned on, an arc strikes, emitting a feeble bluish glow. In about five minutes the lamp is fully "warmed up" and gives a brilliant stream of light. Unlike present 250-watt and 400-watt mercury lamps the bulb-within-a-bulb operates from either a 110-115 or 120-volt line and without the need of a voltage stepup for starting. It is expected to prove useful in street lighting and photography. Tests are being conducted at laboratories of General Electric company.

☐The first farm tractor powered by internal combustion engine was built in 1901 and today there are 1,248,000 on farms in the United States.

*Ohio
Rela Park
Cleveland*

Left, giant tubes in X-ray machine. Right, adjusting lead stop in treatment port

Es 108 "Bulb-Within-Bulb" Lamp

Rated at only 100 watts but capable of producing as much light as a standard 200-watt lamp, an experimental mercury lamp is being tested. It is a bulb within a bulb, the outer one being six inches long and one and one-half inches in diameter. The inner bulb is made of extra-hard heat-resisting glass and is two inches long and one inch in diameter. Within it is a small amount of mercury and enough argon gas to "start" the lamp.



27 W. 39 St. New York

*S.A. & Journal
Feb 1937*

So 191

Capt. Chas. A. ...
Middletown Air Depot.
POPULAR MECHANICS 645
Middletown, Pa.

Latest U. S. Fighting Planes Built for Speed

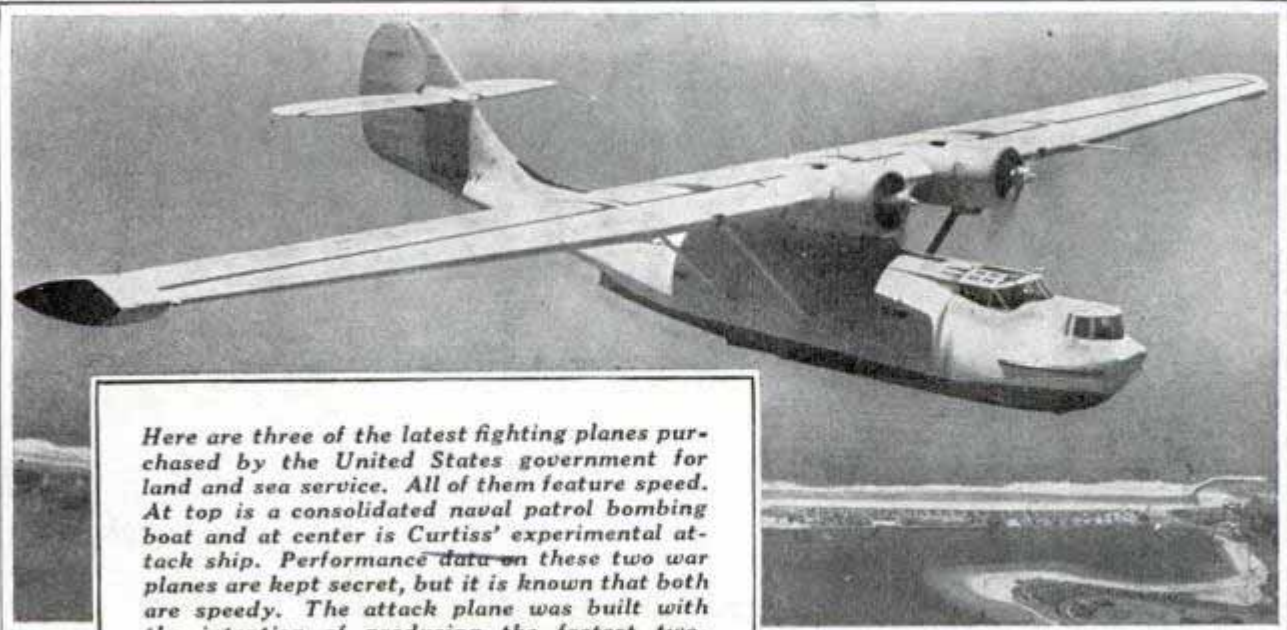

Here are three of the latest fighting planes purchased by the United States government for land and sea service. All of them feature speed. At top is a consolidated naval patrol bombing boat and at center is Curtiss' experimental attack ship. Performance data on these two war planes are kept secret, but it is known that both are speedy. The attack plane was built with the intention of producing the fastest two-engine military craft in the world. Bottom, the navy's monster amphibion. It cruises at 160 miles an hour and can carry a 7,000-pound load

Sikorsky S-437

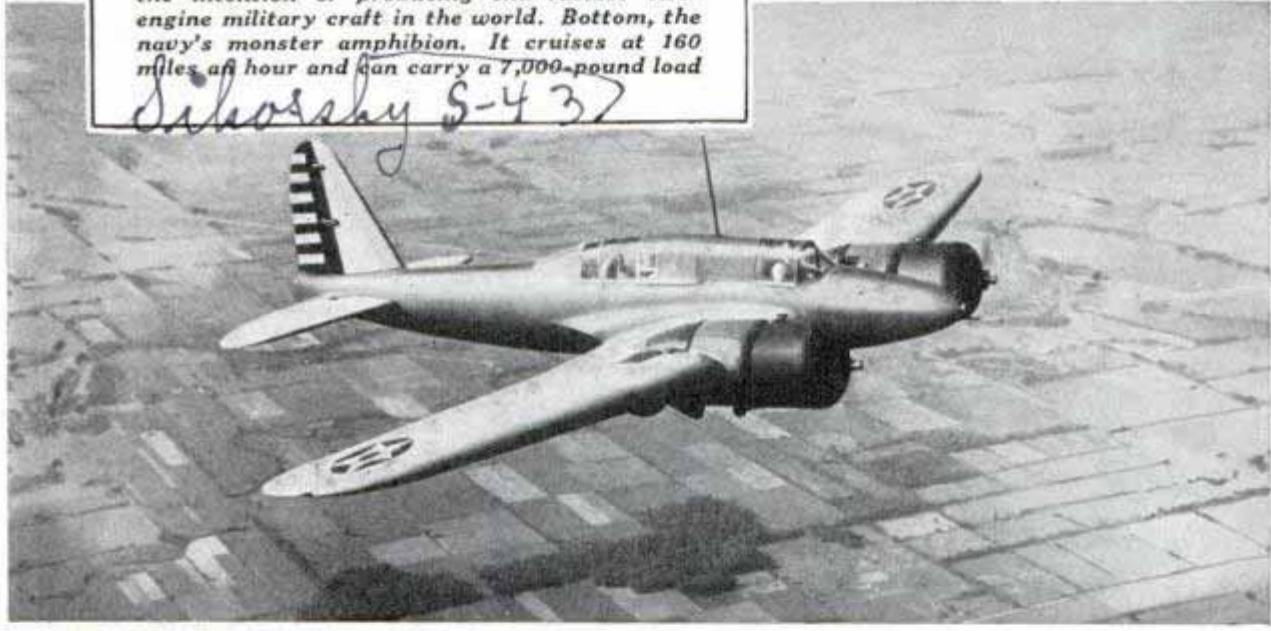

Handwritten notes at the bottom of the page.

Windlass Lifts Rescue Basket Up Seaside Cliff

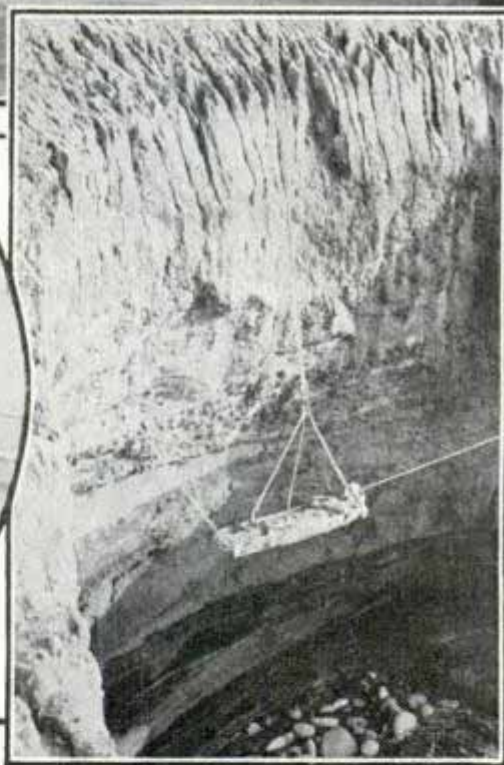
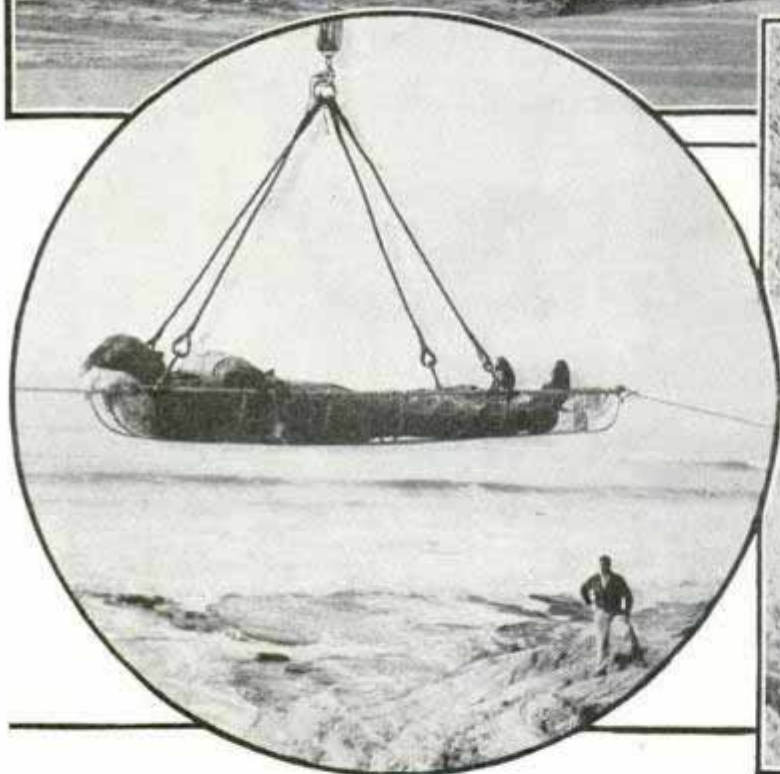
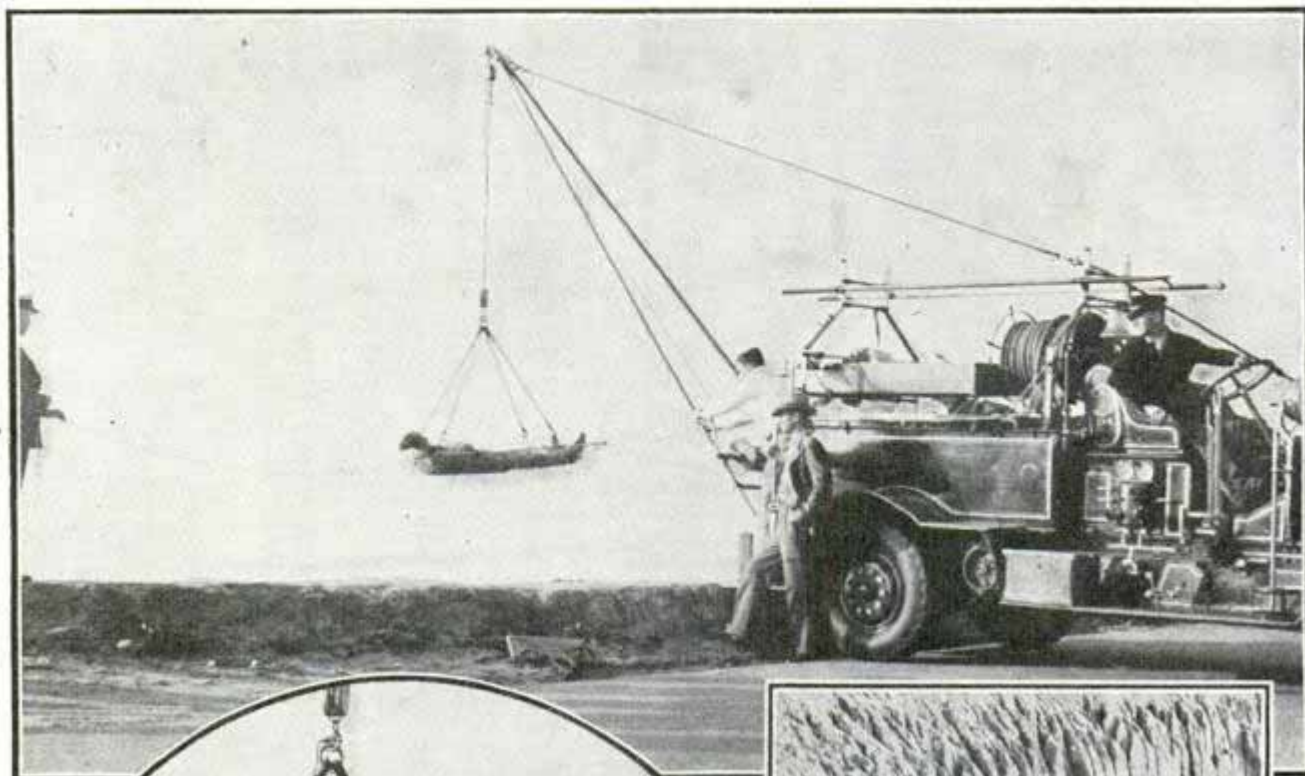

Top, hauling in rescue basket by hand windlass mounted on fire-department truck. Closeup of splint basket is shown below, and at right victim is hoisted up seaside cliff while guy ropes steady basket

San Diego firemen called upon frequently for rescue work along the Pacific shore have designed a splint basket drawn by a hand windlass to haul up victims who have fallen off the cliffs or been trapped by rocks or tides. It is arranged so that a boatswain's chair can be attached to lower and raise a rescuer along with the victim or patient, who lies supine in the basket. The windlass can be erected on the ground

or attached to the rear of the fire engine, and the entire rescue apparatus can be assembled in a moment. Guy ropes stabilize the basket while it is being hauled up or lowered.

Without shutting down, a "scab" deposit eight feet thick was removed from the lining of a Birmingham, Ala., blast furnace by dynamiting it.

*Slow Sheffield Steel
L. S. Co.*

S. O. Rappaport, Fire Prevention Bureau

Sensitive "Ear" Spots Plane as It Approaches

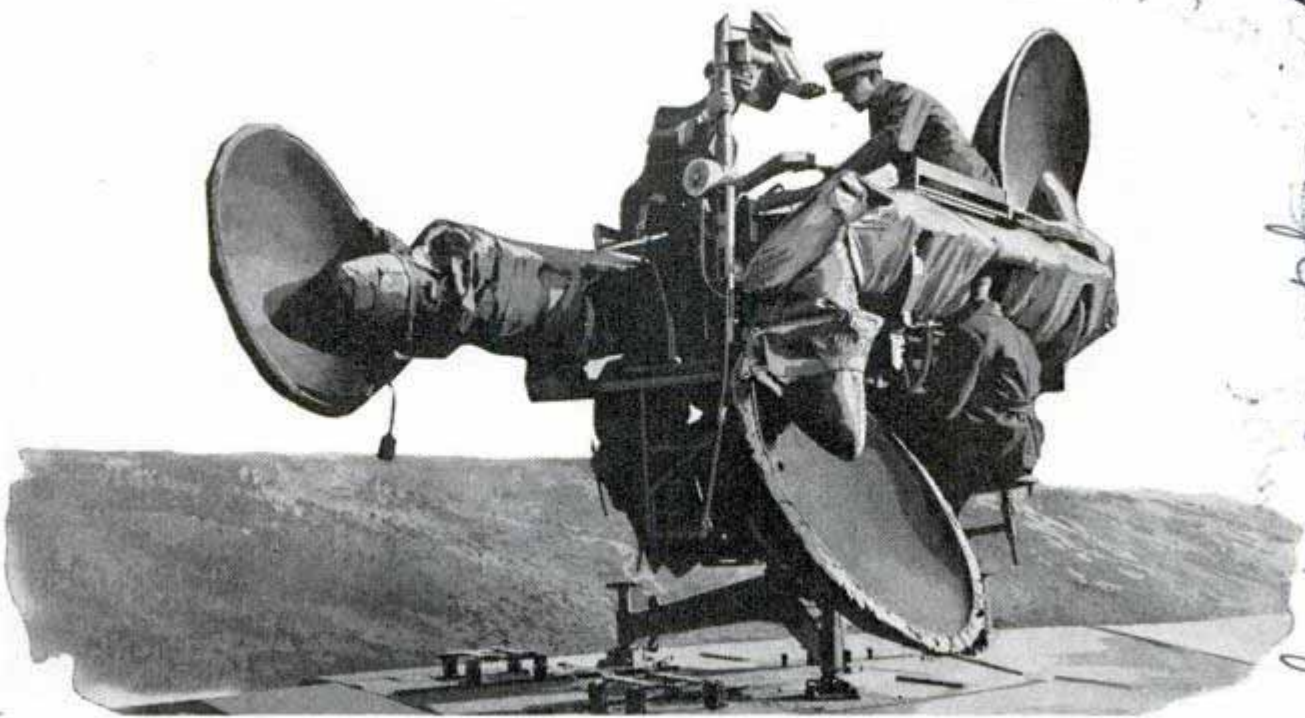

Airplane detector employed by Austrian flying corps to spot presence of enemy aircraft long before human eyes and ears can detect the ships.

Anti-aircraft guns are more efficient if the gunners are warned in advance of the approach of enemy bombers and their location, so most air-defense forces today are equipped with mechanical "ears" to detect enemy air raiders long before the attackers can be seen or heard by human eyes or ears. The apparatus pictured is the sensitive "ear" employed by the Austrian flying corps. Most plane recorders actually "listen" for the sound of the motors of approaching ships, picking up the noise of the engines and showing the direction from whence it comes. Faster planes, however, have decreased the efficiency of listening apparatus, due to the relatively low speed of sound waves as compared with light. As a result, experiments have been conducted with detecting apparatus using invisible infrared rays which travel with the speed of light, and ordinary high-frequency radio waves. The latter have been found to possess curious reflection characteristics and have been used to detect the presence of airplanes flying high above the clouds. A radio pulse is sent from the ground and the exact time of its departure is recorded. The time the reflected impulse comes back also is recorded. This provides a means for determining the plane's position.

es 156.

Mirrors Made of Metal Films Millionth of Inch Thick

Evaporated metal films, one-millionth of an inch thick, are being used in the manufacture of a new type of mirror. The films are aluminum, chromium and gold. This new business developed from a machine evolved when a Cornell University scientist wanted a new telescope mirror.

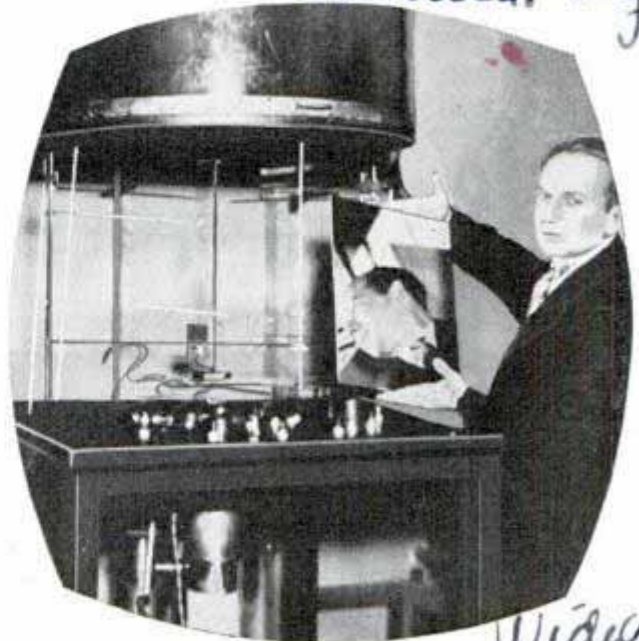

Here is one of the mirrors manufactured from aluminum, chromium and gold film

Widawald

Electric Stove Is Room Heater and Hair Drier

50.7 - 6th Avenue
20153
Journ
4-98
Pan Electric Products Co
New York

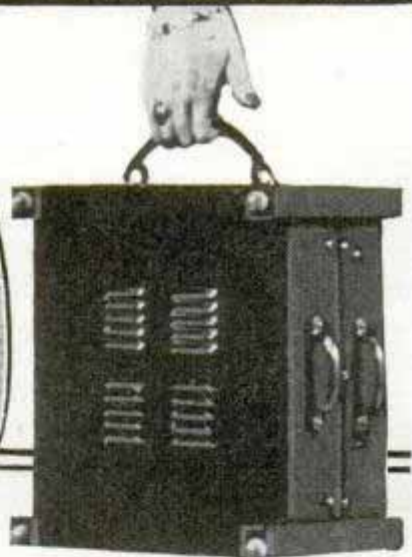
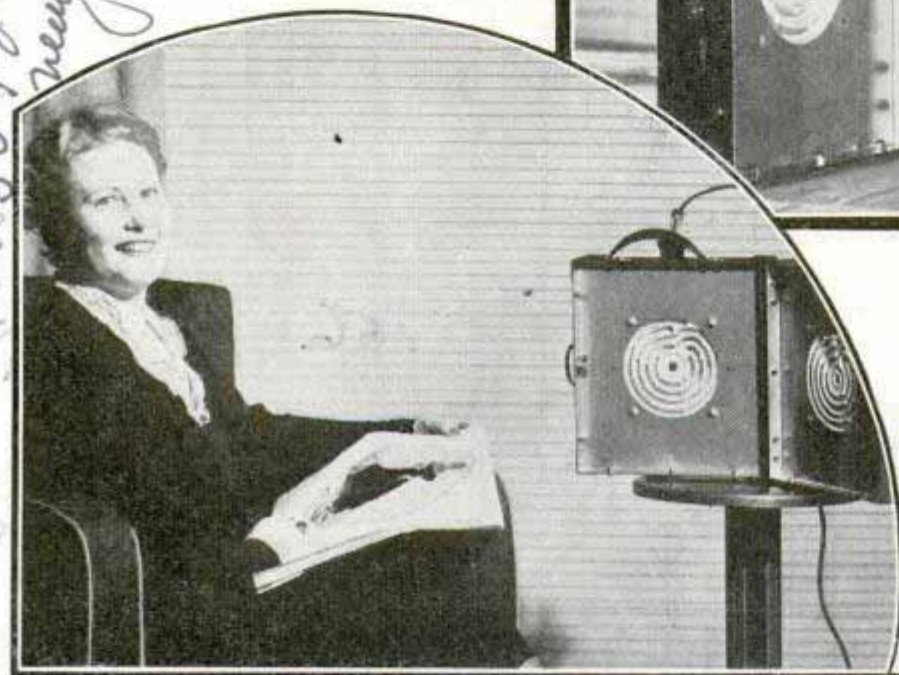

Two-burner electric cookstove used for toasting bread, as a hair drier, and to warm a room. At right it is folded for carrying

Especially useful in trailers, an electric cookstove which can double as a hair drier or a room heater is now offered. It is a two-burner folding type. Laid on a table horizontally it serves as toaster, broiler or cooker. Set up vertically, its twin coils shed a warm glow in the room, or become a double-beam drier for your hair. It folds in a compact case easy to carry or to pack away in the car for touring.

Popular Mechanics Magazine does not publish the name of the maker of, or dealer in, any device described in its pages, but this information will be furnished by our Bureau of Information upon request, accompanied by stamped envelope.

Electric-Lighted Casting Lure Attracts Fish at Night

For fishing at night or in muddy waters, an electrically lighted fish lure has been developed. Flash-light battery, bulb and holder are enclosed in a housing with hooks, made watertight by a rubber cap. Made in several colors, it is used in casting or trolling, and when the electrical assembly is removed it can be used as a surface lure or on a fly rod.

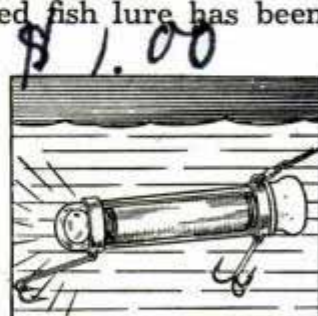

20-190
Seigler's Night Fishing
7' Rod Co. Hunter Okla



“-and
There was
LIGHT”

Part II

DRESSING table equipped with tubular lamps and mirror flanked by two wall lights—a good example of efficient local lighting.

*Chicago Lighting Institute
20 N. Wacker Drive
Chicago*

650

41339

Westinghouse Electric & Mfg Co
Mansfield, Ohio



PRESSING a master switch beside the bed to flood entire house with light, inside and out, thus frightening away intruders. Below, gooseneck fixture which holds a "foot light" for polishing shoes.

By H. W. MAGEE

SIGHT is the most valuable of all our senses. Through our eyes, we gain more than eighty-five per cent of our knowledge and control eighty per cent of our actions. And today, with more things to be observed than ever before, we are in a position for the first time to do some real seeing after sundown.

It has taken us a long time to find it out, but we have discovered at last that the secret of seeing is light—light in the right amount and of the correct quality. The complex process of seeing involves more than our eyes. It involves our very selves, our nerves, our muscles, our brains, even our hearts. Most of us are born with good eyes, but it is a deplorable fact that in the United States one grade-school child in five, two college students in five and three middle-aged persons in five, have defective vision. And

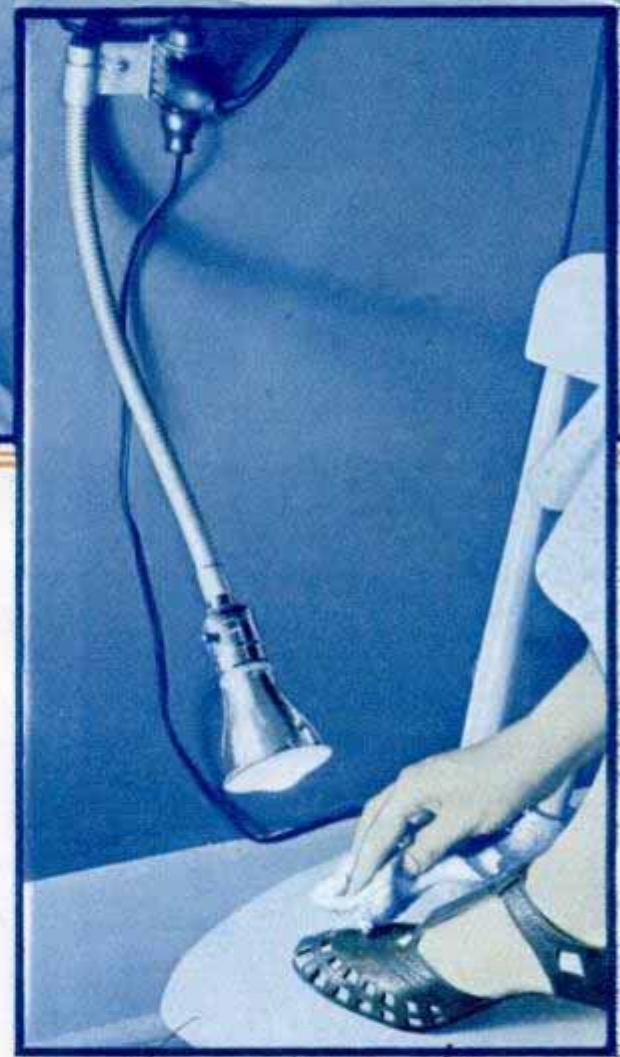

No information

one of the principal causes of poor vision is poor lighting.

Our eyes see best in natural daylight, and if we did all our seeing out-of-doors in the day time, our eyesight would be conserved and fewer of us would peer through spectacles. Unfortunately, however, our eyes do much of their work indoors or after dark and we are forced to supplement or supplant daylight with artificial light. And the artificial lighting in most of our homes is not very far

Chicago Institute
20 N. Wacker
Drive Chicago

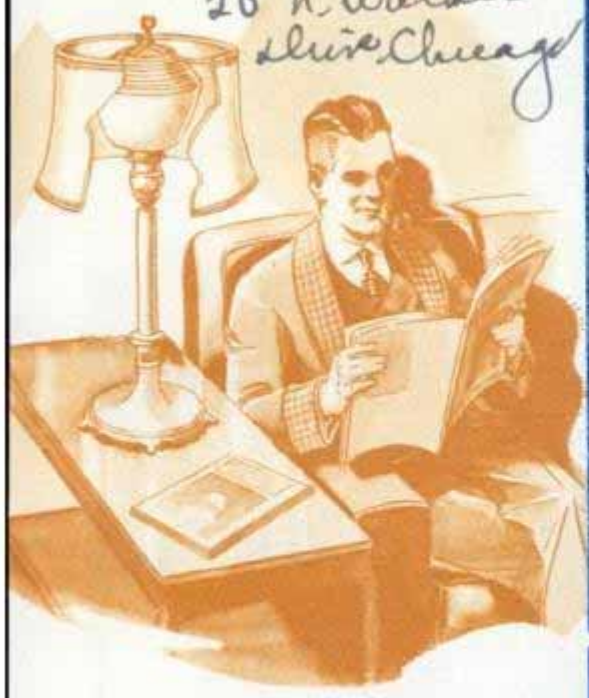
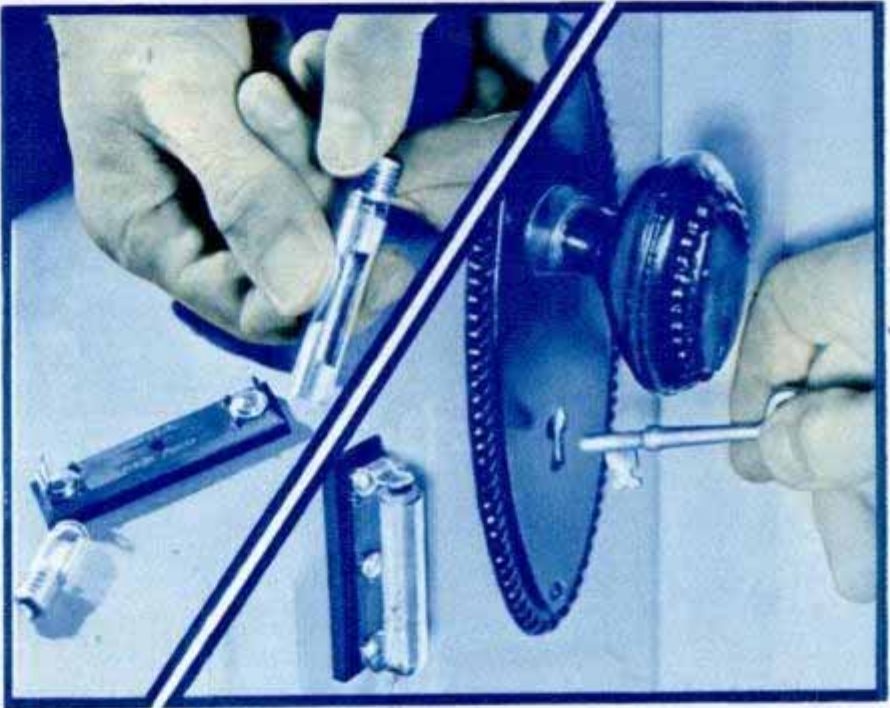

TABLE lamp, above, with frosted-glass globe to diffuse light. Top, right, bedroom lighted with lumiline lamps, "pin-it-up" lamp and ceiling fixture with diffusing bowl. Center, two six-volt radio dial lamps can be used to illuminate doorbell button or keyhole. Bottom, efficient local lighting for the bedroom.

beyond the tallow-candle age when we interpret light in terms of seeing, rather than in mere terms of lamps and fixtures.

Light, like oats or gasoline, can be measured and the foot-candle is the unit used to measure lighting in terms of seeing. A foot-candle is the amount of light you would get on your page held one foot from the flame of a standard candle. Outdoors on a clear day you'll find from 5,000 to 10,000 foot-candles, and on your porch on the shady side of the house there may be 500. But in your living room in the evening, you may have only five. Your eyes don't tell you they are being cheated, so you probably don't even realize your lighting is inadequate. Well, here's one way to



General Electric Co. 1234
Nela Park, Cleveland
No information
General Electric Co.

652

41337

General Electric Co. Nela Park
Cleveland Ohio



USING light meter to check intensity of illumination for reading. Below, all-purpose floor lamp with three candle sockets and large bulb with three light intensities.

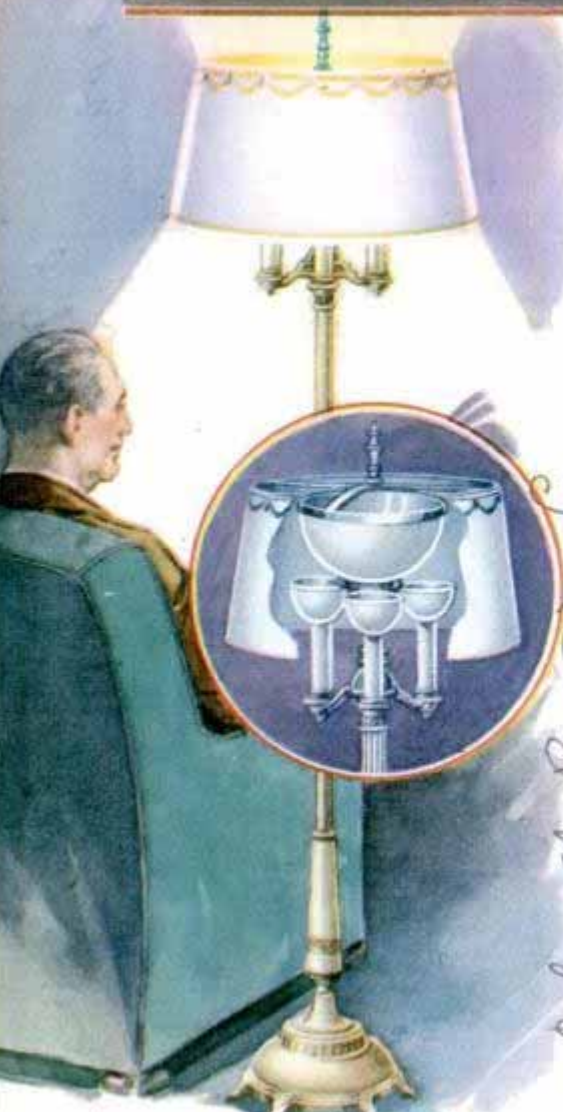

Colonial Bryn Mawr Co. Chicago
450 W. Superior

determine quickly whether you are providing enough light for your eyes to work. A marvelous little instrument known as a light meter does the trick. It contains a light-sensitive cell and registers the number of foot-candles on a dial. With its aid, you can find out exactly how much light for seeing you are getting in any spot in any room in your home. And, of course, your needs vary from room to room or even in two spots in the same room.

In the first place, you require both "local" lighting or light which is directed specifically on eye-work, and "general" lighting or illumination throughout the room. Ten foot-candles or less is the danger zone for close visual work but is satisfactory for casual seeing, as at the dining-room table or for card playing. As an example, five twenty-five watt bulbs in a good ceiling fixture probably will deliver from five to ten foot-candles of light to a table beneath it.

Ten to twenty foot-candles of local lighting is desirable for moderate visual tasks like reading good print on white paper, easy sewing on light goods, coarse knitting, the play of children, washing at tubs or sinks,



BOOKCASE made more attractive by indirect lighting under the shelves, and diagram showing how tubular lights were installed. Below, inexpensive lighting unit installed above doorway.

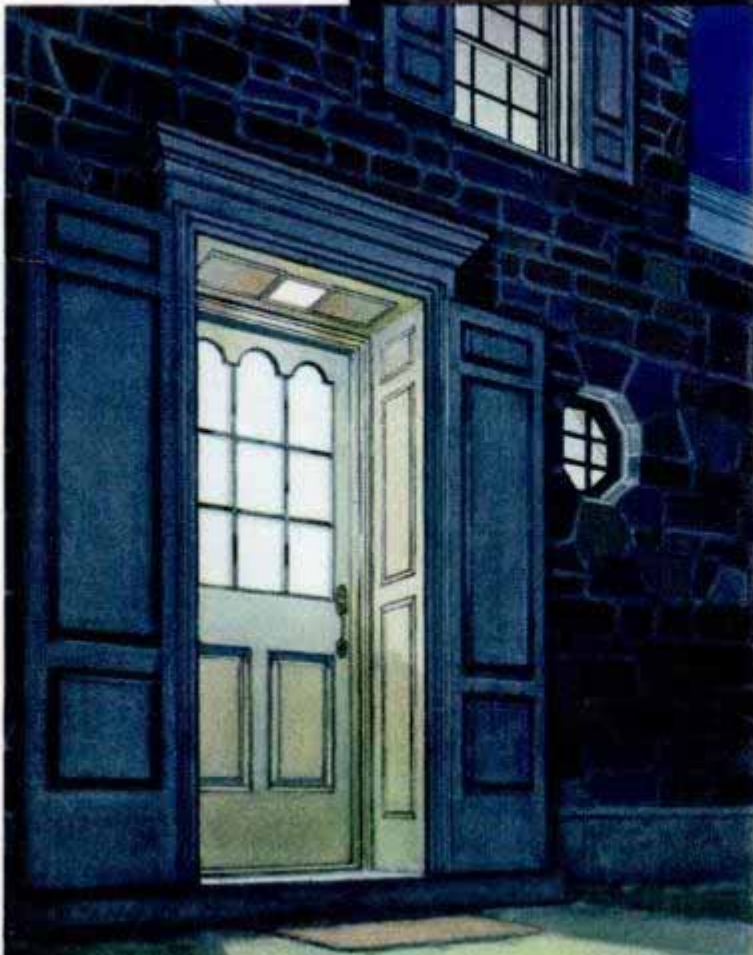

*Chicago Lighting (653)
 & installate 20 h washer
 ironing and cleaning vegetables.*

Two sixty-watt bulbs in a table lamp should deliver about twenty foot-candles at a distance of two feet, or a well-designed floor lamp with a seventy-five watt bulb ought to supply about twenty foot-candles at a distance of about thirty inches.

For rather prolonged and intense eye use, such as reading newspapers, sewing at a machine, fine mending, stamp collecting, drawing and shaving, you should have from twenty to fifty foot-candles. A 100-watt bulb in a table lamp should deliver about twenty-five foot-candles at a distance of twenty-seven inches.

*General Electric Co.
 Nela Park Cleveland
 Ohio*

Bloomfield N.Y.

BATHROOM mirror illuminated by lamps behind panels of diffusing glass, and floor lamp which has bulb in diffusing bowl to provide three light intensities.



*General Electric
Cleveland*

of course, often requires the use of supplementary "fringe" and decorative lighting for certain areas.

But the quantity of lighting is only half the story. Quality of lighting—the manner in which your light is distributed—is just as important. If you have glare, if there are areas of brightness and dark shadows, your lighting is inefficient, regardless of the quantity of light you have. What you want is light that is soft and pleasing, light that gives a minimum of harshness in contrasts. This is accomplished by having

For severe, prolonged and detailed tasks like reading fine print, sewing with dark thread on dark goods and home drafting, you need from fifty to 100 foot-candles and you can get them by using a 150-watt bulb in a table lamp at a distance of twenty-two inches. In order to maintain a satisfactory distribution of light throughout any room, the general lighting should be between one-fifth and one-tenth of the local lighting. This,

lights balanced throughout the room, by placing lamps to obtain the proper distribution of light.

Amazing advancements have been made by lighting engineers in the design of fixtures. Shades, reflectors and globes now are being formed scientifically to provide diffusion and reflection and produce a light that is easy on the eyes. In selecting lamps, certain qualifications must be kept in mind in order to obtain

Wesley Park, Cleveland, Ohio



light scientifically correct for seeing. There should be sufficient height and shade size to cast the light over a generous area. Also, remember that white or near-white shade linings prevent coloring the light and distorting and wasting the light you pay for.

Except where lamps are on low tables, open-top shades usually are desirable because more light is shed up into a room, and you run less chance of harsh contrasts. Lamp bulbs housed in light-diffusing glass or plastic bowls, hidden under the shade, provide eye-comforting results. And be sure your shades have enough density so they don't stand out as bright spots against their background.

Modern light fixtures no longer attempt to imitate candles and kerosene lamps. They are made to conform to structural lines and decorative detail, and they are designed to use electricity and not to imitate tallow candles. They are large enough to conceal the lamp bulbs, they are designed to reflect or diffuse the light without glare, they quite often fit snugly to the ceiling and in some modern homes they are built into the ceiling and are as much a part of the house as the

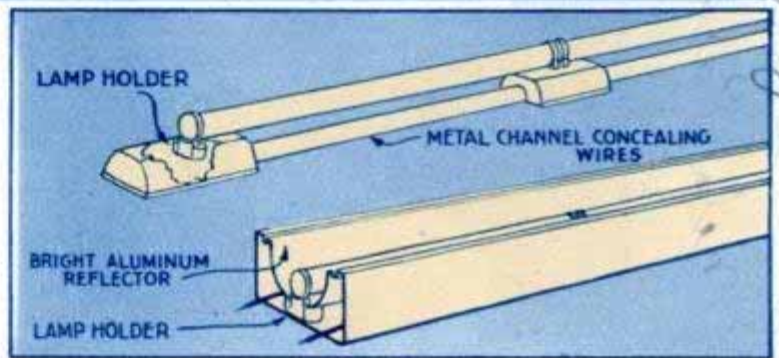

MODERN all-electric kitchen. Note lighting over window and sink and small lamp over range. Below, one way to mount lumiline lamps, and the snap-button socket.

Westinghouse Lamp Co

Curtis Lighting Co. 11. 11.

General Electric Co.
Cleveland, Ohio
Nela Park



EFFECTIVE combination of candle lighting and modern electric lighting for the dining room. Left, window with illuminated scene placed outside.



plumbing. And where wall brackets are used, they are employed for the specific and honest purpose of seeing—in the kitchen over the sink, in the bathroom on each side of the mirror, or in the living room to add interesting touches of “frill” lighting. Brackets of the urn and bowl type have been found to be decorative and at the same time to contribute materially to the effective lighting of a room.

This is all very well, you say, but who can afford it? That question could be answered by asking another. How much
(Continued on page 132A)

Robot Pen Copies Handwriting from a Record

Connect your fountain pen to a recording machine, write a letter in longhand and a robot penman will reproduce that letter, faithful in microscopic detail to your handwriting. The mechanical writer was developed to save busy executives time in signing letters and papers and writing other legends repeatedly. The signature or legend is recorded on a master record, comparable to a phonograph record, by a secret proc-

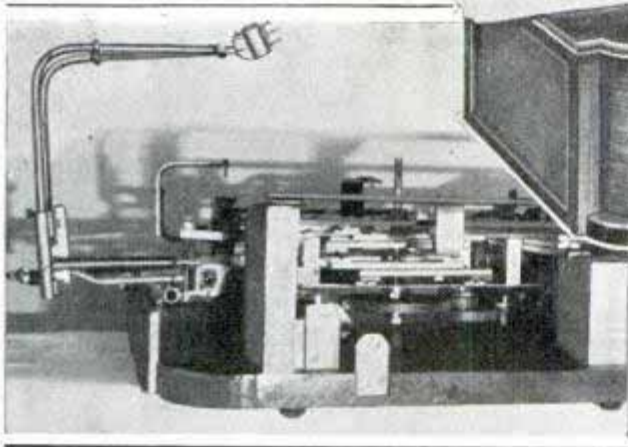

Above, reproducing pen writes a letter previously written by hand into recorder. Notice exact similarity of actual signature and robot pen's copy. Left, cabinet removed to show reciprocating plates which guide movement of penholder arm

ess. The disk is then placed in a portable reproducing unit about twelve by fifteen by six inches in dimensions. The master recorder has "broken up" the original writing into its component directional movements in every possible plane, and in the reproducing unit there is a reciprocating plate for each of these movements. Impulses from the disk strike these plates, pass to a central plate where they are "blended" into the movements of the original handwriting, then are transmitted to the mechanical arm holding the pen or pencil. A mere signature or a long text can be recorded and reproduced an indefinite number of times. Individual letters of your handwriting could be set up like type into a text not written as a whole. To prevent illicit use of a record, a small segment can be removed, without which the machine would write a meaningless scrawl.

Ring Seals Gasket Head on Pail Used for Shipping Fluids

Five-gallon pails with gasket-lined heads which can be sealed for shipping with quick-locking rings are being introduced by a barrel manufacturer. The head can be removed entirely, permitting easy filling with a minimum of spilling. Throwing a lever locks the ring over the head.



Inquiries as to makers of articles described in Popular Mechanics, will be answered by our Bureau of Information upon receipt of return postage.

national Steel Barrel Co 3850 E 91st

2/14/37

Veteran Two-Cylinder Car Crosses the United States



Here is the 1900 auto, closely resembling a buggy, as it appeared in one city through which it passed. Note that its tires have worn off

Resembling a buggy, even to whip socket on the dash, a 1900 Schacht automobile recently was driven across the United States, a journey which occupied about three months. The car has a two-cylinder, seven-horsepower motor located under the rear of the body, chain drive with six forward speeds and one reverse, carbide headlights and an oil-burning taillight. Its top speed is fifteen miles per hour. The greatest expense of operation is for tires, which are solid rubber costing \$7.50 each and good for only one or two thousand miles. On one mountain grade encountered on the long trip, the brakes failed. The primitive construction makes the car almost impossible to steer at speeds above thirty miles per hour, but the driver, Paul Hubbard, stuck to the tiller as the car attained fifty miles per hour and managed to reach the bottom of the incline safely.

Foghorn Teams Up with Radio to Guide Ship into Harbor

Making use of the constant speed of sound waves, pilots guide their ships into port at Ludington, Mich., by checking the

harbor foghorn against the radio beacon. The Ludington lighthouse broadcasts a signal and sounds a foghorn at the same time. Out on Lake Michigan on the bridge of a steamer, a navigator hears the radio beam and notes the interval of seconds until he hears the foghorn. Sound travels roughly a mile in five seconds. If the foghorn is heard ten seconds after the radio beam, the pilot knows he is two miles from harbor.

Photo Film Washer Attaches to Any Water Faucet

Photograph negatives can be cleaned quickly and thoroughly with a film washer which attaches to the water faucet. It accommodates film of any size, and the hose attachment fits any faucet.



Film washer is adaptable to any faucet and sends stream of water over both sides of negative

Central Camera Co.
230 S. Wabash

Letter sent 9/10/37
Cml. Paul R. Hubbard 318
W. Noble St., Oklahoma City, Okla.

es 193

Old Battleships Made New by World Powers

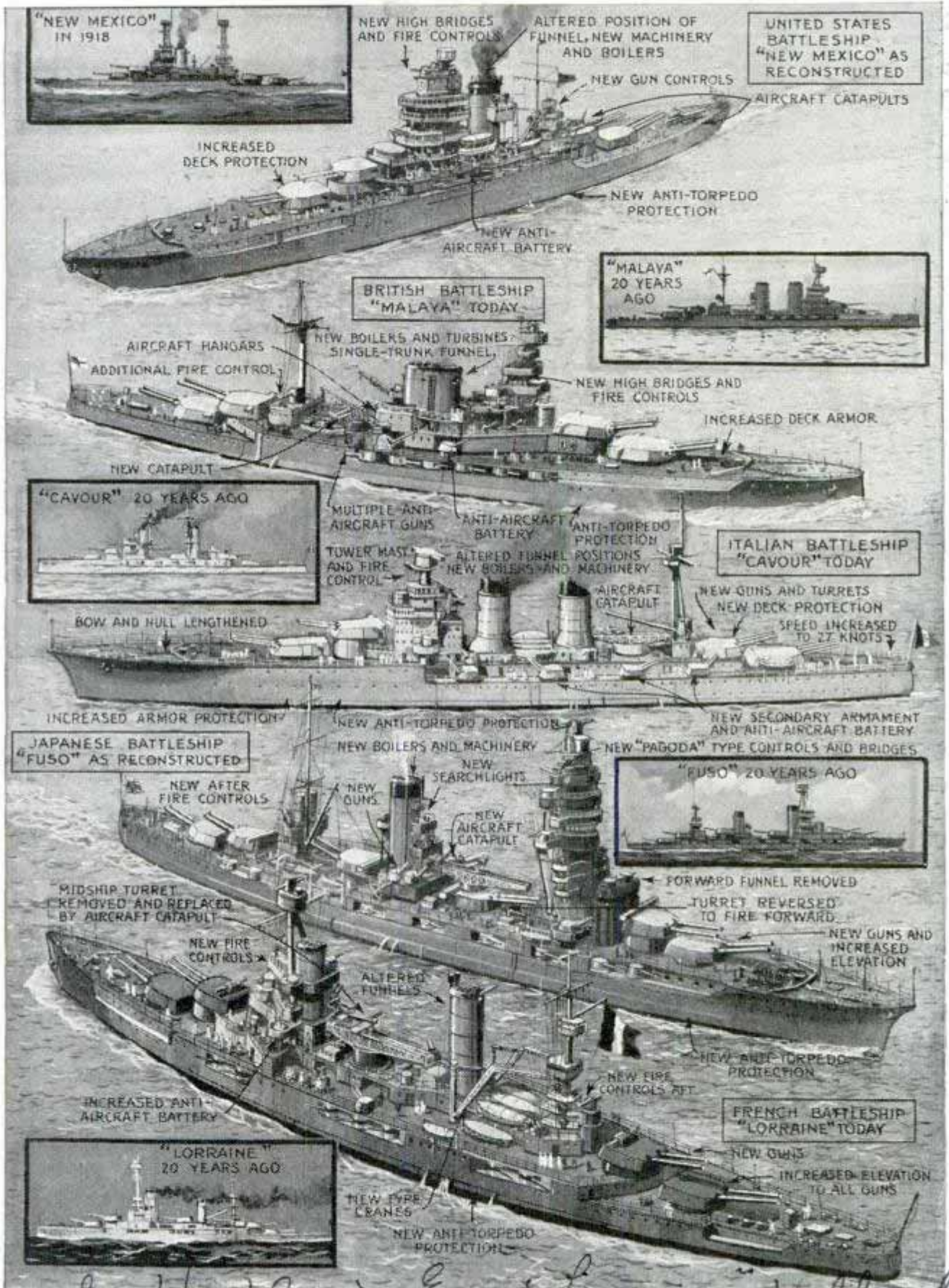

*Es. H. Evans Esq., Linnets, Hillside
 By reconstructing old battleships world powers comply with naval limitation agreements not to build new ones. Modernizing one ship costs millions of dollars. Frequently few parts of the original craft appear in the up-to-date ship. Note changes made in Italy's "Cavour" (center)
 Road Ewell, Surrey, England.*

The BEAN

W. J. Morse
Bureau of Plant
Industry, Washington
Dec

Emb. Walter L. Burton, Akron, Ohio
1032 Lincoln Ave.

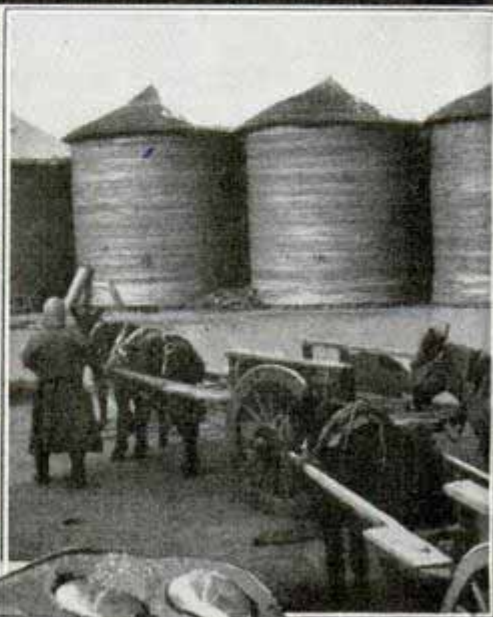

WHAT is it you can find on the dining table, in a can of paint, on the floor, in a dead insect, on the pages of a newspaper, in the delicatessen and on the soap dish?

The answer to this riddle is "soy." For the soybean, an oriental legume of ancient lineage, is now on the threshold of a widespread conquest of the agricultural and industrial world. Already the number of food and industrial products modern science makes from this bean is truly amazing. Few other plants are put to so many uses. A research laboratory has been set up by state and federal agricultural experts for the sole purpose of studying the soybean and finding still more ways of using it.

The soybean plant is a hairy, leafy bush. There are many varieties, and the beans have a wide range of size and shape. The colors range from yellow to black. Ancient Chinese writings mention the grow-

Soybeans from Japan used as green vegetables and, above, some of food products made from soybeans

ing of soybeans for food. In 1804, somebody brought some of the beans to the United States, and for many years they were grown as curiosities. Toward the end of the past century, the bean began to take on some importance as a farm crop. State agricultural experiment stations began to study it. Today more than sixty varieties are in active cultivation. In 1917 less than 500,000 acres of soybeans were being grown. In 1936 the total acreage was 4,380,000.

Farmers have learned the soybean makes, in many ways, an ideal crop. It will grow almost any place corn or cotton can be raised. It is not bothered much by

price list on 'Plant' (Government Printing Office) for pamphlets on soybeans

that MADE GOOD



Above, soybean storage yard in Manchuria. Right, candied soybean products from Japan. Bottom, field of soybean hay mixed with grain hay

insects, disease and adverse weather conditions. It is easy to plant, cultivate and harvest. It can be grown in combination with other crops such as corn. Like the pig and its squeal, almost every part of it but its shadow can be put to some profitable use. The soybean is adapted especially to the southern part of the corn belt and the northern half of the cotton belt. Almost any type of soil will grow soybeans, but the best are mellow, fertile and sandy loams.

Soybeans are, like other legumes, active nitrogen-fixation factories. They capture nitrogen from the air and convert it into useful plant food. But in doing this they

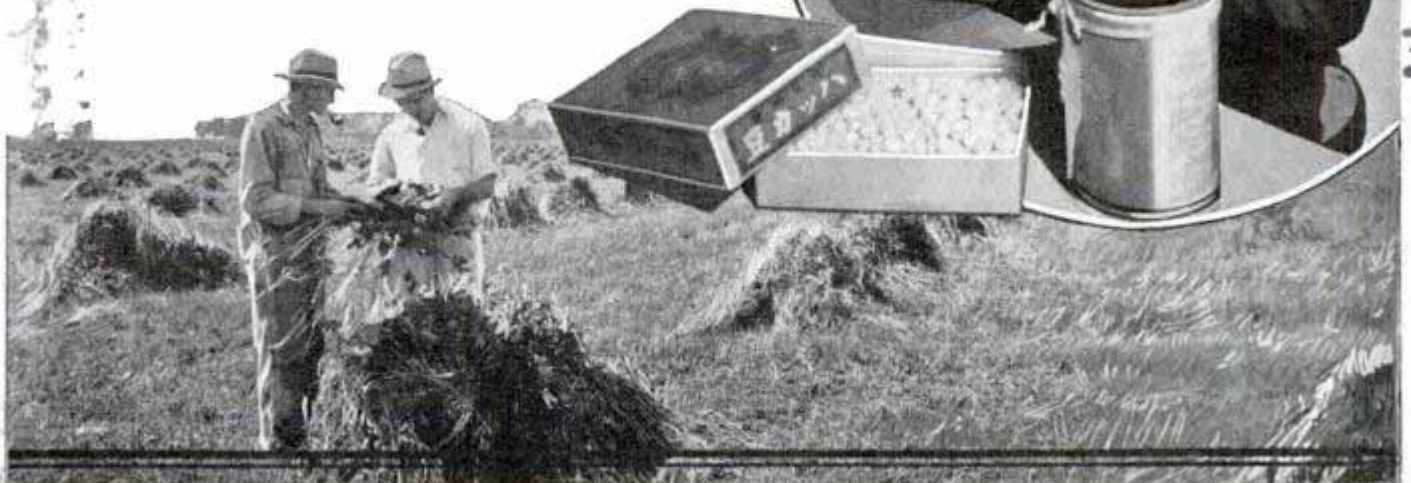

W. J. more of packing candied soybean products



In general, soybeans are planted in the spring and harvested in the fall. The beans can be separated from their pods in an ordinary threshing machine modified for the purpose, or in several ways. Binders, threshing machines that straddle the rows and collect beans from the standing plants, corn knives, flails, and other devices have been used. The combine has made headway since 1927 as a means of harvesting and usually is cheaper than other methods.

You are likely to meet a soybean, in one form or another, almost anywhere you turn—from the feed manger of a dairy barn to the shiny paint on your automobile. The plant itself is a competitor of grass, alfalfa and other crops which can be

dried and used as feed for farm stock. Soybean hay, rich in protein, makes an excellent ration for any farm animal. It may contain a considerable percentage of woody stems but this trouble can be reduced by proper growing and harvesting. Because of its high protein content, soybean hay is not fed alone, but is used in combination with other feed. The soybean is particularly suitable to

(Continued to page 120A)



must have an ally, hordes of bacteria that live in the soil and roots. If soybeans are planted in a field where there are no helpful bacteria, the plants are likely to be sickly. To prevent this, the soil is inoculated. There are many ways of doing this. Prepared cultures of suitable bacteria, obtainable from seed dealers, can be scattered about, usually by mixing them with the seed beans. Or a quantity of soil from a field where soybeans have been grown successfully, and which therefore is rich in the right kind of microorganisms, can be sowed along with the seed. Once the bacteria are "planted," no further inoculation is required if soybeans are grown on the area with more or less regularity. The presence of root nodules indicates the active cooperation of the right bacteria.



Top, crushing boiled soybeans in wood mortar in Japan. Center, making soy sauce in China. Bottom, inspecting root system of soybeans

Extension specialist and county agent.
W. Bator

H. Needer, Chang, Fupoh, China

W. Bator, Agricultural Experiment Station, W. Bator Co.

Propeller Drives "Skate-Sled" on Ice or Water

Before no further date

Right, Paris inventor twists the propeller to give a demonstration of his skate-sled for a passenger. Triangular brace under rear end supports motor and keeps sled upright when not traveling. Below, tuning up the engine for a thirty-mile-an-hour run over the ice. Observe the chain drive

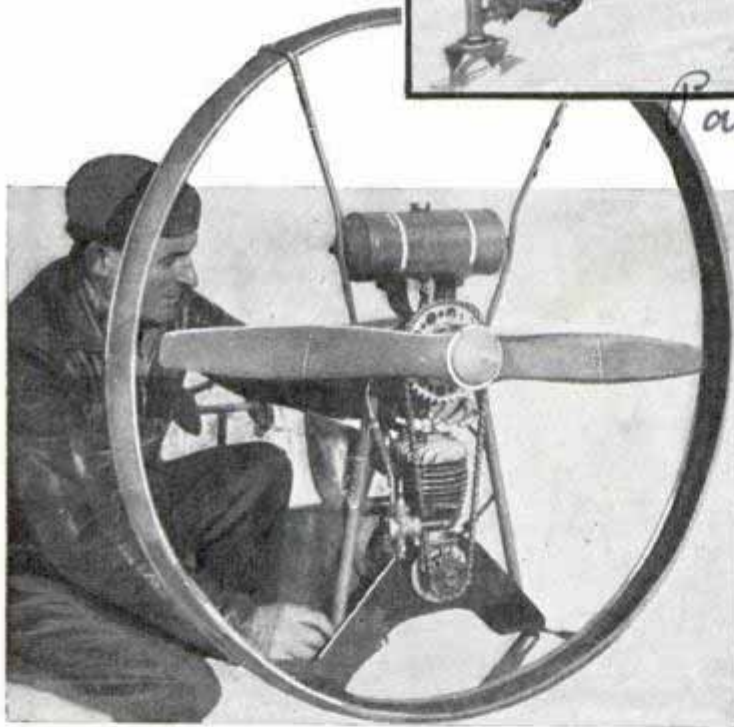

Paul's Photos

Two wide skates are the runners of a propeller-driven "skate-sled" which skims over the ice at thirty miles an hour. The invention of a French engineer, it is built so that pontoons can be added for traveling on water in summer. A triangular brace supports the rear end while the motor is being tuned. A chain drive spins the propeller at 5,000 revolutions per minute. The skate-sled is guided like a bicycle, with two long handle bars that extend back from the post which rests on the forward skate. A metal ring protects the whirling blades.

Holder Keeps Door Open for Any Degree of Ventilation

Any degree of ventilation can be obtained by using a small, inexpensive holder which slips under the door. It is not attached to the door. Made of two soft grooved cushions connected by a spring metal strip, the holder is placed in position by bending and slipping under the door. The metal strip then straightens and forces the cushions against the floor.

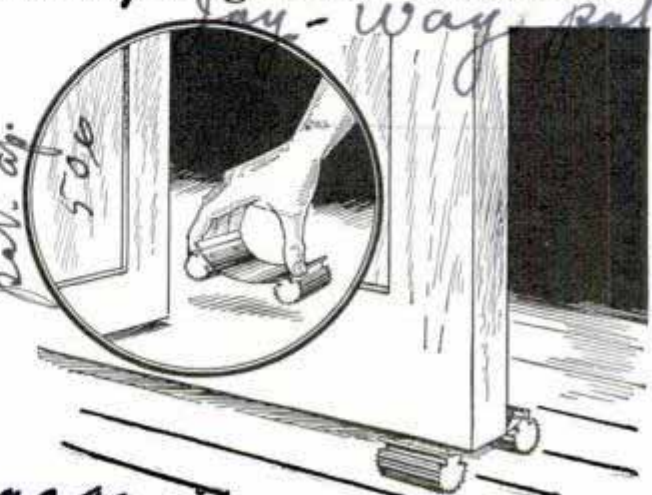

☐ The Hudson river once flowed past Sandy Hook in a gorge 4,000 feet deep now submerged beneath the ocean.

Compressed Air Magazine
Jan 19 37

*Both One & 1/2 yds
W. Lemmings*

es 185

Chimney Is Rid of Smoke by "Whistling" It Down



Smoke precipitates in flakes and settles to bottom of test jar after high-pitched vibration is set up

One way to eliminate the smoke nuisance is to "whistle" it down. High-pitched sound waves cause smoke to "clot" and drop in flakes while the cleansed gas emerges from the chimney top invisible. In a laboratory test of this method at the bureau of mines in Washington, white smoke was pumped into a glass jar, then vibration was set up which caused a screeching noise. The smoke precipitated in mid-air, and when the vibration ceased it dropped in chunks.

Human Body Keeps Growing Until Late in Life

Thousands of measurements made by Dr. Ales Hrdlicka and other scientists reveal that growth of the human body does not stop at twenty-four years of age, nor even at forty. A person may increase in height more than one-third of an inch after he is an adult, his legs and trunk keep growing slightly late in life and his arm length appears to increase slightly. Hands and feet tend to become larger and may grow even more than the body as a whole. A "grown" person's chest contin-

ues to broaden slightly until forty to fifty years, and sometimes later. Dr. Hrdlicka suggests that this new knowledge may be valuable in medicine. When normal growth changes are definitely determined for various parts of the body, it may be possible to recognize variations from the normal growth curves as pointing to defects in an individual's general constitution.

es 16a

Supercharger for Light Cars Fits V-Eight Engines

Designed to increase horsepower as much as thirty-eight per cent, a supercharger for V-eight engines of light cars is on the market. Claims by the manufacturer include better gasoline mileage, smoother performance and longer engine life. The supercharger consists of a centrifugal pump of special design coupled to the crankshaft. It revolves six times faster than the motor. Rotor vanes take the mixture from the carburetor, atomize it and pass it on to the cylinders. The supercharger is mounted on top of the engine in place of the carburetor intake. Horsepower of the Ford V-eight is said to be increased from around eighty-five to more than 120.

\$1 ~~74~~ 50

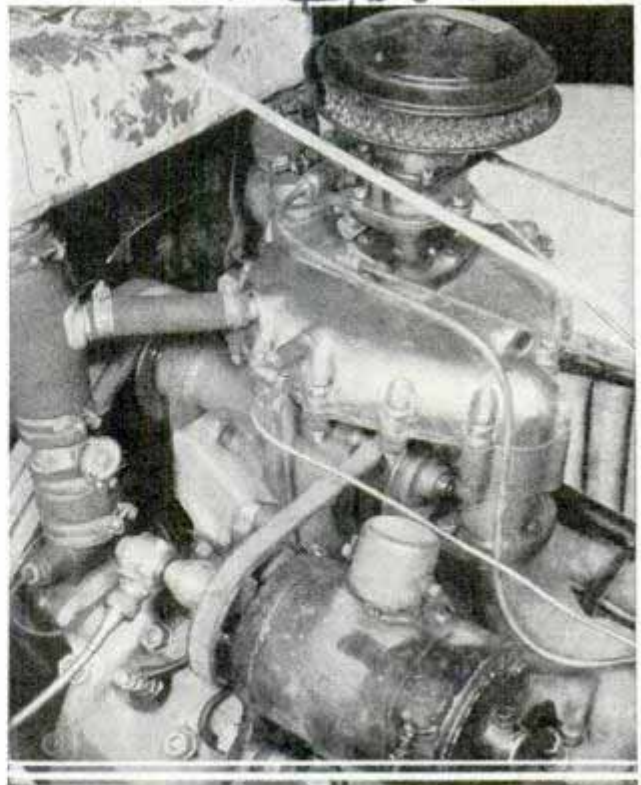

Here is a typical installation of supercharger on V-eight engine of late model Ford

The Culloch Engineering Co. 1327 S. 70th

Developed by H.W. St. Clair

Survey Service 2/11/57

U.S. National Museum Washington D.C.

Sixteen-Ton Plane to Link U. S. and Germany

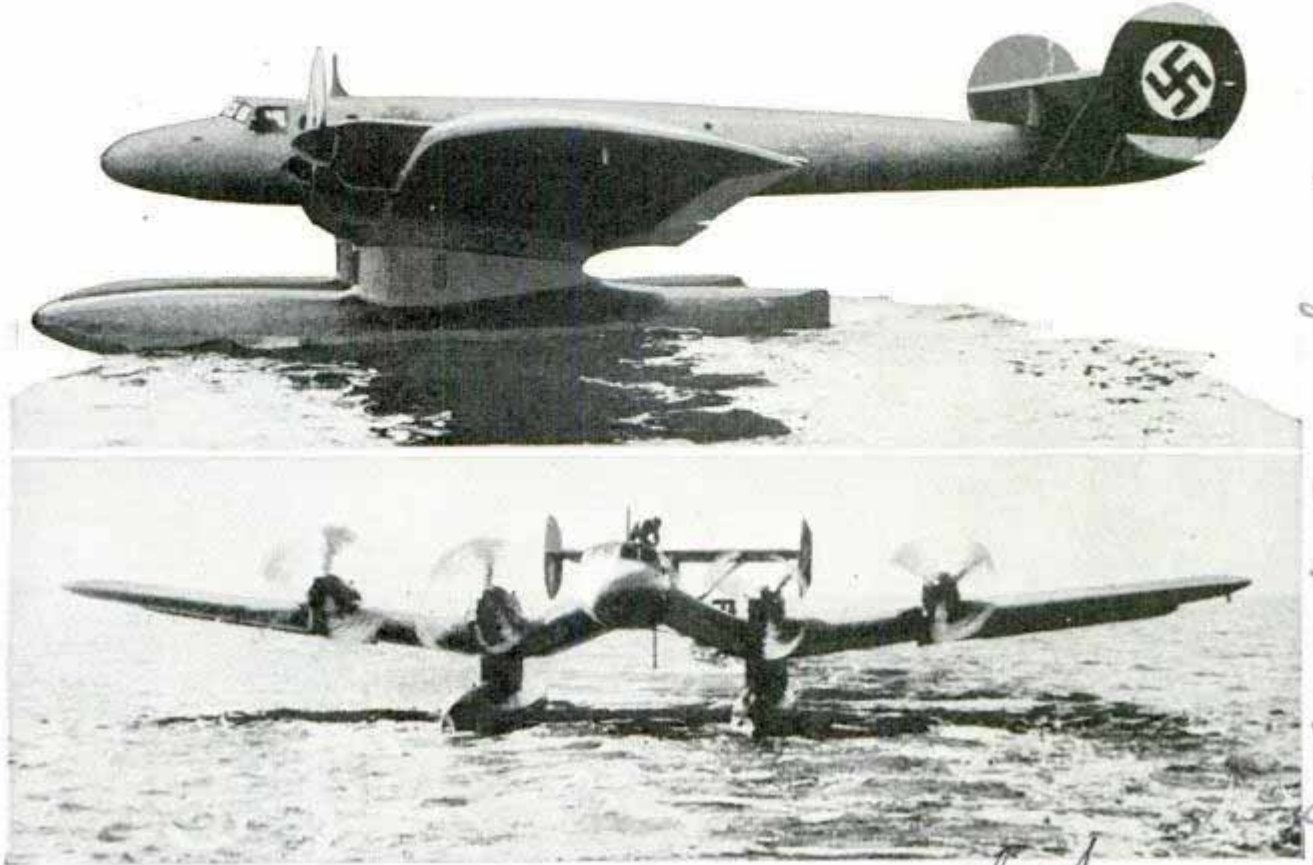

Here are two views of the huge plane which Germany has been testing for the Atlantic service scheduled to open soon. The pontoons are for emergency landings only, since the ship is not a flying boat

Constructed for service on a north Atlantic route to the United States, a sixteen-ton plane has been undergoing tests in Germany. It is not a flying boat, but is equipped with two pontoons which will support its weight if the ship is forced down on the water. Each pontoon consists of twelve airtight compartments. The plane is of the single wing design and can reach a speed of 186 miles per hour while carrying a full load. First flights across the Atlantic were scheduled by the Berlin postal authorities for the early spring.

Synthetic Odor Warns Miners of Underground Fire

Because an alarm bell might not be heard in the clatter of underground workings, factory-made skunk odor is used to warn miners in case of fire. It goes under the scientific name of butyl mercaptan, one of about 3,000 chemicals manufactured by Eastman Kodak company. Sent through the mine circulating system, it gives quick warning to those below.

Chuck Grips Broken Drill Ends and Does Accurate Work

Sharply reducing operating costs by making possible the use of broken drill ends, a keyless chuck has been designed

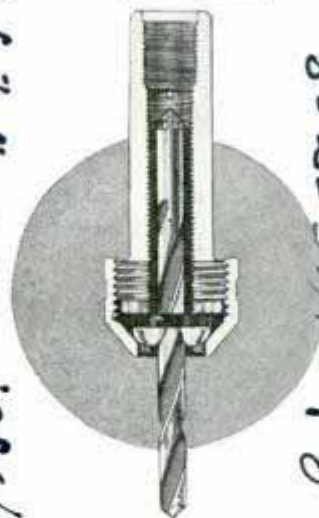

for lathes, drill presses, portable drills and other drilling machines. The broken drills are prepared to give a rounded section for contact with an adjustment screw which takes the thrust of driving and permits the drill, regardless of size, to run on true center.

Names and addresses of manufacturers and dealers in articles described in this magazine will be furnished by our Bureau of Information upon request accompanied by stamped, self-addressed envelope.

Rochester, N.Y.

Co. 1938 First City South
Pat. 1,453,838
Dr. H. Park mfg

es 222

es 148
6.00 x 9.50
4.50

es 86 G. I. du Pont de Nemours
 & Co. Wilmington, Del.

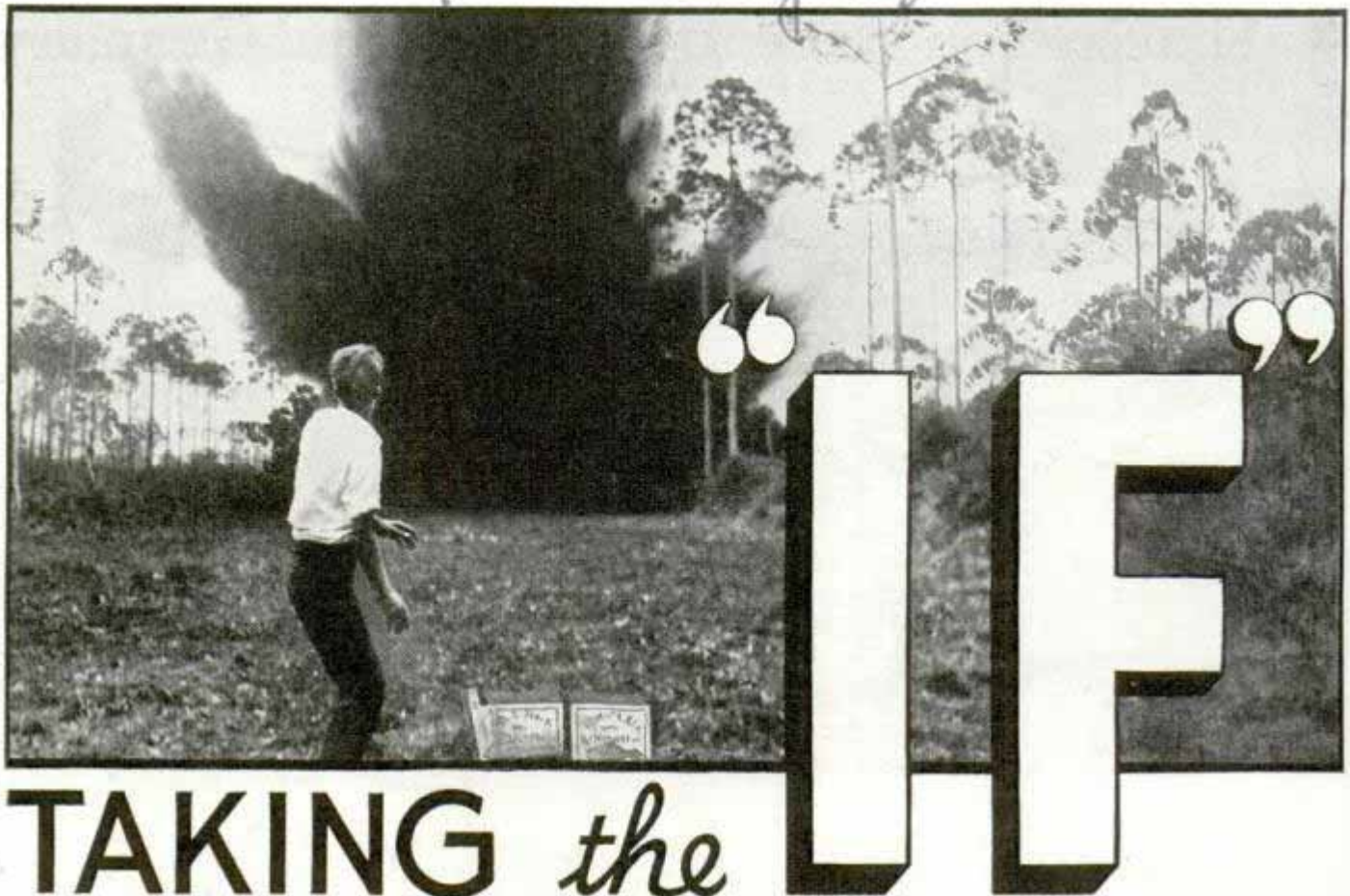

TAKING *the* IF

THE farmer is probably the world's greatest gambler. He has to be. Each year he assumes risks which make the wildest Wall street plunger look like a piker. His is a life of perpetual uncertainty. "If"—that's the little word that plagues him night and day.

If his seed is infected, there is no crop. If it doesn't rain, there is no crop. If it rains too much, there is no crop. If insect pests overwhelm him, there is no crop. And if he does get a crop despite bugs, droughts, hail, floods and frost, he still may lose money on it if the price isn't right.

Some of the biggest "ifs" of agriculture

are being eliminated today by a new hired hand who is working for farmers everywhere. This hired man is the industrial chemist, a versatile chap who not only assists the farmer in raising his crop but also helps him sell it.

First of all, the industrial chemist is providing new and steadily expanding markets for farm products by finding new uses for them. By chemical skill, for example, he converts cotton into a man-made fabric, a lacquer, a plastic or some other thing of beauty and utility quite unlike the plant the farmer produced. And the more substances the chemist makes out of cotton,

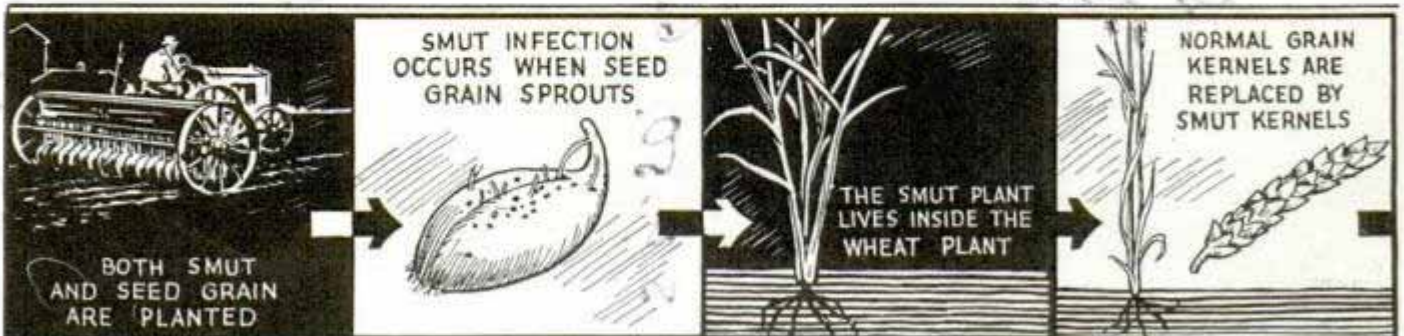

Top, the agricultural engineer does his farming with a bang. With the aid of explosives, he straightens streams, digs ditches, clears land and remodels the contours of the entire farm. Below, drawings show the life cycle of wheat infected with smut and the place where smut can be stamped out by seed treatment

Es 06-701

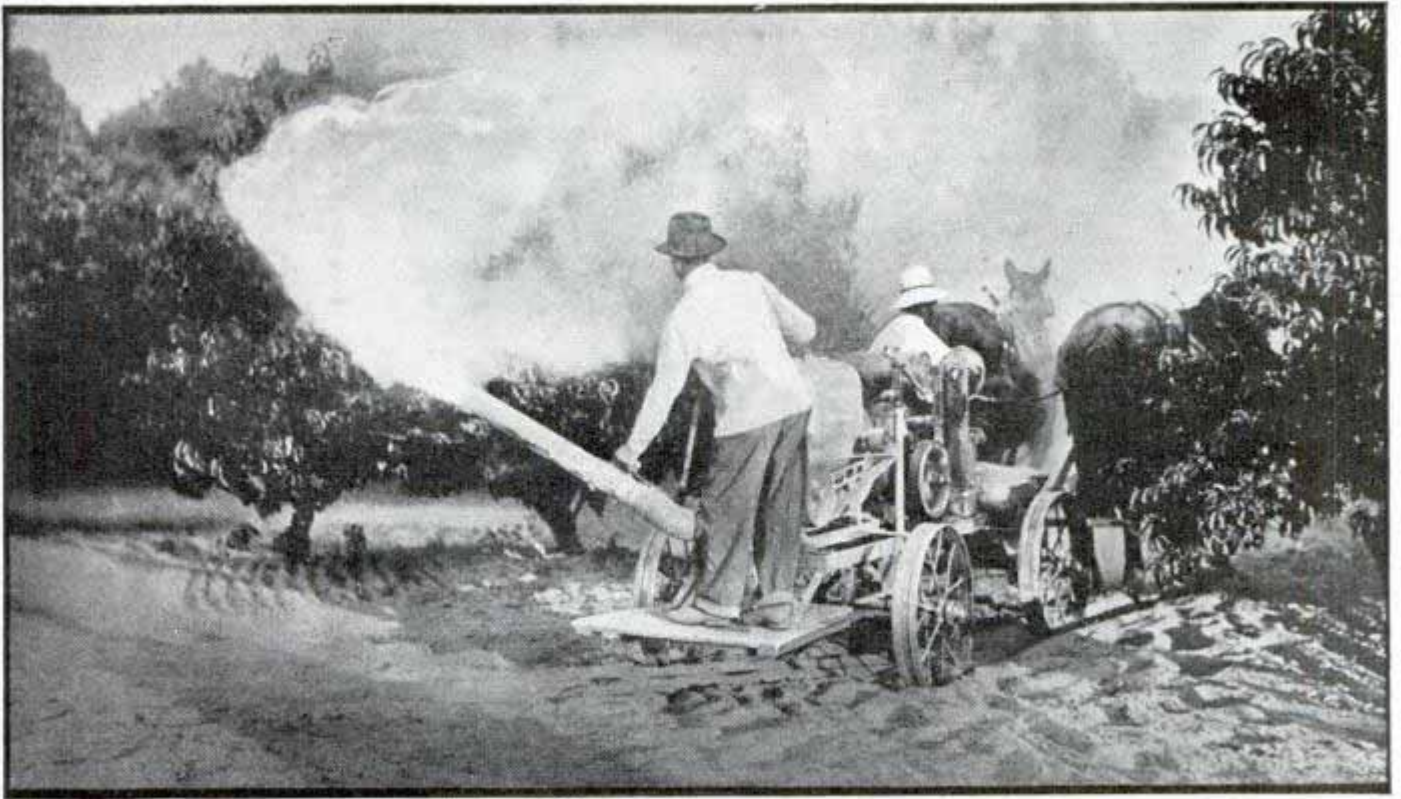

OUT *of* FARMING

the greater is the demand and consumption.

So efficient have chemists become in utilizing farm products in industry that men of vision see the day approaching when more farm crops will be consumed by the factory than are consumed as food. Feeding the world then will be only a part of the farmer's job. He will become essentially a manufacturer, turning out the raw products required by industry.

"Chemistry, especially organic

Photos courtesy E. I. Du Pont De Nemours and Co.

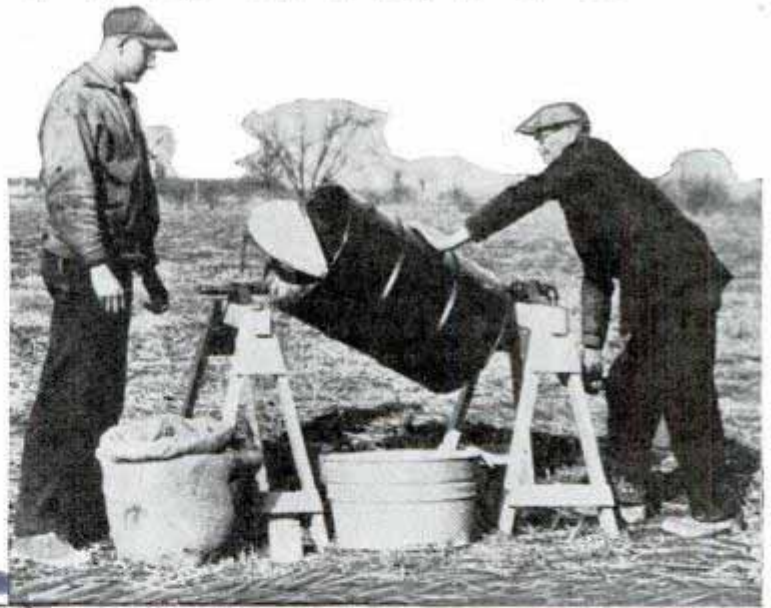

Top, dusting an orchard with an insecticide mixed with low-grade wheat flour which increases the adhesive property. Below, operating a homemade seed duster consisting of a steel oil drum fitted with an axle and crank and supported by two sawhorses. Seed is rolled and thrown against a mixing board and surges from end to end of the drum

Bayer Semesari
100 ...
667

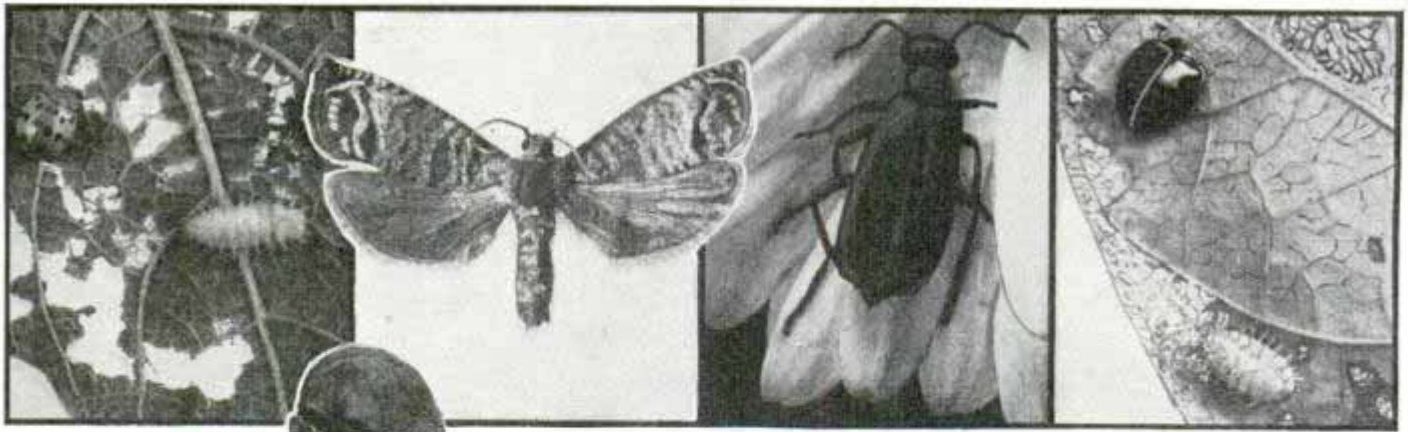

Simple method of dusting small quantities of seed. Top, left to right, Mexican bean beetle, adult codling moth, black blister beetle, bean beetles at various stages of development, striped cucumber beetle and tobacco worms

chemistry, as it is practiced today, is a science of revolution," says L. F. Livingston, manager of the agricultural extension section of E. I. du Pont de Nemours and Company. "The chemist has learned how to create, not by accidental discovery or by black magic but by cold scientific calculation based on experience and accumulated knowledge. His objective is no longer imitation or duplication of natural products, if it ever was that, but the creation of materials non-existent in nature. For example, rayon is not artificial silk but a new fiber with properties of its own. Neoprene is not a synthetic rubber but a material of totally different chemical composition that in many ways is superior to the natural product. But what is most to the

point, the chief raw materials of the organic chemist, the main tools of his trade, are organic things that grow from the soil. The organic chemical march toward change is over a road paved in large part by the products of American forests and farms."

But expanding the market for farm crops is just part of the industrial chemist's service to agriculture. He is also providing crop insurance for the farmer. Thus far, he hasn't been able to control the weather, but he has succeeded in eliminating or greatly decreasing other hazards the farmer faces. He has become, for example, the Nemesis of the innumerable pests which bedevil man, particularly the man engaged in farming.

Pests compete with man for his very existence. They attack from the air, the soil and the water, destroying man's plants, his animals, his food, his clothing, even his shelter. In order to exist, man must wage continual warfare against insects, rodents, fungi, bacteria, weeds and a host of other destructive agents. Insects alone cause an annual loss in the United States estimated at \$2,000,000,000 and losses to agricultural products caused by fungi and bacteria are estimated at \$1,000,000,000 a year. And the loss due to weeds, including actual damage and cost of control, is estimated at about \$3,000,000,000 a year. The farmer's new hired man is helping reduce these huge losses by waging chemical warfare against these and other crop pests.

Pest control with the aid of chemicals is not new. Arsenious oxide mixed with honey was used as an ant poison in the seventeenth century. In the past, however, most poisons used against insects have also been poisonous to man. Today chemists are seeking and finding insecticides of a

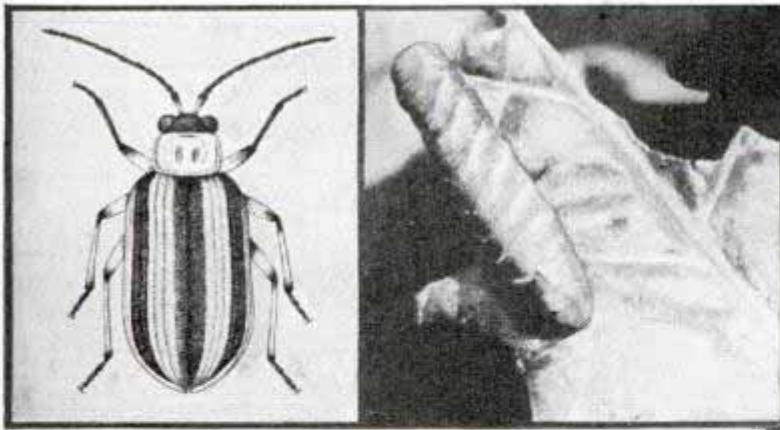

different kind, substances deadly to insect pests but non-injurious to man or plants.

They are seeking these dusts, sprays and repellents among organic, rather than inorganic substances, animal and vegetable products. Vegetable products in particular offer great possibilities as insecticides either directly or as the starting point for the preparation of synthetic compounds. Many insecticides used today are derived from such plants as tobacco, pyrethrum, cube, hellebore, larkspur, quassia, red ce-



dar and other plants from which essential oils can be obtained. The finding of rotenone, highly toxic to some insect pests but of low toxicity to animals, in the devil's-shoestring indicates how common weeds yield insecticides. Thus chemistry puts one pest to work eliminating other pests.

Many of the most destructive plant diseases are transmitted on, in or with the seed and one of the chemist's most important services to the farmer has been the development of seed disinfectants and also soil disinfectants to control certain soil-borne diseases of plants. Accident was largely responsible for teaching man how

(Continued to page 156A)



Top, treating seed potatoes with aid of wire basket and barrel of solution. Center, meandering stream before it was straightened with aid of explosives and afterward. Bottom, cost and profit on cotton as result of seed treatment

ag... 2/28/37

Floodlights on 'Queen Mary' Speed Up Dry-Dock Work

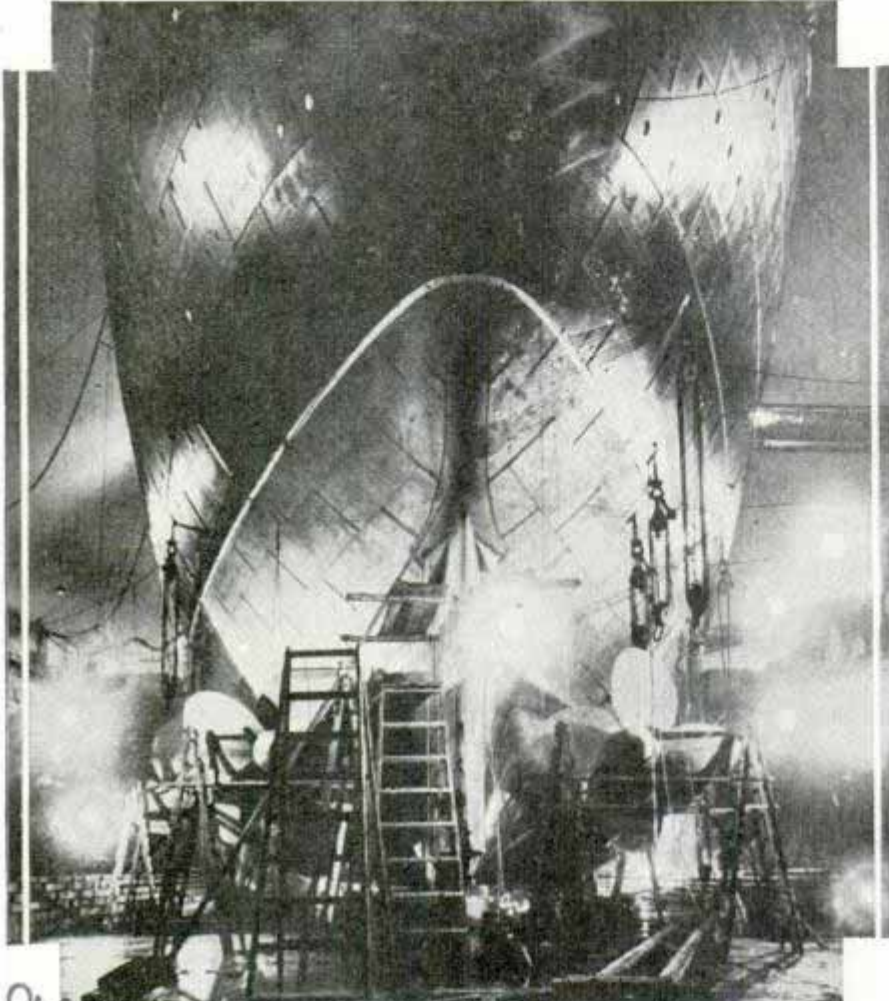

While the "Queen Mary" was being prepared for another season, this unusual photo was snapped, showing the big ship in dry dock

Repair crews worked night and day to hasten the great liner's return to transatlantic service when the "Queen Mary" was being overhauled recently in dry dock at Southampton, England. Each night a battery of floodlights illuminated every part of the mighty ship where work was going on, almost turning night into day.

wire in the fog indicator responds quickly to this temperature change, lengthening and closing a contact that sends a signal to observers below. By night it lights a lamp by day it explodes a cap or releases a small parachute. Calculating with a theodolite, the weather observers estimate the height of the warm-air layer and predict the arrival of fog or cloud.

White Concrete Is Permanent Road Marker

Eliminating the necessity of repainting the center traffic line on highways, a white concrete strip is built into the latest road pavement as a permanent marker. Since this line will not fade or be erased by the tires of passing cars, the new construction is regarded as a safety factor. The traffic lanes on either side of the marker strip are of darker concrete.

Fog Finder Carried by Balloon Foretells Low Visibility

When foggy weather is on the way, weather bureau balloons can forewarn airmen several hours before visibility is bad. In some regions, particularly along the Pacific coast, a warm layer of air several thousand feet high means fog is coming. If the balloon during its ascent strikes a zone of rising temperature, a fine Nichrome

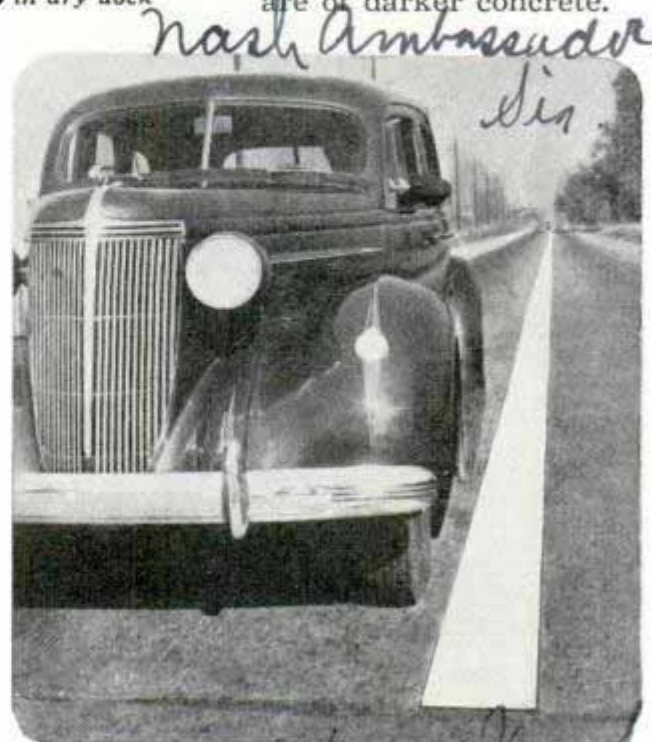

Nash Ambassador
Donor from Nash
Vol. 9 Motop

Gathering Wild Roots Is Odd, Lonely Job

While financial returns are not large, gathering wild roots, herbs and barks is a fascinating job which enables its follower to make a living and keep healthy. It's a lonely occupation because the quest requires trips into the remotest woodlands.

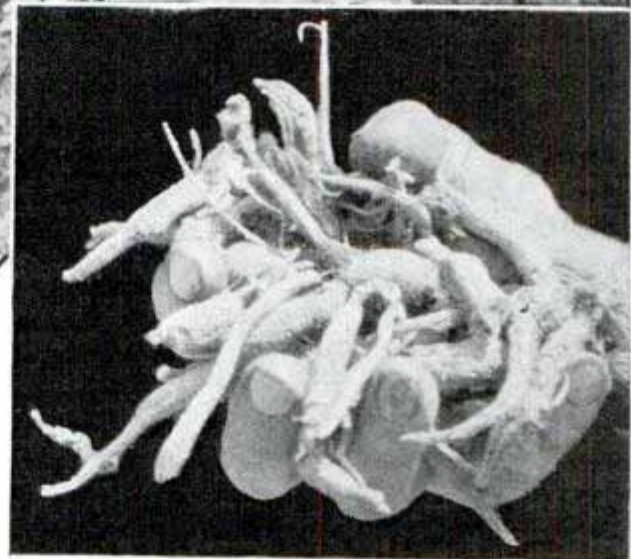

Two gatherers of herbs and roots at their lonely occupation. Bottom, right, a handful of roots before being prepared for sale

With bag over one shoulder and small grubbing hoe in hand, the root gatherer trudges wherever he knows certain plants may be expected to grow. There are in the United States more than 250 species of roots, barks and herbs of value in the manufacture of drugs. They range from the common dandelion to the almost extinct ginseng, golden seal or snakeroots. Leaves from the deer's-tongue plant are used in flavoring smoking tobacco. Roots and bark from the sassafras bush are used in making medicinal tea and perfumes. One wild herb is necessary in the manufacture of a silverware polish. The business is regarded as important by the government, which issues bulletins on the drying of medicinal herbs and the growing of ginseng, golden seal and the mints. Many common plants, regarded by most people as weeds, such as ironweed, mul-

lein, jimson weed, yellow dock, burdock and pokeweed, have a sale value. Often the root gatherer supplements his income by picking up and selling Indian relics, wild ferns and other plants and rare stones for rock gardens. One root gatherer in northern Indiana collects snakes for carnival performers. Now and then he sells information to lumber buyers on the location of trees in the country through which he plies his trade. Frequently the root gatherer lives in a shanty boat from which he makes side trips, then floats on down stream to a new location.

☐Inquiries as to makers of articles described in Popular Mechanics, will be answered by our Bureau of Information upon receipt of return postage.

Fast Air Liner to Compete in Atlantic Race

Under construction at Southern Aircraft and Engineering Co. London, England.

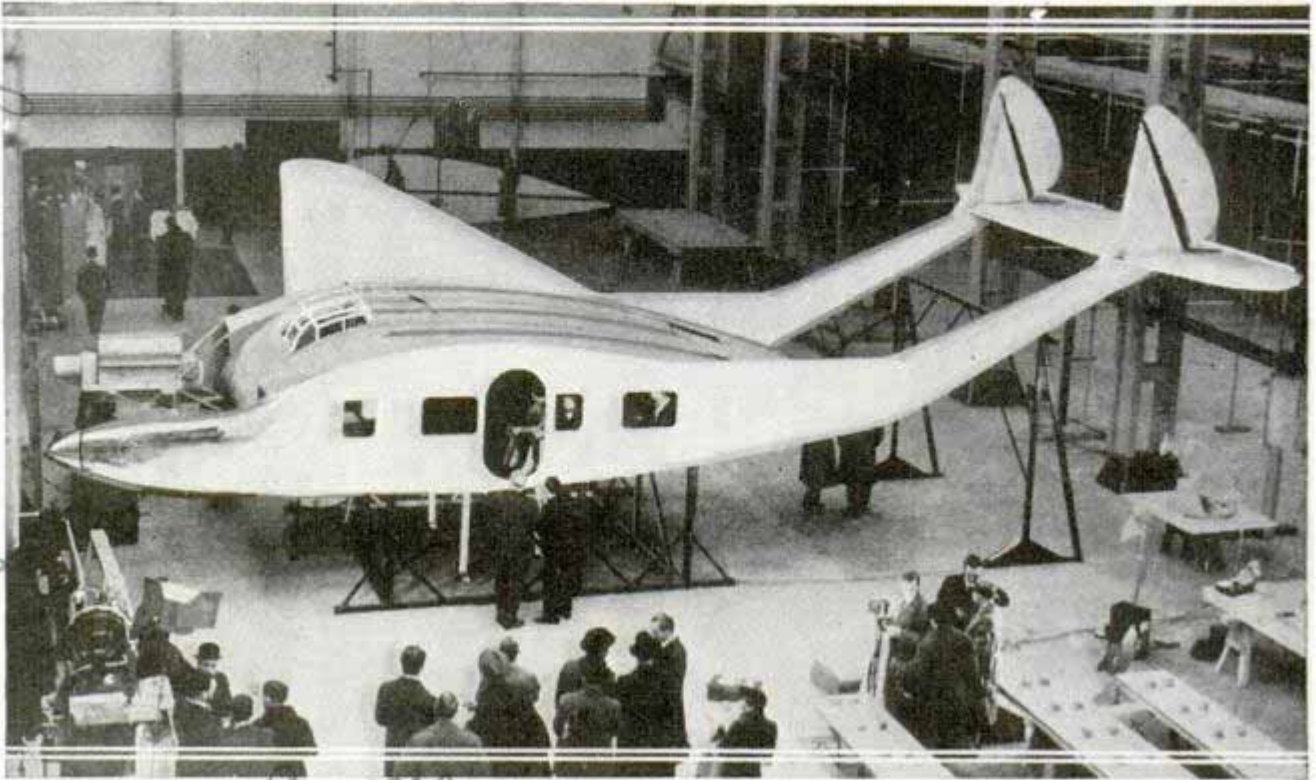

Here is racing plane under construction, as it was being prepared for New York-to-Paris dash. Note that the left wing has not been installed. Unusual streamline effects have been achieved in this air liner

Equipped with a power plant which will give a speed of 225 miles per hour while operating at eighty-three per cent capacity, a big air liner has been prepared to represent England in the New York-to-Paris air race. The ship is expected to make the trip in fourteen hours. Weigh-

ing 15,000 pounds, the plane has two rudders, one at the end of each section of the divided fuselage or tail. A large cabin, with the pilot's compartment located at its front, is built between the wings and the two tail sections. The design of the ship is unusual for air liners.

Tiny Earphone Fitted to Wearer Gives Better Service

Hard-of-hearing persons may select the earphone which enables them to hear the most clearly by using a fitting machine developed recently. By pressing small switches controlling transmitters, receiv-

ers, amplifiers and bone-conduction instruments the individual determines the proper combination. Then the company builds the earphone in accordance with the results of the tests. One of the latest developments in the same field is an electrical earphone which operates on a small flashlight battery which can be purchased at any hardware store for fifteen cents. This battery is tucked away in a case beneath the microphone so that the instrument is all in one piece. The new earphone weighs only seven ounces, small enough to be slipped into a man's vest pocket. Instead of a heavy amplifier on top of the battery the phone has a twin microphone, eliminating a booster. A single cord leads from the midget receiver which will fit into the orifice of any ear.

Standard Acetate \$40.00 to \$45.00

Electro-Ear

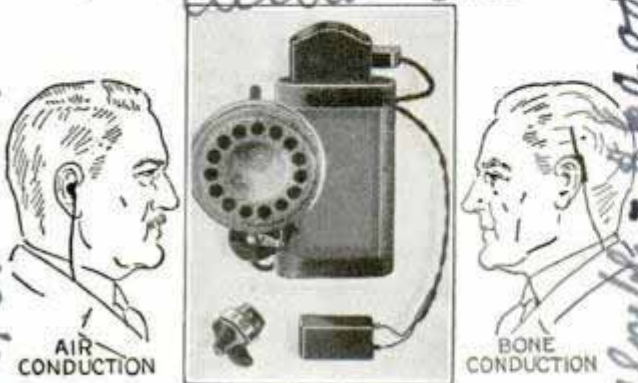

Small earphone to aid hearing. Left and right, two types of phones available

Double \$10.00 to \$15.00

American Earphone Co. 118 4th and New York

Besler Systems, 4053 Harlan St Emeryville, Calif.

Two-Car Streamline Train Is Driven by Steam

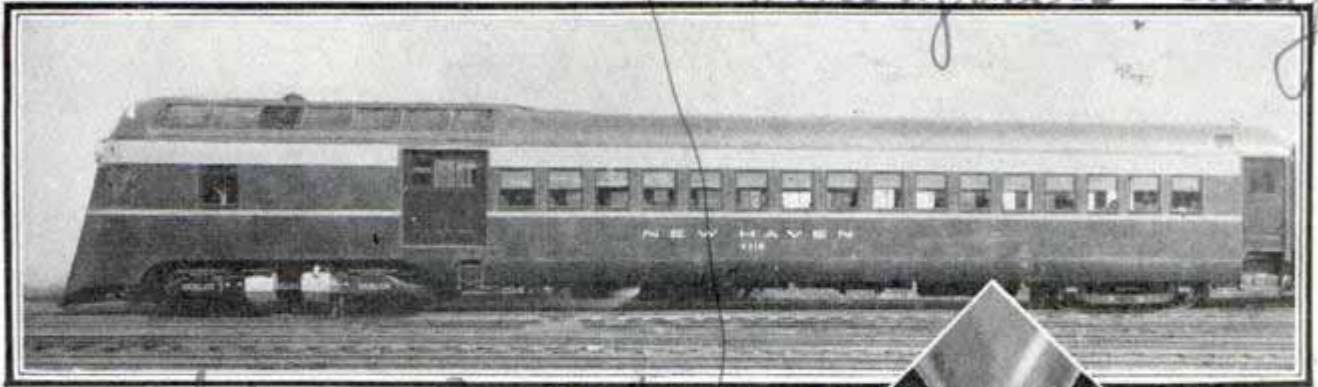

Between Bridgeport and Hartford

Two old railway coaches of the New York, New Haven and Hartford line have been converted into a modern streamline train driven by a high-pressure steam plant installed in an eight-foot space in the forward end of the front car. The two-car unit, with its compact steam engine and power truck designed by Besler Systems, replaced a steam locomotive more expensive to operate, a baggage car and two coaches. It was chosen as lighter and less costly than a Diesel-electric power car. The boiler, heated now by oil but convertible into a coal burner, automatically keeps steam pressure at 1,200 pounds, which is delivered to two high-pressure and two low-pressure cylinders located directly on the power truck. Steam first enters the high-pressure cylinders, then passes to the low-pressure cylinders, doing double duty; then it goes to the condensers on top of the train and repeats the cycle. Water enters the boiler at the top, passing down through pancake coils where it is heated, then boils in the helical coils at the bottom, surrounding the combustion space, passing on to the superheater coils above the firebox

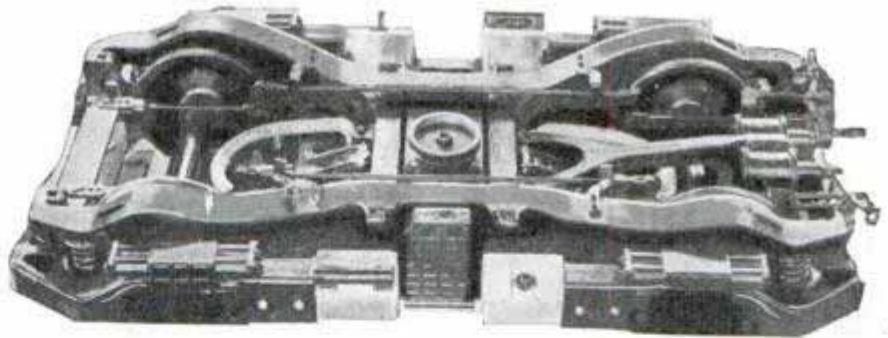
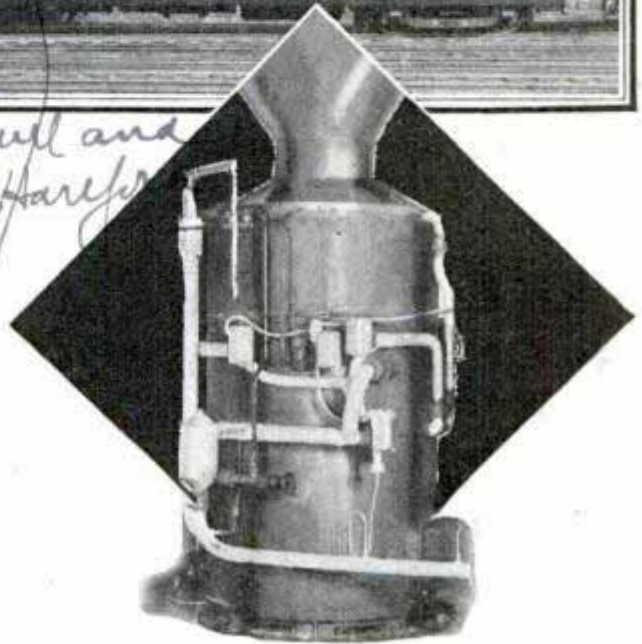

Top, rebuilt railway coach with compact steam power plant installed in streamline forward end. Center, type of boiler used. Below, power truck

and emerging as superheated steam. Working pressure can be obtained from a cold boiler within four minutes. The train, which has driving controls at both ends, has reached eighty-two miles an hour. The engine delivers 500 horsepower.

20158

Age Cools Electric Heaters as Wires "Grow" in Length

If your toaster, percolator or iron seems to take longer to heat than it did when first purchased, it may be the result of "growth" of the alloy wires used as heating elements. This growth occurs in all

resistance wires, but is more pronounced in certain alloys used in inexpensive heating elements. The wire lengthens, building up resistance and cutting down wattage and heat.

Wilbur B. Sluice Co, Newark, N.J.

You're WRONG

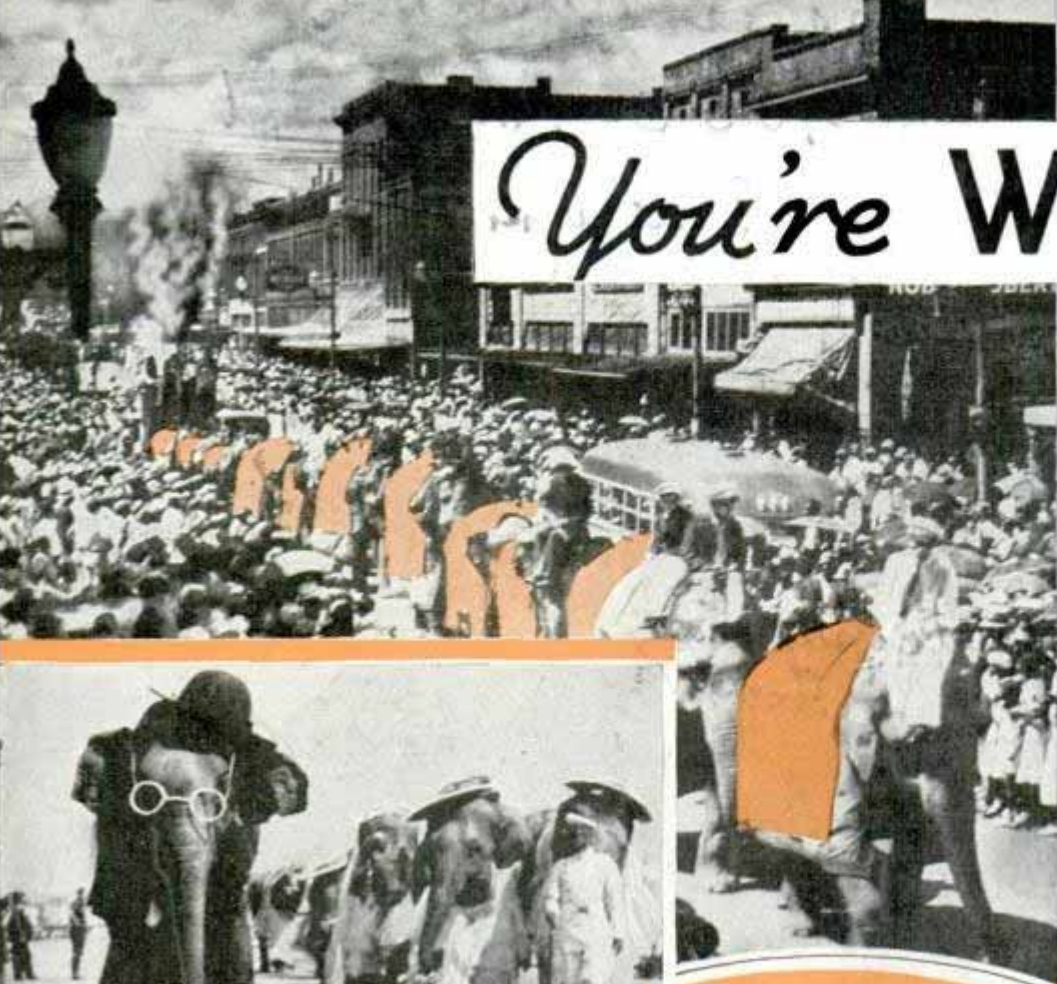

derms. Despite this strong bond of friendship, however, the public probably knows less about elephants than about all other animals of the menagerie. A young man in the crowd explains to his girl friend that an elephant will bludgeon anyone who feeds him tobacco; a farmer tells his wife the big beasts live in mortal fear of cats, dogs and mice, particularly the latter which have a penchant for running up elephants' trunks; an elderly gentleman relates to

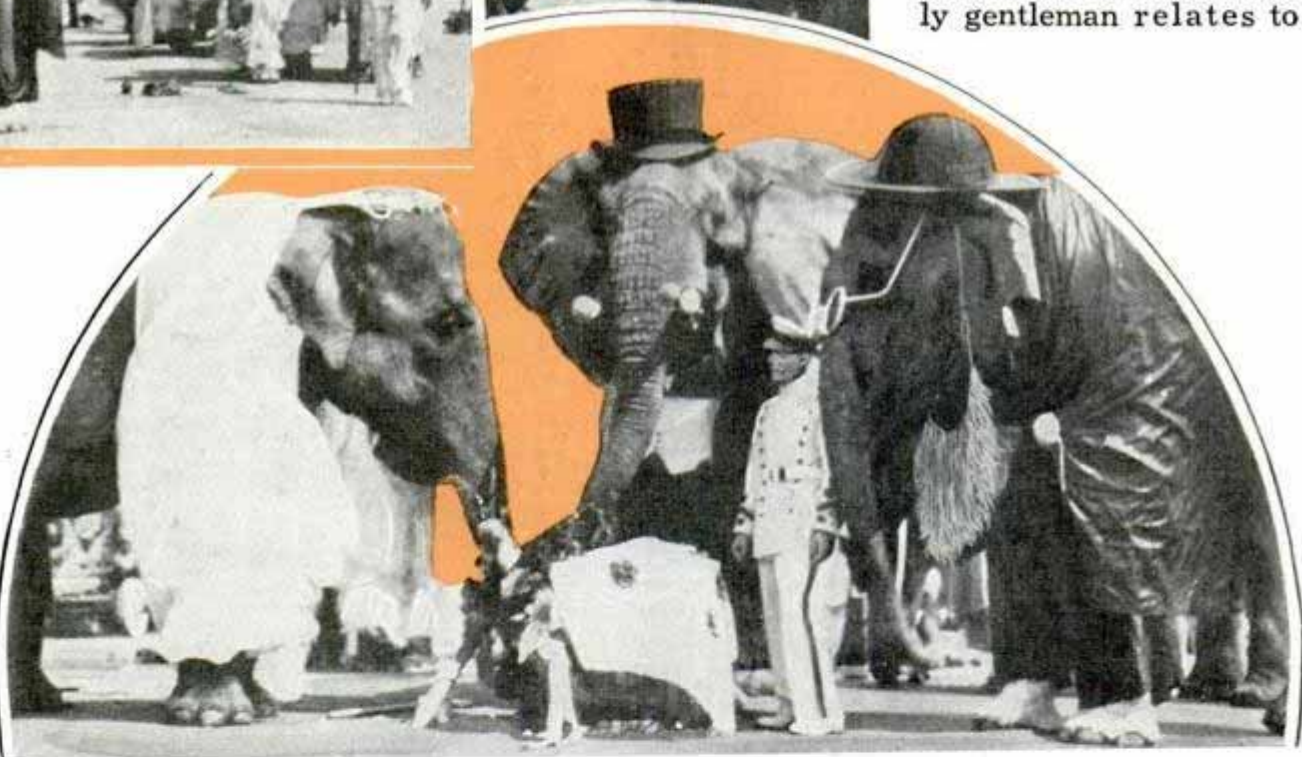
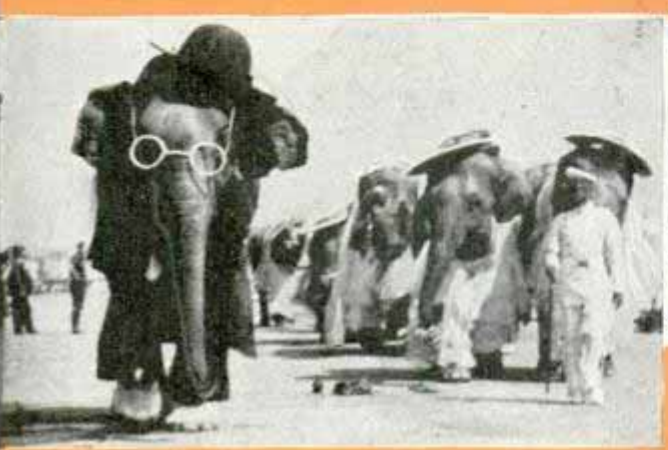

Top, elephants on parade—the big attraction of the circus. Center, wedding march of "Jumbo 2nd" and "Miss Ragoona." Bottom, another view of the elephant "wedding" party

By Eddie Allen

Veteran Animal Trainer

THREE-QUARTERS of an hour before the start of the big show the crowd moves gradually from cage to cage toward the elephant line—and stops. Here the circus fan, armed with a sack of peanuts, renews old acquaintances with the pachy-

his grandchildren their wonderful powers of memory, and someone else comments on the toughness of their hides.

I have spent fifteen years working, training, and studying elephants, and the opinions I have formed are decidedly contrary to popular beliefs.

Elephants, especially the males, love tobacco. I make it a point to have tobacco

2096
Chief elephant trainer,
Cole Bros. Circus

2596

about

ELEPHANTS

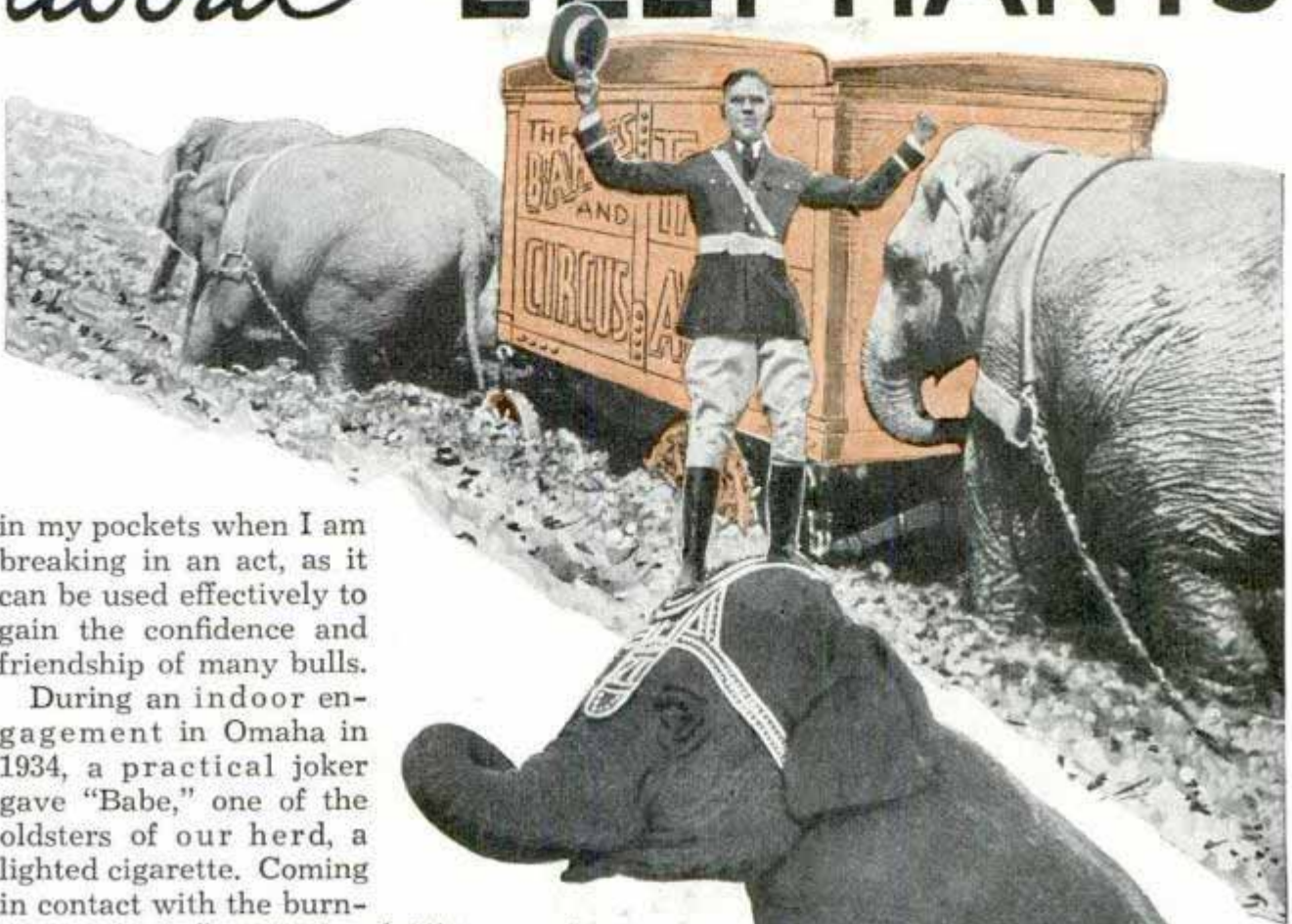

in my pockets when I am breaking in an act, as it can be used effectively to gain the confidence and friendship of many bulls.

During an indoor engagement in Omaha in 1934, a practical joker gave "Babe," one of the oldsters of our herd, a lighted cigarette. Coming in contact with the burning tip "Babe" emitted a shrill trumpeting blast. The other elephants took up the cry immediately and it was all that we could do to keep them from breaking their chains and bolting. Finally the show got under way. "Babe," although showing signs of nervousness, went through her performance without a hitch. When the bulls were returned to the picket line the practical joker again approached "Babe," this time with an apple in his hand. She accepted the peace offering, allowing him

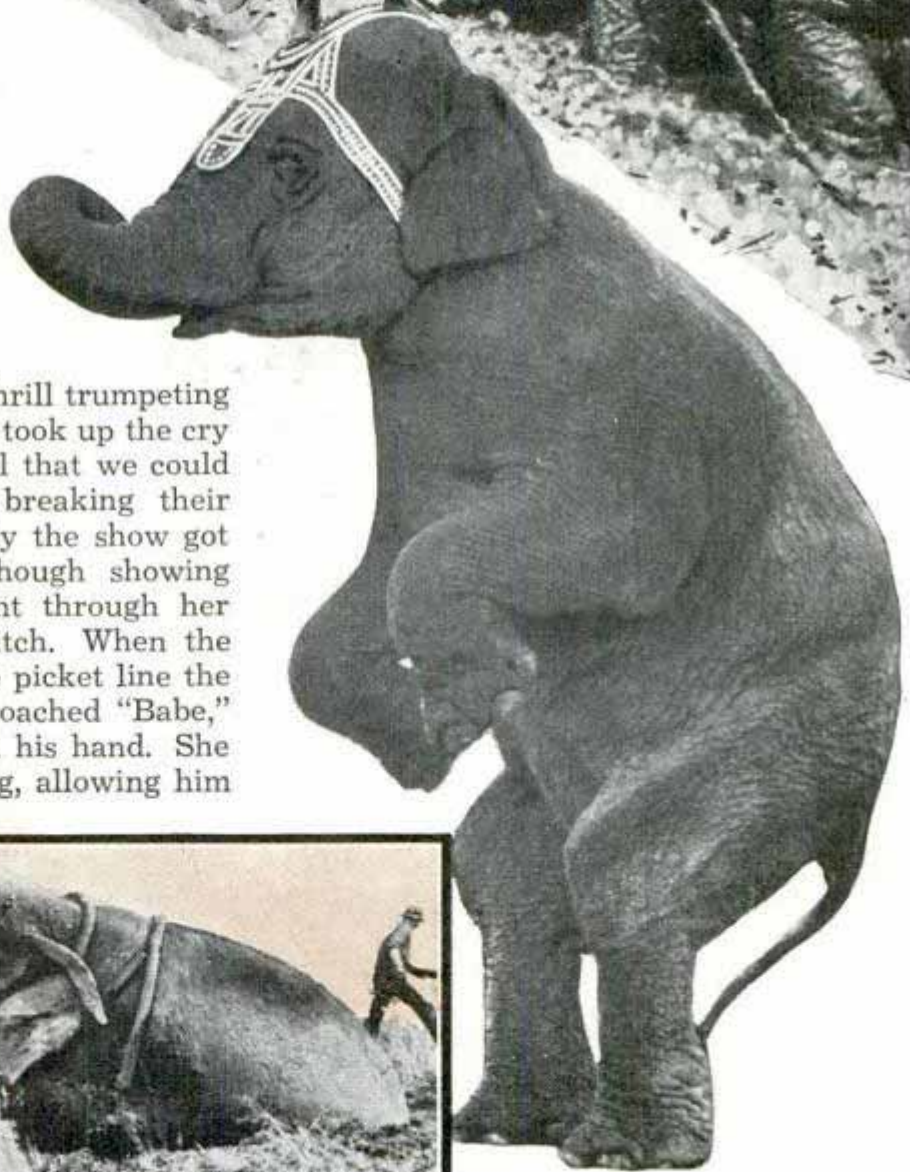

Top, elephants to the rescue, pushing circus wagons out of mud. Center, performance of this act calls for months of patient training. Bottom, big bull wallowing in mud, a delight to any elephant

*Capt. James M. Sullivan, 431
 Ill. 60th Service, City M*

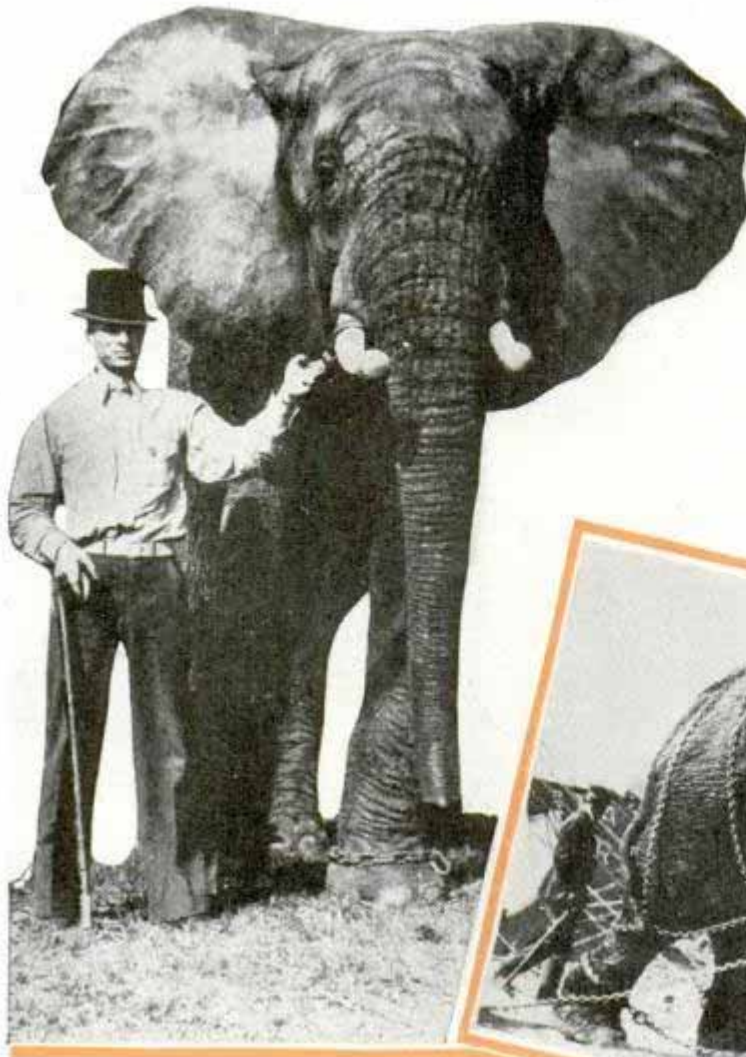

phant carrying a grudge makes no effort to conceal it and when his enemy comes within striking distance he will slap him with his trunk until he is on the ground and will then proceed to do a headstand on the victim's chest. But "Willie" would bide his time until he would catch his victim off guard. Then in a twinkling he would wrap his trunk around the person, lift him to his mouth, and crush his skull. Seven persons fell victim to his treachery.

It was only through the pleas of

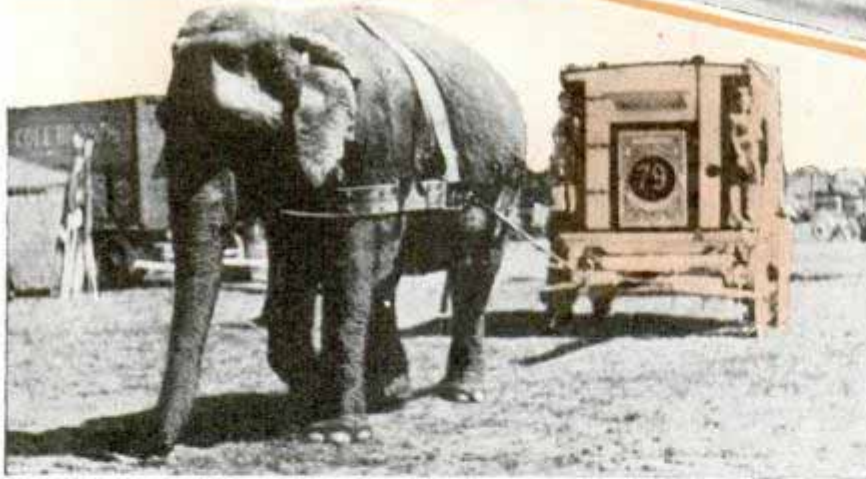
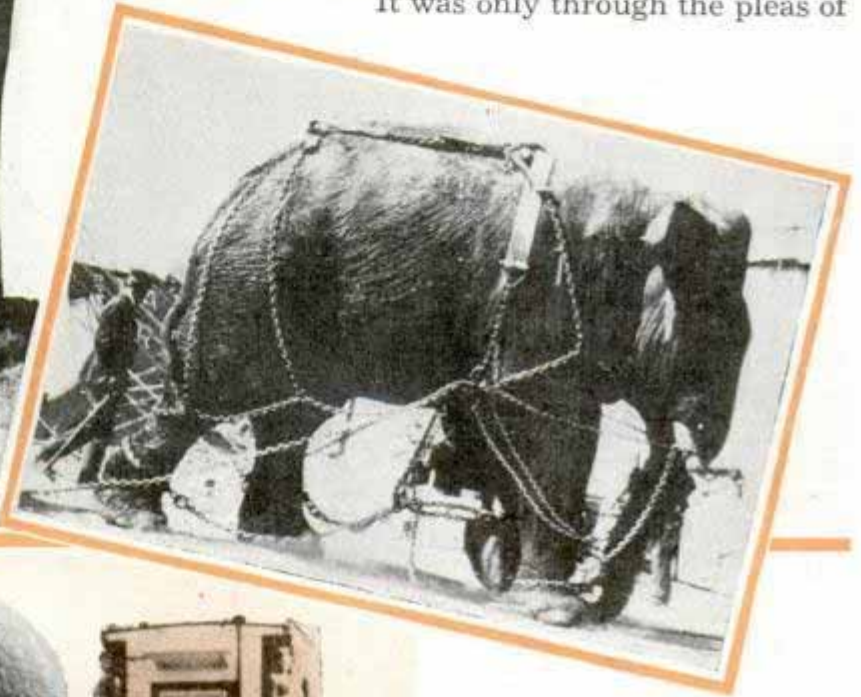

Top, Trainer Allen with "Jumbo." Center, "Tusko," giant Indian elephant, in chains. Bottom, animal den being pulled into menagerie tent by working elephant

to pat her, and they became good friends.

This instance upsets the theory that elephants have remarkable memories. There have been cases where they evened up old scores years later, but their memories are no better than those of other animals. They may remember their routines but not human beings. Evidence of this is shown in the case of "Willie," the gangster bull. "Willie's" tactics were different from most of his kind. The average ele-

his trainer that he was saved from the firing squad. This particular trainer, who had repeatedly befriended "Willie" in many other ways, left the circus for a short time and upon returning to the lot approached him, thinking "Willie" would remember him. As he drew near "Willie" knocked him down and wrapped his trunk around his body. Only the intervention of the entire menagerie force saved him.

(Continued to page 127A)

How Chicago Looks from 10,000 Feet in Air

Stand beside a thirty-eight foot table in a Chicago office and look down at the miniature city spread across the board. You see Chicago as you would see it from a balloon 10,000 feet up. It is a city carved from balsa wood: 387,426 tiny wooden models colored and carved to scale representing the 387,426 buildings in Chicago. If you live there, you can find your own street, the house you live in, the garage where

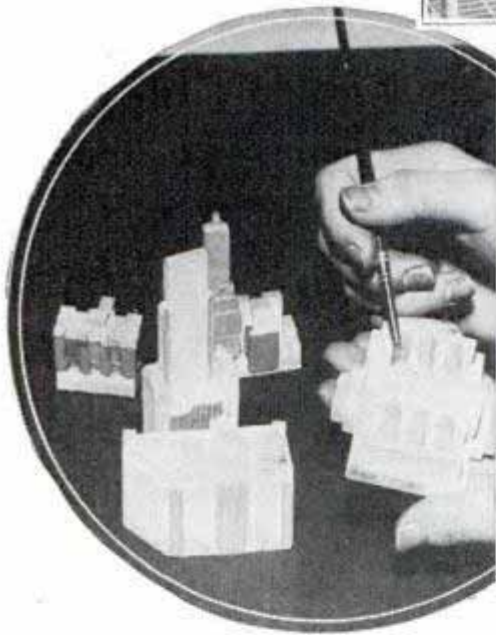

Above you see Chicago as you would see it from a plane 10,000 feet over city. Left, brushing the finishing touches on tiny model of big museum, and setting downtown section, studded with skyscrapers, into its place in vast diorama comprising 387,426 buildings and covering 836 square feet

you keep your car. This vast diorama, just being completed, measures thirty-eight by twenty-two feet, built on a horizontal scale of 300 feet to the inch and a vertical scale of one-eighth inch for the first floor of a building and one-sixteenth inch for every additional floor. The houses, apartments, factories and offices are colored according to building material; red for brick, white for stone or concrete, yellow representing wood. A field force gathered data, then the balsa models were made from drawings. The relief map is of value to engineers making studies of traffic, railroad terminals, school sites, fire protection, airports, street improvement and utility company services.

Fruit Juicer in a Quart Pitcher Is Handy on Breakfast Table

To obviate the trouble of emptying a tiny bowl several times for one or two glasses of juice, a citrus fruit juicer that holds a full quart has been introduced. It



is a sturdy pottery pitcher containing an integral, scientifically constructed juicer. Gracefully designed and available in several colors, it adorns the breakfast table.

Bauer Pottery Co.
Los Angeles, Calif.

Best: Calypso Hardware Co.
Los Angeles, Calif.

Sportsmen Ski or Swim in Idaho Winter Resort

Swim Valley Lodge, Ketchum, Idaho

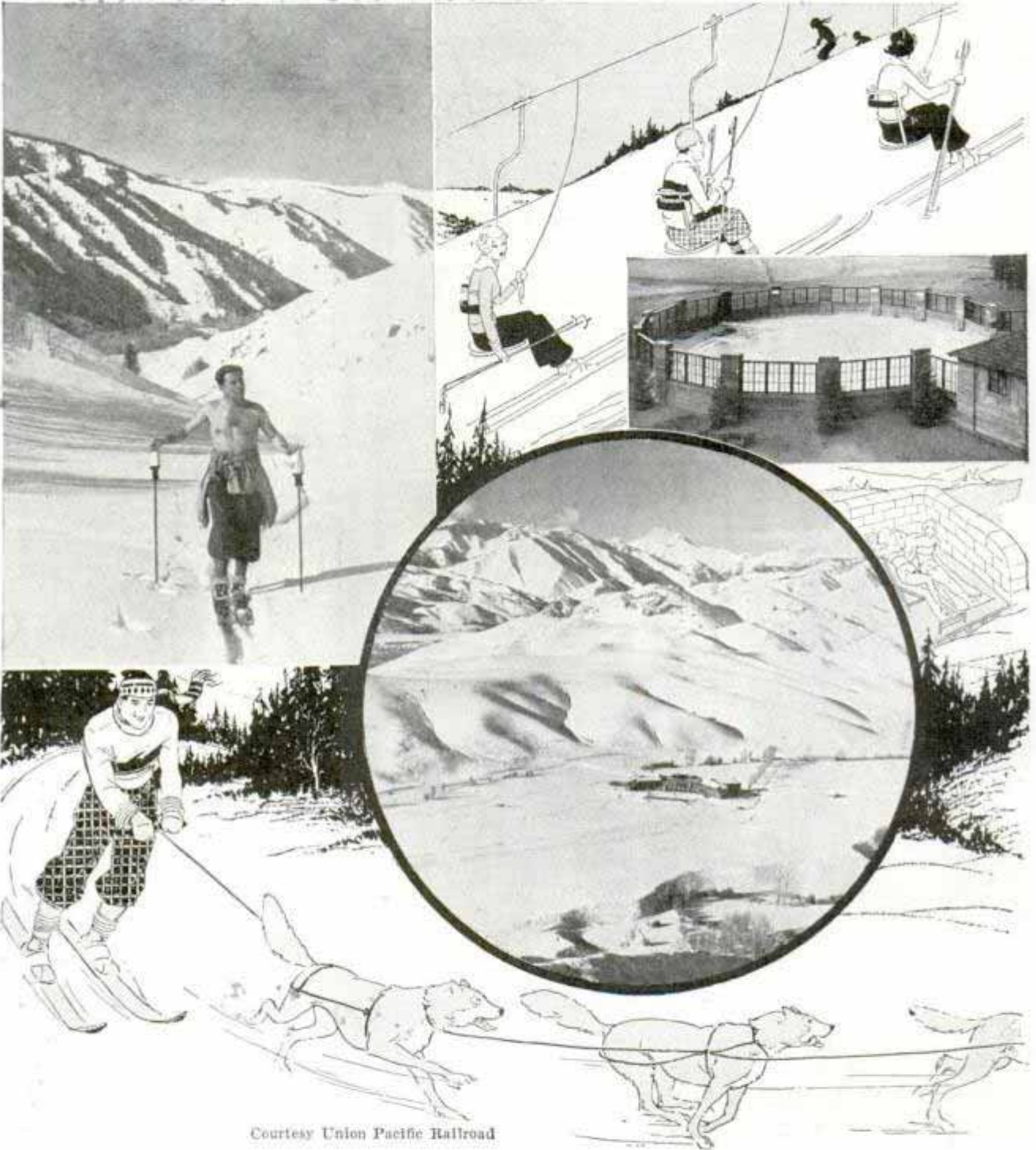

Courtesy Union Pacific Railroad

New winter resort in Idaho offers sunbathing on skis and in open "igloos," trolley seat to take skiers up mountain, and midwinter swimming in outdoor pool shown above at right, fed by hot springs

Swimmers splash beneath a February sun, skiers strip to the waist to glide over snow trails, winter meets summer in the Sawtooth mountains of Idaho where an outdoor sports center has just been opened. It is located in a valley near Ketchum, sheltered by an east-and-west mountain range from cold northern gales, and with a climate compared to that of the Swiss winter resorts. Adjacent to the new hotel

is an open-air swimming pool fed by hot springs and protected from wind by a glass wall. Cable-suspended lifts haul skiers up the mountainside with ease to a point 1,500 feet above the lodge where a two-mile run begins: The ride up is effortless, for chairs are hung on the moving cable at intervals and the skier simply grasps a rope suspended six feet ahead of the chair and eases himself into the seat as it comes

along. The chairs travel 400 feet a minute. There is also a ski tow or dragline which pulls the skier about 3,000 feet up a narrow valley to meet the chair elevator line. Three-sided "sunroom" igloos permit visitors to acquire a winter tan with daily sun baths, and winter sportsmen go in for sleigh rides, skating, and skiing and sledging with dog teams.

Engine Driven by Liquefied Air Propels Launch on Test Run

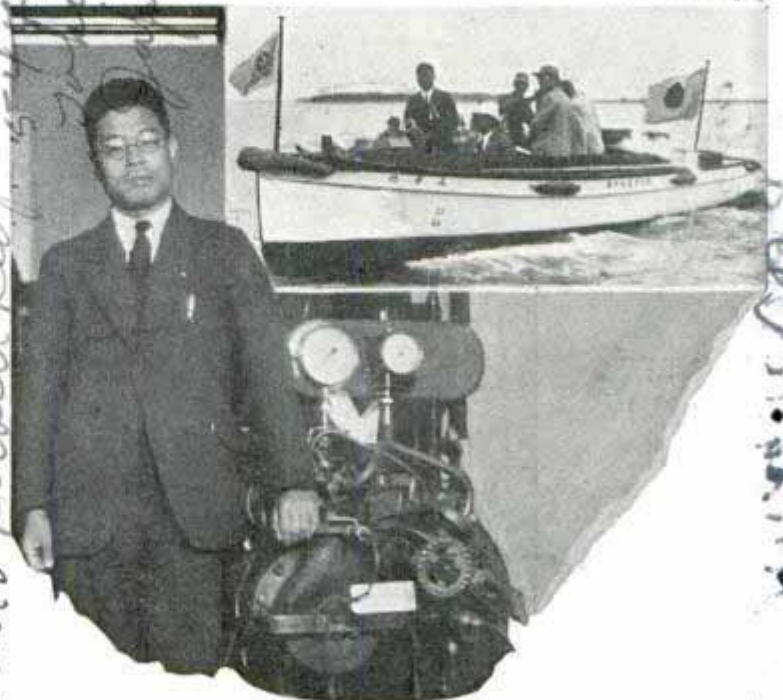

Inventor with liquefied-air engine. Inset, boat on test run. Note white cloud (near flag) of escaping air

Envelope Flap Moistened with Sponge Fed by Tube

For moistening envelopes and labels, the latest tongue-saving device is an unbreakable tube in which a vacuum mouth of sponge rubber is fitted. When the fingers press the tube vertically, the sponge draws moisture from the tube and applies it to the label or envelope flap. When pressure is released, the water automatically returns to the reservoir.

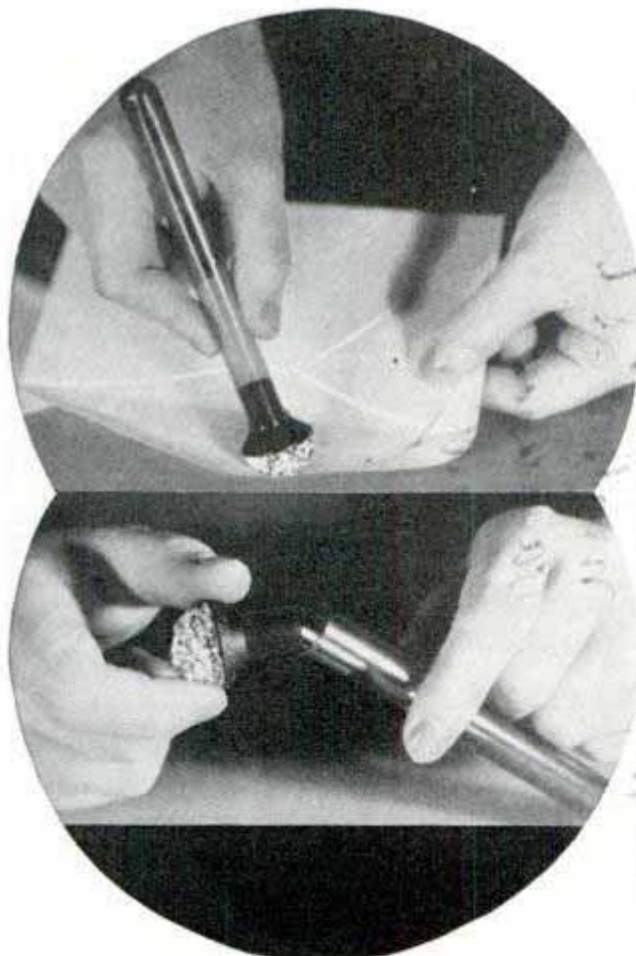

Pressing sponge rubber cap applies moisture to envelope. Vacuum cap is removable for refilling

Evaporation of liquefied air propels a twenty-seven foot launch equipped with a two-cycle engine invented by Jiro Okada of Japan. The engine, which operates under a pressure of forty atmospheres at a temperature of 100 degrees centigrade below zero, does not exhaust the air as it is vaporized, but liquefies it again. Hence the operation is almost continuous, except for the small quantity of air which must be introduced to make up for leakage from various parts of the power plant. The engine consists of a container of liquefied air, a pump, a vaporizer, a prime mover and a liquefier. The liquefied air is vaporized and forced into the engine cylinders under high pressure, where it causes the pistons to rotate the crankshaft.

Twenty Thousand Ice Cubes Cut in Hour by Machine

Capable of turning out 20,000 one and one-half inch ice cubes per hour, an automatic machine has been developed to meet demand for cubed ice. It is operated by feeding a full-size block of ice into the carriage. A twelve-inch saw cuts off the cubes and they pass down a chute.

Hydraulic Mfg. Co.
Des Moines, Ia.

City of Cleveland
Cleveland, Ohio

Jiro Okada, Building Engineer
 to Shunryu Iwami, Chamberlain

Es/28
 Emb. Perker...

Propeller with Single Blade Is Fast and Steady



It looks like half a propeller, but this single blade outdoes performance of conventional type

Tests of a single-bladed propeller invented by a Baltimore aviation engineer indicate that it has far greater climbing power and speed than the traditional twin-bladed or triple propeller. It appears to be only half of a conventional propeller, a wooden blade set in the hub, with only a stub opposite it. In actual flight, an airplane equipped with the single blade took off in four and one-half seconds compared with nine seconds with its regular propeller, climbed one-third faster, and was twenty-five per cent faster in the air.

Electric Choke on Auto Engine Reduces Stalling

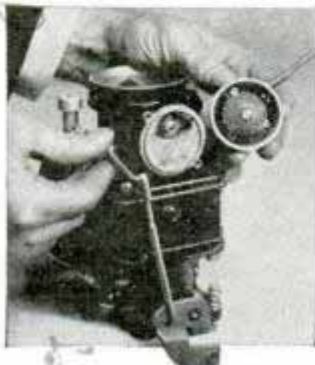

Fitted with an electric element which supplies heat for the thermostatic spring controlling the carburetor's butterfly valve, the latest automatic choke is positive

in action. Formerly heat from the exhaust manifold was used as a source of energy to open and close the valve. The electric unit, supplemented by the action of the thermostat, reduces stalling by preventing the choke valve from opening suddenly when air rushes against it after the engine is started. Thereafter the control permits only a gradual opening of the valve until the motor is warmed up. The heating element remains hot all the time the engine is running and thus causes the valve to stand open, reducing the possibility of flooding. When the ignition key is switched to off position the electric choke control cools off and allows the choke valve to close gradually until it is in the proper position for starting a cold engine quickly.

Combined Shredder and Grater Handy in the Kitchen

Providing a means of shredding small vegetables and grating the peel of citrus fruits, the latest kitchen tool is made of stainless steel and long-wearing maple

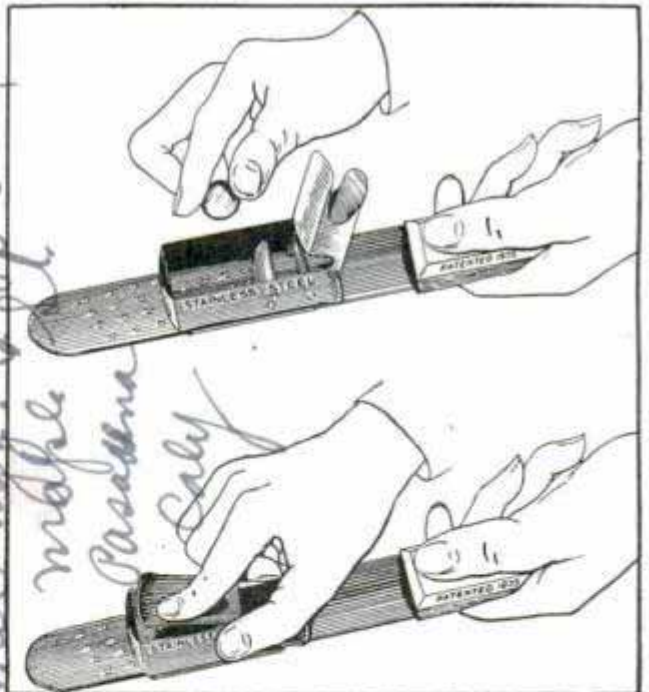

Two views of handy kitchen tool. Bottom, tool in use as vegetable grater

handle. It slices and minces garlic pods, onions, pimentos, green peppers, carrots, mushrooms, reduces nuts of all kinds and grates orange and lemon peel to the thinness desired. By separating the carriage from the handle, the whole lemon or

Handwritten notes on the left margin:
1. ...
2. ...
3. ...
4. ...
5. ...
6. ...
7. ...
8. ...
9. ...
10. ...
11. ...
12. ...
13. ...
14. ...
15. ...
16. ...
17. ...
18. ...
19. ...
20. ...
21. ...
22. ...
23. ...
24. ...
25. ...
26. ...
27. ...
28. ...
29. ...
30. ...
31. ...
32. ...
33. ...
34. ...
35. ...
36. ...
37. ...
38. ...
39. ...
40. ...
41. ...
42. ...
43. ...
44. ...
45. ...
46. ...
47. ...
48. ...
49. ...
50. ...
51. ...
52. ...
53. ...
54. ...
55. ...
56. ...
57. ...
58. ...
59. ...
60. ...
61. ...
62. ...
63. ...
64. ...
65. ...
66. ...
67. ...
68. ...
69. ...
70. ...
71. ...
72. ...
73. ...
74. ...
75. ...
76. ...
77. ...
78. ...
79. ...
80. ...
81. ...
82. ...
83. ...
84. ...
85. ...
86. ...
87. ...
88. ...
89. ...
90. ...
91. ...
92. ...
93. ...
94. ...
95. ...
96. ...
97. ...
98. ...
99. ...
100. ...

Handwritten notes on the right margin:
es 126
es 78

orange may be grated, the curvature of the blade fitting the outside circumference of the fruit. The utensil is ten inches long, complete with its concave blade.

es 64.
Powerful Streamline Engines to Haul Fast Trains on Coast

es 64
Small Tractor Meets Needs of One-Man Farm

Designed to meet the needs of truck gardeners and operators of small farms, a light two-wheel tractor handles standard implements in preparing the soil and in harvesting the crop. It has a gasoline engine, automobile transmission and differential, wheels equipped with special tread tires to improve traction and may be converted for certain jobs by installing lug chains. Built of standard parts the tractor has a surplus supply of power which makes it possible for the operator to ride while cultivating. Normally the operator walks, guiding the plow. Operating costs are said to be five cents per hour.

es 64
James Sawyer
Myrtle Creek, Oregon



Lined up for exhibition on four parallel tracks are the first of a fleet of streamline locomotives for California passenger service



Farm tractor ready for plowing

Rated among the most powerful locomotives in the world, a fleet of streamline engines has been built to pull the fast passenger trains between San Francisco and Los Angeles on the Southern Pacific railroad. These steam locomotives develop 4,500 horsepower and have a top speed of ninety miles an hour. Accenting their racy lines are red and orange stripes, which are carried out the full length of the new trains.

Popular Mechanics Magazine does not publish the name of the maker of, or dealer in, any device described in its pages, but this information will be furnished by our Bureau of Information upon request, accompanied by stamped envelope.

es 64.
Kulter King
700.5 N.W. 114th Ave. Portland, Ore

F1691.

CAMERA SHOTS *that*



newspapers and magazines. You have—or you can get—what it takes. It takes a helping of ingenuity, three helpings of experience; an eye for composition, and a wide eye to spot photographic “game” worth shooting; some knowledge of tricks you can teach your camera. Besides that, about



Acme

YOU might have been burned as a witch a few score years ago for producing out of a little black box the startling effects you can achieve with your camera today.

Instead of pulling a rabbit magically out of a hat, you can put a rabbit into a hat that wasn't in the picture by a bit of photographic legerdemain; introduce glorious clouds to enhance a landscape taken on a dull day; hang a full moon in a moonless sky or “shoot” the family clustered about the fireplace, their faces alight with the glow from a blaze that hasn't been started.

Simple tricks, all of these. It doesn't take costly apparatus, hundred-dollar lenses and intricate attachments to make “show” pictures—those shots that bring prizes at exhibitions and earn money in the news columns and roto sections of



Top, sunlight creates theatrical effect in smoky atmosphere of Grand Central station, New York. Bottom, child photographed in charming natural pose

CLICK

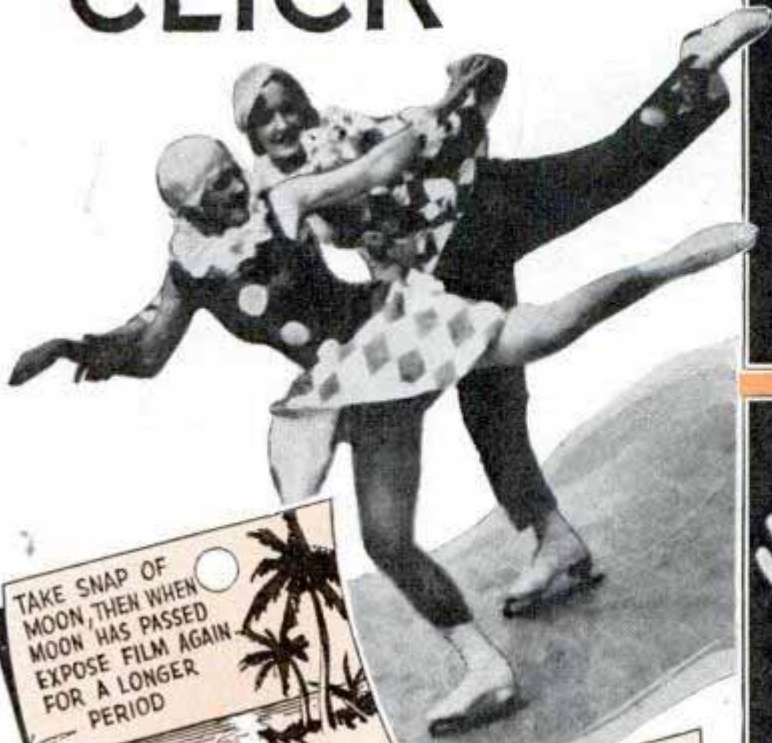

Skating picture taken at ice carnival calls for fast shutter to "stop" the action. The drawings show camera setup for silhouette and moon photographs

all you need is a camera, almost any camera, and a load of film.

It was an ordinary box camera in the hands of a novice snaphooter, a cabin boy, that took the now famous news pictures aboard the sinking steamship "Vestris." There was no trick to that. The youth merely saw a scene packed with human drama and clicked his camera shutter. But the box camera has plenty of tricks in its repertoire. Perhaps, for example, you'd like to try a stereoscopic picture.

Twenty-five years and more ago stereoscopies were the rage. Folks would spend a Sunday evening looking through the twin eyes of the holder at travel scenes that had a third dimension, depth. Now the fad is returning, and amateurs make their own. You can do it with two box cameras strapped together so that their lenses are level, and about as far apart as



These pictures tell a story! Sequence taken in nursery catches quick changes in baby's expression

FIG 71

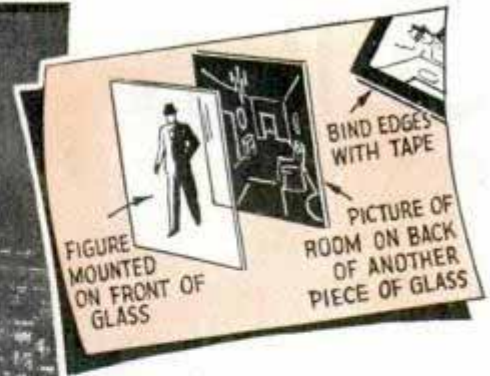

Sketch shows how to mount two exposures of same setting for stereoscopic effect. At left, a city poses in evening wrap and jewels—view of New York City at night with Empire State building at center

your own eyes, two and one-half inches. The shutters must be snapped simultaneously. Developed, printed and mounted on a card—the picture from the right-hand camera mounted on the left of the card—the photographs seen through the refracting lenses of the stereoscope appear to gain perspective and depth.

There is another way to obtain a stereoscopic effect. Have a friend pose before the camera in the foreground of a room, with a front light trained on him. Snap the picture. Then without disturbing the room or moving the camera except to wind a new film

into place, have your friend step out of the scene and take a second picture of the room, exposing long enough to bring out detail. Develop and enlarge both pictures to the same size; cut out the figure and mount it on the front of a sheet of glass. Place the print of the empty room on the back of a thicker sheet of glass, mount the two pieces of glass together in proper register with scotch tape and note the stereoscopic appearance!

into place, have your friend step out of the scene and take a second picture of the room, exposing long enough to bring out detail. Develop and enlarge both pictures to the same size; cut out the figure and mount it on the front of a sheet of glass. Place the print of the empty room on the back of a thicker sheet of glass, mount the two pieces of glass together in proper register with scotch tape and note the stereoscopic appearance!

A touch of finesse can raise what might have been just another picture into a photograph of "salon" caliber. You can break up the hard quality

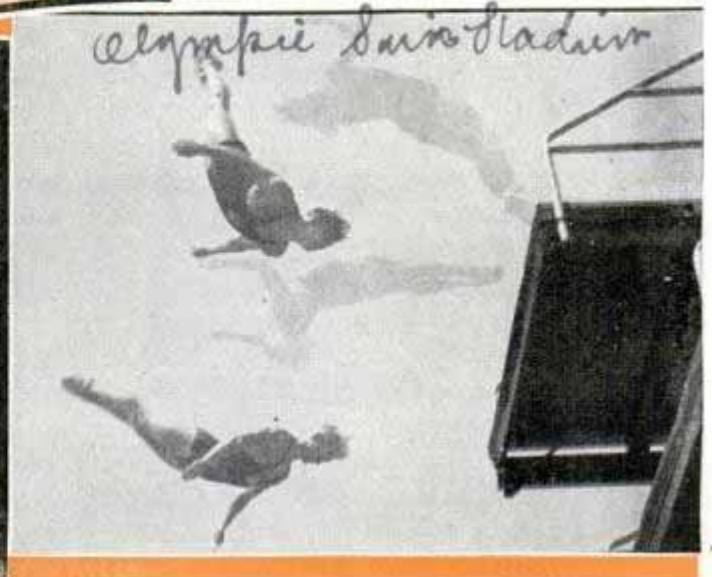

Toe dancer was "snapped" in one hundredth second; for stage photography you need an f 4.5 lens or faster. Shadow shot of two divers was obtained by tripping focal plane shutter twice

J. Frank Kutz, U.S.G.
W. J. ...

of a landscape by filming through silk. Cut out the center of an old lens cap and replace it with fine, transparent silk and expose through it until you obtain the soft, diffused quality you desire. One photographer, by dropping three pebbles to disturb the glassy surface of a lake with intersecting ripples, created a focus of interest and achieved a prized picture. Another, remembering theatrical effects of railway depot scenes where slanting rays of the sun pierced the smoke-laden air, captured the same effect with his camera in the woods, trampling dry leaves to send dust clouds floating up the long shafts of late afternoon sunlight. Take advantage of summer clouds; make a few negatives when they are at their fleecy best, and when you have a "baldheaded" landscape with uninteresting sky, improve on nature by double-printing in one of your cloud negatives.

You can improve on nature, too, with floodlights and flashlights. Hollywood professionals use booster light in broad daylight, and your own outdoor snapshots may be made more striking by spotting edgelights and highlights where they are needed. Even the

(Continued to page 114A)

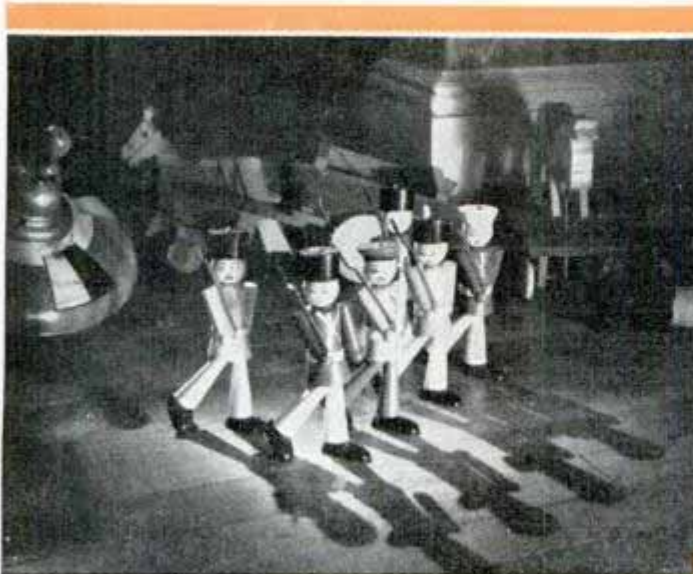

Photoflash caught child and dog in amusing pose. "Table-top" picture of toy soldiers was a four-second exposure. Vivid shot of bucking motorcycle was snapped in one two-hundredth second

Signal Lamp for Airport Flashes Messages

London. & W. England



New neon lamp may be used to flash messages automatically at landing field

Numerous uses can be found for a neon signal lamp designed for airports. It may be used for sending messages from ground to planes by Morse code; it may be placed in corners of a flying field for boundary lighting, and it is fitted with automatic devices for flashing a Morse code message continuously.

Rotary Shears for Sheet Metal Have Automatic Self-Feeder



Rotary shears now available for sheet-metal cutting do the work with less effort than hand snips and eliminate manual operations with the attendant risk of hand injuries. The rotary cutter is light weight, easy to operate, and self-feeding. The roller cutters are set in motion by up-

and-down movement of the upper hand lever, while the lower lever guides the shears along the line marked. The tool can be backed out of the cut by inserting a wire nail in a hole in the axle carrying the ratchet. The cutting wheels can be removed for sharpening, and special knives are offered for cutting ultrahard steel.

Floating Church Is Built on Hull of Old Argentine River Boat

Instead of worshipers going to church, church goes to the worshipers on the delta of the Parana river in Argentina. Getting to church was always a problem for residents of the delta, with many streams to ford, until a practical "padre" solved it with the idea of a floating place of worship. In the government shipyard at

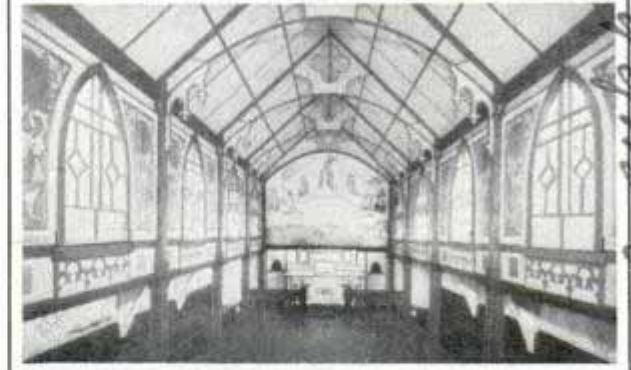

Exterior and interior views of cruising church which navigates delta of a river in Argentina

Buenos Aires a church, complete with stained-glass windows and steeple topped by a crucifix, was arc-welded on the hull of an old river boat 108 feet long. Now the church cruises to its congregation.

Names and addresses of manufacturers and dealers in articles described in this magazine will be furnished by our Bureau of Information upon request accompanied by stamped, self-addressed envelope.

Wandybeke Werkzeug & ml. P. C. Watkins, Super Power Co
40. Kuzge Reiche. Wandebek na Hamburg German

es 138 138
es 131
Natural supplied by Lighter Chile Co. 1901
Cob Road, Cleveland Ohio

Royal Air Force

Plane Fires Torpedo at Ships Attacking Coast

One important phase of the British coast defense is a squadron of fighting planes carrying torpedoes which are launched from the air against enemy warships. The torpedoes weigh 1,500 pounds and are capable of inflicting heavy damage on even the heavily armored vessels. The planes are specially built for this hazardous phase of warfare. The torpedo is fastened under the fuselage.

Right, British air corps men fastening 1,500-pound torpedo under coast defense plane. Below, plane swoops low and launches torpedo, which is seen dropping into sea aimed at side of enemy war vessel

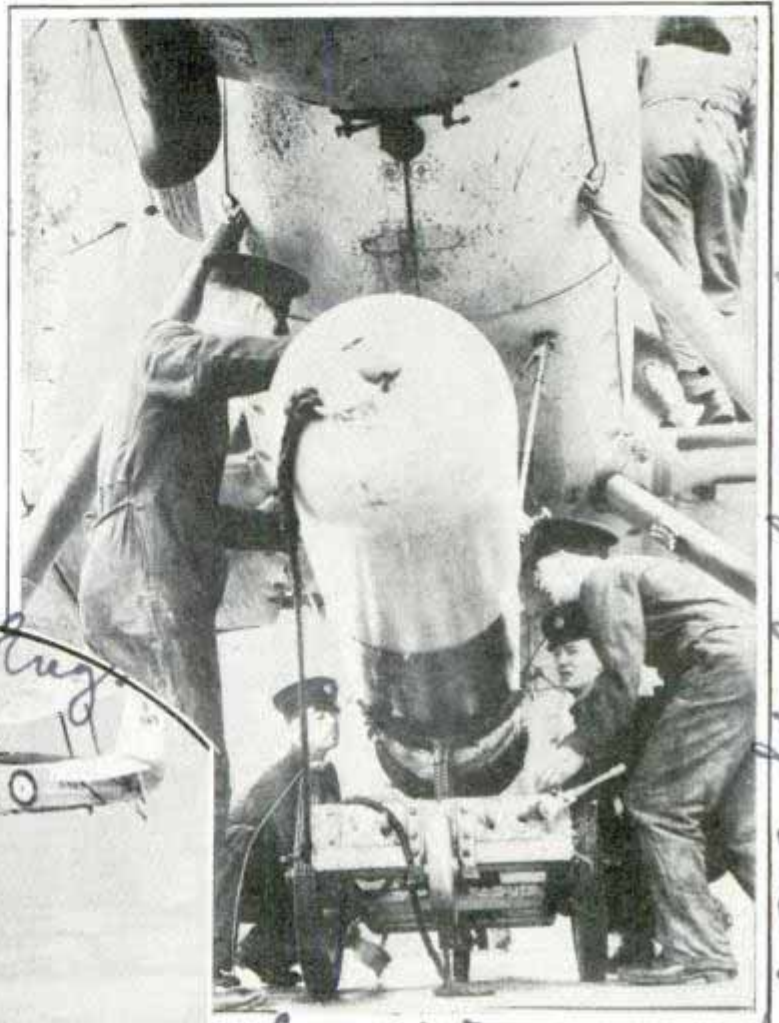

Isospart. Eng.

ls 173

20140

Bikes Break All Records.

Thirty million pounds of steel were used in more than 1,200,000 bicycles manufactured in 1936, the largest amount ever purchased in one year by bicycle makers. In 1899, the previous record year, 1,182,700 bikes were built, but only about twelve pounds of steel went into each, while the 1936 bike contains about twenty-five pounds.

Steel Facts

Fast Drivers in More Wrecks Than the Cars They Pass

Fast drivers head into more accidents than those who take it easy. Figures in Connecticut, at least, prove it. For six months traffic investigators recorded license numbers of cars, listing separately the drivers traveling faster than fifty miles an hour and those between thirty-five and forty-five miles an hour. Checking these

lists against accident reports, they found that thirty per cent more of the high-speed drivers had accidents than those in the moderate group, and the total number of accidents by fast drivers exceeded the slower group by forty-five per cent, without taking into consideration the severity or responsibility for accidents.

Survey of Service

Committee on Transportation. Yale University, New Haven

350 million tons of steel distributed in 1936

Guitar with Tone Control Sounds Like a Harp



Here is the radio guitar. Note tubes which amplify tones from the strings

Equipped with seven strings instead of six and with a tone control, the latest guitar produces music much like that of the harp. A supermagnet mounted in rubber creates a magnetic field from which vibrations from the strings are picked up and transmitted to an amplifier with tone control. Pick noises are eliminated and the tone softened. Called the "radio guitar," it is held on the knee instead of under the arm when being played.

Instantaneous List Finder Ends Tedious Work



Tedious thumbing of sticky pages is eliminated by an instantaneous list finder by means of which lists of telephone numbers, customers' addresses, rates, recipes, prices and

other frequently consulted memoranda are made available. To find any certain list of

names, the user slides a red arrow to the letter or numerical figure desired. Then, when a spring at the bottom is pressed, the device lifts the top leaves and snaps open at the page wanted. This is accomplished in two seconds. Made of molded plastic with aluminum trim, the list finder has a capacity of 1,380 names or items.

Model of Hotel on Road Sign Latest in Advertising

To increase the effectiveness of a roadside signboard advertising a Lakewood, N. J., hotel, a model of the hotel has been built against the board. At different hours of the day the sun throws different sides of the model into shadow, creating an illusion of reality. The outer edge of the model is supported by a two-by-four post painted white. The color of the post blends with that of the lower part of the advertising sign, making it almost invisible a short distance away. Thus the hotel appears to be unsupported.



Viewed from the road this model of hotel presents a realistic appearance

Bates Mfg. Co. Orange N.J. 30 Vesey St. New York

See page 4 of same

Eustice, Neb.

5124

may flower

Engine Builders Speed Up in Aviation Boom

Working at top speed to supply the military and commercial demand, airplane engine builders are producing hundreds of big power plants. Floors of factories are lined with giant cylinders which will be fitted into place on powerful engines. In some plants the big engines, some of which develop 1,000 horsepower, are ready to be installed in fighting planes ordered by the army and the navy. Pratt and Whitney, for instance, is building 794 engines for the navy and the Wright factory in New Jersey has an order for 180 power plants for the navy, in addition to a larger one from the army. One item in the army order is for 150 of the 1,000-horsepower models, the most powerful built by the company.

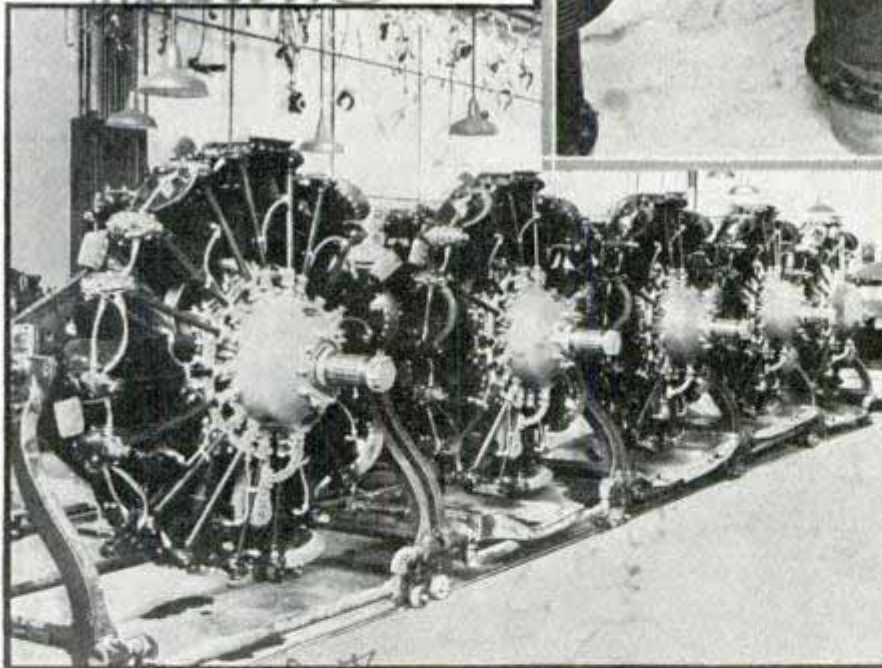

Write World

Top, row upon row of big cylinders ready to be incorporated into powerful airplane engines. Left, some of the giant motors assembled, waiting to be installed in military or commercial planes. Assembly of these engines is a job for experts

Rivers Polluted by Acid Seeping from Abandoned Mines

Engineers are endeavoring to stop the costly pollution of the Ohio river and its tributaries by sealing off abandoned coal mines which every day pour an estimated 20,000,000 pounds of concentrated sulphuric acid into the Ohio. Oxygen combines with iron sulphide in the mines to produce, eventually, iron oxide and sulphuric acid. The Monongahela river is

distinctly acid because of seepage. Purification plants for city water supplies far down the Ohio are affected detrimentally, and docks, dams, locks and even ships deteriorate excessively in acid waterways. By sealing the mines, the engineers hope to cut off the oxygen supply and decrease sulphuric-acid production, and to keep surface water from entering the mines.

Acid mine seepage

E. H. Tisdale, Director, Division of Sanitation, U. S. Department of Health

State health Dept.

404 N. Wells Chicago

Double-Decked Streetcar Has Booth for Driver

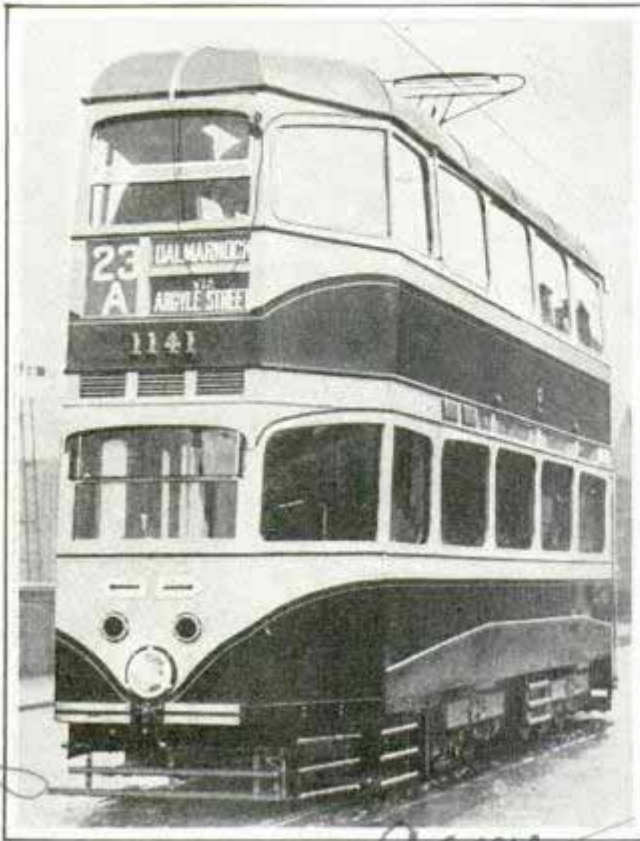

Here is the latest streetcar in Glasgow. Note the full-vision driving compartment

With its driver in a small booth or compartment which protects him from weather, the double-decked streetcar has been introduced in Glasgow, Scotland. The car has front and rear entrances, fog lights and direction indicators.

Adjustable Needle for Hook Rug Makes Stitch of Any Length

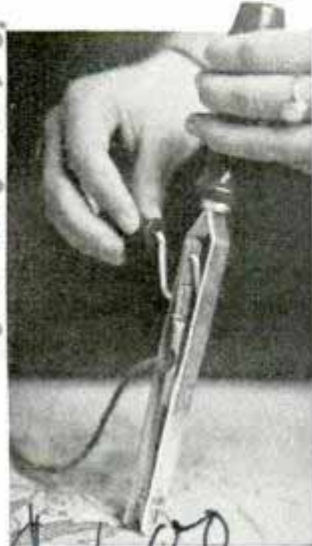

Making hook rugs is simplified by an automatic needle now available, which can be adjusted for any desired length of stitch and saves much material. The needle has two points, the yarn feeding down through a hollow shank. It can be operated at a fast

pace, stitches spaced accurately by turning the handle which pushes the needle's eye partly through the base fabric and loops the yarn evenly on the under side. There is no up-and-down movement of the main frame and handle.

Non-Skid Deck Coating for Boats Is Waterproof

Handy kits of cold asphalt in liquid and plastic form are offered the boat owner for applying to decks and cabin roofs. This material makes the deck less slippery, and is waterproof and durable. It is colored with mineral pigments which will not deteriorate, and the deck coating contains no oils or solvents. The maker claims it will not soften, crack or peel away. No special training nor equipment is needed to apply the asphalt.

Lightweight Air-Cooled Engine Produces High Power

Designed with few moving parts, a lightweight air-cooled engine operating on the double-action principle, holds the possibility of application to aviation and the

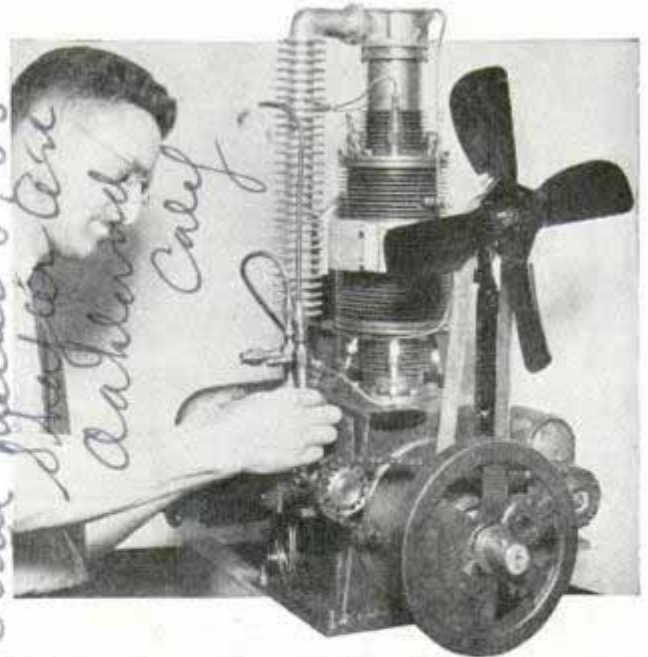

Double-action engine of light weight produces high power. Note cooling fins

automobile. The peculiar design of its pistons and cylinders provides for interior cooling, eliminating the necessity for a cooling system in which water or other liquid is used. Double action, which pro-

*Perfecto Rug Needle Co
5620 S. Lafayette
Portland Oregon*

\$7.00

*Paul Miller 5955
Shafter Ave
Oakland Calif*

vides a power impulse at both top and bottom of the stroke, is obtained with a conventional connecting rod between the piston and the crankshaft, greatly reducing the length, bulk and weight of the whole engine. As a result, cost also is reduced. The shape of the combustion chamber makes more practical the use of the two-cycle principle, which together with the double action, gives a highly concentrated, lightweight source of power. One model of the engine, weighing 120 pounds, produces thirty horsepower.

Es 122

Three Tanks Form Roof of Oil Man's Single Garage

Needing some elevated tanks and a garage for his pleasure car, an oil dealer in New Jersey combined them. He built a garage with three tanks forming the roof. An elastic seam compound was poured into the spaces between the tanks, and the roof is leakproof.

near Freehold.



Garage built by oil dealer has three tanks for its roof, the seams made leakproof by elastic compound

Es 66.

Tree Top Measured on Ground to Predict Possible Growth

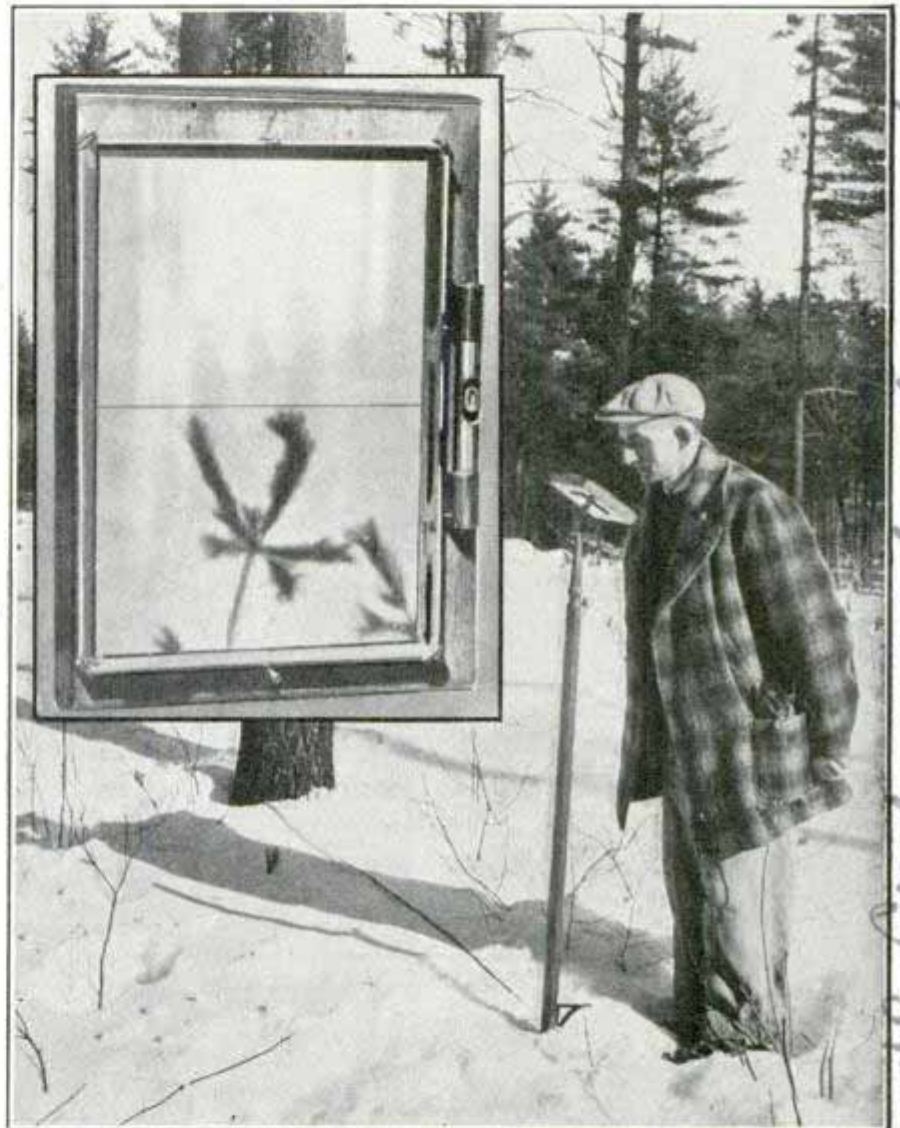

Forester measuring tree top with simple instrument. Inset, how top of tree appears on the measuring mirror

With the aid of an instrument called the reflecting crown meter, foresters may measure the tops of trees up to 100 feet high without leaving the ground. By measuring the "spread" at right angles it is possible to ascertain the possibility for future growth and to determine which tree should first receive attention of wood choppers. The instrument consists of a small mirror mounted horizontally on a four-foot Jacob's staff. This staff is pushed into the ground beneath the outermost points of the tree's crown. Reflections of these crown points are located by a center line on the mirror and lines are drawn joining the points established by the staff to form a reproduction of the crown area.

Developed by James H. Cupper, Inglewood, in forestry in Massachusetts State. Collect. Amherst, N.H.

es 16. / Wm. de Cerville, 875 N. Mauris
Oak Park, Ill

LITTLE BUGS

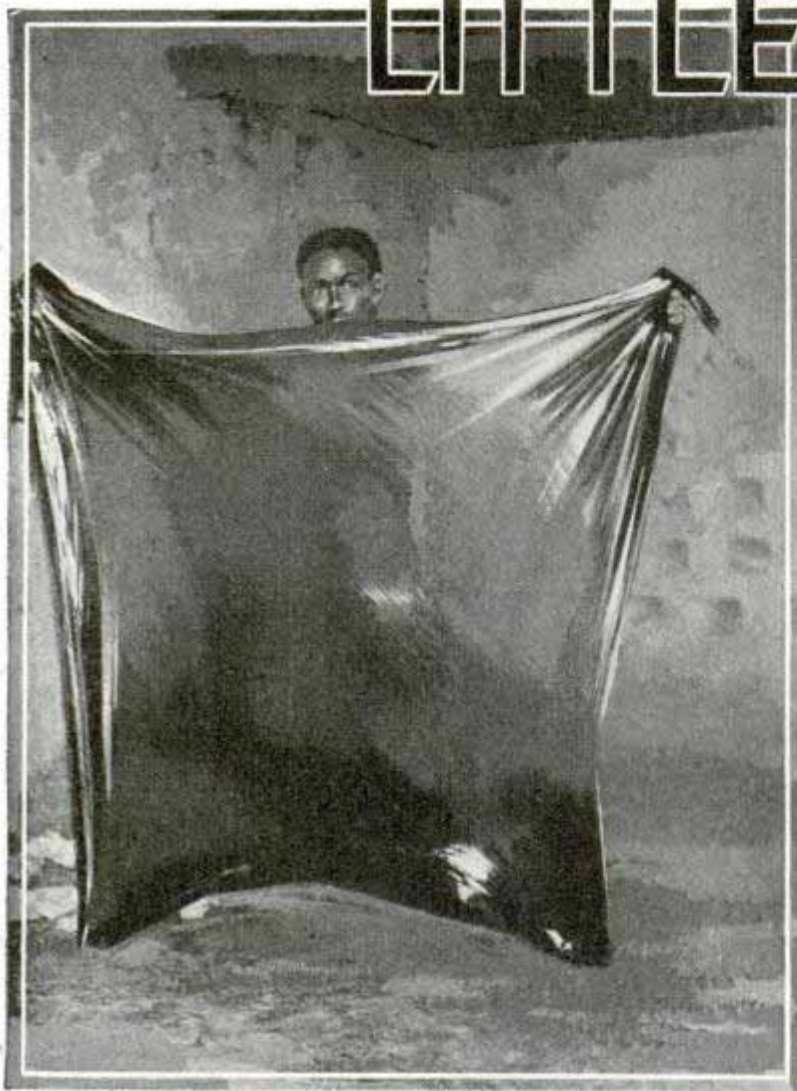

PLAGUED for centuries by insect pests, man today classifies all bugs as bad bugs. And why not? Locusts, grasshoppers, ants, flies, beetles, borers, moths, mosquitoes and a host of other flyers, crawlers, skippers and jumpers poison his body, ravage his crops, devour his food, ruin his clothing and even destroy his home.

But there is at least one exception to take the curse off insects, an anomaly of nature, a beneficent little bug which works for man, an insect in industry, a bug whose product has become a big business. The world used more than 67,000,000 pounds of this industrious insect's "handiwork" in 1934 and paid up to a dollar a pound for it. And one pound represents six months of work for each 150,000 bugs hatched.



Above, toes, teeth and hands are used by the expert natives of India in stretching the shellac into sheets. Below, sifting and sorting the stick-lac

and **BIG BUSINESS**

Right, squeezing molten lac from bag in front of fire. Below, exporter buying stick-lac. Price is kept secret by using fingers under cloth to settle value

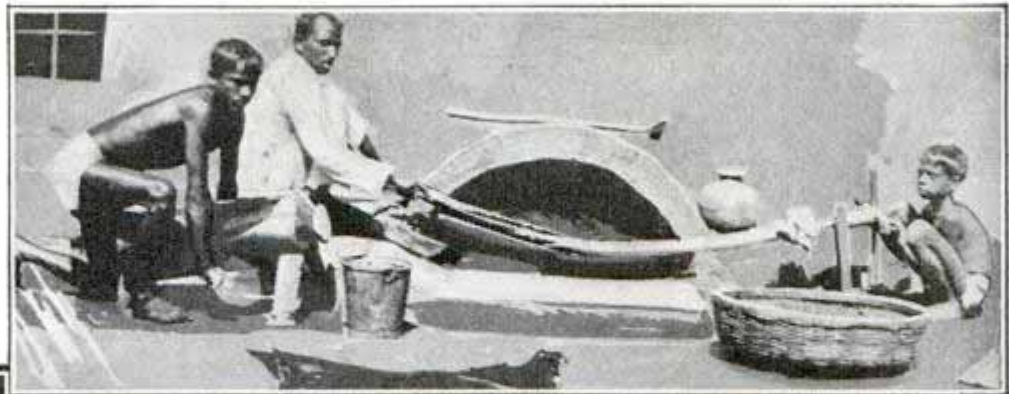

Laccifer lacca is the euphonious name of this little insect which is important to man because nature endowed it with a trade secret—a formula which man has tried in vain to duplicate. The lacca family knows how to make shellac, one of the most efficient wood preservatives. Man has used shellac for hundreds of years. He has tried repeatedly to make it synthetically, but the best he has been able to do is to produce substitutes. Mr. and Mrs. Lacca still retain the world monopoly on the shellac business. When man needs real shellac today, he still must rely on a bug—and like it.

Not only has man failed to discover how the bugs make shellac; he has also failed to improve very much on the primitive way of extracting the commercial product from the substance the bugs non-

(Continued to page 146A)

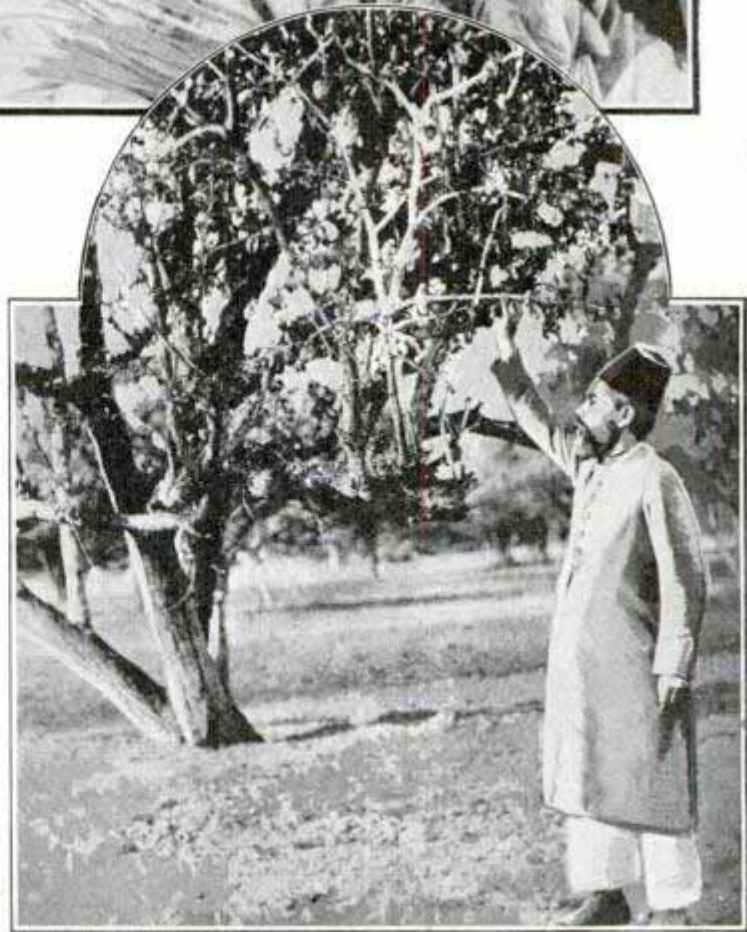

White streaks on this plum tree indicate it has been inoculated with the lacca insects which in six months will produce a crop of gum

Engine Delicate as a Watch Built on Jeweler's Lathe



Its parts turned on a jeweler's lathe, this four-inch locomotive is run by a six-volt electric motor

Building a four-inch locomotive that runs is as delicate a job as making a watch. Squinting through a jeweler's eyepiece as he worked, a model maker spent three months fashioning a miniature engine of the Central Railroad of New Jersey, weighing one and one-half pounds and developing a drawbar pull of four pounds with its six-volt electric motor.

Chandelier Holds Organ Pipes Hung from Ceiling of Home

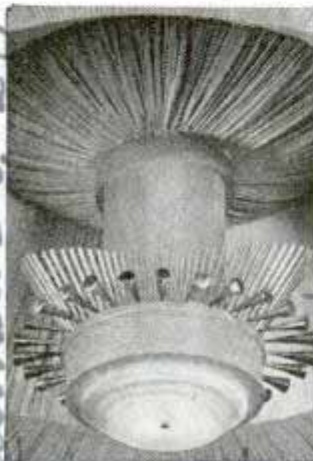

To install an organ in the limited space of a modern dwelling, a German pipe-organ builder combines the pipes with a chandelier suspended three feet from the ceiling of the room. There are 138 pipes, including twenty-

seven woods, grouped around a cylinder which contains everything except the console. At the bottom of the chandelier is a bowl-shaped lamp. The ceiling and upper walls are draped for sound reflection, adapting the organ to rooms otherwise unfavorable acoustically. The console occupies less than a cubic yard.

Beverage Dispenser Fits Bottle and Pours Without Spilling

Fitting over the top of the decanter, a beverage dispenser pours liquid in any quantity desired at the touch of its cap. A full glass is poured by pressing the cap all the way down, and a half glass by pressing it half way. If too much is poured, it can be withdrawn from glass to decanter. It does not drip nor spill.



Oil Drums Protect Shrubbery from Damaging Winds



Storm guards for shrubbery shown in place. After storm passes they can be removed

Empty oil drums cut in half have been found excellent protection for shrubbery subject to damaging winds, such as those along the seacoast. Two lengths of pipe,

*Hollywood
Alexander Wood
72 22 Melrose Ave
Los Angeles
Model Craft Supply Co*

*Commercial Day
when Corp
1900 S. 24th Cleveland
Ohio*

Es 155

Es 123

Es 145

*Lothar Hintz
Blumenstr. 224*

*Frankfurt a. Oder,
Lokmann*

bolted to the half drum, permit the home owner to anchor the shrubby shelters until the storm is over. Then the drums may be pulled up and stored until needed again. Sand blown by high winds frequently destroys privet bushes and other shrubbery around homes near the ocean.

Heater for Wet Race Track Puts an End to Muddy Turf

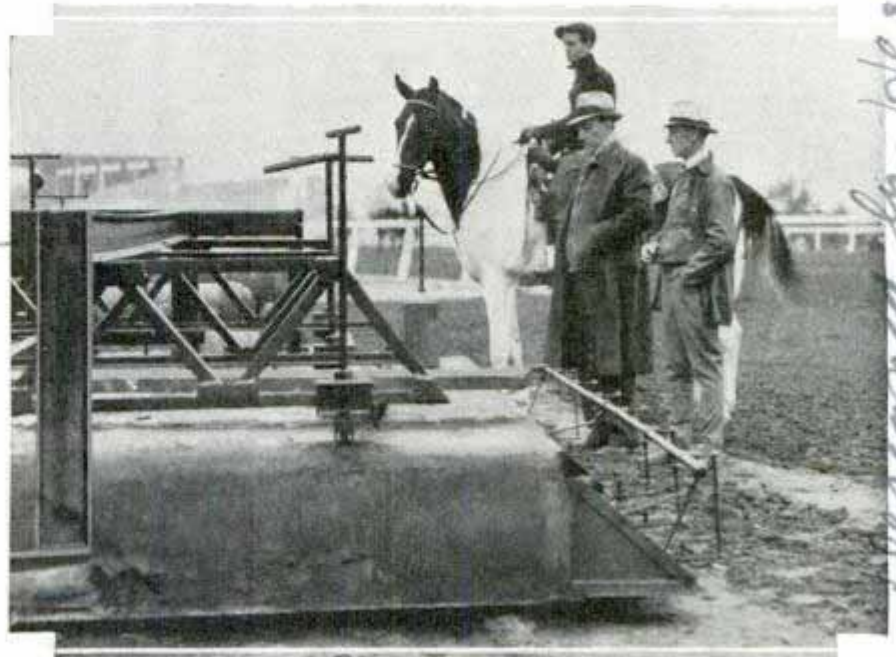

Soggy race track is "ironed" dry by this machine. Drawn over the turf, its steel plates heated to 3,000 degrees Fahrenheit bake the track.

201 75

Worn Stair Treads Renewed by Cold Asphalt Filler

Stairs that have been hollowed and worn by long use can be leveled off with a cold asphalt product now available. It is furnished in plastic form, in various colors, ready for application without requiring any special skill. It is a long-wearing material and is especially valuable where a non-skid step is desired.

82

Memo Pad Is Lighted by Bulb When Pencil Is Withdrawn

For jotting down notes in the dark, a lighted memorandum block has been developed. When the pencil is drawn from its holder a flashlight bulb is lighted, and switched off when the pencil is replaced.

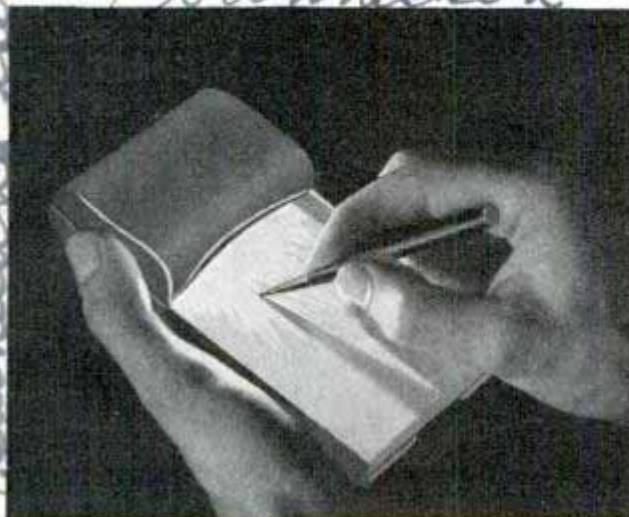

Memorandum pad is illuminated by a flashlight bulb which lights when pencil is withdrawn from holder

"Mudders" have seen their day if the race-track drier now being tried out is adopted generally. It is a huge machine similar to those used to melt asphalt in road building. The bottom is lined with steel plates heated by torches to 3,000 degrees. Drawn over a muddy track, it "burns" the turf dry.

13 4

Marker Imprints Golf Ball with Owner's Name

Printing the player's name on his golf balls is made easy by a handy marker patented recently. The work is done by the "point type" method, but the points of ink are so small that the wind cannot cause the ball to hook or slice by striking them. The ink is deeply imbedded in the surface of the ball, making the single impression permanent. A decrease in the number of golf balls lost through lack of identification is expected to result from use of the marker.

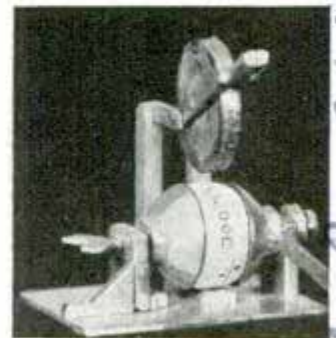

L. J. Wallace
Shawnee Sporting

209. Mrs. Miss U. L. White
 115 W. 70th, NYC

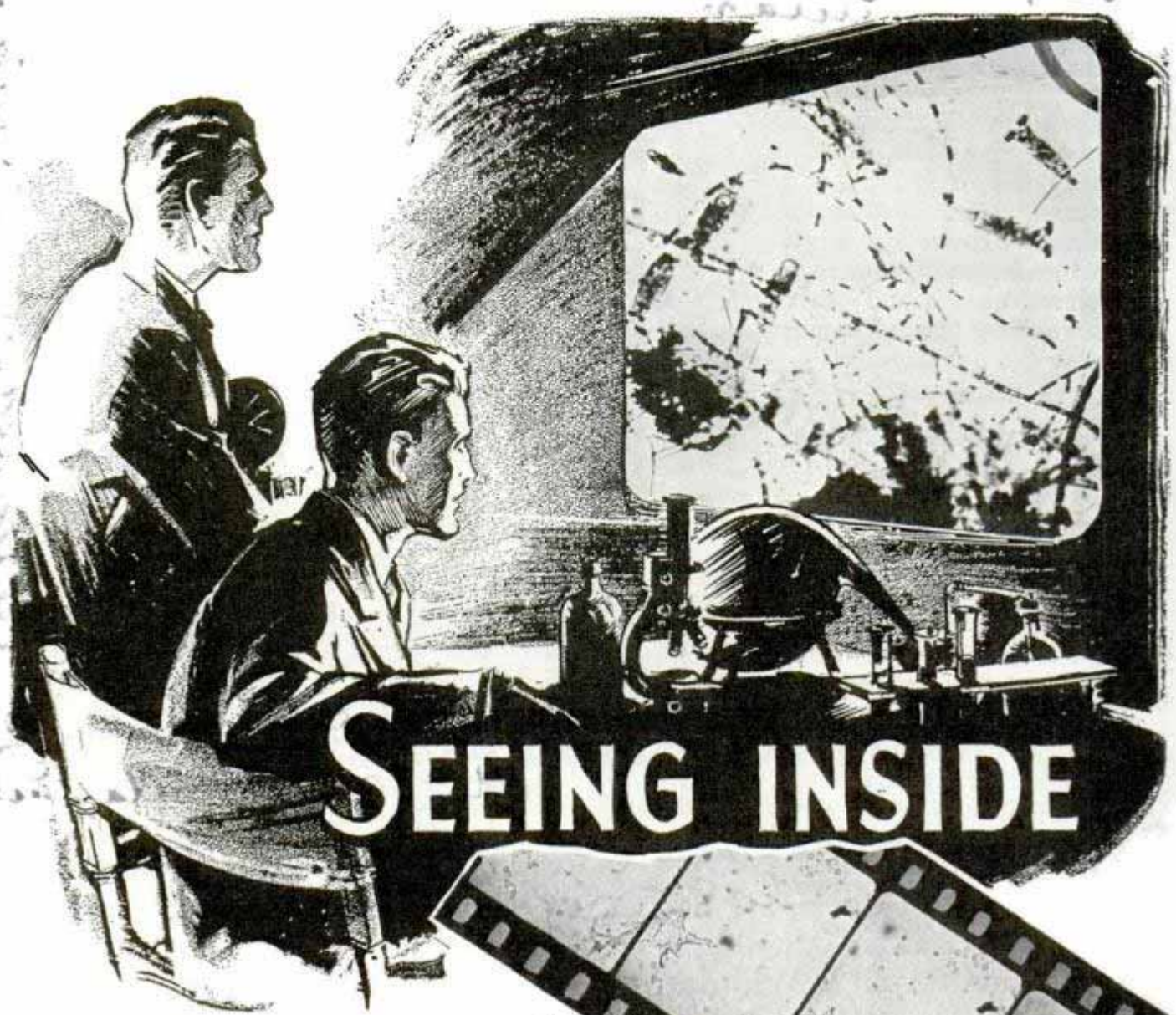

SEEING INSIDE

A RECENT motion picture, "The Magic of Oil," enables the spectator to see inside two drops of oil and to observe how temperature changes affect the oil in a motor. The whole picture, scientifically accurate in every detail, was taken with a special camera built onto a microscope, magnifying as much as 2,000 diameters.

The picture enabled an oil company to demonstrate the effects of a new ingredient added to ordinary motor oil. At low temperatures the wax in motor oil forms crystals large enough to interlock, making the oil stiff. But the addition of small quantities of the new ingredient to ordinary motor oil, the picture showed, kept the wax crystals small and round, not touching each other. Oil so treated remains more fluid at low temperatures. Microscopic views of oils at twenty degrees below zero were shown on the screen, and in making these several weeks

Top photo courtesy Erpl
 Strip shows large cell absorbing small one.
 Above, micromovie "still" of animalcules in pond water

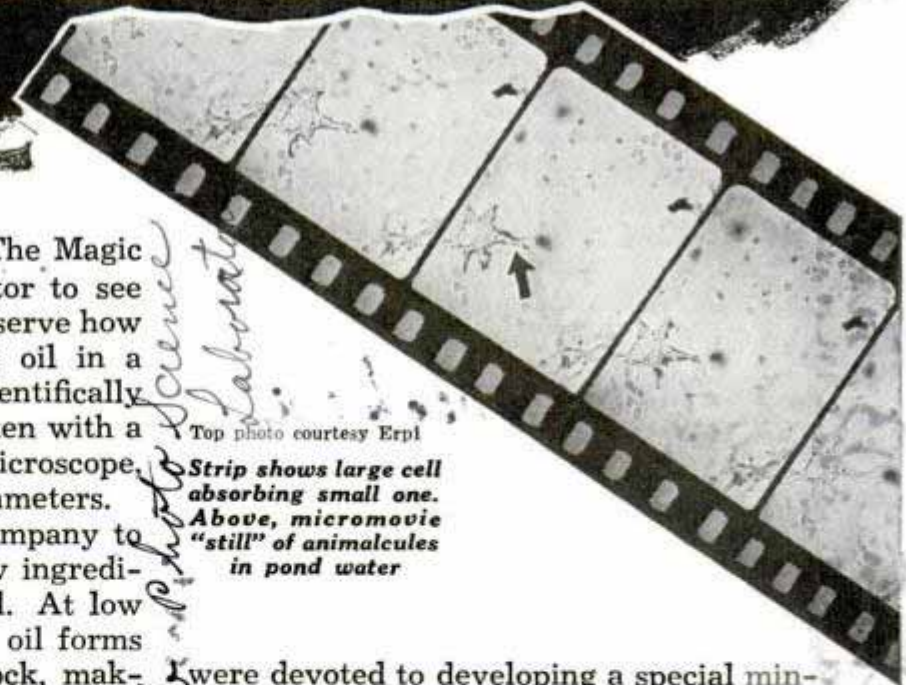

were devoted to developing a special miniature refrigerating unit to cool the oil on the microscope.

Pictures that disclose the inside workings of very small particles and organisms are not trick photography, but the result of the scientific development of "microcinematography." In a laboratory in Connecticut, Dr. Henry Roger, one of the country's specialists in this art, and his as-

Road Photo Science Laboratory

Sandy Hook
 Conn

25.9

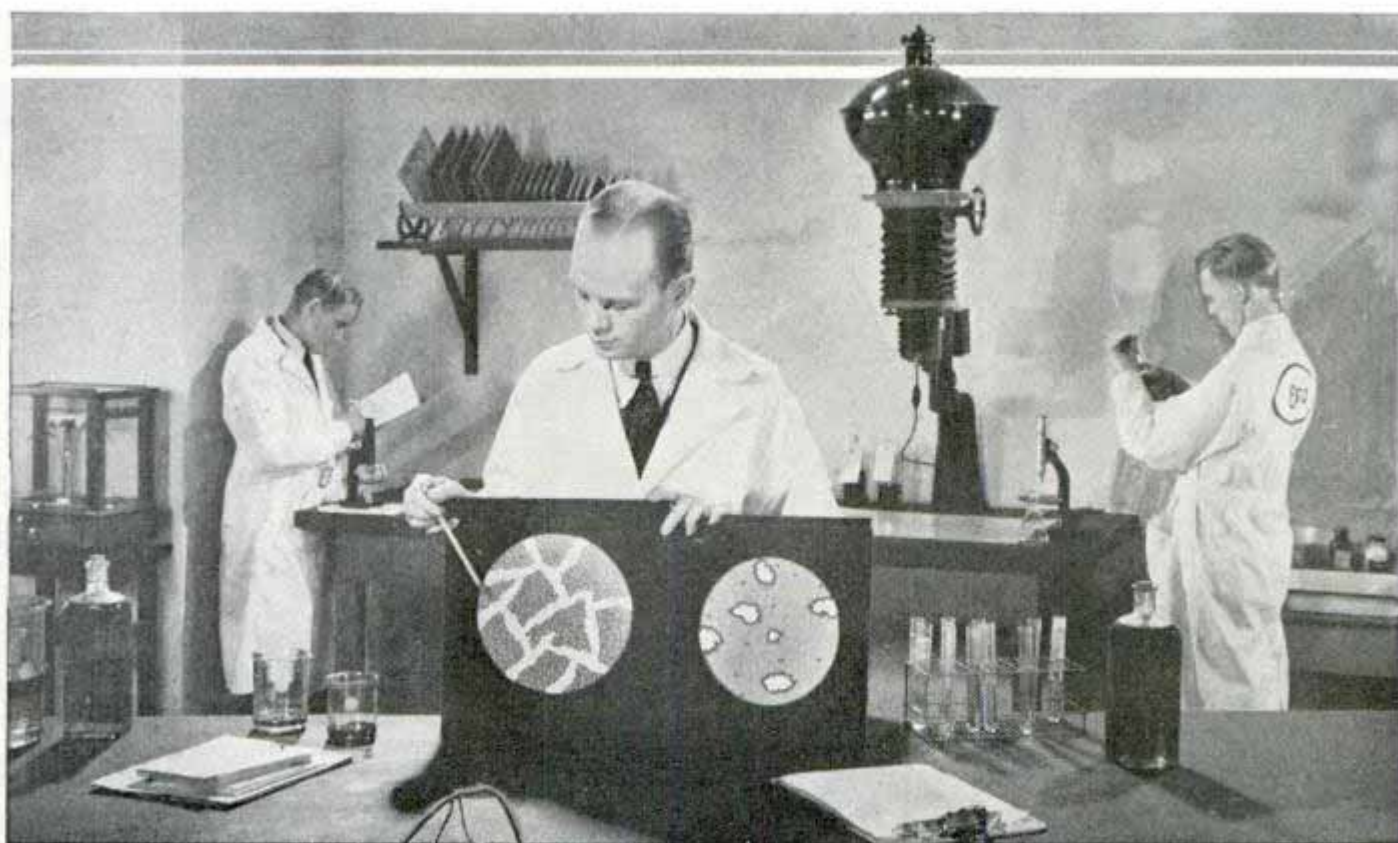

a DROP of OIL

Top photo courtesy "Esso"

Above, chart showing difference in wax in drop of treated oil and drop of untreated. Left, housefly greatly magnified and strip showing division of white blood corpuscle



sociates work with special apparatus combining the advantages of the microscope and of the motion-picture camera. With this equipment and many special types of cameras they produce scientifically accurate microphotographic effects.

Micromotion-picture photography differs from ordinary microscopic photography. In the latter the specimens are inactive or dead and are often stained or otherwise prepared to show structural details. The material for micromotion pictures is active and must be kept under its own normal conditions while being photographed. This work is complicated by the fact that living material is extremely delicate and sensitive to light and heat, and when active objects are magnified, any vibration of the microscope, itself, would be magnified in the same degree. Precautions, therefore, must be taken.

The standard equipment now often used for this work has been evolved by a slow

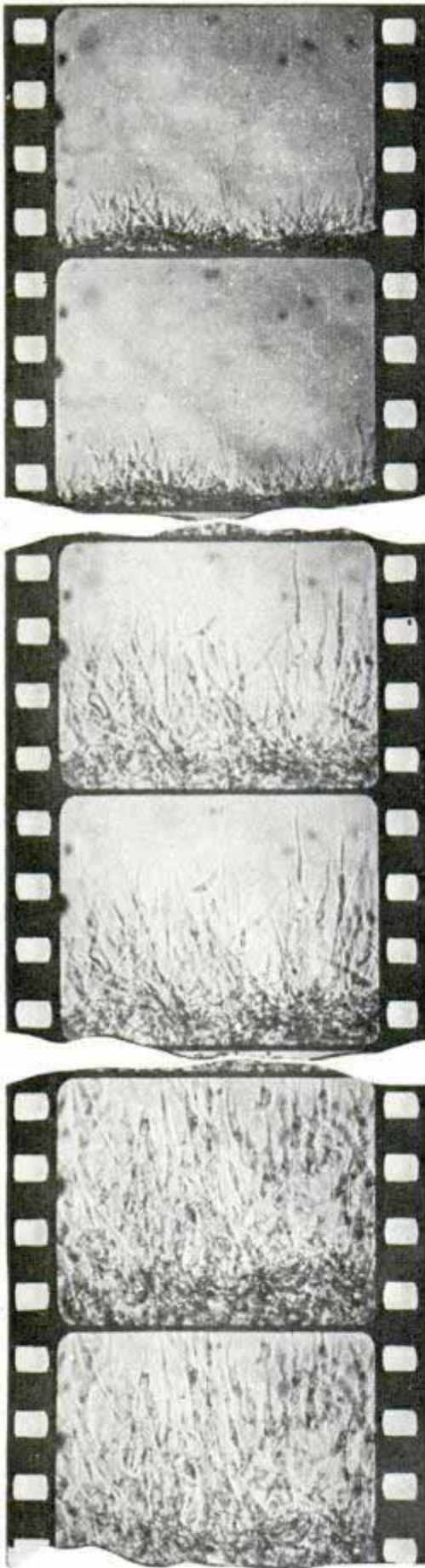

Micromotion picture apparatus and strips showing various stages in the growth of living tissue as recorded with the aid of this equipment

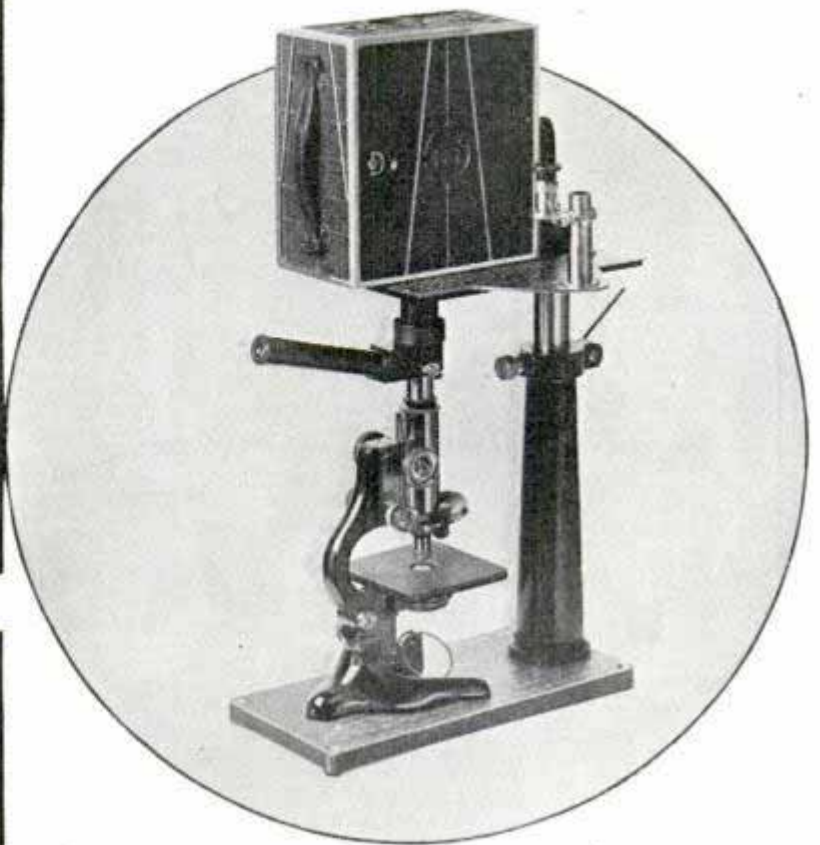

process of development over a period of about twenty years. The operation of this apparatus is as simple as possible without sacrificing accuracy. To avoid vibration as far as possible, the standard equipment is heavy, largely made of cast iron, and vibration absorbers are placed under the legs of the optical bench and of the camera support, making these units "floating."

Dials and timing devices are used for setting the time intervals, per hour or per minute, and a time clock makes it possible to start and stop the apparatus automatically at any predetermined time within twelve hours. The whole apparatus can be set to take successive photographs automatically as the object under observation develops and changes. A chart shows the time required for photographing any material, in terms of length of film, number of images and rate of exposure. In working with tissue cultures and bacteria, it is necessary to control the temperature. Consequently, the microscope is surrounded by an incubator which can be removed and replaced in a few seconds without touching the microscope.

Micromotion pictures are used for research, for educational purposes and in various ways in industry. They have even been introduced as evidence in law courts. Amateurs sometimes take up this art as a hobby, often using a machine which takes a sixteen-millimeter picture, instead of the standard thirty-five millimeter.

This type of photography has helped scientists

Making micromovie of drop of motor oil while holding temperature of oil at twenty degrees below zero and, below, culture of white blood corpuscles just removed from the blood

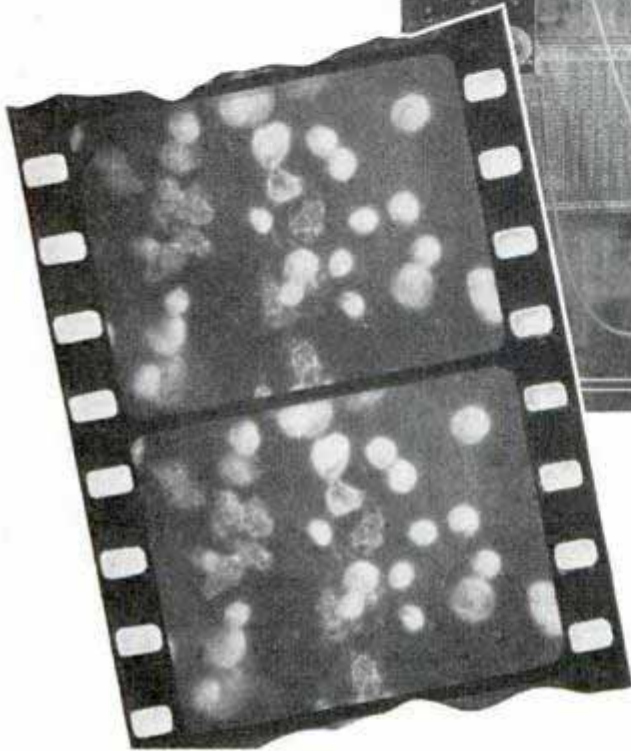
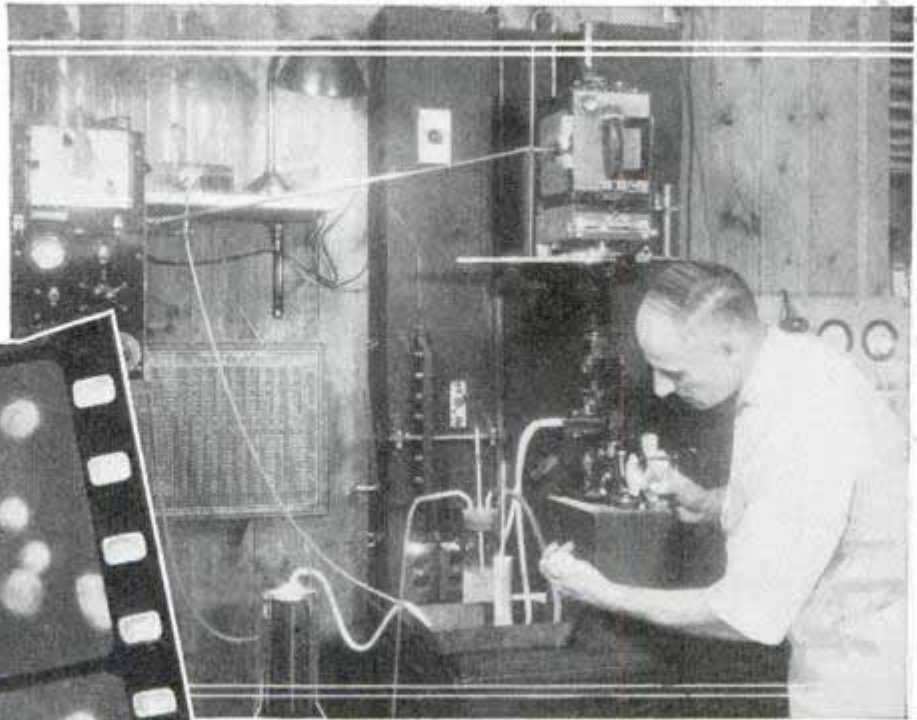

learn about living cells of blood and tissue, bacteria, and various diseases and has been particularly helpful in the study of cancer. By means of these photographs an important discovery was made concerning the action of the white corpuscles of the blood. For many years it had been known that these white corpuscles combat infection but scientists could not understand the ability of a white corpuscle to "scent" bacteria or dead cells even when these were at a considerable distance. Micromotion pictures revealed an undulating membrane many times larger than the cell itself, and surrounding the white corpuscle. When a foreign body comes within this membrane, the white corpuscle is after it.

Many film records taken for research have never been used with a projector but have been made in order to study, frame by frame, every minute change in specimens under observation. By the projection of micromotion pictures we learn new facts about all sorts of things hitherto hidden from our gaze. Because of the microscope and time-lapse photography we can

see a plant unfold before our eyes, learn about lower forms of animal life, or be warned in graphic form of certain dangers to our health from the spreading of germs.

By one such picture the housewife is warned of the danger from the common housefly. The life development of the fly is shown, its habits, and how it spreads disease by carrying germs to food. Scientific educational films are becoming an important part in modern teaching and the demand is growing for accurate films for use particularly in the natural sciences—physics, chemistry, biology and entomology. One picture shows the growth of the pea plant from the time the seed first sends out its root and stalk until the ripened seeds are scattered. Another gives the entire life cycle of the frog.

Appreciating the effectiveness of these micromotion pictures for revealing unrealized qualities of various products, business men use these films in production studies and for advertising purposes. By means of these pictures the food industry can study conditions in packing and canning. Fermentation and the effects of refrigeration are revealed, and the durability of various metals and paints under certain conditions have been determined. One soap manufacturer has recently used micromotion pictures to emphasize the necessity for cleanliness and from other such films we learn of the effects of face creams and powders on the skin.

*Highway Carriage Corp
3100 S Redzie
Chicago*

20/28
**Ice-Cream Slot Machine
Sells Five-Cent Brick**

*Borden's Ice Cream Co
2350 7th Ave. New York*



While waiting for a subway train, a customer drops a nickel in the slot and gets an ice-cream brick

Ice cream is now for sale in slot machines. Drop a nickel in one of the vending machines in the New York subway stations and you receive a five-cent brick. Dry Ice keeps it properly refrigerated.

20/154
**Brake-Lining Mortar Solves
Replacement Problems**

*Benders Product
Corp Benders Lignite
and*



Sand Cement

By using a new mortar the repairman may build a firm foundation for the lining and solve problems incidental to automobile brake replacements. The mortar fills and

hardens in any irregularities in the brake-shoe rim incurred in service or in the liner segment through fabricating processes. The mortar eliminates the spongy feeling in brake operation, retards tendency to-

ward brake "fade-out"; helps to eliminate brake friction noises and prevents moisture from getting between the brake-lining segments and the brake shoes.

20/106

**Refrigerating Unit for Truck
Uses "Dry Ice" and Alcohol**

Substantial payloads of meat or other perishables can be kept at twenty-seven to forty-five degrees in a Dry Ice, thermostatically controlled refrigerating unit designed for trucks. The Dry Ice chills alcohol which circulates on the thermosiphon principle through a system containing a cooling surface similar to that of an automobile radiator. Small electric fans blow air downward through this radiator onto the payload. As the chilled alcohol is warmed by this air, it automatically rises in the system and its place is taken by colder alcohol freshly drawn from the bottom of the insulated Dry Ice compartment. The process continues until the temperature in the truck reaches the level at which the thermostat is set, at which point a valve stops circulation of the alcohol. The only power required for operating the unit is that taken from the truck storage battery to drive the small fans.

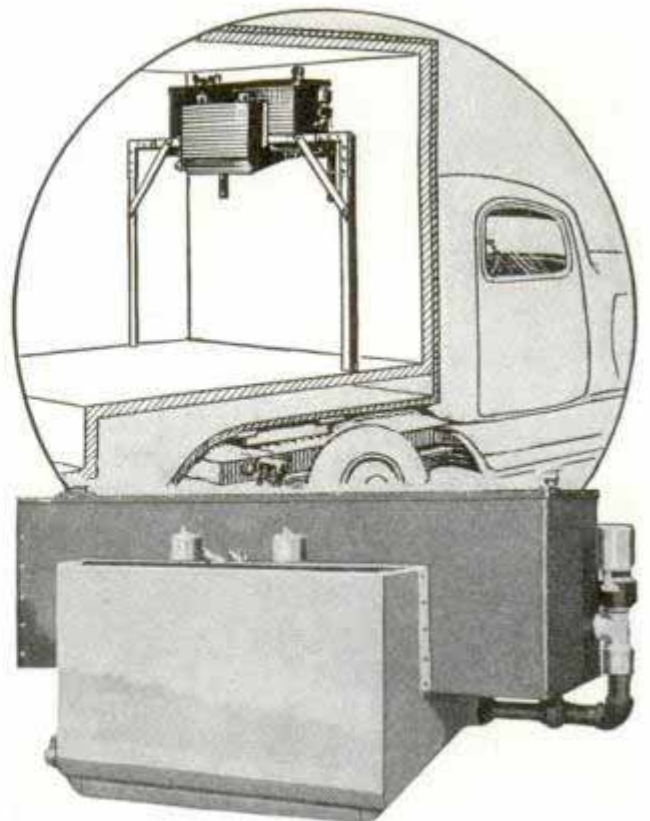

Refrigerating unit for truck. Sketch shows how it is installed in cooling compartment

20178 Air France, Channel Ferry
610 Flight One New York

Flying "Club Car" Is Channel Ferry De Luxe



Air France is building a fleet of luxurious air leviathans to ferry forty passengers between Paris and London. Main lounge, above, is spacious and has comfortable seats. Notice observation lounge in nose of plane at right



Passengers commuting by air over the English channel are served at a buffet counter, shown above, in the center of the flying "club car." Right, a view of the unique "winter garden" in the forward cabin of the "Farman 224"



Above, the library corner. The ship is powered by four engines, two of them mounted tandem as pushers. With top speed of 220 miles per hour, it will fly between Le Bourget and Croydon airports on seventy-minute schedules

Avion Identi and marque Farman, 1669 me de Filly Villamont - France

Handwritten notes at the top of the page, including the number "6889" and some illegible text.

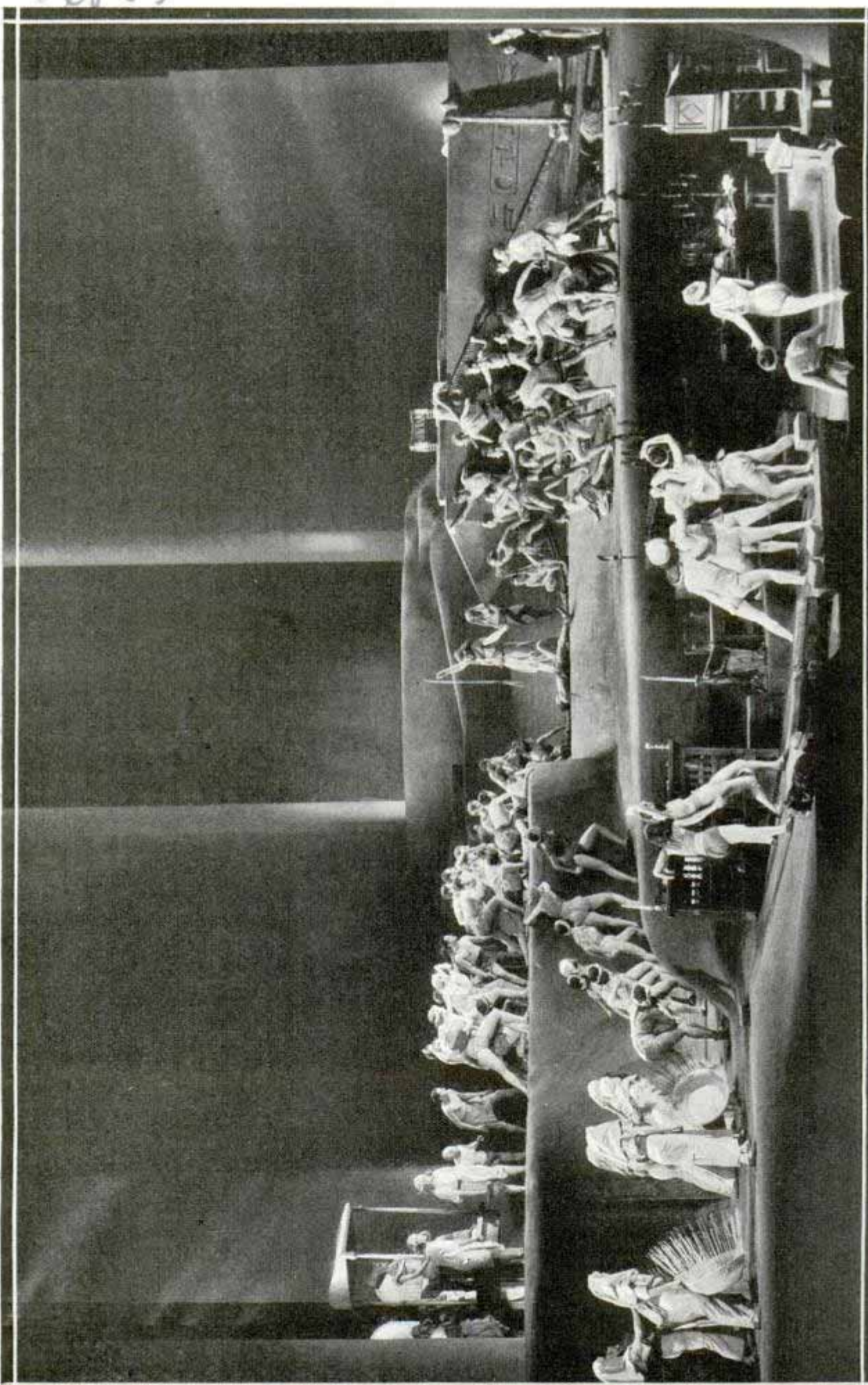

Spectacular scene from Max Reinhardt's stage production, "The Eternal Road," showing the revolt of the slaves in Egypt. On opposite page is a sketch of the same scene showing the location of each loudspeaker, which has been carefully concealed from the audience

es 83 Cmt. George A. Cahoon.
 2047 North Park Av.
 Phila.

SOUND ENGINEERS help the stage

A WE-INSPIRING effects for a Biblical spectacle in which 300 actors appear in a New York theater are achieved by sound engineers. From the "heavens" come angel choruses and the "voice of God," from some parts of the great stage are heard huge volumes of orchestral music and from other parts come choral numbers—all blended with scientific precision into the action and spoken parts of the big cast. Two men, working calmly in a sound-proof room in the dress circle, control all

(Continued to page 144A)

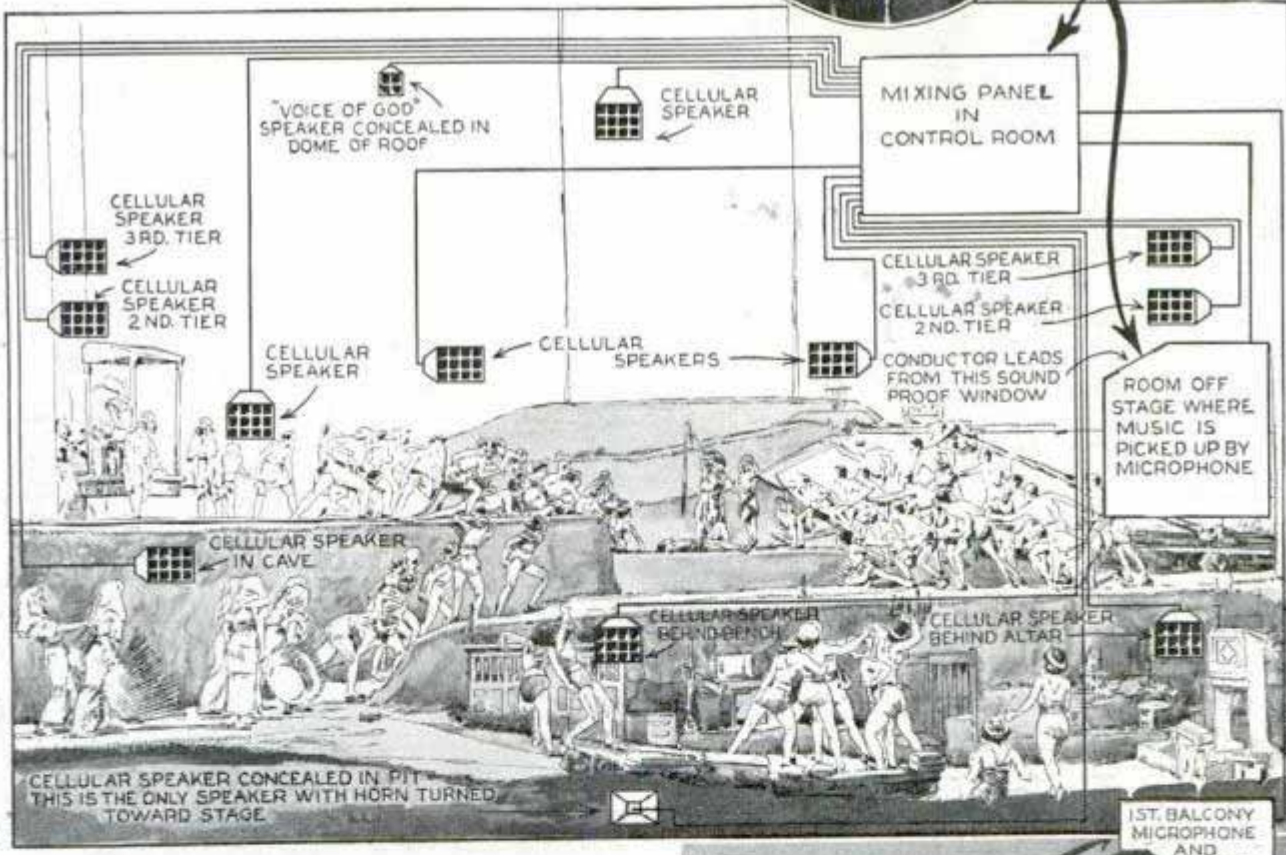

Here is a diagram of the slaves' revolt scene. Note the twelve loudspeakers, which are concealed from the audience. One, designated as "voice of God" speaker, carries answer of the Lord to praying people. Photo, top, shows mixing panel in main control room. Circle, Conductor Isaac Van Grove, Dr. Leo Kopp, his associate, and Kurt Weill, composer, during sound-film recording. Bottom, signaling from recording room



Worker Climbs Big Stack on Ten-Foot Ladders

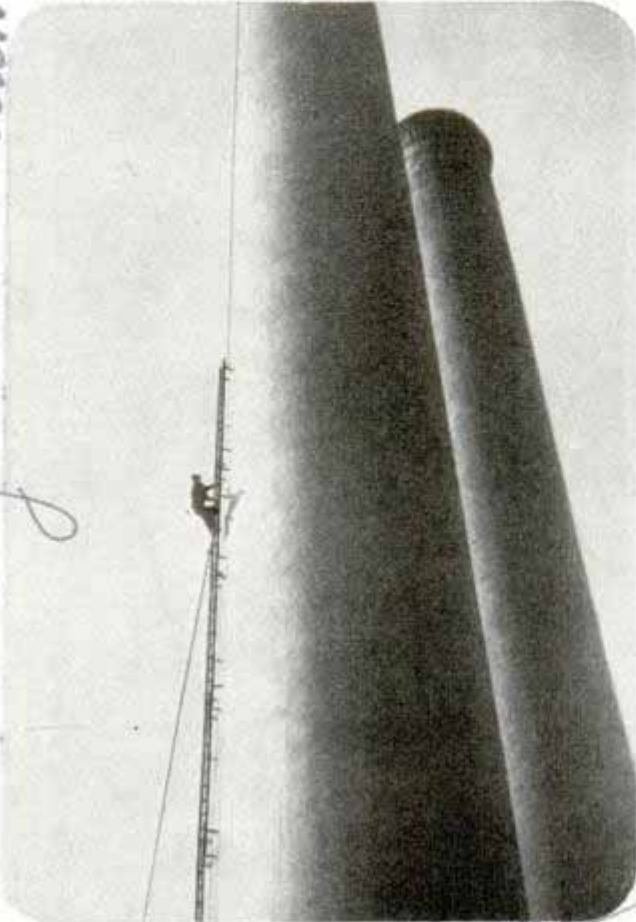

Intrepid stack worker on his way up giant chimney. Ten-foot sections fit into his ladder

Climbing to the top of lofty chimneys to make repairs is a job which requires unusual skill and daring, but the feat of a steeplejack who scaled a 285-foot stack in Washington, D. C., recently was almost too much for even the spectators. Using only ten-foot sections to build his ladder as he ascended, this expert calmly made his way to the very top of the Benning power plant's chimney to replace a broken lightning rod. His work done, he descended and the spectators breathed easier.

es 115
Argona
Lava Woods
at Benning Power Plant

tal cost to about \$1,750,000,000. Great Britain, Russia, Germany, France and Italy lead the European group in spending \$677,000,000; Japan and other Asiatic countries are spending \$99,000,000; Canada and the United States \$112,000,000, and Latin America \$20,000,000. All the countries will build 28,500 new planes. Of this total, 21,150 will be constructed by the United States, Great Britain, Russia, France, Germany, Italy and Japan. More than two-thirds of the American planes will be civil or commercial.

es 47

Trailer Brake Set by Valve on Car's Steering Post

Controlled by a valve lever mounted on the steering post of the tow car, the latest trailer brake is vacuum operated. The valve permits metering the amount of vacuum power desired to bring the trailer to a gradual stop, independently of the action of the automobile brakes. The lever is hand-operated. For down or upgrade parking, the lever can be locked to hold the trailer as long as the auto engine runs.

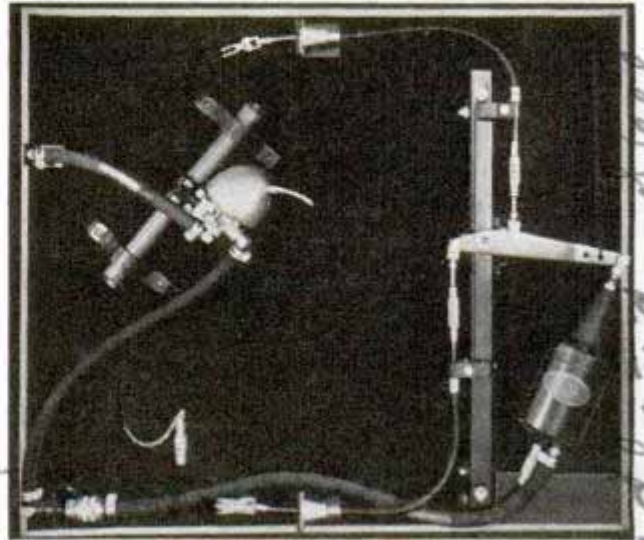

Top, trailer brake control lever is shown mounted under wheel. Bottom, the brake system

Billion Dollars for Airplanes to Be Spent in Year

Fifty-six countries are spending almost one billion dollars for new airplanes this year, according to estimates by the Bendix Aviation corporation. Four-fifths of this amount will go for military craft. Maintenance of air corps personnel and upkeep of airways and airports will bring the to-

es 182
H.A. Bruno and Associates
106 N. Cleveland

Washington
106 N. Cleveland

High-Definition Television Broadcast to City

Built in the suburbs of Philadelphia, the Farnsworth high-definition television station "shoots" its signals into the city, using directional broadcasting. Experimental broadcasts employing 441-line definition in its

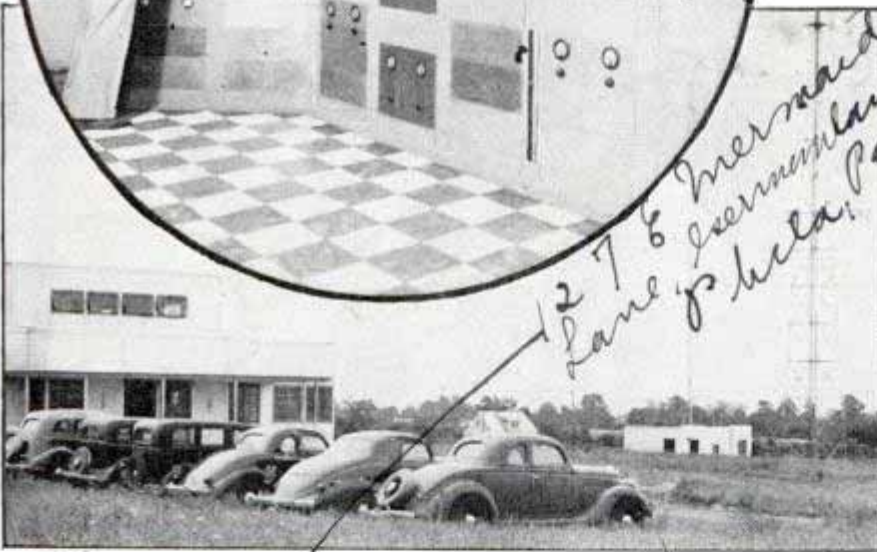
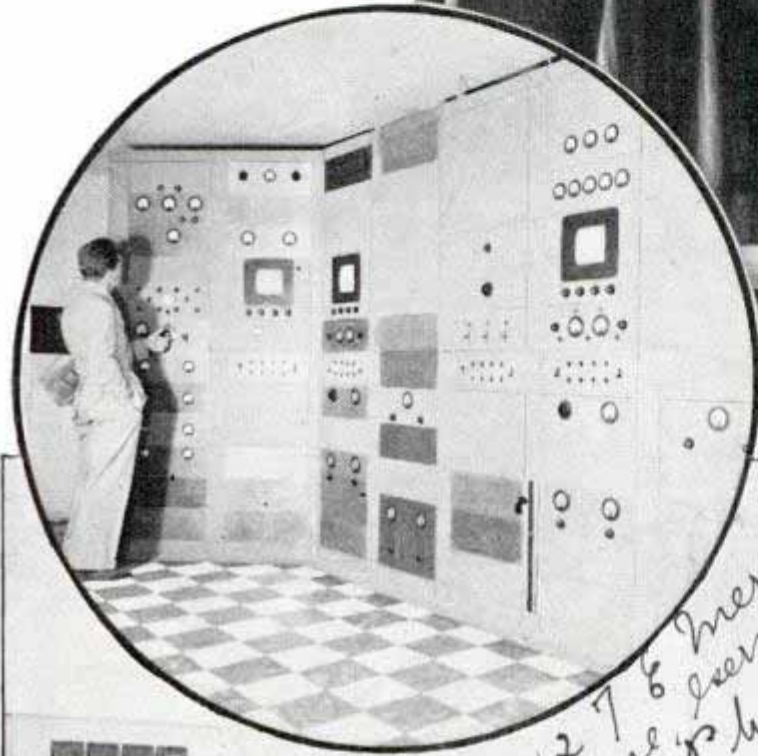
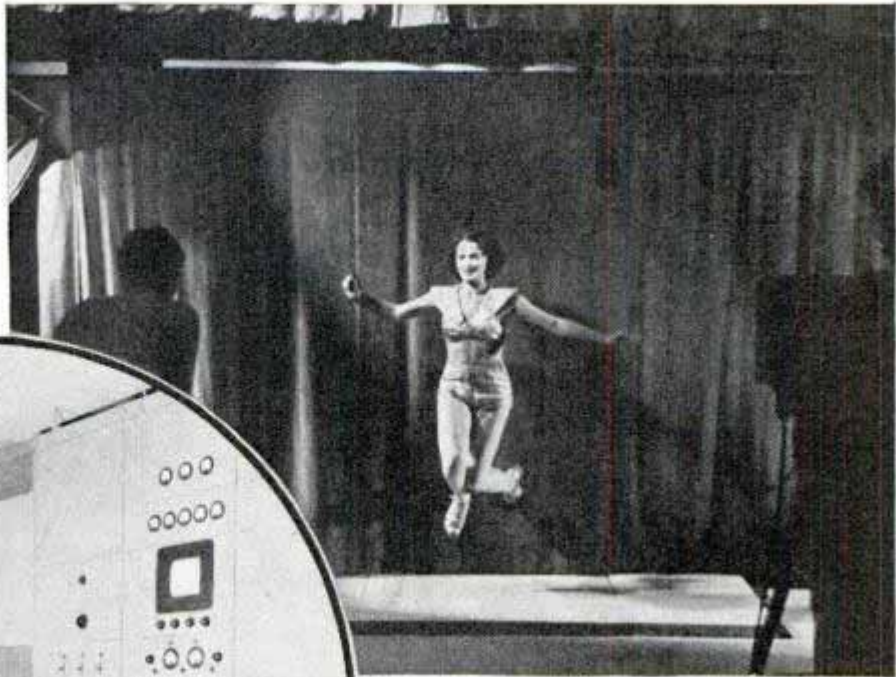

pictures are being radiated from a 150-foot tower situated on the highest point of land in the vicinity of Philadelphia. The station operates on 62.75 megacycles, the highest frequency ever used in television broadcasting, by means of cold-cathode tubes in the transmitter for modulating and amplifying over the broad band frequencies required. Experts believe directional broadcasting will minimize interstation interference when television stations are located in cities near by.

© Farnsworth Television, Inc. Top, performer before television camera. Circle, controls in transmitting room. Bottom, station and directional antenna tower

Flowers Are Kept Warm by Ice in Air-Express Shipment

Cut flowers shipped by air express are kept from freezing at high altitudes by coating them with ice. The flowers are packed in an ordinary shipping box wrapped tightly with wax paper, then surrounded with thirty thicknesses of newspaper which have soaked up about ten pounds of water. This again is wrapped in waxed paper to keep the moisture in, and the package then is placed in a paper-

board shipping box covered with fifteen layers of newspaper. In the zero temperatures of high altitudes the water-soaked paper freezes, liberating the "heat of fusion" of the water, which keeps the inside temperature above thirty-two degrees.

Oil production in the United States reached 1,090,000,000 barrels in 1936, sixty-three per cent of the world output.

Survival To Fisher Compressed Air magazine
Refrigeration Special
Jun. 1938

Es 20
2047 N. Park Ave
Phila

1276 Mermaid Lane, Germantown, Phila, Pa

2515

EASY CARD and ROPE TRICKS



4529. Malden St.
Chicago
By Anthony Marks
(Professional Magician)

THERE is an irresistible appeal in magic for everyone from six to sixty, and this is particularly true of card tricks.

Nearly anyone can perform at least one card trick and make a stab at others. People discover the secrets of card tricks more quickly than other forms of magic, however, so the beginner should confine himself to a few simple tricks learned to perfection rather than muddle through a routine in which he deceives no one but himself.

Card predicting meets with favor whenever it is properly presented, and here is a sample. Write the suit and number of two cards on a slip of paper and place in a sealed envelope. Then casually pick up a deck and flip the top card onto the table with its face showing. Ask some person to place this card in the deck, face up, stating you will predict the card above and below it. When the sealed envelope is opened, it is discovered that the two cards on the slip correspond to the suit and number of the cards between which the face-up one has been sandwiched.

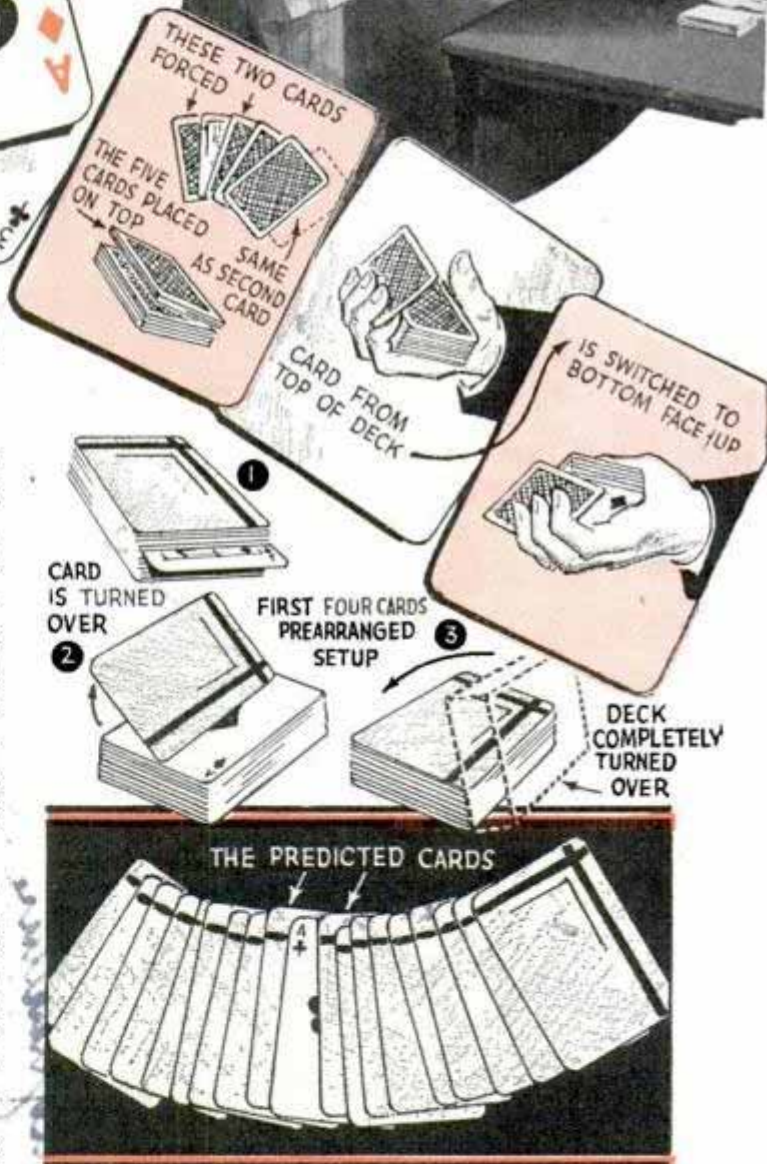

These sketches show steps in the card prediction trick. Though it appears difficult, this trick is easy if the amateur practices a little and prepares his cards properly. At bottom is shown the deck with the two predicted cards, face down, with the identifying card, face up, between them. Arrows point to cards which the performer shows audience

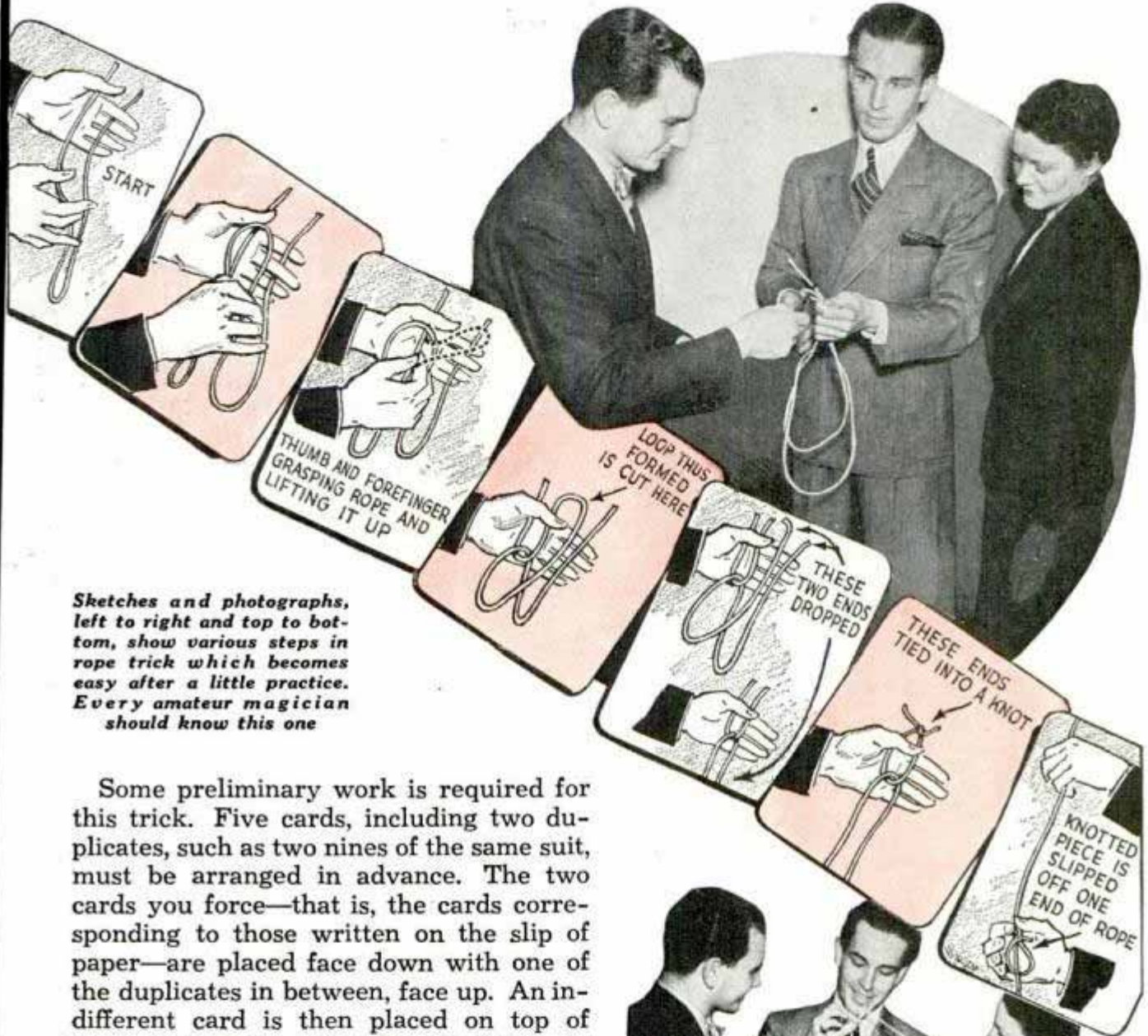

Sketches and photographs, left to right and top to bottom, show various steps in rope trick which becomes easy after a little practice. Every amateur magician should know this one

Some preliminary work is required for this trick. Five cards, including two duplicates, such as two nines of the same suit, must be arranged in advance. The two cards you force—that is, the cards corresponding to those written on the slip of paper—are placed face down with one of the duplicates in between, face up. An indifferent card is then placed on top of these three with the other duplicate on top of it. This entire setup tops the deck when the trick is begun.

Upon completion of your explanation, flip off the top card, one of the duplicates, in an offhand way for someone to pick up. While this is being done, slip the top card between the first two fingers of the hand holding the deck and switch it to the bottom to give the pack a double back. In the next movement turn over the deck so the cards are face up, although they appear to be backs up to the audience because of the top card. Thus when the bystander inserts the card discarded at the start of the trick into the deck he believes it is going in face showing. In reality it is facing the same as the other cards. Now take the deck in both hands and while it is being turned over, change the position of





the movements and with the second finger you lift this card and shove it a little way out of the pile. By using a ring and your little fingers you pull the card all the way out and put it at the bottom of the deck.

Then divide the deck into two portions, retaining the bottom half that contains the selected card. While the spectator is examining his portion, you shove the selected card up from the bottom to the top of the pack with the first finger of the left hand into the palm of the right. Then skim through your cards. While the spectator places his cards on the table, hold yours in the left hand at your side. When explaining the purpose of the trick, grasp the top card in your own portion of the deck between the first two fingers and shunt it

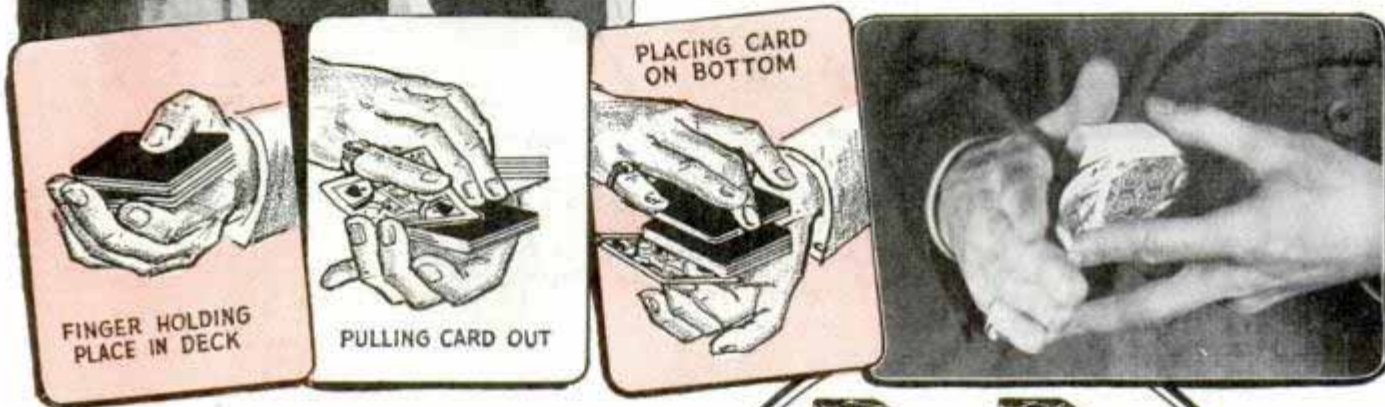

the bottom card so all are running in the same direction with the exception of the prearranged setup on the top of the deck. Cut the cards to bring the setup to the middle. As the spectator reads the suit and number on the slip of paper, skim through the deck, pulling out the three cards to prove your prediction has been correct.

Another mystifying routine is to have a card selected by a bystander as you riffle through the deck. Cut the deck in two portions, giving one to the spectator and retaining the other. The two piles are again cut and stacked into one deck. You then find the selected card by having it appear face up in the deck.

This is effected by a few deft movements with the selected card. You riffle through the deck until the spectator tells you to stop. After he looks at the card momentarily, you snap the stack shut, but hold the spot with the second finger. Your other hand is then brought over to cover



Various steps in picking out the card selected by spectator while magician riffles deck. Circle, dealing and reassembling the cards for the spelling trick

to the bottom, turning it and bringing it face up. Dividing the cards into four piles you restack them, being careful not to show the face-up card at the bottom. When the cards are spread out the selected card appears with its face up.

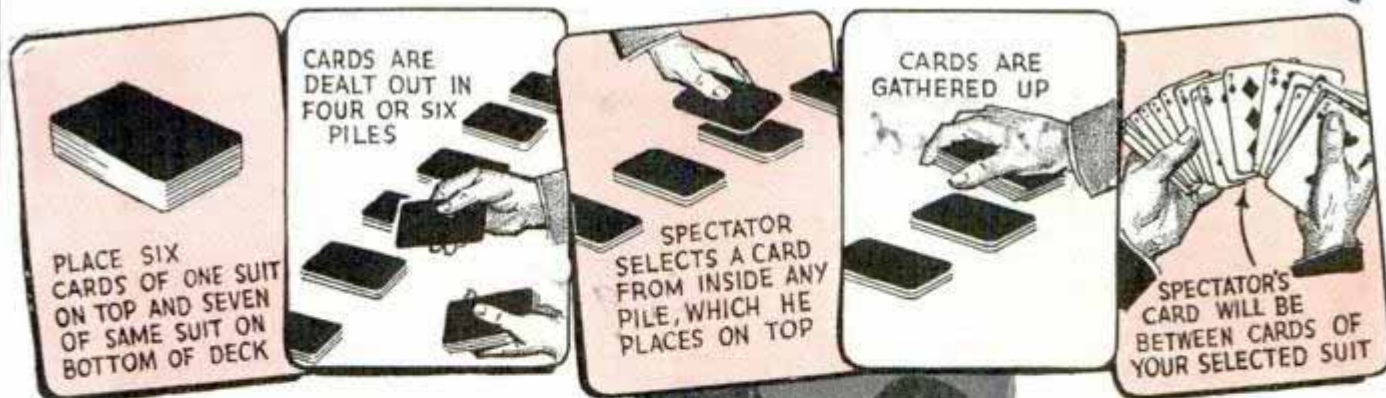

A spelling trick can be done with cards. Four people are handed a number of cards and while you turn your back each selects one card from the respective packs and after looking at it places it at the bottom of each pile. The cards are gathered up and you spell out each of the four selected cards, spelling the name of the card by counting off one from the top of the deck for each letter.

To perform this feat eliminate four cards from the deck in advance so as to leave forty-eight, each spectator being given twelve. Although not foolproof entirely, it is possible to spell out virtually every card in the deck. For example: t-h-r-e-e-o-f-c-l-u-b-s-o-r s-e-v-e-n o-f s-p-a-d-e. Some will finish on the singular of a particular suit, others on the plural. After the four packs have been picked up, the selected cards will become twelve, twenty-four, thirty-six, and forty-eight in position. Be careful to pick up the four piles in the opposite order to which they were handed out. Then ask the No. 1 spectator to name the card he placed on the bottom of his pile and



Top, easy trick in which magician picks out card selected while his back is turned. Left, method by which the four aces can be made to vanish from beneath spectator's hand and reappear in another pile of cards

when this is done, take the top card for the first letter, the second for the second letter, and so on until you spell out each of the four selected cards. So long as the number of the card, plus the name of the suit, plus the two letters "of" total twelve, the trick works. You can prepare for this trick by working out the various combinations which will add up to twelve, such as "deuce of clubs" instead of "two of clubs."

Another trick is to deal out four piles of cards in

(Continued to page 128A)

es 34

Pyrometer for Molten Metal Easily Kept Calibrated

Pyramid



\$ 4.00

Taking the temperature of molten metal by means of thermo-electric pyrometer with flexible arm

Temperatures of molten metals can be taken with great accuracy by means of a pyrometer that can be kept in perfect calibration quite easily. It is reset by a simple turn of a small set screw on the dial. The pyrometer works on the thermo-electric principle, has a lightweight aluminum extension tube and a flexible arm adjustable to 180 degrees in any direction. A pistol grip affords ease of handling.

Torqueless Axle for Trailer Runs Smoothly, Steadily

Designed to eliminate torque, cranking and whipping strain, the latest axle for trailers carries only the weight. Its construction is a simple "Hotchkiss" drive through spring and spring saddle, con-

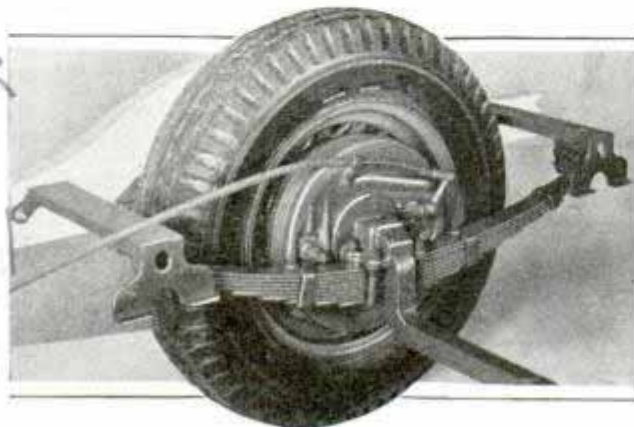

Showing new style drop axle for trailers in relation to spring, brake and the wheel

verting the axle into nothing more than a spacing bar between the wheels to carry the weight of the steel or wood chassis. Of the drop-axle design, it has a spring spread of fifty-three and three-fourths inches on a sixty-four inch tread. Smooth and steady in operation, the axle provides for a low floor line, as well as high road clearance.

Boxcar Has Removable Roof to Make Loading Easier

To facilitate loading and unloading of automobiles, timber, newsprint rolls and other heavy, bulky objects, the latest freight car has a removable roof. Built in three sections the roof is held in place with

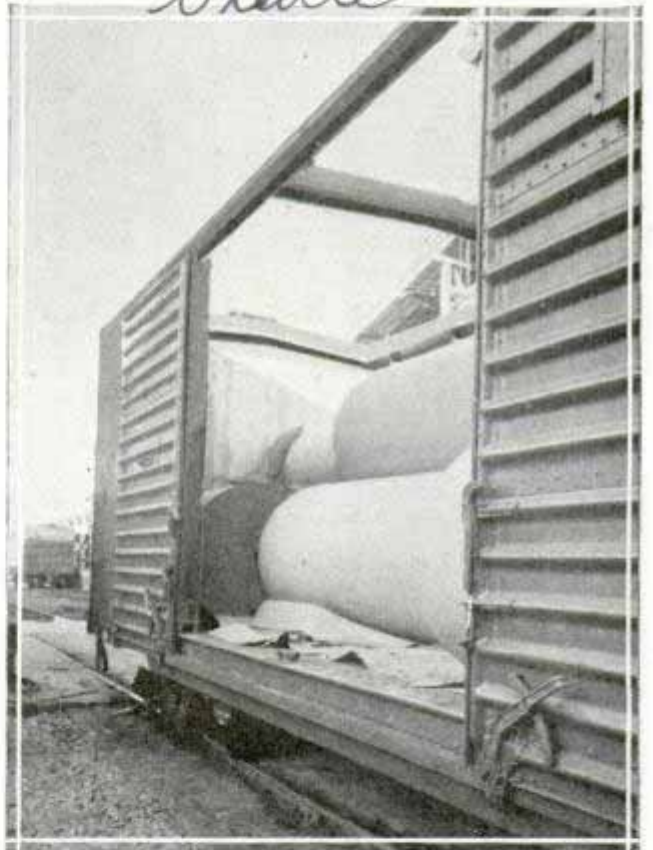

Photo courtesy of Armstrong Cork Co. Here is freight car with roof removed to facilitate loading of large objects

clamps which lock and unlock by manipulating hand levers inside the car. The sections are entirely removable or may be stacked at one end, one on top of the other. The car has the customary side doors, permitting it to be used in the usual manner, thereby not restricting operation. In tests thirty rolls of felt paper weighing 1,660 pounds each were loaded into the car, compared to nineteen rolls comprising capacity load for the ordinary car.

Armstrong Cork Co. Lancaster Pa.

Samirgo Sillia Co, 228. La Salle, Cheay
es 55
Hammer Blow Tool Co Wausau, Wis

Fleet of Big Air Liners to Fly British Routes

GENERAL VIEW OF "ENSIGN" TYPE AIR LINER NOW BEING BUILT FOR IMPERIAL AIRWAYS LENGTH 114 FEET, SPAN 127 FEET, SPEED 200 M.P.H.

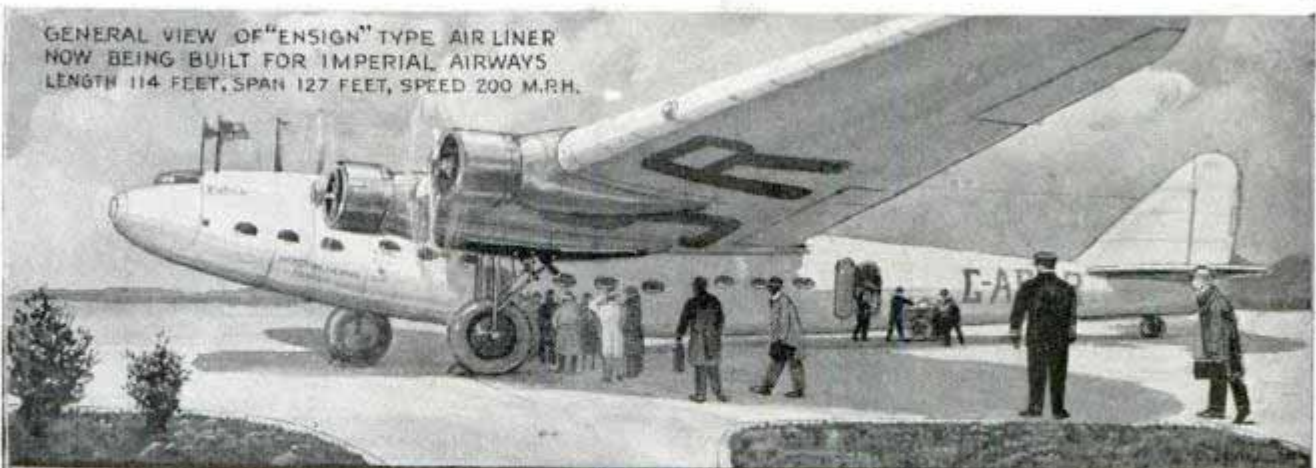

SECTIONAL VIEW OF SHIP EQUIPPED FOR FLYING ON BRITISH EMPIRE ROUTES

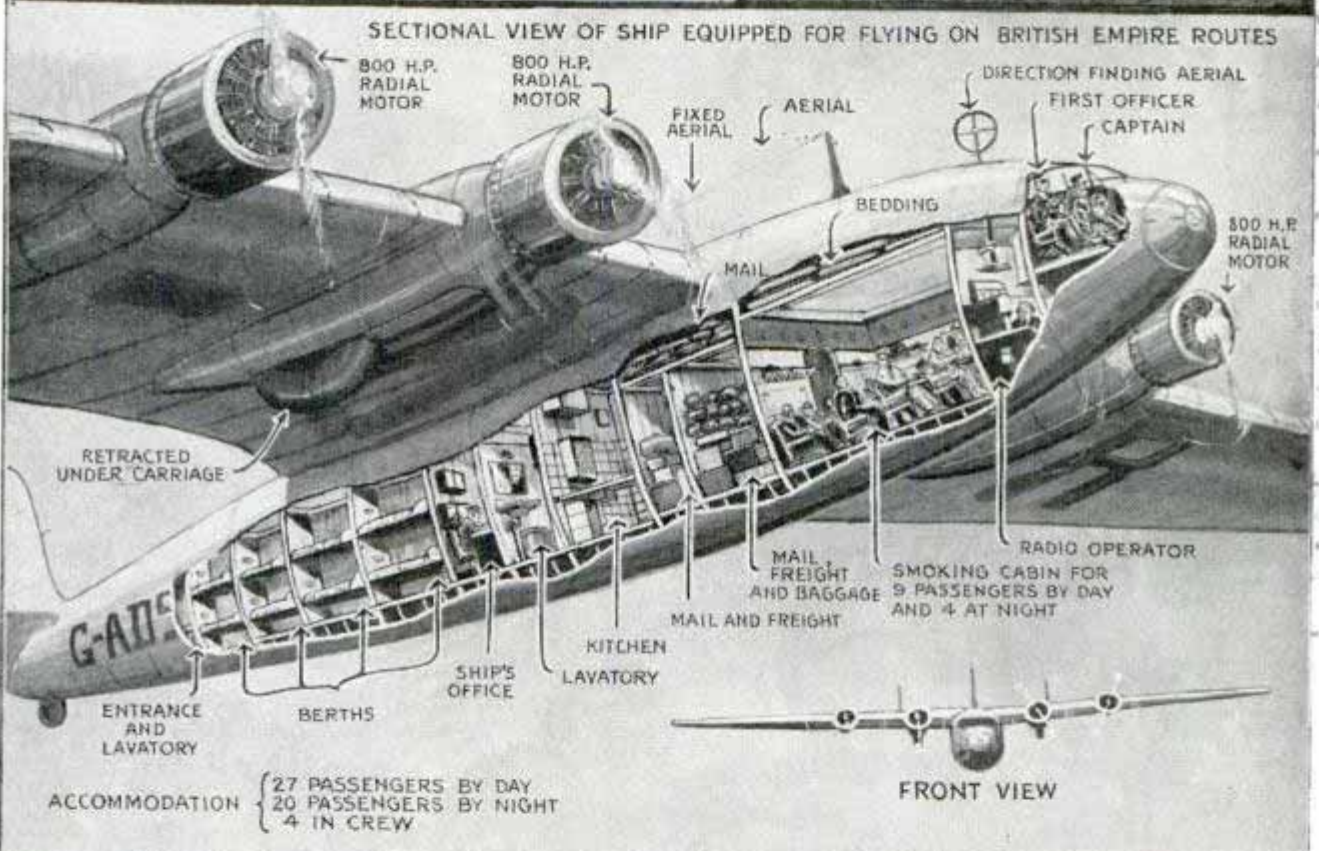

ACCOMMODATION { 27 PASSENGERS BY DAY
20 PASSENGERS BY NIGHT
4 IN CREW

FRONT VIEW

SECTIONAL VIEW OF "ENSIGN" CLASS FOR USE ON EUROPEAN ROUTES ACCOMMODATION - 40 PASSENGERS, 5 IN CREW

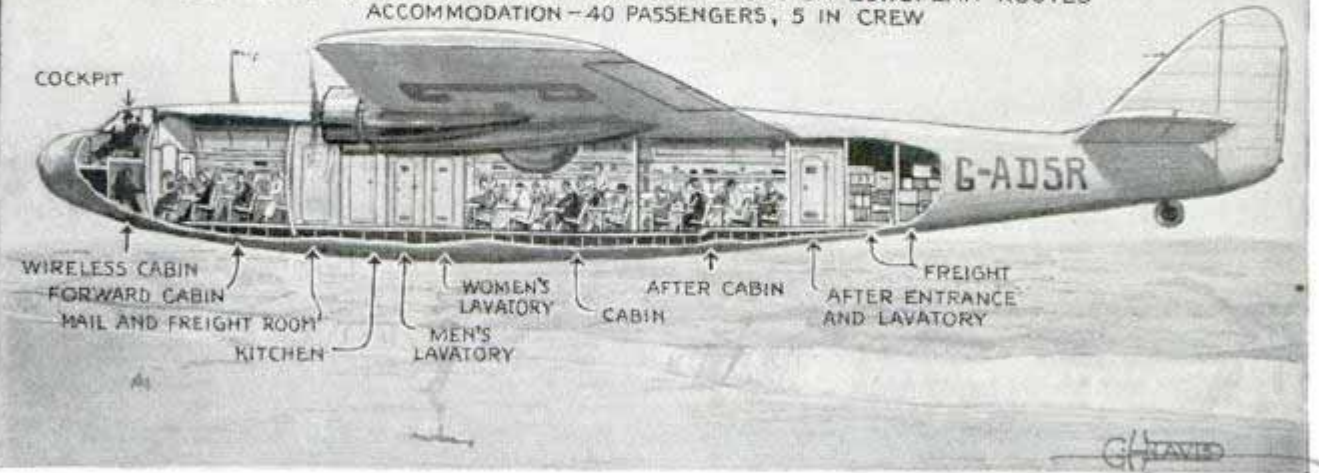

Top and bottom, giant land plane being constructed for Great Britain's European routes. Center, flying boat which will fly Empire air lanes. Forty ships of these two designs will be constructed.

Emp. ... Lemmer ... Road, Ewell Surrey

Historic Census Lists Copied on Movie Film

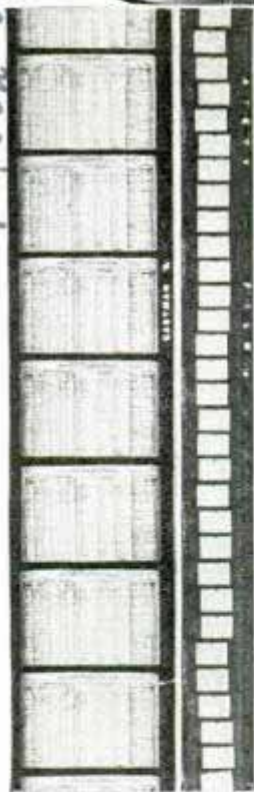
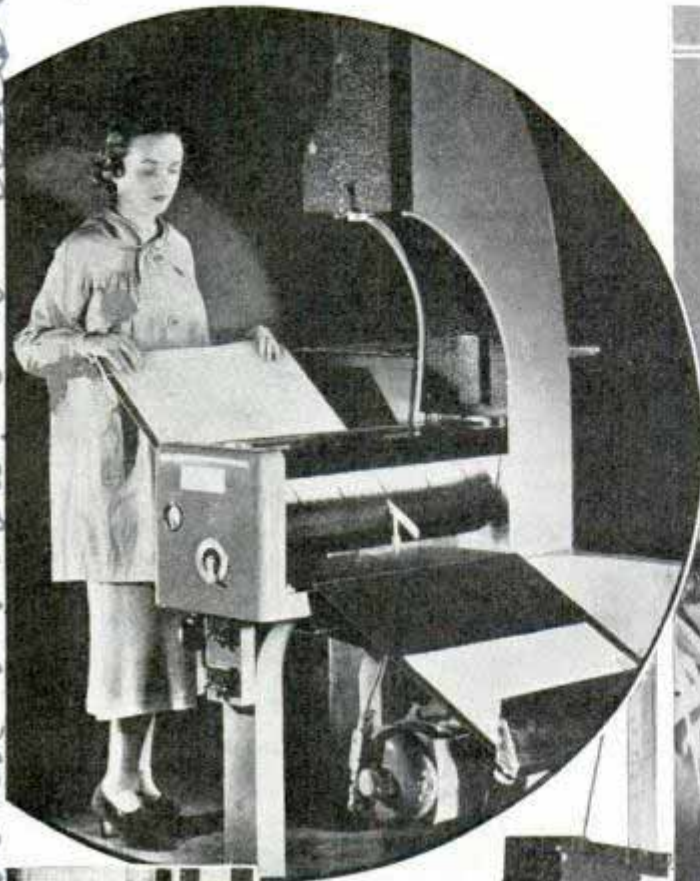

Yellowing pages from the United States census rolls are being copied for permanent preservation on motion-picture size film, so small that the written record on the photographic negative seems microscopic. Yet the special projector at the census bureau throws the record up clearly, one-half size larger than the original page. Cameras eleven feet high perform the copy work, starting with the citizen rolls in the censuses of 1880 and 1900, these names being of particular value in administering the new Social Security Act. Loose pages are fed down a sloping tray and a suction roller carries them under the camera lens

Upper left, pages of census roll are fed down sloping tray to suction roller and filmed as they travel beneath camera lens. Right, projector throws up image one-half size larger than original page although negative is too small to be read. Below, at left, are reproduced at about half their actual size a thirty-five-millimeter film of census sheets and sixteen-millimeter film of 1900 census cards. Camera at bottom is photographing pages of bound volumes

filled film made up Eastman Kodak Co. Rochester NY

Cent. John L. County 221 The Mavery 19th and 1st St. W. Washington

which films them "on the move." Other cameras photograph pages of bound volumes, a carriage moving the book back and forth automatically to film each of the two facing pages. Thirty-five-millimeter film, standard size for professional movies, is used in copying pages and sixteen-millimeter film records the census cards. When the records of 1880 and 1900 are completed, the bureau plans to go back to the earlier documents which include the names of Washington, Jefferson, Madison and other founders of the nation. By preserving these records on film, further wear and tear by reference to the paper volumes are eliminated; the films can be circulated among historical societies, and considerable storage and transfer cost is saved. One roll of film less than four inches in diameter holds the names of 70,000 persons, which on paper occupy a volume twice the size of a large dictionary. The 1880 census alone contains 50,000,000 names and required 1,024 volumes, and that of 1900 recorded 76,000,000 names on 33,000,000 cards.

Right 1200. Nippon and American Es 62 Philadelphia
Vise Removable from Base for Drill-Press Jobs
"Yankee"



Vise removed from base may be used, as illustrated, to hold work under drill press

20143
Fly Box Has a Transparent Lid with One Small Opening

Fishermen can choose a fly readily and obtain it with ease from a circular fly box with transparent, revolving cover. The box is divided into compartments and there is one section of the lid that opens above a single compartment. Selecting his fly, the fisherman twirls the cover until the opening is over the right compartment, flips the sectional lid up, takes his fly and lets the lid spring shut.



Fisherman can flip up lid over small opening and remove fly without disturbing other compartments

Serving as a two-in-one tool, a handy vise now on the market may be removed from its swivel base and used to hold work firmly in the drill press. The vise may be obtained with or without the base. Hardened steel blocks with V-shaped grooves for holding round stock are available. Made in four sizes with the smallest about five inches long over-all, the vise can be locked on the swivel at any handy position.

20944
Instrument Board on Bicycle Has Clock, Speedometer

Fitted with clock and speedometer, an instrument board is standard equipment on the latest bicycles. It is attached to the handlebar bolt. Besides offering means of telling time and speed, the board adds to the appearance of the bicycle.



adds to the appearance of the bicycle.

J. H. Leyburne, Leaning Fly Box

*Junior \$3.50
 Senior \$3.75*

*Westfield Mfg. Co.
 911 North 1st St.*

NOMADS *of*

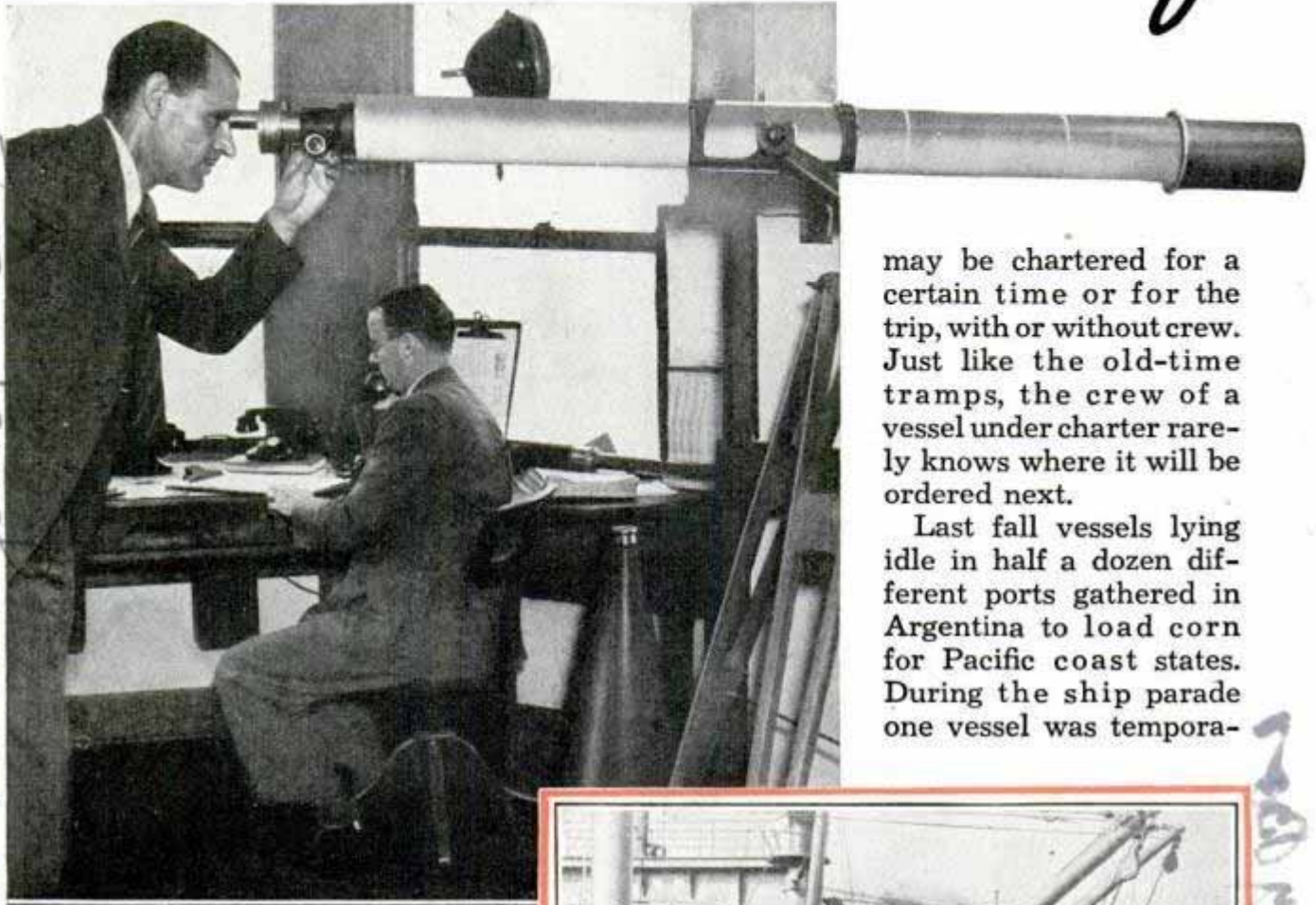

may be chartered for a certain time or for the trip, with or without crew. Just like the old-time tramps, the crew of a vessel under charter rarely knows where it will be ordered next.

Last fall vessels lying idle in half a dozen different ports gathered in Argentina to load corn for Pacific coast states. During the ship parade one vessel was tempora-

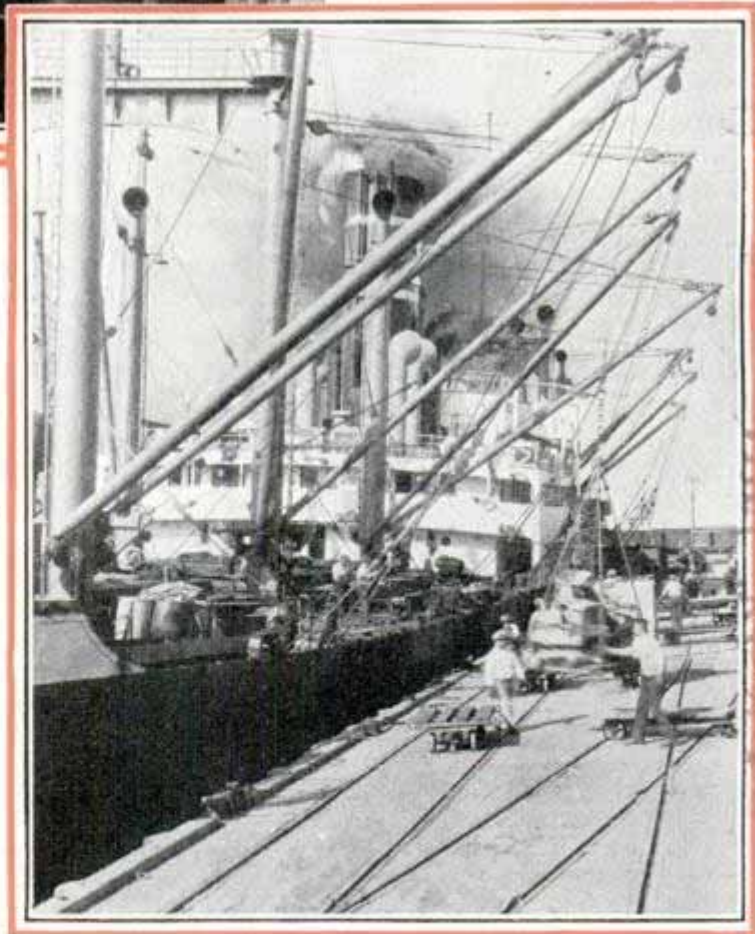

UNDER a dozen flags trim fleets of freighters are prowling around the world, modern ocean tramps scouting for cargoes in every latitude from Cape Horn to the Baltic.

"In the old days," says one ship operator, "a tramp ship was a broken-down vessel grimed with soot from worn-out engines. Their modern counterparts are economical, medium-sized freighters often built especially for the service. Some ship operators who like gambling in world markets wouldn't think of entering any other sort of trade."

In the early days a tramp carried goods for many shippers on the same voyage but under modern arrangements a ship usually loads with one commodity for one destination. Vessels that earn their keep by tramping the seas

Top, marine exchange officer identifying inbound ship through telescope. Bottom, modern freighter being loaded with cargo for another of its adventurous trips

Cont. Thomas & Steam, Jr. 10555 Hollywood
 Are Los Angeles Calif

Ref

Capt. Chandler, Marine Dept.

Capt. Chandler, Marine Dept.
 Chambliss, P. Rimmey

the SEVEN SEAS



rily disabled by striking a rock, while another rammed an iceberg on its way around the tip of South America. No one knew just where the boats were bound, for their instructions were that they would receive final orders by radio while approaching Los Angeles. Meanwhile their agents shopped for the best markets and at the last minute radioed the directions that sent them to several ports.

"On a typical tramp voyage a vessel may leave Liverpool with coal for the River Platte," outlines a ship operator. "At Montevideo, if nothing else offers, she may lay over six months waiting for grain for Los Angeles. There she may get a load of tires for Seattle, or may go up in ballast to the Puget Sound to pick up lumber for China. On the way across the Pacific her owners and agents are offering her in the world markets as being free at Pukow at a certain date. If there is a demand for soybeans in the United Kingdom she may load with them and return at once to Liverpool. Or she may steam down to French Indo China to pick up a load of rice for Cuba. From there she may carry sugar to the continent, or, if Australia needs asphalt, she sails to Trinidad for a cargo of that material.

"Where a vessel will go next depends upon the prices she gets for carrying goods, which in turn depends upon the ever-

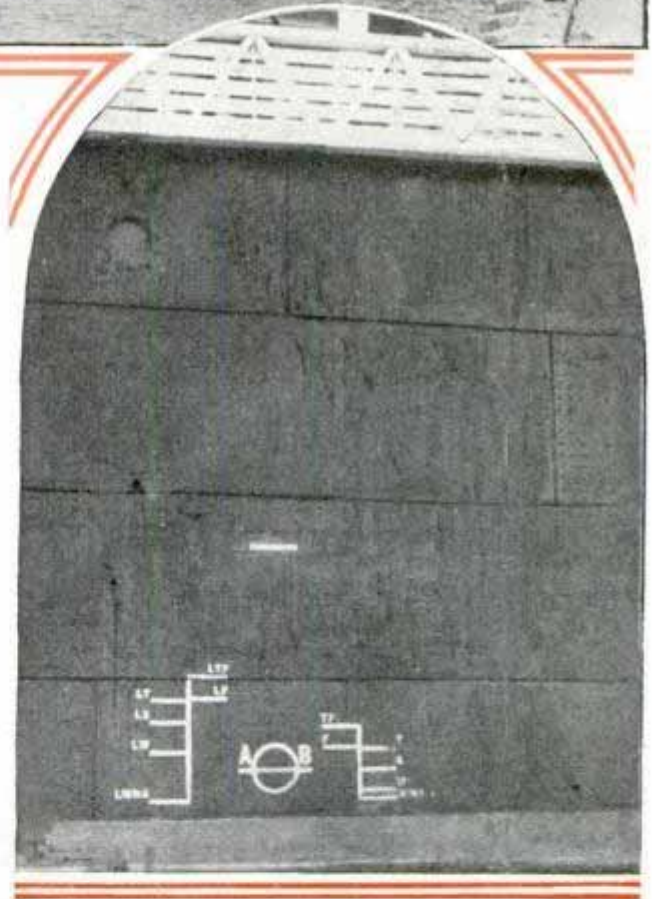

Top, freighters berthed for discharging cargo. Bottom, marks on ship showing safe load lines for different seasons in different oceans

changing demands in international markets. Sometimes it pays to turn down a profitable charter if she has to make a long trip in ballast afterward. The problem of the tramps is to keep the ships always running and always full. This calls for a constant watch on world markets with a weather eye on possible shifts in trade."

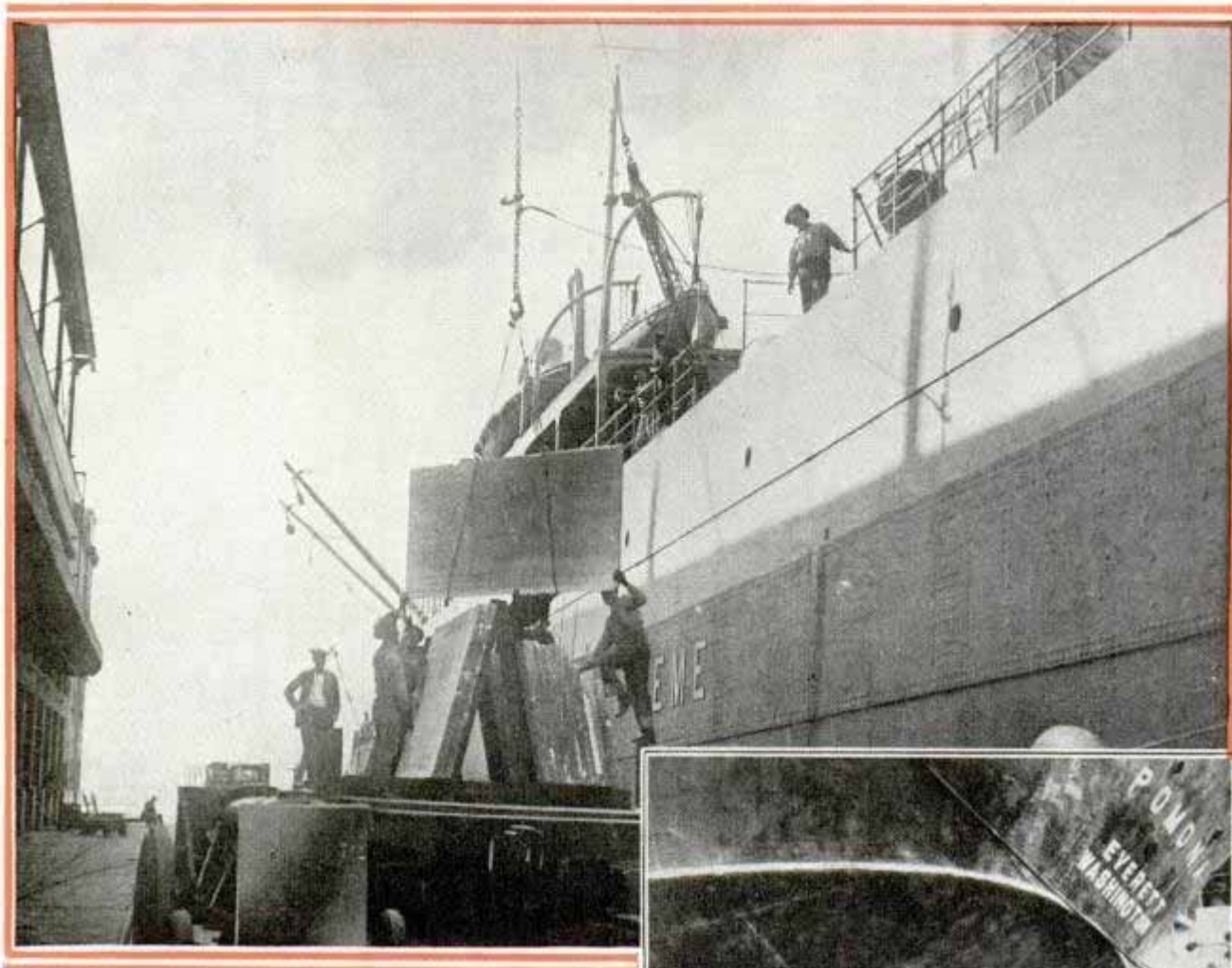

Often freak movements result from conditions such as a rice famine in China or a corn drought in the United States. Changing embargoes and tariffs influence the markets and a ship that one year carries copra from the Celebes Islands to an American soap factory may be bound for the same destination next year with a cargo of Brazilian cottonseed oil instead. Phosphates, grains, ores, coal, and lumber are important items upon which the tramps depend for business. Oil is another important commodity and in this specialized service a whole fleet of tankers keeps on the move.

Modern "liner service" freighters that operate on fast schedules have taken much business away from the tramps in the last few decades. Competition is so great that practically all of the little out-of-the-way ports that once depended upon an occasional tramp are visited regularly. But the freight liners, carrying general cargo and operating on schedule, can't meet the demand when shiploads of special materials must be moved across the oceans.

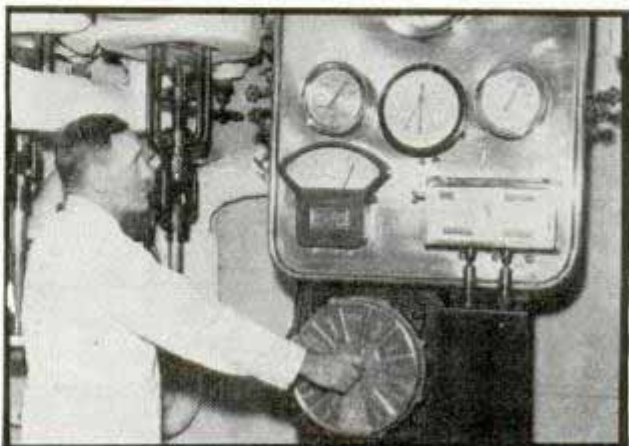
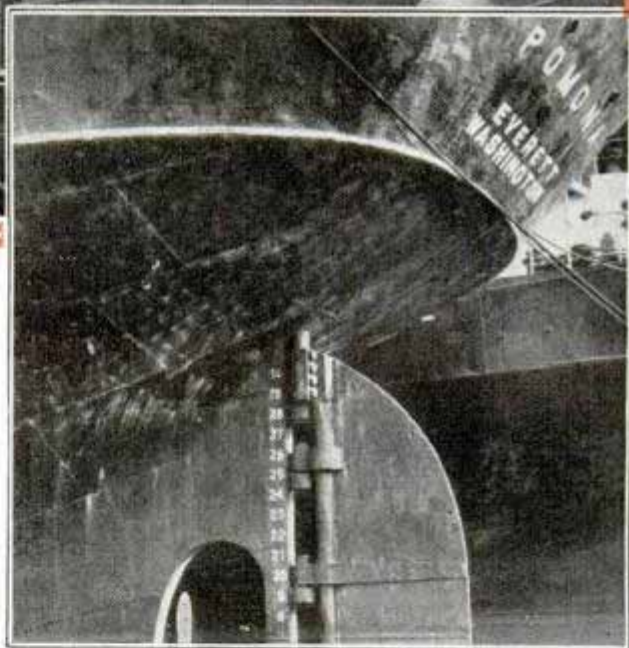

Top, unloading slate. Center, numbers on rudder show how ship is trimmed. Bottom, engineer turning telegraph

Up-to-date tramps are oil burners that steam along at twelve knots. They carry from 5,000 to 7,000 tons of cargo, since larger ships might go half empty part of the time. They are equipped with all the latest fire-prevention and fire-detection devices, including smoke detectors, automatic fire alarms, and steam smothering lines.

In the early days nearly every freighter was a tramp. Owners sent their ships to sea expecting that the captains would shop at every port for the best bargains they could get without knowing when or with what kind of cargo the ship would return.

Upon entering a strange port a captain would fly his house flag marked with some letter or symbol that the local agent of his owner could recognize. Then the captain

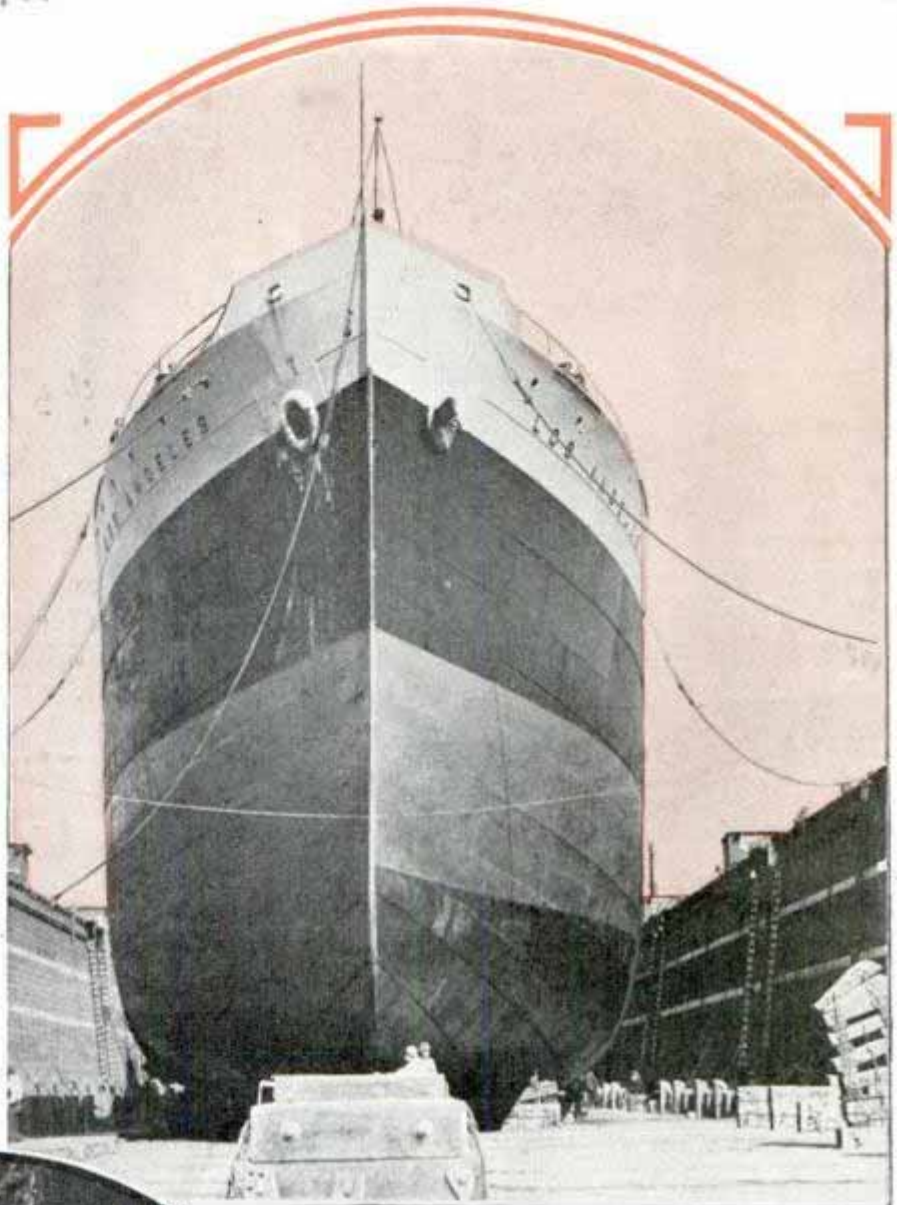

Top, oil tanker in dry dock. Bottom, scene in ship's hold during unloading of raw silk from Japan.

would look for a similar flag to be run up at one of the wharves. In that way he would know where to berth his ship. If he had cargo to discharge he might not get to sea again within a week. Storage space in a warehouse had to be cleared, arrangements made to pick up other cargo, longshoremen hired, and a score of other details attended to. The trouble with such arrangements was that they were too haphazard to last. Ships lying idle in a port "eat their heads off" without earning revenue.

Radio has cured some of these troubles and clocklike precision in cargo handling has fixed the rest. These days all shore ar-

(Continued to page 124A)

High-Speed French Engine Has a Streamline Face

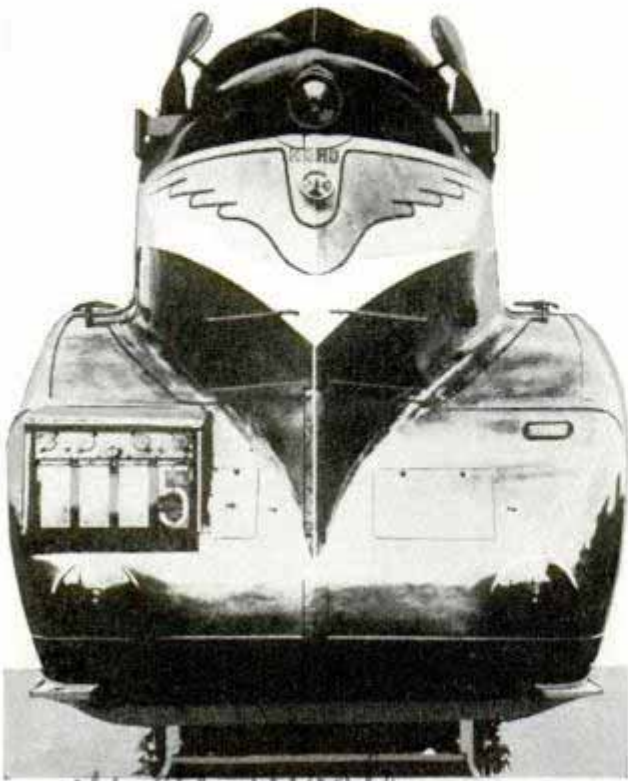

Striking head-on view of streamline locomotive on French railroad, upper part resembling speedboat

Built for fast passenger service on the Nord railway, a French locomotive shows the world a new streamline face. Its design embodies the latest European ideas of aerodynamic lines and speed-train construction. The upper part of the locomotive resembles the prow of a speedboat.

Truck Signals Tell Car Driver If It's Safe to Pass

Designed as a new aid to highway safety, red and green signals have been at-



Driver points to signals which he controls from dash when car seeks to pass

tached to his truck by one commercial driver. When an automobile driver blows his horn, the driver may flash the green light, marked "O.K.," to indicate that the road is clear and that it is safe for the car to pass. The red light, marked "no," tells the driver behind that it is dangerous to pass. Thus may be reduced the number of accidents resulting from auto attempting to pass a large truck when the driver cannot see the road ahead.

Smart Boat Instrument Panel Has Dual Engine Controls

Equipped with dual controls for operating two engines, a smart new instrument panel is a feature of the latest Chris-Craft boats of thirty-two feet length, and up. The controls are designed for independent

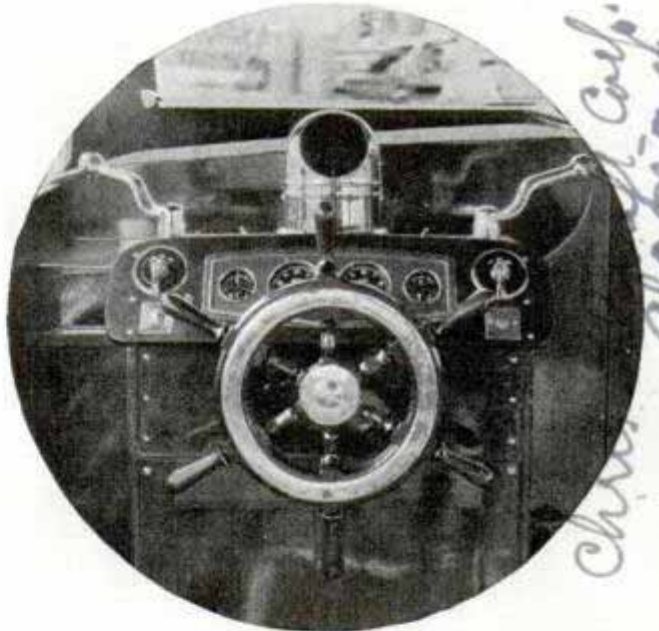

Instrument panel for latest motorboat. Note the dual controls and indicators

operation so that either one or both engines may be used. Tachometers on each side of the instrument panel show engine speed. Twin rudders connected with a heavy drag link are also fitted.

"Walking Pugmill" Speeds Up Surfacing of Highways

Instead of mixing the paving materials before laying a new highway surface, a "walking pugmill" speeds up road building by reversing the process. Trucks spread gravel or stone, sand, and asphalt in proper proportions and then the pug-

*Emir C. Denthorpe
Duchner, Md.
D.M.*

*Employer of car
Shopper dispatched
between lanes at
signal*

2045

*Chris-Craft
alg triad*

*Galger Machine Co
Columbus Ohio*

mill comes along, mixes the materials where they lie and levels them. Rollers follow the pugmill, and it is claimed the road is ready for traffic ten minutes later.

X-Ray Gun on Wheels 'Sees' Through Heavy Steel Pipe

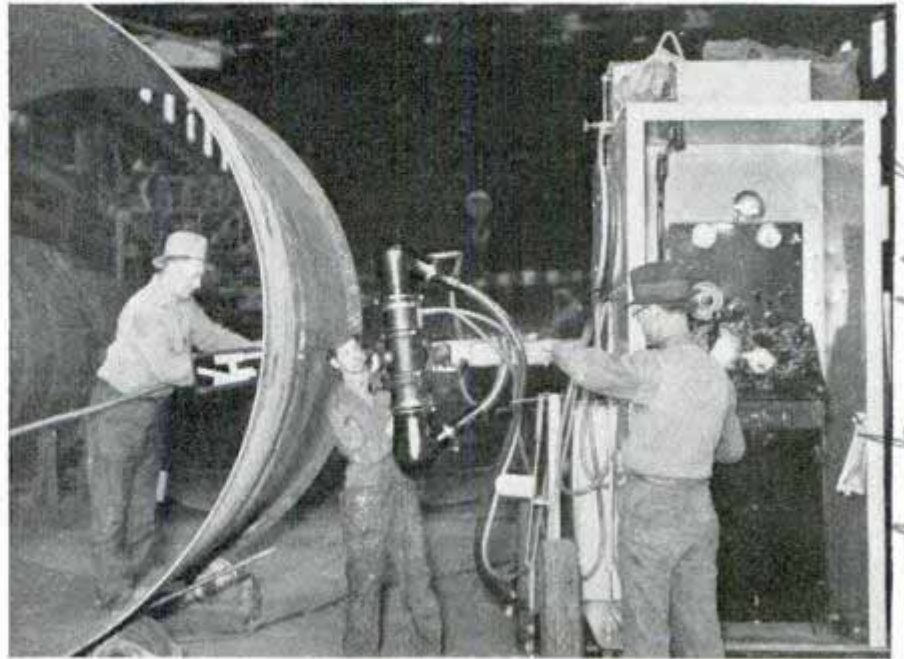

Subjecting steel pipe to rays from portable X-ray machine at right. Photographic film on inside of pipe records flaws in metal

Plant Traps a Frog to Vary Its Diet of Flies

No shy little prairie flower is the "Venus's fly-trap." Its usual diet consists of flies and other small insects which are caught and digested when they touch the sensitive "fingers" of the plant. But when it is really hungry this strange plant will even eat a frog! The fly-trap grows profusely in the region of Wilmington, N. C., and a florist searching the woods for some plants came upon a flytrap which had seized a small frog in its "jaws." The frog

Operating on 100,000 volts of electricity, a powerful X-ray machine on wheels "sees" through heavy steel pipe and makes a record on photographic film held against the inside of the pipe. The rays are projected through an aperture in the center of the "gun," penetrating two-inch steel. The equipment is used in construction of siphons and delivery lines of the Colorado aqueduct to test the pipe for flaws.



Emir C. Henthorn lives

near Kansas City.



Photo courtesy Adams Studio, Wilmington, N. C. This Carolina plant was strong enough to nab a baby frog and hungry enough to eat it

was only a youngster, yet it is remarkable that the plant had sufficient strength to clutch it until the frog was dead.

Prospectors for oil last year drilled 74,000,000 feet of holes in American soil, sufficient to bore clear through the axis of the earth and halfway back again.

Funnel Speeds Filling Without Spilling Fluid

To keep funnel from tipping and speed pouring of fluid into a bottle, a new rubber core funnel has been invented. The core is tapered, holding the funnel upright. Four ribs underneath provide air vents so fluids pour through the stem without gurgling.

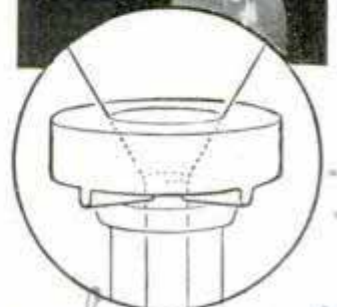

Wilmington Chamber of Commerce

Fisher Scientific Co. 711 Forbes St

Clump of and especially by the Westward Pipe and Steel Co.

Eight and a Half Foot Giant Gives Tailor a Big Job



The tallest young man in America wears trousers longer than his tailor is tall

They don't carry clothes in the men's stores big enough for Robert Wadlow. Even the tailor finds it a full-size job to give him a fitting, and to do it right he needs a stepladder. An Illinois youth, Robert Wadlow is eight feet five inches high, the tallest human being known. He is eighteen years old.

Plane for Model Boat Makers Rounds Off the Hull



Constructed with a curvature at the bottom to make easier the task of rounding off the hull of

model ship or boat, a handy wood plane for the craftsman has been placed on the market. The tool decreases the time required to plane any object into circular or semicircular shape. It enables the model maker to turn out ship hulls correctly proportioned and rounded in much less time than craftsmen usually spend on such jobs.

Motor Fan Cuts in Louder Horn for Fast Country Driving

Capable of producing an ultraloud sound of warning, a horn designed for fast country driving is switched into the regular horn circuit by the air stream from the motor fan. As the automobile's speed rises the increasing air stream from the fan closes a switch and cuts in the loud horn so that it sounds with the regular horn when the button is pressed. At moderate speeds a spring holds the switch open and only the regular horn sounds. The sound of this horn penetrates closed windows of other cars, is audible above the roar of truck engines and reaches far ahead to warn the farmer turning onto the highway. The bracket switch which controls the horn may be attached anywhere on the motor, so long as it is in the air stream from the fan.

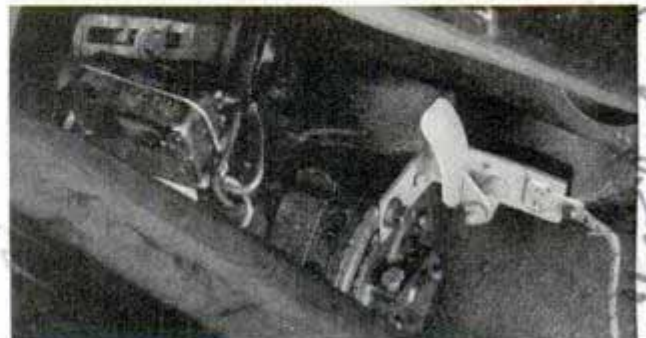
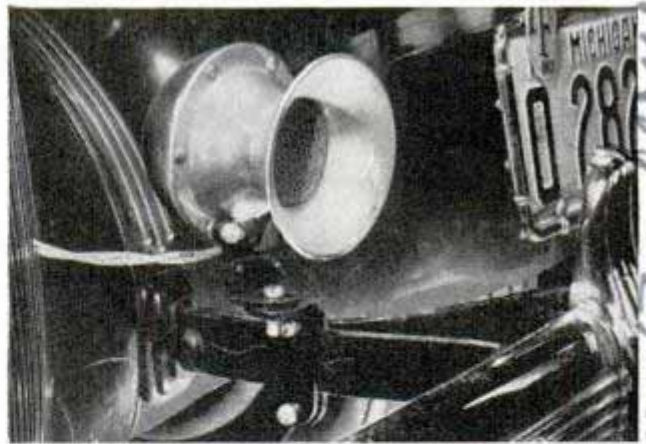

Top, ultraloud horn. Bottom, wind vane (colored white) which controls the horn

Stanley Tool Co
195 East W
Chicago
11659
3044 W Grand Ave
3044 W Grand Ave
Chicago, Ill.

Pressure Gun Injects Termite Poison in Wood

Right, injecting the patented chemical into house timbers with pressure gun. The liquid permeates wood, evaporates and leaves a crystalline barrier of poison which stops any encroachment of termites. Below, cross-section of beam showing destructive work of termite colony

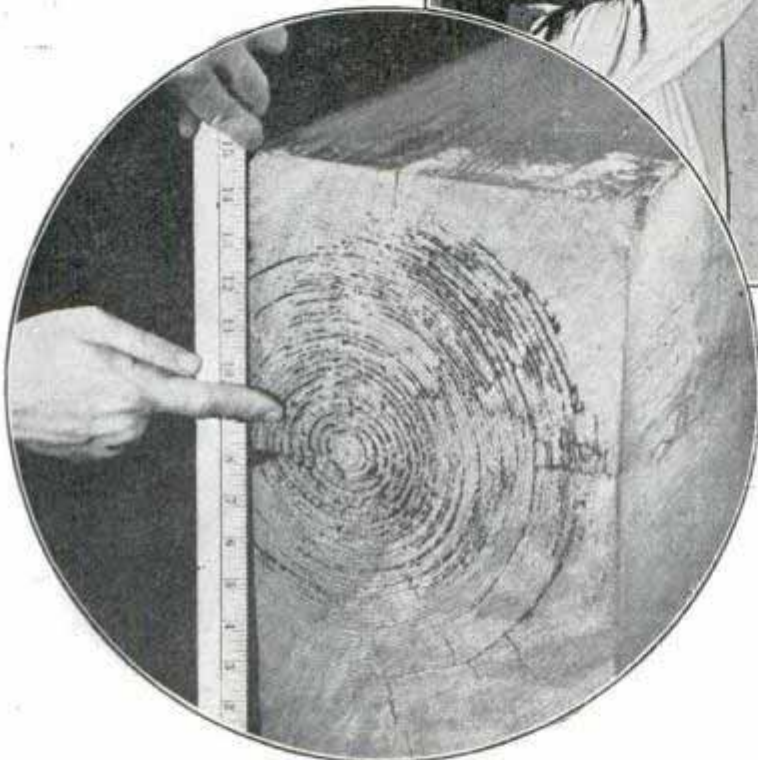

Surface or Spray Treatment



Brush or spray treatments cannot penetrate wood. The termites still work on the inside.

Terminix Pressure Treatment

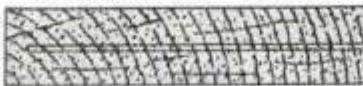

Terminix penetrates deeply and is injected into the wood under high pressure.

INSIDE PENETRATION

Man is carrying the war against termites right into the insects' parlor. Deep in the timbers of your house, impossible to see, termite colonies may be eating away the heart of the wood. To stop their advance where it has begun, and to block any future invasion, a Memphis company has developed a liquid poison called "Terminix" which, shot deep into the wood with high-pressure guns, evaporates in a few hours leaving a lasting crystalline barrier which the termite cannot pass. The chemical itself is harmless to man or ani-

mals. Thorough insulation against termites is achieved by first inoculating the soil, then treating all contact points in foundation walls and supports, and finally impregnating all understructure wood members at their bearing points on all supporting construction with the chemical, forced through the wood by the pressure guns. A few hours later the liquid has evaporated and there remains a toxic chemical shield. It is estimated that termites cause \$50,000,000 damage every year.

Brain Increases in Size Till Age Fifty or Sixty

Human brains that are mentally active continue to grow in size up to the age of fifty or sixty years, Dr. Ales Hrdlicka of the Smithsonian Institution has found. There is, however, no evidence to show that any change in brain functions accompanies the increase in brain dimensions. The head itself enlarges very gradually until the changes of old age enter the picture, and since there is no growth of the frontal sinuses nor thickening of scalp or bones after age thirty in men and twenty-five in women, the conclusion is that the growth of the head is attributable to enlargement of the brain.

Washington D.C.

Handwritten notes:
about 8/15 0.00 per house
L. O. Bruce Co., Terminix Memphis
Memphis, Tenn.

F14# 8649 *Local maintain
Hollywood Calif*

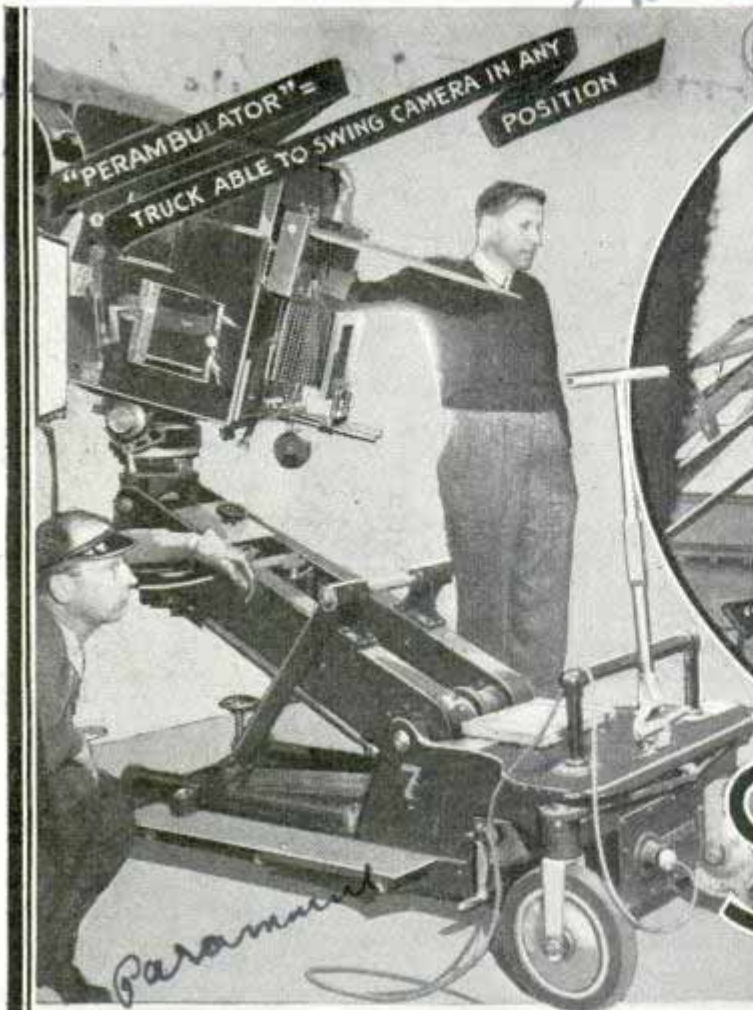

STRANGE LINGO

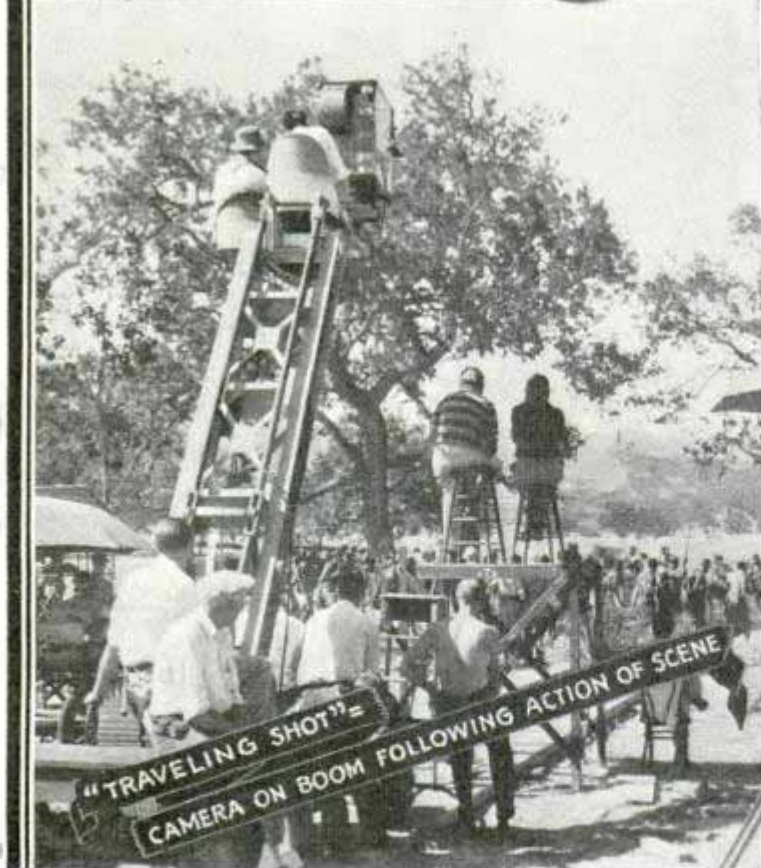

© Paramount

Three odd terms used in movies are illustrated. In circle, top, note the P. A. or public-address system. The big horn conveys instructions to extras in the scene being filmed

MOTION-PICTURE workers have developed a strange lingo unintelligible to the outsider. It is a short cut consisting of technical slang, phraseology, and peculiar words that have come into use to speed up filming and to convey a more exact meaning than could be done with a regular vocabulary.

Each studio department, of which there are more than sixty in most film plants, ranging from police, postoffice, factories, to the shoeshiner, has a special slang.

"Break-away," to the construction man, means a prop made of plaster or balsa wood used in movie scenes where the materials are to be broken, such as imitation dinner plates. "Glass" is the cameraman's name for a lens. "Soup" is used to develop photographic films, while anyone going

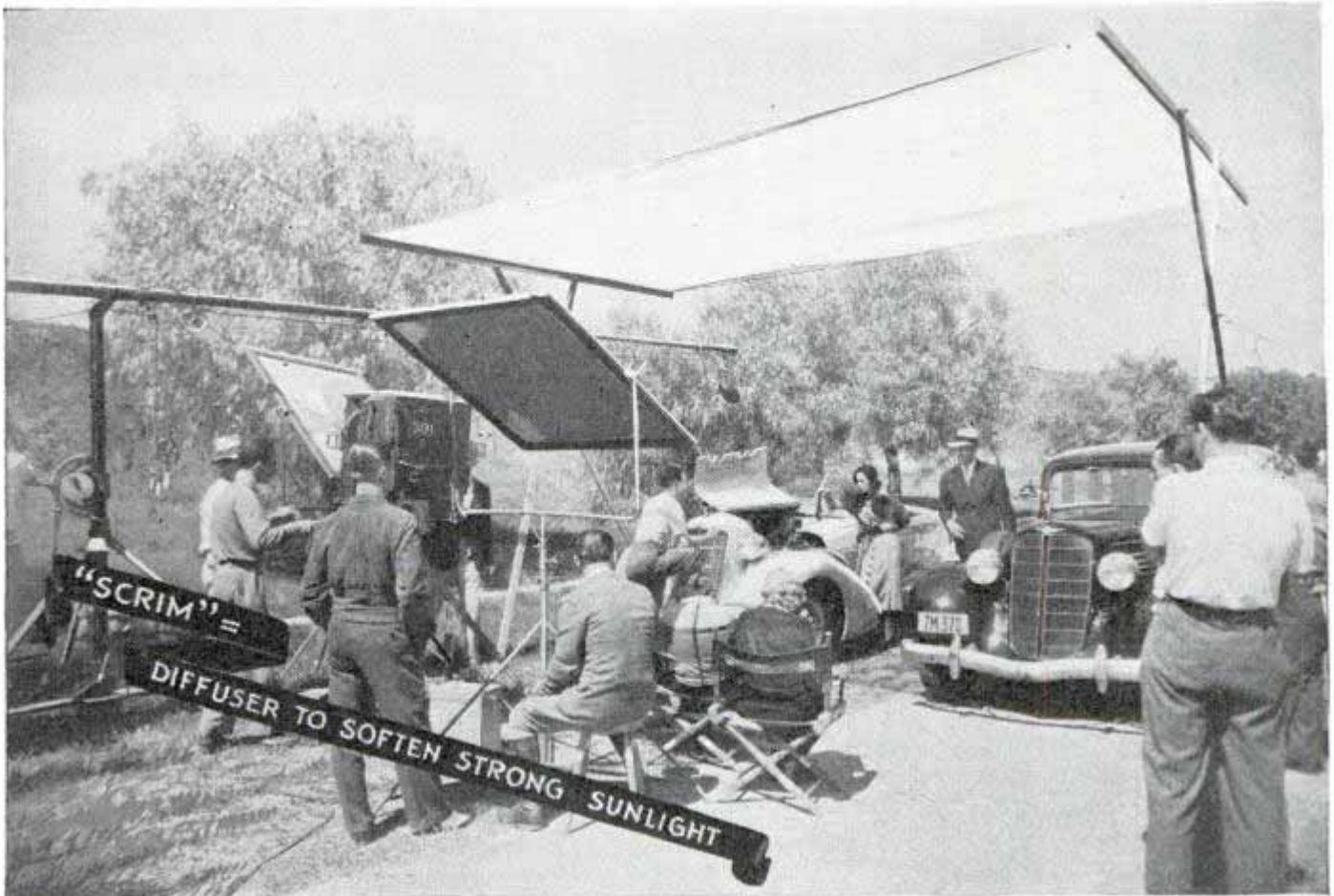

of the MOVIES

to the studio restaurant is going to "grab a sandwich" whether they intend eating soup or salad. The extra hanging around a casting office is "speck-in' a job." A "bon-bon" to an electrician is the name for a light. "Minnie" is the studio name for an electric truck used about the studios where silence is essential.

The movie language is composed of words often descriptive of a peculiarity of a piece of equipment, or adopted as a result of some incident. Once an electrician dropped a lighting unit. Now, much to his chagrin, the light is known by his name. The "milk" is not put in the icebox in the studio; instead, the camera is put in the

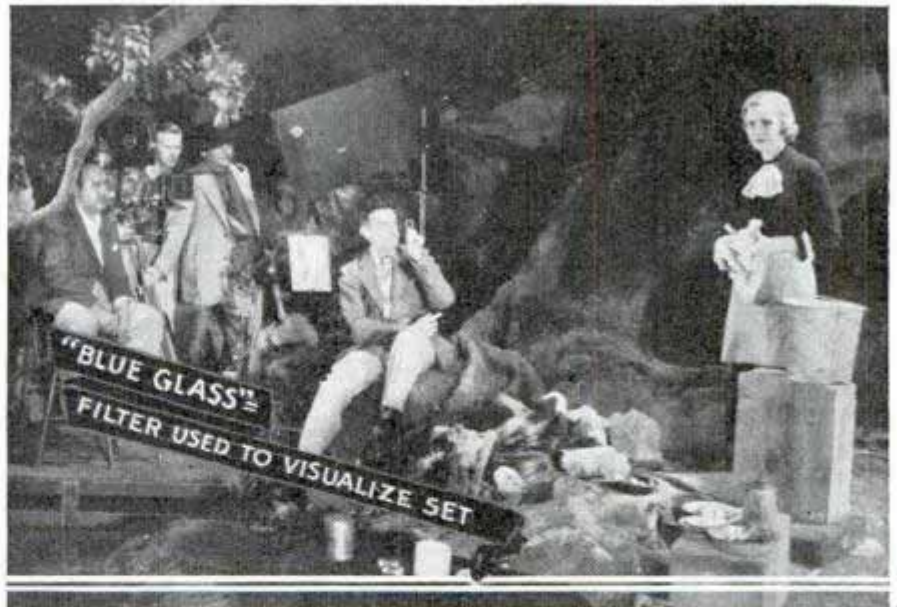

© Paramount

Top, note the "scrim" over players' heads. This device softens sunlight. Bottom, cameraman giving the setup the "blue glass" to determine how the scene will photograph

Karl Stuss

"milk." It is a soundproof box used for silencing camera noise, and the name came from the fact that once a studio worker kept his lunch milk in a discarded one. A

select - el pino 60

30/30/30/30/30



© R.K.O. Radio Pictures, Inc.
Cameraman "lining up" the set, directing the electrician, or "gaffer" in placing lighting equipment

"milk" is also known as a "blimp" because it is large and may be likened to an airship when being floated about the setting on a huge "camera crane" during the filming of a "moving shot." A "camera crane" or "boom" is a five or ten-ton piece of machinery that resembles a steam shov-

el and is used for maneuvering the camera to follow the actors in intricate scenes. A moving camera shot is known as a "pan."

A "dolly" is the platform set on rubber-tired wheels on which the camera is anchored for ordinary moving or "running" scenes. A visitor to a movie set needs an interpreter. Often one or two apparently meaningless words will be elaborate instructions for fifty or a hundred men. "Strike Capra on eighteen," for example, will be the terse instructions to a gang foreman to dismantle Director Frank Capra's set located on sound stage number eighteen. To tear down a set, the laborers "pull toe-nails from the flats," a toe-nail being a double-headed nail that can only be driven into the wood to the first head. The second head protrudes so the claw hammer may hook the head for easy removal. A "flat" is a rectangular section of a setting, groups of which fit together to make the desired set. The studios have "flats" that may be fitted to-

gether to make any sort of home or building. The "fly-squad" is the gang of "grips" that help the "set-dresser" move furniture and arrange the setting before shooting begins. "Furniture" designates props too large to carry in the hand, while a "hand-prop" is a small item such as a vase.

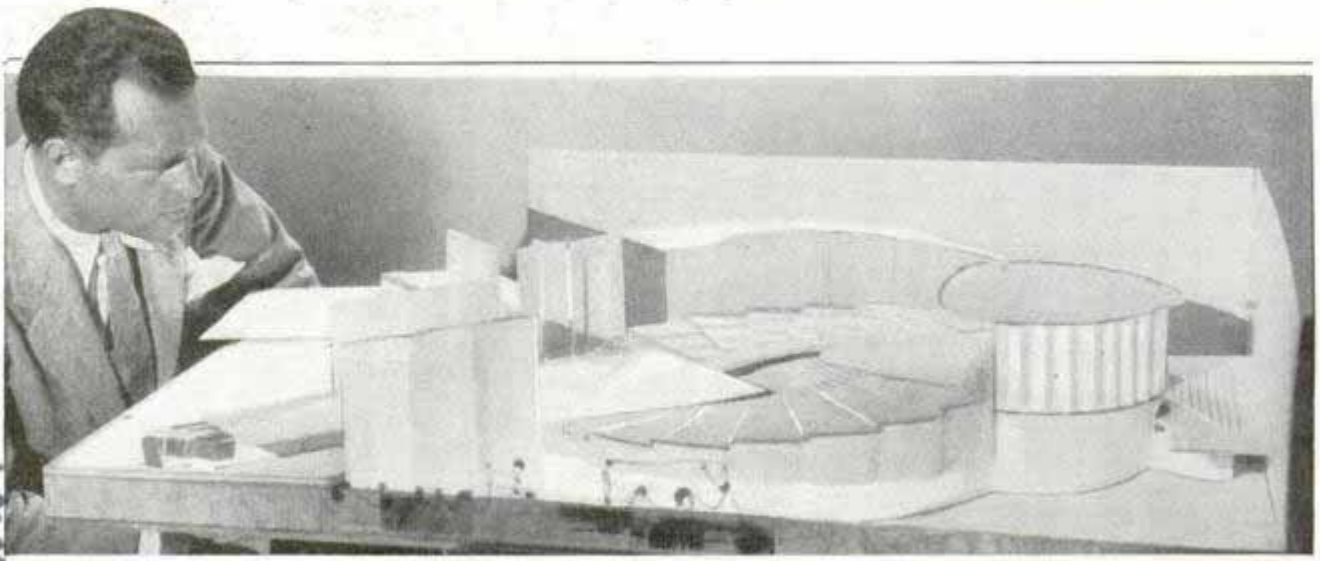

© R.K.O. Radio Pictures, Inc.
Set designer pictured with model of set used in scene played by Fred Astaire and Ginger Rogers in "Swing Time." The model represents a large stage for the dance number

Boyz n' the Hood

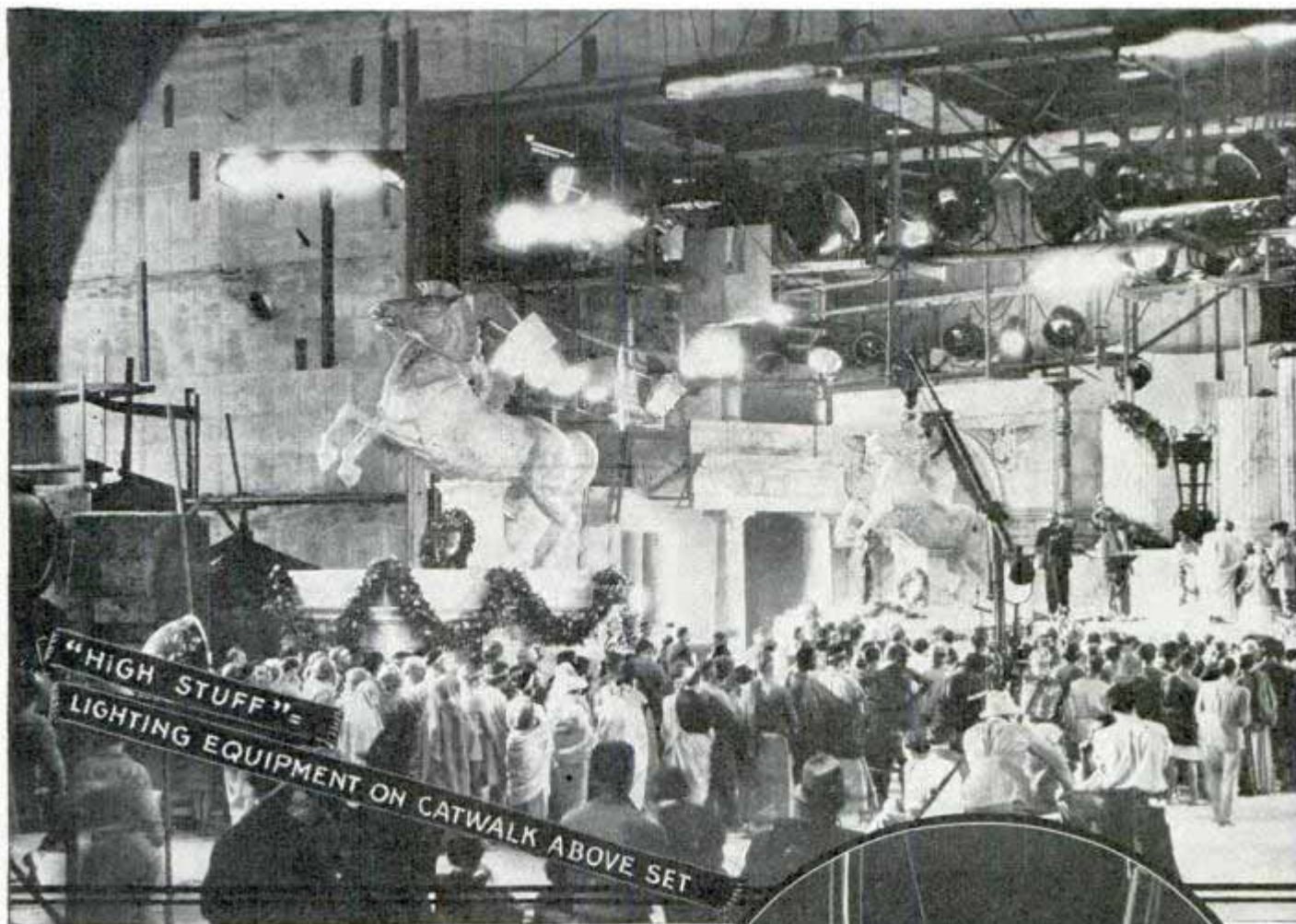

Often a set dresser may be heard to order a "grip" to "scoot over and get some stuff to sweeten 'Another Dawn' on ten." "Ten" is the stage number where "Another Dawn" is being filmed, while to "sweeten a set" means to add frilly feminine things.

Perhaps the most picturesque language is used by the cameraman and the electricians when they are "lining up the set." The cameraman, eye glued to the camera finder (the device used for focusing and centering the lens), works with the head electrician to get the setting properly illuminated. "Catch the hot-spot on Colbert's shoulder; throw a baby on her" is the cameraman's way of saying the illumination on Claudette Colbert's shoulder is too intense; that the light must be softened, otherwise the attention of the audience will be drawn away from Claudette Colbert's face.

The head electrician is known as the "gaffer" or "juicer." Under him is his first assistant or "best boy," while his crew is known as the "rigging gang" because they



© Paramount

Top, "catwalks" fifty feet above set hold the lighting units. Bottom, sound man at controls of boom which moves microphone in "traveling shot"

rig up the set with the light units, cables, and electrical paraphernalia.

In order to soften down the "hot-spot," the "gaffer" would issue instructions such as, "change that 'rifle' and put a 'cello' on the 'go-devil.'" The "rifle" is an intense

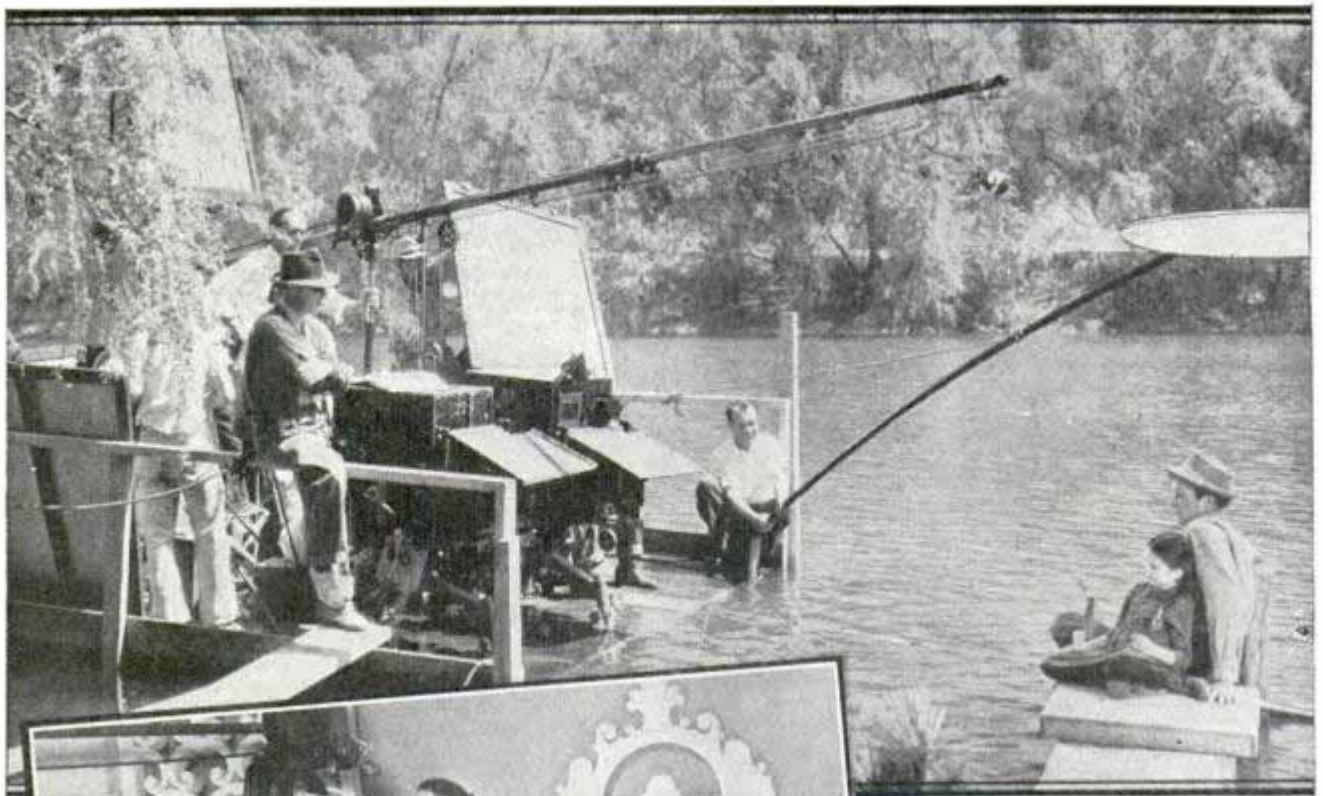

© Paramount



Top, "butterfly," made of gauze, is held above players to diffuse sunlight. Bottom, "grips" polish floor while "lensers" prepare camera for shot from "dolly" on which camera will be rolled back as players advance

spotlight usually placed on the "catwalks" or platforms built high above the setting under the roof of the sound stage. The "rifle" is used for highlighting desired portions of the setting. A "cello" is a diffuser for the lights and is composed of a sheet of celluloid with frosted surfaces mounted in a frame for inserting in the slots in front of the light housing.

The term "inkie," derived from incandescent globes, is the name for a "soft light" in contrast to the "hard light" obtained from the arc light. The arc light is "hard" because it is bluer and gives a more sharply defined shadow and a harsh-

er photographic image. The "inkie" has relatively more orange-red in its content which permits a softer and more pleasing effect. The globes used in the "inkies" are called "eggs" at Paramount Studios and "bottles" at Universal Studios.

A "Lupe" light is named after Lupe Velez because this light, which is easy to operate and may be employed to follow actions, is used where this temperamental and rest-

less actress works. A "bon-bon" is a large round spotlight that uses a globe of 2,000 watts, or enough "juice" to light a dozen homes. The "cracker-box" is a similar light of 500 watts. The "broad" is a light unit used very often overhead the set in banks for "filler," or over-all illumination. A "baby" is a small spotlight used for special effects such as the light on an actor's face when he lights a cigarette. The "twin" is a double-light unit used for obtaining a wider beam of illumination.

The "sky-pan" is like a huge inverted dishpan hanging over the setting and con-

(Continued to page 116A)

Ten Moving Stairways Serve Big London Store

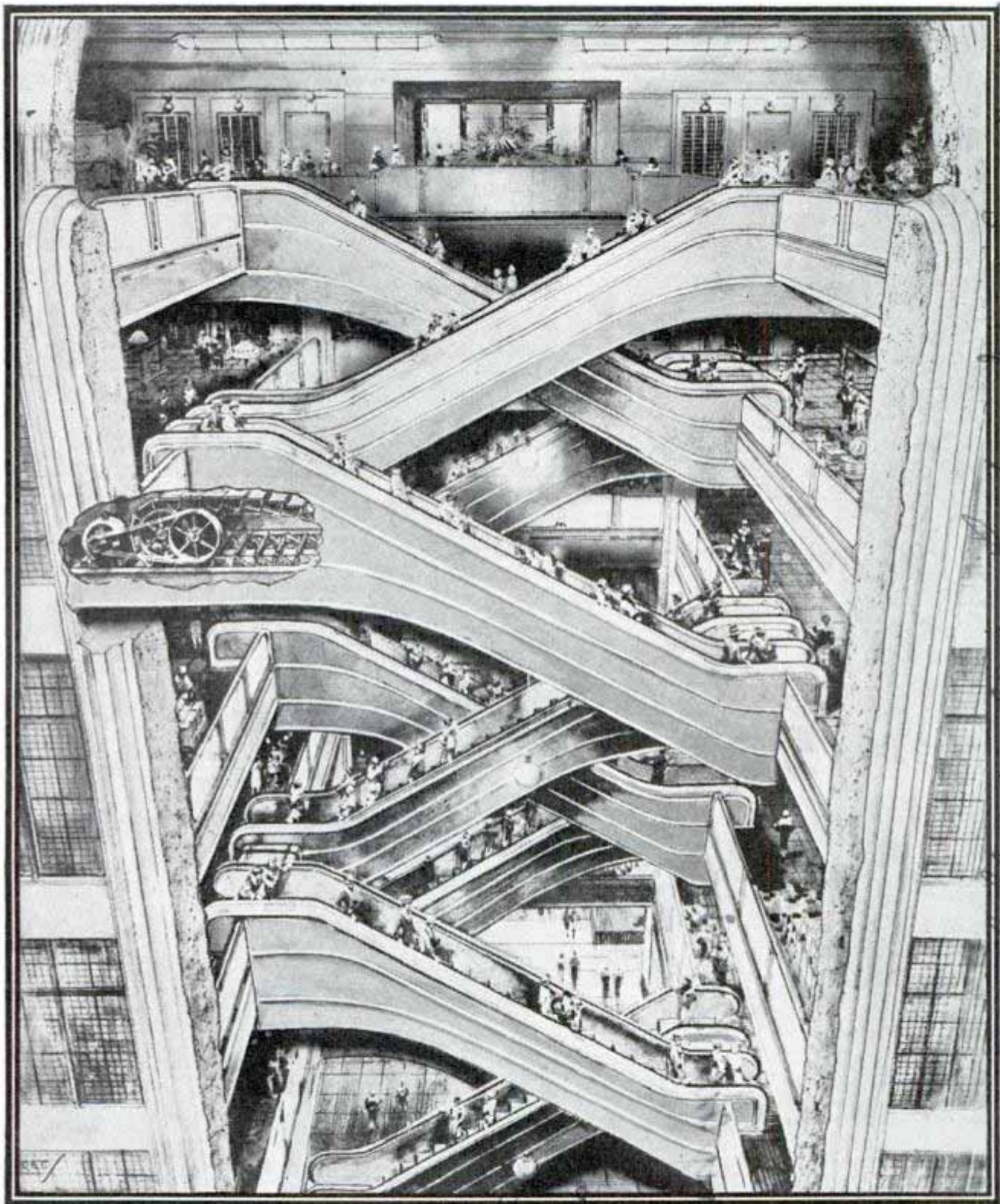

Here is a sketch of the ten escalators installed recently in one of London's big stores on Oxford street. Designed to accommodate the maximum number of people entering the store the moving stairways are reversible and could all operate downward in case of fire. Lower escalators are driven by nine-horsepower motors, the upper ones by seven and one-half horsepower motors. Cutaway view at left, center, shows one of the motors. Every precaution has been made for noiseless operation. All departments of the store are accessible from the central hall in which the escalators move. Elevators and stationary stairways also are provided in the building.

*Installed by J & E. Hall
Stratford Kent, England*

A Illustrated London News Jan 4 1911

Toy Plane Shows How Blind Landing Is Made

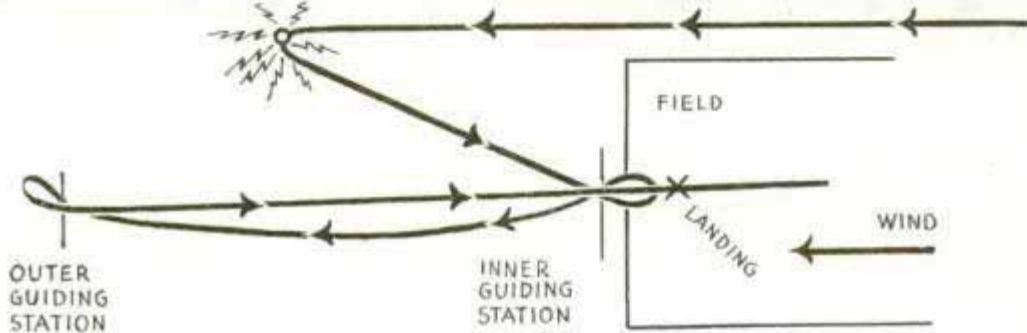
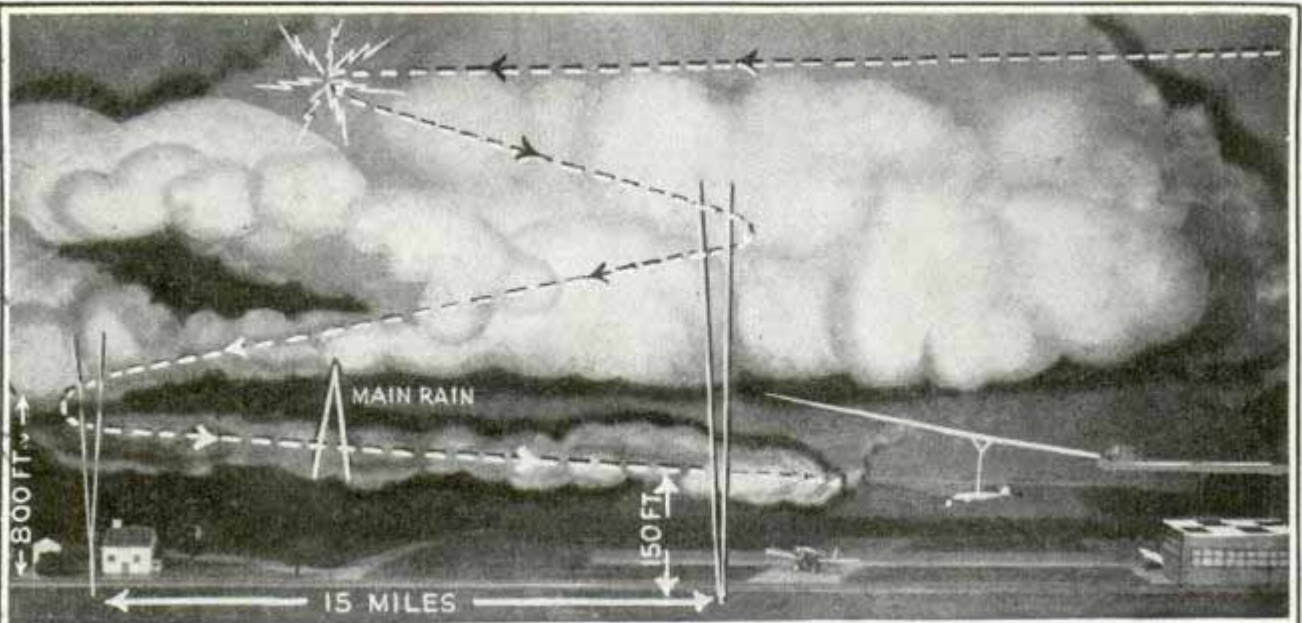

BLIND LANDING SYSTEM
 The display shows the method used in making a blind landing in fog, or bad weather



Top, general view of three-dimension model which demonstrates blind landing system. Arrows in this photo, and those in sketch pictured below, indicate progress of the toy plane from the moment radio signal is received until the ship comes to rest on the ground. Bottom, disk which enables the tiny plane to make the various turns necessary. The plane moves on an endless chain as it goes through the maneuvers to land by radio direction as artificial clouds obscure the miniature airport. This model, used at Wright Field, and the blind landing system are explained more fully on the page opposite

Col Charles J. Davis Dayton Daily News
 May 1935
 Dayton, Ohio

GREATER

The complete **FISK**
line:

- Fisk Balloon*
- Fisk Rugged Heavy*
- Duty*
- Fisk Rugged*

The country is taking to the road
placements in staggering numbers

For nearly 40 years the name **FISK**
mark, has been the best buy in
FISK is an assurance of maximum

The public puts its faith in **FISK**
stock, you have an investment tha



The motorcycle trailer was made by Otto Gerling of Ellendale, North Dakota. Last summer he made a 6000 mile trip, with no hotel bill, averaged about 60 miles to the gallon of gasoline. The trailer loaded weighs about 500 lbs., and is equipped

—Photo by Bernard L. Kobel
the current coming from the motorcycle
The windows are screened, and there is also
a roof ventilator. It is 7' long

Latest Blind Landing System Explained by Model

How airplanes may land in murky weather by using the latest blind landing system is shown by a three-dimension working model at Wright Field, Dayton, Ohio. The miniature scene, ten feet long and four feet high, depicts an airport countryside obscured by low-hanging artificial clouds. A four-inch plane suspended from an endless chain simulates the movement of radio-guided aircraft. The landing system, now being installed at a number of airports, employs the radio compass, which when tuned on a station gives a needle indication of the plane's flight direction in relation to the station. To fly straight to the station the pilot keeps the needle centered on a dial. Arriving over the station, the pilot sees the needle fluctuating sharply, so he tunes in on a portable radio station located near the field boundary and radios his altitude as indicated by the altimeter. From the ground he receives by radio a correction based on prevailing atmospheric conditions. As he flies toward this station he loses altitude and when directly over it he notices the needle again fluctuating. The pilot then tunes in another portable station fifteen miles away, placed in the direction in which the wind is blowing. Still losing altitude he crosses the outer guiding station at between 600 and 800 feet and a red light flashes on his instrument panel on radio impulse from the ground. The pilot makes a 180-degree turn and tunes in on a line formed by the guiding stations. Still gliding he crosses the inner station at between 150 feet and 200 feet, receives another red flash if in correct position, and settles to a landing. In the working model the plane executes all the movements of a ship making a blind landing, even to the three-point landing. On the turns the model ship banks by passing around a disk. Toy trucks are placed to represent the guiding stations.

Popular Mechanics Magazine does not publish the name of the maker of, or dealer in, any device described in its pages, but this information will be furnished by our Bureau of Information upon request, accompanied by stamped envelope.

Ether Preheater Mixes Gas Properly for Patient



Giving ether to patient. Note the apparatus which converts ether into pure gas

Reducing the danger of ether pneumonia and nausea, a small preheater prepares ether so that it is a pure gas mixed with air or oxygen when drawn into the patient's lungs. The device consists of an ether container and a hot-water jacket which retains the heat.

Seven-Foot Trailer Is Home for Motorcyclist on Tour

Tiny but complete, a seven-foot trailer towed by a motorcyclist touring the west contains his bed, kerosene stove, and radio, storage space for food, utensils and suitcase, and it is electrically lighted. This home on wheels cost sixty-five dollars to build. It is forty-three inches wide.



Motorcyclist with the trailer he built for a home while touring the western states

*Otto Gerlinger
El Paso, Texas 2/10*

2025 D. Brand

565

Los Angeles, Calif.

F1323

Capt. Don Macquinn
4 W. 10. 3 rd
Newark

STOP and GO at the

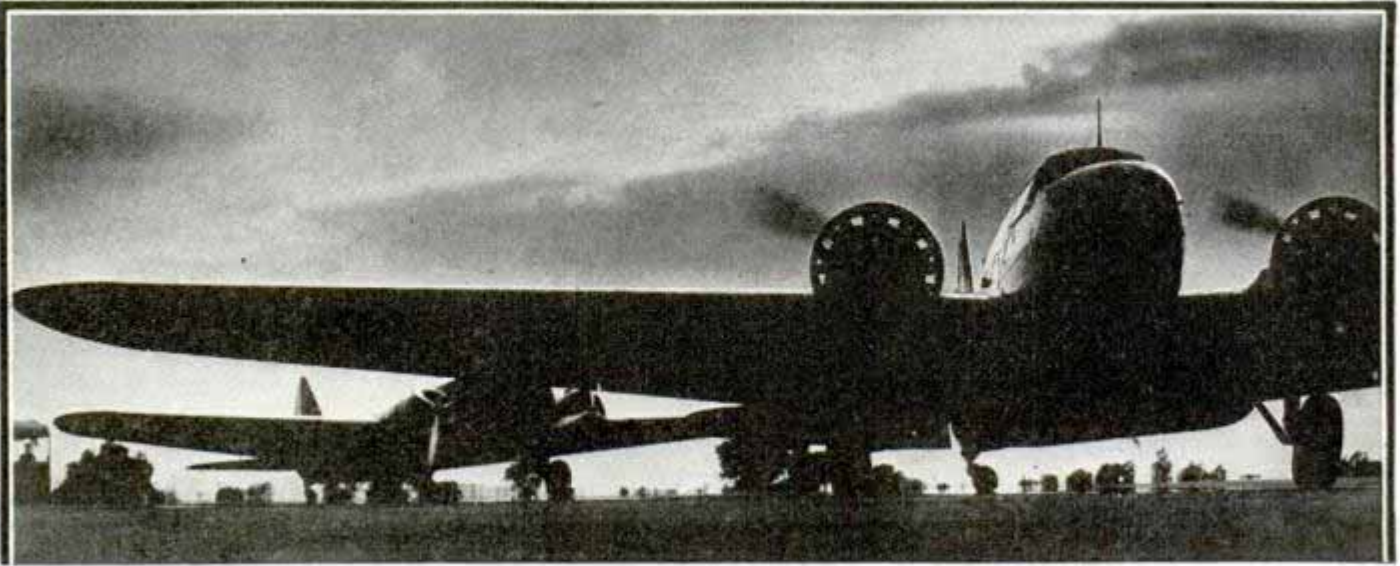

BUZZERS, jingles, the crackle of static and the sharp voices of dispatchers in the control tower at Newark, N. J., indicate when the night traffic jam starts over the world's busiest airport. Fleets of scheduled transports come booming down the radio ranges from north, south and west. And when those boys arrive, they want to get down without a moment's delay.

Newark airport handles more mail, express and passengers than Tempelhof, Berlin; Croydon, London; and Le Bourget, Paris, combined. At present the traffic averages 210 flights per day, including 118 scheduled flights. More than thirty per cent of all traffic in air passengers, mail and express in the United States is cleared through Newark.

The traffic operators dish out sharp radio commands and while talking, they listen for incoming requests and keep an eagle eye on the field operations. The traffic control operations are more complicated by night than by day. Information about conditions on the field, the weather and the movement of traffic is given in great detail and pilots are led in as carefully as if they were blind.

Pilots have their own preferences about landing lights. Some want lots of illumination, some would rather land in a dark field. The field lights are turned on and off by the traffic operator. At Newark there is a bank of twenty-five floodlights with an intensity of 35,000,000 candlepower. From the air, Newark airport glows like a spot of incandescence on an otherwise black earth.

Lights or no lights, the hazards of night operations at a busy airport allow for no mistakes. The field is marked by boundary lights. Construction work, chimneys, tanks, and other obstacles are

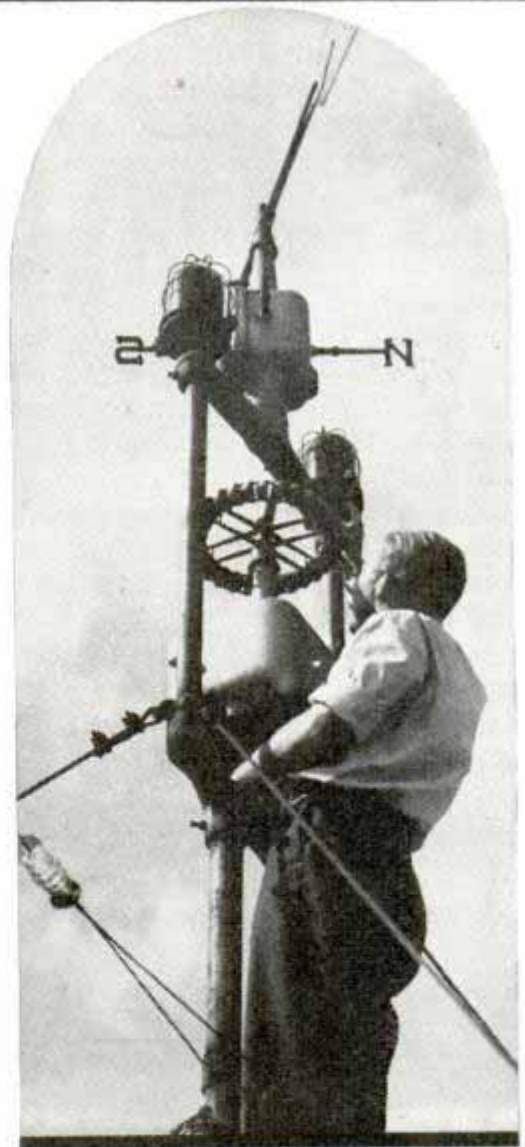

Top, transports ready to take off at dusk. Below, inspecting wind-direction and velocity indicator at Newark airport, the world's busiest landing field

WORLD'S

Busiest AIRPORT

lighted and emergency crews are always available. Roughly the area lying within a fifty-mile radius of Newark airport is within the jurisdiction of the traffic control tower. Ordinarily the pilot "checks in" at this point and thereafter is kept in-

Top, Newark airport at night. Right, tower operator using stop and go light. Below, plotting plane movements





The transport pilot, above, keeps in constant touch with the ground through the radio operator, below

formed of traffic movements and field obstacles from the control tower.

One of the traffic officer's duties is to keep privately owned planes out of the way of transports. Since most privately owned ships have one-way radio, the traffic officer's job is all the more difficult. Communication with private planes may be as follows:

"That blue and red plane—if you're receiving me, kindly wiggle your wings."

Apparently the pilot doesn't hear. He glides across the field, and without clearance from the traffic tower, takes off. The traffic officer whistles softly. The pilot

disobeyed two regulations. He took off in a crosswind and he did not wait for clearance from the traffic tower. These violations are sufficient to ground a pilot.

If radio connections fail, the traffic operator may use his special traffic light, which operates day or night. It can be seen for five miles in daylight and for twelve miles by night. If the airport runways are clear, he turns the green light on; if he wants to warn a pilot against changing his position, he turns on the red light.

The transport pilot observes all regulations carefully. He takes no chances. He follows the "highway" and sticks to his schedule; he never deviates except in an emergency or in compliance with

orders from his superiors. Airways are as accurately laid out as roadways. The airline pilot sticks to the right side of an imaginary line which runs down the center of his airway. The line is a radio beam signal, corresponding to the white streak painted down the center of an auto road.

Transports coming from Washington make radio contact with the airport upon reaching Elizabeth, N. J. They charge down the radio beam at a cruising speed of about 180 miles per hour, and soon are sighted by the control tower. The traffic officer then calls:—

"All clear 120...variable northeast..."

come straight in but keep your eye on that small ship down there...let it go if you're ready!"

The conversations between the traffic control operator and the transport pilot reveal what scrupulous care they exercise.

"You're over Harrison, Dick," says the traffic man. "You're descending to the field. You cannot get through construction area on the south side—so go around it."

The night pilot flies by sight and sound. He works the range most of the time, observes the flashing beacons when they are visible, listens for the identification signal of the range station, and compares the weather reports. He need not look at the ground until he approaches his destination. Modern instruments not only keep the transport on a given route but also reveal the movements of adjacent aircraft.

Eyes and ears are a good sense-combination for the transport pilot, but the reliability of aviation instruments has reached the stage where it is possible to

(Continued to page 118A)



Top, stowing the mail into nose of a modern transport. Center, talking and listening at once during rush of traffic. Below, traffic officer's desk and control tower at Newark

131 Cleveland
Elkhart club

Motor 'Bike' Is Streamlined to Cut Wind Resistance

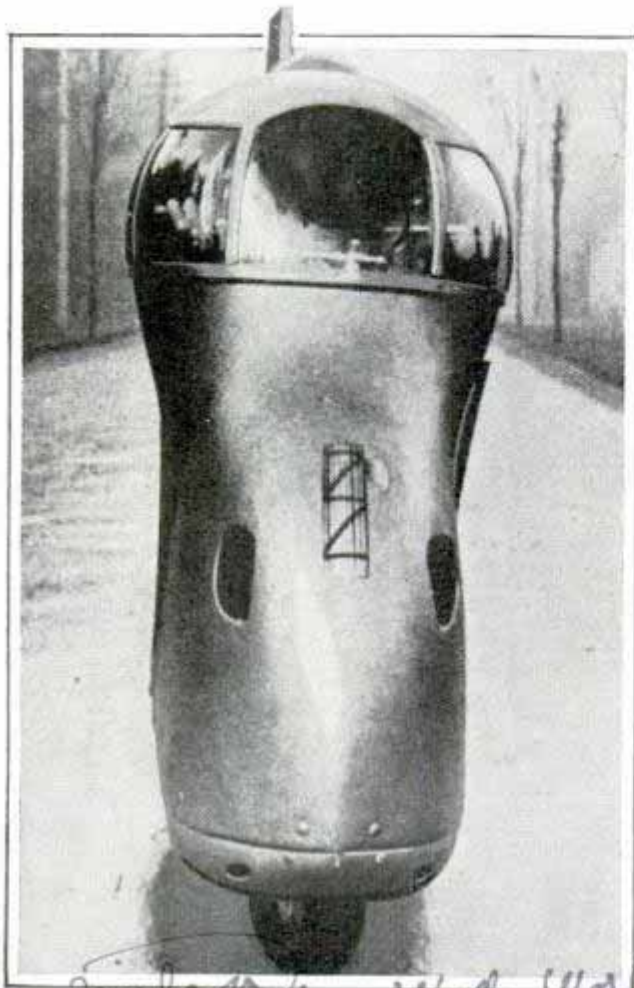

Italian motorcycle enclosed in weather-tight body streamlined for least possible resistance to wind

Completely enclosed in a metal body with glass windows, a streamline motorcycle is not only weatherproof but wind-resistant. The emblematic fascias on the front are evidence of its Italian make.

Radio "Hams" on Six Continents Join in Vast "Round Table"

In twenty-one minutes operators of six amateur radio stations located on as many different continents exchanged greetings in a recent world-wide "round table." W. S. Burkhart of Goulds, Fla., operator of station W4DLH; M. Mozoomder, operating VU2CQ, Bombay, India; E. M. Chorlian, at SU1CH, Cairo, Egypt; Antonio J. Restrepo, at the microphone of HK1Z, Cali, Colombia, South America; Fred W. Miles, G5ML, Kenilworth, England, and Frank Nolan, VK4LO, Brisbane, Australia, were the "ham" operators participating in the round

Amateur Radio News

table which was the result of months of experimentation. While the stations in North and South America were being operated at 7:30 a.m., the English amateur was at lunch and it was 2:30 p.m. in Egypt, 10:30 p.m. in Australia and 6 p.m. in India.

Tiny Maps Magnified in Globe for Driver or Executive

Designed to afford coverage of a large area, yet small enough to be used on the instrument panel of an automobile, a handy revolving globe fitted with magnifying lens enlarges minute details of tiny, almost microscopic maps. Each map has complete information useful to the automobile driver or busy executive.



Autos Freed of Static Charge by Flexible Rod on Bumper

Many motorists have experienced the shock which occurs when their hands touch that of the toll collector at bridges. The shock is the result of the passage of static electricity, built up in the moving car by friction, from the car into the ground through the medium of the collector. An automatic static discharger, con-



Small rod shown touching bumper of car releases static charge and prevents shock

New York Tribune Judge

American Radio West Hartford, Conn. Relay League.

es 105

Milan Wild Walk

es 80

es 99

sisting of a stream of water which played on the wheel of the car before the car reached the toll collection window, solved the problem for summer, but when cold weather interfered with this method, another was devised. This consists of a flexible rod which touches the car, shunting the static charge before the driver touches the hand of the collector. Being flexible, the shock eliminator does not damage the car.

2044.
Electric Iron Folds into a Compact Travel Case

Convenient and practical for travelers, a folding electric iron that fits into a handy, small suede case has been placed on the market. Although the iron has a full-sized ironing surface, the entire outfit, including kit and cord set, weighs but two and one-half pounds. The case, six and



Lightweight electric iron set up for use and folded to fit into compact case for traveling

one-half by nine inches, is only one inch thick. The folding handle snaps into position securely and has a six-foot cord.

es 103
Five-Ton Silo on Top of Auto Shows Strength of Steel Body

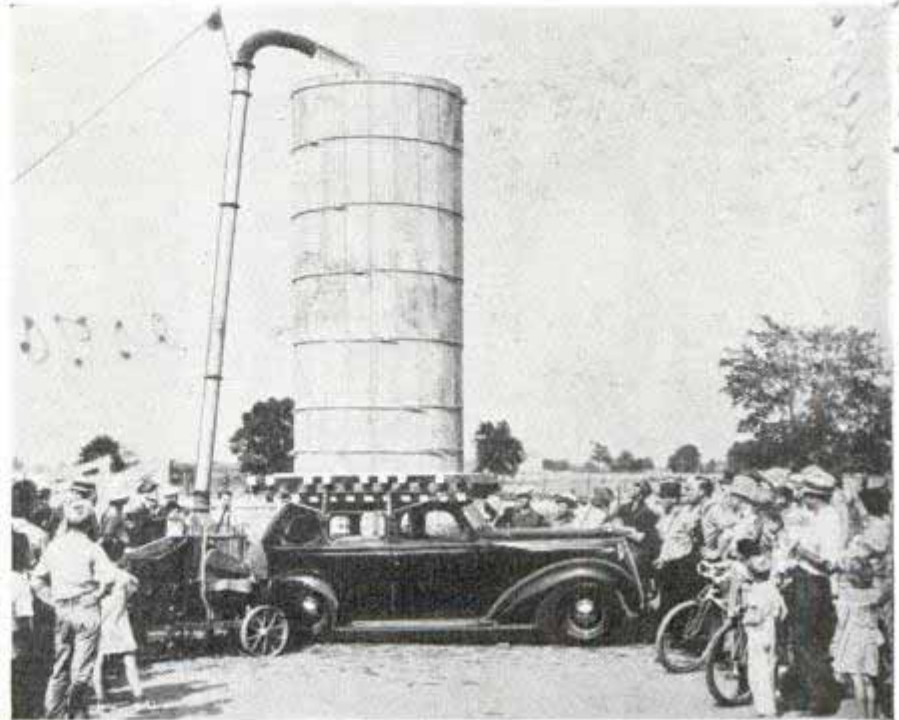

As if a five-ton weight were not enough proof of strength of a steel car body, silo is filled to show what a load the automobile can "take"

Studebaker Corp. - South

To demonstrate the sturdiness of modern automobiles, a concrete silo weighing 10,000 pounds was loaded on the top of a new sedan at a farm exhibit in Indiana. A wooden platform was securely fixed on the roof of the car and the big silo was hoisted upon it. Finally several hundred pounds of silage were blown in. At the end of the test there was no indication of strain on the all-steel body, the doors opening and closing as easily as before.

es 112
Torpedo Dropped by Parachute Circles in Search of Enemy

Italy has developed a "crazy torpedo" that is dropped by parachute and starts circling as soon as it strikes the water. Bombing planes would release such a bomb over a hostile harbor. The impact of hitting the sea would start mechanism spinning a small propeller; the parachute cord, impregnated with a chemical, would burn through at the touch of water and release parachute from torpedo. A set rudder then would guide the torpedo in a broad circle, on the theory that it would be certain to strike a ship or dock.

David Low Co. Chicago Tribune 1/28/39

"Electric Eye" Flashes Red Light When Auto Travels Too Fast

*Exhibited by Radio Corporation of America
30 Rockefeller Plaza
New York*



Demonstrating highway speed warning which flashes red light ahead when car is traveling too fast

Like the automatic train control which signals the engineer when his locomotive exceeds the allowed speed, a highway danger signal has been devised to warn speeding motorists. Two "electric eyes" are so arranged that they flash a red light on the road whenever an automobile passing them is exceeding a predetermined rate of speed. Ahead of him the driver reads the red warning signal: "You are driving too fast."

Flight Recorder for Planes Latest Aid to Safety

*New York Times
2/4/37*

Offered as a means of increasing air safety, a flight recorder for airplanes makes a record of altitude and other features under the control of the pilot. It is essentially a barometric altimeter, equipped with a drum and three recording pens which automatically set down the story of the flight. One pen traces the altitude from takeoff to landing, another records the time and the number of times the pilot makes use of his two-way radio in communication with the ground and the third sets down the record of the radio beacon

receiver, showing whether it functions and for how long. The instrument is designed to make pilots "altitude conscious." Low flying, government and air-line officials believe, has been responsible for a number of accidents. Hitherto there has been no way of checking the altitude, save when a disastrous crash revealed that the pilot had been too close to the ground. One feature of the system is the possibility that the cards on which the instrument pens its records may be made in the form of route or contour maps so that the tracings will actually follow the route flown.

Paint Gives Warning of Danger by Changing Color

Paint that changes its color with excessive heat is being used in industrial plants to warn of overheating at danger points. One type of paint changes color at 300 to 734 degrees Fahrenheit and must be re-coated after the change. Another type, however, changes at 104 to 464 degrees and when cooled reverts to its original color. This paint can be used through twenty-five to fifty changes of color. Power plants use the paint where excess heat would cause damage to bearings.

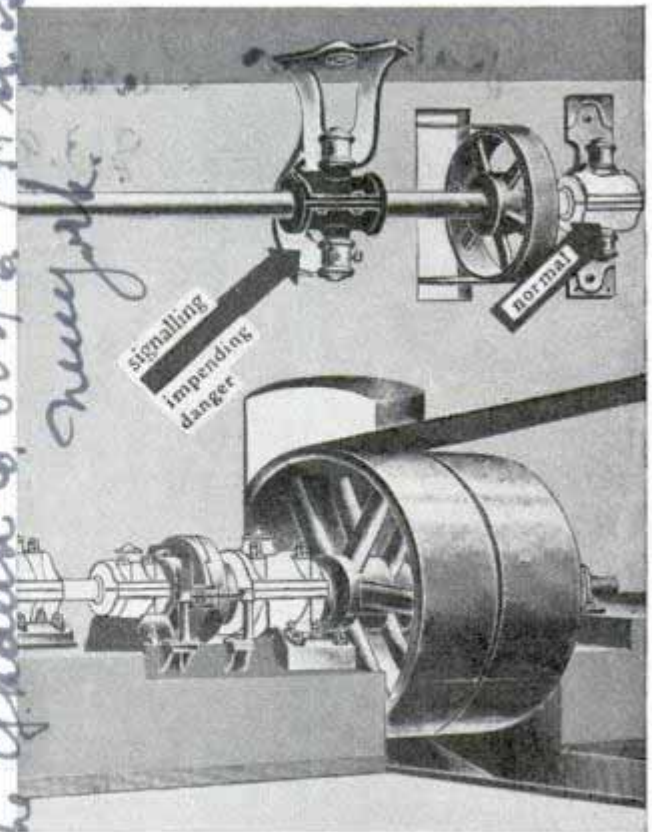

Danger spots in industrial plant are coated with paint that changes hue when overheated

Bureau of Air

R A D I O . . .



RADIO SPEAKERS *in Lamps*

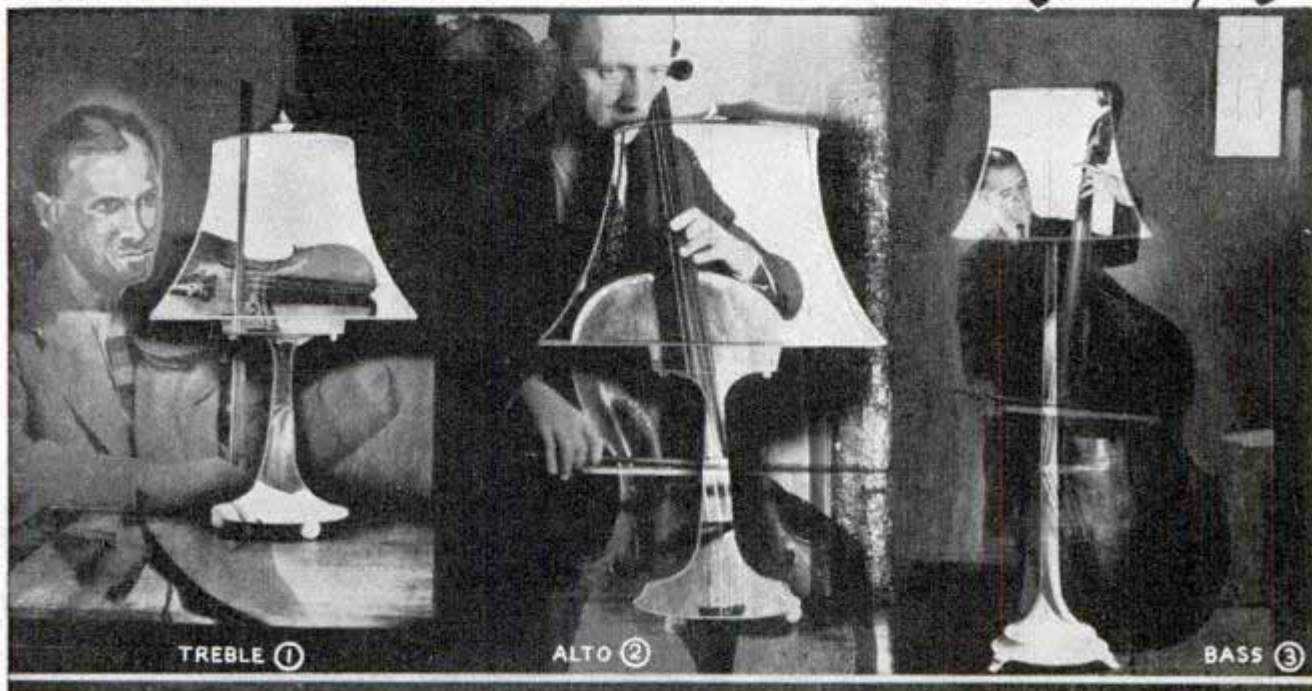

HORNS stood on end and disguised as lamps, give a three-dimensional quality to the tone of a modern receiver. The lamps are connected to any radio set by means of a remote control box, which in turn is connected to the receiver output tube by means of a simple adapter.

Three lamps, two table and one floor model, comprise the group that bring the sound of each instrument out of the radio cabinet into the room. A six-inch speaker is mounted in the head of each lamp shaft which acts as an exponential air column. Fig. 1 shows the complete assembly; bass notes are reproduced by the floor model, while the alto and treble ranges are correctly handled by the table types.

The control box is available either as a separate unit or built into a specially designed 8-tube receiver as shown in the lower photo. One or more of the lamps may be used in combination with your set speaker to "brighten" any particular tone.

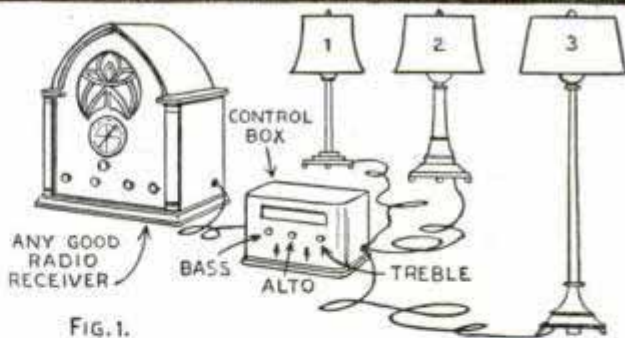

FIG. 1.



*Radio Lamps Co. Inc.
744 Madison Ave
New York*

One 6-Volt STORAGE



BY CUTTING the filament drain in half, a new series of 6.3-volt tubes now solve the troublesome problem of keeping a 6-volt storage battery fully charged by means of a windcharger, auto generator or similar battery-charging methods. These tubes draw only .15 amp. filament current as compared to .3 amp. for previous 6.3-volt tubes commonly used in six-volt broadcast receivers for the home, automobile and boat, where all power must come from a single 6-volt storage battery.

Although of simple design and easy to build, this 4-tube receiver is a full super-heterodyne and has the efficiency of a 6-tube set. It is a real distance-getter, with tone and volume equal to that obtained with the same number of tubes operating on regular 110-volt a.c. supply lines. Automatic volume control, tone control and the use of a permanent-magnet dynamic speaker leave little to be desired, in fact, nothing has been omitted to

make this up-to-date receiver suitable for a wide range of useful applications. Owing to its compact design it may be housed in either a table-type cabinet or console. The console instal-

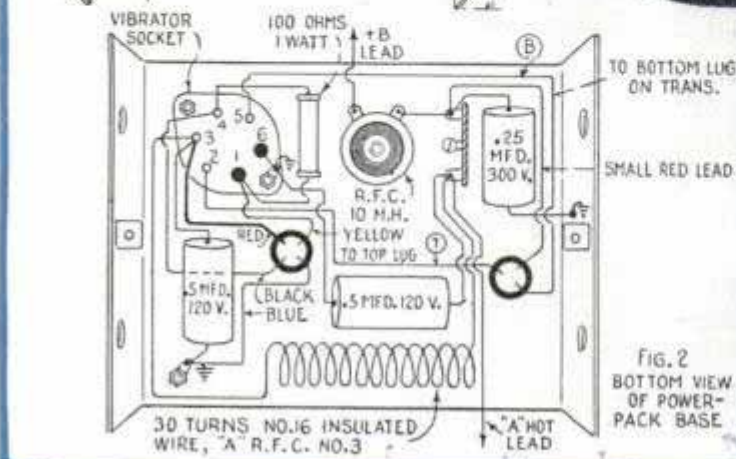
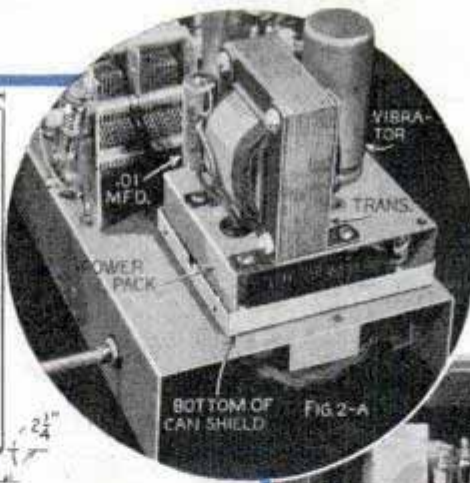
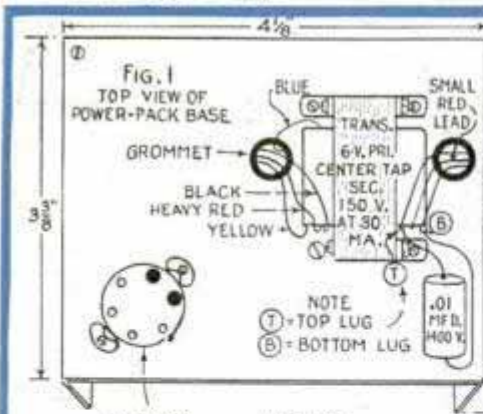

BATTERY

*operates this
low-drain
receiver...*

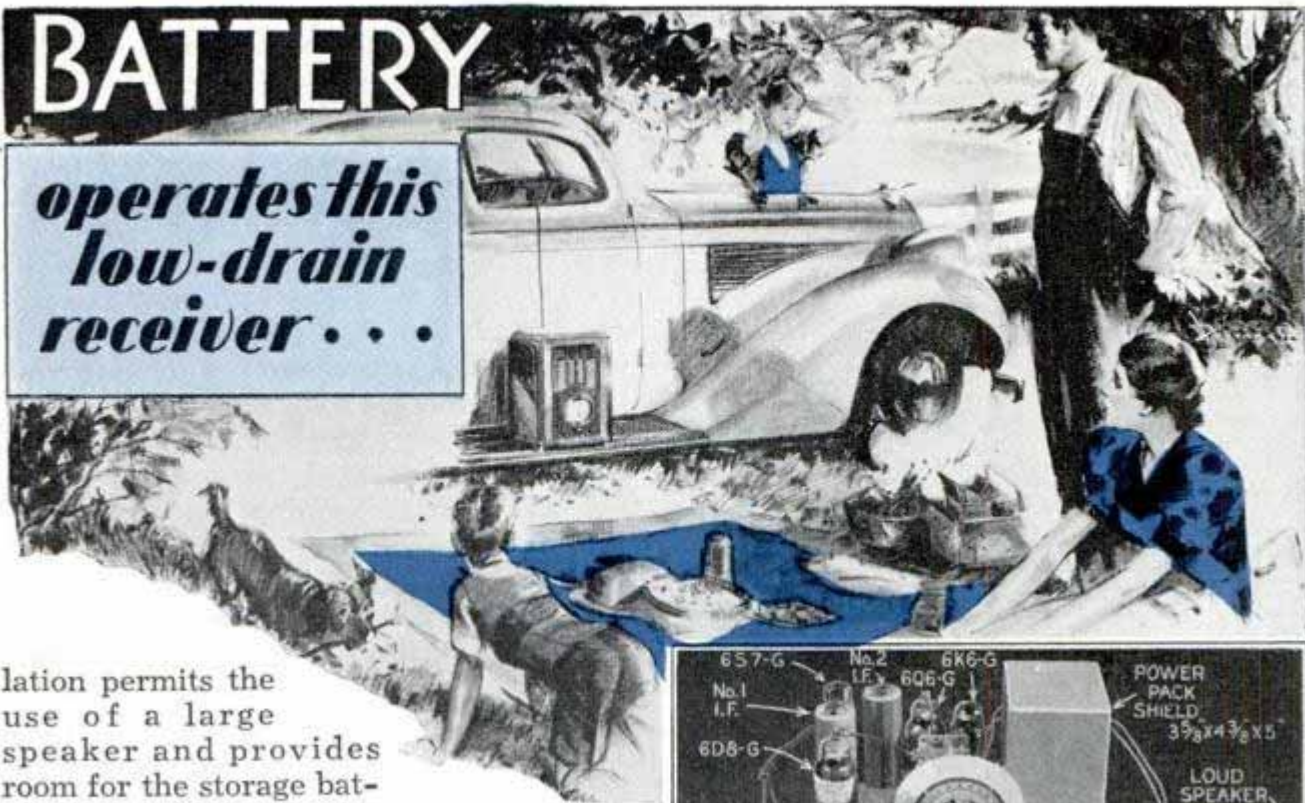

lation permits the use of a large speaker and provides room for the storage battery, as will be noted in the photos. On the other hand, if housed in a small cabinet it can be taken in the car on picnics, used in a boat or wherever

(Continued to page 142A)

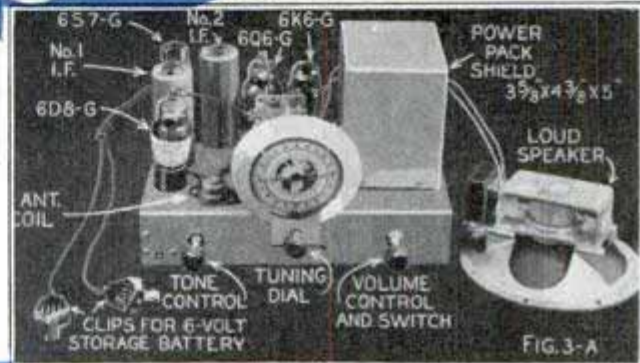

FIG. 3-A

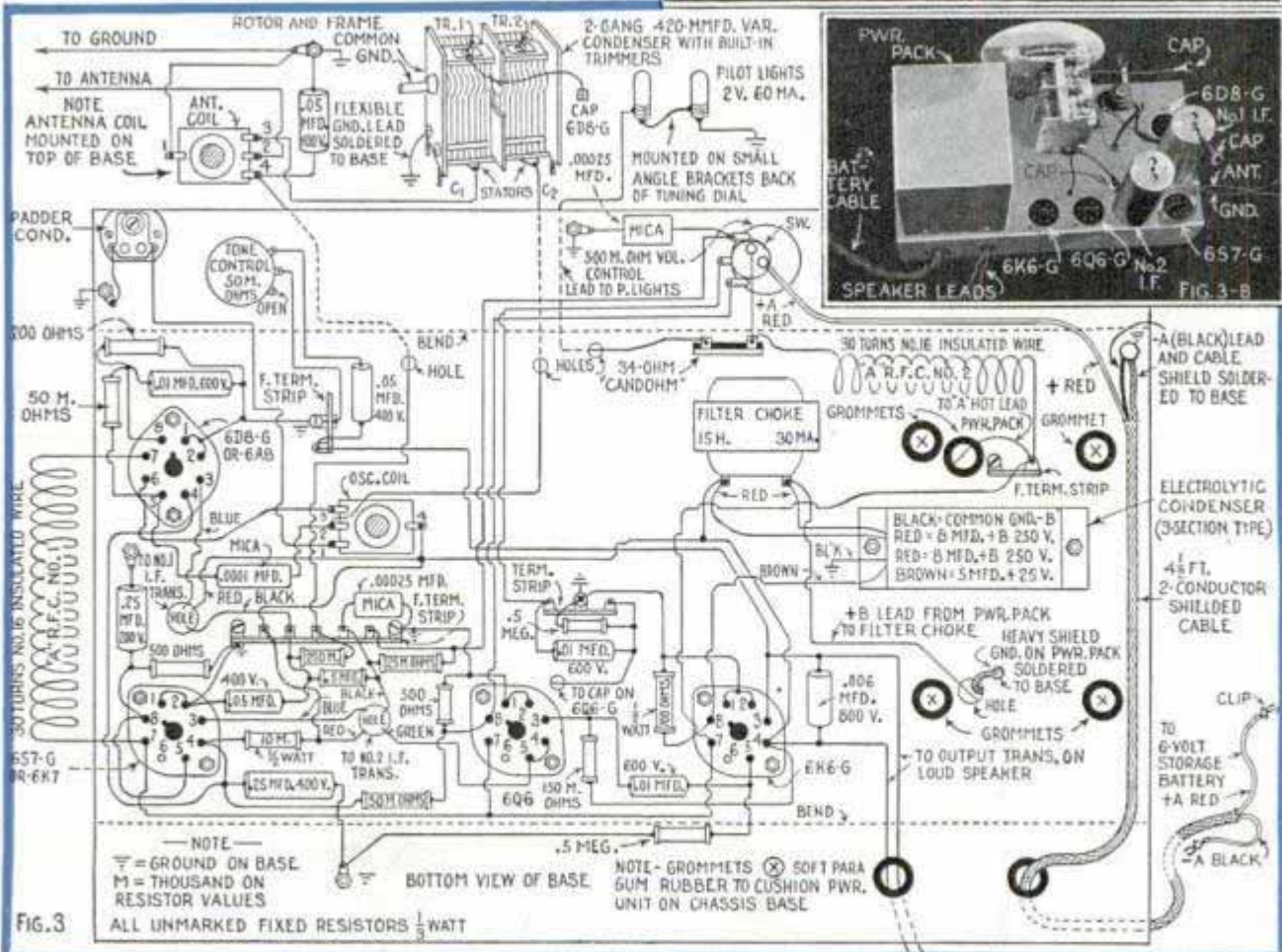

FIG. 3

Code-Practice Oscillator Built in Coffee Can

By M. N. Beitman

ONLY a few radio parts and an empty coffee can are required to assemble this vacuum-tube audio oscillator. When hooked up with a key and headphone it gives the future "ham" a means for needed practice and will familiarize him with the actual tone of code signals.

All parts, including the tube and battery, are housed in the can. Fig. 1 shows the schematic circuit diagram, and a simplified wiring diagram is given in Fig. 2. It will be noted in photos 2-A and 2-B that the parts are all mounted on the underside of the can lid; a small metal bracket, soldered to the lid, supports the wafer-type socket for the RCA-30 tube. The battery leads terminate in a plug that fits a socket in the top of a 4½-volt "C" battery which lies flat in the bottom of the can. These plug-in type "C" batteries are now available from any radio supply house. The plug acts as a switch to disconnect the battery, and is removed when the unit is not in operation. Only 1½ volts are used for the filament of the tube, the remaining voltage being applied to the plate.

Plain binding posts are specified for the key connection and small pin-type jacks for the headphone. Please note that these binding posts and tip-jacks must be insulated from the can lid.

To place the oscillator in operation, plug in the battery connector and attach the phone and key; the signals, controlled by the key, will be heard in the headphone.

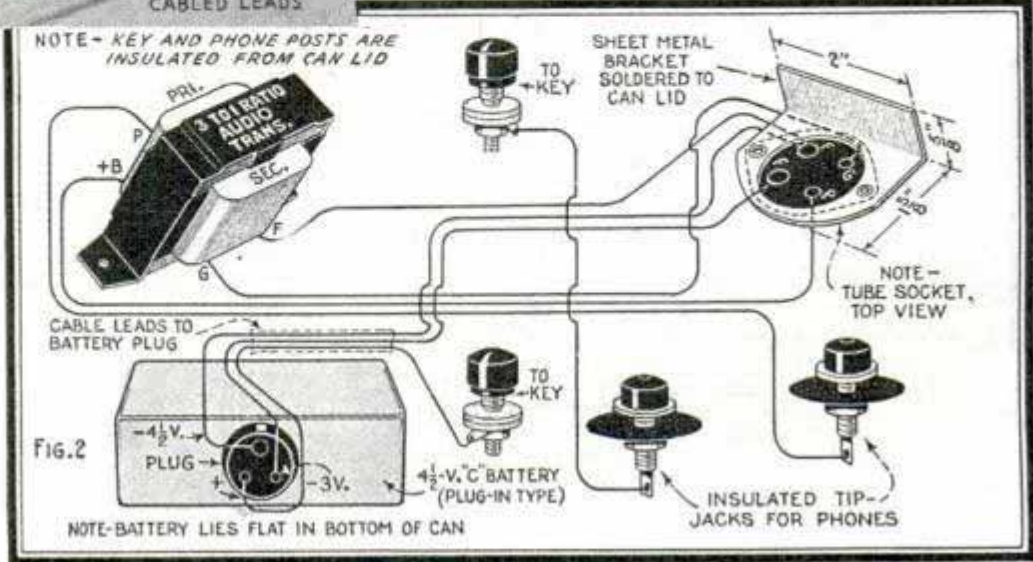
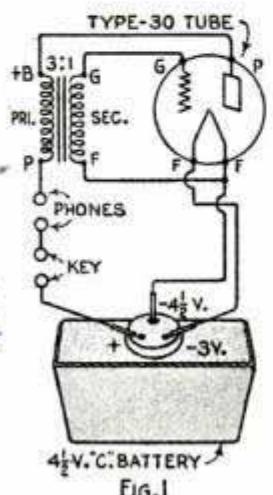
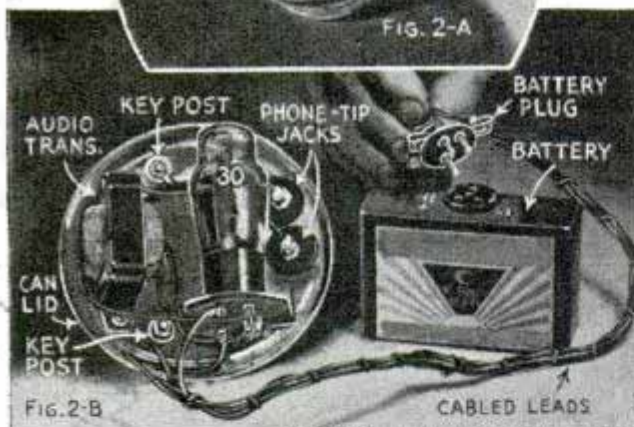

*John - Deussen
Co., Canton, Mass*

Hints for RADIO EXPERIMENTERS

Right, added height above the mast tip to increase sending and receiving range of a vertical 5-meter antenna easily gained by using simple rig shown in detailed sketch. Extension stick keeps feeder out of antenna field. Guy wires are fastened below top to reduce absorption losses

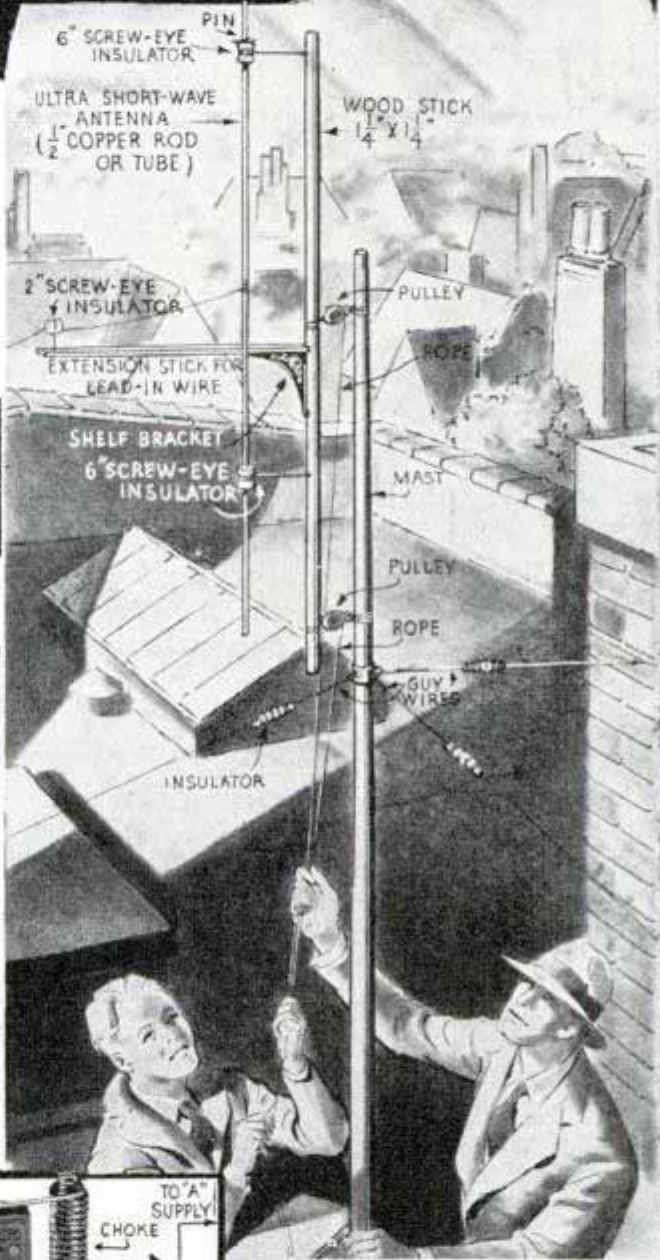

Left, husky r.f. choke for transmitter, random-wound, filling flutes of two stand-off insulators

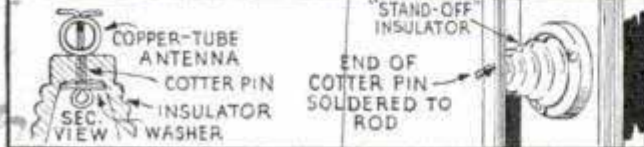

Above, efficient mounting for a long vertical tube or rod antenna for 10 and 20 meters. Right, flexible insulated coupling takes 3/4-in. shafts. Below, twin power-line chokes keep interference from electrical apparatus out of receiver. By-pass condensers .1 mfd., best location found by trial

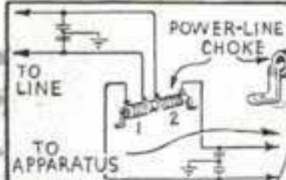

Right, noise filter for electric razor prevents interference with morning broadcast while whiskers are being removed

Figs. 1, 2 and 2-A show homemade noise filter for auto radio "A" battery lead

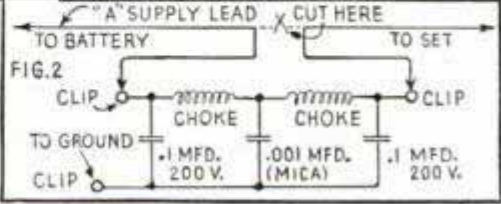
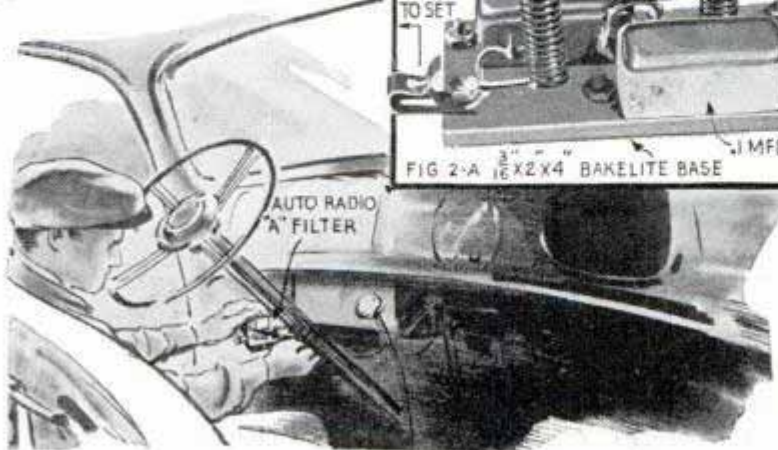
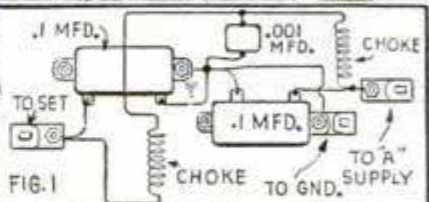
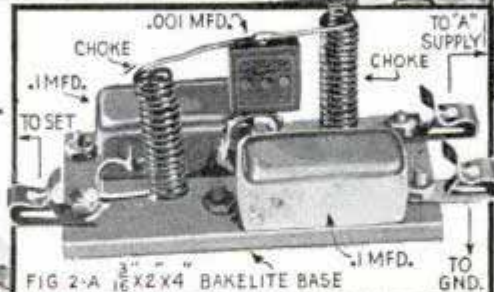

Chokes are 17 turns No. 14 enameled wire wound around a pencil

*Nationality Company, Inc. 61 Sherman, Malden, Mass.
Ward Product Corp. 1523 E. 4th St., Cleveland, Ohio*

Modern Answer to Old Problem



Left, unit containing individually shielded plug-in coils in a cast-aluminum container; a twist of the knob at lower center on panel above, moves unit into position and plugs in coils

Retaining the convenience of knob-controlled range changing without the use of a coil switch, this 12-tube super, of advanced design, employs a movable-coil tuning unit containing highly efficient plug-in coils for 5 ranges from 540 kilocycles to 30 megacycles. Idle coils are completely isolated, leads are short and calibration is permanent.

Universal Turret-Top Antenna

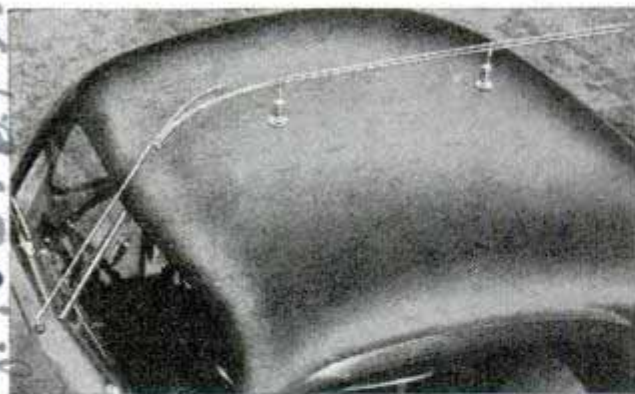

Adjustable to fit all body styles, coupe, coach or sedan, this chrome-finished antenna for turret-top cars is easily installed

without drilling the car top. Stand-off insulators, in a choice of red or ivory finish, prevent shorts in wet weather; a special mounting cement insures rigid installation.

Oscilloscope for Amateurs

Designed especially for use in conjunction with amateur transmitters for checking purposes, this self-contained low-cost oscilloscope employs the new RCA type-913 midget 1-in. cathode-ray tube. The tube is mounted at an angle above the controls so that the viewing screen is in line with the eyes of the operator.



Sliding Scale Time Converter

The purpose of this sliding scale is to convert instantly, in a simple operation, the time and date of any one country to that of any other, as well as Greenwich mean time (GMT) to local time the world over. A helpful aid for short-wave DX listeners and owners of all-wave receivers.



Blueprints covering radio construction articles in past issues are available for 25 cents each; original material lists and additional information can be obtained from our Radio Department without charge upon receipt of postage.

NEXT MONTH—How to Build a Compact Portable Amplifier. Designed to fit into a standard portable speaker case, this amplifier is easy to build; suitable for outdoor or indoor use, window demonstrations, schools, and for amplifying stringed instruments. Also, **How to Build a 5-Meter Transceiver for Bicycle Installation.**

*Chicago
N. Salzman
565
W. H. Weeks*

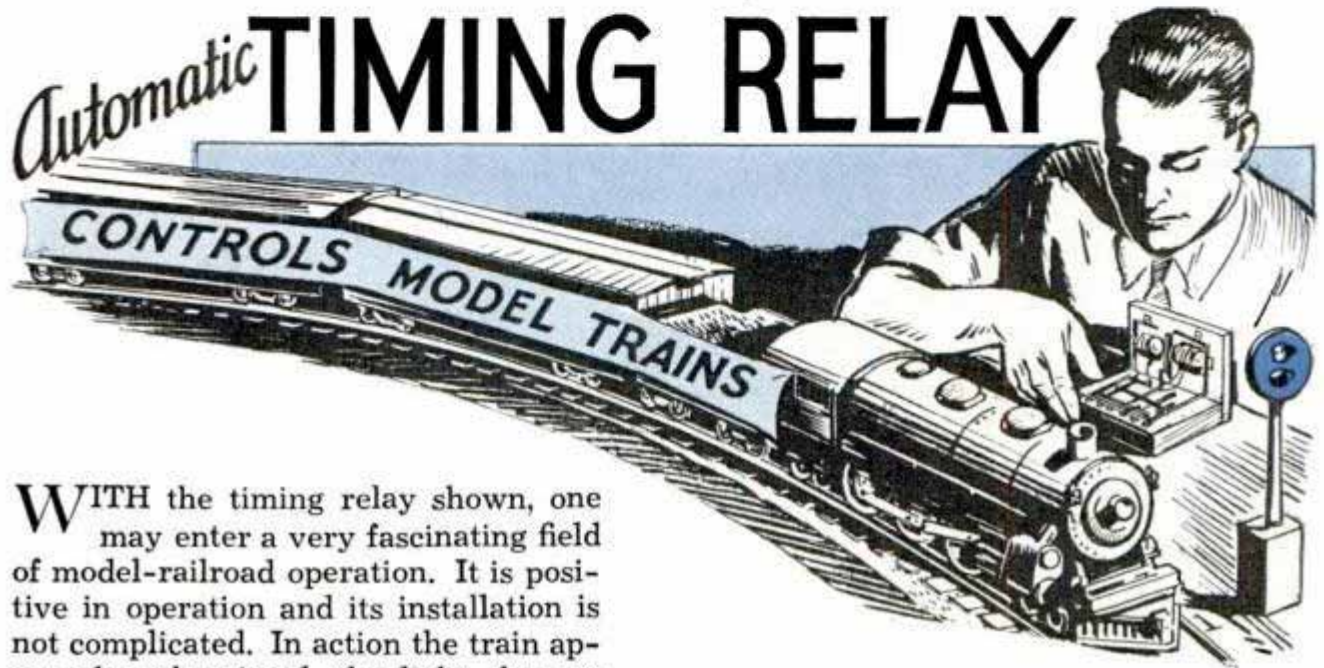

WITH the timing relay shown, one may enter a very fascinating field of model-railroad operation. It is positive in operation and its installation is not complicated. In action the train approaches the signal, the light changes from green to red and the train comes to a stop. After a few seconds the light changes back to green and the train proceeds. This action is repeated each time the train approaches the signal controlled by the relay.

The completed unit is shown in Fig. 1. It consists of a base $2\frac{1}{2}$ by $3\frac{1}{2}$ in. with a thin board about 3 in. wide nailed in an upright position to the back as shown. The relay switch is mounted on the back board and consists of an armature actuated by the two magnets R and G in Fig. 3. This armature is pivoted at the point B by means of a brass screw. A bushing of copper tubing $\frac{1}{2}$ in. long is soldered on the end of the armature to provide a bearing. The two magnets R and G are 1-in. flat-head stove bolts, mounted on small angles of tin. Each is wound with 150 turns of No. 27 copper wire and mounted one on each side of the armature as shown. The distance between the armature and the core of the magnet should not exceed $\frac{1}{16}$ in. The contacts are soldered on small angles of tin and mounted so as to make contact with the armature as it is drawn

toward either magnet. The adjustment of these should be such that they make firm contact but do not impede the free operation of the armature.

The timing is done by means of a thermostat mounted on the base. The arm is a section of bi-metal taken from a thermometer. This arm is 2 in. long and is mounted on a small angle of tin after determining in which direction it will swing when heated. When properly mounted it should swing toward the contact. The heater unit is a piece of wire 1 in. long, taken from the heater element of a toaster. It is insulated by means of a strip of mica obtained from the same source.

The wiring is clearly shown in Fig. 3, and should be followed carefully to insure proper operation. Brass screws are used as terminals. To install this unit it is necessary to remove the pins from the third rail of the track section at the location of the signal. This section will be dead when the signal is red, and energized when the signal is green. The contact T_1 is of very thin brass and is placed about 6 in. from the entering end of the dead section. This

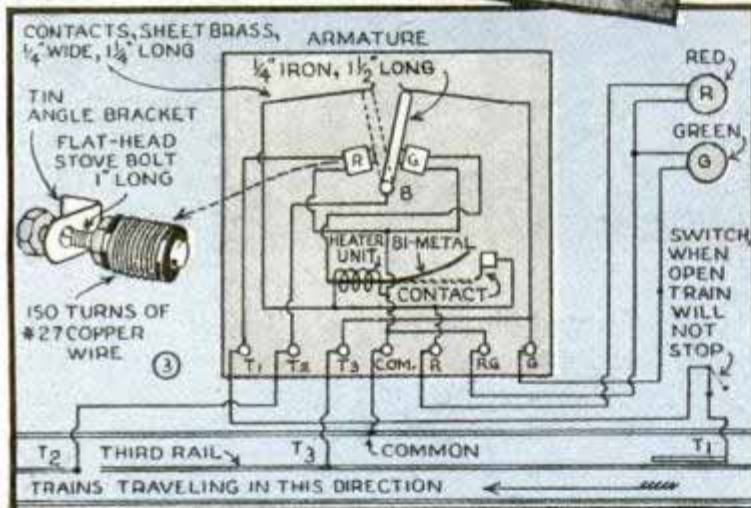
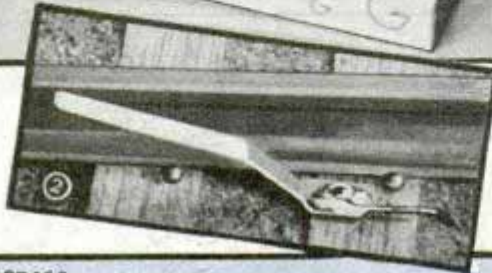
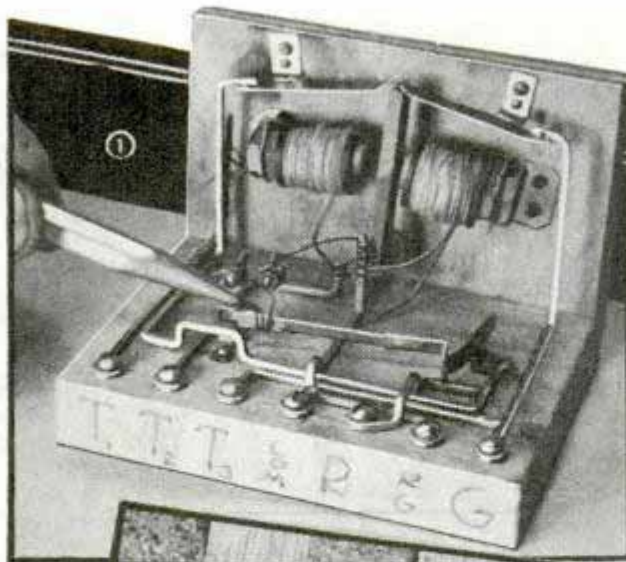

contact is shown in Fig. 2. It is mounted alongside the third rail, close enough so that the shoe on the locomotive will form a bridge between it and the third rail.

In operation the normal indication of the signal is green. When the armature is in contact as shown, current flows from T_2 through the armature into the contact energizing the section fed by T_3 and lighting the green light. When the train approaches the signal the third-rail shoe on the locomotive forms a bridge between the third rail and the contact T_1 . This energizes magnet R and draws the armature over to the position shown by the dotted lines. When the armature is in this position current is no longer being fed to T_3 , and the train stops. Current is then fed to the heater unit and the red light. When the unit is heated, this swings the thermostat arm over in contact and energizes magnet G . This draws the armature over to its normal position and the train proceeds. The thermostat cools in a few seconds and returns to its normal position. The unit may be concealed in a small building along the track or in the lower part of the signal.

Leaning Tree Is Straightened Up by Simple Windlass

When a small tree leans at an angle which detracts from its beauty, it can be straightened up with this windlass made of 1-in. pipe and fittings. The windlass is driven into the ground at an angle opposite to that of the tree. Several wrappings of old inner tube should be provided under the windlass cable where it is attached to the tree. Over a period of several weeks, the tree is gradually straightened by frequently tightening the windlass, the crank of which is held by a short rope and ring dropped over a stake near by.

☐ Lamp chimneys cleaned with a newspaper on which a little kerosene has been poured will give a clearer light and be less likely to crack.

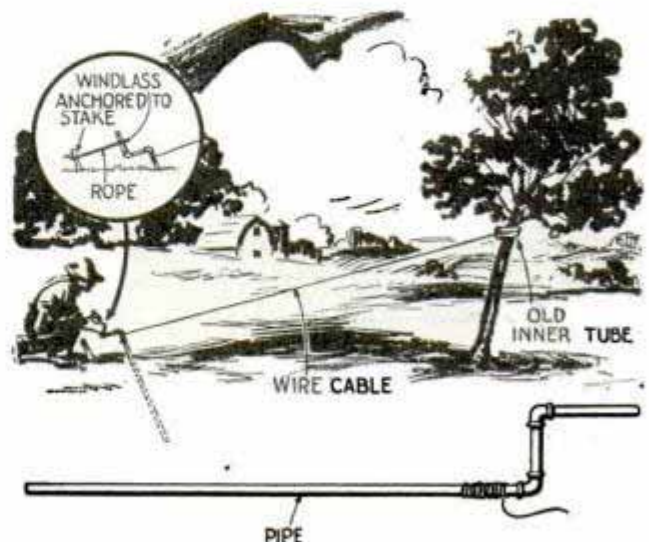

A fair-size tree can be straightened by tightening up the windlass at regular intervals

Urn-Top Columns Add Beauty to the Home

Truly graceful in themselves, urn-top columns enameled in the popular bone-white finishes lend a striking decorative touch to bare walls and corners when used alone or as flower vases. The whole job can be done on the wood lathe, the column being formed by gluing up eight tongue-and-groove segments cut from 1 $\frac{1}{8}$ -in. stock and clamped together until the glue dries, with clamps made from flat iron. A wood disk is screwed to each end, then the job is set up in the lathe and turned to the cylindrical form. To get the reeded effect, the column is covered with half-round molding which can be obtained in various stock sizes. The base is built up and turned in the same way, but is left plain as shown in the illustration. The urn is made by stacking a number of wood disks, with glue in all joints, then turning to contour in the lathe. After turning, coat the urn inside and out with shellac.

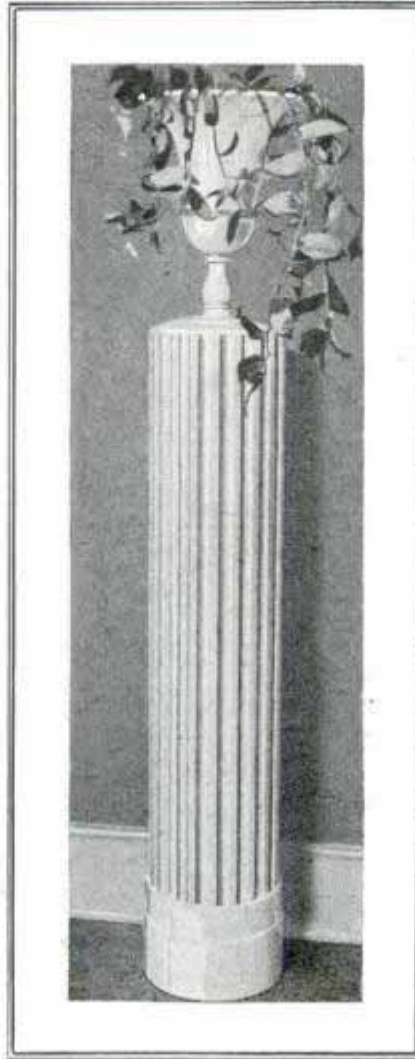

Finished in white, these columns will help to modernize the living room or sunroom

Coil Springs Hold Aquarium Sides While Cement Sets

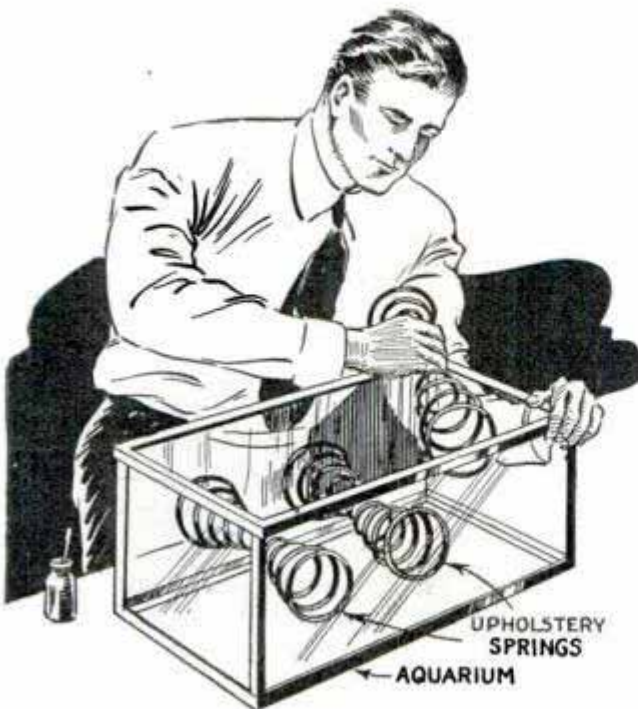

The often difficult job of holding the sides of an aquarium firmly in place until the cement sets is made easy by using three or four upholstery springs, which can be picked up at almost any junk yard. After the cement has been applied to the aquarium frame and the sides set in place, the springs are put between them, where they will exert enough pressure to hold the glass firmly in the cement.

Bouquets Colored by Water

To obtain unusual bouquets of cut flowers I use fruit coloring in the water. You can have bouquets of delicate pink or creamy yellow lilacs, spirea, iris or any other flower which is naturally white. The amount of coloring to use depends on the amount of water in the vase.

—Mrs. Edward O'Berg, Merrill, Wis.

Tee in Return Line of Boiler Permits Removing Sludge

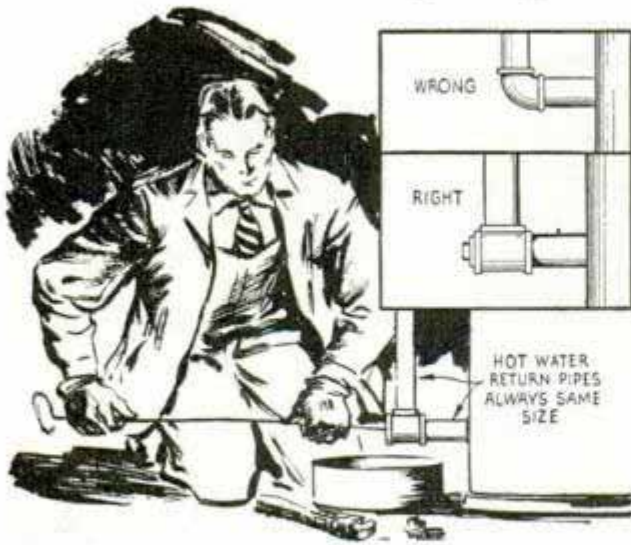

Sludge that accumulates in the boiler nipple of a heating plant is readily removed when a tee is used

Instead of connecting the return pipe to the nipple of a hot-water boiler in a heating plant, which is often done, use a tee with a brass plug in the opening. Then you can remove the sludge which accumulates in the nipple in a few minutes by simply taking the plug out and running a wire brush through the nipple.

Small Faceplates for the Lathe

Small faceplates for the lathe can be made from standard pipe plugs, which are obtainable in a variety of sizes. First, the threaded section of the plug is cut off

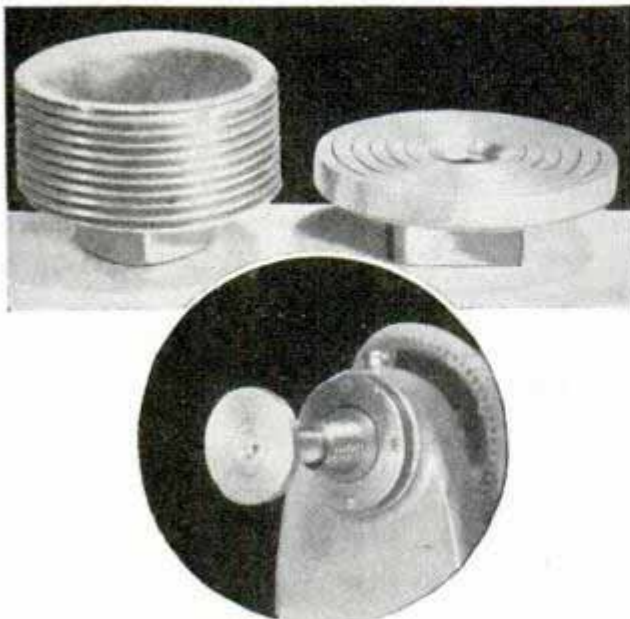

You can make a number of small faceplates for regular or special jobs from pipe plugs

down to the back wall. This will leave the closed end of the plug in the form of a rough plate, with more than enough thickness to make the finished job heavy and rigid. Then, the rough plate is fitted to the spindle which is to carry it by drilling a hole through the center. The projecting end of the plug which ordinarily takes the wrench provides ample material for threading or fitting with set screws, as the spindle may require. Next, the plate is run on the spindle and trued up, front, back and edge. Holes may be drilled, or slots cut in the face as desired.

—Kingsley W. Greene, Wood Ridge, N. J.

Bearings for Lawnmower Roller from Caster Sockets

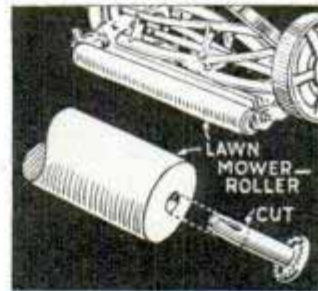

If the wooden roller on your lawnmower is of the type that turns on small projections extending from the castings and the roller is not fitted with

bearings, you can improvise some from caster sockets that will last quite a while. Just saw off the slotted ends of the sockets as indicated and drive them into the holes in the end of the roller. The sockets should be selected to fit the projection.

Eraser Shielded with Tape

If you carry an eraser in your pocket, it's an easy matter to keep it from becoming soiled by simply wrapping Cellophane tape around the eraser. The



tape, which can be obtained at most ten-cent stores, is gradually peeled back as the end of the eraser wears down.

—Lawrence B. Johnson, Spokane, Wash.

☐ When it is necessary to send coins through the mails, fasten them to the inner surface of a piece of folded cardboard with a strip of gummed paper.

Mounting Your MODEL

LOOKING at the various types of mountings shown here you will see that several are designed to portray the model in action. This makes it doubly attractive and in no way detracts from the constructional features of the model itself.

For example, a mounting for a model speed plane can be a pylon, as shown in Figs. 1 and 2, the plane being held in place with a length of piano wire. Details of the general proportion between plane and pylon are shown in Fig. 2. Simple bracket mountings like that in Fig. 3 are always effective. The bracket can be made from plywood, metal or plastic.

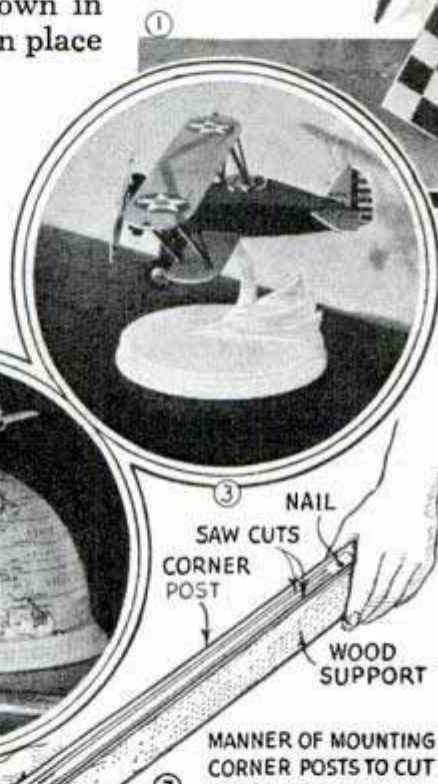
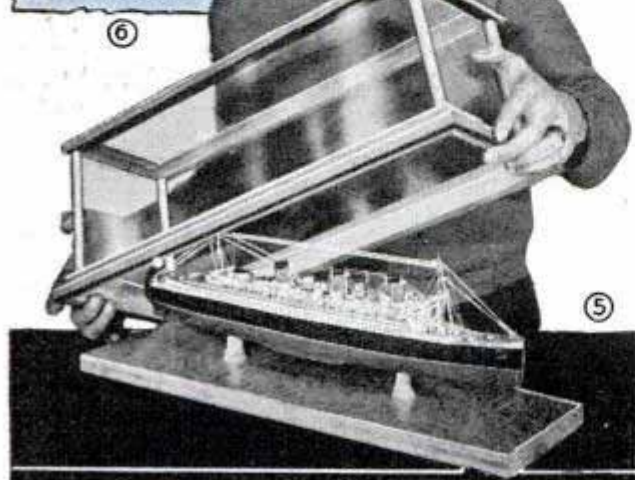
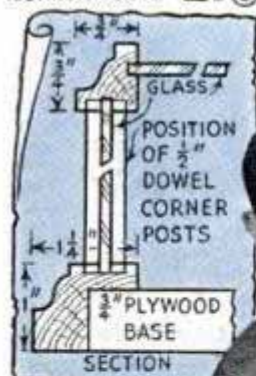
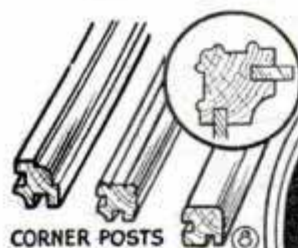
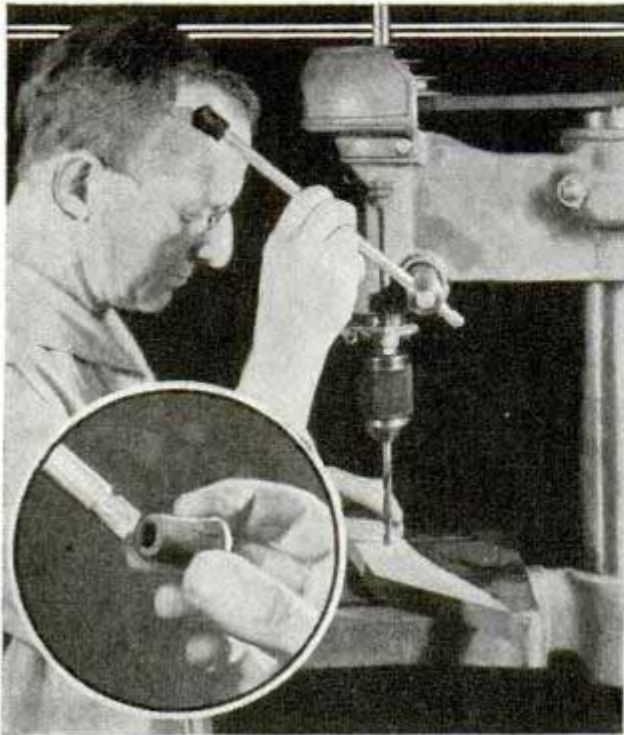

Fig. 4 shows the popular "top of the world" mounting for transport planes. The size of the globe is dependent on the size of the model. Small globes, about 6 in. in diameter, are suitable for plane models up to about 5 in. long. In Figs. 3 and 4 the base is a wood turning, that supporting the globe being turned from $\frac{3}{4}$ -in.

$\frac{1}{4}$ in. to fit inside the globe. Larger models, especially the delicate kind that cannot be dusted, are best mounted in the museum-type glass case as in Fig. 5, a cross section of this case being shown in Fig. 6. The moldings are grooved to take double-strength glass. The corner posts can be made from $\frac{1}{2}$ -in. dowels, by nailing an oversize length of the stock to a wood support as in Fig. 7 so that the grooves can be cut on the circular saw. The posts are then cut to length and doweled into the corners of the framework. Other corner-post designs, made on the shaper, are shown in Fig. 8. These can also be made on the circular saw.



Drill-Press Handle Shielded to Protect Your Head



A rubber crutch tip slipped over your drill-press handle may prevent an injured eye or bruised face

Handles of drill presses having powerful springs for raising the spindles can cause serious injury to the eyes or other part of the face if they accidentally fly upward when released. One way of eliminating most of the danger is to cap the ends of such handles with small rubber crutch tips which can be purchased at drug stores. Besides acting as a safety device, the tips form convenient grips.

Adjustable Gasket Cutter Uses Razor Blades

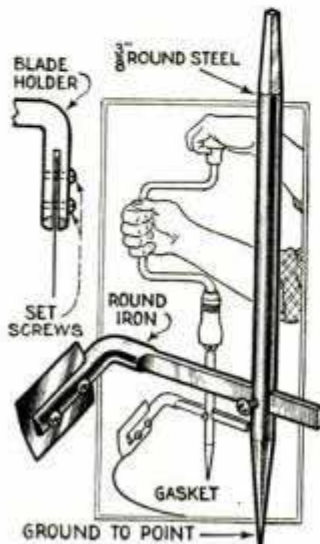

Easily made to any size desired, this gasket cutter is always sharp as it uses an old safety-razor blade, which is quickly replaced by removing two screws. Used in a drill brace, the cutter holder consists of two iron or steel rods, one of which has shoul-

ders ground at one end to fit the brace and a point at the other end to perforate the work and serve as a center. The second rod serves as an arm which carries the razor-blade cutter. It is ground flat on four sides from one end to about the center to slip into a hole in the other piece as indicated, where it is held by a set screw. The arm is bent at right angles and is slotted to take the blade, which is clamped in place by two set screws.

—L. B. Robbins, Harwich, Mass.

Line Inked on Drawing Board Aids in Lettering

Not having a triangle with the correct slant for lettering, I inked a line on my drawing board as shown, so that a 60°-30° triangle could be used. I measured up the working edge of the board five units and



Using a T-square and a regular triangle to draw the guide lines for letter work

two over, which gives the correct slant for lettering. It is then a simple matter to fit the triangle to this line, put a T-square in place and, tightly holding it, slide the triangle along and draw the guide lines wherever needed.

—Clarence Hamersen, Florissant, Mo.

Dry-Cleaning Soap

A soap that is soluble in naphtha and, therefore, can be used in ordinary dry-cleaning solutions to add to their effec-

tiveness is made by thoroughly mixing oleic acid (red oil), 10.7 lbs., butyl cellosolve, 2.7 lbs., and naphtha (dry cleaners'), 2.5 lbs. This mixture is inflammable and should be heated carefully over a water bath away from a flame to a temperature of 140° Fahr. In another container prepare the following solution: Potassium hydroxide, .85 lb., and water, 1.35 lbs. When dissolved add triethanolamine, 1.97 lbs. After stirring thoroughly, this solution is heated to 140° Fahr. and is poured into the first solution while stirring vigorously. The stirring should be continued leisurely for a half hour or until an even and fairly clear solution is obtained. To use the soap, add a small quantity of it to cleaners' naphtha or other spirit-cleaning mixture.

Lettered Trees Along Fairway of Golf Course Aid the Player



Golf balls hooked or sliced into the timber along this fairway are located by taking a bearing on the lettered trunks

Mandrel on Leg of Workbench for Shaping Sheet Metal

Screwed to the leg of your home-workshop bench, this removable pipe nipple will come in handy for occasional jobs of shaping light sheet metal and similar work. It is attached by means of a floor flange which is screwed to the bench leg. Several nipples of different sizes can be accommodated by using pipe bushings in the flange.



Pipe nipple on bench leg provides mandrel which can be removed when not in use

At a golf course in Bartlett, Ill., the trunks of the trees along one of the fairways have letters painted on them in white, which serve as a guide in locating a ball that has been sliced or hooked into the rough. The player merely watches the ball and notes the letter of the tree nearest the spot where it falls. Or, if the ball goes far into the timber, he takes a bearing from the tee on two or more of the lettered trees in line with the flight of the ball.

Making Uniform Seed Furrows

If you have trouble in making furrows of uniform depth for sowing seeds that must be planted near the top of the ground, a short length of garden hose will solve your problem.



Just take a sharp knife and make a slit through opposite sides of the hose, near the center, to take the corner of your hoe as indicated. The hose, which can be adjusted on the hoe so that the latter will make furrows of different depths, will "ride" on top of the soil.

Hanging CHINA CABINET

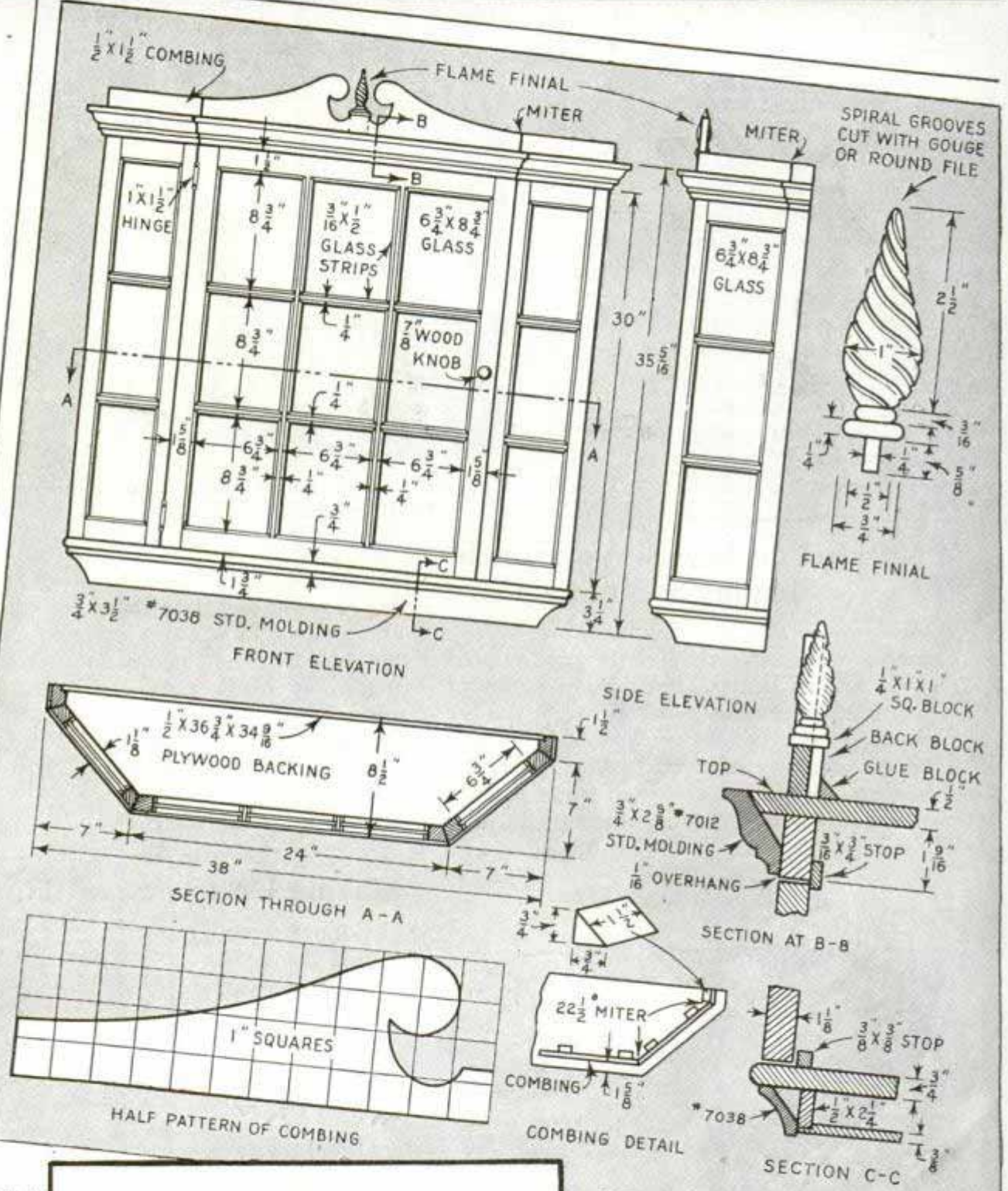

SCALE OF
 DESIGNED
 DRAWN BY

Especially suitable for the small dining room in a home where space is limited, this hanging china cabinet not only adds a decorative touch to the room but also has the advantage over the usual cabinet in that it does not take up any floor space. It is easy to build as ready-made molding is used which eliminates the necessity of using a shaper

POPULAR MECHANICS
 MAGAZINE

of Colonial Days

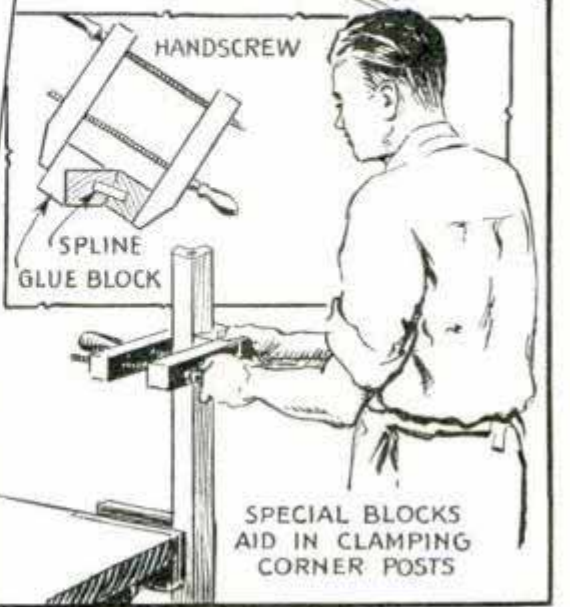
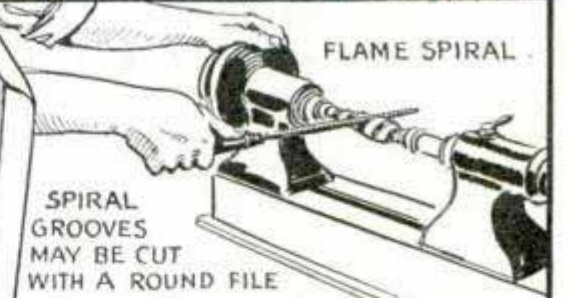
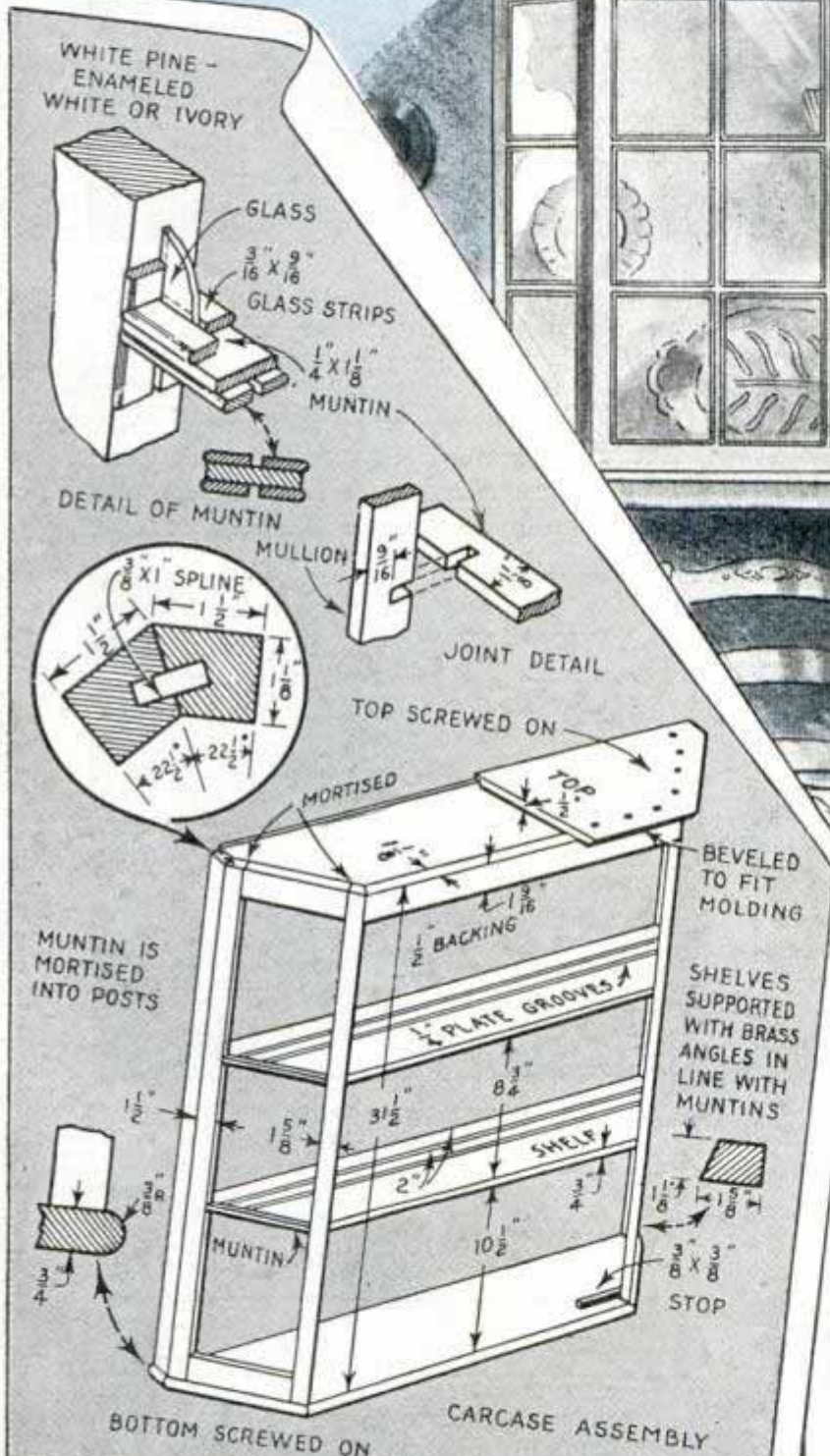
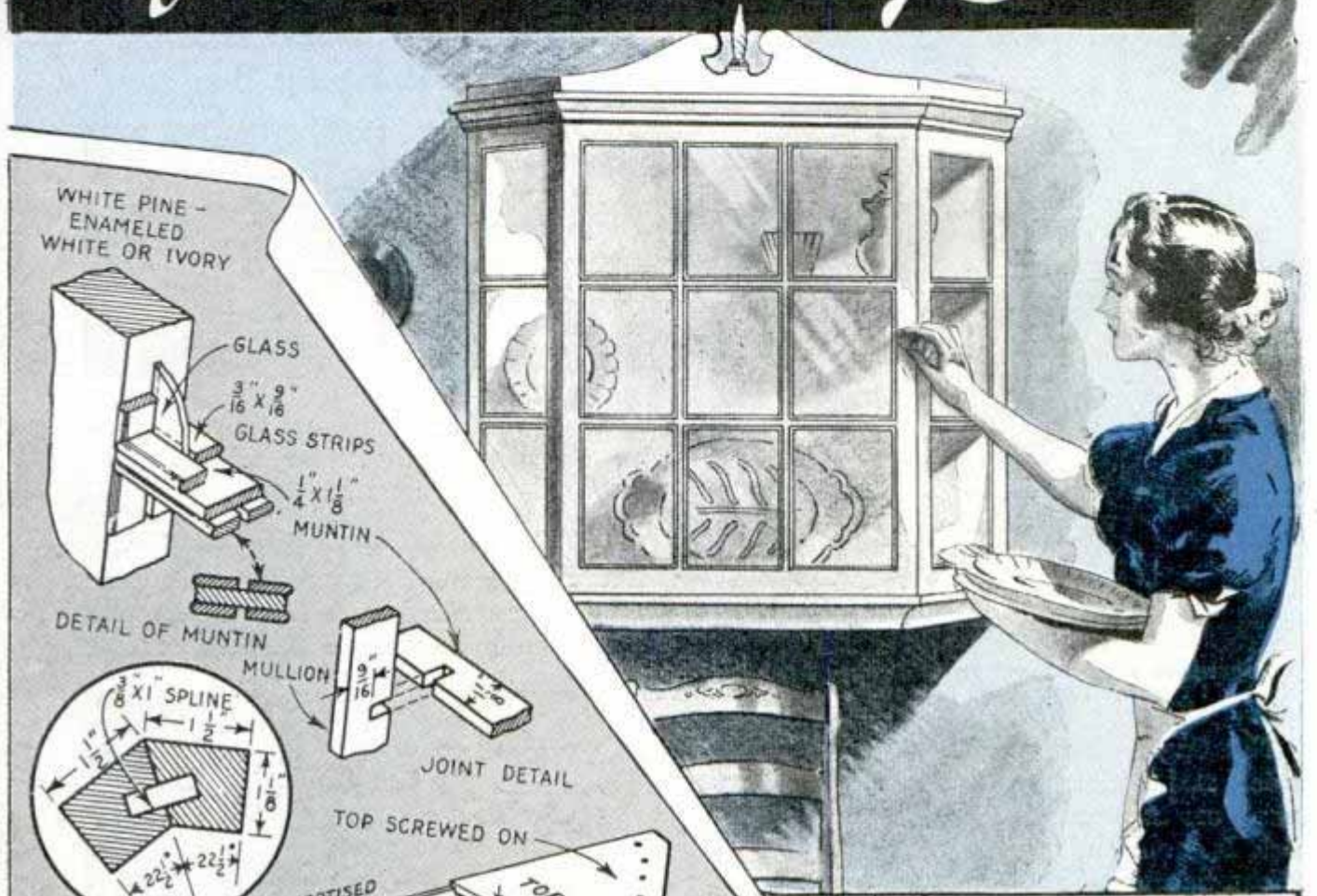

SHEET NO. 1

ISSUE

POPULAR MECHANICS MAGAZINE

200 E. ONTARIO ST. CHICAGO

BLUEPRINT No. SN 961

Artist Stores Paper and Drawings in Steel Kitchen Cabinet



Inexpensive steel cabinet provides good storage space for artist's materials

Needing a storage cabinet for his paper stock and unfinished drawings, one artist used an inexpensive steel kitchen cabinet. It should be fitted with casters so that it can be moved about easily. A letter file placed on top of the cabinet provides storage space for drawing instruments, a spring pencil holder being attached to the underside of the lid for brushes, pens, etc., while scales, triangles and other instruments are kept in the bottom of the file.

Rough Guide on Fishing Pole Often Breaks Line

Have you ever had a fine, silk fishing line break near the end of the pole after it was used a short time? If so, you will probably find that the inside surface of the guide on the end of the pole is rough enough to fray the line. The roughened part of the guide may be

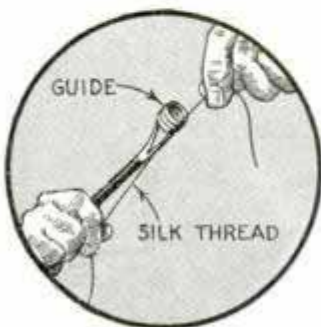

too small to detect with the eye, but you can quickly make a test by holding the

line and pole as indicated and slowly passing the line over the inside surface of the guide with a revolving motion of the hand.

Ink Roller for Stroke Sanding Avoids Wear on Belt

By using a heavy, rubber ink roller in place of the regular stroking block for surface sanding, one home craftsman prevents wear on the belt of his sander. As the roller rotates when in contact with the belt, there is no friction.

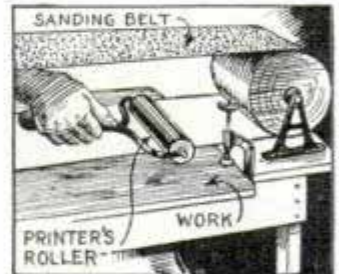

T-Square From Two Rulers

An inexpensive T-square for school use may be constructed by joining a 6-in. and a 12-in. ruler as shown. In order to get

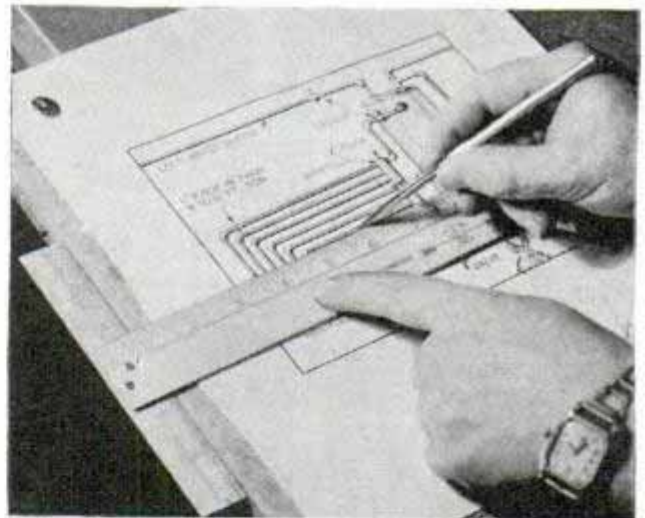

It takes only a few minutes to make this T-square from a couple of cheap rulers

them accurately set at right angles a carpenter's square is helpful. The rulers are held together with small screws or brads.

A Photo of Your Workshop

Can you help us make up an interesting photo collection on "Home Workshops of Popular Mechanics Readers"—where you and others find relaxation in various hobbies? Your offering will be appreciated and with it let's know your favorite hobby, besides your name, address and professional activity. Send to Workshop Photo Editor, Popular Mechanics Magazine, 200 E. Ontario St., Chicago.

This Arm Chair Has Back to Form Large Table

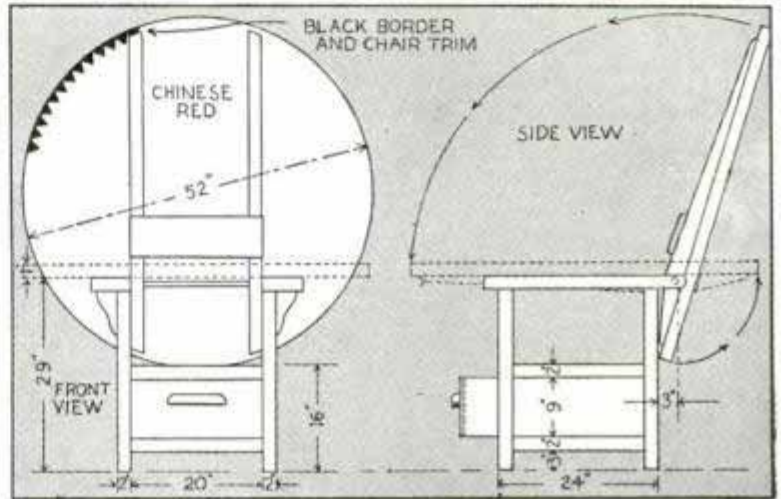
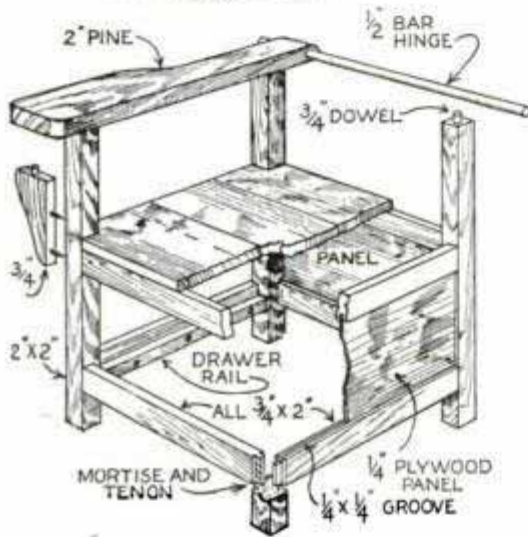
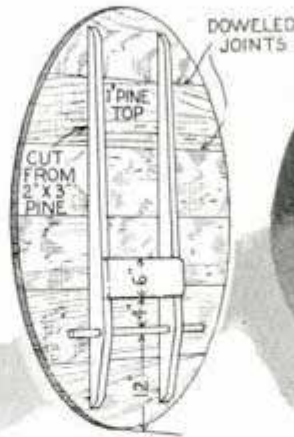

Serving either as an arm chair or as a dining table, this attractive piece of furniture, with its tilting back and large drawer for storing linen, is particularly adapted to the cottage or porch. In making the chair, white pine is used for the frame, which is assembled with mortise-and-tenon joints, and plywood is used for the panels, these being rabbeted into the frame. Tapered members of 2-in. material

serve as cleats for the circular top, which is built up of 1-in. boards glued together. The top is hinged to the chair arms by means of an iron rod, which is located so that the top tilts back a few inches at the upper side to prevent its falling forward when used as a chair. The original chair was given a pleasing appearance by finishing it in Chinese-red brushing lacquer with black trim.

Insecticide Spray to Kill Insects on Bushes and Vegetation

For spraying ornamental bushes and vegetation to kill insects which commonly infest the foliage, a preparation is made by dissolving any good grade of soap chips, 5 lbs., in hot water, 10 gal. When the soap has been dissolved completely and the mixture has cooled, nicotine sulphate, 1 oz., is stirred in, after which kerosene, 10 gal., is also stirred in vigorously. The mix-

ture forms a white, milky preparation. Although the nicotine sulphate is poisonous, the small amount contained in this preparation does not offer any particular hazard. A quantity of the spray may be made and kept for future use if it is well stirred immediately before using. A garden sprinkler can offers the easiest means of applying the insecticide.

"DILATOSCOPE" *takes guess-*



EYE PUPIL DILATES OR CONTRACTS ACCORDING TO INTENSITY OF LIGHT. COMPARING SIZE OF PUPIL WITH A CHART GIVES EXPOSURE TIME

With this exposure meter you compare the eye pupil with dots on the chart and refer to the figures giving lens openings and shutter speeds

By ALEXANDER MAXWELL

WHAT'S wrong with your photos? Are some as black as ink and others show only a ghost of a picture? In that case you need an exposure meter which will tell you where to stop the lens and what fraction of a second the exposure should be made. If you will cut out the chart on the last page of this article and apply it to an auto rear-vision mirror, after removing some of the silvering to take the chart and some more for two "peepholes," you will have a "dilatoscope" all ready for use with super-panchromatic film. In assembling the dilatoscope, cut out a piece of stiff cardboard the size and shape of the mirror. Glue the chart to the cardboard, which is held in place against the back of the mirror with cellulose tape.

The dilatoscope depends for its accuracy on the sensitiveness of the human eye. When you look in the mirror you will notice the pupils of your eyes are not

always the same size. In bright light the pupil becomes a mere "pin point." On a dark night just the opposite takes place, the pupil dilates to receive all the light possible. Dilation of the eye is in direct proportion to the amount of light present and as the eye is always the same size when a specified amount of light is present, it can be calibrated. By checking the human eye against a photometer the table of values as given in the chart was evolved. It is consistent and works equally well indoors and out, summer or winter.

To use the dilatoscope aim at your subject, holding the mirror about one foot from the eye. Look through either of the 1 by $\frac{3}{4}$ -in. windows until your eyes become regulated to the light, then look into the mirror and compare the pupil with the chart figures. Under each is a double column marked s and f; s is for shutter speeds and f for diaphragm stops. The

work out of exposure



simpler cameras have but one shutter speed, which is $\frac{1}{25}$ sec., and one stop which is usually f 11. With them good results can be obtained only in bright sunshine. In the case of a box camera with three stops, they are f 11, f 16 and f 22, the speed being $\frac{1}{25}$ second. From here, speeds and stops multiply rapidly up to the expensive newspaper cameras which may have twenty shutter speeds and fifteen stops. Fortunately, amateur cameras stop at a reasonable number, and with proper handling such numerous settings are not needed.

When making adjustments on speed and lens opening, a few facts should be kept in mind. If the picture is a still life it is gen-

erally best practice to shoot it at the maximum time, with the lens stopped down in accordance with the figures in the chart. This setting brings out details in deep shadows much more than a faster speed, and also tends to sharpen the focus. Where there is any movement, shutter speeds and lens opening will have to be increased. To illustrate the points just mentioned, suppose you want to take a picture in the back yard showing the progress of a flower garden. There is no action and you want sharp detail, so you choose a high f number. The higher the f the sharper the picture, but the slower the shutter speed must be. For a second example, suppose the children and the dog are romping on

from the film, burning the silver into a dense black mass without quality or character. To guard against this, to a certain extent, films have an anti-halation coating on the reverse side. This is a light absorbing dye which prevents reflection. On very high-speed film, such as is used in "cat's-eye" cameras, the celluloid itself is gray instead of being clear. A normal exposure should be sufficient to enable the strongest light entering the camera just time enough to reach the lower layer of silver grains. With a negative of this type the whites will be crystal clear and the deepest darks not yet black. This is what we are seeking, and is what we will get by the proper use of the dilatroscope.

Mimeograph Ink Pad Improved with Cambric Cloth

When a mimeograph machine has been used for some time, the fibers of the ink pad often become pressed into the per-

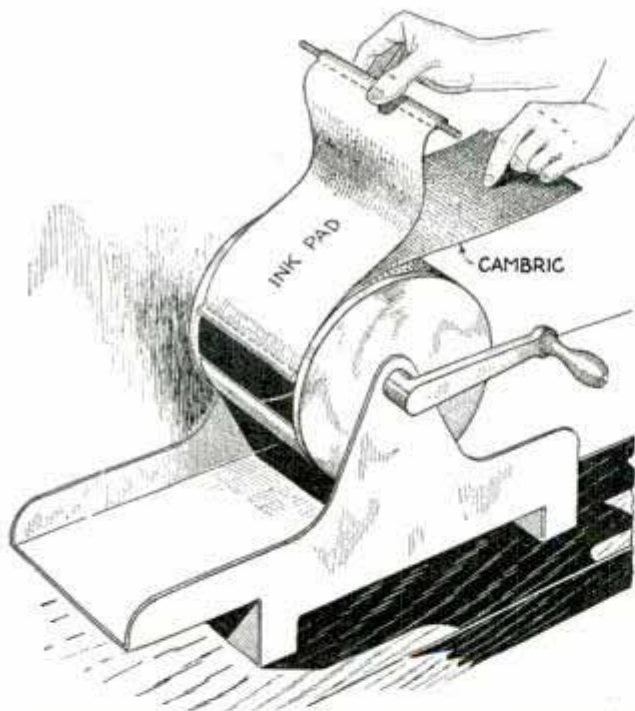

Inserting cambric cloth under mimeograph ink pad to prevent fibers from clogging cylinder perforations

forations of the cylinder so that the ink flow is impeded and the reproductions are faint or spotty. To avoid this trouble, lift the pad from the cylinder and insert a sheet of white cambric under it as shown. This will prevent the fibers from packing into the perforations and allow the ink to flow freely.

—G. E. Hendrickson, Argyle, Wis.

Sawhorse Converted for Ripping by Extra Top Member

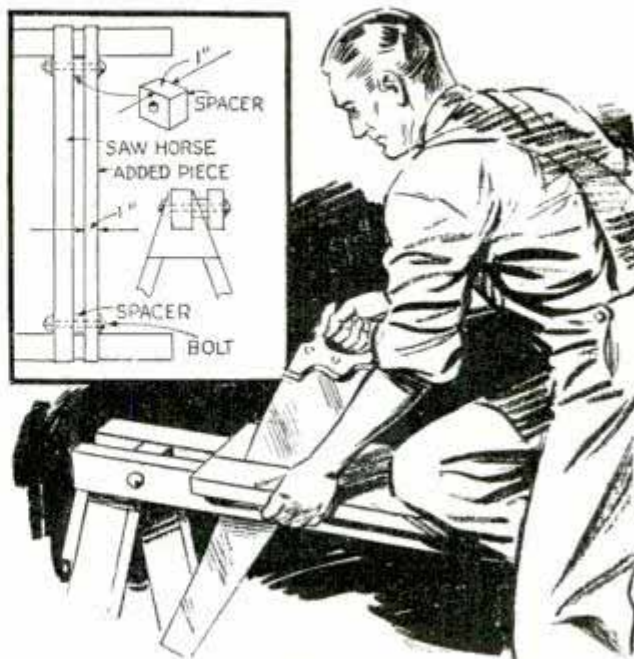

Piece of 2 by 4-in. stock bolted to top member of sawhorse to hold work for ripping it by hand

Here is a way to convert your sawhorse to support work while ripping it by hand. Just bolt a piece of 2 by 4-in. stock to one side of the top member, using 1-in. spacer blocks to provide a slot. It takes only a couple of minutes to remove the member when not needed.

Shielding the Motorboat Compass in an Iron Kettle

Copying an idea of Newfoundland fishermen, who venture far out in 30 and 40-ft. motor skiffs and must depend on their compasses, the owner of a small motorboat, or even the motorist, can shield a compass against the magnetic attraction of the motor by placing it in an iron kettle. Unless the compass is protected, the reading may be inaccurate.

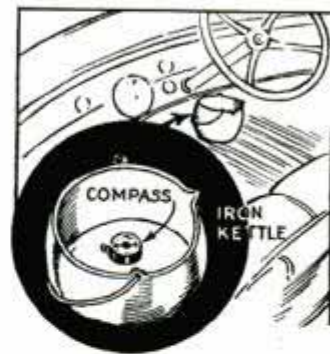

Unless the compass is protected, the reading may be inaccurate.

☞ Place a piece of cheesecloth under the grating of your cold-air register and it will filter dust and lint from the air and, also prevent anything from being dropped inside the air duct.

Swing Cradle for Corn Popper Eliminates Scraping Noise



If you use a coal stove, get up a bed of hot coals and set the cradle over one of the lid openings

To eliminate the scraping noise of a corn popper on the stove, and also to prevent wear on the thin bottom of the popper, one man uses this swinging cradle, which sets over a burner of the stove. Consisting of a heavy wire frame of the shape shown, the cradle supports the popper above the flame at any desired height. The swinging U-shaped wire on which the popper rests can be made to support the popper at a set height, or, it can be folded double at regular intervals and the folded portions bent to form hooks, which permit it to be swung at different heights.

Adjustable Garden Row Marker from Rake and Spools

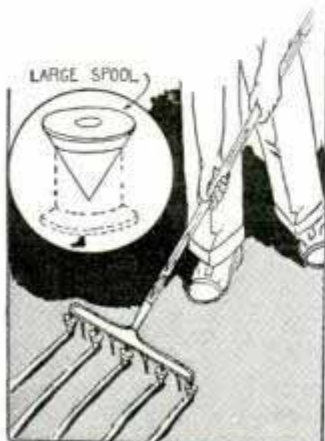

By cutting off one end of two or three empty thread spools and whittling them to a cone shape, they can be slipped over the teeth of your garden rake to mark off evenly spaced rows in your garden. For shallow-planted

seeds, you can even make the small furrows with the rake.

—A. H. Waychoff, Tempe, Ariz.

Lantern Bail Stays Upright

By simply attaching a lead weight to a short length of wire, which is in turn soldered to one side of your lantern bail as indicated, the bail will remain in a vertical position when the lantern is set down. The weighted wire should be soldered to the bail in a position to clear the lantern frame.

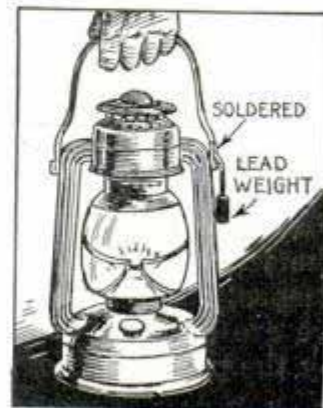

—Frank S. Reynolds, Ft. Morgan, Colo.

Serving Tongs Handle Hot Flasks in Home Laboratory

By gluing pieces of sheet cork to a pair of ten-cent serving tongs as shown, they come in handy in the home chemical laboratory for gripping hot flasks, beakers, test tubes, crucibles, etc. The cork is cut to the shape of the tong jaws and is glued to their inner surfaces, providing a non-slip grip against the glass.

—George J. Vias, Chicago.

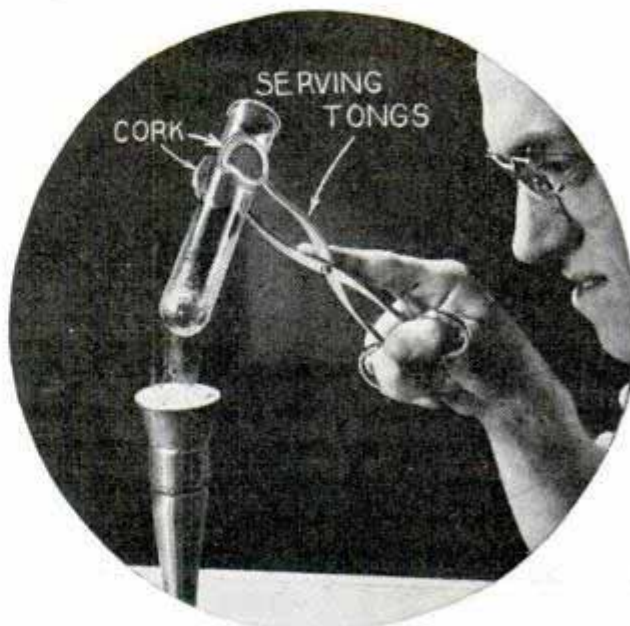

Cork glued to jaws of serving tongs provides non-slip surface to handle hot test tubes, etc.

Canopy and Playthings on Baby's Play Pen

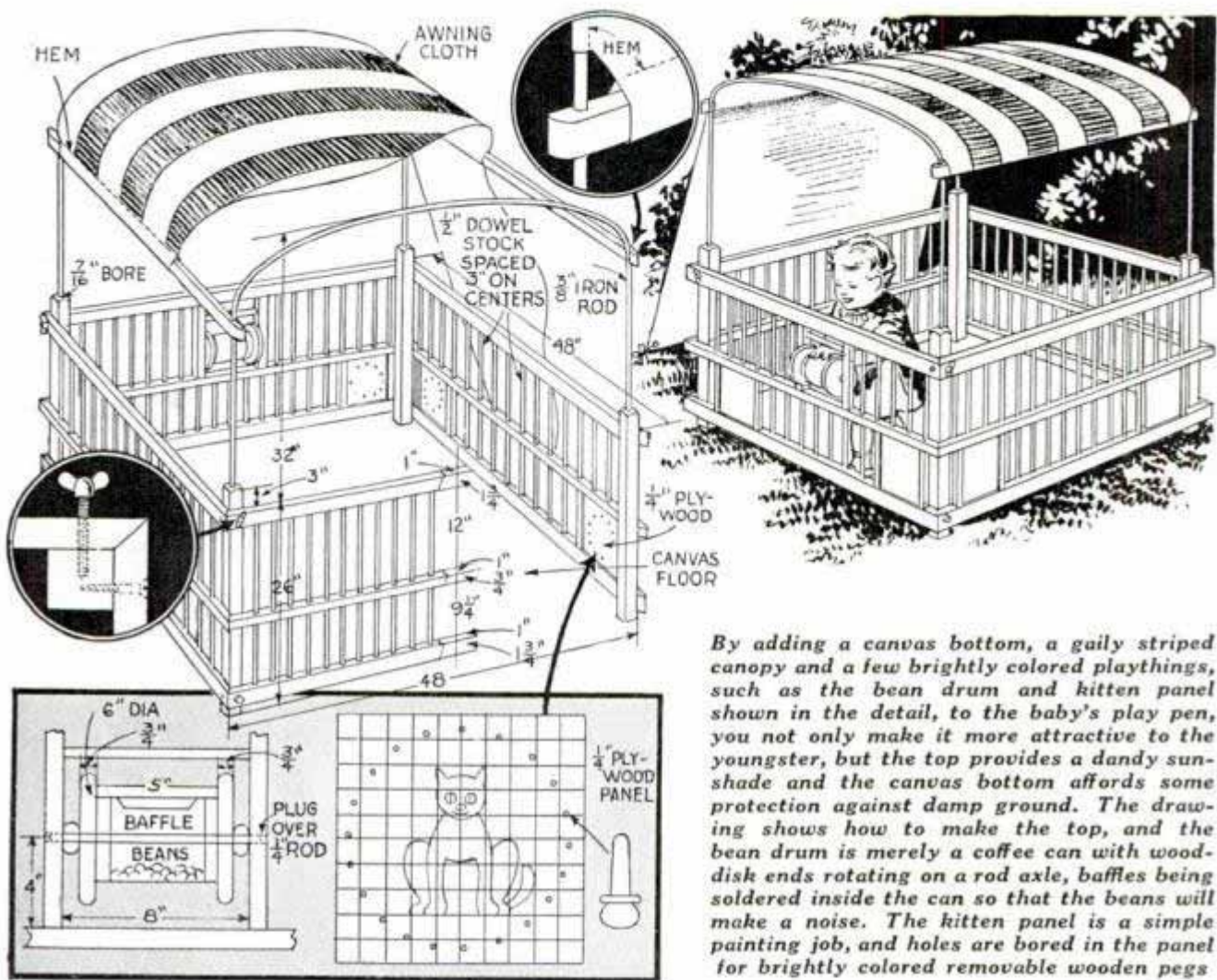

By adding a canvas bottom, a gaily striped canopy and a few brightly colored playthings, such as the bean drum and kitten panel shown in the detail, to the baby's play pen, you not only make it more attractive to the youngster, but the top provides a dandy sunshade and the canvas bottom affords some protection against damp ground. The drawing shows how to make the top, and the bean drum is merely a coffee can with wood-disk ends rotating on a rod axle, baffles being soldered inside the can so that the beans will make a noise. The kitten panel is a simple painting job, and holes are bored in the panel for brightly colored removable wooden pegs.

This Strong Gate Closer Makes Use of Lock Unnecessary

If you have your property fenced to keep a small child or pet inside, here is a closer for the gate that makes it unnecessary to use a lock or catch as two springs hold it so tightly against the jamb that a large dog or small child cannot open it. All you need to make it is two lengths of 1 by 3-in. wood, two screen-door springs and three small strap hinges. The two wood pieces are hinged together, after which one end is hinged to the center of the gate and the other to a near-by building or a post set 18 to 24 in. from the fence. The springs are attached to the fence and to the hinged pieces in approximately the position indicated.—George Vias, Chicago.

☛ If the inside surfaces of the ferrules of your casting rod are polished with a piece of wax paper, it is not likely to stick at the joints when taking it apart.



Building the

BILOXI



It is used quite extensively for rowing, and is sometimes towed behind a launch, and behaves splendidly for both these purposes. For sailing it is excellent, and I do not think I have ever sailed a small single-sail boat that is so well balanced.

"The little Gorenflo boat which I bought performs under sail better than any small boat of its kind that I have seen, and has proved quite dry under power.

As a sea boat the little thing is quite astounding. With two in her she rides like a duck. Our inlets here are notoriously treacherous, with a current of four knots or more. That against an ocean swell rolling in with a southeasterly breeze behind it kicks up some nasty water but, using motor, we play around in any ordinary weather out to the break of the outer bar and ship nothing but an occasional quart or so of spray.

he: Gorenflo Dinghy.

You may be interested to learn that Region eight comprising six States have decided to adopt the Dinghy as a Sea Scout project and will lend effort and time towards having the boys build a number of the boats. It is contemplated that these boats may

HERE'S just what prospective builders of small sailboats have been looking for, as you will see from a glance at the facsimiles on the left, which reproduce excerpts from letters written by enthusiastic owners. And, the Biloxi Dinghy is not only seaworthy, as they say, but it's easy to build. Look over Figs. 1 and 2, which detail the frames and stern board, or transom. There are several points to keep in mind before you begin cutting the parts: The lower cross members of all frames are cut to the same radius; the top cross-pieces are a given distance above the lowest point of the curved member, and the frame uprights are joined to the curved members with an angle joint housed in gusset plates, as in Fig. 2. With the frames, stern board and building board made, the work on the hull is well along.

You start assembling the boat by placing the building board on two sawhorses as in Fig. 3. The lines marked on the building

DINGHY

by
L. J. Gorenflo

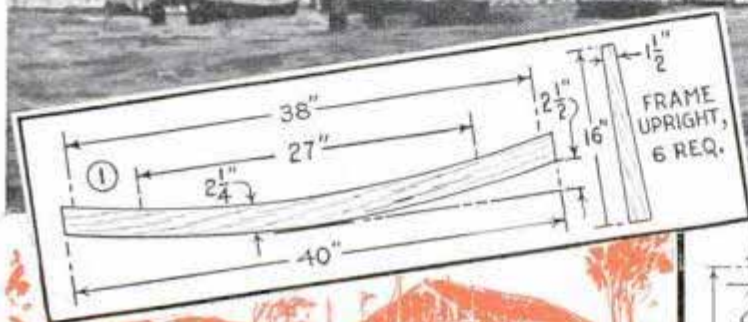

board, Fig. 4, indicate where to place the frames. These are placed upside down and the center line of the building board must match up with that on the frames. Place frames Nos. 1, 2 and 3 along the lines and fasten through the building board with 8-d common nails or 1½-in. screws, also a brace to each frame. After all three frames have been attached to the board, the next step is to fasten the sides to the stem, Fig. 6. This can be done before mounting the stem on the building board although it is shown mounted with the frames in Fig. 3. If the sides are built up of several pieces, you simply screw the two lower planks to the stem, but should the sides be made up of narrow planks, the first plank on the lower side should be at least 8 in. wide. When building up the sides you can use shiplap construction which will eliminate battens. The stem is fastened to the sides at the zero (0) line, Fig. 5. Use 1½-in. No. 8 flat-head brass screws spaced about 1½ in. apart, in a staggered row. In Fig. 3 is a detail showing the exact distance from the lower edge of the boat to the building board. By mak-

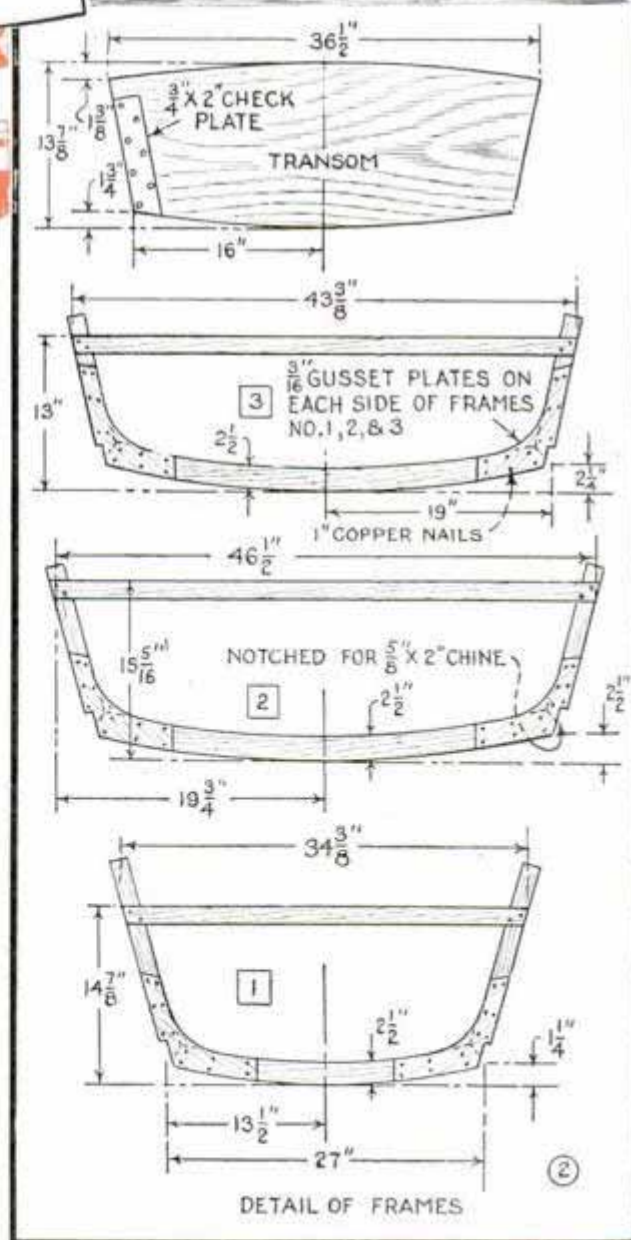

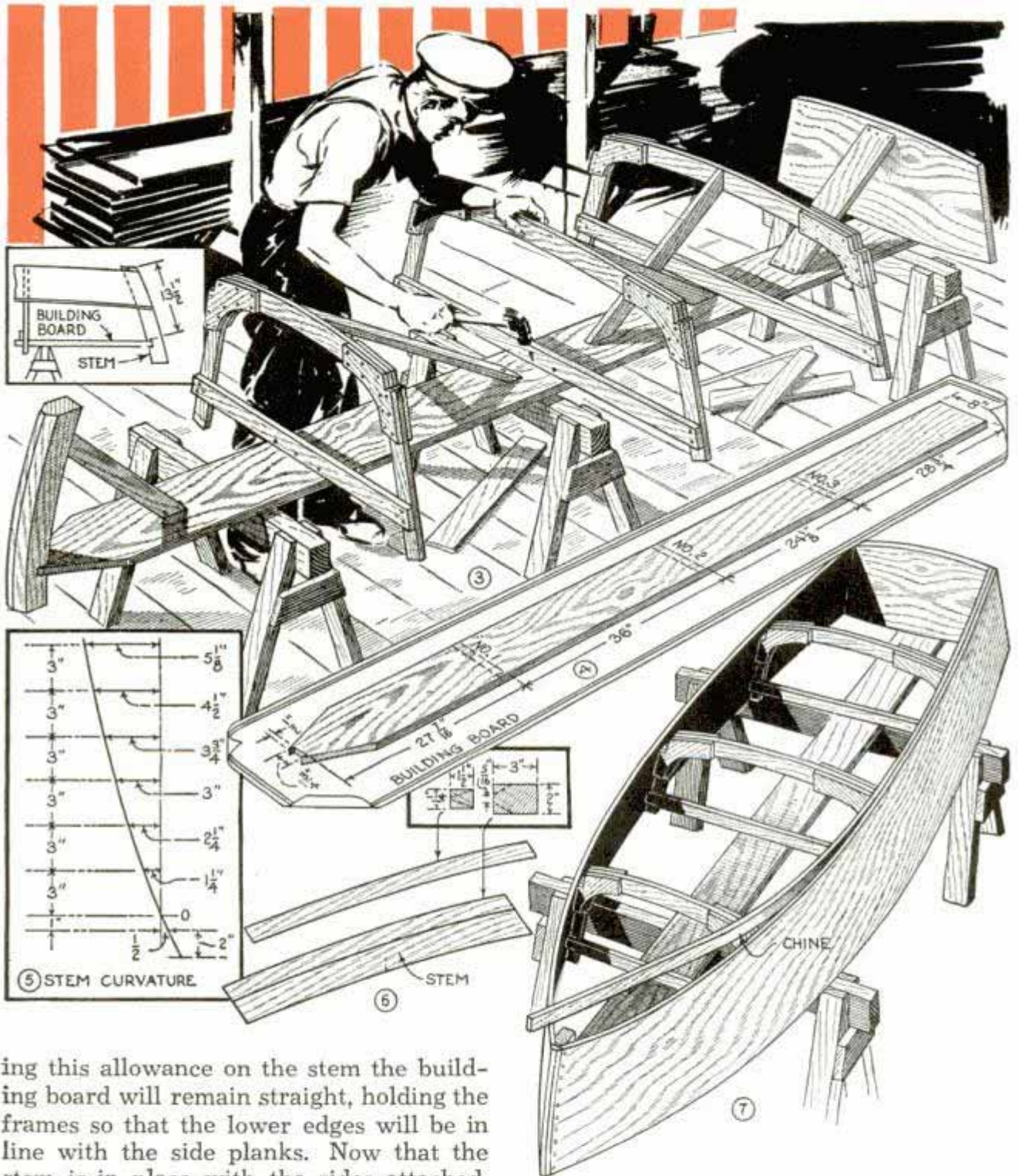

ing this allowance on the stem the building board will remain straight, holding the frames so that the lower edges will be in line with the side planks. Now that the stem is in place with the sides attached, you may continue by bending the sides around the frames and holding them in place with a piece of rope. Fasten the sides to the frames with $1\frac{1}{2}$ -in. No. 8 flat-head brass screws. The transom is also fastened with $1\frac{1}{2}$ -in. flat-head brass screws driven into the check plate and 2-in. screws driven into the end grain of the transom. Fig. 16 shows the offsets and also the exact positions of frames Nos. 1, 2 and 3. Be sure to mark these positions on the sides before bending the latter in position around the frames. The lines are

drawn at right angles to the base line and serve as a guide to placement of the frames in an upright position. Move the temporary braces if necessary to bring the frames into the proper position. Now the second and third planks are placed on each side. The shiplap joints are fastened with $\frac{7}{8}$ -in. copper tacks spaced $2\frac{1}{2}$ in. apart and clinched across the grain. Use marine glue to make the joint waterproof. When the sides are fastened, the next step is to insert the chines as in Fig. 7. Chines are fastened to the frames with $2\frac{1}{2}$ -in. No. 8

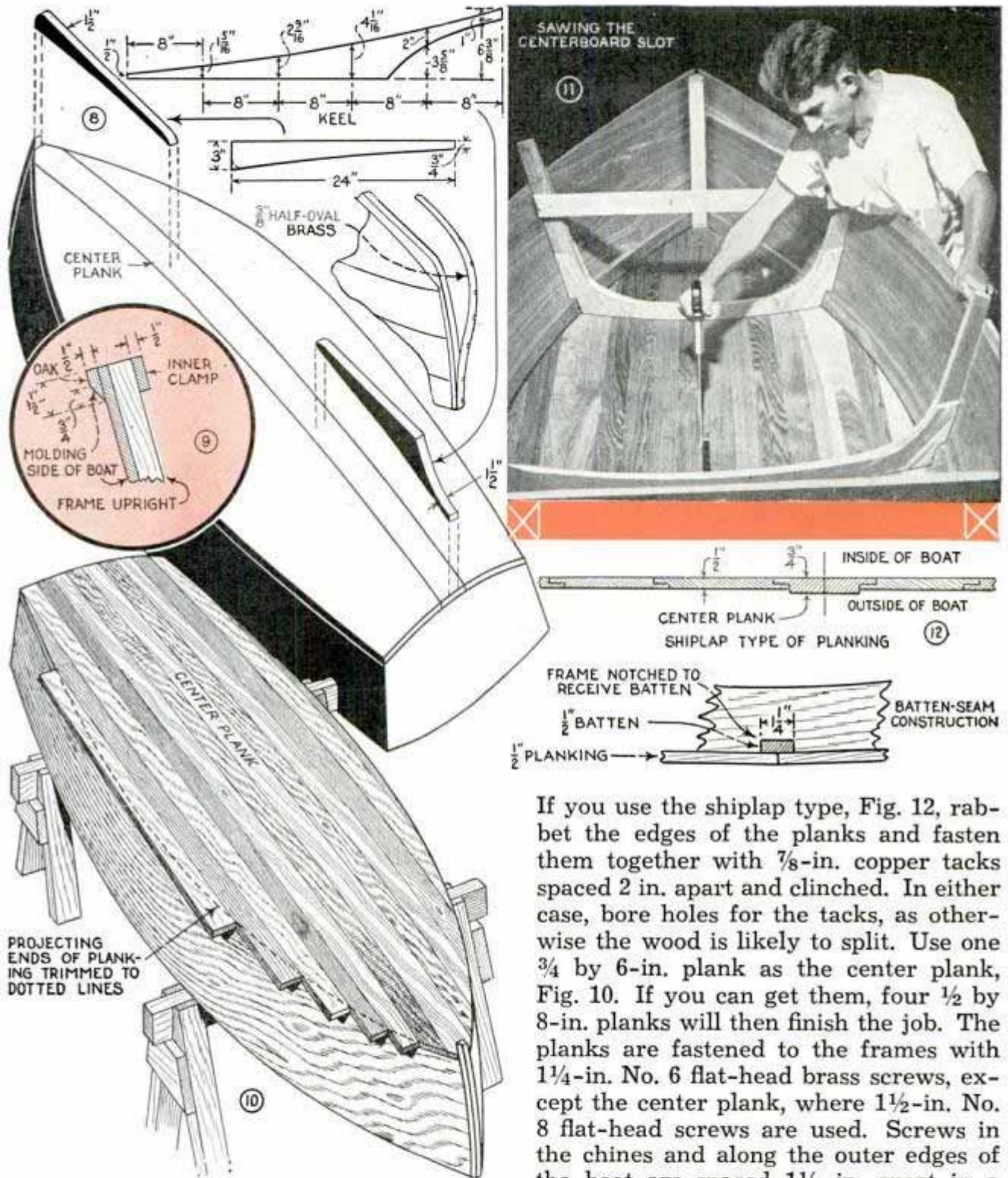

flat-head brass screws and to the sides with $1\frac{1}{4}$ -in. No. 6 flat-head brass screws spaced $1\frac{1}{2}$ in. apart in a staggered row. Then fair off the sides, transom and stem, a job which must be done carefully to avoid leaks. At this point, select the type of bottom construction. If it is to be the batten-seam type, battens must be mortised at the proper places and the planks are fastened to the battens with $1\frac{1}{4}$ -in. copper nails spaced 2 in. apart and clinched.

If you use the shiplap type, Fig. 12, rabbet the edges of the planks and fasten them together with $\frac{7}{8}$ -in. copper tacks spaced 2 in. apart and clinched. In either case, bore holes for the tacks, as otherwise the wood is likely to split. Use one $\frac{3}{4}$ by 6-in. plank as the center plank, Fig. 10. If you can get them, four $\frac{1}{2}$ by 8-in. planks will then finish the job. The planks are fastened to the frames with $1\frac{1}{4}$ -in. No. 6 flat-head brass screws, except the center plank, where $1\frac{1}{2}$ -in. No. 8 flat-head screws are used. Screws in the chines and along the outer edges of the boat are spaced $1\frac{1}{2}$ in. apart in a staggered row. Use $1\frac{1}{4}$ -in. No. 6 flat-head brass screws along this line, as well as into the lower edges of the transom.

This done, the boat is turned over and the centerboard installed. Make up the centerboard well or casing as in Fig. 15. The oak king posts are fastened to the casing with $1\frac{1}{2}$ -in. No. 8 flat-head brass screws, spaced $1\frac{1}{2}$ in. apart. The case should fit snugly against the bottom of the boat, and should be notched out at the after end to fit over the No. 2 frame. A

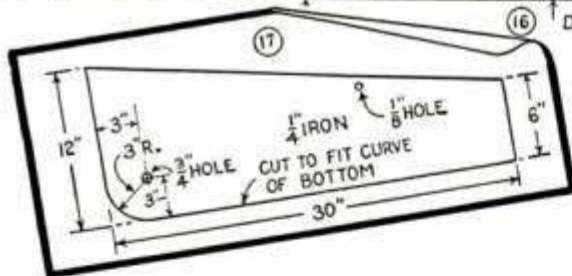
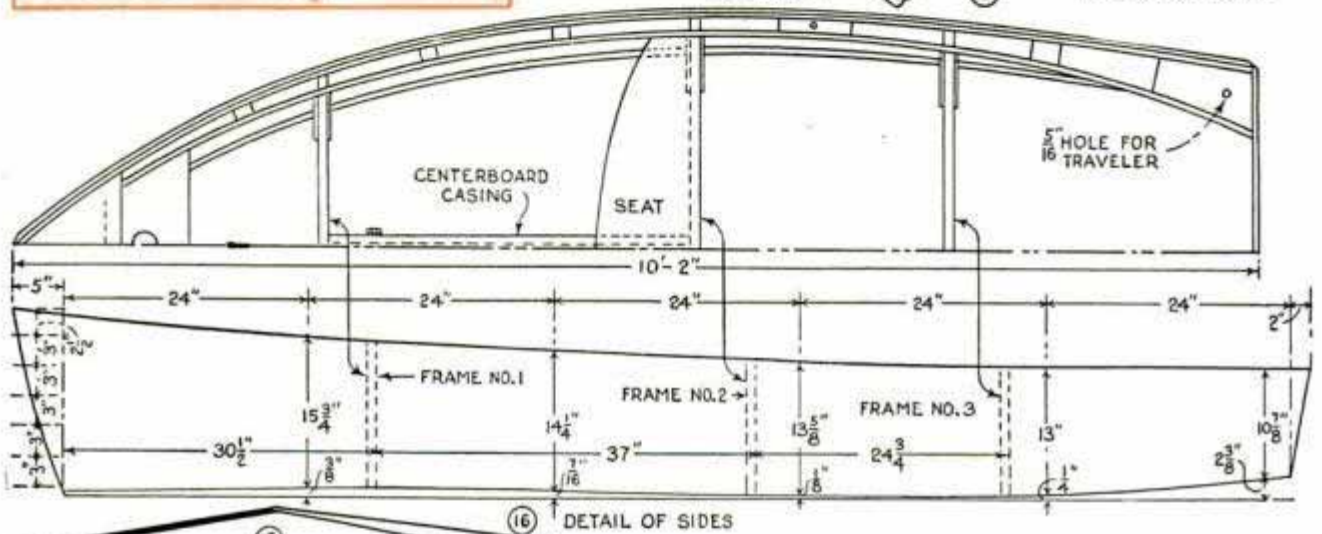
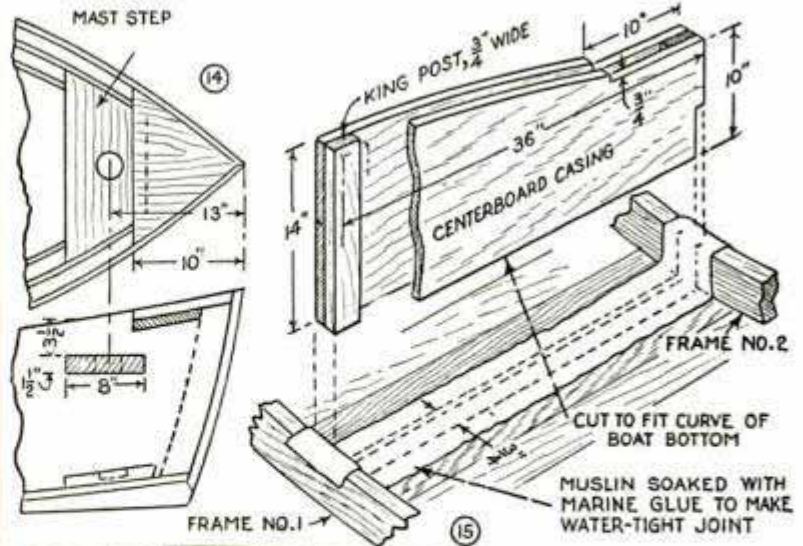

$\frac{3}{4}$ -in. slot is cut in the boat bottom along the centerline as in Fig. 11, the slot being the same length as the opening in the casing. The slot is covered with a gasket made of heavy muslin and coated with marine glue to insure a water-tight joint. The casing is fastened to the bottom with 2-in. screws placed $2\frac{1}{2}$ in. apart. The iron centerboard, Fig. 17, has a $\frac{3}{4}$ -in. hole drilled 3 in. up from the bottom edge and 3 in. in from the side as shown. A hole is bored in the centercase with an $\frac{1}{16}$ -in. bit and the pin used to pivot the board is a $\frac{3}{8}$ -in. pipe nipple, 3 in. long, with a lock nut on each end. By placing a small gasket or piece of cotton behind the lock nut and tightening it, there will be no chance for a leak at this point. A piece of jack

chain is used to raise and lower the board, a pin made of $\frac{1}{4}$ -in. brass rod being slipped through the chain to act as a stop.

The cross member of No. 2 frame is now removed and the seat, Fig. 16, put in place. The seat fits over the lower end of the casing and notches into the uprights of the No. 2 frame on each side. This joint beneath the seat must be water-tight as it is near the level of the water on the outside. A cap of $\frac{3}{8}$ -in. material, 3 in. wide, is bent over the curved portion of the casing.

The breast hook, Fig. 14, is made of two pieces of wood with the grain running at right angles. The mast partner, cut from $1\frac{1}{2}$ -in. material, is fastened through the sides with 2-in. screws. Now screw the stern knees in place and put the inner clamps in position, Fig. 16. The knees are fastened with 2-in. No. 8 flat-head brass screws and the inner clamps with $1\frac{1}{2}$ -in. No. 8 screws. Between the sides and the clamps, the filler blocks, Fig. 16, must be placed. These are made of $1\frac{1}{2}$ -in. material, 2 in. long with the exception of those

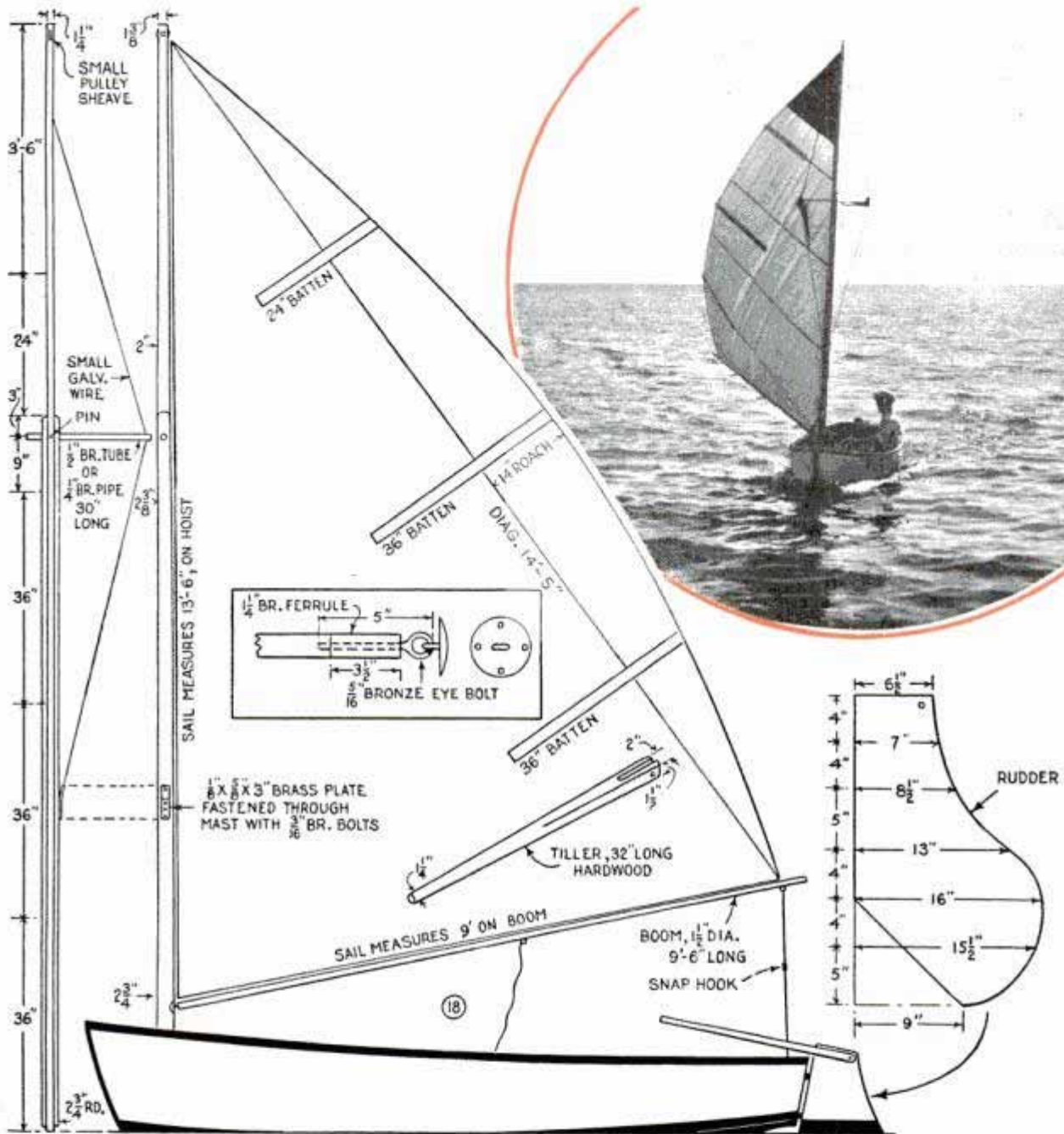

between No. 2 and No. 3 frames, which are 6 in. long and drilled for the oarlock sockets. The boat is now turned over and the keel and skeg put in place as in Fig. 8. When these pieces are made to fit they are fastened from the inside with $1\frac{1}{2}$ -in. and 2-in. screws. Before fastening the skeg (forward), the cutwater is shaped up to fit in its proper position. When the cutwater fits perfectly, you calk the ends of the sides and fasten the cutwater in place permanently, which is done with 10-d galvanized finishing nails spaced 3 in. apart. The cutwater is trimmed with $\frac{3}{8}$ -in. half-oval brass, which extends from the top edge of the boat to about halfway down the skeg. Finally, the molding, Fig. 9, is

fastened in place with 1-in. No. 6 screws spaced 10 in. apart. Use $1\frac{1}{2}$ -in. screws through molding at both stem and stern. Bore two $\frac{1}{4}$ -in. holes in the stern knees and put in $\frac{1}{4}$ -in. cotton rope for the traveler. Finally, the rudder is made up as in Fig. 18, and attached with rudder irons to the stern. The lower edges of the rudder are slightly tapered to prevent dragging.

The mast, Fig. 18, is quite simple to make by using one $1\frac{1}{4}$ by 3 in. by 16-ft. piece of cypress and two pieces of $\frac{3}{4}$ by 3 in. by 10 ft. Casein glue is used to assemble these parts. With a table saw set at a 45° angle you can rip off the corners up to the 10-ft. mark. This will give you an eight-sided section that can be rounded easily



by hand with a small plane. The portion above the 10-ft. mark can be left as it is. At a point 3 in. below the 10-ft. mark a $\frac{1}{2}$ -in. hole is bored through the mast to take the spreader, which is a $\frac{1}{2}$ -in. brass tube, 30 in. long. A small brass pin through the tube and mast holds the spreader in place. Small holes are drilled in the ends of the tube for the galvanized rigging wire which can be of single strand. It is fastened to the mast 5 ft. above the spreader and 5 ft. below. A $\frac{5}{8}$ -in. mast track starting 10 in. below the top sheave extends 12 ft. down the mast. Details of the gooseneck are shown in Fig. 18. The boom is tapered to $1\frac{1}{4}$ in. and a ferrule is slipped over the end, extending $3\frac{1}{2}$ in. back.

When the mast is made up and all the fittings are in place, you install it in the boat. Bore a hole through the mast partner, Fig. 13, and allow the mast to go through until it reaches the step, which is made of $1\frac{1}{2}$ -in. material placed in the bow as far up as possible. Do not nail or fasten it in position until you have set the mast plumb. Scribe a line around the squared end of the mast and another outlining the location of the step on the bottom. Then cut a rectangular socket in the step into which the foot of the mast fits snugly. Fasten the step with $1\frac{1}{2}$ -in. and 2-in. screws through the bottom and into

the skeg. Two upright deck blocks are placed one on each side of the mast on the mast partner. One of these pulleys is used to hoist the sail and the other takes care of the top'n lift. Cleats are attached to the sides of the centercase. A tent cover, Figs. 19 and 20, is quite simple to make and is a protection to the boat and occupants when making short cruises. The edges are held down by a series of screw eyes spaced 8 in. apart just beneath the molding.

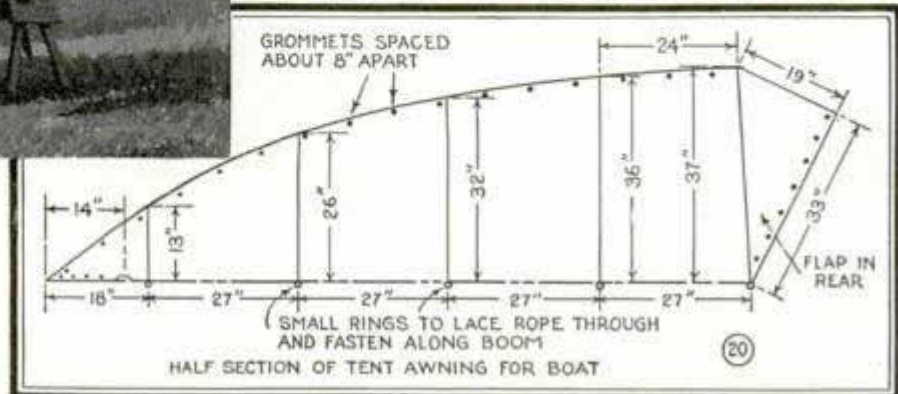

HALF SECTION OF TENT AWNING FOR BOAT

MATERIAL LIST

2 pcs. $\frac{1}{2}$ x 18 in. x 12 ft. (or equivalent in narrow widths)	side pieces
1 pc. $\frac{5}{8}$ x 6 in. x 10 ft.	chines
1 pc. $\frac{3}{4}$ x 6 in. x 10 ft.	bottom center plank
4 pcs. $\frac{1}{2}$ x 6 in. x 10 ft.	(2 each side)
2 pcs. $\frac{1}{2}$ x 8 in. x 8 ft.	(1 each side)
6 pcs. $\frac{1}{2}$ x $1\frac{1}{4}$ in. x 10 ft.	battens
2 pcs. $\frac{1}{2}$ x $1\frac{1}{2}$ in. x 10 ft. 6 in.	inner clamps
1 pc. $\frac{3}{4}$ x 14 in. x 6 ft.	sides of centercase
1 pc. $\frac{3}{4}$ x 2 x 26 in.	king posts
1 pc. $\frac{1}{4}$ -in. iron	for centerboard
1 pc. $\frac{3}{4}$ x 14 x 30 in.	rudder
1 pc. $1\frac{1}{4}$ x $2\frac{1}{2}$ x 30 in.	tiller
1 pc. $\frac{3}{4}$ x 14 x 38 in.	transom
1 pc. $1\frac{1}{2}$ x 8 x 20 in.	mast partner
1 pc. $\frac{3}{4}$ x 10 in. x 4 ft.	seat
1 pc. $\frac{3}{4}$ x 10 in. x 12 ft.	frames and crosspieces
1 pc. $\frac{1}{2}$ x 3 in. x 12 ft.	oak molding
1 pc. $1\frac{1}{2}$ x 8 in. x 1 ft.	mast step
2 pcs. $1\frac{1}{2}$ x 4 in. x 1 ft.	stern knees
1 pc. $1\frac{1}{2}$ x 8 in. x 4 ft.	skeg and keel
1 pc. 2 x 8 x 24 in.	stem and cutwater
1 pc. pine $\frac{3}{4}$ x 8 in. x 12 ft.	building board
1 pc. $1\frac{1}{4}$ x 3 in. x 16 ft.	mast
2 pcs. $\frac{3}{4}$ x 3 in. x 10 ft.	mast
1 pc. 2 x 2 in. x 10 ft.	boom

Hardware

2 gross $1\frac{1}{2}$ -in. No. 8 flat-head brass screws
$\frac{1}{2}$ gross 2-in. No. 8 flat-head brass screws
5 gross $1\frac{1}{4}$ -in. No. 6 flat-head brass screws
$1\frac{1}{2}$ lbs. of $1\frac{1}{4}$ -in. copper nails (if battens are used)
$\frac{1}{2}$ lb. copper tacks, $\frac{1}{8}$ -in. (if lap joint is used)
1 sheave for top of mast
2 swivel pulleys for sheet line
2 deck blocks for halyard and top'n lift
1 flat deck block for top'n lift
75 ft. $\frac{1}{4}$ -in. cotton rope for lines and rope traveler
$\frac{1}{2}$ pint, C-quality marine glue
$\frac{1}{4}$ lb. casein glue
Brass and brass volts for guy-wire attachments
3 ft. $\frac{3}{8}$ -in. half-oval brass for bow trim
25 ft. galv. wire
$\frac{3}{8}$ -in. brass tubing, 30 in. long
2 ft. jack chain for centerboard lift

Woods generally used for small-boat construction are: Spruce or oak for frame; pine or oak for the stem, and mahogany, cedar or cypress for planking. Knees, mast steps, inwales and other small parts either visible or subject to strain—oak or mahogany.

A Seaworthy Mooring to Hold Your Boat

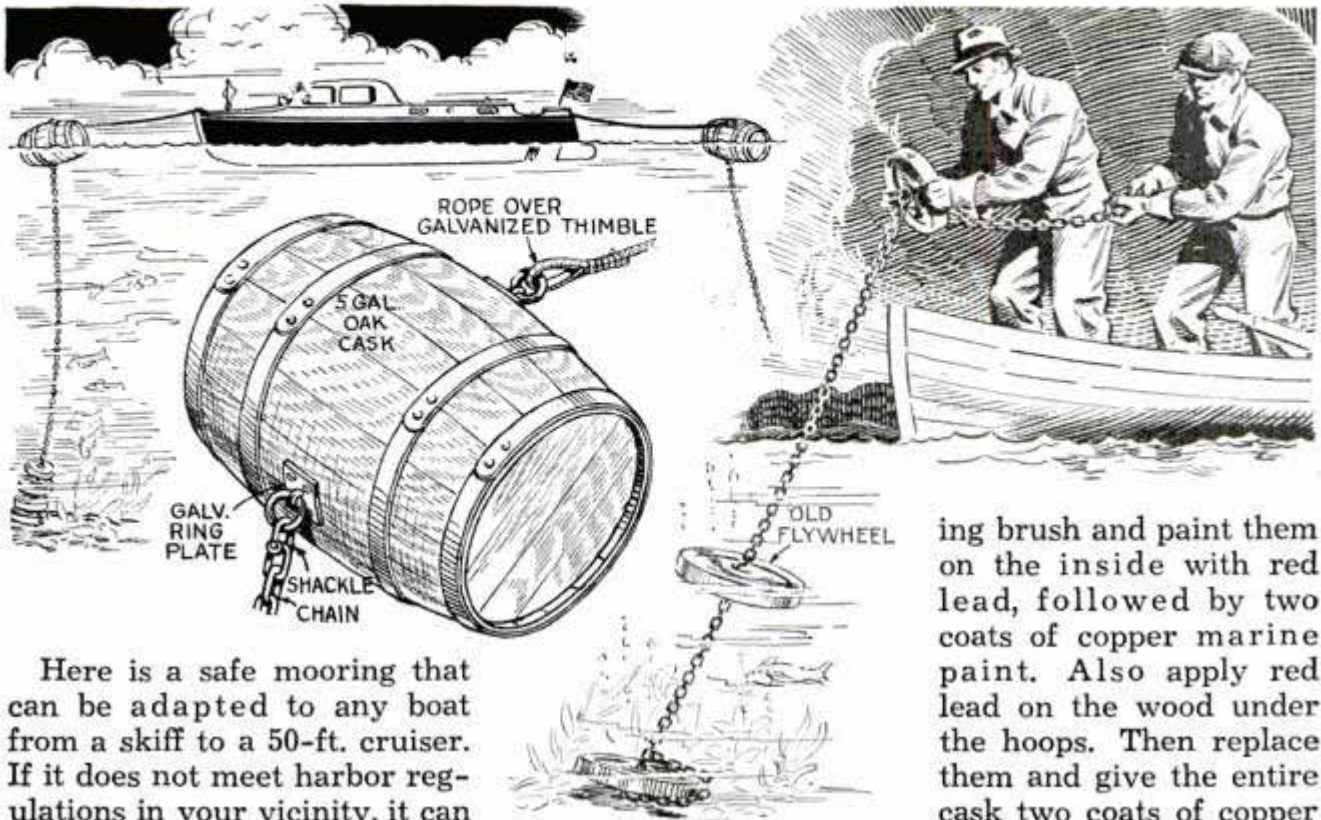

Here is a safe mooring that can be adapted to any boat from a skiff to a 50-ft. cruiser. If it does not meet harbor regulations in your vicinity, it can be modified easily. The mooring consists of an airtight oak cask having galvanized or copper ring plates attached to staves on opposite sides to take the anchor chain and rope or chain fastened to the boat. Before attaching the ring plates, remove the iron hoops, one at a time, clean off rust with emery paper or a buff-

ing brush and paint them on the inside with red lead, followed by two coats of copper marine paint. Also apply red lead on the wood under the hoops. Then replace them and give the entire cask two coats of copper paint. Any scrap metal

can be used for the anchor, old motor flywheels being handy as they can be slipped over the chain one at a time until the anchor weighs about 300 lbs., depending on the size of your boat. The chain from anchor to buoy should be about 2 ft. longer than the depth at high-water mark.

Scroll-Sawed Letter Rack a Pleasing Novelty on Your Desk

Here is a novel letter rack for your writing desk—a simple job of scroll-sawing. You use $\frac{1}{4}$ -in. wood, either solid stock or plywood. The original model was especially attractive in that the sides were slightly rounded in shape. This is done by first gluing together two pieces of $\frac{1}{16}$ -in. veneer, with the grain running at right angles. When dry, the piece is scroll-sawed to shape, then the surface having the horizontal grain is moistened. The result will be that it assumes a convex shape. Then the parts are assembled, stained and finished. If desired, small contrasting overlays, such as the diamond shape shown, may be added.—A. Holm, Chicago.

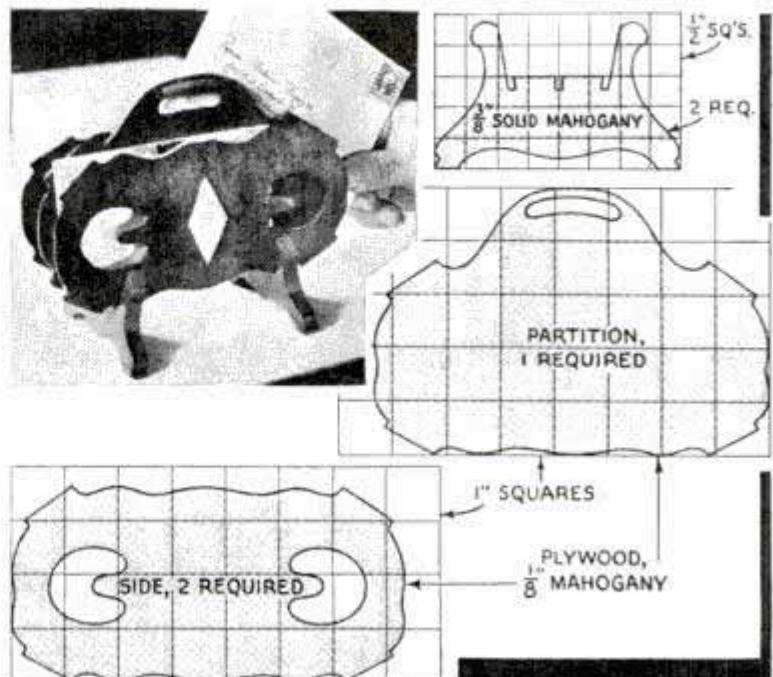

T-Square Held in Any Position by Friction Catches

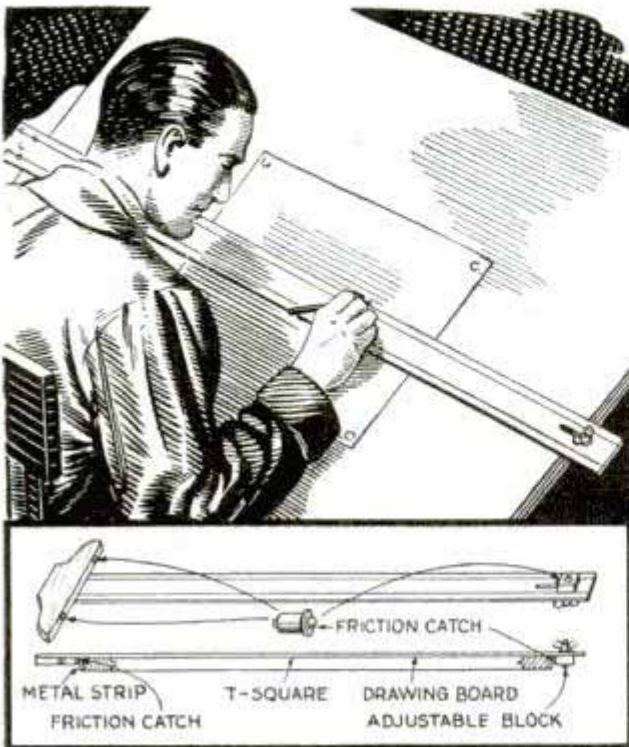

Friction catches hold T-square firmly on the drawing board, yet allow it to be moved easily

To permit a T-square to remain at any set position on his tilted drawing board, one artist equipped it with small friction catches. These were fitted to the head and to a small block fastened to the underside of the blade as shown. By adjusting the block to allow the spring-loaded catches to bear slightly against the edges of the board, the square can be moved across the drawing board easily, yet it will remain at any desired position. Narrow strips of metal along the edges of the board permit the square to move smoothly.

Bent Shrub Support Clears Roots

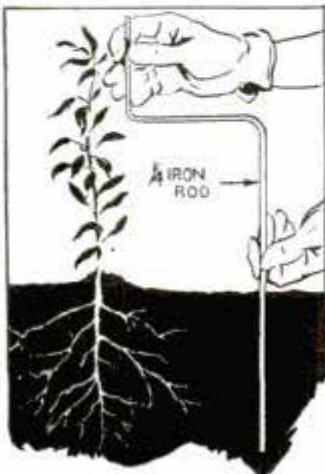

Instead of driving a stake into the ground near a shrub or plant to support it, which may injure the roots, take a length of heavy wire and drive it into the ground several inches from the base of the shrub. Then bend the

support over to the plant as shown. The first bend may be made at the top of the ground, or higher up to support the shrub its entire length or just at the top.

Hooks and Eyes Replace Tacks for Furniture Curtains

When curtains are hung around a homemade dressing table, stand, chair and other furniture, they will be easy to remove for laundering if attached with hook-and-eye tape. The eyes are sewed to the edges of the curtains.



—G. E. Hendrickson, Argyle, Wis.

Frogs in Well Removed on "Lift"

During the dry weather last year when many wells were contaminated by frogs getting into them in search of moisture, one Illinois resident removed them in a novel but effective manner. He took a wide board as long as could be lowered into the well horizontally, tied stout cords to the four corners and lowered it to float on the water overnight. The next morning the frogs in the well would be sitting on the board, which was then raised to the surface. If this is done slowly and carefully without jarring the board, the frogs will stay on the board until it is taken out of the well.

—Truman Greenwalt, Litchfield, Ill.

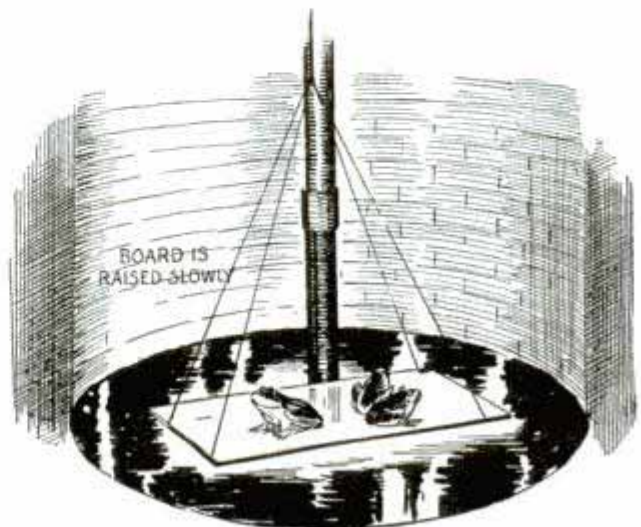

Keeping the Birds at Home in Your Garden

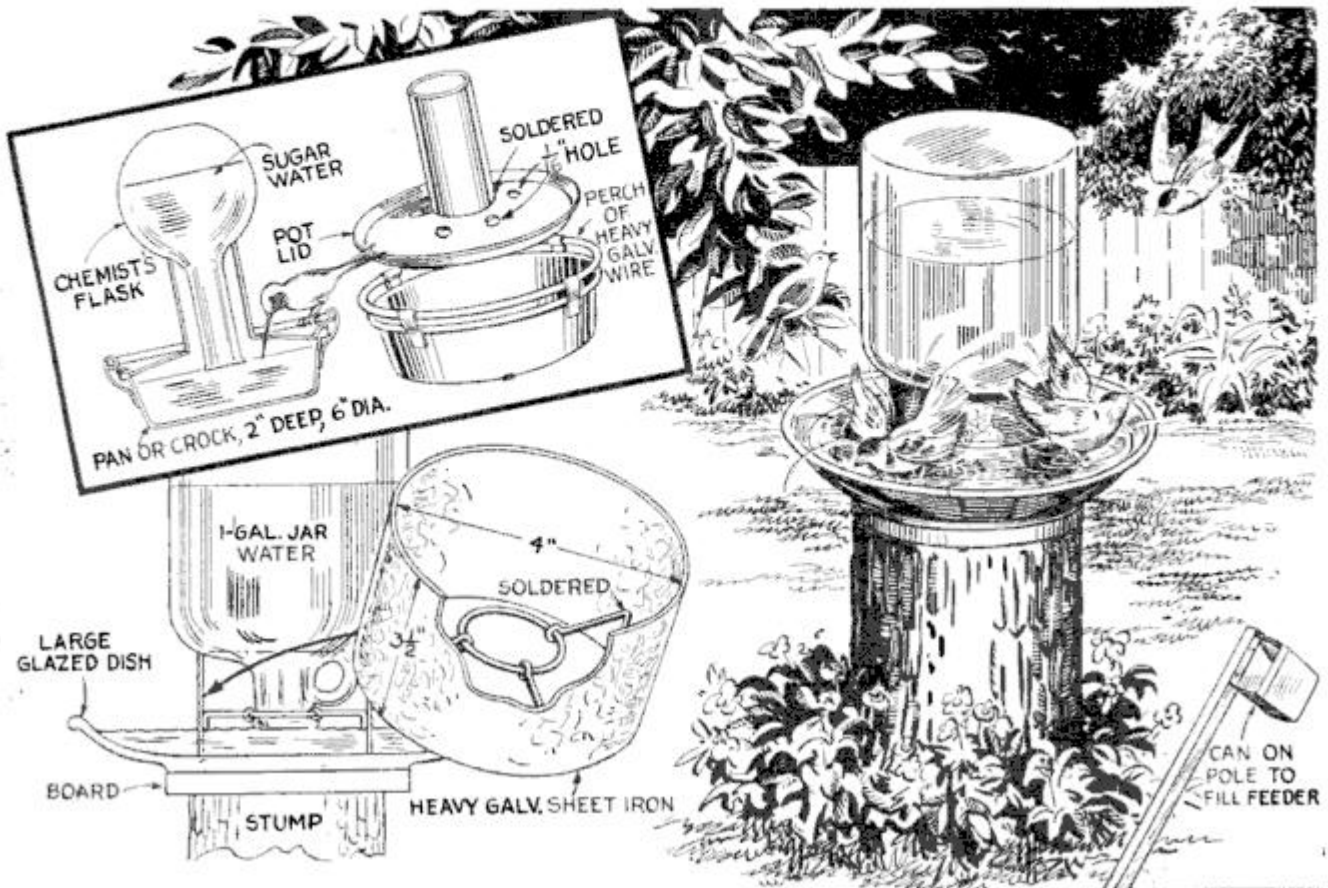

Chances of attracting birds and keeping them around are increased if you will provide water which is readily accessible to them. Where water quickly evaporates from a shallow dish, a constant supply can be maintained by using inverted flasks or jugs held a short distance above the bottom of the pans or dishes as shown in the pictures above. Take the simple type of bird bath at the right: A large, shallow dish, preferably light green in color, is set on a stump or pedestal and a gallon jug of water, fitted with a sheet-metal collar, is placed inverted in the center of the dish. The collar is wide enough to keep the mouth of the jug above the bottom and a wire frame in the collar serves to hold the jug in position securely. The result is a constant supply of water until the jug is empty. The same principle is used in making the small sugar-water feeder at the left. In this case, a flask or bottle is used as the reservoir while the pan is covered with a perforated cover to minimize evaporation. The cover should be located just above the level of the liquid so that birds will have no difficulty in getting at it. A California bird lover succeeded in attract-

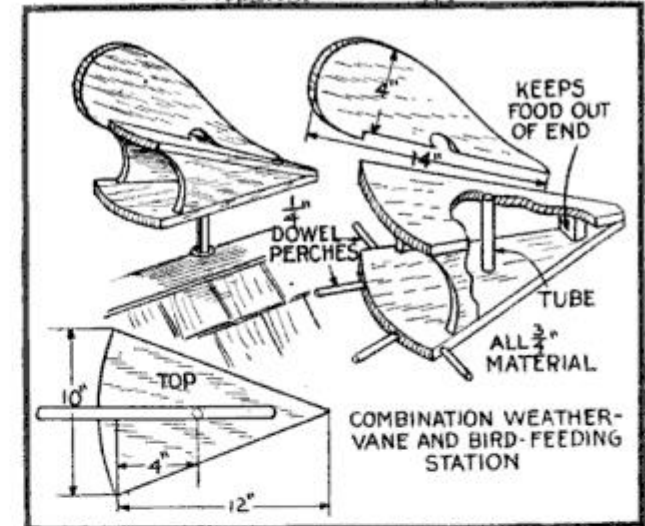

ing hundreds of hummingbirds to his grounds by using such feeders. For hummingbirds, the feeder should be arranged so that they have access to the liquid while on the wing as they seldom alight. The lower detail shows a protected feeding shelter in which crumbs can be placed. The shelter is pivoted to rotate and the vane on top keeps it pointed into the wind. Keeping the feeder supplied with crumbs is easy if you use a long stick or pole having a can nailed to the top end.

IT'S TIME *Joe*

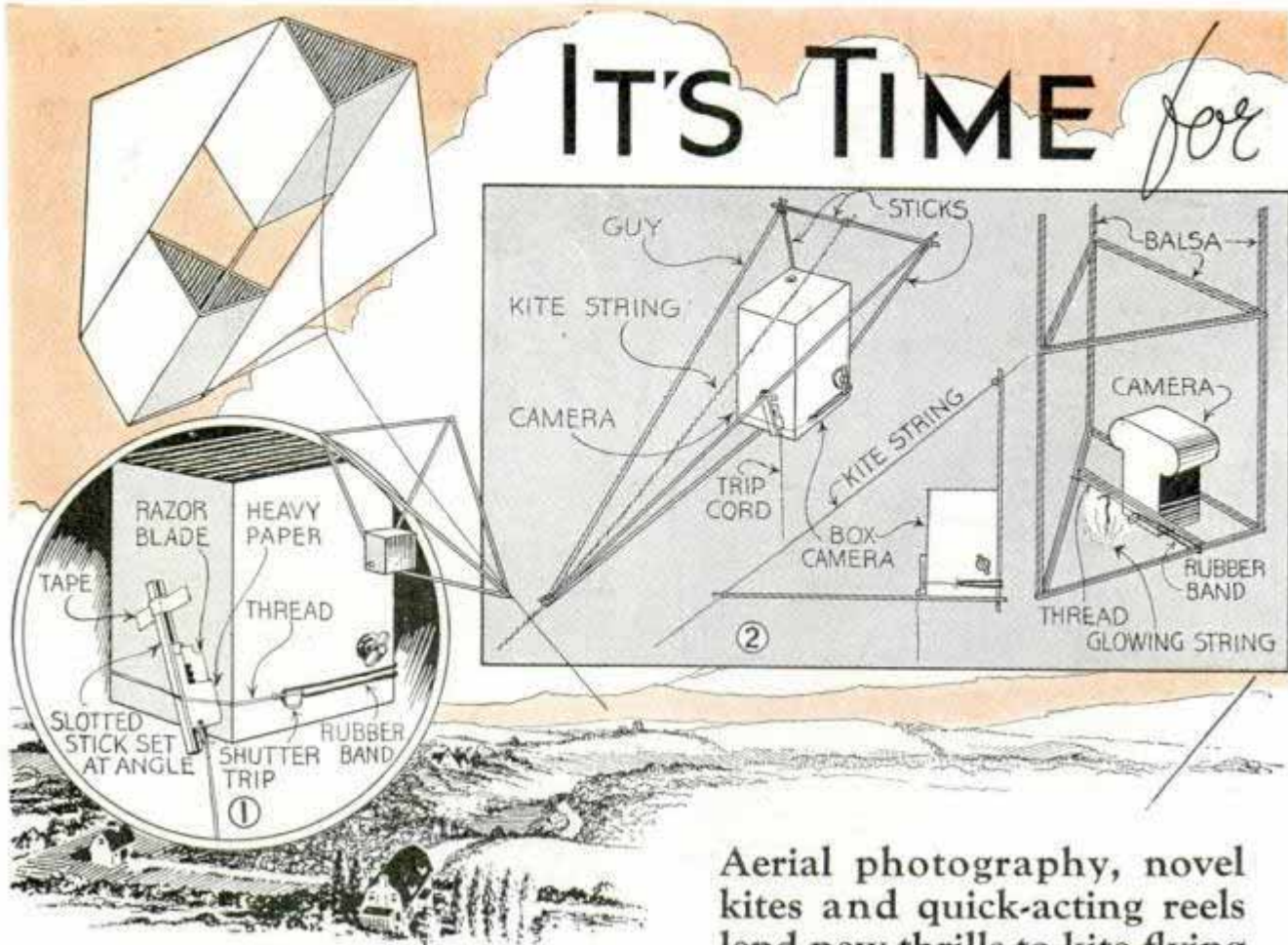

Aerial photography, novel kites and quick-acting reels lend new thrills to kite flying

THINK of the fun you'll have taking pictures—real aerial views of the countryside from a high-flying box kite. It's easy when you rig the simple apparatus detailed in Figs. 1 and 2. A triangular frame, to which the camera is lashed, is fastened to the kite string just below the bridle. The camera is lashed in the bottom triangle with a thread holding the shutter release against the pull of a rubber band. Underneath the string is a safety-razor blade sliding in a slotted stick

as in Fig. 1. When you pull the trip cord, the razor blade severs the string attached to the rubber band, thus tripping the shutter. Another arrangement, shown at the right in Fig. 2, makes use of a glowing string, the latter attached to a thread holding the shutter release. The string can be 4 or 5 in. long. No separate sling is used, the camera being lashed directly to the frame of the kite. When you're ready for launching, you light the end of the string and blow out the flame as soon as the string starts to glow. Then send up the kite in a hurry. When the glowing string reaches the thread holding the shutter, you have your picture. The secret of taking good pictures in this way is the selection of a day when the wind is blowing steady so that you can maneuver the kite into the desired position.

Fig. 4 details the type and average size of the kite required for carrying a small camera aloft. Such a kite will lift a pound or less in a very light breeze. It's simply a triangular box kite with wings, the frame being made from $\frac{1}{4}$ by $\frac{1}{4}$ -in.



KITE FLYING

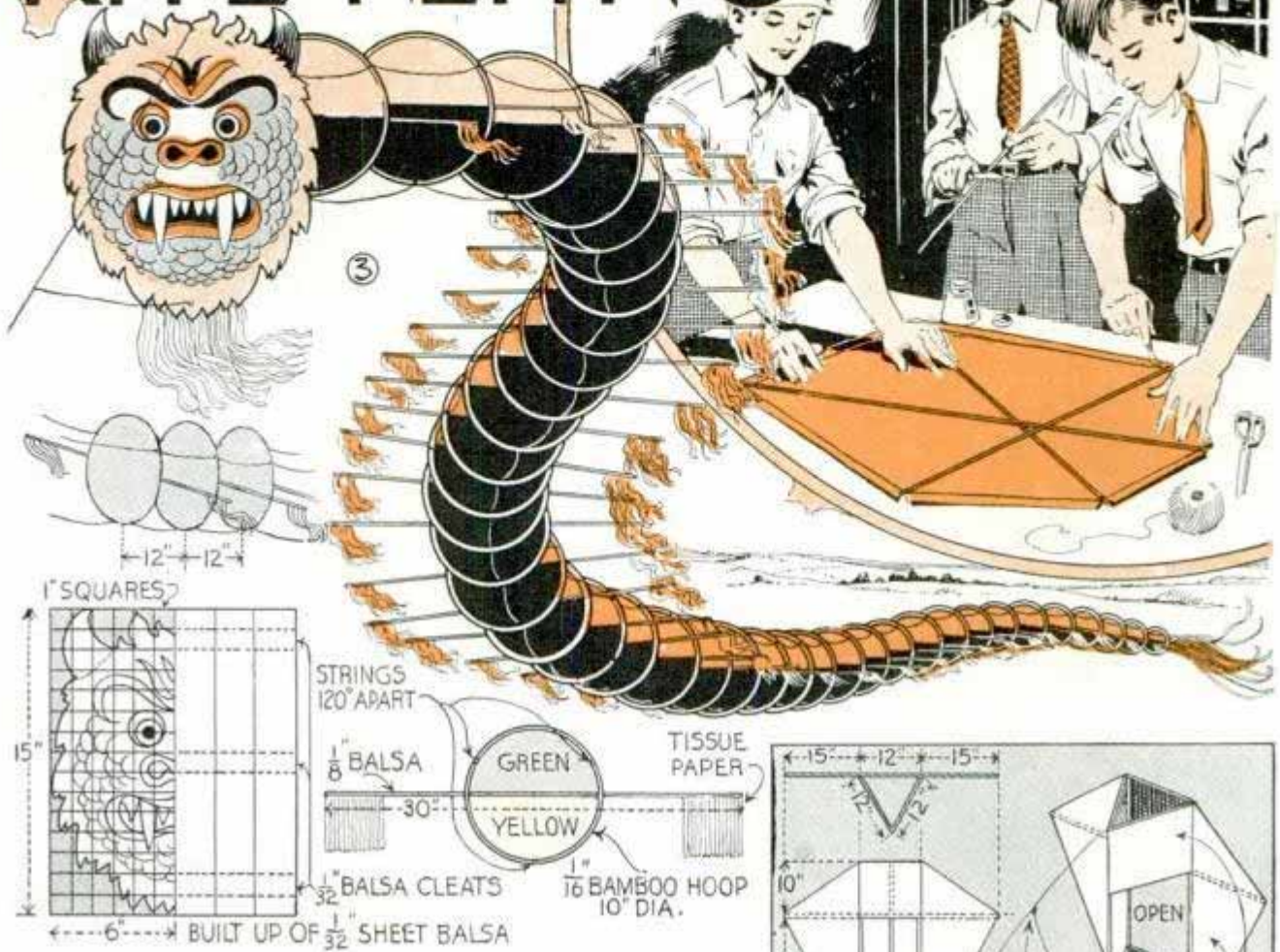

strips of either balsa or spruce and covered with medium heavy wrapping paper. In constructing this kite and others like those shown in Figs. 5 and 6, model-airplane cement is used to assemble the frame, and glue or wing dope will do to stick the paper to the frame.

Now for something different which you'll find in Fig. 3. Dragon kites demand accurate workmanship and some experimenting to get them into the air successfully. The disks should not only be extremely light, but accurately made and evenly balanced. Rings and balancing sticks are of bamboo about $\frac{1}{16}$ in. in diameter, or lighter. Make the head of very thin strips of sheet balsa with cleats across the back as shown in the squared detail, Fig. 3. Streamers on the chin serve as a balance. A two-string bridle is attached to the top and bottom of the head. First, try out ten or twelve disks, then add others in decreasing diameters until the kite is the desired length.

A shark chasing a school of fish high above the housetops as in Fig. 8, will create a sensation. A box kite will keep several 10-ft. fish in the air in

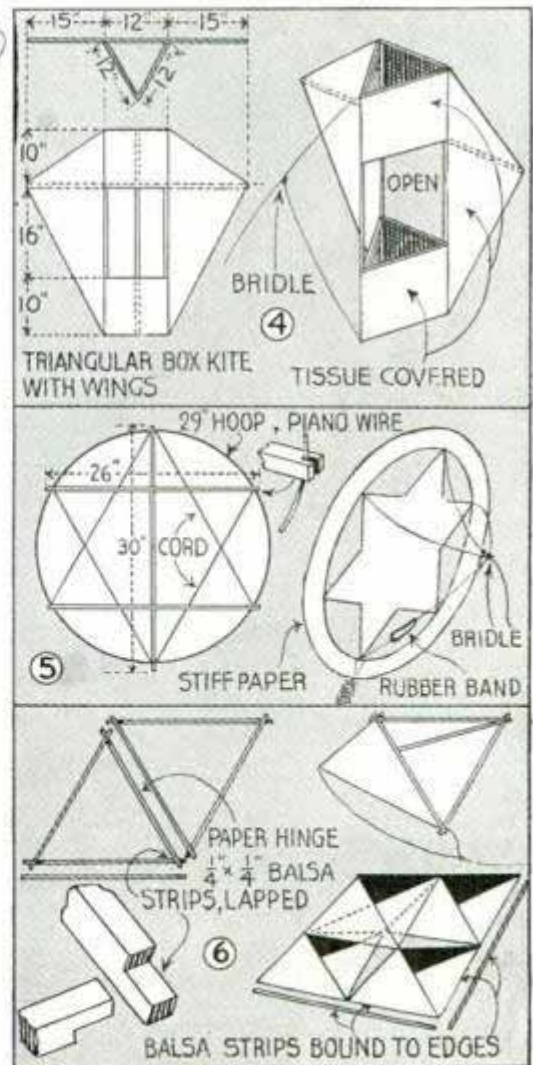

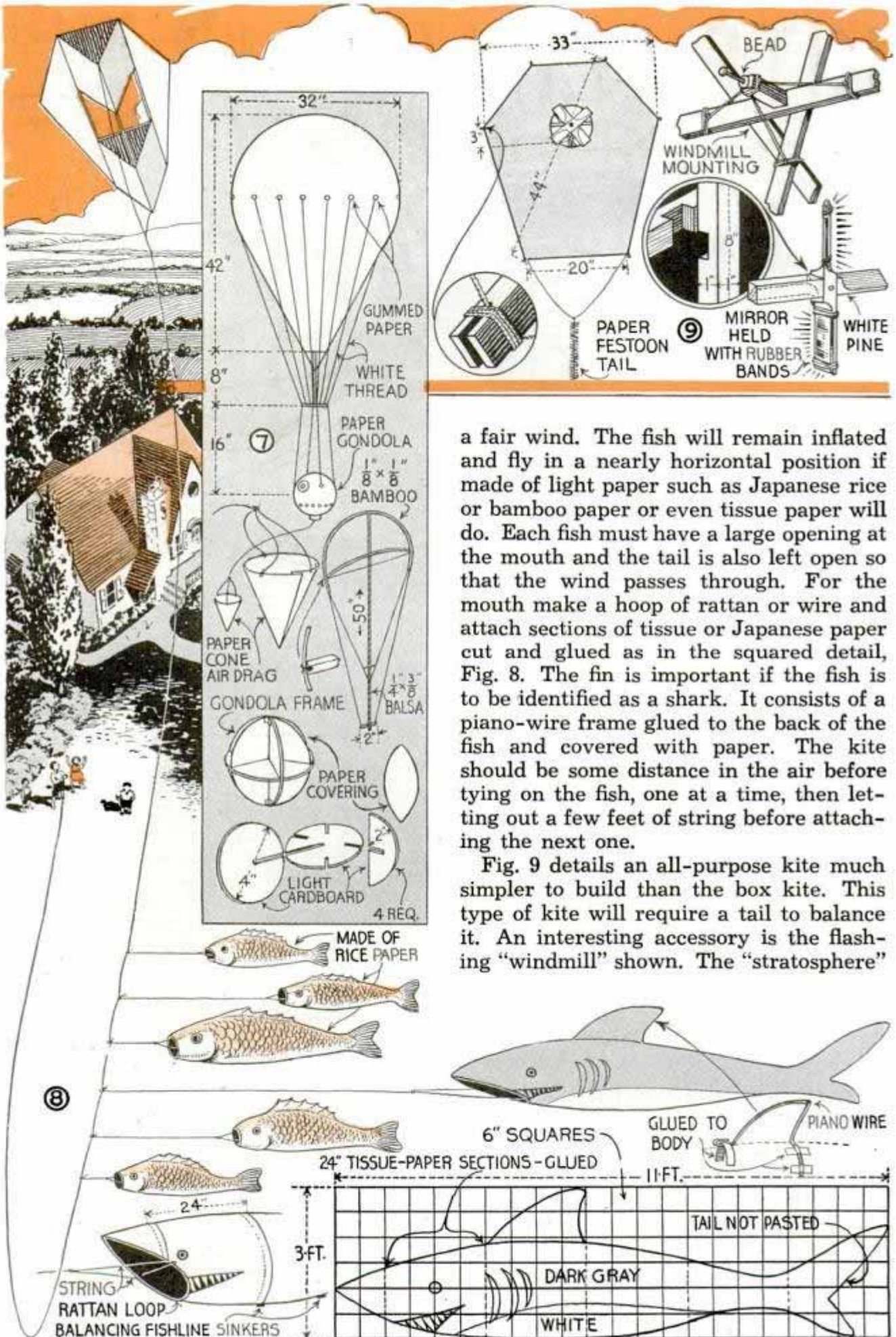

a fair wind. The fish will remain inflated and fly in a nearly horizontal position if made of light paper such as Japanese rice or bamboo paper or even tissue paper will do. Each fish must have a large opening at the mouth and the tail is also left open so that the wind passes through. For the mouth make a hoop of rattan or wire and attach sections of tissue or Japanese paper cut and glued as in the squared detail, Fig. 8. The fin is important if the fish is to be identified as a shark. It consists of a piano-wire frame glued to the back of the fish and covered with paper. The kite should be some distance in the air before tying on the fish, one at a time, then letting out a few feet of string before attaching the next one.

Fig. 9 details an all-purpose kite much simpler to build than the box kite. This type of kite will require a tail to balance it. An interesting accessory is the flashing "windmill" shown. The "stratosphere"

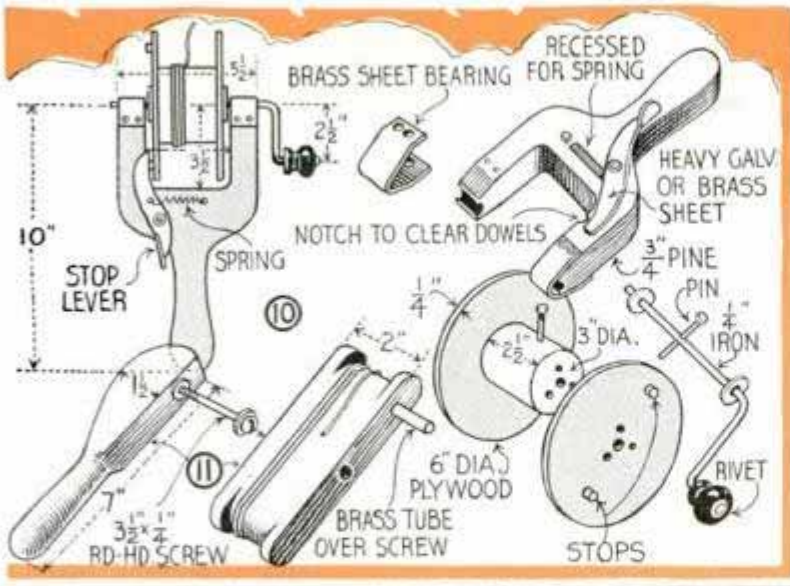

kite, Fig. 7, is designed for novelty, and must be made of light materials, slightly bowed at the back. With exception of the bow it is similar to the well-known two-stick kite with bowed top. A six-pointed star kite, Fig. 5, is not only easily made but is a striking design when the paper covering is of different color in bright shades. For example, use silver paper on the points, red for the center and blue for the circle. The star kite also requires a tail. Tetrahedral kites, Fig. 6, require a stronger wind for successful flying than do the flat or bowed kites. To make them, light balsa sticks are cut to lap and made into a pair of equilateral triangles. Match them up for size and then cover with paper. When dry, put a gummed paper strip or hinge along the edges of the triangle and with an extra stick, set them to form a "vee." Four of these can be built up to form a larger kite by binding a stick along the edges to keep the units together.

A simple hand reel is shown in Fig. 11. A piece of tubing over a screw makes a good crank. In Fig. 10 is a more elaborate job of the same general type, with a stop to prevent the string running out when the hand is off the crank. To wind the string evenly on the drum a cam-arm design is shown in Fig. 12. The cam is merely a wooden cylinder mounted eccentrically, and the arm made of plywood. The slower the cam revolves in relation to the drum, the better job of winding it will do. The two-crank model in Fig. 13 gives a variable winding speed. For fast winding the geared-up crank is used; the direct crank for slower and heavier work. One of the best arrangements for handling a large kite is the free-wheeling reel with a clutch, shown in Fig. 14. The crankshaft is divided in the middle—one end fixed in the hub by means of a pin, the other sliding in and out. Normally it is forced in by a coil spring, bringing into contact the two clutch faces of garnet paper cemented to rubber.

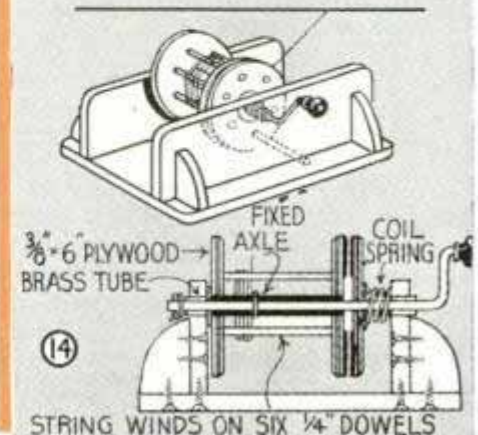
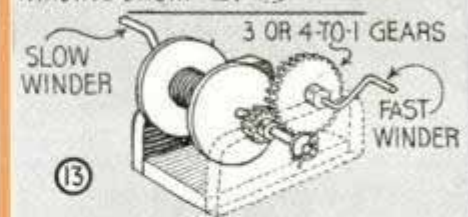
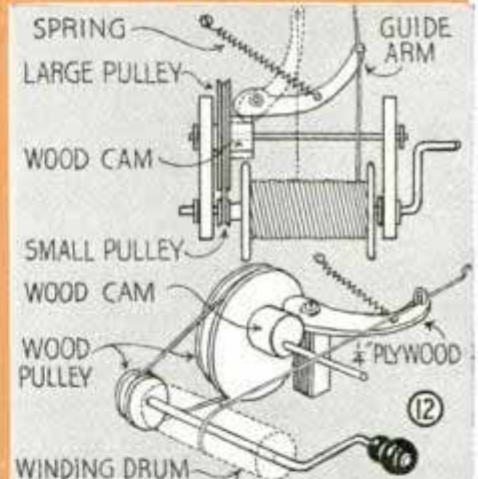

Accurate Lock Mortises Laid Out with Aid of Striker Plate

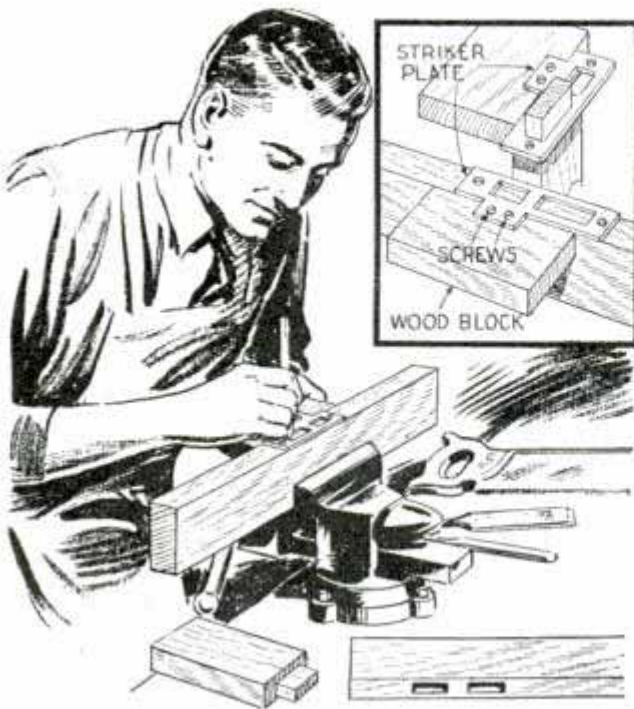

You can get the lock mortises accurate in a door if you use the striker plate as a template

To save time in accurately laying out any number of duplicate door-lock mortises, the striker plate will serve as a guide. The lip of the plate is drilled and is screwed to a hardwood block to aid in holding it on the edge of the door.

Invisible Catches on Windows Keep Out Intruders

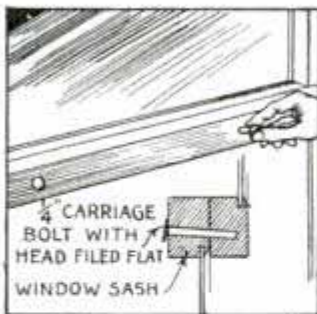

Two small holes drilled through the upper frame of the lower sash and partly through the lower frame of the upper sash, will take pins to lock the window.

For pins, you can use small carriage bolts with the heads filed flat, or even large spikes cut off to the right length. The pins will be unnoticeable under a curtain.

Making Asbestos Cement

Asbestos boiler covering mixed with boiled linseed oil makes a cement that will stick to iron or brick, when heated, almost

like iron itself. We have tried it to point up or repair the firebrick in two fireplaces and to cement firebrick in a conversion gas unit around the door opening. Judging from appearances now, the repair is as permanent as the brick themselves.

—C. M. Lyman, New Hartford, N. Y.

Golf Club Strapped to Wrist Prevents Accidents

Looped over your golf club and slipped over the wrist as shown, a small leather strap may save you from injuring someone should the club accidentally slip out of



your hands when the handle is wet. The strap, which should be long enough to allow free movement of the hands, can be carried in the bag when not needed.

Lock Cap for Filler Pipe of Fuel-Oil Tank

If you want a lock cap for the filler pipe on a fuel-oil tank, here is one that you can make and install without altering the pipe in any way.

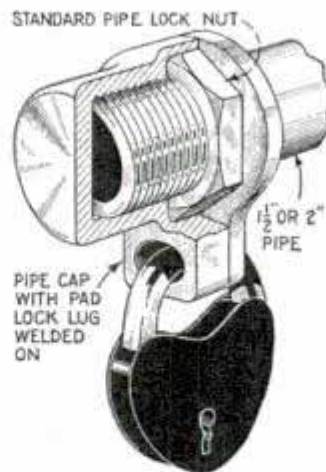

From $\frac{5}{16}$ -in. flat iron, saw out a piece large enough to be drilled and tapped to screw onto the end of the pipe. Make the upper portion of the piece rounding with a lug formed on the lower end,

which is drilled to take the shackle of a padlock. Drive this onto the end of the filler pipe and lock it with a pipe nut. Then take a pipe cap and counterbore the open end so that it will clear the pipe nut when driven onto the end of the pipe. Weld a lug onto one side of the cap and drill it to take the padlock, aligning the hole with the one in the flat iron.

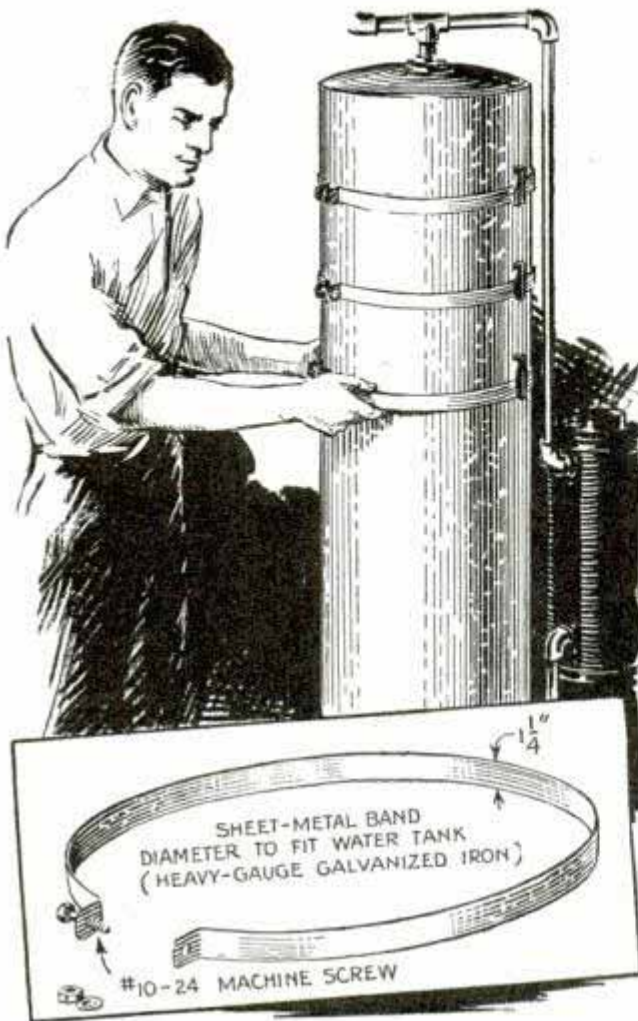

piece of $\frac{1}{4}$ -in. Bakelite. Brass strips equipped with silver contact points are mounted on the Bakelite part as shown.

When the units have been assembled, the adjusting screws "A" should be set so that the contacts on the brass strips do not touch the silver contacts of the thermostatic strips. The units are mounted rigidly on the hot-water tank as shown, and wired with an 8-wire cable to an indicator box fitted with eight switch points and a rotary switch lever. Connections for hooking the indicator box to the transformer and the thermostats are shown in the diagram. A doorbell transformer delivering 12 volts should be provided, preferably a heavy-duty type.

In order to adjust the thermostats once and for all, set the switch lever on the indicator box on contact 1 when the tank is cold. Then turn on the heat and as soon as the water in the tank adjacent to the top thermostatic unit has become hot, the adjusting screw "A" of this unit should be tightened up carefully until the lamp on the indicating panel is illuminated and

the bell rings. Next, the switch is set to point 2, and the operation repeated. The process is continued until all seven of the thermostats have been adjusted so that their screws cannot slip and easily get out of adjustment. When the water cools to a sufficient amount so that the bimetal strips contract, the light will go out. Inasmuch as the continuous ringing of a bell when hot water is available is not desirable, a snap switch of any convenient size should be inserted in the line.

In use, this apparatus is extremely convenient. If it has been found that one-third of a tank of water is adequate for the bath, then the switch lever can be set to point 3 and the heater turned on. When this quantity of water has been heated, the light will be turned on and the bell will sound. By this means, it is possible to heat just the amount of water required.

Accurate Inside Measurements with Sliding Curtain Rod

To quickly obtain accurate measurements when fitting cabinet shelves and similar work, where it is necessary to transfer an inside dimension, a sliding curtain rod will be found handy. A nut soldered to the rod as shown, and fitted with a thumbscrew, holds the adjustment.

—Wayne C. Leckey, Aurora, Ill.

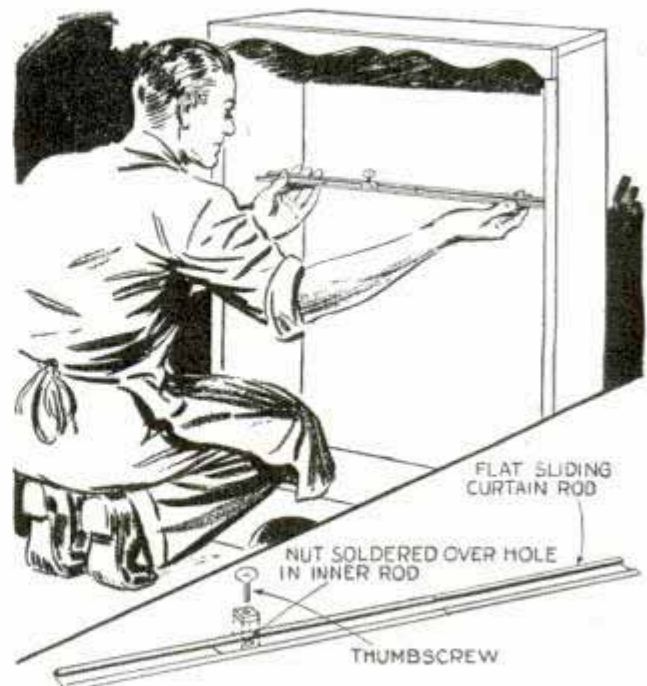

Thumbscrew and nut hold adjustment of sliding curtain rods while transferring measurement

"Cartridge Candle" Produces Hot Flame



For the boy who likes to perform experiments and needs a small flame for heating test tubes, beakers, etc., but does not have a bunsen burner, this cartridge candle will solve the problem.

It is a discharged shotgun shell filled with melted paraffin. To use the candle, ignite the rim of the shell and let it burn a few minutes.

Padded Scissors Ease Strain on the Fingers

If your work requires using a pair of scissors for long periods, and the handles make your fingers sore, pad them with short lengths of small rubber tubing. Just slit the tubing along one side

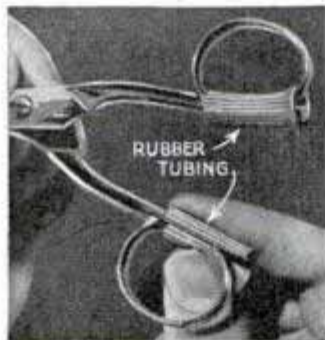

and slip it over the handles as shown, using an all-purpose cement inside the tubing to attach it to the handles. If the holes in the handles are large, put the tubing clear around instead of just on one side.

Insect Bait Wired to Fishhook



When using grasshoppers or other insects for fishing bait, and you have trouble keeping them on the hook, take a hairpin or a piece of soft wire and form a holder on the hook for the

bait as shown. Just run the hairpin through the eye of the hook and then twist the legs around it in opposite directions, turning up the ends at right angles.

Fan-Shaped Trellis Easily Made for Small Vines

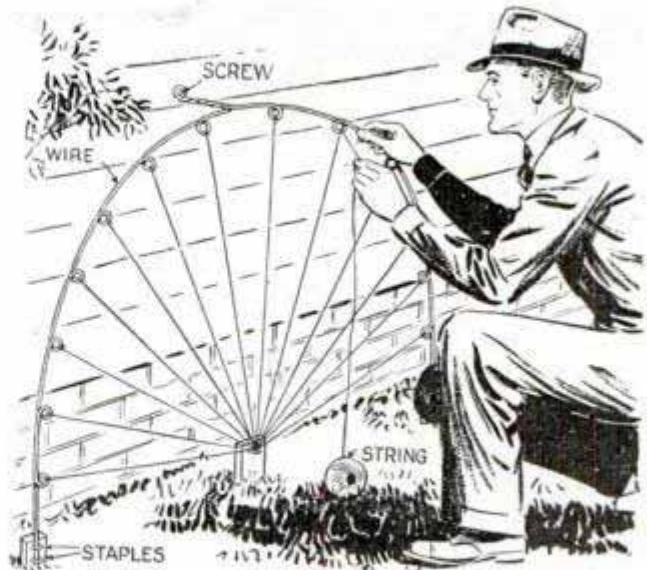

When frost comes, you can pull up both the dead vines and the trellis and store the latter until spring

Shaped like a fan, this wire trellis will hold small vines neatly spread and away from the wall of the house. The wire is bent with evenly spaced loops, including one or more long ones for attachment to the house, and the full length of the wire is bent in the form of a half circle, with the ends attached to stakes driven into the ground. From a third stake driven into the ground, stout strings are fastened and drawn up to attach to the loops.

Shrinking of Wet Woolen Socks Avoided with Stones

If you get your woolen socks wet, while on a hike or a camping trip, fill them with small stones before hanging them up to dry. The weight of the stones will tend to stretch them and help prevent shrinking. The socks can be pulled into shape when dry. Woolen socks should never be dried near an open fire. If the wool is even slightly scorched, it will tear apart quickly.—S. Sameth, New York City.

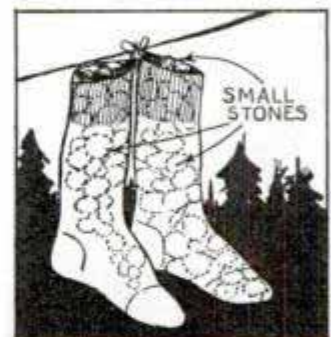

Woolen socks should never be dried near an open fire. If the wool is even slightly scorched, it will tear apart quickly.—S. Sameth, New York City.

Asbestos covering from a boiler can be used again by softening it with water.

EASY SOLUTIONS *for*



A vine-covered arbor adjoining the rear gate will conceal refuse cans in your back yard. The plan view gives a suggested arrangement and shows the offset at one side to accommodate the cans. You will find it much handier to reel up your clothesline than to remove it in the usual way. Besides, by installing the reel in a wooden box permanently fastened to the post, the rope will be kept clean. Construction of the box and reel is shown in the detail below

Arbor Conceals Refuse Cans

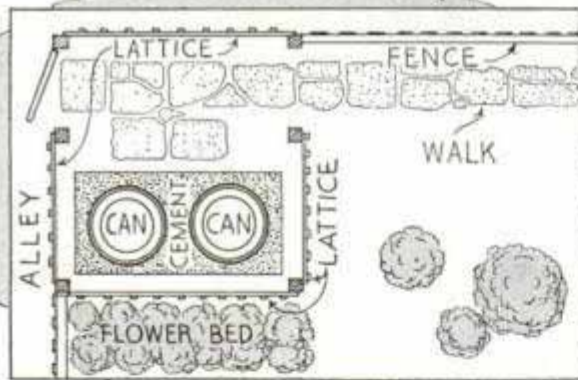

Set over the hot-air register of a pipeless furnace, this sheet-metal hood, which is 13 in. high, tends to deflect the heated air so that it will spread over the lower portion of the room

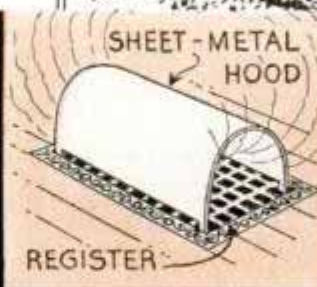

Long lines of stove-pipe can be made rigid without wires by clamping a sheet-metal sleeve around each pipe joint, using small bolts to draw the ends of the sleeves together

Eccentric stop solves the problem of holding open a window sash that has no weights. The stop is merely a small hardwood disk, which is pivoted off center on the window frame

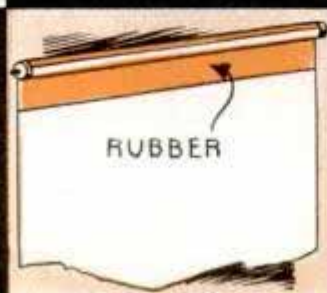

By attaching window shades to the rollers with 3-in. strips of rubber sewed to the ends of the cloth, you provide shock absorbers that will prevent the shades from being torn off

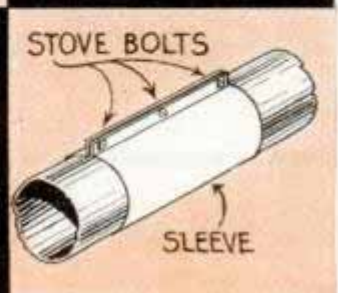

YOUR Home Problems

Space Savers

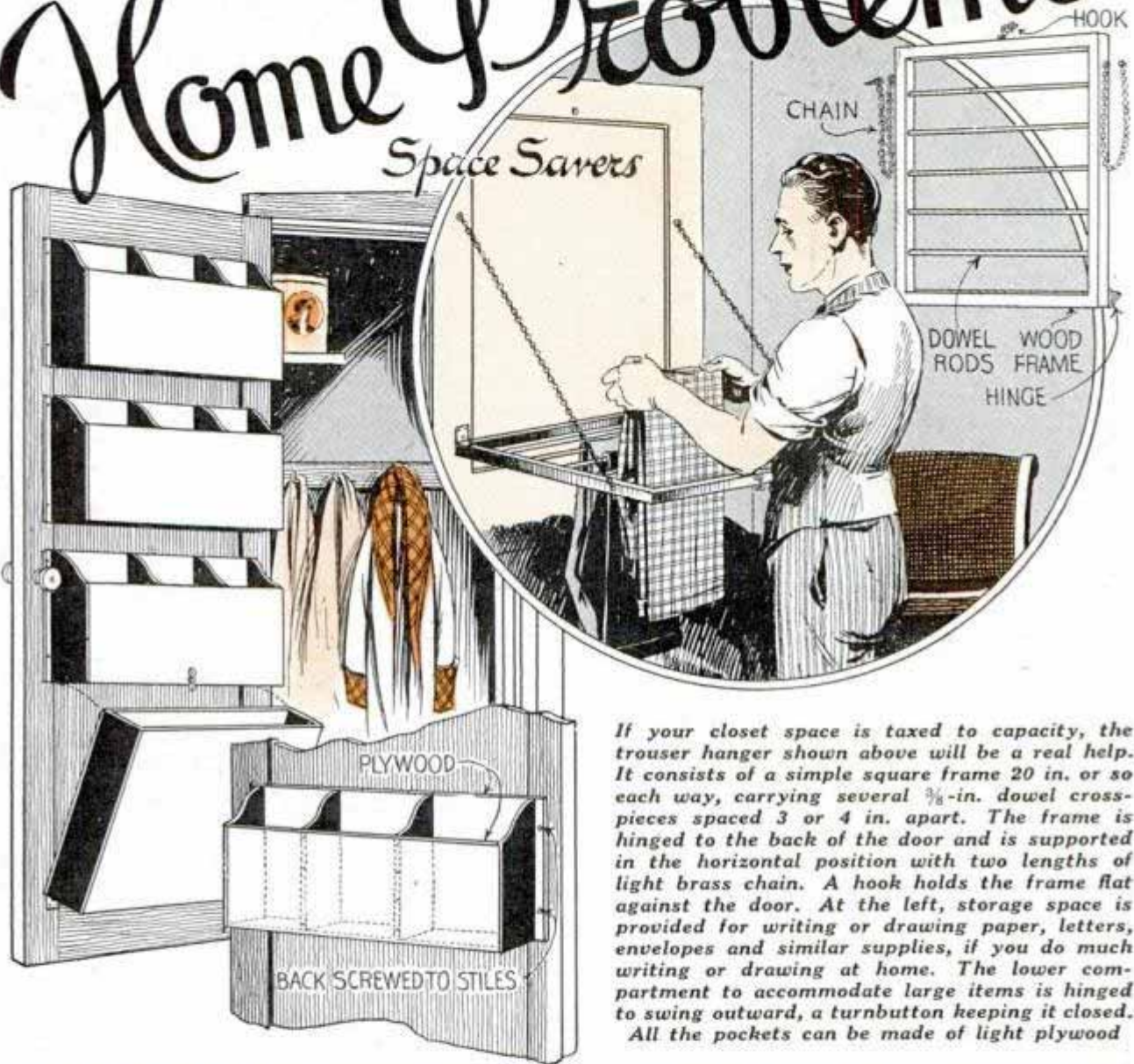

If your closet space is taxed to capacity, the trouser hanger shown above will be a real help. It consists of a simple square frame 20 in. or so each way, carrying several $\frac{3}{8}$ -in. dowel cross-pieces spaced 3 or 4 in. apart. The frame is hinged to the back of the door and is supported in the horizontal position with two lengths of light brass chain. A hook holds the frame flat against the door. At the left, storage space is provided for writing or drawing paper, letters, envelopes and similar supplies, if you do much writing or drawing at home. The lower compartment to accommodate large items is hinged to swing outward, a turnbutton keeping it closed. All the pockets can be made of light plywood



Small match boxes that lie around on your smoking table can be embellished by covering them with fancy colored paper such as used for many of the better-grade envelopes



TWINE

If a door latch is not fitted with a catch to lock it from the inside, just drill a small hole in the bolt, as shown, to take a steel pin, which can be kept on a chain fastened to the door

When you hang a picture on a nail, make an inverted V-cut in the wall-paper as shown so that the paper can be turned back over the hole if the nail is removed later



A coconut with facial features painted on one side and dressed in a bandana-handkerchief hood with large brass earrings attached to the cloth, forms this 'mammy' twine holder

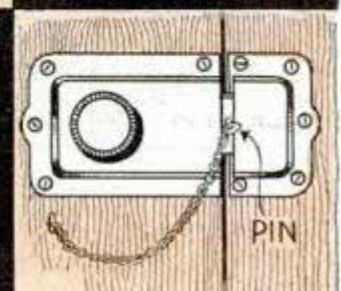



BY HOLDING WORK
ON DESIRED LINES
ACCURATE MITERS
ARE EASILY MADE

Protractor on Table of Sander for Accurate Angle Work

Drawn on the table of a disk sander, a large protractor scale will enable you to finish accurately, miters, bevels and other angles. The scale is drawn with the aid of a straightedge and is simply an enlargement of one on a protractor scribed in the surface of the table.

—A. H. Waychoff, Tempe, Ariz.

Window-Cleaning Fluid

Here is a solution with which you can clean and polish your windows with a minimum of labor. To make it, mix ammonia (strong 28 per cent), 4 fl. oz., alcohol (denatured), 8 fl. oz., whiting, 8 oz., and water, 7 pts. The solution can be bottled and kept, but it must be shaken thoroughly before using.

It's Easy to Build Bird Houses

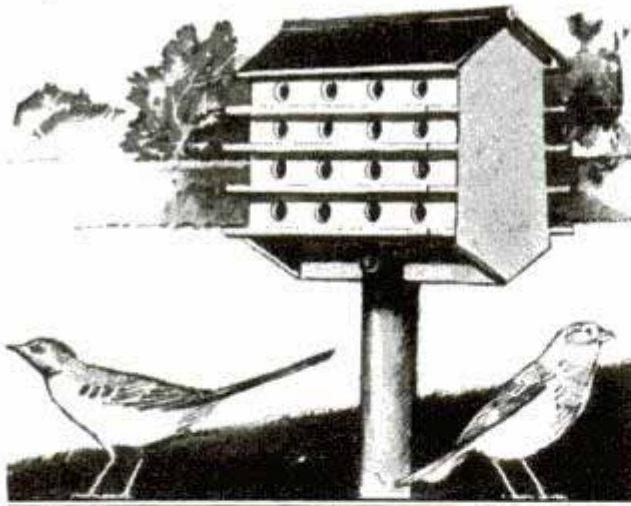

that will attract peppery little wrens, martins, bluebirds and others. Our plans include a wide variety of nesting boxes that not only look good to the songsters, but also add a delightful touch to the garden.

COLONY HOUSES AND APARTMENT LOG CABINS—884 and 885. Only a saw, hammer, nails and easily obtainable material required. Two prints 50c.

SINGLE APARTMENTS IN RUSTIC DESIGN—886: Fourteen easy-to-build houses on one print. 25c.

Outstanding Spring Numbers

DUTCH WINDMILL AND WATER WHEEL—911: Mill, 40 in. high. Small water wheel. 25c.

LOG-CABIN CONSTRUCTION—916: Two floor plans. Shows how to make corner joints. 25c.

17-FT. KAYAK—928 and 929: Light framework covered with canvas. One-man size. 50c.

12-FT. UTILITY ROWBOAT—707: Flat bottom. Four seats. Sturdy design. 25c.

"ZIP," MODEL RACING YACHT—880 to 884: 50 in. long. Plans include full-size lift templates. Four prints \$1.00.

TRELLIS SUGGESTIONS—639: Six types that will help beautify your home. 25c.

LAWN CHAIR—529: Plain sawed from $\frac{3}{4}$ -in. stock. Easily made with hand tools. 25c.

ORNAMENTAL WOOD FENCES—640: Five artistic designs for standard wood stock. 25c.

CIRCULAR ARBOR AND GATE—637: Popular style anyone can build. 25c.

LAWN AND GARDEN FURNITURE—920 to 922 incl.: Collection of designs for arbor-and-seat combinations and swings. (3 prints) 75c.

Any six of these blueprints will be sent postpaid upon receipt of \$1.00. Address Blueprint Dept.

POPULAR MECHANICS MAGAZINE, 200 East Ontario Street, CHICAGO



Works on light current.

Electric ARC TORCH

Carbon Electrodes Produce Arc for Soldering, Brazing and Light Welding

By C. A. CROWLEY

HERE'S a tool you'll find handy. It's light and easily made, ready for use on a wide range of small work where it is unnecessary to heat large areas or quantities of metal. Dental laboratories have used it for melting alloys in connection with the casting of bridgework. It has also proved satisfactory on light welding jobs where a $\frac{1}{16}$ -in. welding rod can be used.

The complete unit consists of a reactance coil connected in series with a carbon holder. Fig. 1 shows the core dimensions for the coil. A pile of transformer steel or, for that matter, stove-pipe iron will be satisfactory. The iron is piled 2 in. thick from laminations each 2 by $7\frac{1}{2}$ in. as shown. The exact thickness of the steel is of no importance so long as it is no thicker than ordinary stove-pipe iron. When the core has been stacked to a compressed thickness of 2 in. it is bound securely with tape. Upon this core are wound 10 layers of No. 14 double cotton-covered magnet wire. The first layer consists of 72 turns of wire. The starting end of the wire should be left 8 in. long and marked S, as in Fig. 2. When the first layer has been wound in place, the wire is folded out as shown in Fig. 3 to form a tap connection. After this, the second layer is wound on without cutting the wire. A total of 70 turns should be wound in the second layer. When this layer has been finished,

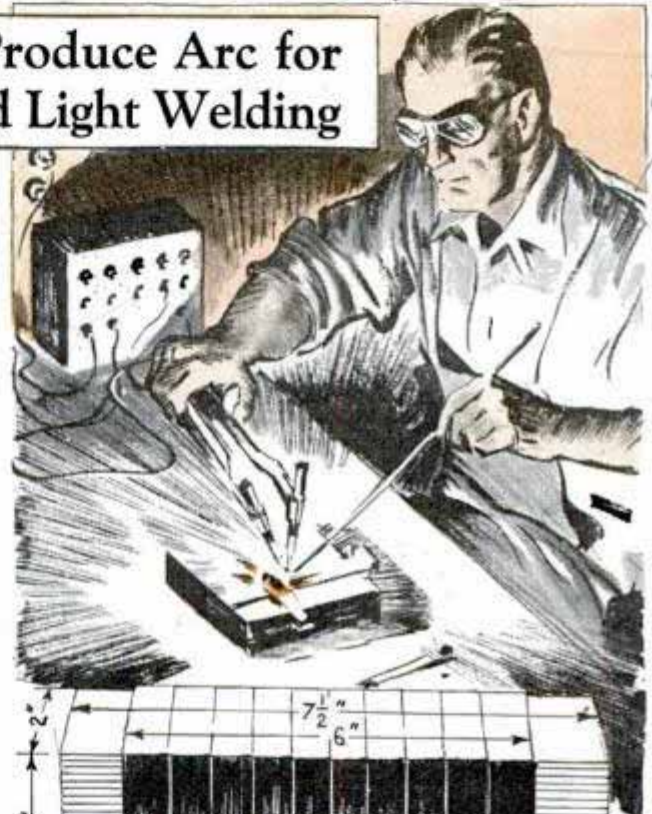

*B.P.
006*

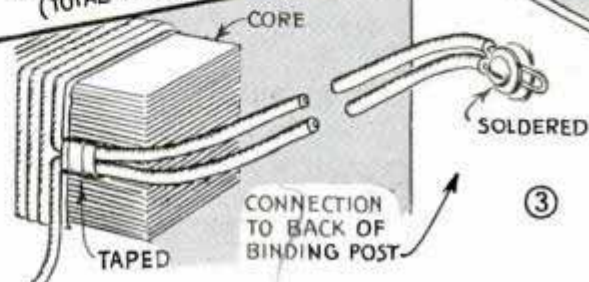
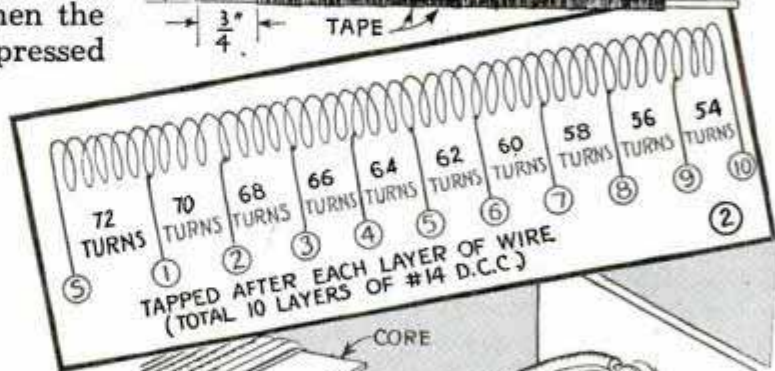
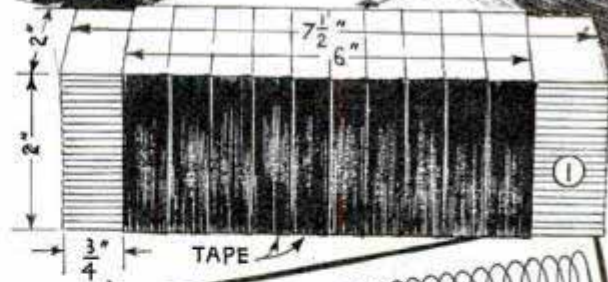



it is tapped exactly as previously described and succeeding layers wound on with the number of turns indicated in Fig. 2, tapping at the end of each layer. As the taps are made, they are numbered 1, 2, 3, and so on. Having completed the winding of the coil, a pair of mounting brackets, Fig. 6, are formed from channel iron. The detail shows the dimensions and method of forming these to produce a pair of combination mounting and clamping brackets suitable for preventing hum in the core and for mounting the coil on a base as in Fig. 5. The various tap wires from the coil are connected to binding posts on the terminal board, detailed in Fig. 4. Fig. 8 shows a back view of this terminal board together with all of the connections needed to put the unit into service. It should be noted that the taps from the coil are marked on this detail with the same numbers as were used in Fig. 2 for winding and in Fig. 4 for the terminal board.

With these connections completed, a length of flexible cord equipped with a plug is attached to the binding posts marked S and U in Fig. 8. One of the wires from the electrode holder, Fig. 7, is connected to binding post L. The other wire from the holder is connected to binding post No. 5 for the preliminary trial. This connection may be made to binding posts Nos. 4, 3, 2, or in rare cases, No. 1, if a heavier current is desired and to binding posts Nos. 6, 7, 8, 9, or 10 to produce small values of welding current. The binding post to which this connection is made should be determined in each case in accordance with the

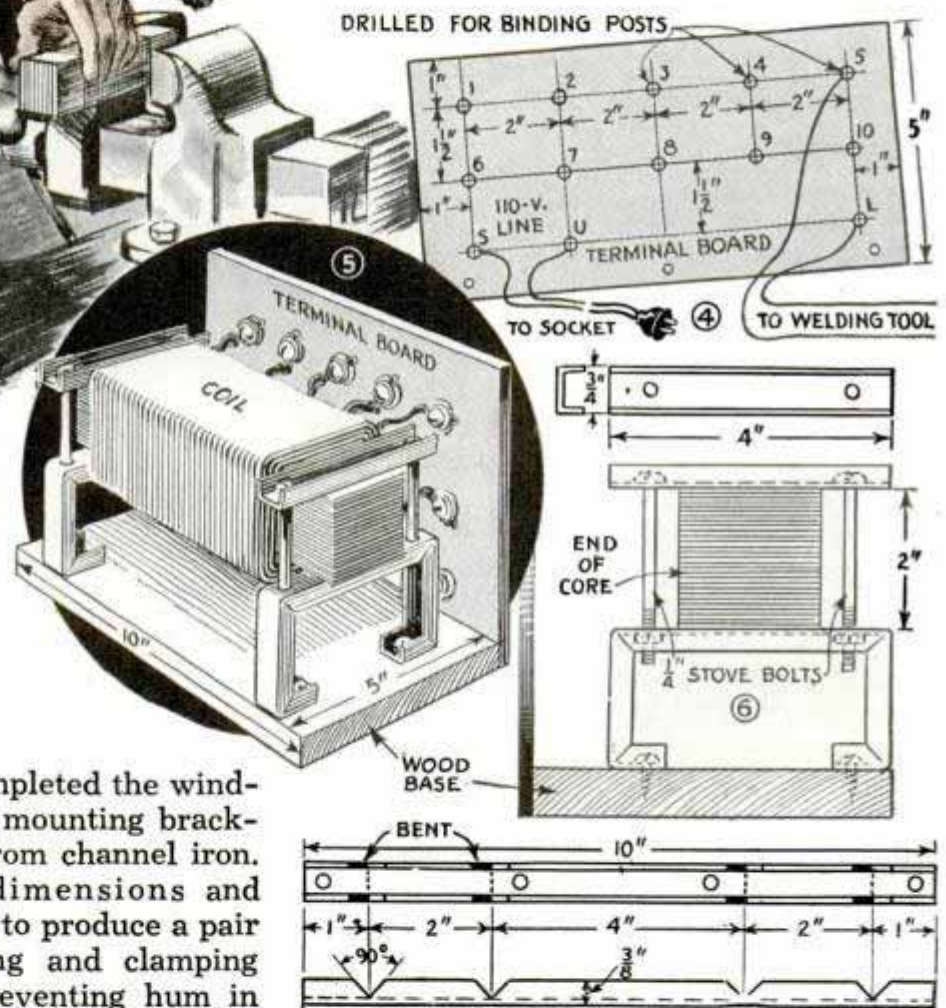

current requirements for the particular job. This arrangement gives great flexibility to the unit and will enable the user to do many jobs which would not be possible if all work had to be done with a fixed value of welding current.

The electrode holder detailed in Fig. 7 is used for the holding of a pair of $\frac{1}{8}$ -in. carbons. Larger size carbons should not be used, inasmuch as this unit was designed to give a large, intensely hot arc

with this particular size of carbon. The permanently fixed carbon-holding bracket detailed as B in Fig. 7 is made from two strips of heavy sheet brass $\frac{1}{2}$ or $\frac{5}{8}$ in. wide. This composite pair of strips is fastened to the handle with a pair of wood screws. It is important that care be taken to prevent the wood screws from coming into contact with the wires in the handle. The carbon-holding bracket, C, is similarly constructed from a pair of heavy brass strips and fastened to the angle bracket, E.

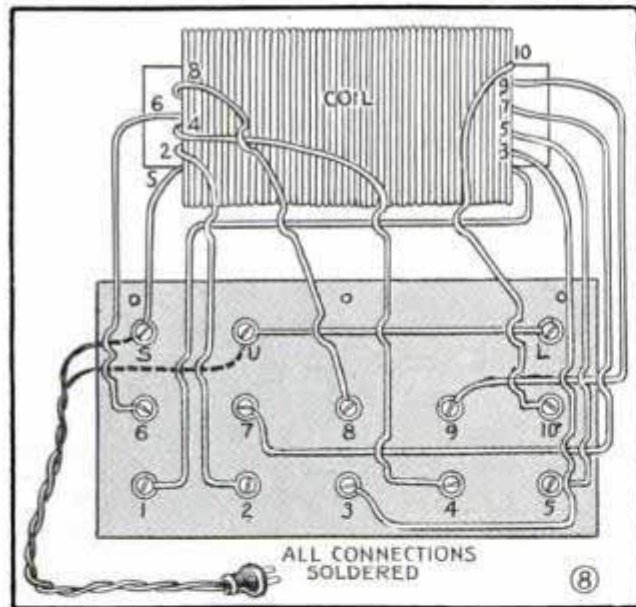
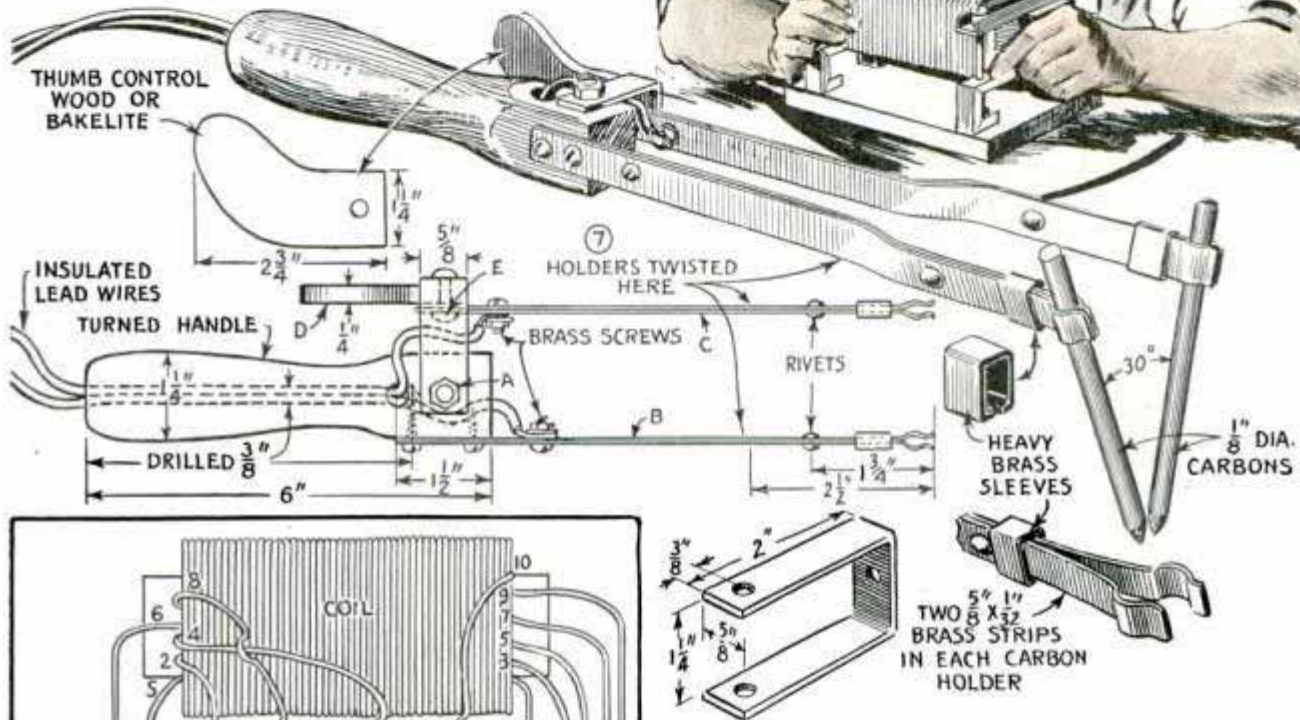

This bracket as well as a wood or Bakelite thumb control, D, is attached to the U-bracket, which in turn is screwed to the handle. The joint should be just tight enough so that when the handle is gripped you can easily manipulate the thumb control and thus adjust the arc. As indicated, the sections of brass used to make the carbon holders are riveted together $1\frac{3}{4}$ in. from the ends and twisted just back of the rivet joint so that the carbons will be giv-

en a 30° angle. Of course, some experimenting will be necessary to bring the carbons to just the right position.

To use the torch, connect the leads from the carbon holder to the unit as previously described, plug into the power supply and bring the carbons together by adjusting with the thumb. The arc is easy to pull and can be maintained without difficulty. For soldering or brazing, the torch is applied to the work and the brazing spelter or solder slowly fed in. The same procedure is used when welding. Welding rods should not be placed in the holder. Use the unit as a torch to supply the heat and feed in the welding or brazing rod in much the same manner as is standard practice in gas welding.

When a wood screw becomes loose, force a match stick into the enlarged hole and then drive the screw into the stick and it will usually hold.

Merchandise Displayed on Scales Gets Customers' Attention



Grocer's display shows quantity of merchandise in given number of pounds

Here is a method of displaying fruit, vegetables, etc., that not only shows up the merchandise to good advantage but also assists customers in estimating the quantities of the various items desired. It is especially useful for advertising specials, and in moving perishable fruit which might otherwise be wasted. Having several filled bags near the scales saves disturbing the display after each sale.

Centrifugal Pump Kept Primed by Hole in Check Valve

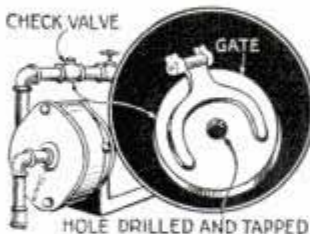

If a centrifugal water pump loses its prime, when a foot valve is used at the submerged end of the suction line and a check valve in the delivery line, the trouble often can be eliminated by drilling and tapping a small hole in the gate of the check valve so that a No. 10 brass machine screw can be inserted. The hole allows enough return water to keep the pump primed without destroying the effectiveness of the check valve. The hole may be closed any time a com-

plete seal of the valve is necessary by inserting the screw. This method has been used on check valves from 2 to 4 in. in diameter under lift heads to 400 feet.

Cardboard Boxes Set on Floor Protected by Tires

One merchant who kept cardboard cases and boxes stored in his basement, found that several old auto tires laid on the damp floor gave the boxes better protection against absorbing moisture from the concrete than

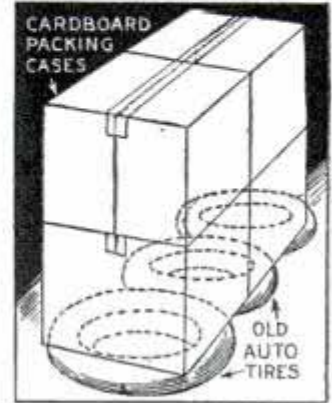

wood. In addition to the protection afforded the boxes, the tires last much longer than wood, which soon rots

Rack Cut on a Milling Machine Without Vertical Attachment

In a shop where a 6-ft. rack had to be cut, and the milling machine at hand had no vertical attachment, the job was done on the dividing head. A large lathe faceplate was fitted to the head and the stock for the rack was fastened around the faceplate with a bolt as shown. After the teeth had been cut in the rack, it was removed and straightened out, and then a gear to suit was cut in the regular way. This method, of course, is suitable only where extreme accuracy is unnecessary.

—Charles Kugler, Philadelphia, Pa.

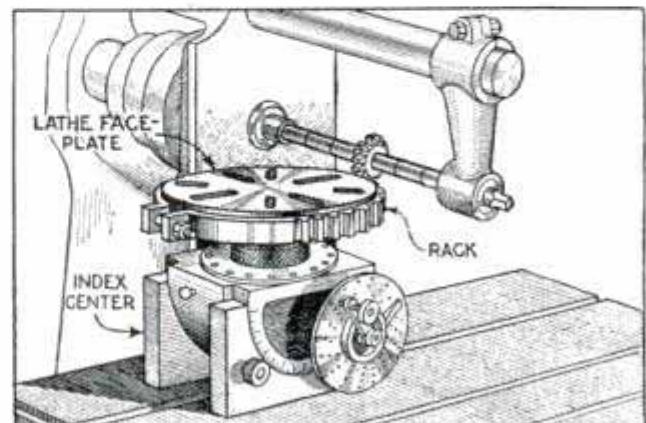

Stock for rack clamped around faceplate in indexing head to cut teeth in milling machine

"Poultry Yard" on Wheels Is Moved Easily

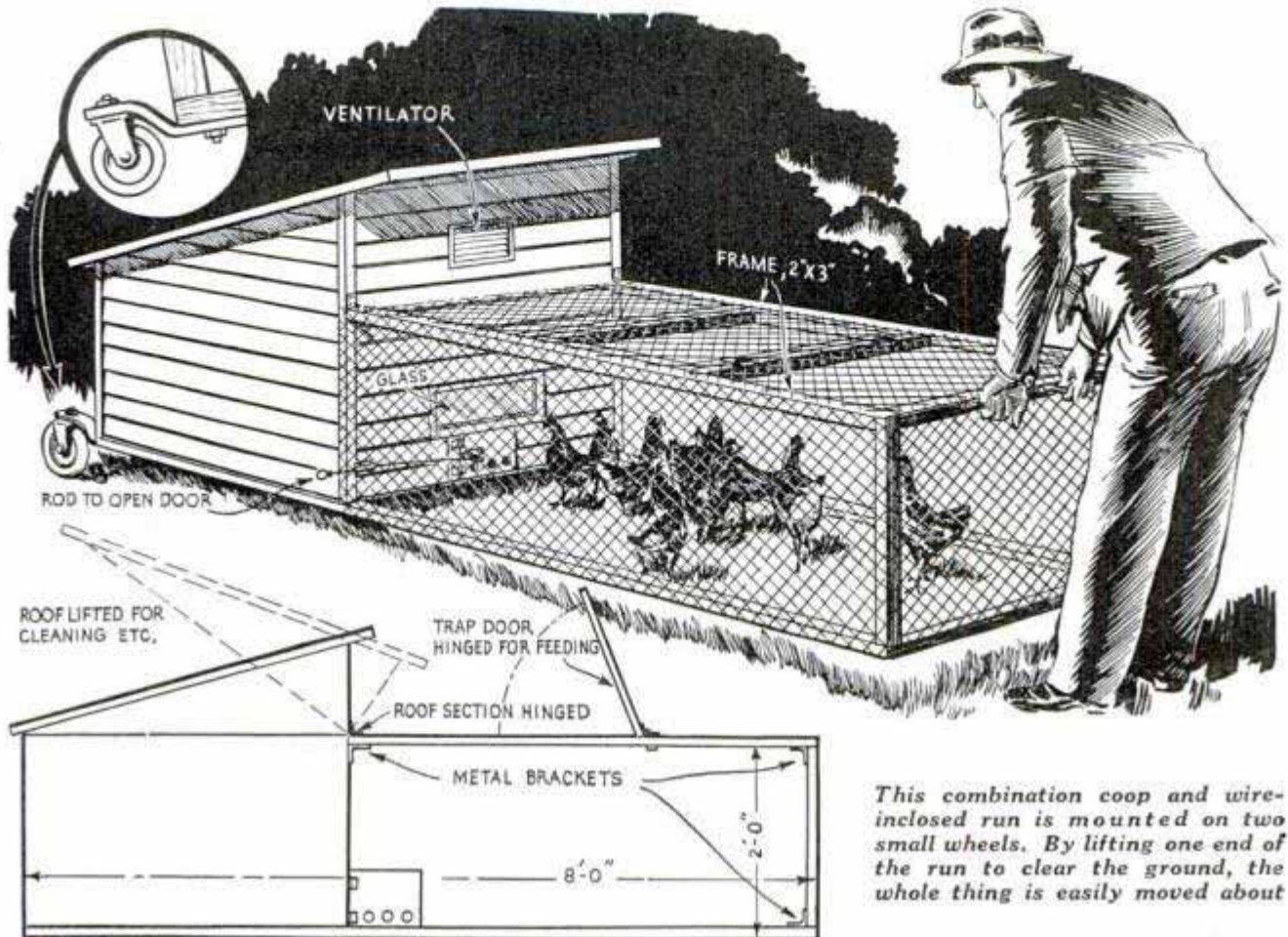

For the city or small-town dweller who keeps a few chickens and wants to change the location of the pen at intervals, this movable coop is just the thing. It is framed of $1\frac{1}{2}$ by $1\frac{1}{2}$ -in. pine and is covered with 4-in. lap siding. This is broken at one joint on three sides and the top section is hinged so that it lifts for clean-

ing. The frame of the run is joined to the coop, and all corners are stiffened with metal brackets. Fine poultry wire covers the top, sides and one end. A small trap door is framed into the top and is hinged so that it can be lifted for feeding. The 6-in. wheels are mounted on brackets made from $\frac{1}{4}$ -in. flat iron.

Pencils Are Tried Out by Customers Before Purchasing

To assist his customers in selecting a pencil with a lead to suit their needs, a merchant suspended one pencil of each type carried in stock from a small wood frame with rubber bands. The frame was kept on the counter with a tablet on which the customer could try out each pencil. The rubber bands were hung on small screw hooks so that the pencils could be removed easily for sharpening.

☞ To rid tubers and seeds of vegetables of many diseases, wash them in a solution of formalin, 1 pt., and water, 30 gals., before planting them.

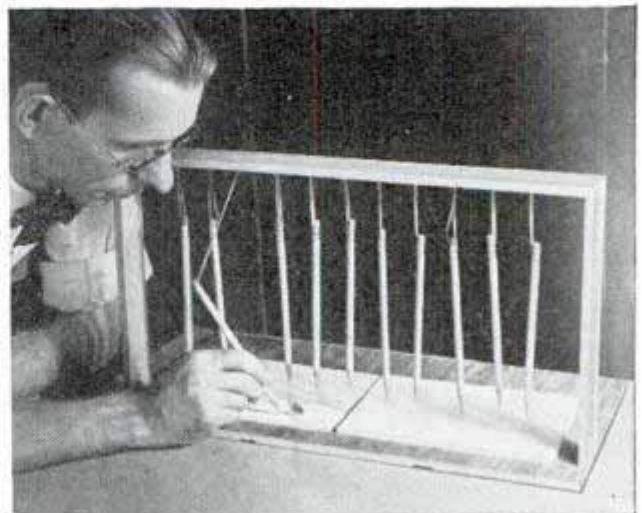

"Knocker" Nailed to Grain Chute Is Always at Hand



Give the grain chute a slap with this "knocker" and the resulting vibration will loosen packed grain

If you have overhead bins in your barn or granary and the grain or ground feed packs in the chutes leading from them, good knockers to loosen the grain can be had by tacking old harness traces to the chutes as shown. These knockers are always at hand, and a couple of slaps with them will usually loosen the grain.

Concentric Micrometer Adapter

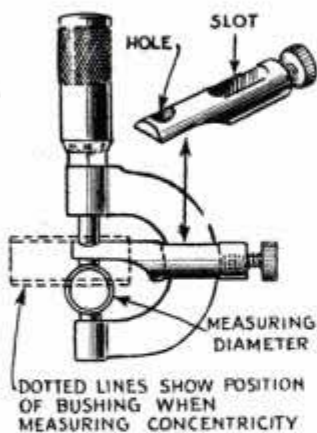

On a job of making a number of steel bushings, which called for close diameter limits and strict concentricity, the micrometer adapter shown was used during the grinding operation. The adapter is a piece of round steel ground to fit the bore of the bushing, slotted to suit the micrometer frame and tapped for a tightening screw. The end of the slot that bears against the frame is rounded suitably as shown, and a hole is drilled through the adapter to clear the

micrometer spindle. The last operation consists of grinding away the adapter sufficiently, to allow the bushing to go between it and the anvil of the micrometer.

Indicator Helps Engage Half Nuts on Lathe Lead Screw

By attaching a piece of metal on the side of the lathe carriage apron to act as a pointer, the half nuts may be meshed into the lead screw with ease. A small hole

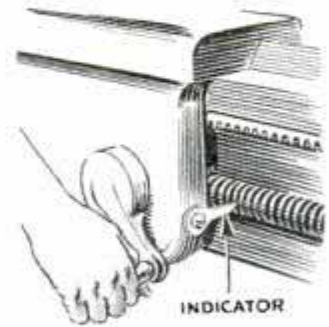

is drilled in the apron and is tapped to take a bolt which holds the indicator. The indicator should be of a thickness to match that of the threads on the lead screw, and should be long enough to just miss them. Bend it so that it is in line with the top of a thread when the half nuts are in mesh.

—Burl Knutson, Bismarck, N. D.

Gears Cut in One Operation

Instead of making two cuts with a fly cutter to form the teeth on a blank gear, a mechanic completes the job in one operation with the milling-machine setup shown. The fly cutter is bent to fit the milling arbor and is set central to the old gear, then a slitting saw is put on the arbor. The saw rough-cuts one tooth while the fly cutter finishes the preceding one.

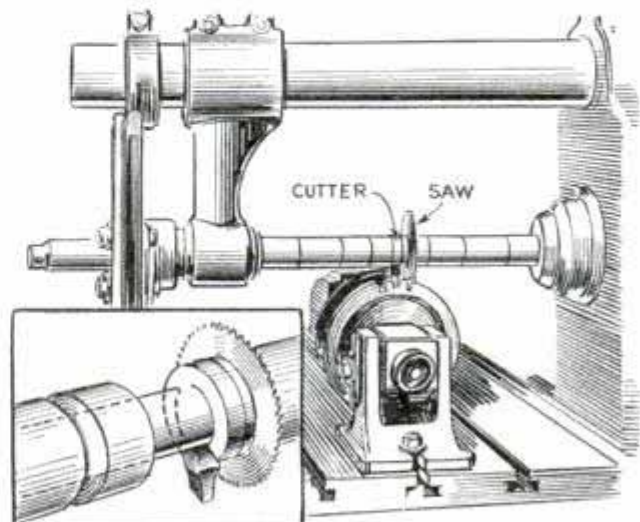

Using a fly cutter and a slitting saw to cut gear teeth in one operation in a milling machine

Simple JIGS

for the BELT SANDER

ACCURACY and speed in belt-sander operations are possible with simple jigs. A typical operation, Fig. 1, shows the sanding of a disk. The stock is roughly band-sawed to shape, then finished accurately on the sander by pivoting it on a vertical support. This is a piece of $\frac{3}{4}$ -in. stock about 8 by 12 in., with a line of $\frac{1}{4}$ -in. holes on 1-in. centers, Fig. 2. The jig is fitted to the sander fence with two carriage bolts, the heads of which have been cut off. A nut on each, as in Fig. 3, permits adjustment for any size disk within the capacity of the jig. The work is revolved against the sander belt.

Figs. 4 and 5 show a tilting fence for sanding or cutting beveled edges. It is the same size as the standard wood fence, and is fastened to it with two metal arms, which are slotted so the fence can be tilted up to 45° . To prevent the bottom of the tilting fence from riding

can be seen, it consists of a narrow table which is pivoted to the standard fence by means of a bolt. Work to be cut is placed on the pivoted arm, which is swung upward, bringing the work in contact with the sanding belt until the stop block is reached. Many jobs, such as pointing square stock, can be done with this jig.

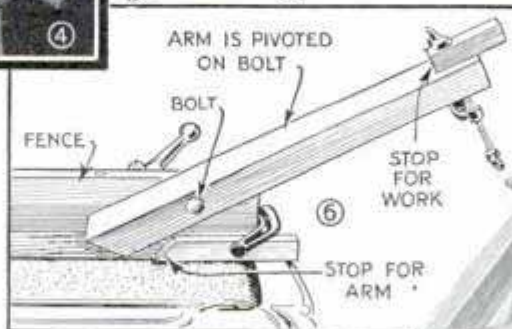
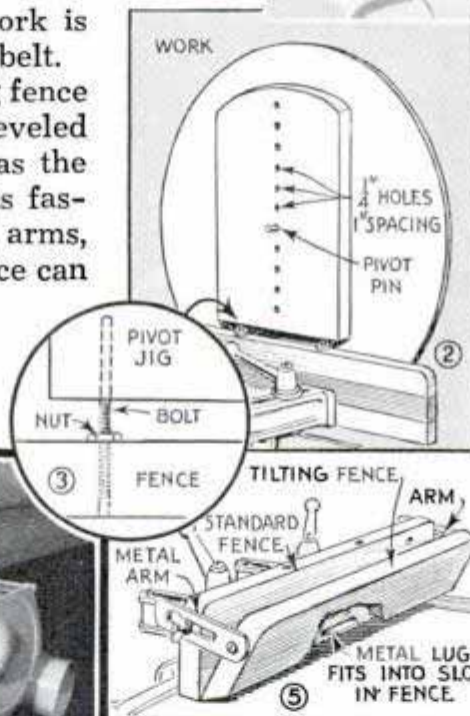
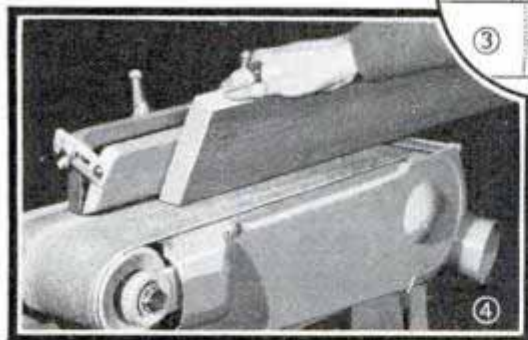

the sanding belt, the fence is fitted with a metal lug. This fits into a corresponding slot cut near the bottom of the standard fence. The slot should be wide enough to permit the lug to rest in it at all settings of the fence. The tilting fence can be left on the standard fence as a permanent fixture or it may be removed if desired.

One of the simplest, yet most useful jigs for end work is shown in Figs. 6 and 7. As

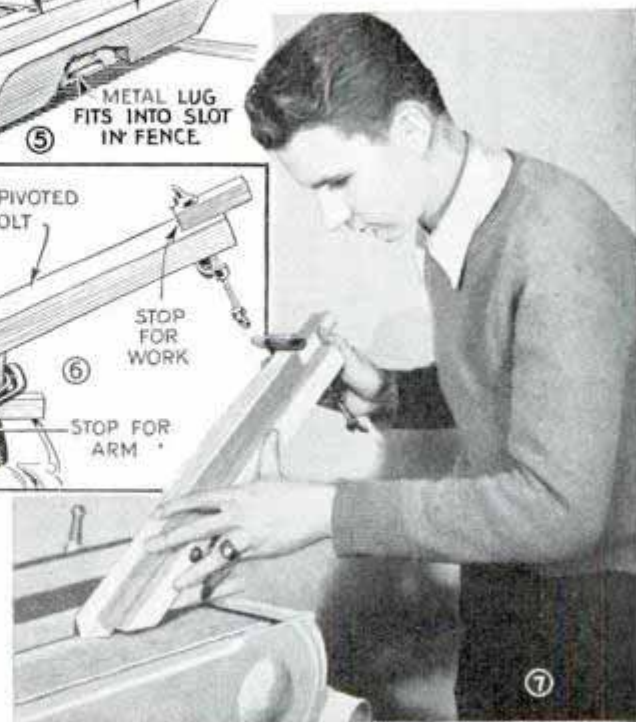
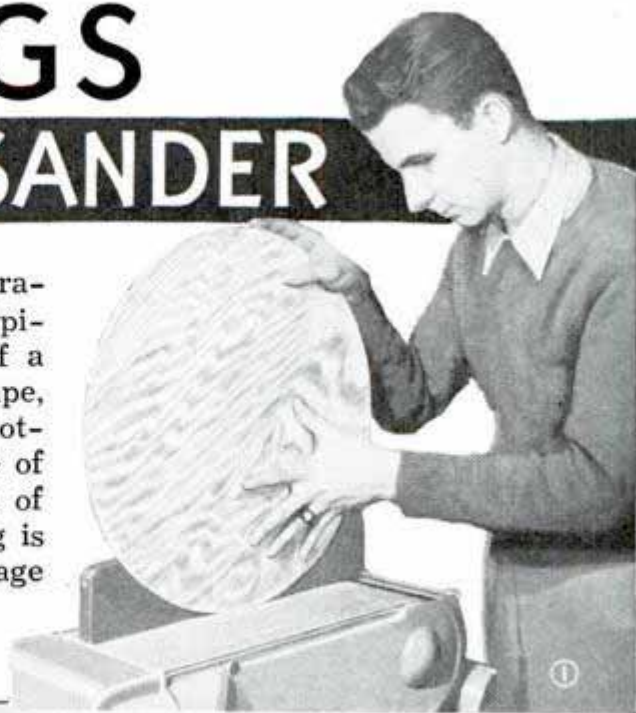

Basket Hooked on File Cabinet Saves Time for Clerk



Basket of letters or bills, etc., to be filed, is attached conveniently right on the filing cabinet

Those who do file work in offices will find that a mail basket fitted with a hook to engage brackets on the fronts of the file-cabinet drawers will save time and labor, as the work to be filed can be stacked in the basket and kept right at hand. If you do not care to go to the trouble of putting brackets on the drawers, it may be possible to arrange a hook on the basket to slip over the drawer handles or over the edge of the drawers.

Simple Electric-Current Indicator

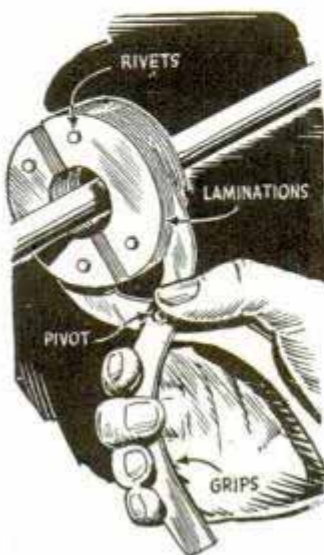

Without making an electrical connection or disturbing the insulation in any way, you can tell if current is flowing in an electric power line with this indicator. It is especially handy for determining which wire of a three-phase circuit is open, or for testing stator connec-

tions on generators. In use, it is slipped over the wire to be tested, and the jaws closed slowly. If there is current in the line, they will suddenly snap shut. The jaws, which are $\frac{1}{4}$ in. thick, are made of transformer iron or silicon steel, and are about 2 in. in diameter when closed with a 1-in. opening in the center. The handle consists of two pieces of heavy fiber.

Fowls Have Spur Guards on Feet to Avoid Injury in Fights

When an old male bird of a poultry flock is given free range with others, it often happens that he becomes a nuisance on account of his desire to fight and injure the weaker members. To avoid this, one poultryman obtained a length of small rubber hose from which pieces were cut somewhat longer than the spurs and slipped over them.



Cutting Sheet Plastics Neatly

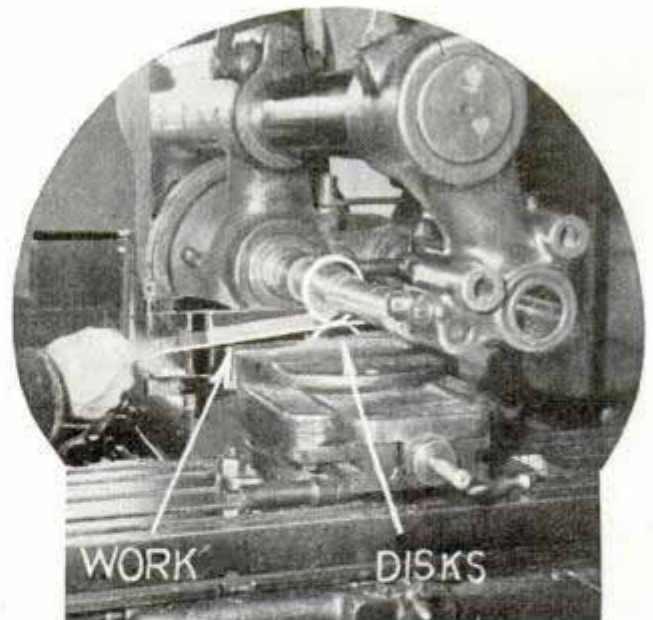

Scoring both sides of sheet plastic in milling machine so that it can be broken neatly into small squares

On a job of cutting several thousand small squares of $\frac{1}{8}$ -in. plastic, and sawing left a ragged edge and too much clinging sawdust, a clean break was obtained in the work by running it between

two sharp disks, which scored the material deeply on both sides so that it could be broken cleanly. The disks were mounted in a milling machine, one on the arbor and the other on an idler, which was mounted in a vise on the machine table. The latter was moved until the proper depth of mark was obtained. A guide similar to the rip fence on a circular saw was clamped to the vise, making it a simple matter to keep the marking parallel to the edge.—D. R. Tompkins, Pasadena, Calif.

Shipping Clerk Clips Stamps to His Apron



One shipping clerk who had to go into the shipping room and onto the loading platform to stamp boxes and packages, carried the stamps used most frequently on an apron around his

waist. The regular spring holders for the stamp handles were attached to small wood blocks, which were in turn attached to the apron front with screws, large washers being used under the screw heads to keep them from tearing out of the cloth.

Gas Pockets in Refrigerant Lines Prevented by Two Elbows

One mechanic solved the problem of gas pockets in pipes carrying refrigerant by substituting two 45° elbows connected with a close nipple, for each 90° elbow in the line. It was found that the sharp turns caused by the right-angle elbows increased the flow at these points to such an extent that gas pockets formed at the top sides of the elbows, while the wider turns formed by the two 45° elbows reduced the flow sufficiently to prevent the pockets.

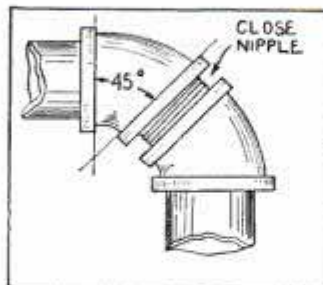

—L. H. Georger, Buffalo, N. Y.

Welding Unit on Auto Wheels Is Easy to Push

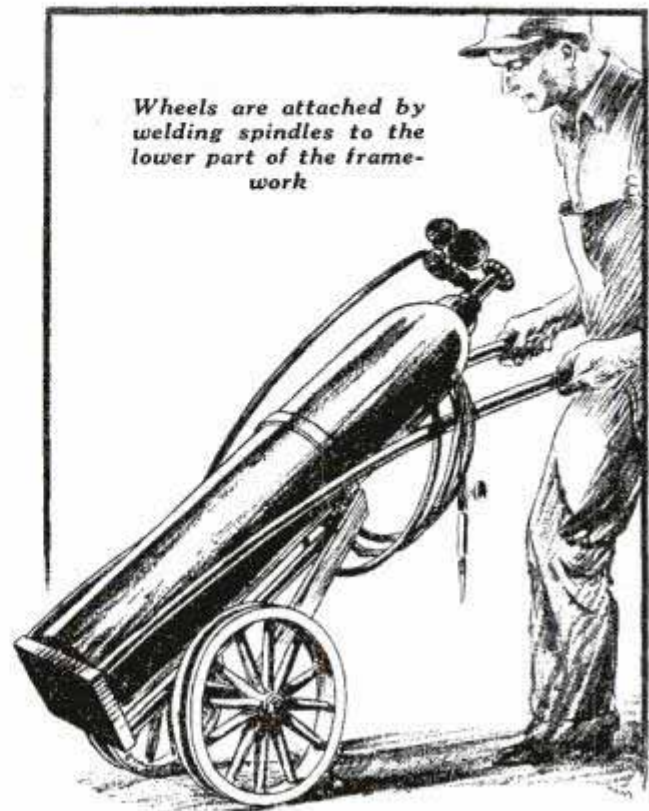

Old auto wheels are excellent for use on the usual type of acetylene-welding truck. They may be attached quickly by welding the spindles to the framework at the bottom of the truck. Rubber tires may be used if desired. The platform for the carbide container may be elevated to better balance the unit so that the oxygen tank rests on the floor when the truck is tilted upward. A metal band with a hook at each end holds the tank in place, and is quickly removed when the tank is empty.

—Jos. C. Coyle, Phoenix, Ariz.

Wrist Memo Pad for Policeman

By wearing a tiny pad of paper on his wrist like a watch, a police officer always has a memo pad at hand for instant reference where he can keep data such as car licenses, etc. The paper pad is slotted near the sides to take a watch strap with which it is attached to the wrist.



—Opie Read, Jr., Chicago.

The MECHANICS

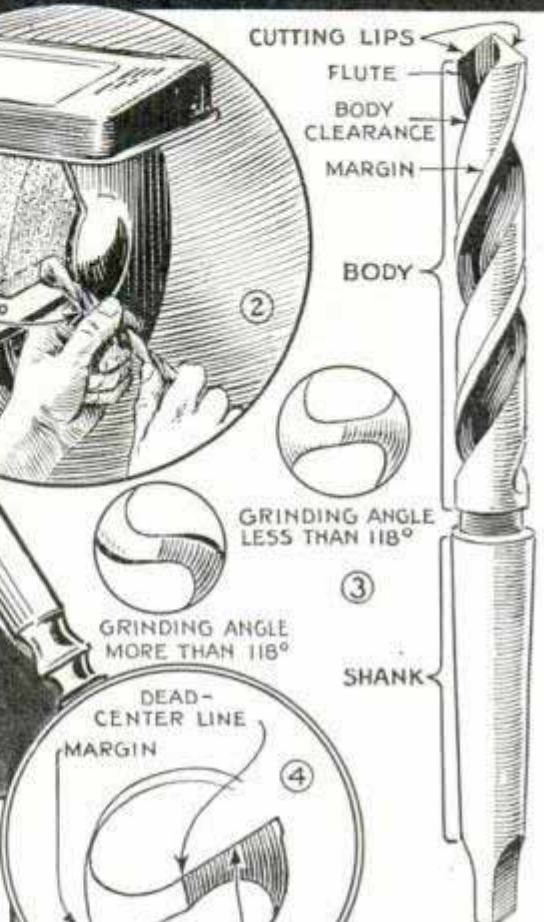

DRILL SPEEDS AND FEEDS (5)

FINDING DRILL SPEEDS
 I - NORMAL SPEED (N) WILL BE FOUND ON CURVE AS 1/4" OR .250" DRILL (BOTTOM) REQUIRES 450 R.P.M. (LEFT)
 II - MULTIPLY (N) BY VALUE SHOWN IN TABLE BELOW

METAL TO BE DRILLED	KIND OF DRILL	
	CARBON STEEL	HIGH SPEED
CAST IRON (ANNEALED)	2 1/3 X N	5 X N
CAST IRON (HARD)	N	2 1/3 X N
MILD STEEL	N	3 1/3 X N
DROP FORGINGS	2/6 X N	2 X N
MALLEABLE IRON	1 1/6 X N	3 X N
CAST STEEL	2/3 X N	1 1/3 X N
TOOL STEEL	5/6 X N	1 2/3 X N
BRASS, BRONZE AND SOFT METALS	5 X N	10 X N

LUBRICANTS

Cast Iron—None	Tool Steel—Lard Oil
Mild Steel—Lard Oil	Cast Steel—Lard Oil
Drop Forgings—Lard Oil	Brass and Bronze—Dry or Paraffin Oil
Malleable Iron—Soda Water	Wrought Iron—Lard Oil
	Aluminum—Kerosene



of DRILLS

PART I

Practical data for every shop man on the technique of using drills; how to select the right type for certain jobs, what speeds for efficiency and many other pointers

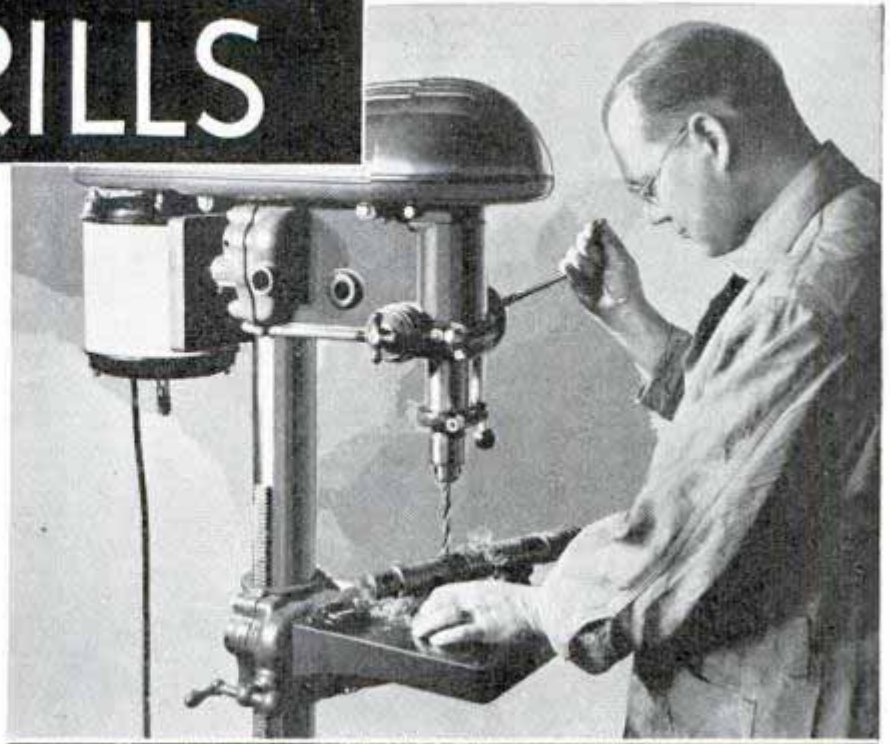











CLOSE examination of a drill of any size will reveal that there are three main operating parts which enable this tool to do its important job. As you will see from Fig. 3, these are the shank, the fluted body, and the cutting lips. Like all cutting tools which remove material in the form of chips, the lips of the drill must be ground with a clearance and rake angle. Each lip is really a chisel, each must have exactly the same clearance and rake, and, due to the characteristics of the drill and the nature of the materials in which it must work, the uniformity of these angles determines its performance.

Types of Twist-Drill Shanks: Fig. 6 shows the four standard shanks which are in general use. The taper-shank drill is used in a drill press, the hollow spindle of which has an internal taper. When the shank does not fit the drill-press socket, a suitable adapter is used. The straight shank is the type most commonly used. It fits both drill-press and hand-drill chucks. Bit-stock shanks may be used in ordinary bit braces. The type of drill used for wood only has a sharper point than do the others and, by observing the point angle, it is possible to easily distinguish wood-working drills from those made for metal.

Body and Flutes: The body of the drill, Fig. 3, consists of a spirally fluted section to give strength, curl the chips, provide a

means whereby they may be ejected, and to allow for the entrance of oil or cutting compounds to lubricate and cool the drill. Note that the outside edges of the flutes are ridged to form a margin of slightly greater over-all diameter than the rest of the body. The recessing back of the margin is very slightly tapered toward the shank to give the drill body clearance and prevent binding. The angle between the flutes and work when the drill stands perpendicularly, Fig. 10, is the rake angle. The steeper this angle, the tighter the chips are rolled. For most jobs the angle produced when the drill is manufactured is satisfactory.

Cutting Lips and Grinding Methods: From the standpoint of shop care, the most important parts of the drill are the point and cutting lips. Fig. 4 shows an enlarged point-on view from which it should be observed that the faces on either side of the dead-center line are ground to a very definite angle and when this is done, the edges of the cutting lips are parallel as shown. If a gauge, Fig. 11, is placed across the tip of a properly ground drill with its edges parallel to the cutting lips, it will be found that the angle is 118° . As it is possible to grind a drill more on one side than on the other and still produce this angle, the marks on the gauge should also be observed. With the point registering with

Causes and Cures for Drill Troubles ⑦		
TROUBLE	CAUSES	CURES
 <p>A—Broken Drill</p>	1—Work mounted so that it is springy 2—Not enough lip clearance 3—Dull drill 4—Speed low or feed too fast 5—If drilling wood, brass or soft metal, chips may pack in flutes	1—Fasten work rigidly so it cannot spring 2—Regrind properly 3—Grind 4—Increase speed or feed slower 5—Increase speed, grind drill with more lip clearance or use drills designed for the material
 <p>B—Breaking of Cutting Edges—Particularly at Corners</p>	1—Too much lip clearance 2—Material has hard spots, sand inclusions or scale 3—Drill running too fast 4—Wrong cutting compound or lubricant 5—Feed too rapid	1—Regrind and reduce lip clearance to between 12 and 15 degrees 2—Reduce speed 3—Reduce speed 4—Use proper lubricant or compound 5—Reduce feed
 <p>C—(High-Speed Drill) Chipping or Checking</p>	1—Drill heated or cooled too rapidly while drilling or grinding 2—Feeding too rapidly	1—Warm drill slowly before using—Do not use cold water while drilling or grinding 2—Reduce feed
 <p>D—Oversize Hole</p>	1—Lip angles are not equal	1—Regrind drill and equalize lip angles
 <p>E—Oversize Hole</p>	2—Length and angle of lips not equal	2—Regrind drill and equalize lip angles and lip lengths
 <p>F—Oversize Hole</p>	3—Length of lips not equal (Lip angles o.k.)	3—Regrind and equalize lip lengths
 <p>WORN SPINDLE BEARING</p> <p>G—Oversize Hole</p>	4—Spindle of drill press loose	4—Tighten or adjust until spindle is rigid
 <p>H—Broken Tang</p>	1—Poor fit of tang in socket caused by nicks, burrs, dirt or wear 2—Mutilated tang	1—Ream out socket or replace with new one. Cleaning sockets before use lengthens their life. 2—Dress or replace
 <p>I—Hole Is Rough</p>	1—Drill dull 2—Drill not properly ground 3—No lubricant or wrong lubricant 4—Feed too rapid 5—Work poorly supported	1—Grind 2—Inspect and regrind 3—Use proper lubricant 4—Reduce feed 5—Support work rigidly and free from vibration
 <p>J—Form of Chips Tells How Work Is Progressing</p>	1—Chip changes form 2—Lubricant not reaching proper location	1—Drill chipped, dulled or damaged—Inspect and regrind 2—Remove drill and check lubricant

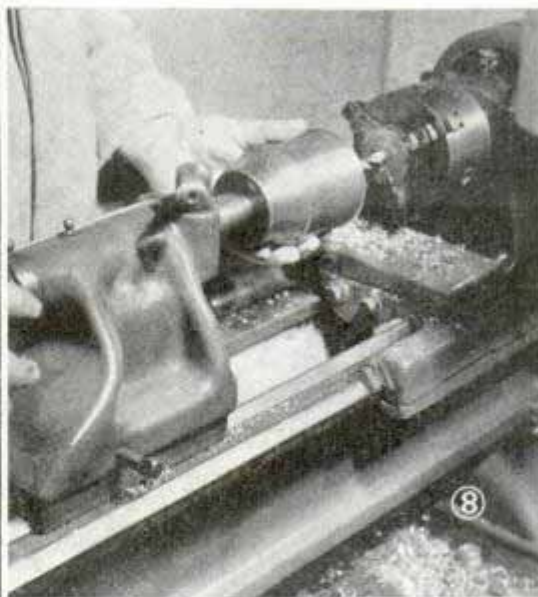

the center "O" line, the readings at the points where the edges of the lips meet the gauge should be the same to insure that the cutting lips are at the same angle with respect to the center line of the drill. In the case shown, this value reads one in both cases, therefore, the drill has not only been ground to the proper total angle but it is also ground with equal cutting-lip angles. A drill which is ground so that one of the cutting lips is longer than the other will not drill accurately. Fig. 7 shows the troubles which result from improper cutting-lip angles. Other illustrations in Fig. 7 show the cause and cure for other drill difficulties.

Clearance Angle: If the gauge, Fig. 11, is rotated until its edges meet the two points of the faces back of the cutting lips, it will be found that the gauge no longer rests on the flat surfaces. Fig. 12 shows this condition clearly. The angle at this point is therefore less than 118° . The difference between 118° and this angle is the clearance angle. If a drill has no clearance, that is, the angle across the points shown in Fig. 12 is 118° , the flat areas will ride on the work without cutting. To get a better idea of the necessity for lip clearance in all cutting tools, look at Fig. 9 and the left detail in

Fig. 10. The angle between a line drawn squarely across the point with a line drawn between the cutting-edge tip and the heel or trailing edge of the lip should span an angle between 12° and 15° for best results.

For a practical method of determining when the lips of a drill have been ground to a proper angle compare the two point-on views in Fig. 3 with that in Fig. 4. Note the variations in the curve of the cutting edges caused by varying the angle. On the other hand, when the drill is properly ground as in Figs. 1 and 2, with the correct clearance angle, the cutting edges will be parallel as in Fig. 4. In other words, the cutting edges are in the form of a straight line offset by the dead-center line and the trailing edges back of them are rounding.

When drilling very hard material, it has been found helpful to modify the rake angle slightly, as shown in Fig. 17. The nearer this angle is made to 90° the tighter the chips will be rolled and the less will be the likelihood of breaking or chipping the cutting lip. This modification should not be made except in those cases where very hard material is being drilled and when the use of proper lubricants, as explained later, has failed to produce satisfactory results without damage to the drill.

Grinding High-Speed Drills: When grinding carbon-steel drills they are cooled by immersion in water to avoid burning. This practice must not be used with high-speed drills as sudden changes of temperature check, crack, and weaken them. They will stand high temperatures if heated slowly. Accordingly, they should be ground slowly to avoid sudden overheating and must be allowed to cool in the air to prevent checking. For grinding drills, a good grade of vitrified Alundum wheel should be selected, the most acceptable type being grade K, grain M. The grinder should be operated at a surface speed of between 4,000 and 5,000 feet per minute. A good rule for finding the speed in r.p.m. required is to divide the diameter of the wheel in inches into 14,000. Thus, a 10-in. wheel should run at 1,400 r.p.m. The drill is carefully brought up to the edge of the grinder as shown in Figs. 1 and 2, and should be held rigidly, the angle between the wheel and the drill being maintained at 59° . After a little practice, this is a simple operation and the eye will be adequate to insure an accurate job. As the drill is brought up to the wheel, it should be rotated clockwise while at the same time the angle is gradually decreased to produce the clearance.

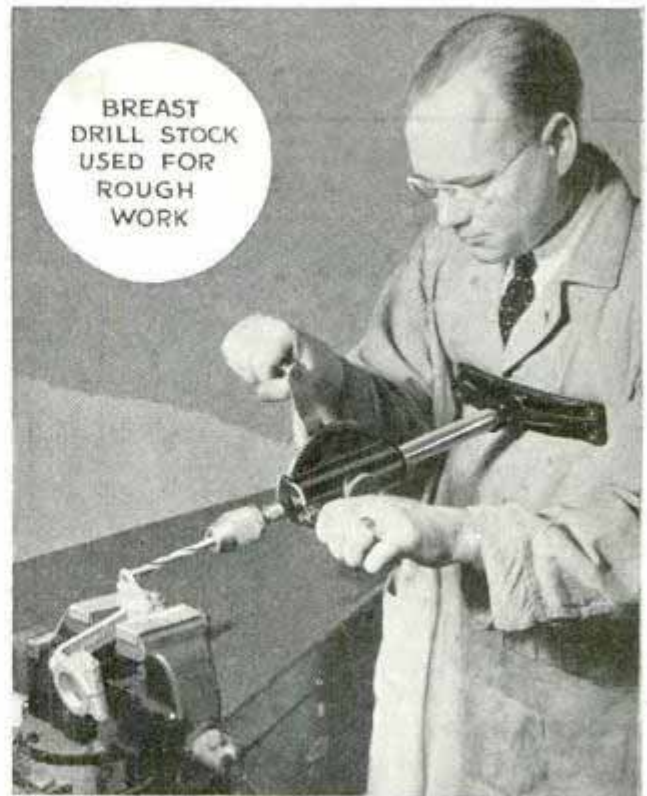

ALL CUTTING TOOLS MUST BE OPERATED WITH CLEARANCE



CLEARANCE ANGLE PERMITS CHISEL TO CUT ⑨



WITH A LARGE RAKE ANGLE THE CHIPS ARE CURLED TIGHTLY ⑩

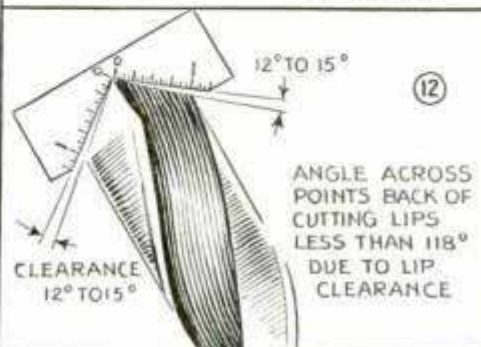
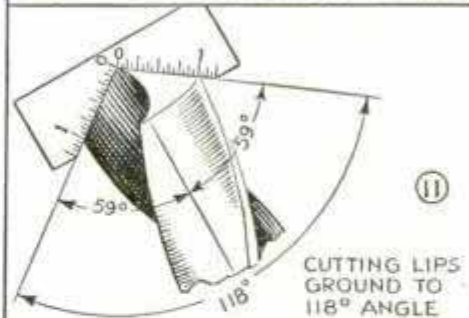

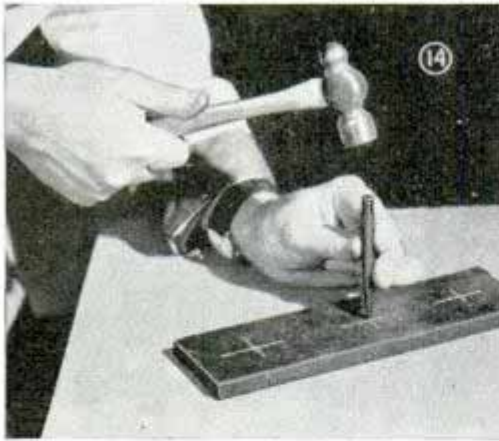

Sizes, Feed and Speeds: The ordinary jewelers' drills, or, as they are sometimes called, steel wire-gauge drills, are numbered from 1 to 80, the No. 1 drill being the largest and No. 80 being the smallest. Letter-sized drills bear the alphabetical letters from A to Z, the A drill being the smallest and the Z drill the largest of the series. In addition to wire-gauge drills and letter drills, jobbers drills are made in sizes ranging upward in steps of $\frac{1}{64}$ in., from $\frac{1}{32}$ in. to several inches in diameter. To make it convenient to select the proper size of drill for any purpose, refer to Fig. 13 which includes the various size drills of each type listed in the order of increasing sizes. Although power-driven drill presses constitute the most satisfactory means of using drills, various drill stocks, both manually and electrically driven, Fig. 15, are in common use. Many exacting drilling operations are also handled in the lathe as in Fig. 8. For small drills, light-weight high-speed geared hand-drill stocks should be selected. The larger sizes of hand-drill stocks are made so that the driving wheel can be set for either one of two speed ratios, the low ratio being used for larger drills. The handle also can be adjusted to increase the leverage. Ordinary drill presses are usually equipped with $\frac{1}{4}$ -hp. motors. These are satisfactory for drilling holes up to $\frac{3}{8}$ in. in diameter. For heavier work, larger motors should be

FIG. 13
Steel Wire and Jobbers Drills in Sizes Up to $\frac{1}{4}$ "

Wire Gauge Drills	Jobbers Drills	Decimal Size	Wire Gauge Drills	Jobbers Drills	Decimal Size
No. 80		.0135	No. 37		.1040
No. 79		.0145	No. 36		.1065
No. 78		.0160		$7/64"$.10938
No. 77		.0180	No. 35		.1100
No. 76		.0200	No. 34		.1110
No. 75		.0210	No. 33		.1130
No. 74		.0225	No. 32		.1160
No. 73		.0240	No. 31		.1200
No. 72		.0250		$1/8"$.12500
No. 71		.0260	No. 30		.1285
No. 70		.0280	No. 29		.1360
No. 69		.02925	No. 28		.1405
No. 68		.0310		$9/64"$.14063
	$1/32"$.03125	No. 27		.1440
No. 67		.0320	No. 26		.1470
No. 66		.0330	No. 25		.1495
No. 65		.0350	No. 24		.1520
No. 64		.0360	No. 23		.1540
No. 63		.0370		$5/32"$.15625
No. 62		.0380	No. 22		.1570
No. 61		.0390	No. 21		.1590
No. 60		.0400	No. 20		.1610
No. 59		.0410	No. 19		.1660
No. 58		.0420	No. 18		.1695
No. 57		.0430		$11/64"$.17188
No. 56		.0465	No. 17		.1730
	$3/64"$.04688	No. 16		.1770
No. 55		.0520	No. 15		.1800
No. 54		.0550	No. 14		.1820
No. 53		.0595	No. 13		.1850
	$1/16"$.06250		$3/16"$.18750
No. 52		.0635	No. 12		.1890
No. 51		.0670	No. 11		.1910
No. 50		.0700	No. 10		.1935
No. 49		.0730	No. 9		.1960
No. 48		.0760	No. 8		.1990
	$5/64"$.07813	No. 7		.2010
No. 47		.0785		$13/64"$.20313
No. 46		.0810	No. 6		.2040
No. 45		.0820	No. 5		.2055
No. 44		.0860	No. 4		.2090
No. 43		.0890	No. 3		.2130
No. 42		.0935		$7/32"$.21875
	$3/32"$.09375	No. 2		.2210
No. 41		.0960	No. 1		.2280
No. 40		.0980		$15/64"$.23438
No. 39		.0995		$1/4"$.25000
No. 38		.1015			

Letter and Jobbers Drills, $15/64"$ and Larger

Letter Drills	Jobbers Drills	Decimal Size	Jobbers Drills	Decimal Size
A	$15/64"$.2344	$33/64"$.5156
B		.238	$17/32"$.5313
C		.242	$35/64"$.5469
D		.246	$9/16"$.5625
E	$1/4"$.2500	$37/64"$.5781
F		.257	$19/32"$.5938
G		.261	$39/64"$.6094
H	$17/64"$.2656	$5/8"$.6250
I		.272	$41/64"$.6406
J		.277	$21/32"$.6563
K	$9/32"$.2812	$43/64"$.6719
L		.290	$11/16"$.6875
M	$19/64"$.2969	$45/64"$.7031
N		.302	$23/32"$.7188
O	$5/16"$.3125	$47/64"$.7344
P	$21/64"$.3281	$3/4"$.7500
Q		.332	$49/64"$.7656
R	$11/32"$.3437	$25/32"$.7813
S		.348	$51/64"$.7969
T	$23/64"$.3594	$13/16"$.8125
U		.368	$53/64"$.8281
V	$3/8"$.3750	$27/32"$.8438
W	$25/64"$.3906	$55/64"$.8594
X		.397	$7/8"$.8750
Y	$13/32"$.4063	$57/64"$.8906
Z		.413	$29/32"$.9063
	$27/64"$.4219	$59/64"$.9219
	$7/16"$.4375	$15/16"$.9375
	$29/64"$.4531	$61/64"$.9531
	$15/32"$.4688	$31/32"$.9688
	$31/64"$.4844	$63/64"$.9844
	$1/2"$.5000	$1"$	1.0000

used, as indicated in Fig. 18. Small drills must be operated at much higher speeds than larger ones. To calculate the proper speed with the various metals and in connection with both carbon steel and high-speed drills, make use of Fig. 5. This chart will be found a great shop convenience as it condenses several pages of hard-to-read figures into easily used form.

Laying Out Work for Drilling: In laying out drilling jobs, a combination square may be used for measuring angles, for locating centers, etc. A scribe and other tools are indispensable to accurate work. Having located the exact point to be drilled, it next remains to impress into it a center punch mark of sufficient depth to insure that the point of the drill will be guided properly as in Fig. 14.

Drifting a Wandering Drill: Sometimes a drill will show a stubborn tendency to wander off the punch mark when starting the hole. To correct this you first check up on the condition of the drill and see that the work is level. After eliminating these possibilities, remember that the relation between the circle described by the dead-center line of the drill and the diameter of the punch impression has a definite bearing on accurate starting of the drill. If the first circle is larger than the second the punch mark will have no wedging or "drawing" effect on the drill, thus failing to hold it on center until the lips begin to cut. The remedy is to use either a punch with a shorter bevel, Fig. 14, or spot the hole with a smaller drill before introducing the larger size. Where the work requires extreme accuracy, holes are frequently spotted with several progressive drill sizes. Another method used where dimensions are not critical is that in Fig. 16. Here the drill, starting off-center as at A, is drifted back by means of cold-chisel impressions as at B and C.

Drill Blocks: Blocks and flat sections of steel are useful around the drill press. When sections of cold-rolled steel plates about $\frac{1}{4}$ in. thick are used as pads under the work, the drill may be allowed to go through without damaging the drill-press table. Materials which tend to form a burr on the bottom are drilled clean if a plate is used under the work.

In drilling fiber, soft metal, plastics, and other materials which tend to form a burr



or jagged edge as the drill cuts, it is advisable to clamp a thin piece of metal on top of the work as well as place a drill pad under it. If the work, together with the top plate and drill pad, is clamped to the bed of the press, it is possible to drill through the assembly without forming burrs on either top or bottom. Where it is not possible to drill through a top plate, a hole of the required diameter is drilled in a piece of flat metal and this is placed over the center-punched fiber. With the drill lined up with the punch mark, through the hole in the top plate, the clamps are tightened and the job completed.

(To be continued)

Filing-Cabinet Marker Shows Where Folder Was Removed

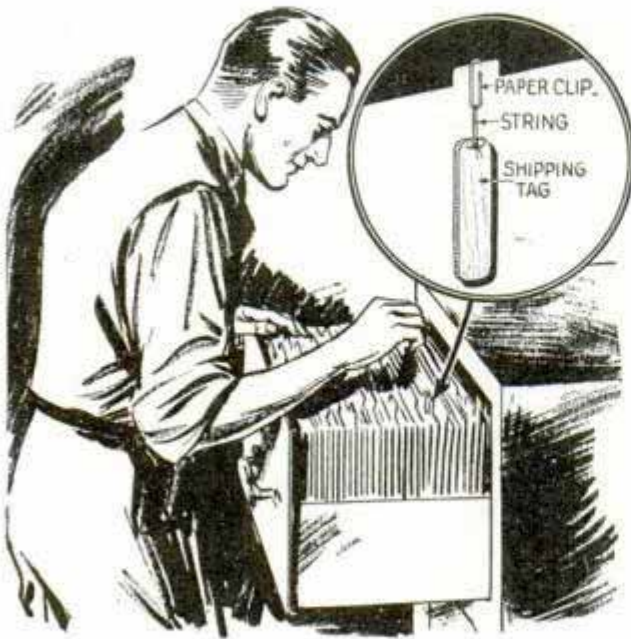

When a folder is removed from a filing cabinet, clip this marker to the divider

By clipping a small shipping tag, or even a piece of thin wood to the top edge of a divider in your filing cabinet, you can see at a glance where a folder has been removed. If a number of these markers are kept handy, they will save time.

"Safety-Pin" Tool Holder on Farm Machines



If tools are jostled out of the toolboxes on your farm implements, and lost when driving over rough ground, this "safety-pin" holder will solve the problem. It consists of a length of iron rod bent to the shape shown,

a half loop being formed on one side to slip under a nut on the machine.

—Benjamin Nielsen, Aurora, Nebr.

Shavings Keep Fruit in Cars from Freezing

To keep fruit from freezing while in transit, layers of wet shavings were placed

on the floors of the refrigerator cars with the idea in mind that freezing water gives off a certain amount of heat per pound. When the car temperature falls to 32°, the water in the shavings begins to freeze and the heat which is released prevents the temperature from falling very far below that point until all the water in the shavings has been frozen. It is claimed that this method of keeping fruit from freezing has less adverse effect than the use of heaters which might produce enough heat to cause damage.—A. P. Child, Kansas City, Mo.

Flexible Milling-Machine Fixture Cuts Costs on Small Jobs

In shops handling small milling jobs, labor cost can be reduced considerably if the change-over from one job to another can be done quickly. For such shops, the fixture shown will be found handy. It consists of a series of double V-blocks through which pass two alignment rods. The rods are pinned to one end block, the other end block being made adjustable by means of nuts on each side of it. This block is drilled and tapped in the center for a clamp screw, which tightens the

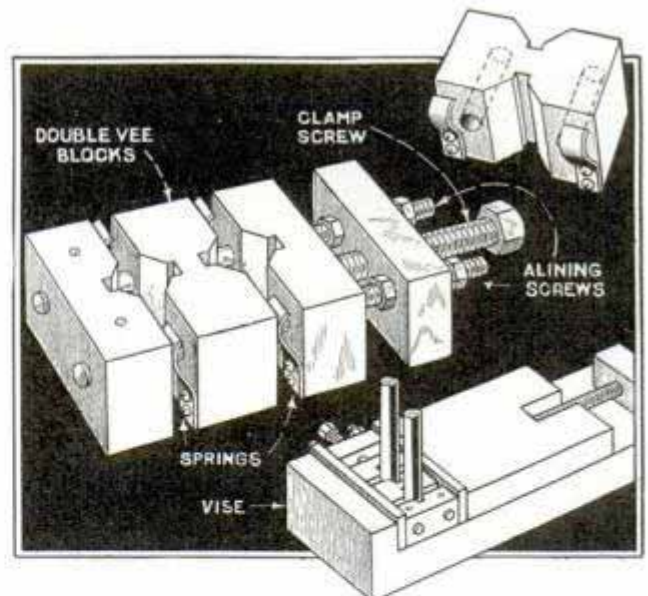

This simple clamping block permits quick change-overs from one job to another

blocks on the work. Small, flat springs between the blocks spread them when the screw is loosened to permit easy removal of the work. The fixture can be made any size desired by adding V-blocks. For milling special work, blocks of the required contour can be used.

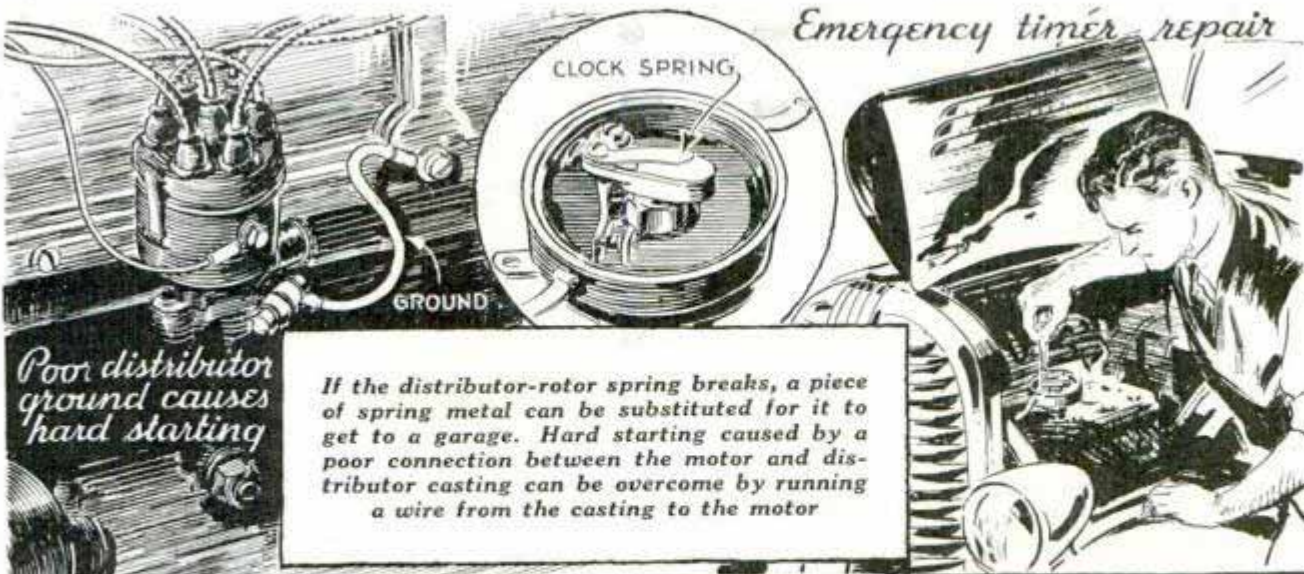

Emergency timer repair

Poor distributor ground causes hard starting

If the distributor-rotor spring breaks, a piece of spring metal can be substituted for it to get to a garage. Hard starting caused by a poor connection between the motor and distributor casting can be overcome by running a wire from the casting to the motor

Auto SHORT CUTS



Starting "drowned" motor

Preventing vapor lock

Vapor lock in the fuel line can be prevented often by insulating the line where it passes near the motor with electrician's loom. When the ignition system gets wet, here's an emergency trick that seldom fails to start the motor: Just take out about half of the spark plugs and space the gaps to take a piece of tin cut from a can. The weak spark will usually fire these plugs, and, with the motor running on half the cylinders, the others will soon "cut in," after which the altered plugs are set correctly

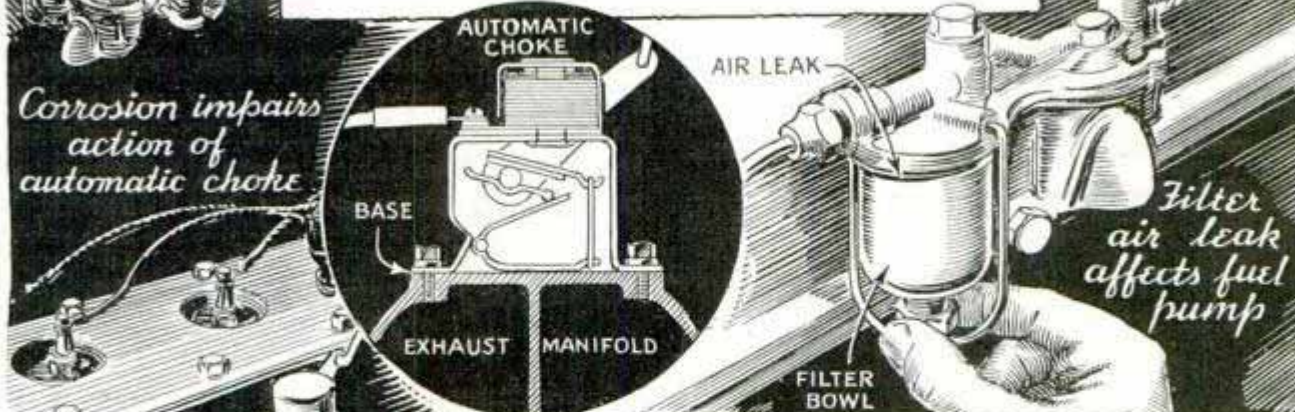

Corrosion impairs action of automatic choke

Filter air leak affects fuel pump

Corrosion between the exhaust manifold and an electrically controlled automatic choke often causes sluggish operation of the latter, which results in hard starting. To cure the trouble, remove the choke and clean the contacting surfaces. If your car is new or the motor has just been overhauled, and it misses or stops, look at the gasket on the fuel filter bowl. Perhaps it wasn't assembled tightly and air is leaking into the fuel pump

Truck Spare Tire Shielded Against Road Grime

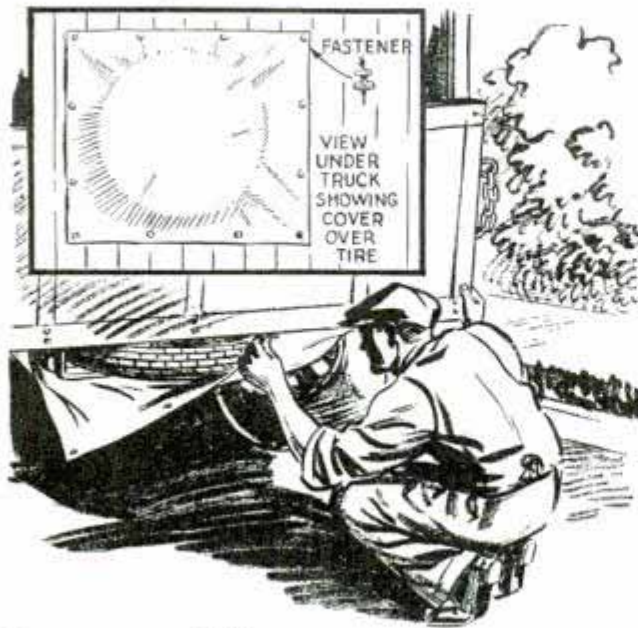

Heavy canvas shield protects truck tire against road grime and exhaust gases

To protect the spare tire of his truck against road grime and exhaust gases, which tend to deteriorate the rubber, one driver shielded it with a piece of waterproofed canvas. It is tacked to the underside of the body at the front of the tire, and is provided with fasteners at the rear end so that it can be dropped quickly to remove the tire.

"Police" Sign on Squad Car Illuminated at Night

To illuminate the sign "police" on squad cars at night, lamps were installed directly above the signs, shades directing the light downward. The lights were wired to a convenient switch on the instrument



Police officers illuminate sign on side of squad car to show motorist their identity

panel and to the wiring at the ammeter. Where signs are located on the door panels, a length of heavy standard rubber-covered cable should be arranged to permit the door to open fully without any strain on the cable. Rather than using a shaded lamp of the usual type, which would project too far and perhaps be subject to constant breakage, a flat, wide fixture can be used. It would not be difficult to install a small socket inside a brass drawer pull to suit the purpose.

Cream Cans Kept Upright

Truckers who haul cream cans and similar containers will find that an old inner tube stretched across the body of the truck as indicated will hold the cans so

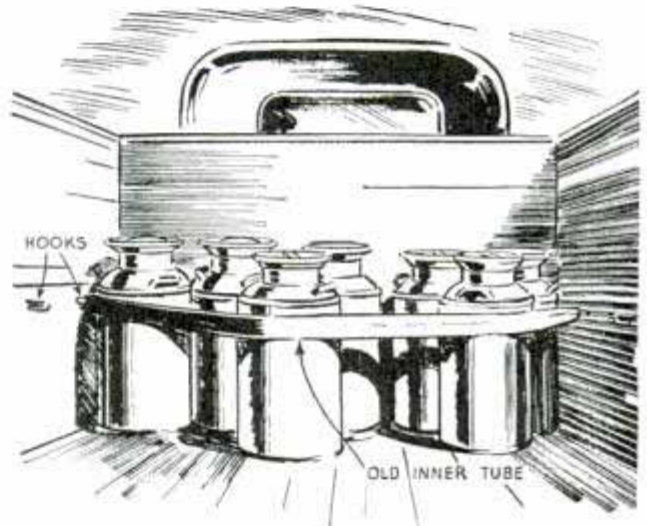

Inner tube stretched across truck keeps cream cans and similar containers from upsetting on rough roads

that they will not bounce around and tip over. Heavy wire rings on the ends of the tube engage hooks placed at intervals in the truck sides which permit the tube to be adjusted for a few cans or a full load.

Repairing Worn Adjusting Screws on Valve Tappets

Sometimes the top of a valve tappet wears concave where the stem hits directly on the face of the adjusting screw, making it impossible to set the tappet clearance accurately. When a thickness gauge is slid between the stem and the screw, it passes over this concave surface and only measures the space between the valve stem and the outside edge of the adjusting

screw, thus making an inaccuracy in the adjustment equal to the depth of the concave surface. Instead of going to the expense of buying new adjusting screws, I remove them and grind down the face on the flat side of an emery wheel, after which they are smoothed on an oilstone.

—Raymond Moore, Roosevelt, L. I., N. Y.

Window Glass of Car Covered While Painting

Before spray-painting a car, coat the windows with a thin paste of powdered chalk and water. Then, after the job is finished, a dry cloth rubbed over the glass quickly removes the dry chalk, and any paint that got onto the windows.

Step Cut in Corner of Tailboard to Enter Truck

By simply cutting a semicircular opening in the lower corner of the tailboard, one driver provided a step to enter the rear end of the truck. The bottom of the step is covered with a piece of angle iron to prevent wear on the wood.



This step is never in the way and is always right where you want it when the tailboard is lowered

Car Jack Has Underslung Arm to Raise Low Axle

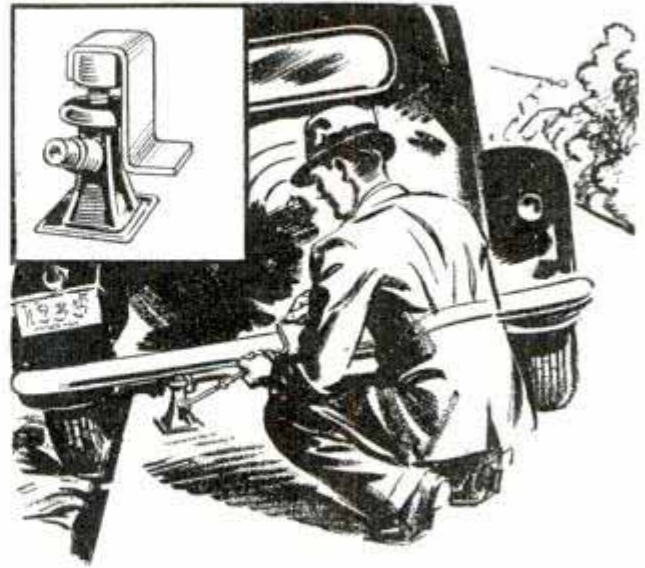

If you get a rear wheel down in the mud, this attachment will enable you to raise it with the jack

Have you ever accidentally run off the road and got stuck on the soft shoulder along the pavement? If so, you probably found that the rear axle was too low to get the jack under to raise the wheel so that something could be placed under it to afford traction. For such emergencies, a short length of heavy flat iron bent to the shape shown and welded to a collar that fits over the top of the jack screw, can be carried in the car. The lower end of the flat-iron piece is slipped under the axle.—Opie Read, Jr., Chicago.

Separating Spot-Welded Metal with a Drill

In repairing car bodies, one mechanic finds that he can separate spot welds by drilling through them with a $\frac{1}{8}$ -in. drill. If the drill does not separate the welds, it weakens them enough to permit prying them apart with a screwdriver. In reassembling the parts, the drill holes can be used for rivets if the nature of the work permits their use. Otherwise, the holes can be filled with solder.



Oil Drum to Heat Water Tank Has Novel Draft Arrangement

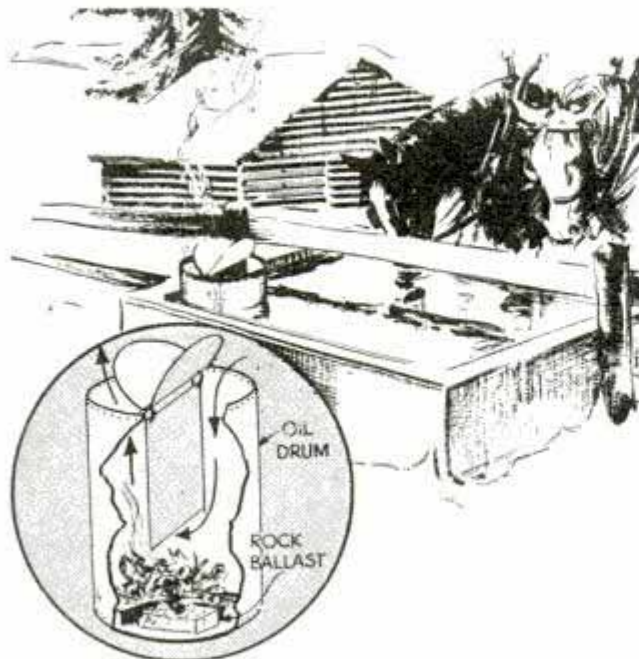

This inexpensive tank heater will burn wood, coal, corncobs or other solid fuel

Costing practically nothing, this watering-tank heater is simply an oil drum with the upper inside portion divided by a

sheet-metal flap so that a draft is provided over the fire in the bottom. The top is cut so that two sections may be bent upward to serve as deflectors, and the flap, which is equal in width to approximately the inside diameter of the drum, is suspended within 12 in. of the bottom. When the heater is sunk to the bottom of the tank with rocks, and a fire is started, air enters at one side while the fumes and smoke go up the other.

Cement to Hold Tool Handles

Cement to hold tools in their handles can be prepared by mixing rosin, 4 oz., beeswax, 1 oz., and fine brick dust, 1 oz. Grind the rosin and brick dust to as fine a powder as possible with a mortar and pestle. Then melt the mixture, stir it thoroughly and fill the hole in the handle. While the mixture is still molten, force the tool into the handle. To give added firmness, it is a good idea to roughen the tool shank with a file before forcing it in place. The melted cement may be poured into molds and be kept for use as required.

The Next Issue

MASTERING ROD AND LINE TO CAST A FLY

There's a real thrill in whipping a fly over fast water but you must know the tricks in handling the tackle used by fly fishermen. This article gives suggestions on selecting the proper rod—why a tapered line is generally used, the fine points of casting the fly, etc.

ELECTRIC FURNACE GIVES HIGH TEMPERATURE

Especially useful for annealing and enameling metals, certain heat-treating jobs and the production of alloys, requiring temperatures up to 1650° Fahr.

TOY STEAM ENGINE HAS ROTARY VALVE

High-speed engine that will propel toy boats, autos, cranes, steam shovels, etc. Practically all the work is done with file, drill and soldering iron.

THE "MAYFLOWER" IN MINIATURE

This 11-in. model of simplified design is easy to construct. The hull consists of three wood blocks roughly cut and then carved and sanded to shape.

MONTEREY BREAKFAST SET

Buffet, table and chairs in Spanish style, reminiscent of early California. To build it, use ordinary hand tools and lumber which is available in any locality.

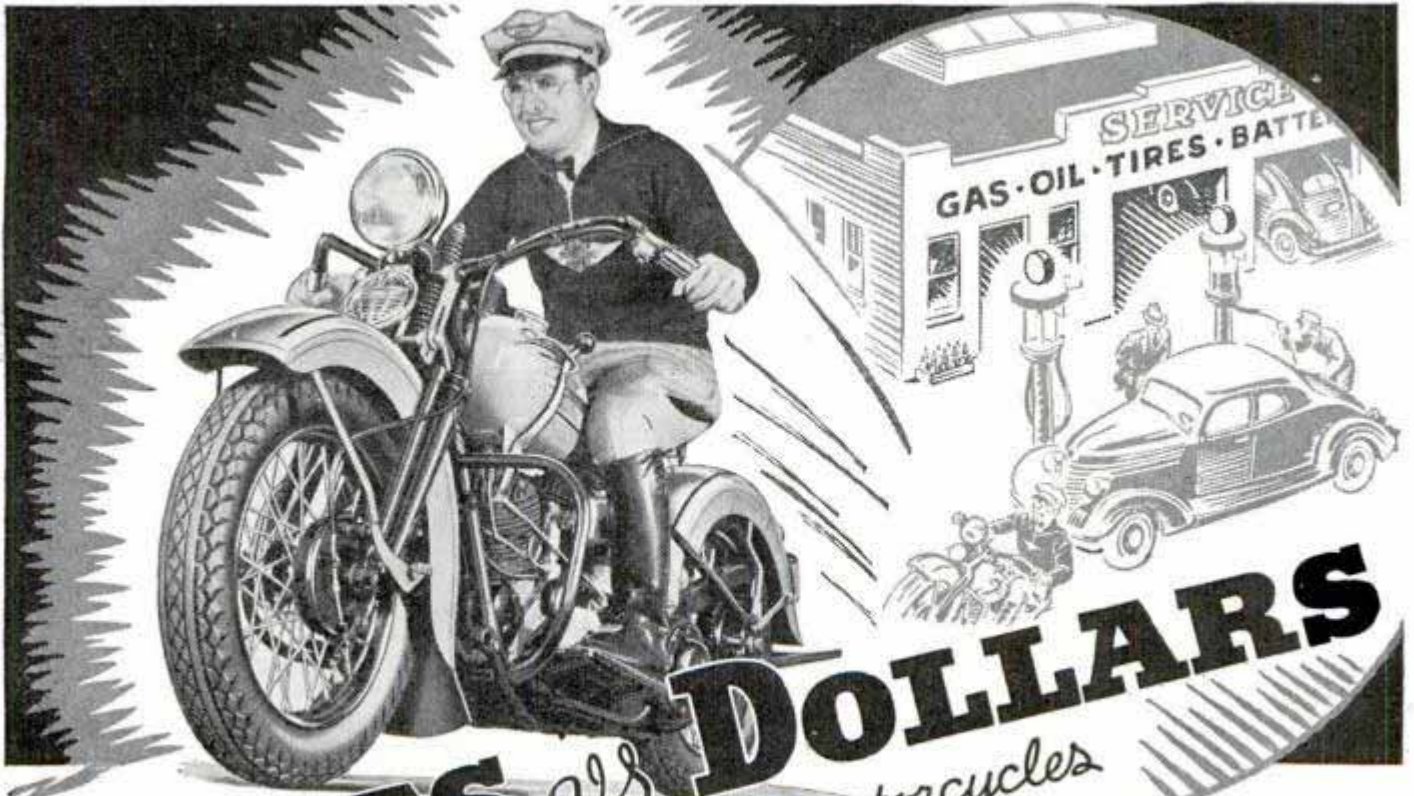

DIMES vs DOLLARS

with HARLEY-DAVIDSON Motorcycles

It's vacation time! And the ground you can cover—the number of places you can go—need no longer depend on the size of your pocketbook. When you own a 1937 Harley-Davidson—dimes will take you where it costs dollars to go by other transportation methods! The 1937 models are built for stamina....but they're built for economy, too! Stream-line design and snappy color combinations are matched by motor improvements that give greater sustained horsepower, that cut gas and oil costs to the bone. You don't have to be a millionaire to run a 1937 Harley-Davidson....but you sure feel like a millionaire when you ride one!

See your nearest Harley-Davidson dealer NOW for a FREE RIDE—ask about his Easy Pay Plans—and send in the coupon!

Ride a
HARLEY-DAVIDSON

MAIL THIS COUPON

Harley-Davidson Motor Co.
Dept. P, Milwaukee, Wis.

Interested in motorcycling. Send illustrated literature. Postage stamp is enclosed to cover the mailing cost.

Name _____

Address _____

My age is 16-19 years, 20-30 years,
 31 years and up, under 16 years,
Check your age group.

When writing to advertisers please mention Popular Mechanics

Camera Shots That Click

(Continued from page 685)

desert sun was not enough for the movie cameramen when they were filming "The Garden of Allah" recently, and high-powered lamps were called for to help Old Sol produce the effect of intense sunshine. If you are trying for a picture of angry



Dramatic lighting in this self-portrait was achieved by holding a single photoflood below the face

clouds after a storm, with sunlight bursting through, underexpose the negative to enhance the dramatic effect. In trapping lightning with your shutter, be careful not to overexpose. Train the lens at a point where lightning is most frequent, open the shutter at "time" and close it after the flash. But remember that lightning is intense, and a very small lens opening is sufficient—an aperture of perhaps f22 or f32.

Night scenes require practice, but today such sensitive film is available that pictures made by long exposures a few years ago are taken in a few seconds today. To show the versatility of film, two men took prizes for snow pictures "shot" at night with only street lights for illumination; one made an exposure of less than a minute on fast film with an aperture of f11, the other used a slower film, an aperture of f4.5 and an eight-minute exposure. An-

other thrilling moonlight scene in winter was given a thirty-minute exposure at f6.3. Only by your own experience can you be sure what your camera will do.

For an unusual scene of a city at night, place the camera on a windowsill or tripod and, at dusk, make an exposure of one-third the usual time; then leave the camera undisturbed, shutter closed, until lights appear in the buildings. A second short exposure of the same film then will record the city lights. If you try planting the moon on your film with a long time exposure, you'll find, of course, a curved white track in the picture, for the moon moves. Instead, when the moon is hanging just where you want it over the mountain or back of the elm tree, screw the camera on a tripod, aim, and fire—leaving the shutter open only a few seconds to capture the moon; then when the moon has passed out of the scene, give the landscape its longer second exposure. To film a night scene in broad daylight, face the sun, shading the lens with your hat to prevent direct rays striking the lens. Undertime the picture to produce the effect of darkness, and, if you like, double-print a moon in the sky. A figure, tree, or boat in the foreground improves such a scene.

Attractive family pictures suitable for greeting cards are easily made. Seat the family around the fireplace, placing the camera at one side to focus on their faces. Run an extension cord into the fireplace and instead of a log fire put a flashlight bulb there. When everything is set, open the lens, set off the flashlight and close the lens. The light on your subjects will appear to be that of the fireplace, and the effect may be enhanced by dyeing the print red. For a picture of the log fire itself, try a double exposure, the first to obtain detail of the fireplace and room before the logs blaze up; the second after setting a match to newspapers under the wood.

There is a world of fun in table-top photography, building landscapes of doll houses and twigs and cotton snowmen, lakes of glass and rivers of Cellophane, and clouds of cotton or cigarette smoke. Dolls and toy soldiers and animals are the

(Continued to page 136A)

MAN BEATS NATURE AT OWN GAME



Saves Money for Motorists with Man-Made Rubber for Spark Plug Wiring!

What does the development of man-made rubber have to do with the performance of *your* car? Just *this*: Those vital, power-giving spark plug wires in your car wear out *all too soon*. Their cotton braid and lacquer covering (both of vegetable origin) can't forever stand the torture of heat, cold, oil and abrasion that goes on under the hood! This covering breaks down—often within 10,000 miles of driving. Then corona, an "electrical field" which surrounds any high-tension wire, reacts on air to form ozone—and ozone destroys the insulating power of *rubber*! As soon as this deterioration takes place, your car loses pep—gets away slowly at traffic signals—starts poorly—and wastes costly gasoline.

Again Science Supplies the Answer

Packard, oldest and largest maker of automotive wiring, has continually applied the discoveries of science to improve its products. And from the scientists Packard obtained a secret-formula inorganic compound that resists all the formerly unbeatable

enemies of spark plug wire—oil, heat, cold and corona. This new man-made rubber, derived from coal, salt and water, now sheathes Packard FOUR-FORTY spark plug wires—providing protection that is impossible with coverings of vegetable origin.

Packard FOUR-FORTY Pays for Itself

Packard FOUR-FORTY spark plug wires, in sets for all cars, are available at better garages and service stations; and take only a few minutes to install. A set of Packard FOUR-FORTY spark plug wires will pay for itself in gas saved and in the elimination of minor repairs caused by weak and irregular firing.

When you prepare your car for summer driving, remember that the *wiring system* is the nervous system of your car. Efficient, trouble-free operation of lights, battery, generator, spark plugs—all depends on proper wiring. Don't drive with costly faulty wiring any longer. Re-wire with Packard FOUR-FORTY spark plug wires, and replace worn battery cables and ground straps with genuine Packard cable today! Packard Electric Division, General Motors Corporation, Warren, Ohio.



Packard
REG. U. S. PAT. OFF.
TRADE MARK

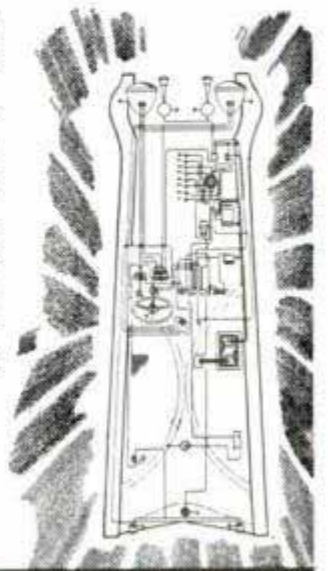

THE STANDARD WIRING EQUIPMENT OF THE AUTOMOTIVE INDUSTRY

When writing to advertisers please mention Popular Mechanics

Strange Lingo of the Movies

(Continued from page 726)

tains five globes each of five-kilowatt rating. It is used to evenly illuminate large surfaces, while the "orange-peel" is used for lighting flat wall surfaces. Other lights such as the "strips" containing a series of



"Standing chair" permits actor to rest between scenes without wrinkling costume

globes in a row, "mamma Dietz" lights, "square-heads," "eighteen-inch," "twenty-fours," "thirty-sixes," are only a few of the lights used. The largest light is the "sixty" which means the light is six feet across the face with a six-foot reflector.

"Save it" or "cut the hardlight" means switch off the lights. A "pin-box" is a plug at the end of an electric cable into which may be plugged a number of other cables. "High-stuff" is the lighting paraphernalia anchored above the settings on "parallels" and "catwalks." "Parallels" are platforms usually set on rollers, ranging in height from two feet to thirty or forty. A "nigger" is a flat, black shield used to prevent illumination on the set from striking the camera lens or spreading to unwanted places.

A "mixer" is a sound engineer who controls volume of the dialogue or music and blends the various sounds for proper dramatic effect during the filming of a scene. "Get the 'duck' nearer" means, to a sound

man, that the microphone should follow the players more closely. The "duck" or "mike," is suspended over the actors' heads out of "camera lines" on a "boom."

After suitable rehearsals of the actors and all is in readiness for filming, the assistant director shouts, "Silence, roll 'em!" In a few moments off to the side of the setting comes the announcement from the sound man "Speed," then the director shouts, "Action; camera!" That procedure, which has become ritualistic in all studios, first, starts the motors going, then announces when they have attained speed, and the orders for the actors to start the action. If the "take" is good the director says, "Print that one" which means that he wants to see the scene on the screen the next morning. The film shown the director the next morning is called "rushes" or "dailies" because they are rushed through the finishing laboratories for a trial projection. A "lily" is a "good take."

An actor who wrings his hands and overacts "chews up the scenery." "Turn



© R.K.O. Radio Pictures, Inc.

"Character lights" enhance illumination during filming of outdoor scene

on the personality" is the dance director's way of saying that he wants his "lineup" to smile and be more vivacious.

When the day's work is done, all the workers understand "wrap it up" as time to go home. Will Rogers varied this with "All right, Santa Monica Canyon."

Clayds of London

1441

New Engines for Old

WITH MIRACULOUS NEW-TYPE EXPANDER PISTON RINGS

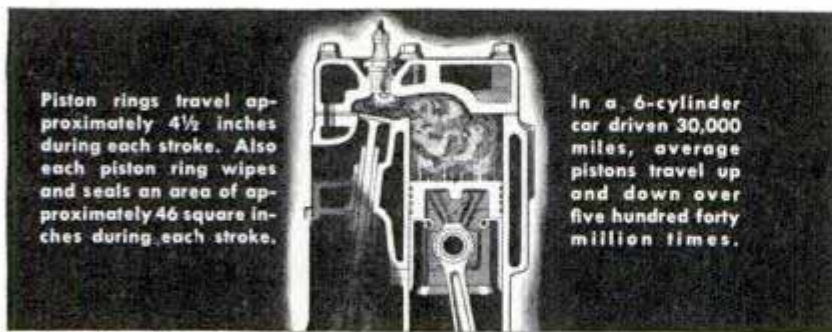

Piston rings travel approximately $4\frac{1}{2}$ inches during each stroke. Also each piston ring wipes and seals an area of approximately 46 square inches during each stroke.

In a 6-cylinder car driven 30,000 miles, average pistons travel up and down over five hundred forty million times.

U. S. Pat. Nos. 1,414,796; 1,848,953; 2,025,334; 2,025,335; RE: 10,900

50 Times a Second the pistons flash up and down when you drive at about sixty miles an hour. When cylinders become worn, they are larger at the top than at the bottom. That means the piston rings must expand and contract fifty times a second to seal

the cylinder walls properly. Ordinary rings aren't equal to this terrific task, but Perfect Circle X-90 Piston Rings have solved the problem. They have an amazing ability to flex lightning-fast and seal worn cylinders without paralysis, even at highest speeds.

New-Car Pep and Oil Mileage Restored by PERFECT CIRCLE X-90 RINGS

AT LAST a piston ring that actually cuts piston drag! No towing the car after installation. No breaking in. It seals even badly worn cylinders. Brings back original performance and oil mileage. Doesn't paralyze even at highest speeds.



"Nope! Don't Need Oil." Increased oil mileages up to 500% amaze owners who install Perfect Circle X-90's

Why the X-90 Saves You Money.

Six individual double-leaf springs operate independently, giving the X-90 ring amazing flexibility. Friction and piston drag are cut to the vanishing point. The heavy black line in this pressure chart shows the uniform, circular pressure of X-90 rings. A better seal is effected. More oil and compression are saved.

The dotted line shows how old-type expander rings "stiff-arm" cylinder walls. The pressure varies from 12 pounds to zero.

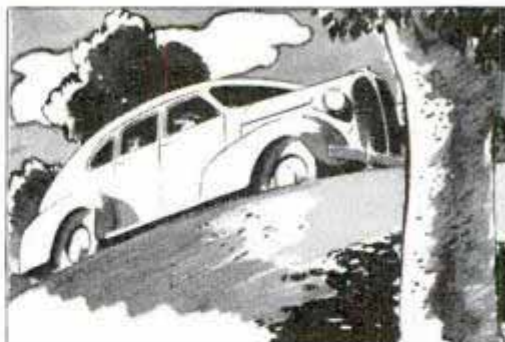
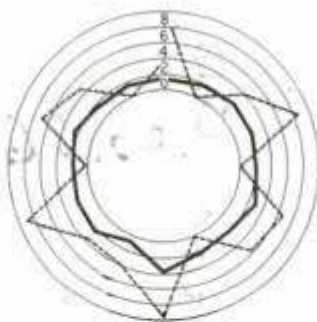

Old Bus Takes It in High. Worn cylinders mean lost compression. Horsepower snaps back to new-car pep with X-90 Rings

Copyright, 1937, The Perfect Circle Company

The Perfect Circle Companies
Hagerstown, Ind., Dept. PM5, U. S. A.
and Toronto, Canada

Send me without cost or obligation your booklet, "How to Double the Life of Your Car," and information on my car.



Name _____
 Address _____
 City _____ State _____
 Make of car or truck _____ Model _____
 Mileage _____ Trouble _____
 Name of garage, mechanic, or car dealer (fill in carefully) _____
 Address _____

PERFECT CIRCLE



Trade-mark Reg.

U. S. Pat. Off.

PISTON RINGS • PISTON EXPANDERS

When writing to advertisers please mention Popular Mechanics

Stop and Go at the World's Busiest Airport

F1323

(Continued from page 733)

fly by ear alone. The technique of piloting while blindfolded was demonstrated recently by Luis de Florez, member of the Council of the Institute of Aeronautical Sciences, who flew for forty minutes at a time, depending solely on the ability of his brain to interpret differences in sound which occur when sound waves strike the ear unevenly. Mr. Florez showed he could pull a plane out of a spin while blindfold-



Dusk at Newark airport and a transport plane waddling down the field for a night flight

receiving orders from his company's operations office. If the weather is thick and the visibility is very poor, the trip may be held up indefinitely. The different companies have different rulings, but ordinarily, a plane does not leave the ground unless visibility is more than 500 feet.

When the weather is thick, the pilot is like a blind bird. The traffic officer may tell him to fly for ten minutes on a compass course of 150 degrees, without turning in either direction. If he clears the overcast, the pilot is then allowed to take care of himself. Ordinarily the pilot traveling on a compass reading of zero to 179 degrees must fly at an odd altitude, that is, 3,000, 5,000 or 7,000 feet. When traveling between 180 to 359 degrees, he must fly at an even altitude. Thus from Boston to Newark he flies at an even altitude, and from Newark to Boston, he flies at an odd altitude. The department of commerce assigns different altitudes in a fog. If the regular altitudes are unsuitable, the pilots may travel at emergency altitudes of 4,500 feet westbound and 3,500 feet eastbound.

ed. Such experiments are expected to be of assistance to transport pilots who must fly through "soupy" weather. The hearing sense can be a valuable check on the accuracy of flying instruments.

One of the marvels of aviation is the system by which pilots are enabled to keep "on course" from city to city without having to navigate by landmarks. Radio stations are about 200 miles apart, and they send two Morse signals, the letter "A," which is "dot dash" and the letter "N," which is "dash dot." If one of these signals is superimposed upon the other, the combined signal becomes the letter "T," merely a dash, signifying the pilot is on course. If the pilot flies on a "T" he goes directly to the source of the signal, a "cone of dead silence." When the radio suddenly goes dead, he knows he has arrived at his destination.

However, the pilot usually knows his position before he reaches the cone of silence. Upon nearing the airport, he "checks in" and identifies himself. No commercial pilot leaves Newark airport without first

Three agencies direct the operations and movements of commercial aircraft. First, the traffic tower, then the company operations office, and finally, the department of commerce. The latter employs men to broadcast weather, maintain the radio beacons, transmit information and inter-city traffic movements and enforce the federal regulations regarding the altitude at which planes fly.

Mine Drill Digs Five-Foot Hole Fifth of a Mile Deep

Future possibilities of mining with a newly developed drill are enormous, according to the American Institute of Mining and Metallurgical Engineers. The drill digs a hole five feet in diameter and 1,125 feet deep, slightly more than one-fifth of a mile. When the 1,125-foot level is reached a chamber can be hollowed out and operations repeated for another 1,125 feet, and so on. The drill works on the principle of the old-fashioned cookie cutter except that it carves out a cylindrical section of rock weighing about eleven tons.

City, Calif.
es 186
Newada
1907-1923
Newson
Idaho Maryland



S. S. VAN DINE

Celebrated author of popular mystery thrillers and creator of "Philo Vance"

40-50-60 MILES AN HOUR! THEY ALMOST HAD THEIR MEN WHEN... *BANG!* A BLOW-OUT!

Read S. S. Van Dine's breath-taking description of Sergeant McCabe's* thrilling man hunt

"**T**HERE they are! Not more'n a quarter mile ahead of us. We'll overhaul 'em before they reach the Bad Lands." Sergeant McCabe's voice was excited and triumphant.

And just then a sharp explosion rent the air, and the police car leaped from the narrow road and lurched crazily to a sudden stop in a rock-strewn sandy field.

"A blow-out!" snarled the driver. In the distance the faint tail-light of the criminals' car could be discerned, rapidly disappearing into the now unbroken blackness.

"No chance now," the Sergeant complained sullenly. "They've escaped."

The criminals did escape that time. But, thanks to the persistence of Sergeant McCabe and his men, they were later captured.



It's bad enough to have a man-hunt frustrated by a bursting tire. Think of how terrible it must be, though, to have an innocent, carefree motorist start off on a pleasure trip only to have a blow-out catapult his car crazily into anything that blocks the way.

The solution to all this havoc on the highways has seemed to me to depend on the manufacture of a *safer* tire. That's why the invention of the Life-Saver Golden Ply by Goodrich should be the "Good News" to every American Motorist that it was to me. As one of the Goodrich engineers explained, "This Golden Ply, which is now found in every Silvertown Tire, is a layer of special rubber and full-floating cords, scientifically treated to resist the terrific blowout-causing heat generated inside *all* tires by today's high speeds. By resisting this heat, the Golden Ply provides motorists with *real* protection against high-speed blow-outs."

No wonder thousands of motorists are changing to Silvertowns. Silvertowns *below* mean *safety above*. Remember, you can purchase these at Goodrich Silvertown Stores and Goodrich dealers everywhere.



**Names and localities are fictitious, but the episode is suggested by an actual occurrence.*



Goodrich SAFETY Silvertown

With Life-Saver Golden Ply Blow-Out Protection

The Bean that Made Good

(Continued from page 662)

pasture hogs, usually as a supplement to a corn ration. Soybeans also improve the soil by increasing the nitrate content.

The bean, after removal from the hull, lends itself to a wide variety of treatment for the production of food for human consumption and stock feeding, and for a surprisingly wide variety of industrial products. The soybean, rich in protein but low in starch, contains a high percentage of both fat-soluble and water-soluble vitamins, and other materials that make it a desirable food.

Soybeans may turn up at the dinner table in a variety of forms. The dried beans can be prepared like navy beans. Dried soybeans, properly roasted, become the basis of a cereal beverage resembling coffee. Shortly before they mature, they can be prepared like green peas or lima beans. The oil is extracted either by pressing or by removing it with solvents, which later are recovered and used over again. Extraction of the oil leaves a compressed cake, which can be put to a great many uses.

Soybean flour is produced by grinding either the whole bean, the pressed cake, or the cracked or flaked bean from which most of the oil has been removed by a solvent. It has been used for years as a food for invalids and infants. The flour, when mixed with wheat flour in about the proportions of one-fourth to one-half soy flour, makes baked goods which, because of the low starch content of the soy flour, are suited for diabetic persons and others who require a low-starch diet. Soy flour is rich in vitamin B, contains considerable vitamin G and some A; and vitamin C is present if the flour was made from germinated seed. Soy flour is a cheap food, be-

ing surpassed only by lard, sugar and corn meal as a cheap source of energy.

Refined and deodorized soy oil can be used, like any other table oil, for salads, in cooking, and in the manufacture of butter and lard substitutes. The best known soy food outside of the orient is soy sauce or shoyu. It is a dark-brown liquid used as a condiment or relish. A mixture of cooked soybeans, roasted wheat or barley, salt and water is ground up. A culture of bacteria called rice ferment is added and the preparation stored in vats for six to eighteen months to ferment. Food experts have recommended soybean sprouts as a green vegetable for the winter diet. These sprouts are obtained by arranging seed beans on a cloth that is kept moist, and letting them germinate and grow until the shoots are two inches long.

A vegetable milk that closely resembles

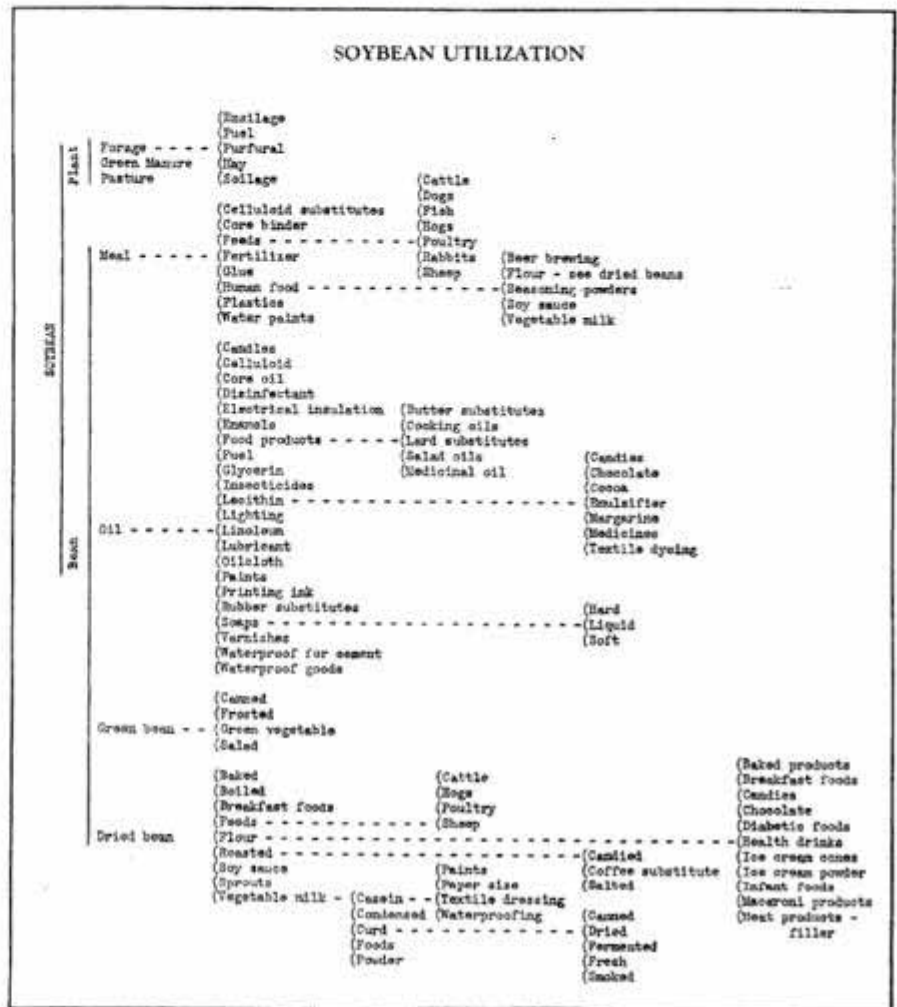

This chart shows the scores of uses for the lowly soybean. Note that both the plant and the bean are utilized

\$80,000 — Awards for boys in the United States

Fisher Body Craftsman's Guild announces
TWO competitions for 1936-37
of which one is new and entirely different

- ➔ Four \$5,000 University Scholarships
- ➔ 882 Cash Awards Ranging from \$25 to \$100
- ➔ 36 Trips to the 1937 Guild Convention
- ➔ **922 AWARDS IN ALL!**

Here is the biggest and most interesting news that you have read in a long time. If you are from 12 to 19 years of age, you are eligible to try for a university scholarship, or for one of

the many cash awards, or one of the all-expense-paid trips offered by the Fisher Body Craftsman's Guild in these two competitions.

There are TWO competitions THIS year!

1. Napoleonic Coach Competition

The Napoleonic Coach project remains the same as it has been for the past 6 years. In it, you build a miniature model Napoleonic Coach to the same specifications as in the past. In this competition forty-nine boys have won scholarships ranging from \$500 to \$5000 during the past six years. This year, there are state and regional awards which add to the interest of the competition.

2. Model Car Design Competition

The Model Car Design competition is new and will appeal to all of you who would like to try your hand at something different. You start from scratch here. All you have to do is fashion a miniature automobile embodying your own ideas of motor car design. This competition has to do only with the outside appearance or design of the car.

So send in the COUPON at once

The requirements are simple. Decide now whether you choose to build the Napoleonic Coach or a modern automobile of your own design. Then fill out and mail the coupon for membership in the Fisher Body Craftsman's Guild.

As soon as we hear from you, we will send you free of charge your membership card, the official Guild button, and all the scale drawings, specifications, and instructions you will need to construct either the Napoleonic Coach or the scale model automobile of your own design.

These drawings, specifications, and instructions show everything to do in making your coach or car—step by step. You can't go wrong.

But the more time you have, the better job you can do. Don't wait. Fill out the coupon now, tear it out, and mail it at once.

There are no dues or fees. Guild membership and competitions are open to all boys in the United States between the ages of 12 and 19 inclusive.

\$80,000 in Scholarships, Cash and Trips. 922 Awards

1

Napoleonic Coach Competition
 216 Awards, Cash Value, \$32,650

Grand National Awards TOTALS
 1 Junior and 1 Senior, 2 Scholarships—
 \$5,000 each \$10,000

1st State Awards

1 Junior and 1 Senior, in each of the 48 states and District of Columbia—
 \$100 each \$9,800

2nd State Awards

1 Junior and 1 Senior, in each of the 48 states and District of Columbia—
 \$75 each \$7,350

18 Regional Awards

A trip to the 1937 Guild Convention for 9 Juniors and 9 Seniors.

2

Model Car Design Competition
 706 Awards, Cash Value, \$47,350

Grand National Awards
 1 Junior and 1 Senior, 2 Scholarships—
 \$5,000 each \$10,000

1st State Awards

1 Junior and 1 Senior in each of the 48 states and District of Columbia—
 \$100 each \$9,800

2nd State Awards

1 Junior and 1 Senior in each of the 48 states and District of Columbia—
 \$75 each \$7,350

3rd State Awards

1 Junior and 1 Senior in each of the 48 states and District of Columbia—
 \$50 each \$4,900

Four cash awards of \$25 each for both Junior and Senior in each of the 48 states and District of Columbia \$9,800

18 Regional Awards

A trip to the 1937 Guild Convention for 9 Juniors and 9 Seniors.

Rules and Regulations

In both competitions, the following regulations will prevail. Boys 12 years old or older, and not yet 16 on September 1, 1936, compete in the Junior division. Boys 16 years old or older, and not yet 20 on September 1, 1936, compete in the Senior division. All boys within these age limits are eligible for Guild membership. There are no dues or entrance fees of any kind. Each member shall receive, without charge, an Official Guild membership card and button, and a full set of Guild drawings and instructions. The Napoleonic Coach competition closes August 2, 1937 at midnight. The Model Car Design competition closes July 1, 1937 at midnight.

FISHER BODY CRAFTSMAN'S GUILD
 8-168 General Motors Bldg., Detroit, Michigan.

Gentlemen: Please enroll me in the Fisher Body Craftsman's Guild for 1937 in the

- Napoleonic Coach Competition,
 Model Car Design Competition.

Also please send me my official membership card, button, and full instructions, free of charge.

Name.....

Address.....

City..... State.....

I was born on the.....day of.....19.....

Be sure to check the class in which you wish to be enrolled.

FISHER BODY CRAFTSMAN'S GUILD

An Educational Foundation sponsored by General Motors

GENERAL MOTORS BUILDING • DETROIT, MICHIGAN

(Continued from page 120A)

2567
 cow's milk, both in appearance and nutritive value, is prepared from soybeans and used widely in the Orient. It is made by soaking dried soybeans in water for a number of hours, crushing them, and then boiling for a half hour in three times their volume of water. The milk is separated from the solid mash by straining. Milk can be made equally well from soybean cake or meal from which the oil has been extracted. The residue is valuable as a food for cattle, or for grinding into soy flour. If hot soybean milk is treated by adding rennet, lactic acid, calcium or magnesium salts, a grayish-white curd is precipitated. It is made into a considerable variety of dried, fermented and smoked cheeses.

Industrial applications of the soybean have centered largely about the oil. Soybean oil is a type known as a semi-drying oil. That is, it will dry into a solid if exposed to air sufficiently long. It is classed about midway between linseed and slow-drying cottonseed oils. Soybean oil is being used in paints and enamels as a substitute for part of the linseed oil. For making hard soap, it first must be treated with hydrogen, which makes it a substitute for cottonseed oil. Properly refined, the oil lends itself to an almost endless variety of uses in the manufacture of foods. It is also being utilized in the making of candles, printing ink, linoleum, waterproof goods, and for lubrication.

Water paints, glue, paper sizing, celluloid substitutes, medicinal substances, vegetable casein, textile waterproofing material, paper sizing and a vegetable milk powder are among the products that have been made from soybean meal either commercially or experimentally. Usually soybeans grown in this country are not bothered much by insect pests. Grasshoppers sometimes damage soy crops. They are combated by poisoning with arsenic or paris green. Blister beetles, or Spanish flies, also have caused trouble. They are killed by dusting with powdered sodium fluosilicate and hydrated lime.

Mexican bean beetles, leaf hoppers, and the green clover worms are the remaining most dangerous enemies of soybeans. The plants may be attacked also by other insects, and by bacterial blight, bacterial pustule, soybean mosaic disease, and several other ailments. An interesting disease

is root knot, caused by tiny eelworms or nematodes growing in the roots. Rabbits and woodchucks also sometimes destroy soybean plants but in general, the soybean is easier to raise than many other farm products. Its future will be made more secure by the activities of a soybean laboratory recently established at the University of Illinois, by the U. S. Department of Agriculture and twelve north central states. The soybean scientists at the laboratory are working toward three objectives—finding new ways of using soybeans in industry, and improving the applications already made; studying the effects of different processes on quality and quantity of soybean products and working out better methods of testing different varieties of soybeans as to adaptability for industrial uses.

It is the industrial angle that the laboratory will emphasize, at least for the present. Most future increases in growing activities are expected to be for the purpose of providing beans for use in making paints, foods, linoleum, rubber substitutes, insecticides, plastics, glycerin, varnish and a wide variety of other useful things. One thing the laboratory hopes to discover is why one variety of soybean shows analysis of twelve per cent oil and twenty-eight per cent protein under one set of conditions, and twenty-six per cent oil and fifty-four per cent protein under another. Lecithin, a product of soybean oil used in the making of medicines, candies, chocolate and margarine also is being studied.

The soybean, although one of the oldest known cultivated plants, seems just now to be on the threshold of a new era of popularity. Agricultural experts expect a sudden big increase in soybean growing, particularly in the middle west states. The demand for soybean products for industrial uses is greater than the supply, and importations reach a considerable figure. The future of the bean seems to be linked closely with the use of automobiles, modern houses and other products of our industrial civilization.

It looks as if there might be a lot of jack in the soybean stalk, for farmer and manufacturer alike. And the general public will benefit too, from new foods and the scores of industrial products this bean makes possible.

"Hello Old Man!"

Get yourself a Barbasol Face

Barbasol does to your face what it takes to make the ladies want to touch it.

Barbasol not only gives you the smoothest, sweetest shave of your life.

It also keeps your skin soft to feel, young and handsome to look at.

That's the beauty of Barbasol—no harshness to bite the skin. No dry, tight feeling after the shave.

Being a wonderful cream—no brush, no lather, no rub-in—Barbasol soothes and refreshes your face like the cool kiss of dawn.

If you have never tried Barbasol, buy a tube, use it for two solid weeks, and note how much



smoother and younger your skin looks.

Then you'll understand why Barbasol is favored by millions of men—why Barbasol is

America's fastest-selling shaving cream. Generous tube, 25¢; giant size, 50¢; family size, 75¢. And for 15¢, five scalpel-sharp Barbasol Blades. At all drug stores!

For modern shaving



No Brush—No Lather—No Rub in

PRIZES FOR GOOD GUESSERS

Are you good at guessing? If you are, you may win any one of the valuable prizes given away every week—a new automobile, big money prizes, hundreds of \$3 Barbasol Razors. Absolutely free to enter, takes only a few seconds to do. Simply guess a number, that's all. For details, tune in Singin' Sam (NBC Blue Network) every Friday evening. See local paper for time.

When writing to advertisers please mention Popular Mechanics

Nomads of the Seven Seas

(Continued from page 717)

rangements are made ahead of time. A day or so before he is due in port a captain radios his expected time of arrival and later on, while he is still miles at sea, corrects it to within a minute or two. Preparations on shore are started while the ship is still out of sight. Before the ship arrives trucks are already backing up to the wharf. Longshoremen report for work and begin clearing space for handling the cargo. Goods on railway cars and trucks as far as 100 miles away begin moving toward the port so that loading of the new shipment can start as soon as the discharging is finished. While the cargo is being worked, fuel barges move up alongside the ship, fresh-water connections are made with the shore, and ship's stores and food supplies begin to come on board.

Even such a task as loading cargo is done according to a scientific plan. Masters and mates have to study cargo loading just as they study navigation and seamanship. If a vessel is to pick up general assortments of cargo at New York and Philadelphia for several Pacific coast ports, an officer prepares a chart of his cargo spaces and plans to take the shipments on board so that they can be unloaded without disturbing other consignments. Cargo for Portland, for example, must not be loaded on top of shipments to be discharged at Los Angeles or San Francisco.

At the same time heaviest items such as steel rails must be stowed low in the ship to preserve stability. Likewise heavy shipments are balanced fore and aft so as not to affect the trim of the ship. What are known as offensive items can't be stowed near materials that might be affected by them. It would never do to place a shipment of fishmeal near sugar, since the sugar would absorb some of the odor.

In the old days it was not uncommon for a tramp captain to load cargo for half a dozen different ports and then skip some of the stops if he learned of a richer shipment that could be had by hurrying elsewhere. In that case he would calmly discharge all of the cargo consigned to the ports he was missing at the nearest port of call, possibly 1,000 miles away. The owners of such shipments would know nothing about the changes in plan until

(Continued to page 126A)

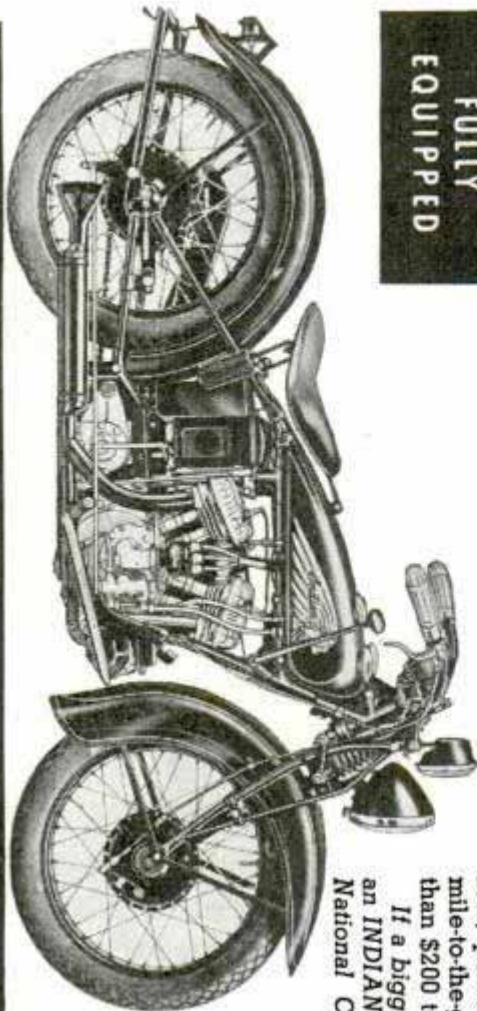

F. O. B. FACTORY
\$195.
FULLY
EQUIPPED

FOR THIS GREAT TWIN CYLINDER

YOU CAN'T BEAT IT!

More motorcycle per dollar than ever before! A real, powerful, twin-cylinder motorcycle with 70 mile-to-the-gallon economy—yet costs you less than \$200 to own.

If a bigger machine interests you—Ed Kretz on an INDIAN SPORT SCOUT just won the 200-Mile National Championship Road Race at Daytona Beach, Florida, in record time.

You can see both of these machines at any Indian Dealer's—they can be bought on easy terms. And when you order you get a FREE RIDER'S HELMET and WINGED PIN!

Indian Motorcycle Co.,
Springfield, Mass.

Indian

JUNIOR

Scout



FREE



MAIL
COUPON
TODAY!

INDIAN MOTORCYCLE CO., Springfield, Mass.—Please send me at once, with or without obligation, the new Indian Motorcycles and related folder described in the new Indian Motorcycles and related folder of VALUE entitled when I place my order. CERTIFICATE of VALUE as illustrated when I place my order.

Name.....

Address.....

Please be sure to check your age group:

16-19 years

20-30 years

under 16 years

F.M.I.

31 years and up

THE *Mighty* NEW McCULLOCH

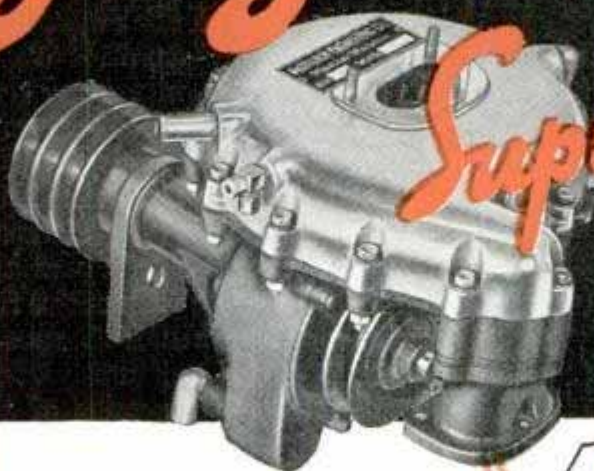
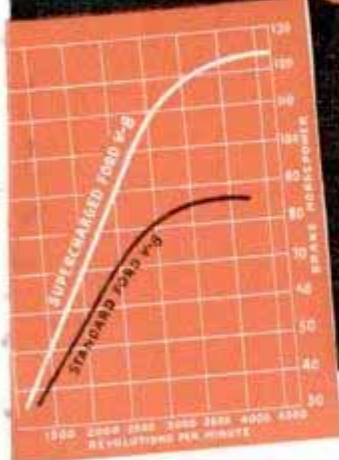

Supercharger

FOR FORD V-8 ENGINES

\$84.50

Develops 124 Horsepower!

Power that defies the steepest hill. Power that plows through stubborn desert sands. Power that makes you master of all traffic. 38 per cent more power by actual dynamometer tests! That's the quiet, overwhelming power you'll get from the *Mighty New McCulloch Supercharger*.

LIKE THE FINEST EUROPEAN ENGINES

For many years the highest priced cars in Europe have had supercharged engines. Airplane designers also employ them to compensate for reduced atmospheric pressures at varying altitudes — the perfect remedy for sluggish performance. Now you can have the utmost in motor car performance — saving gas and prolonging engine life.

7.3% to 19.7% BETTER GAS MILEAGE

124 Horsepower! But even that's not all. Gasoline is mixed and distributed more efficiently with the *Mighty New McCulloch*. The already remarkable acceleration of the Ford V-8 engine is also increased. No wonder the McCulloch plant is already behind in its orders.

Fuel mixed by the action of the rotor in the *Mighty McCulloch* under tremendous centrifugal force, is

so well atomized and evenly distributed to all cylinders that there's amazing smoothness and steadiness. This Supercharger is also perfectly quiet. Any mechanic with the simplest tools can install it in a short time. Engine life is prolonged because the pressure which the incoming fuel mixture exerts on top of the pistons counteracts the reverse shock load usually imposed on the bearings on the intake stroke.

FACTORY BEHIND IN ITS ORDERS!

Mail coupon at once for complete details. You must act immediately to have this mighty power this summer! . . . Order your *Mighty McCulloch* today. Send no money. We will ship C.O.D.

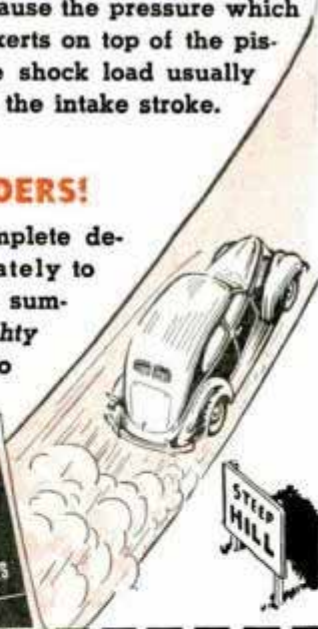

McCulloch Engineering Co.
1327 S. 70th St., Milwaukee, Wis.
 Please send literature and further information.
 Please rush.....McCulloch Ford V-8 Superchargers to me at once C.O.D.

Mail Coupon **NOW!**

DEALERS: WRITE FOR FRANCHISE

Name.....
(Print or write plainly)
City..... State.....

67.



NOW'S THE TIME TO CLEAN OUT YOUR RADIATOR

PUT your car in shape for summer driving, right now. Remove anti-freeze and clean out all the rust and sediment that are clogging your radiator. You can do it yourself for ten cents—in a few minutes. Just get a can of Sani-Flush.

Pour a little in the radiator (directions are on the can). Run the motor. Drain. Flush. Then refill with clean water. Sani-Flush removes lime and scale from the cooling system. Opens the circulation of water. Insures an efficient flow through the cooling system. Sani-Flush cannot injure aluminum cylinder heads or motor fittings. Most bathrooms have Sani-Flush for cleaning toilets. Sold at grocery, drug, hardware, or five-and-ten-cent stores—25 and 10 cent sizes. The Hygienic Products Co., Canton, Ohio.

Sani-Flush *Safe NOT CAUSTIC*
KEEPS RADIATORS CLEAN

NEW BENJAMIN AIR PISTOLS

Powerful—Accurate—Economical—Practical—Adjustable Shooting Force—Amazing Maximum Velocity—cal. 177 or 22 and BB—For Target and Small Game—the only Genuine Compressed Air Pistol on the market—Single Shot with Bolt Action—Hammer Fire—Hair Trigger—Safety. Price \$7.50. Also 177 and 22 Single Shot Air Rifles \$7.50—Single Shot BB Air Rifle \$6.00—25 Shot BB Repeater Air Rifle \$7.50—at Dealer or Direct—No license required—Safe for indoor use. FULL DETAILS—TARGETS—FREE—WRITE TODAY. Benjamin Air Rifle Co., 691 N. Broadway, St. Louis, Mo.



AUTO ENGINE SPEED CONTROL GOVERNORS

To control speed of any make of auto or truck engine, regardless of load changes, when used as a stationary or portable power plant. Fully guaranteed. No cash down. Governor speed range from 400 to 3000 R.P.M. Fine opportunity for established agencies. Send for free circulars. Mrs. Candee-Smith Gov., Dept. 112-E 215 No. L. A. St., Los Angeles, California.

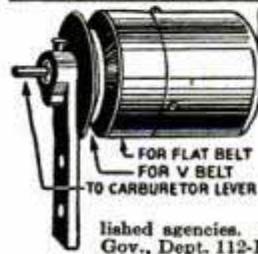

When writing to advertisers please mention Popular Mechanics

(Continued from page 124A)

they received storage bills for the goods from some waterfront warehouse.

In the past, also, the master of a tramp might advertise for cargo, collect the freight money in advance, and then sail away in the night, leaving the cargo on the wharf. Another way to make money was to sign on a crew and then haze them all through the voyage so that they would desert at the first port, leaving their uncollected wages behind them.

Unscrupulous masters used to load their vessels away past the point of safety in order to collect the freight money on a few extra hundred tons of cargo. Later on when load lines were required to be painted on the sides of ships the trick was to "hog" a vessel by overloading it at the bow and stern, thus bending the ship up in the middle so that the Plimsoll mark was still above water.

These days a seaworthiness certificate must be issued to every ship on each trip before leaving port. Before a certificate is issued the inspectors make sure that the ship is not overloaded and that the cargo is stowed safely. In some cases the inspectors may allow a vessel to sail even if it is slightly overloaded, if it is certain that she will encounter good weather during the first part of her voyage. By the time she reaches an area where rough weather may be looked for, weight losses from fuel consumed on the trip will raise the hull up above the line of safety.

es 189.

Steam Heat Keeps Road Clear of Winter's Snow and Ice

No matter how heavy the snowfall, a Pennsylvania estate keeps its road clear by steam heat. A discarded water-heater coil was installed in an empty oil drum below the road level. Two-inch galvanized iron pipe was run from the top of the coil along one side of the road and back along the other side, with a two-inch vent at the high point farthest from the heater. The pipe is buried eight inches deep. Gas is used for heating, and the system needs no attention except to introduce water through the vent once a month.

Our Bureau of Information will answer questions regarding articles in this magazine, if accompanied by return postage.

Wm. Wynne D. Brock. 166 Kansas St. Bradford Pa.

You're Wrong about Elephants

(Continued from page 676)

That a mouse could run up an elephant's trunk is ridiculous. On the tip of the trunk is a finger, or feeler as it is called, which is the most sensitive part of the beast's body. Here more than forty thousand nerves are centered and this finger acts as a cap to close the vents of the trunk. It is virtually impossible for anything to get into the trunk unless the elephant wants it.

To dispel the idea that elephants are afraid of mice I have taught one of my charges to pick one up with its trunk. The

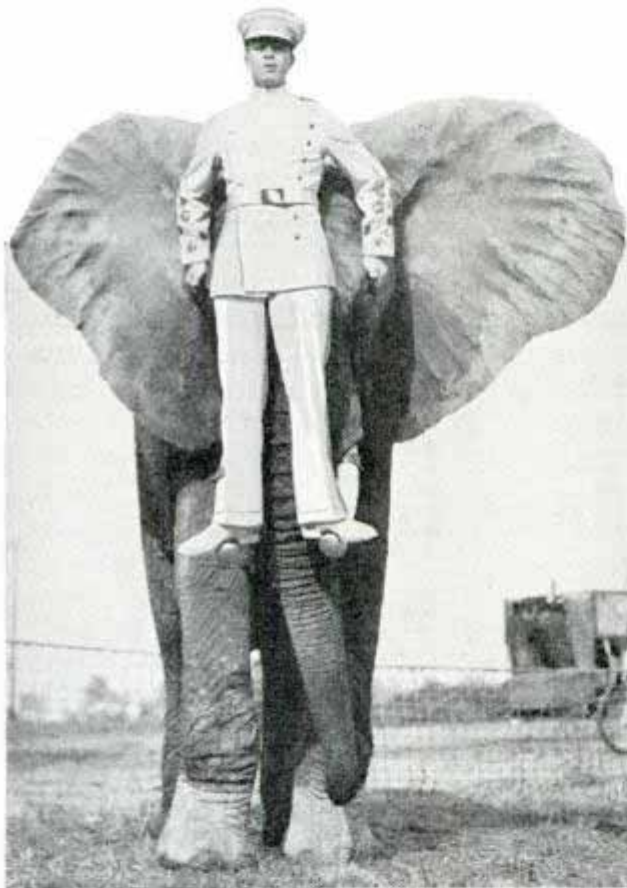

Trainer Allen in circus uniform perches on the tusks of "Jumbo," giant pachyderm

stunt was successfully worked after two months of training.

An elephant's hide is not tough. The reputed toughness comes from inner muscles. The hide itself is so sensitive that elephants spend hours blowing dirt and chaff on their backs to keep flies from biting them.

An elephant has poor eyesight, but its sense of hearing is very acute. Sudden noises frighten it, but with training it grows accustomed to them. As part of a

(Continued to page 128A)

WIN PART OF \$200.00 CASH



FREE ENTER THIS BIG CONTEST TODAY

Write an advertising slogan for the spectacular 1937 Model Musselman Coaster Brake. See this superior coaster brake at your dealer's and read this advertisement carefully so you can write a winning slogan in 10 WORDS OR LESS. Here's a simple slogan, "The 1937 Musselman obsolesces all other coaster brakes." Your slogan must refer to the

MUSSELMAN Replaceable Cartridge COASTER BRAKE



THE AZ CARTRIDGE UNIT

Here are some EXCLUSIVE FACTS that will help you. The Musselman 1937 Model Coaster Brake is superior in every way; it is years ahead in mechanical simplicity and actually makes every old style brake obsolete. The AZ Cartridge can be instantly applied as easily as changing a razor blade. The smooth mechanism requires 10% less leg power for pedaling. Built for quick stopping and the only brake ever made that stood the Pike's Peak test—a steep 25 mile down mountain ride braking all the way. It is self lubricating. The only brake using only three moving parts while pedaling and no moving parts while coasting (except ball bearings). The brake that wins all coasting contests.

DEMAND THE MUSSELMAN 1937 COASTER BRAKE WITH YOUR NEW BICYCLE. IT WILL BE PROVIDED BY ALL MANUFACTURERS AT NO EXTRA COST. DON'T BUY AN OBSOLETE BRAKE — BUY MUSSELMAN.

Prizes are: 1st Prize \$100.00; 2nd Prize \$35.00; 3rd Prize \$15.00; and 25 prizes of \$2.00 each. Write your slogan and mail to

THE MUSSELMAN HUB BRAKE CO.
6220 St. Clair Avenue Cleveland, Ohio

Musselman patented brakes are used today on leading airplanes because they are safe.

You're Wrong About Elephants

(Continued from page 127A)

bull's training we take barrels and steel drums to the loft of the elephant barn in winter quarters and drop them on the concrete floor below near the picket line. After repeating this a few times the elephants pay no attention to the noise.

Bulls become restless fifteen to twenty minutes before a thunderstorm. Their means of warning is to put their trunks high in the air as if to smell the moisture, at the same time trumpeting and weaving. If they are led into the open and chained to stakes with their heads facing into the storm, they will quiet down. Last year we were playing in upstate New York when a terrific wind and rain storm came up as the show was starting. The elephants were just out from under the menagerie top when it was blown down. The entire lot was thrown into a panic, but the elephants gathered in a huddle and did not move until the storm had passed.

In order to acquaint elephants with other animals, dogs and cats are housed in the elephant barn at winter quarters and run in and out among the big beasts' legs

without causing any excitement. In Tyler, Tex., in 1925, three lions escaped into the arena during the show. Gaining their freedom, two of them headed toward the line of elephants waiting to enter the arena. The crowd screamed and shouted. We expected the elephants to bolt as soon as they saw the charging lions. One of the lions darted between me and the lead elephant and ran in front of the entire group while the other cat ran to the rear. Instantly there was a low, sharp trumpet from the lead elephant. As though obeying a command the fifteen bulls immediately bowed their heads and remained in that position until the lions had been recaptured.

Last summer at a town in Pennsylvania, the six-horse team pulling the steel calliope bolted. The driver shouted to the elephant men just ahead to get the bulls out of the way. Immediately the elephant men started speeding the bulls until they were lumbering along at a full run. After seven blocks they were crowded onto a side street allowing the calliope to go by.

Easy Card and Rope Tricks

(Continued from page 709)

rotation until the deck has been exhausted. You turn your back and one card is taken from the middle of any of the four piles and placed on top of it. When all the cards have been gathered together again you go hurriedly through the deck and find the selected card.

Prearrangement for this calls for the removal of all cards of any one suit, placing six on top of the deck and seven on the bottom. The fact that there are six spades, for example, on top and seven on the bottom arranges them so that the top and bottom cards are each a spade. Thus when a card is selected from the middle and placed on top of the packs it is bound to be between two spades. Then by running through the deck you can detect the card instantly.

The vanishing aces trick deserves a place in the repertoire of every amateur magician. The four aces are removed from the deck and placed face up on the table and on top of each of these are put three

regular cards. The packets are picked up one at a time and the three indifferent cards of each are thrown off onto the table face downward. The aces are placed on the table the same way and the twelve remaining cards are returned to the deck and three packs of cards of four each are dealt off in rotation. While the spectator holds his hand over the pile containing the aces, you cause the aces to disappear from under the spectator's hand into another pile which you show the audience.

To do this, spread out the four aces with three regular cards on top of them. Pick up the first packet by the left hand with their faces upward. Discard the first two cards but upon coming to the third flip off the ace instead of the indifferent third card. This is done by shoving the third card out about half an inch. As the hand turns over the thumb draws the third card back into the palm and at the same time the fingers throw the fourth out in its stead.

(Continued to page 130A)

NEW CHEVROLET 1937

The Complete Car - Completely New

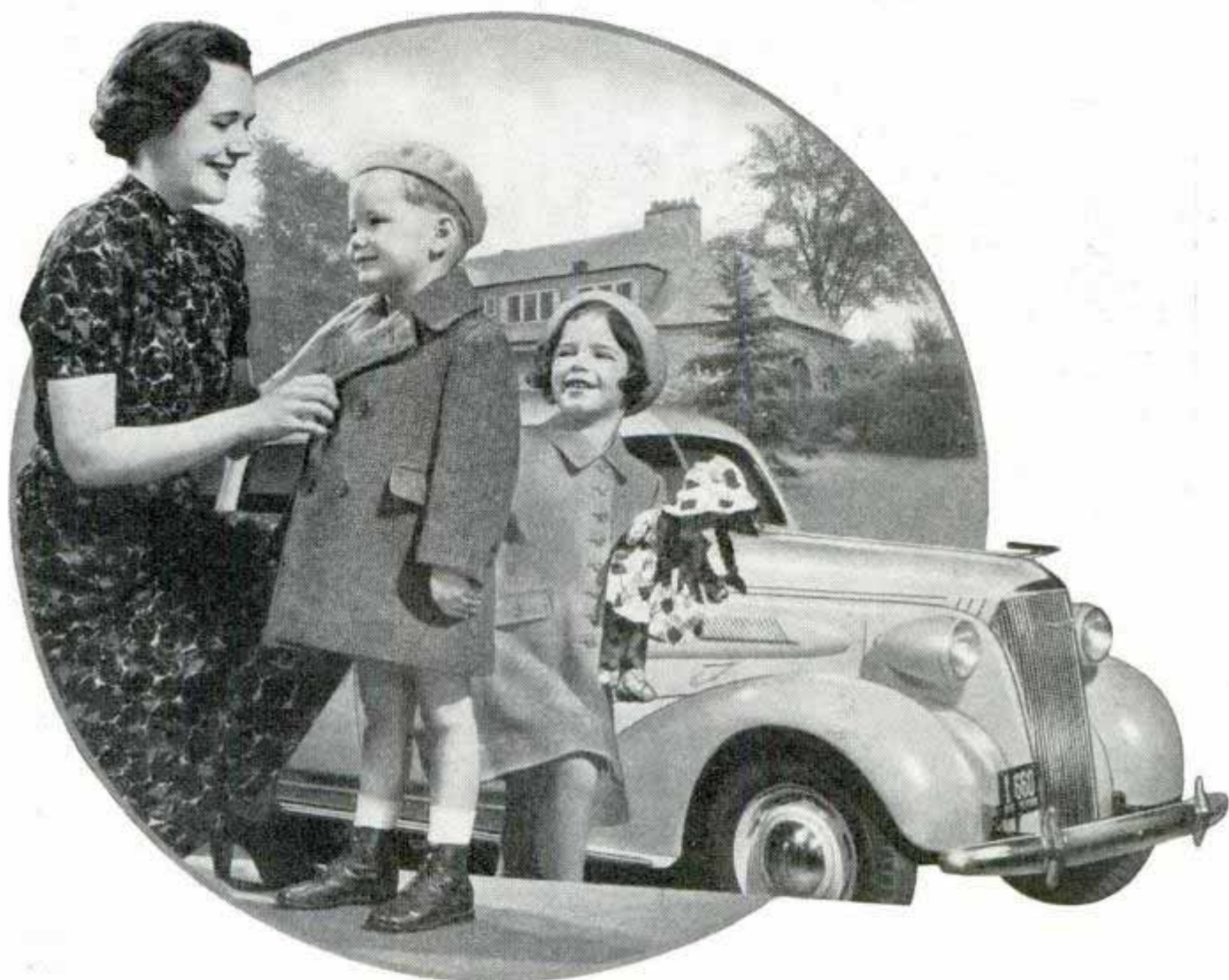

For their sake
 buy the only low-priced car that
 can give this **COMPLETE SAFETY**



NEW HIGH-COMPRESSION VALVE-IN-HEAD ENGINE • NEW ALL-SILENT, ALL-STEEL BODIES •
 PERFECTED HYDRAULIC BRAKES • IMPROVED GLIDING KNEE-ACTION RIDE* • SAFETY PLATE GLASS
 ALL AROUND • GENUINE FISHER NO DRAFT VENTILATION • SUPER-SAFE SHOCKPROOF STEERING*

CHEVROLET MOTOR DIVISION, General Motors Sales Corporation, DETROIT, MICHIGAN

*Knee-Action and Shockproof Steering on Master De Luxe models only. General Motors Installment Plan—monthly payments to suit your purse.

ATTENTION: Users of Steel and Fountain Pens

**New Ink Discovery Is
Equal or Superior to
U. S. Gov't. Standards**



- | | |
|--------------------|-------------------------|
| 1. Water-resisting | 5. Correct flowing |
| 2. Anti-fading | 6. Anti-corroding |
| 3. Non-clogging | 7. Non-molding |
| 4. Quick-drying | 8. Anti-deposit forming |

Once you try The Parker Pen Company's new \$68,000 ink creation—Parker PERMANENT Quink—you'll pour your old ink down the drain. By actual test, Parker PERMANENT Quink in Royal Blue, Blue-Black and Black equals or surpasses 8 Gov't. Specifications shown above. PERMANENT Quink makes office records and documents as permanent as paper—flows at exactly your writing speed—works equally well in steel and fountain pens—is anti-deposit forming, 24 times better than Gov't. Standard, and 56% more anti-corrosive. And Parker Quink does this:

1. Cleans a pen as it writes—a Parker or any other pen. Contains a harmless ingredient that dissolves sediment left by pen-clogging inks.

2. Quink dries ON PAPER 31% faster than old-style; much faster than Gov't. Standard. Yet, Quink does NOT dry in a pen.

Made 2 ways—WASHABLE for home and school—PERMANENT in all standard colors for accounting and permanent documents. Parker Quink gives writing new distinction because it's always rich, brilliant—never watery. From small bottles at 15c and 25c, up to quarts, 5-gal. jugs and 50-gal. kegs.

**Parker
Quink**

Get it at any store selling ink.



BUILD CLOCKS with our help

Cash in on the demand for Mantel, Banjo, GRANDFATHER'S CLOCKS. Ask about our new, low-priced Hall Clock and Special Blue Print Offer. Send dime for illustrated working drawing of Hall Clock; 25c for plans of 16 Mantel & Banjo Clocks. Catalogue FREE.

AMERICAN CHIME CLOCK CO.

1676 Ruffner St (Established 1877) Philadelphia, Pa.



PHOTO ENLARGEMENTS

Is Photography your hobby? Do you want a profitable easy business at home? Make PHOTO ENLARGEMENTS for yourself and others. Your cost 5c each and less. The Ideal Photo Enlarger is AUTOMATIC. No experience required. Also COPIES any picture. \$5.94 COMPLETE. Interesting circular FREE.

IDEAL-O, 122 East 25th Street, New York City

5¢
ANY
SIZE

MANY CALCULATOR
CHICAGO U.S.A.
PATENT APPLIED FOR

ADDITION
SUBTRACTION
MULTIPLICATION
DIVISION

VEST POCKET ADDING MACHINE

IDEAL For Business or Personal Use. Adds, subtracts, multiplies, divides. Does work of more costly machine. Counts up to million, made of steel—weighs 8 ounces. Simple, accurate. Not a toy. Guaranteed 5 years.

— FREE TRIAL —
SEND NO MONEY!

\$2.50
Total Cost

Order from ad, not sold in stores. Just send name and address. On delivery pay postman \$2.50 (plus few cents postage). (If outside U. S. send cash.) 10c additional in Leatherette Case. If not satisfied after 10 days' trial you get your money back. Thousands of satisfied users. Write for Agents' proposition. **CALCULATOR MACHINE CO.** (Mfrs.) Dept. 313, P. O. Box 1118, Chicago, Illinois.

Easy Card and Rope Tricks

(Continued from page 128A)

Thus the fourth card, which the bystander believes to be the ace, is put in a separate pile to one side. When all the packs are separated the aces are the first, fourth, seventh, and tenth cards respectively in position. Place that packet on top of the deck. When you deal the three piles of four cards each in rotation the aces automatically fall into the first pile. Then as the spectator covers the pile of cards at one side, the pile in which he believes you placed the aces, you announce that the aces have vanished from under his hand into the first of the piles of cards you have just dealt. Upon picking up this pile the spectator finds the four aces.

The rope trick also is mystifying. The spectator cuts a piece of rope with a knife and it is then knotted together. You then restore the rope to its original form, the knot disappearing.

At the outset, hold the rope with one end in each hand. Place the end in the right hand in the left hand and draw up the center loop and place it between the two ends. In order to satisfy the audience that the rope is all right, grasp the loop in the teeth and allow the ends to fall. Then gather up the two ends in the left hand. As you pull up the loop this time hold it by the thumb and cover it with the fingers of the left hand. Loop the end of the rope nearest the palm through the center fold so it will take the place of the latter when the cutting is done. After it has been cut by the spectator, allow the two outside pieces to drop down so that four cut ends are visible. While the knot is being tied in the ends at the top, be careful to conceal the loop with thumb and fingers. After the knot has been tied securely roll the rope around your hand and while doing this, slide the false knot off the rope, and slip this small piece into the pocket. To achieve a convincing performance you should practice this trick before trying it on an audience.

Popular Mechanics Magazine does not publish the name of the maker of, or dealer in, any device described in its pages, but this information is kept on file and will be furnished by our Bureau of Information upon request, accompanied by stamped, self-addressed envelope.

"I'M KIND TO YOUR SKIN!"

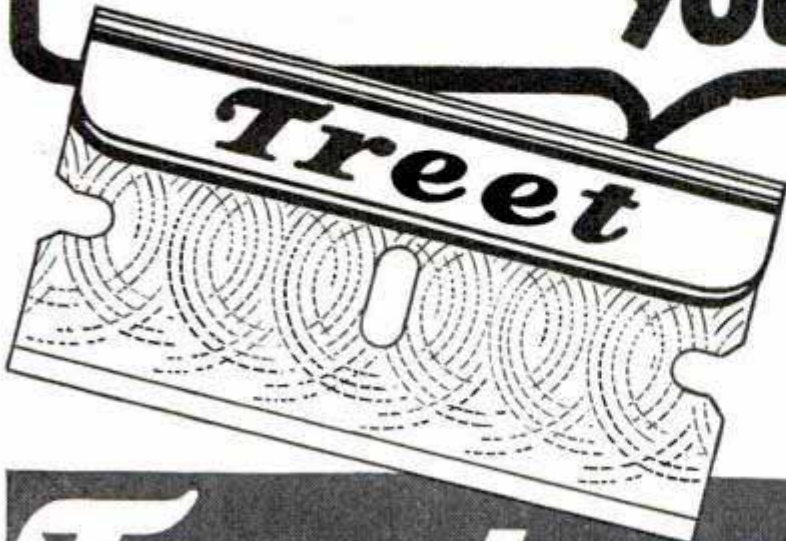

- Tough-bearded men like Treet's sharp edge! Thrifty men like Treet's *long-lasting* keenness! Better steel, better sharpening, better try Treet Single-edge Blades today!

Treet Safety Razor Corp., Newark, N. J.

Treet BLADES
FIT GEM AND EVER-READY RAZORS

4 FOR 10¢

Makes marvelous movies at everybody's price
CINÉ-KODAK EIGHT—only \$34.50
See it at your dealer's

FREE TREASURE BOOK RINGS \$1.50

30 PINS Write For Big FREE Catalog Of Pins, Rings, Emblems, Medals, Trophies, Etc.

Class Pins, any letters, numerals, colors. Silver Plate, 25 or more, 30c ea.; 7 to 24, 35c ea.; 1 to 6, 40c ea. Gold Plate, add 10c ea. to above. Ster. 50L, add 20c ea. Ster. 50L Hint shown, 20 or more, \$1.50 ea.; 12 to 25, \$1.00 ea.; 1 to 11, \$1.75 ea.

4754 METAL ARTS CO., INC. FACTORY 44... ROCHESTER, N. Y.

NEW INVENTION MAKES \$34.50 IN 5 HOURS • YOU WILL DO IT! •

With The "BIASCOPE-NICKEL-PLATED-CAMERA" Loads with 200. FILMLESS-POSITIVES In DAYLIGHT. Snaps, Develops on the Spot. Automatically Discharges TWO-PHOTOS-SIMULTANEOUSLY In One Minute; NO PHOTO EXPER. NEEDED; Men, Women—CASH IN with this FAST MONEY MAKER. WRITE FOR FREE ILLUSTRATED BOOKLET RIGHT NOW.

PACIFIC BIASCOPIES
Rm. 515-B, Cotton Exchange Building, LOS ANGELES, Calif.

\$10 UP Profit on every Dime

PAT. PEND.

Collect BIG PROFITS in Advance

Something that every man wants... **INDIVIDUAL BUCKLE AND BELT.** Every buckle different, made to personal order. Initials or name in raised letters and colors... Non-tarnishable, lasting finish. Including genuine Cowhide Leather Belt with famous "Hook-Fast" catch.



Volume orders easy from Colleges, Schools, Lodges, Clubs, Bus Companies, Group Organizations, etc. Many sales from friends, neighbors. Write today for special outfit offer.

HOFMANN "HOOK-FAST" SPECIALTIES, INC.
P. O. Box 1425 Dept. 20 Providence, R. I.

DO YOU WANT a new business profession of your own, with all the trade you can attend to? Then become a foot correctionist, and in a few weeks earn big income in service fees,—not medical nor chiropody—easy terms for home training, no further capital needed, no goods to buy, no agency. Established 1894. Address Stephenson Laboratory, 1 Back Bay, Boston, Mass.



1937 SPEED MODEL CORONA

Corona Standard (illustrated) is today's "tops" in popular-priced portables. All the usual features, free touch-typing lessons, smart carrying case... plus the effortless "Floating Shift", exclusive to Corona. Also Touch Selector, Anchored Carriage, Speed Booster, Piano Key Action... faster, easier to operate, amazingly complete. Price, subject to revision, \$49.50... or on terms as low as \$1.00 a week if desired.

Whether it's school work, business, or heavy correspondence, literary or professional work, Corona can save you time and labor. Ask for booklet.

..... **MAIL COUPON TODAY**
L C Smith & Corona Typewriters, Desk 5
723 E. Washington St., Syracuse, N. Y.

I'm thinking of buying a Corona. Please send free booklet showing models and prices.

Name.....
Street.....
City..... State.....

PLEASE PRINT PLAINLY

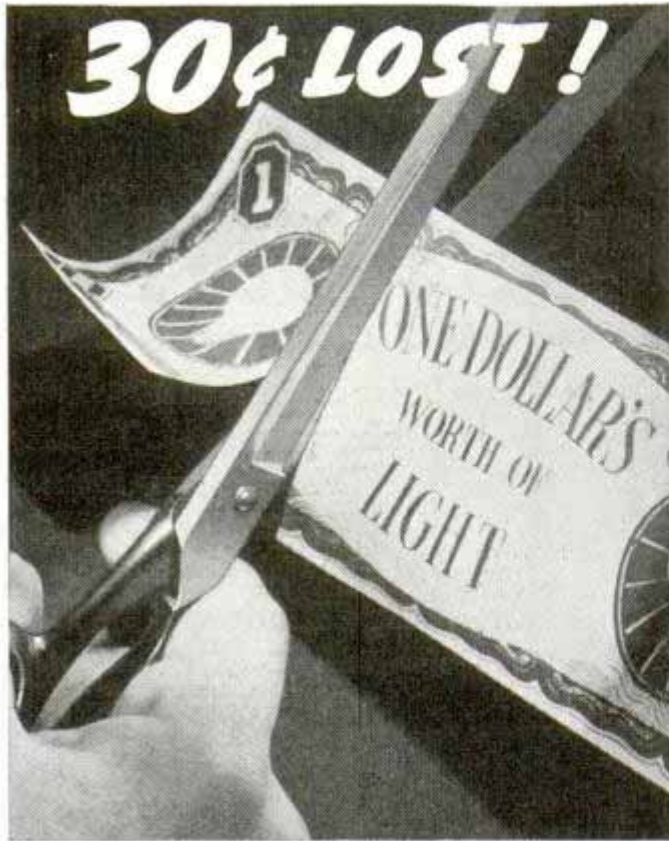

How to avoid wasting 30¢ of every dollar you spend for light

Few people know that inferior light bulbs actually *waste* electricity... often as much as 30 per cent of the current they consume. There is only one sure way to tell a good lamp. Look for the trade-mark of a reputable manufacturer on the bulb... such as the General Electric trade-mark.

Edison MAZDA Lamps don't waste electricity

General Electric makes 480 tests and inspections during the manufacture of MAZDA lamps to guard against the flaws and imperfections that are so costly to the user. Edison MAZDA lamps do not waste electricity. They Stay Brighter Longer. Why not get a supply of these good lamps today?



GENERAL  ELECTRIC

"And There Was Light"

(Continued from Coloroto Section)

are your eyes and the eyes of your family worth in dollars and cents? Aside from this, however, you'll find a pleasant surprise awaiting you when you have finished lighting your home for actual seeing. The original cost of modern fixtures and the light bill, you'll discover, both are lower than you anticipated. This will be due, in part, to the fact that you have replaced outmoded fixtures with modern ones which give you more useful light.

You probably will be forced to bid a sad farewell to some antique shades, lamps and fixtures to which you have clung for years, but in their place you will have charming new shades, graceful efficient lamps and modern fixtures designed primarily for seeing, rather than for decoration. And when you've weeded out glare, shades with colored linings and closed tops and dirty lamp bulbs, you've rid yourself of wasteful enemies which sometimes steal as much as one-half of the light you pay for. Then you're ready for real economy, because every one of your lighting dollars will buy more useful light.

As for electricity costs, you'll find that the difference between poor lighting and efficient lighting makes very little change in your light bill, once you are equipped with fixtures to give you efficient light. A living room about thirteen by twenty feet, with light wallpaper and ceiling, for instance, can be well lighted for eye comfort by using a total of about 900 watts in lamp bulbs. At an average current rate, this amount of light, with full usage, will cost a family of four a little more than two cents per person per day. And an average kitchen can be well lighted with one 150-watt bulb in a ceiling fixture and one or two sixty-watt lamps for close work at the sink and stove at an average cost of a little more than one cent an hour.

Once you've witnessed the magic of light, seen it bring new beauty and comfort into your home, observed how it enriches the patterns of upholstery fabrics and drapes and brings out new loveliness in pictures, you'll be ready to try the dramatic and luxurious things which can be done with light. You'll consider built-in lighting for bookcases, night lighting for

(Continued to page 134A)



A CANOE
FOR
TWO

GLIDE through the glories of game-filled woods—away from the world on the water. You two, a canoe and rippled reflections . . . alone on a lake with your dreams. An Old Town Canoe brings the wonders of wilderness, quiet contentment, and peace! Our Indian ancestors paddled canoes as quick and responsive as these. But an Old Town is tougher and steadier. Safe. Built to bear hard use for years. Write for a catalog showing paddling, sailing and sponson models. It is free. Also a fleet of outboard boats, including big, fast seaworthy types. Rowboats. Dinghies. Address: Old Town Canoe Company, 335 Main Street, Old Town, Maine.

"Old Town Canoes"

Rider Agents Wanted

Select from many styles, colors and sizes of Mead Bicycles. Many recent improvements. Ride and exhibit sample RANGER and make money.

Direct to Rider: We ship on approval for 30 Days' Trial—Get our marvelous offers and terms—only \$1 a week.

Tires lamps, horns, wheels, parts, equipment, and repairs at half usual price. Established 48 years.

Mead CYCLE COMPANY
DEPT. E-116, CHICAGO

Write us today for free catalog



STRING your own RACQUET



Same Quality String As in Expensive Racquets with string, tools and directions

\$1.65

SPECIAL INTRODUCTORY OFFER:

Good profits made restringing racquets, 37 ft. string. Colors Purple, Green, Red or White—also White & Blue Spiral—with contrasting silk trim, awls, stringer's wax, illustrated easy directions. Money back guarantee. Send for Free Catalog and Money Making Plan!

MAKE MONEY TOO! Send Cash, Check or Money Order \$1.65, which includes Postage and Insurance. Sent C.O.D. if desired. 15c extra.

Pro Tennis String Co., Dept. Q-8, Harmon, N.Y.

BUILD YOUR OWN

Wind Driven Light Plant

from old auto generator. We show you how. Make money building for others. Light your buildings, play radio, operate washing machine and other motors. Dime brings complete plans and 1937 catalog. Over 50 other changes for 6-12-32 and 110 volt plants.

LEJAY MFG. CO., 1447 W. Lake St., Minneapolis, Minn.

FREE Lights

ONE-MAN SAWMILL



TURN TREES INTO MONEY WITH A BELSAW

Three capacities: 10, 14 and 20 ft.

Accurate set works positive dogs.

Full or one way type power feed runs on low power—Many owners use old auto engine.

Pays for itself quickly—thousands in commercial service, everywhere. Write for free lumber handbook and catalog of mills, supplies, tools, saw tables, and woodworking equipment.

Belsaw Machinery Co., 811-D Davidson Bldg., Kansas City, Mo.

FARM MODEL \$49.00

Better, easier work



with

PLUMB
DOUBLE LIFE
Hammers Hatchets
Files Sledges Axes

● Modern design gave the Plumb Nail Hammer a *built-in balance* that helps you do a better, easier job . . . makes it rise, fall and strike as part of your arm.

Craftsmen everywhere *feel* this the minute they heft the Plumb. The handle is tapered to give a safe, comfortable grip...with flared end to prevent slipping. The neck is slim and supple, with more spring.

The head is a marvel of streamlined beauty; the claws catch the head of a closely driven nail; their beveled edges grip the smallest brad. The wide chamfer around the face guards against chipping and marring your work.

● Go to your hardware dealer. Select the Plumb Hammer (shown here). Look for the Red Handle and Black Head, and the Patented Take-Up Wedge.

FAYETTE R. PLUMB, Inc., Phila., U.S.A.

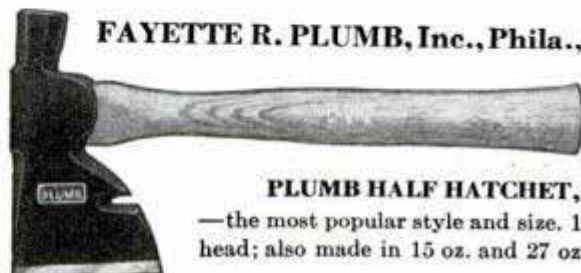

PLUMB HALF HATCHET, 2962

—the most popular style and size. 1 lb., 5 oz. head; also made in 15 oz. and 27 oz. weights.

(Continued from page 132A)



"Be Oil Wise", says
 This canny bird—
 The best advice
 You ever heard.
 Use Pennzoil, and
 Have less to pay
 For gas and oil,
 Day after day.
 With mileage up,
 Your bills decline;
 Save money at
 The Pennzoil sign.



Thompson
BEATS
the World
on BOATS

**Only Boats With
 Full Length Spray Rails**

Keep passengers perfectly dry—even at high speeds. Catalog also shows today's five most popular models of sailboats. Two big factories. Prompt shipment.

CATALOG FREE

Write for your copy. State kind of boat in which you are interested.

THOMPSON BROS. BOAT MFG. CO. (79)
 213 Ann St. Write to either place
 PESHTIGO, Wis. 113 Elm St.,
 CORTLAND, N. Y.

**Better Built
 Lower Prices**

Canoes \$54 and up

Rowboats \$42 and up

Outboards \$42 and up

Very fast utility model

halls, panel lighting for mirrors, three-way switches to operate your garage lights from the house and color lighting for the garden and for certain inside areas.

And you'll discover that color in lighting lends a new beauty to your home, when properly used. In fact, color and light are the same thing in their general sense. A flower appears of a certain color because it absorbs light of a certain wave length. Thus, a blue flower absorbs red, orange and yellow rays. All colors of the spectrum are contained in daylight because it is a mixture of all the wave lengths of light.

Perfect daylight is thirty-two per cent red, thirty-two per cent green and thirty-six per cent blue. For years lighting engineers have been searching for a combination of artificial light which will offer a similar color band, and thus provide real man-made daylight. Recently a light has been developed which gives real daylight within two points.

Perhaps you'll discover that the color lighting in your home will "match your eyes." Brown and black-eyed people usually prefer red and other colors associated with autumn, russet, brown, gold, purple, orange and the darker shades of green. Blue-eyed people are partial to blue as well as the lighter hues such as yellow, pink, jade and light green. But if you're color blind, you won't care what color scheme is used because, in one type of color blindness, red and green appear gray, while in another type, blue and yellow also appear gray. You'll find, too, that optical illusions can be created with the aid of colors. The flag of France, for instance, has its three stripes made in the proportion of thirty for blue, thirty-three for white and thirty-seven for red so they will appear to be of equal width when seen side by side.

But, whether or not you go in for color, you'll discover, as others are doing, that once you begin to enjoy the real magic of good lighting, once you begin to really see after dark, nothing could induce you to go back to those "cozy" dim lights with which you used to abuse your eyes. Those dim lights hidden under big, heavy shades you'll see for just what they are—relics of the tallow-candle age, decrepit heirlooms of the past.

Governs Speed OF ANY GAS ENGINE

Take any car motor out of the chassis, equip it with a Pierce Universal Governor, and you have a stationary power unit that runs steadily enough to operate even an electric welder. And that's some test for close speed regulation.

Pierce Universal Governors are standard controls on gasoline engines for commercial purposes—for electric lighting plants, refrigerating units, air compressors, feed grinders, hoists, saw mills, welders, etc.

Pierce Universal Governors are the time-tested flyball type and respond instantly to each change in engine load, maintaining uniform speed. Belt driven, either V or flat. Easily installed and never equaled for close regulation of speed and for dependable performance.

Write for illustrated literature and prices, whether you want to equip one used motor or a thousand new ones.

The Pierce Governor Company
1600 Ohio Avenue, Anderson, Indiana



A Pierce Governor puts "brains" into any gas motor.

Synco JIG SAW

FASTER—SAFER—CLEANER

Astounding performance! Cuts up to 1" or more, with smooth, clean edges. No sanding required. Accurate, sturdy, efficient—a revelation to skilled craftsmen in handling both intricate designs and heavy work. Ideal for cutting light metals, veneers and plastics. Operates on 60 cycle, 110 volt AC, without motor or any reciprocating parts. Requires no oiling. 10" square table; 13 1/2" throat; adjustable guide; variable stroke. Complete with underwriters approved cable and rubber plug. Built for years of continuous service.



Electric Operation

7200 Strokes per Minute

No Motor Required

FREE FOLDER

GET FREE LITERATURE TODAY
Ask your dealer to show you the models now available. Or send your name for full information and illustrated literature, FREE.
SYNCO DEVICES, INC.
511 Boydell Building Detroit, Mich.

OTTAWA LOG SAW

only \$39

GREATEST OFFER EVER MADE

PUTS THIS OTTAWA TO WORK FOR YOU

Make Money!

Wood is valuable. Saw 15 to 20 cords a day. Does more than 10 men. Ottawa easily operated by man or boy. Falls trees—saws limbs. Use 4-hp. engine for other work. Write today for FREE book.

OTTAWA MFG. CO., 513 Wood St., Ottawa, Kansas

NEW JUNIOR DRILL \$19.95

BLACK & DECKER

605 Penna. Ave., Towson, Maryland

INVENTORS Be Sure to See Page 23A

ALL-PURPOSE MOTO-TOOL

Does many jobs speedily, easily—grinds, drills, engraves, sharpens, routs, carves, polishes, etc. Universal motor—about 20,000 R.P.M.—plugs in any light socket A. C. or D. C. Handles as lightly as a pencil. Weighs 6 oz. and is amazingly powerful. Oilless—self aligning—ball thrust bearings.

TEN DAY TRIAL, satisfaction guaranteed or money back. 20 pc. general utility tool set \$5.75 extra. Send for Free Booklet.
DREMEL MFG. CO., 1117-Ct., Racine, Wis.

only \$9.85

TO GET A STRONG HOLD OR TIGHTEN LOOSE PARTS

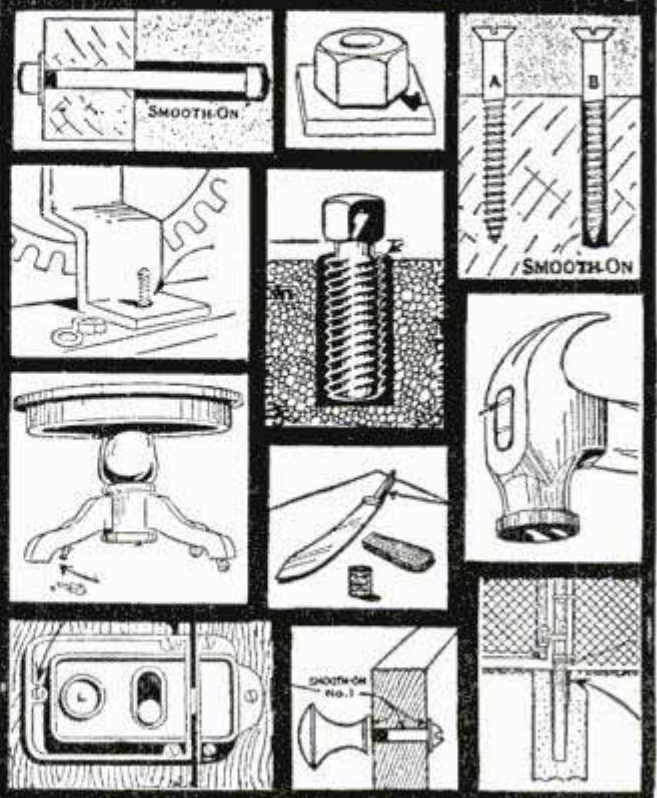

Smooth-On No. 1 restores full usefulness of household fixtures, utensils and tools that would otherwise have to be discarded.



Write for FREE BOOK



Do it with SMOOTH-ON

SMOOTH-ON MFG. CO., Dept. 37, 574 Communipaw Ave., Jersey City, N. J.
Please send the free Smooth-On Repair Book.

Name.....
Address.....
5-37.....

Try it for tightening loose parts and stopping leaks, use it also on your car for stopping leaks in the radiator, hose connections, gas tank, oil and exhaust lines, for patching cracked water jackets, for tightening loose hub caps, mud guards, lamp and tire supports, etc.

Smooth-On No. 1 is simple to apply and hardens to everlasting tightness. Merely follow directions in the Smooth-On Book which is sent free if you return the coupon.

Buy in 7-oz., 1-lb. or 5-lb. can from your nearest hardware store.



A new sponge made (like rayon) of Cellulose. Soft, durable, sanitary, absorbent.

Get this
AMAZING SPONGE
FREE

with every
pint can of

No. 7
POLISH



WE make this generous offer so that new thousands of car owners will try No. 7 Duco Polish immediately, and see how greatly it improves the appearance of the car. You should use No. 7 Polish on

new cars as well as old. It keeps new cars beautiful and restores the color and lustre of old finishes dulled by grime and Traffic Film.

Now we offer a Du Pont Cellulose Sponge (25c size) FREE to everyone who buys a pint can of No. 7 Polish. (Offer good in U. S. only.) This sponge, created by du Pont chemists, is ideal for bath and household cleaning, as well as for the car. See your dealer **WHILE THEY LAST!**

GRIME DOES NOT PAY
... USE No. 7

(Continued from page 114A)

actors in table-top camera dramas. Fruits and vegetables can be made into grotesque figures.

There are two easy ways of making silhouettes. Stretch a sheet across the room and place floodlights some distance behind it, facing the camera. Station your subjects so that they are outlined against the white sheet—either in front of the sheet or behind it, according to the effect desired. Then make a short exposure. In this case you must forget the old rule to expose for the shadows; expose, instead, for the light. Another method is to cover a window with white tissue paper or cloth and paste cut-outs on it—a candle, a



Swift action enhanced by lights and shadows as five skiers race down mountainside against setting sun

wreath, or a lettered greeting. Or a child's profile, or a family pet, can be silhouetted in the window. Again, a short exposure will do.

Be alert for the unusual and the beautiful: patterns in sand, a dog's ear cocked attentively, the view from behind a dentist's chair with his drill silhouetted against the window; frogs posing in your home aquarium, a trail in deep snow, giant locomotive wheels shot from a close angle—all these pictures are worth money to someone, worth a place in your own "gallery."

And remember, as the shutter clicks—the cameramen who are "tops" today were amateurs day before yesterday.

Our Bureau of Information will answer questions regarding articles in this magazine, if accompanied by return postage.

DIESELECTRIC PLANTS

UNBELIEVABLE ECONOMY

Produce **ELECTRIC LIGHT & POWER**
for **LESS than ONE CENT per KILOWATT**

Simple in design and construction, the WITTE is the most important development in the small engine field. Thoroughly modern in every respect, incorporates every worth-while advance in Diesel Engine design. The 1600 watt Dieselectric Plants are small, compact and radiator cooled. Installation is simple—upkeep low—unusual flexibility for power applications. 110 volt A.C. and D.C. plants for direct lighting. 32 volt plants for low cost battery charging.

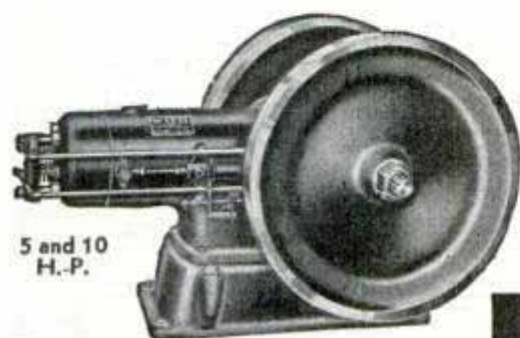

5 and 10 H.P.

110 Volt D.C.

\$565

F.O.B.
Kansas
City,
Mo.



1600 WATTS

3000-6000
WATTS

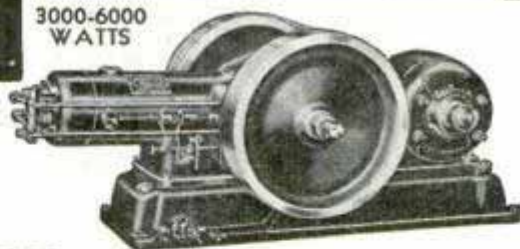

Make your own electric light and power—be independent of the power companies. Cut your power bills 75% with a WITTE Dieselectric Plant 1600 to 6000 watts. Smooth, flickerless current—close voltage regulation. Alternating or direct current. Uses non-explosive fuel. WITTE Diesel Engines offer the small power user the same important features, operating characteristics and startling economy of the large Diesel. Quality assured by more than 67 years of manufacturing experience.

CHOOSE A DIESEL FOR POWER ECONOMY

WITTE Stationary Diesel Engines are offered in 3, 5 and 10 H.-P. sizes. Install a WITTE Diesel and **watch it pay for itself.**

RESPONSIBLE DIESEL DEALERS WANTED

1745 Oakland Ave.

Kansas City, Mo.

WITTE ENGINE WORKS

BURN YOUR NAME ON TOOLS

WITH THE ARKOGRAF

PROTECT YOUR TOOLS FROM THEFT

Write with electricity any name or design on the hardest and finest tools and instruments, or any metal, like writing on paper with pen or pencil. **Complete Outfit \$3.50—Prepaid Anywhere** Interesting illustrated circular free. **Write today.** Agents wanted. **ARKOGRAF PEN CO., 3927 S.E. Stark St., Portland, Ore.**

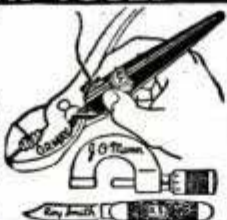

MICROMETERS

Six piece set, in velvet lined leather case. Special price, only \$11.95. Precision machined in one thousandths, up to 4" outside and 3/4" inside measurements. Guaranteed accurate, easy to read and adjust. Satisfaction guaranteed or money back.

This is your opportunity to get one at a Bargain Price if you act now. Shipped prepaid on receipt of remittance. On C.O.D. shipments, send deposit of \$2.00.

FREE FOLDER

MICRO PRODUCTS, 529 E. Jefferson Ave., Detroit, Mich.

SEND 25¢ FOR A COPY OF

HOW TO RUN A LATHE

RUNNING A REGAL

Special low price for complete 72-page Manual of Operation and Maintenance of Modern Geared Head Engine Lathes for student, apprentice, home mechanic. Written in simple language... easily understood... profusely illustrated. Includes technical data, metric conversion tables, etc. Supply limited. Write today for this big value text book. Address Department P 34 G.

THE K. LeBLOND MACHINE TOOL CO.
CINCINNATI, OHIO

New HULL AUTO COMPASS



Saves miles of travel in wrong direction. This handsome, STREAMLINE Airplane Type Compass keeps you on the right road. Easily installed. 3 1/2 inches high. Bakelite case, sapphire bearing. Built-in compensator. Only \$2.95 POSTPAID. SATISFACTION GUARANTEED.

MODEL A

Airplane Type. 1 3/4-inch diameter. Sticks to windshield. Guaranteed. With separate compensator, only \$1.95 POSTPAID.

If your dealer cannot supply you, order direct.



HULL MFG. CO., Box 246-D, WARREN, OHIO



BALL JOINT \$1.95

AUTO TRAILER COUPLER

Rocky Mt. States West, \$2.25. Postpaid

ADJUSTABLE BUMPER HITCH \$1.35

This hitch can be put on, taken off, or adjusted to 6 different positions with a wrench. Postpaid, \$1.35 without ball. (Rocky Mt. States West \$1.50.) Write for catalog on trailer hardware and camping trailers. **ZAGELMEYER AUTO CAMP CO.** 1475 S. Henry St. Bay City, Mich.

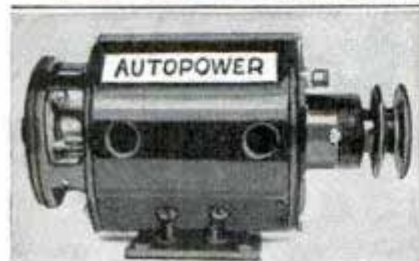

TURN SCRAP INTO MONEY

AUTOPOWER tells you how in plain, easy, simple, and illustrated instructions that anyone can follow. Change auto generators into useful, practical A C and D C generators and motors with voltage from 2 to 1,000 volts, for power, light, welding, radio, sound, etc. No previous experience nor special tools needed. Generators can be driven by wind, water, fan belt, etc. Already used and endorsed by thousands. Send today for your copy, and also receive FREE a copy of PRACTICAL ELECTRIX, the new publication for the man who wants to KNOW, BUILD, REPAIR and READ about electrical apparatus and machinery. Book and magazine postpaid only \$1.00.

AUTOPOWER,

Dept. N

410 S. Hoyne Ave., Chicago



Mechanical devices, ancient and modern, have counterparts in plant life



On the newsstands now, and selling fast. Get your copy today. Better still, use the coupon for a year's subscription and be sure of getting every issue. Any one may contain an article affecting your business or profession.

SINGLE COPY 25¢

A YEAR'S SUBSCRIPTION \$2.50

Outside the Americas and Spain add 50 cents for overseas postage.

Science Digest, Inc.

631-643 St. Clair St., Chicago, Ill.

Gentlemen: I enclose

- 25c for May Science Digest
 \$2.50 check or money order for a year's subscription beginning with May issue.
 Please bill me for year's subscription.

Name.....

Street.....

City.....State.....

FOR the scattering of their seeds, plants employ devices similar to the airplane, the parachute, the catapult, the compressed spring, the explosive bomb. Anyone with a mechanical turn of mind can read with interest "Ingenuity of the Plants" in the May issue of Science Digest.

And perhaps with profit you can read "The Diamond—Keenest of Tools" because in certain work where other material had to be renewed each day, the diamond die showed no wear in six months' time.

These are but two of the many absorbing articles in the May issue of Science Digest that deal with men and plants, with chemistry and astronomy, with birds and insects—scientifically but readably.

Always concise, clear, and easy to read, Science Digest presents ninety-six pages of editorial devoted to scientific progress in all its branches.

Men and women, in business, in industry, in the professions, are reading Science Digest. Every issue brings hours of fascinating reading. Any issue may contain an article of profit to you. Your subscription mailed today will insure your receiving every number.

BETTER USE THAT CONVENIENT COUPON NOW

When writing to advertisers please mention Popular Mechanics

2014
Cross-Canada Airway Next

(Continued from page 643)

the airway by the Canadian government. Safety has been stressed at every point. For instance, when surveyors found that fog was prevalent near Lake Superior the route was changed to run farther north through a region known to be free from such weather. Because of Canada's low temperatures in winter the operators do not expect interference with flights from ice forming on the wings. This condition, which has caused serious difficulties in the Great Lakes and Atlantic coast regions of the United States, occurs when the temperature is hovering around freezing point and the atmosphere is heavily charged with moisture.

The Canadian airway will operate for the first year as a mail carrier, although some express may be accepted. Passenger service may be offered on limited sections of the line. The operators will be a private company, with railway and Canadian government helping financially. Ground operations will be under direction of the air-service branch of the Dominion department of transport.

Mail has been taken off inbound ships by government planes for several years, saving twenty-four to forty-eight hours in delivery as far west as Winnipeg. This service has been operated only in summer. But the new airway will send faster planes to meet all ships coming to Canada on the Atlantic and the Pacific and will accept first-class mail at no extra cost for faster delivery to any point in the Dominion. When transatlantic service from England is begun air-mail costs within the empire, which includes Canada, will be three cents per half ounce.

The route of the airway will be from Halifax to St. John, New Brunswick, across the state of Maine, to Montreal, where the transatlantic and United States routes will connect. From Montreal via Ottawa, Elmsdale and Cobalt the air liners will speed west across northern Ontario to Winnipeg. At Elmsdale planes from Toronto and Buffalo connect. Then the route touches Regina, Lethbridge, Cranbrook and Princeton before arrival at the Pacific coast destination, Vancouver. Connections with United States lines are made at Winnipeg and Vancouver and with Arctic routes at Winnipeg and Lethbridge.

Here's Why
 Clark Gable
 Switched to
 Dodge



CLARK GABLE, now appearing in Metro-Goldwyn-Mayer's "Parnell," says: "I switched to Dodge because it handles so magnificently...and has all the swift smoothness I enjoy in driving." Thank you, Mr. Gable! You're one of the thousands of motorists—people who, like yourself, can afford the most expensive cars—who are switching to Dodge! See this new Dodge! Drive it! And remember, Dodge now delivers for just a few dollars more than the lowest-priced cars!

DODGE
 Division of Chrysler Corporation
 Easy terms gladly arranged to fit your budget, at low cost, through Commercial Credit Company.

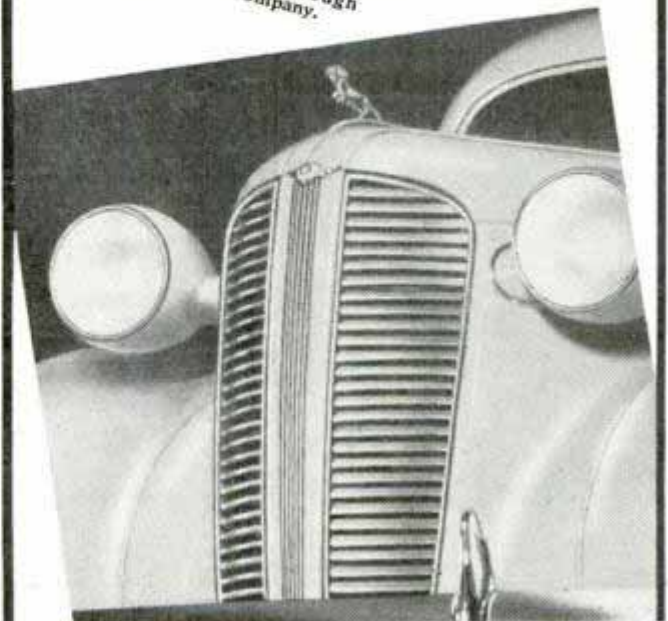

Sensational BARGAINS

Guaranteed \$102.50 Model

Now Only

\$44.90 Cash or

On Easy Terms

Small Carrying Charge

10 Day Trial
No Money Down



Fully Guaranteed

Positively the greatest bargain ever offered. A genuine full sized \$102.50 office model refinished Underwood No. 5 for only \$44.90 (cash) or on easy terms. Has up-to-date improvements including standard 4-row keyboard, backspacer, automatic ribbon reverse, shiftlock key, 2-color ribbon, etc. The perfect all purpose typewriter. Completely rebuilt and FULLY GUARANTEED.

Learn Touch Typewriting
Complete (Home Study)
Course of the Famous Van Sant Speed Typewriting System—fully illustrated, easily learned, given during this offer.

Money Back Guarantee

Send coupon for 10-day Trial—if you decide to keep it pay only \$3.00 a month until \$49.90 (term price) is paid. Limited offer—act at once.

INTERNATIONAL TYPEWRITER EXCHANGE
231 West Monroe St., Chicago, Ill., Dept. 501.
Send Underwood No. 5 (F. O. B. Chicago) at once for 10-days' trial. If I am not perfectly satisfied I can return it express collect. If I keep it I will pay \$3.00 a month, until I have paid \$49.90 (term price) in full.
For quick shipment give references and occupation.

Name.....Age.....
Address.....
Town.....State.....

2 DOG WORM CAPSULES

Now Combined in

ONE TREATMENT

NO LONGER need you guess which kind of worms afflict your dog—or guess which type capsule to use. Pulvex Worm Capsules expel "all three": Tape and Round, and Hook worms. Now you can be sure of worming your dog correctly. Easily given. No gassing, gagging or harmful effects. Guaranteed. At pet, drug, department stores, 75c.

Expels
HOOK, TAPE
and ROUND
WORMS



PULVEX WORM CAPSULES



NEW Light Weight Paint Sprayer—Only \$31.15

1/4 H.P. Motor AC110 Volts. 60 Cycles—COMPLETE
Quick, easy way to paint screens, furniture, radiators, machinery—anything—in homes, factories, stores, schools, hospitals, office buildings, etc. Small, compact. Carry anywhere. Weight 44 lbs. Complete with Spray Gun; 15 ft. Hose. FULLY GUARANTEED. Only \$31.15 f.o.b. Chicago. \$5.00 Deposit, Balance C. O. D., or see your dealer. Free Circular. Ideal Pump Co., Dept. P-5, 801 Washington St., Chicago, Ill.

450 Miles In a Gallon of Gas!

Potential Gasoline Mileage

ACCORDING to an article by the president of the world's largest motor research corporation, there is enough energy in a gallon of gasoline if it were converted 100% in mechanical energy to run a four cylinder car 450 miles.

NEW GAS SAVING AND TOP-OILING INVENTION Astonishes CAR OWNERS

A Marvelous Device has accomplished wonders in utilizing a portion of this waste energy. It saves gasoline, gives better mileage, reduces carbon formation, creates more power, gives quicker starting, snappy pick-up and a smoother running motor. Saves many repair bills.

Big Profits and Free Offer! ... To obtain national distribution quickly, men are being appointed everywhere to help supply the tremendous demand. Free samples furnished to workers. Write today for this free sample and big money-making offer.

Diamond Fuelizer, Dept., 157, 600 High St., Akron, Ohio

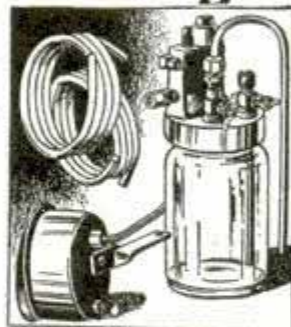

COLUMBIAN METAL BOATS

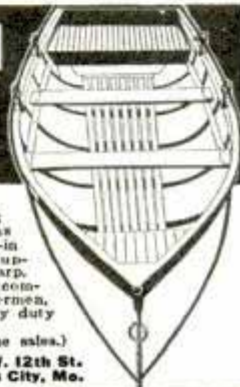

Light weight, durable, carefully built of toughest galvanized copper bearing steel; low prices. Wood gunwales. Heavy transoms for out-board motors. Two or more built-in air chambers for extra buoyancy in case of upset. Easy to handle. Never leak or warp. Write for Free Boat Booklet and prices of complete metal boat line—knockabouts for fishermen, light weight lively boats for resorts, heavy duty craft for out-board motors. (Dealers wanted—who can develop volume sales.)

Columbian Steel Tank Co. 1509 W. 12th St. Kansas City, Mo.



FREE—32-page catalog

Spray gun \$6.96—Wet grinder with 10 x 1 1/2" sand stone and jack shaft \$7.45—Back gear Power Hack Saw with vise \$7.95—1/2" Elec. Drill \$8.95—Spray Unit Comp. with 110 V. A.C. Motor (1/2 H.P.) and gun \$14.95. Compressor only \$3.75. Many other tools at popular prices. FREE CATALOG.

BALKO ELECTRIC MOTOR & SUPPLY COMPANY
Dept. A15 10 S. Clinton St. Chicago, Ill.

MAKE ORDINARY STONES LOOK LIKE PRECIOUS GEMS

Everyone picks up pretty stones on their hikes at summer camps. Don't throw them away! With the new, inexpensive Johns Gem Cutter YOU can polish them for a collection or for jewelry. ASK US HOW—Send for folder "P."

THE JOHNS COMPANY

SAPPINGTON, MO.



Print Your Own

Cards, stationery, circulars, tags, labels, advertising, etc. Save money. **Print for Others; Big Profits;** easy rules sent. Will do popular Raised Printing like Engraving. Junior press \$3.90, job presses, \$11 up, power \$149. Send for free catalog and all details. **THE KELSEY COMPANY, R-37, MERIDEN, CONN.**

NEW BOOK CRAFTSMEN SHOULD HAVE—100 Pages—No. 9—Make Beautiful Furniture

10c
Rebated
on first
order.

at a fraction of store cost. 14 pages of lumber with prices. Veneers and plywoods of all woods cut in usable sizes without waste. USE THE CRAFTSMAN new process of inlaying, using our new process ART INLAY GLUE, needing no clamps for the finest work. Hard-to-find rare grains for all wood, including foreign.—hard-to-find cabinet hardware. Lists and illustrates 76 blueprints of scroll patterns, inlay table tops—Kits for inlaid art boxes, plaques, trays, book ends, etc., that anyone can make—22 pages in color. VENETIAN BLINDS for one-third of usual price. All material requiring only a saw, screw driver, a tack hammer and paint to assemble.

CRAFTSMAN WOOD SERVICE CO. 2721 MARY STREET CHICAGO

**Make Glazed Concrete Products
NEW MONEY MAKING BUSINESS**



MAKE beautiful, colored glaze finishes on concrete pottery, tiles, walls, novelties. New, perfected, low cost method. Make 2,500 designs of vases, jars, birdbaths, etc., without molds, power or costly tools. Use only sand and cement. No experience needed.

Decorative waterproofing, pottery making, statuary casting, giftware. Send 10c TODAY for illustrated booklet, folders, color plate, cost data and complete information about this new money making business for men.



NATIONAL POTTERIES COMPANY
13 West 26th Street, Form 21
Minneapolis, Minnesota

BIG 1937 LEADER

For greater profits, steady income and repeat business, sell Century.

GENUINE LEATHER TIES
NO SALES EXPERIENCE NEEDED. Beautiful 4-in-Hands for Men and Boys, sell on sight, everybody buys. LOOK LIKE SILK; cleaned with a damp cloth. Famous Century Bows sell to uniform men, such as policemen, firemen, letter carriers, etc. Write today for our new FREE DEAL OFFER, or send 50c for samples, 4-in-Hand and Bow.
CENTURY TIE CO., 2345-L, W. Grand Blvd., Detroit, Mich.



**FREE ELECTRICITY
From Wind Power**

For Lights, Power, Radio, from Auto Generators. New Copyright Book with over 100 Facts about Wind Chargers. Wind-Propellers—Generators—Plants—Batteries. Answers all questions you should know. Including plans for 6 or 32 V. Plant. Send 25c for plans, facts and catalog.

CURRIER MFG. CO.

421 Terminal Minneapolis, Minn.



DEAFNESS IS MISERY

Many people with defective hearing and Head Noises enjoy Conversation, Movies, Church and Radio, because they use Leonard Invisible Ear Drums which resemble Tiny Megaphones fitting in the Ear entirely out of sight. No wires, batteries, or head piece. They are inexpensive. Write for booklet and sworn statement of **DRUM** the inventor who himself has been benefited by the use of the drums.

A. O. LEONARD, Inc., Suite 699, 70 5th Ave., New York

RADIOS..SAVE UP TO 50%

DEAL DIRECT...FACTORY PRICES! Many models to select from: AC-DC; All-Wave; Farm sets that operate like city radios! Your name and address on postcard brings you NEW Bargain Catalog in colors FREE. Get details of 30-DAY TRIAL plan and agent-user proposition! **GOLDENTONE RADIO CO.** Dept. E5, DEARBORN, MICHIGAN

Free Catalog

30 DAY TRIAL \$6.98 UP

GET YOUR TRACTOR AT FACTORY PRICE

3 Speeds Forward and Reverse. Runs 4 to 8 hours per gal. Amazing money maker for farms, truck gardens, orchards, nurseries, poultry ranches, country homes, etc. Plows, discs, harrows, cultivates, mows lawns, cuts lawns, runs belt machinery. 2 to 6 H.P. riding or walking types. Write for FREE CATALOG, Low Factory Prices and 10 day Trial Plan. Address Nearest Office.

SHAW MFG. CO., 4505 Front St., Galesburg, Kans.
130 G West 42nd St., New York, N.Y., 5812 G Magnolia Ave., Chicago, Ill., 668 G North 4th St., Columbus, O.

SHAW DU-ALL TRACTOR

Air Tires or Steel Wheels

Earn Money Re-stringing TENNIS BADMINTON and SQUASH RACKETS!

AT HOME

Make big profits restringing rackets for tennis, badminton, squash players — and save money on your own tennis cost. Work at home in spare time. We show you how and supply equipment, instructions. Everybody's playing tennis and badminton! CASH IN! Write quick for free details and



WILLS' Free 1937 TENNIS BARGAIN BOOK listing everything for tennis players and re-stringers at money-saving prices. Send coupon now!



JUST OUT!

DON'T buy any racket, silk or gut strings, re-stringing equipment, or tools — till you see **WILLS'** marvelous new Tennis Bargain Book — just out. Here's a real opportunity for you to pick up some easy cash this season and to save money on your own tennis supplies.

Buy Gut Direct and Save!

Buy quality gut strings direct from manufacturer and save! Save on Silk strings too! Prompt service. Satisfaction guaranteed! Rush coupon for your free Tennis Bargain Book before they're all gone!

H. E. WILLS CO.

1047 W. 47th St. Chicago Dept. 1355



Un-Strung Racket Frames for Badminton, Tennis and Squash!



Rubber Handle Grip! Pure gum rubber, red or black colors. Priced low.



MAIL COUPON NOW!

H. E. WILLS CO. 1047 W. 47th St., Dept. 1355 CHICAGO, ILL., U. S. A.

Gentlemen: Please rush me your Special Money-Making Plan, and new, 1937 TENNIS BARGAIN BOOK, without cost or obligation on my part.

NAME.....
St. & No.....
CITY.....STATE.....

RESET LOOSE CASTERS

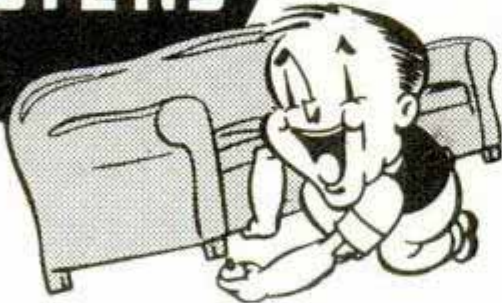

Now... It's Easy To Make 1001 Repairs!

Fix... once and for all time... those pesky things around the house that are always needing attention—

- Loose casters, drawer pulls
- Loose bathroom fixtures
- Broken furniture
- Loose tiles
- Cracks in baseboards, floors
- Old nail and screw holes
- Etc., Etc.

Plastic Wood—the marvelous preparation that handles like putty and hardens into lasting, waterproof wood—will end these and other troubles forever. It adheres to wood, metal, tile, stone, porcelain—holds nails and screws without splitting and can be finished just like real wood. You can get handy Plastic Wood in cans and tubes—in 9 colors including white—at all paint, hardware and variety stores. Try it—you'll say it's great.



HALF AND HALF MAKES ONE SWELL SMOKE! RE-STRING RACKETS AT HOME



• EARN MONEY •

It's easy, pleasant, profitable work. No experience required. Learn in a FEW MINUTES. I supply everything needed. Earn \$50 to \$100 cash in your spare time. Act QUICK—write for details FREE.

Set Permatex Silk Strings with instructions, postpaid, **SPECIAL 50c**
W. A. BICKEL, Dept. A-5, 809 W. Madison St., Chicago, Ill.

Six-Volt Battery Receiver

(Continued from page 739)

there is a 6-volt storage battery available.

The power pack is built on a separate sub-base and then assembled on the chassis by means of shock-absorbing para-rubber grommets to insure freedom from noise. It employs a 6-prong synchronous vibrator of the standard plug-in type used in high-grade auto receivers. Figs. 1 and 2 show simplified wiring diagrams of this unit; a photo of the complete assembly appears in photo 2-A. The 6-volt vibrator transformer delivers 150 volts at 30 ma. and has a static shield built into the core; this is grounded on the base by means of the blue lead. Photos 2-B and 2-C show under-

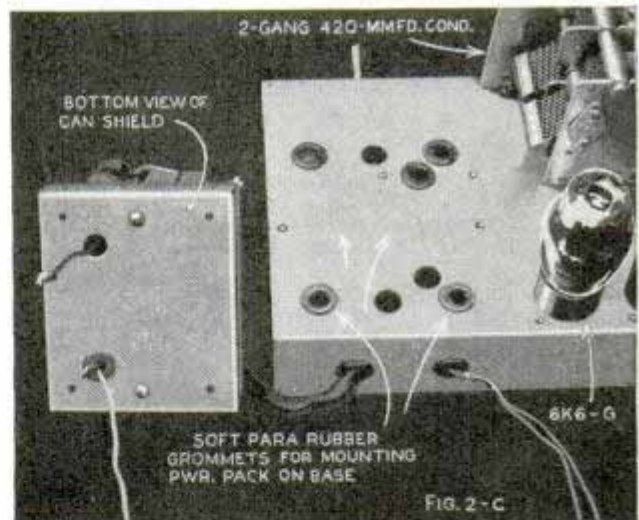

side views of the completed unit. This power pack is available assembled and wired, if desired.

A carefully prepared simplified wiring diagram of the receiver proper appears in Fig. 3, and the complete schematic circuit diagram is given in Fig. 4. Photos 3-A, 3-B and 3-C show various views of the top and underside of the completed receiver. All parts specified for this set are available at reasonable prices; the type-G tubes have glass bulbs and are equipped with octal (8-prong) bases. These tubes cost no more than former types and the set is designed so that similar metal tubes may be used. However, the metal tubes

(Continued to page 152A)

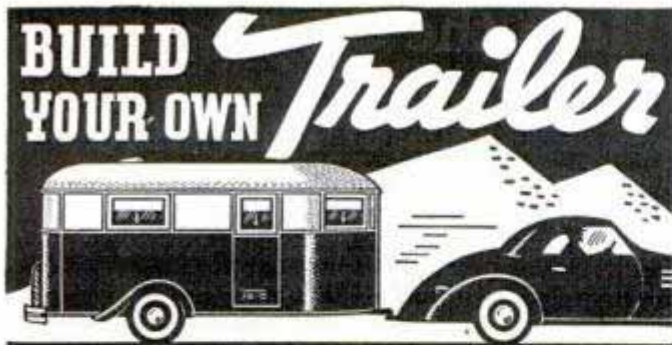

BUILD YOUR OWN Trailer

WE FURNISH THE PLANS AND PARTS

You can build the Jim Dandy Cabin Cruiser—the trailer that has everything—save money and have a better trailer. Plans and instructions are easy to follow and show you how to build a substantial chassis and body. Finish and equip it to suit yourself. No special skill or tools required. Can be built in any size. Rush \$1.00 for these plans today. Include 25c more and

Get Our Big New 1937 Catalog

and Trailer Builders Manual—the most valuable book ever published for Trailer Builders and Owners. Full of helpful ideas and suggestions. Tells what you've wanted to know about trailers. Catalog illustrates and describes over 500 items of Parts, Supplies and Equipment. Everything is here from wheels to top at the lowest, money-saving prices. Get this book. Everybody highly pleased. Satisfaction Positively Guaranteed!

Rush 25c for this Valuable Book Today 25c in U. S. 50c in Can.



TRAILER SUPPLY CO.

Box 4381, WAUSAU, WIS.



GERSTNER Tool Chests

Sound Construction of Assures long life. Free catalog shows many styles for Machinists and Toolmakers. GERSTNER TOOL CHESTS 465 Columbia St. Dayton, Ohio



ACE Set Tools for every operation on metal-cutting lathes \$14.50

Insist on ACE Tool Holders Drop forged by ARMSTRONG, makers of cutting tools used by 95% in industry. 8 ACE TOOL HOLDERS with Cutters and Wrenches in fitted steel case—Turning, Boring, Knurling, Threading and Cutting off.

Write for Circular ARMSTRONG BROS. TOOL CO. "The Tool Holder People" 368 N. Francisco Ave., CHICAGO, U.S.A.

STANDARD GARDEN TRACTORS

Plow Seed Cultivate Mow Hay and Lawns Powerful Gas Tractors for Small Farms, Gardeners, Florists, Nurseries, Fruit Growers & Poultrymen. 1 & 2 Cylinders Walk or Ride-Do Belt Work High Wheels—Free Catalog

STANDARD ENGINE CO. Minneapolis, Minn. Philadelphia, Pa. New York, N. Y. 3221 Como Ave 2546 Market St. 290 Cedar St.

HIGH POWERED TELESCOPE

GENUINE AMERICAN MADE BROWNSCOPIES Most powerful made for the money! 15 power long range telescope. Can see moon's craters or time on pocket watch a block away, 5 sections Approx. 3 ft. long. Fine lenses. Brass bound. Can be used as powerful microscope. Vol. magn. 512X. Only \$1.09 postpaid. C. O. D. 24c extra.

\$1.69

Special Super-Power 30X Telescope Similar to above but more powerful. Guaranteed to see 900 times larger in surface and 30 times closer, 31 mm. objective 4 powerful lenses. Large field. Includes powerful microscope feature. 5 day money back guarantee. Only \$1.98 postpaid.

BROWSCOPE CO., Dept. 45, 234 Fifth Ave., NEW YORK, N. Y.

Sell Improved Leather Ties. DON'T waste effort on second raters. Sell fast and repeat on handsomest improved ties. Rich colors, embossed like silk. Fulllest cut; long wear; wrinkle-free. Wipe clean like new with damp cloth. Send 50c for sample tie (65c value) and Big Free Sales Kit of new season's smartest patterns. Money back plan. Free premiums.

NU-MODE TIE CO., Dept. 202 1333 N. 12th Street Milwaukee, Wis.



FRANK HAWKS CHOOSES CUB!

America's Speed King knows his airplanes! That's why he chose a Cub—and why he writes so enthusiastically: "I am very much impressed with my Cub. It is the most dependable, safe and economical airplane in its field!" Thousands of owners find the new Silver Cub the ideal plane for every purpose. Buy your Cub now at the amazingly low price of \$1270 F.A.F. Bradford, Pa., and it's yours for only \$425 down—the balance in easy monthly instalments! Act at once!



Free!

Write for our free, illustrated Cub folder and name of your nearest Cub dealer. Use coupon below. Don't delay! Do it now! And remember your wings!



TAYLOR AIRCRAFT COMPANY, 57 W Street, Bradford, Pa., U. S. A.

Please send me your free illustrated Cub folder and name of my nearest Cub dealer. Enclosed find 10c for my "wings" insignia pin.

NAME _____
ADDRESS _____
CITY _____ STATE _____

HANDEE TOOL OF 1001 USES

Grinds - Drills - Cuts - Polishes
Carves - Routs - Saws - Sands
Sharpens - Engraves

A whole shop full of tools in one for work on all metals, alloys, bone, resins, glass, stone, wood, etc. Uses 200 accessories. Saves hours of tedious work. 13,000 r.p.m. A C or DC, 110 volts. \$10.75 and up, postpaid. 3 Accessories Free.



Plug in any Socket

DE LUXE MODEL

For constant service, nothing compares with this easy-to-handle production tool. Saves time and labor. Fastest, smoothest, most powerful tool for its type and weight. 25,000 r.p.m. \$18.50 postpaid. 6 Accessories Free.



Get a Demonstration at Your Dealer's or Order Either Model on 10-Days Money-Back Trial. Catalog Free.

CRAFTSMAN'S PROJECT BOOK "Pleasure and Profit with a Handee" Easy working plans for making many interesting and unusual projects, 25c stamps or coin.

CHICAGO WHEEL & MFG. CO. 1101 W. Monroe St., Dept. Q. Chicago, Illinois

Send Catalog Project Book \$10.75 Handee De Luxe Model
Name _____
Address _____

When writing please mention Popular Mechanics

Sound Engineers Help the Stage

(Continued from page 703)

of these sounds for the play, "The Eternal Road." Their means of producing the various effects are the work of experts in the recording and reproduction of sound film. To achieve the fidelity necessary, a process employing ultraviolet light in sound-film recordings and a new type of loudspeaker

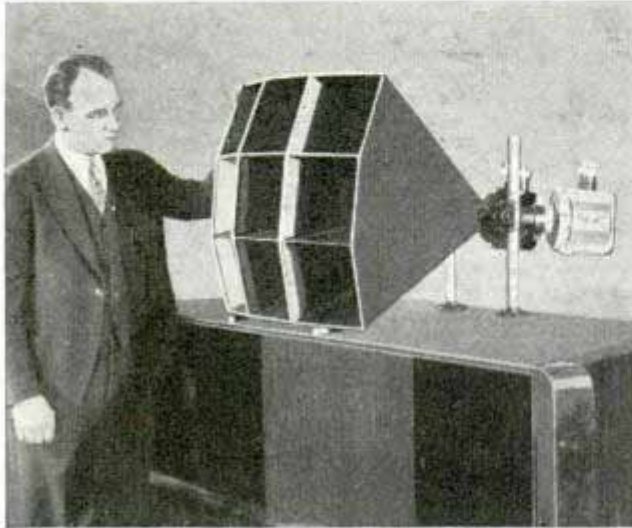

Special cellular-type loudspeaker which sends out sound in many directions

which directs sound in many directions were used by the engineers. Sound films made in ultraviolet light instead of ordinary white light possess clearer detail, which is especially important in reproducing the higher-frequency tones.

Picked orchestras and choral singers were used in making recordings on three separate film sound tracks. In voice recordings it was necessary that singers hear the orchestra while they sang, but if the orchestra recording had been played while they sang, it would have been picked up again by the microphone. So each singer wore a tiny oscillator on his temple, enabling him to hear through bone oscillations. There was no audible sound. The singer heard the orchestra but the microphone "heard" and picked up nothing but the singer's voice.

With the sound recordings it is comparatively simple for control men to dispatch each channel to the loudspeaker where it is wanted. Thus a voice from heaven comes from a loudspeaker high above the stage, or orchestral music from several speakers located at other points.

In one scene a host of angels appears. A

loudspeaker concealed in their midst produces music sung by the best voices obtainable, creating the illusion that the angels are singing. Thus is solved the problem of finding angelic-looking actors who can sing. Since the recordings and loudspeaker do the singing the actors are picked for appearance only. The hum of praying worshipers is produced in another scene by concealing a loudspeaker in their midst. Thus the actors speak their lines to the accompaniment of low-voiced prayers.

A real orchestra, which is invisible to the audience, also is used in the play. It plays in a room of the theater and its music is picked up by microphone and sent out over loudspeakers, with control-room men regulating volume to blend with the recorded sound effects. This orchestra and some of the actors are really in a broadcasting studio. The conductor, looking out of a window onto the stage, is on constant telephonic communication with the control room. One control man is at the mixing panel where he modulates the sound from a score which has each part marked off in electrical units as well as music. The other control man dispatches the sound to the proper concealed loudspeaker.

Up in the first balcony is a microphone, connected with the control room. Through this the control men hear what the audience hears and regulate volume accordingly. A sentry, seated beside this microphone, has a telephone by which he communicates criticism of the sound to the control room.

All these special sound effects are carried to the audience by cellular-type loudspeakers which consist of two parts, an upper one to send out higher frequencies and the lower to carry low-pitched sounds. Instead of directing sound in one direction, as most loudspeakers do, this cellular speaker sends it in many directions.

So much electrical power is required for the play that a special vault constructed beneath the stage houses two transformer stations.

Our Bureau of Information will answer questions regarding articles in this magazine, if accompanied by return postage.

How to get A BETTER RUN FOR YOUR MONEY



YOUR
CAR +



GASOLINE WITH
Ethyl



= 100%
PERFORMANCE

AND THIS IS WHY:

- 1** You get more anti-knock fluid (containing lead tetraethyl) at pumps marked "Ethyl" than you get in the best regular-grade gasoline.
- 2** You get all-round quality (including quick starting) that is *double-tested*—by the oil company and by the Ethyl Gasoline Corporation.
- 3** You get 100% performance from your high compression engine.
- 4** You save on oil as well as gas by preventing knock and overheating.



NEXT TIME GET ETHYL . . . A BETTER RUN FOR YOUR MONEY

Little Bugs and Big Business

(Continued from page 693)

chalantly turn out by the millions of pounds. Here is one almost indispensable material which science, after years of effort, is unable to reproduce or even to improve upon to any great extent.

The versatile tribe of lacca worked for man even before shellac was used widely. Originally the creatures were the source of a red dye. Man found how to make a synthetic red dye, but the bugs still hold the secret of shellac. The insects are natives of India and for protection wear overcoats of their own making. When they discard these garments, man gathers them up—and has shellac in the raw. The hard-



Crated shellac ready for shipment abroad

working bugs secrete a resinous material called lac which acts as a protective coating for the makers. When treated, the same substance becomes a protective coating for man-made things.

Laccifer lacca is red, about one-fortieth of an inch long and shaped like an apple seed. The babies swarm soon after hatching. The fortunate ones reach the twigs of certain trees, bore through the bark to reach the sap and are fixed for life. Then they begin to secrete lac gum. This hardens and eventually encompasses them. At the end of six months the female hatches a family of about 1,000 babies and dies. The babies feed on her body until they swarm. There are two life cycles each year but, due to varying weather conditions and to different kinds of trees selected for feeding, four lac crops are produced annually in various parts of India.

After the swarming, natives collect the discarded overcoats—known as stick-lac.

This is ground in hand mortars to break up the original cells. Dead insects, twigs and bark are sieved and washed out and the result is seed-lac which is dried and blended, rosin and a bleaching agent sometimes being added. The mixture is placed in a cloth bag twenty or thirty feet long and two inches in diameter. The bag is slowly revolved in front of an open charcoal or coke furnace by two natives, one at each end. As it heats the ends are twisted in opposite directions to squeeze out the melted gum. This gum is kneaded on a cylinder filled with hot water until quite molten. Then comes fun.

A native grasps the mass with toes, teeth and hands and stretches. This pulls the mass into a thin sheet. When cooled and cured the sheets are broken into small sections resembling shells—hence the name, shellac. While a few secret processes are employed in which machines are used, about three-fourths of all the shellac used today is made by the ancient hand methods. This is due in part to the fact that lac gum is very reactive to heat and the natives acquainted with the exact amount of heat necessary to melt the gum become experts at producing a high-grade, uniform product.

Most of the material used in this country was originally orange shellac, so named from the color of the gum. Modern processes and modern chemicals are employed in bleaching and removing impurities, but otherwise the shellac used today is quite similar to that used a century ago. Bleached gum shellac dissolves in alcohol to form white shellac varnish, the wood-preserving agency. Varnish, to most of us, means a solution of drying oils and a gum. This definition does not apply to shellac varnish. It is not an oil varnish but a spirit varnish—shellac gum and alcohol.

An oil varnish dries by oxidation or polymerization—rearrangement of the atoms of the molecule. Shellac varnish dries by the speedy evaporation of the alcohol, leaving a sealed surface with the pores of wood filled with gum. Thus a mahogany or walnut stain may be sealed under the thin film of shellac. No one knows how long a shellac varnish will

(Continued to page 148A)

CHAMPIONS AT 1936 INDIANAPOLIS 500-MILE RACE

**ECONOMY DEPENDS ON SPARK PLUGS****YOU CAN DEPEND ON CHAMPIONS**

● Modern engines offer outstanding economy combined with top-notch performance, that can and should be lasting if a program of periodic servicing is adhered to. So often both performance and economy drop off from new car levels, simply because spark plugs that are worn out are prolonged in service, or inferior quality spark plugs are used. Champion Spark Plugs provide such outstanding performance that practically all victorious racing drivers for the past 13 years have insisted on them. In the 1936 Indianapolis 500-Mile Race, gasoline limitations made it imperative that maximum performance be combined with maximum economy. It is significant that the first 10 to finish all used Champions. Louis Meyer, the only three time winner of this great event, is pictured above setting a new track record using Champions. Maximum economy depends to an extraordinary degree on spark plugs, and the records prove that you can always depend on Champions.

THE
SPARK PLUG
CHAMPIONS USE



CHECK AND CLEAN SPARK PLUGS WHEN YOU CHANGE OIL

When writing to advertisers please mention Popular Mechanics



The entire family
endorses the reliable
MYERS

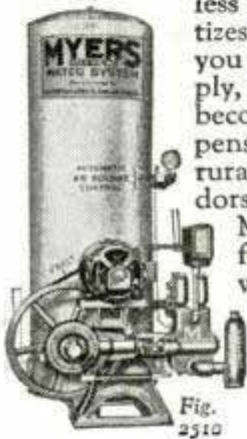

FRESH running water, both hot and cold, at the turn of a faucet! How it speeds and lightens countless tasks—how it protects and sanitizes. Yet do not forget that once you install an individual water supply, any interruption to its service becomes both aggravating and expensive. Thousands of suburban and rural families enthusiastically endorse the absolute reliability of MYERS Water Systems. These families use all the water they want to without skimping. MYERS Water Systems are so wonderfully well built that operating expenses are greatly reduced and repairs rarely needed.

MYERS Electric Water Systems are entirely automatic; self-starting, self-stopping, self-oiling. Other MYERS models for operation by hand, windmill or engine. Styles for deep or shallow wells. Write for interesting free water system booklet.

Sump Pump for Cellar Drainage

Keeps cellars and basements perfectly drained. Silent centrifugal pump operated by electric motor. Entirely automatic in action. Starts whenever water enters drain pit or sump. Stops when water has been pumped out. Low in cost; easily installed. Circular on request.



MYERS

WATER SYSTEMS

THE F. E. MYERS & BRO. CO.
71 Orange Street, Ashland, Ohio.

Send free, information checked and name of your nearest dealer. Water Systems Sump Pump

Name _____

Address _____

(24-7)



(Continued from page 146A)

protect wood for hundreds of ancient pieces protected by shellac still are in use, seemingly as good as when the shellac was applied.

Shellac varnish makes wood resistant to termites and also tends to eliminate warping of wood due to an uneven distribution of moisture. Shellac varnishes and oil varnishes each have their own places in preserving and finishing wood today. It is now common practice to apply an oil varnish over the protective shellac coating, the oil varnish serving to protect the shellac coat from moisture.

Cleaning a floor or other surface coated with shellac requires care since you must deal with a gum produced by nature and not by man. One expert recommends that where the surface is well covered with shellac, it be scrubbed with turpentine and steel wool. Where the wood is rather bare, this may redden the floor, so instead a mild soap can be used with the steel wool. Rinsing with a solution of seventy-five per cent water and twenty-five per cent vinegar removes any action left by the soap. If any parts of the floor require bleaching, this should be done before the rinsing treatment by using a solution of one-half pound of oxalic acid in one-half gallon of hot water.

Few realize the wide applications of shellac. It is used as a sizing for cloth, felt hats, millinery materials, playing cards, plaster and paper. As a protective coating it is spread on floors, furniture, bowling alleys and it also is used on mirror backs, tennis racket strings, tin foil, gold leaf, as a leather and rubber coating, on linoleums and in shoe polish, lithograph ink and cold top enamels. As a cement you will find it in sealing wax, marble cements, light bulb bases, brush bristle cements and ceramic cements. It is employed as a dielectric in the manufacture of laminated cloth, paper and mica and it is very widely used as a molding material in making phonograph records and grinding wheels.

Almost daily new applications are being found for this age-old material. But a bug in India with a yen for turning out overcoats continues to baffle modern science by concealing within its red body the formula for this substance so widely applied by man.

STUCCO SPRAYING MASONRY SURFACES NOW OFFERS BIG EARNINGS



This new machine and process fuses a waterproofed plastic mixture on any masonry. It beautifies and weatherproofs both old or new buildings, walls, etc., at low cost. It fills all cracks and can be applied in any thickness desired and in 30 colors and shades. Fully proven by over twelve years actual use under all conditions and every climate.

LARGE WAITING MARKET

Owners everywhere want to enhance present values and make their buildings more attractive and livable. The better builders are striving for greater permanence, beauty and salability in their new construction. With Colocrete stucco spraying you can supply this waiting market and can offer permanent colorful surfacing at amazingly low cost. Many operators report costs of 2c to 4c per sq. ft. and sell at from 4½ to 7c. Some have paid for their equipment from first couple of jobs. Machine capacity up to 1000 sq. ft. per hour.

Get the facts. The new Colocrete books tell the whole story. Write today. It may mean business independence for you.

COLORCRETE INDUSTRIES, Inc., 570 Ottawa Ave., Holland, Mich.



**Saves
TIME
and
MONEY**

WHIZ Electric Tool

**DRILLS, GRINDS, POLISHES,
SHARPENS, SANDS, SAWS,
CARVES — easily, quickly**

A whole shopful of tools in one. Indispensable and economical for

**Homecraftsmen, Mechanics and Carpenters.
POWERFUL — SPEEDY — DEPENDABLE**

110 volt A.C.-D.C. Motor. Universal chuck, ¼" capacity. Ball-bearing thrust. Self-enclosed fan. Highest quality workmanship and materials. Uses 50 different accessories, instantly interchangeable. **10-DAY money-back TRIAL.**

FREE Accessory outfit, including set of drills, mounted grinder, sanding discs, mandrel, mounted brush, etc., sent free with each WHIZ tool ordered now. Complete outfit for only \$6.95 postpaid.

PARAMOUNT PROD. CO., Dept. 6A, 245 Broadway, New York



**ONLY
\$6.95
POSTPAID**

RADIO-ELECTRICAL EXPERIMENTAL KIT

Complete! Greatest value! Fascinating! Educational! Instruction manuals make experiments easy. Wire up thief detector, extension phone, elec.-welder, electro-plating, arc-furnace, AC to DC rectifier, 110-volt motor. Make powerful arc light, generate ultra-violet and infra-red rays, make electric stove, elec. door lock, etc. Build radio circuits, crystal set, 2-tube circuit, AC-DC set, code practice set, 110-volt rectifier, radio transmitter, scores more. If bought separately, \$18.50. **NOW... FREE!** 6 Books, value \$5.50, with kit. Elec.-Radio Short Courses. Fun with Elec., Electrical-Are, Motor-transformer, Exper. Lab. Plans. 3c stamp brings Elec.-Radio-Tool bargain catalog. **SEND! ELECTRICAL SALVAGE CO., Box 524-A37, Lincoln, Nebr.**



\$3.99

WORLD WIDE ALL WAVE ~ RADIO \$1.55 POST PAID



A sensational Radio! Thousands now in use. Can actually bring in foreign stations, police calls, aeroplanes, amateurs, etc., as well as local broadcast! Short and Long Wave. Ace Radios give guaranteed **residual**! For only \$1.55 we send you the complete kit containing an attractive metal chassis panel and every part needed to build a powerful one-tube receiver, **AMAZING VALUE!** Works for months on two inexpensive dry batteries. Our clear diagrams make it simple to hook up. Not a feeble crystal set!

TWO TUBE KIT (More volume)—\$2.00.
ALL-ELECTRIC two tube house current set. No batteries! Complete kit \$3.00.
(Sets laboratory assembled and wired 75c extra.)
Enjoy NEW thrills! Send for your ACE Radio today!
Ace Radio Laboratories, 70 Barclay St., Dept. P-5, N.Y.C.

BIG MONEY

Assembling Mead's New

Portable

OUTBOARD BOAT!

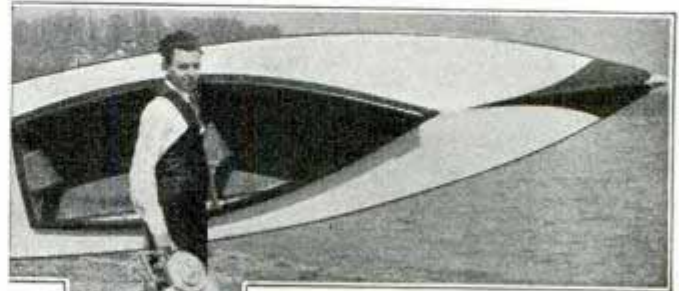

The OK-2 is strong as a giant. Yet Weighs only 50 LBS. ! Portable.



Priced Low—and PAY as You BUILD!

A sensation! Build this 50-lb. tough, durable, seaworthy, portable Outboard Ki-Yak in 2 days at home! Then it's always ready to go anywhere by hand or car. Safe, leakproof. More speed per horsepower. More miles per gallon! Mead's perfected aluminum-ribbed, Cut-to-Fit Construction Kit guarantees successful assembly, easily, quickly—and profitably (if you build to sell to others). Amazing LOW Introductory Prices, and if you wish you can even *Pay as You Build!* RUSH dime and Coupon below, for details!



9 HOURS TO BUILD NEW SPORTSMAN'S BOAT!

"CK-2"

Paddle Boat

Quickly Converted
Into Speedy Sailboat!

**\$6 PAD-
DLE
GIVEN**

Assemble Mead's "CK" Sportsman's Ki-Yak in 2/3 LESS time with new construction principle. "Home Assembly" saves you nearly HALF factory-built cost! Most sensational boat development in years! Weighs only 30 lbs. Portable by hand or car! Thousands in use! RUSH dime (covering handling, postage) and Coupon for giant new Colored Circular, Low Introductory Prices, \$6.00 Gift Paddle Offer. (Dealers write for Profit Plan!) *Hurry!*

with your Ki-Yak
—if you hurry!



MAIL COUPON RIGHT NOW!

Gentlemen: I am enclosing 10c postage, handling charge. Please rush me your New Boat Catalog, Low Introductory Prices and \$6 Gift Paddle Offer.

NAME

STREET & NO.

CITY.....STATE.....

RUSH ME WITH 10c TO:

**MEAD GLIDERS 15 So. Market, CHICAGO
Dept. B-57**

When writing please mention Popular Mechanics

FACTORY TO YOU

NEW REMINGTON NOISELESS PORTABLE



10¢ A DAY

FAMOUS Remington Noiseless Portable that speaks in a whisper, only

10c a day, direct from factory. Standard Keyboard. Automatic ribbon reverse. Variable line spacer and all the conveniences of the finest portable ever built. PLUS the NOISELESS feature. Act now. Send coupon TODAY for details.

You don't RISK a Penny. We send you a Remington Noiseless Portable for 10 days' free trial. If not satisfied, send it back. We pay all shipping charges.

FREE typing course and carrying case. You will receive FREE a complete simplified home course in Touch Typing. Also FREE, a handsome, sturdy carrying case. No obligation. Mail coupon for full details—NOW.

Remington Rand Inc., Dept. 152-5
315 Fourth Ave., New York, N. Y.

Tell me, without obligation, how to get a new Remington Noiseless Portable, plus Free Typing Course and Carrying Case, for 10c a day. Send Catalogue.

Name

Address

City..... State

BILD-UR-OWN

COASTERS • MIDGET AUTOS • SCOOTERS • BIKE TRAILERS, ETC.

DISC WHEEL! S equipped with 10"x2 3/4" (GOODRICH-GOODYEAR-FIRESTONE) Balloon Tires offered at LOWEST PRICES Also larger tires and wheels—Motors, etc.

WRITE TODAY FOR PRICES

5237 Lake St. Dept. MM Chicago, Ill.

HOME AUTOMATIC CIGARETTE MACHINE

Have YOUR OWN Monogrammed Cigarettes

Put tobacco and block of papers on machine, TURN THE CRANK—PRESTO—CIGARETTES. Easy—simple. All metal construction. Guaranteed. No dust ribbon; no special tube or gummed papers required. ASK FOR FREE ILLUSTRATED FOLDER.

A. C. MACHINE WKS., PM-5, 1055-57 Devon Ave., Chicago, Ill.

CROSMAN SILENT .22 RIFLE

Adjustable peep sight

NO CLEANING ADJUSTABLE POWER LOW COST AMMUNITION

Rifled Barrel

Grooves inside barrel make the Crosman a real rifle with all the hair-splitting accuracy this term implies. Shoots bullet (pell) same diameter as .22 powder rifle, but silently, powerfully, with no recoil, using the terrific force of compressed air—same force U. S. Navy uses to drive 2000 lb. torpedoes. Marvelous for target, small game. Single and 20 shot repeater models. No license required. New features!

SuperPells **FREE BOOK**

Best for all .22 cal. air rifles. Heavier, longer, more perfectly formed (secret process), thus harder hitting and more accurate. Made to American standards by American workmen. Free folder.

Containing important target and game shooting facts; also Crosman Catalog. Write. Ask Your Dealer to Show You a Crosman.

CROSMAN ARMS CO., Inc., 396 St. Paul St., Rochester, N. Y.

PORTABLE ELECTRO-PLATING OUTFIT

Retails for **\$3.75** DOES SAME HIGH QUALITY PLATING AS BIG TANK OUTFITS

New patented invention. **GUARANTEED to PERMANENTLY** electroplate Silver, Brass, Nickel, Copper, Zinc or Cadmium WITH A BRUSH—as easy to apply as a coat of paint.

A NON-LIQUID process, always ready for use, quickly applied, and equal to any commercial electroplating. Used in factories, hospitals, work shops, garages, stores, jewelers, etc. Operates from dry cells, automobile battery or battery charger—nothing else needed. Retails \$3.75 (Silver \$7.25). Specify metal finish wanted when ordering or write for full particulars **Money back guarantee.**

RAPID ELECTROPLATING PROCESS.
2135 N. Cicero, Dept. 24, Chicago, Ill.

TURN THEM INTO MONEY

BUILD THESE PROJECTS

Easy to build. Easy to sell. Beautify your lawn or garden. Note the special low prices on BLUEPRINTS ORDERED FROM THIS AD.

ACTUAL BLUEPRINTS (Fully detailed and dimensioned)

- Model B-25 DUTCH WINDMILL, 20 in. high (girl churning butter).....\$0.50
- Model B-30 DUTCH WINDMILL, 24 in. high (farmer using bucksaw)..... .65
- Model B-10 DUTCH WINDMILL, 32 in. high (Hexagon style)..... .75
- Model OM-60 OLD MILL, 30 in. high (15 inch diameter water wheel)..... 1.00
- Model F-100 CAPE COD LAWN CHAIRS..... .50
- Model M-10 MARTIN HOUSE (8 family Castle Style)..... .50
- Model M-15 NEW MARTIN HOUSE (tower style 12 family) with unique flying goose weather vane mounted on top..... .65

SPECIAL: ANY 3 OF ABOVE PATTERNS ONLY \$1.00

LAWN FAIRY TALE FIGURES PATTERNS (Approx. 20" high) Dutch Schoolboy, Holland Pair, Sunbonnet Girl, Dutch Tulip Girl, Jack and Jill, Little Bo-Peep, Fuse-in-Boots, Red Riding Hood, Peter, Peter, Tom The Piper's Son, each 35c.

(Note: Color arrangement included on all patterns. Trace direct to wood.)

SPECIAL: ANY 5 OF THE ABOVE PATTERNS, \$1.00.

Five wall and corner bracket blueprints, including a famous Chippendale design, all five for only \$1.00.

Dutch Schoolboy Doorstop pattern FREE with each order. For CATALOG illustrating many models, kits and supplies, SEND 10c.

CRAFTSMAN'S MODEL CO., Dept. P-5, 2030 N. 41st St., Milwaukee, Wis.

OWN A GENUINE ZIRCON

Positively the nearest stone to a diamond!

Gem of Mystery—the rare genuine White Zircon (mined—not synthetic) is equal in fire, brilliancy, and sparkle to the finest diamond, yet costs but a fraction. Many experts cannot distinguish between the two. Thrill at owning a genuine White Zircon when your friends and jewelry experts believe you possess a valuable diamond. Send name and address for FREE revealing information and price list—no obligations. Courtesy to dealers & agents.

SECURITY JEWELRY COMPANY, 742 South Hill Street
Over 30 years in Diamond business. **LOS ANGELES, CALIF.**

STRIPE YOUR OWN CAR

Anyone can stripe a car with a ROLL-A-STRIPE. You can save the price of your striping job and earn money doing others. Specially knurled roller and dependable gauge. Paint, lacquer, enamel, or varnish may be used. Stripe signs, furniture, models, etc. See any Duco Dealer today or send direct. Postpaid \$1.50.

MODCRAFT INDUSTRIES, Dept. P25, 2908 N. Nordica Ave., CHICAGO, ILL.

Atlas ANNOUNCES

a Modern, Up-to-Date **LATHE MANUAL**

272 Pages - Metal Binding

Pictures clearly how to operate the modern lathe—has easy to understand technical data for machining new metal alloys, plastics, etc. Opens easily—lies flat. Sold on money back guarantee \$1 postpaid \$1

ATLAS PRESS CO.
543 N. Pitcher St.
Kalamazoo, Mich.

FOR THE FIRST TIME IN HISTORY



• A combination of alternate firing, underwater exhaust and full pivot reverse in a light weight, medium priced motor! Just \$85. And developing 4.2 N.O.A. certified brake h.p. at 1600 r.p.m. A Single at \$72.50; super-powered to step along super-controlled to give you the slowest controlling speed ever attained by Johnson! Two deluxe streamlined beauties at \$85.00 and \$130.00 (pictured above). See them at your Johnson dealer!

FREE Write for fully illustrated literature, including 1937 Sea-Horse Handy Chart of sizes and specifications. Packed with new features, new performance! Prices f.o.b. factory. Subject to change without notice.

JOHNSON MOTORS
400 Pershing Rd., Waukegan, Ill.
Johnson Motors of Canada, Peterboro, Canada

OTHER MODELS AS LOW AS \$59.50

Rural Electrification is Here!

LIGHT YOUR FARM For only 50¢ A YEAR

Power Operating Cost



There is only one genuine WINCHARGER

CHEAPER THAN THE HIGH LINE

32-VOLT
170 lbs. of fine precision machinery

32-VOLT 650-WATT GIANT

NOW ONLY \$15 DOWN 10 MONTHS TO PAY

WINCHARGER
REG. U. S. PAT. OFF.

\$69.95

Don't wait for the high line! Have all the electricity you want on your farm right now. Let the amazing new 32-Volt Giant Wincharger bring you real RURAL ELECTRIFICATION! Use the FREE POWER OF THE WIND that's blowing across your farm every day. Wincharger is far cheaper than the high line in first cost, and instead of having a meter ticking your dollars away—\$5 or more every month—the power operating cost of Wincharger is only 50c a year!

Electric Lights Everywhere! Sweep, Wash, Pump by Electricity!

Have the same comforts that city folks have! Get rid of smoky oil lamps—stop wearing yourself out sweeping, washing, pumping water by hand! Wincharger's free electricity will do dozens of farm jobs quicker and easier. If you own a gasoline-operated electric plant, Wincharger will save you \$30 to \$60 a year on gas and oil. There's no tax on the wind—IT'S FREE!

Sold Direct—Fully Guaranteed

Wincharger is sold direct from factory to you, without dealers' or agents' commissions. This saves over \$100 on the price we should otherwise have to charge you. More than 500,000 farm folks all over the world now enjoy free electricity from Wincharger. Every Wincharger is fully guaranteed—"Satisfaction or Your Money Back."

MAIL THE COUPON TODAY

WINCHARGER CORPORATION
World's Largest Makers of Wind-Driven Generating Equipment
Dept. PM5-37, Sioux City, Iowa

Please tell me all about how I can have electricity on my farm at a power cost of 50c a year.

Name.....
P. O.....Route.....
County.....State.....
If you now own an electric plant, what make?.....

Save Postage: Paste coupon on penny postal card

When writing please mention Popular Mechanics

TECHNICAL BULLETINS
Technical Data Simplified for the Practical Man

A New and Valuable Popular Mechanics Service • \$1.00 Each

Here is a valuable, inexpensive service for mechanics, inventors, technical specialists and practical craftsmen of all kinds. Popular Mechanics Technical Bulletins give the needed basic and practical information on a wide variety of subjects—

briefly, concisely and simply presented—yet complete in every detail. No advanced mathematics, chemistry or physics needed to understand them. Material never before in print, now specially prepared in bulletin form. Postpaid \$1 each or sent C.O.D. in United States. Ask for list of complete bulletin service.

- D-101—Using Nichrome Resistance Wire.—Features electrical appliance repairs.
- D-102—Cleaning Products for all Purposes.—Includes ten formulae for making.
- D-103—Automobile Specialty Chemical Products.—Complete instructions for making wide-selling products.
- D-104—Silver Soldering and Brazing.—Includes data, methods and materials needed.
- D-105—Latest Gas-Welding Practice.
- D-106—Rewinding Electric Motors.—A difficult subject made simple and easy.
- D-107—Electro-Plating with Copper, Nickel and Chromium.
- D-108—Electro-Plating with Gold and Silver.
- D-109—Electro-Plating with Zinc and Cadmium.
- D-110—Electro-Plating Non-Metallic Objects and Electro-Forming.
- D-111—Designing and Building Transformers.
- D-112—Designing Electro-Magnets.
- D-113—How to Design Solenoids and Plunger Magnets.
- D-114—Designing Thermostats for Air Conditioning and Heat Control Purposes.
- D-115—Flexible Molds for Casting Small Objects.
- D-116—Printing Photos on Cloth, Paper, Etc.
- D-117—The A B C of Air Conditioning.

POPULAR MECHANICS PRESS

Room 537B 200 East Ontario Street Chicago



Send for the new Spring 1937 ALLIED Radio Catalog! 156 big, value-packed pages with Everything that's months ahead in Radio; more than 10,000 exact duplicate and replacement parts; 53 new Knight Radios, featuring Automatic Dialing, AFC, plastics cabinets, Touch-O-Matic Tuning, etc.; dozens of Build-Your-Own Kits; Amateur transmitting and receiving gear; test instruments; Public Address; books, tools, etc. Why shop skimpy, incomplete "radio booklets"? Buy with confidence from the new ALLIED Catalog—Radio's Complete Supply Guide!

BUILD POPULAR MECHANICS CIRCUITS

We can supply matched kits for building any Popular Mechanics circuit. Write for Free Parts Lists covering: 1 Tube Portable (R209); 2 Tube AC-DC (R211); 1 Tube Flashlight Set (R227); "Hurricane" Set (R234); Little Giant AC-DC (R235); 1 Tube 6N7 S. W. Set (R236); "Beam" Tube X-mitter (R237) and many others.



ALLIED RADIO

833 W. Jackson Blvd.,
Chicago, Ill.

Dept. 5-E

Send me your New Spring Radio Catalog.

Send me parts list for.....

Name.....

Address.....

City.....State.....



A TRAILER FOR LESS THAN \$100.00

The Ideal Trailer For Week-end and Vacation Trips. Contains Fully Equipped Kitchen, Dinette and Borth For Two.

With only a few hand tools you can assemble this sturdy compact trailer in a few days' time; we furnish necessary parts at exceptionally low prices.

MAIL \$1.00 TODAY FOR COMPLETE PLANS AND PARTS LIST.
TRAILERCOACH, 3219 N. 15TH ST., PHILA., PA.

CAST IRON FURNACE PIPE

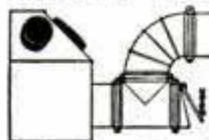

ECONOMY SAFETY

Faultless cast iron pipe eliminates repairs and fire hazard. Easy to clean out, fits all heating plants. Send for literature.

C. C. HUESTIS COMPANY

222 LORA AVE.

YOUNGSTOWN, OHIO

KILL RATS WITHOUT POISON



This proven exterminator won't kill Live-stock, Pets or Poultry—Gets Rats Every Time. K-R-O is made from Red Squill, a raticide recommended by U. S. Dept. Agr. (Bul. 1533). Ready-Mixed, 35¢ and \$1.00; Powder, 75¢. All Druggists. Results or Your Money Back. K-R-O Company, Springfield, O.

K-R-O KILLS RATS ONLY

(Continued from page 142A)

will draw more current than the low-drain types and are therefore not economical especially when the owner is depending upon a windcharger to keep the battery up. An original list of all materials, and further information, can be obtained from Popular Mechanics radio department, without charge. The blueprint number is R-238.

Before starting construction, the builder should make sure that he has all parts just as specified. Do not buy cheap parts for a receiver of this type. The plug-in vibrator unit is replaceable and should last a long time under continuous use.

It will be noted that the simplified wiring diagram, Fig. 3, shows an underside view of the base. Every connection is clearly indicated and all parts are in their relative positions. The receiver parts on top of the base are sketched above, so that every lead is shown. Please note that a

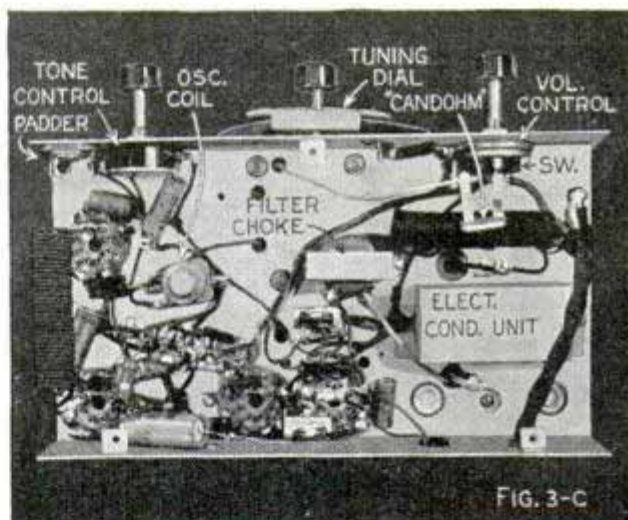

FIG. 3-C

flexible lead is used to ground the 2-gang condenser on the base, as this condenser unit "floats" on three soft-rubber grommets mounted on the base to prevent vibration. Three machine screws pass through the grommets, and hex nuts are threaded on the underside. All "A" r.f. chokes are hand wound on a wood or cardboard form $\frac{5}{8}$ in. in diameter. The form is then withdrawn as each coil is self-supporting. Every circuit connection should be soldered carefully with rosin-core solder. Make all grid and plate leads as short as possible. Be sure that the power pack is well insulated from the base by the rubber grommets and is grounded only

(Continued to page 154A)

QUICK MEALS

FOR OUTDOOR APPETITES
—WITH A

Coleman CAMP STOVE

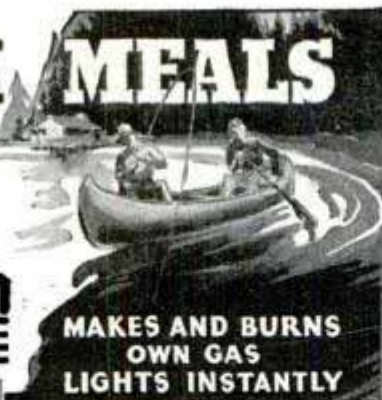

MAKES AND BURNS OWN GAS LIGHTS INSTANTLY



"When do we eat?", yell big outdoor appetites. "Right now" is the answer when a Coleman Camp Stove is on the job. With this miniature gas range you'll have better cooked meals... more fun... less work! Cooks anything you want, the way you want it, any time you want it.

Band-A-Blu type burners light instantly. Produce a clean, fast-action gas flame. Everdur metal fuel tank can't rust; easily removed for filling. See them at your dealer's.

COLEMAN LANTERNS. Get a sturdy Coleman Lantern for brilliant night light. Chases the dark with powerful, dependable light in any weather. Pyrex glass globe protects mantles. Can't blow out. Gasoline and kerosene models to fit every purse and purpose. **FREE FOLDERS**—Send a postcard for illustrated Folders on Coleman Camp Stoves and Lanterns.



THE COLEMAN LAMP AND STOVE CO.

Dept. PM-538, Wichita, Kans.; Chicago, Ill.; Philadelphia, Pa.; Los Angeles, Calif.; Toronto, Ont., Canada. (7638)

Extra Money From Books

SEND NO MONEY • Books Sent C.O.D. Anywhere in U. S.

These famous Pay-Raising, Extra Money Books have helped thousands of others. Let them help you too. Check this list and mail with your name and address. Pay postman on delivery plus few cents postage. Send 3c stamp to cover postage and ask for catalog of other books.



SELECT FROM THIS LIST

- HIGH-SPEED DIESELS**
New, practical, non-technical. \$2.50
- INVENTIONS**
1500 Needed. \$2.50
- LEATHER MAKING**
and Home Tanning... \$1.00
- MACHINE SHOP WORK**
Tools and Methods. ... \$2.50
- MAGICIAN'S MANUAL**
New, 100 Tricks for Amateurs. \$1.39
- METAL SPINNING**
Practical New Book. \$1.00
- MONEY MAKING FORMULAS**
10,000 Practical. \$4.00
- MOTOR VEHICLE**
'Trouble Shooters' Handbook. \$2.00
- PLASTERING**
Best Instruction Manual. \$1.25
- RADIO PHYSICS COURSE**
New edition. Everything about Radio. ... \$4.00
- SHEET METAL**
Construction Work. \$2.00
- STEAM ENGINEER'S LICENSE**
How to Obtain. \$2.00
- STEEL SQUARE**
Hodgson. 500 pp. 300 Illustrations. ... \$2.00
- TAXIDERM Y, HOME**
Mount Trophies Profit, Pleasure. \$1.50
- WROUGHT IRON WORK**
Practical. \$1.35
- ARMATURE WINDING**
For A.C. and D.C. Machines. \$2.00
- AUTO REFINISHING**
Duco With Spray Gun. \$1.50
- BLUEPRINT READING**
For Machine Trades. ... \$1.50
- BRICKLAYING**
Plain and Fancy. \$1.50
- CARBURETORS (All Makes)**
New, Revised Edition. ... \$2.50
- CHEVROLET SIX**
Car, Truck, Operation Repair. \$2.50
- COLONIAL FURNITURE**
Making, 95 Pieces. \$3.50
- DANCE**
Learn at Home Without Music or a Partner. ... \$2.00
- DIE CASTING**
Machines, Dies, Alloys. \$3.00
- ELEMENTS DIESEL**
Engineering Questions and Answers. \$4.00
- FOUNDRY WORK**
Molding, Casting, etc. \$2.00
- FURNITURE REPAIRING**
Finishing and Decoration. \$3.00
- HEATING, VENTILATING**
Homes and Buildings. ... \$2.50

POPULAR MECHANICS PRESS

Room 537A 200 E. Ontario St., Chicago

Do a faster, cleaner job WITH WHEELS BY CARBORUNDUM

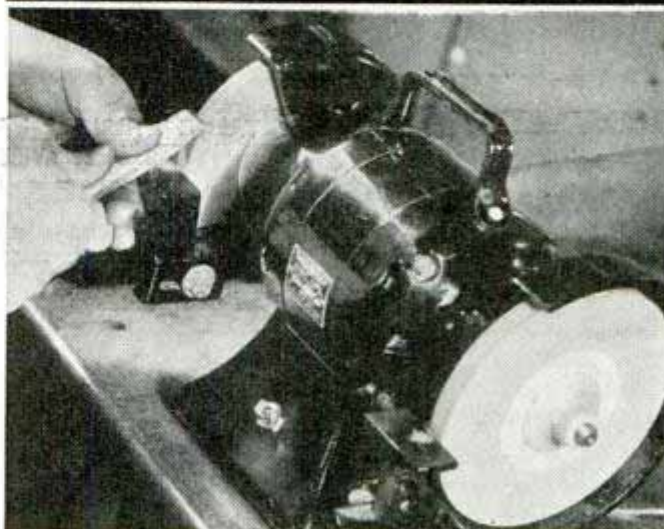

Every workshop should have a two-wheel stand grinder. For cleaner edges, faster cutting and better work, it should be equipped with Carborundum and Aloxite Brand Grinding Wheels.

Use the Aloxite Brand Aluminum Oxide Wheel for tool grinding... and the Carborundum Brand Silicon Carbide Wheel for general purpose grinding.

Hundreds of workshop jobs can be done faster and better with these two wheels. They'll save you time and money in grinding parts and fittings, removing burrs, smoothing down welds, etc. Available in many shapes, sizes and grits.



SEND FOR 90-PAGE BOOK AND SHARPENING STONE

Mail coupon and 20c today for useful handbook and sample sharpening stone. Shows how hundreds of jobs can be done better with abrasives.



CARBORUNDUM ABRASIVE PRODUCTS

THE CARBORUNDUM COMPANY
Dept. PM7-5, Niagara Falls, N. Y.

I enclose 20c (coin or stamps) for your new book, "Carborundum Brand Products for the Home Craftsman," and FREE Pocket Sharpening Stone.

Name _____
Address _____
City _____ State _____

Carborundum and Aloxite are reg. trade-marks of The Carborundum Co.

When writing to advertisers please mention Popular Mechanics



SKINNY?

Thousands Have Gained Normal Attractive Flesh This Special Quick Way

WHY should thousands of people today remain skinny and friendless when this new discovery is giving other thousands solid, normally attractive flesh—gains of 10 to 25 pounds—in just a few weeks!

People who never could gain an ounce before have not only put on all the weight they wanted, but also report naturally clear skin and good-looking color, wonderful new pep and energy that bring loads of new friends and joyous new popularity. Don't be a "stick-in-the-mud" when you too may build yourself up this easy way.

Why it builds so quick

Doctors now know that thousands of people are thin and rundown for the single reason that they do not get enough Vitamin B and iron in their daily food. Without these vital elements you may lack appetite and not get the most body-building good out of what you eat.

Now one of the richest known sources of Vitamin B is cultured ale yeast. By a new process the finest imported cultured ale yeast is now concentrated 7 times, making it 7 times more powerful. Then it is combined with 3 kinds of blood-building iron, pasteurized whole yeast and other valuable ingredients in pleasant little tablets known as Ironized Yeast tablets.

If you, too, need these vital elements to aid in building you

up, get these new "7-power" Ironized Yeast tablets from your druggist today. Note how quickly they increase your appetite and help you get more benefit from the body-building foods that are so essential. Then, day after day as you take them, watch flat chest develop and skinny limbs round out to natural attractiveness. See better color come. Soon you feel like an entirely different person, with new charm.

Money-back guarantee

No matter how skinny and rundown you may be from lack of sufficient Vitamin B and iron, try these new Ironized Yeast tablets just a short time. See if they don't aid in building you up in just a few weeks, as they



YOU'RE GORGEOUS HOW CAN I GAIN 10 POUNDS?



Posed by professional models

have helped thousands of others. If you are not delighted with the benefits of the very first package, money back instantly.

Only be sure you get genuine Ironized Yeast. Beware substitutes. Look for "IY" stamped on each tablet.

Special FREE offer!

To start thousands building up their health right away, we make this absolutely FREE offer. Purchase a package of Ironized Yeast tablets at once, cut out the seal on the box and mail it to us with a clipping of this paragraph. We will send you a fascinating new book on health, "New Facts About Your Body." Remember, results with the very first package—or money refunded. At all druggists. Ironized Yeast Co., Inc., Dept. 535, Atlanta, Ga.

es 86



**EASY TO BUILD
PLANS
FREE!**

New Class "PLOVER" Sailboat—one of a series of watercraft projects designed by William Crosby, Editor of "Rudder" Magazine. Desk with concealed typewriter drawer—one of 8 associated modern living-room pieces by Gilbert Rohde, internationally famous furniture designer.

● Twenty-four of the finest projects ever offered to homecrafters: kayak, surfboard, inlaid card table, Colonial desk, radio end-table, cocktail cabinet and many other new and exclusive projects. Casein Company—makers of CASCO—famous casein glue—makes it possible for you to build them easily...inexpensively...from complete plans which are Free in 1937 CASCO Project Service.

How to Get Free Plans

Every 25c (or larger) package of CASCO contains a green ticket listing all 24 projects. Check project you want and complete plans will be sent you Free, postpaid. If you want to see pictures of projects, ask your Dealer for new 1937 Free Project Folder... or use coupon below.



FIXES THINGS PERMANENTLY

Sold by Hardware, Paint and Lumber Dealers Everywhere

SEND FOR FREE FOLDER	CASEIN COMPANY OF AMERICA, Inc.
	350 Madison Ave., Dept. PM-537, New York, N. Y.
	Please send folder about FREE Project Service.
	Name..... Street..... City..... State.....

EARN MONEY

Stringing TENNIS RACKETS

BUILD UP YOUR OWN BUSINESS

An opportunity to earn as much as \$3.50 for a few minutes of your spare time. String your own racket and save money. Tennis players need restringings frequently. Every stringing means profit for you. No experience needed—we teach you how. TOMGUT Equipment makes it easy. Costs practically nothing to start. Easy work. Begin NOW!

FREE Write today and we will send you FREE our new low prices of TOMGUT "Court-Tested" Tennis and Badminton Strings, Restringing Equipment, and a complete line of Racket Frames.

THOMPSON MANUFACTURING COMPANY

4535 Packers Avenue, Chicago, U. S. A.
TOMGUT "Court-Tested" Tennis & Badminton Strings

Please send, without charge or obligation, the new price list of TOMGUT Tennis & Badminton Strings, Racket Frames, and Restringing Equipment.

Name.....
Address.....
City..... State.....

Taking the "IF" Out of Farming

(Continued from page 669)

to control wheat smut and this started him searching for methods of control for other plant diseases transmitted by the seed. In 1670 a vessel laden with wheat went down off the coast of England. Farmers salvaged some of the grain, found it too saturated with sea water to use for flour, but planted it for seed. And, to their astonishment, they found the wheat from the wreck was fairly free from smut. Soon the brining of wheat became a general practice. Later other substances replaced salt but all were liquids and involved soaking the seed.

In 1917 Darnell Smith, an Australian, suggested dusting wheat seed with copper carbonate to kill smut spores. Others ridiculed the idea. Might as well dust it with talcum powder, they said. But copper carbonate worked and wheat production during the world war, when every bushel counted, was greatly increased by dusting the seed with it. About the same time it was found that organic mercury compounds were effective seed disinfectants but the cost was high. Chemists began making hundreds of such compounds and thousands of modifications of them and found a way to produce them at less cost.

Today those English farmers who sprinkled their grain with sea water, or their sons who waited for hours while the seed soaked in a copper-sulphate solution, would be amazed at the sight of a modern seed-treating plant treating grain as it passed through a gravity treater at a rate of 500 bushels per hour. And our children probably will laugh at our own clumsy efforts because new advances in seed treating are being made daily. The cereals are only one of the many kinds of plants now being freed of seed-borne diseases. Cotton, corn, vegetables, flowers, potatoes and many other plants each have their parasites, fungi and bacteria transmitted through the seed. By seed disinfection, science has placed in the hands of the farmer one more effective weapon to take the "if" out of agriculture.

But the variety and extent of the problem confronting the plant pathologist can be realized only if we remember that the use of chemicals for the control of seed-borne diseases represents only one phase

(Continued to page 160A)



3-IN-ONE OIL IS A BLEND OF THREE FINE OILS

BEST FOR CLEANING AND OILING TOOLS, EASING ACTION POINT OF TOOLS, LIGHT MOTORS, GUNS, WATERPROOFING LEATHER, CLOCKS, HINGES, LOCKS, ETC.
LUBRICATES • CLEANS • PREVENTS RUST



HANDY Taps and Dies

Electrically heat treated for long, accurate service. Every tool guaranteed to give complete satisfaction. When you need 'em you'll realize why they're named Handy.



Made by **HENRY L. HANSON**
 Worcester, Massachusetts
 At Your Local 5 and 10 Cent Store

Making it Easier to Make Worthwhile Things



Tests show the ability of the new Nicholson Files to remove stock more rapidly, and in doing so to help every home craftsman complete hard projects with less effort.

In a recent test, Nicholson Files completed 30 units of work while other brands completed only 25, 23.6, and 20.5 units respectively.

Use these new files that remove stock fast from the first stroke, that hug the line of uniform performance and actually cost less to use.

Your hardware store carries Nicholson Files for every home filing need. Nicholson File Company, Providence, R. I., U. S. A.

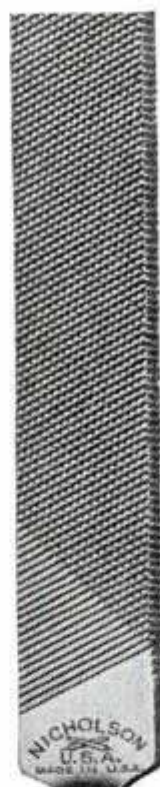

FOR THE DELICATE FILING JOBS

Ask us about Nicholson X.F. SWISS PATTERN FILES — Set of 1 dozen assorted 6 1/4" knurled handle needle files in a wooden box which, with top removed, serves as a convenient holder on the work bench.

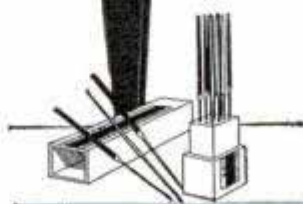

A FILE FOR EVERY PURPOSE

When writing please mention Popular Mechanics



BONNEY TOOLS

are the

Finest that money can buy

Write for Catalog M

Bonney Forge & Tool Works
 Allentown, Pa.



The NO. 25 ENGINEERS' WRENCH SET of 'CV' Chrome-Vanadium Steel, chrome-plated, consists of six double head, open-end wrenches with openings from 3/8" to 1".



BUILD
Your
HOME
For
30%
LESS

We Pay Freight

WORLD'S LOWEST PRICED
QUALITY HOME \$495 AND UP

Now you can own a fine, 4 to 10 room modern home—the *World's lowest priced quality home*—and save \$200 to \$800. Buy direct from the big Aladdin Mills. Save 18% material waste. Save 30% labor, or build it yourself with our easy to follow plans. Our prices include all lumber *Ready-Cut*, aluminum protected siding, millwork, windows, doors, interior woodwork, flooring, roofing, hardware, nails, paints, stains, varnish—and *we pay freight!*

SUMMER COTTAGES \$230 up
Write today for catalog No. 277, use coupon or postcard.

ALADDIN CO.
Bay City, Mich. or Portland, Ore.

Send me Free Catalog No. 277,

Name _____

Address _____

City or Town _____ State _____

Saw-Filing

MAKES BIG MONEY
In Spare Time

Louis P. Wadowick,
Cleveland, Ohio,
Builder Says—"My

FOLEY
Saw Filer

has made it possible for me to file 764 saws in spare time, and I have earned \$850 in carpenter work due directly to my saw filing contacts.

You, too, can have your own cash business at home. Earn up to \$2 to \$3 an hour filing saws automatically. With the building boom now developing, there is a big demand for saw filing. No experience needed, no eyestrain, no canvassing. The Foley Automatic Saw Filer files hand, circular, and band saws quicker and better than the best hand filer. You get an average of 50c for hand saws, much more for others.

FREE PLAN Other men are making big money and building up independent year 'round businesses, why don't you? Fill out the coupon. There is no obligation.

We also make the **FOLEY LAWN MOWER SHARPENER**
Does a perfect job in 15 or 20 minutes—sharpens all kinds and sizes of mowers.



FOLEY MANUFACTURING CO.
516-7 Foley Bldg., 11 Main St., N. E., Minneapolis, Minn.
Send me **FREE PLAN**, for starting my own business in spare time filing saws on the Foley Automatic Saw Filer, without obligation to me.

NAME.....

ADDRESS.....

IVER JOHNSON
AMERICA'S FINEST
and MOST POPULAR
Bicycles
for Boys, Girls
Men and Women

Send for folder
66B

\$27.50
UP

IVER JOHNSON'S ARMS & CYCLE WORKS
21 River Street, Fitchburg, Mass.
New York San Francisco Montreal
85 Chambers St. 731 Market St. Coristine Bldg.

PAINT SPRAY OUTFITS

National Paint Spray Units suitable for all purposes. 5 Sizes, \$14.50, \$22.50, \$32.50, \$47.50 and \$98.50. Best value money can buy. Send for free folder. **NATIONAL ELECTRIC TOOL CO., Dept. 05, 560 W. Washington Blvd., Chicago, Ill.**

Billion
Ideas

in
POPULAR
MECHANICS
BOOK
CATALOG

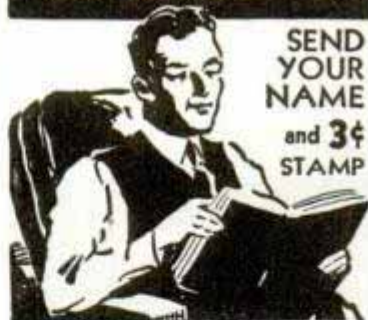

SEND
YOUR
NAME
and 3¢
STAMP

Every man who reads Popular Mechanics will want this new big illustrated catalogue of practical, helpful and money making books.

It describes over 5,000 informative and authoritative books, alphabetically arranged under a thousand subjects—everything from ACCIDENT PREVENTION to X-RAYS. It's an amazing guide to the world's BEST practical books. You must see it to appreciate its value. Only limited edition printed. Send your name and address and three cent stamp to cover postage on your copy. Do it today.

Popular Mechanics Press
200 E. Ontario St., Chicago

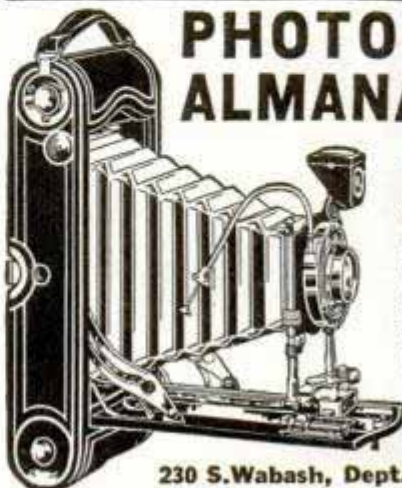

PHOTOGRAPHIC
ALMANAC AND 148 PAGE
BARGAN BOOK

FREE

Explains latest inventions, methods in Photography and Home Movie Making, for fun and profits. Offers hundreds of amazing, money-saving Bargains in still and movie Cameras, Lenses, Films, etc. Used equipment accepted in trade. Satisfaction guaranteed! **WRITE!**

CENTRAL
CAMERA CO.

230 S. Wabash, Dept. K-5, Chicago, U. S. A.
PHOTOGRAPHIC HEADQUARTERS SINCE 1899

When writing please mention Popular Mechanics

LOW COST POWER

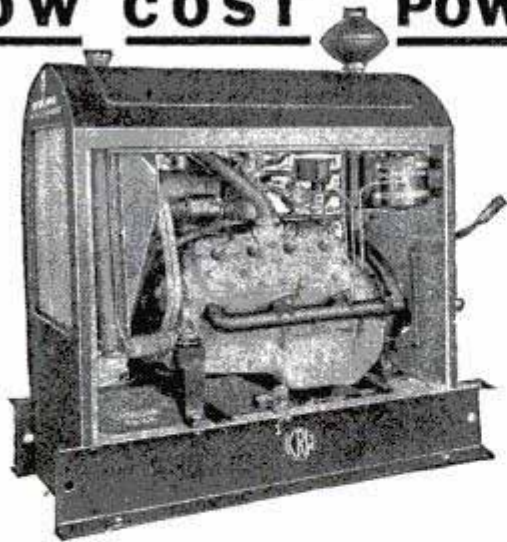

with this KRW-FORD V-8 unit

Here's dependable, low-cost power up to 60 H.P.—complete, compact, portable. Ideal for line shafts, welders, compressor, hoists, pumps, amusement devices, well drillers, agricultural, oil field and contractors' equipment, etc., etc. The most complete industrial power plant built. Uses gasoline or natural gas.

Assembled with brand new heavy duty Ford V8 Truck engine. Large capacity radiator protected by heavy screen. Engine rubber mounted—outfit complete with governor, gas tank, 17-plate battery, instruments and louvered side panels to thoroughly enclose the engine.

Write for complete information, price, and data showing how this unit will pay for itself out of savings in a few weeks, whether operated on gasoline or natural gas. You can buy thru your Ford Dealer and benefit by local service and low-cost Ford engine replacement feature.

K. R. WILSON 17 Lock St. BUFFALO, N. Y.
EXCLUSIVE BUILDER OF APPROVED FORD SHOP EQUIPMENT SINCE 1916



Over 50 Ways to Make Money

We Show You How Own your copy of the original "LeJay Manual."

New enlarged 1937 edition just off the press. Proved and tested by thousands—it has no equal in the field of electricity. Anyone can understand our simplified illustrated plans. Learn how easy it is to convert auto generators into 6-12-32 or 110 volt useful motors or generators to be driven by wind, water or gasoline.

No special tools, no experience needed. Contains plans for complete wind-plants—all voltages; generator arc welder; transformer arc-welder; spot welder; bench grinder; drill press; electric outboard motor; 6 volt washing machine motor; wind propeller blades; also other motor and generator changes.

\$1.00 bill plus 6c postage brings your copy. Satisfaction guaranteed or money refunded.



LEJAY MFG. CO.

1347 W. Lake MINNEAPOLIS, MINN.

EXTRA 55¢ in SPARE TIME PRINT at HOME

Letterheads, Circulars, billheads, cards. Printing pays BIG. Easy, interesting, educational. **PRINTING PRESS BARGAINS \$12.** Types and Supplies, lowest prices. Send stamp for catalog. **PEIFFER Co., 11-B, 6 Columbia St., Newark, N. J.**

24 in. Models of Famous Clipper Ships

Complete Construction Kits



\$2. EACH
Plus 15c Postage



Your Choice of

CUTTY SARK or SOVEREIGN OF THE SEAS

Construction Kits contain Carved Wood Hulls; Printed Balsa Decks; Lifeboats, Anchors, Bits, Wheel (all Cast Metal), Chains, Masts, Spars, Rigging, Cement, Colored Lacquer, Full Size Plans and Instructions—Your choice **\$2. Plus 15c Postage**

Send for Catalog Model Ships, Fittings, Materials—5c

IDEAL AEROPLANE & SUPPLY COMPANY, Inc.
26 West 19th Street : : : : New York, N. Y.

When writing please mention Popular Mechanics

This spring your car gets a break



Here's a radiator cleaning process that **Really Cleans**

"EVEREADY"

3-STEP

COOLING SYSTEM PROCESS



The Professional Cleaning Job

- ✓ Cuts all grease and sludge!
- ✓ Removes even hard rust scale!
- ✓ Leaves inside of radiator bright and shiny!
- ✓ Is harmless—less corrosive to aluminum and radiator metals than water!

The New "Eveready" Cleaner was developed exclusively for car radiators. It is an entirely new solution, using new ingredients developed during the past three years just for this job. There's nothing else like it.

Manheim POCKET SLIDE RULE

With A-B-C-D Scales. Multiplies, divides, squares, takes square root, finds circumference and area of circles. 6 inches long—thin construction. NO WOOD OR CELLULOID. Fits in vest pocket. Send \$1 in cash, money order or check (\$1.25 Canada & foreign countries) and receive slide rule with genuine leather case and instructions. Box M-7. **M. MANHEIM COMPANY, Inc.** 15 E. 26th St. New York, N. Y.

es 86

(Continued from page 156A)

of man's struggle with plant afflictions. Thousands of diseases call for an entirely different form of control measure. Working hand in hand, the chemist and the plant pathologist have developed the use of sprays for the protection of fruit and foliage, fumigants and disinfectants for soils and many other methods of increasing production. And of course the extensive development of fertilizers has likewise been a task for the chemist and agronomist.

Since pests of various kinds continually threaten man's existence, it would seem that man should bend his efforts to exterminating all bugs, all fungi, all bacteria, all molds, all weeds and everything else likely to prove a nuisance. If man should do this successfully, he would perish.

There is a beautiful system of checks and balances in nature. Entomologists have declared that insects, if freed of their natural enemies, would devour the earth and slaughter mankind. On the other hand, insects are necessary for man's existence. The farmer might plant seeds and the orchardist grow trees, but before these yield crops, the insects must function. A honey bee can pollenate a field of buckwheat much better than any mechanical method man has been able to devise for doing the task.

Because it is easier to kill insects indiscriminately than to kill particular kinds of insects, the bees are being slaughtered in man's war on pests. An airplane is an efficient weapon in dusting a field with insecticide and can cover more ground in a day than 100 men could cover with wheeled or hand apparatus in a week. But the good insects perish with the bad. Here again the industrial chemist is coming to the aid of agriculture. He is attempting to develop poisons or repellents for insect pests which will not attract or kill other insects which aid man. Man's task is to control the insect world, not to exterminate it.

Science and mechanics have joined forces with chemistry in developing methods of selective control. Each kind of insect seems to have a weakness. Codling moths insist on laying their eggs in the dark—so flood an orchard with lights and the moths won't reproduce. It has been noted that mosquitoes are attracted by the

360-cycle hum of an electric furnace, the heat of which kills them. This may lead to the development some day of an "electric chair" for the exclusive use of mosquitoes.

Experiments also are being conducted with high-frequency electric waves as death rays for insects. It has been found that at a frequency of about 3,000,000 cycles per second, they will kill all insects within their field. Between 12,000,000 and 15,000,000 cycles they kill plants. Perhaps some day it may be possible to use particular cycles to kill particular insects. One method of selective picking of insects is with ultraviolet light. The Japanese beetle, for instance, is responsive to a particular wave length of black light which does not appear to attract other insects.

One outstanding service of chemistry to agriculture has been the development of agricultural explosives. The use of such explosives for removing stumps and stones, for drainage, stream correction, sub-soiling and tree planting enables the farmer to improve and maintain his land today in a fraction of the time and with but little of the human drudgery formerly necessary. In the old days grandfather boasted if he had been able to clear forty acres of land during his lifetime—and he had a right to boast. Today thousands of farmers, with the aid of a few hundred pounds of explosives, clear forty acres in a few years of part-time work.

Agricultural explosives have also brought to the farmer another ally, the agricultural engineer. With a few sticks of dynamite and some blasting powder judiciously used, the agricultural engineer can make over a farm until the old homestead looks like a different place. He not only blasts out stumps and boulders, he straightens streams, digs ditches, drains sink holes, plants trees, blasts wells, excavates cellars and even digs post and pole holes. The agricultural engineer's method of "farming with a bang" has relieved the business of much of its back-breaking toil.

In the development of refrigerants for mechanical refrigeration, the chemist has rendered a service not only to farmers but to city people who consume the products of the farm. Without such a method of preservation, there would be no market

(Continued to page 162A)

IT COSTS NO MORE TO USE GENUINE FORD PARTS

—But see what it means!

Most Genuine Ford Parts cost no more than parts that are not genuine. That's because of Ford facilities, Ford resources, Ford large-scale production. But regardless of price, Genuine Ford Parts are economical to use because of the extra quality, the extra precision of manufacture, the extra long life they provide.

Consider these facts: All Genuine Ford Parts are made of the highest quality materials. The tensile strength of the steel in Genuine Ford Springs, for example, equals 200,000 pounds per square inch. At 31 points in a Ford V-8 Engine, the precision requirements are equal to those of a fine watch. In manufacturing Genuine Ford Pistons, diameters are held to a limit of variation of two-thousandths of an inch. Ring-groove widths are held to one-thousandth of an inch varia-

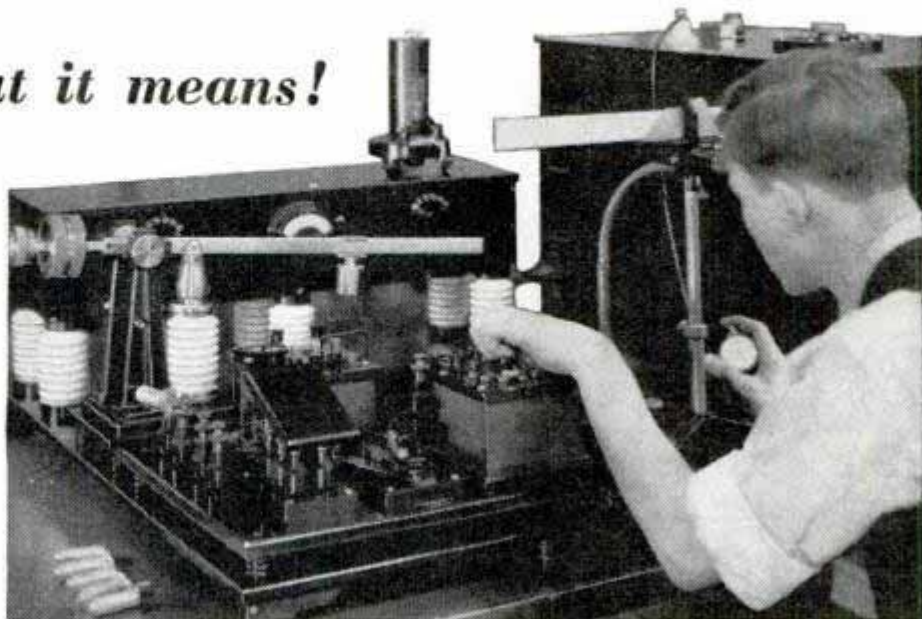

Constant tests and inspections insure the quality of Genuine Ford Parts. Here an operator is checking the resistance of condensers on an insulating test bridge.

tion. And piston-pin holes must not vary more than three ten-thousandths of an inch. These are but a few typical examples of the care used in making all Genuine Ford Parts.

In many ways, it pays to use Genuine Ford Parts. It pays in better performance, in longer performance, in the satisfaction you get in knowing that behind Genuine Ford Parts is an organization interested in the performance of its cars and trucks over the years.

Genuine Ford Parts may be obtained at all Ford dealers or at any garage that displays the sign, "Genuine Ford Parts."

FORD MOTOR COMPANY
DEARBORN, MICHIGAN
Prices subject to change without notice.

Genuine Ford V-8 Piston Rings. Complete set of 16 compression and 8 oil regulating rings, \$1.90.

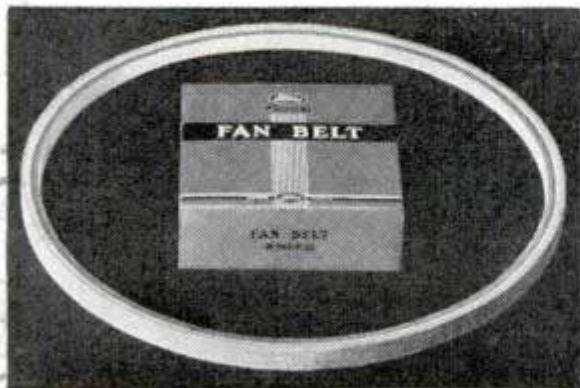

Genuine Ford Fan Belts, like many other Genuine Ford Parts, are packaged for your protection. Ford V-8 car fan belts are only 50c to 60c, according to car model.



This kit contains all of the necessary parts to do a complete job of spindle rebushing. Price complete, \$2.70.

When writing to advertisers, please mention Popular Mechanics



WHY

CLIPSHAVE'S SIMPLIFIED TWO-WAY
SHEARING HEAD *gives*

SMOOTH shaves
CLOSE shaves . . .
QUICK shaves . . .

1. It shaves *in plain sight* at the leading edge. You always see exactly what you are doing, so hard-to-reach places do not exist for Clipshave. Trims sideburns accurately.
2. The V-shaped openings are so designed that all types of hair—long or short, fine or coarse—enter freely and are shaved skin-close with amazing comfort. Clipshave's unique triple-impulse motor is a marvel of swift, silent, vibrationless power.
3. Because all hairs are ejected from the shearing system and not into it, Clipshave is absolutely clog-proof, and needs no special cleaning. Clipshave's very simplicity, with the fewest possible moving parts, makes it the most efficient electric shaver and lowers its cost to you. Operates economically.

BUY A CLIPSHAVE TODAY

If your dealer can't supply you, send \$10 to Dept. B, Clipshave, Inc., Port Chester, N. Y.



es 86

(Continued from page 160A)

for many of the products of the soil. Today mechanical refrigeration is recognized as just as important on the farm where the food originates as in cold-storage plants, retail shops and in the home. Milk, eggs, fruits, berries, vegetables, poultry, meats and many other foodstuffs must be refrigerated before they are consumed and in most cases, the sooner they are placed under refrigerating conditions, the higher will be their quality. Modern farmers are realizing this and reaping greater profits from their products.

Thus this new hired man of the farmer, the industrial chemist, begins by treating the seed the farmer plants and finishes by preserving the crop the farmer harvests until it reaches the consumer. And each year, in the quiet of the research laboratory, he is finding new substances and new tools to eliminate more and more of the drudgery and uncertainty from one of man's oldest occupations—tilling the soil.

es 169

Trim Hat Box Is Made of Cork Tinted in Pastel Shades

Cork is being used to make trim-looking hat boxes and other household articles such as hampers, yarn holders and book covers. They are lightweight and soft, and can be tinted in pastel colors.



Here are some of the household articles being made from cork—decorative hampers, scrap book covers, desk set, and a hat box in pastel colors

The main and
Morgan 4030
Bendish Island
Los Angeles, Calif.

New 6-Volt TRINDL Electric ARC WELDER

PATENTS PENDING

**Works on Storage Battery
or with Converter on
110 Volt Light Circuit**

A REAL WELDER

Men, here is the hottest specialty item that has come along in years. A real honest to goodness electric arc welder that does a man size job. Built sturdily of the finest materials. Requires no mechanical knowledge—any one can use it. Every demonstration should make a sale. This new Trindl Electric Arc Welder is made possible by the invention of a low voltage carbon which gets white hot from the current of an ordinary 6 volt storage battery such as in your automobile. It only uses about 20 to 25 amperes of current which is about the same current drain as 4 head-light bulbs, yet develops about 7000 degrees of heat.

**MELTS IRON AND STEEL
INSTANTLY**

The Trindl Welder is simple to use. Expert welding can be done by anyone. It is ideal for making permanent fender repairs—also for brazing broken castings and water jackets, repairing radiators, holes in auto bodies, hog troughs, small tanks, milk cans, radios, batteries, etc. Iron, steel, brass, copper and tin can be worked on for a quick and permanent repair. The repaired part will be as strong as before.

NEW 110 VOLT CONVERTER MAKES FULL SIZE PROFESSIONAL UNIT

This new converter is used on any 110 volt 60 cycle electric light socket in place of a storage battery. It is especially designed to be used with the Trindl Electric Arc Welder—**COSTS LESS THAN A GOOD BATTERY**—The combination makes a full size professional electric arc welder that everybody can use. Ideal for fender and repair shop needs. This is a sensation, not only in price but also in actual results. The converter represents the same fine construction and engineering skill as the arc welder. The complete outfit, including the transformer, is easily portable so that it can be brought right to the job.

USERS SWEAR BY IT—The price is so low that now anyone can afford to have a real welding outfit. Think of the profit you can make introducing this Trindl Welder and Converter—a simple five minute demonstration should make a sale to every interested prospect, especially when they hear the amazingly low price. Garages, radio and battery men, tanners, sheet metal workers, janitors, farmers and home-owners all need the Trindl Welder and Converter.

ACT NOW! There are big profits and a steady business waiting for you taking care of your territory for us. Don't let someone else get in before you—Send coupon Today.

TRINDL PRODUCTS
2229-K A Calumet Ave. Chicago, Ill.



FACTS

Here are just a few excerpts from the many letters of praise we have received from Trindl Electric Arc boosters.

"Please find enclosed for 12 welders by return mail for I am about sold out now. They are selling fine."—W. C. Anderson, Nebr.

"Received my Trindl Arc Welder and am both pleased and surprised."—Louis F. Glier, Ohio.

"Results are very gratifying with your welder. I am enclosing an order for 12 more Electric Arc Welders."—Nelson O. Lyster, Florida.

"I received my welder, and it is a regular repair shop in itself."—J. R. Harper, La.

"I sold 4 of your Trindl Electric Arc Welders in three minutes."—C. Gillies, Canada.

"I sold 9 welders in my first ten calls."—F. W. Stice, Iowa.

\$10.50 a day profit for you for only selling 6 Trindl Arc Welders. No matter where you turn, you will find people who will want to buy arc welders from you. Garages, shop men, radio repair men, farmers, home-owners, mechanics, janitors, all of them need Trindl Electric Arc Welders. Be the man in your territory to clean up with Trindl.

MAIL COUPON NOW!

TRINDL PRODUCTS
2229-KA, Calumet Ave.
Chicago, Illinois

Yes! Rush me free particulars of how I can make big money with Trindl Electric Arc Welders and Converters. This does not obligate me in any way.

Name

Local Address

City

State



GET INTO ELECTRIC WELDING—MAKE \$150 TO \$300 EXTRA MONTHLY!

Low Investment . . . Liberal Time Payments . . . Easy to buy the New Guaranteed FlexArc Welder.

Hundreds of shops are now taking in new high-profit jobs by providing customers with the big savings of electric welding. YOU can do the same with low investment. But make sure you get a wide-range, high-capacity set. Don't make the mistake of buying a welder that can only handle small jobs. The New FlexArc is the one machine that does all types of welding at lowest cost. Revolutionary new-type design; easiest to use on the market today; makes welding completely safe.

Backed by Written Guarantee—Westinghouse, a company that has made electrical history for 50 years, is the only manufacturer that has dared put its guarantee in writing.

Build Your Own—All you need is an auto engine, chassis and the FlexArc Generator. Make your own Portable Welder and easily save \$300 to \$500.

Electric-Driven FlexArc—Portable or stationary types available. If you have electric power this is most profitable FlexArc for you.

Gas Engine Driven—Portable or stationary models, Dodge truck engine, with electric starter.

Earn While You Buy—New Easy-Payment Plan enables you to pay for your FlexArc out of monthly profits. Send coupon NOW for details. J 20248



GASOLINE DRIVE



ELECTRIC DRIVE

30-Day Trial
Easy Payments
Priced Right

Westinghouse Electric, Room 5N1, East Pittsburgh, Pa.
Without obligation send your new "1937 Catalog of Popular FlexArc Models." I am interested in: Building my own Electric Driven FlexArc Gas-Engine Driven 30-Day Trial Easy Payment Plan.
Name _____
Address _____

Westinghouse Flexarc Welder

FASTEST SELLING WELDER ON THE MARKET TODAY

Atlas

LOOK FOR THE RED STARS IN THE CATALOG



METAL WORKING LATHES \$45.50 to \$124.50

FREE
style

★ Red Stars in the Atlas Catalog lathe descriptions show exclusive Atlas features provided as regular equipment at no extra cost—savings of over \$35, on back geared models. Before you buy any lathe get an Atlas catalog and make your own comparison. Write today to—

ATLAS PRESS CO.

543 N. Pitcher St., Kalamazoo, Mich.

Factory Displays at
Chicago—35 E. Wacker at Wabash
New York—130 W. 42nd St.
Philadelphia—113 N. 3rd St.



new EVINRUDE

"Scout"

\$44

15 POUNDS

F. O. B. Milwaukee



Here is the lightest, handiest slickest little motor that any fisherman, cottager, vacationist ever dreamed about . . . and, complete, ready to go, it costs only \$44! Drives good sized boats up to 5½ miles an hour! Uses only a single quart of fuel in 1½ hours.

Write today for catalog on the 15 lb. Scout and brilliant new Evinrude Streamflow models for 1937. Address, EVINRUDE MOTORS, 5178 N. 27th St., Milwaukee, Wis.

Prices subject to change without notice.



EVINRUDE SEND FOR CATALOG

RIDE AN AUTO-SCOOT!

"The Mightiest Midget of Them All"

Loads of fun and designed for practical use. Powered by the famous Briggs & Stratton Motor with engine starter, clutch-mission and real brakes. An honest to goodness vehicle. Can be ridden by anyone that can ride a bicycle including women and small girls. Can be used instead of a bicycle for pleasure, rental service or commercial.

Extremely high gas mileage. Speeds up to 25 M.P.H. Safety controls. Meas. uses only 57 inches over all and 33 inches high. Weighs only 92 lbs.

\$98.50

F. O. B. Chicago

WRITE FOR FULL PARTICULARS

RENMOR MFG. CO., NOT INC.

4877 ARMITAGE AVE., CHICAGO



BUILD CLOCKS for PLEASURE—PROFIT



Wall clocks are high priced in stores—you can make good money building them or electrifying spring clocks. Dime brings drawing of easily built Grandfather Case with "HOW" Book pricing banjo, desk, mantel, RADIO, spring, ELECTRIC, chime, BATTERY from \$1.40. Brass weight movements from \$16.95. Start now.

KUEMPEL CHIME CLOCK CO., Bldg. 4, Gutfenberg, Iowa

WOODWORKERS Send for Free Catalogue.

Large Chicago Warehouse Stock

PLYWOOD AND VENEERS AT WHOLESALE PRICES
PLAIN AND FANCY INLAID TABLE TOPS
PLAIN AND FANCY DOMESTIC AND IMPORTED VENEERS
"25 years in Veneers"

Rosenthal Plywood & Veneer Co. 1308 N. Halsted St. Chicago

Catch Fish!



Eels, Mink, Muskrats, with our new folding galvanized STEEL WIRE TRAP. Write for our FREE TRAP OFFER and Bargain Catalog. \$1 Box of our famous Fish Bait FREE to introduce our traps.

WALTON SUPPLY CO., 3501 JUNIATA AVE., ST. LOUIS, MO.

Men & Women Earn Cash at Home!

We paid M. M. \$267 in 3 weeks for exceptional "cellar crop" patented mushrooms! Big free picture book tells if your cellar, shed, barn suitable. We buy all crops thru ten branches. Write today.

Est. 1908 UNITED CO., 3848 Lincoln Ave., Dept. 310, CHICAGO

New "Delta" Tools

More complete than ever before, the Delta line for 1937 includes a full line of wood working and light metal working tools and all necessary accessories and incorporates many new features and improvements and new units. This year the Delta line includes:

Combination Ten-Inch Circular Saw Six-Inch Jointer



A remarkable NEW Belt Sander; Revolutionary NEW 17" Drill

Presses, a NEW Precision 4' Jointer; a NEW Precision 11' Drill Press; Improved 14' Drill Presses; Improved Combination Units; NEW Tapping Attachments; NEW Shaper Cutter-head; NEW Tenoning Collars; NEW Belt-Drive Buffer; NEW Belt Guards and Improved Safety Features.

Write for Catalog

Send today for latest 1937 Delta Catalog containing photographs, prices, and full details on the complete line of Delta motor-driven tools.

DELTA MFG. COMPANY

Dept. A-537, 600-634 E. Vienna Ave., Milwaukee, Wis.



New 17-inch Drill Press

NEW SEVENTEEN-INCH DRILL PRESS. The greatest drill press value ever offered. Nothing quite like it on the market today.

Learn BRASS TAPPING

FUN and PROFIT! Get this big new outfit. Learn "raised metal" work. Sell gift and art wares. **Complete Outfit \$2.00** Make Bookends, What-Not Racks, Twin Plaques. Equipment includes non-tarnishable jewelers' metals, handcraft hammer, plywood backing-board, noiseless tapping tools, special nails and design patterns. Send \$2.00 money order for outfit complete. State choice Brass or Copper. ("Silver" or "Gold" \$2.50.) **FREE CATALOG** with outfit or send 3c stamps. Write today. **RAPAPORT BROS., 701 W. Ohio St., Chicago**

SELLEY-TEX REARWIN SPEEDSTER

patented **FLYING MODEL AIRPLANE KIT**, with moulded fuselage, wheel shoes and cowl practically crashproof. Nothing else to buy. Kit complete... **SHIP MODEL FITTINGS**—Die-cast—box-wood brass. Most complete catalog 5c. **SELLEY CO., Dept. 805, 1375 Gates Av., Brooklyn, N.Y.**

75c



16" Wingspan.

INVENTORS Be Sure to See Page 23A

Make Money at Home

GROW MUSHROOMS in cellar or shed, with AMI selected-spore spawn and step-by-step, easy-to-follow **MANUAL OF INSTRUCTIONS**. Book Free. **Anglo-American Mushroom Industries, Dept. 110, Toronto, Ont.**



Neon Truck Signs

Now Possible with Amazing New TRANSFORMER and Novel Method of Tube Installation!

DISTRIBUTORS WANTED

Old, established factory wants financially responsible business executives—to handle distribution in exclusive territories. Signs fill long-felt Advertising need! Enable any advertiser to have brilliant, colorful, attention-getting Neon Advertising message on trucks, both day and night. Expected to quickly sweep country! Easily installed on top driver's cab. Amazing **NEW TRANSFORMER** enables Sign to operate on any truck's standard 6-volt auto storage battery—using only about same amount current as an extra tail light. Novel method tubing installation protects against breakage. Reasonable capital handles exclusive Distributorship Contract. Big Profits. No sign experience necessary. We furnish entire product. **FREE LITERATURE** gives details, explains liberal proposition. Write today! **E. E. SOUTHER IRON CO., -1952-A-36 Kienlen Ave., St. Louis, Mo.**

GIVE AWAY FREE R.C.A. LIC. RADIOS

MAKE \$15.00 ON EVERY DEAL Send 10c for sample adcard and plan. Many making up to \$150 weekly. **BUY AT FACTORY PRICES** Resell at 100% profit Get into radio business. 1937 catalog **FREE**. 25 new models for farms, homes and autos, 5 to 15 tubes. **FOREIGN Reception**. New "MAGIC-EYE" tuning. **ONE YEAR** guarantee. **FREE** home trial. **MONEY-BACK** if not 100% satisfied. **SILVER MFG. CO., 606 N. Michigan Ave., Chicago, Ill.**



Write for FREE CATALOG

RAISE GIANT FROGS



NUFOND GIANTS WEIGH UP TO 3 LBS. EACH

EASY TO START!

Markets Waiting. Frog legs in big demand at good prices the year 'round. Millions used yearly!

WE BUY We have one of the largest frog markets in the world! Sell to us in addition to other markets.

Men and Women starting in every state and Canada. See what others already doing. Small pond starts you. **FREE FROG BOOK** explains our unusual offer to beginners! Now's the time to begin! Write today!

AMERICAN FROG CANNING CO. (Dept. 133-EE) New Orleans, Louisiana

FREE BOOK



Flying High



WITH A

SEA GULL

\$ 39.50 UP

Yes sir - the 1937 SEA GULLS "hit the high spots" of anyone's requirements! Quality - power - performance - everything has soared **except the cost.** For as little as \$39.50 you can buy the famous SEA GULL Outboard Motor! 2, 4, 6 and 16 H. P. models are available - all with . . .

THESE EXCLUSIVE FEATURES:

- Automatic float-feed carburetor
- Monel metal shafts
- Underwater exhaust
- New type sensational magneto
- Carburetor control in steering handle.

STEEL BOATS

\$24.50 UP

Send for complete details of our money-saving 2-IN-1 Offer. Any one of our steel boats - safe, sturdy, seaworthy - and a SEA GULL Outboard Motor of the size you require - at a **combination price** that will amaze you!

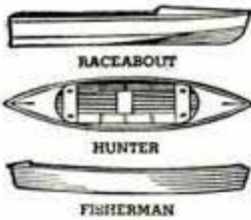

WRITE FOR FREE ILLUSTRATED LITERATURE

NATIONAL OUTBOARD MOTOR CO.
DEPT. PM MARSHALL, MICHIGAN



WINCHESTER

NEW
Model 697 Bolt Action
Six Shot

*Low Cost
Telescope Sight
.22 Rim Fire Rifle
and 'Scope to Fit it*

YOU will instantly want this new Winchester pair. Lower in cost than lots of .22 repeaters with ordinary sights. A full man's size, fast-handling, finely accurate rifle equipped with Winchester telescope-sight mount blocks. No metallic sights. Superior bolt action. Positive safety lock. Six shot repeater. Shoots .22 short, long and long rifle cartridges, both regular Winchester Staynless and Super Speed. Take down. Weight 5 lbs. New popular style universal-focus telescope sight—choice of 2 3/4 or 5 power—with micrometer adjustments . . . If you want a single shot rifle for less, Model 677 . . . Or there's choice of Model 67, 68 or 69 ready equipped for interchangeable use of metallic sights and a scope sight. Ask your Dealer. For FREE folder write Dept. 46-C, Winchester Repeating Arms Co., New Haven, Conn., U. S. A.

When writing please mention Popular Mechanics

Do You Want a WATCH or DIAMOND?



Thousands have found it easy to own America's finest diamond rings, watches, silverware or jewelry by the Santa Fe Plan. Bulova, Hamilton, or Elgin watches—brilliant blue-white diamonds—silverware from world-famous companies, and the great Santa Fe Specials—offered to you at startling cash prices on confidential liberal credit terms.

A Few Cents a Day is the Santa Fe Way

That watch or diamond you've always wanted, longed for—you needn't wait any longer for it. The Santa Fe will trust you—let you wear the watch or diamond you want while you pay only a few cents a day.



Gifts for Every Occasion

TURN PIN MONEY INTO DIAMONDS

Don't Pay Extra For Credit!

No honest person should pay extra to have someone trust him. The Santa Fe trusts you the way you want to be trusted—straight from the shoulder without any extra charges, extra fees, or taxes. You pay only the low advertised cash price in small monthly payments. Send for 1937 Catalog NOW!

FREE to Adults—Send for this beautiful book today. Sent ABSOLUTELY FREE to adults. Send your name and address, and the beautiful catalog will come to you by return mail. Do it now while you think of it.

SANTA FE WATCH COMPANY
Dept. 56, Thomas Bldg., Topeka, Kans.

PAINT SPRAY OUTFIT \$6.95

A guaranteed outfit that does the work with least effort.

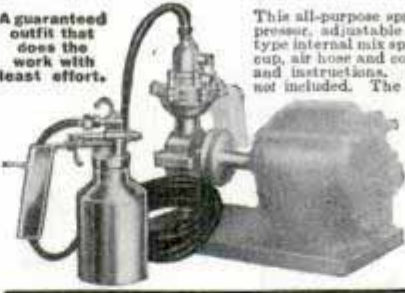

This all-purpose spray outfit has a two valve air compressor, adjustable safety air release valve, pressure type internal mix spray gun, extra nozzle and aluminum cup, air hose and connections, all mounting accessories and instructions. Uses a 1/4 H. P. motor, which is not included. The gun alone is worth more than we are asking for the entire outfit. Works equally well with lacquer, enamel, or insecticide. Spray your car, spray your furniture. Compressor can be used for vacuum or operate gas blow torch for welding.

Send \$1.00, balance C.O.D.
PHILADELPHIA MACHINERY CO.
603 Arch St., Philadelphia, Pa.

NEW TRAILER PARTS CATALOG

New catalog of trailer parts at bargain prices. Drop center axle undercarriage, \$25, complete less tires. Utility trailer plans, 50c. Cabin trailer parts, \$1. Send for FREE Catalog today.
SHAMROCK TRAILER PARTS, 12321 Turner, DETROIT, MICH.

AUTO ALTIMETER

\$12.50
2 1/2" DIAMETER
ENJOY your trip
ANOTHER GROVER PRODUCT
8575 BEVERLY, LOS ANGELES

BUILD WITH DOENUTS

Build with the original patented low pressure Musselman Doenut cord tires and wheels. They absorb surface obstructions, eliminate jolts and reduce pushing and pulling effort approximately 50%. Tire requires only 12 to 15 lbs. air pressure for loads up to 200 lbs. per wheel. Size: 16" x 2 1/4". Cadmium plated steel disc wheel with adjustable ball bearings. Doenuts are ideal for building hand trucks, midget autos, wheelbarrows, lawn mowers, lawn furniture, portable painting, spraying and greasing equipment or any portable unit under 850 lbs. Boys: send 50c for full set blue prints for building wagons, wheelbarrows, bicycle trailers, mowers and midget autos, with free literature.
MUSSELMAN PRODUCTS CO.
6247 ST. CLAIR AVE. CLEVELAND, OHIO

Voice Tester Shows Mistakes and Aids in Training

Kymograph

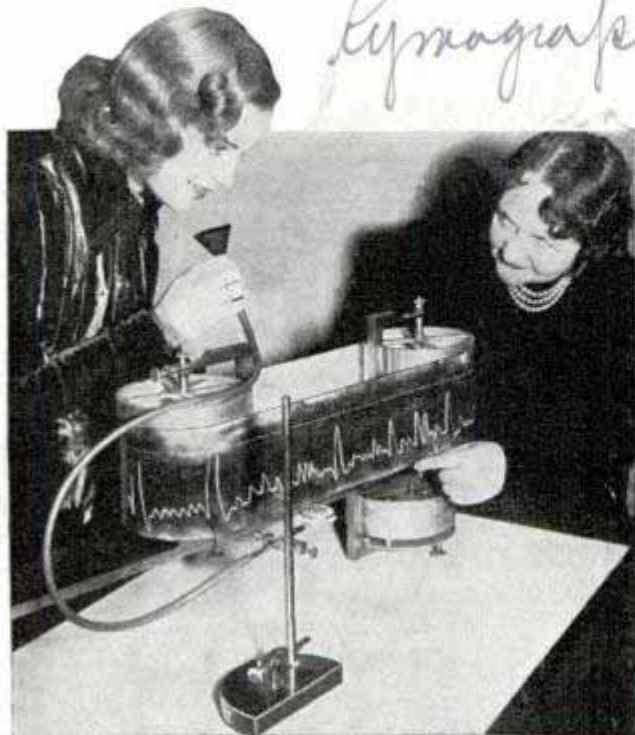

White wavy lines on voice tester reveal defects in speaking or singing

Writing down voice vibrations in graph form, the latest device to aid in the training of actors or speakers quickly reveals mistakes in speech. The subject can see at a glance the point at which the vocal chords fail to function as desired, enabling him to concentrate on correcting the mistake. Called the kymograph the device was developed by a London physicist.

Self-Energizing Drill Chuck Needs No Tools Nor Key

Knockout



Requiring no tools, wrenches or keys, a self-energizing drill chuck is available for heavy-duty, precision and high-speed drilling operations. Spoilage and chewing of drill shanks are avoided. The grip tightens in proportion to resist-

ance encountered, without slippage. A finger-tip twist of the feed screw cap is enough to grip the drill.

*R. G. Lee + Son Co
Aberdeen, S. C.*

All America is talking about it!

The Sensational New WILLIAMS OIL BURNER

MADE BY

WILLIAMS OIL-O-MATIC HEATING

selling for less than \$200

GOOD news travels fast! Already, people throughout America are talking about this amazing new Williams Oil Burner which is priced—believe us!—below \$200!

Included are an inside storage tank, a combustion chamber built to fit your heating requirements, plus all installation costs! Only local permits are extra!

Amazing? We'll tell the world! Orders are simply pouring in! Production is limited! So—don't wait! Act at once!

BUILDERS ATTENTION! Investigate this new Williams Oil Burner! It is what you have been looking for!

STUDY THESE FEATURES!

- ★ Fully Automatic
- ★ High Pressure continuous spark—no radio interference
- ★ 1/10 h.p. motor—very low current consumption
- ★ Burns low cost No. 3 fuel oil
- ★ Silent as a whisper
- ★ Two-stage pump with automatic safety shut-off—uniform pressure—constant flame
- ★ Williams engineered throughout
- ★ Easy payments—12-36 months to pay

WILLIAMS OIL-O-MATIC HEATING CORP.
Dept. 395, Bloomington, Ill.

Please give me full particulars about your new low priced Williams Oil Burner.

Name.....
Address.....
City.....State.....

NEW Xpert .22's For GREATER ACCURACY

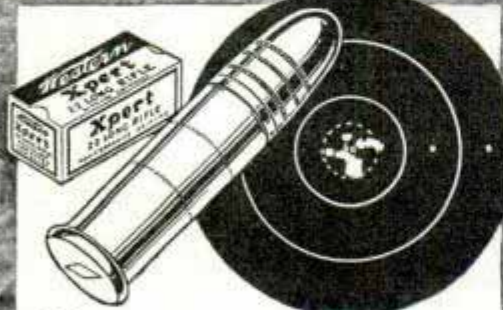

Here's a new cartridge for all-around use and target shooting! MORE ACCURATE than ordinary .22's yet NO HIGHER IN PRICE!.. Western XPERT .22 Long Rifle is built of same components as SUPER-MATCH, the sensation of 1936!... XPERT .22's are available also in Shorts and Longs. SMOKELESS! NON-CORROSIVE! Lead lubricated bullets! Ask your dealer to stock XPERT .22's! Mail Coupon!

FREE, AMMUNITION HANDBOOK!

Western Cartridge Company, Dept. E-46, East Alton, Illinois.

Send, FREE, the new Western Ammunition Handbook—a complete guide to modern shooting that tells all about the new Xpert .22's.

Name.....
Address.....
Post Office.....State.....

For..BIG Money-Making..Doing ALL Work Use the EIJEL-GEARED PIERRENCH KITS

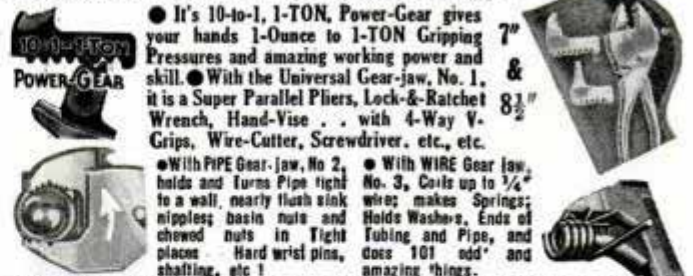

● It's 10-to-1, 1-TON, Power-Gear gives your hands 1-Ounce to 1-TON Gripping Pressures and amazing working power and skill. ● With the Universal Gear-jaw, No. 1, it is a Super Parallel Pliers, Lock-& Ratchet Wrench, Hand-Visc . . . with 4-Way V-Grips, Wire-Cutter, Screwdriver, etc., etc. ● With PIPE Gear-jaw, No 2, holds and turns Pipe tight to a wall, nearly flush sink nipples; basin nuts and chewed nuts in tight places. Hard wrist pins, shafting, etc! ● With WIRE Gear jaw, No. 3, Coils up to 1/4" wire; makes Springs; Holds Washers, Ends of Tubing and Pipe, and does 101 odd' and amazing things.

● You Get ALL 3 . . . a \$50 Tool Service at the Price of ONE Good tool in the 8 1/2" (20-Oz.) KIT; or, in the 7" (12-Oz.) KIT; and, the 2 KITS give you 9 Different Super-2-Tool Combinations!

●WHAT'S MORE..These "Miracle KITS" are making \$30 to \$85 WEEKLY for AGENTS and DISTRIBUTORS, and We Need More..

● MAIL this Part of Ad TODAY with your Address (on a Postcard will do). Get FREE—this 7-Edge-End-&Angle SCREWDRIVER (It Turns Screws in ALL Positions and does many useful things) . . . and 101-PICTURE MANUAL OF MECHANICS, with . . . User Offers; or, With . . . DISTRIBUTOR, Territory and Free Kit Offers!

AMERICAN PIERRENCH CORP'N EPM-4809N, Ashland Ave. CHICAGO, ILL.

FREE

DRESS YOUR OWN LUMBER—SAVE \$ \$

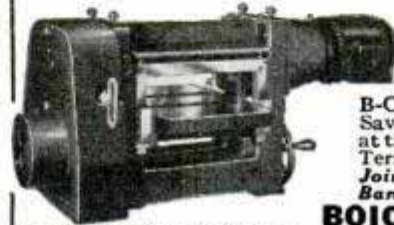

12' x 4' Capacity Thickness Planer Finished lumber from low cost rough stock in your own shop with a B-C 12"x4' Thickness Planer. Save planing cost and waiting at the mill. Pays for itself. E-Z Terms. Also, B - C Saws, Jointers, Sanders, Shapers, Band and Jig Saws.

BOICE-CRANE TOOLS Dept. PM-5M, Toledo, O.

Send 10c for Catalog

900 WORKSHOP IDEAS!

How to Make Articles of Beauty and Utility that Sell

Get the most out of your hobby. Turn your Work Shop hours into profit. The "Make It Yourself" book shows you what to make and how to make it, with that "professional touch"—models—toys—useful decorative articles of all kinds. Newest edition—480 pages, 823 pictures, 7 x 10 inches. Sent postpaid for \$3.00 or in U. S. and possessions C.O.D.—you pay postman. Order Now.

"MAKE IT YOURSELF" INCLUDES:

- Toys—Models—Furniture
- Garden Equipment
- Home Repairs—Sports Equipment—Auto Kinks
- Radio Equipment—Workshops Tools and Machinery. Articles on Working Wood, Metal, Leather, Glass, Etc., Etc., Etc.

POPULAR MECHANICS PRESS,

Room 537B 200 East Ontario Street, CHICAGO



TRAILER DESIGNERS BUILDERS TRAVELERS TRAILER PLANS

SEND 25c TODAY FOR this big 68 page Trailer Manual printed in color. It is chock full of builders' information—Over 350 illustrations, 500 exclusive Trailer supplies, equipment and accessories needed to build the most modern Trailer. BUILDERS GUIDE with complete plans, instructions, designs, specifications, listing practical material. Trailer cabinets, stoves, refrigerators, sinks, water tanks, cushions, table, drawers, bathtubs, toilet, etc. Also a complete Trailer shell built into 10 sections ready to set up and bolt together. Takes low freight rate. Send 25c, coins or stamps today. A. J. Stephens & Co., 1403 Chestnut St., Kansas City, Mo.

RAISE JUMBO FROGS

Fun and Profits raising Frogs. Wonderful, easy method. No experience needed. Complete 20 lesson course tells all: catching frogs, how to use back yard, how to mate, breed, raise jumbos up to 3 lbs., prepare for sale, etc. WE BUY FROM YOU! Just pay postman \$1 plus postage, or send dollar now and we pay P. O. charges, 6 days trial. Money back guaranteed. Send today!

J. B. Frog Company, Dept. 2 Memphis, Tenn.



\$6 MOTOR \$1.75
1/10 H. P. Utility motor—Double end—3/4" Shaft F.O.B. Phila.

With the accessories as shown, including pulley and 3" Grinding wheel; the price is only \$2.50 F.O.B. Phila. Variable Speeds to 6000 R.P.M. Base 4 1/2" x 5 1/4". Rebuilt, guaranteed perfect for sewing machine, polishing, buffing, coal-blower, etc. Order at once all you can use at this amazingly low price. Send \$1.00 with order. Balance C.O.D. Send \$1.00 extra for orders to Canada and same will be shipped prepaid. Send 10c for catalog showing 163 new and used items of tools and machinery.

MARTIN ELECTRIC T. & S. CO., 604 Arch St., Philadelphia, Pa

BUILD a BOAT AT HOME

FOR PLEASURE OR PROFIT

Now you can have just the boat you've always wanted—power, sail, or rowboat—and at rock bottom cost, plus the fun of building. Make a nice profit if you want to sell. Get the

BOAT BOOK—New Edition

This famous book with 6 new boats added, shows exactly how to build 15 different popular boats. Step-by-step instructions with hundreds of pictures. Gives all plans, methods and materials. Includes racing hydroplane, inboards, out-boards, sailing and sectional boat to carry on car. Also old Ford motor for marine use and all boating terms, pilot rules, boat kinks, navigation rules, etc. You can't go wrong. Specially prepared for those with limited tools and skill. Price only \$3. Write for descriptive folder or order now and pay postman on delivery.

Have Your Own Boat This Year or Build Them to Sell!



Popular Mechanics Press Room 537B 200 East Ontario Street, CHICAGO

When writing please mention Popular Mechanics

RISKY BUSINESS

Experts don't take chances. For example, the automobile manufacturers who install PUROLATOR OIL FILTERS at the factory do so because they know that closely-fitted engine parts must be protected from the abrasive substances that form in all lubricating oil. A genuine PUROLATOR keeps your oil so clean that it even retains its color for thousands of miles.

The PUROLATOR OIL FILTER collects all sludge, dirt, metal particles, and hard carbon abrasives. In time it becomes filled to capacity and must be replaced. It's risky business to neglect this important matter. So . . . have your station attendant check the condition of your oil and see if you need a new PUROLATOR. He'll know. Motor Improvements, Inc., Newark, N. J., makers of PUROLATOR, The Oil Filter on your Motor Car.

MAKE YOUR OWN VENETIAN BLINDS
 Complete instruction book shows how easy you can make them in your own home shop. Postpaid only 25c. We furnish hardware, ladder-tape and cord at amazing direct-to-you low prices. Cost of book applied against hardware cost (\$5.00 or more) if purchased from us. Write To-day.
HESTON & ANDERSON 505 PINE STREET FAIRFIELD, IOWA

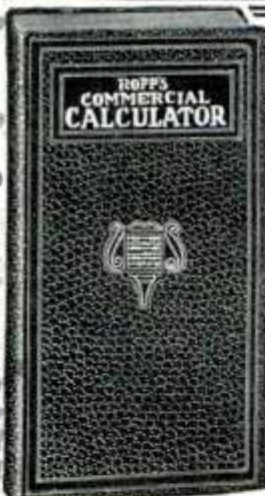

Mathematics Made Easy by ROPP'S CALCULATOR AND SHORT-CUT ARITHMETIC

Shows the Answer as Quickly as a Watch shows the Time to all Problems likely to occur in the Office, Store, Shop, Bank, Farm, or Factory.

Over 2,000,000 Sold
 Explains and simplifies every principle in Arithmetic, Mechanics, and Mensuration.
PRICES POSTPAID
 Desk Size, Flexible Keratol Binding. \$2.00
 Pocket Size, Art Leather Binding. \$1.00
 Pocket Size, Cloth Binding. \$0.50
POPULAR MECHANICS PRESS
 Room P-9 200 E. Ontario St. CHICAGO

Whether you design for welding, build by welding, or use welding in any way YOU NEED THIS BOOK

PROCEDURE HANDBOOK OF ARC WELDING DESIGN AND PRACTICE
 819 pages, 990 illustrations

Long recognized throughout the world as the authority on the art of electric welding. Standard welding reference guide in thousands of industrial plants in U. S. A. and foreign countries. New Handbook makes all others obsolete. Contains complete, authentic, up-to-date data on all latest arc welding applications and design procedure. Order your copy now.

Fourth edition gives you, at no extra cost, 223 pages of new welding data, 289 new illustrations

POPULAR MECHANICS PRESS
 Room 436-B, 200 East Ontario Street, Chicago



ONLY \$1.50 IN U.S.A.
 \$2.00 elsewhere. Prices are postpaid.

When writing please mention Popular Mechanics

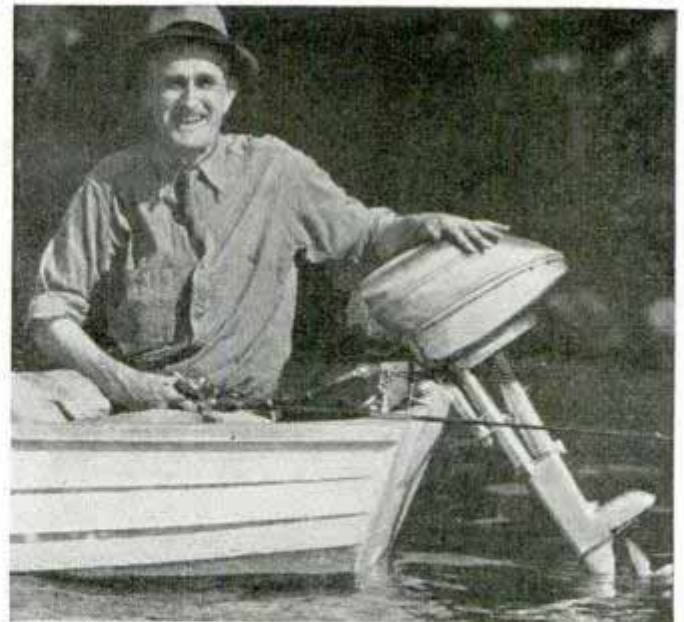

The Outboard that gets you GOIN'!

For fishing, for dinghy service, for small sail-boat auxiliary use, nothing matches this new 1937 Bendix-built Eclipse Air-Cooled. No water system troubles. Starts like no other outboard in history, due to sensational new magneto that packs a 15,000-volt spark wallop!



Magneto Model SM \$69.50
 Battery Ignition Model SB \$61.50
 Eclipse Electric Outboard \$35.50
 (less batteries) all models f.o.b. South Bend

- * New Aerotype Carburetion by Stromberg!
- * New outside controls!
- * Outside Fuel-fill!
- * Full-level tilt-up!
- * Full 180-degree steering—turn "on a dime!"
- * No-Fume Airstream Cooling! No water-jacket and pump to clog or corrode!
- * Silenced Underwater Exhaust!

SEE BENDIX DEALER—OR WRITE FOR DETAILS
BENDIX MARINE PRODUCTS COMPANY
 (Subsidiary of Bendix Aviation Corporation)
 459 Bendix Drive, South Bend, Indiana

NEW 1937 BENDIX-BUILT ECLIPSE AIR-COOLED OUTBOARD MOTOR



**120 MI. PER GAL.
30 MI. PER HOUR
SELF-STARTER
ONLY \$119.00**

New!

PERFORMS LIKE AN AUTO!

It's a knockout! There's not another vehicle in the world like Blue Ribbon Skoot-Mo-Bile, because it's the only motorized scooter that has a self-starter and a real automotive clutch!

Step on the starter and Blue Ribbon is r'arin' to go. No dangerous running start—no killing of the engine at every stop—no uncertainty of any kind. The machine accelerates swiftly—holds its own in traffic—glides smoothly and quickly to its destination.

Use Blue Ribbon Skoot-Mo-Bile for pleasure, for deliveries, for collections, to and from office and factory. Just think of the economy: **one pint of gas takes you 15 miles!**

Ignition Switch and Key; one gallon gas Tank; 1/4 h.p. Motor mechanical Brake; spring suspension Front End; Automotive Choke for all-weather starting; Carburetor Breather that keeps out dirt and grit; high speed Chain Drive; G&L Clutch; Kick Starter and Muffler; Goodyear puncture-proof 12x3 balloon Tires, self-released Hand Accelerator; large comfortable seat.

Write at once for free folder, pictures and complete details. AGENTS: Here's the biggest money-maker of all. One machine sells dozens! Write Blue Ribbon Skoot-Mo-Bile, Inc. 1712 S. Michigan Ave., Dept. PM, Chicago, Ill.

Blue Ribbon SKOOT-MO-BILE

LEUDI

No more poorly exposed pictures. Use the Leudi, the world's most popular, dependable, simply operated, least expensive photographic

EXPOSURE METER
Illustration, Actual Size
At All Dealers
Literature on Request
MIMOSA AMERICAN CORPORATION
485 Fifth Avenue NEW YORK

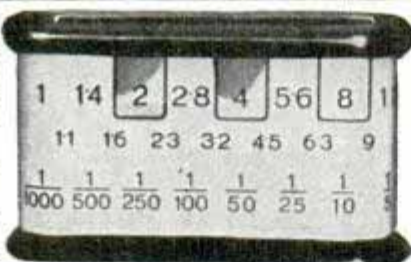

ALL STEEL TRAILER KIT

SAFE—STRONG—EASILY ASSEMBLED—COST UNDER \$300

All steel chassis and body in knock-down kit. Complete with springs, wheels, and tires, hitch, doors and windows. Furnish to suit yourself, and you will have a custom built coach which will last a lifetime. Low freight rates throughout the U. S. Send for free illustrated circular giving specifications and prices.

STEFCO STEEL COMPANY . . MICHIGAN CITY, IND.
"Largest Exclusive Manufacturer of Sectional Steel Buildings"

POWERlite
ELECTRIC LANTERN

The most powerful, serviceable hand electric lantern for all needs—home, work, fishing, camping.

80 to 100 Hours Light
On One 6-Volt Dry Battery

2 lights on a double action switch, 800 ft. spot beam from the front reflector; broad floodlight from top. Handle reverses. Unbreakable lens, 6 1/2 inches high. At sport, hardware, electrical dealers or write

DELTA ELECTRIC COMPANY
Marion, Indiana Dept. 300

\$3³⁵
Less Battery



Get only a **GENUINE DELTA**

Glasses Wrapped in 'Cellophane'
Furnished to Guests of Hotel



Maid in Detroit hotel brings you a clean glass every day, sealed in Cellophane after being sterilized

Guests in a Detroit hotel are furnished drinking glasses wrapped in Cellophane to assure cleanliness. Each day the glasses are collected, sterilized, and again sealed in the transparent covering.

Windmills Fight Corrosion

Transmission lines and internal-combustion engines almost doomed the windmill to extinction, but today the windmill is making a comeback as a means to combat corrosion in pipe lines. Iron and steel pipes in moist ground are attacked by electrolytic corrosion, a one-ampere current from pipe to soil carrying away as much as twenty pounds of steel in a year. To change the current and make ions of iron flow toward the pipe instead of away from it, pipe-line windmills are erected to supply low-voltage current.

Our Bureau of Information will answer questions regarding articles in this magazine, if accompanied by return postage.

25194
Arthur D. Little Charles River Cambridge Mass
Wade Wilson
2/20/37
227
Samuel Bernini

PATCH HOLES IN WALLS

EASILY AND PERMANENTLY

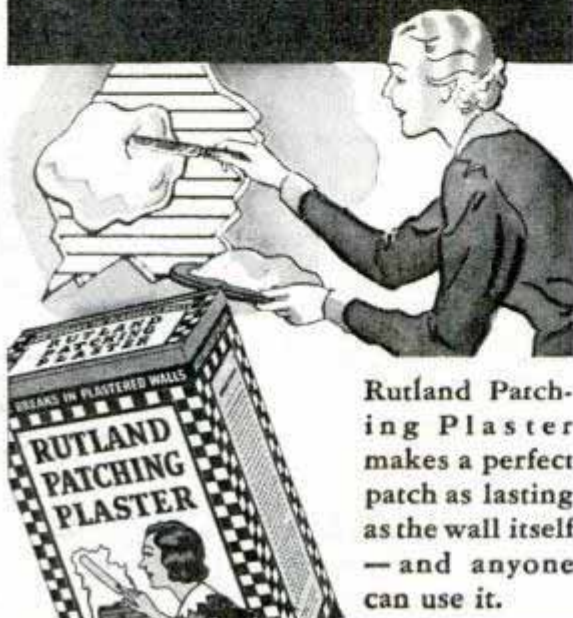

Rutland Patching Plaster makes a perfect patch as lasting as the wall itself — and anyone can use it.

CARE AND OPERATION OF OFFICE MACHINES



First and only book of full and complete instructions on the following:

- Typewriters**
- Standard and Portable
- Royal Remington
- Underwood Corona
- L. C. Smith Woodstock
- Dictating Machines**
- Dictaphone Ediphone
- Adding Machines and Calculators**
- R. C. Allen Corona
- Allen-Wales Dalton
- Friden Marchant
- Monroe Victor
- Remington-Rand
- Sunstrand
- Duplicators**
- Mimeograph Ditto
- Multilith Pruitt
- Multigraph Heyer
- Niagara

Addressing Machines
Addressograph Elliott

Bookkeeping Machines
Dalton
Remington-Rand

Doubles value office equipment; efficiency of workers and develops new uses of machines.

Covers also English, Address Forms, Letter Writing, Filing, Touch Typing, Accounting and Stenotype.

384 pp. Illus. \$2.50 ppd.

POPULAR MECHANICS PRESS
Room 537—200 E. Ontario St. Chicago

Now BOAT BUILDING MADE EASY

Famous Boat Book Shows How

Detailed instructions, plans, materials, methods for building 15 most popular power, sail and row boats. Get Popular Mechanics BOAT BOOK and build your own at low cost. Prepared for those with limited skill and few tools. Includes also—"What a boat enthusiast should know." Only \$3.00. Pay postman on delivery or write for descriptive circular.

Popular Mechanics Press
Room 537-D,
200 E. Ontario St.
Chicago



"YANKEE" Handyman Spiral SCREWDRIVER

for \$1

NEW
AMAZING
VALUE

★ Famous "Yankee" quality! Same as high-speed "Yankee" Spiral Screw-driver used for half a century by mechanics the world around. Now made "Handyman" size because of its many home uses, the time it saves, and the skill it puts into the user's hands—man, woman or boy.

No. 33 - H. Only \$1.00, at your dealer's.

BORES HOLES, too, for small screws or other purposes around the home. Ask dealer for "Yankee" Chuck and 3 Drills, to fit "Yankee" Handyman Screw-driver. Sold separately, 39c set.

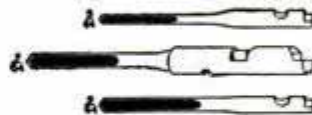

"Yankee" Chuck & 3 Drills. Fit Driver in Place of Blade.

INTRODUCTORY OFFER

North Bros. Mfg. Co., Philadelphia, U. S. A.



NEW TOOL! If not at dealer's, send us \$1 with this coupon. Receive *postpaid* this ingenious "Yankee" Handyman that drives or draws screws at a *push* on the handle.

"Yankee" Tool Book, included FREE

Name.....

Address..... (PM5)

When writing please mention Popular Mechanics

NEPTUNE

takes the
LEAD!



Far and away the best value of the season, the new 1937 NEPTUNES lead the field! Plenty of power and speed - easy starting - economical operation - quality that endures - smooth performance at high or trolling speeds, in any kind of weather - these are the things that make NEPTUNE the unanimous choice of outboard enthusiasts everywhere.

And LOOK! For as little as \$49.50 you may own a NEPTUNE 2 H.P. Single. A sturdy motor unequalled in its price class. For a little more you may buy the famous 4 H.P. Junior Twin, the 6 H.P. Improved Twin or the 16 H.P. Neptune Master Twin at \$149.50!

OUTSTANDING FEATURES:

- New type sensational magneto.
- Automotive float-feed carburetor.
- Monel metal shafts.
- Underwater silencing.
- Carburetor control in steering handle

WRITE FOR ILLUSTRATED LITERATURE

MUNCIE GEAR WORKS Inc.
DEPT. PM MUNCIE, INDIANA

2 H. P. Single
\$49.50

ATTENTION WOODWORKING LATHE OWNERS: Make turnings accurate to form from drawings or blueprints with the B & T LATHOGRAPH. Write for free data on this new invention of a lathe attachment tool. **THE BUSCH AND THIEM COMPANY, DEPT. C, SANDUSKY, OHIO.**

NOW - Truly Low-Cost Transportation! \$125

Auto-Glide

f. o. b.
Factory

100 Mi. to the Gallon!

It had to come! Modern progress demanded it! New type, low-priced, cheap-to-operate motor-powered vehicle. 1/10th the operating cost of an auto—almost as comfortable. Easy to ride, park. 30 miles per hour—fast enough, yet SAFE! Saves walking, time, expense—going to and from office, factory, school, etc. Parcel carrier available—ideal for making light deliveries quickly, cheaply. **GENUINE CUSHMAN ENGINE**—one of the world's best. 12"x3 1/2" balloon air tires. Extra strong channel steel frame. Drum brake. Clutch. Hand throttle. Double steering head. Cushion seat.



DEALERS

Someone in your town will soon be selling Auto-Glides. Why not YOU? Write for Special Offer!

WRITE! Send today for copy of Free Booklet, Photos, Complete Details, etc.

THE CUSHMAN MOTOR WORKS, Dept. 53, LINCOLN, NEBR.



Use These In Your .22 Rifle for More Speed and Power

WHILE a regular .22 Long Rifle rim fire bullet is covering 75 yards, a Winchester Super Speed Stayless bullet goes 100! In shooting woodchucks, crows, other farm pests, that 25-yard gain in speed is vital. Beating the jump or dodge that eludes a slower bullet. And how Super Speeds do bit! You get 35 to 60% more power, according to whether using Shorts, Longs or Long Rifles. Accuracy? Plenty—with the added help of flatter trajectory. And clean, no-rust Stayless priming. Hollow-point or solid lead bullets, wax-coated Kopperklad or lead greased. Get Super Speeds at your Dealer's. Same cost as regular Winchester Stayless .22s. For folder and 56-page Gun and Ammunition Catalog—FREE—write Dept. 46-C, Winchester Repeating Arms Co., New Haven, Conn., U. S. A.

WINCHESTER

TRADE MARK

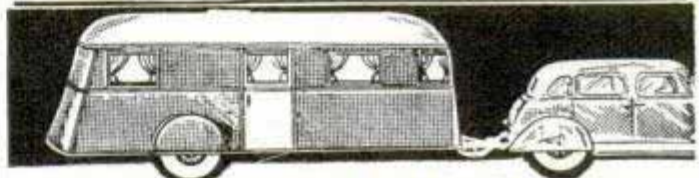

LARGE SIZE WORKING PLANS 25 CTS.

Cost of all parts less lumber—\$230.00; 18 ft. all steel chassis, 4 passenger. Build it yourself, save half the cost. Complete trailer parts catalog—10 cents, or sent FREE if you send 25 cts. (coin) for set of plans. Order yours today.

KARAVAN—A.H.—INDUSTRIES, 308 W. Randolph St., Chicago, Ill.

NEW!



IMPROVED!

DUAL RAY HEALTH LAMP

TWO SEPARATE LAMPS IN ONE ULTRA VIOLET—INFRA RED RAY

Health giving. Prevents Rickets. Gives **SUN-TAN**. Vitamin "D." Automatic safety control. 110 Volt AC-DC current. Also experimental work. Free Details.

Complete with Goggles Ready for Use. Only \$3.90

Beyer Mig. Co. 4655 Lincoln Ave., Dept. PM-5 CHICAGO, ILL.



MONUMENT

\$9 UP. WORLD'S BEST MARBLE OR GRANITE. Direct from factory. U. S. MARBLE & GRANITE CO. Dept. A-18, ONECO, FLA.



Freight Paid or Erected. Lettered, Guaranteed. 30% savings. Thousands sold. Write for Big Free catalog.

FREE TO EVERYONE interested in doing better shop work — new 48-page 1937 catalog describing and illustrating latest Driver Engineered Power Tools and accessories. Write to-day to Walker-Turner Co., Inc., 157 South Ave., Plainfield, N. J.

DRIVER Engineered POWER TOOLS

In answering advertisements always write name and full address clearly.

ARE YOUR KEYS THE ONLY KEYS to your shop, home, office, store, garage, etc.? Why be in doubt! Don't take chances. Learn how to reset your own cylinders so that keys that may be in the hands of old tenants and landlords or perhaps burglars will not work. Our locksmith manual for resetting cylinders sent for \$1. After several minutes with our manual you will be able to reset cylinders very easily.



SEND NOW!



Midwest Locksmiths, 3711-G-W. Chicago Ave., Chicago, Ill.

When writing please mention Popular Mechanics

COMPLETE PLANS

FOR A PERMANENT PROFITABLE BUSINESS OF YOUR OWN—FREE

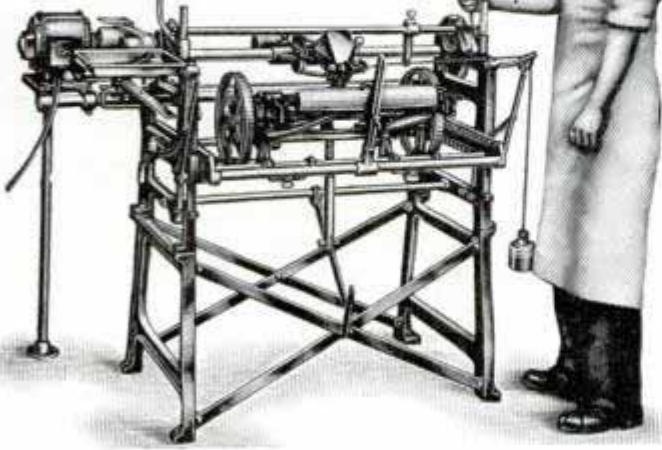

MAKE \$30 TO \$40 A WEEK

Our free plans show you how to build a successful business of your own sharpening lawnmowers. Positively no experience necessary. Most men average from \$30 to \$40 a week. J. B. Van Dien writes: "Some weeks I earned \$40 a week with my Ideal just as a side line." H. Greenlau writes: "In May I sharpened over 200 mowers at \$1 each." N. C. Race writes: "I have sharpened 785 mowers at \$1 each."

THE IDEAL LAWNMOWER SHARPENER

Makes old, dull lawn mowers cut like new. Mowers run easier, stay sharp longer—customers come back year after year. Start right at home. Attach the Ideal to your lamp socket. Sharpens any make of mower in 15 to 20 minutes—you get \$1.00 to \$1.50. Attachments for grinding skates, grass shears, hedge shears, sickles, scythes, axes, etc.



Send Post Card for FREE CATALOG and Complete Plans
THE FATE-ROOT-HEATH CO.
 437 Bell St., Plymouth, Ohio

Metal Castings Schools and Craftsmen

Make your own castings of aluminum, copper, bronze, silver, brass. Outfit contains gas furnace with 110 volt, universal motor blower, moulding sand, crucibles, tongs, rubber hose, flask, parting materials and instructions for use. For making models, trays, dishes, art objects, tools, shop equipment, etc.; also used for forging, case hardening and heat treating. Three outfits available. \$13.50, \$19.00 and \$27.50. Further details April issue, Page 163A. Prices f.o.b. K. C., Mo. Weights 25, 40 and 65 lbs. Check or money order acceptable, express charges C.O.D. Write for Free Circular.

KANSAS CITY SPECIALTIES CO.
 P. O. Box 6022 Kansas City, Mo.

In answering an advertisement with a coupon, be sure to write name and complete address clearly. Sometimes advertisers are unable to respond to inquiries due to lack of complete information.

The New UNIVERSAL GRINDER

The grinder that is truly universal in its application to jobs before impossible with any other power tool. This versatile tool is needed by every jeweler, optician, dentist, laboratory model maker and home craftsman.

Sensational Offer to Popular Mechanics Readers



Use it as a Bench Grinder

LOOK AT THESE AMAZING FEATURES
 Featherweight dynamically balanced hi-speed motor gives you vibrationless power. Self-aligning bearings semi-oolites and oil reservoir in each bearing. Tool steel motor shafts. Compact design, fits the hand and enables you to work on delicate jobs. Equipped with a three jaw universal arbor chuck, adjustable to take drills as fine as a hair. Arbor tool set enables you to grind, drill, route, carve, sand or polish. Operates on any 110 volt A. C. or D. C. current.
30 PIECE ARBOR TOOL SET FREE—A \$6.00 Value
 9—Grind stones with brass centers assorted sizes. 2—Bakelite cut off wheels. 3—Assorted engraving or carving burrs. 2—Polishing buffs. 1—Mounted point. 1—Bristle polishing brush. 10—Assorted sanding discs emery, sand, garnet, fine, coarse and medium. 2—Screw mandrels. 1—Large grind stone.
Rush \$1.00—Balance C. O. D.

PHILADELPHIA MACHINERY CO.

Now Complete \$3.95



Used as a hand tool

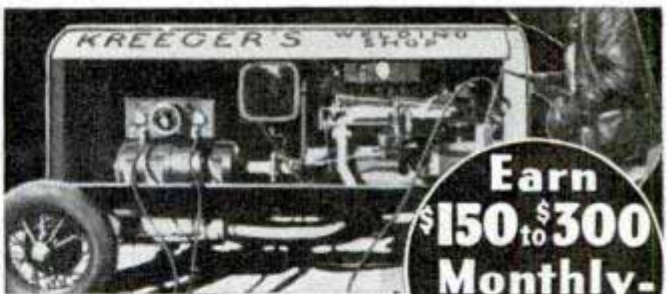

START BIG PAYING BUSINESS "Simplified" 40 VOLT ARC WELDING

New low prices on modern 40 Volt "Simplified" Arc Welders make this big pay business available to shops that never before could afford it. It opens the doors to the bigger profit jobs. The new Hobart is easier to operate, much faster. This is today's opportunity. Don't miss it.

Build Your Own

Portable Welder with Hobart Generator unit and auto engine or chassis. Lets you operate any place, especially on the profitable outside jobs. Easily saves you \$300 to \$500.

Portable Electric

New low cost on small sizes as well as large. The most profitable arc welder your shop can own. Welds faster, better, easier, saves current.

Easy to Operate

Hobart Welders have "Simplified" operation. This means faster welding—with the right current for every job. Hobart is simplified, so any of your men can weld easily and successfully. The mystery and uncertainty of obtaining correct welding current settings are removed.

60% Extra Capacity

Over old style 25 Volt Welders—necessary for welding with the new coated rods. Automatic reactance lets you handle light welding work without losing the arc. Users don't understand how they got along with the old style welders after using this new Hobart.

Remote Control

at no extra cost with Hobart. Think of being able to control your welder from any working point. Saves time, temper, and eliminates the need for a helper on overhead or concealed work.

"Pays-For-Itself" Terms

Extra earnings and savings make it easy for you to own a Hobart without expense to you. You can even rent a new Hobart—and later purchase it without loss of rent. Check Rental Purchase Plan.

GET THIS VALUABLE MANUAL

Sent Free if you will tell us the welding you plan doing.

Earn \$150 to \$300 Monthly—Let PROFITS Pay for it



30 DAYS TRIAL at Our Risk to Prove it Pays
 Mail Coupon for further Details

HOBART BROS.,
 Box M-57, Troy, Ohio

Tell me more about—
 () Building My Own Portable () Complete Gas Engine Drive Welder () 30 Days' Trial—Easy Terms
 () Electric Drive Welder () Rental Plan Privilege of Purchase.
 () Send FREE Manual on Welding. Attached letter tells about the work we want to do.

Name.....
 Address.....
 Interested in 30 DAYS' TRIAL EASY TERMS

HOBART ONE OF THE WORLD'S LARGEST BUILDERS OF ARC WELDERS

JUNGE FOLD BOAT A RUBBER KAYAK

Cheaper than a home made boat and it folds up. Easily carried or transported with your luggage. Stores in the corner of a closet.

JUNGE FOLD BOAT WORKS, 209—30th St., Brooklyn, N. Y.

This Much More Exclusively in a **SHELVADOR**

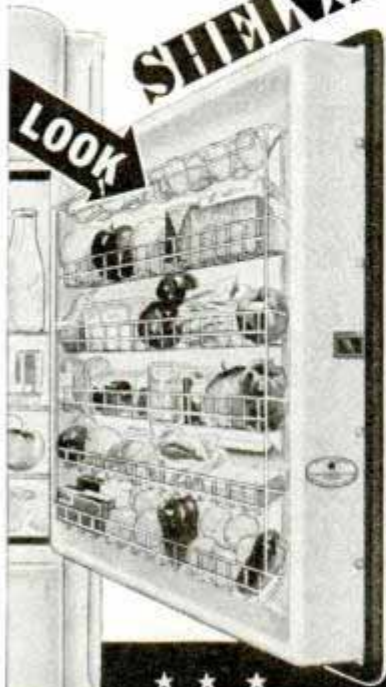

MORE BEAUTY
ECONOMY
CONVENIENCE
USABLE SPACE
ACCESSIBILITY

EXCLUSIVELY IN
CROSLEY
ELECTRIC REFRIGERATORS

Wolverine Motor Corp
4140 N 27th
19198 with Fishing Tackle
Wolverine is



Sportsman's traveling case carries outboard motor, fuel tin, rods and reels and tackle box

Fishermen can carry their outboard motor, fuel can, and fishing tackle in a compact kit just put on the market. In the cover of the waterproof metal "suitcase" is room for three casting rods. The kit itself accommodates a fifteen-pound motor, a tight-closing container holding one gallon of fuel for a full day's boating,

ZOWIE!
DONT PASS BY THIS!
Learn the Newest Dance Steps from **ARTHUR MURRAY**
World's Greatest Dance Instructor
FREE!



4 WEEKS LATER
BEN SENDS FILLED-IN DANCE CARD FOR BOOK



*Link Engineering & Supply Co.
1054 W. Baltimore Ave. Detroit Mich*

three or four reels, a tube of grease, a tackle box, with enough space left for sweater or slicker. Loaded, it weighs about thirty pounds.

es 106

Coil Spring Tested Quickly for Strength under Load

Coil springs, which are widely used in modern mechanisms, may be tested for strength and uniformity by an appliance designed for repair shops or factory production line. The spring is tested by being placed on the table of the machine and subjecting it to the load imposed by pulling a lever. Scale and dial readings give the information desired. The machine is accurate beyond government requirements.

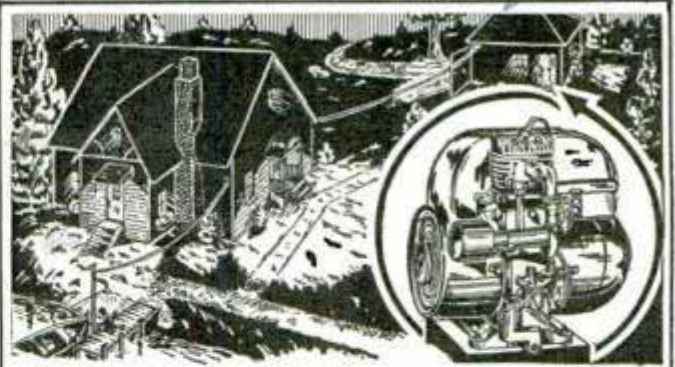
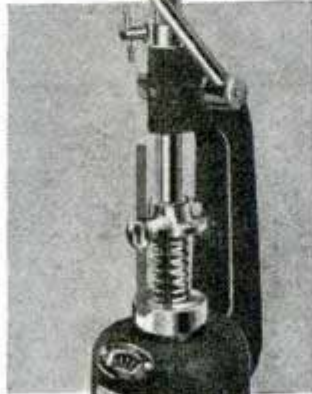

ONAN A. C. ELECTRIC PLANTS

FOR THOSE WHO MUST PROVIDE THEIR OWN ELECTRICITY

ONAN ELECTRIC PLANTS furnish the same current as supplied by power lines—110 volt, 60 cycle, ALTERNATING CURRENT. Operate Radio, Water System, Washing Machine, Electric Iron and all Electric Appliances.

Run from gasoline or gas and generate electricity for Farms, Lake Cottages, Oil Stations, Commercial Places. A woman or child can operate it.

SIZES 350 WATTS AND UP

Each ONAN PLANT is a complete Unit, ready to run. No battery used except to start the engine. Easy to install. Available from stock. 32 volt, Direct Current Models also available. Write for details.

D. W. ONAN & SONS

1004 Royalston Ave.

MINNEAPOLIS, MINN.



DODGE ARC-WELDER—25-200 AMPERES

Learn Direct Current welding by building it yourself, pleasure or profit. \$5.00 converts old North-East automobile generators. Low costs and upkeep permits building you can afford. Guaranteed Certified Plans \$1.00 postpaid. COD \$1.12. WELDERS CLUB OF AMERICA, P. O. Box 3432-H, Merchandise Mart Station, Chicago, Ill., U. S. A.

AT ONCE to Clear Your Skin! Dance Smartly! BE POPULAR!

THEN BEN GETS A GOOD TIP →



GET THIS FREE FLEISCHMANN DANCE CARD FROM YOUR GROCER TODAY! →

Boys! Girls! Here's how you can get a copy of ARTHUR MURRAY'S exciting dance book!

It is NOT FOR SALE. The only way to get your copy is with Fleischmann Yeast labels! Paste these on FREE Fleischmann Dance Card your grocer will give you. Send it in.

If your grocer has no Dance Cards, you can get

the book by pasting the 81 labels on paper, or putting them in an envelope, and sending with your name and address to Fleischmann's Yeast, 701 Washington St., N. Y. C. (This offer holds good until August 31st, 1937.)

(Details of securing Dance Book differ slightly in states West of Denver and in Canada, see newspapers or ask your local grocer.)



Dr. R. E. Lee, well-known physician, says: "Eat Fleischmann's Yeast if you want to help clear up ADOLESCENT PIMPLES."

● During adolescence important glands develop. The whole body is disturbed. The skin gets oversensitive. Waste poisons in the blood irritate this sensitive skin—pimples break out! Fleischmann's Yeast helps to clear up pimples by clearing these skin irritants out of the blood. Eat 3 cakes daily—plain, or in water—about ½ hour before meals.

Copyright, 1937, Standard Brands Incorporated

New 9" x 3' Genuine SOUTH BEND WORKSHOP LATHE

ON
NEW LOW
TERMS

Lathe may be
operated from any
ordinary lamp
socket

\$85⁰⁰
Less Motor Drive
—
Terms as Low as
\$6⁰⁰
A Month



A Back-Geared Screw-Cutting Precision Lathe
Weight 320 lbs.

No. 415-YA 9 1/4" swing by 3' bed Workshop Bench Lathe with Horizontal Motor Drive, \$116⁰⁰
3/4 h.p. Reversing Motor, Switch and belt tension countershaft as shown above.
(\$15.00 Down, \$6.00 a month for 18 months)

THE new 1937 model 9-inch Workshop Precision Lathe is a back-geared Screw Cutting Lathe and is recommended for the finest, most accurate jobs in manufacturing—in the tool room, in home workshops and automotive machine shops. Workmanship and materials used are exactly the same as used in more expensive models of larger size, making it represent the greatest value we have ever offered in 31 years of fine lathe building.

Features include Twin Gear Reverse to lead screw, Ball Thrust Bearing on Spindle, Longitudinal Screw Feed to Carriage, Precision Lead Screw for Cutting screw threads—and scores of other important features. Takes 38 practical attachments for milling, grinding, draw-in collet chuck work, and many other manufacturing jobs.

South Bend Lathe Works

617 E. Madison St., South Bend, Ind., U.S.A.

5 OTHER SIZES: 9", 11", 13",
15" and 16" SWING IN ALL BED
LENGTHS
PRICED \$97 to \$1200
Lathe shown below is No. 117-C 16"
x 6' Quick Change Gear Underneath
Belt Motor Driven Lathe with 1 h.p.
motor. Complete as shown. **\$869**
Weight 2300 lbs.
(\$87.00 Down, \$38.50 Monthly
for 22 Months)

Write FOR NEW CATALOG 15-K

New catalog illustrates and describes in detail this new Workshop Lathe in 8 different drives, 4 bed lengths. Shows the 38 attachments for use with this lathe. A valuable book for all interested in metal working lathes. This catalog sent free, postpaid. Use the coupon shown below.

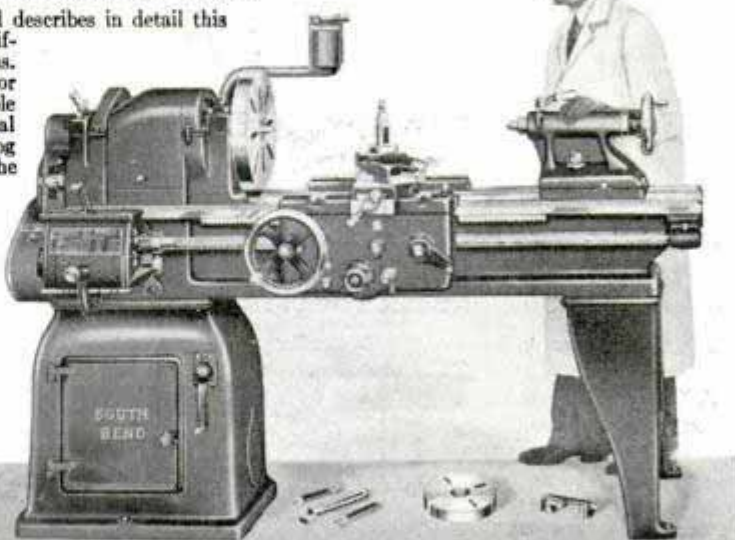

South Bend Lathe Works,
617 E. Madison St.,
South Bend, Ind., U.S.A.
Please send the following free, postpaid:
() 9" Workshop Lathe Catalog No. 15-K.
() General Catalog No. 98.
Class of work
Name.....
Address.....
City..... State.....

SOUTH BEND Precision LATHES

TO EARN MORE MONEY • HAVE MORE FUN

Invest in PRACTICAL PROFITABLE Books



Whatever your interest—whatever your need—here are books that will help you. Popular Mechanics experts have selected them for you. Books to help you on your job . . . to help you to a better job . . . to help you earn extra money in spare-time work . . . to profitably develop a hobby . . . to gain advancement through home study. Other books for entertainment and recreation.

Successful businesses . . . profitable sidelines . . . doubled incomes . . . have resulted from a single idea. Popular Mechanics Books are filled with money-making ideas. Select from the list on this page. Profit with the latest and best-proven facts—ideas and information.

SELECT FROM THIS LIST

AUTO POWER: A fine, practical book on winding auto generators and converting "Model T" and other units into 110 and higher voltages. \$1.00.

EASY-TO-MAKE TOYS: 67 varied and novel designs. Just the thing for the home workshop or a guide to an interesting small business. \$1.50.

BOAT BOOK: Just published! New edition with six additional boats. Build your own boat. Full directions and details for all types small pleasure craft. 312 pages. Illustrated. \$3.00.

DYKE'S AUTO ENCYCLOPEDIA: World's Greatest Auto Book. New 17th edition just out. Now more than ever before the only book for auto and shop mechanics. 1396 pages. 4,600 illustrations. Cloth. \$6.00.

MODERN RADIO SERVICING: This radio man's "Book of Knowledge," by Ghirardi, covers every phase of radio servicing today. 1,300 pages. 706 illus. \$4.00.

AIR CONDITIONING: By Riesbeck. The book of the hour in this big new field. Get started in America's next big industry with this new, authoritative work. 369 pages. Illustrated. \$3.50.

DIESEL HANDBOOK: By J. Rosbloom. The standard book on modern Diesel practice. Adopted everywhere for instructions in land, marine, locomotive, automotive, aero and portable services. 544 pages. Illustrated. \$5.00.

OUTDOOR SPORTS: The one book for out of doors folks. Covers everything, including homemade equipment. For young and old. 352 pages. 650 Pictures. Cloth. \$2.00.

SHIP MODEL: Build finest ship model of them all. Sovereign of the Seas. A real masterpiece. Detailed instructions, plans, etc. Authentic design. 180 Pictures. \$1.00.

REWINDING SMALL MOTORS: Details of repair shop practice for rewinding all fractional horse power motors. \$2.50.

FURNITURE DESIGN AND CONSTRUCTION: Shows how to design and make tables, chairs, desks, lamps, shelves, candlesticks, etc. \$2.50.

COLONIAL FURNITURE: The finest Colonial furniture adapted for home and school shop reproduction. An excellent book for the home furniture maker. Illustrated. \$3.50.

WOOD TURNING: A real course of instruction in this fascinating art. Starts with simple operations. Includes spiral turning and complete jobs. \$1.50.

PROSPECTOR'S HANDBOOK: Tells what minerals to look for and where. How to locate, sample, test, appraise, mine and market; also prices. \$3.00.

HIGH SPEED DIESEL ENGINES: New practical book includes fuel injection, combustion systems, frames, cylinders, running gear, construction details. Clearly written. \$2.50.

200 TRICKS YOU CAN DO: By famous Magician Thurston. Explains 200 tricks the average person can easily learn and do. \$1.00.

2000 WAYS TO MAKE MONEY

A THOUSAND WAYS TO MAKE \$1,000: Tried and Tested Methods that Work—That You Too, Can Use. How hundreds of men made their first \$1,000 in their own business. \$2.50.

MONEY MAKING IDEAS: 1000 spare time ways to make money. Practical guide for young and middle aged men and women, students, boys, girls. \$1.00.



RADIO PHYSICS COURSE: New edition. 992 pages. 500 illustrations. All about radio explained step by step. \$4.00.

ELECTROPLATING: Practical book of modern methods. Includes zinc, cadmium, and chromium plating. Also copper, gold, alloys, other metals and metal coloring. \$2.25.

SHOP NOTES LIBRARY: 5 vol. 2000 Wonderful shop ideas. Volumes reprinted annually from Shop Notes section Popular Mechanics. \$2.50.

WIRING: Approved economy methods for homes, buildings. Standard up-to-date book meets every requirement. \$2.50.

SEND NO MONEY—BOOKS SHIPPED C. O. D. IN U. S.

Select books from list above. Help yourself to more profitable—more enjoyable days. Send No Money. Pay postman above prices plus postage. (C.O.D. in U. S. and possessions only). Add ten cents for each book for postage if remittance is sent with order. Act Now.

POPULAR MECHANICS PRESS
Room 537—200 East Ontario St., Chicago, Ill.



FOR DIGESTION'S SAKE... SMOKE CAMELS

"That's what I do—and my digestion goes along O. K.," says Glenn Hardin, champion hurdler and Olympic winner



"I'M A GREAT BELIEVER in the way Camels help to ease strain and tension," says Glenn, one of America's great athletes. "It wouldn't do me much good to eat and not digest properly. So I smoke Camels with my meals and after 'for digestion's sake.' Camels are mild. You'll notice, as I do, that Camels don't get on your nerves." Choose Camels for steady smoking.

COSTLIER TOBACCOS

Camels are made from finer,
MORE EXPENSIVE TOBACCOS
...Turkish and Domestic...
than any other popular brand

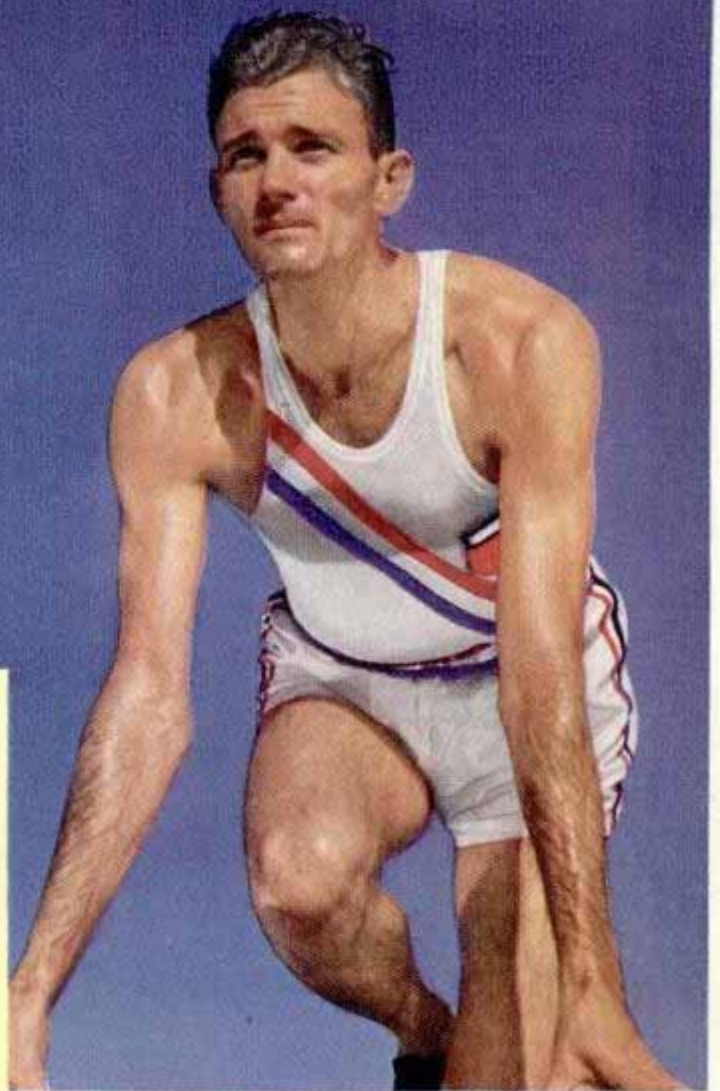

A feeling of well-being comes after a good meal and plenty of Camels

Smoking Camels at mealtime and afterwards helps to keep digestion on its proper course. At the first few fragrant puffs, the flow of digestive fluids — *alkaline* digestive fluids — speeds up. You get in the right mood to *enjoy* eating.

You'll welcome Camels between meals too!



MRS. ANTHONY J. DREXEL 3rd, of the famous Philadelphia family. "Camels are a bright spot in my entertaining," she says. "I think they make food more enjoyable — encourage a sense of well-being. And Camels are mild—I smoke as many as I like."