

HOW GOOD A DRIVER ARE YOU?

POPULAR MECHANICS

★

MAGAZINE

WRITTEN SO YOU CAN UNDERSTAND IT

REG'D. TRADE MARK, GREAT BRITAIN, NO. 410426

REG. U.S. PAT. OFF.

APRIL
25 CENTS

SEE PAGE 538

FLYING FREIGHT TO THE ARCTIC

CAR OWNERS

Guilty

OF NEGLECT



Guilty of neglect . . . sentenced to drive a car that uses too much gas, has no pep, starts slowly, and may even break down completely. All because the punishment taken by those life-giving wires under the hood was overlooked. Here the spark plug wire insulation is cracked by engine heat and outdoor cold; rotted by oil, water and age; worn by abrasion; oxidized by the ozone from corona. The resulting leakage in current causes cross-ignition, fouled spark plugs, wasted gas and poor performance. *When spark plug wires need replacing, nothing else you can do to your car will make it perform satisfactorily.* So don't neglect your spark plug wiring. Replace worn, old and oil-soaked wires with Packard FOUR-FORTY—a new kind of wire—employing a man-made inorganic rubber that provides far greater resistance to heat, cold, oil, moisture, age, abrasion

and corona than ordinary cotton braid and lacquer covered cable. Packard FOUR-FORTY can be installed in a few minutes . . . it is obtainable at better garages and service stations . . . and *it will save you more than it costs.* Packard Electric Division, General Motors Corporation, Warren, Ohio.

Packard
REG. U.S. PAT. OFF.
TRADE MARK

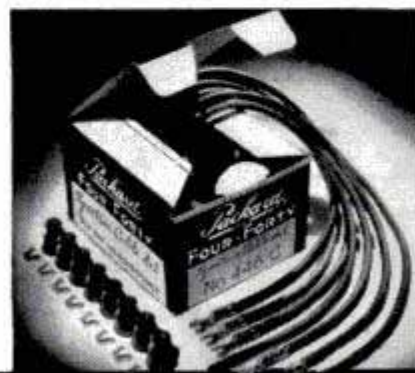

THE STANDARD WIRING EQUIPMENT OF THE AUTOMOTIVE INDUSTRY

"SAFETY INTERIORS" SENSATIONAL NEW IDEA IN MOTOR CAR SAFETY!



SMOOTH... all instrument board controls are recessed... lower edge of panel is rounded... soft rubber windshield-wiper knobs.

Every Detail Inside the Car Recessed or Padded or Redesigned for Protection of Passengers

HERE'S ONE of the most interesting improvements in 1937 automobiles... the handsome, new interiors of Plymouth cars... designed and planned for safety, as well as beauty.

This has been done, as a result of clinical research, to eliminate minor mishaps inside the car... bruises in case of sudden stops... torn clothing... barked knuckles.



SUDDEN STOP: No harm! The deep padding of the front seat is carried over the back edge in a heavy roll that prevents bumps.

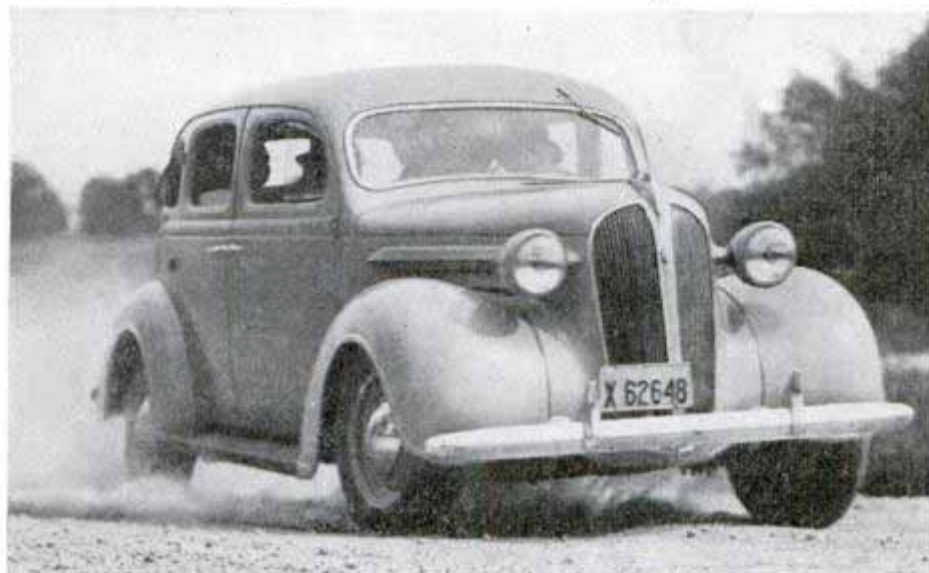

The beautiful 1937 Plymouth De Luxe Four-Door Sedan

SAFER - AND EASIER! Driving the new Plymouth is effortless. Easiest steering you have ever experienced; easy, quiet gear shifting; no sway on curves. Plus big, double-action hydraulic brakes that stop you smoothly, *safely!*



BETTER VISION AHEAD... the ventilating windshield is clear, and wider by 3". Warm air defroster vents built in.

WHAT MAKES A SAFE CAR

- ★ **DOUBLE-ACTION HYDRAULIC BRAKES**... self-equalizing... sure, swift, safe stops.
- ★ **ALL-STEEL BODY**... the top is one solid "stamping" of steel... walls, doors, floor are all steel reinforced with steel.
- ★ **EFFORTLESS STEERING**... responds to a touch... no sway on curves. Driving is really restful; parking's a cinch!
- ★ **NO SWAY ON CURVES**... rigid stabilizer at front end of extra-rigid frame keeps car on even keel... steady on the turns.
- ★ **SAFETY INTERIOR**... every detail carefully styled and designed for greater safety as well as beauty.



LOW FLOORS—No "hump" in rear. Wide doors. "Chair-height" seats that support your whole body properly... and permit you to ride in restful, relaxed comfort.



HEAR A WATCH TICK! Big all-steel body is sound-proofed like a modern broadcasting studio. Noise shut out... prevents nerve-strain and fatigue... another big safety factor.



EASY TO BUY

You'll discover this beautiful, new 1937 Plymouth is priced with the lowest... and offers a payment plan which will fit your budget. See your Chrysler, De Soto or Dodge dealer—for the convenient purchase terms made available by the Commercial Credit Company... terms as low as \$25 a month. **PLYMOUTH DIVISION OF CHRYSLER CORPORATION, Detroit, Mich.**

When writing to advertisers please mention Popular Mechanics

"Did you ever
see **THIS** before?"

Western Electric

• **INCONSPICUOUS** but important is the name "Western Electric" on your telephone.

You may never have noticed it, yet it has been there for years. And it has a great deal to do with the quality and low cost of telephone service.

Western Electric has been making Bell System equipment for over half a century. Its specialized production and purchasing have enabled the operating companies in the Bell System to buy equipment and supplies of the highest quality at reasonable prices. Western Electric serves fur-

ther by maintaining a nation-wide system for the rapid delivery of material and apparatus.

This is an important factor in providing good telephone service from day to day and speeding its restoration in time of fire, flood or other emergency.

Western Electric is an integral part of the Bell System and has the same objectives as the rest of the organization. It plays its part in making your telephone service dependable, efficient and inexpensive — the best in the world.

B E L L T E L E P H O N E S Y S T E M



Popular Mechanics Magazine

H. H. WINDSOR, Founder

H. H. WINDSOR, Jr., Editor and Publisher

April, 1937

Vol. 67, No. 4

Special Features

Radio Fights Old Man River . . .	481
"Let There Be Light—" . . . Coloroto	
How Hughes Broke the Record . . .	500
Latest Comforts for Homes on Wheels	508
Flying Freight to the Arctic . . .	514
There's Money in Herbs . . .	522
Kings of Speed Groom Their Racers	530
New Uses for Wood . . .	538
Moonbeams Balk the Fisher Folk . . .	546
Movies That Show You the Invisible	554
Stunts of the Aerial Acrobats . . .	564
How Good a Driver Are You? . . .	572

(Continued on next page)

Why Is Jumbo Like a Lady?

"WHY is an elephant like a lady?" asked Eddie Allen, veteran animal trainer. "Well," we hazarded, "offer an elephant a chew of tobacco and he'll whale the daylights out of you. Offer a lady a chew and—ditto." "Wrong," laughed Eddie. "Elephants love tobacco." After while we tried again. "Here it is, Eddie," we shouted. "Elephants are scared of mice. So are ladies." "Wrong again," chortled Eddie. "Mickey Mouse himself couldn't scare the most timid elephant." So we gave up. And here's Eddie's answer. "Elephants," quoth he, "are like women because the average man doesn't understand either." We suggested that Eddie take his pen in hand and debunk this elephant business. Eddie obliged and his article next month will convince you, too, that "You're Wrong about Elephants."

Next Month

THROUGH our eyes we gain more than eighty-five per cent of our knowledge and control eighty per cent of our actions. Today, with more things to be observed than ever before, we are able for the first time to do some real seeing after sundown. In the May Coloroto section you will find the sequel to the modern lighting article in this issue. It is titled, we think, most appropriately, "—and There Was Light."

Pictures That Click

YOU might have been burned as a witch a few score years ago for producing out of a little black box the startling effects you can achieve with your camera today. An article next month explains some simple tricks of photography which will enable you to achieve unusual picture effects without any costly equipment.

A Bean Makes Good

WHAT is it you can find on the dining table, in a can of paint, on the floor, on the pages of your newspaper and on the soap dish? Give up? The answer is beans—soybeans. Few plants are put to so many uses today as this oriental legume of ancient lineage, and man still has not tapped all its possibilities. Read in the May issue how a humble bean has contributed so much to our comfort and happiness.

Published monthly by POPULAR MECHANICS CO., 200 East Ontario Street, Chicago, U. S. A. Single copy in United States, 25 cents; \$2.50 a year, \$4.00 for two years, \$5.00 for three years in United States and possessions, Canada, Newfoundland, Labrador and countries of the Americas and Spain. To all other countries add \$1.00 a year extra for overseas postage. Changes in address must be reported to us immediately to eliminate delay. Entered as Second Class Matter, Sept. 15, 1903, at the Post Office at Chicago, Illinois, under Act of March 3, 1879. Entered as Second Class Matter at the Post Office Department, Canada. Copyright 1937, by Popular Mechanics Co. in the United States, Australia and France.

This One



095G-KTT-XSQ2



NOW PYROIL IS YOUR FRIEND IN NEED

Piercing, blustery cold often comes unexpectedly at this time of year. And it can work tragedy for your car. Vital mechanisms are quick to be affected by radical temperature changes.

When you use Pyroil your valuable investment in motor car equipment is safeguarded against extremities the year 'round. Merely add Pyroil—an ounce or two at a time—with each filling of gasoline and oil. In this manner the protective Pyroil gloss film is sheathed over frictionized parts, where it resists cold, heat, friction and wear. It supplies protection far beyond the usual for bearings, gears, pistons, rings and other parts.

For the best interests of your motor car investment use Pyroil regularly throughout all seasons. Mail coupon for facts. Sold the world over. Manufactured and Guaranteed by Pyroil Company, W. V. Kidder, Founder, 54 Pyroil Bldg., La Crosse, Wis., U.S.A.

PYROIL HAS BEEN TESTED BY POPULAR MECHANICS AND IS USED BY POPULAR MECHANICS' PRESSES AND EQUIPMENT.

DISTRIBUTORS:

NEW PYROIL PREMIUM PLAN NOW IN EFFECT GIVES NATIONALLY ADVERTISED MERCHANDISE OF HIGH VALUE ABSOLUTELY FREE. CHECK COUPON FOR FULL DETAILS, AND FACTS OF BUSINESS OPPORTUNITY.



Genuine Pyroil bears this signature on every can

W. V. Kidder
Founder

SIMPLY ADD TO GAS & OIL

PYROIL COMPANY, 54 Pyroil Bldg., LaCrosse, Wis., U. S. A.

- Please send Free facts on Pyroil's money saving features.
- Send details of Premium Plan and Business Opportunity for me.

Name.....

Address.....

City.....County.....State.....

(Contents—Continued)

AUTOMOTIVE

Giant presses shape car tops from steel498
 Trailer has restaurant inside503
 All car doors locked by single handle506
 Tires inflated with water aid tractor operation...507
 Analyzers diagnose ills of modern motor car.....519
 Rocker for auto aids lubrication.....528
 Amphibian "marsh buggy" used to hunt oil529
 Parking mirror gives motorist view of curb534
 Four-burner stove for trailer558
 Slender trucks for citrus groves558
 Oil-can opener on motor stops waste563
 Fifth wheel on trailer recharges battery569

AVIATION

Forty-passenger planes to cross English channel...499
 Static-proof direction finder aids safe flying.....511
 "Flying billboard" flashes across night sky521
 Heavier guns for air fighters535
 Plane takes off from roof of auto536
 Airplane engine heater made from oil drum542
 Airplane tire changed quickly with jack and vise..550
 High-flying pilot checks weather at night552
 Two-seater plane carries fourteen in wings559
 Ground training plane converted for flying561

HOUSEHOLD

Celluloid buggy top protects baby from weather...507
 Resealer for tin cans518
 Delivery box protects milk on cold mornings520
 Eight-needle toy knitting machine produces fabrics.534
 Low-cost air-conditioning seen in simple methods.536
 Five degrees more heat costs one-fifth more.....542
 Vacuum scrubber for floors570
 Awning of metal louvers576

MOVIES AND PHOTOGRAPHY

Swinging X-ray blots out disturbing shadows....506
 X-ray helps packer see heart of orange526
 Pictures of insect's heart562
 Luminous paper used to light darkroom576

RADIO AND ELECTRICITY

Master clocks for powerhouses503
 Power companies erect "nest poles" for birds507
 English television receiver for home construction...577
 How to build a one-tube 6N7 receiver578
 "Beam" tube in 40-meter c.w. transmitter580
 Practical radio suggestions581
 Movie dial flashes call letters on screen582
 Noise filter for oil burner.....582
 Rainproof umbrella speaker for public address....582

SCIENCE AND INDUSTRY

New radioactive mineral found in Wyoming512
 Automatic vendor shines shoes for two cents.....520
 Two-weeks' forecast goal of solar heat study.....528
 Minerals live and suffer disease say research men..534
 Ranch-bred carp go to market544
 Research brings better products at lower cost....550
 Bank offers curb service551
 Radiators heated with alcohol vapor552
 Electric clocks show time of stars558
 Electric eye starts shower for bus and car.....568

SHIPS AND SHIPPING

Sunken ship located in lake by mathematics518
 Ship raised from sea after eighteen years520
 Radiophones connect yachts with systems ashore..526

SPORTS

Auto trailer is kennel for hunting dogs.....499
 Plan to restore game birds512
 Electric fan cools off boxer between rounds542
 Ice skating rink in heart of New York569

MISCELLANEOUS

Man-made weather speeds up paint tests497
 German switch engine has ten drive wheels498
 Sidewalk grating protects tree499

(Continued to page 6A)



SEALED POWER PISTON RINGS

Best in New Cars! Best in Old Cars!



SEALED POWER SUPER DRAIN-OIL DESIGN ASSURES CORRECT OIL FLOW

Increased unit pressure in oil rings has become so necessary in high speed engines that Sealed Power's Super-Drainoil design is not only preferable; it is essential. The wide precisely designed slots assure full drainage for oil control.

The Super-Drainoil design is obtainable in both conventional and expander-type rings. In the expander ring, full drainage is guaranteed by ample slots in the expander as well as in the ring.

OLDSMOBILE engineers demand rigid oil economy . . . with maximum power and performance. So, of course, the great new Oldsmobile Eight uses Sealed Power Piston Rings as standard equipment.

Easy to understand why. For over 25 years, Sealed Power Rings have been setting records for genuine oil economy. They provide maximum pep, speed, power, too—in such completely satisfying fashion—that America's leading car and truck manufacturers use Sealed Power Rings. Buick, Cord, Hudson, Pontiac, Nash, LaFayette, Terraplane, Willys—plus Oldsmobile and many others feature these great rings as standard equipment.

New Ring for Old Cars—Sealed Power now offers a marvelous, patented ring of exclusive design for cars that have gone 10,000, 20,000, 30,000 miles or more. It is an expander ring with springs of finest imported Swedish steel which without excess tension create a perfect seal against blow-by—ending "between meal oil hunger"—saving gas—restoring first year pep and power. Engineers recommend them.

But—if new valve guides, bearings or Lo-Ex Ebonite Pistons are needed, even these great rings will not end excess oil consumption. They will do all—and more—than any other ring. But they cannot do the impossible. Seek your Sealed Power ace mechanic's advice on what your car needs. Meanwhile, write for our new, free booklet, "New Low Cost Way to Save Oil and Gas and Increase Pep." You'll like it!

SEALED POWER CORPORATION
Dept. 274 Muskegon, Michigan

Canadian Factory at Walkerville, Ont.
Manufacturers of Piston Rings, Pistons, Piston Expanders, Piston Pins, Valves and Cylinder Sleeves



When writing to advertisers please mention Popular Mechanics



For A Smooth Shave Every Time

Use the blade that was made for your razor

MEN everywhere say it makes a wonderful difference in shaving comfort when you use a Gillette Blade in your Gillette Razor. That's because this razor and blade are made for each other. Designed to function as a unit, they give shaves that are matchless for ease and comfort. Buy a package of Gillette Blades from your dealer today. Slip one into your Gillette Razor tomorrow morning and enjoy the most comfortable shaves you ever had.

Reputable merchants never offer substitutes for Gillette Blades. Always ask for them by name.

Tune in Gillette's "Original Community Sing" with Milton Berle and other stars Sundays 10 P.M., E.S.T., CBS Network, Coast to Coast.



Gillette Blades

Precision-made for the Gillette Razor

(Contents—Continued)

Strange undersea life	504
Vast antelope refuge established in Oregon	507
High-speed oil engine has few working parts	513
Pistol shoots life line three hundred feet	513
Portable steel forts guard miners in blasting	518
Fins in fire hose nozzle throw water farther	526
Super crops grown in tanks without soil	527
Motorcycle cops perform riding stunts	528
Bank counts its checks by weight	536
Police speed to action in steel fortress	537
Utility and beauty mark latest furniture	543
Flat models given depth with knife and paint	545
Magazine-feed stapler holds thousand staples	545
Memorial made of concrete and crushed marble	551
Building on stilts as subway track is laid	552
Wildcats captured alive by daring hunter	553
Cloth filter bags clean air of dirt	559
Glue "stronger than nails" holds house together	560
Metals in liquid form applied like paint	560
Newsboy wears neon sign on chest	561
Tight-rope stunting high in air	563
Dialing "Taxi" on telephone brings cab	568
Harness lifts dog over muddy spots	570
Milk bottle carrier protects hands	570
Rubber monsters inflated for gay parade	571
Solving riddle of light at sea	576
Motor-driven "carrier pigeon" serves buildings	124A

Craftsman and Shop Notes

AUTOMOTIVE

Coaster trailer carries six passengers	609
"Gangplanks" to trucks hinged on loading platform	635
Helps for the auto mechanic	637
Air nozzle cleans grease fittings	638
Clamp holds piston rings for filing	638
Dog's basket hooks over seat of car	638
Removing grease from housing of steering gear	638
Arrows at filling station guide customer	639
Installing differential housing with headless studs	639
Marked wheel hub shows location of nuts	639
Oil pan installed with aid of spring jack	639
Improvised die stock for tight places	640
Wooden arm signals for truck drivers	640

BOATS AND BOATING

Boats for sale	594
Mending sails and tents	606
Rolling cradle to beach the sailboat	607
Speed riggings for model yachts	610
"Floor freighter" for the young skipper	617

FARMS AND GARDENS

Backyard screens and trellis hedges	587
Trellises on concrete bases avoid rot	592
Trellis attached to house with door stops	608
Avoiding leaks in garden pool	614
Removing plants potted in cans	617
Non-sag gate for small cost	626

FURNITURE

Tubular smoking stand	583
Sturdy ladder chair	590
Modern desk has pleasing lines	601

HAND TOOLS

Rotary chisel to cut sheet metal	588
Gasket punches from tubing	592
Saw-blade marker	600
Tool-handle ferrules from caster sockets	615
Locking pump-rod couplings	616

HOME IMPROVEMENTS

Venting basement fuel-oil tank	588
Hinged step on closet door	609
Heating water in summer cottage	626
Sealing joint between downspout and soil pipe	636

(Continued to page 8A)

Promoted—when others were fired!

The Story of LaSalle Student Shaw



"Since the War I have been book-keeper at \$35 a week. Married, with one baby girl, I found it harder every month to make ends meet. I was desperate!



"Last winter my wife brought me a LaSalle ad on Higher Accounting—showing how I could study in spare time for the job ahead. I investigated, and enrolled January 23. Just in time! For—



"Suddenly, orders came through to cut the force. I watched seven men in my department get the bad news and leave. Then the office boy tapped me, said I was 'next.' My heart sank as I followed him to the Front Office.



"Smiling, the boss handed me a letter. It was from LaSalle to him, announcing my enrollment and my good work on the first lesson. 'We are keeping you,' he said, 'because we like your spirit.'



"Naturally, I had more work to do, with the smaller force, but my training made it easier. I learned quickly, and when the Department Manager left, the boss moved me up.



"I have since been promoted twice, and now carry the title of Chief Accountant—at a salary several times greater. The future looks bright. If it had not been for LaSalle, I would be looking for a job right now."

BIGGER PAY FOR YOU— thru LaSalle Spare-Time Training

That's a story of what spare-time study has done for just one man. There are thousands of others like Shaw who found themselves through LaSalle. Now—how about yourself? Do you want a better position and higher pay?

You can win them, even today, if you can do the work. LaSalle experts will show you how, personally guide you step by step to success. Simply mark on the coupon the field you are interested in, and we will send you FREE, a valuable booklet about it, telling of opportunities open to you. No cost or obligation—and what you find out may put you on the road to success and financial independence.

The opportunity that is open today—right now—may not be here tomorrow. Don't put it off—but reach for your pencil, fill out, and mail today.

LASALLE EXTENSION UNIVERSITY Dept. 464-R, Chicago

Please tell me how I can take full advantage—right now—of the opportunities in the business I am checking below. And send along your free booklet on that field.

- | | |
|---|---|
| <input type="checkbox"/> Business Management | <input type="checkbox"/> Railway Accounting |
| <input type="checkbox"/> Traffic Management | <input type="checkbox"/> Business Correspondence |
| <input type="checkbox"/> Modern Salesmanship | <input type="checkbox"/> Personnel Management |
| <input type="checkbox"/> Paper Salesmen's Training | <input type="checkbox"/> Law: LL. B. Degree |
| <input type="checkbox"/> Railway Station Management | <input type="checkbox"/> Commercial Law |
| <input type="checkbox"/> Industrial Management | <input type="checkbox"/> Office Management |
| <input type="checkbox"/> Higher Accountancy | <input type="checkbox"/> Chain Grocery Management |
| <input type="checkbox"/> Expert Bookkeeping | <input type="checkbox"/> Business English |
| <input type="checkbox"/> Effective Speaking | <input type="checkbox"/> Foremanship |

Name.....

Address.....

Position.....

LASALLE EXTENSION UNIVERSITY



"This is Where I Get the REAL LOWDOWN!"

"My business is batteries. I have opened up hundreds of them right here on this bench and believe me, it's the *inside* of a battery that reveals its true worth.

"This winter I had lots of batteries come in here that I *know* cost more for up-keep than their owners paid for them originally.

"Of all the batteries we service at this station, Willards require the least amount of recharging and repairing."

Records show that 45% of all Willards *never* need a recharge. Another 41% require only one recharge during their entire lifetime.

This low up-keep cost and their extra long life make Willards *Cost Less To Own!*

Willard Storage Battery Co.
Cleveland • Los Angeles
Toronto, Canada



Willards

COST LESS TO OWN!

Because they last longer . . .
crank faster . . . don't let you down

(Contents—Continued)

HOUSEHOLD

Fireplace wood box of plywood	589
Nail your candles to the holders	606
Spice boxes on stepped support	616
Simple methods of solving your home problems.....	618

MODELS

Imitating planked ship-model decks	592
Carving tool for model work	599
Sanding wheels for model work	606

PAINT AND PAINTING

Keeping gelatine size warm	585
Holes in rim of can prevent dripping	586
Paint scraper from old hacksaw blades	616

POWER TOOLS

Wood-boring bits	621
Countersink "setting plate" saves time	625
Combination lathe parting tool speeds production..	628
<u>Boring tool makes rough and finish cuts</u>	<u>629</u>
<u>Drum sander on lathe has adjustable table</u>	<u>635</u>

SPORTS

Speed wings for your bicycle	588
Croquet equipment held in portable rack	599
Fishing-rod joints loosened by flashlight lens.....	608
Numbered stakes mark path of lost arrows	615

STORE AND SHOP

Breaking stout twine in your hand	608
Ball of twine fed through counter	628
<u>Signwriters' ruler has handle</u>	<u>629</u>
<u>Metal stencils have handles</u>	<u>629</u>
<u>Castered display rack wheeled to sidewalk</u>	<u>636</u>

WOODWORKING

Friction clamping blocks for gluing mitered joints.	585
How to set hollow spindles in lathe	593
Sawhorse has rubber shoes to protect floors	600
Paraffin finish on turned work	609
Four simple hints for the carpenter	627

MISCELLANEOUS

Guide strips to whitewash tree trunks	586
Photo-squeegee tray handles excess water	586
Sidewalk built to resemble flagstones	586
Disk microscope slide holds many specimens	588
Roll film drier handles negatives safely	589
Reinforcing sidewalks	592
Relief lettering cut on scroll saw	593
T-square has scale on one edge	593
Handles on inside of drawers for carrying	599
Ladder has roller on upper end	600
Sled held against wall with caster cups	600
Miniature china figures depict fairy tales	605
Rubber-band arrow guns quickly sawed out	605
Hint for amateur pipe fitter	606
Rivets heated for small jobs by blowtorch	606
Blowtorch held on roof by vacuum cup	608
Non-slip feet on ladder	608
Pivoted trough fills two rain barrels	615
Soil-pipe joints cemented with rubber forms	616
Adjustable holder for drill bits	620
Folding scaffold adjustable to roof pitch	625
Hoisting bucket with rollers on side	626
Holding centers of shafts the same height	626
Welding joints in angle iron	626
Belt stick for hard-to-reach pulleys	628
How to install sheet-metal ducts	628
<u>Copper and nickel plating without cyanides</u>	<u>630</u>
<u>Taxidermist's lead arsenate jelly</u>	<u>635</u>
<u>Indexed letter file strengthened with clips</u>	<u>636</u>
<u>Repairing small motor bearings</u>	<u>636</u>

DO YOU JUST DREAM OF FAT PAY ENVELOPES?

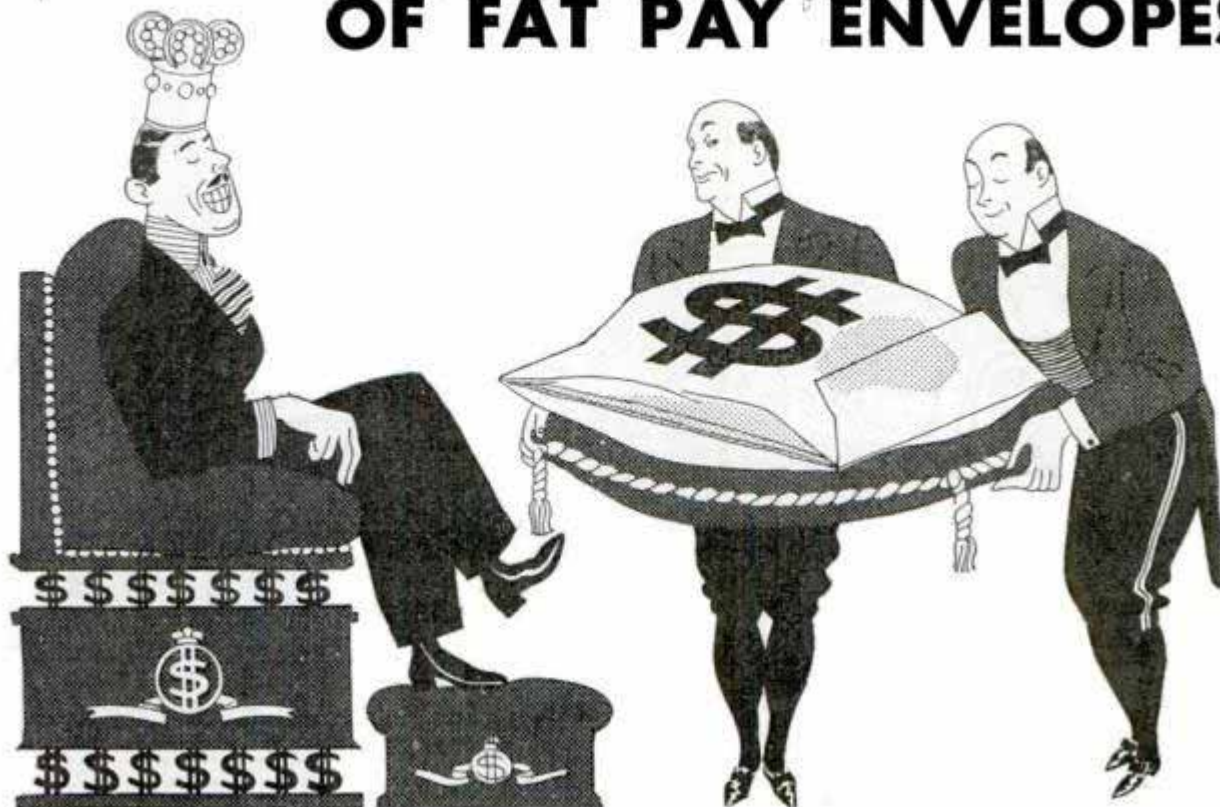

DREAMING is a grand pastime but it will never add a single dollar to your pay envelope. The truth is, the only safe way to get more money is to deserve more money! You will never be surprised in the pay envelope unless you surprise somebody on the job. TRAINING (you can acquire it through spare-time study of an L. C. S. Course) is the answer! This coupon is the first step.

INTERNATIONAL CORRESPONDENCE SCHOOLS

BOX 5667-H, SCRANTON, PENNA.

★ Without cost or obligation, please send me a copy of your booklet, "Who Wins and Why," and full particulars about the subject *before* which I have marked X: ★

- | | | |
|---|--|--|
| TECHNICAL AND INDUSTRIAL COURSES | | |
| <input type="checkbox"/> Architect | <input type="checkbox"/> Sheet Metal Worker | <input type="checkbox"/> Plumbing <input type="checkbox"/> Steam Fitting |
| <input type="checkbox"/> Architectural Draftsman | <input type="checkbox"/> Boilermaker | <input type="checkbox"/> Heating <input type="checkbox"/> Ventilation |
| <input type="checkbox"/> Building Estimating | <input type="checkbox"/> Telegraph Engineer | <input type="checkbox"/> Air Conditioning |
| <input type="checkbox"/> Contractor and Builder | <input type="checkbox"/> Telephone Work <input type="checkbox"/> Radio | <input type="checkbox"/> Steam Engineer |
| <input type="checkbox"/> Structural Draftsman | <input type="checkbox"/> Mechanical Engineering | <input type="checkbox"/> Steam Electric Engineer |
| <input type="checkbox"/> Structural Engineer | <input type="checkbox"/> Mechanical Draftsman | <input type="checkbox"/> Marine Engineer |
| <input type="checkbox"/> Management of Inventions | <input type="checkbox"/> Machinist <input type="checkbox"/> Toolmaker | <input type="checkbox"/> R. R. Locomotives |
| <input type="checkbox"/> Electrical Engineer | <input type="checkbox"/> Patternmaker | <input type="checkbox"/> R. R. Section Foreman |
| <input type="checkbox"/> Electric Lighting | <input type="checkbox"/> Diesel Engines | <input type="checkbox"/> Air Brakes <input type="checkbox"/> R. R. Signalmen |
| <input type="checkbox"/> Welding, Electric and Gas | <input type="checkbox"/> Aviation Engines | <input type="checkbox"/> Highway Engineering |
| <input type="checkbox"/> Reading Shop Blueprints | <input type="checkbox"/> Automobile Mechanic | <input type="checkbox"/> Civil Engineering |
| <input type="checkbox"/> Heat Treatment of Metals | <input type="checkbox"/> Refrigeration | <input type="checkbox"/> Surveying and Mapping |
| BUSINESS TRAINING COURSES | | |
| <input type="checkbox"/> Business Management | <input type="checkbox"/> Bookkeeping | <input type="checkbox"/> Service Station Salesmanship |
| <input type="checkbox"/> Industrial Management | <input type="checkbox"/> Secretarial Work | <input type="checkbox"/> First Year College Subjects |
| <input type="checkbox"/> Traffic Management | <input type="checkbox"/> Spanish | <input type="checkbox"/> Business Correspondence |
| <input type="checkbox"/> Accountancy | <input type="checkbox"/> French | <input type="checkbox"/> Stenography and Typing |
| <input type="checkbox"/> Cost Accountant | <input type="checkbox"/> Salesmanship | <input type="checkbox"/> Civil Service <input type="checkbox"/> Mail Carrier |
| <input type="checkbox"/> C. P. Accountant | <input type="checkbox"/> Advertising | <input type="checkbox"/> Railway Mail Clerk |
| DOMESTIC SCIENCE COURSES | | |
| <input type="checkbox"/> Home Dressmaking | <input type="checkbox"/> Advanced Dressmaking | <input type="checkbox"/> Millinery |
| <input type="checkbox"/> Professional Dressmaking and Designing | | <input type="checkbox"/> Tea Room and Cafeteria Management, Catering |
| | | <input type="checkbox"/> Foods and Cookery |
| | | <input type="checkbox"/> Bridge Engineer |
| | | <input type="checkbox"/> Bridge and Building Foreman |
| | | <input type="checkbox"/> Chemistry |
| | | <input type="checkbox"/> Pharmacy |
| | | <input type="checkbox"/> Coal Mining |
| | | <input type="checkbox"/> Mine Foreman <input type="checkbox"/> Fire Bosses |
| | | <input type="checkbox"/> Navigation |
| | | <input type="checkbox"/> Cotton Manufacturing |
| | | <input type="checkbox"/> Woolen Manufacturing |
| | | <input type="checkbox"/> Agriculture |
| | | <input type="checkbox"/> Fruit Growing |
| | | <input type="checkbox"/> Poultry Farming |
| | | <input type="checkbox"/> Grade School Subjects |
| | | <input type="checkbox"/> High School Subjects |
| | | <input type="checkbox"/> College Preparatory |
| | | <input type="checkbox"/> Illustrating |
| | | <input type="checkbox"/> Cartooning |
| | | <input type="checkbox"/> Lettering Show Cards <input type="checkbox"/> Signs |

Name.....Age.....Address.....

City.....State.....Present Position.....

If you reside in Canada, send this coupon to the International Correspondence Schools Canadian, Limited, Montreal, Canada

When writing to advertisers please mention Popular Mechanics

Prepare to Fill These JOBS



More Pay-Interesting Work-Security

LEARN DRAFTING at home from an ENGINEER

Now is the time to prepare at once for a better job, more pay, increased security. Your opportunity is here—if you only grasp it. Government efforts to help are making things hum. In some factory towns a shortage of draftsmen already appears at times. Drafting is not only a good paying field—but offers splendid opportunities for advancement along many lines. You can learn drafting at home in your spare time by the DOBE Practical Method. You learn by doing—under the guidance of a successful engineer. Drafting is a fascinating profession. The work is interesting and different. Each day new problems, new jobs and new types of work arise. Moreover, in every walk of life practical training in DRAFTSMANSHIP will prove valuable. Even if you don't accept a job as a DRAFTSMAN, you will be MONEY AHEAD by taking Engineer Dobe's Course.

Jobs Now Open

In all industries, Drafting leads the way. In Aviation, Electricity, Building, Machinery, Automobile, Draftsmen must be used, and their work comes first. Recovery in industry and building is definitely on the way. Many trained Draftsmen will be needed on better jobs at better pay and shorter hours. Prepare for your chance NOW!

Learn At Home From An Engineer

I will teach you my practical method that has been successful with thousands since 1900. I will furnish you with all tools and a drawing table. I will teach you in a very short time by mail in your spare time until you actually have a desirable Draftsman's job, or prepare you for better pay in the job you now have. No High School or previous experience needed. You must be entirely satisfied with my personal training UNTIL COMPETENT and until assisted to a position, OR YOU GET ALL YOUR MONEY BACK. Start NOW and get the training. Prepare for more pay and a better job. Send the coupon below TODAY! Time is money! Don't delay! No obligations! Write at once.

ENGINEER DOBE Div. 3374
Libertyville, Ill.

"I'LL SEND YOU
MY FREE
PAY-RAISING BOOK"



If you're a mechanic, a knowledge of draftsmanship may make you a foreman or superintendent in short order. Get out of overalls and draw the pay of a boss. If you are a boss, learn draftsmanship, a foundation stone of many a line of business.

You'll be amazed at the speed with which you can learn in your spare time by Engineer Dobe's Practical Method. Send coupon TODAY for free book entitled "Success in Draftsmanship".

All Working Tools Furnished

Here's a valuable set of tools—sent at once (also a drawing table)—all without extra charge the day you enroll.

Complete Outfit, size 20x25 in., furnished to you.

These TOOLS and Other EQUIPMENT Given When You Start

Free Book!

ENGINEER DOBE, Div. 3374 Libertyville, Ill.

Send me your free book "Successful Draftsmanship". Please explain how you assist your graduates to good positions as draftsmen.

Name

Address

Town

State..... Age

When writing to advertisers please mention Popular Mechanics

TRIPLED MY PAY

Working steady... Making three times money I was... before I took up Coyne Training—Bert Farley.



\$300 A MONTH

Two weeks after graduation I had job with large Electrical Co. at \$300 a mo., with car furnished—H. C. Omer.



THANKS TO COYNE

I secured a position with an Electrical Construction Company, paying me three to four times more a week than I was getting before I entered Coyne—J. O. Whitmeyer.



THOUSANDS are MAKING \$30-\$40-\$50 a WEEK in ELECTRICITY

Huge Developments Ahead

LEARN BY DOING — 12 WEEKS TRAINING IN BIG COYNE SHOPS

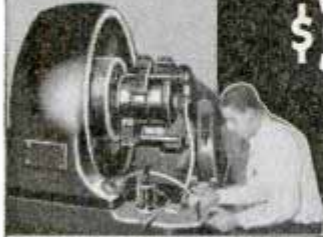

Thousands of Trained Electrical Men are making good money in the many branches of Electricity. Train for a better job—Right NOW!—whether you're 16 or 40. Look about you. Industry everywhere is being modernized with new electrical equipment—will use more ELECTRICITY. Many power plant operators now make up to \$50 a week. Electrical Maintenance Men are paid \$150 a month and up. Refrigeration and Air Conditioning Service Men earn \$30—\$40—\$50 a week. Armature winders make \$40 a week and more. Aviation Ignition Men also make good money at steady jobs. Many others operate their own business. These are only a few of the opportunities in Electricity.

COYNE extends the helping hand to YOU, too, if you're in a low-pay, discouraging job. Break out of the untrained class! If you are interested in bettering your place in life, get into ELECTRICITY—the gigantic growing field that employs more men than any other industry on earth!

Train on FULL SIZE Equipment—NOT by Correspondence—NOT by Text Books

COYNE Shop Training is NOT by correspondence or Home Study. You come right to the big COYNE Shops in Chicago to get this practical Training. You work on real equipment—such as generators, real dynamos, you wind armatures, work on diesel engines, airplane motors, and do many other practical Electrical jobs. Here is one of the greatest working outlays of its kind in America. No embarrassing reciting. No dry text books. You don't need high school education or previous experience. It is this real job Training that enables COYNE to train you for a better pay job.

AIR CONDITIONING, DIESEL and ELECTRIC REFRIGERATION included

Spreading over the nation is a vast network, these fast developing branches of ELECTRICITY are employing more men and paying more in salaries every year. Homes, offices, factories, trains, autos, airplanes are being air-conditioned. Autos may soon be diesel-powered. Instruction in these courses included without extra cost.



YOU TRAIN HERE
Many thousands of dollars worth of real practical equipment and machinery is installed in our fireproof modern school.

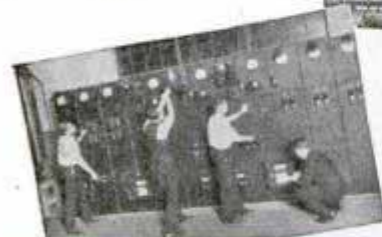

Many shop views like this shown in my catalog



Send for EASY PAYMENT PLAN —New Low Cost Board and Room Plan

My friend, don't waste the golden years of your life saying, "I can't afford Specialized Training!" Of course you can! Get my catalog—see for yourself how we help graduates year after year. I have a special new low cost Board and Room Plan whereby students take care of their living expenses while at COYNE. Get training first, then pay tuition in 18 easy, monthly payments, starting 5 months after you begin school. So don't let lack of money keep you from sending this coupon for full details of my amazing plans!

PART TIME EMPLOYMENT

If you need part time work to help pay living expenses while here, we'll help you. We help hundreds of students through this special department and may be able to help you.

JOB AFTER GRADUATION SERVICE

We keep in touch with many large firms in many branches of ELECTRICITY, ready at all times to supply their needs for trained men. After you graduate you get Lifetime job assistance through our Free Employment Department. As a COYNE graduate you get free business service and technical consultation to help you as you advance in your job; also, the privilege of review at any time without additional tuition charge.

Employers PRAISE These COYNE Graduates

"Mr. Lingerfelt's services very satisfactory. His practical shop training at COYNE has certainly helped increase his efficiency."

"John Lindquist was given an increase in salary due to the high quality of his work."

(Names of companies on request). We have scores of such letters. Get complete story. You owe it to yourself. Clip and send Coupon—NOW!

GET FULL FACTS

You'll see everything in the Big FREE COYNE Book... facts, opportunities... jobs... salaries... actual photos of hundreds of ambitious fellows preparing for better jobs. You'll see proof that COYNE training pays. This big Book is yours without obligation. So act at once. Just mail Coupon.



MAIL THIS NOW for MONEY MAKING DETAILS

H. C. LEWIS, President, COYNE ELECTRICAL SCHOOL, 500 S. Paulina St., Dept. 47-72, Chicago, Ill. Without obligating me, send full details and your Big FREE Illustrated Catalog.

Name..... Age.....
Street.....
Town..... State.....
Mail in Envelope or paste on Postcard

COYNE ELECTRICAL SCHOOL
H. C. LEWIS, President
500 S. Paulina Street Dept. 47-72 Chicago, Illinois

START DRAWING BIG MONEY!



LEARN TO DRAW AT HOME

MAKE 30-50-75 A WEEK

BE an artist and be your "own boss." You can learn AT HOME in your spare time this simple, practical way. There's a big future in this fascinating and profitable field for men and women of all ages. A few pleasant hours a week should give you the ability to earn good money.

COMMERCIAL ART CARTOONING AND DESIGN—All In ONE PRACTICAL COURSE

Our proven method of instruction includes every branch of Commercial Art, and your drawings are given the correction and criticism of an experienced Art Instructor. You start by drawing straight lines and in advancing from lesson to lesson you receive all the constructive help you need.

IT'S AS EASY AS One - Two - Three!



From a simple framework to the finished figure. Art made easy by simple steps that the average person can follow. The above is one of the 16 key poses in our LIFE CLASS BOOK. Full Size Artists' Outfit Given—AT NO EXTRA COST!

Includes everything you need to get started in Art. Mail coupon today for complete details.



This FREE BOOK Shows How

WASHINGTON SCHOOL OF ART
Studio 124, 1115—15th Street, N. W.
Washington, D. C.

Without obligation, please send me a FREE copy of your Book, "Art for Pleasure and Profit."

Name..... Age.....

Address.....

City..... State.....

(No salesman will call)

When writing please mention Popular Mechanics

1,500 NEEDED INVENTIONS



Last Edition of this remarkable source book for inventors by R. F. Yates tells what to invent, what inventions manufacturers are looking for, what will pay most money. Also gives new scientific discoveries important to inventors. Enables you to work on inventions that pay. Simple, practical ideas

Large cloth-bound book, 250 pages. Don't waste time. Send \$2.50 today, or send \$4.00 for this great book and INVENTORS' SELLING GUIDE which tells you where and how to sell safely your patented or unpatented inventions to its list of nearly 1000 buyers. Everything you must know about Selling Methods, Law, Royalty Contracts, Financing, Finding Buyers. 224 pages, cloth \$2.00. Send no money if you prefer C. O. D. shipment. Money back if not satisfied.

Write for FREE catalog of valuable books for inventors and sample pages of above books.

Donley Publishing Co., 509 Fifth Ave., Dept. P-4, New York, N.Y.

ENGINEERING DEGREE IN TWO YEARS

B.S. DEGREE courses in engineering: Electrical, Civil, Chemical, Mechanical, Radio and Television, or Aeronautical. Intense, practical, thorough program. No extras for preparatory or review work. Earn while you learn in this industrial center. Low tuition. Enter March, June, Sept., Dec. Write for catalog. 229 E. Washington Blvd., Fort Wayne, Ind.

INDIANA TECHNICAL COLLEGE

MASTER MUSICIANS

TEACH YOU BY MAIL Amazing home method—low cost—easy terms. New, quick way for beginners in Piano, Violin, Cornet, Trumpet, Mandolin, Guitar, Organ, Banjo, Accordion, Saxophone, Clarinet and other instruments. Wonderful results whether for pleasure, profit or both. 300,000 satisfied students. Your satisfaction guaranteed. Write for FREE CATALOG giving all details.

NATIONAL ACADEMY OF MUSIC
Dept. 792 1525 East 53rd Street, Chicago

BE A CARTOONIST

AT HOME IN YOUR SPARE TIME under personal supervision of the famous cartoonist NORMAN MARSH creator of "DAN DUNN" appearing every day in big papers. Success—Fame—Real Money may be Yours when you learn Marsh's easy simple methods and secrets. Send name and six cents—stamps or coin—for details of MARSH'S Personal course. ACT TODAY! MARSH CARTOON SCHOOL
Chicago Daily News Bldg., Dept. D-1, Chicago, Ill.

RADIO ENGINEERING

RCA Institutes offer an intensive course of high standard embracing all phases of Radio. Practical training with modern equipment at New York and Chicago schools. Also specialized courses and Home Study Courses under "No obligation" plan. Catalog Dept. PC-37.

RCA INSTITUTES, Inc.
75 Varick St., New York 1154 Merchandise Mart, Chicago
Recognized Standard in Radio Instruction Since 1909.

MAIL FOR FREE INFORMATION

BEDFORD 1117 Bedford Ave., Dept. PM-47
Brooklyn, New York City, N. Y.

Diesel Engines
 Diesel Engineering Oil Burner
 Aviation Mechanic Welding
 Aeronautical Engineering
 Auto Mechanic Talking Pictures
 Refrigeration Machine Shop
 Radio and Television Mechanic
 Air Conditioning Sign Painting
 Architectural-Mechanical Drafting
 Electrical Window Display
 Armature Winding

YMCA TRADE SCHOOL
Name.....
Address.....

To help you answer these **3** questions:



1—What are today's opportunities in Drafting?

2—Will I like the work?

3—Can I learn Drafting readily?

2 Beginning Lessons in Drafting **Free**

Drafting Opportunities Growing Daily

Before anything can be made or built, the Draftsman *first* must draw it. Building trades, transportation, manufacturing — ALL depend on him. That is why *any* pickup in *any* line means *first call for the Draftsman!*

Fit Yourself for a Job with a Future

Drafting welcomes ambitious men — offers good pay to start, with splendid opportunities for promotion. One of the *steadiest* of all lines. Right from the start, the beginner works side by side with experienced men—inking in their drawings, making tracings, constantly profiting by his contact with seasoned engineers. The “higher ups” see his work. If it is good, advancement is sure and steady.

Pleasant, well-lighted offices are the Draftsman's workroom. He keeps regular hours, with congenial, high grade fellow workers. The work is fascinating—embraces not just *one* line, but *hundreds*.

Drafting Experience NOT Necessary

You can master Drafting readily by home study because you learn and advance *exactly* as professional Draftsmen work—with T-square, dividers and drawing board. *Actual* working conditions are duplicated to the final detail. *Thousands* of successful graduates enthusiastically endorse American School methods, nowhere better exemplified than in our Drafting course.

We want you to see for yourself—before you come to ANY decision—exactly what Drafting is like. We want you to judge your own interest in the work—and our ability to teach you. So we make this 2 Free Lesson Offer.

American School, Drexel Ave. at 58th St., Chicago, Ill.

Prove That You Can Qualify

The 2 lessons will be sent absolutely without obligation. In the privacy of your own room, look them over. See how simply you start—how gradually you are led step by step—how thoroughly you master each point—how, as time goes on, you can pass from a raw beginning to complete *mastery* of Drafting—able to get and hold a pleasant, profitable, steady job. Such a future is well worth looking into **RIGHT NOW**, so . . . just mail the coupon!



Mail Coupon for 2 Lessons FREE

American School, Dept. DD-445

Drexel Ave. at 58th St., Chicago

Without the slightest obligation, send 2 beginning Drafting Lessons and free Bulletin. I am not to return them.

Name.....Age.....

Address.....

City.....State.....

When writing to advertisers please mention Popular Mechanics

Diesel did it

20 x 1932 = 1936 DIESEL ENGINE PRODUCTION



Diesel powered Zeppelin shatters records for airship dependability.



Trans-Atlantic flying boat service standardizes on Diesel engines.

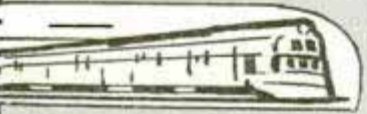

Train and locomotive building revived by Diesel economy.



Hemphill Schools equip test cars with six cylinder Diesels.



—all previous records were broken— a far greater increase than the automobile, steel or petroleum industries. Diesel will be even greater in 1937.

DIESEL MARCHES UPWARD— one engine builder has produced 25,000 Diesels in 6 years, is now delivering 1500 per month — another has orders covering their entire 1937 production—and every Diesel manufacturer is striving to increase production to meet the demand.

KEEPING PACE WITH DIESEL'S tremendous progress are many Hemphill graduates who are accepting new responsibilities. As each year goes by the opportunities offered them are even greater. If you seriously want a career with a future you should get the facts about Diesel.

Send for the 32 page book "March of Diesel". **FREE.** Written by authorities for America's original exclusive Diesel training institution.

HEMPHILL DIESEL SCHOOLS

(Use nearest address at right)

I want more information on Diesel and its employment opportunities. Please send without obligation 32 page "March of Diesel" and data on your Diesel courses.

Name.....Age.....
 Street.....
 City..... State..... m-19-p

HEMPHILL DIESEL SCHOOLS

are located only in the cities and at the addresses given below. In no way connected with any other schools—

- BOSTON 114 Brookline Avenue
- NEW YORK . . . 3126 Queen's Blvd., L.I.C.
- DETROIT 2341 W. Lafayette Blvd.
- CHICAGO 2014 Larrabee Street
- MEMPHIS 417 Monroe Avenue
- LOS ANGELES . . 2120 San Fernando Road
- SEATTLE 501 Westlake North
- VANCOUVER B.C. 1363 Granville Street

1932



J. E. SMITH, President, National Radio Institute
The man who has directed the home study training of more men for the Radio Industry than any other man in America.

Be a Radio Expert

Many make **\$30 \$50 \$75** a week

I will train you at home for many Good Spare Time and Full Time Radio Jobs

Do you want to make more money? Radio offers you many opportunities for well-paying spare time and full time jobs. And you don't have to give up your present job or leave home and spend a lot of money to become a Radio Expert.

Many Radio Experts Make \$30, \$50, \$75 a Week

Radio broadcasting stations employ engineers, operators, station managers and pay up to \$5,000 a year. Spare time Radio set servicing pays as much as \$200 to \$500 a year—full time jobs with Radio jobbers, manufacturers and dealers as much as \$30, \$50, \$75 a week. Many Radio Experts operate their own full time or part time Radio sales and service businesses. Radio manufacturers and jobbers employ testers, inspectors, foremen, engineers, servicemen, paying up to \$6,000 a year. Radio operators on ships get good pay and see the world besides. Automobile, police, aviation, commercial Radio, and loud speaker systems are newer fields offering good opportunities now and for the future. Television promises to open many good jobs soon. Men I have trained are holding good jobs in these branches of Radio. Read their statements. Mail the coupon.

Extra Money Job Sheets. They show you how to do Radio repair jobs that you can cash in on quickly! Throughout your training I send you plans that made good spare time money—\$200 to \$500 a year—for hundreds of fellows. My training is famous as "the Course that pays for itself."

I Give You Practical Experience

My Course is not all book training. I send you special Radio equipment and show you how to conduct experiments and build circuits which illustrate important principles used in modern Radio receivers, broadcast stations and loud speaker installations. I show you how to build testing apparatus for use in spare time work from this equipment. This 50-50 method of training makes learning at home interesting, fascinating, practical.

You Get a Money Back Agreement

I am so sure that I can train you successfully that I agree in writing to refund every penny you pay me if you are not satisfied with my Lessons and Instruction Service when you finish. I'll send you a copy of this agreement with my Free Book.

Find Out What Radio Offers You

Act Today. Mail the coupon now for "Rich Rewards in Radio." It's free to any fellow over 16 years old. It describes Radio's spare time and full time opportunities and those coming in Television; tells about my training in Radio and Television; shows you actual letters from men I have trained, telling what they are doing and earning. Find out what Radio offers YOU! MAIL THE COUPON in an envelope, or paste on a postcard—NOW!

J. E. SMITH, Pres., National Radio Institute

Dept. 7DP
Washington, D. C.

THIS FREE BOOK HAS HELPED HUNDREDS OF MEN MAKE MORE MONEY



Broadcasting Stations

Employ managers, engineers, operators, installation and maintenance men for fascinating jobs and pay up to \$5,000 a year.

Set Servicing

Spare time set servicing pays many \$5, \$10, \$15 a week extra while learning. Full time servicing pays as much as \$30, \$50, \$75 a week.



Loud Speaker Systems

Building, installing, servicing and operating public address systems is another growing field for men well trained in Radio.



HERE'S PROOF THAT MY TRAINING PAYS

\$80 Monthly in Spare Time

"I work on Radio part time, still holding my regular job. Since enrolling five years ago, I have averaged around \$80 every month." **JOHN B. MORISSETTE, 773 Silver Street, Manchester, N. H.**

Makes \$50 to \$60 a Week

"I am making between \$50 and \$60 a week after all expenses are paid, and I am getting all the Radio work I can take care of, thanks to N. R. I." **H. W. SPANGLER, 308 Walnut St., Knoxville, Tenn.**

Operates Public Address System

"I have a position with the Los Angeles Civil Service, operating the Public Address System in the City Hall Council. My salary is \$153 a month." **R. H. ROOD, R. 136, City Hall, Los Angeles, Calif.**

There's a Real Future in Radio for Well Trained Men

Radio already gives jobs to more than 300,000 people. In 1935 over 300,000,000 worth of sets, tubes and parts were sold—an increase of 20% over 1934! Over 1,100,000 auto Radios were sold in 1935, 25% more than in 1934! 22,000,000 homes are today equipped with Radios, and every year millions of these sets go out of date and are replaced with newer models. Millions more need servicing, new tubes, repairs, etc. Broadcasting stations pay their employees (exclusive of artists) more than \$23,000,000 a year! And Radio is a new industry, still growing fast! A few hundred \$30, \$50, \$75-a-week jobs have grown to thousands in less than 20 years!

Many Make \$5, \$10, \$15 a Week Extra in Spare Time While Learning

Practically every neighborhood needs a good spare time serviceman. The day you enroll I start sending you

This Coupon is Good For . . . One FREE Copy of My Book

J. E. SMITH, President, Dept. 7DP National Radio Institute, Washington, D. C.

Dear Mr. Smith: Without obligating me, send "Rich Rewards in Radio," which points out the spare time and full time opportunities in Radio and explains your 50-50 method of training men at home in spare time to become Radio Experts. (Please Write Plainly.)

NAME.....AGE.....

ADDRESS.....

CITY.....STATE.....

NOW FIX ANY MAKE OF AUTO



SIX BIG AUTO BOOKS ALL SHIPPED FREE

on approval; whether you want to qualify as garage owner, auto repair expert or merely wish to know how to keep your own car 100% efficient, look at these books—they are sent to you for free examination. This brand new edition has been prepared by a large group of America's greatest automotive engineers. Anybody who can read will understand them, for this great automobile encyclopedia is a veritable

gold mine of valuable facts. Take advantage of this offer now; send in the coupon for FREE examination. You don't pay us a penny, you don't obligate yourself to pay anything unless you decide to keep the books. Just tell us you want to see them and the full set of 6 great volumes, just off the press, will be sent to you! Read them, and prove to your own satisfaction that one fact alone, which you will find in them, may save you an expensive repair, or help you to a better job.

- DIESEL ENGINES
- AVIATION MOTORS
- MOTORCYCLES
- OUTBOARD MOTORS
- MARINE ENGINES
- TRACTORS
- AUTOMOBILE RADIOS
- ALL COVERED

Very Latest Edition

Imagine books which are so new that every page is right up to date—wiring diagrams, construction details, service problems—are all right up to the minute. Nowhere else can you get as complete and timely information. Over a million dollars of resources have enabled us to give you the most authoritative books on the subject ever published. Everybody interested in automobiles in any way will welcome these books published by the world's largest publishers of Technical Cyclopedias (est. 1897) with agencies all over the world.

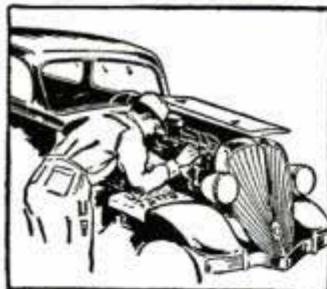

Can You Fix It?

Can you take out "play" in differentials? Can you kill the "shimmy" in steering? Can you reset TIMING? Can you put your finger on engine trouble without guessing or tinkering? Can you pull the starter off and fix it? Can you adjust and repair transmission, engine, rear axle, bearings?

These Books Tell How and tell you how to do any and every auto job right, the first time.

6 Big Volumes

Nearly 3,000 pages, over 2,000 illustrations, wiring diagrams equipment charts, etc. De Luxe edition with gold-stamped flexible binding. Sent FREE for 10 days' use. If not wanted return express collect. If kept, send only \$2.00 after 10 days, then \$3.00 a month until low advertising price, \$24.80 is paid.

A Year's Consulting Membership Included

Privilege of consulting engineers of million-dollar American Technical Society for one year if you mail coupon immediately. We also include 2 extra books, "Service Shop Management" and loose leaf book of new diagrams without extra charge if you send NOW.

SEND NO MONEY

AMERICAN TECHNICAL SOCIETY,
Drexel Ave. at 58th St., Dept. A419, Chicago, Illinois.

I would like to see the brand new 6-volume edition of your automobile books but without any obligation to buy. I will pay the few cents delivery charges only and will examine the books and return them at your expense in 10 days unless I like them. In which case I will send you \$2.00 then and only \$3.00 per month until the total price of only \$24.80 is paid. You are to include consulting membership certificate in the American Technical Society and the two extra volumes mentioned above.

Name.....
Street.....
City..... State.....
Employer's Name.....
Employer's Address.....

Please give us, in addition, the name and address of at least one business man as reference.

If outside continental boundary of U. S. send \$5.00 deposit with coupon.

When writing please mention Popular Mechanics

Sax

What a thrill when you play your first tune the very first week on a P-A Sax'. Then popularity... admiring friends, good times, a glorious future. Try a new model P-A Sax', Trumpet, Trombone, Clarinet at your local music store, or write for beautifully illustrated book. Finest instruments at amazingly low prices. Easy terms. Write today sure. 1245

FREE PAN-AMERICAN BAND INST. & CASE CO. BOOK 403 P-A Building, ELKHART, INDIANA

CARTOONING PAYS WELL

Turn your talent into dollars. Develop your ability with personal instruction from an internationally-known cartoonist. His exclusive, successful method of drawing and creating ideas makes it easy to attain success. Write for details of this exceptional home-study course. No salesman will call.

National School of Cartooning, 437 Penton Building, Cleveland, Ohio

LEARN WATCH REPAIRING

AT HOME You can learn by our modern and original system of instruction every part of the Watch Repairing Trade at home. You can earn money while learning and prepare yourself for a well paying position or start in business after completing our course of instruction. Good watch repairers are in demand and generally earn very good salaries. For particulars apply to the Wisconsin School of Watch Repairing 524 E. Mason St., MILWAUKEE, WIS.

AVIATION APPRENTICES

Ambitious, air-minded young men, interested in entering the well paid field of Aviation, write immediately, enclosing stamp, to

Mechanix Universal Aviation Service, Incorporated
Strathmoor Station Dept. E Detroit, Mich.

KNOCK-EM-COLD!

THE BIGGER THEY ARE, THE HARDER THEY FALL. **LEARN JIU JITSU!**

13 secret knock-out blows without fists by 15c world famous Police Jiu Jitsu instructor

A little jab with tip of fingers or strike with edge of hand to right spot and tough guys go out like a light. Northwest "Mounties" use Jorgensen's system. G-Men must be Jiu Jitsu experts. He has taught many in U. S. Army, Navy, Marines, National Guard, Coast Guard, Police, etc. Send for illustrated course. Price 15c. Also learn how you may defend yourself against any man regardless of size or strength whether he is armed with gun, knife or club.

S. J. JORGENSEN, 791 Maritime Bldg., Seattle, Wash.

GOV'T. JOBS

MANY SOCIAL SECURITY JOBS

SALARY TO START \$90 to \$175 MONTHLY

MEN WOMEN
Age Range 18 to 50

- Railway Mail Clerk
- P. O. Laborer
- R. F. D. Carrier
- Special Agent
- Customs Inspector
- City Mail Carrier
- P. O. Clerk
- Stock Clerk
- Spec. Investigator
- Typist
- POSTMASTER
- Elevator Conductor
- Auditor
- Stenographer
- U. S. Border Patrol
- Telephone Opr.
- Watchman
- Meat Inspector
- Secret Service Opr.
- File Clerk

OZMENT INSTRUCTION SERVICE, Dept. 111, St. Louis, Mo. Send me FREE particulars about Social Security Jobs. "How to Qualify for Government Positions" marked "X". Salaries, locations, opportunities, etc. ALL SENT FREE.

Name.....
Address.....

BE A RADIO EXPERT



LEARN at HOME
from
REAL RADIO ENGINEERS

RAY D. SMITH, Pres. R-T-I

If you're dissatisfied with small pay—lay-offs and an uncertain future—here's an opportunity that's too good to miss. At the cost of only the time it takes you to mail the coupon, you can get my big FREE book, "RADIO'S FUTURE AND YOUR OPPORTUNITY." This book tells how you can learn at home under the supervision of factory engineers, to make more money almost as once in Radio—whether you want to make Radio your life's work, or use it to pick up an extra \$5 or \$20 a week in your spare time.



TRAIN NOW FOR GOOD PAY FULL-TIME AND SPARE-TIME JOBS THAT PAY UP TO

\$75 A WEEK (and more)

Radio is still forging ahead. 1936 beat all other years. Over 6 million new sets sold. Over 30 million dollars paid for service alone in 1935. Where only a few hundred men were employed a short time ago, thousands are employed today. And where a hundred jobs paid up to \$75 a week—there are thousands of such jobs today—many paying even more. And new jobs are being created all the time—full time jobs and spare time jobs. Get my book and see how easy it is to learn at home for this good-pay work.

"Shop Training" for the Home

R-T-I Training is different than any training you ever heard about. It comes to you right from the heart of the Radio Industry—right out of the factories where Radio sets and other vacuum-tube devices are made. It was planned and prepared and is supervised by big radio engineers IN these factories—by men appointed for the purpose. This means that trained the R-T-I way, you'll be trained as the Radio Industry wants you trained—just as the Radio Industry, itself, would train you if it was doing the job.

Television, Photo Electric Cells, Public Address Systems Included

Radio service work is only the starting point in R-T-I Training. From there it will take you through the whole field of Radio and Electronics. You will learn about every new development, including Television, so you'll be ready when Television breaks. You'll also learn the big money subjects such as Aviation and Auto Radio; Public Address Systems; how to handle Photo Cells; Sound Picture Recording, Etc.

4 Working Outfits Furnished

Start almost at once doing part time radio work. I furnish 4 outfits of apparatus that you build into test equipment with which you can do actual jobs and earn extra money. My Training pays its own way and you get your money back if not satisfied.

Age or Lack of Experience No Handicap

You don't have to be a high school graduate, nor even have finished the grades. My Training is so simple, easy, and practical, that the average man, regardless of age, education, or previous experience can master it. It offers the chance you have wanted to get out of a small-pay, no-future job, into good pay work with a future, in Radio and all its branches.

Get My Big New Free Book

INVESTIGATE! Learn why R-T-I Training is different. Find out why R-T-I Trained men get "Quick Results" and "Big Results." Send for your copy of "Radio's Future and Your Opportunity" today. It tells you about Radio's amazing opportunities. It describes my approved training. It tells what R-T-I students are doing and making. It gives the history of my Advisory Board and 50 endorsing manufacturers. It's FREE. Clip, sign and mail coupon RIGHT NOW!

RAY D. SMITH, President



RADIO AND TELEVISION INSTITUTE

Dept. 14 • 2130 Lawrence Ave. • CHICAGO

When writing to advertisers please mention Popular Mechanics

Let these Engineers, RIGHT FROM THE HEART OF THE GREAT RADIO INDUSTRY TRAIN YOU IN SPARE TIME FOR A *Good Pay Job!*

HERE THEY ARE:

Kendall Clough
Chief Engineer,
Clough-Brengle Co.

E. E. Gramer
Chief Engineer,
Standard
Transformer
Corporation.

Karl E. Hassel
Chief Engineer,
Zenith Radio
Corporation.

H. C. Tittle
Chief Radio Engineer,
General Household
Utilities (Grunow).

Dr. C. M. Blackburn
Asst. Factory Manager,
P. R. Malloy &
Company, Mfrs. of
Radio Apparatus.

F. L. Howard
Chief Engineer,
Radio and Television
Institute.



HAS MADE \$250 IN RADIO IN ONE WEEK



Wm. T. Ridd, Verdun, P. Q., Canada, formerly an \$18 a week car washer, averages more than \$75

a week as an R-T-I Trained man. He says: "Have made \$250 in single week. R-T-I is entirely responsible for my success."



STARTING SALARY HIGHEST HE EVER EARNED

Harold Apley, 2658 Brookside Ave., Indianapolis, made as high as \$30 a week in spare time while getting his R.T.I. training. Starting on a regular job, obtained because of his training he said: "This job is starting me in at better pay than I ever got on any job before."

MAIL FOR FREE COUPON BOOK

RAY D. SMITH, President,
Radio & Television Institute (R-T-I)
2130 Lawrence Ave., Dept. 14,
Chicago, Ill.

Without obligating me, send me your book that explains your Engineer-Directed and Industry-Endorsed method of training men quickly and inexpensively at home in their spare time to be Radio Experts.

Name

Address..... Age.....

City..... State.....

NEW ELECTRIC LIBRARY

\$ 1.50 A VOLUME



WHAT EVERY ELECTRICIAN WANTS TO KNOW!

is easily found in AUDEL'S NEW ELECTRIC LIBRARY. Electricity made simple as ABC. Up-to-date, trade dope for the expert and ALL electrical workers. Questions, answers, diagrams, calculations, underwriter's code; design, construction, operation and maintenance of modern electrical machines and appliances FULLY COVERED.

All available at small cost, easy terms. BOOK-A-MONTH service puts this NEW information in your hands for 6c a day. You can start your subscription with any volume. Write TODAY for electric Folder and FREE TRIAL offer.

THEO. AUDEL & CO., 49 W. 23rd St., New York City

Mail Vol. I, Electric Library on 7 days' free trial. If O. K. I will remit \$1.50, otherwise I will return it. I also request you to mail one book each month on same terms. No obligation unless I am satisfied.

Name.....

Address.....

Occupation.....PM

Learn this Profitable Profession



in 90 Days at Home

Hundreds of men and women of all ages 18-50 are making \$10.00 to \$20.00 a day giving scientific Swedish Massage and Hydro-Therapy treatments. There is a big demand from Hospitals, Sanitariums, Clubs, Doctors and private patients as well as opportunities for establishing your own office.

Learn this interesting money-making profession in your own home by mail through our college extension course. Same instructors as in our NATIONALLY KNOWN resident school and a diploma is awarded. Course can be completed in 3 to 4 months. No High School training necessary. Many earn big money while learning.

Anatomy Charts & Supplies Included

Enr all now and we will include anatomy charts, medical dictionary, patented reducing roller and Hydro-Therapy supplies without extra cost. The reducing course alone may be worth many times the modest tuition fee. Send coupon now for reduced price offer. Complete details with booklet containing photographs and letters from successful graduates together with illustrated sample lesson sheets will be sent FREE.

National College of Massage & Physio-Therapy
Dept. 464—20 N. Ashland Boulevard, Chicago

You may send me FREE and postpaid, your illustrated catalog, sample lesson sheets and details of your special offer, also booklet containing photographs and letters from successful graduates.

Name.....

Address.....

City.....State.....

When writing to advertisers please mention Popular Mechanics

Law!

LEARN AT HOME

Are you adult, alert, ambitious, willing to study? Investigate LAW! We guide you step by step—furnish all texts, including 14-volume Law Library. Training prepared by leading law professors and given by members of bar. Degree of LL. B. conferred. Low cost, easy terms. Send NOW for Free, 64-page "Law Training for Leadership."

LaSalle Extension University, Dept. 464-L, Chicago



TRI-STATE COLLEGE

B. S. Degree in 2 years. World famous for technical 2-year courses in Civil, Electrical, Mechanical, Chemical, Radio, Aeronautical Engineering; Business Administration and Accounting.

Those who lack high school may make up work. Low tuition. Low living costs. Short diploma courses in Surveying (36 weeks), Drafting (36 weeks), Students from every state and many foreign countries, 54th year. Enter March, June, Sept. and Jan. Write for catalog. 447 College Ave., ANGOLA, IND.

VOICE

100% Improvement Guaranteed

We build, strengthen the vocal organs—not with singing lessons—but by fundamentally sound and scientifically correct silent exercises... and absolutely guarantee to improve any singing or speaking voice at least 100%... Write for wonderful voice book—sent free. Learn WHY you can now have the voice you want. No literature sent to anyone under 17 years unless signed by parent.

PERFECT VOICE INSTITUTE, Studio 1354
64 E. Lake St., Chicago



You Can Regain Perfect Speech, if you

STAMMER

Send today for beautifully illustrated book entitled "DON'T STAMMER," which describes the Bogue Unit Method for the scientific correction of stammering and stuttering. Method successfully used at Bogue Institute for 36 years—since 1901. Endorsed by physicians. Full information concerning correction of stammering sent free. No obligation. Benjamin N. Bogue, Dept. 177, Circle Tower, Indianapolis, Indiana.



Learn to Write

Begin Today. Write for our Free Book, "How to Become a Good Penman." It contains specimens and tells how others learned to write in spare time. Your name elegantly written on a card if you enclose stamp for postage. Write today. F. W. TAMBLYN, 418 Ridge Bldg., Kansas City, Mo.

Photography

for

PLEASURE or PROFIT

Prepare for profitable business or fascinating hobby, at home under guidance of qualified instructors. No previous experience necessary, common school education sufficient. Many earn while learning. Our practical studio methods also qualify for well-paying positions upon graduation. Send coupon below at once for free booklet "Opportunities in Modern Photography", particulars and requirements.

AMERICAN SCHOOL OF PHOTOGRAPHY
3601 Michigan Avenue Dept. 1354 Chicago, Illinois
Send booklet, "Opportunities in Modern Photography", full particulars and requirements.

Name.....Age.....

Address.....

City.....State.....

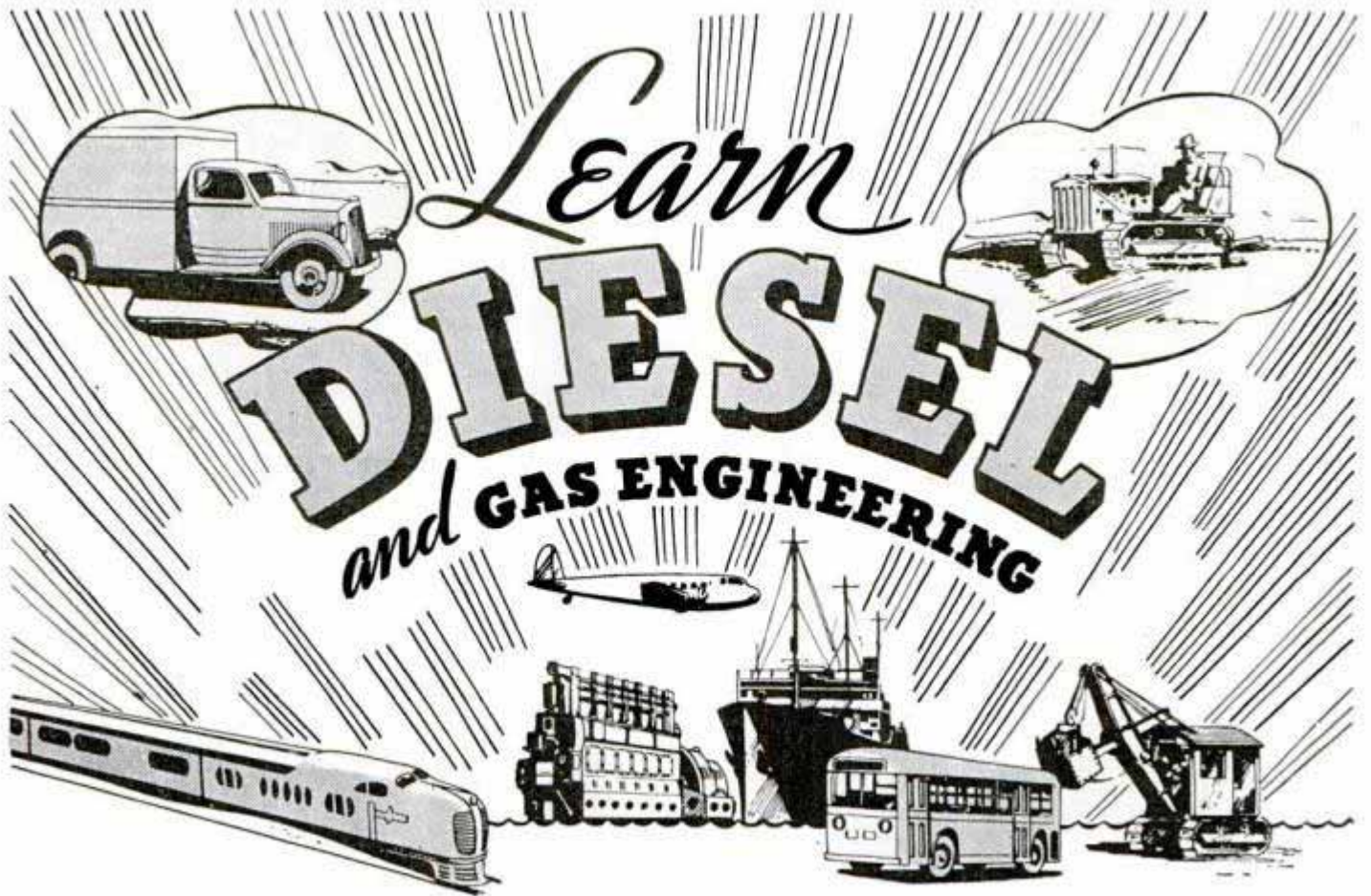

TESTED SYSTEM OF DIESEL AND GAS ENGINE TRAINING

To qualify for a good Diesel job you must receive training in an institution that can offer you **practical** instruction. At National Schools you actually work on the latest equipment, including practically every approved make of Diesel engine. You get the kind of instruction that serves your every day needs in the Diesel field after you have graduated. It's the type of training you can "cash in" on. You are trained under the direct, personal supervision of licensed Diesel Engineers. You learn Diesel and gas engine operation, repair, trouble-shooting, theory.

Easy-to-Learn Master Training

National Schools' training is complete in every respect. It includes all phases of Diesel engines, fuel injection, gasoline, butane, propane and natural gas engines, also Auto-Diesel electrics, machine shop practice, batteries and other essentials that must be learned in order to give you well rounded-out training.

Learn in Los Angeles

The most delightful place to learn—Los Angeles—the playground of America. Fascinating surroundings. Your coach railroad fare will be allowed to Los Angeles from any point in the U. S.

Earn Room and Board

We help students obtain part-time jobs to earn room and board while learning. This service only for residents of U. S.



Partial Room, Diesel Engine Dept.

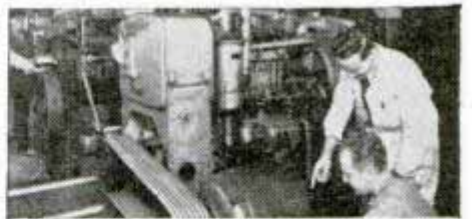

Student Servicing Diesel Electric Unit



Diesel Generating Unit. Diesel Converted Ford Auto

NATIONAL SCHOOLS

Special Added Feature
DIESEL ELECTRIC POWER GENERATION

A new feature essential to the complete training of Diesel experts. Completely covers power generation. This extra course is now presented to all Diesel students without extra tuition.



MAIL COUPON for FREE BOOK

National Schools, Dept. 4-PMA
4000 So. Figueroa St., Los Angeles
Send Free Diesel Book of Details.

Name.....Age.....

Address.....

City.....State.....

INVESTIGATE

DON'T BUY

Mandolin
Guitar
Banjo or
Drums



Don't buy Guitar, Mandolin, Banjo, Electric Guitars, Ukuleles, or Drums, until you have tried the Slingerland May-Bells, Guaranteed More for your Money. Wonderful, snappy, powerful, pleasing tone. No equal in price. Sold on easy payments and 5 days free trial by all leading music dealers.

Send for free catalog. Mention instrument wanted.

Write today:

Slingerland Musical Instrument Mfg. Co.,
1325 Belden Ave., Chicago, Illinois



Cut This Adv. Out — Good for \$1.00 Credit



DRAFTING

BOOKS SENT FREE!

ON APPROVAL
5 VOLUMES BRAND NEW EDITION

Only 15 minutes a day with these WONDER BOOKS can prepare you for a good drafting job in less than a year. Mechanical and architectural drafting from simple straight lines to important complex plans. A step at a time! Built especially for beginners, for men with only grammar schooling. Drafting room practice, PLUS ENGINEERING, made easy and clear. Includes complete course in blue-print reading.

Big Field Big Demand Big Pay

Competent draftsmen are urgently needed right now in all building and manufacturing lines at \$30.00 to \$75.00 a week. That's just the beginning—FOR DRAFTSMEN HAVE THE BEST CHANCES FOR ADVANCEMENT. Pleasant, fascinating work, easy to learn and do. Learn quickly with these books—send coupon for a set and see for yourself.

A year's consulting membership in the American Technical Society now given to all readers of this famous cyclopedia of drafting. Many say that it is worth more than the cost of the books.

Complete set of drawing instruments if you send for these drafting books NOW. These instruments are made of the finest of German silver, are absolutely accurate and are packed in velvet lined leatherette pocket case. Real \$10 value, but included with these books.

AMERICAN TECHNICAL SOCIETY
Dept. D419, Drexel at 58th St., Chicago, Ill.

American Technical Society, Dept. D419, Drexel at 58th St., Chicago, Ill. Send for 10 days' trial New 5 volume set of drafting. I will pay the few cents delivery charges. If I wish, I may return books in 10 days and owe you nothing but if I decide to keep them, I will send \$2.00 after 10 days, then only \$3.00 a month until \$24.50, the advertising price, is paid. Send latest edition and include drawing instruments.

Name.....
Address.....
Attach letter stating age, occupation, employer's name and address and that of at least one business man as a reference.

When writing to advertisers please mention Popular Mechanics

EXTRA MONEY

\$10 to \$35 a week
Yes, you — anybody can make a lot of money right at home, and what's more, have real fun doing it. We show you how, we furnish everything necessary on an easy basis.

COSTS NOTHING

to learn about our plan, all details are given you free. Write today for idea book full of colored pictures telling all about our methods which have made so many people independent. Learn how easy it is to make from \$10 to \$25 per week in the most delightful home work you can imagine. Don't miss this opportunity. Write Now—It's FREE!

FIRESIDE INDUSTRIES, Dept. 66-D, Adrian, Mich.

Write and Speak MASTERLY ENGLISH

Learn correct English with Sherwin Cody's new invention. No rules to memorize. Like a fascinating game. Spare-time study. 15 minutes each day, quickly gives you command of English. Send for free book, "How You Can Master Good English in 15 Minutes a Day." Write today.

SHERWIN CODY SCHOOL OF ENGLISH
54 Searle Bldg. Rochester, N. Y.

BE AN ARTIST

WE CAN TEACH YOU DRAWING in your own home during your spare time. Thirty-five years of successful teaching proves our ability. Artists receive large salaries.

Write today for Art Year Book
SCHOOL OF APPLIED ART
Dept. 147, 10 E. Huron St., Chicago, Ill.

ENGINEERING

TECHNICAL AND APPLIED COURSES. Nonesentials omitted. TIME AND MONEY SAVED. Degree in 2 yrs., diploma in 1 yr. Electrical, Mechanical, Architectural, Structural, Aeronautical, Civil, Highway. Short intensive courses in Diesel-Electric, Electricity, Power Plant, Drafting. All courses include Refrigeration, Diesel, and Air-Conditioning. Low tuition. Extensive modern equipment. Part-time work for room and board. 37th year. Thousands of successful graduates in U. S. and foreign lands. Approved by industry, endorsed by educators and alumni. One and two-year courses begin in Sept. Short courses open the year round. Catalogue free.

FINLAY ENGINEERING COLLEGE
1001 Indiana Avenue Kansas City, Mo

LEARN WATCHMAKING AND ENGRAVING

BY OUR PROFIT-SHARING PLAN
OUR GRADUATES SUCCEED

One of our Iowa students started in a very small way—now doing over \$30,000 a year. Another in Wisconsin, over \$10,000 the first year. Day or night classes. Call or write for FREE BOOK. Chicago School of Watchmaking, Dept. 5001, 155 N. Clark St., CHICAGO.

Amazing Sensational Discovery

REFINISHES AUTOS LIKE NEW!

NOT A WAX OR POLISH—LASTS 8 TO 12 MONTHS—SHABBY CARS GIVEN NEW LUSTER AND SHINE
Men — It's unbelievable, a miracle! KAR-NU refinishes old shabby cars in a few minutes. Gives them like-new shine. Not a polish, wax, or paint, but a real finish that lasts 8 to 12 months. Stands washing, sunshine, long wear. No rubbing—no polishing—nowaxins. Just apply with rag. Guaranteed.

FREE SAMPLE

What a profit-maker for agents and distributors! Millions of cars need this new LOW PRICED auto finisher. BIG PROFITS—up to \$7.00 in an hour, easy. Ten second demonstration on any man's car sells him QUICK. Hurry—get FREE SAMPLE which proves all claims. Write or wire to-day. Distributors Wanted in Foreign Countries. KAR-NU CO., Dept. P-30, Oakley, Cincinnati, Ohio

LOW PRICED GUARANTEED



Get into the Biggest,
Livest Industry in
America

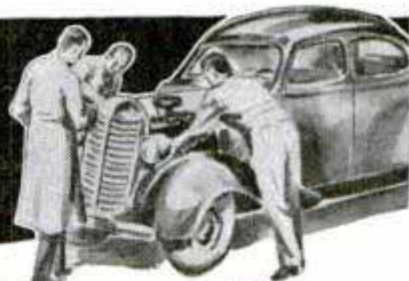

Learn AUTO MECHANICS IN 8 WEEKS

More Jobs than Ever for Trained Men

Automobiles now constitute the greatest, most thriving industry in all America. Millions of cars are on the streets and highways daily. All need servicing, upkeep, repair. Think what that means. If you are a *trained auto mechanic*, you are fitted for a job in any of the thousand upon thousands of garages and service

stations throughout the nation. Prepare *now!* McSweeney trains you in just 8 weeks. Think of that, too. No long-drawn-out course of study, but *practical* training that gets down to essentials and fits you for a real job, at good pay, in shorter time than ever before possible. You save time and money the McSweeney way.

Actual Shop Training

Every moment of McSweeney training counts—because it is all actual shop work. Not a correspondence course—not a book course—but real *shop* training that makes you an experienced workman. You work on real equipment with real tools. Expert instructors show you how, explain everything; then you do the work yourself.

When you leave the McSweeney School you have a training that *means* something to the man who has a job to offer you. You are experienced, ready for the job. Or you are ready to set up your own repair business—as hundreds of McSweeney-trained men have done.

Dear Mac: I am proud to say that now I can always get a job without any trouble and get money for it. I am at present with the Packard garage—have made good and have a good position. I get \$45.00 a week, short hours, and get my expenses paid.

R. W. Oliver,
Upperville, Va.



Good-Pay Jobs Waiting

Experience of the past few years has taught men that it doesn't pay to just *look* for a job. The thing to do is *train* for it. And the wise man today is choosing a field that is big and growing, with the most openings and opportunities. What can compare with the automotive field? The call now is for more and more men—but only for *trained* men. Why not decide *now* to choose this big, good-pay field as yours?

Send for the new McSweeney book. It will tell you about jobs, wages, everything—about McSweeney men who are making good. It will tell you about McSweeney additional training in Diesel, Aviation and Welding. Send coupon today.

WRITE NOW FOR BOOK OF FACTS

Here is our new book—the greatest ever published for men interested in automotive jobs. Full of information about good-pay opportunities. Send coupon—the book is free. It may start you on a great new career.

McSWEENEY'S
PRACTICAL
SHOP-PLAN
AUTOMOTIVE
TRAINING

McSWEENEY

TRADE SCHOOLS

DETROIT, MICHIGAN

KANSAS CITY, MISSOURI

Write Our School Nearest You

AUTO • DIESEL • AVIATION • WELDING

MAIL COUPON AT ONCE FOR FREE BOOK

McSWEENEY AUTO AND AVIATION SCHOOL
Dept. 10-40, Detroit, Mich., or Kansas City, Mo.

Without cost or obligation, send me your Big FREE Book; also full information about your Low Tuition Offer.

NAME _____

STREET _____

TOWN _____ STATE _____ AGE _____

A frank man to PATENTS-INVENTIONS

THE world of invention moves on. About a hundred years ago people were saying, "There's nothing left to invent"—today we know that is one of the funniest things ever said. Just think what has happened in the last hundred years! Autos, radios, airplanes, and thousands of useful, practical devices for home, shop and office have been invented and put on the market. Inventors are constantly making the world a better place to live in. Did you see a notice in the paper that an obscure worker, Hans Wach, has invented a simple device to utilize exhaust steam on steam boats? *Already, the report states, the steamship lines have saved more than \$15,000,000 in fuel bills with his invention.* Almost in the same breath the Dept. of Commerce announced that it will soon test out a new, non-crashable aeroplane, which the average man can learn to fly in a day, which will travel at 110 miles an hour and sell at the price of a cheap automobile. An unknown Seattle man has invented a robot to go 5,000 feet under the sea and recover millions and millions of dollars worth of gold lying at the bottom of the ocean since the days of the early Spaniards.

Remember this: For every outstanding big invention there are thousands of small, simple things for use in the home, the office, the factory, on the farm, on every sort of travel conveyance. Little articles like you find on the counters of a 10-cent store, hardware store, drug store, toy and novelty shop.

Many Little Ideas Have Big Commercial Possibilities

A person finds something he's using doesn't work right, or it's clumsy, or costs too much. He gets a happy thought. He improves the old Article. That's contribution to human progress. That's the way that many, many men have reached the goal of financial comfort, independence and even wealth. Most of the things millions of us use didn't come from the brains of engineers and physicists. They came from the mind and maybe the crude home work bench of Mr. Average Man, busily engaged in earning his bread and butter at whatever chance or circumstance has given him to do. The "little" man's opportunity as an inventor was never greater than it is today.

Who Are Inventors?

You'd be amazed at the men we contact in the course of a busy year. Most of them do not consider themselves inventors at all. During their work or leisure they get an idea. They work it out on paper. They get in touch with us about Protection. Did you know that a dentist invented the stock ticker, a school teacher the telephone, a farmer the typewriter, an artist the telegraph? Did you know that the crinkly hair pin—sold by millions now—came about because a husband saw his wife twisting the old-fashioned straight hair pin to make it stay in place? **Poor men who have no thought of invention now will be financially well-fixed in a few years because of a happy thought that the world could use to advantage.**



Can You Answer These Questions?

Ask yourself these questions: How do the Patent Laws protect me? What easy steps can I take, without cost, to put myself in position to support my belief that I am the first man to think of my invention? Is a Patent worth the cost? Do I need a model? Should I try to sell my invention before I have it Patented? Is there any safe, business-like way to secure financial help? If I do apply for a Patent, how shall I reach people who can market my invention? Can I protect and sell an improvement on some invention that has already been patented? These are but a few of the questions which usually confront the average man. You need the answers! **YOU CAN HAVE THEM, without cost, trouble, or delay.**

Our Business Is to Help You. Write Us Today

For more than thirty-seven years, this firm has been helping men with an inventive turn of mind. We maintain a large staff of trained, experienced specialists—Registered Patent Attorneys, Draftsmen, and Searchers to help our clients secure all the protection to which they are entitled. Fees are reasonable. Deferred payments frequently arranged. Questions promptly answered. Write us frankly with absolute assurance that what you say will be treated with strictest secrecy. **BUT FIRST, send for the FREE BOOKS shown on the opposite page.** They are filled with facts, pictures and suggestions. They tell you things about Patents, Inventions and Selling Inventions that we have learned in our long experience. **They may save you time, expense, EVEN LATER DISAPPOINTMENT.** Simply fill in the coupon. No charge, no obligation. Write us TODAY.

Copyright 1937, Victor J. Evans & Co.

RUSH COUPON TO WASHINGTON, D.C. TODAY

When writing to advertisers please mention Popular Mechanics

man talk about - SELLING INVENTIONS

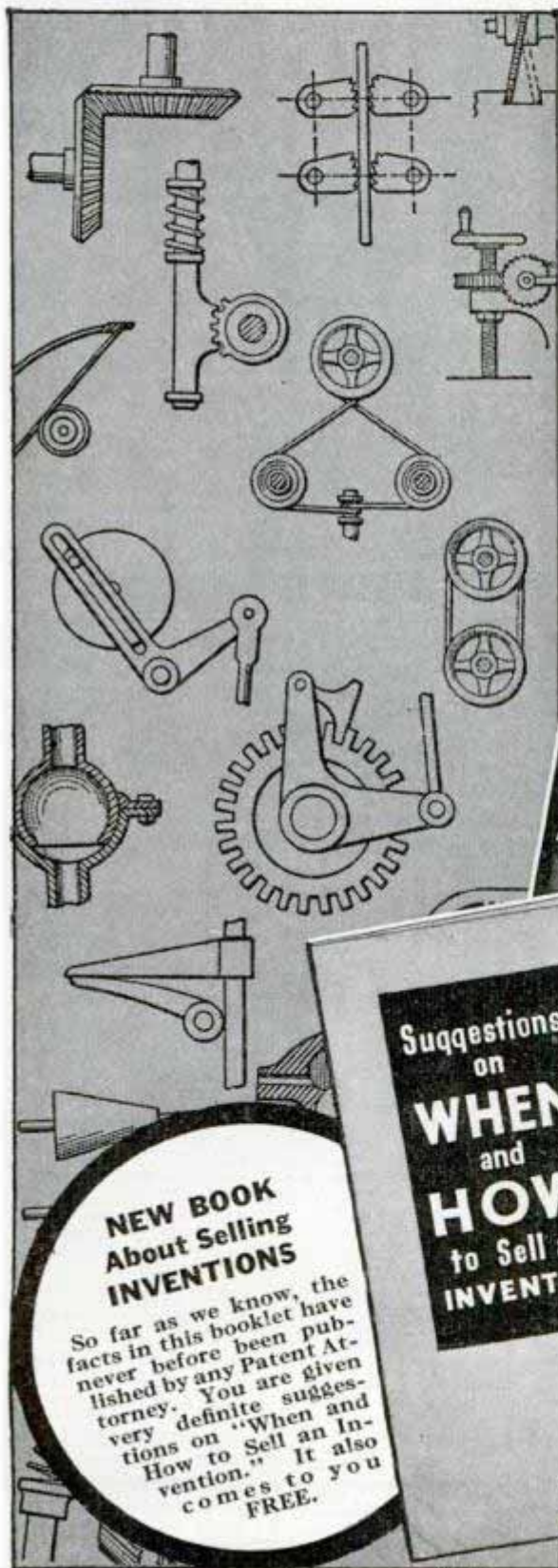

115 Mechanical Move- ments Like These

Besides many other features and facts there are 115 different mechanical movements and principles in the big, 48-page Book below. Maybe there is just the idea you need to solve some mechanical problem. Use the coupon or write us a card or letter.

2 FREE BOOKS
with
68 PAGES
of Facts and Pictures!



Suggestions
on
WHEN
and
HOW
to Sell an
INVENTION

NEW BOOK About Selling INVENTIONS

So far as we know, the facts in this booklet have never before been published by any Patent Attorney. You are given very definite suggestions on "When and How to Sell an Invention." It also comes to you **FREE.**

VICTOR J. EVANS & Co.

REGISTERED PATENT ATTORNEYS

Main Office: 200-D Victor Building,
Washington, D. C.

Other Offices: 1007-N, Woolworth Bldg., New York
1445-N, Monadnock Bldg., Chicago
514-N, Empire Bldg., Pittsburgh
1010-N, Hobart Bldg., San Francisco
736-N, Security Bldg., Los Angeles

Send me **FREE** copies of your books "Patent Protection" and "When and How to Sell an Invention." (Note: Same books supplied by any of the branch offices listed above.)

Name.....

Street and No.....

City or Town.....

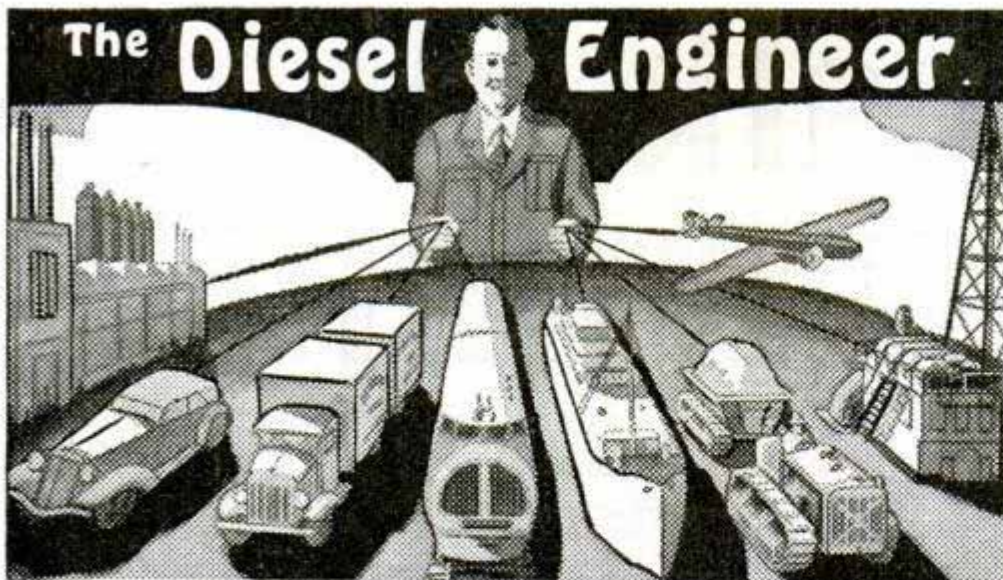

Is Your Job Safe?

Just as the gasoline engine changed or wiped out the jobs of thousands who depended on horse-drawn vehicles for their living—just as electricity changed the entire set-up in the fields of light and power—so now the Diesel engine is fast invading both the power and transportation fields, and threatening the present jobs of thousands of workers.

Our course trains you in all the latest Diesel developments—two- and four-stroke cycles; low- and high-speed and heavy duty types; Diesel-electric generating systems, etc. Includes all text material—with special diagrams for quick understanding of this new power.

2 Beginning Lessons Diesel Free

Diesel—The New, Fast-Growing Power

Diesel engines—because of their high efficiency, dependability, and economy of operation—are fast replacing steam and gasoline engines in power plants, motor trucks and buses, locomotives and ships, aircraft, dredges, drills, pumps, etc. Now is your chance to get into a big new industry and grow up with it to an important position. Today there is practically no competition in the Diesel field, but the increasing use of Diesel engines will soon result in keen job competition. Start training now—keep ahead of competition.

Can You Learn Diesel? We want to give you the opportunity of finding out. So, without cost or obligation on your part, we will send you 2 beginning lessons. In the quiet of your own home, look them over. See how clearly all is explained—how thoroughly you grasp every point—how definitely you progress step by step—so that your knowledge of Diesel grows constantly. Making this simple trial may be the turning point in your life—so write to us TODAY!

American School, Dept. D-445, Drexel at 58th Street, Chicago, Illinois

Test Yourself for a Good Pay Job—Steady Work



Know Electricity as Experts Know It—and Get an Expert's Pay!

Recovery has begun! The months ahead are charged with significance and expectation. What will you do to get the jump on the other fellow? Thousands of men have used

The Croft Library of Practical Electricity

The Croft Library is a complete electrical educator. It is founded on practice—on 20 years of shirt-sleeve experience—on work as it is actually done. It is jammed from cover to cover with the kind of hard-headed facts you want. Written so that the beginner can easily understand it, yet so sound, so thorough, that it is the daily guide of 59,000 highly paid electrical workers and engineers. Croft tells you the things you need to know about motors, generators, armatures, commutators, transformers, circuits, switchboards, distribution systems—electrical machinery of every type—wiring for light and power—wiring of finished buildings—underwriters' and municipal requirements—illumination in its every phase—the most improved methods of lighting—lamps and lamp effects, etc.—how to do a complete job, from estimating it, to completion.

No money down—easy payments

Fill in and mail the coupon attached and we will send you the entire set of seven volumes for ten days' Free Examination. We take all the risk—you assume no obligation. If you decide to keep the books, send \$1.50 in ten days and the balance at the rate of \$2.00 a month. Send the coupon NOW and see the books for yourself.

FREE EXAMINATION COUPON

McGraw-Hill Book Co., 330 W. 42nd St., New York

Send me for ten days' free examination the Croft Library of Practical Electricity. If satisfactory I will send you \$1.50 in 10 days and \$2.00 monthly until the price of \$19.50 is paid. If not wanted, I will return the books postpaid. (To insure prompt shipment write plainly and fill in all lines.)

Name.....
 Home Address.....
 City and State.....
 Position.....
 Name of Company..... PM-4-37

Be a DENTICIAN



Learn at home to make Crowns, Plates, Bridgework, etc., for Dentists. Easy, practical way to learn mechanical dentistry at home in spare time. Full Equipment of Tools and Materials included with Course. Low tuition. Easy terms. Write for FREE BOOK about this money-making profession that is not affected by "machine age."

McCARRIE SCHOOL OF MECHANICAL DENTISTRY
 207 N. Broad St., Dept. 720 Philadelphia, Pa.

RADIO ENGINEERING, broadcasting, aviation and police radio, servicing, marine and Morse telegraphy taught thoroughly. Nine months' engineering course equivalent to three years' college radio work. School established 1874. All expenses low. Catalog free.
 Dodge's Institute, Ada St., Valparaiso, Ind.



Minstrels

Unique First Parts for complete show with special songs and choruses. Make-up. Catalog Free.

T. S. Denison & Co., 623 S. Wabash, Dept. 19 Chicago



WHY NOT spend spring, summer, fall gathering butterflies and moths. I buy hundreds of kinds for collections. Some worth \$1 to \$7 each. Simple work with my low cost Instructions, pictures, price list. Profit—Pleasure. Send 10c for Illustrated Prospectus, terms, before sending any butterflies.
 Mr. Sinclair, Dept. 6, Box 1424, San Diego, California

Print Your Own

Cards, stationery, circulars, tags, labels, advertising, etc. Save money. Print for Others; Big Profits; easy rules sent. Will do popular Raised Printing like Engraving. Junior press \$5.00, job presses, \$11 up, power \$149. Send for free catalog and all details. THE KELSEY COMPANY, R-37, MERIDEN, CONN.



"BECOME A LIGHTNING TRICK CARTOONIST"

Send \$1.00 for Laugh Producing Program of 23 Trick Drawings with Instructions. Catalog of Chalk Talk Supplies Free. BALDA ART SERVICE, Dept. 1, Oshkosh, Wis.

FREE

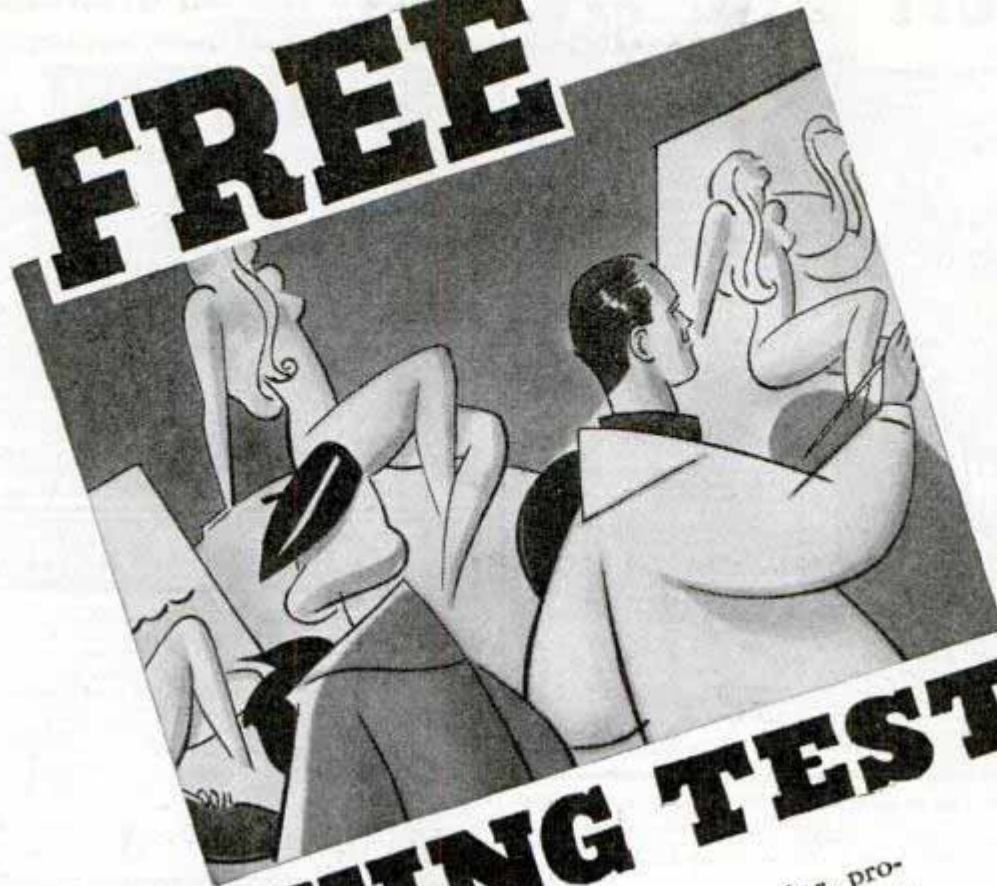

DRAWING TEST!

IF YOU LIKE TO DRAW, test your sense of design, color, proportion, etc., with our simple Art Ability Test. An opportunity to get a frank opinion, *free*, as to whether your talent is worth developing. Magazines, newspapers, publishers and advertisers spend millions yearly for illustrations. Design and color influence the sale of most things we buy. Artists have become important to industry. Machines can not displace them. If you have talent, train it. Drawing may be your surest road to success.

THE FEDERAL SCHOOLS, affiliated with a large art, engraving and printing institution, has trained many young men and women now serving industry as designers or illustrators, capable of earning from \$1,000 to \$5,000 yearly. Its Home Study courses in Commercial Art, Illustrating and Cartooning, contain exclusive illustrated lessons by many famous artists. Practical instruction by experienced men is the reason for its many years' outstanding success. Courses sold on easy payments.

SEND TODAY for Art Test and Free Book explaining present opportunity in art.

FEDERAL SCHOOLS, INC.
 4137 Federal Schools Building
 Minneapolis, Minnesota

JUST FILL OUT
 AND MAIL COUPON

Send me, without obligation, your Art Test and Free Book.

Name

Address

Occupation

Age

When writing to advertisers please mention Popular Mechanics

JUST OUT!

AUDEL'S DIESEL ENGINE MANUAL
QUESTIONS AND ANSWERS

\$2

If you are interested in the construction, operation and maintenance of modern Diesel engines, you will want this new timely book of practical, useful information.

"AUDEL'S DIESEL ENGINE MANUAL" with Questions and Answers explains in simple, concise language the Fundamental Diesel Principles—Operating Principles—Engine Starting—Air Starting Valves—Fuel Spray Valves—Inlet and Exhaust Valves—Valve Timing—Fuel Pumps—Fuel Injection Compressors—Starting Air Compressors—Scavenging Air Compressors—Pistons and Piston Rings—Cylinders—Lubrication—Cooling Systems—Fuel Oil—The Engine Indicator—Governors—Engine Reversing—Semi-Diesel Engines—High Speed Diesel Engines—Answers on Operation—Horse Power Calculations.

The illustrations and texts are clear and easy to understand. All details are plainly brought out. This book is of extreme value to engineers, operators, students and all who desire a knowledge of the Diesel engine. A handsome book, flexible, with gilt edges. 300 pages—illustrated.

Send for free Diesel folder today.

FREE EXAMINATION COUPON

THEO. AUDEL & CO., 49 W. 23rd St., New York **\$2**

Please mail a copy of AUDEL'S DIESEL ENGINE MANUAL. If satisfactory, I will remit \$2 on its safe arrival, otherwise I will return the book.

Name

Address

Occupation PM

Get One of These

NEW JOBS

★ With The ★

U.S. Government

Forget strikes, layoffs, hard times! Work steady for Uncle Sam. Good pay. Vacations. PENSIONS. Automatic raises.

START AT

\$1260 to \$2100 a Year!

Get \$48 to \$80 every pay-day! Age 18 to 50. No special education or experience usually necessary. Extra Social Security jobs expected soon.

Steady Work-Short Hours-PENSIONS

Select job you want. Tested method will help you pass Civil Service Examination. FREE Book tells how.

MEN-WOMEN

Liquor-Gauger.	Office Clerk
Stenographer	Typist
Meat Inspector	Accountant
Custom House	File Clerk
	Income Tax Auditor

FREE BOOK

"How to Secure a Government Position" sent Free, no obligation. Send coupon Now!

Arthur R. Patterson, (Former Govt. Examiner), Principal
PATTERSON SCHOOL, 84 Case Bldg., Rochester, N. Y.

Send FREE Book, list of jobs, salaries.

Name.....

Address.....

If under 18, check here for special booklet "A."

SECRETARIES, STENOGRAPHERS and TYPISTS—Become An Expert

STENOTYPIST

Stenotypists win today's preferred jobs and better pay. Stenotype's machine speed, accuracy and ease make your work faster, better, easier—and you get the credit.

Executives welcome this machine way of taking dictation—faster than any man can talk. Stenotypy is easy to learn—easy to write—easy to read. We train you thoroughly at home in your spare time—at low cost and on easy terms. Write for interesting, free booklet, "Stenotypy, the New Profession," describing the many opportunities in Stenotypy and telling how you may master it successfully.

THE STENOTYPE COMPANY
Dept. 464-ST, 4101 S. Michigan Ave., Chicago, Ill.



JOBS for PHOTO-ENGRAVERS!!

EARN WHILE LEARNING PHOTO-ENGRAVING IN SPARE TIME—Photo-Engravers are needed to operate Tauspe's Photo-Engraving Equipment we sell to publishers everywhere... Start training at home in spare time. We furnish all equipment including photo-engraving camera with lamps, lens and screen. Earn while learning by making engravings for local advertisers, newspapers, printers, etc. Copper plate for picture shown here, size 8x10 inches sells for \$15.87. SEND TODAY for job plan details and catalog illustrated with pictures engraved by equipment we furnish. No cost! No obligation.

THE AURORA SCHOOL OF PHOTO-ENGRAVING
Dept. 147
Aurora, Missouri



BE A RAILWAY TRAFFIC INSPECTOR

A Good Position Will Be Ready for You

TRAINED MEN—19 to 50—are wanted constantly as Railway and Bus Passenger Traffic Inspectors. Simple, home-study course qualifies you and upon completion we help place you at up to \$135 per month, plus expenses, to start, or refund tuition. Advance with experience. Free Booklet.

Standard Business Training Institute,
Div. 204
Buffalo, N. Y.



FOLLOW THIS MAN

Secret Service Operator No. 38 is on the job! Running down dangerous Counterfeit Gang. Tell-tale finger prints in murdered girl's room.

Free The Confidential Report Operator No. 38 made to his chief. Write for it.

Earn a Regular Monthly Salary

YOU can become a Finger Print Expert at home, in your spare time, at small cost. Write for confidential full report and details. Literature will NOT be sent to boys under 17 years of age.

INSTITUTE OF APPLIED SCIENCE
1920 Sunnyside Ave.
Dept. 1354
Chicago, Ill.

NEW YORK SCHOOL OF MECHANICAL DENTISTRY

★ Make more money as a DENTICIAN. We show you how! Oldest school. Real Laboratory Training. Day, Eve. Easy terms. Tools FREE. Ask for Catalog P. N. Y. SCHOOL OF MECHANICAL DENTISTRY, 125 W. 31 St., N. Y. C. ★

BARBERING OR BEAUTY CULTURE OLDEST, LARGEST SCHOOLS. Est. 1893. EARN WHILE LEARNING.

Day, Night classes. Free National employment bureau. Prize winning teachers. Big pay. Professions. Low rates. Easy terms. Free booklet "B."

MOLER SYSTEM, NEW YORK, N. Y., 303 Fourth Ave.

NEW SCIENTIFIC WONDER

"X-RAY" CURIO

10c
3 for 25c

"Silver Only"

BOYS BIG FUN. You apparently see thru stone, Wood, Stone, any object. See Bones in Flesh. **FREE PACKAGE** radio picture films, take pictures without camera. "You'll like 'em." 1 package with each 25c order.

MARVEL MFG. CO., Dept. 80 — NEW HAVEN, CONN.

"I'll PROVE in Only 7 Days that I Can Make YOU a New Man!"

No other Physical
Instructor in the
World has ever
DARED Make
such an Offer!

By **CHARLES ATLAS**

Holder of the Title:

"The World's Most Perfectly Developed Man"

Won in open competition in the only National and International contests held during the past 15 years

I HAVE proved to thousands that my system of building powerful, big-muscled men begins to show real results in only 7 days—and I can prove it to you.

You don't have to take my word for it. You don't have to take the word of my thousands of pupils who have added inches to their chests, biceps, neck, thighs and calves in only a few days. No sir! You can prove for yourself—in just one week—by the change you see and feel in your own body—that you can actually become a husky, healthy NEW MAN—a real "Atlas Champion."

All I want to know is: Where do you want big, powerful muscles? How many pounds of firm flesh do you want distributed over your body to fill you out? Where do you lack vitality, pep, and robust health? Where do you want to take off flabby, surplus fat?

Just tell me, give me a week, and I'll show you that I can make a New Man of you, give you bodily power and drive, and put you in that magnificent physical condition which wins you the envy and respect of any man and the admiration of every woman.

My own system of *Dynamic-Tension* does it. That's the way I built myself

from a 97-pound weakling to "The World's Most Perfectly Developed Man." And now you can have a big, balanced muscular development like mine in the same easy way.

No "Apparatus" Needed!

You begin to FEEL and SEE the difference in your physical condition at once, without using any

tricky weights or pulleys, any pills, "rays," or unnatural dieting. My *Dynamic-Tension* is a natural method of developing you inside and out. It not only makes you an "Atlas Champion," but goes after such conditions as constipation, pimples, skin blotches, and any other conditions that keep you from really enjoying life and its good times—and it starts getting rid of them at once.

Let Me Tell You How

Gamble a stamp today by mailing the coupon for a free copy of my new illustrated book, "*Everlasting Health and Strength*." It tells you all about my special *Dynamic-Tension* method. It shows you, from actual photos, how I have developed my pupils to the same perfectly balanced proportions of my own physique, by my own secret methods. What my system did for me, and these hundreds of others, it can do for you, too. Don't keep on being only one-half of the man you can be! Find out what I can do for you.

Send for FREE BOOK

Where shall I send your copy of "*Everlasting Health and*

Strength?" Write your name and address carefully on the coupon, and mail it today. Your own new "Atlas body" is waiting for you. This book tells you how easy it is to get, my way. Send the coupon to me personally.

CHARLES ATLAS
Dept. 8S
115 E. 23rd St.
New York, N. Y.

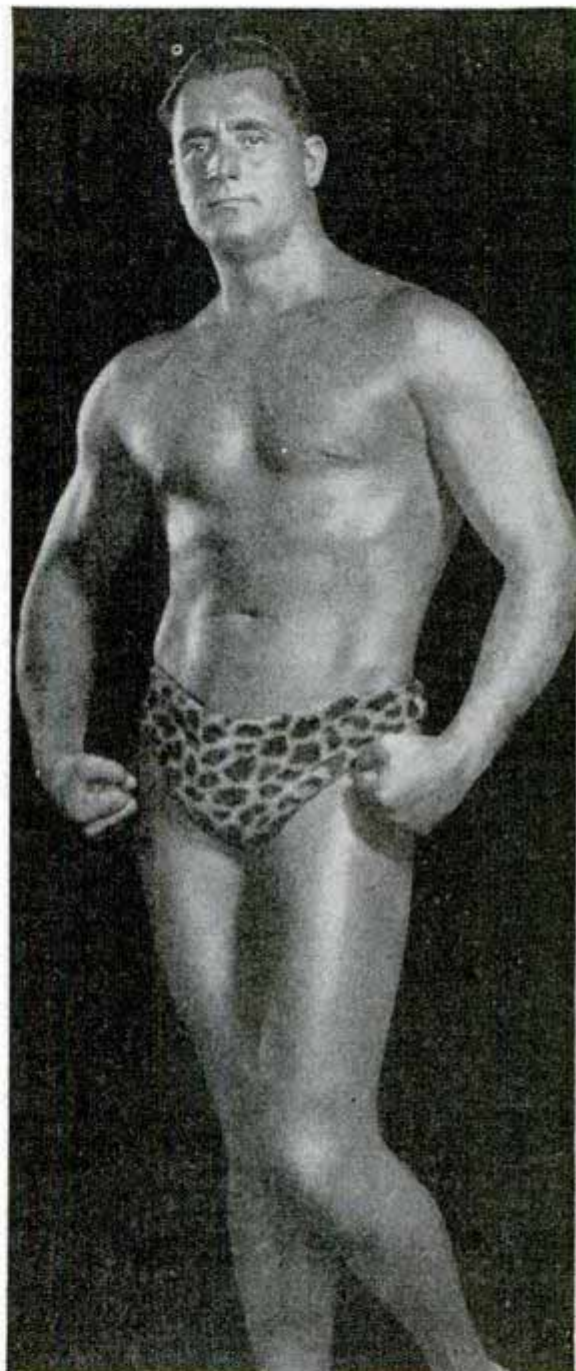

Charles Atlas—
As He Is Today

Photo by Joel Feder

**CHARLES ATLAS, Dept. 8S,
115 East 23rd Street
New York, N. Y.**

I want the proof that your system of *Dynamic-Tension* will make a New Man of me—give me a healthy, husky body and big muscle development. Send me your free book, "*Everlasting Health and Strength*."

Name

(Please print or write plainly)

Address

City..... State.....



**THIS STERLING
SILVER CUP
BEING
GIVEN AWAY**

This valuable cup stands about 14 inches high on a black mahogany base. I will award it to my pupil who makes the most improvement in his development within the next three months.

**STEP NO. ONE**

Make a rough pencil sketch of your invention, describe it fully, and send it to us for preliminary search through United States Patents in the U. S. Patent Office.

**STEP NO. TWO**

Our trained searchers will then make a preliminary search of the pertinent U. S. patents to determine if your invention is probably patentable.

**STEP NO. THREE**

Our complete report of search and opinion on patentability will be mailed to you with copies of U. S. Patents that we consider nearest to your invention.

**STEP NO. FOUR**

If you decide to make patent application, for customary fees explained in our booklet, our draftsmen will make drawings and proper papers will be prepared for presentation of your invention to the Patent Examiner in U. S. Patent Office.

INVENTORS

KNOW HOW TO START KNOW EACH STEP TO TAKE *Before Going Too Far With Your Inventions*

Very often, the patent procedure is what we call a "simple" one—as illustrated here. Our FREE BOOK, "Patent Guide for the Inventor," describes what to do and how to go about it. Send for it by all means—let us urge, however, that you take the first step (Step No. 1 to left) without further delay. It will prevent wasted work, mis-steps, and going ahead "in the dark"—your whole patent procedure depends upon the first step.

If you have an invention that is patentable—and want to secure for yourself your inventor's sole right to profit from the invention—you can't afford to lose time in securing the protection of a U. S. Patent. Other inventors may be working on the same thing right now. Should they develop this invention and file patent application before you do—the burden of establishing priority will be upon you. Our Big Book—"Patent Guide for the Inventor"—will tell you the quickest possible way to secure Patent Protection for your invention. SEND FOR IT TODAY!

Immediate Search Necessary

A search at the U. S. Patent Office will disclose one of three things: That you have hit upon an entirely original invention—that you have suggested patentable improvements upon an existing invention—or that your invention has been anticipated throughout, and you should drop it. You should have this information at once. The next steps (the whole procedure of obtaining a patent) will be thoroughly explained to you in our FREE BOOK.

Our FREE BOOK tells everything you need to know about patents. We will mail this book upon receipt of your letter requesting search—or if you want to read it before having search made, simply fill out the coupon on opposite page.

FREE RECORD OF INVENTION

This FREE Record of Invention Form enables you to make in convenient form a sketch of your invention and have it witnessed in a manner of value to you should the occasion for evidence arise. MAIL THE COUPON TODAY and obtain our FREE BOOK and Record of Invention Form.

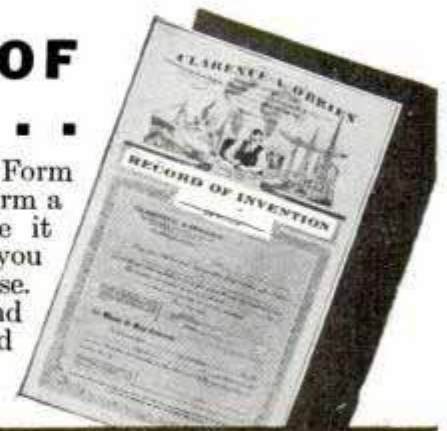

CLARENCE A. O'BRIEN & HYMAN BERMAN

703 Adams Bldg.

Washington, D. C.

Registered Patent Attorneys Before U. S. Patent Office

PATENT YOUR INVENTIONS *Act Now!*

DELAYS ARE DANGEROUS IN PATENT MATTERS

The Free Book shown here was prepared for inventors, to show them exactly what steps they must take to secure a PATENT. If you have an invention, you should send for this book AT ONCE. It will tell you exactly how an application for a Patent is made, what information you must furnish your attorney, and what steps he must take in order to protect your interests. Remember, inventing an article is one thing—securing the exclusive right to manufacture it, use it, or sell it is another. Without a U. S. Patent, you cannot expect to reap the profits that your invention may make possible. Send at once for this book. After you get that, you'll know exactly what to do to protect yourself.

WHAT A PATENT DOES FOR YOU

Every year thousands of Patents are granted. Very few, however, represent the discovery of entirely new principles. Most of them provide new methods of doing some everyday thing in a better way—changes for greater efficiency, usefulness, adaptability, or beauty in some previously Patented thing. These IMPROVEMENTS are Patentable if new, and actually represent new inventions. These improvement Patents offer large chances for profit if commercially useful. The business world wants improved products and services.

WE SERVE YOU QUICKLY AND SECRETLY

Anything you write us or send us is strictly confidential between us. All letters and drawings are kept in strong, steel, fireproof files, which are open only to ourselves or authorized members of our staff. We have secured patents for inventors located in every state in the Union. Our organization is a large and efficient one. Our practice is confined entirely to Patents, Trade-Marks, and Copyrights. We have had years of experience in Patent Matters. When you place your invention in our hands, we are in position to proceed at once to secure protection for you. Our fees are reasonable, and, if you desire, we can arrange convenient terms of payment.

IMPORTANT!

Please understand that you are not under the slightest obligation in sending for this book. We will mail it, together with the Record of Invention Form, the same day we receive your request. Use the coupon to save yourself time and trouble. After that, you will be in position to proceed or not as you choose, to make your application for a patent.

THIS FREE BOOK ... Tells How!

How your Patent Application is made; what kind of sketches or drawings are necessary; what other papers must be made out; how the Patent Laws protect you; why it is important to avoid loss of time in getting your application filed; and many other important points. Even a very simple invention, if new and useful, may prove very valuable. You may have much to gain and nothing to lose by sending for this book TODAY.



CLARENCE A. O'BRIEN & HYMAN BERMAN

703 Adams Building

WASHINGTON, D.C.

REGISTERED PATENT ATTORNEYS
BEFORE U.S. PATENT OFFICE

Please send me at once your Big Free 48-Page Book, "Patent Guide for the Inventor" and your Specially Prepared "Record of Invention" form. This request does not obligate me.

NAME.....

ADDRESS.....

(Please write or print plainly.)

PATENTS

Booklet Free Highest References
Promptness Assured Best Results

Send drawing or model.

ALL BUSINESS GIVEN PROMPT AND PROPER ATTENTION

Listed Patent Lawyer in the latest editions of the Rand-McNally Directory of Bankers and Bank-Recommended Attorneys, published by Rand-McNally & Co., Chicago, Ill.; The Baggott & Ryall Directory of Guaranteed Attorneys, published by Legal Directory Corporation, Boston, Mass.; American Lawyers Annual, Cleveland, Ohio; Bankers Service Legal Directory, published by Bankers Service Co., Boston, Mass.; Eyre's Law List, 9 Park Place, New York City; Snow-Church Directory Co. Lawyers List, published in New York City, and the Central Guarantee Co., Bankers and Lawyers Directories, 630 Fifth Avenue, New York City.

WATSON E. COLEMAN, Victor Building, 724 Ninth Street, N. W.
REGISTERED PATENT LAWYER **WASHINGTON, D. C.**

INVENTORS PATENT YOUR IDEAS SEND FOR FREE BOOK



HOW TO OBTAIN A PATENT

Written by a Former Member of the Examining Corps (1922-24) of the U.S. Patent Office. If you want to profit by your idea, you should take steps to apply for a U. S. Patent at once. Your first step is to get this Free Book. This interesting illustrated book contains valuable information you should have. It tells you fully how to obtain a patent on your idea in the quickest way. With this Free Book you will also receive a "Record of Invention" form on which you can easily record your idea. Personal and Confidential Service: Your case will be personally handled only by a Registered Patent Attorney who is also a Former Member of the Examining Corps of the U. S. Patent Office. All communications confidential.

MAIL COUPON TODAY for FREE PATENT BOOK and RECORD OF INVENTION Form.

CARL MILLER

REGISTERED PATENT ATTORNEY
FORMER MEMBER EXAMINING CORPS U. S. PATENT OFFICE

1638 Woolworth Bldg., Dept. 47A, New York City
MILLER BUILDING, Dept. 47A, WASHINGTON, D. C.
Please send me your Free Book, "How to Obtain a Patent," and your "Record of Invention" form.

NAME.....

ADDRESS.....

PATENTS—TRADE MARKS

All inventions submitted held confidential and given personal attention by members of the firm.

Form, "Evidence of Conception" and instructions, "How to Establish Your Rights"—FREE!

LANCASTER, ALLWINE & ROMMEL

Patent Law Offices

412 Bowen Bldg.

Washington, D. C.

STOP Your Rupture Worries!

Why suffer with that rupture? Learn about my Appliance for reducible rupture. Automatic air cushion assists Nature to close the opening—has relieved thousands of men, women and children. No obnoxious springs or hard pads. No salves or plasters. Sent on trial to prove it. Beware of imitations. Never sold in stores. Write today for confidential information sent free in plain envelope. Brooks Company, 111-G State Street, Marshall, Michigan

Inventions Wanted Patented or Unpatented

We have been successfully selling inventions, patented and unpatented, since 1924. Write for proof, and tell us what you have for sale.

Chartered Institute of American Inventors
Dept. 4, Barrister Building, Washington, D. C.

ALBERT E. DIETERICH

REGISTERED PATENT ATTORNEY

512 B Colorado Building, WASHINGTON, D. C.
Booklet on Patents sent free

PATENTS Protect Your Idea: By securing FREE my "PROOF OF INVENTION" folder. *Exceptional Personal Service.* Excellent References. Established 1906.
E. E. VROOMAN, 871 Woodward Bldg., WASH., D. C.

INVENTORS who derive largest profits know and heed certain simple but vital facts before applying for patents. Our book, Patent-Sense, gives those facts; sent free. Trade Marks—Copyrights.
LACEY & LACEY, Est. 1869, 635 F St., N. W., Dept. 5, WASHINGTON, D. C.



G E A R S

In Stock—Immediate Delivery

Gears, speed reducers, sprockets, thrust bearings, flexible couplings, pulleys, etc. A complete line is carried in our Chicago stock. Can also quote on special gears of any kind. Send us your blueprints and inquiries.

Write for Catalog No. 10

CHICAGO GEAR WORKS
769-773 W. Jackson Blvd., CHICAGO, ILL.

No JOKE TO BE DEAF

—Every deaf person knows that—
Mr. Way made himself hear his watch tick after being deaf for twenty-five years, with his Artificial Ear Drums. He wore them day and night. They stopped his head noises. They are invisible and comfortable, no wires or batteries. Write for TRUE STORY. Also booklet on Deafness.



Artificial Ear Drum
THE WAY COMPANY
729 Hofmann Bldg. Detroit, Michigan

In answering advertisements always write name and full address clearly.

To PROTECT YOUR INVENTION Use this coupon, NOW

Delays are dangerous and may be very costly. My personal service assures prompt action, strict confidence, and a minimum of expense. I suggest that you send me a model or drawing, or sketch and description of your invention, and \$5.00. I will make a search and report

promptly as to its patentability and send you a copy of my 72-page booklet. Or, if you prefer to read my booklet first, mail the attached coupon at once. I will also send my "Record of Invention" form. (Over 38 years experience as a Registered Patent Attorney.)

L. F. Randolph, 302-D Victor Bldg., Washington, D.C.

Please send me at once, free of charge, your 72 page booklet and "Record of Invention" form

Name.....

Address.....

A PERSONAL CONFIDENTIAL PATENT SERVICE

AMAZING NEW COMET ELECTRIC ARC WELDER



RETAILS
Only

\$ **1.95**

Complete



HOOK UP TO A BATTERY!

Just invented! Amazing new Comet ELECTRIC ARC WELDER—hooks up to storage battery—generates tremendous heat to weld all metals. **ONLY \$1.95 COMPLETE!** Repairs fenders, auto bodies, galvanized cans, radiators, castings, machinery parts, etc. Fuses broken parts permanently, stronger than before. Low power consumption. Take the Comet anywhere, work it from an auto battery. Sturdily built of finest materials to last for years.

World's Lowest Priced ARC WELDER!

Factories—repair shops—mechanics—farmers—inventors—home workshop enthusiasts—tanners—plumbers! Think of it—only **\$1.95 complete!** You'll find a thousand uses for the Comet in your home, garage, and work shop. You'll save many dollars with the Comet. Why pay big money to professional welders?

GUARANTEED

The Comet is FULLY GUARANTEED. You take no risks. If you are not positively delighted with the Comet within 15 days the Comet costs you nothing—simply return and every penny paid us for it will be cheerfully refunded.

SEND NO MONEY!

Don't send a penny now. Just mail coupon. Pay postman only \$1.95 on delivery plus a few cents postage. Act NOW! Rush coupon AT ONCE.

Specifications

Comet is 11½ in. long, made of highest quality materials throughout. Design principles as used on expensive professional arc welders. Heavy alloy brass Tong; cool, balanced Wood Handle; Carbon Electrode; 6 ft. No. 8 weatherproof. Braided Cable; 25 amp. cap. Battery Clip complete with supply of steel Welding Wire, and clear, easy INSTRUCTIONS.

Solders and Brazes, Too!

The Comet is a real welder's tool, the same as used by thousands of professional welders. Husky, man-sized. Uses little current—only 20 to 25 amperes—yet quickly brings heat to welding point. Ideal for soldering and brazing. No skill or experience needed.

COMET WELDERS

Halifax St., Dept. T-155, Cincinnati, Ohio

COMET WELDERS, Halifax St. Dept. T-155, Cincinnati, O.

Send me—Comet ELECTRIC ARC WELDERS. I will pay postman only \$1.95 each, on delivery, plus few cents postage. If I am not more than satisfied, I may return within 15 days of date of shipment, and every penny I paid you for it will be instantly refunded.

Name.....Address.....

City.....State.....

GAG-CARTOON!



AND MAKE BIG MONEY!

Magazines pay up to \$200.00 per cartoon. Get in this new field and be your own boss! My 50 lesson—1000 illustration course shows you how. Markets included—**\$280** only course of its kind. All for... **Free Drawing Set if you act at once.** Stamp brings free details.

MOON GAG-CARTOON SCHOOL
Paramount Bldg. Dept. A, Fall Creek, Wis.

Greater opportunities now in advertising. Learn easily and quickly in spare time. Practical work. No text books. Old established school. Low tuition—Easy terms. Send for free booklet of interesting information.

Page-Davis School of Advertising
Dept. 1354, 3601 Mich. Av., Chicago

Learn
ADVERTISING
at Home



Send for Catalog Today

BUCHSTEIN'S FIBRE LIMB

is soothing to your stump—strong, cool, neat, light. Easy payments. Braces for all deformities. Agents wanted. **D. BUCHSTEIN CO.**
610 3rd Ave., So., MINNEAPOLIS, MINN.

SEND FOR THIS BIG
FREE ELECTRICAL
BOOK—TODAY!

LEARN ELECTRICITY BY PRACTICAL SHOP METHODS
ON REAL EQUIPMENT—RIGHT IN YOUR OWN HOME

RADIO, REFRIGERATION, AIR-CONDITIONING,
DIESEL ELECTRIC POWER and MANY OTHERS INCLUDED

Learn how YOU, TOO, can train for a BETTER JOB and MORE MONEY in Electricity. Also, how you learn by Actual Work on Real Electrical Equipment and Apparatus, right in YOUR OWN HOME. My Spare Time Job Sheets help you earn while you learn. Other important features. Send coupon!



H. W. Petersen, President
ELECTRIC INSTITUTE, Inc., Dept. 67D, Hinsdale, Ill.
Send Free Book and full details of E. I. Home Shop Training.

Name.....Age.....
Address.....
City.....State.....

AUDELS MATHEMATICS AND CALCULATIONS FOR Mechanics



\$2
A
HANDY
BOOK

Good News!

MATHEMATICS AND CALCULATIONS FOR HOME STUDY AND REFERENCE

PRACTICAL MATHEMATICS ILLUSTRATED. How to figure correctly. EVERY MECHANIC can use the new, correct, easy methods, covering a complete review of practical arithmetic—with examples including mensuration—plane and solid geometry—trigonometry—algebra—calculus—ELECTRICAL and MECHANICAL SHOP CALCULATIONS—practical tests—reference tables and data—how to use the slide rule—700 pages—550 illustrations—pocket size.

Highly endorsed. Let us mail you copy for free trial. Price \$2, postpaid.



FREE
EXAMINATION
COUPON

THEO. AUDEL & CO.
49 W. 23rd St., N. Y. C.
Mail Audel's Mathematics on 7 days' free trial. If O. K. I will remit \$2, otherwise I will return it.

Name.....
Address.....
Occupation.....P. M.



High School Course at Home

Many Finish in 2 Years

You can complete this simplified High School Course as rapidly as your time and abilities permit. Equivalent to resident school work—prepares you for entrance to college. Standard H. S. texts supplied—Diploma. Credit for H. S. subjects already completed. Single subjects if desired. High School education is very important for advancement in business and industry and socially.

College Entrance

During the past 14 years, our High School graduates have been admitted to 531 different Universities, Colleges, Junior Colleges and Normal Schools—80% of them without entrance examination. Course also prepares for teachers' certificate and pre-professional examinations.

Business—Industry

To get and hold a good position in Business today you must be able to write clear, accurate letters and reports—do figuring involving Algebra and Geometry—talk intelligently on matters requiring a knowledge of Geography, History, and Economics.

In Industry—Mechanical and Engineering lines—you must have at least an elementary knowledge of Physics and Chemistry—be able to figure quickly and accurately—know something of Mechanical Drawing and blueprints—and be able to talk and write accurately and clearly on both your work and ordinary topics of conversation.

Our High School course meets the preparatory educational requirements for Business and Industry.

An Educational Institution

The American School was chartered in 1897 as an educational institution, not for profit—and is exempt from paying Federal income tax, like the best resident colleges and universities.

Don't Be Handicapped— Complete Your Training Now

Be a High School Graduate! Prepare yourself for promotion in Business and Industry—for the Professions, College Entrance and social success. No matter what line you may select, High School training will prove invaluable to you! Our moderate fees cover all instruction, standard textbooks and Diploma. Easy monthly terms. Get ahead in life. Start your training NOW!

20 Other Courses

Over 150 noted Educators, Engineers, and Business Men helped prepare our special instruction material, which is used by many resident schools and colleges, U. S. Navy, and Province of Manitoba, Canada. We offer you quality training at home for the best-paying lines of Industry and Business, as listed in the coupon.

Mail coupon for information about line that interests you
American School, Drexel at 58th, Chicago

American School, Dept. H-445, Drexel at 58th, Chicago

Tell me how to train for success in line checked. No obligation.

- | | |
|--|--|
| <input type="checkbox"/> Accounting & Auditing | <input type="checkbox"/> Diesel Engineering |
| <input type="checkbox"/> Architecture & B'ldg | <input type="checkbox"/> Drafting & Design |
| <input type="checkbox"/> Automotive Engin'ring | <input type="checkbox"/> Liberal Arts |
| <input type="checkbox"/> Business Management | <input type="checkbox"/> Private Secretary |
| <input type="checkbox"/> Commercial Aeronautics | <input type="checkbox"/> H'per Ac't'g (C.P.A.) |
| <input type="checkbox"/> Electrical Engineering | <input type="checkbox"/> Highway Engin'ring |
| <input type="checkbox"/> Electrical Refrigerat'n | <input type="checkbox"/> Mechanical Eng'ring |
| <input type="checkbox"/> Air Conditioning | <input type="checkbox"/> Radio & Television |
| <input type="checkbox"/> Civil Engineering | <input type="checkbox"/> Salesmanship |
| <input type="checkbox"/> Complete Law | <input type="checkbox"/> Steam Engineering |

Name.....

Address.....

When writing please mention Popular Mechanics

PLASTIC RUBBER



BOOTS-SHOES



AUTO TIRES

Hundreds
of
OTHER
USES

Every handy man needs So-Lo! Mends holes in shoes, boots, galoshes, only 1c a repair. Fills cracks and worn places in everything of rubber, leather and cloth. WEARS—and won't come off!

So-Lo Spreads on Like Butter Dries Tough Overnight WATERPROOF-FLEXIBLE-NON SKID

Big 25c can contains enough for 25 repairs! Satisfaction guaranteed or money back. Tear out this ad as a reminder to get So-Lo at Kresge's, Woolworth's, Gamble's, Grant's, Green's, Kress', McLellan's, McCrory's, Morris', Murphy's, Neisner's, Newberry's, Sears', Ward's or at your nearest 10c or hardware store.

Learn to DRAW AT HOME \$ COMPLETE ANYWHERE

ARTISTS AND MODELS STUDIO,

OVER 150 LESSON SIGHT-CORRECTING ART COURSE

Nothing like it. Simplified, easy method, originated by former university instructor, enables you, right at home, without loss of time, to analyze your drawing and make corrections instantly. You enjoy unbelievable progress the Sight-Correcting way. You start drawing the first day. Great fun. Illustrate magazines, draw gorgeous girls, landscapes, animals, interiors, anatomy, etc. Artists make BIG MONEY. Complete 150 lessons, including 40 beautiful figure poses, drawing paper, \$1.00. Guaranteed. Nothing more to buy. Limited offer. Rush \$1.00 today!



Dept. PM-4 Memphis, Tenn.

ELECTRICAL ENGINEERING

For those who can't afford the time and expense of a 4-year college course, Bliss offers a condensed ONE YEAR residence training, combining essential Theory and Practice. 45th year. CATALOG ON REQUEST!



BLISS ELECTRICAL SCHOOL

134 Takoma Ave., Washington, D. C.



PLAY A SAW!

Produce wonderful music in 5 days... quickly play popular and classical numbers. No notes to read, no dreary practice—success guaranteed. Since 1924 thousands of my students have amazed friends, starred in shows and broadcasting orchestras. Without obligation, write for 5 DAY TRIAL OFFER now.

MUSSEHL & WESTPHAL
110 W. Water St., Fort Atkinson, Wis.



Learn Public Speaking

At home—in spare time. Many overcome "stage-fright," gain self-confidence, and increase their earning power, through ability to sway others by effective speech. Write for free booklet, *How to Work Wonders With Words* and requirements.

NORTH AMERICAN INSTITUTE, Dept. 1354
3601 Michigan Avenue Chicago, Illinois



Itching TORTURE In One Minute

For quick relief from the itching of eczema, blotches, pimples, athlete's foot, rashes and other skin eruptions, apply Dr. Dennis' pure, cooling, antiseptic, liquid D.D.D. PRESCRIPTION. Its gentle oils soothe the irritated skin. Clear, greaseless and stainless—dries fast. Easy to use. Stops the most intense itching instantly. A 35c trial bottle, at drug stores, proves it—or money back.

DIESEL

Gives Big-Pay Jobs to
Adcox Graduates

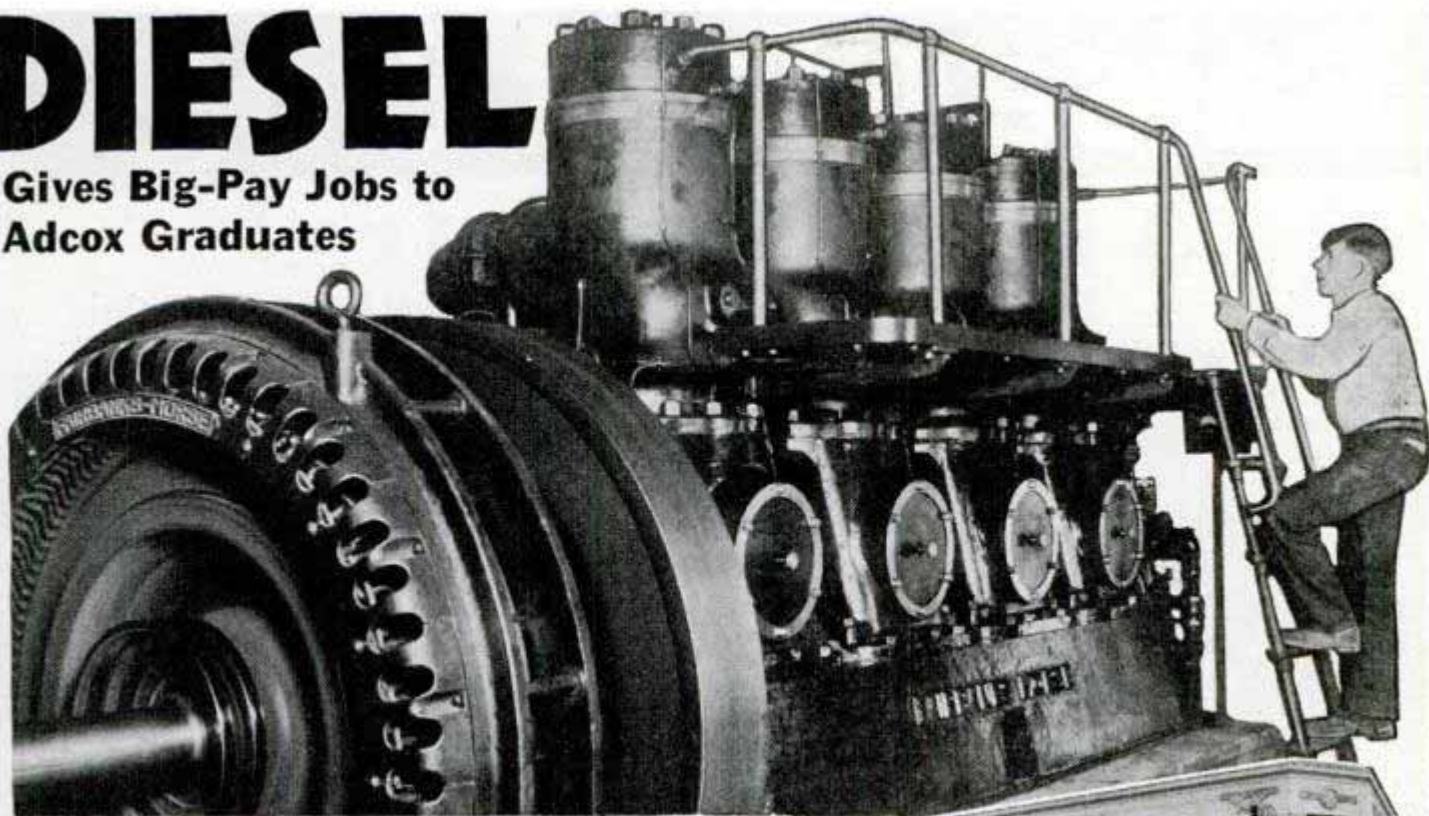

Within 24 hours after completing his Diesel Training, Adcox Graduate Cecil Edwards (pictured above at work) climbed the ladder of success to the kind of a Diesel job fellows dream about. This is a fair example of what Adcox Training has done for hundreds of ambitious men and an example of Adcox employment service to graduates.

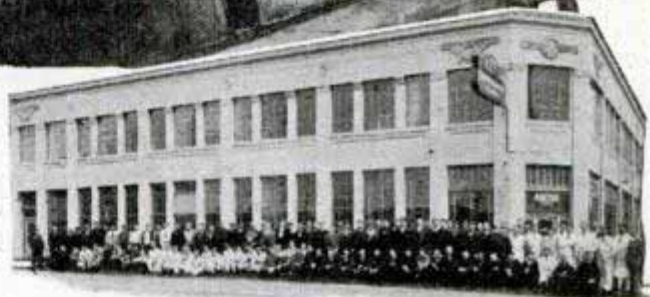

Let me put my 27 years' experience to work for YOUR success, just as I have done for Cecil Edwards and many others. Send at once for my new, big, FREE, 40-page catalog. It tells you frankly *why* you should study in the thrilling Pacific Northwest, home of the Adcox School and a "hotspot" of Diesel

activity and employment—straight-from-the-shoulder facts you should know before choosing *any* trade or *any* school. You owe it to yourself, your future happiness, your ambition for success in life to learn, first hand, of the exceptional opportunities before YOU as an Adcox Graduate. Earn board and room while learning. Get my valuable Catalog without further delay—



**I'LL HELP YOU
LAND A
WELL PAID
DIESEL
JOB —
GET MY
FREE BOOK
NOW!**

**Send This Coupon
At Once**

BIG 40 PAGE DIESEL SCHOOL CATALOG FREE

Mr. L. L. Adcox, President
L. L. Adcox Trade School,
Portland, Ore.

Without obligation, please send FREE Diesel Catalog No. 18-I. I am interested in attending school. Home study.

Name.....Age.....

Address.....

Town.....State.....



When writing to advertisers please mention Popular Mechanics

Raise Giant Frogs

A New Industry!

"Nufond Giants"
weigh up to
3 pounds
each!



Start With Small Pond

Begin with small pond size 20 x 25 feet for five pairs "Nufond Giant" Breeders. Then expand with the increase.

We Buy! Our products are on sale in principal cities throughout the country. In addition to other markets frog raisers can also ship to us.



A Model Frog Pond

Good Market! Easy To Ship!

Millions of frogs used yearly! Nationwide market at your command. Easy to ship to any part of the country.

Frog Ponds Now In Every State!

Many in Canada too. Marsh or swamp not necessary as you dig the ponds yourself. No running water needed. Plants keep the water fresh.



"Nufond Giant" Spawn

Breeder May Lay 10,000 Eggs Yearly!

Of course not all these eggs turn into frogs but we invite you to see what raisers are actually doing with our methods.

See What Others Already Are Doing!

Get the facts on our special offer to beginners. Send for the big, illustrated FREE book, "Future in Frogs," explaining this new industry in detail. Be sure to write today.

MARKET WAITING



MAIL THIS COUPON TODAY!

AMERICAN FROG CANNING CO. Dept. 133-D New Orleans, La.

Gentlemen: Please send me your free book "A Future in Frogs" without any obligation on my part.

Name.....

Address.....

City.....State.....

THIS IS THE
BEST TIME
TO START

**FREE
BOOK**



DANCE IN 5 HOURS

A whole family can learn from one set!



Realize your ambition—become a good dancer quickly, easily, at home! Arthur Murray, world-famous dance authority, with his new picture course teaches you popular Fox Trot, Waltz steps, poise, balance, correct following, self-assurance. No music or partner needed. Write today for 10 Lesson Introductory Course. Pay postman \$1.98 when he brings Course or send \$2 with order and save 24c postage. Try it 5 days. If not delighted with results money promptly refunded.

ARTHUR MURRAY, Studio 308, 7 E. 43 St., N. Y. C., N. Y.

New York Established 1902
Electrical School
 Ask for free booklet
 44 West 17th St., N. Y. C.

SEND FOR PICTURE ART MAGAZINE Magazine for Artist, Teacher, Student, Lover of Body Beautiful; Contains fine Rotogravures, Articles, Lessons in Cartoon, Design, Chalk-talk, Nature, Animal, Figure dg., ETC. Can't be described! To INTRODUCE we offer 24 BIG BACK ISSUES, also large Cartoon book, also 2 fascinating books "Pete the Gritty" and "Briggs the Sky-rocket," also "The Story"—how 24 Art Students succeeded, also "Talks to J. Henry, Art Student" and 6 more. ALL FOR \$2. Exp. for 7 Magazines, \$1 prepaid. Student writes—"Without exception the finest magazine I've seen." A gold mine of Art and Inspiration. None free. You can't lose, OK or refd. Supply limited. CUT THIS OUT. Send with \$2, or \$1, NOW
 LOCKWOOD ART STUDIO, Dept. 375, Kalamazoo, Mich.

CIVIL SERVICE
 VALUABLE INFORMATION
 COLUMBIAN CORRESPONDENCE COLLEGE
 WASHINGTON, D. C.

FREE 1937 SQUAB BOOK
 Squabs selling for 55c lb. wholesale, more than double other poultry. Thousands wanted by best city marketmen weekly. Supply scarce. Cash for you when only 25 days old. Make money breeding them. We sell breeders at low prices. Send U. S. stamp for picture book, facts. PR CO., 636 How St., Melrose, Mass.

RAISE RABBITS FOR US
 WE PAY YOU UP TO \$5.00 EACH. ALSO PUT YOU IN TOUCH WITH MARKETS EVERYWHERE. Large illustrated book and catalog, also copy of the AMERICAN RABBIT FARMER and monthly market bulletin showing names of buyers in various parts of America who continuously buy all rabbits offered them. All for 10 cents. Address OUTDOOR ENTERPRISE CO., 101 Main Street, NEW CITY, N. Y.

LOOK! Baby Chicks
 THOUSANDS WEEKLY ALL YEAR
 Finest quality & Layers in 40 breeds. Hybrid Baby Pullets and Cockerels, B. W. D. Tested. 25 lbs. feed FREE with each 100 chicks. Ducklings, Goslings, Baby Turkeys, Guineas. Mature Breeders priced right. In business 27 years. Catalog free. Nabob Hatcheries, Box M, Gambier, Ohio.

Best Poultry Paper 6 BIG ISSUES 10¢
 Helps Increase Poultry Profits. Send coin or stamps. 50 cents for 3 years or 10 cents for 6 months trial. Agents wanted. American Poultry Journal 632 So. Clark Street Chicago, Illinois

Forms to cast Lead Soldiers, Indians, Trappers, Hunters, Wild and Farm Animals. 239 different forms to select from. Every form guaranteed to cast perfect figures. Send 5c stamp for illustrated catalogue.
 HENRY C. SCHIERCKE Spencer Rd. GHENT, N. Y.

EXTRA!
 ★★ ★★
EXTRA MONEY FOR YOU IN THE POULTRY BUSINESS

Here's PROOF

MONEY AHEAD
 Says F. R. Ostrowski
 F. R. Ostrowski of Chicago, recently wrote: "I have found that training pays in the poultry business as in any other business. Since finishing I have received offers to manage several Commercial Poultry Farms."

100% Booster says MEYER
 "I have recently finished your commercial poultry farming course. It is the best investment a person can make that is interested in poultry raising." So says Harvey Meyer and many others.

Course Best Investment Says Zimmerman
 "I congratulate you on your practical and thorough Poultry Farming Course. Any one interested in poultry will find your course the very best investment for success. I can highly recommend your training and personal service." Geo. E. Zimmerman, Union, N. J.

SEND FOR This Book of FACTS!

Is there a shed or garage in your back yard, or extra room in your basement?

For the last 16 years I have been showing men and women how to make quick cash out of poultry. Thousands have turned to poultry raising for PART TIME EXTRA MONEY, or full time BIG PAY. Scientific methods make it easy to start in your back yard or on a vacant lot, or even in your basement. No matter what you are doing now, I can show you how to succeed. Chickens and eggs bring high prices—your margin of profit is large.

My Proved METHODS Assure Success Right from START
 All the "mystery and guess work" are taken out of poultry raising by my sure, tested, proved methods. My home study course, produced by eighteen famous experts and endorsed by thirty leading Agricultural Schools, puts in your hands the success-secrets of leaders. Satisfaction guaranteed, if you follow our methods. Be your own boss—make from \$1000 to \$2500 in spare time—or qualify for a fine salary in one of the big established poultry plants.

FREE BOOK EXPLAINS
 My big, new, free book, "How to Raise Poultry for Profit" will amaze you! Brings proof of what my course and training have done for others. Get in line for QUICKER, BIGGER MONEY. Don't delay. Get this coupon into the very next mail.



Get this FREE Book NOW!

HARRY M. LAMON, President, National Poultry Institute, Dept. 38-B, Adams Center, N. Y.

I want to know how to make big money raising poultry. Send me your FREE book explaining your home-study course and PROVED methods.

Name

Address

City..... State.....

AUTO-MECHANICS & WELDERS

GOOD JOBS and Mighty GOOD PAY

Do you want to earn big money? If so let us know which of the following trades you prefer. You learn by doing. Practical work. Expert teachers. Low tuition. Personal attention. It will pay you to investigate AT ONCE. Just check the courses you'd like to take and mail today. You will receive full information, absolutely without cost or obligation. But don't delay.

Check the Trade You'd Like to Learn

- Auto Mechanics
- Welding
- Auto Collision
- Spray Painting
- Metal Finishing
- Torch Soldering

Ask about our "Pay After Graduation Plan"

Name

Address

Mail the above to

MICHIGAN TRADE SCHOOL

Write for FREE CIRCULAR

3758 Woodward Avenue DETROIT, MICH.

AUDELS Carpenters and Builders Guides

4 vols. \$6



Inside Trade Information for Carpenters, Builders, Joiners, Building Mechanics and all Woodworkers. These Guides give you the short-cut instructions that you want—including new methods, ideas, solutions, plans, systems and money saving suggestions. An easy progressive course for the apprentice and student. A practical daily helper and Quick Reference for the master worker. Carpenters everywhere are using these Guides as a Helping Hand to Easier Work, Better Work and Better Pay. To get this assistance for yourself, simply fill in and mail the FREE COUPON below.

Inside Trade Information On:

How to use the steel square—How to file and set saws—How to build furniture—How to use a mitre box—How to use the chalk line—How to use rules and scales—How to make joints—Carpenters arithmetic—Solving mensuration problems—Estimating strength of timbers—How to set girders and sills—How to frame houses and roofs—How to estimate costs—How to build houses, barns, garages, bungalows, etc.—How to read and draw plans—Drawing up specifications—How to excavate—How to use settings 12, 13 and 17 on the steel square—How to build hoists and scaffolds—skylights—How to build stairs—How to put on interior trim—How to hang doors—How to lath—lay floors—How to paint.



THEO. AUDEL & CO., 49 W. 23rd St., New York City

Mail Audel's Carpenters and Builders Guides, 4 vols., on 7 days' free trial. If O.K. I will remit \$1 in 7 days, and \$1 monthly until \$6 is paid. Otherwise I will return them. No obligation unless I am satisfied.

Name

Address

Occupation

Reference

MARVELOUS INVENTION!

"All-in-one" Combination Blow Torch & Soldering Iron



Now garage men, plumbers, mechanics, engineers can cut cost and time—with this new Justrite Combination Blow Torch and Soldering Iron! Supplies its own pressure—without pumps of any kind. Generates its own heat—without charcoal or stove. Light, convenient, portable, foolproof gives 100% customer satisfaction. SELLS ON DEMONSTRATION.

AGENTS' SAMPLES: A special proposition for new, fast-working agents who can start now—and produce! **Exclusive Territories** are open for agents who know how to sell this PROVED MONEY MAKER. Thousands of Justrite Torches are in use now. This success is ready for YOU! Write today!

JUSTRITE MFG. CO.
2061 Southport, Dept. 54, Chicago

Learn to Draw



for pleasure and profit. At home—by mail. No experience necessary. You study from photos of artist's models just as they pose in the life class.

FIRST LESSON FREE

Send name and address and only 10c to cover mailing cost to—

TOWERTOWN STUDIOS, Dept. 436
520 N. Michigan Ave., Chicago, Ill.

Men Needed Quick!—Not hundreds—but thousands!

Learn NOW—at home, in spare time—(or at our School in Chicago.) Qualify for steady work and big profits in

AIR CONDITIONING and REFRIGERATION

GET Free PROSPERITY BOOKLET

Get in on ground floor. Send for "Prosperity Booklet." **CHICAGO TECHNICAL COLLEGE** 34th D 301 Tech Bldg. 118 East 26th St., Chicago, Ill. Year

AUTOMOBILE RACING New Book

(FOURTH EDITION)

Nine Chapters—66 illustrations of dirt, midget and championship cars and drivers. How to build cars and bodies—14 plates working drawings. Converting stock cars to 135 m.p.h. racers. Answers all questions on speeding up cars, balance, speed, revs., rules, specifications, track records, etc. Postpaid \$1.00, C.O.D. \$1.12. Order NOW. Ray Kuns, Dept. B-4, Madisonville, Cincinnati, Ohio.



PLAY GUITAR!



We guarantee to teach you for less than 2c per day. You'll enjoy learning to play this fascinating instrument by our easy, illustrated lessons. FREE Guitar Tuner when you enroll. Ask for full details—no obligations. Write TODAY—Sure. **HAMANN INSTITUTE, 3019 N. 24th Place, P-5, Milwaukee, Wis.**

NEON

Prepare yourself quickly for today's biggest opportunity—design, build, sell and service NEON or "gaseous tube" lighting—for lighted displays. Future's greatest source of illumination. Most complete, practical, low-cost, home-study course. FREE book gives full details, student letters, Low Price! WRITE! **COMMERCIALITE LABORATORIES Box 47-P OMAHA, NEBR.**

New Oil Burner Heats Cheaper

Saves 25% Fuel Cost

New perfected oil burner! All the best features combined in one burner—LACO's patented "Mineral-Wick" gives hotter gas flame from cheap fuel oil—extremely simple—only one moving part—nothing to cause trouble. Underwriters Lab. 25,000 in use.



WRITE! Free booklet gives complete details of oil burners for your present heating plant—complete oil burning heating plants—oil burning circulating room heaters, all at amazing low prices. LACO will ship any model to a new dealer subject to examination without costing you a cent. SEND NOW!

LACO OIL BURNER CO.
147 Union Ave., Griswold, Iowa

Look Here, DEALERS! LACO sales doubled this year! LACO has a most profitable dealer's proposition—you can fill any order for oil heat from a small cafe hamburger griddle up to a large industrial plant. I mean what I say, LACO is the best money-maker for the dealers. L. A. COCKLIN, Pres.

When writing please mention Popular Mechanics

Ruptured?

Save yourself the misery of wearing leg-straps and cutting belts. Learn about the famous Cluthe Comfort Truss positively guaranteed to hold—a condition absolutely necessary for possible improvement or recovery. Water and perspiration proof; wear it in bath; Automatic Pad insures safety; hips left free. Made to your order for your individual requirements by mail on a liberal 60 days trial plan. Send for FREE 100-page Book of Advice and endorsements (publication permitted) from grateful patrons in your own neighborhood. No obligation. Write today.
 Dept. 31, CLUTHE SONS, Bloomfield, New Jersey
 (Serving the Ruptured Since 1871)

MAKE MONEY with your CAMERA

Thousands of publications buy MILLIONS of photos yearly from amateurs. We show you what to photograph, how to do it, where to sell for biggest profits. Learn at home, in spare time, at small cost. Use any camera. Write for FREE BOOK about this fascinating field. **UNIVERSAL PHOTOGRAPHERS, Inc.**, Dept. 74, 10 W. 33 St., New York, N. Y.

FREE BOOK

LES Correspondence Courses in **RADIO and ELECTRICAL ENGINEERING** **SPECIAL Only \$25**

ELECTRICAL ENGINEERING. Covers complete electrical field. Most modern course. Very understandable.
RADIO ENGINEERING. Ultra-modern course in radio, public address, photo-electric work. Trains you to be super-service man, real vacuum tube technician. Tuition ONLY \$25, either course. Deferred payment plan. Exper. kit free—limited time offer. **WRITE TODAY** for free copies of school catalogs, student magazines, etc.
LINCOLN ENGINEERING SCHOOL, 931-17 So. 37th St., Lincoln, Nebr.

AGENTS UP TO 50 IN A WEEK

Big Cash profits for you; full or spare time. Over 250 household necessities—things people must buy. Proven fast sellers; steady repeaters, earnings very first day. **FORD TUDOR SEDAN GIVEN YOU AS BONUS.** I'll show you how to start at once; send you everything—Big Display Outfit and quick cash plans. Details FREE—no obligation. Just return on postcard.
ALBERT MILLS, 3884 Moonpath Ave., Cincinnati, O.



Save Your Feet



When all else fails end your suffering with the flexible "no metal" **Heefner ARCH SUPPORT**
 Write for Free Booklet

HEEFNER ARCH SUPPORT CO., 656 Commercial Bldg., LOUISVILLE, KY.

Full Size Professional ARC WELDER

Details FREE! Full size, heavy duty Aladdin Electric ARC WELDER only \$39.25 with De Luxe Accessories! Has efficiency of machines costing \$145.00 to \$800.00. Welds all metals and alloys from heavy motor block and castings to fenders and light sheet metal. Also fine for soldering and brazing. Fully guaranteed. Approved by Automotive Test Laboratories. Easily portable on casters. **WORKS FROM 110-V SOCKET.** Simply plug into 110 Volt or 220 Volt light socket—costs only few pennies an hour to use. Has complete heat controls. Any one can use easily. Full instructions included. **AMAZING DETAILS FREE!** Write today for sensational facts about Aladdin Arc Welder for \$39.25 including De Luxe Accessories!
COMMONWEALTH MFG. CORP., 4208 Davis Lane, Dept. T-51, Cincinnati, Ohio

Only \$39.25 With De Luxe ACCESSORIES



Does your **PAY ENVELOPE** keep you out of this picture?

● If it does, do something about it! Get a raise in salary—but first get the training that will entitle you to this raise. Thousands of men in the same fix as you have gotten this training by spare-time study of an I.C.S. Course. Mail the coupon today!

INTERNATIONAL CORRESPONDENCE SCHOOLS

Box 5668-II, Scranton, Penna.

Without obligation, please send full particulars about the subject before which I have marked X:

- TECHNICAL AND INDUSTRIAL COURSES**
- Architect
 - Architectural Draftsman
 - Building Estimating
 - Contractor and Builder
 - Structural Draftsman
 - Structural Engineer
 - Electrical Engineer
 - Electric Lighting
 - Welding, Electric and Gas
 - Reading Shop Blueprints
 - Telegraph Engineer
 - Telephone Work
 - Mechanical Engineer
 - Mechanical Draftsman
 - Machinist
 - Patternmaker
 - Foundry Practice
 - Sheet Metal Worker
 - Boilermaker
 - Heat Treatment of Metals
 - Management of Inventions
 - Diesel Engines
 - Aviation Eng.
 - Plumbing
 - Air Conditioning
 - Steam Engineer
 - Steam Electric Engineer
 - Marine Engineer
 - Civil Engineer
 - Bridge Engineer
 - Bridge and Building Foreman
 - Surveying and Mapping
 - R. R. Locomotives
 - R. R. Section Foreman
 - R. R. Signalmen
 - Chemistry
 - Coal Mining
 - Navigation
 - Cotton Manufacturing
 - Woolen Manufacturing
 - Agriculture
 - Poultry Farming
 - Auto Mechanic
 - Heating
 - Refrigeration
 - Highway Engineer
 - Air Brakes
 - Pharmacy
- BUSINESS TRAINING COURSES**
- Business Management
 - Industrial Management
 - Traffic Management
 - C.P. Accountancy
 - Bookkeeping
 - Secretarial Work
 - Cost Accountant
 - Salesmanship
 - Service Station Salesmanship
 - Business Correspondence
 - Lettering Show Cards
 - Stenography and Typing
 - Civil Service
 - Railway Mail Clerk
 - Grade School Subjects
 - High School Subjects
 - College Preparatory
 - First Year College Subjects
 - Illustrating
 - Cartooning
 - Signs
 - Mail Carrier
 - Spanish
 - French

DOMESTIC SCIENCE COURSES

- Professional Dressmaking and Designing
- Home Dressmaking
- Advanced Dressmaking
- Millinery
- Foods and Cookery
- Tea Room and Cafeteria Management, Catering

Name.....Age.....
 Address.....
 City.....State.....
 Present Position.....
 If you reside in Canada, send this coupon to the International Correspondence Schools Canadian, Limited, Montreal, Canada

STAMPS

and *Collecting*

By Richard McP. Cabeen

P. 900 123 H. Buchanan Ches



Courtesy De Soto Stamp and Coin Co., and Garden City Stamp Agency, Chicago

Recent stamp issues, including the semi-postal issue of Austria at the bottom of picture, depicting prominent inventors, technicians and engineers of that country

SUDDEN changes in the coinage system of a country, or in the political structure, or the need for increased rates of postage often require that the current issue of stamps be adapted to the new conditions, by printing some new information across the face. Such an inscription is known as an overprint, or surcharge.

Some authorities insist the latter term be reserved for overprints which alter the face value of the stamp. This is due to a confusion in the definition of the word, "charge," which really means, when used in connection with the prefix, "sur," that a new obligation or responsibility has been placed upon the stamp beyond that originally expressed, rather than that a new price is involved. If the word "surcharge" were limited to overprints affecting the face value of the stamp, it would

nearly always be used incorrectly for overprints are seldom used to increase the face value of stamps but generally reduce the value. This prevents counterfeiting which would be possible if stamps were overprinted with higher values.

Overprints are often used to render useful those stamps which are no longer needed on account of changes in postal rates. During the inflation period of 1923, Germany had recourse to overprints of value to use up stamps voided by the day by day reduction in the real value of paper marks. Overprints were used by the German forces in Belgium and were made by printing the regular German stamps with the word "Belgien" and a new value in centimes. These are known as occupation stamps.

(Continued to page 41A)

Over 700,000 People have studied music this easy way

Now You Can Learn to Play Your Favorite Instrument Without a Teacher

Easy as A-B-C

MOST of these 700,000 students didn't know one note from another—yet in an amazingly short time they learned to play their favorite instrument. Best of all they found learning music *amazingly easy*. No drudgery—no expensive teachers. This simplified method, perfected by the U. S. School of Music, made learning music as easy as A-B-C.

From the very start you are learning *real* tunes by *note*. Every step, from beginning to end, is right before your eyes in print and picture. First you are *told* how to do a thing, then a picture *shows* you how, then you do it yourself and *hear* it. And almost before you know it, you are playing your favorite pieces—jazz, ballads, classics. No private teacher could make it clearer. The cost is surprisingly low—averaging only a few cents a day—and the price is the same for whatever instrument you choose.

Learn now to play your favorite instrument and surprise all your friends. Change from a wallflower to the center of attraction. Musicians are invited everywhere. Enjoy the popularity you have been missing. Start now!

Free Booklet Demonstration Lesson

If you really *do* want to play your favorite instrument, fill out and mail the coupon asking for our



Free Booklet and Free Demonstration Lesson. These explain our newly perfected method fully and show you how easily and quickly you can learn to play at little expense. Instruments supplied when needed, cash or credit. U. S. School of Music, 74 Brunswick Bldg., New York City.

U. S. School of Music,
74 Brunswick Bldg., New York City

Send me your amazing free book, "How You Can Learn Music in Your Own Home," with inspiring message by Dr. Frank Crane; also Free Demonstration Lesson and particulars of your easy payment plan.

Name.....
Address.....
Instrument..... Have you Instr?.....

LEARN TO PLAY BY NOTE

- Piano
- Guitar
- Violin
- Saxophone
- Organ
- Mandolin
- Tenor Banjo
- Hawaiian Guitar
- Piano Accordion
- Or Any Other Instrument

CARTOON YOUR WAY TO SUCCESS!

DON'T COPY—LEARN TO ORIGINATE!
RAYE BURNS will teach you HOW to CREATE ORIGINAL CARTOONS at home that you can SELL! Course contains 26 lessons and over 600 illustrations. All for Only... **\$2.85**
Send name and address for free details.

RAYE BURNS SCHOOL, Dept. M-X, BOX 2194, Cleveland, Ohio

ARMY AND NAVY SUPPLY CO.
Bargains—Army, Sport Goods, Firearms, Clothes, Shoes, etc. Send 10c for new catalog, to be redeemed on first order
Army & Navy Supply Co., 4772 Lester St., Richmond, Va.

MAN IN EACH TOWN To Plate Auto Parts,

Reflectors, Mirrors, etc., by late method. Experience unnecessary. Free particulars and proofs. Write today.
GUN METAL CO., Ave. M, Decatur, Ill.

THE WONDER BOOK OF THE AIR

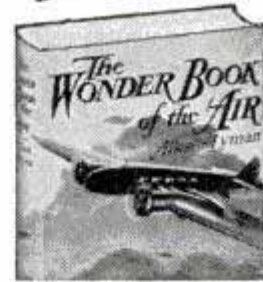

2300 years of flying history—down to Pacific flights of giant clippers. Facts about every kind of aircraft, instruments, blind flying, etc. Thrilling flights across oceans, to the Poles, into stratosphere.

SEND NO MONEY NOW

Called "best book on aviation ever written." 350 pages, 172 photographs. Just send name and address. Pay only \$2.50, plus few cents postage charges, on delivery. Write today to JOHN C. WINSTON CO., Dept. 100, Phila., Pa.

Be a GUNSMITH Learn this fascinating

big pay profession at home. Repair, restock, blue, check, refinish, make new parts, etc. Write for Prospectus.

GUILD SCHOOL OF GUNSMITHING, Dept. A-4, Newark, O.

PARKS AIR COLLEGE

Offers COLLEGE AND PROFESSIONAL TRAINING Majoring in Aviation

FOUR two-year courses (96 weeks) lead to Bachelor of Science degrees in Professional Piloting, Aviation Operations, Aviation Mechanics and Aeronautical Engineering.

THIRTEEN TRAINING PLANES are on the flight line. They range from the Kinner Sportster to the high speed twin-engined Monocoach equipped with retractable landing gear, air brakes, two-way radio, radio direction finder, and blind flight instruments.

58,000 hours flight instruction have been given, 650 hours now being flown monthly. THE FACULTY of 33 is composed of specialists in the various fields of aviation. AN ENROLLMENT of 260 resident students for the 1936 Fall term. On its 100-acre airport, Parks has 14 buildings with a total floor area of 2 1/4 acres, devoted to school purposes exclusively.

Accredited by the Illinois Superintendent of Public Instruction. Government approved as a Transport Ground and Flying School and Mechanics' School.

DORMITORIES AND DINING HALL ON THE FIELD.

1371 graduates.

Graduates are being placed prior to graduation.

63 per cent of graduates enter air transport operations in North and South America.

At Parks you train for aviation *in* aviation. Parks is recognized as the training division of the industry. Ask any one who is in aviation. You can expect more at Parks and still be agreeably surprised when you come.

The 60-page catalog gives complete information. Send for it. It is FREE. It is packed full of valuable information. A letter or post card will bring it to you.

PARKS AIR COLLEGE
437-M Cahokia Rd. East St. Louis, Illinois



**This
MACHINISTS'
Home-Study
Course**



helps men get ahead

Newly assembled—specially priced—these five recent books give you the practical facts on modern machines, up-to-date methods, you need to advance in machine shop work. Take advantage of the other man's experience as found in books, to solve your problems, increase your efficiency, with the new

**Library of MODERN
MACHINE SHOP PRACTICE**

5 volumes—2000 pages—1600 Illustrations
(A combined home-study course and reference library)

This library of machine shop practice was written for practical men. It gives you the best methods for every kind of machine shop work. It fully explains lathes, drills, and other machine tools and their operation, automatic screw machines, speeds and feeds, gear design and production, punch and die work, metal finishing, etc., etc. Plainly written—completely illustrated—the best kind of help to the machine-shop man who wants to advance himself.

No money down—special price—easy payments.

FREE EXAMINATION COUPON

McGRAW-HILL BOOK CO., 330 W. 42nd St., New York

Send me for ten days' free examination the Library of Modern Machine Shop Practice. If satisfactory I will send you \$1.50 in 10 days and \$3.00 monthly until the price of \$16.50 is paid. If not wanted, I will return the books postpaid. (To insure prompt shipment write plainly and fill in all lines.)

Name
Home Address.....
City and State.....
Position.....
Name of Company..... PM-4-37



**Learn this Profession and
Make Up to \$7000 per Week**

Fascinating and Profitable for both MEN and WOMEN. Swedish Massage is still an uncrowded profession with big salaries paid by Clubs, Hospitals, Sanitariums, and still greater opportunities from private patients. Many specialize in reducing and command experts' pay. Course can be completed in 3 months. Write for FREE ANATOMY CHARTS and details of our home training course. No obligation. NATIONAL COLLEGE OF MASSAGE & PHYSIO THERAPY 20 N. Ashland Ave., Dept. 477, Chicago, Ill.

**DIESEL
POWER**



Courtesy DIESEL PROGRESS

A Coming American Industry

The internal-combustion engine represents man's supreme triumph of machine power. Diesel operators are in demand. Here is real opportunity for mechanics, draftsmen, owners of shops, motormen, farmers and all others employed where Diesel replacements will be made. Get necessary knowledge through study of the modern I. C. S. Course on Diesel engines. Free booklet!

INTERNATIONAL CORRESPONDENCE SCHOOLS

BOX 5670-H, SCRANTON, PENNA.

Please send information on course checked.

- DIESEL POWER ELECTRICAL ENGINEERING
 Mechanical Engineering Automobile Course
 Aviation Engines Air Conditioning

Name..... Age.....

Address.....

**NEW models
EASIER TO PLAY**

Find out about these sensational new Conn Band Instruments. Many wonderful, exclusive features! Today, more than ever, Conns are the "choice of the artists." You'll advance faster and take more pride in a genuine Conn—made by the world's largest manufacturer. See your dealer or write us for Home Trial, Easy Payment offer. Mention instrument.

C. G. CONN, LTD.
431 Conn Bldg., Elkhart, Ind.

WRITE FOR FREE BOOK

CONN
BAND INSTRUMENTS

**Cheaper HEAT
Without COAL**



Agents Wanted
EARN \$60 A WEEK!
Write for FREE Burner offer and protected territory

New Invention Fits Any Stove or Range — 30 Days Free Trial
Remarkable invention burns 96% air, 4% of a cheap variety of oil obtainable everywhere. Does away with coal, wood, ashes, dirt and drudgery. Clean, silent, quick, like gas heat. 3 times hotter than coal and cheaper. Temperature controlled. No more getting up on bitter cold, wintry mornings. Many automatic features. No gas or electricity needed. Safe as any ordinary kitchen range. Easy to install—no damage to stove—simply sits in firebox of any stove, range, heater or furnace. Costs just a few cents a day to operate. TRY 30 DAYS AT OUR RISK. Low introductory price and 30-day trial. Write for FREE CATALOG. AGENTS and spare time workers: Oil heat saves money this year; people buy to save. Write for free burner offer that starts you in business for yourself. Act NOW! Listed as approved by Nat'l. Board of Fire Underwriters. BRIGHAM OIL BURNER CO., 2927-D Clark Ave., St. Louis, Mo.

STAMMERERS

Write for our Free List of ethical schools that correct stammering.
STAMMERERS' GUILD
Maccabees Bldg., Suite 1236, DETROIT, MICH.



CARTOONING COURSE \$1.00

A complete, simplified, practical course in Cartooning, consisting of 30 lessons, with over 500 illustrations, including drawing pens and pencils. \$1.00 Postpaid. SCOVELL STUDIOS, Box 748, Hollywood, Calif.

INVENTORS PATENT YOUR IDEAS...

Send for Free Book and record of Invention Form today. Personal Service.
L. EDWARD FLAHERTY Registered Patent Attorney—
Electrical Engineer
708-International Bldg. WASHINGTON, D. C.

New Pocket Radio



Operates Without Tubes, Batteries or Electric Connections

Amazing midset radio fits in pocket or purse. NEW MODEL weighs only 2 ozs. as shown in ACTUAL photo! Smaller than a cigarette package! Separates and receives stations with beautiful clear tone. Range to 50 miles—MUCH GREATER under good conditions—no noise! Employs new Hi-Efficiency fixed crystal. Not to be confused with cheap imitations. Tunes broadcast band. NOT A TOY, but an unusual practical radio—a sensation everywhere—a delight to anyone every way. Comes in several beautiful colors (state yours). ABSOLUTELY COMPLETE ready to listen with midset phone and instructions to use in hotels, offices, camps, at home, in bed, on sea or wherever you may be. TAKES ONLY A SECOND TO CONNECT—no messy hookups. THOUSANDS OF SATISFIED OWNERS—many report wonderful service in ALL PARTS OF THE WORLD! THESE ARE FACTS! Carry one with you always and be assured of many hours of entertainment AT NO COST! Can be used by ANYONE—even a child! Send only \$1.00—pay postman balance or send \$2.99 (M. O., Cash, Check). WE PAY POSTAGE. GUARANTEED. A most unusual value. Foreign orders 75c extra.

TINYTONE RADIO CO., Dept. P-4, Kearney, Nebraska

(Continued from page 38A) *ES 127*

It is not unusual to overprint stamps of a near-by colony with the name of a new region to which postal service is to be extended. Such stamps are provisional and are in use only while the definitive stamps are being prepared. Very often a shortage in a special purpose stamp results in an overprint on the corresponding value of the regular postage stamps. This is especially common in the case of "Postage Due" stamps. There have been very few overprinted United States stamps in its extended postal and revenue history.

The first of the few were the overprinted stamps used in 1898 to provide revenue to finance the Spanish-American war. In 1928 three commemorative stamps were issued which were made by surcharging the regular stamps. These were the two-cent Battle of Monmouth, or Molly Pitcher issue, and the two-cent and five-cent stamps of the Hawaiian sesquicentennial issue. These are rather special overprints for they were made by the bureau of engraving and printing in the same operation which produced the stamps, and before the gum was applied or the perforating accomplished. By some they are looked upon as bicolored rather than overprinted.

In 1929, the United States again resorted to overprinting when the entire set of the regular issues from one-cent to ten-cents was overprinted with the state abbreviation, "Kans." or "Nebr." These overprinted stamps were produced in an endeavor to lessen the facility with which thieves could dispose of stamps procured in postal robberies, and such stamps were not to be accepted in quantity for the prepayment of postage outside the state for which they were overprinted. The idea was never carried beyond the experimental stage in the states named.

Many collectors have horror of surcharged stamps which has been engendered by the carelessness or premeditated viciousness of printers entrusted with overprinting. When the overprinting plates are carefully prepared and made up of electrotypes or stereotypes from a correct master die, and when the printing is in the hands of a watchful inspector, there will be no more trouble than with a regular stamp issue, but when the surcharging plate is typeset, there are varieties without end. Often various fonts and sizes of

(Continued to page 43A)

More GOOD JOBS in DRAFTING NOW!

Calls for Draftsmen Are Increasing! Wants prove it. Steel mills—railroads—buildings—all are "on the up" . . . all are calling for Draftsmen. New fields like Air Conditioning and Diesels join in the call—"Give us more trained DRAFTSMEN." Some who read this advertisement will do nothing. Others, smart enough to realize this means Opportunity, will Send A Post Card or Mail The Coupon for Free Trial Lesson.



This Complete Drawing Outfit, Tools and Table sent to Chicago Tech Home-Study students in Drafting.

The draftsman's work comes *first*. When business improves . . . and it *is* improving . . . there is new construction work, new buildings, new machines, repairs and reconstruction work. All these must *first* be laid out on paper. So the *FIRST* man that *must* be hired is the DRAFTSMAN.

Drafting is Well-Paid Work

Drafting is clean, interesting professional-type work. It pays well to start . . . offers real opportunities for promotion. You need no previous training or experience . . . no special talent—to learn Drafting. It is one of the steadiest employment fields. No machine ever did the Draftsman's work . . . and no machine can be invented. So your job is *always* secure.

Learn at Home in Spare Time

(or at the College in Chicago,) by the fascinating, easy, step-by-step plan originated by this 34-year old school for Draftsmen. This is the way thousands of successful men started their careers. Begin *yours* without delay . . . terms are low . . . and we help you to a job when ready. Send now for

FREE TRIAL LESSON in Drafting

Sample this easy-lesson system of learning Drafting. Send post card or this coupon. No charge now or later for this **FREE LESSON**. Prove to yourself how easy it is to learn Drafting by the C. T. C. Method.

CHICAGO TECHNICAL COLLEGE

CHICAGO TECHNICAL COLLEGE

D208 Tech Bldg., 118 E. 26th St., Chicago, Ill.

Send me **FREE BOOK** as checked below. No obligation.

- DRAFTING—in Spare Time—at Home.
- DRAFTING, at Chicago Tech—in Chicago.

Name..... Age.....

Address

P. O. State.....

Other C.T.C. money-making training by home-study shown below. Check one of these if you prefer it to Drafting.

- Air Conditioning and Refrigeration.
- Builders' Course for Carpenters and Builders.



50 more LINCOLN Graduates take important positions in AVIATION

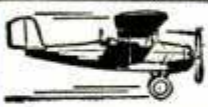

These 50 recent Lincoln graduates, quickly snapped up by an industry waiting for properly trained men, are now on the road to success! Proof again that Lincoln-trained men are preferred. But still more Lincoln men are wanted. Already ten

leading Aviation Companies have written in advance indicating they will want us to supply more trained men in the coming months. Now is the time, and Lincoln is the place, for you to prepare for one of these good pay positions!

Lincoln Government Approved Training is practical, thorough, complete. In just a few short months you are ready to take your place in aviation. Airline Pilots get up to \$700 a month; Co-Pilots get \$250 a month. Under Government Licensed instructors you prepare for your license as Transport, Limited Commercial, Private or Amateur Pilot.

Licensed Mechanics get up to \$200 a month. In Lincoln's Mechanics School you will learn aircraft motor overhaul and repair, airplane design, construction, aerial radio, welding, sheet metal—everything to qualify you for one of aviation's good-paying jobs.

Start training now. School now in 27th year; 17th year teaching aviation. Mail coupon now.

LINCOLN AIRPLANE & FLYING SCHOOL
Division of Lincoln Aeronautical Institute, (Inc.)
207G Aircraft Bldg., Lincoln, Nebr.

Lincoln Airplane & Flying School,
207G Aircraft Bldg., Lincoln, Nebr.

YES! I want further facts about Lincoln's complete training and the big-pay opportunities ahead in aviation.

Name..... Age.....
City..... State.....

STEP INTO THE Spotlight



Banish Boredom... Earn Extra Money START TO PLAY VERY FIRST DAY

Picture the joy of playing a snappy foxtrot, dreamy waltz or mellow old favorite on the Xylorimba. No reason why you shouldn't! Xylorimba is easiest of instruments to play and yet the most spectacular. In constant demand by orchestras, radio stations, at lodge meetings and parties. Marvelous opportunity to increase popularity, make big spare-time money. No bothersome practice or exercises. With Free easy lessons you actually **Start to Play Very First Day.**

BIG FREE BOOK tells all about Deagan line, liberal trial offer and easy payments. Send coupon today for your free copy.

J. C. Deagan, Inc., Dept. 1454, 1770 Berneau Ave., Chicago
Send me, without obligation, full details of Free Trial offer and easy-payment plan on the Deagan Xylorimba.

Name.....
Address.....

When writing please mention Popular Mechanics

Two Giant Industries NEED MEN NOW!



AIR CONDITIONING ELECTRIC REFRIGERATION

We supply trained men for America's two fastest-growing industries. If you can meet our requirements, we will train you in spare time at home for a good pay position as an Installation and Service Expert in the Electric Refrigeration and Air Conditioning fields. In addition we will give you **ACTUAL Shop Practice** when you graduate, and help you to qualify for profitable employment with an exceptionally bright future.

Can You Qualify?

To be acceptable for enrollment you should be mechanically inclined, between ages of 18 and 40, have fair education and be able to furnish character references.

GET FREE BOOK

Get amazing facts about actual opportunities for ambitious men in Air Conditioning and Electric Refrigeration. Our new Free Book describes these money-making opportunities and tells about our low-cost, easy-pay plan of training. Write for your copy today stating age and which industry interests you most. No obligation.

UTILITIES ENGINEERING INSTITUTE (Established 1927)
400-410 N. Wells St. Dept. 147 Chicago, Ill.

BECOME A SUCCESSFUL FINGER PRINT EXPERT

Prepare for a Thrilling Career with a splendid, steady income. Write for Free Publication and Particulars. **NATIONAL INSTITUTE, Dept. G, Fremont, Nebraska.**

Signs and Show Cards

Learn at home in your spare time. 27 Big, color, layout, design, airbrush, silk screen, how to start in business, trade secrets, etc. Size 9 x 12 inches. Thoroughly illustrated. Complete with alphabet charts. Written by D. Rogers Stewart. Money Back Guarantee. **Stewart Sign School, Dept. P4, 3555 Aberdeen, Alton, Ill.**

\$1



All About DIESEL Power

Diesel Power is no passing fad. It's the coming world power. In the air—on land and sea—thousands of men who know about Diesel Engines will be in demand. Plan ahead. Get the most timely book of the day—**ELEMENTS OF DIESEL ENGINEERING** by Orville Adams. The ideal book for beginners, students, mechanics of all kinds and the only book you need. Large size 6 x 9 inches. 450 Pages. 284 Illustrations. 22 Fact Filled Chapters. Send for your copy today and get out in front in Diesel Power. Sent postpaid only \$4.00. Order today.

472 PAGE BOOK Complete \$4 Only
POPULAR MECHANICS PRESS
200 EAST ONTARIO ST. ROOM 237-B CHICAGO, ILL.

Billion Ideas

POPULAR MECHANICS BOOK CATALOG



SEND YOUR NAME and 3¢ STAMP

Every man who reads Popular Mechanics will want this new big illustrated catalogue of practical, helpful and money making books. It describes over 5,000 informative and authoritative books, alphabetically arranged under a thousand subjects—everything from ACCIDENT PREVENTION to X-RAYS. It's an amazing guide to the world's BEST practical books. You must see it to appreciate its value. Only limited edition printed. Send your name and address and three cent stamp to cover postage on your copy. Do it today. **Popular Mechanics Press 200 E. Ontario St., Chicago**

(Continued from page 41A)

type are used, the alinement may be irregular with letters above or below the line, or letters fall out of the form. All sorts of errors are produced which reached a climax, perhaps, in one variety listed as being with triple surcharge, one inverted and one upon the back of the stamp.

In a few cases stamps have been made available for postage by surcharging them with inscriptions upon the back. Generally the stamps had previously received so many surcharges upon the face that further printing would have made them illegible. The fact that many people refuse to include surcharged stamps in their collections has been responsible for a lessening of the "errors" and varieties which were once foisted upon them, but such collections are not true mirrors of the philatelic history of the country, as many of the most important events of a nation's history are reflected in the stamps which must of necessity be overprinted upon a moment's notice.

New Stamp Issues

Among recent issues which should be of interest both to collectors and noncollectors is the semi-postal issue of Austria which pictures prominent inventors and technicians or engineers of that country. The following personages appear upon the stamps:—Josef Ressel Schraubens, inventor of the screw propeller; Karl Ritter v. Ghega, builder of a famous funicular railway; Josef Werndl, arms technician; Carl Freih. Auer v. Welsbach, inventor of the Welsbach gas light, the osmium lamp and Auer metal; Robert v. Lieben, inventor of an amplifying tube; and Victor Kaplan, inventor of the Kaplan turbine.

Also shown is one of a set of three stamps issued by Egypt to commemorate the Anglo-Egyptian treaty. There are three values in the set which went on sale last December. It is understood some values were sold out the first day of the sale. Two examples appear of the set of stamps issued by Colombia in connection with the national exposition at Barranquilla, 1936-1937. These show views of the exposition buildings. Two other Colombian stamps are part of a set issued in connection with the national Olympic games being held at Manizales.

(Continued to page 63A)

"I will train you in this famous Radio-Television Studio and our costly experimental laboratories for the money paying jobs in this great industry—Radio-Television," says S. Q. Noel, President, First National Television, Inc.



Learn Radio-TELEVISION

Are you satisfied with the money you are now making? With the success and future of your job? Is your field over-crowded? Don't go to sleep while destiny is shaping new careers, new fortunes in the great field of RADIO and TELEVISION.

Learn by Actual, Practical Training in a Leading Radio-Television Station

Radio Station W9XBY, and Television Broadcasting Station W9XAL, owned and operated by First National Television, Inc., are the practical laboratories where you actually put into practice what you learn in class rooms. **YOU LEARN BY DOING!** Think what it means to you! The most elaborate and complete broadcasting stations at your disposal. This practical experience is absolutely vital to rapid progress, and to the thorough and advanced knowledge necessary to win **SUCCESS.**

Big Money and Ready Jobs Await Television Experts

Unlimited opportunities in this new, expanding profession await alert, aggressive, trained men... men who **LEARN NOW**... men with vision to get in on the ground floor when the profession is young and uncrowded. You know the truth of this. You know that **TELEVISION** is already a reality and is just waiting development of man-power when it will sweep the nation with its marvels.

ONLY 6 MONTHS TRAINING FOR U. S. GOV'T. LICENSE

Our "training on the job" qualifies you in only 6 months for a U. S. Government License (First Class) at minimum cost. Our new profusely illustrated 48-page **FREE** book, "Pictures on the Air", gives you complete information.

You owe it to yourself and your family to investigate. Don't wake up a year from now and find your friends making big money in fascinating **Radio-Television** careers... while you have stood still! **ACT NOW!** Send the coupon today!

FIRST NATIONAL TELEVISION CO., Inc.
Training Division Kansas City, Mo.

MAIL COUPON NOW!

S. Q. NOEL, Pres., First National Television, Inc.
Dept. AA-4, Power & Light Building, Kansas City, Mo.

Rush my Free copy of "Pictures on the Air" describing opportunities in Television. I am 17 years old, or older.

Name _____

Street _____

Town _____ State _____



**Arrest Him, officer
I'LL HAVE COMPLETE FACTS ON
THE OTHER FELLOW TONIGHT!**



Secret Service Operator No. 38 is on the job . . . FOLLOW HIM through all the excitement of his chase after the counterfeiter gang. Write NOW for FREE Confidential Reports No. 38 made to his Chief!

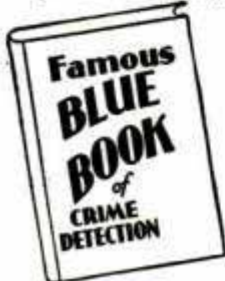

Secret Service Book

**Only
10¢**

Here is one of the greatest books that has ever been written on Crime Detection, Secret Service and Finger Print Identification Work. Written by a well-known authority. Scores of gripping mystery cases. Actual crime cases—not fiction. If you act quick we will send you this stirring book for only 10¢. Send at once.

Not sent to boys under 17 years of age.

T. G. COOKE, 1920 Sunnyside Ave., Dept. 1354, Chicago, Ill.

MAKE MONEY AT HOME!
Learn to color photos and miniatures in oil. No previous experience needed. Good demand. Send for free booklet, "Make Money at Home" and requirements.
NATIONAL ART SCHOOL
3601 Michigan Ave. Dept. 1354 Chicago

In answering advertisements always write name and full address clearly.

WOODWORKERS!

Here's How to Get the Most Out of Your POWER TOOLS!

New 220-page book tells all about various types of power tools used by amateurs at home—different makes, costs, new uses, how to care for and get most service from them. 85 illustrations amply illustrate the text.

SEND NO MONEY! Use coupon. Pay postman price of \$1.75 plus a few cents postage. If not satisfied, return book in 5 days for complete refund. Mail coupon now!



J. B. LIPPINCOTT CO., Dept. PM, Washington Sq., Phila., Pa.
Send me Collins' "Amateur Power Working Tools" on 5-day, money-back approval. I will pay postman \$1.75 plus postage.
Name
Address

When writing to advertisers please mention Popular Mechanics

FREE WHOLESALE CATALOG of 4000 FAST SELLERS

Hot off the press. Opportunity to make up to \$15 a day. Shows fast sellers of every description from many parts of the world, at rock bottom wholesale prices. 256 pages chock full of the biggest bargains you ever saw, many new items just being introduced, articles for every member of the family, office necessities, etc. One of the most complete lines in America. The 15 proven money making plans are fully explained in the catalog and may increase your earnings a hundred fold. This catalog is FREE—Send for it, today.

SPORS COMPANY
WHOLESALE IMPORTERS AND MANUFACTURERS
LE CENTER, MINNESOTA

SPORS CO.
2-37 Main St. Le Center, Minn.

Now! IT'S HERE! MIDGET POCKET RADIO

MIGHTY MIDGET TUBE RADIO CAN BE TAKEN WITH YOU!
Small and compact. All one unit—just like the big sets, but this LIGHTWEIGHT radio measures only 5 ins. x 3 1/2 ins. Fits pocket easy. Take it with you. Nothing to adjust.

No Electric Socket Connections Required!
Brings in stations with fine tone quality. Tunes broadcast band. Accurately made, precisely assembled, rigidly tested, assures excellent performance. Comes complete with phone in set, with easy instructions for use in camps, office, picnics, home, bed, etc. Listen to music, sports, radio entertainment, etc. The Mighty Midget is ABSOLUTELY GUARANTEED—all ready to connect and tune in. Thousands in use. An ideal gift. Order now.

SEND NO MONEY! Its enjoyable radio entertainment should delight you! Amaze your friends. Get yours today. Pay postman on arrival only \$3.49 and a few cents postage.

Little Giant Radio Co., 3959 Lincoln Ave., Dept. 705, Chicago

Excerpts From Satisfied Users
... I like the radio. It works immediately.
... This radio is a marvel and has far exceeded all my expectations. I am extremely satisfied. You may use this if you wish for advertising as I want everyone to know how marvelous this radio is.
... The Pocket Radio is very satisfactory. I get good reception... Reception is marvelous. Volume is very clear...
(Letters on File)

INVENTING Now Taught for the First Time!
Home study course. Send 3c stamp for free catalog TODAY.
TROFIMOV SCHOOL OF INVENTIVE PRACTICE, INC.
3859 Northampton Rd., Cleveland, Ohio

POTATO CHIP BUSINESS PAYS BIG! Buy potatoes 2c lb.—make Sensational new "Greaseless" Potato Chip and sell for 35c a lb. Big money spare or full time. No experience needed. I tell you how to get stores to sell for you—how to make profit first day. Small investment buys complete equipment. Write for FREE FACTS today!
G. H. Hardt, 325 W. Huron, Dept. C-54, Chicago.

NOTHING TO SELL GIVE IT AWAY!

Queer Way to Make Money—Try It!

Nothing to sell. The strangest money-making invention in years. Anyone can do it. No experience required. No house-to-house selling. No sample cases to buy. You simply give it away—in a few days people come to you with money. Davis made \$3,300.00 in three months—Rice, \$17.00 first day.

INSTRUCTIONS FREE Make the biggest money of your life—full time or spare time. Complete instructions will be sent free. Send your name today and learn, FREE, how to start at once. A penny postcard will do. Address N. A. Stoddard, 4325 Ravenswood Avenue, Dept. 124, Chicago, Ill.

NEW! COMPLETE and Up-to-the Minute Book on HOUSE WIRING

Covers, in great detail, all phases of practical wiring for homes, garages, farm buildings, etc. Written in the simplest language; describes and illustrates fuses, circuits, switches, installation plans; also wiring diagrams; over 200 illustrations; cloth binding \$1.50 post-paid. 5-day money-back guarantee.

FREE Complete catalog of practical books on Painting; Decorating; Commercial Art; Sheet Metal; Welding; Radio; Electricity; Engineering; Carpentry and Building; Plumbing; Heating and Ventilating. **WRITE TODAY.**

FRED'K J. DRAKE & CO., 179 N. Michigan Av., Chicago

AMATEUR CARTOONISTS WIN \$25.00

Wanted—Amateurs with humorous ideas. No drawing ability necessary. The amateurs of today are the professional cartoonists of tomorrow. Ideas judged and prizes awarded by Applause-O-Meter test before movie audiences. Everyone has an equal chance. 26 cash prizes in all. Rush name on penny post card for "Valuable Tips on How to Make Money With Simple Cartoons and Humorous Ideas", Cash Prize Entry Blank and Rules—SEND NO MONEY.

CARTOONISTS' EXCHANGE
Dept. 94 Pleasant Hill, Ohio

COMPLETE ELECTRIC PLANTS

ONAN ALTERNATING CURRENT PLANTS furnish same as city current anywhere. Operate on gasoline. Run Radio, Water System, Refrigerator, all Appliances. Complete, ready to run.

SIZES 350 WATTS UP

Easy to install. Available from stock. Ideal for Farms, Camps, Lake Homes, Commercial use. Sizes for any purpose. Write for details.

D. W. ONAN & SONS
1002 Royalston Ave. Minneapolis, Minn.

ROTARY STENCIL DUPLICATOR

Sensational PRINT-O-PRESS. Prints Post Cards and up to 8 1/2 x 11 letters. Many advance features. Fully warranted. Agents write.

\$995 complete Does work of \$150 machines

Professional Products
Dept. 412, Silverton, Ohio **Order Direct**

HOME STUDY COURSES

Home-Study Courses, leading to Degrees in Arts and Sciences; Education; Writing; Psychology; Chemistry; Business and Commerce; Law; Theology; Agriculture; Engineering; also courses in Business Training; Accounting; Advertising; Sales Management; Public Speaking; Radio. Many others. Low Cost; Easy Terms.

McKinley-Roosevelt College of Arts and Sciences, 4247 Clarendon Ave., Chicago

GO INTO BUSINESS MAKE 100% TO 300% PROFIT!

Sell new and used clothing direct from your home, auto or store. Underseil all competition. **EASY SALES—FAST REPEAT ORDERS!** We furnish everything and show you how. Handsome profits every day in the year. No selling experience necessary. Write at once for our Big Money Catalog—It's FREE!

Liquidation Merchandise Co., 550 E. 43rd St., Dept. D-16, Chicago, Ill.

BECOME A VENDING MACHINE OPERATOR!

Own a "chain" of 1c peanut and chewing gum vending machines. Large, steady profits, as people eat peanuts and chew gum daily. Start with \$100. Write for details today!

D. ROBBINS & CO.
1141P DeKalb Ave. BROOKLYN, N. Y.

AGENTS 500% Profit GOLD LETTERS

For Store Fronts and Office Windows. Anyone can put them on. Free samples. Liberal Offer to general agents.

METALLIC LETTER CO., 438 N. Clark St., Chicago

Men & Women Earn Cash at Home!

We paid M. M. \$267 in 3 weeks for exceptional "cellar crop" patented mushrooms! Big free picture book tells if your cellar, shed, barn suitable. We buy all crops thru ten branches. Write today.

Est. 1908. UNITED CO., 3848 Lincoln Ave., Dept. 307, CHICAGO

When writing please mention Popular Mechanics

U.S. GOVERNMENT JOBS

Start \$1260 to \$2100 a Year

OVER 42,000 APPOINTMENTS

LAST GOVERNMENT YEAR

Railway Postal Clerks

Railway Postal Clerks get \$1,900 the first year regular, being paid on the first and fifteenth of each month. (\$79.17 each pay day.) Their pay is automatically increased yearly to \$2,450. Advance may be had to Chief Clerk at \$2,700 a year. (\$112.50 each pay day.)

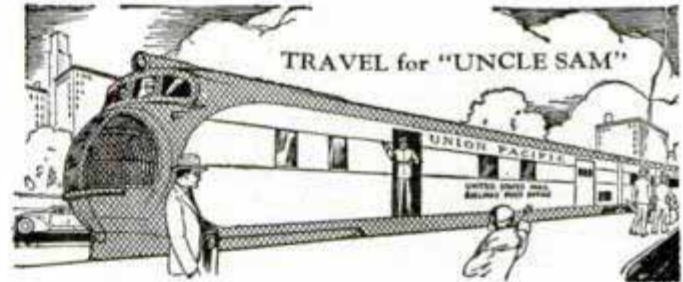

3 Days On—3 Days Off—Full Pay

Railway Postal Clerks on long runs usually work 3 days and have 3 days off duty or in the same proportion. During this off duty their pay continues just as though they were working. They travel on a pass when on business. When they grow old, they are retired with a pension.

City Mail Carriers, Post Office Clerks

Clerks and Carriers now get \$1,700 the first year on regular and automatically increase \$100 a year to \$2,100 and \$2,300.



Customs Inspector

Salary \$2,100 to start. Men 23 to 45. Work connected with examining baggage and merchandise entering the country from foreign parts covering boats, trains, roads, automobiles, etc.

Many Other Positions

Many other positions are obtainable. Those wishing these positions should qualify at once.

Get Free List of Positions

Fill out the following coupon. Tear it off and mail it today—now at once. This investment may result in your getting a big-paid government job.

FRANKLIN INSTITUTE, Dept. B 173, Rochester, N. Y.

Rush to me, entirely free of charge (1) a full description of U. S. Government Jobs; (2) Free copy of illustrated 32-page book, "How to Get a U. S. Government Job"; (3) List of U. S. Government Jobs; (4) Tell me what to do to get a U. S. Government Job.

Name.....

Address.....

Use This Coupon Before You Mislays It. Write or Print Plainly.

MIDWEST.

FACTORY TO YOU
SAVES 50%



Why be content with an ordinary 6, 8, 10, or 12-tube set when you can buy an 18-tube deluxe Midwest for the same money... direct from the factory, at half the cost. Not a cut-price set, but a more powerful super-performing radio in a big, exquisitely designed cabinet of matched walnut.

Only
\$39.95
AND UP
NEW LOW BASE PRICE*
FOR A WORLD-WIDE
MIDWEST



Your radio enjoyment is doubled with Dial-A-Matic Tuning* (*optional) the amazing new Midwest feature that makes this radio practically tune itself. Zip!... Zip!... Zip!... stations come in instantly, automatically, perfectly... as fast as you can push buttons.

30 DAYS FREE TRIAL

You have a year to pay... terms as low as 10c a day... you secure privilege of 30 days' Free trial in your own home. Other Midwest radios complete with tubes and console, \$29.95 and up! (*Base price, less tubes and console).

SEND FOR FREE
40-PAGE CATALOG

You are triply protected with Foreign Reception Guarantee... Money-Back Guarantee and One-Year Warranty.



Dept. M-15 Midwest Radio Corp., Cin'ti, O.

MIDWEST RADIO CORPORATION
DEPT. M-15 CINCINNATI, OHIO
Send me your new FREE 40-page catalog.

Name.....
Address.....
Town..... State.....
User-Agents Make Easy Extra Money. Check Here for details.

NEW TYPE CHEAP OIL BURNER

Sweeping the Country!!

COOK and HEAT Without Coal or Wood

In Your Present Stove or Furnace—**HOTTER—CHEAPER—No Dirt or Ashes—Twice the Heat Quick at SMALL COST**



COOKS A MEAL FOR LESS

Beats any oil burner ever gotten out for low cost, perfect performance. Burns cheap oil a new way, without pre-generating or clogging up. Quick intense heat by Simple Turn of Valve.

Try At Our Risk

30 DAYS' TRIAL
Prove it ends drudgery and dirt of coal or wood; cuts fuel bills in half, pays for itself quickly by what IT SAVES.

FREE SAMPLE FOR AGENTS

offered to one energetic man or woman in each locality who will demonstrate and take orders. Write quick, be first to learn how to make REAL MONEY right now, spare or full time—mail in postcard today.

AGENTS Salesmen BIG MONEY
Drop Everything for this Quick Seller. Get YOUR OWN oil burner FREE and make REAL Money. Write now.



Slips into Any STOVE RANGE or FURNACE
Quick HEAT at Turn of Valve!

MIDGET BATTERY OR ELECTRIC RADIOS

World's smallest Loudspeaker Radios Self contained Battery set for farms, etc. All electric for any house lighting current. Just a handful—Wt. only 1 1/4 lbs. (2 1/4 lbs. for battery model). Size only 3 1/2 x 2 1/2" both models. Has two multi-purpose hi-gain tubes. Hi-efficiency coils and precision parts—BUILT IN AERIAL. Midget BUILT IN speaker operates with beautiful tone and clarity on any station including POLICE calls. ACTUAL four tube performance with real distance and punch for so tiny a radio. Easily carried in any large pocket or tucked in knapsack or suitcase. Ideal second or personal radio. Colors to match any room—beautifully finished break-proof cabinets. Only hi-grade parts used—a truly trouble proof midget. Late improvements. Users report wonderful reception in ALL PARTS OF THE WORLD. Every model uses 110 volts A.C. D.C. (220 volt adapters for foreign use extra.) Battery model has midget batteries inside case. Kit of parts with tubes and diagram \$6.45 either model. WIRED AND FACTORY CHECKED \$96 extra or \$6.98 as shown. Send only \$2.00—pay postman balance on delivery. Guaranteed to operate. Colors, Black, Brown, White, Green, Blue (State yours). Set of special batteries for battery set \$1.25 extra. (These will last 4 to 6 weeks average.) Order your set now and be pleasantly surprised!

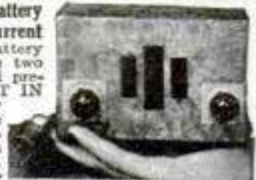

TINYTONE RADIO CO. P-4 Kearney, Nebraska

Electric Arc Welding
Revolutionizes modern Industry

U.S. Manufacturers desire men to learn Electric Arc Welding and get practical experience under actual production conditions in the laboratories of the School of Engineering. Moderate training Fee. Accepted applicants will be fully trained until ready to pass rigid test and assisted in securing employment.

ARC WELDING presents one of the outstanding opportunities for steady income and future success. Welding is growing rapidly, replacing large and intricate castings, rivets, nuts, bolts, screws. It is commonly used in assembling cranes, hoists, bridges, structural steel work, etc. No limit to the application of welding to industry, increasing durability and reducing manufacturing costs. There is a decided shortage of properly trained Welding Operators, Technicians, and Welding Engineers. Why be content with ordinary work, hit and miss jobs and low pay when in a short time you can become a trained Specialist in Welding?

MILWAUKEE SCHOOL of ENGINEERING

Institute of Electrotechnics

Dept. PM-4-A. Broadway & E. State, Milwaukee, Wis.

Without obligation send Free Booklet "The Dawn of a Gigantic Industry and Its Outstanding Opportunity." Also tell me How to Become a
Welding Operator (3 mo.)..... Refrigeration and Air
Welding Technician (6 mo.)..... Conditioning Technician (3 mo.)...
Welding Engineer (1 yr.)..... Radio and Television
Electrical Engineer..... Service Man (6 mo.).....
B.S. Degree (4 yrs.)..... Commercial Radio Engineer (1 yr.)...
Student Loan Plan..... Earn Part Expense Plan.....

Name..... Age.....
City..... State..... (PM-4-A)



The Unholy Search!

DID NATURE REVEAL
HER SECRET?

MEDDLERS in God's affairs. Triflers with sacred things, they were said to be. In musty garrets, in the eerie hours of the night, they bent low over iron crucibles and their strange smelling contents. By what right did they match human intelligence with the forces of the universe, and seek to know their mysterious workings? They were not demons or black magicians, as the superstitious masses of the Middle Ages thought them, but wise men—alchemists—who disclosed nature's greatest secrets at a time when the world was in ignorance. They discovered a method to arouse man's inner powers. **MASTERY, DOMINANCE, SUCCESS** are *secret functions of the mind*, they learned. Every man and woman, it was found, can attain personal mastership in life, when shown how, for the elements are hidden within them.

This Amazing FREE Book Can Help You

The Rosicrucians (not a religion) have preserved in their archives for the sincere, this rare knowledge acquired by these daring investigators of centuries past. Write for your FREE copy of "The Sealed Book" which tells what it can do for you. It has helped thousands everywhere. Address: Scribe T.N.T.

The ROSICRUCIANS

[AMORC]

San Jose

California

(Not a religious organization)

CHIPPED GLASS SIGN MAKING MIRROR RESILVERING

Metalware replating; Interesting; Profitable. Write

SPRINKLE, Plater, 129, Marion, Indiana

LEARN CARTOONING

by the method that has developed hundreds successfully. Send name, address and age for free chart to test your ability.

The Landon School, 1738 National Bldg., Cleveland, Ohio

PENNY EACH ! !

Large sizes! Beautiful Gold Reflecting Window Sign Letters. Fine Quality. 5 Year Guaranteed. New Styles. Tremendous Demand. Amazing Profits. Easily applied. Write for FREE SAMPLES and starting equipment. HURRY!

Atlas Sign Works, 7943 Halsted, Chicago, Ill.



IF YOU ARE
**SKINNY
PALE, WEAK
AILING!**

Without Cost—
Test for One
Week This
New
Sea-
Plant
Iodine!

Thousands of
Thin, Sickly, Tired-
out Folks Report Kelpa-
malt, New Mineral Con-
centrate, Adds Extra Lbs.,
New Strength and Energy the First Week!

If you are weak, skinny and rundown—if you go around always tired, nervous, irritable, easily upset, the chances are your blood is thin, pale and watery and probably lacks the nourishment necessary to build up your strength, endurance and the solid pounds you need to feel right. Science has at last got right down to what is frequently the real trouble with these conditions and explains a new quick way which has brought relief to thousands.

The average person usually eats enough of the right kind of food to sustain the body. Frequently the real trouble is assimilation—the body's process of converting digested food into firm flesh, pep and energy. Tiny hidden glands control this body building process—glands which require a regular ration of iodine (not the ordinary, chemical iodine, which may prove toxic, but the iodine that is found in tiny quantities in spinach, lettuce, etc.). One of the simplest and quickest ways to get an adequate supply of this precious needed substance is Kelpamalt—the astonishing new mineral concentrate from the sea. In addition to iodine, Kelpamalt contributes to the supply of other vital minerals necessary to aid digestion, building of sound tissue, good blood and proper elimination. By thus aiding digestion and assimilation you are able to get more good out of the food you eat.

SATISFACTORY RESULTS OR NO COST!

Try Seedol Kelpamalt for one week. See if, like thousands of others, you don't feel better, sleep better, eat better, and add at least 3 to 5 husky new lbs. the first week. If you don't, the trial is free. It costs you nothing! Your own Doctor will approve this way. Get Seedol Kelpamalt today. It costs but a few cents a day to use and is sold at all good drug stores.

SEEDOL Prescribed by professional model.
Kelpamalt Tablets

SPECIAL FREE OFFER

Write today for fascinating, instructive 50-page book on How to Build Weight, Strength and Energy Quickly. Mineral Contents of Food and their effects on the Human Body. New facts about Iodine. Weight and Measurement charts, daily menus, etc. Absolutely free. No obligation. Seedol Kelpamalt Co., Dept. 1139, 27-33 West 20th St., New York City.

Business Demands Accountancy

—because Accountants Command Business

ACCOUNTANTS have been in demand—at far better than average earnings.

But today—more than ever before—the competent accountant finds his services at a tremendous and increasing premium.

In the depression business tightened up the reins and is watching costs—prices—every move—striving to operate on that basis of close control so essential to profits.

Then too, progressive business is building now for the return of prosperity—laying plans for expansion, for new processes, new markets—getting ready for the unparalleled opportunities of the next ten years.

The Home Study Way to Accountancy Success

Thousands upon thousands of men have trained for Accountancy with LaSalle—at night—at home.

Their success—their progress—is a matter of record.

Whether their goal was a C. P. A. degree or advancement in business, our files are full of overflowing with letters reporting income increases so far out of line with the time and cost investment that there is no comparison.

Note, for instance, these four typical cases chosen out of thousands more we might cite. (Names on request.)

F. F. A. was a railroad yard clerk at \$112 a month when he began accountancy training with LaSalle. Five years later, his income was 500% larger and he was a Certified Public Accountant and attorney. F. C. was 22 years of age and general all-around man in an Arkansas lumber yard at \$75 a month. Five months later, his firm made him manager at \$125, and ten months later promoted him to a larger yard at \$250 plus a commission on sales.

O. D. always thought stories about LaSalle training were fairy tales until the training helped him—a clerk at \$75 a month—move up in six months to \$125, and within four years to \$250. Today he is General Auditor of a large national organization—and his income is more than seven times his starting salary.

As an assistant bookkeeper in a great Western bank, C. F. H. looked forward to slow progress. But LaSalle accountancy training speeded up his climb to Assistant Trust Officer and to a salary increase of 400 per cent.



These Men Won Success in Ordinary Times—You Will Profit by Coming Prosperity.

Remarkable as is the success of these men—you will have a decided advantage over them—you will be entering accountancy when unusual business conditions work with you for success.

Present conditions and the upturn to prosperity not only call for more capable accountants—but offer unusual opportunities for both quick and permanent success. The accounting student of 1936 will face real opportunity in 1937 and the accounting leaders of 1940-45 will be largely determined in 1936-1937.

—If You Can Qualify

Ask yourself three questions:

1. Are you ambitious?
2. Have you determination?
3. Can you see and grasp an opportunity?

If the answers are "Yes"—you are qualified.

If you have determination; if you are ambitious; if you can take advantage of circumstances—*prove it* by investigating. A two-cent stamp, sixty seconds time, and the coupon below will bring you full information regarding Accountancy training and the opportunities to which such training leads. Then you can judge intelligently.

LaSalle Extension University

LA SALLE EXTENSION UNIVERSITY, Dept. 464-HR, CHICAGO

Opportunities in Accountancy—Check below and we will send you a free copy of "Accountancy, the Profession that Pays," also information about our new training in Higher Accountancy, all without obligation.

Higher Accountancy

Other LaSalle Opportunities: If more interested in one of the other fields of business indicated below, check that:

- | | | |
|---|--|--|
| <input type="checkbox"/> Business Management | <input type="checkbox"/> Law: LL. B. Degree | <input type="checkbox"/> Business Correspondence |
| <input type="checkbox"/> Expert Bookkeeping | <input type="checkbox"/> Commercial Law | <input type="checkbox"/> Stenotypy |
| <input type="checkbox"/> C. P. A. Coaching | <input type="checkbox"/> Industrial Management | <input type="checkbox"/> Modern Salesmanship |
| <input type="checkbox"/> Railway Accounting | <input type="checkbox"/> Modern Foremanship | <input type="checkbox"/> Effective Speaking |
| <input type="checkbox"/> Traffic Management | <input type="checkbox"/> Personnel Management | <input type="checkbox"/> Business English |
| <input type="checkbox"/> Railway Station Management | | |

Name.....

Present Position.....

Address.....

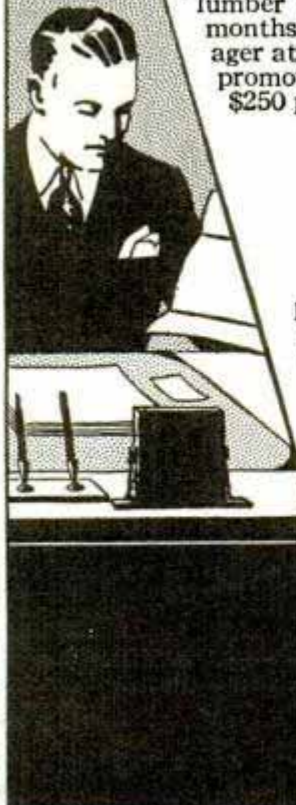

**WORLD'S
BEST
WANT AD
MEDIUM**

CLASSIFIED Advertisements



Advertisements in this section, 35 cents per word, each insertion, minimum 10 words, payable in advance

To be inserted under proper classification in May issue, copy should be in our office March 8th

May issue on sale April 1st

Popular Mechanics Magazine, 200 East Ontario Street, Chicago, Illinois

YOU'LL PROFIT

By reading and answering the classified ads in this section. Hundreds of opportunities to make and save money.

Mr. F. W. Johnson, Mgr. Classified Advertising,
Popular Mechanics Magazine,
200 E. Ontario St., Chicago, Ill.

My Dear Mr. Johnson:—We have been using your publication eight months and in that time we have received orders for over 750 motors, coming from every state in the Union, all over Canada, Mexico, South America, and as far as Africa. We have found that the Classified Advertising Section of Popular Mechanics Magazine has been much superior to any type of advertising that we have ever done in our history, and will continue to use your medium as long as we have any motors left to sell

(Original letter on file in our office)

Yours very truly,
ERIE ELECTRIC MOTOR REPAIR CO., INC.

1000 CLASSIFIED ADVERTISEMENTS 1000 OPPORTUNITIES FOR YOU

AUTOMOBILES

MIDGET Powered car plans. Practical, neat design, \$1.00. Parts service. Complete cars. Send dime for catalog. Derby Midget Car Co., Woodstock, Ill.

NEW Ford repair book for 1937 V-8 and Lincoln-Zephyr cars. Includes data taught in Ford training schools. Answers hundreds of mechanical and electrical questions in non-technical language. Used in thousands of Ford garages. Over 100 pages, many charts and diagrams. Sold on money-back guarantee. Price \$1.00, postage prepaid. Trade Press Publishing Co., Montgomery Building, Milwaukee, Wis.

MIDGET Racing book; facts for fans, builders, drivers; track sizes, regulations; pictures, specifications, working drawings. Also stock car conversions for fastest cars. \$1.00 postpaid. \$1.12 C.O.D. Ray Kuns, Dept. 24, Cincinnati, Ohio.

MIDGET Car plans, parts, engines. Circulardime. Storms, 13 Southside, Asheville, N. C.

FORD V-8's, 1935-37; Model A's, 1928-31; Oldsmobile 8's, 1935-36; saves gas, oil. \$1.00 postpaid. Walert Co., 3429 No. 10th St., Milwaukee, Wis.

LEARN How to repair automobile temperature gauges; We supply kits and instructions. \$8.50. United Gauge and Instrument Company, 436 West 57th Street, New York City.

ROBERT M. Roof, famous automotive engineer, speed and power equipment Fords, Chevrolets, racing cars, midget included, with international reputation. Catalogue 25c. R. & B. Mfg., Anderson, Indiana.

MIDGET Racers, parts, engines. Circulardime. "Kirby's Midgets," Box 1601, Dallas, Texas.

"CALLING-ALL-CARS!" Extraordinary. Ignition supercharger. Performance. Mileage. Economy. Power. Instant starting. Eliminates carbon. Immediately attached. \$1.00 prepaid. Mid-Western Co., Box 1100, Lincoln, Nebr.

ELECTRIC Welder from Dodge generator. Proven blueprints, instructions, \$1.00. Carlson, 2212 Grand, Omaha, Nebraska.

FORD Owners—Improve your 1935-36 car with Brake Kickers, easily installed, full instructions, guaranteed. Eliminates chatter, fade out, etc., giving soft energizing brakes. Used by Ford dealers. Price \$2.50 set. Associated Engineers, 3309 Easton Ave., St. Louis, Mo.

ECONOMY! Performance! Mileage! Semi-diesel conversions for all gasoline motors. \$5.00 up. Deal direct with the manufacturers. Unconditional written guarantee. Special complete units for Ford and Chevrolet. Learn basic facts, illustrated literature free. Des-A-Gas, 1719 Addison, Berkeley, California.

SPECIAL Semi-Diesel, diagrams, instructions, 25c. Sovereign's Sales, Toronto, Canada.

FORD V-8s—5 to 8 more miles per gallon with "Automatic Gasaver." uses the fumes from crank-case. Automatic Gasaver Co., 126 W. Wood Str., Youngstown, Ohio.

AUTOS Now burn fuel oil. "Dieselore" tells three methods to make "change-over," with plain, easy, simple instructions that you can follow. A new publication for the man who wants to know, build, repair and read about semi-diesel conversions. "Dieselore," \$1.00. Box 3083, Hollywood, Calif.

INCREASED Mileage; lowest cost. Old-st original conversion blueprints to burn stove distillate in any car. Complete information and blueprints 50c. Maydwell Mfg. Co., Box 492, Glendale, Calif.

DIESEL! Controlled, complete, combustion chambers. Best auto-diesel conversion. Guaranteed. Complete data \$1. Information dime. Perry, Diesel Engineer, Washougal, Wash.

(SPECIAL) Factory prices, genuine Desogas fuel-oil converters. Two years demonstrated superiority. \$4.75 up. Pretti Desogas, 1618 6th, Berkeley, California.

AUTO SUPPLIES AND EQUIPMENT

USED Auto parts at half price for all cars. Century Parts Co., 1712 Lafayette Ave., St. Louis, Mo.

DEMONSTRATORS. Compressor, test bench, 8-hour battery charger—are welder. Guaranteed. Trial and terms. Ken's Equipment Exchange, Box M-471, Troy, Ohio.

NEW—Ignition supercharger—Easy starting—Wet or cold—More mileage—Pep—Less carbon. Send \$1.25. Easy attached. E. G. Sales Co., 321 Broadway, New York.

TIRES—Firestone's, Goodyear's, others. Cut prices. Tireman, Lake, New York.

PLATING Outfits for automobile parts. Connect to battery. No tanks used. Free particulars and proofs. Gunmetal Co., Ave. J, Decatur, Ill.

A. C. GENERATORS

PRACTICAL Changes for automobile generators. See our advertisement at bottom of page 133A. Autopower, Inc.

AUTO TRAILERS

BUILD The famous Jim Dandy cabin trailer—thousands on the road! A roomy, good looking trailer easy to build at low cost by anyone handy with tools. Complete plans and instructions—only 50c—give every detail of chassis, body, top, beds, cabinets, refrigerator, electric light and water systems and where to buy all parts. Can be built in any size to accommodate 2 to 4 people. Send 50c for these practical plans. Rush your order today to Jim Dandy, Box 1125, Wausau, Wis.

HOUSE Trailer, streamlined, blueprint and specification, fifteen or eighteen feet. \$1.00. Stewart Trailers, Box 174, Cary, Ill.

ANNOUNCING A new house trailer, streamlined, roomy, luxuriously furnished, plus the Fold-a-way feature. Fold-A-Way Trailer Co., Box 642, Davenport, Ia.

\$1.00 BLUEPRINTED Plans, instructions, streamlined trailer, materials \$100. Trailer Designers, Box 885, San Diego, Calif.

TRAILER Axles, wheels, springs, equipment. Roberts Trailers, 11429 Forest Ave., Chicago.

PARTS For the Popular Mechanics "Family Trailer" featured in the February, March and April issues. Everything you need—Axle, hitch, wheel housings, water tank, pump, toilet, sink, stove, wood parts, windows, screens lights, cushions, etc. Send for price list. Include 25c for our big catalog and Trailer Builders' Manual. Trailer Supply Co., 410 Grand Ave., Wausau, Wis.

MOTORCYCLES, BICYCLES AND SUPPLIES

MOTORCYCLE Mechanical manual, 80 illustrations, 100 pages, covering carburetion, ignition, combustion, transmission, compression, electrical units conversion tables, 175 items of upkeep and repair—Indian, H-D., Excelsior. 75c postpaid. The Motorcyclist, 333 W. Second St., Los Angeles, Calif.

SEND 10c For new 1937 Handbook of Information, listing new and used parts, for Indian, Harley, Excelsior, Henderson; accessories, batteries. Bootz, 622 East Grand, Des Moines, Iowa.

MOTORCYCLES—Direct to you at rock-bottom wholesale prices. Rebuilt, roadtested and guaranteed Indians, Harleys, etc. Send 10c today for "Bargain Bulletin 43." Crandall Hicks Co., 780 Commonwealth Avenue, Boston, Mass.

ALLOY Pistons—Harley, Indian, Henderson, Excelsior, new or used parts, cylinder grinding. Catalogue and wings pin 10c. Ballak, 1115 Chestnut, St. Louis, Mo.

NEW And used parts for all makes of motorcycles. Elmer Nelson, LaMolle, Ill.

SEND Dime for sample racing magazine, catalog Indian and English motorcycles, speed books, racing crash helmets, supplies all motorcycle. New and used motor scooters, great fun. Clymers, 434 W. Pico, Los Angeles, Calif.

USED Motorcycles, bicycles, parts, guns, motors, lathes, etc. Catalogue 15c. Dicksons, Beaconsfield, Iowa.

POWER Your bike with low priced Speedbike motor. Attach in one hour. Eighty miles to gallon. Thirty miles an hour. Free folder. Guaranteed. Evinrude Motors, 4048 N. 28th St., Milwaukee, Wis.

RECONDITIONED Motorcycles. New—used parts for all makes. Authorized Harley-Davidson dealer. Whitman Motorcycle & Supply Co., 405-9 Southwest Blvd., Kansas City, Mo.

MOTOR Bicycles \$45.00, tires \$3.00, chains \$1.50. Forks, new magnetos \$10.00. All parts bicycles, tandems. Wheels \$2.00. Send 15c. Deninger's, Rochester, N. Y.

BALLOON Streamline bicycles with built-in lock. Free insurance, \$22.50. Low prices, lamps, horns, wheels, tires, coaster, parts, accessories. Send for free circular. Illinois Cycle Supplies, 4941 South Ashland Ave., Chicago, Ill.

SEND 15c For illustrated used motorcycle catalog. Bargains. Largest stock genuine Indian parts and motorcycles. Indian Motorcycle Sales, Kansas City, Mo.

GENUINE Harley Davidson parts, accessories, repairs. Prompt service. Send 10c for used motorcycle bulletin. Bill Knuth, 2491 Fondulac Ave., Milwaukee, Wis.

MOTORCYCLE Bargains, lowest prices, bargain sheets for stamp. Motorcycle accessories. Rochester Harley Davidson Corp., 129 West Main St., Rochester, N. Y.

REBUILT Motorcycles, all makes, new and used. Harley Davidson parts. Send 10c for bulletin. Western, 914 E. 15th, Kansas City, Mo.

AVIATION

MODEL Airplane supplies. Bargains 18" lengths. 1/16 square, 100—5c; 1/16x1/4, 35—5c; 1/8x1/4, 30—5c; 1/8x1/2, 10—5c; 1/4x1/4, 6—5c; 1x1, 5c; 1x2, 10c; 1/32 or 1/16x2, 8—10c; 1/4x2, 6—10c; 1/4x2, 3—10c. Cement, clear dope or colored, 5c ounce. Tissue, assorted, 19c dozen. Add 15c postage. Catalog 3c. Imperial Model Aero, 416-F McDonald, Brooklyn, N. Y.

WANT To get into aviation? Train at home in spare time. Complete, practical up-to-the-minute home study course trains you to fill many different types of ground jobs. Write for free book. Aviation Institute of America, Dept. A10F, 1115 Connecticut Ave., Washington, D. C.

DON'T Buy anything until you get Ort's Aviation Material Catalogue. Prices are lower. Send thin dime today. (Canada 20c.) Karl Ort, 634 W. Poplar, York, Pa.

PROPELLERS Sled-Lightplane. Literature 10c. Woodcraft Propeller Co., Hillside Station, Wichita, Kans.

22" AIRPLANE Fan propellers, \$2.00 postpaid. Fanco, 7716 South Broadway, St. Louis, Mo.

PROPELLERS For airplanes, iceless, snowless. Catalog dime. Lorenzen Propellers, Niles, Michigan.

YOUNG Men interested in entering aviation under apprentice plan see ad on page 16A.

GET Into aviation. Air transport pilots get up to \$7,000 per year; mechanics, \$2,500. Learn at this government approved school. Write for complete information. State age. Lincoln Flying School, 2004 Aircraft Building, Lincoln, Nebr.

MAKE Money in aviation. Special mechanics training course—Finest instructors and equipment—Located at aviation center. Write Robertson Aviation School, Department D, Lambert-St. Louis Municipal Airport, Robertson, Missouri.

QUALITY Propellers, 4 ft. Harley \$1.95, 4 1/2 ft. Henderson \$5.00, Fordchev \$7.50. Literature free. Standard Propellers, Fort Worth, Tex.

AIRPLANES \$50 Up. Terms. Motors, craccups, salvage. Complete directory 25c postpaid. Aircraft Directory, Athens, Ohio.

NEW Airplanes, \$98.00. Terms. Motors, propellers, air-wheels. Send 25c for information. Hibbs, Fort Worth, Texas.

BATTERIES, GENERATORS, ETC.

ELECTRIC Light plants 350 watts and up. AC or DC. For use with or without batteries. Priced as low as \$95. Ideal for cottages, camps, trailers, etc. Write for bulletin "G." Universal Motor Company, Oshkosh, Wisconsin.

110 VOLT, DC., 2 kw., 600 rpm., water-wheel or engine generator. George Heine, RFD., Orwigsburg, Penna.

USED 3 And 5 hp. generators (welding, searchlight, wind-house-gas). \$30 and \$45. Ev. Scanlon, Lakewood, R. I.

EDISON Storage batteries for light-power systems. Non-acid. Odorless. Fifteen year life. Five year unconditional guarantees. Bargains in complete generating plants. Low prices. Free illustrated literature. "See-Jay" Battery Company, 82 Sterling Avenue, Yonkers, New York.

SPECIAL Wind-electric, diagrams, instructions, 25c. Sovereign's Sales, Toronto, Canada.

ELECTRIC Lights—Wind driven—You build them. Write Wind Motor Electric, Brainerd, Minnesota.

EDISON Storage batteries for light-power plants. Non-acid, non-sulphating. Long life. Fully guaranteed. Low priced. Also attractive bargains in power-light plants, generators, motors, etc. T. Hawley Smith Company, Croton Falls, N. Y.

GENERATOR Propellers, expertly designed at factory prices. Hibbs, Ft. Worth, Texas.

ELECTRICAL SUPPLIES—EQUIPMENT

HUNDREDS Of new and rare items, replacement parts and supplies. Send 10c for new, 60-page wholesale catalog. Autopower, 410-M S. Hoyne Avenue, Chicago.

WELDING AND SOLDERING

SAVE Money on new and factory rebuilt welding and cutting torches, regulators, tips, supplies. Send for current bulletin. Lowest prices. Low cost repair service. Guaranteed. Welding equipment service, Box 242, West Alexandria, Ohio.

60 AMPERE, 110-Volt arc welding transformer \$8.00, 100 ampere, 110-220 volt, \$16.00. Welding supplies. Literature. Arcmaster, 1936 Lyndale, South Minneapolis, Minnesota.

DEMONSTRATORS, Electric arc welders. Money-saving prices. Used by the government. Trial and terms guaranteed. Hobart Welders, M-472, Troy, Ohio.

DODGE Arc-Welder 25-200 amperes. Build it yourself. Low cost and upkeep. Results guaranteed. Certified instructive plans \$1.00. COD \$1.12. Welders' Club of America, Box 3432-A, Merchandise Mart, Chicago.

REPAIR Fenders, braze, solder. New arc-welding outfit, \$1.00. Dickerson Manufacturing, Springfield, Missouri.

ACETYLENE And electric welding equipment. Box 331, Hamilton, Ohio.

REBUILT Electric arc welders, all sizes, a.c.—d.c. Service Co., 3732 Cedar Ave., Cleveland, Ohio.

300 AMPERE Welding generator. Fine condition \$150.00. Wilnot Auto Supply, 1970 Wilnot St., Chicago.

ARC-WELDING Outfit \$1.25. Weld fenders, braze, solder. Lavrow, 4368-W. Warren, Detroit. Stamp appreciated.

MACHINERY, TOOLS AND SUPPLIES

CIDER Presses, graters, pumps, filters, supplies. Booklet free, money in roadside mills and how to keep cider sweet. Palmer Bros., Cos Cob, Connecticut.

BARGAINS, New Vise-Grip wrenches. Write Ralph Waxham, Lincoln, Nebr.

COMPRESSORS, Single cylinder, 100 lb., \$6.00. Edison universal double shaft motors, \$2.00. Powerful G. E. 15 volt transformers, \$2.00. All sizes Edison storage batteries. Pioneer Air Compressor, 33 Warren, New York City.

GLASS Drill 50c. Mason, 14 N. Walnut, East Orange, N. J.

KELLOGG Air compressors. \$6.00. Electric refrigerators \$25. Taylor, 105 East 102nd Street, New York.

REBUILD Ford A or A motor into fast pumping air compressor. Instructions \$1.00. Tuck's Garage, 73 Sherley, Pontiac, Mich.

BARGAINS, Demonstrators, electric arc welders, guaranteed, 30 days trial and terms. Write Ken's Equipment, Box M-473, Troy, Ohio.

LATHE, Bench type, \$39.50. Screw cutting, new. Burk Machine, 1314 Prospect Ave., Toledo, Ohio.

MICROMETERS Repaired, threads lapped \$1.00. Guaranteed. Machinist's tool boxes \$6.00. Schmidt, 3216 Olive, Chicago.

FREE Catalog all shapes brass, copper, steel, aluminum, Dowmetal, monel, stainless steel, gears. Hobby Supply House, Box 2014, Pittsburgh, Penna.

EVERY Tractor owner needs Irving's \$4 page 1937 tractor replacement parts catalog. Absolutely free. Thousands parts, all makes; tremendous price savings. Irving's Tractor Lug Co., 134 Knoxville Road, Galesburg, Illinois.

SPRING Winder, best on the market. Circular 10c. John Bianer, Box 163, Sharon, Pa.

1/2 HORSE, 110 Volt, Universal motors with 14 to 1 gear reduction \$3.50. Wilnot Auto Supply, 1970 Wilnot St., Chicago.

15" x 6" SOUTH Bend screw cutting engine lathe, \$175.00. 14" Steptoe crank shaper \$125.00. All sizes of machine tools. Cincinnati Machinery & Supply Company, 27 West Second St., Cincinnati, Ohio.

TREMENDOUS Surplus of factory tools selling out. Drills, taps, files, hacksaws, etc. Send for free lists, include six cents postage. Travers Tool Co., 264 Jackson Ave., Long Island City, N. Y.

MACHINISTS, Tool makers chests at bargain. Circular free. Cepader, 3602 Wesley, Berwyn, Ill.

ENGINES, MOTORS, DYNAMOS

207 DIAGRAMS Of alternating current motors including three phase Star, Delta, nine lead; two phase; single phase washing machine, fan, drill, refrigerator, dual voltage and speed types. Many special connections. Several valuable tables. \$1.50 prepaid. Satisfaction guaranteed or money refunded. Educational Advancement Company, Box 252, Lakewood, N. Y.

SWEEPER Armatures only \$2.75! Any make, drills, fields. Finest quality. Wolverine Rewinding Service, 3250 Tyler, Detroit, Mich.

ELEVEN 1/2 Hp. a.c. motors, 60 cycle, 1 phase, 110 volt, like new, guaranteed, \$10.50. Send check to Erie Electric Motor Co., 120 Church St., Buffalo, N. Y.

ELECTRIC Motors—New, rebuilt. All makes, all sizes. Tell us your needs. Bargain pricelist free. MalHorder Electric Co., 1718 So. Michigan, Chicago.

MARINE Inboard engines, all sizes: 1 cylinder to 8 cylinders. Featuring our 1 cylinder 8 hp. engine for \$140. Featuring our 4 cylinder, 25 hp. engine, complete with electric starter for \$287. Write for catalogue. "Department G." Universal Motor Company, Oshkosh, Wisconsin.

REWIND Wash machine motors. Particulars stamp. Rewinder, Box 844, Sandusky, Ohio.

SMALL Electric motors, circular free. New, 110 volt rheostats \$2.50 postpaid. L. McConnell, 1619 Edgewood, Racine, Wis.

GOVERNORS Control speed of any make of auto engine, regardless of load changes, when used for stationary or portable power production. Read our ad on page 138A. Man'f'g Candee-Smith Governor.

12 VOLT Dodge generators \$4.00. N. P. & M. Wks., 1367 Niagara St., Buffalo, N. Y.

TO Close out. Slightly used 1/2 horse, 110 volt, alternating motors \$8.50. Wilnot Auto Supply, 1970 Wilnot St., Chicago.

NEW One horsepower motors \$32.00; 32v. Delco light plants \$60.00. A.C. and D.C. generators. Queen City Electric, 1736 Grand Avenue, Chicago.

WINDING Data, 225 motors, single and three phase. Price \$1.00. Motor Data Co., Box 7631, Kansas City, Mo.

BOATS, OUTBOARD MOTORS, ETC.

STOP! Listen! Our fully fabricated boat frames and materials are entirely different. Save 2/3 and costly mistakes. Catalog 100 boats, 9 to 75 feet, 10c. Bay City Boats, Inc., Bay City, Michigan.

15 FT. Canoe \$32.50. Ready to ride. Catalogue free. Jamestown Specialty Company, 377PX, Titusville, Pa.

BOATS—Everything for building, equipping or repairing a boat. Build a boat by the Welch system. Use Welch ready cut parts. Inexpensive, interesting and profitable. Send 10c for catalog showing boats of many types; boat hardware and boat materials. Welch Boat & Supply Company, Station K-1, Milwaukee, Wisconsin.

KAYAKS. Kits. Sensationally new designs. Five remarkable major improvements. Outstanding values. Catalogue dime. Dedham Wood Products, Dedham, Mass.

12-FOOT Flat bottom rowboat—complete plans 25c. Free boatbuilding catalog. The Rudder, 15 Murray Street, New York.

FORD Marine conversion parts and kits. Models A, B, V8 (domestic or foreign). Catalogue 25c (coin). Osmitson, 3101 C St., Philadelphia, Pa.

BOAT Designers are highly paid professionals. Complete course by mail. Catalog. Westlawn, Montville, N. J.

OUTBOARDS. All makes, bought, sold, exchanged. Used parts and accessories. Outboard Headquarters, No. 305 Atlantic Avenue, Boston, Mass.

PROPELLERS. Gear pumps, stuffing boxes, bearings, etc. Wm. Baker, Pond St., Quincy, Mass.

BUILD Your own boat. Save two thirds, use our ready cut semi-assembled materials. Send 25c for catalog. Brooks Boat Co., Inc., G. 20, Saginaw, Michigan.

OUTBOARDS—Save 1/2. Good used parts, all makes and models. Bargains rebuilt motors. Crandall Hicks Co., 780 Commonwealth, Boston, Mass.

KAYAK Construction kits \$9.45 up. Catalogue free. Jamestown Specialty Company, 377P, Titusville, Pa.

SPORTING GOODS, GUNS, FISHING TACKLE, ARCHERY

FENCING Equipment. Foils, swords, masks, etc. Low prices. Free catalog. Industrial Products, 274 Madison Avenue, New York.

FISHERMEN! Finest stock of hooks, Spanish gut, leaders, tools and materials in America. Send 4c in stamps for list and 1937 catalog. Paul H. Young, 8065-3 Grand River Ave., Detroit, Mich.

FLY Fisherman—You can't imagine to what perfection a new Fly Box has been created. If you have not yet seen it on the market write The Daisy Fly Box, Dept. A, Fenton, Mich.

TENTS: Factory to you. Catalog free. Willis Co., Everett, Mass.

BUCKTAILS. Flytied material. Hofmann Studio, 992 Gates Avenue, Brooklyn, N. Y.

HUDSON Bay blankets, Indian pack baskets, camp stoves, knives, compasses, outdoor equipment. Free catalog. Howe Fur Co., Box P, Coopers Mills, Maine.

FIELD GLASSES, TELESCOPES AND MICROSCOPES

POLAROID Junior converts any microscope into a polarizing microscope instantly. It shows a thousand and one objects that appear dull and lifeless through the ordinary microscope in vivid, sparkling color. Send \$3.50, mentioning your microscope model, to Polarizing Instrument Co., 10 West 40th Street, New York.

USED Microscopes, binoculars, astronomical telescopes, surveying instruments—Bought, sold, repaired. Send 10c for list. Rasmussen, P. O. Box 256, Amsterdam, N. Y.

TELESCOPES, Microscopes, binoculars, chemistry, mineralogy. Catalog free. Teeko, Evanston, Illinois.

AMATEUR Telescope maker supplies. 6" aluminumized mirror 52" fl. \$16. Lutts, Norwalk, Ohio.

TELESCOPES, Microscopes, binoculars. Lowest prices. Optical catalog free. Brownscope Company, 234 Fifth Avenue, New York.

FREE Literature—Amateur Telescope Makers Supply Company, 24 West 20 Street, New York.

BUILD Reflecting telescopes; catalog free. Instructions 10c. Optical Laboratories, Larchmont, N. Y.

ANTIQUES, RELICS, INDIAN GOODS

INDIAN Relics, costumes. W. D. Fisher, 800 No. Washington, Hutchinson, Kansas.

20 ARROWHEADS, Spearhead, gempoint \$.99. 10,000 bargains. Firearms. Photolist 10c. Museum, Rutland, Illinois.

5 ARROWHEADS 20c. 3 Birdpoints 18c. Knife, birdpoint, scraper, spearhead 45c. Catalogue, Coins, Minerals, Curios, Lemley Curio Store, Northbranch, Kansas.

100 GOOD Arrowheads \$3.00. Catalog 5c. H. Daniel, Dardanelle, Ark.

TAXIDERMY

MOUNTED Specimens. Glass eyes, supplies. Hofmann Studio, 992 Gates Avenue, Brooklyn, N. Y.

TAXIDERMY Supplies—Quality artificial eyes, teeth, genuine Jonas head forms. Tools, materials, etc. Everything for the progressive taxidermist. Send 10c for big illustrated catalogue. Jonas Bros., 1049 Broadway, Denver, Colorado.

GLASS Eyes, Taxidermists', furriers' supplies. Lowest prices. Forty page catalogue, free. Write today. Elwood Supply Co., 222 Smith Building, Omaha, Nebraska.

DOGS, BIRDS, PETS

NEWFOUNDLANDS. Childrens playmates, home guardians. Dorothy Valke, R 3, Hamilton, Ohio.

AMERICAN Canary Magazine. Monthly. \$1.00 yearly. Sample 15c. 2839-P North Halsted, Chicago.

BEAUTIFUL Pure white police dogs. Ansonia Kennels, Mose, N. Dak.

POULTRY AND SUPPLIES

DAVIS Chicks for immediate delivery. Hatched from big eggs and from egg bred flocks. Barred, White, Buff Rocks, Reds, White Wyandottes, Buff Orpingtons \$8.45—100. White, Buff, Brown Leghorns, Anconas \$7.95—100. Heavy mixed \$6.99—100. Catalogue free. Davis Poultry Farm, Rt. 34, Ramsey, Indiana.

\$4.75—100 AND UP for Seymour chicks. Also we have a "Big Surprise" offer for every chick raiser. We hatch 22 different breeds, sold over 1,500,000 Seymour chicks last year to 8,500 satisfied customers. You can depend on raising around 95% of our chicks. Write for our low prices, big free circular and surprise offer. Seymour Hatchery, Box 39, Seymour, Ind.

BUY Salem's tested chicks. Hatching all popular breeds weekly. Write for our prices on sexed chicks and catalog. Salem Hatchery, Box 19, Salem, Indiana.

FOR Low prices, prompt service, write Smith Chickeries, Box 00-262, Mexico, Missouri. Also selling sexed chicks.

52 BREEDS—Baby chicks, started chicks, baby turkeys, hybrids, pullets, cockerels; hand-picked, Iowa inspected. Beautiful book free. Mrs. Berry's Farm, Rt. 23, Clarinda, Iowa.

POULTRY Tribune—America's leading poultry magazine. Five years \$1.00; one year trial 25c. Poultry Tribune, Dept. 93-C, Mount Morris, Illinois.

FARMS AND FARM LANDS

NEW Farm opportunities! Washington, Idaho, Montana, North Dakota, Oregon, Minnesota. Farm income is up. Good land still at rock bottom prices. Literature. Specify state. J. W. Haw, 119 Northern Pacific Ry., St. Paul, Minn.

STROUTS New catalog, just out! World's greatest farm list. Many pages absolutely new bargains, nearly 1000 equipped farms, country homes, highway businesses. Sure money-saver. Card today brings free copy. Strout Ag'y, 255-P 4th Ave., New York City.

FREE Book on Minnesota, North Dakota, Montana, Idaho, Washington, Oregon farms. Rents are cheaper. Prices lower. Low rates. Write E. C. Leedy, Department 457, Great Northern Railway, St. Paul, Minnesota.

CANADIAN Tax sale lands in parcels at one dollar an acre up. Small monthly payments. Farms, timber, hunting and fishing camps, minerals. Limited number of properties. Write at once for free illustrated booklet. Tax Sale Service, Room 613, 72 Queen St., W., Toronto, Canada.

40 ACRES, Near White River, unimproved, poultry land, \$100, \$5 down, \$5 monthly. Free list and literature. Hubbard, 216 Grossman Bldg., Kansas City, Kansas.

TREES, SHRUBS, ROOTS, HERBS

COLORADO Blue Spruce—From the Rocky Mountains. I will prepay to you. 4 extra strong 4 year old trees for only \$1.00. H. D. Belcher, Brook Forest, Colorado.

BOYSENBERRY! World's largest vine-berri! Hardy. Free pictorial pamphlet! Grower's affidavit making \$311.60 from 100 plants! Amazing information. Rancho Verdad, Mentone, Calif., Hampton, Va., Ardmore, Oklahoma.

JUST Out! World's greatest "Herbalist Almanac." Beautifully illustrated in natural colors. Contains over 200 old-fashioned herb medicine recipes for home use. 10c postpaid. Worth dollars! Botanics, 145 West 112th Street, Chicago.

PROFITABLE OCCUPATIONS

FUR Farming—Profitable business. 60c book, now 25c coin. Fur Farms Publishing Co., Karcade, Utica, New York.

"RAISE Giant Frogs!" We buy! Start small pond. Free frog book. American Frog Canning, (153-D), New Orleans, Louisiana.

IT Pays to raise earthworms. California Earthworm Farms, LaCanada, California.

RAISE Giant mushrooms! We buy! Start cellar, shed. Book, pictures free. United, 3848 Lincoln Ave., Dept. 59, Chicago.

RAISE Canary birds for us. Catalog, instructions 3c. Roderick's, South Bend, Ind.

MINK, Bred females. April delivery. Dime for general information. Lowman's Fur Farm, Barnesboro, Penna.

BOOKS, Plans, Opportunities. Home City Specialties, Dept. 1273, Springfield, Massachusetts.

FREE Circulars describing hundreds of money making opportunities selling by mail. Build your own business. Write now. Progress Publishing Co., 2513-G North 9th St., Milwaukee, Wisconsin.

FREE Booklet describes 107 plans for making \$20-\$100 weekly, in home or office, business of your own. Elite Co., 214 Grand St., New York.

RAISING Jumbo frogs. Interesting. Big future. Females lay 10,000 eggs. Free literature. American Frog Industries, Box 336, Rayne, Louisiana.

OLD BOOKS WANTED

WE Pay up to \$5000 each for old books, also high cash prices for old magazines, letters, newspapers. A single story book, school book, old Bible, travel book, almanac, etc., that looks worthless may bring you \$50, \$100 or \$500 in cash. Thousands wanted! Send 10c now for latest price list. American Book Mart, 140 S. Dearborn, Dept. 1513, Chicago.

BOOKS, PERIODICALS, PICTURES, POSTCARDS

FREE! Big catalog describing hundreds of books on various subjects. Franklin Publishing Company, 800 North Clark Street, Dept. 2213, Chicago.

YOUR Favorite magazines—Half price. Catalog, 10c. Magazine Exchange, Baseline, San Bernardino, Calif.

MOTOR Racing Magazine—Air, auto, boat, motorcycle. Sample, 25c. 56 Congress, Chicago.

DREAM Book, 4,000 interpretations, also lucky numbers, 25c. Kubelka, 58 East 106th, New York.

FREE—Send for list of new technical books at sensational discounts. M. Winn, 124 West 23 St., New York.

50 CUBAN Postcards, \$1.10. Money back guarantee. Fool friends: we'll remail postcards, 2c each. Wholesale Postcards, Box 2343a, Havana, Cuba.

\$400,000 PRIZES. 200 Contests monthly in Contest News. Sample copy 25c, coin, stamps. Contest News, Toledo, Ohio.

EGYPTIAN Dream book explains what 968 dreams mean. Prepaid, 10c. Franklin Publishing Company, 800 North Clark Street, Dept. 2217, Chicago.

NEW Dream book, 116 pages, 1200 dreams 35c postpaid. Buddy Packing Co., Lexington, South Carolina.

GAMES—ENTERTAINMENT

FORTUNE Telling by cards, 10c. Latest methods; entertain your friends. Franklin Publishing Company, 800 North Clark Street, Dept. 2216, Chicago.

PLAYS, Operettas, musical comedies, complete minstrel first-parts with song programs, blackface skits, vaudeville acts, monologs, dialog, recitations, juvenile plays and songs, musical readings, entertainments, make-up goods. Catalog free. T. S. Denison & Co., 623 So. Wabash, Dept. 11, Chicago.

MAGIC TRICKS, PUZZLES, JOKER NOVELTIES

AMAZING Hindu mystery trick vanishes money! Together with complete catalog of magic tricks, novelties, jokers, mind reading items, etc., for only 5c! National Magicians, 226 S. State, Dept. 250, Chicago.

LARGE Illustrated magic catalogue 20c. Lynn, Midland Ave., Paramus, N. J.

LEARN Ventriloquist art. Easy. Low cost. Free details. Apex, 221 E. 31, New York.

MYSTERY Exploding device. Novelties, tricks, samples. All postpaid 20c. Woodcraft Service, Novelty Dept., Plainview, Minnesota.

25c COIN Brings new amateur and professional catalogue and sample tricks. Major A. Drum, 114 West 13, New York.

LEARN Fire eating. Safe method. Manly, 1315 Ferris A, Los Angeles.

NEW Magic book. Tricks, acts. 25c. Weston, 607 - 8th So., Seattle, Wash.

FUN—Magic—Mystery. "Hindo Prayer Chain." The greatest optical illusion of the age. Illustrated instructions enclosed. 50c each, postage prepaid. Stamps not accepted. The Magic Mart, 1228 Eye St. N. W., Box 322, Washington, D. C.

FREE Tricks! Join Magicians' Fraternity! Monthly magazine, sample, 10c. International Magicians, Mt. Morris, Ill.

FIFTEEN New tricks. Sample 50c. Catalogue free. Eagle Magic, Minneapolis.

AMAZE And mystify! Hundreds of tricks for home or stage require no skill. You can perform them—be popular entertainer. Learn fifty good ones by sending 10c for "50 Magic Mysteries," and receive free "Book of 1000 Wonders," America's most complete catalog of low-priced magic. Lyle Douglas, Station A-5, Dallas, Texas.

FIRE Mysteries tricks. Fifteen for 25c. Octave Verret, Raceland, Louisiana.

FREE! 12 Amazing card tricks fully explained with new magic catalog. All sent for 12c. Nutrix, Box 16-N, Station "O," New York City.

SECRET Purse. Baffle your friends. \$1.00 postpaid. Details 10c. Ernie's, Kindred, N. D.

84 MYSTIFYING Card tricks, 10c. Explained in simple language, illustrated. Franklin Publishing Company, 800 North Clark Street, Dept. 2215, Chicago.

BE A Magician. Send 20c mailing fee for our large catalog. Chicago Magic Co., 2300 N. Mason Ave., Chicago.

MAGIC Apparatus, illusions, catalog 3c. McKwade, 600 Martinique, Dallas, Tex.

EARN Money in any crowd. Call names of strangers, tell unspoken questions. Professional course mind reading, spirit writing, etc., \$1. Henderson, Box 341, San Bernardino, Calif.

LARGE Professional magic catalogue, 25c. Holden, 220 W. 42nd St., New York.

LEARN Ventriloquism, 3c stamp brings particulars. Smith, 125 North Jefferson, Peoria, Ill.

FREE—6 Magician's tricks to all requesting our new magic catalogue. Inclose quarter for postage and packing. Supreme Magic Co., Mt. Kisco, N. Y.

RARE COINS

1909 CENT \$10—We buy certain coins, common and rare—Others worth to \$6000; 1864-1865 Indian head cents \$100 each; dimes before 1895, \$450; Liberty head nickels before 1914, \$300; large pennies, \$2000; encased postage stamps, \$13; half cents, \$275; half dimes, \$175; quarters, \$300; fractional currencies; paper money; gold dollars \$1,500; colonial coins, \$300; silver dollars, \$1,000; 1933, 50c, \$4.00; foreign coins \$165, etc. Send 15c today for illustrated 1937 coin book, before sending coins. National Coin Corporation (82), Springfield, Massachusetts.

OLD Money wanted. Will pay fifty dollars for 1913 Liberty head nickel (not buffalo). I pay cash premiums for all rare coins. Send 4c for large coin folder. May mean much profit to you. B. Max Mehl, H. Mehl Bldg., Fort Worth, Texas.

COMMEMORATIVE \$1/2s, Illinois, Stone Mountain, Oregon, Texas, Long Island, \$1.50 each. California gold quarter size and illustrated catalogue 25c. Auction catalogue 50c. Norman Shultz, Salt Lake, Utah.

COLLECT Old coins? We have them. Send stamp for list. Frank Lenz, 50 Station L, New York City.

OLD Books wanted. We pay cash for old books, newspapers, letters, etc. A single book in your home may bring you as much as \$10, \$50, \$100, \$2500 or even more. We will pay up to \$6000.00 each for certain books. Many old books that look worthless are worth big money. Check up on what you have. Send 10c for our latest complete 24 page buying catalogue and other valuable information. May mean much profit to you. New England Book Exchange (25A), Nantasket, Massachusetts.

NEW Illustrated coin book 15c. Auction catalogue free. Entire collections wanted. Ira S. Reed, Sellersville, Penna.

WANTED—Will give 2 beautiful 50 peso magnificent Angel of Mexico centennial gold coins for one U.S.A. Panama Pacific \$50.00 gold coin. Other coins for sale. List 10c. Name coins you want. Roy Radtke, 56 Dale Street, Rochester, N. Y.

COMMEMORATIVES: Bay Bridge, California jubilee \$2.75 each, San Diego, Oregon \$1.45 each, Spanish trail \$6.25, Hudson \$9.25, Hawaii \$12.50, Vancouver \$7.50. Coin book 15c, circulars 3c. Coinshop, 2510 Chester, Alameda, California.

U.S. TWO Cent piece in 1860's with lists 20c. Acorn Stamp & Coin Co., South Norwalk, Conn.

50 OLD Coins, all different, \$1.00. 10 dates 3c nickels \$1.00. Texas half dollar unc. \$1.25. Claud Denney, Box 1825, Dallas, Texas.

WE Pay \$3.00 each for 1914 Lincoln cents D or S mint in uncirculated condition. We purchase all kinds of coins and paper money. Send 15c for new and interesting 28 page buying catalog before sending coins. (No other book purchases requested.) American Coin Company, Box 3507-A, Cleveland, Ohio.

ANCIENT Coins, all United States series and foreign always carried in stock. Write us your wants. United States premium booklet 20c. New Netherlands Coin Company, Suite P, 95 Fifth Ave., New York.

COIN Collectors—Read "The Numismatist." Monthly news on coins, medals, and paper money. Published by American Numismatic Association. \$3.00 annual dues includes subscription. Write for descriptive circular. Suite P, 159 Washington Street, Mount Vernon, N. Y.

COLUMBIA And Stone Mountain commemorative half dollars, both \$1.60. Hubert Careaba, Numismatist, St. Augustine, Fla.

10 COINS, Bills, tokens and catalog, 10c. Otto Oddehon, Springfield, Missouri.

25 COINS, 25c; 100, \$1.00. Coin Exchange, Box 2544, Kansas City, Mo.

UNITED States. Large cent, 2c bronze, 3c nickel and bargain list, 25c. Eleven dates large cents, \$1.00. George P. Coffin Company, Augusta, Maine.

\$5.00 TO \$500.00 Each paid for old coins. Keep all old money. Send 10 cents for illustrated coin value book. 4x6. Guaranteed prices. Buying and selling. Coin Exchange, Box 5, Le Roy, N. Y.

FREE! Foreign coin, banknote, and large illustrated coin catalogue. Send 4c postage. Coin approvals sent. Tatham Coinco, Springfield-125, Mass.

RARE United States, foreign coins, war medals. Catalogue 10c. Mengelle, Colorado Springs, Colorado.

STAMP COLLECTING

ZANZIBAR—Also Sudan, Somaliland, Tiger stamps, Togoland, Caribbean, Archer, Algerian, Central American, British Colonials. This magnificent collection free for 5c postage. Gray Stamp Shop, Dept. PM, Toronto, Canada.

OLD U. S., 15 different Newfoundland, 20 different Liechtenstein. All only 10c with approvals. Valley Stamp, 1876 So. Penn., Denver, Colo.

WORTHWHILE Premiums given with selections from our better approvals. Cosmo Stamps, 1929 Broadway, Denver, Colorado.

ATTENTION! King Edwards, jubilees, Neid, Gibraltar, Congo, Manchukuo and over 100 different others. Everything only 10c to approval applicants. Atlas Stamp Co., 3 Dumfries St., Galt, Ontario, Canada.

FREE! Scarce mint U. S. telegraph stamp cataloging 50c, and valuable 56-page illustrated catalog: "United States, British, North American, and Foreign Stamps." Send today. Harris & Co., 137-G Transit Building, Boston.

GIANT Liberia triangle, tiniest airmail, packet 55 different including Togo, Gabon, Indochina, 5c with approvals. Killbuck Exchange, Wooster, Ohio.

SCARCE Airmail and triangle. Beautiful Uruguayan "flying horse" airmail and scarce Guatemala triangle (smallest in the world) are included in our big packet of 60 different stamps from Alouites, Grand Liban, Venezuela, British and French Colonies, etc. All for 5c to approval applicants. Big illustrated lists free with each order. Write today! Mystic Stamp Co., (Dept. 80), Camden, New York.

\$5.00 U. S. With complete U. S. price list 10c. Adam Bert, Parke Building, Pittsburgh, Pa.

33 FREE!! American approvals 2c! Loring's, 319 Belmont, Brockton, Massachusetts.

FREE—100 Different stamps to approval applicants sending 5c postage. Yale Stamp Co., 226 W. Longwood, Detroit, Michigan.

SUPERIOR Approval selections foreign stamps. U. S. list free. Aldrich, Box 744, St. Joseph, Mo.

BLACK Lion and giant triangle 5c. Free packet. Approvals. Quality Stamp Shop, Englewood, Colorado.

MONTHLY Stamp and coin magazine, six months and 25 foreign stamps, 25c. American Stamp Journal, Cedar Rapids, Iowa.

WORLD'S Smallest stamp with 200 all different 5c, with approvals. Franklin Shultes, Berne, New York.

FREE Airmails, colonials with approvals. American Stamp Company, Frankfort, Ohio.

52 STAMPS, 52 Countries 10c. Ralph Tanner, Red Creek, N. Y.

60! JUBILEES, British Colonies, airmail, pictorials, 10c. Sachse Stamps, London, Canada.

100 FRENCH Colonies \$0.25 to approval applicants. "Jewells," Tamaqua, Penna.

FREE—U. S. Zeppelin set. 1000 winners will receive 1000 valuable prizes with a total catalogue value of thousands of dollars in our big history making stamp contest. Wouldn't you like to win a complete United States Zeppelin set of 3 values (which costs more than \$40.00 to buy) or a collection of 25 complete mint British jubilee sets including Falkland Island, Seychelles, etc. (which costs over \$45.00 to buy) or a complete collection of Italian colonial airmails face value 545 lira (which costs over \$50.00 to buy)? These are just a few of the thousand valuable prizes we are giving away in this record breaking contest. The complete list of the 1000 prizes will amaze you. No strings or obligations. Get full details of this astounding stamp contest in the new edition of our magazine "Stamp Lore" which will be sent absolutely free together with an attractive approval selection to approval applicants. Write today! It's open to all! Globus Stamp Company, Approval Headquarters, 268 - 4th Ave., Dept. 50, New York, N. Y.

BARGAIN: 50 Different British Empire including jubilee, Edwards, 50 different new, recent and pictorial world issues, 15 different airmails, 500 hinges, perforation gauge—all for 25c. Approvals sent. Lists free. Victoria Stamp Co. London 4, Canada.

25 AFRICA, 25 Japan, 10 cent each. Price list free. Graf, 1874 Loring Place, New York.

KING George first-day covers mailed from England. 10c. Theron Fox, 810M Auzerals, San Jose, California.

NETHERLANDS: Packets, sets. Want lists priced. W. E. Ruddick, Dundee, N. Y.

STAMPS From broken collections. David Hill, 1541 Jefferson, Charlotte, N. C.

NICARAGUA — 100 Different — \$2.00. Zephir's, Stonewall Park, Ellicott City, Md.

FREE—25 Scandinavia to approval applicants enclosing three cents postage. Alfred C. Johns, Sidney, Montana.

UNITED States. 75 different commemoratives, etc., 20c. Steger, Box 154, Crown Point, Ind.

DOMINICAN Republic. 70 different \$1.00 postpaid. Ralph Davison, St. Augustine, Fla.

500 VARS. (100 U. S., 400 foreign) post free, \$1.00. C. Ritchie, Watertown, S. Dak.

1000 MIXED United States, 40 varieties, 25c. Kaystamps, Harrison, Virginia.

EXTRAORDINARY Free offer—Turks Caicos, \$5 U. S., Caymans, Western Samoa (native girl), genuine Baden. Everything free to approval applicants enclosing 3c postage. Viking Stamp Company, 1-Z Hanson Place, Brooklyn, N. Y.

GIGANTIC Collection, containing rare triangle, air mail, Abyssinia, Andorra, Barbados, Carameons, Cape Verde, Dahomey, Kouang-Techeou and other scarce stamps. Only 10c with approvals. Stamp Supply, Redondo Beach, California.

A BIG Bargain—All for only 55c. Stamp album, providing spaces for 2200 stamps with 700 illustrations, packet of 500 different stamps, 500 hinges, and millimetre measure. Free with each order our pamphlet which tells "How To Make A Stamp Collection Properly," and our price list of albums, supplies and hundreds of bargains in sets and packets. Queen City Stamp Company, Room 36, 604 Race Street, Cincinnati, Ohio.

SMALLEST Airmail only 1/2 inch high, free stamp magazine, \$2.00 U. S. stamp, bird, animals, train, Indian, airplane, commemoratives, special issues, with many scarce stamps from 25 different countries, 5c with approvals. Capital Stamps, 413K Roosevelt, Little Rock, Arkansas.

FREE! Unused Texas centennial with order for 50 United States commemoratives—25c. Foreign and foreign airmail approvals. Wunsch, 4320 Sycamore, Dallas, Texas.

FREE Stamps! "Half my valuable collection was given me by acquaintances who noticed the insignia pin," writes Eldon Foster. Dignified silver—Stamp shape—Raised wording. You too may now acquire this extraordinary emblem, plus official card for 50c (coin). Limited offer. United Stamp Collectors Society, Box 1485, Hollywood, Calif.

EDWARDS, Jubilees, etc., included in our 100, different packet including 50 British to approval applicants. Lists free. Mantle Stamp Company, London, Canada.

NEW Rivera Nude stamp! World's largest triangle! Congo, Sudan, South Seas, airmails, pictorials, and many others. Only 3c with approvals. Cactus Junior Approvals, Box 1870, Tucson, Arizona.

MARVELOUS! Scarce! 4 different India jubilees 4c with approvals. Plymouth Company, Bell, California.

150 COMMEMORATIVES, etc. Selected, 10c—"Sur-prize" approvals. Alliance Company, Bolivar, Ohio.

FREE—With approvals. Twenty-five different Canada, Woods, 13 Bayview, Hamilton Beach, Ontario.

\$4, \$5, \$10 U.S. For 5c. Tomlinson, Friends Ave., Haddonfield, N. J.

KING Edwards (4) mint 20c. Approvals. Hunt, 184-U Lambertrille, N. J.

SET King Edwards free, approvals. Enclose postage. Ephriam, River Forest, Ill.

UNITED States—60 different, postage 18c. Galt Keyworth, Hyattsville, Md.

1000 HINGES 3c. Bargain approvals included. V-J Sales, 2729 N. Summit, Milwaukee, Wis.

SPECIAL: Canada edition coronation first day covers. Prices on request. Luke Morgenroth, Tavistock, Ont.

PRECANCLES—500 Different \$17.00, 1000 different \$67.00. Jockey, Box 90, Armada, Mich.

50—15c, 500—60c, 1000—\$1.50. All different stamps; all countries; choice selections. 1000 mixed 35c. Free premiums. Approval applicants, 10c postage. M. Bender, 4434 Second Blvd., Detroit, Michigan.

FREE—50 Italy—Large commemoratives, etc. Approvals—Postage please! "X" change, 4715 Adams, Chicago.

SURPRISE Packet to approval applicants sending postage. Y Company, Box 107, Portchester, N. Y.

FROM Earth's far corners. 25 Republics, Dominions, 40 U.S. commemoratives, airmails, etc., 10c with approvals. Stamp Shop, 809 Holland Bldg., St. Louis, Mo.

COCO Island. Ships, maps. Two values, mint, 5c with approvals. R. McKinney, Elsie, Mich.

FREE—2 Paraguay airmails 40-80, with price lists to advanced stamp collectors. Koenigsmark, 3225 So. 53 Court, Cicero, Ill.

CANADA—35 Different including silver jubilees, pictorials, commemoratives. 10c with approvals. Crescent Stamps, Box 653, London, Canada.

3000 FINE U. S. Hundreds commems., 78c postpaid. John Nagle, North Judson, Indiana.

DIAMOND-SHAPED Rarity, two Tanna-Touva triangles, pictorials, landscapes, others. Everything 3c. Approvals included. Laffal, 91-01EM 102nd Street, Richmond Hill, New York.

1000 MIXED Stamps. Prize packet cat. \$1.00 included. 50c. MacDonnell, 39 Lakewood, Worcester, Mass.

1000 WORLDWIDE Stamp mixture 25c. Moniar, 1542 Waverly, Cincinnati, Ohio.

75 MEXICO, Peru, Ecuador, etc., 5c. Clark, 3024 Lakeview, Dayton, Ohio.

FREE—10 Newfoundland to approval applicants enclosing 3c postage. Douglas, Hawkesbury, Ontario.

U. S.—57 Different (commemorative, airmail, etc.) with approvals 9c. Moseley, 4932 Forestpark, St. Louis, Mo.

CHINA—15 Different, 10c. 25 Finland, 8c. (Stamps accepted.) Eisea, Bowling Green, Ohio.

SCARCE Six-sided stamp (found in very few collections) and 60 different stamps; including U. S. commemorative, new airmail, Cape Verde, Soudan, Honduras, Hyderabad, Brazil, \$2 U. S. All for only 5c to approval applicants. Lennott Stamp Company, Dept. 2, Claiborne, Maryland.

TRIANGLE Map stamps, jubilees, old U. S. and 100 different others, all for 10c to approval applicants. Jones Stamp Company, Box 146, Norristown, Pa.

300 DIFFERENT 20c; 1,000, \$1; 2,000, \$3.00; 3,000, \$7.00; 5,000, \$17.00. Fred Orton, 630 79th St., Brooklyn.

JUBILEES!! Used Trinidad, Jamaica, plus 50 different, 6c with approvals. Stampercraft, Box 126, Kansas City, Kansas.

100 DIFFERENT Stamps and surprise bonus, 5c to approval applicants. Premier Stamps, Box 18, Station K, New York City.

BEAUTIFUL Minerva triangle with 100 different Netherlands 50c. Price lists free. L. C. Trading Company, Box 38A, Bellerose, N. Y.

FREE—Wholesale pricelists. Prince Warren, Grant Hotel, Chicago. No approvals.

FREE—Ten varieties Japan. Japan Co., 4512 North Racine, Chicago.

500 MIXED 18c. Animals, birds, boats, rulers, scenes. Approvals sent. Elmer's, 196A Washington St., Boston.

SUPER Value! 50 select commemoratives 50c. Bay Nielsen, Cornwall, Ontario.

UNPICKED! 100 U. S. revenues on documents—10c. Vanvorhis, Hyndman, Penna.

CASH For mint or used U. S. stamps, accumulations, collections. State price. Any quantity. Arthur W. Gustafson, 1036 North Dearborn, Chicago.

CLASSY Latinamerica pictorials, airmails, latest, 20 different, 10c; 40 different, 25c. H. Chitraro, 521 W. 122nd St., New York.

30 AIRMAILS, Commemoratives, etc. 10c. Approvals. Star Supply Company, Lima, Ohio.

FREE! Rare airmail! Jubilee! Pictorials! Extraordinary packet 65 different stamps from strange countries (no Europe), 5c postage to approval applicants. Bargain Co., Box 39P, Station H, New York.

OBSOLETE. Scarce \$1.00 Abyssinia elephant and thirty other rare stamps totaling \$1.67 sent approval applicants for 3c. Kumbler, King, Lancaster, Ohio.

COCOS Island, complete set, with world's greatest bargain offer, 10c. Gold Crown Stampco, Pasadena, Calif.

MAKE Money! Buying, selling, stamps, coins. Illustrated coin, stamps catalog with prices 25c. Bauer Coin Co., Rochester, N. Y.

15 AIRMAILS Free to approval applicants. Robert Mueller, Johnson Street, Dundee, Illinois.

FREE—Mozambique airmail set, postage 3c. Bauer, 110 Coe Ave., Hillside, N. J.

ITALIAN Commemoratives. 25 varieties 10c. "Good." Edgar Meitzen, Fayetteville, Texas.

NYASSA And New India triangles; Egypt; Lebanon airmails; giant Belgium balloon; packet Congo; SanMarino; Charkhart; China; Mexico; Brazil; many British Colonies; No. Borneo, etc. 6c to approval applicants. Eureka Stamp Co., 602, Burbank, Calif.

AUSTRALIAN Submarine telephone commemorative, French Guiana (anteater); Ceylon jubilee, Canada (Niagara Falls), large Ecuador commemorative, Haiti (aqueduct), also Congo, Jamaica, etc., only 3c to approval applicants. Maynard Sundman, M4, Bristol, Conn.

FREE—25 Different with approvals. Hawthorne Stampco, 3221 So. 53 Ct., Cicero, Ill.

BLOCK Rare Christmas seals and supply maller Kolnkards, 25 cents. Stamps, Sanator, South Dakota.

FREE—Dollar packet to approval applicants. Arrow, 5228 South Paulina, Chicago.

COMPLETE—Mint Japan parks 15c, New Zealand Anzacs 10c. German zeps., used 35c. Free list. Phila-Tel., 1039 Hall Place, Bronx, New York.

NEVER Before! Never again! Real old United States stamp collection! 50 different all before 1905. Only 50c. Bauer Coin Co., Rochester, N. Y.

FREE—\$2.00 And fifteen other United States with approvals. Postage 3c. Wm. Clatworthy, Upland, Calif.

FREE!! Edward stamp, packet Canada 3c, approvals. Hazett Stamp Shop, 701P Fourth, Baycity, Mich.

100 DIFFERENT, 10c. Numbered approvals, postage paid. Traders Club, 16150 Snowden, Detroit, Michigan.

MAMMOTH Mystery packet rare stamps only 10c to serious approval applicants, also valuable free premiums with every selection afterwards. Our stamps are better, our service is different. Fair-Play Stamp Service, 1215 Browning Blvd., Los Angeles, Calif.

111 U. S. Commemoratives 5c; 555, 25c. Williamson, Fontana, Calif.

SILVER Jubilees, 10 different, only 10c with approvals. New Empire Stamps, 269M Jewett, Jersey City, N. J.

SPECIAL This month only. Sizeable packets Brazil, Ecuador, French Morocco, Iceland, Nyassa or your favorite country, only 15 cents with approvals. Send for your wants now. Seascout Service, Box 52, Chelsea, Mass.

PRODIGIOUS Gift! Negri Sembilan, scarce Perak, bi-colored airmail, cheery French colonies, gorgeous Trinidad pictorial, Siberia. Absolutely free with approvals! Postage 3c. Saxon Stamp Co., Dept. 65, Albee Bldg., Brooklyn, N. Y.

KING Edward VIII packet, containing 5 different stamps of the abdicated king, together with 5 different jubilees, 10 different Canada and 15 different Soviet Russia, all for 10c to approval applicants. B. F. Stern, 23-56P Crescent St., Long Island City, N. Y.

ARGENTINE, 60 Diff. 10c with bargain approvals. Davis, Silver Lake, Ind.

FREE—25 Different North-American to approval applicants, 3c postage. Seidenberg, Baroda, Mich.

FREE—\$1.00 U. S. stamp with request for 52 page list of United States and foreign stamps. Stamps on approval. References necessary. 1000 U. S. no current \$1.46. New Hussman Stamp Co., 1122 Pine St., St. Louis, Mo.

21 ISLANDS of the sea including Cyprus, Iceland, Jamaica, Philippines—only 5c to new approval applicants. Foreign approvals only. Nomad Stamp Co., Flint, Michigan.

FREE—Beautiful Minerva triangle and airmails to approval applicants enclosing postage. Green & Company, Norwood, Ohio.

FREE—100 Different to those sending 25c for 5 months of Pacific Philatelist, 2495 Telegraph, Berkeley, California.

U. S. MIXTURE—3 lbs. \$1.00. Holmes Stamp Co., New Albany, Ind.

20 LIECHTENSTEIN .04c To approval applicants. Sodak Stamps, Sioux Falls, S. D.

QUEEREST Stamp packet. Receive world's smallest stamp; Vatican City; scarce Liberia triangle (value 15c); 1925 Greek Red Cross picturing coiled snake in Garden of Eden; Australian Bushman; new Spanish Morocco; Japan "quake stamp; Manchukuo; many others. Only 5c to approval applicants. R. M. Stamp Co., P. O. Box 230P, Port Chester, N. Y.

ILLUSTRATED Album. Spaces 4000 stamps; to approval applicants 20c. Swan Stamps, 604 Swan, Dunkirk, N. Y.

WHOLESALE Approvals. References. Fuld, 3153 So. Grand, St. Louis, Missouri.

UNITED States, Canada, Newfoundland, Mexico! Where? Our "Four Star" approvals. Nothing like them! Write today. Kessels, Box 808, Tucson, Arizona.

AMAZING Offer! Army and navy commemoratives, imperforate Chicago, packet of 23 North American stamps from U. S., Canada, Mexico, Newfoundland. Catalogue value over 65c—all for 5c to approval applicants. Illustrated pricelist free. Curhan Stamp Co., Dept. P. Gloucester, Mass.

NEWFOUNDLAND, 15 Different 5c with approvals. Frederick Brown, Plainfield, N. J.

FREE—Dollar packet to approval applicants. Harlan, 5307 S. Marshfield, Chicago.

UNITED States and foreign approvals. Huber, Three South Eighth, Minneapolis.

SCARCE New giant sized, diamond-shaped Russian "sports" stamp; Nyassaland "leopard"; Morocco; Tanganyika, and other scarce countries included in our big packet of new and recent issues—stamps most collectors have never seen! Get this valuable packet today. 5c to approval applicants. Reimers, 115 Flatiron, Fort Worth, Texas.

50 STAMPS Free, Manchukuo, etc. Postage 1c. Approvals not necessary. Album 3c. Bullard, 268 Northampton, Boston.

\$5.00 U. S. Postage due, No. 2284, fine copy 5c with general approvals. Hudson Company, 116 Nassau St., New York City.

ILLUSTRATED U. S. list, price 50c, large complete U. S. price list free. Send postage. Stanley Gibbons, 38P Park Row, N. Y.

PENNY Approvals that please. Haywood, 395 Adams St., Pomona, Calif.

FREE—15 Different Peru to approval applicants enclosing postage. Ranson, 3555 Fullerton, Chicago.

AIRMAIL Triangles from Liberia and Mozambique, 3 British silver jubilees, new King Edward stamp and packet 25 different stamps from Azerbaijan, China, Ukraine, etc. All for 5c to approval applicants. Clipper Stamp Co., Dept. 7, Gloucester, Mass.

ASK For our wonderful one cent approvals. Prospect Stamp Co., 225 Broadview, Toronto, Canada.

MIDGET Airmail (1/2 in. tall), Szechuen, Kouang-Tcheou, Mozambique, etc., 30 stamps—5c Depraw, Ocean Park, California.

CANNON! Set of stamps showing cannon, firing squad, cavalry charge and 200 other different stamps only 10c to approval applicants. Paramount Stamp Co., 4225 Broadway, Chicago, Ill.

STAMPS: A splendid selection sent on approval. Quality at low prices. Scarce and high value stamps are included in our approval books. Fred Herzberg, Box 91-P, Elmhurst, Ill.

STAMP Dealers, your ad here will bring wonderful returns. Ask me for proof. F. W. Johnson, Manager, Classified Advertising, Popular Mechanics Magazine, 200 E. Ontario St., Chicago.

GIANT-SIZED Russian Zeppelin stamp (cat. val. 20c!) and beautiful Lithuania airmail triangle; also big packet of 53 dif. stamps including Azerbaijan, Epirus, new Martinique, etc. and illustrated lists—all for 5c to approval applicants! World-Wide Stamp Co., Box 600, Camden, New York.

WEEKLY Stamp magazine, thirteen weeks, 10c. Stamp Journal, Kalamazoo, Mich.

PENNY Approvals, that satisfy. Neil Gronberg, Box 5441-P, Philadelphia, Pa.

44 DIFFERENT United States including \$5 stamp, or complete set United States bi-centennials, or 30 different obsolete Canada, 13c postpaid with approvals. C. A. Lennan Co., Box 322, City Hall Annex, New York, N. Y.

\$5.00 U. S. Red and blue liberty, present postage value, Scott No. 573 cat. \$1.25 (retails as high as \$1.00 net by some dealers) only 5c to approval applicants. Giant U. S. pricelist free! Tatham Stamp Company, Springfield-5, Mass.

25 UNITED States, including \$4 and \$5 stamps free to approval applicants. 3c postage. Brownie Stamp Shop, Flint, Michigan.

DIAMOND-SHAPED Stamp, Liberia gunboat triangle, two other triangles, silver jubilee, 27 others, 5c. Crowder Company, 127E North, Baltimore, Md.

FREE!!! King George memorial packet, 15 varieties. Postage 3c. Roberts 901F Fourth, Baycity, Michigan.

LIBERIA Snake triangle, giant Spanish ship triangle, 50 other stamps, 5c. Abell Company, 2527 Guilford, Baltimore, Md.

SET Of twelve New Zealand pictorials, used, 45c. Unused \$1. Stampco, Box 81, Ashburton, New Zealand.

JAVA No. 299-303 used set complete 40c. Solos, Indramajoe, Java.

PHOTO FINISHING

IMMEDIATE Service! No delay! Roll developed, carefully printed and two beautiful 5x7 double weight professional enlargements or one tinted enlargement or six reprints—all for 25c coin. The expert's choice. Reprints 3c each. The Photo Mill, Box 629-Z, Minneapolis, Minn.

ROLLS Developed, remarkable quality, two master enlargements, eight gloss prints 25c. Reprints 3c. World Famous Johnson Studio, Eau Claire, Wisconsin.

HANKIE-FOTOS. Snapshot negative beautifully reproduced on handkerchief. Quarter. Hankiefoto, 205 Jackson St., Apt. 6, Dayton, Ohio.

FILMS Developed 2 prints of each 25c; 20 reprints 25c. Pine Photo, M-5134 Nevada, Chicago.

ROLLS Developed, two sets dated Velox prints 25c. Hench Studios, 1814 Chestnut, Harrisburg, Penna.

MAIL Your rolls to The Kodak City. 8 guaranteed glossy Velox deckle-edged prints, 25c coin. Two professional enlargement coupons free! Photo Finishing Shop, Est. 22 yrs., 411-G Genesee Valley Trust Bldg., Rochester, N. Y. "The Kodak City."

20 REPRINTS 25c. 100 Reprints \$1.00. Rolls developed with 16 prints 25c. Nordskog, 4, Maywood, Ill.

DEVELOP And print your own pictures. Save time, money with our complete \$1.49 outfit postpaid, or pay postman \$1.55 COD. Includes electric ruby lamp, printing frame, photo paper, chemicals and equipment. One of hundreds of amazing bargains in our free, newest, money-saving bargain book. Send for it today! Central Camera Co., 230 So. Wabash, Dept. 14-K, Chicago.

20 REPRINTS 25c. Films developed, two prints each negative, 25c. Skrudland, 6970-8 George, Chicago.

ROLL Film developed and printed, including two beautiful double weight olive tone enlargements free. 25c coin. Nu-Art Photo Shop, LaCrosse, Wis.

ROLL Developed, 8 fadeproof Velox prints and a photo-file 25c. Reprints 3c. Professional 8x10 enlargement 25c. Beautiful premiums. Young Photo Service, 405-B, Albany, N. Y.

ANTIQUE Walnut easel frames, 120-116. Send negative and 20c, two 30c, coins. Fotofram, Riverhead, N. Y.

20 REPRINTS 25c. Films developed, 16 prints 25c. Enlargements 8x10—25c; 5x7—10c. Low Photo, M-2657 Neva, Chicago.

LOOK! Colored enlargement and 8 Monex Art prints from every roll only 25c. Comet Photo Service, Box 266-O, Minneapolis, Minn.

FREE Contest. Your photo may win up to \$15 prize. Mail your roll of films with 25c for 8 permanent prints and magazine describing contest. Home Life, Berwyn, Ill.

IDEAL Finishing. Your roll developed and printed 25c. Snapshot folder and enlargement coupon with each order. Ideal Photo Service, Box 2255, Paterson, N. J.

"HOLLYTINTS Mean better prints." Two Hollywood professional enlargements with trial roll—25c. Handsome premium coupons free. Unequaled service. Hollytints, P-1350, Hollywood, California.

ROLLS Developed 8 prints on Velox, 25c. Enlargement free. Reprints 3c. Photo Shop, Department P, Box 218, Augusta, Ga.

CLEAR, Brilliant prints; prompt service. Roll developed, 2 prints each negative 25c. Enlargement coupon. Photo Finishers, Dept. 5, Cleveland Heights, Ohio.

WHY Wait for pictures? We give 8 hour service! Eight beautiful new Crystallone prints and coupon for 2 enlargements, one colored enlargement, or 8 extra prints, 25c. Bob's Studios, LaCrosse, Wis.

ROLLS Developed, 8 prints and enlargement, 25c. Reprints 3c each. U. S. Film Co., Ogden, Utah.

ROLLS Developed. Two professional double weight, enlargements, 8 Nu Tone prints 25c. Herman Studio, Ft. Wayne, Ind., 105 Main.

22 REPRINTS 25c; 105—\$1. Rolls developed, 16 prints, giant enlargement—25c. Four 5x7 enlargements 25c; 17—\$1. Truefoto, Des Moines, Iowa.

ROLLS Developed—Two new Beautitone double weight professional enlargements, 8 guaranteed fadeless Beautitone prints, 25c. Giant Snapshots, Inc., 667A Green Bay, Wis.

GUARANTEED. 20 Prints 25c. Film developed, 2 prints each, 25c. Rush service. Quality Photo, Hutchinson, Kansas.

PICTURES That compliment your skill, rolls developed and printed 35c each, the best, worth it. Casey, Leakey, Texas.

ENLARGEMENTS—3 For 10c. Roll finished complete and enlarged 25c. Negatives 127-120-116. California Film Service, Department 60, Box 379, Pasadena, California.

ROLLS Developed, remarkable quality, two master enlargements, eight gloss prints 25c. Reprints 3c. World Famous Johnson Studio, Eau Claire, Wisconsin.

ROLL Developed, 8 guaranteed prints and beautiful enlargement, 25 cents. Reprints 3c each. World Photo Service, Box 2154, Spokane, Wash.

ROLL (127 To 122) developed, and 5x7 enlargement of each negative 50c. Extra enlargements 7c each. Send for complete price list. Knickerbocker Photo Co., 127 West 27th Street, New York City.

TWO Beautiful Masterprint enlargements included with roll developed, printed, 25c; finest quality reprints, 2c each. Brown Photo Company, 2209-12 Lowry, Minneapolis, Minnesota.

QUICKER Service, sparkling double-clear never-fade prints. Roll developed, two prints each negative, enlargement coupon 25c. Willard's, Box 3535-A, Cleveland Heights, Ohio.

FINER Photos guaranteed. 48 hour service! Rolls developed professionally—8 Velox prints, 2 bromide enlargements—25c coin. Finerfotos, Box D-898, Minneapolis, Minn.

ROLL Developed, 2 prints each negative, 25c. Reprints 2c. Photoshop, Ogden, Utah.

FILMS Developed and printed, also two double weight enlargements 25c, 8 reprints and one enlargement 25c. Photoart Shop, Box 3406 P, St. Paul, Minnesota.

IMMEDIATE Service! No delay! Roll developed, carefully printed and two beautiful 5x7 double weight professional enlargements or one tinted enlargement or six reprints—all for 25c coin. The expert's choice. Reprints 3c each. The Photo Mill, Box 629-12, Minneapolis, Minn.

ROLL Developed, two prints each, two enlargement coupons 25c. Summers' Studio, Unionville, Mo.

ROLLS Developed, 16 guaranteed prints, two coupons on plain or colored enlargement 25c. Smart Photo, Winona, Minnesota.

LARJAGRAPHER Reprints: (5x7), five 25c. Cardinal Photos, Berkeley Heights, N. J.

ROLLS Developed, 116 size or smaller, eight beautiful enlargements, no small prints, 25c (coin). LaCrosse Photo Works, LaCrosse, Wis.

TWO Glossy enlargements, 1 colored, with roll 25c. Arbor Service, 10 Joliet, Ill.

FOR The discriminating amateur—roll developed and printed on super gloss Velox paper 25c, reprints 2c. Quality instead of quantity, same day service. Paramount Co., 403 E. 92nd St., New York City.

FINER Finishing. Rolls developed and printed, with one colored enlargement, or two professional enlargements. All for 25c (coin). Genuine, nationally known, Moentone superior quality. Moen Photo Service, La Crosse, Wis.

KODAK Enlargements 5x7, 10c; 3 for 25c coin. Send best negatives (film). Dept. 5, Xint Photo Lab., Cedar Rapids, Iowa.

ROLLS Developed. Two beautiful double-weight professional enlargements and 8 guaranteed Never Fade Perfect Tone prints. 25c coin. Rays Photo Service, LaCrosse, Wisconsin.

ROLL Developed and 8 beautiful Velox glossy prints 25c coin or stamps. Reprints 3c each. Fotoprint Service, Box E, Roanoke, Virginia.

DAILY Service—Roll developed, 16 guaranteed prints, 25c. Valuable enlargement coupon; 16 reprints 25c. Modern Finishers, Box 3537-L, St. Paul, Minnesota.

COMPARE The difference! Roll developed, two professional double weight enlargements, 8 guaranteed prints, 25c coin. Excellent service. Nationwide Photo Service, Box 3333, St. Paul, Minnesota.

GET The best. Roll developed, beautiful hand colored enlargement, 8 neverfade border prints, 25c coin. Prompt service. Sun Photo Service, Drawer T, St. Paul, Minn.

CAMERAS, PHOTO SUPPLIES

ANNUAL Clearance sale on guaranteed used cameras in excellent condition. 1/2 V.P. Piccochic, F 4.5 lens \$10.00; 1/2 V.P. Dolly, F 4.5 lens \$12.50; Ikomat A, F 4.5 Novar \$17.50; Baby Ikomat, F 4.5 Tessar Compur \$22.50; Duo Kodak, F 3.5 lens, Compur \$35.00; 9x12 Pioneer, F 4.5 Xenar \$27.50; 9x12 Ideal, F 6.3 Tessar, Compur \$32.50; 3A Kodak, F 6.3 Zeiss Compound \$15.00; Icarrette, F 4.5 Tessar Compound \$20.00; V.P. Primarette, F 2.8 Tessar Compur \$50.00; 2x3 Cocarrette, F 4.9 Tessar Compur \$15.00; 2x2 Icarrette, F 4.5 Icar, Compur \$12.50; 2 1/4 x 3 1/4 Graffex, F 6.8 lens \$15.00. Liberal allowances on used cameras. Henry Herbert, 483-A - 5th Ave., New York City.

PHOTOMURALS—Giant enlargements—Easily made at home. Complete illustrated instructions \$1.00. Information free. Fogarty, 1689 Capitol, Bridgeport, Conn.

CAMERA Owners. Valuable information free. Hively Publishers, Beech Rd., Alliance, Ohio.

INTERESTING Sample copy of 25c photographic magazine for 10c. Special 6 months trial subscription for \$1.00. Photographic Digest, 1666 Linden Street, Brooklyn, New York.

KEEP Your developing solutions. Brown gallon jugs 35c, 4 for \$1.00. Zieter, 1215 E. Fairchild St., Danville, Ill.

ARGUS Camera owners. \$3.50 carrying case \$2.29 and this ad. Mirotext, 6241 Southwood, St. Louis.

INTERESTING Photo free!! Amateur, Postfach 20, Porzellangasse, Vienna, Austria.

MAKE Money with your camera at home. By our new cooperative plan we teach photography, retouch, enlarge and color your work, and aid you to start a studio of your own. Cooperative Photographers, Box 346-J, Patchogue, N. Y.

CAMERAS And supplies. Free illustrated catalog listing everything photographic—still and movie cameras, films, lenses—at tremendous savings. Hundreds of bargains, new and used. All guaranteed. We take your old camera or equipment in trade. Write now for your free copy of our newest money-saving bargain book—just out! Limited edition. Hurry! Central Camera Co., (Photographic Headquarters since 1899), 230 So. Wabash, Dept. 4-K, Chicago.

WE Buy snapshots. Send 10c for list. Emery Photo Service, Adam St., Pittsfield, Mass.

STEREOSCOPIC Photography. Simple device applicable ordinary camera. Easy and cheap to construct. Blueprint, instructions, \$1.00 currency. Lester, 1927 Hawthorne, Houston, Texas.

GET Inside! Fire lines; parade lanes; courts. Photographer's Press Card (like reporters) 25c each. Emery Service, Adam St., Pittsfield, Mass.

MAKE Money in photography. Learn quickly at home. Spare or full time. Easy plan. Previous experience unnecessary. Common school education sufficient. Write for full information and requirements. American School of Photography, 3601 Michigan Avenue, Dept. 3431, Chicago.

35% DISCOUNT On films. Write Paramount Photo Division, 403 E. 92nd St., New York.

HAVE You a camera? Send ten cents for recent number of our big magazine, showing how to make better pictures and earn money. American Photography, 116 Camera House, Boston, 17, Mass.

BASS Will postpay to you the Argus Candid Camera with f:4.5 lens, speeds to 1/200th of a second, \$12.50. New Argus enlarger at \$12.50. Daylight Pan film, all speeds, 36 shots, 85c. Welli Precision Candid camera with genuine Carl Zeiss Tessar f:2.8 lens in Compur shutter, \$48.50. Voigtlander Duo Bessa 2 1/2 x 3 1/4 or 16 Vest Pocket, with f:4.5 Anastigmat lens, speed shutter, \$27.50. Write for free Bargaingram 227 now ready. Largest stock of new and used apparatus in America. Dept. AG, Bass Camera Company, 179 West Madison Street, Chicago.

INCOME From your camera instead of expense. Low cost home course teaches you to make photographs for magazines, newspapers, advertisers. Tremendous demand. Earn good money wherever you live. Free book. Universal Photographers, Dept. 104, 10 West 33rd St., New York.

MOTION PICTURES AND SOUND EQUIPMENT

READY For you—No. 224—the latest and greatest Bass Bargaingram of Cine Apparatus. Acknowledged leadership in the cinema field. A few of the fine values: Filmo 70A, 1" F:3.5 lens and case, \$39.50. Cine Kodak, model B, F:1.9 lens and case, \$54.50. 100 ft. DeVry 16 mm. camera, F:3.5 lens, \$22.50. Model PG 71 RCA sound projector, 750 watt lamp, regularly lists \$500.00; our price, \$245.00. Willo Cinemeter with case, \$37.75. Write today to Cine headquarters and start to save now. Bass Camera Company, Dept. A, 179 W. Madison St., Chicago, Ill.

CENTRAL'S Free, new, money-saving bargain book explains latest movie developments, offers money-saving bargains in cameras, lenses, projectors, films. Used equipment taken in trade. Write for free copy. Central Camera Company, (Photographic Headquarters since 1899), 230 So. Wabash, Dept. 24-K, Chicago.

SALE On—DeVry and Bell and Howell used motion picture equipment. Also used binoculars. Send for list. Lowman & Handford Co., 1515 Second Ave., Seattle, Wash.

New 16mm. Projectors, films, cheap. Special samples, 5c. Superior, 126 Fourth, Paterson, N. J.

SELLING Out movie films, accessories. List. Moorfield-Shannon, Nutley, New Jersey.

BARGAINS—Cameras, films, projectors, accessories, lists. Shook's Photo Service, 38-40 Fort St., Forty-Fort, Pa.

8—16MM. TITLES, 2c Word. Catalogue. Cineshop, 1560 Jackson, Charleston, West Virginia.

16MM EXCEL Motor driven projector, 100-ft. reel \$3.95. Pop-Eye, Betty Boop, Hal Roach, "Our Gang," comedies and others. 3c stamp for catalogue. Excel Home Movies, 622 Madison, Toledo, Ohio.

NEWSREEL 16mm. Automatic 100 ft. F3.5 camera with film \$14.95. Our pick complete 100 ft. 16mm. subject \$1.49, 400 ft. \$5.58. Soundfilm 200 ft. \$5.75, 400 ft. \$9.85. 8mm. 50 ft. subject \$1.49, 1,000 ft. 35mm. subject \$1.00. DeVry 35mm. automatic camera F3.5, visual focus, 100 ft. capacity complete \$55.00, 1,000 ft. 35mm. capacity, motor driven, 500 watt projector, fan-cooled, portable suitcase \$35.00. DeVry soundfilm 35mm. projector, 1,000 watt, complete with amplifier, speaker, \$185.00. Kodak projector 16mm. for church, school, roadshow \$58.00. R.C.A. soundfilm 16mm. projector 1,600 ft. capacity, with amplifier, speaker, complete, \$149.75. Victor soundfilm complete outfit \$198.50. Silent, sound library for all, sent anywhere, special low rates. Leica F3.5 camera \$49.50. 30"x40" beaded screen, \$2.49. Free bargaingram full real buys. Trades accepted, bought. Mogul's, 1944-J Boston Road, New York City.

LEARN Motion picture theatre business. Home-study training; management, advertising, projection. Tenth year. Catalog. Theatre Institute, Elmira, New York.

MOVIE Matic 16MM. Three cameras in one. \$5.95. Barrington Sales, Barrington, N. J.

16MM BELL Movie camera \$9.95. 16mm. film \$98. Projectors. Circular free. Bytom, Dept. C, Park Ridge, Ill.

"THE World's Greatest Passion Play." Seven reel sound with dialogue and silent (new) 16 mm. Superior than Oberammergau stage play. Rent or purchase. Write with stamp. Hemenway Film Co., 37 Church St., Boston, Mass.

BARGAINS! 8mm, 16mm. Catalogue free. Elder, Dept. B-34, Chelsea, Mass.

35MM. 75c EACH. DeVry projectors. Savarese, Woodcliff Lake, New Jersey.

8MM.—16MM. SPECIAL Bargains in films, supplies, and equipment. Send for complete catalogs and lists. Hollywood Cine Film Distributors, Dept. C, 1431-33 No. Highland, Hollywood, Calif.

SALE! 35mm. Features \$4.99. Shorts \$1.25. Odd reels 79c. Lists. Calderara, 5119 South St. Louis, Chicago.

SUNSHINE 16mm. Camera film, \$1.50 for 100 feet. Optional processing \$1.00. Sunshine Film Company, Lynwood, Calif.

16MM. FILMS Exchanged, rented, sold, bought. Cameras, projectors, many bargains. Free catalog. Parkway Exchange, 1040 Eastern Parkway, Brooklyn, N. Y.

TALKIES \$25.00. Silents \$5.00. Simpson, 1275 South Broadway, Dayton, Ohio.

GIGANTIC Sale 35mm. List stamp. Bargains. Mutual, 6800 Racine, Chicago.

FILMS, Projectors, 10c coin for lists. Capital Productions, Rosedale, Kansas.

1001 BARGAIN List. Trades accepted. BL-Camex, 1451-P Broadway, New York.

ANNIVERSARY Sale, everything cinematic. Arts, listings stamp. Box 2133, Paterson, N. J.

HOLLYWOOD Camera film, 100 feet, 16mm., \$2.95; 50 feet, 8mm., \$1.45, including processing; 16mm. arts, 100 feet, \$1.50. Hollywoodland Studios, South Gate, Calif.

DIME Brings 3 free 16mm end titles and lists of new and used 8mm and 16mm films and equipment. Films and equipment bought, sold, exchanged. Lists only, 3c. Pacific, 1040 N. McCadden, Hollywood, California.

FREE—"Home Movies" magazine. Stamp brings details. Pacific, 1040 N. McCadden, Hollywood, California.

HOME Movies cost less than snapshots. Automatic \$9.95 camera takes 2400 pictures with 60c film and shows in \$12.50 motor projector. Order now! Send no money. Pay postman. Free lists. Home Movies, Box 32, Easton, Pennsylvania.

WESTERN Thrillers, 500 feet 75c. Jersey Filmco, 2075 Richland, Lakewood, Ohio.

35MM. FILMS. Bargain lists 3c. Hoffman Film Service, 57 Broad, Albany, N. Y.

BASS Now exclusive distributor for Radio Corp. of America 16mm. R.C.A. Sound on Film Cameras. Anyone can record sound pictures. New low price. News reporter model was \$350.00, now \$210. Send for complete details. Bass Camera Co., Dept. AK, 179 W. Madison St., Chicago, Ill.

8MM FILMS: Cartoons, travel. List. Lincoln Film Service, Box 293-A, Saginaw, Mich.

RADIOS, SUPPLIES, INSTRUCTION

RADIO Experimenters and set builders: parts and kits of parts for improved Little Giant R235, six tube R233, Pre-Amplifier R228, Portable battery R223, Little Giant R220 and 205 and Economy three 206, described by Popular Mechanics. Guaranteed specified parts. Lund Manufacturing Co., 43 East Ohio, Chicago.

TUNE In the world on your old radio. Any set a world wide receiver. Anyone can build for self or others. Doesn't interfere with present receiver. Complete plans, instructions, fully illustrated, only 25c. Stanley Radio, Box 2566, Kansas City, Mo.

SAVE Money on radios and parts. Send for our money saving catalog. United Radio Company, N-Newark, N. J.

CODE Automatic home teacher. Easy, practical. Terms. Omnigraph, 810 E. 39th, Brooklyn, N. Y.

CRYSTAL Sets—Blueprint 18 distance models with catalog; "Radiobuilder" year—25c. Laboratories, 151-C Liberty, San Francisco.

PHILCOS, Zeniths, Majestics, others. Cut prices. Radioman, Lake, New York.

RADIO Engineering, broadcasting, aviation and police radio, servicing, marine and Morse telegraphy taught thoroughly. All expenses low. Catalog free. Dodge's Institute, Ames St., Valparaiso, Ind.

MUSIC AND MUSICAL INSTRUMENTS

REBUILT Band and orchestra instruments. Honestly rebuilt—fully guaranteed. Catalog of new instruments on request. Weymann Company, Dept. M-4, 1613 Chestnut St., Philadelphia.

PIANO Jazz guaranteed by mail in 20 lessons. Erskine Studios, 810 East 14th St., Oakland, Calif.

ORCHESTRA Business cards, two colors. Samples, stamp. Pearce Print, R5, Danbury, Conn.

LEARN Piano accordion. Quick method by mail. Giggy, 5201 Bernard, Chicago.

SONG-WRITERS. Professional phonograph record of your song. Musical arrangements. Free information. Paramount Song-Recording Studio, J-8, Box 190, Hollywood, California.

SONGPOETS. Royalty publishing. Poem lessons 50c. Songland, "PM," Thomaston, Maine.

SONGWRITERS: Send for free rhyming dictionary and Writers' Guide. MMM Publishers, 607 Studio Bldg., Portland, Ore.

JAZZ Piano by ear. Mail \$1.00 bill today for new magic guaranteed course. Hollywood Piano Studios, 6842 Sunset Boulevard, Hollywood, California.

WANTED! Lyrics, melodies for songs. We arrange, publish, sell. Superior Song Studios, Passaic, N. J.

DO You crave that desire to possess an imported grand piano? Tone and quality far superior to other makes. Big saving when purchased through the importer Henry Kreh, Barrington, N. J.

FREE Booklet by famous Broadway composer. Songwriters Institute, 1234-C Broadway, New York.

DUO-FLEX Reeds for clarinets, and saxophones eliminate your reed troubles. Write for circular. Duo-Flex Reeds, 1204 1st Ave., Evansville, Ind.

SONG Poems wanted—Home, love, sacred, any subject. Send best poem today for offer. Richard Bros., 24 Woods Bldg., Chicago.

SONGS Published, method, 30 cts. E. Madden, 1017 Danforth, Syracuse, N. Y.

MUSIC Arranged for songs; orchestra. Frank S. Wildt, Lancaster, Pennsylvania.

SONGWRITERS! Outstanding proposition. Inquire. Hibbeler, D1, 2157 No. Avers, Chicago.

EARN Your own musical instrument. Get free details and free attractive savings bank at your music store, or write Fred Gretsch Mfg. Co., 521 1/2 So. Wabash, Chicago.

VIOLINS—Handmade. Best since Stradivarius days. (Curious don't bother.) John Lehto, San Pedro, Cal.

SONGS Published, arranged and composed, royalty basis. W. Coast Music Pub., 942 Market, San Francisco.

MUSIC Composed to words. Wonderful proposition. Bauer Bros., Oshkosh, Wis.

WRITE Songs. Big money and reputation. Write for information. J. Gordon Pub. Co., 201 N. Hoyne Ave., Chicago.

SONG Poems set to music. Get our phonograph recording plan. Zerse Bros., 210 Olive, St. Louis, Mo.

ORIGINAL Music composed to your words \$5. Reginald Belcher, Chatham, New Jersey. 25 years church organist, musical director.

SONG Writers. Send for our "Publishing Agreement." McKinley Music Printers, 1501 E. 55th St., Chicago.

HAVE Phonograph record made your song. Rainbow Recording Studios, 210 Olive, St. Louis, Mo.

BUSINESS OPPORTUNITIES

DISTRIBUTORS: Amazing patented screw-holding screw drivers! No competition! Factories, garages, mechanics, electricians buy quantities. Big profits, repeats. Exclusive territories; also foreign. Free trial offer! Toolco, 5079 Winthrop Bldg., Boston, Mass.

SMALL Inventions wanted by manufacturers. I'll help you sell your invention. Stanley Hull, M-7829 Euclid Avenue, Cleveland, Ohio.

CHIPPED Glass sign making; mirror resilvering; metalware replating. Interesting. Profitable. Write Sprinkle, Plater, 127, Marion, Indiana.

START Candy business! \$15 course \$1; currency. Suchan, Alpha, Minnesota.

FORMULAS—Fast selling products. Guaranteed. Laboratory tested. Lowest prices. Catalog free. Kemico, 55D, Park Ridge, Ill.

FREE—Thirty-six page book, "The Key to Business Opportunities," mailed on request, 348 Belmont Ave., Los Angeles, Calif.

AMAZING Opportunities. Booklet for stamp. Publishing Service, Box 101, Aurora, Ill.

MONEY At home. Making flavors, lotions, shampoos, medicines. Materials furnished. Your name on labels. Quality Chemicals, E-20030 Russell, Detroit, Michigan.

MAKE Money while others try. Our systems are authentic. Details free. Box 344, Summit, N. J.

PRACTICAL Mailorder plans. Details free. Fred Rothe, 3949 Ontario, Chicago.

BIG Mail offering latest opportunities and ten blades, either type, 10c. Absolute guarantee. Joseph Castell, 1663 Madison St., Brooklyn, N. Y.

COLOR Concrete with chemical solutions. Better results. Lower costs. Your own business. Fifteen formulas with directions \$1.00. Sample 10c. Hollywood Cementcraft, 8527 Wonderland, Hollywood, California.

\$5 STARTS You in business selling your own products. Complete stock, plans. Nothing else to buy. Make money. Details free. Gassol Company, Troy, N. Y.

FREE Booklet describes plans for starting paying spare-time mail order business. Many began at home, today independent. Belmar, M-127 Cap-Hill Sta., Denver, Colo.

IT Pays to raise earthworms. California Earthworm Farms, La Canada, California.

CALIFORNIA Vegetable concentrates, powders, tablets, vitamins, (millions vitamin E already sold). Health foods offer quickest mail success. Your own labels. Samples, dime. Gardena Products, 128B, Station "S," Los Angeles, Calif.

CAPITAL Seekers—Put your project before 260 key-men. Cost trifling. Details free. Amster Leonard, Fox Theatre Building, Detroit, Michigan.

BARGAINS—Paint spray outfit, gasoline engine drive. Terms—trial. Helmick Paint Spray Exchange, M-474, Troy, Ohio.

MARBLEIZING; Porcelain enamel finish. Cement prepared, mix with water, applied to wood, wall-board, concrete, etc. Flintlike hardness, brilliant. See our 85c liquid rubber for mold making. Sets solid in four hours. Any thickness. Send dime for assorted samples, both rubber and porcelain. Cowell Institute, Grayling, Mich.

1,000,000 ARTICLES Wholesale, latest directory 10c. JelSmith, 163 Myrtle, Waltham, Mass.

STAR Magazine, 50 or more pages. A fast growing monthly publication. \$1.00 per year with free membership in the Star Association. The legal reporter alone is worth many times the subscription price. Sample copy 10c. Star Magazine, Fero, N. Dak.

BOOKS, Money-making ideas, formulas, plans, information. National Sales Service, Box 1773-P, Roanoke, Virginia.

MONEY—"Hit" magazine, brings you ideas, money, success. \$1 year, sample 25c, none free. General Publishing Co., Peekskill, N. Y.

START Your own business. Splendid opportunity. Valuable information for stamps. Edward Johnson, Dept. P, West Creek, N. J.

INCOME Without investment, home mail-order business. Write Dixie Mailers, King, North Carolina.

YOUR Old plans—Regardless of original cost—taken in exchange for my new original booklet, "A Fortune in Dollars." Details free. National Mail Agency, 2045 Snyder Avenue, H. Philadelphia, Pa.

FREE Circulars describing hundreds of money making opportunities selling by mail. Build your own business. Write now. Progress Publishing Co., 2513-H North 9th St., Milwaukee, Wisconsin.

WHERE To buy at lowest wholesale prices. Information free. Yorena, Box P-312, Bayonne, N. J.

ENORMOUS Profits, home business, making specialty products. Easily started. Phillarst, Jefferson City, Missouri.

MASTER Business opportunity. Particulars—stamp. Staebler Products, 45th, Elmhurst, N. Y.

INCORPORATE Or reorganize your business. Expert service. Reasonable rates. Acme Company, Knickerbocker Building, Baltimore, Md.

LATEST Dollar getting schemes, ideas, plans. Send dime. Tips, Paulding, Ohio.

START Magazine. Thirty-second year. Dolsen, 89-91 Pineapple, Brooklyn, New York.

CAPITAL Secured, corporations organized. James Murrow, 299 Broadway, New York.

RAISE Giant mushrooms! We buy! Start cellar, shed. Book, pictures free. United, 3848 Lincoln Ave., Dept. 69, Chicago.

REAL Money maker for distributors. Patented amnl-flectors needed in every store, factory, office. Cuts electric bills in half or doubles light. Wonderful convincing demonstrator. Pays up to 200% profit. Moderate investment for stock refundable. Write today for convincing proof how you too can make big money. Apex Works, 146 West 25th, New York.

FORTUNES From old books, prospectus free. Fairmont, 9 Heister, New York.

IMPORT—Export, start your own business! Deal with South America, Europe, Japan, etc. Uncrowded fields. Unlimited opportunities. Addresses of buyers, sellers from over 100 countries. Prospectus "A" free. International Service, 1229 Park Row Building, New York.

COMPLETE Money making plans 10c. National Service, 7026 Normal, Chicago.

"FREE Literature"—Formulas, mailorder plans. Sockel, 734 South St., Philadelphia.

ROACHES Killed positively, simply and cheaply. And you can add to your income besides. Details free. Parkers, Wetumpka, Alabama.

MAKE Artificial marble, glossy tiles, uncanny. Tabletops, plaques, floors, whetstones, novelties. Cement secrets, hard, fire-proof, inexpensive. Brilliant tile and liquid rubber samples 3c. John A. Payn, 945 Grande Vista Avenue, Los Angeles, Calif.

OPERATE Electric Simonizing station. Cash in on national advertising with proved labor-saving invention. \$195 starts you. Should net you approximately \$500-\$400 month. Write Bissell Co., 3320-A Archer, Chicago. Distributors wanted.

BIG Mails galore—Magazines, samples, opportunities 10c. Wynn's Service, 345-B, Lamar, Missouri.

NATIONWIDE Home money-making propositions and sample "Mail Trade Guide" Magazine 10c. Sarvov, Arlington, Kentucky.

\$1.50 POCKET Radio, agents sample 60c. Radio Exchange, Richland Springs, Texas.

PROFITABLE Mail business enterprises. Information free. Delmao, 6 East 15th, Wilmington, Del.

AMATEUR Cartoonists—Win \$25.00. No drawing ability necessary to win. 26 prizes in all. Rush name on postcard for valuable tips on "How to Make Money With Simple Cartoons," cash prize entry blank and rules. Send no money. Cartoonists' Exchange, Dept. C-94B, Pleasant, Hill, Ohio.

DOLLARS Daily. Start home! Mailorder business. Details. Duffy, Covington, Ky.

MAILORDER Book; plans. Stamp brings particulars. Box 1165, Stockton, California.

PROFIT With new products. Make, sell, repeat. Analysis. Research. Guaranteed formulas. Biggest catalog free. Special prices, leads. Gibson Laboratory, Chemists, BD-1142 Sunnyside, Chicago.

\$2.00 STARTS Profitable manufacturing business. Stamps for particulars. E. Leach, McAlester, Okla.

SELL Secrets through mails. Amazing profits! \$25 weekly spare time! Complete plan 50c. Simons, 1806 Ocean Avenue, Brooklyn, N. Y.

YOU Can make imitation marble on wood, metal or glass so beautiful that only an expert can detect it. For information and free samples enclose 10c for postage. Marble-Cote Co., Dept. F, 1890 Jerome Ave., New York City.

MAKE Money at home. Be independent. Details for stamp. Veteran, 166 W. Washington, Chicago.

WHY buy lists of names? Plan gets names cheaply. Anytime. Anywhere. 25c coin. Midwest Specialty, Box 3, Ashton, Iowa.

"SCHEMER," Monthly Magazine, Alliance, Ohio, prints schemes, tips, ideas, formulas—big winners—\$10,000 to \$25,000 reported. 39th year; \$1.00. Special: Trial six months only 30c.

START A collection business. No capital, good living. Fundamentals revealed, 25c. Sutton Press, 3185 Fowler, Omaha, Nebraska.

WE Teach you new business, then buy your product. Write Superior Specialties, Springfield, Illinois.

MANUFACTURE Newest profit-making specialties from guaranteed formulas, trade secrets, analyses. Complete chemical service. Charges most reasonable. Interesting literature free! Miller, Manufacturers' Chemist, Tampa, Florida.

LEARN Modern rent collecting from successful operator. Big pay. All or part time. No investment. Fine side line to real estate or insurance. Circular free. Sicoan, 2038 Obeart, St. Louis, Mo.

MAKE \$2 To \$5 hourly operating Lord's Prayer penny engraving machine. Sample free. Midwest, 5511 Euclid, Cleveland, Ohio.

INVENTION Finance Magazine, 80-G Wall Street, New York. Year subscription 60c entered upon promise to pay on receipt of first copy.

START Your own circulating library. We furnish and exchange your books. Fireside Rental Library, 210 Crosby Bldg., Buffalo, N. Y.

BED Bugs. Our new formula kills them every time without danger or trouble. You can start good business selling product or using it for exterminating. All details including secret formula \$1. Particulars free. Stamp appreciated. Benton Company, 29 Buckley, Liberty, New York.

PLASTEX Industries offer industrious men an opportunity to start a business of their own, manufacturing art goods, novelties and utility products in Plastex and marble imitation. 1/2c material makes regular 10c store sellers. Rubber moulds furnished for speed production. Small investment brings big returns. Since the crash, low priced goods are needed and this line meets the demand. Interesting booklet mailed free. Plastex Industries, Dept. A, 1085 Washington Avenue, New York.

WE Start you in business, furnishing outfits and instructions, operating "Specialty Candy Factory" home. Men and women, earn \$25.00 up to \$60.00 weekly, all or spare time. Booklet free. W. Hillyer Ragsdale, Inc., Drawer 4, East Orange, N. J.

HOW And where to obtain capital fully explained, free particulars. Star Service, Wanakoneta, Ohio.

500—1936 NAMES Of opportunity seekers 50c. Trial hundred 10c. Carl Edquist, Odessa, Minn.

SUCCEEDED With your products. Make-sell them. Formulas. Processes. Accurate analyses. Catalog free. B. Thaxly Company, Washington, D. C.

CHEMICAL Expert furnishes manufacturing formulas with complete working directions. Reliable individual services. Charges reasonable. Dr VanHeeden, 1410 East 54th, Chicago.

SELL By mail. Books, novelties. Bargains! Big profits! Particulars free. B. Elfc, 438 North Wells, Chicago.

CHARTERS: Delaware; best, cheapest; free forms. Colonial Charter Co., Wilmington, Del.

MANUFACTURE Polishpuffs. Amazing proposition 10c. Particulars free. Hickory-dell, Glenbeulah, Wisconsin.

ARTIFICIAL Marble sanitary flooring, instructions covering wood or cement flooring 1/2 inch thick, fireproof, all colors, low cost, ornamental casting, concrete, plaster, papier-mache, garden furniture, statuary, flexible molds, particulars free. Chris Mahler, Elmont, N. Y.

START Little business anywhere. Everything furnished. No canvassing. Maywood, PM-923 Broadway, New York.

FREE Booklet describes 107 plans for making \$20-\$100 weekly, in home or office, business of your own. Elite Co., 214 Grand St., New York.

MAIL Order business is your opportunity. Many began small, now earn thousands yearly. No personal contact. Boundless opportunities. Have had over 30 years experience; will help you succeed. Send 25c for valuable booklets, none free. B. Breniser, 257 South 21st, Philadelphia.

I WANT to send you proof of the wonderful pulling power of Popular Mechanics Magazine's classified pages. What's your proposition? Write me today. F. W. Johnson, Manager Classified Advertising, 200 E. Ontario St., Chicago, Ill.

COMPLETE Chemical service, analysis, formulas, processes, trade secrets. Particulars free. W. L. Cummings, 228 Gordon Avenue, Syracuse, N. Y.

MONEYMAKING OPPORTUNITIES

SELL Your snapshots. Booklet describing 100 magazine markets. 25 cents. Wun Service, California, Penna.

NEW Mailorder and local opportunities. Merchants Sales, 617M North Second, Milwaukee, Wis.

10c BRINGS Copy National Mail Order News. Box 1773PM14, Roanoke, Virginia.

RIGHT This way! Moneymaking opportunities. Details free. A. Francum, Hoopst., Morganton, N. C.

BUSINESS Of your own. National system mail order business plan. Sweeps country. Best ever. Price advance soon. Only 50c now. Premium free with order. Fallon Advertising Service, Lock Box 205PM, Oak Park, Ill.

BETTER Yourself—Gain success. Right thinking makes that possible. Amazing test instructions, 25c coin. Bureau Psychology, 503 Fifth Ave., New York City.

YOUR Guide to opportunity. Magazine, plans, formulas, one dime. Katz, 4254 N. Kimball, Chicago.

MONEY Making deals. Particulars, samples, 10c. Trader, 216 Degraw, Brooklyn, New York.

WHOLESALE Sources, 500,000 articles. Free directory. Maywoode, 925 Broadway, New York.

BOOKS—Full of plans to make money at home. 25c each. Literature free. Smith, Box 6618, N. E. Sta., Kansas City, Mo.

FINANCIAL Independence—New dollar copyrighted book money making opportunities, formulas, ideas. Sample, with wholesale prices, quarter. Self-Help, Twin Peaks, California.

IT Pays to raise earthworms. California Earthworm Farms, La Canada, California.

GOOD income at home anywhere in U. S. Write E. Hoffnagle, Blue Island, Ill.

1000 MONEYMAKING Ideas, book 50c; literature free. Harvey Teeple, Decatur, Ind.

MONEY By mail. Gain wealth! Sound, legitimate business plans. Descriptive booklets free. Specialties, 198 Harker St., Mansfield, Ohio.

WISE Home workers: Send dime for copy of "Starting a Mail Order Business." Get posted on new money making developments. Julius, Amarillo, Texas.

BIG Money making proposition. You can share if you act quickly. Details free. Hall Products Co., 9304 Amesbury, Cleveland, Ohio.

OPPORTUNITIES, Ready for you. Write Modern, Box 5283, Tampa, Fla.

AUTOMOBILE Batteries exchanged \$1.50. New process. P4-42 East End, Buffalo.

EARN Extra money. Particulars free. Tumsted, Box 214, Newport, Arkansas.

MAKE Liquid wax at home. Supplies locally cost 14c gallon. Retail \$4.00. Original formula \$1.00. Crane, 3340 Englewood, Philadelphia, Pa.

WHOLESALE 1937 Buying Guide, 132 page directory listing supply source of 500,000 articles. \$1 postpaid. Associated Products H-3, Box 694, Muncie, Indiana.

"PROFITABLE Ideas" Magazine, Six North Dearborn, Chicago. 50 pages 10c.

SIGN Painting letter patterns ready to use for quick layout. Illustrations postpaid. Thompson School, Pontiac, Michigan.

INVESTIGATE Real dollar getting opportunities. Sinclair, Box 861, Hollywood, Calif.

SPARE Time, full time moneymaking opportunities. Steady incomes year around. Write: Germann, 1015 West Eighth, Los Angeles, Calif.

SELL By mail, at home, shoe string capital eye opener folio \$1. Edwin Dornbush, Box 382, Waukegan, Illinois.

AMATEUR Cartoonists—Win \$25.00. No drawing ability necessary to win. 26 prizes in all. Rush name on postcard for valuable tips on "How to Make Money With Simple Cartoons," cash prize entry blank and rules. Send no money. Cartoonists' Exchange, Dept. C-94A, Pleasant Hill, Ohio.

500,000 ARTICLES Wholesale. Latest directory, 10c. Gibson, 5413 Calumet, Chicago.

INVESTIGATE New moneymaking opportunity which builds income anywhere, for man with small capital. Particulars free. Seneca Specialties, 24 Main, Geneva, N. Y.

QUICK Cash daily. Big profit plan. Working sample. Details 10c. Box 684, Sioux City, Iowa.

ANALYSIS. Research. Newest guaranteed formulas. Biggest catalog free. Special prices, leads. Gibson Laboratory, Chemists, CS-1142 Sunnyside, Chicago.

"OPPORTUNITY Offerings" (copyrighted) filled with newest money-making deals, laboratory tested formulas, business building plans. Dollar copy, wholesale prices, only 10c. Dauffeldt Service, Atalissa, Iowa.

STEADY income home work. Experience unnecessary. Jankus, Box 103, Kenosha, Wisconsin.

FERGUSON Manufacturing Co., 322 N. Senate Ave., Indianapolis, manufacturers of trade stimulators for operators since 1919. Wholesale catalog, 10 cts.

ESTABLISH Permanent well paying first aid supply business with ethical surgical dressings. Needed in every home, office and industrial plant. Exclusive territory open. Amazol Products Co., 5515 South Vermont Ave., Los Angeles, Calif.

FREE Circulars describing hundreds moneymaking opportunities. Wyatt, Box 2322, Houston, Texas.

FREE! Profitable circular mailing instructions. Mail service, 2231 McKinley, Berkeley, Calif.

BETTER Money making ideas and opportunities. Literature free. Barfield, Box 5032, Metropolitan Station, Los Angeles, Calif.

LAWN Mower sharpening made easy, plenty business everywhere. Write Engle & Wirt, West Burlington, Iowa.

107 PLANS For making \$20-\$100 weekly in home or office business of your own. Descriptive booklet free. Elite Co., 214 Grand Street, New York.

TO Win success you must do something different; particulars free. Publishers Sales Company, Box A-76, Nelson, Georgia.

OPPORTUNITIES For money making. Summit Press, Box 123, Jackson, Mich.

MILLIONS Jobless! Get dollars in mail daily, like we do, for amazing employment information (got man 76 jobs). Keep money; we fill your orders free. Stamp brings details. Co-Operative Service, 77 Swan, Buffalo.

BIG Money at home plating auto parts, reflectors, mirrors, chandeliers, by late method. Experience unnecessary. Free particulars. Gunmetal Co., Ave. N, Decatur, Ill.

FORMULAS, PLANS, ETC.

GLASS Cleaner formula 50c. Newton, 425 Seventh Ave., South Great Falls, Montana.

GUARANTEED Formulas—New fast sellers. None better. Lowest prices. Catalog free. Kemico, 49D, Park Ridge, Ill.

RELIABLE Products spell success. Formulas, analysis, literature free. Herstein, Chemist, 1811 Paris Ave., Grand Rapids, Mich.

500 MONEYMAKING Formulas 25c. Descriptive literature free. Harvey Teeple, Decatur, Indiana.

SUCCESS! Dependable formulas make meritorious products. Details. VG Chemical, Box 4651, Pittsburgh, Pa.

ANY Formula 30c or money back. List free. Ogg's, Tamna, Florida.

MAKE Own products. Instructions, 10-25c. Literature free. Sylco-P, Downers Grove, Ill.

ANALYSIS. Research. Newest guaranteed formulas. Biggest catalog free. Special prices, leads. Gibson Laboratory, Chemists, BD-1142 Sunnyside, Chicago.

A \$50.00 GUARANTEED Formula for own use or start business of your own for dime and stamp. The Huot Publishing Co., Dept. W, New Hampton, New York.

RUG Cleaner—Formula \$1. Huge profits. Roffler, Bx. 763, Coral Gables, Fla.

FORMULAS—All lines, biggest-selling products. Special offers. Philarst Company, Jefferson City, Missouri.

KEEP Cool without ice. Ice-Ola artificial ice keeps food, drinks, etc., cool and fresh. No more ice bills. Few cents to make. Formula 25c coin. Samuel B. George, 285 E. Queen Lane, Philadelphia, Pa.

ANYTHING Analyzed. Duplication guaranteed. Practical formulas. Associated Chemists, Indianapolis, Indiana.

ANALYSIS And formulas, all modern, including medicines. Gallagher, c/o Goods Drug Store, Allentown, Pa.

ICELESS Ice. Colder, cleaner, cheaper. Complete 25c. Duffy, Covington, Ky.

CORRECT Formulas. Samples furnished. Details free. Box 768, Waco, Texas.

FORMULAS—Latest, best selected sellers. List free. Persian Laboratories, Bay City, Mich.

CERTIFIED Formulas, best science can produce for making popular, biggest-selling specialties. All lines. Before buying formulas, get my valuable "Eye-Opening" literature, including free subscription to Miller's Monthly Messenger. Miller, Chemist, 1706-A, Tampa, Fla.

SUCCEED With your products. Make-sell them. Formulas. Processes. Accurate analyses. Catalog free. B. Thaxly Company, Washington, D. C.

FORMULAS—Latest money makers. Literature free. Belfort, 4042 N. Keeler, Chicago.

CHEMISTRY

TECHNICAL Service; chemical, metallurgical questions answered by graduate engineers, or money returned. One dollar per question. Scientific Service, 4520 N. Maplewood, Chicago.

MAGIC Chemical submarine, three issues chemical magazine, book of experiments, solubility chart, all six, 25c. Clinton Chemical, Swedesboro, New Jersey.

RARE And micro chemicals. List free. Ernest Snow, Lexington, Mass.

CHEMISTRY. Mineralogy, microscopes, telescopes, binoculars. Catalog free. B. Teeko, Evanston, Illinois.

NEW Chemistry supplies catalogue, lowest prices, 10c. Handbook for chemical experimenters, hundreds of experiments, 50c. Reading Scientific Company, Reading, Penna.

FURNACE, Electric, 2550° Fahrenheit. Melting, half pound copper. Muffle, 30 cubic inches. Metallurgical, ceramic, chemical work. Silent, clean. Uses ordinary house current, alternating or direct. Easily built. Not expensive. Heat controlled. Drawings, directions, materials list \$1.25. Pyroelectric Company, Box 6, Trenton, N. J.

FORTY Pure metallic elements in bottles \$5. Silver, barium, selenium, vanadium, etc. J. J. Gossard, Wood River, Ill.

CHEMISTRY Magazine. Research, experiments, magic. Three months subscription 15c. Spamer, 100 Forsyth, New York.

SEND Your chemical problems to German chemist. Twenty years experience in research work. Box 451, Leominster, Mass.

SEND 25c For new illustrated chemical experiment book with over 300 formulas and tests. Also receive 32 page illustrated catalog of apparatus, microscopes, telescopes and chemicals free. N. Winn, 124 West 23 St., New York.

FREE Chemistry catalogs. Supplies at 5c! Equip complete laboratory. Send 10c (rebatable) for postage and handling. Kemkit Scientific Corp., 135P Johnson Street, Brooklyn, New York.

CHEMICALS. Laboratory glassware, apparatus. Send 3c for catalog CP. Biological Supply Company, 1176 Mt. Hope Avenue, Rochester, New York.

CHEMICALS In 5c quantities. Catalog 5c. Fleischer's Laboratories, Everett, Massachusetts.

HELP WANTED

BEFORE You accept any job write for my offer—absolutely free, no obligation. Shows you independent way to make up to \$45 and more in a week. Send no money—just postcard. Address Zanol, 2360 Monmouth, Cincinnati, Ohio. Act quick.

USE \$500.00? Raise canaries for us. Free particulars. Crimmins, 3741-B 60th Street, Woodside, New York.

MONEY In butterflies, moths. See Sinclair Display Advertisement on page 24A.

AGENTS WANTED

HOLDS-UM Cement, (dry powder), holds anything, anywhere. Never shrinks, will not deteriorate, fireproof, waterproof. Mixes with water. Easy to use. Package, 20c. Dozen with samples and advertising, \$1.00 postpaid. Literature free. Holds-um Company, Royal Oak, Mich.

CASH Profits every day with America's fastest selling line of men's ties, priced 85c to \$6.00 doz. Over 100% profit. Leather ties, patented Slide-On ties, adjustable bat ties, money-making novelties. Every man buys! Write for catalog and free sample swatches. Boulevard Cravats, 22 West 21st St., Dept. M-35, New York.

BRAND New honey candy product starts national craze. Huge profits, big repeater. Clean up. Samples free. Send quarter covering postage, handling. Hurry! Honey-crisp, 126 W. Kinzie St., Chicago, Ill.

NO Competition. Money saving device. Usually saves customer investment in ninety days. 100% profit. White Electric, 632 Clifford, Lansing, Michigan.

FYLE-KOMB. File carried in comb. Just out. Sells quickly. Best quality. Sample 25c. Literature free. Fyle-Komb Co., Garrison, N. Dak.

SELL Extracts, household needs, dental creams, shaving creams, etc. Send for our special low prices. E. M. Strang and Company, 20 Wood Street, Willoughby, Ohio.

SALESMEN And distributors—Sell to mechanics, machinists, plumbers, metal workers and garages—"Universal Snips." Sale at every call. Write Grobette, 3 Park Place, New York.

500% PROFIT Selling new "20-in-1" kitchen utensil. Retail 25c. Costs you \$1.00 a dozen. \$7.20 a gross. Sample 10c. New Method Co., PMM-52, Bradford, Pa.

MAKE More money taking orders: Shirts, ties, hosiery, raincoats, uniforms, dresses. Sales kit free! Experience unnecessary. Nimrod Company, Department 8, 4922-28 Lincoln Avenue, Chicago.

RAZOR Blade conditioners—Smoother shaving, great invention. Bargain sample twenty-five cents. Charlton Corporation, Chicago.

STRANGE Ironing cord. Saves electricity. Abolishes scorching and kinking. For telephones also. 150% profit. Sales guaranteed. Big free offer. Neverknot, Dept. 4-A, 4525 Ravenswood, Chicago.

LADY Friends enthuse over "Yearning" and "Full Moon" perfumes. Each \$1.00. Both \$1.75. Dealers—get prices. Louis Barlevy, 247 West 116th Street, New York, N. Y.

MEN And women make big easy money as our agent. New kind of cosmetics for colored. Free samples. Write Lucky Heart Company, Dept. PM-41, Memphis, Tenn.

MAKE 212% Profit! Metalfix—amazing new "metallic liquid" instantly, permanently repairs metal, wood, glass, leather, etc., without heat, acid or tools. Holds forever! Free sample. Write, Metalfix, Dept. P-313, Cincinnati.

CHIPPED Glass sign making; mirror re-silvering; metalware replating. Interesting. Profitable. Write Sprinkle, Plater, 128, Marion, Indiana.

UP To \$6.00 an hour. Amazing Karnu refinishes autos like new without rubbing, polishing, waxing or painting. Inexpensive—costs little. Wipes on with cloth. Lasts 8 to 12 months. Free sample. Karnu, Dept. P-8, Cincinnati, Ohio.

AGENTS! Dresses 33c, men's suits \$1.50-\$2.00, shirts 46c, ties 6½c, chiffon hose 42c. Amazing prices. Big profits. Catalogue free. Aeme, AB-558W Roosevelt, Chicago.

400% PROFIT In new perfected (1937)—quick action self-starting no-flint cigar lighter. Retail 50c. Sample 25c. Get details quick on wonder seller. New Method Co., Box PM-52, Bradford, Pa.

\$6.85 HOURLY! Amazing No-Flatz fixes punctures without patching; makes tires puncture proof! Instantly—permanently seals holes made by nails, etc. Big seller. Free sample offer. No-Flatz, Dept. P-172, Cincinnati, Ohio.

SELL Social Security booklets. Sample and three way profit plan 10c. Stenger, 901 Bedford Building, Chicago.

450% PROFIT In perfected (1937) quick action automatic gas lighter. No flint or flame. Lights gas instantly. Retail 25c. Costs you \$1.00 a dozen or 15 dozen for \$8.00 postpaid. Sample 10c. New Method Co., Box PMG-52, Bradford, Pa.

JOIN New profit sharing Guild Salesmen Association. Canvassers buy household products cheaper. Your own literature, latest premium deals. Paty Co., Dept. B, Somerville, Mass.

500% PROFIT; Gold reflecting letters for store windows. Large sizes 1c. Free samples. Modernistic Sign, B-3004 Lincoln Ave., Chicago.

GOLDEN-GLO Gospel wall mottoes. 200% profit. 25c seller. Ten samples \$1.00. Finnell Co., North Manchester, Ind.

EARN 200% Profit selling Lak-tay, new mystery drink which replaces tea and coffee. Write for free sample offer. Lak-Tay, 1000 Bedford Bldg., Chicago.

SIMPLE Plan sells startling invention! "Vaposeal"—World's finest kitchen utensil! May make you independent! New, novel, different! Write R. Conway, 209 Church, Champaign, Illinois.

NEW Household product. Makes hardest household task easy. Amazing, fast repeating 25c seller. Women rave about it. Opportunity to pocket up to \$60 in a week with marvelous line of money makers. Everything sent on trial; no money risk. Details free. Albert Mills, 2366 Monmouth, Cincinnati, Ohio.

RAZOR Blades, neckties, shoe laces, etc., all big sellers. New bargain list. Heil Premium Co., M9, Gaylord, Minn.

MEXICAN Finest feather pictures, blankets, carved leather. Free particulars. Samples 10c stamps. Gampoco, Apartado 1176, Mexico City.

FREE Offer describes how to earn \$20-\$75 weekly, home-office. John Co., 104 Garfield, Brooklyn, N. Y.

AMAZING Ironing device. Saves electricity! Prevents scorching! Free offer. Iron-So-Ezee Company, Mt. Washington, Ohio.

NEW Discovery "Prevents-Runs" silk hose. Manufacturer, 1700 S. Ogden, Los Angeles.

GREAT Opportunity unique pants hanger. Sample 20c. Garden tool specialties. 1937 breadwinners. Hurry. Diamond Products, 4188 Union Pacific, Los Angeles.

WEBSTER Oil burner—gun type, for furnaces. Very economical. Opportunity for dealers. Webster Oil Burner Co., Barrington, N. J.

NEW Cleaner—Amazes everybody. Cleans everything. Washes clothes snow-white quickly. Spots, stains removed like magic. Startling demonstrator. Free samples make fast sales. Quick repeater. Immense profit. Write quick for "free sample." Super-X Cleaner Co., 11, Berwyn, Illinois.

MANUFACTURER Offers real opportunity. Big daily commissions. Liberal cash bonuses. Complete made to order shirt, neckwear, hosiery, pants line. Direct to consumer. Handsome outfit free. Experience unnecessary. Part or full time. Packard Corp., Dept. S-346, Terre Haute, Ind.

BIG Money selling old books, literature free. Fairmount, 9-11 Hester, New York.

SELL Made to measure raincoats. Outfit free. Goodyear Rainwear, 106 East 19th, New York.

WE Have lowest prices on razor blades. Gallen Blade, 8 Hixon St., Rochester, N. Y.

THYDRO-X (Extra miles). Fast seller! 25%-50% increases guaranteed! Tremendous profits! Automotive men—a million dollar market waiting. Particulars free. Thermo-P Works, Peoria, Ill.

PORTRAIT Agents, something new, Hexagon portraits, frames. Lowest prices. Booklet free. Picture-Man Friedman, Dept. 9, 528 Cornelia, Chicago, Ill.

MONEY In butterflies, moths. See Sinclair Display Advertisement on page 24A.

625,000 ARTICLES For sale cheap. Lists 10c. Duffy, Covington, Ky.

AGENTS. Start exterminating and sales business. Details free. Sanitary Products Company, Box 768, Waco, Texas.

LAWN Edger for trimming grass or sod from edge sidewalk. Salesmen earn \$10 a day. Send \$1 for sample. Squier Products Co., West Symmes Rd., Hamilton, Ohio.

MAKE Your own products!! Luminous paint formula—\$1.00. (Request needs.) T. Galluzzo, Wilkinsburg, Pennsylvania.

SELL Glas-Glo for windows, windshields. Glas-Glo, Phelps, N. Y.

PROFIT With new products. Make, sell, repeat. Analysis. Research. Guaranteed formulas. Biggest catalog free. Special prices, leads. Gibson Laboratory, Chemists, BD-1142 Sunnyside, Chicago.

CONSIGN Stores confection product. Sample free. Lorrac Products, Albany, N. Y.

TRANSPARENT Neon-like signs. Cost 4c—retails 25c. 1000 designs. Sample and 1937 catalog free. Lowy, Dept. 707, 8 West Broadway, New York.

AGENTS Get cash hourly. Thrilling new kind guaranteed silk hosiery plan. Start without experience. Full or spare time. Your hosiery free as bonus. Send size. Rush name. Wilknit, Desk 4B37, Greenfield, Ohio.

BIG Money applying gold initials on automobiles. Easiest thing today. Free samples. Also, sideline salesmen for name plates and tire cover transfers. "Ralco," 1084 Washington, Boston, Mass.

MAKE Your own products. We sell formulas for highest quality toilet preparations, extracts and household specialties. Catalog free. Scientific Laboratories, 1950-W Broad, Richmond, Va.

ATTENTION Hustlers, clean up. Costs 10c. Sells for \$1.00. For particulars write J. M. Jones, 724 W. Trade St., Charlotte, N. C.

GOLD Reflecting window sign letters. Penny each. Large sizes. Easily applied. New styles. Absolutely beautiful. Free samples. Atlas Sign Works, 7941 Halsted, Chicago, Ill.

SALESBOARD Men—New put and take jars. Details, samples free. Tom Thumb, Dept. PM, Nauvoo, Ill.

MEXICAN Feather pictures. Unusual novelty, 50c (stamps) bring \$2.00 worth samples, details. Refunded if unsatisfied. Mexican Art, Apartado 1593, Mexico City.

BIG Money and fast sales. Every owner buys gold initials for his auto. You charge \$1.50, make \$1.45. Ten orders daily easy. Write for particulars and free sample. American Monogram Company, Dept. 40, Dunellen, N. J.

AGENTS: Smash go prices. Santos coffee 12c lb. 4-oz. vanilla 8½c. Razor blades 10 for 8½c. 100 sticks chewing gum 12c. 150 other bargains. Premiums. Experience unnecessary. Carnation Co., PO, St. Louis, Mo.

SUCCEED With your products. Make-sell them. Formulas. Processes. Accurate analyses. Catalog free. B. Thaxly Company, Washington, D. C.

ENGRAVED Name plates, numbers, signs, etc., easily sold, profits large. Brett Bros., Winthrop, Mass.

MAN In each town to plate auto parts, reflectors, bathroom fixtures, refinish beds, mirrors, chandeliers, by late method; experience unnecessary. Simple plan of manufacturing at home starts you in big money making business. Free particulars and proofs. Gunmetal Co., Ave. H, Decatur, Ill.

FREE Sample—Amazing cleaner; sells homes, taverns, everywhere. Big profit—fast repeater. Betco, 5007 Irving Park, Chicago.

GENUINE Gold letters for store windows. Easily applied. Free samples. Liberal offer to general agents. Metallic Letter Co., 438-B North Clark, Chicago.

SELL Novelty fun cards, novelties, etc. Samples 10c. National, Box 500M, Cincinnati.

AGENTS: Stamping names on pocket-key protectors. Sample check with your name, address, 25c. Stamping outfits. Emblem checks, check-fobs, name plates. Hart Mfg. Co., 303 Degraw St., Brooklyn, N. Y.

AGENTS—Opportunity to make money; book containing 107 successful business plans; home or office; send for free introductory booklet. Elite Co., 214 Grand St., New York.

WANTED—District purchasing agents. No experience or money required. Write Purchasing Manager, 174 N. Halsted, Chicago.

COSTS 1c—Sells 25c. Make non-explosive cleaner from benzene crystals. 1c gallon. Sample 10c. Literature free. Western Reserve Laboratories, 6615 Denison Ave., Cleveland, Ohio.

DO You want agents for your proposition? Your ad in this space will place your message before hundreds of men seeking fast-selling products. My folder "How to Secure Agents" is filled with proof. I'll gladly send you a copy free. F. W. Johnson, Manager Classified Advertising, Popular Mechanics Magazine, 200 E. Ontario St., Chicago.

PROFITABLE Home business. Legitimate. No canvassing. Maywood Publishers, P-923 Broadway, New York.

BOOKS Covering hundreds of subjects. Big catalog for 3c postage. Popular Mechanics Press, Room (C37), 200 E. Ontario St., Chicago.

HIGH-GRADE SALESMEN

NEED a new car? Aggressive salesmen who contact business firms can earn a new car this year with spare time commissions selling Glassarts and Silhouette Advertising. Old established firm. Top notch line. Weekly commissions. Write today, stating experience, territory covered, lines of business usually solicited, etc. Newton Mfg. Co., Box CK, Newton, Iowa.

WANTED—Men for good paying work with a large shoe company. Good pay every day. Free shoes as bonuses to "go-getters." No experience needed. Complete sales outfit sent free. Write Consolidated Shoe System, Dept. G3, Chippewa Falls, Wis.

LONG Needed invention—proved success. Ready for national distribution. Powerful demonstration. Every home, store, office, school, factory a prospect. Low price—long profit. Exclusive. Get facts quick. Write Barker, Box 604, Littleton, Colorado.

AT Last a new idea in shirts. Rosecliff shirts are worn and endorsed by famous movie stars assuring latest, fastest selling styles. You can make big cash daily. Complete sample outfit free. Write today. Dept. P4, Rosecliff, 1239 Broadway, New York.

SELL Celluloid and cardboard pricing tickets, steel shelf moulding, changeable signs, menu covers. Every store prospect. P. Pricing Press, 124 White St., New York.

CASH In quick. Federal law forces every business to buy—Worthmore 3-in-1 New Improved Social Security pay roll records. 350% profit. Your low cost 22c. Worthmore, 221MH East 20th, Chicago.

BIG Money selling advertising book matches. Amazing low prices. Wonderful full time or sideline. Liberal commissions paid daily. Free elaborate outfit. Regal Match Co., Dept. 54, Hamilton & Gladys, Chicago.

YOU Get paid first. Take orders for 200 home necessities. Pay after you collect. Big profits. Write Ho-Ro-Co, 2786-R Dodier St., St. Louis, Mo.

JAY-WAY Door holder. New. Sensational. Moneymaking. Jay-Way, One East 42nd Street, New York.

SELL Nothing! \$95.00 weekly. \$500,000 punchboard firm announces new, no investment plan. Season starting. K&S, Dept. C124, 4329 Ravenswood, Chicago.

SELL Rubber renewer to garages, big profit. Liner Co., Canton, N. C.

WANT A better income? Wonderful opportunity ambitious, intelligent men. New federal-state tax laws; social security act compel merchants to keep records, file returns, penalties severe! Two-year simplified system including social security records and tax service \$7.95; lowest commission each sale \$4; leads furnished. Protected territory. Amazing self-seller makes sales for you. Live wires average \$100 weekly commissions. Dept. PM-2, Income Record Publishing, 480 Canal, New York.

MAKE More money taking orders: Shirts, ties, hosiery, raincoats, uniforms, dresses. Sales kit free! Experience unnecessary. Nimrod Company, Department 65, 4922-28 Lincoln Avenue, Chicago.

APPLICATIONS Now being accepted for sales work with Remington-Rand, Inc., (Portable Typewriter Division). Experience or investment not essential. Apply to M. N. Rand, Remington-Rand, Inc., 315 Fourth Ave., Dept. D-50, New York.

IF You are ambitious you can make good money with a Rawleigh route. We help you get started. No capital or experience needed. Steady work for right man. Write Rawleigh's, Dept. D-2-PPM, Freeport, Ill.

REPRESENT Manufacturer—Automobile specialty. Write National, P4-42 East End, Buffalo.

SALESMEN—Sell 150 letterheads, envelopes, etc., cost 60c. Maloney Sales, 724 Parsells, Rochester, N. Y.

SALESMEN, Distributors: New deal, more profit, exclusive territory. 125 varieties, brushes, mops, specialties. Neway Brush Co., Hartford, Conn.

SELL Complete federal-state social security record. Unusual demand. \$100 weekly. Write immediately. Rimer, Silver Springs, N. Y.

PERMANENT Full time business opportunity for responsible salesmen-distributors, selling our complete line of quality auto accessories to service stations and garages. Merchandise investment necessary. Exclusive territory. W. E. Johnson & Co., Lincoln, Nebraska.

SALESMEN: Sell complete line Hammermill bond business stationery, book matches, business cards, labels, salesbooks, garage forms, etc. Free deals, premiums. 35% comm. daily. Free sales portfolio. Willens, Dept. RV, 2130 Gladys, Chicago.

GENUINE Opportunity representing large advertising book match factory direct. Sell manufacturers, merchants. Full or part time. Big commission. Fast repeats. G. made \$500 in a month. Free kit, samples. Match Corp of America, Dept. E-4, 6041 Grand, Chicago.

SALESMEN: An unusual opportunity. Sell famous Wondercloth cleaning cloth to housewives, department stores, jobbers. Huge profit. Send for particulars. National Guard Equipment Co., 155 East 34th, New York City.

SOMETHING Entirely new! Low voltage soldering iron. Instant heat used from any storage battery, sells on sight, real opportunity to earn good money. \$3.25. Steiner Bros., Dept. O, Long Island City, N. Y.

SALESMEN—Four \$15 sales to stores net you \$40 daily. Sayers Systems, Est. 1895, 2801-123 Sheffield Ave., Chicago, Ill.

BE Independent. Own your business; experience unnecessary, selling \$10,000 accidental death, \$50 accident; \$25 sick weekly benefits—\$10.00 yearly. Other amounts proportionate. Guaranteed steady renewal income. \$726,415.63 securities deposited. Universal Policy, 716-A Lefcourt Bldg., Newark, New Jersey.

GOOD Long profit side or main line. Exclusive makers radiator stop-leak and flush. Zenith, 3635-S Lyndale, Minneapolis, Minn.

SALESMEN: Sell advertising novelties, calendars, fans, thermometers, etc., for nationally known firm. Liberal commissions. Stanwood Hillson Corp., 21 Station St., Brookline, Mass.

WE Need experienced salesmen for a real money making article. Wide sales field with exclusive territory. Richmond Chemical Company, Silver Spring, Maryland.

NEW Specialty—Sells every business and professional man. Four \$15 sales daily pay \$280 weekly. Ferrell cleared over \$1,000.00 monthly. Write, F. E. Armstrong, President, Dept. PM, Mobile, Ala.

BE Your own boss. Make the largest commissions selling our complete line of brushes. Write for sales plan. Wire Grip Sanitary Brush Corp., 220 Southern Boulevard, N. Y.

BRUSH Salesman—If you ever sold brushes write for our money making proposition. Donald Brush Co., Camden, New Jersey.

FREE Booklet describes 107 plans for making \$20-\$100 weekly, in home or office, business of your own. Elite Co., 214 Grand St., New York.

EDUCATIONAL AND INSTRUCTION

SHORTHAND Brings opportunities. Free catalogue. Shorthand Institute, 6330b Clayton, St. Louis.

GET \$50 To \$87.50 every pay day on Uncle Sam's payroll. Many appointments expected soon. Our coaching helps qualify you for Social Security, liquor gauger, meat inspector, office clerk, stenographer, typist, customs, postal and many other positions. Write today for free book, list of positions, etc. Patterson School, (Arthur R. Patterson, former Government examiner, Principal), 8 Case Bldg., Rochester, N. Y.

GET 1937 Government jobs. Start \$105-\$175 month. Steady raise. Men-women. Prepare now for next announced examinations. Full particulars—list positions, free. Write today sure. Franklin Institute, Dept. B3, Rochester, N. Y.

GOVERNMENT Job seekers. Attention: civil service, arithmetic, spelling, geography, clerical tests. Questions. Answers. Only \$1.00 complete, postpaid. Free descriptive folio. Merit Publications, Munsey Building, Washington, D. C.

BECOME An Investigator—Secret service agent. New "Test Problem Method." Develops your ability. Particulars free. International Secret Service Institute, (PM47), Hoboken, N. J.

WRITERS! Public speakers! Take advantage of our distinctive services also new, practical course in journalism. Low rates. Free circulars. Continental Writers' and Speakers' Bureau, 705 Railway Exchange Bldg., Montreal, Canada.

KNOCK 'Em cold. Learn police Jiu Jitsu. 13 secret knockout blows without fists. Illustrated course by world famous instructor. Price 15 cents. S. J. Jorgensen, 402 Maritime Bldg., Seattle, Wash.

OPERATE A collection business. Outstanding opportunity. Quickly learned. Fine income assured. Write Cole Associates, Syracuse, New York.

RITE-IT-RITE, Complete and perfect shorthand. Fifty lessons, fifty hours, fifty cents. Send to McDevitt's, 2079 Sutter, San Francisco.

AMATEUR Cartoonists—Win \$25.00. No drawing ability necessary to win. 26 prizes in all. Rush name on postcard for valuable tips on "How to Make Money With Simple Cartoons," cash prize entry blank and rules. Send no money. Cartoonists' Exchange, Dept. C-94C, Pleasant Hill, Ohio.

WANTED—New writers! Write for magazines, books, newspapers. Free literature! United States School of Writing, 20 West Sixtieth, New York City.

DIESEL! Modern, scientific instruction. Illustrated chart system with comprehensive explanations. Drafted by experts. For limited time 25c (coin). Diesel Institute, Box 1485, Hollywood, California.

CIVIL Service training—City, state, government examinations. Our slogan, "Every Student Must Pass." Chance to earn tuition. Lincoln Institute, 10 Tremont Street, Boston, Mass.

WELDING, Bumping, metal finishing, torch soldering taught. Days, nights. Jobs open. Men from this school getting good jobs right now. Free employment service. Factory Trade School, 8807 Harper, Detroit, Michigan.

AT Last Give yourself a break. Learn forestry at home. Easy. Big salaries. Get new forestry book \$2.75. Wholesale Book Co., Box 305, Altoona, Pa.

AIR Conditioning—Diesel engineering. 1937 course. Write. Free lesson. National, 3943 N. Broad Street, Philadelphia, Pa.

TYPING—Learn in two weeks, complete. \$2. Joseph Mancha, 433 Fairroaks, San Francisco.

OIL Burner installation—Service. Practical homestudy training. Write. National, 3943 Broad Street, Philadelphia.

GOVERNMENT Social security jobs. For men and women, age 18-50. Are you interested in obtaining one? Write immediately for full information and how to pass entrance test, etc. Instruction Service, 101, St. Louis, Mo.

BECOME Business investigator. Earn \$1.00 hourly, upwards—spare time. Experience unnecessary; we teach you. Details free. Business Detective System, 1009 Oak, Elmira, N. Y.

MEN Wanted willing to learn landscape designing and fill big paying position as landscape architects. Free test of your natural ability and chance to win in \$750 contest. No experience needed to start. Earn while you learn. Write today for free test blank. American Landscape School, 837 Plymouth Bldg., Des Moines, Iowa.

PSYCHICAL Culture Collegium, S-Whitley, Ind. Homestudy doctor degree. Worldwide enrollment.

HOME Study courses leading to degrees: Arts and sciences, philosophy, education, law, letters, theology, psychology, engineering, chemistry, business and commerce. Many others. McKinley-Roosevelt College of Arts and Sciences, Chicago.

SECRET Service. Particulars free. Write immediately. George Wagner, M-2640 Broadway, New York.

BIG Bargain catalogue educational matter 10c. Handling, Y-799 Broadway, New York.

MASSAGE, Hydrotherapy, dietetics, drugless therapeutics, chiropody, taught by mail. Evans Correspondence School, Montgomery, Ala.

LEARN Machinist trade, tool, die making. Automatic and hand screw machines. Modern shop methods. Actual work. Jobs open for trained men. Employment help. Illustrated booklet free. Allied Screw Machine Company, 601 Lake Street, Chicago.

LEARN Auto mechanics, body, repairing, welding, electricity, refrigeration. Diesel. Stevinson's, 2008A Main, Kansas City, Mo.

LEARN Latest methods solving arithmetical problems quickly. Frederick A. Smith, 2410 Smalley Court, Chicago.

PLAYS—STORIES—MANUSCRIPTS

CASH Paid for your legends, ballads, poetry, riddles, friendship, humorous, pets, sparetime money-making ideas and other interesting short stories. Contest prizes and up to 4c per word will be paid for acceptable material. Home Life, Berwyn, Illinois.

STORIES Needed for sales department. Commission basis. New sales plan. Crown Service, 917 Shreve Bldg., San Francisco.

WRITERS! Public speakers! Take advantage of our distinctive services, also new, practical course in journalism. Low rates. Free circulars. Continental Writers' & Speakers' Bureau, 705 Railway Exchange Bldg., Montreal, Canada.

POETRY: Revision, instruction, sales suggestions. Anton M. Romatka, 25 W. 3rd Street, New York.

CARTOONING AND COMMERCIAL ART

AMATEUR Cartoonists—Win \$25.00. No drawing ability necessary to win. 26 prizes in all. Rush name on postcard for valuable tips on "How to Make Money With Simple Cartoons," cash prize entry blank and rules. Send no money. Cartoonists' Exchange, Dept. C-94, Pleasant Hill, Ohio.

CARTOONING, Sketching, etc., by Alexander Murray. 46 lessons, 600 illustrations, including practice sheets, pens, pencils, drawings criticized, \$1.00 complete. Slinger Service, 1782 E. 100th, Cleveland, Ohio.

CASH Paid for your sketches, cartoons, illustrations and photographs. Contest prizes and up to \$10 will be paid for acceptable drawings or photos. Home Life, Berwyn, Illinois.

LEARN Lettering \$1 complete course. Northeastern School of Lettering, Bangor, Maine.

CARTOONISTS: Free market guide—with 25c purchase "Money Making Plans." Cartoon Studios, LaCrosse, Wisconsin.

CARTOONING Course \$1.00—30 lessons, over 500 illustrations, with drawing pens and pencils. Scovell Studios, Box 748-P, Hollywood, Calif.

LEARN Modern cartooning—Tom Doerer method—individually taught by recognized master. First lesson free. Send 6c postage only. National Arts Guild, Dept. B, Washington, D. C.

AMATEUR Cartoonists—Sell your work. Write Smith's Service, Wenatchee, Wash.

SIGN Painting. 27 large illustrated lessons, \$1.00! Vocational, 3555 Aberdeen, Alton, Ill.

SELL Drawings. Read Art Advisor Monthly, Parkville, Missouri. Samples 20c.

CHALK Talks. Laugh producing program, \$1.00. Catalog free. Balda, The Cartoonist, Oshkosh, Wis.

AMATEUR Cartoonists earn excellent income, spare time, duplicating cartoons for advertisers. 3-M Service, Argyle, Wisconsin.

CARTOONING, Sketching, etc.—46 lessons, 600 illustrations, including practice sheets, pens, pencils, \$1.00 complete. Fraba Service, Cashton, Wisconsin.

BUSINESS SERVICE

DELAWARE Charters: Complete service \$35. Submitted forms. Chas. G. Guyer, Inc., Wilmington, Delaware.

INFORMATION Where to buy anything! Correct address of reliable manufacturers, wholesalers, \$1.00. King Buyers' Service, 702 Lakeview, Jamestown, N. Y.

DELAWARE Mail address. Business, personal, representation, forwarding, \$1.00 monthly. Delmaco, 6 East 15th Street, Wilmington.

WANT Branch office nation's capital? Trifling expense for prestige it gives to business or social use; letters forwarded daily. Only \$2.00 monthly. Hawkins Mail Service, 309 Burchell, 817-14th Street, Washington, D. C.

CHICAGO! Business-personal mail address, representation, forwarding; \$1.00 month. Established 1919. General Business Service, 56 West Washington.

ALL International legal matters. Lic. Victores Prieto, Mexican Attorney at Law, P. O. Box 122 M. Juarez, Mexico.

ADVERTISING AGENCIES

INCH Display advertisement 30 magazines year \$24. Wood's Popular Services, Atlantic City, (N. J.)

LEARN Advertising quickly at home. Easy practical plan. No text books. Common school education sufficient. Interesting booklet and requirements free. Page-Davis School of Advertising, 3601 Michigan Avenue, Dept. 3431, Chicago.

ADVERTISE: 24 Words in 250 newspapers \$10. Lists free. Advertising Service Bureau, 4258-C Drexel, Chicago.

ADVERTISING Placed anywhere. Helpful, free service. Rate guide book free. Baker Advertising Agency, 189 W. Madison, Chicago. Successors to Ankrum Advertising Agency. Established 27 years.

ADVERTISE Profitably: \$15 reaches 6,000,000 Sunday newspaper readers with 24 word ad. Newspaper, magazine rate-guide, free. Chicago Union Agency, 20 West Jackson, Chicago.

FREE—New Advertisers Rate Guide, 44 pages. Includes everything. Lowest rates. E. H. Brown Advertising Agency, 140 S. Dearborn, Chicago.

FOR ADVERTISERS

ADVERTISE 40 Words display, 75c. 20,000 circulation. Classified 1c word. Joseph Vickers, Missouri Branch, W. Va.

DRAWINGS, Lettering, trademarks, letterheads drawn. Write for prices. Wilford Glatfelter, Springvalley, Ohio.

TELEPHONE Book names, 200—\$1.00. A. Bennett, 2914 Manistique, Detroit, Mich.

ADVERTISE. 30 Words, 25 magazines, \$1.00. Goodall, 742 Market, San Francisco.

RUBBER STAMPS AND OFFICE SUPPLIES

CUSHION Mounted, one-two lines, 25c; three 35c. Signatures \$1.50. Pocket stamp 60c. Stamp Works, 814 Bradley, Peoria, Ill.

NAME, Address. Rubber stamps 35c. Newman, 1825 Ryons, Lincoln, Nebr.

NAME, Address, 2 lines 25c; 3 lines 35c. Stamp Works, Auburn, Nebr.

2 LINES 25c, 3 Lines 35c. Stamprite, FP13, Springfield, Mass.

2 LINES 25c, 3 Lines 35c. Stamp Works, Centerport, N. Y.

TYPEWRITERS, DUPLICATORS, OFFICE DEVICES

INCREASE Business now. "Excellograph" Rotary Stencil Printer reprints thousands everything you typewrite, handwriting, draw or trace. Colors. \$19.75 to \$44.00. Terms. Illustrated literature free to business or professional men. Pittsburgh Typewriter Supply, Department K-2, Pittsburgh, Pa.

PRINT-O-PRESS, World's lowest priced rotary stencil letter duplicator \$9.95 complete. Details and samples of work free. Professional Products, Dept. 410, Silverton, Ohio.

DUPLICATOR. Special \$1. Complete with type, 150 or less your own words ready, ready to print thousands perfect copies. Corbino, 964 Greene Ave., Brooklyn, N. Y.

NEW \$4.75 Automatic adding machine. Fully guaranteed. Bassett, Box 302A, Altadena, California.

TYPEWRITERS, Duplicators, multi- graphs. Write for free list office machine bargains. Save half. Pruitt, 518 Pruitt Bldg., Chicago.

PRINTING, MULTIGRAPHING, MIMEOGRAPHING, GUMMED LABELS

LET A mail order expert do your print- ing. Low overhead, automatic high speed presses, quantity production offer you amazingly low prices. Two-color broadsides, folders, letterheads, envelopes, forms, etc. Let us quote you prices. Prompt delivery anywhere. Ray's Printing Service, Dept. 64, Pleasant Hill, Ohio.

SAVE 50% On printing. Letterheads, statements, cards, envelopes. Samples free. Conway Press, 2013-K Huron, Chicago.

1,000 MIMEOGRAPHED Letters, \$3.85. Bur-Wil Enterprises, 24 Louisa, Binghamton, N. Y.

QUALITY Printing, low prices, samples free. Charles Harmon, Chester, W. Va.

1,000 CIRCULARS 4x6, 75c, 200 words. Arco, 236 Pearsall, Jersey City, N. J.

1000 LETTERHEADS \$2.00, Hammermill bond, \$3.00. Jennings-Poble Press, Dept. B, Honesdale, Penna.

HALL'S Professional printing!! Your suc- cess! Samples! Hall's Printing, Dalton, Massachusetts.

200 TWO Color bond letterheads or 500 6 1/2 envelopes \$1.00. Morey Press, 87P Somerset St., Springfield, Mass.

\$1.85—1000; LETTERHEADS, Envelopes, statements, circulars. Samples. Midwest Printing, Northfield, Minn.

1000 6 1/2 ENVELOPES, Letterheads, \$2.35. Schneider, 951 West 68th Street, Chicago.

LETTERHEADS, 500—95c Postpaid. Other bargains. Samples sent. Foxvale Printers, Geneva, Illinois.

125 BUSINESS Envelopes, 200 letter- heads, \$1.00. Larger quantities, letterheads, statements, etc. Samples. Becker Bros., Portchester, N. Y.

1000 STATEMENTS \$2.50; 1000 Cards \$1.50, postpaid. Olsen, 1551 Southeast Powell, Portland, Oregon.

QUALITY Printing. 1000 envelopes, cards, billheads \$2.90. Mayflower, 227A Brookline Street, Cambridge, Massachusetts.

ECONOMY, Quality—Distinctive printing. Get our prices, samples. EPress, Box 103, Station W, Brooklyn, N. Y.

1000 LETTERHEADS, Statements, bill- heads, envelopes, \$2.95. Central Printers, 727 West 69th Street, Chicago.

2,000 BUSINESS Cards \$1.50, Bobby, Box 371, Bayonne, New Jersey.

50% DISCOUNT! 1,000 Business cards regularly \$1.50. Your wholesale cost 50c (no stamps). Copy neatly printed; 2x3 1/2 white 2-ply. Attractive mounted sample display 10c. VanDorn Cardcrafters, Ottawa, Illinois.

CIRCULARS, Envelopes, letterheads, statements \$2.85, 1000. Business cards \$1.75, 1000. Send cash with order. Fridlund Press, 106 Milwaukee, Elgin, Illinois.

FOLDING, Multigraphing, mimeograph- ing, printing. Let our low overhead save you money. Get our prices. Coleman Press, Smithboro, N. Y.

250 ENVELOPES \$1.00. Mimeographing. Office supplies. Catalog-P, Sylco, Downers Grove, Ill.

1000 BUSINESS Cards \$1.00. Cycle Press, Box 325, Lawndale, Calif.

100 LETTERHEADS, 100 Envelopes, 100 business cards; your name, address, postpaid, \$1.00. Cash with order. Noice Printing Company, Columbus, O.

LETTERHEADS, 8 1/2x11. Heavy bond— envelopes. 100 each \$1.00. Evans, 44P North Tenth, Reading, Pa.

QUALITY Printing. Reasonable prices. Estimates free. Windy City Printers, 3301 Carroll, Chicago.

1000 BETTER Grade business cards \$1.50 postpaid. Harris Printing Co., Lawrenceburg, Tennessee.

500 CARDS With cardcase \$7.99. 500 mim- eographed letters \$2.00. Samples free. Colopress, Larned Bldg., Detroit.

BUSINESS Cards, 1000, \$1.00; 2000, \$1.50 postpaid. McBride Printery, 646 McBride Avenue, Los Angeles, Calif.

RAISED Letter printing. Letterheads— envelopes—100 of each—\$1.00. Perry Press, Albion, Maine.

PERSONALLY Printed vellum stationery, 200 sheets, 100 envelopes, \$1.00 postpaid. Sphere Service, Margaretville, N. Y.

ENGRAVINGS From photographs or draw- ings, 2x3, \$1.00. Teel Rumbaugh, Aurora, Missouri.

WHOOPIE!—Comic "business" cards, 25c packet. Hilarious knockouts! (Don't miss.) David Sanderson, Ottawa, Illinois.

6x9 CIRCULARS, Letterheads, envelopes, postcards, \$2.95 1000, 5000, \$8.99. Booklets, folders, low prices. Goodprint, Harrisonburg, Va.

COLORED Circulars, 6x9, \$1.50 thousand. Samples. Tribune Press, Fowler, Indiana.

1000 6x9 CIRCULARS \$1.50; 3x6, \$1.00. Lawndalepress, Box 303-B, Franklin, N. H.

LABELS. Amazing values. Color samples free. 6018K Quimby, Cleveland, Ohio.

500 TWO-COLOR Howard bond letter- heads, \$2.75. Press, Jamestown, Indiana.

1,000 3 1/2x5 1/2 PRINTED Adcards \$1.89; 5,000, \$7.95. Samples. Comstock, Charleston, New Hampshire.

100 SOCIALLY Correct calling cards \$7.75. Nixprintco, 241 North Street, Chillicothe, Ohio.

PHOTO Engravings—Zinc line cuts made, 10 square inches, \$1.00 up; halftones; electros; artist; speedy; free price list. Riteway Engraving, 1457P Broadway, New York.

PRINTED Stationery—300 sheets, 150 en- velopes \$1.00. Cards 50c hundred. Hennessee, 907 West Roosevelt Blvd., Philadelphia.

5000 LETTERHEADS \$8.95. Stamp sam- ples. Square Deal Printery, Humboldt, Iowa.

294 LETTERHEADS, 5 1/2x8 1/2; 150 En- velopes; three lines; dollar, 10c extra west Mississippi. Perry Printer, Lafayette, Ind.

500 3/4x2 1/4 FOUR Line gummed stickers, 25c. Moritz Printery, Saginaw, Mich.

WEDDING Invitations. Samples, prices. Drachprint, 1619 Hogan St., St. Louis, Mo.

250 LETTERHEADS, Envelopes, state- ments, or cards—\$1.00. Globe, Pottstown, Penna.

CHROMO—Mimeo—Multigraphing prop- erly processed, illustrated, displayed, attracts attention; brings results. Summers Letter Shop, Jasper, Florida.

BETTER Grade printing, reasonable priced. Free samples. Economic Press, Leonia, N. J.

\$1.00 SPECIAL—1000 3x6 Circulars. 100 word limit. Postpaid. Hustler, Advance, Indiana.

2000 BUSINESS Cards neatly printed \$1.50. Quick service. Free samples. Atlas Distributing Co., 1814 Bedford Ave., Pittsburgh, Pa.

LABELS—All kinds. Write, samples. JBSCO, Box 93, Holyoke, Mass.

500 LETTERHEADS, Envelopes, statements \$1.10; 1,000, \$2.00. Samples. Raymond's, Newport, New York.

1000 BUSINESS Cards, card case, \$1.50. Miller, Printer, Ambler, Pa.

CUTS 2x3, \$1.10, from drawings and photos. Joe Rek, 118 Gazette Ave., Lexington, Ky.

PRINTING OUTFITS AND SUPPLIES

ZINC Cuts mounted 2x3, \$1.00; 3x4, \$1.75. Cozatt, Danville, Ill.

STOCK Cuts 40c up. Catalog dime. None free. G. Gregor, 79-N Main Street, Belleville, N. J.

BUILD 9"x15" Printing press worth \$85 for \$5. Plans \$1.00. A. Huebl, LeSueur, Minn.

BOND Letterhead paper. Mill prices. Samples 3c. Cascade, North Adams, Mass.

HAND Press, type and complete printers' supplies. Advise equipment you need and we quote prices; or send stamp for catalog. P. Peiffer, 10 B; 6 Columbia St., Newark, N. J.

SENSATIONAL Inventions! Sun-Printer, prints greeting cards, etc. Complete outfit \$1.00. Picture-enlarger complete \$1.00. Tempo, 158 Grand Street, N. Y.

LONG Established amateur printers warehouse. Lists 3c. Landis, Richland, Pa.

PRINT Your own cards, stationery, circulars, advertising, etc. Save money. Easy rules furnished. Print for others, big profits. Junior press, \$5.90; job presses, \$11, power \$149. Write for details. Kelsey Co., A-11, Meriden, Conn.

BARGAINS—Presses, type, supplies. Send stamp. 159 Harvard, Cambridge, Mass.

PRINTING Outfits—Presses, type, supplies, type novelties. Send 20c for card case samples. Catalog free. Model Press, York, Pa.

BARGAINS, Presses, type. List 3c. Exchange D-15, 22 Orient, Meriden, Conn.

PATENT ATTORNEYS

INVENTORS: Send immediately for your copies of our new free books, "Patent Protection" and "Suggestions on Selling an Invention." Sixty-eight pages of interesting facts. They tell how patent laws protect you; kind of sketch or model needed; simple steps to take without cost; how successful inventors have secured financial assistance; show interesting inventions; illustrate important mechanical movements. With books we also send free Evidence of Invention form to help establish date of disclosure. Prompt service, reasonable fees, special deferred payment plan. Strictest secrecy. Thirty-six years' experience. Highest references. Write us today. The facts in our books are worth money to the man with a good invention. Address: Victor J. Evans & Co., Registered Patent Attorneys, 900-D Victor Building, Washington, D. C.

SELL Your unpatented ideas. We tell you how; help you make the sale. Particulars free. Write W. T. Greene, 976 Barrister Bldg., Washington, D. C.

PRACTICAL Inventions now salable before patenting. What have you? Write Chartered Institute of American Inventors, Dept. 4B, Washington, D. C.

DO You feel you have a valuable invention—but can't get it before the right people? Are you groping in the dark—wondering which way to turn—getting nowhere? Learn how other men with inventions have cashed in. Write for our free book, "Patent Guide for the Inventor," which tells you of fields where inventions earn big money if they are good patented ones. Clarence A. O'Brien and Hyman Berman, Registered Patent Attorneys, 58-X Adams Bldg., Washington, D. C.

PATENTS—Proper service for manufacturers and individual inventors. Established 1895. Reasonable charges. Consult Chandler & Chandler, Patent Attorneys, 902 F. Street, Washington, D. C.

INVENTORS—Send for free booklet "Patent-Sense." Information based on 64 years experience. Lacey & Lacey, Dept. 5A, 635 F St., Washington, D. C.

PATENTS—Personal, confidential services for protection of your invention at reasonable cost. Preliminary information and approximate cost of patent furnished without obligation. John B. Thomas & Co., 902 F Street, N. W., Washington, D. C.

PATENTS—Trade marks—Personal service, reasonable charges. Preliminary advice, book and disclosure form free. Irving L. McCathran, 1060 International Bldg., Washington, D. C. Registered Patent Attorney.

L. F. RANDOLPH, 302-B Victor Building, Washington, D. C. Low cost. Book and information free.

PATENTS. Protect your idea by securing free "Proof of Invention" folder. Exceptional personal service. Established 1906. E. E. Vrooman, 871 Woodward Building, Washington, D. C.

PATENTS. Instructions "How to Establish Your Rights" and form, "Evidence of Conception"—sent free! Lancaster, Allwine & Rommel, 411 Bowen Building, Washington, D. C.

PATENTS. Booklet free. Highest references. Best results. Promptness assured. Watson E. Coleman, Patent Lawyer, 724 Ninth St., Washington, D. C.

"INVENTOR'S Guide", 100 mechanical movements, free; advises on patenting, selling inventions. Frank Ledermann, Tribune Bldg., New York.

THEODORE H. Rutley, Registered Patent Attorney, 512 Colorado Bldg., Washington, D. C.

FOR INVENTORS

DO You feel you have a valuable invention—but can't get it before the right people? Are you groping in the dark—wondering which way to turn—getting nowhere? Learn how other men with inventions have cashed in. Write for our free book, "Patent Guide for the Inventor," which tells you of fields where inventions earn big money if they are good patented ones. Clarence A. O'Brien and Hyman Berman, Registered Patent Attorneys, 58-X Adams Bldg., Washington, D. C.

INVENTORS: Send immediately for your copies of our new free books, "Patent Protection" and "Suggestions on Selling an Invention." Sixty-eight pages of interesting facts. They tell how patent laws protect you; kind of sketch or model needed; simple steps to take without cost; how successful inventors have secured financial assistance; show interesting inventions; illustrate important mechanical movements. With books we also send free Evidence of Invention form to help establish date of disclosure. Prompt service, reasonable fees, special deferred payment plan. Strictest secrecy. Thirty-six years' experience. Highest references. Write us today. The facts in our books are worth money to the man with a good invention. Address: Victor J. Evans & Co., Registered Patent Attorneys, 901-D Victor Building, Washington, D. C.

NATIONAL Inventors Congress holding five day meeting and exhibit March 29th to April 2nd. Write for details. Blum Building, Chicago.

GET Copies of patents similar to your ideas. L. A. Summers, 5229 7th Street, N. W., Washington, D. C.

35 YEARS Of service to inventors, developing ideas into working models, securing patents, designing machinery and devices, making shop drawings, starting production and sales. Henry, 1113 West Tioga St., Philadelphia, Pa.

WE Successfully sell inventions, patented and unpatented. Write for proof, and tell us what you have for sale. Chartered Institute of American Inventors, Dept. 4-C, Washington, D. C.

FREE Information about new magazine for inventors who want more profit from their ideas. Write "Successful Inventions," 809 Barrister Bldg., Washington, D. C.

INVENTORS. A good useful invention will sell before or after patent, depending upon idea; after much research, experience, we propose logical effective plan you may follow at small cost. Send full details your problem with two stamps and we shall advise. Bureau Patent Research, Box 628, Ben Franklin, Washington, D. C.

INVENTORS—We prepare lists of manufacturers who may be interested in your invention. 50 individually selected names \$3. State name type of invention. Commercial Listing Service, Box 1364, Minco, Okla.

RADIO—Experimenter's—Inventor's surprise kit—\$1.00. "Inventor's Paradise," 372 Tremont, Boston.

TO Inventors: We are in the market to purchase a good patent, preferably a small item made of metal. Will purchase outright or royalty. Purchasing Agent, 241 Front St., New York, N. Y.

INVENTORS: "Making Inventions Pay," our 32-page illustrated book, mailed upon receipt of 3c postage. Crescent Tool Company, Dept. Z, Cincinnati, Ohio.

INVENTORS—Send for 72-page book on patents. Reasonable terms. Conscientious treatment to inventors. L. F. Randolph, Registered Patent Attorney, 302-E Victor Bldg., Washington, D. C.

UNPATENTED Ideas can be sold. We tell you how and help you make the sale. Particulars, with list of manufacturers and wanted inventions sent free on request. Write W. T. Greene, 944 Barrister Building, Washington, D. C.

I SELL Patents. Established in 1900. Charles A. Scott, 773PM Garson Ave., Rochester, N. Y.

SELL Your patent through a small classified ad in Popular Mechanics. Many inventors have found buyers in this way. Ask me for proof—I'll gladly send it to you. F. W. Johnson, Manager, Classified Advertising, 200 E. Ontario St., Chicago.

INVENTOR'S Universal Educator; contains 900 mechanical movements; 50 perpetual motions; instruction on procuring and selling patents and selecting an attorney, etc. Suggests new ideas. Price \$1.00 postpaid in U.S.A. Address Albert E. Dietrich, 511-B Colorado Bldg., Washington, D. C.

BOOKS Covering hundreds of subjects. Big catalog for 3c postage. Popular Mechanics Press, Room (C37), 200 E. Ontario St., Chicago.

INVENTIONS WANTED

SMALL Inventions wanted by manufacturers. I'll help you sell your invention. Stanley Hull, K-7829 Euclid Avenue, Cleveland, Ohio.

ITEMS For manufacture and mail order sale by metal stamping concern now making homecraft tools. J. & H. Metal Products Co., 5 Commercial St., Rochester, N. Y.

CASH For unpatented ideas, particulars free. Mr. Ball, 9441 Pleasant Avenue, Chicago.

HAVE You a sound, practical invention for sale, patented or unpatented? If so, write Chartered Institute of American Inventors, Dept. 4A, Washington, D. C.

MANUFACTURER Will buy practical, useful invention. Box 374, Vicksburg, Mich.

WE Show you how to sell your invention, before or after patent; write what you have and we shall advise what to do. Bureau Patent Research, Box 628, Benjamin Franklin, Washington, D. C.

INVENTIONS Wanted—Patented, unpatented. If you have an idea for sale, write Hartley's, Inc., Box 928-E, Bangor, Maine.

PATENTS FOR SALE

FOUNTAIN Tooth brush connection. Connects brush to water faucet. Flushes mouth while cleaning teeth. Investigate this. John Morka, 58 Hincley Ave., Stamford, Conn.

SMALL Domestic invention. Great possibilities. Practical. Easily manufactured. Reasonable. Max, 324 Roesch, Buffalo, N. Y.

TEN Million prospects, mail box signal. Patented. Cheaply manufactured. Postal Dept. endorsed. C. A. Klingensmith, 61 N. Pershing, Indianapolis.

COLLAPSIBLE Showerbath for trailers. Outright or royalty. Descriptive blueprints. Write, Leon Whitton, Oteen, N. C.

POCKET Tablet dispenser. A. Pearson, 5012 Tioga Street, Duluth, Minnesota.

EXTENSION-LEVEL Patents. U. S. 2957404. Canada 362681. C. Wahlstrom, 3141 Turk St., San Francisco, Calif.

PRACTICAL, Economical, single prong appliance plug. Earl Allabach, Treviso, Pa.

MANUFACTURING

ANALYSIS. Research. Newest guaranteed formulas. Biggest catalog free. Special prices, leads. Gibson Laboratory, Chemists, DS-1142 Sunnyside, Chicago.

MANUFACTURING. Dies, machinery, models, brasswork, white metal casting moulds. Catalog 3c. Baum's Metal Specialties, Kansas City.

INVENTIONS Manufactured in any quantity at low cost. Stampings, dies, models, etc. Estimates and free catalog. Crescent Tool Co., Dept. X, Cincinnati, Ohio.

MODELS AND MODEL SUPPLIES

BUILD Queen Mary, 27 in. long, all wooden model. Fully finished hull, cut to fit parts, and plans. \$2.50 complete, plus postage. Send 3c stamp for catalog. Miniature Ship Models, Perkasis, Pa.

FREE! Illustrated circular. Listing 40 engines. Locomotive castings. Supplies. Stamp required. Howarco, A-2417 N. Ashland, Chicago.

1937 MODEL Railroad catalog. Locomotives, cars and parts, 25c. Refunded first order. Rollin L. Lobaugh, 1179 Howard Street, San Francisco, Calif.

RAILWAY Models. Catalog handbook 25c. Walthers, 247 East Erie, Milwaukee.

ELECTRIC Motor kit, variable speed, reversible. Operates on dry cells. Knock down kit. Send \$1.00 to 209 United Building, Louisville, Kentucky.

3/4" SCALE Steam locomotive easily built by "Step" method. Latest catalog of castings, boiler fittings, track materials, etc. 25c coin (returned on first order). Little Engines, Box B15, Wilmington, Calif.

HEADQUARTERS For yacht fittings—Marblehead (50-800) and Class A. List free. Illustrated catalog of ship fittings and construction sets 15c. A. J. Fisher, 1002-1 Etowah Ave., Royal Oak, Mich.

GASOLINE Motor 1/2 hp. Circular 5c. Anton Bohabov, Rahway, New Jersey.

MODEL Airplane supplies!! Free introductory gift and catalog. Stamp required. Models, 4802P Clarendon, Brooklyn, New York.

MARINE Model builders supplies. Ships, yachts, speedboats. Catalogue dime. Weicher, Fulton, N. Y.

BIG 96-Page model engine catalog, postpaid 20c. Particulars free. Evraymesco, 28 No. Clinton, Chicago.

POWER Modelers—Read Modelmaker Magazine. Current sample 15c. Special big buy, 25 assorted back issues, \$1.00. Model steam locomotives, gas engines, power boats, stationary engines. Box 196-P, Wauwatosa, Wis.

MODELS, Stampings, and special machinery. Send for catalog of brass gears and model supplies. The Pierce Model Works, Tinley Park, Ill.

SHIPS—18" Flying Cloud, Constitution or Galleons. All materials including easy plans only \$1.50. Catalog 15c. Hancock, 323 Douglass Ave., Portsmouth, Virginia.

MODELS—Your ideas developed into practical working models. 30 years' successful experience; thousands of satisfied customers. Confidential service guaranteed. Bank references. Send 3c postage for 32-page book—"Making Inventions Pay." Crescent Tool Company, Dept. Y, Cincinnati, Ohio.

HOME CRAFTSMEN

LOW-COST House plans. Quarter brings illustrated folder. Dana Co., Box 1381, Indianapolis, Ind.

24 FULL Size Homecrafters' prints (14"x21"). Many uses. Copyrighted instructions. \$1.00. Satisfaction guaranteed. Lists free. "Rork's," 3739 Fulton, Saginaw, Michigan.

MANUFACTURE Novelties. 500% profit. Five assorted illustrated plans. Sample. All postpaid 35c. Satisfaction guaranteed. Woodcraft Service, Plainview, Minnesota.

PLEASURE And profit in handicraft. How to start and catalog 5c. Handicraft Headquarters, Davenport, Iowa.

JUMPING Cactus wood, sample 25 cents. 63 Roanoke, Phoenix, Arizona.

GLASS Etching compound. Decorate monogram glassware. Formula, dime. Joseph Sine, 323 South 8th East, Salt Lake City, Utah.

WESTERNERS: Venetian blind supplies at real savings in time and shipping costs. Woodcraft Shop, San Rafael, Calif.

20 FULL-SIZED Lawn ornament prints 25c. 20 full-sized silhouette patterns 25c. Modern Woodcraft, Saginaw, Michigan.

"MODERN Wood sculpture." Complete instruction book on carving statues \$1.00. Lee, Wood Art Studio, Centerville, Ia.

LEATHERCRAFTSMEN—Write for free instructions and price list of leather, tools and beginners' kits. Send 5c for sample cards. Address Wilder & Company, Dept. F, 1638 Crosby St., Chicago, Ill.

HOMEMADE Drill press, belt sander, forge and 328 other practical shop articles in Shop Notes, Vol. 31, only 50c postpaid. Popular Mechanics Press, 200 E. Ontario St., Chicago.

OLD GOLD, WATCHES, JEWELRY, PRECIOUS STONES

AUSTRALIAN Opals. Beautiful blue, green, red, colorings. Catalogue free. Norman Seward, Melbourne, Australia.

OLD Gold, silver, platinum. Any condition or quantity for cash. Satisfaction guaranteed or goods returned. Vulcan Refining Works, Elizabeth, N. J.

CASH For gold. Anything. Metal Exchange, 3320 So. New York Ave., Milwaukee, Wis.

OPAL Wood settings. Name your wants. Box 808, Tacoma, Washington.

DIAMONDS—Wedding rings—25% to 50% discount. Free catalogue. Sweazey, Manufacturing Jeweler, Park Ridge, Ill.

5000 HUNTING Waltham, Elgin watches. New chromium engraved open face cases. Make big money! 16 size, 7 jewel, \$3.75; 16 size, 17 jewel, \$6.25. Send 3c stamp for free catalog. New plan. The New York Jobbers, Dept. M, 74 Bowers, New York, N. Y.

GOLD \$35.00 Ounce. Ship old gold teeth, crowns, jewelry, watches—receive cash by return mail. Satisfaction guaranteed. Free information. Dr. Weisberg's Gold Refining Company, 1593 Hennepin, Minneapolis, Minn.

CASH For old gold, teeth, watches, jewelry. 100% full cash value mailed day shipment received. Satisfaction guaranteed or articles cheerfully returned. Information free, or ship today. Chicago Gold Smelting Company, 300P Champlain Building, Chicago.

FOR THE HOME

CLINICAL Thermometers guaranteed. Accurate. Rubber case 75c postpaid. Associated, Box 694, Muncie, Indiana.

TOBACCO

GUARANTEED: Cigarette, pipe or chewing, 5 lbs. \$1.00; ten \$1.75. Pay when received. Pipe and box cigars free. Rives Tobacco Co., Paducah, Ky.

BUY At wholesale prices by mail—Cigarettes, cigars, tobaccos. All brands. No tax. Postal naming your favorite brands brings low wholesale prices. Moberly, Box 1016, Owensboro, Kentucky.

HIGHER Quality! Milder, golden yellow smoking or rich ripe chewing, four pounds, postpaid, \$1.00. Riverside Ranch, Hazel, Kentucky.

RAZORS—BLADES—SHARPENING

BRAND New machine for grinding, sharpening razor blades. Only \$1.25. John Deegan, 506 Liberty St., Newburgh, N. Y.

SURVEYING INSTRUMENTS

GUARANTEED Factory rebuilt transits and levels for rent (with purchase option) or sale (cash or terms). Order now before prices advance. We will repair, trade in, or buy your old instruments. Ship prepaid for estimate and valuation. Write for List M-24 and complete information to Warren-Knight Co., 136 N. 12th St., Philadelphia, Pa.

WANTED—MISCELLANEOUS

OLD Bonds. Give full description, quote low price. A. Baker, Hermon, N. Y.

CASH For used microscopes, binoculars, slide rules, drawing sets, cameras, surveying, medical and scientific instruments, tools, marine equipment. Highest prices paid day shipment received. Satisfaction guaranteed or shipment promptly returned. Elman's, 2302 Van Buren, Chicago.

PERSONAL

NATURAL Method speech correction at home. Particulars. Dowden, 509 Fifth Ave., New York.

HAIR Getting thin? Then investigate my "No Hair—No Pay" offer. No obligation. Paul Downing, 625 Swetland Bldg., Portland, Oregon.

RID Yourself of dandruff. Improve hair growth. Particulars free. Trable, 528 Garfield, Chicago.

EVERYONE Everywhere acquire that spark, that drive all topnotchers possess. Particulars for stamp. Give complete address. Edw. Johnston, 257 North Washington St., Tiffin, Ohio.

SAMPLE Personal notepaper sent free. Paul Cornish, Schenectady, N. Y.

CASH'S Woven names. For marking men's, women's, children's clothing. Free sample. Ouimette's, 1007A Water, New Bedford, Mass.

STUTTERING And stammering corrected at home. Descriptive booklet free. Paul J. Wolfe, Box 52, Pittsburgh, Penna.

ENJOY Sound sleep, drink Amazon Mate, natural beverage, refreshing, non-acid, stimulating. Millions in South America use Mate daily. Sample (20 cups) 10c. Write for details. Meyart, Box 1305X, St. Louis, Mo.

MISCELLANEOUS

MAGIC Light! Ornament your room with luminous stars; shine with beautiful violet light in dark, 25c each. "Nite-Lite" Luminous Paint, ounce jar, \$1.00. Luminart Co., Box 494, Hoboken, N. J.

REBUILD Discarded refrigerator unit into air compressor for home work shop or small garage. Plans 25 cents coin. No stamps. H. S. Bryan, 624 So. Durbin, Casper, Wyoming.

BUILD Poultry house under \$5. Garages under \$10. Cabins, etc., proportionately low. Substantial. Weatherproof. Guaranteed instructions 25c (coin). Woelk, 324 Wauhtown, Winston-Salem, N. C.

TATTOOING Outfits, supplies. Illustrated list. "Waters," 965 Put-nam, Detroit.

CHIPPED Glass sign making; mirror re-silvering; metalware replating. Interesting. Profitable. Write Sprinkle, Plater, 288, Marion, Indiana.

ADVERTISING Puzzle worth 25c, free for postage. Woodcraft, Anthony, Kans.

SIGNS—By new method. Particulars 10c. Straley, 13 1/2 Main, Springfield, Ohio.

FREE Razor—With our guaranteed blades. Twenty double-edge blades—50c. Clark's, Route Three, Kansas City, Kansas.

SWAP Or sell articles you don't need. Get those you want. Send dime for Swapper's Guide, listing articles from all over United States. Dept. P.M., Swapper's Guide, Delphos, Ohio.

KITT'S: The game of thought! New! Modern! Fun! De luxe, handpainted sets. Very attractive. A bargain. Order now. Satisfaction guaranteed. \$3.00 plus postage. Free folder. Kitt's, Box 655-M, Los Angeles.

WORLD Time clock. Sensational value. Marsala Company, Hillsdale, New Jersey.

DICTIONARY And Manual of Fireworks. More fun than model making for amateurs. Authority for professionals or attorneys. Colored illustrations. \$5.00. Geo. W. Weingart, New Orleans.

GRANITE Monuments, markers, \$8 up. Free catalog. Mihelich Monument Co., St. Cloud, Minn.

AMATEUR Cartoonists. Sell your work. Write Smith's Service, Wenatchee, Wash.

MONEY In butterflies, moths. See Sinclair Display Advertisement on page 24A.

TELETERMOMETERS—Weather bureau type. Highly accurate. Write, C. A. Laird, 1924 E. 29th, Des Moines, Iowa.

SAFETY Razor blades sharpened free. Send four as a trial. 3c stamp to P. O. Box 672, Newark, N. J.

STARTLING Information! Graying middle aged. Two amazing formula manuscripts combining "unique" business opportunity. Particulars free. Davis, Box 1484-A, Clarksburg, W. Va.

MEN—Do you want a Packard Lektro Shaver without cost? Write Packard Novelty Company, Kalispell, Montana.

AIRPLANE Wrecks! Interesting, educational photographs, 2 for 25c. Lynnpelcher, 2030 Julian, San Diego, Calif.

MONUMENTS \$9 Up delivered, erected, guaranteed. Thousands sold. Catalog free. Marble Granite Factory, A-17, Oneco, Fla.

AMATEUR Tattooing outfits, illustrated catalog 6c. "Tatuco," 651A South State, Chicago.

CUTS Anybody can make. Zinc etching process. Specimens, particulars, testimonials for stamp. J. C. Day, Windfall, Ind.

COCOONS, Butterflies, collectors' supplies, butterfly art materials. Free lists. Maynard, 1192 Lewiston, Rochester, New York.

BRONZE Tablets, desk plates, wall plates, memorials, grave markers. Bronze, brass and aluminum casting. Wandkey Pattern & Foundry Co., Anderson, Ind.

SWAPPER'S Friend, R4, Saline, Michigan. Interests swappers, collectors, sportsmen. 50c year, sample 10c.

(Continued from page 43A) *es 21*

There is also an example of the set issued by Zanzibar to commemorate the twenty-fifth year of the reigning sultan Calif ben Harub, one example of a set of two stamps issued by Costa Rica to advertise Cocos island and two semi-postal Red Cross stamps issued by Finland. The latter make an interesting addition to a collection of ship stamps. The Chinese stamps are part of a recent set to commemorate the fortieth year of postal service. These stamps show the G. P. O. at Shanghai, a mail boat, and methods of mail communication.

Also illustrated is a new Japanese stamp issued to commemorate thirty years occupation of Kwantung, and another Japanese issue to commemorate the opening of the new Imperial Diet. The Brazilian stamp bearing the inscription "Centenario Farroupilha," was issued last year to commemorate the hundredth anniversary of the "ragged" revolution. *es 21*

The Lesser Gold Coins

Three-dollar gold coins are seldom seen outside a collection. They are all of one design and show the Indian with feather headdress. Coinage was commenced in 1854 at Philadelphia, Dahlonega and New Orleans, and was continued in the first city to 1884 without missing a year. There was no further coinage at Dahlonega and New Orleans, but in 1855 the mint at San Francisco started with this value and continued in 1856, 1857, 1860 and 1870.

The three-dollar pieces issued by Philadelphia in 1854 are most common, with those issued by the same mint in 1878 holding second place. Of the first date about 138,000 were minted and of the second, about 82,000. Of all other varieties, only eight had an issue greater than 7,500 pieces. From 1860 the issue generally ranged from one to four or five thousand, but there were some issues smaller than one thousand, four dates with less than 100 each. Of these latter the 1870 coin of San Francisco holds the low record with two pieces minted. These of course are unobtainable, as also, for that matter, are the coins minted in 1873, 1875 and 1876, which amounted to twenty-five, twenty and forty-five respectively. The 1875 coin has sold for as high as \$500, with 1876 selling at \$200.

Get the FREE Book of opportunity

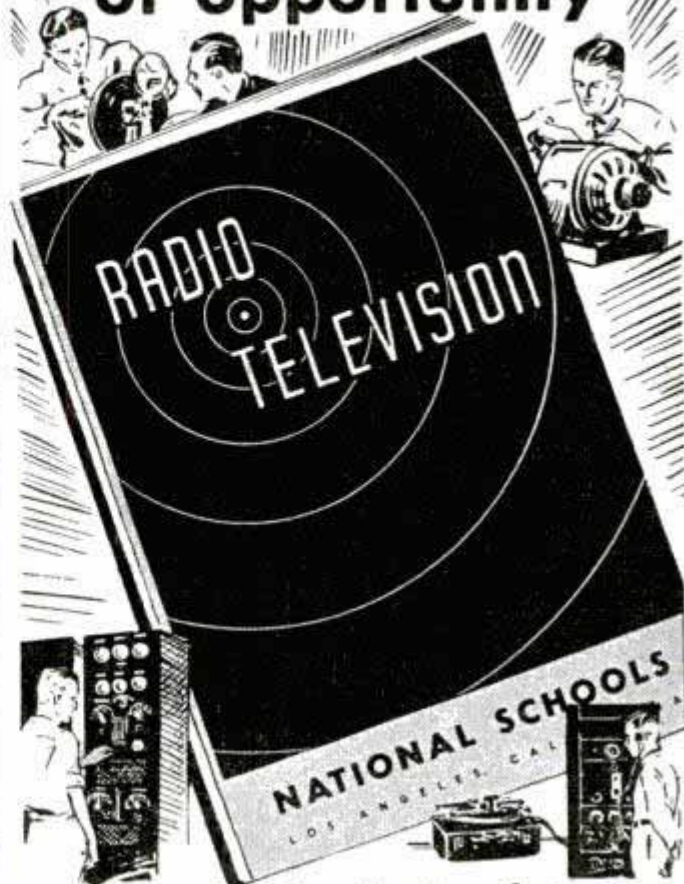

Brimful of terse instructive facts about TELEVISION RADIO SOUND RECORDING ELECTRICITY

Note These Interesting Contents

Written in plain, understandable language, this free book gives facts you want to know about the best-paying trades and opportunities. 95 illustrations. Major subjects include Television Theory and Construction, Pick-up Systems, Amplifiers, Transmitters, Receivers, Cathode Tubes; Radio in all its branches, Receiving, Broadcasting, Trouble-shooting, Construction and Theory; Sound-recording on Disc; Loud Speakers, Talking Picture Projection, Radio Communication, Laws, etc. This book also tells how you can qualify for these good pay trades by training at NATIONAL SCHOOLS. Send coupon now for free book.

National Schools is the oldest trade Institution in the West. Est. 1905. More than 30,000 graduates. You can earn room and board while learning. Coach railroad fare allowed to Los Angeles. This service only for residents of U.S.

NATIONAL SCHOOLS

LOS ANGELES

MAIL FOR FREE BOOK

NATIONAL SCHOOLS, Dept. 4-PMR,
4000 So. Figueroa St., Los Angeles, Calif.

Without obligation send your free book.

Name..... Age.....

Address.....

City..... State.....

INVENTORS all PATENTS ARE NOT GOOD PATENTS

Free



There Are Many Degrees Of PATENT PROTECTION

A good patent depends not only on the invention itself, but upon the skill and interest of your patent attorney in drawing up the claims and specifications and in following your case to a successful conclusion. C. A. Snow and Company have had over 61 years of specialized patent experience. We know the difference between strong patents and weak ones.

Write today for our free document: "CERTIFICATION OF INVENTION" and our two free booklets: "HOW WE PROTECT YOU" and "SUGGESTIONS ON HOW TO COMMERCIALIZE YOUR INVENTION." Fill out the coupon below NOW.

Cut Coupon On Dotted Line

DEPT. A-16 SNOW BUILDING, WASHINGTON, D. C.

Gentlemen: Please send me absolutely free and without obligation on my part, your free guides for inventors.

NAME.....

ADDRESS.....

CITY.....STATE.....

(PLEASE PRINT NAME CLEARLY)

C. A. SNOW & CO.

Registered Patent Attorneys Since 1875

Diesel... *the NEW POWER*

The amazing performance of the Diesel powered Burlington Zephyr trains has opened a new era of power efficiency. Airplanes, automobiles, great industrial plants will soon be using these marvelously efficient engines. This means a new profession, a new trade for thousands of men. Learn Diesel operation, construction and repair NOW through our brand new quick reference cyclopedia, the only complete encyclopedia on Diesel Engineering.

5 Big Books Shipped FREE

for examination. If you want to get into the most promising new field of the century, the liveliest, most up-to-date, most talked of profession, send for these books on our amazing free shipment offer. Over a thousand pages profusely illustrated and right up to the minute. Examine these books, read them, test them and if not thoroughly satisfied return them at our expense and you won't owe us one cent.

➔ Consulting Membership Included

Send now and we will include without extra charge a one year consulting membership in the American Technical Society with privilege of consultation with our engineers on any difficult problem.

AMERICAN TECHNICAL SOCIETY

Drexel at 58th Street, Dept. 0419, Chicago, Illinois.

You may send me the new 5 volumes on Diesel Engineering for ten days free examination. I will pay the few cents express only. Will examine the books and return them in ten days unless I decide to keep them, in which case I agree to send you \$2.00 in ten days and \$3.00 a month until the introductory price of only \$15.80 is paid.

Name.....

Address.....

City.....State.....

Please attach a letter giving age, occupation and the name and address of your employer and that of at least one business man as reference.



STEP UP TO BETTER JOBS AND BIGGER PAY WITH GOOD PRACTICAL BOOKS

Thousands of others have found extra cash between the pages of the selected, practical books listed below. Make these books your guides too—guides to better jobs—bigger pay—extra money.

AIR CONDITIONING

Live Field; Great Future.....\$3.50

AUTO ENCYCLOPEDIA

The Famous Dyke's Latest Edition.....\$6.00

110-V. GENERATORS

Made From Old Auto Units.....\$1.00

BIRD HOUSES

Build to Sell; Easy Designs.....\$1.00

BLUEPRINT READING

For Building Trades.....\$1.25

BOAT BOOK

Power, Sail, Rowing, Paddle Plans.....\$3.00

BOY MECHANIC

Hundreds Things Boys Can Make.....\$2.00

CARPENTRY, PRACTICAL

Complete 436 pages, 1936 Edition.....\$2.00

CHEMISTRY, PRACTICAL

Make Hundreds Things Daily Use.....\$2.00

CIVIL SERVICE

Home Study Courses Federal, State, City Positions.....\$1.00

DIESEL HANDBOOK

New! Latest Information.....\$5.00

EGG FARMING

Profitable Production Eggs, Poultry for Market.....\$2.00

ELECTROPLATING

Modern Practice Including Nickel, Zinc, Cadmium and Chromium.....\$2.25

FURNACE HEATING, WARM-AIR

Every essential covered, 568 pages.....\$3.00

FORD V-8 CARS, TRUCKS

New, 700 Pages. Includes Details 1937 Cars.....\$2.50

FORMULAS

10,000 Money Making.....\$4.00

FROG INDUSTRY

New! Raise and Sell Profits!.....\$1.00

FURNITURE MAKING

Tools, Materials, Designs.....\$2.50

HYPNOTISM

How to Become an Expert.....\$2.00

LATHE WORK (Metal)

Drilling, Threading.....\$1.00

LOCOMOTIVE

Folding Chart Shows all Parts.....\$1.00

LOG CABINS

Easy Plans; Build for Profit. Value!.....\$2.50

MATHEMATICS

Easy Guide for the Practical Man.....\$1.50

MECHANICAL DRAWING

Learn Drafting; Good Salaries.....\$1.00

MONEY MAKING IDEAS

1000 Ways to Make \$1000.....\$2.50

MOTOR CAR TRAILERS

How to Build.....\$2.00

OIL HEATING HANDBOOK

Just Out.....\$3.50

PLUMBING

500 Facts Every Homeowner Should Know.....\$1.50

TEST GOLD—PLATINUM

Identify—Buy—Sell. By C. M. Hoke.....\$1.00

PROSPECTORS' HANDBOOK

How to Mine, Appraise, Equip.....\$3.00

RADIO SERVICING

Profit by Knowing Costs, Kinks, Etc.....\$4.00

REFRIGERATION

Electric. Gas. Be a Service Expert.....\$5.00

REWINDING ELECTRIC MOTORS

Fractional Sizes. Value!.....\$2.50

SHIP MODEL

Entire Text, Famous "Sovereign" of 1637.....\$1.00

SHOP NOTES LIBRARY

5 Vol. 2000 Wonderful Shop Ideas.....\$2.50

STAMP ALBUM

Modern, 400 Pages.....\$1.00

STEEL SQUARE

How to Figure Angles of Rafters, Roofs, Etc.....\$1.00

TELEVISION

New! Book of the Hour.....\$2.50

TOYS

For Amusement or Profit. Saleable Designs.....\$1.50

UPHOLSTERY

Always a Big Market. Start Own Business.....\$2.00

WELDING ENCYCLOPEDIA

Covers all kinds welding thoroughly.....\$5.00

WIRING

Approved Economy Methods for Homes, Buildings.....\$2.50

WOOD TURNING

Woods, Tools, Methods; Practical Teacher.....\$1.50

WRIGHT ENGINE

Chart of "Whirlwind"; All Parts.....\$1.00

SEND NO MONEY!

Check the books wanted on the above list. Tear out and mail with your name and address. When postman hands you the books pay him price and a few cents postage. (In U. S. and possessions only.) If remittance is sent with order add 10 cents per book extra for postage. Send 3c stamp for postage and ask for catalog of other books.

POPULAR MECHANICS PRESS

Room 437A 200 East Ontario Street Chicago

When writing please mention Popular Mechanics

AIR CONDITIONING OPPORTUNITY

QUALIFY FOR GOOD JOBS QUICKLY!

BIG MONEY-MAKING OPPORTUNITY IF YOU LEARN TO BE AN EXPERT IN AIR CONDITIONING NOW! ACT!!

Think what tremendous success, fame, fortunes were reaped by the alert, aggressive men who pioneered the automobile, the airplane, the radio when those industries were young, just on the threshold of universal recognition. You now have greater opportunities if you have the right stuff in you in Air Conditioning. Don't wait a year and be too late for the big jobs. The industry is clamoring for trained men. Be an Air Conditioning Expert. Learn in 6 months by Home Study! Act Now!

FREE COMPLETE DATA! WRITE TODAY!
Address letter to J. J. STRANG, President

AIR CONDITIONING INSTITUTE OF AMERICA
Dept. A-4, FAIRFAX BUILDING KANSAS CITY, MISSOURI

WELDERS WANTED!



ELECTRIC ARC — OXY-ACETYLENE
Skilled Welders earn \$8 to \$15 a day. The demand now greater than the supply. Learn this highly paid trade in 4 weeks by actual shop work. One of America's leading schools. Established 1902. 7 floors of shops. Endorsed by welding industry. Limited number of students. Write or wire for reseraction. Send \$5 (credited on tuition) for valuable 512-page illustrated Welding Encyclopedia—also "Welding Facts". State age.

GREER COLLEGE, 2025 S. Wabash Ave., CHICAGO

ENGINEERING



Get a Bachelor of Science Degree! Complete courses and fully accredited degrees in Aeronautical, Architectural, Chemical, Electrical, Industrial and Mechanical engineering. Modern equipment. All college activities. Low tuition. Write Registrar today for full information and catalog.

LAWRENCE INSTITUTE OF TECHNOLOGY
15102 Woodward, Detroit, Mich. **CATALOG ON REQUEST**

JOBS FOR THOUSANDS



New opportunities open. Calls are increasing for men trained in **Drafting, Air Conditioning, Electricity, Housing, Engineering or Radio.** Choose your position if you have C. T. C. training. Free help to job when ready. No time to lose—start training now. B. S. Degree or shorter courses. 34th year, accredited. Send post card for 80 pg. "Blue Book." Mailed FREE.

CHICAGO TECHNICAL COLLEGE
D75 Tech Bldg., 118 East 26th St. Chicago, Ill.

SAVE UP TO 60% Italian Accordions

FREE case and lessons. Write at once for our New Free Illustrated catalog showing All Types of Italian Accordions at Big Savings to you. Satisfaction Guaranteed. Major Accordion Co., 1323 S. California Ave., Dept. 10, Chicago, Ill.



Trailer Travel Magazine



If interested in trailer lore, as owner, builder, buyer or prospect, you want the only magazine devoted exclusively to trailer news, stories, features, designs and plans; touring and camping; laws, and directory. Profusely illustrated. The Trallerite's guide. 10c For 12 issues mail \$1, or for sample copy....

TRAILER TRAVEL, PM4, 35 E. Wacker Drive, Chicago, Illinois

In answering advertisements always write name and full address clearly.

PATENTS

TO THE MAN WITH AN IDEA
Personal service, reasonable charges. Preliminary advice, book and disclosure form free. Registered Patent Attorney.

IRVING L. McCATHRAN, PATENT LAWYER
Formerly with and successor to RICHARD B. OWEN
1020 International Bldg., Washington, D. C.
TRADE-MARKS

When writing please mention Popular Mechanics

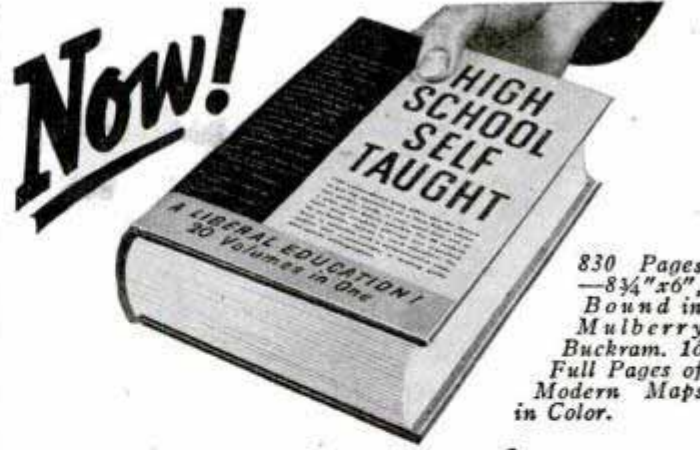

830 Pages
—8 3/4" x 6"
Bound in
Mulberry
Buckram. 16
Full Pages of
Modern Maps
in Color.

Get the Essentials of a High School Education

in This One Amazing Book for Only **\$1.98** no other payments

This single easy-to-read volume—**HIGH SCHOOL SELF TAUGHT**—will give you the equivalent of four years High School in just a few minutes a day of fascinating reading! Here is the easiest, most effective, practical way to make up for missed schooling. For your own success—in business, in friendships, in making the most of your own ability—this is the most IMPORTANT book you will ever read!

The Quickest, Surest, EASIEST Way to Acquire a Cultured Education!

Think of getting in one remarkable volume everything you need in History, Literature, Art, Science, Government, Mathematics, English—even French and Spanish! Here is the knowledge-background that can win YOU the leadership and admiration that brings SUCCESS. Written simply, concisely, to save you time, this fascinating volume puts the POWER of a better education squarely in your hands! Each branch of knowledge is presented in a clear, unforgettable story that will hold you spell-bound. But you must see HIGH SCHOOL SELF TAUGHT to appreciate it. Grasp this special opportunity!

SEND NO MONEY

We guarantee that the essence of a High School education can be yours in this single amazing volume. Send no money with the coupon below. When postman delivers book, pay only \$1.98 plus postage. If not convinced immediately—return book within 5 days, we refund your money at once. Mail coupon, without money, NOW. HOME-EDUCATION BUREAU, Dept. 24, 386 Fourth Ave., New York, N. Y.

- These 20 High School Subjects Made EASY**
Each section is complete. A marvel of concentrated education!
- HISTORY**
Ancient, Medieval, Modern, and U. S. History to date.
 - CIVICS**
City, State, National Gov't's explained.
 - ENGLISH**
Make words your servants and get ahead!
 - LITERATURE AND ART**
Know great Novels, Poems, Paintings, Sculpture, Music.
 - SCIENCE**
Biology, Psychology, Physics, Chemistry, Physiology, Astronomy, Geography, made clear.
 - MATHEMATICS**
Algebra, Geometry now simplified.
 - FOREIGN LANGUAGES**
Simplified French, Spanish, give you language power.
 - SELF-TESTING STUDY**
Outline, Reading Guide Over 1,000 self-testing questions, with 1,000 correct answers, check your progress!

HOME-EDUCATION BUREAU, BLUE RIBBON BOOKS, INC., Dept. 24, 386 4th Ave., New York, N. Y.

Please send "High School Self-Taught." When postman delivers it, in plain wrapper, I will deposit with him only \$1.98 plus few cents postage. I will examine it for five days. If I am not completely satisfied, I will return it and you will refund my \$1.98.

Name

Address

City..... State.....

Check here if enclosing \$1.98 WITH this coupon, in which case we will pay the postage—you save. Same return and refund privilege applies, of course.

NOW-IT'S SCIENTIFIC CRIME DETECTION



that PAYS BIG REWARDS

New Easy Training Endorsed by Experts Prepares You For BIG EARNINGS

The Nation's cry these days is for scientifically trained investigators. Never before has there been such an opportunity for young men scientifically trained as at the present time.

Study At Home—Advanced Education Or Previous Experience Not Necessary

This new training is not difficult. No deep book or technical data. Anyone 17 to 70 eligible. A little time each day qualifies you for big earnings in most fascinating profession on earth. Course includes every important branch of crime detection. Only course in existence that offers combination of the Science of Finger Prints, Secret Service and Private Investigation, Identification of Handwriting, Secrets of Defense and Attack, and Police Photography, ALL IN ONE GREAT COURSE!

Easy Terms—Big Regulation Outfit Free To Students

Write for easy terms policy enabling you to secure this scientific training with practically no sacrifice. You train with regulation police equipment and employ methods used in finest equipped bureaus of identification. Internationally famous leaders in police world endorse this training. Instructor a nationally known expert in scientific crime detection. Private industry also now demanding scientifically trained experts. Now is your opportunity to get into this new fascinating field.

FREE TO ANY YOUNG MAN 17 OR OVER

Send today for big new book, "Get Into Scientific Crime Detection," including 14 famous scientifically solved cases. This free book tells how and why you can earn big money in this great profession. Fill in coupon—mail today sure.

SCIENTIFIC CRIME DETECTION INSTITUTE of AMERICA, Inc.

Dept. 2D37 Chesapeake and Ohio Bldg.
Huntington, West Virginia
J. T. BURDETTE, President

SCIENTIFIC CRIME DETECTION INSTITUTE of AMERICA, Inc.

Chesapeake and Ohio Building Dept. 2D37
Huntington, West Virginia

Gentlemen: Without any obligation whatsoever, please send me your big book containing 14 famous scientifically solved cases, together with full particulars on how I can get into SCIENTIFIC Crime Detection.

Name.....

Address.....

Age.....

When writing please mention Popular Mechanics

FUN!

MAKE THIS Squirrel Lamp
Yes sir, out of a real squirrel! Also make ash-trays, book-ends, etc., using rabbits, frogs, etc. LEARN AT HOME TO MOUNT BIRDS, ANIMALS & FISH; tan skins and make rugs. Decorate your room. **It's FUN! BIG profits in spare time!** Free book tells how.

FREE BOOK! Write TODAY for beautiful free book telling how to learn this fine hobby. Book is free. Contains many fine pictures. **STATE YOUR AGE.**

N. W. SCHOOL OF TAXIDERM, Dept. 3374, Omaha, Neb.

Aviation Career OFFERS YOU GREAT FUTURE

Demand for trained aircraftsmen in Southern California plants is increasing and already exceeds supply. Curtiss-Wright Technical Institute, Aviation's foremost and oldest school, is located in heart of this activity and specializes in Sheet Metal, Master Mechanics and Aero Engineering. (No flying involved.) Graduates are obtaining immediate employment. Write for details NOW. Curtiss-Wright Technical Institute, Glendale, Los Angeles, Cal. Dept. PM-4.

AMAZING NEW BUSINESS
Sell to Stores

Get Set for Life!

MAKE up to \$65 WEEKLY

In new kind of wholesale business. Place famous line 5c-10c goods with stores. Merchants grab our FREE GOODS Deals. 200 fast-selling products—all on salesmaking Counter Displays. Up to 140% profit for you and merchant. No experience or investment to start. Big catalog and facts FREE. World's Products Co., Dept. 4810, Spencer, Ind.

BUILD a BOAT AT HOME

FOR PLEASURE OR PROFIT

Now you can have just the boat you've always wanted—power, sail, or rowboat—and sit rock bottom cost, plus the fun of building. Make a nice profit if you want to sell. Get the

BOAT BOOK — New Edition

This famous book with 6 new boats added, shows exactly how to build 15 different popular boats. Step-by-step instructions with hundreds of pictures. Gives all plans, methods and materials. Includes racing hydroplane, inboards, outboards, sailing and sectional boat to carry on car. Also old Ford motor for marine use and all boating terms, pilot rules, boat kinks, navigation rules, etc. You can't go wrong. Specially prepared for those with limited tools and skill. Price only \$3. Write for descriptive folder or order now and pay postman on delivery.



Popular Mechanics Press
Room 636B
200 East Ontario Street,
CHICAGO

Whether you design for welding, build by welding, or use welding in any way YOU NEED THIS BOOK

PROCEDURE HANDBOOK OF ARC WELDING DESIGN AND PRACTICE 819 pages, 990 illustrations

Long recognized throughout the world as the authority on the art of electric welding. Standard welding reference guide in thousands of industrial plants in U.S.A. and foreign countries. New Handbook makes all others obsolete. Contains complete, authentic, up-to-date data on all latest arc welding applications and design procedure. Order your copy now.

Fourth edition gives you, at no extra cost, 223 pages of new welding data, 289 new illustrations

POPULAR MECHANICS PRESS
Room 436-B, 200 East Ontario Street, Chicago

ONLY \$1.50 IN U.S.A.
\$2.00 elsewhere. Prices are postpaid.

Increase Your Earning Power

Apply time and labor-saving kinks to your work. Your efficiency will soon be recognized and you will be in line for advancement.

If you do machine shop work of any kind, sheet-metal work, painting, carpentry, auto repairing, farming, concrete work, plumbing, electrical work, welding, building-glass work, general repairing, tool-making, poultry raising, masonry or home repair work, get this

LIBRARY OF 2000 TIME AND LABOR SAVING IDEAS FOR SHOPMEN AND HANDYMEN

JUST OUT

SHOP NOTES for 1937

357 Articles
703 Illustrations
224 Pages
Price 50c
See partial list of contents below

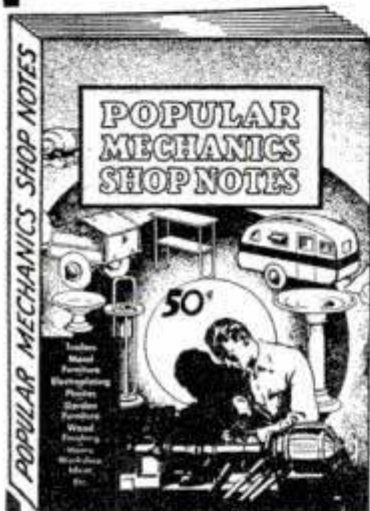

Including the new 1937 issue illustrated above, there are five volumes in the Shop Notes Library of 2000 easily understood short cuts to every-day jobs. Here are just a few of the subjects taken from the latest issue:

- | | | |
|-------------------------------|---|-----------------------------------|
| Alloys, Electroplating With | Fly Chaser for Door Folding Bed in Auto | Sawhorse for Uneven Floors |
| Belt Sander | Fruit-Picker's Ladder | Shop Heating Unit |
| Ceasopods, Repairing | Gold, Finding | Soldering Aluminium |
| Concrete Garden Furniture | Humidifier for Furnace | Thermostats, Designing |
| Dovetails, Making | Magnet Recharger | Tools from Drill Rod |
| Dowel Making | Metal Awnings | Trailer, Contractor's |
| Efficient Farm Weeder | Metal Furniture | Truck Lift, 3 Speed |
| Electric Motors, Servicing | Oil Finishing | Universal Tripod for Cameras |
| Electrical Test Board | Photo "Spot" Light | Window Displays, Novel |
| Electroplating Non-Conductors | Plastics, Working With | Window Sign "Flasher" |
| Family Auto Trailer | Pottery, Concrete | Winter Starting Aids |
| Fence Posts, Pulling | Reilvering Mirrors | Wood Lathe Used for Metal Turning |
| | Rewinding Auto Generators | Wooden Bowl Forming |

Each volume contains approximately 400 articles and 700 illustrations and has 200 or more pages. This unrivaled library of shop helps may be secured for a limited time only. After the present supply of books is exhausted the offer must be withdrawn.

*** Send No Money ***

POPULAR MECHANICS PRESS, 200 E. Ontario St., Room 437, Chicago, Ill.

Send me, as per your offer, the following books. I will pay postman price and small amount of postage. My money will be refunded if I am not satisfied. (Check what you want.)

- 1937 Shop Notes and Lathe Handbook (Metal Working), both for 98c.
- Shop Notes Library (5 vols.) \$2.50.

Name.....
Street and No.....
City..... State.....

* C. O. D. applies to U. S. and possessions only. If you reside elsewhere, remittance must accompany order.

MECHANICAL ENGINEERING

—A Field with a Future



This course has meant advancement to hundreds of ambitious men, mechanics, draftsmen, blacksmiths, foundrymen, patternmakers, apprentices, and mechanical engineers — men who wanted to get ahead and to earn more money. You will find, as they have found, that enrolling for an I. C. S. Course is an investment in a Bigger Future. Use the coupon!

ELECTRICAL ENGINEERING

—A Great Industry with a Great Future



The new course in Electrical Engineering covers this fascinating field thoroughly. If you are just starting or are partly on the way to a real paying position in this industry, this new course brings the broader knowledge necessary for advancement. The coupon brings complete information.

DIESEL POWER A Coming American Industry



Courtesy "Diesel Power"

The internal-combustion engine represents man's supreme triumph of machine power. Diesel engineers are in great demand. Many acquire necessary knowledge through spare-time study of this modern I. C. S. Course on Diesel engines. Free booklet!

AUTOMOBILE EXPERTS

are always in demand

The rapid progress in manufacture and service of the modern automobile brings new opportunities to thousands of ambitious and forward-looking men. There's always a demand for trained men. The new I. C. S. Automobile Course will make you a trained man! The time to act is now. Use the coupon.



INTERNATIONAL CORRESPONDENCE SCHOOLS

Box 5689-H, Scranton, Penna.

Without obligation, send me full information on subject checked below:

- | | |
|--|--|
| <input type="checkbox"/> MECHANICAL ENGINEERING | <input type="checkbox"/> ACCOUNTING |
| <input type="checkbox"/> ELECTRICAL ENGINEERING | <input type="checkbox"/> GOOD ENGLISH |
| <input type="checkbox"/> DIESEL POWER | <input type="checkbox"/> SALESMANSHIP |
| <input type="checkbox"/> AUTOMOBILE COURSE | <input type="checkbox"/> ADVERTISING |
| <input type="checkbox"/> ARCHITECTURE | <input type="checkbox"/> SHOW CARD LETTERING |
| <input type="checkbox"/> CONCRETE CONSTRUCTION | <input type="checkbox"/> CIVIL SERVICE |
| <input type="checkbox"/> READING SHOP BLUEPRINTS | <input type="checkbox"/> HIGH SCHOOL SUBJECTS |
| <input type="checkbox"/> CIVIL ENGINEERING | <input type="checkbox"/> AIR CONDITIONING |
| <input type="checkbox"/> DIESEL ENGINES | <input type="checkbox"/> INVENTING AND PATENTING |
| <input type="checkbox"/> GAS ENGINE OPERATING | <input type="checkbox"/> AVIATION ENGINES |
| <input type="checkbox"/> REFRIGERATION | |
| <input type="checkbox"/> CHEMISTRY | |
| <input type="checkbox"/> HIGHWAY ENGINEERING | |
| <input type="checkbox"/> POULTRY FARMING | |

Name.....

Address.....

When writing please mention Popular Mechanics

OL' JUDGE ROBBINS

CURIOUS AFRICAN PIPE

HELLO, JUDGE — HELLO, CHUBBINS — A BIT OF A SURPRISE, WHAT?

SIR CLEVE — I THOUGHT YOU WERE IN AFRICA! COME IN, MAN, COME IN!

BY GEORGE, THIS IS A SPLENDID NATIVE PIPE YOU'VE BROUGHT ME. IT'S A WHOPPER TOO!

OF COURSE IT'S ONLY ONE OF THE MANY TYPES OF AFRICAN PIPES

NATURALLY IT'S LARGE — IN THE DARK CONTINENT 'BIGGER' MEANS 'BETTER'

I'VE SEEN CHIEF'S PIPES TEN FEET LONG, A REAL 'TOP-HAT' PIPE, SO TO SPEAK

YOU WOULD HAVE ENJOYED THE TIME I DISTRIBUTED PRINCE ALBERT TO MY BOYS, JUDGE. OF COURSE THEY HAD NEVER SMOKED ANYTHING SO TASTY, MILD, AND MELLOW. P. A. WAS A SENSATION

- IN THEIR NATIVE TONGUE, THEY CALLED IT 'TOBACCO LIKE HONEY FROM STINGLESS BEES'

- AND THAT'S A MIGHTY FINE DESCRIPTION OF COOL-SMOKING 'NO BITE' PRINCE ALBERT

Copyright, 1937, R. J. Reynolds Tobacco Company

THIS NO-RISK OFFER TAKES YOU STRAIGHT TO SMOKIN' JOY, MEN!

PRINCE ALBERT MONEY-BACK GUARANTEE
 SMOKE 20 FRAGRANT PIPEFULS OF PRINCE ALBERT. IF YOU DON'T FIND IT THE MELLOWEST, TASTIEST PIPE TOBACCO YOU EVER SMOKED, RETURN THE POCKET TIN WITH THE REST OF THE TOBACCO IN IT TO US AT ANY TIME WITHIN A MONTH FROM THIS DATE, AND WE WILL REFUND FULL PURCHASE PRICE, PLUS POSTAGE.
 (Signed) R. J. Reynolds Tob. Co., Winston-Salem, N. C.

PRINCE ALBERT THE NATIONAL JOY SMOKE!



'CRIMP CUT' PRINCE ALBERT GIVES YOU A NEW SLANT ON COOL SMOKIN'

MY HAT'S OFF TO P. A. IT HAS YET TO BITE MY TONGUE

AND, PARDNER, IT'S A MIGHTY FINE 'MAKIN'S' TOBACCO TOO

50 pipefuls of fragrant tobacco in every 2-oz. tin of Prince Albert

When writing to advertisers please mention Popular Mechanics

Popular Mechanics Magazine

REGISTERED IN U. S. PATENT OFFICE AND CANADA

WRITTEN SO YOU CAN UNDERSTAND IT

Vol. 67

APRIL, 1937

No. 4

RADIO BATTLES

Old Man River

BOAT! Send boat to 230 South Main.
People are screaming."

"Warning! Residents of Third and Broadway turn out all fires immediately. Gas escaping from mains."

Boat—save—hurry—urgent—rescue—emergency—attention—help—hour after hour, through dripping days and long, terrifying nights, the air waves of the nation crackled with such words a few weeks ago when the radio, modern miracle conceived by man, concentrated all its facilities in a grim battle with the most disastrous flood in American history. And radio won the fight—won where other relief agencies were helpless.

From Pittsburgh down to Cairo, "the beautiful Ohio" had become a river gone mad, a menacing, raging, relentless force



Wide World Photos

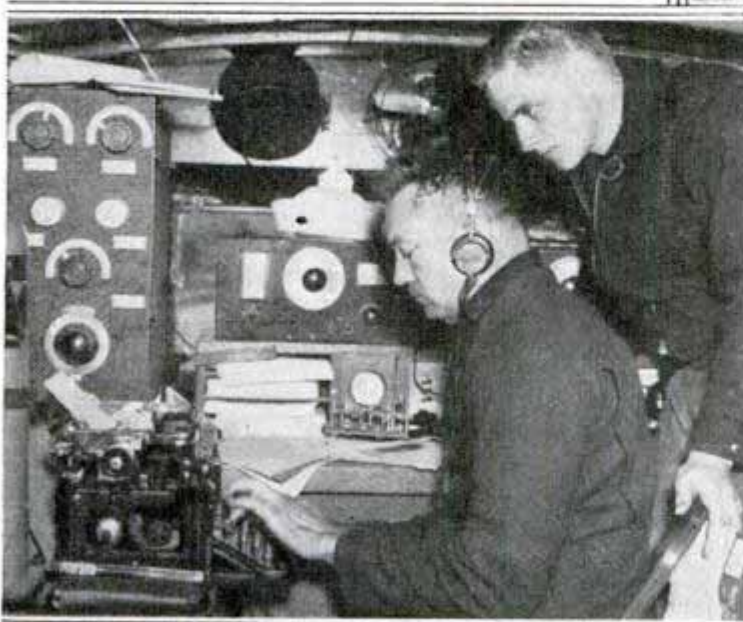

Directing boat rescues, above, with portable radio at Louisville. Left, mobile radio outfit set up by government in Memphis to direct flood relief work

which had flooded cities, drowned towns and hamlets, swept over thousands of farms, washed out roads, stopped trains, wrecked telephone and telegraph lines, paralyzed power plants, cut off food, polluted water supplies. Stricken multitudes were homeless and helpless. Thousands were trapped in their homes.

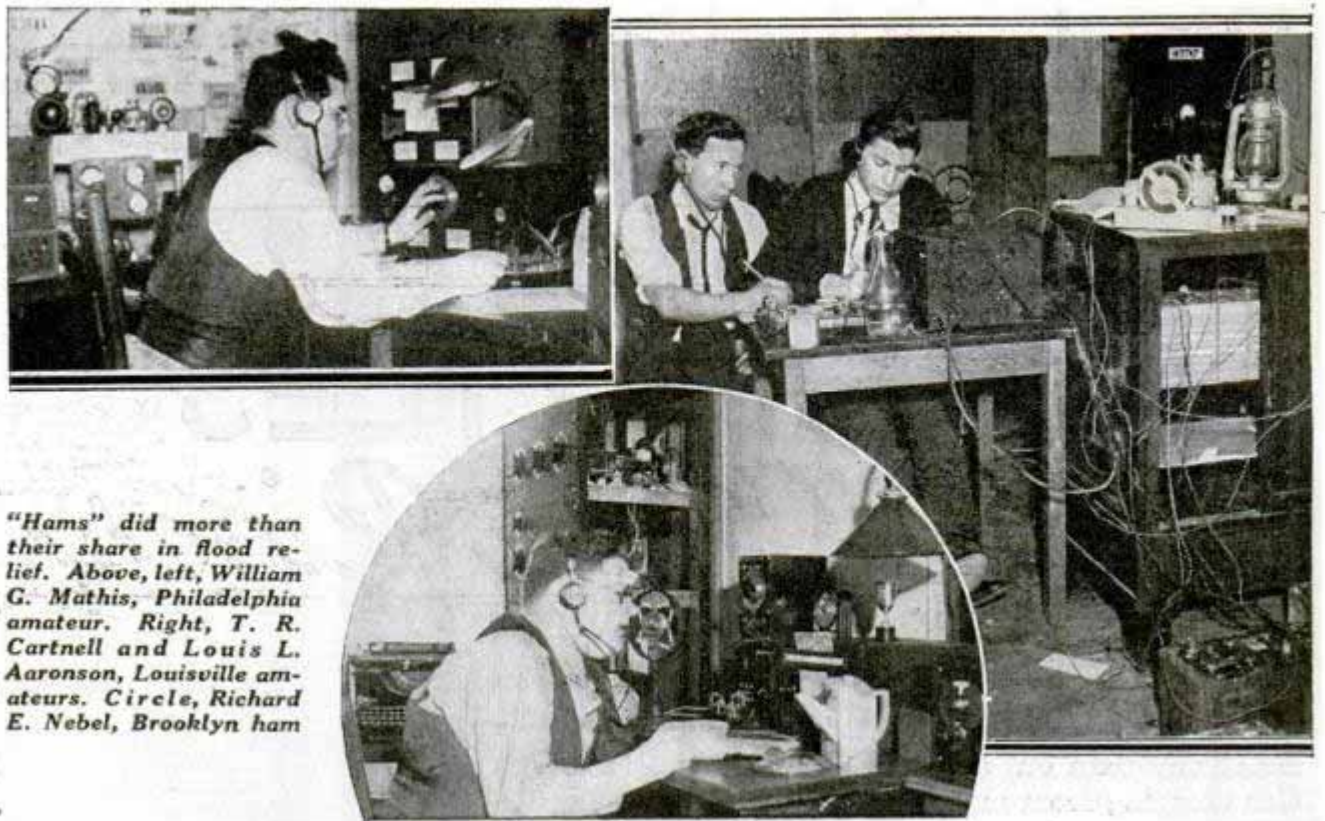

"Hams" did more than their share in flood relief. Above, left, William G. Mathis, Philadelphia amateur. Right, T. R. Cartnell and Louis L. Aaronson, Louisville amateurs. Circle, Richard E. Nebel, Brooklyn ham

Into this situation came radio with all its artillery, big guns and little guns—great national networks, powerful 50,000-watt stations, little 100-watters, "hams" with both code and phone sending sets, police and military short-wave transmitters—all banded together in a work of mercy, directing rescue operations, informing the nation of relief requirements, reuniting separated families, getting messages to alarmed relatives, alleviating human suffering and misery.

Flood waters drowned some little stations, surrounded big ones, dunked power plants, tore down feed lines, cut off the "juice." But an army of engineers, trouble shooters, announcers, radio reporters and just plain hams were equal to the task the river set them. Storage batteries, portable generators, makeshift apparatus and temporary wiring all helped. As the flood assumed record-breaking proportions, stricken cities began filling the air waves with their cries for help. Tragedy, usually mute, was being made articulate for every person with a radio receiver to hear. The situation in Louisville, Ky., was typical. Here hundreds were trapped in their homes. Without help, they faced drowning, sickness from exposure, slow starvation. There were not enough boats to effect all the rescues unless order was

brought out of the confusion by some universal means of communication. Any ordinary communication facilities were crippled or entirely wrecked. All of them except the radio.

Stations WHAS, the Columbia Broadcasting system's outlet at Louisville, and WAVE, the National Broadcasting company's outlet, discarded scheduled programs and blanketed the area with relief and rescue messages until they were drowned out. Then, without power, the Louisville stations were helpless. To the rescue came WSM, the NBC station at Nashville. A wire from the center of the Louisville flood district to WSM enabled announcers at the WHAS microphone in Louisville to relay through WSM in Nashville—two competing stations affiliated with competing networks joining forces to save human lives. More than 16,000 rescue messages were transmitted over WHAS-WSM in this manner.

And lives were saved because the WSM broadcast could be picked up by any kind of receiver. Console battery sets were taken from homes and loaded into rescue boats; automobile sets, batteries and all, were used for the same purpose. Thus rescue messages could be heard by all. As soon as a plea for help was received by WHAS from the police, over crippled tel-



The great national networks sent broadcasting trucks, announcers with pack transmitters and others broadcasting from airplanes into the flooded area to arouse the nation to the emergency by eye-witness accounts of the disaster. Here is a National Broadcasting company field crew operating at Evansville, Ind., and a map showing how NBC covered the flood from various key points

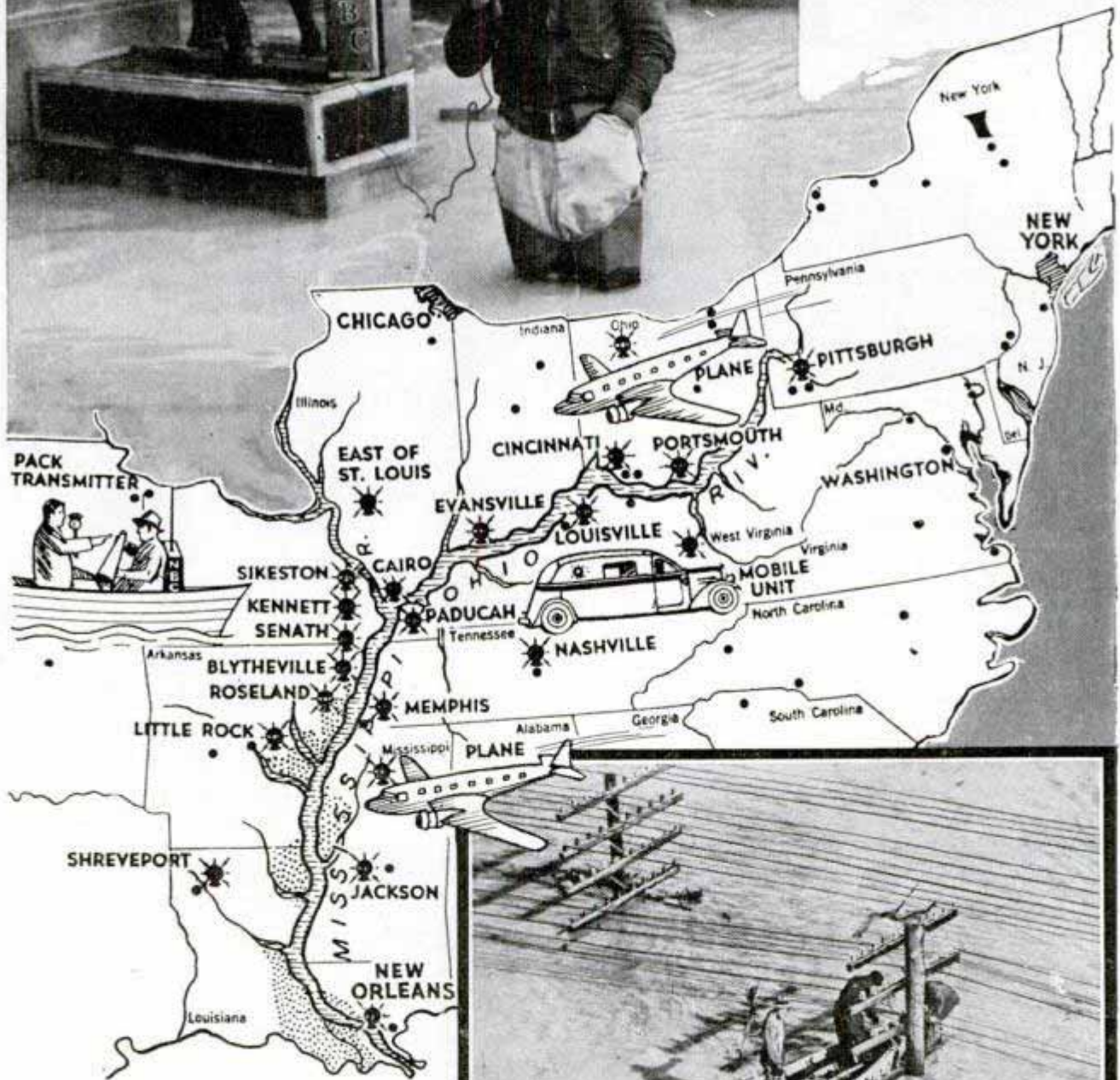

It wasn't necessary for this crew of linemen to climb any poles to mend breaks in the wires caused by Old Man River

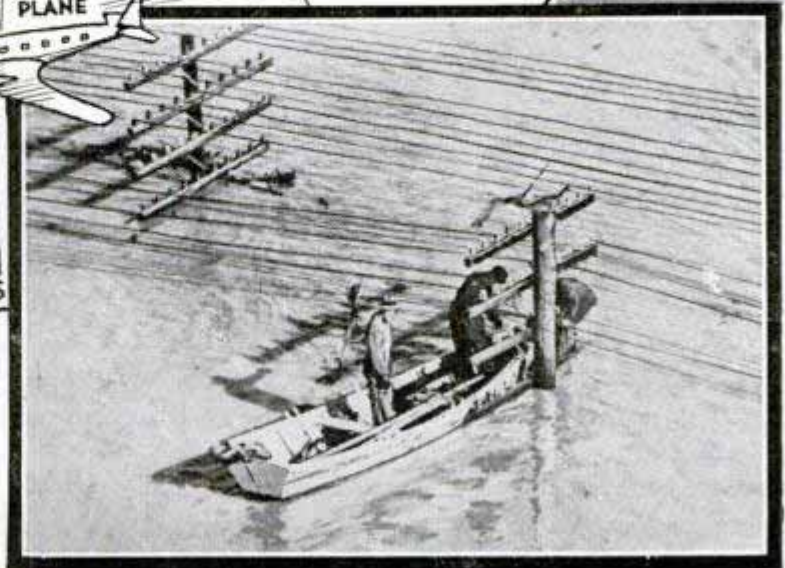

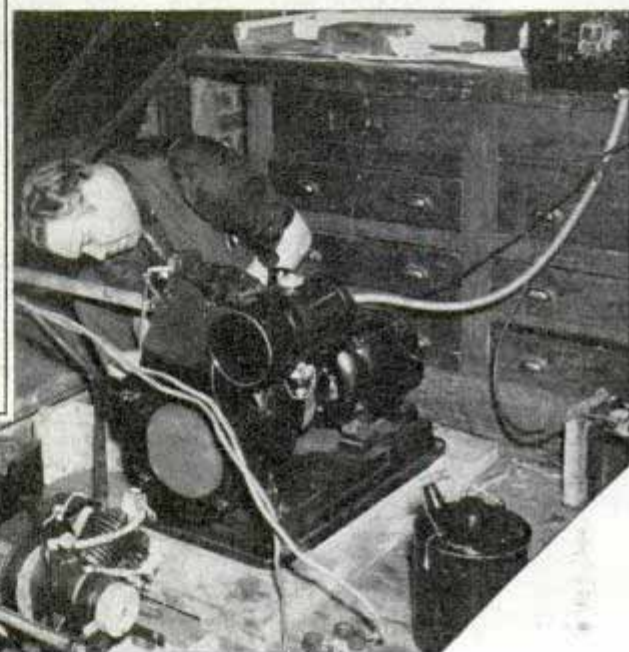

Above, left, Don Hancock, WBBM's flying announcer, broadcasting over Cairo, Ill. Above, right, Columbia Broadcasting System's control point in Evansville, Ind. Below, right, using gasoline motor to generate power in flood zone

ephone lines or from some amateur using his short-wave transmitter, it was relayed to the rescuers over WSM. Even boats without radio facilities were directed by radio through three advertising sound trucks which installed receiving sets tuned to the relief broadcasts and cruised continually along the shore line. In this manner appeals for help for persons marooned in buildings could be heard a mile or more over the water.

Soon after WSM began broadcasts over temporary telephone lines from WHAS, many other stations and the networks formed a voluntary inter-city network which extended from New York to California—all relaying the WHAS-WSM transmissions full time or periodically. Hour after hour, day and night, the relief

and rescue messages flowed over the air from Louisville via Nashville to the world until the crisis was past. Both Louisville stations later obtained temporary power from borrowed generators and resumed transmission direct from Louisville.

In like manner, Cincinnati stations devoted themselves to an around-the-clock effort to help city, state and national rescue and relief workers. Although its own power supply was depleted, and it had its own rescue relief messages to carry, WLW also carried the broadcasts of WAVE in Louisville, received by wire, and relayed messages of the mobile transmitting units sent out by itself, the networks and the military and police.

NBC and CBS, along with other networks not only awoke the nation to the



Above, loading a 400-pound, gasoline-driven generator into airplane at Chicago. This generator was flown to Louisville where it enabled Station WAVE to resume operations at the height of the flood. Above, in circle, WHAS staff setup for broadcast of emergency flood relief messages at Louisville

Equipped with short-wave pack transmitters, microphone reporters of the National Broadcasting company are sending out the story of the flood from a boat on a street in Portsmouth, Ohio. Right, when rescue boats were needed at Louisville, the messages went out from this room





Above, operator and stenographer at Chicago amateur station being interviewed while taking flood messages. Left, using portable pack transmitters

crisis by transmitting the pleas for rescue and relief from the stations in the flood district, but sent their own broadcasting trucks and radio reporters with pack transmitters into the flood area to send out eye-witness accounts of the disaster.

Not only did the radio direct the rescue and relief work, but it also disseminated invaluable information to those in the flooded cities and towns. The air was filled with advice—boil your drinking water, tap your downspouts and use rain water, be careful of fire, stay at home if you have a home and are not engaged in relief work, conserve gasoline, return your milk bottles.

While the big broadcasting stations in or near the flood district and the networks bore the brunt of the relief work, they were augmented by police and military short-wave sets, aviation stations, the coast guard, dozens of small broadcasting stations of low power which served their individual communities just as heroically as the big stations served the cities and—last but not least—hundreds of hams, those unsung heroes who stuck to their transmitters sending messages for supplies, pleas for medicine, orders for routing trucks of clothing and bedding and a thou-

sand and one other communications which speeded up relief work. Many small stations used Diesel engines, dug up old generators or strung batteries together for power—any radio man with an important message jammed it through somehow.

The disaster set many radio precedents. It was the first time that commercial, amateur, aviation, coast guard and police radios ever were coordinated on a large scale for relief in a far-flung emergency. And the merging of all the branches of radio proved effective in the crisis. It was the first time major broadcasting stations were used as a direct and continuous link with relief leaders, police and rescue squads. And that worked too. It was the first time broadcasting stations and networks were on the air twenty-four hours a day, day after day, to help relieve a national emergency. That worked too. And it was the first time a big broadcasting station ever cancelled all its scheduled programs to carry on the relief work of another station, and a competing station at that. And that worked too.

Thus the same radio which brings so much pleasure into our daily lives has proved its ability, when disaster strikes,

(Continued to page 162A)

Aircraft Corp. *c/o Barclay's* Lightweight Metal Wing and 'Prop' Invented *Detroit Wash*

French made one six hubblad
Stronger and lighter than those in use, a new type of wing and a hollow steel propeller are innovations on an all-metal transport plane now under construction. The wing is said to be practically invulnerable to gunfire. The propeller has an inner construction supported by a single steel strut running from tip to tip. It is thirty per cent lighter than wooden propellers. The ship, which will be equipped with the wing and propeller, will have space for eight passengers.

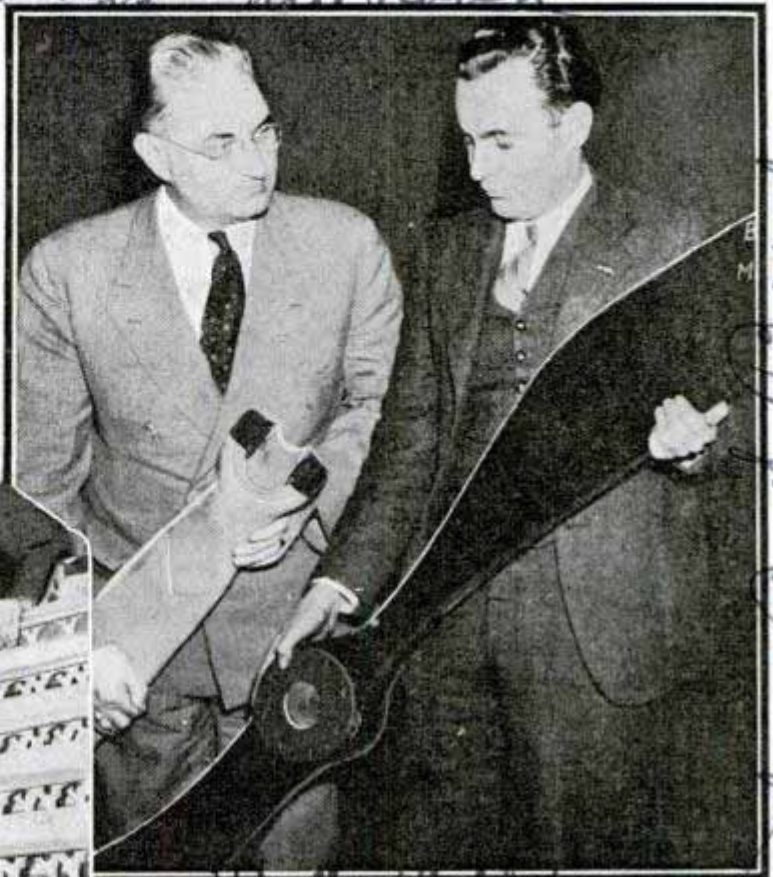

White wood
Top, comparing new lightweight, metal propeller with old wooden type. Bottom, section of wing, said to be almost invulnerable to gunfire.



es 136
Plywood for Walls and Ceilings Applied with Invisible Joints

Plywood paneling made without visible joints or unsightly battens is being manufactured for interior walls and ceilings. Instead of covering the joints with battens, a neat, narrow molding is laid in flush to the surface, breaking the wall into decorative panels. These are available in random or uniform width planks, rectangular or square tile effects. Three-ply Douglas fir is used. The rabbeted edge is nailed to the wall and the molding applied with brads or glue.

Vancouver Plywood and Veneer Co. used

es 107
Linoleum Cutter Helps Novice Do Precision Work

Linoleum laying jobs which only skilled workers formerly could do are made possible for the amateur by a precision cutter recently placed on the market. Blade holders on the tool may be fastened at any point on the compass bar for straight cuts, recess-scribing or wall-scribing. The tool cuts straight lines, arcs, circles and rings with great accuracy. Two blades are employed in cutting rings and straight strips. Adjustable to conform to the thickness of the linoleum being cut, the blades are easily sharpened.



To eliminate headlight glare, amber lights will be required by law on all new cars sold in France after April, 1937, and on all cars after January, 1939.

Armstrong Cork Co. 12/19/36

"Flying Pullman" Offers Air-Travel Luxury



Top, interior of "Flying Pullman," one of fleet placed in service by United Air Lines. Below, liner in flight. Two 1,150-horsepower engines give these planes a speed of 212 miles per hour

Left, individual table set with real silver, china and linens. Below, stewardess preparing meal in galley located at rear of plane's cabin. Hot meals served aloft are another feature of this new air service



Left, playing checkers on magnetized board. Note that the chairs may be swung in any direction. Fourteen or twenty-one passengers may be carried in these ships



Handwritten notes on the left margin:
 1937
 1938
 1939
 1940
 1941
 1942
 1943
 1944
 1945
 1946
 1947
 1948
 1949
 1950
 1951
 1952
 1953
 1954
 1955
 1956
 1957
 1958
 1959
 1960
 1961
 1962
 1963
 1964
 1965
 1966
 1967
 1968
 1969
 1970
 1971
 1972
 1973
 1974
 1975
 1976
 1977
 1978
 1979
 1980
 1981
 1982
 1983
 1984
 1985
 1986
 1987
 1988
 1989
 1990
 1991
 1992
 1993
 1994
 1995
 1996
 1997
 1998
 1999
 2000
 2001
 2002
 2003
 2004
 2005
 2006
 2007
 2008
 2009
 2010
 2011
 2012
 2013
 2014
 2015
 2016
 2017
 2018
 2019
 2020
 2021
 2022
 2023
 2024
 2025

Skylounge

*La Salle. Wacker
 Betty
 Chue*

Handwritten notes at the bottom of the page, including names and dates.

F132

48

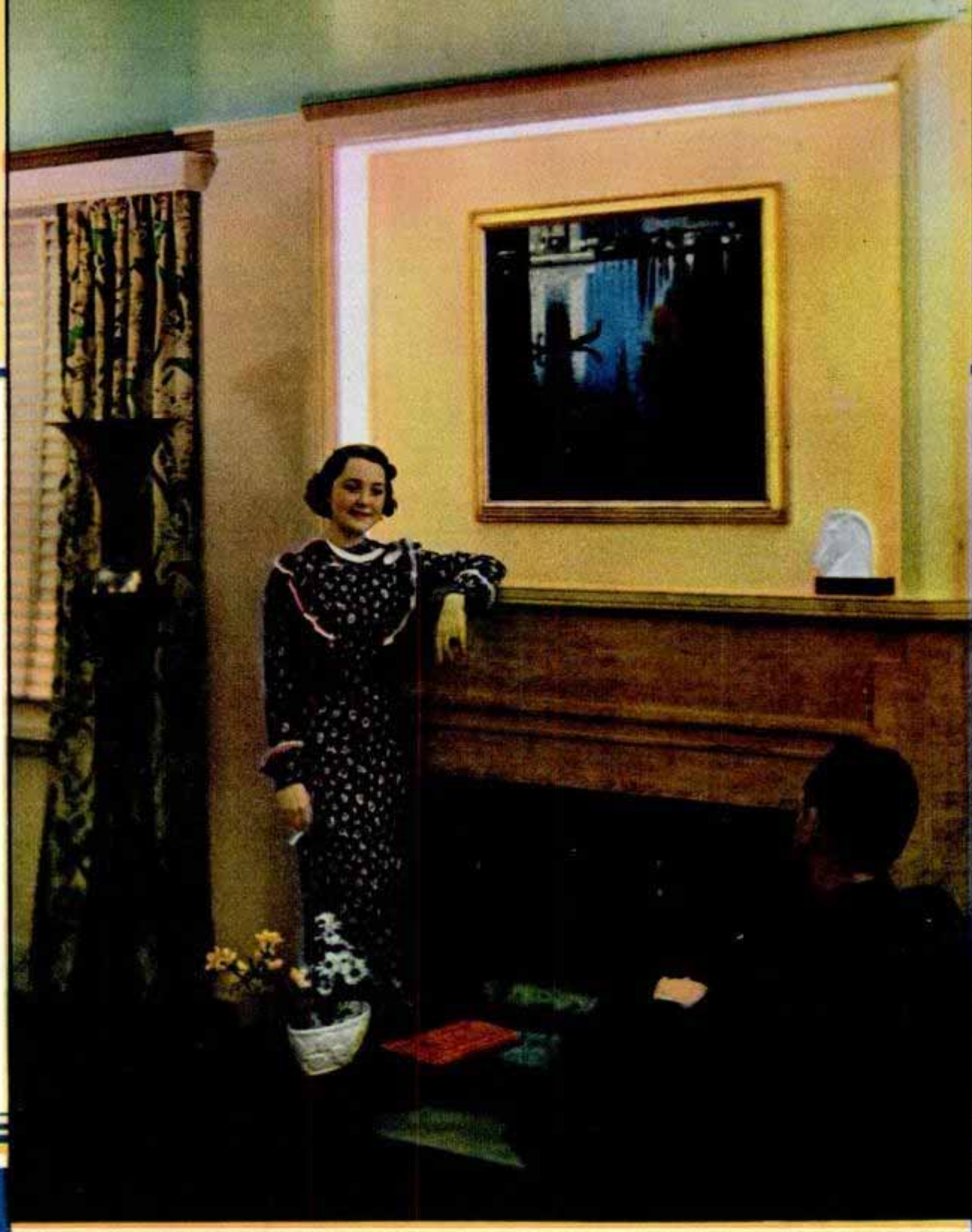

Chicago Lighting
 & Hardware, 20 N
 Wacker
 Drive
 Chicago

“ Let There Be Light - ”

CONCEALED tubular lights behind paneling illuminate picture and area above fireplace.

Part I





490

THIS living room is made more attractive by good lighting. Ceiling units and wall brackets are of new plastic materials. Concealed lights are used in bookcase.

General Electric

By H. W. MAGEE

THE story of human progress is a story of man's triumph over failure. Sixty years ago a young inventor began seeking a method of "bottling up" electricity in a vacuum to provide a practical means of electrical illumination.

Conservative men ridiculed his efforts and "proved" it couldn't be done. No combustion can occur in a vacuum, they said. Therefore, you can't make light in a vacuum, so why try? But, indifferent to criticism, the young inventor kept on. For two years he patiently tried one process after another. None worked.

Finally, in 1879, after spending more than \$40,000 in fruitless experiments, he

saturated a cotton thread with a carbon paste and heated it to produce a carbon strand. He looped this inside a glass bulb from which the air was pumped. Then he passed an electric current through the strand. And there was light!

There was light for forty hours, light in a vacuum, light where everyone said no light could be. Thus Thomas A. Edison achieved success through repeated failure and gave to the world the incandescent electric lamp. Today, if an ambassador from Mars visited the earth in search of a typical example of the patience, ingenuity and precision of modern earthly science and industry, he could select no object more fitting to take back than an ordinary electric lamp. For there has been a world of progress in

Carl. Walter E. Burton - 1032 Florida Ave Akron, Ohio

Westinghouse
Electric Corp #1325
E. Pittsburgh, Pa

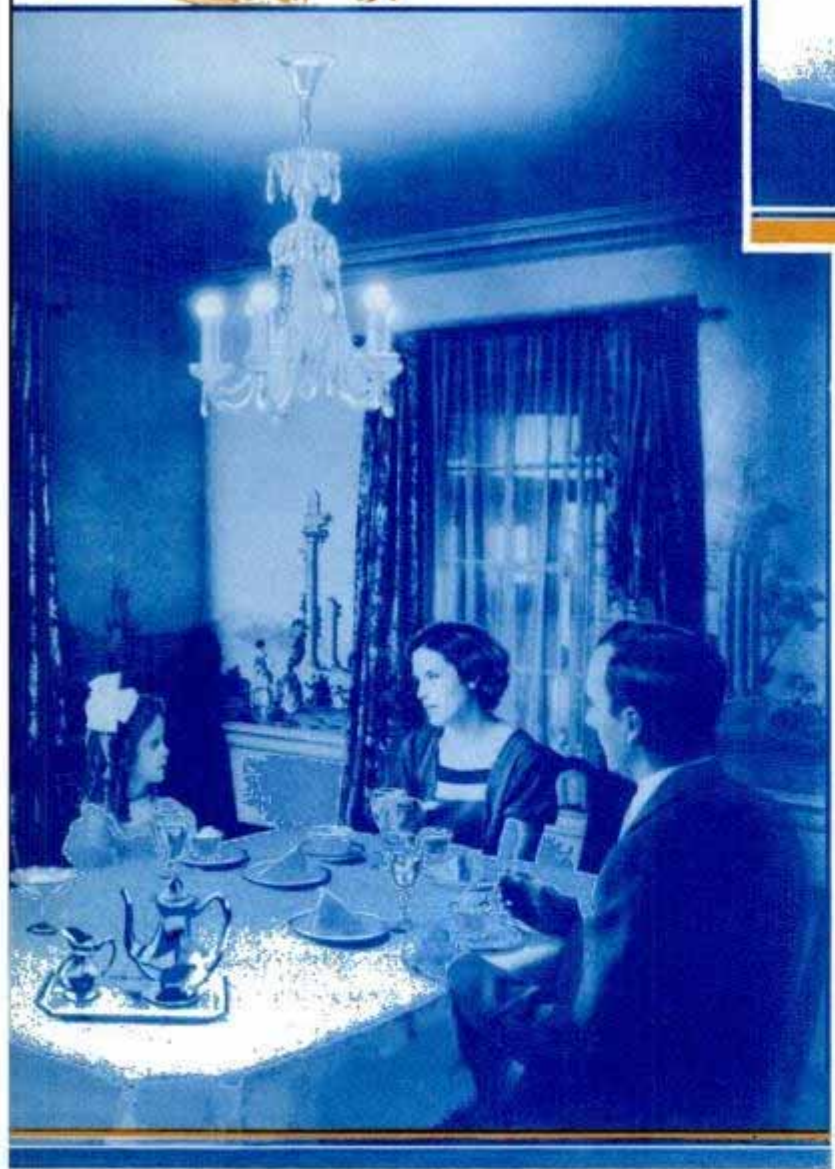

491
DINING room with modern indirect lighting, and same room with old-fashioned fixture. Top, left, 150-watt floor lamp for close visual work.

Chicago Lighting Club
electric lighting since Edison produced his first lamp with nothing more complicated than a piece of cotton thread and a glass bulb.
Almost from the moment when Edison's first light burned out at the end of forty hours, improvements started. Edison himself developed a method of using cardboard instead of a cotton thread, then both gave way to bamboo fiber. The idea was to get more illumination for the current consumed, more efficient light—more lumens per watt. A lumen is a unit of light measure used by lighting engineers. You probably never saw one, but you can make one easily. Place the flame of a standard candle at the exact center of a balloon two feet in diameter. On each square foot of the inside surface

Chicago Lighting Institute
20w. Washburn Ave., Chicago
F1325

492

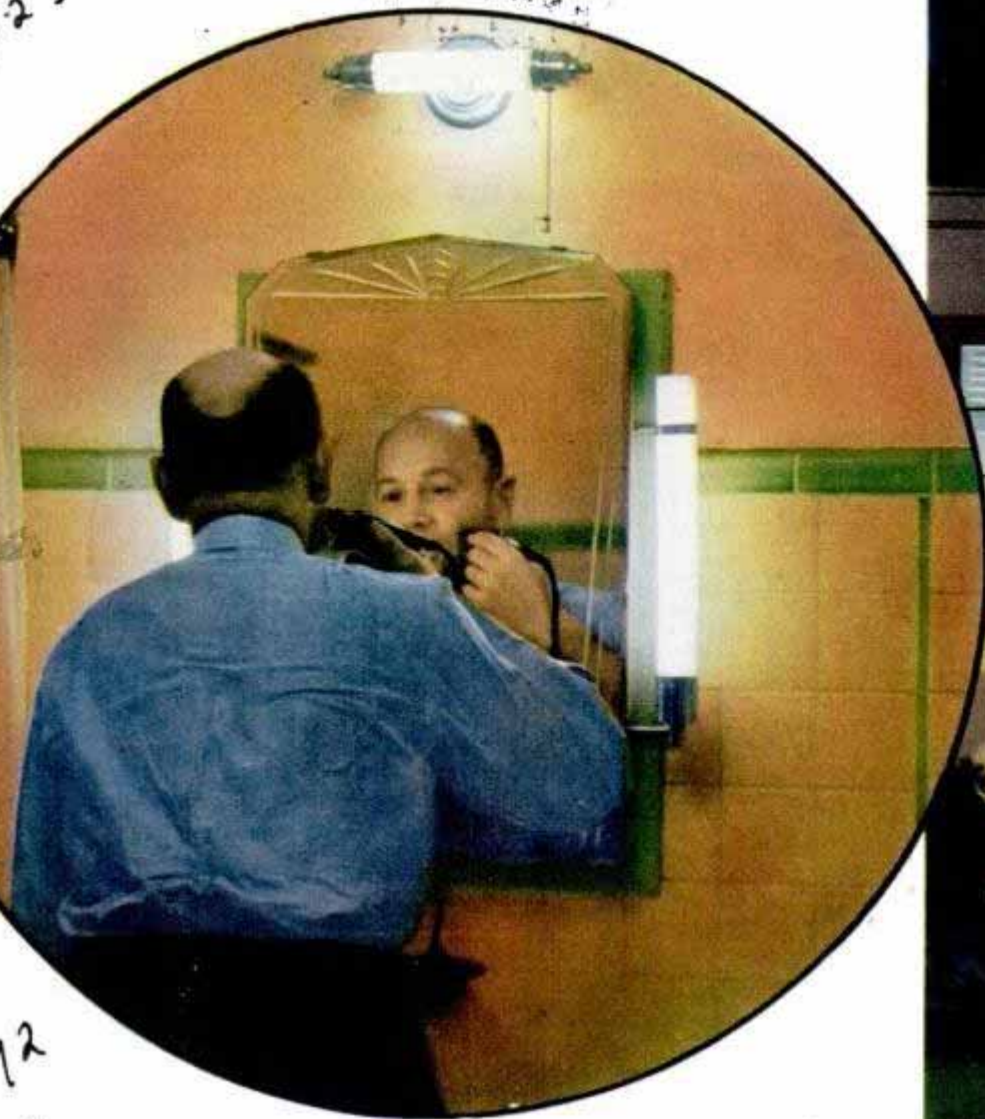

TUBULAR lights at sides and above bathroom mirror give good illumination for shaving because they cast a uniform light, leaving the face without shadowed or shaded areas.



of the balloon you will find—one lumen.

Edison's first lamp had an efficiency of one and one-half lumens per watt. In 1894, Leigh S. Powell, an Englishman, squirted a mixture of carbon and cellulose through a tiny hole and made a filament. And his squirted-filament lamps developed more than three lumens per watt.

Ten years later, Dr. Willis R. Whitney, later vice-president of the General Electric company, in charge of research, found how to make metallized carbon filaments. Lamps using them developed four lumens. Then a way was found to make tantalum ductile. Tantalum lamps produced five lumens per watt, but could be operated only on direct current. Lumen by lumen, the efficiency of electric lamps was increasing.

Finally, in 1908, Dr. William B. Coolidge made a great discovery. He found how to press together pieces of specially-

treated tungsten and draw them through dies to produce filaments which could be bent and which were ductile when cold. These early tungsten filament lamps produced eight lumens per watt. Tungsten filament lamps today produce from eleven to more than fifteen lumens per watt.

Another step forward was taken when Dr. Irving Langmuir found that a lamp filled with an inert gas like argon, instead of being evacuated, can be operated at a higher filament temperature and thus be made more efficient. At the same time, he developed the coiled filament, greatly superior to the straight-wire type. Today all lamps larger than the thirty-watt size are filled with argon gas and have filaments shaped like screen-door springs.

Modern incandescent lamps used in general lighting, which means sizes up to 1,500-watt, develop as high as twenty-two lumens per watt, twenty times as



208 F1325

EFFECTIVE night lighting enhances the beauty of your garden. The parasol is illuminated by an inexpensive "pin-it-up" light and the hose in the foreground is attached to an illuminated spray unit. Right, frosted-glass fixture above workbench provides an excellent light for the home workshop.

not shown

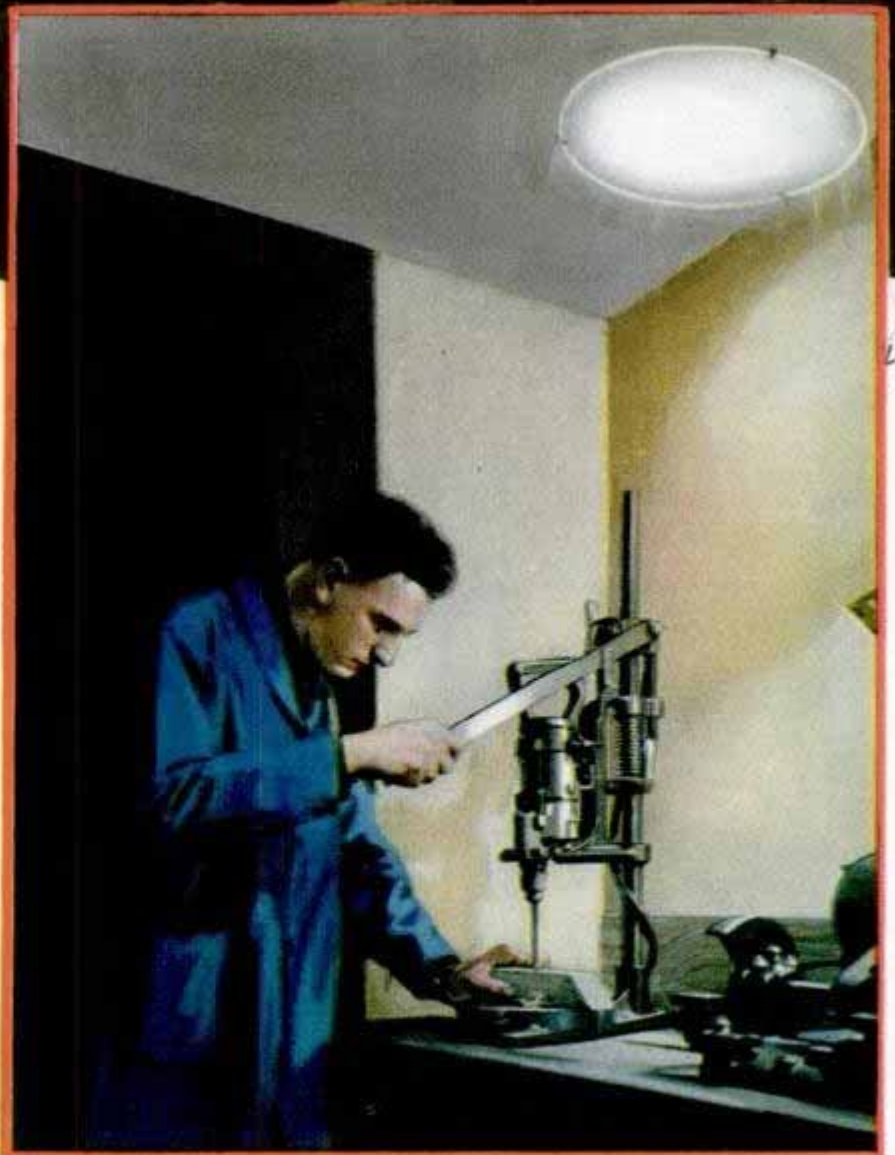

493

4132

Chicago
Engineering
Institute

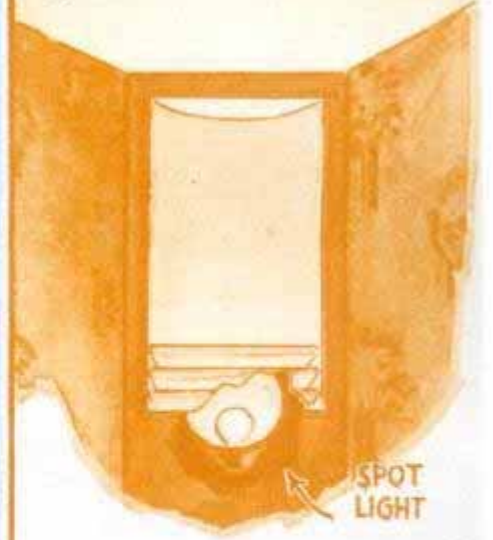
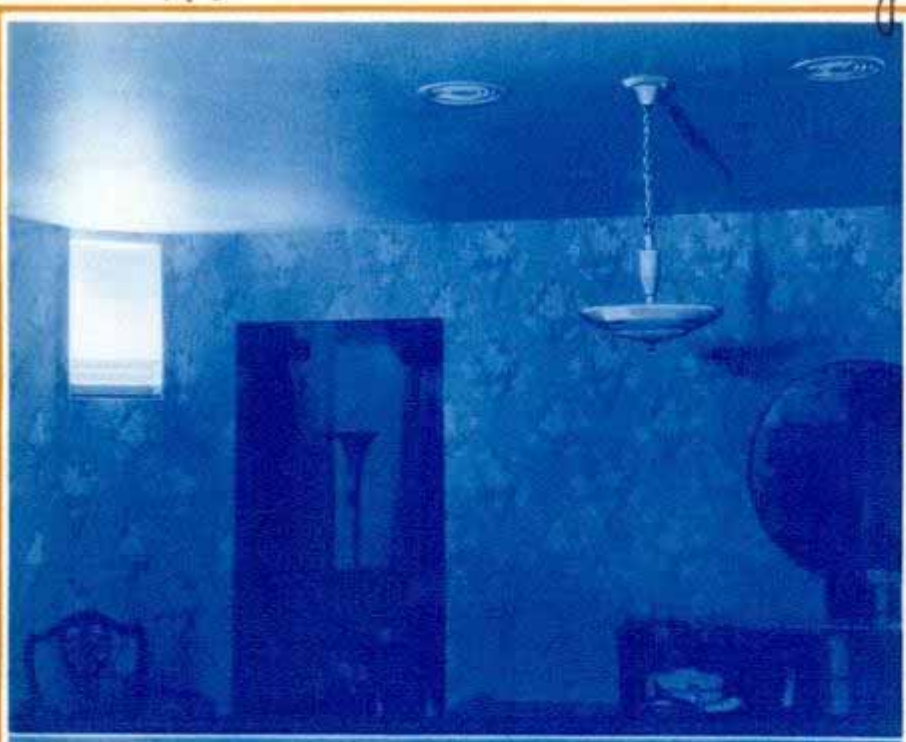

THREE lighting effects for dining room. Top, indirect light as illustrated in diagram. Center, spot lights in ceiling. Bottom, indirect ceiling fixture augmented by wall lights and spot lights.



424

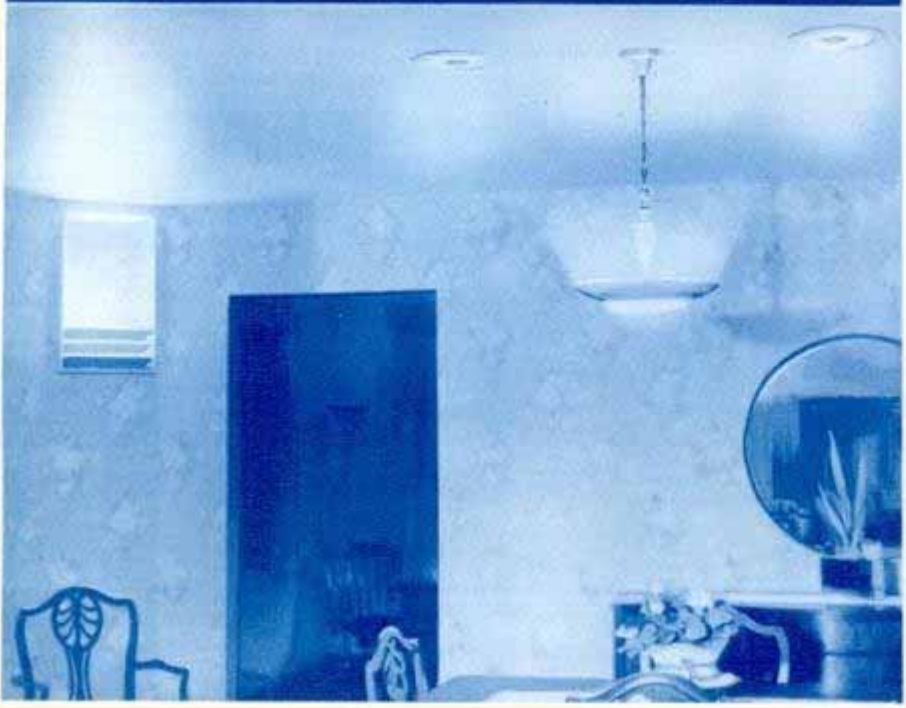

much as Edison's first lamp. And they are being made more efficient. As a lamp burns, it blackens slightly, due to condensation of vaporized tungsten from the filament on the glass bulb. The efficiency level throughout lamp life has been raised until today a lamp ready to burn out is about ninety per cent as efficient as when new. And, yet, the incandescent lamp is far from perfect, even today. It is being improved each year and there is room for still further improvement.

While the incandescent lamp consisting of a tungsten filament inclosed in a glass bulb is the standard source of electric light today, there are other sources, some of which show a better lumen score. The mercury-vapor lamp, for example, in which the mercury is subjected to a tremendous pressure while forming an electric arc, develops, in the 250-watt size, thirty lumens per watt, and, in the 400-watt size, forty lumens.

No info

41325



But the sodium-vapor lamp, used for highway lighting, takes top score in the battle of the lumens. The 10,000-lumen lamp develops fifty-five lumens for every watt of power. Neon tube lights develop an average of about thirteen lumens per watt. Tubular fluorescent lamps, filled with a gas which, under the action of current, produces ultraviolet light which in turn causes an inside coating of fluorescent materials to glow, hold promise as efficient producers of colored light.

Mercury-vapor, sodium and fluorescent lamps operate under one handicap—they require transformers and reactances as auxiliary equipment. The incandescent lamp has a tungsten filament whose resistance to the flow of electricity increases as its temperature goes up. Thus it reaches a point of balance where temperature and current flow are constant. But luminous vapor lamps behave exactly opposite because a gas forming a path for the flow of electricity offers less resistance as it becomes hotter. Thus, if attempts were made to operate such a lamp on a 110-volt line without regulation, more and more current would flow as temperature increased until something gave way. So such lamps usually are equipped with transformers to provide voltage enough to send

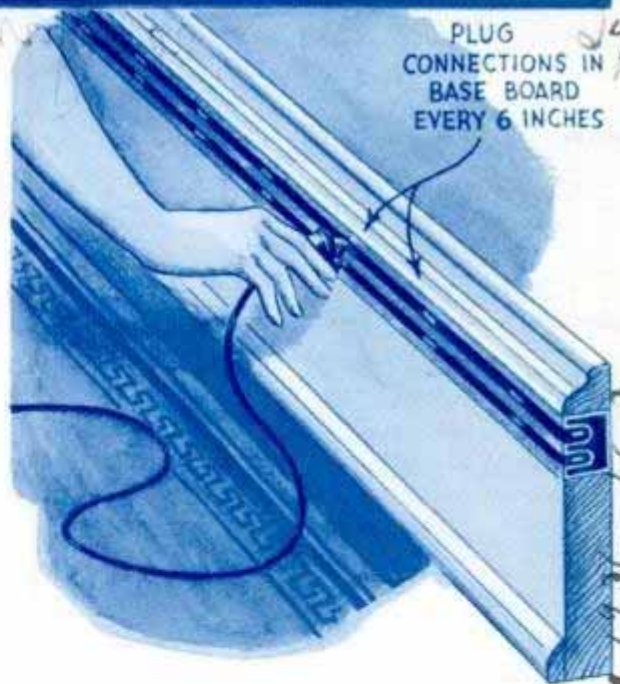

PLUG CONNECTIONS IN BASE BOARD EVERY 6 INCHES

CLOSE visual work requires from fifty to 100 foot-candles which can be obtained with a 150-watt bulb in a light like the one pictured. Below, plug-in attachment for the baseboard with receptacles for plugs every six inches provides plenty of outlets for the home without adequate wall plugs.

Commonwealth Edison Co. Wholesale

495
 1136-163
 suggest - Aug 11, 1936
 National Electric 8 W. W. C. Co.



the current from one electrode to the other, and a reactance to limit the current flow.

The dream of producing cold light, like that of the firefly, probably can never be realized because it involves producing light without generating heat. Nevertheless, the struggle for cooler light still goes on. From the standpoint of energy expended, the electric lamp still is rather wasteful. A twenty-five watt vacuum lamp, for instance, converts only seven per cent of the energy going into it into useful light, and a 500-watt gas-filled lamp converts less than twelve per cent of its energy into visible light. The rest is lost as heat.

The search for cooler light really involves compressing into the visible region the spectrum radiated by a lamp in action, including the heat rays and ultraviolet light which today are invisible. The more efficient production of colored light is also being studied hand in hand with cooler light. Just as the squeezing of the lamp spectrum into the visible re-

(Continued on page 132A)

TUBULAR fixtures, as illustrated in the diagram, provide plenty of local light for the kitchen table and stove. They are attached under cupboard.

Es. 50

431 W. 60th St.
Terrace, Kansas City, Mo

Man-Made Weather Speeds Up Paint Tests

Durability of paint is tested quickly in laboratories by an accelerated weathering device which manufactures rainstorms, sunlight, heat and cold. Within two weeks the machine will put paint samples through a course of weathering equivalent to a year of ordinary outside exposure. For determining resistance to blistering a special device has been designed. It is a metal cabinet with openings at the top and over these are clamped pieces of siding painted on the outside. Inside the cabinet are two lamps with circular wicks extending into water at the bottom of the cabinet. This creates warmth and humidity on the unpainted side. By putting a sample into a dark cabinet at a temperature of 100 degrees and having the atmos-

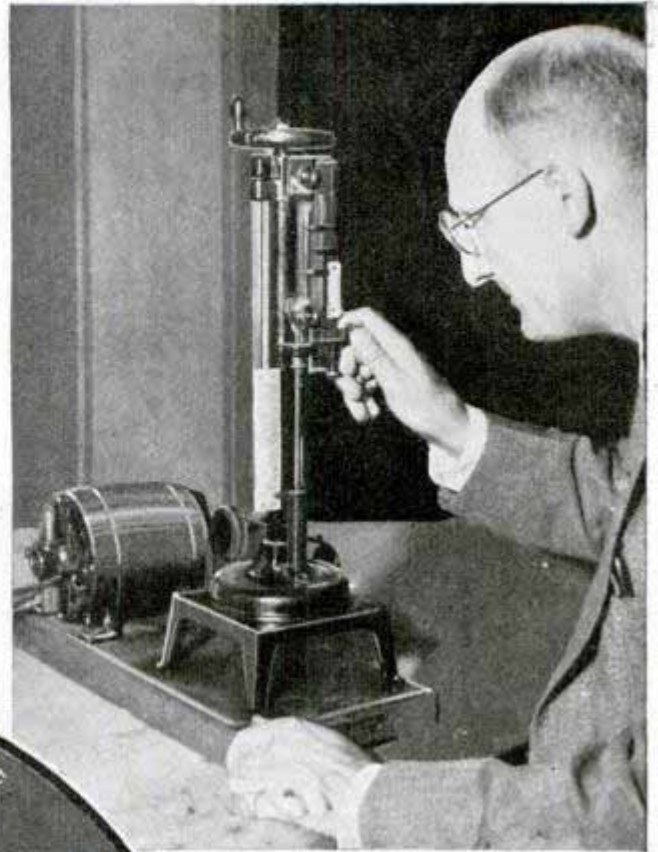

The machine is used to test the strength and elasticity of paint. It is a metal cabinet with openings at the top and over these are clamped pieces of siding painted on the outside. Inside the cabinet are two lamps with circular wicks extending into water at the bottom of the cabinet. This creates warmth and humidity on the unpainted side. By putting a sample into a dark cabinet at a temperature of 100 degrees and having the atmos-

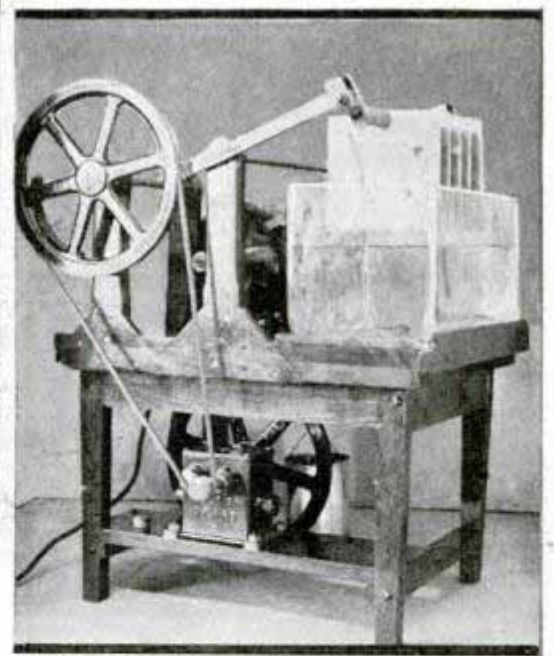

Top, W. R. Fuller of Pratt Lambert laboratories using machine to test strength and elasticity of paint. Bottom, left, testing consistency of paint. Right, immersion machine tests seaplane hull metals

phere saturated with moisture, the laboratory worker quickly finds the extent to which white enamels will yellow in a prescribed period of time. A salt spray cabinet is used for testing the resistance of metals to the corrosive action of seawater. An alternate immersion machine

plunges test panels from seaplane hulls into and out of seawater to determine resistance to the alternate action of salt water and of the air. Properties of varnishes are tested in many ways, from scratching the surface with a penknife to application of strain and stress machines.

*Werhlim and Thomas St.
Buffalo NY*

German Locomotive Has Ten Drive Wheels

Chrysler Corp. Plymouth Div. at Boring Locomotive Works

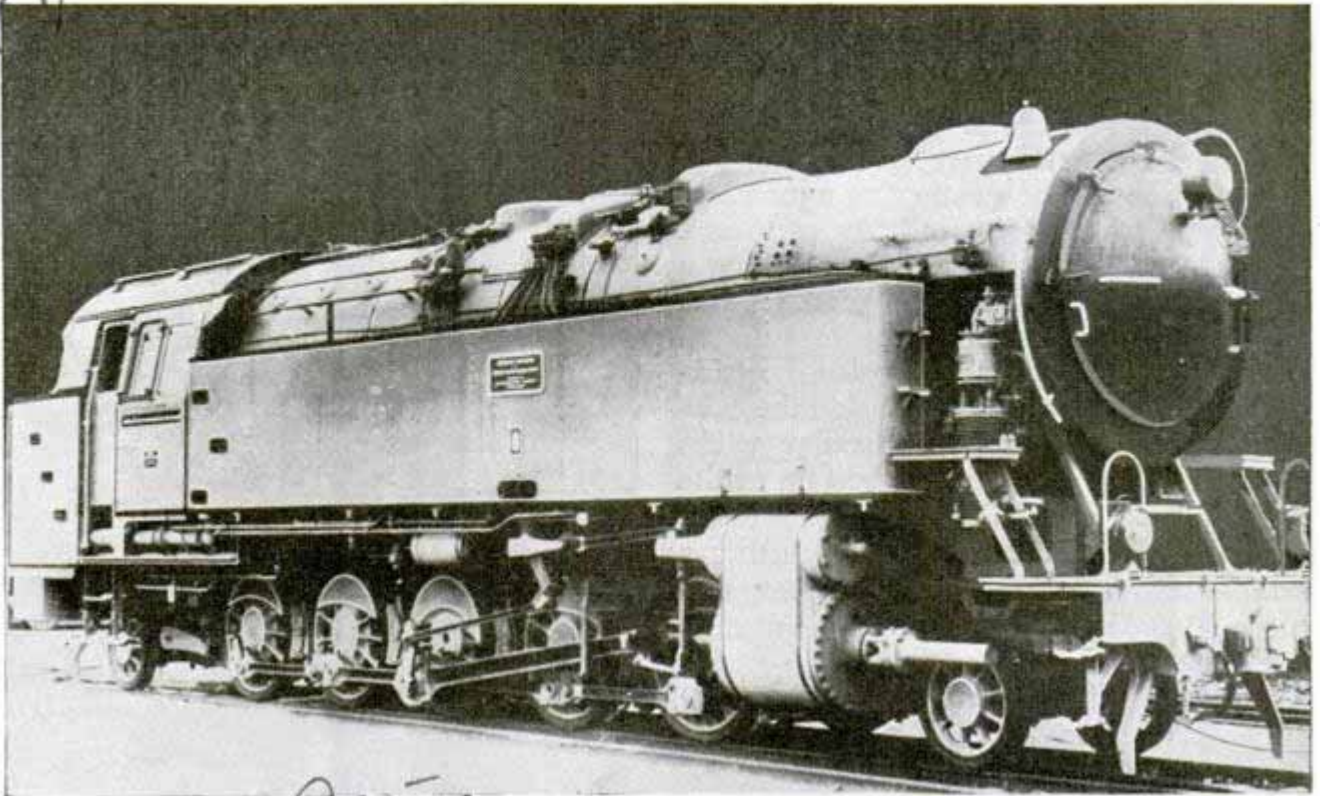

acme
Here is Germany's latest locomotive. Note the small size of the drive wheels, indicative of power rather than speed. Its designers follow the modern practice of streamlining, though in modified form

Said to be the largest tender locomotive ever built in Germany, a giant engine designed especially for work in railroad yards has five small drive wheels on each

side. Since it is not intended for use on the main lines, its wheels are small to give power instead of speed. The locomotive has an axle load of twenty-three tons.

Latest Auto-Top Presses Squeeze Steel to Exact Shape

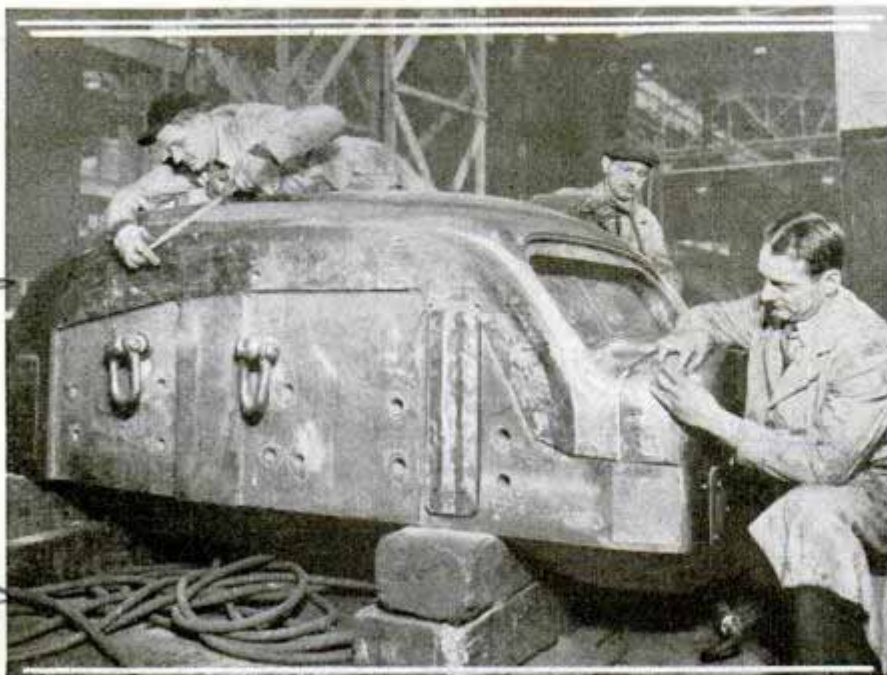

This is one of the giant dies, weighing several tons, used in the auto-top presses. These workers are polishing the die to exact size

Mammoth machinery, designed to shape sheets of steel into automobile tops at a pressure of 3,000,000 pounds, is handling nine miles of steel per hour, in strips six feet wide. In one large plant the giant presses squeeze the metal into a complete body section including the cowl, windshield frame, top and back panel as far as the trunk, all constructed in one unit from a single sheet of steel. Inside the mouth of each big press are ponderous steel dies, ground and polished with greatest care by experts to at-

all same to auto top presses

tain the exact shape of the automobile top. One set of dies inside such a press weighs about 240,000 pounds. More than forty-five feet high these presses are half-buried in concrete to withstand the tremendous pressure they exert. Instead of bending the metal these machines clamp down on it with such pressure that the cold steel "flows" into the contours desired. One set of dies requires 45,000 man-hours of grinding and smoothing the curved surfaces. As a result of this construction the steel body of the latest automobile withstands strains thirty times more severe than any encountered in actual use. One of the twist tests given the body calls for application of strains of 22,500 pounds, equivalent to loading a single automobile with 150 passengers.

Shaner, Miller & Levon, Pa.
Auto Trailer Built as Kennel
Fig 2 **to Carry Two Hunting Dogs**



Releasing dogs from their special trailer at starting point of a hunting trip. It serves as traveling kennel for two dogs

to 5
Sidewalk Grating Guards Tree and Lets in Food and Water

Rather than kill its beautiful old trees by surrounding them with cement sidewalks, a Washington, D. C., park has built gratings around the trees. The gratings permit moisture, plant food and some sunlight to reach a broad area around the base of the tree and still serve satisfactorily as part of the sidewalk.



Tree in Washington, D. C., protected by grating which serves as sidewalk but allows water, air and light to reach base

Sportsmen can take their dogs on a hunting trip in a specially built trailer kennel. The trailer provides ample room for two dogs. Streamlined to conform with the lines of the automobile, it can be painted to match the car.

ES 104
Forty-Seat Plane to Commute between Paris and London

Harnast 22
 Gigantic land planes powered by four 815-horsepower engines soon will be carrying forty passengers and a four-man crew on fast flights across the English channel between Paris and London. Their luxurious appointments include a miniature winter garden in the fore part of the hull, a library and bar. Air France plans to operate the ships on seventy-minute schedules between the two capitals. With a wing span of 116 feet, the ships will be ninety feet long and sixteen feet high, weighing eighteen tons and capable of 220 miles an hour top speed. Equipment includes de-icers on wing edges, automatic pilot, radio direction finder, variable pitch propellers and blind-flying instruments.

Cont. R. E. Hardeman, 1805-20th St. S.W., Washington, D.C.

Chicago Tribune 1/13/33

Arms, Idem and Maurice Thompson 1/6/33

How HUGHES

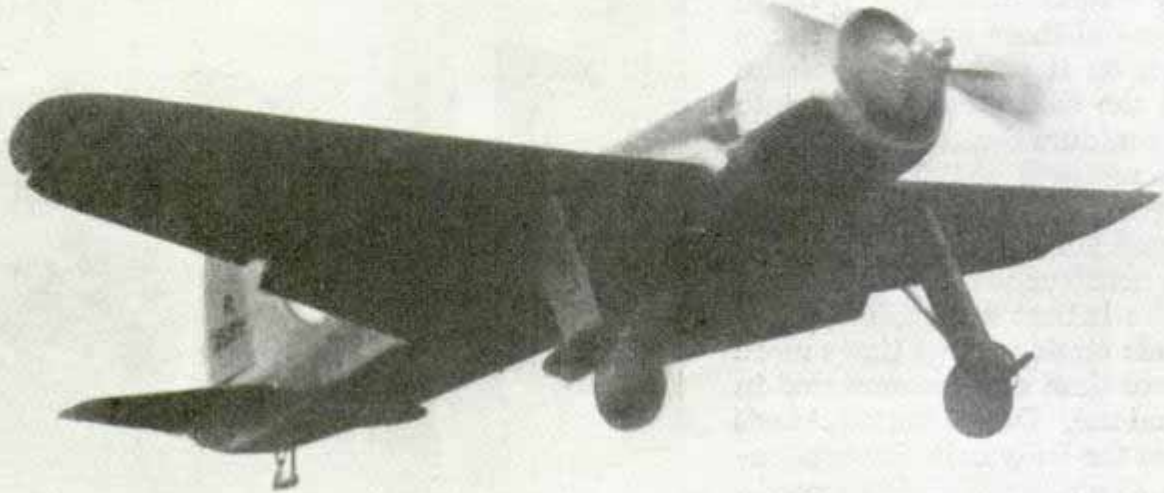

Top photo, courtesy Russell Cole
Hughes' racer landing after test flight and, left, plane with small racing wing before remodeling

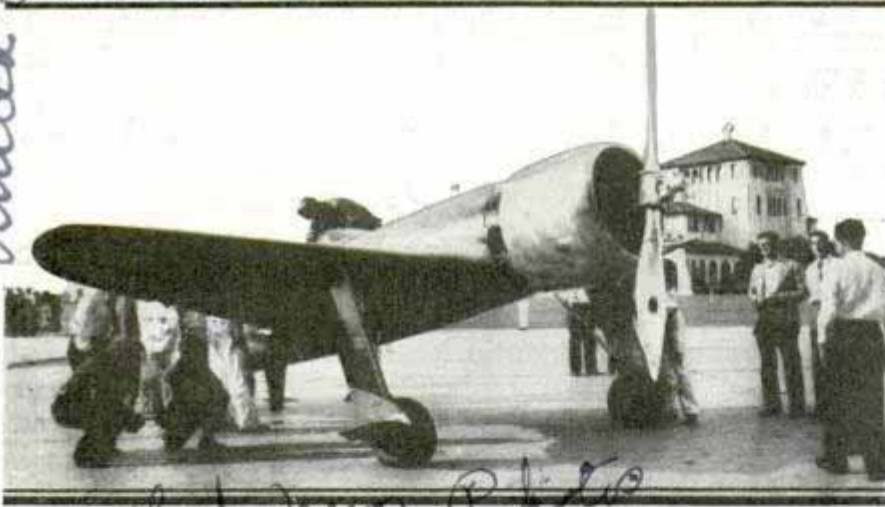

Ant. News Photo

LONG months of secret research by a corps of engineers and then more months of building and fitting behind guarded doors—that is the inside story of the mystery monoplane that Howard Hughes flew across the United States in seven hours and twenty-eight minutes in January.

The flight seems like fiction, almost like moving your finger across the map to span a continent. Yet Hughes' associates think he can beat his new record almost any time he desires. A mark of around six hours may be in the offing. For on his latest dash Hughes simply cruised from coast to coast. Mostly he used only fifty

per cent of his power. One of the miracles of the flight is that Hughes used a strictly stock engine that was not "hopped up" for racing. Another is that his airplane is not a freak affair that must be pampered and groomed for a high-speed dash, but a sturdy practical plane that flies safely and easily at the speeds for which it was designed.

Instead of using tremendous power Hughes depended more upon perfect streamlining for his speed. All planes are streamlined to some extent but even on a modern transport the wings are dotted with tiny rivet heads, each of which contributes to resistance. The metal skin of Hughes' fuselage is not riveted in the usual way. Instead all plates are butt-jointed with splice plates underneath, using flush-type rivets to eliminate every vestige of drag. Of course, streamlining is not the whole story. Much of it lies in the months of wind-tunnel research at the

Reference Mr. DeBerk Hughes Aircraft Co. Burbank, Calif. United Airport Burbank, Calif.

1. 0. 2. 3. 4. 5. 6. 7. 8. 9. 10. 11. 12. 13. 14. 15. 16. 17. 18. 19. 20. 21. 22. 23. 24. 25. 26. 27. 28. 29. 30. 31. 32. 33. 34. 35. 36. 37. 38. 39. 40. 41. 42. 43. 44. 45. 46. 47. 48. 49. 50.

BROKE *the* RECORD

California Institute of Technology.

"In the wind tunnel we worked with speeds never before seriously studied in this country," says one of Hughes' engineers. "Compressibility of air is different at high speeds and this had to be studied in designing the special wing curve. But the result is a sturdy airplane that can carry a good load at a top speed of around 400 miles per hour at 8,500 feet altitude, with a cruising speed of around 340 miles per hour. At sea level these speeds are somewhat slower."

Hughes averaged 332 miles per hour on his transcontinental flight

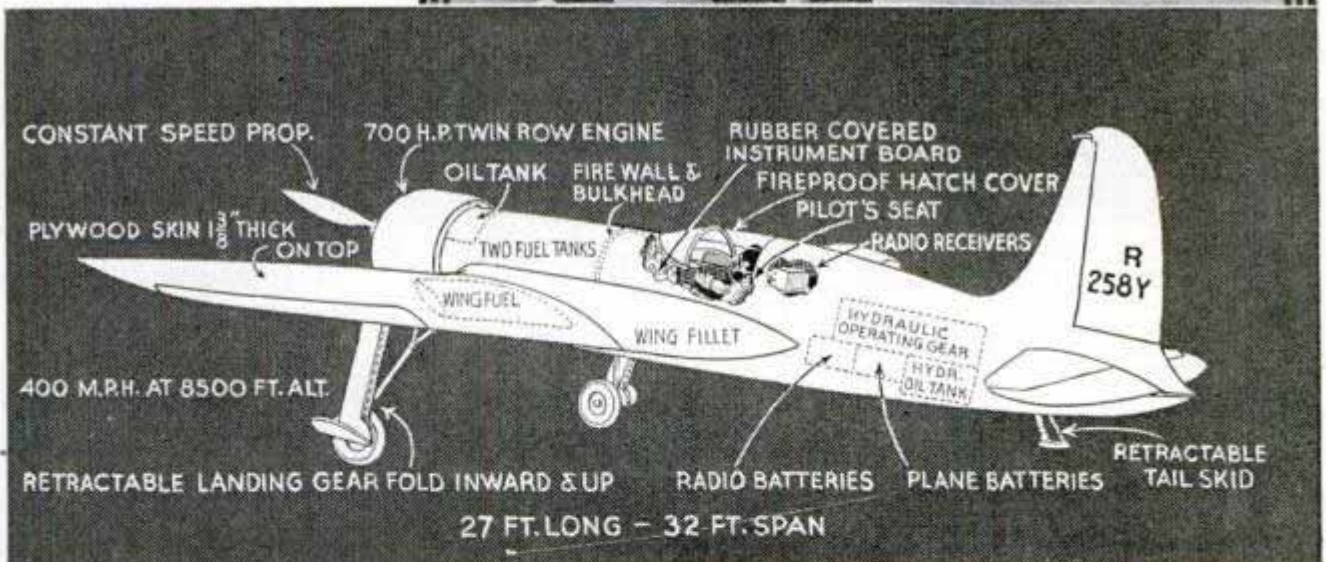

Howard Hughes who flew from Los Angeles to New York at better than five miles a minute and diagram showing details of his plane

and flew at an average altitude of 15,000 feet except when mountain ranges forced him up. His plane is the same \$125,000 ship with which he established a world record of 352 miles per hour two years ago, except that a number of its parts have been improved. The changes, including a larger wing, increased its speed about twenty miles per hour at all altitudes

In spite of his high top speed Hughes is able to land at seventy miles per hour. "Air brakes" of the split trailing edge type that are mechanically operated help slow him down. Another factor in safe landings is the wide tread of the retractable landing wheels. The wheels are farther apart than usual and, with the retractable tail skid, provide three widely spaced

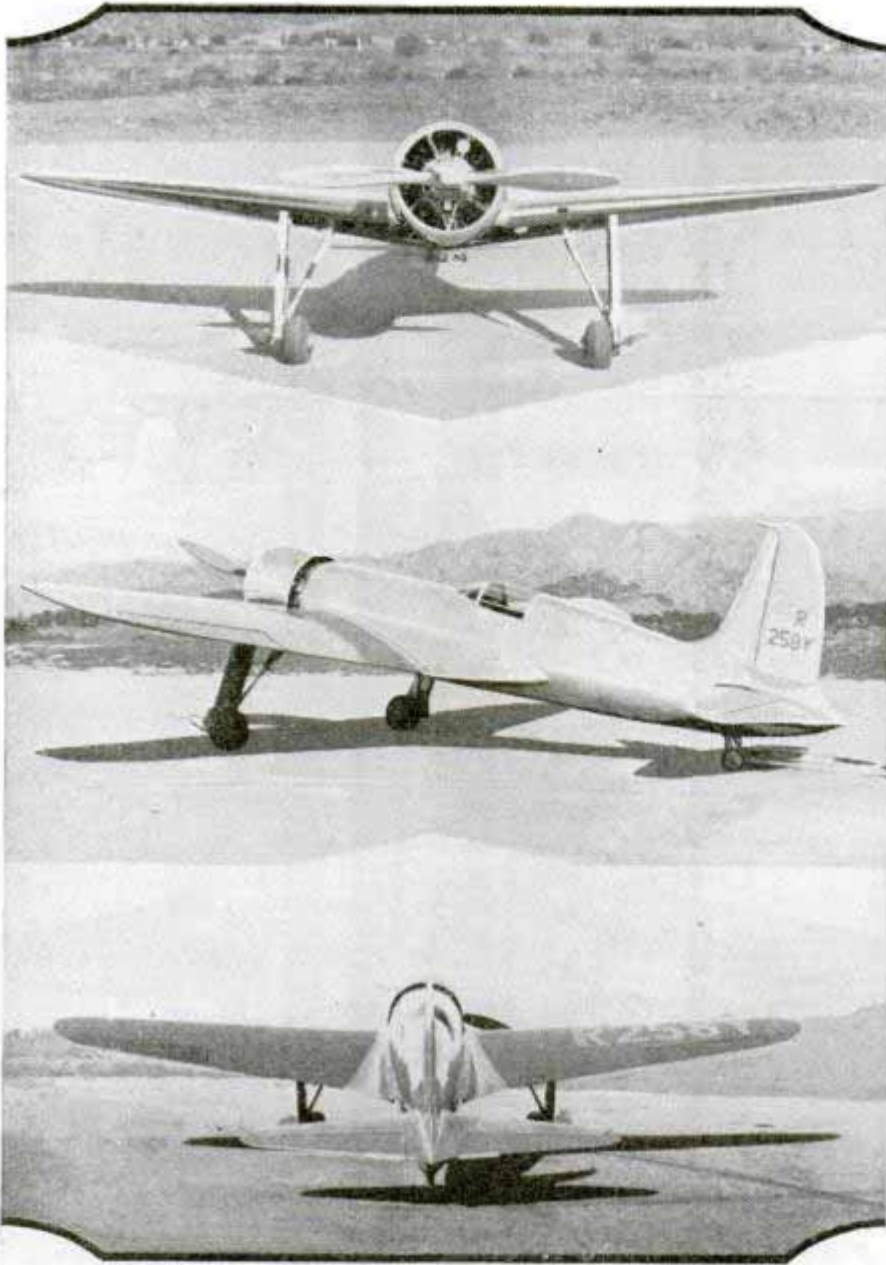

Three views of Hughes' plane as it appears with new and larger wing after alterations which added to speed

points for landing. Once Hughes blew a tire upon landing after a test hop, an accident that would have wrecked most racing planes, but he brought the monoplane to a stop without damage. The plane is fitted with standard air wheels and conventional brakes. It is twenty-seven feet long and the wing span is thirty-two feet. The wing is ten feet wide at the roots, tapers to a width of four feet at the tips, and is attached to the fuselage with a fillet of unusual design. Wing loading is thirty-five pounds per square inch with full load.

Although the fuselage is of metal, the wood wing is covered with a spruce plywood skin one and three-eighths inches thick on top. This is about an inch thicker

than most plywood wing skins and seems to be a waste of material and weight. But it gives the wing a safety factor of five times at speeds above 600 miles per hour, a speed which the plane is theoretically able to achieve in a dive. The constant speed type of propeller is ten feet long and makes two revolutions to every three revolutions of the engine. Near the nose the fuselage skin is many times thicker than usual and averages three times the thickness used on lower-speed airplanes.

Hughes' motor is a stock air-cooled fourteen-cylinder twin-row radial Pratt & Whitney wasp junior that develops 700 horsepower at 2,500 revolutions per minute at 8,500 feet altitude. The engine has an outside diameter of forty-four and one-eighth inches, a dry weight of 1,060 pounds, and a displacement of 1,535 cubic inches. Compression ratio is 6.7 to one and the supercharger ratio is ten to

one. Carburetion and magneto ignition are stock.

The plane carries 280 gallons of special 100-octane aviation fuel in two tanks aft of the motor and in smaller wing tanks. The engine and fuel compartment in the front of the fuselage is sealed from the cockpit by a heavy fire wall and bulkhead, behind which the instrument board is located. Although the plane is fitted for an automatic pilot, none was used for the last flight as there was not time to install it.

The instrument board contains a complete set of flight, navigational and engine instruments, including directional gyro and artificial horizon. Temperature gauges show the temperature of the outside air, carburetor heat, and head temperatures of

the individual motor cylinders. Radio beam and weather broadcast receivers are located in the fuselage aft of the cockpit, where batteries, hydraulic oil tank, and hydraulic mechanisms for elevating the pilot's seat, operating retractable landing gear and tail skid and moving the windshield and hatch covers are also located.

Elaborate precautions were taken to protect Hughes against every conceivable danger. The large instrument board in front of him is completely covered by a four-inch pad of sponge rubber with holes cut into it to reveal the dials. Fresh air enters the cockpit from an intake on the leading edge of the right wing far away from exhaust fumes. Hughes controls the amount of air by means of a valve and with a similar valve regulates the flow of warm air that passes through a heater after being taken in at the leading edge of the engine cowling. The inflowing air, fresh or heated, puts a slight pressure on the inside of the inclosed cockpit to prevent engine fumes or exhaust gases from leaking in.

One of the problems was to fit all the gear into the small available space. In the cockpit, instruments and controls take up so much room that there was no place for an oxygen tank for high-altitude flying. The problem was solved by installing the oxygen tank in the right wing above the space into which the retractable landing gear fits. From the tank an aluminum

(Continued to page 160A)

20 43

Trailer Like Giant Ear of Corn Has Restaurant Inside

pat. pend

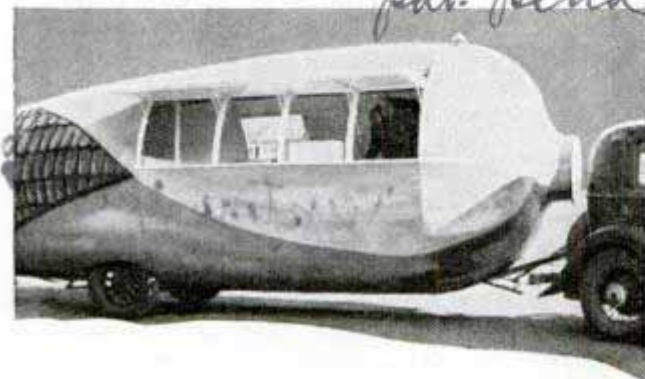

This odd trailer which houses restaurant has space inside for ten diners

Cabilla Corp. des Machines d'ava

20 4.

Big Clocks for Powerhouses Govern Electric Time Pieces

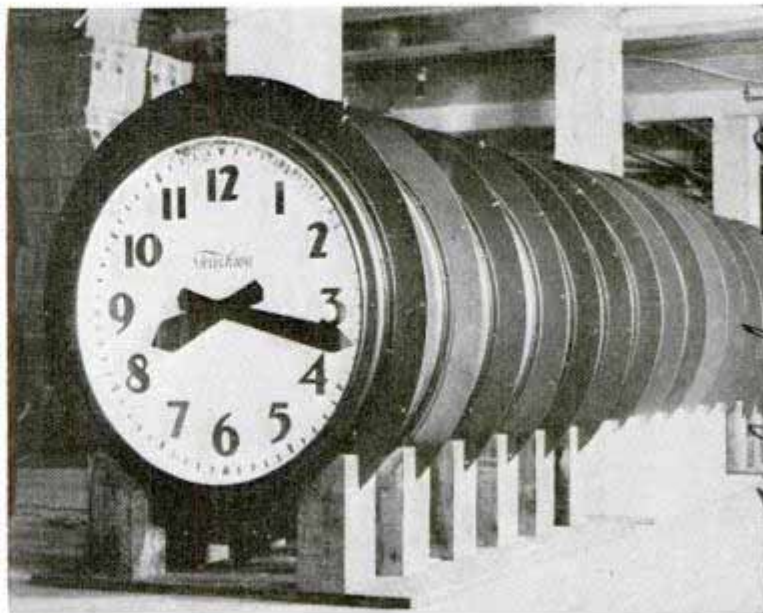

Master clocks for power stations. They hold current alternations uniform so your electric clock keeps time

When synchronous electric clocks which measure time by the cycle change in alternating current first were marketed, it was found they would gain or lose as much as ten minutes a day due to variations in the speed of generators at local powerhouses. This difficulty was corrected by producing giant master clocks for the power stations. These neon-illuminated clocks, now installed in almost every powerhouse, automatically keep current alternations uniform, thus making possible the uncanny accuracy of synchronous electric clocks in the home and office. The master clocks illustrated are in a stockroom awaiting delivery to power stations.

is Warren Telephon Co
W. S. Laird, Manager

Under direction of Professor Johann

Strange UNDERSEA

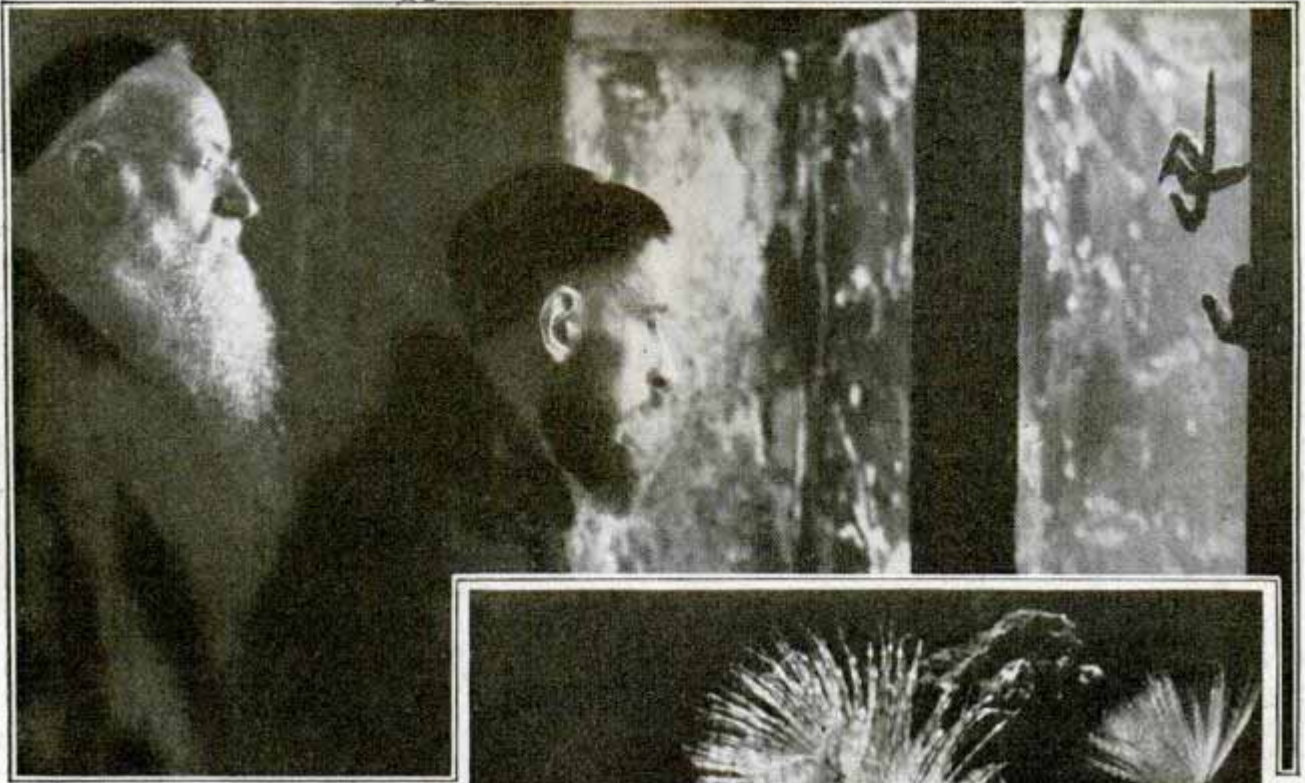

To give the world a glimpse of the weird undersea life of the Mediterranean, German scientists have established a zoological station and an aquarium at Naples, famous for its beauty. Strange animals and marine vegetables are shown there, and to study this life and obtain exhibits from the ocean floor the scientists must remain for days on their research ship and put on diving suits for deep-sea exploration. Top, visitors watching one of the aquarium exhibits

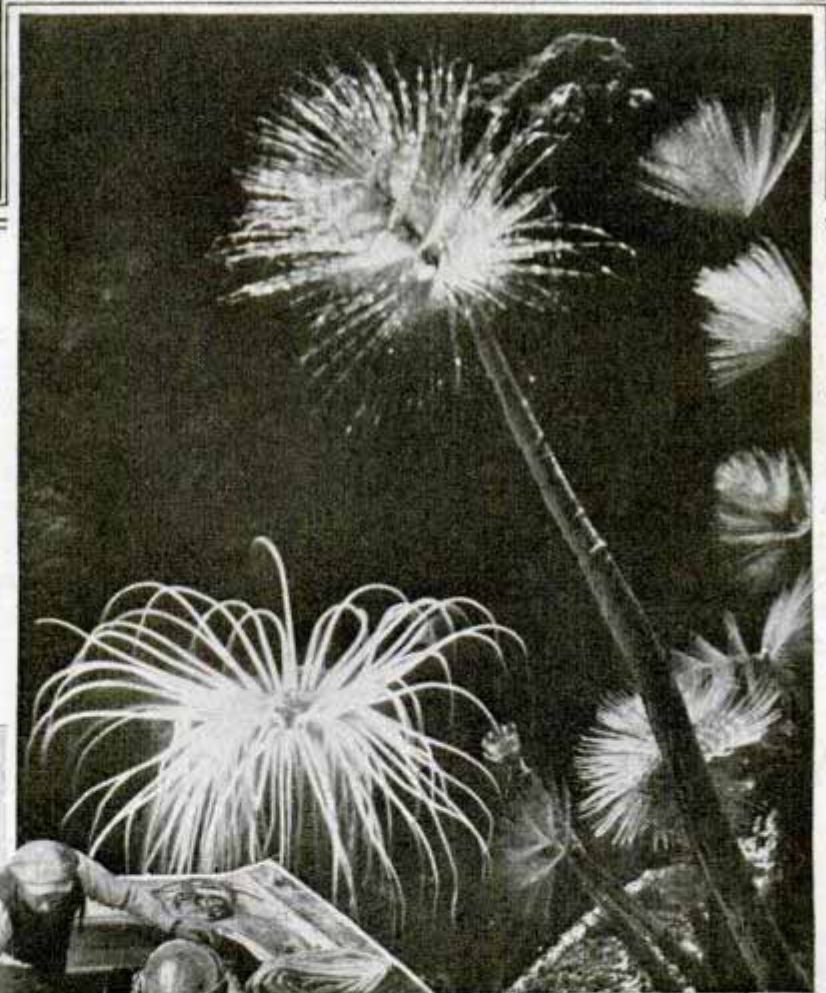

Keystone View
No tropical flowers are those shown above, but Mediterranean sea animals transplanted to the Naples aquarium. Left, scientist goes over the side in diving outfit to hunt on the bottom for salt-sea fish and "flowers"

LIFE

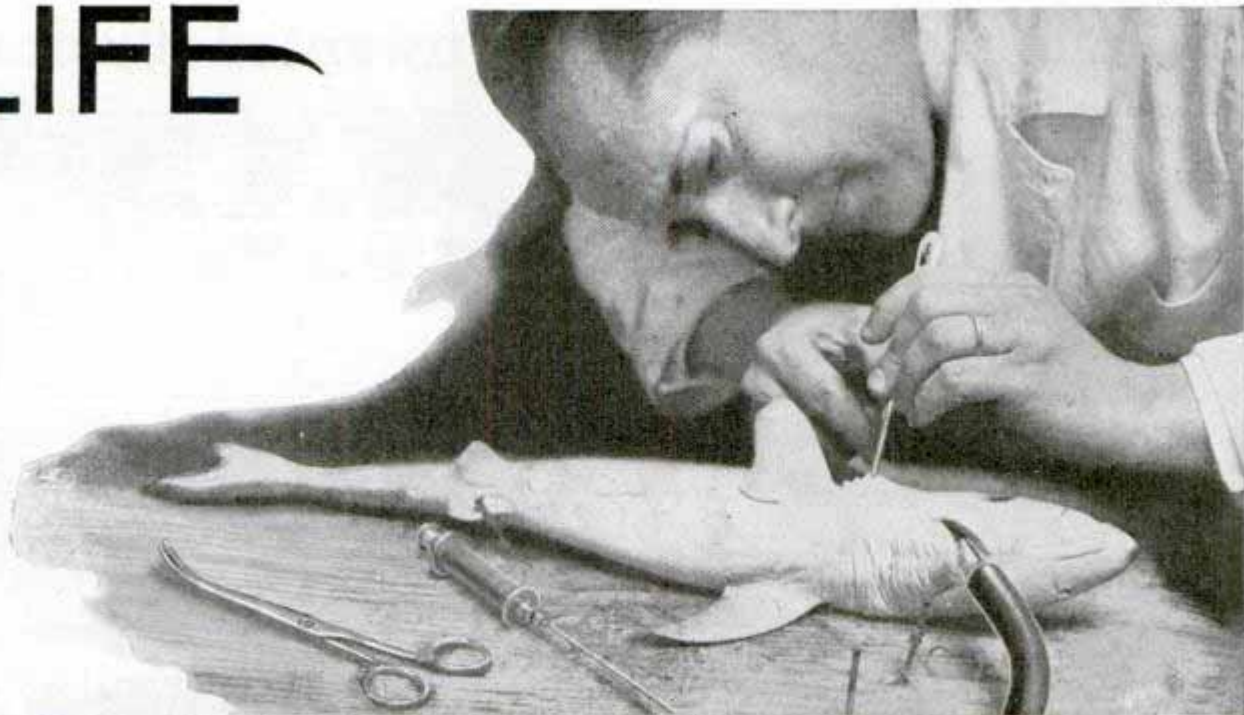

Top, operating on a baby shark. Diseases that have been considered difficult or impossible to deal with are now treated by taking the fish from its tank and operating surgically while fresh sea water is administered by tube



Above, starfish and a visitor pose for silhouette portraits against the submarine background of an exhibit in the Naples aquarium. A day spent in this huge institution, the exterior of which is shown at right, is like a day spent at the bottom of the Mediterranean



es-6

Swinging X-Ray Avoids Unwanted Shadows

Electricitäts-Gesellschaft 'Sautors'
Berlin, Germany

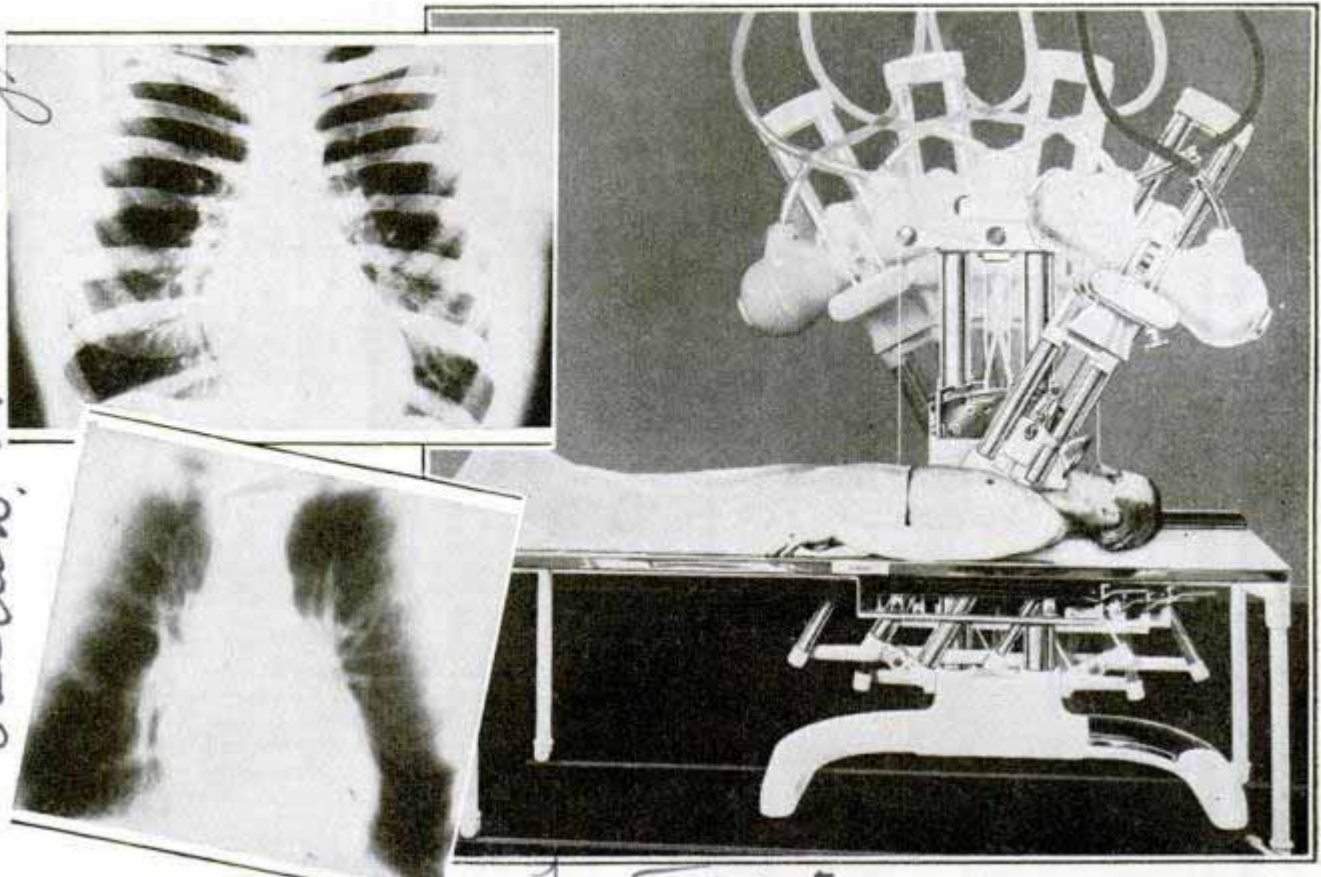

Tomogram

Photo shows how X-ray tube swings above subject while film moves in opposite direction below. X-ray picture above at left was taken in traditional way; that below in new way, eliminating shadows of ribs

X-ray photography has always been hampered somewhat by the inability to cut out unwanted shadows. An X-ray study of the lung would be cluttered up with shadows of the ribs, obscuring parts of the lung the physician desires to examine. This fault has been conquered by a swinging X-ray machine developed in Germany, which excludes undesired portions of the picture. It follows the principle of the time exposure taken at twilight with an ordinary camera, in which a moving person is not recorded in the brief moment when he passes the lens. In the case of the X-ray, it is the X-ray tube and film container which move, swinging as a unit like a pendulum. The X-ray focus moves along the arch of a circle from left to right above the person or object being photographed; it is focused constantly, as it moves, at the particular object of the picture. Meanwhile the film moves below the table from right to left, but always parallel to the table and to the plane of the section being photographed.

Thus every point in the plane of that section always falls on the same point of the film, and other points of the body are at constantly changing points on the film and are therefore underexposed and do not record so clearly. One second is usually sufficient for the moving exposure. Adjustments make it possible to cut out sections of the body from a few millimeters to two centimeters thick for photographic purposes. Thus disease focuses or foreign objects in the body are located exactly.

All Car Doors Locked at Once by Single Handle

Intended for installation on new cars at the factory, a four-door locking system controlled by one handle has been developed. The control handle is located on the right front door. Cars now in use may be locked only by manipulating the handle or locking pin on each door. The new system makes it impossible to leave the key locked in the car and permits entering

so 79
Hoydville - Hershey
Cars: 2160 & 2300

Electrol, Mech

Sept. of Automobile Press Service 12-3

the car from the left or right side, eliminating the necessity for crawling across the front seat to reach the driver's position. The single locking motion is regarded as a safety factor in prevention of stop-light holdups in which the marauder quickly steps into the car through a door the driver may have forgotten to lock.

B. J. Soodrich
Tires Inflated with Water
Improve Tractor Operation
Abert Blue

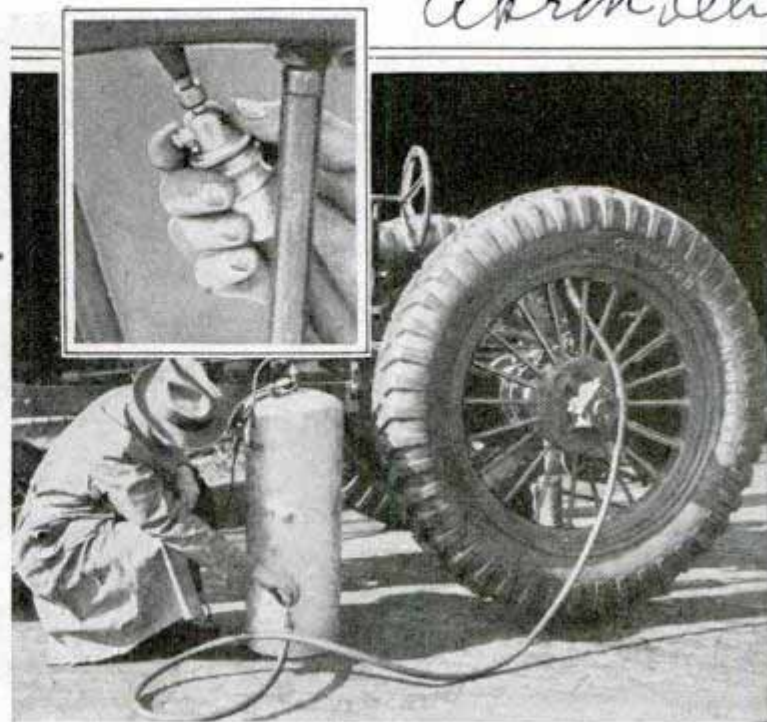

Filling tires with water to improve tractor operation. Inset, water nozzle applied to the tire valve

Es 95
Antelope Refuge Set Apart on Vast Western Tract

In the heart of its native range in southeastern Oregon the government has established a 276,000-acre refuge for the antelope, fleet-footed animal which was widely distributed over the west until civilization, hunters, disease and predatory animals reduced its numbers. Near the new Hart Mountain refuge is a 539,000-acre winter and spring range where the antelope will also be protected. It is estimated there are 10,000 pronghorns in the Nevada-California-Oregon region and 15,000 in Wyoming.

Es 40
Celluloid Top for Baby Buggy Is Put on When It Rains

On windy or rainy days, a homemade "coupe" top which fits over a baby carriage protects an English youngster from the weather. His mother devised a frame with celluloid windows to fit on the buggy.

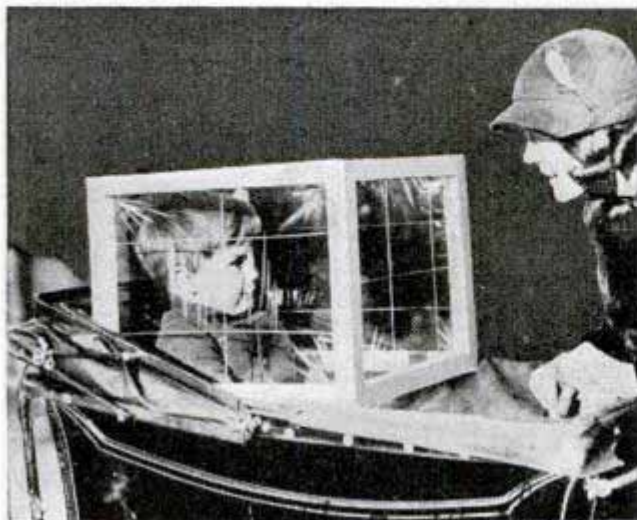

Celluloid windows in frame make weatherproof top for baby buggy. Child's mother designed it

Water-filled tires may solve many problems of tractor operation. Tests have shown such tires provide a normal cushion that eliminates virtually all sway and rebound on the road, reduce wheel chatter and improve traction. These results are achieved by balancing the tires with the water instead of using expensive metal wheel weights. An adapter which connects to any garden hose may be used for inflating the tires with water. After filling, the tires then are filled with air to the usual pressure. A pressure tank is available for putting the water into the tires. In winter, an anti-freeze solution is used instead of water.

Es 97
"Nesting Poles" Built by Utilities to Keep Birds Off Power Line
Atlantic

Power companies along the seaboard sometimes are forced to erect "nesting poles" for fish hawks to keep the big birds from building nests atop high-voltage power-line poles. The hawks use bits of fish net and rope, old fence wire and sometimes cornstalks to make their nests and this material could "short" the power line and burn the pole.

Wm. W. Jones
 Mrs. A. French
 Cliftonville, Md.
 Eng.

Wm. W. Jones
 346 D. Centre Ave.

es 8.

Latest **COMFORTS**

James McQuerry 436 W. 60th
 Terrace, Kansas City, Mo.



Modern trailer camp in California, above. Left, trailerites enjoy solid comfort

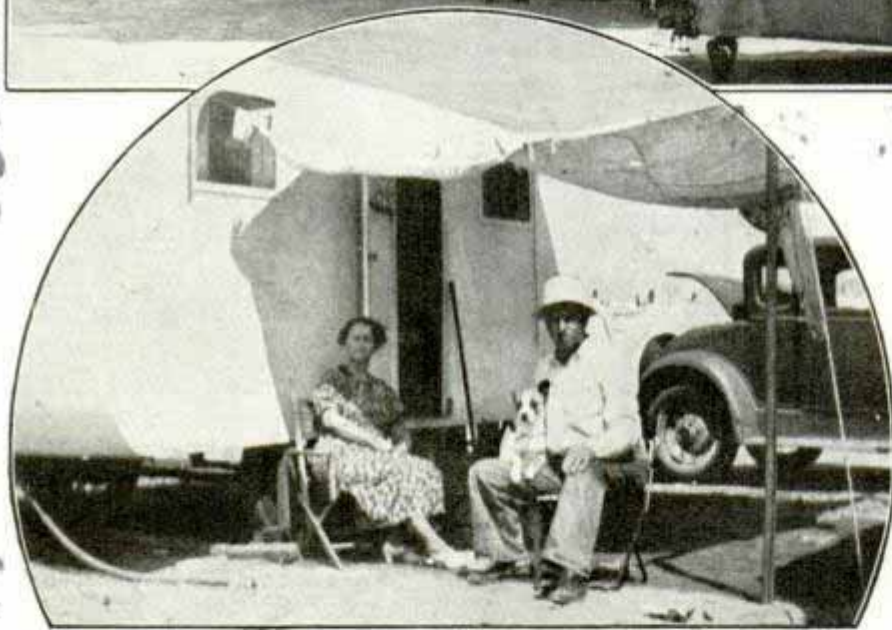

80,000 trailers. Likewise, home craftsmen everywhere helped swell the year's output. The production mark of recognized builders for 1937 is around 200,000.

This means about 500,000 potential customers for the trailer camp owner. And there is a need for adequate camps in virtually every section of

WOULD you like to go in business for yourself—perhaps get into something requiring only a small amount of capital and promising a reasonable return?

Then start a trailer camp.

The growing need for such camps is apparent to those who have watched the portable home zoom to national popularity in the last three years. There are more than 200,000 trailers in use today. Last year more than 300 companies built about

the country. The average tourist camp cannot accommodate them, the trailer owners say, and the spots in many public parks set aside for their use are not properly laid out, so dusk usually finds the tin-can tourist camped along the highway or in a field. Under these conditions, trailerites must forego the use of electricity and other comforts of their homes on wheels. Some towns and a few individuals have opened trailer camps on well-

As 8

for HOMES on WHEELS

A rolling home in the south and, below, the trailer camp should be equipped with water taps and electric-light sockets which can be connected to the trailer as soon as it is parked



traveled highways, but in the main the field is still wide open.

The portable home owner doesn't like to park at the rear of a tourist camp or a filling station. Neither furnishes the peace and quiet, the pleasant surroundings or the adequate facilities he is willing to pay for. The opportunities in this field may be adduced from the sales reports of trailer makers. The foot-loose and the retired represent a big portion of present trailer owners. They range from those with small pensions or modest savings to the wealthy who follow the sun throughout the year.

Surveys show most trailer owners roll their own homes more than half the time and a considerable number use them continuously. They like to be on the wing—

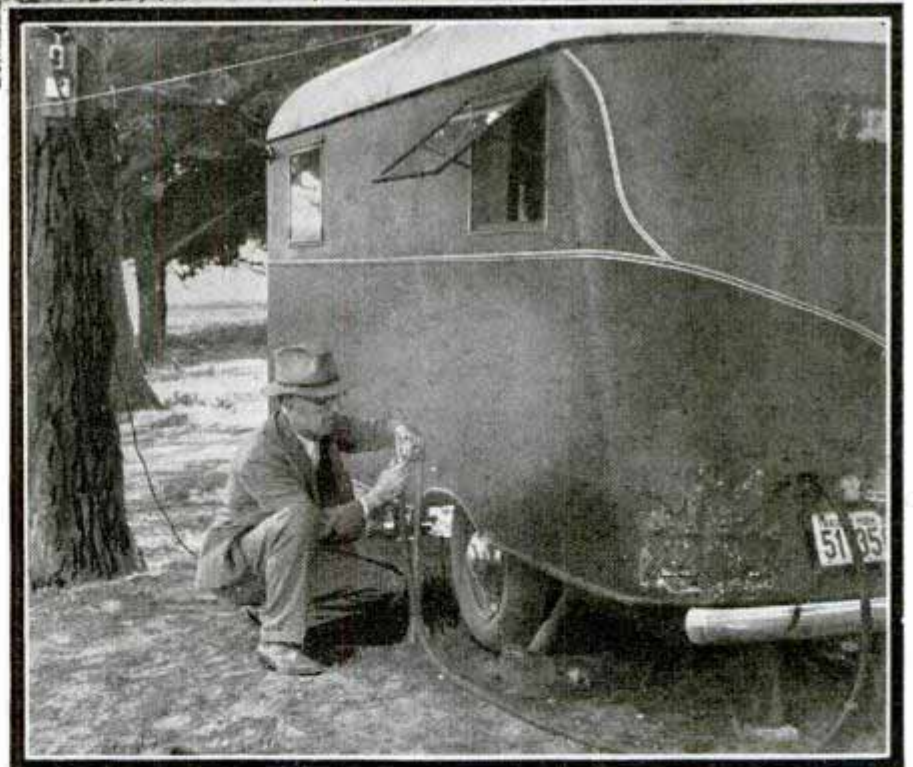

in Michigan or Minnesota or Maine in the summer, then to Florida, Arizona, or California for the winter. There are stop-overs and side trips along the way. The prospective trailer-camp owner also may find added confidence in the predictions of those who see a great future in portable



Top, Florida trailer park. Below, laundry of trailer camp equipped with coin-operated washing machines and rental irons

homes because of the house shortage, fluctuating employment and high taxation of property.

One of the advantages of going into this business is that no great amount of capital is necessary at the outset. An unimproved camp site may be leased reasonably—frequently for the amount of the taxes, and it can be made to pay its way, improvements and extra features being added as the business becomes established. An example of this method of operation is offered by C. H. Treffenger of Ocean Beach, Calif. Three years ago, he was working in a filling station when a prop-

erty owner offered to lease him three city blocks of vacant lots overlooking the ocean if he would keep up the taxes.

An entrance drive and a restroom were the only improvements the first year. Electricity, showers, and a sewage system connecting with the trailer drains were added later. Owing to his location on the ocean front, Treffenger has accommodated as many as 150 trailers at one time and

he has a regular patronage of around fifty trailers per day, many on a monthly basis. To add to his profit he has built a small grocery store on the premises and the trailerites are supplied with provisions, notions and ice. In starting, this spot was open to both trailers and campers but by degrees the campers have been segregated and now occupy only a small section of the grounds.

In contrast to this camp, Ollie Trout operates a trailer park in Miami, Fla., that represents an investment of \$150,000. A landscaper before entering this business,

(Continued to page 158A)

Farmer-Hunter Plan to Restore Game Birds

Cooperation between farmer and hunter is the key to the Western-Winchester plan for restoration of game birds in areas gradually becoming barren. The plan calls for the farmer to restore natural cover, eliminate animals which prey on the birds and plant and care for food patches. This work is to be done with the financial and advisory assistance of the sportsman. The plan is designed for one hunter and one farmer, or for a group of sportsmen and a group of farmers. It gives the sportsman permission to hunt the lands of the farmer with whom he is



Top, eight-hour old quail on incubator tray. Circle, day-old quail compared to twenty-five cent piece. Bottom, checking temperature of incubator at Western-Winchester experiment farm to insure proper incubation of quail or pheasant eggs. Tests on the farm prove that wild game can be raised with minimum equipment and special handling



working and it compensates the farmer at so much per acre for agricultural land permitted to revert to cover and so much per acre for food patches. Exclusive shooting privileges would be arranged, perhaps through payment of a fixed sum per acre. A lease between farmer and hunter covers the part which each agrees to perform, and provides that the farmer receive some revenue each year for labor and material expended and land employed in the scheme. In an experimental area, the cost to the sportsman per season's bag of fifty birds was \$15.75, a figure believed to represent the average expense under average conditions of field management.

New Radioactive Mineral Found in Wyoming Highway Bed

Workmen excavating for a highway west of Rawlins, Wyo., noticed a strange yellow mineral deposit in the soil but cast it aside as sulphur. When a prospector sent a sample to Portland, Ore., for analysis, it proved to be a hitherto unknown mineral, highly radioactive and possibly of tremendous economic importance. Named dakeite for Prof. H. C. Dake of Portland, who participated in classifying it, the mineral carries a large percentage of uranium and if the Wyoming deposit proves extensive it may become a commercial source of radium. Under ultraviolet lights the material gave a fluorescent reaction quite powerful and different from other minerals of its type. The deposit is in a matrix of gypsite, and it is believed a rich source is located not far below the earth's surface.

Little Crumbe...
 1/16 9/3
 7/16 9/3
 512
 POPULAR MECHANICS
 Farmer-Hunter Plan to Restore Game Birds
 Cooperation between farmer and hunter is the key to the Western-Winchester plan for restoration of game birds in areas gradually becoming barren. The plan calls for the farmer to restore natural cover, eliminate animals which prey on the birds and plant and care for food patches. This work is to be done with the financial and advisory assistance of the sportsman. The plan is designed for one hunter and one farmer, or for a group of sportsmen and a group of farmers. It gives the sportsman permission to hunt the lands of the farmer with whom he is working and it compensates the farmer at so much per acre for agricultural land permitted to revert to cover and so much per acre for food patches. Exclusive shooting privileges would be arranged, perhaps through payment of a fixed sum per acre. A lease between farmer and hunter covers the part which each agrees to perform, and provides that the farmer receive some revenue each year for labor and material expended and land employed in the scheme. In an experimental area, the cost to the sportsman per season's bag of fifty birds was \$15.75, a figure believed to represent the average expense under average conditions of field management.

20 111
 Top, eight-hour old quail on incubator tray. Circle, day-old quail compared to twenty-five cent piece. Bottom, checking temperature of incubator at Western-Winchester experiment farm to insure proper incubation of quail or pheasant eggs. Tests on the farm prove that wild game can be raised with minimum equipment and special handling
 New Radioactive Mineral Found in Wyoming Highway Bed
 Workmen excavating for a highway west of Rawlins, Wyo., noticed a strange yellow mineral deposit in the soil but cast it aside as sulphur. When a prospector sent a sample to Portland, Ore., for analysis, it proved to be a hitherto unknown mineral, highly radioactive and possibly of tremendous economic importance. Named dakeite for Prof. H. C. Dake of Portland, who participated in classifying it, the mineral carries a large percentage of uranium and if the Wyoming deposit proves extensive it may become a commercial source of radium. Under ultraviolet lights the material gave a fluorescent reaction quite powerful and different from other minerals of its type. The deposit is in a matrix of gypsite, and it is believed a rich source is located not far below the earth's surface.

*129 Niagara
Buffalo N.Y.*

Fast Oil Engine Has Fewer Working Parts

Known as "a crankless, opposed-piston, two-stroke cycle, internal-combustion, oil-burning engine," the latest development in power plants has few working parts. Built for marine use the high-speed engine has no cylinder heads, valves, camshafts, push rods, rocker arms, springs, gaskets nor crankshaft. The plant develops 150 horsepower at 1,200 revolutions per minute. One feature is the absence of electrical ignition. The engine is the compression ignition type, the fuel mixture igniting in the cylinder from the heat of the air compressed therein. The few working parts of the motor are accessible through plates on each side. Great reliability and lower maintenance costs are claimed for the engine.

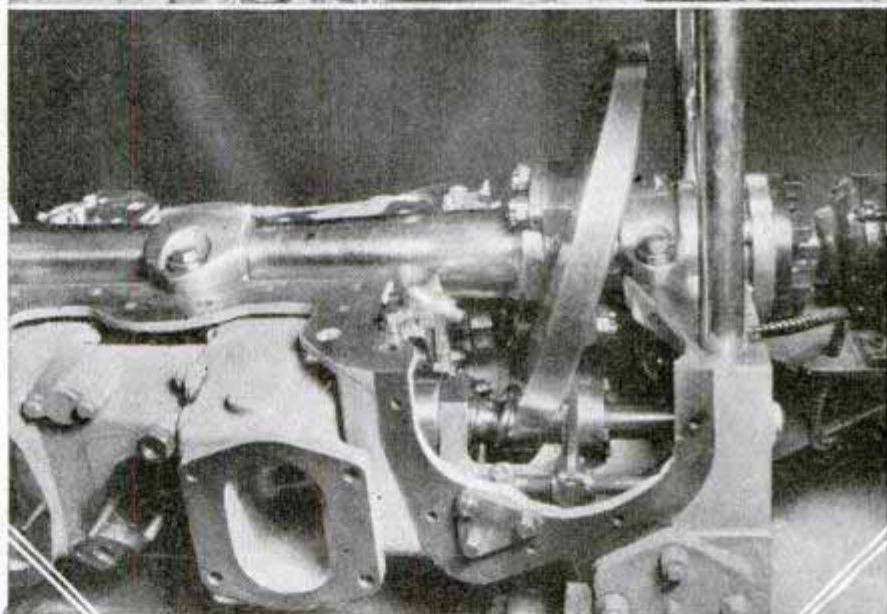
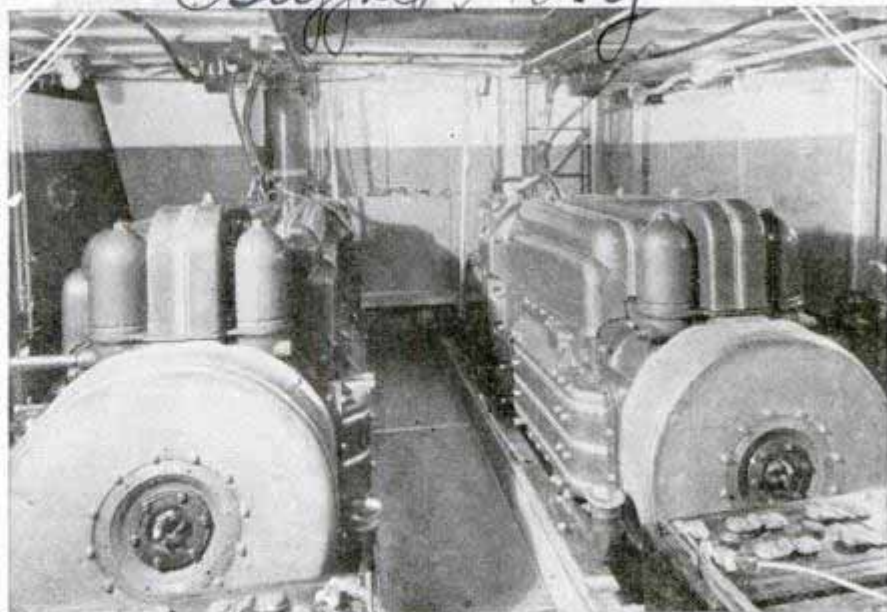

Top, oil-burning engines installed in large boat. Bottom, close-up of engine showing its compactness

F170

Pistol Shoots Lifesaving Line over Three Hundred Feet

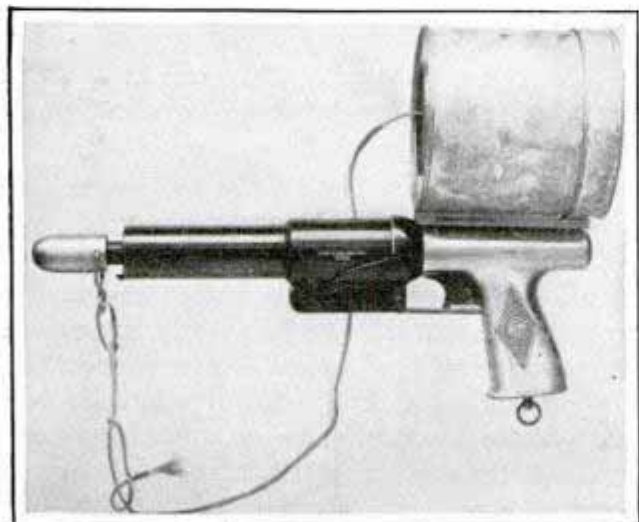

Especially woven line coiled into a container mounted on a new lifesaving pistol can be fired 350 feet. Soft and of tremendous strength, the line is manufactured like a fabric. Folding the line into its container is done in a peculiar manner so that it will pay out at great speed without tangling. The pistol is nine by thirteen inches. A projectile drags the line to the target, perhaps to a foundering boat. There the line may be used to pull a heavy hawser from shore to ship. The pistol also may be employed for firing parachute flares.

Life-line coiled in container on top of pistol is more than three hundred feet long
W. J. Sedgley, Inc.
2311 N. 1st St.

Motor vehicle users paid \$950,971,000 in special state taxes during 1935.

Automotive Industries

12/19/36

71563

Emb. James Montaguil, 617 Harbor
Commission Bldg. Toronto 2. Ont. Canada

FLYING FREIGHT

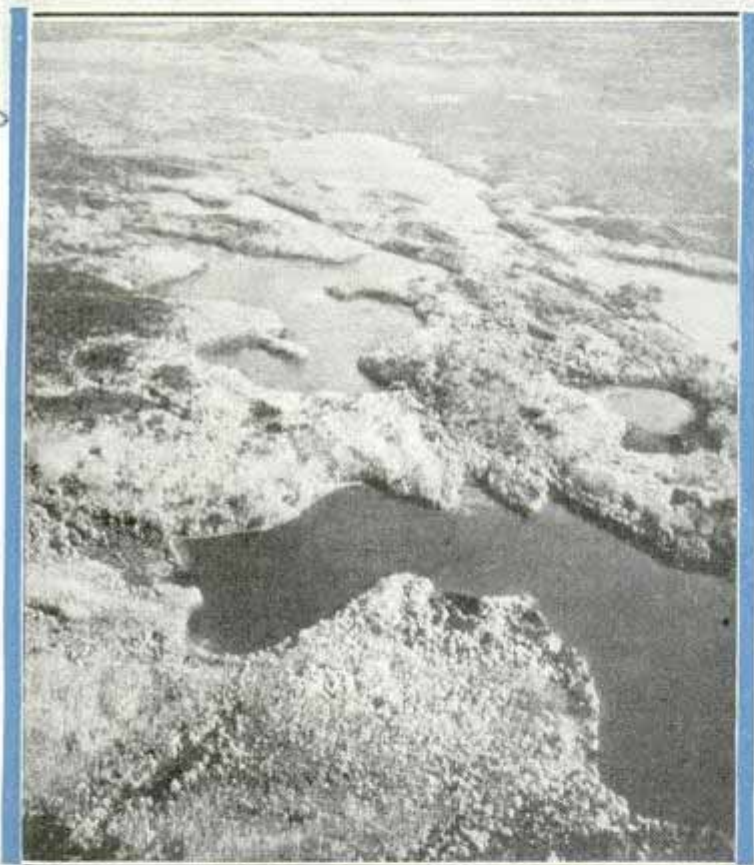
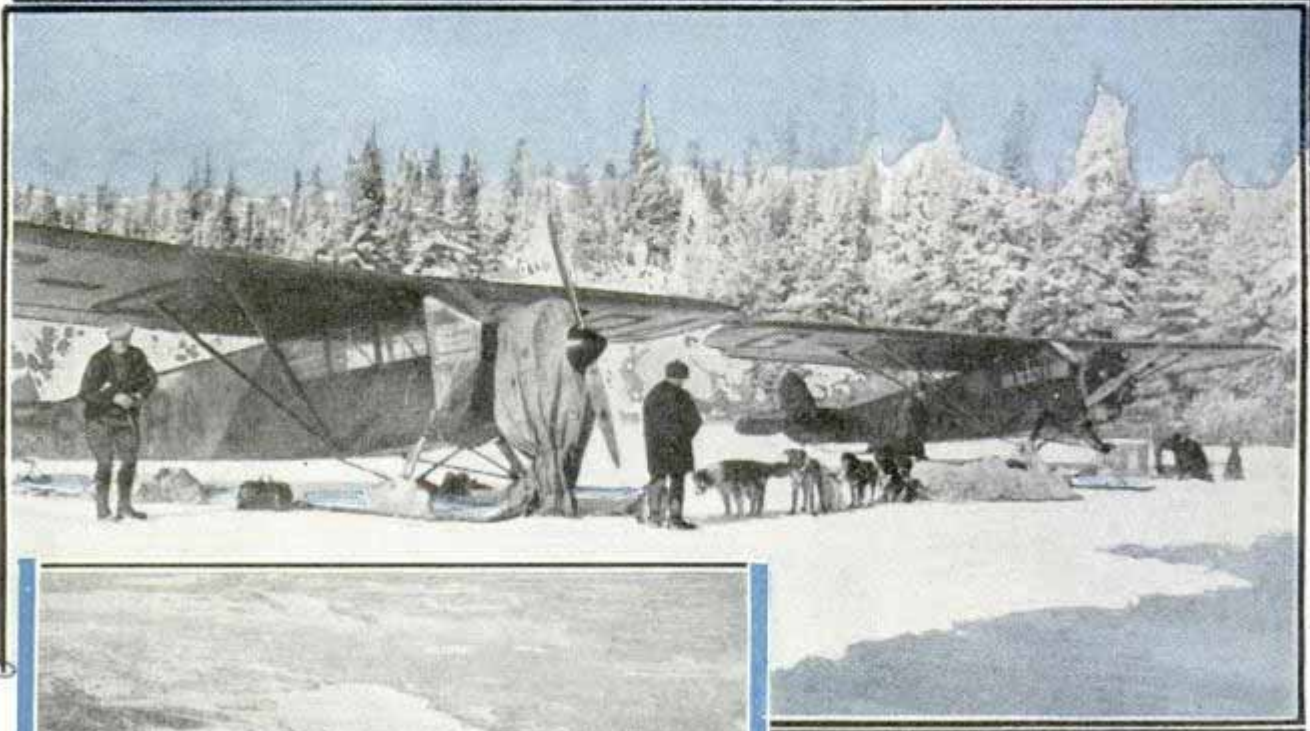

Above, the old and the new—airplanes and dog teams at a Canadian bush camp. Left, typical country over which the aerial freighters fly

CANADA is having a flying gold rush. Gold mines are being opened in territory far north of the railway, country that ten years ago was still unexplored. Last summer one of the largest mines went into operation in northern Ontario, more than 200 miles north of the last railway track. Rivers and lakes flow part way to the mine. The rest is virgin bush grown over glacial formations. Ten years ago the transportation problem would have been

insurmountable. Airplanes solve the problem now. From railway freight cars mining machinery, fuel oil for Diesel engines, lumber for houses and mine shafts and food supplies—hundreds of tons of equipment were loaded on barges and taken about 100 miles to Gold Pines, end of water transportation. Here waited a fleet of seaplanes, the smallest capable of a ton load at a time, the largest taking two and one-half tons. From early June to freeze-up in October those planes flew back and forth. They ate up ten carloads of gasoline and oil. They flew in all weathers. They had no air beacons to guide them. Below was only unsettled bush, with a few small lakes for emergency landings. Only radio weather reports were available at each end of the run. They finished their contract ahead of time. They flew 780 tons of freight into that new mine site. The flying boxcar of the fleet averaged twenty tons a day, often

F 1563
1937

to the ARCTIC

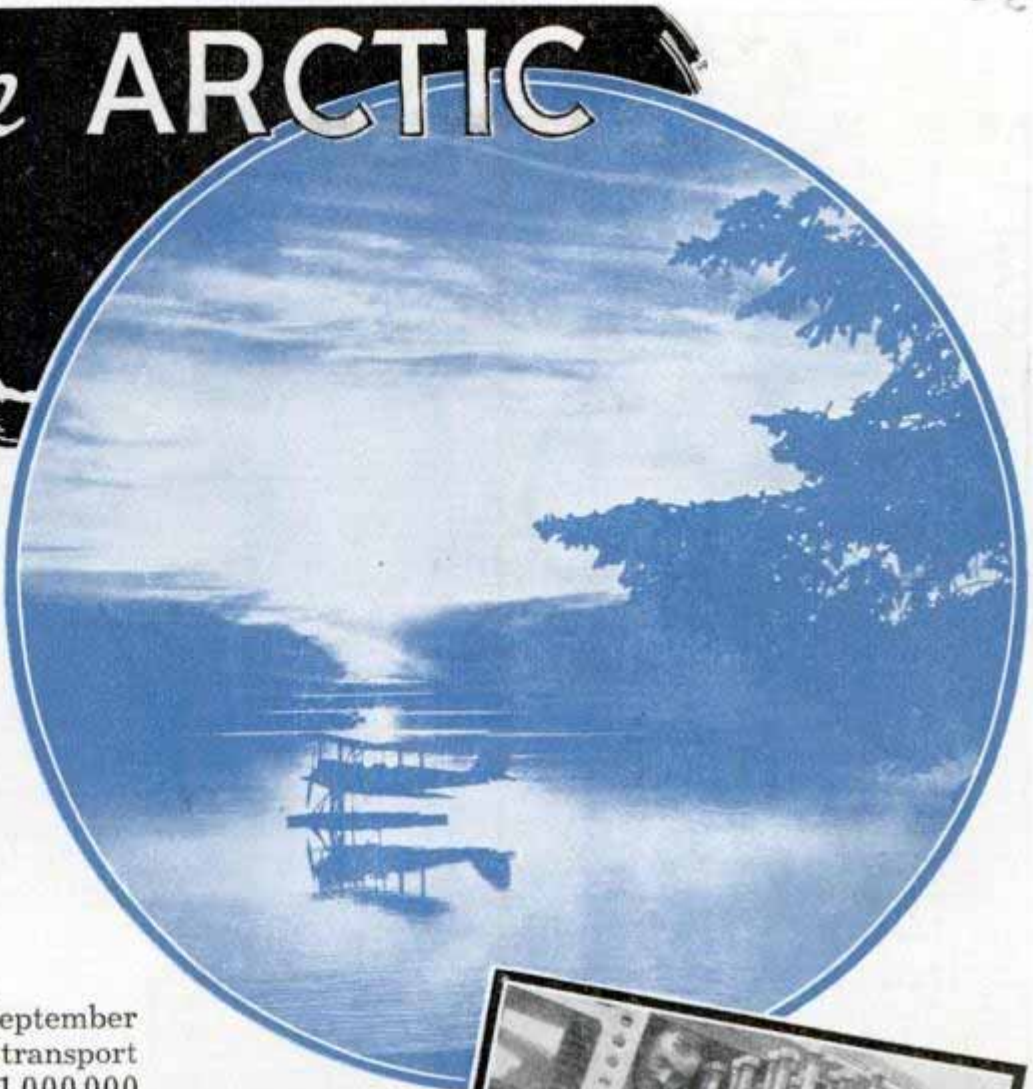

Right, mine executive's light plane at northern mine site. Below, unloading a 1,950-pound Diesel engine from flying freighter, and one of the freighters with its nose in a "nose hangar" to keep engine from freezing

twenty-four. In September one Canadian air-transport company flew 1,000,000 pounds of supplies into the mining areas of Manitoba and Saskatchewan. Canadian air-transport operators have in recent years carried more freight and express than all the other air-transport operators of North and South America combined. In 1935 Canadian air companies flew 13,000 tons of freight and express. And 1936 was ahead of 1935, incomplete figures show.

Mining has become Canada's second



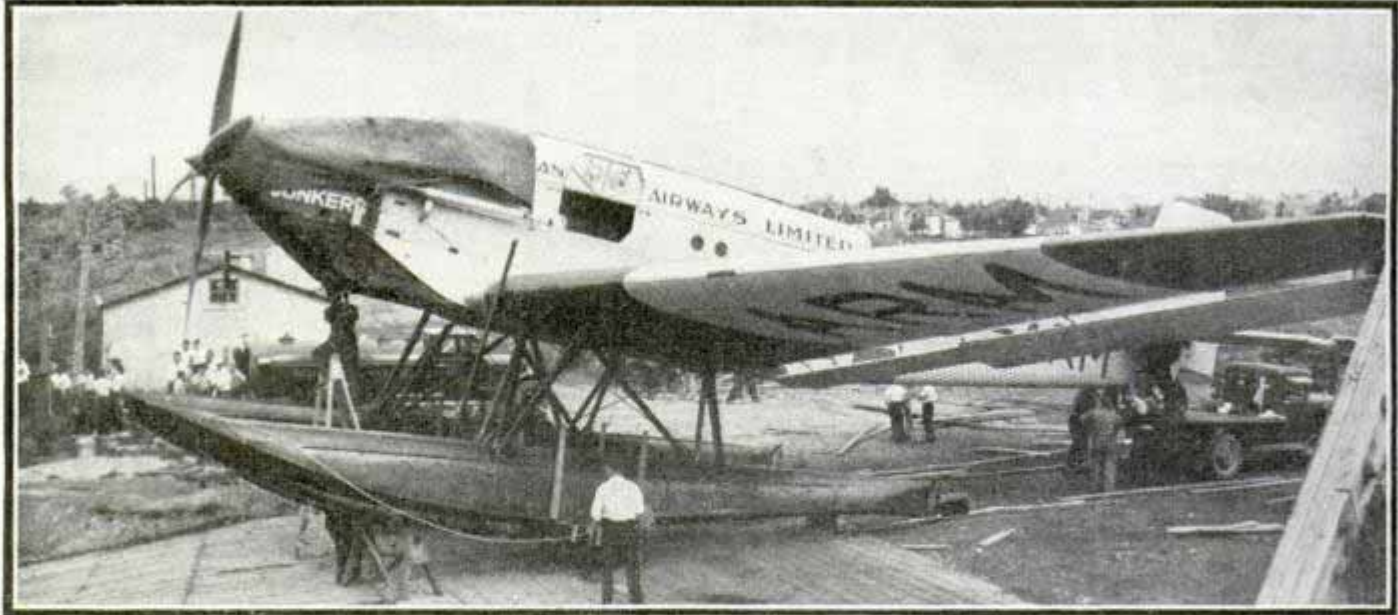

airplane, by doctors, nurses, office workers, scientists, geologists, all traveling on the wing. In 1933 there were but twenty-eight producing gold mines. Government estimates for 1936 show there are now 121 producing mines. In 1933 the production of gold was \$61,000,000. The 1936 figure is more than double, \$135,000,000.

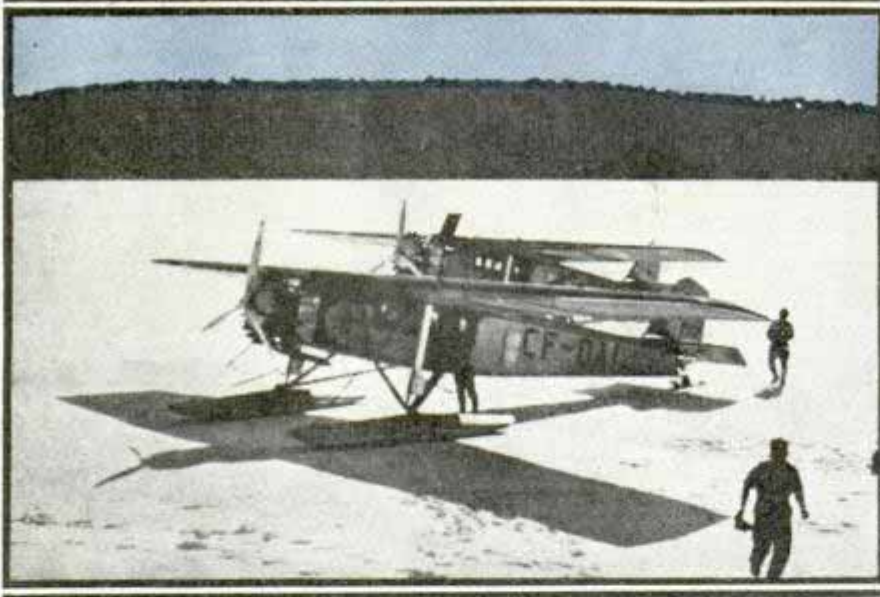

Top, freighter which carries three-ton payload. Center, tractor hauling a barge. Bottom, aerial freighters on Canadian lake

largest industry, and gold mining leads. Aerial prospectors are traveling the farthest reaches of Canada's northland in the search for the yellow metal. They are followed by mining crews flown in by air, by financiers who travel into the bush in city clothes by air, by women and children who form new settlements where their husbands and fathers work, coming in by

Gold has become the reason for the rapid pushing back of the northern frontier. Gold has resulted in log-cabin towns where a few years ago was wilderness. Gold has meant the pushing of highways farther north, the establishment of navigation lights and aids to mariners on waterways on the Arctic Circle. Ten years ago the first daring prospector used an airplane, a wartime crate. Today the largest Canadian air company has nearly fifty planes plying

the northland, and some thirty other companies operate anywhere from one to a dozen ships. One operator started in northern Ontario with one canoe and forty dollars. Last year his planes transported 2,000,000 pounds of freight for mines.

New gold mines need constant provisions. Typical is the report of one north-

(Continued to page 128A)

Right, freighter at mining camp. Below, left, loading freight for an air trip to a northern mine. Right, a northern mine shaft. All the equipment for this mine was brought in by the flying freighters

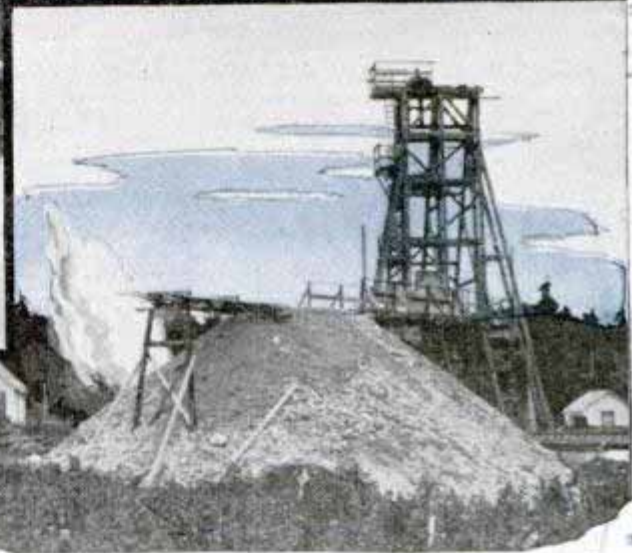
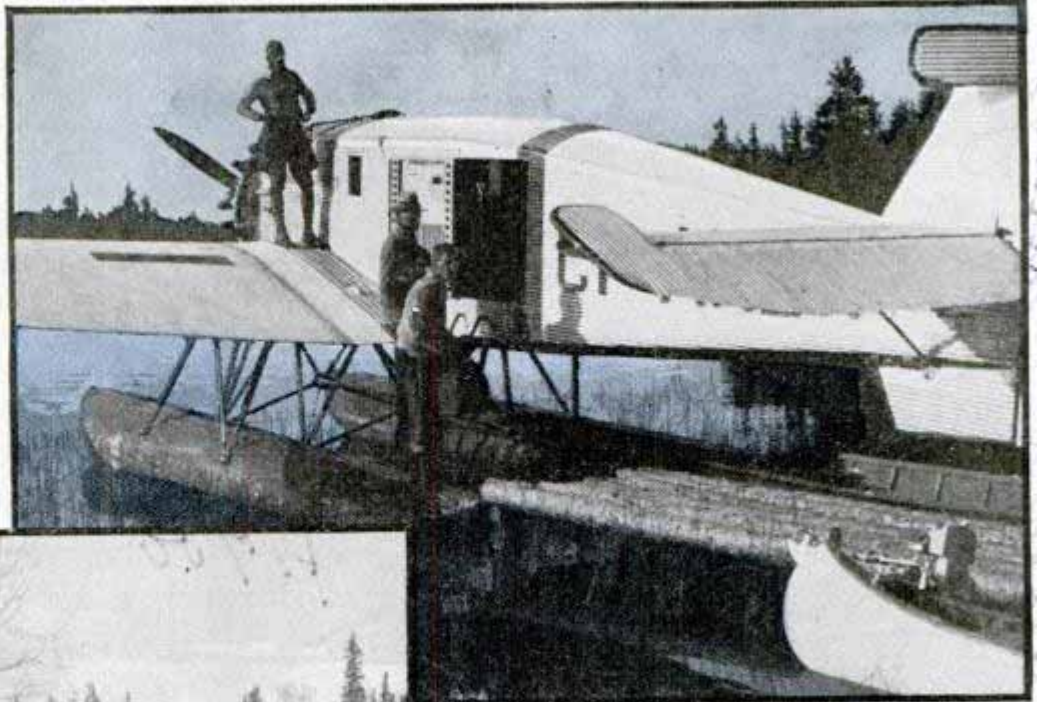

Above, a typical tractor train used to haul in equipment too bulky to be loaded on airplanes. Right, a mining town of unpainted lumber and log cabins in northern Canada. Building materials come by air, too



Resealing Tin Can Is Easy as Turning a Crank



Girl at right is sealing a new lid on can of preserves by merely giving the crank a turn

Home canning is made easy and economical by an automatic sealer which re-flanges and reseals the can as easily as turning a crank. It can be adjusted for the four popular sizes of tin cans, and forms a seal that has withstood tests of thirty-five pounds per square inch internal pressure.

Sunken Ship Is Located in Lake Erie by Applying Mathematics

Lost for weeks after it foundered in a gale on Lake Erie the night of last October 17, the lake ship "Sand Merchant" was at length located on the bottom by applying a common mathematical method. Tugs



Map shows how sunken ship was found in triangle formed by plotting observation lines of witnesses

and airplanes had searched the waters near Cleveland nearly two months without success. Finally United States engineers made contact with three persons along the Ohio shore who had seen the boat's distress flares. When the lines of their observations, north by fifty-six degrees east, north by thirty degrees east, and north by two and one-half degrees east, were plotted on a map they crossed to form a small triangle six miles off shore and just east of the area that had been searched. The sunken wreck was found immediately, just inside the eastern edge of the triangle.

Portable Steel "Forts" Guard Miners in Rock Blasting



One of the steel shelters in open mine. Note that it also serves first-aid purposes

Designed so they may be moved by crane from one spot to another, steel "forts" are being used in open-pit mines to protect men from flying rock during blasting operations. Just before explosives are set off in the mine, the crews are ordered into the steel shelters, to remain until the charge has been exploded. Several of the shelters are used in the mine, so that any miner may have protection near at hand.

Clifford E. Ives 2400 W Madison St Chicago

F 1699
all days mine, eye any

E.A. Jaqueth, 1515
112 Cleveland

71686

Analysts Diagnose Ills of Modern Motor Car

*Microphone type analyzer
motor laboratories, Inc.
504 W. 57th, New York*

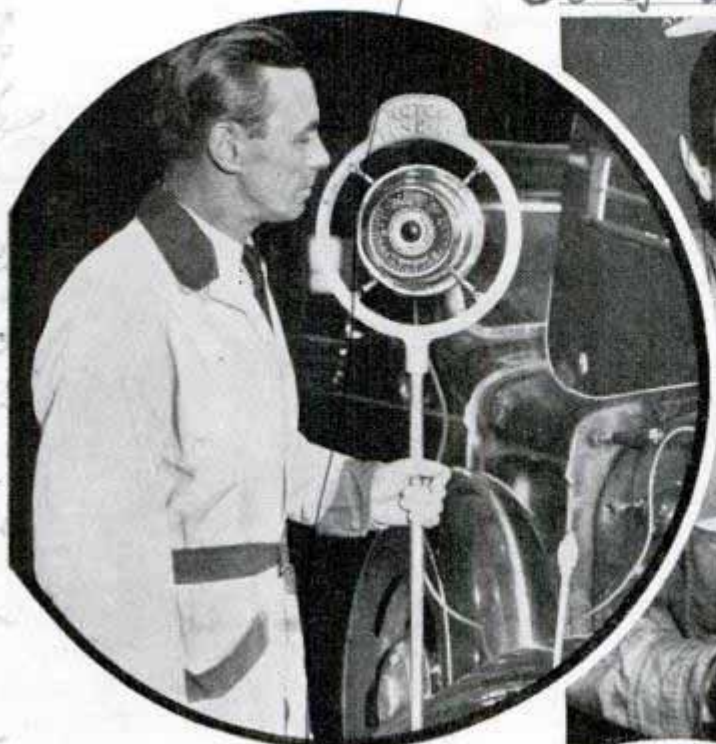

Above, mechanic locating motor trouble by watching small indicator connected to intake manifold by rubber tube. Variations in speed of engine cause the double-dial device to show whether valves are sticking, carburetor out of adjustment or ignition at fault



Above, oscillograph in use for testing and adjusting distributor. Left, headlamp tester which works in daylight. It records intensity of light, shows condition of car battery and reveals dirty reflectors, weak bulbs, poor contacts and other things as the causes of weak, uneven lights. The two knobs shown on the device are compensating controls

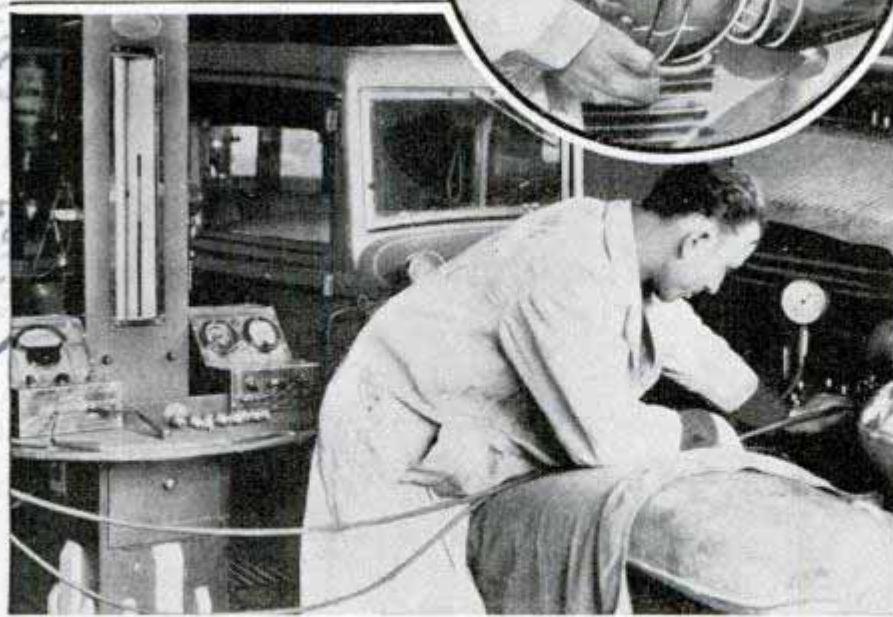
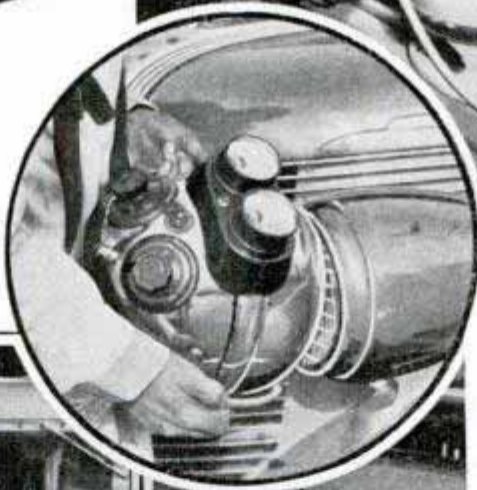

Above, variations in motor's vacuum cause mercury in indicator at left to show true condition of power plant. This device is supplemented by electrical analyzers for checking ignition and electrical equipment. Right, testing car under road conditions by means of electric dynamometer. Car's rear wheels cause drums to turn, showing true horsepower

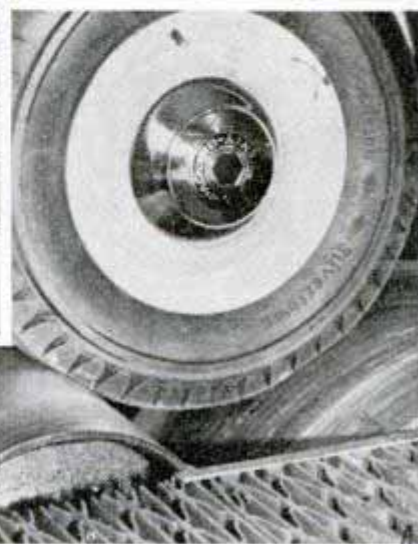

Guide Lamp-C.

504 W. 57th

United Motors Co | Bendix Products Corp

Ship Wrecked in Black Sea Raised After Eighteen Years

F1706

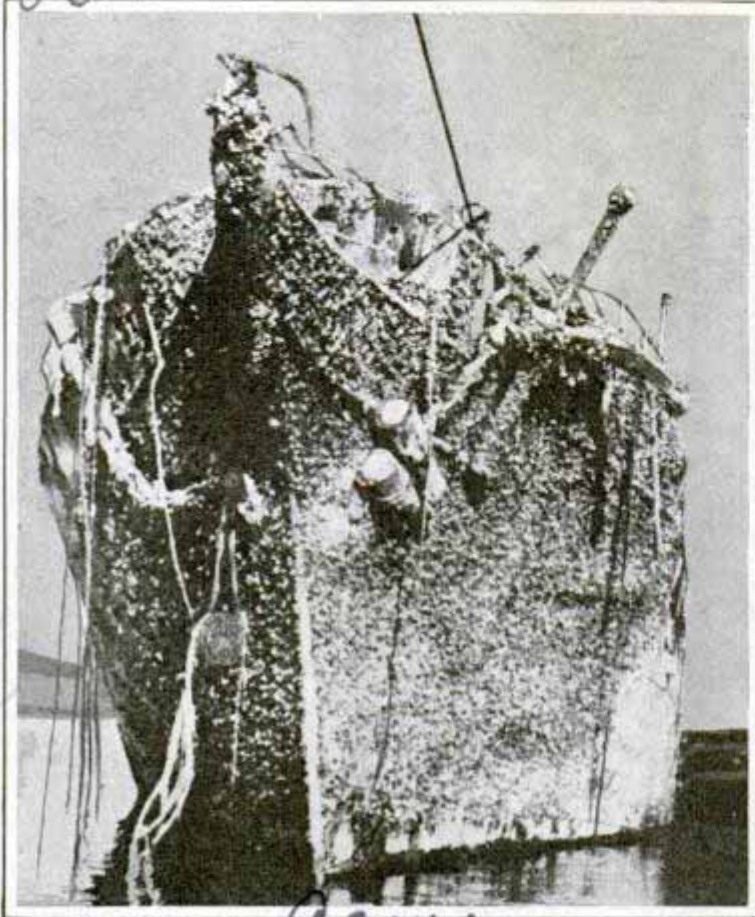

Grizzled hull of the steamer "Doris," covered with barnacles, when it was raised after eighteen years on bottom

Bearded with an eighteen-year growth of barnacles, the wreck of the steamer "Doris" was raised recently from the bottom of the Black sea near Sevastopol on the Crimean coast. The ship foundered in 1918, and late in 1936 Russian divers located and floated the overgrown hulk.

Delivery Box Protects Milk on Cold Mornings



Installed outside the house, a delivery box equipped with a forty-watt electric bulb protects milk and cream from freezing on cold mornings. The box is heavily insulated. When the milkman makes the delivery he turns

on the light and closes the box. The heat from the lamp provides warmth sufficient to keep the milk from freezing. With the electrical fittings removed in summer, the box protects milk from heat, due to the heavy insulation.

Automatic Bootblack Sells Shine for Two Cents

Slot machines are in the shoe-shining business. You shine 'em up, yourself, after dropping two cents in the slot of the automatic vendor. The pennies release the cover of a polish container, and polish is fed out in a limited amount like a grease gun. Dipping a dauber, which is mounted above on a flexible rod, you apply the polish to both shoes by hand and then close the lid of the container. This starts a motor which revolves a brush on another flexible shaft, and you administer a final shine. Replacing the brush handle in its holder prongs stops the motor, but even if it is not hung properly a timing device is arranged to shut off the motor after a reasonable period.



You might call this a shoe-shining "cafeteria." Two cents in slot starts brushes and feeds polish

Alan L. Beckett
350 Springdale Ave.
East Chicago

Louis
201
S. La Salle

"Flying Billboard" Flashes Across Night Sky

Equipped with thirty searchlights and its own plant for generating electricity, a tri-motor airplane recently renovated for use in advertising literally is a flying billboard. On its night flights, rolls of smoke are projected by the ship to serve as background for the lights. More than 50,000,000 candlepower may be turned on the smoke clouds, giving the plane the appearance of a fire rocket flashing across the dark sky. This exhibition attracts attention to the ship, whose operator then switches off the big searchlights and turns on four large neon signs in color to present the advertiser's message. So powerful are the searchlights, one of which

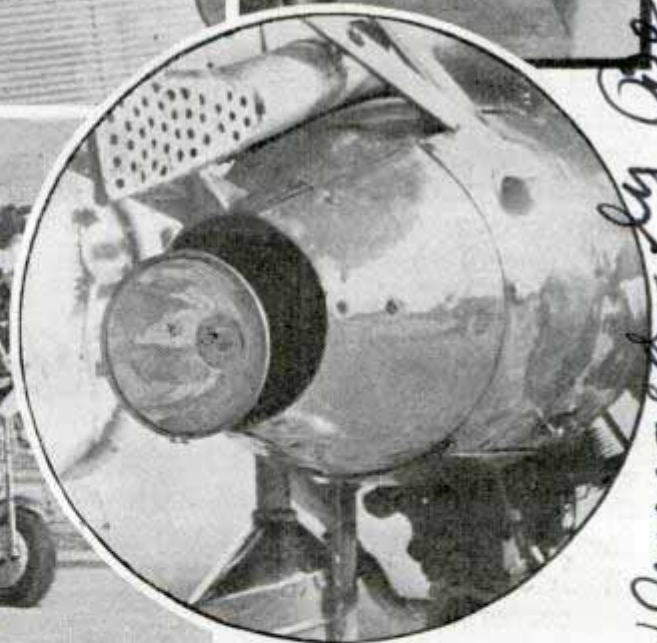
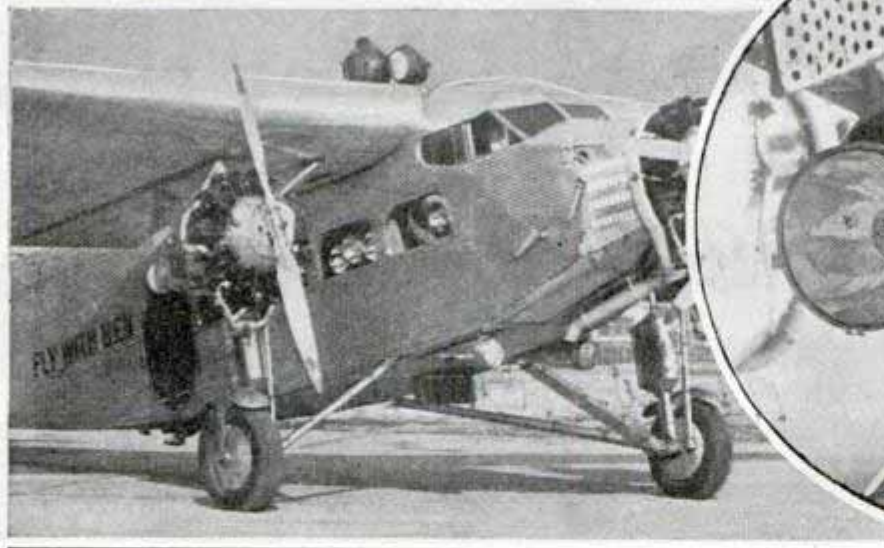
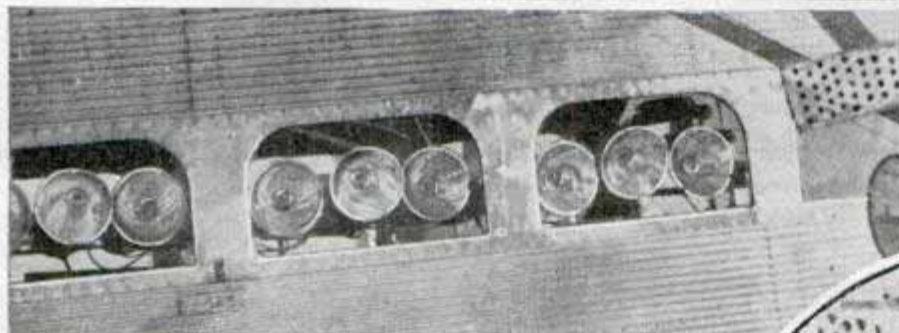

Designed by Owen S. Long, Fairfax Airports
Designed by Owen S. Long, Fairfax Airports

Top, right, control board for operating lights and neon signs. Left, battery of spotlights behind heat-treated glass installed in cabin. Bottom, left and right, views of the "flying billboard"

is 10,000,000 candlepower, that special heat-treated glass is used in the cabin windows. The heat would damage ordinary glass. A twenty-two horsepower gasoline engine and a twelve and one-half kilowatt generator, one of the largest

plants of its kind ever installed in a plane, provide the current. The neon signs under each wing measure five by twenty-five feet and those on the sides of the ship are four by eighteen feet. A special switchboard controls the lights and signs.

es 10.
see Sept 1941 #88



A window-sill herb "garden." These little pots grow the herb requirements of an average kitchen

OURS could be the greatest herb-growing nation in the world, but it isn't. Medicinal plants and herb flavors are an important factor in our \$500,000,000 a year pharmaceutical industry, our \$1,000,000,000 tobacco industry and many great food industries.

Yet we import about eighty-five per cent of all plant flavors and medicinal herbs used, ranging from mints, basis of candy and gum flavors, to licorice, an essential of the tobacco industry, and the common foxglove, the plant source of digitalis, an important pharmaceutical. Herbs are a \$100,000,000 resource which waits all but unnoticed at the gardener's doorstep.

Many important herbs are hardy plants which can be grown successfully in garden corners, along fence rows, in window boxes, or on almost any tillable land.

Nowadays commercial herb growing is largely a garden industry. There are several reasons for this. Demands for most herb crops are not extensive enough to warrant their being major field crops. Since quality and care are the greatest assets in herb marketing, it is usually more profitable to grow and pack a small quantity well than a large quantity care-



There's MONEY

By Charles Morrow Wilson
114 W. 11th St. New York

lessly. Finally, since there are few set rules for herb growing, it is usually wise for the home gardener to begin by experimenting with small quantities, then improve and correct his methods and develop a sale based upon outstanding quality. Having done this, he can expand as time, space, and markets allow. Drug supply houses frequently let profitable contracts on a basis of the gardener's ability to supply quality wares.

A drive to reawaken herb growing in the United States is now under way in

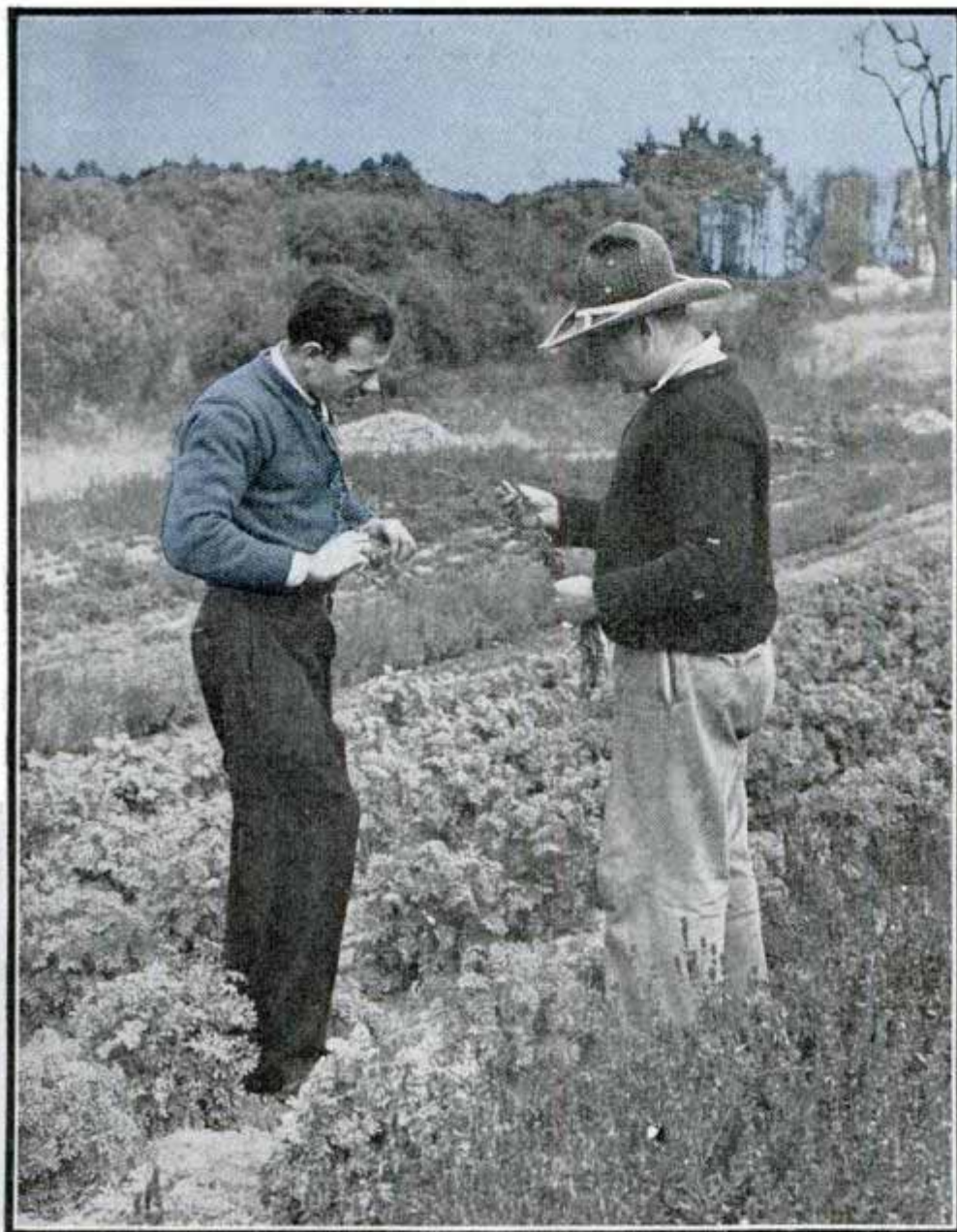

perts on seeding, cultivation and curing of herbs.

The first step was to locate and recommend twenty-nine varieties of common wild herbs which can profitably be gathered and marketed. This report was published by the state and WPA in a bulletin entitled "Profitable Wild Plants of New Hampshire." Most of the plants described are indigenous to large areas of the United States. The next step was preparation of a bulletin "Herb Plants Which Can Be Cultivated with Profit in New Hampshire," which includes instructions for growing and marketing about fifty-six medicinal plants most of which are potential nation-wide

Herb growers must watch their crop carefully because it must be harvested at just the right time



Medicinal Herb Research

in HERBS

New Hampshire. The undertaking was begun in the vicinity of Concord, where herb gardening has been an important industry in one of the outstanding herb-garden centers of the nation. Growers of the area, aided by the state department of agriculture and the WPA, have completed a survey of the American herb industry and herb markets, which may lay the foundation for extra income to thousands of gardeners throughout the country. A group of jobless chemists and pharmacists first were hired to give expert advice upon drug requirements and market demands. Helping in the survey were a group of ex-

garden crops. Within limits of supply, these publications are available from the New Hampshire department of agriculture at Concord. The U. S. department of agriculture also supplies publications upon the subject of herb gardening.

In addition to garden herbs, the New Hampshire survey includes other sources of possible garden revenue: condiments and perfume plants; flax, the source of linen which is a \$40,000,000-a-year import; and hemp, principal rope and twine fiber, now imported principally from Italy. In general, our profitable herbs can be di-

vided into three groups: the common wild herbs such as ginseng, horehound, henbane, boneset and jimson weed, which anyone can gather, cure, and market without extensive study or complicated instruction; hardy drug plants and flavorings which can be grown indoors or in home gardens, and the more specialized medicinal plants which need be grown and cured under expert advice.

For the beginner the greatest interest lies in the second group and in possibilities for adapting native herbs to garden culture. Native herbs still supply the largest volume of medical materials obtained from plants. Finding and propagation of curative herbs is one of the oldest interests of mankind. In the pioneering era of this nation, the herb garden was a staple part of the frontier farm because medicines had to come from gardens or from the woods and pastures beyond. Cur-

sively in medicine. Seed is sown in early spring, drilled in rows eighteen inches apart, thinned to one plant to the foot. Roots are dug in the fall of the second season after planting, washed clean and dried. Prices for the cured root range from nine to eighteen cents a pound, the yield is around half a ton to the acre and the demand is fairly dependable.

Catnip is a hardy garden herb in commercial demand for leaves and flowering tops. Catnip grows best in sandy soil. Seeds are sown in rows, in late autumn, and after reaching a height of four or five inches, plants are thinned to foot intervals. Flowering tops, including leaves, are harvested when the plant is in full bloom and dried in the shade to preserve the green-gray color. When grown in large quantity, the herb is cut with scythes or mowers, left in swaths until partly dry and curing is finished in small field stacks



Left, leaf herbs must be well spread and turned frequently while drying. Right, looking for beetles and other insect pests which may destroy the leaves

rent research suggests about thirty herb plants likely to be suited to home gardens today and there seems to be a "big twelve" among hardy garden herbs.

First, the well-known dandelion, a foremost lawn pest, is also a herb crop of importance since the roots are used exten-

or under a covered shed. Catnip yields about a ton to the acre and prices range from eight to twenty-five cents a pound.

Lobelia is an important poison herb which thrives in rich loam and grows from seed so small they must be sown upon well-prepared soil. Usually the seeds are

sown in the fall. The plant is harvested in full flower, dried in shade to preserve the green color and stripped of coarser stems. There are record yields of 1,000 pounds to the acre and record prices of eighty-five cents a pound.

Horehound, a hardy leaf herb, grows as a common weed in many parts of the country. It grows well in light, dry soils, even poor soils. Seeds are planted in early spring, covered an inch deep, plants are thinned to row intervals of from six to eighteen inches. Some gardeners



Above, New Hampshire herb garden. Left, drying trays, for herbs, made of loosely woven canvas

start the plants in cold frames and transplant. The herb is harvested just before flowering, cured in the shade. Market requirements prohibit coarse stems. A good yield is a ton to the acre. Prices range from four to ten cents a pound.

Licorice, candy and medicine flavor and curer of tobaccos, is a dry-weather herb native to California and the far southwest

where it is a weed pest. In sandy loam the plant grows well in various parts of the country. The plant can be grown from seed, but many use cuttings taken from the new roots which are set about eighteen inches apart in rows and cultivated. Roots are harvested at the end of the third year and on good soil yields are as high as 5,000 pounds of cured root to the acre. Prices range from five to twenty cents a pound.

Common sage is a hardy perennial herb and a staple seasoning as well as a basic pharmaceutical. Once planted, it grows for years without reseeding. It will thrive in almost any well-drained soil. Since the value of the plant lies in its leaf, it is best to grow a broad-leaved variety with few blooms. Seeds are sown in early spring in rows two or three feet apart and plants are thinned to foot intervals. Some gardeners use sage as a second crop after early vegetables. Leaves are picked only

(Continued to page 136A)

X-Ray Sees Heart of Orange and Helps Pick Best to Pack

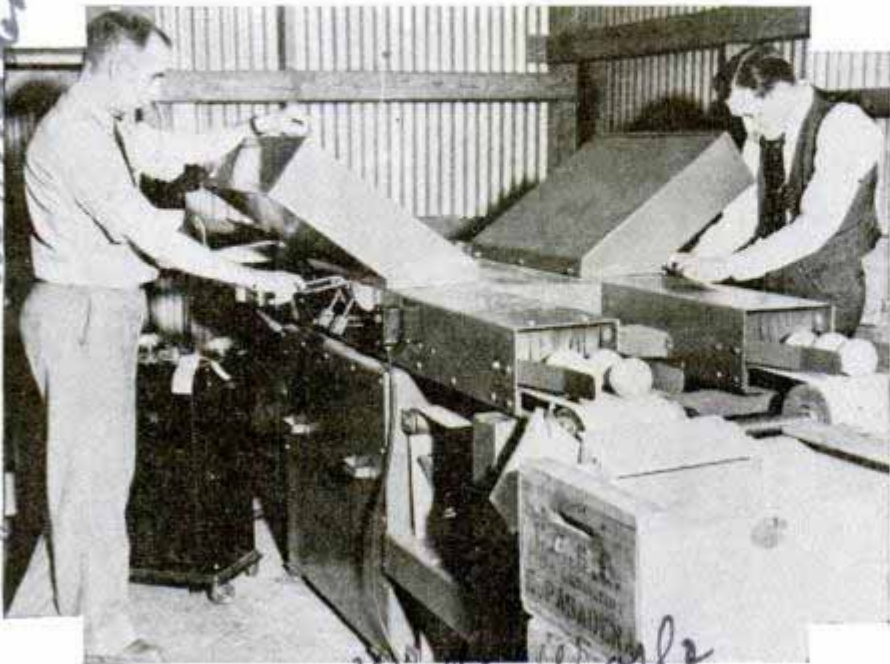

Operator gets X-ray view into heart of oranges as they pass through fluoroscope on moving belt, and ejects imperfect fruit by pressing lever

In a darkened room of a fruit-packing house, two men stand peering into the windows of an X-ray machine. Each is looking into the heart of an orange. At the rate of 22,500 an hour, a carload every four hours, the oranges flow along traveling belts through the fluoroscopes. As they cross the path of the X-ray, the operator can tell the quality of the core by the shadow cast, and he can throw out imperfect fruit by pressing a lever. Perfect oranges move on and are fed into packing crates. Faulty grains, dry cells and hollows are detected by the X-ray shadow and even the quality of the juice can be determined. A single X-ray tube serves for two fluoroscopes. The machine is undergoing tests in a laboratory before being adopted for commercial use by a packing organization.

stations to enable persons on yachts in the vicinity of Boston, New York, Miami, Seattle, San Francisco and Los Angeles to connect with phone subscribers on land.

Fins in Nozzle Give Fire Hose Long Stream

Reducing the spiraling course of water under pressure, fins in the latest fire hose nozzle cause the water to go farther before breaking and turning into spray. The increase in efficiency is about twenty-five per cent. Since the water is kept in a solid column longer, there is less tendency for it to turn into

steam as it strikes a hot fire. The nozzle has two sets of fins, one at the mouth and the other at the base.

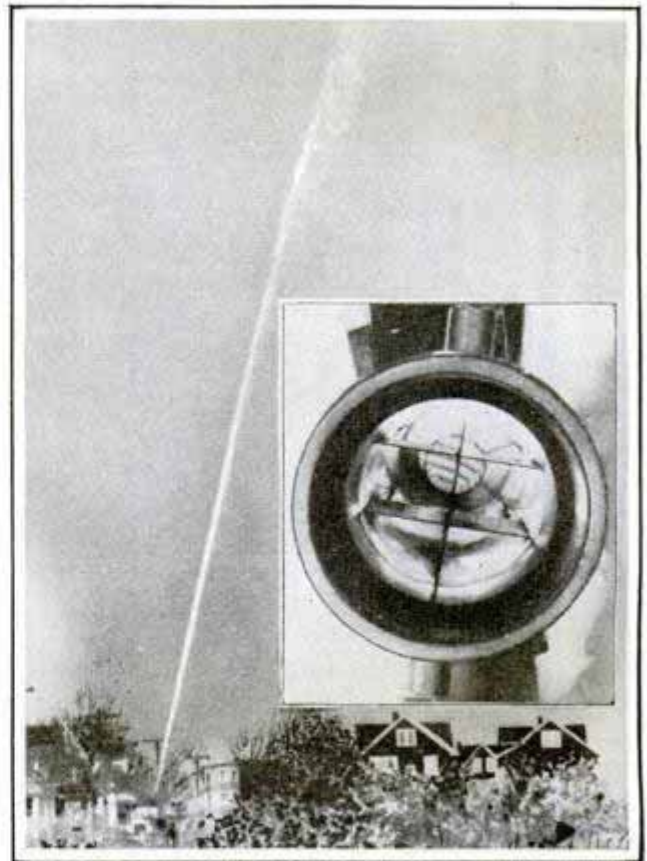

Testing fire hose equipped with interior-finned nozzle like that shown inset

Radiophones Connect Yachts with Wire System Ashore

Yachtsmen on small pleasure craft along the seaboard can now talk to their homes and offices ashore by telephone. Five-watt and fifty-watt radiotelephone equipment is available for coastal vessels, and telephone companies have established shore

Western Electric Co.
125 Broadway New York
D. W. Hagar Jr.
Parker, Sherman

California
Los Angeles
Fruit growers to change
Calif. Cherry 189
W. H. H. H.

General Electric
X-ray
2012 Jackson Blvd
Chicago

F1687

Wide World

71970

see Oct. 1928
Aug 1928-1929

Super Crops Grown in Tanks Without Soil



Dr. Gericke and wife use a stepladder to harvest tomatoes from plants that yield 217 tons per acre of tank surface, compared to five tons per acre of soil surface. Dr. Gericke harvests 2,465 pounds of potatoes per acre. The tomato plants bear fruit over their entire length



Gardener "planting" corn in shallow tank filled with nutrient salt solution covered with layer of excelsior. Straw or peat moss also may be used. In similar tanks super crops are produced by Dr. W. F. Gericke in experiments at the University of California, Berkeley

Experiment Station



W. F. Gericke



Left, Dr. Gericke almost hidden in tall wheat grown in soil-less tank. Above, the experimenter inspects flower beds planted in tanks. Vegetables, grain and flowers have been produced in startling quantities by this method. Seeds placed on straw, peat moss or excelsior reach down into the salt solution and draw nourishment, growing faster and producing better quality fruit or flowers than soil-grown plants. Electric cables heat the solution. Nothing is left to chance. So successful have been the experiments that two commercial companies are growing vegetables in tanks

9 1/2 ...

Acrobatic Motorcycle Cops Perform Stunts on Crossbar



Balancing on a crossbar above a speeding motorcycle furnishes as much of a thrill to the acrobats on the police force as to the spectators

Perhaps it is a "bicycle built for two," but four can ride it if they know where to hang on. With a crossbar mounted on a mast attached to their motor "bike," four acrobatic police perform thrilling riding tricks at a Los Angeles bicycle show. Two of them balance the bar by hanging from the ends by their knees, a third rides on his stomach at the center, and the fourth takes them for a ride.

Two-Weeks' Weather Forecast Is Goal of Solar-Heat Study

Weather forecasts looking two weeks ahead are foreshadowed by studies now being made of the relation between earthly weather and day-to-day changes in the heat output of the sun. Dr. Charles G. Abbot, secretary of the Smithsonian Institution, appears to have developed proof

Washington, D. C.

that short-interval changes in solar radiation have a definite influence on our weather for the ensuing two weeks, and weather bureau scientists are seeking to use this knowledge in predicting weather conditions ahead.

Rocker for Auto Found an Aid to Lubrication

More efficient lubrication of the automobile is made possible by a motor-driven machine which rocks and sways the car to duplicate road conditions. Thus may be greased those parts which once required use of crowbars and high-pressure grease guns. The machine raises the body of the car off the springs, shackles and king pins and then sways it, revealing squeaks and flexing the spring leaves for oiling. The machine is equipped with electric motor or may be operated by compressed air.

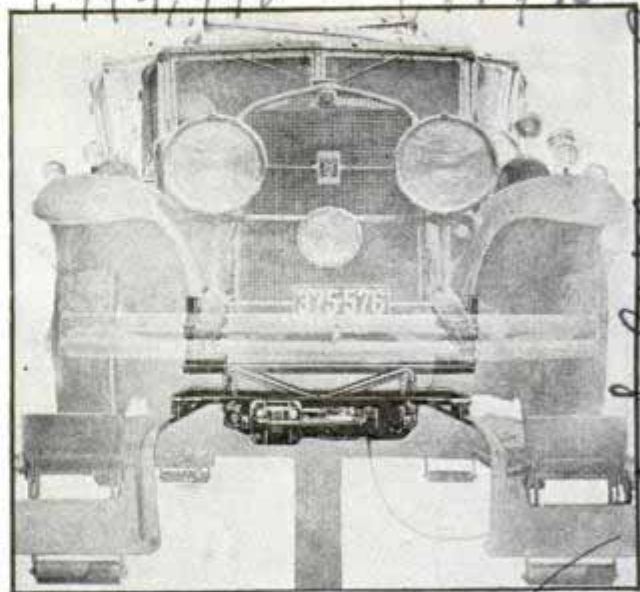

Sway machine, propelled by motor, rocks automobile in this manner to facilitate lubrication

Moto. Sway Corp
of American.

at Vegas me tagler in Stadium
Los Angeles. Calif

Scene Serene 1/4/37

Acme

1.944,942 - 1877369

437 d screen, Chevy

Amphibian 'Marsh Buggy' Used to Hunt Oil

Weighing 7,500 pounds and equipped with tires ten feet in diameter and three feet wide, an odd vehicle transports geophysical crews searching for oil-bearing strata in the Louisiana swamps. It runs on land, in waist-deep mire or in deep water. The giant tires have a displacement so great that the vehicle, known as the "marsh buggy," floats with an immer-

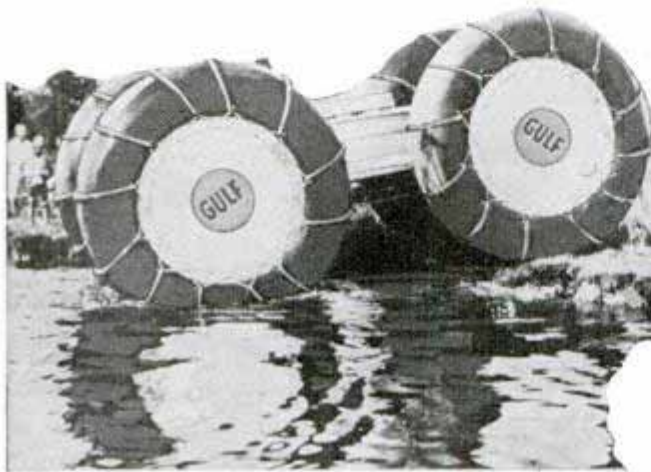

sion of less than two feet. If one of the tires becomes punctured a compressor keeps the tube inflated until the repair station is reached. Pressure in the tires never exceeds six pounds per square inch and the buggy's weight is supported by only one-pound pressure. In water or marshes traction is obtained by attaching twelve treads to each wheel. These are made from two-inch rubber hose sealed at the ends and provided with a valve through which they are inflated to a pressure of twenty-five pounds per square inch. Inflation is necessary to keep the

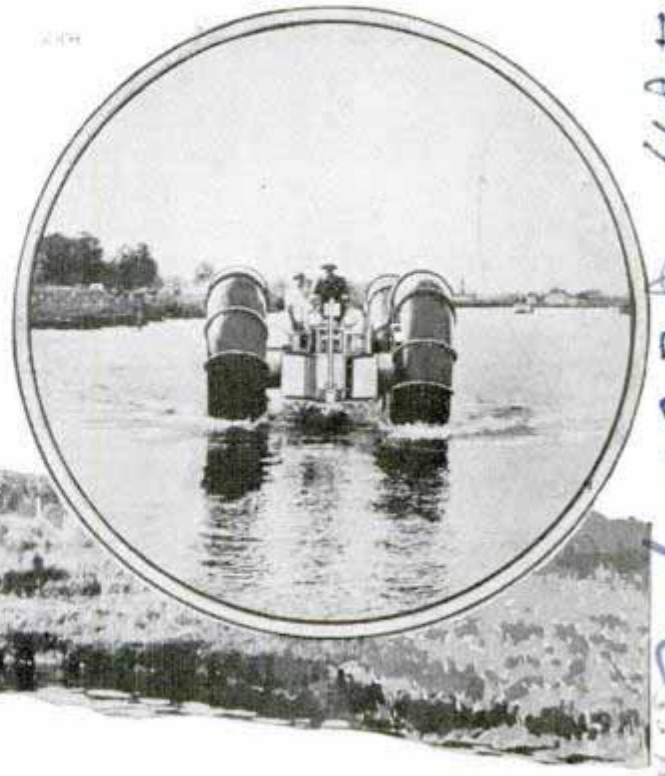

Three views of "marsh buggy" in operation. Top, circle, and bottom, left, the vehicle navigating in deep water. Top, left, the buggy emerging from the water to travel marsh or highway without changes in its equipment

links from flattening under the weight of the buggy. Aluminum alloys were used to keep down the weight of the vehicle. The large aluminum wheels, shaped like huge drums, contain sufficient air to keep the machine afloat even with all four tires deflated. The buggy is powered by a small V-eight engine equipped with an over-size cooling system. Since it frequently operates on inland waterways, the operator of the giant vehicle must carry a marine license. The buggy is equipped with all the running lights and other requirements for Class 1 power boats. On smooth ground, a speed of thirty-five miles per hour is possible, in marshes between ten and twelve miles per hour and in water six knots. The vehicle is operated by the Gulf Refining company.

☐ Popular Mechanics Magazine does not publish the name of the maker of, or dealer in, any device described in its pages, but this information is kept on file and will be furnished by our Bureau of Information upon request, accompanied by stamped, self-addressed envelope.

786-2361
 see out 1938-487

KINGS *of* SPEED

THE lid is off at Indianapolis this year. Nearly three dozen heavy-footed drivers all with the urge to "get in front and stay in front" will transform the two and one-half mile course into a merry-go-round of speed on Memorial Day.

No one will slow down to conserve fuel. In effect track officials have told the drivers: "Use as much fuel as you want, boys, just so it is a grade any motorist can buy."

Last year each car was limited to thirty-seven and one-half gallons for the 500 miles. The race was a scientific guessing

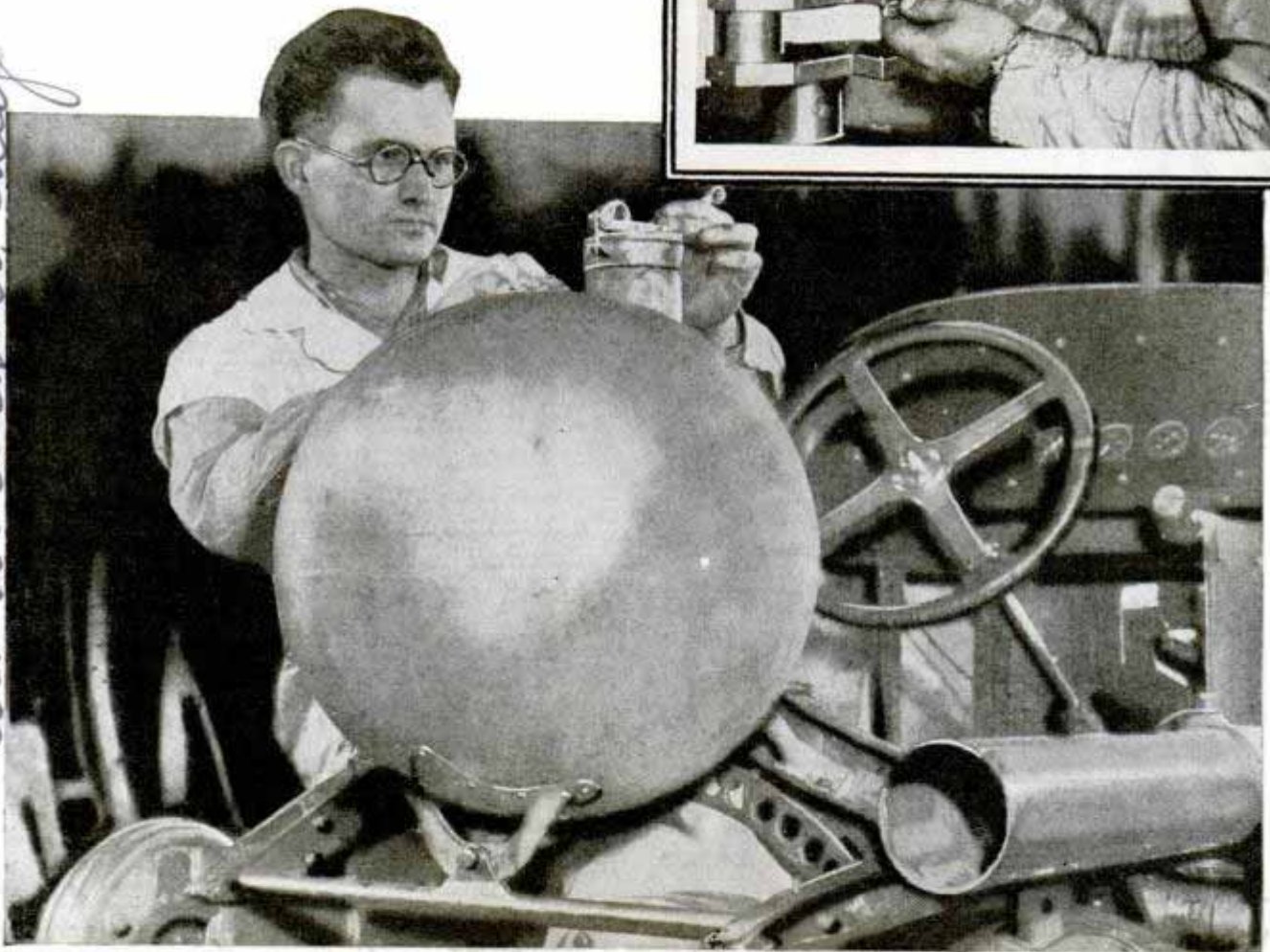

Spherical gasoline tank in tail of racer, over which streamline body fits. Above, measuring counterbalancing fins on modern four-cylinder racing crankshaft

contest with each driver going as fast as he dared without using too much fuel. The drivers used highly leaded secret compounds of gasoline and employed compression ratios as high as fourteen to one to squeeze the last mile out of every gallon. This year they will use ordinary

high-grade commercial brands. That means compression ratios will be lower. But the engines will be larger and the drivers think the cars will be faster.

"Barring rain or accidents that would slow down the race, the winner this year will probably have to average 112 miles

Emb. Thomas & Stinson Jr. - 10555 Holman Ave Los Angeles Calif.

Los Angeles Calif

GROOM *their* RACERS

25



per hour," says Louie Meyer, who in 1936 won the Indianapolis race for the third time. "That includes pit stops and means the winner will have to drive better than 115 miles per hour all the time he is rolling and 135 miles or more on straightaways.

"The best way to win a race is to guess as closely as you can what the speed of the winner will have to be and then drive at that speed consistently. That's what I did last year. We estimated it would take



Top, cars in pits ready for action just before a race. Center, mask worn by mystery driver in one race. Bottom, driver signaling that official has declared a false start

108 miles per hour to win. I drove at about 112 miles per hour for the first half, which allowed time out for pit stops. Later the pit crew found I was using less fuel than we had reckoned so I stepped up to 114 miles per hour. That boosted my average to 109 miles per hour."

Another thing that plays a part in making a fast race is whether the leading drivers are bunched or several laps apart. If one driver can get a lead of three or four laps the race is apt to turn into an endurance contest with the men in second

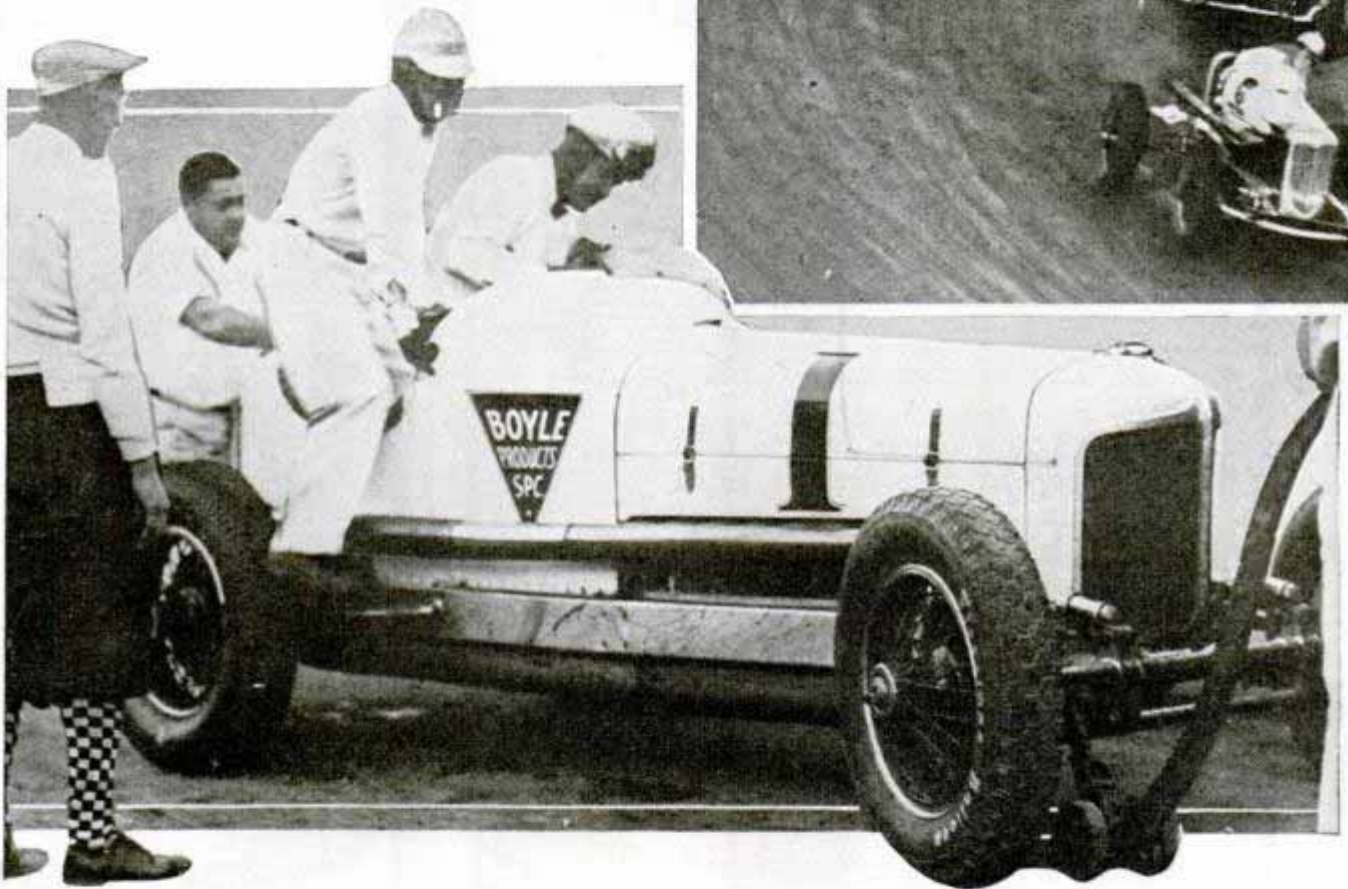

Half a dozen cars tightly bunched on a turn and, below, driver and mechanic leaping into racer after a hasty pit stop to change a tire

and third maintaining their positions while waiting for the leader to falter. But if the first three are within half a lap or so of each other the leader must drive as fast as he can to hold his position. "Hot shot" drivers who usually drive as fast as they can while their "iron" holds together have taken the tachometers that indicate engine speeds from their instrument boards. The feel of the car tells them when they are approaching dangerously high speeds and they have no time to consult the instruments. The dangerous brick turns on the Indianapolis course have been paved with an oil-absorbing asphalt this year, another

feature that will permit high speeds.

Sometimes the driver who has the worst luck before a contest gets the good breaks while a race is on. Last year Louie Meyer broke three cylinder blocks in practice and got his car assembled just before the starting bomb. Then he went out and won. The year before, Kelly Petillo cut his engine in half when a connecting rod went wild in practice. There was no time to order a new motor so the block was welded and the patched-up job carried him to victory.

There will be few new cars on the track this year. Most drivers are waiting for



1938 when a complete set of new specifications will govern motors and cars. The changes contemplated will be for the purpose of placing American cars more on a par with European racers, thus affording a true competitive basis for international racing. The 1938 specifications will allow the building of cars suitable for road racing as well as speedway racing.

This year most drivers are altering their engines merely by decreasing compression ratios. A racing engine has no head that can be separated from the block, everything above the crankcase being in one piece. To reduce compression the drivers install short "low-compression" pistons that travel not quite so far up in the cylinders. At the same time, the total displacement is increased. Some cars are being equipped with impeller



Above, testing hydraulic connection to brakes of race car. Left, fifty-dollar connecting rod used in racing engine. Below, fitting part of body to a race car chassis



(Continued to page 148A)

Fred Affenhaus, 1935 at 62nd St. Los Angeles, Calif

Professor Schroni

Eight-Needle Knitting Toy Makes Fabric and Cord

Knit-Master

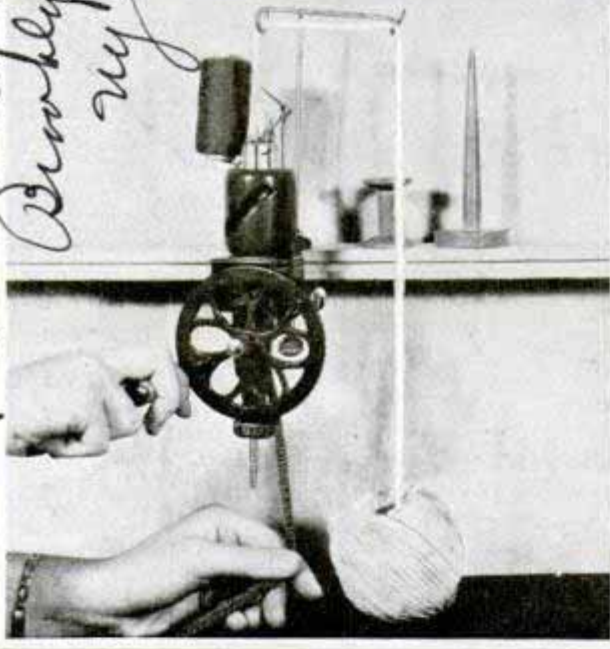

Above are some articles made with the knitter, and below a close-up of the toy knitting machine itself

Both educational and practical, a toy knitting machine which produces knitted fabrics and cord or tubing of various textures has just been introduced. It has eight automatic latch needles like those of the commercial power-driven machines which fabricate sweaters, underwear and knit hosiery, and any number of these needles from one to eight can be used. By introducing a filler for a core, the little hand-operated knitter can turn out a sturdy tubular fabric or cord suitable for making rugs, mats, bags, and similar articles requiring strength and bulk. Silk yarn similarly can be knitted around a

core of inexpensive cotton, lending the appearance of silk with the bulk and economy of cotton. Combination yarns of varying weight and texture can be made by knitting together, for example, worsted and silk strands, using different combinations of needles.

Esq 2

Minerals Live and Suffer Illness Is Belief of Research Men

Evidence that minerals live, suffer communicable diseases and reproduce their kind is reported by research scientists. Microphotographs by a professor at Naples indicate that crystals not only move but exhibit generative processes similar to those of vegetables. German chemists have found an infectious disease called "tin-pest" which attacks tin roofs and may be communicated from one roof to the next. At Calcutta a scientist demonstrated that a mineral can be poisoned.

FIG 91 Parking Mirror Helps Driver Maneuver Close to Curb

Parking close to the curb without scraping tires or fenders is aided by a special mirror just put on the market. It is installed above the right front door of the car, at such an angle that it gives the driver a "periscopic" view of the curb and guides him in parking without having to leave his seat or open the door.

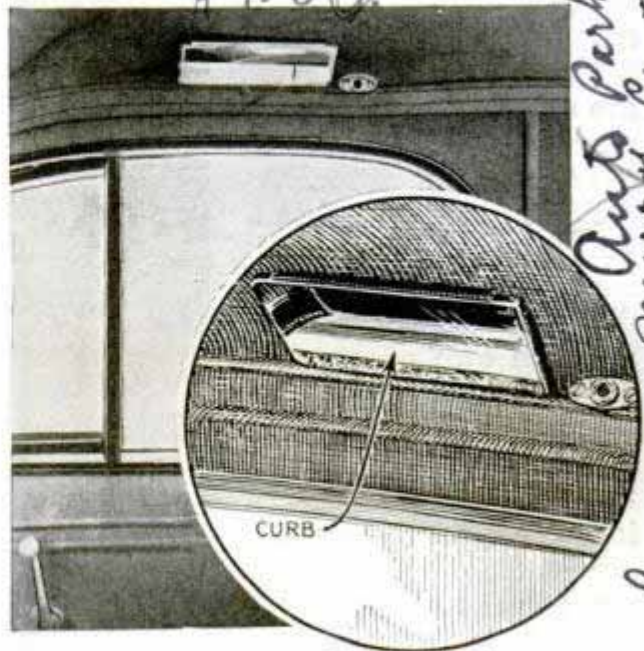

Photo shows mirror mounted above right front door, and inset reveals reflection of curb in mirror

*Rivislie Knitting Machine Co. Inc
740 Island St
Brooklyn NY*

*Auto Parking
Murphy Co 1728 S. Hill
Los Angeles Calif. 11/26/40*

Handwritten notes at the bottom of the page, including numbers and names.

Plane Takes an Auto Ride Then Hops Off from Roof

Mike Murphy at All American
Auto Races

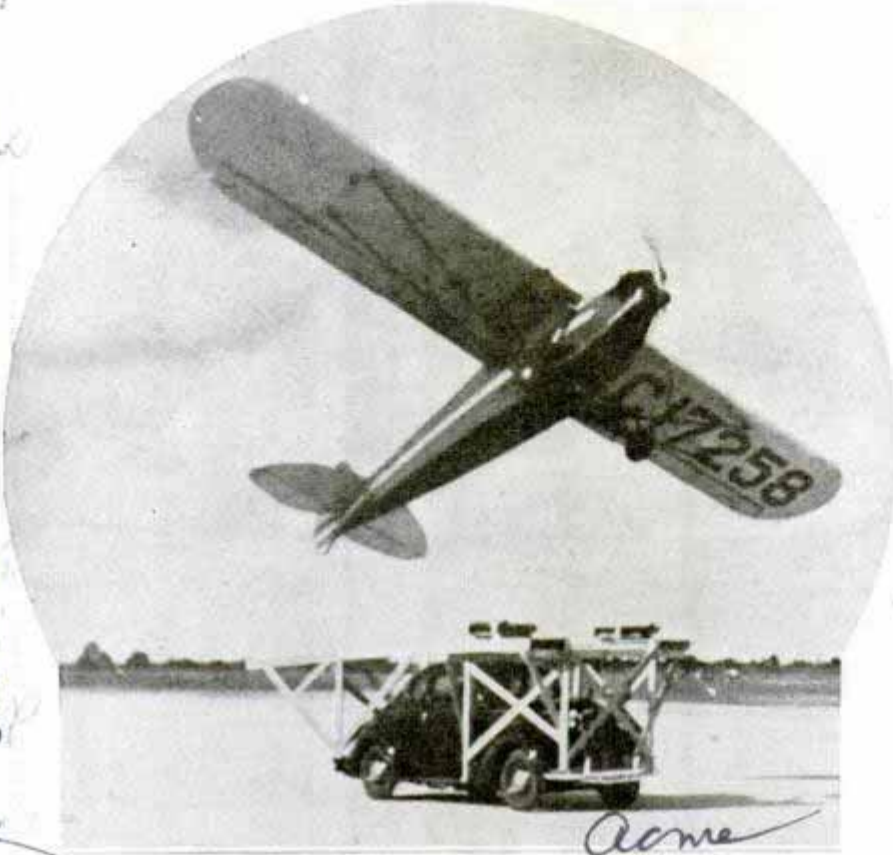

Monoplane taking off from scaffolding built over automobile, which gave plane a running start at high speed across airport runway at Miami

Using an automobile for a "catapult," an aviator successfully lifted his plane into the air from the car roof as the motorist drove at high speed across a runway of the Miami, Fla., airport. The two-cylinder high-wing monoplane was perched on a special scaffolding built on top of the coupe. With its own motor roaring, the plane waited until the car was traveling at a safe speed before taking off.

es 90

Low Cost Air Conditioning Seen for the Home of Tomorrow

Keeping the house cooler in summer by placing window shades or Venetian blinds outside the window instead of inside is but one of the simple methods being developed by ventilating engineers to cut the cost of home air conditioning. Blower systems cool the house by sucking in night air and forcing out heated air from attic and other hot rooms. Forced-air heating systems which distribute cleaned, heated and moisture-controlled air through small ducts are growing popular, and it is not dif-

Science Service
1/25/37

American Society of Heating and

icult to add refrigeration to this system. Heating engineers are experimenting with water insulation on flat-roofed houses. A two or three inch layer of water on the roof would freeze in winter, insulating against outdoor cold, and in summer would be tied up with the spray system cooling the air-conditioning unit.

Bank Totals Checks by Weight

Instead of laboriously counting the thousands of checks which clear through its various offices every day, a western bank counts the checks by weight. If the needle on the scales points to an even ten pounds, the teller knows he has 3,500 checks. They run twenty-two to the ounce, or 350 per pound. This figure was determined by weighing 8,000,000 checks.



"Weighing in" checks at a bank. Figuring them at twenty-two checks per ounce is easier than counting

Com. Andrew R. Boone
1651 S Broadway

Riot Squad Speeds to Action in Steel Fortress

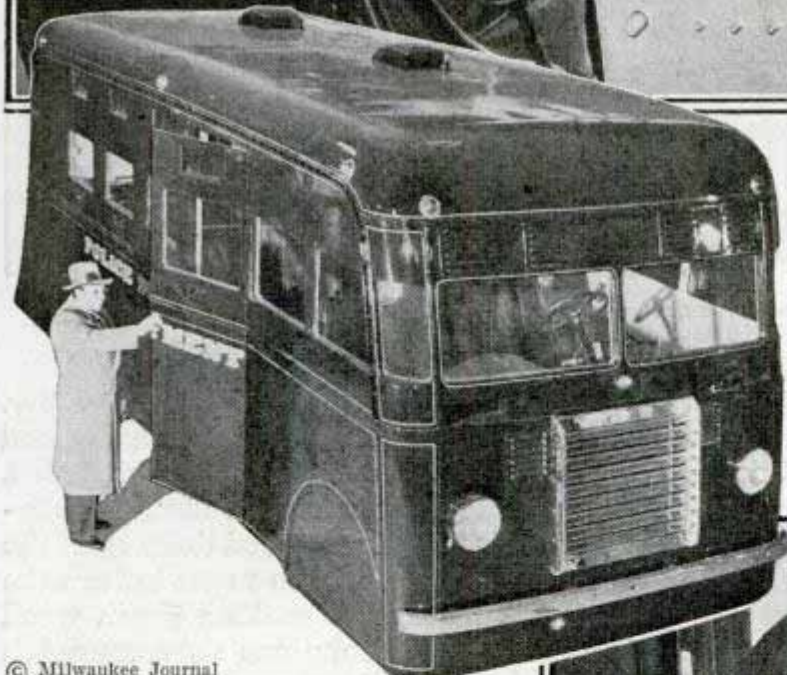
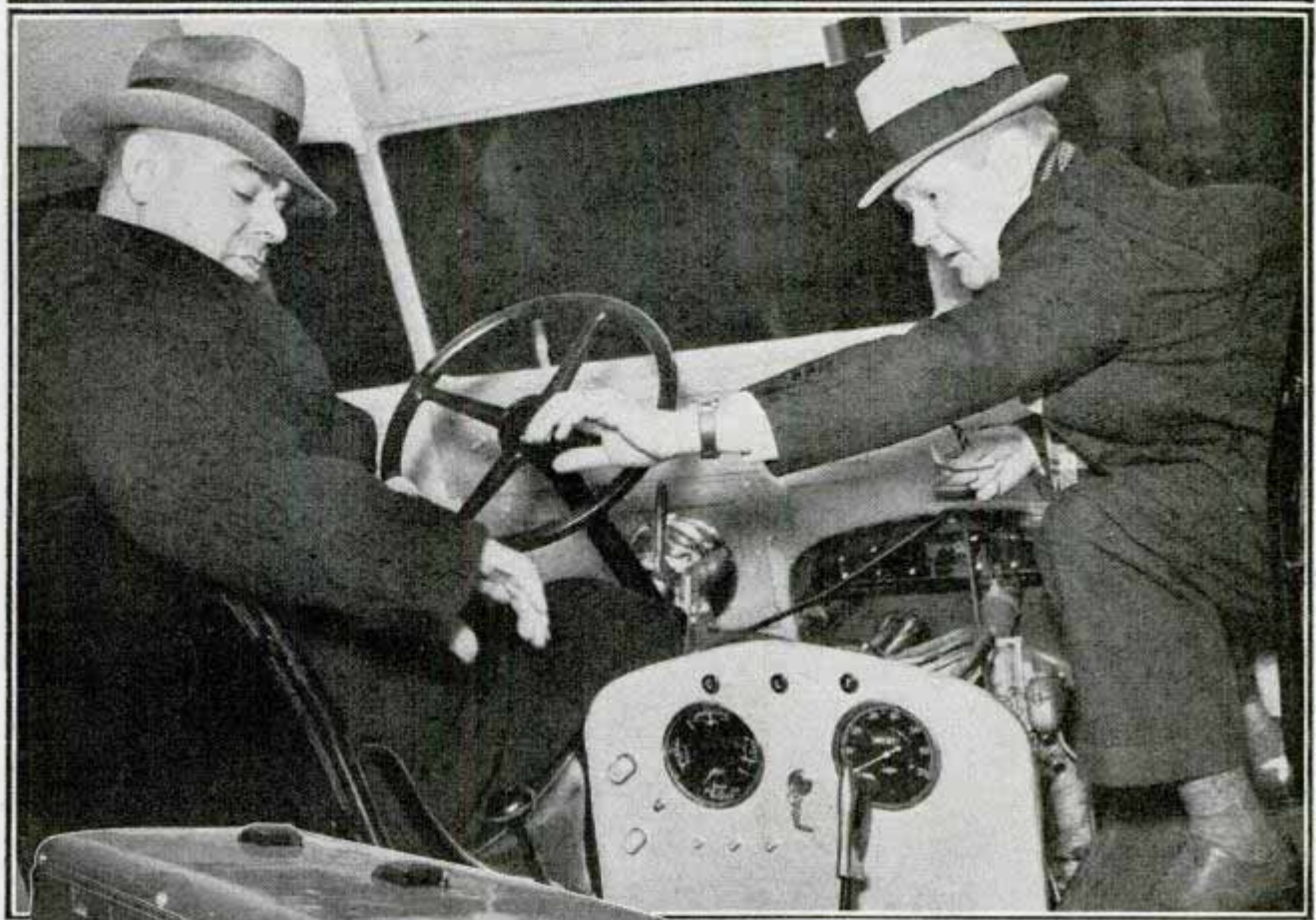

Milwaukee police are ready for action against bandits or rioters in impregnable steel-and-aluminum fortress on wheels with windows one and three-sixteenths inch thick. A machine gun took more than an hour to pierce glass. Steel shields drop to ground to protect tires in battle. Top picture shows engine mounted inside, as are siren, gong and spotlight. Left, and below at right, notice slots above windows for throwing bombs, and gun slots under windows. Bottom, left, officers emerge from car carrying full-length metal shields

© Milwaukee Journal



Experimental Department
61617

Emb. La Pl. Stacy. 4639 Montgomery
Ave Bethesda, Md

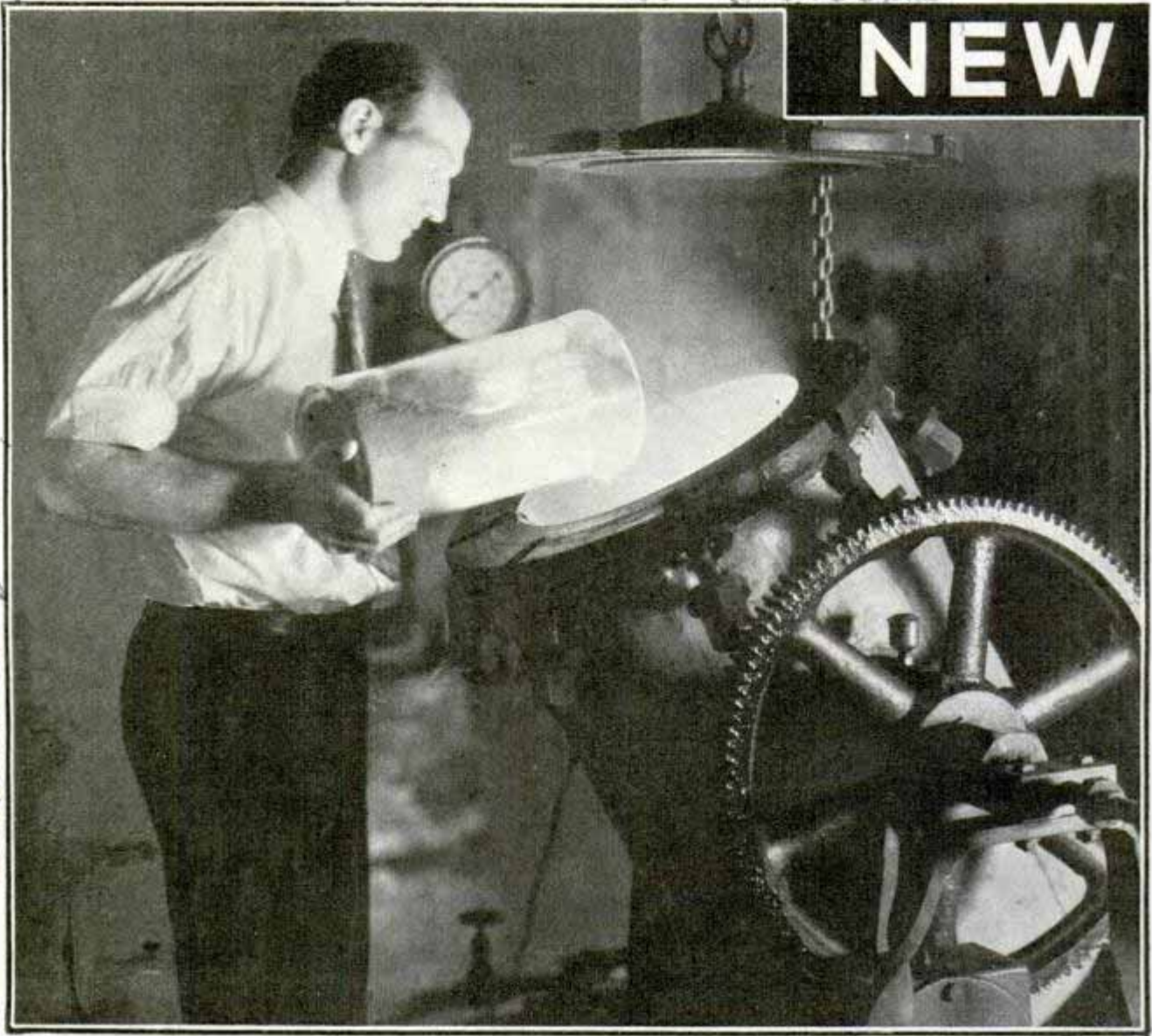

Preparing sawdust for conversion into a new plastic molding powder, one way in which science is helping to convert waste into wealth

WOOD, the wonderwork of nature, is being used in new and amazing ways as a result of practical research triumphs of the United States forest products laboratory, Madison, Wis

Added safety and security in frame construction are made possible by impregnating wood with fire-retarding chemicals developed and tested by these national researchers. They have capitalized on the fact that wood inherently is gifted with good insulation and is less apt to buckle, twist and collapse under load at high temperatures than are many structural metals. Treated wood is an effective means of reducing our stupendous annual fire losses, particularly in homes and small commercial buildings.

Previously much wood was wasted because it could not be seasoned without

checking, cracking and splitting badly. Believing chemical seasoning of such wood was possible, the experts experimented. They wanted to reverse the natural method of curing in which wood dries from the outside in. It took three years to turn the trick but finally, by soaking green wood in ordinary salt solutions they caused it to dry from the inside out. The soaking coats the outer surface with salt which has an affinity for water. Such a difference in vapor pressure is developed between the natural water in the core of the wood and the salt-saturated surface that the moisture is drawn to the exterior where it evaporates until the desired degree of seasoning is attained. The experimenters also found the attractive force of wood for water is double that of water for wood. They now are seeking a double treatment

USES *for* WOOD



Top, modernistic wood home of forest products laboratory and, below, inspecting test fence made of plywood panels exposed to determine durability

by which they can chemically season and "fireproof" wood in one operation.

It used to take a year to air dry Douglas fir timbers in southern Wisconsin to a moisture content of fifteen per cent and uncontrollable surface checks cut nearly two inches into the wood. Similar timbers now can be chemically seasoned in thirty-four days, and the very limited checking is restricted to intergrown knots. Southern swamp red oak after soaking a week in the salt solution can be kiln-dried in twenty-eight days. It used to take seven times as long to kiln-dry untreated timber and a prohibitive amount of checking occurred.

Wood radio towers used to be limited to

heights of about 100 feet. Ordinary spike and bolt joints could not withstand the attacks of windstorms at loftier levels. That led the federal wood investigators to test several thousand samples of the eight leading types of metal connectors in southern pine and Douglas fir construction of different kinds. They solved the secrets of safe wooden joints and splices without wasting wood. The former custom was to



Shaping test, above, for southern hardwoods and, right, testing relative effectiveness of fire-retarding chemicals for wood

use oversize timbers big enough to accommodate the many spikes or bolts needed to produce safe joints. Towering construction with wood was impossible under that practice. The scientists have shifted the set-up by determining the strength values of metal connectors such as split rings, shear plates and ring, dowel and key fasteners under various conditions of load angle and placement in the timbers.

These vital building facts recently have been applied in the construction of wood radio towers 326 feet high, four stories taller than the dome of the capitol in Washington. The insulating and nonmagnetic properties of wood especially adapt it for such purposes. Over Dolan Creek, in California, a 180-foot arched timber bridge has been built of redwood with split rings instead of a superfluity of spikes and bolts. The forest service is now building its highest fire-lookout towers in this

way. Tank towers, railroad sheds, riding halls, auditoriums and hangars also are being built of wood with metal connectors.

The forest products laboratory has completed more than 600,000 mechanical tests of the strength characteristics of some 160 species of native woods. As a result, various woods now are being used for purposes which a few decades ago would have seemed fantastic. For example, the research service building consists of plywood panels mounted upon a substantial framework of glued arches which span a width of forty-six feet. This building, pio-

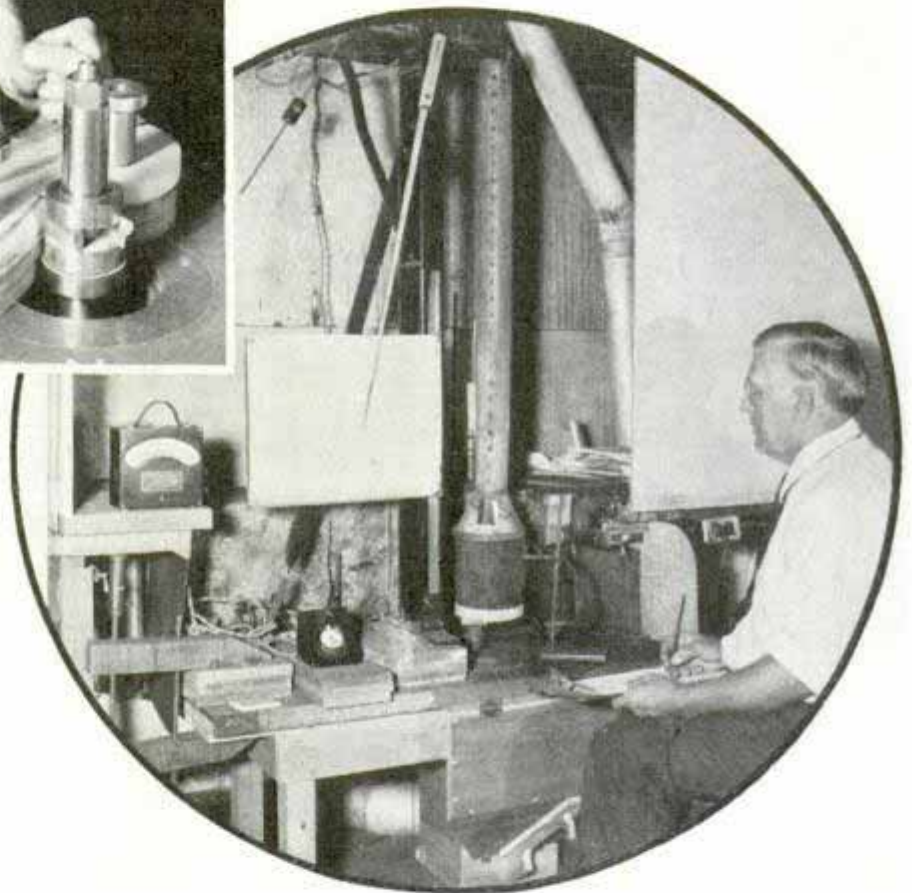

neer of its kind, is prophetic of extensive future use of wood in a new way. The skeleton of the structure is composed of laminated and composite wooden arches made of short-length boards assembled with water-resistant casein glue. Each arch was bent against a model curved form, the clamps remaining in place until the glue in each layer had set. The arches were built up in this fashion until the desired dimensions were attained.

A tier of sandbags forty-five feet long and six feet high, weighing 31,500 pounds, was placed on the roof along the line of one of the arches and remained as an

overload throughout the winter. That burden was fifty per cent heavier than the mythical snow load of thirty pounds per square foot of roof area specified in many building codes. Precise measurements showed a deflection of but 1.04 inches at the peak of the loaded arch and an outward spread of but one-quarter of an inch at each shoulder.

This type of building is extraordinarily strong, economical, attractive, both inside and out, and eliminates the use of obstructive trusses and braces. It is an exemplification of the magic worked by modern glues

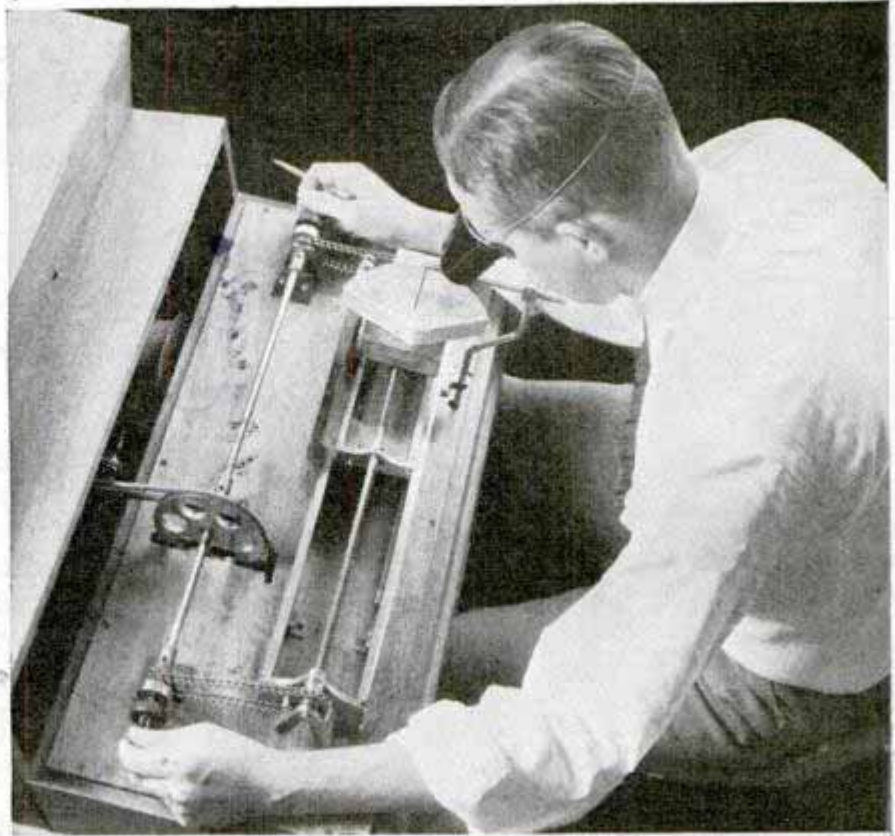

Top, measuring comparative amounts of spring and summer wood in specimen. Below, demonstration low-cost, prefabricated, all-wood house covered with panels of glued plywood

as substitutes for the joinery of nature. Detailed tests of the laboratory have placed the design of the wood arch on a sound engineering basis. The use of laminated arches eliminates the warping common in large solid timbers and the built-up arches can be made longer than any solid timbers now procurable.

The laboratory has built a model low-cost pre-fabricated house which stresses the use of built-up plywood panels. Each panel consists of two plywood faces glued to either side of an inner structural frame-

work. In effect the individual panel is really a box girder and is weatherproofed, wired electrically, and insulated against sound, heat and cold. The complete and continuous rigid joint formed by the glue between the plywood faces and joists gives astonishing strength to the panel, making it much stronger than would be possible with nails. The arrangement is such that the joists actually support but one-fourth of the load on the floor of the room. These stressed covering panels are so strong

(Continued to page 144A)

Heater for Airplane Engine Made from Old Oil Drum

vided by a heavy canvas-covered blanket around the cowling. Charcoal and paper kindle the fire, on which is then thrown a shovel or two of coke. This can be fanned into a solid bed of coals.



Simple heater being used to warm compartment surrounding engine of big plane

Inexpensive to construct and operate, a heater for airplane engines has been introduced by Chicago and Southern Air Lines for use at airports subject to low temperatures. This heater warms up an engine in less than twenty minutes, with the outside temperature at fifteen degrees. The heater is constructed by installing a small grate about twelve inches from the bottom of an old thirty-gallon oil drum and then placing a pipe beneath the grate to carry the air current generated by a six-volt auto fan. The pipe from the heater to the engine compartment has three wire screens to prevent sparks or flames from reaching the engine. The heater is attached to the nose cowling behind the propeller and is held in place by a flange extending into the cowling. Made in two sections, the flange is held together by ordinary hood clamps. A deflector forces heat to the bottom of the engine compartment, allowing it to rise around the engine. Additional insulation is pro-

One-Fifth Is Added to Fuel Cost by Five Degrees More Heat

Twenty per cent more fuel is required to raise the temperature of a house from seventy to seventy-five degrees. Tests by government engineers indicate that the cost of moderately high home temperatures is greater than most people suspect. Testing oil burners, the engineers found it cost seven per cent more to heat a house to seventy-two degrees than to seventy.

Electric Fan Cools Off Boxer

F1584 Between Rounds

Replacing the old-fashioned flapping towel, an electric fan has made its debut as a means of cooling off boxers between rounds. The fan is mounted on a frame which extends over the corner where the boxer sits between the rounds.



Electric fan, attached to extension arm, in use to cool off fighter between rounds

Mr. B. E. Oray, operating manager
Lambert-St. Louis Municipal Airport
Robertson

Home Heating #406
Supt. of Documents
11/3/13

U.S. Dept. of Agriculture

Used at Royal
Air Force Depot

Utility and Beauty Mark Modern Furniture

Virginia Lincoln Co. Marion, Va.



Above, quilted maple and mahogany bed of modernistic lines combines beauty and utility. Note matching stand and lamp. Below, easy chair has reading lamp built into the wings. Illumination is supplied by two twenty-five watt bulbs



Left, milady finds this full-length vanity cabinet the ultimate in convenience. It lends itself to conservation of space by folding. The wings contain shelves for many aids to beauty



Right, cabinet resembling radio when closed holds an entire kitchenette. Electric coffee pot, toaster and electric grill are in upper compartment, storage space is in lower left cabinet and an ice box using Dry Ice is in right-hand compartment. It is designed for small apartment or cottage. This and other photos on this page were taken at 1937 American Furniture Mart



Shower Bros. Co. Bloomington, Ind.

Large Furniture Company - American Furniture Mart

Is 49 J. Isoldstein, Inc. POPULAR MECHANICS 322 Delaware Ave Philadelphia Pa

Fish Go to Town in Air-Conditioned Comfort

Fish are fattened for the market these days on middle western "carp ranches," and are taken for their last ride to town in "air-conditioned" comfort. These fish ranches in Wisconsin, Michigan, Minnesota, Nebraska and the Dakotas sprang from a demand in the big cities for live carp for food. Close to some inland wa-

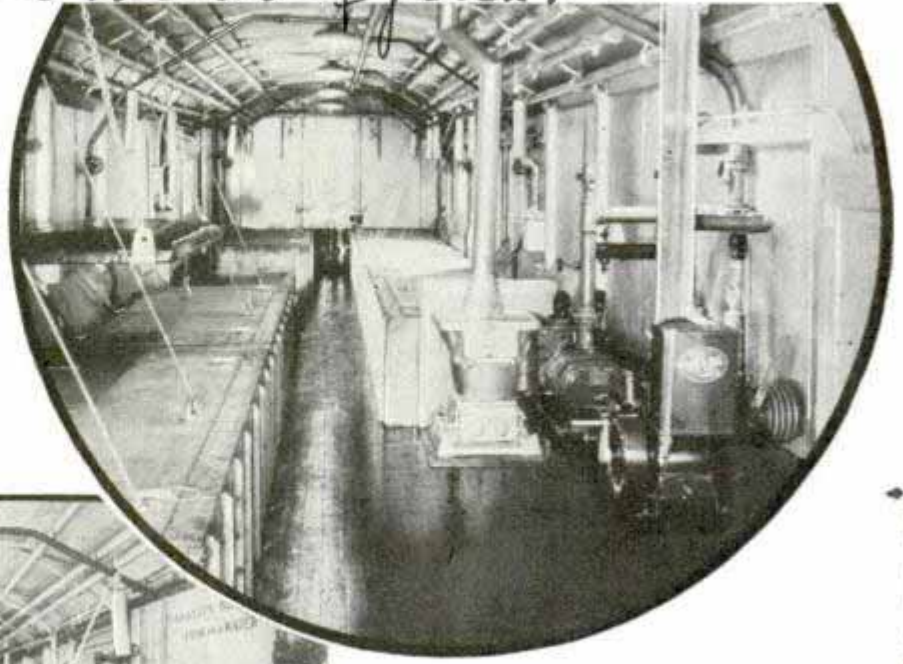

Above, gas engine in fish car operates blower sending fresh air through the tanks constantly. When train is in motion, steam from locomotive relieves gas engine of work. Left, two views of interior of fish car showing huge tanks closed and open. The fish are not fed during the railway journey to market

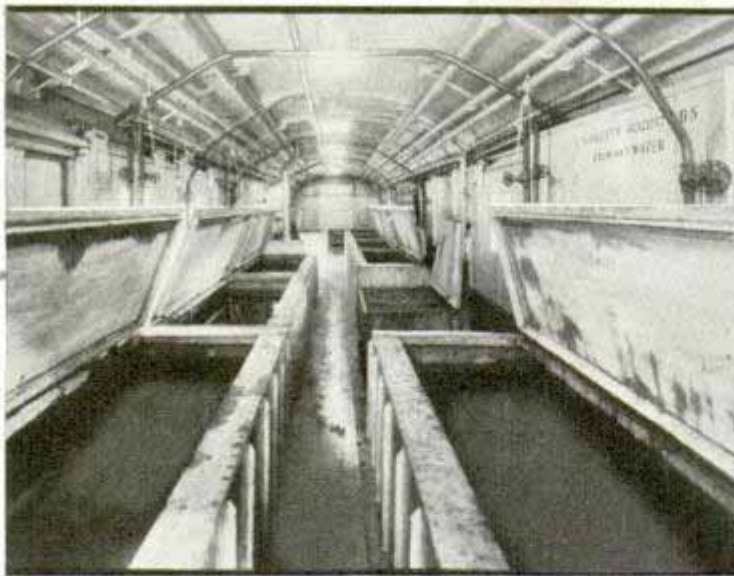
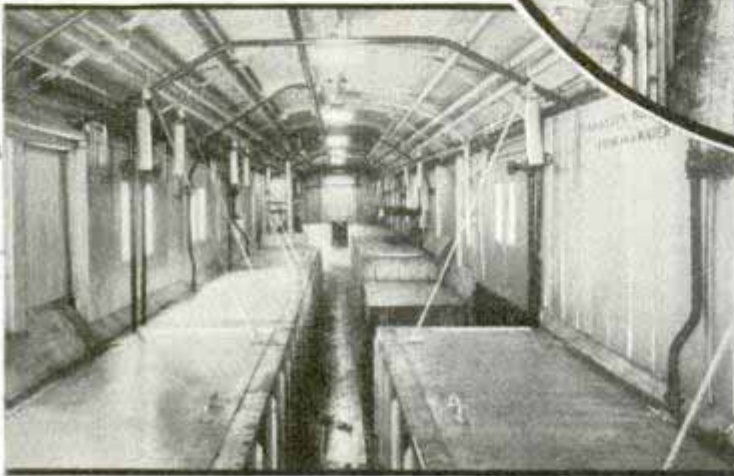

from living in waters tainted with motorboat oil or gasoline. Ready for market, the fish average three to eight pounds each and sometimes run up to forty-five pounds. The ride to market must be swift and healthy, so the carp are transferred to huge tanks in a specially built fish car which travels on the fast passenger trains. The water is maintained at the same temperature as the pond, heated if necessary or cooled with ice—sometimes thirteen tons of ice are consumed on the trip to the Atlantic seaboard. The tanks are covered to prevent splashing, and are constantly aerated by a blower operated by steam from the locomotive when attached

ter where carp can be caught with nets, the rancher would flood a low tract of land by damming a small creek. To this artificial pond the carp would be transferred for fattening. Every day they would be fed corn mash, such as chickens are fed, at a bushel of corn per ton of fish. Besides fattening, this period in the pond would serve to cleanse the carp of any oily flavor

to a train and by a gas engine in the car when detached. There is little loss in transferring these fish from river to pond, to car, and then to warehouse tanks at destination, for carp can live four or five hours when taken out of water, and revive when placed in water again. While in the tank cars on the way to market the fish are given no food.

Vertical handwritten notes on the left margin.

Vertical handwritten notes on the right margin.

Flat Models Given Depth by Knife and Paint

Instead of making models in three dimensions, government designers are imparting the appearance of depth to flat-surface exhibits, simply by skillful use of knife and paintbrush. The exhibits are of the diorama type used so extensively at fairs and expositions for several years, but do not fol-

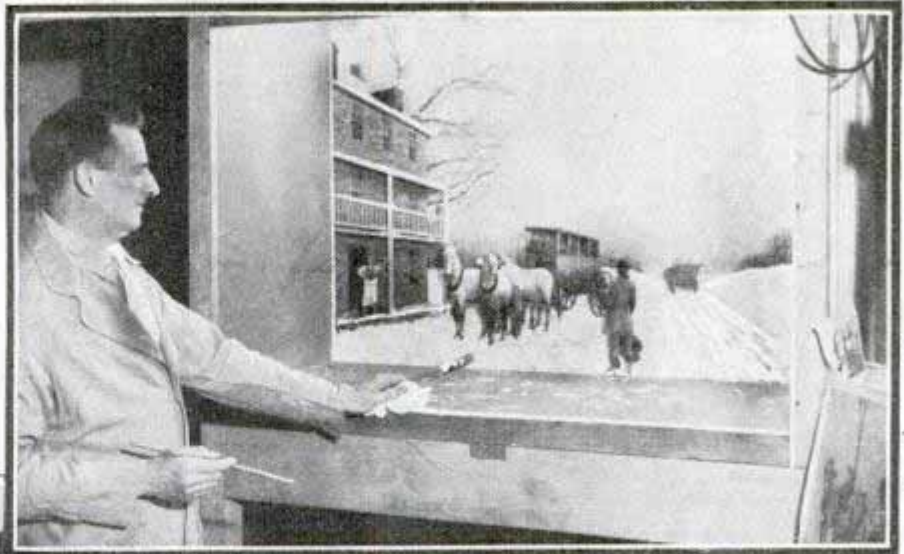

Top, artist at work on new type of diorama which is only six inches deep but appears to have much greater depth. Left, diorama of super-highway

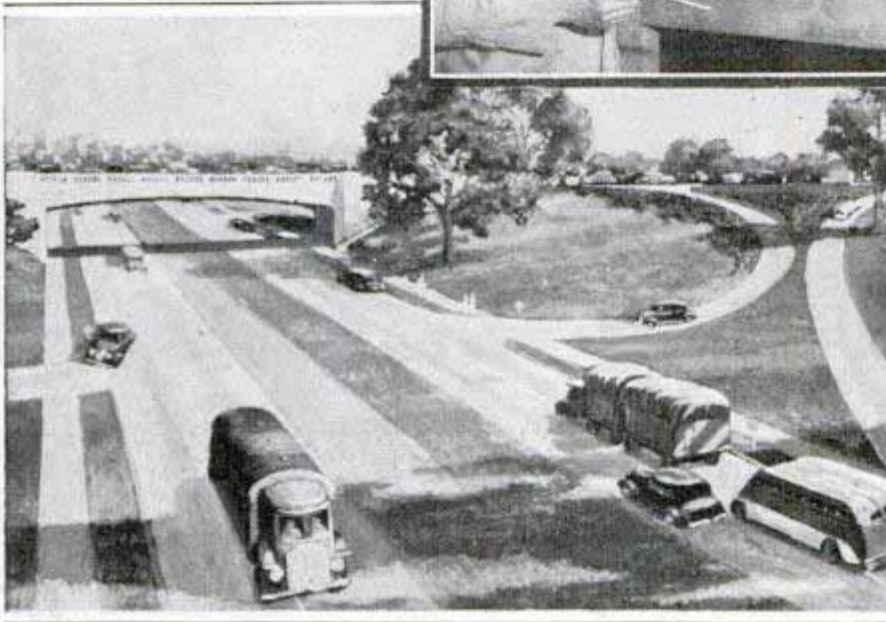

inating the possibility of distortion. Since the models are made of basswood, the exhibits are lighter in weight, less fragile and easier to crate for shipment than were the original type of diorama, which frequently was made of clay, plaster,

low the traditional formula of being twice as long as deep to achieve perspective. Only six inches deep and provided with flat instead of semicircular backgrounds, the exhibits are so built that the point of view of the spectators is controlled, elim-

bronze, copper, steel and iron. So skillfully do the government's craftsmen shape the models in alto-relief with sharp knives and shade them with appropriate colors of paint that they appear to the spectators as three-dimension figures.

Handy Magazine-Feed Stapler Holds Thousand Staples

With a capacity of 1,000 flat steel staples, a vest-pocket stapling machine designed for use on wood, paper, leather, canvas, felt, fiber and other materials is on the market. It has a magazine feed and is easily loaded. If a defective staple gets into the machine, a few blows on the plunger will cut it up and the pieces will fall through the staple opening.

(Pulverized waste granite can be combined with china clay to make porcelain, the Bureau of Mines has found.

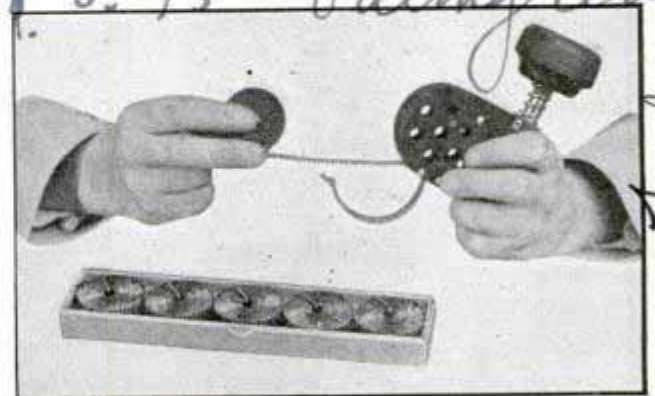

Loading the vest-pocket stapler with roll which carries 1,000 steel staples

Empresses Oil Magazine

Experiments at Osage, Ok.

Chicago Tool & Engineering Co. 8389 S. Chicago Ave. 41 30

7/650

Washington

F1483

MOONBEAMS *Bulk*



MOOONBEAMS govern a \$20,000,000 American industry. When the moon floats in a clear Pacific sky, a great fishing fleet floats idle at anchor and ten thousand cannery workers idly await a night fog, an overcast heaven or a lunar change. For more than ninety-nine per cent of the annual billion-pound sardine catch of the Pacific is seined by night, in the dark of the moon. Seldom is this fish family seen

by day, never by moonlight. Even starlight is a curse to the fisherfolk.

Paradoxically, the few sardines caught by daylight are found by a dark hue they cast at the surface of the sea, while at night their presence is indicated by a bright glow over the water. So nearly is the glow a twin to moonbeams that the fishermen do not even attempt to seine on clear, moonlit nights.

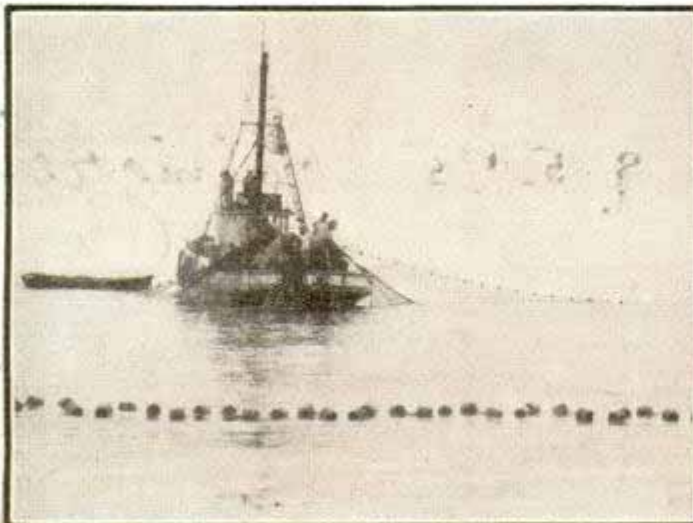

Photos courtesy California State Fisheries Laboratory
Top, one of the few instances of successful daylight fishing for sardines. The fish are being removed from the net and loaded on two boats. Below, hauling in bag of ring nets

Confession of

789 Castro St.
San Francisco, Calif

71483

the FISHER FOLK

The sardine, like the anchovy, smelt and mackerel, is a surface-feeder, and when dining at night it lights up its table, so to speak, with a white-blue glow that has the appearance of a patch of molten silver floating on the water. The darker the night, the brighter these "fish lamps," and the easier the job of the fishermen.

Each family of night surface-feeders has its own lighting effect, which is easily read by an experienced fisher. Different styles of maneuvers reveal the different kinds of fish, each making a distinctive sign when it darts through the water. Sardines make long, slightly curved lines, like the tails of skyrocket; smelt cut the sea in undulating arcs, leaving a zigzag path. Anchovies squirm in short, angleworm curves, while mackerel make wide, straight paths.

These families of smaller fish feed on billions of almost microscopic crustaceans which float near the surface. When disturbed the tiny creatures



Photos courtesy California State Fisheries Laboratory
Top, striped bass caught in San Francisco bay. Below, left, removing fish from net to boat, one of few daylight pictures ever obtained. Right, taking a net ashore to make repairs after making a heavy haul

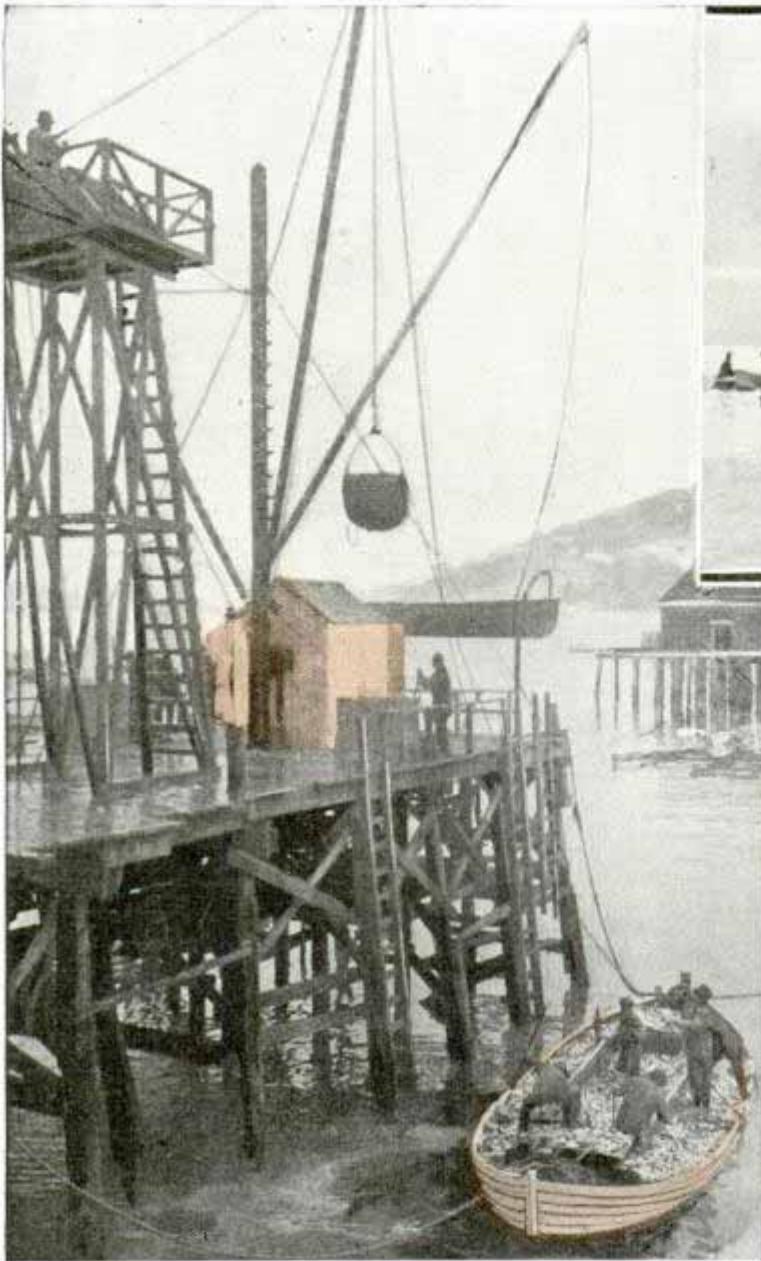

Unloading one night's catch in the early morning, and salmon fishermen at mouth of Klamath river



bigger outside the Golden Gate and off the Farallones. Fifteen-inch sardines are caught in Alaska, while twelve inches is the average in canneries on Vancouver island. Scientists are uncertain how far the sardine travels on its northern cruise, and in how many parts of the Pacific it may be found. It appears in tremendous schools in South American waters and south of the equator.

When spawning age is reached by the northern voyagers, the schools head back to the waters of their nativity. Few are seined on the southern spawning run; for the fish then travel in broken schools and seldom stop for food. Although they require more than a year to make the northern trip,

exude a phosphorescent glow that lights up the water and serves as a guide to the seining crews.

Pacific sardine propagation in the North American area is confined to a circular zone, about 200 miles in diameter, off the south coast of California and north coast of Lower California, Mexico. Upon hatching, the little fish start north in vast schools, at first swimming very slowly, then gaining speed with size. They are from five to six inches long and about a year old when they reach San Diego, site of the southernmost American canneries; seven to eight inches when they appear off San Pedro harbor. At Monterey, some 400 miles north of San Pedro, they are from eight to twelve inches, and are only a little

the return is a matter of days. All the hunters of the sea and of the air above the sea prey upon the little travelers. The annual fishboat catch of a billion pounds is only a minor fraction of the toll. Great flocks of gulls swoop down to feast on the fish; droves of sea lions devour tons. An open-mouthed whale, swimming through a sardine school, will swallow two thousand pounds of fish. Nature tried to compensate for this destruction by creating the female sardine with capacity to produce from 100,000 to 300,000 eggs, and by teaching the fish to swim in split schools en route to their spawning waters.

Up to the time of the world war, nearly all west coast sardine seining was carried on from little power boats patterned after

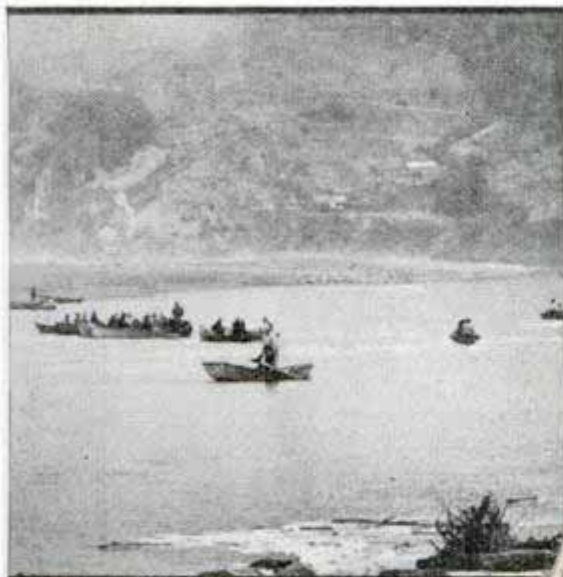













Mediterranean fishboats, the design of which has gone unchanged for 3,000 years. Today's boats are bigger and faster, ranging from thirty-five to seventy feet in length, ten to twenty-five feet beam and three to five feet draft. They are powered with gas and Diesel engines. They are seaworthy, for virtually all seining is done from five

(Continued to page 126A)

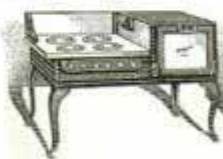

Fishermen at the mouth of the Klamath river when the salmon run starts and, above, unloading fish at one of the canneries. This represents only a small part of one night's catch

Research Brings Better Goods at Lower Cost

| | | | | | |
|---|---|--|---|---|--|
| <p>1891</p>  <p>\$3.50
100 candlepower used 310 watts</p> | <p>TODAY</p>  <p>20¢
100 candlepower uses 100 watts</p> | <p>1922</p>  <p>\$200
Nearby stations only. Needed batteries</p> | <p>TODAY</p>  <p>\$30
Long-distance reception. Just plug in</p> | <p>1902</p>  <p>3 lb coal per kw-hr
22 kw per sq ft of floor area</p> | <p>TODAY</p>  <p>1 lb coal per kw-hr
76 kw per sq ft of floor area</p> |
| <p>1927</p>  <p>\$205
Slow No thrift cooker.</p> | <p>TODAY</p>  <p>\$107
Fast Thrift cooker included</p> | <p>1891</p>  <p>1/3 hp \$80
28 lb</p> | <p>TODAY</p>  <p>1/3 hp \$12
28 lb</p> | <p>1926</p>  <p>6-foot box \$295
50 kw-hr per month</p> | <p>TODAY</p>  <p>6-foot box \$165
21 kw-hr per month</p> |

Here is a graphic story of the rapid advance of engineering in recent years, showing side by side the superior products of today and the less efficient ones which cost far more a few years ago

Thanks to inventive research engineers, many of the products of industry today deliver far superior performance at a fraction of their cost a few years back. Your hundred-candlepower lamp in 1891 cost \$3.50 and used 310 watts; today such a lamp can be had for twenty cents and uses 100 watts. A slow-cooking electric stove only ten years ago cost \$205, while today a fast and efficient model lists for \$107. As late as 1921 an electric bulb that sells for fifteen cents now, cost forty-five cents and today's gives eighty per cent more light! Thomas A. Edison's first generating station in 1882 required ten pounds of coal to generate one kilowatt-hour of electricity.

In 1902 it took three pounds of coal. The latest turbine-generator matches every pound of coal with one kilowatt-hour. You paid eighty dollars for a one-third horsepower electric motor in 1891 and you could buy one today for twelve dollars. In ten years the price of a six-foot electric refrigerator has been slashed from \$295 to \$165, and the new one consumes only twenty-one kilowatt-hours per month compared with fifty kilowatt-hours used by the old model. Back in 1922 you bought a \$200 battery-operated radio set that could pick up only near-by stations. Today a thirty dollar set gets distant stations, and you merely plug it into a socket.

Airplane Tire Changed Quickly with Aid of Jack and Vise



Changing airplane tires was a sixty to ninety minute task until mechanics of United Air Lines at Seattle improvised a jack and vise arrangement which does the job in five minutes. Two parallel pieces of one and one-half inch angle iron are welded on top of a welded steel automobile rim. These support two sections of one-inch pipe on which a hydraulic jack is mounted. To remove a tire from its wheel, it is laid on the floor and deflated, then the auto rim is laid over the inner edge of the tire and the jack is pumped up, with pipes bolted and welded to a hangar

girder supplying the resistance. Steady pressure from the jack breaks the tire loose, this operation being applied to both sides of the tire. Next, to facilitate removal of the tire, a wheel vise was built consisting of a two and one-half inch pipe with a fork to keep the wheel from turning.

Bank Provides Curb Service with Tube from Teller to Car

F1656 material information

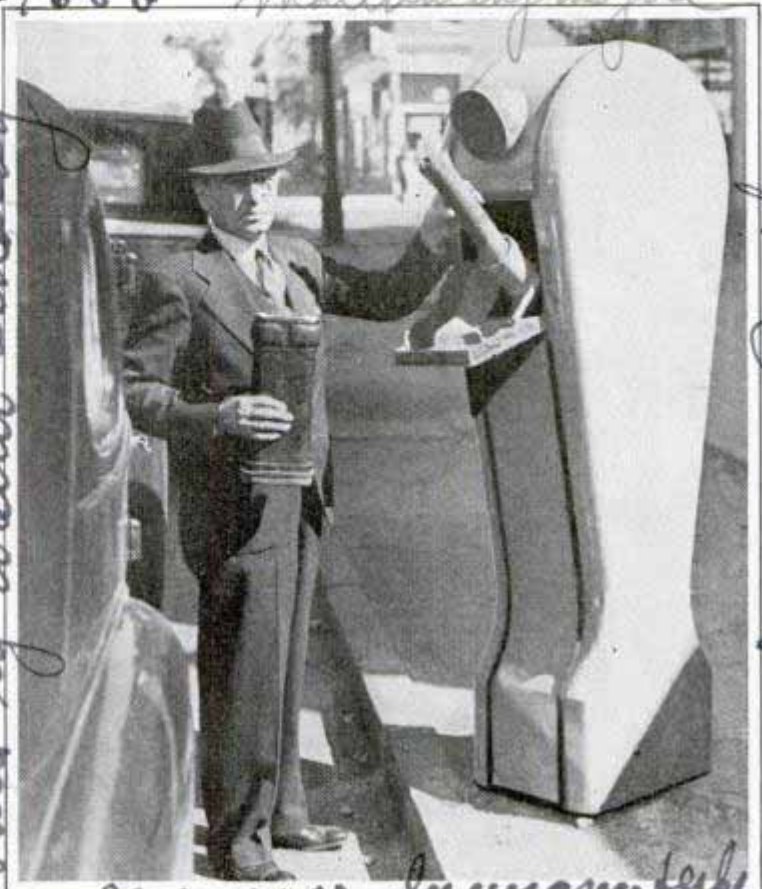

Customer making a bank deposit from the curb, sending his money and book to teller by pneumatic tube

Concrete Memorial Shaft Has Marble Luster

F1583

Memorializing the heroes of American wars, a thirty-two foot monument erected recently in Lincoln, Neb., is constructed of sixty tons of concrete and fifteen tons of crushed marble. The marble was added to lend luster. Ten men completed the work in nine months. The memorial consists of a shaft surmounted by a figure, "Victory and War," with four figures at the base, representing soldiers of the American Revolution, the Civil War, the Spanish American War and World War. The base is twenty feet square.

Paid by Walter Anderson

in Antelope Park



This thirty-two foot memorial is constructed of concrete and crushed marble

Carl Everett Rudisil

In a hurry to cash a check? You can get curb service in front of a Denver bank. There is no need to drive around the block looking for a parking space. Just drive up to that streamline metal case at the curb. The teller, watching from his window, recognizes you and presses an electric switch to open a small door which reveals pneumatic dispatch tubes, cylindrical carriers and a telephone. The teller greets you over a loudspeaker above the door. You slip the check or your bank book and deposit slip into a carrier and send it through the underground tube to the teller's desk. If you wish, you can pick up a telephone in the metal case and speak to the banker. Within a minute or two your money or bank book comes back through the dispatch tube and you drive away.

Out of 22,702,000 motor vehicles examined by an insurance organization, three out of every four had some defect. Tires were close to the danger point on half of the cars.

Automotive Industries

Central Savings Bank and Trust Co. 1601 W. Washington Chicago

under direction of E.S. Lee

Pilot Ascends at Midnight to Check Weather



Pilot checks up fastenings of weather instruments before taking off at midnight

through the radiator and, condensing, runs back to a reservoir for further use. Radiator valves are eliminated, 250 pounds of steam can be used safely, and with thermostatic control there is no turning off and on of steam and no fluctuation in heat. Not yet on the market, this alcohol bottle is being tested in heating and air-conditioning plants.

F1641

Big Building Stands on Stilts as Subway Track Is Laid

When the New York Central railroad began digging a tunnel for a subway in New York recently, a large building stood directly in its path. Instead of tearing down the structure at great expense, the railroad and the owners reached an agreement whereby a few of the lower floors were taken out giving the subway workers headroom to work on the tunnel and leaving the building standing on steel stilts. While the work was in progress, the building had the appearance of being under construction from the top down.



Central Station, New York
Here is how building appeared while subway construction was under way

Perhaps the loneliest job in aviation is that of a California pilot who ascends 16,000 feet every night to collect weather data. The flights are made at midnight. His plane carries special equipment, including an aero-meteorograph which records air pressure, temperature and humidity. The pilot makes observations on fog banks, cloud thickness, smoke layers, air currents and other conditions. This information is used by the government weather bureau in making forecasts. The pilot wears a sheep-lined flying suit because he encounters temperatures of fourteen below zero on his flights.

Alcohol Vapor Heats Radiator Instead of Using Steam

Tomorrow's homes may be heated with alcohol vapor. From the laboratories of the General Electric company comes word of an alcohol "bottle" which replaces the valve of a steam radiator. It holds one or two pints of alcohol. Steam is piped to the bottle, but not into the radiator itself; instead, the alcohol readily takes up the full heat of the steam and vaporizes, flowing

*Chicago Tribune 1/20/37
Alameda, Calif
Johnnie Martin*

not a commercial

Wildcats Captured Alive by Daring Hunter



With wildcat treed by the dogs, the hunter goes after him with chain snare fastened to rod

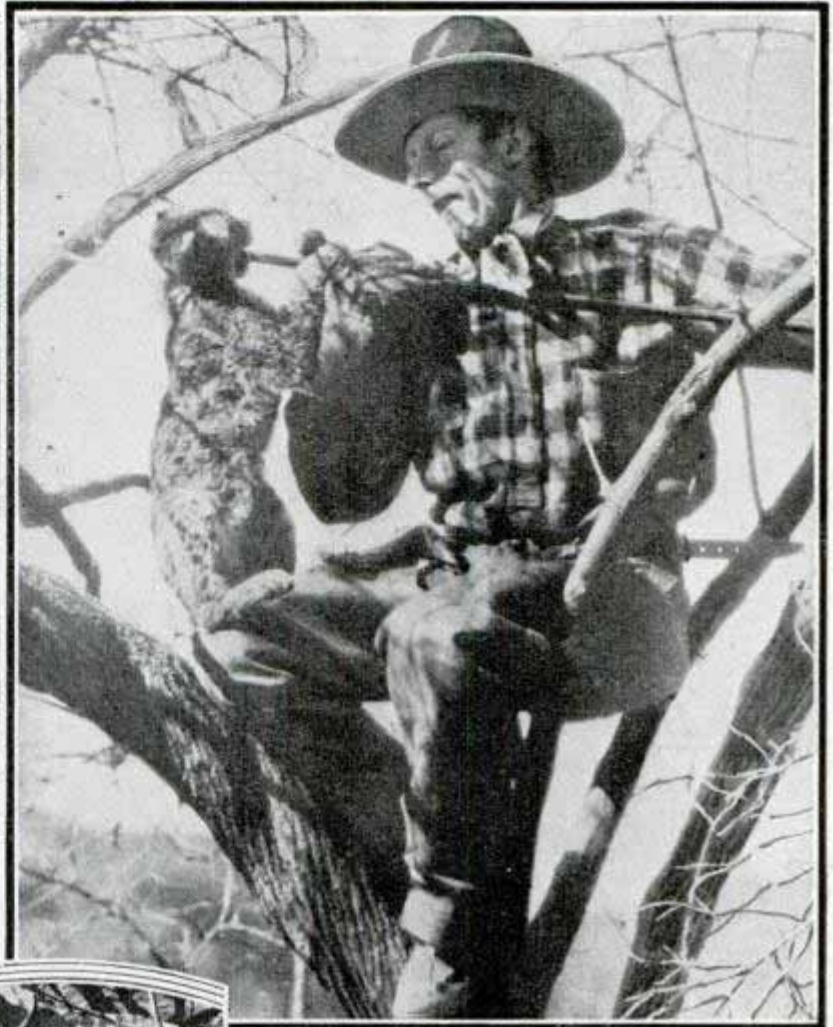

After hand-to-hand fight the hunter is shown with noose slipped over cat's head



Lowering cat from tree while dogs beg for chance to finish off the quarry. Right, close-up of captured wildcat. These vicious animals, weighing up to thirty-five pounds, are found in the Sierra Madre mountains north of Los Angeles. It takes a daring hunter to bag them



Acme

Weapons

30 minute

MOVIES *that* SHOW *you*

Emb. Thomas E. Timmer Jr. 10555 Hollywood Ave. Los Angeles, Calif.

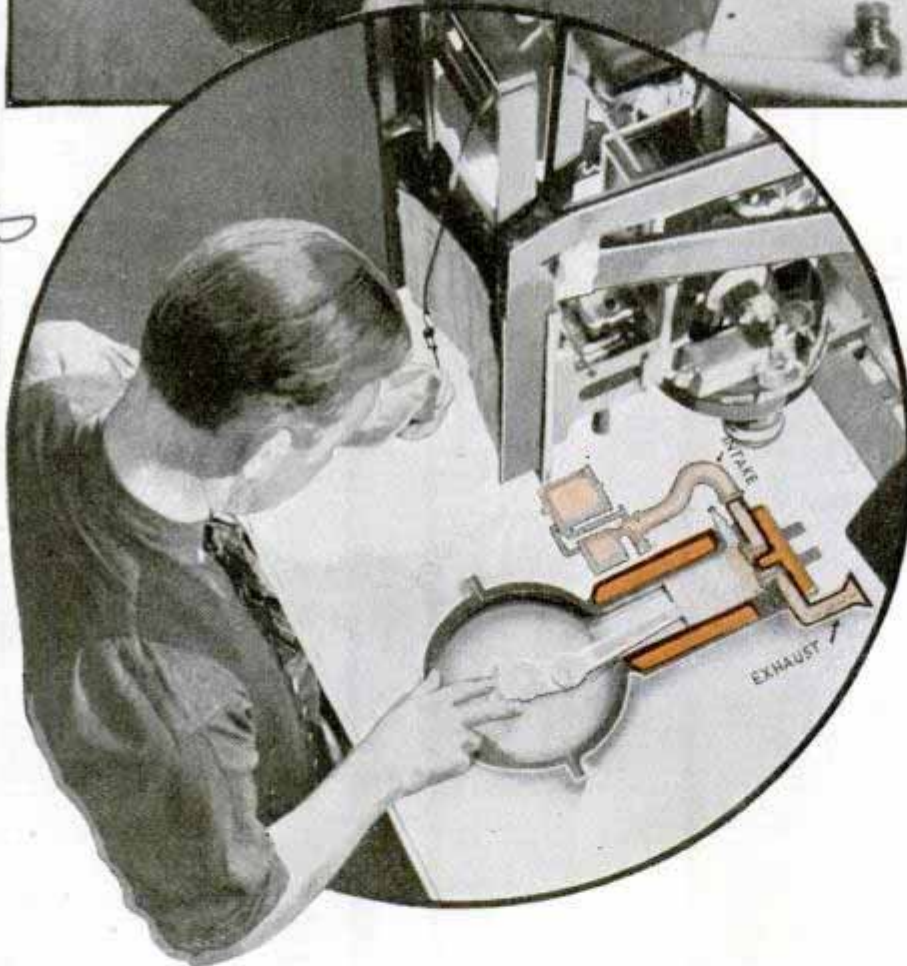
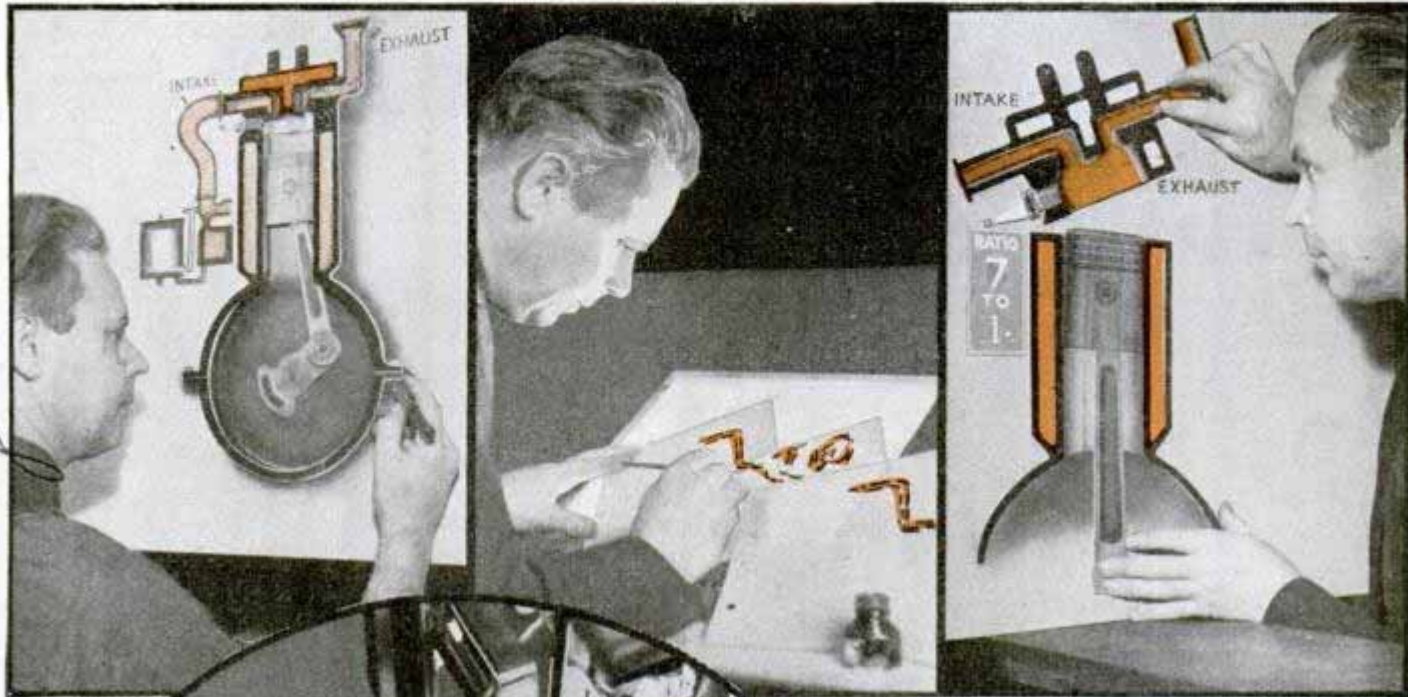

Above, left to right, painting in details of cutaway engine model for movies, animator preparing drawings to illustrate flow of exhaust gases, and changing cylinder heads on cutaway engine model. Below, overhead movie camera that makes one picture at a time after operator moves engine parts

“Let’s take a movie,” the superintendent suggested, and sent to Hollywood for a trouble shooter.

They did the job over the next day with a cameraman on the sidelines. As usual, the cable snapped. But the oil-well crew had the answer when they saw the “rushes” of the film in slow motion.

Moving at a fraction of normal speed, the pictures showed the cable descending from the crown block into the hole. Then it started to weave and finally kinked over on itself. Then it snapped. Air pressure in the deep hole was slowing up the dropping of the pipe, allowing the cable to slacken. The action was too fast for the eye but the film showed every detail. The crew dropped its

THE heavy wire cable had been tested with a load of twenty tons but the first time it was put to work lowering a string of pipe down an oil well it snapped like a piece of thread. Something was wrong. The load was only a fifth of what the cable should stand. And this was the fourth cable that had snapped.

showed the cable descending from the crown block into the hole. Then it started to weave and finally kinked over on itself. Then it snapped. Air pressure in the deep hole was slowing up the dropping of the pipe, allowing the cable to slacken. The action was too fast for the eye but the film showed every detail. The crew dropped its

adv. 554 Union Oil Co. Los Angeles

7766/1

the INVISIBLE

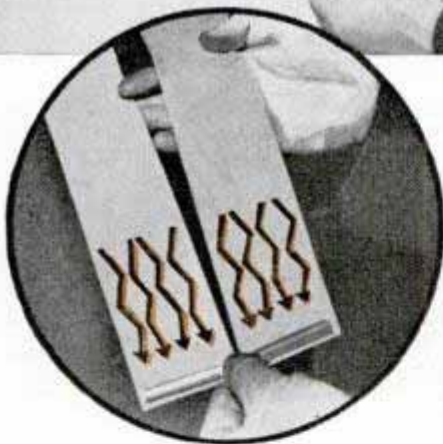
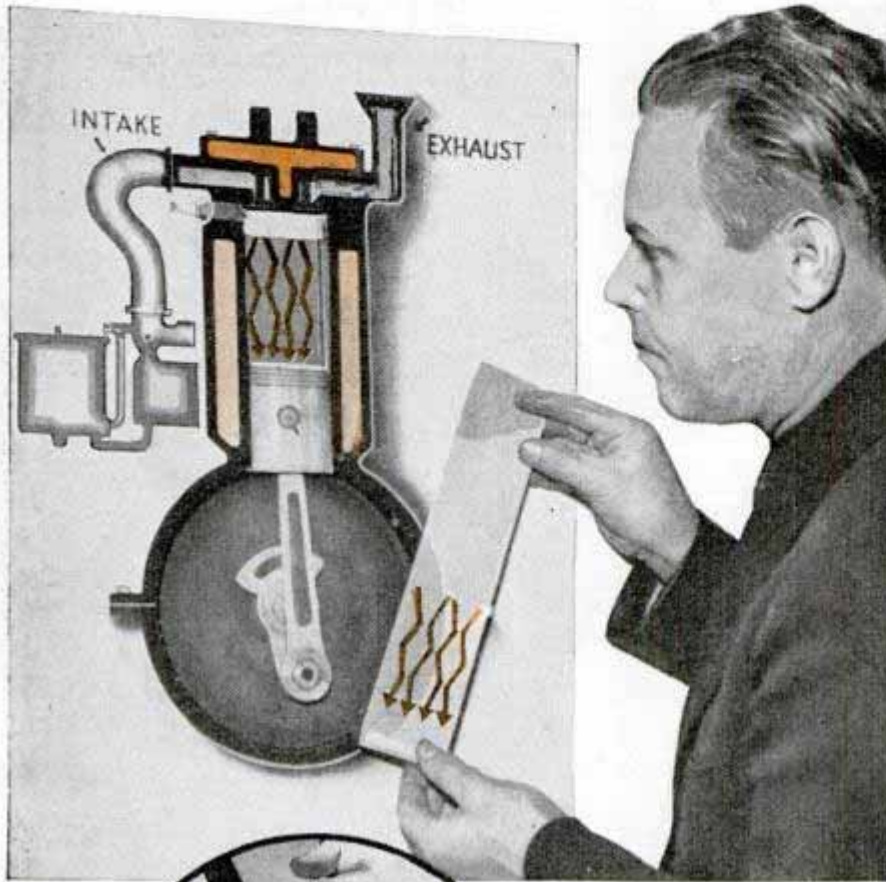

Above, vibrating arrows which indicate drive of power in engine. Left, close-up of arrows showing reversed direction which makes them appear to vibrate. Right, film strip showing animation of flames by use of drawings and progressive steps in animation of engine cylinder

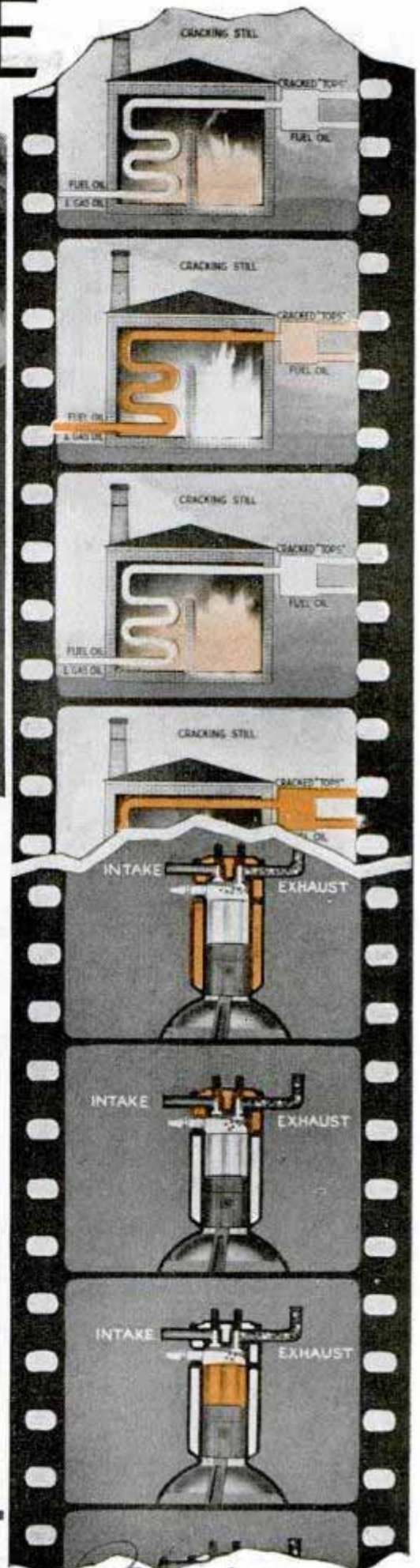

pipe more slowly and its cable troubles were over. Solving industrial problems by "making visible the invisible" is an important task for motion pictures. Many things happen too quickly for the eye but when you put to work a motion-picture camera that can see at any speed, it catches things the eyes overlook. Recently a railroad tested a preliminary design of a new lightweight boxcar by rolling into it an old car loaded with sandbags. The technical men wanted to know where strains developed and what parts buckled first, so they took movies of the crash. Out of the pictures they evolved a design of car that is both light and strong. In the Hollywood studio of F. K. Rockett, cameras are used as detectives to trace down the causes of trouble when things go wrong in indus-

6050 Sunset Blvd
Los Angeles Calif

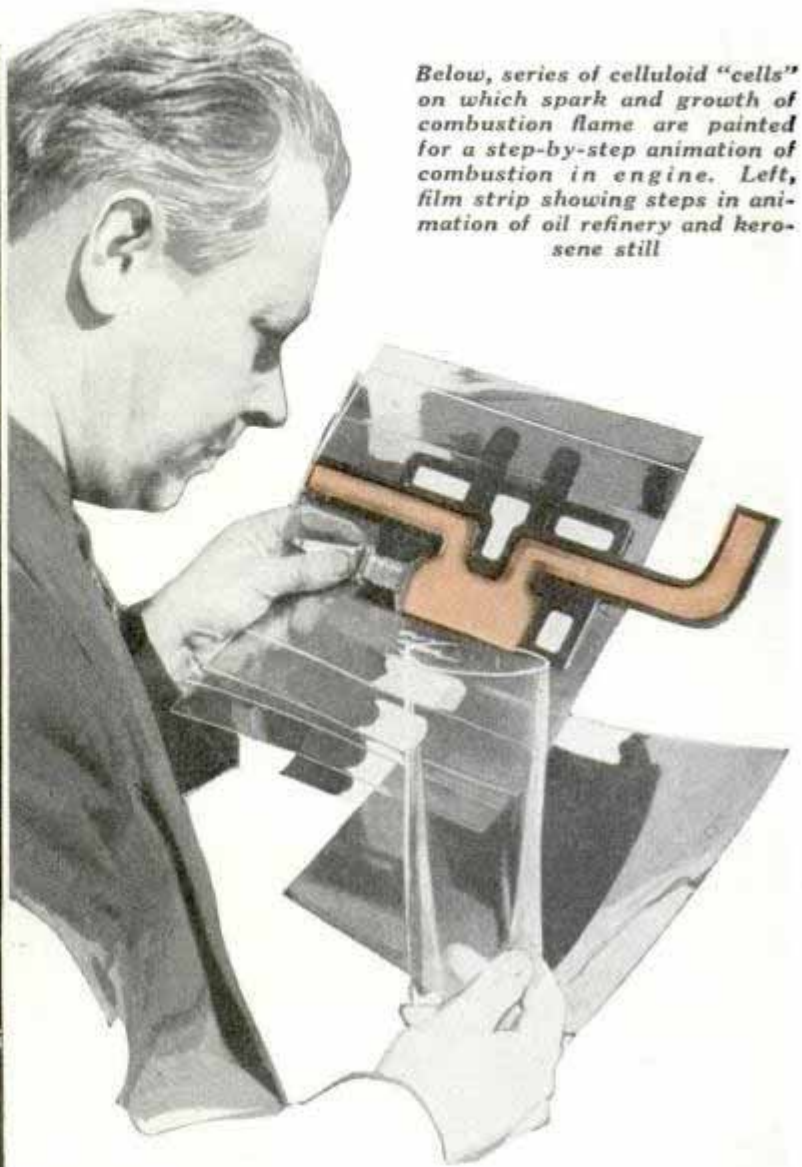
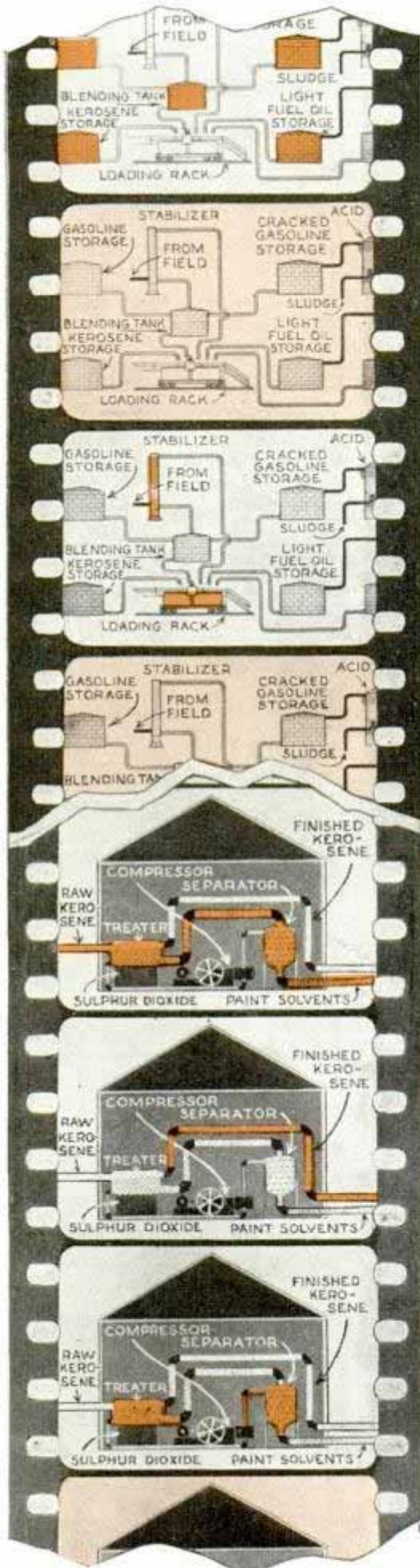

Below, series of celluloid "cells" on which spark and growth of combustion flame are painted for a step-by-step animation of combustion in engine. Left, film strip showing steps in animation of oil refinery and kerosene still

try. The camera can peer through microscopes and literally look through solid walls.

What goes on inside an automobile engine is a pretty hard thing to photograph but recently an oil company asked Rockett to do just that. The idea was to visualize on the screen the four cycles of combustion. This was a typical case of making visible the invisible and Rockett supplied the answer by building a cutaway model of cardboard, glass, and aluminum parts. In the model a flat aluminum piston slides up and down the cylinder and is connected to a cross section of crankshaft by a replica of a connecting rod. Moving valves and a spark plug were also parts of the model. Building the model was easy. The rest was a long tedious process in "stop motion" that took weeks to finish. It might take a full day to turn out six feet of film that runs on the screen four seconds.

"The first step," Rockett explains, "was to place the model under a vertical motion-picture camera and expose one frame of film in the camera while the piston was at the top of its stroke. Next

the animator moved the piston down a fraction of an inch in the cylinder. Then he opened the intake valve slightly and placed in the combustion chamber a celluloid sheet on which were painted a few dots to represent the incoming fuel charge. Then he was ready to expose one more frame of film. The third frame showed the piston lowered a little more and a larger quantity of fuel on its way in. Just 325 rearrangements of the moving parts were necessary to show the full operation of the engine."

In addition to all this, carbon deposits building up on cylinder head, carbon particles flying out of the exhaust, and arrows representing heat dissipating into the cooling system all had to be represented at each step. One of the requirements was to indicate the fluctuating cylinder head temperatures on a celluloid thermometer placed alongside the model, and to show the power being developed at each stage on a chart beside the thermometer. In the finished picture, with the engine slowly and steadily moving through a complete cycle, temperatures flow up and down the thermometer and the power line on the chart rises and falls in accordance with the stroke.

Another part of the same film shows the actual building up of carbon deposits on a cylinder head. To get this, Rockett mounted a camera on a steady support and photographed a cylinder head in clean condition. Then the head was installed on an engine, operated long enough to represent 300 miles of driving, unbolted, and placed in front of the camera again. This time

(Continued to page 116A)

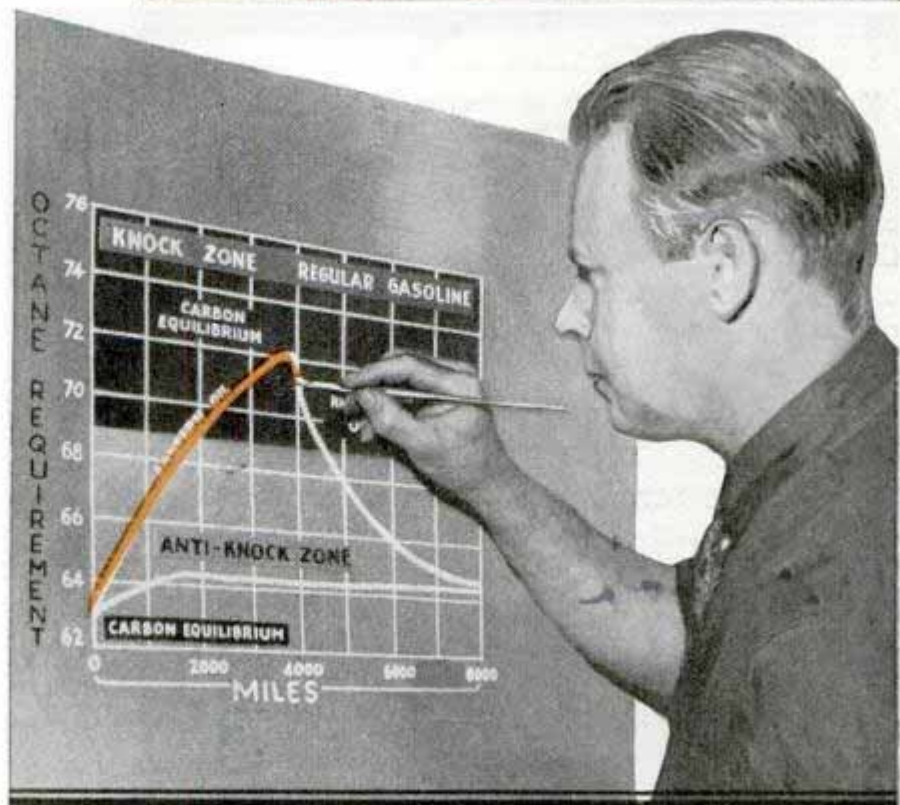
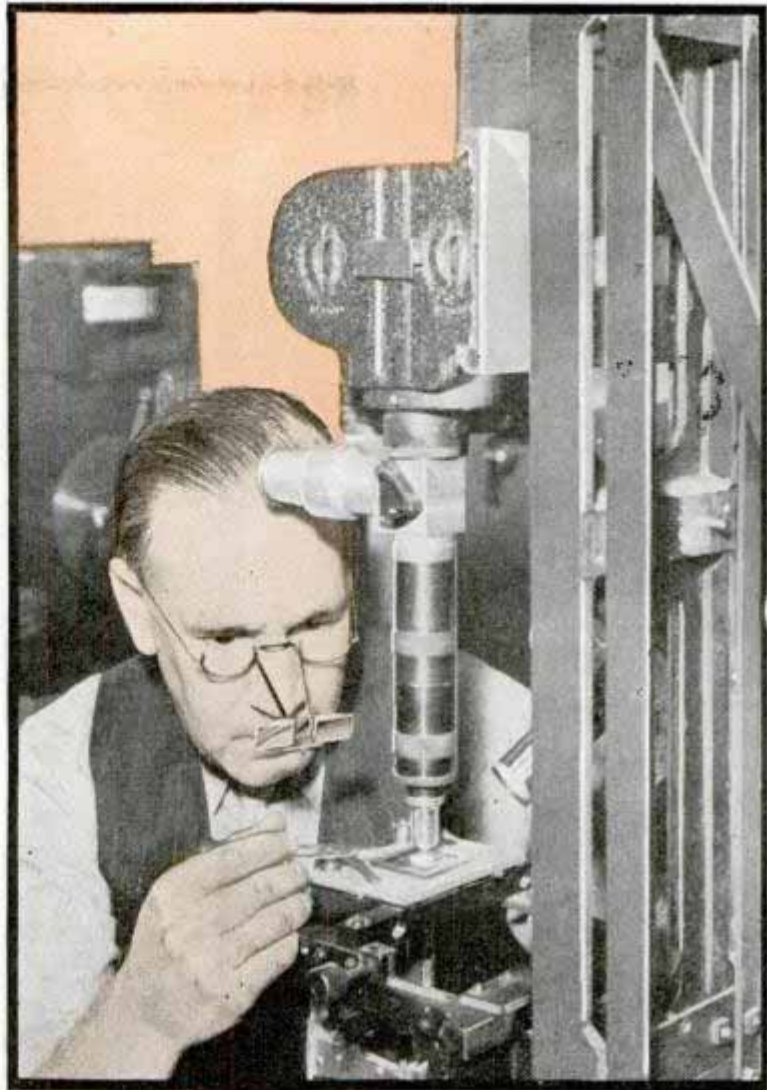

Top, adjusting automatic camera which takes motion pictures through a microscope. Below, completed graph animated by photographing it each time new dot in curves was painted on

Slender Truck Saves Trees from Damage in Fruit Grove

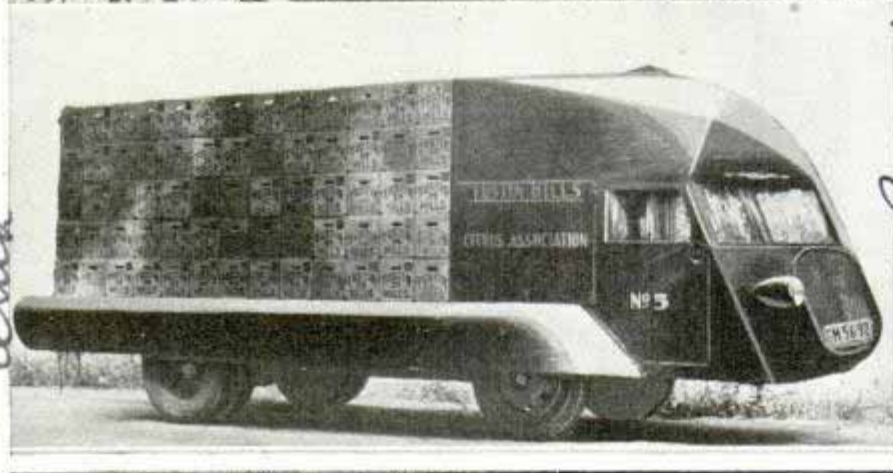
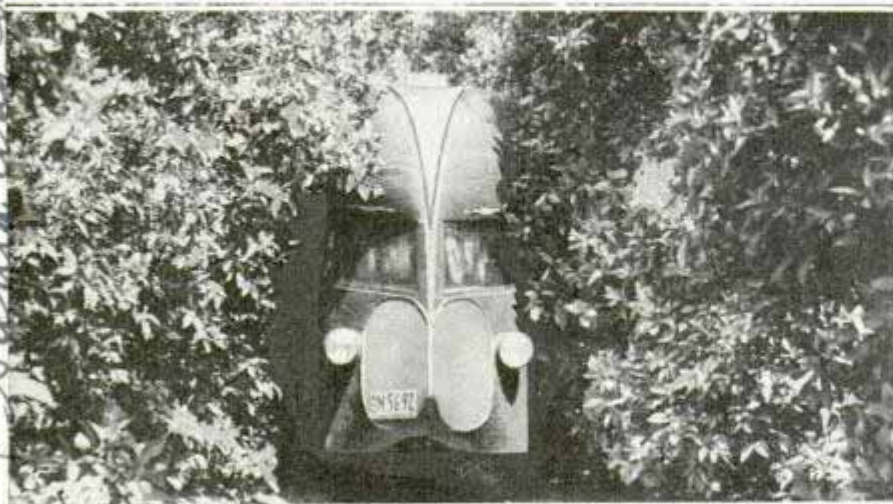

Head-on view of narrow truck constructed to pass between fruit trees. Bottom, on the way to market with a full load

Constant breaking of trees and bruising of fruit by trucks hauling fruit through the groves has been ended by California citrus growers. On the recommendation of automotive engineers they now use a long, slender truck which rolls through the grove without causing damage.

Four-Burner Stove for Trailer Occupies Little Space



There is ample room for four large cooking utensils on a four-burner stove designed for use in trailers, yet the stove requires a space only eight-

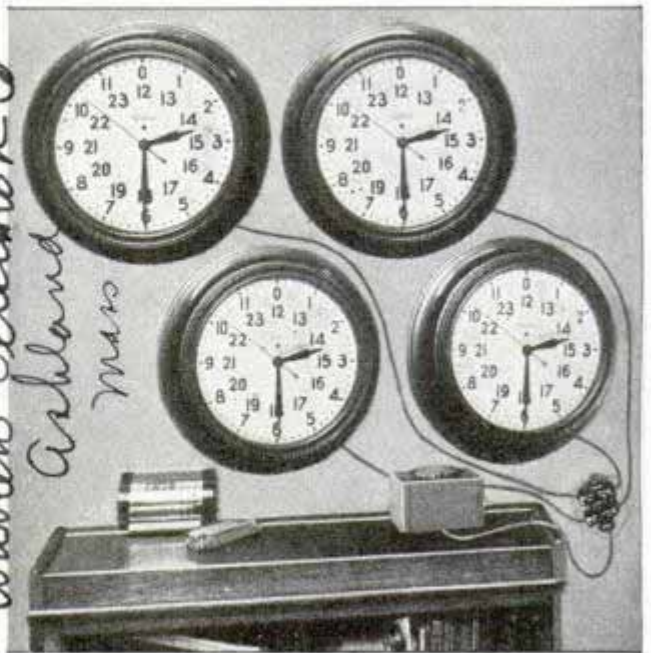

Electric clocks keep sidereal time for Mt. Wilson observatory and California Institute of Technology

een by twenty-two by six and three-quarters inches. Regardless of the number of burners in use, the flame is always even. The small gas tank has a built-in pump.

Electric Clocks Tell Sidereal Time for Observatories

Cook a five-minute egg by a sidereal clock and it will boil only four minutes, fifty-nine and 181 thousandths solar seconds. Four of these electric clocks that tell star time have been built for installation at the California Institute of Technology and in the observatory on Mt. Wilson. The sidereal day lasts twenty-three hours, fifty-six minutes and four and ninety-one thousandths seconds in solar time. These electric clocks therefore will gain about one second for every five minutes your kitchen clock runs.

*Body - O. H. Egge
F. Co. 429 W. 5th St
Pasadena, Calif
White Motor Co
84 2 E 79 St Cleveland
Ohio*

Pasadena

*F1664
Safe-J. Cook*

*Warren Telephon Co
Ashland
Mass*

*Midland Steel Products
Co., 6600-Mt. Elliott Cwy, Detroit*

Plane Carries Soldiers Concealed in Wings



Here is how the latest two-seater plane built in Russia carries fourteen soldiers in the wings. Before taking off the hinged leading edge of the wing is closed, concealing the extra troops

Designed like the conventional two-seater airplane, the latest Soviet ship has space in the wings for fourteen persons, giving it a capacity of sixteen. This feature is regarded as important from a military standpoint, since it would permit

speedy transportation of a large number of soldiers from one point to another in an emergency. Access to the wing compartments is made possible by placing the leading edges of the wings on hinges. In flight, the "doors" cannot be opened.

Cloth Filter Bags Clean Air of Dirt, Dust and Pollen

Two quarts of dirt removed from an air conditioner after one month's operation in a single room prove the efficiency of the cloth filter bags with which one of the latest conditioners is equipped. These bags, which are specially woven, remove bacteria-laden dust, dirt and pollen from polluted air moving through the unit. The cleaned air, pumped by a power blower, then contacts heating surfaces before being humidified and circulated through the rooms of the house. The cloth filter bags may be cleaned in the family washing machine.

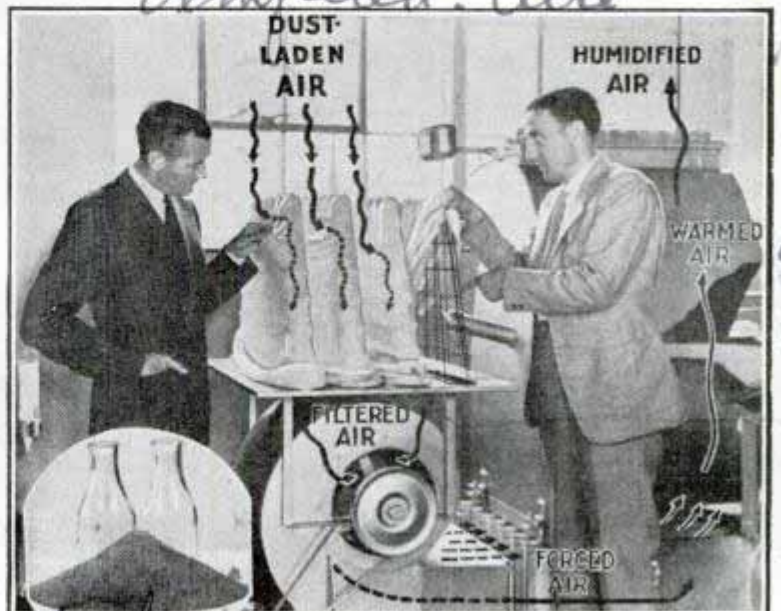

*Isar Ward Industries
415 Commercial Ave*

Metals in Liquid Form Are Applied Like Paint

Applicable to almost any surface in cold form like paint, liquefied metals provide excellent protection against corrosion. Liquefied forms of lead, copper, aluminum, chromium, zinc and tin are available, as

well as brass, bronze and other alloys. Unlike galvanizing which is destroyed at welded spots, liquid metal can be painted over welds or cuts. In one case where fumes from a 10,000-gallon tank of hydrochloric acid were destroying metal fixtures in a factory, a thin coat of lead ended the corrosion. Three coats of lead paint will stop X-rays. Thin coats of copper may be applied to shingled roofs, to ships' bottoms or may be used for forming metallic designs on glassware and ceramics. The metals may be applied with brushes or spray guns or by dipping. Coats a few thousandths of an inch thick up to any desired thickness may be applied. The liquefied metals form perfect bonds on such materials as wood, metal, concrete, glass, leather and most other substances.

*Cold Liquid Metals Co.
200 Metropolitan Bldg
205 W. Fifth
H. Los Angeles
Calif*

*Nobs Chemical &
2465 E. 53rd
Los Angeles
Calif*

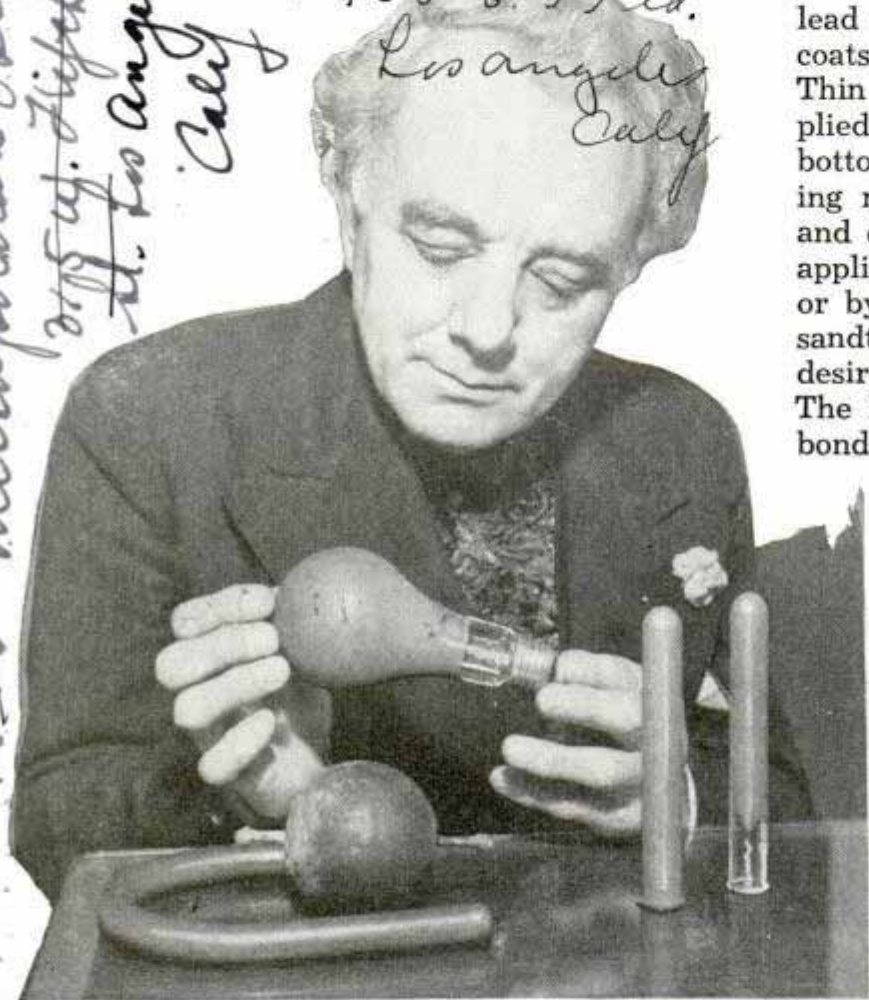

Glue 'Stronger Than Nails' Holds House Together

More than 3,000 tons of prefabricated buildings, including houses which are glued together instead of being nailed, have been shipped to South Sea islands along the trans-Pacific air line. In the erection of walls, roof and floor, glue, which H. F. Luxford of forest products laboratory describes as "stronger than nails," replaces nails almost entirely. Fir plywood panels are glued to studs, plates and sills throughout. The glue is moistureproof and immune to wood-boring insects.



Top, electric-light bulb coated with lead paint shows no scaling after burning twenty-four hours. Copper-coated ball and test tubes after severe tests. Bottom, another example of work with the liquid metal paints

*Madison Wis
37*

*See letter to
engineer*

Ground Training Plane Converted for Flying

used in Hanworth England

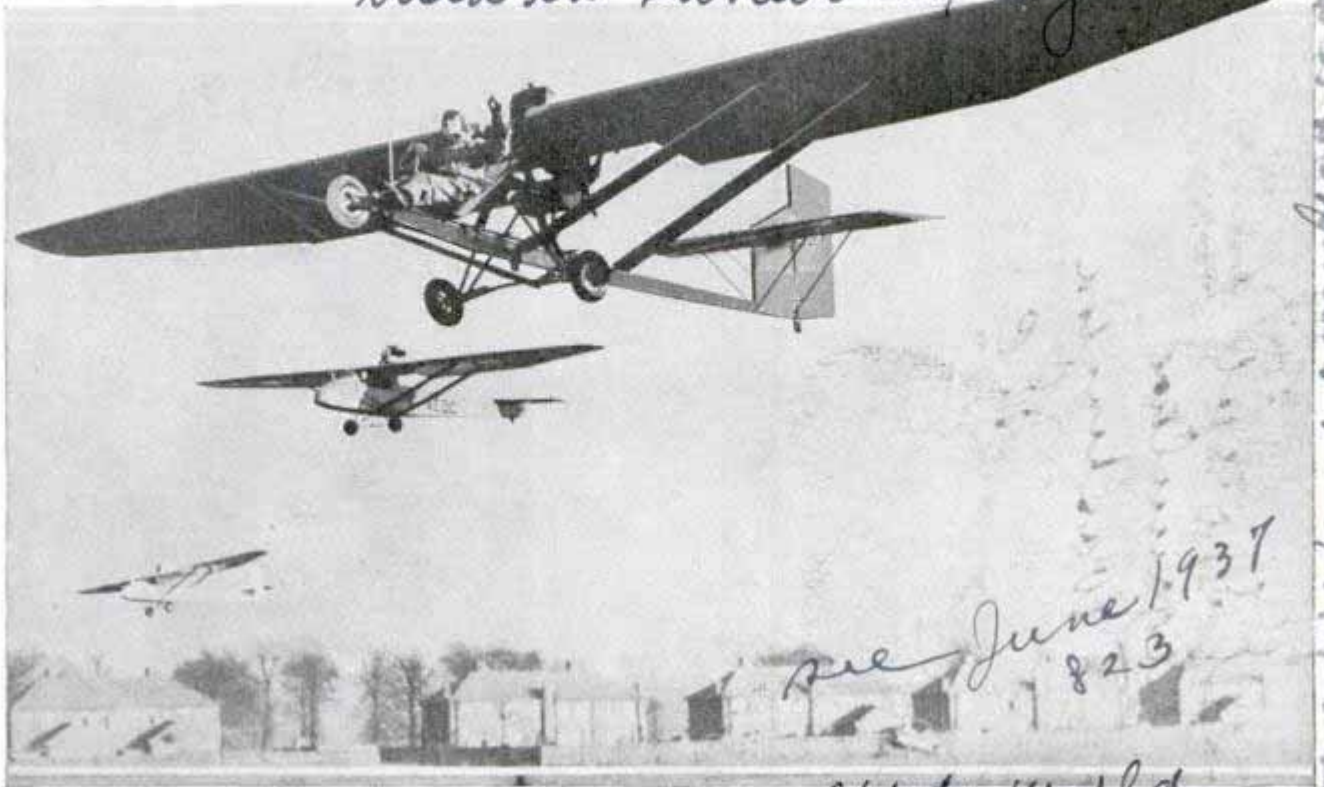

Wide World
Student takes off in ground training plane which is converted for flying by replacing its stubby wings with long ones. Thus, the ship serves as ground and air trainer. Note resemblance to glider

Equipped with drone wings for safe training on the ground, the latest plane for teaching flying may be converted for use in the air after the student has com-

pleted his course in ground work. The student sits at the front as in a glider. A pusher-type power plant drives the plane at speeds sufficient for training purposes.

Newsboy Wears a Neon Sign Lighted by Pocket Battery

Newsboys in Philadelphia wear neon signs that flash across their chests the name of the paper they represent. The neon lamp not only has a strong advertising appeal, making it easy to "spot" a newsboy on a crowded street at night, but it protects the boy selling papers in automobile traffic. To be practical, the chest lamp had to be shockproof and operate on a portable battery. The name of the newspaper is made of a single continuous tube of glass, its base imbedded in a plastic substance which protects the tube from shock and breakage. The neon is activated by a battery which gives forty-eight hours service on one cell. A small vibrator changes the direct current to alternating current and a transformer steps up its voltage. Battery, vibrator and transformer are carried in the boy's apron.



*made and sold by 440 S. Wilton Place, Los Angeles
111 St. Mc Intire*

Handwritten notes on the right margin, including 'see June 1937 823' and other illegible text.

Photos of Bug's Heartbeat Help Fight Pests

Mr. James F. Yeager, Chief, Control and Plant Quarantine Division, Bureau of Entomology and Plant Quarantine, U.S. Dept. of Agriculture, Washington, D.C.

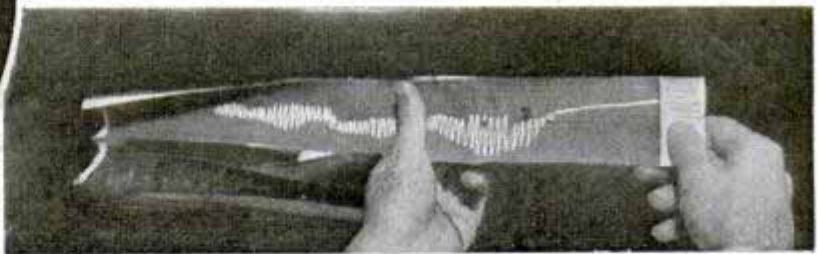
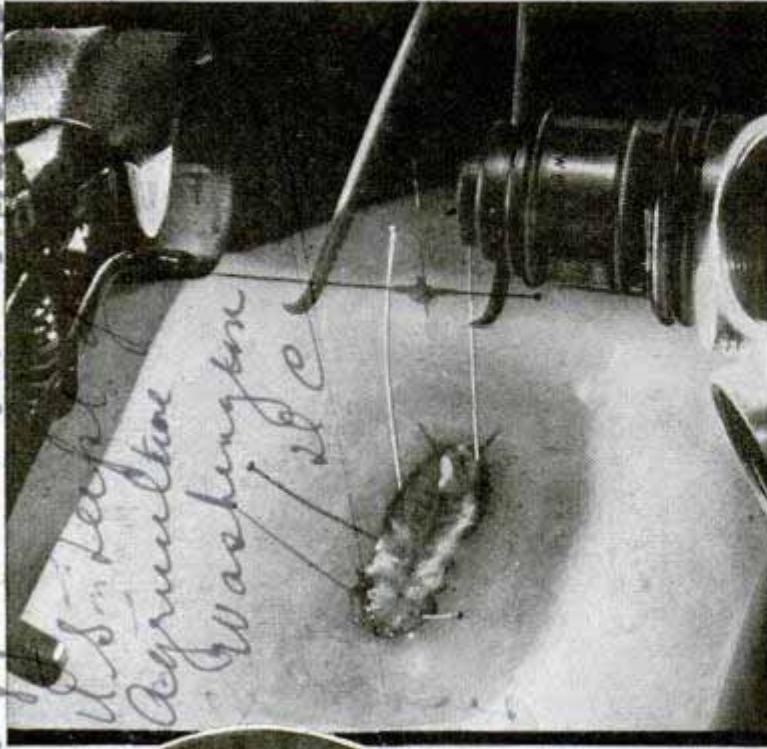

Back of insect with heart attached in block of beeswax preparatory to making pictures of heart throbs. At bottom, picture showing the heart action

Pictures of the heart throbs of insects are aiding man in the war on crop pests by serving as a measure of value of various insecticides. Entomologists figured that if they could obtain photographs of the heart action of an insect before and after it is brought in contact with a potential insecticide, they would have a picture of the worth of the insecticide. The first step was to get the heart. Since it is too small to be handled easily, the back with the attached heart is dissected and pinned in a depression in a block of beeswax. Salt solution acts as artificial blood to keep the tissues alive and active. A human hair connects the heart with a tiny

lever which moves with every movement of the heart, the motion being transmitted through the hair. An upright and longer lever arm is stained to make it opaque and a strong beam of light is trained on it. The shadow thus cast is magnified and projected from a microscope into a camera which registers the greatly magnified fluctuations on a moving roll of sensitized paper. The camera is similar to that used by physicians to make electrocardiograms of the electrical currents produced by the contracting heart. Analysis of the heartbeat of a cockroach shows the insect's heart throbs rhythmically, like the human heart, but when nicotine was added to the

Handwritten notes at the bottom of the page, including "The heart of the insect..." and "The heart of the insect..."

salt solution, the heart lost its ability to relax completely at the end of the beat. As more nicotine was added the heart relaxed less, finally remaining contracted.

Tight-Rope Stunts High in Air Require Skill and Nerve

Oil-Can Opener on Car Motor Stops Waste

Attached to the oil intake side of the automobile engine, a new oil-can opener prevents waste and saves time. It is a container slightly larger in diameter than a one-quart can. In the bottom is a sharp point which pierces the can, releasing the lubricant. If only one quart is needed, the cover of the container may be replaced, so the motorist may drive away while the oil is draining into the crankcase. Every drop may be delivered to the motor by leaving the can in the draining position as long as desired. The attachment fits several types of motors.



Here is one of the stunts which a tight-rope artist performs hundreds of feet above the street. A slip would mean death.

It takes iron nerves and unusual skill to perform on a tight rope hundreds of feet in the air. Recently a performer startled Los Angeles crowds by balancing on a rope strung between the wings of a skyscraper hotel. Among his breath-taking stunts is that of lying down on the rope, then getting to his feet again. A slip or misstep would send him plunging to the earth far below.



Inserting unopened oil can into container. Sharp points in bottom cut the can

Popular Mechanics Magazine does not publish the name of the maker of, or dealer in, any device described in its pages, but this information will be furnished by our Bureau of Information upon request, accompanied by stamped envelope.

U.S. agent wanted
Isma Lubricants Ltd. Frimbury Circus

Vertical handwritten notes on the right margin, including 'Bunny Snyder' and other illegible text.

F125 2.

the AERIAL

Train Air Terminal
Berbank, Calif.

STUNTS of

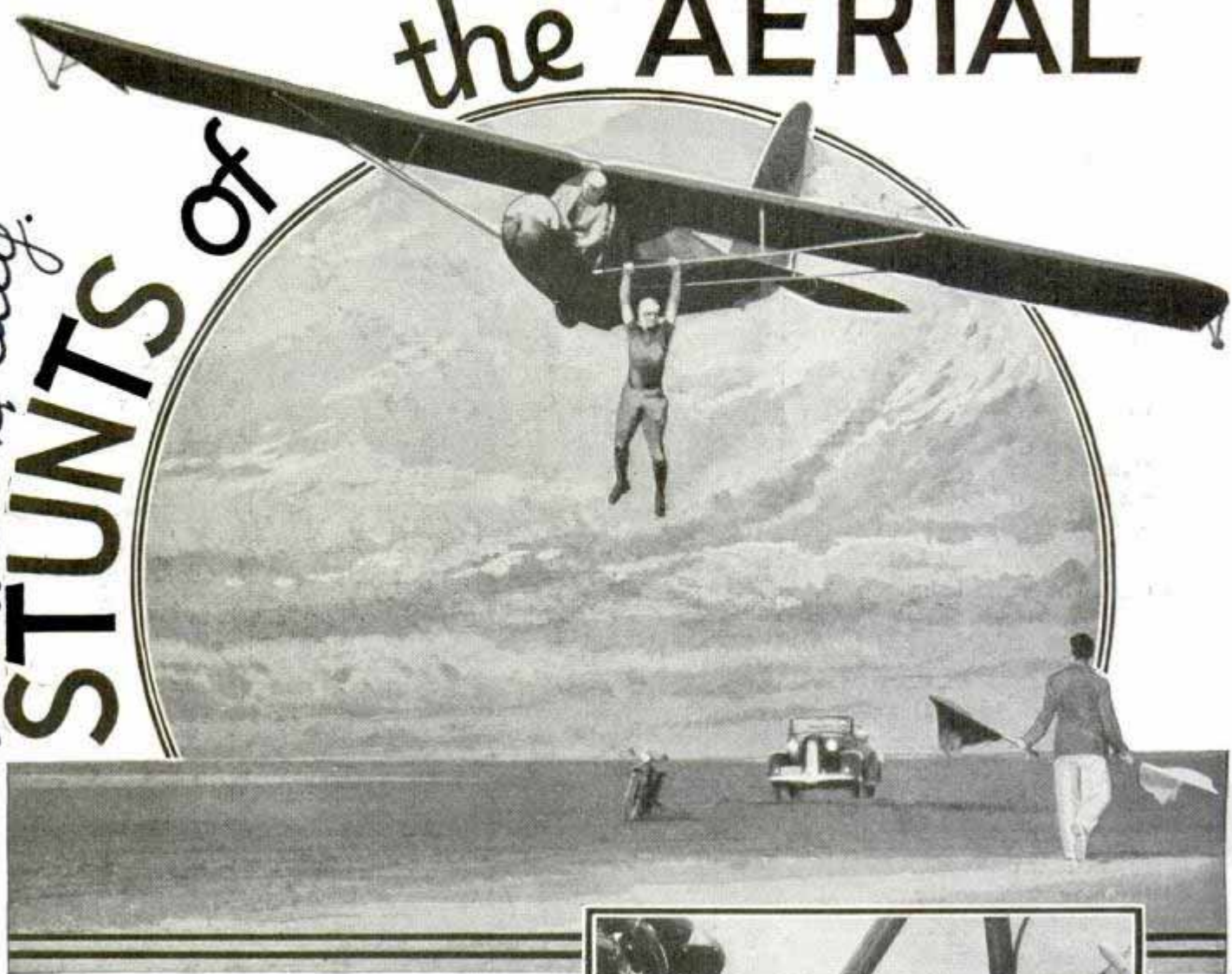

of United Air Service,

RECENTLY spectators at an air show rose up in horror at something not on the program.

"Look out," they screamed, "that plane is going to hit the other! They've collided in the air!"

Two planes had come together high above the field and were looping with locked wings. They hung together for long seconds and then miraculously one pulled away from the other. Shortly afterward both landed safely.

If the audience had overheard a conversation just before the show started they would have realized the "collision" had been planned to the last inch. While the mechanics were warming up the motors Paul Mantz, leader of the "Hollywood trio," approached Frank Clarke, another motion-picture stunt flyer.

"Let's give them a real thrill, Frank," Mantz said. "At the end of the third event

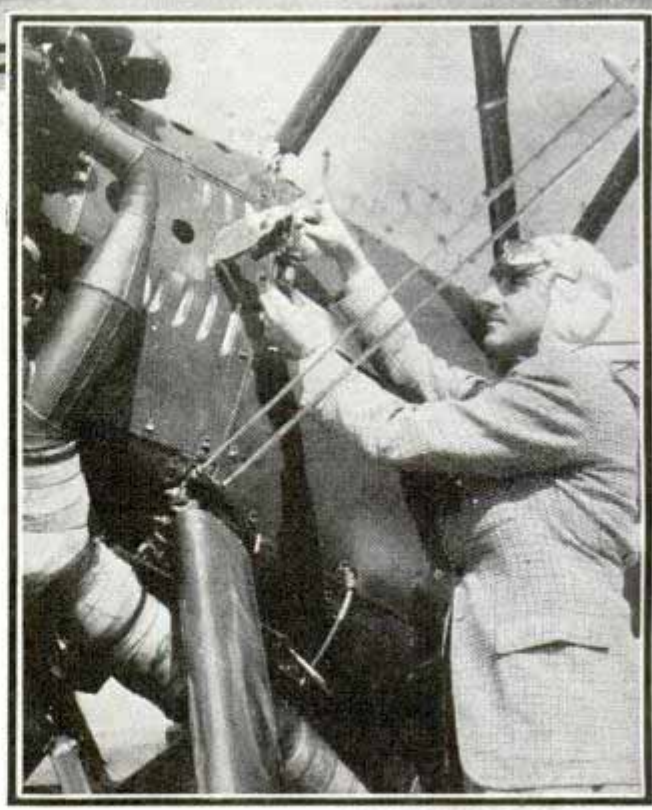

Stunt man, top, has just transferred from a motorcycle to a towed glider. Below, adjusting wind fan that pumps chemical into exhaust for smoke display

[Handwritten scribbles and signatures at the bottom of the page]

Capt. Thomas G. ...
712 500
Jr. 10555 Holman Ave
Los Angeles Calif

ACROBATS

you dive down on me from behind and lay your upper wing tip on top of my lower wing. Then we'll loop right up and over. But don't scratch my paint!"

That was the secret of the apparent collision. It came off safely because the pilots had flown together for years and each knew just what the other could do. If the slightest thing had gone wrong, the crowd would have seen an actual collision.

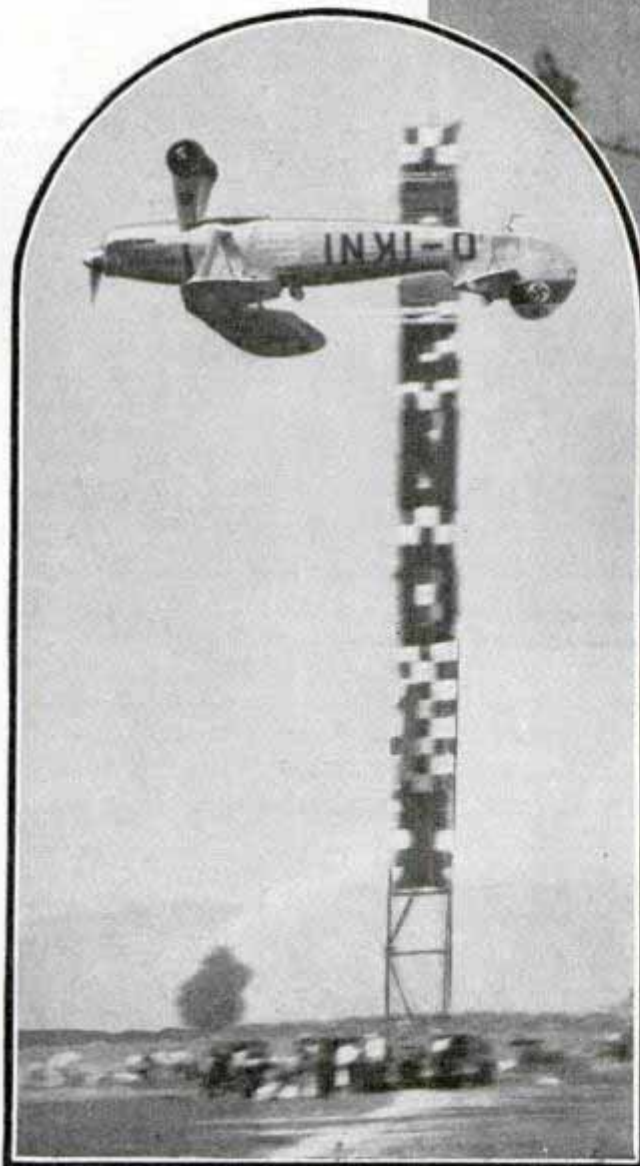

Stunt squadron leader signaling for left turn. Left, stunt pilot flying upside down

These days stunt men and exhibition flyers are thinking up new thrills for the crowds. The loops, barrel rolls, and power dives of half a dozen years ago are still good entertainment but with modern planes and engines, the pilots do things they never dared try before. Still, simple stunts are often the crowd pleasers because most of the spectators are unable to appreciate how difficult some of the new stunts are.

One of Mantz's hardest stunts is a new way of getting off the ground. With the 500-horsepower engine roaring wide open,

F1252

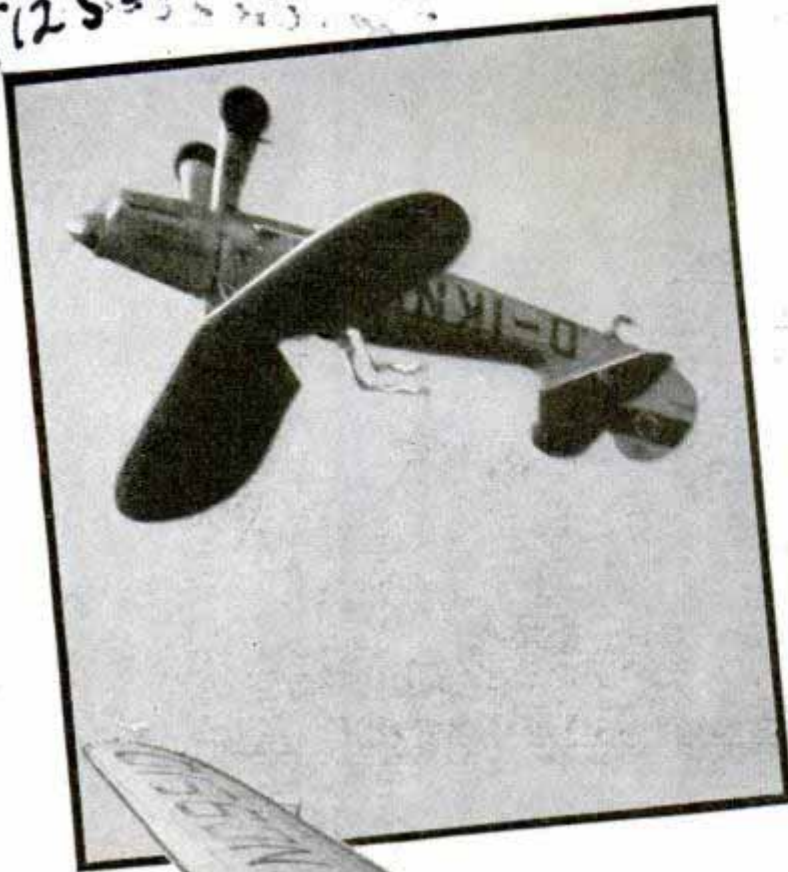

the spin. It's easier but it looks more spectacular.

Frank Clarke does one of the most dangerous stunts. Flying at 2,000 feet, he puts his plane in a vertical dive to gain speed, then pulls up sharply and points his propeller at the sky, barrel rolling the plane as he regains altitude. Clarke leaves the controls locked as the plane loses its speed and falls off into a spin. But instead of pulling out of the spin the flyer lets the plane gyrate straight toward the earth. By this time the spectators are on their feet with anxiety, but Clarke keeps falling. Fifteen or twenty feet above the ground he pulls out of the spin, just a fraction of a second before a fatal crash. Two other stunt men

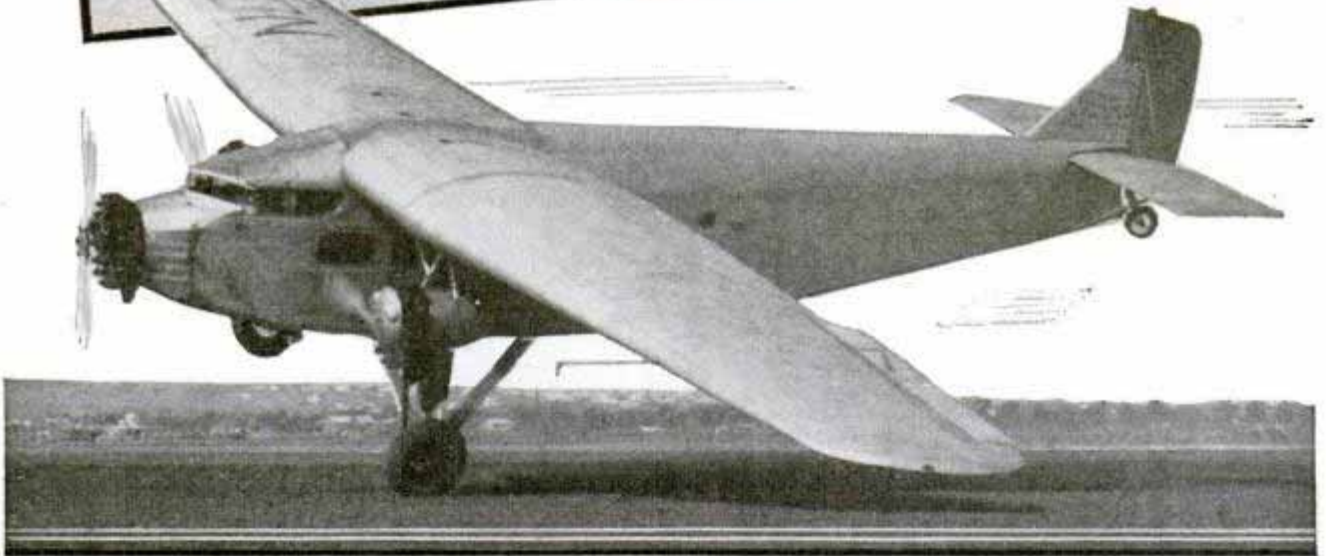

Top, stunt pilot flying upside down and holding streamers from his arms to show his hands are off the controls. Below, "crazy" flyer proceeding down field on one wheel

he gets up flying speed within a few feet of his start. When he gets off the ground, he climbs six or seven feet, rolls the plane on its back, and flies the length of the field with his head only a few feet above the ground. Then he pushes the stick forward to perform half an outside loop. This brings him right side up and headed back along the course.

A stunt like that is extremely dangerous and is hard on plane and pilot, but seemingly the crowds don't understand how difficult it is. Audiences get bigger thrills, Mantz finds, when he spins down a few thousand feet and loops the plane out of

have tried this stunt and both were killed.

One exhibition that looks pretty is painting the sky with smoke. Mantz's trio lays smoke trails through the air, each plane putting out one color of a red, white, and blue smoke screen. The planes maneuver side by side, loop with wing tips almost touching, and crisscross each other's path. For a fleur-de-lis Mantz flies straight ahead and then doubles back in a half loop to put a curl on the end of his smoke trail while his two partners, one on each side, branch away to lay the other trails. The flyers produce the smoke by pumping chemicals into their exhaust pipes, and

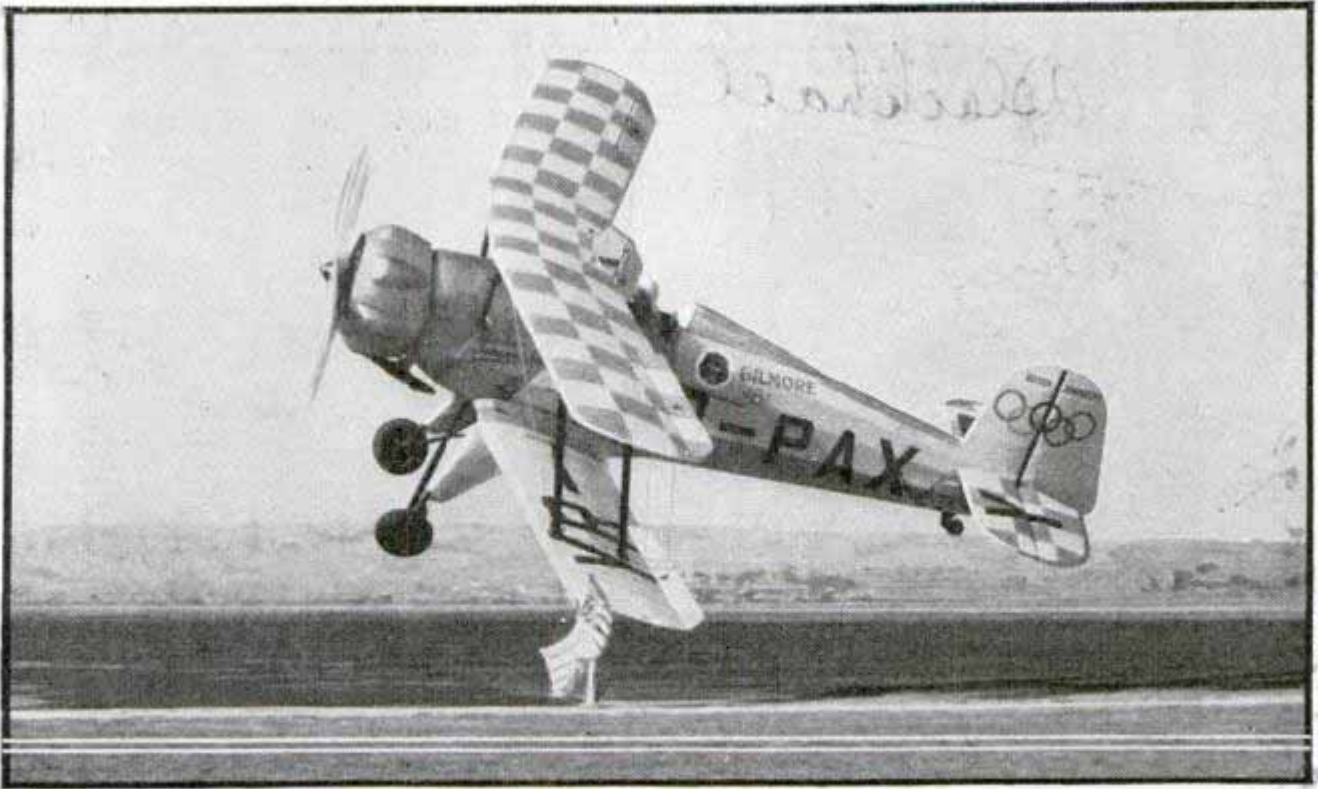

their chief concern is to stay clear of the smoke trails so there will be no chance for a collision.

The hardest smoke stunt, one that requires split-second timing, is a chain of interlocking loops. First, Mantz dives at the ground and pulls up into a loop. He starts his smoke a yard or so off the ground and shuts it off when the loop is completed. Then Clarke starts another loop above the top of Mantz's circle, laying a smoke trail that joins the first loop. Easton Noble, third member of the trio, makes the third loop above the others. By this time Mantz has gotten into position to draw the fourth

and final loop in the chain of gigantic smoke rings.

The end of the smoke show is a 10,000-foot terminal velocity dive. Two miles up, Mantz pushes his stick forward and flies wide open straight toward the ground. A trail of smoke as straight as a pencil is left above the plane. The terminal speed is 325 miles per hour and with less than 1,000 feet of altitude left Mantz "horses" back on the stick to pull out of the dive. This is the hard part of the stunt and the flyer keeps an eye on the "G-meter" so as not to pull out too sharply and fold back

(Continued to page 122A)



Top, pilot picking up flag from ground with hook attached to wing tip. Bottom, stunt pilot flying through scaffolding which represents doors of hangar

Photocell Starts Bath for Bus and Street Car

Blackhall

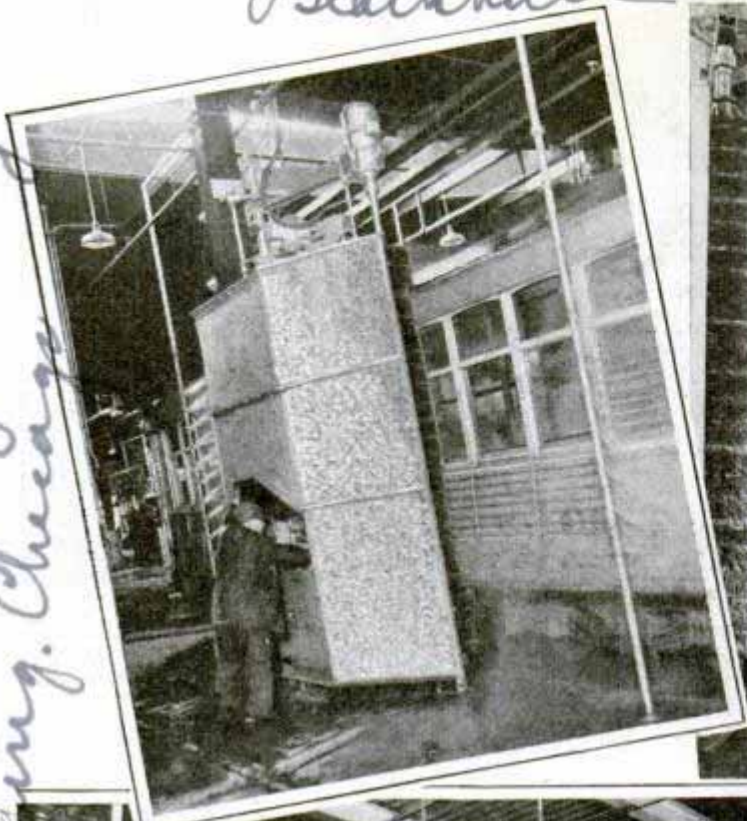

Wide World

Top, street car is first sprayed, then passes between two pairs of revolving brushes which scrub it thoroughly. Second pair, at window height, rotates in opposite direction. Below, a bus takes a shower

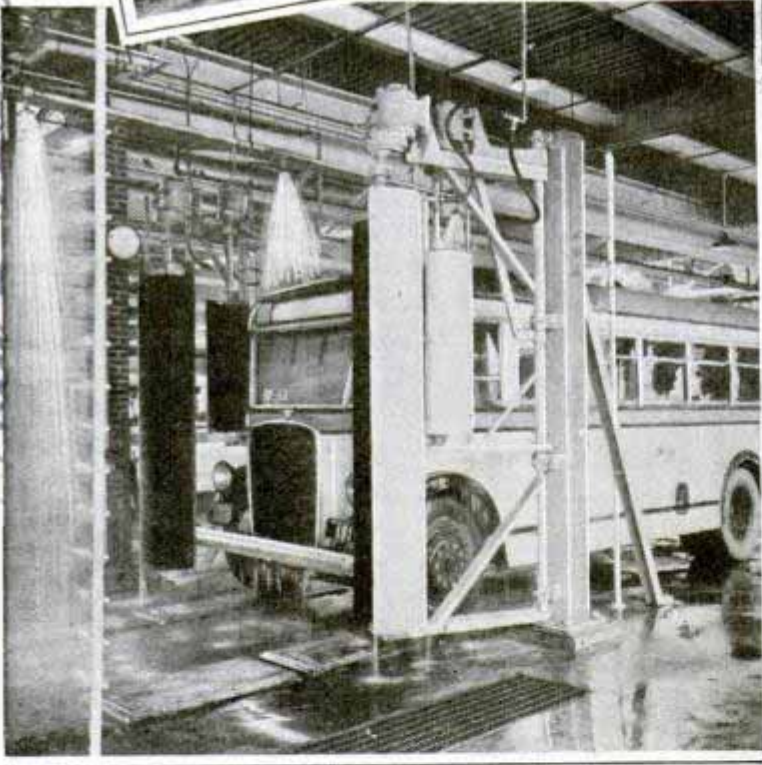

full-height brush rotating in one direction and a window-height brush rotating in the opposite direction. In this way the bristles reach into every recess and corner, thoroughly scrubbing the car from top to bottom while sprays keep drenching the brushes. Finally the car moves on toward the exit, passes through a rinsing spray and then intercepts another photoelectric cell beam which stops the brush motors and shuts off the water.

2027

Dialing "Taxi" on Telephone Brings Cab Quickly

When anyone in Stockholm, Sweden, wants to call a taxicab, he merely dials "T-A-X-I" on the telephone and a cab quickly reaches the spot. Owners of Stockholm taxicabs are member of an association which has a central control of-

Science Service.

Ross and White Co. Chicago daily News Building. Chicago

In the up-to-date bathroom for street cars and buses, an "electric eye" turns on the shower as the vehicle approaches its washing stall. No manual attendant is necessary. The car or bus intercepts a light beam and sets in motion a series of sprays and revolving brushes. An initial spray wets the sides. Then the vehicle passes between two pairs of brushes, a

...fice and 187 stations with one-way telephone connections. When a call is received at the control office, it is relayed automatically to the station nearest the address at which service is desired. Stockholm also boasts a weather-forecast service and a time service for telephone subscribers. Both are automatic.

28

Battery Is Charged by Extra Wheel under Trailer

To provide extra current for trailers and trucks, and recharge storage batteries, a special generator operated by a fifth wheel on the trailer is being manufactured. The small auxiliary wheel is fixed by a pivoted casting to the underside of the vehicle, and as it whirls along the highway it develops twenty amperes at twenty-two miles an hour. It is particularly useful on tourist trailers where there is heavy demand for current from lights, and other accessories.

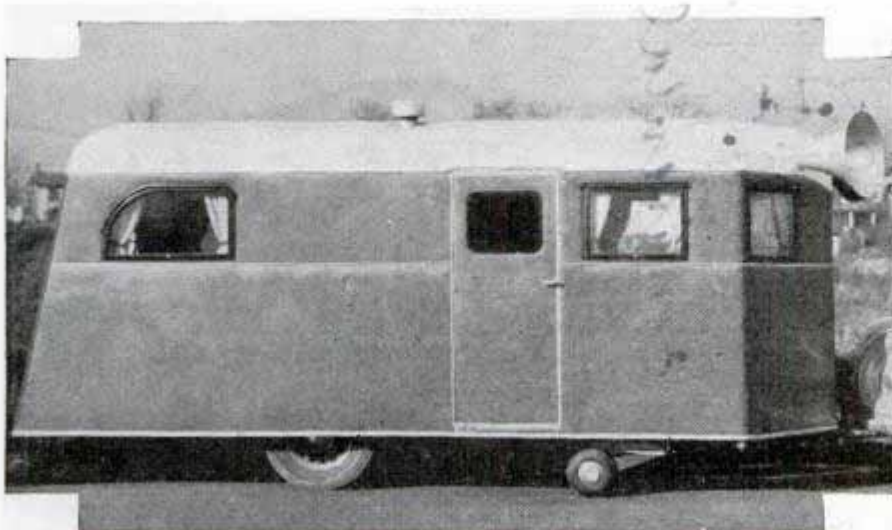

Lights, radio and other outlets on trailer homes tax the battery heavily. The small wheel under this trailer generates current while touring

Plaza Flooded for Skaters in Heart of New York City



Even New York City is not so crowded as to shut out winter sports. The plaza at Rockefeller Center was flooded to create this skating rink

You might call it a million dollar skating pond, this rink on the plaza in Rockefeller Center. For, although it cost little, the ice rink occupies a valuable piece of property in the heart of New York City. It was installed during the holiday season so that skaters could enjoy a bit of winter sports in the shadow of two gigantic Christmas trees.

Iodine, a foreign monopoly until 1932, is now produced in the United States from salt brine and the waters from oil wells at the rate of 276,000 pounds a year, making this country the second largest producer.

General Armature Corp. Industrial and Engineering News
700 Clinton Avenue

330 City 42nd Street
APR 19 1936

Harness Lifts Small Dog over Muddy Places

F 1709



Lifting a short-legged dog over muddy places is made easy by this harness

Fashioned so that it will lift the dog without discomfort, a harness introduced recently in Paris is used to carry short-legged canines over muddy ground. The harness is especially handy at street crossings in rainy weather, because it keeps the dog from getting wet and muddy.

Sanitary Milk-Bottle Carrier Protects Hands from Injury

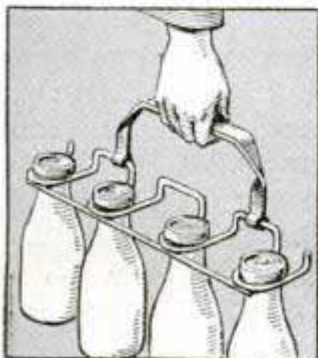

Safe and sanitary, a milk-bottle carrier which obviates any handling of the bottles by the milkman himself has been invented. The carrier grips the bottle by the

lip or rim, and the delivery man need not touch the glass in transferring bottles from case to house. This eliminates the hazard of cuts from nicked bottles.

Is. 3.

Vacuum Scrubber Cleans Floor and Picks Up the Lather

Floors are scrubbed and thoroughly cleaned in one simple operation with the aid of an electrically operated vacuum scrubber which not only does the cleaning but picks up the dirty lather as it moves along. The cleaning solution is fed from a tank through a fifteen-inch revolving brush which distributes the solution evenly and cleans as it moves. A fraction of a second later, a nineteen-inch vacuum nozzle sucks up the used lather and deposits it in an exhaust tank. This prevents the dirty solution from drying into the floor and eliminates any chance of soaking or warping the floor surface. The scrubber works sidewise, as well as backward and forward, with the entire weight of the machine on the brush which is operated by a splash-proof, geared-head motor. The scrubber can be used for shampooing rugs without removing them from the floor, the carpets requiring no rinsing or resizing. The scrubber also can be used for dry vacuuming and can be obtained with or without the vacuum attachment.



Vacuum scrubber which cleans the floor and picks up the dirty lather in one operation

Mr. Charles D. Hoffmann, 206 Hill St. Fairbanks, Pa.

Continental Car. Co. of Pa.

Rubber Monsters Inflated for Gay Parade



Putting finishing touches on "Snake Charmer" for gay parade down Broadway



Grotesque rubber figures inflated and ready to be carried in the parade

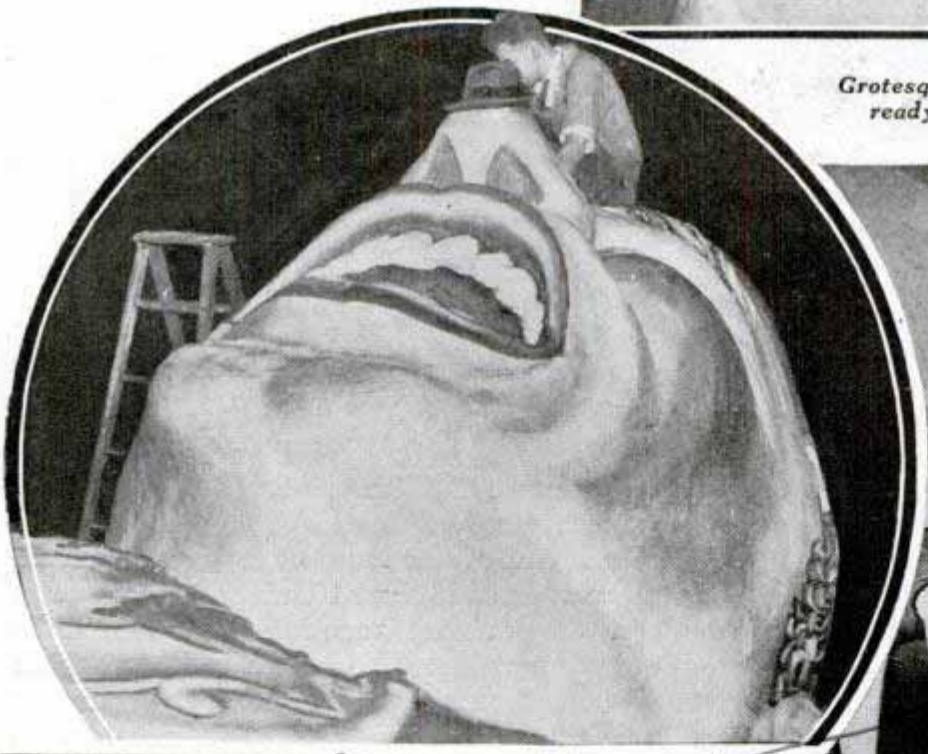

Working on head of rubber giant. Right, inflating with helium a mammoth made of rubber. These monsters were features of Christmas parade down Broadway in New York, an event witnessed by 2,000,000 people. Constructed by a rubber company, the figures were designed like balloons and were handled by "ground crews." One of the giants represented Father Knickerbocker, a sixty-eight foot balloon which peered into sixth floor windows and was held to earth by a crew of thirty-five men

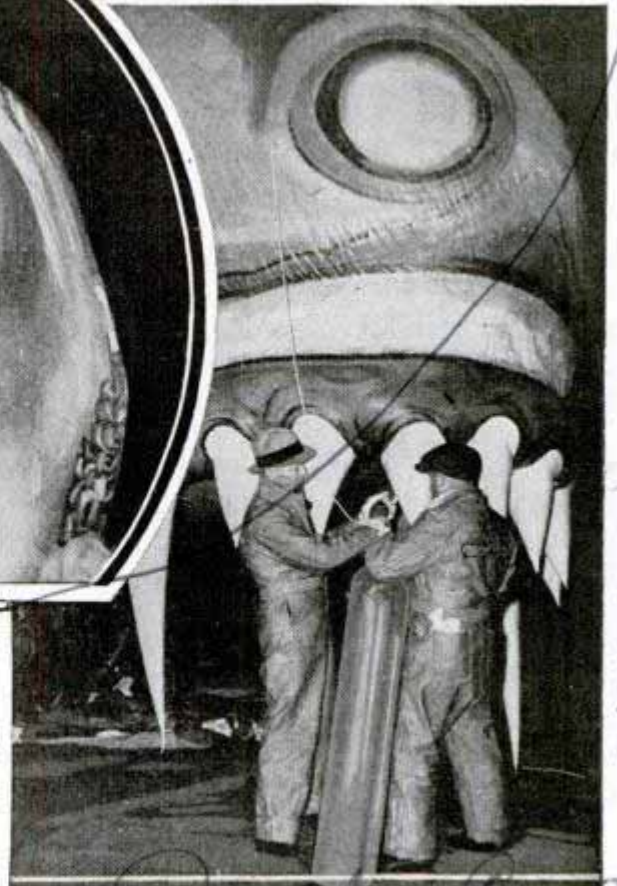

Hoodyear Tree + Rubber Co

*Macy's
34th St
New York
Nov 1934*

71640.
64 Kerbland St.
Cambridge Mass
Bureau of Street Traffic Research
Cambridge, Mass.

Mr. G. S. Jordan
64 Kerbland St.
Cambridge Mass

How GOOD a DRIVER

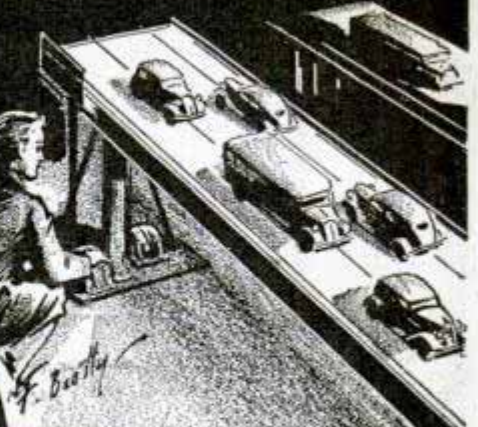

How do women compare with men in driving ability?
Does your age affect your ability as a driver?
Is a youth of twenty-three with five years of driving experience likely to be a better or worse driver than a man of sixty with forty years of experience?
At fifty miles an hour, how far do you travel while moving your foot from accelerator to brake pedal?
After twenty-five years of driving experience, which would be likely to steer a car best—a man or a woman?
How can you equip your car to compensate for "tunnel vision"—inability to see out of the corner of your eye?

Giving vigilance test which indicates ability to concentrate and act in emergency

HOW good a driver are you, or how good a driver would you make?

How do women compare with men in driving ability?

Has the average man or woman the strength, mental alertness and nervous stability to handle the powerful cars of today at the high speeds now common?

More than 40,000,000 men, women and even children drive 26,000,000 motor vehicles a distance of 400,000,000,000 passenger-miles annually. The automobile has brought happiness, richer opportunities and new horizons to millions, but it also brings sudden death to about 36,000 persons each year. Since we cannot change our individual natural equipment, what can we do to become safer, more efficient drivers?

A Harvard scientist, Dr. Harry R. De Silva, can answer these and many other questions about driving with a fair degree

of accuracy. With specially designed instruments and scientific equipment, Dr. De Silva, of the Bureau for Street Traffic Research of Harvard University, has tested the driving reactions of more than 70,000 persons. The results indicate where we excel, where we are poor, and whether we can or cannot correct our weak spots.

Several general findings may be stated immediately. One is that women, on the average, did not do as well as men in the tests. At the risk of stirring a hornets' nest, it must be stated that women, as a whole, did not come up to the men either in the potential or natural abilities which go to make up a good driver or in the acquired skill.

are YOU ?

see Dec. 1936
855

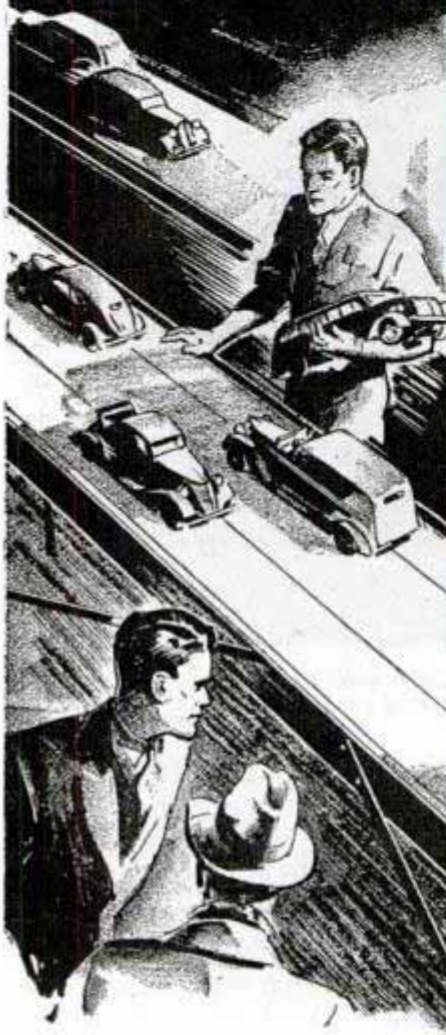

Model of street intersection, above, used to teach safe driving to Chicago high-school students. Below, miniature highway used in driving test

Another observation applicable to the majority of those tested is that youth has much to do with driving ability. The peak of efficiency was found to be about twenty-three. A slow decline in driving efficiency was noted up to the age of sixty or sixty-five, and after that the decline in almost every ability required for motoring was very rapid. As people grow older they slow up in certain reactions. This might seem to justify the law in Massachusetts requiring licensed drivers of sixty-five to pass a new driving examination.

A third discovery is that experience in driving adds greatly to efficiency. This may seem obvious, but it is a challenge to states which do not require any driving license, giving anyone the privilege of op-





Driving school of Lane Technical high school in Chicago where indoor instruction is given. Later the students go to an outdoor driving course and pilot real cars

erating an automobile regardless of training or experience. The tests showed that, up to a certain point, the longer a person has been driving, the better he is. Perhaps the most encouraging finding of all was that the great majority of people have all the potentialities for becoming good and safe drivers. Even when they lack some natural requisites, they can usually compensate for them, as by wearing glasses.

Dr. De Silva's instruments are designed to measure physical characteristics such as eyesight, hearing and the coordination between eyes and hands; mental characteristics such as vigilance, self control in emergencies and other psychological factors, and acquired characteristics such as skill in passing, sense of hazardous situations, attitude toward individual responsibility and conscious allowance for known physical and mental limitations. These devices duplicate certain emergency situations and give more accurate and significant indications of the driver's responses than could be obtained by unaided human observations.

For nearly ten years most of the increase in motor deaths has been due to collisions, so Dr. De Silva tested brake-

reaction time, the time it takes a driver to appreciate danger and start to apply the brakes. The average was found to be .44 of a second, but in this, as in other tests, men on the average did better than women. Reaction times up to a full second were recorded, which means that after seeing danger the driver going fifty miles an hour travels seventy-three feet before the brakes begin to take effect. Then he must allow time for stopping after the brakes are applied.

The ordinary person under forty takes about one-fifth of a second to start to lift his foot from the accelerator and the same or a little longer to move his foot and stamp it on the brake. As people grow older their thinking time remains practically constant, but their foot-movement time slows up.

When the driver is required to stop at the same time he steers, braking time lengthens by about .12 of a second, coming up to about .56 of a second if you are an experienced driver. With the inexperienced driver it lengthens by about .45 of a second, bringing the total braking time to nearly one second. To these figures must be added the time required to bring the

71690

car to a stop after brakes are applied.

Many persons are distracted more easily than others; when out on the road their minds wander. Then their reaction time goes way up. Women were found to be quite fast when all they did was apply the brakes, but much slower than men when steering was added. When people do braking and steering at the same time, the unskilled driver will do both much worse; the driver of some experience will do either poorly, putting his whole attention on one and forgetting the other. The driver of long experience does both only slightly more slowly than when he does them separately.

Steering ability alone also varies enormously with the experience of the driver. In this test—essentially one of eye-hand coordination—the group with no driving experience scored below the average for all groups. Those with some learning experience scored close to the average, while those with from one to five years' experience did consistently better.

The high point both for women and men seemed to be reached with a driving experience of from six to ten years, the men's average standing about six per cent higher. However, while the men's steering ability declined steadily with years of experience beyond the tenth year, the women's remained constant up to the twen-

(Continued to page 118A)



STOPPING DISTANCES OF MOTOR VEHICLES WITH BRAKES IN AVERAGE CONDITION (INCLUDING THINKING TIME)

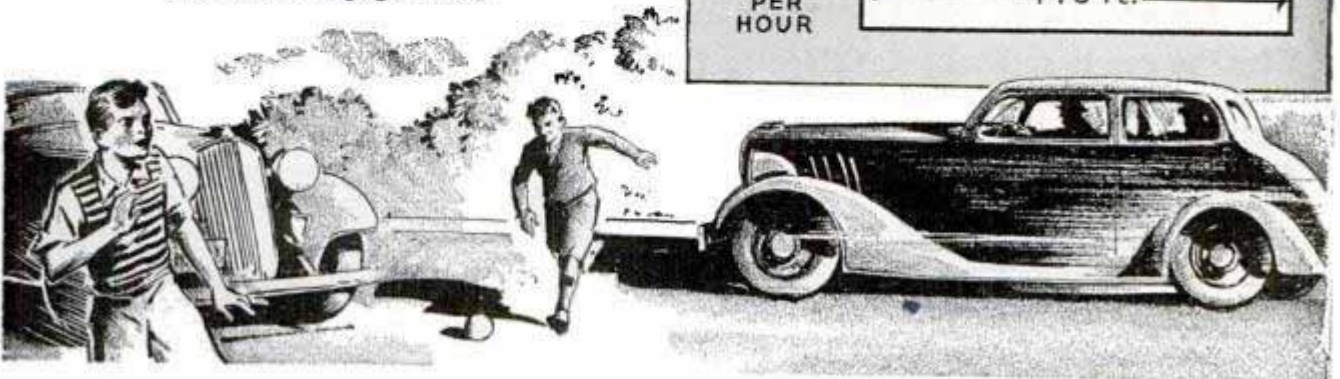
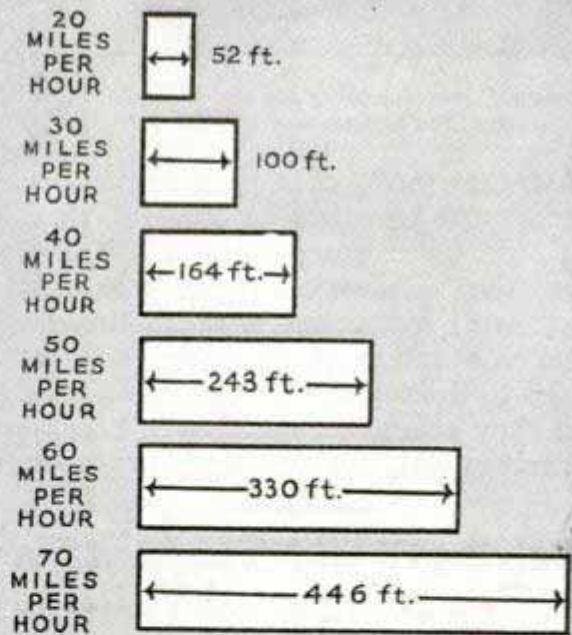

Driver, above, ready to take reaction test. Below, chart shows how stopping distance goes up with increase in speed. Note difference between thirty and sixty miles an hour

Metal Louvers of Awning Lifted by Turning a Crank

Brins metal Lite Awnings. Inc. 2 Ralph Ave. Brooklyn, N.Y.

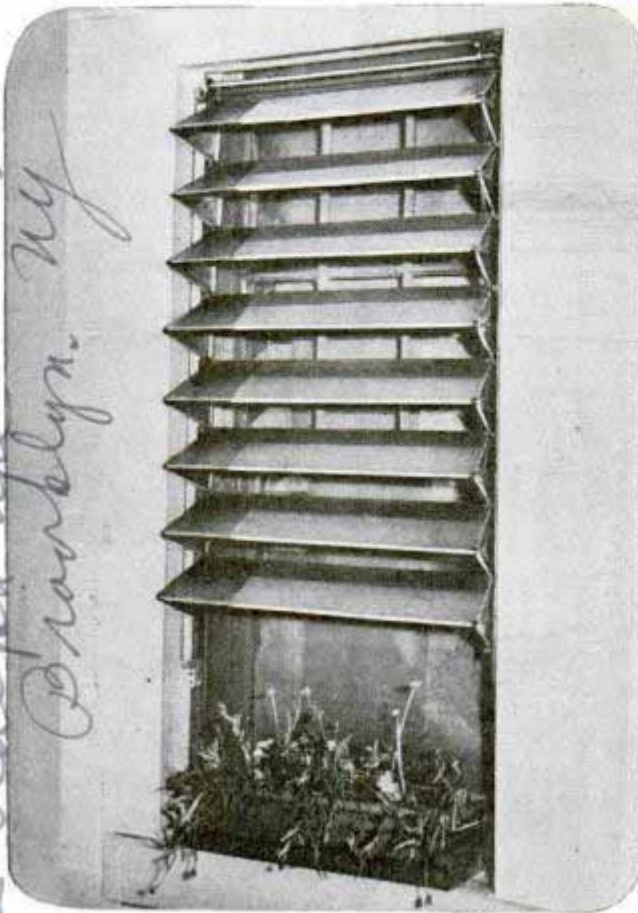

Fireproof, metal awning for the home is raised or lowered like the window of your automobile

Awnings made of copper or aluminum louvers can be raised or lowered to control light by turning a crank just as you open the window of your automobile. They are constructed to allow the maximum ventilation at all times, and when raised to the top the louvers are nested so that they occupy but a few inches. Being entirely metal, the awning is fireproof.

Solving Riddle of Light at Sea Brings Improved Vision

F169 Physicist Science Service

Why the sea is so blue, why ships and cliffs near the horizon sometimes have no reflection in the water and why big black clouds on the rim of vision do not darken the sea until they are high in the sky are some of the old riddles solved recently by Dr. E. O. Hulburt of the Naval Research Laboratory, Washington. As a result of Dr. Hulburt's experiments in this field, there has been developed an optical filter which improves marine vision with binoc-

ulars and sextants. The physicist found that light from the sky reflected off the waves is strongly polarized and the light from the rim of a breezy sea is mainly sky light reflected from a region about twenty-five to thirty-five degrees above the horizon. The reflecting facets of the waves are thus only at an angle of about fifteen degrees from the horizontal. For this reason a ship coming over the horizon may be seen directly without having any reflection in the water. Similarly black clouds do not start to turn the sea black as soon as they come over the horizon, but only do so when they reach an altitude of about twenty-five degrees. Using special polarizing filters on marine binoculars and sextants, Dr. Hulburt was able to cut out much of the polarized glare from the sea's surface and render the horizon more distinct with resulting increased accuracy of navigating sights.

Luminous Paper Used to Light Photographer's Darkroom

Gummed white paper coated with a luminescent compound is being used as a "safe light" for the photographer's darkroom. It emits a pale greenish glow which, properly used, does not affect fast panchromatic emulsions. The salt-compound coating requires activation from time to time by exposure to light, a few seconds exposure to a bright light being sufficient to cause it to glow for hours.

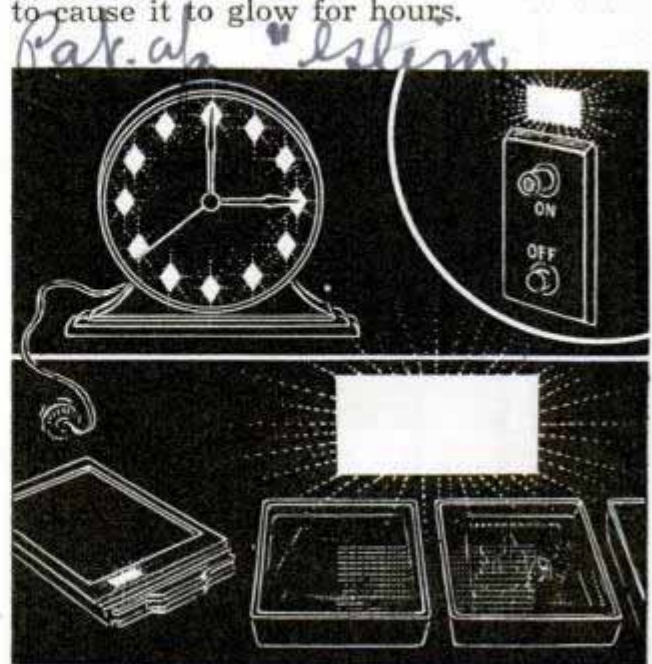

Patches of luminous paper used as guide in photographic darkroom without affecting emulsions

Photo Research, Inc.



English TELEVISION RECEIVER *for* Home Construction

COMPLETE construction details for a cathode-ray television receiver suitable for tuning in both the Baird and Marconi E.M.I. systems operating in England, have been made available to English amateurs by "Television and Short-Wave World" published in London.

Of low-cost unit construction, it is said to be easy to build and results are guaranteed to compare favorably with those obtained from a high-class commercial television receiver if the builders faithfully follow the instructions in every respect. This high-definition receiver employs a cathode-ray tube having a 10-in. black-

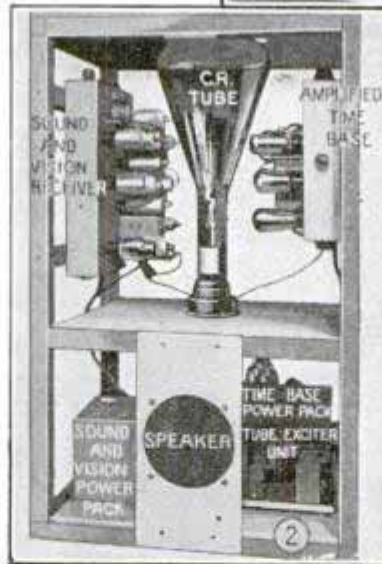

and-white screen. All units are assembled in a simple wooden framework, two photos of which appear in Figs. 1 and 2, a control panel being omitted in order not to obstruct the view. The sketch below shows the relation of the various units used in the receiver.

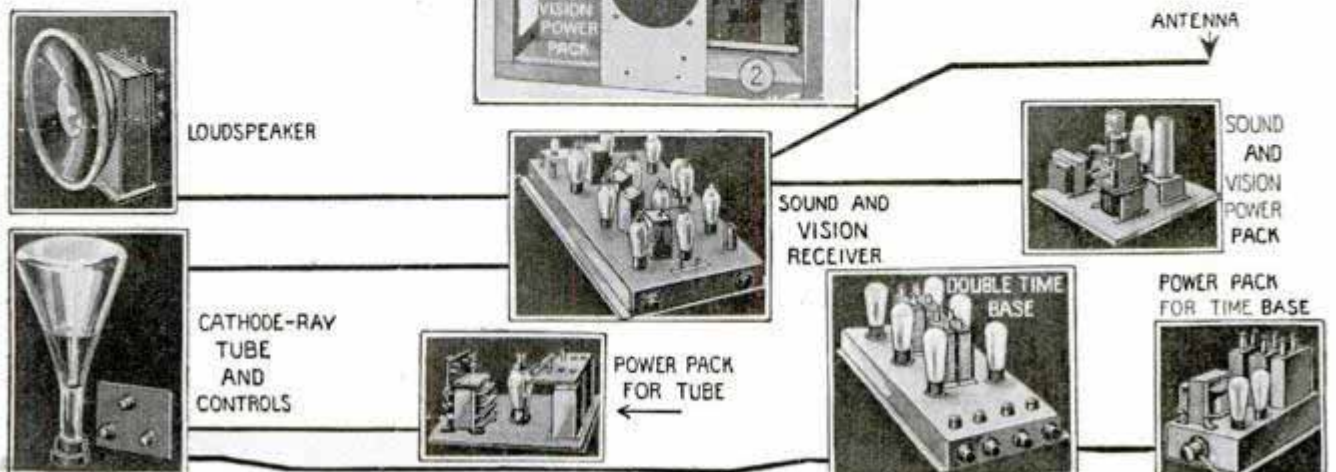



ONE-TUBE Receiver for

volts, which is easily obtained from either a 6-volt storage battery and B-batteries, or a 6.3-volt transformer and a small well-filtered B-eliminator. Maximum results, however, are obtained with battery operation.

Schematic diagram Fig. 1 shows one triode section of the tube is used as a regenerative detector and the

ONE metal tube does the work of two, in this inexpensive short-wave receiver which demonstrates a "DX getting" ability equal to that of many sets using several tubes. Since its features include band-spread tuning, it is an excellent performer in the crowded amateur bands as well as for foreign and domestic programs on 19 and 31 meters which are of special interest to all short-wave listeners.

This type-6N7 tube has a 6.3-volt heater and requires a B-supply of from 45 to 135

other is employed as an audio amplifier. Midget variable condensers, "C₂" 15 mmfd. and "C₃" 140 mmfd., also variable resistor "R₃," are mounted directly on the aluminum front panel. A stand-off insulator supports the 0 to 30-mmfd. antenna-trimming condenser "C₁," which is adjusted with a small screwdriver for best reception with each plug-in coil. The ½-watt 3-megohm fixed resistor "R₁" is mounted directly on the terminals of the tube socket. Hook-up wire with push-back insulation is used for all connections, which must be soldered carefully with rosin-core solder. Direct short leads are

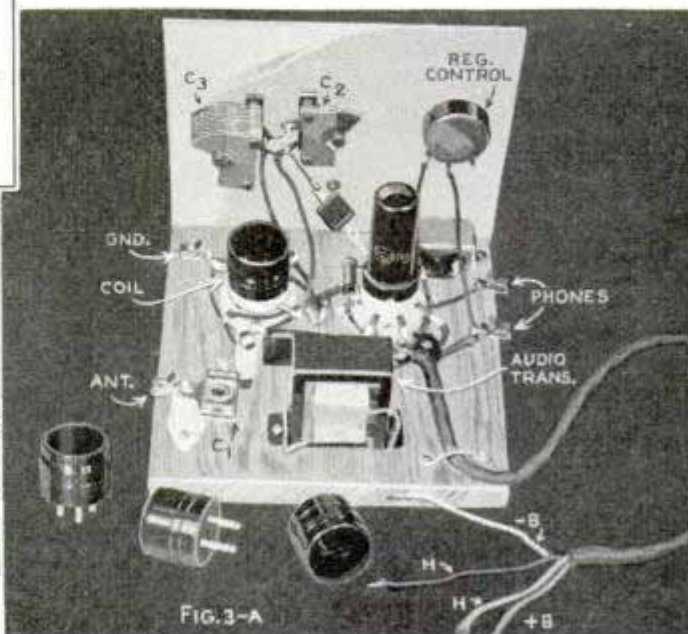
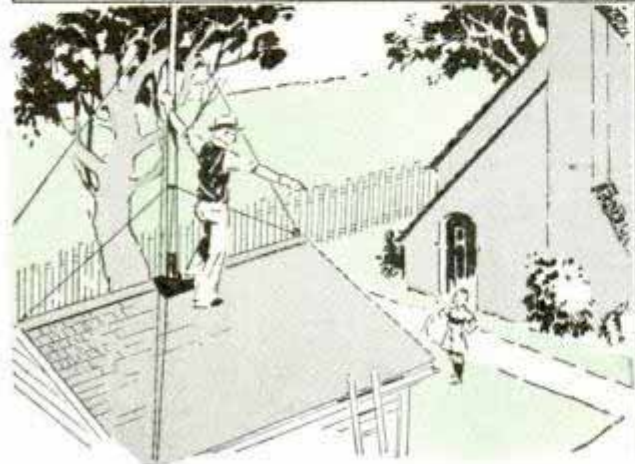
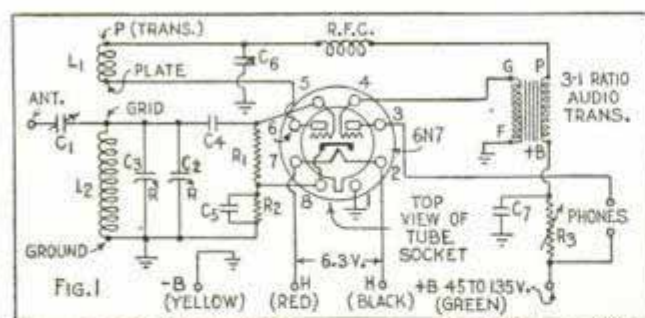

6N7 Short-Wave Beginners

more important than attractive wiring. All ground connections are made to the cluster of soldering lugs.

Any standard 4-prong, plug-in short-wave coils may be used, those shown being of the "tube-base" variety. Proper connections to the coil socket will depend upon the particular set of coils employed. The important thing is that the coil socket be wired so that the coils are "poled" as shown in diagram Fig. 2, which is necessary if the set is to oscillate properly. Following these

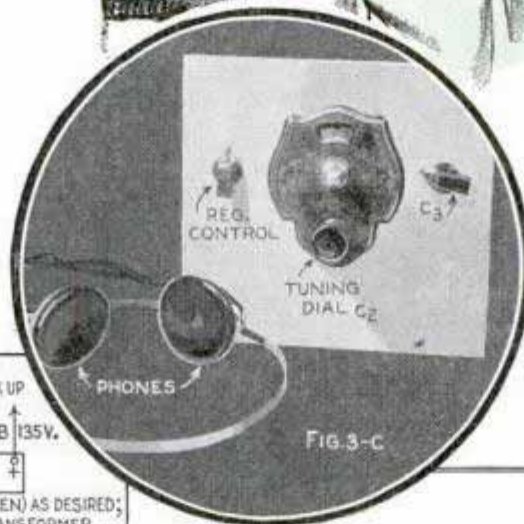
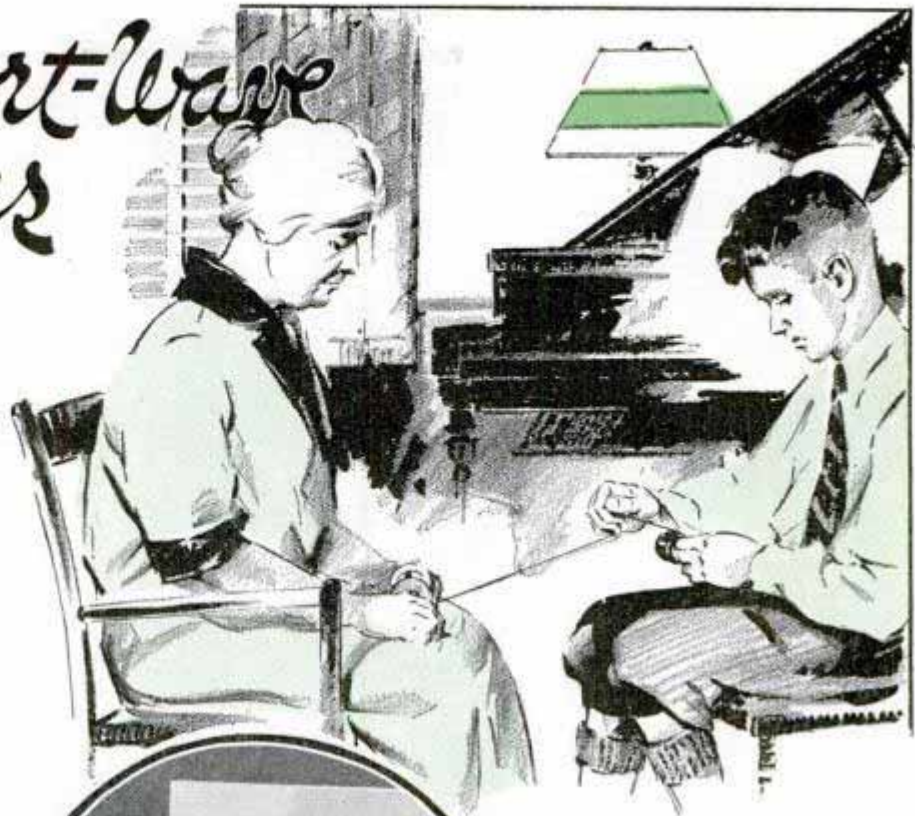

coil-winding details, the builder can easily wind his own coils if desired. A complete simplified wiring diagram is shown in Fig. 3 and the battery hook-up in Fig. 3-B; photos, Figs. 3-A, 3-C

(Continued to page 146A)

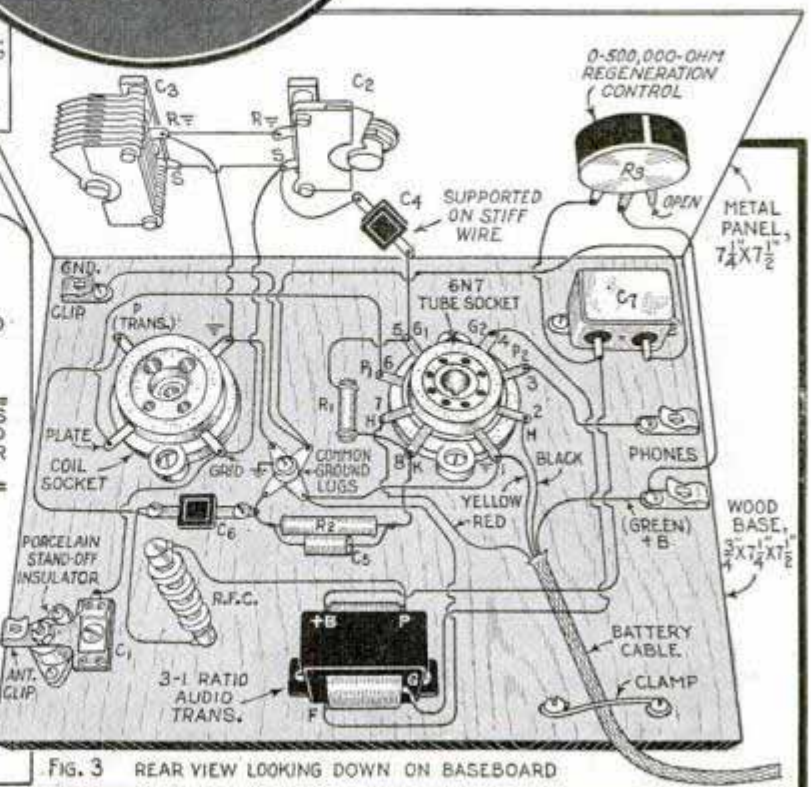
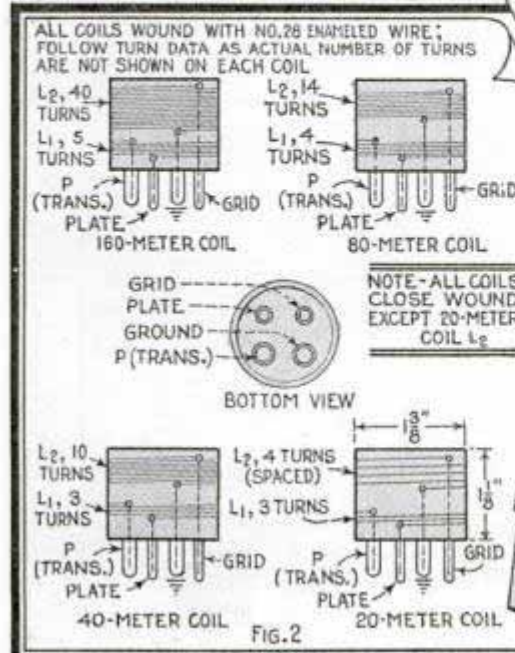
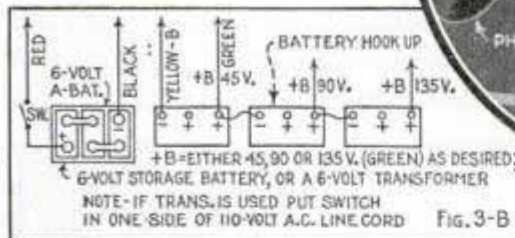

"Beam" Tube in 40-Meter C.W. Transmitter



MODERN as the metal tube, this 40-meter crystal-controlled transmitter is especially designed for the beginner. It costs no more than the average 2 or 3-tube short-wave receiver and has a range of about 500 miles.

A single type-6L6 "beam" tube is employed in a highly efficient crystal-controlled circuit, complete with an antenna-matching device for coupling to an easily erected single-wire transmitting antenna. The 6L6 serves as a "tritet" crystal oscillator using an 80-meter crystal and doubling to 40 meters in the plate circuit. Operating the transmitter at a frequency twice that of the crystal insures clean keying and good frequency stability. The tube is such an efficient oscillator that the output is as much when doubling as it is when the plate circuit is tuned to the crystal frequency.

Built in "breadboard" layout fashion, the "Masonite" baseboard is supported on wood cleats and clears the table by about 1 1/4 in. so that some of the small parts may be mounted on the underside. The baseboard material is inexpensive, a good in-

(Continued to page 156A)

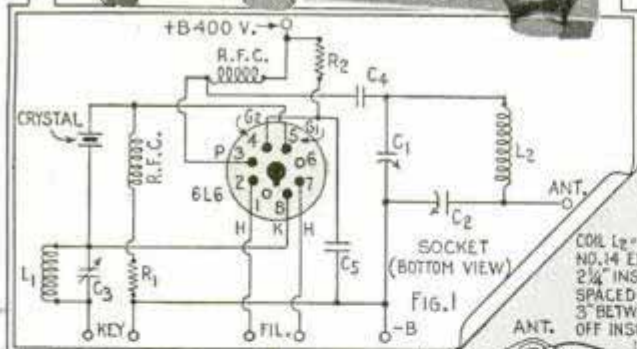
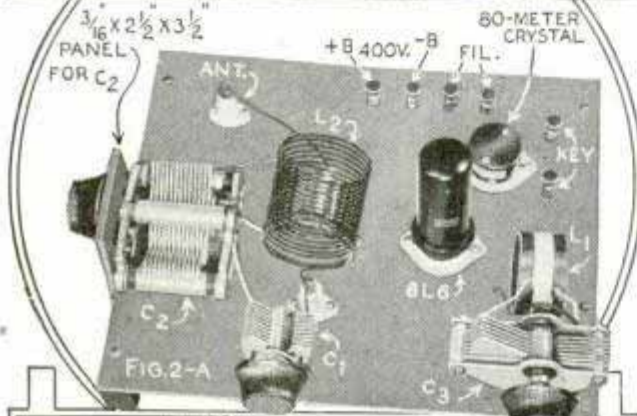

MASONITE BASEBOARD
3/8" X 10" X 12"
(SUPPORTED ON WOOD CLEATS)

Fig. 2

X-RAY VIEW LOOKING DOWN ON BASE

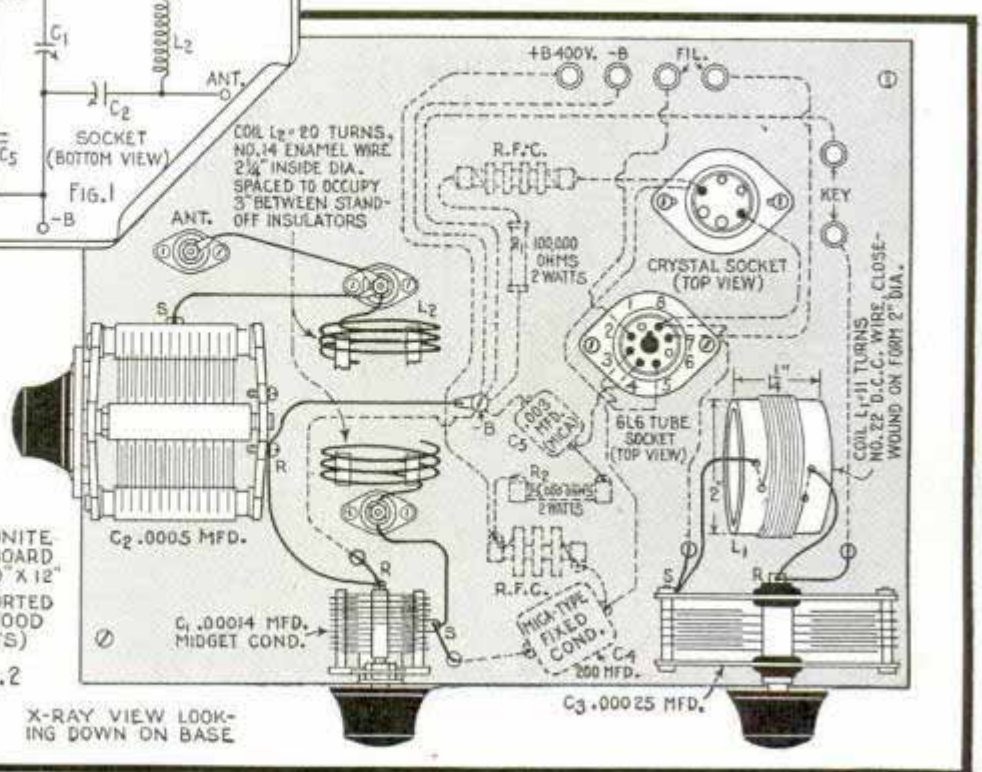

Practical RADIO SUGGESTIONS

Right, midget receiver built into a modernistic bookcase; almost any small set can be arranged in this manner. Photo No. 1 shows the matched panel assembly made by a reader who merely altered the dial and speaker arrangement of a midget a.c.-d.c. receiver described in a recent issue

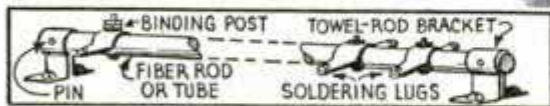

Terminal strip for experimenters. Below, holder for drilling tube-base coil forms

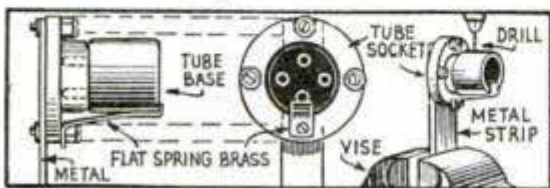

Below, tapered reamers, side-cutting nippers and pliers for radio workers

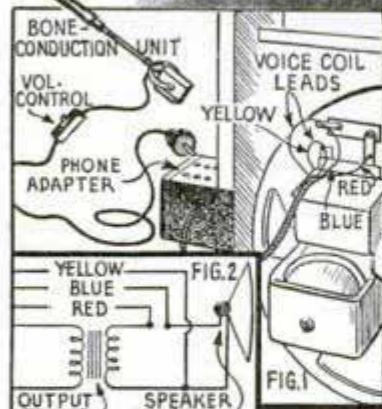
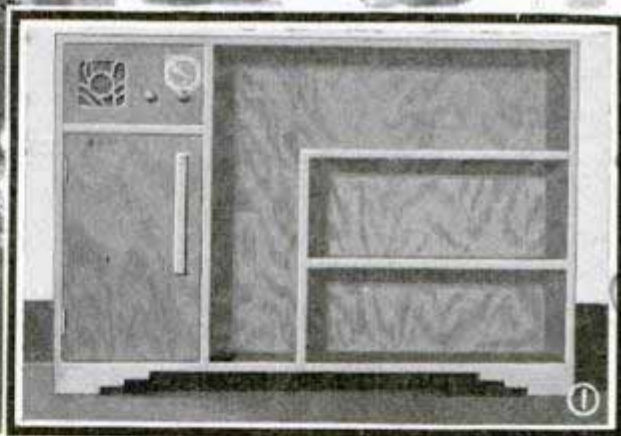
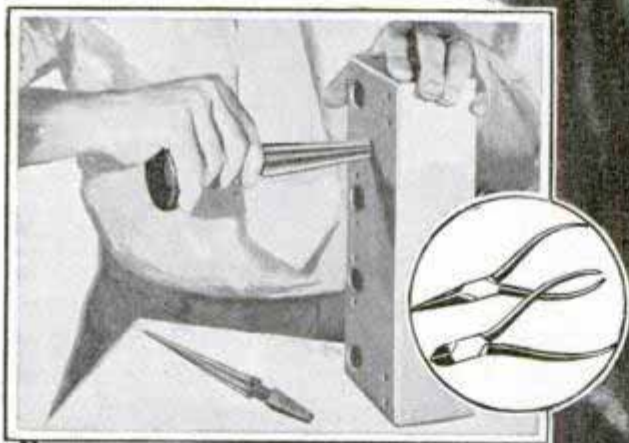

Left, hearing-aid adapter easily connected to the voice coil of your loudspeaker permits the use of earphones for listeners with sub-normal hearing, or bone-conduction units for those having defective eardrums. Fig. 1 illustrates the method of mounting and connecting the adapter. Fig. 2 is schematic diagram. Below, suggested hook-up diagrams for using a double-button carbon microphone with any audio amplifier. Fig. 1 employs a rheostat to control the button current. A potentiometer may be substituted at X and Y as in Fig. 2

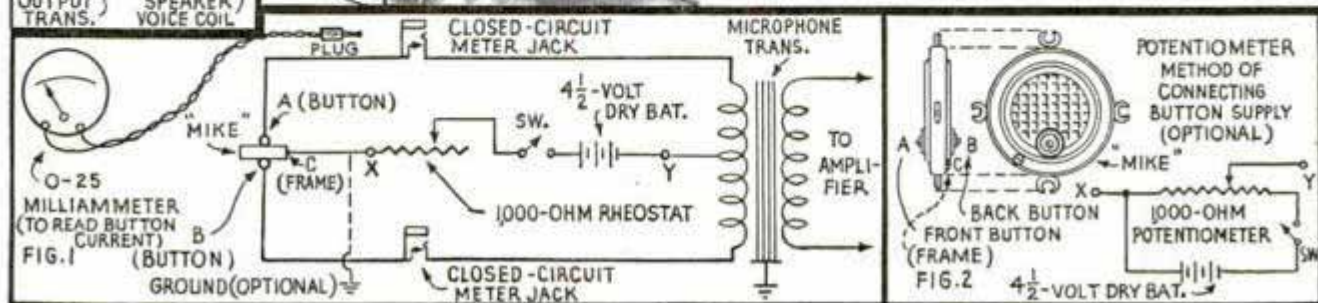

Movie Dial Flashes Call Letters from Motion-Picture Film



Above, dial drum and projector lens. Right, front view of screen and tuning controls

Operating on the principle of a motion-picture projector, enlarged call letters and cities of 130 broadcasting stations in the United States and Canada appear on a ground-glass screen in this all-wave receiver. The dial scale is printed on a strip of film mounted on a drum which rotates with the tuning condenser. Light from a projector lamp passes successively through a condenser lens, the dial film, color filter and a projector lens to a reflecting mirror.

Noise Filter for Oil Burner

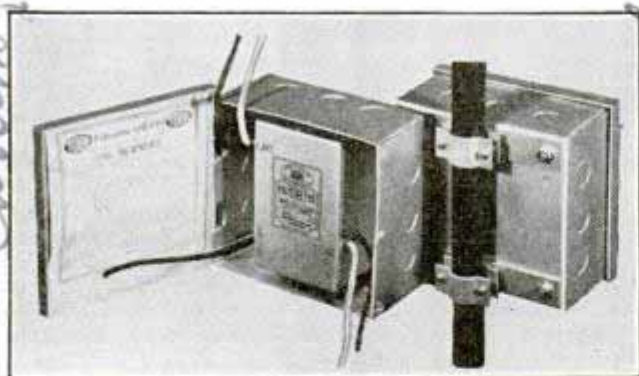

Designed to eliminate interference which prevents good reception of broadcast and short-wave programs during the ignition

period of an electrically ignited oil burner, this compact unit offers a simple solution to a troublesome problem. The filter is connected to the oil-burner transformer and the remaining wiring by means of color-coded, insulated, flexible leads so that any serviceman or electrician may install it on all makes of oil burners. Inserted between the primary of the ignition transformer and the other wiring it keeps ignition interference off the power system without in any way affecting the operation of the burner. The rear view shows two detachable mounting brackets by which the unit is fastened to one of the pipe standards supporting the burner assembly.

Rainproof "Umbrella" Speaker



This umbrella-type dynamic speaker, for public address, is suitable for either outdoor or indoor use in parks, auditoriums or dancing pavilions where uniform sound distribution is desired. A single 12-in. speaker does away with the usual horn clusters having beam effects that sometimes cause microphone feed-back. It may be suspended from a ceiling, or supported on a pipe from the ground.

Blueprints covering radio construction articles in past issues are available for 25 cents each; original material lists and additional information can be obtained from our Radio Department without charge upon receipt of postage. Note—Blueprint for the March, 1937, Little Giant Portable 2-Band A.C.-D.C. Receiver is No. R-235.

NEXT MONTH—How to Build a Six-Volt Farm Set for Windcharger Operation. An excellent 4-tube receiver with 6-tube efficiency; uses new low-drain tubes and a single 6-volt storage battery, a real distance getter with good tone and volume. Other features include a **One-Tube Code-Practice Oscillator**, built in a coffee can.

John Deulachman's Coffee can

South Bend cond colorless



Tubular SMOKING STAND

has large ash well

Modern styling combined with simplicity of construction

By Walter T. Warde

THE very latest style with its gleaming metal legs and trim, and polished base, this smoking stand has deep ash well with a Bakelite tray large enough to hold a glass or two. All dimensions are shown in Fig. 2, including the bending jig for the handle. This can be cut from any soft wood of sufficient thickness. Fasten the disk firmly to the workbench with the stops screwed in place as in Fig. 2. Now take a 6-ft. length of $\frac{5}{8}$ -in. aluminum tubing and plug one end tightly with a dowel. Then fill the tube with dry sand, tapping down and filling until the tube is well packed, then plug the open end. It is important that the tube be packed tightly with the sand, otherwise a flattened bend will result. The tube is bent around the disk with a steady, even pull

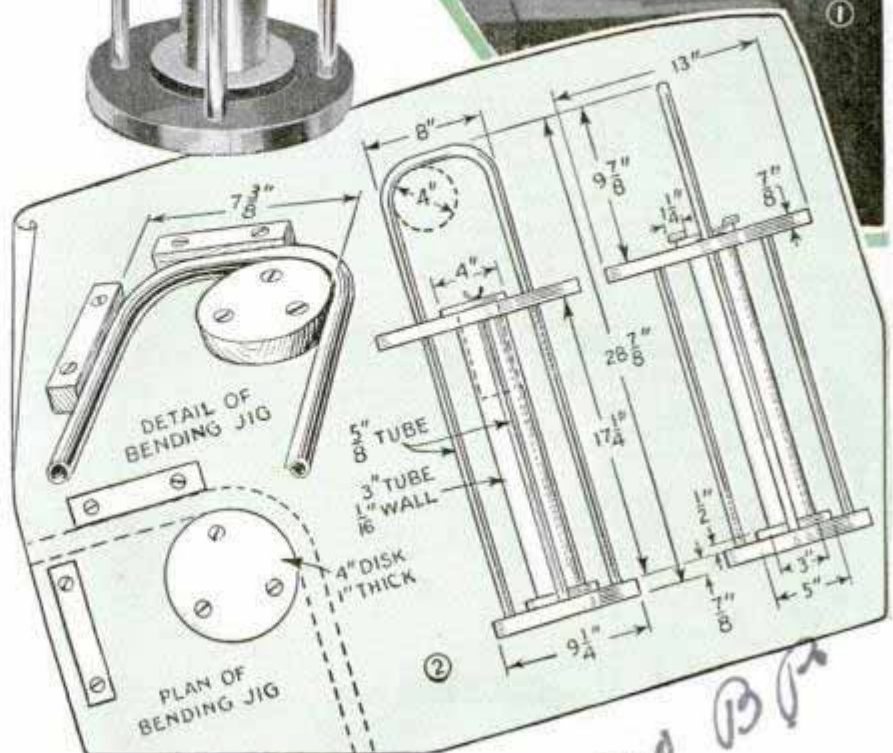

no B 1/2

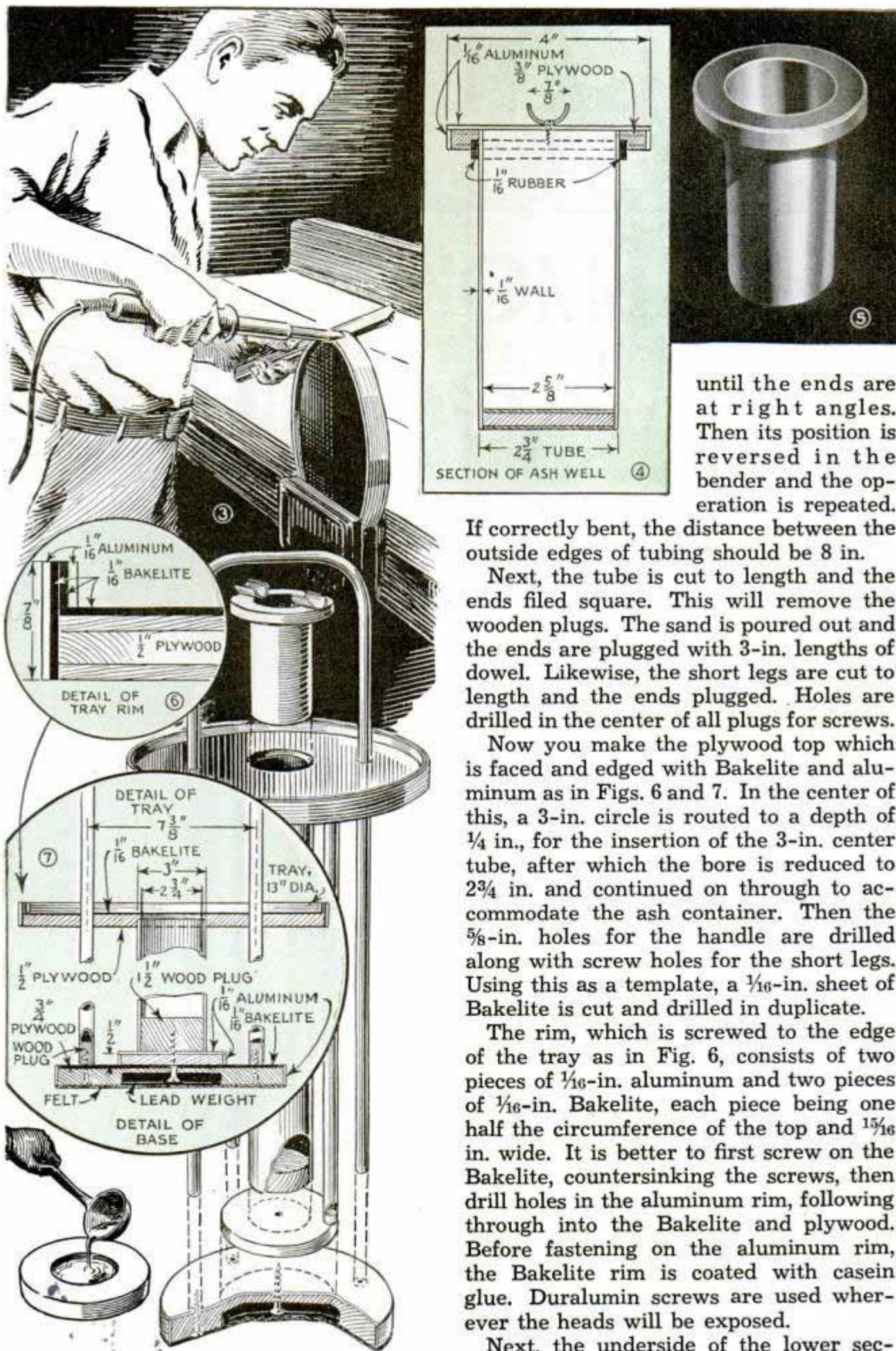

until the ends are at right angles. Then its position is reversed in the bender and the operation is repeated.

If correctly bent, the distance between the outside edges of tubing should be 8 in.

Next, the tube is cut to length and the ends filed square. This will remove the wooden plugs. The sand is poured out and the ends are plugged with 3-in. lengths of dowel. Likewise, the short legs are cut to length and the ends plugged. Holes are drilled in the center of all plugs for screws.

Now you make the plywood top which is faced and edged with Bakelite and aluminum as in Figs. 6 and 7. In the center of this, a 3-in. circle is routed to a depth of $\frac{1}{4}$ in., for the insertion of the 3-in. center tube, after which the bore is reduced to $2\frac{3}{4}$ in. and continued on through to accommodate the ash container. Then the $\frac{5}{8}$ -in. holes for the handle are drilled along with screw holes for the short legs. Using this as a template, a $\frac{1}{16}$ -in. sheet of Bakelite is cut and drilled in duplicate.

The rim, which is screwed to the edge of the tray as in Fig. 6, consists of two pieces of $\frac{1}{16}$ -in. aluminum and two pieces of $\frac{1}{16}$ -in. Bakelite, each piece being one half the circumference of the top and $1\frac{5}{16}$ in. wide. It is better to first screw on the Bakelite, countersinking the screws, then drill holes in the aluminum rim, following through into the Bakelite and plywood. Before fastening on the aluminum rim, the Bakelite rim is coated with casein glue. Duralumin screws are used wherever the heads will be exposed.

Next, the underside of the lower sec-

tion of the base is recessed $\frac{3}{8}$ in. deep and 4 in. in diameter for the insertion of a lead weight. For this you use about 3 lbs. of molten lead poured into a sand mold or one made by recessing a disk of soft wood.

Now, you're ready to assemble. First, the 3-in. tube is cut to length and the ends filed square. The lower end is plugged as shown. Then the two portions forming the base and the 3-in. tube are assembled and held firmly together by a 2-in. screw inserted from the underside of the base, through the lead weight and both portions of base, into the wooden plug in the center tube. With this in position, the two short legs are screwed to the base and the top is fastened to these legs, the center tube fitting into the recess routed in the top. Then the Bakelite disk is glued on with the $\frac{5}{8}$ -in. holes in position for passage of the handle. When these legs are in position, contacting the base, they are fastened with 2-in. screws. Now you finish up the rim, Fig. 6. This is made up of $\frac{1}{4}$ -in. strips of $\frac{1}{16}$ -in. aluminum and Bakelite, in two sections, glued to the inner side of the rim. Fill the two joints of the outside aluminum rim with aluminum solder, Fig. 3. When dry, the edges are filed flush and polished with fine steel wool.

Details of the ash container are shown in Figs. 4 and 5. The wood forming the top of the ash container is routed out on the underside to a depth of $\frac{1}{8}$ in. in a 3-in. diameter and a 2 $\frac{3}{4}$ -in. circle is continued through. When the ash tray is completed, a rubber jar ring is slipped over the tube and fitted into the offset in the wood flange. The rim on the top flange is glued and screwed on, with the screws filed down and polished and the joint filled with solder. Cigarette holders are made from $\frac{7}{8}$ -in. tubing cut in half lengthwise, and screwed to the top of the ash container. After fastening, the screw heads are ground flush with the tube.

Lubricating Plunger of Jig Saw

When the upper plunger of my jig saw became worn so that it let oil pass and drop onto the work, I substituted pressure-gun grease for the regular lubricant. This proved satisfactory as it not only eliminated leakage, but it lubricated the moving parts better than oil.

—Joseph L. Gibbons, Chicago.

Gluing Mitered Joints with Aid of Friction Clamping Blocks

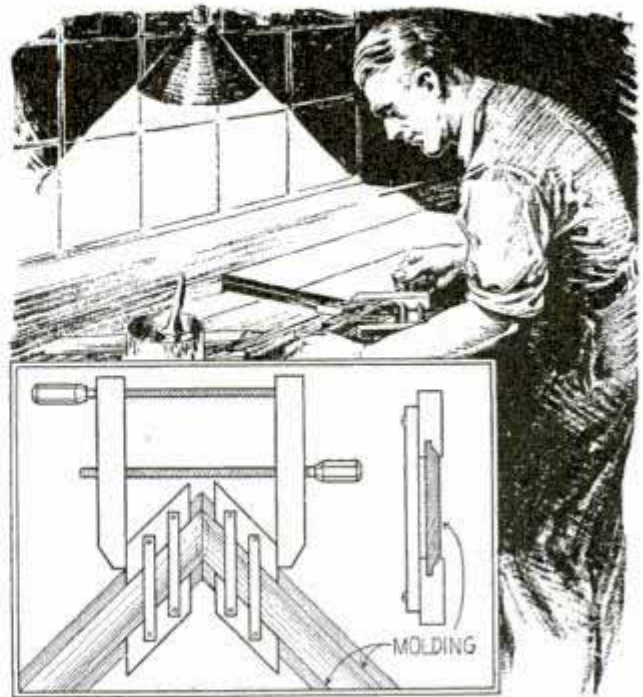

A few of these clamping blocks take the guesswork out of clamping picture frames and similar work

With these clamping blocks, which hold by friction against the work, you can assemble mitered joints for gluing with ease. Two blocks are needed for each joint and they are made by pivoting small wood blocks together with loosely screwed hardwood strips, the inner edge of each block being shaped to fit the edge of the work. In use, a clamping block is placed on each side of the joint, after which they are drawn together with a hand clamp.

Keeping Gelatine Size Warm

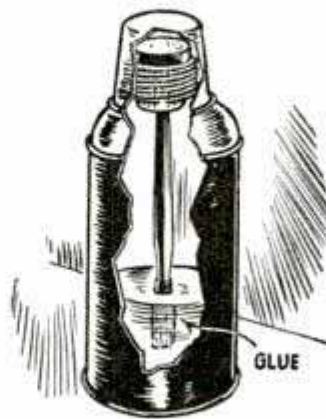

One sign painter has his gelatine size always warm and ready for use on the job, when lettering windows with metal foil, by putting the heated mixture in a small vacuum bottle before he leaves his shop. The handle of the brush is inserted into the bottle cork as shown so that the mixture does not harden on the bristles between jobs.

—A. H. Waychoff, Tempe, Ariz.

Water from Photo Squeegee Drained in Metal Tray



This tray carries water squeegeed from photo prints to a bucket or to the sewer

Made from galvanized sheet iron and mounted on a table or bench under your photo squeegee wringer, this tray will take care of the water as it is squeezed from the prints. The tray is fitted with a drain pipe at one corner which carries the water to a bucket under the table. The detail shows a pattern for the tray, which can be made to the dimensions given or to suit.—E. W. Tock, Santa Ana, Calif.

Holes in Rim of Paint Can Prevent Dripping



Before starting a paint job, punch a few small holes in the rim of the can so that the paint that accumulates in the sunken portion of the rim will run back into the can.

This will keep the paint from running down the outside and spotting your floors

or furniture. Of course, a can with a perforated rim should not be used for storing paint, as it cannot be made airtight.

Whitewashing Tree Trunks

When brushing whitewash on portions of tree trunks to check climbing insects, use a couple of strips of inner tube as shown, and you can do a uniform job that is more attractive than when the brushing is done without a suitable guide. Just wrap the strips around the tree and slip clothespins over the ends.



Concrete Sidewalk Is Built to Resemble Flagstones

The neat flagstone effect of this sidewalk was obtained by dividing the space between the concrete forms with 1-in. strips before pouring the walk. The strips were oiled so that they could be removed easily after the concrete had set. The "cracks" were filled with soil and seeded with grass.

—Harold O. Hayes, Wilmette, Ill.



This flagstone sidewalk was made by using dividing strips between the concrete forms

Bronze

Backyard SCREENS and TRELLIS HEDGES

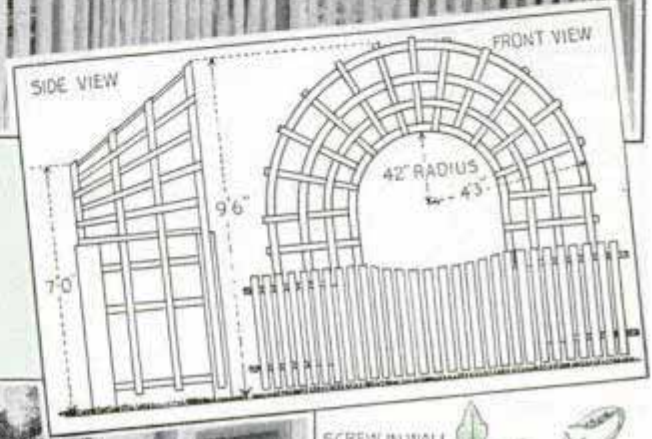
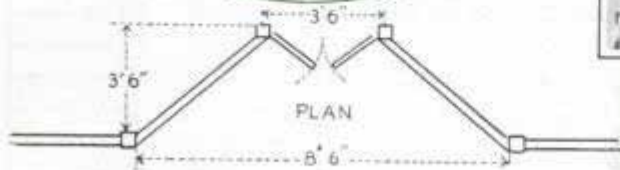
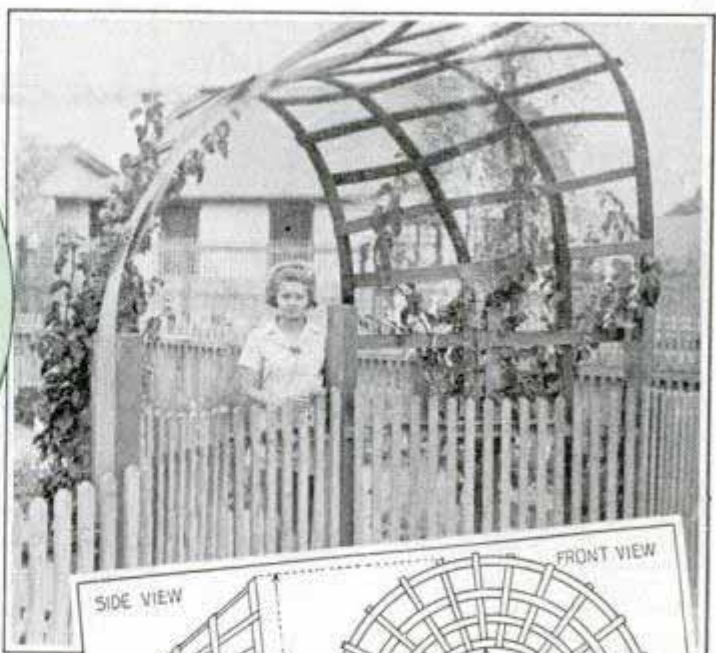

$\frac{1}{4}$ " x 2" ROUGH BATTENS IN LOOSE BASKET WEAVE

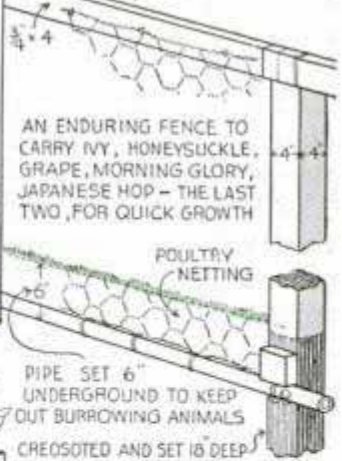
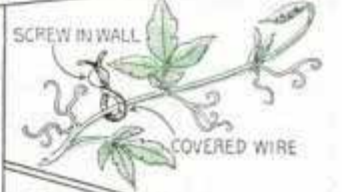

AN ENDURING FENCE TO CARRY IVY, HONEYSUCKLE, GRAPE, MORNING GLORY, JAPANESE HOP - THE LAST TWO, FOR QUICK GROWTH

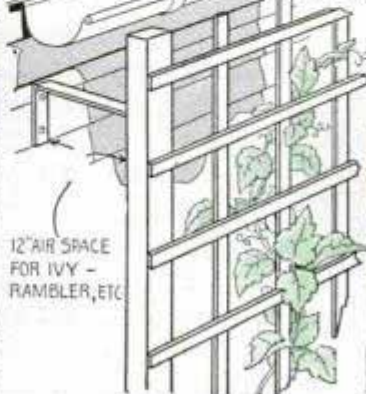
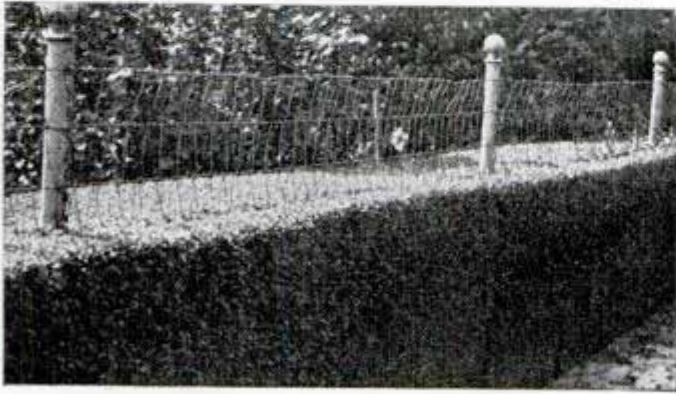

HEDGE PLANTS SET 12 TO 15\" APART IN A PREPARED TRENCH



Showing of Microscope Specimens Speeded by Disk Slides



A number of specimens can be viewed in succession rapidly with this disk slide

Have you ever attempted to show friends a series of microscope views, and found them growing disinterested because of the time lost in changing slides? If so, a disk slide of the type shown will solve your problem. The slide consists of a celluloid disk having a paper disk of the same size cemented to it, holes being punched in the paper near the edge to hold the specimens. The disks are pivoted to a sheet-metal arm which is soldered to a large paper clip. The clip holds the assembly to your microscope stage.

—Oliver H. Dennis, Pittsburgh, Pa.

"Speed Wings" Dress Up Bicycle

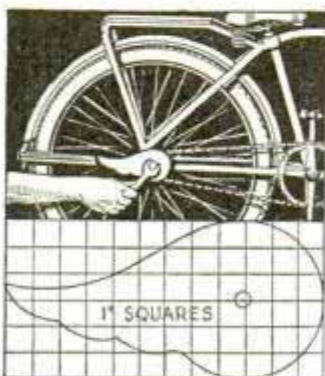

Slipped under the rear spindle nuts, these wings will add considerably to the appearance of your bicycle by covering the hub and brace junctions, and they also offer a suggestion of

speed. Cut from sheet aluminum, the wings are especially effective on streamlined models.

—E. E. Youngkin, Altoona, Pa.

Venting Basement Fuel-Oil Tank

If you have a fuel-oil tank in your basement, here is a good method of providing a vent and a filler opening to the end of the feed pipe outside the building. A short distance above the ground, a Y-fitting is screwed onto the feed pipe so that a nipple and a return elbow can be added. A brass pipe plug in the opening of the fitting keeps out dirt and water. A fine copper screen soldered over the open end of the inverted return elbow keeps out insects, yet allows air to enter the tank as the oil is being used.

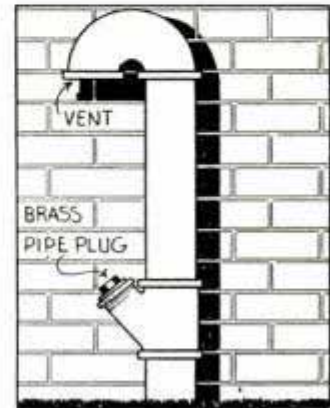

Rotary Chisel Cuts Designs in Sheet Metal

For cutting scrolls and similar designs in light sheet metal, where it is difficult to use tinner's shears, this chisel is hard

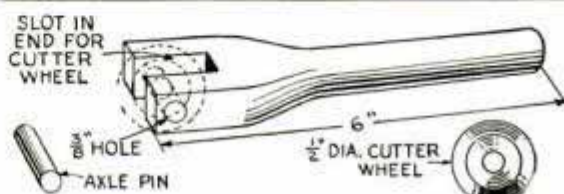
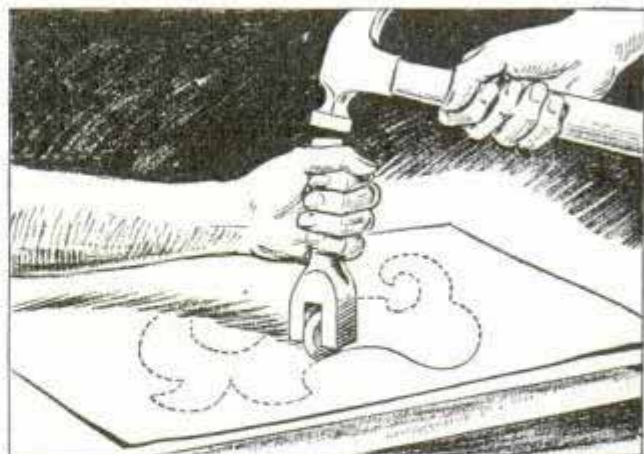

Using this chisel, you can make curved cuts in light sheet metal with ease and accuracy

to beat. It consists of a pipe-cutter wheel pivoted in one end of a short iron or steel handle. In use, the chisel is pushed slowly over the work while the handle is being tapped with light hammer blows in rapid succession. After a little practice you will be able to cut designs of almost any shape neatly and accurately.

A Modern Wood Box for the Fireplace

This sturdy, inexpensive fireplace wood box fits in well with the modern trend in interior furnishings. Made entirely of $\frac{3}{8}$ -in. plywood, except the handle, which is a length of broomstick, the box is readily cut out on a scroll saw. Narrow cleats nailed to the bottom, near the front and rear edges, give rigidity to the base and help prevent warping. The circular pieces shown on the sides are plywood disks attached for decorative purposes. The box can be finished as desired, although the original looked very attractive with a red trim on a black background.

—K. R. Edson, Logan, Utah.

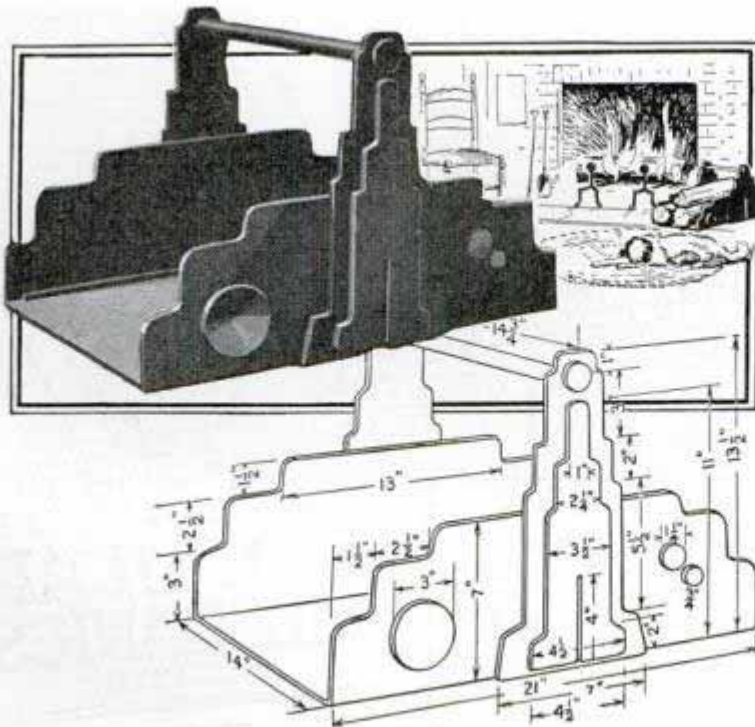

Patterned along modern lines, this fireplace wood box is a project that you can turn out in one evening on your scroll saw

Roll Films Dried in Tube Safely with Heat from Electric Lamp

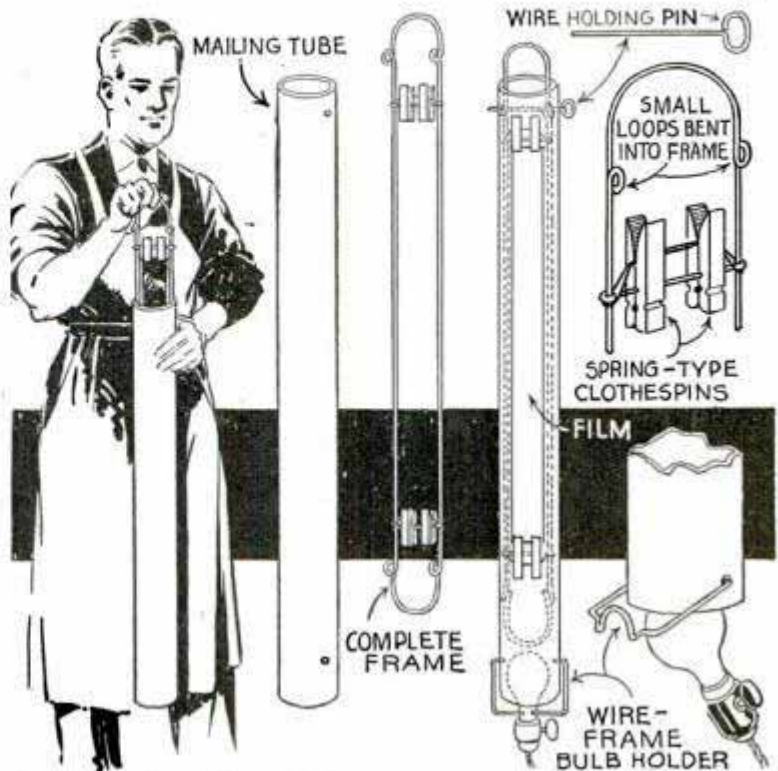

Drier is adjustable to different lengths of roll film by merely sliding the cross wires carrying the clothespins up or down

Utilizing a 60-watt electric lamp, this roll-film drier handles negatives without them collecting dust or getting scratched on the emulsion side. The drier consists of a cardboard tube, four spring-type clothespins and a wire frame bent as indicated. Eyes formed near each end of the frame take pins

which hold it inside the tube, and cross wires just below the eyes are threaded through the springs of the clothespins, which hold the ends of the film to be dried. These wires should grip the frame with a snug, sliding fit so that they can be adjusted to suit the length of the film. Another frame of wire at the lower end of the tube holds the lamp in place. The tube should be waterproofed inside and out with two or three coats of shellac. Use a strong tube having an inside diameter an inch or so greater than that of the lamp.

—M. Winterton, Fort Lewis, Wash.

☐ If painted surfaces around a kitchen sink are rubbed with floor wax, it will help prevent the appearance of unsightly water spots on the wall.

LADDER CHAIR

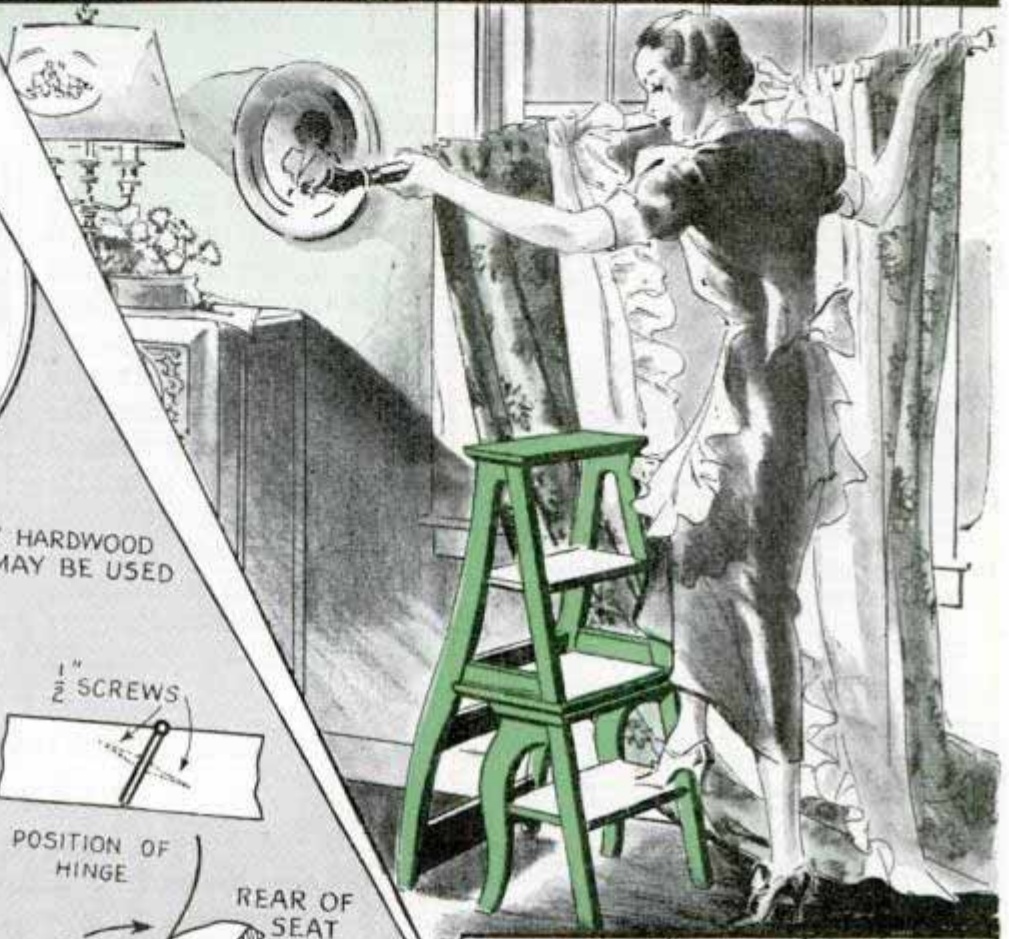

ANY HARDWOOD
MAY BE USED

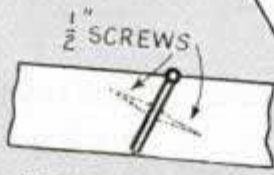

POSITION OF
HINGE

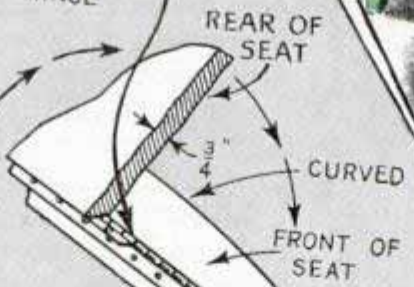

REAR OF SEAT

CURVED

FRONT OF SEAT

$\frac{1}{4}$ " x $16\frac{1}{4}$ " CONTINUOUS HINGE



SCREW POCKETS

STEP

ROUNDED

FRONT LEG

DADO

SCREW

FRONT SECTION DETAIL



BLOCKS

BLOCKS ARE
PLACED UNDER
THE CLAMP JAWS
WHEN GLUING

DADO
HEAD

THE GROOVE FOR STEP IS CUT
BEFORE BAND-SAWING TO SHAPE

SHEET NO. 1

ISSUE

POPULAR MECHANICS MAGAZINE
200 E. ONTARIO ST. CHICAGO

BLUEPRINT No. SN 960

Sidewalks Reinforced with Wire to Prevent Frost Cracks



Wire mesh imbedded under expansion joints of sidewalks to avoid uneven raising of the sections

When laying a new sidewalk, it's a good idea to imbed strips of wire mesh in the concrete under the expansion joints, which reinforces the concrete and helps it withstand "heaving" action of the ground underneath when it freezes. If frost causes the walk to crack through at the joints, the wire mesh helps keep a block or section from raising above the surface of the abutting one.

—L. H. Georger, Buffalo, N. Y.

Paper and Leather-Cutting Punch of Pipe or Tubing

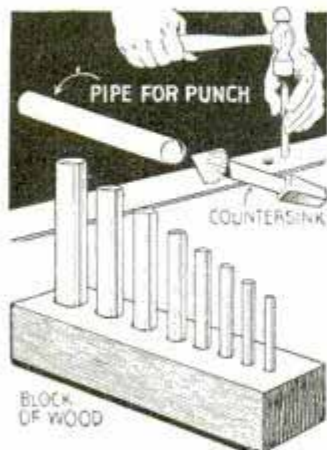

To make small punches for cutting paper and leather, select a steel tube or pipe of the required diameter, lock it in a vise and then bevel the inside surface of one end to a sharp edge with a countersink. Be careful to hold the countersink true with the tube so that the bevel will be cut uniformly around the end. It's

best to place the material over the end of

a wood block when cutting gaskets so that the edge of the punch will not be damaged.

—M. W. Mutschler, Lincoln, Nebr.

Imitating Planks on Ship Models

To get a good imitation of a planked deck on a ship model, I cover the deck with a piece of $\frac{1}{8}$ -in. holly wood, score the wood with a pointed instrument and make a few cross scores to simulate joints at the plank ends. Then I make indentations in the wood with a small punch to simulate nail heads and fill these with colored plastic wood, sand them down and rub linseed oil thoroughly over the whole surface.

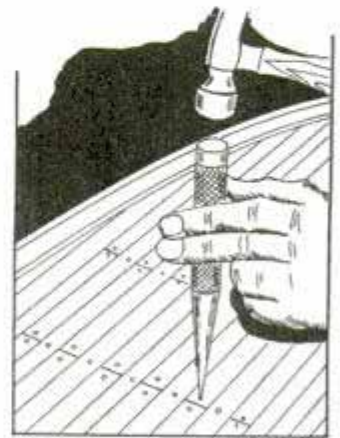

—C. Arnold Baer, Portland, Ore.

Trellises Set on Concrete Bases to Avoid Rot

When you build arbors or trellises, anchor them in concrete as shown and you need not worry about them rotting off. Just take some old crocks, set them in the ground and fill them with concrete. Then insert a length of flat iron in each one, first drilling four holes in it, two to take bolts for anchoring the iron in the concrete and two for bolting the trellis standards in place. When you drill the standards, it is best to locate the holes so that the ends of the standards will clear the top of the concrete about $\frac{3}{4}$ of an inch.

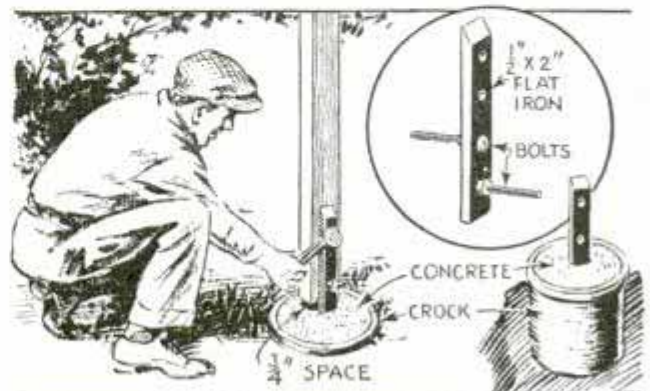

Here is a method of anchoring your trellises so that they will not rot off at the ground

Relief Lettering Cut on Scroll Saw or Router

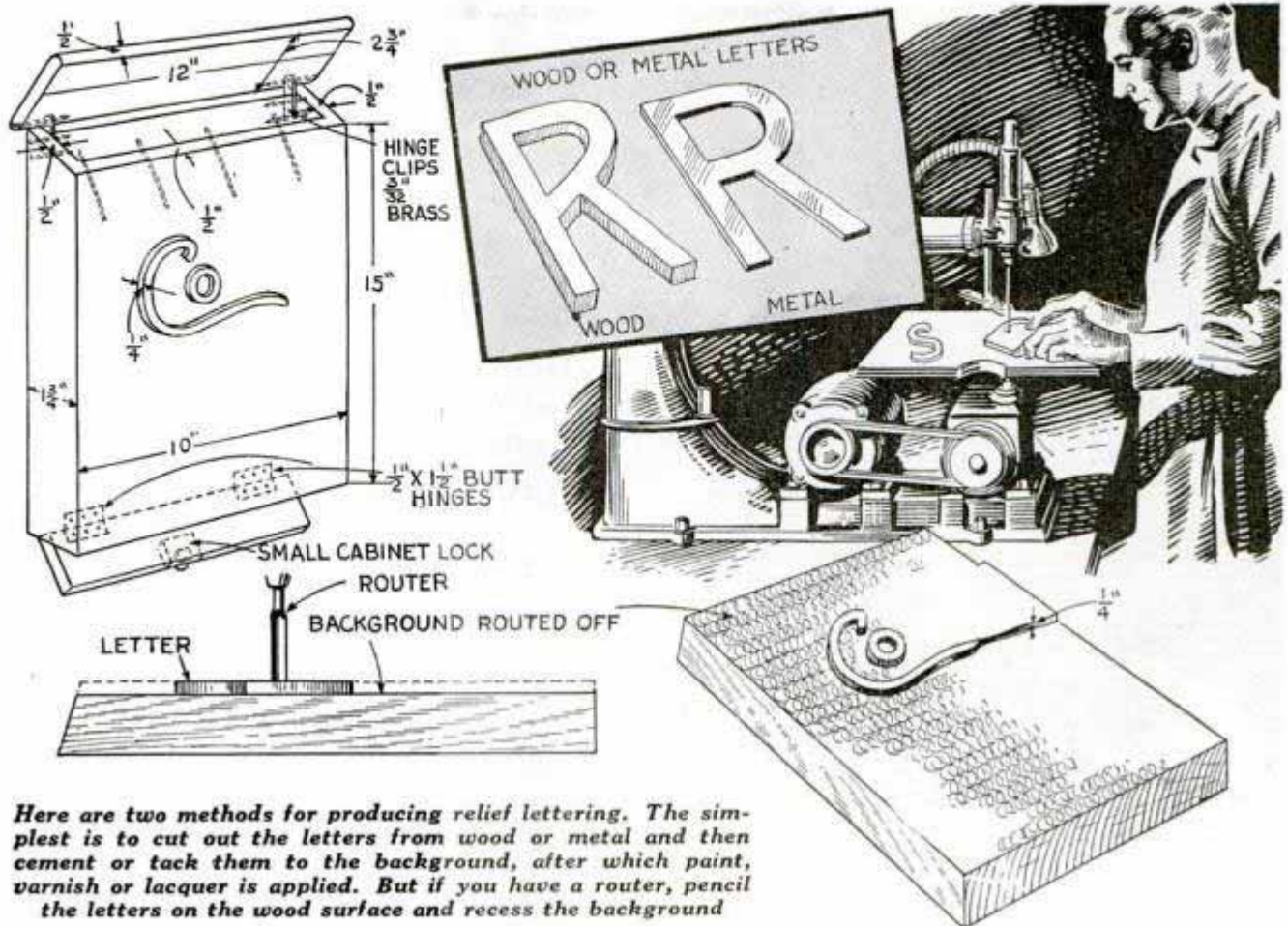

Here are two methods for producing relief lettering. The simplest is to cut out the letters from wood or metal and then cement or tack them to the background, after which paint, varnish or lacquer is applied. But if you have a router, pencil the letters on the wood surface and recess the background

Hollow Spindles Set Up in Lathe with Aid of Tapered Plugs

When you have a long, hollow wood spindle to turn, the job of setting up the work in a lathe is done easily by using tapered plugs in the openings in the ends of the stock as shown. By tapering the plugs, they not only center themselves when driven in tightly, but they can be used in openings of different sizes.

—Dale R. VanHorn, Lincoln, Nebr.

T-Square Has Scale on One Edge



An accurate tape measure cemented along the edge of a T-square will enable you to make measurements without having to reach for a ruler each

time. This idea will be found especially handy when laying out advertisements or straight-line drawings.



You can center hollow stock in a lathe accurately by using these tapered plugs which center themselves when driven in tightly



BOATS

How to check a boat quickly for the more common defects.
How to tell if the keel, frames and planking are sound.
How to check a propeller shaft for alinement.
How to judge condition of the ribs by the planking seams.

Inspect the stem closely

By
WALTER E. STEWART

WHETHER you are buying a rowboat or a steam yacht, the most important thing to you is the condition of the hull. Paint and varnish and cabin accommodations and equipment are all eye-catchers, but without the foundation of a sound, seaworthy hull they are worthless. Don't buy a boat that does not have a conventional hull; it may be V-bottom or round bottom, keel or centerboard, but it must be of a shape that years of experience has caused to be accepted as good. Freak hulls are almost never successful; they are either difficult to push through the water, or they are not seaworthy. The second reason is that the market for freak hulls is almost nil, and when you wish to dispose of yours a loss will be in prospect.

The frames or ribs of a boat shape the hull and give it strength. Often in old boats the frames are cracked. This is especially true of steam-bent frames. Look at them carefully. Get a flashlight and a penknife and poke about under the floor

boards until you are satisfied that the hull has not been weakened seriously by cracked frames. Bear in mind that the cracks usually occur on the side of the frame toward the planking. Another way to check up on bad frames is to look carefully at the planking seams on the outside of the hull at the turn of the bilge. Unusually wide seams at this point may indicate weakened ribs. Often the widened seams have been filled in, so it may be necessary to dig a little with a pointed knife to discover them. Also walk far enough away from the hull to be able to sight along it so as to detect any bulges or irregularities due to deformed frames. V-bottom boats often have frames which are bolted together. Make sure that these fastenings have not rusted to the point of failure, or have not chewed out the wood until they are no longer tight. Rot often sets in at the ends of sawed frames, so dig your knife into them to be certain they are sound.

While you are off from the boat, sight along the keel. Many boats have had their keels broken or warped out of true by careless hauling. When this has happened, incurable leaks often result, and the boat almost never sails satisfactorily. Be sure to inspect closely every inch of the bottom of the keel. It is here that teredo

FOR SALE

Check ends of planking



worms often start their work of destruction. The entrance holes of these pests are no larger than pinheads, but once the entrance is made the whole interior of the timber will be eaten out. If you see evidence of worms the only safe thing to do is bore a number of small holes into the keel so that you can inspect the shavings for the white pulverized material with which the teredo lines his cavities. If worms are in the wood the only remedy is to replace it. For this reason many boats have a 1-in. worm strip on the bottom of the keel. This strip is replaced every season so that the teredo may not pass from it into the keel. Unscrupulous boat sellers sometimes plug teredo holes with putty. Therefore, the use of putty on a keel is invariably a bad sign. No matter how sound a keel appears do not conclude your purchase until you have drilled at least one small inspection hole. A sound, old keel will produce tough, dark shavings, and a good, new keel will give tough, white shavings, so regard dark, crumbly shavings as a sure sign of decay. A new keel in an old boat should be subjected to rigorous examination, for in many cases it will be found that these are merely append-

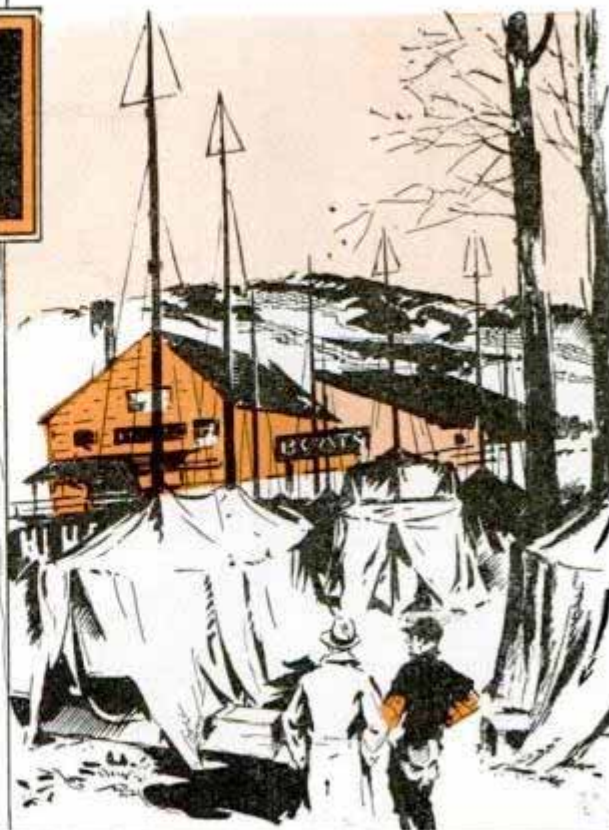

Examine the frames

ages and do not properly support the hull.

Hull fastenings are of vital importance, for to replace them is always a difficult and often an impossible task. If they are copper, brass, or bronze, corrosion will not have affected them, so you will only need to make sure they are tight. Discover this by trying to insert a thin strip of metal between frames and planking at a number of spots. Galvanized iron fastenings require a more thorough investigation. Dig out some of the plugs on the outside of the hull to see if the nails are badly rusted, and try your thin metal feeler in many places to find whether the fastenings have rusted through between planks and frames. A good stunt is to hammer on the outside of the hull over a frame and listen



for the hollow sound which would indicate the lack of a fastening.

About the only thing to watch for in the planking, other than obvious holes, warping, or splitting, is rot. Wet rot most often occurs in the garboard strake, that is, in the plank next to the keel. Try to stick the point of your knife into any likely place for rot. No matter how old the boat, sound wood will prevent the point from sinking more than about a quarter inch. Dry rot may occur anywhere, but wood which is alternately wet and dry, is particularly susceptible to it. Use your knife at the joints of planks to stem and to transom or stern post. Pull out the ice box and pry around behind it, for the condensation caused by its coolness often creates rot. Examine carefully all joints of deck beams and frames, and of frames and sheer clamps, for dry rot is an insidious weakness that often leaves an apparently sound exterior.

A leaky boat may yet be a good boat, but be sure that you determine definitely where the leak is and how much trouble it will be to stop. An improperly packed stuffing box on the propeller shaft may cause a serious leak, but it is only a matter of minutes to stop it completely. On the other hand a leak where the centerboard trunk passes through the keel is extremely difficult to stop. A loose seacock at a through hull connection is likewise trivial, but rotten wood around it is a serious matter. Boats which have been out of water for several seasons dry out until the seams are gaping cracks. If the wood is relatively new and "live" it will swell together and close the cracks after launching, but if it is old and has been through many wet and dry cycles it may never close up satisfactorily.

A sturdy, leak-proof deck is almost as important as a sound hull. The deck stringers must be large enough and spaced closely enough to brace the hull adequately, as well as support the deck planking. The top of the cabin should be just as strongly built as the remainder of the deck, for often your entire party will be spread out on it. Dry rot often attacks the under side of deck planks where they join the hull—look for it carefully. The best time to inspect a deck for watertightness is immediately after a heavy

Check the alinement of propeller shaft

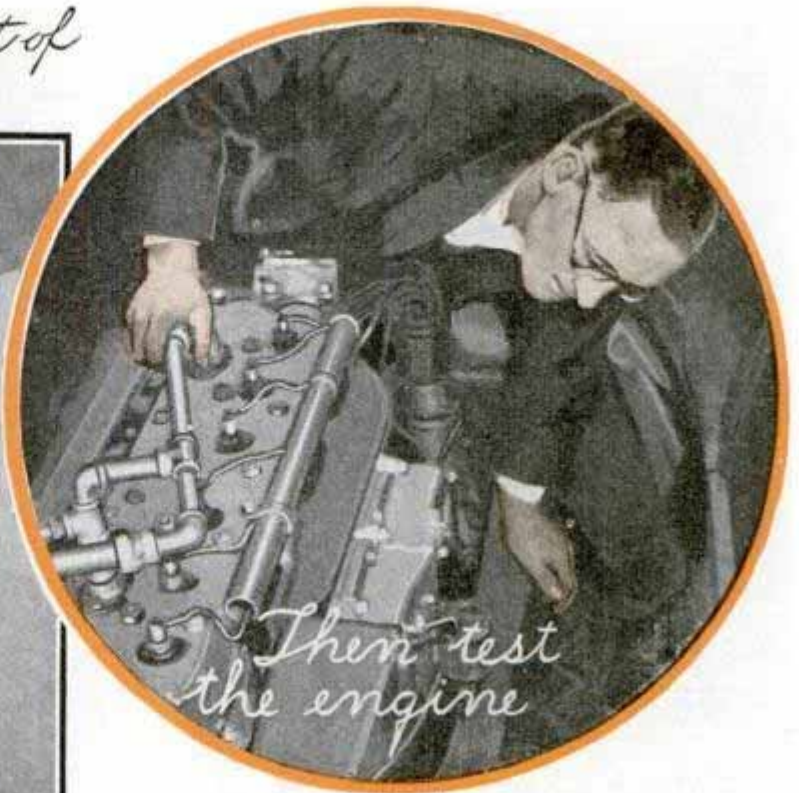

Then test the engine

shower. Look inside the cabin and under the decks to see how much water came through, and be sure to locate where it came from so you will know how much of a job will be the repair.

Try turning the propeller by hand with the clutch out. It should turn easily, with no evidence of binding at any part of the revolution. If it seems to stick at some particular point, the shaft perhaps is misaligned or sprung. See that the outboard bearing and stuffing box are in good condition and that the shaft has no play in them. A bent or battered propeller may cause a boat to pound and make little headway. Repairing a damaged propeller is a job for experts who have special equipment for adjusting and testing the blade contours. Rudder, rudder post, bearings, and rudder stuffing box will all require careful examination; solidity being the chief requirement, with water-tightness a close second.

Gasoline motors in boats are susceptible to all the usual wear encountered in auto motors plus that caused by salt water and often improper attention to lubrication. To check up the main bearings, place a crowbar under the flywheel and try to jiggle it. Ability to shift the main shaft indicates loose bearings. Remove spark plugs or open priming cups and turn the motor

over by hand to detect undue stiffness, then try it with plugs replaced, or priming cups closed, to test for compression. Remove a cover plate from the water jacket to see the extent of the corrosion due to salt water. Test the engine bed and fastenings for solidity and tightness. Above all insist upon running the motor under normal operating conditions for at least 30 min. before giving it your approval.

If you are considering a sailboat, bear in mind that spars and rigging and sails are your prime motive power. Examine them just as carefully as you would a motor. The mast step is the socket into which the base of the mast fits. It should be a very heavy, strong timber extending over at least five ribs. The partners are the heavy deck timbers through which the mast passes. They must be sturdy enough to resist the great force exerted by the wedges driven around them to hold the mast in place. Often rain water filters down the mast and saturates both partners and step, causing dry rot to set in. Use a good flashlight and your penknife in your search for it. If a canvas coat covers the wedges at the deck be sure to take it off and see what is underneath.

Longitudinal cracks in a mast have little effect on its strength, and usually are not the seat of dry rot unless some attempt



Look for leaks around the centerboard well



has been made to fill them. Filling such cracks only causes rain water to be trapped in them, and dry rot soon follows. Wire stays, chain plates, bowsprit, and bobstay are additional supports for the mast and must also come in for careful scrutiny. It is essential that boom and gaff be perfectly straight if sails are to set efficiently.

The greatest trouble encountered in sails, other than straight wear, is mildew. The dark little spots of this growth cause weakness and quick failure, even in new sails. As a matter of fact, mildew is more prevalent in new sails than in old, due to the sizing which is retained in new cloth.

Improper use often causes sails to be stretched into misshapen bags or to be pulled out until they are too long for the spars. Insist upon seeing the sails up and full of wind.

The type of boat to buy depends upon what you want, and where you wish to use it. If you are to live aboard during week ends and vacations, a cabin will be required, and if you must handle and care for the boat alone, 30 to 32 ft. is about the practical limit of size. A beginner who wants a sailboat should pick up a small open sloop or cat, say about 16 ft. long, preferably a centerboard type, for such a boat is better than any other for teaching the fundamentals of sailing. Use on a narrow or swift river dictates a motorboat, shallow lakes or bays a motorboat or centerboard sailboat, while open, deep water spells husky motor cruiser or deep-draft sailboat. Be guided by the types of boats already in use on the waters which beckon to you, for usually experience has dictated the types best suited to any particular locality.

Holder for Sharp-Pointed Tools

For leather workers and others who use sharp-pointed hand tools, a wooden container filled with beeswax is just the thing to hold the tools at hand, besides protecting the ends and preventing rust. Any shallow wooden bowl about 1 in. deep and having a fairly large diameter may be turned of hardwood to the shape shown. It should be filled with melted beeswax. When the latter becomes perforated, a few light taps with a hammer will close the holes again.

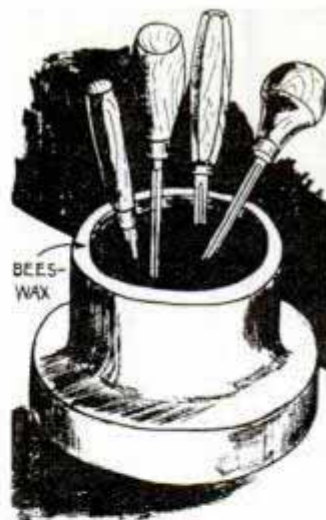

☐ After an ice-cream freezer has been properly packed with cracked ice and salt, pour a quart of cold water over it. The water will cause the ice and salt to combine more quickly and freezing will be hastened.

Croquet Equipment Held in Portable Rack

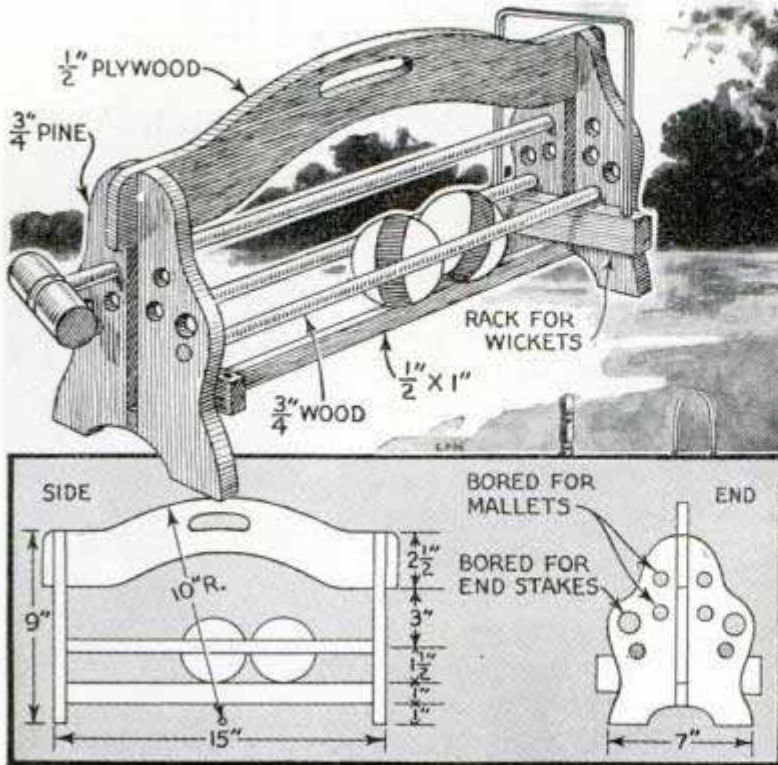

All of your croquet equipment is kept at hand in this simple wooden rack. Holes bored in the divided end members receive the stakes and mallet handles besides two $\frac{3}{4}$ -in. dowel rods for retaining the balls on the lower crosspiece. Cleats across the end members are drilled to hold the wickets and a hand-hole is cut in the upper crosspiece.

Carving Tool for Model Work Has Interchangeable Blades

Using a pin vise as a handle to hold tiny blades or chips broken off a safety-razor blade, you have a handy carving tool for which an almost unlimited supply of interchangeable blades of any shape desired can be made. Chips for general carving are easy to break off by grasping the edge of the razor blade with the tip of a pair of

long-nose pliers, holding them at an angle of 30° to 40° to the blade. Chips for cutting curves are made by holding a narrow strip of the blade in the pliers or vise. If a point is desired, allow a portion of the blade to extend beyond the pliers or vise. With a little practice, you can break off a chip of any shape desired. As small fragments may fly off when breaking the blade, don't fail to protect the eyes with a pair of goggles.

—John S. Wilcox, Los Angeles, Calif.



Drawer Has Handles on Sides for Carrying

If handles are screwed to the inside surfaces of large cabinet or workbench drawers in which odds and ends are kept, they are easily pulled out and carried to the light

when looking for an article. The handles should be located close to the drawer top.



Saw-Blade Marker Simplifies Fitting of House Siding



When a siding board is held in place and scored with this marker, it will fit perfectly when sawed

Leaving one hand free to hold the work in position, this simple tool accurately marks siding boards for sawing. It is made from a short length of saw blade, which is screwed to a block cut to the shape shown. The teeth of the blade are filed coarse to a sharp knife edge. In use, the siding board is held in place and scored while the marker is pressed firmly against the corner board, window or door frame.

Long Extension Ladder Improved by Roller on Upper End

You will find that an extension ladder with a rubber roller substituted for the upper rung is easy to raise and lower against the side of the building, as it reduces friction and also helps prevent marring the siding. In addition to this, friction between the

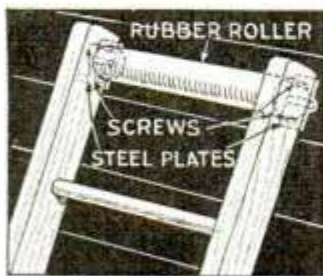

rubber surface of the roller and the side of the building tends to keep the ladder from slipping sideways. An old roller from a clothes wringer is handy for this purpose, and is fastened to the underside

of the ladder rails by means of steel plates, which are bent to form bearings for the roller ends.

—Bob Poulson, Los Angeles, Calif.

Sled Held Against Porch Wall with Caster Cups

One boy, who kept his sled leaning against the side of the porch wall, when not in use, put rubber caster cups on the floor to take the runner ends so that they would not mar the painted surface. The casters also helped to prevent the sled from slipping. They were taped to the floor, but rubber cement could be used.

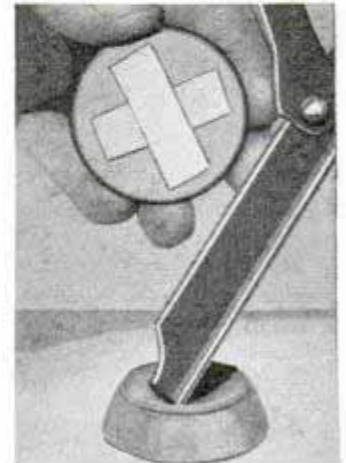

Sawhorse Has Rubber "Shoes" to Protect Floor Finish

When it is necessary to use a sawhorse on a finished floor, just take some lengths of inner tube and fold them over the lower ends of the legs. Lengths of wire are twisted around the legs to hold the rubber in place.—W. Skeen, Pawnee Rock, Kan.

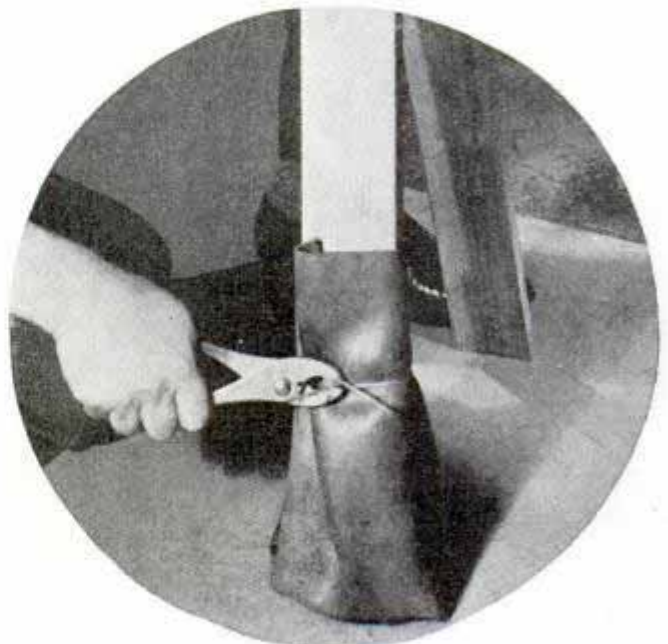

A few moments spent to fasten rubber strips over sawhorse legs will prevent marring finished floors

Modern DESK

has
pleasing
lines

A typewriter slide at just the right height and plenty of drawer space for supplies and correspondence

By RALPH L. KUNAU

BUILT of walnut and hard-pressed board, this desk has contrasting maple drawer pulls, which are arranged in line vertically, appearing as one piece when the drawers are closed. A curved member combines as a leg and stretcher to support the overhanging top. Hard-pressed board "veneered" over a core built up from soft wood makes an excellent desk top, is ideal for the drawer bottoms, and, in double thickness, is used for the panels of the pedestal as well. Fig. 1 shows how the pieces are cut from a standard 4 by 12-ft. piece of hard-pressed board, $\frac{3}{16}$ in. thick. The core for the top is built up from $1\frac{1}{8}$ -in. pine, edge-glued and fitted with reinforcing end cleats as in Fig. 4. After the top is planed flat, a sheet of $\frac{3}{16}$ -in. pressed board is glued to the upper side. If a press large enough is not at hand the work may be weighted until the glue has set. Casein glue is the thing for this job, as it is more easily handled than the hot cabinet glue. When dry, the lower side of the top should be grooved on the circular saw to a depth of $\frac{1}{2}$ in., the grooves being spaced 3 in. apart. This will minimize

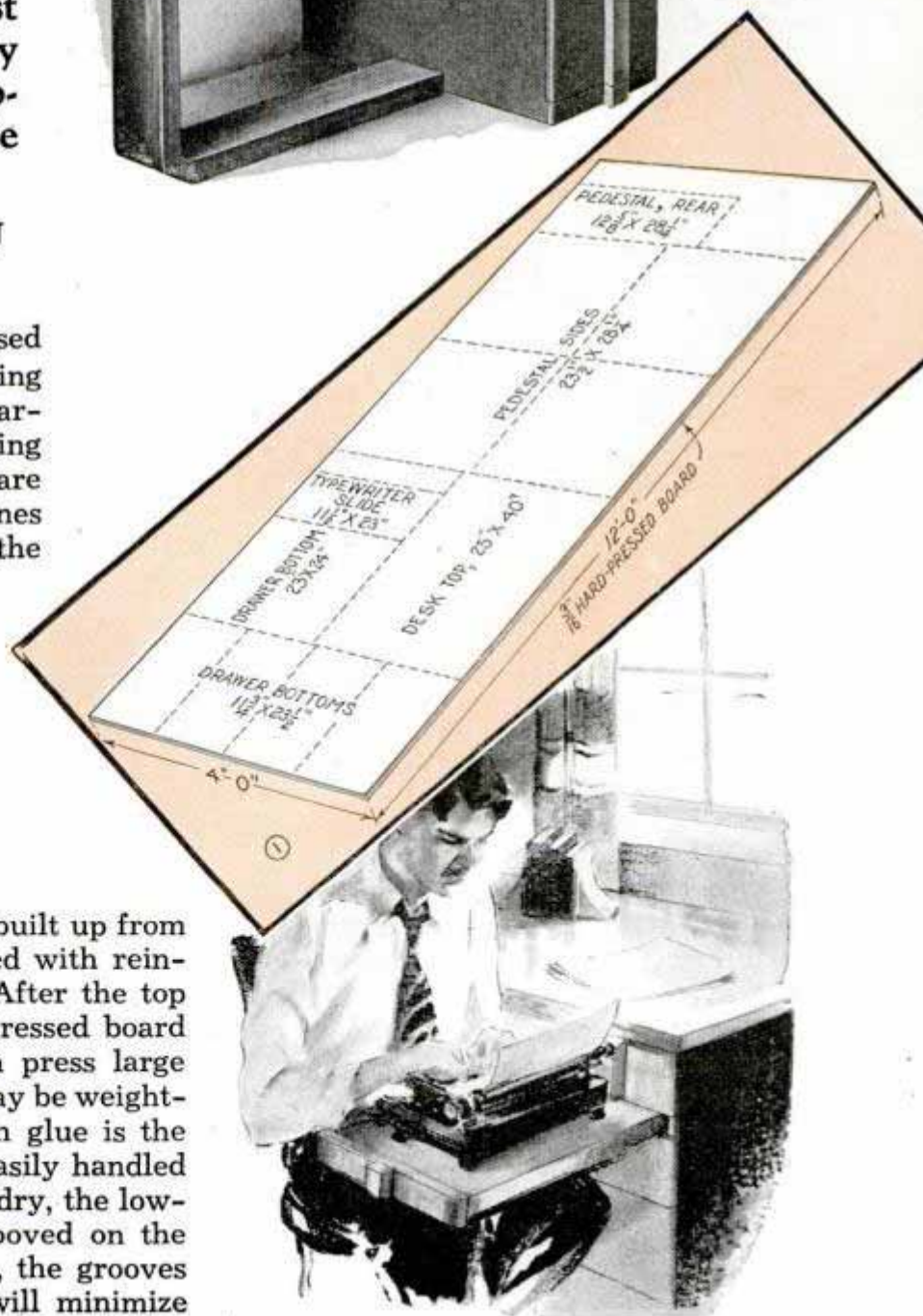

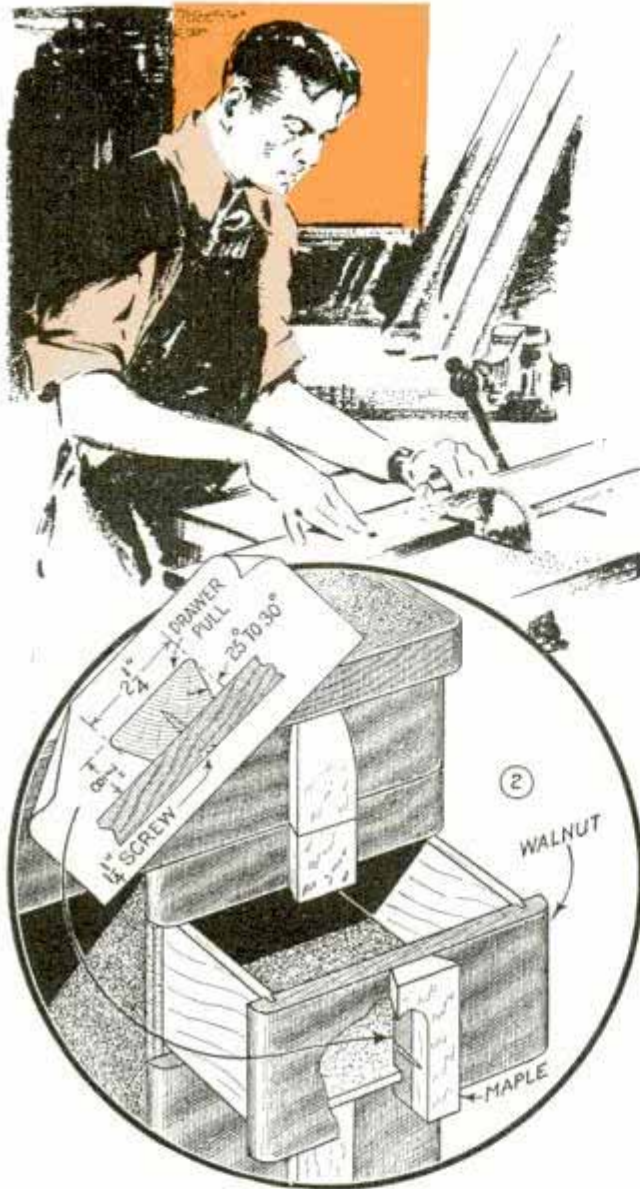

any tendency to warp. The edges are squared and $\frac{5}{8}$ -in. walnut strips are glued to the ends and the front and back. Then the edges are sanded flush and the corners are rounded as in Fig. 4.

Drawers slide on $\frac{3}{4}$ -in. plywood shelves supported by two panels of $\frac{3}{16}$ -in. pressed board, placed with the smooth side in, and screwed to the shelves. A second pair of sides are added with the smooth side out and are held by a line of screws at the edges. In this way the screws supporting the shelves are hidden. After squaring the side panels, lines are scribed to locate the upper edges of the shelves. Holes for the screws are countersunk so the screwheads will be flush. Details in Fig. 4 show the rear corner construction. An apron screwed to the top incloses the sides and back of the wide drawer, which may be supported either by cleats or by a dustproof panel.

Pieces of walnut from which the leg is assembled, as in the detail in Fig. 4, are joined with glue. Notice particularly that the tongue on the horizontal piece is cut off-center, so that the outer corner can be rounded after assembly without weakening the joint. A fillet for the inside corner can be cut by boring a $\frac{1}{2}$ -in. hole in a walnut plank, edgewise, and then sawing out a piece with a right angle, the sides tangent to the hole. The fillet is glued in place and cut to the outside curve. If you have a shaper it's an easy matter to make a suitable fillet. Corners at the top also can be filled with pieces similarly made.

The drawer sides have a shoulder cut

Material List

| | | |
|-------------------------------------|--|--------------------------------|
| Edge of top | | |
| 2 pcs. walnut | | 11/16 by 1 1/2 by 40 in. |
| 2 pcs. " | | 11/16 by 1 1/2 by 24 in. |
| Edge of shelf | | |
| 2 pcs. walnut | | 11/16 by 1 1/2 by 24 in. |
| Drawer fronts | | |
| 1 pc. walnut | | 3/4 by 3 3/8 by 40 in. |
| 1 pc. " | | 3/4 by 2 1/4 by 13 in. |
| 1 pc. " | | 3/4 by 5 by 13 in. |
| 1 pc. " | | 3/4 by 6 3/4 by 13 in. |
| 1 pc. " | | 3/4 by 9 1/2 by 13 in. |
| 1 pc. " | | 3/4 by 1 1/2 by 13 in. |
| Leg | | |
| 1 pc. walnut | | 1 1/2 by 5 by 29 in. |
| 1 pc. " | | 1 1/2 by 5 by 38 in. |
| Apron | | |
| 1 pc. walnut | | 3/4 by 3 3/8 by 24 in. |
| 1 pc. " | | 3/4 by 3 3/8 by 26 in. |
| 1 pc. hardwood | | 3/4 by 3 3/8 by 24 in. |
| Cleats for drawer | | |
| 2 pcs. hardwood | | 11/16 by 11/16 by 24 in. |
| Bottom cleats | | |
| 2 pcs. hardwood | | 3/4 by 4 by 12 1/4 in. |
| Feet | | |
| 3 pcs. hardwood | | 3/8 by 3 by 4 in. |
| Drawer sides | | |
| 4 pcs. hardwood | | 1/2 by 3 by 24 in. |
| 2 pcs. " | | 1/2 by 4 3/8 by 24 in. |
| 2 pcs. " | | 1/2 by 6 1/2 by 24 in. |
| 2 pcs. " | | 1/2 by 8 1/2 by 24 in. |
| Drawer rear ends | | |
| 1 pc. hardwood | | 1/2 by 2 1/2 by 24 in. |
| 1 pc. " | | 1/2 by 2 1/2 by 11 3/4 in. |
| 1 pc. " | | 1/2 by 4 by 11 3/4 in. |
| 1 pc. " | | 1/2 by 5 3/8 by 11 3/4 in. |
| 1 pc. " | | 1/2 by 8 by 11 3/4 in. |
| Drawer pulls | | |
| 1 pc. maple | | 7/8 by 2 1/4 by 37 in. |
| Shelves | | |
| 5 plywood or built-up panels | | 11/16 by 12 1/4 by 23 5/16 in. |
| Core | | |
| 1 pine (built-up) top | | 1 1/8 by 24 by 39 in. |
| Shelf | | |
| 1 pc. pine | | 1 1/8 by 12 by 24 in. |
| 1 sheet tempered hard-pressed board | | 3/16 in. by 4 ft. by 12 ft. |

made on the circular saw to fit a dado on the drawer front as shown in Fig. 3. If a dovetail plane is at hand, a vertical dovetail joint is a good construction for this type of drawer. As you will see from Fig. 3, the groove for the drawer bottom does not extend the full length of the front piece as the back is set in a dado and the bottom is slid in after the pulls are attached. The drawers must be made accurately for, owing to the overhang of the front piece, they cannot be planed readily to fit if they should be made too wide. A clearance of $\frac{1}{32}$ in. is sufficient. Should the clearance show up greater than this, a thumbtack can be placed on one or both sides of the opening.

A sliding shelf for a typewriter is built up in the same way as the top. It must be fitted closely and the front piece is not glued on until the drawer pull is attached.

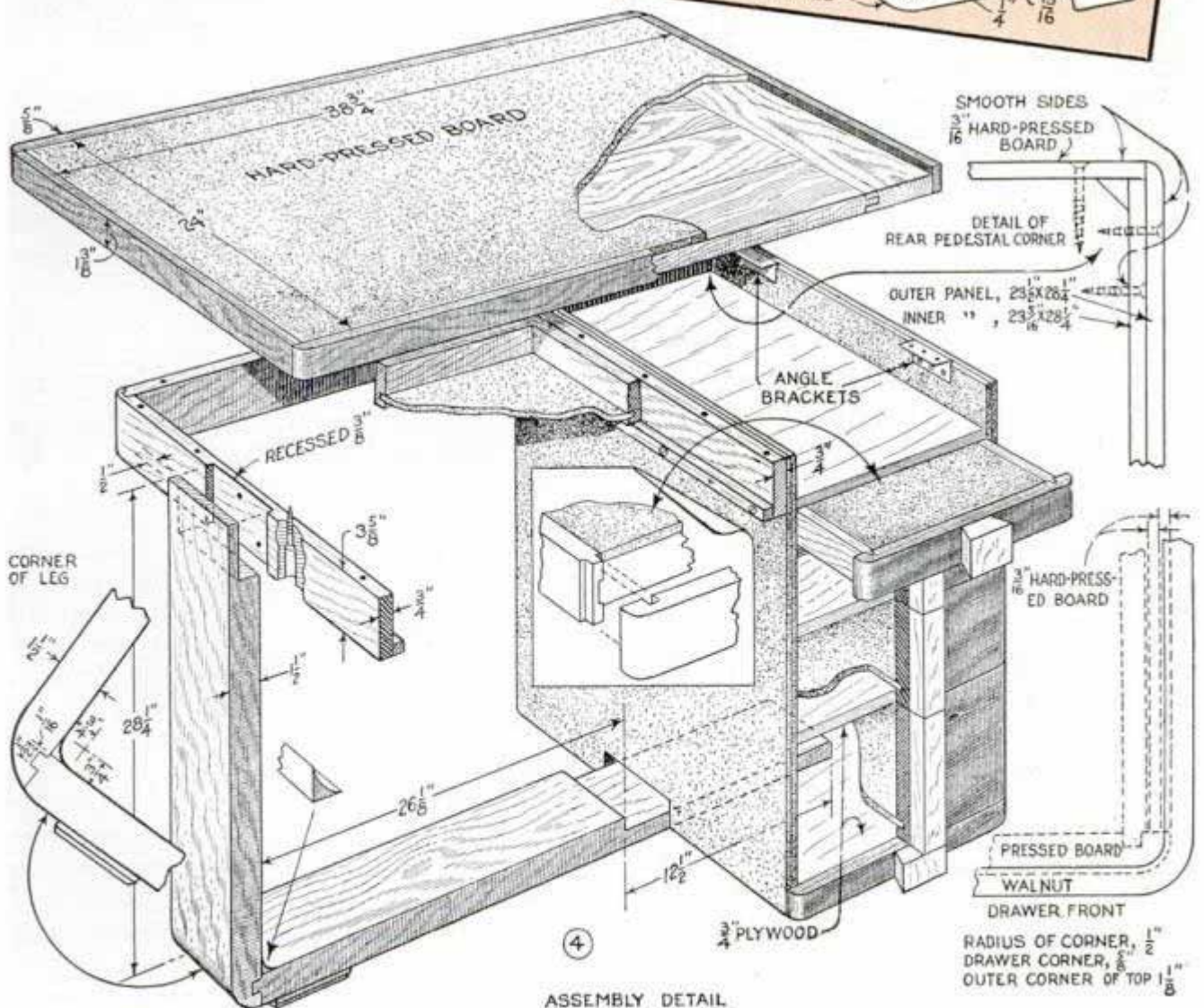
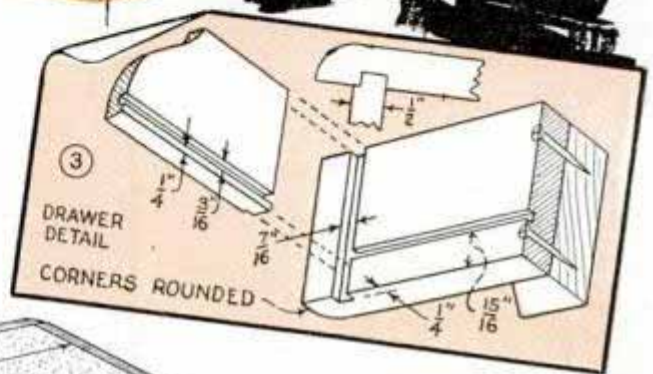

ASSEMBLY DETAIL

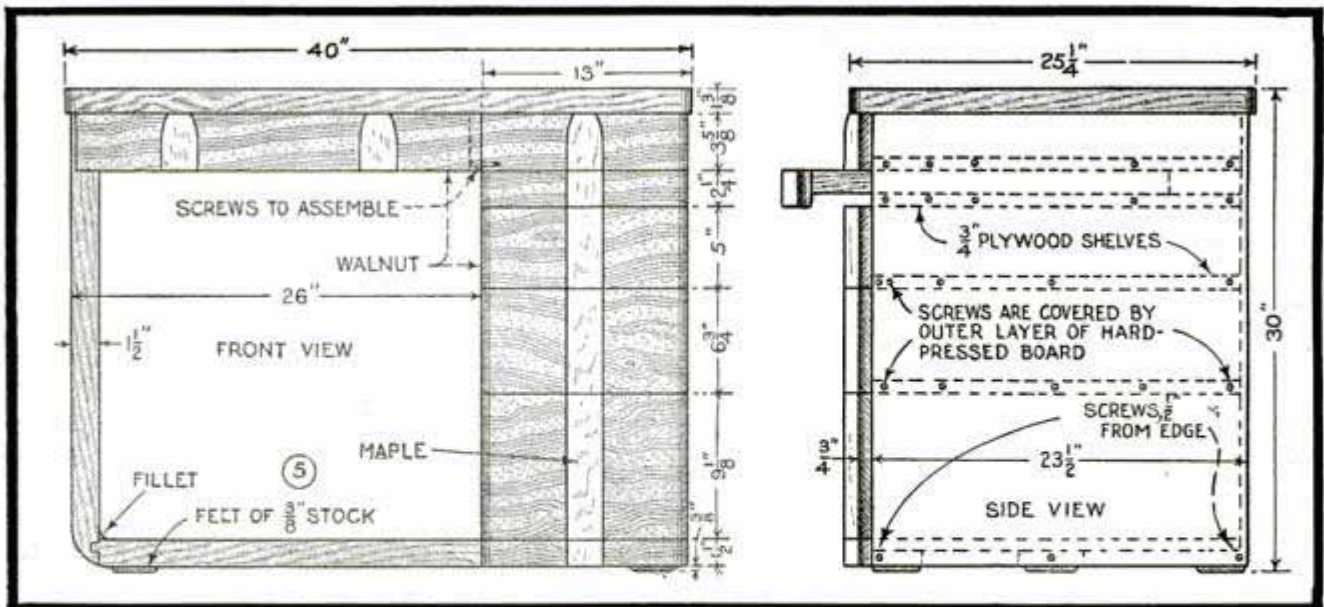

After the parts of the drawers are glued and fitted, the fronts are cut to length and the corners rounded to a $\frac{5}{8}$ -in. radius. The adjoining ends of the upper drawers may be left square if desired. Then the fronts are sanded and a line is scribed down the center to locate the screw holes for the pulls. These are made in one piece. Fig. 2 shows a sectional and side view of a pull on the upper drawer. A center line is scribed down the back, the edges are beveled, and the front corners rounded. Registering holes are then drilled through the fronts and the strip from which the pulls are to be cut. Finally, the strip is screwed to one drawer at a time and sawed off. This is done with the drawers in order to assure the grain in the pulls will match. Holes in the drawer fronts are drilled a size larger than the body of the screw so that after the pulls are screwed in place, they may be tapped with a mallet to align the strip perfectly. Note that the upper pulls are curved in from a point $1\frac{1}{4}$ in. from the top end to meet the edge of the desk top.

Screws fasten the apron to the leg and left side of the pedestal. The right side of the pedestal is held to the top by brass angles recessed to clear the drawers as in Fig. 4. Three feet, of $\frac{3}{8}$ -in. material, are attached as shown in Fig. 5. This brings the over-all height to just 30 in. All exposed edges are rounded slightly and sanded smooth. Walnut parts of the desk are given two coats of boiled linseed oil to darken the wood. When this is dry it is followed with several coats of wax, each

coat thoroughly polished. The pressed board is simply waxed, without an undercoat, but the maple drawer pulls require a coat of clear lacquer before waxing.

As you will see from the details, considerable variation of the materials used in this design is possible. For example, you can do the whole job in plywood, combining light and dark woods and finishing them in the natural colors. In this construction, the shelves on which the drawers slide would be glued in dadoes cut in the sides of the pedestal. The general appearance may be changed also to suit the surroundings by using the new modern drawer pulls in polished metal.

Spoon Makes Spray Nozzle

An old teaspoon lashed to the tip of a hose through which liquids are to be sprayed makes a simple and efficient spraying nozzle which can be adjusted to control direction, degree of diffusion and area to be covered. This is governed by the size and concavity of the spoon, angle of contact, size

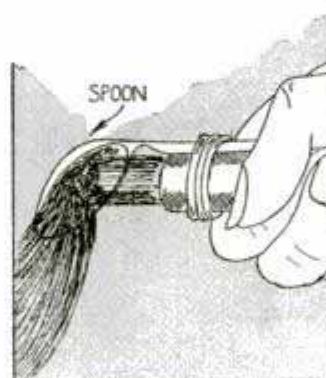

of outlet and the volume and pressure of the liquid. With a little experimenting, you can produce a spray that will suit many washing or irrigation requirements.

Miniature China Figures Depict Fairy Tales

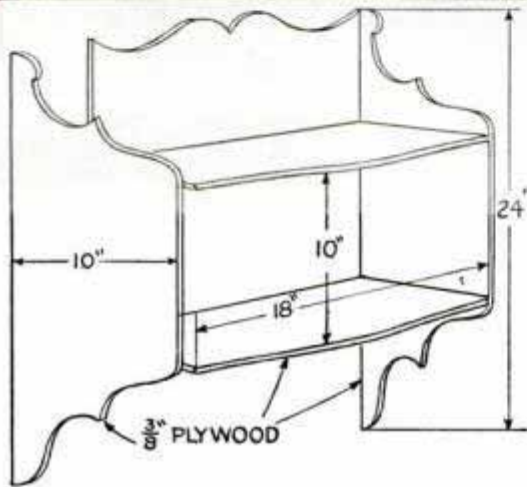
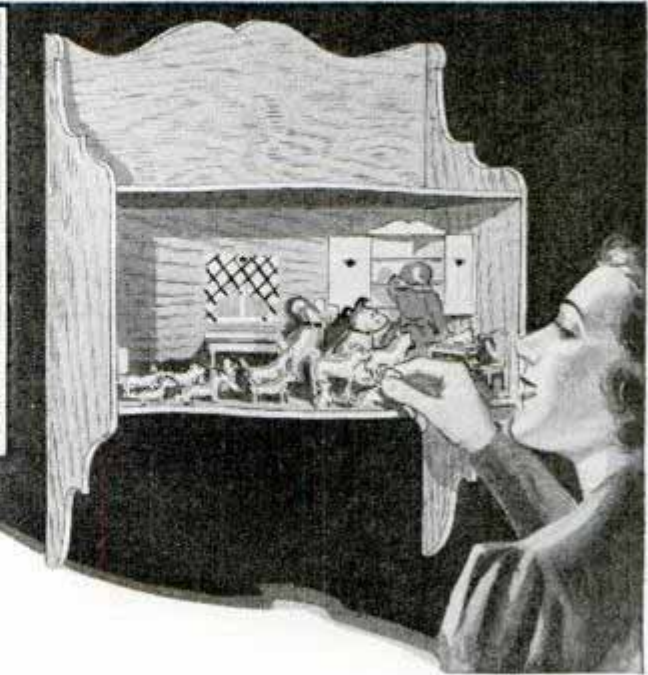
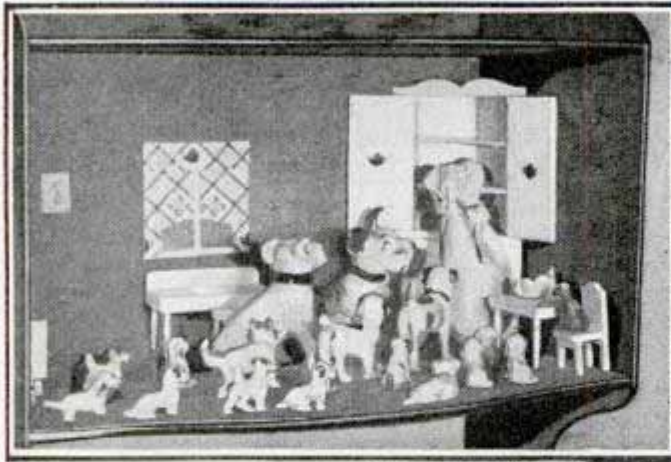

Instead of the usual hodgepodge arrangement of miniature china figures, why not fill out your collection and arrange them to depict some nursery rhyme, fable or fairy tale? This one, for instance, shows Old Mother Hubbard with her kitchen full of dogs, which, of course, amuses everyone. The cabinet may be built of light plywood and, although dimensions of one designed for this particular collection are given, it is best to plan the size and perhaps even its shape to suit the story you have in mind. Painting or staining the cabinet should be done with an eye for obtaining contrast.

Rubber-Band Arrow Guns Are Sawn Out in Quantities

If you are looking for a project to turn out at a profit in your home workshop, these rubber-band arrow guns are just the thing, as they are safe, inexpensive, and have a wide appeal to children. Cut on your band saw in quantities of eight or ten at a time with the jig shown, the guns can be retailed profitably even at a nickel each. Use $\frac{1}{2}$ -in. white pine in 4 or 8-in. widths. Some clear white pine can be bought as low as five cents a foot by specifying mill shorts of random lengths and widths. The arrows are tipped with rubber tubing.

One of the easiest ways of removing feathers from a wild duck, is to dip the fowl in boiling water and then wrap it in a thick towel, which steams the feathers loose.

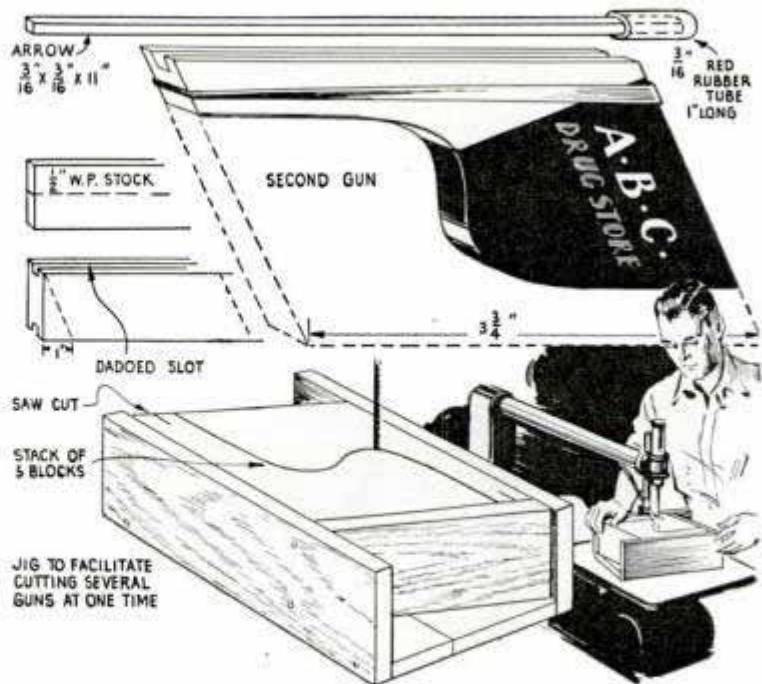

Retailed directly at five cents each or sold to merchants and manufacturers to be offered as prizes to their trade, these guns bring the home craftsman good spare-time profits as several hundred can be made in one evening

Rivets Heated for Small Jobs by a Blowtorch

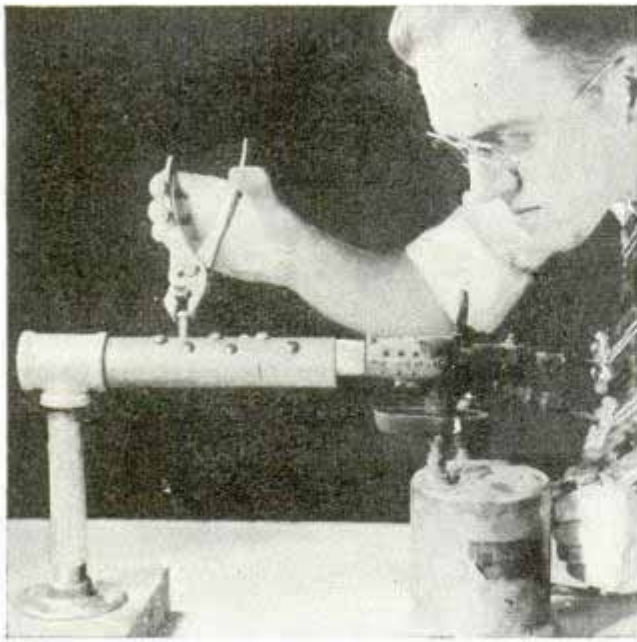

Flame of blowtorch concentrated inside of drilled sleeve which holds the rivets

Consisting of two short lengths of pipe, a tee and a floor flange, this rivet holder is handy when a few rivets must be heated for small jobs. The parts are assembled as shown and screwed to a table or large wood block. The flame of a blowtorch is directed into the end of the horizontal pipe, which is drilled to take the rivets.

A Hint on Branch Line Control for the Amateur Pipe Fitter

The amateur pipe fitter often runs into trouble when he installs a branch line because the control valve is not properly placed. In the detail marked "wrong," the branch line is suspended from the main line, and when the valve is closed, the pipe

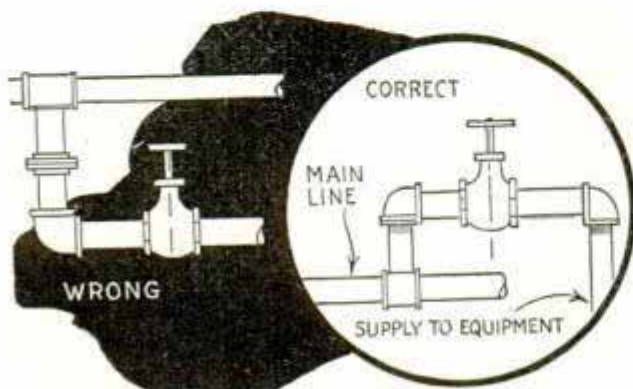

How to install the shut-off valve on a branch pipe line to avoid water hammer

on the pressure side fills with water or condensed steam, as the case may be, which surges forward when the valve is opened, causing "water hammer," and often more serious damage. The circular detail shows how to install the valve to prevent this trouble.

Sanding Disks for Model Work from Golf Tees

Using golf tees in the chuck of his hand grinder, one home craftsman has found them ideal for sanding delicate parts in intricate model work. The face of each tee is flattened and to it is glued a tiny disk of sandpaper. Several of the disks kept at hand will allow a new wheel to be inserted instantly as soon as one becomes worn.



"Nail" Candles to the Holders



If you have a pair of wooden holders in which it is difficult to keep the candles upright, drill small holes through from the bottom so that nails can be driven to project inside the holders. Then slip the lower ends of the candles over the projecting nails.

'Embroidery Hoop' to Mend Sails

For holding canvas of a sail or tent taut when mending a tear, you can use the rim from a coaster-wagon wheel and a heavy rubber band. Stretch the canvas over the rim, then pull the rubber band over the cloth and rim as shown.

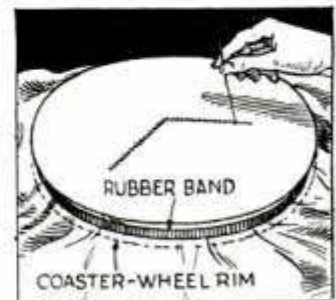

ROLLING CRADLE

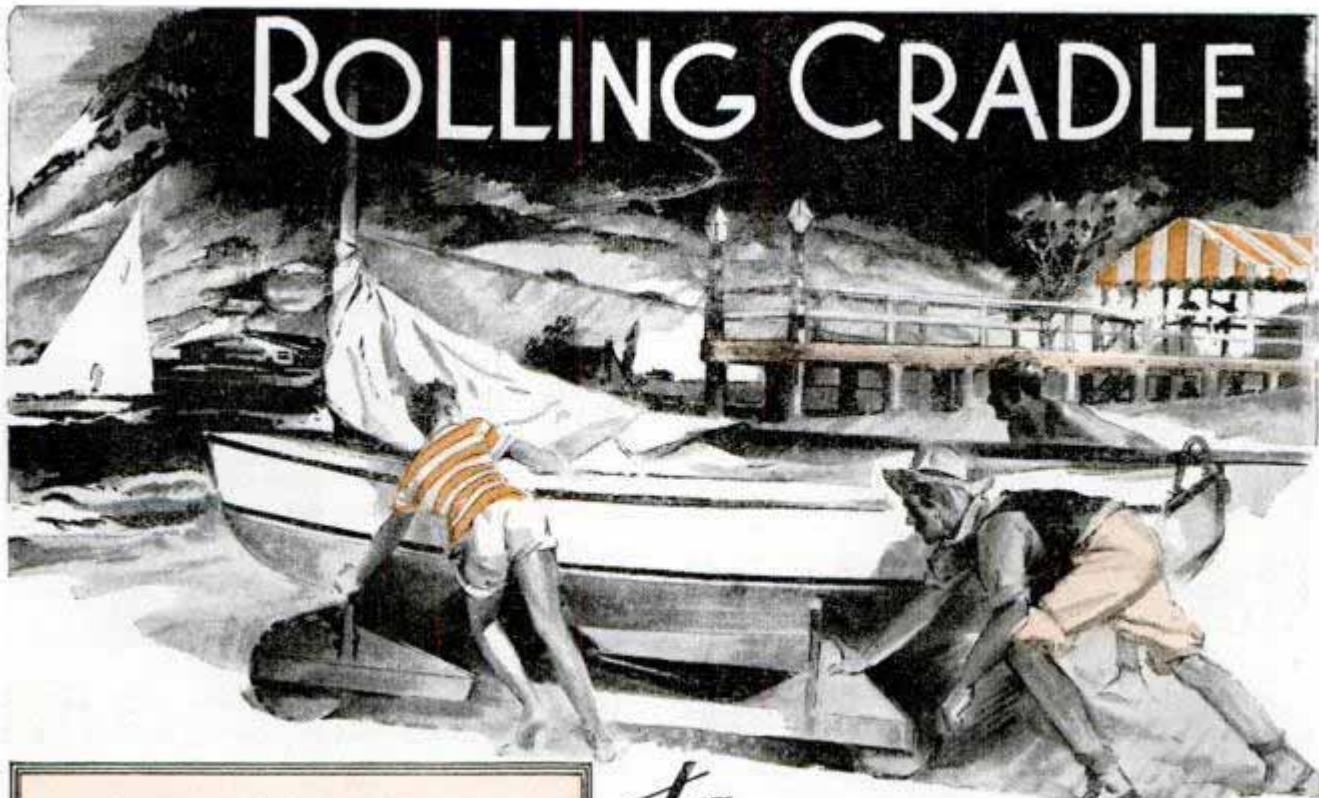

to

beach the sailboat.

"Caterpillar" treads on the rollers enable you to beach a large boat without getting stuck in the deep sand. The whole affair is knocked together out of rough lumber so that you can roll it right into the water and sink it under the boat. Dimensions are suitable for a 12 to 16-ft. hull. Bearings for the rollers are short sections of brass tubing set in blocks screwed to the side frames. Slats on the rollers are spaced about $\frac{1}{4}$ in. apart. Use galvanized nails in assembling and pad the cradles with several layers of canvas

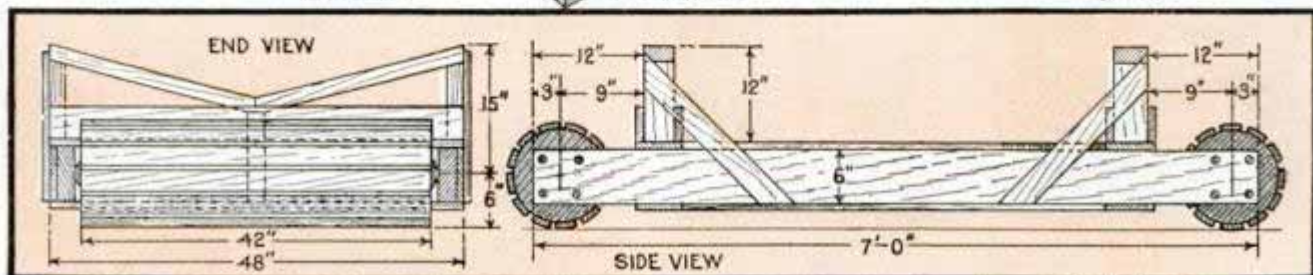
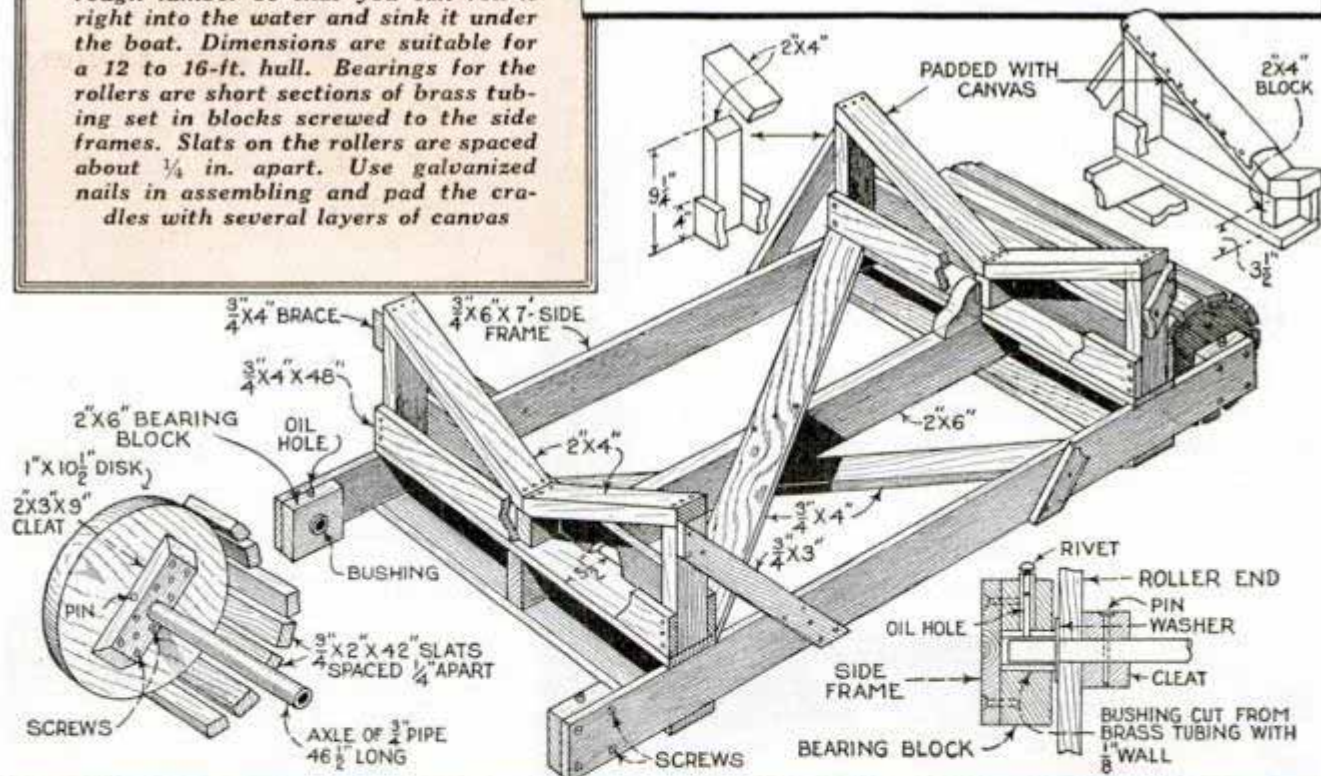

Speedy Coaster Trailer Carries Six Passengers

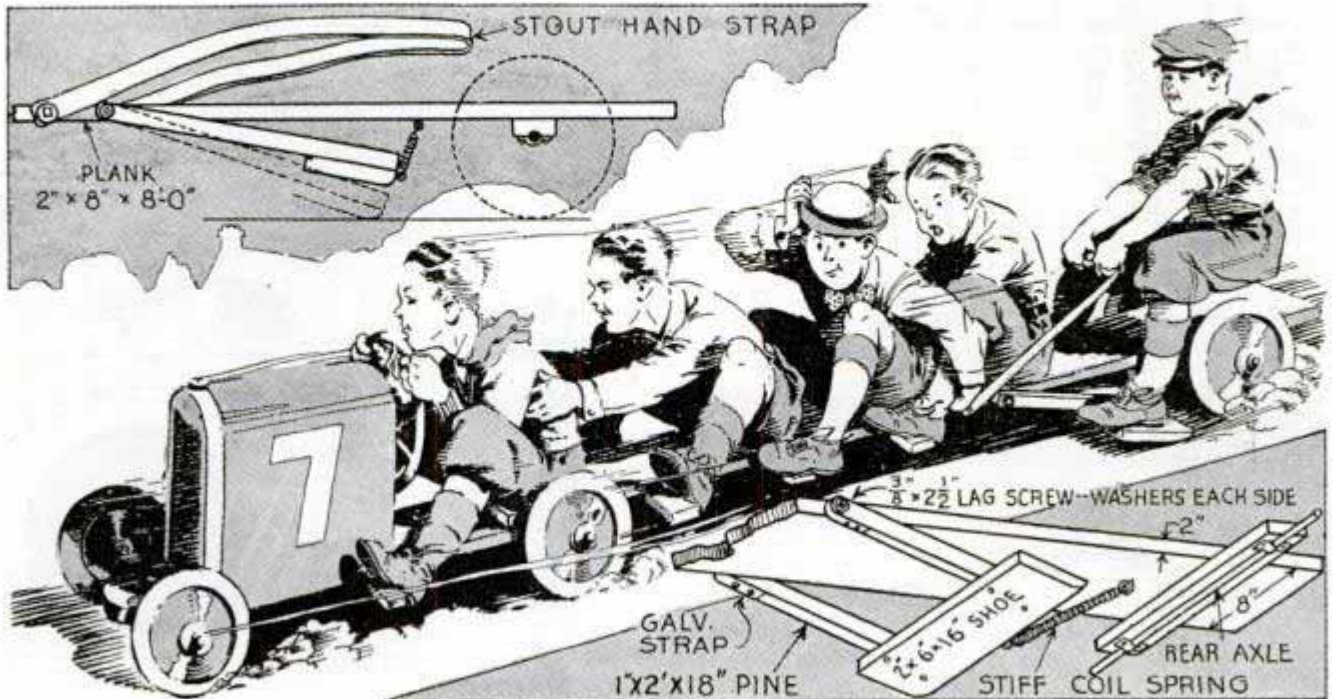

Piloted by a driver and brakeman, this five or six passenger coaster trailer will give all the thrills of bobsledding, while quick stopping is easy with a powerful friction brake. The trailer consists of a 2-in. plank about 8 in. wide and 8 ft. long, the front end being pivoted to a coaster wagon. Crosspieces for footrests are bolted on the underside, and a pair of sturdy wheels are mounted about a foot from the rear end. The brake unit is attached just in front of rear wheels, and consists of a wood "brake shoe" fastened to the main frame by a pair of wood arms swinging on lag screws. A coil spring keeps the brake off the ground when not in use. To make it work, the brakeman puts his feet on the brake shoe and grasps a stout strap to exert as much pressure on the brake as needed.

Hinged Step in Closet to Reach Articles on High Shelves

Instead of getting a box, stool or chair to reach articles on high shelves of a closet or pantry, this hinged step is much handier and also much safer. It consists of an 8 or 10-in. board cut long enough to fit inside the door frame and is hinged to one side of the frame with strong hinges. A cleat or similar support near the bottom of the other side of the door frame holds the free end of the step when it is lowered. A turnbutton or spring catch holds the end of the step when it is in the raised position.

Paraffin Finish on Turned Work

After a turning in a lathe has been sanded smooth you can give it a finish that will bring out the color and grain of the wood with paraffin. Just hold a cake of the latter against the work as it rotates, then polish the work by holding a piece of cardboard against it.

—Robert D. Krout, Findlay, Ohio.



SPEED RIGGINGS *for*



MOST racing yacht models are fitted with a sliding mast step and jib rack. If you move the mast and sails forward, the boat will not have the same tendency to point up into the wind, while if you move it back, the boat will luff, or point into the wind more. In the 50-in. class there is no restriction on the movement of the mast, but in the International A-class the limit is $\frac{1}{2}$ in. either way from the measured point, which is fixed by trial. Almost the same effect can be obtained by raking (slanting) the mast. The angle at which the shrouds come down to the deck should remain approximately the same. This explains why the chain plates have several holes.

Most model yachtsmen now use a "kicking strap," to prevent the main boom going up while running, causing the sail to wrap around the mast. It consists of a double gooseneck with a stiff-wire kicking strap tightened by a turnbuckle, Fig. 2. The whole thing turns without friction caused by pulling against an outside object. When a boat is beating to windward, the steering sheets are not used, and the rudder is left free. Both jib and mainsail are trimmed in fairly tight, but not right amidships. The angle of both sails with the cen-

Important details on fittings, sails and rigging that make for quick handling during a race when every second counts

ter line of deck should be about the same. Should there be any difference, the jib should be in slightly more, as then the boat will pay off more quickly, in case she should luff up in irons (both sails flapping). If the course is a little more off the wind, say a close reach, Fig. 1, you can use the jib to steer by. Unhook the jib beating sheet and set the bowser on the running sheet on the jib boom to a position which lets it out to the angle required, and set the mainsail to a corresponding angle. The jib steering lines on deck should hook to the holes near the outside edges of the quadrant because there is not so much pull on the jib. Now place the slides in position to allow quadrant to turn a little. It is better to start with them about half way along the slots and just enough tension on the rubber to pull the rudder straight when the strain goes off the sail. Then, if the boat comes ashore you can quickly re-adjust the slide to the tension required. The tension required on the rubber will be found to vary with different wind velocities; the more wind the more tension required, and also the more rudder necessary to keep the boat off the wind.

When running true down wind, the main-

Model Yachts

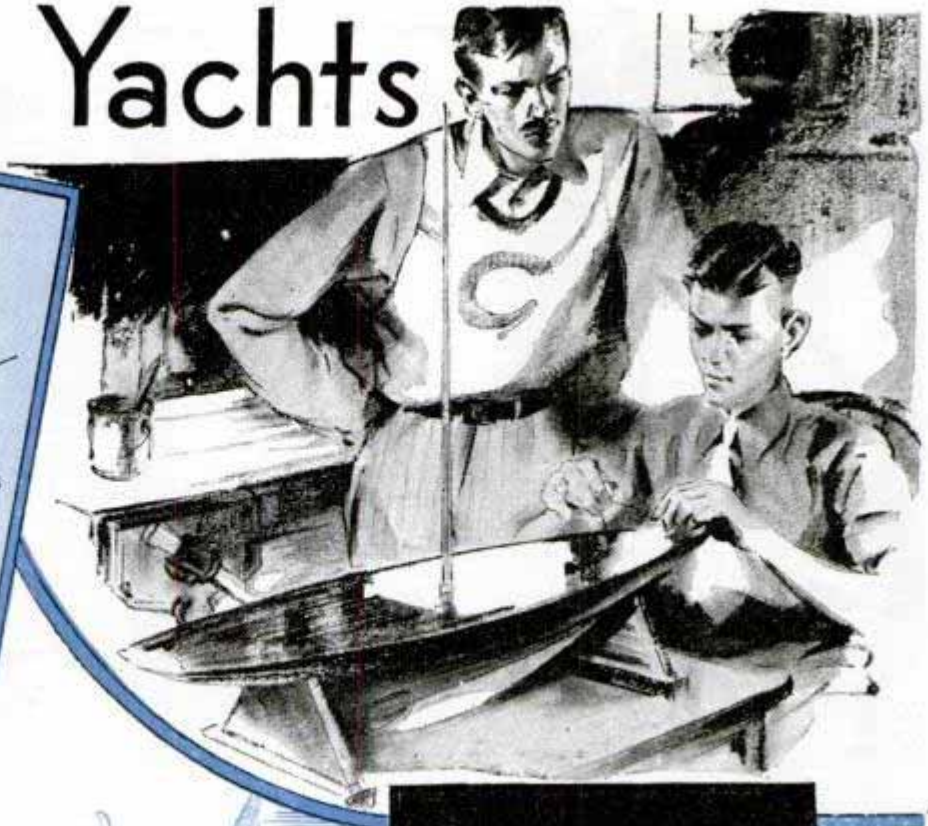
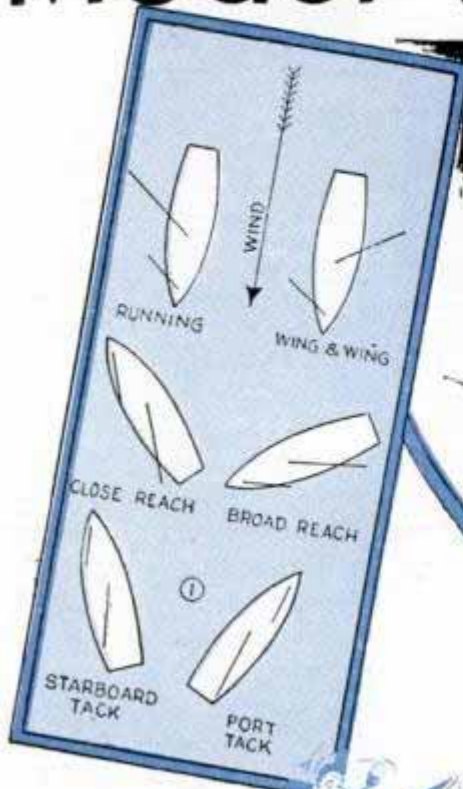

sail should be well out, but not enough for the boom to hang against the stays. The jib should be out at about the same angle. In this position the tendency should be to "jibe," or swing around on the other tack. But the jib would jibe first and at this position, Fig. 4, the jib will be pulling against the mainsail and should prevent it from jibing. If you are not using a spinnaker this method of sailing would be the best if you can get the mainsail and jib to stay on opposite sides. In any case you should be prepared for a jibe and have the other steering sheet set so that she will immediately jibe back, Fig. 5.

Spinnakers are now used in all model-yacht racing. In the A-class the size of spinnaker is limited by the hoist and foot of the jib. The spinnaker boom must not be longer than the distance from the foot of mast to where the luff of the jib cuts the deck, and must not be hauled up higher than where the jib halyard cuts the mast. In the Marblehead class the boom is limited to 12 in. and the hoist the same as the jib. Parachute-type spinnakers can

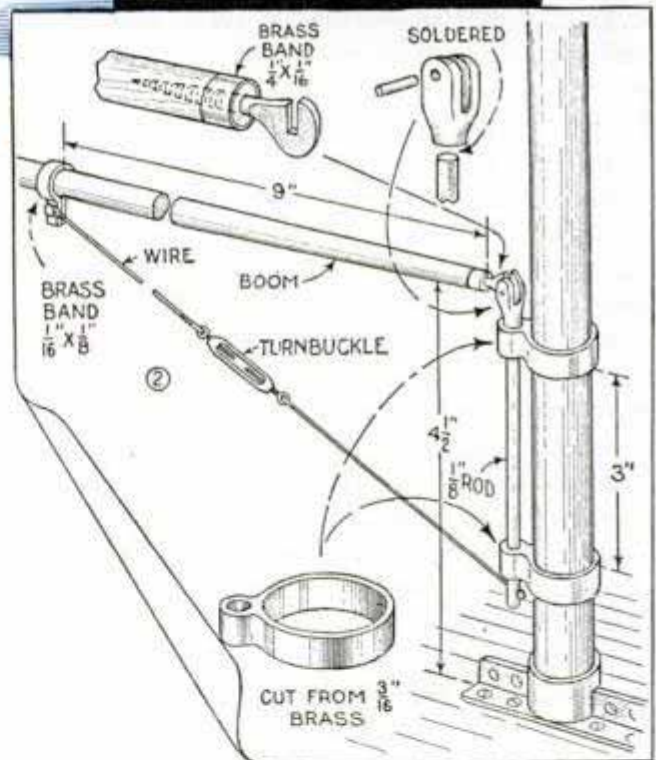

be made very large. Some are 72 in. along the foot, and are made in four triangular pieces with about 2 1/2-in. curve on each joining edge. They only work well in a good steady breeze. A gooseneck is necessary on the mast for use of the spinnaker boom. The beginner is advised to use a small, fairly flat spinnaker at first, cutting the foot the length of the base of the fore triangle plus half the beam of the

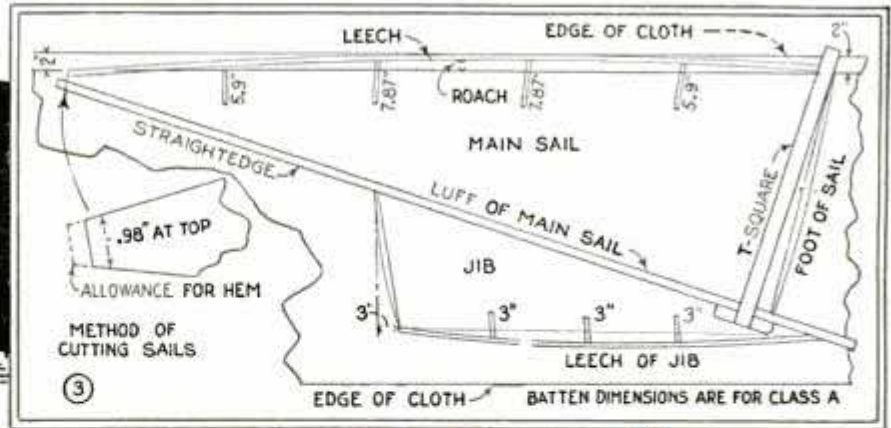

boat at the mast. This sail should be set between the jib and the mast, the sheet fastened aft of the stays on the rail. It is a good plan to have scale markings on the deck where the bowsers are, to enable you to get the same setting each time.

Sails are the most important fittings on a model yacht and if you make them yourself mark them out directly on the cloth, which should be pre-shrunk and pressed. You will need a straightedge about 7 ft. long, a $\frac{1}{4}$ by $\frac{1}{4}$ -in. batten about the same length, a T-square, and weights to hold the straightedge in place. On the straightedge mark a point a distance from one end equal to the length of the luff of the sail. At this point set the T-square and mark on it a distance equal to the length of the foot of the sail as in Fig. 3. Now move both so that the mark on the T-square will come to one end of the cloth about 3 in. from the edge, and the end of the straightedge about the same distance from the edge of the cloth at what will be the top of the sail. Before marking out, check the measurements with the sail plan, making any necessary changes. When you have the corner points correctly located, join with straight pencil lines. Next lay off the curve of the roach, the amount which you can put in depending on the length of battens and stiffness of the cloth. This is limited to 2 in. in the Marblehead class. If you put in too much roach the sail will

not draw. Pencil the curved line of the roach with the batten, using weights to hold it in place, and be sure you have a fair curve running well up above the top batten pocket and below the lower one. There are four batten pockets spaced equal distances apart. Make allowance for the headboard; for the A-class .98 in. and for the 50-in. Marblehead class, .75 in. Without making the sail wider at the foot you can increase it at the top the width of the headboard before adding roach. With the roach correctly located, mark lines on the inside and outside curve of the batten to give a $\frac{1}{4}$ -in. allowance for the hem. The writer prefers a straight luff. The foot of the main sail should have a little fullness, about $\frac{1}{2}$ in. in 36 in. Next, you mark out the jib. As the cloth lies on the bench, the luff of jib will be about parallel to the luff of the mainsail, Fig. 3. The roach in the jib is put in similar to the mainsail, and similar fullness allowed on the foot, in proportion to the length.

The leech of the sails is hemmed first and if corner pieces are used they fit under the hem. Great care must be taken not to stretch the cloth. The other sides should be taped as follows: Take some $\frac{5}{8}$ or $\frac{3}{4}$ -in. tape (linen preferred), wet it and iron it doubled. Fold the tape over one end of the sail and slowly start the machine by hand, taking only two or three stitches. Then pull the tape tight with one hand and feed the cloth into the fold with the other, keeping it straight. When the sail is finished you should be able to put considerable strain on the tape without pulling the sail. In making sails to meas-

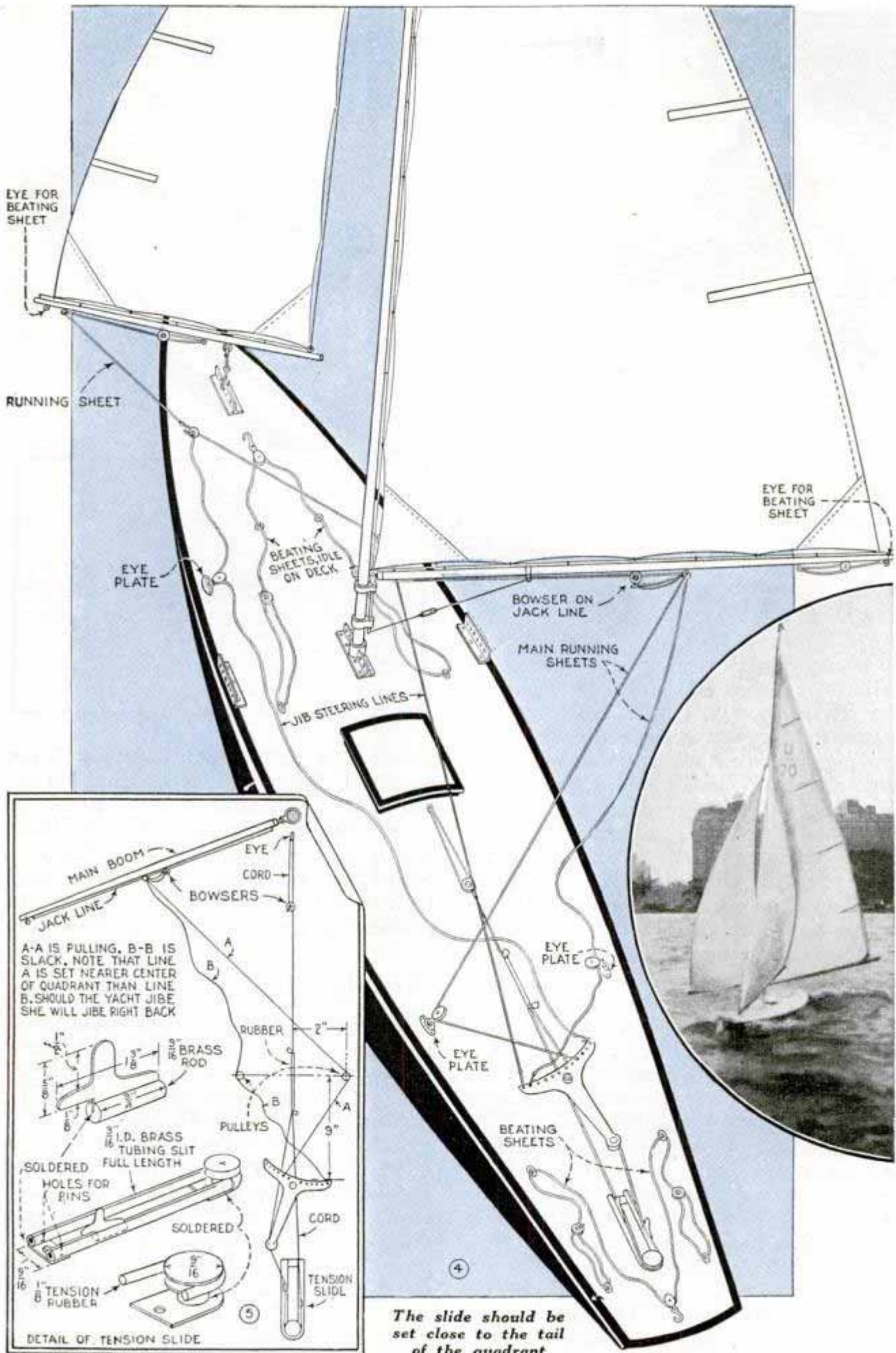

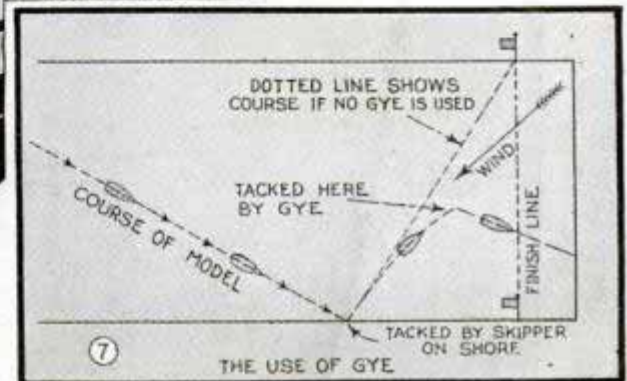
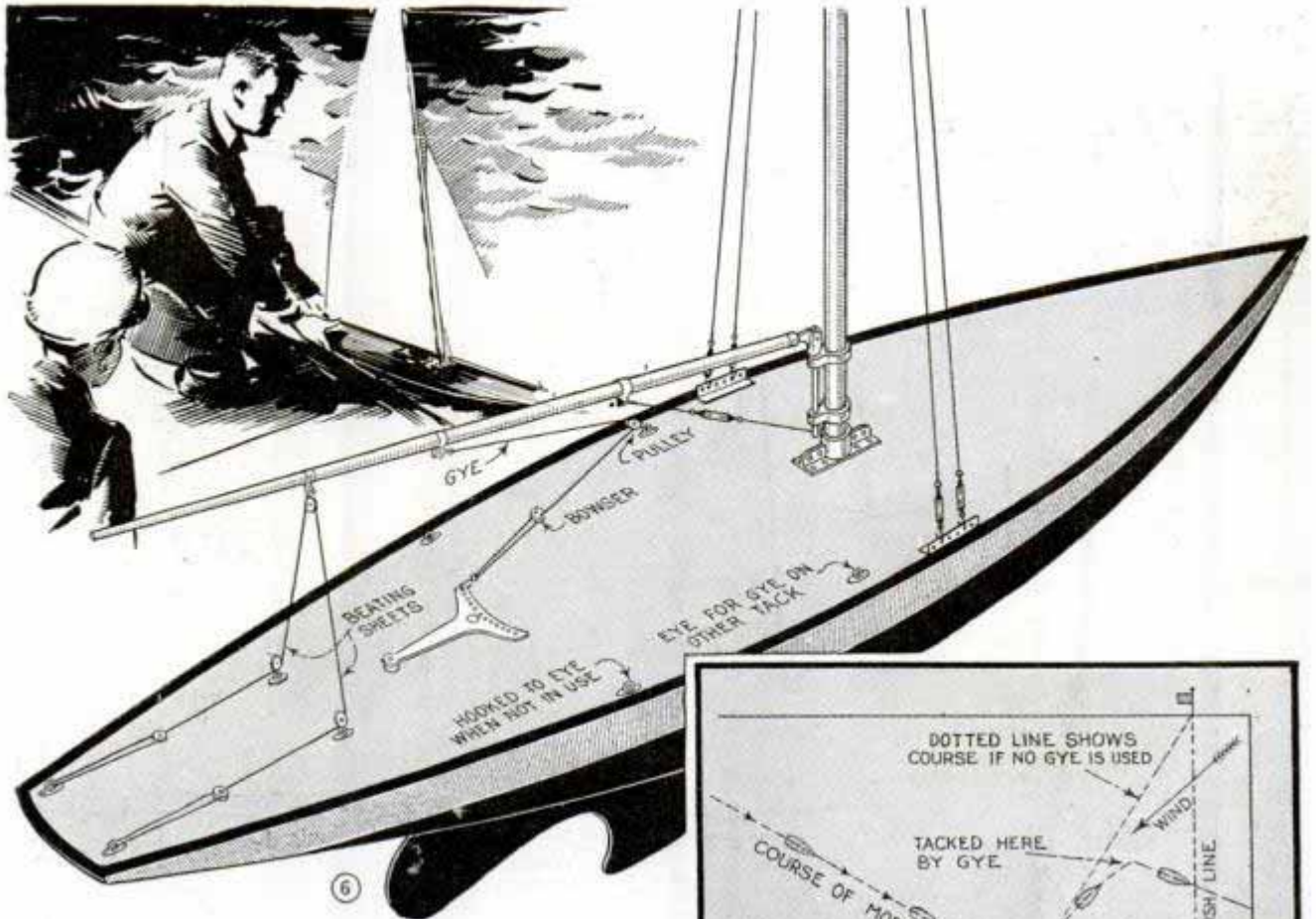

urement for classes where restrictions are strictly observed, allowance must be made for stretching, say, 1 in. in height and $\frac{1}{2}$ in. on the foot of the mainsail. The jib is not measured in A-class, but some allowance should be made in 50-in. class. Batten pockets may be made of sail cloth or tape, the latter being easier. The battens can be made out of $\frac{1}{16}$ -in. celluloid, $\frac{1}{4}$ in. wide. Push in the battens, cut to length, then close the pocket with several stitches across the open end. When setting the sails, do not stretch them out the first few days, but let them gradually "bend" into shape. Should they get wet be sure to loosen them at both ends immediately, or in shrinking they will pull out of shape.

In pond sailing, where the models are handled from the shore, a "gye" is used to tack the boat a few yards off shore as in Figs. 6 and 7. It consists of a cord with a hook at one end, a pulley on a hook at the middle, and a hook and bowser at the other end. The first hook fastens to a ring on the main boom about 18 or 20 in. from the mast. The pulley is hooked to an eye plate on the rail about 1 in. aft of the stays. The other hook is fastened to the quadrant. To adjust the gye, hold the boom amidships and set the bowser so that

the cord is tight and ready to pull the quadrant. The gye is hooked up, but not set to "act" unless required. When the boat is sailing on the tack where the boom and pulley are on the same side, the gye is not pulling. If the boat is put on the other tack the gye should start to pull as the mainsail crosses the center of the deck.

Avoiding Leaks in Garden Pool

If a garden pool leaks and the concrete mix was correct, plastering and cement waterproofing coat properly applied, the trouble may be traced to lack of preparation given the rocks. The pores of rocks picked up in fields, or along streams are often clogged with foreign material and should be scrubbed with a stiff brush and strong soap, followed by a rinsing. Another cause of failure is using dry, porous rocks, which absorb water from the cement, causing it to shrink away from the rock slightly. Before beginning pool construction, pile the rocks and thoroughly drench them, then cover with wet sacks.

Numbered Stakes Mark Path of Lost Arrows

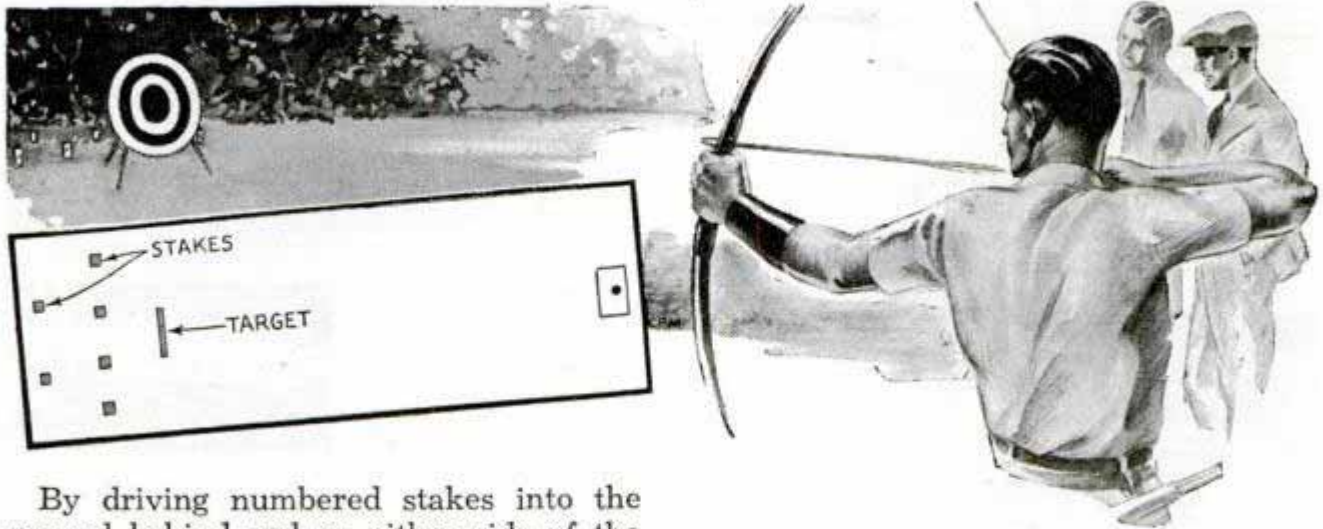

By driving numbered stakes into the ground behind and on either side of the archery target, you'll save both time and arrows when they are lost in the tall grass or shrubs. Remember the stakes marking the path of the missing arrows. When you are in the grass looking for them, place yourself in line with both the point where you were shooting and the point where an

arrow passed certain markers. While walking along in a line thus laid out it will be necessary to look only a few feet on either side of it to locate the arrow. For markers, use shingles painted white with large black numerals on both sides.

—Joseph Scott, Cambridge, Mass.

Pivoted Trough Automatically Fills Two Rain Barrels

If you keep a barrel at one of your downspouts to store rain water, here is a simple method of installing a short trough to automatically carry the water to a second barrel near by when the first one is filled. The trough is pivoted to the edge

of one barrel, as indicated in the detail, with the closed end directly under the spout so that this end hangs downward. A wide block nailed to the underside of the trough at the rear end serves as a float, which raises it as the barrel fills with water. When the barrel is filled, the trough conducts the water to the second barrel.

—A. S. Wurz, Jr., Rockyford, Alta., Can.



With this automatic arrangement you don't have to run out in the rain to switch the water trough from one barrel to another

Tool Handles Given Neat Ferrules with Caster Sockets

Needing several ferrules to strengthen his tool handles, one craftsman utilized caster sockets taken from old furniture. The ends of the sockets were cut off to the right

length, after which they were driven firmly into suitable holes bored in the ends of the handles. Besides giving added support to the tools, the sockets gave the handles a neat finished appearance.

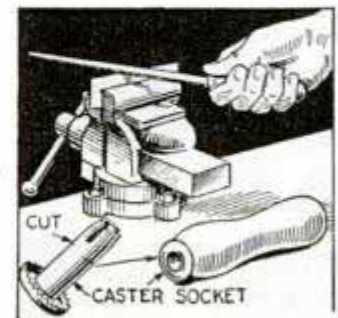

Soil-Pipe Joints Are Cemented Neatly with Rubber Forms

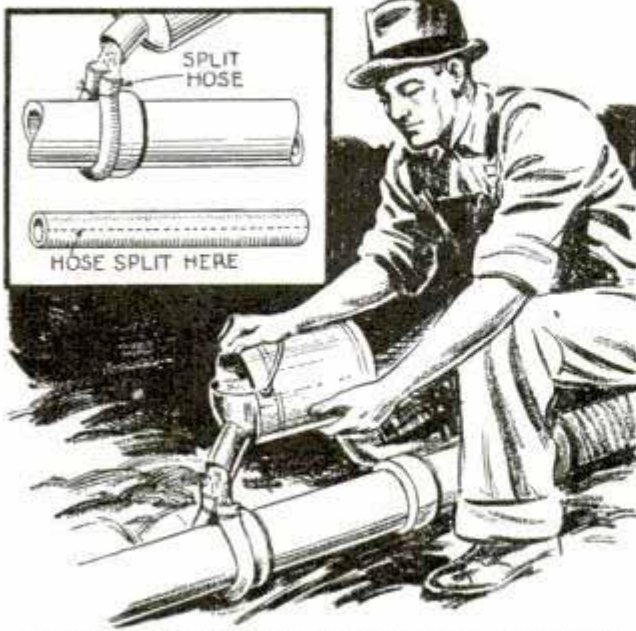

Anyone can do a first-class job of cementing soil-pipe joints with these rubber forms

Any inexperienced worker can cement sewer or soil-pipe joints neatly by using rubber-hose forms, which are made by cutting out a strip lengthwise after cutting it in pieces long enough to reach around the pipe. In use, a piece is drawn up around the pipe with the open side butting against the bell end of the pipe, after which the ends are tied together. Be careful not to fold or tie the hose so tightly that it closes. Next, a thin mixture of cement is poured into the hose, lightly tapping it with a hammer at the same time so that the cement will work well into the joint. When the cement has set, the form is removed, leaving a neatly rounded job.—A. H. Waychoff, Tempe, Ariz.

Paint Scraper of Hacksaw Blades



With this scraper, the painter who must remove old paint from a large area can do the job in a short time. It is made from ten or twelve hacksaw blades held parallel in a frame consisting

of a length of broom handle and two strips of sheet steel assembled as shown, wash-

ers being used between the blades to space them.

—Paul H. Smith, Charlestown, Mass.

Locking Pump-Rod Couplings

If a coupling on a pump sucker rod has a tendency to loosen, the trouble can be stopped by using lock nuts at each end of the coupling as shown. The nuts are driven on the threaded ends of the rod, after which the coupling is screwed on until the ends of the rod meet. Then the nuts are turned up snugly against the ends of the coupling.

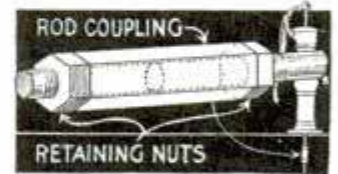

—Don C. Higbee, Cantil, Calif.

Spice Boxes Placed on "Steps" Are Easy to Locate

If you keep your spice boxes and similar small containers in a cabinet or cupboard, here is a simple support, shaped like steps, that will raise each row of boxes above the one in front so that any article can be picked out at a glance. Besides this, the support makes it an easy matter to clean the cupboard or cabinet, as all the boxes can be removed at one time.

—M. McElravy, Denver, Colo.



You can pick any spice at a glance if you keep the boxes on this stepped support

Sturdy "Floor Freighter" for Young Skippers

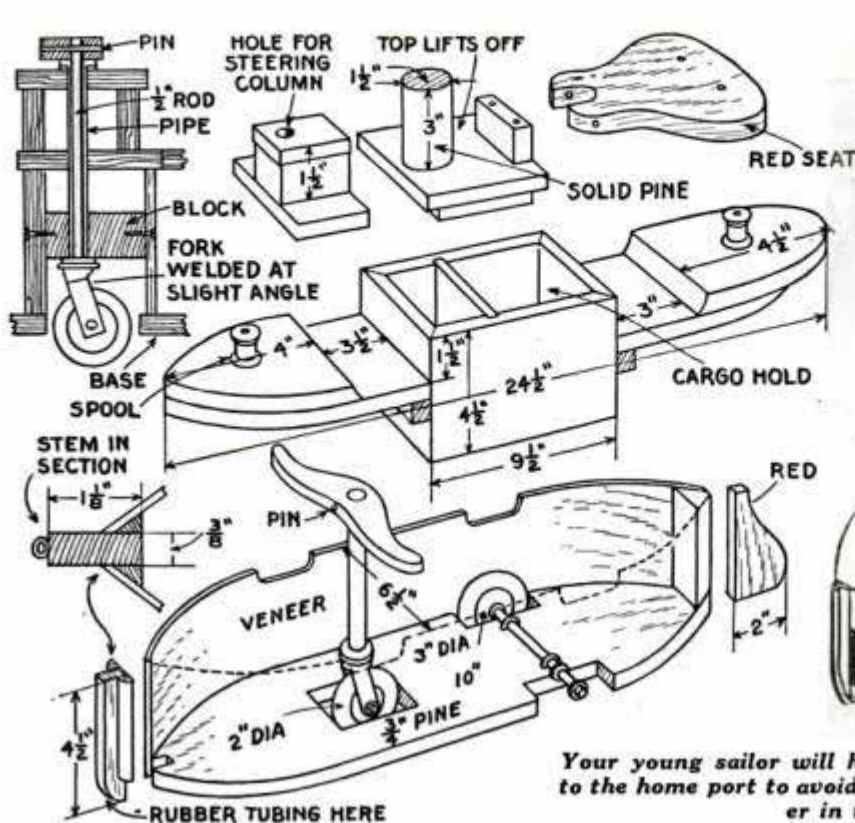

Your young sailor will have a lot of fun beating a sou'wester to the home port to avoid foundering this heavily laden freighter in the living-room sea

Youngsters will have a lot of fun with this trim "floor freighter" because they can fill the hold with building blocks and other freight, then climb aboard and pilot it to any port in the house. It is sturdily built and provided not only with rubber tires but has $\frac{1}{4}$ -in. rubber tubing along the "water-line" as well as on stem and rudder to prevent marring woodwork or furniture. The ship consists of a base and deck joined with sides of light plywood. A cargo well or hold is built in amidships and the decks are fastened to this by means of cleats. Note that part of the roof of the main cabin, carrying the funnel and seat, lifts off to give access to the cargo hold. The seat straddles the funnel and rests on a supporting block, screws being used for attachment. Steering is by a single small wheel, which is set in an inclined fork, so that in towing with a string tied to the capstan the ship will follow the direction of the pull. The steering post is set in a short section of pipe to serve as a bearing, and the handlebar is attached with a pin.

Removing Plants Potted in Cans

As it is difficult to remove potted plants from cans after they have established their roots, it is a good idea to cut the sides of the cans before potting the plants. After cutting, wire binding is used to hold each can together. When you are ready to remove the plants, simply untwist the wires and open the cans.

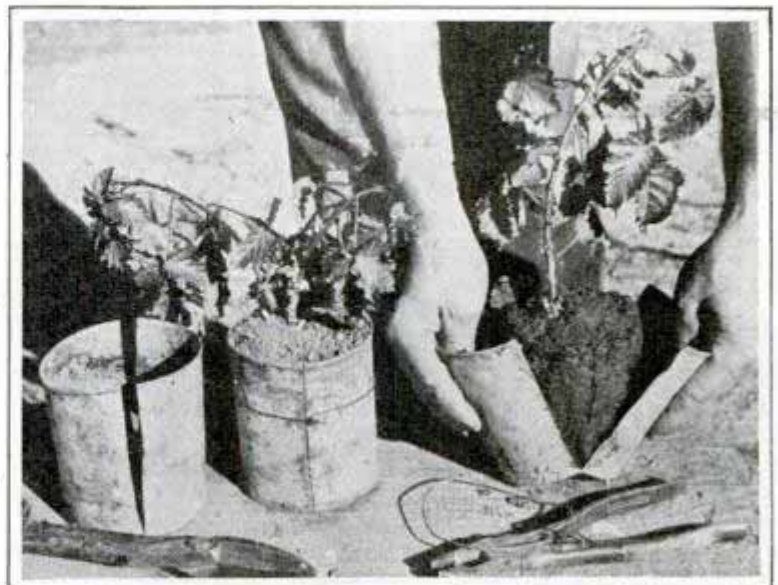

Plants may be removed from cans without disturbing the roots if the sides of the can are cut

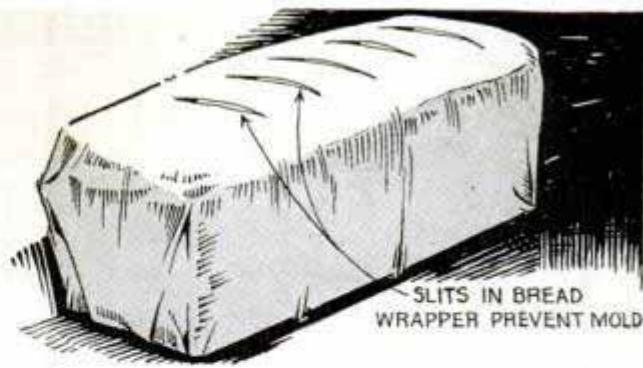

SLITS IN BREAD WRAPPER PREVENT MOLD

If you keep several loaves of bread on hand, it's a good idea to slit the wrappers as shown above, which will admit just enough air to retard molding. When skirts slip toward one end of a clothes hanger, just bend up the lower portion as shown at the left and pin the skirt to the ends, which will keep it straight and prevent wrinkling

Simple Methods of Solving Your

HOME

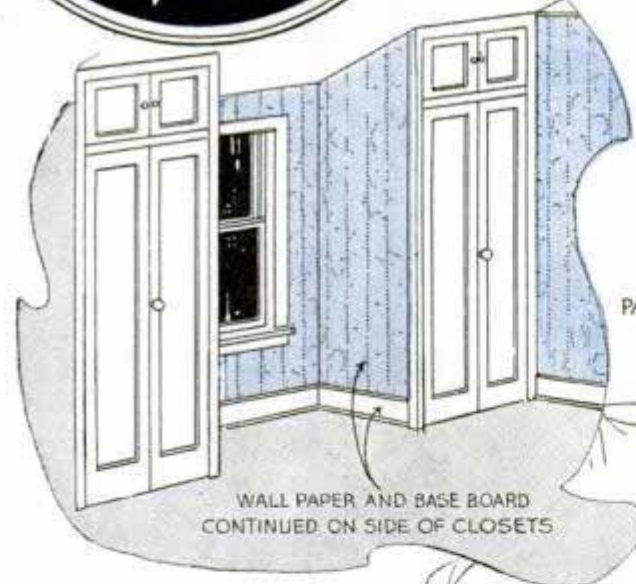

WALL PAPER AND BASE BOARD CONTINUED ON SIDE OF CLOSETS

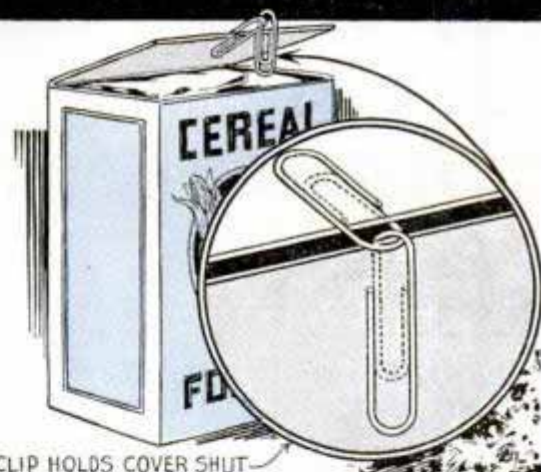

PAPER CLIP HOLDS COVER SHUT



NON-TIPPING CLOTHESLINE PROP

To close a cereal box tight you can use two paper clips as shown at the upper right. Corner closets of a bedroom will appear as part of the room instead of added "boxes" by simply continuing the wall paper and baseboard as shown above. A clothesline prop that won't tip and slide down the line is made easily from three light strips and a brace as shown at right

"Pin-hole" leaks in hot-water tanks are repaired by first enlarging the hole with a taper punch and tapping it. Then, after threading a piece of soft copper wire, turn this into the hole and cut it off, leaving a short projection, which is hammered down to expand the wire. Below, a weight fastened to the cistern cover makes it impossible for youngsters to lift the top

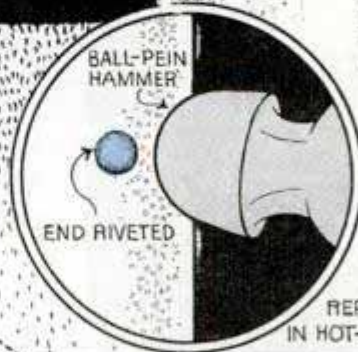
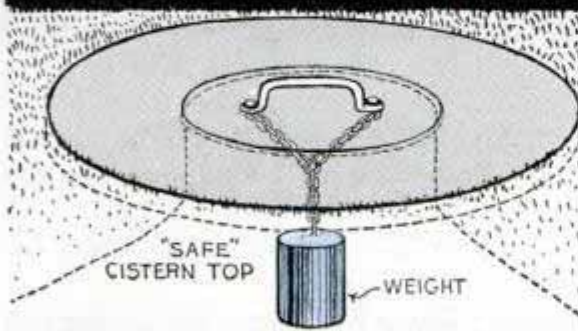

REPAIRING LEAKS IN HOT-WATER TANK



PROBLEMS

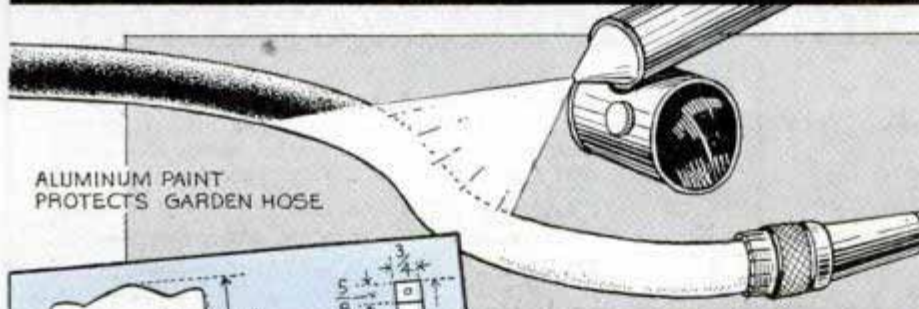

THERMOMETER MADE EASY TO READ

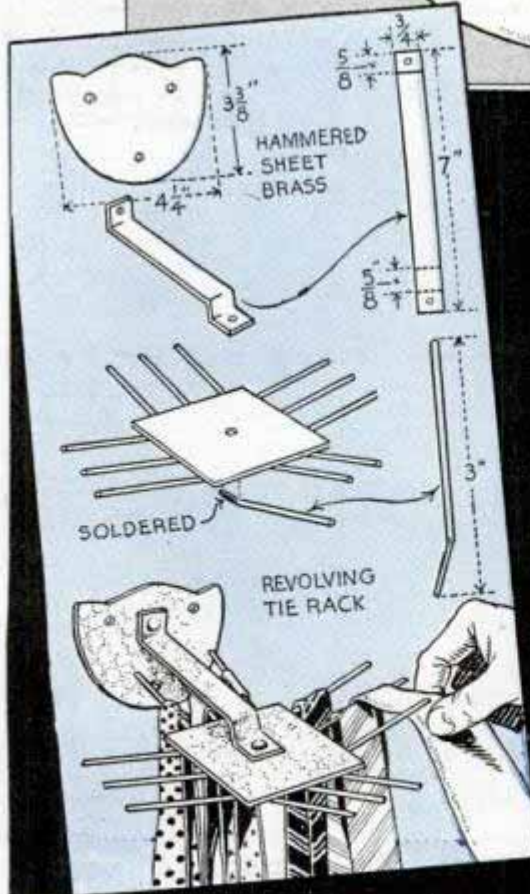
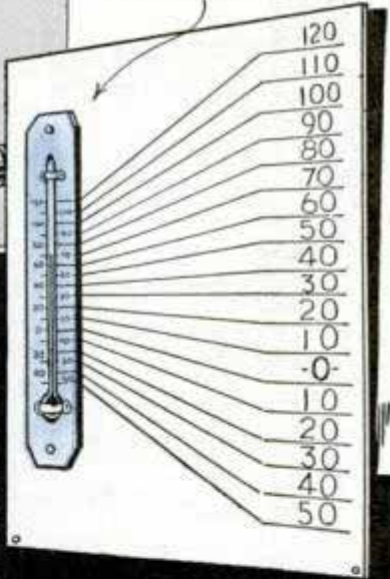

Aluminum paint sprayed on a garden hose reflects heat and keeps the rubber relatively cool. Right, extending and enlarging the temperature graduations of a thermometer on a cardboard mounting. The instrument is glued or riveted to a piece of cardboard. At the left are complete details for making an attractive revolving tie rack in hammered sheet brass



Cellulose tape, 1/2 in. wide, wrapped about the trigger guard of a loaded revolver reduces the danger of having it accidentally discharged if a youngster should happen to find it. The tape can be broken quickly in an emergency

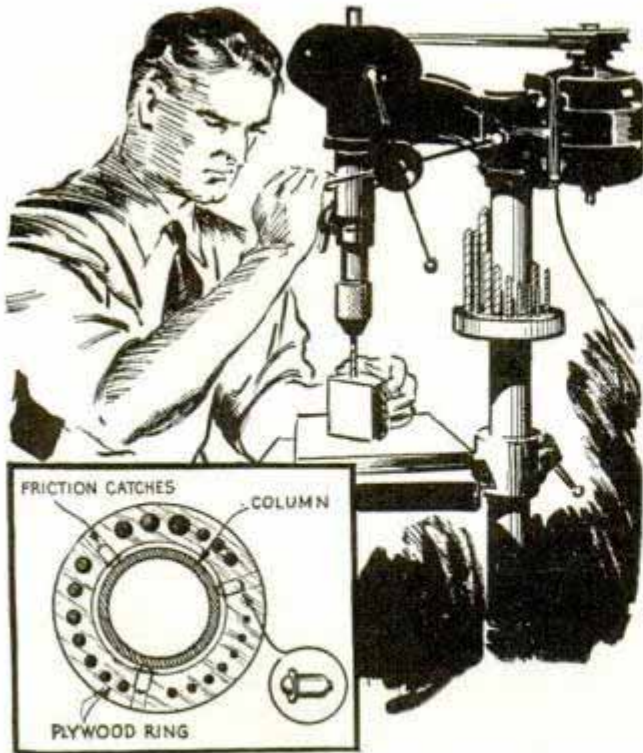

Adjustable Holder for Set of Bits on Drill-Press Column

Fitted with friction catches so that it will "stay put" at any desired height on a drill-press column, this holder consists of a plywood ring in which blind holes of various sizes are bored to take the drill bits. The inner opening of the ring is slightly larger than the column so that the friction catches can be fitted. The catches exert sufficient pressure to keep the holder from slipping, yet permit it to be moved when desired. The drill-press head is removed to slip the tray on the column.

—Wayne C. Leckey, Aurora, Ill.

☐ If large rubber heels are put under the legs of a mechanical refrigerator, they will help absorb vibration and make the machine more silent in operation.

Why Not Start a Home Workshop?

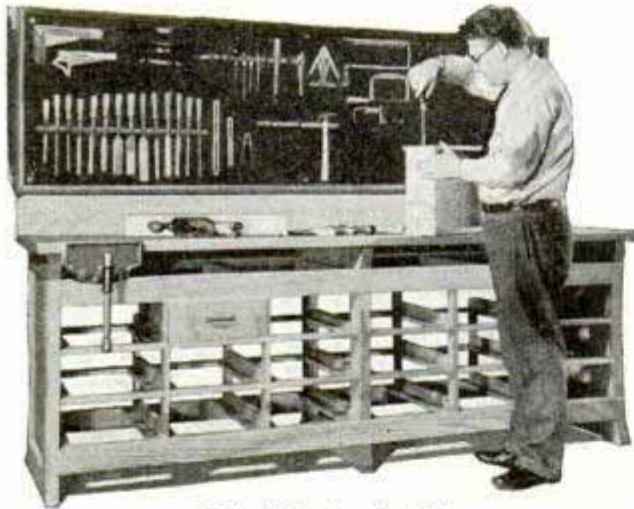

Cabinet Workbench—898

DRILL PRESS—895: Pipe fittings. $\frac{1}{2}$ -in. chuck and ball-bearing spindle. 28 in. high—25c.

BELT SANDER—579: Heavy-duty type. Angle-iron framework and a 5 by 46-in. belt—25c.

CIRCULAR SAW TABLE—910: Angle-iron frame. 24 by 36-in. table. 10-in. blade—25c.

All six blueprints listed above will be sent to you prepaid upon receipt of \$1.00, or separately for 25c each. Also send 15 cents for our 1937 "What to Make" booklet which lists hundreds of other blueprints for practical craftsmen. These include plans for home improvement, furniture, novelties, toys, boats, models, outdoor sports, and many other miscellaneous subjects.

A few homemade machines will enable you to get into this interesting field. Whether you want a shop for pleasure or profit, our plans will give you all of the information you need.

CABINET BENCH—898: Nearly 8 ft. long, 27 in. wide, 35 in. high. 20 drawers—25c.

22-IN. SCROLL SAW—771: Pipe fittings and hardwood. Has sewing-machine drive—25c.

12-IN. BAND SAW—836: Smooth running and sturdy. Cuts 2-in. stock easily—25c.

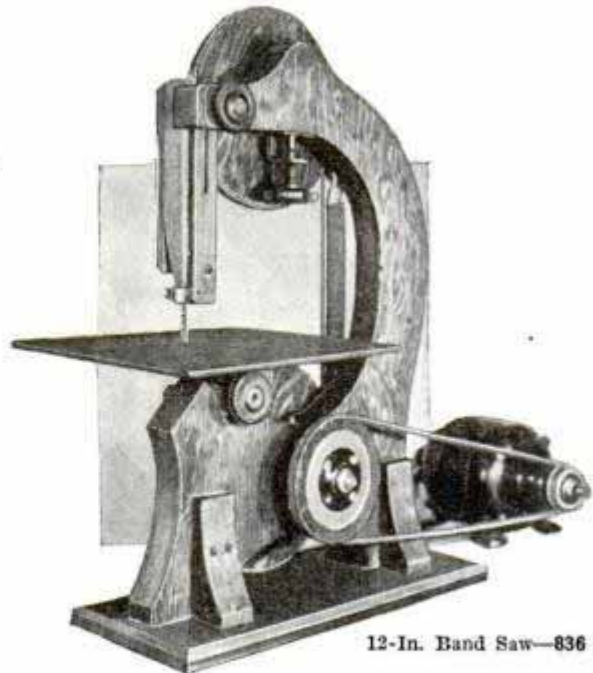

12-In. Band Saw—836

Blueprint Department, Popular Mechanics Magazine, 200 E. Ontario St., Chicago

*A run/angle 120 to
Wilmington, Ohio*



KNOW *your* BITS

*All about
wood-boring bits—
how they work—
how to select the
right bit for the job—
how to sharpen—
etc.*

IF YOU pick up a wood-boring bit and examine it closely you will see that the head of the bit consists of a number of parts as shown in Fig. 1. Each of these does its own job when the tool is in use. The screw enters the wood first; then the spurs follow and finally the cutters. As soon as the latter strike the wood, the strain of cutting is thrown on the screw. In addition to this, the screw bears the lateral strains set up by the spurs when passing through irregularities of the grain. There is both pull and severe side thrust taken solely by the screw when the bit is passing through the wood. The spurs, it will be seen, function both as guides and cutters and determine the

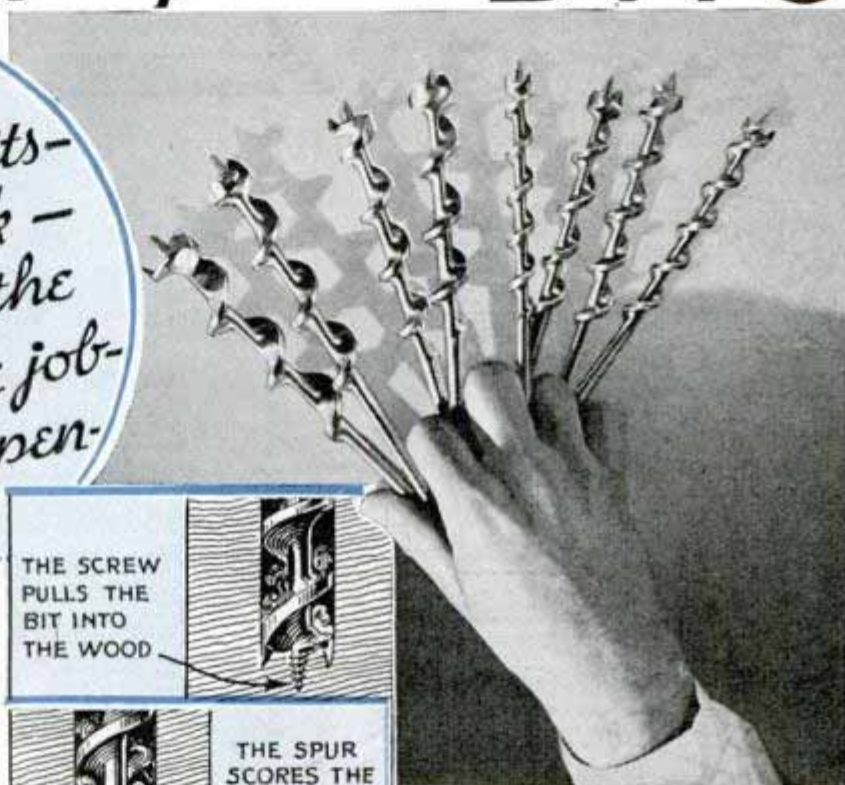

exact diameter of the hole. The leading edge of each spur scores the wood deeply, severing the fibers and forming a V-shaped groove, the outer side of which is vertical. The cutters merely lift the chip into the throat, from which it is carried upward by the flutes. Here is really a double-wedging action with force exerted in opposite directions. The wedging action of the cutters in lifting the chip tends to draw the bit into the wood, but the same action of the spurs tends to force it out. The pull of the screw

Stebbins Hardware Co
Woodworkers Tool Works

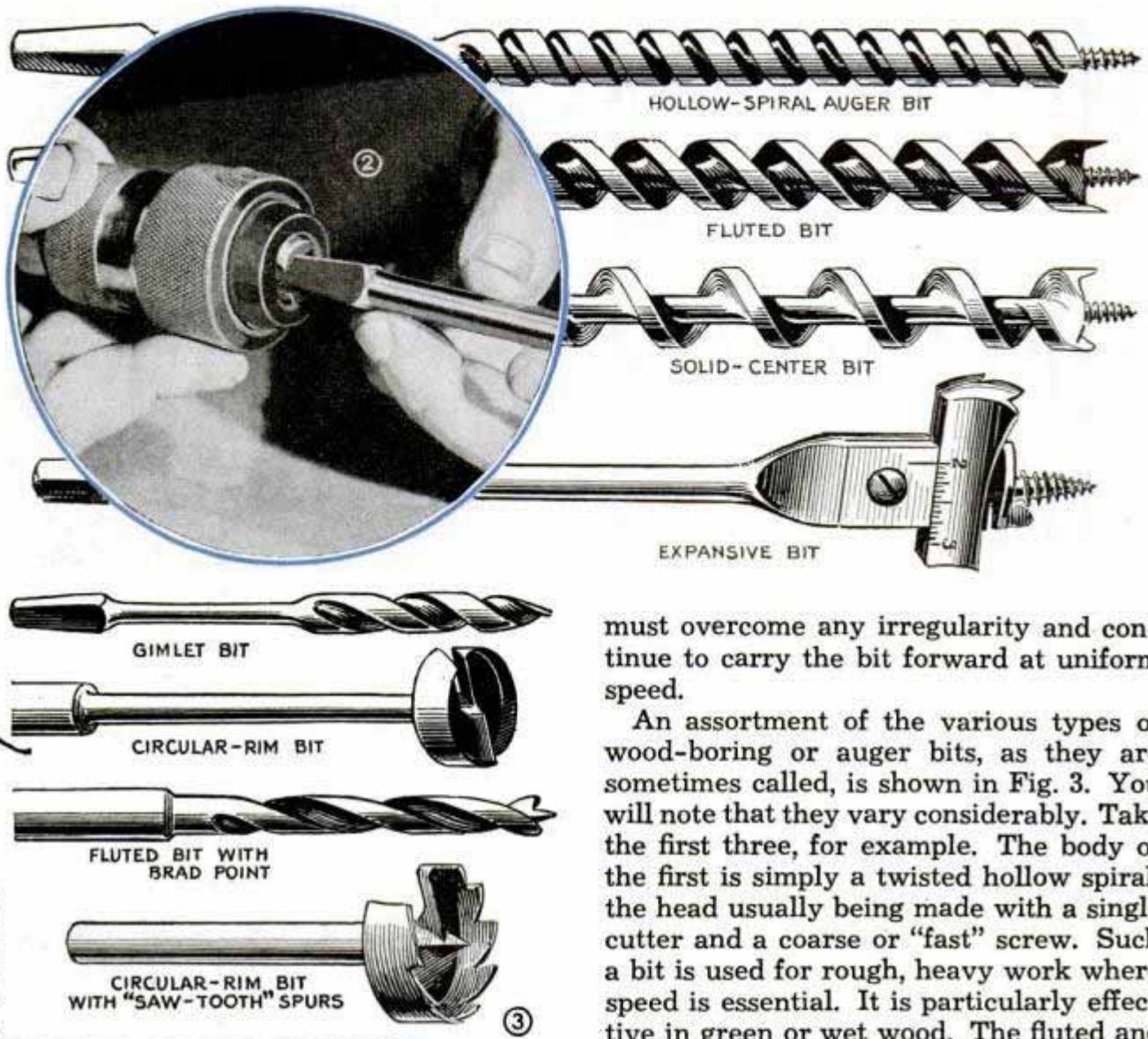

must overcome any irregularity and continue to carry the bit forward at uniform speed.

An assortment of the various types of wood-boring or auger bits, as they are sometimes called, is shown in Fig. 3. You will note that they vary considerably. Take the first three, for example. The body of the first is simply a twisted hollow spiral, the head usually being made with a single cutter and a coarse or "fast" screw. Such a bit is used for rough, heavy work where speed is essential. It is particularly effective in green or wet wood. The fluted and solid-center bits are designed for fine work where holes must be bored smooth and to exact diameters. Both types of bits are usually furnished with either a medium or "slow" screw, Fig. 4, and have two spurs and cutters. The characteristics of the expansive bit differ from the others in that there are no flutes along the body, and one cutter and spur are adjustable in a transverse direction so that the bit can be made to bore holes of varying diameters. The expansive bit and the gimlet bit are handy to have, even in the household tool kit, the gimlet being especially useful for boring holes in either hard or soft wood. Two of the remaining three styles shown are designed exclusively for use in a drill press, although any one of them will operate satisfactorily when turned with a brace. Two types of circular rim bits are shown, the first having what is really two continuous spurs, each extending from the cutter around the cir-

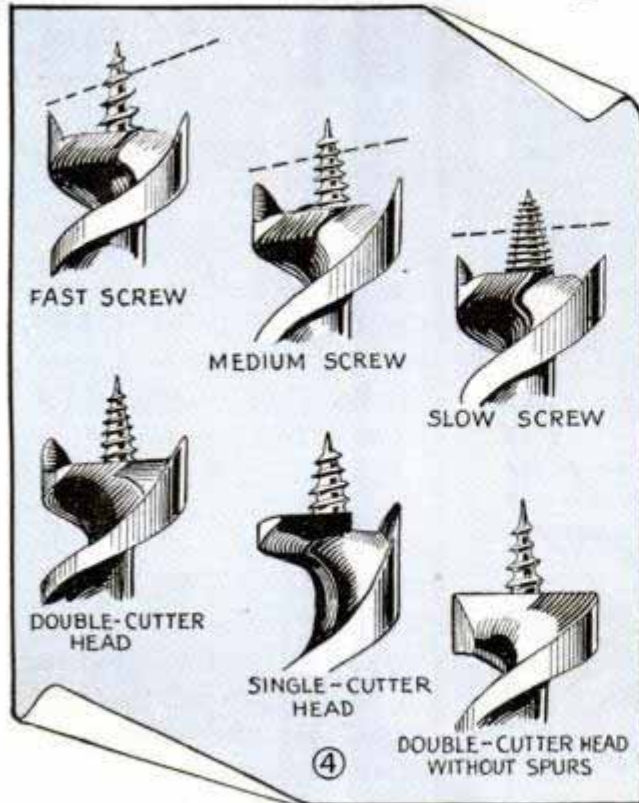

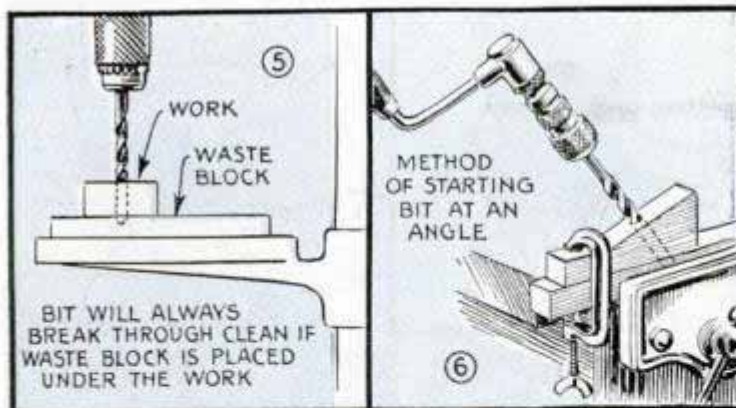

cumference to the chip slot just ahead of the cutter following. There is no screw or brad point, the circular rim acting as a guide. Although this bit bores slowly and, when driven in a drill press, must run at a comparatively slow speed, it is capable of producing the finest and most accurate work. It is supplied with either a straight shank for the drill press, or with a squared and tapered shank for the brace. The second bit of this type shown in Fig. 3 has a single cutter and a continuous saw-tooth spur. It is especially suitable for boring holes in thin wood and is supplied with a straight shank only. The fluted machine bit, Fig. 3, is similar to the metal drill except that it has two cutters, two spurs, and a brad point. It is suitable for high-speed work and is supplied with a straight shank.

One essential step to good work with a wood-boring bit is shown in Fig. 2. The jaws of the better grades of braces are curved and V-grooved and are opened and closed by tapered or beveled rings actuated by the outer threaded sleeve of the chuck. When chucking a bit it is necessary to see that the corners of the square shank are placed in the V-grooves and also that the shank is pushed into the chuck as far as it will go. To assure that the corners of the shank remain in the grooves, the jaws are opened just far enough to admit the shank. When the chuck is tightened, the bit will be straightened and held parallel with the axis of the brace. A bit in good condition will enter the wood and continue to bore with very little downward pressure on the brace, as in Fig. 7. Bits that are well cared for seldom need sharpening, but it is important that this be done properly. Fig. 8 shows how the cutters are sharpened with a special auger-bit file having one smooth or "safe" edge. The

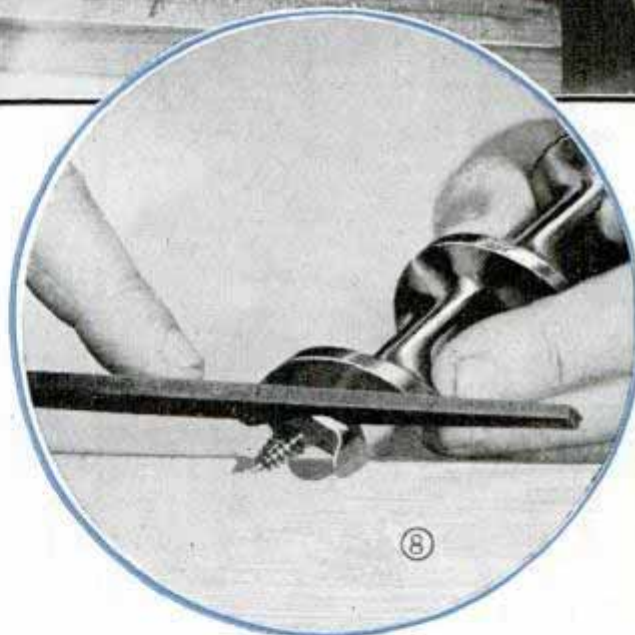
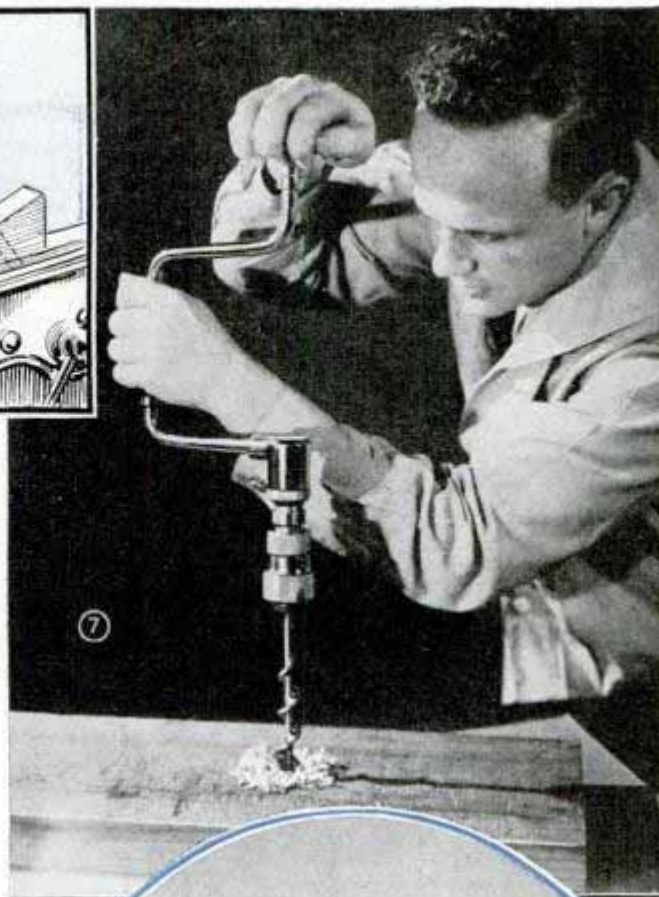

bevels on the cutting edges should be kept just as near the original form as possible. If, for example, the angle of the bevel is shortened, the chip will be curled tightly and the bit will tend to clog. Only the top of the cutter should be filed; never the bottom as this will flatten the clearance angle. When you file the cutters it's a good idea to touch up the spurs also. In filing the spurs, the important thing is to keep the original shape. With care, this can be done with the bit file as in Fig. 10. Notice particularly that the inside face of the spur is convex and that the sharp edge is continuous. It is necessary that the cut-

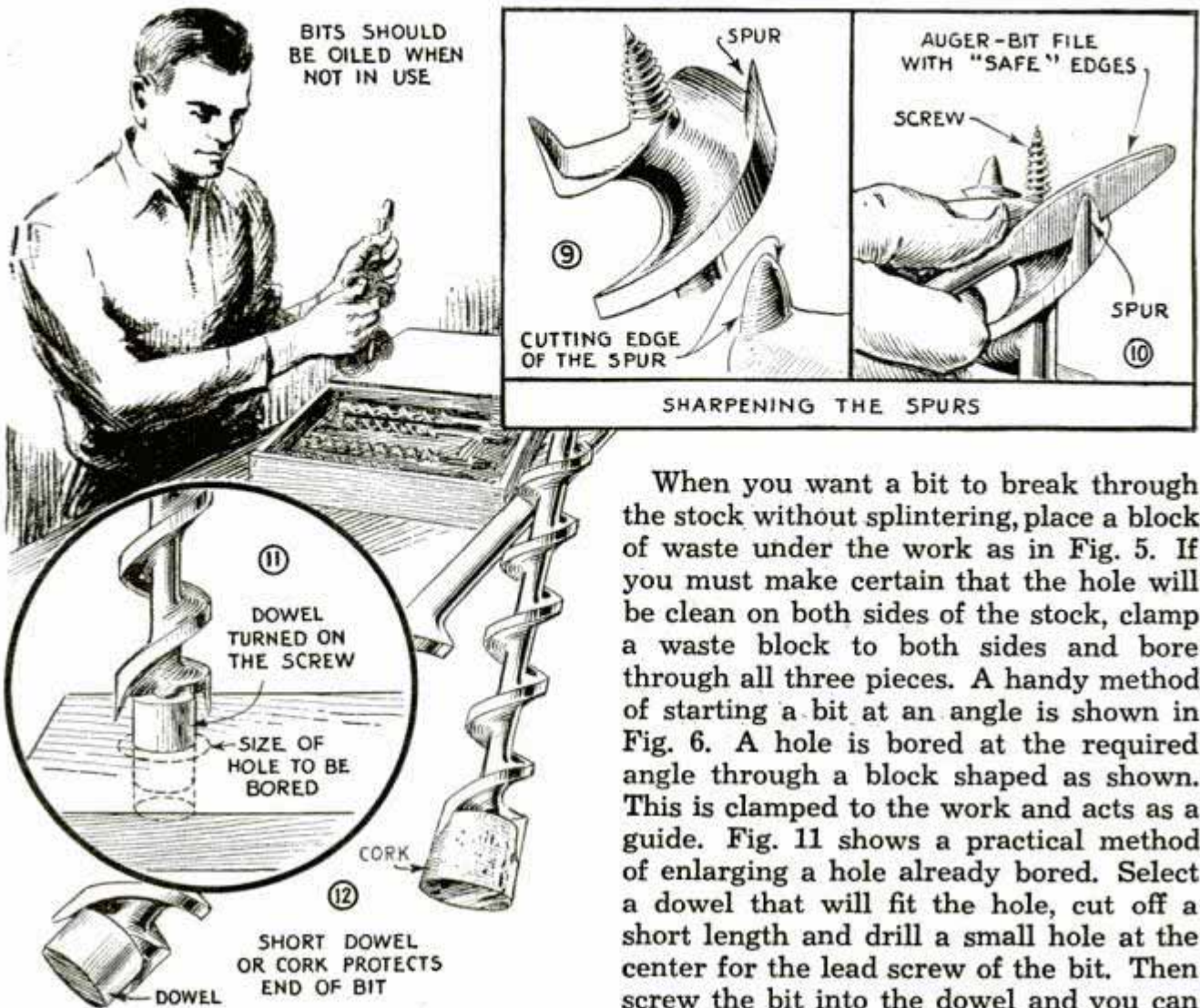

ting edge be sharpened so that it will cut in either direction. This prevents possible breakage should it be necessary to back the bit out of an unfinished hole. The smooth edge of the file should ride on the bottom of the cutter. The trick in filing is to take off an equal amount from each spur, the greatest care being taken in each filing to avoid reducing the thickness of the spur at the base. Likewise, when filing the cutter, care must be taken to round the end of the bevel at the point where it meets the solid center just above the screw. This can be done with a small round file, taking out the square corner formed by the filing of the bevel. Should this corner be allowed to deepen gradually, it will materially weaken the support of the screw. If you keep your bits in a soft-wood box or in a folding cloth holder they will need very little sharpening. It's a good idea to have an oily cloth handy and turn the bit through a fold of the cloth when you finish using it.

When you want a bit to break through the stock without splintering, place a block of waste under the work as in Fig. 5. If you must make certain that the hole will be clean on both sides of the stock, clamp a waste block to both sides and bore through all three pieces. A handy method of starting a bit at an angle is shown in Fig. 6. A hole is bored at the required angle through a block shaped as shown. This is clamped to the work and acts as a guide. Fig. 11 shows a practical method of enlarging a hole already bored. Select a dowel that will fit the hole, cut off a short length and drill a small hole at the center for the lead screw of the bit. Then screw the bit into the dowel and you can bore the hole easily, the dowel acting as a guide to keep the larger bit in line with the axis of the smaller hole. If you have to carry your bits with other tools, Fig. 12 shows one way of preventing damage to the head. Select a cork or dowel to fit each bit and, as soon as you have finished using the tool, turn the screw into the cork or dowel in the manner shown.

Heating Water in Summer Cottage

In our summer cottage we had running water and a cesspool, but used kerosene for cooking and a fireplace for heating. We also had a shower bath and kitchen sink with only cold-water connections from a spring so cold that the water was unbearable. Getting an old gas-heater coil, I removed the gas burner and substituted a one-burner kerosene stove. Then I connected the coil to a tank. This apparatus heats our water satisfactorily and is inexpensive to install and operate.

—F. Austin Troutman, Fremont, Nebr.

Folding Scaffold Is Adjustable to Roof Pitch

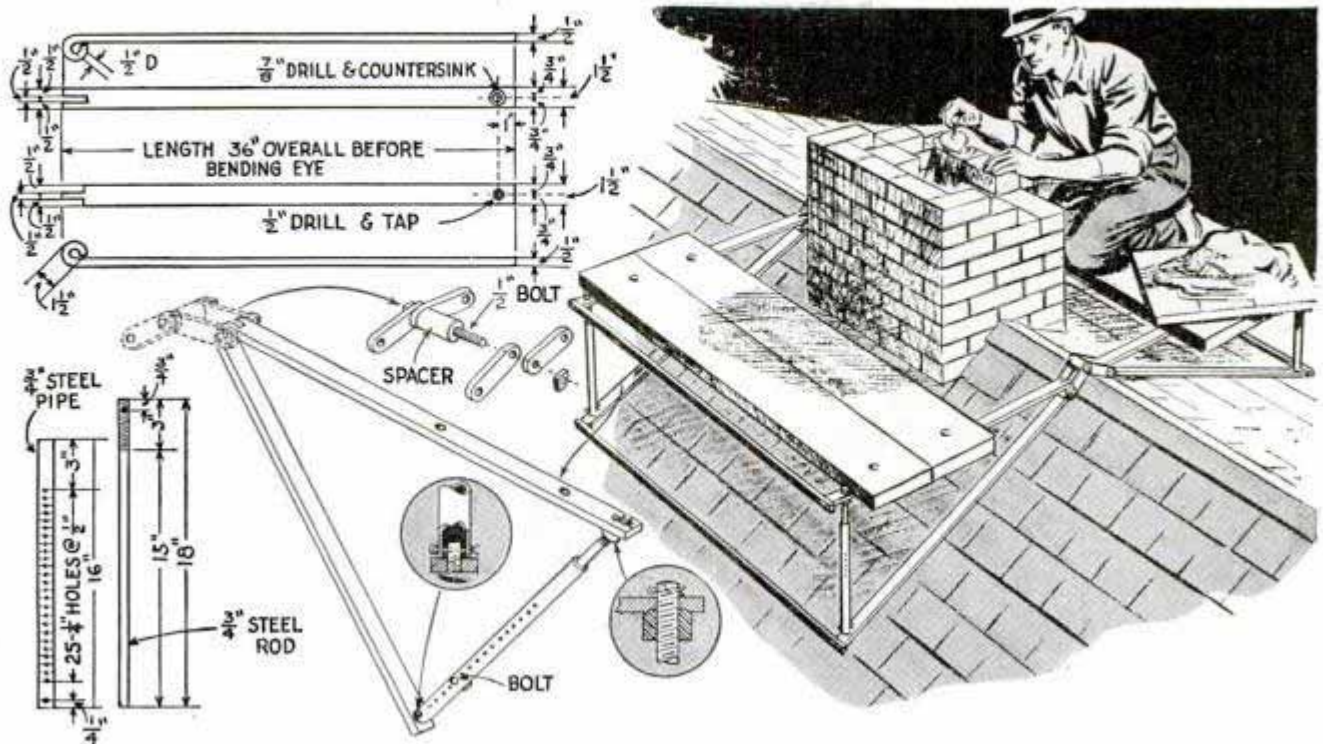

Amplly strong and rigid when set up, this scaffold folds into a small, compact unit for transporting to or from the job. It consists of four triangular members hinged together to support the planking on which the workman stands. The whole thing straddles the gable, the triangular

supports being adjusted to bring the planking level. This adjustment is made by sliding a 3/4-in. rod in a length of pipe through which a number of holes are drilled transversely for a pin which is slipped under the end of the rod.

—Paul H. Smith, Charlestown, Mass.

This Countersink "Setting Plate" Assures Accurate Work

A good way to set a countersink to the correct depth without trial is to use a setting plate as shown. It is a flat piece of steel or cast iron with various sizes of standard countersunk holes in it. To use the plate, lay it on top of the work. Then bring the countersink down into the hole to be duplicated in the work, and tighten the drill-press stop. Then remove the plate and place it under the work, so that the latter will be in the same relative position as the plate was, and the hole in the work will be an exact duplicate of the one in the plate.

—Harry Moore, Hamilton, Ont., Can.

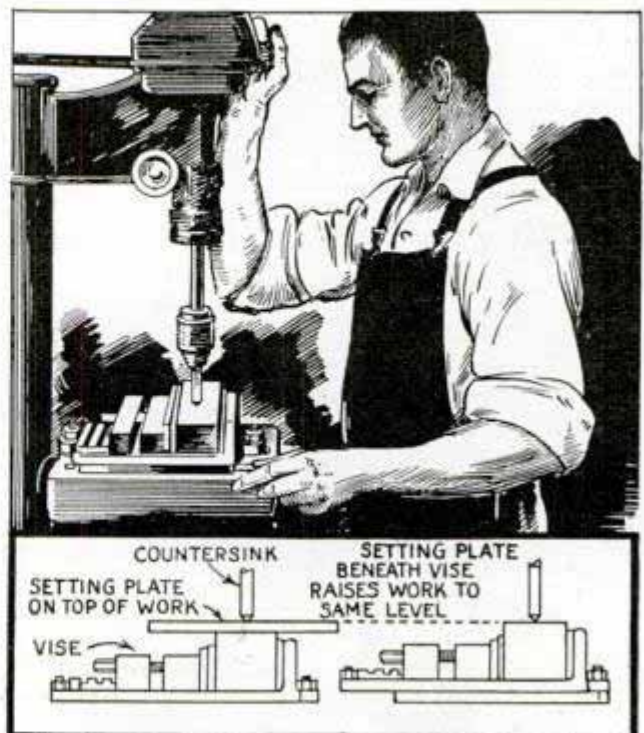

ⓘ Before attempting to grind bronze or aluminum, give the surface of the grinding wheel a liberal application of soft soap, which will help keep the wheel from "loading up" with the soft material.

Contractor's Hoisting Bucket Has Rollers on Side

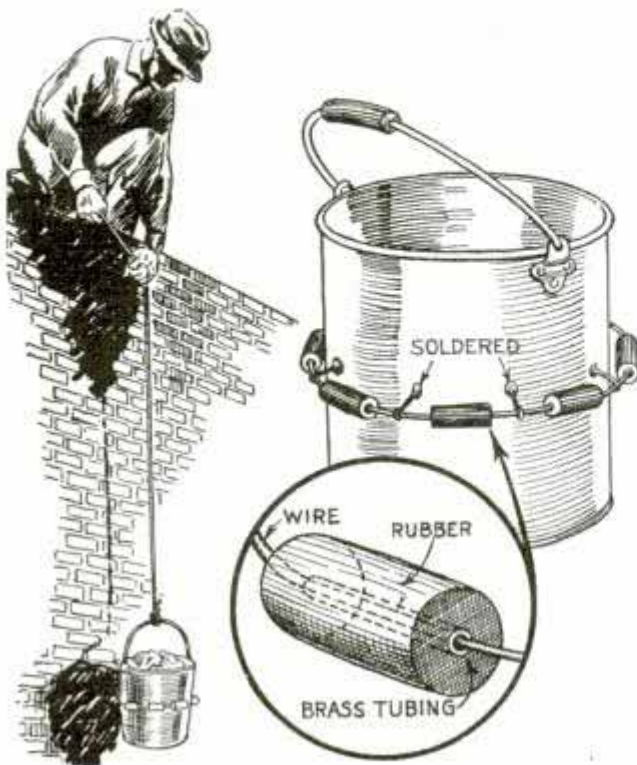

Rubber rollers on side of hoisting bucket keep it from catching on side of building

On a repair job where it is necessary to raise materials to the top of a building in a bucket, one contractor uses a container fitted with rollers around the side so that it will not catch on the wall. They are cut out of solid rubber and are fitted with bearings of brass tubing. The rollers are strung on a heavy wire ring, which is attached to the bucket by short pieces of wire soldered or welded in place as shown. Sections of the wire ring between supports are straight to prevent binding

Holding the Centers of Two Shafts at the Same Height

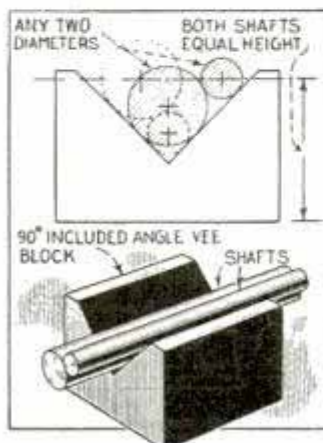

When two shafts of different sizes have to be marked off in the center, and it is necessary that they be held at the same height for testing, but welding or brazing, an easy way to hold them is to use a 90° V-block.

Lay the shafts on one side of it as shown. Then, if the position of the shafts is reversed, the center height of the top shaft will be the same. This holds true for any size work that will lie in the block.

—H. Moore, Hamilton, Ont., Can.

Welding Joints in Angle Iron

Although angle-iron joints are often welded on the inside surface for the sake of appearance, they will be much stronger if the welding is done on the outside surface where most of the strain is found. The outside weld is especially important if the angle iron is used in machinery or structural work where there is considerable vibration.

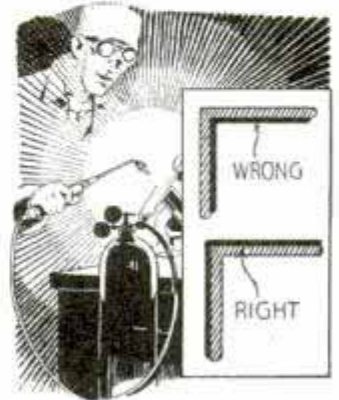

—L. H. Georger, Buffalo, N. Y.

Non-Sag Gate for Small Cost Is Easy to Build

Why pull sagging gates around when this one can be made quickly and inexpensively? It is made of only four pieces of 2 by 4-in. stock, yet it is unusually

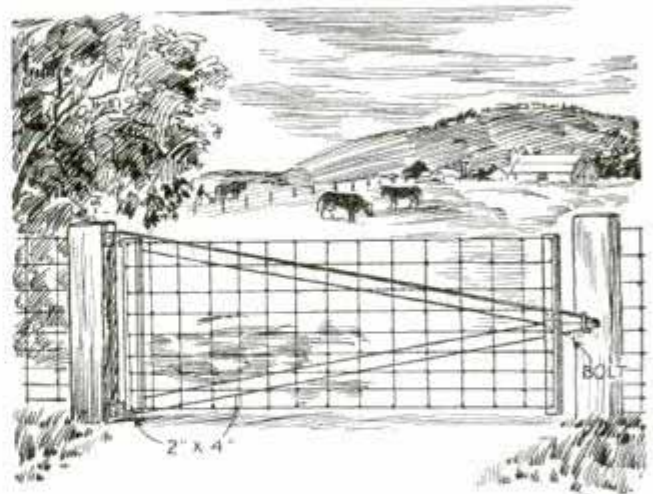

Here is a gate that you can make and hang in an hour, yet it is as strong as any fence

strong. Woven or barbed wire is stretched tightly between the end pieces, the gate being swung by means of hook and strap hinges.—Denver Jewell, Sullivan, Ind.

Four Simple Hints That Help the Carpenter

In order to space picture molding uniformly from the ceiling, try this simple gauge block. It is a wedge-shaped piece of wood which you slip between the molding and the ceiling as shown in the upper photo. To keep the block at hand, tie an 8 or 10-in. length of cord to it, the cord being looped to slip over your left wrist. In this way you can use both the wedge and the nailset without the bother of searching your pockets for them.

On a job of building in a corner table or cabinet, where the table top or shelves are to fit closely against the wall, two edges must be cut to conform to the irregularities of the wall while the front edge is kept at a 45° angle. Marking the sides to be fitted is an easy matter if you take a small block of the same shape as the piece to be cut. The block is placed against the wall with one edge parallel to a line drawn at right angles to the front. Then, with the pencil point placed at the edge of the block as shown, a short distance from the wall, the block and pencil are moved together, keeping the latter from slipping out of place. After one side has been marked in this way, the block is reversed and set against the other wall and marking is done in the same way. To compensate for the stock removed, the shelf or table top should be cut slightly oversize.

A nail set will punch its way through the tubular pocket in your overalls and will then slip down below the top where you can't reach it without fumbling and loss of time. Such trouble can be avoided by cutting a 5/8-in. dowel of a convenient length, boring a 3/8-in. hole nearly full length to form a socket, then pushing this into the pocket to serve as a liner.

If holes must be bored in the sides of small boxes or cases where there is no room to use a brace to turn the bit, a handy method of getting around this difficulty is to clamp a bit gauge to the body of the bit and use it as a wrench. If you have no bit gauge you can easily make one for this purpose. Using the same bit, bore a hole through a square of hardwood. Then rip it lengthwise through the center. Draw the two pieces together with a screw on each side of the hole, providing a combination clamp and handle.

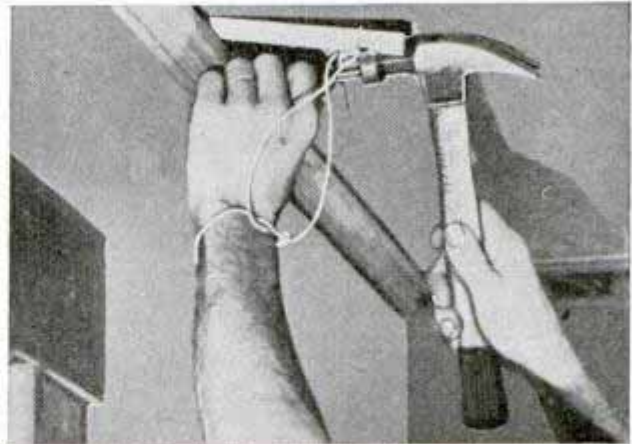

STRING ABOUT WRIST HOLDS GAUGE AND NAILSET



FITTING CABINET INTO CORNER

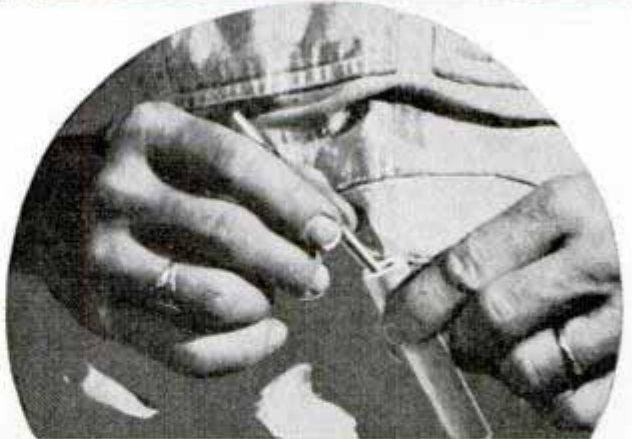

ABOVE - POCKET HOLDER FOR NAILSET
BELOW - BIT GAUGE SERVES AS A BRACE

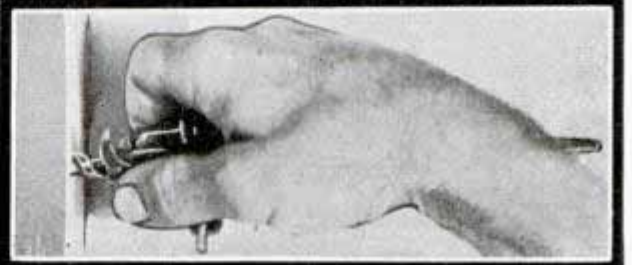

Belt Stick Has Hook on One End for Hard-to-Reach Pulleys

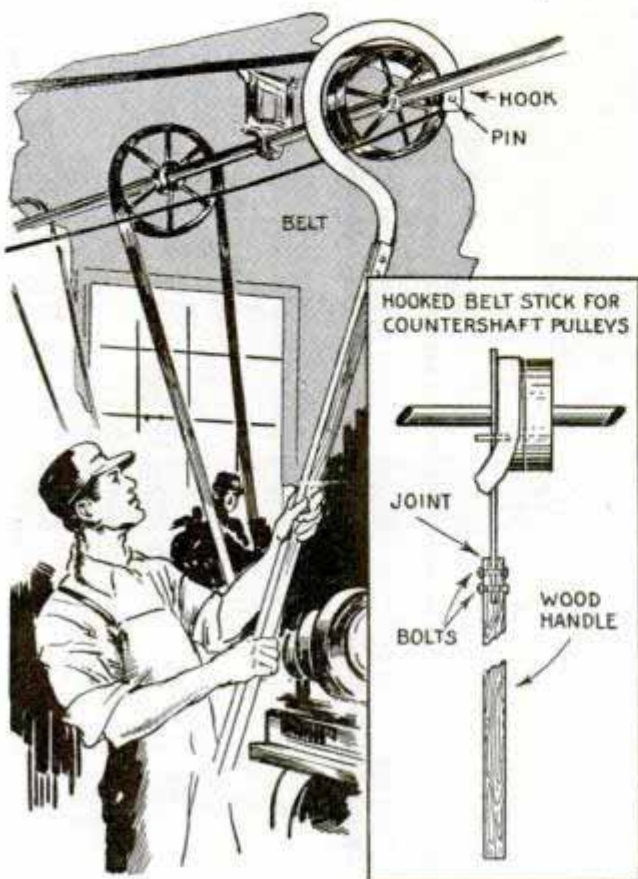

Here is a belt stick that will take care of those pulleys that are too close to a wall to use a straight stick

In places where countershaft pulleys are so close to walls or other obstructions that a straight stick cannot be used to remove the belts, this one will do the trick. It consists of a long handle with a length of flat iron bent to form a large hook, which is bolted to one end. With this stick a belt can be lifted up and placed on a pulley from either side, as a glance will show that the pin controls the belt clear around the pulley while the flat steel, bearing against the part of the belt already on, prevents it from coming off before the belt is in place.

Twine Fed Through Counter

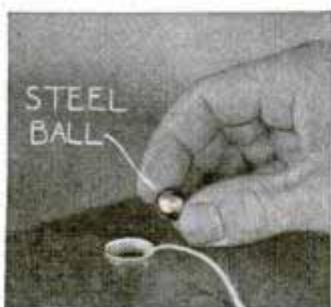

After remodeling his store, one merchant concealed his twine ball by mounting it under the counter and bringing the end of the string up through

a hole. To keep the string from slipping back through the hole, an aluminum thimble, with the closed end sawed off to form a sleeve, was forced into the hole, after which a ball bearing was placed on top of it, the end of the thimble being flared to hold the ball. The bearing acts as a check, permitting the twine to come forth easily, but preventing its return.

Combination Lathe Parting Tool Speeds Production Jobs

To speed up the work of turning out a quantity of internally threaded collars on a lathe, the foreman of one shop used a combination threading and parting tool. Shaped and ground as indicated, the tool does not have to be

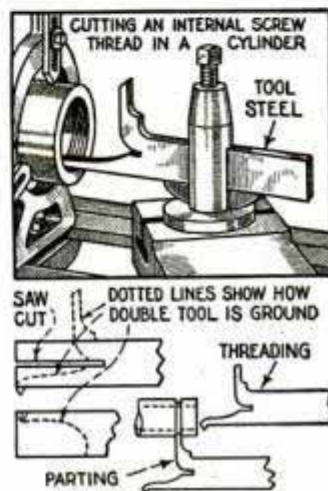

changed in the tool post to perform the two operations. After cutting the threads, the carriage and cross-feed are merely manipulated to bring the parting edge of the tool into contact with the work.

How to Install Sheet-Metal Ducts

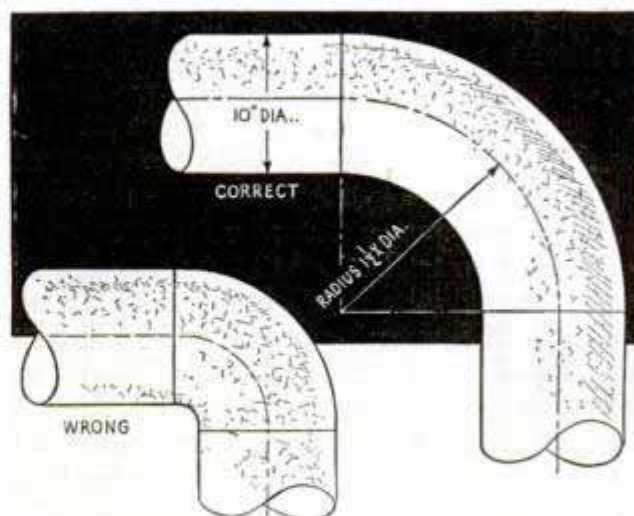

Turns in sheet-metal ducts should have a radius one and one-half times the diameter of the ducts

When installing sheet-metal ducts to carry air, it is necessary to avoid right-angle turns as much as possible if best

results are to be had. In the drawing, note the smooth, easy turn of the angle of the upper detail and the sharp, cramped angle of the lower one, which causes a high-velocity turn. In actual tests, it has been found that best results are obtained when the radius of the angle is at least one and one-half times the diameter of the pipe. With this radius, the loss is only 17 per cent in head, while a turn having a radius equal to $\frac{3}{4}$ the diameter of the pipe gives a loss of 37 per cent, and a radius equal to $\frac{1}{2}$ the diameter of the pipe gives a loss of 75 per cent in head.

—L. H. Georger, Buffalo, N. Y.

Boring Tool Makes Both Rough and Finish Cuts

This unusual boring tool is constructed to take advantage of the return feed to finish the bore when used on a radial drill press. The bar is slotted and drilled at right angles to take the cutter as shown at A and B, the slot being so shaped that in the finishing position the tool lies at the extreme point from the center line of the bar. In the roughing position, the cutter is swung slightly back. But once the cutter is set to bore the right diameter, its action is automatic. When the bar is fed down, the cutter is forced against the top end of the slot for the roughing cut. And, when it has passed through the bore, the cutter drops so that when the bar lifts on the return feed, the cutter is forced against the bottom end of the slot.

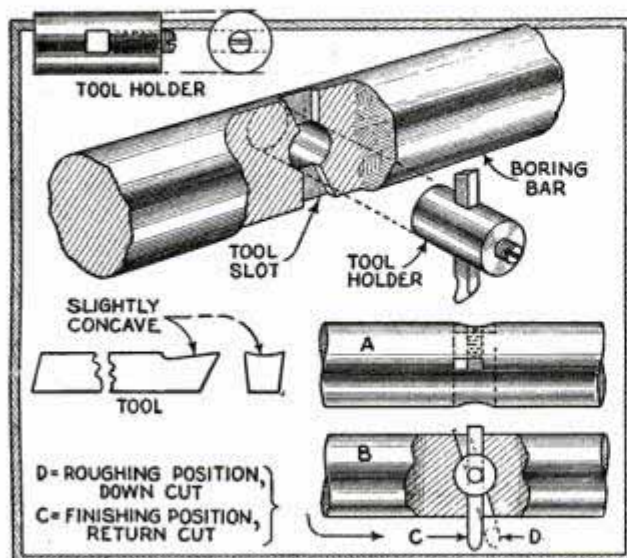

Used in a radial drill press, this boring tool makes the rough cut as it goes through the work and takes the finish cut as it is returned

Metal Stencils That Have Handles Aid Shipping Clerk



There's no paint on this shipping clerk's hands because his stencils are fitted with handles

Shipping clerks will find that handles soldered or riveted to metal stencils will make them easier to use, and that it will also help to prevent smudged fingers. Handles from discarded kitchen utensils and cutlery are just the thing for this purpose. They should be bent to the shape indicated, and before attempting to solder, all traces of grease must be removed.

Improving Signwriter's Ruler

Signwriters will find that a handle attached to their rulers makes them easy to hold on flat surfaces, such as doors, windows and walls. The handle is removable and is made to slip into a flat, U-shaped piece of sheet metal screwed or bradded to the ruler as shown. The U-shaped piece should be at least an inch wide and the flattened end of the handle should fit snugly into it so that the rule can be held rigidly.

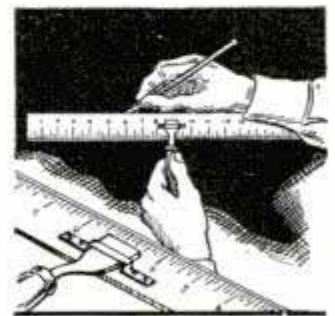



COPPER *and* Without

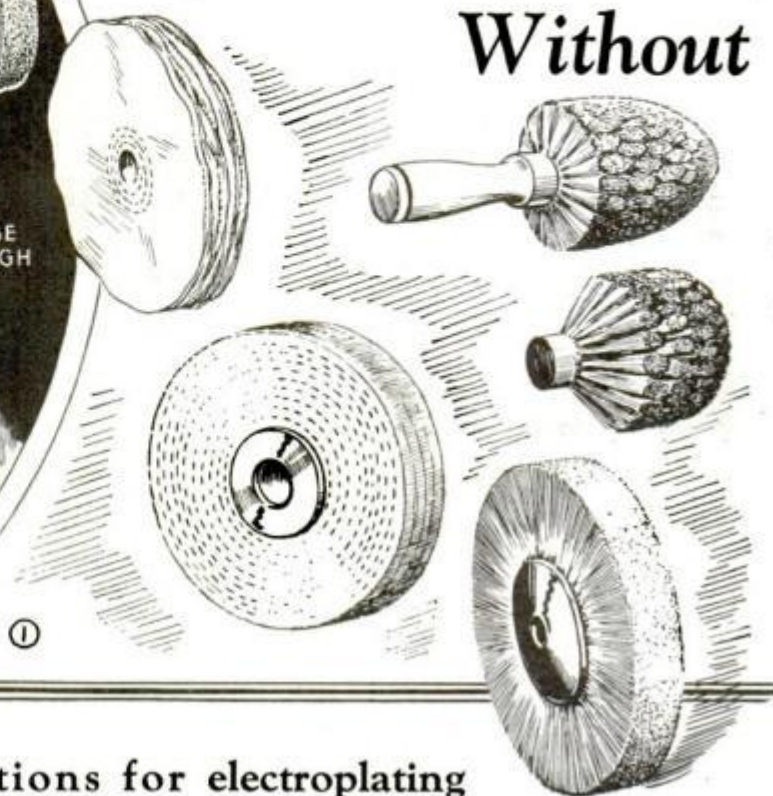

New solutions for electroplating copper and nickel—how to prepare work by thorough cleaning procedure, both chemical and electrical

By C. A. CROWLEY

ELECTROPLATING solutions can be made now without the use of poisonous cyanides. By the improved methods, it is also possible to plate zinc castings and zinc-base die castings which have proved so troublesome by other methods.

Polishing the Work: Before electroplating, it is important that the object be buffed and polished carefully to remove all surface imperfections. Flaws in the surface of the work to be plated will show noticeably after the plating and therefore, these must be removed first if a first-class job is to be produced. A buffing wheel treated with any good quality cutting compound is used for this purpose. Simple buffing heads may be equipped with a variety of interchangeable wheels, Fig. 1, for the application of cutting and buffing compounds as required to produce the

final finish. It is advisable to use a separate wheel for each grade of compound to avoid scratches during the final polishing operation with finishing compound.

Cleaning Iron and Steel Objects: The type of cleaning operation before electroplating depends upon the metal from which the object is made. After buffing thoroughly, objects made of iron and steel are cleaned by washing in a solvent such as gasoline (not Ethyl), benzene, carbon tetrachloride or xylene. The wash, Fig. 4, removes grease from the surface and prepares the work for the electro-cleaning operation which is next.

An electro-cleaning solution is made by dissolving trisodium phosphate, 13½ oz., and sodium carbonate, 10¾ oz., in enough water to make 1 gal. of cleaning solution. The solution should be placed in an iron

*Mallinckrodt
Chemical Works*

NICKEL PLATING

Cyanides

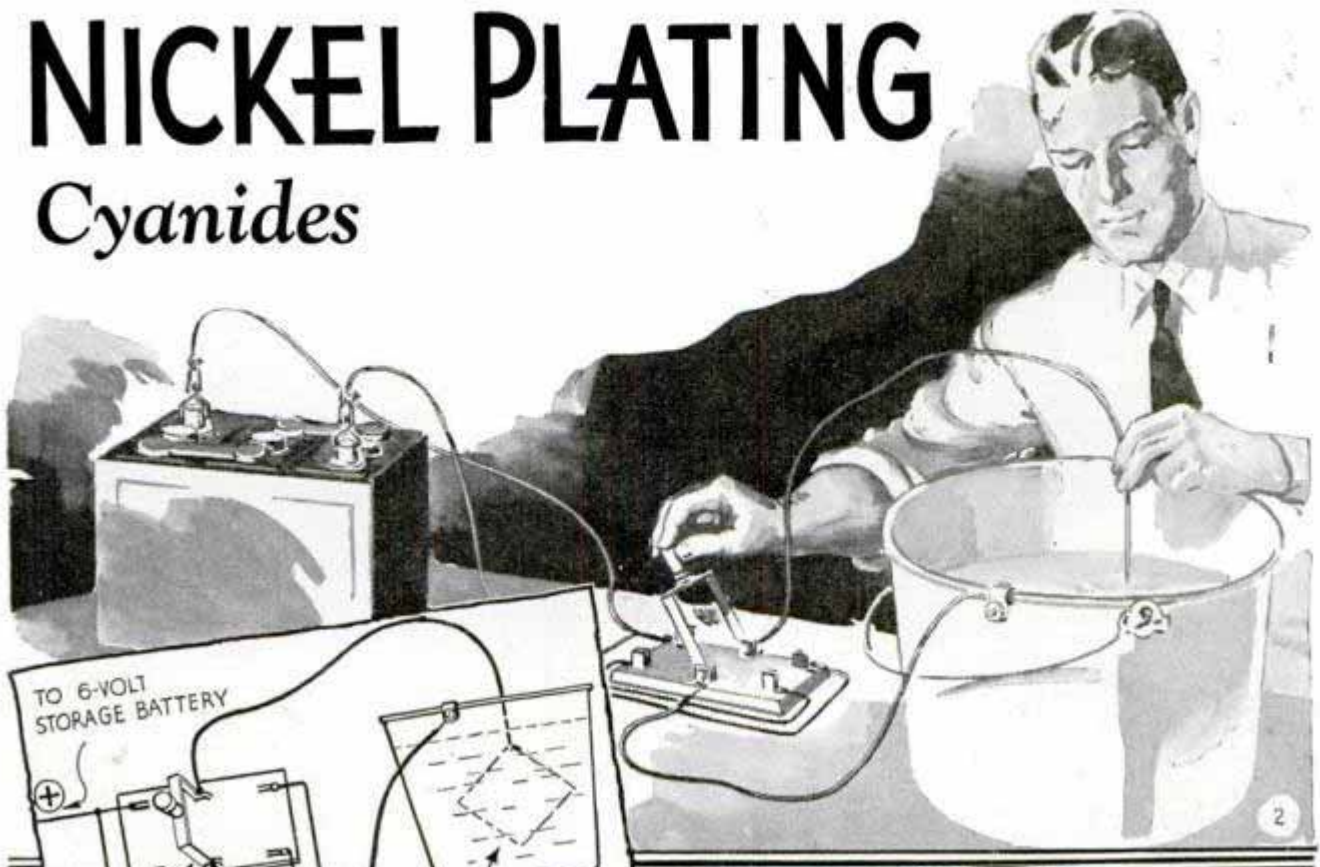

pail large enough to hold the work without its coming in contact with the container, Fig. 5. For electro-cleaning steel and iron, the pail is connected to the negative pole of a 6-volt storage battery with heavy copper wire, while the work is connected to the positive pole of the battery. The work is suspended in the cleaning solution for 1 or 2 min.—no longer than necessary to remove the dirt film. Bubbling from the surface of the work mechanically tears the dirt away. While electro-cleaning soldered work, the current is reversed by means of a switch as shown in Figs. 2 and 3.

Following the electro-cleaning operation, the work should be rinsed thoroughly in running water as in Fig. 6. Then it is immersed for 1 or 2 min. in a solution made by adding concentrated hydrochloric acid, 1 lb., to water, 7 pts. The acid rinse, Fig. 7, performs the very important function of putting the metal surface into a condition so that electroplate will stick to it. Stoneware vessels are used for all acid solutions. Following the acid treatment,

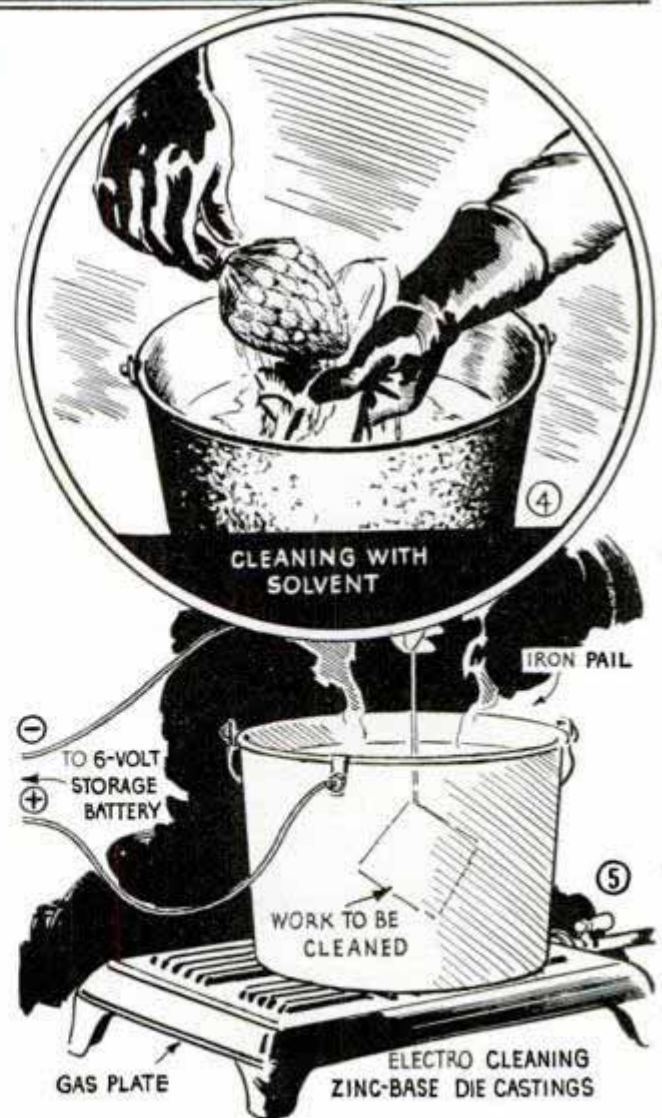



the work is rinsed thoroughly in running water and kept submerged in clean water until it is put in the plating tank.

Cleaning Zinc Objects: Objects made of zinc should be cleaned with solvents as explained for iron to remove excess grease. Following this, the work is scrubbed with soapy water to remove the last trace of foreign matter. Then the work is dipped into a solution made by adding concentrated hydrochloric acid, 1 lb., to water 1 pt. The work should be dipped merely into this solution and not allowed to remain there, or it will become pitted. After the acid dip, the work is rinsed in running water and submerged in clean water until plating.

Cleaning Zinc-Base Die Castings: To plate zinc-base die castings the cleaning operations must be followed with greater than normal care. The well buffed castings are freed from grease by washing in a solvent such as trichlorethylene, benzene, carbon tetrachloride or xylene. The latter will be found the most satisfactory. Then the work is suspended in an electro-cleaning bath made by dissolving trisodium phosphate, 6 oz., in water, 1 gal. This solution is heated and used at the boiling point. It is important to note that the connections shown in Fig. 5 are just the opposite to the connections for elec-

tro-cleaning iron and steel, as already explained. The work should be suspended in the electro-cleaner for only 3 min. at the most, although 2 to 2½ min. is usually sufficient. An immersion longer than 3 min. is likely to cause pitting. Following the electro-cleaning operation, the work is rinsed rapidly in running water and immersed for only 1 min. in a solution made by mixing hydrochloric acid, 1 lb., with water, 4 pts. Following the acid treatment, the work is washed in running water and submerged in clean water until plating.

Cleaning Copper and Brass: After buffing and polishing, objects made of copper or brass should be cleaned thoroughly in any of the solvents already mentioned to remove excess grease. An electro-cleaning

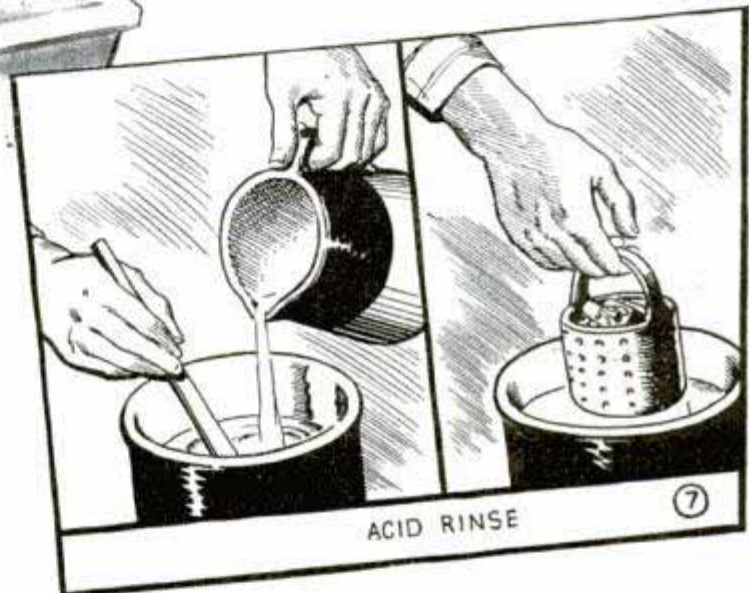

bath arranged as shown in Fig. 5 is next. The wires are connected directly to a 6-volt storage battery, the negative line being connected to the work, which is left immersed in this solution from 3 to 5 min.—no longer to avoid pitting. A cleaning solution which has been found exceedingly satisfactory for use with these metals is made by dissolving sodium carbonate, 8 oz., and sodium hydroxide or ordinary lye, 2 oz., in enough water to make 1 gal. of solution. In electro-cleaning objects of copper, brass, and other metals that have been soldered, connections are made to a double-pole, double-throw switch as in Fig 3, to permit reversing the polarity, as the action of the electro-cleaning solution, without reversing the polarity every few seconds, tends to dissolve part of the solder.

Copperplating: A non-poisonous solu-

tion for plating copper or iron or other metal is made by dissolving copper sulphate, 2 oz., and sodium oxalate, 1 oz., $2\frac{3}{4}$ drams, in enough water to make 1 gal. of solution. Finally, triethanolamine, 3 fl. oz., is added to this solution and stirred in. See Fig. 8. The solution should be prepared in a stoneware container, preferably the one which is to be used for plating. The solution should be stirred until the precipitate which at first forms is dissolved. After using this solution, a slight sediment may be found but this does not interfere with plating. Connections for plating in a stoneware or other non-conducting container, are made as in Figs. 11

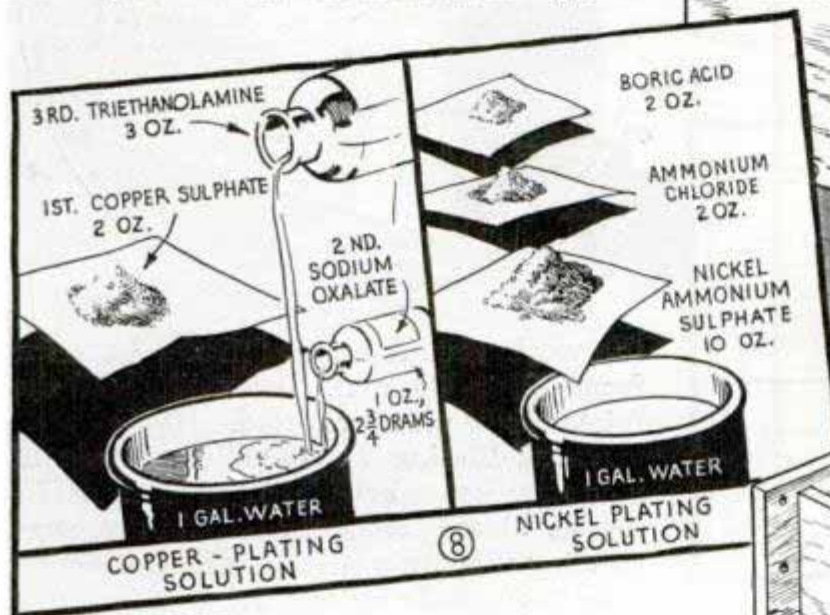

and 13. An old rubber battery box is suitable, or you can make a wooden tank as shown in Figs. 9 and 10. Almost any rheostat will do. If one is not available a substitute may be made as in Fig. 12. It is filled with a solution made by dissolving as much ordinary salt as possible in cold water. A pair of metal plates are inserted into the salt solution. The closer the plates are together, the higher the voltage.

To use the copperplating solution, the work is hung with a copper wire on the middle rod and immersed in the plating solution. Large sheets of copper are attached to the rods which are connected to the positive pole of the battery. With the work immersed, the switch is closed and the rheostat adjusted until the voltmeter reads between $1\frac{1}{2}$ and $2\frac{1}{2}$ volts. The exact voltage will have to be determined by experiment in any particular case to control the brilliancy of the plate, the work

PLATING TANK IS
COATED WITH
MOLTEN TAR.

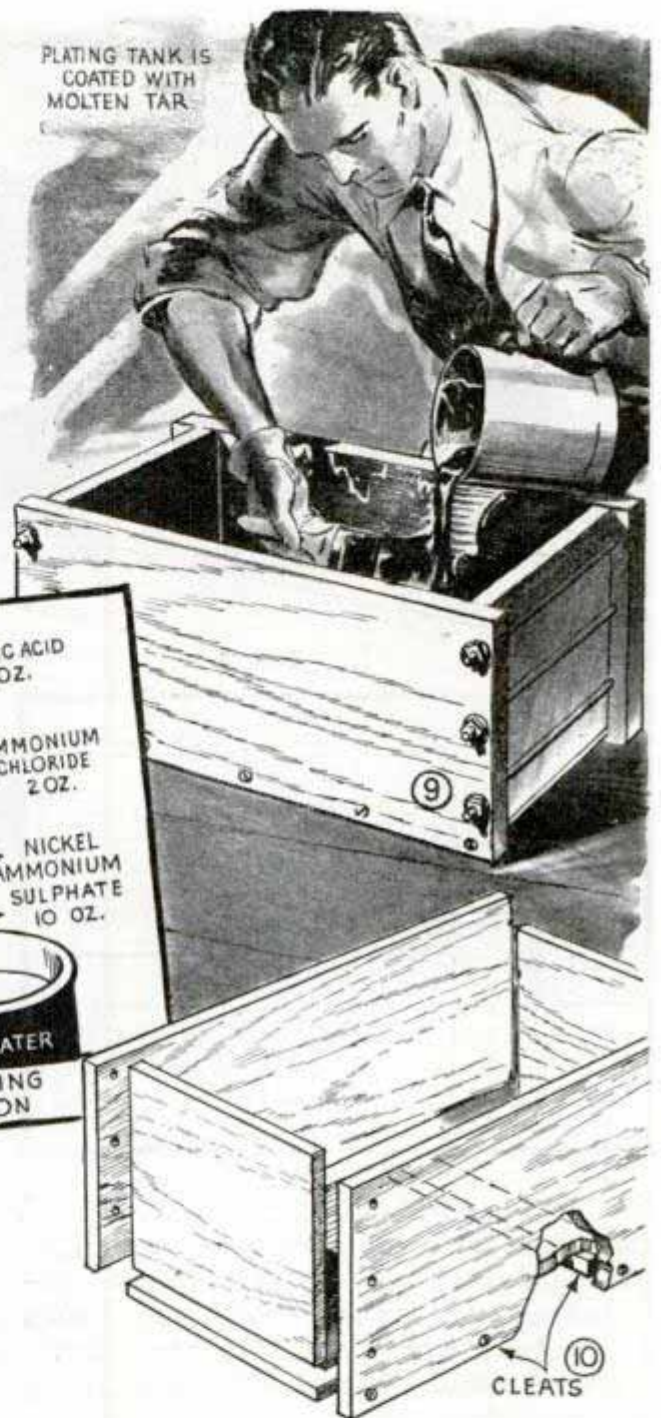

being lifted from the bath frequently to note the color of the deposit. The rheostat is adjusted until a suitable bright deposit is produced. The work should be left in the plating bath for 3 min. to produce a good durable plate. Where it is necessary to build up a heavy plate of copper, the work, which has been plated for 3 min., is transferred to another plating solution made by dissolving copper sulphate, 22 oz., in water, 1 gal., to which sulphuric acid, $6\frac{1}{2}$ fl. oz., is added slowly. Before transferring the work to this solution, it should be rinsed thoroughly in water to remove all traces of the alkaline triethanolamine. It is then immersed in

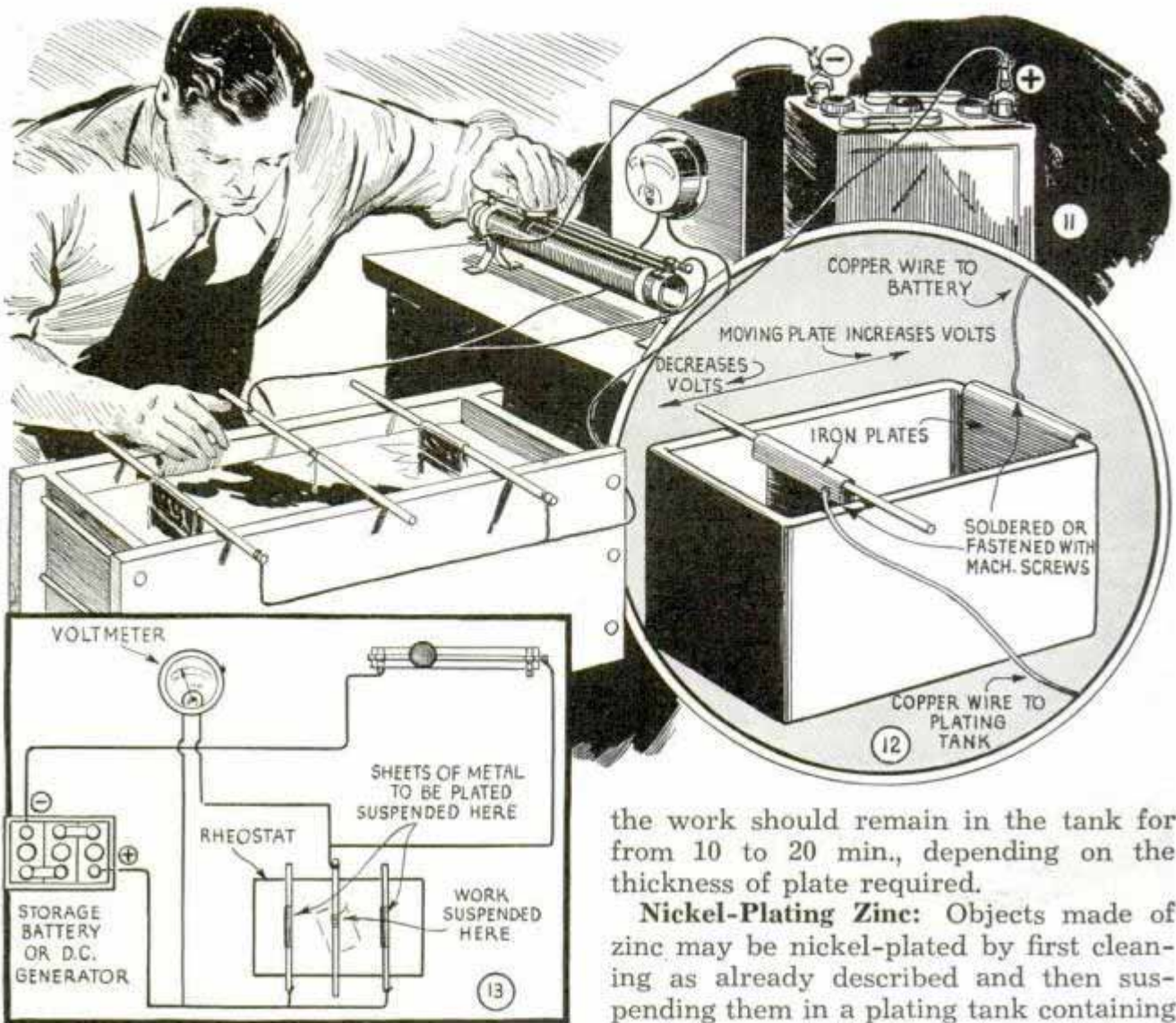

the acid copper-sulphate solution and connected in the same way as in the first plating bath. The rheostat is adjusted until the meter reads between $1\frac{1}{2}$ and 3 volts as required to produce the proper color.

Nickel-Plating Iron: The nickel-plating of iron objects offers material protection against corrosion and the plate will be quite durable if it is applied after the work has been given a 3-min. plate of copper. For plating nickel over copper, a solution made by dissolving nickel ammonium sulphate, 10 oz., ammonium chloride, 2 oz., and boric acid, 2 oz., in water, 1 gal., will give satisfactory results. See Fig. 8. The solution is poured in a clean plating tank connected as before. Strips of sheet nickel are suspended from the outside rods across the plating tank. If the nickel plate is to be used for protective purposes as well as for ornamentation, it should be rather thick. The meter should read between 2 and 3 volts, and

the work should remain in the tank for from 10 to 20 min., depending on the thickness of plate required.

Nickel-Plating Zinc: Objects made of zinc may be nickel-plated by first cleaning as already described and then suspending them in a plating tank containing a solution made by dissolving nickel ammonium sulphate, 11 oz., and nickel sulphate, $5\frac{1}{2}$ oz., in water enough to make 1 gal. When the chemicals have been dissolved in the water, triethanolamine, 23 fl. oz., is added and mixed in thoroughly. The work is hung from the center rod and sheets of nickel from the two outside rods. The voltage should be adjusted to between $1\frac{1}{2}$ and 3 volts. If the nickel-plate is not sufficiently brilliant, a small amount of boric acid may be stirred into the solution.

Nickel-Plating Zinc-Base Die Castings: Zinc-base die castings cleaned as explained are suspended in a plating tank and connected as in Fig. 13. The plating solution is made by dissolving nickel ammonium sulphate, $3\frac{1}{4}$ oz., and nickel chloride, $1\frac{1}{2}$ oz., in water, 1 gal. After the salts are dissolved, triethanolamine, $8\frac{3}{4}$ fl. oz., should be added and stirred in thoroughly. The voltage should read between $1\frac{1}{2}$ and 3. Boric acid, about $\frac{1}{2}$ oz., can be added to this solution to brighten the plate.

Drum Sander on Lathe Has Adjustable Table

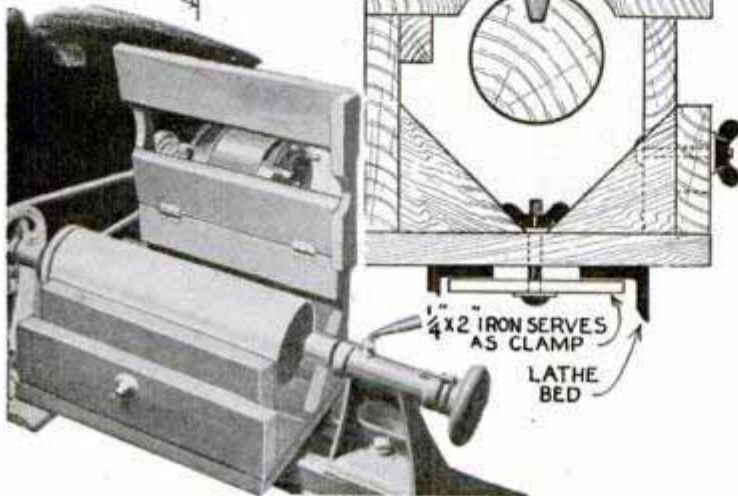
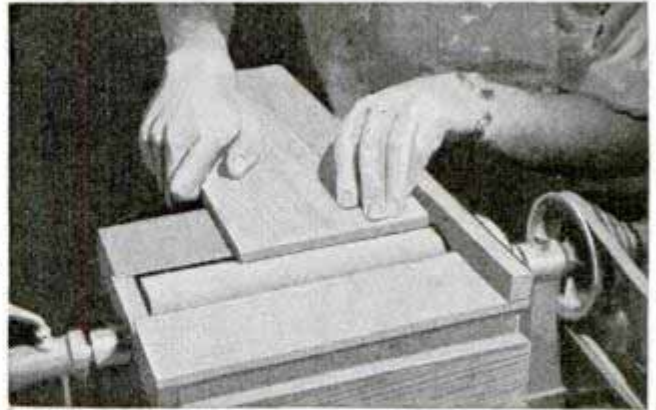
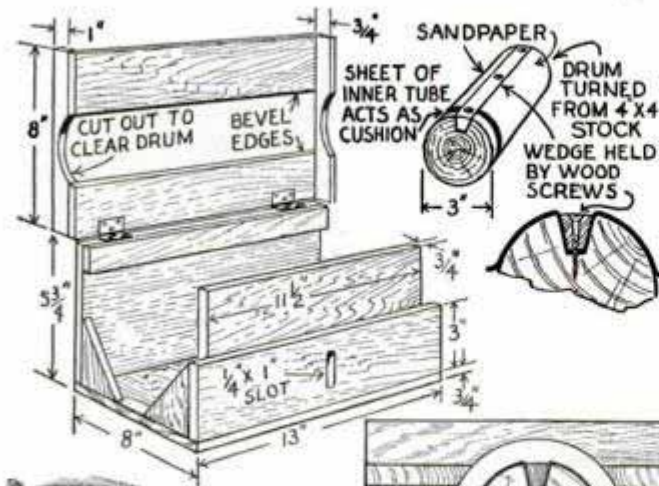

It takes only an hour or so to get this drum sander working on almost any wood lathe. The dimensions merely give an idea of the size and you will have to build the unit to suit your own lathe. First, the drum is turned between centers to a uniform diameter of 3 in. Then it is slotted as indicated and a hardwood wedge is cut to fit the groove loosely. The rest is a simple job—much like building a box. Note the loose member at the front, held by a 1/4-in. bolt and wingnut sliding in a slot in the outer piece. This arrangement enables you to set the table to just the right height. The drum is cushioned with a sheet of rubber cut from an inner tube. In placing the sandpaper on the drum be sure the wedge is drawn down tightly so that it does not strike the work

"Gangplanks" to Trucks Hinged on Loading Platform

Hinged to the edge of a loading platform, large sheets of heavy boiler plate provide smooth "gangplanks" to facilitate using hand trucks and rolling heavy barrels. The gangplanks are especially useful when the truck bed is higher or lower than the platform. When not in use, they are swung back so that they lie flat on the platform.

Taxidermist's Lead Arsenate Jelly

Instead of dusting arsenic powder on the bones and skins of animals to preserve them, it is better for the taxidermist to paint them with a lead-arsenate jelly. Arsenic dust in the air may collect in the nose and throat and cause death. The jelly is made by mixing high-grade soap containing carbolic acid, 4 oz., with water, 16 oz., to which is added lead arsenate, 2 oz. Boil the mixture 15 min. and apply with a brush or swab.

—Edward Lopkoff, Denver, Colo.



Heavy steel plates between trucks and loading platform provide smooth surface

Index Tabs on Filing Cards Strengthened by Clips



Paper clips slipped over tabs of letter file protect identifying data on division cards

To prevent the index division cards in his filing cabinet from becoming soiled and worn by constant fingering, one stenographer slipped a wire paper clip over the projecting tab of each card. Besides protecting the card against wear, the clip prevents constant bending of the tab and its breaking off.

—Wayne C. Leckey, Aurora, Ill.

Sealing Joint Between Downspout and Soil Pipe

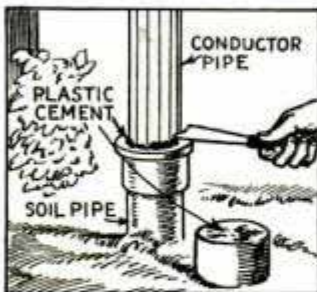

Instead of using cement to seal the joint between the eave downspout and the soil pipe, use a non-hardening plastic. Then, if it is necessary to open the

joint to make repairs, the job is done easily. When hard cement is used, there is a possibility of cracking the soil pipe.

Repairing Small Motor Bearings

Here is a good method of repairing worn bronze bushings in electric motors. First, remove the bearing, split it length-

wise along one side with a hack saw, and then press the severed edges together in a vise, shaping it over the shaft. Solder the edges together and tin the outside of the bearing. Another method is to saw a 1/8-in. ring from each end of the bearing, place them on an anvil and tap the inside with a hammer until they fit the shaft snugly. Then place the rings in each end of the bearing cavity and coat the bearing surface of the shaft with white lead. Next, assemble the motor and pour high-speed babbitt into the cavity through the grease cup or oil hole. When the babbitt hardens drill out the oil hole.

Display Rack on Casters Wheeled to Sidewalk

Providing a means of attractively displaying fruit, vegetables, etc., this rack may be moved out on a sidewalk during the day and rolled in at night without disturbing the display. A cross of 2 by 4-in. stock with casters at the ends supports the rack, which is made of either light lumber or metal. A low rim of thin veneer nailed around the bottom keeps the display in place, while a stick or small pipe inserted in the top takes a price tag.

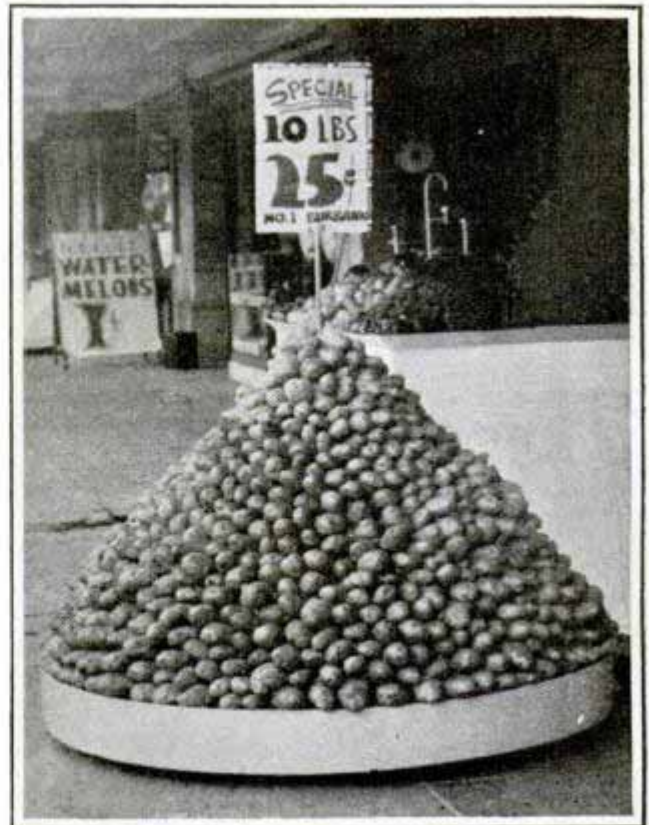

Anyone handy with a hammer and saw can assemble the display in an hour or two

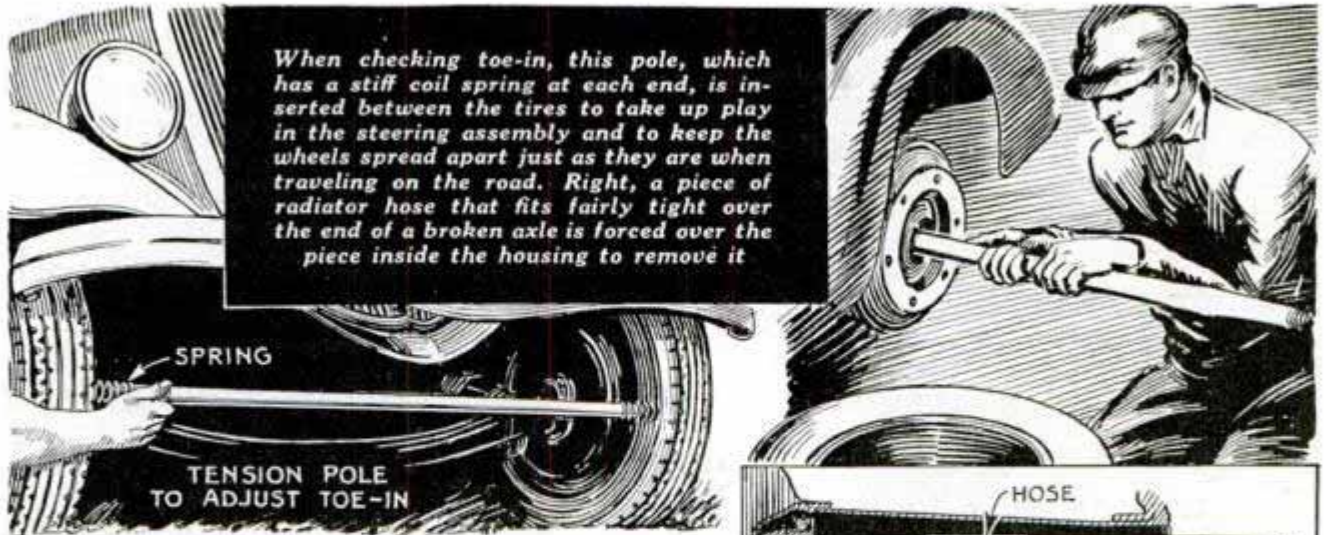

Helps for the AUTO MECHANIC

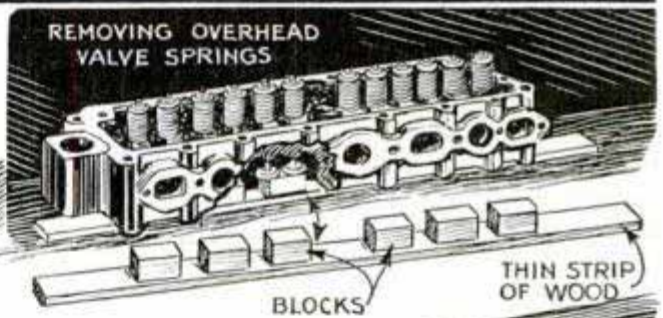
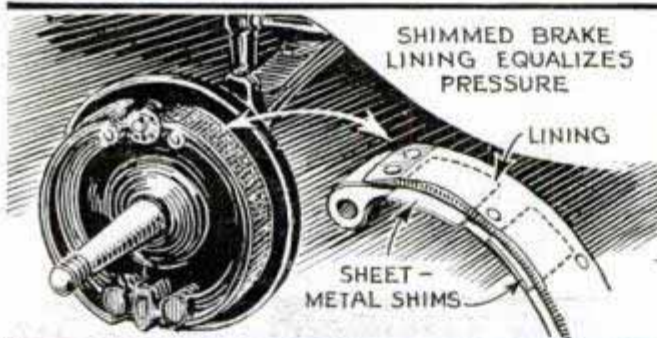

To utilize the entire surface of the brake lining, when the drums wear and their inside diameter is increased so that only the centers of the shoes touch, shims are sometimes inserted under the lining near the ends of the shoes. Right, small blocks nailed to a thin wood strip hold the valves up in an overhead-valve motor while compressing the springs to remove the retaining keys

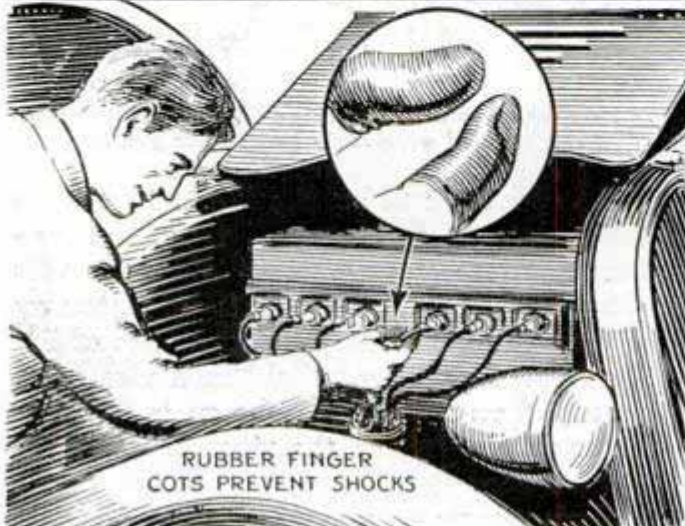
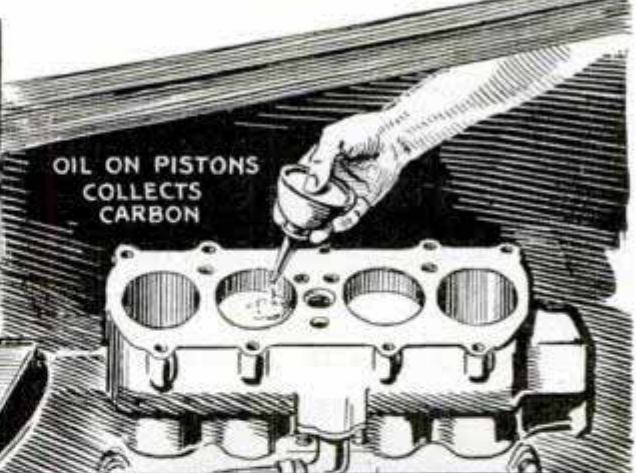

Left, rubber finger cots help to avoid shocks when handling "hot" wires to make various checks on the ignition system while the motor is running. Above, if heavy oil is applied liberally to the piston tops before starting to scrape carbon, it will fill the space between the cylinder walls and the tops of the pistons, keeping hard carbon particles from collecting on the upper rings where they may score cylinders when the motor is run. To remove the oil, just crank the motor and wipe off the cylinder walls carefully as the pistons go down

Dog's Basket Hooks over Seat of Your Car



Basket on back of front seat keeps dog off of car cushions and saves the upholstery

To take my small dog in the car without allowing him to get on the seats, I used the basket shown, which hooks over the back of the front seat. It consists of an iron-rod frame and a canvas basket hemmed around the top edges to slip over the rod. If the basket is plenty long and a partition provided, you also have a place to carry packages.

—R. E. Boody, Portland, Ore.

To Remove Grease from Housing of Steering Gear

Stiff steering in winter with its accident hazard can often be overcome by thinning the steering-gear lubricant. Removal of enough old grease to make room in the

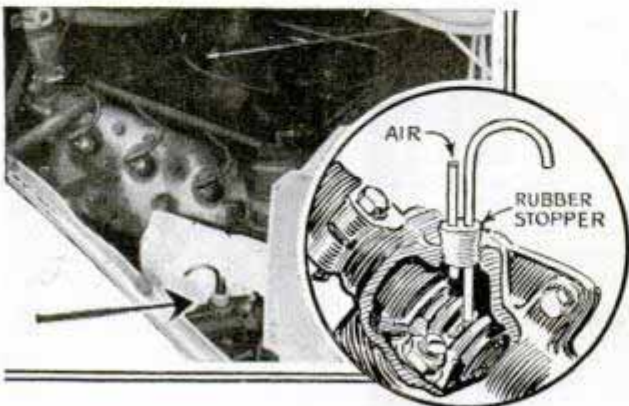

Hard steering avoided by removing some of the grease so that a thinner can be added

housing for the addition of a thinning agent is easy with a simple air-operated grease remover. This is made of copper tubing and a rubber stopper for the filler hole. Assembled as shown, the tubing and stopper are put in the filler hole after which air is forced into the housing through the short tube to force grease out of the long one.

Air Nozzle Handy Around Car

An old rubber valve stem with some of the inner tube attached to it makes a handy nozzle when using compressed air to clean grease fittings, plugged fuel lines, etc. The

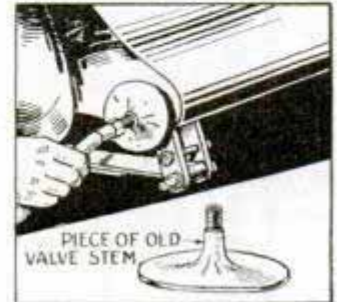

valve is also handy for removing dust from hard-to-reach places about the car.

—Paul A. Ruddell, Fort Scott, Kan.

Clamp to Hold Piston Rings When Filing Them

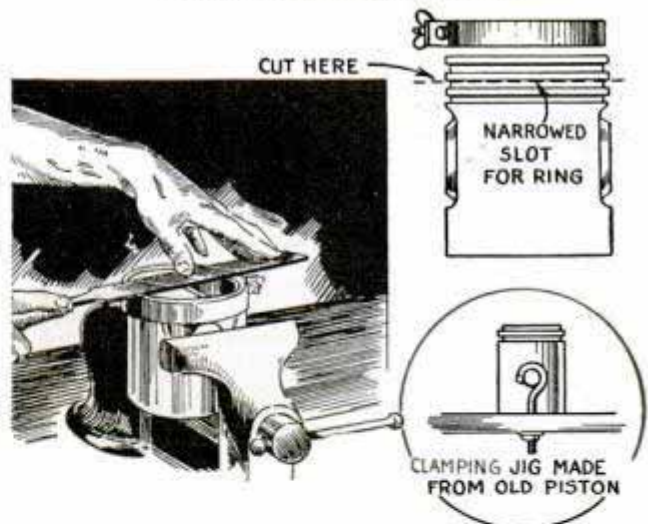

This clamp holds piston rings tightly so that they can be filed accurately to fit their grooves

The problem of holding a piston ring to file off a little from one edge to fit it correctly in its groove, is solved with this simple clamp. Made from an old piston by sawing off its top at the edge of one of the grooves, the clamp is held in a vise or is mounted on a bench as shown in the circular detail. In use, the ring to be filed is placed over the top of the altered piston and clamped tightly in place by means of

a strap-iron band fitted with a bolt and wing nut. The top edge of the ring is allowed to project slightly above the band. Held in this manner, the entire edge of the ring is exposed for rapid, accurate filing.

Mark on Hub of Car Wheel Shows Location of Nuts

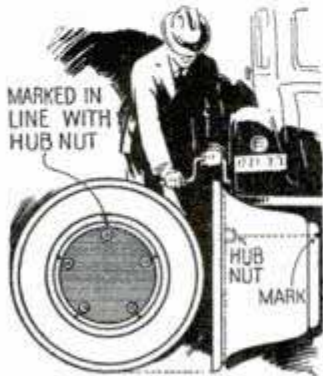

On car wheels where the retaining nuts are set far back in the hub, you can get the wrench on them without stooping over if marks are made on the edge of the hub in line with the nuts. The marking can be

done with a file or small holes can be made with the end of a drill.

Arrows Guide Filling-Station Customer to Air and Water

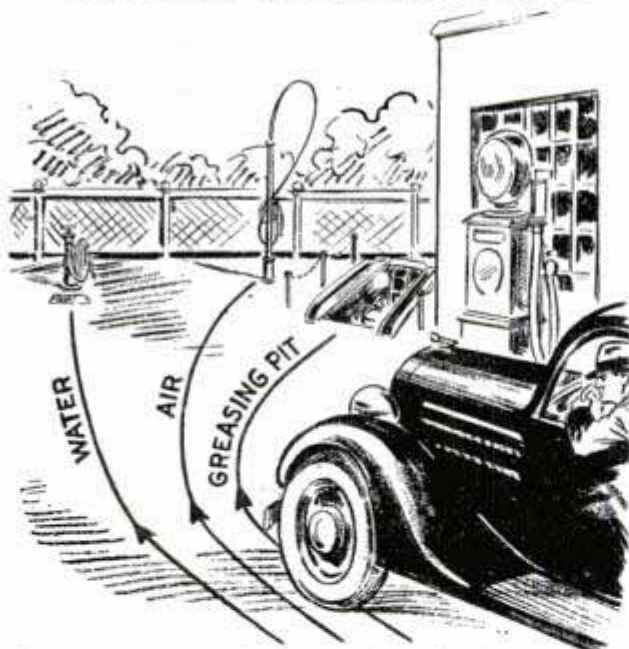

Arrows save attendant's time by showing customer location of water, air and greasing pit

As a guide for customers in locating the water and air hose or greasing pit, one filling-station attendant painted arrows on the driveways. The arrows not only saved the attendant's time but they helped increase his lubrication business as they often reminded the customer of an oil change or greasing job.

Differential Housing Assembled Easily with Headless Studs



Two headless studs driven into the axle housing serve as guides when installing differential plate

If two short, headless studs are placed at the top of a dismantled differential housing, the plate may be replaced with little trouble. As soon as a few bolts have been started, the studs are removed.

—James W. Clift, Columbus, Ohio.

Oil Pan Supported by Spring Jack While Replacing Bolts

For holding an oil pan in place while starting the bolts, this spring jack is handy. It consists of a short length of wood with a seat-cushion spring attached to one end. The jack is slipped under the pan and leaves both hands free to start the bolts.

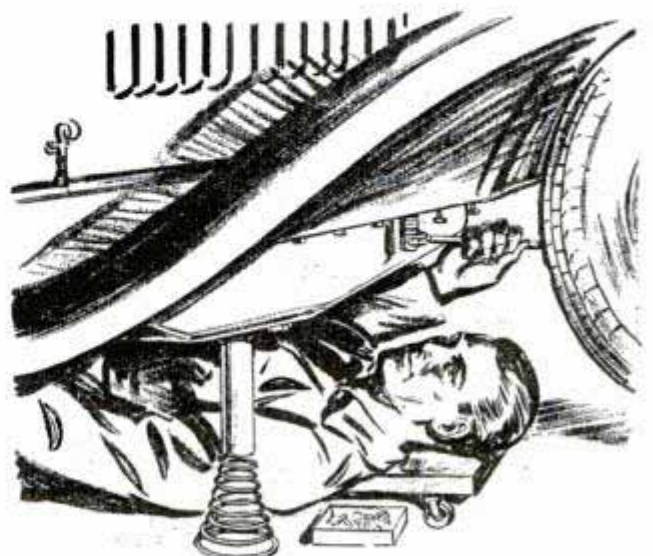

Oil pans easily installed single-handed by using this spring jack which holds them in place

Wooden Arm Signals for Drivers of Large Trucks

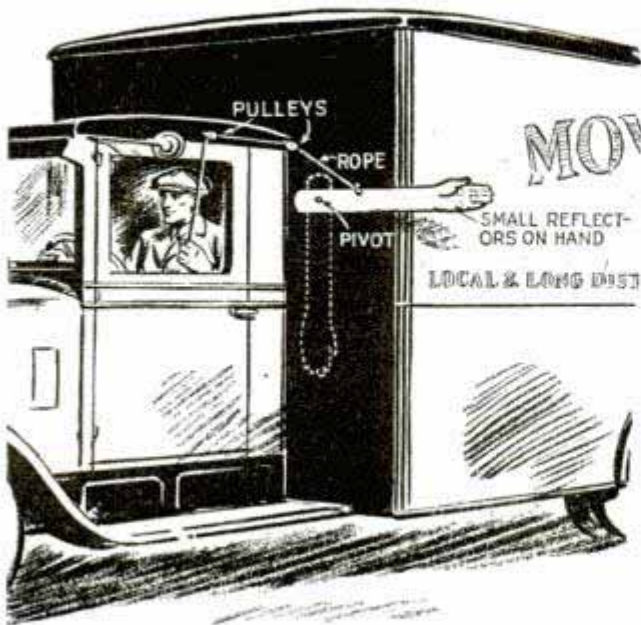

This hand will solve your signaling problems if you cannot see around the body of your truck

Drivers of trucks having bodies so wide that they cannot use their hands to signal traffic in the rear, will find that this wooden hand solves the problem. It is

pivoted to the front of the body so that it can be actuated by a cord running into the cab, where the driver can raise or lower it to give the signals.

—Philip Chandler, Nashville, Tenn.

Die Stock Improvised from Pipe

Here is a simple die stock that auto mechanics will find handy for cutting new threads or for cleaning up old ones in restricted places where a regular stock cannot be used. It consists of a length of pipe, which is fitted with a handle at one end and has two small holes drilled and tapped near the other end to take set screws to hold a die.

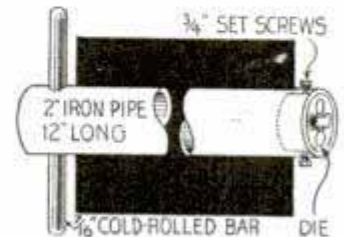

When the lock on your car door turns hard, you can lubricate it by blowing powdered graphite into the keyhole with a soda straw.

The Next Issue

BUILDING THE FAMOUS BILOXI DINGHY

A trim and speedy sailing skiff, seaworthy and stanch, carrying a mast stepped well forward for easy handling. One of the simplest hulls to build that ever went under sail—three frames, transom and stem, two chines and the planking—that's all there is to it.

THE MECHANICS OF METAL-WORKING DRILLS

Tells how to select, grind and care for drills as well as how to drill different materials, lay out work, select drill blocks, determine operating speeds, etc.

CARBON-ARC TORCH GIVES HIGH HEAT

Does all kinds of soldering jobs as well as light brazing and welding work. Produces temperatures high enough to melt small quantities of alloys.

IT'S TIME FOR KITE FLYING

Kites of unusual designs, including the "Dragon," "Big Fish," box type and one to carry a camera. Story also shows how to make various reels.

URN-TOP COLUMNS

Finished in bone-white, these turned columns of wood add a modern touch when used either as flower holders or to get unusual lighting effects.

Open Season on

FUN!

Ride a HARLEY-DAVIDSON Motorcycle

It's outdoor time—and the open season for going places! When you own a 1937 Harley-Davidson you light out for the fun spots any time—evenings, Saturday afternoons, and over week-ends. Distant places are brought nearer—your mount has speed galore. Costs are way down low—the new Harley-Davidsons have many new and unusual motor improvements which cut gas and oil consumption tremendously. No other type of transportation can match these up-to-the-minute motorcycles for economy. And say—if it's smart styling, class, and riding comfort you want—get aboard one of these 1937 models!

See your nearest Harley-Davidson dealer—PRONTO. Ask him for a FREE RIDE — about his Easy Pay Plans — and send in the coupon.

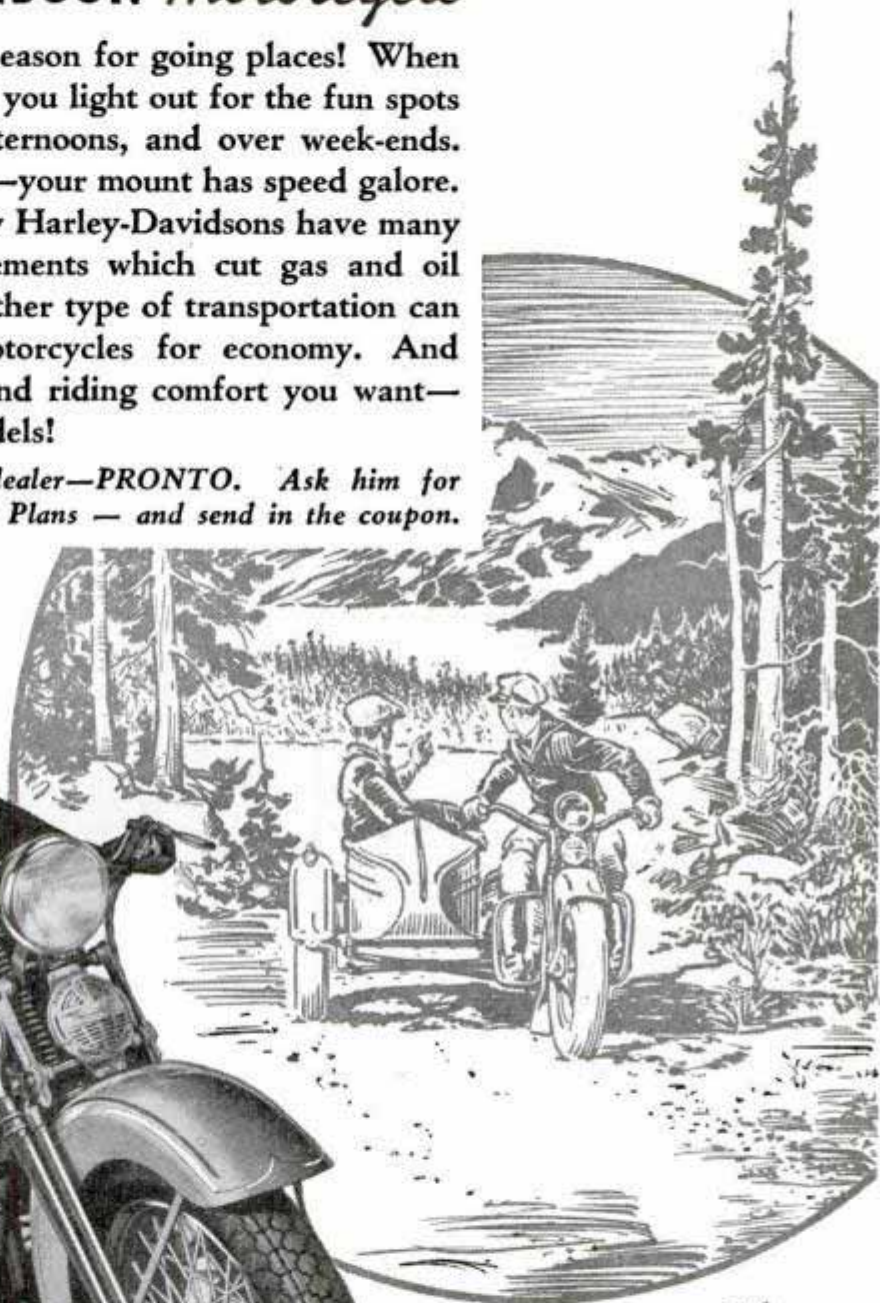
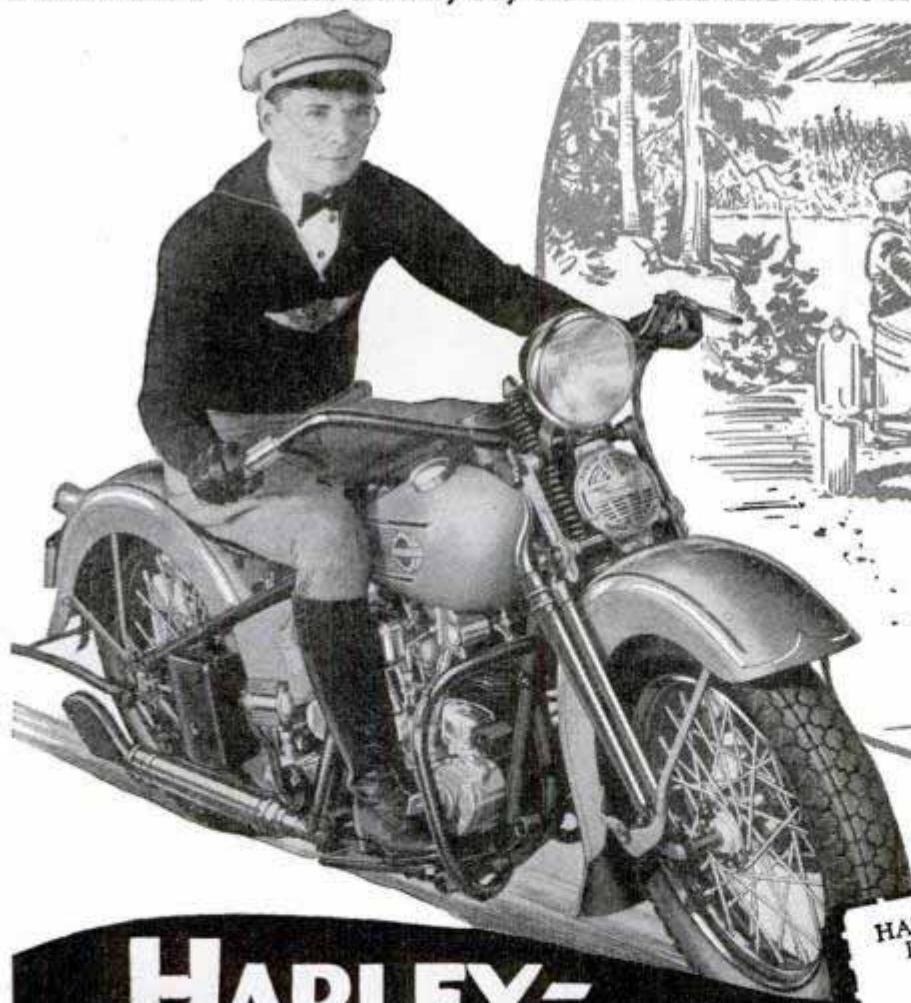

HARLEY- DAVIDSON

MAIL THIS COUPON

HARLEY-DAVIDSON MOTOR CO.,
Dept. P, Milwaukee, Wisconsin
Interested in motorcycling. Send il-
lustrated literature. Postage stamp
is enclosed to cover mailing cost.

Name

Address

My age is 16-19 years, 20-30 years,
 31 years and up, under 16 years.
Check your age group.

HIGH-SCORING HOCKEY ACE

Herb Lewis, of the Detroit Red Wings, says: "I go for Camels in a big way!"

THE lightning-quick camera eye caught *Herb Lewis* {extreme right} in this slashing set-to before the goal. Next split-second he scored! After the game {right}, Herb said: "You bet I enjoy eating. And Camels help me enjoy my food. Smoking Camels with my meals and afterwards eases tension. Camels set me right! And they don't frazzle my nerves."

Camel smokers enjoy smoking to the full. It's Camels for an invigorating "lift." At mealtimes it's Camels again "for digestion's sake." Thanks to Camel's gentle aid, the flow of the digestive fluids—*alkaline* digestive fluids—speeds up. A sense of well-being follows. So make it Camels.



FOR DIGESTION'S

COSTLIER TOBACCOS

Camels are made from finer, **MORE EXPENSIVE TOBACCOS**—Turkish and Domestic—than any other popular brand.



TUNE IN EVERY TUESDAY

Hear "Jack Oakie's College"—a full-hour gala show with Jack Oakie in person! Benny Goodman's "Swing" Band! Hollywood comedians and singing stars. Special college talent every week! Tuesdays—9:30 pm E.S.T., 8:30 pm C.S.T., 7:30 pm M.S.T., 6:30 pm P.S.T., WABC-Columbia Network.

When writing to advertisers please mention *Popular Mechanics*

Copyright, 1937, R. J. Reynolds Tobacco Company, Winston-Salem, North Carolina



SAKE — SMOKE CAMELS!



"I'VE SMOKED Camels since they were introduced," says *James Gould*, sports writer. "They help me digest well. Camels are famous as the favorite smoke of athletes."

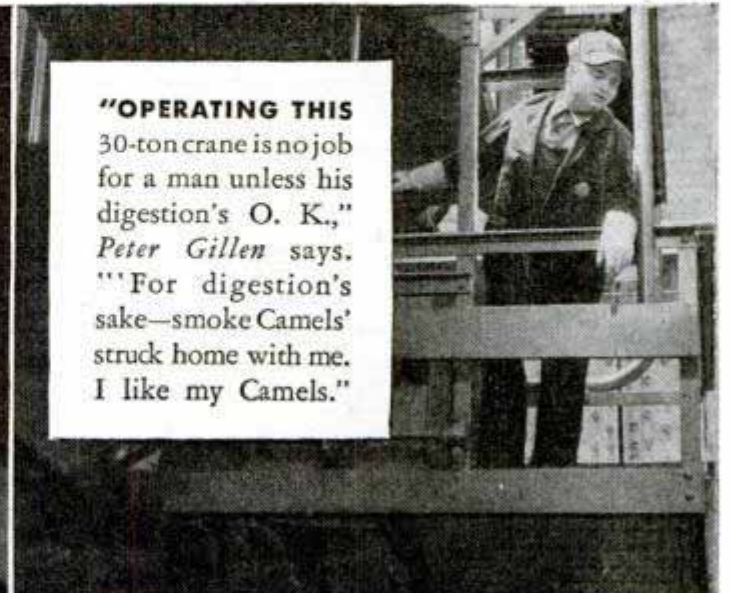

"OPERATING THIS 30-ton crane is no job for a man unless his digestion's O. K.," *Peter Gillen* says. "'For digestion's sake—smoke Camels' struck home with me. I like my Camels."

When writing to advertisers please mention Popular Mechanics

Movies That Show You the Invisible

(Continued from page 557)

there was a slight deposit of carbon. Step by step the cylinder head was used and then photographed until thousands of miles had elapsed. The result is that on the screen you watch the carbon particles slowly attach themselves to the metal, thicken, and crack under the heat just as if you were actually inside the combustion chamber.

Not all industrial pictures take as long as this one to make. Under good conditions a full motion picture may be made in a week or less. Once Rockett got an order for a film to show several stages in the life of the pineapple. The nearest pineapple field was in Hawaii but this order called for delivery of the finished picture in Chicago seven days from that time. From a film library he rented several hundred feet of film showing a typical pineapple field. This motion picture was thrown on a screen background in front of which fresh pineapples from a fruit stand and characteristic leaves had been planted in a layer of earth. An actor playing the part of a field laborer walked down the row harvesting the fruit while a camera recorded both the foreground and the Hawaiian background. The end of the picture showed a housewife purchasing cans of the fruit from a grocer. This was filmed on a set rushed together in the studio while other parts of the picture were being made.

One client wanted a picture showing the effects of refrigeration on the growth of food molds. By using a microscopic camera the studio was able to demonstrate on the screen the movement of a forestlike growth of fungus spreading across the skin of an orange. A thermometer beside the exhibit indicated the temperatures and showed that mold growth stopped when the temperature dropped, and started when the temperature climbed. Microscopic photography throws into giant proportions on the screen the actions of ants and other small insects.

Producers of industrial motion pictures make vest-pocket visualizations of almost anything. One film re-creates the earth right before your eyes and then in a few minutes takes you step by step through the geological ages. Another may show a

cutaway model of a petroleum refinery with flowing lines and arrows to demonstrate how gasoline is made. Still another may show the earth cut in half and the different strata laid bare, with a dramatized close-up of strata movements in mountain building. By filming models of miniature "props" the producers take you back 250,000,000 years or give you eyes that see right down into the earth.

By means of cutaway animations you are able to watch in detail the invisible forces that operate electric motors. Difficult points are usually made clear by animations purposely exaggerated. For example, most people assume that a shaft that turns inside a bearing remains centered between the bearing surfaces. Actually, the shaft revolves in a slightly eccentric manner, and this can be illustrated clearly on the screen.

One of Rockett's most interesting assignments was to show in natural color the prehistoric eruption of an extinct volcano at the north end of Death Valley. Rockett represented the mountain by a piled-up heap of colored plastic material. Underneath the five-foot miniature was a maze of pipes and electrical leads by which the volcano was made to erupt by remote control. The wires ran to detonating caps buried in the summit. Some of the pipes were for discharging clouds of smoke.

The mountain was first filmed with a few wisps of smoke blowing from the peak. Then cap after cap was exploded in the summit to portray the blasting away of the mountain top. At the same time more smoke was released. Fiery lava began pouring down over the sides of the crater. The lava was compounded of colored paints into which gasoline and sulphur had been mixed, forming colorful blazing streams that were discharged from some of the hidden pipes. Like other pictures filmed in miniature, this scene was photographed at high camera speed so when the film was run off at normal speed the rapid flickering of the small flames and plumes of smoke would be slowed down to imitate the slower motions of great size.

During the last several years more film

(Continued to page 118A)

Here's all there is to making Snapshots at NIGHT

1 Load your camera with Kodak "SS" Film



2 Use 2 or 3 Photoflood Lamps and Reflectors



HATE to lay your camera aside at sundown? Now you can snapshot right around the clock—get instantaneous pictures indoors after dark with your present camera, even if it's a simple Brownie.

Just use Kodak "SS" Film, and two or three of the new No. 2 Mazda Photoflood lamps, which last for hours, and Model B Kodak Handy Reflectors.

If your camera has an *f.6.3* or faster lens, No. 1 Photoflood lamps are powerful enough.

FREE BOOKLET . . . Contains all you need to know about *both kinds* of night pictures—*snapshots* with Photoflood lamps, *fast exposures* with Photoflash lamps. (You can use Photoflash lamps, each good for one picture, if your camera can be set for "time.") The booklet's pictures and diagrams show how to arrange your lights . . . how to place your subject . . . and it even suggests a variety of picture opportunities! Get a copy at your dealer's . . . Eastman Kodak Company, Rochester, N. Y.



Movies That Show You the Invisible

(Continued from page 116A)

has been used for non-theatrical purposes than has been required by the major studios for making pictures for entertainment. In the non-theatrical class, educational movies, "trouble shooting" films and amateur pictures are each important divisions. Motion pictures also serve as an aid in making sales. One concern found it hard to convince prospective customers that its twelve and one-half pound anchor would hold better than a 200-pound an-

chor of ordinary design. Now the company exhibits a motion picture of a tractor dragging an ordinary anchor all over a beach while with the same pull the improved type just digs in deeper.

Salesmen with motion-picture projectors under their arms are performing such miracles as "making flames forty feet high on the office wall" and "blowing up fifty tons of dynamite in the directors' room" to demonstrate their products.

How Good a Driver Are You?

(Continued from page 575)

tieth year and then became even better! After the twenty-fifth year women, on the average, surpass men in steering ability. Both, nevertheless, definitely decline in general driving efficiency as they get past middle age. The braking and steering test has given many drivers the first indica-

testing instrument shows one car pursuing another at such speed as to overtake it. The person taking the test must judge the distance required by the second car to catch the first, and the moment when the cars come together. Most people had the cars meet too soon; such people tend to allow more leeway than is strictly necessary in passing a car ahead when an oncoming car approaches. Those who did badly on estimating the point at which the cars would meet generally did badly also on estimating the time required.

Driving at night is much more difficult for all drivers, and doubly so for those abnormally sensitive to glare. Such persons need to be more cautious than the rest, yet few are aware of their glare-blindness. In this test, the driver is asked to detect, against the headlights of an oncoming automobile, a miniature pedestrian on the right side of the road. The degree of brightness of his own headlights required to detect the pedestrian indicates the observer's sensitivity to glare. About ten per cent of those examined, Dr. De Silva concludes, should not do any driving at night.

A person lacking in peripheral vision—or ability to see out of the corners of the eyes—cannot see a car approaching from a side road, or one coming around from the rear until it is nearly in front of him. From three to four per cent of those tested had "tunnel vision." They could see little except what was directly in front of them. One way to compensate for this is

(Continued to page 120A)



Speed and timing estimation test which shows whether you can judge clearance in passing

tion that they do not perform this elementary maneuver as well as they should. Practice with a competent instructor should soon correct this.

Inability to judge correctly the speed of other cars and the distance and time required to pass often leads to sideswipes or collisions. In the speed and timing estimation test, great differences were observed among individual drivers. The

Half & Half Makes
ONE Swell Smoke!

In other words, Half & Half and all's swell. Cool as a ticket-line half a block long. Smooth as recalling you bought yours last week. Fragrant, friendly, full-bodied tobacco that won't bite the tongue . . . in a tin that won't bite the fingers. Made by our exclusive modern process including patent No. 1,770,920. Cool and smooth. Smells good. Makes your pipe welcome anywhere. Tastes good. Your password to pleasure!

Copyright 1937, The American Tobacco Co.



No Bite!



No Bite!



Still no Bite!

Not a bit of bite in the tobacco or the Telescope Tin, which gets smaller and smaller as you use up the tobacco. No bitten fingers as you reach for a load, even the last one.

HALF ^{AND} HALF
The Safe Pipe-Tobacco
FOR PIPE OR CIGARETTE

How Good a Driver Are You?

(Continued from page 118A)

to equip your car with good rear-view and side-view mirrors. Another is to turn your eyes in each direction before making a maneuver.

To find how one will act in emergencies, the person being tested sits in a standard automobile seat and pilots an imaginary car on a highway unrolling before him on a screen. In this way he goes through many dangerous situations in about three minutes.

"We have discovered highly emotional individuals who have almost 'gone to pieces' while being thus examined," Dr. De Silva points out. "Several had a tendency to 'freeze up' so they could not move when they found themselves in a tight place. Others gripped the steering wheel so tightly they could not maneuver the car freely."

In special tests of more than 500 "repeaters"—motorists who had frequent accidents—Dr. De Silva found most of them owe their poor records to one or two bad habits or disabilities which they seldom suspect they have, and which in many cases can be corrected. From a study of this group he concludes the foreign born are likely to have more accidents than the native; the very poor and very rich than the middle class economically; the very young and very old than the middle aged, and unmarried men more than married.

"Many repeaters with a foreign background were handicapped in understanding English signs or traffic rules," said Dr. De Silva. "All sorts of visual difficulties, especially shortsightedness, were found in this group. The wealthy repeater seemed to take accidents lightly, since he could foot the repair bills or get legal service when in a jam. The very poor man lacked a sense of responsibility for opposite reasons—he seldom owned his car and was pretty sure his impecuniousness would save him from a suit for damages.

"The very young had little realization of the seriousness of accidents. The very old had a full sense of responsibility, but failed to realize their reactions were slowing down, or they had not improved their driving to cope with the more speedy cars. Marriage seems to make for more careful driving, especially when there are

small children in the family. Relatively few repeaters were married."

Dr De Silva believes the tests are a real help to the driver, since they tell him exactly what his weak points are. It is then up to him to correct his driving habits or to compensate for any natural disabilities.

"If you find you are slow in your braking reaction," he advises, "you should make allowance for this deficiency by starting to apply the brakes farther back and by following other cars less closely. If you are poor at estimating passing distances, allow a greater distance than you have been doing, or do not pass at all if there is a car coming from the opposite direction.

"If you are blinded more than the average person by the glare of headlights, do less driving after dark, or drive very slowly and keep to the extreme right. Since all drivers deteriorate as they grow older, it is necessary for elderly people to compensate for their loss of skill by decreasing their speed and exercising greater caution. Most elderly people drive with greater care, but there are some who have never realized how their lowered physical efficiency has affected their driving."

Dr. De Silva believes only a small minority of the thousands he has tested could justly be denied the privilege of driving because they are mentally or physically feeble or nervously unstable. Such persons are a menace to themselves and to others on the highways. The great majority of drivers—and of people in general—have all the potential abilities to make excellent drivers. All many of them need to become skillful and safe is to have their weaknesses pointed out to them.

"I have found the ordinary driver a pretty good fellow all around," says Dr. De Silva. "Many do certain things wrong and have certain erroneous notions about driving, but generally they are glad to have these pointed out. I have found only a few really 'ornery' motorists, and almost invariably these have done poorly in the tests."

Our Bureau of Information will answer questions regarding articles in this magazine, if accompanied by return postage.

10^{TO} 25 LBS. GAINED WITH NEW 3-WAY TREATMENT

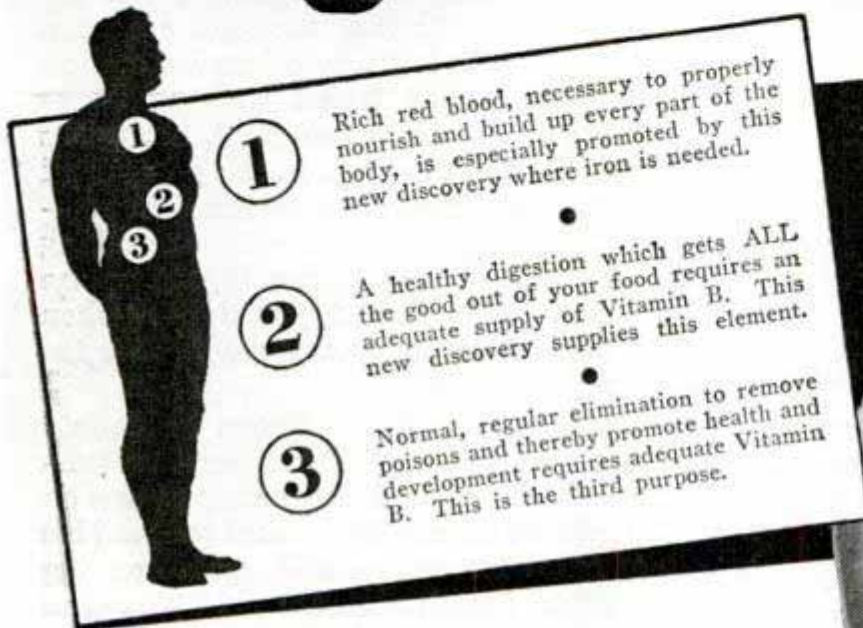

Posed by
professional
model

SKINNY?

New Quick Way Gives Thousands Solid Pounds Fast!

WHEN thousands of formerly skinny, run-down, friendless people have gained pounds of solid, normally good-looking flesh with this new triple-acting treatment, it's a crime for thousands of others to remain thin and unattractive. Actually, with this sensationally quick new body-builder, you may not only gain normal, flattering pounds, but also naturally clear skin, freedom from indigestion and constipation, new pep and popularity.

Doctors now know that the real reason why many find it hard to gain weight is they do not get enough Vitamin B and iron in their food. Without these vital elements you may lack appetite and not get the most body-building good out of what you eat. Now with this new discovery which combines these elements in little concentrated tablets, hosts of people have put on pounds of firm flesh, normal heftiness—in a very short time.

This amazing new product, Ironized Yeast, is made from special imported cultured ale yeast,

one of the richest known sources of Vitamin B. By a new process this special yeast is concentrated 7 times—made 7 times more powerful. Then it is combined with 3 kinds of iron, pasteurized whole yeast and other valuable ingredients in pleasant little tablets.

If you, too, need these vital elements to aid in building you up, get these new "7-power" Ironized Yeast tablets from your druggist today. Note how quickly they increase your appetite and help you get more benefit from the body-building foods that are so essential. Then day after day watch flat chest develop and skinny limbs round out to natural attractiveness. Soon you feel like an entirely different person, with new charm, new personality.

Money-back guarantee

No matter how skinny and rundown you may be from lack of enough Vitamin B and iron, try these new Ironized Yeast tablets just a short time, and note the marvelous change. See if they don't aid in building you up in just a few weeks, as they have helped thousands of others. If you are not delighted with the benefits of the very first package, your money will be instantly refunded.

Special FREE offer!

To start thousands building up their health right away, we make this absolutely FREE offer. Purchase a package of Ironized Yeast tablets at once, cut out seal on box and mail it to us with a clipping of this paragraph. We will send you a fascinating new book on health, "New Facts About Your Body." Remember, results with very first package—or money refunded. At all druggists. Ironized Yeast Co., Inc., Dept. 534, Atlanta, Ga.

When writing to advertisers please mention Popular Mechanics

Here it is!



TWIN CYLINDER

Indian JUNIOR SCOUT

What a "honey" this Junior Scout is! Only Indian could bring you an engineering triumph like this—a real "twin" at the lowest price in American history!

This snappy, streamlined machine is easy to handle—with peppy power that flashes you over the road, and economy that gives you 70 miles to the gallon.

Here's the chance you have waited for—the thrill and joy of having a machine of your own—at a price that makes this possible.

Better see your Indian dealer today! Don't wait. And remember, you can buy any Indian model on easy payments and get a fine RIDER'S HELMET and INDIAN PIN absolutely FREE. Send the coupon now!

NOTE: Still a few dealer franchises open for the right men who are interested in a profitable business that is practically non-competitive. Write us.



FREE



MAIL
COUPON
TODAY!

INDIAN MOTORCYCLE CO., Springfield, Mass.
Please send me at once, and without obligation, illustrated Folder describing the new Indian Motorcycles and CERTIFICATE of VALUE entitling me to FREE Rider's Helmet and Pin as illustrated when I place my order.

Name.....
Address.....
Please be sure to check your age group:
 16-19 years
 20-30 years
 31 years and up
 under 16 years

PM4

INDIAN MOTORCYCLE CO., Springfield, Mass.

71252

Stunts of the Aerial Acrobats

(Continued from page 567)

his wings. Military airplanes are tested to nine "G's," which means their wings must stay on when subjected to nine times the normal pull of gravity. Mantz pulls out at a reduced strain.

Upside-down flying is a big part of modern stunting and the engines of stunt planes are rebuilt for inverted flight. No matter in what position a stunt plane is placed, the engine still operates and the instruments still give accurate readings. Flying on your back, held into the cockpit with straps that fasten with a quick-release hook across the chest, multiplies the difficulties of flying. In this position all control movements are reversed in relation to the ground. For instance, pulling back on the stick in normal flight puts the plane in a climb, but if you do this when the plane is on its back it would dive toward the ground.

Flying upside down fifteen or twenty feet above the earth, Mantz must remember this. He must dodge racing pylons on the field, be careful not to skid and lead his two followers astray, and avoid crossing the white deadline on the field placed to protect spectators. At the same time, he must operate the pump that sprays smoke chemical into the exhaust. Finally, he must remember all the details of the maneuvers he is expected to lead.

The leader of a stunt group controls the other planes with a few simple arm movements or nods of his head. Sometimes the leader changes the program while in the air. He calls the other two planes in close for a "conference" while flying on a straight course and shows each pilot what he is to do by outlining the stunt with movements of his hands.

"Crazy flying" is one of the hardest acts in the stunt man's repertoire. The flyer uses a slow old plane in dilapidated condition. If it looks too new, he smears it with oil and partly rips off a few sections of fabric. Then he does every stunt the way it shouldn't be done. He takes off down the field with one wing tip dragging along the ground and wobbles into the air in imminent danger of crashing. Once off the ground his troubles have only started. From the stands it looks like the pilot had never been in the air but before he gets

through you are wondering how he does it. Every maneuver is sloppy and air men know sloppy stunts are close to suicide.

When the "crazy" flyer tries a loop, his power fails on the climb and he falls into a spin. When he gets out of the spin he falls into another. If he tries a barrel roll he gets stuck when the plane is upside down and doesn't seem to be able to complete the roll. He comes across the field in a continuous stall with the plane moving too slowly for safety. When he lands he fishtails sideways until the last possible moment, or sits the plane down with a crash that bounces it twenty feet in the air.

But don't try crazy flying, even if you are a competent pilot. This is definitely precision flying and the pilot doesn't dare relax for a second. A slight misguess at any point would put the plane out of control, and at low altitudes where there isn't room to recover from a spin a plane that gets away from its pilot is almost certain to crash.

In a variation of crazy flying, Mantz acts as a greenhorn pupil with Clarke as instructor. After both have crawled into the plane a bomb explodes, simulating a backfire. Mantz hastily scrambles out. After he has been forced back into the cockpit the plane starts to careen down the field, smashing into a refreshment stand on the sidelines. The stand is constructed of balsa wood and paper for the stunt. Finally, the pupil manages to get the plane in the air and the crazy flying begins.

Wing walking used to be a standard act but that is a thing of the past because modern airplanes are too fast to permit it. At anything except slow speed a wing walker would be blown right off the plane. Airplanes are so streamlined nowadays and have so few places for holding on that a wingwalker can't do such favorite old stunts as hanging by one hand or a foot from the end of a wing. One of Clarke's old stunts was to leave the controls and crawl under the plane on the landing gear, returning to the cockpit by the other side. That's impossible today, as is his old trick of crawling out of the cockpit and straddling the tail, maneuvering the plane by means of ropes attached to the controls.

Clarke used to perform a loop from the

(Continued to page 124A)



Masonite

ENDORSED BY

16 OF 23

TRAILER MANUFACTURERS



• At the Chicago Automobile Show in November, twenty-three trailer makers exhibited their 1937 models. And sixteen of them — about 70% — used Genuine MASONITE Products for interior, exterior or both surfaces.

This overwhelming endorsement of MASONITE Products is doubly significant. First, because trailer construction is one of today's most recent and fast-growing industries. Secondly, because trailer travel exacts the maximum in service and economy from the materials employed.

MASONITE Products are sturdy grainless boards. Moisture-resisting, they will neither warp nor curl when properly applied. They tend to eliminate condensation of moisture on side walls and ceilings. They provide a beautiful warm-brown finish, without further treatment. They can be varnished, painted or enameled where desirable. And their ease of handling reduces building costs to a minimum.

Whatever you plan to build — a trailer, a new home or new rooms in your present home — why not follow the example set by most trailer manufacturers? . . . Specify MASONITE! Mail the coupon for FREE samples and more information.



MASONITE CORPORATION, Dept. PM-4
111 W. Washington St., Chicago, Ill.

Please send FREE samples and further details about Genuine MASONITE Products.

Name _____

Address _____

City _____ State _____

THAT BIRD DOESN'T KNOW
SANI-FLUSH
CLEANS OUT ANTI-FREEZE



NOW'S THE TIME TO CLEAN OUT YOUR RADIATOR

A WHOLE WINTER'S accumulation of rust and sludge is choking the cooling system of your car. Clean it out! You can do it in a few minutes—for 10 cents—with Sani-Flush.

Don't take a chance on an overheated motor. It's dangerous and expensive. Just pour in Sani-Flush. (Follow directions on the can.) Run the motor. Drain and flush once. Refill with clean water. Sani-Flush cannot injure aluminum cylinder heads or motor fittings. You find Sani-Flush in most bathrooms for cleaning toilets. Sold by grocery, drug, hardware, and five-and-ten-cent stores—25 and 10 cent sizes. The Hygienic Products Company, Canton, Ohio.

Sani-Flush *Safe* NOT CAUSTIC
KEEPS RADIATORS CLEAN

PHOTO ENLARGEMENTS



Is Photography your hobby? Do you want a profitable easy business at home? Make **PHOTO ENLARGEMENTS** for yourself and others. Your cost 5c each and less. The Ideal Photo Enlarger is **AUTOMATIC**. No experience required. Also **COPIES** any picture. \$5.94 COMPLETE. Interesting circular **FREE**.

5¢ ANY SIZE

IDEAL-O, 122 East 25th Street, New York City

NEW BENJAMIN AIR PISTOLS

Powerful—Accurate—Economical—Practical—Adjustable Shooting Force—Amazing Maximum Velocity—cal. 177 or 22 and BB—For Target and Small Game—the only Genuine Compressed Air Pistol on the market—Single Shot with Bolt Action—Hammer Fire—Hair Trigger—Safety. Price \$7.50. Also 177 and 22 Single Shot Air Rifles \$7.50—Single Shot BB Air Rifle \$6.00—22 Shot BB Repeater Air Rifle \$7.50—at Dealer or Direct—No license required—Safe for indoor use. **FULL DETAILS—TARGETS—FREE—WRITE TODAY.** Benjamin Air Rifle Co., 691 N. Broadway, St. Louis, Mo.



F1252

(Continued from page 123A)

ground as he came in to land and after finishing the loop, climb to a stall. Then he allowed the plane to whip back out of the stall and settle gently to the ground. This whip-stall landing is possible only with very slow airplanes and if a pilot tried it with a high-speed ship his speed would carry him 500 feet or more above the field, far too high for a landing.

Clarke has flown planes in nearly 100 different motion pictures. Once, with Mantz flying the camera ship right behind him, his job was to corkscrew down a narrow, twisting canyon at full speed. Everything went well until Clarke had to bank around a particularly sharp turn. At that instant he felt a jolt and then discovered that his left wing had partly folded up. He had struck an unseen power line and torn off 500 feet of copper cable which was trailing from the wing. When both planes got back to the field, the cameraman discovered his camera had broken down and the scene had to be shot over.

F1683

Motor-Driven "Carrier Pigeon" Serves Two Buildings

For transporting messages between two buildings at Harvard University, a mechanical "carrier pigeon" is operated back and forth on cables. It is driven by a small motor whose power is shut off when the device reaches either terminal. Communications are placed in an aluminum cylinder for the trip from the laboratory to one of the engineering buildings. A red light indicates that a message is in the cylinder.

Cambridge, Mass

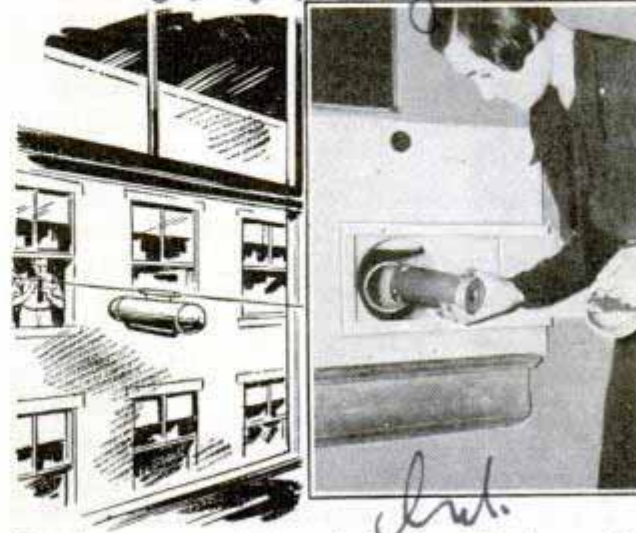

Putting message into cylinder for trip to another building. Left, sketch of the carrier system

"LET ME IMPROVE YOUR SHAVES"

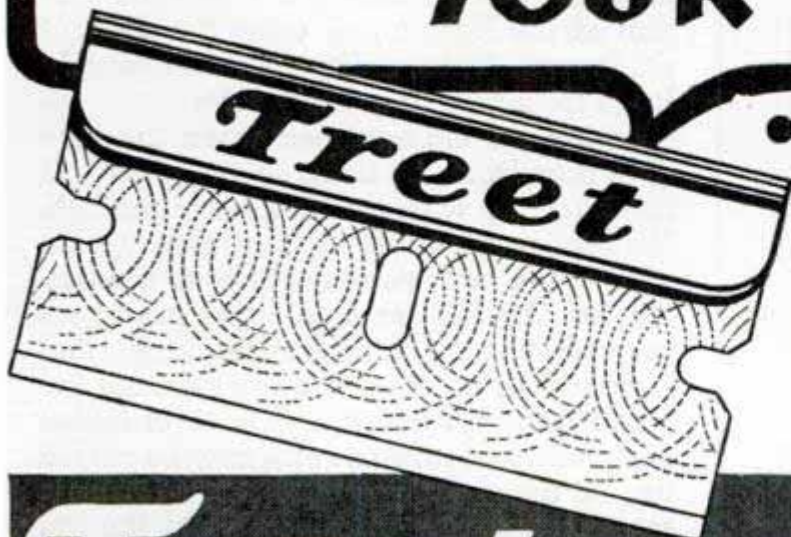

• Better steel, better sharpening, better inspections make Treect a better blade. Keener...it removes your beard smoothly, gently, comfortably. It stays sharp for more shaves! Treect Safety Razor Corp., Newark, N. J.

Treect BLADES
FIT GEM AND EVER-READY RAZORS

4 FOR 10¢



New HULL AUTO COMPASS

Saves miles of travel in wrong direction. This handsome, STREAMLINE Airplane Type Compass keeps you on the right road. Easily installed. 3 1/2 inches high. Bakelite case, sapphire bearing. Built-in compensator. Only \$2.95 POSTPAID. SATISFACTION GUARANTEED.

MODEL A

Airplane Type, 1 1/4-inch diameter. Sticks to windshield. Guaranteed. With separate compensator, only \$1.95 POSTPAID.

If your dealer cannot supply you, order direct.



HULL MFG. CO., Box 246-D, WARREN, OHIO

BUILD IT YOURSELF **PLANS \$1.00**



JIM DANDY CABIN CRUISER
The Trailer that has Everything

With my plans you can build this beautiful coach with ease and save money. Plans show every detail of building body, chassis, beds, cabinets, drawers, refrigerator, top, electric light and water systems and where to buy all parts. The Jim Dandy Cabin Cruiser can be built in any size to accommodate 2 to 4 people. Send \$1.00 for these plans today—get started now!

COMPLETE BUILDING PLANS \$1.00

MAIL DOLLAR BILL TO JIM DANDY, Box 125-A, WAUSAU, WIS.

DO YOU

WANT a new business profession of your own, with all the trade you can attend to? Then become a foot correctionist, and in a few weeks earn big income in service fees,—not medical nor chiropody—easy terms for home training, no further capital needed, no goods to buy, no agency. Established 1894. Address Stephenson Laboratory, 1 Back Bay, Boston, Mass.

Catch Fish!

Eels, Mink, Muskrats, with our new folding galvanized STEEL WIRE TRAP. Write for our FREE TRAP OFFER and Bargain Catalog. 51 Box of our famous Fish Bait FREE to introduce our traps. WALTON SUPPLY CO., 3501 JUNIATA AVE., ST. LOUIS, MO.



BUILD Your HOME For 30% LESS
We Pay Freight

WORLD'S LOWEST PRICED QUALITY HOME \$495 AND UP

Now you can own a fine, 4 to 10 room modern home—the World's lowest priced quality home—and save \$200 to \$800. Buy direct from the big Aladdin Mills. Save 18% material waste. Save 30% labor, or build it yourself with our easy to follow plans. Our prices include all lumber Readi-Cut, aluminum protected siding, mill-work, windows, doors, interior wood-work, flooring, roofing, hardware, nails, paints, stains, varnish—and we pay freight!

SUMMER COTTAGES \$230 up
Write today for catalog No. 276, use coupon or postcard.

ALADDIN CO.
Bay City, Mich. or Portland, Ore.
Send me Free Catalog No. 276,

Name _____
Address _____
City or Town _____ State _____

UNSIGHTLY WALLS

MADE GOOD AS NEW



You can easily repair holes in walls with Rutland Patching Plaster. Anyone can make a perfect job with Rutland.

CATCH MORE FISH

Send for **FREE BAIT BOOK**



This practical handbook, for fishermen, is a fascinating, reliable guide to better fishing! It tells how and why Creek Chub True-to-Nature Lures and Flies Catch More and Bigger Fish! Beautifully illustrated! Sent FREE upon request!

CREEK CHUB BAIT COMPANY
414 Randolph St. Garrett, Ind.



BUILD THIS 6' YAWL MODEL, ONLY \$1.50

Everything furnished including semi-shaped hull of white pine and mahogany with black water line. All rigging material, airports, pedestal, base, plans and instructions. Mailed postpaid for \$1.50 in U.S.A. \$1.65 Canada. No C.O.D. orders. Our 44 page illustrated catalog listing kits and separate fittings mailed on receipt of 15c.

A. J. FISHER, 1002-1 Etowah Ave., Royal Oak, Mich.

2 DOG WORM CAPSULES

Now Combined
in

ONE TREATMENT

NO LONGER need you guess which kind of worms afflict your dog—or guess which type capsule to use. Pulvex Worm Capsules expel "all three": Tape and Round, and Hook worms. Now you can be sure of worming your dog correctly. Easily given. No gassing, gagging or harmful effects. Guaranteed. At pet, drug, department stores, 75c.

Expels
HOOK, TAPE
and ROUND
WORMS



PULVEX WORM CAPSULES

Moonbeams Balk the Fisher Folk

Fly 83 (Continued from page 549)

to twenty miles off shore, often in rough weather. Each boat carries its own tender, tows its own lighter. A lighter is imperative, for piling of cargoes is prohibited by law. The catch is spread out over the bottom of the lighter and upon the deck of the launch. Thus, a fifty-foot boat usually loads from fifty to seventy tons.

Lights are extinguished when the sardine boat starts its hunt, so the glow will not interfere with the watch for the fish. On leaving port the captain takes up his vigil at the bow, peering out over the water for the "Silver Sea." He may pass several schools of anchovies, smelt and mackerel or ignore schools of sardines too small to merit attention. Schools of mixed anchovies and sardines also may be passed up. At times, for an undetermined reason, the fish are very wild, and when the net is cast will sound and escape. That necessitates several casts before a load is obtained. Recasting also is practiced when the quarry is running in broken schools too small to complete a cargo.

On sighting a desirable school, the boat is maneuvered to proper position, and one end of the seine, attached to a buoy, is cast overboard. The lighter's hawser also is fast to the buoy, and is cast off with the first length of seine. The boat then slowly surrounds the school, or segment of the school, moving in a circle as the seine is payed out. When the circle is completed back to the buoy and lighter, the purse of the seine is closed by a winch, and the wings are hauled in by hand.

While this operation is going on, a lighted electric bulb is dropped overboard from the stern of the boat and lowered to deep water under the purse; then moved up and down in jerks to frighten the fish and keep them from sounding before their twine prison closes. This "scare" is ineffective when the game is wild. With the closing of the purse, lights again are turned on, and brailing lights are flashed over the water. The brailer, a huge steel-mesh bucket, is lowered by crane, bringing up a hundred pounds of fish or more.

Boats return to shore in the cold dawn to unload. Cargoes are pumped from decks and lighters to conveyors, which dump them on scales. Then they are sluiced into

(Continued to page 128A)

NEW SCREW FEED LATHE

No. 355-6 x 18-inch METAL TURNING LATHE WITH LONGITUDINAL SCREW FEED. Length overall 30 inches. Machined semi-V ways. Threaded hollow spindle No. **ONLY \$1195**



O MORSE TAPER CENTERS. BRONZE TAPERED TAKE-UP BEARING. 1/2 inch tailstock set-over. Compound carriage travels on semi-V ways gibbed for take-up. Included: Two 60° centers, tool post assembly and 4 inch face plate.—3 inch four jaw chuck \$3.50; 4 inch chuck \$4.50; adaptor bushing 50 cents. Send \$2.00 with order, balance C.O.D. Shipping weight 30 lbs.

FREE—32-page catalog



BALKO ELECTRIC MOTOR & SUPPLY COMPANY
Dept. A14 10 S. Clinton St. Chicago, Ill.

ONE-MAN SAWMILL

Makes lumber, shingles, lath, ties, crates, boxes, coars, all forms lumber

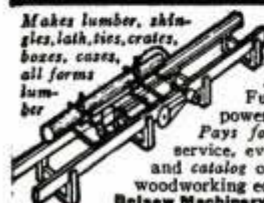

TURN TREES INTO MONEY WITH A BELSAW

FARM MODEL **\$49.00**

Three capacities: 10, 14 and 20 ft. Accurate set works positive dogs. Full or one way type power feed runs on low power—Many owners use old auto engine. Pays for itself quickly—thousands in commercial service, everywhere. Write for free lumber handbook and catalog of mills, supplies, tools, saw tables, and woodworking equipment.

Belsaw Machinery Co., 811-C Davidson Bldg., Kansas City, Mo.

MAKE GLAZED CONCRETE PRODUCTS

LEARN to make garden vases, jars, birdbaths out of sand and cement without molds or costly tools and glaze them like clayware. Also beautiful, colored, glazed tiles, novelties, walls, etc. Statuary casting, giftware. No experience needed. Money-making employment. Send 10c for booklet, color plate, details.

NATIONAL POTTERIES COMPANY

13 West 26th Street, Room 21, Minneapolis, Minnesota

STANDARD GARDEN TRACTORS

Plow
Seed
Cultivate
Mow Hay
and Lawns

Powerful Gas Tractors for Small Farms, Gardeners, Florists, Nurseries, Fruit Growers & Poultrymen.

1 & 2 Cylinders

Walk or Ride-Do Belt Work
High Wheels—Free Catalog



STANDARD ENGINE CO.

Minneapolis, Minn. Philadelphia, Pa. New York, N. Y.
3221 Como Ave 2546 Market St. 290 Cedar St.

BURN YOUR NAME ON TOOLS

WITH THE

ARKOGRAF

PROTECT YOUR TOOLS FROM THEFT

Write with electricity any name or design on the hardest and finest tools and instruments, or any metal, like writing on paper with pen or pencil. **Complete Outfit \$3.50—Prepaid Anywhere** Interesting illustrated circular free. Write today. Agents wanted.

ARKOGRAF PEN CO., 3927 S.E. Stark St., Portland, Ore.

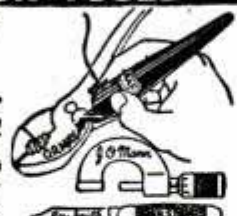

INVENTORS Be Sure to See Page 23A

BIG 1937 LEADER

For greater profits, steady income and repeat business, sell Century.

GENUINE LEATHER TIES

NO SALES EXPERIENCE NEEDED. Beautiful 4-in-Hands for Men and Boys, sell on sight, everybody buys. **LOOK LIKE SILK**; cleaned with a damp cloth. Famous Century Bows sell to uniform men, such as policemen, firemen, letter carriers, etc. Write today for our new **FREE DEAL OFFER**, or send 50c for samples, 4-in-Hand and Bow.

CENTURY TIE CO., 2345-L, W. Grand Blvd, Detroit, Mich.

BE YOUR OWN FIXER AND SAVE THE REPAIR MONEY

Typical repairs that can be made perfectly with Smooth-On:—Stopping leaks in steam, water, gas, oil or stove pipes; mending cracks, breaks or leaks in furnaces and boilers, radiators, tanks, sinks, pots and pails; making loose handles tight on umbrellas, knives, hammers, brushes, drawers, etc.; tightening loose screws, hooks, locks, door knobs, etc.

On the Automobile:—Making cracked water jackets and pumps good as new; stopping leaks in radiator, hose connections, gas tank and gas, oil and exhaust lines; making a fume-proof joint between exhaust pipe and tonneau heater; tightening loose headlight posts; keeping grease cups, hub caps, and nuts from loosening and falling off, etc.

Practically every householder spends at least \$10.00 to \$50.00 each year and many spend several times that much on the above and other simple repairs that can be made quickly, easily and well with Smooth-On No. 1.

With a can of Smooth-On you can save this money in your own home—and by doing similar repair work for others, you can make money.

No skill is required to make repairs and the amount of Smooth-On used on any one job seldom costs more than a few cents.

To get perfect results, write to us for and use the Smooth-On Repair Book.

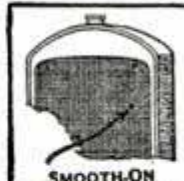

SMOOTH-ON Radiator

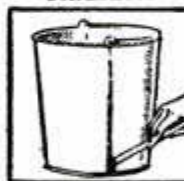

Leaky Pail



Leaky Kettle

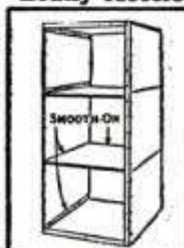

Leaky Tank



Stove Pipe

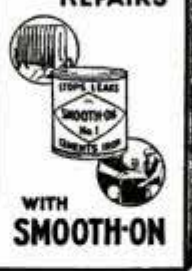

Oil Leaks

HOME and AUTO REPAIRS

WITH SMOOTH-ON

Get Smooth-On No. 1 in 7-oz., 1-lb. or 5-lb. tins at nearest hardware store or if necessary direct from us.

SMOOTH-ON MFG. CO.,
Dept. 37,
574 Communipaw Ave.,
Jersey City, N. J.

Please send the free Smooth-On Repair Book.

Name.....
Address.....
4-37.....



Do it with SMOOTH-ON

When writing please mention Popular Mechanics

F1483 Moonbeams Balk the Fisher Folk

(Continued from page 126A)

revolving cylinders of heavy screen into which jets of cold water are forced at high pressure to remove the scales. Waste water sluices scales to a vat for reduction to fertilizer, while another stream carries scaled fish to cutting and cleaning machines.

Heads and viscera are removed in one process by revolving knives, brushes, augers, gimlets or by vacuum. Heads and offal are sluiced in one direction to reduction tanks; fish in another direction to vats of ice-cold brine to whiten the meat. Then they are carried on conveyors to sorting tables. Bruised fish are sent to reduction vats to be turned into meat and oil.

Before the fish go to the broil, the oven, the fry or the steam cook, they pass through a drier to remove moisture and set the skin. The drier is a long tunnel containing a series of chain belts, staggered one beneath the other. The sardines ride back and forth on the belts until properly hydrated by hot air forced into the tunnel at one end and out the other. Coming out of the driers, the fish fall into wire baskets and are conveyed to fry vats to be submerged in boiling oil. Emerging,

the cooked product passes through a hot-water or steam spray to remove excess oil, is drained, canned and labeled by machines. Broiled and baked sardines go through the same process, except that ovens serve the purpose of hot oil, and the broil or bake is by radiant heat.

The ring net is now used by more Pacific fishboats than any other seine. All nets operate on the same principle. They are closed by ropes through rings at the bottom, forming a purse that imprisons the catch. All are made of tanned webbing, with a central bag or purse of fine mesh, and with wings of coarse webbing and heavier cord. They range from 660 to 1,800 feet long and from 150 to 240 feet deep.

Seines cost from \$1,000 to \$5,000, and are good for from one to three years. They require frequent patching and immersion—tanning—in huge vats of hot oil.

A drove of sea lions trapped with a school of fish will damage a net as much as \$1,000 by tearing holes in the bag. Although sardines rank second to salmon in commercial importance on the west coast, they do not lure the sportsman.

F1563 Flying Freight to the Arctic

(Continued from page 516)

ern Manitoba pilot. "Called at Jackpine bay to pick up grocery order." That afternoon he landed at his base 100 miles to the south, handed the order to the base manager, and that evening the grocery order was piled in the shed waiting aerial transport. If airplanes had not been available

it would have taken more than a week to have gotten those provisions to the mine, and they would not have been fresh. But within twenty-four hours of picking up the order, the pilot had it at the camp, everything fresh. Nearly as fast as if the mine were next door to a city, instead of hundreds of miles from the nearest town.

Planes have actually cut down the cost of living at northern camps. Because of the heavy overhead on overland transport, miners' wives used to buy potatoes at \$10 a bag, canned foods at sixty-five cents a tin, sugar at fifty cents a pound. Today potatoes are \$3 a bag, flour \$4.80 a bag, sugar fifteen cents a pound, and canned fruits thirty cents a tin.

Last spring cakes of ice thirty feet high crashed about the hangars of the air base at McMurray, at the end of steel in Alberta, where planes leave on the Arctic routes. The ice barrage pushed trees and

(Continued to page 130A)



An air base on the shores of a frozen lake in the Canadian northland

STUDEBAKER ANNOUNCES

\$10,000.00 IN CASH PRIZES

Free TO USED CAR BUYERS

ALL you need do to qualify for one of these 452 cash prizes is to buy from an authorized Studebaker dealer a Pledge-backed used car of any make—and then write a letter of 50 words or less stating why you did so. For the best letter, Studebaker will pay \$1,000.00 in cash! For the next best letter, \$500.00 in cash! For the 450 next best letters cash prizes ranging from \$100 to \$10 in cash!

Studebaker is making this sensational offer of \$10,000.00 in cash prizes in order to call attention to the many amazing values in used cars of all makes which Studebaker dealers have taken in trade on new 1937 Studebakers.

2 GOOD REASONS WHY STUDEBAKER DEALERS SELL BETTER USED CARS

1 The famous Used Car Pledge—introduced by Studebaker eleven years ago—assures you honest pricing and fair treatment.

2 You have many makes of cars to select from, including a fine assortment of Studebakers—the make preferred by shrewd used car buyers.

The Studebaker Corporation asked its dealers to take this Pledge eleven years ago.

As years passed, other organizations have fallen in line with varied imitations of this sound policy. But regardless of the wording of the imitations no other organization can match Studebaker dealers in carrying out the spirit as well as the letter of this sound policy.

RULES: Buy a Pledge-backed used car from an authorized Studebaker Dealer (the make of car or amount you pay, however small, makes no difference) and then write a statement of 50 words or less on the entry blank the dealer will give you, sign with your name and address (give street and number as well as city and state) and mail to Studebaker, South Bend, Ind. Your entry must be postmarked not later than midnight March 31, 1937. Employees of Studebaker and Studebaker dealers—or members of their families—are not eligible and duplicate prizes will be awarded in case of ties. No entries will be returned. Paul G. Hoffman, President, Studebaker Corp., and staff will be the final judges. Spelling, grammar and penmanship will not count against you. Just give a statement of 50 words or less as to "why you bought a used car backed by the Studebaker Pledge."

| | |
|--------------------------------|--------------------|
| 1st PRIZE, IN CASH | \$1,000.00 |
| 2nd PRIZE, IN CASH | \$500.00 |
| NEXT 10 PRIZES, IN CASH, EACH | \$100.00 |
| NEXT 40 PRIZES, IN CASH, EACH | \$50.00 |
| NEXT 100 PRIZES, IN CASH, EACH | \$25.00 |
| NEXT 300 PRIZES, IN CASH, EACH | \$10.00 |
| 452 CASH PRIZES | \$10,000.00 |
| TOTALING | \$10,000.00 |

Studebaker Dealer's Pledge to the Public on Used Car Sales

1. Every used car is conspicuously marked with its price in plain figures, and that price is rigidly maintained.
2. All automobiles which are sold as **CERTIFIED CARS** have been properly reconditioned and carry a 30-day guarantee for replacement of defective parts and free service on adjustments.
3. Every purchaser of a used car may drive it for five days and then, if not satisfied for any reason, turn it back and apply the money paid as credit on the purchase of any other car in stock—new or used. (It is assumed that the car has not been damaged in the meantime.)



QUICK, EASY PROFITS
WHILE YOU BUY A
FLEXARC WELDER

GASOLINE DRIVE
ELECTRIC DRIVE

Big profits, low outlay . . . pay as you earn with guaranteed FlexArc. Get into electric welding, as hundreds already have done. Make your place local welding headquarters. Cash in on the new high profits of the welding age. It's easy, if you are careful to buy a full-range machine that does all kinds of work.

The new Westinghouse FlexArc is the one welding machine that does all kinds of welding at lowest cost. Don't take our word for it. Take the word of operators. In a recent nation-wide poll among welding operators, 74% said the FlexArc EARNs MORE MONEY; 89% said it welds FASTER; 91% said BETTER; 96% preferred its SAFETY.

Build Your Own—It's easy! An auto engine and chassis, plus a FlexArc generator are all you need. Save \$300 to \$500.

Electric Driven FlexArc—With electric power available, your most profitable buy is the FlexArc motor-driven set—portable or stationary models.

Gasoline Engine-Driven FlexArc—Driven by powerful Dodge truck engine. Self starter. Rubber or steel tires. Fully complete!

Easy to Buy—Don't be afraid of price! Distributors offer easy payments. Pay for FlexArc out of profits. Get complete information. Send coupon.

Westinghouse Flexarc Welder

FASTEST SELLING WELDER ON THE MARKET TODAY

Westinghouse Elec., Room 5N3, East Pittsburgh, Pa.

Without obligation send your new "1937 Catalog of Popular FlexArc Models." I am interested in:

Building my own Electric Driven Gas-Engine Driven 30-Day Trial Easy Pay Plan.

Name _____

Address _____

30-Day

Trial

Easy Payments
Priced
Right

J 20250

PHOTOGRAPHIC BARGAIN BOOK

of Cameras & Supplies

FREE

Explains latest inventions, methods in Photography and Home Movie Making, for fun and profits. Offers hundreds of amazing, money-saving bargains in still and movie cameras, lenses, films, etc. Used equipment accepted in trade. Satisfaction guaranteed! WRITE!

CENTRAL CAMERA CO.

230 S. Wabash, Dept. K-14, Chicago, U. S. A.

PHOTOGRAPHIC HEADQUARTERS SINCE 1899

Long, Reliable, Economical Service built into every

GERSTNER TOOL CHEST

Free Catalog for Machinists and Toolmakers.

GERSTNER TOOL CHESTS

464 Columbia St., Dayton, Ohio

Make **MORE MONEY**

Send for this Big **FREE** Catalog

SHOWS THOUSANDS OF NEW, FAST SELLING ITEMS!

Our brand new 1937 Catalog is now ready! It lists thousands of fast-selling products, including many imported novelties gathered from the far corners of the world—at amazingly **LOW WHOLE-SALE PRICES**. It also lists hundreds of everyday necessities—big year-around sellers. Write today for your **FREE** copy.

B & N SALES COMPANY

119 So. Wells St. Dept. G Chicago, Ill.

Flying Freight to the Arctic

T1563 (Continued from page 128A)

houses before it, jammed the rivers and threatened to smash through the hangars where the aerial freighters stood on skis, waiting to change over to pontoons. Though it looked like suicide, mechanics and pilots hopped into canoes, made their way to the hangars and tied floats to the planes so in case of a crash they could float away with little damage on the flood waters which preceded the ice barrage. Others pushed against the current with dynamite, picks and shovels, to blow that ice jam and its flood waters out of the way.

In the midst of it all the doctor at the settlement called for a plane to take a sick woman to a city hospital, 400 miles to the south. He gave her twelve hours to live without an operation. So a couple of airmen hooked pontoons to a freighter, and took on the sick woman and her nurse. Pilot Archie McMullen decided it was possible to navigate through the ice and take off. And he did, but just as he was leaving the water he hit a submerged piece of drift ice. With that cracked pontoon he took off and landed his patient safely at Edmonton.

While the trips north are usually well loaded, airway operators have had to find ways of getting full loads back. Some mines ship their ore or bullion out by plane. One mine has its own plane to fly radium-bearing ore 1,000 miles, and it takes hundreds of tons of ore to produce one ounce of radium. But an ounce of Canadian produced radium sells for \$1,000,000, a low price made possible largely by the use of the plane. Prior to the Canadian production, radium mined in the Belgian Congo sold at \$2,000,000 an ounce.

Fur also comes out by plane. A load of white fox valued at \$60,000 is not unusual. Fresh fish make up another cargo for returning planes. One company last year brought 150 tons of fresh caught fish south on its return flights.

Canada's aerial freighters plying the bush and barrens last year flew more than 7,500,000 miles. But not all freight goes in by air. During eight or ten weeks each winter tractors run heavy loads across frozen lakes and deep snow with a hard surface. Extremely heavy loads are carried this way, one mine transporting in eight weeks 20,000 tons of machinery. Sometimes the waters shift under the thick

ice, a slush forms under the top layer and the heavily loaded tractors go crashing through. It is quick jumping for the drivers, and quicker work to put tackle onto those mighty engines. Little time is wasted by tractors near by. A derrick is assembled, steel oil barrels are snubbed together, and the heavy machines pulled out. Airplanes are used by some operators to keep in touch with their tractors on long hauls. Tractors operate far above the Arctic Circle, pulling equipment too big and clumsy to go into a plane.

Canadian air operators will fly anywhere. Scheduled flying is carried out on

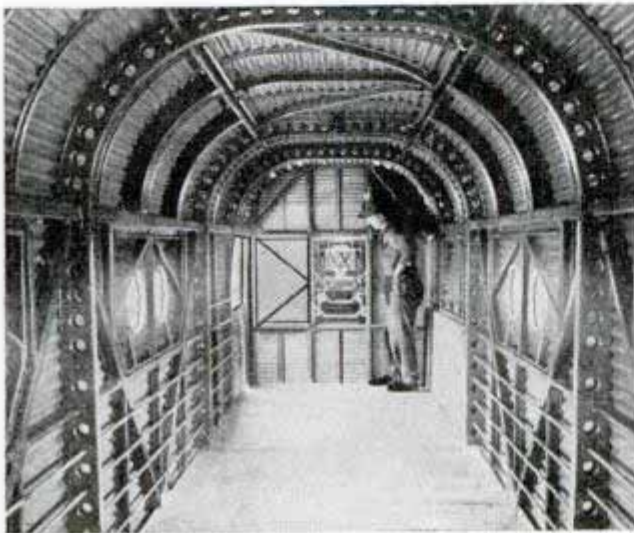

The flying boxcar, or the interior of a Canadian express plane carrying three tons

the mail runs, but charter service is more usual than scheduled flying, and pilots often drop in at points on their route for which they have no mail, freight or passengers, just to see if there is anything needed at the mine or any freight to go out. While most freight is moved in summer, planes crisscross the northland all year round. Special means of heating engines in winter, keeping oil from freezing, and making repairs have been devised.

Portable stoves are carried by big planes on remote runs and tarpaulins are part of the emergency equipment, so a pilot can throw a cover over the engine, tack it down to the ice, and put his stove in to heat it up. Repairs have been made in fifty-below-zero weather on the Arctic coast. Portable nose hangars are common on all ice landing fields. Portable stoves keep the engine thawed out overnight in these wooden, tarpaulin or even ice block nose hangars. Thus do Canadian pilots solve the problems of Arctic air service.

RE-STRING RACKETS



Make Big PROFITS
EASY SPARE TIME WORK

AT HOME!

Make big profits restringing rackets for tennis, badminton, squash players — and save money on your own tennis cost. Work at home in spare time. We show you how and supply equipment, instructions. **Everybody's** playing tennis and badminton! **CASH IN!** Write quick for free details and



WILLS' Free 1937 TENNIS BARGAIN BOOK listing **everything** for tennis players and re-stringers at money-saving prices. **Send coupon now!**

TENNIS BARGAIN BOOK FREE!

JUST OUT!

DON'T buy any racket, silk or gut strings, re-stringing equipment, or tools — till you see **WILLS'** marvelous new **Tennis Bargain Book** — just out. Here's a real opportunity for you to pick up some easy cash this season and to save money on your own tennis supplies.

Buy Gut Direct and Save!

Buy quality gut strings direct from manufacturer and save! Save on Silk strings too! Prompt service. Satisfaction guaranteed! Rush coupon for your free **Tennis Bargain Book** before they're all gone!

H. E. WILLS CO.

1047 W. 47th St. Chicago Dept. 1354



Un-Strung Racket Frames for Badminton, Tennis and Squash!



Rubber Handle Grip! Pure gum rubber, red or black colors. Priced low.



MAIL COUPON NOW!

H. E. WILLS CO. 1047 W. 47th St., Dept. 1354 CHICAGO, ILL., U. S. A.

Gentlemen: Please rush me your Special Money-Making Plan, and new, 1937 **TENNIS BARGAIN BOOK**, without cost or obligation on my part.

NAME.....

St. & No.....

CITY.....STATE.....

BROADCAST and AMAZE Your Friends!

Put on your own broadcast with the WALCO MIKE, most entertaining radio device yet produced. Sing, laugh, talk, crack jokes from another room and your radio will produce every sound as though you were miles away at a regular broadcasting station.

Marvelous Fun at Parties

Imitate the big radiostars and crooners. Do a "Ben Bernie" or "Rudy Vallee." No end of pleasure for grown-ups or kiddies. Excellent training in elocution. "Amateur Hour" practice, or broadcast announcing. Special cut-out button allows you to switch from home broadcasting to regular radio reception in an instant. Can not injure your radio in any way.



THE WALCO MIKE

In handsome black metal. Long cord. Less than a minute to attach to any radio without tools. Fully guaranteed.

ONLY \$1

Send No Money

5 Days Trial at Our Risk! Merely mail the coupon. On delivery pay postman \$1 plus few cents postage. If not delighted return it in 5 days and your \$1 refunded at once.

ELECTRICAL LABORATORIES, Dept. 74,
49 East 21st St., New York, N. Y.

Send Walco Mike, with complete instructions. Will pay postman \$1, plus few cents postage. If not delighted, will return in 5 days for \$1 refund.

Check here if ENCLOSING \$1—thus saving postage charge. Same refund guarantee applies.

Name

Address

Check here if you prefer chromium plated De Luxe model. Price \$1.39.



HANDY Taps and Dies

Electrically heat treated for long, accurate service. Every tool guaranteed to give complete satisfaction. When you need 'em you'll realize why they're named Handy.



Made by **HENRY L. HANSON**
Worcester, Massachusetts
At Your Local 5 and 10 Cent Store

NEW THREE STREAM AUTO WASH NOZZLE **Auto-matic Shut-off**

TRIGGER CONTROLLED

NOSE NOZZLE **RADIATOR FAUCET** **LAWN SPRINKLER**

Newest thing in nozzles. Saves time—water. (Patented). Every home and commercial user should have one. Fully Guaranteed. Postpaid receipt \$1.50.

MOLDED SPECIALTIES CO., 4709 Chester Ave., Cleveland, Ohio

FACTORY TO YOU

WRITE for FREE CATALOG

NEW SUPER-QUALITY KITSELMAN FENCE

Heavier, tougher pure zinc galvanizing. Stronger, tougher Copper-Bearing Steel. Same low Factory Prices. WE PAY FREIGHT. 160 styles and heights Farm, Poultry and Lawn Fence; Steel Posts, Gates, Barb Wire, Paints, Roofing. Write today.

KITSELMAN BROTHERS
Box 94 Muncie, Indiana

"Let There Be Light"

(Continued from Coloroto Section)

gion is the goal of the white-light searcher, so the narrowing of the spectrum until it lies in a single color region is the objective of colored-lamp development.

The familiar method of placing colored glass or gelatin over an ordinary lamp is a wasteful way of producing colored light because the glass or gelatin must absorb certain colors in order to let others pass through. The absorbed rays are converted into heat and lost. The dream of lamp scientists is to make a colored-light generator which will produce no wave lengths other than those in the color band desired. The sodium lamp is an approach in this direction, as nearly all its light is in the yellow region. So, too, are the fluorescent tubes whose color emission is controlled by the kind of powder with which their inner glass walls are coated. But, until one-color lamps are produced, incandescent lamps with colored glass bulbs will continue in use. Even here, there are problems to solve. Light engineers are searching for purer and more brilliant colors and better ways of putting color on the inside surface of bulbs where it will not rub off.

While lighting specialists constantly are seeking ways to produce better lamps, they have incorporated amazing features in the ordinary brass-capped glass bulbs by whose light you possibly are reading this page. The inside of a good lamp bulb, for instance, is one of the hottest and one of the driest spots on earth. Lamp filaments burn at temperatures of 3,800 to 4,500 degrees Fahrenheit, almost half as great as the surface temperature of the sun. And one drop of water distributed equally among 500,000 lamps would be enough to blacken them early in life. A "getter" is used to remove the last trace of moisture from inside a lamp. It is a chemical which, when heated, enters into combination with water and other undesirable molecules to form harmless compounds.

Your lamp filament in action is a little Vesuvius. Like a volcano, it gives off ashes—tungsten ash which condenses on the glass bulb to cause blackening. The filament of a sixty-watt lamp is about the

(Continued to page 134A)

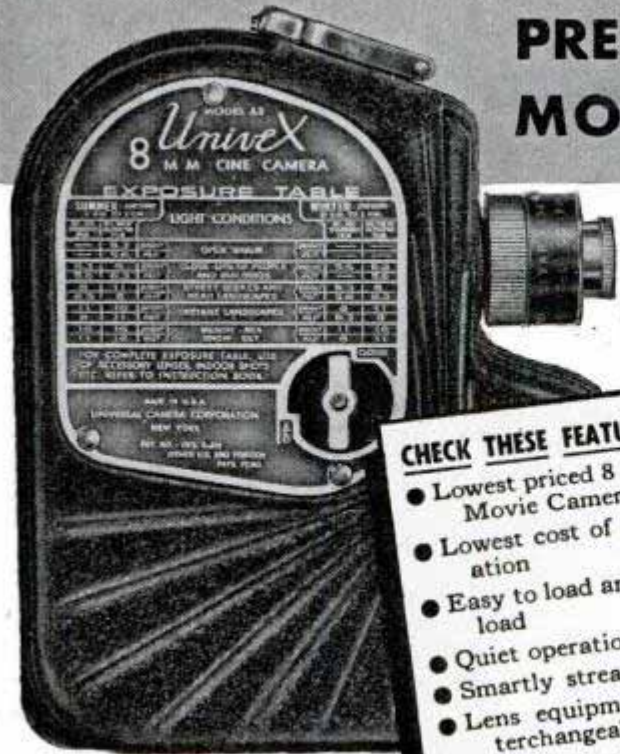

PRECISION-BUILT MOVIE CAMERA \$9⁹⁵

USES 60¢ CINE FILM

Never before have you heard of a fine 8 mm. movie camera selling for less than \$30! Never before have you heard of an 8 mm. movie film selling for only 60c a roll! Just think of it—now you can take *movies for only 6c a scene including processing charge*. Clear, sharp, true-to-life. UniveX Cine "8" is streamlined! Compact! Sturdily constructed! Equipped with precision Univar F:5.6 lens. Don't put off for another moment the joy of making your own movies. Go to any dealer who sells fine cameras, and ask for a demonstration today!

FREE BOOKLET giving complete details may be secured by writing Dept. 15, Universal Camera Corp., New York City.

- CHECK THESE FEATURES**
- Lowest priced 8 mm. Movie Camera
 - Lowest cost of operation
 - Easy to load and unload
 - Quiet operation
 - Smartly streamlined
 - Lens equipment interchangeable
 - Pictures screen up to 6 feet x 4½ feet
 - Long scenes per single motor winding
 - Backed by written guarantee

UniveX 8 mm. Projector Complete \$14.95

MOVIES AT LESS COST THAN SNAPSHOTS!

UniveX CINE "8"

TYPEWRITER ½ Price



Easy Terms Only 10c a Day
 Save over ¼ on all standard office models. Also portables at reduced prices.
SEND NO MONEY
 All late models completely refinished like brand new. **FULLY GUARANTEED.** Big free catalog shows actual machines in full colors. Lowest prices. Send at once. Free course in typing included.
INTERNATIONAL TYPEWRITER EXCHANGE
 231 W. Monroe St., Dept. A-401, Chicago

10-day Trial

HIGH POWERED TELESCOPE

GENUINE AMERICAN MADE BROWNSCOPIES
 Most powerful made for the money!
 15 power long range telescope. Can see moon's craters or time on pocket watch a block away. 5 sections. Approx. 3 ft. long. Fine lenses. Brass bound. Can be used as powerful microscope.
 Vol. magn. 512X. Only \$1.69 postpaid. C. O. D. 24c extra.



\$1.98

\$1.69

Special Super-Power 30X Telescope.
 Similar to above but more powerful. Guaranteed to see 900 times larger in surface and 30 times closer. 31 mm. objective 4 powerful lenses. Large field. Includes powerful microscope feature. 5 day money back guarantee. Only \$1.98 postpaid.

BROWNSCOPE CO., Dept. 44, 234 Fifth Ave., New York, N.Y.

HANDICRAFT

Caning and weaving materials, chair frames, basketry materials—reed, rattan, raffia, grass, rush, fibre. Leathercraft. Cotton, Yarn, Wool, Warp. Send 10c for Catalog. Instructions free.
AMERICAN REEDCRAFT CORPORATION
 Dept. P 130 Beekman Street New York City

Thompson BEATS the World on BOATS



Only Boats With Full Length Spray Rails

Keep passengers perfectly dry—even at high speeds. Catalog also shows today's five most popular models of sailboats. Two big factories. Prompt shipment.
CATALOG FREE
 Write for your copy. State kind of boat in which you are interested.
THOMPSON BROS. BOAT MFG. CO. (79)
 213 Ann St., PESHIGO, WIS. (Write to either place) 113 Elm St., COCKLAND, N. Y.

Better Built Lower Prices

- Canoes \$54 and up
- Rowboats \$42 and up
- Outboards \$42 and up
- Very fast utility model

BUILD YOUR OWN



Wind Driven Light Plant
 from old auto generator. We show you how. Make money building for others. Light your buildings, play radio, operate washing machine and other motors. Dime brings complete plans and 1937 catalog. Over 50 other changes for 6-12-32 and 110 volt plants.
LEJAY MFG. CO., 1447 W. Lake St., Minneapolis, Minn.

FREE Lights

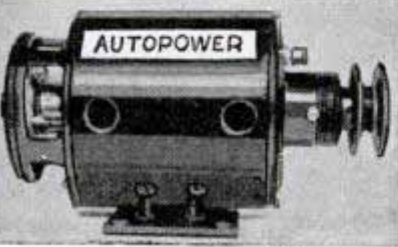

TURN SCRAP INTO MONEY

AUTOPOWER tells you how in plain, easy, simple, and illustrated instructions that anyone can follow. Change auto generators into useful, practical A C and D C generators and motors with voltage from 2 to 1,000 volts, for power, light, welding, radio, sound, etc. No previous experience nor special tools needed. Generators can be driven by wind, water, fan belt, etc. Already used and endorsed by thousands. Send today for your copy, and also receive **FREE a copy of PRACTICAL ELECTRIX**, the new publication for the man who wants to **KNOW, BUILD, REPAIR and READ** about electrical apparatus and machinery. Book and magazine postpaid only \$1.00.
AUTOPOWER, INC., Dept. M 410 S. Hoyne Ave., Chicago



When writing to advertisers please mention Popular Mechanics

RESETS BATHROOM FIXTURES



Now... It's Easy To Make 1001 Repairs!

Fix... once and for all time... those pesky things around the house that are always needing attention—

Loose bathroom fixtures
Loose drawer pulls, casters
Broken furniture
Loose tiles
Cracks in baseboards, floors
Old nail and screw holes
Etc., Etc.

Plastic Wood—the marvelous preparation that handles like putty and hardens into lasting, waterproof wood—will end these and other troubles forever. It adheres to wood, metal, tile, stone, porcelain—holds nails and screws without splitting and can be finished just like real wood. You can get handy Plastic Wood in cans and tubes—in 9 colors including white—at all paint, hardware and variety stores. Try it—you'll say it's great.



NEW Light Weight Paint Sprayer—Only \$31.15

1/4 H.P. Motor AC110 Volts. 60 Cycles—COMPLETE
Quick, easy way to paint screens, furniture, radiators, machinery—anything—in homes, factories, stores, schools, hospitals, office buildings, etc. Small, compact. Carry anywhere. Weight 44 lbs. Complete with Spray Gun, 15 ft. Hose. FULLY GUARANTEED. Only \$31.15 f.o.b. Chicago. \$5.00 Deposit, Balance C. O. D., or see your dealer. Free Circular. Ideal Pump Co., Dept. P-4, 801 Washington St., Chicago, Ill.



NEW INVENTION MAKES \$34.50 IN 5 HOURS • YOU WILL DO IT!

With The "BIASCOPE-NICKEL-PLATED-CAMERA." Loads with 200. FILMLESS-POSITIVES In DAYLIGHT, Snaps, Develops on the Spot. Automatically Discharges TWO-PHOTOS-SIMULTANEOUSLY In One Minute; NO PHOTO EXP. NEEDED; Men, Women—CASH IN with this FAST MONEY MAKER. WRITE FOR FREE ILLUSTRATED BOOKLET RIGHT NOW.
PACIFIC BIASCOPIES
Rm. 515-A, Cotton Exchange Building,
LOS ANGELES, Calif.

\$10
UP
8c
Profit
on
every
Dime

PAT.
PEND.

(Continued from page 132A)

size of a human hair. The smallest filament, that used in a three-watt, 110-volt lamp, is one-eighth the size of a human hair. The largest incandescent lamp, rated at 50,000 watts, has a three-pound filament made of tungsten wire coils as large as screen door springs. The smallest filament that can be drawn through a diamond die is about one-fourth the size of a hair. Smaller ones are made by etching them to size with acid.

If a filament varies in diameter by only one hundred-thousandth of an inch the life of the lamp may be affected twenty-five per cent, if the mandrel on which a filament is wound is off size one ten-thousandth of an inch, lamp life may be shortened twenty per cent, and an almost imperceptible error in the spacing of filament coils may shorten the life of the lamp by ten per cent.

Because of the extreme precision required to produce a good lamp, it pays you to buy lamps made by a reputable manufacturer. The normal life span of a good lamp is about 1,000 hours. They could be made to burn longer, but their efficiency would fall off so rapidly that they would become highly expensive. For every dollar you spend for new lamps, you probably will pay about nine dollars to operate them during their lives. So if you save ten cents on the dollar by buying so-called "bargain" lamps, your total saving would be less than one per cent of the money you spend for light. And these bargain lamps usually waste current, which makes them very questionable bargains.

In 1908, a sixty-watt lamp cost \$1.75 and produced a total of 480 lumens. Today, for the same money, you can get a sixty-watt lamp and eight 100-watt lamps, producing a total of more than 13,000 lumens. Thus science has given you twenty-seven times as much light for your lamp dollar as you could buy thirty years ago—and tomorrow you may expect to buy more light per lamp dollar than you can today because men of achievement still are undaunted by "impossibilities."

(Concluded next month)

☞ Inquiries as to makers of articles described in Popular Mechanics, will be answered by our Bureau of Information upon receipt of return postage.

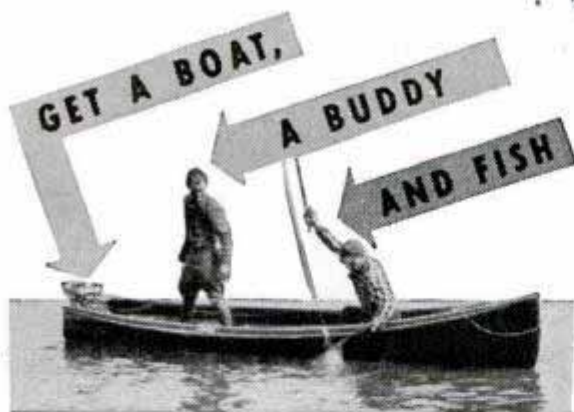

An Old Town Boat is the shortest distance to the best fishing. It's fast. It's steady and sturdy. Open sporting outboard boats are made of tough wooden planking . . . reinforced where the strain comes . . . sheathed with tough, water-tight canvas. Never spring, shrink or swell. Never need calking. Always ready for fishing and fun.

Have a look at the many models, illustrated in the free catalog. Prices begin at \$73. Small boats for sportsmen, big fast all-wood models for family use. Dinghies and rowboats. All kinds of canoes. Write today. Old Town Canoe Company, 334 Main Street, Old Town, Maine.

"Old Town Boats"

Win her with a **LUCKY 7 DIAMOND GOLD WEDDING RING**

\$770 COMPLETE Every woman will thrill at possessing this stunning ring, with 7 genuine blue-white cut diamonds (not chips) mounted in solid gold. Be modern! Replace your old-fashioned gold band ring with sparkling diamonds. Send this ad, size, and post office money order for \$7.70. **MONEY BACK GUARANTEE AS REPRESENTED.**

SECURITY JEWELRY CO. \$770
742 b South Hill Street Los Angeles, Calif.
IN BUSINESS OVER 30 YEARS - COURTESY TO DEALERS AND AGENTS

RADIOS..SAVE UP TO 50%

DEAL DIRECT...FACTORY PRICES! Many models to select from: AC-DC; All-Wave; Farm sets that operate like city radios! Your name and address on postcard brings you **NEW Bargain Catalog** in colors **FREE**. Get details of 30-DAY TRIAL plan and agent-user proposition! **GOLDENTONE RADIO CO.** Dept. E4. DEARBORN, MICHIGAN

30 DAY TRIAL **\$6.98 UP** **Free Catalog**

Printing Offers BIG PROFITS

Cards, stationery, circulars, etc. Easy rules sent. Does raised printing like engraving. **Do your own printing. Save money.** Junior press \$5.90; job press \$11; power, \$147. Sold direct from factory only. Send for free catalog and all details. **THE KELSEY CO., P-37** MERIDEN, CONN.

OTTAWA LOG SAW **only \$39**

GREATEST OFFER EVER MADE **PUTS THIS OTTAWA TO WORK FOR YOU**

Make Money! Wood is valuable. Saw 15 to 20 cords a day. Does more than 10 men. Ottawa easily operated by man or boy. Falls trees—saws limbs. Use 4-hp. engine for other work. Write today for **FREE** book.

OTTAWA MFG. CO., 413 Wood St., Ottawa, Kansas

NOW only **\$19.95** buys a 6" Ball-Bearing **BLACK & DECKER BENCH GRINDER**

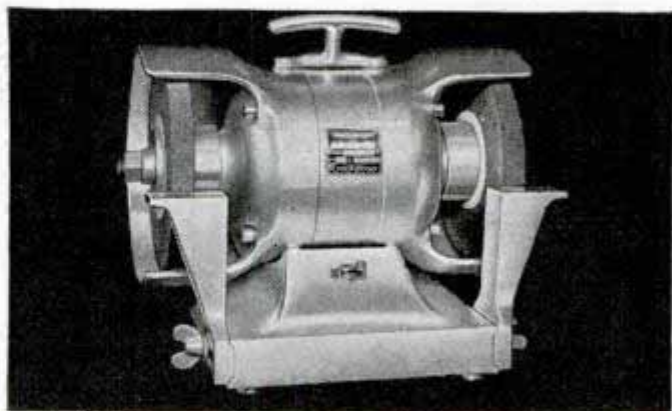

Look at these features of the new 6-Inch Junior—offered for the first time in a low-priced bench grinder of Black & Decker Quality: 1. $\frac{1}{4}$ -H.P. Universal Motor. 2. Anti-friction ball bearings. 3. Light, strong aluminum housing. 4. Adjustable tool rests, easily removable. 5. Convenient carrying handle. 6. Rubber Feet which hold Grinder firm on bench without bolts. 7. All moving parts carefully balanced. The 6-Inch Junior Grinder is just the thing for small tool-sharpening, light grinding, polishing, wire-brushing, etc. A sensational value for only **\$19.95**

BLACK & DECKER $\frac{1}{4}$ " JUNIOR DRILL

makes quick work of a thousand and one jobs around the shop, garage or home. Capacity, $\frac{1}{4}$ -inch holes in steel, $\frac{1}{2}$ -inch holes in wood. Also drives wheels for light grinding, etc. So powerful it cannot be stalled even when drilling up to rated capacity in steel. A wonderful drill for only **\$19.50.**

$\frac{1}{2}$ -Inch JUNIOR DRILL for larger, heavier work, is an equally great value for only **\$35.00.**



MAIL THE COUPON TODAY for complete information and name of nearest dealer where you can see these and other Black & Decker tools.

BLACK & DECKER

World's Largest Manufacturer of **PORTABLE ELECTRIC TOOLS**

MAIL THIS COUPON NOW

The Black & Decker Mfg. Co.,
604 Pennsylvania Ave., Towson, Md.

Please send Free Literature describing the new Black & Decker Junior Tools and address of nearest B. & D. dealer.

Name

Occupation.....

Address.....

City..... State.....

When writing please mention Popular Mechanics

GET YOURS TODAY FREE!



Ask your Hardware, Paint or Lumber Dealer...or use coupon below... for booklet picturing and describing the 24 new and exclusive projects for which you can get plans and detailed working instructions—absolutely free.

Here are the new 1937 projects...including a group of 8 associated living room pieces by Gilbert Rohde, internationally famous furniture designer... and new watercraft projects designed by William F. Crosby, Editor of "Rudder":

Round Occasional Table
Typewriter Desk
Book and Magazine End Table
Radio End Table
Coffee Table
Cocktail Cabinet
Cabinet and Writing Desk
Folding Card and Game Table
Sailing Skiff "Plover"
Kayak Boat
Nut Bowl and Hammer
Fruit Bowl and Candy Dish
Wood Jewelry
Dutch Windmill
Portable Boat
Modern End Table
Modernistic Clock
Governor Winthrop Desk
Corner Cabinet
Jewel Case and Tray

Pin Cushion and Darning
Magazine Basket
Table Lamp—Floor Lamp
Waikiki Surfboard



**FIXES THINGS
PERMANENTLY**

*Sold by Hardware,
Paint and Lumber
Dealers Everywhere*

Ask your Hardware Dealer—
or Stick This Coupon on Penny
Postcard and Mail Today!

CASEIN CO. OF AMERICA, Inc.
350 Madison Ave., Dept. PM-437, New York, N. Y.

Name

Address



FREE ELECTRICITY From Wind Power

For Lights, Power, Radio, from Auto Generators. New Copyright Book with over 100 Facts about Wind Chargers. Wind-Propellers—Generators—Plants—Batteries. Answers all questions you should know. Including plans for 6 or 32 V. Plant. Send 25c for plans, facts and catalog.

CURRIER MFG. CO.

421 Terminal Minneapolis, Minn.

The NEW KINKADE GARDEN TRACTOR

and Power Lawnmower

A Practical Power Plow and Cultivator for Gardeners, Suburbanites, Florists, Truckers, Nurserymen, Fruit Growers.

Low Prices—Easy Terms

AMERICAN FARM MACHINE CO.
1058 33rd Ave. SE., Minneapolis, Minn.



Catalog
Free

Operator
No. 38



FOLLOW THIS MAN

Secret Service Operator No. 38 is on the job! Running down dangerous Counterfeit Gang. Tell-tale finger prints in murdered girl's room.

Free The Confidential Report Operator No. 38 made to his chief. Write for it.

Earn a Regular Monthly Salary

YOU can become a Finger Print Expert at home, in your spare time, at small cost. Write for confidential full report and details. Literature will NOT be sent to boys under 17 years of age.

INSTITUTE OF APPLIED SCIENCE
1920 Sunnyside Ave.
Dept. 9354 Chicago, Ill.

There's Money in Herbs

(Continued from page 525)

once the first year, two or three times each growing season thereafter. For the best product the leaves should be picked by hand, dried in the shade, and turned frequently to avoid mold. It is best to market the crop promptly, since the dry leaf loses strength with age. On good land sage bears as much as a ton of dry leaf to the acre.

Peppermint, spearmint and wintergreen are the three most valuable of our native mints. Peppermint is a perennial native to moist areas throughout the eastern half of the United States. Its principal product



Bundling catnip for market. The dried leaves are tied tightly and wrapped in burlap

is volatile oil, worth from \$2.50 to \$4.00 a pound, though the crude drug trade also uses the dried leaves and flowering tops. The plant is usually propagated by roots or runners, planted in rows to a depth of about three inches, preferably in moist soil. Commercial growers usually apply garden fertilizer and grow only two or three successive crops. Harvest is in late summer when the herb is in full bloom. The crop is cut like hay. Leaf and flower crops are cured indoors to retain the green color, packed in bales or carton, and sold direct to drug houses. Spearmint is much the same as peppermint in culture and harvest. The dried leaf is worth about the same—from ten to twenty-five cents a pound. Wintergreen, usually the most valuable of native mints, is a low, broad-leaved evergreen with a creeping stem and small red berry. The herb grows best when planted in rich leaf mold under par-

(Continued to page 138A)

ENGINEERED!

What a wealth of meaning in a single word! Applied to the 1937 Driver Engineered Power Tools, it means long careful study of all the essential requirements for home workshop tools—safety, adaptability, service, appearance—*together with expert planning for their manufacture.* Have your dealer show you

these Driver Engineered Power Tools for 1937. You will be tremendously impressed with their fine quality, low cost and many plus values. Write—if there is no dealer near you—for a copy of the colorful 1937 folder which illustrates and describes the entire line in all three price ranges.

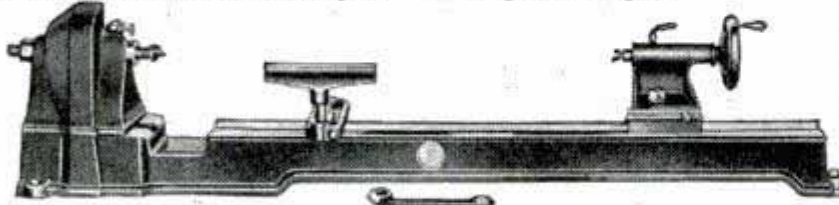

DRIVER L751 GAP BED LATHE

\$31.50 as shown, including Belt, Box Wrench and 72 page Instruction Book. Here is a genuine all purpose lathe that is in a class by itself. Built with watchlike precision, it has ample reserve strength for working metals. The heavy gray iron bed is 54" long, with 37" between centers. Hollow head ($\frac{3}{8}$ " I.D.) spindle. 4 speeds. Pre-loaded SKF ball bearings. Shipping weight 130 lbs. Undoubtedly the best lathe buys on the market today. Driver Engineered Power Tools include Band Saws, Jig Saws, Bench Saws, Jointers, Motor Grinders, Flexible Shafts—Three Complete Lines in Three Price Ranges.

ASK YOUR DEALER ABOUT THE DRIVER EASY PAYMENT PLAN

DRIVER *Engineered* POWER TOOLS

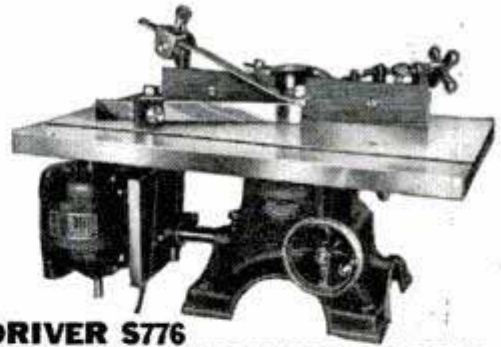

DRIVER S776 VERTICAL SPINDLE SHAPER

\$26.25 less Motor and Pulley, with 21" x 15" Table and 72 page Book of Instructions. This high speed shaper is a superior machine in every respect—design, construction and adaptability. The simple, positive adjustments make it unusually efficient and accurate. Precision worm gear raises spindle assembly $1\frac{1}{4}$ ". Heavy duty sealed-in dust-tight SKF ball bearings. May be operated in either direction. Shipping weight (without motor) 64 lbs.

USE THIS COUPON

Walker-Turner Co., Inc.
147 South Ave.,
Plainfield, N. J.

Gentlemen: Please send me copy of the colorful folder on 1937 Driver Tools.

Name.....

Address.....

DRIVER *Engineered* POWER TOOLS

Stoves AT FACTORY PRICES!



Sale Catalog—FREE!

200 Styles and Sizes of Stoves, Ranges, Furnaces at Factory Prices, Easy Terms—as little as 13c a day. More Bargains than in 20 Big Stores. New styles, new features, new colors. Year to Pay—30 days' free trial—360 days' approval test—24-hour shipments. Over 1,100,000 Satisfied Users. 37 Years in Business.

Write for FREE Catalog
THE KALAMAZOO STOVE CO. MFRS.
391 Rochester Avenue
Kalamazoo, Michigan

**"A Kalamazoo
Trade Mark
Registered
Direct to You"**

RE-STRING RACKETS AT HOME



• EARN MONEY •

It's easy, pleasant, profitable work. No experience required. Learn in a FEW MINUTES. I supply everything needed. Earn \$50 to \$100 cash in your spare time. Act QUICK—write for details FREE.

SPECIAL 50c

Set Permatex Silk Strings with instructions, postpaid.
W. A. BICKEL, Dept. A-4, 809 W. Madison St., Chicago, Ill.



NEW BOOK CRAFTSMEN SHOULD HAVE—100 Pages—No. 9—Make Beautiful Furniture

10c
Rebated
on first
order.

at a fraction of store cost. 14 pages of lumber with prices. Veneers and plywoods of all woods cut in usable sizes without waste. USE THE CRAFTSMAN new process of inlaying, using our new process ART INLAY GLUE, needing no clamps for the finest work. Hard-to-find rare grains for all wood, including foreign,—hard-to-find cabinet hardware. Lists and illustrates 78 blueprints of scroll patterns, inlay table tops—Kits for inlaid art boxes, plaques, trays, book ends, etc., that anyone can make—22 pages in color. VENETIAN BLINDS for one-third of usual price. All material requiring only a saw, screw driver, a tack hammer and paint to assemble.

CRAFTSMAN WOOD SERVICE CO. 2723 MARY STREET CHICAGO



BONNEY TOOLS ARE THE FINEST THAT MONEY CAN BUY



BONNEY NO. 39 BOX WRENCH SET
A set of 6 Box Wrenches for automotive and general use. Made of 'CV' Chrome Vanadium Steel, with double hexagon openings from $\frac{3}{8}$ " to $1\frac{1}{8}$ ". Ask your Jobber or send a post-card for Catalog "M."
**Bonney Forge & Tool Works
Allentown, Penna.**

DARLING, WILL YOU PLEASE BE MINE?
I GUARANTEE TO TREAT YOU FINE!
FOR INSTANCE, LOVE, IF
HEARTBURN COMES . . .
I'LL OFFER YOU MY ROLL OF TUMS!



**YOU'LL LOVE THIS
FAST RELIEF
FOR ACID INDIGESTION**

WHY WAIT for relief when you're troubled with heartburn, sour stomach, gas? Keep your relief right with you always, for unexpected emergencies. Carry Tums . . . like millions now do! Tums are pleasant-tasting . . . only 10c . . . yet they give relief that is scientific, thorough. Contain no harsh alkalies . . . cannot over-alkalize your stomach. Just enough antacid compound to correct your stomach acidity is released . . . remainder passing un-released from your system. For quick relief . . . Carry Tums, 10c at any drug store, or the 3-roll ECONOMY PACK for 25c.

TUMS FOR THE TUMMY



TUMS ARE ANTACID . . . NOT A LAXATIVE . . . HANDY TO CARRY

FREE: Beautiful Six-color 1937 Calendar-Thermometer. Also sample of Tums and NR. Send stamp for packing and postage to A. H. Lewis Co., Dept. 32D-72, St. Louis, Mo.

USE THIS WONDER WRENCH
For 10 Days at Our Risk

ENDS OLD-FASHIONED THUMB-SCREW ACTION
A Super-Power Giant That Can't Slip

Treat yourself to the "last word" in wrench service with this amazing **SPEEDNUT AUTOMATIC WRENCH**—the sensation of the National A to Shows. A whole kit of wrenches in one amazing tool. Automatically grips square and hex nuts—1/4", 1/8", 1/8", 1/12" turn grip. Can't slip! The tighter it's pulled the tighter it grips. You'll do the job quicker, easier, safer with this non-thumb-screw wonder wrench.

No Other Wrench Like SPEEDNUT

Send \$1.95—our Special Price to introduce in your locality (regular price \$2.75) and we'll send your SPEEDNUT postpaid. Use for 10 days and return for full refund if you're not amazed and delighted.

LEEMAN MERCANTILE CO., 30 W. Washington Street
Dept. 10 Chicago, Ill.



AUTO ENGINE SPEED CONTROL GOVERNORS



To control speed of any make of auto or truck engine, regardless of load changes, when used as a stationary or portable power plant. Fully guaranteed. No cash down. Governor speed range from 400 to 3000 R.P.M. Fine opportunity for established agencies. Send for free circulars. Mfra. Candee-Smith Gov., Dept. 112-D 215 No. L. A. St., Los Angeles, California.

FOR FLAT BELT
FOR V BELT
TO CARBURETOR LEVER

es 10.

There's Money in Herbs

(Continued from page 136A)

tial shade. The cured herb is usually worth from five to ten cents a pound.

The larkspur is a garden flower which bears a seed used in remedies for external parasites. The flower grows best in rich sand or gravel soil, and when seeds have germinated plants should be thinned to nine inches in the rows. When seed capsules are fairly ripe but not yet brittle enough to shatter, the crop is harvested by collecting the tops, curing the heads in well ventilated sheds, threshing or sifting out the seed when thoroughly dry. It is best to clip the seed heads in early morning, while still damp with dew or rain. Value of the dried seed varies, ranging from fifty to eighty cents a pound.

Burdock, a large biennial, is known as a troublesome weed. Dried roots from first-year growth are the basis of its herb value, though seed and leaf also have medicinal use. On good soil the roots yield as high as a ton an acre, and ten cents a pound is an average price. Seeds are sown in late fall or early spring. The best stand is about six inches apart in rows about two feet apart. At the end of the growing season, tops are cut off, and the roots, sometimes two or three feet long, are dug with long spading forks or plows, washed and dried—preferably with low artificial heat. Large roots are split lengthwise to facilitate drying.

Thyme is a shrublike perennial herb used for seasoning and for oil of thyme, a common pharmaceutical. Seeds are sown early in the spring and plants are thinned to intervals of about eighteen inches in rows two or three feet apart in mellow upland soil and are well cultivated during the growing season. For the dry herb, flowering tops are cut when the plant is in full bloom and dried in the shade. Yields are as high as a ton to the acre. Prices vary from five to twenty-five cents a pound.

Ginseng is the most valuable root herb and one of the most difficult to grow in a home garden. The plant is native to rich soil in partly shaded forests and in garden culture must be shielded from direct sunlight. Leaf mold and fine bone meal are the best fertilizers, but should be applied

(Continued to page 140A)

ALL PURPOSE
MOTO-TOOL



10 DAY MONEY BACK TRIAL for Home - Shop - School - Profession

Grinds, drills, engraves, routs, carves, sharpens, polishes and does hundreds of jobs quicker, better and with greater precision. Handles easily as a pencil—weights only six ounces, and is amazingly powerful. 110-Volt Universal Motor—about 20,000 r.p.m.—oilless self-aligning ball thrust bearings. Handy built-in switch. Easily replaceable brushes. Universal Collet Chuck. Bakelite housing. You must see and use it to appreciate its tremendous value.

Order on 10-day trial. Money refunded if not more than satisfied. **Booklet Free.** 20-piece Craftsmans Tool Set for all types of Moto-Tool work, \$5.75.

ONLY \$9.85

DREMEL MFG. CO.
2816-CT., Racine, Wis.

SENT POST PAID

Start A Business IN YOUR HOME
Make Big Money Like H. E. BOWMAN OF TEXAS



—WHO EARNED \$7000.00 IN 1936. Exceptional earnings like this show the possibilities of the profitable business opportunity I now offer you *without any investment on your part.* Our new "DEALERSHIP" PLAN will appeal to the man who is looking for a **greater income.** Write details about yourself and past experience and we will mail you our "DEALERSHIP" PLAN which is now providing excellent incomes for many reliable men. A fine opportunity for *retired business man or salesman.*

FYR-FYTER CO. Dept. 90-16 Dayton, Ohio

ENGINES

Enclosed, Self-Oiling, Roller Bearing



A reliable engine, using all fuels, for farm or factory. Cheapest power for pumping, sawing, separating or similar work. The best engine for the money. Put one to work and watch it pay for itself. Sold Direct From Factory to YOU. Immediate Delivery. Write today.

WITTE ENGINE WORKS
4744 Oakland Ave., KANSAS CITY, MO.

RADIO-ELECTRICAL EXPERIMENTAL KIT



Complete! Greatest value! Fascinating! Educational! Instruction manuals make experiments easy. Wire up thief detector, extension phone, elec.-welder, electro-plating, arc-furnace, AC to DC rectifier, 110-volt motor. Make powerful arc light, generate ultra-violet and infra-red rays, make electric stove, elec. door lock, etc. Build radio circuits, crystal set, 2-tube circuit, AC-DC set, code practice set, 110-volt rectifier, radio transmitter, scores more. If bought separately, \$18.50. NOW... **\$3.99**

FREE! 6 Books, value \$5.50, with kit. Elec.-Radio Short Courses, Lab. Plans, 3c stamp brings Elec.-Radio-Tool bargain catalog. SEND! **ELECTRICAL SALVAGE CO.,** Box 524-A32, Lincoln, Nebr.

Men & Women Earn Cash at Home!

We paid M. M. \$267 in 3 weeks for exceptional "cellar crop" patented mushrooms! Big free picture book tells if your cellar, shed, barn suitable. We buy all crops thru ten branches. Write today. Est. 1908. **UNITED CO.,** 3846 Lincoln Ave., Dept. 308, CHICAGO

EXTRA \$5 in SPARE TIME PRINT at HOME

Letterheads, Circulars, billheads, cards. Printing pays BIG. Easy, interesting, educational. **PRINTING PRESS BARGAINS \$12.** Types and Supplies lowest prices. Send stamp for catalog.

GINSENG SEED.

rt Wertz, R. #1, Hollidaysburg, Pa.
W. Coast, R. #3, Emmleton, Pa.

Sensational BARGAINS

Guaranteed \$102.50 Model
Now Only \$44.90 Cash or On Easy Terms
Small Carrying Charge
10 Day Trial No Money Down



Positively the greatest bargain ever offered. A genuine full sized \$102.50 office model refinished Underwood No. 5 for only \$44.90 (cash) or on easy terms. Has up-to-date improvements including standard 4-row keyboard, backspacer, automatic ribbon reverse, shiftlock key, 2-color ribbon, etc. The perfect all purpose typewriter. Completely rebuilt and **FULLY GUARANTEED.**

Money Back Guarantee
Send coupon for 10-day Trial—if you decide to keep it pay only \$3.00 a month until \$49.90 (term price) is paid. Limited offer—act at once.

INTERNATIONAL TYPEWRITER EXCHANGE
231 West Monroe St., Chicago, Ill., Dept. 401.
Send Underwood No. 5 (P. O. B. Chicago) at once for 10-days trial. If I am not perfectly satisfied I can return it express collect. If I keep it I will pay \$3.00 a month, until I have paid \$49.90 (term price) in full.
For quick shipment give references and occupation.

Name..... Age.....
Address.....
Town..... State.....

Send FOR THIS 112 PAGE GUIDE ON FISHING!

IF YOU LIKE FISHING You'll Want This Book FREE! 14th edition of "Fishing—What Tackle and When." All new—revised. Articles by Rex Beach, Corey Ford, and Courtney Ryley Cooper. Identifies fish in colors. Casting lessons. Facts anglers want. Free! **Write today.** South Bend Bait Co. 568 High St., South Bend, Ind.

SOUTH BEND

COMPLETE ELECTRIC PLANTS

ONAN ALTERNATING CURRENT PLANTS furnish same as city current anywhere. Operate on gasoline. Run Radio, Water System, Refrigerator, all Appliances.

SIZES 350 WATTS UP
Easy to install. Available from stock. Ideal for Farms, Camps, Lake Homes, Commercial use. Sizes for any purpose. Write **D. W. ONAN & SONS** 1003 Royalston Ave. Minneapolis, Minn.

hem POCKET SLIDE RULE



With A-B-C-D Scales. Multiplies, divides, squares, takes square root, finds circumference and area of circles. 6 inches long—thin construction. **NO WOOD OR CELLULOID.** Fits in vest pocket. Send \$1 in cash, money order or check and receive slide rule with genuine leather case and instructions. Box M-6. **M. MANHEIM COMPANY, Inc.** 15 E. 26th St. New York, N. Y.



**BE
OIL WISE**

These wise old birds
Give sage advice.
They want to help
You lower the price
You pay for transportation.
Your car will show
New pep and dash;
Gas—oil—repairs
Will cost less cash
With Pennzoil lubrication.



**USE
PENNZOIL**

BONDED PENNZOIL DEALER
100% Pure Pennsylvania
PENNZOIL
Safe Lubrication

Governs Speed OF ANY GAS ENGINE

Take any car motor out of the chassis, equip it with a Pierce Universal Governor, and you have a stationary power unit that runs steadily enough to operate even an electric welder. And that's some test for close speed regulation.

Pierce Universal Governors are standard controls on gasoline engines for commercial purposes—for electric lighting plants, refrigerating units, air compressors, feed grinders, hoists, saw mills, welders, etc.

Pierce Universal Governors are the time-tested flyball type and respond instantly to each change in engine load, maintaining uniform speed. Belt driven, either V or flat. Easily installed and never equalled for close regulation of speed and for dependable performance.

Write for illustrated literature and prices, whether you want to equip one used motor or a thousand new ones.

The Pierce Governor Company
1600 Ohio Avenue, Anderson, Indiana



**A Pierce
Governor
puts "brains"
into any
gas motor.**

There's Money in Herbs

(Continued from page 138A)

lightly. The seeds are soaked in water for partial germination, then planted in beds and transplanted eight to ten inches apart at the end of two years. A mulch of straw or leaves is necessary for winter protection but should be removed in the spring. Planted from seeds, the roots do not reach marketable size until the sixth or seventh year. When dug they are washed and cured in a well-ventilated shed or loft and stored in a dry airy place until ready for sale. The price ranges from \$4 to \$15 a pound. Culture of goldenseal or seal herb is almost identical to that of ginseng. It is somewhat more hardy and the roots grow to a marketable size in about five years. The dried leaves and stems are also marketable at prices ranging from five to fifty cents a pound. Prices for the dried roots vary from \$3.50 to \$5 a pound.

Lavender, one of the most fragrant of all perfume herbs, is a shrubby perennial which grows on almost any well-drained loam. The plant is usually grown from cuttings or root divisions, placed in rows about a foot apart, heavily mulched during winter, or in cold climates wintered in greenhouses or cold frames. The blossom is the valuable part. Flowering tops are harvested when in full bloom, dried carefully in the shade and the flowers are later stripped from the stems by hand. As a rule one planting produces three crops of flowers. Harvests of flowers when dried usually range from 400 to 800 pounds to the acre. Market value of the dried flowers ranges from twenty-five to fifty-five cents a pound.

Other hardy garden herbs adapted to most parts of the United States east of the Rockies include henbane, fennel, dill, coriander, conium, caraway, anise, belladonna and camomile. Such herbs as arnica, lovage, poppy, seneca, valerian, and wormwood usually grow best in the northern part of the United States, while cannabis and wormseed are better suited to the south. Aletris, or star grass; angelica, a cooking herb; blue flag, a drug root; boneset, calamus or sweet flag, castor bean, digitalis or foxglove, yellow gentian, insect powder flowers, melissa or lemon balm, parsley, pennyroyal, pokeweed, jim-

(Continued to page 142A)

DIESELECTRIC PLANTS

UNBELIEVABLE ECONOMY

Produce **ELECTRIC LIGHT & POWER**
for **LESS** than **ONE CENT** per **KILOWATT**

Simple in design and construction, the WITTE is the most important development in the small engine field. Thoroughly modern in every respect, the WITTE incorporates every worth-while advance in Diesel Engine design. The 1600 watt Dieselectric Plants are small, compact and radiator cooled. Installation is simple—upkeep low—have unusual flexibility for many power applications. 110 volt A.C. and D.C. plants for direct lighting. 32 volt plants for low cost battery charging. Let us figure with you, estimates free.

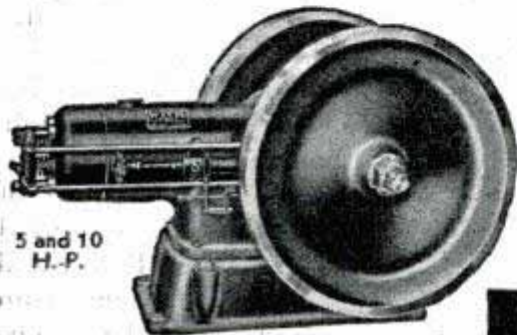

5 and 10
H.-P.

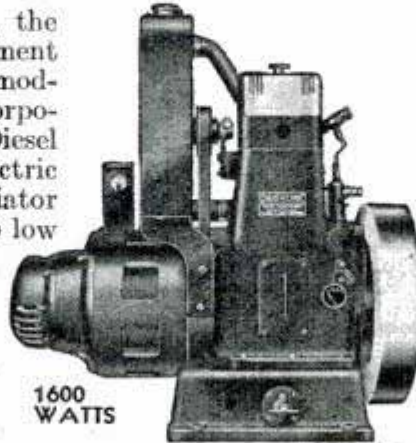

1600
WATTS

3000-6000
WATTS

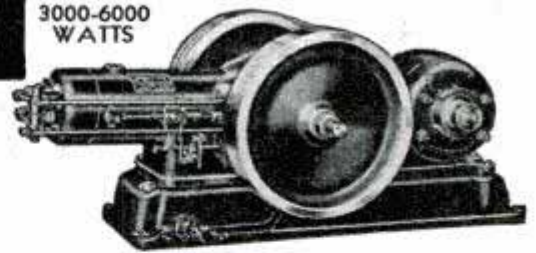

Make your own electric light and power—be independent of the power companies. Cut your power bills 75% with a WITTE Dieselectric Plant 1600 to 6000 watts. Smooth, flickerless current—close voltage regulation. Alternating or direct current. Uses non-explosive fuel. WITTE Diesel Engines offer the small power user the same important features, operating characteristics and startling economy of the large Diesel. Quality assured by more than 67 years of manufacturing experience.

CHOOSE A DIESEL FOR POWER ECONOMY

WITTE Stationary Diesel Engines are offered in 3, 5 and 10 H.-P. sizes. Where power is used 800 or more hours a year, install a WITTE Diesel and **watch it pay for itself**. Use our easy payment plan.

RESPONSIBLE DEALERS WANTED

1744 Oakland Ave.

Kansas City, Mo.

WITTE ENGINE WORKS

a real MICROMETER BARGAIN!

Genuine, American made, six piece micrometer set, in velvet lined leather case. Special price, only \$11.95, a fourth off regular price and a fraction of the cost of other sets on the market.

These micrometers are precision machined for accuracy in one thousandths of an inch, up to 4 inches outside and $3\frac{3}{4}$ inches inside measurements. Guaranteed accurate, easy to read and adjust. Built to stand hard wear and give satisfaction. Every mechanic, apprentice, garage and repair shop needs these accurate and dependable micrometers. This is your opportunity to get one at a Bargain Price if you act now. Shipped prepaid on receipt of remittance. On C.O.D. shipments, send deposit of \$2.00.

Money back if not satisfied

MICRO PRODUCTS 529 E. Jefferson Ave.
DETROIT, MICH.

MICROMETERS • INDICATORS • PRECISION TOOLS

FOR MODERN SHAVING **Barbasol** NO BRUSH NO LATHER NO RUBIN

PORTABLE ELECTRO-PLATING OUTFIT

Retails for **\$3.75** Does Work of Big Outfit

New patented invention. GUARANTEED to PERMANENTLY electroplate Nickel, Copper, Zinc or Cadmium WITH A BRUSH—As easy to apply as a coat of paint. A NON-LIQUID process, always ready for use, quickly applied, and equal to any commercial electroplating. Used in factories, homes, home work shops, garages, stores, art studios, etc. Operates from dry cells, automobile battery, or battery charger. Does work of big outfit. Retails \$3.75. Specify metal finish wanted when ordering or write for full particulars.

RAPID ELECTROPLATING PROCESS
2135 No. Cicero Ave., Dept. 23, Chicago, Ill.

HANDEE TOOL OF 1001 USES

Grinds - Drills - Cuts - Polishes
Carves - Routs - Saws - Sands
Sharpens - Engraves

A whole shop full of tools in one for work on all metals, alloys, bone, resins, glass, stone, wood, etc. Uses 200 accessories. Saves hours of tedious work. 13,000 r.p.m.

AC or DC, 110 volts. \$10.75 and up, postpaid. 3 Accessories Free.

DE LUXE MODEL

For constant service, nothing compares with this easy-to-handle production tool. Saves time and labor.

Fastest, smoothest, most powerful tool for its type and weight. 25,000 r.p.m. \$18.50 postpaid, 6 Accessories Free.

Get a Demonstration at Your Dealer's or Order Either Model on 10-Days Money-Back Trial. Catalog Free.

CRAFTSMAN'S PROJECT BOOK

"Pleasure and Profit with a Handee" Easy working plans for making many interesting and unusual projects, 25c stamps or coin.

CHICAGO WHEEL & MFG. CO.

1101 W. Monroe St., Dept. Q. Chicago, Illinois

Send Catalog Project Book \$10.75 Handee DeLuxe Model

Name _____ PM4

Address _____

When writing please mention Popular Mechanics

STRONGEST PADLOCK ever built!

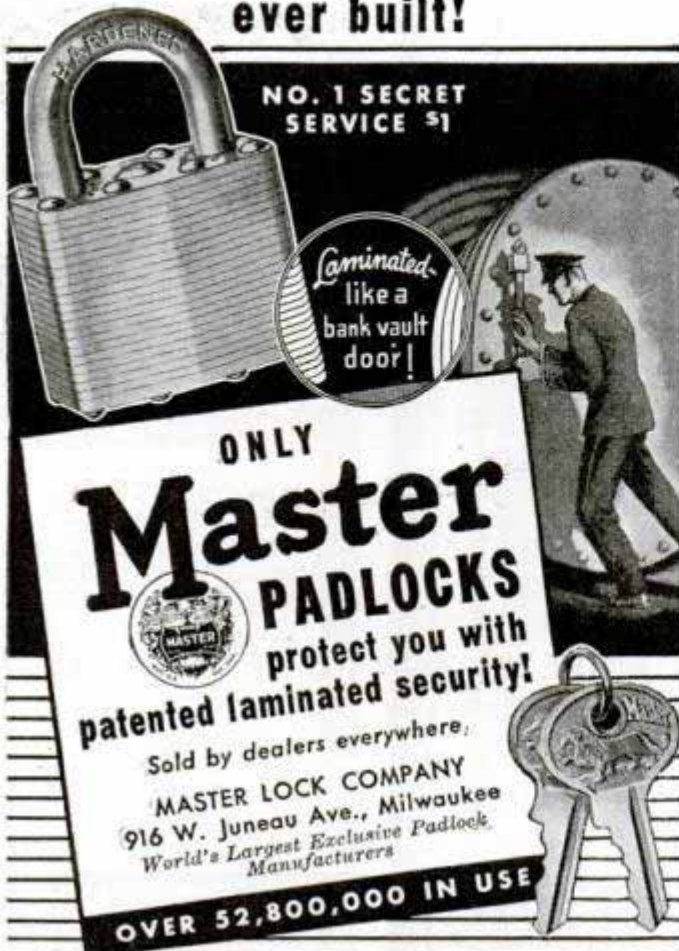

NO. 1 SECRET SERVICE #1

Laminated like a bank vault door!

ONLY **Master** PADLOCKS protect you with patented laminated security!

Sold by dealers everywhere:
MASTER LOCK COMPANY
916 W. Juneau Ave., Milwaukee
World's Largest Exclusive Padlock Manufacturers

OVER 52,800,000 IN USE

Collect BIG PROFITS in Advance

Something that every man wants... **INDIVIDUAL BUCKLE AND BELT.** Every buckle different, made to personal order. Initials or name in raised letters and colors... Non-barnishable, lasting finish. Including genuine Cowhide Leather Belt with famous "Hook-Fast" catch. Volume orders easy from Colleges, Schools, Lodges, Clubs, Bus Companies, Group Organizations, etc. Many sales from friends, neighbors. Write today for special outfit offer.

HOFMANN "HOOK-FAST" SPECIALTIES, INC.
P. O. Box 1425 Dept. 20 Providence, R. I.



3-IN-ONE OIL IS A BLEND OF THREE FINE OILS

BEST FOR BICYCLES, TOYS, SKATES, LIGHT MOTORS, HINGES, LOCKS, CLEANING AND OILING GUNS, TOOLS, CLOCKS, WATER-PROOFING, ETC.

LUBRICATES • CLEANS • PREVENTS RUST

There's Money in Herbs

(Continued from page 140A)

son weed or stramonium, and wormwood are among other herbs the home gardener can grow. Seed, roots, or planting parts of most garden herbs can be purchased from large nurseries or seed houses. The home gardener probably will do best to begin with a leaf or root which can be cured simply. Extraction of herb oils usually involves a steam-vat process which is likely to require a sizable production in order to be profitable.

In harvesting herbs whose value depends upon flowers and seed, a berry scoop or seed picker frequently saves labor. A homemade picker can be built with a stout wooden box about ten inches wide, fourteen long, and six deep. Remove one end and connect the remaining sides at the top with a stout strip to serve as a handle. Drive long slender nails at quarter-inch intervals through a strip of wood, thus forming a comb, the teeth of which should be about two inches long. This comb is fastened to the bottom of the box so the teeth will project upward through the opening left by the removed end. On swinging this device teeth-forward through the flowers, heads will be snapped off by the comb and will fall into the box.

Where weather permits, most herbs can be cured economically by air-drying. As a rule the root crops, after being washed, can be cured in sunlight. The south slope of a low roof is a good sunning place and vacant hothouses make an ideal curing place. Roots should be turned frequently. Leaf and flower herbs are best cured in the shade, since this keeps them green and betters their appearance. Where heat is applied, temperatures should never go higher than 150 degrees Fahrenheit and should always be applied gradually. Otherwise the herbs may be scorched or shriveled.

There's money in herb growing. And here's betting dollars to doughnuts there will be a great deal more in it within another ten years.

(Names and addresses of manufacturers and dealers in articles described in this magazine will be furnished by our Bureau of Information upon request accompanied by stamped, self-addressed envelope.

STUCCO SPRAYING MASONRY SURFACES NOW OFFERS BIG EARNINGS



This new machine and process fuses a waterproofed plastic mixture on any masonry. It beautifies and weatherproofs both old or new buildings, walls, etc., at low cost. It fills all cracks and can be applied in any thickness desired and in 30 colors and shades. Fully proven by over twelve years actual use under all conditions and every climate.

LARGE WAITING MARKET

Owners everywhere want to enhance present values and make their buildings more attractive and livable. The better builders are striving for greater permanence, beauty and salability in their new construction. With Colocrete stucco spraying you can supply this waiting market and can offer permanent colorful surfacing at amazingly low cost. Many operators report costs of 2c to 4c per sq. ft. and sell at from 4 1/2 to 7c. Some have paid for their equipment from first couple of jobs. Machine capacity up to 1000 sq. ft. per hour.

Get the facts. The new Colocrete books tell the whole story. Write today. It may mean business independence for you.

COLORCRETE INDUSTRIES, Inc., 570 Ottawa Ave., Holland, Mich.

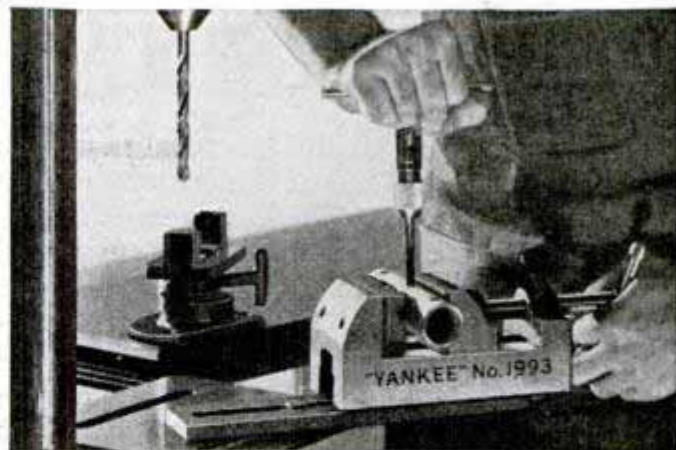

FOR THE HOME WORKSHOP

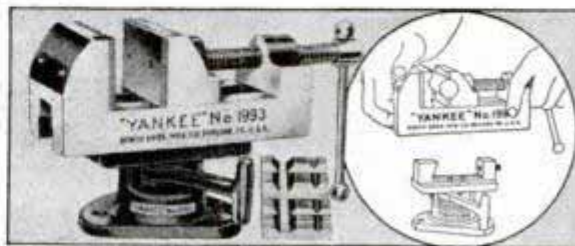

● "Yankee" No. 1993.—Handiest Vise for Homecraft work! With swivel base. Removable from swivel base. Accurately machined. Used on either side or end, as well as base, for work anywhere the craftsman pleases. On bench. At drill press. In shop, home, garage. Price (3 1/8" open) \$9.90. Smaller and larger sizes, same style, \$3.75 up. Ask at dealer's, to see these ingenious vises.

MONUMENT \$9 UP Freight Paid or Erected.
World's Best Marble and Granite. Direct from factory. Lettered. Guaranteed. 30% Savings. Thousands sold. Write for Free catalog. U. S. Marble and Granite Co., Dept. A-18, Oneco, Florida.

Fishing Tackle At Low Prices!

Send today for our Big Free Catalog listing hundreds of Bargains in Fishing Tackle, Baseball, Golf and Tennis Equipment, Guns and Sporting Goods of all kinds. Here are some typical examples: \$17.50 DeLuxe Fly Rod, 2 tips, aluminum case, \$8.95; \$4.00 Steel Casting Rod, 1 piece, offset handle, \$1.89; \$15.00 Level Wind anti-back-lash Reel, \$6.98.

FREE CATALOG Send today for our Big 104 Page Catalog; chuck full of Bargains for every Sportsman. We guarantee satisfaction.
GATEWAY SPORTING GOODS CO., 1334PM Main St., Kansas City, Mo.

GAS MOTORS Ready-to-Run



Never in the history of gas engines was a motor ever offered at so low a price. All America has acclaimed this engineering triumph—accomplished by outstanding G.H.Q. designers and engineers after years of exhaustive, scientific, aerodynamic research. Has broken records for amazing performance. Flies model planes up to 10 ft. wingspread. Also used for boats. And look at all these extra features! Easy starting—just a twist of the wrist. Steady running—runs 27 minutes on ounces of gas. Precision, replaceable parts. Cylinder and Piston Lapped. Longest crank shaft ever made on miniature motor. Chrome nickel steel shaft with 1 1/4" bearing surface. Connecting rod of high speed bronze. 1/5 horse power at 300 to 8000 R.P.M. This famous motor complete, entirely assembled on a stand. Tested and run before shipment—performance guaranteed. No oil, gas or batteries included. Only \$12.50. Send 3c for illustrated catalogue.

G. H. Q. MODEL AIRPLANE CO.
854-B East 149th St. New York, N. Y.

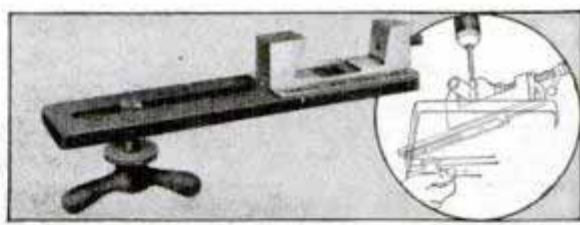

● "Yankee" Vise Clamp.—Holds "Yankee" Vise securely to face plate. Gives rigidity and accuracy, for drilling and machining. Made in two sizes: No. 2992, for use with Nos. 992 or 1992 Vise, \$1.35. No. 2993, for use with Nos. 993 or 1993 Vise, \$1.80.

ALSO "YANKEE" No. 990



without swivel base

Not for use with "Yankee" Clamp

Accurately machined to support work squarely on face plates. Holds irregular shapes, tapered pieces, round stock. Jaw width, 2 3/8". Removable swivel jaw. \$3.30.

==== Coupon for FREE Tool Book ====

North Bros. Mfg. Co., Philadelphia, U. S. A.

Ask dealer for "Yankee" Tools. Mail us this coupon to get free copy of "Yankee" Tool Book for homecrafters.

Your Name.....

Address..... (PM4)

When writing please mention Popular Mechanics

F1617

New Uses for Wood

(Continued from page 541)

that two by six inch structural members can be used instead of the customary two by ten inch joists. The floor panels of this five-room and bath dwelling supported test loads of more than 300 pounds per square foot over a thirteen and one-half-foot span. The wall panels under the attack of a simulated sixty-mile gale developed a fiber stress in the plywood of less than one-third the allowable safe stress.

Speed in assembly is another feature of this prefabricated house. It occupies a

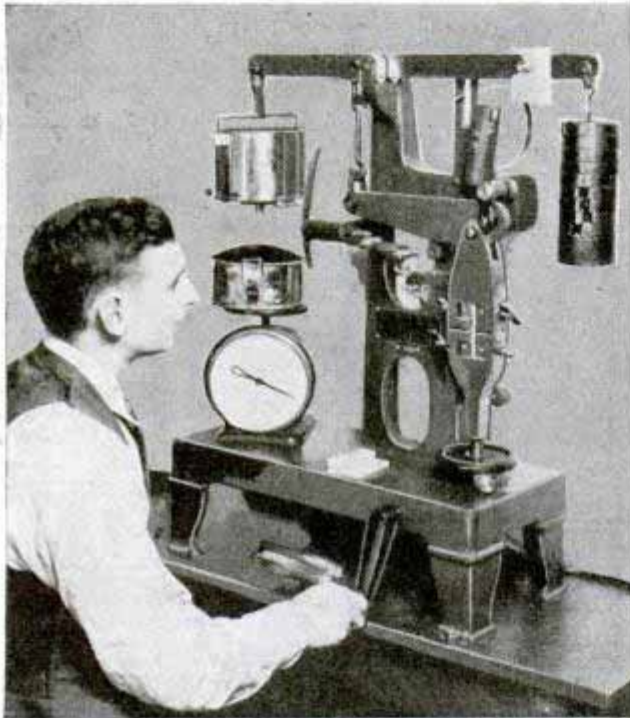

Apparatus used by forest products laboratory to test strength of glued joints of plywood

floor space twenty-one by twenty-nine feet and was put together in twenty-one hours by two carpenters and five helpers. Some estimate this simple, attractive and readily portable home could be sold for under \$3,000 on a mass-production basis.

Engineers can now design heavy-duty beams from thirty to fifty per cent smaller than those formerly used. This is because the experimenters have answered another enigma of wood behavior. Study of the fissures produced in wooden beams during seasoning, supplemented by breaking tests, revealed that a checked or severely sheared beam really functions in service as two beams instead of one. There has also been evolved a process for making a moldable, durable and machineable plas-

tic resembling hard rubber from hardwood sawdust. This plastic possesses high density, a good body and a glossy surface, is strong and water-resistant and can be sold at the price of ordinary lumber.

Wood is composed of cellulose and lignin. To study the fine grains of cellulose in wood, the technologists had to magnify a single fiber to the dimensions of the largest redwood tree. If the tree itself were magnified on a similar scale it would be 4,000 miles high and 300 miles in diameter. Thus enlarged the grain of cellulose is seen to consist of quadruplet parts, clinging together in chains like spider webs, amazingly complex material. New uses for cellulose are being disclosed by such ferreting. Cellulose is already used in the manufacture of paper, Cellophane, rayon, plastics, lacquers and gunpowder. It has other potentialities which are just beginning to be explored.

Lignin is a challenge to both scientific exploration and commercial exploitation. Its efficient utilization remains a conundrum because of its elusive composition although it comprises twenty-five per cent of the volume of wood. The forestry technicians have made progress in isolating this material and predict wonderful economic possibilities will be tapped by ultimate solution of the lignin mystery.

One problem delegated to the research foresters was to evolve a method for determining the twisting strength of airplane wing beams, the members apt to break in forced landings. The scientists found that if a beam of unusual shape is transformed into a hollow pipe with a soap film smeared over the end, inflation would produce a flat bubble whose volume was an accurate index of the twisting strength of the beam. Hence they cut holes—accurate cross sections of the airplane wing beams to be tested—in aluminum plates and then blew soap bubbles through those openings and with a micrometer screw determined the volume of each bubble. But first they had to find a special soap whose bubble film would persist for hours and would not burst even when touched. Many months were spent in experimentation but they found it and soon were blowing bubbles to solve a mystery.

see letter



PRESSURE—600 lbs. per sq. in.!
TEMPERATURE—3000 degrees!

... but FORD GASKETS
are built to take it

The Genuine Ford V-8 Gasket is packaged for your protection.

Each explosion inside a Ford V-8 combustion chamber may exert a pressure of as much as 600 pounds per square inch. The flames from the burning gases reach temperatures as high as 3000 degrees. At such temperatures and pressures, a lot depends upon gaskets. They must keep these hot gases from leaking into the water jackets. They must keep the jacket water from entering the combustion chambers. They must provide as effective a seal between head and block as the metal of these parts themselves.

Genuine Ford Cylinder Head Gaskets are built to give long, dependable service under these severe conditions. A steel core is permanently bonded between two thicknesses of specially treated asbestos that resists the effects of water, gasoline and oil. Combustion chamber openings are reinforced with a steel edging for protection against blowing out. And correct compression in the cylinder heads is assured because Genuine Ford V-8 Cylinder Head Gaskets compress to the correct thickness (.048 to .051 inch).

As with all Genuine Ford Parts, Ford Gaskets are made of the highest quality materials. Insist upon Genuine Ford Parts when replacements are needed.



FORD MOTOR COMPANY, DEARBORN, MICHIGAN



These rolls clinch the two asbestos sheets to steel core.



Putting grommets on combustion chamber openings, Ford V-8 Gaskets.



Sizing Ford V-8 Gaskets to correct thickness.

Everything in RADIO in ALLIED'S New SPRING CATALOG

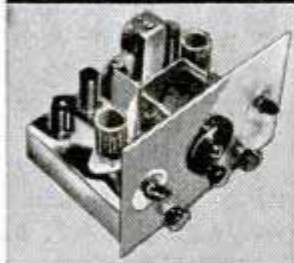

**156 PAGES of INTEREST
FOR EVERY AMATEUR
AND RADIO BUILDER**

Send for the new Spring 1937 ALLIED Radio Catalog! 156 big pages packed with Everything in Radio—Radio's most complete supply book. It includes more than 10,000 radio parts; dozens of Build-Your-Own kits; 50 new Knight Radios; Amateur receiving and transmitting gear; Public Address; test instruments; Rurlipower generators and Windchargers; books, tools, etc. You'll find everything you need in this great book!

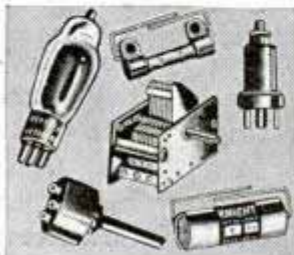

**BUILD YOUR OWN!
MORE THAN 10,000 PARTS**

The new ALLIED Catalog includes more than 10,000 parts for building or repairing any circuit. We can supply matched kits for building any Popular Mechanics circuit. Write for FREE parts lists for 1 Tube Portable (R209); 2 Tube AC-DC (R211); Beginners' 3 Tube All-Wave (R224); 1 Tube Flashlight Cell Set (R227); Beginners' S-W 2 Tuber (R232); "Hurricane" Set (R234); Improved Little Giant (R235), etc. A 150—see pages 123-4-5 of the new ALLIED Catalog for other new, low-priced kits.



NEW SOUND SYSTEMS

See the newly designed Knight Sound Systems—8 to 60 watts—permanent, portable and mobile, for 110 volt, 6 volt, and universal operation. Featuring the exclusive "Calibrated Output Indicator," higher fidelity, greater dependability, and beautiful new cases—at new low prices. Here are tremendous money-saving, profit-making opportunities!



**50 NEW KNIGHT
RADIOS!**

The famous Knight line of Radios has been increased, improved, and refined. The sensational 11 Tube AC Superhet with Automatic Dialing, AFC, Tone Expansion, etc.; new plastic radios; portable battery sets; phono-radio combinations, etc. 50 great models—a set for every purse and purpose!

**FASTER SERVICE . . .
LOWER PRICES**

You can buy with confidence at ALLIED—Radio's Leading Supply House! Our tremendous stocks, our central location, our economical merchandising methods and our efficient shipping department mean a greater value, fastest service and lowest prices for you! You save on every purchase when you order from ALLIED—Radio Supply Headquarters.



ALLIED RADIO Corporation

833 W. Jackson Blvd.,
Chicago, Ill.

Dept. 5-D

Rush me your new Spring 1937 ALLIED Radio Catalog.

Send me FREE parts list for.....

Name

Address

City..... State.....

One-Tube Short-Wave Receiver

(Continued from page 579)

and 3-D clearly show all parts. A 4-conductor color-coded cable is used to bring the A and B-voltages to the set.

Fixed condensers "C₄" and "C₆" are .0001 mfd. midget mica types; "C₅" is a .01 mfd. tubular variety and "C₇" is a .5 mfd. shielded, paper by-pass type. A 1-watt 400-ohm fixed resistor is used at "R₂," and the r.f. choke coil is a standard 2½ mh. variety. An original list of all materials, and further information, can be obtained upon application to Popular Mechanics radio department without charge. The blueprint number is R-236.

To tune the set, fasten a 40 or 50-ft. antenna to the clip and adjust "C₃" for the

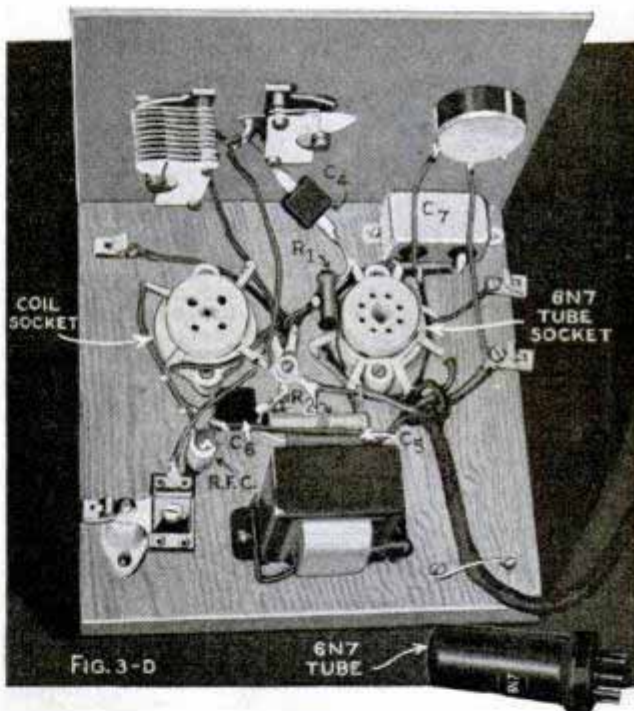
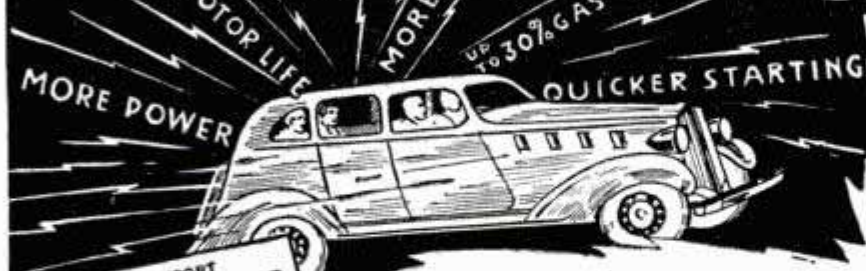

FIG. 3-D

approximate frequency of the stations you wish to hear. All actual tuning is done with the small variable condenser "C₂" which "spreads" the stations over the dial. Tune in stations with the regeneration control "R₃" advanced so that the set is oscillating, a whistle indicating a station, then back off the control until the station is heard clearly. It may be necessary to remove a turn or two from the small "L₁" windings in order to insure smooth regeneration. Turning the adjusting screw in, on "C₁," increases signal strength; however, this adjustment should not be carried too far or the set will refuse to oscillate over certain portions of the dial.

New Invention WITH SUPERCHARGE PRINCIPLE SAVES GAS



AT LAST! Automotive engineers have smashed down the barriers to perfected combustion! The new VACU-MATIC solves the secret of greater power! With almost magical action, this amazing invention instantly puts new life and pep in any motor. It adds mileage to every gallon of gasoline... produces split-second pick-up, sensitive accelerator response, quicker starting, greater speed and smoother running.

Automatic -- Nothing Like It!

The self-starter — four wheel brakes — knee action — streamlining... and now VACU-MATIC! The sensational money-saving invention! With it, engineers have achieved a practical means of balancing air and gasoline automatically for all speeds.

VACU-MATIC is *entirely different!* It operates on the supercharge principle by automatically adding a charge of extra oxygen, drawn free from the outer air, into the heart of the gas mixture. It is entirely AUTOMATIC and allows the motor to "breathe" at the correct time, opening and closing automatically as required. No idling troubles—no carburetor adjustments necessary. It is so simple it will amaze you —so practical it will save you many dollars on gas costs.

USERS REPORT
3 to 7 MILES MORE PER GALLON
MOTORIST SAVES \$180.00 a YEAR

"On my V-8 Ford it works miracles. Its added power, acceleration and top speed has sold me. The results are too believable." —Ralph Fields, Mass.

"Very glad to say, the Buick showed an increase of 3 miles more per gallon." —A. F. Greer, Washington.

"On my Plymouth, I obtained an average of 22 miles per gallon, an increase of 7 miles. This means a saving of \$15 a month or \$180 a year." —P. S. Peck, Calif.

"It saves me one gallon a day. I had to buy 3 gallons each day—now only 4 gallons." —L. F. Sweet, Pa.

"I have twelve VACU-MATICS on cars now, and they all show an increase in mileage. The car owners are very well pleased." —Fred Taylor, Okla.

"I have been placing VACU-MATICS on expert mechanics' cars. All are well pleased." —J. W. Donaher, W. Va.

Guaranteed Gas Savings

VACU-MATIC proves itself on every car. It is guaranteed to give worthwhile gas savings, quicker pick-up, and more power or it costs you nothing. You can instantly tell the difference in added power and motor performance — you quickly notice the cash savings on gasoline.

Fits All Cars

VACU-MATIC is constructed of six parts, assembled and fused into one unit, correctly adjusted and sealed at the factory. Nothing to regulate. Any motorist can attach VACU-MATIC in ten minutes. Once in, its only reminder is the surge of instant power and speed it gives to the motor and the savings it affords your pocketbook.

AGENTS & SALESMEN

VACU-MATIC offers a splendid opportunity for unusual sales and profits. Valuable territories now being assigned, check and mail coupon.

Free Details

You owe it to yourself to know all about this remarkable discovery. Mail the coupon below. Start saving gas with VACU-MATIC and enjoy a new driving thrill! There's no obligation—so get the facts now! Write today!

The VACU-MATIC Co., Wauwatosa, Wis.

FREE OFFER COUPON

THE VACU-MATIC COMPANY
7017-298 W. State St., Wauwatosa, Wis.

Gentlemen: Please send me full particulars concerning the VACU-MATIC and details of your Free Offer. This of course does not obligate me in any way.

Name

Address

City..... State.....

Check here if interested in selling proposition.

SAVE PRINTING COSTS



with the COPY-STAMP

Prints postcards, letters, menus, notices, etc., etc. Works like a mimeograph. Quick, clean, compact, instantly changeable.

Ask your stationer or write us direct.

THE STENCIL-STAMP CO., Inc.
Department E, Amsterdam, N. Y.

SELLEY-TEX REARWIN SPEEDSTER

patented
FLYING MODEL AIRPLANE KIT, with moulded fuselage, wheel shoes and cowling practically crashproof. Nothing else to buy, kit complete... SHIP MODEL FITTINGS—Die-cast—brass—wood brass. Most complete catalog 5c. SELLEY CO. Dept. 804, 1375 Gates Av., Brooklyn, N.Y.



16" Wingspan.

DEAFNESS IS MISERY

Many people with defective hearing and Head Noises enjoy Conversation, Movies, Church and Radio, because they use Leonard Invisible Ear Drums which resemble Tiny Megaphones fitting in the Ear entirely out of sight. No wires, batteries, or head piece. They are inexpensive. Write for booklet and sworn statement of the inventor who himself has been benefited by the use of the drums.

A. O. LEONARD, Inc., Suite 699, 70 5th Ave., New York



PARTS for the POPULAR MECHANIC FAMILY TRAILER

Everything you need! Axle, Tongue, Hitch, Wheel Housings, Wood Parts, Tank, Sink, etc. Send for price list. Include 25c (coin) for our big Catalog and Trailer Builders' Manual. Satisfaction guaranteed! **TRAILER SUPPLY CO., Box A, Wausau, Wis.**



BUILD CLOCKS with our help

Cash in on the demand for Mantel, Banjo, GRANDFATHER'S CLOCKS. Ask about our new, low-priced Hall Clock and Special Blue Print Offer. Send dime for illustrated working drawing of Hall Clock; 25c for plans of 16 Mantel & Banjo Clocks. Catalogue FREE.

AMERICAN CHIME CLOCK CO.
1675 Ruffner St. (Established 1877) Philadelphia, Pa.

DEVELOP & PRINT YOUR OWN SNAPSHOTS

Save One Half!

Save money and have fun developing, printing your own pictures—for fun or profit! No experience needed. Everything included in Central's professional Dark Room Outfit.



A \$265 Value SPECIAL COMPLETE OUTFIT \$195

Send us only \$1.95 money order for the professional outfit (pictured here) including electric ruby lamp, developing and fixing trays, chemicals, photograph paper, complete directions—everything needed. Or send C. O. D. \$1.95 plus postage. Unless perfectly satisfied, return outfit within 10 days and your money will be refunded! Order today—start printing your pictures right away! WRITE for Free Bargain Book of Cameras and Supplies.

CENTRAL Camera Co. (Est. 1899) 230S. Wabash, Dept. K-4, Chicago

FREE SHIRTS, TIES, and HOSIERY OFFERS TO CUSTOMERS

SELLING TANNERS NEW SPRING SHOE LINE

For Men, Women, Children. Newest colors! Newest leather! Superb quality assures repeats. \$10,000 Gold Bond guarantees satisfaction. AMAZING FREE SHIRTS, TIES, HOSIERY OFFERS TO CUSTOMERS BRING LARGE ORDERS. Latest sport styles. Full range of sizes. Exclusive specialty featured! Extra profits getting orders for Men's and Women's Hosiery, Men's Shirts, Ties. Liberal bonus plan provides our representatives with FREE bonus shoes.

EARN BIG COMMISSIONS and YOUR OWN SHOES FREE

LASTING FOOT HEALTH WITH SELF-ADJUSTING ARCH

Wonderful special inbuilt steel arch support exclusive with Tanners makes easy sales! Famous self-adjusting arch protector gives support to feet and entire body. Needed by hundreds in your territory!

WRITE AT ONCE Big selling season on. No experience or investment needed. We furnish all equipment FREE including big \$33 sample outfit of actual shoes. We pay postage. Send today for FREE Sales Kit.

TANNERS SHOE CO. 579 C Street BOSTON, MASS. OUTFIT FREE

Speed Kings Groom Their Racers

(Continued from page 533)

type superchargers to increase horsepower. Among older engines to be in the race is an eight-cylinder in-line engine Meyer plans to drive. It was first used in 1932.

Compared to the popular four-cylinder racing engines, sixes and eights have the disadvantage of more moving parts, which means more parts that might fail. On the other hand, they are smoother and allow steadier driving. They have better pick-



Polishing racer's exhaust pipes which provide whirling motion to gases and reduce pressure

up at high speed, because above ninety miles per hour the driver of a four-cylinder engine is apt to spin his wheels instead of leaping ahead when he pushes on the throttle, due to the greater power jerks.

Among the new cars at Indianapolis in addition to several foreign cars will be a four-cylinder job of 316 cubic inches displacement being built for Bob Swanson. Swanson is the former midget champion who sputtered from forty-fourth to fourth place in twenty-five laps in the Roosevelt race and then lost his position when a fuel line broke. His new engine will have a four and one-half-inch bore and a five-inch stroke, two sets of valves per cylinder, supercharger, one carburetor, and spherical combustion chambers.

The spark plugs of most racing engines do not fire into the combustion chambers. Instead they fire the fuel mixture that is drawn up into a small pre-firing chamber. The flaming gas then expands through a three-eighths-inch hole into the combustion chamber where it ignites the main charge. This system keeps the plugs cooler and prevents them from fouling.

Art Sparks expects to use a six-cylinder motor of 330-cubic-inch displacement, having three and three-quarter-inch bore and four and three-quarter-inch stroke. It will have a compression ratio somewhere between five and one-half to one and eight to one, depending upon what results are obtained with commercial fuel at four pounds per square inch manifold pressure. The four-wheel brakes will be sixteen inches in diameter, larger than usual, and the whole car will weigh 1,850 pounds dry. The body will be thirty-one inches wide, with a 101-inch wheel base and a sixty-inch tread.

Road racing apparently is going to attract more attention during the next few years. The Roosevelt track on Long Island is being improved by straightening some of its twenty-seven turns to permit qualifying speeds of 100 miles per hour instead of under seventy. A similar track is projected for the west coast and others are planned elsewhere. These tracks, together with the new rules, will bring out a flood of new cars next year. The reason is that typical American speedway cars are not suited for road racing, although a good road race car is satisfactory for speedway contests. European cars led the field at Roosevelt last year principally because of better brakes, better springing, and improved transmissions. Motor power compared with the power in American cars although some of the foreign racers used twelve-cylinder engines, an advantage in short races but a feature apt to cause trouble in long grinds.

As the designers see it, road race cars next year will be equipped with four-wheel brakes having drum diameters of sixteen or seventeen inches and will possibly be operated with compressed air. The cars will have lower centers of gravity and will carry torsion bars at the front axles to prevent bending axles when brakes are applied. Road racing also calls for individual spring suspension on all four wheels, a feature that allows a car to squat and hold its traction in a turn, with the driver in perfect control. The present way of going through a turn is to slide the rear end around, extremely dangerous on

(Continued to page 152A)



REX BEACH
well-known author

Read REX BEACH'S thrilling True Story of the man who is living on "Borrowed Time"

"**H**URRY! Your wife is ill!" Constable Stilling, of Philadelphia, leaped into his car. There was no time to spare. 'Faster! Faster!' Then—without warning—BANG! A blow-out! The car leaped out of control like a wildcat—swerved to the left—just missed crashing head-long into a telephone pole.

But Lady Luck smiled that night—and the extent of Constable Stilling's injury was a wrenched shoulder. Some miracle had saved him. As he, himself, says: "I feel now that I am living on 'borrowed time'."

Just stop to consider what happens to your tires when you're skimming over the pavements at 50, 60 miles an hour. Naturally, the heat generated is terrific, and you're totally unaware of it because the trouble begins *inside* the tire. A tiny invisible blister may form between

the rubber and the fabric. This blister keeps getting bigger and BIGGER until BANG! And then it may be too late.

It seems to me that, as far as safer tires are concerned, the greatest single contribution has been from Goodrich engineers. They have developed a real blow-out protection called the Golden Ply.

It is a layer of special rubber and full-floating cords, scientifically treated to resist internal tire heat. You can easily see what this means. Blisters don't get a chance to form between the rubber and fabric inside your tires . . . and that means blow-outs due to this heat don't get started.

You can be sure that Constable Stilling doesn't take any chances with his tires these days. He's ready for any emergency and so are his Goodrich Silvertown

**HIS WIFE WAS ILL.
HE WAS RUSHING TO
HER...WHEN BANG!
...A BLOW-OUT!**



Tires. Remember, you can buy these life-saving Silvertowns at Goodrich Silvertown Stores and Goodrich dealers everywhere.

Rex Beach



Goodrich SAFETY Silvertown

With Life-Saver Golden Ply Blow-Out Protection

This Year



\$39.50
buys a famous
Sea Gull

It's the **best outboard motor investment** of the year! When you equip your boat with a famous SEA GULL Outboard Motor - powerful, swift, dependable, surprisingly **economical** - you are assured the maximum of pleasure and convenience throughout the summer. SEA GULL motors are available in 2, 4, 6 and 16 H.P. models, priced from \$39.50 up.

Exclusive Features: All SEA GULLS have • Automatic float-feed carburetor • Monel metal shafts • Underwater exhaust • New type sensational magneto • Carburetor control in steering handle.

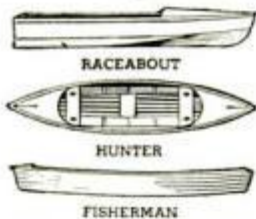

STEEL BOATS - \$24.50 UP

Compare our smart line of steel boats with any on the market! Sturdy - seaworthy - safe - remarkably low-priced - they are unexcelled for rowing or outboard motor use. Also high quality elm and maple oars.

WRITE FOR FREE ILLUSTRATED LITERATURE

NATIONAL OUTBOARD MOTOR CO.
DEPT. PM MARSHALL MICHIGAN



HOME AUTOMATIC CIGARETTE MACHINE
Have YOUR OWN Monogrammed Cigarettes
Put tobacco and block of papers on machine, TURN THE CRANK - PRESTO - CIGARETTES. Easy - simple. All metal construction. Guaranteed. No cloth ribbons; no special tube or gummed papers required. ASK FOR FREE ILLUSTRATED FOLDER.
A. C. MACHINE WKS., PM-4, 1055-57 Devon Ave., Chicago, Ill.

PRECISO RELIABLE MICROMETER
YOU NEED AN EXTRA MICROMETER
1 Inch Adjustable. Measures in Thousandths of Inch. Rustless Body. Mailed for \$1.00. Money refunded in five days on request.
SAFE HOLDER CO., 104 W. 42nd, New York City

FREE!
HAMMARLUND 25th YEAR RADIO CATALOG

The most complete catalog ever published with illustrations, drawings, curves and a complete description of the famous 16-tube "Super-Pro" Receiver. Address Dept. P. M. 4-37.
HAMMARLUND MFG. CO. INC.
424-438 West 33rd Street, New York City

100 Mi. per Gal.
30 Mi. per Hour
ONLY \$125

Auto-Glide

THIS IS GREAT!



It is simply amazing the way folks are taking to Auto-Glide! Thousands are writing... folks from Florida to Washington are buying! Soon you'll see Auto-Glides everywhere - used for deliveries, pleasure, to and from office or factory. Cheapest, easiest way to get places quick. Comfortable. Easy to ride and park. Large rear parcel carrier available, space for firm name, makes novel, economical delivery cycle. Powered with genuine Cushman Husky 4-cycle engine. 12"x3 1/2" balloon air tires. Extra strong channel steel frame. Double steering head. Drum brake. Clutch. Hand throttle. Large cushioned seat.

WRITE TODAY for Free Booklet, Photos, Complete Details.
THE CUSHMAN MOTOR WORKS, Dept. 46, Lincoln, Nebr.

IDEAL 24. in. Model of the Clipper Ship
CUTTY SARK



A beautiful, perfect Model of this famous, fast sailing vessel. IDEAL Construction Kit contains Carved Hull, Stamped Wood Decks, Lifeboats, Anchors, Bits, Chocks, Steering Wheel (all Cast Metal), Chains, Rigging, Cement, Colored Lacquer, including Full Size Plans.

New Low Prices

| | |
|-----------|----------|
| 3 1/2 in. | 10c doz. |
| 1 1/2 in. | 12c doz. |
| 3/4 in. | 15c doz. |
| 1/2 in. | 18c doz. |

Pat. Pend. Cast Metal DEAD EYES Postpaid.

Complete Kit. Plus 15c Postage or Order Direct. Send for Catalog Model Ships, Model Airplanes, Parts, Supplies, 5c. IDEAL AEROPLANE & SUPPLY COMPANY, Inc. 26 West 19th Street, New York, N. Y.

Sell Improved Leather Ties

DON'T waste effort on second raters. Sell fast and repeat on handsomest improved ties. Rich colors, embossed like silk. Finest cut; long wear; wrinkle-free. Wipe clean like new with damp cloth. Send 50c for sample tie (65c value) and Big Free Sales Kit of new season's smartest patterns. Money back plan. Free premiums.

NU-MODE TIE CO., Dept. 201
1333 N. 12th Street Milwaukee, Wis.

\$1.00 A WEEK Buys The RANGER!

Pay while you ride this glittering new Ranger - as low as \$4.00 down and only \$1.00 a week. **30 Days' Trial** We ship on approval. If not satisfied after trial return the bicycle, lamps, wheels, equipment at half usual prices. Write for marvelous new prices and terms.

Mead CYCLE COMPANY
DEPT D-116 CHICAGO

Write us today for free catalog

DUTCH WINDMILLS

Lawn Chairs, Lighthouses, Lawn Figures, Wall Brackets. Easy to build from our detailed BLUEPRINTS. BEAUTIFY GARDEN AND HOME. MAKE MONEY SELLING OTHERS. DUTCH WINDMILL BLUEPRINTS 34" high. Operates Farmer sawing wood. B-30, 65c. CAPE COD LAWN CHAIR, beautiful, modern. F-100, 50c. WALL BRACKET, Early American style. W-100, 50c. LAWN FIGURES patterns 20" high. Dutch Schoonboy, Tulip Girl, Holland Pair, Sunbonnet Girl, Puss In Boots, Red Riding Hood, Little Bo Peep, Jack and Jill, Tom The Piper, Peter Peter, LP-20, patterns 32c ea. (Any 5 \$1. Color arrangements included.) FREE. Dutch Schoonboy Doorstop Pattern With Any Order. For catalog send 10c.

CRAFTSMAN'S MODEL CO., Dept. P-4, 2030 N. 41 St., MILWAUKEE, WIS

POPULAR MECHANICS FAMILY TRAILER PARTS

Available from Hammerblow Tool Company - the original.

Don't build until you get Hammerblow facts. Save money, time, wasted labor. Hammerblow guarantees a rugged, non-sway, perfect trailer! BLUEPRINTS FREE WITH PARTS. Hammerblow parts are world's best. Used by nationally known mfrs. and engineers who know. Send only 50c for 64-page Trailer Builder's Guide and Free 40 page supplement. Immense value. Or write for Free Literature.
HAMMERBLOW TOOL COMPANY, Dept. 104, Wausau, Wis.

There's this much MORE in Atlas

METAL WORKING LATHES

\$45.50 TO \$124.50



Look beyond the basic price when you buy a lathe. For example, this back-geared 36" model at \$97.50 (less motor) includes, as regular equipment, items that cost over \$35.00 from other sources in addition to the basic lathe price. Atlas pioneered the small precision metal-working lathe and continues to lead in value. Sold on easy terms. Write for catalog today.

FACTORY DISPLAYS AT

Chicago, 35 E. Wacker New York, 130 W. 42nd Philadelphia, 113 N. 3rd

ATLAS PRESS CO. 443 N. Pitcher Street Kalamazoo, Michigan

AT... NO EXTRA COST!

- 1—Built-in adjustable counter-shaft.
- 2—Complete V-belt drive.
- 3—Automatic, reversible power feeds.
- 4—Gears to cut 4 to 96 threads per inch.

And many other features.

GET A CATALOG AND MAKE YOUR OWN COMPARISON

DRILL PRESSES \$16.45 TO \$42.45



FREE 1937 CATALOG

52 pages showing the latest in metal and wood working lathes, drill presses, tools, attachments.



Send FOR THIS BIG BOOK

TRAILER BUILDERS MANUAL

SEND 25c TODAY

for this big 64 page book that tells how to build Tops, Beds, Cabinets, etc. All about Electric Light and Water Systems, Floor Plans, etc. Pages full of valuable information, ideas, suggestions that save time and money for trailer builders, buyers and users. Catalog of parts and equipment includes everything you want—Axles, Hitches, Pumps, Stoves, Lights, Windows, Sinks, Toilets, Mattresses—over 200 items exclusively for building and equipping a trailer. Rush 25c (coin) today—satisfaction positively guaranteed.

TRAILER SUPPLY CO., Box 438-A, Wausau, Wis.

*** BUILDERS * BUYERS * OWNERS**

GIVE AWAY FREE R.C.A. LIC. RADIOS

MAKE \$15.00 ON EVERY DEAL

Send 10c for sample micscard and plan. Many making up to \$150 weekly.

BUY at FACTORY PRICES

Resell at 100% profit

Get into radio business, 1937 catalog FREE. 25 new models for farms, homes and autos. 5 to 15 tubes. FOREIGN Reception. New "MAGIC-EYE" tuning. ONE YEAR guarantee. FREE home trial. MONEY-BACK if not 100% satisfied.

SILVER MFG. CO.
606 N. Michigan Ave., Chicago, Ill.

Write for FREE CATALOG

MEN—MAKE MONEY

Get into something for yourself, where your income is practically unlimited—The American Electric method of floor surfacing gives you that opportunity. Large profits—Work easy to get—No previous experience necessary—Small amount starts you—Write quick—No obligation.

The American Floor Surfacing Machine Co.
523 So. St. Clair St. Toledo, Ohio

IVER JOHNSON

FOR THREE GENERATIONS AMERICA'S FINEST BICYCLES

\$27.50 up

IVER JOHNSON STREAMLINE

You'll be Happier and Safer on an Iver Johnson—

Send for color folder 66B describing many models for Boys, Girls, Men, and Women.

IVER JOHNSON'S ARMS & CYCLE WORKS
21 River Street, Fitchburg, Mass.

New York San Francisco Montreal
85 Chambers St. 731 Market St. Coristine Bldg.

POWER PAINT SPRAYER \$22.50

Ideal for all around Spraying work. Sprays Lead Paint, Lacquers, Enamels, Varnishes, Cold Water Paint, Dyes, Insecticides, Disinfectants. Suitable for Homes, Schools, Clubs, Hospitals, Stores, Factories, Office Buildings, and Work Shops. Furnished complete with Internal Mix Pressure Feed Gun, Quart Aluminum Cup, 2 Nozzles (Fan and Round), adjustable Air Control; Compressor Piston Type, size 1 1/2 x 1 1/2; Air Cooling Pulley, V-Belt Drive; Filter; 1/8 H.P., 110 volt, 60 cycle, AC Motor; 8 ft. Cord and Plug; mounted on Base; 15 ft. Oil Resisting Air Hose.

The National Utility is a low priced Power Sprayer; the kind of machine that usually sells for \$35.00 to \$40.00. **OUR SPECIAL PRICE \$22.50 Complete, plus postage.** Shipping weight 50 lbs. Sold with money back guarantee. Cut out this ad. Print name and address in margin below. Send \$5.00 deposit, bal. C.O.D.

NATIONAL ELECTRIC TOOL COMPANY, Dept. O4, 560 Washington, CHICAGO, ILL.

es 25

(Continued from page 148A)

Where
WATER
comes
first..



You can rely
on a **MYERS**

RUNNING water is the most important modern convenience in any home. The water system used to supply it must be absolutely reliable or the entire household is discommoded. When you turn the faucet, the water must run. You can trust a MYERS Water System to make good. Thousands of suburban and rural home owners testify to the trouble-free performance and remarkable durability of these high quality units. MYERS products are backed by sixty-seven years of specialized water service experience.

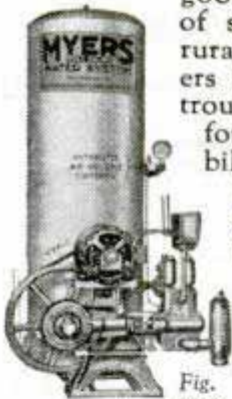

Sump Pump for Cellar Drainage

Keeps cellars and basements perfectly drained. Silent centrifugal pump operated by electric motor. Entirely automatic in action. Starts whenever water enters drain pit or sump. Stops when water has been pumped out. Low in cost; easily installed. Circular on request.

MYERS Water Systems meet all needs. Models for deep or shallow wells; for operation by electricity, engine, windmill or hand. Write for booklet TODAY.



MYERS WATER SYSTEMS

THE F. E. MYERS & BRO. CO.

70 Orange Street, Ashland, Ohio

Send free, information checked and name of your nearest dealer. Water Systems Sump Pump

Name _____

Address _____

(19-7)

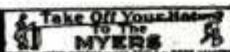

the sharper turns of a road race course.

Finally, the new cars will have a pre-selective "electric hand" type shifting mechanism on the transmission. This feature on the Alfa Romeos at Roosevelt last year was a distinct advantage and allowed a driver still on the straightaway to select a lower gear for pulling through a turn at high speed. As he entered the turn he accomplished the shift merely by flicking his foot from the accelerator for a second. Drivers of American cars had to shift gears manually.

The prospects are that the 1938 cars will have four-speed transmissions although some of them probably will be equipped with over-drives or under-drives on the rear axle instead of a full set of gears in



Race car "broadsliding" down track out of control of the driver

the gear box. This would be an improvement even over the electric hand, designers think, since gear changes could be made even more rapidly.

To insure safety, all new drivers at Indianapolis this year are to be given a "driving lesson" at various high speeds under the eyes of a veteran. Before a race all parts of the steering apparatus of each car are given a magneflux test in which the parts are magnetized and then sprinkled with fine steel dust. If tiny surface cracks or even interior flaws are present the dust reveals them by forming around the area.

"Safety on the track these days is mostly just a matter of common sense," remarks Louie Meyer. "That makes it practically the reverse of ordinary highway driving, judging by the dangerous things some motorists insist on doing."

For..BIG Money-Making..Doing ALL Work
Use *The* **FIFEL-GEARED PIERRENCH KITS**

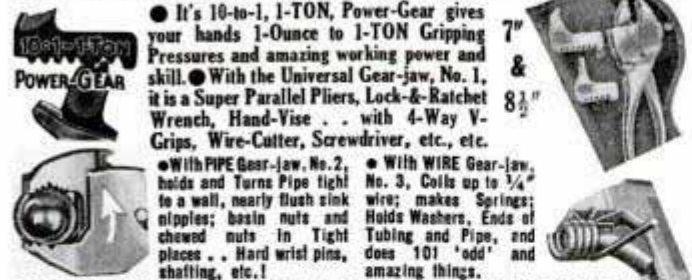

● It's 10-to-1, 1-TON, Power-Gear gives your hands 1-Ounce to 1-TON Gripping Pressures and amazing working power and skill. ● With the Universal Gear-jaw, No. 1, it is a Super Parallel Pliers, Lock-& Ratchet Wrench, Hand-Vise . . . with 4-Way V-Grips, Wire-Cutter, Screwdriver, etc., etc.

● With PIPE Gear-jaw, No. 2, holds and Turns Pipe tight to a wall, nearly flush sink nipples; basin nuts and chewed nuts in Tight places . . . Hard wrist pins, shafting, etc.!

● With WIRE Gear-jaw, No. 3, Curls up to 1/4" wire; makes Springs; Holds Washers, Ends of Tubing and Pipe, and does 101 'odd' and amazing things.

● You Get ALL 3 . . . a \$50 Tool Service . . . at the Price of ONE Good tool in the 8 1/2" (20-Oz.) KIT; or, in the 7" (12-Oz.) KIT; and, the 2 KITS give you 9 Different Super-2-Tool Combinations!

● WHAT'S MORE, These "Miracle KITS" are making \$30 to \$85 WEEKLY for AGENTS and DISTRIBUTORS, and we Need More . . .

● MAIL this Part of Ad TODAY with your Address (on a Postcard will do), Get FREE—this 7-Edge-End-&-Angle SCREWDRIVER (It Turns Screws in ALL Positions and does many useful things) and 101-PICTURE MANUAL OF MECHANICS—with User Offers; or, With . . . DISTRIBUTOR, Territory and Free Kit Offers!

FREE

AMERICAN PIERRENCH CORP'N DPM-4809N, Ashland Ave. CHICAGO, ILL.

WHIZ Electric Tool
DRILLS, GRINDS, POLISHES, SHARPENS, SANDS, SAWS, CARVES — easily, quickly



A whole shopful of tools in one. Indispensable and economical for Homecraftsmen, Mechanics and Carpenters

POWERFUL — SPEEDY — DEPENDABLE

A.C.-D.C. Motor—1/4" capacity. Cannot over-heat. Highest quality workmanship and materials. 10-DAY money-back TRIAL.

FREE Accessory outfit, including set of drills, mounted grinder, sanding discs, mandrel, etc. Complete outfit for only \$6.95 postpaid.

PARAMOUNT PROD. CO., Dept. 5A, 245 Broadway, New York

ARE YOUR KEYS THE ONLY KEYS to your shop, home, office, store, garage, etc. Why be in doubt? Don't take chances. Learn how to reset your own cylinders so that keys that may be in the hands of old tenants and landlords or perhaps burglars will not work. Our locksmith manual for resetting cylinders sent for \$1. After several minutes with our manual you will be able to reset cylinders very easily. SEND NOW!



Midwest Locksmiths, 3711-F-W. Chicago Ave., Chicago, Ill.

BUILD YOURSELF OR HAVE Carpenter or Garageman BUILD

USE ANY AXLE OR REGULAR TRAILER AXLE

RITZY Standard RITZY Camp Cruiser RITZY Air Cushion

11-00 13-00 14-00

SMALLER PLANS AND SPEC BY REG. ENGINEER. 11-00 HILL TODAY FOR ALL THREE PLANS TO EASY TO CHANGE LENGTH AND WIDTH. MAIL 11-00 HILL TODAY FOR ALL THREE PLANS TO RITZY CABIN TRAILER. BOX 252X, WAPAKONETA, OHIO

INVENTORS Be Sure to See Page 23A

4 KEYS to SUCCESS in the BUILDING INDUSTRY

The Ideal Combination—Big In Opportunity—High In Earning Power—Timely, Because Building Is Making Greatest Come-Back In History—Protected Because Operated On Franchise Basis.



1—QUALITY PRODUCTS AT LOWEST COST
This revolutionary production machine and process permits large production—2000 brick per hour of superior quality. With this enormous output day after day, picture your tremendous market with DUNBRIK made at lower cost and with 20% savings in material and weight. Then think of the control this exclusive product would give you over this market and the possibilities for profit and independence that would naturally result.

2—TODAY'S TREND PERMANENT FIREPROOF CONSTRUCTION
When modern buildings are being erected with 1/3 saving in material cost, 1/2 in mortar and 1/3 in labor, it again furnishes definite proof that DUNBRIK and DUNSTONE build better buildings for less. In addition multiple sizes up to 12"x24" offer wide flexibility, permitting solid—veneer—ashlar and hollow wall construction at lowest cost.

3—MULTIPLIES YOUR OPPORTUNITY
In addition to the advantage of 20% saving in materials and low cost production, the Mat Glazing Process makes it possible for you to transform your common DUNBRIK and DUNSTONE into face units of enduring beauty and at low cost. Never before have these three been so effectually combined in a building product.

4—SAFEGUARDING YOUR BUSINESS AND FUTURE
Your product is exclusive—No temptation to sacrifice quality to meet competition. Your business has the advantage of efficient organization through this Company as a clearing house for the DUNBRIK-DUNSTONE industry. Your future is protected because of only one DUNBRIK-DUNSTONE plant to a territory. No building up your business to high earning power and then have another plant spring up beside you to cut in on the market.

INVESTIGATE NOW
Write today for complete information. Let us show you how present manufacturers are making outstanding progress in a business that offers unlimited opportunity for growth, expansion and profit. Be the first to investigate this outstanding opportunity for your territory. Send for free book "Modernized Materials and Construction." Then decide.

W. E. DUNN MFG. CO.
600 W. 24th St. HOLLAND MICH.
In answering advertisements always write name and full address clearly.

MORE PROFIT—MORE PLEASURE—WITH BOICE-CRANE TOOLS



Write for Catalog Get full details . . . Twenty different Tools . . . New designs . . . Ahead of field . . . High quality . . . Dependable . . . Accurate machines of low cost.

Only ONE motor (not 2) needed to drive both this Tilt-Arbor Saw and Jointer. That saving of \$3 (impossible on most other saws) pays for your Boice-Crane Jointer.

New 10 Inch, Tilt-Arbor Saw is big and heavy. Accurate. Refined details. Easiest to use. Gives greater production. Investigate its greater safety, too.

6 Inch Jointer. Extra long tables. Very long fence guidance for accuracy. Fence locks rigidly at front, and at rear. Is spring-proof. Cutterhead 3 inch diameter.

BOICE-CRANE CO. Dept. PM.4-M. Toledo, Ohio

What one metal is good for both men and motors?



Run down that partial table of contents for April and get your copy from your newsstand today. Don't delay. Many stands sell out early. Better still, use the coupon for a year's subscription and be sure of getting every issue, promptly.

SINGLE COPY 25¢

A YEAR'S SUBSCRIPTION \$2.50

Science Digest, Inc.

631-643 St. Clair St., Chicago, Ill.

Gentlemen: I enclose

- 25c for April Science Digest
- \$2.50 check or money order for a year's subscription beginning with April issue.
- Please bill me for year's subscription.

Name.....

Street.....

City.....State.....

ONE of the metals, mined with a pump, is the basis of an antacid for digestive ills. Alloyed, this metal, lighter than aluminum, becomes stronger than steel and when used for pistons helps make a sweet running motor. What is it? And what other useful elements are mined with pumps? Read Science Digest for April.

Pre-fabricated houses go up in hours, yet over 1,200 years were spent in erecting one ancient structure. Read "Pre-Fabricated Houses" and "Engineering in Ancient Egypt" in the April issue of Science Digest.

How should frozen foods be treated in the kitchen? Do laymen make medical discoveries? Why do men join Klans and Legions? Why do your feet hurt you? Where is the border line of life? These and a score of other subjects are treated in the April issue of Science Digest.

Concise, clear and easy to read, Science Digest presents the important news of scientific progress in all branches in time-saving form for busy men and women, in the professions or in business.

Manufacturers, executives, medical men, scientists, teachers, army officers, housewives are reading Science Digest. Surely it would prove interesting to you. Mail your subscription today and miss no more issues of Science Digest—in a field of its own.

BETTER USE THAT CONVENIENT COUPON NOW

When writing to advertisers please mention Popular Mechanics

MODERN FRICTION ELECTRO PLATING WITHOUT USING A TANK

Aladdin Portable Electro Plater

PATENTED Sept. 8, 1925 — May 13, 1930 — Jan. 6, 1931.

Deposits - Nickel - Silver - Brass - Copper - Gold and other metals
A REAL MONEY MAKING OPPORTUNITY



INEXPENSIVE—DURABLE—ECONOMICAL—ANYONE CAN DO IT

It is easy for anyone to electro-plate with nickel—silver—brass—copper—gold—etc.

Not a dope or paste, but a metal deposit from an anode without using a bath or tank and without the necessity of completely dismantling of the objects to be electro-plated.

ESTABLISHED IN 1924

Aladdin Portable Electro Platers have been on the market since 1924. Over 20,000 units have been shipped to 54 countries.

USED EVERYWHERE

Aladdin equipment is used by large industries, the U.S. Government, mechanics, individual men and women who like to do high grade work at home or plate for others.—No skilled labor is required.—Complete instructions are furnished, easy to understand. The work is fascinating and educational.—Do your own plating—sell Aladdin Electro Platers, Chemicals, and Accessories to your customers.



PROFITABLE BUSINESS

Electro - silver plating is in great demand. Automobile headlights, table ware, ornaments, musical instruments, or utensils. See the silver flow into the crevices. We manufacture a complete line of Electro-Platers to suit your requirements.

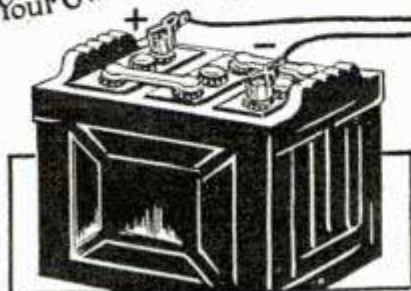

A 6 volt battery or 3 dry cells supply the "juice." The + pole is connected to the plater and the - pole is connected to the work to be plated.

AGENTS' INTRODUCTORY OFFER

The Aladdin Master Outfit "A," to plate with nickel, retails at \$9.50. The introductory offer to agents is \$6.50. All outfits come complete with chemicals already mixed ready to use, also with cleaning and polishing compounds. Write for full details and prices for any combination of metals with which you desire to electro-plate.

AGENTS AND DISTRIBUTORS

WANTED EVERYWHERE
Write Today for Complete Information

P. J. F. BÄTENBURG CO.
RACINE, WISCONSIN DEPT. 24

Introductory
AGENTS OFFER
\$6.50



IM GLAD I BOUGHT THIS LAFAYETTE

I'm a "slip-stick" engineer - the kind of a fellow who knows value - and this NEW LAFAYETTE receiver is value with a capital "V". But don't take my word for it, do what I did - get the GD-11 on a 30 DAY FREE TRIAL in your own home and see for yourself.



Lafayette 5 TUBE SUPERHET AN UNUSUAL RADIO VALUE

Here it is folks!

It will bring 'em in from Europe and America with the same tone you'd hear in the broadcast studio. You'll never have a dull moment with this swell LAFAYETTE SPECIAL in your front room. Features 3 band reception (18 to 560 meters), dynamic speaker, and automatic volume control. Send in that order today. Find out what real radio reception is.

ONLY \$16⁸⁵
WITH TUBES
CABINET ETC.
NOTHING ELSE TO BUY

Send for FREE parts list of circuits described in this magazine. Specify circuit desired.

**NEW!
SPRING
CATALOG
FREE**

Our new 116 page spring catalog will soon be off the press. Your eyes will pop at the thousand and one bargains offered by the world's largest distributor of radio products. Look for the new auto sets and 50 other Lafayette radio models at remarkable savings to you. Send for your copy at once. It's FREE

WHOLESALE RADIO SERVICE CO., INC.

NEW YORK, N. Y. • CHICAGO, ILL. • ATLANTA, GA.
100 SIXTH AVENUE • 901 W. JACKSON BLVD. • 430 W. PEACHTREE ST., N. W.

USE
COUPON
FOR ORDER
BLANK

WHOLESALE RADIO SERVICE CO., INC.
100 SIXTH AVENUE, NEW YORK, N. Y.

Please rush FREE NEW SPRING CATALOG No. 68-7D7. Enclosed find check..... money order.....
.....for my MODEL GD-11.

Name.....

Address.....

City..... State.....

Send orders either to New York, Chicago, or Atlanta.

'Beam' Tube in C. W. Transmitter

(Continued from page 580)

ulator, and easy to cut for mounting the wafer-type sockets. A schematic circuit diagram is given in Fig. 1; in this diagram it will be noted that a bottom view of the tube-socket connections is shown. An "X-ray" top view of the assembly, looking down on the baseboard, is given in Fig. 2. This simplified wiring diagram shows all parts in their relative positions and every connection above and below the baseboard. Photos of the top and underside of the completed transmitter appear in Figs. 2-A and 2-C, a close-up of the 6L6 tube being given in Fig. 2-B.

Exact placement of parts is not important. However, the various leads should be short and direct, with all connections

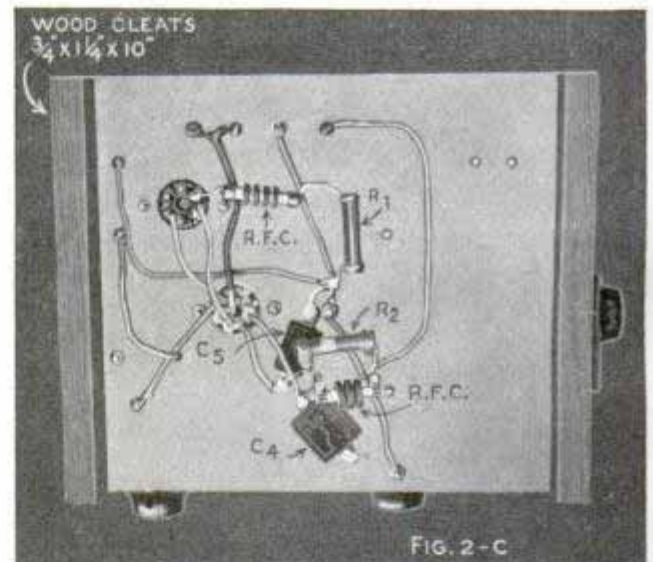

FIG. 2-C

well soldered. A large soldering lug serves as the point to which all r.f. grounds to negative-B are made. No. 14 wire, with push-back insulation, is employed for connections. An original list of all parts used and further operating data, can be obtained upon application to Popular Mechanics radio department, without charge. The blueprint number is R-237. Angle brackets mount variable condensers C₁ and C₃, the antenna tuning condenser C₂ being mounted on a small panel.

Coil L₂ is of the popular low-loss type made with enameled wire, spaced and supported by strips of celluloid. It is easy to wind, as a 2¼-in. cardboard mailing tube may be used for a form.

The power supply should furnish about 400 volts at 100 mils. or more, and should have a 6.3-volt winding for the filament.

New Delta Tools for 1937

More complete than ever before, the Delta line for 1937 includes a full line of wood working and light metal working tools and all necessary accessories and incorporates many new features and improvements and new units. This year the Delta line includes:



New 17-inch Drill Press

New Seventeen-inch Drill Press. The greatest drill press value ever offered. Nothing quite like it on the market today.

A remarkable NEW Belt Sander; Revolutionary NEW 17" Drill Presses; a NEW Precision 4" Jointer; a NEW Precision 11" Drill Press; Improved 14" Drill Presses; Improved Combination Units; NEW Tapping Attachments; NEW Shaper Cutter-head; NEW Tenoning Collars; NEW Belt-Drive Buffer; NEW Belt Guards and Improved Safety Features.

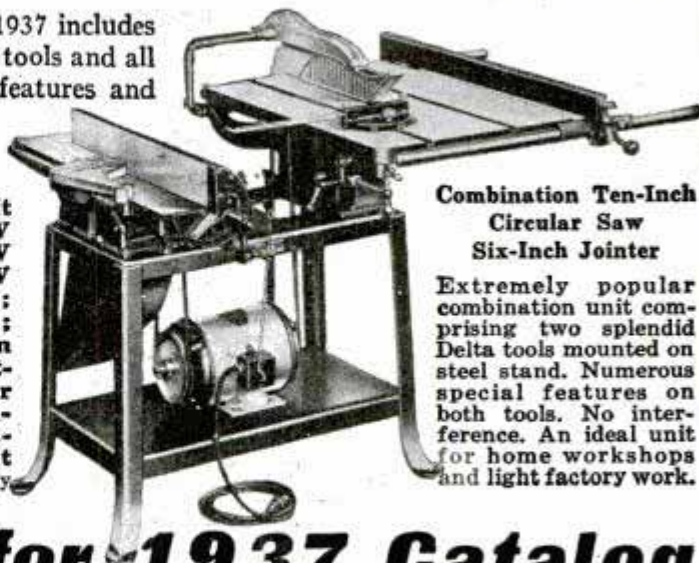

Combination Ten-Inch Circular Saw Six-Inch Jointer

Extremely popular combination unit comprising two splendid Delta tools mounted on steel stand. Numerous special features on both tools. No interference. An ideal unit for home workshops and light factory work.

Write for 1937 Catalog

And also the New 32-page book No. 3 of "Practical Delta Projects" crowded with new and "out of the ordinary" things to make—with many photographs, working drawings, and easy-to-understand illustrations. Every craftsman should have this book. Send 10c with coupon for Delta Project Book No. 3. 1937 Delta Catalog mailed postpaid.

DELTA MANUFACTURING CO. Dept. A437
600-634 E. Vienna Ave., Milwaukee, Wis.

I enclose 10c (stamps or coin) for which please send me one copy of the new 1937 Book No. 3 of "Practical Delta Projects." Also place me on your mailing list to receive 1937 Delta catalog of quality motor-driven tools. I am interested in Delta Tools for:

Home Shop Industrial Use School Shop

Name

Address

City..... State.....

() Check here if you are a Delta user now.

ACE Set



Tools for every operation on metal-cutting lathes \$14.50

Insist on ACE Tool Holders Drop forged by ARMSTRONG, makers of cutting tools used by 96% in industry. 8 ACE TOOL HOLDERS with Cutters and Wrenches in fitted steel case—Turning, Boring, Knurling, Threading and Cutting off.

Write for Circular

ARMSTRONG BROS. TOOL CO.
"The Tool Holder People"
368 N. Francisco Ave., CHICAGO, U.S.A.

CLAMPS

Embodied in each "Jorgensen" and "Pony" clamp is the excellence developed thru over a quarter century of specialization in the design and manufacture of CLAMPS. That is why industry standardizes on "Jorgensen" Hand screws; why we are the largest exclusive clamp manufacturers; why you should insist on clamps stamped "Jorgensen" or "Pony." If your dealer can't supply, order direct... Send \$1—pay the postman balance.

ADJUSTABLE CLAMP CO.

"The Clamp Folks"
421 N. Ashland Ave., CHICAGO

CATALOG Pony Fittings go on ordinary pipe—

FREE make clamps of any length. No. 52

(for 3/4 in. pipe). Fitting for

2 clamps... \$1.50 plus postage (4 lbs.).

No. 50 (for 1/2 in. pipe). Fittings for 2

clamps... \$3.00 plus postage (6 lbs.)



● Handiest power mower ever built—only one with easy one-hand control. Cuts 18' swaths; trims closer than hand mower; adjustable to 4 cutting heights; light weight, won't pack soil; rubber tires; fuel cost only 20c a day. \$110 f.o.b. factory; easy terms.



Address EVINRUDE
1656 W. Hope Ave.,
Milwaukee, Wisconsin

EVINRUDE LAWN-BOY POWER MOWER

BE ACCURATE AND POSITIVE

To examine diamonds, coins, machine parts, ores, specimens, and paintings use this fine double lens diamond eyeglass. Diamond experts, jewelers, watch repairers, and engravers use this very same kind of glass. Small defects, flaws, names, and details cannot be found with the naked eye. Therefore this powerful double-lens glass will be an amazing help to anyone. Price \$1.00 postage prepaid.

Security Jewelry Co., 742 So. Hill St., Los Angeles, Calif.
In diamond business over 30 years.



BUILD CLOCKS for PLEASURE—PROFIT



Hall clocks are high priced in stores—you can make good money building them or electrifying spring clocks. Dime brings "NOW" Book pricing: banjo, desk, mantle, RADIO, spring, ELECTRIC, chime, BATTERY from \$1.40. Brass weight movements from \$16.95 with drawing of easily built Grandfather Case—sent now. KUEMPEL CHIME CLOCK CO., Bldg. 3, Guffenberg, Iowa



BUILD YOUR OWN ELECTRIC OUTBOARD MOTOR

from old auto generator. We show you how. Variable Speed. Light weight and Silent. Operates from 8 to 12 hours on ordinary storage battery. Dime brings complete

plans and catalog. Wind Driven Cottage Light Plants, Motors, etc. LEJAY MFG. CO. 1947 W. LAKE ST. MINNEAPOLIS, MINN.



VEST POCKET ADDING MACHINE

IDEAL For Business or Personal Use. Adds, subtracts, multiplies, divides. Does work of more costly machine. Counts up to million, made of steel—weighs 5 ounces. Simple, accurate. Not a toy. Guaranteed 5 years.

— FREE TRIAL — SEND NO MONEY! \$2.50 Total Cost

Order from ad, not sold in stores. Just send name and address. On delivery pay postman \$2.50 (plus few cents postage). (If outside U. S. send cash.) 10c additional in Lenthert's Case. If not satisfied after 10 days' trial you get your money back. Thousands of satisfied users. Write for Agents' proposition. CALCULATOR MACHINE CO. (Mrs.) Dept. 312, P. O. Box 1118, Chicago, Illinois.

BIG MONEY!

ASSEMBLING MEAD'S
New PORTABLE **KI-YAK**
IN A FEW DAYS AT HOME!



—from Complete Cut-To-Fit Construction Kit!

Use with PADDLE!
OARS! SAIL! MOTOR!

Weight as little as 20 LBS.

**Assemble for PROFIT or Personal FUN!
NO Experience Needed!**

MEAD'S perfected, patented, aluminum-ribbed Cut-To-Fit Construction Kit GUARANTEES successful assembly easily, quickly, **INEXPENSIVELY**—in a few days at home with simple hand tools without previous experience. Build yours for personal sport use, or sell at splendid profit! Mead's quality KI-YAKS (available in 4 models, kits or factory assembled) are beautiful and PORTABLE. Take yours anywhere by hand or car for paddling, sailing, rowing, *subboarding*, touring, fishing, camping, hunting, *Leak-proof*, *Seaworthy*. Durable. THOUSANDS in use. Strong as a giant—light as a feather! More fun at less cost! \$6.00 Double-Blade Paddle GIVEN with your OK KI-Yak—if you hurry! Mail 10c and Coupon below for Giant Colored Circular, Money-Making Plan, special offer, Low Introductory Prices!

OK-2

Weights only 50 lbs.
Takes ANY Outboard 4 1/2 H. P. or less!

Carry motor in one hand—OK-2 in other!

AMAZING LOW COST!

Don't buy any boat until you see the amazing Low Introductory Prices on MEAD KI-YAK Construction Kits and Factory-Built jobs. (You can even Pay As You Build, on our special Progressive Group plan!) EARN money assembling, selling! Remember, Mead KI-YAKS are unsurpassed . . . the lightest, strongest, most portable boats of their kind! Join in the FUN—and PROFITS being made. Rush Coupon and dime NOW for Free details BEFORE prices go up!

Mail Coupon NOW!

OK-2 as rowboat

OK-2 as motor boat. Convertible in 10 minutes into fast sailboat.

\$6 PADDLE GIVEN
with your OK-KI-YAK—if you hurry!

Gentlemen: I enclose 10c as handling, postage charge. Please rush your New Colored KI-YAK Circular, Low Introductory Prices, Money-Making Plan and \$6 Gift Paddle Offer. (Please Print Plainly.)

NAME.....
STREET & NO.....
CITY.....STATE.....

RUSH ME WITH 10c TO

MEAD GLIDERS
15 S. MARKET ST. DEPT. B-47 CHICAGO, U.S.A.

Comforts for Homes on Wheels

(Continued from page 510)

Trout has transplanted \$30,000 worth of trees and several thousand dollars worth of shrubbery and plants to his eight-acre tract which is covered with Bermuda grass and dotted with palm trees. The grounds have lawn tables, chairs, and umbrellas. At night the park is illuminated by neon lights and the reflection of these on the palms supplies an enchanting effect.

Well-constructed buildings house rest-rooms, laundry, and showers. Clotheslines adjoin the laundry room and ground rules prohibit the drying of clothes elsewhere.



Trailer camp in Florida set back from the highway in quiet and peaceful surroundings

More than a mile of paved roads have been laid, making each lot convenient to reach. There are also children's playgrounds with swings, seesaws, and sandpits; a commissary with a complete stock of groceries; a filling station and wash-rack; ice and milk deliveries three times daily, and regular distribution of mail. Each lot is equipped with running water that may be attached to trailers if so desired, and drains are installed under sinks.

One requisite for a good trailer camp is ample space so cars with trailers can drive in and out without much backing and maneuvering. The amount of ground allotted to each car can be determined by the topography of the site. If possible, a tract should be selected offering plenty of shade trees and also bathing and fishing facilities, particularly if the owner is to cater to the vacation-minded tourist. The camp should be laid out so there is an electric-light socket for every trailer, water taps at frequent intervals, and a central wash-

(Continued to page 160A)

DOUBLE A Power TOOLS

10" JIG SAW

The Champion cuts up to 1 1/2". Sturdy frame, 8" table, 10" throat, adjustable guide, enclosed top spring. Quiet, V-belt drive. Shipping wt. 11 lb. Price, \$1.95. 6 all-purpose blades, 15c extra. 5 assorted blades 15c extra.



\$1.95

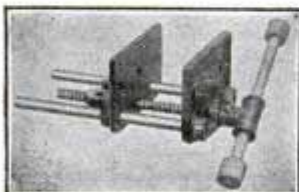

Woodworkers' Vise, \$1.00
Strong, rugged, practical. Accurately finished. Jaws, 6"x2 1/4" open to 6". Needed in every shop. Shipping wt. 6 lb. Price, \$1.00.

Start Your Work Shop NOW!

Add good tools! Wood lathe, \$5.95; 4" table saw, \$2.90; belt sander, \$1.95; disc sander, \$1.50; spindle shaper, \$2.00; metal lathe, \$11.95; 4" power grinder, \$2.00; power drill press, \$2.50; motor driven hack saw, \$7.95. All F. O. B. Ann Arbor.

Write Today for **FREE CATALOG**

**DOUBLE A
Products Co., Inc.**
407 No. Fifth Ave.,
Ann Arbor, Mich.

*America's Leading
Manufacturers of*

LOW PRICED POWER TOOLS



MICROMETER

HERE AT LAST
WITHIN THE PRICE RANGE
OF EVERYONE

An accurate 0' 1-2" MICROMETER
Caliber Accurate To 1/1000 Of An Inch
Can Also Supply 0' 1" For Only \$2.00
COMPLETE WITH INSTRUCTIONS

\$1.00
POST
PAID

The ATCO CO., Dept. 5, 1426 Adams St., TOLEDO, O.

Trindl ELECTRIC ARC WELDER



**Works Off Any Storage
Battery or Ordinary Light Socket**

This low electric arc welder is made possible by the invention of a low voltage carbon. Auto batteries may be used without removing from car. Uses about same current as four headlight bulbs. Can be used on electric light socket by using a Trindl Converter in place of battery.

Broken parts are simply melted together by the white hot electric arc, in just few seconds. Produces about 7000 degrees heat. **HOTTEST FLAME KNOWN** Melts iron and steel instantly. Welds fenders, radiators, holes in bodies, milk cans, tanks, brazes broken castings. Works on anything iron, steel, brass, copper, tin or galvanized metal. Permanent repairs made for almost nothing. Used by factories in many operations. Positive money back guarantee by a responsible firm.

AGENTS

Men with cars to sell mechanics, repairmen, farmers, radio and battery shops, factories. Five minute demonstration makes sales. Up to 150% profit. Write today.

TRINDL PRODUCTS

2229-FZ Calumet Av.
CHICAGO, ILL.

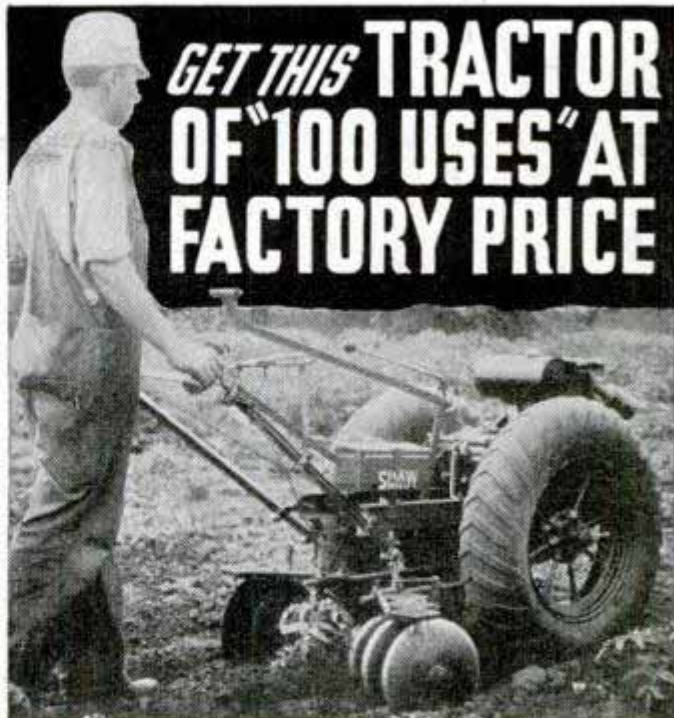

GET THIS TRACTOR OF "100 USES" AT FACTORY PRICE

DOES WORK OF MANY MEN OR 2 HORSES!

Here's untiring speed and power—that gets field and belt work done on time! Smallest size does work of many men—saving wages. Larger sizes do work of 2 horses or mules—quicker, cheaper, more efficiently—saving costly animal keep. Runs all day for 33c. Greatest time, labor and money-saver made!

"Tractor of 100 Uses"—Does all field, road, belt work. Plows, discs, harrows, furrows, seeds, cultivates, harvests, mows, rakes, cuts tall weeds, hauls. Runs washing machines, feed grinders, corn shellers, light plants, saws, concrete mixers, water pumps, lathes, other belt machinery. Does deep mold-board plowing, other heavy work. **Amazing money-maker** for farms, truck gardens, nurseries, orchards, suburban homes, golf courses, parks, etc.

SHAW GARDEN TRACTOR

New 1937 Model Has 3 Speeds Forward, and Reverse. Special to Order, 6 Speeds Forward—runs from 1/4 mile to 15 miles per hour. New Power Turn enables Shaw to turn in its tracks with no lifting or pushing. Reverse Gear makes it easy to work among rocks, roots, in close quarters. Tool Attachments for different uses. Convenient Jiffy Hitches. Improved Tool Control gives tools a wider range of movement - - Increases tractor's usefulness. Briggs & Stratton air-cooled, 4-cycle engine. 4 Models, 2 to 5 H. P., Walking and Riding Types. Available With Air or Steel Tires. Air tires save 25% fuel. Enable Shaw to do more work in a day. Provide better traction.

LOW FACTORY PRICE!! Mail Coupon for details of price and terms today!

10-DAY TRIAL FREE BOOK!

OFFER! Use on your own work for 10 days. Know how Shaw makes you much more money—with less work and trouble! Mail Coupon for details 10-DAY TRIAL OFFER today!

Explains everything about Shaw. Tells what enthusiastic owners say. Shows photos of tractors in use. Gives LOW Factory Prices on 4 different size models—with different attachments. Mail Coupon today!



AGENTS
—wanted. Liberal proposition. Mail Coupon for full information.

FREE BOOK COUPON

THE SHAW MFG. CO. (Address Nearest Office)

4504 Front St., Galesburg, Kans.; 5812-G Magnolia Street, Chicago, Ill.; 130-G West 42 St., New York, N. Y.; 608-G No. Fourth St., Columbus, Ohio.

Send me FREE information at once about the Shaw "Du-All" Garden Tractor as checked below:

- FREE Book and Low Factory Prices 10-Day Trial Offer Liberal Agent's Proposition

Name.....

Address.....

Town.....State.....

Comforts for Homes on Wheels

(Continued from page 158A)

room. H. P. Palmer, who operates a modern camp at Encinitas, Calif., says the laundry can be made to pay for itself with a coin-operated electric washing machine and irons.

To operate a successful camp, the grounds must be kept free of litter. With the exception of a few lawn tables and chairs for cards and checkers, a horseshoe pitching court, and possibly a swing, no other entertainment features are necessary, as most trailerites spend their time visiting with other trailer owners and prefer peace and quiet after sunset. The method of lighting a camp depends on the layout. In some cases, minimum area lighting is sufficient, the trailers being parked close together. In other camps thirty or thirty-five feet is allotted for each unit. In the more pretentious layouts, however, underground wiring using parkway cables is desirable, with outlets for electrical connections to the trailers.

Some general lighting is usually required so trailers may be parked after dark and so visitors may locate their units without trouble. For general purposes, floodlighting projectors located at strategic points provide the most economical method of lighting. However, when floodlighting is used, it is important that the units be placed high, to reduce glare which

might cause accidents and to reduce the amount of light thrown into the windows of trailers. For a large lot a lighting engineer recommends a minimum mounting height of forty feet for floodlight projectors. Projectors are available for virtually every type of layout; narrow beam projectors where long throw is required, and wide beam ones for short throws. The longer the throw the longer the shadow cast by any obstruction. At a considerable distance from a projector a trailer might throw a shadow of 100 feet or more.

The prices charged for trailer privileges depend on the location and equipment of the camp. An average rate is fifty cents per day or two dollars a week, exclusive of the electric current cost, or a monthly rate of eight dollars including electric lights. For the elaborate camps rates run as high as five dollars per week for two people and fifty cents a week extra for additional guests. This includes electric lights and radio. Where trailers are equipped for electrical cooking, special meters are usually installed and the trailerite is charged the same rate the owner pays the power company. As an added source of revenue many camps have set aside sections for display trailers only. These are offered to manufacturers on a monthly or seasonal basis.

How Hughes Broke the Record

(Continued from page 503)

tube carries the oxygen to the cockpit, where the pilot inhales through a rubber tube. To prevent possible failures the mixing regulator is attached to the tank, eliminating high pressures in the tube, with a shut-off needle valve to control the flow in the cockpit.

For take-offs and landings the pilot's seat is raised hydraulically to increase his scope of vision. The streamlined transparent hatch that covers the cockpit is of fireproof Puralin. Instead of sliding back, the two sides of the hatch slide down into the fuselage skin. The plane was designed by engineers under the direction of Richard Palmer, together with Hughes himself.

"If Hughes desires he might be able to

cut as much as an hour and a half from his present record with the same plane," one of his engineers declares. "He landed in Newark with more than fifty gallons of gasoline. To break his present record he would simply fly faster, since he cruised at half power this last time. To materially break his record, the fuel capacity would have to be increased, or one stop to pick up fuel would be necessary."

Ⓢ Popular Mechanics Magazine does not publish the name of the maker of, or dealer in, any device described in its pages, but this information will be furnished by our Bureau of Information upon request, accompanied by stamped envelope.

The Passing of THE WHITTLER



All over the United States in well equipped shops in their homes, intelligent craftsmen are doing difficult jobs, showing rare skill with good tools.

What a difference from the time when men whittled aimlessly to pass the time away.

Helping home craftsmen everywhere are Nicholson Files. Their modern tooth construction makes possible faster filing, better filing, more economical filing.

These files—

| | |
|------------------------|------------------|
| Mill Bastard . . . | 6" 8" 10" |
| Slim Taper . . . | 5" 5 1/2" 6" |
| Extra Slim Taper . . . | 4 1/2" 5" 5 1/2" |
| Round Bastard . . . | 6" 8" 10" |
| Warding Bastard . . . | 4" 6" 8" |
| Flat Bastard . . . | 6" 8" 10" |

are an indispensable part of your home equipment. Let your hardware store or supply dealer take care of your needs. Nicholson File Company, Providence, R. I., U. S. A.



PATENTS PENDING

A FILE FOR EVERY PURPOSE

The Disston Brand On Your Saw

means finest value obtainable. There is a Disston Saw or a Keystone Made-by-Disston, at price you want.



You will take life's-time satisfaction in a Disston De Luxe — finest home workshop saw made.

De Luxe Cross-Cut — Rip — Combination

| | | | |
|----------------------|--------|----------------------------------|--------|
| 6" (1/2" hole) . . . | \$2.40 | 8" (1/2", 5/8", 3/4" hole) . . . | \$3.20 |
| 7" (1/2" hole) . . . | \$2.80 | 10" (5/8", 3/4" hole) | \$4.05 |

De Luxe Hollow Ground Combination

| | | | |
|----------------------|--------|----------------------------------|--------|
| 6" (1/2" hole) . . . | \$3.90 | 8" (1/2", 5/8", 3/4" hole) . . . | \$4.90 |
| 7" (1/2" hole) . . . | \$4.40 | 10" (5/8", 3/4" hole) | \$6.20 |



In the Keystone Made-by-Disston Circular Saws, very little money buys a blade you can depend on.

Keystone Cross-Cut — Rip — Combination

| | | | |
|----------------------|--------|----------------------------------|--------|
| 6" (1/2" hole) . . . | \$1.20 | 8" (1/2", 5/8", 3/4" hole) . . . | \$1.60 |
| 7" (1/2" hole) . . . | \$1.40 | 10" (5/8", 3/4" hole) | \$2.00 |

Keystone Hollow Ground Combination

| | | | |
|----------------------|--------|----------------------------------|--------|
| 6" (1/2" hole) . . . | \$3.00 | 8" (1/2", 5/8", 3/4" hole) . . . | \$4.00 |
| 7" (1/2" hole) . . . | \$3.50 | 10" (5/8", 3/4" hole) | \$5.00 |



"The Saw Most Carpenters Use".—Disston D-8, skew back, \$3.25. D-7, straight back, \$2.90. Disston D-23—Lightweight, straight back, \$3.60. SEE ALSO the Keystone Made-by-Disston Hand Saw. Skew back and straight, Cross-cut and rip. Price, 95c, \$1.10, and up. K-3 "Pacemaker", skew back, full 26" blade \$1.35

In Canada, prices slightly higher
How to Choose and Use Saws—answered in Disston "Saw, Tool and File Manual".

COUPON



For free copy of Saw Manual, mail coupon to:
HENRY DISSTON & SONS, INC.
411 Tacony, Philadelphia, U. S. A.

Name _____

Address _____



★ **JOHNSON "Alternate Firing" at \$95 is NEWS!**
 Add underwater exhaust, full pivot reverse, synchro-control and 23 other important features and you've got the smash hit of outboard motoring—the new Johnson All-Star model LT! Eight other models, embodying the greatest outboard developments in Johnson history—and priced as low as \$59.50!
 (Prices f.o.b. factory. Subject to change.)

ALL-STAR DE LUXE



TWIN \$130

FREE Write for this special, fully illustrated literature, including the 1937 Sea-Horse Handy Chart of sizes and specifications. Packed with new features, new performance.



JOHNSON MOTORS
 400 Pershing Road
 Waukegan, Ill.
 Johnson Motors of Can., Peterboro, Can.

JOHNSON ALL-STAR *Sea-horses*

COLUMBIAN METAL BOATS

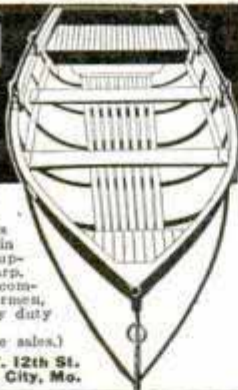

Light weight, durable, carefully built of toughest galvanized copper bearing steel; low prices. Wood gunwales. Heavy transoms for out-board motors. Two or more built-in air chambers for extra buoyancy in case of upset. Easy to handle. Never leak or warp. Write for Free Boat Booklet and prices of complete metal boat line—knockabouts for fishermen, light weight lively boats for resorts, heavy duty craft for out-board motors.
 (Dealers wanted—who can develop volume sales.)

Columbian Steel Tank Co. 1509 W. 12th St. Kansas City, Mo.



BUILD WITH DOENUTS

Build with the original patented low pressure Musselman Doenut cord tires and wheels. They absorb surface obstructions, eliminate jolts and reduce pushing and pulling effort approximately 60%. Tire requires only 12 to 15 lbs. air pressure for loads up to 200 lbs. per wheel. Size 10 in. x 2 1/2 in. Cadmium plated steel disc wheel with adjustable ball bearings and "knockout" type axle. Doenuts are ideal for building hand trucks, midget autos, wheelbarrows, lawn mowers, lawn furniture, portable painting, spraying and greasing equipment or any portable unit under 850 lbs. Write for literature and prices, explaining uses you contemplate.

MUSSELMAN PRODUCTS CO.
 6247-S ST. CLAIR AVE. CLEVELAND, OHIO

VENETIAN BLIND MATERIALS

You can make fine blinds for your own home at low cost, also go into the business. All parts supplied. Send 10c for circular and samples of ladder tape, cord, slats and rails.

Venetian Blind Mfg. & Supply Co., Dept. 2., 1760 Lunt Ave., Chicago, Ill.

VACUUM CLEANER SERVICE MANUAL

At last the book every vacuum cleaner service man is looking for. Full of practical money-making information on construction and servicing for all makes. Tells you how to check, test, clean, repair and price every job. Covers sources of material, parts, tools, supplies, ball bearing assemblies, armature checking, trouble locating and complete list of cleaners compiled by experienced men. Simple, clear and easy to understand. Illustrated. Durable artificial leather binding. \$1.00 Postpaid. Sold on 1-day trial basis.

SEND FOR THIS BOOK \$1.00

THE ELECTRIC SWEEPER SERVICE CO.
 1878 EAST 18TH STREET, CLEVELAND, OHIO

Radio Battles Old Man River

(Continued from page 486)

to cope with emergency, to help save human lives, to alleviate distress and suffering, to hurry relief to those in need. Up and down the Ohio valley today are hundreds of people who owe their lives to the man-made miracle we call radio, the magic carpet which carries man's voice through space, summoning aid to those in distress.

**No Single Cure-All for Floods
 Replanting, Dams and Reservoirs
 All Will Aid in Control**

Great floods, like most great maladies, arise from a combination of causes, and no one medicine is likely to eliminate all the contributing factors. Destruction of trees and grasses has been blamed almost entirely for floods of recent years, but there

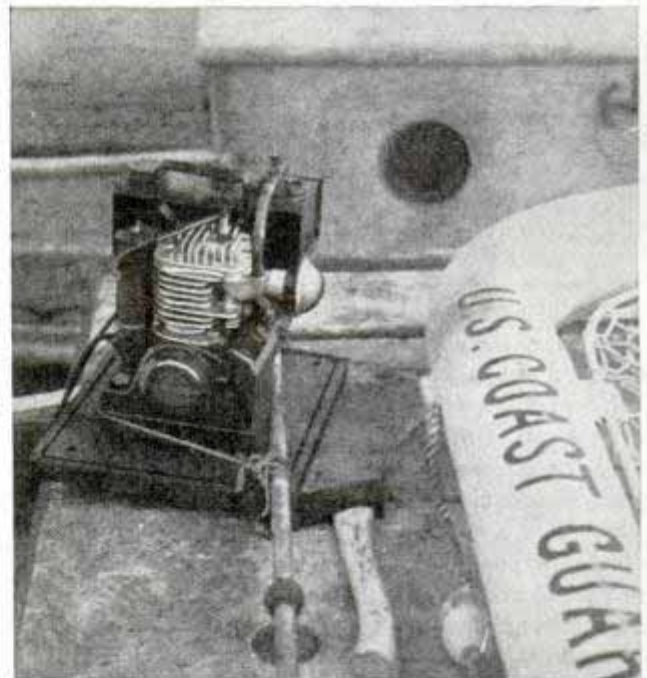

Portable generator used by Coast Guard boat to charge batteries for operating automobile radios

were great floods before the forests were stripped away from the hills.

Floods are likely to occur in the future when circumstances are right, regardless of anything man can do, but it is likely man will be able to prevent some floods and to diminish the volume and violence of others through control measures.

A stubbornly unmoving mountain of tropical air off the southeast coast of the United States was the primary cause of

(Continued to page 164A)

BETTER COOKED MEALS

Hunting · Fishing · Touring · Anywhere

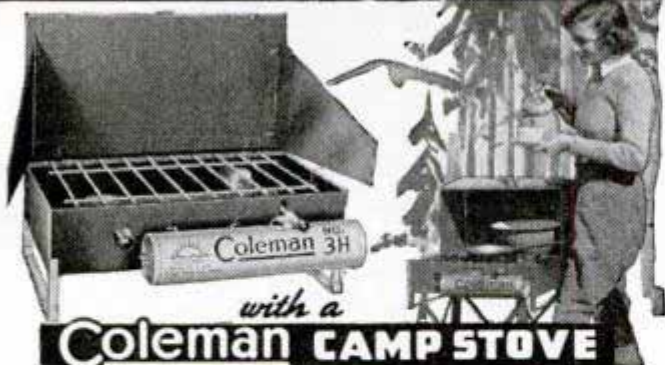

MAKES and BURNS OWN GAS • LIGHTS INSTANTLY
 You'll be happier...have more fun...enjoy meals that satisfy big outdoor appetites...if you take a Coleman Camp Stove along on your outing. It makes and burns its own gas from regular gasoline. Speedy, wind-proof burners light instantly. No wood to cut, no smoke. Sturdily built to give years of service. Everdur Metal Fuel Tank won't rust; easily removed for filling. Folds up like a suitcase for easy carrying. Six models, all moderately priced.

The FINEST OUTDOOR LIGHT—A COLEMAN. A real light for fishing, hunting, workshop, all kinds of uses. Lights instantly. Provides high candlepower pure white light. Sturdily built. Pyrex glass globe protects mantles from wind and insects. No storm can put it out. Gasoline and kerosene models to fit every lighting need.



FREE! Write for Free Folders illustrating and describing Coleman Camp Stoves and Lanterns. **THE COLEMAN LAMP AND STOVE COMPANY** Dept. PM531, Wichita, Kans.; Chicago, Ill.; Philadelphia, Pa.; Los Angeles, Calif.; Toronto, Ont., Canada (7531)

FACTORY PRICES



BIG Direct-Drive Wind-Electric Plants

Lifetime, self-controlled, heavy slow speed, "air cooled," direct-drive Generator (no gears). Powerful wide blade Impellers, 1200 and 2400 watt 32-volt sizes. Weights 460 and 680 pounds. Also huge 110-volt sizes. Heavy duty batteries and towers at factory prices. **FREE** literature. **DEALERS**—Write for territory franchises.

\$300.00 AND UP

Wind Impeller Electric Works, Dept. PM-4, Ellsworth, Ia.

BE YOUR OWN BOSS! Operate quality used and new clothing business from your own store, home or auto. Make 200% to 300% profit. No selling experience required. Everything furnished. Catalogue **FREE**. Write for it today.

PORTNOY & SONS, 566 Roosevelt Road, Dept. 106, Chicago, Ill.

Home Craftsmen, Schools, Hobbyists METAL CASTINGS



produced in your own workshop allow you to design and build your own GASOLINE ENGINES, STEAM ENGINES, STATUARY, ART OBJECTS, SPECIAL TOOLS, NEW INVENTIONS, ETC. You can also make forgings and case harden steel. Your shop is not complete without a **FOUNDRYETTE**. Three sizes are available capable of making bronze castings of 1½, 3, and 6 pounds weight, aluminum, copper, brass, etc., in proportion to specific gravity. Clean scrap metal suitable for use. Domestic gas supply and 110 volt Electric energy required for operation.

| Size | Crucible Capacity | Wt. | Price Complete |
|------|-------------------|---------|-----------------|
| 351 | 6 cu. in. | 25 lbs. | 1½ lbs. \$13.50 |
| 352 | 12 cu. in. | 40 lbs. | 3 lbs. 19.00 |
| 353 | 24 cu. in. | 65 lbs. | 6 lbs. 27.50 |

Above price includes Universal high speed blower. For low speed blower good on 110 volt 60 cycle only, deduct \$4.00. Aluminum Casting Alloy 30¢ per lb. Prices f. o. b. K. C. Check or money order acceptable, express charges C. O. D. Write for circular.

KANSAS CITY SPECIALTIES CO.
 P. O. Box 6022 Kansas City, Mo.

Sharp tools DO A BETTER JOB...FASTER



SHARP tools are the watchword of every good craftsman. He knows that all the skill in the world is wasted with dull chisels and knives. It's best to keep your tools razor-sharp all the time. They'll cut clean and do faster, better work.

Nothing sharpens tools like a Carborundum Brand Combination Stone. One side is coarse grit to remove nicks; the other fine enough to give any tool a razor-sharp, keen cutting edge. Try this stone next time you sharpen your chisel, plane, gouge, or draw knife.



ABOVE—Carborundum Brand Silicon Carbide and Aloxite Brand Aluminum Oxide Grinding Wheels and Sharpening Stones for general metal grinding and tool sharpening. Available in all standard sizes and grits.

SEND FOR 90-PAGE ILLUSTRATED BOOK AND SHARPENING STONE

Mail coupon and 20c today for useful handbook and sample sharpening stone. Shows how hundreds of jobs can be done better with abrasives.



CARBORUNDUM ABRASIVE PRODUCTS

THE CARBORUNDUM COMPANY,
 Dept. PM 7-4, Niagara Falls, N. Y.

I enclose 20c (coin or stamps) for your new book, "Carborundum Brand Products for the Home Craftsman;" and **FREE** Pocket Sharpening Stone.

Name _____ Street _____
 City _____ State _____

Carborundum and Aloxite are reg. trade-marks of The Carborundum Co.

When writing please mention Popular Mechanics

Dollar for Dollar
**the Greatest
 Outboard
 Motor Buy**
*on the
 Market!*



2 H. P.
 FAMOUS
 SINGLE

\$
49⁵⁰
 UP

At \$49.50 - you simply can't buy more power, speed and downright dependability than in the new Neptune "Single" for 1937.

And for only \$20.00 more - \$69.50 - you can buy the still more powerful and speedy Neptune "Twin". Your most rigid comparison will prove these two motors the outstanding bargains of the new year.

Exclusive Features

Neptunes have . . .

- New type sensational magneto
- Automotive float-feed carburetor
- Monel metal shafts
- Underwater exhaust
- Carburetor control in steering handle

Available in 2, 4, 6 and 16 H.P. models.
 Write for Illustrated Literature



MUNCIE GEAR WORKS Inc.

DEPT. PM

MUNCIE, INDIANA

\$1200.00 CASH
FOR DOG OWNERS
33 Monthly Prizes



At last an **easy** letter-writing contest **just for dog owners**. 33 cash prizes each month for letters about Miller's Dog Foods. Get rules and helpful winning suggestions from your dog food dealer or write us for complete information, FREE samples, and FREE Dog Book.

B. C. Dog Food Co.,
 446 State St.
 Battle Creek, Mich.

"BATTLE CREEK HEALTH FOODS for DOGS"



Draw Fat Weekly Income
from NEW TWIN VENDORS

Vending Machine Operators
and Men Who Want to Be!

This new, double profit vending machine offers you the opportunity of a lifetime in big money making field. Vend candy in one section and peanuts in other. Handles many varieties of candy. Wonderful operation. Very low price. Install in beer parlors, taverns, stores, restaurants, counters, booths, bars, walls, tables. Write **Neko Mfg. Co., Dept. T-74, 1201 S. 3rd St., Minneapolis, Minn.**



the recent Ohio valley flood, according to the weather bureau. Ordinarily storms from the northwest bring cold weather and the cold holds most of the seasonal precipitation in storage as snow and ice until the spring thaws. But the mountain of air off the coast stopped the midwinter flowing of storms and kept temperatures abnormally warm. Frequent rains saturated the soil and when a whole procession of lows came along and dumped their moisture, there was nowhere for the water to flow but down to the streams.

The extent of the precipitation was enormous. From January 1 to January 25, the clouds poured down on thousands of square miles of land a layer of water that would have been nearly sixteen inches deep if none had run off. A belt extending about fifty miles on each side of the Ohio river and 550 miles long was deluged with more than 60,000,000,000 tons of water. And the losses of top soil reach almost astronomic figures. From the Ohio watershed, it is estimated that the storms carried away 300,000,000 tons of soil. From plowed land the run-off was as much as eight inches, but from comparable areas under grass and trees, the loss was only two inches. This indicates that replanting holds back the soil, but no amount of forestation could have prevented an Ohio river flood in January because rains were falling continuously on already soaked soil, with no more chance of sinking in than they would have on a tin roof.

Government engineers have demonstrated on the Muskingum river in Ohio that floods can be controlled to some extent by a system of dams and reservoirs. The Muskingum meanders through eastern Ohio, draining 8,000 square miles, and enters the Ohio at Marietta. By a system of reservoirs and dams, it is estimated this river can be brought sixty-nine per cent under control sixty miles north of Marietta and that floods there can be reduced more than fifteen feet. It is also estimated that floods on the Ohio at Marietta can be reduced about six feet, three feet at Cincinnati and eighteen inches at Louisville, all by this one project alone. Three feet may not seem much, but even a few inches often is the difference between having electric power and not having it.

(Continued to page 170A)

LOW COST POWER

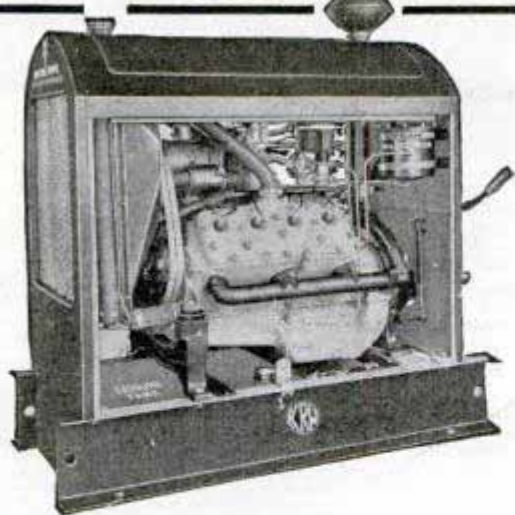

with this KRW-FORD V-8 unit

Here's dependable, low-cost power up to 60 H.P.—complete, compact, portable. Ideal for line shafts, welders, compressor, hoists, pumps, amusement devices, well drillers, agricultural, oil field and contractors' equipment, etc., etc. The most complete industrial power plant built. Uses gasoline or natural gas.

Assembled with brand new heavy duty Ford V8 Truck engine. Large capacity radiator protected by heavy screen. Engine rubber mounted—outfit complete with governor, gas tank, 17-plate battery, instruments and louvered side panels to thoroughly enclose the engine.

Write for complete information, price, and data showing how this unit will pay for itself out of savings in a few weeks, whether operated on gasoline or natural gas. You can buy thru your Ford Dealer and benefit by local service and low-cost Ford engine replacement feature.

K. R. WILSON 17 Lock St. BUFFALO, N.Y.
EXCLUSIVE BUILDER OF APPROVED FORD SHOP EQUIPMENT SINCE 1916



CATCHES FISH ANYWHERE

THE WEEDLESS SHANNON TWIN SPINNER

Smiling Bill

Millions of fishermen swear by the Shannon—the weedless lure that gets 'em casting or trolling—in deep or shallow water, clear or weedy. No other lure like it. Feather or Bucktail Fly, 95c at your dealer.

Made Under J.P. Shannon Patents.

THE W. J. JAMISON COMPANY

735 S. California Ave.

Chicago

SEND FOR JAMISON'S TACKLE BOOK—NOW!

NEW BIG TRAILER PARTS CATALOG

Shows 329 valuable trailer items. Build your own trailer or recondition the one you have. Wholesale prices for quality merchandise. Send 10c for this money saving catalog today.

C. M. Hoof Company, 1736 S. Michigan Ave., Dept. P-4, Chicago, Ill.

Synco JIG SAW

FASTER—SAFER—CLEANER

Astounding performance! Cuts up to 1" or more, with smooth, clean edges. No sanding required. Accurate, sturdy, efficient—a revelation to skilled craftsmen in handling both intricate designs and heavy work. Ideal for cutting light metals, veneers and plastics. Operates on 60 cycle, 110 volt AC, without motor or any reciprocating parts. Requires no oiling. 10" square table; 13 1/2" throat; adjustable guide; variable stroke. Complete with underwriters approved cable and rubber plug. Built for years of continuous service.

Electric Operation

7200 Strokes per Minute



No Motor Required

GET FREE LITERATURE TODAY

Ask your dealer to show you the models now available. Or send your name for full information and illustrated literature, FREE.

SYNCO DEVICES, INC.

511 Boydell Building

Detroit, Mich.

FREE FOLDER

MAN'S PIPE BITES DOG!



... then he switched to the brand of grand aroma



THAT'S news, all right—and a dirty trick on Fido! Pipes need a good Spring cleaning now and then to cure their bite. And for your throat's sake—if not for Fido—try switching from your old hot-and-heavy brand of pipe tobacco to mild Sir Walter Raleigh. It is milder. That's no idle boast—it's a cool-burning, fragrant-smelling, Kentucky Burley fact! 15¢ for two full ounces buys you and Fido a million dollars' worth of fine, full-flavored smoke aroma!



FREE booklet tells how to make your old pipe taste better, sweeter; how to break in a new pipe. Write for copy today. Brown & Williamson Tobacco Corporation, Louisville, Kentucky, Dept. P-74

HOW TO TAKE CARE of YOUR PIPE

TUNE IN JACK PEARL (BARON MUNCHAUSEN) NBC BLUE NETWORK, MONDAYS 9:30 P. M., E. S. T.

COMPLETE PLANS

FOR A PERMANENT PROFITABLE BUSINESS OF YOUR OWN—FREE

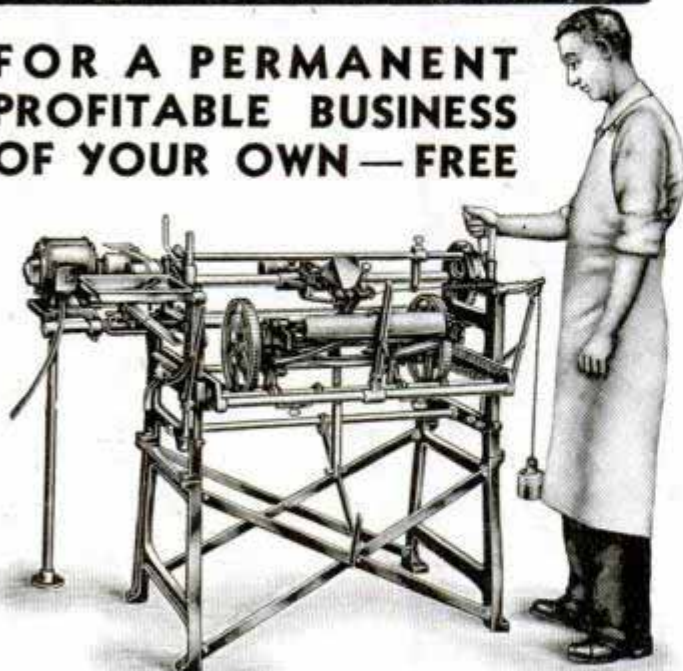

MAKE \$30 TO \$40 A WEEK

Our free plans show you how to build a successful business of your own sharpening lawnmowers. Positively no experience necessary. Most men average from \$30 to \$40 a week. J. B. Van Dien writes: "Some weeks I earned \$40 a week with my Ideal just as a side line." H. Greenlau writes: "In May I sharpened over 200 mowers at \$1 each." N. C. Race writes: "I have sharpened 785 mowers at \$1 each."

THE IDEAL LAWNMOWER SHARPENER

Makes old, dull lawn mowers cut like new. Mowers run easier, stay sharp longer—customers come back year after year. Start right at home. Attach the Ideal to your lamp socket. Sharpens any make of mower in 15 to 20 minutes—you get \$1.00 to \$1.50. Attachments for grinding skates, grass shears, hedge shears, sickles, scythes, axes, etc.

Send Post Card for FREE CATALOG and Complete Plans

THE FATE-ROOT-HEATH CO.
437 Bell St., Plymouth, Ohio



FACTORY TO YOU

NEW REMINGTON NOISELESS PORTABLE

AT LAST! The famous Remington NOISELESS Portable is yours for only ten cents a day. Brand new. Not rebuilt. Standard keyboard and every modern feature. Free carrying case and typing course. 10-Day free trial. You don't risk a penny. WE PAY ALL SHIPPING CHARGES. Act now! Write Remington Rand Inc., Dept. 152-4, 315 Fourth Ave., New York, N.Y.



10c A DAY



ADDRES-O-LITE Illuminated House Number

Makes your home STAND OUT! Easy to read from street day or night. Operates from door-bell transformer. Tiny 3-CP 6-V bulb. 3c per mo. current. No switch. Neat, durable. Anyone can install easily. Instructions furnished. 2,3 or 4 number complete \$3. Money-back GUARANTEED. Order today. (Send house number.) FREE FOLDER! Unique Mfg. & Mach. Co., 4807-9 N. 31 Ave., Omaha, Nebr.

AGENTS: Write for Spl. Offer!

BUILD IT YOURSELF

You can build this Trailer with ordinary tools easily from our step-by-step constructional sheets and large sized blueprints. Finest designed Trailer in existence, sleeps 4. Toilet, Shower, Electric Light, etc.

Save 75% of the cost by building it yourself. Send 25c for plans sheet, illustrations and details.

THE PLAN SHOP, 508 Palmolive Bldg., Chicago, Ill.





Do You Want a WATCH or DIAMOND?

Thousands have found it easy to own America's finest diamond rings, watches, silverware or jewelry by the Santa Fe Plan, Bulova, Hamilton, or Elgin watches—brilliant blue-white diamonds—silverware from world-famous companies, and the great Santa Fe Specials—offered to you at startling cash prices on confidential liberal credit terms.

A Few Cents a Day is the Santa Fe Way

That watch or diamond you've always wanted, longed for—you needn't wait any longer for it. The Santa Fe will trust you—let you wear the watch or diamond you want while you pay only a few cents a day.



TURN PIN MONEY INTO DIAMONDS

Gifts for Every Occasion

Don't Pay Extra For Credit!

No honest person should pay extra to have someone trust him. The Santa Fe trusts you the way you want to be trusted—straight from the shoulder without any extra charges, extra fees, or taxes. You pay only the low advertised cash price in small monthly payments. Send for 1937 Catalog NOW!

FREE to Adults—Send for this beautiful book today. Sent ABSOLUTELY FREE to adults. Send your name and address, and the beautiful catalog will come to you by return mail. Do it now while you think of it.

SANTA FE WATCH COMPANY
Dept. 46, Thomas Bldg., Topeka, Kans.

Smooth Birch Wood DOWELS Use 10,000 Ways

1/8-3-16-1/4 dia. 3 Ft. long 25c Per Doz.
5/16-3-8-7/16 " " " 35c " "
1/2-5-8-3/4 " " " 65c " "

\$1.00 Minimum Order. \$5.00 or over 10% Discount. Prepaid if cash with order. **H. FRANK, R.1. Box 142, Elgin, Ill.**

Make Money at Home

Grow Mushrooms in cellar or shed, with AMI selected-spore spawn and step-by-step, easy-to-follow Manual of Instructions. Ready Market. Book Free. Anglo-American Mushroom Industries, Dept. 102, Toronto, Ont.



Make VENETIAN BLINDS for YOUR HOME

Make and sell blinds on spare time or full time basis. Save 50%. We furnish slats, rails, tape, cord, hardware, finished or unfinished. Send 10c in stamps for sketches, instruction sheets and list of materials necessary.

HOMECRAFT VENETIAN BLIND CO., 832 Lakeside Pl., Chicago, Ill.

STRIPE YOUR OWN CAR

Anyone can stripe a car with a ROLL-A-STRIPE. You can save the price of your striping job and earn money doing others. Specially kaurled roller and dependable glue. Paint, lacquer, enamel or varnish may be used. Stripe signs, furniture, models, etc. See any Duce Dealer today or send direct. Postpaid \$1.50.



MODCRAFT INDUSTRIES, Dept. P24, 2908 N. Nordica Ave., CHICAGO, ILL.

WIND CHARGER EARN

Genuine DUNN CHARGER for supplying 6-volt radio and house lighting current operating at less than one cent a week. Guaranteed. Be first in your community to make quick money showing world's best windcharger using the famous patented Dunn governing principle to friends and neighbors, and own yours FREE. Mail post card today.



Parris-Dunn Corp., Dept. 10, Clarinda, Iowa

NEW 4 IN 1 ANGLE VISE**THE HANDIEST
VISE BUILT**

This amazing new invention, the Palmgren 4 in 1 angle vise makes it possible to cut, drill or grind at any angle by means of one quick simple adjustment. Has far greater strength and holding capacity than ordinary vises. The new Palmgren Angle Vise is accurately graduated in degree for all production, tool and general shop use. Saves hours in wedging and setting angle plates, making jigs and fixtures. Every work bench, farm, repair shop, etc., needs this vise. Sold on money-back guarantee.

**\$7.50
RETAIL
PRICE**

AGENTS make big profit selling homes, mechanics, repair men, farms, radio and auto shops, factories, etc. One minute demonstration makes quick sales.

WRITE TODAY.

CHICAGO TOOL & ENG. CO., Dept. 10, 8355 S. Chicago Ave., Chicago

**FREE
CATALOG****JUST OFF THE PRESS**

Fully illustrated showing special footwear and clothing for fisherman and camper, also special fishing tackle.

L. L. BEAN, INC.
39 Main Street
Freeport Maine

WOODWORKERS

Send for Free Catalogue. Large Chicago Warehouse Stock

Plywood and Veneers at Wholesale Prices

PLAIN and FANCY INLAID TABLE TOPS

All sizes 3 and 5 ply plywood: $\frac{1}{8}$ ", $\frac{3}{16}$ ", $\frac{1}{4}$ ", $\frac{3}{8}$ ", $\frac{1}{2}$ ", $\frac{5}{8}$ ", $1\frac{1}{16}$ ", $1\frac{1}{4}$ ", $1\frac{1}{2}$ " thickness.

Plain and Fancy Domestic and Imported Veneers

Will sell any quantities—We invite visitors.

*"25 years in Veneers"***Rosenthal Plywood & Veneer Co.**

1308 N. Halsted St.

Chicago

WATERPROOF Roofs, Basements, Floors, Tanks, Etc. with AZTEC cold liquid ASPHALTS DURABLY in colors at less than the cost of other methods with everlasting asphalt. No skill or equipment needed to apply these perfected products. **GUARANTEED** not to crack or weather away. Improve the appearance and value of your property. Write today for **FREE** particulars and prices.

AZTEC ASPHALT COMPANY

404 N. Wells Street Department B Chicago, Illinois

**ITALIAN ACCORDIONS**

HAND MADE. Very best. Lowest prices. Direct from Factory Representative. Send your name and address for **FREE** catalog. **ITALIAN ACCORDION COMPANY** 323 W. POLK ST., DEPT. P-6; CHICAGO, ILL.

You BUILD IT!**TO BUILDER, BUYER AND OWNER**

Easy to build this big roomy trailer. Illustrated book saves you 70% and more when building a trailer. Improve your present trailer at low cost. Book shows where to buy chassis, axles, brakes, hitches, pumps, body materials, cabinets, electric plants. Everything that goes into a trailer. Page after page of valuable information and ideas. This trailer is substantial yet easy for your car to pull. Any size—for two, four or more people. Book is **FREE**. Write for it today—Spring here soon. Be ready for the open road. **New York Trailer Builders' Supply Co., 227 West 58th Street, New York, N. Y.**



When writing please mention Popular Mechanics

World's
"STARTIN'-EST"
Outboard!

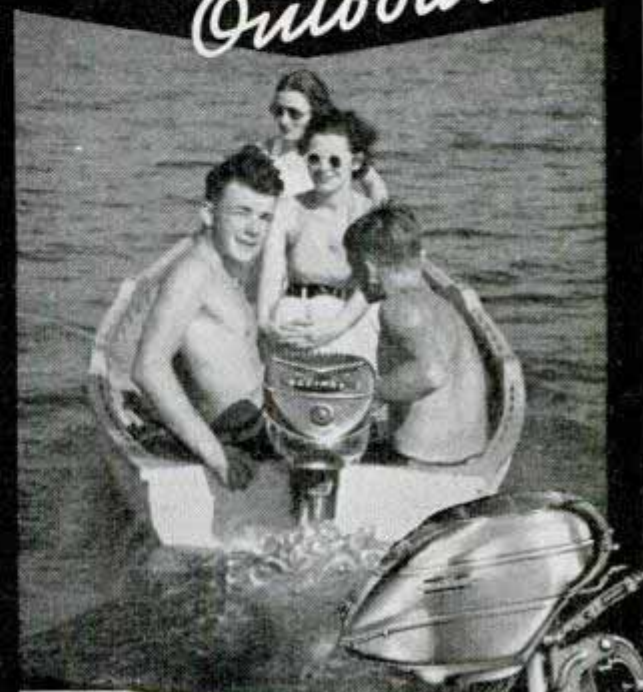

- * New Giant-Spark Aero-type Magneto Ignition by Scintilla!
- * Permanent Magnet Life!
- * New Aero-type Carburetion by Stromberg!
- * New Finger-tip outside controls!
- * Outside Fuel-fill!
- * Full-level tilt-up!
- * Full 180-degree Steering—turn "on a dime!"
- * No-Fume Airstream Cooling!
- * Silenced Underwater Exhaust!

Ask your nearest Bendix Dealer!

**BENDIX MARINE
PRODUCTS COMPANY**(Subsidiary of Bendix
Aviation Corporation)459 Bendix Drive
South Bend, IndianaMagneto
Model**\$69.50**Battery
Ignition
Model**\$61.50**Eclipse
All-Electric
Outboard**\$35.50**F. O. B.
South Bend,
IndianaNEW 1937 **BENDIX-BUILT****ECLIPSE**

AIR-COOLED

OUTBOARD MOTOR

Now-Western Xpert .22's For GREATER ACCURACY



Here's a new cartridge that meets the challenge of better rifles! Xpert .22 Long Rifle gives target accuracy at no extra cost! Same components as Super-Match, the sensation of 1936! SMOKELESS! NON-CORROSIVE! Lubricated lead bullets. .22 Short and Long, also. A WINNER! Ask your dealer to stock it. Send for FREE new Handbook.

FREE HANDBOOK!

Western Cartridge Company
Dept. D-46 East Alton, Illinois

Mail the new Western Ammunition Handbook, a complete guide to modern shooting. Tells all about XPERT .22's and entire Western line.

Name.....
Address.....
Post Office.....State.....

In answering an advertisement with a coupon, be sure to write name and complete address clearly. Sometimes advertisers are unable to respond to inquiries due to lack of complete information.

EARN MONEY Stringing TENNIS RACKETS

An opportunity to earn as much as \$3.50 for a few minutes of your spare time. String your own racket and save money. Tennis players need restringing frequently. Every stringing means profit for you. No experience needed—we teach you how. TOMGUT Equipment makes it easy. Costs practically nothing to start. Easy work. Begin NOW!

FREE Write today and we will send you Free our new low prices of TOMGUT "Court-Tested" Tennis and Badminton Strings, Restringing Equipment and a complete line of Racket Frames.

THOMPSON MANUFACTURING CO.

4535 Packers Ave., Chicago, U. S. A.
TOMGUT "Court-Tested" Tennis & Badminton Strings

Please send, without charge or obligation, the new price list of TOMGUT Tennis and Badminton Strings, Racket Frames, and Restringing Equipment.

Name.....
Address.....
City.....State.....

MAIL THIS COUPON

"JUNIOR"
Throw-away when empty
Flexophane Model,
about 900 applications.
ON DISPLAY
AND INSTRUCTIONS 30¢
CARD EACH

HAVE YOU DISCOVERED GRAPHITE?

THE POWDERED LUBRICANT

DIXON'S JUNIOR GRAPH-AIR GUN

30¢ buys the most remarkable lubricating device and lubricant of all time. A puff of dry powdered Microfyne graphite instantly and lastingly takes the "stick", squeak or rattle out of everything—Wonderful in sticky locks, never gums; is water, heat and cold proof.

At stores selling hardware, automobile and marine supplies, firearms, sporting goods or sent postpaid in U. S. A. on receipt of price (Stamps) and your dealer's name if possible.

- USED BY EVERYBODY IN SOME WAY, THE FOLLOWING GENERAL USES SUGGEST ENDLESS OTHER USES:
- | | | | |
|------------------------|---|----------------------------|--|
| HOMES | Locks. Clocks. Machines. | AUTO-MOBILES | Locks-Door, Switch, Tire, Door Dovetails, Checks, Window Slides. Motor Oil. Cylinders—blow in plug holes or manifold. Gaskets. Springs. Hood. etc. |
| OFFICES | Bicycles. Window, Furniture, File, Case, Slides. Office, Store. Machines, etc. | SERVICE STATIONS | |
| SPORTS, SEA AIR | Locks. Firearms. Fishing Rod Reels, Ferrules. Pulleys. Gaskets. Packings. Race Boat Bottoms. Airplane Gear Quadrants. Motors—see Auto Uses. etc. | FACTORIES RAILROADS | Locks. Tools. Gaskets and Threaded Joints. Machinery. Bearings. Gears. Chains. Pianos. Coin Devices. Linotypes. Alarm Boxes. Windows. Seats. etc. |
| FARMS | Locks. Planters. Coating Seeds. Gaskets. Packing. Pipe Threads. Machinery. Pumps. Bearings. Gears. Chains. Field and Hand Tools. Motors—see Auto Uses. etc. | | |

JOSEPH DIXON CRUCIBLE CO., Dept. 26 C-G, Jersey City, N. J.

DIXON'S "JUNIOR" GRAPH-AIR GUN

WITH MICROFYNE POWDERED GRAPHITE

INVESTIGATE OUR OTHER "FAMOUS FIFTY" GRAPHITE PRODUCTS

MAKE YOUR OWN VENETIAN BLINDS

Complete instruction book shows how easy you can make them in your own home shop. Postpaid only 25c. We furnish hardware, ladder-tape and cord at amazing direct-to-you low prices. Cost of book applied against hardware cost (\$5.00 or more) if purchased from us. Write To-day.

HESTON & ANDERSON 604 PINE STREET FAIRFIELD, IOWA

ALL STEEL TRAILER KIT

SAFE—STRONG—EASILY ASSEMBLED—COST UNDER \$300

All steel chassis and body in knock-down kit. Complete with springs, wheels, and tires, hitch, doors and windows. Furnish to suit yourself, and you will have a custom built coach which will last a lifetime. Low freight rates throughout the U. S. Send for free illustrated circular giving specifications and prices.

STEFCO STEEL COMPANY . . MICHIGAN CITY, IND.
"Largest Exclusive Manufacturer of Sectional Steel Buildings"

GIVEN CLIPSHAVE ELECTRIC RAZORS

The deal of a lifetime! Tremendous earnings possible. Genuine \$10 Clipshave—a nationally advertised product with a sure-fire plan. Appeals to both sexes. No selling! No canvassing! Send for sample sales card. SALESBOARD OPERATORS! Write or wire at once.

AMERICAN NOVELTY COMPANY
1841 Broadway, Dept. PM-4, New York, N. Y.

WIND TURBINE BLADES

of **STAINLESS STEEL** for

WIND DRIVEN RADIO BATTERY CHARGERS & WIND ELECTRIC PLANTS, 6 volt and 32 volt

HIGH EFFICIENCY EASILY APPLIED LIGHT AND STRONG DEVELOPS MAXIMUM POWER REPLACES WOOD PROPELLER NOT AFFECTED BY WEATHER CONDITIONS

Prices \$5.25 and up. Send for circular to **WIND TURBINE COMPANY, West Chester, Pa.**

Patented Construction

When writing please mention Popular Mechanics

Potato Chip Business

Greaseless Potato Chips

Here's your opportunity to get into business for yourself. Turn potatoes into cash by making potato chips. I'll show you how with my improved outfit. Makes delicious, crispy, tasty, superior, "greaseless" chips at a surprisingly low cost. Also Doughnuts and Salted Nuts. Very little cash needed. No previous experience required if you follow the instructions and selling plans I furnish. Begin in any location, village, city or suburb. An opportunity is waiting. Steady year 'round business. Groceries, delicatessens, restaurants, taverns do the retailing for you. Merely keep them supplied.



WE HELP START YOU IN BUSINESS

Raw material plentiful and low priced. Simplified process and confidential plans. Profit large—unusually so. Enormous quantities of Potato Chips are bought daily.

We Have a Credit Plan

Find out how you can buy equipment on a monthly payment plan. Let us tell you what others say about the Potato Chip business. Get all the facts. Get into this dignified, year 'round business with its money-making opportunity. Send for FREE booklet entitled, "How to Start a Factory." Do this AT ONCE.

LONG-EAKINS COMPANY

428-S High St., Springfield, Ohio

Complete 16-unit outfit includes new type white vitreous enamel ROUND Cooking Vat; Direct-to-fat high speed slicer; centrifugal Grease Extractor; Thermometer—Positively everything necessary to start—all at new low price.

WORLD WIDE ALL WAVE RADIO \$155 POST PAID



A sensational Radio! Thousands now in use. Can actually bring in foreign stations, police calls, aeroplanes, amateurs, etc., as well as local broadcasts! Short and Long Wave. Ace Radios give guaranteed results! For only \$1.55 we send you the complete kit containing an attractive metal chassis panel and every part needed to build a powerful one-tube receiver, AMAZING VALUE! Works for months on two inexpensive dry batteries. Our clear diagrams make it simple to hook up. Not a feeble crystal set!

TWO TUBE KIT (More volume)—\$2.00.
ALL-ELECTRIC two tube house current set. No batteries! Complete kit \$3.00.
 (Sets laboratory assembled and wired 75c extra.)
 Enjoy NEW thrills! Send for your ACE Radio today!
 Ace Radio Laboratories, 70 Barclay St., Dept. P-4, N.Y.C.

Learn BRASS TAPPING FUN and PROFIT!

Get this big new outfit. Learn "raised metal" work. Sell gift and art wares.

COMPLETE OUTFIT \$2.00

Make Bookends, What-Not Backs, Twin Plaques. Equipment includes non-tarnishable jewelers' metals, handcraft hammer, plywood backing-board, noiseless tapping tools, special nails and design patterns. Send \$2.00 money order for outfit complete. State choice Brass or Copper, ("Silver" or "Gold" \$2.50.) FREE CATALOG with outfit or send 3c stamps. Write today.
 RAPAPORT BROS., 701 W. Ohio St., Chicago



OWN A GENUINE ZIRCON

Positively the nearest stone to a diamond!

Gem of Mystery—the rare genuine White Zircon (mined—not synthetic) is equal in fire, brilliancy, and sparkle to the finest diamond, yet costs but a fraction. Many experts cannot distinguish

between the two. Thrill at owning a genuine White Zircon when your friends and jewelry experts believe you possess a valuable diamond. Send name and address for FREE revealing information and price list—no obligations. Courtesy to dealers & agents. SECURITY JEWELRY COMPANY, 742 South Hill Street Over 30 years in Diamond business. LOS ANGELES, CALIF.



THIS WONDERFUL INVENTION



converts any ordinary cook stove into a modern gas range. BLUE BLAZE GAS is made from kerosene and air. Cheaper, cleaner and more efficient than coal. Responsible distributors wanted.

HEAT APPLIANCE COMPANY, 1617 Walnut St., Chicago, Ill.

When writing please mention Popular Mechanics



START BIG PAYING BUSINESS "Simplified" 40 VOLT ARC WELDING

New low prices on modern 40 Volt "Simplified" Arc Welders make this big pay business available to shops that never before could afford it. It opens the doors to the bigger profit jobs. The new Hobart is easier to operate, much faster. This is today's opportunity. Don't miss it.

Build Your Own

Portable Welder with Hobart Generator unit and auto engine or chassis. Lets you operate any place, especially on the profitable outside jobs. Easily saves you \$300 to \$500.

Portable Electric

New low cost on small sizes as well as large. The most profitable arc welder your shop can own. Welds faster, better, easier, saves current.

Easy to Operate

Hobart Welders have "Simplified" operation. This means faster welding—with the right current for every job. Hobart is simplified, so any of your men can weld easily and successfully. The mystery and uncertainty of obtaining correct welding current settings are removed.

60% Extra Capacity

Over old style 25 Volt Welders—necessary for welding with the new coated rods. Automatic reactance lets you handle light welding work without losing the arc. Users don't understand how they got along with the old style welders after using this new Hobart.

Remote Control

at no extra cost with Hobart. Think of being able to control your welder from any working point. Saves time, temper, and eliminates the need for a helper on overhead or concealed work.

"Pays-For-Itself" Terms

Extra earnings and savings make it easy for you to own a Hobart without expense to you. You can even rent a new Hobart—and later purchase it without loss of rent. Check Rental Purchase Plan.

GET THIS VALUABLE MANUAL

Send Free if you will tell us the welding you plan doing.

Earns \$150 to \$300 Extra Profit Monthly Pays for itself

WITHOUT COST TO YOU
 Hobart pays its own way out of profits in a short time, without a cent of cost to you. The Hobart payment plan is the most liberal offer ever made.



30 DAYS TRIAL at Our Risk

to Prove it Pays

Mail Coupon for further Details

HOBART BROS., Box M-47, Troy, Ohio

- Tell me more about—
 Building My Own Portable () Complete Gas Engine Drive Welder () 30 Days' Trial—Easy Terms
 Electric Drive Welder () 30 Days' Trial—Easy Terms
 Rental Plan Privilege of Purchase.
 Send FREE Manual on Welding. Attached letter tells about the work we want to do.

Name.....
 Address.....
 Interested in 30 DAYS' TRIAL EASY TERMS



HOBART ONE OF THE WORLD'S LARGEST BUILDERS OF ARC WELDERS



Balance as above with 1-50; 1-20; 2-10; 1-5 and 2-2 gram weights base 6 3/4" x 3 3/4" - \$4.75. Catalog with 3000 illustrations of laboratory apparatus sent for 50c. Catalog listing 10,000 chemicals, drugs, flavors, etc. and 1700 scientific books sent for 25c; Wholesale Price List 1000 Ill. 10c.

Laboratory Materials Company, 639 E. 71st St., Chicago, Ill.

Saw-Filing

Pays Up to \$2 or \$3 an Hour in Spare Time—No Experience

A FOLEY Automatic Saw Filer files hand, circular and band saws better than the best hand strain. Cash business, no canvassing, no eye-strain. Louis W. Wadwick, Ohio, says, "I have filed 764 saws in spare time and have earned \$850.00 in carpenter work due directly to my saw filing contract." Send postcard for FREE PLAN, no obligation.



FOLEY MFG. CO., 416-7 Foley Bldg.

11 Main St. N.E., Minneapolis, Minn.

*This Much More
Exclusively
in a*

SHELVADOR

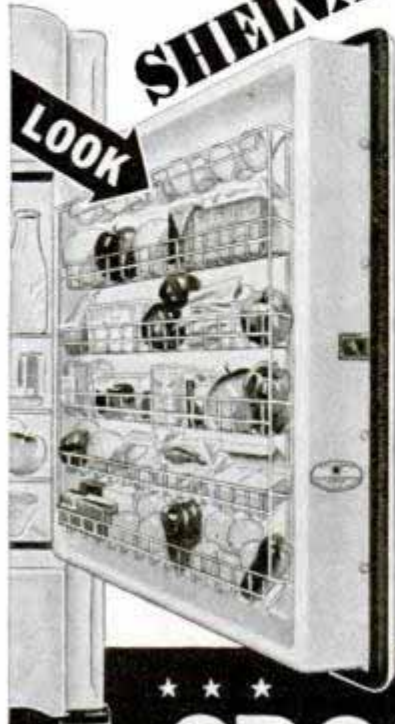

★
★
★

**MORE BEAUTY
ECONOMY
CONVENIENCE
USABLE SPACE
ACCESSIBILITY**

★ ★ ★ EXCLUSIVELY IN
CROSLEY
ELECTRIC REFRIGERATORS

es 1 3 3
(Continued from page 164A)

The Muskingum river flood control plan provides centralized control in one office which can communicate with the various dams, ordering that water be stored or released, according to conditions over the entire drainage basin. The idea is to plan so that neither the capacity of a stream channel nor the storage capacity of any reservoir is exceeded, keeping all river channels filled and storing excess water in the reservoirs as long as possible.

Building such a control system is both costly and slow, almost as slow as reforestation. So, for the immediate future, endurance or avoidance of floods may be the only practicable remedies. Keeping costly economic works away from floods seems only elementary discretion. Much business in flood areas today is organized for a quick getaway when the river comes knocking at the door, and that is another temporary solution. In the meantime, plant trees and grass. They will help.

Our Bureau of Information will answer questions regarding articles in this magazine, if accompanied by return postage.

HEY GANG!
DON'T MISS THIS!
Learn the Newest
Dance Steps from
ARTHUR MURRAY
-The World's Greatest
Dancing Instructor-
FREE!



*Start Now
yourself a*



**4 WEEKS
LATER**
BUD
SENDS
FILLED-IN
DANCE
CARD
FOR
BOOK



White Disks on Horse's Legs
Serve as "Taillights"



Write about

farmer. Kent England

Taking no chances with traffic, a draft horse in England wears "taillights" on his legs. The farmer straps white disks on the animal's hind legs to serve as reflectors for any automobile headlights coming up from the rear.

new EVINRUDE
"Scout"
15 POUNDS \$44

F. O. B. Milwaukee

Here is the lightest, handiest slickest little motor that any fisherman, cottager, vacationist ever dreamed about . . . and, complete, ready to go, it costs only \$44! Drives good sized boats up to 5½ miles an hour! Uses only a single quart of fuel in 1½ hours . . . 100 miles of carefree water motoring for less than 60 cents! Write today for catalog on the 15 lb. Scout and brilliant new Evinrude Streamflow models for 1937. Address, EVINRUDE MOTORS, 5136 N. 27th St., Milwaukee, Wisconsin.

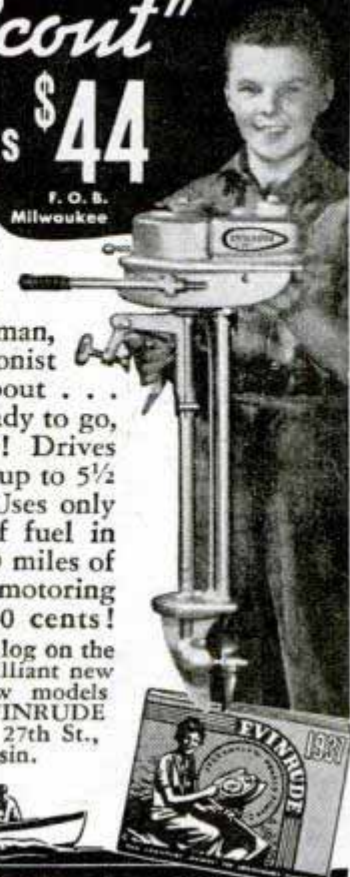

EVINRUDE SEND FOR CATALOG

to Clear up your Skin! Make Good Dancer! WIN POPULARITY!

THEN
BUD
GETS
A
TIP
➔



ASK YOUR GROCER FOR THIS FREE FLEISCHMANN DANCE CARD

Don't miss this CHANCE to get your ARTHUR MURRAY Dance Book. Learn the new steps. Make yourself the best dancer in your crowd! Pictures . . . diagrams make every step easy.

This book is NOT FOR SALE. The ONLY WAY to get it is with Fleischmann Yeast Labels! Paste these on the Fleischmann Dance Card your grocer will give you. Send it in—the dance book is yours!

If there are no Dance Cards at your grocer's, you can still get the book by pasting the 81 yeast labels on a sheet of paper, or putting in an envelope, and mailing with your name and address to Fleischmann's Yeast, 701 Washington St., New York City. (This offer holds good until August 31, 1937.)

(Details of securing Dance Book differ slightly in states West of Denver and in Canada, see newspapers or ask your local grocer.)



"Stick to it—and Fleischmann's Yeast will help to clear up Adolescent Pimples," says Dr. R. E. Lee, well-known physician

● After the start of adolescence important glands develop. The entire body is disturbed. The skin gets oversensitive. Waste poisons in the blood irritate this sensitive skin—pimples break out! Fleischmann's Yeast helps correct pimples by clearing these skin irritants out of the blood. Eat 3 cakes every day—a cake about ½ hour before meals—plain, or in a little water.

New 9" x 3'
**Genuine SOUTH BEND
 WORKSHOP LATHE**

on
**NEW LOW
 TERMS**

Lathe may be
 operated from any
 ordinary lamp
 socket

\$85⁰⁰
 Less Motor Drive
 —
 Terms as Low as
\$6⁰⁰
 A Month

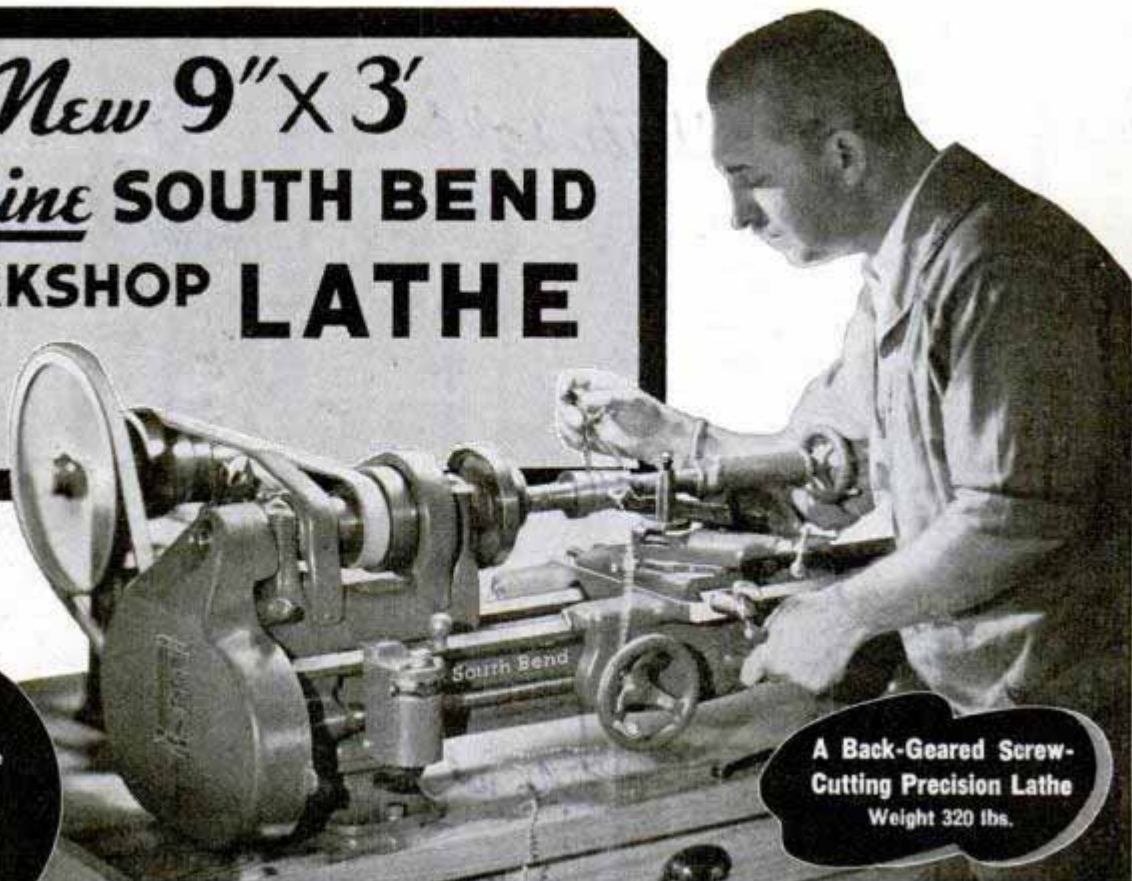

**A Back-Geared Screw-
 Cutting Precision Lathe**
 Weight 320 lbs.

No. 415-YA 9 1/4" swing by 3' bed Workshop Bench Lathe with Horizontal Motor Drive, 1/4 h.p. Reversing Motor, Switch and belt tension countershaft as shown above. **\$116⁰⁰**
 (\$15.00 Down, \$6.00 a month for 18 months)

THE new 1937 model 9-inch Workshop Precision Lathe is a back-geared Screw Cutting Lathe and is recommended for the finest, most accurate jobs in manufacturing—in the tool room, in home workshops and automotive machine shops. Workmanship and materials used are exactly the same as used in more expensive models of larger size, making it represent the greatest value we have ever offered in 31 years of fine lathe building.

Features include Twin Gear Reverse to lead screw, Ball Thrust Bearing on Spindle, Longitudinal Screw Feed to Carriage, Precision Lead Screw for Cutting screw threads—and scores of other important features. Takes 38 practical attachments for milling, grinding, draw-in collet chuck work, and many other manufacturing jobs.

South Bend Lathe Works

616 E. Madison St., South Bend, Ind., U.S.A.

**5 OTHER SIZES: 9", 11", 13",
 15" and 16" SWING IN ALL BED
 LENGTHS**
PRICED \$97 to \$1200
 Lathe shown below is No. 117-C 16" x 6' Quick Change Gear Underneath Belt Motor Driven Lathe with 1 h.p. motor. Complete as shown. **\$869**
 Weight 2300 lbs.
 (\$87.00 Down, \$38.50 Monthly for 22 Months)



Write FOR NEW CATALOG 15-K

New catalog illustrates and describes in detail this new Workshop Lathe in 8 different drives, 4 bed lengths. Shows the 38 attachments for use with this lathe. A valuable book for all interested in metal working lathes. This catalog sent free, postpaid. Use the coupon shown below.

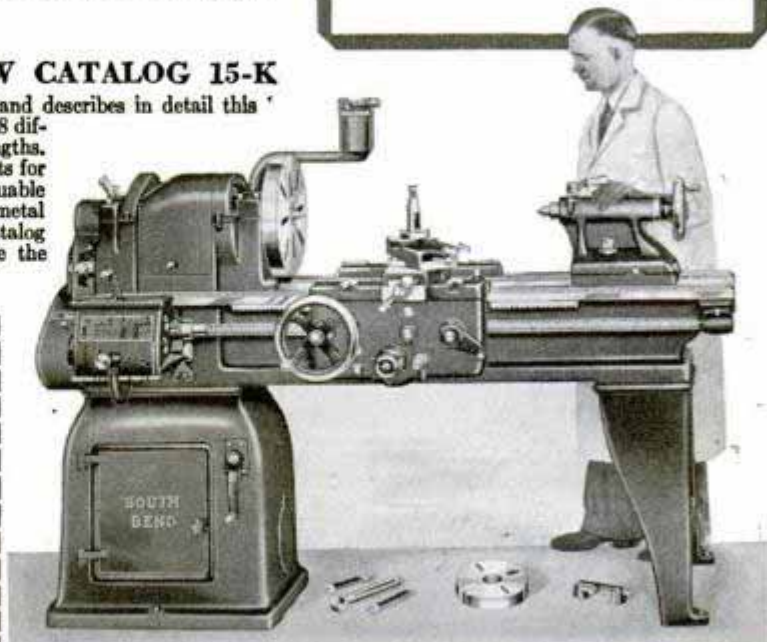

South Bend Lathe Works,
 616 E. Madison St.,
 South Bend, Ind., U.S.A.
 Please send me your new 1937 Catalog 15-K.
 Size of lathe interested in.....
 Class of work.....
 Name.....
 Address.....
 City..... State.....

SOUTH BEND Precision LATHES

New York to Los Angeles...and BUST!

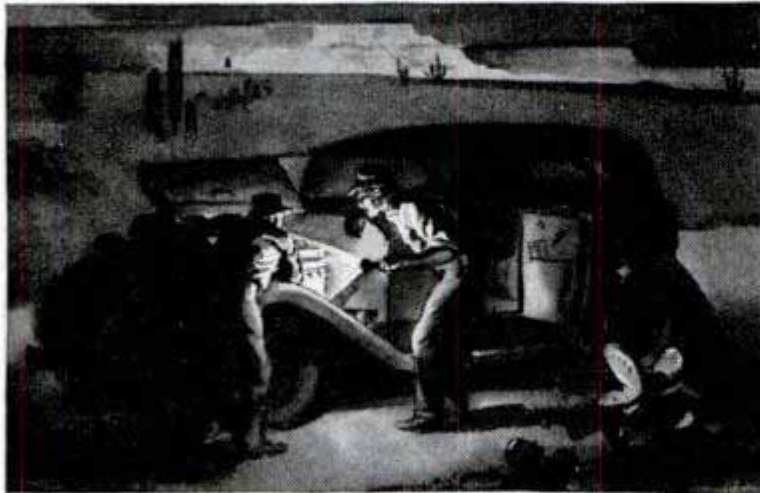

Battery Goes Dead in Desert!
But Long Island Boy
Drives On Without It

"We had just hit the desert country when the generator gave out...and then, surrounded by empty miles of sand and sagebrush and cactus, the battery went dead and the motor died," writes Ben Feinstein of Blue Point, Long Island.

"There we were, no one to help us, and night coming. My partner got out the flashlights in case we might need them, and I had a wild idea.

"I took the five cells out of my long-range 'Eveready' flashlight, taped them together in series, held a wire from the ignition switch firmly against the positive pole of the top cell, grounded the bottom cell on the emergency brake handle. My companion cranked the motor and she caught ...and those five DATED 'Eveready' batteries



took us over thirty miles of desert that night.*

"Believe me, I know now what it means to be able to buy batteries when they are still fresh—not stale and dried out from standing on a dealer's shelf. And here's telling everybody that 'Eveready' batteries last longer than others.

(Signed) *Ben Feinstein*

*For technical explanation, write us; or ask any engineer.

"EVEREADY" BATTERIES ARE FRESH BATTERIES

The **DATE-LINE** guarantees FRESHNESS

NATIONAL CARBON CO., INC., 30 East 42nd Street, New York, N. Y.

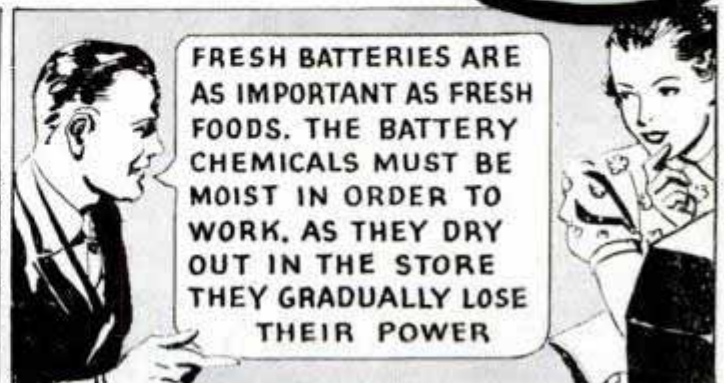



You need this throat protection too!

... That only a light smoke offers

The stars of radio have to protect their throats—naturally. But keep in mind that your throat is just as important to you...be sure you have a light smoke. You can be sure Luckies are a

light smoke because the exclusive process, "It's Toasted", expels certain natural impurities harsh to the delicate tissues of your throat. So follow the stars to a clear throat! Choose Luckies.



a light smoke

OF RICH, RIPE-BODIED TOBACCO—"IT'S TOASTED"