

CRIMES SOLVED BY SAWDUST

POPULAR MECHANICS



MAGAZINE

WRITE TO US AT THE BOTTOM OF THE PAGE TO GET THE ANSWERS TO YOUR QUESTIONS. WE'LL TRY TO UNDERSTAND IT.

REG'D. TRADE MARK. GREAT BRITAIN.

U.S. PAT. OFF.

MARCH
25 CENTS

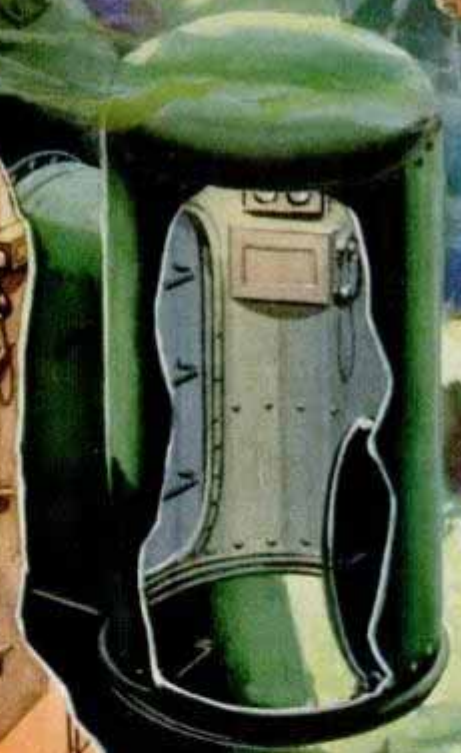

SEE PAGE 365

Atlas

METAL WORKING LATHES

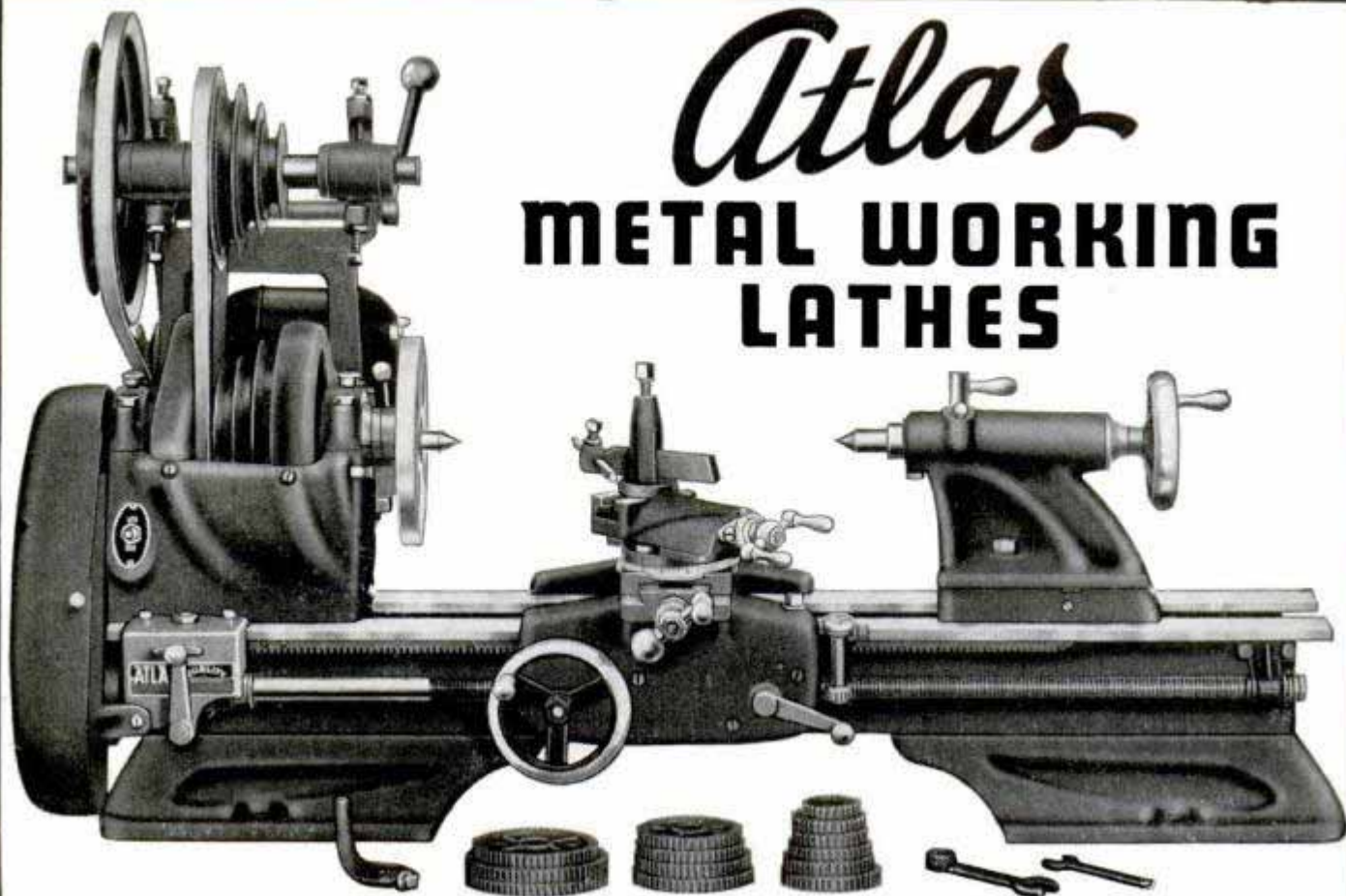

\$39.75
to
\$112.50

A complete line of metal cutting lathes. Back-gear model, illustrated, \$87.50 complete less motor. Sold in 4 bed lengths. Many exceptional features including built in countershaft and motor bracket, automatic, reversible power feeds, V-Belts, cuts 4 to 96 threads per inch. Attachments available for all lathe operations.

ATLAS
DRILL PRESSES
\$16.45 to \$42.45

Just Off the Press!

The new Atlas Manual of Lathe Operation is a complete, up-to-date textbook for the lathe operator. It comprises over 200 pages of authoritative facts and principles on the care and operation of modern back-gear and compound-drive screw-cutting lathes.

Each of the operations which make the lathe the "King of All Tools" is illustrated and described in detail. The Atlas Manual also includes instructions for machining various types of metals and composition materials, grinding tools, proper cutting speeds, tables and charts, etc.—all logically arranged and accurately indexed for quick reference. Operators say that its completeness of detail makes it the most valuable book of its kind ever written. Sent postpaid, \$1.00 per copy. Get yours today—use coupon below.

NEW CATALOG FREE

Send for your copy of the new 1937 Atlas catalog. It describes and illustrates the latest in lathes, drill presses, arbor presses, tools and other shop equipment at popular prices. Write today.

DISPLAYS AT

Chicago—35 E. Wacker Dr.
New York—130 W. 42nd St.
Philadelphia—113 N. 3rd St.



4 sizes and prices to choose from, latest construction features—6 splined spindle, balanced pulleys, ball bearing heads, full tilting tables. See all details in new catalog.



- Send the new 1937 Atlas Catalog FREE.
- Enclosed find \$1.00 for which send me the new book, "Manual of Lathe Operation" postpaid.

Name.....

Address.....

City..... State.....

ATLAS PRESS COMPANY
343 No. Pitcher St., Kalamazoo, Michigan

NOISE STOPPED NEW CAR SOUND-PROOFED LIKE A BROADCASTING STUDIO



Five Kinds of Scientific Insulation Protect Your Ears

NOISE WEARS NERVES. Stopping noise increases motoring safety. That's why the remarkable sound-proofing of new Plymouth cars is one of the year's big automobile developments.

The engineers tracked down noise to its source, analyzed it, developed new ways to stifle it. Five materials are used. Road rumble, drumming and noise are now scientifically shut out or absorbed!

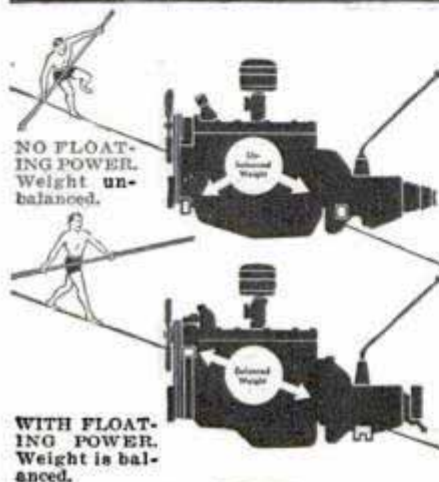

RESTFUL "Hushed Ride"...bumps and vibration killed by airplane-type shock-absorbers and new, live rubber cushions between frame and body.

FLOATING POWER mountings (lower left diagram) keep engine perfectly balanced... dissipate vibration.



"BALD HEADS" (above) —formerly these round, rear corners reflected sound like a band shell. Now these noise-spreading spots have been scientifically silenced.

"SOUND MOVIES"... using cathode rays and a special movie camera, engineers took pictures of noise...enabling them to measure its exact pitch and frequency, and learn the efficiency of their new insulation.

(Below) The new DeLuxe 4-Door Touring Sedan.

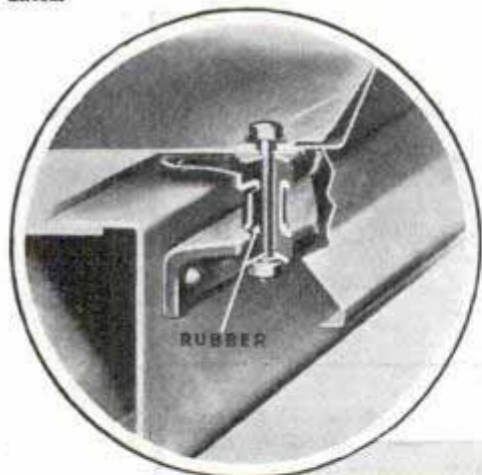
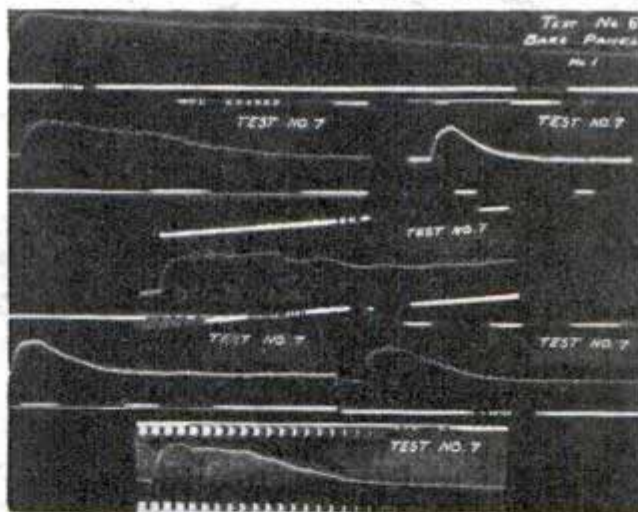

LIVE RUBBER mountings (above) between body and frame cushion the car from road shocks and vibration... add greatly to riding comfort.

EASY TO BUY

You'll find this beautiful 1937 Plymouth is priced right down with the lowest and the Commercial Credit Company offers low terms through DeSoto, Chrysler and Dodge dealers. Plymouth Division of Chrysler Corp.

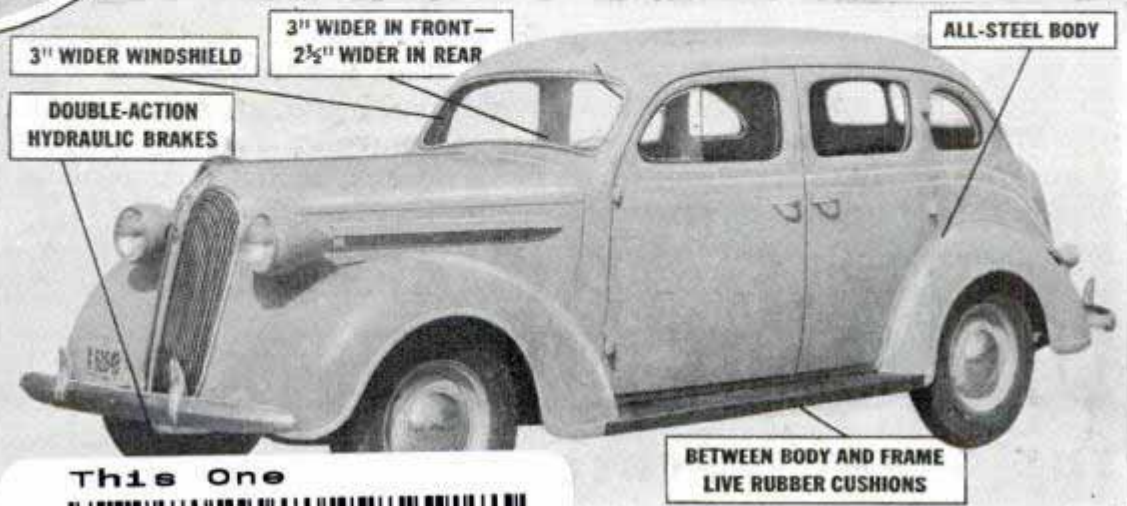

This One



7575 WAE 0008

"How I Subdued a Vicious Pipe" by SVEN GALI Famous Hypnotist

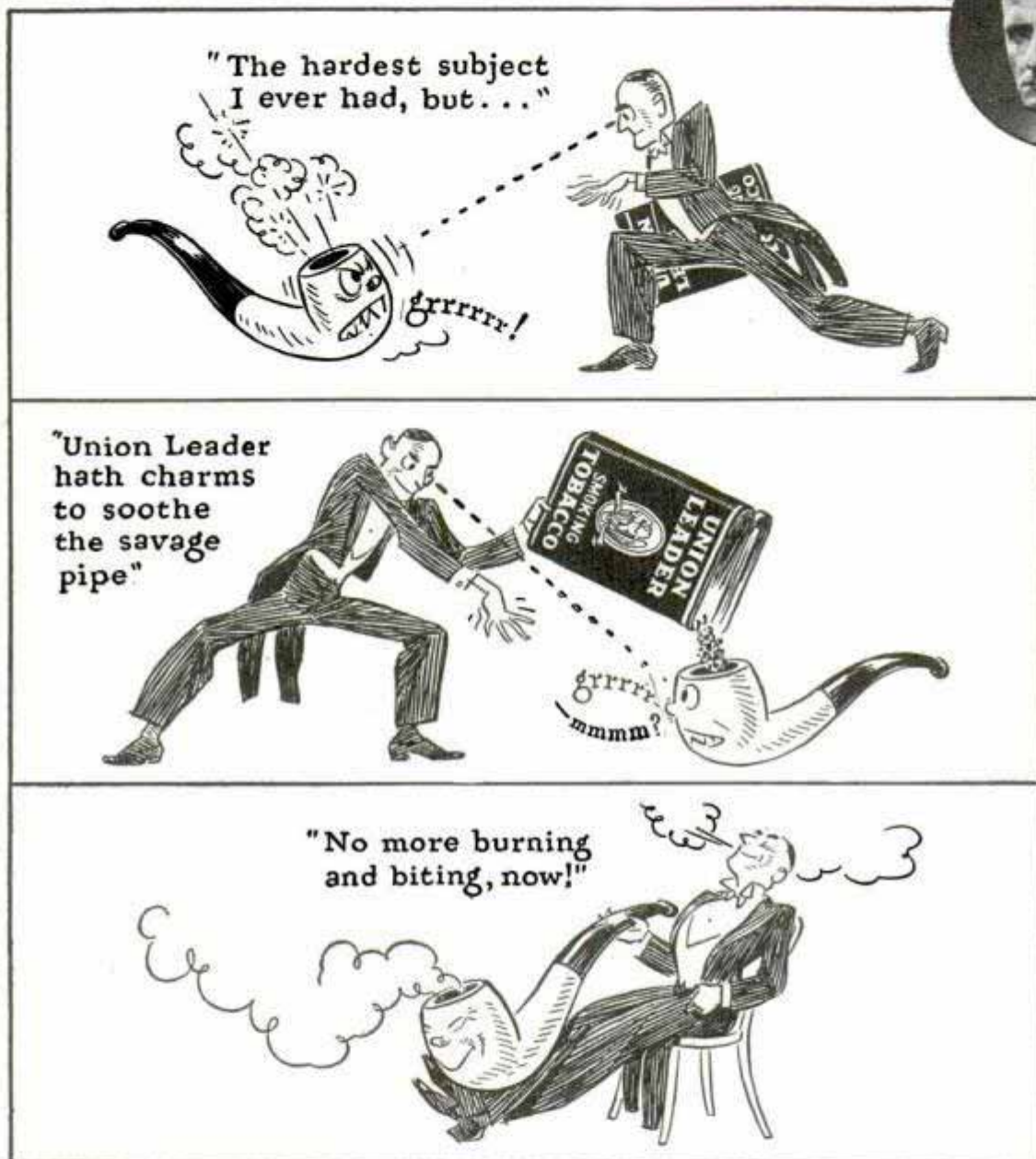

You too, can Pacify Pipes this easy way!

Just look the nearest tobacconist in the eye . . . place ten cents on the counter, and say firmly—"Union Leader." This qualifies you at once as a Master Pipe-Hypnotist, who knows the secret of "pipe-pleasure without punishment." Specially selected *ripe leaves* of Kentucky Burley, richly flavored by Nature, are expertly cured and *aged-in-wood* to give Union Leader full flavor and fragrance, without bite and burn. (Try it for a new cigarette thrill, too!)

UNION LEADER

THE GREAT AMERICAN SMOKE

When writing to advertisers please mention Popular Mechanics

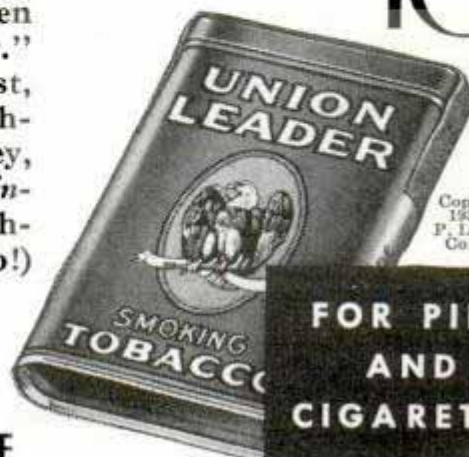

Copyright,
1937, by
P. Lorillard
Co., Inc.

FOR PIPE
AND
CIGARETTE

10¢

Popular Mechanics Magazine

H. H. WINDSOR, Founder

H. H. WINDSOR, Jr., Editor and Publisher

March, 1937

Vol. 67, No. 3

Special Features

<u>Smashing Atoms</u>	<u>321</u>
<u>Around the World by Air</u>	<u>Coloroto</u>
<u>Scrambled Voices around the World</u>	<u>340</u>
<u>The Thrill Hunters</u>	<u>348</u>
<u>Snow Fighters Clear the Way</u>	<u>354</u>
<u>Wood Detective Solves Mysteries</u>	<u>360</u>
<u>Harnessing Radio's "Baby Waves"</u>	<u>370</u>
<u>Dating Up the American Desert</u>	<u>378</u>
<u>The Latest in the Movies</u>	<u>386</u>
<u>Mighty Midgets of the Speedways</u>	<u>394</u>
<u>Air Liners to the Rescue</u>	<u>404</u>
<u>Fishing Through the Ice</u>	<u>412</u>

(Continued on next page)

"Let There Be Light—"

SIXTY years ago a young inventor began seeking a method of "bottling up" electricity to provide illumination. People ridiculed the idea. For two years he patiently tried one process after another. None worked. At last he looped a carbon strand inside a glass bulb from which the air had been pumped. Then he turned on the "juice." And there was light, light in a vacuum, light where everyone said no light could be! The modern electric lamp is many times as efficient as that first lamp of Thomas A. Edison's, but even modern lamps convert only a small amount of current into light. There is still room for more improvement and lamps are being improved each year. Watch next month for the first of two articles on modern lighting. You'll find the story illustrated with eight pages of Coloroto pictures.

Next Month

HOW good a driver are you? How do women compare with men in driving ability? Which would be likely to handle a car best, a youth of twenty-five with five years of experience or a man of sixty-five with forty years of driving? You'll find the answers next month in an article describing the work of the Bureau for Street Traffic Research of Harvard University which has tested the driving reactions of more than 70,000 persons.

Camera Detectives

WHEN things go wrong in industry today, the boss calls for a movie camera. And the camera, peering through microscopes and even looking through solid walls, makes visible things the eye cannot see and frequently locates the trouble. Movie cameras have even photographed what goes on inside an automobile engine. Watch for "Movies That Show the Invisible," in the April issue.

Aerial Daredevils

SPECTATORS at a recent air show saw two planes lock wings and waited breathlessly for the crash. There was none. In a few seconds one ship pulled away from the other. It was all a stunt of a couple of aerial acrobats. An article next month tells you how this trick and many others are performed safely.

DIVIDENDS NEXT SUMMER



FROM PYROIL PROTECTION NOW

At times like this your automobile investment suffers great risk. For sudden cold puts a task upon your engine that may ruin vital parts.

Pyroil lends important aid to motors that struggle all winter through varying degrees of cold. It is a constant safeguard. In starting, it protects frictionized areas until cold lubricants circulate. Pyroil's tenacious oriented film takes the shock load, saves the metal from undue harm.

Pyroil lessens drain on the battery, too. A Pyroil-treated engine is easier to start, easier to run.

Pyroil's cost is small; yet the dividends it pays you in better operation, longer life, are mighty large.

Ask your service station attendant. Also, mail coupon. Manufactured and Guaranteed by Pyroil Company, 53 Pyroil Bldg., La Crosse, Wis., U.S.A.

PYROIL HAS BEEN TESTED BY POPULAR MECHANICS AND IS USED BY POPULAR MECHANICS' PRESSES AND EQUIPMENT.

DISTRIBUTORS:

NEW PYROIL PREMIUM PLAN NOW IN EFFECT GIVES NATIONALLY ADVERTISED MERCHANDISE OF HIGH VALUE ABSOLUTELY FREE. CHECK COUPON FOR FULL DETAILS, AND FACTS OF BUSINESS OPPORTUNITY.



Genuine Pyroil bears this signature on every can

W. H. Harrison
Founder

**SIMPLY
ADD TO
GAS & OIL**

**PYROIL COMPANY,
53 Pyroil Bldg., LaCrosse, Wis., U. S. A.**

- Please send Free facts on Pyroil's money saving features.
- Send details of Premium Plan and Business Opportunity for me.

Name.....

Address.....

City..... County..... State.....

(Contents—Continued)

AUTOMOTIVE

Trailer carries bottled gas in outside tanks347
 Rubber paint protects underside of auto fenders.....352
 Secret electric time alarm stops truck hijackers.....358
 Electric brakes for trailers366
 Exhaust heater warms auto quickly.....369
 Noiseless street-car has dead-man control374
 Auto headlight reflector polish377
 Illuminated map shows routes for tourists382
 "Block signal" operated by auto384
 Steel in 1937 car weighs more385
 Rubber-tired trailer wheel fits parking leg.....398
 Repair truck travels on road or rails402
 Rubber drip molding for car124A

AVIATION

Flying ability shown by reaction timer338
 Fire engine hurls snow on blazing plane339
 Plane increases speed by folding wings366
 Bird-proof windshield for airplanes is sought.....374
 Stands for servicing big air liner381
 Kite attracts flyers to wrecked plane393
 Plane takes wing loading test lying down399
 Passenger cabins in wings of clipper402
 Four-motored plane to cross America overnight....410
 Sound movie shown in passenger plane118A

CONSTRUCTION

"Yardstick on wheels" takes lineal measures344
 Wood veneered wallboard aids builders375
 Floral conservatory is glass skyscraper385
 Welded steel rods form framework of church.....410

FARMS AND GARDENS

Paper "overcoats" for plants put on by machine...339
 Cotton picker twice as fast as human worker.....377
 Gasoline explosion pumps liquid manure into tank..411

HOUSEHOLD

Hat rack for top shelves375
 Glass screen for fireplace383
 Glass shelf to hang on window398
 Matches light when pulled from tray409
 Clothes drier for home410
 Repair cement sets quickly416
 Baby's bottle holder as teething ring116A

RADIO AND ELECTRICITY

Mirror on pole helps lineman inspect insulators....338
 Television pipe carries 240 phone calls at once....344
 Electric outlets in handy stand give safety366
 Short-wave radiophone speeds work on observatory.400
 Thirty-seven-tube receiver for large homes417
 Little giant portable a.c.-d.c. receiver418
 Phono-radio oscillator420
 Easy solutions for everyday radio problems421
 Austrian receiver has built-in timing unit422
 Rotary station log and time compensator422
 Three-band superheterodyne receiver in end table..422
 Two-way speaker for side-wall installation422
 Spare filament doubles life of light bulb.....131A

RAILROADS

Scenic car with roll-back top352
 Lightweight sleeping car built like skyscraper....353
 Billions saved on railroads by mechanical progress.368
 Rail grinder rides on track384

SCIENCE AND INDUSTRY

Sand "dry cleaned" to recover precious metals....346
 Water squeezed into solid in laboratory346
 Deaf taught to hear vibrations through body.....399
 Million-pound pull of jack snaps rope403

SHIPS

Tractor helps launch coast-guard boat.....347
 Streamline tank ship without keel or ribs392
 Model of cup-race yacht given speed test398
 Ship's propeller worn away by water144A

SPORTS

Rifled single-ball shotgun shell increases accuracy.344
 Ski jump at indoor winter carnival345
 Streamline golf club head352
 Ski slide built for indoor use359
 Ice thrones lighted by concealed bulbs363

(Continued to page 6A)



SEALED POWER PISTON RINGS

Best in New Cars! Best in Old Cars!

MILLIONS of America's great new cars this year—as well as for 25 years past—are equipped with Sealed Power Piston Rings. Buick, Cord, Hudson, Nash LaFayette, Oldsmobile, Pontiac, Terraplane, Willys, and others are in this imposing group.

But new car owners are not the only ones to enjoy the advantages of Sealed Power Rings. Sealed Power engineers have invented a revolutionary ring for use when cylinder walls have been worn out-of-round by hard service. These rings have proved their merit by millions of miles of service in hundreds of thousands of cars.

Actually, Sealed Power Rings are the talk of the motoring world. Springs of the finest imported alloy steel hold these thin, flexible rings against the cylinder walls—creating a perfect seal against blow-by, saving gas, restoring new car performance, paying for themselves over and over by stopping the "between meal" oil hunger of your car.

Ask a Sealed Power ace mechanic to go over your engine. Perhaps you need a complete reconditioning with the marvelous Sealed Power Lo-Ex pistons. Perhaps new bearings, or valve guides are required to get 100% oil economy. A Sealed Power ace mechanic will tell you what your car needs. Have faith in him. He'll justify it.

Meanwhile, drop us a postal for a valuable, money-saving booklet, "New Low Cost Way to Save Oil and Gas and Increase Pep."

SEALED POWER CORPORATION
Dept. 273 Muskegon, Michigan

Canadian Factory at Walkerville, Ont.
Manufacturers of Piston Rings, Pistons, Piston Expanders, Piston Pins, Valves and Cylinder Sleeves

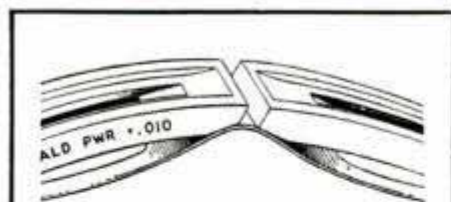

The Famous MONITOR NOTCH

Here is a big feature available *only* in Sealed Power Piston Rings. The "Monitor Notch" absolutely prevents inner ring from slipping, guarantees uniform performance, prevents gap end flutter and consequent loss of power. Just a *little* thing—but it makes a **BIG** difference in ring performance.

When writing to advertisers please mention Popular Mechanics



You Get "Million Dollar" Shaves

when you use the blade that is made for your razor

GILLETTE has spent millions of dollars to make the Gillette Blade and Gillette Razor the world's most perfectly matched shaving combination. *They are made for each other.* Both were designed as a unit by the same engineers. Every step in their manufacture is directed to making them function perfectly together. That is why you get cleaner, smoother shaves every time you use a Gillette Blade in your Gillette Razor. Prove this to your own satisfaction. Buy a package of Gillette Blades today and enjoy the thrill of "teamwork shaving."

Reputable merchants never offer substitutes for Gillette Blades. Always ask for them by name.

Tune in Gillette's "Original Community Sing" with Milton Berle and other stars Sundays 10 P.M., E.S.T., C B S Network, Coast to Coast.

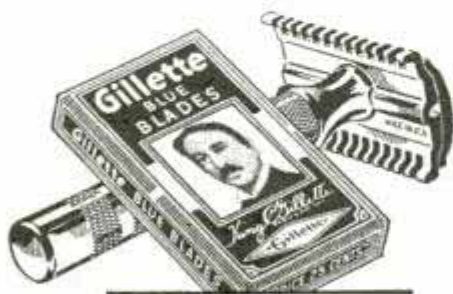

Gillette Blades

Precision-made for the Gillette Razor

(Contents—Continued)

Lights flash when basketball score is made	364
White decoy rabbits for dog races	375
Thirteen-hundred-mile bicycle tour for \$22	376

TOOLS

Metal snip cuts squares and circles	363
Shop vise with swivel jaws	390
Spray gun adapter fits on paint can	391

MISCELLANEOUS

House paint in rolls applied like wallpaper	337
Machines create more jobs than they destroy	338
Special truck carries fire hose	345
Pipe lines rank second in cargo carried	347
Foot guard made of aluminum	359
Twin microphones in stethoscope aid diagnosis	359
Barrel rack made of iron pipe	364
Oil-well output increased	364
Deep-sea "home" for divers	365
Old square riggers help train Italy's sailors	367
Motor driven by contraction of rubber	368
"Siamese twin" guitar has double neck	368
Wonders of Boulder dam draw sightseers	373
Sound record for newspaper supplement	376
Folding violin fits in pocket	377
Film expert searches history for movies	382
Cattle ranch goes modern with mechanical aids	383
Canary's broken leg mended with splints	384
Measuring the horsepower of an athlete	390
Giant "monsters" for parades built like balloons	391
Milking rattlesnakes for their venom	392
Air-cooled coaster brake latest for bicycle	393
Trolley car is schoolhouse for railway men	393
Snow loader scoops up autumn leaves	400
Time clock operates school traffic signal	400
One-inch newspaper printed in miniature plant	401
Fruit kept fresh by air-gas control	403
Photographs solve "dark lightning" mystery	409
Lights of giant bridge create night spectacle	411
Magnifying glass and flashlight	416
Toy train on suspension track attains speed	416

Craftsman and Shop Notes

AUTOMOTIVE

Handy hints for the motorist	477
Installing Ford distributor points quickly	478
Removable step for high truck bodies	478
Silencing noisy overhead valves	478
Windows in garage doors aid night attendant	478
Extra mirror in squad car aids police	479
Removable package rail for coupe seat	479
Rolling shelf for greasing pit	479
Removing auto hood easily	480

DRAWING

Ellipse drawn with aid of cord	426
Homemade drawing pen	432
Finding center of circle without compass	449
Angle attachment for your T-square	453
Ruler has combination handle and scale marker	476

ELECTRIC LIGHT

Test prod serves two purposes	426
Temporary mounting for electric lamp	450
Portable tester for electrical trouble shooting	465

FARM

Fencing wire stretched with auto jack	427
Success with seeds and seedlings	434
Non-slip post anchor is inexpensive	450
Pickling jar cover held by barrel stave	456
Wheelbarrow has hole in floor for milk cans	464
Catching mice in poultry house	472

FURNITURE

Colonial corner cupboard	428
In-a-cabinet bed	431
Repairing torn upholstered cushions	455
Footstool has three-way column of dowels	457

HAND TOOLS

Changing hack-saw blades	426
Screwdriver ground to prevent slipping	426

(Continued to page 8A)



Plan Your Future

Choose Your Field NOW For Success

Will you master fate or will fate master you? That's a question deserving your honest answer . . . right now! Actually it is all up to you. You can do with Life almost what you will. LaSalle will help you establish yourself for real success by providing you with the comprehensive, specialized training for which it is so famous. Choose your field . . . now! Check the coupon below for the free booklet you want us to send you. It can be your first step toward assured success.

Opportunities in Traffic Management

The field of Traffic Management offers real opportunity only to the man who knows. Spare time study and the will to succeed have pushed scores of Traffic employees up the ladder to financial success. Many LaSalle-trained traffic managers—both in the railroad and industrial field—now command salaries of \$3,000.00 to \$5,000.00 a year—and better. Investigate. Find out how you can qualify for these higher positions through LaSalle home-study and guidance.

Law for Business Success

And it isn't necessary to practice law to get this Success. In fact probably most of the men who study law today have no idea of taking the bar examination or becoming lawyers—they want law training to give them mastery of men and situations in business. You know that—

- (1) the man with legal training is a leader—not a follower.
- (2) legal training keeps your mind—clears away the problems that stump the ordinary fellow and makes you master instead of man.
- (3) knowledge of law simplifies the complications of executive work.
- (4) Many top executive places are filled by men who have studied law.

No matter whether you are in a big corporation or a small business—in a great city or a little town—a practical knowledge of law cannot fail to be of real and vital help to you in making a more successful career.

In every state in the union you'll find law-trained men who came up through LaSalle. What others have done, you can do.

And LaSalle offers either a full law course leading to LL. B. or a shorter business law training—whichever you prefer. All text material, including valuable 14-volume Law Library. Training comprises the most effective features of modern law instruction.

Executive Training

Executives who are efficient managers command responsible positions and good incomes. And the need for

trained executives is growing rapidly. We train you thoroughly at home in your spare time for every type of executive work—teach you the principles and practices used by our most successful business leaders and help you develop your management capacity—by a training built with the aid of outstanding executives.

Become an Expert Accountant The Profession That Pays

The demand for skilled accountants—men who really know their business—is increasing rapidly. New state and federal legislation requires much more, and more efficient accounting from business—big and small. Corporations are in constant need of expert counsel in matters relating to Auditing, Cost Accounting, Business Law, Organization, Management, Finance. Men who prove their qualifications in this important branch of business are rapidly promoted to responsible executive positions—given an opportunity to earn real salaries. The range is from \$3,000.00 to \$15,000.00 a year—even to higher income figures.

Under the LaSalle Problem Method you can at home acquire a thoro understanding of Higher Accountancy, master its fundamental principles, become expert in the practical application of these principles—this without losing an hour of work or a dollar of pay.

Your training will be under the direct supervision of a staff of legal, organization and management specialists, business efficiency engineers and Certified Public Accountants.

Preliminary knowledge of bookkeeping is unnecessary. We train you from the ground up, or from where you now are, according to your individual needs.

Mr. Salesman: What's Wrong?

Why aren't you making more sales—more money? Is it you—or your proposition? Check up first on yourself. Other men—no better than you—have found their earnings jump and stay up when they trained with LaSalle. Literally thousands of men—many of them years at the game—have increased their sales volume and earnings through home study with LaSalle guidance. Sound—practical—usable—right from field experience. Train for top-notch production with LaSalle.

LASALLE EXTENSION UNIVERSITY, Dept. 364-R, Chicago

I would like to have your special booklet—without any cost or obligation to me—about my opportunities and your success training in the business field I have checked.

- | | | |
|---|--|--|
| <input type="checkbox"/> Higher Accountancy | <input type="checkbox"/> Commercial Law | <input type="checkbox"/> Business English |
| <input type="checkbox"/> Law: Degree of LL.B. | <input type="checkbox"/> Expert Bookkeeping | <input type="checkbox"/> Business Correspondence |
| <input type="checkbox"/> Traffic Management | <input type="checkbox"/> C. P. A. Coaching | <input type="checkbox"/> Effective Speaking |
| <input type="checkbox"/> Modern Salesmanship | <input type="checkbox"/> Industrial Management | <input type="checkbox"/> Stenotypy |
| <input type="checkbox"/> Business Management | <input type="checkbox"/> Modern Foremanship | |

Name _____ Age _____

Position _____ Address _____



DIRTY WORK AT THE CROSSROADS!

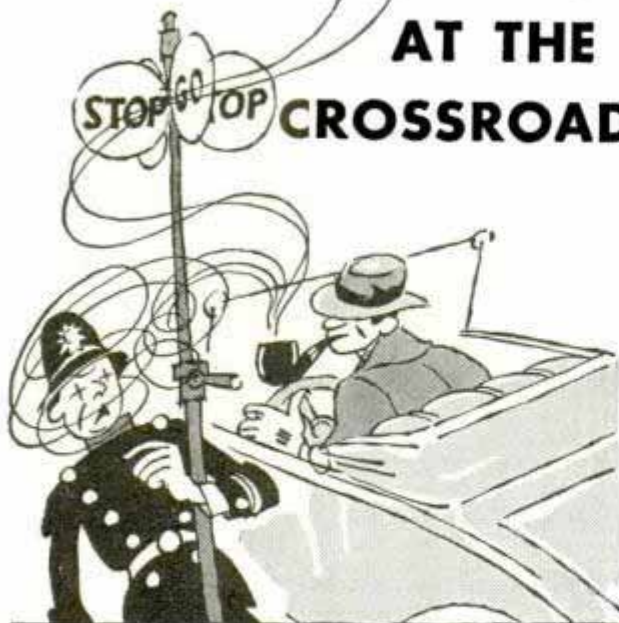

...then he switched to the
brand of grand aroma



A SOUPY PIPE plus strong tobacco will K.O. any copper. All motorists should use pipe cleaners regularly and smoke only a certain mild fragrant mixture. Like Sir Walter Raleigh? Uh-huh. Sir Walter is a grand combination of well-aged Kentucky Burley leaf that burns cool, slow, while giving off a delightful aroma. This easier-on-the-tongue brand has become a leader in a few short years because it really *has* the mildness that pipe lovers since Adam have patiently sought. Test it in your briar.



FREE booklet tells how to make your old pipe taste better, sweeter; how to break in a new pipe. Write for copy today. Brown & Williamson Tobacco Corporation, Louisville Kentucky, Dept. P-73.

HOW TO
TAKE CARE
of
YOUR PIPE

TUNE IN JACK PEARL (BARON MUNCHAUSEN)
NBC BLUE NETWORK, MONDAYS 9:30 P. M., E. S. T.

(Contents—Continued)

Drawshave from steel tubing	430
Shovel scraper from shoehorn	430
Soldering table for the home workshop	430
Hand press for type or linoleum cuts	439
Avoiding drill marks on work	448
Drawing-knife edge protected by wood trough	456
Vest-pocket wire cutter	456
Screwdriver improved with dome glide	460
Star drill has rubber grip	464
Rubber shield for a file	480

HOME IMPROVEMENTS

From coal bins to play rooms—Part II	441
Built-in clock uses wall for dial	453
One form to fill space between joists	472

HOUSEHOLD

Alarm clock has self-contained light	427
Keeping books erect in case	432
Rocking play pen amuses baby	430
Pincushions of wood and cork	433
Handle to open large screw-top cans	440
Stove-lid lifter from shoehorn	448
Fork to handle butter squares	450
Protecting furniture against vacuum cleaner	456
Aquarium made from glass jug	457
Easy ways to solve your home problems	458
Cleaning dirty hairbrushes	459
Cooking odors absorbed by coffee	459

OFFICE

Shielding rubber stamps against dirt	432
Slide rule protected with transparent tape	432
Fruit-jar rubbers keep rolled papers on desk	440
Swinging holder keeps ink bottle level	460

PAINT AND PAINTING

Painting temporary signs	427
Blackboard and slating paint	433
Luminous paint is easy to make	473

PHOTOGRAPHY

Exposure data recorded on film-pack holder	437
Testing photoflash bulbs	438
Improved lighting for enlargers	440
Improving clothespin-film holders	448

POWER TOOLS

Scroll saw for modelmakers	448
Centering heavy drill-press jigs	472
Bending brake for small shop	475

STORE AND SHOP

Assembling finished furniture	471
Stacking sacked material	476
Stamp pad weighted to avoid creeping	476

MISCELLANEOUS

Modern telephone set	423
Models assembled from celluloid	430
Plywood splines make strong glue joints	432
Face shield for amateur chemists	433
Ladder pail holder quickly adjusted	437
Bicycle-spoke wrench from glass cutter	438
Shoulder pad for carrying pipe	438
Violin muted with clothespin	438
Reddening copper-coated articles	440
Removable strap handle lifts trunk lid	440
Midget oarsman works toy rowboat	449
Arrow gun shoots several hundred feet	450
Cutting paper streamers easily	450
Motorboat equipment in portable "pilothouse"	451
Dog racing sulky pulls on balloon tires	455
Sawhorse with heavy base doesn't tip	456
Reel for winding yarn single-handed	459
Sensitive thermostat for 50 cents	459
Plastic ornaments cast in flexible molds	461
Ball on brush aids show-card writer	464
Rubber doorstep aids in nailing studs	464
Tree signs hung with rubber bands	464
Hand truck has extension pieces	465
Guarding against corrosion	466
An aid in feeding a job press	472
Shaping artists' brushes	472
Easy way to mill keyways in shaft	475
Warning flags that can be used anywhere	476

IF MEN WORE PRICE TAGS



HOW WOULD YOU FEEL?

WELL, your boss thinks of you in terms of so much a week! You are worth this or that to him. How much you are worth depends upon—YOU! You decide the amount chiefly by your ability—by your

training. Why not increase the amount by increasing your training? Thousands of men have done it by spare-time study of I. C. S. Courses. You are invited to earn more money. Mail this coupon.

INTERNATIONAL CORRESPONDENCE SCHOOLS

BOX 5661-H, SCRANTON, PENNA.

★ Without cost or obligation, please send me a copy of your booklet, "Who Wins and Why," and full particulars about the subject *before* which I have marked X: ★

- | | | | | |
|---|---|--|--|--|
| <input type="checkbox"/> Architect | <input type="checkbox"/> Sheet Metal Worker | <input type="checkbox"/> Plumbing | <input type="checkbox"/> Steam Fitting | <input type="checkbox"/> Bridge Engineer |
| <input type="checkbox"/> Architectural Draftsman | <input type="checkbox"/> Boilermaker | <input type="checkbox"/> Heating | <input type="checkbox"/> Ventilation | <input type="checkbox"/> Bridge and Building Foreman |
| <input type="checkbox"/> Building Estimating | <input type="checkbox"/> Telegraph Engineer | <input type="checkbox"/> Air Conditioning | | <input type="checkbox"/> Chemistry |
| <input type="checkbox"/> Contractor and Builder | <input type="checkbox"/> Telephone Work | <input type="checkbox"/> Steam Engineer | | <input type="checkbox"/> Pharmacy |
| <input type="checkbox"/> Structural Draftsman | <input type="checkbox"/> Mechanical Engineering | <input type="checkbox"/> Steam Electric Engineer | | <input type="checkbox"/> Coal Mining |
| <input type="checkbox"/> Structural Engineer | <input type="checkbox"/> Mechanical Draftsman | <input type="checkbox"/> Marine Engineer | | <input type="checkbox"/> Mine Foreman |
| <input type="checkbox"/> Management of Inventions | <input type="checkbox"/> Machinist | <input type="checkbox"/> R. R. Locomotives | | <input type="checkbox"/> Fire Bosses |
| <input type="checkbox"/> Electrical Engineer | <input type="checkbox"/> Patternmaker | <input type="checkbox"/> R. R. Section Foreman | | <input type="checkbox"/> Navigation |
| <input type="checkbox"/> Electric Lighting | <input type="checkbox"/> Diesel Engines | <input type="checkbox"/> Air Brakes | <input type="checkbox"/> R. R. Signalmen | <input type="checkbox"/> Cotton Manufacturing |
| <input type="checkbox"/> Welding, Electric and Gas | <input type="checkbox"/> Aviation Engines | <input type="checkbox"/> Highway Engineering | | <input type="checkbox"/> Woolen Manufacturing |
| <input type="checkbox"/> Reading Shop Blueprints | <input type="checkbox"/> Automobile Mechanic | <input type="checkbox"/> Civil Engineering | | <input type="checkbox"/> Agriculture |
| <input type="checkbox"/> Heat Treatment of Metals | <input type="checkbox"/> Refrigeration | <input type="checkbox"/> Surveying and Mapping | | <input type="checkbox"/> Fruit Growing |
| | | | | <input type="checkbox"/> Poultry Farming |
| TECHNICAL AND INDUSTRIAL COURSES | | | | |
| <input type="checkbox"/> Business Management | <input type="checkbox"/> Bookkeeping | <input type="checkbox"/> Service Station Salesmanship | <input type="checkbox"/> Grade School Subjects | |
| <input type="checkbox"/> Industrial Management | <input type="checkbox"/> Secretarial Work | <input type="checkbox"/> First Year College Subjects | <input type="checkbox"/> High School Subjects | |
| <input type="checkbox"/> Traffic Management | <input type="checkbox"/> Spanish | <input type="checkbox"/> Business Correspondence | <input type="checkbox"/> College Preparatory | |
| <input type="checkbox"/> Accountancy | <input type="checkbox"/> French | <input type="checkbox"/> Stenography and Typing | <input type="checkbox"/> Illustrating | |
| <input type="checkbox"/> Cost Accountant | <input type="checkbox"/> Salesmanship | <input type="checkbox"/> Civil Service | <input type="checkbox"/> Cartooning | |
| <input type="checkbox"/> C. P. Accountant | <input type="checkbox"/> Advertising | <input type="checkbox"/> Railway Mail Clerk | <input type="checkbox"/> Lettering Show Cards | <input type="checkbox"/> Signs |
| BUSINESS TRAINING COURSES | | | | |
| <input type="checkbox"/> Home Dressmaking | <input type="checkbox"/> Advanced Dressmaking | <input type="checkbox"/> Millinery | <input type="checkbox"/> Foods and Cookery | |
| <input type="checkbox"/> Professional Dressmaking and Designing | | <input type="checkbox"/> Tea Room and Cafeteria Management, Catering | | |
| DOMESTIC SCIENCE COURSES | | | | |

Name..... Age..... Address.....

City..... State..... Present Position.....

If you reside in Canada, send this coupon to the International Correspondence Schools Canadian, Limited, Montreal, Canada

When writing to advertisers please mention Popular Mechanics

LEARN DRAFTING

The foundation of Success
IN EVERY INDUSTRY



Better Job - MORE PAY - Security

New York Sun Survey of Employment

Referring to its comprehensive industrial survey just completed, the New York Sun says "Running thru these figures and these pages is the plain evidence that business—big, medium and little—has been putting men back to work by the millions."

SHORTAGE OF SKILLED LABOR

"Already a shortage of skilled labor is manifesting itself throughout the country." According to the survey, cities report an actual shortage of trained men in many lines.

BASIC INDUSTRIES UP!

Steel, automotive, petroleum, building and other basic industries are definitely on the upswing. Opportunities are opening up. Now is the time to train for them.

The Dobe Method is
Practical Method. You
learn by doing—under the
supervision of a practical engineer.

All Tools Furnished NO EXPERIENCE REQUIRED

Complete Outfit, including 20 in. x 25 in. drawing table and all tools, furnished to you. With Engineer Dobe's method no previous experience is necessary. High School education not needed. Everything made plain. Practical work from the start until you're in position.

Time is money. Learn drafting in your spare time. It's high time now to prepare. Don't wait another day. Send coupon for Dobe's free book.

ENGINEER DOBE Div. 3373
Libertyville, Ill.

You are on the threshold of a new industrial era! Increased mechanization, modernization of production, new high standards of living are here. For this new day men with new training are required. You can make this your great opportunity by becoming a trained Draftsman. For Drafting is the "key" to all industrial progress. Drafting leads the way in all industries. Plans must be developed, perfected, finished before actual work begins. The Draftsman is the "Key Man." With recovery in industry and building definitely on the way—many trained draftsmen will be needed on better jobs at better pay and shorter hours. **PREPARE NOW!**

Drafting—The Road to Advancement

If you're a mechanic, a knowledge of draftsmanship may make you a foreman or superintendent in short order. Get out of overalls and draw the pay of a boss. If you are a boss, learn draftsmanship, a foundation stone of many a line of business.

In every walk of life, practical training in draftsmanship will prove valuable. Even if you never accept a job as a draftsman, will you not be money ahead by taking Engineer Dobe's course?

You'll be amazed at the speed with which you can learn in your spare time.

Learn at Home From an ENGINEER

I will teach you my practical method that has been successful with thousands since 1900. I will teach you in a very short time by mail in your spare time until you actually have a desirable draftsman's job, or prepare you for better pay in the job you now have. You must be entirely satisfied with my personal training UNTIL COMPETENT and until assisted to a position, OR YOU GET ALL YOUR MONEY BACK. Send the coupon below TODAY! No obligations!

Free Book!

ENGINEER DOBE, Div. 3373 Libertyville, Ill.

Send me your free book "Successful Draftsmanship". Please explain how you assist your graduates to good positions as draftsmen.

Name.....

Address.....

Town.....

State..... Age.....

When writing to advertisers please mention Popular Mechanics

TRIPLED MY PAY
Working steady... Making three times money I was... before I took up Coyne Training—*Bert Farley.*



\$300 A MONTH
Two weeks after graduation I had job with large Electrical Co. at \$300 a mo., with car furnished—*H. C. Omer.*



THANKS TO COYNE
I secured a position with an Electrical Construction Company, paying me three to four times more a week than I was getting before I entered Coyne—*J. O. Whitmeyer.*



THOUSANDS are MAKING \$30-\$40-\$50 a WEEK

in ELECTRICITY
Huge Developments Ahead

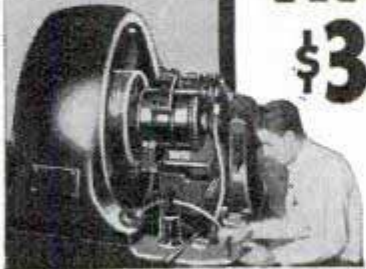

Learn by doing — 12 WEEKS TRAINING IN BIG COYNE SHOPS

Thousands of Trained Electrical Men are making good money in the many branches of Electricity. Train for a better job—Right NOW!—whether you're 16 or 40. Look about you. Industry everywhere is being modernized with new electrical equipment—will use more ELECTRICITY. Many power plant operators now make up to \$50 a week. Electrical Maintenance Men are paid \$150 a month and up. Refrigeration and Air Conditioning Service Men earn \$30—\$40—\$50 a week. Armature winders make \$40 a week and more. Aviation Ignition Men also make good money at steady jobs. Many others operate their own business. These are only a few of the opportunities in Electricity.

COYNE extends the helping hand to YOU, too, if you're in a low-pay, discouraging job. Break out of the untrained class! If you are interested in bettering your place in life, get into ELECTRICITY—the gigantic growing field that employs more men than any other industry on earth!

Train on FULL SIZE Equipment—NOT by Correspondence—NOT by Text Books

COYNE Shop Training is NOT by correspondence or Home Study. You come right to the big COYNE Shops in Chicago to get this practical Training. You work on real equipment—such as generators, real dynamos, you wind armatures, work on diesel engines, airplane motors, and do many other practical Electrical jobs. Here is one of the greatest working outlays of its kind in America. No embarrassing reciting. No dry text books. You don't need high school education or previous experience. It is this real job Training that enables COYNE to train you for a better pay job.

AIR CONDITIONING, DIESEL and ELECTRIC REFRIGERATION included

Spreading over the nation is a vast network, these fast developing branches of ELECTRICITY are employing more men and paying more in salaries every year. Homes, offices, factories, trains, autos, airplanes are being air-conditioned. Autos may soon be diesel-powered. Instruction in these courses included without extra cost.



YOU TRAIN HERE
Many thousands of dollars worth of real practical equipment and machinery is installed in our fireproof modern school.

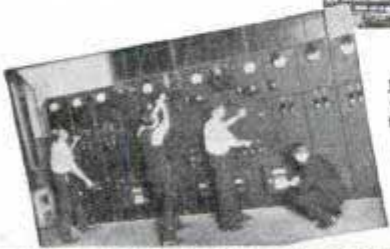

Many shop views like this shown in my catalog



GET FULL FACTS
You'll see everything in the Big FREE COYNE Book... facts... opportunities... jobs... salaries... actual photos of hundreds of ambitious fellows preparing for better jobs. You'll see proof that COYNE training pays. This big Book is yours without obligation. So act at once. Just mail Coupon.



"Mr. Lingerfelt's services very satisfactory. His practical shop training at COYNE has certainly helped increase his efficiency."
"John Lindquist was given an increase in salary due to the high quality of his work."
(Names of companies on request). We have scores of such letters. Get complete story. You owe it to yourself. Clip and send Coupon—NOW!

MAIL THIS NOW for MONEY MAKING DETAILS

H. C. LEWIS, President,
COYNE ELECTRICAL SCHOOL,
500 S. Paulina St., Dept. 37-72H, Chicago, Ill.
Without obligating me, send full details and your Big FREE Illustrated Catalog.

Name.....Age.....
Street.....
Town.....State.....
Mail in Envelope or paste on Postcard

COYNE ELECTRICAL SCHOOL
H. C. LEWIS, President
500 S. Paulina Street Dept. 37-72H Chicago, Illinois



**New, Complete
HARMONICA INSTRUCTION BOOK**

The simplest and easiest instruction book ever prepared for the harmonica. It describes and shows you in pictures just how to blow each note, and takes you step by step until in a short time you are able to play the popular selections contained in the book. Tells how to organize a Harmonica Band . . . explains the different kinds of harmonicas and their uses.

**BE POPULAR—BECOME
AN EXPERT HARMONICA PLAYER**

Boys and girls who are good harmonica players are always wanted at parties and social meetings. They are the leaders who get the fun going and make the party peppy. Learn this fascinating way to become popular. Send for free instruction book today.

M. HOHNER, Inc.
351 Fourth Ave. NEW YORK CITY

**HOHNER
HARMONICAS**

Mail This Coupon Today

M. HOHNER, Inc., Dept. 20C
351 Fourth Ave., New York City

Please send me your new Instruction Book FREE.

Name.....

Address.....

City..... State.....

Address Canadian Inquiries to Hough & Kohler, Ltd., Toronto.

**LEARN AT HOME TO
MOUNT
BIRDS, ANIMALS,
Gameheads, Fish**



Learn By Mail—Easily—Quickly!

Old reliable school—250,000 students! Mount WILD GAME, also common specimens, easily obtained—squirrels, rabbits, frogs, etc. Learn TANNING, too. Send for beautifully illustrated FREE BOOK. Tells how YOU can learn to MOUNT and preserve, as in life, BIRDS, ANIMALS, REPTILES, FISH and INSECTS. Write NOW!

SAVE Your BEST TROPHIES!

Wild Game is getting scarcer every year. KILL LESS and MOUNT your trophies. Apart from your own pleasure in them, they may be very valuable some day. Mount for other sportsmen, too. They'll pay you well!



FUN - PROFITS!

Taxidermy is the most fascinating hobby! It's FUN getting your specimens—MORE fun to preserve them. It's PROFITABLE, too! Learn Craft and NOVELTY Taxidermy. Mount into interesting and humorous groups, owls, pigeons, rabbits, squirrels, pets, even frogs.



Craft Taxidermy teaches you how to make useful articles, such as lamps, book-ends, ash trays, gun-racks, door stops. They are wonderful for your home, and sell readily.

Learn all phases of Taxidermy and Tanning in one easy, inexpensive course. No experience needed.

WRITE TODAY for 48-page FREE BOOK, contains over 100 interesting photos and tells all about Taxidermy and how you can learn AT HOME IN SPARE TIME, to mount specimens and also to TAN and make Real Leather. A BIG OPPORTUNITY. The free book tells about it. Write! State your age.

FREE BOOK



N. W. School of Taxidermy 3373 Elwood Bldg., Omaha, Neb.

**ELECTRICAL
ENGINEERING**

A BROAD, basic, intensive course complete in one school year. Includes fundamentals of Refrigeration, Air-conditioning, Electronics. Approved by educators, endorsed by industry. 45th year. Catalog.



BLISS ELECTRICAL SCHOOL

133 TAKOMA AVE., WASHINGTON, D. C.



BE A CARTOONIST

AT HOME IN YOUR SPARE TIME under personal supervision of the famous cartoonist NORMAN MARSH creator of "DAN DUNN" appearing every day in big papers. Success—Fame—Real Money may be Yours when you learn Marsh's easy simple methods and secrets. Send name and six cents—stamps or coin—for details of MARSH'S Personal course. ACT TODAY! MARSH CARTOON SCHOOL Chicago Daily News Bldg., Dept. C-1, Chicago, Ill.

MAIL FOR FREE INFORMATION

BEDFORD

**YMCA
TRADE
SCHOOL**

1117 Bedford Ave., Dept. PM-46
Brooklyn, New York City, N. Y.

- Diesel Engines
- Diesel Engineering
- Aviation Mechanic
- Aeronautical Engineering
- Auto Mechanic
- Refrigeration
- Radio and Television Mechanic
- Air Conditioning
- Architectural-Mechanical Drafting
- Electrical
- Armature Winding
- Oil Burner
- Welding
- Talking Pictures
- Machine Shop
- Sign Painting
- Window Display

Name.....

Address.....

2 Beginning Lessons in Diesel Engineering Free

Test Yourself Without Cost See how readily you, too, can Learn Diesel

At your leisure in your own home, read these 2 Diesel lessons carefully. Judge for yourself our ability to teach—and your ability to learn—this fast-growing new line of work.

No Previous Experience Necessary

See for yourself how *practical* American School training is—how clearly every fact is presented—how *thoroughly* you can master Diesel through home study.

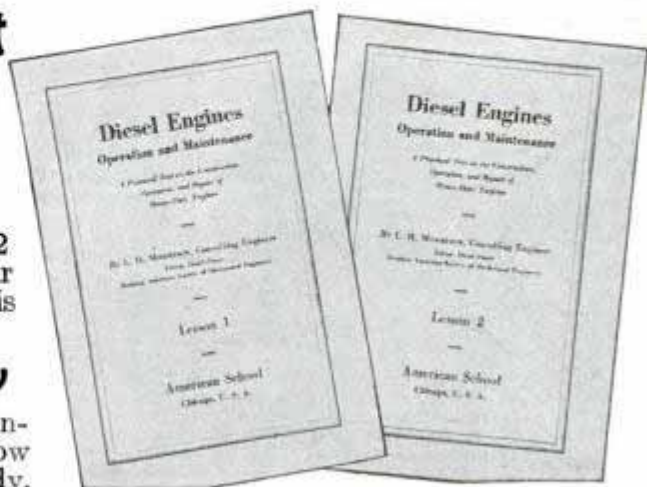

Diesel — the New, Fast-Growing Power

Is Your Job Safe?

Just as the gasoline engine changed or wiped out the jobs of thousands who depended on horse-drawn vehicles for their living—just as electricity changed the entire set-up in the fields of light and power—so now the Diesel engine is fast invading both the power and transportation fields, and threatening the present jobs of thousands of workers.

If jobs in your line are steadily growing scarcer, you owe it to yourself to investigate this new, progressive, uncrowded line, that in our opinion will offer good openings for the next 25 years.

Diesel engines—because of their high efficiency, dependability, and economy of operation—are fast replacing steam and gasoline engines in power plants, motor trucks and busses, locomotives and ships, aircraft, dredges, drills, pumps, etc.—opening up an increasing number of well-paid jobs for Diesel-trained men. The field of Diesel Engineering is on the upgrade and continually expanding. It will provide steady employment, advancement and good pay for those properly trained in this new industry.

What This New Field Offers You

Now is your chance to get into a big new industry and grow up with it to an important position. Today there is practically no competition in the Diesel field, but the increasing use of Diesel engines will result in keen competition for jobs in the near future. By starting your training now, you

can keep ahead of such competition.

You get complete information on all the latest Diesel developments—two- and four-stroke cycles; low- and high-speed and heavy duty types; Diesel-electric generating systems, etc.—in our course. Includes all text material—with special diagrams for quick understanding of this new power.

Real Opportunities for Trained Men

Get our Free Diesel Booklet and learn all about this new, fast-growing line—its opportunities and requirements. Find out what the Diesel field offers you—how rapidly the Diesel industry has developed during the last three years—the large number of Diesel engines and accessories being manufactured today—how quickly you can obtain a complete understanding of Diesel engine principles and operation by home study during your spare time! ... at your own pace—without interfering with your regular work.

American School, Dept. D-345, Drexel Avenue at 58th Street, Chicago

The Diesel Engineer

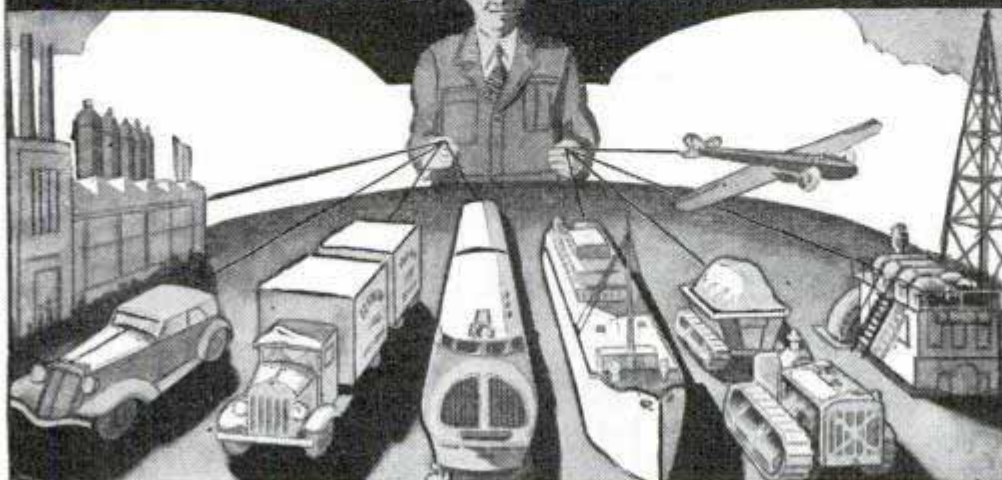

Get These 2 Diesel Lessons

When you learn what worthwhile opportunities Diesel offers and how readily you can cash in on them through American School training, it may mark the turning point in your life. Asking for full information involves NO obligation—so write TODAY for FREE lessons and FULL information.

Free Lesson Coupon

American School, Dept. D-345
Drexel Ave. at 58th St., Chicago

WITHOUT obligation, please send me 2 beginning lessons in Diesel Engineering FREE. They are to be mine, to keep. Also send FREE Diesel booklet.

Name.....

Address.....

START DRAWING BIG MONEY!



LEARN TO DRAW AT HOME

MAKE \$30-\$50-\$75 A WEEK

BE an artist and be your "own boss." You can learn AT HOME in your spare time this simple, practical way. There's a big future in this fascinating and profitable field for men and women of all ages. A few pleasant hours a week should give you the ability to earn good money.

COMMERCIAL ART CARTOONING AND DESIGN—ALL IN ONE PRACTICAL COURSE

Our proven method of instruction includes every branch of Commercial Art, and your drawings are given the correction and criticism of an experienced Art Instructor. You start by drawing straight lines and in advancing from lesson to lesson you receive all the constructive help you need.

IT'S AS EASY AS One - Two - Three!



From a simple framework to the finished figure. Art made easy by simple steps that the average person can follow. The above is one of the 16 key poses in our **LIFE CLASS BOOK. Full Size Artists' Outfit Given—AT NO EXTRA COST!** Includes everything you need to get started in Art. Mail coupon today for complete details.



This FREE BOOK Shows How

WASHINGTON SCHOOL OF ART
Studio 43, 1115—15th Street, N. W.
Washington, D. C.

Without obligation, please send me a FREE copy of your Book, "Art for Pleasure and Profit."

Name..... Age.....

Address.....

City..... State.....

(No salesman will call)

When writing please mention Popular Mechanics

DON'T BUY

Mandolin
Guitar
Banjo or
Drums



Don't buy Guitar, Mandolin, Banjo, Electric Guitars, Ukuleles, or Drums, until you have tried the Slingerland May-Bells, Guaranteed More for your Money. Wonderful, snappy, powerful, pleasing tone. No equal in price. Sold on easy payments and 5 days free trial by all leading music dealers.

Cut This Adv. Out — Good for \$1.00 Credit



Send for free catalog. Mention instrument wanted.

Write today:

Slingerland Musical Instrument Mfg. Co.,
1325 Belden Ave., Chicago, Illinois

LEARN TO PAINT SIGNS AND SHOW CARDS

BIG PROFITS
We teach you quickly, by mail or at school. Enormous, steady demand. Big future. Interesting. Write for full information. **DETROIT SCHOOL OF LETTERING**
5737-A Second Blvd. DETROIT, MICH.



VOICE

100% Improvement Guaranteed

We build, strengthen the vocal organs—not with stinging lessons—but by fundamentally sound and scientifically correct *silent exercises*... and absolutely guarantee to improve any singing or speaking voice at least 100%... Write for wonderful voice book—sent free. Learn WHY you can now have the voice you want. No literature sent to anyone under 17 years unless signed by parent.

PERFECT VOICE INSTITUTE, Studio 1353
64 E. Lake St., Chicago



Minstrels



Unique First Parts for complete show with special songs and choruses. Make-up. Catalog Free.

T. G. Denison & Co., 623 S. Wabash, Dept. 19 Chicago

GOV'T. JOBS

SALARY TO START \$90 to \$175 MONTHLY MEN.. WOMEN Age Range 18 to 50

- Railway Mail Clk.
- P. O. Laborer
- R. F. D. Carrier
- Special Agent
- Customs Inspector
- City Mail Carrier
- P. O. Clerk
- Elevator Conductor
- Special Investigator
- Typist
- POSTMASTER
- Stock Clerk
- Auditor
- Stenographer
- U.S. Border Patrol
- Telephone Opr.
- Watchman
- Meat Inspector
- Secret Service Opr.
- File Clerk

OZMENT INSTRUCTION SERVICE
Dept. 111 St. Louis, Mo.

Send me FREE particulars "How to Qualify for Government Positions" marked "X". Salaries, locations, opportunities, etc. ALL SENT FREE.

Name.....
Address.....

HOW A FREE LESSON STARTED BILL ON THE WAY TO A GOOD RADIO JOB

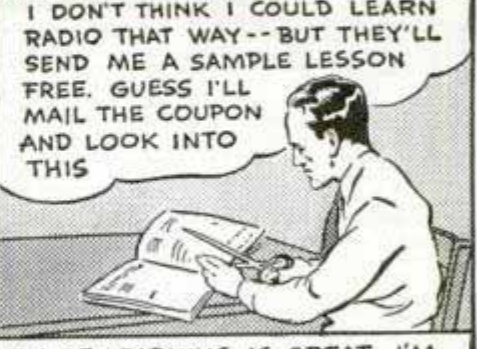

J. E. SMITH, President National Radio Institute

Yes, I will send my First Lesson FREE to show how easy it is to TRAIN AT HOME FOR A GOOD RADIO JOB

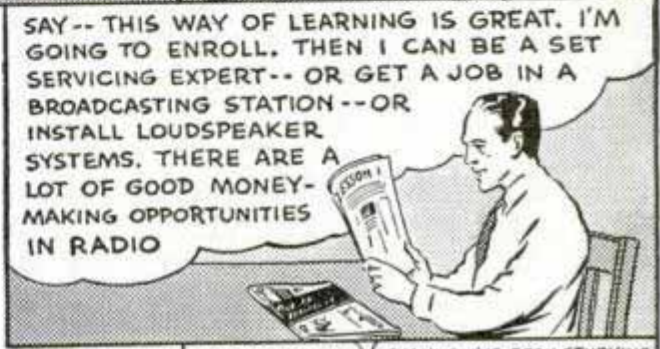

in your spare time for a good Radio Job that I'll send you a sample lesson absolutely FREE. Examine it, read it, see for yourself how easy it is to understand even if you've never had any technical experience or training.

Many Radio Experts Make \$30, \$50, \$75 a Week

Radio broadcasting stations employ engineers, operators, station managers and pay up to \$5,000 a year. Spare time Radio set servicing pays as much as \$200 to \$500 a year. Full time Radio servicing jobs pay as much as \$30, \$50, \$75 a week. Many Radio Experts own and operate their own full time or part time Radio sales and service businesses. Radio manufacturers and jobbers employ testers, inspectors, foremen, engineers, servicemen paying up to \$6,000 a year. Radio operators on ships get good pay and see the world besides. Automobile, police, aviation, commercial Radio, and loud speaker systems offer good opportunities now and for the future. Television promises many good jobs soon. Men I have trained are holding good jobs in all these branches of Radio.

Many Make \$5, \$10, \$15 a Week Extra in Spare Time While Learning

Practically every neighborhood needs a good spare time serviceman. The day you enroll I start sending you Extra Money Job Sheets. They show you how to do Radio repair jobs that you can cash in on quickly. Throughout your training I send you plans and ideas that have made good spare time money—from \$200 to \$500 a year—for hundreds of fellows. I send you special Radio equipment and show you

how to conduct experiments and build circuits which illustrate important Radio principles. My training gives you practical Radio experience while learning.

Get My Lesson and 64-Page Book FREE. Mail Coupon

In addition to my Sample Lesson, I will send you my 64-Page Book, "Rich Rewards in Radio." Both are free to any fellow over 16 years old. My book describes Radio's spare time and full time opportunities and those coming in Television; tells about my Training in Radio and Television; tells about my Money Back Agreement; shows you actual letters from men I have trained, telling what they are doing and earning. Find out what Radio offers YOU! MAIL THE COUPON in an envelope, or paste it on a penny postcard—NOW!

J. E. SMITH, President National Radio Institute, Dept. 7CP Washington, D. C.



J. E. SMITH, President, Dept. 7CP National Radio Institute, Washington, D. C.

Dear Mr. Smith: Without obligating me, send the sample lesson and your book which tells about the spare time and full time opportunities in Radio and explains your 50-50 method of training men at home in spare time to become Radio Experts. (Please write plainly.)

NAME..... AGE.....
 ADDRESS.....
 CITY..... STATE.....2FR

MAIL THIS NOW

NOW FIX ANY MAKE OF AUTO

AUTO



SIX BIG AUTO BOOKS ALL SHIPPED FREE

on approval; whether you want to qualify as garage owner, auto repair expert or merely wish to know how to keep your own car 100% efficient, look at these books—they are sent to you for free examination. This brand new edition has been prepared by a large group of America's greatest automotive engineers. Anybody who can read will understand them, for this great automobile encyclopedia is a veritable

gold mine of valuable facts. Take advantage of this offer now; send in the coupon for FREE examination. You don't pay us a penny, you don't obligate yourself to pay anything unless you decide to keep the books. Just tell us you want to see them and the full set of 6 great volumes, just off the press, will be sent to you! Read them, look them over and prove to your own satisfaction that one fact alone, which you will find in them, may save you an expensive repair, or help you to a better job.

**DIESEL ENGINES
AVIATION MOTORS
MOTORCYCLES
OUTBOARD MOTORS
MARINE ENGINES
TRACTORS
AUTOMOBILE RADIOS
ALL COVERED**

Very Latest Edition

Imagine books which are so new that every page is right up to date—wiring diagrams, construction details, service problems—are all right up to the minute. Nowhere else can you get as complete and timely information. Over a million dollars of resources have enabled us to give you the most authoritative books on the subject ever published. Everybody interested in automobiles in any way will welcome these books published by the world's largest publishers of Technical Cyclopedias (est. 1897) with agencies all over the world.

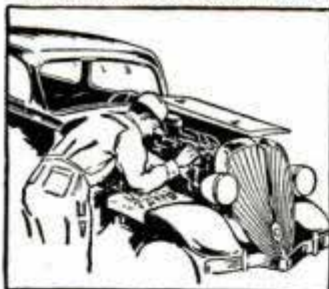

Can You Fix It?

Can you take out "play" in differentials? Can you kill the "shimmy" in steering? Can you reset TIMING? Can you put your finger on engine trouble without guessing or tinkering? Can you pull the starter off and fix it? Can you adjust and repair transmission, engine, rear axle, bearings?

These Books Tell How and tell you how to do any and every auto job right, the first time.

6 Big Volumes

Nearly 3,000 pages, over 2,000 illustrations, wiring diagrams, equipment charts, etc. De Luxe edition with gold-stamped flexible binding. Sent FREE for 10 days' use. If not wanted return express collect. If kept, send only \$2.00 after 10 days, then \$3.00 a month until low advertising price, \$24.80 is paid.

A Year's Consulting Membership FREE!

Privilege of consulting engineers of million-dollar American Technical Society for one year if you mail coupon immediately. We also include 2 extra books, "Service Shop Management" and loose leaf book of new diagrams without extra charge if you send NOW.

SEND NO MONEY

AMERICAN TECHNICAL SOCIETY,
Drexel Ave. at 58th St., Dept. A319, Chicago, Illinois.

I would like to see the brand new 6-volume edition of your automobile books but without any obligation to buy. I will pay the few cents delivery charges only and will examine the books and return them at your expense in 10 days unless I like them, in which case I will send you \$2.00 then and only \$3.00 per month until the total price of only \$24.80 is paid. You are to include consulting membership certificate in the American Technical Society and the two extra volumes mentioned above.

Name.....
Street.....
City..... State.....
Employer's Name.....
Employer's Address.....

Please give us, in addition, the name and address of at least one business man as reference.

PHOTOGRAPHY

offers YOU a wonderful career

Here's a chance to start a career in a field that is interesting, profitable, and growing every day. Get into photography. We give you a practical, thorough training that will qualify you as an expert in whatever branch you choose—Commercial, News, Portrait, Advertising, or Motion Picture Photography. Start any time. Individual instruction by noted experts.

BIG MONEY-MAKING Opportunities

More and more trained men and women are needed to help supply the growing demand for photographs for newspapers, magazines, advertisers, and for business and industrial use. Wonderful opportunities everywhere . . . whether you wish to "free-lance," start your own business, or get a job with an established concern.

Personal Attendance and Home Study Courses

The N. Y. Institute has been teaching photography for over 27 years. It is the only school of photography that offers both *Personal Attendance* and *Home Study* training. A letter or post card will bring you our big booklet that describes the famous N. Y. I. method of training, and tells about the wonderful opportunities in photography.

Send Now for **FREE Booklet** →



NEW YORK INSTITUTE OF PHOTOGRAPHY
10 WEST 33 ST. (Dept. 35) NEW YORK CITY

BE A RAILWAY TRAFFIC INSPECTOR

Traffic at all-time High; Men Needed Now
Railway and Bus Lines are constantly asking for our trained graduates. Our short, home-study course quickly qualifies you, and upon completion we help place you at up to \$135 per month, plus expenses, to start, or refund tuition. Active Men—19 to 50—eligible. Write for facts.

STANDARD BUSINESS TRAINING INSTITUTE
Div. 203 Buffalo, N. Y.



CARTOONING PAYS WELL

Turn your talent into dollars. Develop your ability with personal instruction from an internationally-known cartoonist. His exclusive, successful method of drawing and creating ideas makes it easy to attain success. Write for details of this exceptional home-study course.

National School of Cartooning, 437 Penton Building, Cleveland, Ohio



Learn Write.

Begin Today. Write for our Free Book, "How to Become a Good Penman." It contains specimens and tells how others learned to write in spare time. Your name elegantly written on a card if you enclose stamp for postage. Write today. **F. W. TAMBLYN,** 418 Ridge Bldg., Kansas City, Mo.

AVIATION APPRENTICES



Ambitious, air-minded young men, interested in entering the well paid field of Aviation, write immediately, enclosing stamp, to

Mechanix Universal Aviation Service, Incorporated
Strathmoor Station Dept. E Detroit, Mich.

When writing to advertisers please mention Popular Mechanics

Train at Home...Under Factory Engineers for GOOD PAY Spare-Time and Full-Time Jobs in RADIO



APPOINTED BY RADIO MANUFACTURERS TO SUPERVISE R-T-I TRAINING

This is the R-T-I Advisory Board—Engineers and Executives of large Radio firms—appointed by these firms to supervise and direct R-T-I Training. Put your future in their hands. 50 great radio manufacturers now endorse this Training.

Trained Men Needed in All Branches

If you're dissatisfied with small pay—lay-offs and an uncertain future—here's an opportunity that's too good to miss. At the cost of only the time it takes you to mail the coupon, you can get my big FREE book, "RADIO'S FUTURE AND YOUR OPPORTUNITY." This book tells how you can learn at home under the supervision of factory engineers, to make more money almost at once in Radio—whether you want to make Radio your life's work, or use it to pick up an extra \$5 to \$20 a week in your spare time.

More Opportunities Than Ever Before

Radio is still forging ahead. 1936 beats all other years. Over 6 million new sets sold. Over 30 million dollars paid for service alone this year. Where only a few hundred men were employed a short time ago, thousands are employed today. And where a hundred jobs paid up to \$75 a week—there are thousands of such jobs today—many paying even more. And new jobs are being created all the time—full time jobs and spare time jobs. Get my book and see how easy it is to learn at home for this good-pay work.

"Shop Training" for the Home

R-T-I Training is different than any training you ever heard about. It comes to you right from the heart of the Radio Industry—right out of the factories where Radio sets and other vacuum-tube devices are made. It was planned and prepared and is supervised by big radio engineers IN these factories—by men appointed for the purpose. This means that trained the R-T-I way, you'll be trained as the Radio Industry wants you trained—just as the Radio Industry, itself, would train you if it was doing the job.

Television, Photo Electric Cells, Public Address Systems Included

Radio service work is only the starting point in R-T-I Training. From there it will take you through the whole field of Radio and Electronics. You will learn about every new development, including Television so you'll be ready when Television breaks. You'll also learn the big money subjects such as Aviation and Auto Radio; Public Address Systems; how to handle Photo Cells; Sound Picture Recording, Etc.

4 Working Outfits Furnished

Start almost at once doing part time radio work. I furnish 4 outfits of apparatus that you build into test equipment with which you can do actual jobs and earn extra money. My Training pays its own way and you get your money back if not satisfied.

Age or Lack of Experience No Handicap

You don't have to be a high school graduate, nor even have finished the grades. My Training is so simple, easy, and practical, that the average man, regardless of age, education, or previous experience can master it. It offers the chance you have wanted to get out of a small-pay, no-future job, into good pay work with a future, in Radio and all its branches.

Get My Free Book

INVESTIGATE! Learn why R-T-I Training is different. Find out why R-T-I Trained men get "Quick Results" and "Big Results." Send for your copy of "Radio's Future and Your Opportunity" today. It tells you about Radio's amazing opportunities. It describes my approved training. It tells what R.T.I. students are doing and making. It gives the names of my Advisory Board and 50 endorsing manufacturers. It's FREE. Clip, sign and mail coupon RIGHT NOW!

RAY D. SMITH, President



RAY D. SMITH,
President R-T-I,
who has directed
training of 100,000
men. Read what a
few students say.

"Made my first spare
time money after finishing
four lessons. Over \$500 spare
time money in 10 months.
R-T-I is O.K."
Delmer Grote, Route
5, Greenville, Ohio

"I made \$14.25 in first
11 days of my training
following your instructions."

C. E. Head, 431 Third
St., Alexandria, La.

"Before finishing my
training I was made
Manager of a Department
Store's radio section."

Howard N. Lentz, 123
W. Alexander St.,
Buchanan, Mich.

"My job paid me \$18 a
week before taking
your training. Shortly
after starting was averaging
\$60 a week. Have
made as high as \$250
in single week."
Wm. T. Ridd, 3452
Evelyn St., Verdun,
P.Q., Canada

LEARN TO EARN
UP TO \$75 A WEEK

(MANY R-T-I TRAINED MEN EARN MORE)

MAIL COUPON BELOW



**Big
Money
in Auto
and Police Radio Work**

W. H. Carr, 402 N. 16th St., Kansas City, Kansas, an R.T.I. student, has charge of 35 radio equipped cars for the Kansas City Police and Fire Departments. His salary is \$230.00 a month and he is furnished with an automobile, gas, oil, etc. He says, "If I had not taken your course I would not be able to hold this job."

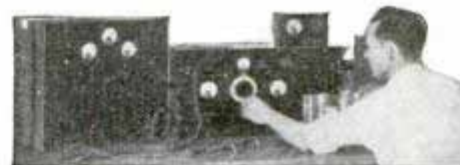

Makes \$600 in One Month

Herbert B. Thomson, Gorman, Texas, formerly an oil well driller, borrowed \$170.00 to start a spare time radio business after completing 12 R-T-I lessons. He made money from the start. In two years his shop was worth \$3500. He says, "Because of my R-T-I Training I made \$450 in September and over \$600 in October 1935. It pays to be R-T-I Trained."

MAIL FOR FREE BOOK

Ray D. Smith, President,
RADIO AND TELEVISION INSTITUTE
(R-T-I),

2130 Lawrence Ave., Dept. 13, Chicago, Ill.

Without obligation, send me a copy of
"Radio's Future and Your Opportunity." I
am interested in your training and the oppor-
tunities in the great field of Radio for the
R-T-I Trained Man.

Name.....

Address.....

City.....State.....



RADIO AND TELEVISION INSTITUTE
PRACTICAL SHOP TRAINING FOR THE HOME

Dept. 13

• 2130 Lawrence Avenue

• CHICAGO

When writing to advertisers please mention Popular Mechanics



Go to High School at Home

● You can secure a high school education in your spare time by studying the new courses prepared by the International Correspondence Schools.

These courses are equivalent to the courses given in resident high schools. They have been specially arranged for men and women who wish to meet college entrance examinations, to qualify for a business position, or to make up the education they missed in past years.

The lessons are easy to understand and you will make rapid progress because you will be *in a class by yourself* and you will study under the guidance of instructors who are sincerely interested in you.

Just mark and mail the coupon and we will gladly send you interesting free booklets describing the High School Courses of the I. C. S. or any other subject in which you are interested.

INTERNATIONAL CORRESPONDENCE SCHOOLS

Box 5664-H, Scranton, Penna.

Without cost or obligation, please send me a copy of your booklet, "Who Wins and Why," and full particulars about the subject before which I have marked X in the list below:

- College Preparatory Course
- High School Commercial Course
- High School English Course
- High School Vocational Course
- High School Agricultural Course

BUSINESS TRAINING COURSES

- | | |
|--|--|
| <input type="checkbox"/> Business Management | <input type="checkbox"/> Service Station Salesmanship |
| <input type="checkbox"/> Office Management | <input type="checkbox"/> Business Correspondence |
| <input type="checkbox"/> Industrial Management | <input type="checkbox"/> Lettering Show Cards <input type="checkbox"/> Signs |
| <input type="checkbox"/> Traffic Management | <input type="checkbox"/> Stenography and Typing |
| <input type="checkbox"/> Accountancy and C.P.A. Coaching | <input type="checkbox"/> Civil Service |
| <input type="checkbox"/> Bookkeeping | <input type="checkbox"/> Mail Carrier |
| <input type="checkbox"/> Secretarial Work | <input type="checkbox"/> Railway Mail Clerk |
| <input type="checkbox"/> Cost Accountant | <input type="checkbox"/> Grade School Subjects |
| <input type="checkbox"/> Salesmanship <input type="checkbox"/> Advertising | <input type="checkbox"/> First Year College |
| <input type="checkbox"/> Wallpaper Decorating | <input type="checkbox"/> Illustrating <input type="checkbox"/> Spanish |
| <input type="checkbox"/> Salesmanship | <input type="checkbox"/> Cartooning <input type="checkbox"/> French |
| | <input type="checkbox"/> Lumber Dealer |

TECHNICAL AND INDUSTRIAL COURSES

- | | |
|--|--|
| <input type="checkbox"/> Architect | <input type="checkbox"/> Plumbing <input type="checkbox"/> Heating |
| <input type="checkbox"/> Contractor and Builder | <input type="checkbox"/> Air Conditioning |
| <input type="checkbox"/> Structural Draftsman | <input type="checkbox"/> Sheet Metal Worker |
| <input type="checkbox"/> Structural Engineer | <input type="checkbox"/> Steam Engineer |
| <input type="checkbox"/> Electrical Engineer | <input type="checkbox"/> Civil Engineer |
| <input type="checkbox"/> Reading Shop Blueprints | <input type="checkbox"/> Surveying and Mapping |
| <input type="checkbox"/> Telegraph Engineer | <input type="checkbox"/> Refrigeration |
| <input type="checkbox"/> Telephone Work | <input type="checkbox"/> R. R. Locomotives <input type="checkbox"/> Air Brakes |
| <input type="checkbox"/> Mechanical Engineer | <input type="checkbox"/> R. R. Signalman |
| <input type="checkbox"/> Mechanical Draftsman | <input type="checkbox"/> Highway Engineering |
| <input type="checkbox"/> Machinist <input type="checkbox"/> Toolmaker | <input type="checkbox"/> Chemistry <input type="checkbox"/> Pharmacy |
| <input type="checkbox"/> Inventing and Patenting | <input type="checkbox"/> Coal Mining Engineer |
| <input type="checkbox"/> Patternmaker | <input type="checkbox"/> Navigation <input type="checkbox"/> Boilermaker |
| <input type="checkbox"/> Heat Treatment of Metals | <input type="checkbox"/> Textile Overseer or Supt. |
| <input type="checkbox"/> Bridge Engineer | <input type="checkbox"/> Cotton Manufacturing |
| <input type="checkbox"/> Gas Engines <input type="checkbox"/> Diesel Engines | <input type="checkbox"/> Woolen Manufacturing |
| <input type="checkbox"/> Aviation Engines | <input type="checkbox"/> Agriculture <input type="checkbox"/> Fruit Growing |
| <input type="checkbox"/> Automobile Mechanic | <input type="checkbox"/> Marine Engineer <input type="checkbox"/> Radio |

Name.....Age.....
Address.....
City.....State.....

Occupation.....

If you reside in Canada, send this coupon to the International Correspondence Schools Canadian, Limited, Montreal, Canada

When writing please mention Popular Mechanics

Cheaper HEAT Without COAL



EARN \$60 A WEEK!
Write for FREE Burner offer and protected territory

New Invention Fits Any Stove or Range — 30 Days Free Trial
Remarkable invention burns 96% air, 4% of a cheap variety of oil obtainable everywhere. Does away with coal, wood, ashes, dirt and drudgery. Clean, silent, quick, like gas heat. 3 times hotter than coal and cheaper. Temperature controlled. No more getting up on bitter cold, wintry mornings. Many automatic features. No gas or electricity needed. Safe as any ordinary kitchen range. Easy to install—no damage to stove—simply sits in firebox of any stove, range, heater or furnace. Costs just a few cents a day to operate. TRY 30 DAYS AT OUR RISK. Low introductory price and 30-day trial. Write for FREE CATALOG. AGENTS and spare time workers: Oil heat saves money this year; people buy to save. Write for free burner offer that starts you in business for yourself. Act NOW! Listed as approved by Nat'l. Board of Fire Underwriters. BRIGHAM OIL BURNER CO., 2927-C Clark Ave., St. Louis, Mo.

ENGINEERING DEGREE IN TWO YEARS

B.S. Degree in Electrical, Civil, Chemical, Radio, Mechanical or Aeronautical Engineering in two years. Located in an industrial center with that Engineering atmosphere. Earn board, Low tuition. Preparatory Department. Enter Mar., June, Sept., Dec. Catalog.

INDIANA TECHNICAL COLLEGE

229 East Washington St., Fort Wayne, Indiana

RADIO ENGINEERING



RCA Institutes offer an intensive course of high standard embracing all phases of Radio. Practical training with modern equipment at New York and Chicago schools. Also specialized courses and Home Study Courses under "No obligation" plan. Catalog Dept. PC-37.

RCA INSTITUTES, Inc.

75 Varick St., New York 1154 Merchandise Mart, Chicago
Recognized Standard in Radio Instruction Since 1909.

LEARN WATCH REPAIRING



AT HOME You can learn by our modern and original system of instruction every part of the Watch Repairing Trade at home. You can earn money while learning and prepare yourself for a well paying position or start in business after completing our course of instruction. Good watch repairers are in demand and generally earn very good salaries. For particulars apply to the Wisconsin School of Watch Repairing
524 E. Mason St., MILWAUKEE, WIS.

LEARN MECHANICAL DENTISTRY

SEND FOR FREE BOOK



Special Tool Offer — Now!

Don't waste the best years of your life. Learn this money-making business in a few months, Day or Evening and become independent. Big demand. Highly endorsed—oldest school. Practical training. Individual instruction. Easy terms. Employment Service. Write TODAY

for FREE Catalog P → New York School of Mechanical Dentistry, 125 W. 31 St., New York

Photography for

PLEASURE or PROFIT

Prepare for profitable business or fascinating hobby, at home under guidance of qualified instructors. No previous experience necessary, common school education sufficient. Many earn while learning. Our practical studio methods also qualify for well-paying positions upon graduation. Send coupon below at once for free booklet "Opportunities in Modern Photography", particulars and requirements.

AMERICAN SCHOOL OF PHOTOGRAPHY
3601 Michigan Avenue Dept. 1353

Chicago, Illinois

Send booklet, "Opportunities in Modern Photography", full particulars and requirements.

Name.....Age.....

Address.....

City.....State.....

Learn **DIESEL** and **GAS ENGINEERING**



Partial view of Diesel-engine operating room—one of the important Departments at National Schools.



Students servicing Fairbanks-Morse Diesel power generating unit.

YOU WORK ON FINEST and LATEST EQUIPMENT AVAILABLE IN AMERICA

QUALIFY FOR GOOD PAY JOBS

National Schools' course of Diesel Training is the outgrowth of years of successful development. The instruction is PROVEN. Over 30,000 graduates have received National Training. Now, National offers the most comprehensive training—actually three complete courses for the price of one—Gas and Diesel Engineering, and Electric Power Generation—all of which are absolutely essential to qualify for best jobs.

Easy, Fascinating "Shop-Practice" Method

The day you begin your training at National you start right in with a practical job on the most modern Gas and Diesel equipment, including Caterpillar, Cummins, McCormick-Deering, Hercules, Venn-Severin, Fairbanks-Morse, Enterprise, and many others. The work is actually a pleasure for students—easy to understand—ever fascinating. You learn in a few months what would ordinarily take far longer.

Complete, Modern Equipment Actually Used by Students

The vast installation of modern Gas and Diesel equipment here is all used by you in learning your trade. You learn to assemble and disassemble all parts, learn trouble-shooting; operating and all essentials to qualify you for big-pay Gas and Diesel opportunities. Your instruction is personalized under direct supervision of a large staff of experts.

**LEARN IN LOS ANGELES, Playground of America
RAILROAD FARE ALLOWED | EARN ROOM AND BOARD**

For a limited time, coach R. R. fare allowed to L. A. from any part of the U. S.

We help students obtain part-time jobs to earn room and board while learning.

NATIONAL SCHOOLS, LOS ANGELES

ESTABLISHED 1905



Electrical trouble-shooting in gas engine department.

- NATIONAL'S**
- Master Training Includes
 - All Phases of Diesel Engines
 - Fuel Injection Gas Engines
 - Butane Engines
 - Propane
 - Natural Gas
 - Auto-Diesel Electrics
 - Also Diesel Power Generation
 - Machine Shop
 - Batteries

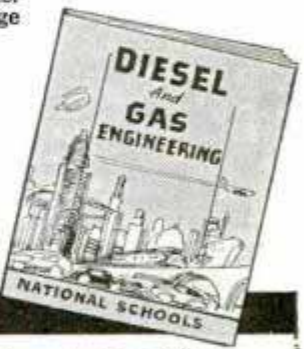

**Special Added Feature!
DIESEL ELECTRIC POWER GENERATION**

In keeping with National Schools' progressive policy of offering the most complete Course, we announce this added feature, made available to you by an investment on our part of thousands of dollars. Full instruction includes:

- Alternating and Direct Current Power Stations
- Switchboards and Instruments
- Station and Motor Wiring
- Motors and Controls
- Distribution Lines, Transformers, etc.

This specialized training enables our graduates to expertly handle Diesel equipment in power plants, mines, public buildings and utilities, boats, trains, etc. Knowledge of Diesel Electrics is just as essential as the fundamentals of Diesels. This school is the only one in the U. S., to our knowledge, offering this extra, yet necessary, specialized training.

MAIL THIS COUPON

NATIONAL SCHOOLS, Los Angeles, Calif.
Dept. 3-PMA, 4000 So. Figueroa St.
Please send Catalog

NAME.....AGE.....
ADDRESS.....
CITY.....STATE.....



High School Course at Home

Many Finish in 2 Years

You can complete this simplified High School Course as rapidly as your time and abilities permit. Equivalent to resident school work—prepares you for entrance to college. Standard H. S. texts supplied—Diploma. Credit for H. S. subjects already completed. Single subjects if desired. High School education is very important for advancement in business and industry and socially.

College Entrance

During the past 14 years, our High School graduates have been admitted to 531 different Universities, Colleges, Junior Colleges and Normal Schools—80% of them without entrance examination. Course also prepares for teachers' certificate and pre-professional examinations.

Business—Industry

To get and hold a good position in Business today you must be able to write clear, accurate letters and reports—do figuring involving Algebra and Geometry—talk intelligently on matters requiring a knowledge of Geography, History, and Economics.

In Industry—Mechanical and Engineering lines—you must have at least an elementary knowledge of Physics and Chemistry—be able to figure quickly and accurately—know something of Mechanical Drawing and blueprints—and be able to talk and write accurately and clearly on both your work and ordinary topics of conversation.

Our High School course meets the preparatory educational requirements for Business and Industry.

An Educational Institution

The American School was chartered in 1897 as an educational institution, not for profit—and is exempt from paying Federal income tax, like the best resident colleges and universities.

Don't Be Handicapped— Complete Your Training Now

Be a High School Graduate! Prepare yourself for promotion in Business and Industry—for the Professions, College Entrance and social success. No matter what line you may select, High School training will prove invaluable to you! Our moderate fees cover all instruction, standard textbooks and Diploma. Easy monthly terms. Get ahead in life. Start your training NOW!

20 Other Courses

Over 150 noted Educators, Engineers, and Business Men helped prepare our special instruction material, which is used by many resident schools and colleges, U. S. Navy, and Province of Manitoba, Canada. We offer you quality training at home for the best-paying lines of Industry and Business, as listed in the coupon.

Mail coupon for information about line that interests you

American School, Drexel at 58th, Chicago

American School, Dept. H-345, Drexel at 58th, Chicago

Tell me how to train for success in line checked. No obligation.

High School Course

- | | |
|--|--|
| <input type="checkbox"/> Accounting & Auditing | <input type="checkbox"/> Diesel Engineering |
| <input type="checkbox"/> Architecture & B'lding | <input type="checkbox"/> Drafting & Design |
| <input type="checkbox"/> Automotive Engin'ring | <input type="checkbox"/> Liberal Arts |
| <input type="checkbox"/> Business Management | <input type="checkbox"/> Private Secretary |
| <input type="checkbox"/> Com'ercial Aeronautics | <input type="checkbox"/> Hi'er Ac't'g (C.P.A.) |
| <input type="checkbox"/> Electrical Engineering | <input type="checkbox"/> Highway Engin'r'g |
| <input type="checkbox"/> Electrical Refrigerat'n | <input type="checkbox"/> Mechanical Eng'r'g |
| <input type="checkbox"/> Air Conditioning | <input type="checkbox"/> Radio & Television |
| <input type="checkbox"/> Civil Engineering | <input type="checkbox"/> Salesmanship |
| <input type="checkbox"/> Complete Law | <input type="checkbox"/> Steam Engineering |

Name.....

Address.....

AMAZING NEW ELECTRIC ARC WELDER

**RETAILS
Only
\$95
Complete**

**HOOK UP TO
ANY BATTERY! \$**

Just invented! Amazing new Comet ELECTRIC ARC WELDER—hooks up to any storage battery—generates tremendous heat to weld all metals. PRICE, ONLY \$1.95, complete. Repairs fenders, auto bodies, galvanized cans, radiators, castings, machinery parts, etc. Fuses broken parts permanently, stronger than before. Low power consumption. Take the Comet anywhere to the job, operate from auto battery. Sturdily built of finest materials to last years. FULLY GUARANTEED BY BIG MANUFACTURER.

SEND NO MONEY! You'll find a thousand uses for the Comet around your home, garage, and work shop. Thousands of garages need the Comet Welder. Also factories, repair shops, mechanics, farmers, inventors, tin shops, plumbers, etc. Order a Comet now. Send no money. We'll rush one to you, complete with rods. Pay postman only \$1.95 plus few cents postage. If not delighted, return Comet in 5 days from receipt and money you paid for it will be refunded instantly. Rush your order NOW. **Comet Welders, Dept. S-17, Cincinnati, Ohio**

ENGINEERING

TECHNICAL AND APPLIED COURSES. Nonessentials omitted. TIME AND MONEY SAVED. Degree in 2 yrs., diploma in 1 yr. Electrical, Mechanical, Architectural, Structural, Aeronautical, Civil, Highway. Short intensive courses in Diesel-Electric, Electricity, Power Plant, Drafting. All courses include Refrigeration, Diesel, and Air-Conditioning. Low tuition. Extensive modern equipment. Part-time work for room and board. 37th year. Thousands of successful graduates in U. S. and foreign lands. Approved by Industry, endorsed by educators and alumni. One and two-year courses begin in Sept. Short courses open the year round. Catalogue free.

FINLAY ENGINEERING COLLEGE
1001 Indiana Avenue Kansas City, Mo.

You Can Regain Perfect Speech, if you STAMMER

Send today for beautifully illustrated book entitled "DON'T STAMMER," which describes the Bogue Unit Method for the scientific correction of stammering and stuttering. Method successfully used at Bogue Institute for 36 years—since 1901. Endorsed by physicians. Full information concerning correction of stammering sent free. No obligation. **Benjamin N. Bogue, Dept. 176, Circle Tower, Indianapolis, Indiana.**

Operator No. 38

FOLLOW THIS MAN

Secret Service Operator No. 38 is on the job! Running down dangerous Counterfeit Gang. Tell tale finger prints in murdered girl's room.

Free The Confidential Report Operator No. 38 made to his chief. Write for it.

Earn a Regular Monthly Salary
YOU can become a Finger Print Expert at home, in your spare time, at small cost. Write for confidential full report and details. Literature will NOT be sent to boys under 17 years of age.

INSTITUTE OF APPLIED SCIENCE
1920 Sunnyside Ave.
Dept. 1353 Chicago, Ill.

12 FEMALE
1129 MALE

WHY NOT

spend spring, summer, fall, gathering butterflies and moths. I buy hundreds of kinds for collections. Some worth \$1 to \$7 each. Simple work with my low cost Instructions, pictures, price list. Profit—Pleasure. Send 10c for Illustrated Prospectus, terms, before sending any butterflies.

Mr. Sinclair, Dept. 6, Box 1424, San Diego, California

VOICE

89 PAGE BOOK
ILLUSTRATED
SENT FREE

(NO OBLIGATION TO BUY!)

If you act quick!—we will send postpaid—for 30 days free reading—new 89 page Voice Book disclosing startling VOICE FACTS that may save hundreds of dollars to every man or woman seeking a strong, rich voice for either singing or speaking. 30 days free reading—then send \$1.00. Otherwise, return it—that's all!

Prof. E. Feuchtinger
Studio 1353
64 E. Lake St., Chicago

DIESEL

*Are you just shoveling, and drifting along,
blind to new opportunities?*

**100 years of steam
40 years of gasoline power
now comes DIESEL.**

HEMPHILL DIESEL SCHOOLS

were America's first institution to devote their entire efforts exclusively to the training of men for the Diesel field.

Located only at the addresses shown below:

BOSTON, 114 Brookline Avenue
NEW YORK, 31-26 Queens Blvd., L. I. City
DETROIT, 2341 W. Lafayette Blvd.
CHICAGO, 3014 Larrabee Street
MEMPHIS, 417 Monroe Avenue
LOS ANGELES, 2120 San Fernando Road
SEATTLE, 501 Westlake North
VANCOUVER, B. C., 1363 Granville Street

INVENTORS

TO be successful as an inventor, you don't need to be an Edison who took out 1099 Patents before he died, or a C. F. Kettering, who helped develop the Self-Starter, Duco, Ethyl Gas and other outstanding inventions, and is today the famous head of the Research Division of the General Motors Corporation. In fact, you don't need to be known as an inventor at all, if you have a practical, useful, salable invention—or an idea for one—and go about it right.

Remember that for every Edison or Kettering, for every McCormick, DeForest or Atwater Kent—there have been thousands of unknown men whose inventions helped along the wheels of progress and helped the inventors financially at the same time.

MANY LITTLE IDEAS HAVE BIG COMMERCIAL POSSIBILITIES

For example, who knows the name of the inventor of the wooden golf tee, the ordinary crinkly hair pin, or the metal ball or disc that the average housewife uses for scouring pots and pans? Who knows the inventors of the thousands of gadgets that you will find in the ten-cent stores, in the modern drug and department stores? Some day, stop and look at some of the simple articles you'll find on the counters of a ten-cent store. Notice how many of them are marked "Patented or Patent Applied For." It is an interesting educational experiment. These inventors, most of them, weren't of the genius class. They simply got an idea for doing something in a better, easier, faster, or more economical way—AND THEN DID SOMETHING ABOUT IT.

Interesting Points

Who is today's "champion inventor"?

Ans.: John F. O'Connor, of Chicago, Ill., holds 949 Patents, more than any other living man.

Who is "Lady Edison"?

Ans.: Miss Beulah Louise Henry of New York City leads all women inventors, holds fifty patents; is known as "Lady Edison."

What is an improvement?

Ans.: Nearly all inventions today are improvements over earlier inventions. Often the improvement proves more profitable than the earlier invention.

Is a model necessary?

Ans.: Today, most inventions are patented without models. A subject fully explained in our book.

What is the preliminary search?

Ans.: The preliminary search is ordinarily the first step to help an inventor. Also fully explained in our book. Send for a copy today.

A New Book about Selling Inventions

There are two sides to every inventive success: The inventive side and the commercial side. A good invention poorly handled, can prove a failure commercially. An ordinary invention, properly handled, can be made a money-maker. In the special booklet, shown here, we give you some suggestions on "When and How to Sell an Invention"; practical hints on the commercial side of inventing. We'll send this new booklet along with the big 48-page book, "Patent Protection" illustrated on the next page. Use the convenient coupon to request your copies.

You may be able to do as well as others who have been successful. That only time can tell. But there is one thing you can do, and do now, without waiting on time. You can find out easily and quickly **exactly what to do to protect yourself.** In the 48-page book, "Patent Protection" shown on the opposite page, which will be sent to you FREE, we tell you what many other inventors have done, just what you yourself must do to make Application for a Patent, give you interesting facts about inventive history, show you 115 mechanical movements that inventors have used in working out ideas, and **much more.** Decide now to get a copy of this interesting book. Its facts can be worth much—**yet they cost you nothing.**



We Cordially Invite You to . . .

NOTE



You may not be an Edison or a Kettering but still you may have a good idea

YOUR QUESTIONS ANSWERED! There are a lot of questions that the average man with an invention, or an idea for one, wants answered before he goes ahead. Here are a few of them that most inventors put up to us: How do the Patent Laws protect me? What easy steps can I take, without cost, to put myself in position to support my belief that I am the **first** man to think of **my invention**? Is a Patent worth the cost? Should I try to sell my invention before I have it Patented? Is there any

safe, business-like way to secure financial help? If I do apply for a Patent how shall I reach people who can market my invention? Can I protect and sell an improvement on some invention that has already been patented? These are but a few of the questions which usually confront the average man. **You need the answers! YOU CAN HAVE THEM, without cost, trouble, or delay.**

Our Business Is to Help You Write Us Today

For more than thirty-seven years, this firm has been helping men with an inventive turn of mind. We maintain a large staff of trained, experienced specialists—**Registered Patent Attorneys, Draftsmen, and Searchers** to help our clients secure all the protection to which they are entitled. Fees are reasonable. Deferred payments frequently arranged. Questions promptly answered. Write us frankly with absolute assurance that what you say will be treated with strictest secrecy. **But first send for the FREE BOOKS shown on these two pages.** They are filled with facts, pictures and suggestions. They tell you things about Patents, Inventions and Selling Inventions that we have learned in our long experience. **They may save you time, expense, EVEN LATER DISAPPOINTMENT.** Simply fill in the coupon or write us a confidential letter. No charge, no obligation. **Mail the coupon today.**

VICTOR J. EVANS & Co.

REGISTERED PATENT ATTORNEYS

Main Office: 200-C, Victor Building, Washington, D. C.

Other Offices: 1007-N, Woolworth Bldg., New York
1415-N, Monadnock Bldg., Chicago
514-N, Empire Bldg., Pittsburgh
1010-N, Hobart Bldg., San Francisco
736-N, Security Bldg., Los Angeles

Send me FREE copies of your books, "Patent Protection" and "When and How to Sell an Invention." (Note: Same books supplied by any of branch offices listed above.)

Name.....

Street and No.....

City or Town.....

.....

.....

MAIL THIS COUPON TODAY

When writing to advertisers please mention Popular Mechanics

DIESEL POWER

A COMING AMERICAN INDUSTRY



Courtesy DIESEL PROGRESS

THE internal-combustion engine represents man's supreme triumph of machine power. Diesel engineers are in great demand.

Many are acquiring necessary knowledge through spare-time study of this modern I. C. S. Course on Diesel engines. Free booklet!

INTERNATIONAL CORRESPONDENCE SCHOOLS

Box 5666-H, Scranton, Penna.

Explain fully about your course in the subject marked X:

DIESEL POWER

- | | |
|---|---|
| <input type="checkbox"/> Mechanical Engineering | <input type="checkbox"/> Architecture |
| <input type="checkbox"/> Automobile Course | <input type="checkbox"/> Radio |
| <input type="checkbox"/> Concrete Construction | <input type="checkbox"/> Chemistry |
| <input type="checkbox"/> Civil Engineering | <input type="checkbox"/> Aviation Engines |
| <input type="checkbox"/> Gas Engine Operating | <input type="checkbox"/> Air Conditioning |
| <input type="checkbox"/> Electrical Engineering | <input type="checkbox"/> Refrigeration |
| <input type="checkbox"/> High School Subjects | <input type="checkbox"/> Civil Service |

Name..... Age.....

Address.....

Now Is the Time
to get **READY**
for Good Pay Jobs
in **AVIATION**



Thousands of new jobs being created in aviation as a result of the greatest growth the industry has ever known. Factories are working night and day building new airplanes. Airlines are adding millions of miles to their flight schedules. Thousands of newly trained men are needed. There is a place for you . . . if you have the proper training . . . the complete training Lincoln offers you.

LINCOLN Prepares You

Lincoln Government Approved Training gives you the accurate technical knowledge and practical experience which qualify you for the better pay jobs in aviation; Airline Pilots get up to \$700 a month, Co-Pilots get \$250 a month. Licensed Mechanics get up to \$200 a month. We train you for Government License as Transport, Limited Commercial, Private or Amateur Pilot. Also every requirement for Government License as Airplane and Engine Mechanic. Sheet Metal Training. Start training now at this Government Approved School. Now in 27th year. 17th year teaching aviation. Mail coupon now.



LINCOLN AIRPLANE & FLYING SCHOOL
Division of Lincoln Aeronautical Institute (Inc.)
206-G Aircraft Bldg., Lincoln, Nebr.

LINCOLN AIRPLANE & FLYING SCHOOL
206-G Aircraft Bldg., Lincoln, Nebraska

YES! I want further facts about LINCOLN'S complete training and the big-pay opportunities ahead in Aviation.

Name..... Age.....

City..... State.....

DANCE IN 5 HOURS

A whole family can learn from one set!



Realize your ambition—become a good dancer quickly, easily, at home! Arthur Murray, world-famous dance authority, with his new picture course teaches you popular Fox Trot, Waltz steps, poise, balance, correct following, self-assurance. No music or partner needed. Write today for 10 Lesson Introductory Course. Pay postman \$1.98 when he brings Course or send \$2 with order and save 24c postage. Try it 5 days. If not delighted with results money promptly refunded.

ARTHUR MURRAY, Studio 306, 7 E. 43 St., N.Y. C., N.Y.



TRI-STATE COLLEGE

B. S. Degree in 2 years. World famous for technical 2-year courses in Civil, Electrical, Mechanical, Chemical, Radio, Aeronautical Engineering; Business Administration and Accounting. Those who lack high school may make up work. Low tuition. Low living costs. Short diploma courses in Surveying (36 weeks), Drafting (36 weeks). Students from every state and many foreign countries. 54th year. Enter March, June, Sept. and Jan. Write for catalog. 437 College Ave., ANGOLA, IND.

LEARN MECHANICAL DENTISTRY

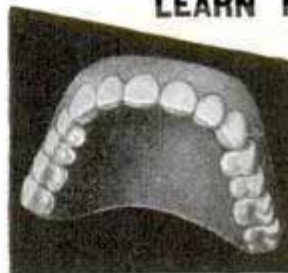

A profession offering unlimited opportunities. Most modern and complete course embracing every branch from Plate to Porcelain Work, which prepares you to work for Dentists or start your own business. Individual instruction—practical training in day or night school. No books—no classes. Catalog upon request.

Dept. 719

McCARRIE SCHOOL
OF MECHANICAL DENTISTRY
207 N. Broad St. Phila., Pa.

LEARN CARTOONING

by the method that has developed hundreds successfully. Send name, address and age for free chart to test your ability.

The Landon School, 1738 National Bldg., Cleveland, Ohio

BARBERING OR BEAUTY CULTURE OLDEST, LARGEST SCHOOLS. Est. 1893. EARN while LEARNING. Day, Night classes. Free National employment bureau. Prize winning teachers. Big pay. Professions. Low rates. Easy terms. Free booklet "B."
MOLER SYSTEM, NEW YORK, N. Y., 112 W. 42nd St.



Printing Offers PROFITS

Cards, stationery, circulars, etc. Easy rules sent. Does raised printing like engraving. Print for others, Big Profits. Save money. Junior press \$5.90; job press \$11; power, \$147. Sold direct from factory only. Send for free catalog and all details. THE KELSEY CO., P-37, MERIDEN, CONN.

Amazing Sensational Discovery REFINISHES AUTOS LIKE NEW!

NOT A WAX OR POLISH—LASTS 8 TO 12 MONTHS—SHABBY CARS GIVEN NEW LUSTER AND SHINE



Men — it's unbelievable, a miracle! KAR-NU refinishes old shabby cars in a few minutes. Gives them like-new shine. Not a polish, wax, or paint, but a real finish that lasts 8 to 12 months. Stands washing, sunshine, long wear. No rubbing—no polishing—no waxing. Just apply with rag. Guaranteed.

FREE SAMPLE

What a profit-maker for agents and distributors! Millions of cars need this new LOW PRICED auto finisher. BIG PROFITS—up to \$7.00 in an hour, easy. Ten second demonstration on any man's car sells him QUICK. Hurry—get FREE SAMPLE which proves all claims. Write or wire today. Distributors Wanted in Foreign Countries. KAR-NU CO., Dept. M-30, Oakley, Cincinnati, Ohio

LOW PRICED
GUARANTEED

Why waste time on old fashioned methods

—when you can learn to play
at home without a teacher

DON'T let the thought of long years of tire-some practice scare you away from learning to play! Don't let the thought of an expensive private teacher keep you from letting your dreams come true! For you — *anyone* — can easily *teach yourself* to play—right in your own home, in your spare time, and at only a fraction of what, old slow methods cost!

It's *so* easy! Just look at that sketch at the right. The note in the first space is *always* f. The note in the second space is *always* a. The way to know the notes that come in these four spaces is simply to remember that they spell *face*.

Now, isn't that simple? You don't have to know one note from another in order to begin. For the U. S. School way explains everything as *you go along*—both in print and picture—so that, almost before you know it, you are playing *real tunes and melodies* right from the notes.

You simply *can't go wrong*. First you are *told* what to do, then the picture *shows* you how to do it—then you do it yourself and *hear* it. No private teacher could make it any clearer.

Easy as A-B-C

No wonder over 700,000 men and women have enrolled! For this famous course is based on sound, fundamental musical principles highly simplified. It's not a "trick" or "stunt" method. You learn to play from notes, just as the best musicians do. You learn to pick up any piece of music, read it, and understand it.

No time is wasted on theories. *You get all the musical facts*. You get the real meaning of musical notation, time and harmony.

You'll find yourself studying the U. S. School way with a smile. Your own home is your studio. The lessons come to you by mail. They consist of complete printed instructions, diagrams, all the music you need. There are no dry-as-dust exercises to struggle through. Instead it's just like playing a game—you learn so fast!



Easy as A-B-C



If you can read the alphabet you can learn to play your favorite instrument in just a few months.

Free Book and Demonstration Lesson

"How You Can Master Music in Your Own Home" is an interesting book that is yours for the asking. With this free book we will send you a typical demonstration lesson that proves better than words, how quickly and easily you can learn to play your favorite instrument by note—in less than half the time and at a fraction of the cost of old, slow methods—the U. S. School way.

If you really want to play—if new friends, good times, social popularity, and increased income appeal to you—clip and mail the coupon NOW. Instruments supplied when needed, cash or credit. U. S. SCHOOL OF MUSIC, 73 Brunswick Bldg., New York City.

Thirty-ninth Year (Established 1898)

U. S. SCHOOL OF MUSIC
73 Brunswick Building, New York City

Please send me your free book, "How You Can Master Music in Your Own Home," with inspiring message by Dr. Frank Crane, Free Demonstration Lesson, and particulars of your easy payment plan. I am interested in the following course:

..... Have you Instrument?.....

Name.....

Address.....

City.....State.....

What Instrument for You?

- | | |
|-------------------------------------|-----------|
| Piano | Guitar |
| Violin | Saxophone |
| Organ | Mandolin |
| Cornet | Ukulele |
| Trombone | Harp |
| Piccolo | Clarinet |
| Flute | 'Cello |
| Hawaiian Steel Guitar | |
| Trumpet | |
| Piano Accordion | |
| Italian and German Accordion | |
| Voice and Speech Culture | |
| Harmony and Composition | |
| Drums and Traps | |
| Banjo (Plectrum, 5-String or Tenor) | |

No Talent Needed

Forget the old-fashioned idea that you need "talent." Just read the list of instruments in the panel and decide which one you want to play. Remember—no matter which instrument you choose, the cost in each case will average only a few cents a day.

You'll never regret having learned to play. For those who can entertain with music at parties—who can snap up things with peppy numbers—are always sought after, always sure of a good time! Start now and surprise your friends!

When writing to advertisers please mention Popular Mechanics



MECHANICAL ENGINEERING

Less than 20 minutes a day with these 7 big mechanical engineering books entitled "Modern Shop Practice," can prepare you for a better job and bigger pay. Machine hands can become foremen and superintendents, helpers become experts, foremen become managers. Machinists, helpers or factory employees can benefit QUICKLY and command more money.

Pays Big NOW!

Your Opportunity Don't miss this chance to off for one minute this Big Opportunity which is yours almost for the asking. Seven Big Books chockful of important mechanical facts told so simply and clearly that any one can understand them. Over 2600 pages, nearly 2700 illustrations cover every subject fully, including Tool Making, Pattern Making, Foundry Work, Mechanical Drawing, Forging, in fact anything you need to know.

Everything Sent FREE for examination. You ALL of these books will be sent to you for examination. Decide in your own home or place of business whether or not you want to keep them, check up on any facts you want to. Note their great MONEY MAKING value, then, if you want them, pay on the easiest kind of payments.



These Instruments Included

Complete set of drawing instruments if you send for these books NOW. These instruments are made of the finest of German silver, are absolutely accurate and are packed in velvet lined leatherette pocket case. Real \$10 value but sent to you with these books without extra charge.

American Technical Society, Dept. M319, Drexel at 58th St., Chicago
 You may send me the 7 big NEW books for free examination. I will pay the few cents delivery charges only unless I decide to keep them in which case I will send \$2.00 in ten days and \$3.00 per month until the total price of only \$29.80 is paid. If I return them in 10 days I will owe you nothing. Because I send now, you agree to give me a membership in the American Technical Society entitling me to Free consultation privileges with any of your experts for one year and set of drawing instruments.

Name.....
 Address.....
 Please attach a letter stating age, occupation, employer's name and address and that of at least one business man as reference.

AUDELS Carpenters and Builders Guides



4 vols. \$6

Inside Trade Information for Carpenters, Builders, Joiners, Building Mechanics and all Woodworkers. These Guides give you the short-cut instructions that you want—including new methods, ideas, solutions, plans, systems and money saving suggestions. An easy progressive course for the apprentice and student. A practical daily helper and Quick Reference for the master worker. Carpenters everywhere are using these Guides as a Helping Hand to Easier Work, Better Work and Better Pay. To get this assistance for yourself, simply fill in and mail the FREE COUPON below.

How to use the steel square—How to file and set saws—How to build furniture—How to use a mitre box—How to use the chalk line—How to use rules and scales—How to make joints—Carpenters arithmetic—Solving mensuration problems—Estimating strength of timbers—How to set girders and sills—How to frame houses and roofs—How to estimate costs—How to build houses, barns, garages, bungalows, etc.—How to read and draw plans—Drawing up specifications—How to excavate—How to use settings 12, 13 and 17 on the steel square—How to build hoists and scaffolds—skylights—How to build stairs—How to put on interior trim—How to hang doors—How to lath—lay floors—How to paint.



THEO. AUDEL & CO., 49 W. 23rd St., New York City
 Mail Audels Carpenters and Builders Guides, 4 vols., on 7 days' free trial. If O.K. I will remit \$1 in 7 days, and \$1 monthly until \$6 is paid. Otherwise I will return them. No obligation unless I am satisfied.

Name.....
 Address.....
 Occupation.....
 Reference..... P.M.

PLASTIC RUBBER



BOOTS-SHOES



AUTO TIRES

Hundreds of OTHER USES

Every handy man needs So-Lo! Mends holes in shoes, boots, galoshes, only 1c a repair. Fills cracks and worn places in everything of rubber, leather and cloth. WEARS—and won't come off!

So-Lo Spreads on Like Butter Dries Tough Overnight
WATERPROOF-FLEXIBLE-NON SKID

Big 25c can contains enough for 25 repairs! Satisfaction guaranteed or money back. Tear out this ad as a reminder to get So-Lo at Kresge's, Woolworth's, Gamble's, Grant's, Green's, Kress's, McLellan's, McCrory's, Morris', Murphy's, Neisser's, Newberry's, Sears', Ward's or at your nearest 10c or hardware store.

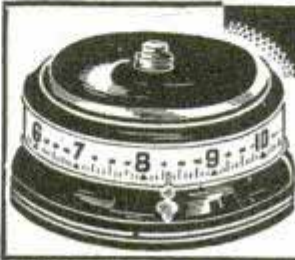

GIVEN AWAY!

You get one—Your friends get one—without cost. Let us give you the details of this amazing Time Teller. Also it can pay you big money giving it away free. Nothing to buy or sell! Write fast!

GARDEN CITY NOVELTY CO.
 Dept. 123
 4318 Ravenswood Ave.,
 Chicago, Ill.

AUTOMOBILE RACING New Book

(FOURTH EDITION)

Nine Chapters—66 illustrations of dirt, midget and championship cars and drivers. How to build cars and bodies—14 plates working drawings. Converting stock cars to 135 m.p.h. racers. Answers all questions on speeding up cars, balance, speed, revs., rules, specifications, track records, etc. Postpaid \$1.00, C.O.D. \$1.12. Order NOW. Ray Kuns, Dept. B-3, Madisonville, Cincinnati, Ohio.



RADIO ENGINEERING, broadcasting, aviation and police radio, servicing, marine and Morse telegraphy taught thoroughly. Nine months' engineering course equivalent to three years' college radio work. School established 1874. All expenses low. Catalog free.
Dodge's Institute, Ada St., Valparaiso, Ind.

MAKE MONEY AT HOME!
 Learn to color photos and miniatures in oil. No previous experience needed. Good demand. Send for free booklet, "Make Money at Home" and requirements.
NATIONAL ART SCHOOL
 3601 Michigan Ave. Dept. 1353 Chicago

You Have a Right to Know The Hidden Truth

What facts of life were concealed in the Middle Ages? What ancient truths were withheld by church and state for centuries? Why did tyrants fear these findings?

Do you want to know the astounding truths about these mysteries and learn how they can help you?

This Sealed Book—FREE

Send for the fascinating Sealed Book revealing what the Rosicrucians know.

Address SCRIBE M.C.P.

The ROSICRUCIANS
 SAN JOSE (AMORC) CALIFORNIA
 [Not a Religious Organization]



J. H. McSweeney
 Founder and
 President

READ What a Few Mc-Sweeney-trained men have to say:

Works for the I. H. C.

Been busy since I came back from your school. I am working here for the International Harvester Company at good wages. I like it fine. Nothing like learning a good mechanical trade and getting a good job.—Ardel Sims, Oklahoma City, Okla.

Pays Income Tax Now

Just got through writing check for income tax. Hope to have a place of my own soon. Am happy, pleased with my job and have everything that could make a person contented. The money I spent at your school was the best I ever invested.—Lee Grant, Ravenna, O.

Now Has Steady Job

Have been working for the past 18 months in a garage. I don't find any job I can't handle and I sure don't regret what I spent in your shops.—Hubert Erwine, Marlinton, W. Va.

LEARN AUTO MECHANICS in 8 weeks!

REAL JOBS ARE OPEN for trained men. The automobile business has come back with a rush. Jobs are waiting everywhere—but only for the man who has had **practical training**. Get into the great, thriving automobile industry. Earn \$35 to \$75 a week. McSweeney fits you in just eight weeks to hold down a good high-pay job, or to open your own repair shop. Don't look for a job—**TRAIN** for it!

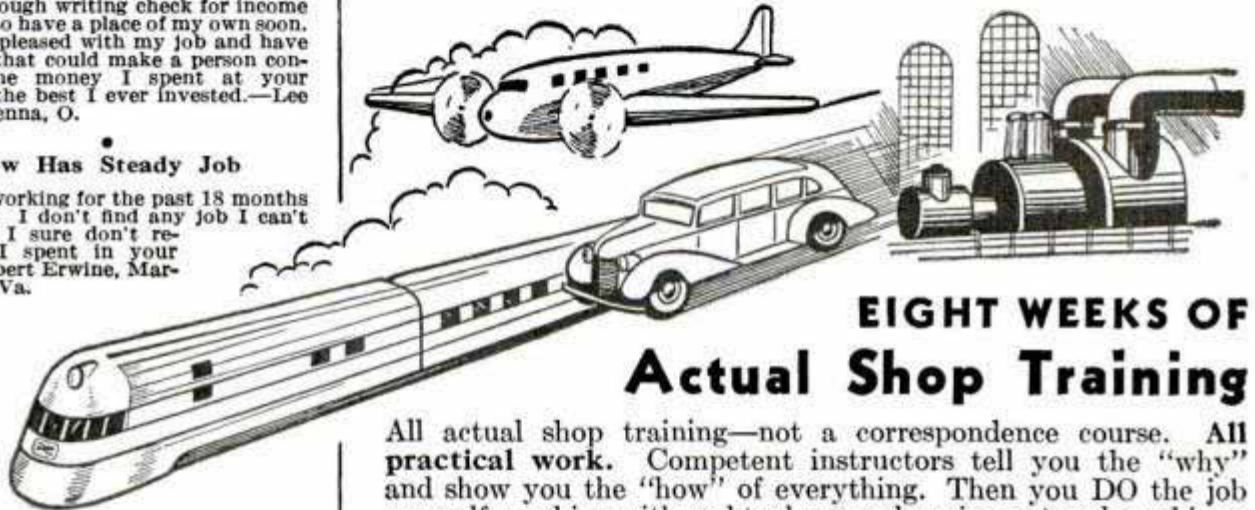

EIGHT WEEKS OF Actual Shop Training

All actual shop training—not a correspondence course. All **practical work**. Competent instructors tell you the "why" and show you the "how" of everything. Then you DO the job yourself, working with real tools on real equipment and machines. Complete rounded out training that makes you an experienced and practical mechanic. Read what a few trained McSweeney men have done. Hundreds of others can tell you similar facts. In eight short weeks, you are **TRAINED**, ready for a permanent job at Good Pay. Any man 16 to 50 can learn. Write today for our Free Book and Low Tuition Offer.

GUARANTEED TRAINING

Eight weeks of intensive shop training, the McSweeney way, fits you for a real job at good pay. If not satisfied, your tuition will be refunded

FREE

This big illustrated Book will be sent you free. Get the facts about jobs and our Low Tuition Offer. Mail coupon right now.

Diesel, Aviation and Welding

Here are three important fields. Prepare now for opportunities that lie ahead.

McSWEENEY

TRADE SCHOOL

AUTO—DIESEL—AVIATION—WELDING

DETROIT, MICH. WRITE THE SCHOOL KANSAS CITY, MO. NEAREST YOU

MAIL COUPON AT ONCE FOR FREE BOOK

McSweeney Auto and Aviation School, Dept. 10-39, Detroit, Mich., or Kansas City, Mo. Without cost or obligation, send me your Big FREE Book; also full information about your Low Tuition Offer.

Name.....
 Street.....
 Town..... State..... Age.....





*Small
Inventions*
**THAT HAVE
BUILT BIG
BUSINESSES**

INVENTIONS do not have to be complicated to be profitable when Patented. The 5c and 10c stores flourish on simple Patented products which are commercially successful. The zipper, safety pin, thumb tack, paper clip, collar button—all simple, yet familiar inventions—brought their inventors rich rewards. If you have a Patentable invention—act to protect it. Many of the most useful, widely popular, greatly profitable, and ex-

tremely successful inventions have been very simple ones. You have only to look at the devices we have pictured here to realize how a simple invention may become a utility bought by a hundred thousand or a million people soon after it is produced. Don't be afraid that the simplicity of your invention makes it valueless. The thing that you find so simple that you wonder why a thousand other people haven't already done it is often the invention worthwhile.

HOW OTHER INVENTORS GOT STARTED



The list of men who succeeded in invention with only a poor boy's start is a very long and noble one. Poverty, hardships, lack of friends, distance from the market—these could not hold back Bell, Edison, Eastman, McCormick, Whitney and others. Everyone cannot succeed. But every man can try. Courage, sacrifice, and hard work may bring you a measure of the success these men had. Lack of mechanical ability is not a serious drawback. You can always get someone able to build a model, draw a detailed design, or otherwise materialize your invention for you. The big draw-back is discouragement.

Your invention of a practical article or an improvement upon an old one should be

patented NOW. Frequently many of the thousands of applications filed in the U. S. Patent Office each year are for the same or almost the same invention. In such a case, the burden of proof rests with the last application filed. Sometimes a delay of even a few days in filing the application means the total loss of the patent. **LOSE NO TIME.**

The entire time of this large and experienced organization is devoted exclusively to patent and trade-mark cases. We know the rules and requirements of the Patent Office. We understand the technicalities of Patent Law. We can proceed in the quickest and safest ways in preparing an application for a patent covering your invention.

FREE THE BIOGRAPHY OF GEORGE EASTMAN
Views of the man who used Patent Protection to amass millions and give perfection to a new art—*Photography*—itself one of the greatest inventions.

CLARENCE A. O'BRIEN & HYMAN BERMAN

702 ADAMS BUILDING

WASHINGTON, D. C.

Registered Patent Attorneys Before U. S. Patent Office

When writing to advertisers please mention Popular Mechanics

Send For This
FREE BOOK

TODAYS

If you have an invention that is patentable—and want to secure for yourself your inventor's sole right to profit from the invention—you can't afford to lose time in securing the protection of a U. S. Patent. Other inventors may be working on the same invention right now. Should they develop this invention and file patent application before you do—the burden of establishing priority will be upon you. Our Big Book—"Patent Guide for the Inventor"—will tell you the quickest possible way to secure Patent Protection for your invention. **SEND FOR IT TODAY!**

The **FIRST IMPORTANT STEP** in **SECURING A PATENT**—is to obtain the services of a Registered Patent Attorney. The U. S. Patent Office advises that you secure the aid of an experienced Registered Patent Attorney to prepare your statements. Establish the date of your invention as explained in our book and disclose your invention to him in correct form. He then makes a **SEARCH** of the Patent Office Records and reports to you on existing U. S. Patents which might bear on your invention, giving his opinion on the advisability of proceeding and filing formal application.

REASONABLE FEES—CONVENIENT TERMS. Don't worry about finances. Our fees are very reasonable—we can arrange convenient terms of payment. It is our custom to permit clients to pay for our services in installments as the application progresses in our office. See our Big Book for fees in obtaining Patent. It explains our arrangements clearly. Send for it **NOW!**

FREE RECORD OF INVENTION FORM—Use our **FREE** "Record of Invention" form to assist you in recording the descriptive outline of your invention and to establish the date of your invention. With it you can make a rough sketch of your invention and have it witnessed in a manner of value to you as evidence should occasion arise.

TEAR OFF AND MAIL NOW!

**CLARENCE A. O'BRIEN
& HYMAN BERMAN**
702 Adams Building
WASHINGTON, D.C.
REGISTERED PATENT ATTORNEYS
BEFORE U.S. PATENT OFFICE

Please send me at once your Big Free 48-Page Book, "Patent Guide for the Inventor" and your Specially Prepared "Record of Invention" form. Also George Eastman Biography, "Inventor and Business Man." This request does not obligate me. (Please write or print plainly)

NAME.....

ADDRESS.....



PROTECT YOUR INVENTIONS WITH U.S. PATENTS



PATENTS

Booklet Free Highest References
Promptness Assured Best Results

Send drawing or model.

ALL BUSINESS GIVEN PROMPT AND PROPER ATTENTION

Listed Patent Lawyer in the latest editions of the Rand-McNally Directory of Bankers and Bank-Recommended Attorneys, published by Rand-McNally & Co., Chicago, Ill.; The Baggott & Ryall Directory of Guaranteed Attorneys, published by Legal Directory Corporation, Boston, Mass.; American Lawyers Annual, Cleveland, Ohio; Bankers Service Legal Directory, published by Bankers Service Co., Boston, Mass.; Eyre's Law List, 9 Park Place, New York City; Snow-Church Directory Co. Lawyers List, published in New York City, and the Central Guarantee Co., Bankers and Lawyers Directories, 630 Fifth Avenue, New York City.

WATSON E. COLEMAN,
REGISTERED PATENT LAWYER

Victor Building, 724 Ninth Street, N. W.
WASHINGTON, D. C.

INVENTORS PATENT YOUR IDEAS SEND FOR FREE BOOK



HOW TO OBTAIN A PATENT

Written by a Former Member of the Examining Corps (1922-24) of the U. S. Patent Office. If you want to profit by your idea, you should take steps to apply for a U. S. Patent at once. Your first step is to get this Free Book. This interesting illustrated book contains valuable information you should have. It tells you fully how to obtain a patent on your idea in the quickest way. With this Free Book you will also receive a "Record of Invention" form on which you can easily record your idea. Personal and Confidential Service: Your case will be personally handled only by a Registered Patent Attorney who is also a Former Member of the Examining Corps of the U. S. Patent Office. All communications confidential.

MAIL COUPON TODAY for FREE PATENT BOOK and RECORD OF INVENTION Form.

CARL MILLER

REGISTERED PATENT ATTORNEY
FORMER MEMBER EXAMINING CORPS U. S. PATENT OFFICE

1638 Woolworth Bldg., Dept. 37A, New York City
MILLER BUILDING, Dept. 37A, WASHINGTON, D. C.

Please send me your Free Book, "How to Obtain a Patent," and your "Record of Invention" form.

NAME.....

ADDRESS.....

PATENTS—TRADE MARKS

All inventions submitted held confidential and given personal attention by members of the firm.

Form, "Evidence of Conception" and instructions, "How to Establish Your Rights"—FREE!

LANCASTER, ALLWINE & ROMMEL

Patent Law Offices

412 Bowen Bldg. Washington, D. C.



G E A R S

In Stock—Immediate Delivery

Gears, speed reducers, sprockets, thrust bearings, flexible couplings, pulleys, etc. A complete line is carried in our Chicago stock. Can also quote on special gears of any kind. Send us your blueprints and inquiries.

Write for Catalog No. 10

CHICAGO GEAR WORKS
769-773 W. Jackson Blvd., CHICAGO, ILL.

New Ideas now Salable Before Patenting

Practical, useful inventions may now be safely marketed without patenting expense. Write for proof that we successfully sell both patented and unpatented inventions.

Chartered Institute of American Inventors

Dept. 4, Barrister Building, Washington, D. C.

PATENTS Protect Your Idea: By securing FREE my "PROOF OF INVENTION" folder. *Exceptional Personal Service.* Excellent References. Established 1906.

E. E. VROOMAN, 871 Woodward Bldg., WASH., D. C.

INVENTORS

who derive largest profits know and heed certain simple but vital facts before applying for patents. Our book, Patent-Sense, gives those facts; sent free. Trade Marks—Copyrights.

LACEY & LACEY, Est. 1869, 635 F St., N. W., Dept. 5, WASHINGTON, D. C.

ALBERT E. DIETERICH

REGISTERED PATENT ATTORNEY

512 B Colorado Building, WASHINGTON, D. C.

Booklet on Patents sent free

Rheumatism

Relieve Pain In Few Minutes

To relieve the torturing pain of Neuritis, Rheumatism, Neuralgia, Lumbago in few minutes, get **NURITO**, the Doctor's formula. No opiates, no narcotics. Does the work quickly—must relieve worst pain to your satisfaction in few minutes—or money back at Druggist's. Don't suffer. Get trustworthy **NURITO** on this guarantee. Don't wait.

ITCH

Use **D.D.D.** Prescription

OF ECZEMA—OTHER SKIN TROUBLES
STOPPED IN 1 MINUTE

AT ALL DRUGGISTS 35¢ · 60¢ · \$1.00

To PROTECT YOUR INVENTION—Use this coupon, NOW

Delays are dangerous and may be very costly. My personal service assures prompt action, strict confidence, and a minimum of expense. I suggest that you send me a model or drawing, or sketch and description of your invention, and \$5.00. I will make a search and report

promptly as to its patentability and send you a copy of my 72-page booklet. Or, if you prefer to read my booklet first, mail the attached coupon at once. I will also send my "Record of Invention" form. (Over 38 years experience as a Registered Patent Attorney.)

L. F. Randolph, 302-D Victor Bldg., Washington, D. C.

Please send me at once, free of charge, your 72-page booklet and "Record of Invention" form.

Name.....

Address.....

A PERSONAL CONFIDENTIAL PATENT SERVICE—

**Learn
This
Profitable,
Fascinating**

Large Incomes FROM Swedish Massage



Profession in 90 Days, at Home

Hundreds of Men and Women have found Independence this way

If you are looking for a *new and better* way to make a living, take up *Swedish Massage*, a **DIGNIFIED, FASCINATING, PROFITABLE PROFESSION**, and one of the few still open to men and women without college training. Hundreds of graduates of our *home study* course, either have fine positions or a private practice of their own. Many report minimum earnings of \$50.00 per week, while H. C. Crittendon, who received his diploma January 1st, 1930, reports averaging \$60.00 *per day*.

Plenty of Opportunities Open

This interesting, big pay profession was for years available only to a few. Its secrets were guarded jealously and fabulous prices were paid for instruction. This same instruction is now available to you at a mere fraction of the former price, and you need not leave your present work until you have qualified as an expert and can command an expert's pay. There is a big demand for National College of Massage trained men and women from beauty shops, hospitals, sanitariums, clubs, doctors and private patients. Prepare for this profitable profession **now**.



Miss E. A. Childs, Md.



D. H. Beam, Calif.



Miss H. Swain, Ariz.

These photographs are representative of hundreds received with letters of praise and recommendation. Send the coupon and we will include a booklet of names and photographs of graduates.

Large Incomes from Doctors,

hospitals, sanitariums, clubs and private patients are bound to come to those of our graduates who profit by the thousands of opportunities available to make money. Mr. Charles Romer, Wisconsin, writes, "At times I have had to turn away people; I have been so busy the depression never touched me." Miss Childs, Baltimore, Maryland, says, "I already have over 40 patients. I hope many others take your course and profit financially and socially as I have." Hundreds and hundreds of graduates have written similar letters. Get into Swedish Massage and Physio-Therapy through our "Right in Your Own Home" Plan.

Regular Diploma Awarded

When you have completed our home study course (high school training not needed), you will be awarded the National College of Massage and Physio-Therapy Diploma. This diploma is a badge of honor, a warranty to the public that you have qualified as an expert and should be accepted by them as proof of your proficiency in your chosen profession. Enroll now, before it becomes necessary to spend years in intensive training to qualify for a permit to practice.

Anatomy Charts and Supplies Included

Many earn **BIG MONEY** while learning. Enroll now and we will include anatomy charts, medical dictionary, patented reducing roller and Hydro-Therapy supplies without extra cost. The reducing course alone may be worth many times the modest tuition fee. Send coupon for special reduced price offer. Complete details with list of successful graduates will be sent **FREE**.

NATIONAL COLLEGE of MASSAGE and PHYSIO-THERAPY

Dept. 364, 20 N. Ashland Ave., Chicago, Illinois

Use this Coupon for FREE information

NATIONAL COLLEGE OF MASSAGE AND PHYSIO-THERAPY
Dept. 364, 20 N. Ashland Ave., Chicago, Ill.

You may send me **FREE** and Postpaid your illustrated catalog, list of successful graduates and complete details of your offer.

Name.....
Address.....
City..... State.....

A Dignified Profession

The expert in Swedish Massage is recognized as a professional of the highest type, commanding the respect of everyone in his community. Here is a profession, now open to you, which makes you a public benefactor; for the skill we teach you is of great aid in many human ailments as well as in building beauty—it offers you position, both professional and social, it offers you independence, freedom from worry and the respect and admiration of your neighbors and friends.

YOU Can Learn at Home

Turn spare hours into money. Use spare time at home to master a profession which has made thousands of dollars yearly for ambitious men and women. Many graduates have completed this training in just a few months, but you can take your own time. It need not interfere with your other work or pleasure. All instruction has been prepared by the teachers in our well known resident school—the same material is used and a diploma is awarded upon graduation.

Experts in Reducing

Many of our students become **specialists in reducing**. Thousands of men and women pay huge sums to take off fat. Enroll now—get the benefit of instruction by the teachers in our famous resident school. This course includes lessons in Dietetics, Reducing Diets, Hydro-Therapy, Anatomy, Medical Gymnastics, in fact everything you need to know to qualify for a Diploma.

JUST OUT!



\$2

If you are interested in the construction, operation and maintenance of modern Diesel engines, you will want this new timely book of practical, useful information.

"AUDEL'S DIESEL ENGINE MANUAL" with Questions and Answers explains in simple, concise language the Fundamental Diesel Principles—Operating Principles—Engine Starting—Air Starting Valves—Fuel Spray Valves—Inlet and Exhaust Valves—Valve Timing—Fuel Pumps—Fuel Injection Compressors—Starting Air Compressors—Scavenging Air Compressors—Pistons and Piston Rings—Cylinders—Lubrication—Cooling Systems—Fuel Oil—The Engine Indicator—Governors—Engine Reversing—Semi-Diesel Engines—High Speed Diesel Engines—Answers on Operation—Horse Power Calculations.

The illustrations and texts are clear and easy to understand. All details are plainly brought out. This book is of extreme value to engineers, operators, students and all who desire a knowledge of the Diesel engine. A handsome book, flexible, with gilt edges. 300 pages—illustrated.

Send for free Diesel folder today.

FREE EXAMINATION COUPON

THEO. AUDEL & CO., 49 W. 23rd St., New York
Please mail a copy of AUDEL'S DIESEL ENGINE MANUAL. If satisfactory, I will remit \$2 on its safe arrival, otherwise I will return the book.

Name

Address

Occupation PM

Be a Civil Engineer!

Learn—Quick Reference Way



It's Paying Big Right NOW

Cyclopedia of Civil Engineering
7 great volumes.
2,800 pages.
1,600 illustrations.
New revised edition by twelve of America's greatest engineers.
Includes: Surveying, bridges, railroads, steel structures, municipal engineering, water supply, road building, etc.
Spanish Grain Flexible Covers Gold Stamped

Earn \$3000 with the help of these books a Year—and Up!

"Civil engineers are wanted NOW. Enormous amounts are being spent in all kinds of public works and not a dime is spent until the Engineer has prepared plans. Then He must direct the work. It's a big job and there are not enough men to go around. Everywhere you go, you see road work going on—water and sewer systems being built—vast projects of all kinds. Here is Your Opportunity to get the necessary training right at home. These books are complete and simply written so anyone can understand them. Start now on our FREE examination plan. Mail the coupon without obligation.

American Technical Society
Dept. C319, Drexel at 58th St., Chicago

American Technical Society
Drexel at 58th St., Dept. C319, Chicago
I want to examine the CIVIL ENGINEERING Cyclopedia for 10 days FREE. I will gladly pay the few cents express, but I am to pay nothing for the 7 big volumes if I return them within 10 days. If I wish to keep them I will send you \$2 after the 10 days, then \$3 a month until advertising price. \$29.80 is paid. Send latest Edition and Slide Rule.

Name

Address

(Attach letter stating age, occupation, employer's name and address and that of at least one business man as reference.)



Slide Rule

will include a brand new, circular slide rule to carry in coat pocket. Invaluable in solving all kinds of engineering problems.

Full Size Professional ARC WELDER

Details FREE!

Full size, heavy duty Aladdin Electric ARC WELDER only \$39.25 with De Luxe Accessories! Has efficiency of machines costing \$145.00 to \$800.00. Welds all metals and alloys from heavy motor block and castings to fenders and light sheet metal. Also fine for soldering and brazing. Fully guaranteed. Approved by Automotive Test Laboratories. Easily portable on casters.

WORKS FROM 110-V SOCKET. Simply plug into 110 Volt or 220 Volt light socket—costs only few pennies an hour to use. Has complete heat controls. Anyone can use easily. Full instructions included. **AMAZING DETAILS FREE!** Write today for sensational facts about Aladdin Arc Welder for \$39.25 including De Luxe Accessories!

COMMONWEALTH MFG. CORP.
4208 Davis Lane
Cincinnati, Ohio

Dept. S-12

Only \$39.25
With Deluxe ACCESSORIES

New Oil Burner Heats Cheaper

Saves 25% Fuel Cost

LACO

New perfected oil burner! All the best features combined in one burner—LACO's patented "Mineral-Wick" gives hotter gas flame from cheap fuel oil—extremely simple—only one moving part—nothing to cause trouble. Underwriters Lab. 25,000 in use.

WRITE! Free booklet gives complete details of oil burners for your present heating plant—complete oil burning heating plants—oil burning circulating room heaters, all at amazing low prices. LACO will ship any model to a new dealer subject to examination without costing you a cent. **SEND NOW!**

LACO OIL BURNER CO.
137 Union Ave., Griswold, Iowa

Look Here, DEALERS!
LACO sales doubled this year! LACO has a most profitable dealer's proposition—you can fill any order for oil heat from a small safe hamburger griddle up to a large industrial plant. I mean what I say, LACO is the best money-maker for the dealers. L.A. COCKLIN, Pres.

LEARN WATCHMAKING AND ENGRAVING

BY OUR PROFIT-SHARING PLAN OUR GRADUATES SUCCEED

One of our Iowa students started in a very small way—now doing over \$30,000 a year. Another in Wisconsin, over \$10,000 the first year. Day or night classes. Call or write for FREE BOOK.

Chicago School of Watchmaking, Dept. 4901, 155 N. Clark St., CHICAGO.

Learn ADVERTISING at Home

Greater opportunities now in advertising. Learn easily and quickly in spare time. Practical work. No text books. Old established school. Low tuition—Easy terms. Send for free booklet of interesting information.

Page-Davis School of Advertising
Dept. 1353, 3601 Mich. Av., Chicago

DENISON'S PLAYS

Musical Comedies, Operettas, Vaudeville Acts, Minstrels, Comedy Songs, Make-up Goods.

Catalog Free

60 YEARS OF HITS

T.S. Denison & Co., 623 S. Wabash, Dept. 9, Chicago

ARMY AND NAVY SUPPLY CO.

Bargains—Army, Sport Goods, Firearms, Clothes, Shoes, etc. Send 10c for new catalog, to be redeemed on first order

Army & Navy Supply Co., 4772 Lester St., Richmond, Va.

don't WORRY ABOUT RUPTURE

Why put up with years of needless discomfort and worry? Try a Brooks Automatic Air Cushion. This marvelous appliance permits the opening to close, yet holds reducible rupture securely, comfortably—day and night. Thousands report amazing results. Light, neat-fitting. No hard pads or stiff springs to chafe or gouge. Made for men, women and children. Durable, cheap, **Sent on trial** to prove it. Never sold in stores. Beware of imitations. Write for Free Book on Rupture, no-risk trial order plan, and proof of results. All correspondence confidential.

BROOKS COMPANY, 111-H State St., Marshall, Mich.

When writing to advertisers please mention Popular Mechanics

TELEVISION AND RADIO •• ARE YOUR OPPORTUNITY

...if you *ACT NOW*

Bigger opportunities than ever before are open to trained men in new fields of radio. Television broadcasting is now a reality and leaders of industry predict immediate commercialization will put thousands of sets in homes; thousands of new jobs for trained men will be created as Television sweeps the nation.

Learn TELEVISION WITH RADIO

in "First National's" huge laboratories and studios, where young engineers are trained on the job—to fit the job—graduates qualify for First Class Government License—which is the "ticket" it takes to get a job—and are First National graduates getting the jobs? I'll tell the world they are.

only 6 months Training required

to qualify for your Government License. Then you are assigned to active duty in broadcasting, immediately getting valuable experience "on the job". You actually handle the control and transmitter of Broadcasting Station KXBY and Television Station W9XAL while training—

WRITE FOR FREE BOOK OF FACTS—Telling of big, genuine opportunities for First National Trained men—

FIRST NATIONAL TELEVISION
INCORPORATED
TRAINING DIVISION . . . KANSAS CITY, MO.

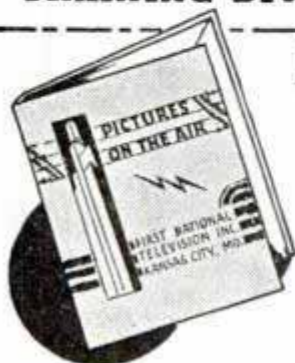

FILL OUT AND MAIL THIS COUPON TODAY

S. Q. NOEL, Pres., First National Television, Inc.
Dept. AA-3, Power & Light Bldg., Kansas City, Mo.

Please send me immediately, without charge or obligation, your big, new book on Television—"Pictures On the Air"—completely illustrating Television methods, and giving full facts about big, new money-making opportunities in this career. I am ___ yrs. old.

NAME _____

STREET _____

TOWN _____

STATE _____

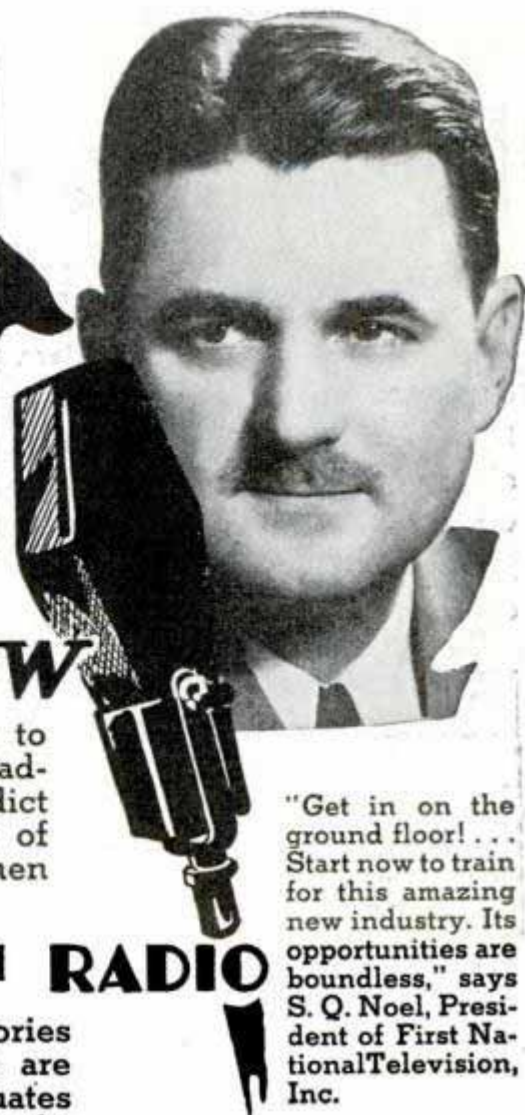

"Get in on the ground floor! . . . Start now to train for this amazing new industry. Its opportunities are boundless," says S. Q. Noel, President of First National Television, Inc.

Get Experience

"On-The-Job" in
CONTROL ROOM
TRANSMITTER
TELEVISION
BROADCASTING
CAMERA-ACTION
STATION OPERATION

FREE
NEW BOOK
ON
TELEVISION

CHEMISTRY

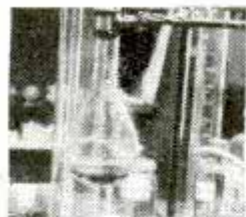

A modern miracle
of money-making

● All modern progress is dependent upon chemistry. The opportunities it presents are unlimited. Right at home, in spare time, through study of an International Correspondence Schools Chemistry Course, you can master the fundamentals of this fascinating science. An interesting book—free.

INTERNATIONAL CORRESPONDENCE SCHOOLS

Box 5665-H, Scranton, Pa.

Send me — *free* — complete information on subject checked below:

- | | |
|------------------------------------|---|
| <input type="checkbox"/> Chemistry | <input type="checkbox"/> Refrigeration |
| <input type="checkbox"/> Radio | <input type="checkbox"/> Air Conditioning |
| <input type="checkbox"/> Aviation | <input type="checkbox"/> Architect |

Name.....

Address.....

WORK FOR THE



GOVERNMENT START

\$1260 to \$2100 YEAR

Many 1937 Appointments

MEN—WOMEN

File Clerks
Postoffice Clerks-Carriers
Railway Postal Clerks
Customs Inspectors
Stenographers-Clerks
Many Other Jobs

GET READY
IMMEDIATELY
Common Education
Usually Sufficient

Mail
Coupon
TODAY—
SURE

Franklin Institute
Dept. A195
ROCHESTER, N. Y.

Gentlemen: Rush to me, FREE of charge, list of U. S. Government big pay jobs. Send FREE 32-page book describing salaries, vacations, hours, work, etc. Tell me how to get one of these jobs.

Name.....

Address.....



AMAZING NEW
BUSINESS
Sell to Stores

Get Set for Life!

MAKE up to \$65 WEEKLY

in new kind of wholesale business. Place famous line 5c-10c goods with stores. Merchants grab our FREE GOODS Deals. 200 fast-selling products—all on salesmaking Counter Displays. Up to 140% profit for you and merchant. No experience or investment to start. Big catalog and facts FREE. World's Products Co., Dept. 3810, Spencer, Ind.

BE AN ARTIST

WE CAN TEACH YOU DRAWING in your own home during your spare time. Thirty-five years of successful teaching proves our ability. Artists receive large salaries.

Write today for Art Year Book
SCHOOL OF APPLIED ART

Dept. 137, 10 E. Huron St., Chicago, Ill.



Learn Public Speaking

At home—in spare time. Many overcome "stage-fright," gain self-confidence, and increase their earning power, through ability to sway others by effective speech. Write for free booklet, *How to Work Wonders With Words* and requirements.

NORTH AMERICAN INSTITUTE, Dept. 1353
3601 Michigan Avenue Chicago, Illinois



Correspondence Courses in RADIO and ELECTRICAL ENGINEERING

SPECIAL
Only
\$25

ELECTRICAL ENGINEERING. Covers complete electrical field. Most modern course. Very understandable. RADIO ENGINEERING. Ultra-modern course in radio, public address, photo-electric work. Trains you to be super-service man, real vacuum tube technician. Tuition ONLY \$25, either course. Deferred payment plan. Exper. kit free—limited time offer. WRITE TODAY for free copies of school catalogs, student magazines, etc. LINCOLN ENGINEERING SCHOOL 931-13 So. 37th St., Lincoln, Nebr.

FREE BOOK



Send U. S. stamp to pay mailing expense of 1937 illustrated free book, latest squab news, how to make money breeding. Thousands of these 25-day-old birds wanted weekly. Market up, now paying 65c lb. wholesale. Write today to

PR COMPANY, 635 Howard St., Melrose, Massachusetts



Best Poultry Paper 6 BIG ISSUES 10¢

Helps increase Poultry Profits. Send coin or stamps, 50 cents for 3 years or 10 cents for 6 months trial. Agents wanted. American Poultry Journal 632 So. Clark Street Chicago, Illinois

RAISE RABBITS FOR US

WE PAY YOU UP TO \$5.00 EACH. ALSO PUT YOU IN TOUCH WITH MARKETS EVERYWHERE. Large illustrated book and catalog, also copy of the AMERICAN RABBIT FARMER and monthly market bulletin showing names of buyers in various parts of America who continuously buy all rabbits offered them. All for 10 cents. Address OUTDOOR ENTERPRISE CO., 101 Main Street, NEW CITY, N.Y.



BERRY'S New POULTRY BOOK

BERRY'S Hand-Selected BABY CHICKS, Pullets or Cockerels. Also HYBRIDS, STARTED CHICKS, Baby Turkeys, Mature Fowls. 52 Breeds, all Iowa inspected, Pullorum tested. Best Service, LOW PRICES. Wonderful Poultry Book FREE, stamps appreciated. BERRY'S POULTRY FARM, Bx 29, CLARINDA, IOWA

NEW SCIENTIFIC WONDER

"X-RAY" CURIO

10c
3 for
25c



BOYS BIG FUN. You apparently see thru cloth, Wood, Stone, any object. See Bones in Flesh. FREE PACKAGE radio picture films, take pictures without camera. "You'll like 'em." 1 package with each 25c order. MARVEL MFG. CO., Dept. 80 — NEW HAVEN, CONN.

When writing please mention Popular Mechanics

To help you answer these **3** questions:



1 What are today's opportunities in Drafting?

2 Will I like the work?

3 Can I learn Drafting readily?

2 Beginning Lessons in Drafting Free

Drafting Opportunities Growing Daily

Before anything can be made or built, the Draftsman *first* must draw it. Building trades, transportation, manufacturing — ALL depend on him. That is why *any* pick-up in *any* line means *first call for the Draftsman!*

Fit Yourself for a Job with a Future

Drafting welcomes ambitious men — offers good pay to start, with splendid opportunities for promotion. One of the *steadiest* of all lines. Right from the start, the beginner works side by side with experienced men—inking in their drawings, making tracings, constantly profiting by his contact with seasoned engineers. The "higher ups" see his work. If it is good, advancement is sure and steady.

Pleasant, well-lighted offices are the Draftsman's work-room. He keeps regular hours, with congenial, high grade fellow workers. The work is fascinating—embraces not just *one* line, but *hundreds*.

Drafting Experience NOT Necessary

You can master Drafting readily by home study because you learn and advance *exactly* as professional Draftsmen work—with T-square, dividers and drawing board. *Actual* working conditions are duplicated to the final detail. *Thousands* of successful graduates enthusiastically endorse American School methods, nowhere better exemplified than in our Drafting course.

We want you to see for yourself—before you come to ANY decision—exactly what Drafting is like. We want you to judge your own interest in the work—and our ability to teach you. So we make this 2 Free Lesson Offer.

American School, Drexel Ave. at 58th St., Chicago, Ill.

Prove That You Can Qualify

The 2 lessons will be sent absolutely without obligation. In the privacy of your own room, look them over. See how simply you start—how gradually you are led step by step—how thoroughly you master each point—how, as time goes on, you can pass from a raw beginning to complete *mastery* of Drafting—able to get and hold a pleasant, profitable, steady job. Such a future is well worth looking into RIGHT NOW, so . . . just mail the coupon!



Mail Coupon for 2 Lessons FREE

American School, Dept. DD-345

Drexel Ave. at 58th St., Chicago

Without the slightest obligation, send 2 beginning Drafting Lessons and free Bulletin. I am not to return them.

Name Age

Address

City State

When writing to advertisers please mention Popular Mechanics

INVENTORS all PATENTS ARE NOT GOOD PATENTS

Free



There Are Many Degrees Of PATENT PROTECTION

A good patent depends not only on the invention itself, but upon the skill and interest of your patent attorney in drawing up the claims and specifications and in following your case to a successful conclusion. C. A. Snow and Company have had over 61 years of specialized patent experience. We know the difference between strong patents and weak ones.

Write today for our free document: "CERTIFICATION OF INVENTION" and our two free booklets: "HOW WE PROTECT YOU" and "SUGGESTIONS ON HOW TO COMMERCIALIZE YOUR INVENTION." Fill out the coupon below NOW.

----- Cut Coupon On Dotted Line -----

DEPT. A-15 SNOW BUILDING, WASHINGTON, D. C.

Gentlemen: Please send me absolutely free and without obligation on my part, your free guides for inventors.

NAME

ADDRESS

CITY STATE

(PLEASE PRINT NAME CLEARLY)

C. A. SNOW & CO.

Registered Patent Attorneys Since 1875

AUTO-MECHANICS & WELDERS

GOOD JOBS and Mighty GOOD PAY

Do you want to earn big money? If so let us know which of the following trades you prefer. You learn by doing. Practical work. Expert teachers. Low tuition. Personal attention. It will pay you to investigate AT ONCE. Just check the courses you'd like to take and mail today. You will receive full information, absolutely without cost or obligation. But don't delay.

Check the Trade You'd Like to Learn

- | | |
|--|--|
| <input type="checkbox"/> Auto Mechanics | <input type="checkbox"/> Welding |
| <input type="checkbox"/> Auto Collision | <input type="checkbox"/> Spray Painting |
| <input type="checkbox"/> Metal Finishing | <input type="checkbox"/> Torch Soldering |

Ask about our "Pay After Graduation Plan"

Name

Address

Mail the above to

MICHIGAN TRADE SCHOOL

Write
for
FREE
CIRCULAR

3758 Woodward Avenue

DETROIT, MICH.

NEW YORK ELECTRICAL SCHOOL

Opportunities for Men of All Ages!

Every phase of all branches of Practical Electricity taught by Actual Practice in America's Foremost Institution of Trade Training.

Special Course in Automotive Technique

Day and Evening Sessions Open All Year.

Write for **FREE Booklets.**

Visitors Welcome.

New York Electrical School
44 W. 17th St., New York City

BE A RADIO SERVICE EXPERT

Modern receivers require men with modern training for service work.

LEARN AT HOME

Our home instruction method and service equipment offer starts you earning money almost at once. Up to \$3 an hour easy in a short time. Write for free book.

Radio Training Association of America
Dept. PM-73
4525 Ravenswood Ave. Chicago

TRAIN WITH
R.T.A.
NOW

Northwest, home of Adcox School is hot spot of Diesel employment. Finest training. Established 27 years. Successful graduates everywhere. Earn room and board while learning. Send for FREE big, 40-page, Diesel School Catalog.

L. L. ADCOX TRADE SCHOOL
Dept. 18 Portland, Oregon

How to MAKE MORE MONEY
with this AMAZING-
NEW-INVENTION!
BIG EARNINGS QUICK!
WITH NEW MONEY MAKER!

NEW! Easy way to make up to \$300.00 a month, full or part time on flash showing of this patented, marvelous new invention.

No Experience Needed. Sells easy to amazing big market. Now you can make real money with this combination.

BLOW TORCH AND SOLDERING IRON

No pressure System. No pumps. No Stove. No charcoal. Operates with 100% satisfaction on 3/4c per hour. Neat, complete, compact. Unconditionally guaranteed by 30 year old company. Territories going fast. "Selling like Hi-Li. Ship 20," wires Agent Krohne. Write quick for New Agents' Plan and Exclusive territory offer! Hurry!

JUSTRITE MANUFACTURING CO.
2061 Southport, Dept. 53, Chicago



"Give Me Your Measure and I'll Prove in the First 7 Days You Can Have a Body Like Mine!"

No other Physical Instructor in the World has ever DARED make such an offer!

I'LL give you PROOF in 7 days that I can turn you, too, into a man of might and muscle. Just think of it! Right in the first week under my guidance you will see and feel the improvement! Then as my weekly instructions arrive in your home you continue to rebuild, renew and "overhaul" your body. By the end of three months you are the owner of a powerful body that you will be proud to display anywhere, anytime! People will notice the ruddy glow of health in your face, the sparkle in your clear eyes, your broad shoulders and they will seek your company. You will be the fellow who will walk off with the prettiest girl and the best job while others wonder how you did it!

Write your name and address carefully on the coupon below. I'll send you absolutely free a copy of my new book, "Everlasting Health and Strength." It reveals the secrets that changed me from a 97-pound flat-chested weakling into a husky fellow who twice won the title of "World's Most Perfectly Developed Man" against all comers! And it shows how I can build you into an "Atlas Champion" the same way.

Are you underweight? I'll add pounds where they are needed! Are you fat in spots? I'll show you how to pare down to fighting trim.

And with the big muscles and powerful evenly-developed body that my method so quickly gives you, I'll also give you through-and-through health—health that digs down into your system and banishes such things as constipation, pimples, skin blotches and the hundred-and-one similar conditions that rob you of the good times and the good things of life.

I've Got No Use At all for "Contraptions"

I haven't any need for contraptions that may strain your heart and other vital organs. I don't dose you or doctor you. Dynamic-Tension is all I need. It's the natural, tested method for developing real men inside and out. It distributes added pounds of powerful muscles over your body, gets rid of surplus fat, and gives you the vitality, strength and pep that win you the admiration of every woman and the respect of any man.

Get my free book, "Everlasting Health and Strength"! Mail coupon today. Gamble a stamp to prove I can make YOU a new man!

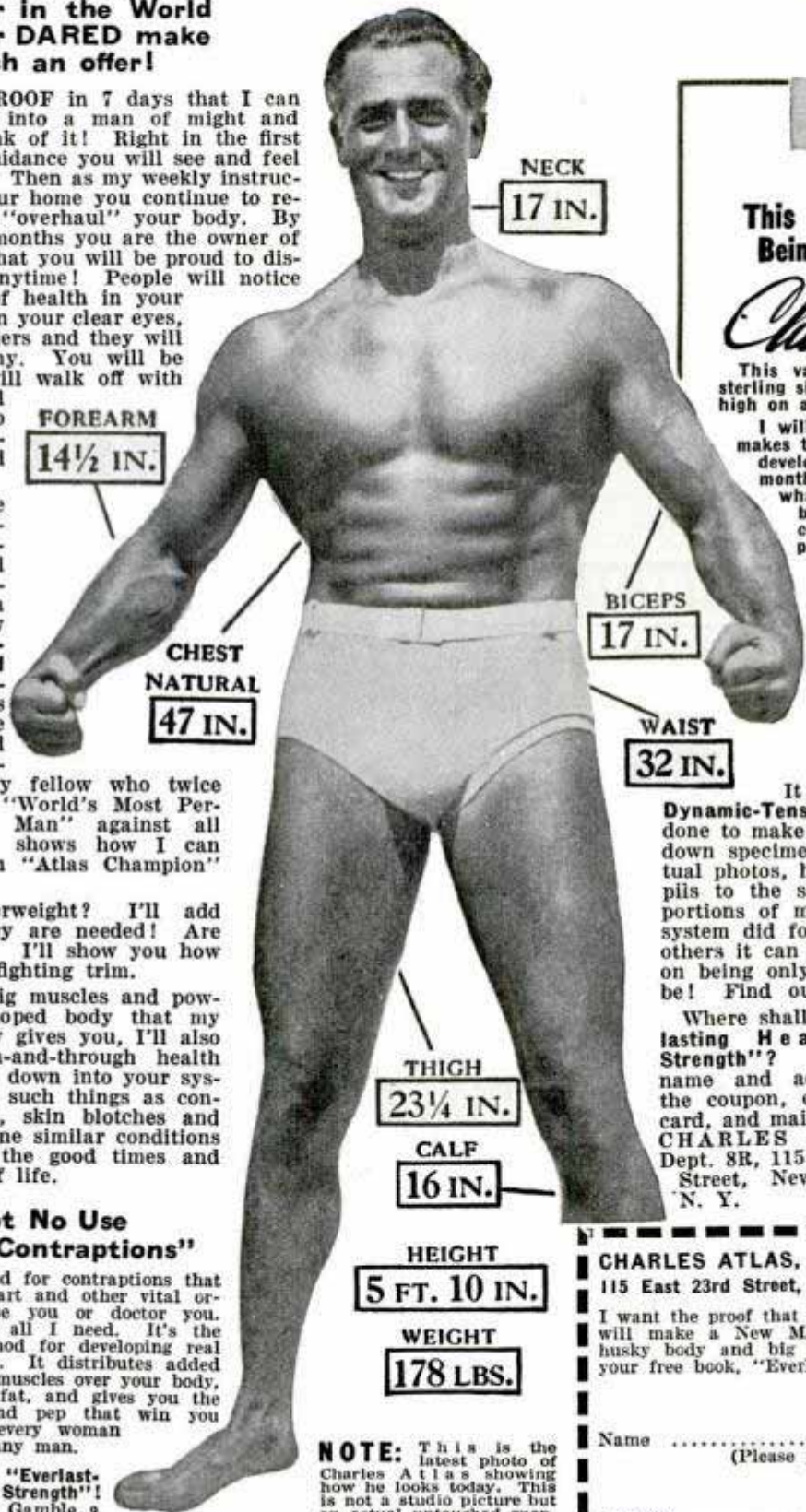

NOTE: This is the latest photo of Charles Atlas showing how he looks today. This is not a studio picture but an actual untouched snapshot.



This Sterling Silver Cup Being Given Away by

Charles Atlas

This valuable cup, made of solid sterling silver, stands about 14 inches high on a black mahogany base.

I will award it to my pupil who makes the most improvement in his development within the next three months. Therefore, no matter what your measurements may be now, you have an equal chance to win this cup for permanent possession—a nd with YOUR name engraved on it!

Get my free book by mailing coupon below!

48-PAGE BOOK FREE

It tells you all about my special Dynamic-Tension method, and what it has done to make big-muscled men out of run-down specimens. It shows you, from actual photos, how I have developed my pupils to the same perfectly balanced proportions of my own physique. What my system did for me and these hundreds of others it can do for you too. Don't keep on being only half of the man you CAN be! Find out what I can do for you.

Where shall I send your copy of "Everlasting Health and Strength"? Put your name and address on the coupon, or a postcard, and mail it today. CHARLES ATLAS, Dept. 8R, 115 East 23rd Street, New York, N. Y.



CHARLES ATLAS, Dept. 8R, 115 East 23rd Street, New York, N. Y.

I want the proof that your system of Dynamic-Tension will make a New Man of me—give me a healthy, husky body and big muscle development. Send me your free book, "Everlasting Health and Strength."

Name
(Please print or write plainly)

Address

City..... State.....

MAIL COUPON FOR FREE BOOK NOW!



MANY TRAINED MEN EARN up to \$30-\$40-\$50 a week and MORE in Electricity

My Big Free Electrical Book tells how YOU, TOO, can train for a BETTER JOB and MORE MONEY right in YOUR OWN HOME. The great, growing field of ELECTRICITY offers opportunities undreamed of a few years ago—steady jobs—interesting work—good pay—a real future.

Learn to Earn Up to \$5, \$10 a Week or More in Your Spare Time While Training

This book also tells how I help you EARN EXTRA MONEY—in your SPARE TIME while TAKING THE TRAINING. Only a few of these small jobs each month should make the training PAY FOR ITSELF. Electric Institute Training also includes 20 big important features to help you INCREASE YOUR EARNING POWER.

Electric Institute Training is DIFFERENT Training

You get, at no extra cost, but as a regular part of your training, a big outfit of Real Electrical Equipment and apparatus to work on. PRACTICAL SHOP TRAINING IN YOUR OWN HOME.

Training in Radio, Refrigeration, Air-Conditioning, Diesel Electric Power and MANY OTHER BRANCHES INCLUDED

START NOW to prepare for the AMAZING OPPORTUNITIES in these and the many other important branches of Electricity included in Electric Institute Training. My Big Electrical Book gives you full details—costs you nothing, and places you under no obligation. Mail the coupon TODAY.

No Salesmen Will Call on You



H. W. Petersen, President ELECTRIC INSTITUTE, Inc. Dept. 67C, Hinsdale, Illinois

Send Free Book and full details of E. I. Home Shop Training.

Name.....Age.....
Address.....
City.....State.....

PRACTICAL SHOP TRAINING ON REAL EQUIPMENT Right in Your OWN HOME

THIS FREE BOOK TELLS YOU HOW!

INVESTIGATE — GET THE FACTS!



DRAFTING

BOOKS SENT FREE!

ON APPROVAL

5 VOLUMES BRAND NEW EDITION

Only 15 minutes a day with these WONDER BOOKS can prepare you for a good drafting job in less than a year. Mechanical and architectural drafting from simple straight lines to important complex plans. *A step at a time!* Built especially for beginners, for men with only grammar schooling. Drafting room practice. PLUS ENGINEERING, made easy and clear. Includes complete course in blue-print reading.

Big Field Big Demand Big Pay

Competent draftsmen are urgently needed right now in all building and manufacturing lines at \$30.00 to \$75.00 a week. That's just the beginning—FOR DRAFTSMEN HAVE THE BEST CHANCES FOR ADVANCEMENT. Pleasant, fascinating work, easy to learn and do. Learn quickly with these books—send coupon for a set and see for yourself.

[A year's consulting membership in the American Technical Society now given to all readers of this famous cyclopedia of drafting. Many say that it is worth more than the cost of the books.]

Complete set of drawing instruments if you send for these drafting books NOW. These instruments are made of the finest of German silver, are absolutely accurate and are packed in velvet lined leatherette pocket case. Real \$10 value, but included with these books.

AMERICAN TECHNICAL SOCIETY Dept. D319, Drexel at 58th St., Chicago, Ill.

American Technical Society, Dept. D319, Drexel at 58th St., Chicago, Ill. Send for 10 days' trial New 5 volume set of drafting. I will pay the few cents delivery charges. If I wish, I may return books in 10 days and owe you nothing but if I decide to keep them, I will send \$2.00 after 10 days, then only \$3.00 a month until \$24.50, the advertising price, is paid. Send latest edition and include drawing instruments.

Name.....
Address.....
Attach letter stating age, occupation, employer's name and address and that of at least one business man as a reference.

NEW! COMPLETE and Up-to-the Minute Book on HOUSE WIRING

Covers, in great detail, all phases of practical wiring for homes, garages, farm buildings, etc. Written in the simplest language; describes and illustrates fuses, circuits, switches, installation plans; also wiring diagrams; over 200 illustrations; cloth binding \$1.50 postpaid. 5-day money-back guarantee.

FREE Complete catalog of practical books on Painting; Decorating; Commercial Art; Sheet Metal; Welding; Radio; Electricity; Carpentry and Building; Plumbing; Heating and Ventilating. **WRITE TODAY.**

FRED'K J. DRAKE & CO., 177 N. Michigan Av., Chicago

BIGGEST BUY EVER OFFERED — ALL



COMPLETE TAXIDERMERY COURSE NO OTHER COST

WITH LIFE MEMBERSHIP—DIPLOMA
SCHMIDT'S original \$15.00 Complete Professional Training in Taxidermy. NOW only \$1.00 postpaid. This marvelous Home Course has easily and quickly taught thousands to mount birds, animals, fish; make novelties, tan hides . . . among the 218 subjects. All comes at once—start mounting first day—anyone can do. Send only \$1.00 with order or pay postman \$1.00 PLUS postage. Guaranteed.

SCHMIDT SCHOOL OF TAXIDERMERY, Dept. G-1-3, Memphis, Tenn.

Write and Speak MASTERLY ENGLISH

Learn correct English with Sherwin Cody's new invention. No rules to memorize. Like a fascinating game. Spare-time study. 15 minutes each day, quickly gives you command of English. Send for free book, "How You Can Master Good English in 15 Minutes a Day." Write today.

SHERWIN CODY SCHOOL OF ENGLISH
53 Searle Bldg. Rochester, N. Y.

CARTOON YOUR WAY TO SUCCESS!

DON'T COPY — LEARN TO ORIGINATE!

RAYE BURNS will teach you HOW to CREATE ORIGINAL CARTOONS at home that you can SELL! Course contains 26 lessons and over 600 illustrations. All for Only **\$2.85**

Send name and address for free details.

RAYE BURNS SCHOOL, Dept. M-X, BOX 2194, Cleveland, Ohio

I WANT MEN

TEA AND COFFEE ROUTES PAYING UP TO \$60.00 IN A WEEK

National company needs more men at once to make regular calls on local routes. No experience needed. Operate on our capital. I give producers brand-new Ford cars bonus. Rush name on postcard for FREE Facts.

ALBERT MILLS
3835 Mosmouth Cincinnati, Ohio

BRING YOUR RADIO UP TO DATE

ADD-A-TUBE Get Rid of Static, Distortion

Strong Local Interference. A "New Radio" For Only **\$1**

Tune out strong local stations—tune in Los Angeles, Canada, Mexico! Increase selectivity, improve tone, cut out static, distortion, interference, with amazing new ADD-A-TUBE. Uses no extra current, fits any radio, electric or battery, works on inside or outside aerial, all waves. Anyone can install in few minutes. **GUARANTEED!** Use 5 days. If not satisfied, return within 10 days from date shipped and your dollar will be refunded instantly!

R-E ENGINEERS, Dept. M-511, Marburg Ave., & B. & O. R. R., Cincinnati, Ohio

Send No Money
Pay nothing now. Just send name and address on postcard. Pay postman only \$1 plus few cents postage on delivery. Send your order today!

Weak, Rundown, Pale and Skinny!

**MAKE THIS FAMOUS
1 WEEK TEST**

**THAT HAS SHOWN THOUSANDS
HOW TO BUILD UP HUSKY NEW
RED BLOODED STRENGTH NEW
ENERGY AND AT LEAST
5 EXTRA LBS. OR NO COST!**

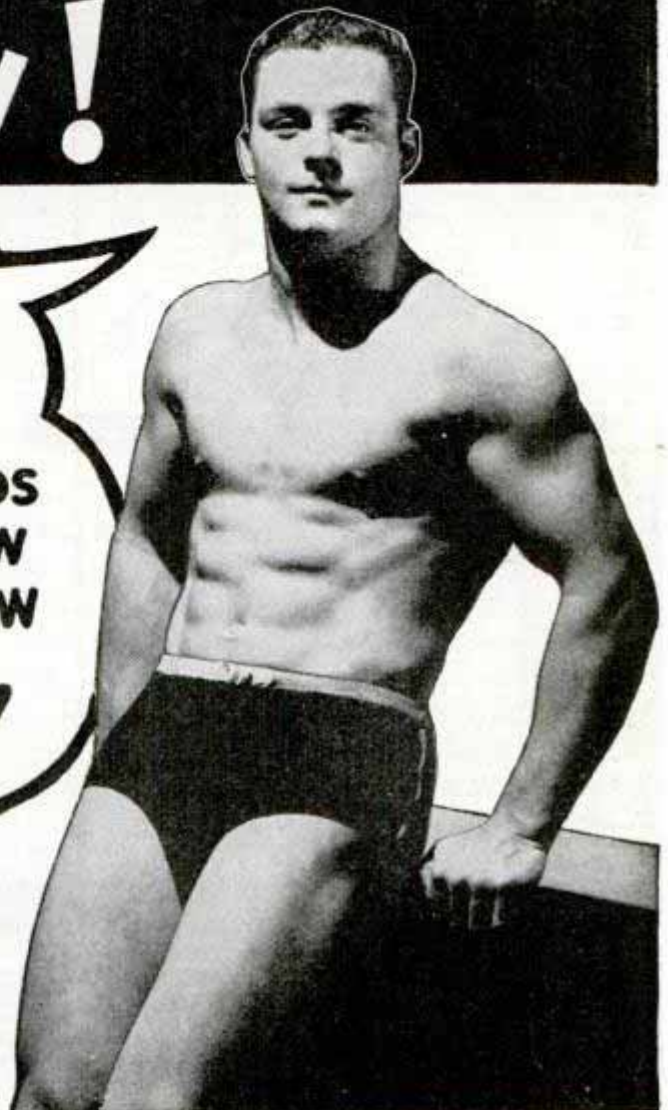

Posed by professional models

As a result of tests covering thousands of cases of skinniness, weakness, poor blood and a rundown condition—many leading authorities now agree that very frequently the trouble may be traced to iodine starved glands. Often these glands, controlling the process of metabolism, receive an inadequate supply of natural iodine from the daily diet. In many instances this explains why such body foods as starches and fats often fail to build weight, strength, and energy. This is why skinny folks with huge appetites often remain skinny, worn out, ailing.

Now, however, with the use of Seedol Kelpamalt, a mineral concentrate from a huge 90-foot sea vegetable harvested off the Pacific Coast, you can be assured of an adequate supply of this precious nat-

ural substance. It is richer in iodine than oysters. In addition to iodine, it contributes to the supply of other vital minerals necessary for digestion, building of sound tissue, good blood and proper elimination. By thus aiding digestion and assimilation you are able to get the maximum benefit from your daily food.

Try Seedol Kelpamalt for one week. See if, like thousands of others, you don't feel better, sleep better, eat better, and add at least 3 to 5 husky new lbs. the first week. If you don't the trial is free. It costs you nothing! Your own doctor will approve this way. 100 Jumbo size Seedol Kelpamalt Tablets—four to five times the size of ordinary tablets—cost but a few cents a day to use. Get Seedol Kelpamalt today. Seedol Kelpamalt is sold at all good drug stores. If your dealer has not yet received his supply, send \$1.00 for special introductory size bottle of 65 tablets to the address at the right.

SEEDOL Kelpamalt Tablets

● **Manufacturer's Note:**—Inferior products, sold as kelp and malt preparations—in imitation of the genuine Seedol Kelpamalt—are being offered as substitutes. The Kelpamalt Company will reward for information covering any case where an imitation product has been represented as the original Seedol Kelpamalt. Don't be fooled. Demand genuine Seedol Kelpamalt Tablets. They are easily assimilated, do not upset stomach nor injure teeth. Results guaranteed or money back.

Thousands Who Have Made This One Week Test Find KELPAMALT

1. Improves appetite.
2. Adds at least 3 to 5 lbs. of good, solid flesh.
3. Improves digestion.
4. Helps banish ordinary stomach distress.
5. Helps bring sounder sleep.
6. Gives new strength, energy and endurance.
7. Helps clear up skin.

SPECIAL FREE OFFER

Write today for fascinating instructive 50-page booklet on How to Build Strength, Energy and Add Lbs. Quickly. Mineral Contents of Food and Their Effects on the Human Body. New facts about NATURAL IODINE. Standard weight and measurement charts. Daily Menus for weight building. Absolutely free. No obligation. Kelpamalt Co., Dept. 1114, 27 West 20th St., New York City.

Name

Street

City



When writing to advertisers please mention Popular Mechanics

DON'T LET OPPORTUNITY PASS YOU BY



• **OPPORTUNITY will pass you**—unless you are prepared to stop it. Knowledge — training — education — facts, whatever you choose to call *personal power*, is the real thing with which to capture passing opportunities or create opportunities. Acquire this *personal power* in your spare time. Mail this coupon and learn what an I. C. S. Course can mean to you. Why not do it right now?

INTERNATIONAL CORRESPONDENCE SCHOOLS

Box 5662-H, Scranton, Penna.

Without obligation, please send full particulars about the subject before which I have marked X:

TECHNICAL AND INDUSTRIAL COURSES

- | | |
|--|---|
| <input type="checkbox"/> Architect | <input type="checkbox"/> Diesel Engines |
| <input type="checkbox"/> Architectural Draftsman | <input type="checkbox"/> Aviation Eng. <input type="checkbox"/> Auto Mechanic |
| <input type="checkbox"/> Building Estimating | <input type="checkbox"/> Plumbing <input type="checkbox"/> Heating |
| <input type="checkbox"/> Contractor and Builder | <input type="checkbox"/> Air Conditioning <input type="checkbox"/> Refrigeration |
| <input type="checkbox"/> Structural Draftsman | <input type="checkbox"/> Steam Engineer |
| <input type="checkbox"/> Structural Engineer | <input type="checkbox"/> Steam Electric Engineer |
| <input type="checkbox"/> Electrical Engineer | <input type="checkbox"/> Marine Engineer |
| <input type="checkbox"/> Electric Lighting | <input type="checkbox"/> Civil Engineer <input type="checkbox"/> Highway Engineer |
| <input type="checkbox"/> Welding, Electric and Gas | <input type="checkbox"/> Bridge Engineer |
| <input type="checkbox"/> Reading Shop Blueprints | <input type="checkbox"/> Bridge and Building Foreman |
| <input type="checkbox"/> Telegraph Engineer | <input type="checkbox"/> Surveying and Mapping |
| <input type="checkbox"/> Telephone Work <input type="checkbox"/> Radio | <input type="checkbox"/> R. R. Locomotives <input type="checkbox"/> Air Brakes |
| <input type="checkbox"/> Mechanical Engineer | <input type="checkbox"/> R. R. Section Foreman |
| <input type="checkbox"/> Mechanical Draftsman | <input type="checkbox"/> R. R. Signalmen |
| <input type="checkbox"/> Machinist <input type="checkbox"/> Toolmaker | <input type="checkbox"/> Chemistry <input type="checkbox"/> Pharmacy |
| <input type="checkbox"/> Patternmaker | <input type="checkbox"/> Coal Mining |
| <input type="checkbox"/> Foundry Practice | <input type="checkbox"/> Navigation |
| <input type="checkbox"/> Sheet Metal Worker | <input type="checkbox"/> Cotton Manufacturing |
| <input type="checkbox"/> Boilermaker | <input type="checkbox"/> Woolen Manufacturing |
| <input type="checkbox"/> Heat Treatment of Metals | <input type="checkbox"/> Agriculture <input type="checkbox"/> Fruit Growing |
| <input type="checkbox"/> Management of Inventions | <input type="checkbox"/> Poultry Farming |

BUSINESS TRAINING COURSES

- | | |
|--|--|
| <input type="checkbox"/> Business Management | <input type="checkbox"/> Lettering Show Cards <input type="checkbox"/> Signs |
| <input type="checkbox"/> Industrial Management | <input type="checkbox"/> Stenography and Typing |
| <input type="checkbox"/> Traffic Management | <input type="checkbox"/> Civil Service <input type="checkbox"/> Mail Carrier |
| <input type="checkbox"/> C.P. Accountancy | <input type="checkbox"/> Railway Mail Clerk |
| <input type="checkbox"/> Bookkeeping | <input type="checkbox"/> Grade School Subjects |
| <input type="checkbox"/> Secretarial Work | <input type="checkbox"/> High School Subjects |
| <input type="checkbox"/> Cost Accountant | <input type="checkbox"/> College Preparatory |
| <input type="checkbox"/> Salesmanship <input type="checkbox"/> Advertising | <input type="checkbox"/> First Year College Subjects |
| <input type="checkbox"/> Service Station Salesmanship | <input type="checkbox"/> Illustrating <input type="checkbox"/> Spanish |
| <input type="checkbox"/> Business Correspondence | <input type="checkbox"/> Cartooning <input type="checkbox"/> French |

DOMESTIC SCIENCE COURSES

- | | |
|---|--|
| <input type="checkbox"/> Professional Dressmaking and Designing | <input type="checkbox"/> Millinery |
| <input type="checkbox"/> Home Dressmaking | <input type="checkbox"/> Foods and Cookery |
| <input type="checkbox"/> Advanced Dressmaking | <input type="checkbox"/> Tea Room and Cafeteria Management, Catering |

Name..... Age.....

Address.....

City..... State.....

Present Position.....

If you reside in Canada, send this coupon to the International Correspondence Schools Canadian, Limited, Montreal, Canada

When writing please mention Popular Mechanics

FOR Real FUN Play. A Soprani ACCORDION



• If you want to be *really* popular, have *all* the fun, the center of attraction *everywhere*, just learn to play this thrilling instrument from Italy. A complete band or orchestra in itself, and so easy to learn to play. You'll master this *easier* Soprani in *no* time, and you'll have real fun from the start. Don't delay. Big future. Send postal for beautifully illustrated literature. No obligation. Easy terms. Write today sure. 122

SOPRANI, INC.

DEPT. 329, 630 S. WABASH AVE.
CHICAGO, ILL.

AMATEUR CARTOONISTS WIN \$25.00

Wanted—Amateurs with humorous ideas. No drawing ability necessary. The amateurs of today are the professional cartoonists of tomorrow. Ideas judged and prizes awarded by Applause-O-Meter test before movie audiences. Everyone has an equal chance. 26 cash prizes in all. Rush name on penny post card for "Valuable Tips on How to Make Money With Simple Cartoons and Humorous Ideas." Cash Prize Entry Blank and Rules—SEND NO MONEY.



CARTOONISTS' EXCHANGE
Dept. 93-A Pleasant Hill, Ohio

ANY BOOK IN PRINT!

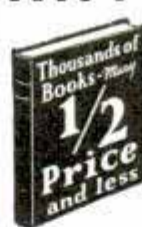

delivered at your door. We pay postage. Standard authors, new books, popular editions, fiction, reference, medical, mechanical, children's books, etc.—all at **guaranteed savings**. Send card now for Clarkson's 1937 Catalog.

FREE Write for our great illustrated book catalog. A short course in literature. The buying guide of 300,000 booklovers. The selection of a Metropolitan book store brought to your home. **FREE** if you write **NOW--TODAY!**

CLARKSON PUBLISHING COMPANY
Dept. M-1259 S. Wabash Ave. Chicago, Illinois

Improves Handwriting In 3 Hours

Marvelous invention. Corrects poor writing in few days. Amazing results guaranteed. No failures. Positive proof and complete outline mailed **FREE**. Write quickly.

OZMENT INSTRUCTION SERVICE, Dept. 34, St. Louis, Mo.

DEAF? AMAZING NEWS!

You may hear like normal again!
Amazing new instrument releases deaf from misery and embarrassment.

The Godsend, new Scientific, Electrical Hearing Aid, is guaranteed to give you same strain-free power to hear as instruments selling for \$50, \$75, \$100, and more. PRICED AT ONLY \$19.75, complete! Backed by \$1,000.00 Money-Back Guarantee. Now you may enjoy sermons from back of church, lectures, conversations, radios, movies. Complete with Microphone, powerful Amplifier, Batteries, and TWO Appliances for BONE or AIR CONDUCTION, both for less than the usual price of only ONE. Music and words heard distinctly from all directions at close range or from distances. No distortion—no head noises. Instrument is lightweight, easily concealed in clothing, no more noticeable than a pair of glasses. Write quick for **FREE DETAILS**, sent in plain envelope. Godsend Company, 4204 Davis Lane, Dept. S-418, Cincinnati, Ohio.

1000 LIGHTS FROM 1 MATCH!



CAN-O-LITES! An amazing new breath-taking invention, with a market running into the millions. CAN-O-LITES banishes lighters and matches forever—gives 1,000 lights with this one mysterious new kind of match. Sure as a match, it strikes like a match and replaces the match, YET there are no burnt out matches strewn around. Instantly you have a big, giant flame that will light a pipe, cigar, cigarette, gas stove, and serves the thousand and one uses a match has. NEVER NEEDS TO BE REFILLED. And CAN-O-LITES sells for the astounding low price of 25c each complete—with whopping big profits.

One Salesman SOLD OVER 15,000 in Three Months!

Does CAN-O-LITES sell? J. C. Ball sold over 15,000 in only 3 months! Sells quick as a flash on demonstration, to every home, office, factory, restaurant, club, college, cigar store, hotel. Everybody who sees CAN-O-LITES is completely captured by its novelty and usefulness. You sell from 6 to 6 dozen at a crack, your repeat business alone can reach a staggering weekly figure.



J. C. BALL

RETAILS

For
Only **25c**

What is the mysterious scientific principle that makes source of 1,000 lights from 1 match? What strange power lies hidden in the little container which, hundreds and hundreds of times, day after day, as easily as you strike a match, instantly produces a giant-size flame many times bigger than a match-flame? Turn CAN-O-LITES upside down—nothing pours out. Shake it—nothing rattles. You don't see any wheels or moving parts. No wicks, no gears. Don't use CAN-O-LITES for weeks—then pick it up and strike, and a big live flame appears, instantly! Yet you NEVER put anything into it to re-fuel or re-fill. Sells in VOLUME—and at 25c, your profits are enormous!

CAN-O-LITES Mfg. Corp.
1455 South Ave. Dept. E-12 Youngstown, Ohio

Millions Want This New Light!

CAN-O-LITES combines all the good features of matches and mechanical lighters and banishes all the bad ones. No sparks. No cinders, no danger of burnt clothes or fingers. No untidy burnt-out match sticks. Works better. Surer than most expensive lighters. Never fails. Absolutely safe. No competition. You can be at the receiving end of the lion's share of the thousands of dollars now being spent for matches in your Community, you can create a sensational, profitable business overnight!

THIS IS A WINNER!

CAN-O-LITES has already chalked up unbelievable sales and profit records. Rush this coupon fast for FREE details and big-profit news. Send no money! Mail this coupon NOW.

CAN-O-LITES Mfg. Corp., 1455 South Ave.
Dept. E-12, Youngstown, Ohio

Yes, I want to know more about CAN-O-LITES. Please rush me free sample offer, free plans and money-making details.

Name

Address

City State

When writing to advertisers please mention Popular Mechanics

STAMPS

Fig 04... *and* **Collecting**

By Richard McP. Cabeen
A. 900 333 N. Michigan Chgo



Some recent foreign stamp issues, including examples from Switzerland, the Philippines, the Netherlands, Belgium, Cuba and France

WHEN stamps were first issued no thought was given to ways of separating them. They were simply printed on a sheet and the user tore or cut them apart. But when stamps came into general use, experiments were made with lines of slits and later with lines of holes between the rows. Nearly all postage stamps have been so treated ever since.

In general, collectors speak of the "separation" of the stamps, with "perforation" applying to all processes which punch out small bits of paper, and "rouletting" applying to any process which cuts slits

without the removal of any paper. Stamps which have not been treated in any manner are classed as imperforated or unperforated. Only a few varieties of perforation are found in modern stamps since nearly all countries use the ordinary punched round holes. In earlier times, there were a few varieties of square and oval shaped holes, and our revenue stamps of the Spanish-American war period used a hyphen hole perforation in which a rectangle of paper was punched out.

In rouletting there is scarcely a shape

(Continued to page 49A)

VACU-MATIC SCORES AGAIN!

BOB MCKENZIE
 TRANSCONTINENTAL AUTOMOBILE CHAMPION
 COAST TO COAST

Vacu-matic Carburetor Co.
 7617 W. State St.
 Wauwatosa, Wisconsin

Dear Sirs:

Having just completed a new speed record between Los Angeles and Chicago, driving a 1936 Chevrolet equipped with a Vacu-matic carburetor control, I thought you might be interested in knowing some of the facts and the important part Vacu-matic played in the success of the run.

The distance covered was 2322 miles in thirty nine hours and forty-two minutes, officially timed by Western Union, which gave me an average speed of 59.7 M.P.H. based on elapsed time and with the Vacu-matic averaged 18 1/2 miles per gallon on gas-line.

Before leaving Los Angeles, we made several test runs both with and without the Vacu-matic, and the tests proved that Vacu-matic increased my gas mileage 3 1/2 miles per gallon at the driving speed of 60 M.P.H. and also very noticeable increase in both acceleration and power.

After this experience with Vacu-matic, you can depend that on my future speed runs across country that I will be depending on Vacu-matic to give me the same added performance it has proven on this last record breaking drive.

Yours very truly,
Bob McKenzie

WESTERN UNION
 TIMED

NEW YORK
 TO
 LOS ANGELES
 24 hrs. 40 min.

LOS ANGELES
 TO
 NEW YORK
 27 hrs. 38 min.

CANADA
 15,000 MILES
 IN 24 HRS.

LOS ANGELES
 TO
 NEW YORK
 AND RETURN
 121 hrs. 22 min.

WASHINGTON, D. C.
 TO
 MEXICO CITY
 42 hrs. 27 min.

LOS ANGELES
 TO
 PHOENIX
 9 hrs. 18 min.

MURDOCK DRYLAKES
 1927 MI. IN 24 HRS.

LOS ANGELES
 TO
 EVANSTON, ILL.
 18 hrs. 27 min.

LIPSA, ME.
 TO
 BULLY, N. C.
 400-27 min.



Sets New Coast-to-Chicago Record

New Supercharge Principle SAVES GAS

MORE POWER - MORE SPEED
 FASTER PICK-UP - NEW LIFE

ESTABLISHING new mileage records on cars in all sections of the country, the Vacu-matic again scores in a new speed record established by Bob McKenzie transcontinental automobile champion. Los Angeles to Chicago—2,322 miles in 39 hours and 42 minutes—driving 75 and 80 to maintain a speed average of 59.7 miles per hour!

Here is speed—a gruelling grind—where quick acceleration, greater top speed — and less stops for gasoline mean those precious moments saved that make new speed records possible. The same Vacu-matic that helped Bob McKenzie establish this speed record and gave him such fine gas savings is now available for all car owners. It is positively automatic—simple to install—inexpensive—and pays for itself many times over in gas savings.

Automatic - - Nothing Like It!

Vacu-matic is *entirely different!* It operates on the supercharge principle by automatically adding a charge of extra oxygen, drawn free from the outer air, into the heart of the gas mixture. It is entirely AUTOMATIC and allows the motor to “breathe” at the correct time, opening and closing automatically as required. No idling troubles—no carburetor adjustments necessary. It is so simple it will amaze you—so practical it will save you many dollars on gas costs.

Fits All Cars

VACU-MATIC is constructed of six parts, assembled and fused into one unit, correctly adjusted and sealed at the factory. Nothing to regulate. Easily attached in ten minutes.

Agents and Salesmen

VACU-MATIC offers a splendid opportunity for unusual sales and profits. Valuable territories now being assigned. Check and mail coupon.

The VACU-MATIC Co. Wauwatosa, Wis.

Guaranteed Gas Savings

VACU-MATIC must prove itself on every car. It is guaranteed to give worthwhile gas savings, quicker pick-up and more power, or it costs you nothing. “On my V-8 Ford it works miracles”, says Ralph Fields. James Seeley —“On an International Truck on a round trip to Cleveland, 385 miles, it saved 19 gallons of gas.” A. V. Grove —“On the Buick it showed 5 miles more per gallon.” F. S. Peck—“I average 22 miles per gal. on my Plymouth, an increase of 7 miles, for a saving of \$15.00 a month, or \$180.00 a year.” Wm. Lyons—“Averaged 25 miles on a gal. with a Model A Ford at 40 miles per hour.”

Free Details

You owe it to yourself to know all about this remarkable discovery. Mail the coupon below. Start saving gas with VACU-MATIC and enjoy a new driving thrill! There's no obligation—so get the facts now! Write today!

FREE OFFER COUPON

THE VACU-MATIC COMPANY
 7617-294 W. State St., Wauwatosa, Wis.

Gentlemen: Please send me full particulars concerning the Vacu-matic and details of your Free Offer. This of course does not obligate me in any way.

Name

Address

City State.....

Check here if interested in selling proposition.

When writing to advertisers please mention Popular Mechanics



START \$1260 to \$2100 YEAR

Many 1937 Appointments
MEN—WOMEN
Short hours. Influence unnecessary.
Dependable Jobs
Common Education Usually Sufficient

Franklin Institute
Dept. A182
ROCHESTER, N. Y.

Gentlemen: Rush to me, FREE of charge, list of U. S. Government big pay jobs. Send me FREE 32-page book describing salaries, vacations, hours, work, and full particulars telling how to get one of these jobs.

Mail Coupon Today—**SURE**

COUPON

Name

Address

Be a GUNSMITH Learn this big pay profession at home. Repair, restock, blue, check, refinish, make new parts, etc. Write for Prospectus.
GUILD SCHOOL OF GUNSMITHING, Dept. A-3, Newark, O.

TRAILER ENGINEERING
(Second Edition)
BRAND NEW BOOK
To Help You Buy or Build. 14 chapters, 130 illustrations. Tells you about bob, roll, weave, snaking, nose diving, rear vision, Ackerman steering, tandem wheels, tow car balance, trailer balance, all State laws, American coaches, English coaches, plumbing, wiring, brakes, step action, chassis, parking jacks, weights, furniture, ironing the tow car, every engineering detail. Get unvarnished trailer engineering facts before you buy or build. Order NOW. \$1.00 postpaid, \$1.15 C. O. D.
RAY KUNS 6 Eastwood Circle Cincinnati, Ohio

In answering advertisements always write and full address clearly.

RAISE GIANT FROGS

NUFOND GIANTS WEIGH UP TO 3 LBS. EACH



SELL UP TO \$5 PER DOZEN!

A New Industry! Millions used yearly! Markets waiting. Prices Steady. Pleasant, outdoor work. Easy to ship to any part of the country. Nation-wide market at your command.
A SMALL POND is all you need to start with five pairs of "Nufond Giant Breeders." Expand with the increase. **WE BUY!** As originators of **Canned Frog Legs**, we are developing one of the world's largest frog markets. In addition to other markets, frog raisers can also ship to us.
MEN & WOMEN! Investigate this interesting, new work. See for yourself what others are already doing. Send for our illustrated, **FREE** book explaining our offer in detail. Write today.
AMERICAN FROG CANNING COMPANY
Dept. 133-C, New Orleans, La.

FREE BOOK



Ruptured?

Save yourself the misery of wearing leg-straps and cutting belts. Learn about the famous **Cluthe Comfort Truss** positively guaranteed to hold—a condition absolutely necessary for possible improvement or recovery. Water and perspiration proof; wear it in bath; Automatic Pad insures safety; hips left free. Made to your order for your individual requirements by mail on a liberal 60 days trial plan. Send for **FREE** 100-page Book of Advice and endorsements (publication permitted) from grateful patrons in your own neighborhood. No obligation. Write today.
Dept. 31, CLUTHE SONS, Bloomfield, New Jersey
(Serving the Ruptured Since 1871)

Save Your Feet



When all else fails end your suffering with the flexible "no metal" **Heefner ARCH SUPPORT**
Write for Free Booklet

HEEFNER ARCH SUPPORT CO., 655 Commercial Bldg., LOUISVILLE, KY.

FREE TREASURE BOOK **RINGS \$1.50**
PINS 30¢
Write for Big FREE Catalog Of Pins, Rings, Emblems, Medals, Trophies, Etc.
Class Pins, any letters, numerals, colors. Silver Plate, 25 or more, 30c ea.; 7 to 24, 35c ea.; 1 to 6, 40c ea. Gold Plate, add 10c ea. to above. Ster. Sil., add 20c ea. Ster. Sil. Ring shown, 20 or more, \$1.50 ea.; 12 to 25, \$1.50 ea.; 1 to 11, \$1.75 ea.
4254 METAL ARTS CO., INC., FACTORY 44, ROCHESTER, N. Y.



PLAY GUITAR!

We guarantee to teach you for less than 2c per day. You'll enjoy learning to play this fascinating instrument by our easy, illustrated lessons. **FREE** Guitar Tuner when you enroll. Ask for full details—no obligations. Write TODAY—Sure.

HAMANN INSTITUTE

3021 N. 24th Place P-4 Milwaukee, Wis.

ARTISTS MAKE MONEY

Find out your ability. Send name, age, occupation and address for Free Vocational Art Test.
Federal Schools, Inc., 3137 Federal Schools Bldg., Minneapolis, Minn.



BUCHSTEIN'S FIBRE LIMB

is soothing to your stump—strong, cool, neat, light. Easy payments. Braces for all deformities. Agents wanted.
D. BUCHSTEIN CO.
610 3rd Ave., So., MINNEAPOLIS, MINN

Send for Catalog Today

MIDWEST..

FACTORY-TO-YOU SAVES 50%

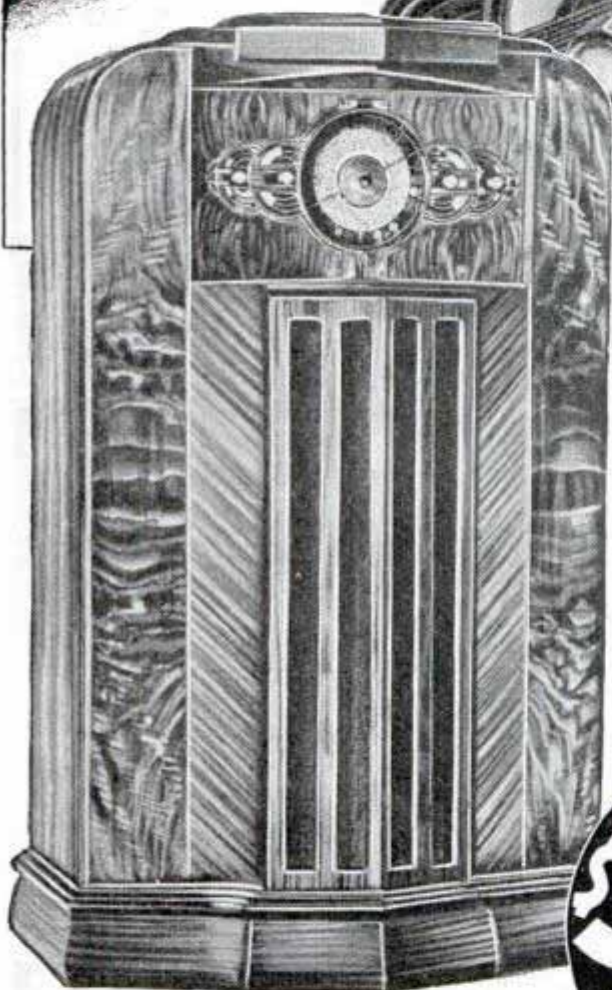

ZIP!
and your
STATION
FLASHES
IN

HALF the Cost... **TWICE** the Performance

14 TUBES FOR THE PRICE OF 8

This great new Midwest has caught the nation's fancy, because scores of marvelous new features like Dial-A-Matic Tuning*, Elektrik-Saver* (optional*) give magnificent world-wide reception and glorious crystal clear realism. America OK's Midwest radios because they out-perform ordinary sets on a point-for-point comparison. Not a cut-price set, but a more powerful super performing radio in a big, exquisitely designed cabinet

of matched walnut! You are triply protected with Foreign Reception Guarantee . . . One-Year Warranty and Money-Back Guarantee. Now, you can roam the world in a flash . . . switching instantly from American programs to police, amateur, commercial, airplane and ship broadcasts . . . to the most fascinating foreign programs. When you buy the Midwest factory-to-you way, you deal directly with the factory that makes radios—instead of paying extra profits to wholesalers, distributors, retailers, etc.

only
\$39⁹⁵ • BUYS
A NEW
**1937 WORLD WIDE
MIDWEST**

Send for **FREE**
40-PAGE CATALOG!

Remember! Nothing of value is added to a radio just because it is handled many times. You have a year to pay . . . terms as low as 10c a day . . . you secure the privilege of 30 days FREE trial in your own home.

ZIP!... and Your Station Flashes In!

Your radio enjoyment is doubled with Dial-A-Matic Tuning, the amazing new Midwest feature that makes this radio practically tune itself. Zip!... Zip!... Zip!... stations come in instantly, automatically, perfectly . . . as fast as you can push buttons.



Your
radio dollar
goes twice as far
when you buy
a **MIDWEST!**

PASTE COUPON ON 1¢ POSTCARD...OR WRITE TODAY!

MIDWEST RADIO CORPORATION
Dept. K-15, Cincinnati, O.
Send me your new FREE catalog and complete details of your liberal 30-day FREE trial offer.
(Special offer and prices prevail only when dealing direct with factory by mail.)

Name _____

Address _____

Town _____ State _____

User-Agents Make Easy Extra Money Check Here for details.

30 DAYS FREE TRIAL!

For seventeen years, Midwest engineers have pioneered many features and advantages which others quickly copied. The new 1937 Midwest is designed years in advance. It has everything! Not just two or three outstanding features, but scores of new developments...many of them exclusive. Send for the FREE 40-page book. See for yourself that Midwest offers today's greatest radio values. See why so many say: "Midwest sets the pace!"



Midwest engineers discussing new chassis

MIDWEST RADIO CORP.

DEPT. K-15 CINCINNATI, OHIO, U.S.A.
Established 1920 Cable Address MIRACO...All Codes

Get the **FREE** Book
of opportunity

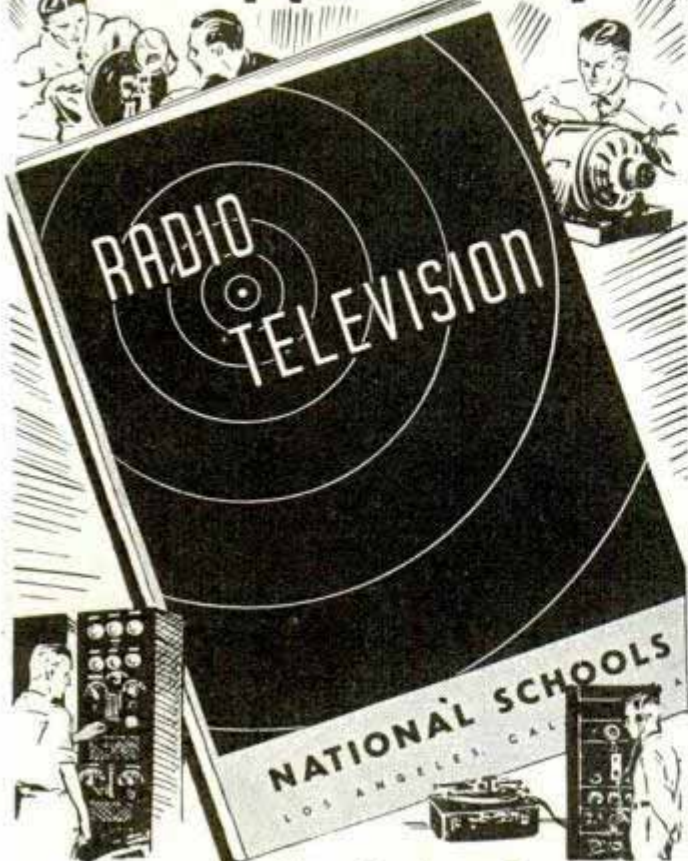

Brimful of terse
instructive facts about
TELEVISION
RADIO
SOUND RECORDING
ELECTRICITY

Note These Interesting Contents

Written in plain, understandable language, this free Book gives facts you want to know about the best-paying trades and opportunities. 95 illustrations. Major subjects include Television Theory and Construction, Pick-up Systems, Amplifiers, Transmitters, Receivers, Cathode Tubes; Radio in all its branches, Receiving, Broadcasting, Trouble-shooting, Construction and Theory; Sound-recording on Disc; Loud Speakers, Talking Picture Projection, Radio Communication, Laws, etc. This book also tells how you can qualify for these good pay trades by training at NATIONAL SCHOOLS. Send coupon now for free book.

National Schools is the oldest trade Institution in the West. Est. 1905. More than 30,000 graduates. You can earn room and board while learning. Coach railroad fare allowed to Los Angeles. This service only for residents of U.S.

NATIONAL SCHOOLS
LOS ANGELES

**MAIL FOR
FREE BOOK**

NATIONAL SCHOOLS, Dept. 3-PMR,
4000 So. Figueroa St., Los Angeles, Calif.

Name..... Age.....

Address.....

City..... State.....

**RIDE ONE
WHEEL**

AMAZE YOUR FRIENDS

Great Fun, Simplified Easy Method. For the first time, I give dimensions of a perfect balanced stage unicycle with instructions to build from junk parts, also principal points of balance that will surprise you with the speed of which you can learn to ride a one wheel.

SEND ONLY \$1

WALTER NILSSON WORLD'S FOREMOST
"UNICYCLIST"
P. O. BOX 812, STATION H, LOS ANGELES, CALIFORNIA

NEON

Prepare yourself quickly for today's biggest opportunity—NEON or "gaseous tube" lighting—most widely used medium of lighted displays, the future's greatest source of illumination. Splendid future

for men in each locality who start now while it is still new.

FREE Send your name for free booklet describing NEON'S opportunities and complete data on the practical C. L. home study course. Low enrollment fee will amaze you. **WRITE TODAY!**

COMMERCIALITE LABORATORIES, BOX 47-P, OMAHA, NEBR.

DIESEL

20,000 more Diesel Engineers will be needed in 1937. This course is **GUARANTEED** to help you obtain one of these highly-paid positions or your **MONEY REFUNDED**.

No experience or college mathematics necessary. 18 Big Lessons, complete, \$1.00. Send no money. Pay Postman on delivery.

Stewart Diesel School, Dept. P3, 3555 Aberdeen, Alton, Ill.



BULL DOG Trailer HITCH

CHEAPEST TRAILER INSURANCE in the world. **DROP FORGED Bull Dog Hitch NEVER LETS LOOSE! GUARANTEED AGAINST BREAKAGE.** Certified tensile strength up to 52,400 lbs. Unfastens easily at any angle **BUT ONLY** when desired. Wear compensator prevents back lash, lost motion, noise. A type for every trailer. Used **EXCLUSIVELY** by Biggest Trailer Manufacturers. **WRITE TODAY** for **FREE** details. (Include only 50c for latest Guaranteed Trailer Builder's Guide.)
HAMMER BLOW TOOL CO. Dept. BD-3 WAUSAU, WIS., U. S. A.

No JOKE TO BE DEAF

—Every deaf person knows that—

Mr. Way made himself hear his watch tick after being deaf for twenty-five years, with his Artificial Ear Drums. He wore them day and night. They stopped his head noises. They are invisible and comfortable, no wires or batteries. Write for **TRUE STORY**. Also booklet on Deafness.



Artificial Ear Drum

729 Hofmann Bldg.

Detroit, Michigan

**Give Your OLD SET
NEWEST FEATURES**
with **Radio-X**

**Amazing Invention...
ELIMINATES LOCAL INTERFERENCE,
BANISHES DISTORTION, STATIC, ETC.**

Get Mexico, Cuba, other distant stations, clear and strong as local! Cut out local interference! Improve selectivity, reduce static noises, better the tone of your old set with **RADIO-X!** Consumes no extra power. For every kind of radio, electric or battery, long or short wave. Attached in 5 minutes.

SEND NO MONEY **RADIO-X** is invention of radio engineer. **GUARANTEED.** Just pay postman \$1.00 plus postage on delivery. Keep 5 days. If you don't say, "It's a miracle," return for refund. Order today. **RADIO-X LABS., Dept. M-1003, Oakley Station, Cincinnati, Ohio.**

\$1

PARKS AIR COLLEGE



Offers COLLEGE AND PROFESSIONAL TRAINING Majoring in Aviation

FOUR two-year courses (96 weeks) lead to Bachelor of Science degrees in Professional Piloting, Aviation Operations, Aviation Mechanics and Aeronautical Engineering.

THIRTEEN TRAINING PLANES are on the flight line. They range from the Kinner Sportster to the high speed twin-engined Monocoach equipped with retractable landing gear, air brakes, two-way radio, radio direction finder, and blind flight instruments.

Accredited by the Illinois Superintendent of Public Instruction. Government approved as a Transport Ground and Flying School and Mechanic's School.

58,000 hours flight instruction have been given, 650 hours now being flown monthly. THE FACULTY of 33 is composed of specialists in the various fields of aviation. AN ENROLLMENT of 260 resident students for the 1936 Fall term. On its 100-acre airport, Parks has 14 buildings with a total floor area of 2 3/4 acres, devoted to school purposes exclusively.

DORMITORIES AND DINING HALL ON THE FIELD.

1371 graduates.

Graduates are being placed prior to graduation.

63 per cent of graduates enter air transport operations in North and South America.

At Parks you train for aviation in aviation. Parks is recognized as the training division of the industry. Ask any one who is in aviation. You can expect more at Parks and still be agreeably surprised when you come.

The 60-page catalog gives complete information. Send for it. It is FREE. It is packed full of valuable information. A letter or post card will bring it to you.

PARKS AIR COLLEGE

337-M Cahokia Rd.

East St. Louis, Illinois

ACCOUNTING

the profession that pays—

Accountants command big income. Thousands needed. About 14,000 Certified Public Accountants in U. S. Many earn \$3,000 to \$20,000. We train you thoroughly at home in your spare time for C. P. A. examinations or executive accounting positions. Previous bookkeep-

ing knowledge unnecessary — we prepare you from ground up. Our training is personally given by staff of experienced C. P. A.'s. Low cost — easy terms. Write now for valuable 64-page book free, "Accounting, the Profession That Pays."

LASALLE EXTENSION UNIVERSITY
Dept. 364-H Chicago, Illinois



Earn Money at Home



GIVEN YOU TO DECORATE

BIG FREE book in colors tells new easy way. You don't need experience. We show you how to decorate beautiful Art Novelties right in your own home by simple "3-step" method. No tedious study. Everything furnished including supply of Novelties for you to decorate and Homecrafters Outfit. Big profit per piece for decorating. Just sit at home, and make up to \$25 to \$50 a week—full time or spare time.

First Lesson Now Free!

Prizes, Toys, etc. More like fun than work and you earn as you learn. Hundreds making big money this fascinating way.

NO CANVASSING You risk nothing in sending for Free Lesson. So sure are you to succeed we give an absolute Warranty backed by \$1,000 Bond. Costs nothing to find out. Openings for new workers now in every locality. Mail coupon immediately for Free Book and Free Lesson. Get started making money at once.

Just mail coupon and get first lesson absolutely free. Start right in decorating Gifts, Bridge



MAIL THIS!

FIRESIDE INDUSTRIES
Dept. 66-C, Adrian, Mich.
Please send big Free Book and FREE LESSON. This does not obligate me in any way.

Name

Address

AUDELS MATHEMATICS AND CALCULATIONS FOR Mechanics



\$2

A HANDY BOOK

Good News!

MATHEMATICS AND CALCULATIONS FOR HOME STUDY AND REFERENCE

PRACTICAL MATHEMATICS ILLUSTRATED. How to figure correctly. EVERY MECHANIC can use the new, correct, easy methods, covering a complete review of practical arithmetic—with examples including mensuration—plane and solid geometry—trigonometry—algebra—calculus—ELECTRICAL and MECHANICAL SHOP CALCULATIONS—practical tests—reference tables and data—how to use the slide rule—700 pages—550 illustrations—pocket size.

Highly endorsed. Let us mail you copy for free trial. Price \$2, postpaid.



FREE EXAMINATION COUPON

THEO. AUDEL & CO.
49 W. 23rd St., N. Y. C.
Mail Audel's Mathematics on 7 days' free trial. If O. K. I will remit \$2, otherwise I will return it.

Name

Address

Occupation P. M.

Questions

about every

Hobby and Special Interest

quickly answered by the
NEW MERRIAM-WEBSTER



DO YOU LIKE sailing? Or building ship-models? Can you name butterflies, birds? Are you acquainted with the wonders of the microscope? These and all other hobbies are fully described in Webster, with hundreds of detailed illustrations, half tones, and color plates. Every science, art, and profession is covered in the New Merriam-Webster with the same unprecedented thoroughness. 600,000 entries—122,000 more than in any other dictionary. 3,350 pages. Edited by 207 authorities. See it at your bookdealer's.

Write for illustrated new booklet, "Through Wonderland with Webster"

G. & C. MERRIAM CO.
Dept. 735 Springfield, Mass.

The Supreme Authority—A New Creation
WEBSTER'S NEW INTERNATIONAL DICTIONARY Second Edition

INVENTORS PATENT YOUR IDEAS

Get this **FREE** Book

SMALL IDEAS ARE OFTEN VERY VALUABLE. If your idea is new and useful, no matter how small or inexpensive to produce, you should take prompt steps to secure protection. Write immediately for a copy of **MY NEW FREE BOOK** and my "Record of Inventions" form. Protect the future profits from your idea by securing a United States Patent. Your first step is to communicate with a competent, Registered Patent Attorney and learn the essential facts about Patents without a day's delay. My **FREE BOOK** gives you these vital facts . . . how to proceed, different kinds of patents, importance of protection and much more. Also explains my **Convenient Payment Plan.**



PERSONAL ATTENTION

Every case that comes into my office receives my **PERSONAL ATTENTION** in every step of the road to protection. If you have faith in your invention, then take care to select the lawyer who will **PERSONALLY** represent you before the United States Patent Office, a registered Patent Attorney and a Graduate Engineer in whom you can feel the utmost faith, and know that he will give your case his **PERSONAL** attention and not turn it over to an assistant or subordinate. **Mail This Coupon TODAY!**

L. EDWARD FLAHERTY
REGISTERED PATENT ATTORNEY

71-H International Building WASHINGTON, D. C.

Please send immediately your **FREE** book and Record of Invention Form.

Name.....

Address.....

City..... State.....

Men Needed Quick!—Not hundreds—but thousands! Everybody's air conditioning. Learn NOW—at home, in spare time—for at our School in Chicago. Quality for steady work and big profits in

AIR CONDITIONING and REFRIGERATION

GET *Free* PROSPERITY BOOKLET

Get in on ground floor. Send for "Prosperity Booklet."
CHICAGO TECHNICAL COLLEGE 34th Year
C 301 Tech Bldg. 118 East 26th St., Chicago, Ill.

NEW TYPE CHEAP OIL BURNER

WHY COOK OR HEAT WITH COAL or WOOD
Quick heat at turn of valve—hotter, cheaper, no dirt, ashes or drudgery. Burns cheap oil new way—no clogging up or carbon. Slips into Any STOVE, RANGE or FURNACE.

SENT ON TRIAL Prove it cuts fuel bills, pays for itself quickly by what it saves at our risk. Offer of **FREE SAMPLE TO AGENTS**

Wonderful money-maker, spare or full time. Write quick—a postal card will do. Address **UNITED FACTORIES, CA. 751 Factory Building, Kansas City, Mo.**

CIVIL SERVICE

VALUABLE INFORMATION
COLUMBIAN CORRESPONDENCE COLLEGE
WASHINGTON, D. C.

Forms to cast Lead Soldiers, Indians, Trappers, Hunters, Wild and Farm Animals. 239 different forms to select from. Every form guaranteed to cast perfect figures. Send 5c stamp for illustrated catalogue.

HENRY C. SCHIERCKE Spencer Rd. GHENT, N. Y.

PENNY EACH ! ! !

Large sizes! Beautiful Gold Reflecting Window Sign Letters. Finest Quality. 5 Year Guaranteed. New Styles. Tremendous Demand. Amazing Profits. Easily applied. Write for **FREE SAMPLES** and starting equipment. **HURRY!**

WINDOW SIGNS

Atlas Sign Works, 7943 Halsted, Chicago, Ill.

STEP INTO THE Spotlight

FREE LESSONS . . . A YEAR TO PAY

Banish Boredom ... Earn Extra Money START TO PLAY VERY FIRST DAY

Picture the joy of playing a snappy foxtrot, dreamy waltz or mellow old favorite on the Xylorimba. No reason why you shouldn't! Xylorimba is **easiest** of instruments to play and yet the most spectacular. In constant demand by orchestras, radio stations, at lodge meetings and parties. Marvelous opportunity to increase popularity, make big spare-time money. No bothersome practice or exercises. With Free easy lessons you actually **Start to Play Very First Day.**

BIG FREE BOOK tells all about Deagan line, liberal trial offer and easy payments. Send coupon today for your free copy.

J. C. Deagan, Inc., Dept. 1453, 1770 Berneau Ave., Chicago

Send me, without obligation, full details of Free Trial offer and easy-payment plan on the Deagan Xylorimba.

Name.....

Address.....

When writing please mention Popular Mechanics

STAMPS and COLLECTING

(Continued from page 42A)

which has not been tried. These vary from the short straight cuts made by a roulette or tracing wheel to the elaborate serpentine roulettes found on the early stamps of Finland. If the rouletting is in straight slits in a line, the simple word roulette is used. If the slits are little curves, the term is roulette in arcs, if the slits are "V's," the term is serrate roulette, and if the slits are curved and reversed to form a wavy line the term is serpentine roulette. Rouletting which consists of pricking small round holes through the paper with a pointed tool is unfortunately termed pin-perforation, but it is a form of roulette.

In some cases rouletting has been employed as the cheapest form of separation. In these cases the units from which the stamps were printed were single electros, or stereotypes, which were locked up in a form with dividing lines of notched printers' rules slightly more than type high. This received ink when the plate was inked and printed a colored frame, at the same time punching its way through the paper. This is roulette in colored lines.

All forms of separation are gauged or measured by the number of holes or slits in twenty millimeters, and the expression "roulette twelve" indicates there are twelve holes in the standard space. When the perforation at the sides differs from that along the top and bottom, the stamp is said to have compound perforation and the horizontal gauge is mentioned first.

Recent Foreign Stamp Issues

Switzerland has issued a set of three stamps to care for the national defense fund. These show a Freiburg cowherder in his picturesque costume. The Philippines has an issue celebrating the first anniversary of its government. There are three stamps featuring Manuel L. Quezon, the president. The annual Netherlands Child Welfare issue contains four values and shows a cherub sounding a trumpet. The Netherland Indies also has a charity issue of four values, showing an infant.

The Belgian semi-postal issue, which assists the Anti-tuberculosis society of that country, contains eight values and shows a portrait of Prince Bandouin, old-

(Continued to page 70A)

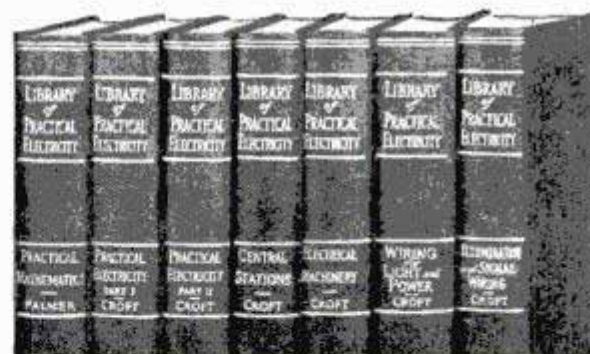

**Know Electricity as
Experts Know It!**

— and get an expert's pay

Recovery has begun! The months ahead are charged with significance and expectation. What will you do to get the jump on the other fellow? Thousands of men have used

The Croft Library of Practical Electricity

A combined home-study course and reference library of master electrical practice.

7 VOLUMES, 3000 PAGES, 2100 ILLUSTRATIONS

THE Croft Library is a complete electrical educator. It is founded on practice—on work as it is actually done. It is jammed from cover to cover with the kind of hardheaded facts you want. Written so that the beginner can easily understand it, yet so sound, so thorough, that it is the guide of 59,000 highly paid electrical workers and engineers.

Explains Every Electrical Problem

This Library covers electricity thoroughly. The sound and usable material it offers will enable you to solve easily and quickly all of the many electrical problems confronted in daily practice. Beginning with the most simple circuits and an elementary discussion of power and electro-magnetic energy, these books advance to the most intricate switchboard wiring, telephony, and the operation of central stations.

They give you complete information on motors—generators—transformer—circuits—currents—switchboards—distribution systems—installation and repair of electrical machinery—wiring for light and power—the National Electrical Code—underwriters' requirements—signal circuits—mathematics—etc. You are taken "on the job" and taught electricity from the standpoint of finished experience. A short time devoted to these books each day will open for you the entire world of electricity and advancement.

NO MONEY DOWN—EASY PAYMENTS



Fill in and mail the coupon attached and we will send you the entire set of seven volumes for 10 days' Free Examination. We take all the risk—you assume no obligation. If you decide to keep the books, send \$1.50 in 10 days and the balance at the rate of \$2.00 a month, while you use the books. Send the coupon NOW and see the books for yourself.

FREE EXAMINATION COUPON

McGraw-Hill Book Co., Inc.
330 W. 42nd St., New York, N. Y.

Send for 10 days' free examination the Croft Library of Practical Electricity. If satisfactory I will send you \$1.50 in 10 days and \$2.00 monthly until the price of \$19.50 is paid. If not wanted, I will return the books postpaid. (To insure prompt shipment, write plainly and fill in all lines.)

Name.....

Address.....

City and State.....

Position.....

Company..... PM-3-37

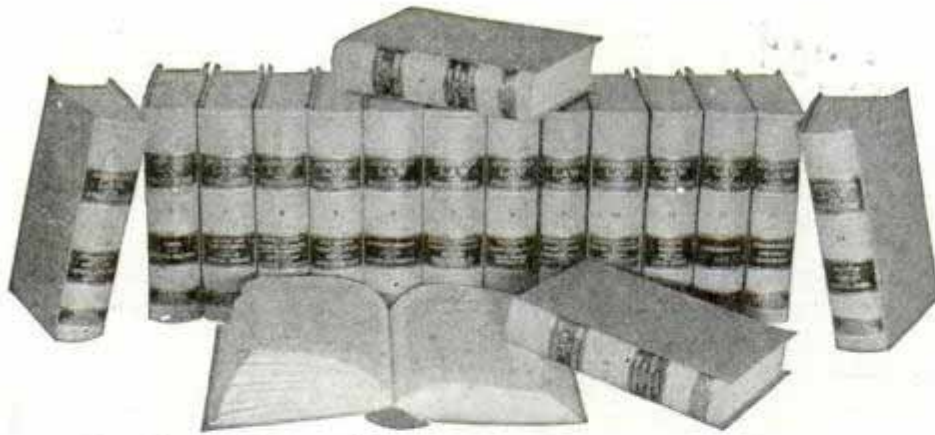

—the law library illustrated here—written by outstanding law professors—supplemented by lectures—cases—and personal tuition by qualified lawyer-instructors, will give you law training by home study.

THOUSANDS of men today, who never intend to practice before the bar, are studying law.

They realize that the law trained man is a leader—that law training makes keen, clear, quick, correct thinking—that there is a real reason why legally trained men head many of America's greatest corporations.

Practical Law Training Through HOME STUDY

The home study Law training offered by LaSalle has proven itself practical and valuable far beyond the time and money cost.

In certain permitted states every year, LaSalle trained men pass bar examinations with high honors.

But many, many more men, take their LaSalle law training to use in business and find in it a quick, sure key to progress and leadership—to the avoidance of pitfalls and the picking of the sure and certain paths of progress.

Many of the leaders of 1937-1940 will be determined in 1937. Will you be one of them?

Acquire LAW nights at HOME

A Most Unusual Law Library

The basis of LaSalle law instruction is a fourteen volume library—we believe the most remarkable set of law books you have seen—compiled by leading professors and authorities.

This library might well be called—"Law Simplified and Condensed"—for it covers the whole basic field of law in an orderly, classified and simple manner. In many resident schools, the LaSalle Law Library is a reference work regularly used by students. In one great law school, fourteen sets of LaSalle's Law Library are at the student's disposal and constantly used.

Supplementing this great library, are lectures and personal instruction of the highest grade, all under a definite, clear plan involving continual use of the Problem Method, where you train in law by dealing with actual legal problems—learn by doing the work—not by memorizing rules.

To get the whole story, you must investigate. And the coupon below is the easy way to start that.

LA SALLE EXTENSION UNIVERSITY, Dept. 364-LR

CHICAGO

Law: Degree of LL. B. I would like to have full information about your law training, together with a copy of "Law Training for Leadership" and your booklet "Evidence," all without obligation.

Other LaSalle Opportunities: LaSalle opens the way to success in every important phase of business. If more interested in one of the fields indicated below, check and mail now.

- | | | | |
|---|--|--|---|
| <input type="checkbox"/> Commercial Law | <input type="checkbox"/> Banking and Finance | <input type="checkbox"/> Expert Bookkeeping | <input type="checkbox"/> Effective Speaking |
| <input type="checkbox"/> Business Management | <input type="checkbox"/> Industrial Management | <input type="checkbox"/> Business Correspondence | <input type="checkbox"/> Railway Accounting |
| <input type="checkbox"/> Modern Salesmanship | <input type="checkbox"/> Modern Foremanship | <input type="checkbox"/> C. P. A. Coaching | <input type="checkbox"/> Credit and Collection Correspondence |
| <input type="checkbox"/> Higher Accountancy | <input type="checkbox"/> Personnel Management | <input type="checkbox"/> Business English | |
| <input type="checkbox"/> Traffic Management | | | |
| <input type="checkbox"/> Railway Station Management | | | |

Name..... Present Position.....

Address..... City.....

LaSalle Extension University



FREE

**WORLD'S
BEST
WANT AD
MEDIUM**

CLASSIFIED Advertisements



Advertisements in this section, 35 cents per word, each insertion, minimum 10 words, payable in advance

To be inserted under proper classification in April issue, copy should be in our office February 8th

April issue on sale March 1st

Popular Mechanics Magazine, 200 East Ontario Street, Chicago, Illinois

YOU'LL PROFIT

By reading and answering the classified ads in this section. Hundreds of opportunities to make and save money.

Popular Mechanics Magazine,
Chicago, Ill.

Gentlemen:—With great pleasure must I inform you that I am just closing my most successful season of selling Christmas cards through agents. My ten word ad in your magazine brought most of them, at less than a single penny per inquiry. It really has me stunned to see the seemingly never ending flood of inquiries come in, day after day, even now, from every state in the U. S. and Canada. Popular Mechanics has them all beat. Thank you and your readers and I will be with you again whenever I need agents.

Yours very truly,

MATT TRABLE.

(Original letter on file in our office)

AUTOMOBILES

DEFROSTER—Conveys hot air from heater to windshield. Eliminates frost, steam, sleet. \$2.00 prepaid. Jiffy Sales, 4029 Binney, Omaha, Nebraska.

MIDGET Racing book; facts for fans, builders, drivers; track sizes, regulations; pictures, specifications, working drawings. Also stock car conversions for fastest cars. \$1.00 postpaid. \$1.12 C.O.D. Ray Kuns, Dept. 23, Cincinnati, Ohio.

FORD Owners—1935-36-37 and Model A. 2 more miles per gallon. Price \$1. Walert Co., 3429 No. 10th St., Milwaukee, Wis.

ECONOMY! Performance! Mileage! Semi-diesel conversions for all gasoline motors. \$5.00 up. Deal direct with the manufacturers. Unconditional written guarantee. Special complete units for Ford and Chevrolet. Learn basic facts. Illustrated literature free. Des-A-Gas, 1719 Addison, Berkeley, California.

FORD Owners! Change to hydraulic brakes cheap. Instructions, 75c. Julius Monge, North Chicago, Ill.

SPECIAL. Semi-Diesel, diagrams, instructions, 25c. Sovereign's Sales, Toronto, Canada.

FORD V-8s—5 to 8 more miles per gallon with "Automatic Gasaver," uses the fumes from crank-case. Automatic Gasaver Co., 126 W. Wood St., Youngstown, Ohio.

REBUILD Ford T or A motor into fast pumping air compressor. Instructions \$1.00. Tuck Garage, 73 Shirley, Pontiac, Michigan.

MIDGET Racers, parts, engines. Catalogue dime. "Kirby's Midgets," Box 213, Winnsboro, Texas.

R & R Mfg. Co., Anderson, Indiana. Racing cars and midgets. Catalogue 25c.

SPECIAL! Factory prices on genuine Desogas fuel-oil converters. Two year demonstrated superiority. Standard unit \$4.75. (Ford V8, \$15.00). Pretti Desogas, 1618 6th, Berkeley, Calif.

PAINT Stripping tool—Automobiles, furniture, everything. Guaranteed. \$1.00. C. Carlson, 2212 Grand Ave., Omaha, Nebraska.

MIDGET Car plans, parts, engines. Circulars dime. Storms, 13 Southside, Asheville, N. C.

AUTO SUPPLIES AND EQUIPMENT

REAL Opportunity. Hustlers, \$9.50 air-vacuum cleaner for automobiles. Superior to any \$50.00 cleaner made. \$3.00 crankcase oil heater for cold weather. Just out. \$3.50 top oiler and gas saver. Sold on guarantee. Send for pamphlet and discounts to agents. Reenan Company, Denver, Colo.

NEW—Ignition supercharger—Easy starting—Wet or cold—More mileage—Pep—Less carbon. Send \$1.25. Easy attached. E. G. Sales Co., 321 Broadway, New York.

ATTENTION Motorists—No need to crawl under your car to change oil. Do it the modern clean way by just pulling a button. \$3.00 money order will bring you by return mail postpaid a guaranteed leak proof Automatic Oil Drain, will out last life of your car. Ten day money back guarantee. Send name, year and model of car. Descriptive circular free. Harrison Distributing Company, 955 Builders Building, Chicago, Ill.

SAVES Gas, oil. Eliminates carbon. Attached easily. \$1.98. Circular 10c. LW, 1639 South Central Park, Chicago.

TIRES—Firestone's, Goodyear's, others. Cut prices. Tireman, Lake, New York.

USED Auto parts at half price for all cars. Century Parts Co., 1712 Lafayette Ave., St. Louis, Mo.

DEMONSTRATORS. Compressor, test bench, 8-hour battery charger—are welder. Guaranteed. Trial and terms. Ken's Equipment Exchange, Box M-371, Troy, Ohio.

GROWLER Armature tester, \$3.45 postpaid. Circular free. Troughton, Aurora, Missouri.

PLATING Outfits for automobile parts. Connect to battery. No tanks used. Free particulars and proofs. Gunmetal Co., Ave. J, Decatur, Ill.

A. C. GENERATORS

PRACTICAL Changes for automobile generators. See our advertisement at bottom of page 137A. Autopower, Inc.

AUTO TRAILERS

SEND \$1.00 For our latest 16 foot streamlined DeLuxe Trailer plans with all the modern improvements known to trailer builders. We supply everything at bargain prices. Our new 1937 trailer supply catalog (largest and most complete) is free. National Trailer Equipment Co., Welsh Bldg., Milwaukee, Wis.

WRITE Today for your copy of our plans. "How to Buy the Fold-A-Way Trailer." Fold-A-Way Trailer Co., Box 642, Davenport, Ia.

DROP Axles, adapting Ford spindles, brakes. \$12. G. Knfght, Riverton, N. J.

BUILD The famous Jim Dandy cabin trailer—thousands on the road! A roomy, good looking trailer easy to build at low cost by anyone handy with tools. Complete plans and instructions—only 50c—give every detail of chassis, body, top, beds, cabinets, refrigerator, electric light and water systems and where to buy all parts. Can be built in any size to accommodate 2 to 4 people. Send 50c for these practical plans. Rush your order today to Jim Dandy, Box 1125, Wausau, Wis.

TRAILER Axles, wheels, springs, equipment. Roberts Trailers, 11429 Forest Ave., Chicago.

PARTS For the Popular Mechanics "Family Traller" featured in the February, March and April issues. Everything you need—Axle, hitch, wheel housings, water tank, pump, toilet, sink, stove, wood parts, windows, screens lights, cushions, etc. Send for price list. Include 25c for our big catalog and Traller Builders' Manual. Traller Supply Co., 410 Grand Ave., Wausau, Wis.

MOTORCYCLES, BICYCLES AND SUPPLIES

POWER Your bike with low priced Speedbike motor. Attach in one hour. Eighty miles to gallon. Thirty miles an hour. Free folder. Guaranteed. Evinrude Motors, 4047 N. 27th St., Milwaukee, Wis.

DIME Secures sample Speedway, Racing Magazine, catalog English motorcycles, crash helmets, speed books, supplies. Clymer, 434 W. Pico, Los Angeles, Calif.

MOTOR Bicycles \$45.00. Motorcycle tires \$3.00. Belts \$5.00. Wheels \$1.00. Brakes \$4.00. Handle bars, frames, chains, tanks, clutches. Send 12c. Deninger's, Rochester, N. Y.

SEND 15c For illustrated used motorcycle catalog. Bargains. Largest stock genuine Indian parts and motorcycles. Indian Motorcycle Sales, Kansas City, Mo.

GENUINE Harley Davidson parts, accessories, repairs. Prompt service. Send 10c for used motorcycle bulletin. Bill Knuth, 2491 Fondulac Ave., Milwaukee, Wis.

MOTORCYCLE Bargains, lowest prices, bargain sheets for stamp. Motorcycle accessories. Rochester Harley Davidson Corp., 129 West Main St., Rochester, N. Y.

HENDERSON, Excelsior, Harley, Indian, used parts, alloy pistons, catalogue and wings pin 10c. Ballak, 1115 Chestnut Street, St. Louis, Mo.

MOTORCYCLES—Direct to you at rock-bottom wholesale prices. Rebuilt, roadtested and guaranteed Indians, Harleys, etc. Send 10c today for "Bargain Bulletin 43." Crandall Hicks Co., 780 Commonwealth Avenue, Boston, Mass.

RECONDITIONED Motorcycles. New and used parts for all makes. Complete service. Whitman Motorcycle & Supply Co., 405-9 Southwest Blvd., Kansas City, Mo.

REBUILT Motorcycles, all makes, new and used. Harley Davidson parts. Send 10c for bulletin. Western, 914 E. 15th, Kansas City, Mo.

AVIATION

WANT To get into aviation? Train at home in spare time. Complete, practical up-to-the-minute home study course trains you to fill many different types of ground jobs. Write for free book. Aviation Institute of America, Dept. A10E, 1115 Connecticut Ave., Washington, D. C.

GET Into aviation. Air transport pilots get up to \$7,000 per year; mechanics, \$2,500. Learn at this government approved school. Write for complete information. State age. Lincoln Flying School, 2004 Aircraft Building, Lincoln, Nebr.

LAWRENCE 60 h.p. New parts assembly. Box 25, Callaway, Minn.

PROPELLERS, Sled, lightplane, literature 6c. Woodcraft Propeller Co., Hillside Station, Wichita, Kans.

BROTHER, Can you spare a dime? If you can, send it to me and I'll send you my low-priced aviation material catalog. (Canada 20c.) Karl Ort, 635 W. Poplar, York, Pa.

KNOW Aircraft. Every type. 92 pictures. \$1.00. Blondin Chart Co., Box 34, Los Angeles, Calif.

AIRPLANE Mechanics trained and placed. Jobs waiting for qualified men. Warren School, Oldest in the West, 230 W. 18th, Los Angeles.

YOUNG Men interested in entering aviation under apprentice plan see ad on page 16A.

MAKE Money in aviation. Special mechanics training course—Finest instructors and equipment—Located at aviation center. Write Robertson Aviation School, Department D, Lambert-St. Louis Municipal Airport, Robertson, Missouri.

RACY R.O.G. models—Easy to build kits. Flights—1500 feet. Catalogue free. Air-King Model Company, 3262 N. E. Dunckley, Portland, Oregon.

POWERED Sled for ice or snow. Pictures with information 25c. 1299 Michigan, Grand Rapids, Mich.

PROPELLERS For airplanes, ice sleds, snow sleds. Catalog dime. Lorenzen Propellers, Niles, Michigan.

AIRPLANES \$50 Up. Terms. Motors, crackups, salvage. Complete directory 25c postpaid. Aircraft Directory, Athens, Ohio.

QUALITY Propellers, 4 ft. Harley \$1.95, 4½ ft. Henderson \$5.00, Fordchev \$7.50. Literature free. Standard Propellers, Fort Worth, Tex.

NEW Airplanes, \$98.00. Terms. Motors, propellers, air-wheels. Send 25c for information. Hibbs, Fort Worth, Texas.

BATTERIES, GENERATORS, ETC.

BUILD Wind light plant from automobile generator. Complete plans and catalog 10c. 50 other generator changes. LeJay Manufacturing, 1647 Lake, Minneapolis, Minn.

SPECIAL, Wind-electric, diagrams, instructions, 25c. Sovereign's Sales, Toronto, Canada.

WIND Charger farm radio. Amazing new. Furnishes electric lights at lowest cost ever known. Agents wanted. Wind chargers as low as \$7.50. Write quick. Parker McCrory Mfg. Co., 751-CX, 2609 Walnut, Kansas City, Mo.

HARNESS Wind—Simplest wind plant, direct drive. Charges below 100 r.p.m. 6/32 volt a.c.-d.c. Guaranteed plans 75c. Main Electric, Hollis, Kans.

EDISON Storage batteries will save you money. Replace your lead with the Edison. Non-acid. Odorless. Fifteen year life. Liberal unconditional guarantee. Bargains in complete generating plants, motor, etc. Free illustrated literature. "See Jay Battery Company," 82 Sterling Avenue, Yonkers, New York.

ELECTRIC Lights—Wind driven—You build them. Write Wind Motor Electric, Brainerd, Minnesota.

EDISON Storage batteries for light-power plants. Non-acid, non-sulphating. Long life. Fully guaranteed. Low priced. Also attractive bargains in power-light plants, generators, motors, etc. T. Hawley Smith Company, Croton Falls, N. Y.

GENERATOR Propellers, expertly designed at factory prices. Hibbs, Ft. Worth, Texas.

ELECTRICAL SUPPLIES—EQUIPMENT

HUNDREDS Of new and rare items, replacement parts and supplies. Send 10c for new, 60-page wholesale catalog. Autopower, 410-K S. Hoyne Avenue, Chicago.

WELDING AND SOLDERING

ARC Welding only \$39.25. Professional type—110-220 volt. Delivers 110 amperes. Easy to use. Details free. Commonwealth, Dept. S-11, Cincinnati, Ohio.

ECONOMICAL Are-welder from Dodge generator. No rewinding. Plan dollar. Pulis, Booker, Texas.

DODGE Arc-welder, 25-200 amperes. Build it yourself. Certified plans \$1.00. Welders' Club of America, Box 3432-A, Merchandise Mart, Chicago.

DEMONSTRATORS, Electric arc welders. Money-saving prices. Used by the government. Trial and terms guaranteed. Hobart Welders, M-372, Troy, Ohio.

REPAIR Fenders, braze, solder. New arc-welding outfit, \$1.00. Dickerson Manufacturing, Springfield, Missouri.

ACETYLENE And electric welding equipment. Box 331, Hamilton, Ohio.

REBUILT Electric arc welders, all sizes, a.c.—d.c. Service Co., 3732 Cedar Ave., Cleveland, Ohio.

300 AMPERE Welding generator. Fine condition \$150.00. Wilmot Auto Supply, 1970 Wilmot St., Chicago.

ARC-WELDING Outfit \$1.25. Weld fenders, braze, solder. Lavrow, 4368-W. Warren, Detroit. Stamp appreciated.

MACHINERY, TOOLS AND SUPPLIES

DELTA Power tools, new, used, parts, repairs. Prompt service. Allowance on used machines on new ones. Blackford Hardware, 424 N. 35 St., Milwaukee, Wis.

KELOGG Air compressors. \$6.00. Electric refrigerators \$25. Taylor, 105 East 102nd Street, New York.

EVERY Tractor owner needs Irving's 84 page 1937 tractor replacement parts catalog. Absolutely free. Thousands parts, all makes; tremendous price savings. Irving's Tractor Lug Co., 134 Knoxville Road, Galesburg, Illinois.

FREE Catalog all shapes brass, copper, steel, aluminum, Dowmetal, monel, stainless steel, gears. Hobby Supply House, Box 2014, Pittsburgh, Penna.

GRIND Your circular saws perfectly by shaping your emery wheels with our New Smooth-Side Dresser. Free catalog. Thompson Mfg. Company, Meadville, Pa.

POWERFUL Half inch electric drill from junk parts. Instructions fifty cents. Imperial Garage, Clarkson, Ontario.

SPRING Winder, best on the market. Circular 10c. John Blauer, Box 163, Sharon, Pa.

½ HORSE, 110 Volt, Universal motors with 14 to 1 gear reduction \$3.50. Wilmot Auto Supply, 1970 Wilmot St., Chicago.

15" x 6" SOUTH Bend screw cutting engine lathe, \$175.00. 14" Steptoe crank shaper \$125.00. All sizes of machine tools. Cincinnati Machinery & Supply Company, 27 West Second St., Cincinnati, Ohio.

TREMENDOUS Surplus of factory tools selling out. Drills, taps, files, hacksaws, etc. Send for free lists, include six cents postage. Travers Tool Co., 264 Jackson Ave., Long Island City, N. Y.

NEW Famous Netco air compressors: 1½x1¼, \$7.00; 1½x2, \$9.00; 2¼x2, \$10.00; 2x2 twin cylinder, \$20.00. Postpaid in United States. National Electric Tool Co., 560 Washington, Chicago.

MACHINISTS, Tool makers chests at bargain. Circular free. Cepader, 3602 Wesley, Berwyn, Ill.

MECHANICS Set three open end wrenches ¼ to 9/16. Sent post paid on receipt 25 cents. Ward, No. 315 Atlantic Ave., Boston, Mass.

BARGAINS, Demonstrators, electric arc welders, guaranteed, 30 days trial and terms. Write Ken's Equipment, Box M-373, Troy, Ohio.

ENGINES, MOTORS, DYNAMOS

LIST Of several hundred electric motors, all sizes, alternating current and direct current. Send \$1.00. Erie Electric, 112 Church St., Buffalo, N. Y.

GET Our book of motor and connection data covering single phase two to eight pole, three phase two to twelve pole in Star and Delta. Postpaid in United States—\$3.00. Washington Electric & Armature Works, 2211 Main Street, Vancouver, Washington.

NEW Generator bargains. 500 watts, 110 volt, 1800 r.p.m., 60 cycle—\$45.00. 600 watts—\$50.00; 1000 watts—\$60.00; also 333 watts, 110 volt, d.c.—\$20.00. Used converters, 32 volt to 110 volt, 60 cycle, a.c., 500 watts—\$20.00. National Electric Tool Co., 560 Washington, Chicago.

TO Close out. Slightly used ½ horse, 110 volt, alternating motors \$8.50. Wilmot Auto Supply, 1970 Wilmot St., Chicago.

MOTORS—Alternating, direct current. All kinds, new, rebuilt. Electric clocks, grinders. Bargain price list free. Mallorder Electric, 1718 So. Michigan, Chicago.

NEW One horsepower motors \$32.00; 32v. Delco light plants \$60.00. A.C. and D.C. generators. Queen City Electric, 1736 Grand Avenue, Chicago.

GOVERNORS Control speed of any make of auto engine, regardless of load changes, when used for stationary or portable power production. Read our ad on page 118A. Man'gs Candee-Smith Governor.

"PEPY" Gasoline engine governor \$7.50 postpaid. Automobile engines made into controlled power plants. Guaranteed. Agents wanted. Harris Machinery, Minneapolis, Minn.

ELEVEN—½ Hp. a.c. motors, 60 cycle, 1 phase, 110 volt, like new, guaranteed, \$10.50. Send check to Erie Electric Motor Co., 120 Church St., Buffalo, N. Y.

WINDING Data, 225 motors, single and three phase. Price \$1.00. Motor Data Co., Box 7631, Kansas City, Mo.

BOATS, OUTBOARD MOTORS, ETC.

15 FT. Canoe \$32.50. Ready to ride. Catalogue free. Jamestown Specialty Company, 377PX, Titusville, Pa.

LATEST Boat sensation! 20-lb. Mead "Ki-Yak"—snappiest thing afloat. Assemble it easily from complete factory-cut kit; best buy in the market. Free—\$6 paddle given with first Ki-Yak purchased in your town—hurry. Rush 10c for catalog. Mead Gliders, 15 South Market, Dept. BC-37, Chicago.

KAYAK Construction kits \$9.45 up. Catalogue free. Jamestown Specialty Company, 377P, Titusville, Pa.

ASSEMBLE A boat. Use Welsh ready cut parts. Simple; interesting; inexpensive. Send 25c for 32 page catalog with material lists; prices and full information. Welch Boat & Supply Company, Station K-1, Milwaukee, Wisconsin.

CARRY Amazing folding boat like luggage. Light, strong, seaworthy, 5 models. Porto Boats, Box 304, Glen Cove, N. Y.

12-FOOT Flat bottom rowboat—complete plans 25c. Free boatbuilding catalog. The Rudder, 15 Murray Street, New York.

ATTENTION Builders—Our fabricated boat frames save ⅓ and costly mistakes. Send requirements for quotation. Illustrated catalog 100 boats, 10c. Bay City Boats, Inc., 1552 Adams St., Bay City, Michigan.

FORD Marine conversion parts and kits. Models A, B, V8 (domestic or foreign). Catalogue 25c (coin). Osmitson, 3101 C St., Philadelphia, Pa.

BOAT Designers are highly paid professionals. Complete course by mail. Catalog. Westlawn, Montville, N. J.

OUTBOARDS, All makes, bought, sold, exchanged. Used parts and accessories. Outboard Headquarters, No. 305 Atlantic Avenue, Boston, Mass.

PROPELLERS, Gear pumps, stuffing boxes, bearings, etc. Wm. Baker, Pond St., Quincy, Mass.

BUILD Your own boat. Save two thirds, use our ready cut semi-assembled materials. Send 25c for catalog. Brooks Boat Co., Inc., G. 20, Saginaw, Michigan.

OUTBOARDS—Save ½. Good used parts, all makes and models. Bargains rebuilt motors. Crandall Hicks Co., 780 Commonwealth, Boston, Mass.

SPORTING GOODS, GUNS, FISHING TACKLE, ARCHERY

BOXERS And training quarters. New, extra heavy, fast training bags. Circular free. J. Andre, 5772 Lenox Ave., Detroit, Mich.

HUNTER'S, Fishermen's joke licenses—Both 25c coin. Gruenewalder's, Webster Groves, Missouri.

FENCING Equipment. Foils, swords, masks, etc. Low prices. Free catalog. Industrial Products, 274 Madison Ave., New York.

FLY Tyers—Send for latest profit sharing material catalog. Exceptional quality. Rollin Sherman, Bristol, Conn.

FISHERMEN! Finest stock of hooks, gut, leaders, tools and materials in America. List free. Write Paul H. Young, 8065-3 Grand River Ave., Detroit, Mich.

HUDSON Bay blankets, Indian pack baskets, camp stoves, knives, compasses, outdoor equipment. Free catalog. Howe Fur Co., Box P, Coopers Mills, Maine.

**FIELD GLASSES, TELESCOPES
AND MICROSCOPES**

TELESCOPES, Microscopes, binoculars, chemistry, mineralogy. Catalog free. Teeko, Evanston, Illinois.

AMATEUR Astron. telescopes complete. Or parts to build, with silvered mirror. Lotts, Norwalk, Ohio.

ALUMINIZE—Aluminum applied to telescope mirrors and other optical surfaces. Replaces silver. High reflectivity, and very durable. Prices reasonable. Leroy Clausing, 3509 Lincoln Ave., Chicago.

TELESCOPES, Microscopes, binoculars. Lowest prices. Optical catalog free. Brownscope Company, 234 Fifth Avenue, New York.

MINERAL Sets, microscopes, etc. Catalog free. Teeko, BL515, Evanston, Illinois.

FREE Literature—Amateur Telescope Makers Supply Company, 21 West 20 Street, New York.

BUILD Refracting telescopes; catalog free. Instructions 10c. Optical Laboratories, Larchmont, N. Y.

ANTIQUES, RELICS, INDIAN GOODS

RELICS From ancient Miami Indian camp-sites. Romey, Bluffton, Indiana.

13 ARROWHEADS, Spearhead, lancehead, wampum, \$.99. Firearms, trophies, 120,000 bargains. Photolist 10c. Museum, Rutland, Illinois.

WORLD War relics, for club house or den. Vickers aircraft machine guns, rendered unserviceable without marring, \$7.75 each. Marlin aircraft machine guns, rendered unserviceable, \$7.75 each. Send money order, check or draft, \$1.00 deposit on C.O.D. orders. Fiala Outfits, 10-C Warren St., New York.

5 ARROWHEADS 20c. 3 Birdpoints 18c. Knife, birdpoint, scraper, spearhead 45c. Catalogue. Coins, Minerals, Curios, Lemley Curio Store, Northbranch, Kansas.

100 GOOD Arrowheads \$5.00. Catalog 5c. H. Daniel, Dardanelle, Ark.

TAXIDERMY

I GUARANTEE To easily teach you by mail to mount animals, birds, tan hides. Have taught thousands. My famous seven-book, complete course, diploma, formerly \$15.00, now only \$1.00. Limited offer. Order now. Schmidt School, G-12-3, Memphis, Tenn.

FREE Official catalogue. Big values. Eyes, head forms. Everything direct from manufacturer. Taxidermic Manufacturers, Memphis, Tenn.

TAXIDERMY Supplies—Quality artificial eyes, teeth, genuine Jonas head forms. Tools, materials, etc. Everything for the progressive taxidermist. Send 10c for big illustrated catalogue. Jonas Bros., 1019 Broadway, Denver, Colorado.

GLASS Eyes. Taxidermists', furriers' supplies. Lowest prices. Forty page catalog, free. Write today. Elwood Supply Co., 222 Smith Building, Omaha, Nebraska.

DOGS, BIRDS, PETS

AMERICAN Canary Magazine. Monthly, \$1.00 yearly. Sample 15c. 2839-P North Halsted, Chicago.

BABY Saint Bernards reasonably priced! Dime brings photographic prospectus. Royal Kennels, Napierville, Que.

NEWFOUNDLAND. Childrens playmates, home guardians. Dorothy Walker, R3, Hamilton, Ohio.

STANDARD Pet Journal, Milton, Pa. Special, year 50c. Sample free.

BEAUTIFUL Pure white police dogs. Ansonia Kennels, Mose, N. Dak.

POULTRY AND SUPPLIES

GET The Seymour big surprise chick offer. Don't order your baby chicks until after you get our "Big Surprise." It is not a free feed offer, something more valuable and it is absolutely free. Write for free catalog at once as this offer may be withdrawn in a few days. Seymour Hatchery, Box 39, Seymour, Ind.

"**POULTRY** Item by far the best," say many readers who read other poultry journals. Twelve issues 35 cents; four years \$1.00. Sample free. Poultry Item, Box 71, Sellersville, Penna.

FOR Low prices, prompt service, write Smith Chickeries, Box 00-262, Mexico, Missouri. Also selling sexed chicks.

DAVIS Chicks for immediate delivery. Hatched from eggs grading 23 ounces and better in all electric Smith, 65,000 egg unit incubators. Barred, White, Buff Rocks, Reds, White Wyandottes \$8.45—100. White, Buff, Brown Leghorns and Anconas \$7.95—100. Heavy mixed \$7.40. Catalogue free. Davis Poultry Farm, Rt. 34, Ramsey, Ind.

BUY Salem's tested chicks. Hatching all popular breeds weekly. Write for our prices on sexed chicks and catalog. Salem Hatchery, Box 19, Salem, Indiana.

52 BREEDS—Baby chicks, started chicks, baby turkeys, hybrids, pullets, cockerels; hand-picked, Iowa inspected. Beautiful book free. Mrs. Berry's Farm, Rt. 23, Clarinda, Iowa.

POULTRY Tribune—America's leading poultry magazine. Five years \$1.00; one year trial 25c. Poultry Tribune, Dept. 93-C, Mount Morris, Illinois.

FARMS AND FARM LANDS

STROUTS Spring 1937 catalog. For months over 200 field representatives have combed the countryside of 18 states for these bargains. Nearly 1000 farms described, nearly 1000 pictures—all kinds, all types, all prices. Catalog ready before March 1st. Write today for free copy and first pick of bargains. Strout Ag'y, 255-P 4th Ave., New York City.

FARMS That pay in the Great Northern Railway agricultural empire—Minnesota, North Dakota, Montana, Idaho, Washington, Oregon—Fertile black soil, high producing crops, grain, fruit, vegetables, feed and livestock. Many kinds of farms for selection. Write for lists and Zone of Plenty book. E. C. Leedy, Dept. 357, Great Northern Railway, St. Paul, Minnesota.

GOVERNMENT Lands ten cents acre up. Information all states twenty-five cents. National Tax Service, 600A Majestic Building, Detroit.

CANADIAN Tax sale lands for a dollar an acre and up. Small monthly payments. Farms, timber, hunting and fishing camps, minerals. Limited number of properties. Write at once for free illustrated booklet. Tax Sale Service, Room 613, 72 Queen St., W., Toronto, Canada.

2½ ACRE Farms \$45, total. \$5 down, \$2 month. 5-10-20 acres in proportion. Near St. Petersburg and gulf beaches. Ideal for poultry and small farming. Established farm communities. No city taxes but near city limits and schools. Write for folders. Liquidator, 806 Florida Theatre Building, St. Petersburg, Fla.

NEW Farm opportunities! Washington, Idaho, Montana, North Dakota, Oregon, Minnesota. Farm income is up. Good land still at rock bottom prices. Literature. Specify state. J. W. Haw, 119 Northern Pacific Ry., St. Paul, Minn.

40 ACRES, Near White River, unimproved, poultry land, \$100, \$5 down, \$5 monthly. Free list and literature. Hubbard, 216 Grossman Bldg., Kansas City, Kansas.

TREES, SHRUBS, ROOTS, HERBS

BOYSENBERRY! World's largest vine-berry, prepaid from original acreage, 10, \$2.00; 100, \$12.00. Free pictorial pamphlet, quantity price. Rancho Verdado, Mentone, California.

JUST Out! World's greatest "Herbalist Almanac." Beautifully illustrated in natural colors. Contains over 200 old-fashioned herb medicine recipes for home use. 10c postpaid. Worth dollars! Botanicals, 145 West 112th Street, Chicago.

PROFITABLE OCCUPATIONS

MINK. Bred females. April delivery. Dime for general information. Lowman's Fur Farm, Barnesboro, Penna.

"**RAISE** Giant Frogs!" We buy! Start small pond. Free frog book. American Frog Canning, (153-C), New Orleans, Louisiana.

BOOKS. Plans, Opportunities. Home City Specialties, Dept. 1273, Springfield, Massachusetts.

FREE Circulars describing hundreds of money making opportunities selling by mail. Build your own business. Write now. Progress Publishing Co., 2513-G North 9th St., Milwaukee, Wisconsin.

MAKE Models for architects, builders, subdividers. Home courses. Information free. Weldner, 4589 Lexington, Hollywood, California.

SUCCEED! Operate profitable new business. Write! Jay, 6054-P Kenwood, Chicago.

MRS. M. received \$238 for 3-week cellar crop patented mushrooms! Exceptional, but your cellar, shed, perhaps suitable. We buy! Book free. United, 3848 Lincoln Ave., Dept. 68, Chicago.

FREE Circulars describing hundreds of money making opportunities selling by mail. Build your own business. Write now. Progress Publishing Co., 2513-H North 9th St., Milwaukee, Wisconsin.

FREE Booklet describes 107 plans for making \$20-\$100 weekly, in home or office, business of your own. Elite Co., 214 Grand St., New York.

RAISING Jumbo frogs. Interesting. Big future. Females lay 10,000 eggs. Free literature. American Frog Industries, Box 336, Rayne, Louisiana.

OLD BOOKS WANTED

\$100—\$200—\$300—\$1000 EACH And even \$5000 cash will be paid for certain old books! We buy thousands of dollars worth annually. We also pay big cash prices for certain old magazines, letters, newspapers. Books even recent as 1931 wanted. A single school book, story book, old bible, travel book, poetry book, etc. in your home may bring you \$10—\$50—\$100 or more in cash! Send 10c for latest list of books wanted. Act now! American Book Mart, 140 S. Dearborn, Dept. 1413, Chicago.

OLD Books wanted. An old book in your home may bring you \$10, \$50, \$100 and as much as \$6000.00. Check up on what you have. Send for our complete 24 page buying catalogue. Enclosing 10c, to cover mailing, handling cost. New England Book Exchange, (25), Nantasket, Massachusetts.

**BOOKS, PERIODICALS, PICTURES,
POSTCARDS**

GEOMETRY, Practical applications. Instructive, entertaining. \$2.00. Kasper, 517 Marwood Road, Philadelphia, Pa.

FREE! Big catalog describing hundreds of books on various subjects. Franklin Publishing Company, 800 North Clark Street, Dept. 2212, Chicago.

NEW Dream book, 116 pages, 1200 dreams 35c postpaid. Buddy Packing Co., Lexington, South Carolina.

EGYPTIAN Dream book explains what 968 dreams mean. Prepaid, 10c. Franklin Publishing Company, 800 North Clark Street, Dept. 2211, Chicago.

YOUR Favorite magazines—Half price. Catalog, 10c. Magazine Exchange, Baseline, San Bernardino, Calif.

GAMES AND ENTERTAINMENT

MONEYMAKING Stunts for entertainers at banquets, lodges, etc., 25c. Hylar's Stunt Bulletin, 849 Main St., Danville, Va.

FORTUNE Telling by cards, 10c. Latest methods; entertain your friends. Franklin Publishing Company, 800 North Clark Street, Dept. 2210, Chicago.

PLAYS, Operettas, musical comedies, complete minstrel first-parts with song programs, blackface skits, vaudeville acts, monologs, dialogs, recitations, juvenile plays and songs, musical readings, entertainments, make-up goods. Catalog free. T. S. Denison & Co., 623 So. Wabash, Dept. 11, Chicago.

**MAGIC TRICKS, PUZZLES,
JOKER NOVELTIES**

MAGICAL Apparatus, illusions, catalog 3c. McKwade, 600 Martinique, Dallas, Tex.

JOIN the I. B. M. and read the Linking Ring, monthly magic magazine. Send stamp for particulars. International Brotherhood Magicians, Kenton, Ohio.

LEARN Fire eating. Safe method. Manly, 1315 Farris, Los Angeles.

KNIFE Throwing instructions, ten cents. Throwing knife, one dollar postpaid. Frank Dean, 1294 E. San Fernando St., San Jose, Calif.

THURSTON'S Latest book of card tricks, fully illustrated, 50c (coin). Damon Co., Geneseo, Ill.

MAGIC Rod glows in six colors, \$1. Kutting Sons, Campbell, Calif.

84 MYSTIFYING Card tricks, 10c. Explained in simple language. Illustrated. Franklin Publishing Company, 800 North Clark Street, Dept. 2214, Chicago.

MYSTERIOUS Links. Only you can part them. Seems impossible. Let others try. 25c. Martan, Box (6), Trenton, N. J.

WHOOPIE!—Comic "business" cards, 25c packet. Hilarious knockouts! (Don't miss.) David Sanderson, Ottawa, Illinois.

COMBINATION Book. Songs, jokes, flirtations, fortune telling, 25c. Lou Cymier, 23 Taylor St., Waltham, Mass.

LARGE Illustrated magic catalogue 20c. Lynn, Midland Ave., Paramus, N. J.

SECRET Purse. Baffle your friends, \$1.00 postpaid. Details 10c. Ernie's Kindred, N. D.

NEW Magic book. Tricks, acts, 25c. Weston, 8th So. Seattle, Wash.

BE A magician. Large professional magic catalogue of latest tricks 25c. Cash paid for complete Tarbell magic courses. Write, Ireland, 804 Wesley, Oak Park, Ill.

MAGIC Bag of tricks. Twelve fascinating mysteries. Value \$2.50. Special \$1.00. Professional catalogs included free. Catalogs and free trick 25c (refunded first order). Cairo, Box 12, Ken. Sta., Brooklyn, N. Y.

CATALOG Exclusive magic 10c. Grant's Studio, Hawthorne Ave., Pittsfield, Mass.

LEARN Ventriloquist art. Easy. Low cost. Free details. Apex, 221 E. 31, New York.

FREE Tricks! Join Magicians' Fraternity! Monthly magazine, sample, 10c. International Magicians, Mt. Morris, Ill.

BE A Magician. Send 20c mailing fee for our large catalog. Chicago Magic Co., 2300 N. Mason Ave., Chicago.

EARN Money in any crowd. Call names of strangers, tell unspoken questions. Professional course mind reading, spirit writing, etc., \$1. Henderson, Box 341, San Bernardino, Calif.

LARGE Professional magic catalogue, 25c. Holden, 220 W. 42nd St., New York.

LEARN Ventriloquism, 3c stamp brings particulars. Smith, 125 North Jefferson, Peoria, Ill.

RARE COINS

COMMEMORATIVES: San Diego, Illinois, Oregon, \$1.45 each; California Jubilee, bridge, Maryland, \$2.25 each. Circulars 4c. Coinshop, 2510 Chester, Alameda, California.

COINS For sale. Price list 10c. Roy Radtke, 56 Dale St., Rochester, New York.

1909 CENT \$10—We buy certain coins, common and rare—Others worth to \$6000; 1864-1865 Indian head cents \$100 each; dimes before 1895, \$450; Liberty head nickels before 1914, \$300; large pennies, \$2000; encased postage stamps, \$13; half cents, \$275; half dimes, \$175; quarters, \$300; fractional currencies; paper money; gold dollars \$1,500; colonial coins, \$300; silver dollars, \$4,000; 1923, 50c, \$4.00; foreign coins \$165, etc. Send 15c today for illustrated 1937 coin book, before sending coins. National Coin Corporation (85), Springfield, Massachusetts.

OLD Money wanted. Will pay \$100.00 for 1894 dime, S. mint, \$50.00 for 1913 Liberty head nickel (not buffalo). I pay big premiums for rare coins. Send 4c for large coin folder. May mean much profit to you. B. Max Mehl, H. Mehl Bldg., Fort Worth, Texas.

UNITED States commemorative half dollars. Lincoln \$1.19; Lexington \$1.75; Monroe \$1.95; Cleveland \$2.00. Bargain selling price list and California 50c gold token 25c. Arcy, Box 3507-A, Cleveland, Ohio.

50 OLD Coins, all different, \$1.00; 100 different coins \$2.50; 20 different dates large cents \$2.00. Claud Denney, Box 1825, Dallas, Texas.

60 DIFFERENT Coins \$1.00. 6 different 10c. Otto Oddehon, Springfield, Missouri.

25 COINS, 25c; 100, \$1.00. Coin Exchange, Box 2544, Kansas City, Mo.

COMMEMORATIVE 3/8s. Illinois, Stone Mountain, Oregon, Texas, Long Island, \$1.50 each. California gold quarter size and illustrated catalogue 25c. Auction catalogue 50c. Norman Shultz, Salt Lake, Utah.

\$3.00 EACH For certain Lincoln pennies dated between 1911 and 1923. Keep posted. Send 15c for complete 28 page buying book. American Coin Company, Box 3507-A, Cleveland, Ohio.

LARGE Copper cent and bargain lists for dime. Acorn Stamp & Coin Co., South Norwalk, Conn.

UNITED States. Large cent, 2c bronze, 3c nickel and bargain list, 25c. Eleven dates large cents, \$1.00. George P. Coffin Company, Augusta, Maine.

\$5.00 TO \$500.00 Each paid for old coins. Keep all old money. Send 10 cents for illustrated coin value book. 42c. Guaranteed prices. Buying and selling. Coin Exchange, Box 5, Le Roy, N. Y.

FREE! Foreign coin, banknote, and large illustrated coin catalogue. Send 4c postage. Coin approvals sent. Tatham Colneco, Springfield-125, Mass.

RARE United States, foreign coins, war medals. Catalogue 10c. Mengelle, Colorado Springs, Colorado.

STAMP COLLECTING

THE World in a packet—100 different stamps from 100 different countries, including Abyssinia, Afghanistan, Brunei, Falkland, Zanzibar, and others from Africa, Asia, South America, West Indies, etc. Our pamphlet which tells "How to Make a Stamp Collection Properly," together with our large bargain list of albums, packets, sets, etc., all for only 20c. Queen City Stamp Co., Room 36, 604 Race St., Cincinnati, Ohio.

FREE!! Giant Spain triangle, United States commemoratives, Mozambique triangle, large colonial pictorials and 25 different given free to approval applicants sending 3c postage. Sierra Stamp Co., Fontana, Calif.

SCARCE Airmail and triangle. Beautiful Uruguay "flying horse" airmail and scarce Guatemala triangle (smallest in the world) are included in our big packet of 60 different stamps from Alouites, Grand Liban, Venezuela, British and French Colonies, etc. All for 5c to approval applicants. Big illustrated lists free with each order. Write today! Mystic Stamp Co., (Dept. 80), Camden, New York.

100 DIFFERENT Including 50 different British with scarce Silver Jubilees, Canada, Newfoundland, 10c to approval applicants. Lists free. Mantle Stamp Company, London, Canada.

WHOPPER Packet 5c. Jubilees, ships, triangle, map, diamond, airmail, Vatican, Jhind, Siam, Iran, Iraq, Iceland, etc. 33 stamps, only 5c with approvals. Dominion Stamp Company, Dept. M, Arlington, Virginia.

BETTER Stamp for less money. Established 1933 and our original customers are still buying from us. Nothing free. Just extra good values. References. Threlfall Brothers, Box 6811 D, Philadelphia, Pa.

\$2.00 FOR 10c. Fine assortment of different stamps cataloging \$2.00, for a dime. Approvals 75% discount. Liberty Stamp Co., Box 677, St. Louis.

GENUINE World wide unpicked Mission mixture; plenty triangles, commemoratives, airmails, pictorials, mourning. One pound \$1.50, 3 pounds \$3.75. Stanley Taflaw, 302 East 56th St., New York City.

FREE—U. S. Zeppelin set, 1000 winners will receive 1000 valuable prizes with a total catalogue value of thousands of dollars in our big history making stamp contest. Wouldn't you like to win a complete United States Zeppelin set of 3 values (which costs more than \$40.00 to buy) or a collection of 25 complete mint British jubilee sets including Falkland Island, Seychelles, etc. (which costs over \$45.00 to buy) or a complete collection of Italian colonial airmails face value 545 lira (which costs over \$50.00 to buy)? These are just a few of the thousand valuable prizes we are giving away in this record breaking contest. The complete list of the 1000 prizes will amaze you. No strings or obligations. Get full details of this astounding stamp contest in the new edition of our magazine "Stamp Lore" which will be sent absolutely free together with an attractive approval selection to approval applicants. Write today! It's open to all! Globus Stamp Company, Approval Headquarters, 268 - 4th Ave., Dept. 50, New York, N. Y.

BRITISH Colonies, 50 different interesting colonial stamps with premium 5c to approval applicants. Dyer, Box 70, Auburn, Maine.

PHENOMENAL!!! Free collection! Azerbaijan, Tanganyika, Belgian Congo, Zanzibar, etc., with approvals. Rosenberg, 3544-B West 12th Place, Chicago.

EXTRAORDINARY Free offer—Turks, Calcos, \$5 U. S., Caymans, Western Samoa (native girl), genuine Baden. Everything free to approval applicants enclosing 3c postage. Viking Stamp Co., 1-Z Hanson Place, Brooklyn, N. Y.

FREE—Diego Suarez, Negri Sembilan, Oltre Giuba, Juby, Senegambia, Mayotte, Benin. Approvals. Robinson, 4982 Jurupa, Riverside, Calif.

GREAT Britain penny red plate numbers, one cent each. J. W. Taylor, 4764 Oak Terrace, Merchantville, New Jersey.

104 DIFFERENT, Travancore, Algeria, Estonia, etc., 3c to approval applicants. Extra—Scarce airmail free!! Hunziker, Box 225V, Minneapolis, Minnesota.

SCARCE United States stamps, 125 different \$1.00. Fred Ruth, 5358 South Ashland, Chicago.

FOREIGN Mission 1000, 35c—approval applicants. Schiffermuller, Bellerose, L. I.

500 MIXED, Containing 20 different Japan, 10c. Approvals. 840 1/2 Perry, Defiance, Ohio.

ARGENTINE, 60 Diff. 10c with bargain approvals. Davis, Silver Lake, Ind.

600 DIFFERENT \$1.00. Catalog \$13.00. Hunt, 184 Union, Lambertville, N. J.

25 DIFFERENT U. S. commemoratives with free premium, 25c! Conklin Stampeo, Osage, Iowa.

FREE Price list of packets, sets, singles. Graf, 1874 Loring Place, New York.

25 BRITISH Colonials, 6c. (Approval.) Star Supply Company, Lima, Ohio.

FREE Stamps, hinges with approvals. Send 3c. Harvey Teeple, Decatur, Indiana.

PACKETS; List free. Desirable stamps. Moderate prices. Premiums. Elite Stamp Shop, Charlevoix, Michigan.

FREE Premiums, credit slips to approval buyers. R. McKinney, Elsie, Mich.

FREE! Curious set Azerbaijan to approval applicants. Riddell, Greensburg, Penna.

CASH For precancels and commemoratives. Judd, 661 Platt, Toledo, Ohio.

FREE—25 Different North-American to approval applicants, 3c postage. Seidenberg, Baroda, Mich.

DISGUSTED? Try my approvals. 1/2c up. Bargains galore. Viscusi, 4, Scotia, N. Y.

FIVE Australian commems., 3c. Approvals. Frye, 171 Highland-park, Los Angeles.

ANNUAL Dealer's catalogue—Illustrated and enlarged. Free upon application. Empire Stamp, Department 5, Toronto, Canada.

"GOYA Nude" stamp \$0.05 to approval applicants. Jewells, Tamaqua, Penna.

LONG Live the kings! Some will never appear on stamps again. Obsolete King George Gold Coast stamp showing Christiansburg Castle; mint surcharged Czar Nicholas II Romanoff Centenary issue; Victor Emmanuel III Italian special delivery stamp and rare unused Jamaica stamp of the late King George V. Only 10c to approval applicants. Lorwin Stamp Company, 1327 Roosevelt Boulevard, Philadelphia, Pa.

1937 POSTMARKS Bought. All states. Size gauge, prices paid, full details 10c. Texas Postmarks Co., Hamlin, Texas.

STAMPS On approval. Mariפוsa Stamp Den, 397 Fourth Street, San Francisco, Calif.

BOLIVIA Triangle, complete issue White Russia, complete set Bosnia. Only 5c to approval applicants. Wyndham Miles, 117 N. 4th St., Camden, New Jersey.

COMPLETE Country 6c, approvals. Hazett Stamp Shop, 701P Fourth, Baycity, Mich.

SPECIAL! 52 Jubilees, airmails, pictorials, 10c. Sachse Stamp Co., London, Canada.

U. S. \$1 Lincoln memorial, \$2 Capitol, only 5c to approval applicants. Maynard Sundman, M3, Bristol, Conn.

45 BELGIUM 40c, 27 Canada 25c, 12 Japan 10c, 35 German 25c, 20 Great Britain 15c. Complete assortment \$1.00. E. Seifert, R. 5, Rome, N. Y.

\$1 TO \$10 U. S. free, with packet of 35 different—25c. Regal Stampeo, 1224 North 19 St., Philadelphia, Penna.

FREE—\$1.00 U. S. stamp with request for 52 page list of United States and foreign stamps. Stamps on approval. References necessary. 1000 U. S. no current \$1.46. New Hussman Stamp Co., 1122 Pine St., St. Louis, Mo.

1000 U. S. including precancels and commemoratives, 15c. Auburn Stamp Co., Bridgeport, N. Y.

21 ISLANDS Of the sea including Cyprus, Iceland, Jamaica, Philippines—only 5c to new approval applicants. Foreign approvals only. Nomad Stamp Co., Flint, Michigan.

200 WORLD-WIDE Different, 10c. Approvals. Packet bargains. Seifert & Son, 1352 Buttonwood, Reading, Penna.

FEROCIOUS Lions, tigers, elephants! Animal packet, 6c (stamps accepted). Elsea, Bowling Green, Ohio.

CARDBOARD Stamp—Odd Siberian triangle, scarce Samoa Islands, Selangor, etc. 5c with approvals. Larry H. Morris, Darlington, Maryland.

GIVEN From Dixie. 50 different stamps from 50 different countries, a Jubilee set, Queen Astrid mourning issue, all for 10c to approval applicants. W. M. Acton, 838 W. 7th St., Birmingham, Ala.

41 DIFFERENT U. S., including \$1.00 Franklin—10c. Brooks, 373C Fifth Avenue, New York.

FREE—Dutch Minerva triangle with 50 different Netherlands for 20c. L.C. Trading Company, Box 33, Bellerose, N. Y.

350 DIFFERENT 20c; 1000, \$1; specially selected. Alvin Zwick, 802 Eddy Rd., Cleveland, Ohio.

FREE—Beautiful Minerva triangle and airmails to approval applicants enclosing postage. Green & Company, Norwood, Ohio.

TEN Australian commemoratives 10c, approvals. Rolke, 309 Greylock, Belleville, New Jersey.

100 DIFFERENT Foreign, 50 different U. S. and copy of Stampland Magazine 10c. W. Keyser, Irvington, N. J.

EXCHANGE Stamps! Your name in Exchange Bulletin 10c. Box 102, Cheswick, Pa.

GIVE References. Order approvals of Harold Bowen, 628 South 12th St., Fort Dodge, Iowa.

MINT Yorktown and twenty Kenya, Inini, Monaco, Cameroons, Andorra, Epirus, etc. Only 6c to approval applicants. Shook, 4526 Stanford, Chevy Chase, Maryland.

YORKTOWNS! Singles 10c. Blocks 40c. Postage. Jack Cuthbert, Box 1736, Pittsburgh, Penna.

SET 9 Magnificent mint Persia 10 cents with approvals. Gilbert, 556 F Center Street, South Haven, Mich.

COLLECTORS Illustrated catalog free—24 pages, featuring United States, Canadians, Newfoundland, British colonials, jubilees, Edwards. Sent for postage or entirely free. Empire Stamp Co., Dept. P.M., Toronto, Canada.

WORLDWIDE Variety approvals that satisfy. McKee, 925 Main, Covington, Ky.

FREE!! Belgium Red Cross set complete, catalogue \$1.18, to approval applicants enclosing 3c postage. Charles Cleveland, 806 North Humphrey Avenue, Oak Park, Illinois.

JUBILEES, Horsemen, 24 others, 4c. Approvals. Simmons Stamps, Elsie, Mich.

GOYA Nude, 4c with approvals. Jack Millhiser, 7724 Abbott St., Pittsburgh, Pa.

SATISFACTION Guaranteed: 10 stamps, cataloging \$5.40, 10c! Vanvoorhis, Hyndman, Pennsylvania.

WHOLESALE Pricelists. Illustrated. Stamp please. Prince Warren, Hotel Grant, Chicago. No approvals.

STARTLING Offer—Airmails from 25 countries, 15c. Approvals sent. Tonka Specialty Co., 719 Union, Fort Wayne, Ind.

YES Sir! 225 United States containing commemoratives, 10c. Box 102, Cheswick, Pa.

FREE Premiums to approval applicants enclosing postage. Carl Brooks, Mount Orab, Ohio.

500 MIXED United States, 25c. Dewey, 603 West 191, New York City.

FOREIGN Stamps on approval. Circular free, also U. S. list. Canada 100 mixed 10c. Aldrich, Box 744, St. Joseph, Mo.

COCOS Isles set—Astrid mourning stamp—15 different stamps, 5c with approvals. Hawthorne Stamp Co., 3221 So. 53 Court, Cicero, Illinois.

12 MEXICO 5c. Approvals. Reidenbach, Lexington Ave., Troy, New York.

UNTIL April first, King Edwards complete set, 11 unused surcharged Morocco Tangler, 25 cents (coin) to approval applicants. M. B. Lockhart, 31-14 Crescent Street, Long Island City, N. Y.

FREE—20 Different Canada to approval applicants. Fort Dearborn, 5439 Aberdeen, Chicago.

TIGER, Other animal stamps, pyramids, ships, pictorials, airmails, colonials, from Barbados, Toga, Eritrea, Abyssinia, etc., included in big packet 56 different. 5c with approvals. American Stamp Company, Dept. 10, Frankfort, Ohio.

FREE—Short set Paraguay airmails with approvals. Ephraim, River Forest, Ill.

UNBELIEVABLE—Suriname, Panama, British Honduras, Jubilees, airmail, triangle. Complete collection every country from Straits Magellan to Arctic, 10c. Approval applicants only. Mutual Stamp Service, Box 666PD, Ventura, Calif.

FREE—100 Different to those sending 25c for 5 months of Pacific Philatelist, 2495 Telegraph, Berkeley, California.

EARN Cash selling approvals. Crystal, 259 W. 30, New York.

FIFTEEN Cents for each dollar catalogue value and multiples. Miller Stamps, 26 Montgomery, San Francisco.

COMPLETE Set Newfoundland commemoratives, five beauties, ten cents with approvals. Globetrotter, Hotel LaSalle, South Bend, Ind.

U. S. MIXTURE—3 lbs. \$1.00. Holmes Stamp Co., New Albany, Ind.

PICTURESQUE Sea stamps, a specialty. Approvals. Premium to first hundred answers with this ad. Seascout Service, Box 52, Chelsea, Mass.

NICE Airmail and general approvals. Clark, 1612 Dial, Springfield, Illinois.

KING Edward VIII set 10c. Approvals. Ditzel, 3201 Phelps Lane, Baltimore, Md.

KING Edward's only stamps are already so scarce, their value multiplies daily! Two beautifully cancelled varieties; also a complete Yugoslavia war set; complete Soviet set; Hindenburg mourning stamp and stamps commemorating the Russian revolution, the greatest social upheaval of modern history. All for 10c! Lyric Stamp Company, 70 Nassau St., Dept. 700, New York.

HORACE Italian stamp, also Queen Astrid, cathedral, Byrd stamps, India jubilees and many others, all for 10c to approval applicants. Bennett, 27 Washington Square, New York City.

MARVEL Packet—Jubilees from Australia, Britain, Canada, Ceylon, Jamaica, 10 different Canada, 15 different Russia—all for 10c to approval applicants. R. F. Stern, 23-56P Crescent St., Long Island City, N. Y.

GIANT Netherlands commemorative triangle, jubilee, airmails, pictorials in mammoth collection—10c with double premium approvals. Free airmail collection given regular customers. Tru-Value Stamp Service, Box P1412, Hartford, Connecticut.

YOU Exchange, buy, sell, your coins, stamps through this medium. Communicate directly with collectors. Send need or offer plus 15 cents for Exchange Pamphlet. Coin and Stamp Exchange, Sidney, New York; Moscow, Idaho.

SMALLEST Airmail only 1/2 inch high, free stamp magazine, \$2.00 U. S. stamp, bird, animals, train, Indian, airplane, commemoratives, special issues, with many scarce stamps from 25 different countries, 5c with approvals. Capital Stamps, 413H Roosevelt, Little Rock, Arkansas.

25 DIFFERENT Switzerland 3c to foreign approval applicants. Penn Stamp Co., P-58 Exchange, Binghamton, N. Y.

SCARCE Nyassa triangle; giant Belgium balloon; Egypt and Lebanon airmails; packet British Colonies including rare Borneo, Congo, SanMarino, Brazil, China, Mexico; perf. gauge; watermark detector. 6c to approval applicants. Eureka Stamp Co., Burbank, Calif.

FREE—Rare China airpost to approval applicants enclosing postage. Gordon Watson, Clifton, New Jersey.

ETHIOPIA—2 Different free with approvals. Neil Duggan, Middleboro, Mass.

AIRMAILS—15 Different 5c with approvals. Wollaston Stamp Co., Wollaston, Mass.

1000 HINGES 5c. Bargain approvals included. V-J Sales, 2729 N. Summit, Milwaukee, Wis.

JUBILEES, Bosnian set, Mozambique, 3c with approvals. Fisher, Box 1505, Lakeland, Florida.

OLD Stamps and envelopes wanted. Will pay \$300 for 1911 Vinfig stamp. Big premiums for all rare stamps. Send 5c for large illustrated folder showing amazing prices paid. Vernon Baker, 444-PM, Elvira, Ohio.

20 LIECHTENSTEIN, 04c To approval applicants. Sodak Stamps, Sioux Falls, S. D.

WORLD Wide—500 different 30c, 1000 different \$1.00, 2000 different \$2.80, 3000 different \$7.00, 5000 different \$15.00. Approvals. Hyman, 36 North Aberdeen, Atlantic City, New Jersey.

THREE 10c Sets free!! Beauties that every collector wants. Sent to applicants for bargain approvals. 3c postage. Kumler, King, Lancaster, Ohio.

LARGE Spanish ship stamp, Azerbaijan, Cameroons, Chad, Dahomey, Gabon, Ubangi in packet of 57 stamps. All for 5 cts. with approvals. Swedell, 3129 Garfield Ave., Minneapolis, Minn.

UNITED States Civil War revenues, commemoratives, early issues, airmails, dollar values, etc., 200 all different \$1.00; 75—25c; 55—15c with approvals. Illinois Stamp Co., Rockford, Ill.

500 BRITISH Colonies 10 cents with approvals. Alex Ullrich, 3025 Market, Jacksonville, Florida.

QUEEREST Stamp packet. Receive world's smallest stamp; Vatican City; scarce Liberia triangle (value 15c); 1935 Greek Red Cross picturing coiled snake in Garden of Eden; Australian Bushman; new Spanish Morocco; Japan 'quake stamp; Manchukuo; many others. Only 5c to approval applicants. R. M. Stamp Co., P. O. Box 230P, Port Chester, N. Y.

ILLUSTRATED Album. Spaces 4000 stamps; to approval applicants 20c. Swan Stamps, 601 Swan, Dunkirk, N. Y.

WHOLESALE Approvals. References. Fuld, 3155 So. Grand, St. Louis, Missouri.

U. S. Post mark collectors—35 different post marks with stamps attached 15 cents. Armour Organization, Flushing, New York.

SUPERIOR "New Issues" collection, airmails, commemoratives, jubilees, pictorials, triangle, etc., with approvals only 10c. Katharine Crane, Stamps, Applegate, Calif.

FREE—6 Different silver jubilees, with approvals. Send 3c postage. Berg, Box 259, Ann Arbor, Michigan.

UNITED States, Canada, Newfoundland, Mexico! Where? Our "Four Star" approvals. Nothing like them! Write today. Kessels, Box 808, Tucson, Arizona.

GIGANTIC Collection, containing rare triangle, air mail, Abyssinia, Andorra, Barbados, Cameroons, Cape Verde, Dahomey, Kouang-Teheou and other scarce stamps. Only 10c with approvals. Stamp Supply, Redondo Beach, California.

SEA-GODDESSES, Ships, Britannia pictorials from Barbados, British Guiana, Trinidad—sixteen varieties only 9c to approval applicants. Douglas, Hawkesbury, Ontario.

AMAZING Offer! Army and navy commemoratives, imperforate Chicago, packet of 23 North American stamps from U. S., Canada, Mexico, Newfoundland. Catalogue value over 65c—all for 5c to approval applicants. Illustrated pricelist free. Curhan Stamp Co., Dept. P, Gloucester, Mass.

NEWFOUNDLAND, 15 Different 5c with approvals. Frederick Brown, Plainfield, N. J.

UNITED States mixtures, 50c lb., 5 lbs. \$2.00. Canada 75c, Japan \$2.00, Mexico \$2.00. Magazine, 4512 North Racine, Chicago.

FREE—Dollar packet to approval applicants. Harlan, 5307 S. Marshfield, Chicago.

UNITED States and foreign approvals. Huber, Three South Eighth, Minneapolis.

SCARCE New giant sized, diamond-shaped Russian "sports" stamp; Nyassaland "leopard"; Morocco; Tanganyika, and other scarce countries included in our big packet of new and recent issues—stamps most collectors have never seen! Get this valuable packet today. 5c to approval applicants. Reimers, 115 Flatiron, Fort Worth, Texas.

GIANT Spain triangle and bi-colored Persia airmail (both illus.); big packet 25 diff. Russia (cat. nearly \$1); pkt. British Colonies including Egypt, Travancore, Ireland, Malay, Silver Jubilee, etc. All for only 5c to approval applicants. Fidelity Stamp Co., Dept. 20, Earle Bldg., Washington, D. C. Free: Large U. S. list.

MONTHLY Stamp magazine; six months and 25 foreign stamps, 25c. American Stamp Journal, Cedar Rapids, Iowa.

200 DIFFERENT 10c. Big 50% approvals. Covert Stamp, 39 State, Rochester, N. Y.

FREE—25c Packet given approval buyers. Lincoln Stampart, Shelbyville, Illinois.

50 STAMPS Free, Manchukuo, etc. Postage 1c. Approvals not necessary. Album 3c. Bullard, 268 Northampton, Boston.

\$5.00 U. S. Postage due, No. 2284, fine copy 5c with general approvals. Hudson Company, 116 Nassau St., New York City.

300 DIFFERENT 20c; 1,000, \$1; 2,000, \$3.00. Fred Onken, 630 79th St., Brooklyn.

ILLUSTRATED U. S. list, price 50c, large complete U. S. price list free. Send postage. Stanley Gibbons, 38P Park Row, N. Y.

PENNY Approvals that please. Haywood, 395 Adams St., Pomona, Calif.

ABSOLUTELY Free! Scarce mint United States telegraph stamp, cataloging 50c, and our big 56-page illustrated catalog, "United States, British North America and Foreign Stamps." Write today! H. E. Harris & Co., 137-G Transit Building, Boston, Mass.

FREE—15 Different Peru to approval applicants enclosing postage. Ranson, 3555 Fullerton, Chicago.

AIRMAIL Triangles from Liberia and Mozambique, 3 British silver jubilees, new King Edward stamp and packet 25 different stamps from Azerbaijan, China, Ukania, etc. All for 5c to approval applicants. Clipper Stamp Co., Dept. 7, Gloucester, Mass.

ASK For our wonderful one cent approvals. Prospect Stamp Co., 225 Broadway, Toronto, Canada.

MIDGET Airmail (1/2 in. tall), Szechuen, Kouang-Teheou, Mozambique, etc., 30 stamps—5c Depraw, Ocean Park, California.

CANNON! Set of stamps showing cannon, firing squad, cavalry charge and 200 other different stamps only 10c to approval applicants. Paramount Stamp Co., 4225 Broadway, Chicago, Ill.

SILVER Jubilees—15 different 25c. World specials—500 different 35c, 1000 different \$1.00, 2000 different \$3.00. These offers to approval applicants only. List free. Victoria Stamp Co., London 4, Canada.

STAMPS: A splendid selection sent on approval. Quality at low prices. Scarce and high value stamps are included in our approval books. Fred Herzberg, Box 91-P, Elmhurst, Ill.

STAMP Dealers, your ad here will bring wonderful returns. Ask me for proof. F. W. Johnson, Manager, Classified Advertising, Popular Mechanics Magazine, 200 E. Ontario St., Chicago.

GIANT-SIZED Russian Zeppelin stamp (cat. val. 20c!) and beautiful Lithuania airmail triangle; also big packet of 53 dif. stamps including Azerbaijan, Epirus, new Martinique, etc. and illustrated lists—all for 5c to approval applicants! World-Wide Stamp Co., Box 600, Camden, New York.

FREE! Rare airmail! Jubilee! Pictorials! Extraordinary packet 65 different stamps from strange countries (no Europe), 5c postage to approval applicants. Bargain Co., Box 39P, Station H, New York.

UNITED States approvals only. Write for selection. Positively no foreign. Jack Daub, Wabash Bldg., Pittsburgh, Pa.

WEEKLY Stamp magazine, thirteen weeks, 10c. Stamp Journal, Kalamazoo, Mich.

WHOLESALE Catalog for dealers. Illustrated. Postage 5c. Frank Co., 4900 Challenge, Baltimore, Md.

PENNY Approvals, that satisfy. Neil Gronberg, Box 5441-P, Philadelphia, Pa.

44 DIFFERENT United States including \$5 stamp, or complete set United States bicentennials, or 30 different obsolete Canada, 13c postpaid with approvals. C. A. Lennan Co., Box 322, City Hall Annex, New York, N. Y.

\$5.00 U. S. Red and blue liberty, present postage value, Scott No. 573 cat. \$1.25 (retails as high as \$1.00 net by some dealers) only 5c to approval applicants. Giant U. S. Pricelist free! Tatham Stamp Company, Springfield-5, Mass.

25 UNITED States, including \$4 and \$5 stamps free to approval applicants. 3c postage. Brownie Stamp Shop, Flint, Michigan.

DIAMOND-SHAPED Stamp, Liberia gunboat triangle, two other triangles, silver jubilee, 27 others, 5c. Crowder Company, 127E North, Baltimore, Md.

FREE!!! King George memorial packet, 15 varieties. Postage 3c. Roberts 901F Fourth, Baycity, Michigan.

LIBERIA Snake triangle, giant Spanish ship triangle, 50 other stamps, 5c. Abell Company, 2527 Guilford, Baltimore, Md.

PHOTO FINISHING

TWO Beautiful Masterprint enlargements included with roll developed, printed, 25c; finest quality reprints, 2c each. Brown Photo Company, 2209-12 Lowry, Minneapolis, Minnesota.

20 REPRINTS 25c. Films developed, 16 prints 25c. Enlargements 8x10—25c; 5x7—10c. Low Photo, M-2657 Neva, Chicago.

QUICKER Service, sparkling double-clear never-fade prints. Roll developed, two prints each negative, enlargement coupon 25c. Willard's, Box 3535-A, Cleveland Heights, Ohio.

ROLL (127 To 122) developed, and 5x7 enlargement of each negative 50c. Extra enlargements 7c each. Send for complete price list. Kniekerbocker Foto Co., 127 West 27th Street, New York City.

ROLL Developed, 8 fadeproof prints and a Photo-file 25c. Reprints 3c. Professional 8x10 enlargement 25c. Beautiful premiums. Young Photo Service, 405-B, Albany, N. Y.

HAND Colored enlargement with each roll 25c. 40 reprints 50c. Colorgraph, Dunning Station, Chicago.

DEVELOP And print your own pictures. Save time, money with our complete \$1.49 outfit postpaid, or pay postman \$1.55 COD. Includes electric ruby lamp, printing frame, photo paper, chemicals and equipment. One of hundreds of amazing bargains in our free, newest, money-saving bargain book. Send for it today! Central Camera Co., 230 So. Wabash, Dept. K-13, Chicago.

MAIL Your rolls to The Kodak City. 8 guaranteed glossy Velox deckle-edged prints, 25c coin. Two professional enlargement coupons free! Photo Finishing Shop, Est. 22 yrs., 411-F Genesee Valley Trust Bldg., Rochester, N. Y. "The Kodak City."

FILMS Developed 2 prints of each 25c; 20 reprints 25c. Pine Photo, M-5134 Nevada, Chicago.

MAIL 25c With film for 8 permanent prints and enlargement. Reprints 3c; enlargement with 8. United Film Service, East Lake, Chattanooga, Tenn.

FINER Photos guaranteed. 48 hour service! Rolls developed professionally—8 Velox prints, 2 bromide enlargements—25c coin. Finerfotos, Box D-898, Minneapolis, Minn.

IDEAL Finishing. Your roll developed and printed 25c. Snapshot folder and enlargement coupon with each order. Ideal Photo Service, Box 2255, Paterson, N. J.

21 EXCELLOTONE Reprints 25c; 45, 50c. Four 5x7 enlargements 25c; 17, \$1.00. Million Pictures, 236, Albany, Wis.

ROLL Developed, 2 prints each negative, 25c. Reprints 2c. Photoshop, Ogden, Utah.

FILMS Developed and printed, also two double weight enlargements 25c, 8 reprints and one enlargement 25c. Photoart Shop, Box 3406 P, St. Paul, Minnesota.

21 REPRINTS 25c. Films developed, 16 prints, beautiful enlargement 25c. Four 5x7 enlargements 25c. Truefoto, 408, Des Moines, Iowa.

BRILLIANT Snapshots. Any size roll developed, 8 glossy Velox prints, 25c coin. Onota Photo Service, Dept. H, Box 1136, Pittsfield, Mass.

ROLLS Developed and eight Velox prints 15c. With 5x7 tinted or two untinted, any negative, 10c additional. Photokraft, Minneapolis, Minn.

ENLARGEMENTS—Three for 10c including book of snapsticker. Roll finished complete and enlarged 25c (coin). Negatives 127, 120, 116. California Film Service, Department 60, Box 379, Pasadena, California.

ENLARGEMENTS 4x6. Five for 25c, 5x7 three for 25c, 8x10 three for 35c. Hand colored and framed each 4x6 25c, 5x7 30c, 8x10 40c. Send film negatives. Enlargers, Maywood, Illinois.

IMMEDIATE Service! No delay! Roll developed, carefully printed and two beautiful 5x7 double weight professional enlargements or one tinted enlargement or six reprints—all for 25c coin. The expert's choice. Reprints 3c each. The Photo Mill, Box 629-12, Minneapolis, Minn.

ROLL Developed, two prints each, two enlargement coupons 25c. Summers' Studio, Unionville, Mo.

ROLLS Developed, 16 guaranteed prints, two coupons on plain or colored enlargement 25c. Smart Photo, Winona, Minnesota.

FRAMETTE—Wooden, easel back, sizes 120, 116, 10c each; \$1.00 per dozen. Coin. Fotofram, Riverhead, N. Y.

LARJAGRAPH Reprints: (5x7), five 25c. Cardinal Photos, Berkeley Heights, N. J.

IMMEDIATE Service! No delay! Roll developed, carefully printed and two beautiful 5x7 double weight professional enlargements or one tinted enlargement or six reprints—all for 25c coin. The expert's choice. Reprints 3c each. The Photo Mill, Box 629-Z, Minneapolis, Minn.

TWO Beautiful Nuborder enlargements, eight guaranteed Nuborder prints, 25c. Giant Snapshots, Inc., B667A, Greenbay, Wis.

ROLLS Developed, 116 size or smaller, eight beautiful enlargements, no small prints, 25c (coin). LaCrosse Photo Works, LaCrosse, Wis.

TWO Glossy enlargements, 1 colored, with roll 25c. Arbor Service, 10 Joliet, Ill.

FOR The discriminating amateur—roll developed and printed on super gloss Velox paper 25c, reprints 2c. Quality instead of quantity, same day service. Paramount Co., 403 E. 92nd St., New York City.

FINER Finishing. Rolls developed and printed, with one colored enlargement, or two professional enlargements. All for 25c (coin). Genuine, nationally known, Moentone superior quality. Moen Photo Service, La Crosse, Wis.

KODAK Enlargements 5x7, 10c; 3 for 25c coin. Send best negatives (film). Dept. 5, Xint Photo Lab., Cedar Rapids, Iowa.

ROLLS Developed. Two beautiful double-weight professional enlargements and 8 guaranteed Never Fade Perfect Tone prints, 25c coin. Rays Photo Service, LaCrosse, Wisconsin.

ROLL Developed and 8 beautiful Velox glossy prints 25c coin or stamps. Reprints 3c each. Fotoprint Service, Box E, Roanoke, Virginia.

ROLL Developed with 16 prints and two professional enlargements 30c, 100 reprints \$1.00, 16 reprints and 2 enlargements 30c. Dependable, RiverGrove, Illinois.

DAILY Service—Roll developed, 16 guaranteed prints, 25c. Valuable enlargement coupon; 16 reprints 25c. Modern Finishers, Box 3537-L, St. Paul, Minnesota.

COMPARE The difference! Roll developed, two professional double weight enlargements, 8 guaranteed prints, 25c coin. Excellent service. Nationwide Photo Service, Box 3333, St. Paul, Minnesota.

GET The best. Roll developed, beautiful hand colored enlargement, 8 neverfade border prints, 25c coin. Prompt service. Sun Photo Service, Drawer T, St. Paul, Minn.

CAMERAS, PHOTO SUPPLIES

CAMERAS And supplies. Free illustrated catalog listing everything photographic—still and movie cameras, films, lenses—at tremendous savings. Hundreds of bargains, new and used. All guaranteed. We take your old camera or equipment in trade. Write now for your free copy of our newest money-saving bargain book—just out! Limited edition. Hurry! Central Camera Co., (Photographic Headquarters since 1899), 230 So. Wabash, Dept. K-3, Chicago.

ENLARGER, \$5.75 Complete. Circular for stamp. Harold Francke, 1926 East Fernwood, Milwaukee, Wis.

LEARN Photography at home. New cooperative plan offers full course of instruction. We retouch your negatives, finish your printing and enlarging. For complete details how we start you in a money making business of your own write Cooperative Photographers, Box 346, Patchogue, N. Y.

NEW Camera attachment. Pictures become lifelike. Send 25c coin. Bottorff, Placerville, Calif., Box 98.

BIG Money. Selling snapshots. Book. Full particulars 20 cents. Duffy's Book Exchange, Oakland, Maryland.

GET Inside! Fire lines; parade lanes; courts. Photographer's Press Card (like reporters) 25c each. Emery Service, Adam St., Pittsfield, Mass.

MAKE Money in photography. Learn quickly at home. Spare or full time. Easy plan. Previous experience unnecessary. Common school education sufficient. Write for full information and requirements. American School of Photography, 3601 Michigan Avenue, Dept. 3431, Chicago.

MAKE Money selling snapshots. Complete instructions, 1800 markets, 10c. Photo Markets, 201-P Barrister Bldg., Washington, D. C.

INTERESTING Sample copy of 25c photographic magazine for 10c. Photographic Digest, 1666 Linden Street, Brooklyn, New York.

35% DISCOUNT On films. Write Paramount Photo Division, 403 E. 92nd St., New York.

HAVE You a camera? Send ten cents for recent number of our big magazine, showing how to make better pictures and earn money. American Photography, 116 Camera House, Boston, 17, Mass.

BASS Will postpay to you the Argus Candid Camera with f:4.5 lens, speeds to 1/200th of a second, \$12.50. New Argus enlarger at \$12.50. Daylight Pan film, all speeds, 36 shots, 85c. Welti Precision Candid camera with genuine Carl Zeiss Tessar f:2.8 lens in Compur shutter, \$48.50. Voigtlander Duo Bessa 2 1/4x3 1/4 or 16 Vest Pocket, with f:4.5 Anastigmat lens, speed shutter, \$27.50. Write for free Bargaingram 227 now ready. Largest stock of new and used apparatus in America. Dept. AG, Bass Camera Company, 179 West Madison Street, Chicago.

INCOME From your camera instead of expense. Low cost home course teaches you to make photographs for magazines, newspapers, advertisers. Tremendous demand. Earn good money wherever you live. Free book. Universal Photographers, Dept. 104, 10 West 33rd St., New York.

MOTION PICTURES AND SOUND EQUIPMENT

8-16 MM. Sound-silent film. Bell-Howell Filmosound, like new, \$385. One reel 16 mm. rents 50c. One reel silent film—new prints—\$25. Address: Pictures, Westport, Conn.

CENTRAL'S Free, new, money-saving bargain book explains latest movie developments, offers money-saving bargains in cameras, lenses, projectors, films. Used equipment taken in trade. Write for free copy. Central Camera Company, (Photographic Headquarters since 1899), 230 So. Wabash, Dept. K-23, Chicago.

8-16MM. TITLING, 2c Word. Catalogue. Cineshop, 1560 Jackson, Charleston, West Virginia.

35MM. SHORTS \$1.25 Reel. Features \$1.00 reel. Lists stamp. Prewitt, 6852 Racine, Chicago.

NEW! Inexpensive 16mm. films. Acme Cine, Box 794, Lima, Ohio.

GREAT Train robbery, longest 1903 thriller. Building Panama Canal, 200', complete \$6.99. New 16mm. prints \$11.99. Special catalog dime. Peerless, 6803 Carpenter, Chicago.

35MM. FILMS. Sound, silent, sales, rentals, equipment. Lists 3c. Box 23, Hagerstown, Maryland.

8-16 MM. SOUND-SILENT FILMS. One reel 16 mm. rents 50c. Bell-Howell 16 mm. sound projector complete like new, \$550. 25 feet 8 mm. Mickey Mouse \$1, postpaid. Address: Pictures, Westport, Conn.

35MM. FILMS \$1.00 Reel. Projector, \$10.00. List 10c coin. Box No. 6, Rosedale, Kansas.

BARGAINS! 8mm. 16mm. Catalogue free. Elder, Dept. B-33, Chelsea, Mass.

EXCLUSIVE New 16mm.—8mm. subjects. Exchange for old. Sale—Rental. Religious pictures. Free lists. National Cinema Service, Hudson City Box One, Jersey City, New Jersey.

"THE World's Greatest Passion Play." Seven reel sound and silent (new) 16 mm. Superior than Oberammergau stage play. Rent or purchase. Write Hemenway Film Co., 37 Church St., Boston, Mass.

8MM—16MM EQUIPMENT. Bargain catalogue free. G. Taylor, Bx-234, Corning, N. Y.

DIME Brings 3 free 16mm end titles and lists of new and used 8mm and 16mm films and equipment. Films and equipment bought, sold, exchanged. Lists only, 3c. Pacific, 1040 N. McCadden, Hollywood, California.

HOLLYWOOD Camera film, 100 feet, 16mm, \$2.95. 25 feet 8mm, \$1.45 processed. Hollywoodland Studios, South Gate, Calif.

DE VRY Portable 35 sound machine with amplifier \$185. 35mm silent 1000 ft. shorts \$1. Films 70-A, F3.5, 16mm \$42.50. 8mm camera \$9.95, 8mm motor projector \$12.50, tripod screen \$4.49. Odd 16mm silent film \$1.00 per 100 ft., \$2.85 per 400 feet. Free film lists 8, 9 1/2, 16, 35mm silent, sound, soundfilm. America's largest film rental library. Bargaingram full new, used equipment, parts. Trades accepted, purchased. Victor sound 16mm machine, complete, \$79.50. Mogull's, 1944-J Boston Road, New York.

35MM ODD Silent sound \$1.00. Bergen, Woodcliff Lake, New Jersey.

NEW \$185.00 Victor projectors, 750 lamp, take 1800 foot reels, \$99.50. List free. Fromader's, Davenport, Iowa.

FREE—"Home Movies" magazine. Stamp brings details. Pacific, 1040 N. McCadden, Hollywood, California.

16MM. FILMS. New low prices. List free. Richards, 124 Kammer, Dayton, O.

ANNIVERSARY Sale—Large movie listings, stamp. Box 2133, Paterson, N. J.

HOME Movies cost less than snapshots. Automatic \$9.95 camera takes 2400 pictures with 60c film and shows in \$12.50 motor projector. Order now! Send no money. Pay postman. Free lists. Home Movies, Box 32, Easton, Pennsylvania.

16MM FILMS. Our big catalogue and two usable "end" titles, 10c. Eastin Pictures, Davenport, Iowa.

FILMS Exchanged free. Bargains cameras, projectors, films. National Service, Box 125, West Springfield, Mass.

LEARN Motion picture theatre business. Home-study training: Management, advertising, projection. Established nine years. Low tuition. Easy to learn. Free catalog. Theatre Institute, Elmira, N. Y.

READY For you—No. 224—the latest and greatest Bass Bargaingram of Cine apparatus. Acknowledged leadership in the cinema field. A few of the fine values: Cine Kodak Model B, f:1.9 lens and case, \$54.50. 8 mm. Stewart-Warner camera with f:3.3 lens, \$15.00. 100 ft. DeVry 16 mm. camera, f:3.5 lens, \$22.50. RCA sound on film projector complete, \$85.00. Willo Cinemeter with case, \$3.75. Write today to Cine Headquarters and start to save now. Bass Camera Co., Dept. A, 179 W. Madison St., Chicago, Ill.

16MM BELL Movie camera \$7.50. Complete outfits \$19.50 up. 16mm film (including processing) \$1.89. Projectors. Circular free. Bytom, Dept. B, Park Ridge, Ill.

WESTERN Thrillers, 500 feet 75c. Jersey Filmeo, 2075 Richland, Lakewood, Ohio.

35MM. FILMS. Bargain lists 3c. Hoffman Film Service, 57 Broad, Albany, N. Y.

BASS Now exclusive distributor for Radio Corp. of America 16mm. R.C.A. Sound on Film Cameras. Anyone can record sound pictures. New low price. News reporter model was \$350.00, now \$210. Send for complete details. Bass Camera Co., Dept. AK, 179 W. Madison St., Chicago, Ill.

8MM FILMS: Cartoons, travel. List. Lincoln Film Service, Box 293-A, Saginaw, Mich.

RADIOS, SUPPLIES, INSTRUCTION

RADIO Experimenters and set builders; parts and kits of parts for Six Tube long and short wave, Pre-Amplifier, Portable Superhet Battery, Improved Little Giant Four and Five tube and economy three sets described by Popular Mechanics. Guaranteed specified parts. Lund Manufacturing Co., 43 East Ohio, Chicago.

BLUEPRINT, Distance record crystal set, 17 others, with "Radiobuilder" year—25c. Laboratories, 151-C Liberty, San Francisco.

MATCH Box pocket size crystal radio, amazing reception. Complete for 50 cents (coin). Sannipetro's Shop, 104 1/2 Balbo Avenue, Providence, R. I.

SPARTON Equasonne parts. Authorized agent. Correspondence invited. Sparton Radio Service, 710 West Jackson, Chicago.

ONE Tube short wave receivers. Complete with 250 tube and coils. 17 to 200 meters, \$5.00. Milton Blake, DeFuniak Springs, Florida.

PHILCOS, Zeniths, Majestics, others. Cut prices. Radioman, Lake, New York.

AMAZINGLY Improved farm radio \$2.95. Full information and illustrated copy "Radio Millions Been Waiting For" postpaid for 10c (silver). Western Radio Corporation, Wichita, Kansas.

CRYSTALS For 160 and 80 meters 75c postpaid. Faberadio, Sandwich, Illinois.

SAVE Money on radios and parts. Send for our money saving bulletin. United Radio Co., Newark, N. J.

RADIO Engineering, broadcasting, aviation and police radio, servicing, marine and Morse telegraphy taught thoroughly. All expenses low. Catalog free. Dodge's Institute, Ames St., Valparaiso, Ind.

MUSIC AND MUSICAL INSTRUMENTS

DUO-FLEX Reeds for clarinets, and saxophones eliminate your reed troubles. Write for circular. Duo-Flex Reeds, 1204 1st Ave., Evanston, Ind.

HAVE Phonograph record made your song. Rainbow Recording Studios, 210 Olive, St. Louis, Mo.

SONG Poems wanted—Home, love, sacred, any subject. Send best poem today for offer. Richard Bros., 24 Woods Bldg., Chicago.

SONGS Published, method, 30 cts. E. Madden, 1017 Danforth, Syracuse, N. Y.

SONGWRITERS! Vital information for stamp. Sudlik, 1813 1st S. W., Cedar Rapids, Iowa.

SONG Poems set to music. Get our phonograph recording plan. Zerse Bros., 210 Olive, St. Louis, Mo.

REBUILT Band and orchestra instruments. Honestly rebuilt—fully guaranteed. Catalog of new instruments on request. Weymann Company, Dept. M-3, 1613 Chestnut St., Philadelphia.

MUSIC Arranged for songs; orchestra. Frank S. Wildt, Lancaster, Pennsylvania.

SONGPOETS. Music guaranteed. Lessons 25c. National Songland, "PM," Thomaston, Maine.

ENTER Monthly song contest. Send lyrics, melodies. Write to Superior Song Studios, Passaic, N. J.

SONGWRITERS! Outstanding proposition. Inquire. Hibbeler, D1, 2157 No. Avers, Chicago.

SONGWRITERS Fifty-fifty Magazine, ten cents. Lee Lee, Marietta, Ohio.

ORCHESTRATIONS—10, \$1.00. Sheet-music, 25, \$1.00. Silverman, 3303 Lawrence, Chicago.

MUSIC Composed to song poems. Our published songs endorsed and featured by stage, radio, screen celebrities. Adelman Bros. Music House, Dept. 601, Washington, D. C.

EARN Your own musical instrument. Get free details and free attractive savings bank at your music store, or write Fred Gretsch Mfg. Co., 521 1/2 So. Wabash, Chicago.

VIOLINS—Handmade. Best since Stradivarius days. (Curious don't bother.) John Lehto, San Pedro, Cal.

SONGS Published, arranged and composed, royalty basis. W. Coast Music Pub., 942 Market, San Francisco.

SONGWRITERS—Send for free copy of booklet revealing Secrets of Successful Songwriting, free rhyming dictionary and market information. If you write poems or melodies, send for our offer today. M.M. Publishers, Dept. E1, Studio Bldg., Portland, Ore.

MUSIC Composed to words. Wonderful proposition. Bauer Bros., Oshkosh, Wis.

WRITE Songs. Big money and reputation. Write for information. J. Gordon Pub. Co., 201 N. Hoyne Ave., Chicago.

ORIGINAL Music composed to your words \$5. Reginald Beicher, Chatham, New Jersey. 25 years church organist, musical director.

SONG Writers. Send for our "Publishing Agreement." McKinley Music Printers, 1501 E. 55th St., Chicago.

BUSINESS OPPORTUNITIES

COSTS Are less when you color concrete with chemicals. Beautiful, permanent results. Details free. Hollywood Cementcraft, 8527 Wonderland, Hollywood, Calif.

SMALL Inventions wanted by manufacturers. I'll help you sell your invention. Stanley Hull, M-7829 Euclid Avenue, Cleveland, Ohio.

FORMULAS—Fast selling products. Guaranteed. Laboratory tested. Lowest prices. Catalog free. Kemico, 55B, Park Ridge, Ill.

DIME Brings you the latest business tips and opportunities. Williams Publishing Co., Gatesville, Texas.

500—1936 NAMES Of opportunity seekers 25c and 12 other M.O. items. Send orders to Matthew Roth, Box 535, Kiefer, Okla.

CHIPPED Glass sign making; mirror re-silvering; metalware replating. Interesting. Profitable. Write Sprinkle, Plater, 127, Marion, Indiana.

INSURE Against failure; build your own paying mailorder business. Consistent profits. Inexpensive. Details stamp. Jennings, 611 Washington Blvd., Baltimore, Md.

"SCHEMER" Monthly Magazine, Alliance, Ohio, prints schemes, tips, ideas, formulas—big winners—\$10,000 to \$25,000 reported. 39th year; \$1.00. Special: Trial six months only 30c.

START A collection business. No capital, good living. Fundamentals revealed, 25c. Sutton Press, 3185 Fowler, Omaha, Nebraska.

BIG Mails galore—Magazines, opportunities, etc. 10c. Wynn's Service, Box 345-B, Lamar, Missouri.

WANT To make more money? Free particulars. Joseph Castell, 1663 Madison St., Brooklyn, N. Y.

OPERATE Profitable business at home. Full or spare time. Stamp. Perry, Albion, Maine.

NEW Free folder describes numerous successful business plans; home or office. Russell Sheppard, Wooster, Ohio.

ZERPID. Amazing new plant fertilizer. 25c. Sanquist Co., Pomeroy, Iowa.

ADVERTISING. Mailing, 250 piece big mail 10c. Ritchie, Box 743, Watertown, So. Dak.

WE Teach you new business, then buy your product. Write Superior Specialties, Springfield, Illinois.

AMAZING New invention, make and sell to merchants in your community. Write, Dixie Sales, King, North Carolina.

OPPORTUNITY!!! Learn outdoor profession. Make \$1.50 hour. Clough Institute, Grayling, Michigan.

SWEETMEATS—A cloth bound book of choice canning recipes. Price \$2.00. E. Guncelle, Westhampton, L. I., N. Y.

AMAZING Opportunities. Booklet for stamp. Publishing Service, Box 101, Aurora, Ill.

PROFITABLE Mail business. No capital. M. Williams, 504 Marion, Bellefonte, Del.

PLANS, Money makers. Circulars free. Modern, Box 5283, Tampa, Fla.

OBTAIN Capital needed for any purpose. Particulars free. Capital Service, Jefferson City, Missouri.

WRITE For money-making offers. Hollywood News for Ambitious, 5c. MSS-1113, Albuquerque, N. M.

A NATIONALLY Known cleaning product for carpets and upholstery is starting a new field. Cleaning carpets—rugs at home without removing from floor. Cleaning machine and cleaner sent you with small deposit. Guaranteed results. Season just starting. Kleen-Rite, 539 E. 61st, Chicago, Ill.

BUILD Your own business. Small capital required. You've watched the automobile, radio, electric refrigeration, air conditioning. Water softening is next. Get in on ground floor. Wolcott Water Softener, 610 Range Line Street, Columbia, Missouri.

MANUFACTURE Newest profit-making specialties from guaranteed formulas, trade secrets, analyses. Complete chemical service. Charges most reasonable. Interesting literature free! Miller, Manufacturers' Chemist, Tampa, Florida.

EUREKA National System plan. Big money maker. 9x12 dollar digest free. Only 100 sold at 50c, thereafter \$2.00 copy. Rush. Fallon Plan Service, Box 205, Oak Park, Ill.

MAKE Artificial marble, glossy tiles, un-canny. Tabletops, plaques, floors, whetstones, novelties. Inexpensive, hard, fire-proof, cement secrets. Brilliant tile and liquid rubber samples 3c. John A. Payn, 945 Grande Vista Avenue, Los Angeles, Calif.

\$25 DAYS Profit possible. Amazing plan. Stamp brings full details. Ralph Brooks, Arkansas, Wis.

MAIL Forwarding business. No capital! No selling! Dime brings everything needed. Delmao, 6 E. 15, Wilmington, Del.

67 PROVEN Plans. 25 cents. Frank Turack, 127 Starr Bldg., Export, Penna.

WE Promote business transactions of all kinds. Cole Syndicate, Bryant Pond, Maine.

LIQUID Marble—Anyone can make! Colorful, glazed! Moulded, brushed, sprayed. Rubberlastic moulds. Composition flooring. Big money in these! Particulars free. Marbleizing Service, Edwardsville, Illinois.

REAL Money maker for distributors and salesmen. Patented amplifiers needed in all stores, factories, offices. Cuts electric bills in half or doubles light. Wonderful convincing demonstrator. Pays up to 250% profit on each quick easy sale. Moderate investment for stock refundable. Write today for convincing proof. Apex Works, 146 West 23th, New York.

PROFIT With new products. Make, sell, repeat. Analysis. Research. Guaranteed formulas. Biggest catalog free. Special prices, leads. Gibson Laboratory, Chemists, BD-1142 Sunnyside, Chicago.

START Your own business. Splendid opportunity. Valuable information for stamps. Edward Johnson, Dept. P, West Creek, N. J.

MAKE Money while others try. Our system is authentic. Details free. Box 344, Summitt, N. J.

OPERATE Chain world's finest money making vending machines. Sells four products—same time. Instant success! Small capital—profits immediately. No curiosity seekers. Penny King, 1233 Chouteau, St. Louis.

MRS. M. received \$238 for 3-week cellar crop patented mushrooms! Exceptional, but your cellar, shed, perhaps suitable. We buy! Book free! United, 3848 Lincoln Ave., Dept. 67, Chicago.

24 SELECTED Opportunities start own business, \$1.00 postpaid. Particulars free. Kubelka, 58 East 106th, New York City.

RELIABLE Person each town for your own outdoor advertising business. Experience unnecessary; we teach you. No selling. Good paying business. Dawson's Service, Cape Girardeau, Missouri.

IDLE Hours Magazine, Edwardsville, Illinois—Tells how others spend spare time. Copy 10c. Year \$1.00.

IF Your business needs capital write Johnson, Bedford Building, Chicago.

ATTENTION: Make money collecting accounts with letters that retain customers. Write Commercial Station, Box 925, Springfield, Missouri.

LEARN Modern rent collecting from successful operator. Big pay. All or part time. No investment. Fine side line to real estate or insurance. Circular free. Sicoan, 2038 Obeart, St. Louis, Mo.

COMPLETE Money making plans free! National Service, 7026 Normal, Chicago.

DOLLARS Daily. Start home mailorder business. Details. Duffy, Covington, Ky.

BARGAINS—Paint spray outfit, gasoline engine drive. Terms—trial. Helmick Paint Spray Exchange, M-374, Troy, Ohio.

WHERE To buy at lowest wholesale prices. Information free. Yorena, Box P-132, Bayonne, N. J.

MAKE \$2 To \$5 hourly operating Lord's Prayer penny engraving machine. Sample free. Midwest, 5511 Euclid, Cleveland, Ohio.

INVENTION Finance Magazine, 80-G Wall Street, New York. Year subscription 60c entered upon promise to pay on receipt of first copy.

PRACTICAL Mailorder plans. Details free. Fred Rothe, 3949 Ontario, Chicago.

START Your own circulating library. We furnish and exchange your books. Fireside Rental Library, 210 Crosby Bldg., Buffalo, N. Y.

MARBLEIZING; Porcelain enamel finish. Cement prepared, mix with water, applied to wood, wall-board, concrete, etc. Flintlike hardness, brilliant. Cheap as white portland cement. See our 85c liquid rubber for mold making. Sets solid in four hours. Any thickness. Send dime for assorted samples, both rubber and porcelain. Cowell Institute, Grayling, Mich.

1000 SURE-FIRE Money-making opportunities! 25c postpaid. Rayburt, 100 Genessee, San Francisco, California.

HEALTH Food products, easiest and safest. Mail sellers. Vegetable concentrates, tablets, powders, vitamins. Your own labels. Samples, dime. Gardena, 128B, Station "S," Los Angeles, California.

RED Bugs. Our new formula kills them every time without danger or trouble. You can start good business selling product or using it for exterminating. All details including secret formula \$1. Particulars free. Stamp appreciated. Benton Company, 29 Buckley, Liberty, New York.

PLASTEX Industries offer industrious men an opportunity to start a business of their own, manufacturing art goods, novelties and utility products in Plastex and marble imitation. 1/8c material makes regular 10c store sellers. Rubber moulds furnished for speed production. Small investment brings big returns. Since the crash, low priced goods are needed and this line meets the demand. Interesting booklet mailed free. Plastex Industries, Dept. A, 1085 Washington Avenue, New York.

WE Start you in business, furnishing outfits and instructions, operating "Specialty Candy Factory" home. Men and women, earn \$25.00 up to \$60.00 weekly, all or spare time. Booklet free. W. Hillyer Ragsdale, Inc., Drawer 4, East Orange, N. J.

HOW And where to obtain capital fully explained, free particulars. Star Service, Wapakoneta, Ohio.

BUSINESS Of your own. No capital required. Details. Wun Service, California, Pa.

500—1936 NAMES Of opportunity seekers 50c. Trial hundred 10c. Carl Edquist, Odessa, Minn.

SUCCEED With your products. Make-sell them. Formulas. Processes. Accurate analyses. Catalog free. B. Thaxly Company, Washington, D. C.

CHEMICAL Expert furnishes manufacturing formulas with complete working directions. Reliable individual services. Charges reasonable. Dr VanHeeden, 1410 East 54th, Chicago.

SELL By mail. Books, novelties. Bargains! Big profits! Particulars free. B. Elfco, 438 North Wells, Chicago.

CHARTERS: Delaware; best, cheapest; free forms. Colonial Charter Co., Wilmington, Del.

MANUFACTURE Polishpuffs. Amazing proposition 10c. Particulars free. Hickory-dell, Glenbeulah, Wisconsin.

ARTIFICIAL Marble sanitary flooring, instructions covering wood or cement flooring 1/2 inch thick, fireproof, all colors, low cost, ornamental casting, concrete, plaster, papier-mache, garden furniture, statuary, flexible molds, particulars free. Chris Mahler, Elmont, N. Y.

FREE Booklet describes 107 plans for making \$20-\$100 weekly, in home or office, business of your own. Elite Co., 214 Grand St., New York.

MAIL Order business is your opportunity. Many began small, now earn thousands yearly. No personal contact. Boundless opportunities. Have had over 30 years experience; will help you succeed. Send 25c for valuable booklets, none free. B. Breniser, 237 South 21st, Philadelphia.

I WANT To send you proof of the wonderful pulling power of Popular Mechanics Magazine's classified pages. What's your proposition? Write me today. F. W. Johnson, Manager Classified Advertising, 200 E. Ontario St., Chicago, Ill.

COMPLETE Chemical service, analysis, formulas, processes, trade secrets. Particulars free. W. L. Cummings, 228 Gordon Avenue, Syracuse, N. Y.

START Little business anywhere. Everything furnished. No canvassing. Maywood, PM-923 Broadway, New York.

YOUR Old plans—regardless of original cost—taken in exchange for my new, original 1000-In-One-Plan. Details free. Write at once. National M. Agency, 2045 Snyder Avenue, H. Philadelphia, Pa.

MONEYMAKING OPPORTUNITIES

FERGUSON Manufacturing Co., 322 N. Senate Ave., Indianapolis, manufacturers of trade stimulators for operators since 1919. Wholesale catalog, 10 cts.

ESTABLISH Permanent well paying first aid supply business with ethical surgical dressings. Needed in every home, office and industrial plant. Exclusive territory open. Amazol Products Co., 5315 South Vermont Ave., Los Angeles, Calif.

BOOKS, Chuck-full of money-making ideas, formulas, plans, information. Literature free. P. Heintz, Papillion, Nebraska.

1000 MONEYMAKING Ideas, book 50c; literature free. Harvey Teepie, Decatur, Ind.

WHOLESALE 1937 Buying Guide, 132 page directory listing supply source of 500,000 articles. \$1 postpaid. Associated Products H-3, Box 694, Muncie, Indiana.

FREE Circulars describing hundreds money-making opportunities. Wyatt, Box 2322, Houston, Texas.

GIVE Away \$10.00 Clipshave Electric Razors free. Make \$5.00 profit each transaction. Novel, new, self starting proposition. Big money for live wires. Send 10c for sale-card and details. American Novelty Co., 1841 Broadway, New York City.

FREE Information describing novelty manufacturing business in your own home. Small investment. Large profits. Write at once. Woodcraft Service, Plainview, Minnesota.

15 NEW Money-making opportunities 15c. Sinclair, Box 861, Hollywood, Calif.

FREE! Profitable circular mailing instructions. Mailservice, 2231 McKinley, Berkeley, Calif.

BETTER Money making ideas and opportunities. Literature free. Barfield, Box 5032, Metropolitan Station, Los Angeles, Calif.

96 GUARANTEED Money-making formulas and ideas mailed, 50 cents coin. Clifford Dunbar, Osgood, Indiana.

SOCIAL Security triple plan, booklet 10c. Millions prospects. Stenger Publishing Co., 901 Bedford Bldg., Chicago.

GOLDEN Opportunity. Particulars, samples, 10c. Trader, 216 Degraw, Brooklyn, N. Y.

LAWN Mower sharpening made easy, plenty business everywhere. Write Engle & Wirt, West Burlington, Iowa.

"FINANCIAL Independence"—New dollar copyrighted book money making opportunities, formulas, ideas. Sample, with wholesale prices, quarter. Self-Help, Twin Peaks, California.

"PROFITABLE Ideas" Magazine. Six North Dearborn, Chicago, 50 pages, 10c. "Badger Advertiser," 3c.

SIGN, Showcard lettering. E-Z method. Instructions 25c. Blake, 1064 Woodcrest, New York City.

TURN Your extra minutes into extra dollars. Send stamp for details about cashable opportunities. Julius, Amarillo, Texas.

BIG Money—Quick results. No canvassing. Battery Exchange, P3-42 East End, Buffalo.

CASH Every week clipping and preparing news items for publishers. Simple, fascinating work. Experience unnecessary. Stamp brings information. Division 55, National Press, 3923 West Sixth, Los Angeles, California.

BOYS—Earn Elgin wrist watch. Sell ten 30c photo enlargements, keep \$1.00, send us \$2.00. "Bill's," Box 368 Bowling Green, Kentucky.

MASTER Key to numerous big paying home enterprises—"20th Century Business Encyclopedia," 144 pages. \$1.00 postpaid. nationwide money-making offers and sample "Mail Trade Guide" Magazine, 10c. Sanvov Service, Arlington, Kentucky.

RAISE Frogs, ginseng, girasol. Particulars free. Specialty Farm, Rockford, Minn.

WEALTH—Quickly and honestly made. One plan earned \$15,000 in a few days; another \$20,000 in eleven months. Plans are explained in every detail. "The Key to Business Opportunities," a thirty-six page book, shows you the way. Just send your name and it will come to you—free. Williamson Sales Co., 36-T Meridian Ave., Sweetser, Indiana.

EXTRAORDINARY Ideas! Nationwide propositions. Stamp. Evers, Box 66PC, Elmhurst, N. Y.

"SNAPPY Service" mail order market. 5c. P. Sidella, Pottsville, Penna.

FREE Literature explains how; make money through mails. Cutler Publishers, Reading, Penna.

PULL In the dollars with the "Money by Mail" system. Particulars free. R. Bowen Company, American Bank Building, Portland, Oregon.

107 PLANS For making \$20-\$100 weekly in home or office business of your own. Descriptive booklet free. Elite Co., 214 Grand Street, New York.

NEW "By Mail" distributing business. Free details. Dollar plan. "Building Mailing Lists" 10c. Merchants Sales, 617M North Second, Milwaukee, Wis.

FIFTY Money-making opportunities, 25c. Carl Greiner, 5112 N. Oakley Avenue, Chicago, Illinois.

TO Win success you must do something different; particulars free. Publishers Sales Company, Box A-76, Nelson, Georgia.

OPPORTUNITIES For money making. Summit Press, Box 123, Jackson, Mich.

MILLIONS Jobs! Get dollars in mail daily, like we do, for amazing employment information (got man 76 jobs). Keep money; we fill your orders free. Stamp brings details. Co-Operative Service, 77 Swan, Buffalo.

BIG Money at home plating auto parts, reflectors, mirrors, chandeliers, by late method. Experience unnecessary. Free particulars. Gunmetal Co., Ave. N, Decatur, Ill.

FORMULAS, PLANS, ETC.

BAR B-Q Sauce, hamburger relish. Sells your sandwiches. Two recipes \$1. Zehnder Sales, Phillipsburg, N. J.

GUARANTEED Formulas—New fast sellers. None better. Lowest prices. Catalog free. Kemico, 49C, Park Ridge, Ill.

FORMULAS—Latest, best selected sellers. List free. Persian Laboratories, Bay City, Mich.

FORMULAS—Newest, profitable, unexcelled. Write for special offers. Philart Company, Jefferson City, Missouri.

RECLAIM Oil drained from automobiles. Instructions fifty cents. Evans Agency, Montgomery, Ala.

ANALYSIS. Research. Newest guaranteed formulas. Biggest catalog free. Special prices, leads. Gibson Laboratory, Chemists, BD-1142 Sunnyside, Chicago.

AMAZING Formula information! "Lin-O-Uth" body invigorator. "Har-O-Uth" hair revivifier. Davis, Box 1484-A, Clarksburg, W. Va.

DOUBLE Your present income. Buy our up-to-date gold and silver mirror formula. Start making mirrors at once. Instructions complete \$10.00. Nashville Mirror and Sign Co., 179 3rd Ave., N., Nashville, Tenn.

ANY Formula 30c or money back. List free. Ogg's, Tampa, Florida.

BENZOLENE Crystals—Amazing non-explosive chemical cleaner. Formula 10c. Waldo, Box 266, Dallas, Texas.

PROFITABLE. Fast sellers—Best household remedies \$1. Tri City Service, Box 151, Davenport, Iowa.

KEEP Cool without ice. Ice-Ola artificial ice. Keeps food, drinks, etc., cool and fresh. No more ice bills. Few cents to make. Formula 25c coin. Samuel B. George, 285 E. Queen Lane, Philadelphia, Pa.

MONEY Detector. Detects counterfeit money instantly. Simple. Guaranteed. 25c. Morell, 1947 "S," Lincoln, Nebr.

MAKE Own products easy. Profitable. Sylco, 417-P, Downers Grove, Ill.

CASH In on the demand for cosmetics and products containing vitamins. Sensational sellers, big profit makers. Send stamp for list of tested formulas. Pickarts, 1525 W. 101 Street, Los Angeles, Cal.

CORRECT Formulas. Samples furnished, details free. Box 768, Waco, Texas.

FORMULAS—Money-making ideas. Literature free. Hoy Service, Valley Junction, Iowa.

CERTIFIED Formulas, best science can produce for making popular, biggest-selling specialties. All lines. Before buying formulas, get my valuable "Eye-Opening" literature, including free subscription to Miller's Monthly Messenger. Miller, Chemist, 1706-A, Tampa, Fla.

SUCCEED With your products. Make-sell them. Formulas. Processes. Accurate analyses. Catalog free. B. Thaxly Company, Washington, D. C.

FORMULAS—Latest money makers. Literature free. Belfort, 4012 N. Keeler, Chicago.

CHEMISTRY

MAGIC Chemical submarine, chemistry magazine, book of experiments, all for 10c. Clinton Chemical Company, Swedesboro, New Jersey.

FREE Literature, apparatus chemical catalog. Lower prices. Meshna, Malden, Mass.

RESEARCH. Experiments, magic. Three months subscription 15c. Spanners Chemistry Magazine, 100 Forsyth, New York.

25 CHEMICALS With experiments, 50c. Kayser Chemical, 5522 P. Ft. Hamilton Parkway, Brooklyn, N. Y.

RUBBER Latex. Dime brings literature, twenty experiments. Eastern Latex Labs., Box 64, Norfolk Downs, Mass.

FREE Chemistry catalogs. Supplies at 5c! Equip complete laboratory. Send 10c (returnable) for postage and handling. Kemkit Scientific Corp., 135P Johnson Street, Brooklyn, New York.

CHEMICALS. Laboratory glassware, apparatus. Send 3c for catalog CP. Biological Supply Company, 1176 Mt. Hope Avenue, Rochester, New York.

CHEMICALS In 5c quantities. Catalog 5c. Fleischer's Laboratories, Everett, Massachusetts.

HELP WANTED

MONEY In butterflies, moths. See Sinclair Display Advertisement on page 20A.

MEN Wanted for coffee routes. Earnings up to \$45 in a week. Automobile given producers as bonus. Write Albert Mills, 2247 Moonmouth, Cincinnati, Ohio.

USE \$500.00? Raise canaries for us. Free particulars. Canary Guild, 3741-B, 60th Street, Woodside, N. Y.

AGENTS WANTED

AGENTS—Lowest prices—Top profits on carded aspirin, razor blades, handkerchiefs, laxatives, shoe laces, etc. Details free. Better Products Co., Dept. 2730, Marion, Ind.

450% PROFIT In (1937) perfected automatic gas lighter. No flint or flame. Lights gas instantly. Retail 25c. Costs you \$1.00 a dozen or 15 dozen for \$8.00 postpaid. Sample 10c. New Method Co., Box PMG-51, Bradford, Pa.

500% PROFIT. Gold reflecting letters for store windows. Large sizes 1c. Free samples. Modernistic Sign, B-3004 Lincoln Ave., Chicago.

STRANGE Ironing cord. Saves electricity. Abolishes scorching and kinking. For telephones also. 150% profit. Sales guaranteed. Big free offer. Neverknot, Dept. 3-A, 4525 Ravenswood, Chicago.

\$6.85 HOURLY! Amazing No-Flatz fixes punctures without patching; makes tires puncture proof! Instantly—permanently seals holes made by nails, etc. Big seller. Free sample offer. No-Flatz, Dept. M-172, Cincinnati, Ohio.

AGENTS—New item for home, store, office. \$1 on every sale. Repeats! United Appliance, 173 Orchard St., Rochester, N. Y.

BIG Suds soap powder. Sample 5c. Manufacturer, 149 Collingwood, Detroit, Mich.

ASPIRIN Agents—Earn more in 1937 with Meills quality aspirin displays—12 tins 21c each; 36 tins 62c each; bottles 100 tablets \$1.20 dozen. Order today. Private Products Mfg. Co., Dayton, Ohio.

SELL Neon signs. Big profits. Free details. Wholesale Neon Supply, Sheboygan, Wis.

WHOLESALE Catalog free. 500 best sellers. Paty Co., 1167 Broadway, Somerville, Massachusetts.

MONEY In butterflies, moths. See Sinclair Display Advertisement on page 20A.

BIG Money applying gold initials on automobiles. Easiest thing today. Free samples. Also, sideline salesmen for name plates and tire cover transfers. "Ralco," 1084 Washington, Boston, Mass.

400% PROFIT In new self-starting no-flint cigar lighter. Retail 50c. Sample 25c. Get details quick on wonder seller. New Method Co., Box PM-51, Bradford, Pa.

AGENTS, Sales promoters, new fast medicine specialties. Big profits. Samples 25c. Damon Co., Geneseo, Ill.

MAKE Your own products. We sell formulas for highest quality toilet preparations, extracts and household specialties. Catalog free. Scientific Laboratories, 1950-W Broad, Richmond, Va.

CHIPPED Glass sign making; mirror re-silvering; metalware replating. Interesting. Profitable. Write Sprinkle, Plater, 128, Marion, Indiana.

5c WILL Make you \$1 profit. Free sample of product, free literature. Stanley Products, Lansing, Mich.

SELL Slogan signs. Free kit offer. Special Kut, Sidney, Ohio.

MAKE 212% Profit! Metallix—amazing new "metallic liquid" instantly, permanently repairs metal, wood, glass, leather, etc., without heat, acid or tools. Holds forever! Free sample. Write Metallix, Dept. M-313, Cincinnati.

AGENTS! Dresses 33c, men's suits \$1.50-\$2.00, shirts 46c, ties 63c, chiffon hose 42c. Amazing prices. Big profits. Catalogue free. Acme, AB-558W Roosevelt, Chicago.

MEXICAN Finest leather pictures, blankets, pottery, carved leather. Free particulars, samples 10c stamps. Apartado 1176, Mexico City, Mexico.

\$6.00 HOURLY. Amazing Karnu refinishes auto like new without rubbing, polishing, waxing or painting. Wines on with cloth. Lasts 8 to 12 months. Free sample. Karnu, Dept. M-8, Cincinnati, Ohio.

ATTENTION Hustlers, clean up. Costs 10c. Sells for \$1.00. For particulars write J. M. Jones, 724 W. Trade St., Charlotte, N. C.

MONEY??? Sell guaranteed, patented household appliance. 25c brings sample and proposition. Winco, Lodi, California.

500% PROFIT! Gold and colored sign letters for windows, offices, trucks, signs. Monograms. Easily applied. Neonite, Akron, Ohio.

500% PROFIT Selling new "20-in-1" kitchen utensil. Retail 25c. Costs you \$1.00 a dozen. \$7.20 a gross. Sample 10c. New Method Co., PMM-51, Bradford, Pa.

GENUINE Remington portable typewriter for 10c a day! Men wanted to take orders; unusual plan. Famous company will employ new field men. M. N. Rand, Remington-Rand, Inc., 315 Fourth Ave., Dept. C50, New York.

MAKE More money taking orders; shirts, ties, dresses, hosiery, raincoats, uniforms. Sales kit free! Experience unnecessary. Nimrod Company, Department 8, 4922-28 Lincoln Avenue, Chicago.

WOMEN Want "Handee Lingerie Drying Rack." Fits bath tub. Big profits. General Industries, Manufacturers Bank, Rockford, Illinois.

AMAZING New product plates real silver. Big profits—repeat sales. Write quick for free offer. Puritan Laboratories, 1612P Summit, Akron, Ohio.

BIG Profits selling powdered hand cleaners. Sell under your own name. Get our low bulk prices. Kleenslick Co., 1992 E. 5th, St. Paul.

AGENTS Get cash hourly. Thrilling new kind guaranteed silk hosiery plan. Start without experience. Full or spare time. Your hosiery free as bonus. Send size. Rush name. Wilknit, Desk 3R37, Greenfield, Ohio.

GOLD Reflecting window sign letters. Penny each. Large sizes. Easily applied. New styles. Absolutely beautiful. Free samples. Atlas Sign Works, 7941 Halsted, Chicago, Ill.

TRIPLE Your sales with amazing premium plan. Lifetime. 5927 Easton, St. Louis, Mo.

WE Teach you new business, then buy your product. Write Superior Specialties, Springfield, Illinois.

did not correct

NORWEGIAN-BALM Lotion—A goldmine for agents. Wonderful sales. Unusual lotion for household. Send \$2.50 for sample. Lema Company, Box 214, Arcade, N. Y.

KNITMASTER Knitting machine makes fabric for rugs, novelties, etc. New, profitable. Retail \$4.98. Literature and samples. Ainslie Co., 738 Grand St., Brooklyn, N. Y.

AGENTS. Start exterminating and sales business. Details free. Sanitary Products Company, Box 768, Waco, Texas.

SELL The Driving Master. Shows miles per gallon when driving. Analyzes motor. Described page 369 September Popular Mechanics. Driving Master Co., Sioux City, Iowa.

AUTOMOBILE Parking mirror. Clever new invention. Installed inside car. Prevents damaging fenders, hub caps, tires. Price \$1.00. Auto Parking Mirror Co., 728 S. Hill, Los Angeles, Calif. Sales agents wanted.

MEN—Women \$3 to \$6 daily. Selling 25c household necessity that repeats. Three to ten sold in every home. Free sample. Write Puro Company, 3107 Pine St., Dept. C-2047, St. Louis, Mo.

TRANSPARENT Neon-like signs. Cost 4c—retails 25c. 1000 designs. Sample and 1937 catalog free. Lowy, Dept. 701, 8 West Broadway, New York.

IF You want a wonderful opportunity to make up to \$7.50 in a day—get a brand new Ford sedan as a bonus—be your own boss, write for free details. I send everything you need. Positively no money risk. Albert Mills, 2250 Monmouth, Cincinnati, Ohio.

NEW Cleaner—Amazes everybody. Cleans everything. Washes clothes snow-white quickly. Spots, stains removed like magic. Startling demonstrator. Free samples make fast sales. Quick repeater. Immense profit. Write quick for "free sample." Super-X Cleaner Co., 11, Berwyn, Illinois.

SOCIAL Security ten year record book. Sample 25c. Triboro Distributors, 3105 30th Ave., Astoria, New York.

"ELECTRIC Powder" cleans, polishes silver, glass, nickel, automobiles, etc. Trial size 10c. "Neway," 513 Chestnut, Waukegan, Illinois.

625,000 ARTICLES For sale cheap. Lists 10c. Duffy, Covington, Ky.

MAKE 300%. New! Big demand! Kruff, 13048 Fountain, Springfield, Ohio.

PROFIT With new products. Make, sell, repeat. Analysis. Research. Guaranteed formulas. Biggest catalog free. Special prices, leads. Gibson Laboratory, Chemists, BD-1142 Sunnyside, Chicago.

SALESBOARD Men—New put and take jars. Details, samples free. Tom Thumb, Dept. PM, Nauvoo, Ill.

MEXICAN Feather pictures. Unusual novelty, 50c (stamps) bring \$2.00 worth samples, details. Refunded if unsatisfied. Mexican Art, Apartado 1593, Mexico City.

MONUMENTS, Markers, beautiful enduring granites \$8 up. Free catalog, samples. Agents wanted. Mihelich Monument Co., St. Cloud, Minn.

BUY Wholesale 1000 bargains. Catalog free. Products Company, Gary, Indiana.

BIG Money and fast sales. Every owner buys gold initials for his auto. You charge \$1.50, make \$1.45. Ten orders daily easy. Write for particulars and free sample. American Monogram Company, Dept. 40, Dunellen, N. J.

AGENTS: Smash go prices. Santos coffee 12c lb, 4-oz. vanilla 8½c. Razor blades 10 for 8½c. 100 sticks chewing gum 12c. 150 other bargains. Premiums. Experience unnecessary. Carnation Co., PO. St. Louis, Mo.

SELL—Blade conditioners—Smoother shaving, millions being sold. Marvelous. Order sample, details quick. Twenty-five cents. Charlton Corporation, Chicago.

SUCCEED With your products. Make-sell them. Formulas. Processes. Accurate analyses. Catalog free. B. Thaxly Company, Washington, D. C.

ENGRAVED Name plates, numbers, signs, etc., easily sold, profits large. Brett Bros., Winthrop, Mass.

MAN in each town to plate auto parts, reflectors, bathroom fixtures, refinish beds, mirrors, chandeliers, by late method; experience unnecessary. Simple plan of manufacturing at home starts you in big money making business. Free particulars and proofs. Gunmetal Co., Ave. H, Decatur, Ill.

FREE Sample—Amazing cleaner; sells homes, taverns, everywhere. Big profit—fast repeater. Betco, 5007 Irving Park, Chicago.

GENUINE Gold letters for store windows. Easily applied. Free samples. Liberal offer to general agents. Metallic Letter Co., 438-B North Clark, Chicago.

SELL Novelty fun cards, novelties, etc. Samples 10c. National, Box 500M, Cincinnati.

AGENTS: Stamping names on pocket-key protectors. Sample check with your name, address, 25c. Stamping outfits. Emblem checks, check-fobs, name plates. Hart Mfg. Co., 303 Degraw St., Brooklyn, N. Y.

AGENTS—Opportunity to make money; book containing 107 successful business plans; home or office; send for free introductory booklet. Elite Co., 214 Grand St., New York.

WANTED—District purchasing agents. No experience or money required. Write Purchasing Manager, 174 N. Halsted, Chicago.

COSTS 1c—Sells 25c. Make non-explosive cleaner from benzene crystals. 1c gallon. Sample 10c. Literature free. Western Reserve Laboratories, 6615 Denison Ave., Cleveland, Ohio.

DO You want agents for your proposition? Your ad in this space will place your message before hundreds of men seeking fast-selling products. My folder "How to Secure Agents" is filled with proof. I'll gladly send you a copy free. F. W. Johnson, Manager Classified Advertising, Popular Mechanics Magazine, 200 E. Ontario St., Chicago.

PROFITABLE Home business. Legitimate. No canvassing. Maywood Publishers, P-923 Broadway, New York.

FREE! 256 Page wholesale catalog showing 4000 fast sellers from all parts of world. Sporax Co., Le Center, Minn.

HIGH-GRADE SALESMEN

WANT A better income? Wonderful opportunity ambitious, intelligent men. No federal-state tax laws; social security act compel merchants to keep records, file returns, penalties severe! Two-year simplified system including social security records and tax service \$7.95; lowest commission each sale \$4; leads furnished. Protected territory. Amazing self-seller makes sales for you. Live wires average \$100 weekly commissions. Dept. PM-1, Income Record Publishing, 480 Canal, New York.

IMMEDIATE Openings for ambitious men! Wear, introduce "Fairbanks" tailored-to-measure clothes, make up to \$10 in a day. Experience unnecessary. Bonus suit offer. Low prices. Quick sales. Free outfit. Permanent! Fairbanks Company, 2278-A Wabasha, Chicago.

MAKE Big money taking orders for men's pants, uniforms, shirts, etc., smashing low prices. Dress pants as low as \$1.95. Biggest cash-in-advance commissions, extra cash bonuses. Free garments to producers. Free complete selling outfit. Rush name on penny postcard. Dunlap Pants Co., Dept. PM-37, Cincinnati, Ohio.

RURAL Men! Manufacturer wants men to take orders for low priced, high quality, guaranteed paint, guaranteed roof coating, motor and tractor oils, and greases sold on long terms. No down payment. Our men earning \$300 to \$800 per month (sworn statement). No investment. E. L. Carter, Box R4306, Fort Worth, Texas.

WE Want ventilating salesmen in every city to sell high grade low priced exhaust fans. Write us today and tell all about yourself. Erie Fan & Blower Co., 122 Church St., Buffalo, N. Y.

BIG Money selling advertising book matches. Amazing low prices. Wonderful full time or sideline. Liberal commissions paid daily. Free elaborate outfit. Regal Match Co., Dept. 53, Hamilton & Gladys, Chicago.

SELL Nothing! \$95.00 weekly. \$500,000 punchboard firm announces new, no investment plan. Season starting. K&S, Dept. C123, 4329 Ravenswood, Chicago.

AMAZING New Tuftwist made-to-measure pants. Smashing low prices. Biggest commissions. Extra cash bonuses. Free pants to producers. Make big money representing old established company. Handsome new spring selling outfit free. Rush name and address. Hutchins Pants Company, Dept. PM-73, Cincinnati, O.

SELL Celluloid and cardboard pricing tickets, steel shelf moulding, changeable signs, menu covers. Every store prospect. P. Pricing Press, 124 White St., New York.

STRANGE Chemical sponge cleans wallpaper like magic. Banishes housecleaning drudgery. Women amazed. Hustlers cleaning up. Details free. Kristee, Dept. 252, Akron, Ohio.

NEW Punchboard line. Free 32 page full color catalog. Nothing to carry. Larger cash commissions daily. Season now! Lea-Moore Co., 180 Adams, Chicago.

SALESMEN—Four \$15 sales to stores net you \$10 daily. Sayers Systems, Est. 1895, 2801-123 Sheffield Ave., Chicago, Ill.

YOU Get paid first. Take orders for 200 home necessities. Pay after you collect. Big profits. Write Ho-Ro-Co, 2792-R Dodier St., St. Louis, Mo.

BE Independent. Own your business; experience unnecessary, selling \$10,000 accidental death, \$50 accident; \$25 sick weekly benefits—\$10.00 yearly. Other amounts proportionate. Guaranteed steady renewal income. \$726,415.63 securities deposited. Universal Policy, 716-A Lefcourt Bldg., Newark, New Jersey.

SELL View post cards. Little competition. Big earnings. Dexter Press, Pearl River, N. Y.

BIG Advertising book match factory offers salesmen amazing full or part time opportunity. Big commission. G. B. made \$77 in 1 day. Fast repeater. Free kit. Match Corp. of America, Dept. E-3, 6041 Grand, Chicago.

NEW Punchboard line. Free 32 page full color catalog. Nothing to carry. Larger cash commissions daily. Season now! Lea-Moore Co., 180 Adams, Chicago.

SALESMEN, Canvassers, male, female, for new patented hot water bottle. Write. Richards Rubber Co., 288 Valley St., Providence, R. I.

SALESMEN, I make \$20.00 daily when I work. Merchants and consumers buy on sight. Write W. E. Bur-Lite, Hudson, Ohio.

MAKE More money taking orders; shirts, ties, dresses, hosiery, raincoats, uniforms. Sales kit free! Experience unnecessary. Nimrod Company, Department 65, 4922-28 Lincoln Avenue, Chicago.

NEW Invention, every market, hotel, cafe, and housewife a sale. 100% profit. Rose Co., 4803 South Sixth St., Louisville, Ky.

SELL Glas-Glo for windows, windshields. Glas-Glo, Phelps, N. Y.

MAN Wanted to supply Rawleigh's household products to consumers. We train and help you. Good profits for hustlers. No experience necessary. Pleasant, profitable, dignified work. Write today. Rawleigh Co., Dept. C-53-PPM, Freeport, Ill.

GOOD Long profit side or main line. Exclusive makers radiator stop-leak and flush. Zenith, 3635-S-Lyndale, Minneapolis, Minn.

REPRESENT Manufacturer — Automobile specialty. Write National, P3-42 East End, Buffalo.

MAN Wanted, by shoe manufacturer established 34 years, for sales work. Ready cash daily and extra bonuses to producers. No experience needed. Your own shoes at factory prices. Sales outfit sent free. Write Mason Shoe Manufacturing Co., Dept. F-8, Chippewa Falls, Wis.

SALESMEN: Sell business cards, lowest prices. Big advance commissions. Free samples. Write S. S. Specialty Company, 611 Madison Street, Oak Park, Ill.

FREE Suits and profits! Do you know a dozen or two men to whom you can sell fine, all wool made-to-measure suits if you show them big savings? If you do you can make easy money for yourself and get your own clothes free. No experience needed. Every garment guaranteed to satisfy. Beautiful outfit—100 big samples—free. Write today! Jim Foster, Inc., 2251-D S. Spaulding Ave., Chicago, Ill.

IMAGINE Going into stores, gas stations, etc., empty-handed and coming out with money in your pocket. New, powerful progressive sales stimulator. Merchants going for it. Fast, advance cash commission getter. Automatically repeats. Average 10 orders daily. Sales outfit free. Melnhardt, Dept. S-7, 18 E. Kinzie, Chicago.

AT Last a new idea in shirts. Rosecliff shirts are worn and endorsed by famous movie stars assuring latest, fastest selling styles. You can make big cash daily. Complete sample outfit free. Write today. Dept. P3, Rosecliff, 1239 Broadway, New York.

SALESMEN: Take orders—business stationery \$2.65 thousand, book matches, labels, salesbooks, pricing sets. Business cards. 35% comm. daily. Free deals. Sales portfolio free. David Lionel Press, Dept. RK, 312 So. Hamilton, Chicago.

NEW "Sellmore" pricing systems are wanted everywhere. Sellmore, Waynesfield, Ohio.

SELL Only (4) all wool suits to get yours without cost. No limit to number of suits you may earn. Prices \$15.95 to \$28.95. Zipper leather carrying case. Sample line free. No experience needed to make big money. All suits individually cut and tailored to measure. Satisfaction or money back guarantee. Three Star Clothes, Dept. 36G, 320 So. Franklin, Chicago.

RADIATOR Stop leak—Guaranteed; fast-selling winter item. Full line automobile tire accessories, with guaranteed 10,000 mile Tiger Grip tire patch. \$75 every week for salesmen-distributors. Write today. Economy Rubber Products, 816 Burkhardt, Dayton, Ohio.

COMPLETE Line private brand auto accessories for wagon jobbers. Exclusive territory. Merchandise stock investment required, with guarantee. W. E. Johnson & Co., Lincoln, Neb.

FLAVOR Concentrates. Add water. Sell large quantities bakeries, restaurants, etc. Concentrated Flavors, 417 First Avenue, Minneapolis.

SALESMEN: Sell advertising novelties, calendars, fans, thermometers, etc., for nationally known firm. Liberal commissions. Stanwood Hillson Corp., 21 Station St., Brookline, Mass.

WE Need experienced salesmen for a real money making article. Wide sales field with exclusive territory. Richmond Chemical Company, Silver Spring, Maryland.

NEW Specialty—Sells every business and professional man. Four \$15 sales daily pay \$280 weekly. Ferrell cleared over \$1,000.00 monthly. Write, F. E. Armstrong, President, Dept. PM, Mobile, Ala.

TRUCK Covers. Complete line waterproofed canvas. Thousands of trucks in your state constantly buying. Open price line. No competition. Michigan Tarpaulin Co., Grand Rapids, Mich.

BE Your own boss. Make the largest commissions selling our complete line of brushes. Write for sales plan. Wire Grip Sanitary Brush Corp., 220 Southern Boulevard, N. Y.

BRUSH Salesman—If you ever sold brushes write for our money making proposition. Donald Brush Co., Camden, New Jersey.

FREE Booklet describes 107 plans for making \$20-\$100 weekly, in home or office, business of your own. Elite Co., 214 Grand St., New York.

EDUCATIONAL AND INSTRUCTION

OPERATE A collection business. Be a credit-collection manager. Short course quickly teaches both. Fine income assured. Write Cole Associates, Syracuse, New York.

"SHORTHAND Simplified," complete \$1.00. Free lessons. Satisfaction. Simmons, Cromwell, Conn.

KNOCK 'Em cold. Learn police Jiu Jitsu. 13 secret knockout blows without fists. Illustrated course by world famous instructor. Price 15 cents. S. J. Jorgensen, 401 Maritime Bldg., Seattle, Wash.

SPECIAL—Complete up to date automobile course \$15. Bains, 1225 Scott, Kansas City, Kans.

SHORTHAND Brings opportunities. Free catalogue. Shorthand Institute, 6330a Clayton, St. Louis.

SUMMER Hotel positions. Instructions. Richard Lee, 176 Mystic, Somerville, Massachusetts.

AT Last Give yourself! a break. Learn forestry at home. Easy. Big salaries. Get new forestry book \$2.75. Wholesale Book Co., Box 305, Altoona, Pa.

BECOME An investigator—Secret service agent. New "Test Problem Method." Develops your ability. Particulars free. International Secret Service Institute, (PM37), Hoboken, N. J.

GOVERNMENT Social security jobs. For men and women, age 18-50. Are you interested in obtaining one? Write immediately for full information and how to pass entrance test, etc. Instruction Service, 101, St. Louis, Mo.

BOOKS Covering hundreds of subjects. Big catalog for 3c postage. Popular Mechanics Press, Room (C37), 200 E. Ontario St., Chicago.

WORK For "Uncle Sam." Many 1937 appointments. \$1250-\$2100 first year. Prepare now for next announced examinations. Influence unnecessary. Many social security jobs expected. Full particulars, list jobs and sample tests—free. Write today sure. Franklin Institute, Dept. A3, Rochester, N. Y.

BECOME Business investigator. Earn \$1.00 hourly, upwards—spare time. Experience unnecessary; we teach you. Details free. Business Detective System, 1009 Oak, Elmira, N. Y.

WELDING. Bumping, metal finishing, torch soldering, taught days, nights. Jobs open. Men from this school getting good jobs right now. Harper Training School, 8807 Harper, Detroit, Michigan.

AIR Conditioning and refrigeration offer greatest opportunities to progressive mechanically minded men. Write for information. Detroit School of Refrigeration and Air Conditioning, 4125 Grand River, Detroit, Mich.

WIN Civil Service position easily through help expert instructors. Graduates hold positions departments Washington, also customs, postal, field service, social security. Ten weeks' course. Prompt information. The Five Tutors, 4 Myrtle Street, Dover, New Hampshire.

BE A radio announcer. Learn at home. Free information. Write Radio Arts Academy, 3819 Wilshire, Hollywood, Calif.

LEARN To dance—Waltz, fox trot, tango, continental, Puccollo, truckin', collegiate steps by new chart method at home. Information free! Franklin Publishing Company, 890 North Clark Street, Dept. 2213, Chicago.

NEED Cash? Learn lettering mail \$1 complete course. Northeastern School of Lettering, Box 561, Bangor, Maine.

DIESEL Enthusiasts—Priceless training you can afford. Box 3361, San Francisco.

MEN Wanted willing to learn landscape designing and fill big paying position as landscape architects. Free test of your natural ability and chance to win in \$750 contest. No experience needed to start. Earn while you learn. Write today for free test blank. American Landscape School, 837 Plymouth Bldg., Des Moines, Iowa.

PSYCHICAL Culture Collegium, S-Whitley, Ind. Homestudy doctor degree. Worldwide enrollment.

HOME Study courses leading to degrees: Arts and sciences, philosophy, education, law, letters, theology, psychology, engineering, chemistry, business and commerce. Many others. McKinley-Roosevelt College of Arts and Sciences, Chicago.

SECRET Service. Particulars free. Write immediately. George Wagner, M-2640 Broadway, New York.

BIG Bargain catalogue educational matter 10c. Handline, Y-799 Broadway, New York.

HEALTHIAN Scientific divine healing. Wonderful proposition. Healthiana, 3137 Tiffin, Toledo, Ohio.

MASSAGE. Hydrotherapy, dietetics, drugless therapeutics, chiropody, taught by mail. Evans Correspondence School, Montgomery, Ala.

LEARN Machinist trade, tool, die making. Automatic and hand screw machines. Modern shop methods. Actual work. Jobs open for trained men. Employment help. Illustrated booklet free. Allied Screw Machine Company, 601 Lake Street, Chicago.

LEARN Auto mechanics, body, repairing, welding, electricity, refrigeration. Diesel. Steinson's, 2008A Main, Kansas City, Mo.

LEARN Latest methods solving arithmetical problems quickly. Frederick A. Smith, 2410 Smalley Court, Chicago.

U. S. GOVERNMENT Positions. \$1700-\$1900 and up a year. Let our expert (former government examiner) prepare you for a position in the railway mail service, rural carrier, post office, customs and other branches. Write today for free booklet. Dept. S, Patterson School, Rochester, N. Y.

PLAYS—STORIES—MANUSCRIPTS

CASH Paid for your story, folk lore, life, nature, legends, ballads, poetry, sports, gardening, sketches, cartoons, photographs, hobbies, puzzles, riddles, friendships, children's bright sayings, baby pictures, humorous stories, cooking and household hints, dogs and other pets, sparetime moneymaking ideas, school, club, church, lodge and benefits derived therefrom and other interesting stories pertaining to home life. Prizes and up to 4c per word will be paid for acceptable material. Send your material today to Home Life Magazine, 6304 Windsor Ave., Berwyn, Illinois.

POETRY: Revision, instruction, sales suggestions. Anton M. Romatka, 25 W. 3rd Street, New York.

STORIES Wanted for sales dept. Also arranging, typing, etc. Crown Service, 917 Shreve Bldg., San Francisco.

STORIES Revised, typewritten, and placed on the market. Details free. Hursh Service, Box 1013, Harrisburg, Penna.

CARTOONING AND COMMERCIAL ART

AMATEUR Cartoonists—Win \$25.00. No drawing ability necessary to win. 26 prizes in all. Rush name on postcard for valuable tips on "How to Make Money With Simple Cartoons," cash prize entry blank and rules. Send no money. Cartoonists' Exchange, Dept. C-93, Pleasant Hill, Ohio.

ATTENTION Professional artists and art students. The mystery of drawing solved. Twenty lessons producing immediate results. Entirely new system. Write Henri Seville Schools, 1530 North Western, Hollywood, California.

CHALK Talks. Laugh producing program. \$1.00. Catalog free. Balda, The Cartoonist, Oshkosh, Wis.

AMATEURS—Make cartoons quick, easy—guaranteed—guarded secrets of professionals. Don't delay. Instructions \$5.00. Amateurs Department, Box 560, Connellsville, Pennsylvania.

GAG Builder teaches how to create gags that sell. Big field. Big pay. Only course on gag writing. Simple, practical instruction, fully illustrated. Author Don Ullah markets your saleable ideas. Free criticism. Price \$1.00. Johnson Press, 443 Wrightwood, Chicago.

AMATEUR Cartoonists earn excellent income, spare time, duplicating cartoons for advertisers. 3-M Service, Argyle, Wisconsin.

18 LESSON Sign course \$1.00. Chalk talking 50c. "Vocational." 3555 Aberdeen, Alton, Ill.

NATIONAL Cartooning Magazine free, sales tips, prizes. Cartoon Publishers, West Springfield, Mass.

CARTOONING Course:—30 lessons, over 500 illustrations, drawing pens and pencils, \$1.00 complete. Scovell Studios, Box 748-P, Hollywood, Calif.

CARTOONING, Sketching, etc.—40 lessons, 600 illustrations, including practice sheets, pens, pencils, \$1.00 complete. Fraba Service, Cashon, Wisconsin.

BOOKS Covering hundreds of subjects. Big catalog for 3c postage. Popular Mechanics Press, Room (C37), 200 E. Ontario St., Chicago.

ADVERTISING AGENCIES

INCH Display advertisement 30 magazines year \$24. Wood's Popular Services, Atlantic City, (N. J.)

LEARN Advertising quickly at home. Easy practical plan. No text books. Common school education sufficient. Interesting booklet and requirements free. Page-Davis School of Advertising, 3601 Michigan Avenue, Dept. 3431, Chicago.

ADVERTISE: 24 Words in 250 newspapers \$10. Lists free. Advertising Service Bureau, 4258-C Drexel, Chicago.

ADVERTISING Placed anywhere. Helpful, free service. Rate guide book free. Baker Advertising Agency, 189 W. Madison, Chicago. Successors to Ankrum Advertising Agency. Established 27 years.

ADVERTISE Profitably: \$15 reaches 6,000,000 Sunday newspaper readers with 24 word ad. Newspaper, magazine rate-guide, free. Chicago Union Agency, 20 West Jackson, Chicago.

FREE—New Advertisers Rate Guide. 44 pages. Includes everything. Lowest rates. E. H. Brown Advertising Agency, 140 S. Dearborn, Chicago.

FOR ADVERTISERS

500 PENCILS. Your advertising, \$10.50. Sample 5c. Ad-Craft, LaCrosse, Wis.

DRAWINGS. Lettering, trademarks, letterheads drawn. Send for pricelist. Wilford Glotfelter, Springvalley, Ohio.

24 WORDS. 45 Newspapers \$2.00. Write, Goodall, 742 Market, San Francisco.

25 WORDS. 25 Magazines, three months \$1.50. Empire, Shawano, Wis.

ADVERTISE—3c Word. Meriden Magazine, Des Moines, Iowa. 10,000 circulation. Sample 10c.

BUSINESS SERVICE

MISSING People located. National Agency, Box 3504, San Francisco.

INFORMATION Where to buy anything! Correct addresses of reliable manufacturers, wholesalers. \$1.00. King Buyer's Service, 564 Delaware, Buffalo, N. Y.

NEW York mail address. Business, personal. \$2.00 monthly. Bachman, 507 Fifth Avenue. (42nd Street.)

BOSTON Business-personal mail address, \$1.00 month. Service, 315 Atlantic Ave., Boston, Mass.

CHICAGO! Business-personal mail address, representation, forwarding; \$1.00 month. Established 1919. General Business Service, 56 West Washington.

DELAWARE Charters: Complete incorporating and organizing service \$35. Submitted forms. Chas. G. Guyer, Inc., Wilmington, Delaware.

ALL International legal matters. Lic. Victores Prieto, Mexican Attorney at Law, P. O. Box 122 M. Juarez, Mexico.

RUBBER STAMPS AND OFFICE SUPPLIES

NAME, Address, 2 lines 25c; 3 lines 35c. Stamp Works, Auburn, Nebr.

OFFICE Supplies—rubber stamps. Premiums. Catalog. Sylco, Downers Grove, Ill.

2 LINES 25c, 3 Lines 35c. Stamprite, FP43, Springfield, Mass.

CUSHION Mounted, one-two lines 25c, three 35c. Signatures \$1.50. Stamp Works, 814 Bradley, Peoria, Ill.

2 LINES 25c, 3 Lines 35c. Stamp Works, Centerport, N. Y.

TYPEWRITERS, DUPLICATORS, OFFICE DEVICES

NEW \$4.75 Automatic adding machine. Fully guaranteed. Bassett, Box 302A, Altadena, California.

3 TYPEWRITER Ribbons \$1.00. Lewis, 413 W. State, Milwaukee, Wis.

TYPEWRITERS, Duplicators, multi-graphs. Write for free list office machine bargains. Save half. Pruitt, 518 Pruitt Bldg., Chicago.

INCREASE Business. "Excelligraph" rotary stencil, clay and film duplicators \$3.85 to \$37.50. Prints anything. Typewritten, penned, drawn, traced. Colors. Folder free. Pittsburgh Typewriter Supply, Suite 518, Pittsburgh, Pa.

PRINTING, MULTIGRAPHING, MIMOGRAPHING, GUMMED LABELS

BETTER Printing. Lowest prices. Specials on labels and tags. 2000 cards \$2.50. Card case, 1000 envelopes \$1.95. 1000 statements, letterheads \$2.50. Fein Bros., 116 Clymer Street, Brooklyn, N. Y.

PICTURE Your product on penny postcards in color. New process prints 5 colors in 1 impression. No cuts needed. Very low cost. Samples free. Burgess, 173 W. Madison, Chicago.

PRINTED Blotters, fine advertising medium. 500, \$1.50 up. Free proof service. Cherokee, Southern Pines, N. C.

\$1.85—1000; LETTERHEADS, Envelopes, circulars. Samples. Midwest Printing, Northfield, Minn.

2000 BUSINESS Cards, \$2.00 postpaid. Heyl, 800 Livingston, Cincinnati, Ohio.

294 LETTERHEADS, 5½x8½; 150 Envelopes; three lines; dollar, 10c extra west Mississippi. Perry Printer, Lafayette, Ind.

500 ¾x2¼ FOUR Line gummed stickers, 25c. Moritz Printery, Saginaw, Mich.

1000 EMBOSSED Letterheads, envelopes, statements, \$3.95. Charles Harmon, Chester, W. Va.

WEDDING Invitations. Samples, prices. Drachprint, 1619 Hogan St., St. Louis, Mo.

1000 ARTISTIC Gummed stickers, 4 lines, 50c. Cott's, Spickard, Mo.

1000 CARDS \$1.50; 1000 Statements \$2.50. Olsen, 1551 Southeast Powell, Portland, Oregon.

ENVELOPE Slips, 3x6, \$1.50 thousand. Thomas Gwynn, Printer, Adrian, Michigan.

250 LETTERHEADS, Envelopes, statements, or cards—\$1.00. Globe, Pottstown, Penna.

CHROMO—Mimeo—Multigraphing properly processed, illustrated, displayed, attracts attention; brings results. Summers Letter Shop, Jasper, Florida.

STATIONERY. Foreign, American types. Inexpensive. Samples. Croydon, 100 Fourth Avenue, New York.

ENVELOPES, 1000, 6¼, \$2.25. Samples. Specialty Sales, 3065 - 5th, Chicago.

1000 BUSINESS Cards \$1.25 prepaid. Hall, 1505 E. 52nd St., Los Angeles.

ENVELOPES! Thousand 6¼ postpaid, \$1.85. 2,000—\$2.95. Samples free! Nu-Print Co., Binghamton, N. Y.

BETTER Grade printing, reasonable priced. Free samples. Economic Press, Leonia, N. J.

FREE Samples name on envelopes, paper. The Democrat, Somerset, Penna.

125 BUSINESS Envelopes, 200 notesheets \$1.00. Becker Bros., Portchester, N. Y.

500 TWO-COLOR Howard bond letterheads \$3.75; 500 6x9 bills \$2.50; 500 6¼ envelopes \$2.50. Press, Jamestown, Ind.

1000 BETTER Grade business cards \$1.50 postpaid. Harris Printing Co., Lawrenceburg, Tennessee.

\$1.00 SPECIAL—1000 3x6 Circulars, 100 word limit. Postpaid. Hustler, Advance, Indiana.

SEND Dollar bill, 1000 business cards prepaid. Woodprint, Woodstock, Virginia.

PRINTING! 1000 Business cards \$1.00. Cycle Press, Lawndale, Calif.

GUMMED Shipping labels 5,000, \$6. Patterson, 305E Southern, Springfield, Ohio.

ECONOMY. Quality—Distinctive printing. Get our prices, samples. DPress, Box 103, Station W, Brooklyn, N. Y.

KEEP With prosperity with Hall's distinctive stationery! Samples! Hall's Printing, Dalton, Massachusetts.

LABELS. Amazing values. Color samples free. 6618K Quinby, Cleveland, Ohio.

TRIAL 200 Hammermill letterheads \$1.00 postpaid. Race Printery, Hudson, N. Y.

1,000 3¼x5½ PRINTED Adcards \$1.89; 5,000, \$7.95. Samples. Comstock, Charlestown, New Hampshire.

RAISED Letter printing. 100 letterheads—100 envelopes—\$1. Perry Press, Albion, Maine.

500 WHITE Envelopes \$1.00. Morey Press, 87 Somerset St., Springfield, Mass.

6x9 CIRCULARS, Letterheads, envelopes, postcards, \$2.95 1000; envelope slips, \$1.75. Half price large quantities. Samples. Goodprint, Harrisonburg, Va.

LETTERHEADS—1000, \$2.00. Hammermill bond \$3.00. Jennings-Pohle Press, Dept. B, Honesdale, Penna.

LETTERHEADS—Heavy bond 8½x11, envelopes, 100 each \$1.00. Evans, 44PM North Tenth, Reading, Pa.

500 ENVELOPES And 500 whitebond letterheads, \$3.00. Webpress, Farnham, Ind.

2000 BUSINESS Cards neatly printed \$1.50. Quick service. Free samples. Atlas Distributing Co., 1814 Bedford Ave., Pittsburgh, Pa.

LABELS—All kinds. Write, samples. JBSCO, Box 93, Holyoke, Mass.

500 LETTERHEADS, Envelopes, statements \$1.10; 1,000, \$2.00. Samples. Raymond's, Newport, New York.

PRINT Your own. Bargains, presses, type. List 3c. Exchange D-14, 22 Orient, Meriden, Conn.

1000 BUSINESS Cards, card case, \$1.50. Miller, Printer, Ambler, Pa.

CUTS 2x3, \$1.10, from drawings and photos. Joe Rek, 118 Gazette Ave., Lexington, Ky.

PRINTING OUTFITS AND SUPPLIES

FOR Sale—Most complete line of type and supplies in the West, new and used. Many bargains now. Get free catalogue and lists. Mocerental Type Fdry., Wichita, Kan.

NEW Type 29c font. Catalog dime. National Type Co., Jackson, Michigan.

HAND Press, type and complete printers' supplies. Advise equipment you need and we quote prices; or send stamp for catalog. P. Peiffer, 8 B; 6 Columbia St., Newark, N. J.

LONG Established amateur printers warehouse. Lists 3c. Landis, Richland, Pa.

PAPER—Wholesale prices 3c. Samples 10c. VanDorn Paperstocks, Ottawa, Illinois.

PRINT Your own cards, stationery, circulars, advertising, etc. Save money. Easy rules furnished. Print for others, big profits. Junior press, \$5.90; job presses, \$11, power \$19. Write for details. Kelsey Co., A-11, Meriden, Conn.

BARGAINS—Presses, type, supplies. Send stamp. 159 Harvard, Cambridge, Mass.

PRINTING Outfits—Presses, type, supplies, type novelties. Send 20c for card case samples. Catalog free. Model Press, York, Pa.

BARGAINS, Presses, type. List 3c. Exchange D-15, 22 Orient, Meriden, Conn.

PATENT ATTORNEYS

INVENTORS: Send immediately for your copies of our new free books, "Patent Protection" and "Suggestions on Selling an Invention." Sixty-eight pages of interesting facts. They tell how patent laws protect you; kind of sketch or model needed; simple steps to take without cost; how successful inventors have secured financial assistance; show interesting inventions; illustrate important mechanical movements. With books we also send free Evidence of Invention form to help establish date of disclosure. Prompt service, reasonable fees, special deferred payment plan. Strictest secrecy. Thirty-six years' experience. Highest references. Write us today. The facts in our books are worth money to the man with a good invention. Address: Victor J. Evans & Co., Registered Patent Attorneys, 900-C Victor Building, Washington, D. C.

SELL Your unpatented ideas. We tell you how; help you make the sale. Particulars free. Write W. T. Greene, 976 Barrister Bldg., Washington, D. C.

PRACTICAL Inventions now salable before patenting. What have you? Write Chartered Institute of American Inventors, Dept. 4B, Washington, D. C.

DO You feel you have a valuable invention—but can't get it before the right people? Are you groping in the dark—wondering which way to turn—getting nowhere? Learn how other men with inventions have cashed in. Write for our free book, "Patent Guide for the Inventor," which tells you of fields where inventions earn big money if they are good patented ones. Clarence A. O'Brien and Hyman Berman, Registered Patent Attorneys, 58-T Adams Bldg., Washington, D. C.

PATENTS—Proper service for manufacturers and individual inventors. Established 1895. Reasonable charges. Consult Chandlee & Chandlee, Patent Attorneys, 902 F. Street, Washington, D. C.

PATENTS—Personal, confidential services for protection of your invention at reasonable cost. Preliminary information and approximate cost of patent furnished without obligation. John B. Thomas & Co., 902 F Street, N. W., Washington, D. C.

PATENTS—Trade marks—Personal service, reasonable charges. Preliminary advice, book and disclosure form free. Irving L. McCathran, 1060 International Bldg., Washington, D. C. Registered Patent Attorney.

INVENTORS—Send for free booklet "Patent-Sense." Information based on 64 years experience. Lacey & Lacey, Dept. 5A, 635 F St., Washington, D. C.

L. F. RANDOLPH, 302-B Victor Building, Washington, D. C. Low cost. Book and information free.

PATENTS. Protect your idea by securing free "Proof of Invention" folder. Exceptional personal service. Established 1906. E. E. Vrooman, 871 Woodward Building, Washington, D. C.

PATENTS. Instructions "How to Establish Your Rights" and form. "Evidence of Conception"—sent free! Lancaster, Allwine & Rommel, 411 Bowen Building, Washington, D. C.

PATENTS. Booklet free. Highest references. Best results. Promptness assured. Watson E. Coleman, Patent Lawyer, 724 Ninth St., Washington, D. C.

"INVENTOR'S Guide," 100 mechanical movements, free; advises on patenting, selling inventions. Frank Ledermann, Tribune Bldg., New York.

THEODORE H. Rutley, Registered Patent Attorney, 512 Colorado Bldg., Washington, D. C.

FOR INVENTORS

INVENTORS: Send immediately for your copies of our new free books, "Patent Protection" and "Suggestions on Selling an Invention." Sixty-eight pages of interesting facts. They tell how patent laws protect you; kind of sketch or model needed; simple steps to take without cost; how successful inventors have secured financial assistance; show interesting inventions; illustrate important mechanical movements. With books we also send free Evidence of Invention form to help establish date of disclosure. Prompt service, reasonable fees, special deferred payment plan. Strictest secrecy. Thirty-six years' experience. Highest references. Write us today. The facts in our books are worth money to the man with a good invention. Address: Victor J. Evans & Co., Registered Patent Attorneys, 901-C Victor Building, Washington, D. C.

DRAWINGS And specifications expertly prepared. Ten years' experience. Low prices. Quick, confidential service. Robert E. Baird, 635 F Street, N. W., Washington, D. C.

TURN Your invention into money. Astounding facts show you the way. Free. Box 12, Cantil, Calif.

TO Inventors: We are in the market to purchase a good patent, preferably a small item made of metal. Will purchase outright or royalty. Purchasing Agent, 241 Front St., New York, N. Y.

DO You feel you have a valuable invention—but can't get it before the right people? Are you groping in the dark—wondering which way to turn—getting nowhere? Learn how other men with inventions have cashed in. Write for our free book, "Patent Guide for the Inventor," which tells you of fields where inventions earn big money if they are good patented ones. Clarence A. O'Brien and Hyman Berman, Registered Patent Attorneys, 58-T Adams Building, Washington, D. C.

PERPETUAL Motion experiments. Prints and data for one experiment, send \$1.00, four experiments \$3.00. My own original motions, I think nobody has ever conceived them. E. Tillert, 1012 Albert St., Racine, Wis.

INVENTORS: "Making Inventions Pay," our 32-page illustrated book, mailed upon receipt of 3c postage. Crescent Tool Company, Dept. Z, Cincinnati, Ohio.

INVENTORS—Send for 72-page book on patents. Reasonable terms. Conscientious treatment to inventors. L. F. Randolph, Registered Patent Attorney, 302-E Victor Bldg., Washington, D. C.

UNPATENTED Ideas can be sold. We tell you how and help you make the sale. Particulars, with list of manufacturers and wanted inventions sent free on request. Write W. T. Greene, 944 Barrister Building, Washington, D. C.

I SELL Patents. Established in 1900. Charles A. Scott, 775PM Garson Ave., Rochester, N. Y.

SELL Your patent through a small classified ad in Popular Mechanics. Many inventors have found buyers in this way. Ask me for proof—I'll gladly send it to you. F. W. Johnson, Manager, Classified Advertising, 200 E. Ontario St., Chicago.

FREE Information about new magazines for inventors who want more profit from their ideas. Write "Successful Inventions," 800 Barrister Bldg., Washington, D. C.

HAVE You a sound, practical invention for sale, patented or unpatented? If so, write Chartered Institute of American Inventors, Dept. 4A, Washington, D. C.

INVENTOR'S Universal Educator; contains 900 mechanical movements; 50 perpetual motions; instruction on procuring and selling patents and selecting an attorney, etc. Suggests new ideas. Price \$1.00 postpaid in U.S.A. Address Albert E. Dietrich, 511-B Colorado Bldg., Washington, D. C.

INVENTIONS WANTED

SMALL Inventions wanted by manufacturers. I'll help you sell your invention. Stanley Hull, K-7829 Euclid Avenue, Cleveland, Ohio.

INVENTORS—Small ideas may have large commercial possibilities. Write us for free book, "Patent Guide for the Inventor" and "Record of Invention" form. Delays are dangerous in patent matters. Free information on how to proceed. Clarence A. O'Brien & Hyman Berman, 58-V Adams Building, Washington, D. C.

LEGITIMATE Buyer interested in invention. Address F. E. Armstrong, Mobile, Ala.

WE Successfully sell inventions, patented and unpatented. Write for proof, and tell us what you have for sale. Chartered Institute of American Inventors, Dept. 4-C, Washington, D. C.

INVENTIONS Wanted—Patented, unpatented. If you have an idea for sale, write Hartley's, Inc., Box 928-E, Bangor, Maine.

PATENTS FOR SALE

PORTABLE Tire spreader will handle truck and bus tires. Also United States and Canadian patents for portable tire spreader. W. H. Dalrymple, Brucefield, Ont., Can.

FOR Sale—Patent rights, portable sander (belt type). N. Degen, Mason City, Ia.

END Mattress—Attaches to foot hospital bed. Removing pressure from feet. Elizabeth Tottenham, Brownwood, Texas.

PATENT For sale—Wire fence crimper. Used for taking up slack and tightening fences. Never on market. For particulars write D. D. Dean, Rensselaer, Indiana.

ENGINE Temperature control apparatus for combustion engines. Mr. Merl F. Pasco, Viborg, South Dakota.

SHUFFLEBOARD. Fascinatingly improved. Opportunity for controlled enterprise. United States and Canada. Patents, copyright. Theo. Reichard, 724 Central, Alameda, California.

PATENTED Up the sleeve tear gas gun. Endorsed by scientific experts, manufacturing dies, outright or royalty. Elmer Carlstrom, 4852 South May, Chicago, Ill.

AUTOMATIC Strainer—Patents pending. Outright or royalty. Terms reasonable. Box No. 15, Boldman, Ky.

NEWLY Invented hoe, every gardener needs. Will sell patent. J. R. Blocher, Box 608, Oklahoma City, Okla.

MANUFACTURING

WANTED—Sheet metal products to manufacture. Accurate Manufacturing Works, 2434 Milwaukee Avenue, Chicago, Illinois.

DIES, Stampings, light manufacturing, development engineering. Hagstrom Model & Tool Works, Kansas City, Mo.

CORPORATION, Amply financed having excess facilities for manufacturing heavy metal specialties in Illinois, Ohio and New York will contract production your specialties; especially interested in new devices. Van Auker-Ragland, Inc., Room 1130, 20 N. Wacker Drive, Chicago, Ill.

MANUFACTURING, Dies, machinery, models, brasswork, white metal casting moulds. Catalog 3c. Baum's Metal Specialties, Kansas City.

INVENTIONS Manufactured in any quantity at low cost. Stampings, dies, models, etc. Estimates and free catalog. Crescent Tool Co., Dept. X, Cincinnati, Ohio.

MODELS AND MODEL SUPPLIES

LOCOMOTIVES. Steam working models to 1/2 and 3/4 inch scales. Castings rough or machined, and prints. Finest quality products with 15 years reputation. Send 6 cents for lists. H. J. Coventry, 2701 Talbot Rd., Baltimore, Md.

MARINE Model builders supplies. Ships, yachts, speedboats. Catalogue dime. Welcher, Fulton, N. Y.

FREE! Illustrated circular. Listing 40 engines. Locomotive castings. Supplies. Stamp required. Howardco, A-2417 N. Ashland, Chicago.

INVENTIONS—Small ideas may have large commercial possibilities. Write us for free book, "Patent Guide for the Inventor," and "Record of Invention" form. Delays are dangerous in patent matters. Free information on how to proceed. Clarence A. O'Brien & Hyman Berman, 58-V Adams Building, Washington, D. C.

STEAM Driven locomotives with electric heater, "0" gauge and standard gauge, steam exhausts from smokestack with thrilling realistic effect. Illustrated catalogue complete locomotives, also parts, 25c. 14" illustration of 4-6-4 Hudson type on heavy cardboard with parts to cut out and assemble and operate to demonstrate valve, piston and running gear operation. Complete with eyelets, punches and riveting tool, 25c. Steam Electric Co., Bloomfield, N. J.

BIG 96-Page model engine catalog, postpaid 20c. Particulars free. Ervaymesco, 28 No. Clinton, Chicago.

POWER Modelers—Read Modelmaker Magazine. Current sample 15c. Special big buy, 25 assorted back issues, \$1.00. Model steam locomotives, gas engines, power boats, stationary engines. Box 196-P, Wauwatosa, Wis.

MECHANICAL Models, new and novel. Popular Mechanics has developed accurate models in the mechanical field. Those now ready are Wright "Whirlwind" Airplane Engine, Ocean Liner "Europa" and Modern Passenger Locomotive. Every part clearly shown and the name given. Invaluable to students and all who are mechanically inclined. \$1.00 each postpaid. Popular Mechanics Press, Room (C37), 200 E. Ontario St., Chicago.

3/4" SCALE Locomotive easily built by "Step" method. Latest catalog of castings, boiler fittings, track material, etc. 25c (coin). (Returned on first order). Little Engines, Box B15, Wilmington, Calif.

MODELS, Stampings, and special machinery. Send for catalog of brass gears and model supplies. The Pierce Model Works, Tinley Park, Ill.

SHIPS—18" Flying Cloud, Constitution or Galleons. All materials including easy plans only \$1.50. Catalog 15c. Hancock, 323 Douglass Ave., Portsmouth, Virginia.

POWER Models, locomotives, steam, gasoline engines, accessories. 80 page catalog 35c. Chas. Cole, Ventura, Calif.

RAILWAY Models. Catalog handbook 25c. Walther, 1584 West Pierce, Milwaukee.

MODELS—Your ideas developed into practical working models. 30 years' successful experience; thousands of satisfied customers. Confidential service guaranteed. Bank references. Send 3c postage for 32-page book—"Making Inventions Pay." Crescent Tool Company, Dept. Y, Cincinnati, Ohio.

HOME CRAFTSMEN

WESTERNERS: Venetian blind supplies at real savings in time and shipping costs. Woodcraft Shop, San Rafael, Calif.

20 FULL-SIZED Lawn ornament prints 25c. 20 full-sized silhouette patterns 25c. Modern Woodcraft, Saginaw, Michigan.

IMITATE Petrified objects by crystallization process. Interesting instructions dime. Joseph Sine, 323 South 8th East, Salt Lake City, Utah.

BUILD Bird houses. Make your workshop pay. Literature free. Albert Publishing Company, 14, Barrington, Illinois.

KNO WOOD, Wood study kit. 24 wood pieces, 24 plates, descriptions, \$1.00 postpaid. Springer, 402 E. Wisconsin, Milwaukee, Wis.

"MODERN Wood sculpture." Complete instruction book on carving statues \$1.00. Lee, Wood Art Studio, Centerville, Ia.

BASEBALL Game for children or adults. Plans, fifty cents. Young, 943 East 57th, Indianapolis, Indiana.

LEATHERCRAFTSMEN—Write for free instructions and price list of leather, tools and beginners' kits. Send 5c for sample cards. Address Wilder & Company, Dept. F, 1638 Crosby St., Chicago, Ill.

HEAVY-DUTY Jigsaw, home workshop shaper, drum sander and 458 other practical articles in Vol 28 Shop Notes only 50c postpaid. Popular Mechanics Press, 200 E. Ontario St., Chicago.

OLD GOLD, WATCHES, JEWELRY, PRECIOUS STONES

5000 HUNTING Waltham, Elgin watches. New chromium engraved open face cases. Make big money! 16 size, 7 jewel, \$3.75; 16 size, 17 jewel, \$6.25. Send 3c stamp for free catalog. New plan. The New York Jobbers, Dept. M, 74 Bowery, New York, N. Y.

LEARN Watchmaking, instructions free with tools. Bargain tool, material, movement catalog 5c. Stewart's, Carleton Building, St. Louis, Mo.

GOLD \$35.00 Ounce. Ship old gold teeth, crowns, jewelry, watches—receive cash by return mail. Satisfaction guaranteed. Free information. Dr. Weisberg's Gold Refining Company, 1593 Hennepin, Minneapolis, Minn.

CASH For old gold, teeth, watches, jewelry, 100% full cash value mailed day shipment received. Satisfaction guaranteed or articles cheerfully returned. Information free, or ship today. Chicago Gold Smelting Company, 300P Champlain Building, Chicago.

BEAUTIFUL Australian opals. Sample \$1.00. Interesting catalogue post free. Norman Seward, Melbourne, Australia.

HOW To identify and determine value of old precious metals. Where to buy. To whom to sell. Reliable and up-to-date information. Complete instructions only \$1.00 postpaid. Popular Mechanics Press, Room (C37), 200 E. Ontario St., Chicago.

FOR THE HOME

ARTISTIC Glass bud vases 35c (coin) each. Glastube Products, Box 5446, Los Angeles, California.

SENSATIONAL Offer! Hand-engraved name plates. Free circular. Acme Engraving Shoppe, 211 Roby Avenue, East Syracuse, N. Y.

BOOKS Covering hundreds of subjects. Big catalog for 3c postage. Popular Mechanics Press, Room (C37), 200 E. Ontario St., Chicago.

TOBACCO

POSTPAID Mellow red leaf chewing, 10 lbs. \$2.00. Smoking \$1.75. Absolutely guaranteed. Albert Hudson, Dresden, Tenn.

GUARANTEED: Cigarette, pipe or chewing, 5 lbs. \$1.00; ten \$1.75. Pay when received. Pipe and box cigars free. Rives Tobacco Co., Paducah, Ky.

BUY At wholesale prices by mail—Cigarettes, cigars, tobaccos. All brands. No tax. Postal naming your favorite brands brings low wholesale prices. Moberly, Box 1016, Owensboro, Kentucky.

HIGHER Quality! Milder, golden yellow smoking or rich ripe chewing, four pounds, postpaid, \$1.00. Riverside Ranch, Hazel, Kentucky.

RAZORS—BLADES—SHARPENING

BRAND New machine for grinding, sharpening razor blades. Only \$1.25. John Deegan, 506 Liberty St., Newburgh, N. Y.

RAZOR Blades for less, save half. 150 brands. Premiums with orders. Details free. Samples 10c. Joseph Kowalski, Haydenville, Greensburg, Penna.

SURVEYING INSTRUMENTS

GUARANTEED Factory rebuilt transits and levels for rent (with purchase option) or sale (cash or terms). Order now before prices advance. We will repair, trade in, or buy your old instruments. Ship prepaid for estimate and valuation. Write for List M-23 and complete information to Warren-Knight Co., 136 N. 12th St., Philadelphia, Pa.

WANTED—MISCELLANEOUS

WANTED—Offers, quotations, particulars suitable for mailorder business and various lines. Dinkelaar, Driehuis (Velsen), Netherlands.

CASH For used microscopes, binoculars, slide rules, drawing sets, cameras, surveying, medical and scientific instruments, tools, marine equipment. Highest prices paid day shipment received. Satisfaction guaranteed or shipment promptly returned. Elman's, 2302 Van Buren, Chicago.

PERSONAL

CASH'S Woven names. For marking men's, women's, children's clothing. Free sample. Ouimette's, 1007A Water, New Bedford, Mass.

RID Yourself of dandruff. Improve hair growth. Particulars free. Trable, 528 Garfield, Chicago.

STUTTERING And stammering corrected at home. Descriptive booklet free. Paul J. Wolfe, Box 52, Pittsburgh, Penna.

BE Alert, be alive, acquire that spark that drive all Topnotchers possess. Particulars free. Edw. Johnston, 257 North Washington St., Tiffin, Ohio.

HEALTHFUL Tan! Dollar of common material builds suntan lamp giving infra red and ultra violet rays. Simple! Rush 50c for plans. Box 21, Dorchester Center, Mass.

ENJOY Sound sleep, drink Amazon Mate', natural beverage, refreshing, non-acid, stimulating. Millions in South America use Mate' daily. Sample (20 cups) 10c. Write for details. Meyart, Box 1305X, St. Louis, Mo.

MISSING Persons located. Attorneys Service Bureau, 70 Chapel Street, Albany, New York.

MISCELLANEOUS

SPONGE Rubber "Bo-tie"! Resembles velvet—wears like iron. 50c. "Start Chile Parlor" 60c; stamps. Suchan, Alpha, Minn.

CHIPPED Glass sign making; mirror resilvering; metalware replating. Interesting. Profitable. Write Sprinkle, Plater, 288, Marion, Indiana.

MONEY In butterflies, moths. See Sinclair Display Advertisement on page 20A.

AIRPLANE Wrecks! Interesting, educational photographs, 2 for 25c. Lynnpelcher, 2030 Julian, San Diego, Calif.

TRADE Useless articles for useful. Swapper, 3808 - 12th Ave., Brooklyn, N. Y.

BIG Pay removing corns. Start free. D. Nash, 1465 - 9th Avenue, Huntington, W. Va.

BULL Fight playing cards, oils by Ruano Llopiz. Send one dollar. Anything from Mexico. Fdo. Montes de Oca, Apartado 2686, Mexico City, Mexico.

KITT'S: The game of thought. New. Modern. Fun. Deluxe, handpainted sets. Very attractive. A bargain. Order now. Satisfaction guaranteed. \$3.00 plus postage. No C.O.D. Kitt's, Box 655-M, Los Angeles.

GEORGIA Paper shell pecans, special offer, 10 lbs., \$2; 5 lbs., shelled pecans, \$2. W. J. Davis Pecan Company, Valdosta, Georgia.

MONUMENTS \$9 Up delivered, erected, guaranteed. Thousands sold. Catalog free. Marble Granite Factory, A-17, Oneco, Fla.

ALASKA—Send stamp for information. Homesteading, fishing, mining. Alaska Information Bureau, Juneau.

1000% PROFIT. Manufacture novelties. Set 35c. Mango, 496-8 16th, Newark, N. J.

SWAP Or sell articles you don't need. Get those you want. Send dime for Swapper's Guide, listing articles from all over United States. Dept. PM, Swapper's Guide, Delphos, Ohio.

FREE—13 Screamingly funny letters with 75 popular cowboy songs, 25c. 200 world-famous recitations, 50c. Empire Novelties, Peterboro, Canada.

COIN Slugs \$1 hundred, postpaid. Baum's Specialties, Kansas City, Mo.

AMATEUR Tattooing outfits, illustrated catalog 6c. "Tatuco," 651A South State, Chicago.

CUTS Anybody can make. Zinc etching process. Specimens, particulars, testimonials for stamp. J. C. Day, Windfall, Ind.

HAWAIIAN Carress perfume, novelty bottle \$1. Lei sachet 25c. Box 2273A, Honolulu.

COCOONS, Butterflies, collectors' supplies, butterfly art materials. Free lists. Maynard, 1192 Lewiston, Rochester, New York.

WANTED—Hear from parties interested gold or silver ores, buried or hidden treasures. Bergman's instrument \$5.00. Particulars free. Henry Bergman, Box 398P, Springfield, Missouri.

BRONZE Tablets, desk plates, wall plates, memorials, grave markers. Bronze, brass and aluminum casting. Wandkey Pattern & Foundry Co., Anderson, Ind.

SWAPPER'S Friend, R4, Saline, Michigan. Interests swappers, collectors, sportsmen. 50c year, sample 10c.

Get One of These NEW JOBS ★ With The ★ U.S. Government

Forget strikes, layoffs, hard times! Work steady for Uncle Sam. Good pay. Vacations. PENSIONS. Automatic raises.

START AT

\$1260 to \$2100 a Year!

Get \$48 to \$80 every pay-day! Age 18 to 50. No special education or experience usually necessary. Extra Social Security jobs expected soon.

Steady Work—Short Hours—PENSIONS

Select job you want. Tested method will help you pass Examination. FREE Book tells how.

MEN—WOMEN

Liquor Gauger, Stenographer Meat Inspector Custom House	Office Clerk Typist Accountant File Clerk Income Tax Auditor
--	---

FREE BOOK

"How to Secure a Government Position" sent Free, no obligation.

Arthur R. Patterson, Civil Service Expert, Principal, PATTERSON SCHOOL, 83 Case Bldg., Rochester, N. Y.

Send FREE Book, list of jobs, salaries.

Name.....

Address.....

If under 18, check here for special booklet "A."

Diesel... the NEW POWER



The amazing performance of the Diesel powered Burlington Zephyr trains has opened a new era of power efficiency. Airplanes, automobiles, great industrial plants will soon be using these marvelously efficient engines. This means a new profession, a new trade for thousands of men. Learn Diesel operation, construction and repair NOW through our brand new quick reference cyclopedia.

5 Big Books Shipped FREE

for examination. If you want to get into the most promising new field of the century, the liveliest, most up-to-date, most talked of profession, send for these books on our amazing free shipment offer. Over a thousand pages profusely illustrated and right up to the minute. Examine these books, read them, test them and if not thoroughly satisfied return them at our expense and you won't owe us one cent.

➔ Consulting Membership Included

Send now and we will include without extra charge a one year consulting membership in the American Technical Society with privilege of consultation with our engineers on any difficult problem.

AMERICAN TECHNICAL SOCIETY

Drexel at 38th Street, Dept. 0319, Chicago, Illinois.

You may send me the new 5 volumes on Diesel Engineering for ten days free examination. I will pay the few cents express only. Will examine the books and return them in ten days unless I decide to keep them, in which case I agree to send you \$2.00 in ten days and \$3.00 a month until the introductory price of only \$15.90 is paid.

Name.....

Address.....

City..... State.....

Please attach a letter giving age, occupation and the name and address of your employer and that of at least one business man as reference.

NOW I KNOW WHAT FRED MEANT WHEN HE SAID HE GOT HIS PAY BOOST OUT OF A TWO DOLLAR BOOK.



PAY RAISING EXTRA MONEY BOOKS THAT WILL HELP YOU WIN SUCCESS

You, too, will find the selected list of practical books below just what you need to help you improve your job, prepare for a better one, or add to your income through spare time earnings. Thousands give these books credit for their success.

SEND NO MONEY! Use this advertisement as an order blank. Check books wanted. Add name and address and mail. Just pay postman price plus few cents postage. (In U. S. and possessions.) Or remit with order and add 10 cents per book for postage.

POPULAR MECHANICS PRESS
Room 337B 200 East Ontario Street Chicago

- AIR CONDITIONING**
Live Field; Great Future.....\$3.50
- AUTO ENCYCLOPEDIA**
The Famous Dyke's Latest Edition.....\$6.00
- 110-V. GENERATORS**
Made From Old Auto Units.....\$1.00
- BIRD HOUSES**
Build to Sell; Easy Designs.....\$1.00
- BLUEPRINT READING**
for the Building Trades.....\$1.25
- BOAT BOOK**
Power, Sail, Rowing, Paddle Plans.....\$3.00
- BOY MECHANIC**
Hundreds Things Boys Can Make.....\$2.00
- BUILT-IN FURNITURE**
Take Orders, Make Money!.....\$2.50
- CARPENTRY, PRACTICAL**
Complete 436 pages. 1936 Edition.....\$2.00
- CHEMISTRY, PRACTICAL**
Make Hundreds Things Daily Use.....\$2.00
- DIESEL HANDBOOK**
New! Latest Information.....\$5.00
- EGG FARMING**
Profitable Production Eggs, Poultry for Market.....\$2.00
- ELECTROPLATING**
Modern Practice Including Nickel, Zinc, Cadmium and Chromium.....\$2.25
- FURNACE HEATING, WARM-AIR**
Every essential covered. 568 pages...\$3.00
- V-8 FORDS**
Also "A" and "B" Models. All New!.....\$2.50
- FORMULAS**
10,000 Money Making.....\$4.00
- FROG INDUSTRY**
New! Raise and Sell Profits!.....\$1.00
- FURNITURE MAKING**
Tools, Materials, Designs.....\$2.50
- HYPNOTISM**
How to Become an Expert.....\$2.00
- LATHE WORK (Metal)**
Drilling, Threading..\$1.00
- LOCOMOTIVE**
Folding Chart Shows all Parts.....\$1.00

- LOG CABINS**
Easy Plans; Build for Profit, Value!.....\$2.50
- MATHEMATICS**
Easy Guide for the Practical Man.....\$1.50
- MECHANICAL DRAWING**
Learn Drafting; Good Salaries.....\$1.00
- MONEY MAKING IDEAS**
1000 Ways to Make \$1000.....\$2.50
- MOTOR CAR TRAILERS**
How to Build.....\$2.00
- OIL HEATING**
Handbook Just Out.....\$3.50
- PLUMBING**
500 Facts Every Homeowner Should Know.....\$1.50
- TEST GOLD—PLATINUM**
Identify—Buy—Sell. By C. M. Hoke....\$1.00
- PROSPECTORS' HANDBOOK**
How to Mine, Appraise, Equip.....\$3.00
- RADIO SERVICING**
Profit by Knowing Costs, Kinks, Etc. \$4.00
- REFRIGERATION**
Electric. Gas. Be a Service Expert.....\$5.00
- REWINDING ELECTRIC MOTORS**
Fractional Sizes. Value!.....\$2.50
- SHIP MODEL**
Entire Text, Famous "Sovereign" of 1637.....\$1.00
- SHOP NOTES LIBRARY**
5 Vol. 2000 Wonderful Shop Ideas.....\$2.50
- STAMP ALBUM**
Modern, 400 Pages...\$1.00
- STEEL SQUARE**
How to Figure Angles of Rafters, Roofs, Etc.....\$1.00
- TELEVISION**
New! Book of the Hour.....\$2.50
- TOYS**
For Amusement or Profit. Saleable Designs.....\$1.50
- UPHOLSTERY**
Always a Big Market. Start Own Business.....\$2.00
- WELDING ENCYCLOPEDIA**
Covers all kinds welding thoroughly...\$5.00



NOW—IT'S SCIENTIFIC CRIME DETECTION

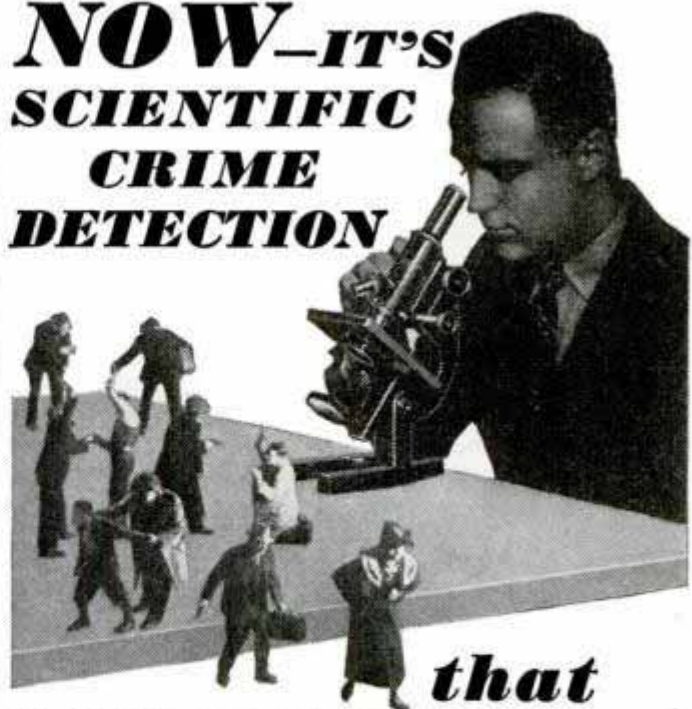

that PAYS BIG REWARDS

New Easy Training Endorsed by Experts Prepares You For
BIG EARNINGS

The Nation's cry these days is for scientifically trained investigators. Never before has there been such an opportunity for young men scientifically trained as at the present time.

Study At Home—Advanced Education Or Previous Experience Not Necessary

This new training is not difficult. No deep book or technical data. Anyone 17 to 70 eligible. A little time each day qualifies you for big earnings in most fascinating profession on earth. Course includes every important branch of crime detection. Only course in existence that offers combination of the Science of Finger Prints, Secret Service and Private Investigation, Identification of Handwriting, Secrets of Defense and Attack, and Police Photography, ALL IN ONE GREAT COURSE!

Easy Terms—Big Regulation Outfit Free To Students

Write for easy terms policy enabling you to secure this scientific training with practically no sacrifice. You train with regulation police equipment and employ methods used in finest equipped bureaus of identification. Internationally famous leaders in police world endorse this training. Instructor a nationally known expert in scientific crime detection. Private industry also now demanding scientifically trained experts. Now is your opportunity to get into this new fascinating field.

FREE TO ANY YOUNG MAN 17 OR OVER
Send today for big new book, "Get Into Scientific Crime Detection," including 14 famous scientifically solved cases. This free book tells how and why you can earn big money in this great profession. Fill in coupon—mail today sure.



SCIENTIFIC CRIME DETECTION INSTITUTE of AMERICA, Inc.

Dept. 2C37 Chesapeake and Ohio Bldg. Huntington, West Virginia
J. T. BURDETTE, President

SCIENTIFIC CRIME DETECTION INSTITUTE of AMERICA, Inc.
Chesapeake and Ohio Building Huntington, West Virginia Dept. 2C37
Gentlemen: Without any obligation whatsoever, please send me your big book containing 14 famous scientifically solved cases, together with full particulars on how I can get into SCIENTIFIC Crime Detection.

Name.....
Address.....
Age.....

There's Quicker, Bigger MONEY for YOU in POULTRY RAISING!



Wherever You Live—Whatever You
Do Now—Extra
Money Can Be
Yours This Year



Spare Time or Full Time YOU Can Cash-In BIG

Instead of knocking at your door, Opportunity is waiting for you in your back yard! Thousands have turned to Poultry Raising for PART TIME EXTRA MONEY or FULL TIME BIG PAY. Many start off in just a small way—with a back-yard or vacant lot flock. My profit-producing methods will make only a few hens pay. No matter what you're doing now—I will show you how to start and keep going successfully. Eggs and poultry meat are commanding high prices—prices that mean a handsome margin of profit on every egg or bird you can produce. There's not a doubt about it—YOU CAN CASH-IN BIG. I'll PROVE that I can put YOU among the big money makers—QUICK.

My Proved Methods Assure Success Right from START

All the "mystery and guess work" are taken out of poultry raising by my sure, tested, proved methods. My home study course, produced by eighteen famous experts and endorsed by thirty leading Agricultural Schools, puts in your hands the success-secrets of leaders. Satisfaction absolutely guaranteed, if you follow our methods. Decide now to get into this fascinating, healthful, profitable business. Be your own boss—make extra money in your spare time—or qualify for a fine salary in one of the big established poultry plants. From now on, let the other fellow pay YOU the fancy prices—Become depression-proof.

FREE BOOK EXPLAINS

My big, new, free book, "How to Raise Poultry for Profit" will amaze you! Brings absolute proof of what my course and training have done for thousands of others. My 44 years' experience as Commercial Poultryman and former Senior Poultryman in the U. S. Dept. of Agriculture is yours to use and profit by. Get in line for QUICKER, BIGGER MONEY. Don't delay a day. Get this coupon into the very next mail.



Egg Profits Up 100% Says Mrs. Alice Roberts. Mrs. Alice Roberts, Four Bush, New York, recently wrote: "Since taking your course, I have increased my egg profits 100% and cut my feed bill over 10%. Am also breeding prize winning birds. My success is due entirely to you."

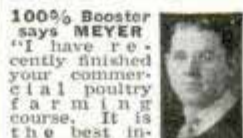

100% Booster says MEYER. "I have recently finished your commercial poultry farming course. It is the best investment a person can make that is interested in poultry raising." So says Harvey Meyer and many others.



32 Pages
of Money-
making FACTS

Get this FREE Book NOW!

Harry M. Lamon, President,
The National Poultry Institute,
Adams Center, N. Y. Dept. 37-B.

I want to know how to make big money raising poultry. Send me your FREE book explaining your home-study course and PROVED methods.

Name

Address

City.....State.....

When writing please mention Popular Mechanics

Two Giant Industries NEED MEN NOW!



AIR CONDITIONING ELECTRIC REFRIGERATION

We supply trained men for America's two fastest-growing industries. If you can meet our requirements, we will train you in spare time at home for a good pay position as an Installation and Service Expert in the Electric Refrigeration and Air Conditioning fields. In addition we will give you ACTUAL Shop Practice when you graduate, and help you to qualify for profitable employment with an exceptionally bright future.

Can You Qualify?

To be acceptable for enrollment you should be mechanically inclined, between ages of 18 and 40, have fair education and be able to furnish character references.

GET FREE BOOK

Get amazing facts about actual opportunities for ambitious men in Air Conditioning and Electric Refrigeration. Our new Free Book describes these money-making opportunities and tells about our lowest, easy-pay plan of training. Write for your copy today stating age and which industry interests you most. No obligation.

UTILITIES ENGINEERING INSTITUTE (Established 1927)
400-10 N. Wells St. Dept. 137 Chicago, Ill.

ENGINEERING



Get a Bachelor of Science Degree! Complete courses and fully accredited degrees in Aeronautical, Architectural, Chemical, Electrical, Industrial and Mechanical engineering. Modern equipment. All college activities. Low tuition. Write Registrar today for full information and catalog.

LAWRENCE INSTITUTE
OF TECHNOLOGY
15102 Woodward,
Detroit, Mich.

A NON-PROFIT
COLLEGE

CATALOG
ON REQUEST



"BECOME A LIGHTNING TRICK CARTOONIST"

Send \$1.00 for Laugh Producing Program of 23 Trick Drawings with Instructions. Catalog of Chalk Talk Supplies FREE-BALDA ART SERVICE, Dept. 1. Oshkosh, Wis.



LOOK! Baby Chicks THOUSANDS WEEKLY ALL YEAR

Finest quality & Layers in 40 breeds. Hybrid Baby Pullets and Cockerels, B. W. D. Tested. 25 lbs. feed FREE with each 100 chicks. Ducklings, Goslings, Baby Turkeys, Guinea. Mature Breeders priced right. In business 27 years, Catalog free. Nabob Hatcheries, Box M, Gambier, Ohio.



ITALIAN ACCORDIONS

HAND MADE. Very best. Lowest prices. Direct from Factory Representative. Send your name and address for FREE catalog. ITALIAN ACCORDION COMPANY 323 W. POLK ST., DEPT. P-5, CHICAGO, ILL.

TO YOUNG MEN— STENOTYPY THE WAY TO SUCCESS!

Stenotypy, the new profession, offers unusual opportunities to ambitious young men. It's a man's way of recording speech in this machine age—a silent little machine that types plain printed letters faster than any one can talk. It opens up preferred jobs now—leads to executive careers later. One of the surest, quickest ways to get into Business on the right basis.

Now you can learn Stenotypy at home in your spare time. Low cost—easy terms. Get full details. Write for valuable, free booklet, "Stenotypy, the New Profession," describing the unusual opportunities for young men in this growing field and telling how you may enter it successfully. Write Dept. 364-ST THE STENOTYPE COMPANY 4101 S. Michigan Ave., Chicago, Ill.





EASY to play

With an easy playing Conn band instrument, you can be ready for band or orchestra in 4 to 6 weeks. A sure road to popularity if you start on a Conn. Choice of the world's greatest artists. Magnificent tone. Many exclusive features—yet they cost no more.

Ask to see the marvelous new models now being displayed by Conn dealers.

WRITE FOR THIS NEW FREE BOOK

Home trial. Easy payments. Write us for free book on whichever instrument interests you most. Mention instrument.

C. G. CONN, LTD., 331 CONN BLDG. ELKHART, IND.

CONN
BAND INSTRUMENTS

More GOOD JOBS in DRAFTING NOW!



Draftsmen are the **MEN IN DEMAND** today!! Upturn in business means new construction work, machines, buildings, and repairs. And . . . before anything can be made or built, it must first be put on paper by the *trained draftsman*. If YOU want to get in on the ground floor of this new boom, and prepare yourself for a good job—*start now!*

Draftsmen have a wide field in which to specialize—air-conditioning, Diesels, architecture, construction, and hundreds of other lines . . . all are open to men with Chicago Technical College training . . . the kind of training executives everywhere recognize and demand. **CLIP AND MAIL THE COUPON BELOW for further information and a**

FREE



WELL-PAID WORK

LESSON IN DRAFTING

Drafting is clean, interesting professional-type work. It pays well to start . . . offers real opportunities for promotion. You need no previous training or experience . . . no special talent—to learn Drafting. It is one of the *steepest* employment fields. No machine ever did the Draftsman's work . . . and no machine can be invented. So your job is *secure*.

Learn at Home in Spare Time!

You can master DRAFTING by the easy step-by-step C. T. C. Method in your spare time at home (or you can attend the College in Chicago). We help you, lesson by lesson, just as though one of our expert faculty members were at your side . . . and when you have completed the course, *we help you get a job*. Tuition is exceptionally low and can be arranged in convenient monthly payments.

When you become a C. T. C. student you will receive, *at no extra cost*, a complete drawing outfit of professional draftsman's tools, including a folding drawing table and set of high quality instruments. Send now for

TRIAL LESSON in Free DRAFTING

Sample this easy-lesson system of learning Drafting. Send post card or this coupon. No charge now or later for this **FREE LESSON**. Prove to yourself how easy it is to learn Drafting by the C. T. C. Method.

FREE TRIAL LESSON

CHICAGO TECHNICAL COLLEGE
CHICAGO TECHNICAL COLLEGE

C208 Tech Bldg., 118 E. 26th St., Chicago, Ill.

Send me FREE BOOK as checked below. No obligations.

DRAFTING—in Spare Time—AT HOME.

DRAFTING, at Chicago Tech—IN CHICAGO.

Name..... Age.....

Address

P. O. State.....

Other C.T.C. money-making training by home-study shown below. Check one of these if you prefer it to Drafting.

Air Conditioning and Refrigeration. Builders' Course for Carpenters and Builders.

BECOME A VENDING MACHINE OPERATOR!

Own a "chain" of 1c peanut and chewing gum vending machines. Large, steady profits, as people eat peanuts and chew gum daily. Start with \$100. Write for details today!

D. ROBBINS & CO.
1141P DeKalb Ave. BROOKLYN, N. Y.

SHORTHAND IN 30 DAYS

Boyd, the wonderful easy system, 150 words a minute guaranteed. Send today for catalog and sample lessons.

CHICAGO HOME STUDY SCHOOLS
801 Reaper Block Chicago, Ill.

POTATO CHIP BUSINESS PAYS BIG! Buy potatoes 2c lb.—

make Sensational new "Greaseless" Potato Chip and sell for 35c a lb. Big money spare or full time. No experience needed. I tell you how to get stores to sell for you—how to make profit first day. Small investment buys complete equipment. Write for FREE FACTS today!

G. H. Hardt, 325 W. Huron, Dept. C-53, Chicago.

In answering advertisements always write name and full address clearly.

New Pocket Radio

Operates Without Tubes, Batteries or Electric Connections

Amazing midget radio fits in pocket or purse. NEW MODEL weighs only 3 ozs. as shown in ACTUAL photo! Smaller than a cigarette package! Separates and receives stations with beautiful clear tone. Range to 50 miles—MUCH GREATER under good conditions—no noise! Employs new Hi-efficiency fixed crystal. Not to be confused with cheap imitations. Tunes broadcast band. NOT A TOY, but an unusual practical radio—a sensation everywhere—a delight to anyone every way. Comes in several beautiful colors.

(state yours). ABSOLUTELY COMPLETE ready to listen with midset phone and instructions to use in hotels, offices, camps, at home, in bed, on sea or wherever you may be. TAKES ONLY A SECOND TO CONNECT—no messy hookups. THOUSANDS OF SATISFIED OWNERS—many report wonderful service in ALL PARTS OF THE WORLD! THESE ARE FACTS! Carry one with you always and be assured of many hours of entertainment AT NO COST! Can be used by ANYONE—even a child! Send only \$1.00—pay postman balance or send \$2.99 (M. O., Cash, Check). WE PAY POSTAGE GUARANTEED. A most unusual value. Foreign orders 75c extra.

TINYTONE RADIO CO., Dept. P-3, Kearney, Nebr.

SEND ONLY \$1.00

**This
MACHINISTS'
Home-Study
Course**



helps men get ahead

Newly assembled—specially priced—these five recent books give you the practical facts on modern machines, up-to-date methods, you need to advance in machine shop work. Take advantage of the other man's experience as found in books, to solve your problems, increase your efficiency, with the new

**Library of MODERN
MACHINE SHOP PRACTICE**

5 volumes—2000 pages—1600 Illustrations
(A combined home-study course and reference library)

This library of machine shop practice was written for practical men. It gives you the best methods for every kind of machine shop work. It fully explains lathes, drills, and other machine tools and their operation, automatic screw machines, speeds and feeds, gear design and production, punch and die work, metal finishing, etc., etc. Plainly written—completely illustrated—the best kind of help to the machine-shop man who wants to advance himself.

No money down—special price—easy payments.

FREE EXAMINATION COUPON

McGraw-Hill Book Co., 330 W. 42nd St., New York
Send me for ten days' free examination the Library of Modern Machine Shop Practice. If satisfactory I will send you \$1.50 in 10 days and \$3.00 monthly until the price of \$16.50 is paid. If not wanted, I will return the books postpaid. (To insure prompt shipment write plainly and fill in all lines.)

Name

Home Address

City and State

Position

Name of Company

**NEW ELECTRIC
LIBRARY**

\$ 1.50 A VOLUME

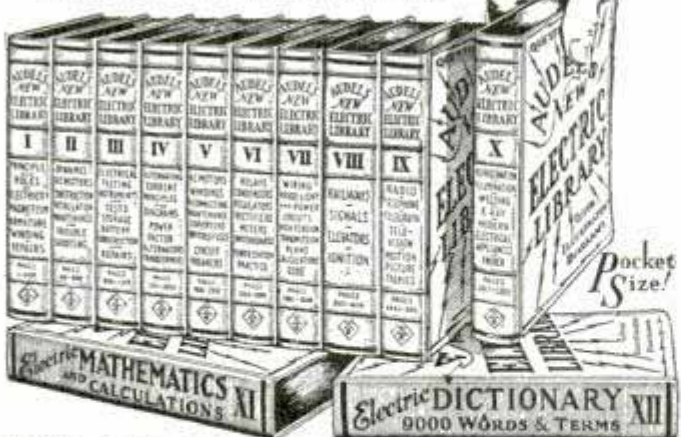

WHAT EVERY ELECTRICIAN WANTS TO KNOW!

is easily found in AUDEL'S NEW ELECTRIC LIBRARY. Electricity made simple as ABC. Up-to-date, trade dope for the expert and ALL electrical workers. Questions, answers, diagrams, calculations, underwriter's code; design, construction, operation and maintenance of modern electrical machines and appliances FULLY COVERED.

All available at small cost, easy terms. BOOK-A-MONTH service puts this NEW information in your hands for 6c a day. You can start your subscription with any volume. Write TODAY for electric folder and FREE TRIAL offer.

THEO. AUDEL & CO., 49 W. 23rd St., New York City

Mail Vol. I, Electric Library on 7 days' free trial. If O. K. I will remit \$1.50, otherwise I will return it. I also request you to mail one book each month on same terms. No obligation unless I am satisfied.

Name

Address

Occupation

**AIR
CONDITIONING
OPPORTUNITY
QUALIFY FOR GOOD JOBS QUICKLY?**

**BIG MONEY-MAKING OPPORTUNITY IF YOU LEARN TO
BE AN EXPERT IN AIR CONDITIONING NOW! ACT!!**

Think what tremendous success, fame, fortunes were reaped by the alert, aggressive men who pioneered the automobile, the airplane, the radio when those industries were young, just on the threshold of universal recognition. You now have greater opportunities if you have the right stuff in you in Air Conditioning. Don't wait a year and be too late for the big jobs. The industry is clamoring for trained men. Be an Air Conditioning Expert. Learn in 6 months by Home Study! Act Now!

FREE COMPLETE DATA! WRITE TODAY!
Address letter to J. J. STRANG, President

AIR CONDITIONING INSTITUTE of AMERICA
Dept. A-3, FAIRFAX BUILDING KANSAS CITY, MISSOURI



WELDERS WANTED!

Electric Arc-Oxy-Acetylene

Welding, America's 7th largest industry, has created thousands of new opportunities. Learn this highly paid trade in 4 to 7 weeks by actual shop work. Taught by oldest, largest, most reliable welding school. Free employment service, or start your own business. 4 weeks course in Electric Arc or Acetylene Welding, including room and board only \$150. Start any time. Write

for "Welding Facts." State age.

GREER COLLEGE, 2025 S. Wabash Ave Chicago, Ill.

**PHOTO-ENGRAVING LEARN IT
AT HOME**



We Furnish all equipment and materials including large photo-engraving camera complete with lamps, lens and screen. When you have finished the course you can establish a good paying independent business with the equipment furnished or work for others at a big salary. Photo-Engraving offers greater opportunities today than any other industry. Every picture in this issue of Popular Mechanics was engraved by the process we teach you. Earn good money while learning. Write today for our new illustrated catalog which was engraved on equipment such as we furnish. You will not be obligated in any way by writing Aurora School of Photo-Engraving, Dept. 137, Aurora, Mo.

A copper plate to print above picture size 3 by 10 inches sells for \$16.37.



Trailer Travel Magazine

If interested in trailer lore, as owner, builder, buyer or prospect, you want the only magazine devoted exclusively to trailer news, stories, features, designs and plans; touring and camping; laws, and directory. Profusely illustrated. The Trailerite's guide. 10c For 12 issues mail \$1, or for sample copy

TRAILER TRAVEL, PM3, 35 E. Wacker Drive, Chicago, Illinois



CARTOONING COURSE \$100

A simple, complete, practical course in cartooning, of 30 lessons, with over 500 illustrations, including drawing pens and pencils. \$1.00 postpaid.

SCOVELL STUDIOS, Box 748, Hollywood, Calif.



**The NATURAL
EYESIGHT SYSTEM Gives
Your Eyes a New Deal**

If you wear glasses, or think you should, our FOUR MONTHS' TRIAL OFFER—containing the inspiring story of glasses discarded for Nearsight, Farsight, Astigmatism, Old Age Sight, Eyestrain, Weak Eyes, Eye Muscle Trouble, Etc., as told by USERS AT HOME of this Revolutionary System—will be mailed FREE upon request.

NATURAL EYESIGHT INSTITUTE, INC.
Dept. 73-C Los Angeles, Calif.

DRAW-O-MATIC DRAFTING BOARD
 ALWAYS READY—ALWAYS SQUARE

ACCURATE. SELF-ALIGNING. SLIDING PARALLEL-BAR



NOW A PROFESSIONAL BOARD AT A REASONABLE PRICE. Speeds up drawing. Eliminates the Old-Fashioned T Square. Ideal for Draftsmen, Artists, Engineers, Architects, Estimators and Designers.

STURDY CONSTRUCTION. Board made of specially treated Fiber Composition which will not Warp, Crack or Chip. No Thumb-Tacks necessary. FOOL-PROOF Mechanism. Rubber Feet prevent slipping and marring. Plated metal parts. No sharp edges. A self contained unit EASY TO CARRY. Attractively finished. Will last a lifetime. Three sizes: 12x16 in. at \$2.50; 16x19 in. at \$3.50; 20x24 in. at \$5.00 plus postage. Shipping weights, 4, 6 and 9 lbs. Send Money-Order. Free Circular. Money back guarantee.

ROLLIN PRODUCTS CO., Dept. P3, 212 W. Hubbard St., Chicago, Illinois

GAG-CARTOON!
 AND MAKE BIG MONEY!



Magazines pay up to \$200.00 per cartoon. Get in this new field and be your own boss! My 50 lesson—1000 illustration course shows you how. Markets included— **\$280** only course of its kind. All for... **\$280** Free Drawing Set if you act at once. Stamp brings free details.

MOON GAG-CARTOON SCHOOL
 Paramount Bldg. Dept. A, Fall Creek, Wis.

JOBS FOR THOUSANDS



New opportunities open. Calls are increasing for men trained in **Drafting, Air Conditioning, Electricity, Housing, Engineering or Radio.** Choose your position if you have C. T. C. training. Free help to job when ready. No time to lose—start training now. B. S. Degree or shorter courses. 34th year, accredited. Send post card for 80 pg. "Blue Book." Mailed FREE.

CHICAGO TECHNICAL COLLEGE
 C75 Tech Bldg., 118 East 26th St. Chicago, Ill.

HOME STUDY COURSES

Home-Study Courses, leading to Degrees in Arts and Sciences; Education; Writing; Psychology; Chemistry; Business and Commerce; Law; Theology; Agriculture; Engineering; also courses in Business Training; Accounting; Advertising; Sales Management; Public Speaking; Radio. Many others. Low Cost; Easy Terms.

McKinley-Roosevelt College of Arts and Sciences, 4247 Clarendon Ave., Chicago

Men & Women Earn Cash at Home!



We paid M. M. \$267 in 3 weeks for exceptional "cellar crop" patented mushrooms! Big free picture book tells if your cellar, shed, barn suitable. We buy all crops thru ten branches. Write today. Est. 1908. **UNITED CO., 3848 Lincoln Ave., Dept. 73, CHICAGO**

U.S. GOVERNMENT JOBS



START \$1260 TO \$2100 YEAR
MANY 1937 APPOINTMENTS
MEN—WOMEN

Social Security Jobs are filled from examination lists.

Mail Coupon immediately. **Hurry.**

COUPON

Franklin Institute
 Dept. A173
 Rochester, N. Y.

Gentlemen: Rush to me, FREE of charge, list of U. S. Government big pay dependable jobs. Send FREE 32 page book describing salaries, vacations, hours, work, etc. Tell me how to get one of these jobs.

Name

Address



MECHANICAL ENGINEERING
LEARN AT HOME

Mechanical Engineering embraces the design, construction and operation of machines and machine tools. It is a profession which offers almost unlimited opportunities to men who combine natural mechanical ability with technical training.

For this is the Age of Machinery. Almost every convenience, luxury or necessity which we enjoy depends on machinery for its production or adaptability to our needs. Every new invention multiplies the opportunities for competent designers, builders, erecting engineers, etc.

The best way to train yourself to secure a position as a Mechanical Engineer is through the home-study courses of the International Correspondence Schools.

These courses are complete and up-to-date, and especially arranged to meet the needs of the student who studies at home.

They are particularly helpful because they are written by well-known mechanical engineers with years of practical experience, who know the quickest, best way to solve every problem.

Just mark and mail the coupon and we'll gladly send you Free Booklets describing the I. C. S. courses in Mechanical Engineering or any other course in which you are interested.

INTERNATIONAL CORRESPONDENCE SCHOOLS

Box 5663-H, Scranton, Penna.

Without cost or obligation, send your booklet, "Who Wins and Why," and full particulars about the course before which I have marked X:

- | | |
|--|---|
| <input type="checkbox"/> Mechanical Engineering | <input type="checkbox"/> Toolmaking |
| <input type="checkbox"/> Mechanical Course | <input type="checkbox"/> Blacksmithing and Forging |
| <input type="checkbox"/> Drafting | <input type="checkbox"/> Patternmaking |
| <input type="checkbox"/> Mechanical Drawing | <input type="checkbox"/> Foundrywork |
| <input type="checkbox"/> Complete Shop Practice | <input type="checkbox"/> Machine Shop Practice |
| <input type="checkbox"/> Architect | <input type="checkbox"/> Plumber and Steam Fitter |
| <input type="checkbox"/> Architectural Draftsman | <input type="checkbox"/> Plumbing Inspector |
| <input type="checkbox"/> Building Foreman | <input type="checkbox"/> Foreman Plumber |
| <input type="checkbox"/> Concrete Builder | <input type="checkbox"/> Heating and Ventilation |
| <input type="checkbox"/> Contractor and Builder | <input type="checkbox"/> Sheet-Metal Worker |
| <input type="checkbox"/> Structural Draftsman | <input type="checkbox"/> Steam Engineer |
| <input type="checkbox"/> Structural Engineer | <input type="checkbox"/> Marine Engineer |
| <input type="checkbox"/> Electrical Engineer | <input type="checkbox"/> Refrigeration Engineer |
| <input type="checkbox"/> Electrical Contractor | <input type="checkbox"/> R. R. Positions |
| <input type="checkbox"/> Electric Wiring | <input type="checkbox"/> Highway Engineer |
| <input type="checkbox"/> Electric Lighting | <input type="checkbox"/> Chemistry <input type="checkbox"/> Pharmacy |
| <input type="checkbox"/> Electric Car Running | <input type="checkbox"/> Mining Engineer |
| <input type="checkbox"/> Telegraph Engineer | <input type="checkbox"/> Navigation <input type="checkbox"/> Assayer |
| <input type="checkbox"/> Telephone Work | <input type="checkbox"/> Iron and Steel Worker |
| <input type="checkbox"/> Civil Engineer | <input type="checkbox"/> Textile Overseer or Supt. |
| <input type="checkbox"/> Surveying and Mapping | <input type="checkbox"/> Cotton Manufacturing |
| <input type="checkbox"/> Bridge Engineer | <input type="checkbox"/> Woolen Manufacturing |
| <input type="checkbox"/> Gas Engine Operating | <input type="checkbox"/> Agriculture <input type="checkbox"/> Fruit Growing |
| <input type="checkbox"/> Automobile Work | <input type="checkbox"/> Poultry Farming |
| <input type="checkbox"/> Aviation Engines | <input type="checkbox"/> Mathematics <input type="checkbox"/> Radio |

BUSINESS TRAINING COURSES

- | | |
|--|---|
| <input type="checkbox"/> Business Management | <input type="checkbox"/> Business Correspondence |
| <input type="checkbox"/> Industrial Management | <input type="checkbox"/> Show Card and Sign Lettering |
| <input type="checkbox"/> Personnel Management | <input type="checkbox"/> Stenography and Typing |
| <input type="checkbox"/> Traffic Management | <input type="checkbox"/> English |
| <input type="checkbox"/> Accounting and C. P. A. Coaching | <input type="checkbox"/> Civil Service |
| <input type="checkbox"/> Cost Accounting | <input type="checkbox"/> Railway Mail Clerk |
| <input type="checkbox"/> Bookkeeping | <input type="checkbox"/> Mail Carrier |
| <input type="checkbox"/> Spanish <input type="checkbox"/> French | <input type="checkbox"/> Grade School Subjects |
| <input type="checkbox"/> Salesmanship | <input type="checkbox"/> High School Subjects |
| <input type="checkbox"/> Advertising | <input type="checkbox"/> Cartooning |
| | <input type="checkbox"/> Illustrating |

Name.....

Address.....

City..... State.....

Occupation.....

If you reside in Canada, send this coupon to the International Correspondence Schools Canadian, Limited, Montreal, Canada

When writing please mention Popular Mechanics

STAMPS and COLLECTING

(Continued from page 49A)

71704
 est son of King Leopold III. A pictorial set issued by Cuba marks the celebration in connection with the unveiling of a monument to General Maximo Gomez. There are five postage stamps, one special delivery and two airmails. France has issued four values for the Unemployed Intellectuals Relief Fund. Another French stamp for the same purpose has been made by reissuing a 1935 stamp and surcharging it with a new value. Greece has a stamp to commemorate the burial in Athens of King Constantine and Queen Sophia. The 1936 New Zealand Health stamp shows a girl's head within a life preserver. Four new values for the Italian occupation of Abyssinia show a portrait of King Victor Emmanuel III. A series of five has been issued by Danzig for Winter Aid.

An All British Album

The recent publicity which the ruling family of Great Britain has received will be reflected by greatly increased sales of coronation issues next May. Many collectors will buy the complete series and mount it in a special album. An interesting introduction may be formed by mounting at the front a selection of stamps showing the previous rulers of Great Britain, and the members of their families. It will be a simple matter to find stamps showing the rulers from Queen Victoria to the present time but only a few of the earlier kings have been pictured on stamps.

Henry VII, who ruled from 1485 to 1509, starts the list, and is found upon the sixty-cent value of the Cabot issue of Newfoundland. Elizabeth, next in order, also will be found upon a Newfoundland stamp, the twenty-four-cent value of the Gilbert issue of 1933. Her successor, James I, shows in the Guy issue of 1910 of the same colony. His son, Charles I, is pictured upon a Barbados stamp of 1927. A long gap follows until the portrait of William IV appears on the 1934 Centenary issue of St. Helena. His niece Victoria, who succeeded him, is found upon great numbers of stamps in a variety of portraits beginning with her coronation and extending on to her death in 1901. The 1897 Jubilee issue of Canada presents her as she appeared in 1837 at the left, and in 1897 at

the right. Her consort, Prince Albert, is shown upon a Canadian stamp of 1851-59. Her son, Edward, Prince of Wales, later Edward VII, appears upon Newfoundland stamps from 1868 to about 1890. Edward VII, as monarch, will be found upon practically all empire stamps issued during his reign. Queen Alexandra is found upon the stamps of Newfoundland in 1898.

The second son of Edward VII, who later succeeded to the throne as George V, appears in the 1898 Newfoundland issue, as does his infant son David, later Edward VIII. His portrait and that of the queen are on stamps issued in 1928 by Newfoundland and in 1935 by Canada. In the few months during which Edward VIII ruled, a beautiful series of four stamps was issued bearing his portrait. These were for use in Great Britain. Newfoundland shows the Duchess of York, the present queen, in 1932 on a seven-cent stamp, and had shown her daughter Elizabeth, now Princess Royal, in the previous year. Canada also gave collectors portraits of Princess Elizabeth and her father in her Jubilee set of 1935.

The Lesser Gold Coins

The coinage of quarter eagles, or \$2.50 gold pieces, commenced at the Philadelphia mint in 1796, and was continued until 1929 except for a few years. Other mints, except Carson City, also have produced them at various times.

The designs have been of three basic varieties, at first Liberty facing the right, then in 1808 Liberty facing the left, and finally in 1908 an Indian facing the left. Many minor changes of design were made. One of the rarest is that minted in 1834 which shows the motto "E pluribus unum" over the eagle. This has sold for \$400.

Coins of 1796 with sixteen stars on obverse and fifteen stars on reverse sell for about \$150 and those of 1806, showing that date impressed over 1805, have brought \$300. The coin of 1863 is very scarce as only thirty pieces were minted, with 1875 as a second choice with 420 pieces minted. A commemorative quarter eagle was minted in 1915 in connection with the Panama Pacific exposition. This also is considered rather rare.

THIS COMPLETE, SIMPLE, PRACTICAL COURSE FOR SELF-INSTRUCTION WILL QUICKLY GIVE YOU
A Complete Mastery of MATHEMATICS



Prepare now to advance yourself to an important job by *Mathematics Training*. Mathematics is the foundation of all mechanical and scientific work, and of all business or industry based on science. Without this essential knowledge even the most capable man is left behind while others forge ahead to better jobs, bigger contracts, more money. You need mathematics to solve technical problems and to improve, speed up and check on your work and the work of others.

Now you can learn mathematics by an easy, inexpensive and time-saving method. A very simple and extremely interesting course in book form has been prepared for you by an expert who has devoted a lifetime to teaching practical men the fundamentals of this important subject.

MATHEMATICS FOR SELF-STUDY

By **J. E. Thompson, B.S., A.M.,**
Dept. of Mathematics,
Pratt Institute

These books start right from the beginning with a review of arithmetic that gives you all special short-cuts and trick methods that save countless hours of your time. Then they go right into higher mathematics and show you how simple it is when an expert explains it for you. In no time at all you will be tackling with ease the most difficult questions on this subject.

An Expert's Simplified Methods

Mr. Thompson, the author of these books, has had many years' experience in mathematical training. He presents each practical method and problem in the clearest, simplest way. He gets right down to the kind of information that you need in your daily work.

A Complete Course and Reference Library in 5 Volumes

- Arithmetic
 - Algebra
 - Geometry
 - Trigonometry
 - Calculus
- 1598 Pages Illustrated

Send No Money—Mail This Coupon for FREE EXAMINATION

D. Van Nostrand Co., Inc., 250 Fourth Ave., New York
 Send me MATHEMATICS FOR SELF-STUDY in 5 volumes. Within 10 days I will either return the books or send you \$2.95 as first payment and \$2.00 per month for 3 months—total \$8.95 (5% discount for cash). (P.M. 3-37)

Name.....
 Address.....
 City and State.....
 Reference.....
 Address.....
 FOR FREE CATALOG of best books of practical instruction and technical information, check here. If you do not want Mathematics for Self-Study cross out paragraph above.

Every Needed Fact, Figure, Formula, Every Shortcut and Special Method in the
WHOLE FIELD of MATHEMATICS
Now in ONE Handy Volume

For the first time you can have this wealth of practical mathematical information, covering every trade and business, condensed into one handy book for quick reference. This volume puts right at your finger tips instant facts and formulas for making every kind of mathematical calculation. From hundreds of different sources, this priceless information has been gathered together, boiled down into brief, simple language, and applied to actual problems. Every man in business, every man in the mathematical trades, every man who ever uses a tool or has to make calculations or estimates in office, shop, or home, will find here a treasury of money-making, money-saving ideas.



THE HANDBOOK OF APPLIED MATHEMATICS

No previous knowledge of mathematics is needed. No study is required. The specific information you want is easy to find, by looking it up in the index. The

Entirely NEW Greatly ENLARGED

Revised throughout, greatly extended in scope, with a wealth of NEW MATERIAL in all sections. The subjects of pulleys, gears, the use of the slide rule, and weights and measures have been greatly lengthened. Valuable new sections deal with the topics of strength of materials, papering, glazing, and radio. Ample new material has been furnished on machine shop practice and sheet metal work. Finally, an entirely new treatment covers exhaustively the great field of business mathematics. In its new form, more than ever before, this book will simplify your most important and puzzling problems.

No Increase in Price
 754 Pages. Lavishly illustrated.
 Strong Cloth Binding. Page Size 5 1/2 x 8 inches.

book takes up every trade and gives you practical methods, easily-worked formulas for solving every problem. Thousands of specific examples show you just how to make your calculations. If your work involves mathematics in any way this complete reference handbook is an indispensable part of your equipment. It is an amazing time saver for any one concerned with engineering, architecture, electricity, mechanics, construction, automobiles, machinery, printing, or any other industrial work; or with accounting, auditing, manufacturing, costs, taxes, or any other

business mathematics. No practical man, no house owner who makes an occasional repair, no one who has a home work-shop can afford to be without the valuable information quickly found in this book. A few of the subjects covered:

- | | | | |
|-----------------------------------|-----------------------------|-----------------|-----------------------------|
| Arithmetic (including Slide Rule) | Excavations and Foundations | Mechanics | Sheet Metal Work |
| Algebra | Concrete | Painting | Radio |
| Geometry | Brickwork | Plumbing | Electricity (D.C. and A.C.) |
| Trigonometry | Carpentry and Building | Paper Hanging | Print Shop |
| Weights and Measures | Lathing and Plastering | Heating | Business |
| | | Machine Shop | Mathematics |
| | | Automotive Shop | Accounting |

EXAMINE THIS BOOK FREE
Send No Money—Mail This Coupon

D. VAN NOSTRAND CO., 250 Fourth Ave., New York
 Send me on approval THE HANDBOOK OF APPLIED MATHEMATICS. Within 5 days after I receive the book, I can return it and owe nothing. If I keep it, I will send you \$2.00 as first payment and I will pay \$2.00 monthly thereafter for 2 months—\$6.00 in all. (5% discount for cash.)

Name..... (P.M.3-37)
 Address.....
 City..... State.....
 Reference.....
 Address.....
 FOR FREE CATALOG of best books of practical instruction and technical information check here. If you do not want The Handbook of Applied Mathematics cross out paragraph above.



OL' JUDGE ROBBINS

THE DISCOVERY OF TOBACCO

PHOOEY ON THIS WEATHER. I'D GIVE UP ANYTHING **EVEN MY PIPE**, IF I COULD BE WARM AND CLOTHES-FREE LIKE THOSE SAVAGES COLUMBUS DISCOVERED

SURE - BUT WHY GIVE UP YOUR PIPE?



BECAUSE MY PIPE IS IMPORTANT TO ME - AND THOSE WEST INDIAN NATIVES DIDN'T KNOW ANYTHING ABOUT TOBACCO

THAT'S WHERE YOU'RE WRONG. THEY WERE SMOKING WHEN COLUMBUS DISCOVERED THEM

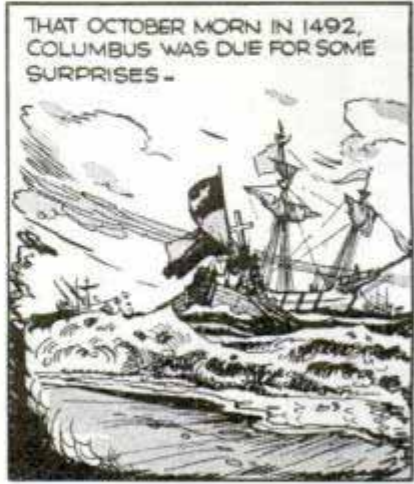
ONE OF THE MOST CHERISHED OFFERINGS OF THE NATIVES WAS LEAF-TOBACCO, WELL DRIED AND READY FOR SMOKING



MOST OF THE NATIVES SMOKED BY MERELY INHALING THE FUMES, BUT SOME OF THEM HAD A LONG, HOLLOW TUBE WITH THE FORKED ENDS INSERTED IN THE NOSTRILS



WELL, COLUMBUS MAY HAVE DISCOVERED THIS INDIAN CUSTOM BUT **PRINCE ALBERT** BRINGS IT TO PERFECTION

YOU BET! IN ALL THE YEARS I'VE BEEN SMOKING P.A. IT HAS YET TO BITE MY TONGUE OR BURN TOO HOT FOR COOLENJOYMENT



Copyright, 1937, R. J. Reynolds Tobacco Co.

DON'T MISS THIS FAIR AND SQUARE OFFER!

PRINCE ALBERT MONEY-BACK GUARANTEE

SMOKE 20 FRAGRANT PIPEFULS OF PRINCE ALBERT. IF YOU DON'T FIND IT THE MELLOWEST, TASTIEST PIPE TOBACCO YOU EVER SMOKED, RETURN THE POCKET TIN WITH THE REST OF THE TOBACCO IN IT TO US AT ANY TIME WITHIN A MONTH FROM THIS DATE, AND WE WILL REFUND FULL PURCHASE PRICE, PLUS POSTAGE. (Signed) R. J. Reynolds Tob. Co., Winston-Salem, N.C.

PRINCE ALBERT THE NATIONAL JOY SMOKE!



PRINCE ALBERT IS MILDER... THE BITE IS REMOVED

TRUST 'CRIMP CUT' P.A. TO GIVE COOLER SMOKING

I ROLL 'EM QUICKER AND EASIER USING PRINCE ALBERT

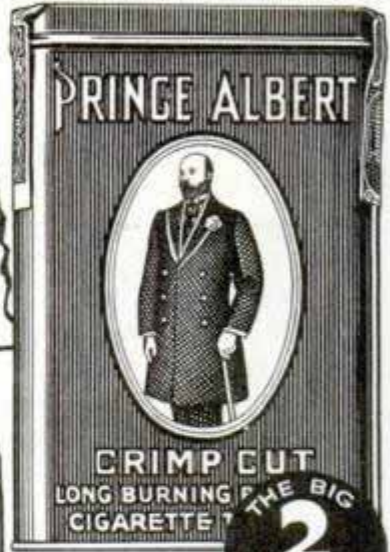
50 pipefuls of fragrant tobacco in every 2-oz. tin of Prince Albert

Popular Mechanics Magazine

REGISTERED IN U. S. PATENT OFFICE AND CANADA

WRITTEN SO YOU CAN UNDERSTAND IT

Vol. 67

MARCH, 1937

No. 3

SMASHING ATOMS

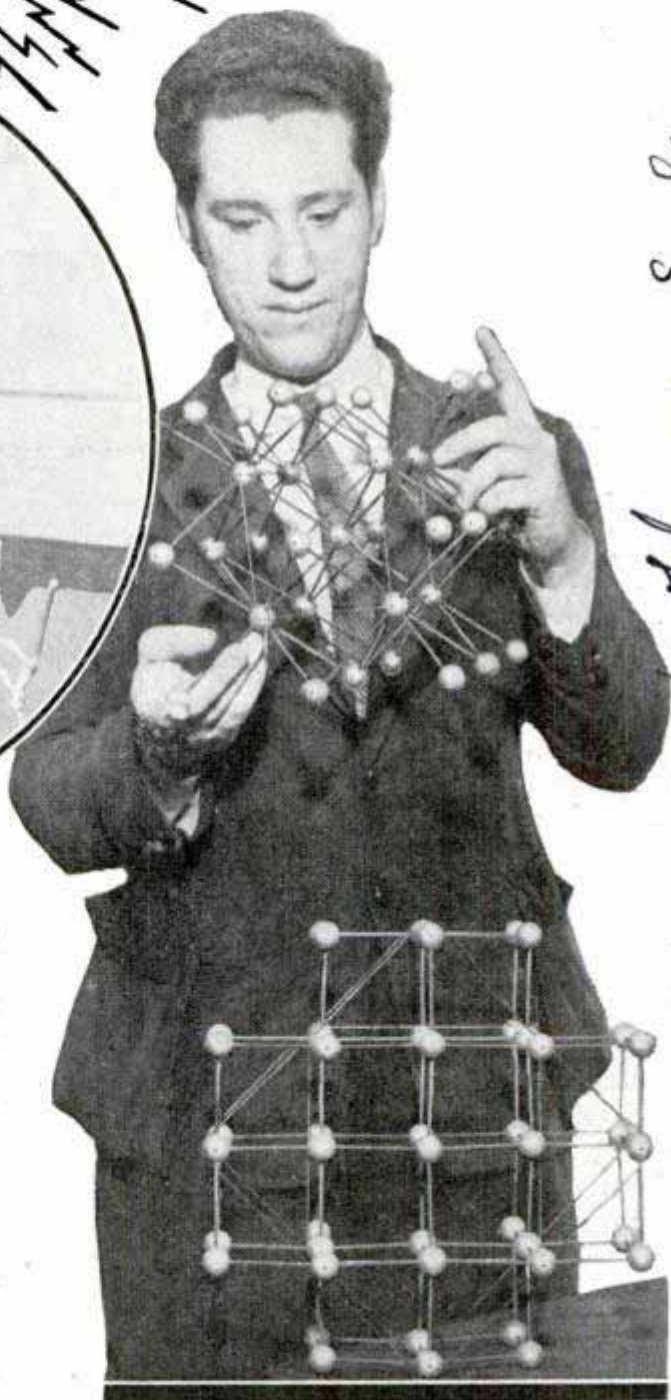
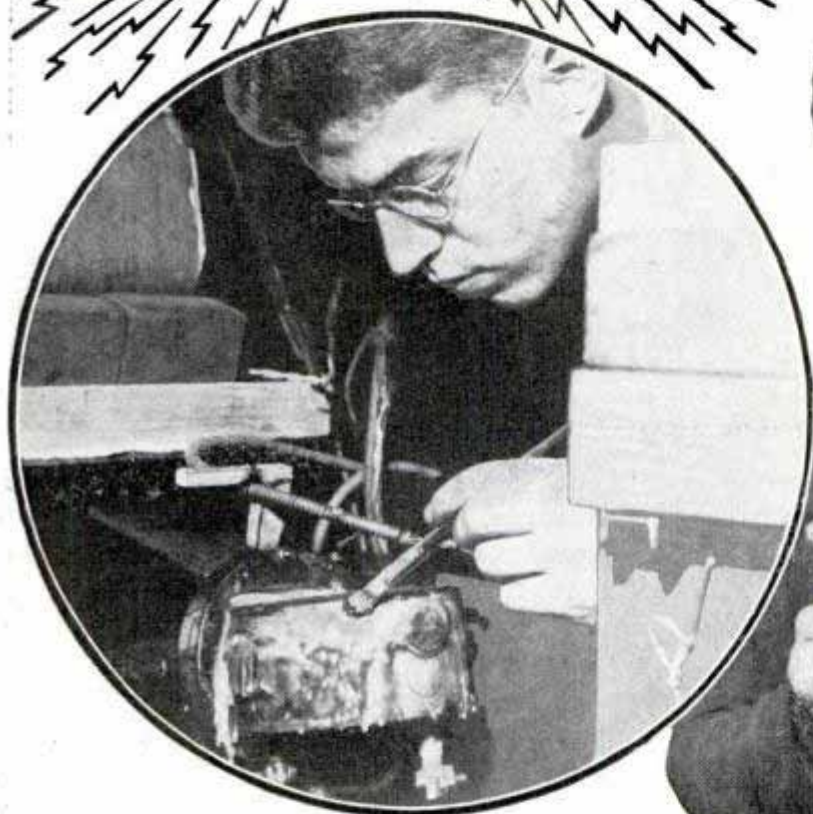

WHAT is an isotope? Does radio sodium mean anything to you? Have you ever heard of protium or tritium?

Possibly not, since these are brand new words. But you are apt to hear more about them in the future because they are symbols of a new kind of chemistry for which great things have been predicted.

The basis of this science was the discovery that instead of the ninety-two elements we believed composed all matter, there are really several hundred kinds of basic matter. No one knows how many because new ones are being uncovered all the time. Late last year the number of stable elements stood at 250 and in addition a large number of unstable elements had been listed.

Model held by man shows crystal structure of potassium and one on table shows structure of tin. In circle, sealing chamber of mass spectrometer with wax

Reference - Mr. Wm. V. Houston 321

Mr. Thomas & Stinson, Jr. 1055 S. ...

Alfonsia ...

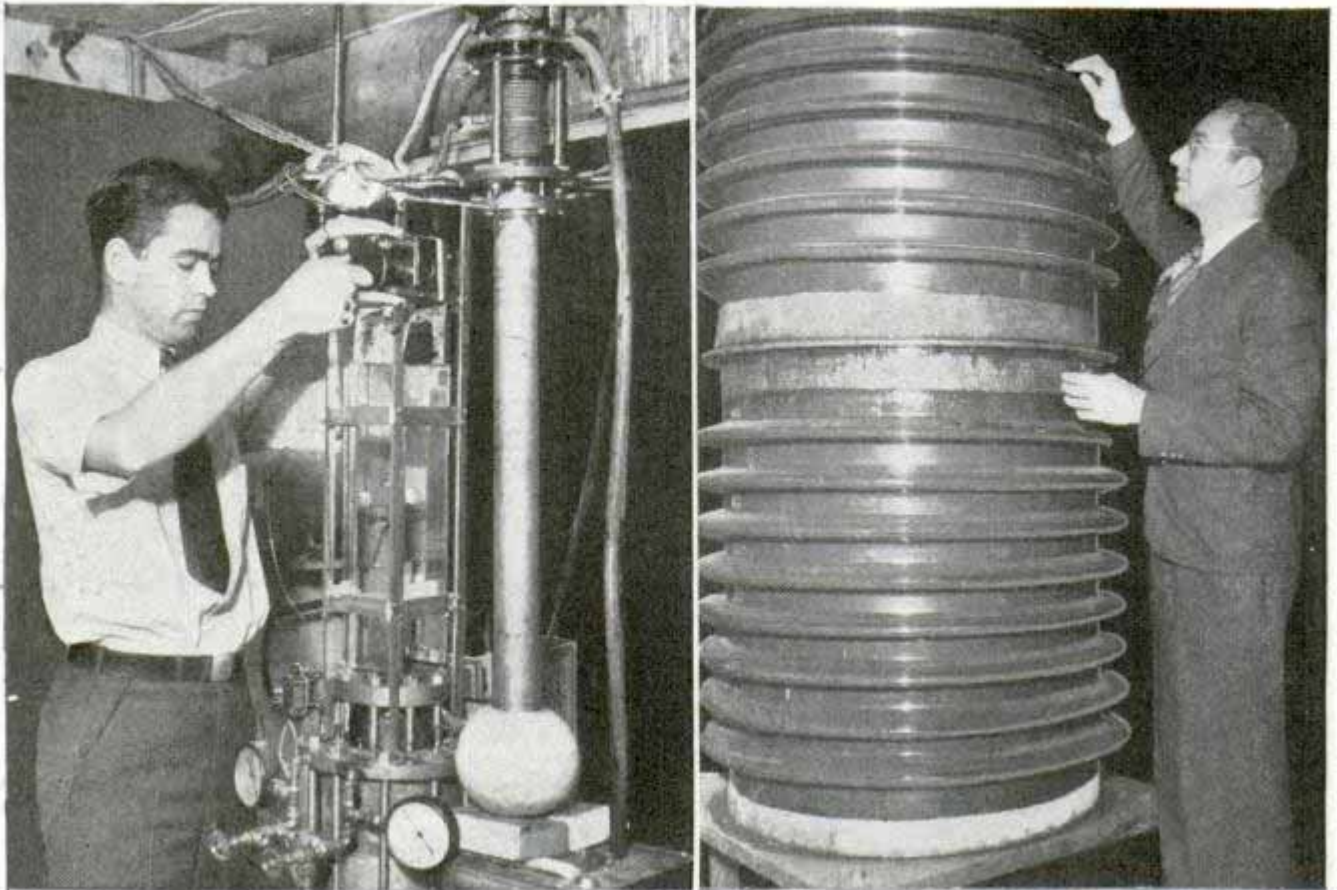

Left, adjusting automatic camera which records transmutation of elements by making pictures of tracks of atoms. Right, part of fifteen-foot vacuum tube used to "shoot" atoms

It isn't quite proper to say these are entirely new elements. In a strict sense, they are merely varieties of the original ninety-two. Scientists call them isotopes. The isotopes of an element are all chemically the same. The difference is in their weight. One kind of hydrogen atom weighs more than another kind even if there is no chemical way to tell them apart. The important thing is that heavy hydrogen can do a lot of tricks that ordinary hydrogen can't. One trick is the creation of the strange liquid called heavy water.

These new chemical tools are expected to enable scientists to go after physiological and biological problems better. By earmarking isotopes of some substance and watching their effect on the body, a better understanding of the body and its chemical processes is anticipated, increasing the ability of the medical world to relieve pain and prevent disease. One way in which this study is being pursued is with heavy water. Until recently there was no exact way of learning how long it took water to be absorbed by the tissues or put to use in other ways in the body. By feeding a "tagged" sample of heavy water to a patient physiologists can trace

its course through the body almost minute by minute.

These new building blocks also are leading to a more complete knowledge of chemical reactions. What chemical transfers of atoms occur when sugar, for instance, is dissolved in water? The answer is supplied by heavy hydrogen. The trick is to start with a compound containing heavy hydrogen instead of ordinary hydrogen, and after the mixture has been made, to examine the other substance and learn whether heavy hydrogen has changed places with some of the ordinary hydrogen atoms in its own structure.

No one knows how important isotopes are going to be in the future. It may take a generation to survey the possibilities. It has been suggested the new isotopes may lead to making poisonous substances non-poisonous and vice versa, giving transparent materials an opaque quality, and giving a flexible condition to some stiff substances. The investigation of isotopes started after it was learned the atomic weight of an element merely represents the average weight of its atoms. It had been supposed previously that all atoms of any element weigh exactly the same.

Scientists now know there are three kinds of hydrogen atoms and each has a different weight. There are three isotopes of oxygen, also, and two weights of helium. Molybdenum has seven isotopes. Almost all the elements have a number of different varieties. In the isotopists' dictionary ordinary hydrogen is called protium. Heavy hydrogen is deuterium, while mass three hydrogen is tritium. Heavy water, in which heavy hydrogen takes the place of ordinary hydrogen, may be called deuterium oxide.

Although heavy water is chemically the same as ordinary water it weighs about ten per cent more. Microorganisms, small fish, and some plant seeds die in it. Some chemical reactions speed up while others are slowed down under its influence. Heavy hydrogen may be one of the most important of the

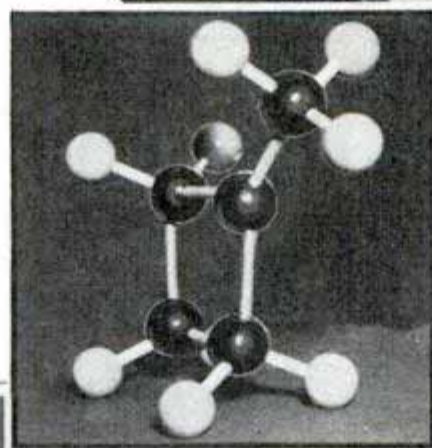
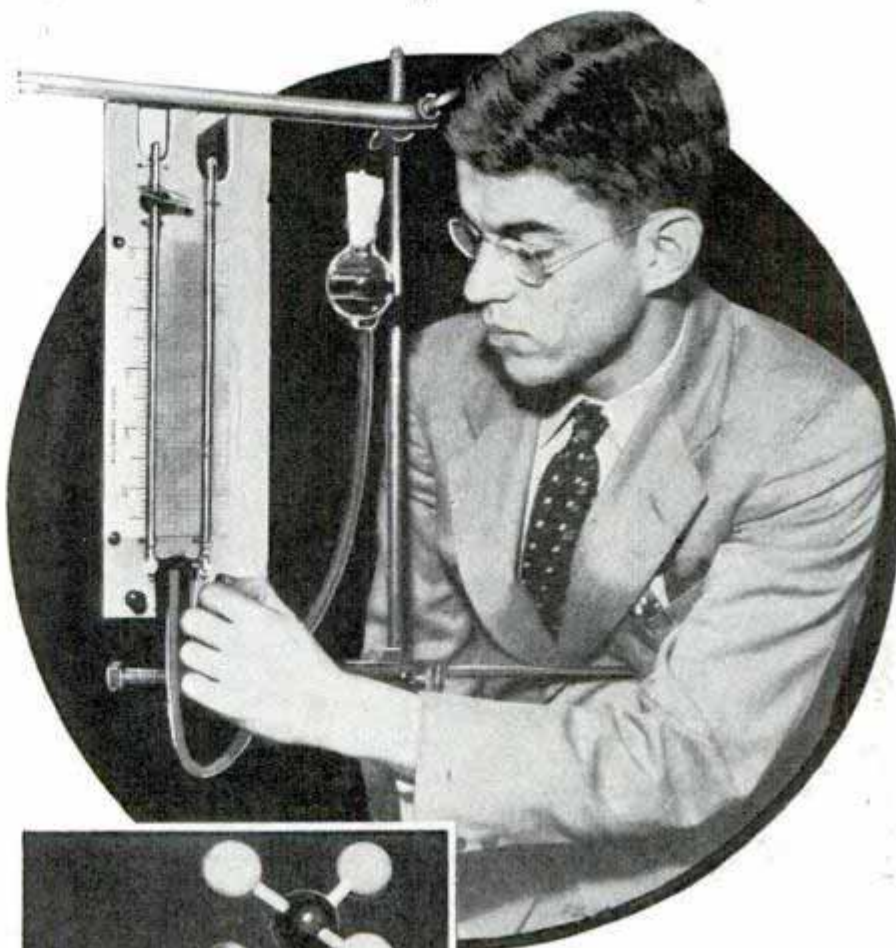

new building blocks. The difference between it and ordinary hydrogen is much greater than between the isotopes of most of the other elements. Its importance rests on the fact that hydrogen is an almost universal element. Ninety per cent of the some 350,000 different chemical compounds known today contain hydrogen or water or both. It may be that substituting double-weight hydrogen in its ordinary proportions in some of these compounds will lead to strange results.

Heavy hydrogen is extremely rare and occurs in the ratio of one to 5,000 with ordinary weight hydrogen atoms. But you might find quite a bit of it in your automobile battery, especially if the



Top, electrolysis gauge which records collection of isotopes. Center, model showing atom arrangement in molecule of rare poison gas. Bottom, apparatus for collecting heavy hydrogen atoms



substances. Scientists know that with the passage of enough time everything changes. The elements they consider to be stable are described as having "a half life one million years." Eighty-one major elements fall into this group while the remaining eleven, including radium and other highly radioactive elements, are classed as unstable. It is estimated that radium is changing form so rapidly that only half as much exists today as was present 2,000 years ago.

Potassium, sodium, and a number of the other stable elements are radioactive to a slight degree. In most cases this radioactivity seems confined to one isotope of an element. But physicists are able to segregate these isotopes, in effect creating a new class of

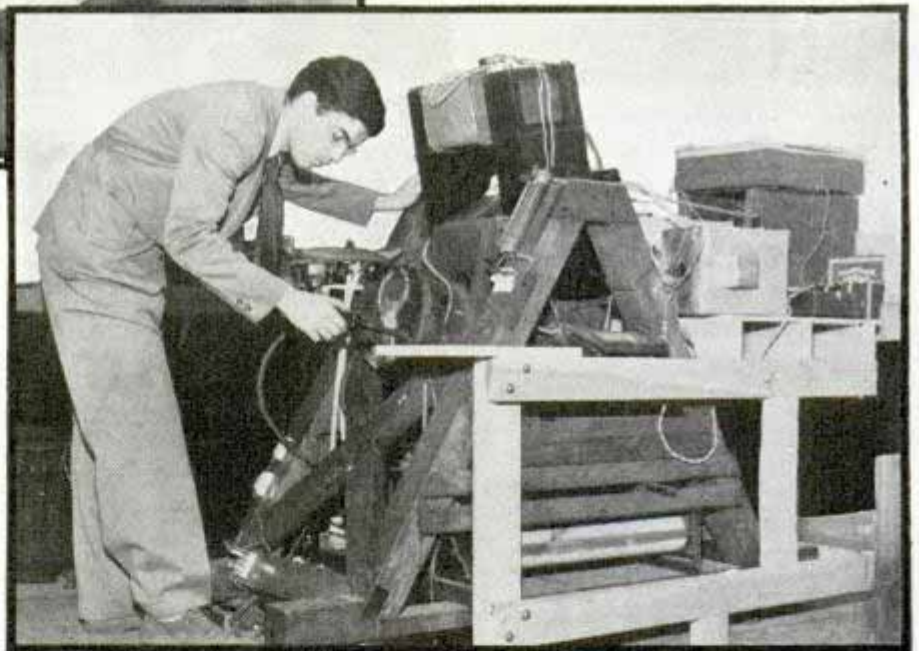

Top, model showing complicated crystal structure of an element. Below, mass spectrometer which segregates isotopes by weight

battery is old. The best method of recovering heavy water is by electrolytic action, the process involved in storage batteries. Ordinary water evaporates with the battery fumes but the heavy hydrogen stays behind. In commercial practice about fifty tons of ordinary water are treated to yield one pound of pure heavy water. The market price is about \$2 per gram.

Tritium, the triple-weight isotope, is the rarest of all hydrogen atoms. It occurs in the ratio of one to 200,000 ordinary hydrogen atoms and would cost something like \$1,000,000 per gram to collect. In combination with oxygen it would create water more expensive than radium. Today it is possible to create twenty-seven different kinds of water all having different densities by using different isotopes of hydrogen and oxygen.

Most people think of elements as stable

elements that might be described as "radio sodium," "radio potassium," and so on. All of these substances are highly unstable. They may change into inert forms within a few seconds or within a few days.

One suggestion is that radio sodium may become the preferred treatment for cancer when it can be manufactured in sufficient quantities. Radio sodium in salt form could be injected directly into a patient so its emanations could attack the cancer at close quarters. Since this isotope is very

F1660

unstable its radioactivity would vanish in a few hours, long before it damaged the rest of the body.

As now understood, the difference between isotopes of an element lies in the make-up of the nuclei of the atoms.

"Scientists visualize an atom as consisting of a nucleus surrounded by one or more moving electrons," explains a physicist of the California Institute of Technology. "The electrons are minute quantities of negative electricity. The nucleus consists of a number of protons carrying positive charges and a group of neutrons, particles electrically neutral. The negative charge of all of the electrons is supposed to balance the positive charge of the nucleus.

"The only difference between one element and another lies in the number of protons in the nucleus. That is the same as saying that if one could add or subtract protons, one could change one element into another. For instance, you could turn lead into gold, or oxygen into radium. To a limited extent this is being accomplished.

"In the same way, the only difference between isotopes of an element is in the number of neutrons contained in the nuclei of its atoms. If you add or subtract neutrons without disturbing the protons you are able to create lighter or heavier varieties of the same element. All parts of the atom bear a mathematical relationship to each other something like the mathematics of chemistry."

So far, the most practical way of obtaining samples of isotopes has been to gather them up instead of manufacturing them. One method is to use a diffusion apparatus that filters them out of gases. A gas such as hydrogen is made to pass through the pores of a thin clay pipe. The light atoms of hydrogen pass through easily while the heavier atoms are left behind. This diffusion is repeated until all the heavy hydrogen atoms have been collected in one place. Many elements aside from true gases can be given a gaseous state and put through the apparatus.

Another way by which isotopes can be

(Continued to page 158A)

F1546
Turtles Kept in Warm Tank Awaiting Lord Mayor's Soup



© Planet News, Ltd.
Selecting turtles to make soup for the Lord Mayor's banquet at London. They are kept in this electrically heated tank

Until time for the traditional Lord Mayor's banquet in London twenty turtles are kept comfortable in a tank electrically heated. Then their turn comes to provide the famous turtle soup which has been a delectable part of the menu for hundreds of years. For the last thirty years one man has performed the annual duty of selecting the turtles for this dinner.

F1662

Automatic Unit Keeps Engine Warmed Up in Winter

Designed to keep the automobile engine warmed up in cold weather without attention, an automatic unit starts the motor when the temperature drops and stops it when the water temperature rises to a predetermined point. It operates when the car is in the garage or parked with ignition and doors locked, but will not start the engine if the car is in gear. An added advantage is that the battery is charged as the motor runs, assuring a full charge throughout the winter.



The Summerheat Co.

John Lucy and Sons

Skiers "Hitchhike" to Hilltop on Cable Line



This is one way to make skis more popular. Skimming down a mountainside takes skill but little effort; climbing up takes plenty of effort, so a cable was installed at Hanover, N. H., to haul skiers to the top

Skiing is more fun and less work at Hanover, N. H., since a trolley line to the hilltop was installed to haul the winter sportsmen up. After a fast slide, Dart-

mouth college skiers grasp poles attached to a traveling cable and are dragged to the top. The cable moves up and down the mountain supported by a series of posts.

Air Hammer for Auto Strikes 4,000 Blows per Minute

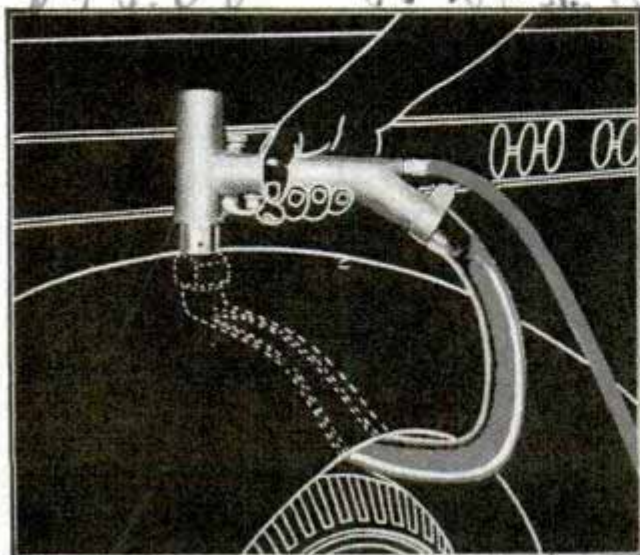

Four thousand blows per minute are delivered by a pneumatic hammer designed for straightening automobile bodies and fenders. The hammer weighs only fourteen pounds and can be manipulated with one hand. Economical in operation, it uses a small volume of air and requires seventy-five pounds or more air pressure. The hammer head moves in a floating piston or guide, and starts pounding instantly when a trigger is pressed. An air valve controls speed and power of strokes. Special arms permit work on deep-skirted fenders without removing the wheel, and four dies to fit all flat or curved surfaces are supplied with the hammer.

F1684
Weaver Mfg. Co. Springfield, Ill.
\$75.00
see April 1935

"Flying Bellhops" Serve Air-Line Passengers

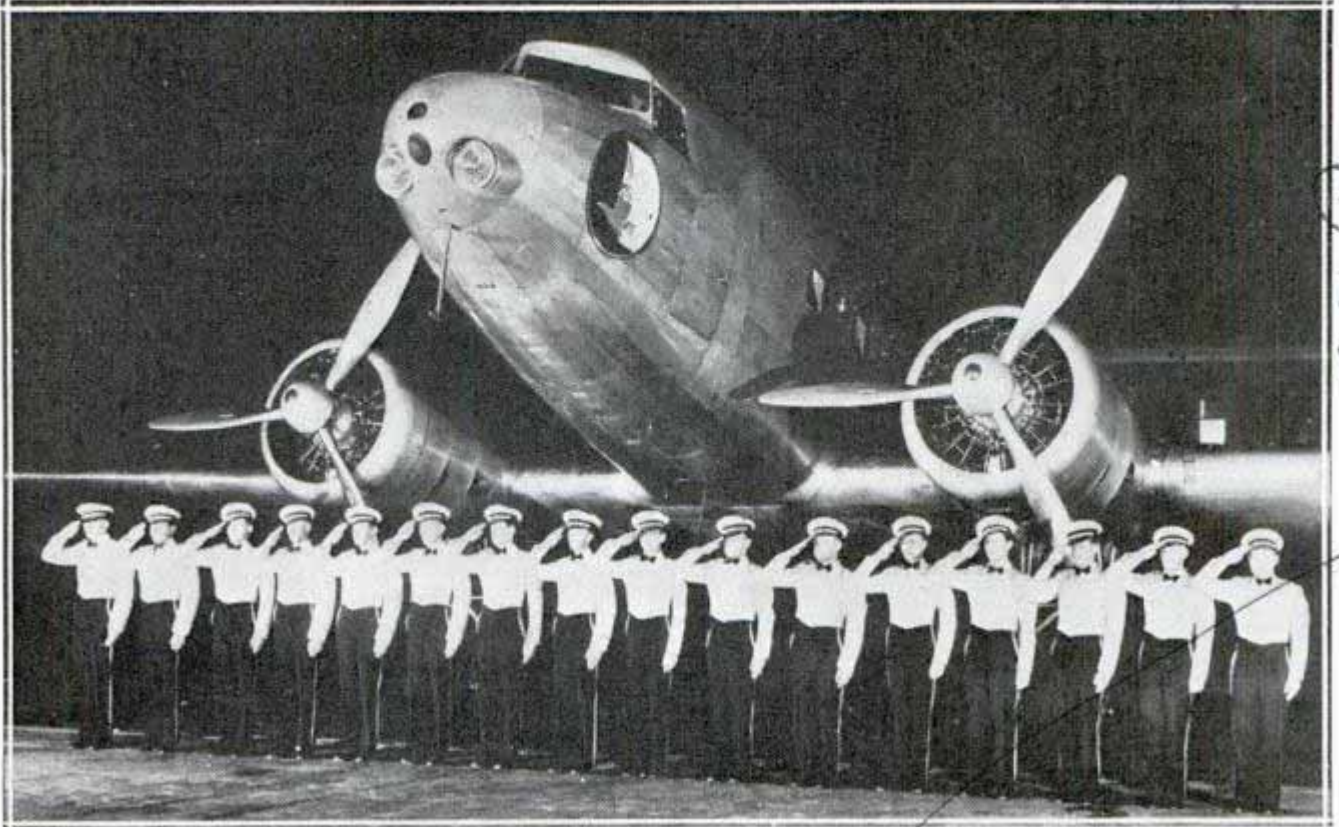

First of the companies of highly trained stewards ready to begin their duties aboard air liners of the type before which the smartly uniformed men stand

Eastern Air Lines

LuB.

Service aboard air liners operating along the east coast of the United States will be dispensed by "flying bellhops," the first squad of which has just completed its training and been placed on the planes.

Wearing trim uniforms, the bellhops are trained to serve meals with finesse, shine shoes, carry luggage and perform any other service conducive to the passenger's enjoyment of the air journey.

F1696

Fireplace Gives Lounge Car Appearance of Living Room

St. Louis - San Francisco Railway Co. St. Louis

Lounge cars built recently by the Frisco lines are given a cozy, home-like appearance by a fireplace at one end of the room. The decorating scheme is of modern character, with aluminum trim, Venetian blinds, bleached-wood furniture and walls of light aspen veneer applied over furniture steel with rubber cement. The fireplace is equipped with a set of andirons and its backlog is electrically wired to simulate the red glow and shimmering flames of a real log fire.

Desmond!



False fireplace with electrically lighted log makes lounge car cozier

1775 Broadway

m

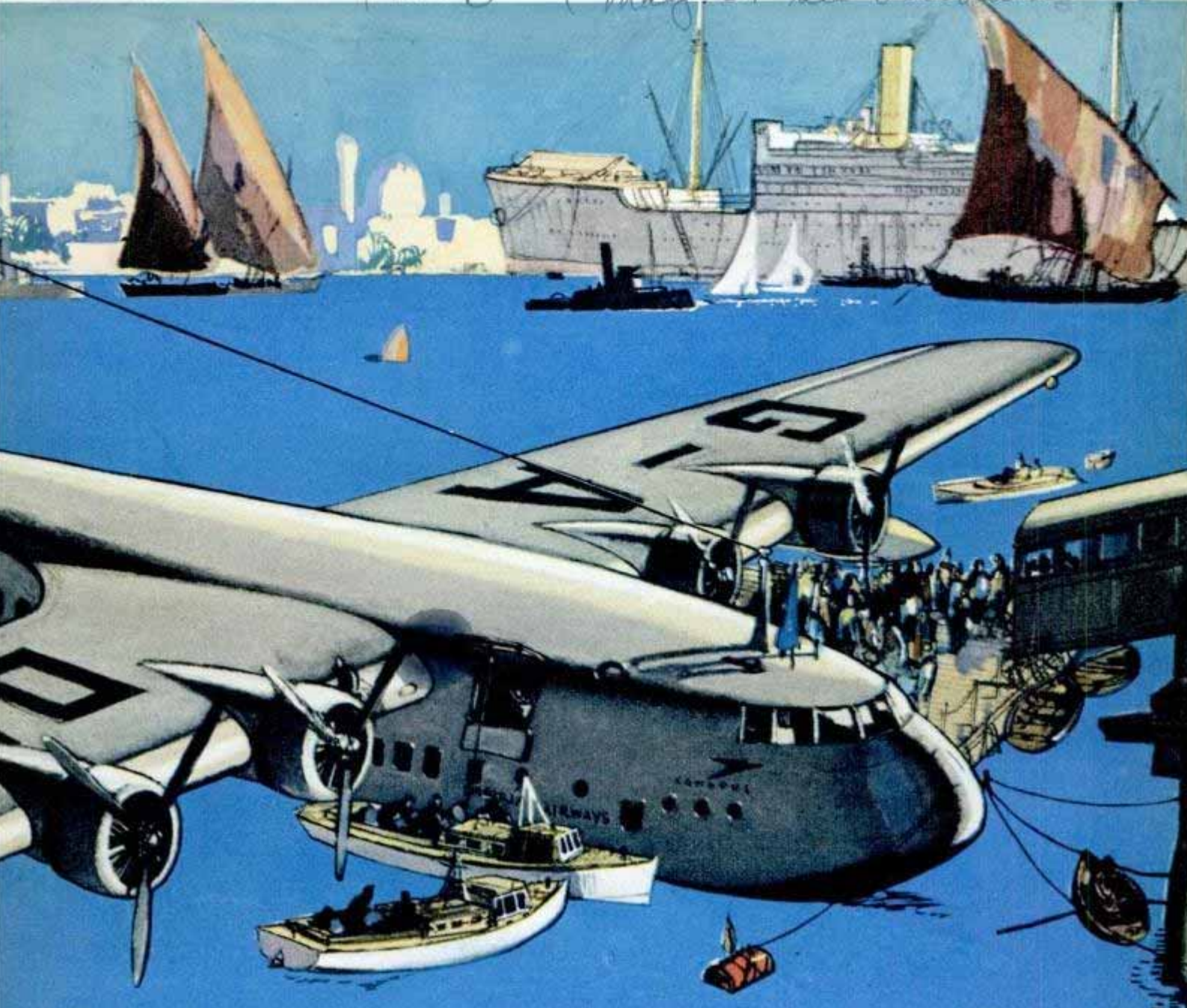

EMPIRE flying boat of Imperial Airways, a twenty-four passenger air liner which weighs eighteen tons, fully loaded, and makes 200 miles an hour.

AROUND *the* WORLD *by* AIR

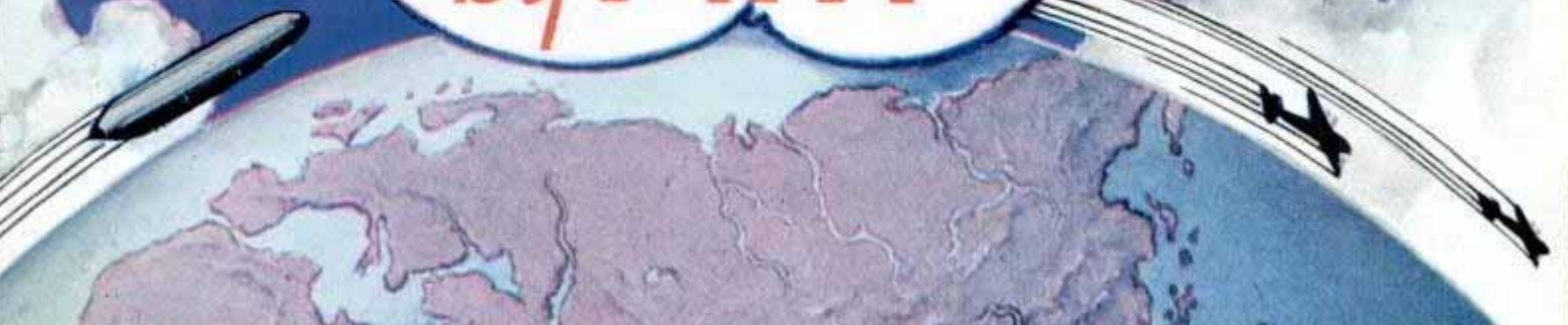

F1267



MODEL of Empire type flying boat of Imperial Airways. It contains a promenade, kitchen, smoker, separate radio room and carries twenty-four passengers.

By H. W. MAGEE

PART II

ON the third lap of your trip around the world by air, you hop across the Pacific. Sounds simple, doesn't it? And, as a matter of fact, it is quite simple today as compared with five or six years ago.

In 1931 no seaplane had been built that could fly the 2,400-mile stretch from San Francisco to Hawaii with a safe fuel reserve, let alone a payload. Nowadays the China Clippers of Pan American Airways are covering the 8,000 miles from San Francisco to Manila in five days—sixty hours of actual flying.

The air conquest of the Pacific stands as a brilliant chapter in aviation history—bold pioneering as thrilling as the building of the first transcontinental railroad. That railroad brought New York and San Francisco within less than a week's

travel. The Clippers have brought San Francisco within five or six days of the Orient, and New York, by air, is about as close to the Orient now in terms of travel as it used to be to San Francisco.

Pan American was operating 25,000 miles of aerial trade routes between the Americas when it began to cast a speculative eye on the Pacific. And at first glance, the thousands of miles of trackless ocean wastes seemed unconquerable. Who ever heard of flying on regular schedules over an ocean extending over about one-third the circumference of the globe? But then, who ever heard of a transcontinental railway until one was built? Pan American decided to conquer the Pacific.

A survey revealed that fate or destiny had taken a hand in the matter by dotting the only logical route with four little islands—Hawaii, Midway, Wake and Guam. What could be more practical than to convert these specks of land, all possessions of the United States, into



530

OPERATING one of the many navigational aids carried on board the Clipper ships of Pan American Airways. During the night celestial navigation is carried on by the stars. Of course, the ship is kept on course by constant radio compass bearings as well. Below, commercial air line map of the world, showing how they connect.

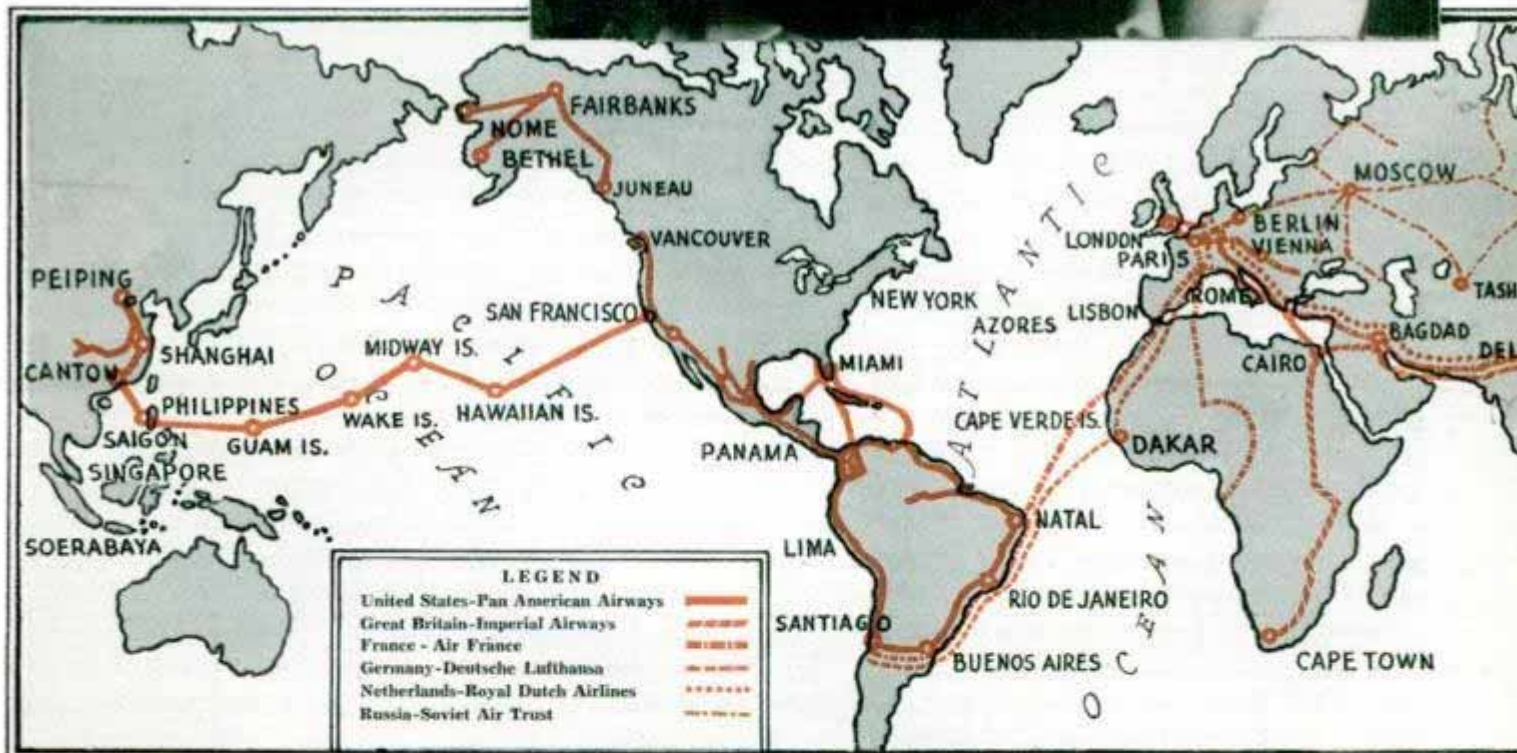
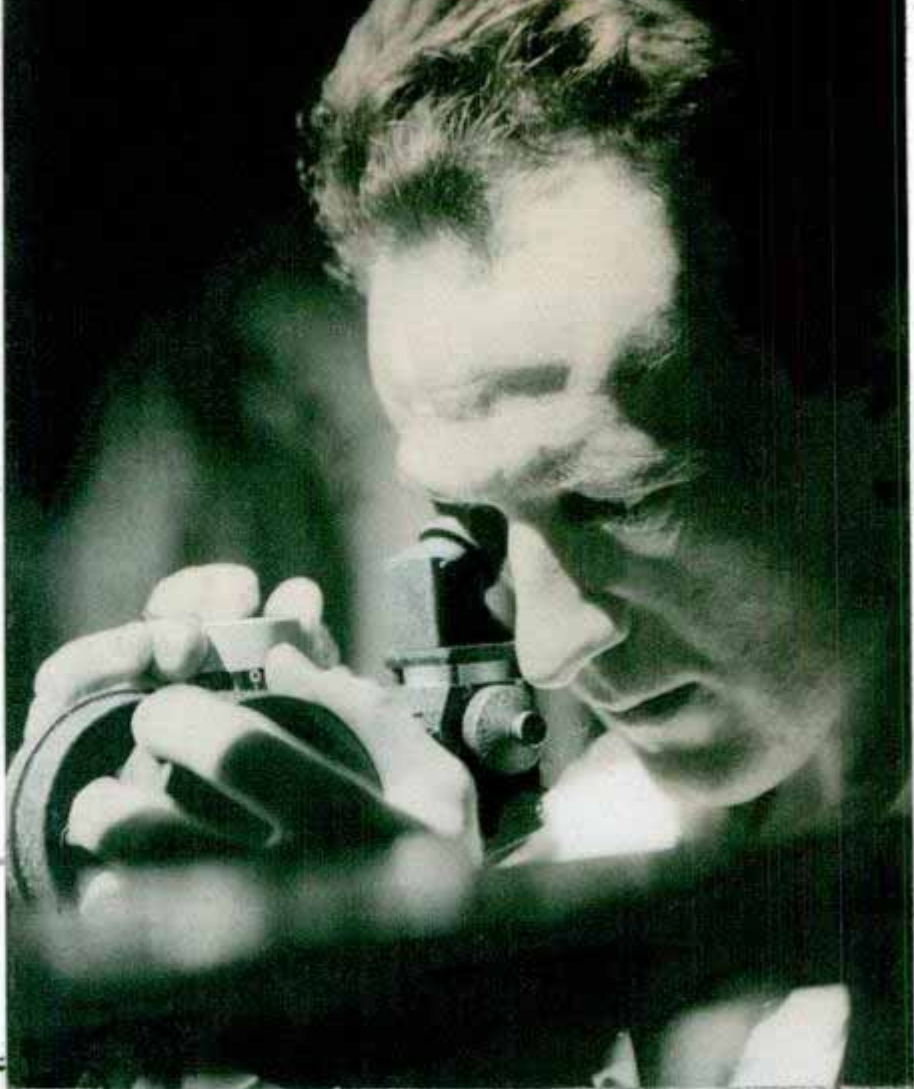

intermediate air bases? But even after the route had been broken up into laps by these islands, the task of flying the Pacific still challenged the imagination.

Better power plants were necessary. Some of the islands were nothing more than barren stretches of coral and sand. Precision methods of navigation were

necessary if seaplanes were to fly over thousands of miles of trackless ocean. No flying crews were trained for trans-oceanic service. No ground organization existed for servicing ocean airliners from the island bases.

Each of these problems was faced and solved before there were any wings over

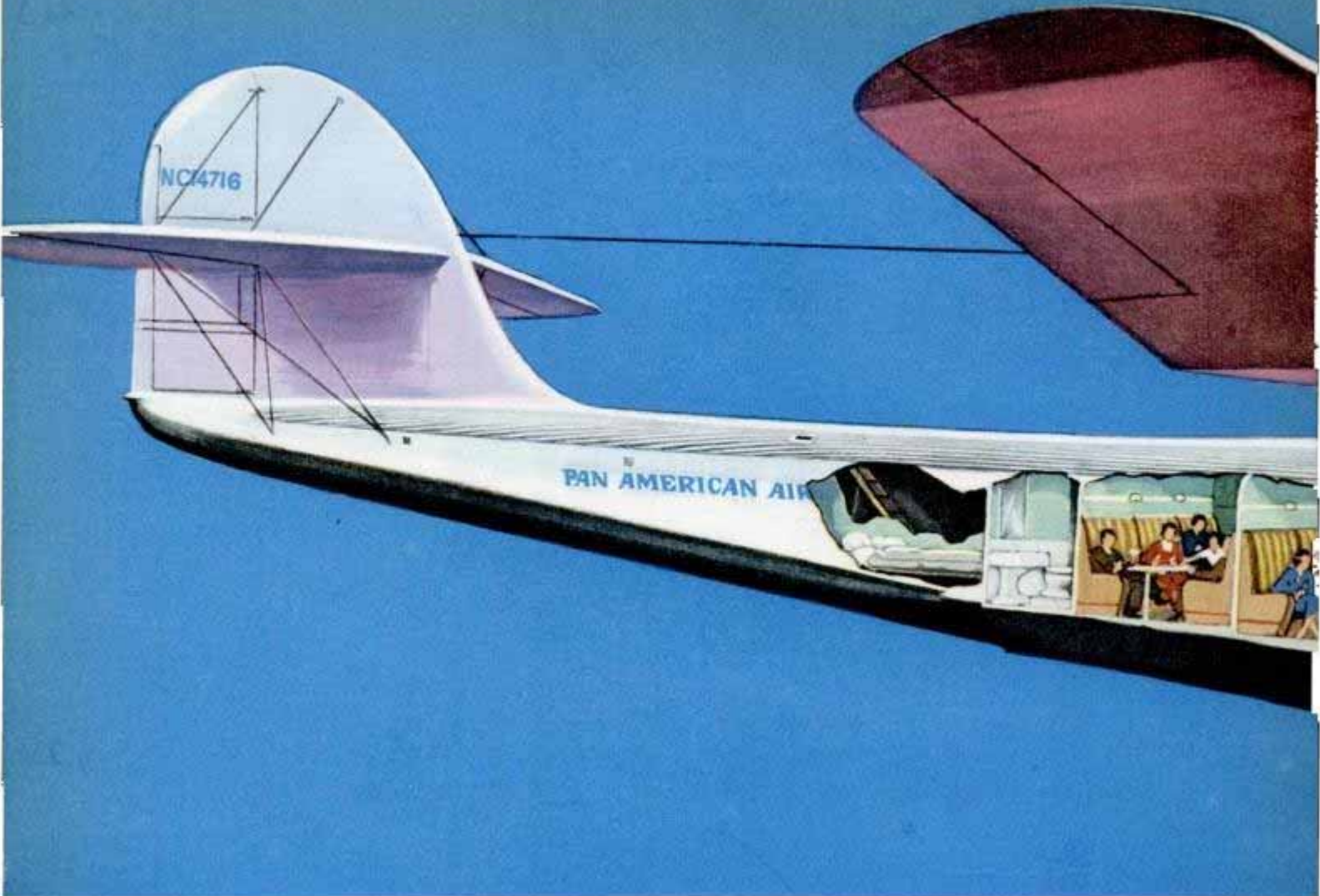

Fl 263
332

the Pacific. The design and construction of the Clipper ships was an epic in itself. Pan American wanted seaworthy flying boats able to cruise 3,000 miles, even against a head wind, at 150 miles an hour. Also they must carry a profitable pay load. Igor Sikorsky built a nineteen-ton flying boat to fulfill trans-oceanic conditions and Glenn Martin built a twenty-five and one-half ton ship. Both planes emerged from flight tests with flying colors. The Brazilian Clipper, Sikorsky's ship, was licensed to carry 99.8 per cent of its own dead weight, the China Clipper produced by Martin, 102.1 per cent. Each had a top speed of more than 180 miles an hour and a cruising speed of 157 miles.

Next in importance were the island bases. Thousands of tons of supplies were taken to the little dots of land. Ground crews were left there to build everything from hotels to weather stations and air beacons. Then there was the matter of developing lightweight, low-powered radio to cover the whole Pacific and extending the range of air-

craft radio direction-finding devices. Crews were trained so that each man could perform the duties of every other member as well as his own. Test flights were made to prove the plans and everything went off like clockwork. Soon Clipper ships were making regular trips over the ocean—the Pacific had been conquered.

And now the Clippers are carrying passengers in five days over a route which the old sailing clippers required two months or more to travel. On your journey over the Pacific, you hop off from Manila, headed for Guam, 1,600 miles distant. The trip gives you ample opportunity to become acquainted with a modern air Clipper. Its two roomy compartments and main salon are equipped with comfortable divan seats. You can stroll about at leisure or, through the large windows, watch the clouds paint shadows on the water below. You see an occasional steamer plodding through the waves, rising and falling on the skyline. Tired of looking, you play cards, read, write, eat or sleep.



CROSS section drawing of China Clipper which has wing spread of 130 feet, length of T1263
 ninety feet and a cruising speed of 150 miles an hour.

Up front the four twin-row 800-horsepower Wasp engines purr smoothly and on the flying bridge those of the crew of five on duty at the moment, are concerned with radio direction finding, navigation and maintaining radio contact with distant stations and steamers. At last your flying boat skirts a massive cliff rim and glides into the harbor at Guam. Perhaps you motor around the island, go to a movie or wander through the quaint old Spanish town. You spend the night at an Airway Inn—a hotel brought piecemeal to the island and set up in sections.

The next lap is from Guam to Wake, one of the longest of your flight. You are off at the crack of dawn and there's another day of watching the water. You'll find Wake a tiny mid-Pacific atoll consisting of three narrow islands, each about one and one-half miles long. Laid end to end, they form a horseshoe, the open end of which is protected by a massive reef to form a lagoon on which your

Clipper lands. Here you find a little village—a dozen houses, a big beacon, an Airway Inn, a dock. You may fish or dive down into the magnificent forest of coral, wearing water glasses so you can get a closeup view of the multi-colored tropical fish.

Another dawn and you're on your way to Midway, 1,300 miles east. On this leg you cross the international date line and lose track of time. If you left Wake Friday morning, you'll land at Midway Thursday evening. Midway consists of two small islands surrounded by a coral reef. On the larger is a cable station which, until the arrival of Pan American, was the only form of habitation. Now there's a hotel with dining rooms, lounges, porches and showers to accommodate forty-eight passengers. Here is a miniature forest of Australian pines, the result of thirty years of effort by cable company employes. Here also, ironically, are three graves of three doctors who, in the course of a quarter

33



PILOT and co-pilot on the flying bridge of the China Clipper. Below, interior of Clipper ship, showing berths. The China Clipper has space for forty-eight passengers on short hops but on the long haul from San Francisco to Honolulu it carries twelve passengers and a crew of five.

of a century have come to the island to look after the health of these employes.

There's a sand golf course, seals basking in the sun on the beach and there are gooney birds—creatures about two feet tall which carry on a ludicrous and amazing dance. There is a regular routine to the dance—papa and mama gooney address each other, bob heads up and down, put them side by side and click beaks, then reverse sides, jump up and down and scream. A gooney dance is worth a trip around the world to see.

If you tire of gooney birds, try collecting shells. If you're lucky you may find a great glass ball used by some Japanese fishermen as a net float. It started its voyage in Japanese waters and followed the Pacific currents all the way to Midway.

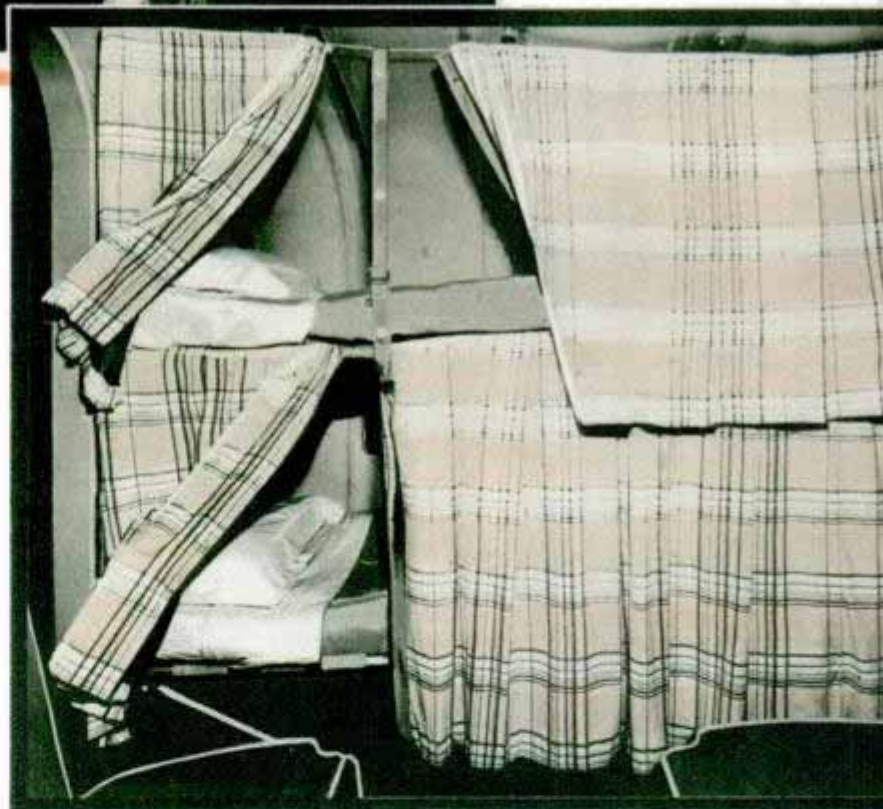

From Midway it's a 1,400-mile hop to Honolulu. On this jump you'll see little strings of coral islands from which thousands of birds rise and if you're flying low you may discern the remains of a vanished civilization which built its temples on some of these islands. You

F1263
334

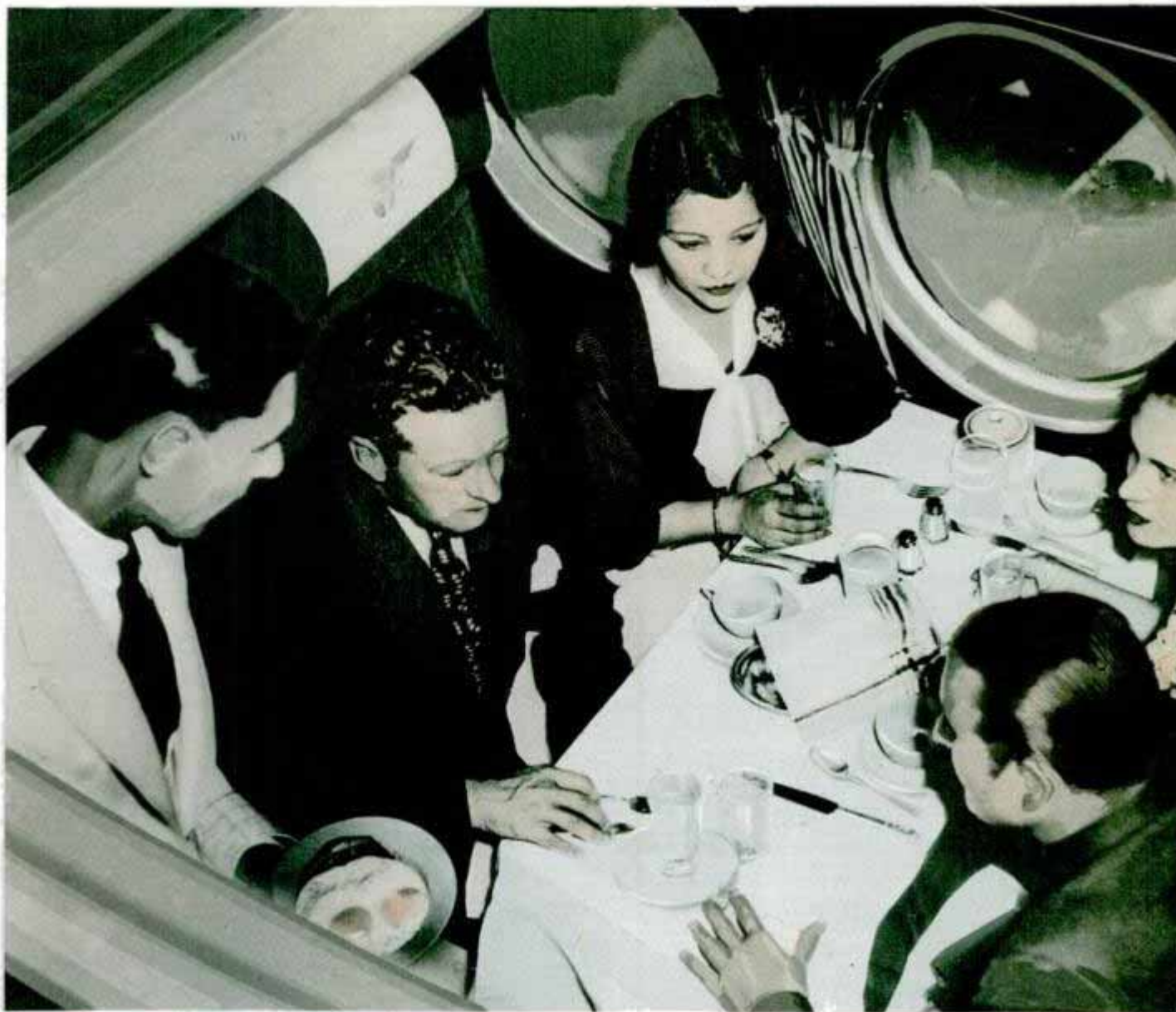

DINNER time aboard one of the Clipper planes operating in South American service. All meals on the China Clippers also are "on the house." 71263

land at Pearl Harbor and have time to become acquainted with the capital city.

The flight from Honolulu to San Francisco, 2,400 miles, is the longest of the passage and requires from fourteen to twenty hours, so you will do some sleeping on this voyage. Comfortable berths are a feature of the Clippers. After a seemingly endless journey over water you'll sight the Faralone islands and soon after the Golden Gate and you land in San Francisco harbor—back in the good old U. S. A. It seems you're home, but you are still 3,000 miles from your starting point.

And the best, most luxurious part of your trip still lies before you. You hop from San Francisco down to Los Angeles, there to board the "American Mer-

cury," giant sleeper plane of American Airlines. It carries you to New York in sixteen hours—while you sleep. Boarding this twelve-ton flying palace is an event. You walk up a gang plank into a spacious cabin divided into sections with facing seats like a Pullman car. Up front is aviation's pride, the "sky room" or private drawing room. Opposite it is the "flying kitchen." In the rear are separate dressing rooms and lavatories for men and women. 33

As your hotel with wings soars aloft you see up front a secretary collaborating with his employer in preparing correspondence on a noiseless portable typewriter—part of the equipment of this flagship of the American Airlines fleet. As you pass over Arizona the stewardess serves a six-course chicken



CONQUEST of the Pacific—a China Clipper leaving San Francisco on the first lap of its long journey to Manila, 8,000 miles distant.

338
X 263
dinner on individual tables with linen tablecloth, silverware and even real china. There's a brief stop at Tucson and soon after, the big ship takes on the appearance of a Pullman at night. Day sections are converted into berths, uppers are pulled down from the ceiling, bedding appears as if by magic, curtains are stretched and long before the "Mercury" lands at Dallas, all the passengers are sound asleep.

It's close to dawn as the "Mercury" settles briefly at Memphis but the sun is up before the first "early bird" among the sleeping passengers shows himself to get first chance at the electric

razor in the men's dressing room. Over Pennsylvania breakfast is served and soon thereafter the "Mercury," the last word in elegance and luxury in the air, settles onto Newark airport.

And you're home—back where you started from—around the world in three short weeks!

Of course, most persons traveling around the world by air prefer to make a more leisurely journey with stopovers along the way and that is easy to arrange.

And now, one word of disillusionment. Don't make a trip around the world by
(Continued to Page 132A)

House Paint in Rolls Applied Like Wallpaper

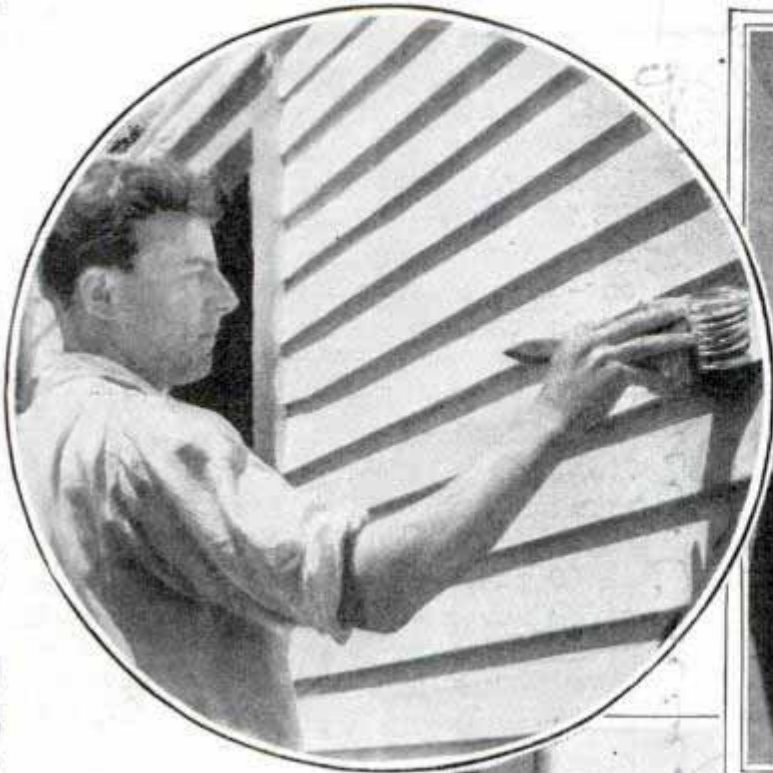

Top, left, brushing on cement. Bottom, applying the cloth-backed paint. Top, right, trimming to fit at ends of the boards

Now undergoing weathering tests, outside house paint in rolls may appear on the market within the next twelve months. Prefabricated by experts, the paint rolls are applied like wallpaper. Of particular importance is the possibility of its application to wooden surfaces which have deteriorated. The rolls cover cracks, blistered paint and splintered spots more satisfactorily than several coats of paint. In experimental form, this product is little more than oilcloth. In fact, a good grade oilcloth might be used for this purpose, but it is not so suitable for weathering as outside paint in similar form. The cloth base has four to six coats of paint. The wall is prepared by coating with a special rubber cement. Then two workmen open the paint roll and hang it horizontally. With a soft brush the paint-covered cloth is pressed into place, following the contour of the wall surface. The material is pliant enough to follow irregularities. The makers expect it to with-

stand the elements from ten to fifteen years. Present plans call for the paint rolls to be marketed at prices below those jobs where paint is brushed on. In addition, the rolls can be applied more rapidly than two or three coats of paint.

☐ The first suspension bridge was built across the Schuylkill river near Philadelphia in 1816, an eighteen-inch pedestrian span 410 feet long.

Standard Paint Co. New York

Being developed by Standard Paint Co. New York

Compressed Air Nov 1936

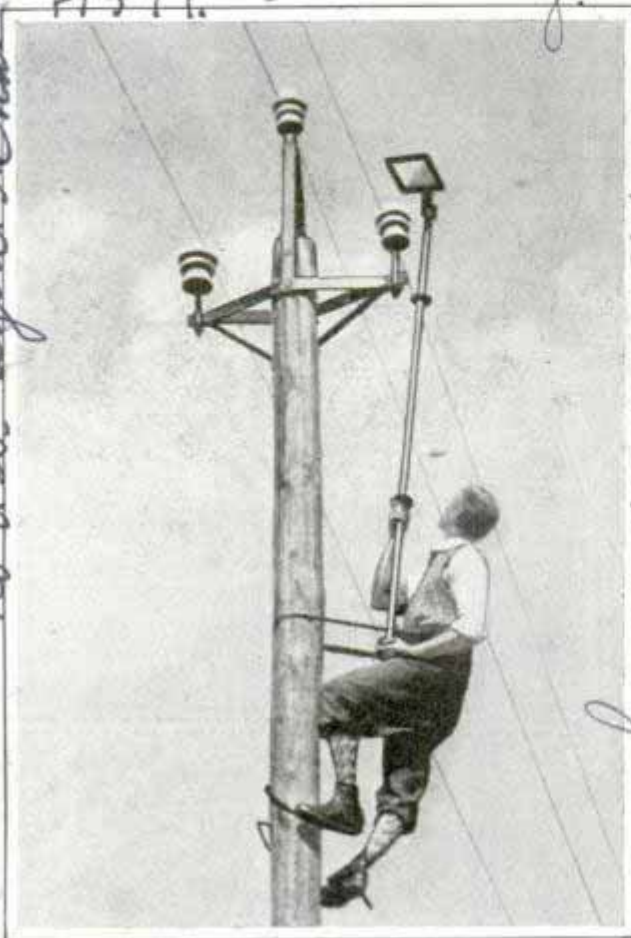

F1599. Germany.
Inspecting insulators on transmission line from every side by means of adjustable mirror on pole

Big brother of the tiny mirror your dentist uses to examine your teeth, a mirror mounted on a six-foot pole is used by linemen to inspect insulators on high-power transmission lines. The handle is hollow, and a rod inside it and a knob on the lower end manipulate a universal joint at the upper end by which the mirror can be adjusted to various angles for inspection purposes. The pole is of Bakelite, lightweight and non-conducting.

F1629
Machines Create More Jobs Than They Destroy

That jobs increase as industry puts more and more machines to work is borne out by a recent survey. The making of a modern automobile now requires twenty-five per cent more employment per unit car than it did in 1929. Instead of robbing operators of work, the dial telephone's introduction was accompanied by an in-

crease in the number of operators from 190,000 in 1920 to 249,000 in 1930. Advances in transportation in airplanes, automobiles, trucks and busses have decreased the 1,000,000 peak employment of railroads, but have increased over-all transportation employment by the addition of 2,700,000 truck drivers, 153,000 bus operators and 301,000 highway maintenance workers. Despite advances in textile machinery, one-third more workers are making women's clothing. Introduction of sound motion pictures and radio brought an increase in the number of musicians and music teachers from 130,000 in 1920 to 165,000 in 1930. Actors have increased in number from 20,000 to 37,000; theater ushers from 5,200 to 12,461, and there are 15,000 people on radio payrolls in jobs which never existed before. The number of ice dealers in the nation increased from 8,000 in 1920 to more than 19,000 in 1930, although gas and electric refrigerators had been expected to reduce jobs in that field.

F1528.

Flying Ability Shown by Timer Without Leaving Ground

With the aid of a reaction timer, the aptitude of a prospective army aviator for flying can be tested without taking to the



Wide World
Flashing lights show how fast this student pilot reacts to forty different situations

Scene Service 12/7/36
Germany
no that agent known

Product literature

air. The timing apparatus presents forty different situations in seven minutes to the prospective pilot and indicates the results by means of flashing lights. The equipment, constructed by the research department of the school of aviation medicine at Randolph Field, Tex., helps to show whether the time required by an individual to react to a situation is fast enough so he can safely be taught to fly.

Paper "Overcoats" Put on Plants by Machine

Designed to save truck gardens from damaging cold weather, the latest machine quickly puts paper "overcoats" on plants. The paper is laid in long strips wide enough to cover ordinary garden produce. An acre of plants can be protected in thirty minutes as the high-wheeled machine passes down the rows. Cost of the paper will be less than ten dollars per acre, compared to two or three times as much when dirt is used.

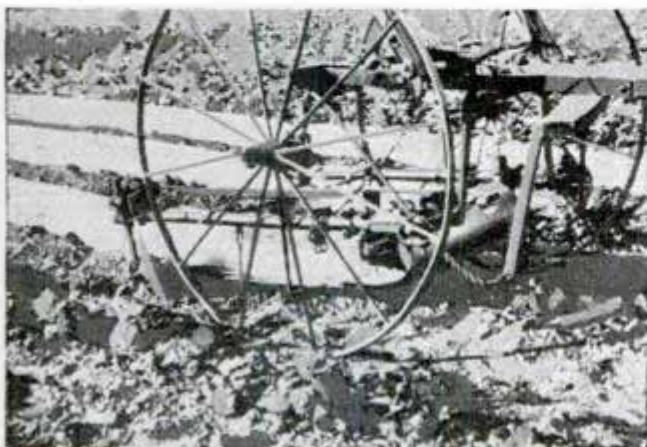

Machine unrolling strip of paper to cover plants as the temperature drops

Fire Engine Hurls "Snow" on Gasoline-Drenched Plane

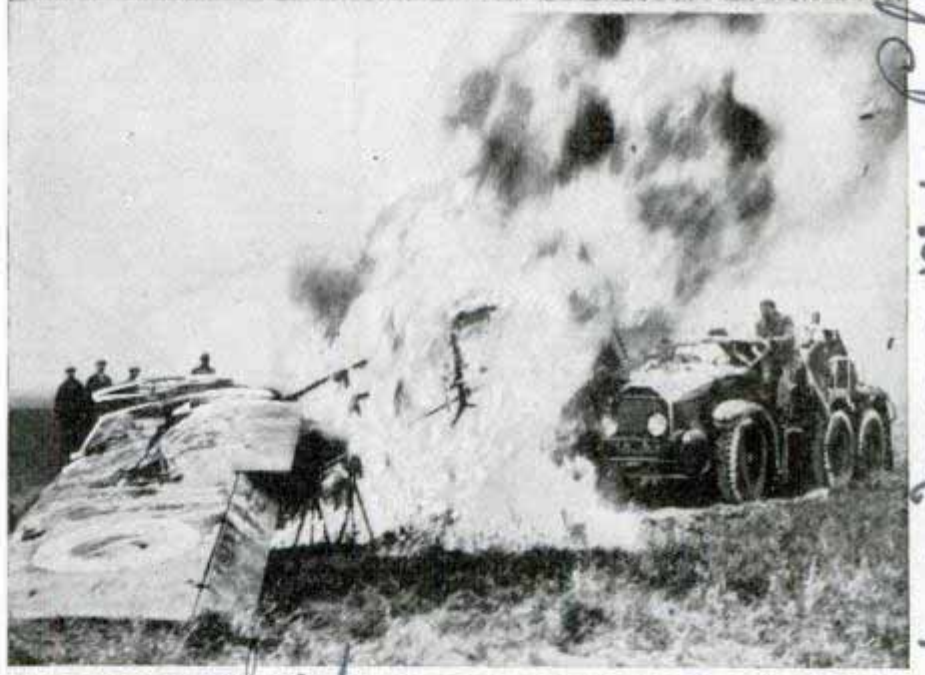

Top, many-wheeled truck with special nozzle to spread chemical froth on gasoline blaze. Below, airplane fire quenched in thirty seconds

Thirty seconds after a gasoline-drenched airplane was set ablaze at Le Bourget airport, Paris, to test a new fire engine, the flames were smothered. The apparatus was designed particularly to fight airport fires and is mounted on a fast, multi-wheeled truck. Special nozzles blanket the flames with a veritable blizzard of artificial snow and chemical froth. This method has been found most effective in battling gasoline and oil fires.

Our Bureau of Information will answer questions regarding articles in this magazine, if accompanied by return postage.

% Guarantee Shot Co

Mr. J. Mason Phillips and James

and Mr. Alfred Pfeiffer

F159.8

C.W.V. 2nd classman
4 W. 10 3rd St, NYC?

SCRAMBLED VOICES

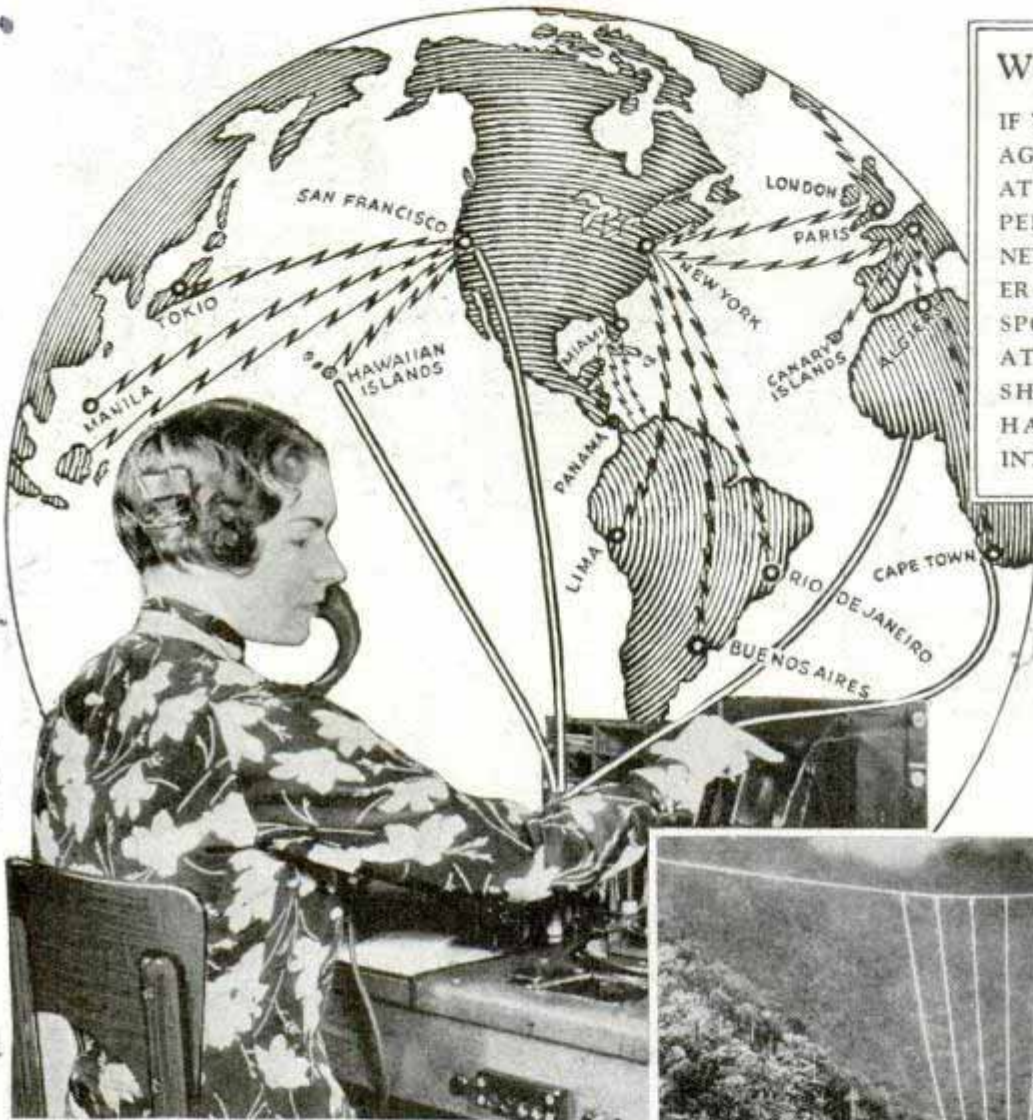

What's Your W. P. M.?

IF YOU'RE JUST AN AVERAGE FELLOW, YOU TALK AT A RATE OF 125 WORDS PER MINUTE. BUT YOU NEED NOT BE A FAST TALKER TO SAY MUCH: LINCOLN SPOKE ONLY 267 WORDS AT GETTYSBURG, AND SHAKESPEARE PACKED HAMLET'S SOLILOQUY INTO 263 PICKED WORDS.

Transoceanic telephone operator and map showing terminals of radio telephone circuits. Below, transmitting station at Bandoeng, Java

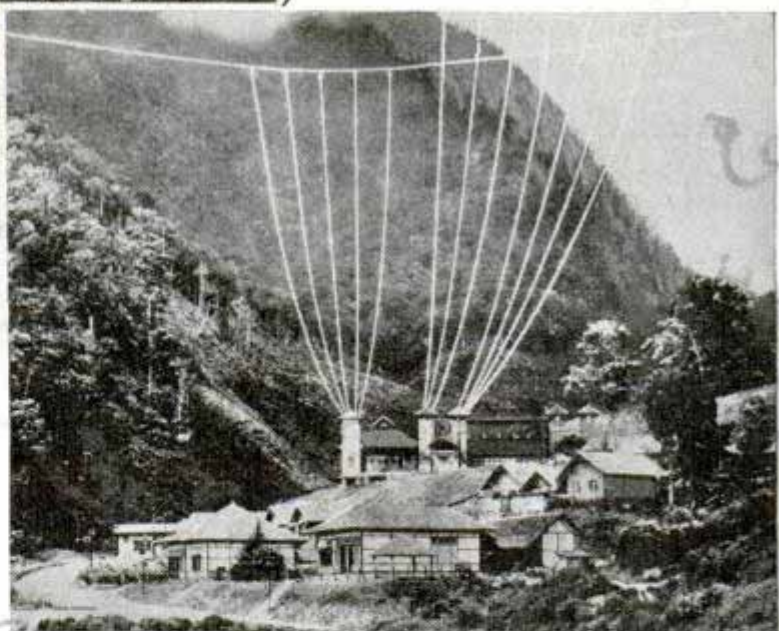

IT IS a small world when you talk on the overseas telephone. Sixty-eight countries can be reached within a few minutes on circuits that lead from your home transmitter.

Man has flung great invisible "word-bridges" across oceans and continents, and united the earth into one compact unit accessible from your home, office, or ship stateroom. You can send your voice speeding around the globe in the time it takes your watch to tick twice.

Barely past its tenth birthday, the overseas telephone service has increased its volume of business by leaps. Last year saw virtually all previous traffic records shattered. In the first ten months of 1936, the volume of calls increased by more than sixty-five per cent over the same period

of 1935. Conversations to ships at sea showed a similar increase. Traffic through San Francisco, to and from the Orient, increased by about thirty-five per cent over 1935. Telephone business between Miami and Latin America increased by about 260 per cent over that of 1935.

All previous records for the number of calls handled in one day also were shattered when 127 were handled over the

F 1598

around the WORLD

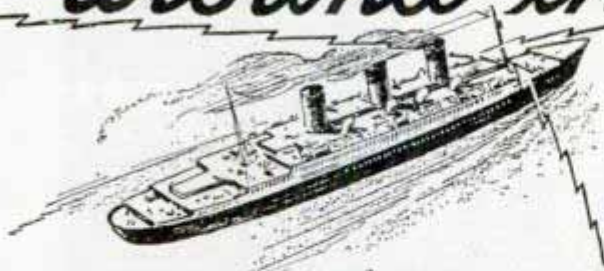

transatlantic circuits in a twenty-four hour period when France went off the gold standard in October, 1936. This figure was exceeded only by Christmas-day traffic and the telephone flood which burst when stock prices crashed in 1929.

More and more, ship passengers are using the ship-to-shore air

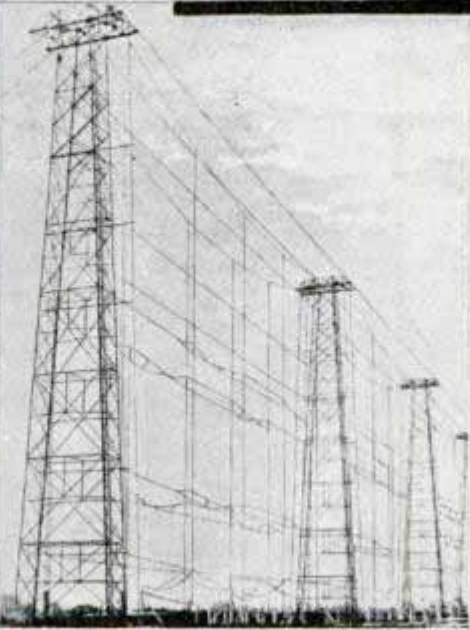

Above, talking from ship to shore, and operator at overseas switchboard. Below, Japanese transmitting station, antennas for circuit to Argentina and radiotelephone transmitting equipment



File of foreign directories for reference in handling overseas telephone calls. In the background are transatlantic telephone operators

waves. Last November eighth, fifty-two conversations were held between ship and shore stations, an all-time record. Thirty-three of these conversations were with one ship. On her maiden voyage across the Atlantic, seventy-four conversations were held between the "Queen Mary" and shore stations, a record for one voyage. From records and reports it appears that the overseas telephone service is equally divided between business and social affairs. Overseas conversations have now become so vital to business that many firms are investing thousands of dollars annually in telephone tolls. While touring Europe recently, a New York business man listened by transatlantic telephone to the stock market pulse. On one occasion he established an all-time record of one hour and thirty-seven minutes of continuous connection. On another his call lasted for one and one-quarter hours. The two calls cost more than \$1,000.

The overseas telephone played a dramatic role during the recent illness of an American boy who was spending the summer alone in the small town of Blois,

south of Paris. One day his parents in Philadelphia received a message that he had been operated on for appendicitis. They asked to be connected by transatlantic telephone. The operator was unable to reach him at his house in Blois, so she tried to locate him at the only hospital there, but he was not to be found. Far from giving up, the operator reached out by remote control and literally ransacked the city of Blois until she located the bed-ridden son in a small clinic. But the parents in Philadelphia were unable to speak French with the clinic attendant in Blois. So the operator suggested relaying the message and connected the Philadelphia subscriber and the Blois subscriber with a "telephonist" in the London trunk exchange, where an interpreter translated the conversation.

Business is now transacted by telephone on a world-wide scale. An American automobile manufacturer, with branches in South America, Asia, Africa and Australia, frequently calls his representatives by telephone. A Toronto miller, learning that a Glasgow merchant wanted a consign-

Lineal Measures Computed with Yardstick on Wheels

F/1622



Figuring cubic space in house by running a wheeled computer along the three dimensions

Taking the measure of your walls and flooring for the purpose of estimating air-conditioning, heating and carpeting requirements is made easy by a "yardstick on wheels." It is a wheeled computer with a long handle, which is rolled along the floor and up the walls, showing footage on a dial. This is a quick way of measuring cubic footage, and it is used, too, to figure footage of pipes.

Rifled Single-Ball Shotgun Shell Increases Accuracy Range

F/1659



By rifling, a single-ball shotgun shell recently introduced doubles the effective accuracy range of a shotgun. Spiral grooves on the slug minimize friction inside the barrel and cause the ball to rotate

on its axis after it leaves the barrel, thus maintaining a more direct line of flight with sustained power than the round, smooth ball achieves. At the end of the slug is a deep cavity adding stability.

F/1612

"Television Pipe" Transmits 240 Phone Calls at Once

Designed to handle 240 telephone conversations simultaneously, a coaxial cable, popularly known as a "television pipe," has been installed between New York and Philadelphia and recently was given a talking test by the Bell Telephone laboratories. Although the cable spans less than 100 miles, the circuit looped within it covers 3,800 miles. When used with the terminal equipment illustrated, the speaker's voice is split up twenty times between New York and Philadelphia. There are twenty loops in the circuit, each having a one-way amplifier. The voice passes through each amplifier twenty times, giving a total amplification of 400. At the sending end the various conversations are gathered together and sent over the one cable, then at the receiving end they are separated and sent along separate circuits. The cable also is adapted to the transmission of television.

col Photo

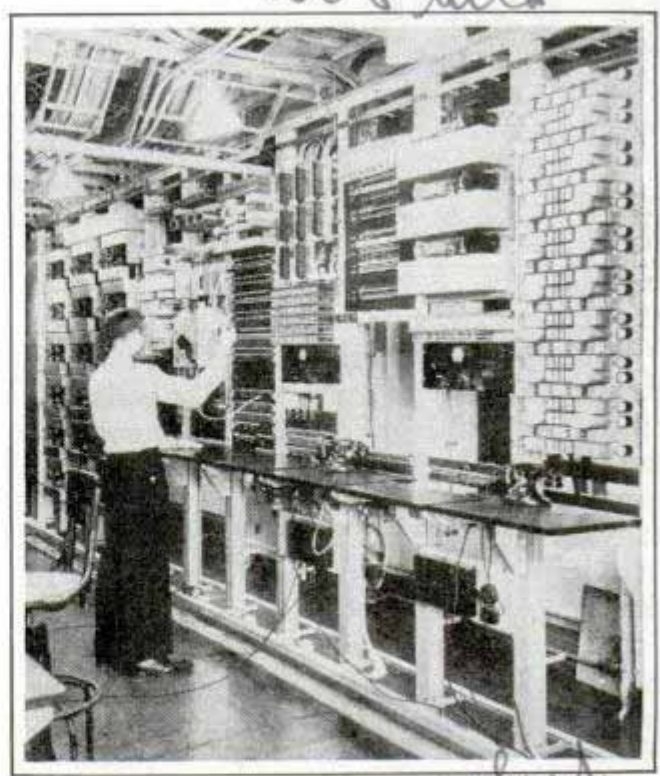

Terminal equipment of coaxial cable which handles 240 telephone conversations simultaneously

Wm. Winchester Repeating Arms Co. New Haven, Conn.

Gas Industry Laboratories, Inc. Long Island City, N.Y.

Agent - Tele. Room 300 - 4th Ave. N.Y.C.

chut

Indoor Ski Jump Has a Realistic Arctic Setting

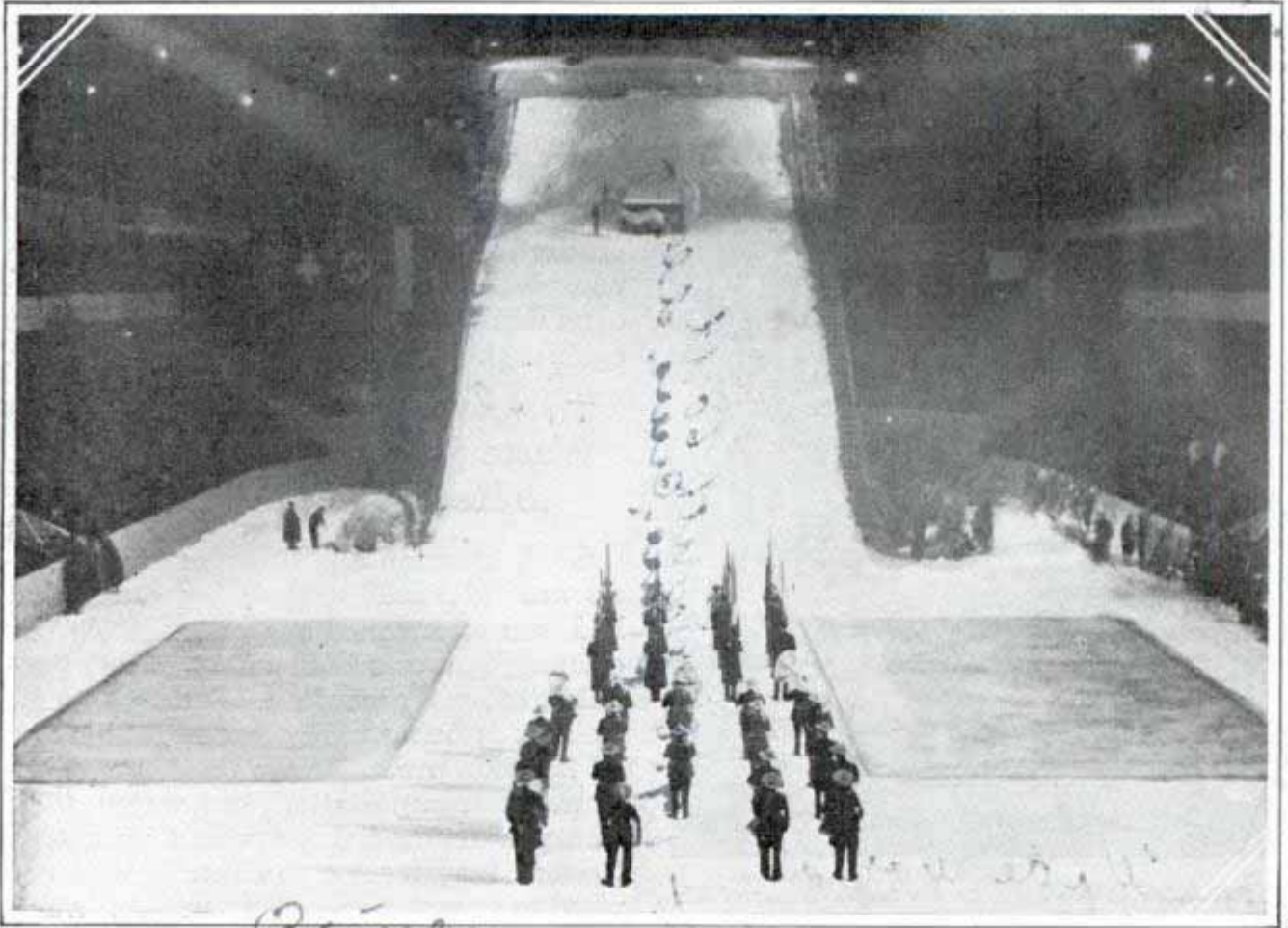

Prime
Ninety-foot indoor ski slide in Madison Square Garden, New York, made realistic by arctic landscaping. The band dressed in uniforms of Royal Canadian "Mounties" and imitation igloo was built at base of slide

Even the band, dressed in uniforms of Royal Canadian "Mounties," was part of the wintry scenery when Madison Square Garden in New York City was converted into a winter sports arena. Ski jumpers

Indoor Winter Sports Show
gave thrilling performances on a ninety-foot slide around which an arctic landscape was created. At the base of the jump was a papier-mache igloo which added to the realistic effect.

Mile and a Half of Fire Hose Is Carried in Special Truck

F. 1627
Designed for duty where long lines of hose must be laid because of water shortage or inaccessibility of hydrants, a special truck commissioned in London carries more than one and one-half miles of fire hose. The truck can lay one or two lines of hose at a speed of fifteen miles per hour. When not in use, the hose is folded in the truck, ready for unreeling on short notice.

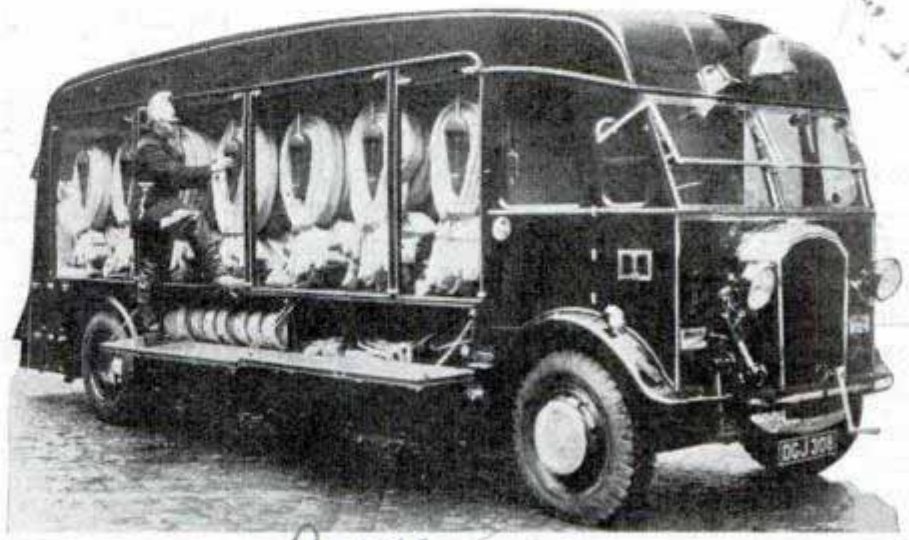

Prime
Here is how mile and a half of hose is stored in truck

Engineering Staff London

Chicago, Ill. 12/21/36

Armless Artist Uses Teeth to Wield Brush

F1606



Artist holds brush between his teeth. Some of his work is shown on the wall

Born without arms, Henry Weigman has overcome the handicap and now is an accomplished artist. He holds the brush between his teeth as he works on plaques and other art works in his shop, the walls of which are decorated with his paintings. The shop also offers the handicraft of other handicapped persons.

Research Foundation under direction of Mr. Thomas C. Poulter

Water Squeezed into Solid in Pressure Laboratory

Squeezing water into a solid and other scientific tricks will be possible in the high-pressure laboratory being installed at Armour Institute of Technology. Pressures as high as 600,000 pounds per square inch will be exerted by equipment for studying electrical, physical, chemical and optical properties of materials. Under such pressure, colloidal constituents are precipitated, water compresses to half its volume and changes to a solid having a melting point of 212 degrees Fahrenheit, glass or quartz sheets one-fourth of an inch thick will bend to a radius of curvature of four

inches several times before breaking, and hydrogen gas will pass rapidly through the walls of a steel container. The structure of the steel is greatly affected, its tensile strength being reduced to less than half its former value. Under this pressure, the molecules are brought closer together and the atoms composing them are actually compressed considerably. Outside the laboratory, pressures of nearly half a million pounds per square inch exist under such conditions as thrusting a needle point against glass or rubbing two files together.

F1609

Waste Sand Is "Dry Cleaned" to Recover Valued Metals

Gold, tungsten and other precious metals are "gleaned" today from sands that had been abandoned as worthless. A "dry cleaning" process that separates tiny particles of ore according to their atomic weights is being used where cyanide and oil flotation processes are uneconomic because of transportation and water costs. The new method was evolved by a New Orleans man from a machine he had devised to separate weevils from rice. Waste ore is crushed and pulverized to 120-screen size and fed into a concentrator. Metallic substances drop by gravity into a bin and the gangue or waste is sucked up by an air draft and cast off as tailings. If the ore

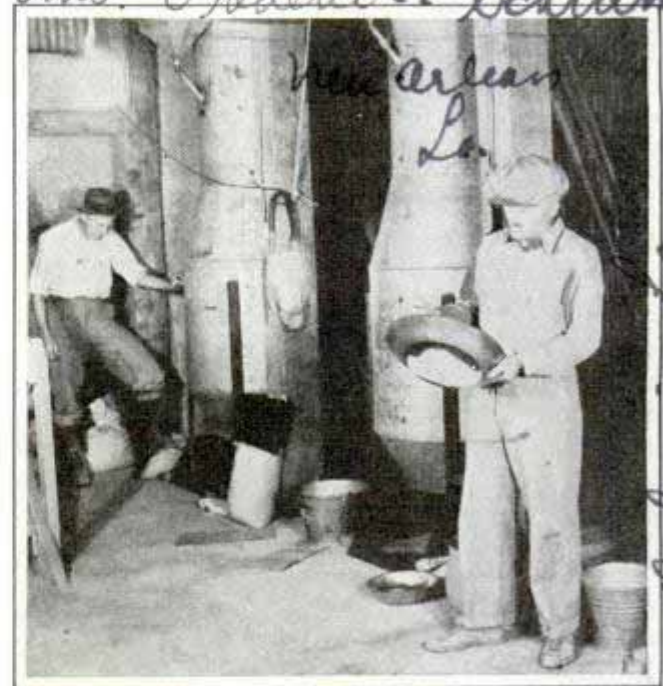

Examining gold dust recovered from waste sand by vacuum applied in the separating bins

Universal Classifier

New Orleans, La.

contains several metals of different weights, the tailings are passed through again, the process being repeated at different vacuum pressures as many times as there are substances to recover. The degree of vacuum is regulated by a gauge according to the atomic weight of the metal it is desired to separate.

F1636

Gas for Trailer Safely Stored in Bottles

Safety and convenience are two features of bottled gas equipment offered for trailers. Tanks, regulator and all high-pressure apparatus are located outside the trailer. In this position, the tanks are available for changing when empty. The two tanks provided carry a ten weeks' supply of fuel for cooking. Each cylinder has built-in safety plug and welded steel collar to protect the valve equipment. A steel cabinet, designed for mounting the cylinders with clamps to prevent rattling, is drilled for brackets to facilitate attachment to the trailer. Copper tubing and fittings for connecting the tanks to the stove also are included.

Trailer Gas

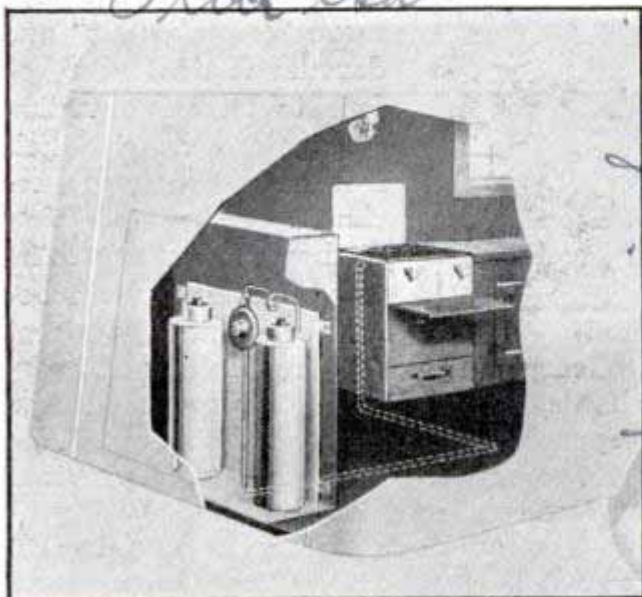

Cutaway view of gas bottles in trailer. Dotted lines show connection to stove

Trailer Equipment Co.

Tractor Helps Launch Boat for Dutch Coast Guard Crew



Wide World
Dutch coast guardsmen starting out on a rescue mission, driving their boat into the surf on a specially constructed truck pushed by a tractor

Coast guardsmen at Muiden, in the Netherlands, have developed a new method of launching their heavy boats. The boat is loaded on a specially built truck and driven into the surf by a tractor.

F1677

Pipe Lines Second to Railroads in Ton-Miles of Cargo

Although the public is seldom conscious of pipe lines, they rank second only to the railroads in ton-miles of cargo carried. There are 425,000 miles of sewerage pipe lines in North America; 312,000 miles of gas pipes lead to your kitchen stove; 211,000 miles of water pipes; 100,000 miles of petroleum and 65,000 miles of natural-gas transmission lines. Ranked according to ton-miles carried, the transportation systems of this continent stand as follows: railroads, 500,000 million ton-miles; pipe lines, 400,000 million; motor vehicles, 34,000 million; electric railroads, 11,000 million; inland waterways, 11,000 million, and airplanes thirty-three million.

Ⓜ A British automobile manufacturer lends a kit of spare parts to motorists taking a car of that make abroad, requiring only a nominal deposit which is refunded if the kit is returned intact.

Walseley Motors

*Bulletin Ontario
Birmingham Research Foundation*

Science Press 2/19/36

F1597 Cmt. Emile C. Schürmacher
727 Park Ave

The THRILL



Stunt driving is typically American. European daredevils concentrate on balancing acts

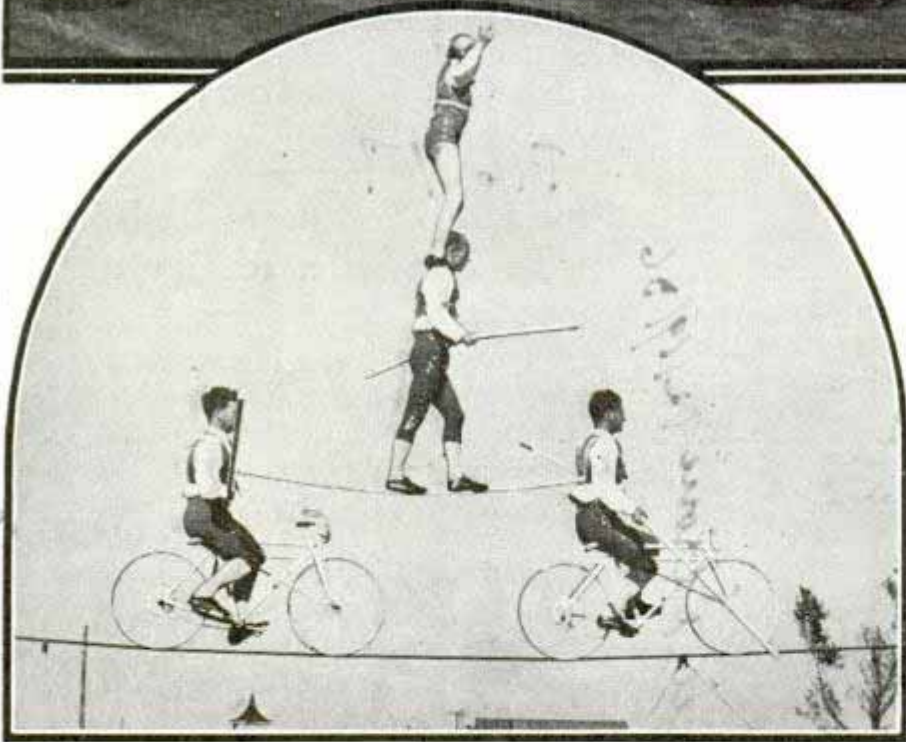

high wire artist emerged unscathed, the crowd gave a sincere sigh of relief.

Last year, at fairs and carnivals, at circuses and expositions there were more "crash artists" and daredevils than ever before to thrill sensation seeking crowds with their feats. Who are these merchants of thrills? How do they get that way? Are they normal human beings or suicidal maniacs?

DURING the past year more than \$25,000,000 was spent by thrill seekers in the United States who came to see accidents which, somehow, just failed to happen. The majority came expecting, even morbidly hoping, to see daredevil performers crash to death or meet with severe injuries. But when the high diver, the glass crasher, the human bullet or the

George A. Hamid, king of the thrill merchants, is probably better qualified than anyone else to answer these questions. Last year his thrill dispensers provided excitement for more than 30,000,000 people who saw them perform at 300 fairs, 200 celebrations, thirty-five amusement parks and many civic carnivals, homecomings, circuses and other outdoor affairs.

vertical text on the left margin, partially illegible

vertical text on the bottom right margin, partially illegible

HUNTERS

*Carnegie's Steving
Horse
"Lorna."*

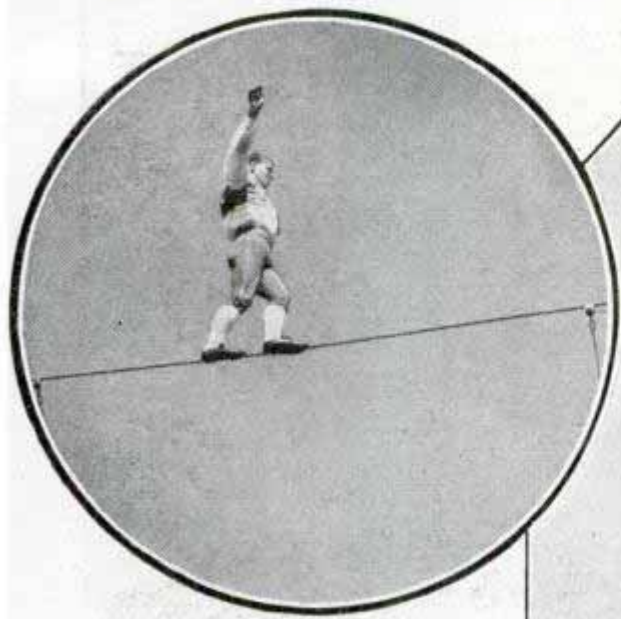

"The public wants the thrill provider to take his life in his hands every-time he does his act," states Mr. Hamid, "The daredevil business has boomed as it never has before. One of the reasons for this, strangely enough, has been the great development in radio entertainment.

"All a person need do to get his fill of jokes, music and singing is to turn on his radio. When he sees performers in the flesh, he wants to see something different and he is most satisfied when he sees an act which provides the maximum in thrills."

As a result, the thrill providers have become increasingly daring. Twenty years ago a high diver who jumped into a shallow tank of water from a height of sixty feet was considered a daredevil. Today the diver must jump from a height nearly twice that



Crowds in the grandstand always fear the worst when the daredevils appear. Top, a high wire walker strutting his stuff, and a diving horse and rider on the way down

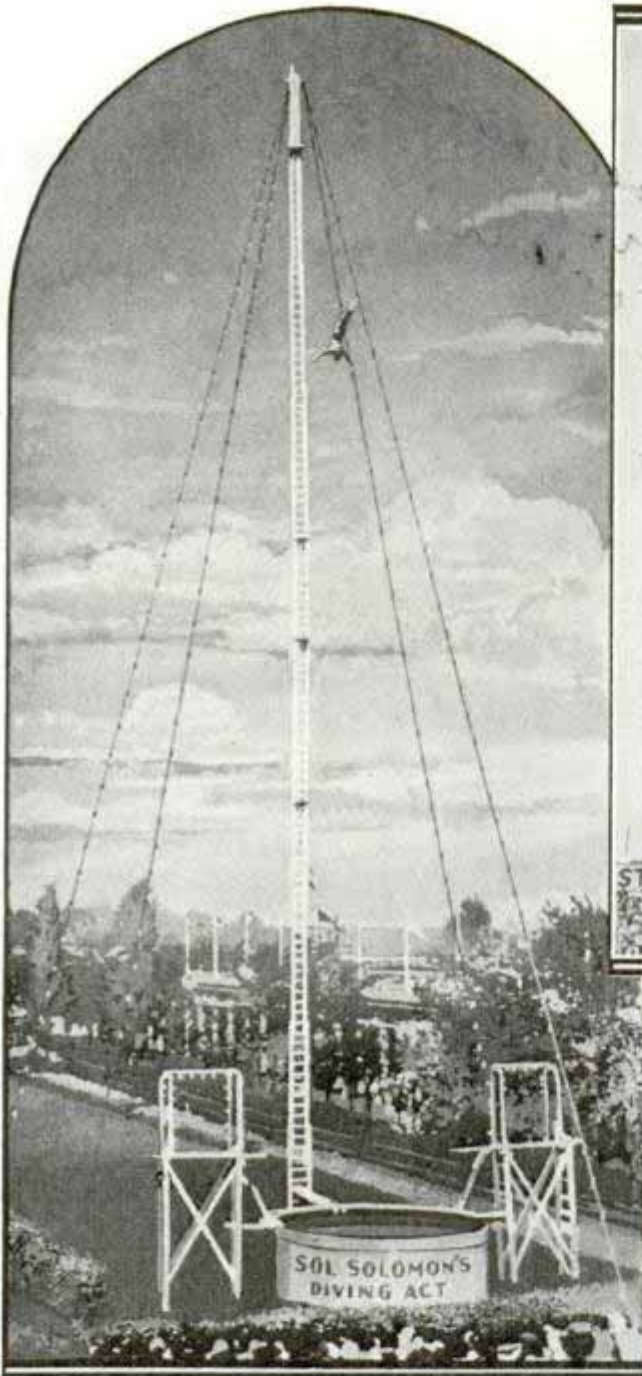

Sol Solomon diving 122 feet into shallow tank, and a hair-raising aerial trapeze act

distance to arouse real enthusiasm. Last year, at Palisades Park, N. J., Capt. Sol Solomon, "king" of the high divers, jumped 122 feet into a five-foot tank of water.

"A few years ago, shooting one man out of a cannon provided a great thrill," says Mr. Hamid. "Today, in order to provide the same enthusiasm, two men must be shot out. Aerialists and wire walkers who used to work at forty feet are now performing at 150 and 200 feet. New acts of crashing through glass on motorcycles, overturning speeding automobiles and jumping through flames are constantly being devised to give audiences new thrills.

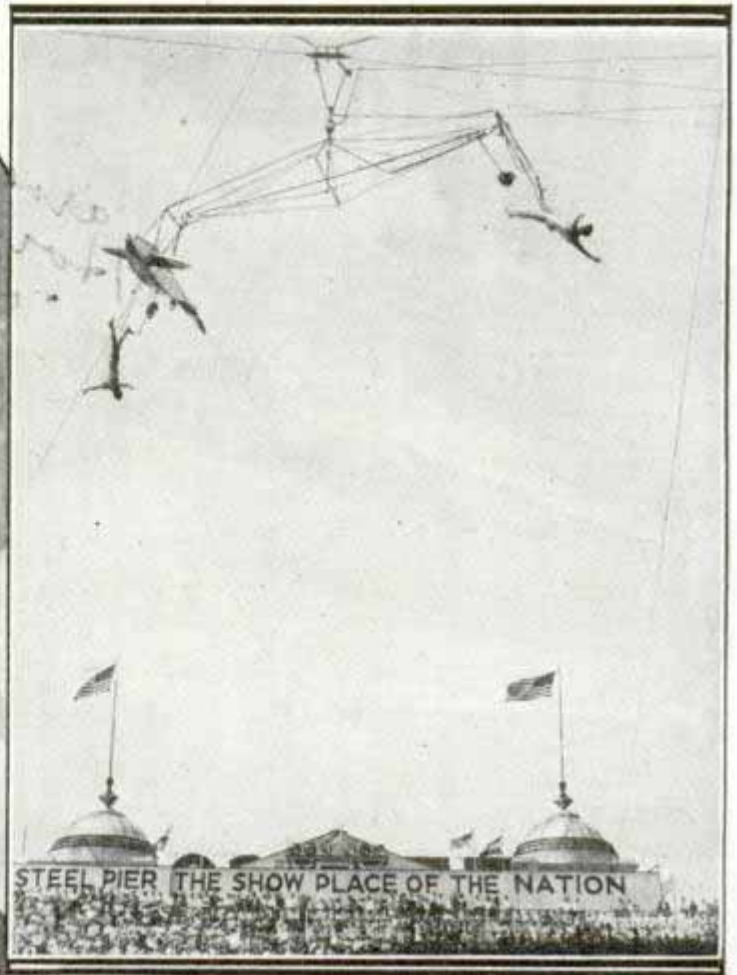

Just how much more the daredevils are risking is shown by the increasing number of fatalities and accidents. From 1921 to 1934 only one daredevil was killed in the United States while performing. But since that time seven have been killed outright and an increasing number have been injured.

There are two principal reasons for these deaths and injuries. The first is overconfidence on the part of the daredevil who has mastered an exceedingly difficult stunt. It may be a glass-crasher speeding on his motorcycle at sixty miles an hour who neglects to crash through the glass exactly head on. Hitting at a slight angle, he is cut or killed. It may be a high diver who, after doing a dozen dives daily, relaxes his vigilance and doesn't hit the water in the shallow tank just right, suffering a broken back or blindness from a hard hit optic nerve.

A German daredevil named Brava, after having performed on a pole 200 feet high for two years without an accident, fell to his death from a height of only forty feet. He plunged from a rope on which he was descending from the pole a bit carelessly.

71597



The second reason thrill merchants are killed or injured is because of some mechanical failure or lack of skill on their part while getting a new act ready or improving on an old one. Since mechanical equipment is constantly inspected, it is rarely that a tragedy occurs for this reason today as it did three years ago when an "iron-jawed" woman swinging 100 feet in the air supported only by the strap which she held in her teeth, came crashing to her death because her teeth had bitten through the strap.

Last season, however, when George Hirsch, the "Rocket Marvel of the Ages" tried to improve on the shot-from-the-cannon act, he met with disaster at Atlantic City. It was his idea to be sealed into a rocket and shot out into the ocean. The rocket was to be caught in a large net and he was to emerge. It cost more than \$8,500 to bring the act to Atlantic City pier. When the rocket was fired the first time, Hirsch received a broken leg.

Performers get into the thrill business in various ways. Some are literally born into it as their fathers and mothers were in it before them. This is particularly true of the high wire artists, aerialists, balancers, trapeze specialists and acrobats



Crash acts, like the one shown, are popular with crowds in this country. Below, shooting man from cannon

many of whom are of foreign extraction. The American thrill merchants specialize more in such daring acts as high diving and jumps and crashes through flames and glass and over obstacles.

Among prominent American thrill merchants is "Lucky" Teter, first to do the

(Continued to page 140A)

6
7
8
9
10
11
12
13
14
15
16
17
18
19
20
21
22
23
24
25
26
27
28
29
30
31
32
33
34
35
36
37
38
39
40
41
42
43
44
45
46
47
48
49
50

Will Graham

Chicago Daily News 12/19/36

Scenic Car's Roll-Back Top Improves Passengers' View

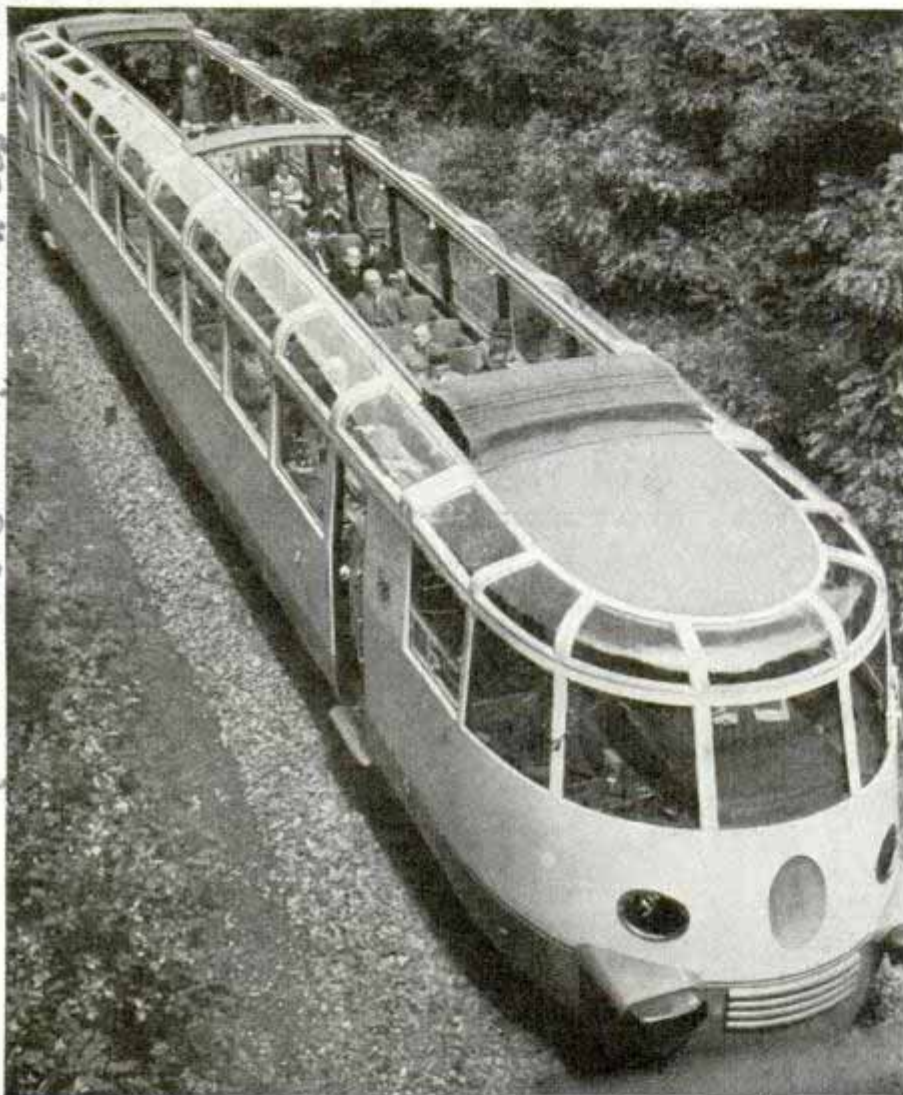

Scenic railway car is shown with top rolled back to give passengers a better view of beautiful mountain country

Equipped with a roller-type roof, a scenic railway car introduced recently in Germany permits better view of the beautiful countryside through which the car operates. Windows extend around the sides of the car, which has capacity for sixty passengers on the run between the German Rhine and the frontier upland district of Eifel.

Rubber Paint Protects Fenders From Winter Damage

Rubber paint is being used to protect automobile fenders and other sheet-metal parts from injury by calcium chloride, which is commonly spread on streets and highways to combat ice and snow. Con-

tinuous contact with calcium chloride might damage the enamel finish. Rubber paint can be sprayed or brushed on the undersides of fenders and aprons, providing a surface the calcium chloride will not hurt.

Teardrop Golf Club Adds Yards to Drive

Streamlining has now reached the golf club. A golfer who is also a physicist has invented a teardrop driving head for brassie, driver or spoon with which he anticipates adding yards to his stroke. A metal shaft is used, the club head being a cylinder of persimmon wood, shaped for the least possible air resistance. The bottom is slightly flattened and has a metal "sole." Golfers who have tried it say the club helps straighten out drives. The shaft goes directly into the central axis of the head without any crook.



Teardrop driver lined up beside conventional type

Conk Harold J. Wylking Esq. Colombarie 29 Dean Road Parsippany Beach N.J. 07054

F169 Pontiac motor dies

Chm. W. J. Crocker Va Leesburg

Lightweight Pullman Built Like a Skyscraper



Top, left, lightweight sleeping car. Note small windows provided for upper berths. Right and bottom, interior views showing arrangement of seats for day travel

Constructed of alloy steel, the latest sleeping car is forty per cent lighter in weight than the standard car of the same capacity, carrying eight sections, two double bedrooms and two compartments. The car has windows for its upper berths, a feature of all the latest Pullman sleepers. Use of a truss-type of side frame to carry the entire load enables the builders to reduce the car's weight. A very light-gauged sheathing covers the frame, along

the lines of a steel skyscraper, the strength of which lies in the frame and not in the facing. The car's frame is entirely welded, eliminating the necessity of overlapping any of the framing parts, and thus avoiding any additional weight. Rolling steps, not visible when the train is in motion, and tight-lock couplers, with rubber draft gears that absorb the shock of starting and stopping and eliminate operating noises, are other features of the new car.

The Pullman Co. 29 & Adams



SNOW FIGHTERS

WHEN grandfather starts to tell you about the winter of 'eighty-eight and the blizzard that piled drifts above the kitchen window, stop him. Maybe it was more romantic in the old days when sleigh bells jingled on graceful cutters and you could guess the temperature by the high-pitched crunching of the snow under wagon wheels; but blizzards still do themselves proud today as they did in the 'eighties, and they pack a punch more paralyzing in this motorized age than when Dobbin pulled a sled.

It has been estimated that a winter's snowfall costs this country more in economic loss than a year's destruction by fires. Death on icy thoroughfares; epidemics of disease, privation, even hunger in communities isolated by snow; millions spent by the railroads to clear their tracks, millions more to bore through highway drifts—these are a few of the items on winter's annual bill.

No one ever thought of plowing all the dirt roads open through the winter. Paved roads have put snow removal into

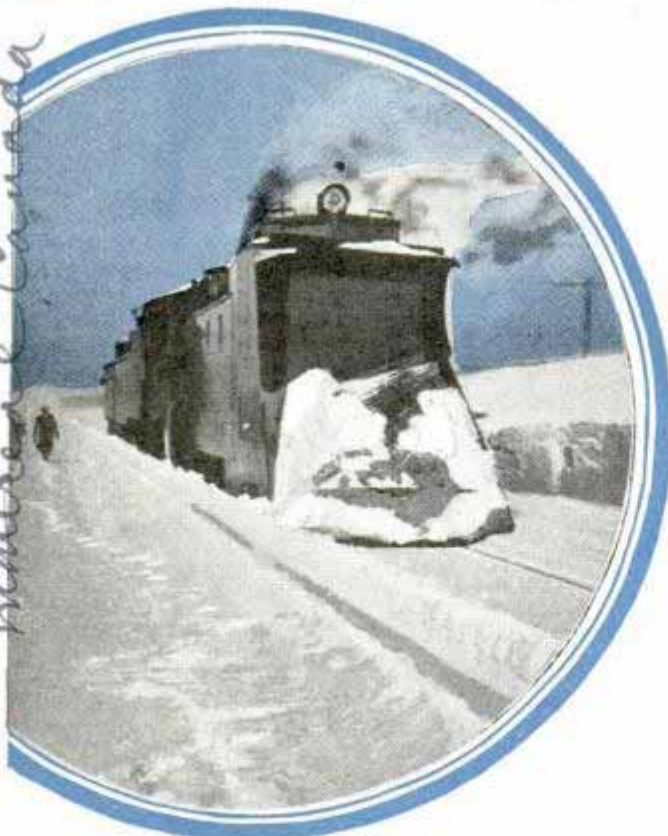

Top, railroad plow churns through drifts that nearly buried telephone poles along right of way in Wisconsin. Sometimes it takes three or four locomotives to bore through. Below, a wedge-type plow

F151
 Capt. Robert H. Foster
 1434 St. Catherine St. West.
 Montreal, Canada

big business. Across the northern belt of states from Virginia, Missouri, Colorado and California up to the Canadian border, brigades of modern motor plows wage war all winter on blockaded roads. The existence of bus and truck companies depends on year-around open roads. Rural life hangs by the thread of transportation. A few decades ago the town-folks of Springville and the neighboring farmers took for granted that snow would lock their doors most of the winter, and they laid in a winter's supply of fuel and food. Sleighs could get through to town, and the town depended on the railroad. Today the



CLEAR *the* WAY

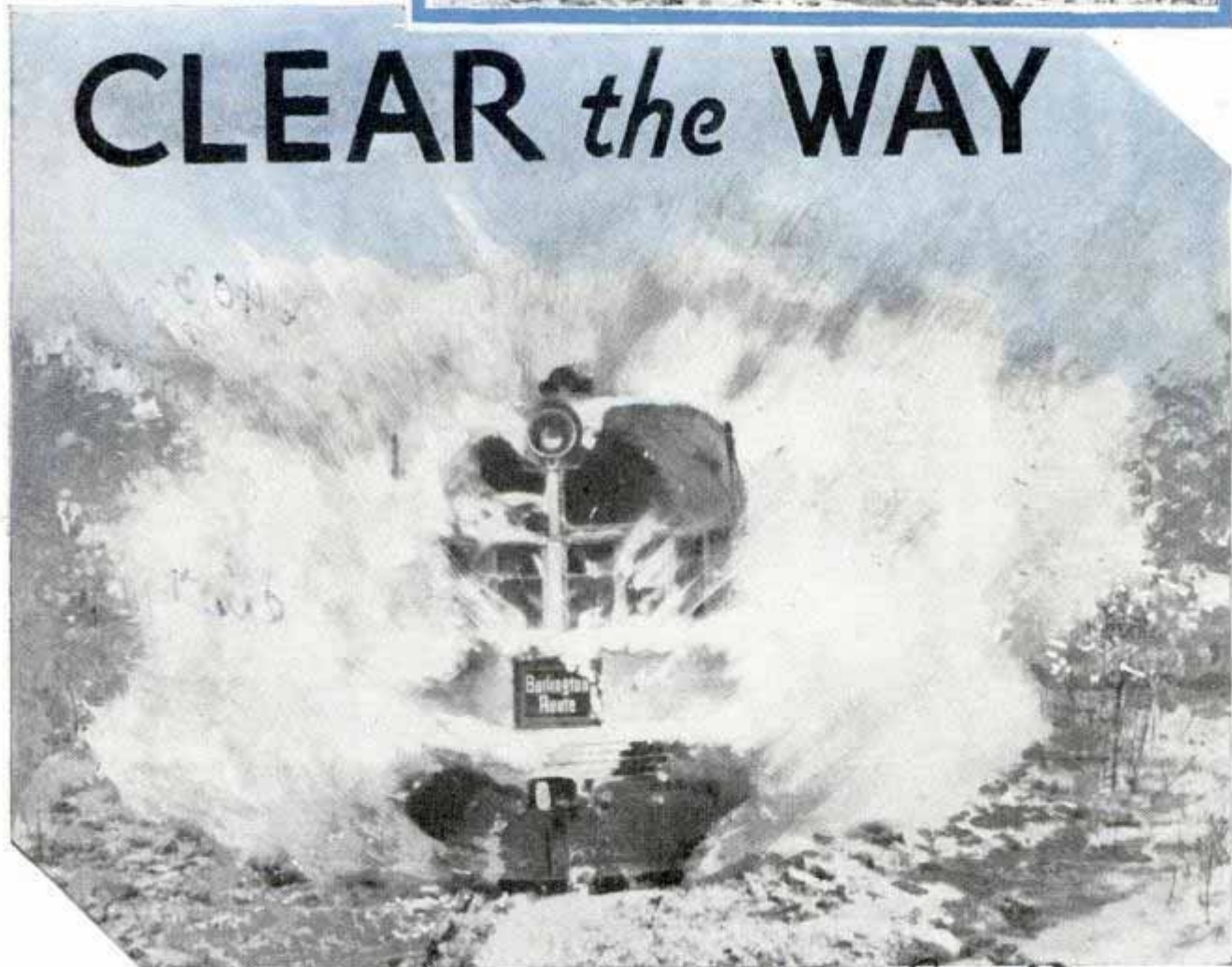

© Burlington Railroad

Wonder what would happen if a streamliner met a snowbank? The pictures tell the story. What looks like an explosion is a Burlington "Zephyr" emerging clear after smashing through a snow-drift 300 feet long. The streamliner struck at eighty miles an hour

Diesel Power.

near Lee Ill.

Minneapolis



waves; powerful rotaries that churn snow mountains into flying clouds, and other specialized power apparatus. Among the latter are "flangers" which follow the big plows and cut a clean channel about eight inches wide just inside each rail—additional safeguards against derailment of fast trains by snow-packed rails. Often enough these modern

community keeps smaller stocks on hand and expects the freight train and the highway truck to buck the drifts with daily supplies. A real, snorting snowstorm that even buries the snowplows can put a city in peril quickly.

A small town in Missouri was cut off from the world for an entire month last winter. Not on any railroad line, it depended on state roads for coal and grocery supplies, and when heroic highway crews finally fought through the drifts the 200 residents of the beleaguered town had but three days' food rations left and were burning shade trees and shacks to keep warm. The mayor of an Iowa city broadcast an appeal for help after seventeen days of isolation, reporting there was no bread, sugar, flour, kerosene, lard nor livestock feed and only a half ton of coal remaining. Rescue came when railway plows succeeded in cutting a hole through the white wall and freight cars rolled again.

Trains must get through. There's no canceling of schedules for snow. As soon as the storm begins, the dispatcher sends out the fighting equipment: wedge plows that turn the drift aside as a farmer plows his furrow; V-type plows that ram the snow wall like a battleship cutting the



After the battle—the big iron horse, above, is home after fighting through a sub-zero blizzard. Center, clearing lines in the switchyard. Below, rotary plow pilots a passenger train

snow-fighters themselves are caught in the drifts, so crews of men with picks and shovels ride every passenger, freight and plow train to help dig out in the old-fashioned way. During the record snows that blocked traffic for days in February, 1936, five of the railroads operating north and west from Chicago kept nearly 250 plows and ninety other pieces of equipment blasting through the drifts at a cost of



\$1,271,000 in labor alone. That's only part of the cost for one small section of the middle west. Multiply it for all the railroads north of Dixie, count in the Rocky Mountain snows that start in September and stop in May or June and you add up a staggering bill.

Climb up the grade into the high Sierras from semi-tropical California and you bump into the biggest snow pile in the land. Five hundred inches of snow, some years, fall on the railroads and transcontinental highways where they cut through the mountain passes. Steep grades and curves on one line required a special plow, with a V blade and two huge rotors driven by a 200-horsepower gasoline engine mounted on a boxcar and pushed by a twenty-ton locomotive. As many as four locomotives have teamed up to shove a single plow through Wisconsin drifts. In what is called the "Thaw Belt," roughly between lines drawn east and west through Albany and Indianapolis, intermittent freezing and thawing results in ice-encrusted highways, and snows frequently are wet and heavy, packing down



Top, a "V" plow mounted on a flatcar. Bottom, automatic snow-loader clearing a city street. Revolving disks feed the snow piles to an endless conveyor which loads two trucks per minute

into barriers that stop a plow dead. But for heartbreaking work take the throttle of a giant rotary plow as it bears down on a dune of "sugar" snow looming twenty to thirty feet above the track. Light, powdery stuff, it is blown aside by the whirling blades and you bore steadily through,

(Continued to page 144A)

Secret Time Alarm on Truck Stops Hijackers

\$150.00 per year



Left, truck driver pressing secret combination of six hidden electric buttons before starting motor. Steel case has been removed to show the heart of the alarm system. Center picture shows driver turning key of timing device before entering cab. Below, siren mounted under truck

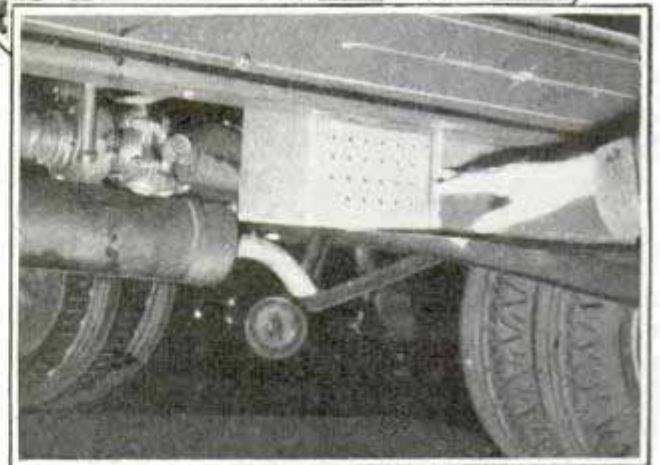
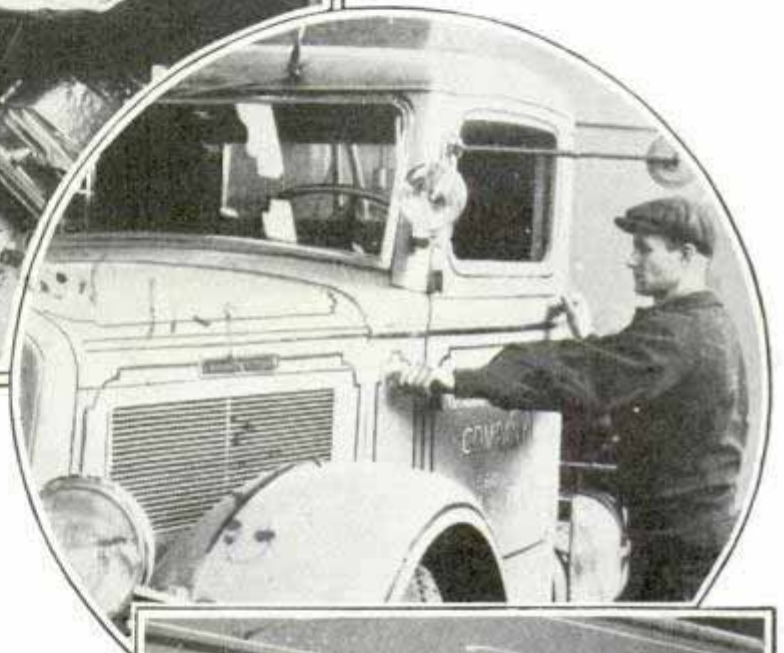

To baffle "pirates" of the highway, trucks laden with precious merchandise are being equipped with a secret combination alarm which stops the engine abruptly and sounds a piercing siren when cargo or cab is attacked. The electric timing mechanism is always in operation, even when the truck is parked in a garage, and any attempt even by the driver to start the engine, enter the cab, tamper with doors or with the alarm system itself will set off the alarm unless the secret combination is worked properly. This combination is known only to the driver and can be changed only by the manufacturer. When a truckman starts out with his valuable load of silks, drugs, cigarettes, tires or other goods, he must first turn a key in a lock in front of the cab door. Then he must enter the cab and within a given number of seconds press a certain combination of six electric buttons concealed in a steel box on the instrument board. This done, he can start the motor and proceed. If he fails to work the combination within the allotted period, the timer will sound the alarm and it cannot

be stopped immediately. The driver can shut it off after a period of time by proper manipulations. If hijackers open the cab door or the door to the cargo, or attempt to cut wires of the alarm, the siren will blow and continue for four to six hours to utter a shriek audible for several miles. It is operated by a powerful storage battery mounted under the truck. All wiring is

Chicago - United Standard Products, Inc.
Tel. Calumet 2323 / 2526 Wabash Ave

F/160

encased in steel pipe, the siren and battery being inclosed in hardened, drillproof steel cases with special baffles. No two trucks have the same combination. The human element is minimized, for the alarm is automatic and needs no motion of the driver to actuate it.

Ski Slide Coated with Borax Is Constructed Inside Store

Mrs. Merle Smith

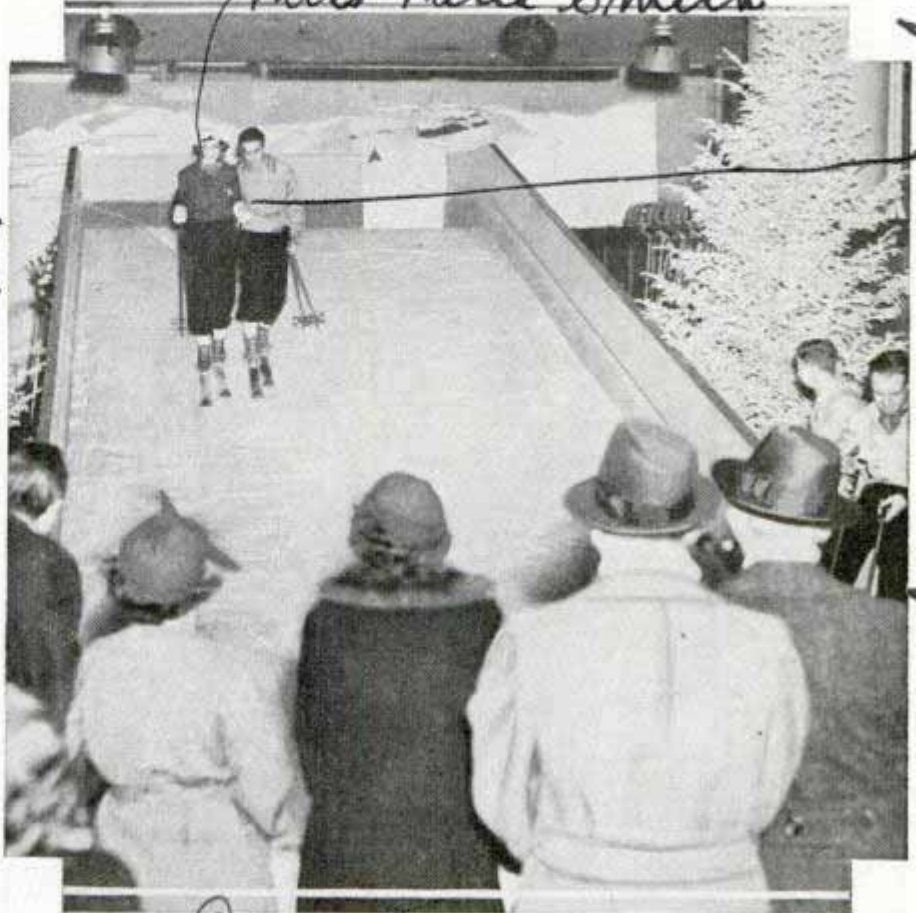

Acme
Here are two demonstrators coming down the borax-coated slide. This novelty helps to sell winter sports clothing and equipment

Marshall Field
Constructed in the sports department of a large store, a ski slide coated with borax gives novices the sensation of skiing and permits experts to demonstrate. Borax facilitates movement of the skis on the slide. A winter scene painted on a backdrop lends a realistic touch.

Foot Guard Made of Aluminum F-159 2 Protects Workers

Protection against injury from heavy objects falling on the feet of steel-mill and machine-shop workers is afforded by an aluminum alloy overshoe. Corrugated across the instep to give it strength and rigidity, this guard has maximum resistance to the impact of heavy objects.



F1559
**Twin Microphones
in Stethoscope
Aid Diagnosis**

Equipped with two microphones and four tubes, an improved stethoscope not only detects the location of noises but tells in what direction they are traveling in the human body, greatly aiding in diagnosis of the disease. The twin microphones, both extremely sensitive, pick up sounds more quickly than the single-detector stethoscope used for many years.



Who Works
More accuracy in locating and diagnosing human ailments is claimed for this improved stethoscope

Prof. Wm. W. Williams, University of California

Christian L. Gerhart

Alwood Safety Appliances Co. 203

University of California

475
4639 Montgomery Ave
Bellevue, Wn

WOOD *Detective* SOLVES

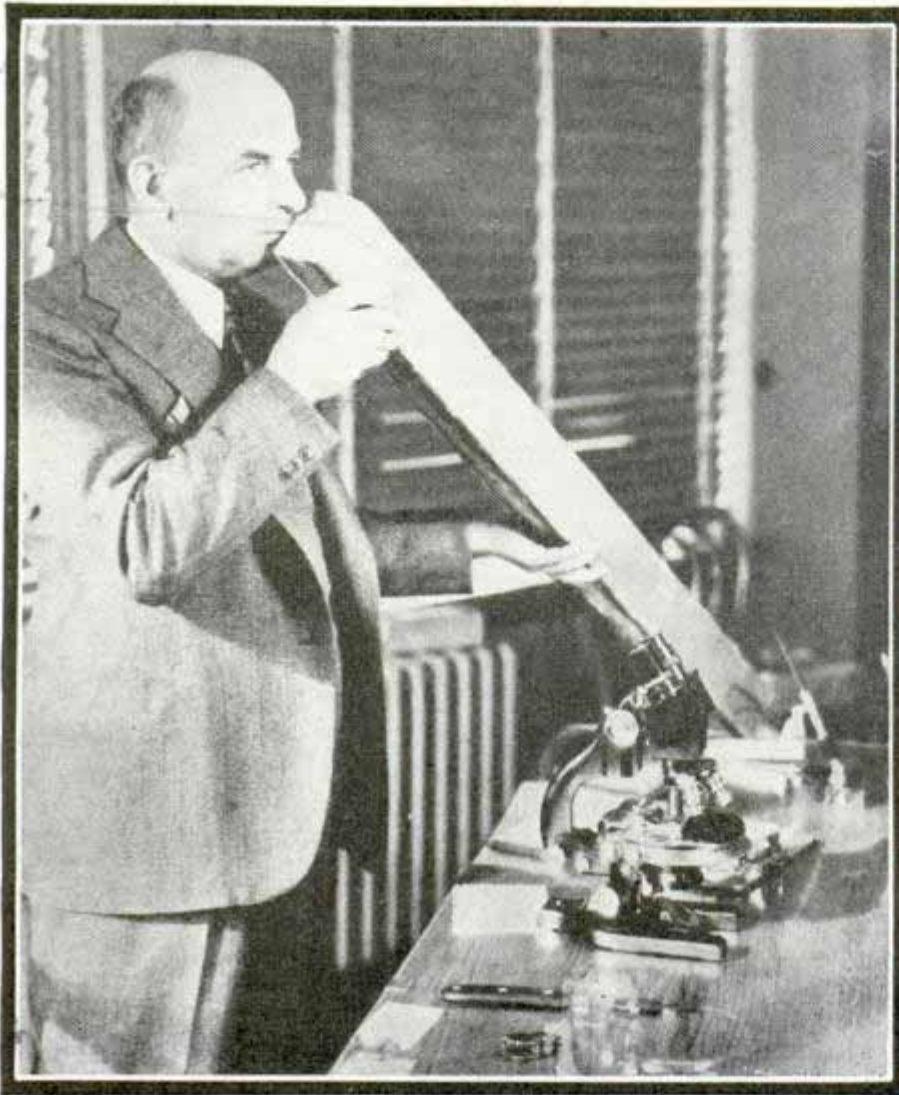

Mr. Koehler identifying deck timber from yacht as northern white pine by its odor



SAWDUST AND SWEEPINGS REVEAL CLUE

ABNORMAL TREE'S HISTORY TOLD

A PACKAGE, addressed to a Wisconsin man, contained a crude homemade bomb which exploded and killed his wife when she removed the wrapper.

For weeks the case challenged solution. A few shattered remnants of the bomb, including some wood debris, were the only clues. Eventually the local authorities appealed to scientific experts of the state university for aid. That led to the appearance in the case of Arthur Koehler of the forest-products laboratory, a research agency of the U. S. Forest Service. Koehler is a trained technician, a specialist in the microscopic identification of wood species.

As a result of Mr. Koehler's study, the bomb was disclosed as an ordinary piece of gas pipe mounted in a block of white elm. The only suspect disclaimed all

knowledge of the "pineapple." He stated repeatedly that there was not a scrap of white-elm lumber on his farm; that he had never used any such material. Special investigators made an examination of his workshop. However, the shop had been swept thoroughly. Apparently not a clue remained. It was only after hours of inspection that they unearthed minute scraps of shavings and grains of sawdust from behind a leg of the workbench, trash which had escaped the broom. Just enough of the debris was found to cover the tip of your index finger, but still sufficient to send the suspect to prison for life.

Magnified to fifty times its normal size the material proved to be white elm. The cellular structure of each species of wood is distinctive to an authority like Koehler. The white-elm sawdust from the shop

Madison, Wis

3000 MYSTERIES *a Year*

PETRIFIED
WOOD IDENTI-
FIED



TRACING
HAUPTMANN'S
LADDER

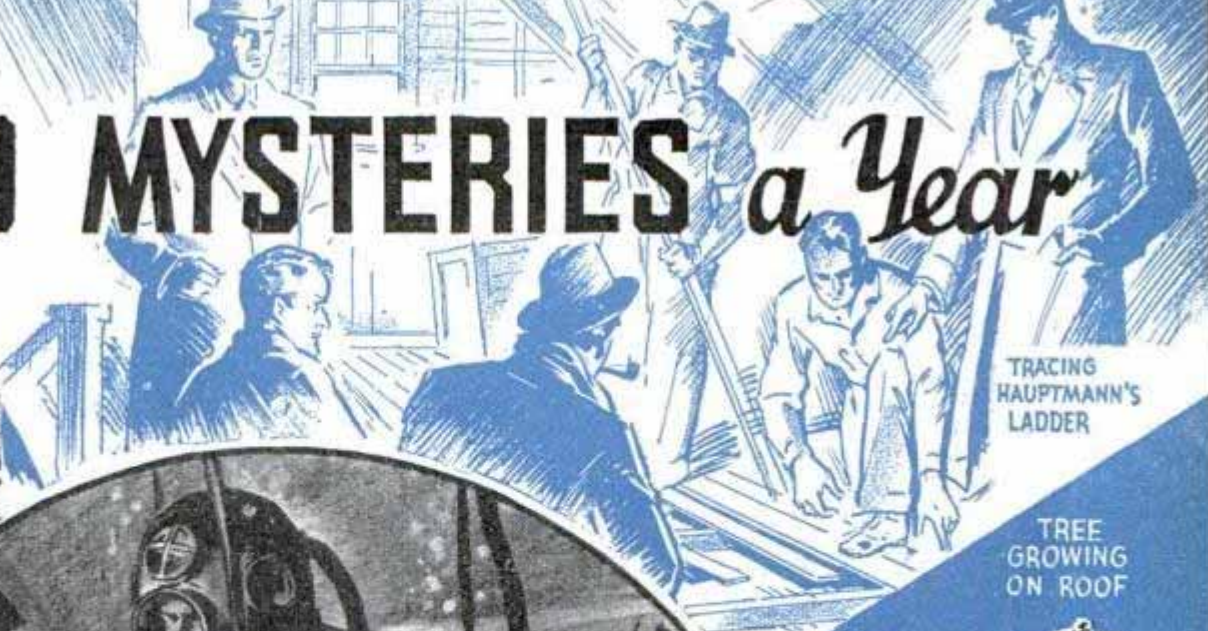

TREE
GROWING
ON ROOF



WOOD IDENTIFIES
SUNKEN SHIP
CONTAINING
GOLD

F15 70

matched conclusively with similar material from the remains of the bomb. Furthermore, fragments of the wood dovetailed as only nature can make such substances dovetail with shavings salvaged from the shop. During the trial in which Koehler was a witness for the state, he brought his powerful microscope into the courtroom. The jury, man by man, viewed the startling evidence in sensational form. The testimony of the microscopes supplemented by the technical explanations of the wood expert was enough for the jury.

A former president of a disbanded miner's union in a Pennsylvania town carried a package which he had received the day

YEAR AND MONTH
OF HURRICANE
REVEALED

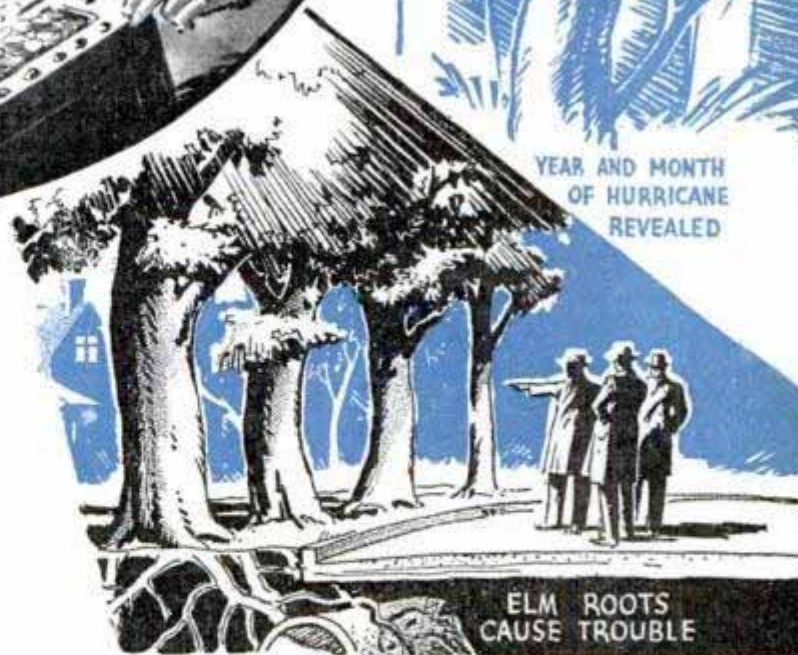

ELM ROOTS
CAUSE TROUBLE

Drawings representing some of the mysteries solved by wood detective, including source of wood used in Lindbergh kidnap ladder and identification of samples of wood from two sunken vessels to establish which was likely to be treasure ship

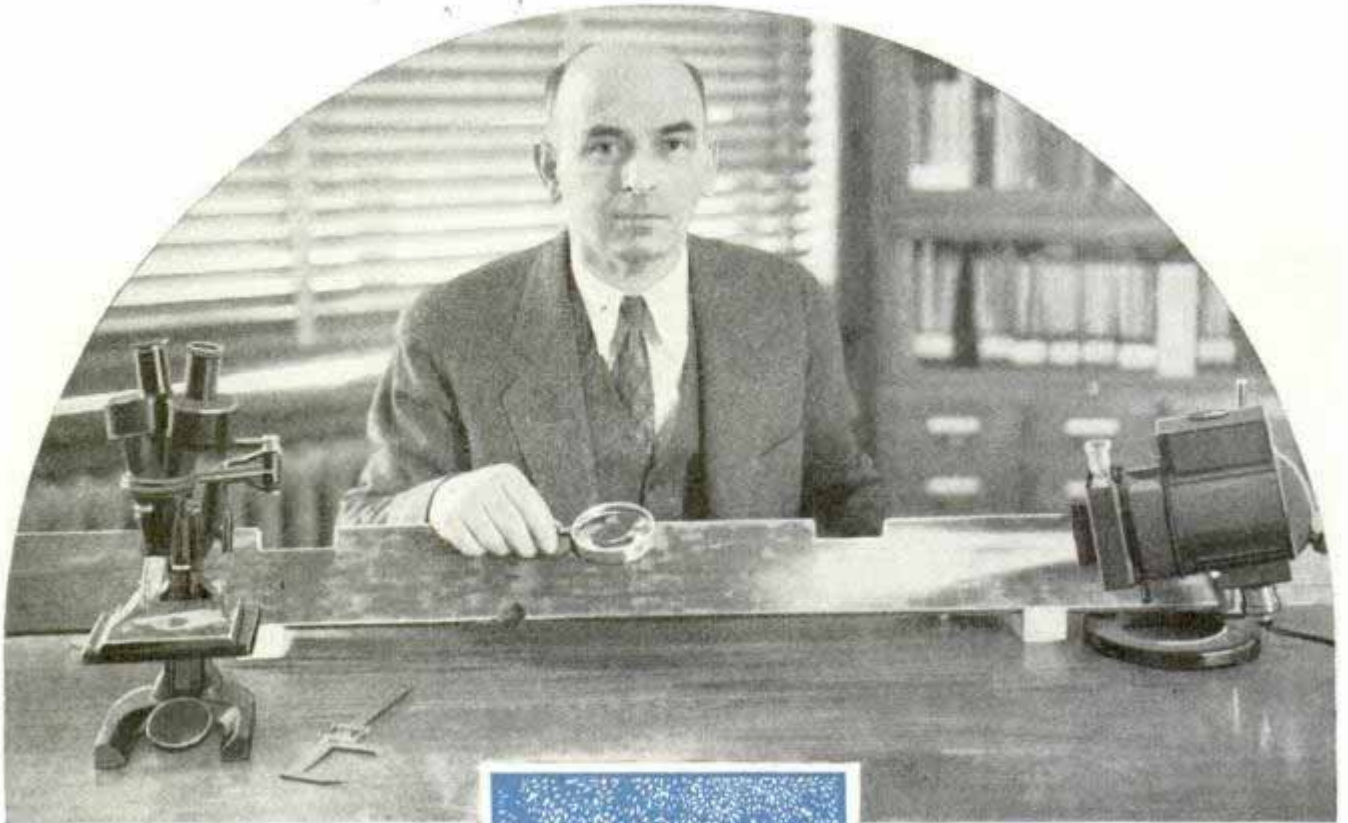

before into the kitchen of his home to open it. His young son and daughter followed. The package contained a cigar-box bomb which exploded, killing him and his boy and severely injuring the girl. About the same time, in another part of the city, another man also opened a box which exploded and snuffed out his life. Four similar packages were sent to others. Two were retrieved from the mails before delivery; one of the delivered bombs was not opened because of its suspicious appearance, another was opened the wrong way and failed to explode.

Several weeks of investigation led to the arrest of a man reputed to hold a grudge against one of the victims. Handwriting experts traced striking similarities between his lettering and that on the packages. In time Koehler was called in. His investigations resulted in matching the wood used in the construction of the bombs with similar material found in the suspect's home and shop. The growth rings as well as the resin ducts in the wood samples were identical as exhibited under extreme magnification. A definitely identifiable make of fish glue had been used



Mr. Koehler with some of his microscopes and other equipment he uses in wood identification

by the suspect in repairing a chair found in his home. This glue was procurable in but one store in the city. He had made such a purchase there. That kind of glue was also used in the bombs that did not explode and was found in the remains of the ones which did. Several sticks of dynamite like those in the bombs were found buried in the suspect's basement. An exact duplicate of the copper wire employed in the bombs was located in his shop. Fine nails which he used in resoling his

shoes were counterparts of those in the bombs. All this evidence was so clinching that the suspect was convicted of murder in the lower court. The case since has been appealed.

In the Lindbergh baby kidnaping case, Mr. Koehler identified all the species of wood employed in the homemade ladder which was left behind by the kidnaper. By studying the nail, tool and machine markings in the wood, he was able to trace the North Carolina pine uprights in the ladder to one particular planing mill by means of the number of knives used in the face and edge cutters and the rate at which the

(Continued to page 128A)

Ice Thrones Are Lighted by Concealed Bulbs

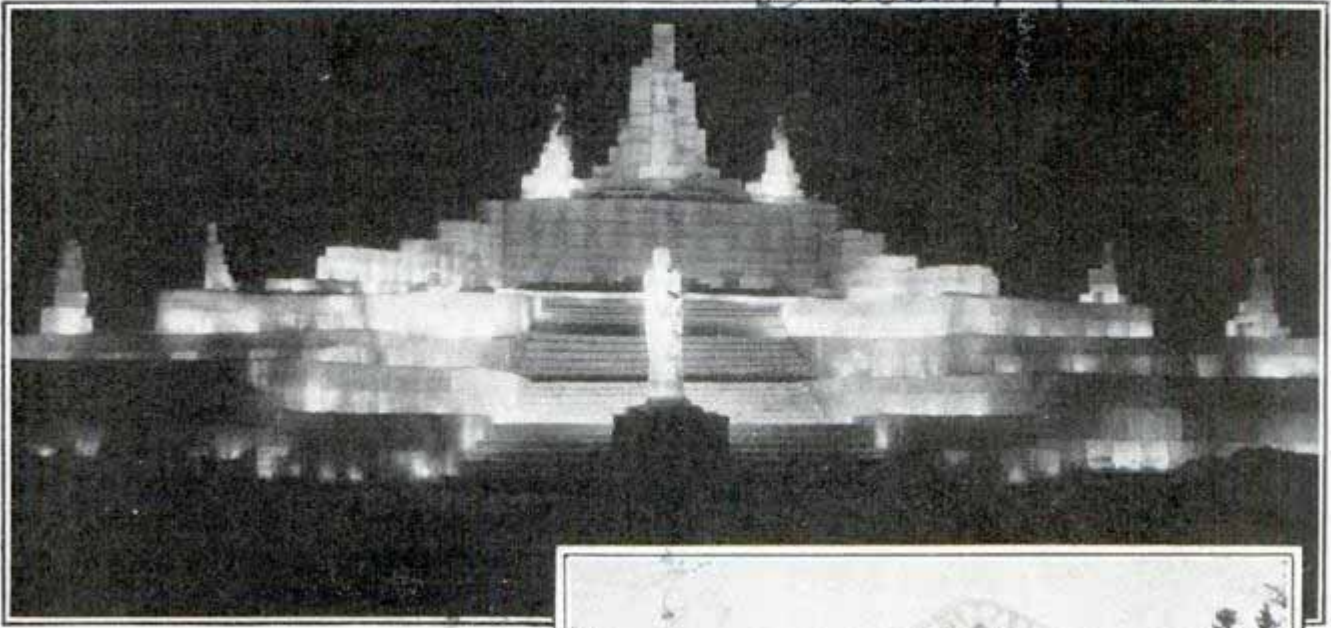

Two examples of the wizardry of ice sculptors. Top, illuminated throne of winter queen. Right, daylight view of another artistic ice throne



Spectacular illumination of giant ice thrones erected for winter sports carnivals in the northern United States is accomplished by placing electric bulbs between the snow and ice blocks from which the thrones are formed. A rheostat, a reducing gear, large crocks and lumber are utilized in changing the lights from one shade to another, with delicate pinks, blues and greens at the base of the throne, and yellows, purples, and lavenders at the top. To the spectator the lights seem to be buried in the throne. One magnificent ice throne created for the Petosky, Mich., carnival of last winter was 125 feet wide, 100 feet deep and towered seventy-five feet above the floor of the huge municipal skating rink. A feature of the structure, which contained 1,300 tons of ice, was the figure of an Indian woman sculptured in ice. The base of the throne was made from snow packed hard into wooden forms, then wet to a slush and allowed to freeze solid. After removal of the forms, huge slabs of ice were swung into place with a derrick, and water was played over the structure to cement the various parts through freezing. Each of the carnivals is ruled over by a Queen of Winter Sports who is crowned on the throne built from ice and snow.

71523
Metal Scrolls and Squares Cut by Pivoting Snip

Cutting scrolls, squares and odd shapes is as easy as cutting a straight line, with a metal snip now available. Its blades lie flat, opposite to the ordinary blades, and they pivot as they cut. It will cut galvanized sheets up to eighteen gauge.



Examples of shapes cut by flat-bladed metal snip

J. W. Wisco & Sons Co.

Handwritten notes on the right margin: "Delmont, Mich", "Newark, N.J.", and "ax scroll & roller \$4.95".

Basketball Flashes a Light When It Drops for Score



Ball trips metal loop as it falls through basket and turns on light momentarily, indicating a score

Red lights flashing behind the basket tell instantly when a basketball player drops the ball through the hoop for a score. When the ball goes through the basket it strikes a metal arm which turns on the light directly back of the basket and two other lamps above the corners of the backboard. The lights remain on for two seconds. This system is being used on some courts for the benefit of spectators seated in such a position that their view of the board is obscured.

Brine Pumped Back into Earth Boosts Oil-Well Output

Science is helping Kansas oil producers to dispose of salt water which comes to the surface with the oil, thus solving an old problem and at the same time increasing the flow from producing wells. The brine is pumped back into the ground, either into abandoned oil wells or into special "dry holes" on the edge of producing fields. The work must be done care-

fully so that the balance of pressure is not disturbed, causing the salt water to flow into fresh-water streams underground. Brine pumped to the surface with oil is separated from it in special gravity tanks. The removal of oil and brine from the producing formations leaves rock openings filled with gas or water. It is to these openings that the brine must be returned. In many cases, returning the salt water to the earth creates a "water drive" or pressure which forces the flow of oil in producing wells, increasing the daily output. Formerly producers disposed of brine by dumping it into surface streams, causing contamination, or by letting it seep out on the ground, which resulted in many damage suits because of vegetation which the salt water destroyed.

F1460

Rack for Barrels Is Made of Welded Iron Pipe

Ordinary plumber's pipe and pipe fittings were used to make a barrel stand for a San Francisco merchant. This rack,

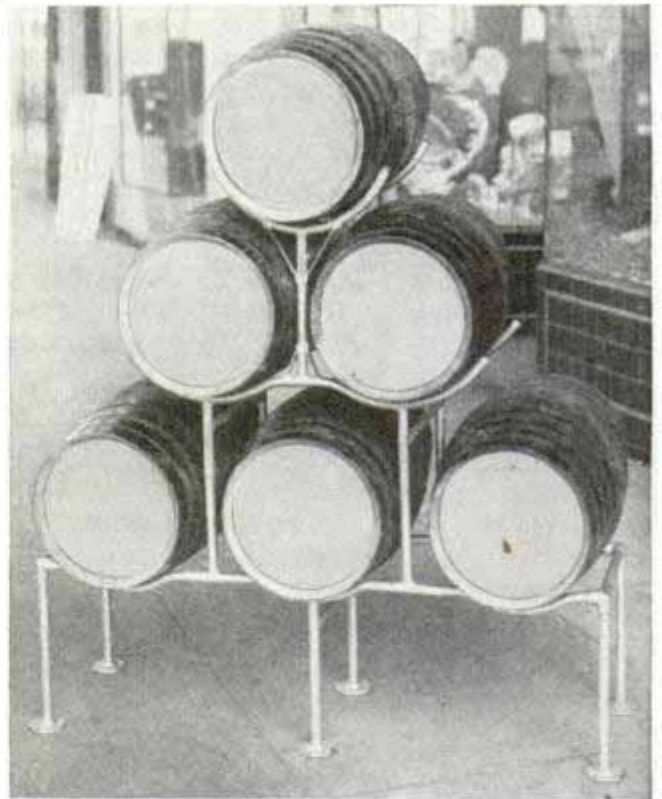

This barrel stand made of welded plumber's pipe is more compact than a wooden rack of same capacity

sturdy and durable, is welded at most of the joints and occupies less space than a wooden barrel stand of the same capacity would require.

*Wm. A. Sanfillipo,
Inventor*

*Wm. A. Sanfillipo, Inventor
308
St. Louis, Mo.
Lawrence, Kan.*

Leading sports goods store

F1542

F1542

Lawrence, Kan.

Deep-Sea 'Home' for Divers Speeds Up Work

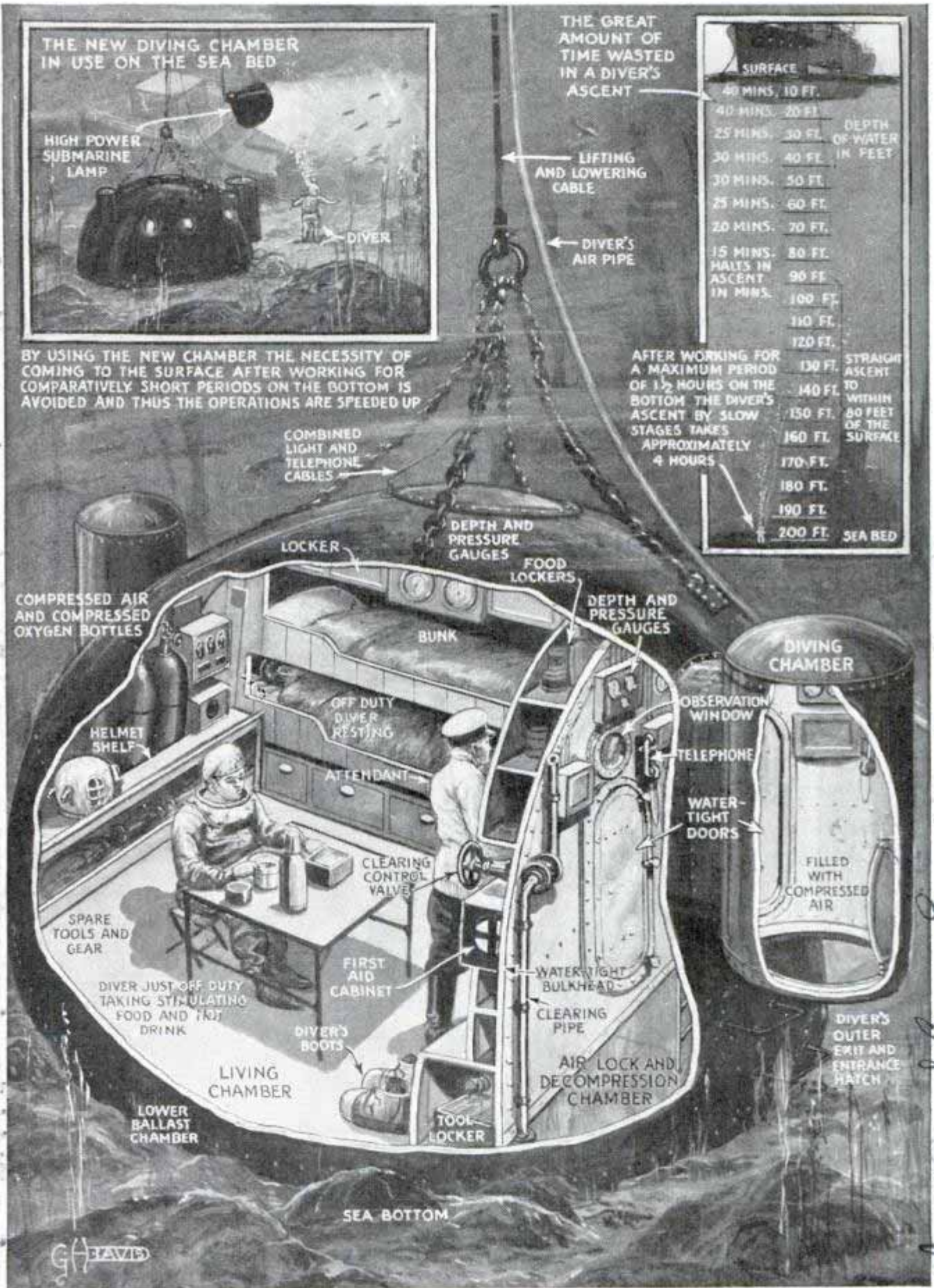

Designed to speed up operations and to prevent injury to divers through too rapid ascent, this submersible chamber serves as a home for diving crews working on the sea floor. This chamber may remain on bottom until work is completed.

Mrs. Siebe, Isorman & Co Ltd

London E.C. 6 England

Old Square-Riggers Help Train Italy's Sailors

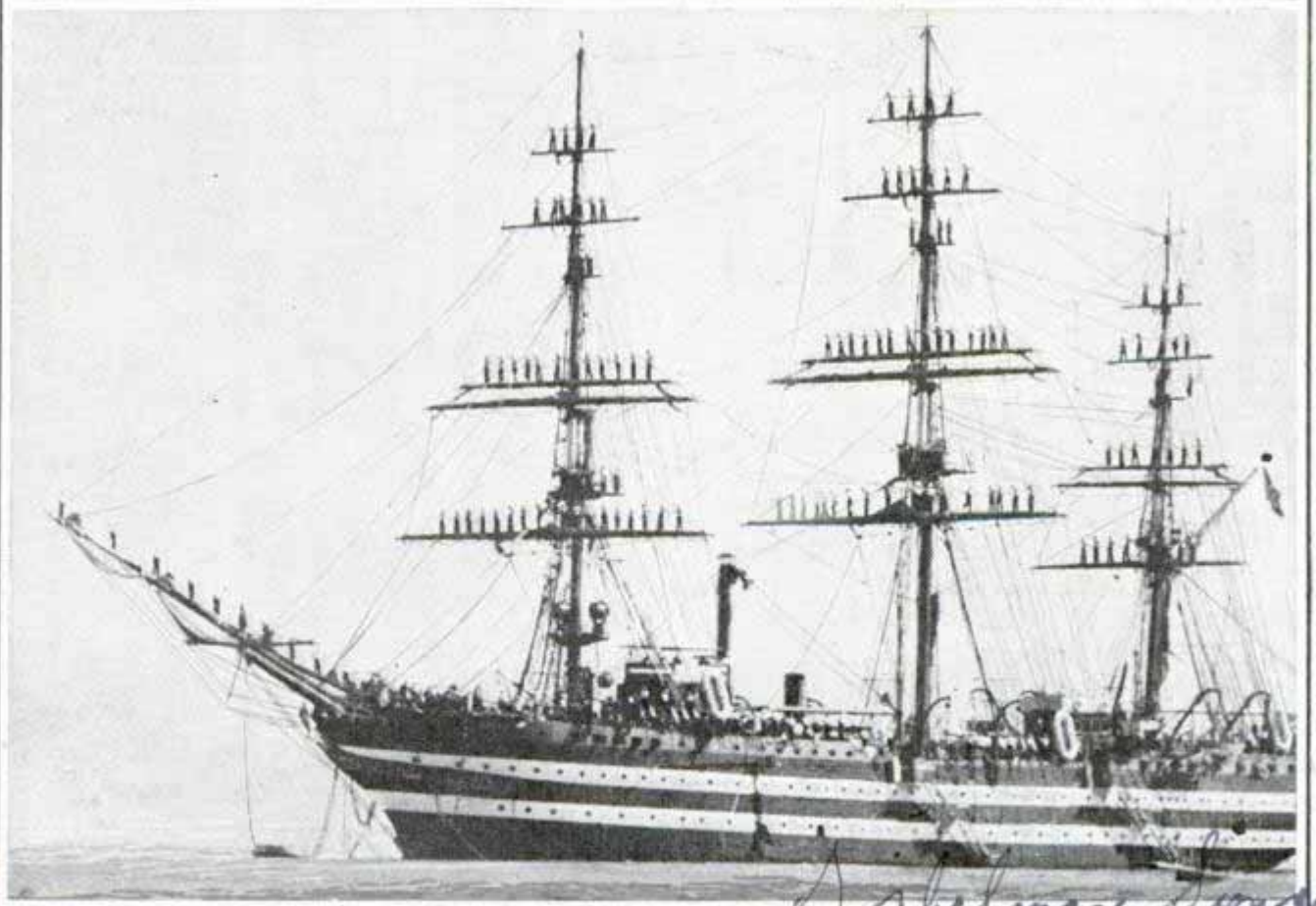
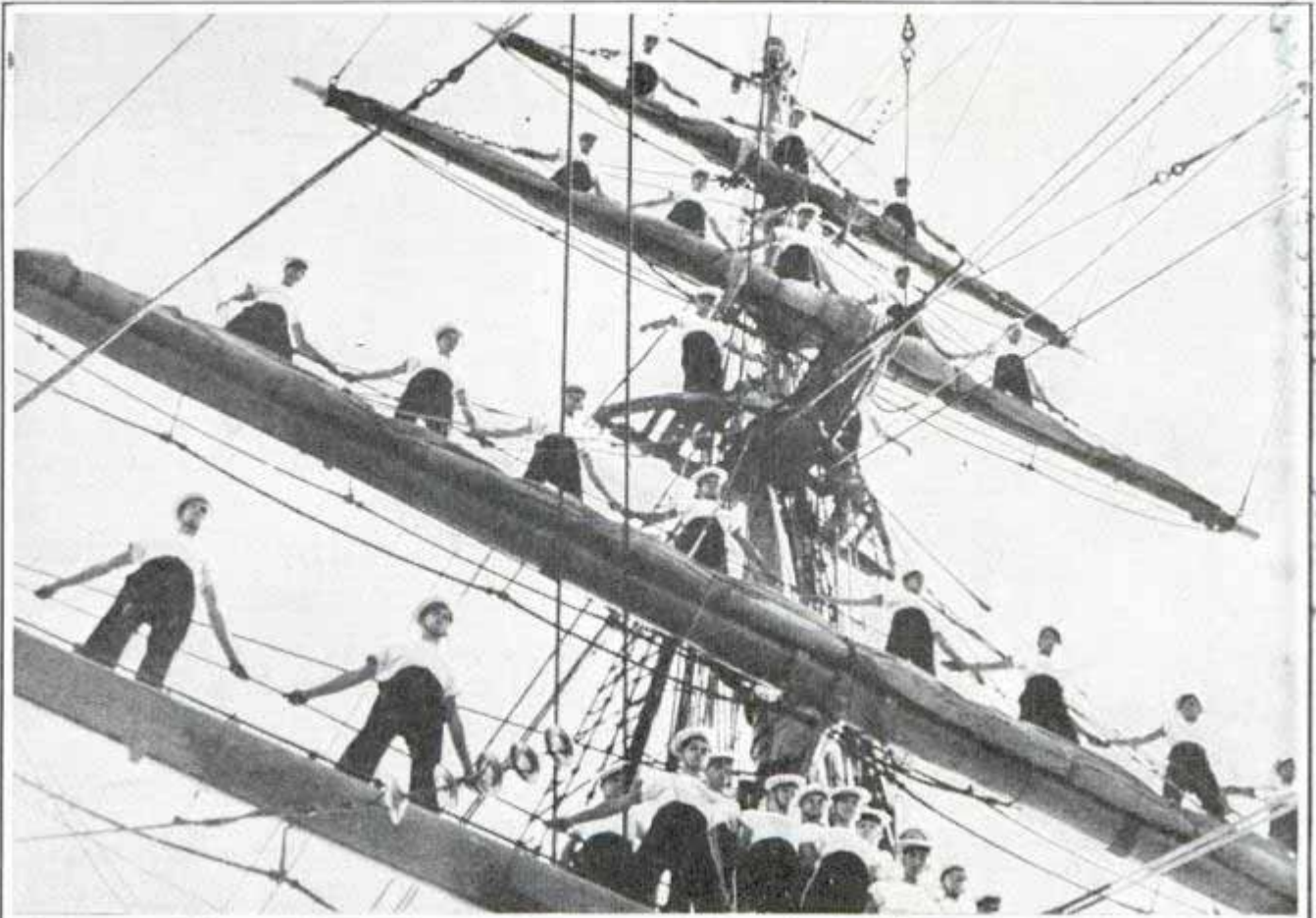

Top, young Italian sailors manning the yardarms as they get their first taste of the sea aboard old square-rigged ships. Bottom, every man at his post in the lofty yardarms of training ship.

"Siamese Twin" Guitar Has Double Neck



Orchestra player invented this twin-necked guitar, which requires skill to play

Playing the ordinary guitar was simple enough, so a Massachusetts musician invented something more difficult—a "Siamese twin" guitar. It has only one sounding box, but there are two necks, each of which has eight strings.

Billions Saved on Railroads by Mechanical Progress

Introduction of mechanical advancements and "mass production" practices resembling those of the automobile industry has resulted in a reduction of more than ten billion dollars in the operating costs of American railroads between 1930 and 1935. L. A. Downs, president of the Illinois Central railroad, points out that the lines have even adopted the assembly line method of the auto industry, using it to advantage in repair shops. Other savings, he says, resulted from: new welding processes which have prolonged the life of steel rail one-third, making possible the repair of worn ends without taking up rails and sawing off the worn segments; increasing the standard rail length from thirty-three to thirty-nine feet, reducing

the number of joints at which expensive maintenance was necessary; chemical treatment which has increased average life of ties from six or eight to twenty years; replacing pick and shovel with steam shovels, pile drivers and other machinery; mechanization of track laying, including machinery to drive spikes, and of track surfacing; installation of electric and oil heaters at switch points to keep tracks open during cold weather; increasing the life and efficiency of locomotives by improved methods of water treatment, by raising boiler pressures, installation of automatic stokers, better lubrication and reduction of weight through use of alloys.

Motor Driven by Contraction of Rubber under Heat

That stretched vulcanized rubber will contract when heated is a little-known fact employed in a rubber-band motor on exhibition in the Franklin Institute, Philadelphia. The device consists of a wire-frame hoop placed about an eccentric hub. Rubber bands are stretched from this hub to the hoop. An electric lamp furnishes heat at one point. When heat is turned on, the rubber band "spokes" contract, exerting a pull on the hub and causing the wheel to rotate. This brings other sets of bands to the point where heat is being applied and the action continues.



Heat of electric lamp, shown behind wheel, keeps this odd rubber-band motor going

Carl Eckhardt

Series made Sympy. Mass with see Skelley's archery

Chicago Tribune. 12/4/36

F1611

F1590

Safe Exhaust Heater Warms Auto Quickly

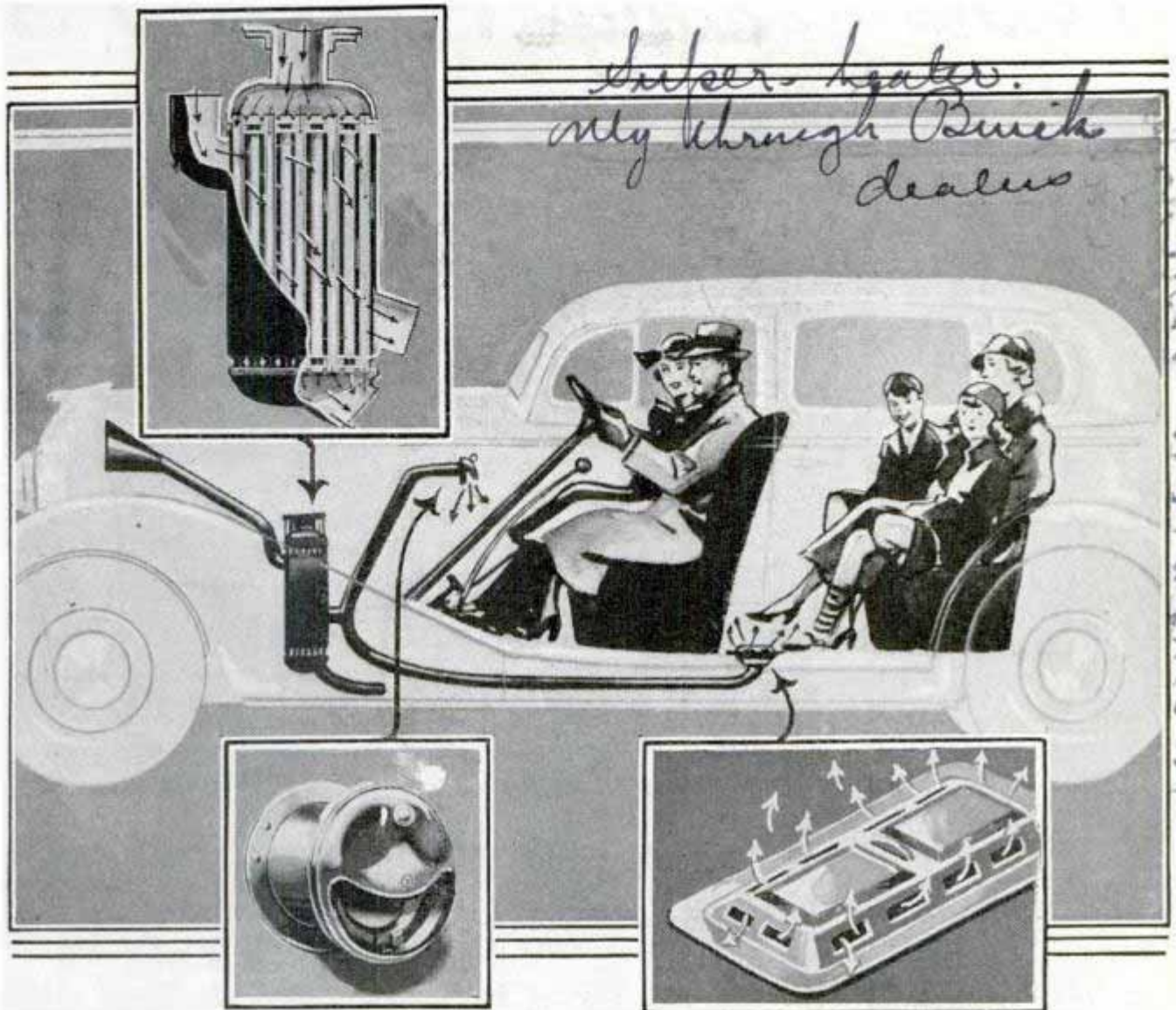

*Super heater.
Only through Buick
dealers*

Diagram at center shows how hot air functions. Sketch, top, left, is radiator. Arrow points to its location on engine. Bottom, left, heater control. Right, outlet for warming rear compartment of car

Designed to warm the interior of the car more quickly than other heaters, a hot-air unit now on the market utilizes high temperatures of the exhaust without permitting poisonous fumes to seep into the car. Installed by substituting the heating unit for the complete exhaust pipe from the outlet manifold to the muffler, the heater supplies warm air to registers in the front and rear compartments of the car. The unit consists of a small radiator around which hot air of the exhaust circulates. Fresh air taken in by a funnel located near the front of the hood circulates through the pipes of this radiator, thence to the registers. Thus, the air is heated quickly, being subjected to exhaust temperatures of 600 to 1,000 degrees. A bi-metal valve in the heating unit opens

when the exhaust temperature reaches approximately 700 degrees, thus preventing the heater from delivering air too hot for comfort. Pipes in the heating unit are of seamless steel and the surrounding chamber which carries the exhaust is welded to the unit so that failure at any point will not result in leakage of exhaust gas into the car. Noise transmitted from engine through the registers is said to be comparable to that caused by the fan in other heaters. No electricity is required for operation.

Names and addresses of manufacturers and dealers in articles described in this magazine will be furnished by our Bureau of Information upon request accompanied by stamped, self-addressed envelope.

Harnessing RADIO'S

have an important future. On the sea they can be used as fog-piercing beams to indicate direction and distance of other ships or the shore. In aviation the short waves can be used to "see" through clouds and fog, acting as an altimeter to give heights above ground and also to register miles per hour across the ground.

They are the all-weather airways beacons of the future. They promise to make blind landings safe and simple. Used similarly to a photoelectric cell, high-frequency radio is an effective burglar alarm and can be made to do

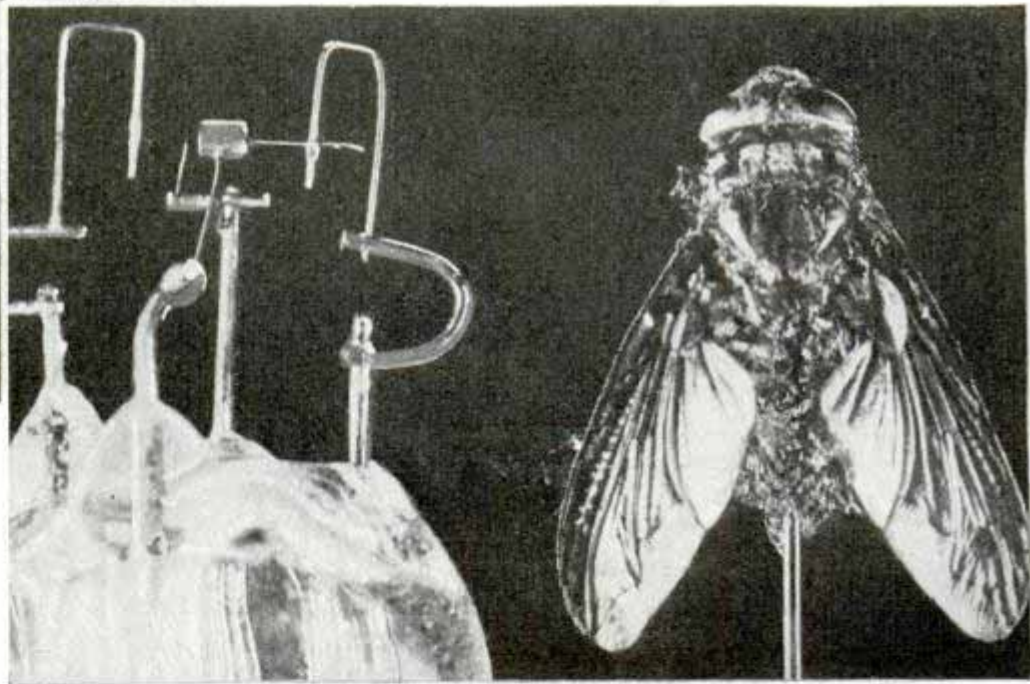

Dr. Potapenko puts unit of five-fingered "tree" tube under magnifying glass. Below, elements of one-centimeter tube compared to horsefly

"CENTIMETER" is the latest word in radio. Baby radio waves only a few centimeters long are performing all sorts of strange tasks.

You can harden metals, measure the speed of moving objects or hold secret radio-beam conversations with ultrashort waves. Transmitted automatically from small balloons, the waves can send back reports of weather in the stratosphere. Their therapeutic and bacteria killing properties are greatly extending the possibilities of radio fever. They make possible midget "transceivers" that you can carry in your pocket to talk to other people blocks away.

As a substitute for light the micro-waves

a multitude of special tricks. So far most of the work that has been done has been in ultrashort wave communication. A commercial radiotelephone circuit across the English channel operates on eighteen centimeters, the narrow "line-of-sight" beam assuring virtual secrecy as well as very low operating costs.

A few years ago twenty-meter telephones were looked upon as experiments that could never become reliable. Today

Col. Thomas E. Stevenson Jr. - 10555
 Holmwood Ave. Los Angeles
 Calif.

F1530

California Institute of Technology
Pasadena
Calif.

"BABY WAVES"

they seem old-fashioned compared to the five-meter radiotelephones in common use. Police, amateurs, commercial operators, and experimenters are all working below ten meters. Amateurs have been assigned bands at five meters and at seventy-five centimeters and in addition have the privilege of operating at two and one-half-meter and one and one-quarter-meter wave lengths. There is practically no static from weather sources between seven and three meters.

Until recently it was thought that all radio waves below seven meters in length had the optical property of traveling only in straight lines. For ordinary purposes it was assumed that short-wave communication would be

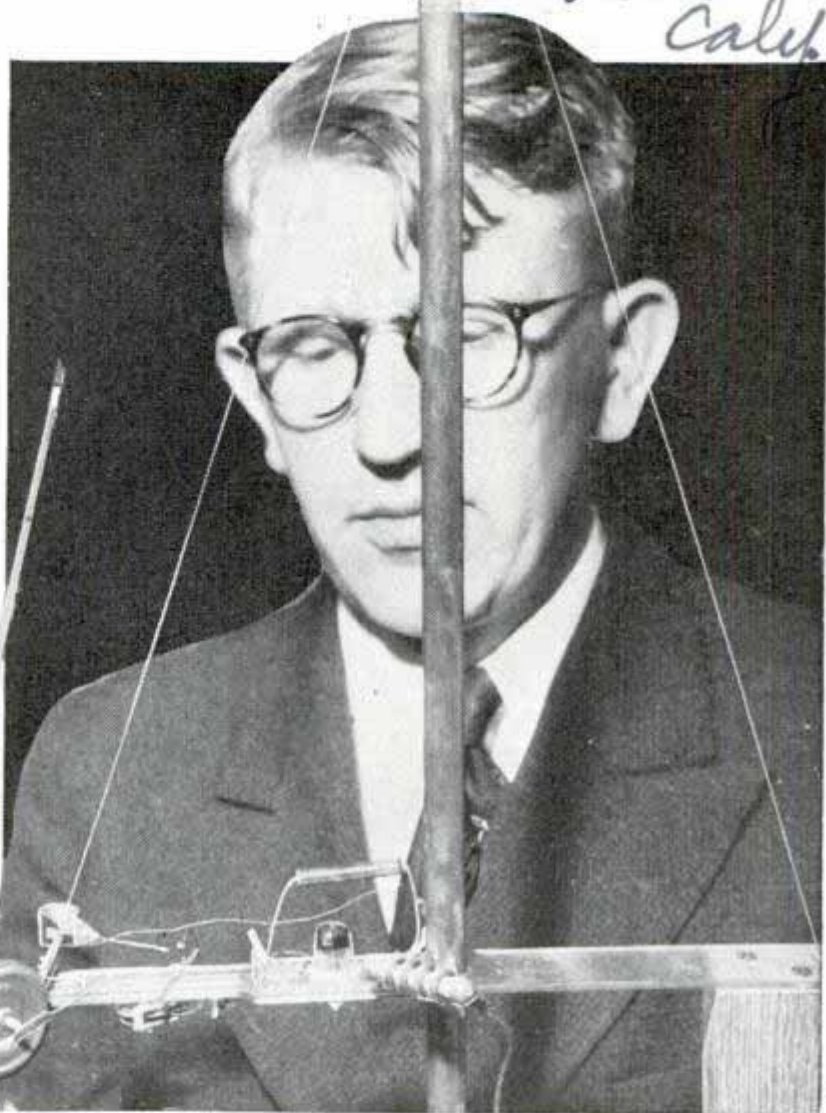

One-pound balloon transmitter which measures stratosphere weather and automatically radios report. Bottom, "transceiver" for communication over short distances, which operates on a wave length of several meters

limited to twenty-five or thirty miles. Beyond that distance the curvature of the earth, buildings, and mountains would prevent reliable reception.

Amateur operators are knocking this theory into a cocked hat. They have worked coast to coast on five meters and at present west-coast amateurs are conducting tests with Australia on five meters. Recently an amateur sitting in his car on a Los Angeles street used his short-wave mobile set to chatter with another "ham" in Massachusetts. With an input of one watt

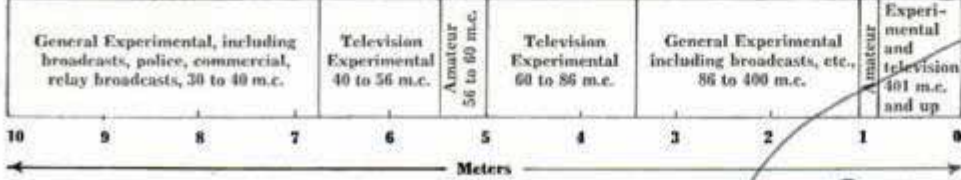

Temporary Federal allocations of wave lengths below 10 meters

Wood Clyde Canoga Park Calif. 5055

J. Roy Hunt



transmission seems to be best when a cold-air mass is invading the upper air.

Long-range communication on short wave lengths such as the amateurs have experienced leads to the hope that improvements in tubes and sets eventually may make communication beyond the horizon completely reliable. Naturally these improvements also will extend the range of short-wave television broadcasts.

The ultrashort centimeter waves, however, are apparently of the true optical type. They travel in

(Continued to page 150A)

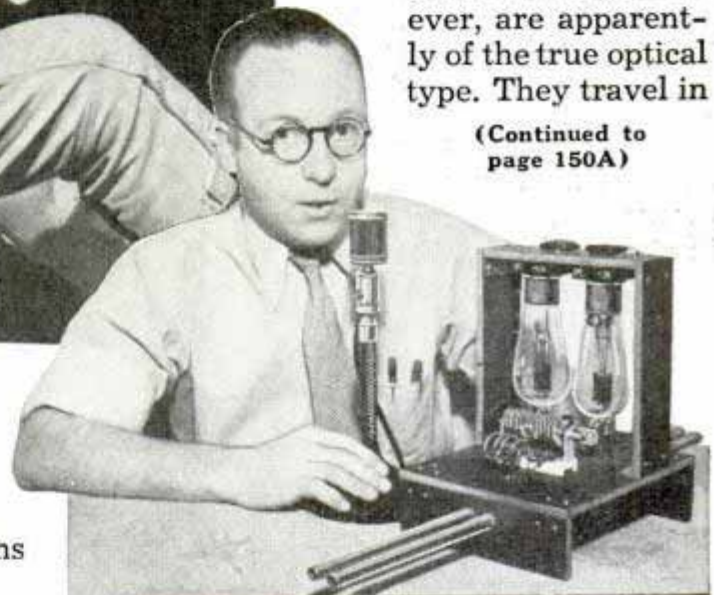

of power, he used one-sixtieth of the amount of electricity consumed by an ordinary light globe for a transcontinental conversation. At other times, however, a five-meter transmitter seems unable to reach past the horizon.

Trying to account for these freak conditions has led to the explanation that the Heaviside layer, through which short waves were thought to pass without reflection, is only one of half a dozen such layers in the upper atmosphere. Each layer, it is believed, reflects radio waves of different lengths. The altitudes of the layers, which would affect the range of the short waves, seems to vary from time to time. Apparently temperature, barometric pressure, and even sunspots cause the layers to rise or fall.

The weather seems to have some effect on short waves and on the other hand it may be that radio will become useful in predicting the weather. Amateurs in one community find they can't "work" stations in another town thirty miles away except in foggy weather. In the east five-meter



Top, police officer using eight-meter set. Center, amateur's transmitter which operates on two and one-half meters. Bottom, eight-meter set in back of police patrol car

Wonders of Boulder Dam Draw Sightseers

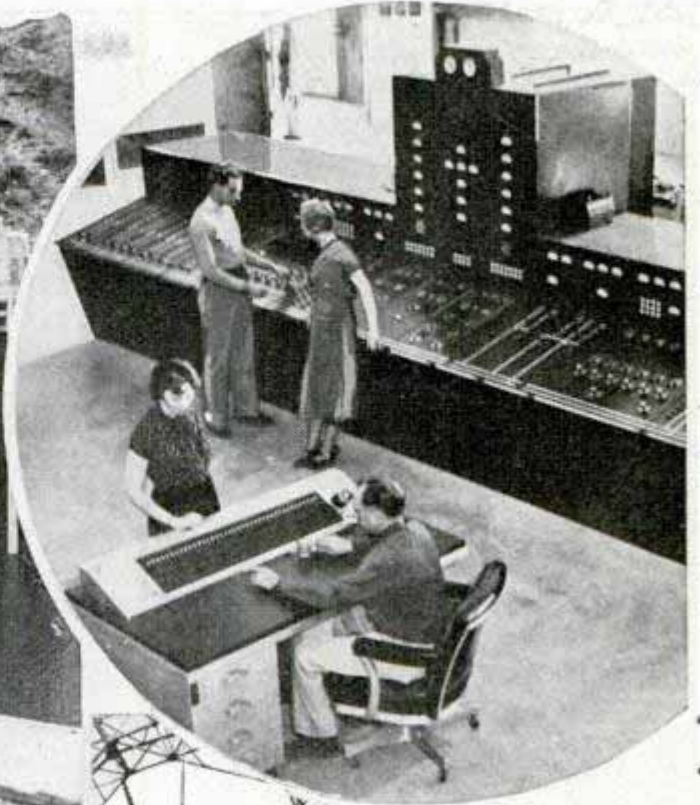
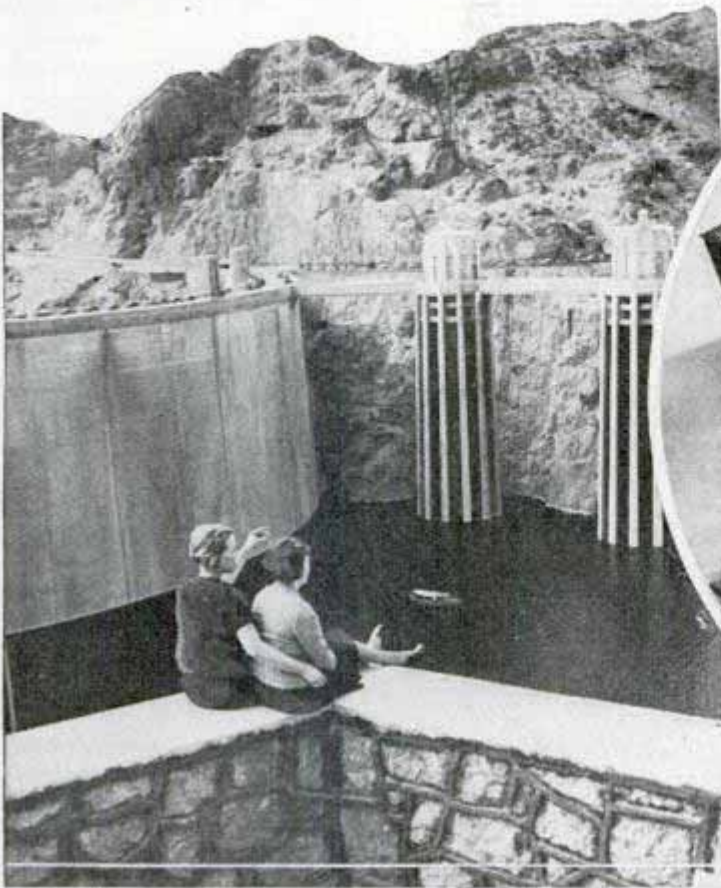

Boulder Dam's scenic and mechanical wonders are making the giant power project one of America's biggest attractions for sightseers



Top, left, observation point with Lake Mead, now 385 feet deep, below. Right, automatic telephone switchboard and powerhouse control board. Bottom, left, looking from exciter platform atop 115,000-horsepower generator. Right, transformers on face of dam handle the flow of power from the big power project through substations to Los Angeles, Calif., 266 miles away

Wide World Photos

Noiseless Street Car Has 'Dead-Man Control'

Triple braking and the "dead-man control" make the 1937 model street car safe, and rubber sandwiches make it smooth and silent. To help overcome the clang and clatter of the old style car, rubber springs supplant steel in the "trolleys" being built today, and wheels have been redesigned with layers of rubber sandwiched between steel tires and

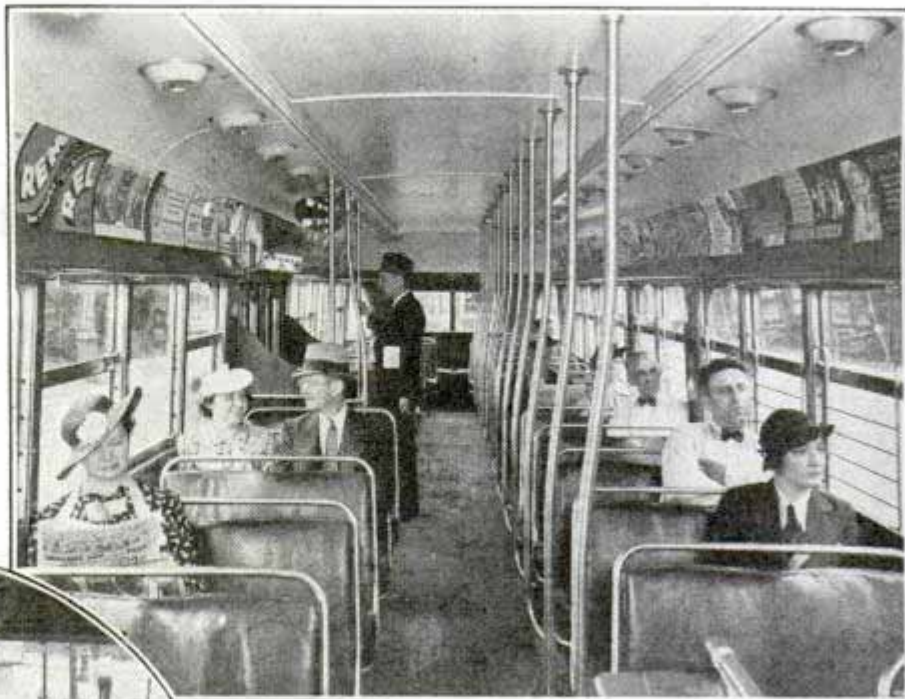

Three views of 1937 street car. Notice similarity of controls to those of an automobile. Magnetic brakes can be seen between wheels in bottom picture

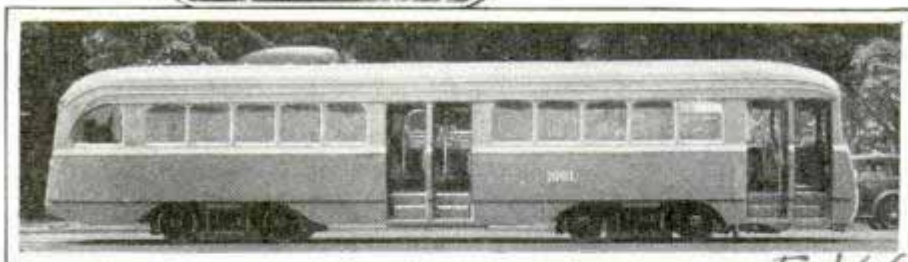

motors into generators, the momentum of the car "backing up" current and slowing it down. This also generates heat which is applied to warming the car in winter. Second, the magnetic brakes are applied. These are huge magnets close to the track between the wheels, which "grip" the track magnetically. Storage batteries supply current. Finally, the foot pedal applies the conventional air brakes. Acceleration and deceleration have been speeded up to a rate of five miles an hour per second.

wheel proper. Noiseless gears have also been developed. The idea of a dead-man control was borrowed from the railroads. The motorman's left foot rests on a safety pedal which must be kept depressed while the car is in motion. If his foot is withdrawn the car stops. The new street car is driven entirely by foot. At the center is a control pedal governing speed, operated just as you drive your car by pressing the accelerator. At the right is the brake pedal, actuating three separate brakes; first, the dynamic brake, which converts the

Bird-Proof Windshield Is Sought to Protect Airplane Pilots

Finding how to build an airplane windshield that can survive the terrific shock of collision with a bird has given the National Bureau of Standards a tough problem. Putting that material to test is still another problem. Engineers are seeking a transparent plastic that would protect the pilot from the danger of a bird smashing through the windshield. Cellulose acetate is one of several materials being tried. If

Cont. George H. Eckhardt 2047 N. Park Ave. Phila.

Mr. G. M. Kline.

12/16/36

the combined speed of plane and bird is 270 miles an hour and the bird weighs four pounds, 10,000 foot-pounds of energy are involved in the impact, and this must be simulated in testing. At present tests are being made by firing a rubber projectile from an air gun against the windshields.

Big White Decoy Rabbits Easy for Racing Dogs to See

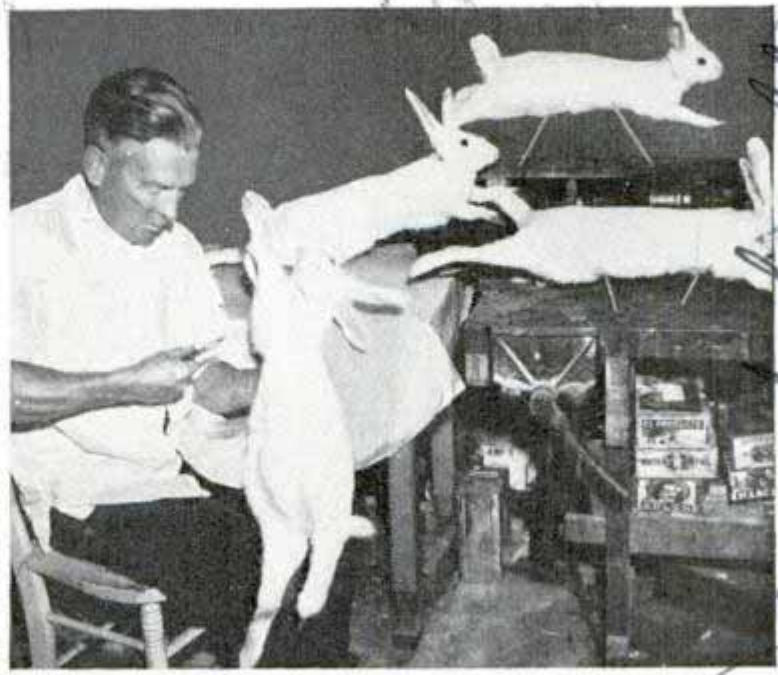

Shop in which big white rabbits are manufactured for dog-racing tracks. The color makes them easy for dogs to see

Wood Veneer Wallboard Is Aid to Builders

Expensive wood finishes for interior of home or office have been brought within reach of the average family or builder by a new product which consists of fine cabinet wood veneer applied to a Celotex base. The material, supplied in walnut, mahogany and avodire, comes in pieces six or nine inches wide and eight or ten feet long. It is easily applied over old walls or in new construction without special treatment. Because of a patented joint, no nails are visible after installation. The veneer may be painted, first being coated with clear shellac and then with flat varnish. The wood finish is only one-quarter inch thick, therefore it is particularly suited to modernization work.

F1539

While watching a dog race several years ago, a New Jersey taxidermist noticed that the hounds became confused because they could not see the decoy rabbit. Racing dogs depend entirely on sight, not on scent, so the taxidermist mounted a big white rabbit in lifelike posture and tried it out on the track. The results were so good that he now supplies most of the decoys for American tracks. The rabbits are mounted with heavy wire at front and back for attachment to the track motor.

F1624

Hat Rack for Top Shelves Is Lowered by Cord

Made in models for attaching to top shelves, wall or door of clothes closets, a handy hat rack introduced recently has a cord by which the hat may be lowered within reach. The round top of the holder is roughened to prevent the hat from slipping off.

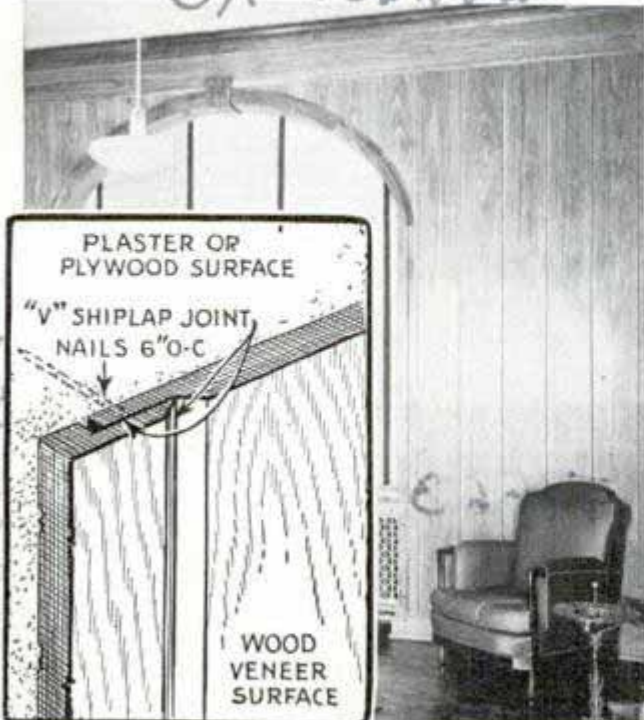
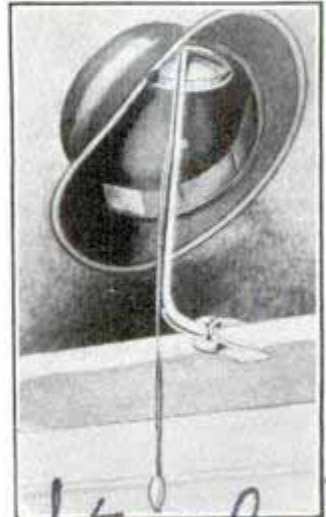

Wood veneered wallboard in room. Inset, how the wallboard is applied

Handwritten notes on the right margin: 'I want to see the one', '12/16/36', 'The New Panting', 'The Stanley', 'Wishes 195 Lake'.

Handwritten text at the bottom left: 'The Celotex Corp'.

Thirteen-Hundred-Mile 'Bike' Tour Costs \$22

George and the author

Shenandoah National Park, Virginia

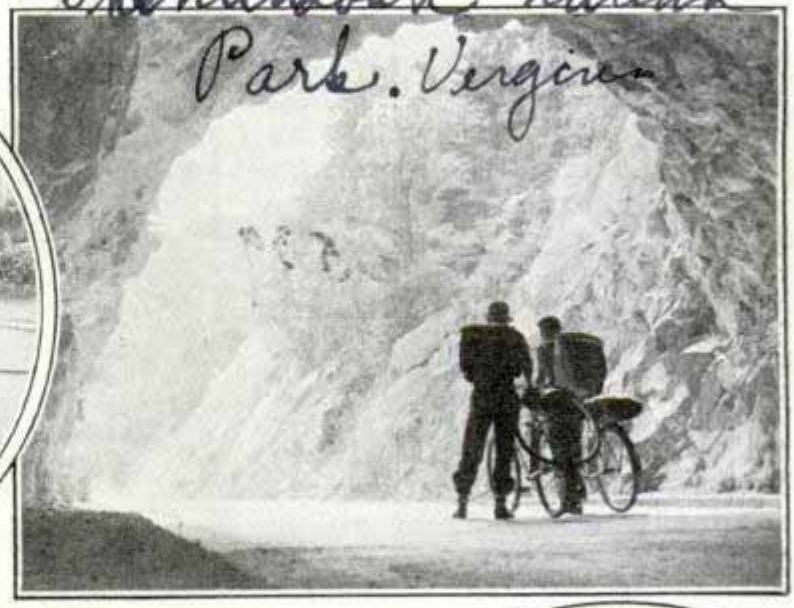

Author

Top, the start of a seven-week bicycle tour and a pause to enjoy scenery from mouth of a tunnel in Virginia. Below, breakfast after a night in the open. The roadside warning didn't stop the boys

Twenty-two dollars for a seven-week trip is a bargain price for all-expense tours in this country. That is exactly what it cost each of two boys for a sight-seeing bicycle tour from New York to Florida. At the end of a journey that took them through Washington, D. C., the Shenandoah valley of Virginia, the Blue Ridge mountains and the Carolinas, the cyclometer showed they had pedaled 1,367 miles. There were no punctures in all those miles, but the boys did have to buy one new front wheel after a collision. The twenty-two dollar expense account included this wheel and tire, a supply of camera film, food and equipment. The boys camped in the open and cooked their

own meals except when hospitality was offered along the way. They carried bed rolls and twenty-five pound packs containing an aluminum cooking set, small stove, food bags, extra clothing, toilet kits, canteen, flashlights, folding candle lantern, cameras, first-aid kit and repair outfit.

J 1663 Sound Track on Paper Invented for Newspaper Supplement

Comic strips and feature sections may soon be accompanied by sound records distributed as newspaper supplements. A patent has been issued for a method of impressing a sound track on a circular record made of printers' mat paper. The

from 1905 by Edward R. Rowe, Jr. Silver Spring, Florida

Pat. # 2063870

F155 3

DATING UP *the*



were similar to those of the Sahara. The land was as fertile as the Nile delta—natural date land—and had been tested to a depth of 1,800 feet without hitting the bottom of the silt.

Other palms were growing on the Colorado desert—palms older than history that came from nobody knew where. True, they were barren palms. But, reasoned horticulturists, where a fruitless tree would thrive, a potent palm should bear fruit. An order was cabled to Egypt for date palms but all we got out of that experiment was a wholesome lesson.

A foreign merchant filled the order. More than half of the shipment were male trees. Inasmuch as one male palm will serve a harem of thirty to thirty-five females, he apparently imposed on American innocence, then compounded the imposition by shipping seedlings instead of born



Truck carrying tower for inspecting date palms for scale and, above, the tower extended and two inspectors at work

THIRTY years ago, Arabs taught Americans how to grow dates. Today, America is teaching the world.

So say the palm culture specialists who brought the date from its cradle in the Sahara and nursed it to supremacy on the great American desert. The Arabs were world champion date growers 4,000 years before Christ; cowboys didn't start until nearly 1,900 years after.

America conceived the idea of a home-made date in 1890 as a possible cure for an agricultural problem child. In the southwest was a tract of some 68,000 square miles devoted to the production of sandstorms and horned toads. Soil and climatic conditions of the Colorado desert

trees. There's a vast difference. About one seedling in 100,000 grows true to type; and for every seedling producing a good new variety, there are 10,000 worthless trees. A seedling female palm may bear the best date in the world, or the worst. Its fruit may throw back 10,000 years to the great-grandma of all its particular kind. It may refuse to yield and, if it does

Cont. Mrs. Jean B. Morris
 789 Castro St. San Francisco, Calif.

Mrs. Jean B. Morris
 789 Castro St. San Francisco, Calif.

Mrs. Jean B. Morris
 789 Castro St. San Francisco, Calif.

Mrs. Jean B. Morris
 789 Castro St. San Francisco, Calif.

F155317

AMERICAN DESERT

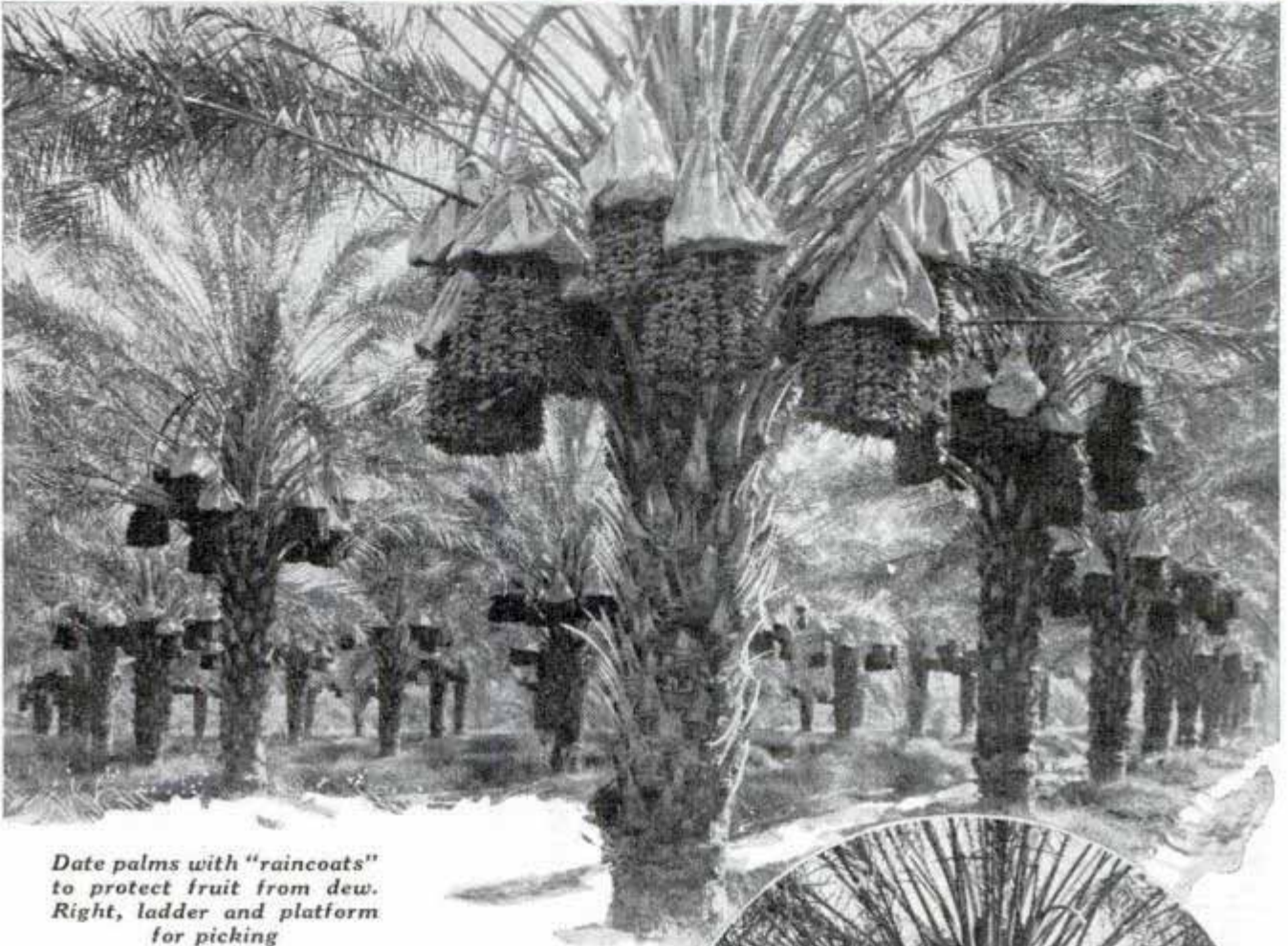

Date palms with "raincoats" to protect fruit from dew. Right, ladder and platform for picking

bear, the odds are 900 to one it will produce something unfit to eat.

It took Uncle Sam ten years to discover something was wrong with his 1890 purchase of baby palms. The trees grew at the prodigious rate of two feet a year; but mostly they were barren, and fruit of the producers was inferior. Dr. David Fairchild went to the Sahara as America's trouble-shooter. He sent home the first shipments of fertile offshoots in 1901, but had to obtain the intervention of the British governor-general of Egypt before he could buy even one date sprig. An Arab may sell his wife—or one of them—his camel or his donkey. But try to buy an offshoot from a choice palm and he reaches for his trusty scimitar. Nor will he dispose of his best fruit unless there is a surplus over family needs. His garden is protected by a high stone wall, and admittance is only by invitation.

Dr. Fairchild returned with enthusiastic reports of a rare date he found in bazaars

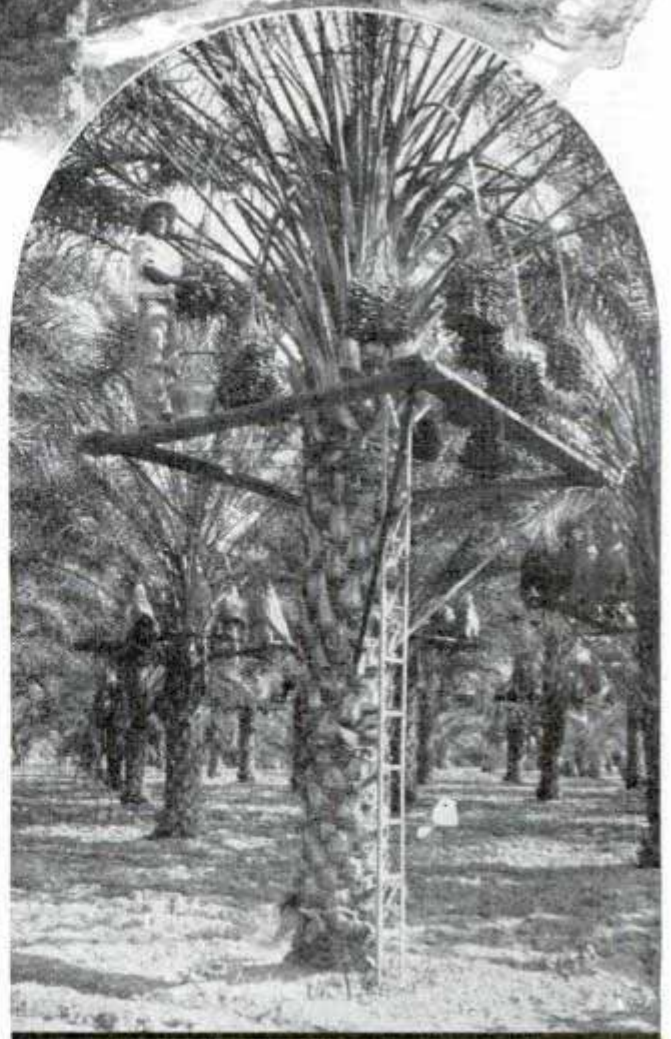



\$2,000 apiece, values depending on maternal variety, quality and productivity. The tree starts to reproduce five to eight years after weaning and being started on her own. She gives up motherhood at the age of twelve to twenty years, then settles down to food production at the rate of 100 to 500 pounds a year. She is in her prime as a fruit producer at 100 years, and is

along the Nile. It was called the wahi, and he traveled thousands of miles by camel trying to trace its source and buy some of its progeny. Other government agents also attempted to trail the wahi without success, until Dr. Silas C. Mason was sent to Egypt in 1913 with instructions to bring home a wahi date child, and bring her home alive. He sent bundles of thousands. A sheik told him the secret.

"We of the oases call it Saidi or Saideh," he said. "But when these Bedouin

traders get over to the valley with it, they call it the wahi. A wahi date is a date from an oasis—any date from any oasis."

A true-to-type palm daughter springs from the body of the mother tree and is nourished by her for the first three to four years of life. When the child has sprouted roots and weighs about fifty pounds, it is taken from mamma. If mother is a good producer, her child is planted to grow up in her own image and with all her virtues. But if she isn't, her children are condemned to the flames, and all her line is doomed to die with her.

A robust female palm produces ten to twenty daughters, worth from \$20 to

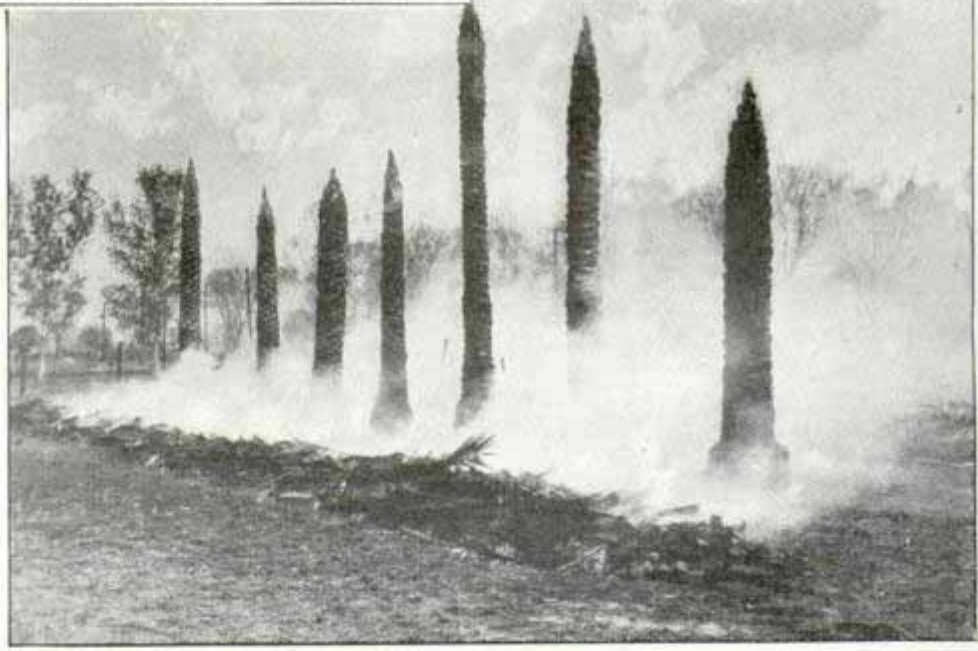

Date palms pruned and "torched" to kill insects. Above, "raincoats" to keep off the dew serve also as sun screens and shields from insects

good for a paying crop up to 500. Until now, she has successfully resisted efforts to induce her to continue bearing daughters after about twenty years. In rare instances, offshoots have been coaxed out by intensive irrigation but they are not so husky as the first-born. Offshoots from high up on the trunk are preferred stock, always true to type, and likely to be heavy producers of exceptionally fine fruit. Male palms bear their sons in the same manner as daughters are born to the female tree.

It was probably nature's plan to produce about an equal number of male and female palms, relying upon the wind and

(Continued to page 134A)

air line. Kansas City Mo

Handy Stands Speed Servicing of Air Liners

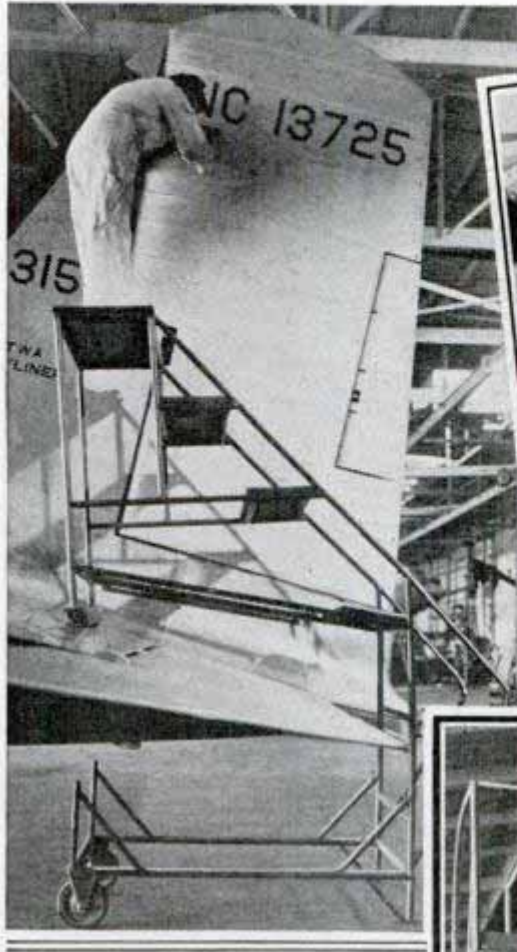

Above, stand used for work on rudder. For tail inspection a padded part rests on stabilizer. It can be placed at footing desired without interfering with tail surfaces. Below, steel frame for towing skyliner permits tractor to turn without bumping tail surfaces

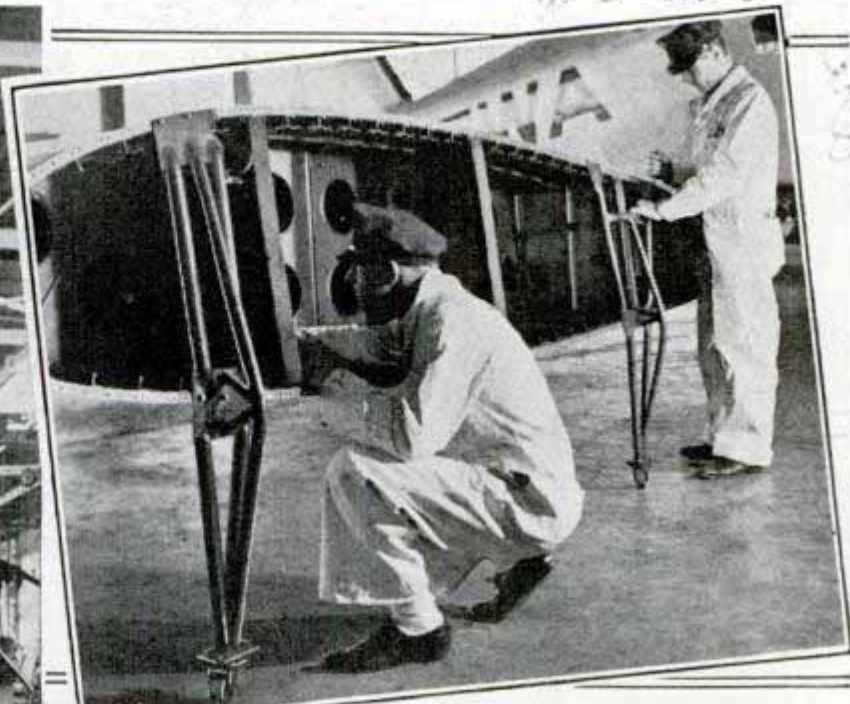

Unusual stands which facilitate servicing of Transcontinental & Western Air skyliners. Above, stand on casters speeds work on wing panels



Center, working on nose of air liner is made easier by stand providing eighteen square feet of space. Right, platform which fits landing-gear structure provides footing for mechanic to do work inside nacelle

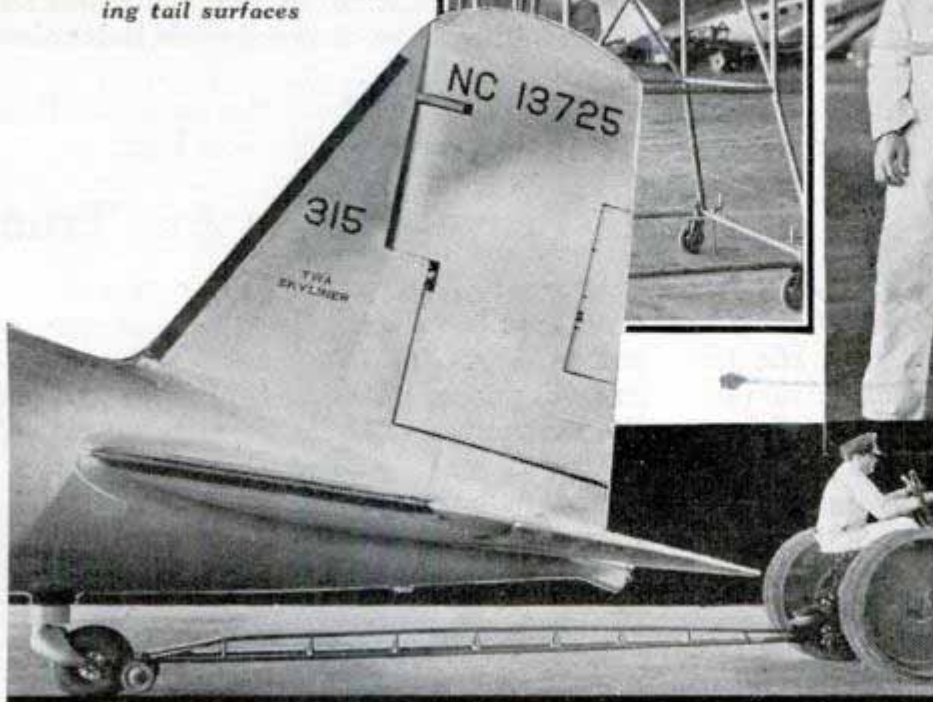

Handy stands speed servicing of air liners

Illuminated Map Shows Routes for Tourists

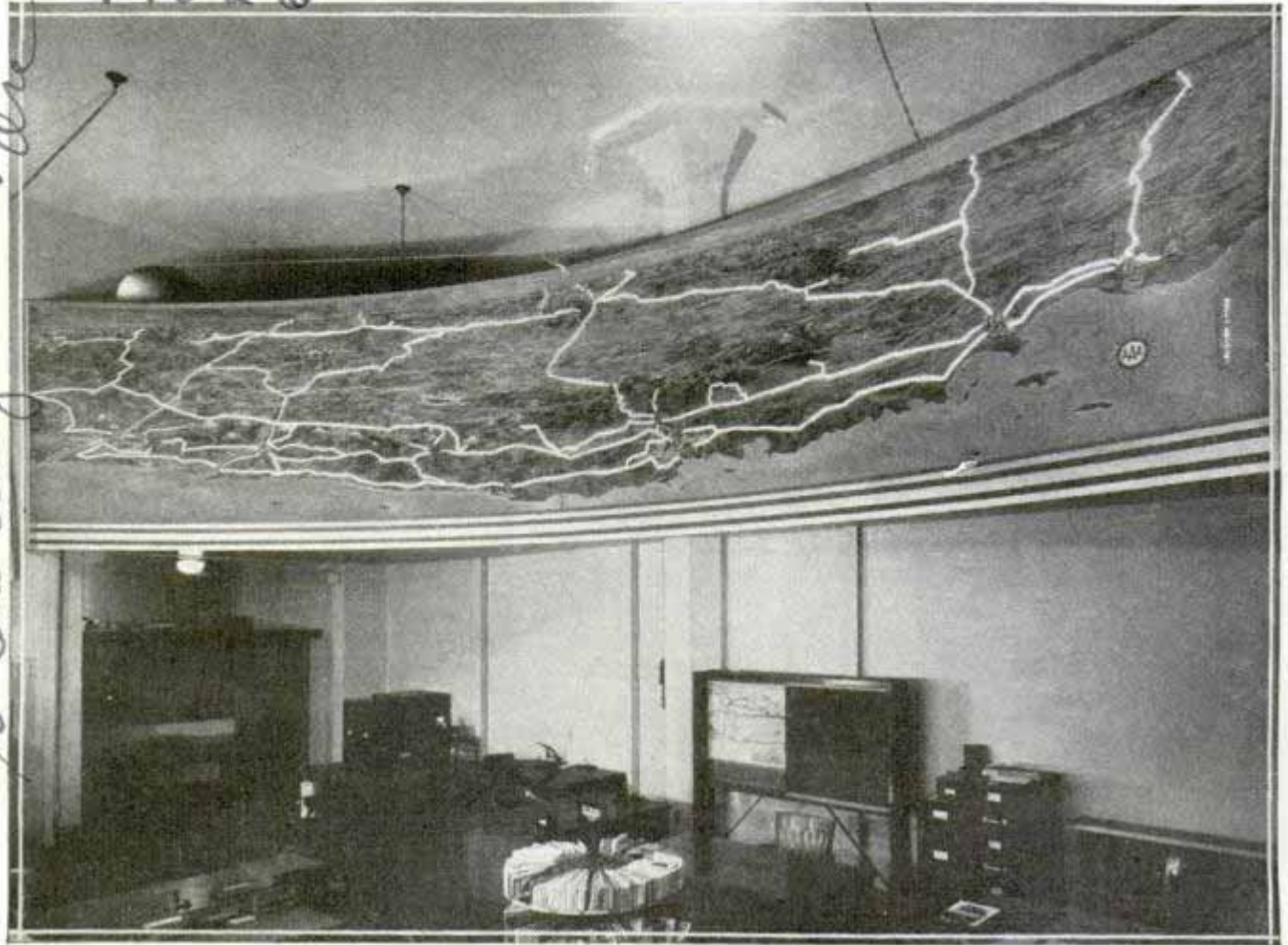

Sections of highways or entire routes can be lighted on this map by operating a control board. The map shows the tourist at a glance the best route for any trip in the Pacific region

Major highway routes of the Pacific coast and Rocky mountain areas may be pictured for tourists on a huge illuminated mural map installed in the office of the Oregon State Motor association at Portland. Controls at a central switchbox provide for illumination of any major section of highway, or an entire trip over various

routes, each being lighted in a different color. The map offers a perspective view of the entire Pacific coast, from British Columbia to Mexico, extending inland as far as Yellowstone National park, Salt Lake City and Santa Fe. Thirty-eight hundred electric bulbs illuminate the map, which is forty feet long and eight feet high.

Film Expert Digs in History to Prove Movies Are True

Fine points and odd facts in history are dug out for motion pictures by Harold Hendee, RKO research director. His job is to make everything authentic in pictures, although after he has approved facts for use in a film, the studio may make a change for box-office purposes. These changes, however, are said to be infrequent. Among the oddities he has been asked to determine are: was "cop" used for policeman in 1840; when was "going on a bender" used in the modern sense, and when was "doughboy" first used in the

language? The research director discovered that "cop" was not a part of speech before 1859, therefore it could not be used in a film dated in 1840. Doughboy was in the vernacular in 1685, when it designated a British sailor's cake, then later it referred to brass buttons on infantry uniforms and finally, in the Civil War, to soldiers. In 1862 the people first began talking about "going on a bender" with the modern implication. Once in a Revolutionary picture, the film used a flag of the colonies instead of the American flag. Many movie

Cmd. J. Lynn Wajkoff.
 o/o The Oregonian, Portland

F165?

Cont. Miss Betty E. Stone

fans protested, referring to the famous painting of Washington crossing the Delaware, which shows the American flag. Mr. Hendee points out that the American flag was not designed until seven months later than that incident in history, so the film was authentic. Once in checking the weather during a battle in the Valley Forge campaign, he found two historians recorded sunshine, but four others declared the men fought in a snowstorm. The studio used the picturesque snowstorm.

Elb26

Old West Goes Modern in Handling Cattle

Handling cattle with special mechanical aids is robbing the old west of some of its glamour, but is introducing efficiency. On the Stanley ranch near Phoenix, Ariz., four operations are performed at one time: dehorning, spraying the cattle's ears to kill ticks, branding and injecting a serum against "black leg." This work is done with the aid of a special cattle chute, the sides of which are operated by a lever to hold the cattle firmly. Only one and one-half minutes is necessary for the whole job and hundreds of cattle are handled daily.

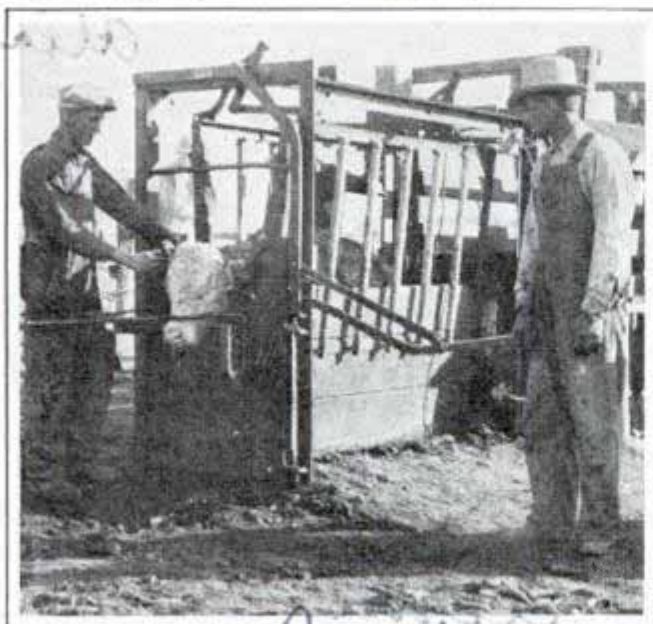

Latest method of handling cattle

Glass Screen for Fireplace Allows Clear View of Blaze

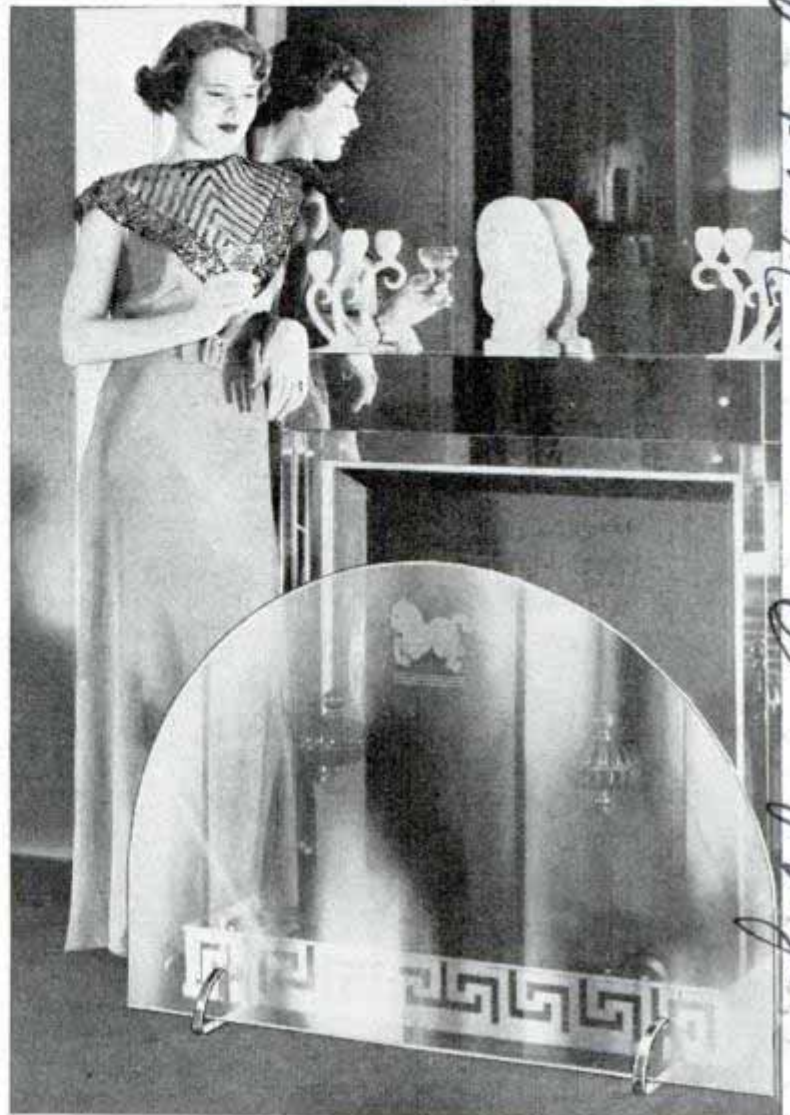

Glass screen fits into modern decorative scheme and does not obscure view of the fireplace. Design can be etched in glass

In keeping with modern decorative trends, a glass fireplace screen has been introduced. It adds charm by permitting an unobstructed view of the dancing flames. Made of tempered glass, it is strong enough to withstand heavy impacts and gives full protection from flying sparks. These glass screens are made in various styles and are decorated by sandblasting designs or monograms. Colored glass could be used to match room decorations.

Popular Mechanics Magazine does not publish the name of the maker of, or dealer in, any device described in its pages, but this information is kept on file and will be furnished by our Bureau of Information upon request, accompanied by stamped, self-addressed envelope.

Labhey - Lewins - Ford - Lyles - Warming - Golds.

7740 South Chicago Ave 220 6 South Road, Chicago

One-Man Grinder Speeds Up Railway Maintenance

Vertical handwritten notes on the left margin, including "Columbiana" and "Pekin".

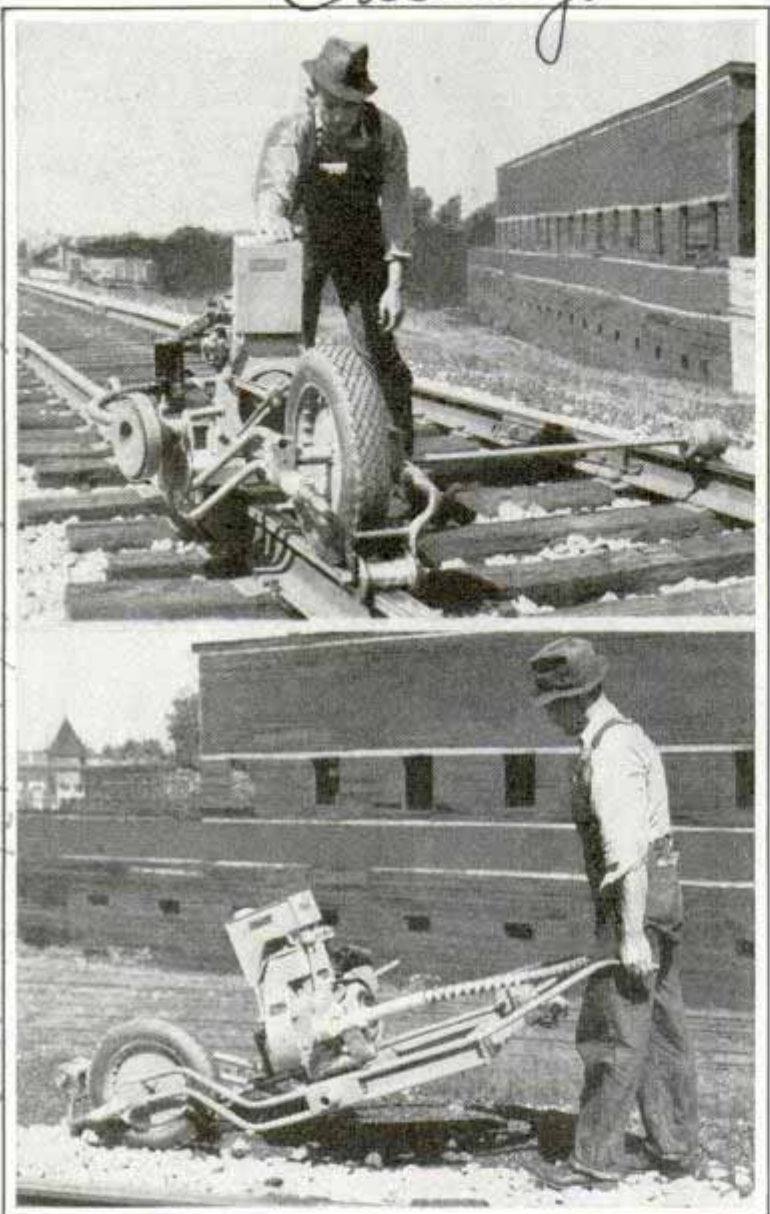

Top, pushing rail grinder along. Bottom, rolling the machine beside tracks. The grinder is handled easily by one man

Designed for one-man operation, an all-purpose rail grinder which may be moved along on the tracks speeds up maintenance. It is useful for reconditioning battered rail ends, frogs, crossings, switches, slotting joints, removing excess metal from rail ends, stock rails and switch points and for general work. A pneumatic-tired wheel permits moving it along the right of way.

"Block Signal" Operated by Auto Slows Traffic on Curves

F/85

Automatic traffic lights which are operated by the automobile itself as it passes

over a sound box have been developed by a Baltimore inventor in an effort to make highway curves safer. The hollow sound box was placed in the roadway about 100 feet from a sharp curve and warning lights were installed directly over the curve. Normally, these lights remain red. But if a car passes over the sound box and continues toward the curve at fifteen miles an hour, the light changes to amber just as the car reaches the turn. If the motorist drives faster, however, the light will still be red and he must stop. If the car was driven on the left side of the road and missed the sound box the light would stay red until another car caused it to change. A similar installation of lights to the left of the road warns the motorist of a car coming from the opposite direction.

Baltimore, Md

F1621 Bird's Broken Leg Mended with Tiny Splints

Major operations are performed in an odd hospital whose only patients are birds. Recently a canary with a broken leg was treated by the skilled bird doctor, a woman, who fashioned tiny splints to hold the fractured parts in place while the patient was convalescing.

Mrs. E. J. Kaash Atlanta, Ga.



Acme

Taping up the broken leg of a canary

Floral Conservatory Is a Skyscraper of Glass

Quite unlike the traditional greenhouse with peaked or arched roof, the new floral conservatory at St. Louis is built like a skyscraper with walls that step back to admit a maximum of sunlight in winter and better control of light in summer. Its vertical surfaces are twenty-four by twenty-six inch double strength panes of glass,

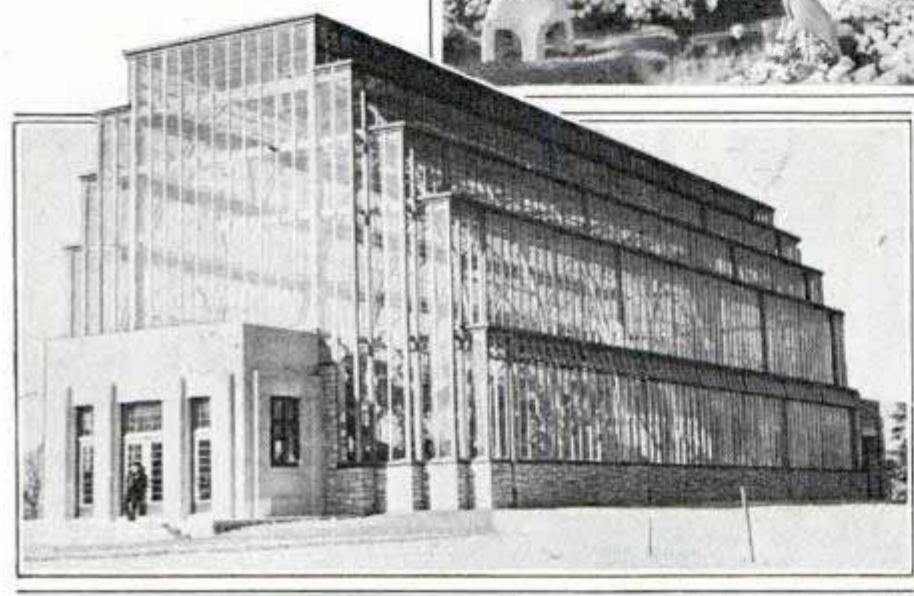

Exterior of the glass "skyscraper" conservatory at St. Louis and interior views showing, at top, the "Japanese garden" of chrysanthemums and, below, the catwalks for workmen at each setback level

fastened with copper glazing strips to resist high wind. Horizontal surfaces of the setbacks are of composition roofing. This type of construction saves breakage by hail, and the shadow from the solid roofing is lessened by its fifty-foot height. Catwalks built permanently at the various levels allow workmen to replace glass without scaffolding. Whitewashing to stop glare in summer is unnecessary, for Venetian blinds are to be installed during that season. There are 15,000 square feet of glass in the walls. The building is fifty-five feet wide and 145 feet long, set in a north and south direction. Aluminum paint covers the steel arches which support the sides and roof, this preventing the fungus growth that attacks oil paint.

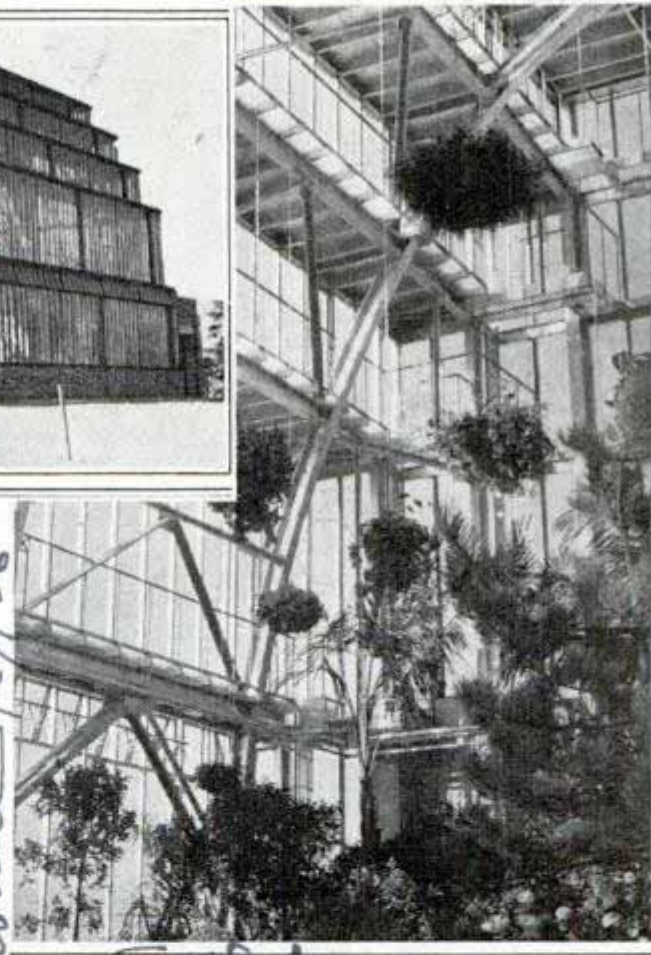

Steel in 1937 Car Weighs More

Eighty per cent of the weight of the average 1937 model automobile is steel. The use of alloys has cut in half the weight of cars as compared with twenty years ago, yet in your 1937 auto there is approximately sixty-five pounds more steel than was used in the same model last year.

Suburban 1/29/36

Washington University of St. Louis

American Iron and Steel Institute

7488
Cmt. Carl Theisen 8649 Lookout Mountain Road, Hollywood, Calif

The LATEST

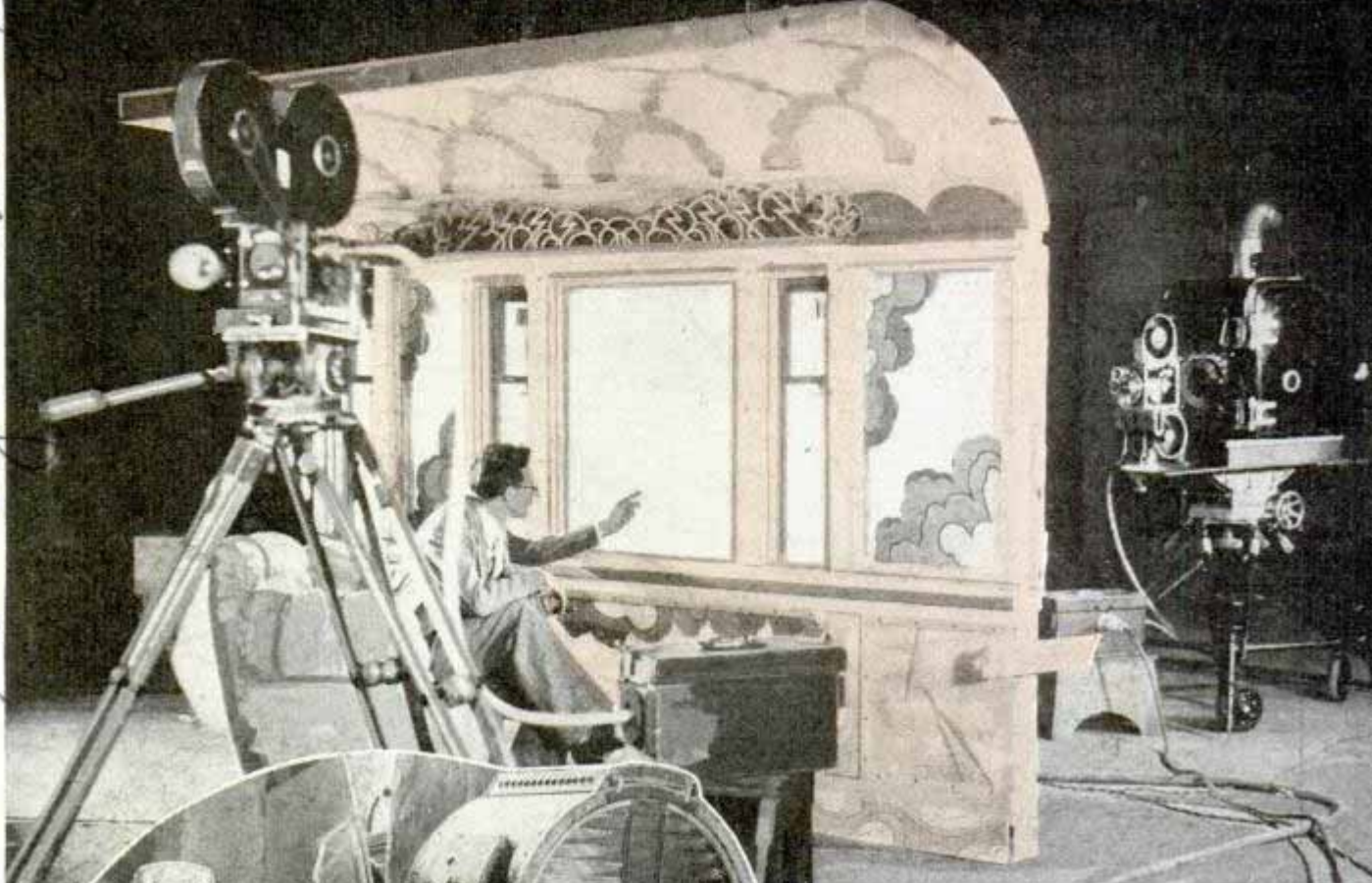

STEP behind that big battery of cameras in the workshop of Hollywood's movie factory and watch them outsmart nature.

The light that plays on the face of your screen here is so intense it could start wood burning. Invisible ultraviolet light captures and stores his voice for you. Huge booms that remind you of steam shovels loom through dense artificial fog, thrusting an armful of cameramen into range for a startling action picture. Man-made lightning rips the sky backdrop and drenches the set with light. Sharp-eyed lenses catch the glitter of dew sprayed on a spiderweb spun by no spider.

Action is swift—cameras, crews, equipment must be as swift. Twelve-ton camera booms must maneuver smoothly and speedily as the players move about. In a manner not unlike that of a steam-shovel boom, the arm, on

Giant early light and its small present-day counterpart. Top, setup for a "rear-projection" shot.

Scenes from *... of ...*
Pioneer Production. F. 48

in the MOVIES

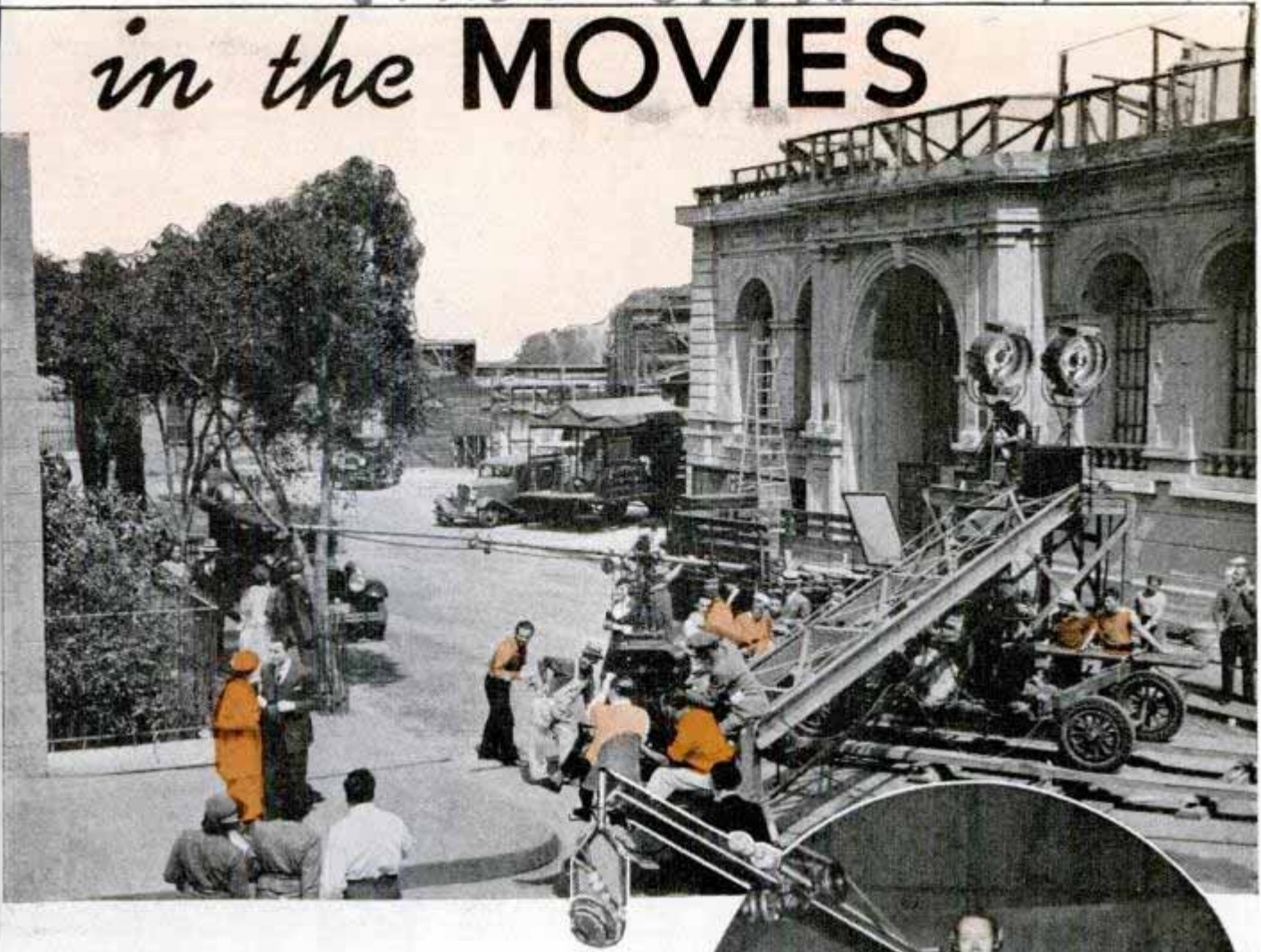

which is a platform with seats for the crew and a turret for the camera, is moved about to any required angle during the shooting of a scene. The largest of these booms at the Universal studios can hoist the camera forty-five feet high, and because it is mounted on an electrical conveyance, it has a ground coverage of 600 feet. Five generators operate the boom arm, the turrets, and the electric truck on which it sets. Power-driven rewind drums either roll up or unroll the electric cable between the main power supply and the truck when in motion.

A number of new cameras have been developed, the Mitchell camera being perhaps the most important. This camera is constructed so its elaborate mechanism operates silently in keeping with the exacting demands for silence during the filming of talking pictures. Exact precision and mechanical balance of moving parts is required because the motion-picture camera, operating at normal speed, starts and stops, and thus exposes about 1,440 photographs each minute. This must

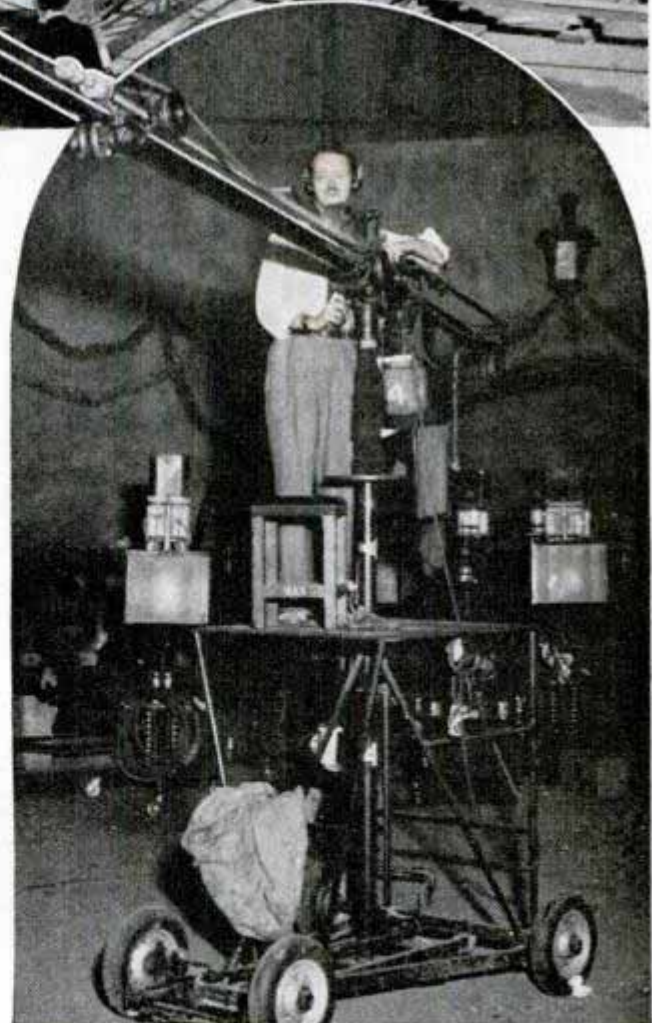

Top, electrically operated boom on tracks. It can hoist camera and crew forty-five feet high. Below, sound crane used in following action of players as they move about the stage

Mitchell Camera Corp.
111 ... and Case

Under Two Flags.



earlier type Mitchell camera, silencing blimps have been developed which absorb the vibration of the mechanism. By combining layers of insulation such as smoked gum rubber, beeswax, cork, felt and other materials of various densities, all the sound frequencies are "killed." Between each layer of insulating material is placed a solid material which prevents the physical vibrations from being transmitted to the adjacent layer. In this way all the vibrations are kept within the blimp.

Another new camera, the Technicolor, has an elaborate prismatic optical arrangement, the light passing through a single lens being split so three negatives are photographed simultaneously in order to get the necessary negative records of the three primary hues for reproducing in color.

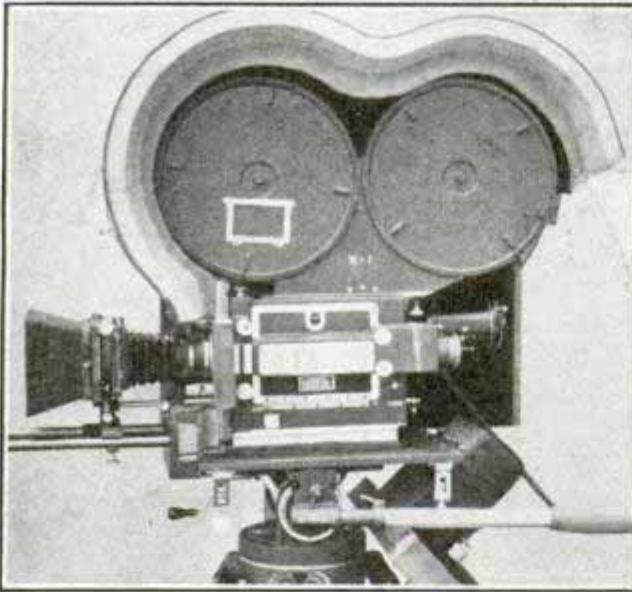

Top, camera truck with very soft tires used for outdoor shots. Below, left, cross-section of early Mitchell camera in sound-silencing cabinet. Right, big fan used for wind effects

be done without appreciable vibration. Cameras used to set up vibrations that recorded as noise in the talkies, and so were encased in an insulated silencing cabinet, called a "blimp." But the new camera is internally insulated so the vibration of moving parts does not reach the exterior of the camera. This camera is fitted to a tolerance of about one ten-thousandth of an inch, or just enough for an oil film between friction parts. It weighs a little more than 100 pounds and costs \$11,500.

Because many studios still are using the

The camera with its silencing blimp weighs more than 500 pounds. Inside the camera case is everything from camphor wells for preventing film shrinkage to tiny electric lamps for sound synchronization starting marks. So delicate and so complicated are these cameras that only six cameramen in Hollywood have been trained to operate them. There are more than 1,000 men who can operate the black-and-white camera.

Technicolor has a novel device which is used on this camera for automatically focusing it from remote distances. By this device, consisting of two synchronous mo-

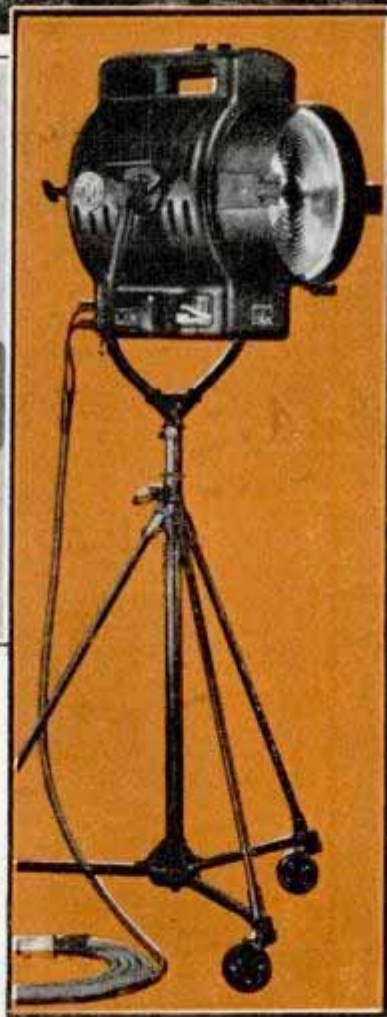
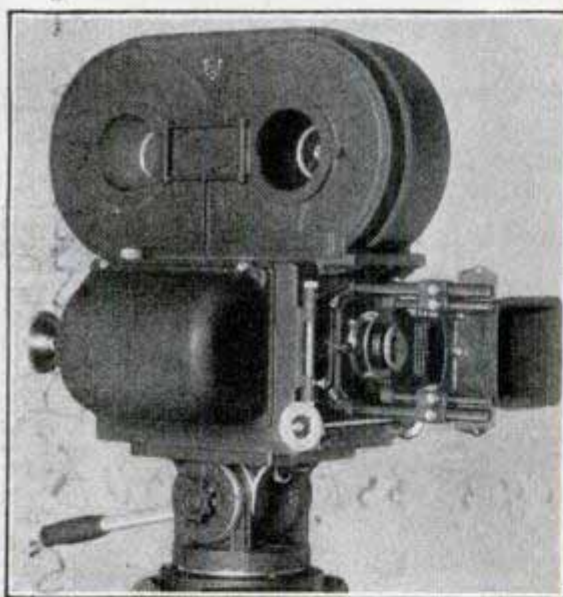
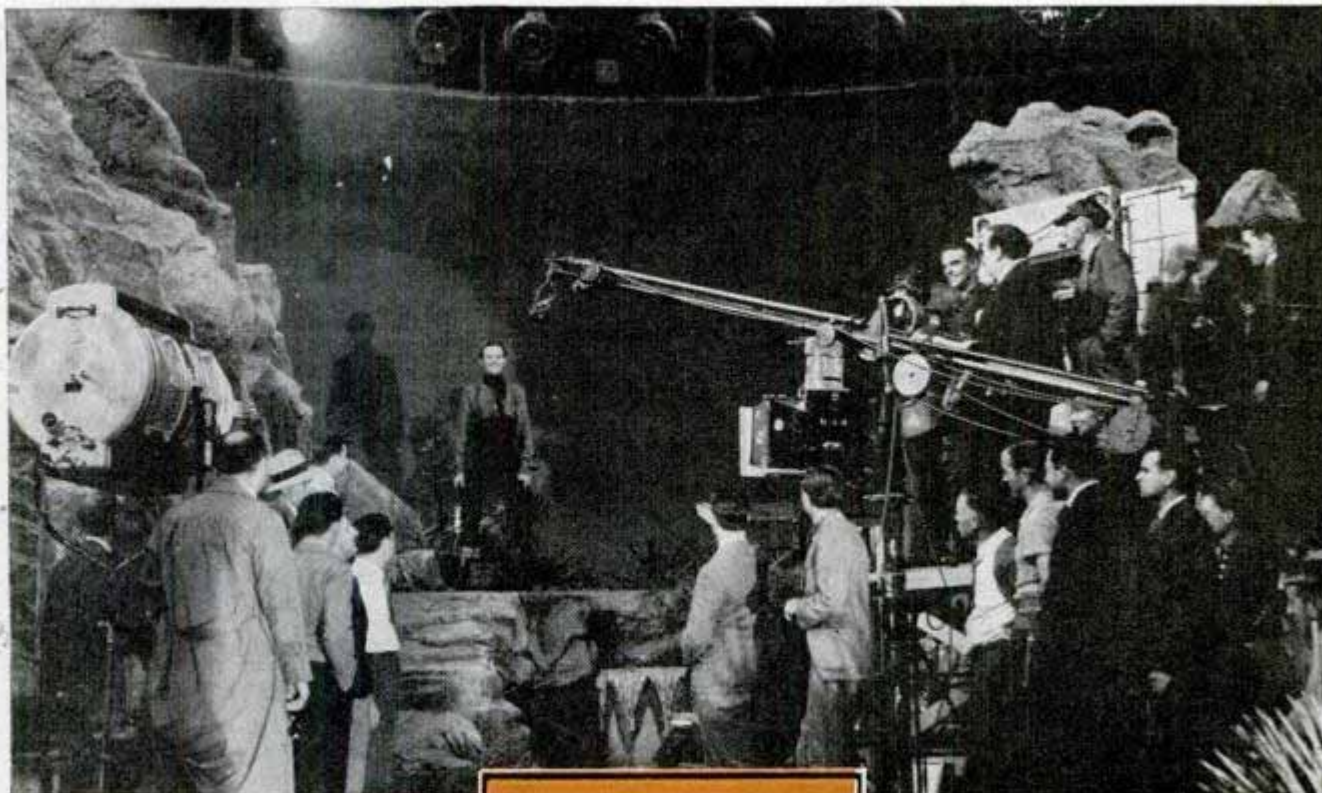

tors, it is possible for the cameraman to keep his camera in focus even though he be 500 feet from it. By manipulating a dial to which is connected a "geared-down" motor, he controls the second motor on the camera which operates a rack on the lens.

New lamps, new optical systems and lighting equipment made of lightweight alloys are now in use. Whereas six men were needed to handle the older type lighting units which

weighed about 120 pounds, the new equipment constructed of aluminum and alloys weighs only sixty-seven pounds for the same size unit and may be handled by two men. Art Reeves designed a lighting unit that weighs only two pounds, including cable, reflector, and a stand that will hoist the light twelve feet high. It is used at present by newsreel photographers. Another portable light recently introduced is the "Cinelite," which uses a 1,000-watt photoflood lamp.

The new lighting equipment includes reflectors which diffuse as well as reflect the light for larger and more uniform coverage. The earlier reflectors and optical systems usually projected a light pattern that was "doughnut" shaped. The light had a bright rim with a dark center which made it difficult to illuminate evenly large surfaces or groups. A parabolic reflector called the

Top, using sound crane to pick up voice of actor during filming of scene. Below, left, Mitchell silent camera, showing the inclosed motor. Right, a 5,000-watt "solar spot," the most intense light used in making the motion picture of today. Note its compact size

(Continued to page 114A)

Measuring the Horsepower of a Football Star

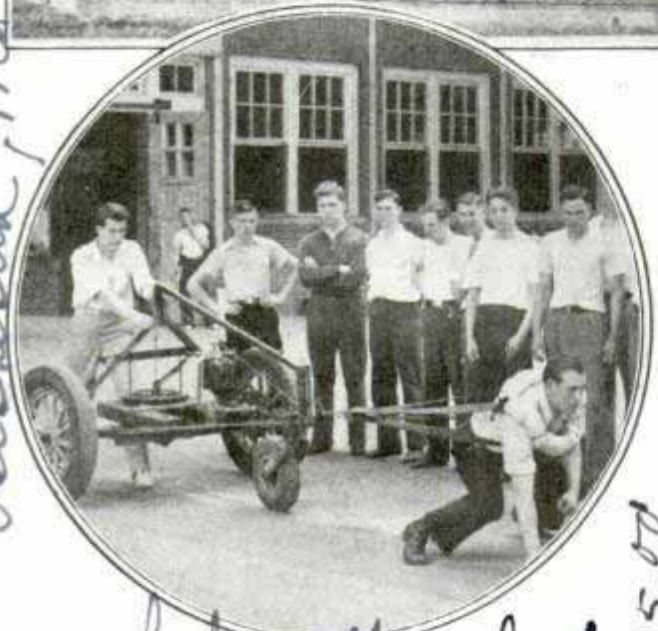
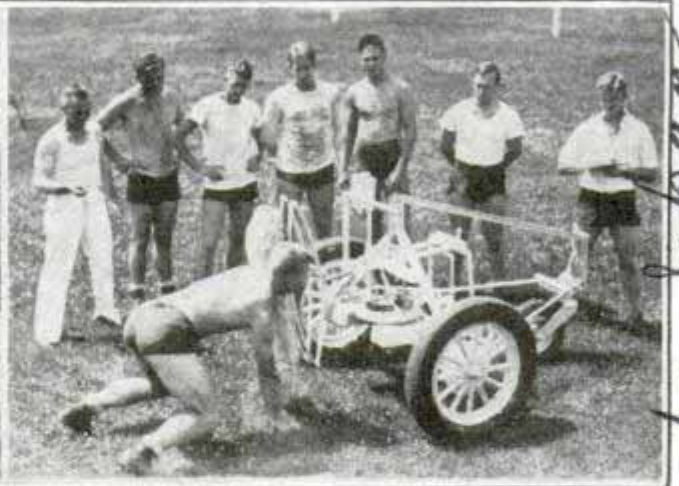

Top, bucking machines test charging power of football players and translate their ability into terms of horsepower. Below, college athletes pit their pulling strength against the dynamometer on wheels

ords of 1.66 horsepower each; in a large group of players the range was from .75 to 1.66 horsepower. The average 155-pound athlete in a group of more than 700 freshmen rated one horsepower. Similar principles were applied in building a bucking machine to test the charging power of the athlete. A padded spring gear received and recorded the initial lunge, the arrangement being such that the recoil of the spring had no effect on the result.

When you charge into a 200-pound football star on the gridiron you are bucking a 1.66-horsepower athlete. Manpower is being translated into terms of horsepower at Purdue University with a testing contrivance rigged up by Prof. W. E. Clevett of the physical education department. It consists of the rear end of a junked automobile, a small guide wheel, a stout spring, a standard and a lifting dynamometer, an oil pressure pump, and slide weights with cable and pulley. For a pulling test, the athlete slips a padded harness over neck and shoulders; his first lunge lifts a weight of about 110 pounds and then he must have the leg drive to keep this weight in suspension and pull the rig thirty feet forward against time. The oil pump blocks the machine until the contestant has pulled up the weight, and then he pulls a constant weight. Three 200-pound football players established equal pulling rec

Shop Vise with Two Swivel Jaws Handles Variety of Jobs

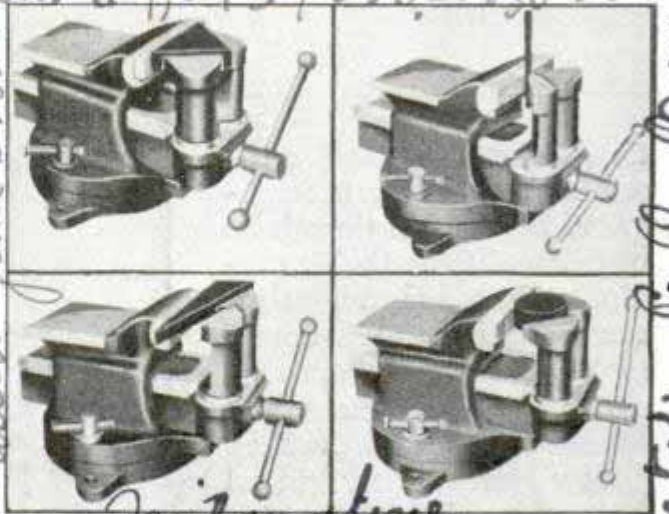

Illustrating different kinds of work for which this handy vise may be used

Constructed with two swivel front jaws and a stationary flat rear jaw, a Japanese made vise handles almost any type of

Emb. Co. H Slacy, 46 39 Montgomery Ave
Bethesda, Md

Lafayette, Ind.

Price will be from \$6.50 to \$15.00

Central No. 226, Osaka, Japan
Proprietor, P. A. Box

U S agent. Kanagaki Shoten

Giant 'Monsters' for Parades Constructed Like Balloons

work, triangular, rods of large or small diameter, T-sections or wedge-shaped objects, as well as the usual jobs. The front jaws may be adjusted at the desired angle to hold irregular-shaped work, or each may be used alone. The vise is small-size, built of cast steel.

F1550

Spray-Gun Adapter Fits on Rim of Paint Can

Paint cans are now being constructed so that a spray gun can be attached to the top with a special cup adapter. This saves time and labor for small paint jobs requiring various colors. Simply attaching the can to the spray gun, the painter can apply a coating and then cover the can for future use. Then, cleaning the gun with some thinner, it can be attached immediately to a can of another color.

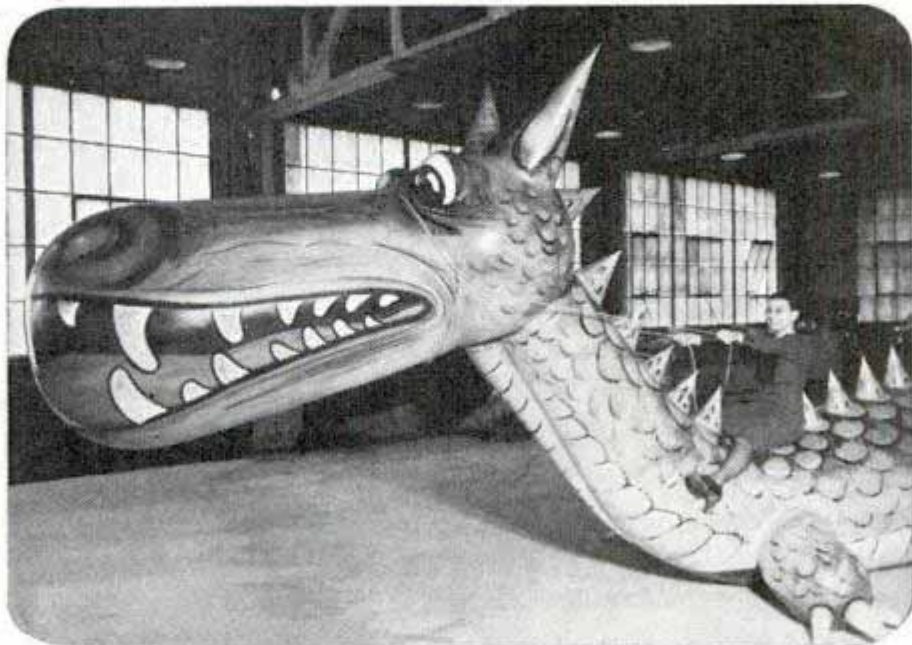

This "monster" will be a feature of parades of carnivals. It is made like a balloon and may be inflated with helium

Constructed in the balloon room of the Goodyear Tire and Rubber company, strange "creatures" known as "figure balloons" become feature attractions in parades and on holidays. One of the latest is a dragon measuring 150 feet from nose to tail. The larger "monsters" are inflated with helium and manned by crews who hold them to the desired height by hand lines, much in the manner of taking a blimp in or out of dock. The figures are built of the same materials as the balloons used for military and commercial aviation. Smaller figures, designed for inflation with air, are carried or mounted on trucks for parade and display purposes.

Abram Ohio



Drawings show how adapter fits rim of paint can allowing spray gun to draw directly from can

F1566 Lectro-Sil Auto Reflectors Resilvered by Dipping in Liquid

Reflectors of automobile headlamps can be resilvered easily by dipping them in a solution after they have been cleaned and polished. The treatment requires no heat or electric current. The plating is accomplished quickly, the solution doing its work in less than one minute, and the interior of the reflector will take on mirrorlike brilliancy with little polishing.

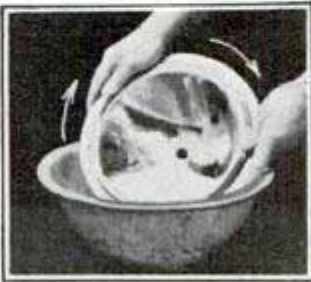

Sherwin-Williams Clapper Chemical Co.

Handwritten notes and signatures on the right margin, including 'reisch, Pa.' and other illegible text.

Streamline Tanker Has Neither Keel Nor Rib

price. see data

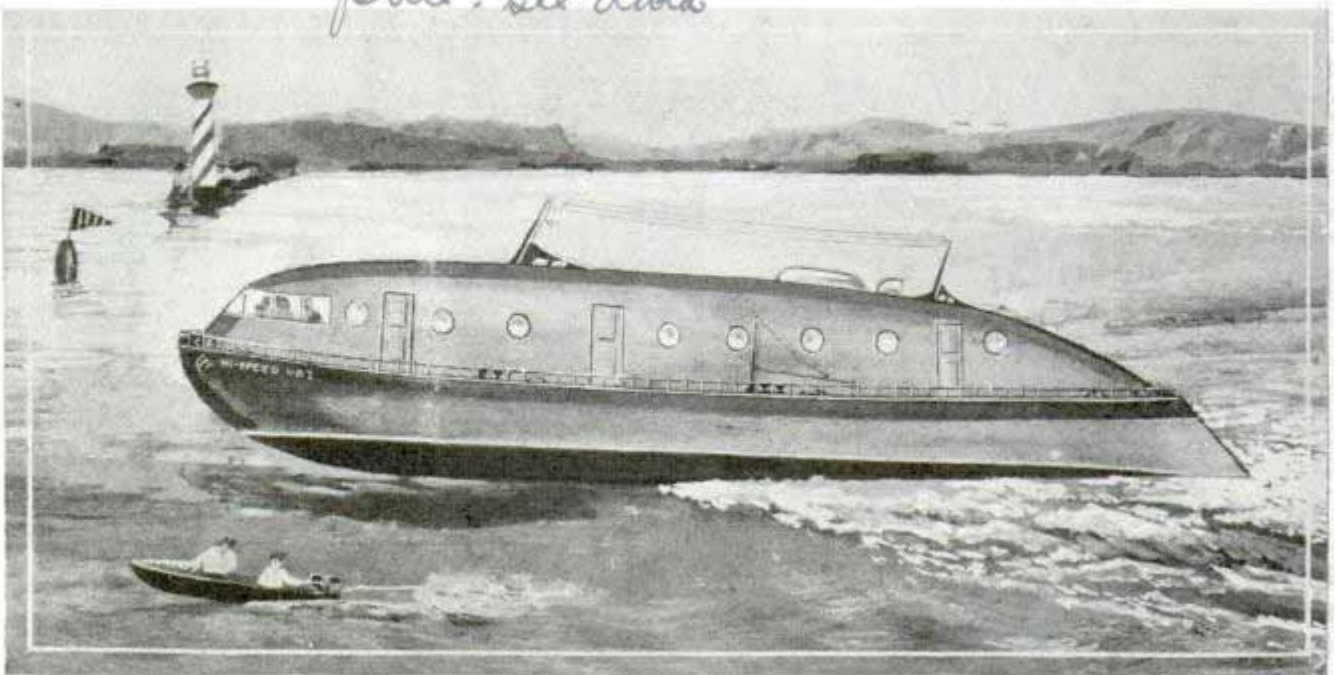

Notice how this tanker "planes" on the water at high speed, reducing the friction. Its hull has neither ribs nor keel, being made of a roll of sheet metal bent and welded into a single rigid piece

Streamline tank boats without keel, ribs, stem or sternpost are being built in a Michigan factory. The bottom and sides are shaped from a single roll of sheet metal bent and welded into a ribless, rigid hull eighty-five feet long, thirty feet wide and ten feet deep. Non-sinkable rowboats and small powerboats have been built on the same principle, attaining speeds higher than fifty miles an hour with small horsepower. These tankers are to be pow-

ered with twin engines of 1,000 horsepower and are expected to travel at forty miles an hour light, and twenty to twenty-five miles loaded. This type of ship, with in-curving bottom, rises to the surface when under headway, "planing" on top of the water and thus reducing friction. Loaded to a depth of nine feet, it is expected the tanker will draw only four feet when in motion. The inclosed superstructure is curved to cut wind resistance.

Rattlesnake Farmers "Milk" Reptiles for Their Venom

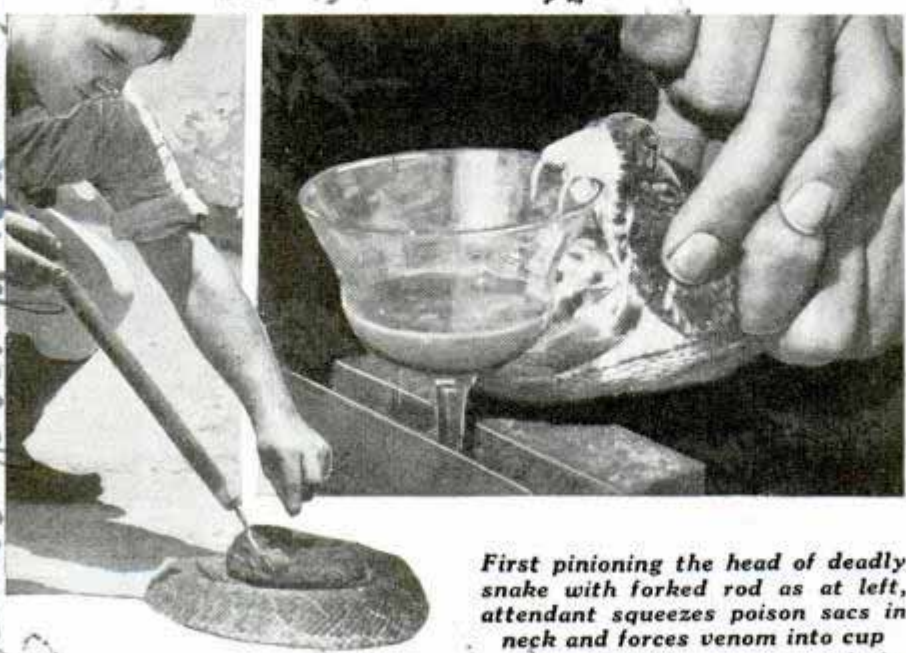

First pinioning the head of deadly snake with forked rod as at left, attendant squeezes poison sacs in neck and forces venom into cup

"Milking" deadly water moccasins and diamond-backed rattlesnakes of their venom is the dangerous business of E. Ross Allen and his staff at the Florida Reptile Institute. The head of the reptile is caught with a metal-tipped stick and pressed firmly to the floor of the milking pit. Then it is grasped at the neck just behind the jawbone, and while an assistant holds the wriggling body still, Mr. Allen forces the snake's mouth open by

Vertical handwritten notes on the left margin, including '1552' and 'George de...'

Vertical handwritten notes on the right margin, including 'pumps' and 'Fila'.

Horizontal handwritten notes at the bottom of the page.

pressure at the side of the neck. The fangs are then held to the lip of a little glass cup into which the venom is discharged by squeezing the poison sacs situated just behind and below the eye. Fifty-nine snakes were milked in thirty minutes in this manner, Mr. Allen believing that at high speed the men are more alert to perceive and avoid danger. After extraction, the venom is placed in refrigerators and later dehydrated and shipped, in crystal form, for use in medicinal laboratories.

Trolley Car Is Schoolhouse for Street-Railway Employees

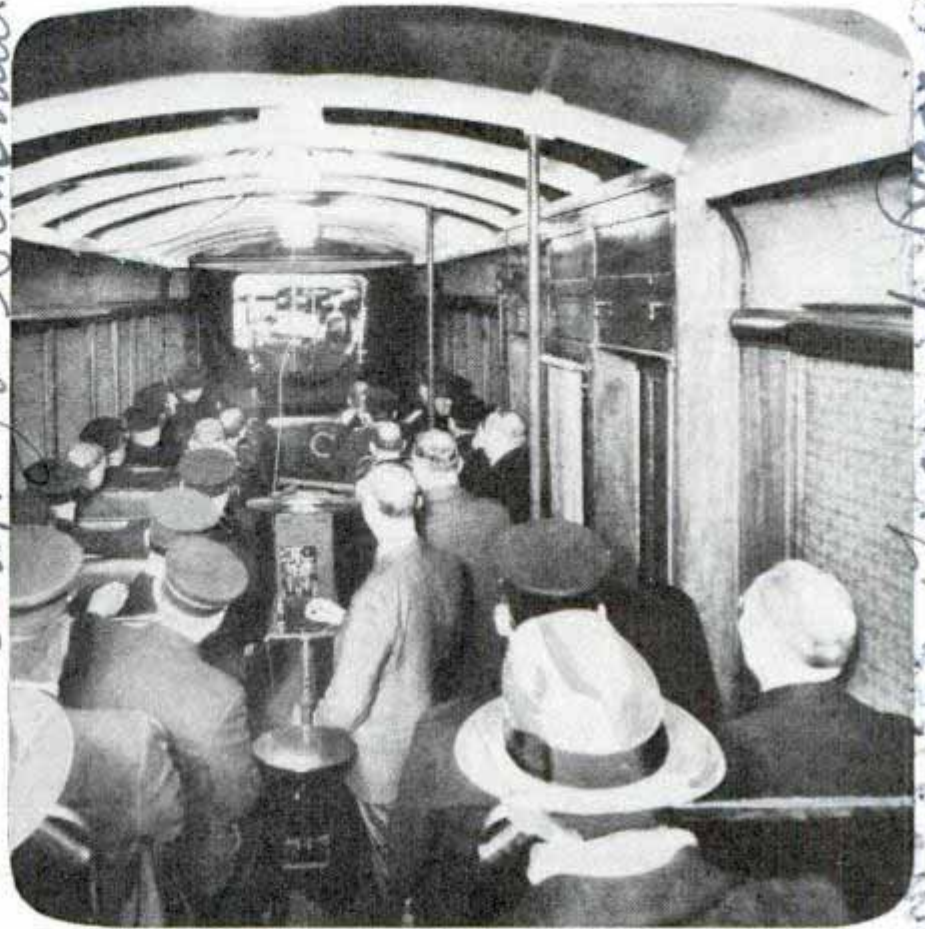

Streetcar men go to school in a streetcar. Educational movies are shown in this remodeled trolley, which travels around the Cincinnati system

F1543

Flyers Summon Aid with Kite Built of Wrecked Plane

Three army flyers used their heads and saved their lives when their ship ran out of fuel and they were forced to make a landing in a remote section of northern Australia recently. They realized that pilots searching for them were likely to miss them, so they made a kite from parts of the smashed ship and sent it aloft. Nine days later a searching plane noted the kite and rescued the flyers.



© Sidney Morning Herald

Kite made from wrecked plane to signal for help

Conductors and motormen of the Cincinnati street railways attend class in a traveling schoolhouse—an old trolley car remodeled. Once in regular passenger service, it is now equipped as a theater with a motion-picture screen at one end. Veteran employes and new men alike are shown instructive movies dealing with salesmanship, courtesy and efficient handling of the streetcar.

F1547

Air-Cooled Coaster Brake Latest for Bicycle

Built like an airplane brake, the latest bicycle brake is air cooled. It has only one internal moving part with the ball bearings while pedaling and no internal moving parts except the bearings while coasting. A triple flange design gives a large cooling surface. The brake has a grease connection and requires only one "shot" every 1,000 miles.

Flight Lt. W. L. Wells, Pilot. Hub. Brake Co. My Clydandy

#1963

Mighty MIDGETS

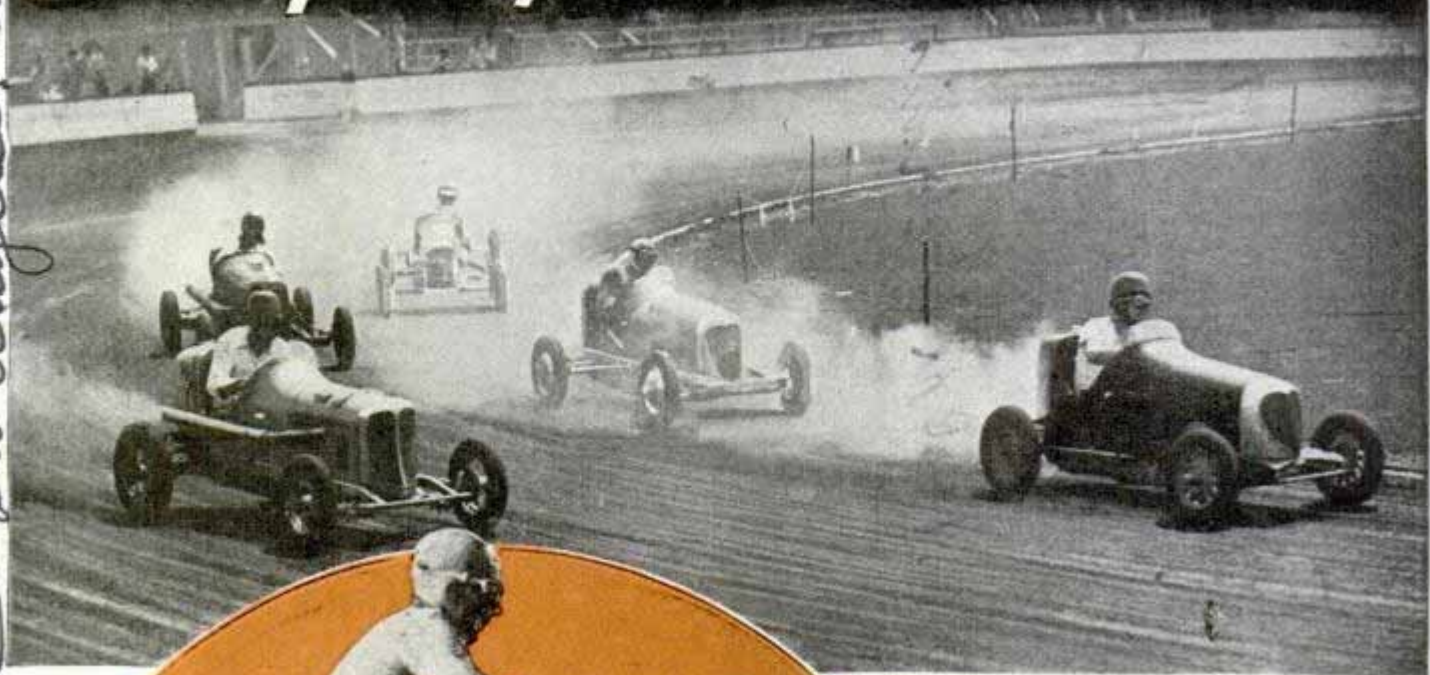

Top, midgets warming up for race. Below, one car crawled over left rear wheel of other in this accident

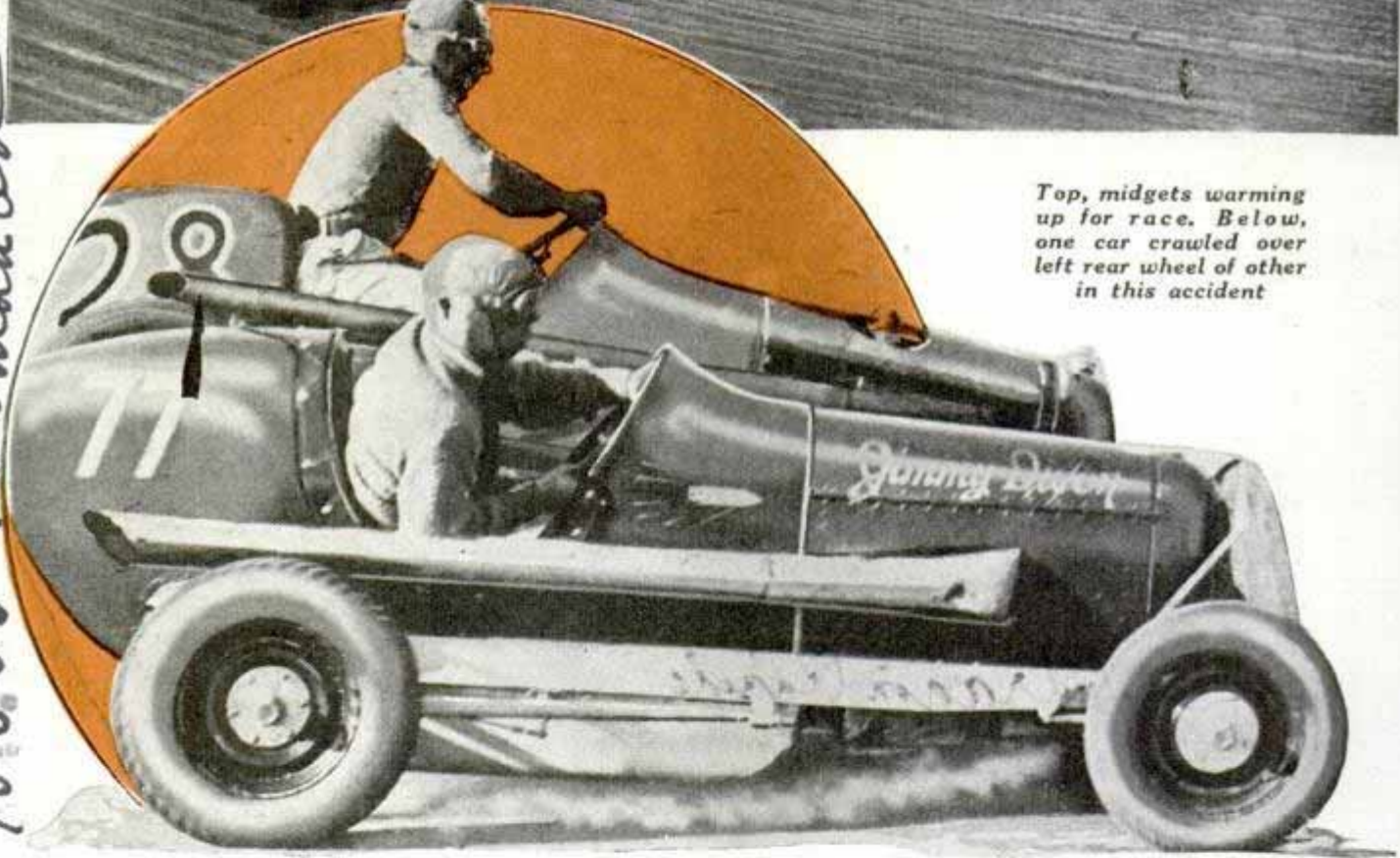

Carl Thomas & Stevenson, Jr. Tolman ABC Los Angeles, Calif. 10.5.65

MIDGET auto racing, which started as a vacant-lot pastime a few years ago, now has attained the prestige and glamour of a big-time sport. Laughed at and derided at first as a game of "motorized kiddie cars," the tiny race cars are attracting thousands of enthusiastic fans who root for their favorites and closely follow the standings of the different drivers.

Part of the fascination is that the races are held "right in your lap," so to speak.

From the grandstand you get a close-up of the whole track and can follow the flashing cars every inch of the way. On a vest-pocket scale you get all the thrills and color of an Indianapolis classic.

Another reason for the popularity of the peewee racers is that they offer more action than do big cars. With as many as two dozen midgets roaring in a tight pack around the turns and into the straight-aways, collisions are bound to occur. Fre-

John... 10.11.65

Facilities and Beverly Hills Los Angeles

of the SPEEDWAYS

quently two cars lock wheels and go skating along for yards before they separate. In a turn one car is apt to slide sideways into another. Occasionally a wheel comes off or a driver loses control and plunges into the infield. Sometimes a leader falters and a car right on its tail rides over one of its wheels.

Breath-taking accidents like these would mean almost certain death in a big-car race but among the midgets it is only part of the game. The drivers get away with it because their cars are lighter and are built closer to the ground. Some of the drivers have been in dozens of collisions without suffering a scratch. Fatal accidents are uncommon although they do happen now and then, sometimes the result of a collision that tosses a car full speed against the safety wall that surrounds the track.

If you know what to look for during a race, you may observe many things that are missed by the average spectator. The best place to see is at the beginning of a turn. From here you can watch the cars weaving down the straightaway toward you and then see them shut off and start their slides into the "corner." But be sure to keep away from the fence if the track

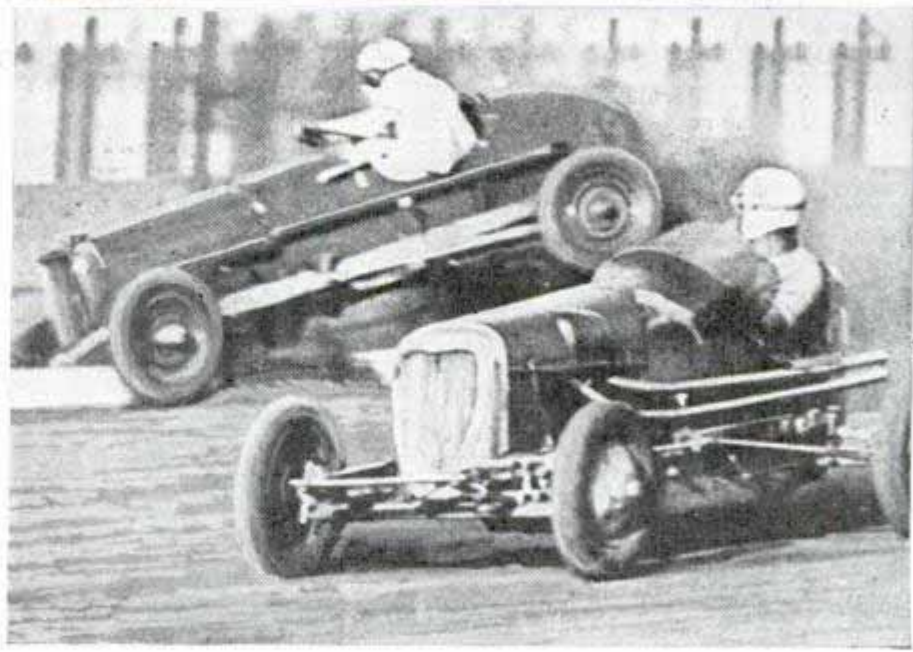

Driver of midget racer wearing crash helmet and goggles and, below, midget car leaping a guard rail after collision with the racer in the foreground

of the
Damon Henderson

see March 1939. 38.6
American Midget Racing Association
3814 1/2 Crenshaw, L.A.

Midget Auto Racing Association

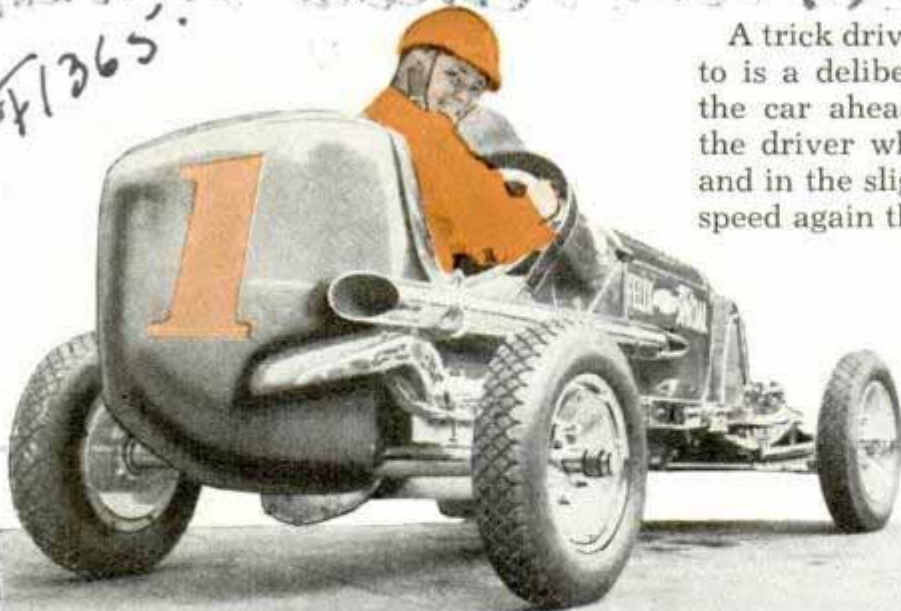

A trick drivers have been known to resort to is a deliberate rear-end collision with the car ahead. The natural tendency of the driver who is struck is to slow down and in the slight interval until he picks up speed again the following driver may have time to pass him. A bump like this must be made to appear accidental for if one driver seems to be having too many such "accidents" he is apt to be flagged down and warned. Most cars these days are equipped with tubular guards around

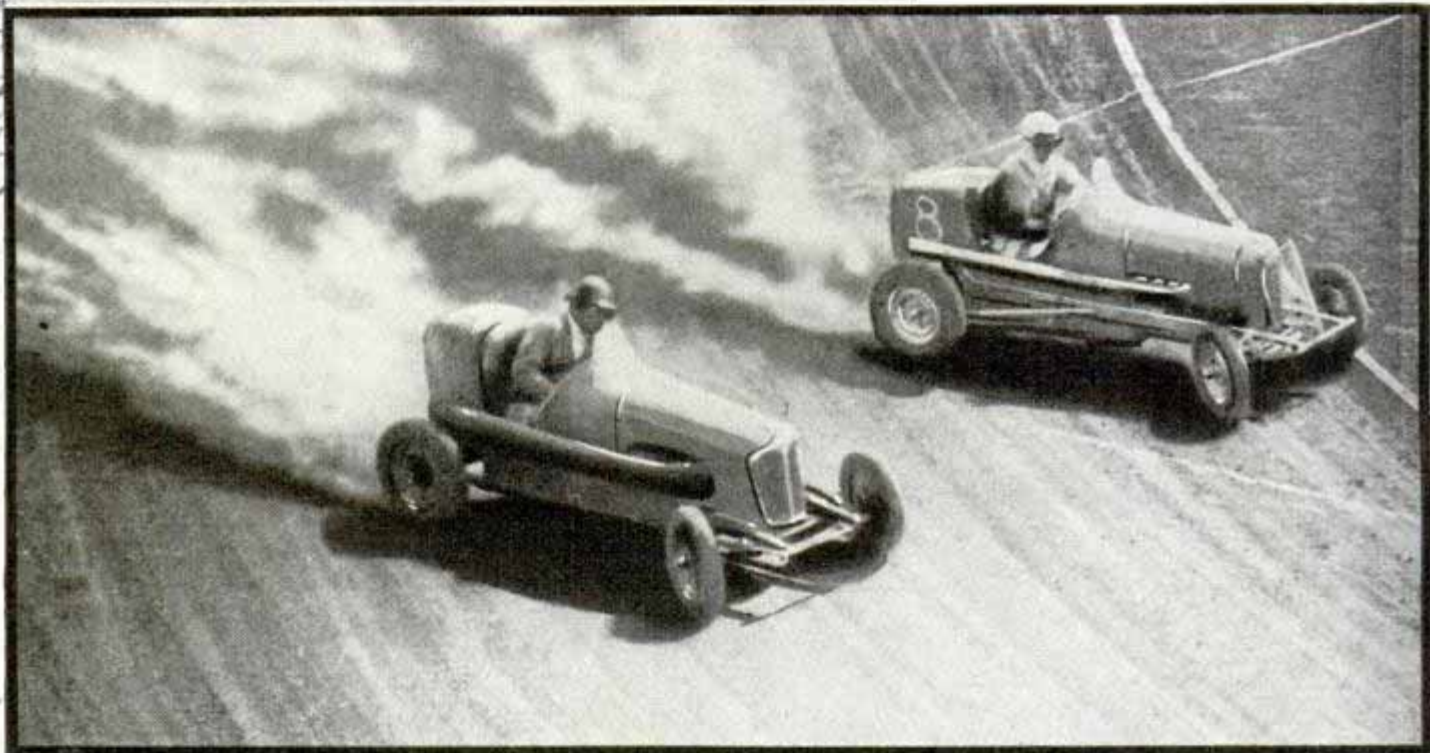

Midget racers in a controlled slide on a turn and, above, close-up of midget racer, showing how closely it resembles its big brothers of the speedway

is unpaved because the wheels of the cars toss a barrage of clay and soil into the lower seats.

When the cars roar around the track three deep for a flying start, only to be waved back time after time, uninformed spectators are apt to think the drivers are incompetent. The real story is that the driver in the pole position happens to have better acceleration than the other cars. He wants to set a slow pace past the starting line, knowing he can "dig out" and beat his rivals to the first turn. The other drivers are trying to force him to a faster speed where they will have a more equal chance to take the lead.

the streamlined stern to protect the sheet metal from such bumps.

On the unpaved tracks, dirt and pebbles are real hazards to the drivers. After a season of hard racing the front end of a car may be covered with dents. Radiators are apt to become clogged with dirt in spite of screens and after every heat the drivers clean out radiators and screens with compressed air.

If the midgets are safer than the big cars, they are also harder to drive. On the short tracks there isn't time for a driver to look around much because his car handles so fast he must work every second. Making seventy miles per hour on the

straight stretches, the cars are comparatively faster, considering the short lengths of track, than the big cars that race on longer tracks.

Drivers of the midgets "steer with their feet" in the turns. The fastest way to get around a turn is by a controlled skid with the car sliding at a forty-five-degree angle. To make the slide properly requires careful coordination of the steering wheel and gas throttle. First, the driver cramps

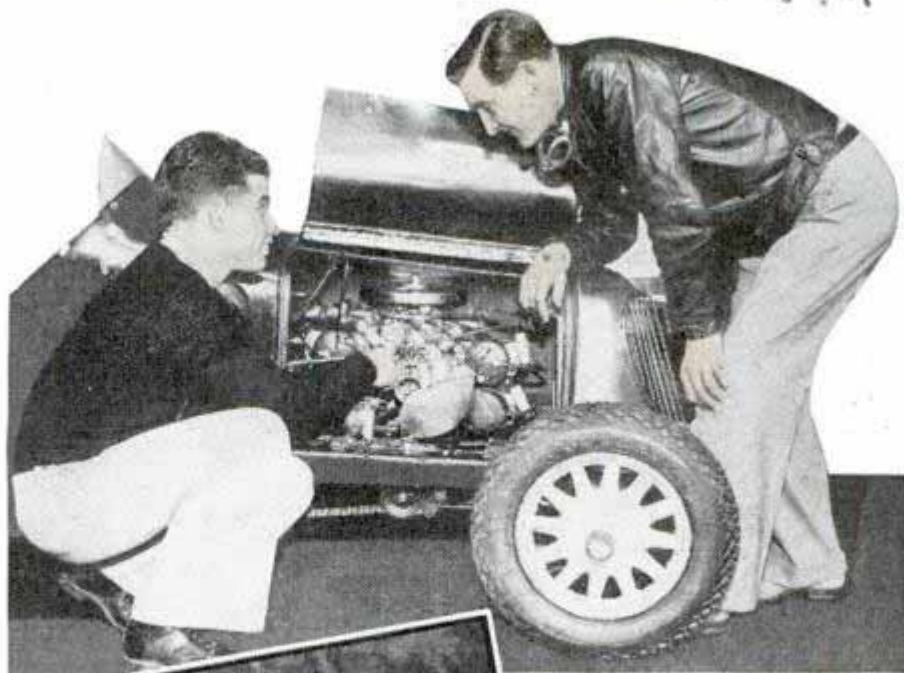

Top, midget racer powered with outboard marine engine. Left, this driver has just dodged car stalled on track

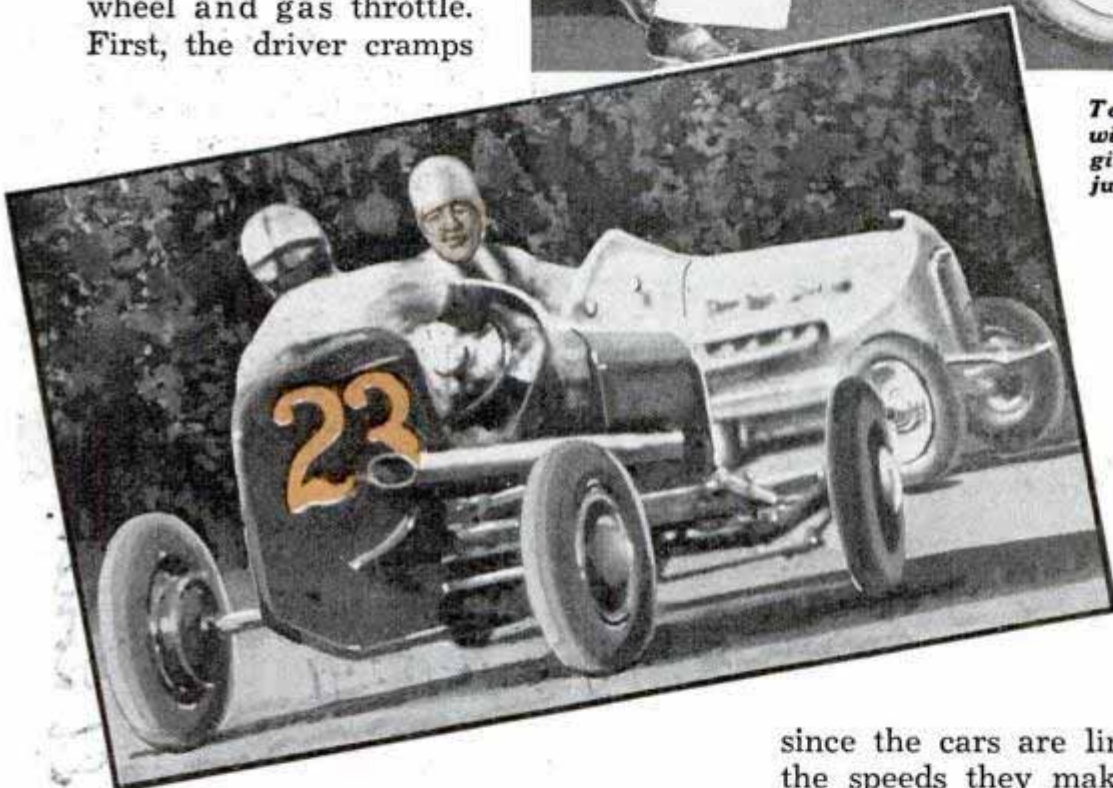

the wheel to enter the turn, then steps on the throttle to start the rear end sliding. If he slides too broadly and threatens to spin he can correct it by speeding up and pulling the front wheels a little in the opposite direction. Always being on the verge of a spin, a light tap from another car may be enough to start a car "swapping ends" or sliding backward down the track. Once a big racing car starts to spin, its weight keeps it going, but the midgets are so light that they usually stop spinning after two revolutions.

It takes a different driving technique to win at midget racing because well-matched drivers find it hard to pass each other on the short tracks. Passing on the

turns is difficult since the cars are normally pushed as fast as they will go without spinning. This puts a premium on the pole position in the starting line-up. It is just about true that many races are won before they start,

since the cars are lined up according to the speeds they make in the qualifying dashes, and the fastest driver gets the pole position. If he can hold his advantage into the first couple of turns, he is well on his way to victory.

Track officials sometimes announce an inverted start and place the slowest cars in front. The fast drivers like to learn about this in advance so they can govern their qualifying speeds accordingly, but these starts are usually ordered without warning. In spite of their smaller size, the midgets are as carefully built as their larger brothers. They are about two-thirds the size of ordinary one-man racing cars. The heaviest power plants weigh 850 pounds as against the one-ton weight of a full-size racing engine. Wheels are

(Continued to page 118A)

Designed for Harold S. Vanderbilt

Model of Cup-Race Yacht Given Speed Test in Basin

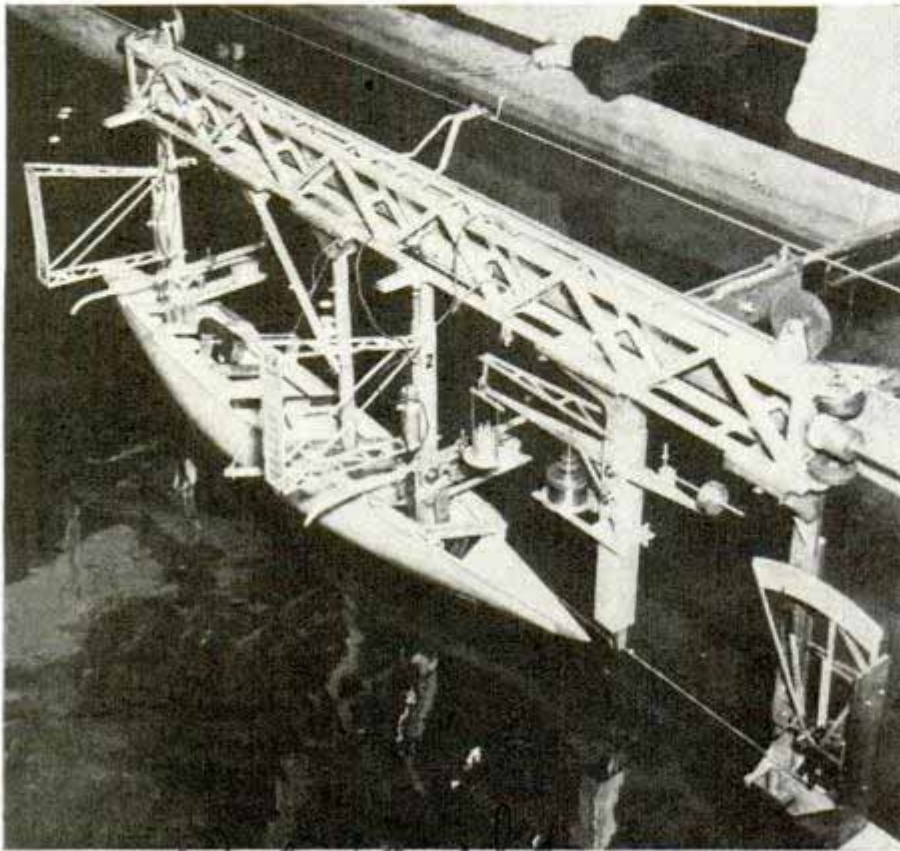

Model of racing yacht's hull being tested in basin. Note measuring devices which record resistance to water when hull is tilted

Models of the new yacht which will defend America's cup in the next race are being tested in experimental basins to determine the efficiency of hull design. In a recent test at Stevens Institute, the model was suspended from an overhead carrier which towed it through the water while various instruments recorded the resistance offered by the hull while tilted at different angles. Many of the conditions to be encountered during an actual race are duplicated in the test basin.

tached to the trailer, the wheel will help support the load on the road, relieving the tow car and the hitch apparatus of considerable weight.

F150 Shelf of Glass Hangs Atop Window Sash

Designed to hang on the top of the window sash and to move up and down with the window, a glass shelf now on the market is both useful and decorative. Made of steel brackets with three-sixteenths inch polished glass shelf, it will not rust nor tarnish. Painted white, green, black, canary yellow or Chinese red, it lends an ornamental touch to the room, in addition to serving the usual purposes of the extra shelf. The shelf comes in several sizes, from twenty inches to twenty-eight inches long. It hangs from two small screw hooks inserted in the sash.

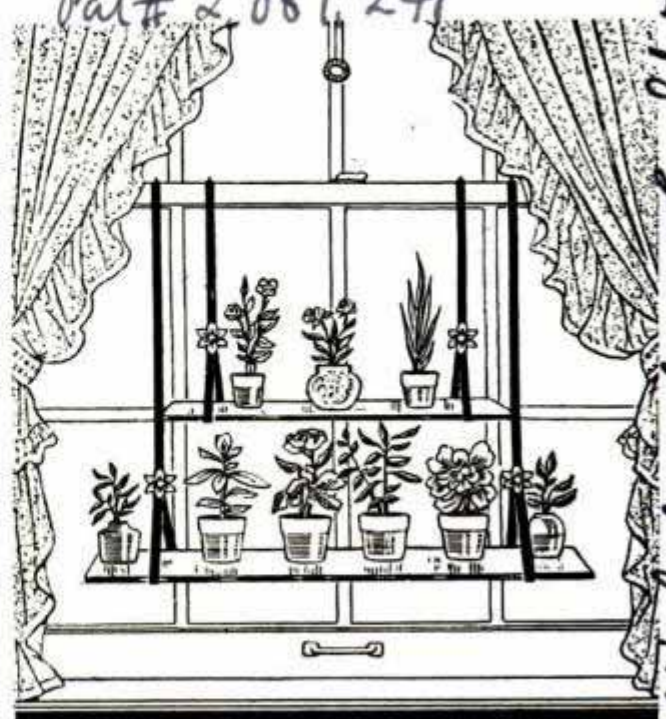

Double glass shelf attached to window

F159 Rubber-Tired Trailer Wheel Fits Parking Leg



Designed to fit the parking leg of trailers, a small rubber-tired wheel with caster mounting is available. The wheel carries a 10 x 2.75-inch tire, of the doughnut type. At-

Hoboken, N.J.

Webster L. L. Jones, Md.

Musselman Products Co

Mrs. M. H. Bigger

71524

Lockheed Aircraft Co
Burbank Calif
POPULAR MECHANICS

Plane Takes Wing-Loading Test Lying Down

When the time came to test the strength of a transport plane's wings, it was flipped over on its back and took the test lying down. Cables attached to the engine nacelles hoisted the eight-seater metal monoplane, nose upward, and laid it down to be loaded with nineteen tons of sandbags. Fourteen tons were piled on the wings and five tons on the engine nacelles to represent the severest load factors that could be encountered in actual flight.

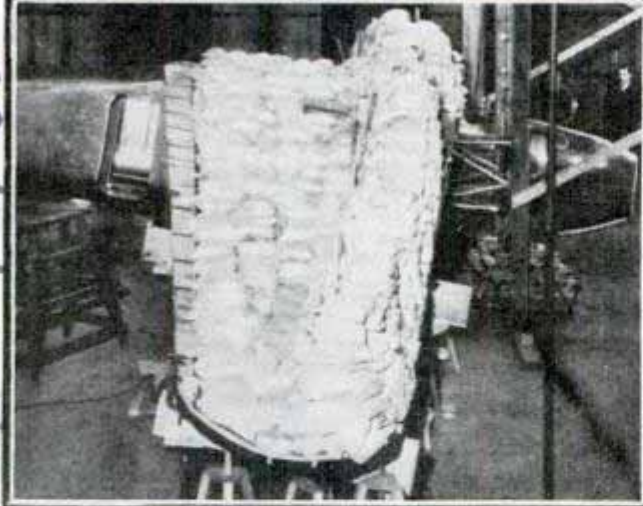
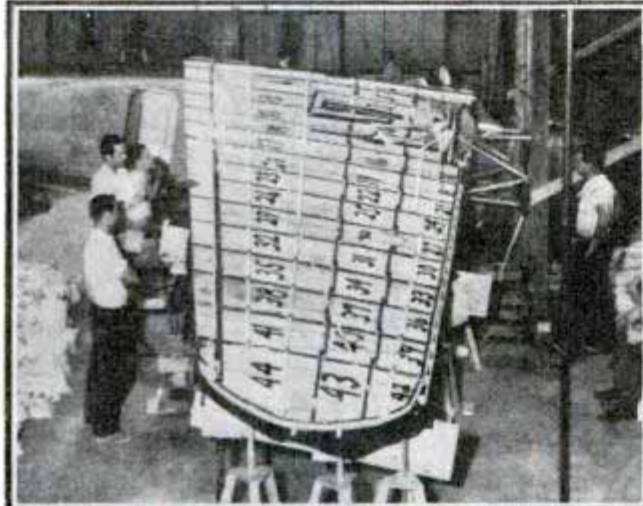
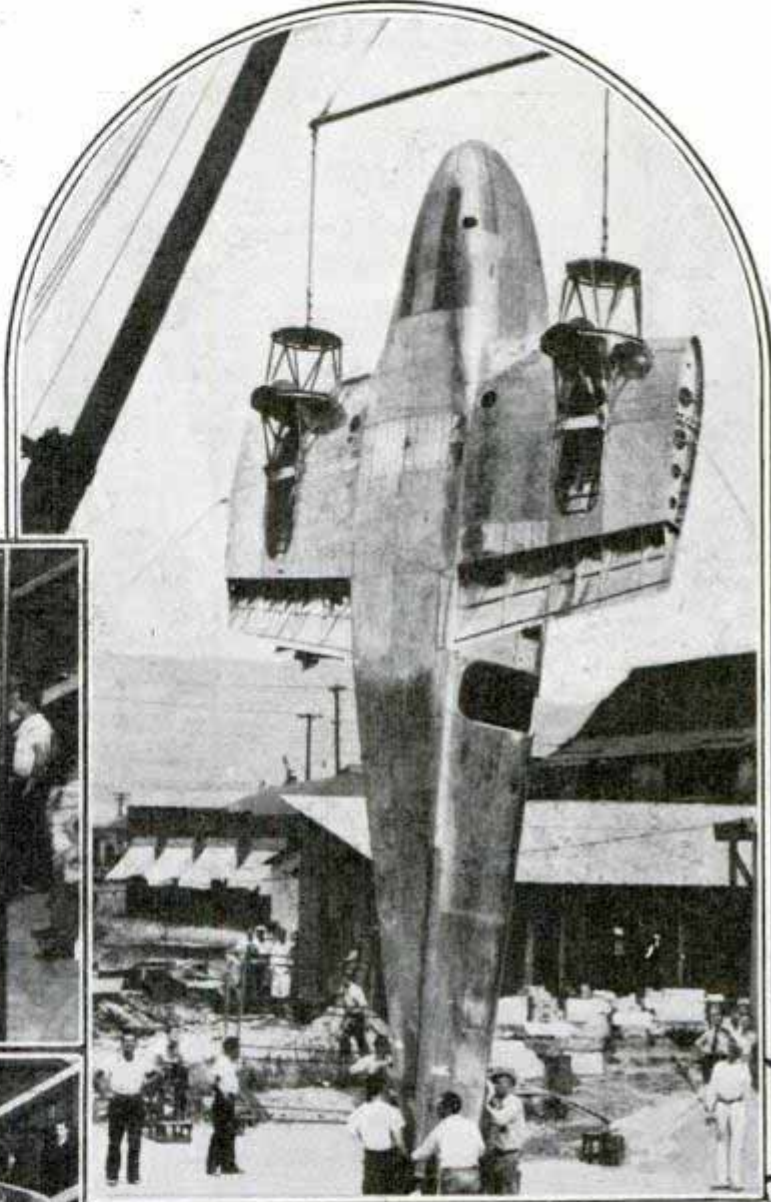

Above, cables pick up metal frame of big transport plane to lay it on its back for wing-loading test. Top picture at left shows the overturned plane, the underside of its wings marked and numbered to receive the sandbags. Below it is seen fully loaded, five tons of sandbags piled on the engine nacelles and fourteen tons on the wings. Under this stress the wing-tip deflection was about eight inches

Chicago Tribune (10/3/36)

71607

Deaf Taught to Hear Vibrations in Toes and Fingertips

By making the whole body an "ear," scientists are teaching the deaf to hear and interpret sound by its vibration patterns. It is predicted that within a few years doctors will know how to fasten a little vibration instrument to the toe of a child born deaf and enable the baby to

overcome its handicap. Deaf children today are taught vibration patterns of speech and music by placing their fingers on a "phonotactor" into which the teacher speaks or music is played. The vibrations are carried through the skin and along the bones to the brain centers.

Deafness: A General American Problem

Dr. Robert H. Isaacs, Professor of Psychology, University of California, Berkeley

Enclosure Enquirer 11/27/36

Scooping up Leaves Is a Job for Snow-Loader in Autumn



Weds World

Brooklyn keeps its automatic snow-loader at work out of season, using it to load trucks with piles of fallen leaves

As a preliminary to its winter's task, a snow loader in Brooklyn was enlisted in the autumn work of collecting leaves from the city streets. Huge piles of leaves were scooped up from the gutters and loaded into trucks for removal.

Short-Wave Radiophone Speeds Work at Observatory

Two-way radio telephones keep scientists at California Institute of Technology in close touch with work being done on the institute's observatory atop Palomar mountain. The 200-inch mirror completed recently at an eastern glassworks will be

installed at the observatory. In four or five conversations daily, members of the institute's staff talk by radio to construction foremen, thus speeding up the work. The system employed is an ultra short wave hookup of two stations officially licensed and operating on a frequency of forty-one megacycles. The distance between the institute and the mountaintop observatory is about ninety-three miles.

F 1485

Time Clock Lights "Stop" Signal in School Hours

Automatic control of traffic near schools has been solved in Lincoln, Neb., by a flasher signal operated by a time clock. When school is not in session the standard highway sign reads "School Crossing," its middle strip remaining blank. During hours when it is needed to protect children at the intersection, the electric time clock flashes "Stop" in red letters across the center strip.

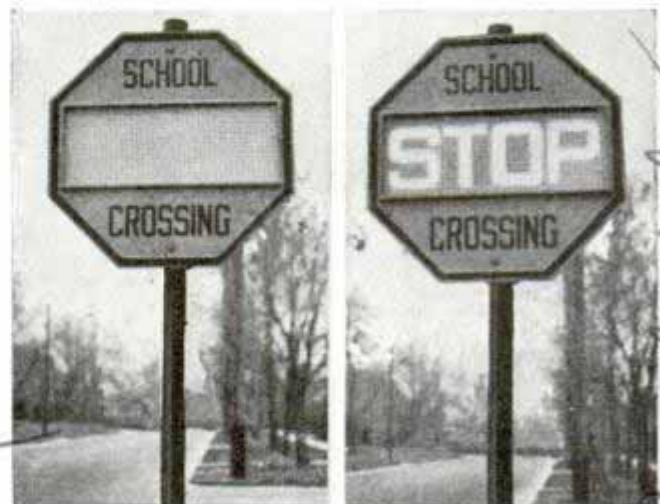

"Stop" signal is invisible except at school hour, when time clock turns on the lights in middle strip

Pasadena Calif

Com. Paul Seely

Experiment Dept

20/10/36

Tiny Newspaper Is Issued from Model Plant

From a miniature model newspaper plant three feet high and five feet square has been issued one of the tiniest newspapers ever published. Printed with pygmy plates, the paper is only an inch high and three-quarters inch wide, yet its headlines are easily read with the unaided

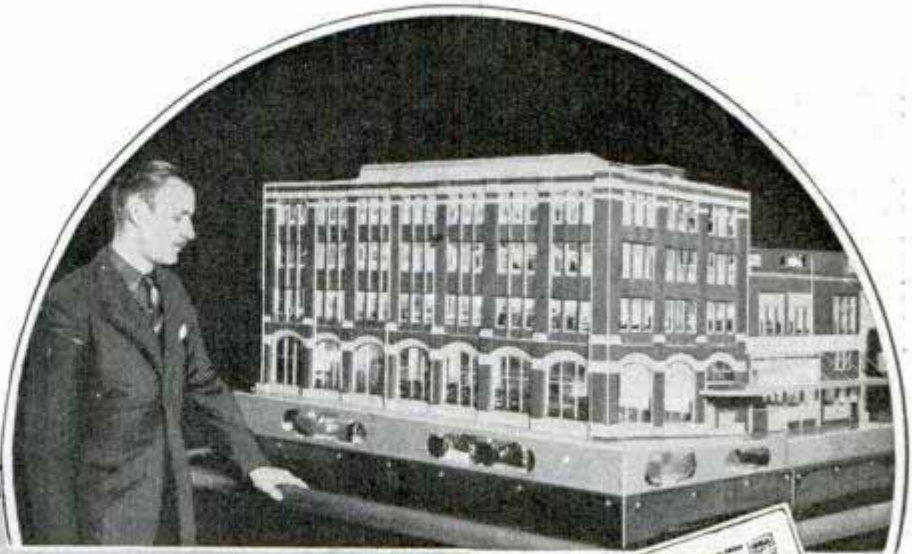

ACTUAL
SIZE



This miniature newspaper was printed in the plant shown at top, a model of the Buffalo Evening News building. At the left is a view of the interior showing the tiny rotary presses and typesetting machines

eye. A linotype operator of the Buffalo Evening News spent eighteen months and \$500 building the model and equipping it as an exact replica, inside and out, of that newspaper's plant. Even tiny telephones on desks, and trucks rolling out with newspapers, copy the original faithfully. Base of the building is of maple and walnut, walls and floors of tempered pressboard, windows of transparent material and roof of fine gravel laid on glue. To simulate a brick exterior, linotype slugs separated by parallel rules were made into a block one foot square and printed on heavy red paper which was pasted on the walls. One hundred lamps light the interior. Miniature paper feeders are located in the basement under the baby presses on the first floor. The three presses, three and one-half inches high, were made of fiberloid, brass and maple doweling, their cams and gears cut with special tools. The levers of the

presses are one-eighth inch long and one-sixteenth inch wide. On the second floor is a financial room and a telegraph room containing toy teletype machines and press wires. Paper rolls, twelve-unit presses, automatic plate caster, mail room and engine room are located on various floors. In the composing room are thirty-two linotype machines two and three-eighths inches high, of fiberloid, maple, aluminum, wire and thread, each containing all the equipment of the real typesetter. Stereotype, photoengraving and picture-reception apparatus are on the second floor, and a penthouse on the roof contains the photo-developing studio.

Names and addresses of manufacturers and dealers in articles described in this magazine will be furnished by our Bureau of Information upon request accompanied by stamped, self-addressed envelope.

Charles J. Seehan

Passengers to Fly Atlantic in Wings of Clipper

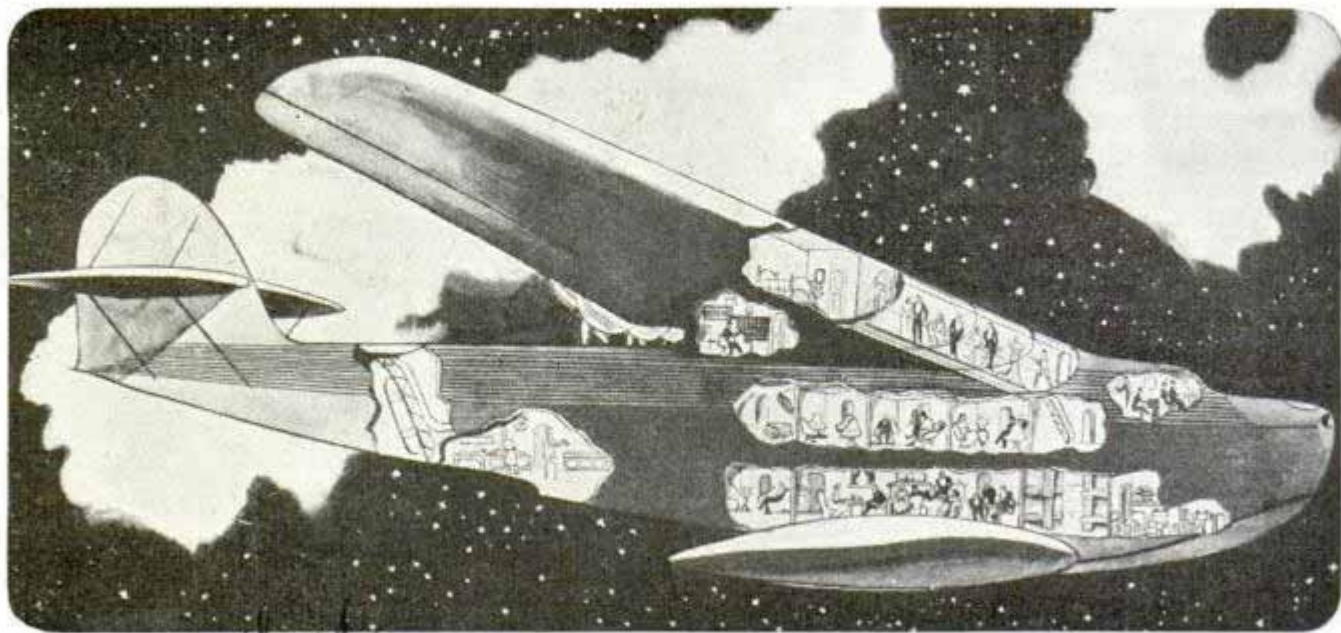

cut
Cutaway view of an air leviathan designed to carry 150 passengers across the Atlantic at 350 miles an hour. Berths and observation rooms would be located in the huge wings of the eight-motored flying boat

Passenger cabins and observation rooms are located in the wings of a 150-passenger Clipper ship designed to fly from New York to London in twenty-four hours.

Structural plans for this behemoth of flying boats have been completed at the Glenn L. Martin plant in Maryland. It will weigh 250,000 pounds

Middle Cover

Railway Repair Truck Chases Trouble on Road or Rails

F1549



Trouble-shooting truck for electric railroad rides on rails or road

Making emergency repairs to overhead power lines caused the Pennsylvania railroad a lot of trouble when some of its eastern lines were electrified because, with wires down, an electric train could not run to the scene, so a steam train had to be kept ready. The railroad now has eliminated the need for a steam repair train by using a trouble-shooting motor truck which runs on the highway or on rails. Today when an emergency arises, the truck is sent over the highway to a point near the trouble, then at a grade crossing, four railway wheels are lowered. These lift the rubber-tired road wheels clear and the truck becomes a railroad car. The

Emt. Eckhardt.

Handwritten scribbles and signatures at the bottom of the page.

truck has a front and rear wheel drive. The back truck wheels, rubber-tired, are drive wheels when the truck is on the road, but the front pair of railroad wheels do the driving when the truck is on the track. The truck is equipped with a lifting platform which can be extended several feet into the air and also carries a small power plant to furnish floodlights for night work. The road-rail truck speeds up repair work since it can travel almost to the scene of the trouble on highways, thus eliminating the necessity for rerouting and sidetracking regular trains so the truck can get through.

11604.

Fruit Is Kept Fresh for Six Months by Air-Gas Control

That fruits and vegetables may be kept fresh from one growing season to another is the goal of experimenters in Great Britain. Already it has been found that pears can be preserved without decay for periods up to six months, if the oxygen and carbon-dioxide content of the storage room be controlled properly. The food investigation board of the department of scientific and industrial research in that country has set up laboratories in various parts of the empire to facilitate work along this line and the progress made thus far indicates that keeping fruit fresh for long periods soon may be commercially practical.

Million-Pound Pull of Jack Snaps Heavy Rope in Two

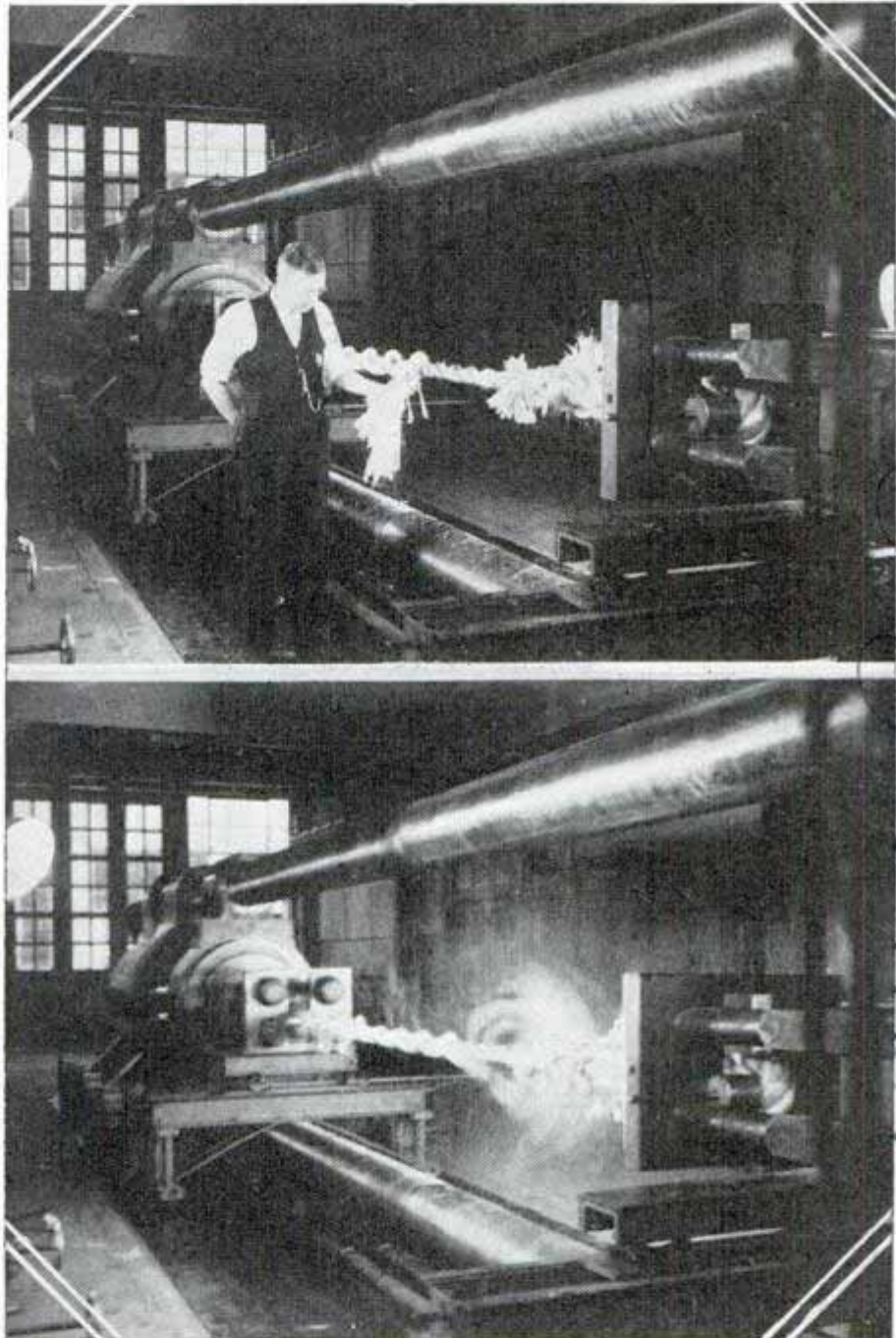

Picture at top shows rope frayed by terrific strain of testing machine. Below, the rope snaps with explosive effect under million-pound stress

It took a pull of a million pounds to break a thick cable rope in two, but under that stress it was snapped like a thread by the testing machine at the U. S. Bureau of Standards. The tester is a big hydraulic jack resembling a coast-defense cannon, and is capable of exerting a pull of 1,500,000 pounds. Besides testing stresses by pull, it is used to determine resistance to compression and is so delicate in operation that it can crack an egg without spilling the contents.

Our Bureau of Information will answer questions regarding articles in this magazine, if accompanied by postage.

*Emb. Andrew C. Boone, Los Angeles
1151 S. Broadway, Los Angeles, Calif.
Washington*

*Compressed Air
November 1936*

AIR LINERS

Air liner flying over the Andes. Below, on the bridge of the "Hindenburg" and, right, air line base where radio reports are received

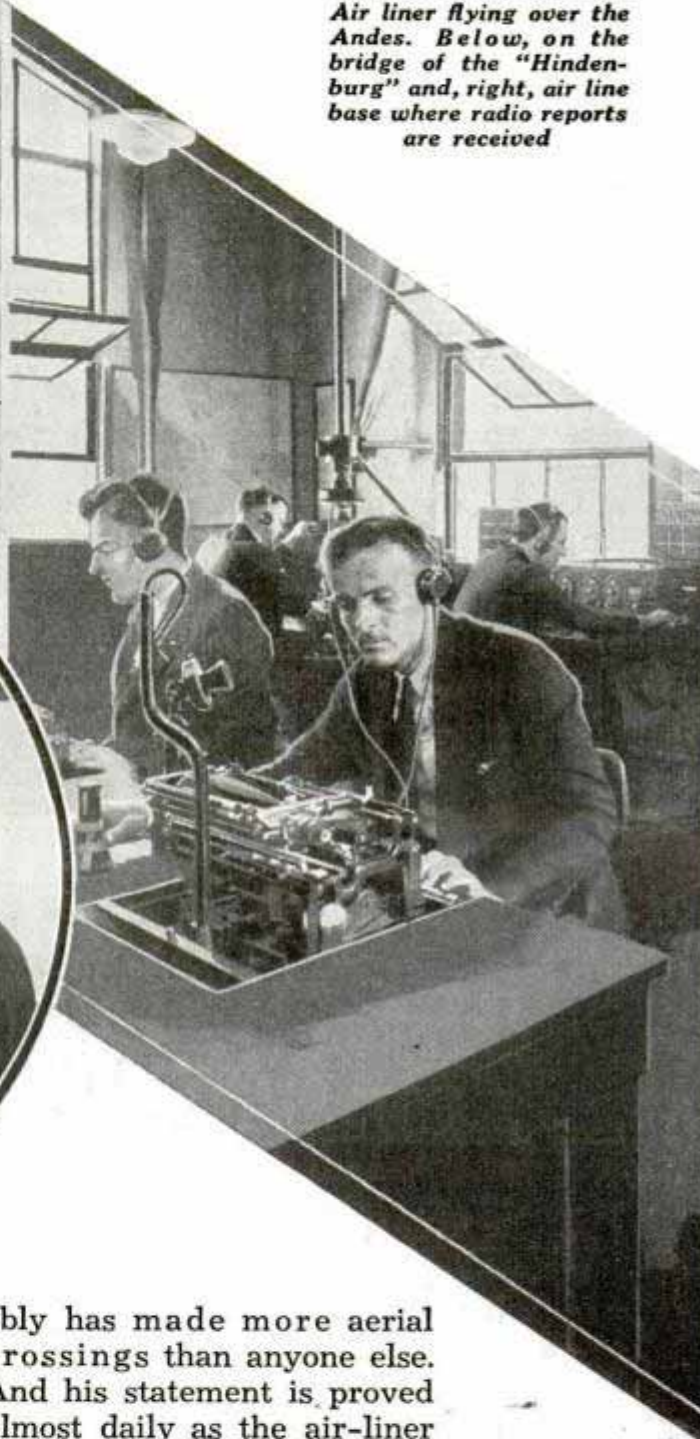
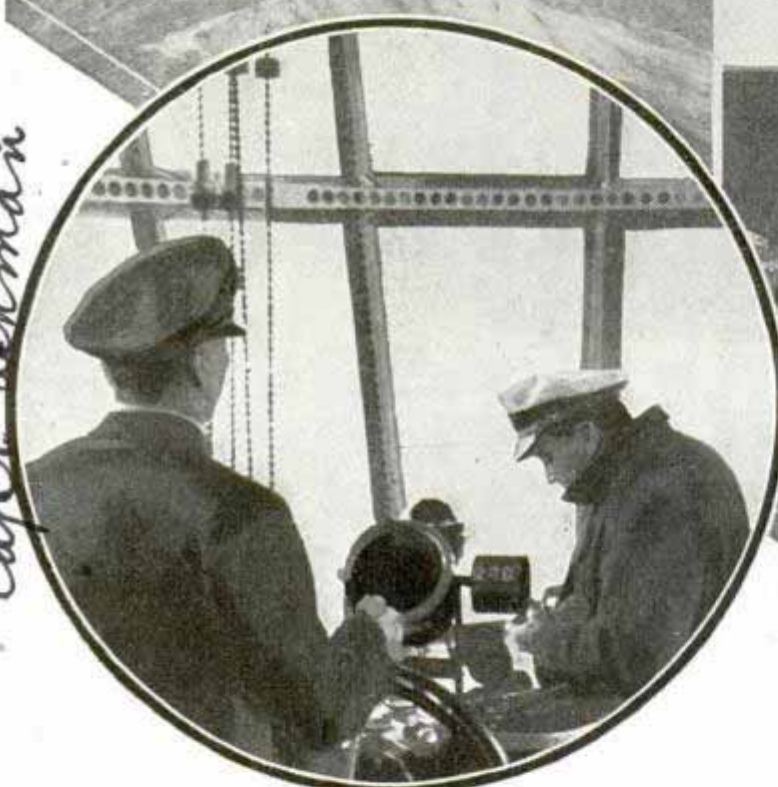
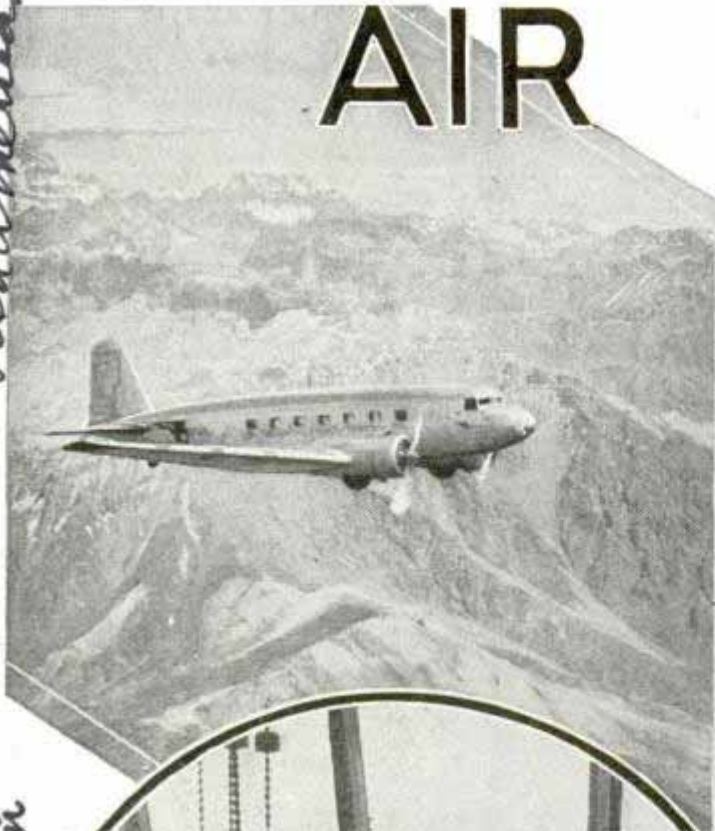

"OVER land and over sea, wherever men fly the commercial air lanes today, they have written a new chapter in the traditional rescue code of the sea. The pilot of the air liner is a scientific skipper of the air. Science has given him the equipment to help in the saving of human lives and the mercantile and naval vessels in which many pilots at one time have served, have given him the tradition. Today the SOS call brings help faster and more efficiently than ever before."

Thus declares Dr. Hugo Eckener, veteran commander of the "Graf Zeppelin" and the "Hindenburg," the man who prob-

ably has made more aerial crossings than anyone else. And his statement is proved almost daily as the air-liner pilot writes a new chapter in the heroic annals of aviation. Whether it be the skipper of the giant lighter-than-air liner droning across the Atlantic, the pilot of the "China Clipper," winging his way across the still wider Pacific, or one of the pilots of a transport plane making a shorter flight over land, he is not only quick to respond to an SOS but through his alertness and keen observation he frequently supplies aid from the air and pre-

1121-79 00
 Capt. Lehman
 Pan American
 1130

...
 ...

Carl, smile
Schuermaier
727 Park Ave New York
F1366

to the RESCUE!



Top, delivering pilot rescued from jungle to waiting ambulance. Below, planes help in surveying flood areas such as this

vents loss of life even before aid has been summoned.

Flying over New Jersey, the skipper of a TWA transport notices a house on fire. He dives and the noise of his powerful motors is loud enough to wake the occupants of the house and enable them to save themselves before being overcome by the smoke and flames.

Flying a Pan American Clipper up the Brazilian coast, the senior pilot observes a small trawler being helplessly pounded to pieces on the rocky shore. Quickly the radio operator communicates with the base airport at Rio de Janeiro. And just as quickly the radio operator at the base summons aid for the disabled vessel.

In far off Haichow, China, an American girl is dying of a rare disease. Only a prompt injection of a serum can save her and the nearest supply is in a hospital in Shanghai. The Chinese National Aviation Corporation—an American air line operated in conjunction with the Chinese government—is notified and soon an Ameri-



navajo
 Top, pilots often drop food from the sky to snowbound Indians. Right, elevator wheelman on bridge of "Hindenburg." Below, good visibility aids rescue work

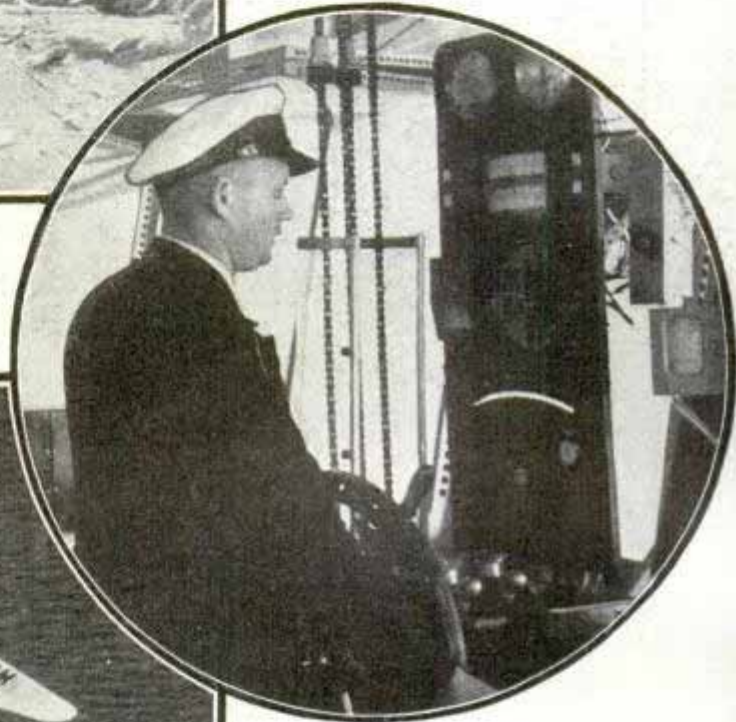

states a TWA official. "The modern air line takes pride in the routine efficiency of its flights and aviation has progressed to the point where the flights have become routine, as has the pilot's response to a call for aid."

Because of this, many heroic rescues are known to few people outside of

the actual participants. The instrumental work which the "Graf Zeppelin" did in locating the stranded crew of a Lufthansa airplane adrift on the South Atlantic, the dropping of food supplies to snowbound Indians by TWA pilots and many

can pilot is winging his way toward Hai-chow with the serum.

And so it goes almost daily in every part of the world as air liners speed to the rescue. The air-line operators prefer to carry on this work as secretly as possible and it is only occasionally, in some major catastrophe or some unusually heroic flight, that the rescue from the air is brought to the attention of the public.

"There is a good reason for this secrecy,"

similar exploits have passed unchronicled, regarded by all concerned as just part of the day's work.

The actual groundwork for aerial rescue was laid eight years ago when Pan American Airways built a network of forty-seven weather reporting and radio stations at various points around the Caribbean sea, breeding ground of many hurricanes. Hourly reports on the progress and course of hurricanes were gathered by these sta-



tions and radioed to weather bureau stations at Miami and San Juan, Porto Rico, where they were in turn radioed to ships at sea. By these timely warnings, since the inception of the service, it is estimated that more than 26,000 lives have been saved.

A few years ago when a hurricane roared over Porto Rico, killing 200 and injuring 1,000, due to the advance notice given by the aviation radio stations, preparations for relief work were being made even before the gale struck the island. The warning broadcasts also enabled ships at sea as well as people on land to take precautions for their safety. By 1931, the air liners themselves were taking an active part in rescue work. It was in the spring of that year that an earthquake rocked Managua, Nicaragua, and help from the skies became an actuality.

Immediately after the earthquake, Pilot

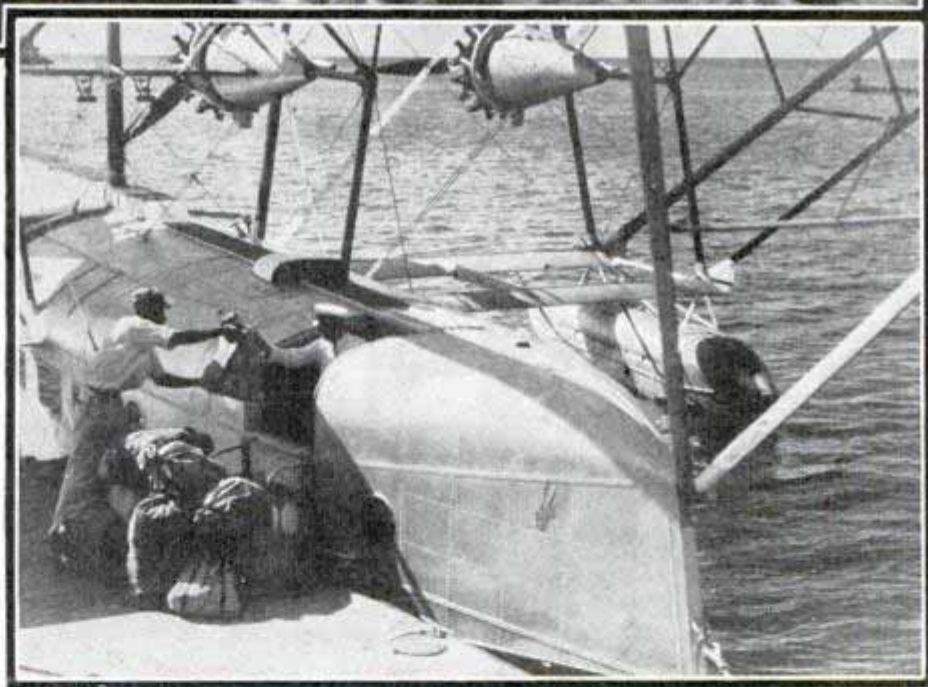

Air liner flying over mountainous country and, below, delivering serum which may save a human life

N. F. Varian and his trimotor Pan American Airways plane in near-by San Salvador took aboard doctors, water, food and medicinal supplies, flew over Nicaragua on this errand of mercy and, at the same time, radioed back the first full report of the devastation caused in the stricken city.

"8.03 a.m.—over Managua—city completely demolished," he radioed. "Fire raging over large portions.

7126
408

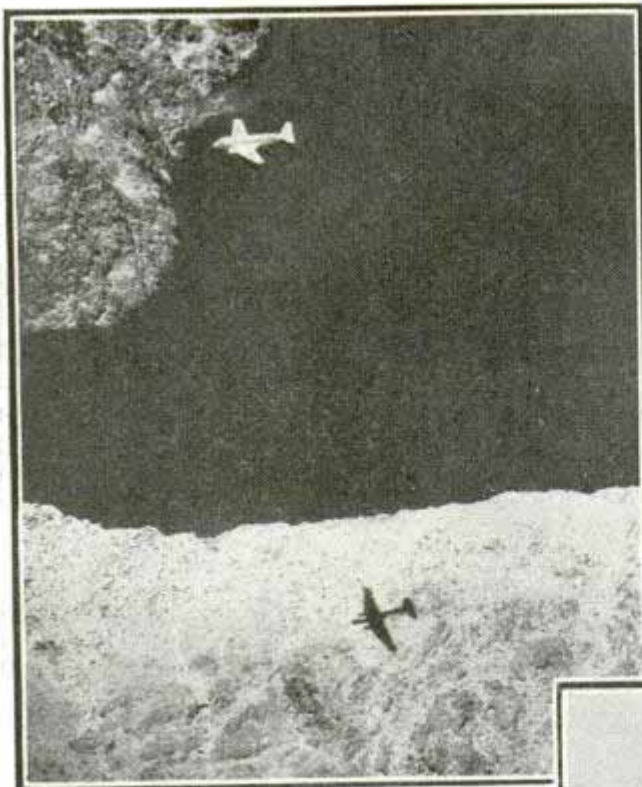

Since that time the aerial help which the air liners have rendered in earthquakes, floods, hurricanes and other disasters has extended to nearly every continent.

"While the construction of an air liner has not as yet made it possible to descend upon the surface of a raging sea to effect a rescue, nevertheless the pilot may perform valuable work in helping to locate a disabled vessel and direct the rescue work," states Dr. Eckener.

"Because of the superior speed of aircraft over seagoing vessels and because of the aerial vantage point, an air liner may spot a small craft which might conceivably go unnoticed by a ship speeding to the rescue. Since the transoceanic air liner of

"Later—have been through city. Catastrophe beyond description. 600 known dead—expected to reach 1,000. Thousands injured. No water. People walking around in daze looking for bodies of loved ones. American legation in ruins. Hundreds killed in penitentiary and hospitals. Marines doing wonderful work. City to be evacuated this afternoon. Bodies burned for lack of burial facilities."



Flying high above the ground or water below him, the pilot is in a position to spot trouble quickly and summon aid by radio

the future, whether heavier than air or lighter than air, undoubtedly will fly over the regular steamship lanes, this is an added measure of safety to vessels, especially to small craft unable to reach other ships with a radio SOS."

Over land, too, the same help from the skies is now given. Last year nearly all of the commercial lines aided in flying over the territory inundated by the spring floods, surveying the extent of the damage, bringing first-aid equipment and medical aid. Recently in Argentina when the waters of

(Continued to page 116A)

Photographs Solve 'Dark Lightning' Mystery

Dupl. Power Plants seeks Physics on
 Lincoln Neb.

Dark branches streaking off from white lightning mystified photographers for years. Open your camera shutter at "time" during an electrical storm, leave it exposed for two or three lightning strokes and you may find several "black lightning" lines in your picture. J. C. Jensen of Nebraska Wesleyan University obtained similar effects in photographs of natural lightning and of laboratory lightning produced with a static machine. Branches

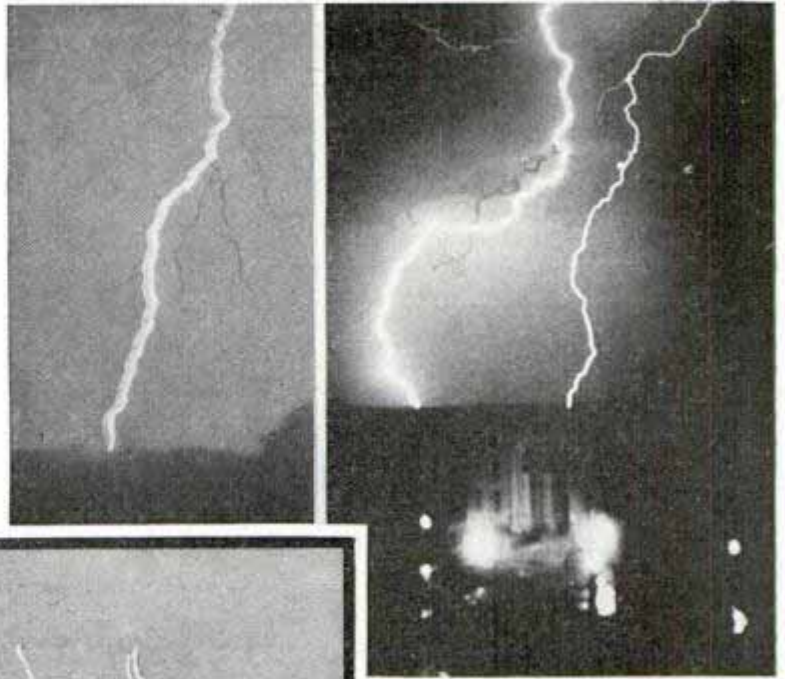

Notice "black lightning" in photographs above. At left, similar effect obtained in laboratory with artificial lightning

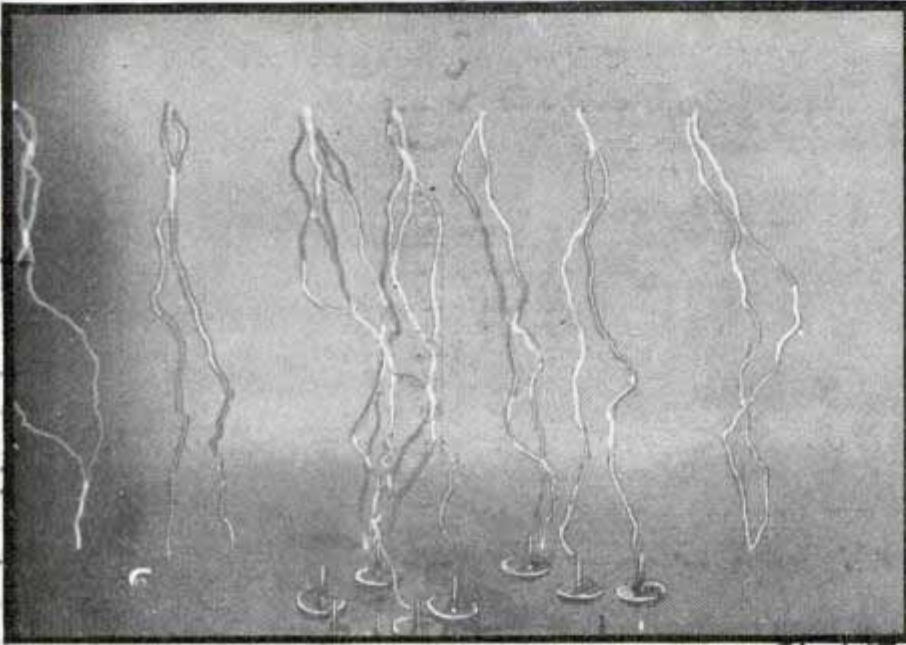

sufficient to cause a second reversal. Mr. Jensen theorized that silver salts energized normally produce a black image, but excess energy reverses the image and under very intense light a second reversal is possible.

of the first stroke reversed themselves and turned dark when the camera caught a second brilliant stroke in the sky, and where the branch approached the main path of the original discharge, it appeared white with a black margin. Had the shutter been closed immediately after the first discharge, main path and branches would have remained white. In the laboratory, one pole of the static machine was connected to a sheet of tin covered with upturned thumbtacks; the other pole was joined to a wire discharge point. After taking a succession of artificial lightning pictures, room lights were turned on and diffused light allowed to strike the lens for fifteen seconds. This caused reversals, the discharges appearing to have black margins. Where discharge paths crossed each other the energy incident on the plate was

716 33

Matches Light When Pulled from Handy Ash Tray

For the convenience of the smoker, a combination ash tray and match holder carries in its circular top a supply of matches which



light when they are pulled out of the holder. The matches come in rolls which fit the top of the holder, each match head being individually inclosed. Match roll refills for the ash tray are available and are easy to attach.

American Pullman

Technology Review

Web of Welded Steel Rods

Forms Church Framework

A. M. Mc Lellan, State Steel Products, Los Angeles, Calif.

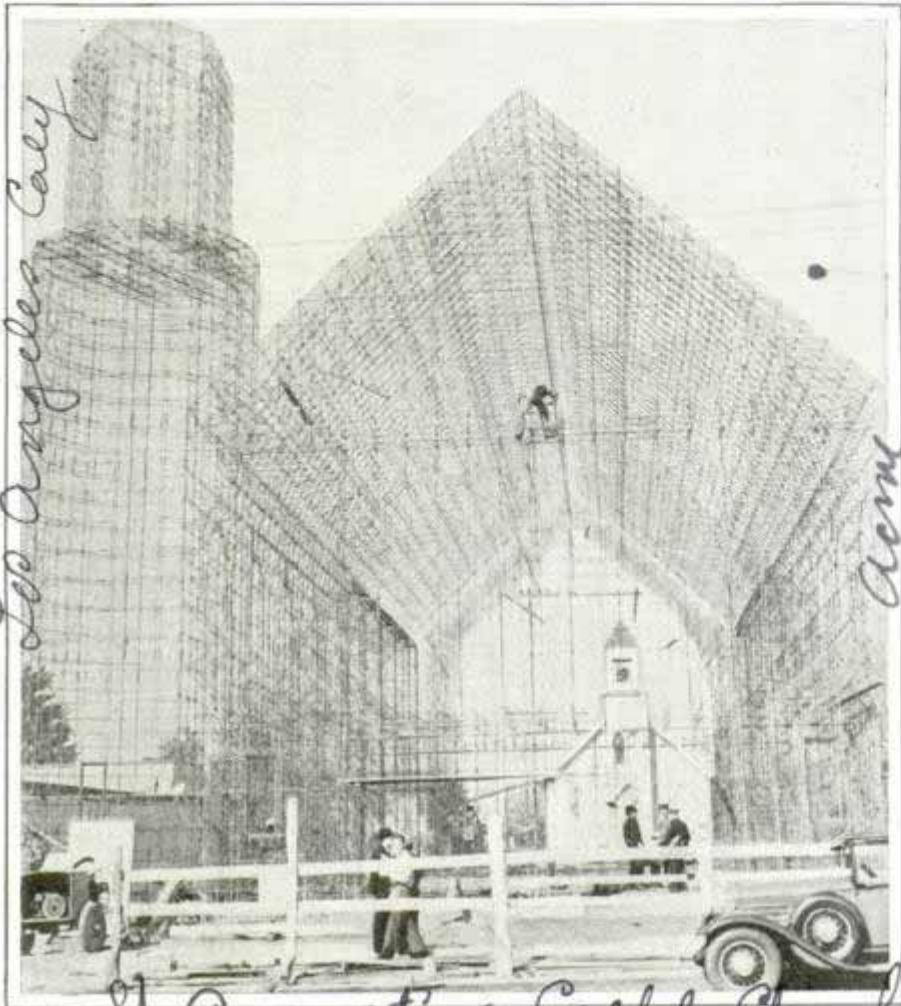

St. Augustine's Catholic Church
Framework of church at Culver City, Calif., built of steel rods woven into twelve by twenty foot panels and welded into a unit

Small steel rods interwoven and welded into a single unit form the framework of a church in Culver City, Calif., built on a new construction plan. Joints are formed by wrapping one member around another. Twelve by twenty foot panels were fabricated by a steel company and delivered to the building site ready to be set in place. When completed the church is to be resistant to fire, termites and earthquake.

Four-Motored Transport Plane Could Span America in Night

Aeronautical experts see as the next step in air travel a twenty-passenger transport plane that could cross the United States overnight at 225 miles an hour. Specifications for this air leviathan call for a low-winged monoplane twice the size of

the passenger ships in use today, equipped with four motors developing three times the horsepower of the current sky liners. It would have a 1,250-mile non-stop cruising range.

F1502

New Clothes Drier Eases the Work of Wash Day

Heat and motion are combined in a clothes drier which makes wash day easier in the home. The heat is provided by electricity or gas flame. The clothes are wrung after washing, and placed in a drum which makes a complete revolution every second. The motor which turns the drum also drives a blower which removes the moist air. About thirty-five pounds of wet clothes can be handled in the three-foot drum at one time. Costs of operation are low and the time required for drying is much less than when clothes are hung out.



Opening drum of clothes drier to remove garments. The machine saves time

F1574

United Aircraft Corp

Universal Drying Co. 35 Palace Bldg. 35th St. N.Y.C.

F1194

Marshall Field & Co.
Chicago

FISHING Through

spotting good stores

Van Lengerhe & Antwine, 33 S Wabash Chicago

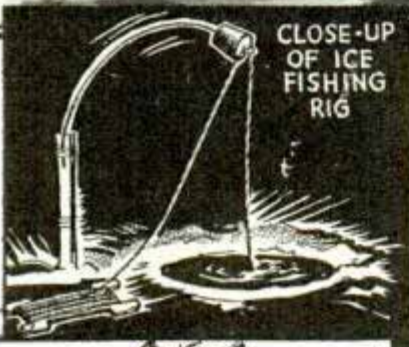

CLOSE-UP OF ICE FISHING RIG

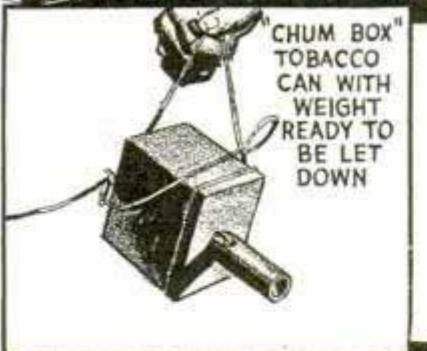

"CHUM BOX" TOBACCO CAN WITH WEIGHT READY TO BE LET DOWN



"CISCO OUTFIT" LEAD WEIGHT AND MINNOW HOOK WITH COLORED BEADS FOR BAIT

By Bob Becker

of Sport Dept. Chicago Tribune

ALTHOUGH thousands of fishermen put up their tackle when cold weather comes there are plenty of chances to catch fish when streams and lakes are frozen over. Contrary to the ideas of many fishermen, fresh-water fish such as perch, walleyed pike, crappies, ciscos, bluegills, lake trout and even bass will take a lure in the heart of winter. If you don't mind the cold and have the right kind of outfit you can have a lot of fun working your tackle during the winter months.

Before you assemble your outfit look up your state laws on ice fishing because the regulations vary. For example, some states permit the construction of huts on the ice so you can keep under shelter and fish quite comfortably, while others do not permit the use of shanties or shacks. So check on your laws and the question of a license.

For ice fishing you will need something to cut a hole in the ice. Many use two instruments, a small ax and a sharp-pointed crowbar. If the ice is only a few inches thick an ax will do. When it is thicker a long steel "hole digger" may be necessary.

Fishing tackle can be simple and inexpensive. You do not need rods and reels. Many fishermen use just a short cane pole about five feet long to which is tied seven or eight feet of strong line. A cork is put on the line so it will float in the hole. The boys simply lay these poles flat on the ice with the hook and bait dropped through the open fishing hole. This is about the simplest outfit you can assemble.

You also need hooks of various sizes and plenty of

Top, a nice black bass that hit a live minnow under the ice. Below, a simple ice fishing rig, chum box used for cisco fishing and a cisco tackle outfit employing colored beads for bait to attract the fish under the ice

the ICE

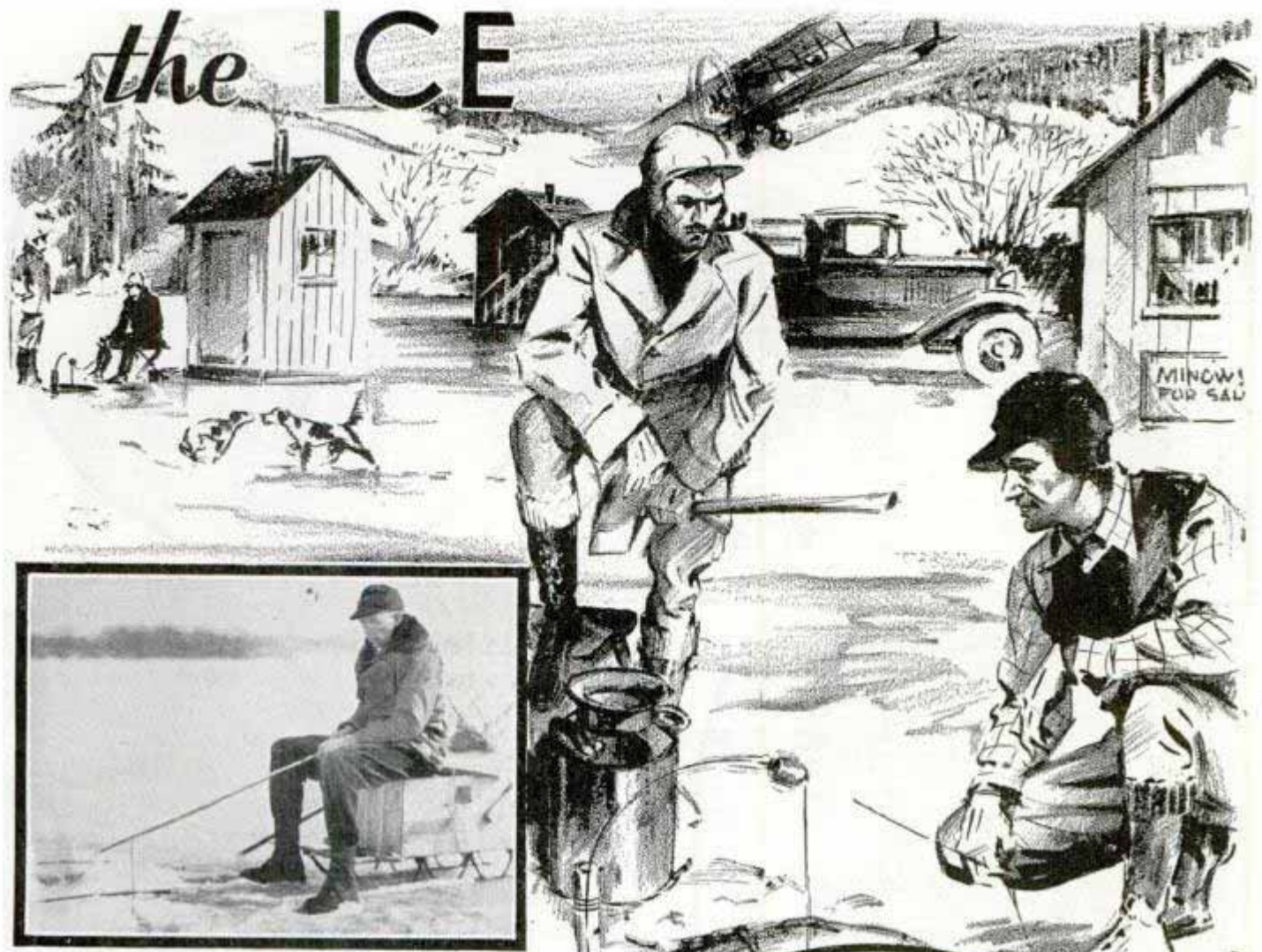

bait. If you're using minnows, a bucket is required. Crappies, bluegills, bass, pickeral and similar species usually bite best on small minnows. To carry a good supply of minnows, poles, ice-chopping tools, lunch, maybe a Thermos of hot coffee and other supplies there is nothing like a sled. This sled also serves as a seat.

Although it's fun to fish with short cane poles and bobbers many like the outfit that calls for the use of a signal bobber above the surface. Fishermen use these especially if they have a sizable string of lines at work. Most boys make these outfits at home. First, you need short pieces of wood twelve to sixteen inches long. These are inserted into the ice close to the

Above, left, ice fisherman using his sled for a seat. He also uses the sled to haul all his equipment to the scene and take it home again. Below, an ice fisherman proving by this string of pickeral, crappies and bass that the fish really do bite in winter if you know how to attract them

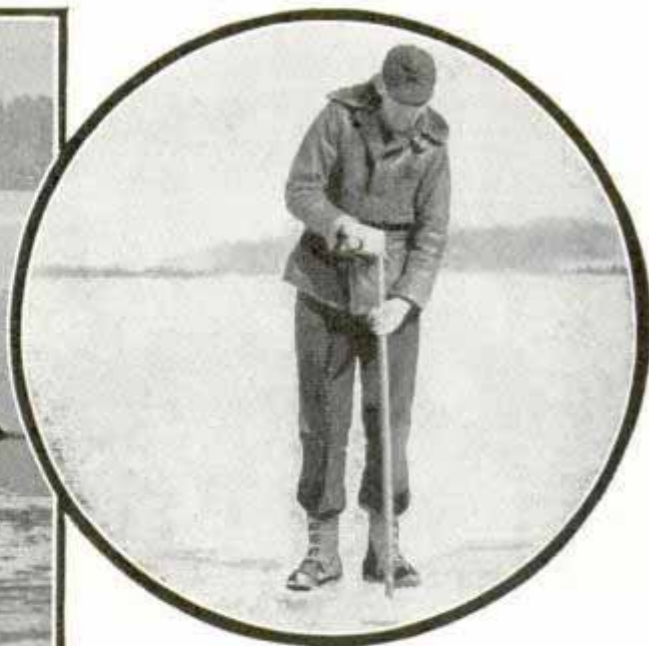

Top, ice fisherman with one day's catch and, right, cutting hole in ice. Below, ice fishing shack

edge of the fishing hole. In the top of such a piece of wood or bound to the side is a short piece of resilient wire or flat steel ribbon, one-fourth inch wide. They're strong and whippy. At the end of this wire where it arches over the fishing hole place a cork and also attach your line. Tie a piece of red cloth or yarn here to catch the eye.

You coil up slack line not being used on the ice next to the hole. When a fish hits this outfit it bends the wire down and the action of the fish working on the minnow and swimming around also makes it dip and bob so you can see a strike quickly. The end of the line is, of course, tied to the stake in the ice. The fisherman who,

under state laws, can put up a shanty on the ice also needs a little oil stove.

When fishing for crappies, bluegills, perch, pickerel and other species usually found in an inland lake, the experienced fishermen make a beeline for a location over a weed bed or bar. Just as the crappies and pickerel and bluegills frequent a weedy area during the summer, so they like to spend their time around such a spot during the winter. Black bass also can be found around a weed bed. So the ice fisherman should know something about his lake before he starts to chop ice.

Some fishermen having heard about the deep water in which, for example, lake trout in the big lakes are caught, are apt to believe they must go way down to the bottom to get fish in winter. Such is not the case. You may need to let down not more than five feet of line to hook them. The size of the hole in the ice may vary. For example, some fishermen cut a hole not more than fourteen or fifteen inches wide. Others make them twenty to twenty-four inches. In the final analysis the hole should be just big enough to facilitate the landing of a fish. It's work cutting holes so why excavate larger openings than needed.

For bait use minnows for bass, pickerel, crappies, perch, and walleyed pike, herring for lake trout and colored beads for ciscos. Worms also make an excellent bait, if you can get them. But for all-around fishing the minnow is preferred. Cisco fishing, calling for the use of beads and a



hook, is one of the most interesting tricks of winter fishing. The cisco is a lake herring, closely related to the whitefish. When you fish for these slim, pearly colored fish, you may have to go down deep for them, so go with plenty of line. You also will need very tiny hooks, heavy sinkers, and a handful of blue, red, pink, and white beads. There are times when you may have to fish in fifty or sixty feet of water and others when you can get the delicious ciscos in twelve feet. Again you may lure them within four feet of the surface. It all depends on how the schools are working.

The comfortable way to fish for the cisco is to use a small wooden shanty on runners so it can be moved from one location to another. Then get an oil stove, implements to cut holes through the ice and at least four lines with sinkers, hooks, and beads on the hooks. Locate your shanty and cut two holes in the ice, one on each side of the shanty. You'll need two old chairs, and a small tin can that you can put on top of the stove to cook up the "chum" also is an asset. Then rig up a small metal box and line so you can drop the chum into deep water. A small net to catch minnows to make the chum also is needed. By "chumming" ciscos is meant putting chopped-up minnows in the water below the fishing holes so the ciscos will come around, feed on these tidbits, linger awhile and eventually hit the bead lure.

Fishermen use two different systems.

(Continued to page 122A)



Top, baiting hook, and pickerel taken through ice. Center, ice fishing shack. Bottom, two sticks and a coat make a windbreak

F1522.

Toy Train on Suspension Track Cannot Be Derailed

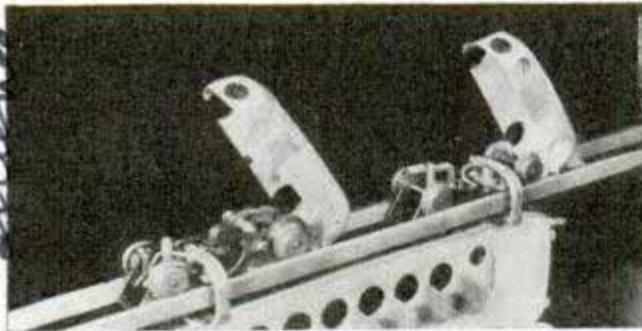
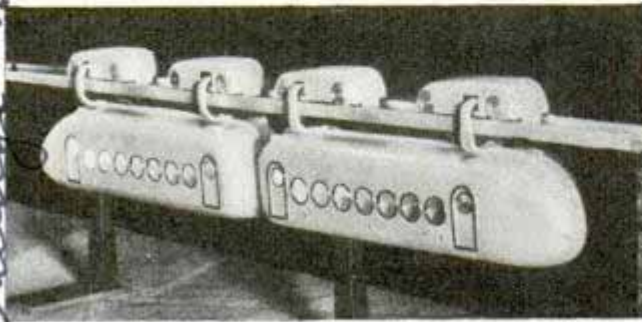
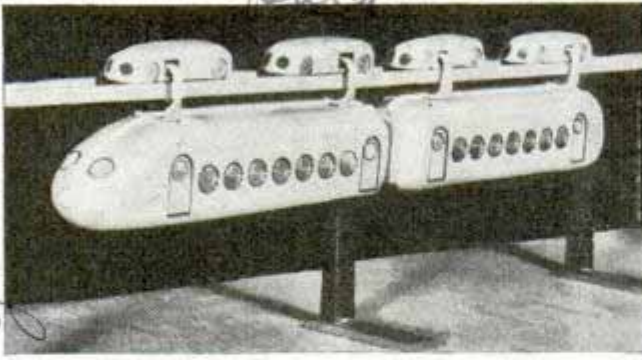

Three views of suspension toy train. Bottom, power trucks exposed for servicing

Running on a suspension-type track, the latest streamline toy train attains speeds unusual in such devices, being able to travel as fast on curves as on straight-aways. Yet it cannot fall off the track, since the wheels are on top of the track and the car beneath. The cars can be opened for children to give their other toys a ride and the wheel trucks can be exposed for repairs. The train is electrically operated by transformer. Metal uprights support the track, keeping the train off the floor and helping to prevent damage to furniture.

Repair Cement Sets Quickly and Holds Nail or Screw

Waterproof, fireproof and a non-conductor, a dry powder cement now on the market will set in an hour's time after

being used to repair cracked laundry tubs, water pipes, washing machines, radiators, and tile. It may be used to set bolts, lags, screws and nails in wall or floor, holding them so firmly that they cannot be removed. If desired, screws may be prepared for removing from the cement by coating them with oil, grease or vaseline. The makers claim that the cement does not shrink and that it sets as hard as stone. The powder is mixed with water to form a thick paste which is easily applied.

Illuminated Magnifying Glass Combined with Flashlight

Serving as an ordinary pocket lamp for casual seeing, a small metal flashlight can be converted into an illuminated magnifying glass for close visual work. The lens is contained in a clip which slides over the battery case when the lamp is used as a flashlight. When this clip is removed and placed in channels at right angles to the case, the user has a magnifying glass, and turning on the light illuminates the field under it. The double convex lens has a focal length of about two inches.

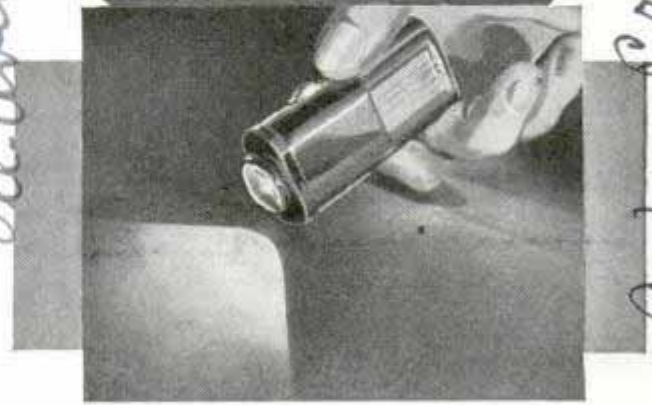

Flashlight, below, becomes illuminated magnifying glass, above, when lens is removed from battery case

Sam. Joseph Cambalich 212-06 Hillside Ave
Greens Village N.Y.

Del. Avenue. 9133

Chicago
P. M. Products Co 47 30 Wagon

The Holders Company

R A

D I O . . .



T 3650

Thirty-Seven-Tube RECEIVER

HOW would you like to tune a 37-tube all-wave receiver that is equipped with a dial 12 in. in diameter and employs six loudspeakers? This giant console receiver weighs 475 pounds, it stands 4 ft. 10 in. high, is 42 in. wide and 22 in. deep.

Suitable for use in auditoriums, large homes and restaurants, it receives the entire range of music; has continuous coverage from 540 kc. to 18,300 kc. and the power output is said to be from 50 to 75 watts. Four chassis bases are required for the arrangement of the equipment as will be noted in the lower photo. All tubes are

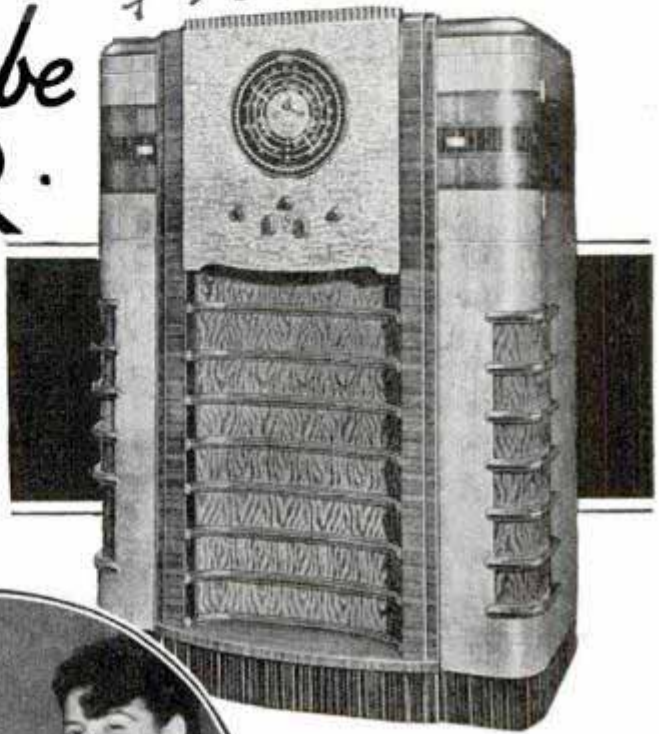

metal with the exception of the one for the tuning light and the auto-expressionator circuit. Other outstanding features include: base compensation; "mystic hand" automatic tuning; six-step tone control, in addition to volume

control for each different audio range—bass, mezzo and treble. In addition to the radio receiver proper, it is provided with a public-address system which has separate controls of its own. The young lady with the "mike" in the center photo is demonstrating this feature in a large auditorium.

One of the six speakers is 18 in. in diameter; this is used for the bass, or low frequencies, down to the lowest notes of a pipe organ. Two 12-in. speakers cover the middle musical scale and three smaller high-frequency diaphragm types receive the higher notes and overtones.

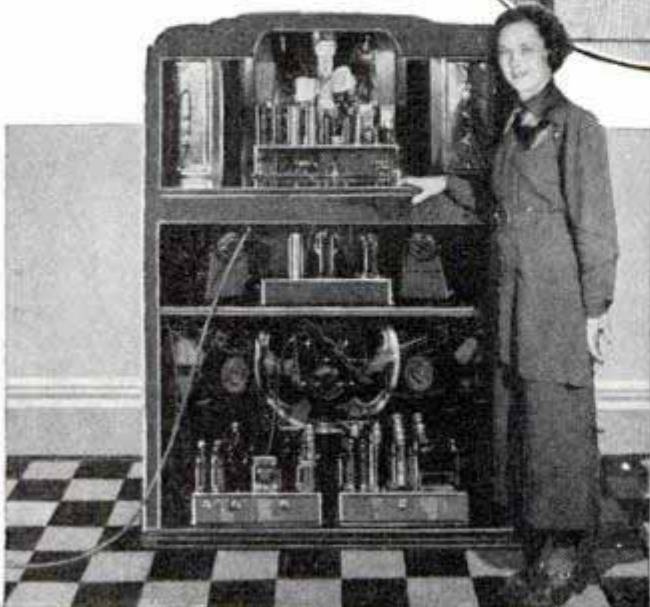

Crosley Radio Corp.
1329 Arlington

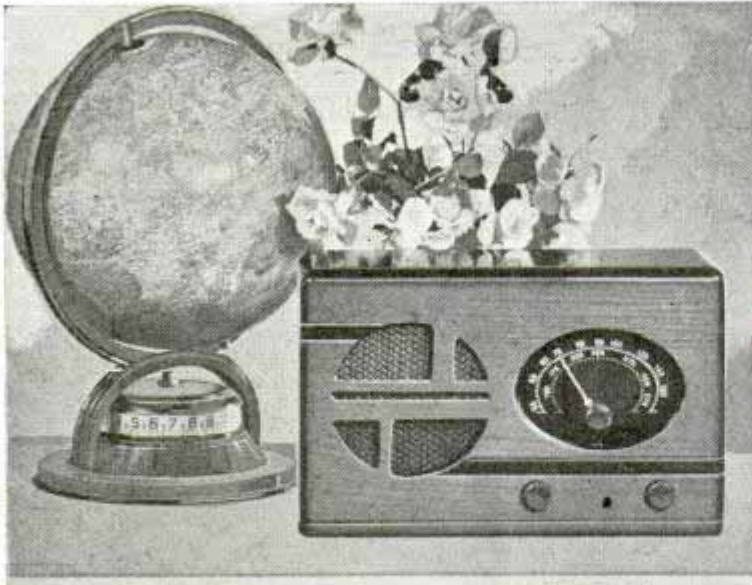

1937

Little Giant

A.C.-D.C. Receiver.

By Frank M. Lund



THIS improved model of the most popular portable a.c.-d.c. receiver ever described in Popular Mechanics Magazine, now has twice the output of the original set which was first-prize winner at a set-building contest held by the Hawthorne radio club, an employes organization of the Western Electric company. There are several good reasons for the popularity of this particular circuit; it makes an excellent general-purpose midget receiver that is easy to build, has distance-getting ability, fine tone and surprising volume.

The parts are carefully selected but not expensive and this new model has several advanced features that are well worth while. Operating on 110 volts, either a.c. or d.c., the line supply may be anything

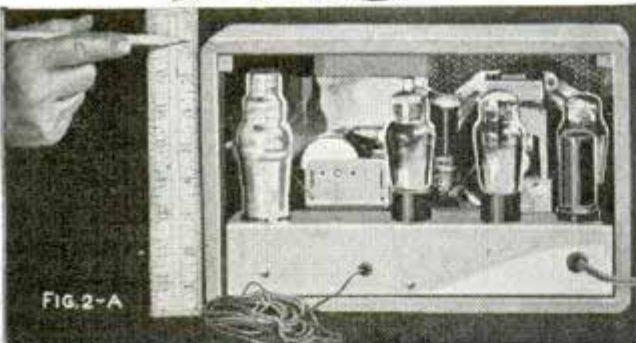

FIG. 2-A

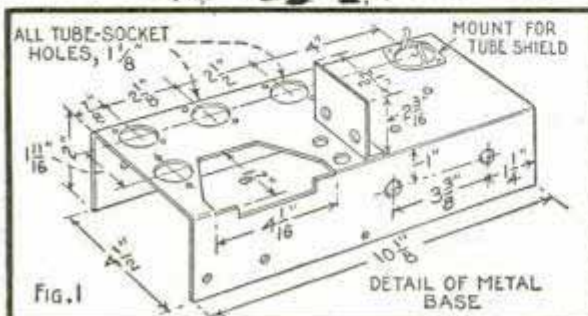
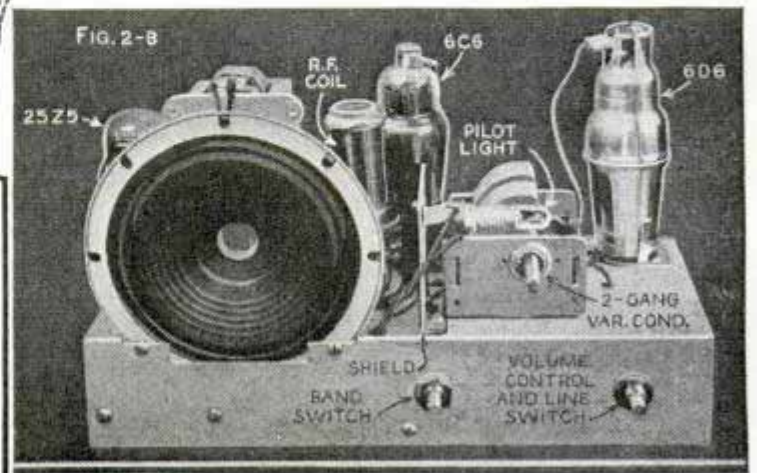

FIG. 1





PORTABLE

*Tunes from
70 to 550
Meters*

from 25 to 60 cycles, which is of interest to many Canadian readers. A resistance, or "ballast," tube eliminates the necessity for using resistance wire in the line cord.

(Continued to page 146A)

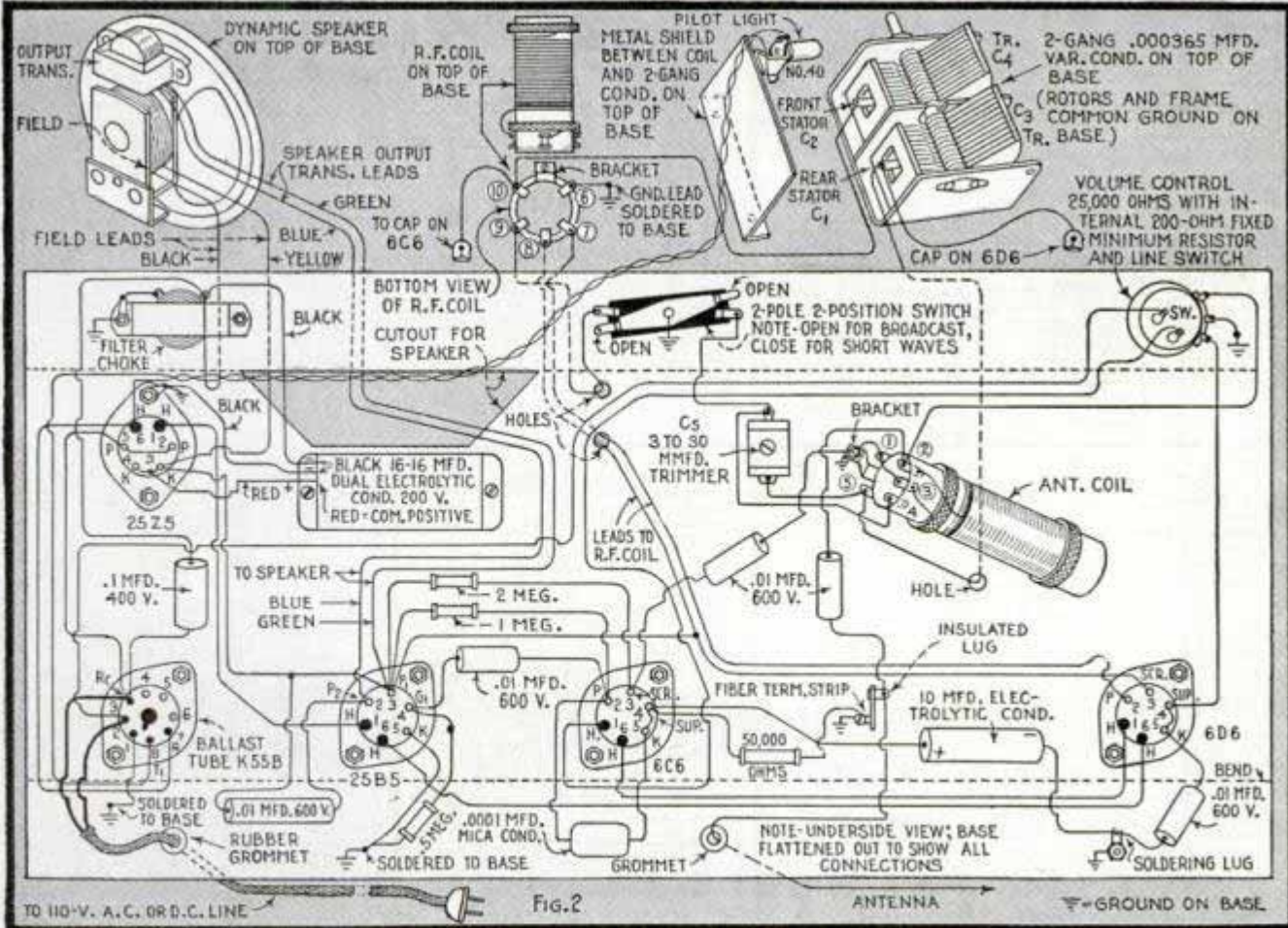
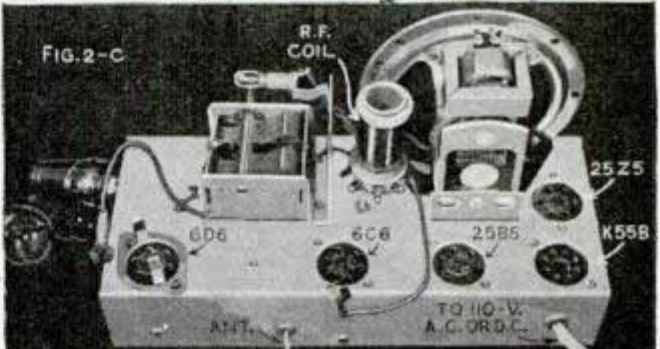

Tune in Records on your RECEIVER



ONLY a few inexpensive parts are required to build this self-powered phono-radio oscillator which will enable anyone to properly reproduce phonograph records through an ordinary radio receiver. It operates like a miniature transmitting station, being modulated with the output of the phonograph pick-up. Usually a single insulated wire from one of the jacks marked "to radio" with a few turns loosely wrapped around the antenna lead-in near your set will give sufficient signal input to your receiver. A magnetic phonograph pick-up arm is then connected to the input jacks and the receiver is tuned to a point on the dial where no broadcasting station is heard. The final step is to adjust the small padding condenser (C_1) with a screwdriver until the oscillator is operating on the same frequency that the receiver is tuned to. Any experimenter can build this simple unit with a few tools.

Working directly from the 110-volt a.c. or d.c. line independent of the receiver, no internal connection to, or change in, the

(Continued to page 126A)



FIG. 2-A

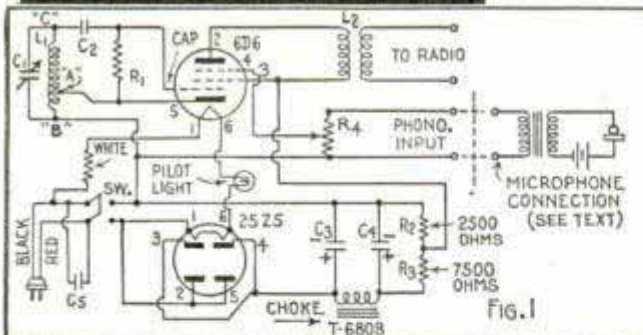

FIG. 1

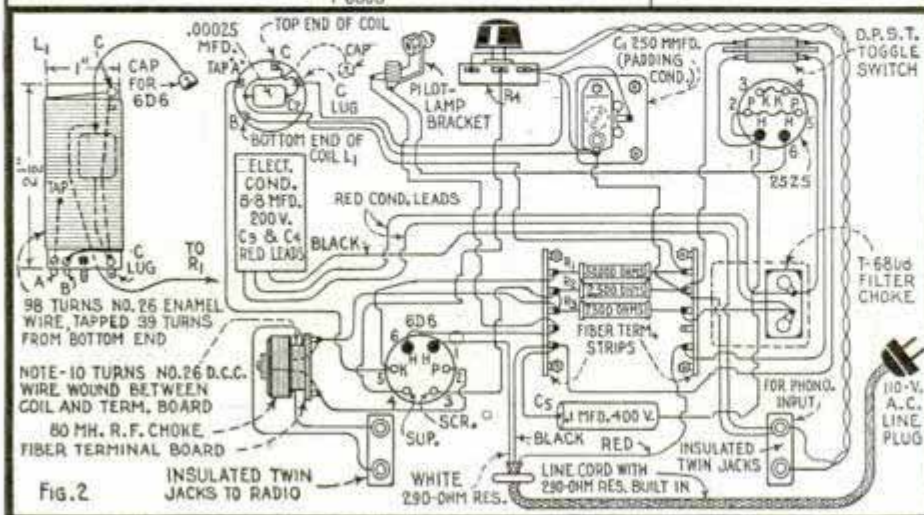

FIG. 2

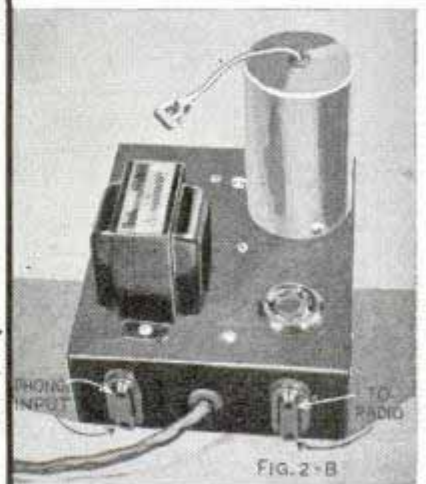
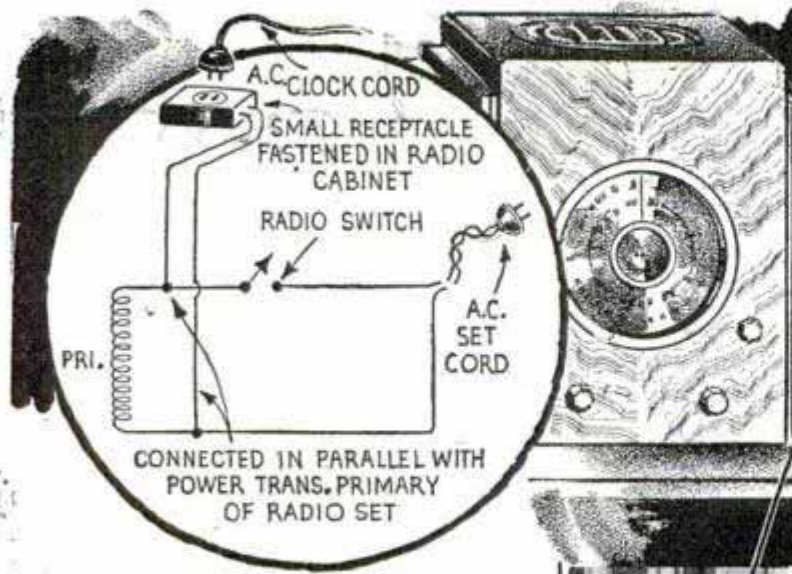
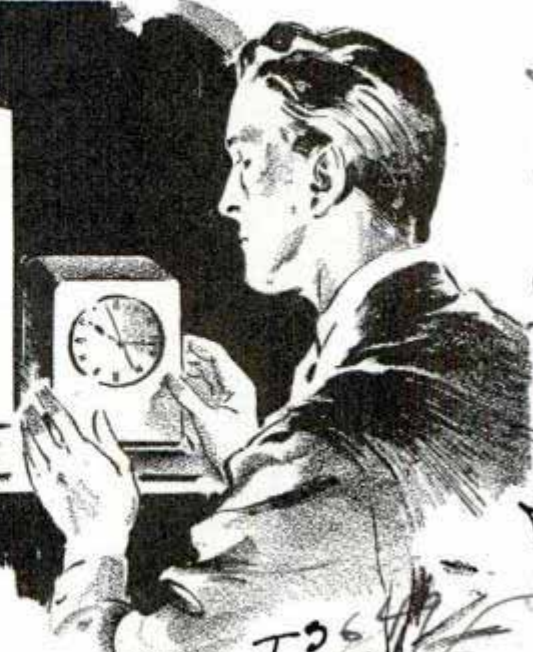

FIG. 2-B

Easy Solutions for Everyday Radio Problems



Above, hook-up for connecting a small electric clock of the "self-starting" variety to act as a timer to determine how much your receiver is used during any 12-hour period. Set hour and minute hands at 12 o'clock. Clock will record time only when set is turned on



Job. Deaneham, Canton, Mass.

Left, telescopic pole-type antenna mounts on sill or window sash. Its extended length is 8 feet

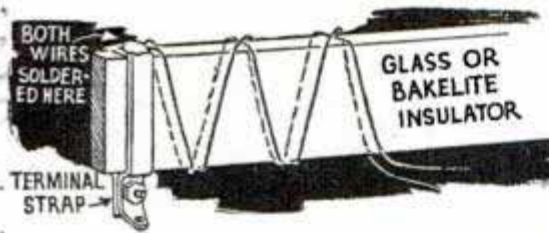

Above, experimental non-inductive wire-wound resistor. A double winding of resistance wire is placed on a glass or Bakelite strip in the manner shown in the sketch. The wires are wound in opposite directions around the form and soldered to the brass terminal strips at each end. Right, electron-eye tuning unit easily installed in any set. Cutaway view shows back of panel assembly

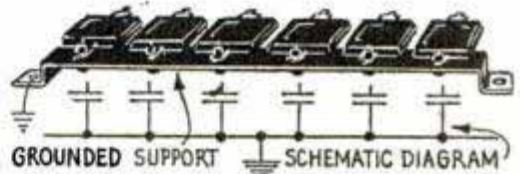

Above, metal strip for grounding several fixed condensers at a common point

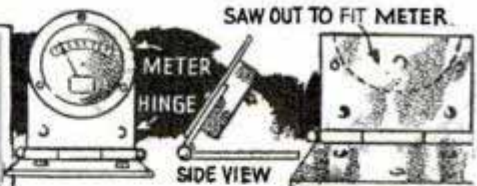

Square door hinge makes adjustable meter support. A tight hinge permits changing angle for convenient reading. This idea and the one above apply to bread-board layouts

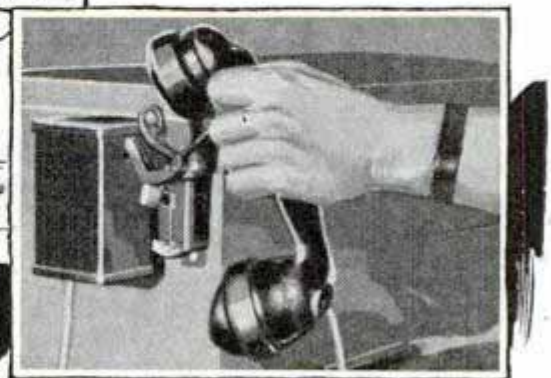
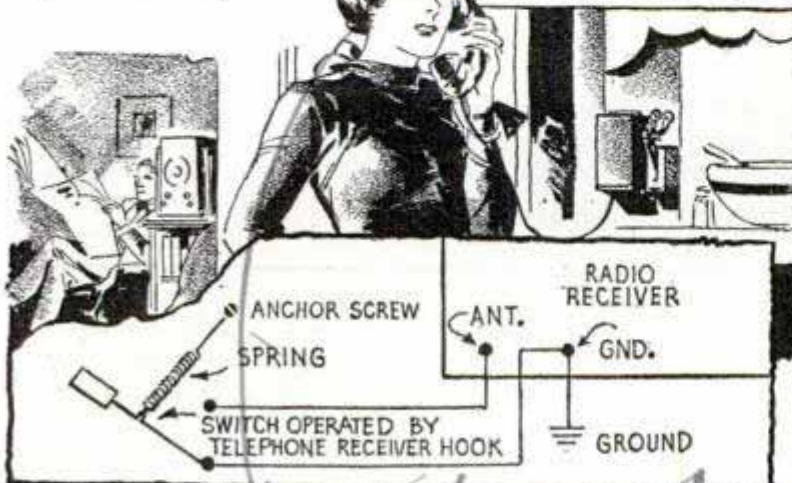

Photo above and diagram at left show how to connect auto stoplight switch on telephone to cut out set when phone is used

*Auto Tuner \$1.50
Technical Appliances Dept. 17 E. 16th*

422

3620 Iron set
POPULAR MECHANICS
F3640 Chicago
End-Table Radio Receiver

Los Angeles, Calif.



Three-band super in end-table cabinet

Available in six and ten-tube super models, this modern end-table receiver is built for domestic broadcasts, short-wave and foreign reception. Placed alongside an arm chair, divan or day bed it is convenient to tune. A plate-glass panel protects the dial and slides out of sight when set is in operation. A hinged top covers a utility compartment in the rear which provides storage space for your log and magazines. Provision has been made for an all-wave doublet antenna connection and the set may be used with hard-of-hearing aid if desired.

with a sturdy side-wall mounting bracket designed for use in halls, corridors and similar locations for public-address.

Photo Log
Radio Log and Time Compensator

Over 1,600 long and short-wave stations in all parts of the world are listed on this rotating log. Its 140-in. tape contains call letters, frequencies, power and chain affiliation. A handy time compensator enables the operator to calculate instantly the time differential at any point on the surface of the globe.



F3642
Austrian Set Has Timing Unit



An electric clock built into this Austrian receiver enables the operator to select station programs in advance. A clock-controlled line switch is set to start, or stop, the receiver at any predetermined time. The chart at center lists more than 100 European stations.

Blueprints covering radio construction articles in past issues are available for 25 cents each; original material lists and additional information can be obtained from our Radio Department without charge upon receipt of postage.

F3631
Two-Way Speaker for Side Wall



Taking advantage of sound distribution from both sides of the speaker cone, a two-way speaker cabinet is now offered with opening at front and rear. It is made of steel and provided

NEXT MONTH—How to Build a One-Tube Band-Spread DX Short-Wave Receiver. A practical inexpensive short-wave set for beginners; uses one of the new dual-purpose 6N7 metal tubes. Other features include construction details for a Simple Crystal-Controlled 40-Meter Transmitter using a type 6L6 "beam" tube.

*6-tube
10-tube
Speradio Manufacturing Co.
St. Charles, Ill.*

*multiplied by 100
U.S. agent name*

*Ward, K.,
Pudolf, J.
Laxen, Hugo
Dance 26
Crescent*

The CRAFTSMAN

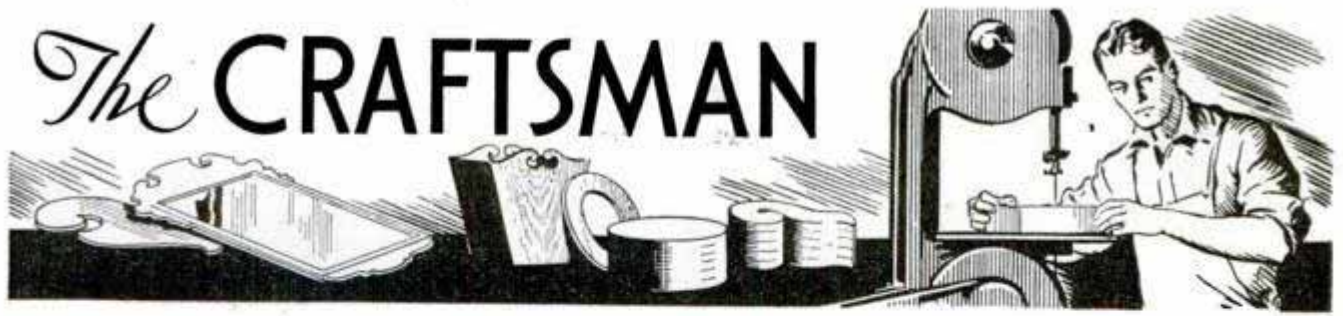

Modern TELEPHONE SET

Snug, upholstered seat, combined with a smart phone stand, offers both comfort and convenience

By WAYNE C. LECKEY

NEW styling makes this modern telephone set, with its invitingly comfortable bench, a striking piece of furniture for the living room or hall. A cloth-backed grille conceals the bell box, and a convenient drawer accommodates a directory, memo pads and pencils.

For a bone-white finish on the table, use poplar, gumwood or pine. Figs. 1 and 7 detail the general construction of the table section. Blind mortise-and-tenon joints are used throughout, and can be cut accurately with a dado head or on the shaper, as in Figs. 2, 3 and 4. To prevent warping of the table top, a spline is inserted as in Fig. 1. The plywood grille for the bell box, Fig. 1, is fitted with two pins and a friction catch. Gold-

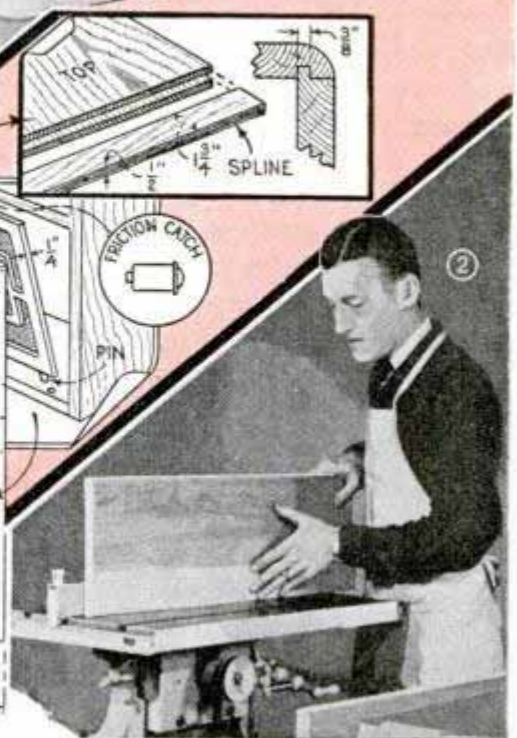
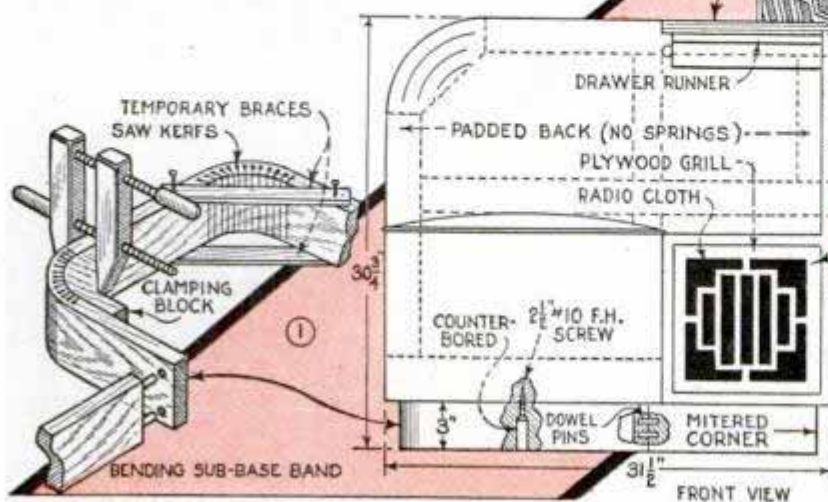
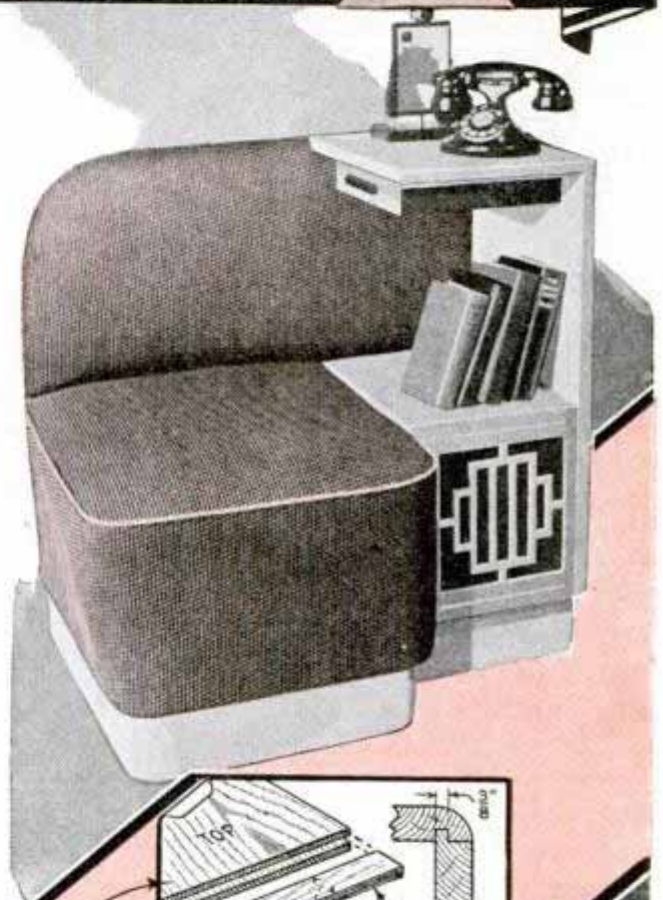

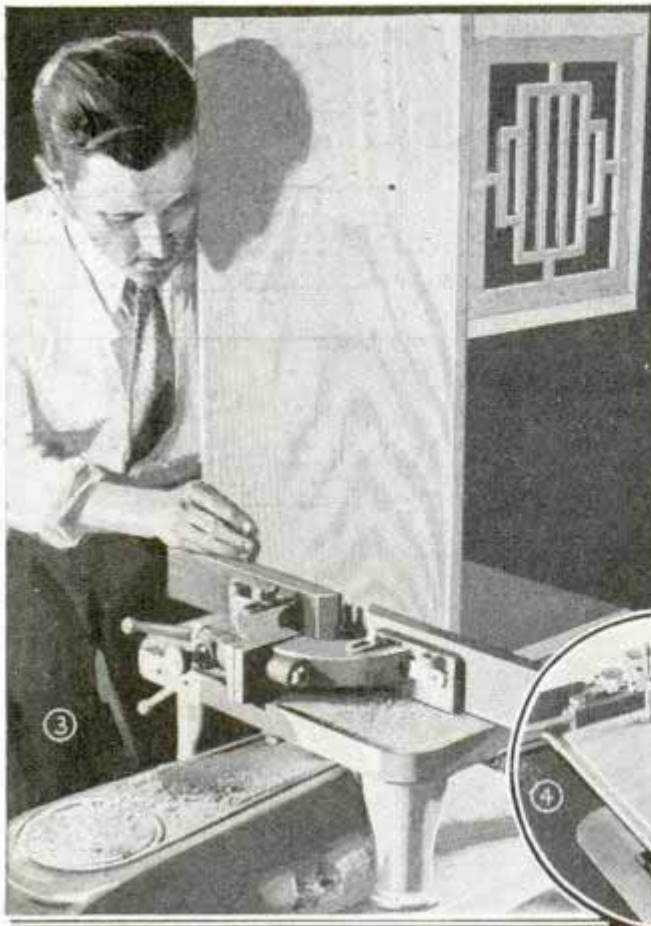

The lower detail in Fig. 10 shows the procedure in tying a single row of springs. The same method is used throughout. Tying is started by compressing the center spring in each row, a length of twine being knotted to the top coil. The ends are brought down through the outer springs and knotted twice to the fifth coil from the top. The twine is continued to the rail and is fastened with a No. 12 tack driven through a knot in the twine. Twines connecting the center springs are then knotted to the outer ones and passed down through to the fifth coil, knotted, tacked to the rail, and then brought up over the wire edge and tied across the tops of the springs. After tying the springs, a covering of burlap is applied over the springs and over the webbing on the back. The burlap pattern for the seat covering is tacked to the inside edges of the frame at the back. The edge is folded over so that

bronze cloth is glued to the back of the grille. The outer edge of the top is rounded after assembly. Figs. 1 and 6 detail the drawer which is fitted to two runners screwed to the underside of the top. The front and sides are $2\frac{1}{4}$ in. wide.

The framework of the bench, Fig. 10, should be made of hardwood. The plain butt joints are reinforced with corrugated fasteners. Curved corners of the frame are formed from thick blocks band-sawed to shape after being glued. Upholstering is begun by webbing both seat and back as in Fig. 10, the webbing on the back being interwoven in the same way as that on the seat. Tacks are staggered in the webbing ends, after which the webbing is folded back and retacked. When the seat is webbed, two 4-in. corner blocks are glued and screwed to the frame for additional support. Nine No. 5 wide-center upholstery springs are used in the seat. These are evenly spaced in line, three in a row, and are sewed to the webbing with strong stitching or mattress twine, as shown in Fig. 10. To shape the corners of the seat, a No. 10-ga. spring wire edge is added.

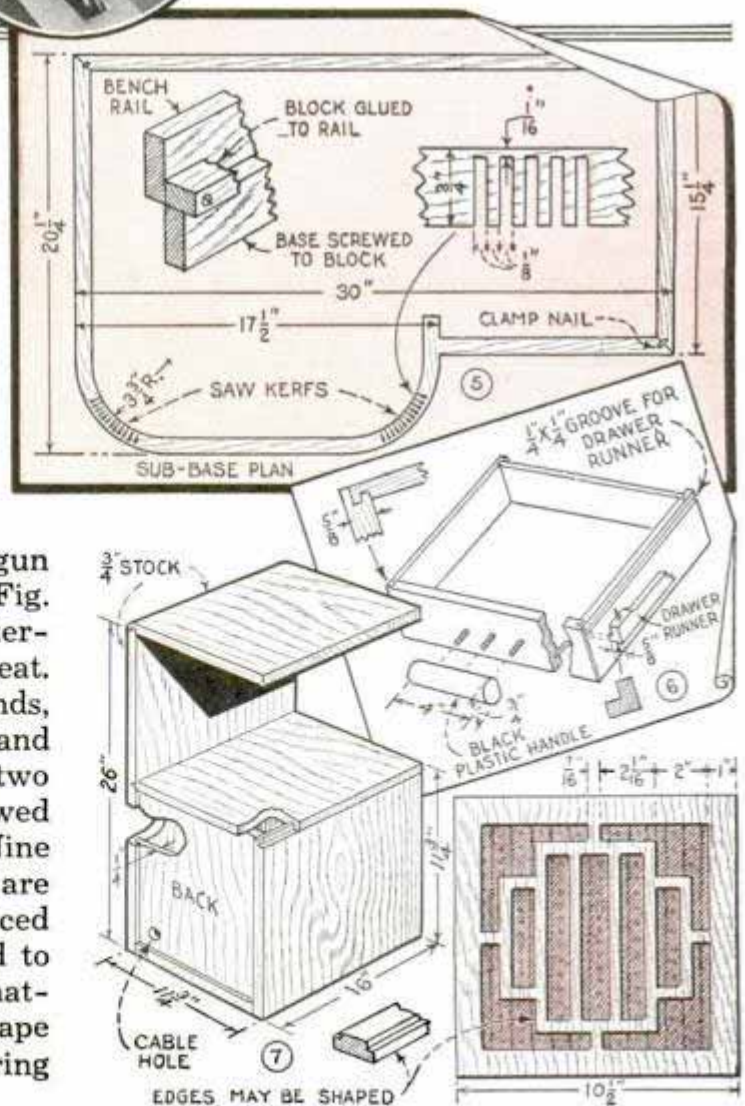

the tacks go through two thicknesses of the burlap.

To shape the seat and retain the padding, a roll edge of tow is sewed around three edges of the seat, Fig. 8, the tow being fashioned by hand into a roll approximately 1½ in. in diameter and sewed to the wire edge with a looping stitch. The top is then padded with a curled-hair filling which is held in place with long, running stitches through the burlap. The back is padded with a 4-in. layer of hair sewed to the webbing. A layer of cotton is applied over the hair to keep the wiry strands from working out through the covering. Now the back is covered with upholstering fabric, tacking the edges to the back of the frame, being careful to keep the cloth pulled evenly and driving the tacks not more than 1 in. apart.

The top covering, Fig. 10, is cut ¾ in.

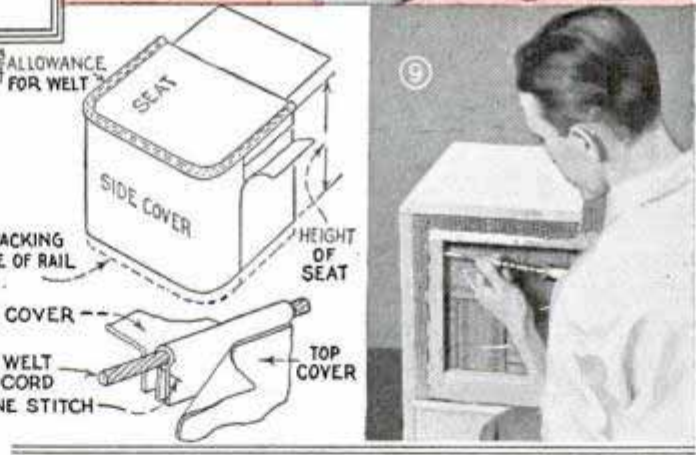
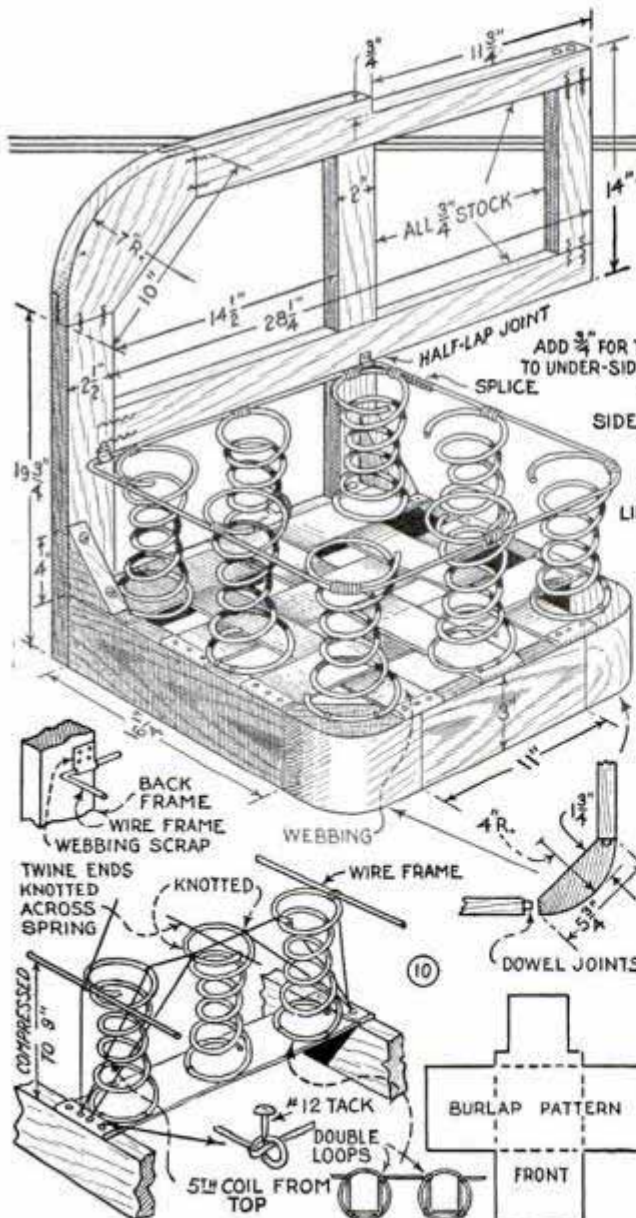
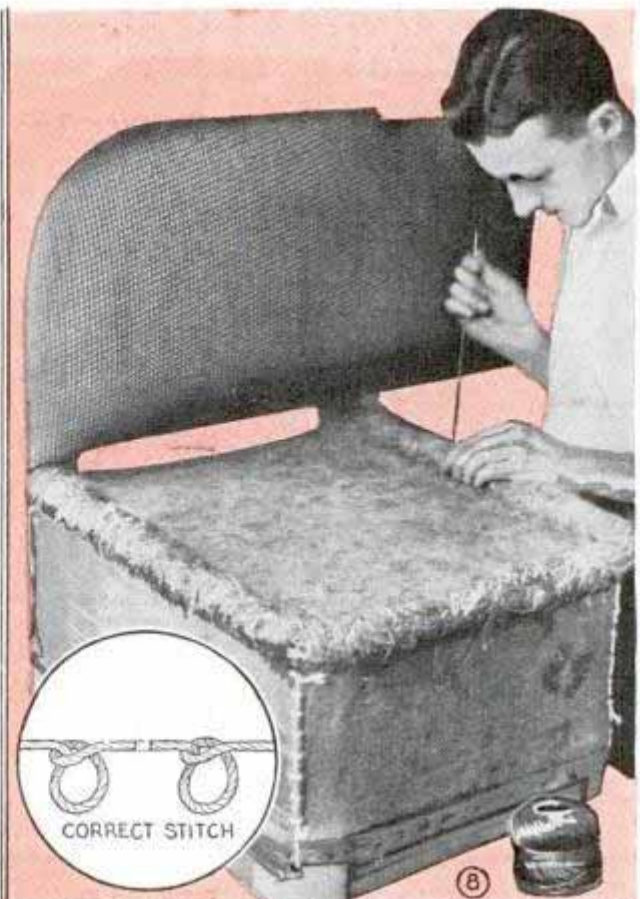

larger than the over-all height of the padded seat. A welt of artificial leather or white piping is sewed in the seam between covers, as shown, keeping the stitch close to the welt and about ¾ in. from the edge of the material. This is brought through the opening at the back, drawn down over the rails and tacked to the under edges. The back covering is applied after the table is attached to the bench by screwing through the frame as in Fig. 9.

The base-band, Figs. 1 and 5, is formed from a single piece by saw-kerfing the back face and clamping around a block as in Fig. 1. The remainder of the base is formed of straight pieces with mitered corners, clamp-nailed and screwed ¾ in. in from the edge to the bottom of the table.

Test Prods Serve Two Purposes on the Test Bench

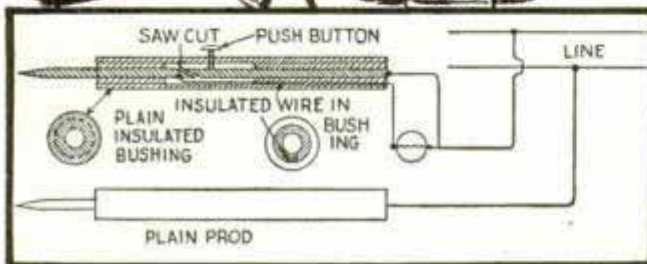
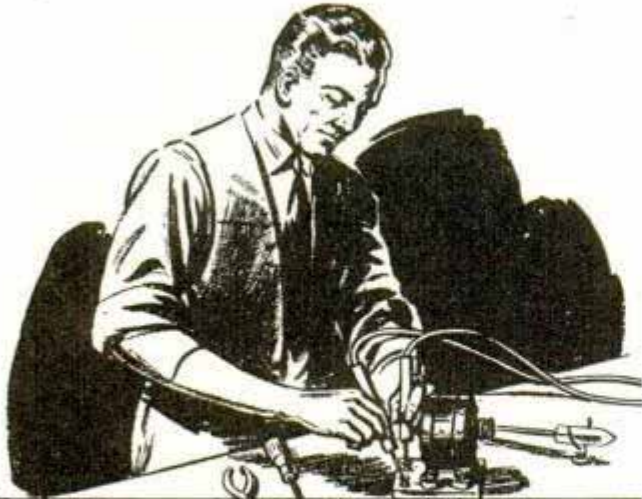

Full line voltage is available through these test prods by merely pressing a button on one of them

Differing from the usual type of test prods in that one of them has a fingertip switch to cut in full line voltage, these prods may be used to supply current for operating small motors and other devices momentarily while making a test. A fiber tube is used as the cover for the dual-purpose prod, which consists of two lengths of brass rod securely held inside the tube with fiber bushings. A small screw with an insulated head serves as the switch, which, when pressed, brings the severed ends of the prod together, thus shorting out the light, bell or other warning device commonly used so that the full line current is available at the end of the prod.

Changing Hack-Saw Blades

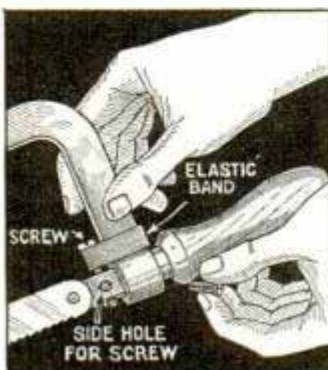

Here is a simple attachment to prevent the handle of a hack saw from turning while changing a blade. It consists merely of a screw clamped to the saw frame with a strong rubber band. In use,

the screw is slipped into one of two holes drilled through the handle shank arm at right angles to each other. The horizontal hole takes care of any occasion when the saw is used sideways.

—H. Moore, Hamilton, Ont., Can.

Screwdriver Scored on Stone to Prevent Slipping

The tendency of a screwdriver blade to slip out of a screw slot can be prevented to a certain extent by sharpening it on a coarse grinding wheel. The blade should be held at right angles to the face of the stone so that the scores parallel the edge of the blade.



—C. E. Packer, Chicago.

Ellipse Drawn with Aid of Cord

A length of hard, braided cord, two pins and a pencil is all the equipment you need for laying out an accurate ellipse of almost any size. First, lay off the center line on

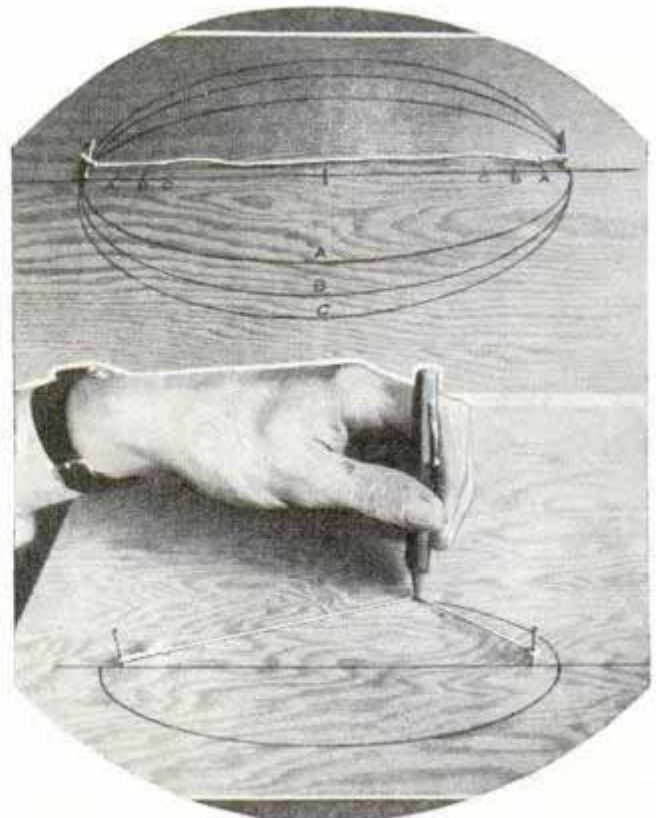

You can draw an ellipse of any size accurately by using a string and a lead pencil

the work. The long dimension of the ellipse is equal to the length of the string between the pins, so you drive the pins into a piece of waste stock a measured distance apart and tie the cord to them so that the cord will be taut. To make the ellipse a given width, measure from the mid-point of the center line, a distance equal to one-half the width desired. Hold the two pins on this mark, hook a pencil point in the doubled string and swing through 180 degrees, marking the points at which the pencil crosses the center line. Set the pins on these points and you have it. Note positions of A, B and C in the illustration, from which you will see that you can vary the width at will.

Clock Lighted by Sleeper Pressing Button on Bed

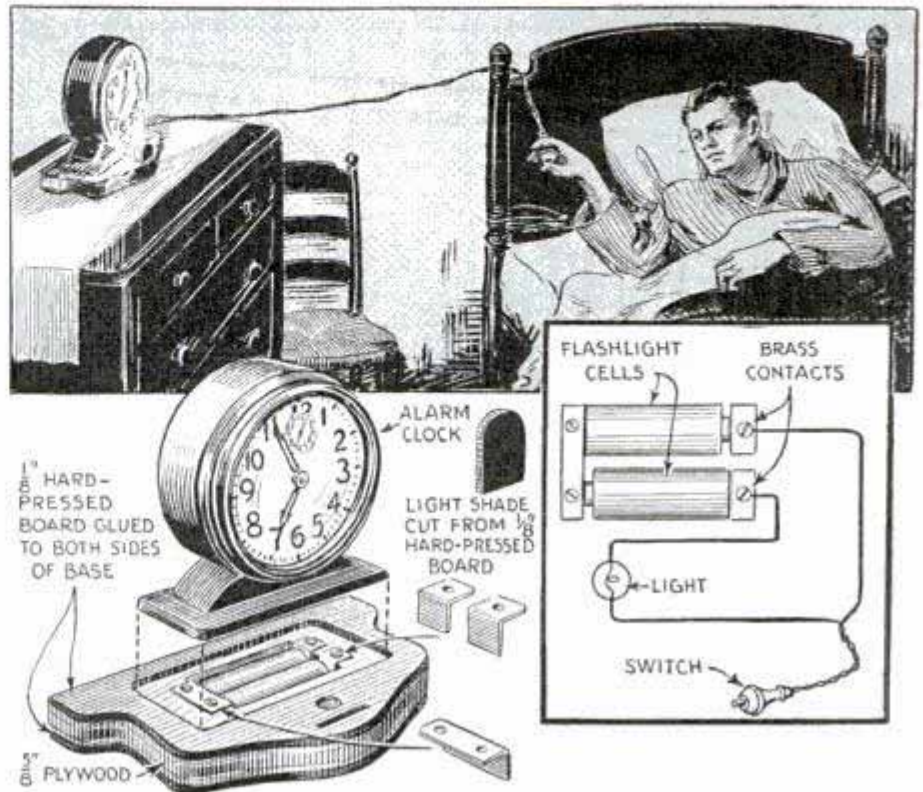

Alarm clock with self-contained light in base shows the time at a press of a button without sleeper getting out of bed

Short Lengths of Fencing Wire Stretched with Auto Jack

For small fencing jobs, especially when repairing a broken wire, where lengths of 10 rods or less are to be stretched, an auto jack will serve as a substitute for a stretcher. A notch is cut in the edge of the jack lift plate to engage the wire.



An auto jack will quickly stretch short lengths of barbed wire when repairing a fence

With this electrified alarm-clock base, you just press a button to see the time instead of getting out of bed to turn on a light. Two pen-type flashlight cells are concealed inside the base and a flashlight bulb is placed behind a small shade in front of the clock. The base is $\frac{5}{8}$ -in. plywood with strips of $\frac{1}{8}$ -in. hard-pressed wood glued to both sides. A small shade for the bulb is cut from the same material. The right-hand detail shows the wiring on the underside of the base before the pressed wood is glued in place, while the other detail pictures the top and battery compartment, which is concealed by the clock.—Kenneth Murray, Sturgis, Mich.

Painting Temporary Signs

When temporary signs are painted on wood, glass or metal, it's a good idea to first apply a thin coat of grease or mineral oil to the surface. Paint applied to such a surface will stand up quite a while, but can be removed easily at any time by merely wiping it with a cloth.

—M. R. Pesce, Chicago.

Colonial Corner

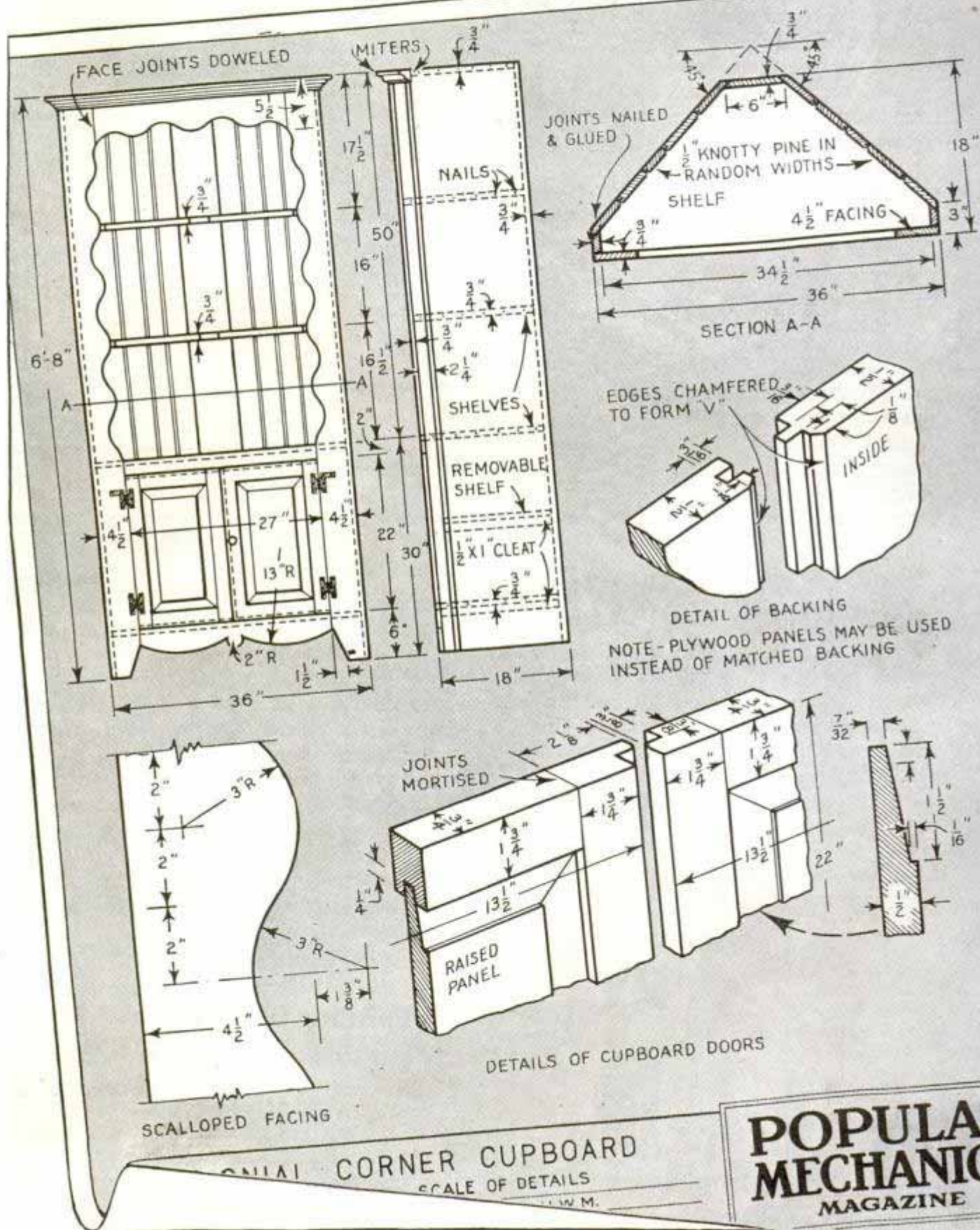

Cupboard

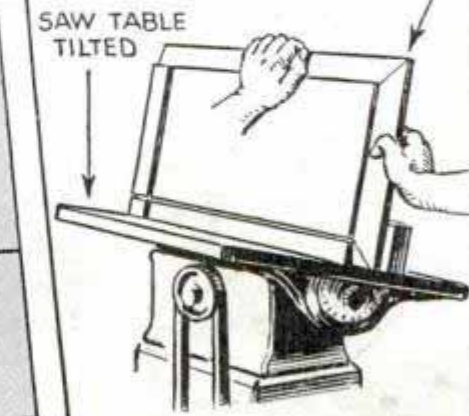
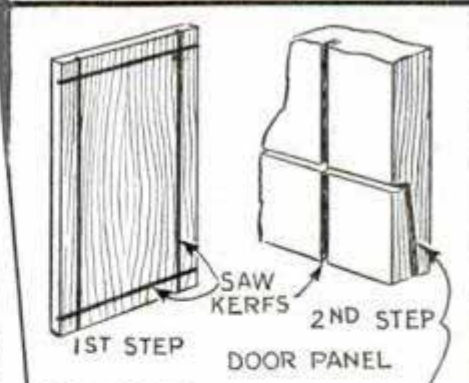
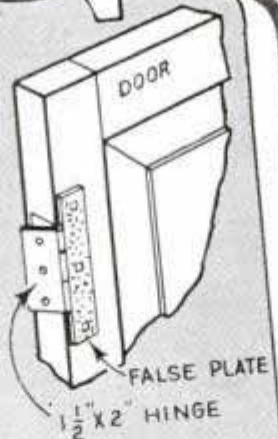
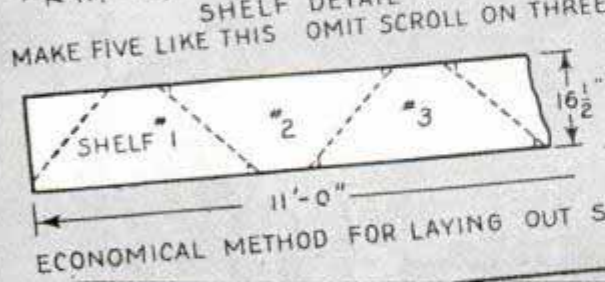
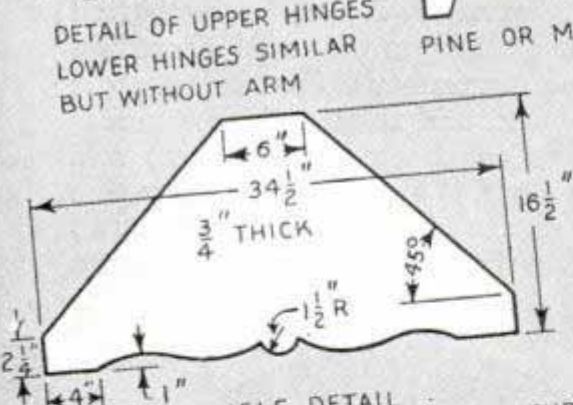
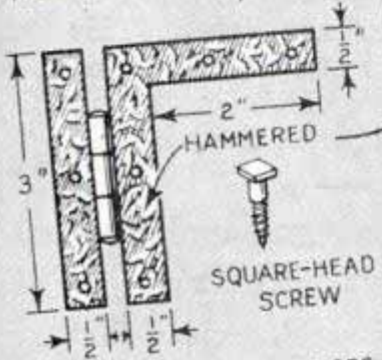
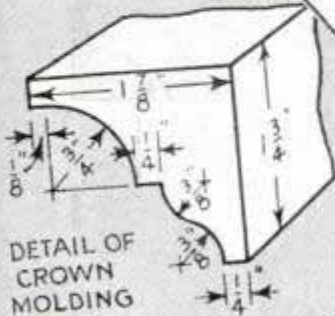

To display your fine pieces of pewter and china on open shelves in the dining room, this colonial corner cabinet is just the thing. Note how it fits snugly against the wall, the legs being recessed to take the baseboard. Facing and back are nailed to the shelves which form the framework

958

B.P.

THE RAISED DOOR PANELS ARE FORMED ON THE CIRCULAR SAW

Models Assembled from Celluloid Show Working Parts Clearly



When building a working model of a device for display or test purposes, it is a good idea to use heavy transparent celluloid for the exterior parts so that the moving parts can be seen clearly. Celluloid is readily cemented together, thus simplifying the assembling of the parts

Home Workshop Soldering Table

For small soldering jobs on your workbench, an asbestos stove mat makes a good table. It should be fitted with four short legs to raise it 2 or 3 in. above the bench top, to permit the use of light clamps or spring-type clothespins to hold small pieces in position for soldering.

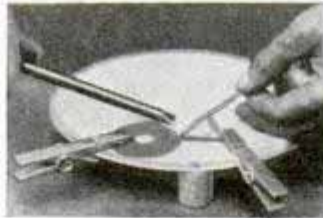

Shovel Scraper from Shoehorn



Instead of wasting time looking for a thin piece of wood to scrape his shovel, one workman carries a shoehorn in his pocket for this purpose. While the horn serves

nicely in its original form, a wider scraping surface can be had by squaring the wide end, rounding each corner slightly to eliminate the pointed ends.

Drawshave of Steel Tubing Smooths Scrollwork

For cleaning up scrolls and similar work where a regular drawshave cannot be used, this tool will do the job quickly. It is made in any desired size from open-seam steel tubing by merely bending down one edge of the seam so that the other edge projects slightly. This is done with a hammer and a piece of flat iron. Beveling one side of the projecting edge of the tubing completes the job.



Rocking Play Pen Amuses Baby for Hours at a Time

If you have an old rocking chair that has been discarded, it can be converted into a small play pen that will afford the baby much amusement. Just remove the seat and back, and then nail slats across the rockers as shown. If the legs and rungs are loose, it is a good idea to reglue and nail them, and it may be necessary to add a few rungs so that the baby cannot crawl out of the pen.

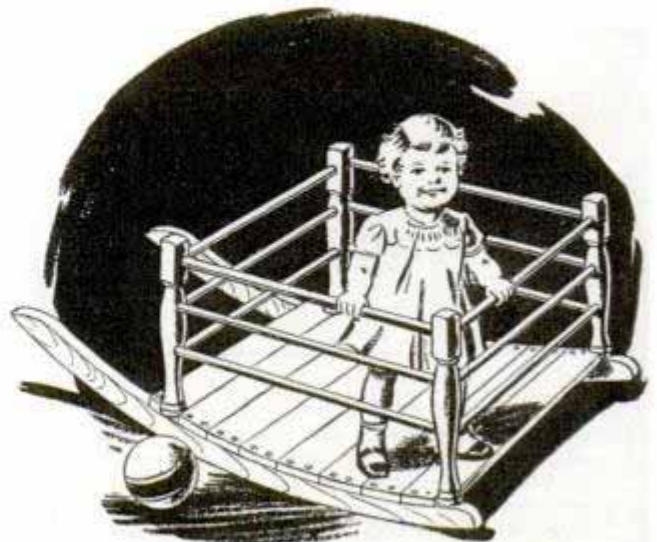

An old rickety rocker is still useful if you convert it into this play pen for the baby

"IN-A-CABINET" BED

Saves Space

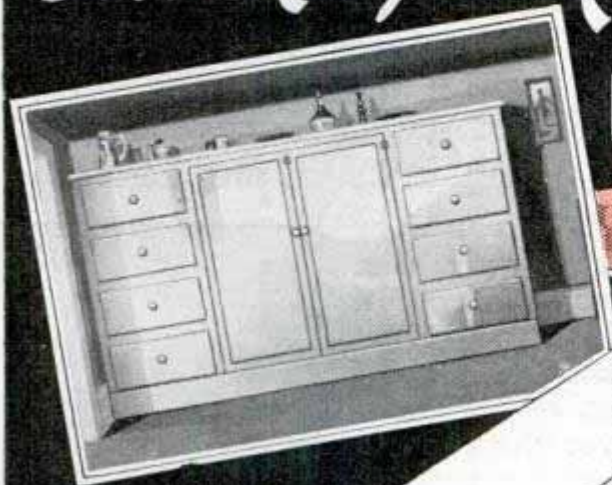

Any room in the house becomes a bedroom when you open this cabinet to reveal a complete double bed. The mattress is strapped to the spring, which is in turn fastened to a 1-in. plywood panel. Counterweights keep the bed in position when the cabinet is closed. Moldings and false fronts fastened to the panel supporting the springs simulate drawers and paneled doors—effectively disguising the real purpose of the cabinet. Folding legs, hinged so that they pivot in two directions, support the bed when the cabinet is open and fold inside when it is closed

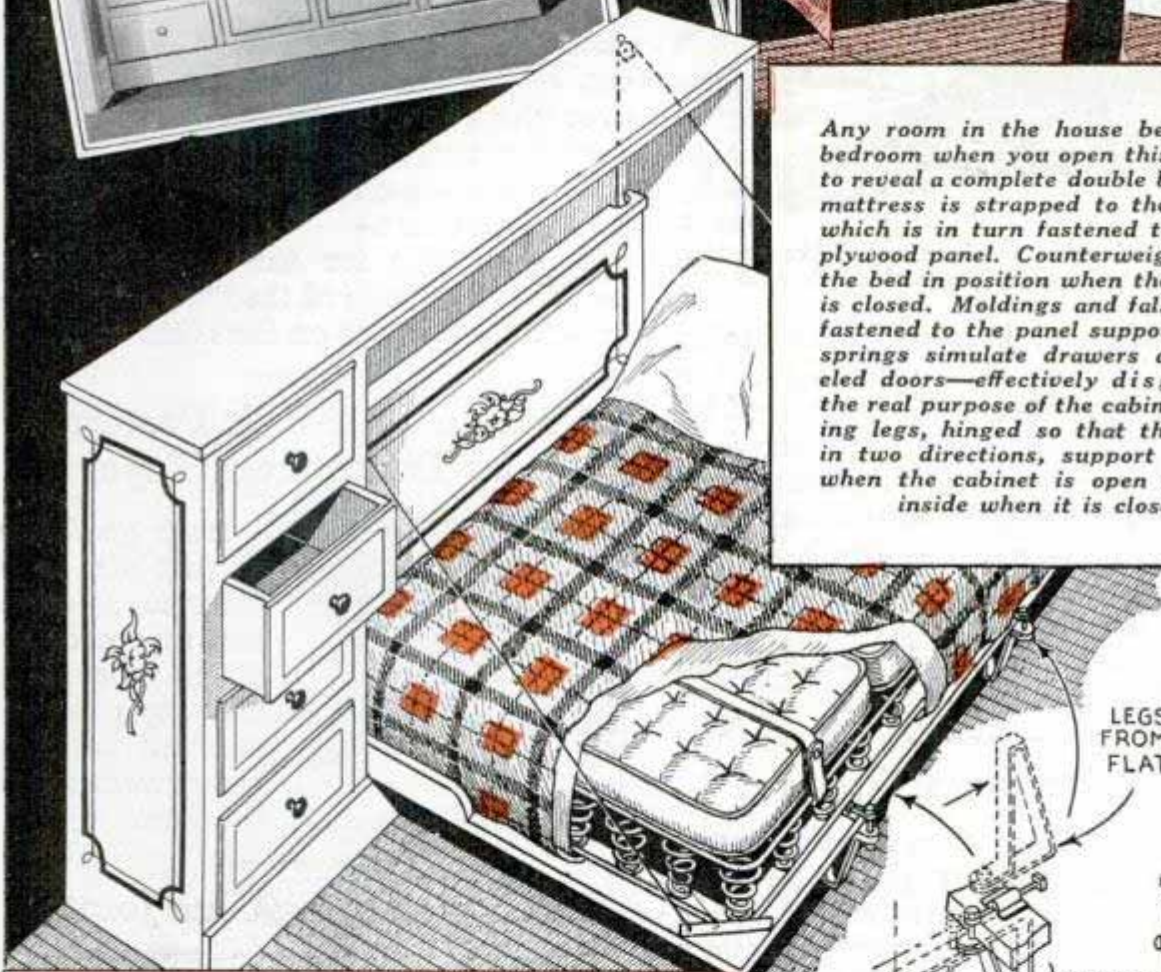

LEGS MADE FROM $\frac{1}{8}$ " X $\frac{1}{4}$ " FLAT IRON

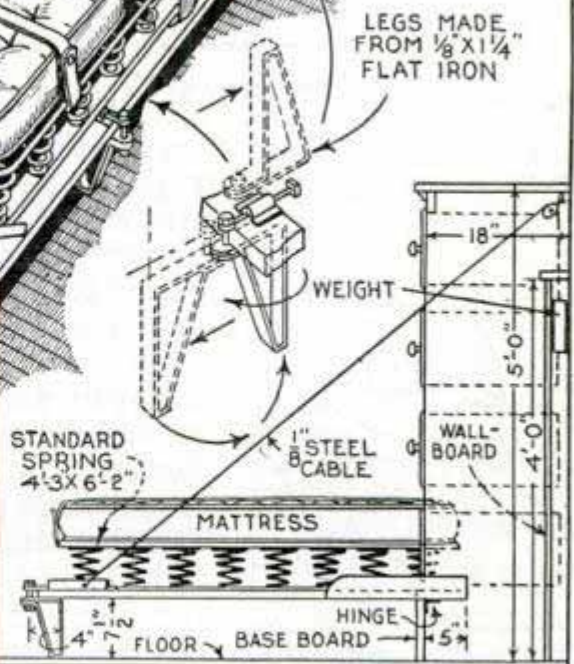
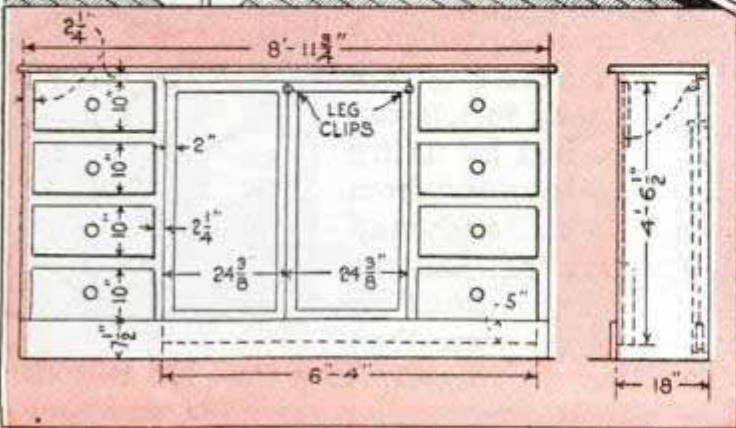

END VIEW OF BED

Bookcase Has Corrugated Back to Hold Volumes Erect



Books will not tip when one is removed if corrugated cardboard is glued to the back of the case

The problem of keeping books neatly erect in a bookcase, especially when the shelves are not entirely filled, is solved by strips of corrugated cardboard glued to the back of the case. The books are pushed against the corrugations to prevent them from tipping. Where the depth of the bookcase is greater than that of the books, which are aligned with the front edge of the shelves, only the last book is pressed against the corrugated backing.

Ruling Pen from Tweezers

Amateur draftsmen who want an inexpensive ruling pen for practicing, can make one for a few cents from a pair of tweezers of the type shown. The ends of the tweezers are ground down on the outside to a long tapered point slightly rounded. A hole is drilled for a small machine screw, the head of which is soldered to one blade of the tweezers while the threaded end is fit-



ted with a thumb nut for adjusting the spacing of the blades. The screw hole in the blade next to the nut should be a little oversize to avoid binding when the blades are spread apart. The rounded portion of the pen point should be sharp but honed carefully to remove burrs from grinding, so that it will slide smoothly.

—Peter Baratta, New York City.

Rubber-Stamp Faces Shielded Against Dirt and Lint

When rubber stamps are seldom used, it's a good idea to provide a cloth shield, which can be fastened over the face to keep dirt and lint from collecting on it. A piece of canvas is suitable for the purpose, being tacked to one edge of the stamp and having a snap fastener on the other edge.

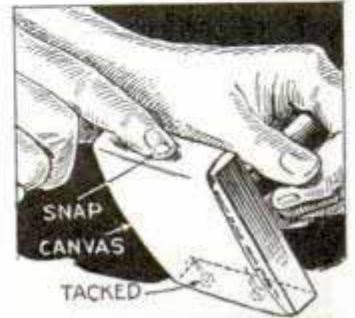

Data on Slide Rule Protected by Transparent Tape

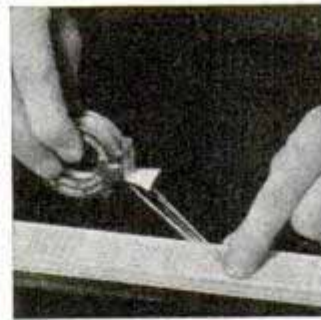

It's a good idea to put strips of transparent cellulose tape over the sides of a slide rule, to prevent constant handling from wearing off the data.

Making Strong Glue Joints

When gluing up table tops and similar work, strong joints can be had by using splines cut from $\frac{1}{4}$ -in. hardwood plywood. Cut the splines about $\frac{1}{8}$ in. narrower than the grooves to allow for glue and have their cores run lengthwise of the grooves.

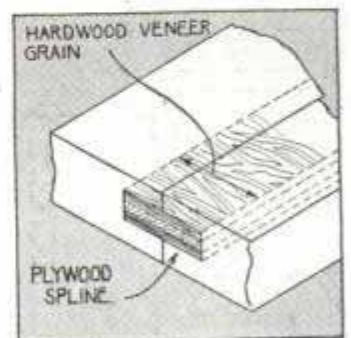

—M. Wood, Port Washington, N. Y.

Pincushions Turned from Wood and Cork

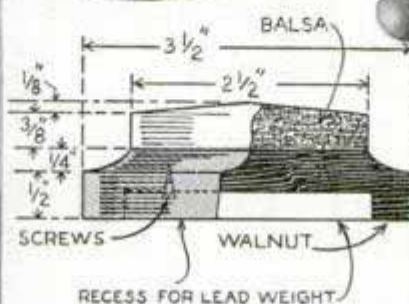
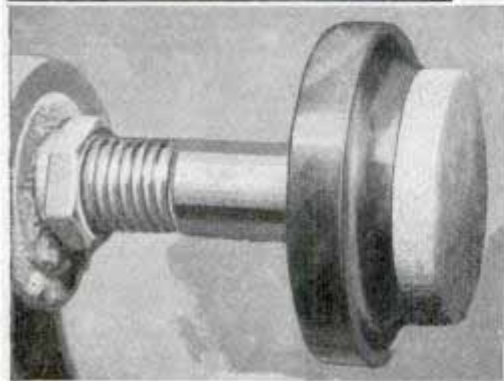
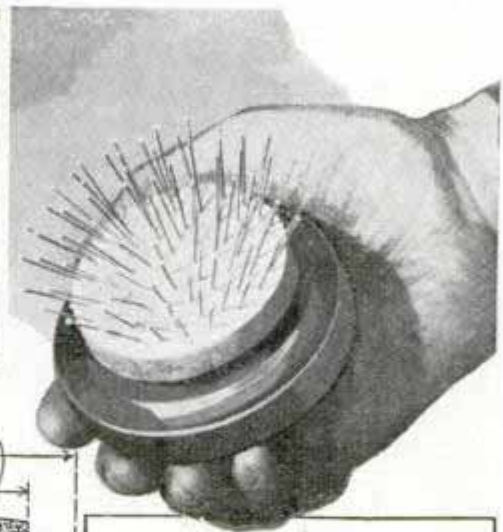
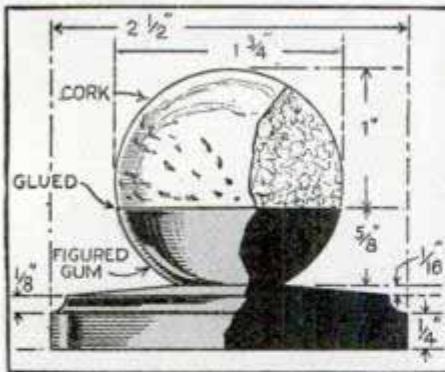

If the pincushion seems too light in weight, the base may be recessed to take a lead disk after which the underside is covered with felt

Attractive as well as useful, these pincushions are easily turned on your lathe, make ideal gifts or prizes for card parties and, if desired, can be turned out in quantities and disposed of at a good profit. To make one, glue the cork or balsa-wood

cushion to a piece of maple, walnut or gum wood from which the base is to be made, and mount the assembly in the lathe. Then turn down the base and shape the cushion with a sandpaper block while the work rotates.

Amateur Chemist's Face Shield Adjusted to Any Position

When working over chemicals, a face shield like the one shown can be adjusted to almost any position desired. It is assembled from a heavy floor flange, a length of flexible conduit and a clear glass disk, which is mounted in a metal frame. Or, if you have an old desk lamp with a flexible support at hand, the framed glass disk can be substituted for the reflector and lamp socket. Or, you can solder two prongs to the glass frame to engage a plug, screwed into the socket.

Blackboard and Slating Paint

Blackboards can be made on a smooth plastered wall or a shellacked wood panel by applying several coats of the following paint: Fine lampblack, 2 oz., mixed with fine pumice stone, 8 oz., and boiled linseed oil, 16 oz. To this, add enough turpentine to make 4 pts. Let the surface dry and sand it smooth between each coat.



Quickly swung into position, the shield is readily assembled from parts easy to obtain

SUCCESS

DO YOU KNOW THAT:

Soil sterilization is important
"Damping off" is a common cause
of failure
Some seeds should be sown broadcast
Constant temperature is essential for
uniform seed germination

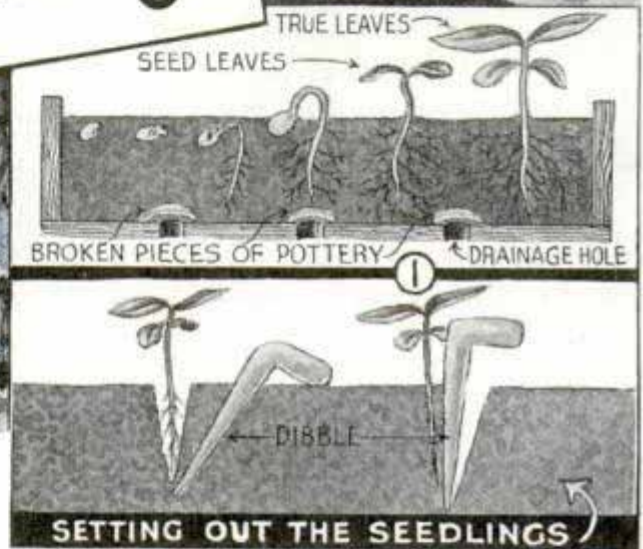

By Clarence Robert Stahler

SUCCESS in starting seeds and maturing sturdy seedlings is not a matter of luck. Satisfactory results depend upon application of fundamental principles and attention given to small and seemingly unimportant details. Failure is often due to fungi, destructive to the seed embryo and to the seedling itself after emergence above the ground. This trouble, known as "damping off," often occurs in seed-sown flats, cold frames and hotbeds. Besides failure of seedlings to emerge at various places throughout the rows, later symptoms are manifested by malformed stems and seed leaves, stunted growth, or collapse and death of the seedling.

Soil sterilization is the remedy for this trouble. Where you have only small quantities of soil to handle, oven-baking will serve the purpose. Sift good garden soil through a sieve, using 6-mesh hardware cloth, and dampen the mass throughout. Then pack the soil in shallow pans, bed a

potato in one and bake in an oven at 300° F. until the potato is well done, Fig. 3. Meanwhile, sterilize all articles used when sowing seed—seed flats, sieves, pieces of broken pottery, etc. Formaldehyde, 2 oz., to water, 1 gal., is very effective for this. A still better method of using formaldehyde is to sprinkle it on a floor, pile the dipped appliances over it and cover with a large canvas.

For sterilizing large quantities of soil where oven-baking is impractical, the soil is treated with formaldehyde dust. This consists of formaldehyde and powdered charcoal in the proportions of formaldehyde, 1 oz., charcoal, 6 oz. Slowly add the liquid to the charcoal powder, stirring constantly. After a thorough mixing, place the mixture in a covered container and shake vigorously. Then sift to break up the lumps and store in an air-tight con-

with SEEDS and SEEDLINGS



Methods of Soil Sterilization

tainer. Next, sift the soil to be sterilized through a screen onto a platform or walk, spreading it out in a 1-in. layer. Apply the dust in the proportion of $\frac{1}{2}$ oz. to each square foot of soil. Mix the dust and soil by shoveling the mass back and forth five or six times as in Fig. 4. Then place the soil in the hotbed and wet down thoroughly. After 24 hrs. seed may be sown. When transplanting seedlings into soil thus sterilized, delay planting at least 72 hrs. after treatment. After sterilizing, avoid introduction of organisms with soiled hands, trowels, watering devices, etc.

While seed flats are soaking in a tub of water, mix the seed-starting medium of equal parts clean, sharp builder's sand (usually sterile if newly obtained), damp peat moss and sterilized soil. Before measuring, sift the sand through a 14-mesh screen, and the soil and peat through the soil sieve. The mixed soil should be damp but not soaked. Test the mixture by squeezing a handful and rolling it between the fingers. If it does not crumble readily it is too wet. Space $\frac{1}{2}$ -in. holes 3 in. apart in the bottom of each flat and place a piece of broken pottery over each hole to provide the proper drainage. Heap soil into a water-soaked flat and strike off the surplus with a straightedge as in Fig. 5. Settle by raising the flat and dropping it on a table. Repeat this several times, then refill and strike off level. To facilitate drain-

THEN SOIL IS BAKED IN OVEN AT 300° F

3

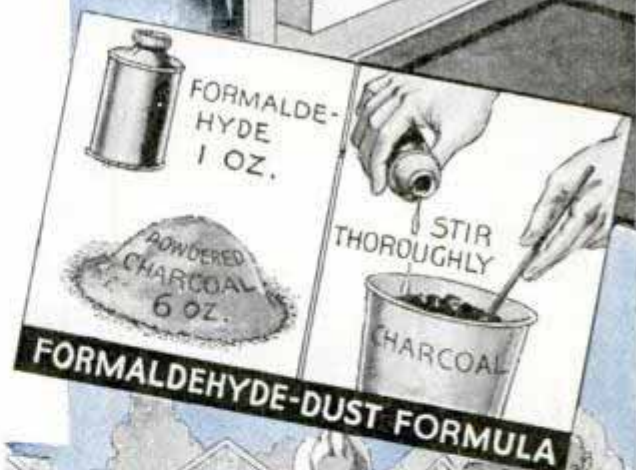

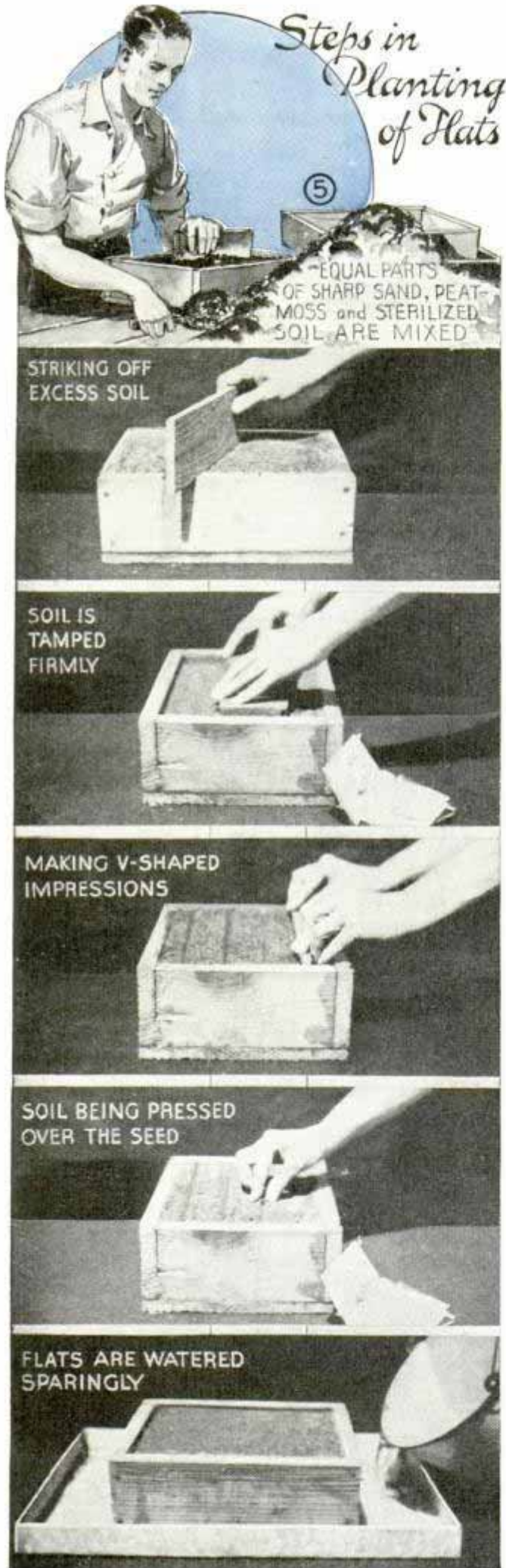

age and to assure rise of the moisture to the surface, the soil particles must be pressed in close contact by tamping firmly.

Tiny seeds—petunia, salpiglossis, campanula and the like—should be broadcast without covering and blocked down against the soil. Larger seeds are sown in a shallow furrow the depth of which should be about four times the thickness of the seed. Sowings may be made a bit thick only if the seedlings are to be transplanted as soon as the true leaves develop. After pinching the soil over the seed, block down firmly. Sow only one variety of seed in a single flat. If the seed flats are thoroughly water-soaked in the beginning and if the soil carries the right moisture content, no watering will be necessary at this time. Seeds do not need a soaking-wet soil in which to germinate. If watering must be done before germination takes place, set the flat in a shallow pan of water and after sufficient moisture has seeped up through the drainage holes to show dampness on the soil surface, remove the flat. Use water from which the chill has been removed.

Covering the seed bed loosely with a single thickness of waxed paper helps prevent drouth, and is particularly beneficial to small seeds. If you do this, remove the paper daily and inspect for signs of germination after which the paper is not replaced. Spontaneous germination of seeds in furrows often heaves the soil badly which increases drouth. To remedy this, wet a piece of loosely woven cloth and press it lightly on the soil. A constant temperature of 60 to 65° F. is best for germination. Never stack the flats.

The upper detail of Fig. 1 shows six stages in the germination and growth of a seedling. In the second stage the seed is swollen into a soft, pulpy mass. At this stage a few minutes of complete drouth will dry out the embryo and kill it. Therefore, keep the top soil dampened until emergence is complete. In the third stage you see the stem boring down and the rootlets forming. The stem will continue downward as in the fourth stage until the roots become fixed, after which the stem grows upward, drawing seed leaves from the seed case. In the fifth stage the seed leaves have expanded. Direct sunlight is not essential but strong, outdoor light is necessary. A few hours of subdued light

will "draw" the seedling badly. Grow slowly in cool temperatures; 45 to 50° F. during the long nights of early spring, 50 to 60° during dull days, and 60 to 70° when the days are bright. Use a thermometer, placing the bulb at the soil level. When necessary, water only during the rising-temperature hours of sunny mornings. At the last stage, the first set of true leaves has formed. (Some varieties at first put forth only one true leaf.) The true leaves contain chlorophyll, a green coloring matter, which is acted upon by the sun, and, combining with the soil elements gathered by the roots, produces food for the plant. At this stage the plant needs early-morning sunlight. It should be protected from the mid-day sun with a shade of burlap.

When watering do a thorough job, but less frequently than at first as the roots are now working in lower soil levels. If the seedlings are propagated under glass, ventilation should be provided immediately after watering. If transplanting is done when the first true leaves are well developed, seedlings suffer little or no shock. Don't forget to sterilize the flats several days in advance. To prepare for transplanting, carefully loosen the soil around the roots with a knife blade and pry up gently. Reset the plants at least 2 in. apart. There is always some root injury, which is really beneficial, as it induces strong lateral root growth. Work in a shady place and lose no time in setting lifted seedlings, otherwise the roots are likely to dry out. Seedlings that have made a long stem growth should be set somewhat deeper and the soil pressed firmly about the roots with a dibble as in the lower detail of Fig. 1. After setting, water and shade according to the weather conditions. When several sets of true leaves have formed, pinch out the top shoots to induce lateral growth. Seedlings remaining too long in the flats may develop a faint, yellowish tinge which indicates depletion of soil food, particularly nitrogen. Should it be impossible to set the plants in permanent locations it is permissible to use a good plant food in the proportions of a rounded teaspoonful to each 2 sq. ft. of soil area. Dissolve the fertilizer in water, and after applying, wet the soil and foliage of the plant thoroughly. However, fertilizers should not be used unless absolutely necessary.

Pail Holder for Your Ladder Is Quickly Adjusted



By merely tipping this pail holder upward, you can adjust it quickly to any height

Made from three pieces of flat iron and a wedge-shaped wood block as indicated, this pail holder slips over the ladder rail and is quickly adjusted to any height by tilting it upward slightly, and pushing it along the rail. It is much better than a hook slipped over one of the rungs, as it holds the pail at the side of the ladder where it is easy to reach.

Paper Pad on Film Pack to Record Data

For convenience in jotting down shutter speed, diaphragm opening, light conditions and similar data pertaining to each exposure at the time it was made, I attached a small pad of paper to the back of my film-pack holder. To assure that a pencil will always be at hand for recording the data, a small leather holder can be provided also on the pack.—Pat Fairmont, Cleveland, Ohio.



Shoulder Pad of Auto Casing for Carrying Pipe

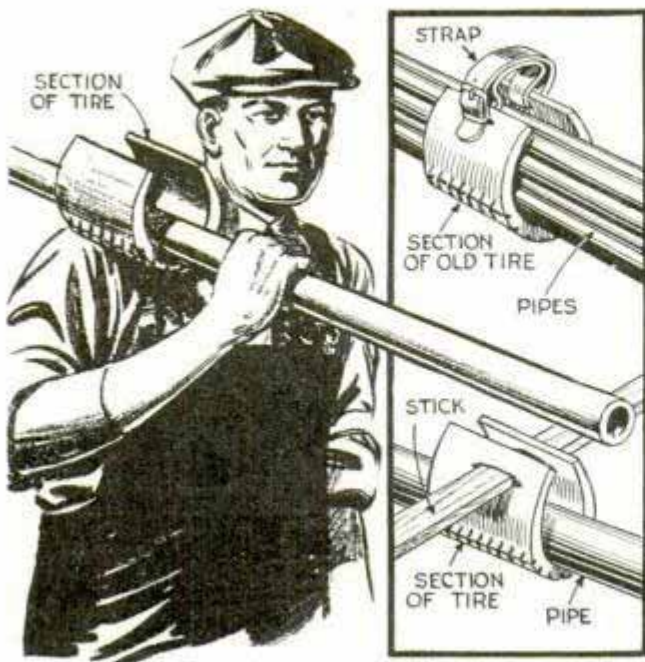

Piece of auto casing makes a good shoulder pad or carrying cradle when handling pipe or iron rods

When carrying long lengths of pipe, iron rod and similar objects, a section cut from an old auto casing makes a good pad for the shoulder. If the section is slotted near the ends for a leather strap, it makes a cradle for carrying a number of small objects. Or, a stick can be substituted for the strap to provide a handle for men working in pairs when carrying heavy lengths.

Bicycle Spokes Tightened with Glass Cutter

I find that an ordinary cheap glass cutter makes a dandy bicycle-spoke wrench. The smallest opening in the side of the cutter fits the spoke nuts, and the handle should be cut off so that the cutter will swing between the spokes. Also, the medium and large openings of the cutter can often be used on other

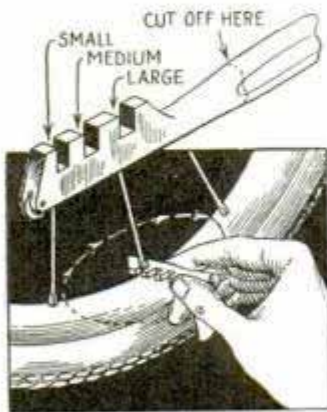

small nuts. In addition to these uses, the cutter comes in handy for cutting paper and cardboard patterns.

—Ira Munro, Brockville, Ont., Can.

Violin Muted with Clothespin

In order to mute my violin while practicing early in the morning, I found that a spring-type clothespin clipped to the bridge as indicated was highly effective, in fact it reduced the loudness of the tone about 75 per cent without affecting the quality of the notes. This idea is especially handy if your regular mute has been mislaid or is damaged.

—N. Jotikasthira, Bangkok, Siam.

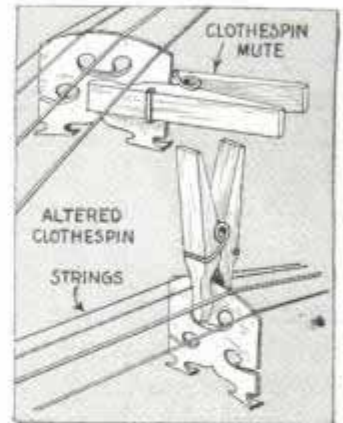

Filaments of Photoflash Bulbs Tested with Neon Lamp

Here is a tester I use for testing filaments of photoflash bulbs to assure that they will flash. The tester is a small box containing two lamp sockets wired in series into which a 1/2-watt neon glow lamp



Neon lamp glows if bulb is good and passes insufficient current to flash it

and the bulb to be tested are inserted. If the filament of the photoflash bulb is in good condition, the neon lamp will glow. The neon lamp passes so little current that the bulb will not flash.

—Jas. A. Wilson, Kalamazoo, Mich.

HAND PRESS

for type or linoleum cuts

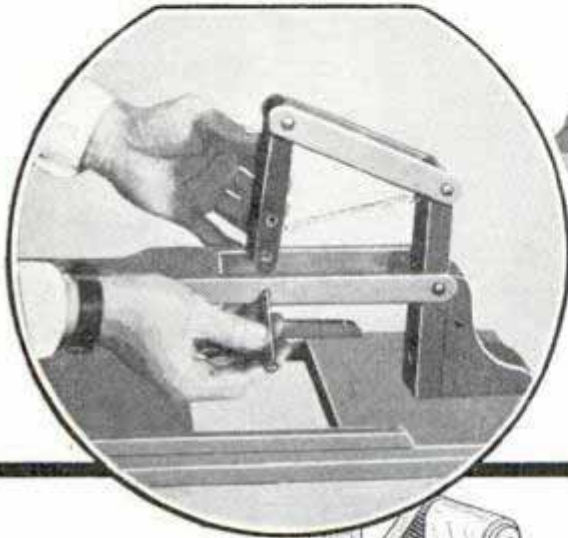

Inking the cut is a simple matter with this hand press, and uniform pressure in printing is assured with the parallel-arm construction. The ink pad is inserted in the base opening and the type or cut in the holder. Inking is done on the pad by depressing the handle lightly. Then the paper on the slide is pushed into position under the cut and the handle is again lowered to make the impression.

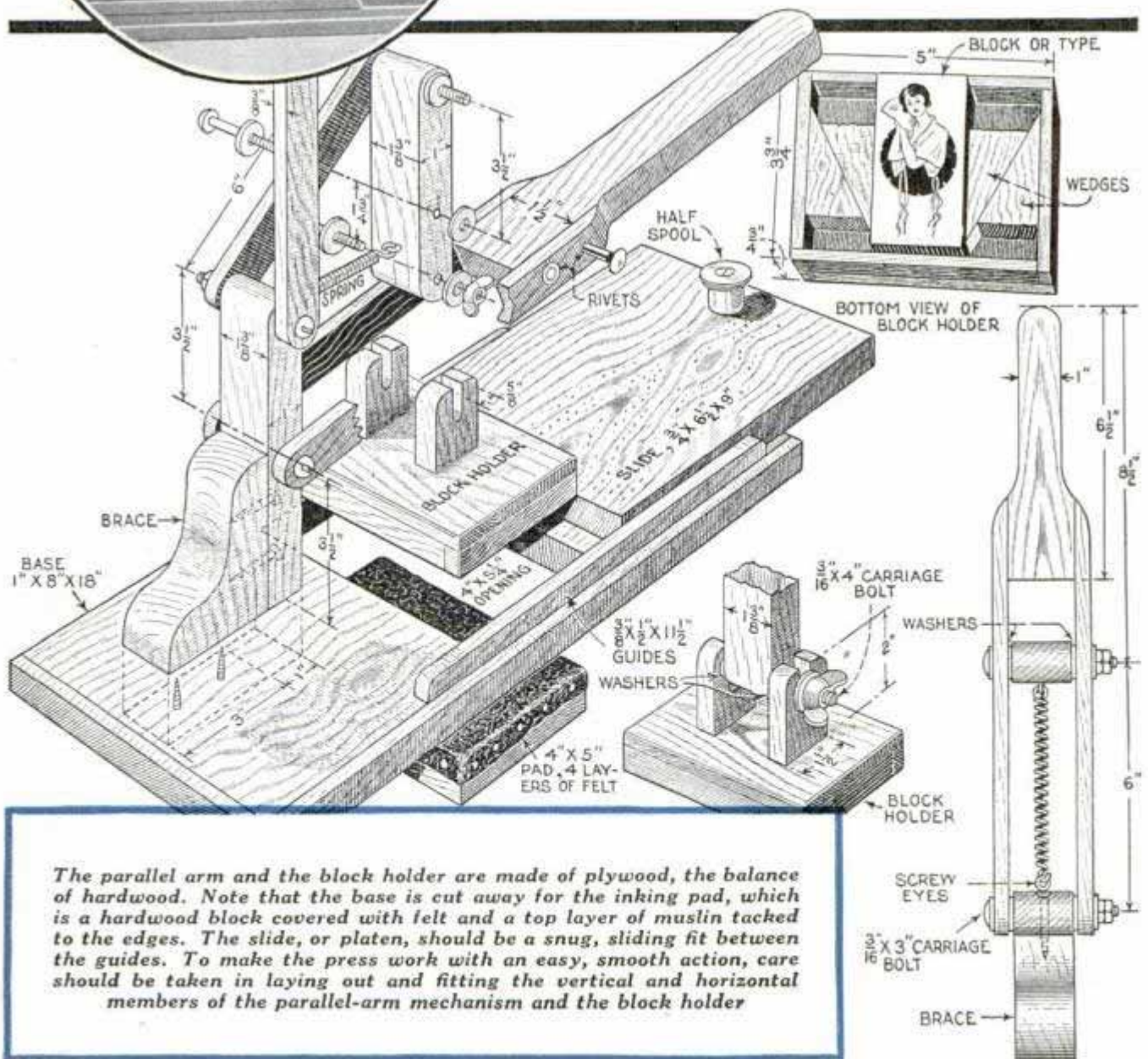

The parallel arm and the block holder are made of plywood, the balance of hardwood. Note that the base is cut away for the inking pad, which is a hardwood block covered with felt and a top layer of muslin tacked to the edges. The slide, or platen, should be a snug, sliding fit between the guides. To make the press work with an easy, smooth action, care should be taken in laying out and fitting the vertical and horizontal members of the parallel-arm mechanism and the block holder.

Screw-Top Cans Easily Opened with Pipe Handle



Plenty of leverage to loosen the screw top of a large can is provided with this handle

Slotted at one end and bent to the shape shown, a length of $\frac{3}{4}$ -in. pipe makes a good handle for opening the screw tops of carbide cans and similar containers. The slot fits over the flanged grip of the top and the handle gives considerable leverage for loosening the tops when they stick.

Trunk Fitted with Strap Handle for Lifting Lid

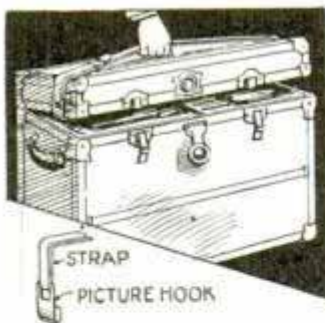

In cases where it is necessary to lift a trunk lid frequently, a long strap with hooks on the ends to clip under the edges of the lid will be found handy. The strap handle is

quickly removed and stored in the trunk when the latter is to be transported.

Improved Lighting for Enlargers

In some photo enlargers the negative is unevenly illuminated, the center receiving more light than the edges. This fault can be determined by placing a sheet of typewriter paper in the negative holder and exposing this on a sheet of enlarging paper enough to bring about a gray tone. A darker center on the paper shows up the lack of uniformity in the illumination. To

cure the trouble paint the reflector with aluminum paint, which has high reflecting quality yet does not give mirror reflection. Also paint the lower part of the light bulb, so that only reflected light reaches the diffusing glass.

Rolled Blueprints Kept on Table by Fruit-Jar Rubbers

For keeping plans and blueprints from accidentally rolling off his worktable while not in use, one draftsman slips fruit-jar rubbers around the rolls. The ears on the rubbers prevent the plans from rolling and, at the same time, keep them compact.

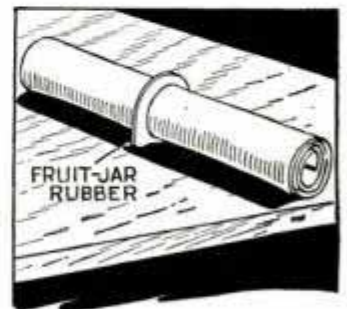

Reddening Copper Articles

A simple method of reddening a copper-coated article is to suspend it in a 5 to 10-per-cent solution of potassium ferrocyanide (poison) and water. If a drop or two of hydrochloric acid is added to the solution, the copper will take a purple color. Leave the article in the solution from a few minutes to an hour, depending on the shade desired. Then remove it, rinse thoroughly in cold, running water to remove all the solution and dry it, after which a coat of wax polish finishes the job.

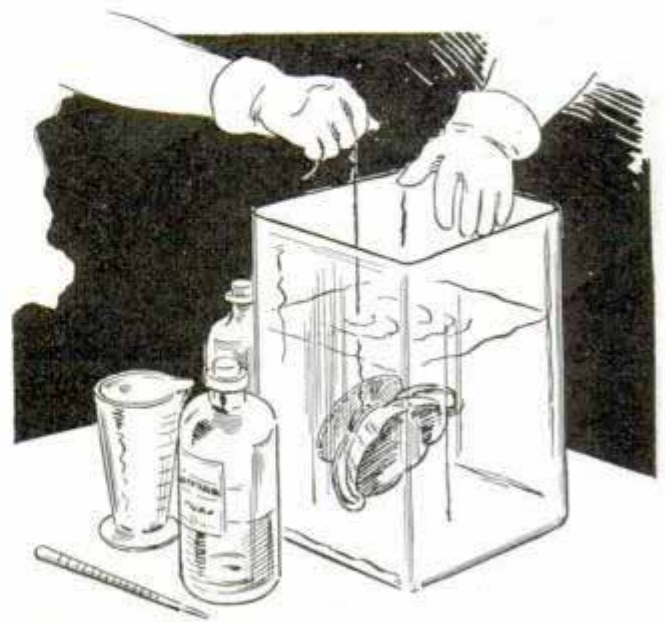

Copper-coated articles suspended in this acid solution quickly take on a red color



From
COALBINS
to **PLAY**
ROOMS
 Part II

Unlimited treatment of floors, walls, windows, stairs, doors, pipes and lighting equipment enable you to create a novel and distinctive atmosphere

By R. O. BUCK

YOUR basement recreation room may be planned for play, study, sports, parties or just a place where you can follow your hobby undisturbed. If you design your room so that it is best fitted for the activities of your particular family group, your efforts will be well repaid. The illustrations of finished rooms in this and the previous article, show just how successfully the ideas of some people have been carried out. Even a small space may be made attractive and usable by a bit of ingenuity. Rooms designed for activity should have vigorous coloring. On the other hand subdued colors are best for rooms planned for study or rest. Remember also that the little details of decoration

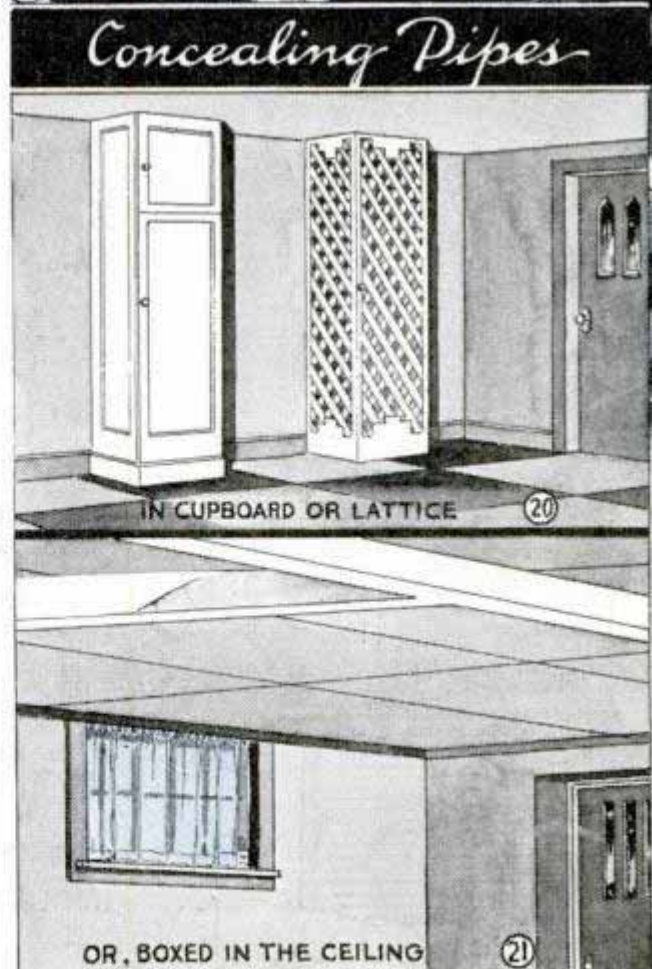

Concealing Pipes

IN CUPBOARD OR LATTICE 20

OR, BOXED IN THE CEILING 21



Enlarging Window Opening



Window Well with Steel Sash

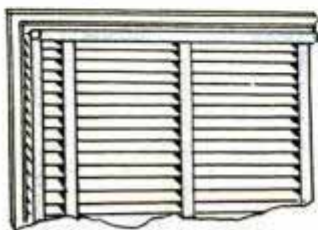
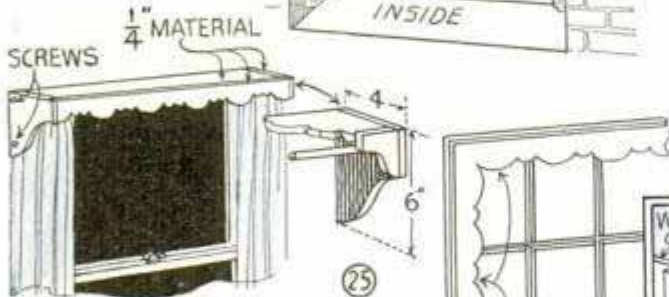

Valances and Venetian Blinds

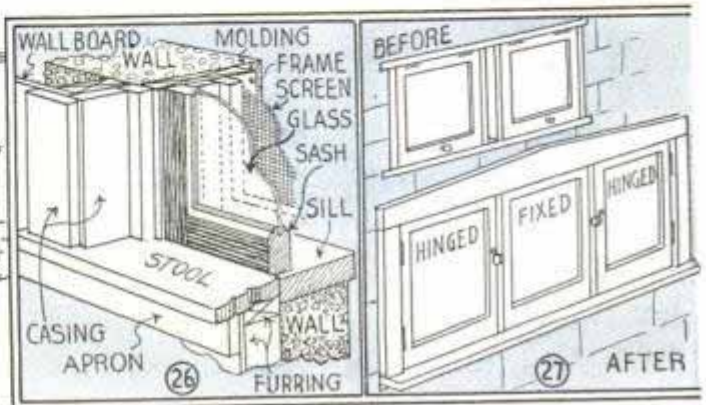
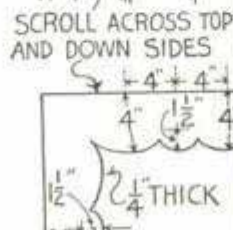

and furnishing make a recreation room a place of real enjoyment. All of the fittings should be of a sort that can take abuse, and come back for more! A place where joy may be unrestrained.

For parties, the basement room is ideal, and a great saving on the upstairs furniture as well. The rest of the household is undisturbed by the noise, and the very atmosphere of the room gives a carefree character to the party. Then too, when the guests have departed there is no midnight "clean-up." You simply close the door and leave it to be put to rights at your leisure.

Concealing Pipes: Every basement presents its own problems in the matter of concealing pipes and ducts. Vertical pipes may be enclosed by building a cabinet or lattice over them as in Fig. 20. Pipes along the ceiling may be boxed in as in Fig. 21, or the ceiling dropped sufficiently so that they will be covered. If concealment of pipes is impractical, the pipes may simply be cleaned of rust with a wire brush, and painted.

Window Treatment: Good light and ventilation are as necessary in the basement as elsewhere in the house. This is especially true if you expect to spend long periods in the room, and wish to have it usable the year around. If the windows are small or too few in number they should be enlarged. Window ventilators of the fan type, to draw in fresh air and expel damp, musty air, may also be required. As moist air is heavy, it has a tendency to remain near the floor so that it is sometimes difficult to remove it by simply exhausting the air at window height. In this case the methods shown

in Fig. 19 of Part I and in Fig. 43 are suggested. The exhaust duct and blower may be concealed behind a partition, in a closet or lead from a imitation fireplace opening.

Enlarging the basement windows is generally quite simple, especially if the wall is framed. Even a masonry wall may be easily cut down to the level of the concrete wall with a chisel, as shown in Fig. 23, and a larger window frame set in. If the openings are fairly large and the bottom of the frame is well above grade, the swing-out type of steel sash can be installed. Windows close to grade may require a well in order to carry the window below grade, as shown in Fig. 24. In this case either a tilting window or swing-in type is recommended. If you have a double-mullion window, it may be converted into an attractive triple casement, as shown in Fig. 27, without enlarging the opening. Fig. 26 shows the method suggested for extending a window frame out to meet your new wall line, in case the present frame is not to be changed. This method makes the window appear larger and more attractive. The method of trimming the window will depend on the type of room you are planning. Figs. 22 and 25 suggest several possible treatments.

Doors: Your room will probably have one or more doors which should be in harmony with the decorations. Of course, doors may be purchased but in case you wish to build them, suggestions in Figs. 28, 29 and 30 may give you an idea. Fig. 28 shows double doors for a modern effect. At the left of Figs. 29 and 30 you will see a group of attractive batten doors that may suit your purpose. Fig. 31 suggests two methods of finishing

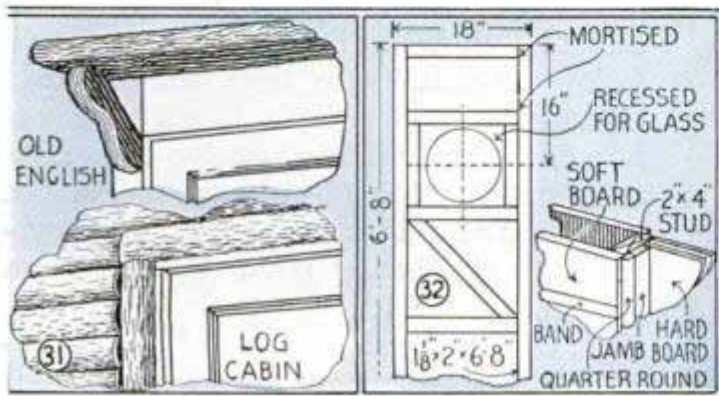
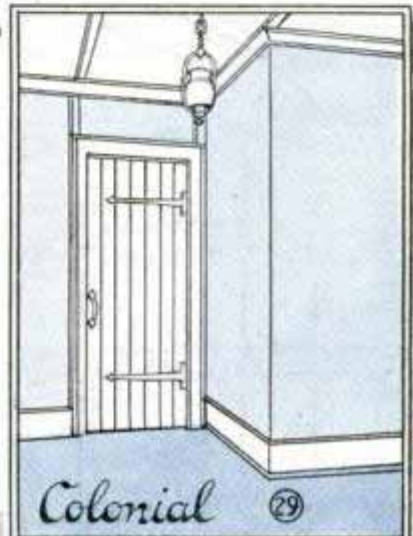
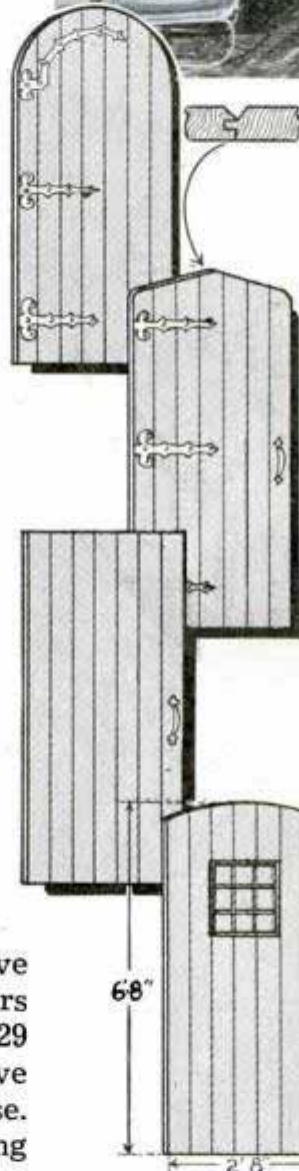

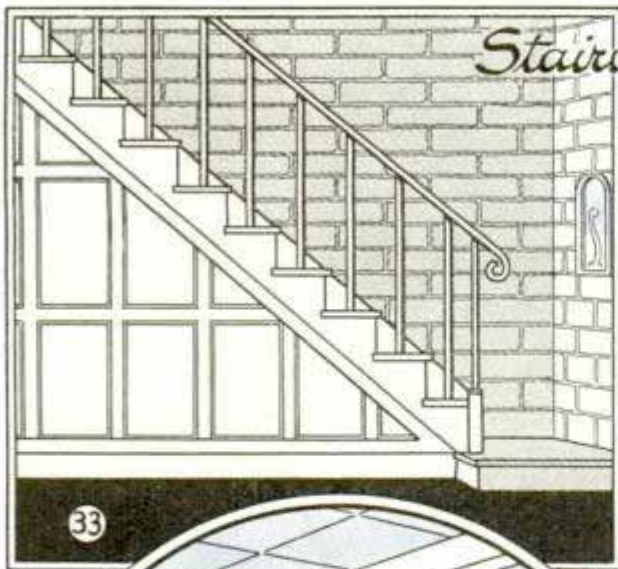

33

Stairways

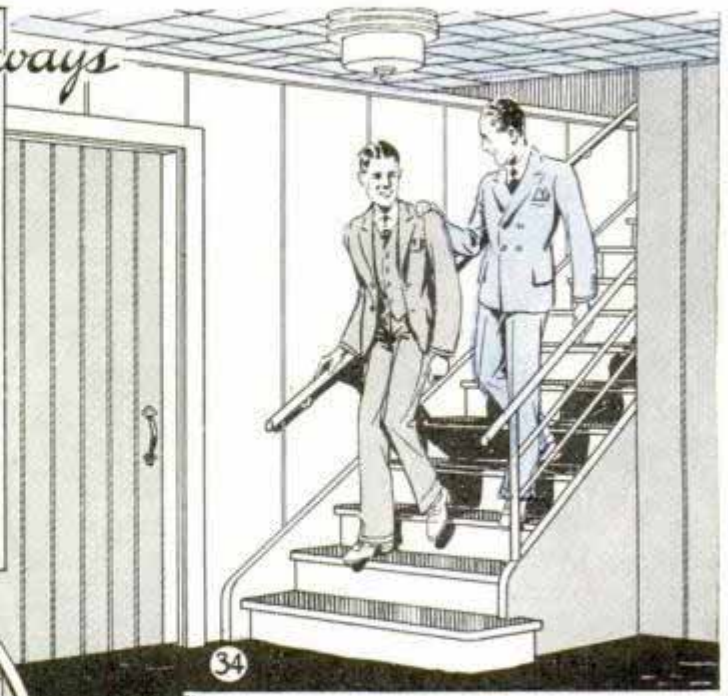

34

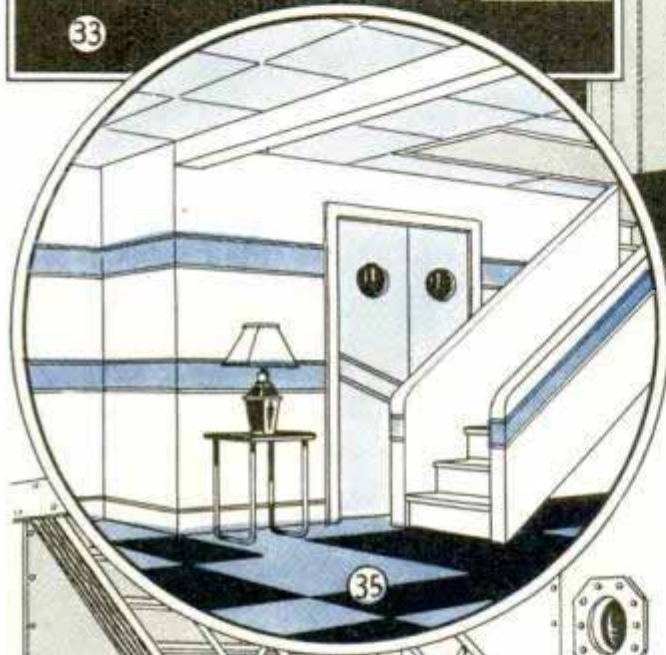

35



The Nautical

36



37

and the Colonial

door frames for log-cabin interiors while Fig. 32 gives construction details on a modern door.

Stairways: Basement stairs usually are not very attractive and if they enter into your recreation room, some finishing will be required as in Fig. 33 to 37 inclusive. The arrangement shown in Fig. 37 works out nicely if knotty pine, or plaster board to simulate pine, is used on the walls. Soft-board tile or paneling looks well with an iron railing, such as shown in Fig. 33. An enclosed rail for a modern effect is shown in Fig. 35, and a bent pipe for a shipboard effect is shown in Fig. 36. Enclosing the stairs between two walls makes the attractive arrangement shown in Fig. 34. As basement stairways are nearly always dark, painting the risers a light color helps to avoid accidents. Proper lighting of the steps is also essential to the safety of your guests.

Lighting: Do not neglect to provide plenty of wall plugs for portable lamps. Also arrange for adequate overhead or indirect lights. While lighting fixtures should follow the character of the room, they may be unique and original. Often they can be constructed of inexpensive materials. Jelly molds, mixing bowls, wheels, bottles and parts of old fixtures are all good material to the handy man. On the other hand, if you wish to purchase fixtures, Figs. 38 and 39, show some of the appropriate fixtures that are available.

Suggested Lighting Fixtures

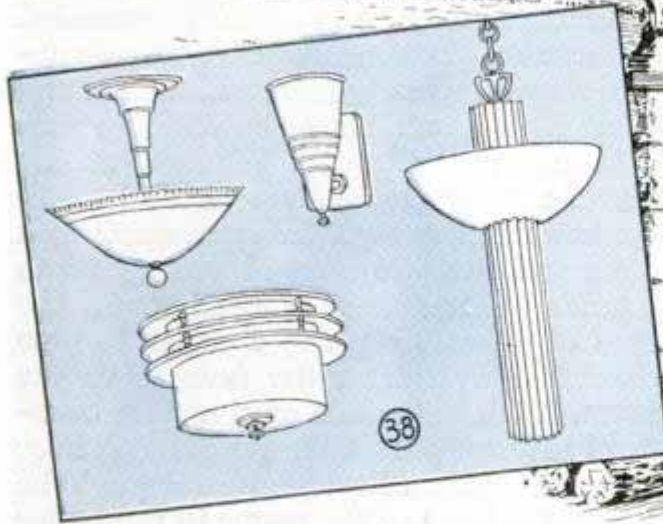

Fireplaces: There are few things that add so much to a recreation room as a fireplace. They are always associated with warmth and good cheer, which are the very attractions you want to build into your room. Fireplaces may be divided into three groups: The purely ornamental electric type, realistic and cheerful appearing nevertheless; the gas, using a radiant heating unit, by means of which considerable heat is sent into the room, and the natural wood and coal-burning sort. If your fireplace is purely for atmosphere, the electric type will serve your purpose. As the material does not need to be fireproof, blocks of soft board, nailed to a wood frame, will do very well. A mortar joint is simulated by chamfering the edges of adjacent blocks. Plastic paint, in a rough finish of suitable color is used to give a stonelike surface. Fig. 42 shows an attractive example of the type that is built out into the room. If you do not wish to sacrifice this much of your floor space, the scheme shown in Fig. 41 can be adapted. This is applicable only where the fireplace is to be located on a partition wall. A realistic stone effect can be obtained for a fireplace by cutting the soft board in random shapes on a bandsaw and roughing the faces to an irregular surface with a rasp, then painting as already described. Sand worked into the paint carries out the illusion still more. An iron door and a piece of linoleum in a flagstone design, for a hearth, complete the fireplace. Electric log units may be purchased in which a colored light and a disk, which is caused to

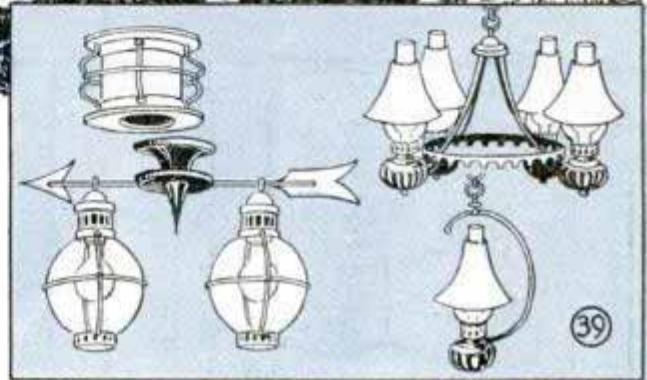

rotate by the heat of the lamp, are concealed behind amber and red-colored chunks of glass resembling burning coal. The effect is surprisingly realistic. Gas-type fireplaces need not be of brick or stone construction if a radiant fire unit is used, nor is a flue connection essential, though it is generally desirable. Fig. 41 shows the method employed. For brick, asphalt or asbestos wall covering, in a brick pattern or the real brick facing on asphalt type of siding may be used. Asbestos paper and sheet iron are sufficient protection to the wood frame as there is only a small amount of heat thrown off from the back of the unit.

Neither the electric nor gas type of fireplace can compare with a natural fireplace for real enjoyment. If you have an oil or gas burner in your heating plant, and the chimney is used only as a vent, it is quite possible that a natural fireplace in your basement is entirely practical. However, before you go ahead it would be well to get the expert advice of the manufacturer of your heating equipment as the installation of a natural fireplace may in some

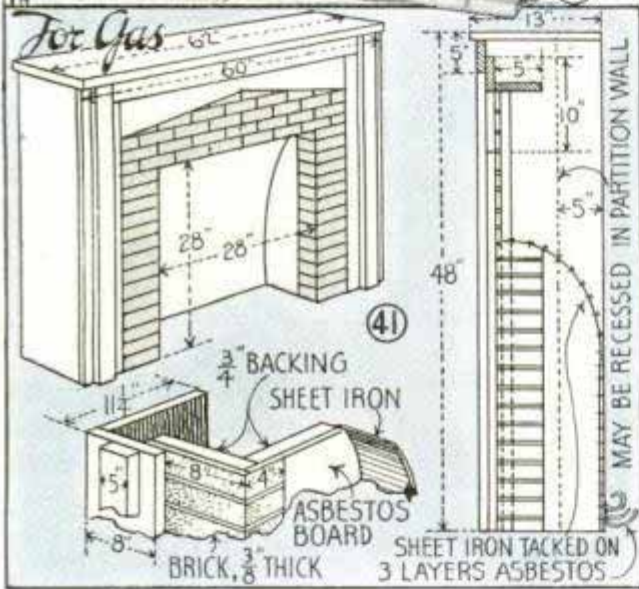
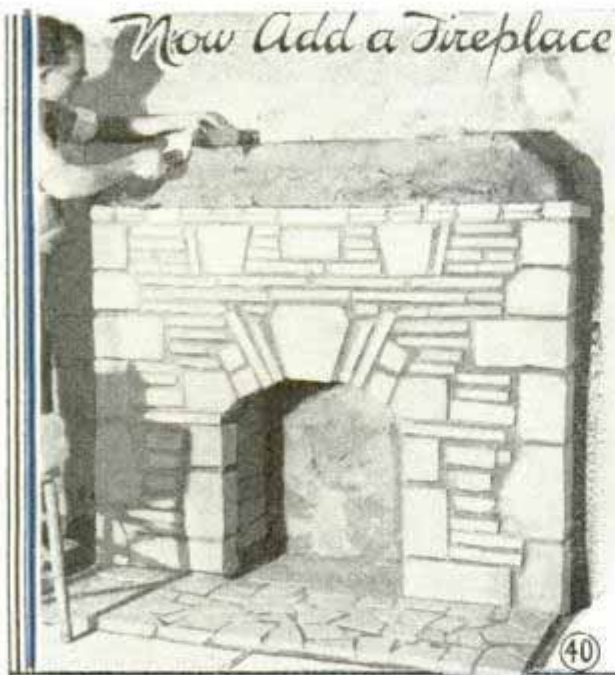

cases, interfere with its operation. Building a good fireplace depends on several factors involving its design. The subject has been covered in bulletin No. 1230 of the U. S. Department of Agriculture which will enable anyone with a bit of masonry experience to do the job. Should you feel doubtful of your ability to construct a proper throat and shelf, in which lies the secret of a good drawing fireplace, you may purchase a metal throat which requires only covering with brick, as indicated in the manufacturer's directions. Fig. 40 shows the construction of an attractive stone front design.

Heating: Now in the matter of heating it should be decided just how you are to heat your recreation room, in case a natural fireplace is not to be built. If your heating plant keeps the basement com-

fortably warm in the coldest weather, a lattice grille built in a partition may be the solution. If the heating plant is within the room it may be practically concealed by means of a lattice structure. This structure may completely surround the heating plant with a suitable grille door, so that heat may pass through. Modern heating plants usually give off very little heat in the basement, except that from uncovered pipes and ducts, so it may be necessary to provide other means of heating. In the case of a hot-air plant, a separate pipe should be run from the furnace to the room. With hot water or steam an overhead radiator serves the purpose. A floor radiator is impractical because it would be below the level of the water in the boiler and so would not circulate properly. If none of these methods solves your problem, or if your heating plant is already taxed to the limit to heat the upper floors, then the installation of a gas-steam radiator is recommended. This is a self-contained unit requiring only a gas connection.

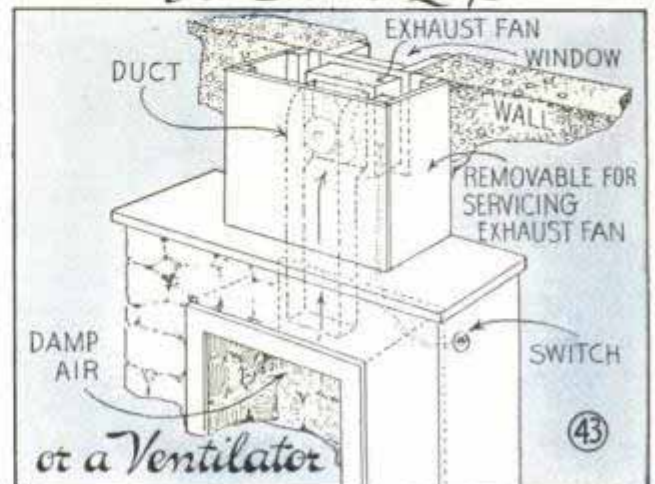
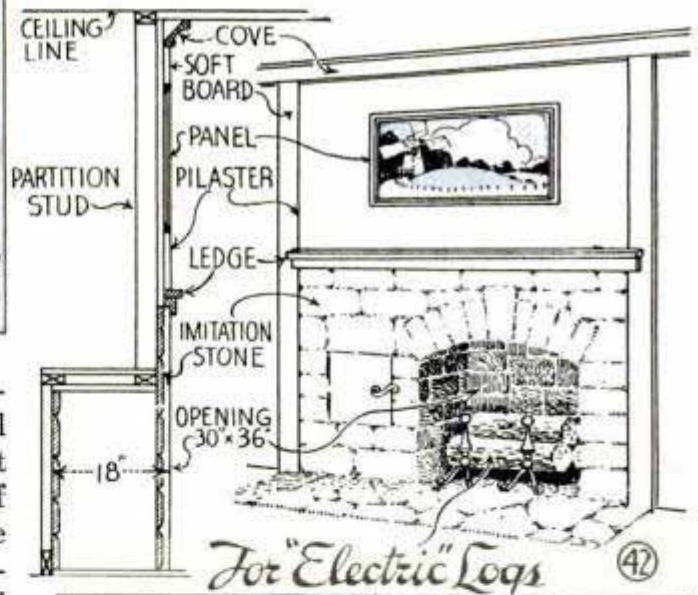

~and Finish off the Columns

Trusses and Columns: Columns can nearly always be effectively worked into the decorative scheme by some simple treatment which is in harmony with the general arrangement. Figs. 45 to 49 inclusive give suggestions for obtaining various effects by covering columns. The tree-trunk effect shown in Fig. 46 goes well with imitation garden and log-cabin interiors.

General Procedure: If you take the room illustrated in Fig. 44 as an example of general procedure, and assuming that you want to enjoy a garden atmosphere the year around, first cover the ceiling with unbleached muslin and top floor with green cement, marked off in squares for a tile effect. The window shown is in a partition, and is not glazed. This permits the entrance of heat from the adjacent furnace room. Blue lights are mounted just out of sight below the window sill, on the outside, to give a twilight effect. Artificial flowers and vines are

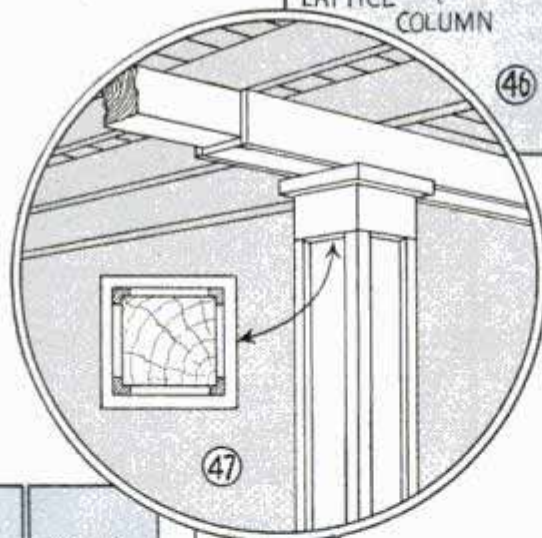
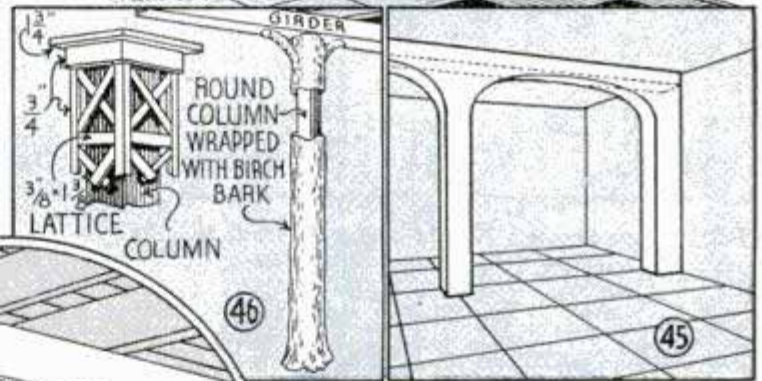
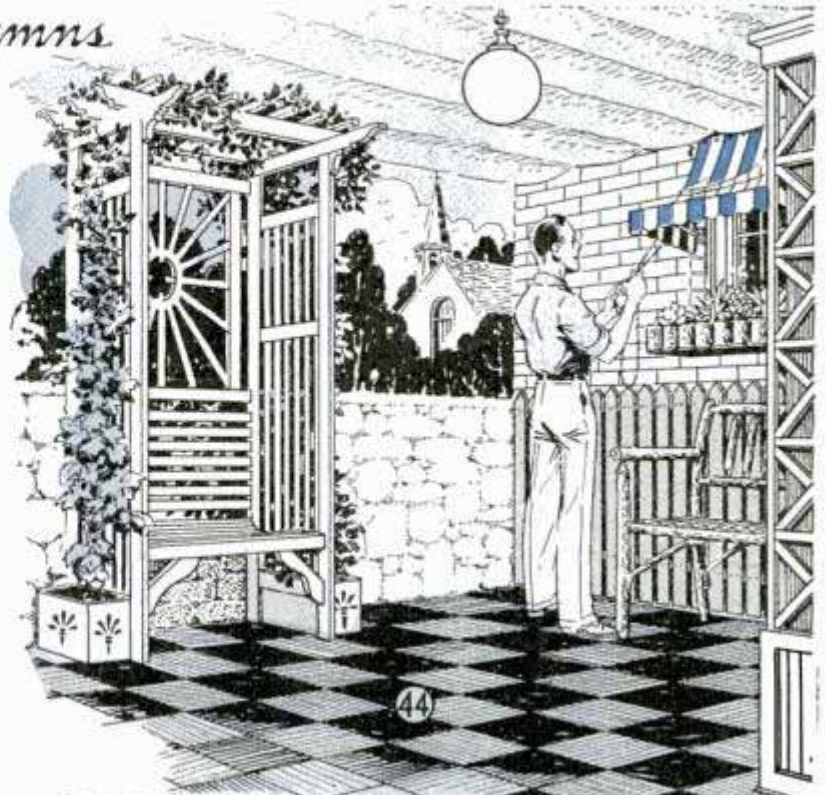

Column Treatments

used for the boxes and arbor. The stone effect is painted on the concrete wall with a distant landscape, in grays and blacks on wallboard above, to produce the illusion of looking over the garden wall. The remainder of the room is furnished with rustic furniture.

The whole arrangement presents a remarkably attractive and realistic effect. In working out any motif, the type of room desired must first be decided on. When this has been decided, the available space should be laid out on squared paper, to scale, and all of the things you wish to include in the room, such as game tables, benches, cupboards, etc., carefully fitted on it. In this way you will be assured an attractive and usable room.

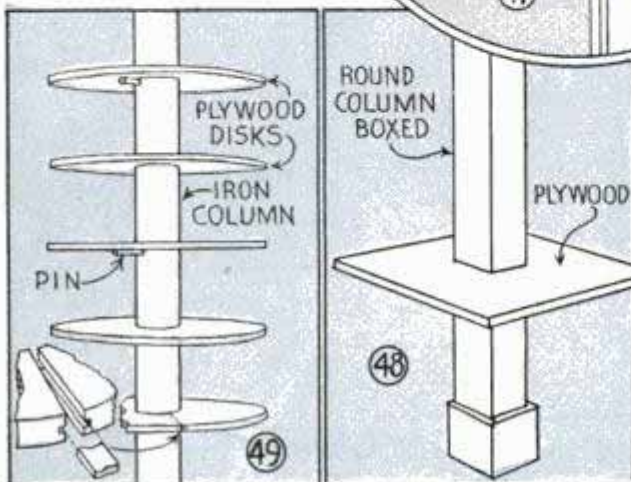

This Scroll Saw for Modelmakers Handles Unusual Work

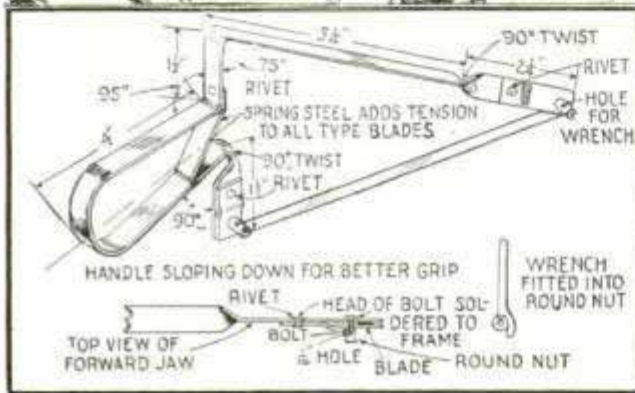

Simple saw frame will hold any type blade from a jeweler's to a hack-saw blade

Holding any type of scroll-saw blade, this light frame is easy to handle, keeps the blade under strong tension and cuts into small places. It is made from a piece of sheet brass $\frac{1}{16}$ by $\frac{1}{2}$ by $24\frac{1}{2}$ in., which is bent to the shape shown and fitted with a piece of spring brass or steel riveted in place between the handles to maintain the tension on the blade.

—S. H. McElroy, Baltimore, Md.

Mask for Mimeograph Stencils Simplifies Typing

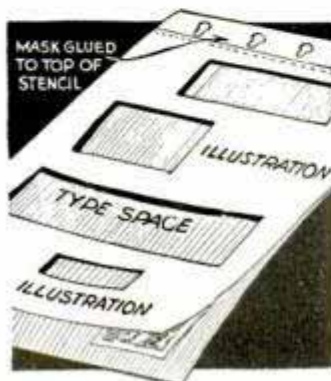

When cutting a mimeograph stencil which is to contain both copy and illustrations, one typist makes up a dummy sheet first and uses it as a mask to assure that the spaces on the stencil are

correctly proportioned. As the illustrations are usually cut first, spaces for the type are cut out of the dummy, which is glued to the top edge of the stencil. The assembly is then slipped into the typewriter and the typing done through the "windows."

Clothespin Film Holder Improved by Common Bank Pin

If you use spring-type clothespins to hold your films while drying, you can further assure a good grip on the negatives by fitting the clothespins with pins as shown. Each clothespin is slipped over the margin of the negative so that the pin puncture will not damage it.

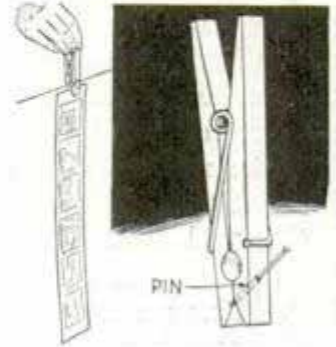

—R. M. Eadie, Granum, Alberta, Can.

Preventing Drill Marks on Work



Slipped over a drill bit as indicated, a short piece of rubber tubing serves as a cushion to prevent the chuck from touching the work and marring it when the drill suddenly

breaks through. This is especially handy when using a brace or a hand drill.

Stove-Lid Lifter from Shoehorn

If you break or misplace your stove-lid lifter, a shoehorn will serve as a substitute until another one can be obtained. It is best to remove the shoehorn from the lid when not needed to prevent it from getting hot.



Midget Oarsman Works This Toy Rowboat

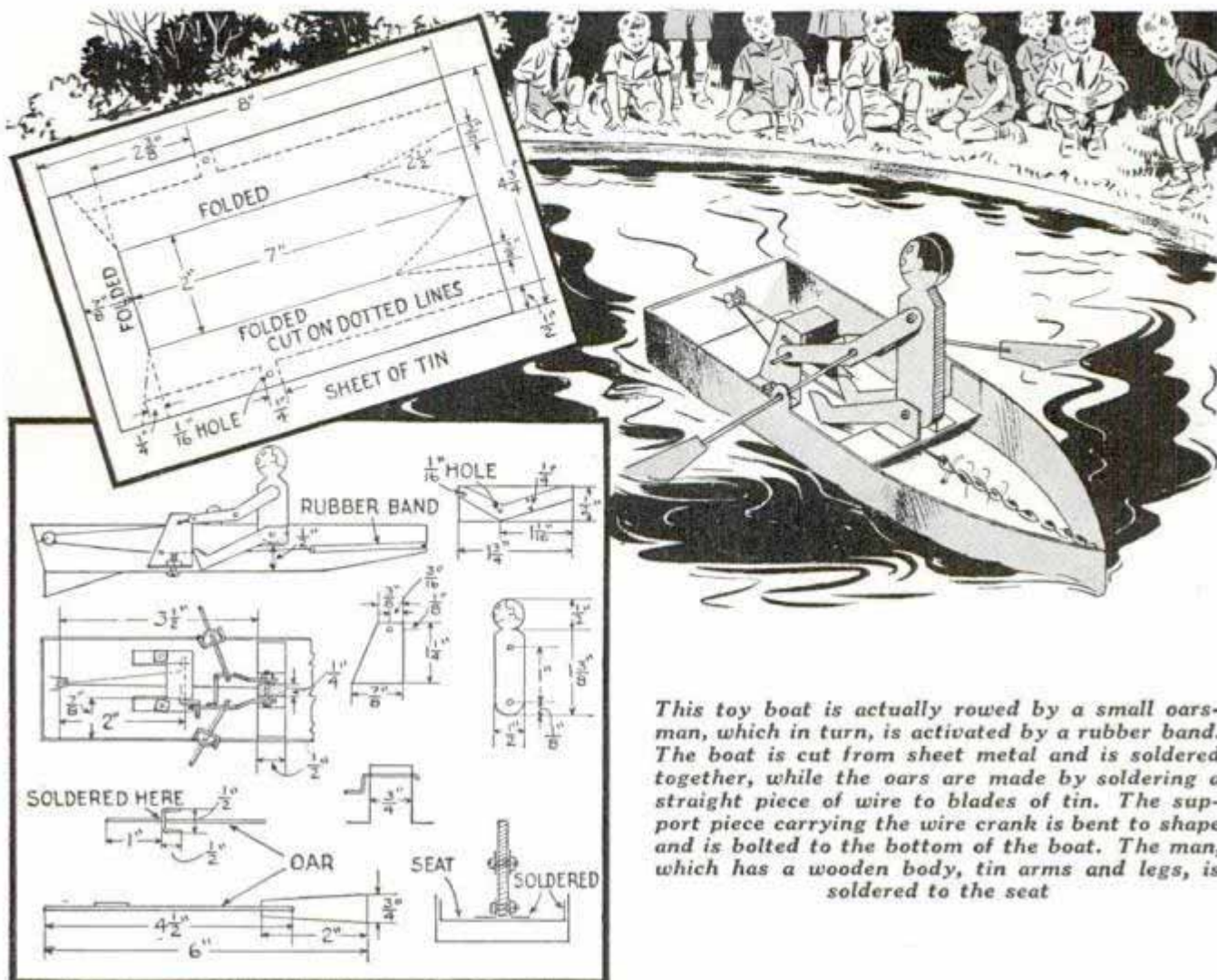

This toy boat is actually rowed by a small oarsman, which in turn, is activated by a rubber band. The boat is cut from sheet metal and is soldered together, while the oars are made by soldering a straight piece of wire to blades of tin. The support piece carrying the wire crank is bent to shape and is bolted to the bottom of the boat. The man, which has a wooden body, tin arms and legs, is soldered to the seat

Finding the Center of Circles Without Rule or Compass

Finding the center of a circle is easy with this simple instrument. It consists of a rectangular sheet of thin, transparent celluloid on which is drawn a right angle in the position shown. Score the lines and ink them so that they are easily seen. Divide the angle in half, locating two 45° points. Then along a line drawn between the points, cut through the celluloid with a sharp knife, guiding it with a straight-edge. Make another cut parallel to the first and cut out the waste, leaving a slot about $\frac{5}{16}$ in. wide. In use, place the instrument over the circle with the right-angle lines tangent to the circle. Then draw a line across the circle, using the long side of the slot as a guide. Shift the instrument 90°, place it in the same relative position and draw a second line which will intersect the first one. The point of intersection is the center of the circle.

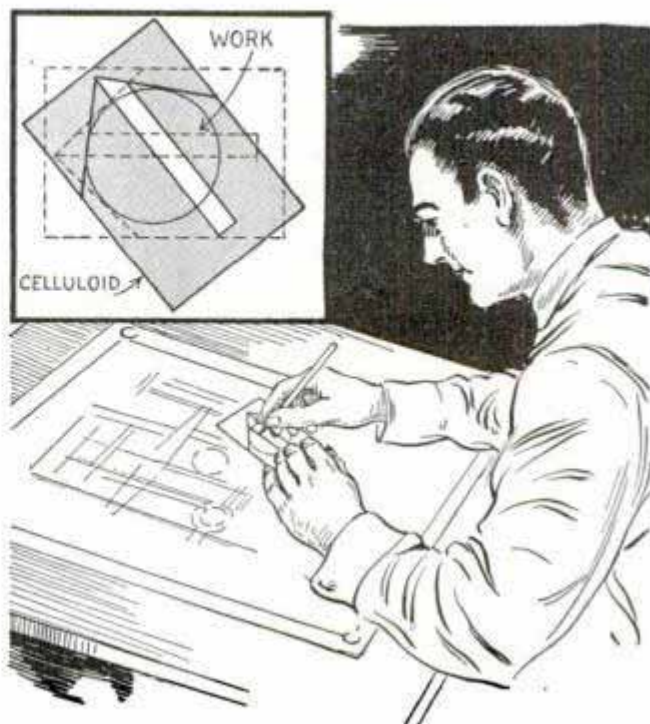

Rubber-Band Gun Shoots Arrow Several Hundred Feet

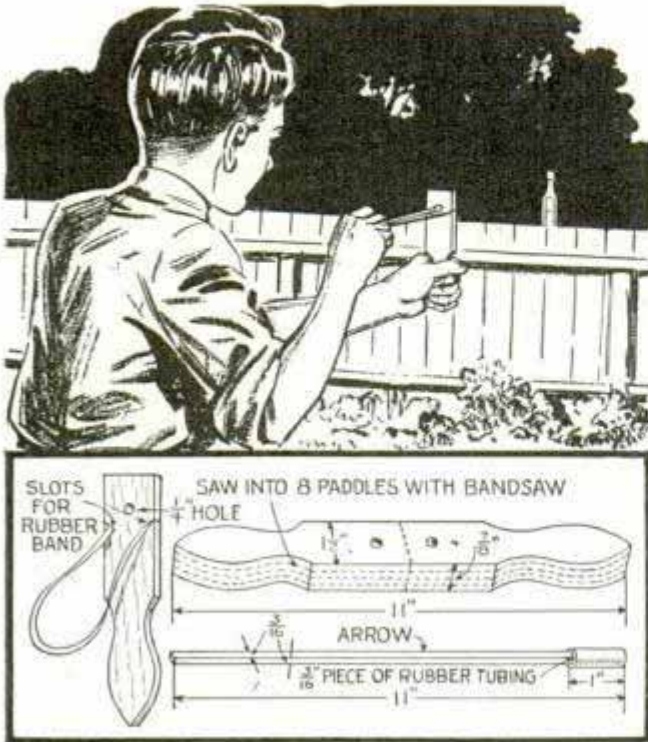

Making these guns in quantities and selling them to merchants offers the craftsman a neat profit

Easily produced in quantities, these guns offer the home craftsman a chance at spare-time profits by making them up and selling them to merchants and manufacturers for prizes with their products. Cutting eight at a time, you can turn out a large number an hour on the average band saw. White pine is used, and a $\frac{7}{8}$ -in. piece 11 in. long is sawed to the shape shown and drilled, after which it is ripped into four $\frac{3}{16}$ -in. strips on the band saw. Then the strips are stacked, the slots for the rubber band made and the stack cut in half. The arrows, which are also 11 in. long, can be sawed out a number at a time by stacking several thicknesses of the stock, and it's merely a matter of seconds to tip them with inch lengths of rubber tubing.—Dale R. Van Horn, Lincoln, Nebr.

"Hold-Fast" Fence-Post Anchor

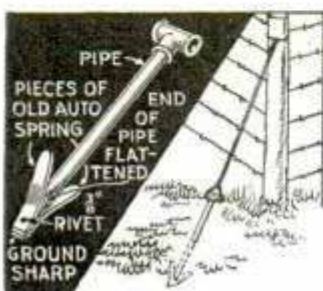

This fence-post anchor is easy to drive and will not slip as the greater the pull against it, the harder the lips or "wings" will bite into the

ground. Made from a length of $\frac{3}{4}$ -in. pipe and a tee, the anchor has the lower end flattened and the lips of old auto spring or heavy flat iron riveted to it as shown.

Pull-Chain Lamp Socket Held on Wooden Arm

A firm mounting for a lamp having a pull-chain socket is obtained by suspending it from a ceiling joist with a wooden arm as shown. A hole slightly less in diameter than the small end of the socket is bored near the lower end of the arm, which is slotted right through the hole. The slot permits the arm to be spread to take the socket, and when released, it grips it securely.

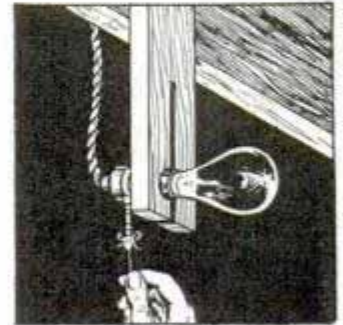

Cutting Crepe-Paper Streamers



When you want a number of crepe-paper streamers, just roll the paper tightly and with a plane iron or similar sharp-edge tool, cut the roll in pieces as indicated.

This should be done on a wood block to avoid damaging the tool.

Fork to Handle Butter Squares

For handling butter squares, this fork has an advantage over the usual table fork in that it drops the square when the grip of the hand is released. The fork is made from a length of spring wire bent to the shape shown with one end pointed and bent at right angles to form a prong, which passes through an eye formed on the other end when the handles are closed.



MOTORBOAT EQUIPMENT *in Portable "Pilot House"*

Clamped to the pilot's seat, it supports the steering wheel, lights and horn. Battery and other accessories are inside

By C. P. FORDYCE

THIS midget "pilot house" and carryall folds up just like a suitcase. In it is contained the equipment required by regulations governing the operation of motorboats—a white light for the transom, a red and green running light, pressure-type motorcycle horn, life-preserver jacket, a fire extinguisher, two copies of the pilot rules, and a steering gear. You have to register your boat to receive an identification letter and number, both of which must be painted on the bows of the craft.

The carryall consists of three separate units

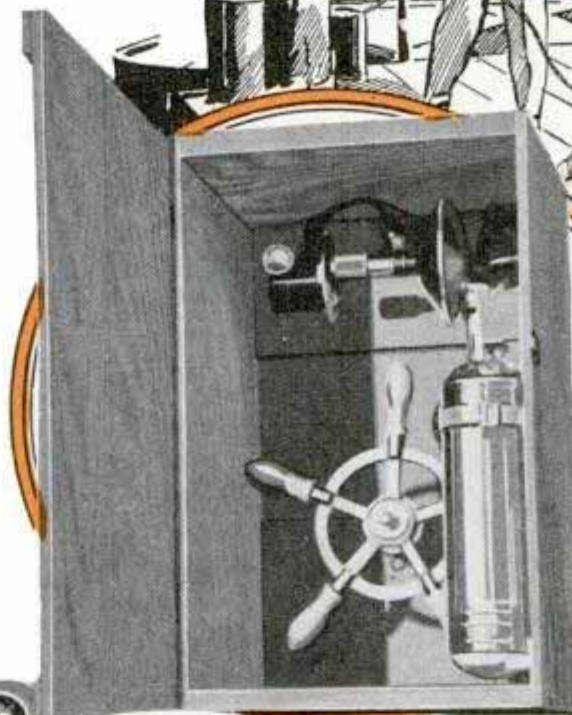
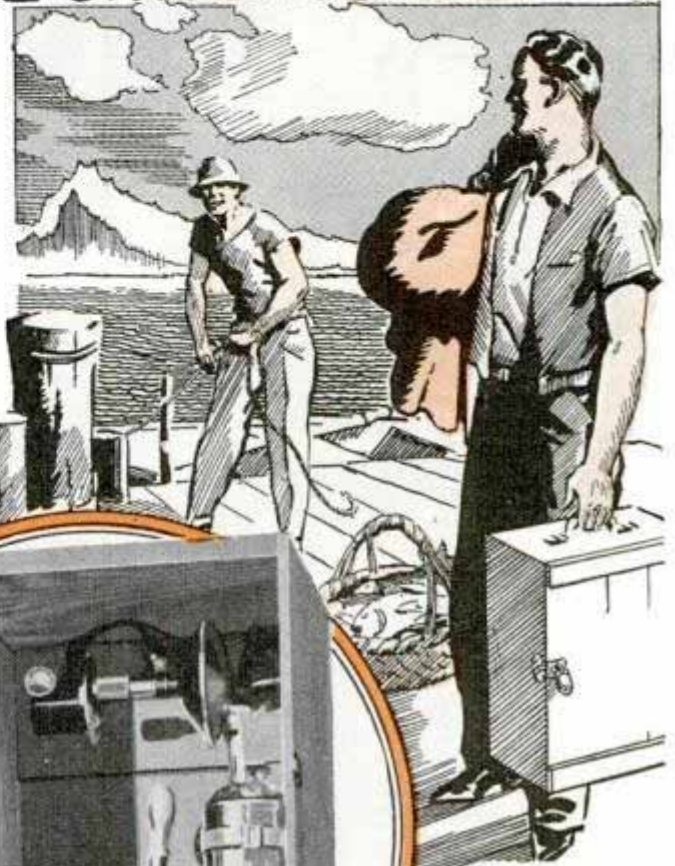

This portable pilot house contains all the necessary equipment. It is carried like a suitcase

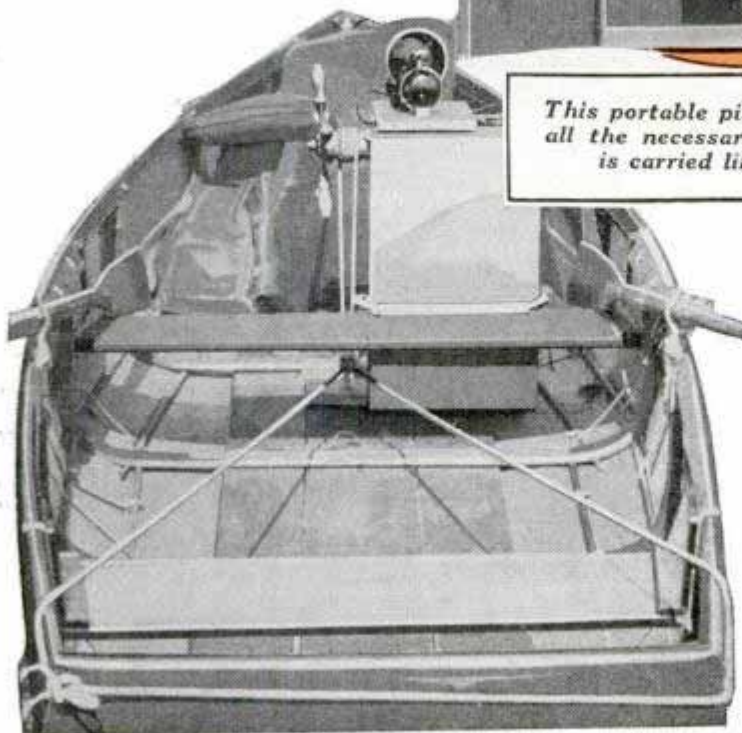

mounted on three small door sections which are hinged to the box. The first door section carries the lighting unit, the second the steering wheel and gear

and the last a pulley unit, as you will see from the illustrations. When the box doors are closed and latched, all units are folded into the box for portability. When opened, the pulley unit is held horizontally by means of a sliding strip. The other two units are brought to a perpendicular position on the top of the box and then the lighting unit is folded over on top of the box, where it is held rigidly with hooks. The one-piece door of

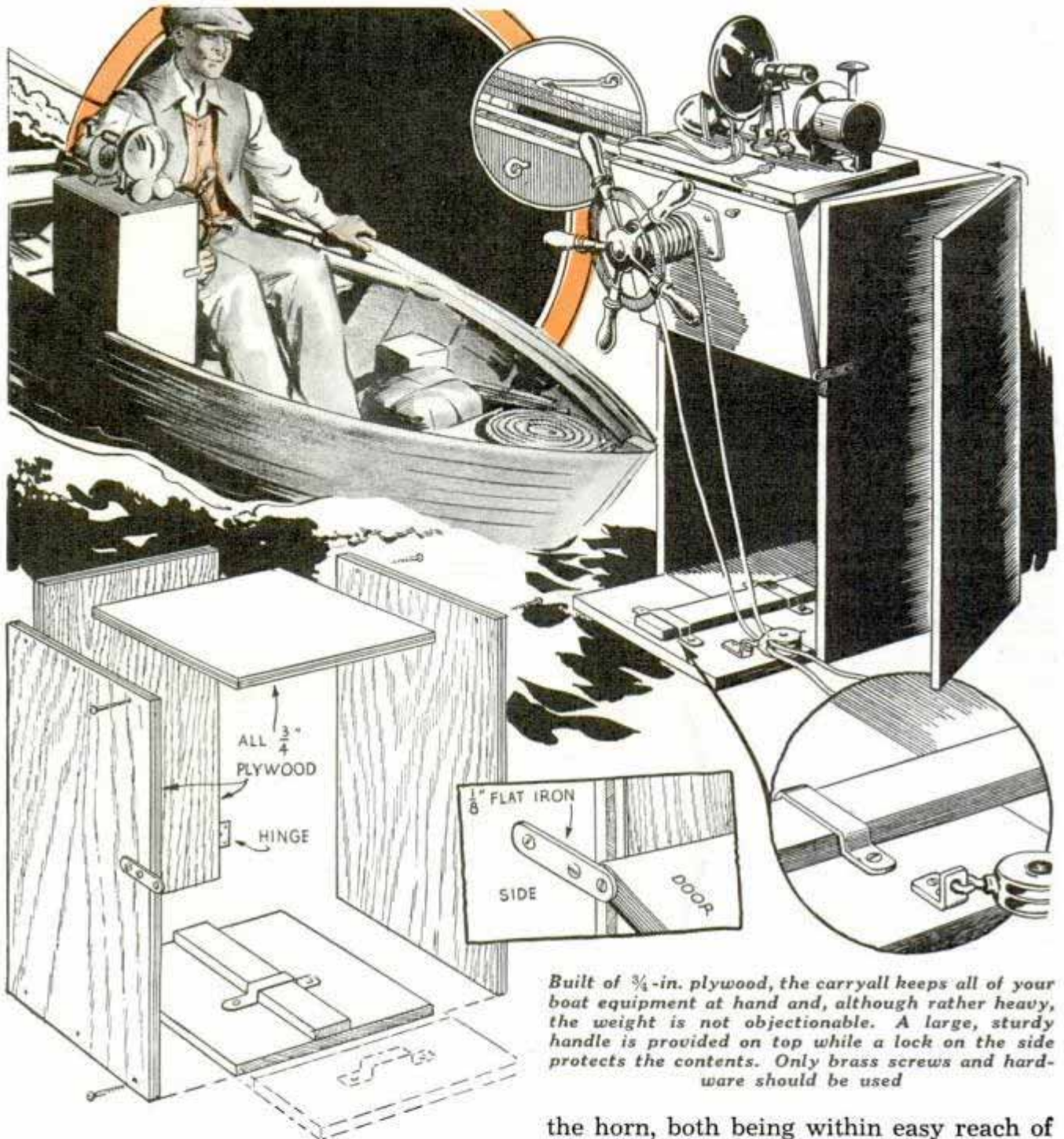

Built of $\frac{3}{4}$ -in. plywood, the carryall keeps all of your boat equipment at hand and, although rather heavy, the weight is not objectionable. A large, sturdy handle is provided on top while a lock on the side protects the contents. Only brass screws and hardware should be used

the opposite side is folded back and set against the front boat seat. A strip 2 in. longer than the door width is clamped to the boat seat, and, with other clamps, to the box door. Thus the arrangement can be used with seats of varying height.

The lighting unit consists of the combination lamps showing green to starboard and red to port, and is so placed that it throws the light from directly ahead to two points abaft the beam. Wires from the lamps are run to a 6-volt dry-cell battery or a small 6-volt storage battery contained in the box. There is room behind the lights for a small auto-type spotlight and

the horn, both being within easy reach of the steersman. The former is not a specified item, but is really essential for safe night cruising. The steering gear is mounted on the center door, as you see it in the illustrations. The cables run to a double swivel pulley on the lower door, which is held against the floor of the boat by the sliding strip. From here the cables run directly back to the motor, or you can run them through an extra set of swivel pulleys placed so that the lines will be parallel to the sides of the boat back of the seat. Even though you make the carryall of sufficient size to accommodate one or two life-preserver jackets and a 2-gal. can of fuel, its weight will not be objectionable.

Built-In Kitchen Clock Uses Wall for Dial

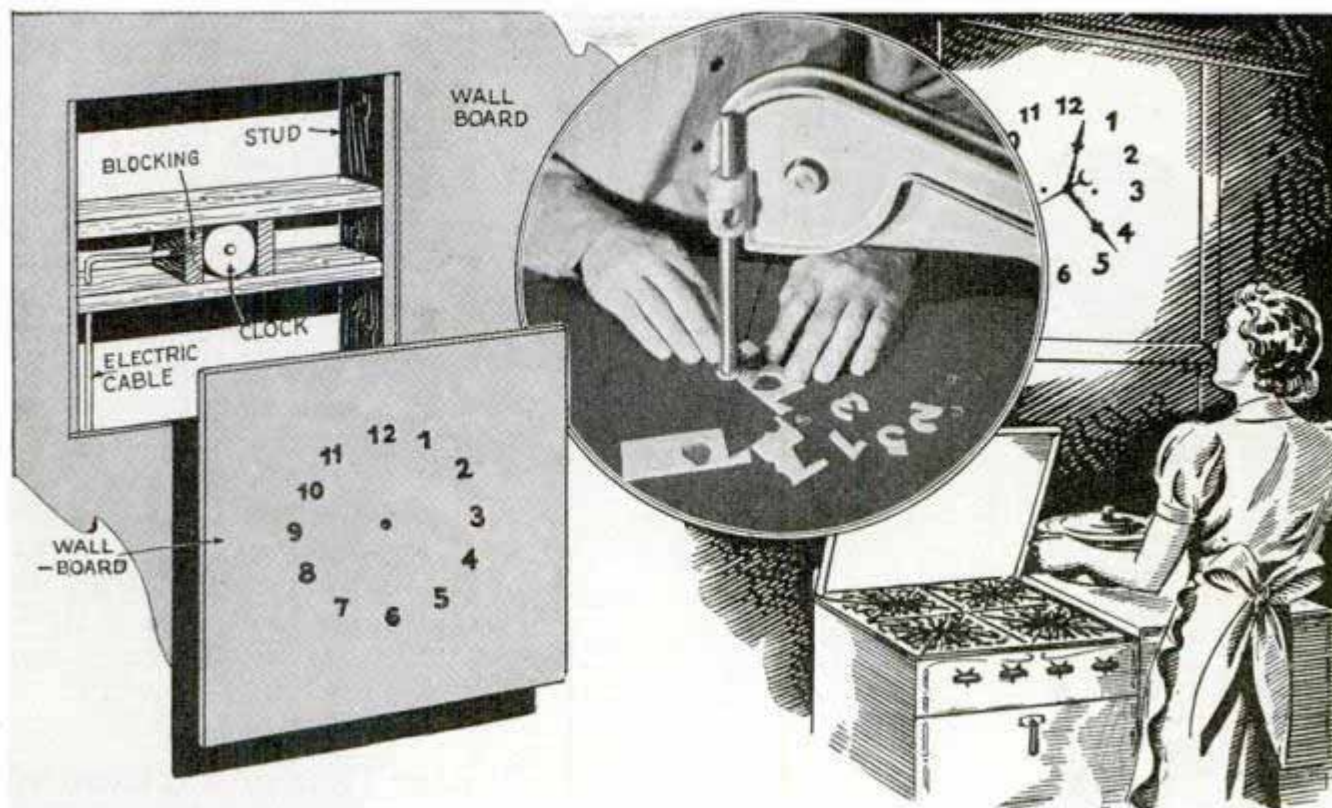

Without the dial, the electric movement for this built-in kitchen clock costs no more than the ordinary alarm clock. There's no case to make—only the numerals and the dial

It's built in the wall between the studs just as you install a medicine cabinet. The electric movement is of the type allowing the use of dials up to $\frac{1}{2}$ in. thick, the hands being large enough to reach a minute circle 10 or 12 in. in diameter. To install the movement you cut a square opening between the studs, nail in two horizontal strips the same width as the studs

and then fit the movement between two small blocks as shown. Numerals can be cut from thin plywood or $\frac{1}{32}$ -in. sheet brass and fastened to the wallboard face with glue or small brads clinched on the back. After assembling with the face and hands in place, a molding will finish up the job nicely.

—D. C. Marshall, Manhattan, Kans.

How to Make Your T-Square Adjustable for Slant Lettering

Here is a simple method of fitting your T-square with an angle adjustment, which will aid in making slant lettering and similar work. The attachment consists of two narrow brass strips hinged together at one end. You can follow the construction indicated or use a hinge from a broken folding rule. One strip is screwed to the edge of the square while the other is fitted with a curved arm, which slides through a simple locking device fastened to the head of the square. The arm is graduated so that adjustment for any desired angle may be obtained, and the thumbscrew on the locking unit is then turned tight.

—Paul H. Smith, Charlestown, Mass.

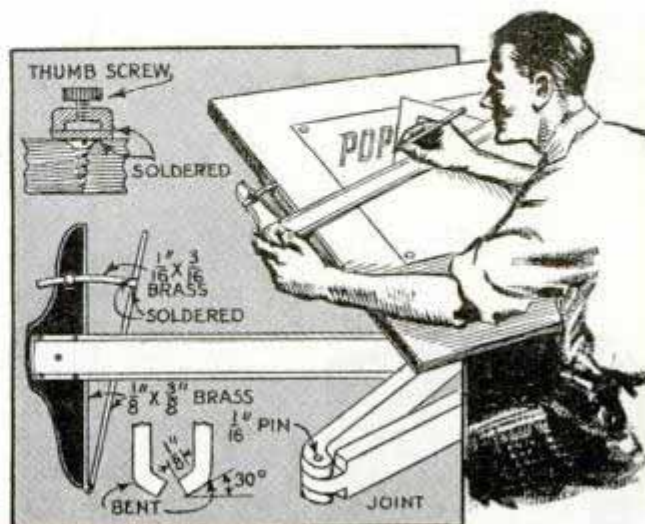

Screwed to the head of a T-square, this homemade attachment permits setting at any angle

This Reel Enables Knitters to Wind Yarn Single-Handed

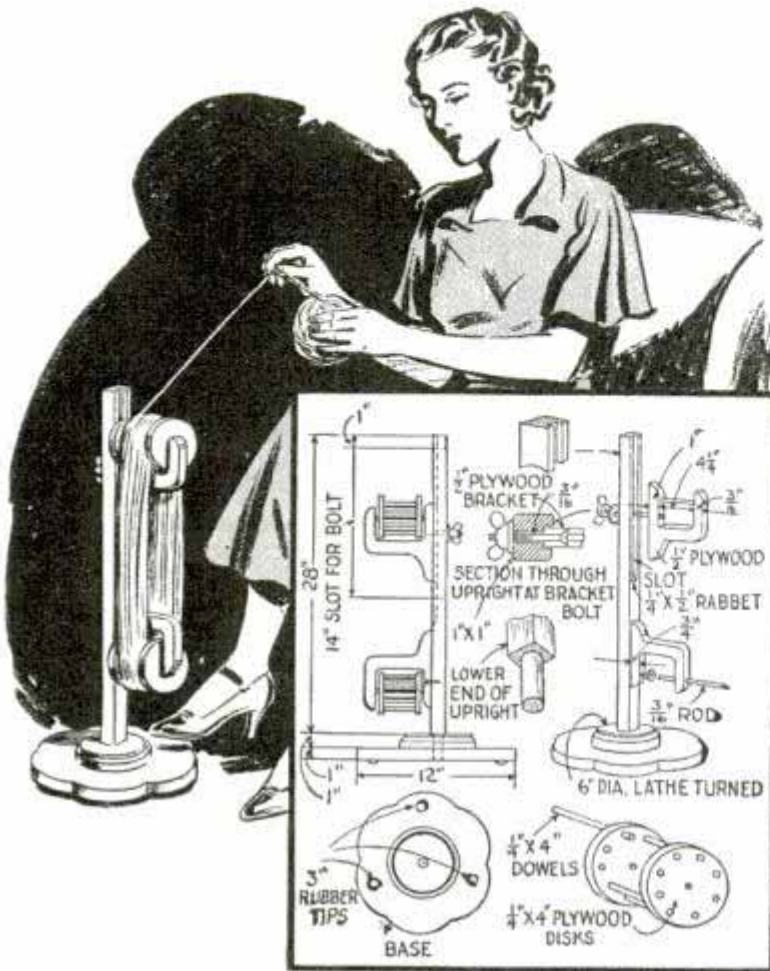

With this adjustable reel, you can wind skeins of yarn into balls quickly and easily

With its adjustable top roller to accommodate skeins of different sizes, this sturdy yarn reel eliminates the necessity of a second person holding the skein over the hand while it is being wound into a ball. The reel has a base of 1-in. pine and a 1 by 1-in. standard, recessed to form a track for the sliding bracket, and slotted for the bracket bolt to permit adjustment. Both brackets, which are made of 1/2-in. plywood, are identical except that the upper one is 1/4 in. wider than the lower one.

Coffee Absorbs Cooking Odors



Placed on a lid inverted over a kettle in which cabbage, cauliflower or similar vegetables are being cooked, a tablespoonful of freshly ground

coffee will absorb the odors to a certain extent. The lid should be set slightly to one side so the steam will tend to curl over the coffee.

Cleaning Dirty Hairbrush

When the bristles of a hairbrush become soft and lifeless, they may be partially restored to their original condition by cleaning them well and dipping them in cold water to which a small amount of alum has been added. To clean a brush, swish the bristles through clean water to which a little baking soda has been added. Do not use soap or hot water and be careful not to wet the back of the brush. Then rinse it thoroughly, shake it vigorously and dry with the bristles down.

Wafer Thermostat Control for Electrical Devices

For operating electrically heated brooders and similar devices where changes in temperature is the controlling factor, a sensitive thermostat can be made from a cheap wafer thermostat and the vibrating points from an old Ford coil. The thermostat has two adjustments, a coarse one obtained by raising or lowering the wafer with a stove bolt which attaches it to a supporting arm, and a fine one obtained by the regular adjustment on the points.

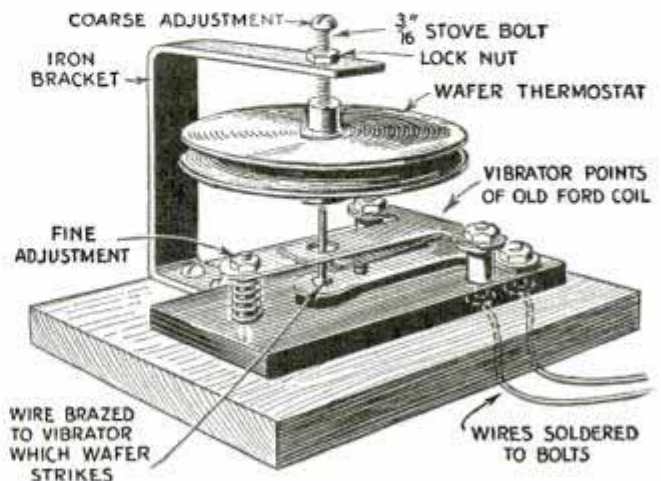

A slight change in temperature causes this thermostat to open or close an electrical circuit

Dog Racing Sulky Fitted with Balloon Tires

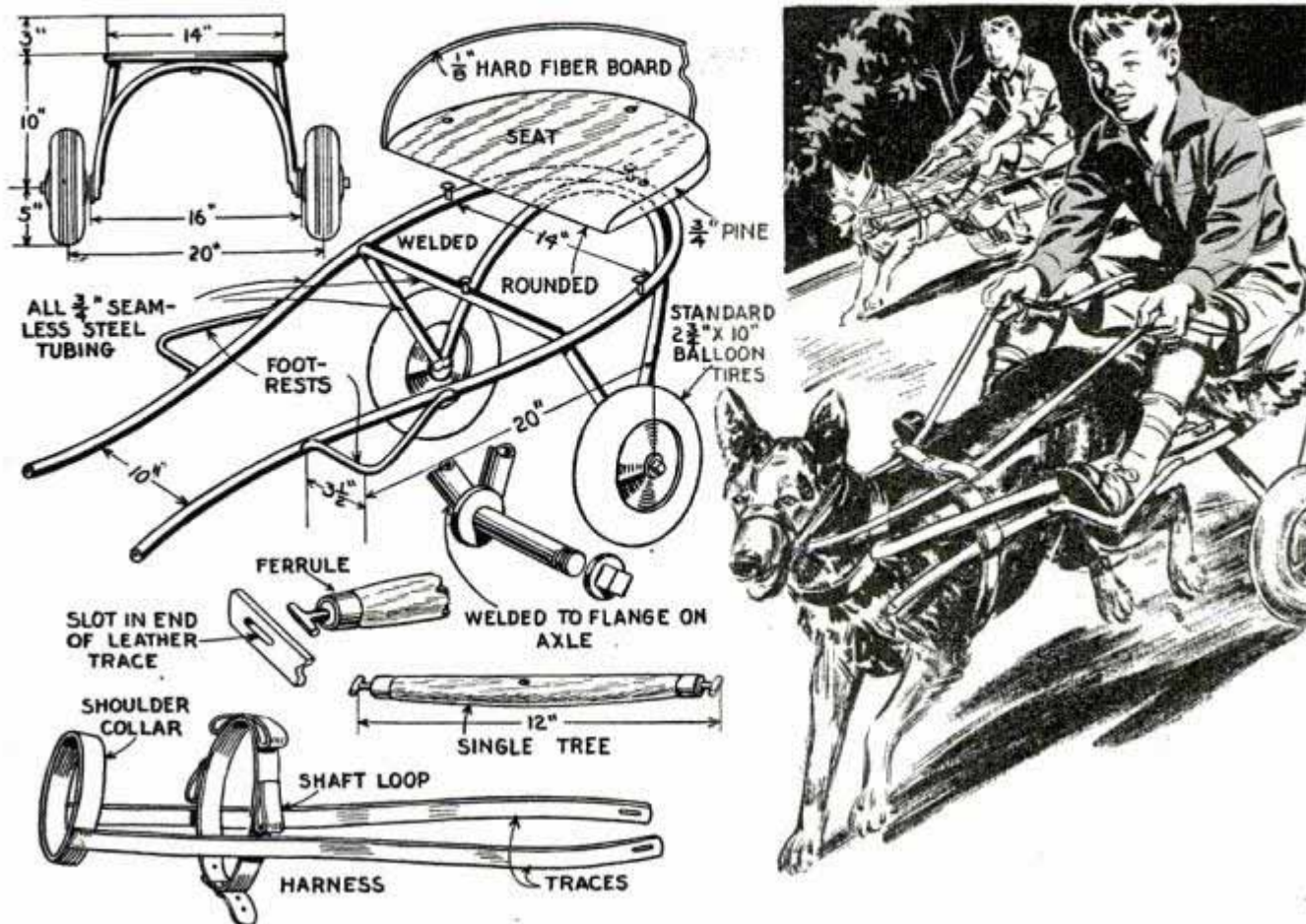

Light and strong, this sulky is easy to make from seamless steel tubing, which is heated with a blowtorch and bent in a vise. Any garage having welding equipment will do the job of joining the parts at a nominal charge. Although the dimensions given were suitable for a police dog, the shafts and harness should be adapted to the size of the dog. Balloon-tired wheels fitted with ball bearings give a smooth ride and, as the seat is placed a trifle behind the center of the wheels, the animal carries very little of the driver's weight. A singletree is important as it allows the tugs to move back and forth as the dog runs without chafing his chest.

Tears in Cushions Sewed so That Threads Won't Pull Out

When an upholstered spring cushion has a tear and the fabric is pulled apart by the under-padding so that it is difficult to close neatly, try the following method of repairing it: First make long stitches across the opening. Then pull them up, gradually drawing the torn edges of the cloth together. When the edges overlap slightly, sew them together with thread that matches the cloth, taking neat, small stitches, close together, as in the lower detail, after which the long stitches are removed.—G. E. Hendrickson, Argyle, Wis.

Water stains on glass pitchers, vases and aquariums usually can be removed by rubbing them vigorously with a piece of freshly cut potato or a cloth which has been moistened with potato juice.



Sawhorse with Heavy Iron Base Does Not Tip Easily



Two lengths of pipe, two floor flanges, an auto cylinder head and a plank make this sawhorse

Needing some sawhorses that would not tip or move easily, one mechanic made them as shown. The bases are old auto cylinder heads and the standards are lengths of pipe attached to the 2 by 4-in. cross members with floor flanges. The standards are set in the spark-plug holes in the cylinder heads and, if desired, can be threaded to screw into them.

Pickling Jar Has Spring Lid to Keep Contents in Brine

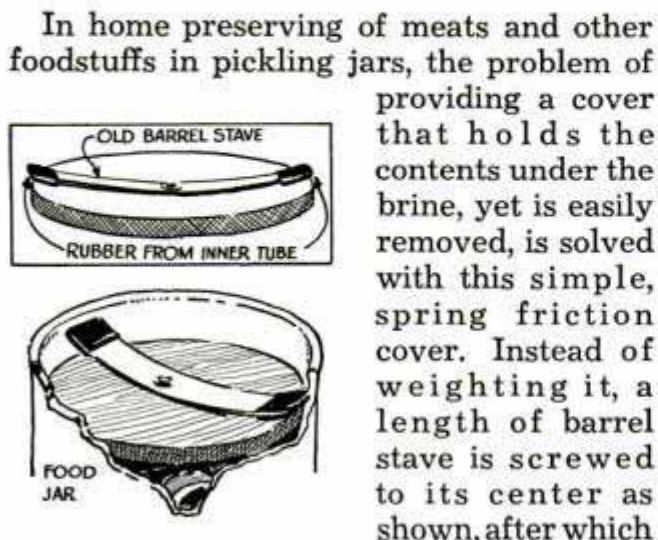

strips of inner tube are fastened over the ends. When the cover is pressed down,

providing a cover that holds the contents under the brine, yet is easily removed, is solved with this simple, spring friction cover. Instead of weighting it, a length of barrel stave is screwed to its center as shown, after which

friction between the jar sides and the rubber will hold the cover firmly. A light pull on the ends of the stave releases it.

Vacuum-Cleaner Nozzle Shielded to Protect Furniture

To prevent accidentally marring your furniture with the vacuum-cleaner nozzle, shield it with rubber. A neat job can be done by using the rubber from an old inner tube if it is carefully cut to shape. Rubber cement is applied to the rubber and the metal, and when nearly dry the two are pressed together.



Vest-Pocket Wire Cutter Is Made from Hacksaw Blade

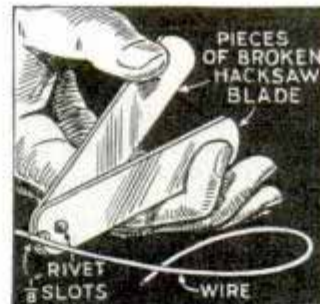

Handy for electricians or those whose work requires the handling of wire, this little cutter is made from two 3-in. lengths of an old hacksaw blade and can be carried

in the pocket or on a key ring. Sharp edges of the blade should be ground smooth and the rivet should be drawn up snugly to get a good cutting action.

Drawing-Knife Shield of Wood

It takes only a few minutes to make this V-shaped trough of light plywood to protect the edge of your drawing knife when it is carried in a box with other tools. The knife is kept in the shield by a sliding top, which works in grooves cut in the sides.



Footstool Has Three-Way Column of Dowels

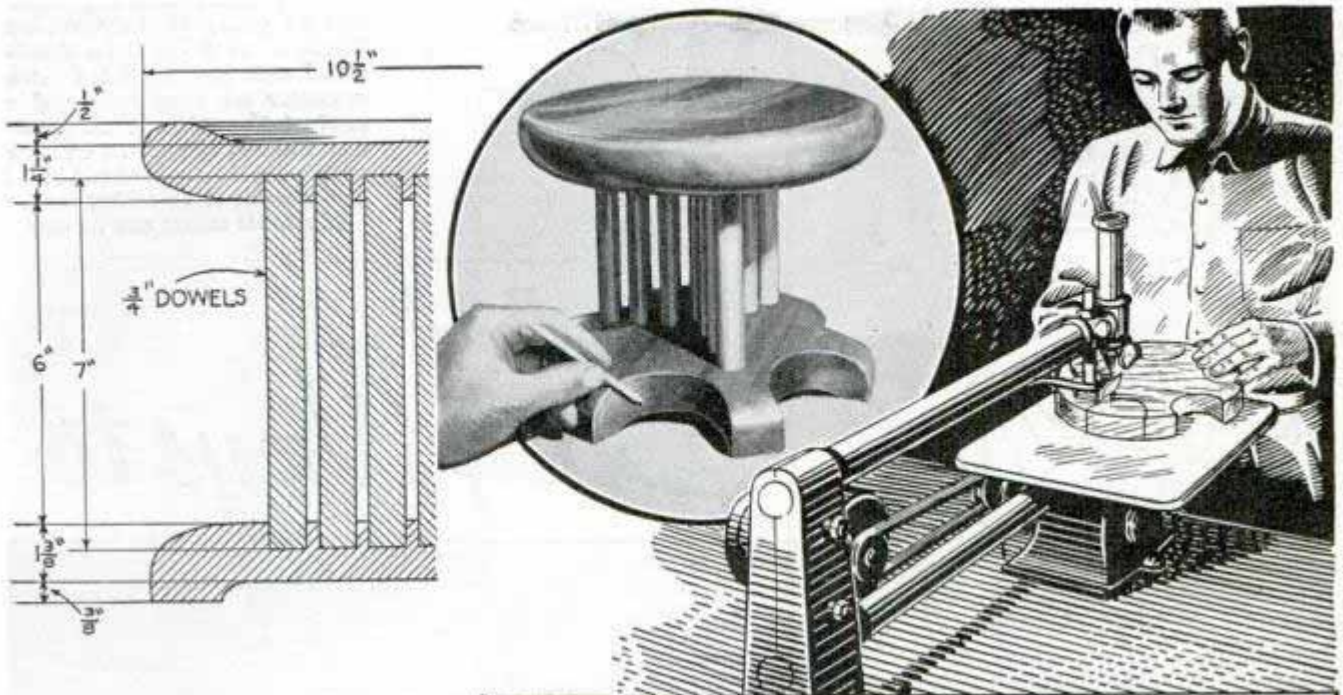

A turned and scalloped base and a "dished" or bowl-shaped top supported on a column made of dowels—that's all there is to it. You can make the base with scalloped edges as shown or a duplicate of the top so that the stool can be used either side up. With the index head on your lathe it's easy to lay out holes for the supporting dowels

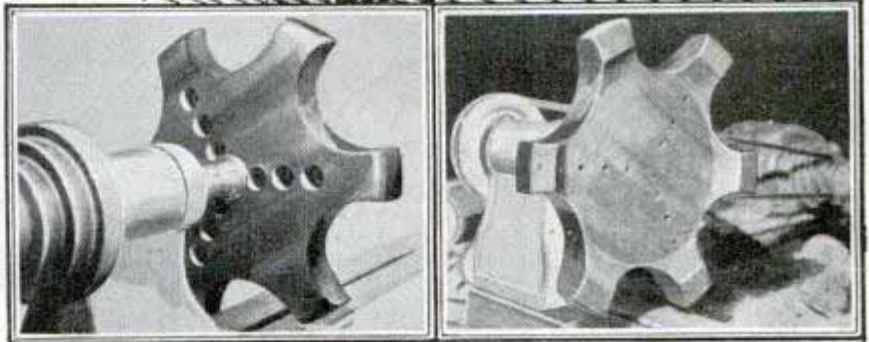

Large Aquarium Formed by Removing Top of Glass Jug

This aquarium is easily made by cutting off the top of a large glass jug and fitting a chromium-plated rim over the edge. Select a bottle with clear glass and fill it nearly to the shoulder with cold water. Wrap a strip of tape around the bottle with its lower edge opposite the water line. Carefully score the glass along the top edge of the tape with a glass cutter, or small three-cornered file. Then tie a string soaked in kerosene just above the score, tightly, and ignite it in three or four places, which will cause the glass to break along the scored line. The rough edge is smoothed with an emery stone or fine file. An attractive rim consists of copper tubing soldered to a brass or copper band, which is then chromium-plated. The edge of the band should be beveled where it joins the tubing, which should be bent to shape before attaching it.



Put washed sand in the bottom of the aquarium along with colored rocks and water plant

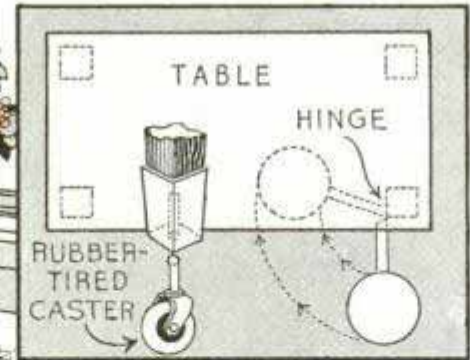

This simple, one-leg stool saves space in a crowded kitchen. A 2 by 2-in. hardwood standard is fitted with a caster at one end and a seat at the other. Two hardwood arms, hinged to one leg of the table, support the stool and permit it to swing under the table when not in use

Stool swings under table

Easy Ways to

To relieve the strain of gripping a heavy cleaver, which may tire your hands in a short time, with the risk of having it slip, fasten a strap or a strip of rubber to the lower edge of the handle as shown in the circular insert. Below, a simple wire holder to keep a spoon from falling into the kettle of hot preserves, or any other preparations that require frequent stirring

Cleaver won't slip



LARGE SAFETY-PINS

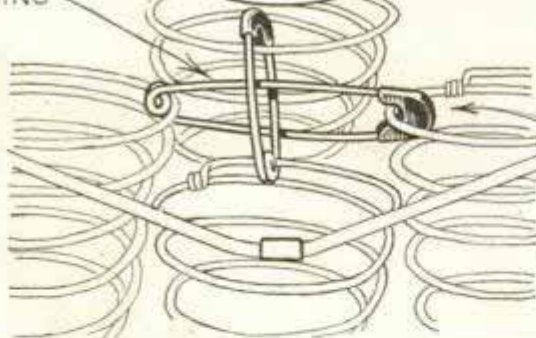

HEAVY WIRE

Repairing seat springs



Strong safety pins offer a means of quickly relocating springs that have slipped out of place in a car seat or a piece of upholstered furniture. The pins should be just long enough to reach from coil to coil when the latter have been located in their original positions. Right, two scrubbing brushes, one with stiff bristles and one with medium stiff ones, fastened to a washboard with brass screws, are always at hand to aid in removing stubborn spots from clothes. Just apply soap to the spot and then rub it briskly over the bristles of the brush most suited to the job



Brushes help remove spots

Putty softened with lacquer

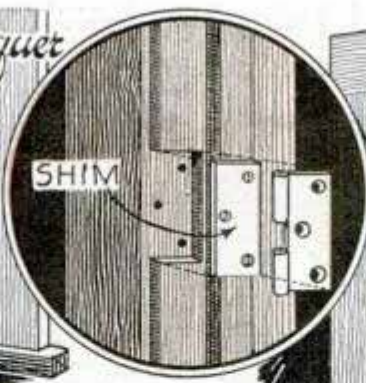
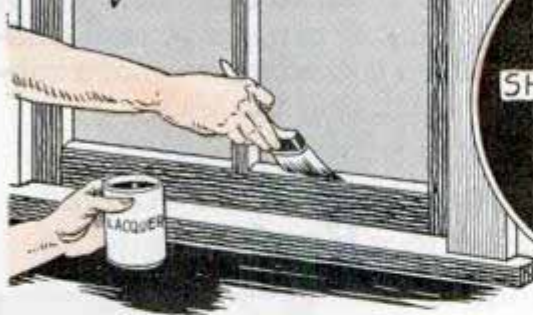

Shrunken door fitted by shimming hinges



Solve Your

HOME PROBLEMS

Above, hardened putty is easy to remove from a windowpane if you first apply lacquer which will soften the putty in a short time. When a door lock fails to engage the striker plate due to lateral shrinkage of the door, the trouble is overcome by shimming up the hinges

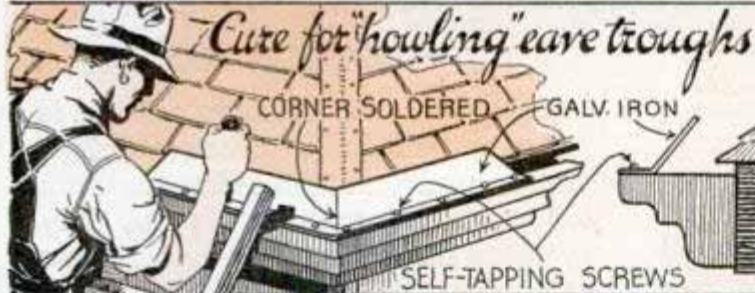

Cure for "howling" eave troughs

CORNER SOLDERED GALV. IRON
SELF-TAPPING SCREWS

Strips of sheet metal, screwed to the edges of eave troughs at the corners and bent upward, will deflect wind, which vibrates them and causes howling noise. Below, a simple arrangement to open a coal-bin window from the door. The spring and pivoted latch arms are mounted on the sash, while the latch brackets or hooks are screwed to the window frame. Lower right, false fireplace that has become gloomy with age given a cheerful look by concealing the opening behind a cloth-backed grille

Remote control on coal-bin window

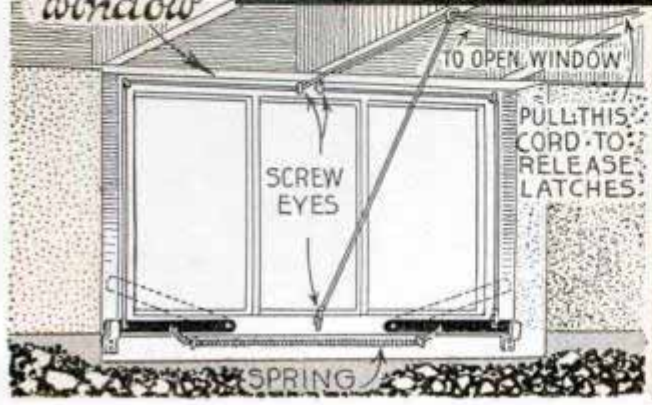

Linseed oil preserves sash cord

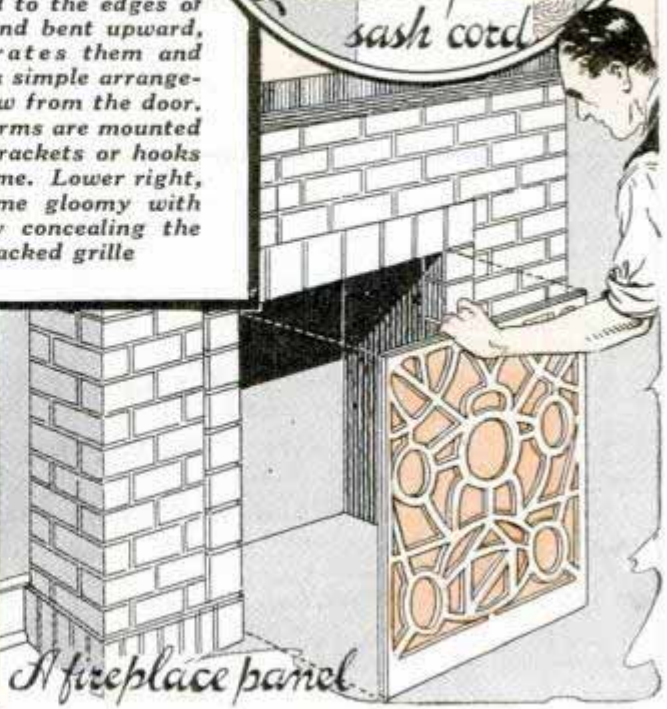

A fireplace panel

Holder Keeps Ink Bottle Upright on Tilted Drawing Board

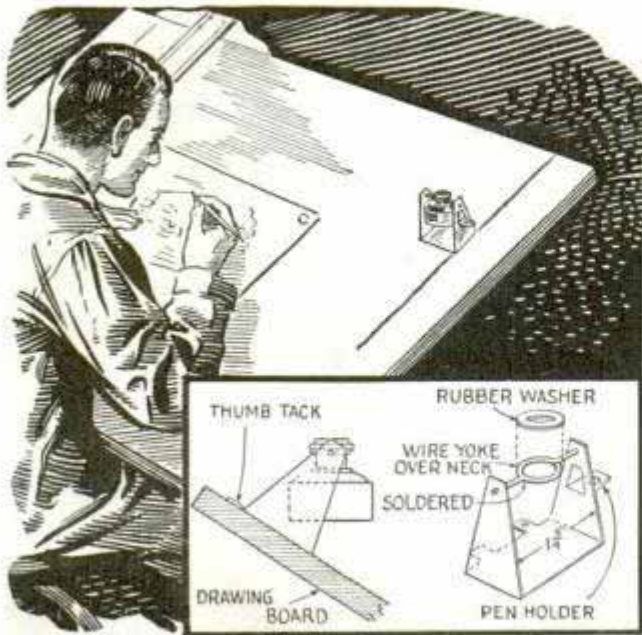

Keeping the ink bottle upright, regardless of the tilt of your drawing board, this holder can be mounted close at hand. A wire yoke, swinging in a sheet-metal holder, supports the bottle by means of a rubber washer fitted over the neck.

Dome Glide on Screwdriver Reduces Hand Fatigue

To reduce the tendency of a screwdriver to tire and roughen the palm of his hand, one carpenter fastened a large dome furniture glide to the end of the handle.



Streamline Trailer Built With Hand Tools

You can tour with all the comforts of home in this 15-ft. family trailer containing a cookstove, sink, icebox, electric lights, closets, and sleeping accommodations for four. If interested, send \$1.00 for blueprints 937 to 942 giving complete details



Streamline Family Trailer—937 to 942

BOATS YOU CAN BUILD

- "Roamer"—765 to 770: 16-ft. outboard cabin cruiser; two berths. Six prints \$1.00.
- "Sea Saucer"—893: 9½-ft. sail boat. Deck, bottom and sides are 3/16-in. plywood. 25c.
- 17-Ft. Kayak—928 and 929: Light framework covered with canvas. Two prints 50c.
- 12-Ft. Utility Rowboat—707: Flat bottom. Four seats. Sturdy design. 25c.
- 16-Ft. Canoe—811 and 812: Cedar planking covered with canvas. Two prints 50c.
- "Arrowhead" Sloop—944 to 951: Fast sailboat 21 ft. long, 5 ft. 11 in. beam. Set of 8 prints \$1.50.

Address Blueprint Dept., Popular Mechanics Magazine, 200 East Ontario, Chicago

1937 "WHAT TO MAKE"

This 96-page Craftsman's Guide is just crammed full of practical information and valuable reference data for workshop owners. It not only suggests hundreds of items that you can make, but also tells where to purchase hard-to-get supplies. Will be sent postpaid on receipt of 15c, in U. S. stamps or money order.



X487



PLASTIC ORNAMENTS

cast in flexible molds

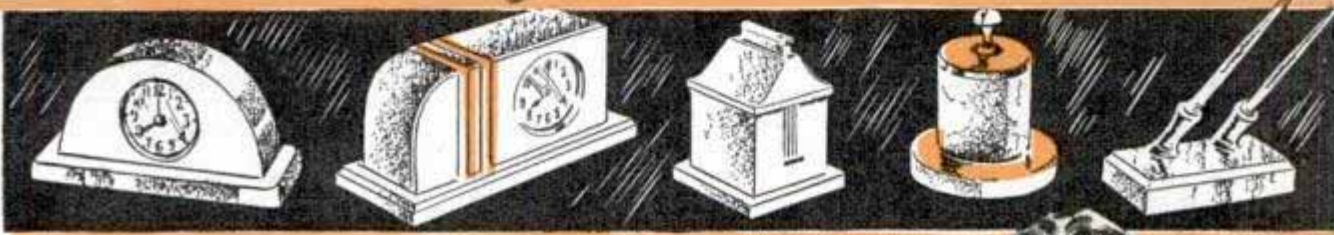

Hot glue poured over a paraffined wood pattern becomes a flexible mold for numerous castings

By C. A. CROWLEY

PLASTIC objects can be made readily by a simple casting process, using flexible glue molds. Besides plaster of paris, imitation marble compositions, including magnesite cement in colors, can be used as the plastic material.

A pattern is first made of wood corresponding in dimensions to the object to be cast. To illustrate the process, the procedure for making a small clock case is shown in successive steps. The hollowed-out portion which is to receive the movement in the finished case should not be cut out. This is formed by a core which is an exact duplicate of the size opening required for the movement. The core is turned from hardwood and is given a slight taper to facilitate removal from the mold and finished casting. Patterns of both the case and core are immersed for 5 min. in melted paraffin to prevent adhesion of the various materials used in making the mold. Excess paraffin is wiped off immediately.

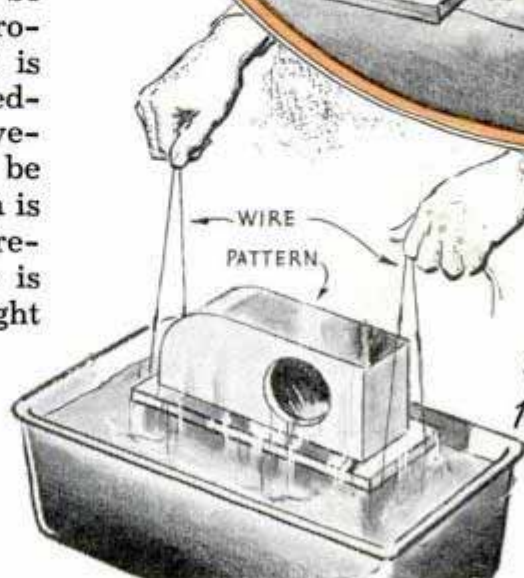

and dip it in melted paraffin

*Chicago
159 W. Kinzie
D. Wagner & Co.
Milliners*

Then follow these successive steps

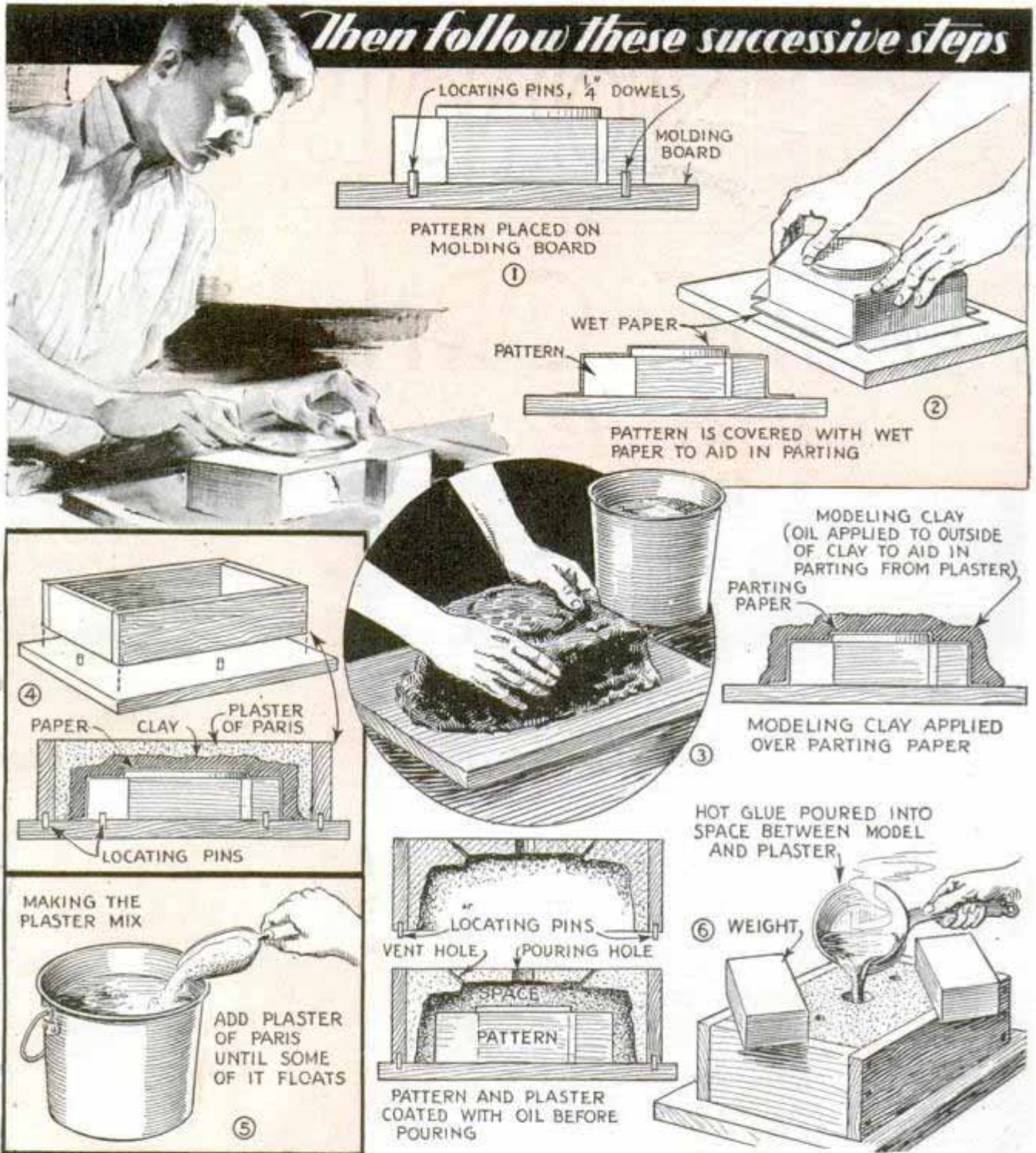

Now, beginning with the molding process, the pattern is placed on a board with locating dowel pins as in Fig. 1. Then in Fig. 2 the pattern is covered with two or three layers of newspaper soaked in soapy water. While the paper is moist, a layer of modeling clay is pressed over the pattern as in Fig. 3. Remember that the glue mold will be the same thickness as the clay coating. On a small clock case this should be about $\frac{1}{2}$ in. Finally, the clay is wiped with medium-heavy lubricating oil. Next a wood box is made, open at the top and bottom, and the inside measurements

about 1 in. larger each way than the pattern with the clay covering. Like the pattern, the box is pinned to the molding board, Fig. 4. Inside and bottom edges are coated with oil and a few small nails are driven through the sides and ends of the box near the top edges to project inside. Plaster of Paris mixed in water as directed in Fig. 5 and stirred thoroughly, is scooped into the box, avoiding air bubbles. When the plaster is dry, vent and pouring holes are drilled as in Fig. 6. Then the box with the plaster is lifted off the pattern, the clay and newspaper are removed, and the

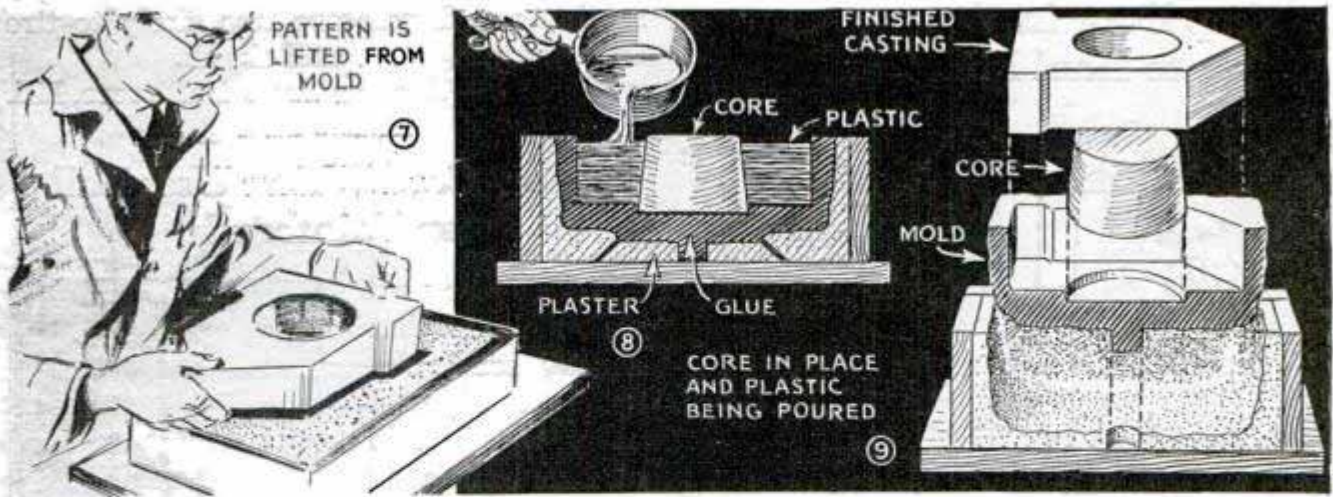

pattern is coated with oil. The box or "flask" is replaced and weighted, ready for pouring glue as in Fig. 6. To prepare the latter, flake glue is soaked 15 min. in cold water, then the excess water is poured off and the glue is melted in an improvised double boiler. After preparing, the glue should be poured into the mold in a warm room, the temperature not less than 72° F. Clay is used to stop glue leaks. The glue is allowed to harden in the mold for 12 to 15 hrs. after which the box is lifted from the molding board and the pattern is loosened by applying light pressure to the glue at the pouring hole, permitting the pattern to be lifted out as in Fig. 7. The oil is wiped from the glue mold and the latter is waterproofed by painting it with two coats of an alum solution or formaldehyde. It is then re-oiled, and the oiled wood core is set back in place, large end down. Now you're ready to pour the casting as in Figs. 8 and 9.

White magnesite molding compound is made by mixing dry the following ingredients: powdered calcined magnesite, 2½ lbs., white talc, 1 lb., fine sawdust or wood flour, 2 pts. To produce colors you can add burnt umber (brown), copper chromate (light green), copper carbonate (dark green), yellow ocher (yellow), cobalt oxide (blue), and carbon black (black or grey). Then a wetting solution is prepared. This consists of magnesium chloride solution (25° Be.) 10 pts., and magnesium sulphate solution (15° Be.) 1 pt. The mixed solution is strained through a piece of cheesecloth and enough of it is added to the dry powders to produce a consistency equivalent to ordinary pancake batter. Then the mix is poured into the mold immediately. After the finished

castings have been removed from mold and allowed to "age" for 36 hrs., the "bloom" may be removed by washing in tepid water and wiping the surface dry with a piece of soft cloth. To produce a final finish, the surface is rubbed thoroughly with moistened pumice stone, wiped dry and painted with boiled linseed oil. Molding can be done also with cement. A dry mix is made from Portland cement, 1 pt., and fine sand, 2½ pts. After thoroughly mixed, enough water is added to produce a mixture of about the consistency of cream. Portland cement requires about 12 hrs. for complete hardening.

Shop-Machine Bases Insulated Against Vibration

You'll find asphaltum a good substitute for cork and other expensive materials when cushioning the concrete base of heavy shop machines against transmitting vibration to the floor. First pour melted asphaltum to a depth of 1½ in., allow it to cool and then pour the concrete. When the forms are removed, the asphaltum can be poured around the sides of the base.

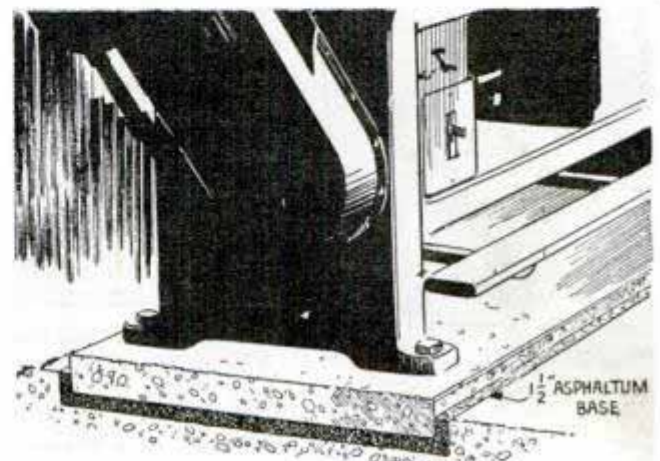

Trap Door in Wheelbarrow to Haul Milk Can



Milk can rests in hole of wheelbarrow floor to lower center of gravity of the load

After upsetting a can of cream, which was being hauled to a cooling cellar in a wheelbarrow, one farmer cut a trap door in the floor of the wheelbarrow so that the can could be set in it to lower the center of gravity of the load. The cut-out section of the floor was hinged so that it could be dropped back in place, and a steel bracket was suspended beneath the wheelbarrow to hold the can.

Rubber Hose on Star-Drill Shank Gives Shock-Absorbing Grip

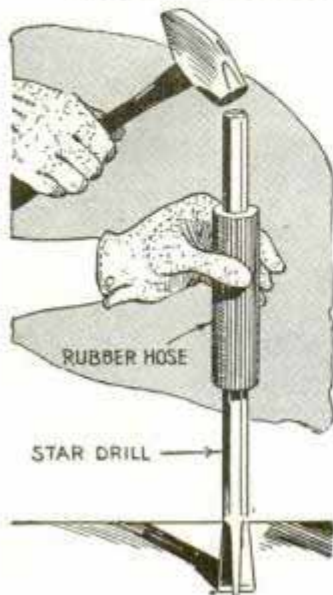

Slipped over the shank of a star drill, a short length of corrugated rubber hose provides a grip that not only tends to absorb shocks to the hand from the hammer blows, but one that assists the fingers in turning the drill. Also, the rubber affords a larger grip on small drills

so that the fingers are less likely to tire from gripping the small shank.

—Thomas Trail, Baltimore, Md.

Show-Card Writer Uses Ball on Paintbrush

A show-card writer claims that a small, solid rubber ball slipped over the handle of his brush as shown, enables him to work for long periods without undue hand strain from gripping the brush handle as the ball provides a large surface for the hand to grip. It's an easy matter to punch a hole through the center of the ball so it can be slipped on and off.



Studs Held Against Doorstop When Toenailing

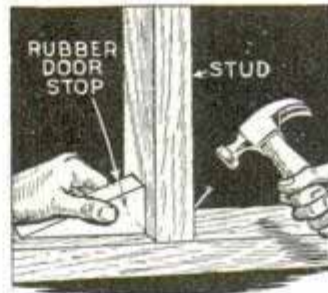

One carpenter carries a rubber doorstop in his tool chest for use in holding a stud while toenailing it to the floor or joist. The blunt end of the stop is held against the lower end of the stud and with the hand while the nails are driven into the other side. Friction of the rubber against the joist or subfloor is sufficient to hold the stud, and the rubber also absorbs much of the shock of nailing.

Tree Signs Have Elastic Holders to Protect the Bark

When temporary signs are put up around parks, farms and estates, it's a good idea to attach them with rubber bands to avoid damaging trees and permit quick attachment or removal.



Junction Box for Electrical Trouble Shooting

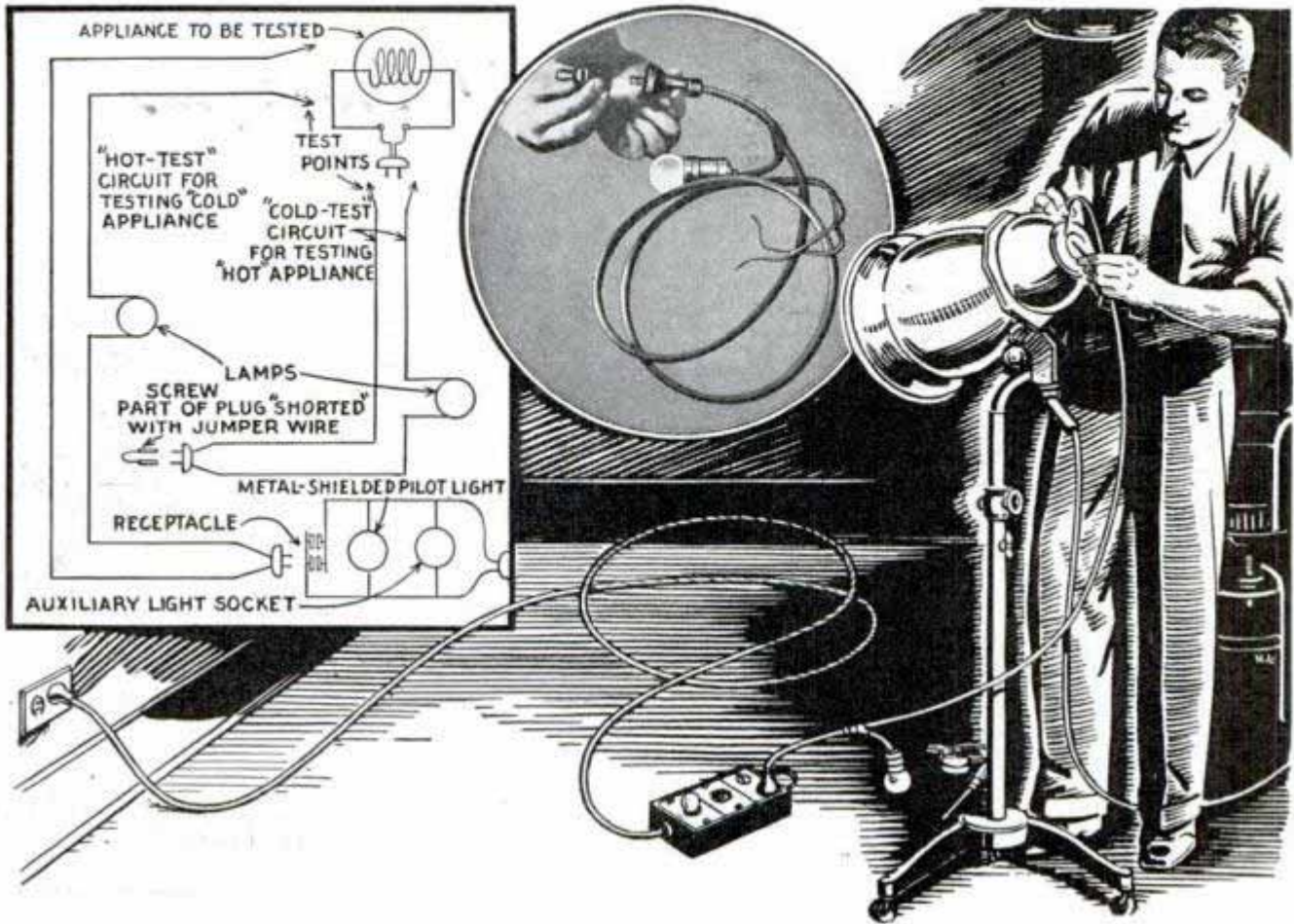

Frequently called out to check electrical equipment installed in beauty shops and similar places, I make use of the junction box and test cord shown. The box has an extension cord to bring the current supply to the spot where needed, and as it is fitted with a pilot lamp, there is no uncertainty concerning the current supply, which is often the source of trouble. Besides a pilot light, a lamp socket and a duplex wall receptacle are wired together in the box. The socket is used in case the pilot lamp burns out, while the cords to the appliances may be plugged into the receptacle. The test cord is a simple series hookup of a plug, light socket and two test points for checking disconnected appliances. The cord is quickly adapted for testing connected appliances by short-circuiting the screw part of a plug and slipping it over the prongs of the plug on the test cord.—P. Fairmont, Cleveland, O.

❑Negatives so dense that they are impossible to print in the regular way may often be used if a photoflood bulb is put in the printer instead of the ordinary bulb.

Hand Truck Extension Pieces Provide Adjustable "Scoop"

In this truck, tubular steel handles are welded directly to the axle and are bent at right angles at the lower end to accommodate extension rods, which are adjusted to suit boxes of varying widths. For rigidity, a wide piece of flat iron is welded across the bent ends and flat-iron cross members are welded on as indicated.

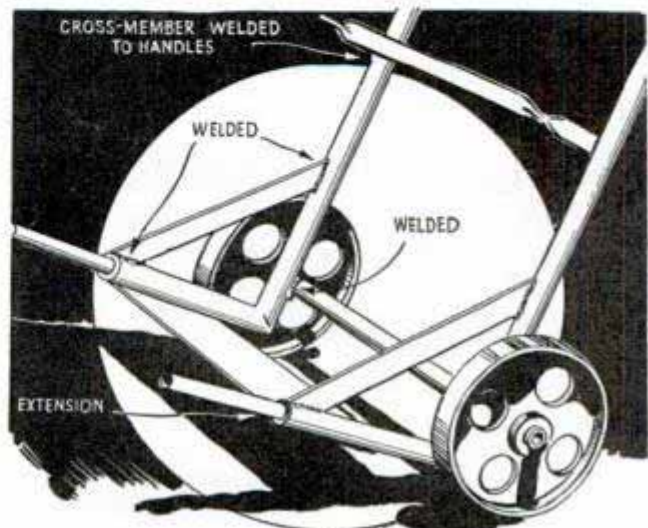

Chemicals Co. Deere & Co.
159 W. Kenzie, Chicago
Mallenhead Chemical Wash

Guarding against Rust

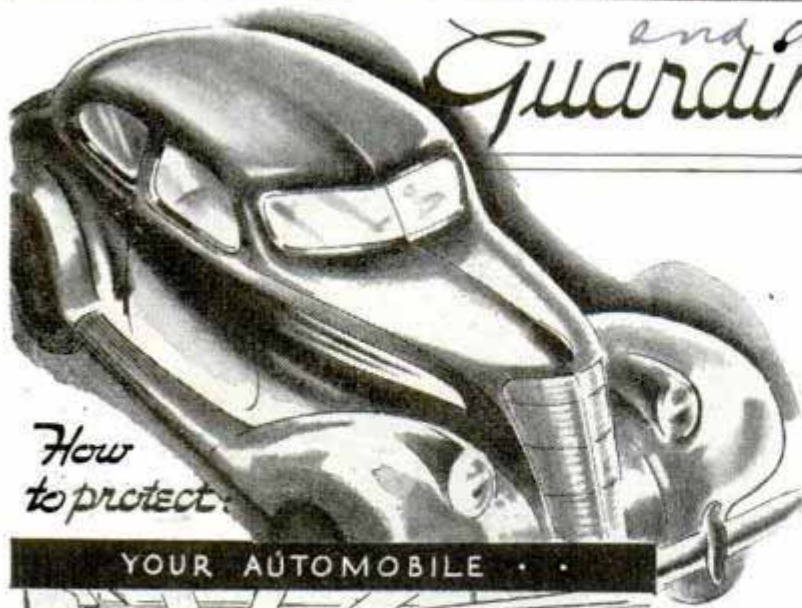

How
to protect:

YOUR AUTOMOBILE



YOUR HEATING PLANT



WORKSHOP TOOLS AND MACHINERY



GARDEN TOOLS



GUTTERS AND DOWNSPOUTS

Corrosion is everybody's problem. Needless waste of millions annually can be reduced by preventive and inhibitive measures

By C. A. CROWLEY

AUTOMOBILES, shop and farm machinery, metal building equipment—all are subject to gradual destruction by corrosion. In industrial cities this action is greatly accelerated because of the acidic fumes in smoke, and along the sea coast the presence of salt in moisture-laden air hastens the process. While there is no "cure-all" for corrosion, it can be minimized and to do this you must first determine the exact cause, which varies.

Electrolytic corrosion is illustrated in Fig. 3, where a sheet of copper and a sheet of zinc are immersed in an acid solution. When the two are connected together by a wire, an electric current flows from the copper to the zinc and at the same time the zinc is gradually dissolved or corroded away. A particle of carbon or metal dust on the surface of steel or other metal may act in exactly the same way where moisture saturated with gases takes the place of the acid in the cell. Another type of corrosion is termed the "concentration-cell" effect and is illustrated in Fig. 4. Rusting through of hot-water pipes at the fittings is caused by a small amount of iron dissolving in water trapped between the threads, forming a solution which contains more iron than does the water flowing through the pipe. Even though the solutions are in contact with the same metal, a slight electric current will be generated and the iron will corrode. The most destructive type of corrosion is caused by the presence of both moisture and oxygen. Neither pure, air-free water nor oxygen alone corrodes dry iron or steel, but these

CORROSION



two harmless components are usually together.

Copper, iron, and aluminum are often observed not to corrode after a non-porous oxide film has been formed on their surface. However, these films are destroyed by acid, where smoky conditions prevail. Mechanical strain in metal also assists in setting up electrolytic action as the strained area and an unstrained area of the same piece act like two different metals. Highly polished surfaces offer increased resistance to corrosion because moisture does not condense upon them so readily and there is less surface on which corrosion may start.

Among the most effective inhibitors of corrosion are potassium chromate and sodium chromate. Their striking action may be demonstrated by a simple experiment, Figs. 1 and 2. Bubbles of hydrogen caused by the action of the lye solution will cease when a few drops of sodium-chromate solution are stirred in. Chromate inhibitors are useful where oxygen is present as in aerated liquids, but are ineffective in closed systems which are oxygen free. Enough of the chromate must be present in a neutral or alkaline solution, and the surface to be protected must be clean. Some hard waters containing magnesium chloride or calcium chloride become acidic after heating. Chromates are not effective in these cases, but such waters may be made less corrosive by adding lye or sodium carbonate until they color phenolphthalein pink as demonstrated at the right of Fig. 5. To determine the resistance of various metals to the corrosive ac-

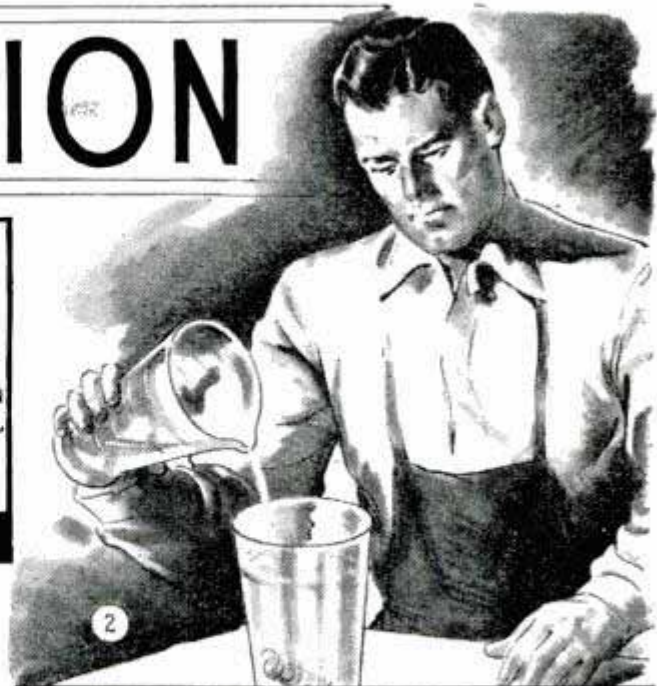

THEN ADD A SODIUM-CHROMATE SOLUTION — THE CORROSIVE ACTION CEASES

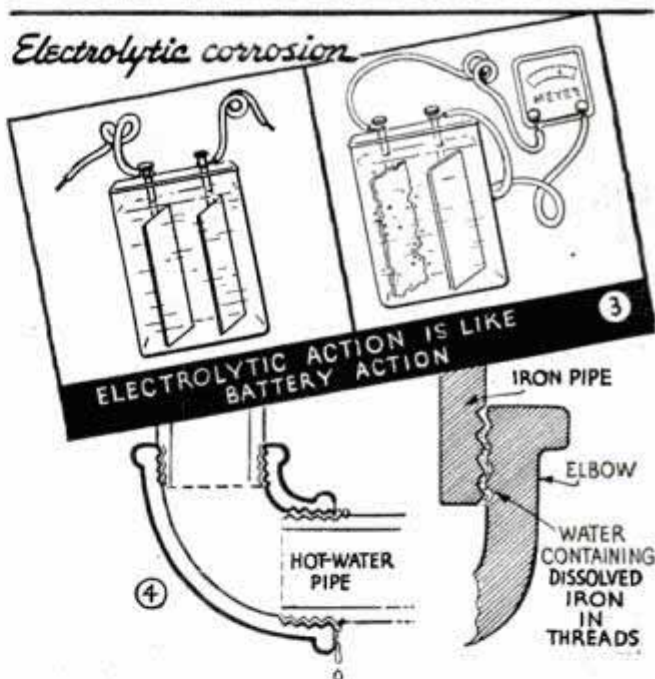

tion of water, samples of similar size and shape of the metals to be tested are placed under funnels in the water as in Fig. 10, and test tubes of water inverted over the openings of the funnels. After standing overnight, the volume of gas collected in each tube is measured and the appearance of the samples compared. Much gas collected in a tube indicates poor resistance.

Application of proper paint is probably the best protection for metal surfaces against corrosion. Paint should be used before corrosion has begun. After corrosion has started, all of it must be removed

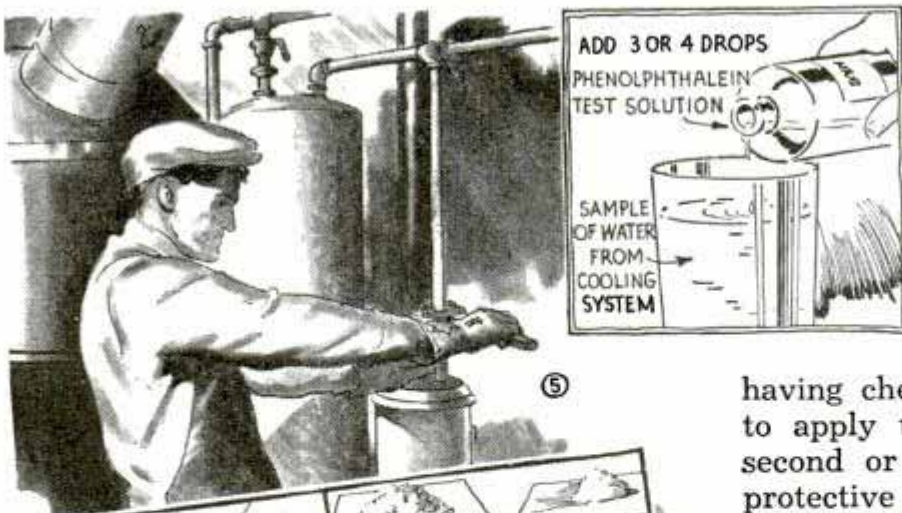

5

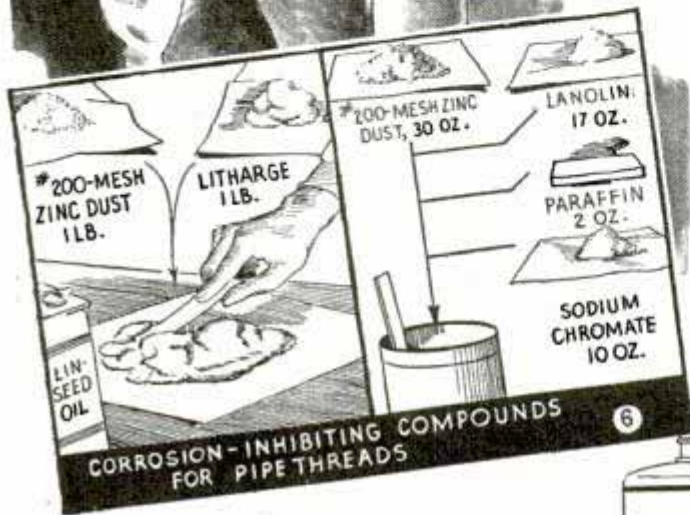

6

and the metal must be thoroughly dry before painting, as the corrosion will eventually loosen and the paint will come off with it. Then, a good corrosion-inhibiting priming coat of paint should be applied and this followed with a waterproof paint coat. The best inhibiting pigment in the priming coat for structural metals has been found to be basic lead chromate (American vermilion). Red lead is also good. To be effective as a corrosion-inhibiting coat, the pigment must be ground very fine. Iron-oxide paints offer physical protection only. They produce excellent films. Blue lead (basic lead sulphate) is also a good pigment for priming coats because, in addition to physical protection, it has a chemical action which inhibits corrosion. Zinc oxide and metallic zinc, when incorporated in paints, have been found to give excellent results. Metallic zinc in a paint offers somewhat the same protection as does galvanizing on iron, as it is destroyed by the electrolytic effect instead of the iron surface to which it is applied. Carbon pigments such as lamp black, graphite, oil black, etc., should not be used in the priming coat as they

start electrolytic corrosion. They are satisfactory ingredients for finishing coats, however. Though aluminum paints have been used as priming coats on metal because of their excellent physical protection, it is better to use a primer

having chemical inhibiting action and to apply the aluminum paint in the second or third coat for its physical protective value. The unusual effectiveness of aluminum paints as physical protective coatings is due to the fact that the tiny flakes of aluminum arrange themselves like fish scales on the surface being painted as shown in Fig. 9. These flakes, being opaque, pre-

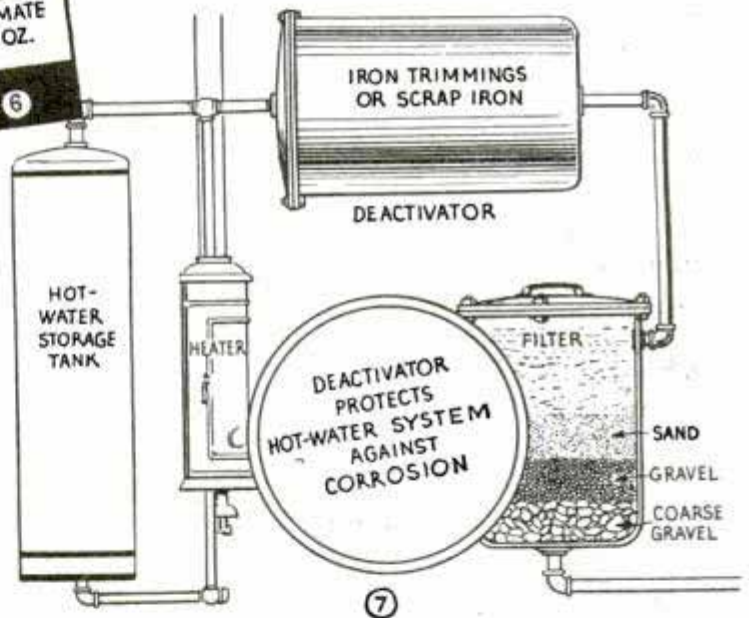

7



8

vent the entrance of ultraviolet light, which is one of the greatest factors in destroying paint films. Aluminum is particularly effective as a physical protection against corrosion when incorporated in one of the modern synthetic resin base paints. To avoid difficulty in making paint stick to galvanized iron surfaces, allow the metal to weather for at least six months before painting. Then it must be cleaned carefully as in Fig. 11, and brushed with a solution made by dissolving copper sulphate, 10 oz., in water, 1 gal. This roughens the surface and causes a thin coating of copper to plate on the surface. After the surface is thoroughly dry, it may be painted with an inhibiting priming coat of paint followed by any desired finish coat.

Draining water from heating systems during summer months and refilling with fresh water causes excessive corrosion in the system, as safe oxygen-free water is being replaced by that containing oxygen. "Stale," rusty water is not injurious and it should not be drained except when making repairs or alterations. If a

ALUMINUM PAINT GIVES BEST PHYSICAL PROTECTION TO METALS EXPOSED TO THE WEATHER.

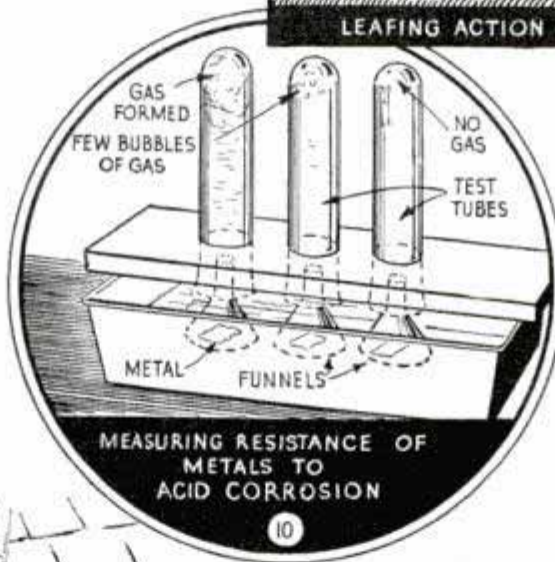
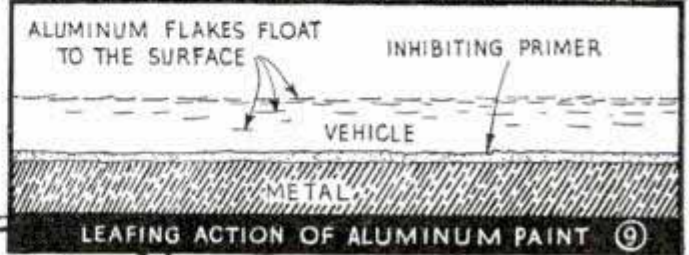

proper type of thread compound is used during installation, or when repairs are made, there will be little trouble from pipes rusting through at the joints. A corrosion-inhibiting thread compound is made by mixing 200-mesh zinc dust, 1 lb., with ordinary linseed litharge thread compound, 1

lb. See Fig. 6. When thoroughly mixed, linseed oil is worked in to reduce the batch to its original consistency. This compound produces a gas-tight joint, even in vacuum systems. A still more effective compound for this purpose is made by warming together lanolin, 17 oz., paraffin, 2 oz., powdered sodium chromate, 10 oz., and zinc dust (200 mesh), 30 oz., at a temperature of 105° F. and thoroughly mixing. If desired, this mixture may be thinned with naphtha.

If the water in a heating system contains acid-reacting materials like magnesium or calcium chloride, it should be made alkaline by adding lye or sodium carbonate to give just a pink color with a phenolphthalein test solution as in Fig. 5. Deactivating a hot-water system to pro-

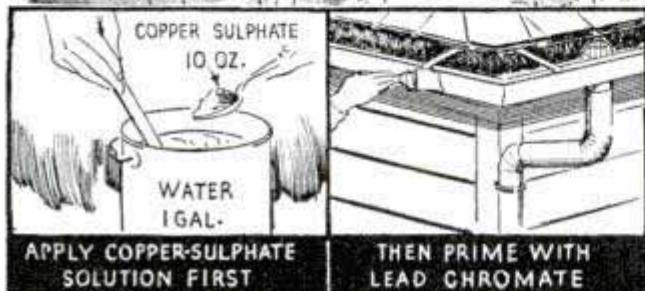

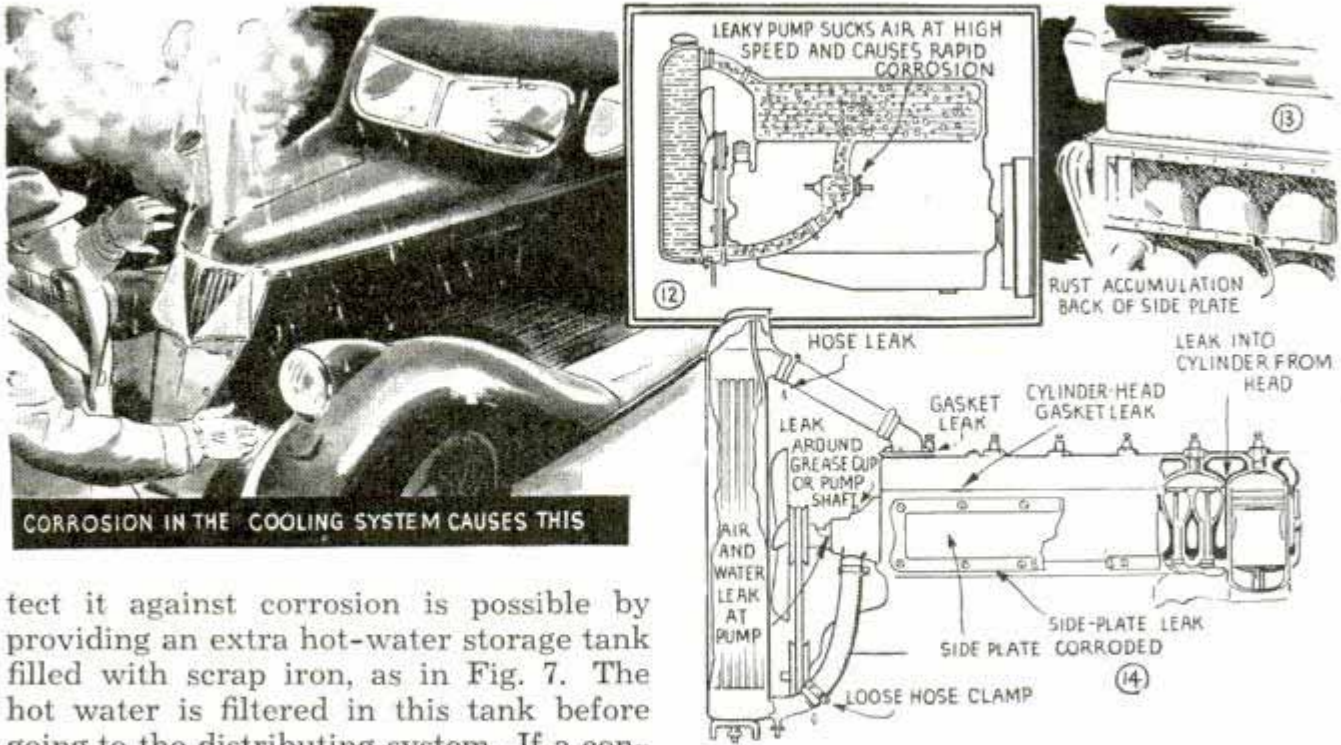

CORROSION IN THE COOLING SYSTEM CAUSES THIS

protect it against corrosion is possible by providing an extra hot-water storage tank filled with scrap iron, as in Fig. 7. The hot water is filtered in this tank before going to the distributing system. If a continual stream of water passes over the valve seat of a leaky faucet, corrosion takes place and roughens the metal. Therefore, a new packing should be installed immediately.

Garden tools, farm implements and shop tools require a corrosion-preventive coating that can be removed, yet not too easily rubbed off. A non-drying compound for this purpose consists of lubricating grease, 1 lb., mixed with sodium chromate, 60 grains, as in Fig. 8. The grease is placed in a pail and heated in a pan of boiling water until soft. The finely powdered sodium chromate is stirred in carefully and completely. The mixture may be thinned with petroleum naphtha for brushing or spraying. Or, it can be applied with a rag. Polished steel surfaces should be cleaned with a hot soap solution and may be dipped in the mixture.

The cooling system of an automobile is most susceptible to corrosion as it consists of several kinds of metals, which promote electrolytic corrosion. Rock salt, calcium chloride and other salts should never be used to prevent freezing because they accelerate corrosion. Alcohol, glycerin, or ethylene glycol, on the other hand, are all effectual and help to reduce corrosion. As auto cooling systems contain considerable air, sodium chromate, 1 oz., should be added to the water. If the water contains calcium chloride or other impurities, it should be made neutral or very slightly

alkaline with soda ash. Greases must not be added as they cause "frothing." One of the worst conditions responsible for corrosion in an auto motor is a leaky water pump or a leak in any part of the cooling system. The rubber hose at the base of the radiator is a frequent offender. When the motor is running, air is drawn in through these leaks and mixed with the water as in Fig. 12, thus saturating it with oxygen. The rate of corrosion has been shown to be increased as much as nine times under these conditions. Another source of corrosion in the motor is a leaky head gasket, Fig. 14, which is sufficient to allow gases from the explosion chamber to be absorbed by the water. Acid fumes in the gas greatly increase corrosion. Modern cars with aluminum cylinder heads are more subject to this trouble than the older types as the rate of expansion of aluminum with changes in temperature is not the same as that of iron. To prevent this, keep the head bolts drawn up tightly.

Where highways are sprayed with a solution containing calcium chloride to lay the dust, fenders and chassis of automobiles will be damaged. Where paint comes off, the exposed parts should be repainted immediately after all trace of rust has been removed by steel brushing and washing with benzine. When bright metal shows, the surface should be painted with a basic lead chromate primer, followed, when dry, by paint having good physical

protective properties such as aluminum paint. If the bright color is objectionable, it may be covered with black paint. The chassis and springs can be protected against corrosion by spraying or brushing with a preparation made by mixing lubricating grease, 1 lb., sodium chromate (powdered), $\frac{1}{6}$ oz., motor oil (S.A.E. 10), 2 qts., and water, 1 oz. The grease is placed in a pail and heated in a larger pan of boiling water. When soft, the finely powdered sodium chromate and water are stirred in until the consistency is smooth. Then the motor oil is added and stirring continued until the mixture is cool.

Carbon tetrachloride is sometimes used for flushing the crankcase. While it does remove sludge which adheres to motor parts, carbon tetrachloride, used even for a brief period, is very corrosive. When the motor warms up, it reacts with moisture in the crankcase, to form phosgene, a toxic gas, and hydrochloric (muriatic) acid which quickly attacks the metal parts of the motor, especially the bearings used in modern cars. The addition of organic chemical compounds containing chlorine to crankcase oils in automobiles to improve lubrication is subject to the same criticism as the use of carbon tetrachloride; when the engine becomes hot, these compounds react with the moisture and produce hydrochloric acid. However, there are available oil-addition products, free from chlorine, which do improve the lubricating characteristics of oils, and some of them have marked corrosion-inhibiting properties in addition. Anyone may readily test an oil or oil-addition product for chlorine by taking a piece of clean copper wire and holding it in the upper portion of a colorless gas flame until it no longer imparts a green color to the flame. While still red hot, quickly dip the heated portion into the oil sample to be tested. Again hold the wire in the upper portion of the flame. First the oil will burn off with a yellow flame. If chlorine is present the flame will turn green.

☐ On some new machines used to churn mayonnaise, one company covered the high-speed shafts of the machines with a welded-on layer of cobalt-base alloy to prevent wear and the chemical attack of vinegar seeping through the packing.

Movable Form Aids Contractor in Filling Between Joists



"Walling out" over foundation between the floor joists with concrete of stiff consistency

Contractors who fill in between floor joists with concrete will find this movable form helpful. If care is taken so that the concrete mixture is not too wet, and sufficient tamping is done, the form can be removed immediately after pouring the concrete and can be used again as many times as needed.

—Franz Serdahely, Wauwatosa, Wis.

Furniture Protected by Block When Assembling

To prevent accidental marring of furniture by having a screwdriver slip when assembling it, one dealer has his workmen use rubber-covered blocks of the type shown. Holes of varying sizes are drilled through the block and rubber covering. Should a screwdriver slip when driving a screw, the point will strike the rubber covering of the block.

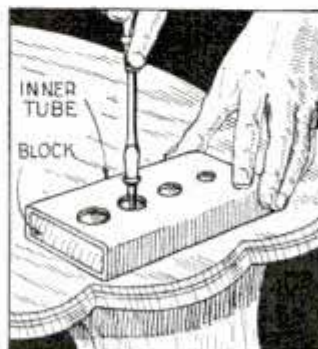

Heavy Drill-Press Jigs Centered by Simple Attachment

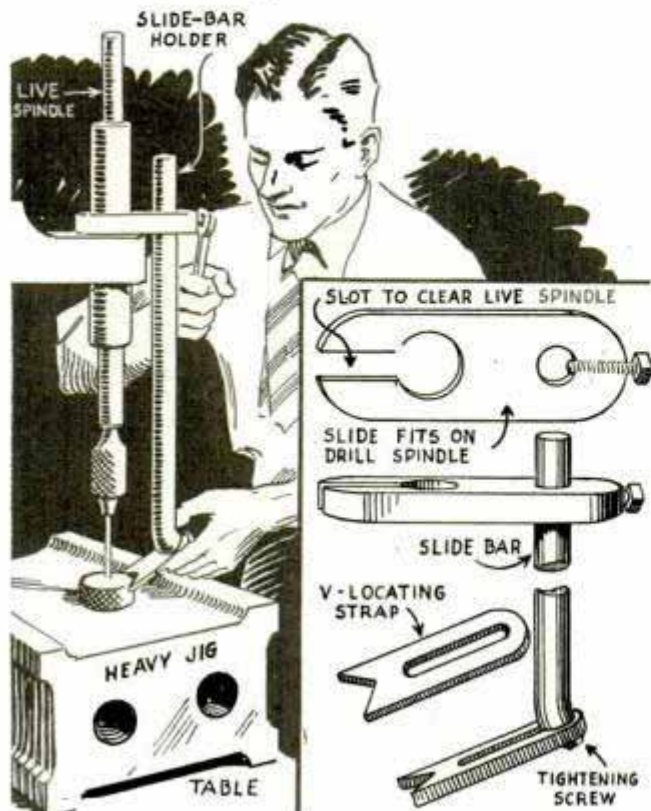

This attachment locates drillpress jigs accurately to avoid breaking small drills

Difficulty often experienced in accurately centering heavy jigs on a multiple drill press is avoided with this simple attachment, construction of which is given in the detail. It consists of a slide-bar holder bored to fit the spindle and slotted to pass over the smaller diameter live spindle. It carries the slide bar which is slightly bent at the other end to take the V-strap, the reason for the angle being so that the strap will clear any obstructions around the bushing. The attachment can be adjusted to suit a jig bushing head of any size. In use, once the attachment is set, the bushing head is brought up against the V-locating strap to center the drill.

Artists' Brushes Kept in Shape with Aid of Soap Cake



Artists will find that by rubbing their wet brushes over a cake of soap before laying them away, the bristles will keep their shape. A depres-

sion large enough to hold a few spoonfuls of water should be gouged out of the cake near one end. Then, after washing a brush, wet it in the soapy water of the depression, and shape the bristles on the smooth surface of the cake. The brush need not be washed out the next time if it is used in water-soluble colors. In fact, the soap often assures a letter of clean outline when the work may be soiled by perspiration from one's hands.

Catching Mice in Poultry House

In order to set mousetraps in his poultry house without endangering the fowls, one poultryman turned a bucket over the trap as shown. Four clothespins slipped over the rim served as legs to raise the bucket above the floor so mice could enter, and a brick placed on top weighted it so that the fowls would not upset it.

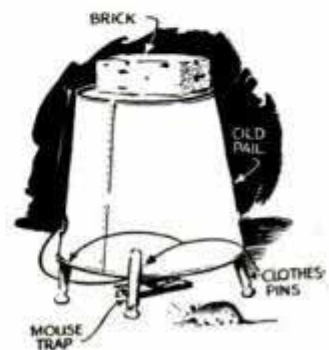

Paper Stock on Press Feed Board Held Between Pegs

If rubber-covered wooden pegs are set in holes drilled in the feed board of a job press to hold the paper stock, there will be less risk of having the sheets blown about in case a window is open. A row of holes should be provided so that the pegs can be located to accommodate various sizes of stock commonly used. Lengths of rubber tubing are slipped over the pegs so that the uncovered ends fit the holes. It is best to have the pegs spaced so that there will be a slight friction against the stack of paper.

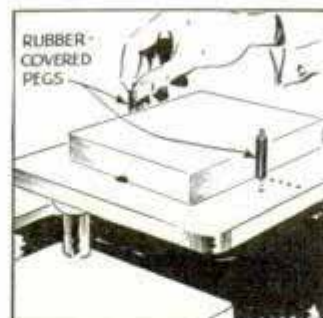

☐ A tiny pinch of salt placed around the wick of a candle will cause it to burn longer and produce a steady flame.

A. Haigler & Co. 107 W. Kenzie
Chicago (all materials)

LUMINOUS PAINT

is easy to make









Novel and practical uses for this paint make it a profitable sales item

YOU can make luminous paint in any quantity—even enough for covering the walls and ceiling of a den or workshop is no more expensive than good wall paint. At night the room will glow with a soft, mysterious light. Small quantities can be made with very simple equipment, a clay pipe and bunsen burner as shown in Fig. 1, being the only equipment needed.

The chemical ingredients must be ground thoroughly as in Fig. 3, then mixed by repeated sifting, Fig. 4. The formula given in Fig. 2 is sufficient for making up a number of 2-oz. batches. Use only the chemically pure grade of calcium oxide. Should there be a trace of iron present, it will cause unsatisfactory results. To mix the bismuth nitrate with the other chemicals, dissolve in water, 5 grains, and then use only one-fifth of the solution. After the compound has dried, pack as much of

The Formula

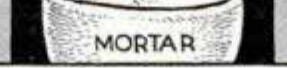
- ②
-  CALCIUM OXIDE, 10 OZ.
-  SULPHUR, 3 OZ.
-  STARCH, 1 OZ.
-  BISMUTH NITRATE, 1 GRAIN
-  SODIUM CHLORIDE, 33 GRAINS
-  POTASSIUM CHLORIDE 33 GRAINS
-  MORTAR

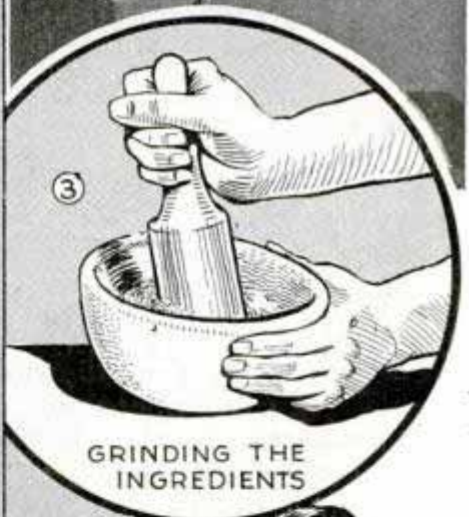

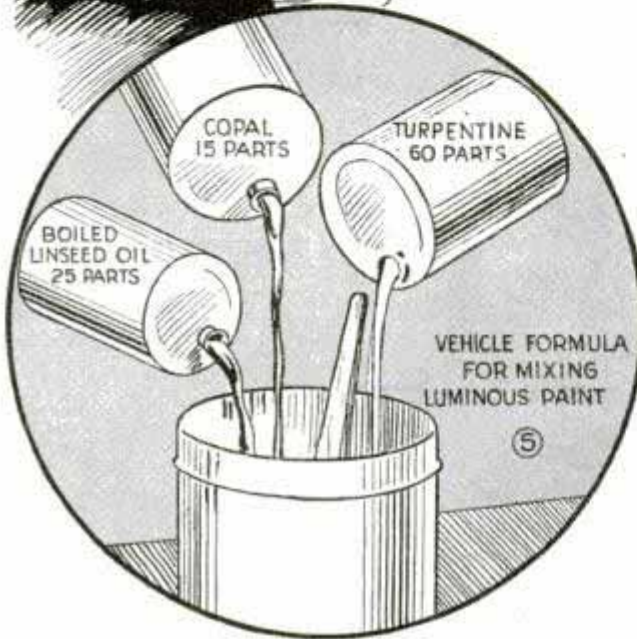
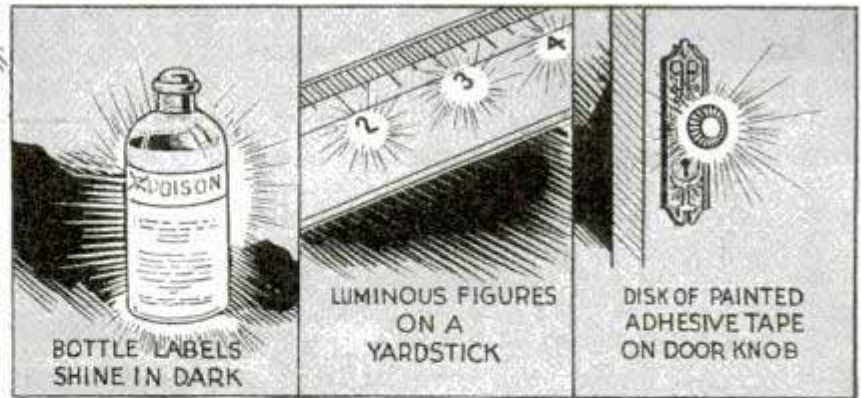

it as possible into the clay pipe and then cover with several layers of asbestos moistened with water glass to insulate against loss of heat in the upper part of the bowl. Then bring the bowl to a low, red heat over the bunsen burner and hold at this temperature for 15 min. At the end of this time, raise the flame to bring the bowl to a bright red or white heat for an additional 15 min. Then allow the pipe to cool slowly. After this treatment the chemicals will have changed their form and must be re-ground to a fine powder and sifted as before.

To make an easy-brushing paint, the luminous powder can be mixed with either a water or spirit varnish. Gum arabic dissolved in water to the consistency of varnish makes a suitable vehicle where the paint is to be applied indoors. A more flexible and durable vehicle is a spirit copal varnish, which can be bought ready prepared or mixed as in Fig. 5.

You'll find many uses for the paint. For example, brush it on the back of adhesive tape and then cut the tape in small squares

or disks. It will stick practically anywhere. Pull-chain pendants can be made by painting the inside of a short piece of glass tubing, allowing it to dry, then plugging the ends and adding a screw eye. For novelty effects, amateur theatricals and the like, you can make gowns and other garments of cheesecloth and coat them with the luminous paint. Remember that if garments or masks have been packed away for some time, they must be hung up before using so that the paint can "drink in" light. To make the luminescent quality serve more practical purposes, paint it on corks or labels of bottles containing poison. Clock hands and numerals also can be given an application with a small camel's-hair brush. By coating the inside of the lid of a fishing-tackle box you can always find just the plug, spinner, or leader you want, even though it is quite dark. Sometimes it's handy to have the numerals on a yardstick, rule or flexible tape show in dark corners. If you use this paint on walls, reduce the solution to an easy brushing consistency so that you can be sure of a uniform application. It should be remembered also that luminous paint gradually loses its effectiveness.

Effective Lock Nut Easily Made

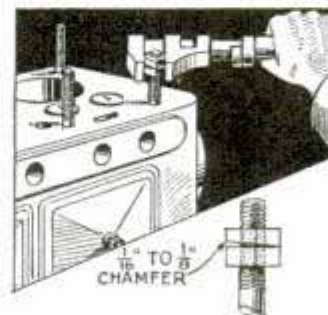

A lock nut that will hold tightly can be made by chamfering the face of a regular nut. When this is screwed tightly against another plain nut, it tends to force the chamfered side down, which binds the threads

firmly against the bolt.

Handy Bending Brake for Use in Small Shops

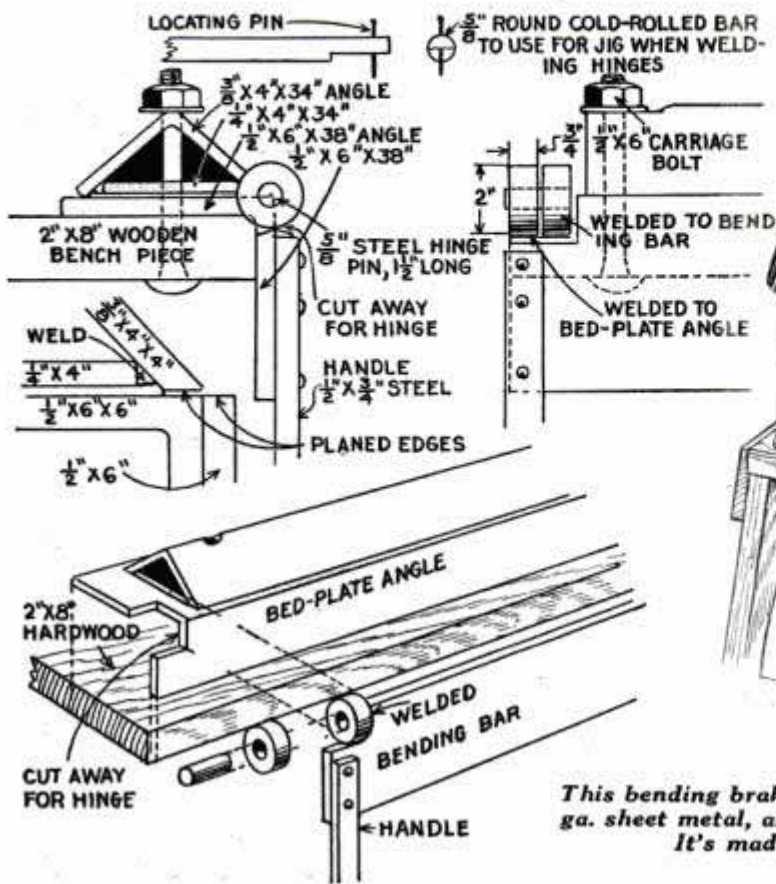

This bending brake will make clean, sharp bends in No. 16-ga. sheet metal, and will take a sheet up to 30 in. in width. It's made from steel bar and angle stock

Built of steel angle and bar stock, this bending brake will handle No. 16-ga. iron up to 30 in. wide. Some machine work and welding are necessary. First, a stiffening bar is welded inside the angle hold-down as indicated in the end views. The second job consists of welding the two parts of the hinge in place, one to the bending bar, the other to the notched end

of the bed-plate angle. Then the forward edge of the hold-down is planed true and one face and edge of the bending bar are milled flat. The hinge consists of two disks cut from cold-rolled shafting, each center-drilled for a 1/8-in. hinge pin. These are held in place for welding by means of a jig as in the top detail.

—G. F. Lampkin, Bradenton, Fla.

Keyways Milled in Shaft by Using Guide Pin and V-Block

If you have occasion to cut two keyways 180° apart on the same shaft, the job can be done easily by using a removable steel pin inserted into a hole drilled in the bottom of a V-block as shown. In use, one keyway is cut in the usual way. Then the work is removed and the pin, which must have a diameter equal to the width of the keyway, is put in the block after which the shaft is again placed in the block with the pin projecting into the keyway. The pin then serves as a guide to hold the shaft accurately for cutting the second keyway. Pins for various keyways can be had by making the projecting ends different diameters.—Ed. J. Hartel, Jamaica Plain, Mass.

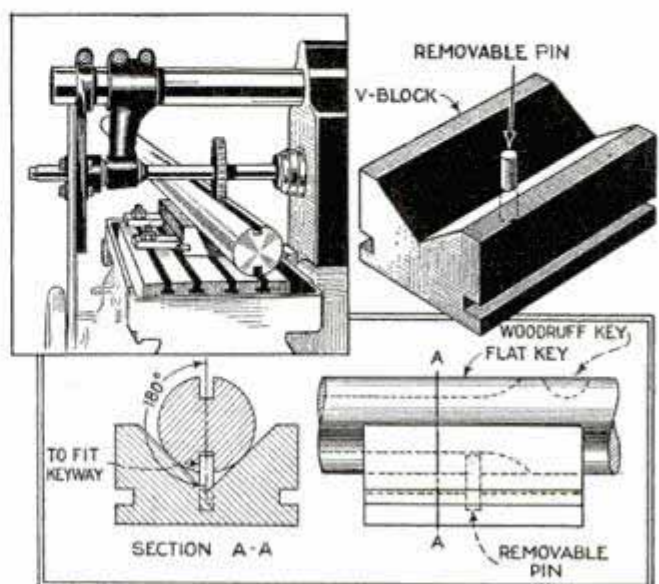

Triangular Rule Has Rubber Grip Which Serves as Marker



Rubber handle is quickly moved to the edge of the ruler carrying the scale being used

A 1/2-in. rubber hose, slit lengthwise, and slipped over one edge of a triangular scale, provides a good handle and serves as a marker for the various scales. As most rulers of this type are provided with several scales, the marker when slipped over the edge of the ruler above the scale being used, serves as a guide in placing the right one on the work.

Warning Flag Has Canvas Apron to Weight It Down

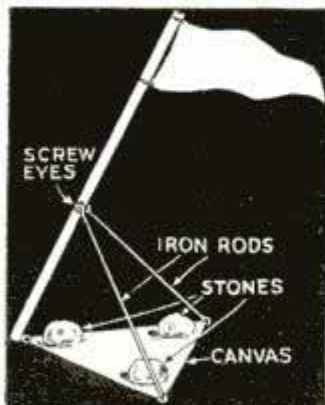

stored in a small space. Such flags offer no dangerous obstacle to traffic when

Fitted with this apron and a couple of iron-rod legs, a warning flag can be set up anywhere and weighted with a few stones to hold it in place. When not in use, the legs are folded against the staff so that the flag can be

they are placed along a street or road, as they readily tip over should a car accidentally strike one of them.

Stamp Pad Steadied on Desk by Lead Base

In shipping rooms and other places where stamp pads are used, the problem of keeping them from moving around when struck with the stamps is solved by fitting them with lead bases.



This is easily done by pouring the lead into a form and then gently pressing the pad in place while the lead is still molten.—Opie Read, Jr., Chicago.

Stacked Sacks of Flour Held with Canvas Strips

Sacks containing flour or other material may be stacked neatly in high piles, without risk of being dislodged, if canvas strips are placed between each layer as shown.



Sacked material readily stacked in high piles, without risk of falling, with aid of canvas strips

☐ If your fingers slip when trying to lift or carry an object having polished surfaces, a piece of rubber or Cellophane put under the fingers will help in gripping it.

Handy Hints for the MOTORIST



JACK UNDER RIGHT FRAME MEMBER TIPS MOTOR TO DRAIN CRANKCASE



CURE FOR GARAGE DOORS THAT DRAG AND ARE PERMANENTLY WARPED

Cars having the oil drain hole slightly above the crankcase bottom will drain thoroughly when one side is jacked up. Right, garage doors that drag provided with hinged flaps, which are raised to open them. Below, a fire extinguisher charged with carbon tetrachloride dries wet ignition wires



FIRE EXTINGUISHER TO DRY WET WIRES



INK ERASER CLEANS DISTRIBUTOR CONTACTS

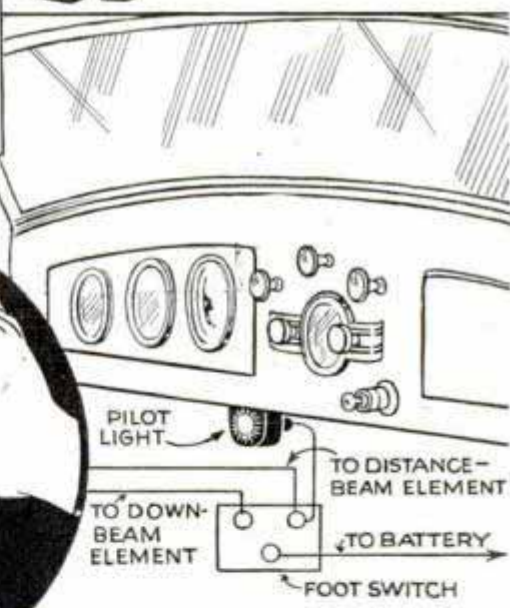

Center, an ink eraser is handy for polishing contacts in a distributor cap without any risk of damaging them. A pilot lamp mounted on the dash will light up and show the driver when the headlight distance beam is on if it is wired to the foot switch as shown above. Left, on cars having the starter switch combined with the accelerator, the hand throttle should be used when starting with a cold motor, as an attempt to go directly from starting to acceleration while the motor is still cold and balky often results in chipping the flywheel teeth

Body of Truck Is Entered Easily with This Removable Step

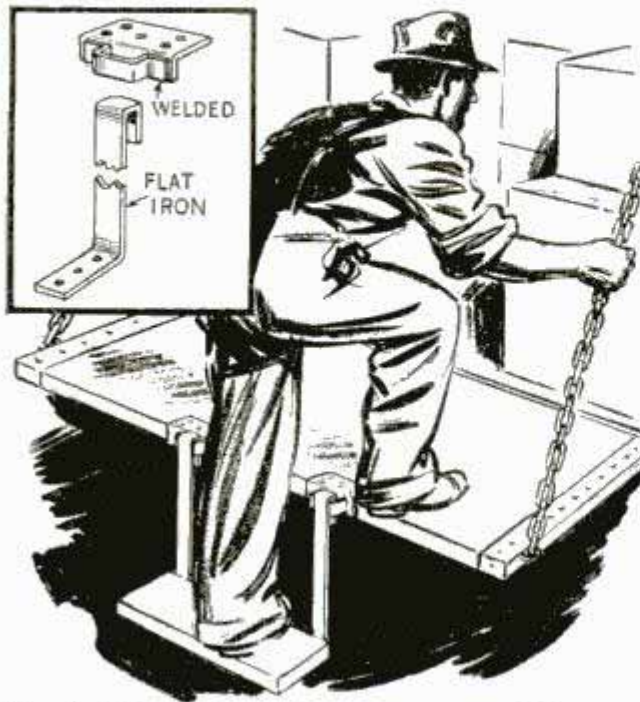

Truck drivers who make many stops in delivering their loads will find this step a timesaver

On trucks where the body is so high that it is hard to enter it at the rear, this removable tailboard step will help you. Made from a couple lengths of flat iron and a wood block, the step hooks into two brackets screwed to the edge of the tailboard. When not in use, the step is carried in a frame mounted under the body, or it can be stored inside within easy reach.

Silencing Noisy Overhead Valves

If your car has an overhead-valve motor and you find that no matter how carefully the valve tappets are adjusted, they are still noisy, the trouble is caused probably by depressions worn into the rocker arms where they contact the ends of the valve stems.



As a feeler gauge bridges this depression, when inserted between the tappets, the valve adjustment will be inaccurate an amount equal to the depth of the depression. To remedy this trouble, remove the rocker arms and grind the ends flat. While you have the arms off, see if the underside of the shaft on which they fit is worn.

Wear here also causes a tapping noise and can be eliminated by turning the shaft so that the worn side is on top. It is also a good idea to drill a small hole through each rocker bearing and then file a small groove from the hole to the end of the arm which assures getting oil on the surface contacted by the valve stem.

—E. A. Corfar, St. Petersburg, Fla.

Installing Ford Distributor Points

Here is a method of quickly installing distributor points in model-A Fords. Just remove the old point arm by breaking out the loop in the end of the spring so that it can be slipped off its anchoring post and lifted out.

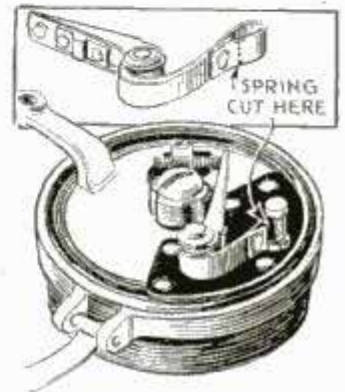

Then cut the loop in the new arm as indicated in the detail and file or grindaway enough of the spring to permit the loop to slip around the post. Renew the screw point and the job is done. If a few altered point arms are kept on hand, the job of installing them for a customer can be done in a couple of minutes without disturbing the motor timing.

Glass Windows in Garage Doors Warn of Approaching Car

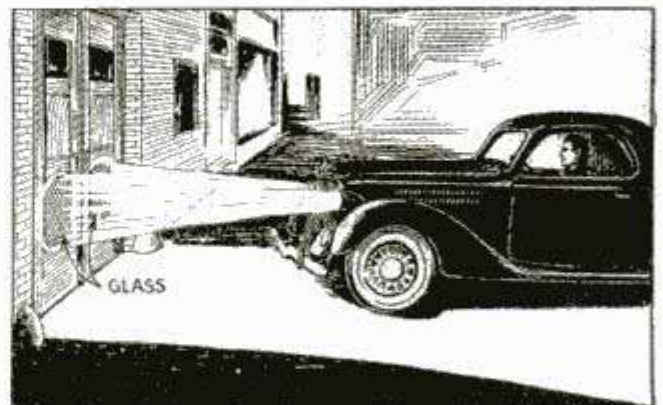

Headlights shining through windows in garage doors warn night attendant of car awaiting admittance

Two wire-reinforced glass panels set in the garage doors at the position shown, will admit light from the headlamps and

serve to notify the night attendant that a car is waiting to be admitted. Also, the glass will pass beams from the headlights when a car is about to leave the garage, and warn pedestrians as they approach the driveway to the street. Such warning is especially convenient when the doors are remotely operated from the garage office.

Package Rail on Coupe Seat Is Removable

Many coupe owners like to carry packages on the shelf or ledge behind the seat, but the ledge is often too shallow to keep large packages from tipping forward when the car is stopped. One owner stretches a

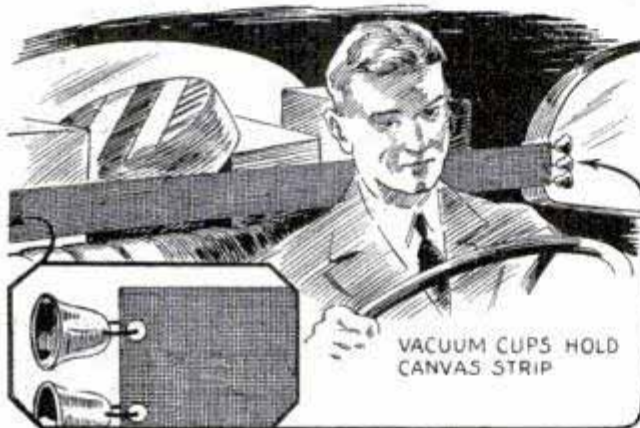

Stretched across a coupe between the windows, a strip of canvas holds packages on seat ledge

strip of canvas across the car just above the seat and attaches the ends to the windows with vacuum cups as shown. When not needed, the canvas is rolled up and stored in one corner of the ledge.

Wanted—More Auto Kinks!

Simple things that will add to the convenience of driving and touring—easily made repairs for minor troubles and disorders of cars—precautions that will avoid troubles—these are some of the many things motorists would like to know about. Possibly you have devised something for your car or garage that will be helpful to thousands of others. Just describe the idea briefly but completely, illustrate it with a sketch or photo and let's have a look. Perhaps it fits in with our needs and if so, a check will be sent promptly. Avoid old practices, ideas that are of use only occasionally or those that involve too much trouble and expense. Ideas accepted must be found workable by actual practice.

Address Technical Editor

Rolling Shelf in Greasing Pit Saves Time and Labor



Holding tools and parts, this shelf is quickly moved to any part of a greasing pit

For convenience in selecting tools and in handling assembly parts without stooping or lifting, one mechanic installed a rolling shelf in the greasing pit. The shelf, about 1 ft. wide, is suspended from iron rollers that travel along the top of the pit.

Police Officers in Squad Car Aided by Extra Mirror

In police squad cars where an officer rides in each seat, an extra rear-view mirror suspended from the car top as shown, will enable the officer in the rear seat to see behind the car as well as in front



Extra mirror in squad car enables officer in rear seat to see behind car without turning his head

without turning his head. The mirror can be suspended with short rods and clamps, or a special bracket may be made of sheet metal and screwed or bolted to a cross member of the car top.

Hood Is Removed Single-Handed with Aid of Support Board

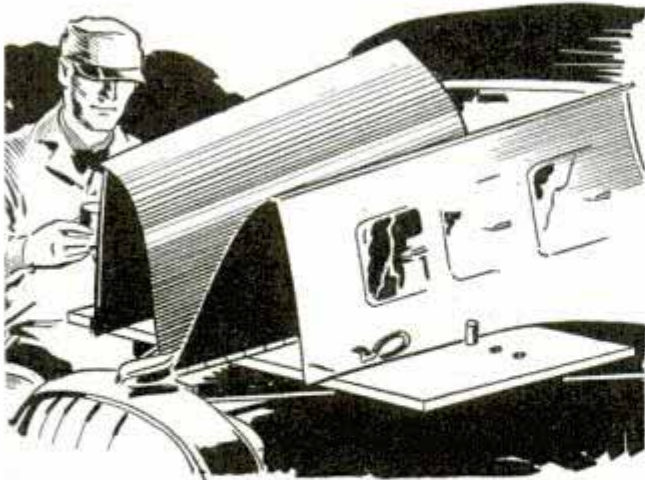

It's a simple matter to handle a large, bulky auto hood with this wide board

The difficult job of removing or installing a large auto hood single-handed is simplified with this device, which consists of a wide board having a number of holes drilled in line, near each end, to take wood pegs. In use, the hood is raised, the board slipped over the radiator braces and the pegs adjusted to hold the hood. Then,

after loosening the mountings, one man can easily lift the assembly and set it aside.
—Ben C. Robinson, Newcomerstown, O.

File Shielded in Tool Kit with Rubber Strip

When a file is carried in a tool kit, it's a simple matter to protect it against damage from other tools by using a rubber strip

cut from an old inner tube. The ends of the rubber can be tied to the file handle, or holes can be made and the ends slipped over the tang after which the handle is forced on. This method of attachment makes the rubber quickly removable when the file is to be used and



eliminates danger of mislaying it.

The Next Issue

COPPER AND NICKEL PLATING WITHOUT CYANIDES

With this new method, solutions for electroplating with nickel and copper are made without using deadly poisonous cyanides. These solutions make it possible to plate easily zinc and zinc-base die castings which are difficult to handle with the cyanide plating solutions.

RIGGING AND STEERING MODEL YACHTS

A nationally known designer of model yachts tells you how to rig the sails and arrange the deck fittings and running lines to get the most speed.

MODERN FURNITURE FOR ANY ROOM

Smart desk has sliding leaf to hold typewriter at the right height. Also, a tubular smoking stand with gleaming metal legs and Bakelite beverage tray.

KNOW YOUR WOOD-BORING BITS

Shows the various types of bits and tells which to use for different boring jobs as well as how to sharpen them for use in both hard and soft woods.

ARE YOU BUYING A BOAT?

Chock-full of information on how to find a good value in a used boat—just what to look for and what to avoid, from a rowboat to a large yacht.

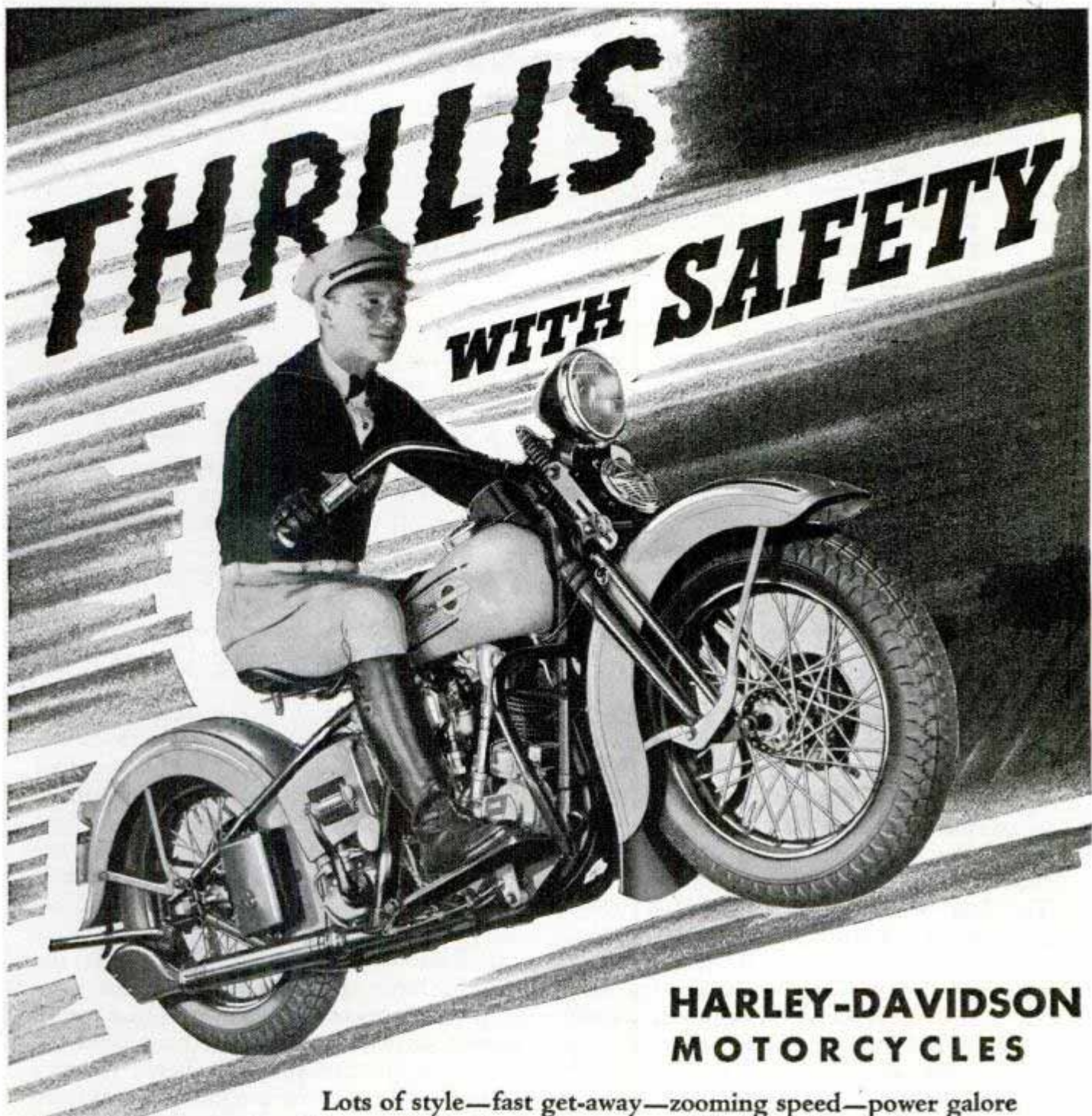

HARLEY-DAVIDSON MOTORCYCLES

Lots of style—fast get-away—zooming speed—power galore—and a gliding ride that's smooth and trouble-free. Sure thing—these streamlined 1937 Harley-Davidsons are ruggedly built—have perfect balance—instant response of power when driving conditions demand—and dependable brakes both front and rear for quick, easy stops. . . Yes, plenty of thrills—go where you will—get there quickly, safely and economically in the saddle of a 1937 Harley-Davidson. . . See your nearest Harley-Davidson Dealer **RIGHT AWAY**. Take a **FREE** ride on a 1937 Harley-Davidson — ask about his Easy Pay Plans. And send in the coupon.

Ride a -

HARLEY-DAVIDSON

HARLEY-DAVIDSON MOTOR CO.
 Dept. P, Milwaukee, Wis. Send illustrated literature. Postage stamp is enclosed to cover mailing cost.

Name.....
 Address.....
 My age is 16-19 years, 20-30 years,
 31 years and up, under 16 years.
 Check your age group.

The Latest in the Movies

(Continued from page 389)

"rifle" because of corrugations similar to the rifling in a gun barrel, now is used to diffuse the light. Other aluminum reflectors are brushed and chemically treated. While the older light units employed polished glass optical reflectors which often broke under the extreme heat, the newer units have chromium-plated brass reflectors. A lens patterned after a lighthouse lens also is now used for focusing and diffusing light.

The most intense light now in general use is the "solar spot." So intense is the light from the 5,000-watt bulbs used in these units that a special arrangement in the focusing device is needed to prevent them from being focused to a narrow crossbeam which would immediately start inflammable material burning. In the earlier equipment, such lights were used to light cigarettes when the "juicers" ran out of matches. While the solar spot emits the more intense light, the sixty-inch sun arc is the largest light unit in the studios. Two of these now in use for sunlight effects at Metro-Goldwyn-Mayer are set on huge stands adjustable to twenty-two feet high. These lights have reflectors of optically polished glass five feet in diameter. The huge reflector gathers and throws a beam from a 150-amp. arc.

Arc lights are used in filming color movies because of a better spectral balance in the illumination emitted. Lamps used in filming black-and-white movies emit more yellow light than is desirable for color filming, while the arclight has more of the needed blue. Lamp bulbs ranging from two-tenths of a watt to 10,000 watts are regularly used in the studios. The small globe, about the size of a match head, is used in miniature sets, while the large globe, about the diameter of a dinner plate, is used for illuminating real settings. Another globe has three contacts and two filaments. By proper switching, three different light levels are produced. Tubular "lumiline" lamps also are used. They may be "buttoned" together, end to end, to form a continuous band of light for decorative effects.

Ultraviolet light instead of white light also has been introduced in talking-picture recording. Heretofore high-pitched

voices have sounded sharp-edged, and the high pitches and overtones of instruments have been lost, due to the inability of sound recorders to make a sharply defined photograph of the high frequencies of sound. By filtering the white light used in making the sound record and using only the one wave length of the violet portion, it is possible to obtain a sharper focus of the sound light ray image. Thus a more faithful replica of the original sound is photographed.

A machine for making artificial cobwebs is in general use about the studios. It consists of a small drum and a fan anchored to the shaft of a portable high-speed motor. In the drum is placed a mixture of liquid rubber and fuller's earth. When the drum is revolved a thread of the mixture is forced by centrifugal pressure through a fine jet which is dried and blown about the setting by the fan.

For making lightning flashes, Harry Redmond of R.K.O. studios uses a barrel of salt water for a resistor and a ten-foot scissorlike arrangement with an arc at the tips for making the electric flash. Two electrode connections in the salt water are moved for the desired resistance while two bundles of carbons at the end of the scissor arrangement make the arc.

For atmospheric background effects, the studios have special equipment for projecting movies of foreign scenes to a transparent screen. In front of the screen the actors sit in automobiles, boats or airplanes while a camera combines both the projected image and the foreground picture. A more advanced form of this type of projector is the George Teague device which can fabricate airplane barrel loops, falling effects, fast and slow motion and various other illusions.

In all motion-picture equipment, the general trend is toward lighter and more durable construction. Today engineers design carefully and spend much money in order to get efficiency and light weight.

Names and addresses of manufacturers and dealers in articles described in this magazine will be furnished by our Bureau of Information upon request accompanied by stamped, self-addressed envelope.

1 Kodak "SS" Film
in your camera



2 Two or three
Photoflood Lamps
and Reflectors



Everything you need to make snapshots at NIGHT

WANT to try your hand at indoor snapshots? No need to wait until you get a better camera.

You can start right in snapshotting tonight. For now, even a simple Brownie makes snapshots (instantaneous pictures) indoors after dark.

Just use Kodak "SS" Film, and two or three of the new No. 2 Mazda Photoflood lamps, which last for hours, and Model B Kodak Handy Reflectors.

If your camera has an $f.6.3$ or faster lens, No. 1 Photoflood lamps are powerful enough.

FREE BOOKLET . . . Contains all you need to know about *both kinds* of night pictures—*snapshots* with Photoflood lamps, *fast exposures* with Photoflash lamps. (You can use Photoflash lamps, each good for one picture, if your camera can be set for "time.") The booklet's pictures and diagrams show how to arrange your lights . . . how to place your subject . . . and it even suggests a variety of picture opportunities. Get a copy at your dealer's . . . Eastman Kodak Co., Rochester, N. Y.

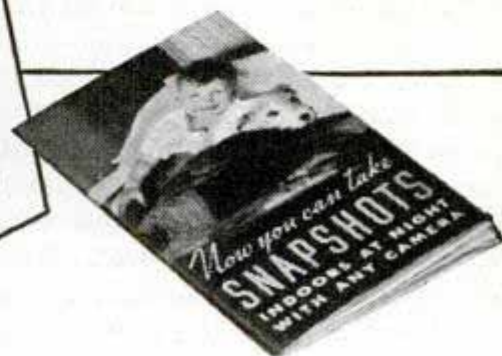

When writing to advertisers please mention Popular Mechanics

Air Liners to the Rescue

(Continued from page 408)

the Mendoza river began to rise, a pilot flew up the river toward its source. In two hours he had climbed over 18,000 feet and was approaching the crest of the Andes. He circled over the Del Plomo glacier and saw that the glacier itself was blocking the path of the Rio del Plomo which in turn fed the Mendoza river. He saw more than this. A seventy-five foot wall of water was racing toward the Mendoza river and the towns and bridges in its path.

Quickly he ordered his radio operator to get in touch with his base which in turn notified all of the towns along the river. By the time the flood waters reached them, although they carried roads, bridges and houses in their path, the inhabitants themselves were safe.

To the skipper of an air liner the saving of a single human life is of as much concern as saving an entire town and there are many reports in the files of the airline companies of pilots who sped on missions to help individuals in need of medical treatment.

Recently in the West Indies, at St. Johns, Antigua, a man lay dying of a strange sickness. Doctors said there was a chance of saving his life if they had a certain serum, but the nearest supply was in Miami, nearly 2,000 miles away. That was all Moody Stuart at the Pan American base wanted to know. Over the air line's radio crackled the life or death message. Division Traffic Manager Dobbs in Miami dashed from one medical supply house to another until the necessary serum was found. And within an hour the life-saving substance was on board the West Indies Express en route for St. Johns. It reached there in time to save the man's life.

On regularly scheduled runs the skippers of the air become thoroughly familiar with the terrain over which they fly and develop a sixth sense which enables them to render aid from the sky sometimes before that aid is demanded. It was this sixth sense which enabled Capt. L. H. Hart to summon aid for a trawler which he sighted from the pilot's compartment of a Pan American flying boat. When he radioed the request for aid, it was discovered the owners themselves had not yet been informed of the trawler's predicament.

Flying skippers also have warned railroad engineers of washouts ahead of them, and in many other ways given timely warnings which have resulted in the saving of lives and property.

In adopting the code of the sea, air liners have also sped to the aid of their own brothers, effecting more rescues of disabled flyers than other types of conveyances. Col. Gustavo de Leon, a flyer of the Mexican army, was found by flying skippers of the Cia Mexicana de Aviacion after he had been missing for fourteen hours on a flight between Brownsville and Tampico. His rescue is but one of many which the flying skippers have to their credit. Recently when Merrill and Richman came down in Newfoundland, it was a flying skipper, Captain Eddie Rickenbacker, general manager of Eastern Air Lines, who flew to their rescue.

And thus, from day to day the rescue work from the air goes on. The flying skippers, prompt to answer an SOS have their own way of applying the traditional code of the sea to fit in with the faster, thoroughly scientific liners which they fly.

F1635

Bottle Holder for Baby's Crib Is Also a Teething Ring

A combination teething ring and bottle holder recently invented can be mounted in the crib or cradle with straps, providing self-service for the child at mealtime and something to chew on the rest of the day.

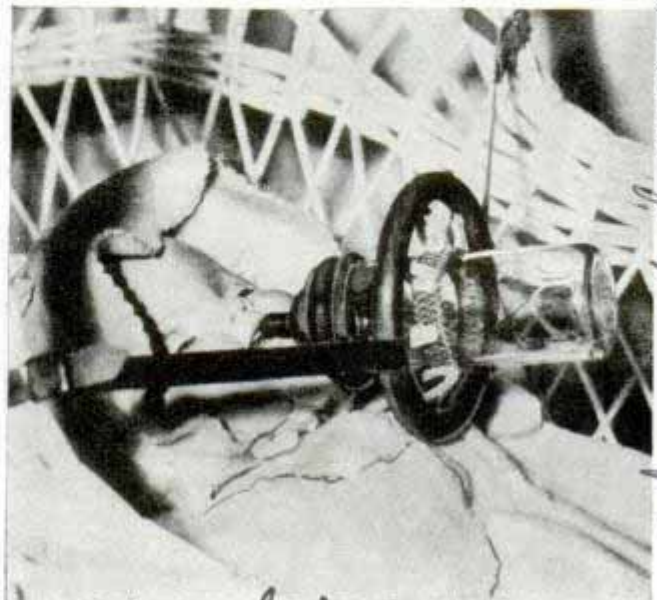

no information

shown at inventors congress. Portland Ore

Let "Yankee" Ingenuity Work for You



No. 33-H.—
NEW AMAZING VALUE.
"Yankee"



Handyman Spiral Ratchet Screw-driver. PRICE ONE DOLLAR. Everybody who tinkers around the home—man, woman or boy, wants this "Yankee" Handyman for driving small screws. BORES HOLES, too, for screws or other purposes. Ask dealer for "Yankee" Chuck and 3 Drills, to fit No. 33-H. 39¢ set.



No. 130-A.—Hobbyist admires ingenuity and convenience of this "Yankee" QUICK-RETURN Spiral with spring in handle. Drives screws one-handed—simply by pushing on handle. Spring keeps bit in screw-slot. Price, \$3.45. No. 30-A.—"Yankee" Standard Spiral Ratchet Screw-driver. Without spring. \$3.00. Attachments.—For "Yankee" Spiral Screw-drivers, include Chuck and Drill-points, Countersink, and Sockets.



No. 15.—"Yankee" Ratchet Screw-driver. Helps amateurs lick pesky little screws . . . starting them by thumb-turn and driving them home with "Yankee" Ratchet. Blade, 1/8"; six lengths, 2" to 8". 70¢ up. No. 10.—For larger screws. Price, 65¢ up. No. 11.—Ratchet Shifter moves across tool.

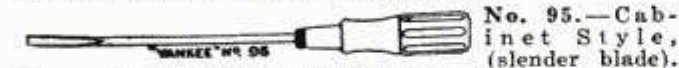

No. 95.—Cabinet Style, (slender blade). Eleven sizes: 2 1/2" to 15 1/2" blades. The craftsman's favorite screw-driver for fine work. 35¢ to \$1.00.



No. 90.—Husky PLAIN screw-driver for any job. Fifteen sizes: 1 1/2" to 30" blades. "Yankee" balance and comfort-grip handle add pleasure to work. Tested blades. Can't loosen. Won't twist, crack, break, or bend at tip. 35¢ to \$2.75.



No. 41.—"Yankee" Standard Push Drill. Choice of mechanics everywhere. \$2.60. No. 44.—A push drill with ADJUSTABLE TENSION . . . to give just the right pressure for hard or soft wood, large or small drills, and save drills. \$3.15. "Yankee" Tested Drill-points, eight sizes: 1/8" to 1/4", included with drill.

"YANKEE" TOOLS

NORTH BROS. MFG. CO., PHILADELPHIA, U. S. A.

"Yankee" Tools inspire the craftsman . . . make him a better mechanic, by making work easier, better, more interesting! Ask at your dealer's to see these ingenious tools. MAIL coupon for "Yankee" Tool Book, free. Enclose dollar bill to get new "Yankee" Handyman Spiral Ratchet Screw-driver, delivered postpaid.



No. 1435.—"Yankee" Hand Drill. Puts expert skill into any man's hands. TWO SPEEDS—fast to slow, for easy drilling through. Changed at a finger-touch. Length, 11". Three-jaw chuck: 1/4". Price, \$4.50.



No. 1530.—Here is ingenuity aplenty to interest tool lovers . . . and speedy, sure help for hole-drillers in tight places! Five adjustments, including "Yankee" Double Ratchet, all in a 10 1/2" hand drill. Three-jaw; 1/4". \$5.25.

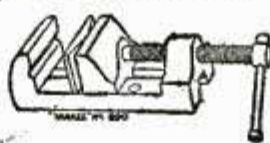

No. 990.—"Yankee" Vise. Without Swivel Base. Accurately machined to support work squarely on face plates. Holds irregular shapes, tapered, round. Removable swivel jaw. Jaw width, 2 3/8". Price, \$3.30.

No. 1993.—Just the Vise for the home workshop. Squared all sides. Swivel Base. REMOVABLE from base—for work anywhere the handyman pleases. On bench, at drill press. Price, (3 1/2" open) \$9.90. Other "Yankee" Vises, \$2.85 up.

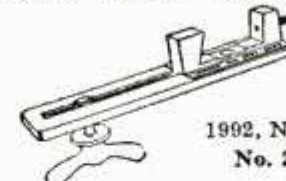
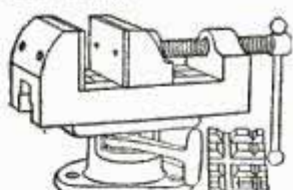

"Yankee" Vise Clamp. Attaches vise to face plate. Made in two sizes only. For use with "Yankee" Vises No. 992, No. 1992, No. 993, No. 1993. Assures rigidity. No. 2992, \$1.35. No. 2993, \$1.80.

No. 2100.—Bit Brace by "YANKEE." Advertisized Price, (10"), \$9.45. Superfine tool for hobbyists and all others who get a "kick" out of ownership of fine hand tools.



Mail this COUPON

For free "Yankee" Tool Book. Also to order "Yankee" Handyman, \$1

- For \$1 enclosed, mail me postpaid "Yankee" Handyman Screw-driver.
- Send "Yankee" Tool Book.

Name.....
Address..... (PM3)

To:
NORTH BROS. MFG. CO.
Philadelphia, U. S. A.

LEPAGE'S GLUE READY TO USE ... INSTANTLY!

No preliminary weighing, soaking or heating is required. LePage's Liquid Glue is always ready for immediate use. Experienced craftsmen find it indispensable for welding joints, reinforcing nails and screws, filling small cracks and nail holes. Ideal for veneering and inlaying. LePaged joints are as permanent as the wood it joins. You can get LePage's Liquid Glue at all hardware and drug stores in tube, bottle or can. Ask for it next time you are in the store. LePage's Adhesives, Laboratories and Factory, Gloucester, Massachusetts.



BUILD WITH DOENUTS



In building wheelbarrows, midget autos, lawn mowers, hand trucks, coasting wagons, platform trucks, portable painting, spraying or greasing equipment, nothing excels the patented **Musselman Doenut cord tire** and wheel. Size 10"x2 3/4". Designed on a new cord angle with greater flexibility and longer life. Requires only 12 to 15 lbs. air pressure. Absorbs ordinary surface obstructions without jolt. Cadmium plated steel disc wheel with adjustable ball bearings and hollow sleeve knock-out type axle. Load capacity 200 lbs. per wheel. Truly the Tiffany of Tires. The Doenut is the most advanced step in tire construction developed by the originator of the air wheel for airplanes. Write for literature and prices, explaining uses you contemplate.

MUSSELMAN PRODUCTS CO.
6247-R St. Clair Ave., Cleveland, Ohio

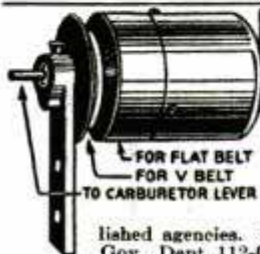

AUTO ENGINE SPEED CONTROL GOVERNORS

To control speed of any make of auto or truck engine, regardless of load changes, when used as a stationary or portable power plant. Fully guaranteed. No cash down. Governor speed range from 400 to 3000 R.P.M. Fine opportunity for established agencies. Send for free circulars. Mrs. Candee-Smith Gov., Dept. 112-C 215 No. L. A. St., Los Angeles, California.

Mighty Midgets of the Speedways

(Continued from page 397)

twelve inches in diameter. The driver squeezes into a tiny cockpit behind a Pyralin shield that partly protects his head from the flying dirt. The pan under his feet is only four inches off the ground and the center of gravity of the entire car is much lower than in ordinary race cars. The motors must be not more than 100 cubic inches in displacement and a car cannot be more than 110 inches in overall length.

In the early days, every kind of power plant available was used, including supercharged motorcycle engines, small automobile engines, one bank of a stock eight-cylinder engine, and small marine engines and outboards. Four-cylinder outboard engines are still popular and on many tracks are as fast as the more expensive special Offenhauser engine that has been developed for the sport. The outboards are often temperamental and the drivers have to ride high around the tracks because with poor acceleration they dislike shutting down to ride the inner rail around the turns.

Many leading drivers are now using an Offenhauser engine that develops one horsepower per cubic inch of displacement. Equipped with a supercharger and using a compression ratio of 11.5 to one, as much as 150 horsepower has been developed by the midget racing motor. The "Offie" is a four-cylinder overhead camshaft engine with a high-pressure dry-sump oiling system. The engine block is iron alloyed with twenty per cent of steel rail for toughness. The crankshaft is turned down from a chrome-nickel-molybdenum block and is hollow drilled. Likewise, the connecting rods are tubular for lightness. Costing \$1,200 as against only a few hundred dollars for an outboard, these engines rarely need repair work and go through a racing season with hardly any attention aside from valve grinds. Depending on the kind of power plant used, a complete midget racing car costs from \$1,500 to \$3,000.

Today there are more than fifty major midget tracks in this country. Most of them are a fifth or a quarter of a mile around. Some are paved, some are dirt,

Offenhauser Engineering Co. 1935 W. 62nd St. Los Angeles, Calif.

Never Before—

—have such fine projects been available to homecrafters

And they're FREE in the 1937 CASCO Project Service

● What a marvelous opportunity for homecrafters! Just look at these stunning pieces of modern living-room furniture. Designs that heretofore have been exclusive only with the world's finest furniture manufacturers—never offered before in any project service. And now Casein Company, makers of the amazing heatproof, waterproof CASCO Glue, offers them to you in the 1937 CASCO Free Project Service. Eight of them in all. Internationally famous Gilbert Rohde designed them exclusively for CASCO. You'll want to build several of the Rohde Group. And you can... easily... with the all-inclusive plans which CASCO offers you free.

HOW TO GET FREE PLANS

Buy a 25c (or larger) size can of Casco from your Hardware, Paint or Lumber Dealer. A green ticket in each can lists the 24 projects for 1937. Choose the one you want to build. Mark your choice on the green ticket, mail it to us and receive complete plans by return mail.

Pictures of 1937 projects and full information in "Free Plan" Folder—ask your dealer for a copy or mail coupon today.



FREE!

SAVE 2c. Stick this coupon on penny postcard to get FREE folder describing 24 CASCO Projects.

CASEIN COMPANY OF AMERICA, INC.
350 Madison Ave., Dept. PM337, New York, N.Y.
Please send folder about FREE Project Service.

Name _____

Address _____



Gilbert Rohde



Three of the eight pieces in the GILBERT ROHDE GROUP—beautiful, useful, artistically correct in the modern motif.



Round Occasional Table



Desk with Concealed Typewriter Drawer



Folding Card and Game Table

F 1469

Power Plow for Sidewalks Cleans off Dirt, Snow



Built with narrow tread, this plow is handy for clearing snow off sidewalks

Designed with narrow tread for operation on sidewalks, a power plow for clearing away dirt or snow is useful the year around. The plow mechanism has an automatic trip spring which adjusts the blade to the surface over which it operates, moving up or down. A large guide wheel in front enables the plow to mount curbs without hand manipulation and to start plowing clean from the edge of the curb. A four-cylinder engine, which gives a speed of four miles per hour in high, drives the plow.

F 1647

Sheet Metal Clipped Together by Handy Punch

For fastening together sheet metal, a new tool punches out a triangular "ear."



When folded down this ear gives a secure three-way lock. The flat nose of the tool permits access to tight places. Any type

of seam, plain, folded or overhanging, may be fastened in this manner.

Whitney Metal Tool
P. O. Box 1000

WITTE DIESELECTRIC PLANTS

NOW! The
LIGHT
PLANT
YOU HAVE BEEN
WAITING FOR

Three Styles

110 Volt. A. C.

110 Volt. D. C.

32 Volt. D. C.

All 1600 WATTS



The
Ideal
Lighting
Outfit

Unbelievable
Economy
.

Cuts Light
Bills 75%

Operates on
Non-Explosive
Fuel

At last it's here! You have never seen a plant like this—there has never been one like it! Full 1600 watts, uses cheap non-explosive fuel, and made in three styles, complete with switchboards. A modern mechanical marvel. Here indeed is the plant you have been waiting for.

Make your own electric light and power at the lowest price per kilowatt hour ever guaranteed in a small plant, "Less Than One Cent per KILOWATT." This is made possible by the WITTE Vertical Diesel Engine. Small, compact and direct-connected to the generator of your choice and operating at medium speed for long generator life. Heavy balanced flywheel for steady, flickerless light. The 110 volt AC and 110 volt DC plants have no batteries and are run when current is wanted. Belt power can be taken off engine pulley when full output of generator is not being used.

For those who prefer a plant with batteries the 32 volt Dieselectric will prove most satisfactory and furnish electricity at a decided saving. Same general description as the 110 volt plants but designed for use with standard 32 volt farm light plant batteries. Battery charging costs lower than ever thought possible. Make 1937 the start of a new era of better living—get a WITTE Dieselectric for greater comfort, convenience and economy.

A quality plant in every detail. The WITTE Vertical Diesel Engine is of Full Diesel construction for greater economy. Easy starting four-cycle type. Full force feed lubrication. Tell us your requirements and we will be glad to recommend the unit which will best serve your needs. Larger plants available.

**Experienced Light Plant Salesmen Wanted to Demonstrate
This Fast Selling Outfit—Demonstrators Sold on Easy Terms.**

215-C So. 2nd St.
HARRISBURG, PA.

WITTE ENGINE WORKS

1743 Oakland Avenue
KANSAS CITY, MO.

COMPLETE PLANS

**FOR A PERMANENT
PROFITABLE BUSINESS
OF YOUR OWN — FREE**

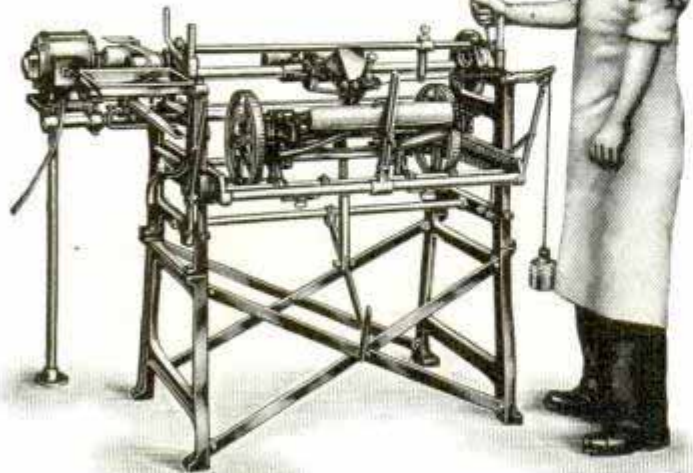

MAKE \$30 TO \$40 A WEEK

Our free plans show you how to build a successful business of your own sharpening lawnmowers. Positively no experience necessary. Most men average from \$30 to \$40 a week. J. B. Van Dien writes: "Some weeks I earned \$40 a week with my Ideal just as a side line." H. Greenlau writes: "In May I sharpened over 200 mowers at \$1.00 each." Niles C. Race writes: "I have sharpened 785 mowers at \$1.00 each."

THE IDEAL LAWNMOWER SHARPENER

Makes old, dull lawnmowers cut like new. Mowers run easier, stay sharp longer—customers come back year after year. Start right at home. Attach the Ideal to your lamp socket. Sharpens any make of mower in 15 to 20 minutes—you get \$1.00 to \$1.50. Attachments for grinding skates, grass shears, hedge shears, sickles, scythes, axes, etc.

Send Post Card for FREE CATALOG and Complete Plans

THE FATE-ROOT-HEATH CO.
437 Bell St., Plymouth, Ohio



BUILD YOUR OWN

Wind Driven Light Plant



FREE
Lights

from old auto generator. We show you how. Make money building for others. Light your buildings, play radio, operate washing machine and other motors. Dime brings complete plans and 1937 catalog. Over 50 other changes for 6-12-32 and 110 volt plants.

LEJAY MFG. CO., 1447 W. Lake St., Minneapolis, Minn.

RADIOS

ALL NEW 1937 MODELS!

SAVE
UP TO
50%



DEAL DIRECT—
FACTORY PRICES! Iron-Clad Written Guarantee!

A penny post card brings you our new, full-color 16-page BARGAIN CATALOG free. Many models to choose from: 4 to 19 tubes; AC-DC, All-Wave and new Farm sets that operate like city radios!

30-DAY NO-RISK HOME TRIAL

Send post card or coupon below for full details of our 30-day no-risk trial and Agent-User proposition!

AGENTS!

\$6.98

NOW - MAIL COUPON



A real money-making offer. Write at once for territory.

GOLDENTONE RADIO CO., DEPT. E,
Dearborn, Mich.
Without obligation, send me new 1937
Catalog and 30-day trial plan.
Name

ADDRESS

Fishing Through the Ice

(Continued from page 415)

One is to dump a small can of chopped minnows, slightly cooked, into the lake through a hole near the fishing shack. The cooking makes the minnows heavy so they sink quickly. The other is to lower a can of the chum way down into the deep water underneath the fishing holes. This involves a clever trick in order to open the can after it is on the bottom.

The can used to carry chum to the bottom is just an old tobacco tin. In the top is inserted a small piece of iron pipe to give the box weight so it will go down easily. When the cover is fastened on the box it presses down on a loop in the line. As soon as the box is on the bottom the fisherman gives the line a jerk. It pulls against this loop which opens the cover of the box and lets out the chopped minnows.

On a clear lake you can see way down, possibly fifteen or twenty feet. Slowly going toward the bottom are the pieces of chopped minnows. Then up come the ciscos, darting here and there to pick up the food. You see twenty or fifty in a school. Here is where the fisherman works his lure steadily to get a strike. Ciscos have tender mouths and require easy handling. When you catch a pickerel or a bass or a walleye you don't have to worry much about the hook tearing out. This is especially true if you coil several feet of line on the ice so the striking fish can run with the live minnow and get it well in its mouth before the line tightens. Then the hook is apt to be well set.

But with ciscos the tactics are different. You sit on your seat over the hole in the ice. You let down the line to the depth frequented by the ciscos. Tie pieces of colored yarn on your line to indicate the number of feet payed out. Jerk the hook with beads on it up and down by bringing your wrist and fingers upward. This moves the baited hook sharply. When you feel a hit you jerk quickly but not too hard. If you set the hook with a powerful swing you may tear the barb out of the mouth of the fish. So be quick on the jerk but gentle.

To some sportsmen unused to much winter weather the clothing outfit is even more important than the tackle require-

(Continued to page 124A)

FASTER - SAFER - CLEANER

**7200 Strokes per Minute
Electric Operation**

No Motor Required

Astounding performance! Cuts up to 1" or more, with smooth, clean edges. No sanding required. Accurate, sturdy, efficient—a revelation to skilled craftsmen in handling both intricate designs and heavy work. Ideal for cutting light metals, veneers and plastics. Operates on 60 cycle, 110 volt AC, without motor or any reciprocating parts. Requires no oiling. 10" square table; 13 1/2" throat; adjustable guide; variable stroke. Complete with underwriters approved cable and rubber plug. Built for years of continuous service.



**New
SYNCR
JIG SAWS**

**FREE
FOLDER**

GET FREE LITERATURE TODAY
Ask your dealer to show you the models now available. Or send your name for full information and illustrated literature, **FREE**
SYNCR DEVICES, INC.
511 Boydell Building Detroit, Mich.

**Thompson
BEATS
the World
on BOATS**



**Better Built
Lower Prices**



Canoes \$54 and up
Rowboats \$42 and up
Outboards \$42 and up
Very fast utility model

**Only Boats With
Full Length Spray Rails**
Keep passengers perfectly dry—even at high speeds. Catalog also shows today's five most popular models of sailboats. Two big factories. Prompt shipment.

CATALOG FREE
Write for your copy. State kind of boat in which you are interested.
THOMPSON BROS. BOAT MFG. CO. (79)
213 Ann St. PESHIGO, Wis. (Write to either place) 113 Elm St., CORTLAND, N. Y.

BUILD IT YOURSELF **PLANS \$1.00**



JIM DANDY CABIN CRUISER
The Trailer that has Everything
With my plans you can build this beautiful coach with ease and save money. Plans show every detail of building body, chassis, beds, cabinets, drawers, refrigerator, top, electric light and water systems and *where to buy all parts*. The Jim Dandy Cabin Cruiser can be built in any size to accommodate 2 to 4 people. Send \$1.00 for these plans today—get started now!
MAIL DOLLAR BILL TO JIM DANDY, Box 125-A, WAUSAU, WIS.

COMPLETE BUILDING PLANS \$1.00

BURN YOUR NAME ON TOOLS
WITH THE ARKOGRAF
PROTECT YOUR TOOLS FROM THEFT
Write with electricity any name or design on the hardest and finest tools and instruments, or any metal, like writing on paper with pen or pencil. **Complete Outfit \$3.50**—Prepaid Anywhere. Interesting illustrated circular free. Write today. Agents wanted.
ARKOGRAF PEN CO., 3927 S.E. Stark St., Portland, Ore.

Sani-Flush **SAFE, NOT CAUSTIC**
KEEPS AUTOMOBILE RADIATORS CLEAN

STANDARD GARDEN TRACTORS
Plow Seed Cultivate Mow Hay and Lawns
Powerful Gas Tractors for Small Farms, Gardeners, Florists, Nurseries, Fruit Growers & Poultrymen
1 & 2 Cylinders
Walk or Ride—Do Belt Work High Wheels—Free Catalog
STANDARD ENGINE CO.
Minneapolis, Minn. Philadelphia, Pa. New York, N. Y.
3221 Como Ave. 2546 Market St. 290 Cedar St.

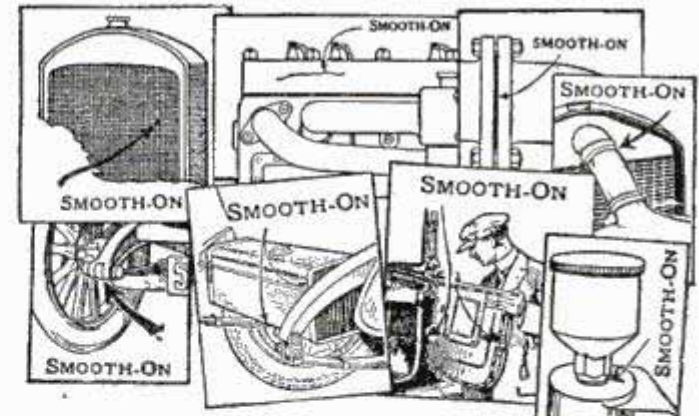

**SAVE MUCH MONEY
ON AUTO REPAIRS**

With Smooth-On No. 1 you can make the following repairs easily, quickly and usually at almost no expense.

STOP LEAKS

of water from a frozen, punctured or corroded radiator (nothing put inside), from a cracked engine jacket or from a loose hose connection; of lubricant from a cracked crank, gear or differential case or bad joint; of gasoline from tank or line joint; of exhaust fumes from manifold, muffler or heater connections.

MAKE LOOSE PARTS TIGHT

Smooth-On No. 1 makes solid connections—keeps lubricator terminals, grease cups, hub caps and nuts from backing or dropping off; tightens loose fenders, lamp, tire and license plate carriers; makes screws stay tight in hinges, locks, robe and foot rails, window and dash mouldings; tightens loose spring bushings to prevent wear and squeaking. A bolt with Smooth-On No. 1 under head and nut washers makes a strong replacement for a weakened rivet.

HOME and AUTO REPAIRS
WITH SMOOTH-ON

Write for **FREE BOOK**



Smooth-On No. 1 metallizes quickly, holds perfectly on any metal and is proof against vibration and heat. Anyone can get thoroughly satisfactory results by following the illustrated directions in the free repair booklet.

Send for your copy, and get Smooth-On No. 1 in 7-oz., 1-lb. or 5-lb. can from your hardware store or if necessary from us direct.

Do it with SMOOTH-ON

SMOOTH-ON MFG. CO., Dept. 37
574 Communipaw Ave., Jersey City, N. J.
Please send the free Smooth-On Repair Book.
Name.....
Address.....
3-37.....

THE SMASH HIT of Outboard Motoring

Perfected Alternate Firing, Full Pivot Reverse, Underwater Exhaust, Synchronizing Control and dozens of quality features formerly found only in the new All-Star Light Twin at only \$95! DeLuxe Streamlined Twin, with Ready-Pull Starter, only \$130! Both develop 4.2 N.O.A. certified brake h.p. at 4000 r.p.m.! Other models as low as \$59.50! (Prices f.o.b. factory. Subject to change without notice.)

JOHNSON MOTORS
400 Pershing Road, Waukegan, Ill.
Canadian Johnson Motor Co. Ltd., Peterboro, Can.

JOHNSON ALL-STAR Sea-horses

FREE Write for special fully illustrated literature describing Johnson's nine All-Star models for 1957. Packed with new features, new performance. Get the new Sea-Horse Handy Chart. **FREE.**

Drop a Line to

Ask for your copy of **Hildebrandt's Hints . . .** tells about spinners and flies and how to use 'em for all kinds of fishing. Good advice from folks who know. Not a dry line in it. Your copy **FREE.** Address —

HILDEBRANDT
LOGANSPORT 838 High St. INDIANA

3-IN-ONE OIL

3-IN-ONE OIL IS A BLEND OF THREE FINE OILS

BEST FOR HINGES, LOCKS, CLEANING AND OILING TOOLS, EASING ACTION POINT OF TOOLS, LIGHT MOTORS, GUNS, WATERPROOFING LEATHER, CLOCKS, ETC.

LUBRICATES • CLEANS • PREVENTS RUST

Fig 4
(Continued from page 122A)

ments. Many find high-top rubber pacs better than leather boots for comfort, especially in fairly mild weather when, during the middle of the day, the ice may get sloppy. These pacs have rubber bottoms up to the ankle and leather tops. The latter may be oiled so they are waterproof. Get a pair large enough to take warm felt inner soles. Wear plenty of socks in the pacs, a pair of light wool plus heavier wool outside. Put on woolen underwear, wool pants, flannel shirt, and a sweater if necessary. Or, better yet, put on a leather, wind-resisting underjacket if the wind is blowing. For an outside garment many like a big Mackinaw coat with a high collar. For headgear some prefer a woolen cap with ear flaps.

Ears, hands and feet are the body points that usually turn the tide between comfort and discomfort when on the ice. So the right kind of mittens or gloves also are important. Some like to carry a couple of pairs of woolen mittens although on some of the coldest days they work the lines with just cheap cotton gloves, take fish off the line with bare hands and then retire fingers to a coat pocket in which they have a heat pack going. This heat pack generates heat by the addition of a small amount of water and on a cold day it may be worth its weight in gold.

Last but not least, is the matter of ice grippers. The old-timers like a pair of metal grippers that fasten on a boot or shoe and dig into the ice, enabling them to walk or run without slipping. They are handy although not absolutely required.

71521

Rubber Drip Molding for Car Fits Top of Door



Requiring no tools for installation, a simple rubber drip molding is available for automobiles. It fits at the top of the door and stops roof drainage from dripping into the

car. The molding can be sprayed or painted to match the automobile. It fits ninety per cent of the cars now on the road.

St. Louis, Mo
42 Washington Ave.
1942
Champion Dist.
Wattles

Stoves AT FACTORY PRICES!



Sale Catalog—FREE

200 Styles and Sizes of Stoves, Ranges, Furnaces at Factory Prices, Easy Terms—as little as 18c a day. More Bargains than in 20 Big Stores. New styles, new features, new colors, Year to Pay—30 days' free trial—360 days' approval test—24-hour shipments. Over 1,100,000 Satisfied Users, 37 Years in Business.

Write for FREE Catalog.
THE KALAMAZOO STOVE CO. MFRS.
391 Rochester Avenue
Kalamazoo, Michigan

"A Kalamazoo Direct to You"

New HULL AUTO COMPASS



Saves miles of travel in wrong direction. This handsome, STREAMLINE Airplane Type Compass keeps you on the right road. Easily installed. 3½ inches high. Bakelite case, sapphire bearing. Built-in compensator. Only \$2.95 POSTPAID. SATISFACTION GUARANTEED.

MODEL A

Airplane Type. 1¾-inch diameter. Sticks to windshield. Guaranteed. With separate compensator, only \$1.95 POSTPAID.

If your dealer cannot supply you, order direct.



HULL MFG. CO., Box 246-D, WARREN, OHIO

JIG SAW \$1.50

COD or outside U.S.A. \$1.75



Including 12 assorted blades. Adapters, Illustrated Manual, and roller Saw Guide formerly found on expensive machines only. All metal, 15" long, 8" high, 6½" table. A swift and easy cutter—best ever made for the money.

"The Jigmaker" cuts wood up to 2" thick

FREE Catalog illustrating complete power tool line; Shaper, Circular Saw with oilless bearings, \$3 each; Drill Press, \$2.50; completely equipped Lathes, \$2 & \$3; Sander, \$1, etc. All practical tools for real work. Order today or send card for catalog.

J & H Metal Products Co. 5 Commercial St. Rochester, N. Y.

Catch Fish!

Eels, Mink, Muskrats, with our new folding galvanized STEEL WIRE TRAP. Write for our FREE TRAP OFFER and Bargain Catalog. \$1 Box of our famous Fish Bait FREE to introduce our traps. WALTON SUPPLY CO., 3509 JUNIATA AVE., ST. LOUIS, MO.

OTTAWA LOG SAW



GREATEST OFFER EVER MADE

PUTS THIS OTTAWA TO WORK FOR YOU

Make Money! Wood is valuable. Saw 15 to 20 cords a day. Does more than 10 men. Ottawa easily operated by man or boy. Falls trees—saws limbs. Use 4-hp. engine for other work. Write today for FREE book.

OTTAWA MFG. CO., 313 Wood St., Ottawa, Kansas

TYPewriter ½ Price

Easy Terms
Only 10c a Day

Save over ¼ on all standard office models. Also portables at reduced prices.

SEND NO MONEY

All late models completely refinished like brand new. FULLY GUARANTEED. Big free catalog shows actual machines in full colors. Lowest prices. Send at once. Free course in typing included.

INTERNATIONAL TYPEWRITER EXCHANGE
231 W. Monroe St. Dept. A-301, Chicago



10-day Trial

Be An ARTIST



LEARN to Draw at Home This Practical, Proven Way!

YOU have always longed for it—this fascinating ability to draw. Now it can really be yours! Illustrating, Rapid Sketching, Decorative Designing, Commercial Art, Cartooning—you can now learn all of this right in your own home. Many of our students never studied art before starting, yet today are successful artists with good incomes.

Our interesting, practical home method makes it fun to learn in your spare time. Get into this interesting, profitable field NOW! Read below what others are making. Then mail coupon for FREE BOOK, "Art for Pleasure and Profit," AT ONCE!

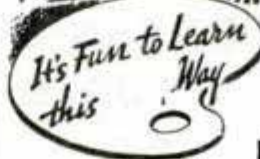

Can YOU Do THIS?

Just a few plain, quickly sketched lines—and you have the "framework" of a drawing. These first lines give you the rough proportions and lines of action.

Then YOU Can Do THIS...

Next we show you how to develop outlines and "block out" areas to be shaded. Then you erase "framework" lines and presto!—you have this!

... and THIS!

Now you are shown how to give your drawing shape, depth, and form by shading and high-lighting. In every single step you are guided by proven rules which skillfully direct your hand!

Course Paid For Itself!

"So much business I hardly had time to finish my last lesson."—J. Halliwell, Jr., N. J.

\$3,000 for W. R. Kent

"Just signed 2 contracts that will bring me \$3,000. Earned \$280 while taking course. Have more orders than I can accept."—W. R. Kent, N. J.

Earned \$100 in 6 Hours!

"I am a freelance and received \$100 for some paintings of 6 to 8 hrs. work."—D. P. Harris, N. Car.

Commercial Art, CARTOONING and Designing, All in ONE Course!

It's like a pleasant game when you learn to draw this way. You study right at home, yet every bit of your work receives the individual attention and criticism of an experienced Art Instructor. It's almost as though he were standing right at your elbow.

With this training you progress by developing ability. Starting with straight lines and curves you move forward to action drawings, perspective and the more advanced principles. You get a sound, complete, all round art training based on our 23 years of successful teaching experience.

Send for FREE BOOK

—describes latest developments and opportunities in this fascinating, good income field—and gives full details of this practical method. Tells about our students—their successes—what they say about our course—shows actual reproductions of their work. Mail coupon or postcard today. Washington School of Art Studio 123, 1115—15th St. N. W., Washington, D. C. (Founded 1914)

THIS BIG ARTIST'S OUTFIT GIVEN

This full-size professional Artist's Outfit comes with your very first lessons—at NO EXTRA COST. It contains everything you need to start—paints, brushes, drawing board, T-square, pencils, paper, pens, etc.

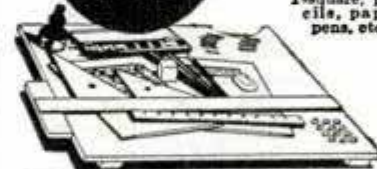

Free Book shows how

WASHINGTON SCHOOL OF ART, Studio 123, 1115—15th Street, N. W. Washington, D. C.

Without obligation, please send me a FREE copy of your Book, "Art for Pleasure and Profit."

Name.....Age.....

Address.....

City.....State.....

(No salesman will call)



**REPLACES
DRAWER
PULLS**



WOOD IN CANS IN TUBES

Makes 1001 Household Repairs

Anyone can now make household repairs that last with easy-to-use Plastic Wood—the wonderful discovery that handles like putty and dries to hard, permanent water-proof wood. Millions are using it to reset—once and for all—loose drawer pulls, bathroom fixtures, casters, repair damaged furniture, fill cracks and old screw holes, etc.

Plastic Wood will stick to wood, metal, stone, glass and porcelain—can be sawed, sanded, carved and finished just like real wood—will hold nails and screws without splitting or crumbling. Get a can or tube for a few cents—at paint, hardware and variety stores. Keep it handy.



INVENTORS Be Sure to See Page 23A

PHOTO ENLARGEMENTS

Is Photography your hobby? Do you want a profitable easy business at home? Make **PHOTO ENLARGEMENTS** for yourself and others. Your cost 5c each and less. The Ideal Photo Enlarger is **AUTOMATIC**. No experience required. Also **COPIES** any picture. **\$5.94 COMPLETE**. Interesting circular **FREE**.

IDEAL-O, 122 East 25th Street, New York City

5¢
ANY
SIZE

Tune in Records on Receiver

(Continued from page 420)

circuit of your broadcast set is necessary.

A schematic diagram is given in Fig. 1 and a simplified wiring diagram showing all connections under the base, appears in Fig. 2. Details for winding coil L_1 are given in the sketch at the left; this coil is close-wound on Bakelite or cardboard tubing. Note that the .00025 mfd. fixed condenser (C_2) is mounted inside this coil with the grid lead for the 6D6 tube projecting out through the top of the coil shield can, which is 2 in. in diameter and $3\frac{3}{4}$ in. high. Photos, Figs. 2-A, 2-B and 2-C show the assembly details clearly.

The sheet-metal base is 6 in. long, 5 in. wide and 2 in. high. Coil L_2 is an ordinary 39-cent, unshielded 80-mh. r.f. choke with

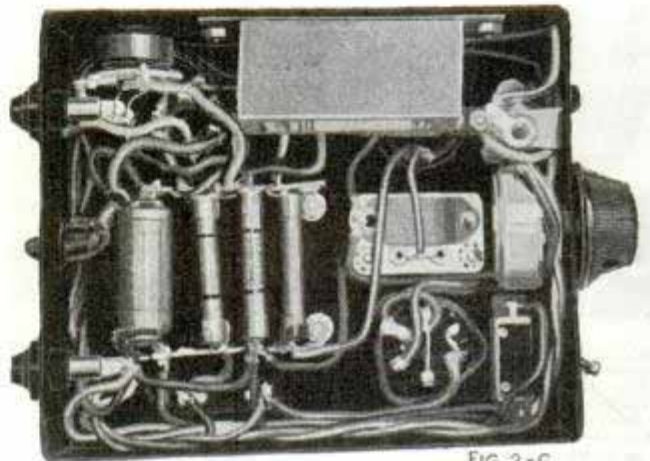

FIG. 2-C

an additional winding of ten turns between the r.f. coil and its terminal board. Both leads from this second winding go directly to the twin output jacks "to radio." A 100,000-ohm potentiometer (R_4) is used for the gain control for percentage modulation but does not control the output of the oscillator, therefore the coupling to the antenna lead-in should be adjusted for best results. In extreme cases, leads from both "to radio" jacks must be used; one connected to the ground post and the other to the antenna post on the set, using a switch to cut in the regular antenna when required for broadcast reception. A list of the parts used in the original model can be obtained from Popular Mechanics radio department upon request, without charge.

A microphone may be connected into the oscillator if desired. The microphone connection is shown to the right of the dotted line in Fig. 1. This enables the operator to use his receiver for public address.

NEW SCREW FEED LATHE

No. 355-6 x 18-inch METAL TURNING LATHE WITH LONGITUDINAL SCREW FEED. Length overall 30 inches. Mached semi-V ways. Threaded hollow spindle No.

ONLY \$1195



O MORSE TAPER CENTERS, BRONZE TAPERED TAKE-UP BEARING. 1/2 inch tailstock set-over. Compound carriage travels on semi-V ways ribbed for take-up. Included: Two 60° centers, tool post assembly and 4 inch face plate.—3 inch four jaw chuck \$3.50; 4 inch chuck \$4.50; adapter bushing 50 cents. Send \$2.00 with order, balance C.O.D. Shipping weight 30 lbs.

FREE—32-page catalog



BALKO ELECTRIC MOTOR & SUPPLY COMPANY
Dept. A13 10 S. Clinton St. Chicago, Ill.

TURN SNAPSHOTS INTO HUMANETTES



Sensational invention. Almost human in appearance. A life-like cut out figure. Any snapshot, photograph or picture can be "immortalized" by this strange new process. Surface covered with moisture-proof transparent PORCELITE. Will not peel, tear, crack, or soil. Looks like porcelain bas-relief.

BIG MONEY FOR AGENTS
Low prices make HUMANETTES big sellers. We furnish list of prospects in your neighborhood who will pay from \$1.00 to \$2.50 for showing samples of LIFETIME HUMANETTES. If you want to make money fast, send name for free sample proposition at once.
AL SCHULER, 1037 Evans Street, Dept. 10-C, Cincinnati, Ohio

BIG 1937 LEADER

For greater profits, steady income and repeat business, sell Century.

GENUINE LEATHER TIES

NO SALES EXPERIENCE NEEDED. Beautiful 4-in-Hands for Men and Boys, sell on sight, everybody buys. LOOK LIKE SILK; cleaned with a damp cloth. Famous Century Bows sell to uniform men, such as policemen, firemen, letter carriers, etc. Write today for our new **FREE DEAL OFFER**, or send 50c for samples, 4-in-Hand and Bow.
CENTURY TIE CO., 2345-L, W. Grand Blvd, Detroit, Mich.

The NEW KINKADE GARDEN TRACTOR

and Power Lawnmower

A Practical Power Plow and Cultivator for Gardeners, Suburbanites, Florists, Truckers, Nurserymen, Fruit Growers.

Low Prices—Easy Terms
AMERICAN FARM MACHINE CO.
1058 33rd Ave. SE., Minneapolis, Minn.



Catalog Free

MOTORISTS WISE SIMONIZ

DO YOU WANT a new business profession of your own, with all the trade you can attend to? Then become a foot correctionist, and in a few weeks earn big income in service fees,—not medical nor chiropody—easy terms for home training, no further capital needed, no goods to buy, no agency. Established 1894. Address **Stephenson Laboratory, 1 Back Bay, Boston, Mass.**

Print Your Own

Cards, stationery, circulars, tags, labels, advertising, etc. Save money. **Print for Others; Big Profits;** easy rules sent. Will do popular Raised Printing like Engraving. Junior press \$5.99, job presses, \$11 up, power \$149. Send for free catalog and all details. **THE KELSEY COMPANY, R-37, MERIDEN, CONN.**

MAN IN EACH TOWN To Plate Auto Parts,

Reflectors, Mirrors, etc., by late method. Experience unnecessary. Free particulars and proofs. Write today.
GUN METAL CO., Ave. M, Decatur, Ill.

The STRANGEST MONEY MAKING IDEA EVER INVENTED!



This Idea Is So Queer It Is Hard to Believe. Yet It's True—Every Word of It.

Listen

Most of the ads in this magazine offer a chance to **SELL** something and make a profit for yourself. By my plan you **DON'T SELL ANYTHING**. You don't have to convince anyone that they want your product. You don't ask anyone to give up their money.

YOU START OUT BY Giving Something Away

You give it away absolutely **FREE** to anyone who wants it (and there are millions, actually **MILLIONS** of people who want it). There are no strings attached. No tricks. No schemes. You just walk into a factory, office or home and hand out something absolutely free. Then you walk away. Easy?

It's so easy it sounds like a "get rich quick" scheme—but it's not. It's a sound, substantial business that is growing so fast there is no way to tell how much will be made this year—maybe millions.

Now, here's the second step. A few days after you give away the first articles, the men or women you gave them to call you up or send you a postal card. They ask you to bring them something else. You take it to them. When you make the delivery they each hand you \$6.50 in cash. This goes in your pocket—It is yours!—over **HALF** of it is **PROFIT!**

You can give away thirty or forty items a day. People are glad to get them. If only half of them call you up—you make over \$3.00 on each one—so that would be \$45 a day. Davis of Ohio wrote me that he made over \$3,000 in three months and his records showed that he was telling the truth.

Here's something so **HOT** it sizzles. I'm ready now to give it to a few more. You can be big or little. You can be satisfied with \$10 a day or you can shoot for \$100 a day. I don't care. But if you send your name on the coupon or a postcard, I'll mail you complete facts—full instructions showing exactly what to do, how to start at once on the strangest money making idea ever invented. These plans won't cost you a cent.

Don't lose a minute. If you want a chunk of the easiest money of your life, go to the mail box or telegraph office now.

N. A. STODDARD 4325 Ravenswood Avenue, Dept. 123, Chicago, Ill.

N. A. STODDARD, 4325 Ravenswood Ave., Dept. 123, Chicago, Illinois

Send me complete instructions—absolutely **FREE**—showing how I can start right away on your "Give Away" Plan for Big Money.

Name.....

Address.....

City.....State.....

When writing please mention Popular Mechanics

Wood Detective Solves 3000 Mysteries a Year

(Continued from page 362)

material passed through the mill. The Wisconsin wood expert matched part of the materials in the ladder with a single shipment of lumber handled by a certain New York dealer for whom Bruno Hauptmann had worked and from whom Hauptmann had purchased lumber during the interval when the shipment was in stock. One board in the ladder matched with those found in the attic of Hauptmann's home. Koehler also demonstrated before the jury the identity of the hand-plane marks discernible on the ladder by direct comparison with scorings made by one of Hauptmann's planes.

Koehler solves at least 3,000 mysteries a year, many of which outrival the cleverest imaginings of the most talented writers of fiction. He is qualified to solve all the major and minor enigmas of wood "parentage" and true names irrespective of the disguises or aliases of the materials presented for identification. Twenty years of experience in his unique technical art have trained and seasoned this technical forester. The exhibits which he identifies range from petrified wood perhaps millions of years old to specimens of fossilized wood whose growth in trees dates back some 120,000 centuries.

Once the incoming mail brought two specimens of wood from wrecked ships, long submerged, from an eastern salvage company. One was a hull hunk from an ordinary wreck off the coast of Delaware. The other, so the salvagers wrote, was clipped from the prow of a famous sailing vessel, reputed to have gone to the bottom with \$5,000,000 in gold. The salvagers did not know which submerged hull was the probable gold ship and did not want to raise both wrecks. They asked Koehler to indicate which of the two specimens was off the likely treasure ship.

When wood is submerged in water, it is preserved for hundreds, or even thousands of years. Being bottled up in the sea actually simulates hermetical sealing in a vacuum. Removing the water-saturated coatings of the specimens, he made microscopic specimens of the undamaged central material which displayed rings of growth that facilitated accurate estimates of the ages of the wood when the original

trees were felled. The specimens by their respective cellular peculiarities also enabled the expert to trace the pedigrees and technical derivations. One proved to be dogwood; the other, a species of juniper. These data "blazed" the salty descent to the probable treasure by establishing the geographic region in which each vessel was built.

Litigation involving large shipments of both lumber and sawdust has been settled on various occasions by Koehler's multiple microscopes. In a recent marine survey, government representatives were befuddled by the difficulty of correctly naming samples of wood from the various ships. The hull of a Norwegian vessel in particular remained unknown until somebody consulted Koehler. He quickly tagged the specimen as Scotch pine, or Norway spruce.

A miracle tree is growing from the roof of the courthouse at Greensburg, Ind. The roots of this tree—now fifteen feet high—are anchored in the slate roof of the building. How the tree lived and obtained nourishment in the absence of fertile soil no one could explain until a sample of the wood and its story of growth were submitted to Koehler. He identified the tree as a species of poplar and attributed its health and growth to soluble nutrients which it obtained from the composition of the roof.

Parts of a wooden clock built several centuries ago came to Koehler's desk. Study of the wood cells revealed to the specialist that the gear of the historic clock was made of cherry; the pinion consisted of mountain laurel. The identification of extinct species of wood is one of the most difficult assignments which filters to the laboratory of the wood detective.

A neighborhood dispute developed in a western city because of a clogged sewer line. Property owners objected to the removal of stately curbside trees that fronted the sewer line, claiming that only those which were blocking the sewer pipe with their root growth should be removed. The wood sleuth was asked to unravel the riddle of the guilty trees. Under the microscope, Koehler identified the offending

(Continued to page 130A)

STUDEBAKER ANNOUNCES

\$10,000.00 IN CASH PRIZES

Free TO USED CAR BUYERS

ALL you need do to qualify for one of these 452 cash prizes is to buy from an authorized Studebaker dealer a Pledge-backed used car of any make—and then write a letter of 50 words or less stating why you did so. For the best letter, Studebaker will pay \$1,000.00 in cash! For the next best letter, \$500.00 in cash! For the 450 next best letters cash prizes ranging from \$100 to \$10 in cash!

Studebaker is making this sensational offer of \$10,000.00 in cash prizes in order to call attention to the many amazing values in used cars of all makes which Studebaker dealers have taken in trade on new 1937 Studebakers.

2 GOOD REASONS WHY STUDEBAKER DEALERS SELL BETTER USED CARS

1 The famous Used Car Pledge—introduced by Studebaker eleven years ago—assures you honest pricing and fair treatment.

2 You have many makes of cars to select from, including a fine assortment of Studebakers—the make preferred by shrewd used car buyers.

The Studebaker Corporation asked its dealers to take this Pledge eleven years ago.

As years passed, other organizations have fallen in line with varied imitations of this sound policy. But regardless of the wording of the imitations no other organization can match Studebaker dealers in carrying out the spirit as well as the letter of this sound policy.

1st PRIZE, IN CASH	\$1,000.00
2nd PRIZE, IN CASH	\$500.00
NEXT 10 PRIZES, IN CASH, EACH	\$100.00
NEXT 40 PRIZES, IN CASH, EACH	\$50.00
NEXT 100 PRIZES, IN CASH, EACH	\$25.00
NEXT 300 PRIZES, IN CASH, EACH	\$10.00
452 CASH PRIZES	TOTALING \$10,000.00

Studebaker Dealer's Pledge to the Public on Used Car Sales

1. Every used car is conspicuously marked with its price in plain figures, and that price is rigidly maintained.
2. All automobiles which are sold as **CERTIFIED CARS** have been properly reconditioned and carry a 30-day guarantee for replacement of defective parts and free service on adjustments.
3. Every purchaser of a used car may drive it for five days and then, if not satisfied for any reason, turn it back and apply the money paid as credit on the purchase of any other car in stock—new or used. (It is assumed that the car has not been damaged in the meantime.)



RULES: Buy a Pledge-backed used car from an authorized Studebaker Dealer (the make of car or amount you pay, however small, makes no difference) and then write a statement of 50 words or less on the entry blank the dealer will give you, sign with your name and address (give street and number as well as city and state) and mail to Studebaker, South Bend, Ind. Your entry must be postmarked not later than midnight March 31, 1937. Employees of Studebaker and Studebaker dealers—or members of their families—are not eligible and duplicate prizes will be awarded in case of ties. No entries will be returned. Paul G. Hoffman, President, Studebaker Corp., and staff will be the final judges. Spelling, grammar and penmanship will not count against you. Just give a statement of 50 words or less as to "why you bought a used car backed by the Studebaker Pledge."

Marvelous New Ink Equals or Surpasses U. S. Gov't. Standards in 8 important respects

1. Water-resisting
2. Anti-fading
3. Non-clogging
4. Quick-drying
5. Correct flowing
6. Anti-corroding
7. Non-molding
8. Anti-deposit forming



Created by The Parker Pen Co. for Steel Pens and Fountain Pens

Now—replace your old-style ink with Parker's new \$68,000 ink creation—called PERMANENT Quink. By actual test this revolutionary ink in Royal Blue, Blue-Black, and Black equals or surpasses 8 rigid Gov't specifications listed above. Now you can make your office records as PERMANENT as paper—waterproof and fadeproof. PERMANENT Quink works equally well with steel pens or fountain pens. Quink is anti-deposit forming, 24 times better than Gov't Standard—and is 56% more anti-corrosive.

Parker Quink does what no other ink can do:

1. Cleans a pen as it writes—a Parker or any other pen. Contains a harmless ingredient that dissolves sediment left by pen-clogging inks.

2. Quink dries ON PAPER 31% faster than old-style; much faster than Gov't Standards. Yet, Quink resists evaporation, hence does NOT dry in a pen. Made 2 ways—WASHABLE for home and school—PERMANENT in all standard colors for accounting, office records and documents. Once you try Parker PERMANENT Quink you'll pour your old ink down the drain. And Quink gives writing new distinction because it's always rich, brilliant—never watery. From 2 oz. bottles at 15c up to quart, 5 gal. jugs and 50 gal. kegs.

Parker Quink

At all stores
selling ink



BUILD THIS 6" YAWL MODEL, ONLY \$1.50

Everything furnished including semi-shaped hull of white pine and mahogany with black water line. All rigging material, airports, pedestal, base, plans and instructions. Mailed postpaid for \$1.50 in U.S.A., \$1.65 Canada, No C.O.D. orders. Our 44 page illustrated catalog listing kits and separate fittings mailed on receipt of 15c.

A. J. FISHER, 1002-1 Etowah Ave., Royal Oak, Mich.

FIG. 1
REMOVING BATTERY NUTS

FIG. 3
TERMINAL SPREADER AND CLEANER

FIG. 5
BATTERY LIFTER AND CARRIER

FIG. 6
USING WRENCH AS HAMMER

AGENTS

Salesmen—Distributors

Take Orders
FOR THE PAZZANO
"7 in 1" battery tool from
Garages, Filling Stations, Car
Dealers, Battery Dealers and
Manufacturers. Does the work
of 7 tools at the cost of 1.
Sells on sight wherever Batter-
ies are handled. Exclusive
territory Open. Send \$1 today
for Sample Tool, Demonstra-
tion Kit, and Order Book.

ACT NOW

FIG. 2
REMOVING BATTERY
TERMINAL CLAMPS

FIG. 4
BOLT
HOLE CLEANER

USING AS
SPANNER WRENCH
FIG. 7

PAZZANO WRENCH COMPANY
732 MOODY ST., WALTHAM, MASS.

Wood Detective Solves 3000 Mysteries a Year

(Continued from page 128A)

roots as those of elm trees. It was then a simple matter to demonstrate to the owner of the elms the guilt of his trees and the necessity for their removal.

Uncle Sam was participant in a lawsuit which was won by the testimony of Mr. Koehler. The biological survey purchased a large tract of submarginal land as a game refuge and bird sanctuary. When government representatives sought possession of the land, the former owner claimed that the boundary was marked by three blazed trees, which had been thus designated a decade previously. Mr. Koehler was asked to determine the age of the blaze marks. He decided the trees had been blazed six years later, as shown by the growth rings adjoining the ax marks, than the erstwhile owner contended. The government won its case.

Identification of wood from aged "witness" trees is a rather routine procedure in the Koehler laboratory. Legally these trees, which usually have long served as base marks in land surveys, are of great importance in the definition of property lines. The fact which Mr. Koehler must demonstrate in most such cases is that the snags or stumps, veritable molars of the earth, are of the same wood species as the witness trees described in the deeds.

One wood specimen found in Wisconsin was identified as spruce from a glacial drift. Mr. Koehler estimated the age of that log as 500,000 years. The wood was crushed and flattened by the pressure of the massive load of rock and soil which for centuries had been bearing down upon it. Another log disinterred from a grave during excavations at the Naval Academy at Annapolis was identified as cypress which dated back to the Pleistocene age. A piece of sequoia tree recovered by the reclamation service 150 feet below the bed of the Yakima river in Washington state was identified by Koehler as an early progenitor of the California redwood of today. He fixed its age as 12,000,000 years.

Compression wood forms on the lower side of leaning trees; is not as strong as normal wood; shrinks readily and causes lumber abnormalities. Where compression wood is used in plywood or pencil

F1570
 manufacture it usually causes bowing and buckling and is a source of commercial and industrial disputes. Such arguments furnish more work for the wood investigator. He also handles many cases involving woods which fail in service under normal loads due to such defects as cellular damage during the growth of the trees. Other breaks are proved the results of overloading and abnormal stresses and strains.

Koehler can even tell the approximate month and year when a hurricane occurred by the examination of native woods in the wind-buffed area. When a softwood tree is bent for some time by a violent wind, abnormal growth is fostered and the rings of growth so affected that the wood specialist can easily translate their abnormalities into definite hurricane data. Similarly, the drainage of swamps writes its indelible impression in tree-ring growth. Tamarack tree rings developed after drainage are larger and whiter than those formed during the waterlogged era.

F1488

Spare Filament in Light Bulb Doubles Its Life

Costing no more than the present type, a new electric lamp has a spare filament and burns twice as long. An automatic switch effects a new circuit when one filament burns out.

Dr. Paul Schverin

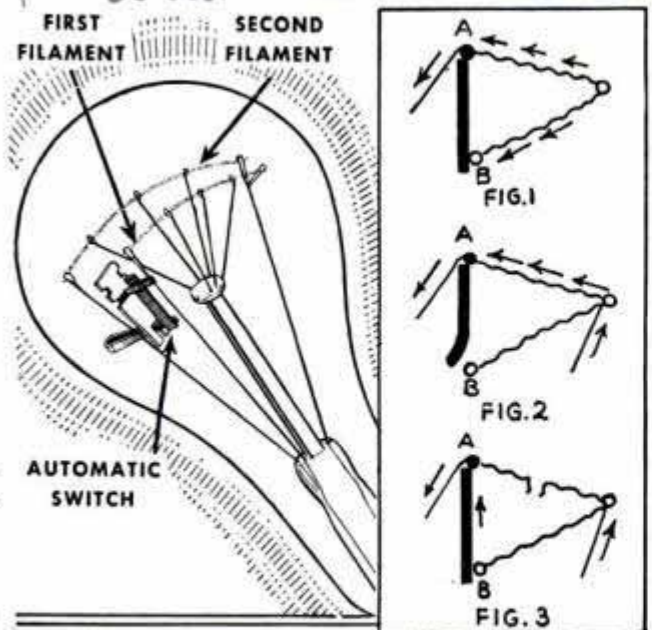

Sketches at right show (top) when light is first turned on; (center) switch breaking circuit on one filament, and (bottom) switch closed to complete new circuit when one filament burns out

*Double Life Lamp Co.
 Woburn N.J.*

Stops Oil Pumping Restores New Car Power

Proved in Millions of Cars



Amazing Ramco Spring Rings Revolutionize Entire Piston Ring Industry

TODAY, at a cost which is unbelievably small, you can make your car run like new. Yes, even though the cylinder walls are so "out-of-round" that your car is lousy, and is pumping oil badly, Ramco Spring Piston Rings will immediately restore lost compression—stop oil pumping—give your motor "new car" snap and power. So perfectly are these amazing rings engineered that they exert the proper pressure on cylinder walls at all speeds. Not only seal the motor completely for maximum efficiency, but totally eliminate piston rock and slap. Ramco Spring Piston Rings have revolutionized the entire ring industry to such an extent that untried imitations are flooding the market. Don't take chances with these unproved rings. Ramco Spring Piston Rings are a proved success. Have successfully restored new car pep, power, and oil economy in millions of cars.

Insist upon the genuine, patented Ramco Spring Piston Rings. For further proof of the amazing performance you can expect from your car after these rings are installed, mail the coupon below, and a FREE booklet will be sent to you which gives proof of results millions of motorists have had.



Ramsey Accessories Mfg. Corporation
 27 South Spring Ave., St. Louis, Mo.



FREE! Ramsey Accessories Mfg. Corp.
 27 South Spring Ave.,
 St. Louis, Mo., U. S. A.

Please send me your free booklet which shows how Ramco Spring Piston Rings have restored new car pep, power, and oil economy in millions of cars.

Name.....
 Address.....
 City..... State.....

RAMCO MOTOR OVERHAUL

RAMCO PISTON RINGS
 RAMCO PISTON SKIRT EXPANDERS
 PATENTED IN THE UNITED STATES AND CANADA. OTHER PATENTS PENDING.



FREE BOOK

**Describes Fully
How to Make
50 Fine Things
of Wood**

60 pages, over 200 illustrations and diagrams. All about woods—their qualities, and uses. Tells how to choose the right saw for the job. Discusses every operation in setting and filing all saws—unusual uses for saws. . . . An invaluable book for your shop!

Paste on a Postal and MAIL TODAY

THE OHLEN-BISHOP CO.
906 Ingleside, Columbus, Ohio
Send my FREE copy of "Saw Efficiency"

Name

Address

City

FISHING TACKLE at LOW PRICES

Send today for our Big 100 Page Catalog listing hundreds of bargains in Fishing Tackle, Baseball, Basket Ball, Golf, Tennis, Archery Equipment, Guns, Sporting Goods and Clothing of all kinds. Here are some typical bargains:

- \$17.50 Fly Rod with Aluminum Case & 2 tips **\$8.95**
- 4.00 One Piece Casting Rod Offset Handle **1.89**
- 6.00 Level Wind Casting Reel **2.69**
- 4.00 Automatic Fly Reel **2.79**
- 1.50 English Snelled Trout Flies per doz. **.49**
- 6.50 Hagen Registered Wood Golf Clubs **3.45**
- 5.00 Hagen Registered Matched Steel Shafted Irons **2.25**
- 8.50 Golf Bag, 7 in. 2 large Zipper Pockets **5.75**

All merchandise guaranteed. You'll save if you join thousands of sportsmen who purchase all their requirements at the Gateway. Free Catalog—Yours for the asking. Invaluable to every sportsman. Contains the famous 'Fisherman's Calendar.'

GATEWAY SPORTING GOODS CO.
1332 PM MAIN ST. KANSAS CITY, MO.

CHIPPED GLASS SIGN MAKING MIRROR RESILVERING

Metalware replating; Interesting; Profitable. Write **SPRINKLE, Plater, 129, Marion, Indiana**

NEW BENJAMIN AIR PISTOLS

Powerful—Accurate—Economical—Practical—Adjustable Shooting Force—Amazing Maximum Velocity—cal. 177 or 22 and BB—For Target and Small Game—the only Genuine Compressed Air Pistol on the market—Single Shot with Bolt Action—Hammer Fire—Hair Trigger—Safety. Price \$7.50. Also 177 and 22 Single Shot Air Rifles \$7.50—Single Shot BB Air Rifle \$6.00—25 Shot BB Repeater Air Rifle \$7.50—at Dealer or Direct—No license required—Safe for indoor use. FULL DETAILS—TARGETS—FREE—WRITE TODAY. Benjamin Air Rifle Co., 691 N. Broadway, St. Louis, Mo.



F1263
Around the World by Air
(Continued from Coloroto Section)

air with the idea that you are enjoying the ultimate in speed. The proponents of this form of travel aver that "you ain't seen nothing yet." Your three weeks' trip around the world today is likely to be considered slow tomorrow.

There's a real probability that within the near future—say ten years—you can fly to Europe in ten hours and make a trip around the world in ten or twelve days. You would go in a huge plane weighing 100 tons or more—a size already being planned in the minds of designers—and at a speed of 300 miles an hour.

Designers anticipate that greater speed can be attained by flying at high altitudes, up to 30,000 feet or more. Up there you won't need to worry about the weather and you'll ride in a sealed cabin supplied with oxygen. Of course, no engine has yet been built for such flying and no 100-ton plane has been constructed. But when you consider that only five years ago an air trip around the world was a spectacular stunt, it does not require a very active imagination to vision 100-ton ships flying around the world at 300 miles an hour in ten more years. Perhaps, as the aviation boys say, we "ain't seen nothing yet."

F1648
Oscillating Rods Drive Bike Faster with Less Effort

More speed and more power are developed by an oscillating rod-driven bicycle which the maker claims has faster pickup and is easier to ride than a conventional bike. Long levers transmit foot power by means of oscillating rods connected to the twin chains by special links. The rider sits nineteen inches off the ground.



St. Louis, Mo. S. L. Lerner, Caly
Chas. W. Williams
811 1/2 Park St.

NEW *Knight* RADIOS offer SUPER VALUES

PACKED WITH NEWEST FEATURES AT AMAZINGLY LOW PRICES!

38 MODELS • 5 TO 19 TUBES • AS LOW AS \$8.45

See them in your ALLIED Catalog! 1937 Knights—America's most amazing radios—bring you sensational new developments in radio at a price every one can afford. Features!—new Giant Magna-Span Dials, mighty "Vita-Tone" super-dynamic speakers, perfected metal tubes, Fly-wheel Tuner, "Electric Eye," Visual Wave-Band Indicator, newly designed beautiful table and console cabinets, etc. Tone quality, sensitivity, selectivity, volume capacity, reserve power, and all-around performance at amazingly low prices that again prove only ALLIED is able to offer such super values. All-Wave, Dual-Wave and Short-Wave—5 to 19 tubes—AC, AC-DC, 6-volt, 32-volt, battery and auto sets—a new 1937 Knight set for every purse and purpose! You'll find them all in your ALLIED Catalog.

THREE FULL BANDS WORLD-WIDE RANGE



8 TUBE AC SUPERHET WITH ELECTRIC EYE

A distinctive new 8-tube All-Wave Superhet that tunes the world! Every new feature yet sensationally low-priced! Electric Eye; three full band coverage from 16 to 555 meters; giant 8" colored easy-to-read airplane dial; flywheel dialing. Newest RCA licensed circuit using latest octal glass tubes. Bass compensation, Automatic Volume Control, Variable Tone Control, full-sized Vita-Tone dynamic speaker—features that bring you a new concept of radio enjoyment. Handsome new "Lay-Down" cabinet. The leading radio value of the season—for full description see page 15 of ALLIED's Free Catalog.

10,000 Radio Parts • Tools • Sound Systems • Amateur Gear

LOWEST PRICES. You need ALLIED's Free Catalog whether you sell, service, or build radios, install P. A. Systems or operate a "ham" station. Besides amazing new Knight Radios, its 152 pages include over 10,000 exact duplicate and replacement radio parts. Test Equipment, latest Public Address Equipment for every Sound need, Amateur Transmitting and Receiving gear, new build-your-own kits, Ruripower units and Windchargers, etc. We buy in vast quantities, get lower prices, and sell for less. See all these great radio values in the 1937 ALLIED Catalog. Send for your copy now!



6 TUBE SUPPRESSORLESS AUTO RADIO

1937's finest 6 Tube Auto Radio! Completely new in design!—brings you enjoyable noise-free operation without suppressors. Fits any car and matches all dashes. All-electric — operates entirely from car battery. Exclusive metal and glass tubes for actual 9 tube efficiency; 3 gang rubber-cushioned condenser; Automatic Volume Control; Variable Tone Control; full 6 3/4" dynamic speaker. Has illuminated tuner, patented antenna circuit. Complete in rugged rust-proof steel case with single hole mounting feature. Luxurious tone and powerful reception range. See full description on page 148 of ALLIED's Free Catalog.



FREE PARTS LISTS

Radio Builders!—Write for Free parts lists covering any Popular Mechanics circuit. (R209); 1 Tube AC-DC (R211); 2 Tube AC-DC (R211); Beginners' 3 Tube Flashlight Cell Set (R227); 150 Watt Transmitter (R231); "A-B" Power Unit for 6 Volt Sets; Beginners' S-W 2 Tuber (R232); 6 Tube AC-DC (R233); efficient Crystal Receiver; "Hurricane Radio" (R234); and many others. ALSO—See pages 125-6-7 of our new, low-priced ALLIED Catalog for dozens of Build-Your-Own kits.



FREE Catalog



ALLIED RADIO CORPORATION

833 W. JACKSON BLVD., CHICAGO

ALLIED RADIO CORP.
833 W. Jackson Blvd., Chicago, Ill. Dept. 5-C.

Rush me a Free copy of your 152-page 1937 Catalog showing the 38 new Knight radios and complete Radio Supplies.

Send me Free Parts List for Kit No.....

Name.....

Address.....

City..... State.....

Sharpened over 2,000 lawn mowers last season

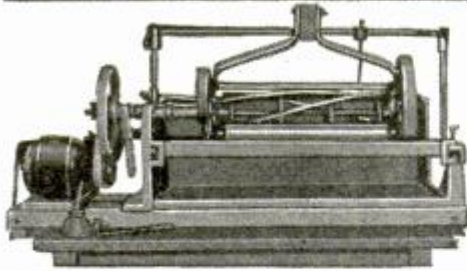

"I sharpened between 2,000 and 2,500 lawn mowers this season. I cover a territory of 50 miles around my home town and have all the work I can handle. With the FOLEY Lawn Mower Sharpener I can handle up to 40 mowers a day."—Ivan G. Long, Penn.

Many other men like Mr. Long are independent and making big money in the fine cash business of sharpening lawn mowers with the

FOLEY Electraken Lawn Mower Sharpener

No experience required. Simply put mower in the machine—the FOLEY does a perfect job automatically, in 15 or 20 minutes. Sharpens all kinds and sizes by factory method. You get \$1.00 to \$2.00 each for hand mowers and \$4.00 to \$6.00 for power mowers. Investigate NOW!

We also make
the
FOLEY
Automatic
SAWFILER

Files hand, band,
circular saws. Saves
eyestrain—does per-
fect work. Used by
over 3000 repair shops.

FREE Attachment for grinding axes, hatchets, knives, etc., included FREE. Brings you business the year 'round. Small investment, easy payments. Best season just ahead! Write today for FREE business-getting plans—no obligation, no salesman will call.

FOLEY MFG. CO.

307-7 Foley Building,
11 Main St. N. E., Minneapolis, Minn.



ACE Set
Tools for every
operation on
metal-cutting lathes
\$14.50

Insist on ACE Tool Holders
Drop forged by ARM-
STRONG, makers of
cutting tools used by 96% in
industry. 8 ACE TOOL
HOLDERS with Cutters and
Wrenches in fitted steel case
—Turning, Boring, Knurling,
Threading and Cutting off.

Write for Circular

ARMSTRONG BROS. TOOL CO.
"The Tool Holder People"
368 N. Francisco Ave., CHICAGO, U.S.A.



Genuine "Jorgensen"
Handscrews
grip at all angles,
never slip, split or
loosen. All sizes.
Send \$3.25 plus
postage (7 lbs.) for
2 No. 1 Handscrews
—open 6".

CLAMPS

INDUSTRY will have only dependable
clamps, correctly designed and honestly
made. That is why industry buys these
clamps by name. Be wise. Take only
clamps stamped "Jorgensen" or "Pony."

YOUR DEALER OR SEND \$1
AND PAY POSTMAN BALANCE.

ADJUSTABLE CLAMP CO.

"The Clamp Folks"
421 N. Ashland Ave., Chicago,
U. S. A.

Pony No. 50 Fittings go on or-
dinary 1/2" pipe. Makes clamps
of any length. Send \$2.00 (new
low price) plus postage (6 lbs.)
for Fittings for 2 Pony No.
50 Clamps.

Pony
Miniatures
Standard
and special
types from
12c to 25c
each—1" to 2 3/4"
cap. Not toys
but fine tools
with 100 uses.



Catalog FREE



[A5]

MATCHES ALWAYS DRY!

—If you carry a Marble's water-proof match
box in your pocket. Absolutely water-proof
—holds supply for several days. Made of
seamless brass, 3/4-inch in diameter. Only
60c at your dealer's, or sent postpaid. Get one
today. Write for complete FREE Catalog.

Marble Arms & Mfg. Company
578 Delta Av. Gladstone, Mich. U.S.A.

Dating Up the American Desert

(Continued from page 380)

insects to serve as carriers in the fertilizing process. But 6,000 years ago, date growers learned how to induce heavy yields by artificial pollination—tying a sprig of the male flower to the female blossom stem. The practice has continued in improved form with resultant preservation of only the choicest male stock. American growers have improved artificial pollination until they now regulate ripening. In regions subject to intense heat, early fall dew, fog or rain, maturity is speeded up by fifteen to forty days, or retarded when a late crop is desired to meet market demands. Pollen from an early ripener and from a retarder have been used effectively on different flowers of a common stem.

As soon as a blossom cluster appears, it is encased in a transparent paper wrapper, which also encloses pollen containers. Fiber or brass triggers, set to regulate the pollen "shot," protrude beneath the edge of the wrappers, so the gardener may manipulate them in accordance with his ripening demands. When fruit starts to mature, the paper wrapper is replaced by a waterproof cloth "overcoat" to protect the cluster from its worst enemy—moisture. A drop of dew may spoil a fifty-pound cluster of ripening dates.

Pollen also influences the size of the crop. Female trees seem to have preferences. One will bear abundantly when pollinated from a certain male tree, while an adjacent sister will curtail output if mated to the same tree. Pollination is done as fast as the flowers open, and the opening process of a single cluster is staggered over eight or ten weeks. The crop ripens in the same manner, and the maturing cluster must be picked over and over. Nor will the unripe mature, like a banana, if the cluster is cut intact from the palm. A green-cut date remains green, and is more astringent than a premature persimmon.

American date pickers work on scaffolds or platforms, which are raised with the growth of the tree, and which are reached by ladders. Old World gleaners climb, using a rope and girdle. The Arab tree-climber has achieved the dignity of a

(Continued to page 136A)

**NO SKINNY MAN
HAS AN OUNCE OF
SEX APPEAL**



**BUT SCIENCE HAS PROVED THAT
THOUSANDS DON'T HAVE TO BE
*SKINNY!***

Posed by professional models



NEW "7-POWER" YEAST TABLETS GIVE THOUSANDS 10 TO 25 LBS. in just a few weeks!

THOUSANDS of skinny people who never could gain before have quickly put on pounds of solid, naturally attractive flesh with these new "7-power" Ironized Yeast tablets. Not only that, but they've gained naturally clear skin and lovely color, new pep, new friends and popularity—in almost no time!

Scientists recently discovered that hosts of

people are thin and rundown for the single reason that they do not get enough Vitamin B and iron in their daily food. Without these vital elements you may lack appetite, and not get the most body-building good out of what you eat.

Now one of the richest known sources of Vitamin B is cultured ale yeast. By a new process the finest imported cultured ale yeast is now concentrated 7 times, made 7 times more powerful. Then it is combined with 3 kinds of iron, pasteurized whole yeast and other valuable ingredients in pleasant tablets.

If you, too, need these vital elements to aid in building you up, get these new "7-power" Ironized Yeast tablets from your druggist today. Note how quickly they increase your appetite and help you get more benefit from the body-building foods that are so essential. Then, day after day, watch flat chest develop and skinny limbs round out to natural attractiveness. See better color and natural beauty come to your cheeks. Soon you feel like an entirely different person, with new charm and new personality.

Money-back guarantee

No matter how skinny and rundown you may be from lack of enough Vitamin B and iron, try these new Ironized Yeast tablets just a short time, and note the marvelous change. See if they don't aid in building you up in just a few weeks, as they have helped thousands of others. If you are not delighted with the benefits of the very first package, your money will be instantly refunded.

Special FREE offer!

To start thousands building up their health right away, we make this FREE offer. Purchase a package of Ironized Yeast tablets at once, cut out seal on box and mail it to us with a clipping of this paragraph. We will send you a fascinating new book on health, "New Facts About Your Body." Remember, results with very first package—or money refunded. At all druggists. Ironized Yeast Co., Inc., Dept. 533, Atlanta, Ga.

7 REASONS WHY

1. Rich red blood, necessary to nourish and build up the body is promoted where more iron is needed.
2. Hearty appetite to enjoy plenty of good food is assured those who specifically need Vitamin B.
3. Needed aid in getting ALL the good out of your food is supplied where Vitamin B is deficient.
4. Nerves depleted by inadequate Vitamin B, are strengthened by this special nerve-aiding vitamin.
5. Unsightly skin eruptions due to Vitamin B deficiency are corrected and natural beauty restored.
6. Growth, development and increase in weight are promoted where retarded by Vitamin B shortage.
7. New energy, strength and pep are quickly given to thousands who need both Vitamin B and iron.



When writing to advertisers please mention Popular Mechanics

BIG MONEY

Assembling Mead's New

Portable

OUTBOARD BOAT!

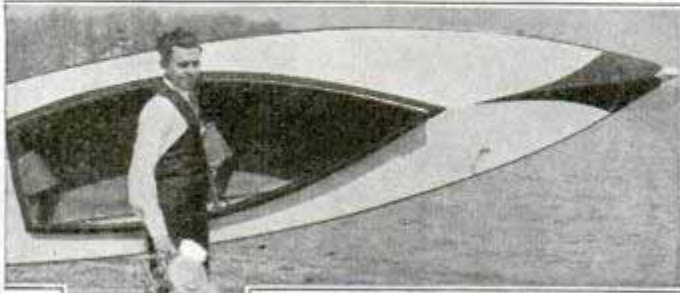

The OK-2 is strong as a giant. Yet Weighs only 50 LBS.! Portable.



Priced Low—and PAY as You BUILD!

A sensation! Build this 50-lb. tough, durable, seaworthy, portable Outboard Ki-Yak in 2 days at home! Then it's almost ready to go anywhere by hand or car. Safe, leakproof. More speed per horsepower. More miles per gallon! Mead's perfected aluminum-ribbed, Cut-to-Fit Construction Kit guarantees successful assembly, easily, quickly—and profitably (if you build to sell to others). Amazing LOW Introductory Prices, and if you wish you can even Pay as You Build! RUSH dime and Coupon below, for details!



9 HOURS TO BUILD NEW SPORTSMAN'S BOAT!

For FISHING CAMPING HUNTING SAILING

"CK-2" Paddle Boat

Quickly Converted Into Speedy Sailboat!

\$6 PADDLE GIVEN

with your Ki-Yak —if you hurry!

Assemble Mead's "CK" Sportsman's Ki-Yak in 2/3 LESS time with new construction principle. "Home Assembly" saves you nearly HALF factory-built cost! Most sensational boat development in years! Weighs only 30 lbs. Portable by hand or car! Thousands in use! RUSH dime (covering handling, postage) and Coupon for giant new Colored Flyer. Low Introductory Prices, \$6.00 Gift Paddle Offer. (Dealers write for Profit Plan!) Hurry!



MAIL COUPON RIGHT NOW!

Gentlemen: I am enclosing 10c postage, handling charge. Please rush me your New Boat Catalog, Low Introductory Prices and \$6 Gift Paddle Offer.

NAME

STREET & NO.

CITY.....STATE.....

RUSH ME WITH 10c TO:

MEAD GLIDERS 15 So. Market, CHICAGO
Dept. B-37

F1653 (Continued from page 134A)

profession, but hasn't improved his methods or equipment for centuries.

Transplanted palms are irrigated morning and night for the first forty days; once a day for the next forty days; every two days for the rest of the year, and every week for the rest of their lives. Where surface water is not deeper than fifteen feet a palm will struggle along without intensive irrigation; but the yield will be lighter. Offshoots from thirsty trees are better producers and more hardy. An outlay of \$4,000 to \$6,000 is required to bring an acre of dates into bearing. But once in full production, the American palm averages 200 pounds a year, or 100 per cent more than the Old World average. Exceptional trees have produced 500 pounds. No other commercially grown crop yields such a quantity of human food over so long a period without seasonal reverses.

America paid \$4,350,000 for 53,181,000 pounds of imported dates in 1935, and grew 6,506,000 pounds in the same year. That was an increase in home production of 9,000 per cent over 1926, when the first American commercial crop of 70,000 pounds was sold. The gain in producing acreage for the same period was only 100 per cent. The 1936 crop, being harvested as this is written, is estimated at 4,000 tons.

Most of our date imports are shipped from near the junction of the Tigris and Euphrates rivers. They are brought from oases in brown goat-hair bags strapped to camels, just as they have been transported since earliest antiquity. An oasis grower depends upon by-products of the palm and crops grown beneath his trees to keep out of the red. The palm supplies him with fiber for rope, cane for baskets, fuel from the stripped limbs and roof thatch and building material from the palm leaves. His bread is a paste of sirupy dates, and his wine and his sugar are distilled from the sap of toddy palms. The entire tree is a potential source of pulp for manufacture of the finest writing paper.

Date palms are undamaged by temperatures of twelve above zero. No one knows how much heat they can stand. Offshoots selected for planting in pest-free zones of America are baked in a temperature that destroys insect life and eggs,

(Continued to page 138A)

LET THE ENGINEERED FEATURES DETERMINE YOUR CHOICE

Tools must be engineered to give service. That in itself is sufficient reason for your selecting these 1937 Driver Power Tools. Every new development is preceded by careful study and expert planning to make Driver Power Tools the outstanding values in home workshop equipment—they are Engineered Tools.

Stop in at your nearest Driver dealer's to-day and convince yourself of their high quality and fine appearance. Or send for a copy of the colorful 1937 folder which illustrates and describes every Driver Engineered Tool in detail.

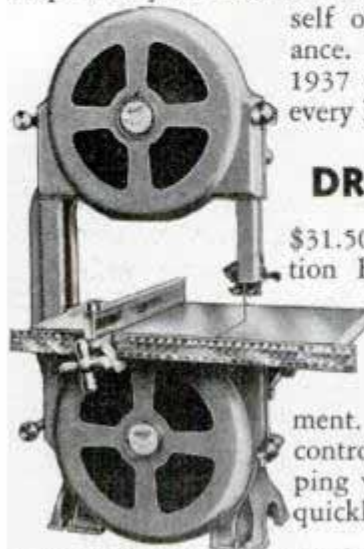

DRIVER BN725 BAND SAW

\$31.50 as shown, including 72-page Instruction Book. Craftsmen who examine this 12" Band Saw wonder how it is possible to sell so much quality for so little money. Guards, ripping guide and table extension are regular equipment. SKF ball bearings throughout. Geared control mechanism for tilting table. Shipping weight 103 lbs. Does all work easily, quickly and smoothly.

Driver Engineered Power Tools include Band Saws, Jig Saws, Bench Saws, Jointers, Motor Grinders, Flexible Shafts—Three Complete Lines in Three Price Ranges.

ASK YOUR DEALER ABOUT THE DRIVER EASY PAYMENT PLAN

DRIVER Engineered POWER TOOLS

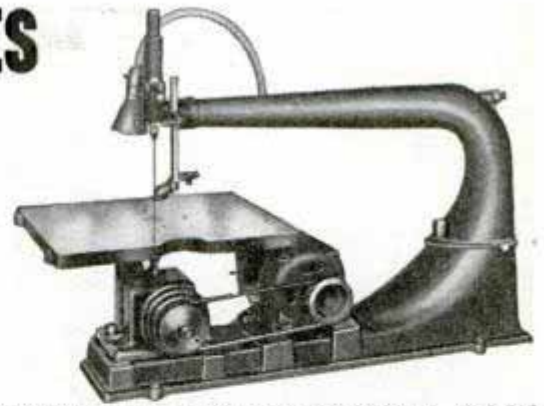

DRIVER J740 JIG OR SCROLL SAW

\$26.95 (as shown less Motor and Saw Blade) including Flexo Lamp, Belt, Motor Pulley, Two 3-way Electric Outlets and 72-page Instruction Book.

In this streamlined 24" Jig Saw still higher standards of utility, efficiency and value are reached. Throat capacity 24". 16" x 12 1/2" machined table tilts to 45° angle—has graduated quadrant. Positive blower in head. Splash oiling. Ground surfaces on arm and head assure easy action and positive alignment. Shipping weight, less motor, 115 lbs.

USE THIS COUPON

WALKER-TURNER CO., INC.,
137 South Ave.,
Plainfield, N. J.

Gentlemen: Please send me copy of the colorful folder on 1937 Driver Tools.

Name

Address

ENGINES

Enclosed, Self-Oiling, Roller Bearing

A reliable engine, using all fuels, for farm or factory. Cheapest power for pumping, sawing, separating or similar work. The best engine for the money. Put one to work and watch it pay for itself. Sold Direct From Factory to YOU. Immediate Delivery. Write today.

WITTE ENGINE WORKS
4743 Oakland Ave., KANSAS CITY, MO.

POPULAR MECHANICS FAMILY TRAILER PARTS

Available from Hammerblow Tool Company—the original.

Don't build until you get Hammerblow facts. Save money, time, wasted labor. Hammerblow guarantees a rugged, non-sway, perfect trailer! **BLUEPRINTS FREE WITH PARTS.** Hammerblow parts are world's best. Used by nationally known infra. and outfitmen who know. Send only 50c for 64-page Trailer Builder's Guide and Free 40 page supplement. Immense value. Or write for Free Literature.

HAMMERBLOW TOOL COMPANY, Dept. 103, Wausau, Wis.



New Adding Machine Fits Vest Pocket!

Adds, subtracts, divides, multiplies as accurately as \$100 machines. Weighs only 4 ounces. Not a toy—strong guarantee. Absolutely accurate, lightning fast. Sells on sight to offices, stores, homes—all who use figures. Write quick for **FREE AGENTS** sample offer and Money-Making Plan.

C. M. Cleary, Dept. 63, 303 W. Monroe St., Chicago



AMATEUR CARTOONISTS WIN \$25.00

Wanted—Amateurs with humorous ideas. No drawing ability necessary. The amateurs of today are the professional cartoonists of tomorrow. Ideas judged and prizes awarded by Applause-O-Meter test before movie audiences. Everyone has an equal chance. 26 cash prizes in all. Rush name on penny post card for "Valuable Tips on How to Make Money With Simple Cartoons and Humorous Ideas." Cash Prize Entry Blank and Rules—SEND NO MONEY.

CARTOONISTS' EXCHANGE
Dept. 93-B Pleasant Hill, Ohio

Learn to Re-Seat Your Chairs

Have you a chair, stool or bench that you would like to re-seat? We will teach you how to do it. Use either Cane, Rush, Reed, Splints, Fibre Rush, Cane Webbing or Grass. **Instruction Book Only 10c** Send 10c today for our illustrated Instruction Book and price list explaining how to do Seat Weaving.

The H. H. PERKINS CO., 252 Shelton Av., New Haven, Conn.

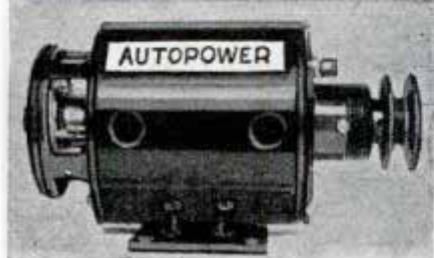

TURN SCRAP INTO MONEY

AUTOPOWER tells you how in plain, easy, simple, and illustrated instructions that anyone can follow. Change auto generators into useful, practical A C and D C generators and motors with voltage from 2 to 1,000 volts, for power, light, welding, radio, sound, etc. No previous experience nor special tools needed. Generators can be driven by wind, water, fan belt, etc. Already used and endorsed by thousands. Send today for your copy, and also receive **FREE** a copy of **PRACTICAL ELECTRIX**, the new publication for the man who wants to **KNOW, BUILD, REPAIR and READ** about electrical apparatus and machinery. Book and magazine postpaid only \$1.00.

AUTOPOWER, INC., Dept. L
410 S. Hoyne Ave., Chicago



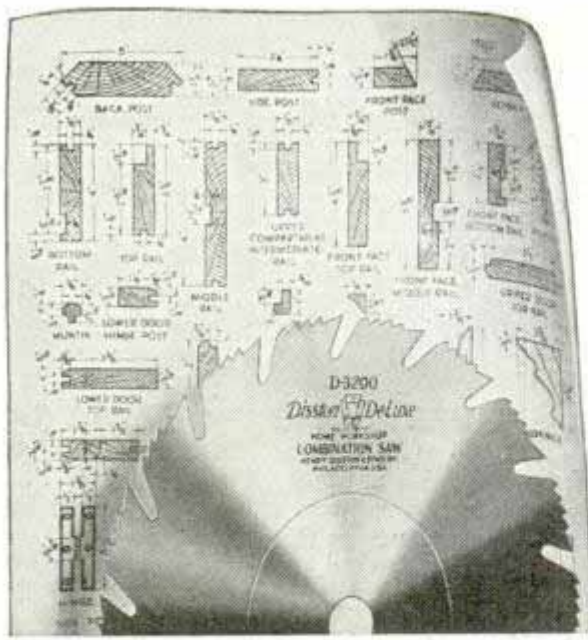

Fine Work Begins with a Disston Saw

New! The Disston DeLuxe is the finest home workshop saw you can buy. Disston steel! Disston workmanship, of the highest standard! On any job you do, Disston DeLuxe means easier cutting. On something that is a real challenge to craftsmanship, you will realize that the easy, accurate cutting of this fine blade is the beginning of fine work.

Ask your dealer for this saw by name: "Disston DeLuxe", etched on the blade. See the high, smooth finish... accurate fitting... keen teeth, that hold their cutting edge. Ownership of a Disston DeLuxe Saw is of itself inspiration to build pieces of which you can be proud.

Cross-Cut — Rip — Combination

- | | |
|-----------------------|-----------------------------------|
| 6" (1/2" hole) \$2.40 | 8" (1/2", 5/8", 3/4" hole) \$3.20 |
| 7" (1/2" hole) \$2.80 | 10" (5/8", 3/4" hole) . . \$4.05* |

Hollow Ground Combination

- | | |
|-----------------------|-----------------------------------|
| 6" (1/2" hole) \$3.90 | 8" (1/2", 5/8", 3/4" hole) \$4.90 |
| 7" (1/2" hole) \$4.40 | 10" (5/8", 3/4" hole) . . \$6.20 |

Use Disston Saws, Tools, Files



in your home workshop. How to choose, use, care for, these better tools and do better work — all is shown in this Disston Manual sent FREE.

MAIL COUPON
 TO: HENRY DISSTON & SONS, INC.
 311 Tacony
 Philadelphia, U. S. A.

Your name.....
 Address.....

T1633

(Continued from page 136A)

yet seldom injures the plant. Growing trees, too, are subjected to fire to kill pests that hide in fiber between the base of the leaf stem and the tree trunk. The fiber is nature's pad to protect palms from injury by threshing stems in frequent desert storms.

No one can predict how far the United States will go with its dates. Irrigation projects connected with Boulder dam will open up and water thousands of square miles of potential date land. Encouraging experiments are being made with production under climatic conditions hitherto believed impossible. They prove palms will thrive away from Sahara sun and soil. It is too early to forecast date gardens north of the arctic circle, but it is quite safe to predict elimination of an annual import item of more than \$4,000,000. For, as time is reckoned in horticultural progress, it was only yesterday that America started to date up old Dame Desert.

T1634

Ski Elevator on Mountainside Gives Sportsman a Lift

It takes no time at all to ski down a mountainside, but climbing back up is another thing. At St. Moritz, Switzerland, the round trip is no effort, for a "ski elevator" hauls the winter enthusiasts back up to the 8,000-foot level in a few minutes.



Skier makes the grade up a Swiss mountainside sitting down, an elevator "trolley" doing the work

ALL PURPOSE
MOTO-TOOL



10 DAY MONEY BACK TRIAL

for Home-Shop-School-Profession

Grinds, drills, engraves, routs, curves, sharpens, polishes and does hundreds of jobs quicker, better and with greater precision. Handles easily as a pencil—weighs only six ounces, and is amazingly powerful. 110-Volt Universal Motor—about 20,000 r.p.m.—oilless self-aligning ball thrust bearings. Handy built-in switch. Easily replaceable brushes. Universal Collet Chuck. Bakelite housing. You must see and use it to appreciate its tremendous value.

Order on 10-day trial. Money refunded if not more than satisfied. **Booklet Free.** 20-piece Craftsmans Tool Set for all types of Moto-Tool work, \$5.75.

ONLY \$9.85

DREMEL MFG. CO.
2815-CT., Racine, Wis.

SENT POST PAID

FACTORY TO YOU
WRITE for FREE CATALOG

NEW SUPER-QUALITY KITSELMAN FENCE

Heavier, tougher pure zinc galvanizing. Stronger, tougher Copper-Bearing Steel. Same low Factory Prices. WE PAY FREIGHT. 100 styles and heights Farm, Poultry and Lawn Fence; Steel Posts, Gates, Barb Wire, Paints, Roofing. Write today.

KITSELMAN BROTHERS
Box 94 Muncie, Indiana



RE-STRING RACKETS AT HOME

EARN MONEY



Instructions FREE

It's easy, pleasant, profitable work. No experience required. Learn in a FEW MINUTES. I supply everything needed. Earn \$50 to \$100 cash in your spare time. Act QUICK—write for details FREE.

SPECIAL 50c

Set Permatex Silk Strings with instructions, postpaid.

W. A. BICKEL, Dept. A-3, 809 W. Madison St., Chicago, Ill.

29-Pc. Electrical Experiment Kit

Wire up thief detector, extension phone, elec. welder, radio code set, electro-plating, arc furnace, circuit tester, rectifier, etc. Build arc light, 4,000-ft. range, secret service phone (listen in private conversations), generate health rays, make electric stove, etc. Kit contains 110-volt A. C. power motor, microphones, transformer, 26 other pieces commercial apparatus. Original cost \$18.50. Now, \$3.99.

FREE! 6 Books, with kit. Elec. Short Course, Fun with Elec., Electric Arc Manual, Radio Short Course, Motor-Transformer Manual, Exper. Lab. Plans.

ORDER NOW!

So stamp brings Electrical-Radio-and-Tool bargain catalog.

ELECTRICAL SALVAGE CO., Box 524-A26, Lincoln, Neb.



NEW Light Weight Paint Sprayer—Only \$29.50

1/4 H.P. Motor AC110 Volts. 60 Cycles—COMPLETE

Quick, easy way to paint screens, furniture, radiators, machinery—anything—in homes, Factories, Stores, Schools, Hospitals, Office Buildings, etc. Small, compact. Carry anywhere. Weight 44 lbs. Complete with Spray Gun; 15 ft. Hose. FULLY GUARANTEED. Only \$29.50 f.o.b. Chicago. \$5.00 Deposit, Balance C. O. D., or see your dealer. Free Circular.

Ideal Pump Co., Dept. P-3, 801 Washington St., Chicago, Ill.



EXTRA \$5 in SPARE TIME

PRINT at HOME

Letterheads, Circulars, billboards, cards. Printing pays BIG. Easy, interesting, educational. **PRINTING PRESS BARGAINS \$12.** Types and Supplies lowest prices. Send stamp for catalog.

PEIFFER Co., 7-B, 6 Columbia St., Newark, N. J.



TOMBSTONES \$9 UP FREIGHT PAID OR ERECTED

WORLD'S BEST MARBLE AND GRANITE. Direct from factory. Lettered. Guaranteed, 30% savings. Thousands sold. Write for Big Free catalog.

U. S. MARBLE & GRANITE CO., Dept. A-18, Oneco, Florida



LET ME TELL YOU HOW TO EARN \$150 TO \$300 MONTHLY

Do Electric Welding... New big-profit jobs... low investment... pay as you earn... with the Guaranteed FlexArc.

Do as hundreds of other shops are doing. Cash in on the new profits of the Welding Age! Be welding headquarters for your community. But, plan wisely. Get a full-range, high-capacity welder that will do all kinds of work. Common-sense says your best guide in picking a machine is the advice of operators who have used all makes. Here's what they said about the New FlexArc in a recent nation-wide poll: 89% said it welds FASTER; 91% said BETTER; 74% said it EARNs MORE MONEY; 96% liked its SAFETY!

It's the only d-c. welder sold with a written guarantee. Backed by Westinghouse, 50-year veteran electrical pioneer.

Build Your Own—With a second-hand auto engine and chassis, all you need is the FlexArc generator. Save \$300 to \$500.

Electric Driven FlexArc—If you have electric power, your most profitable buy is the FlexArc motor-driven set.

Gas Engine Driven—Big Dodge truck engine drive, electric starter, complete!

Easy to Buy—Easy installations. No red tape. Pay out of monthly profits. Act now while offer lasts. Mail coupon.

Westinghouse Electric, Room 5N2, East Pittsburgh, Pa.

Without obligation, send your new "1937 Catalog of Popular FlexArc Models." I am especially interested in:

Building my own Electric Driven Gas Engine Driven 30-Day Trial Easy Payment Plan.

Name.....
Address..... J 20249

Westinghouse Flexarc Welder
FASTEST SELLING WELDER ON THE MARKET TODAY





SENSATIONAL NEW \$125

Auto-Glide

WORLD'S CHEAPEST MOTOR TRANSPORTATION

NEWEST RIDE THRILL!

Sweeping the nation! 30 miles per hour! 100 miles on a gallon of gas! Almost as comfortable and convenient as an auto—at 1/10th the operating cost. Safe. Wonderful for pleasure, school, deliveries, business. Saves walking, saves time. Easy to ride, easy to park.

One of World's Greatest Engines!

Low cost, unfailing, genuine Cushman Husky 4-cycle engine. 12"x3 1/2" balloon air tires. Channel steel frame. Double steering head. Drum brake. Clutch. Hand throttle. Large cushioned seat. Beautifully finished.

FREE Send for booklet, photos, complete details. **WRITE TODAY!**

DEALERS
Someone in your town will soon be selling Auto-Glides. Why not YOU? Write for Special Offer!

CHAS. AMMON, Pres.

THE CUSHMAN MOTOR WORKS, Dept. 38, Lincoln, Nebr.



START A BUSINESS at home

—like J. R. Sammons of Billings, Mont. Started a Fyr-Fyter Dealership in his home a few years ago. MADE PROFITS OVER \$6,900 IN 1935. Business in 1936 will exceed 1935 record. Inspect, Service and Refill all types of Approved Fire Extinguishers. Previous experience unnecessary. We train and advance you to Dealership for complete line of Fyr-Fyter Extinguishers. Schools, stores, homes, auto and truck owners, farmers, warehouses, churches, factories, filling stations, public utilities, etc., are your prospects. Use your home as headquarters. No stock investment required. Real opportunity for men past middle age as well as younger men. Write a letter giving full information about yourself and past work to

THE FYR-FYTER COMPANY, Dept. 90-15, DAYTON, OHIO



KILL RATS WITHOUT POISON



This proven exterminator won't kill Live-stock, Pets or Poultry—Gets Rats Every Time. K-R-O is made from Red Squill, a raticide recommended by U. S. Dept. Agr. [Bul. 1533] Ready-Mixed, 35¢ and \$1.00; Powder, 75¢. All Druggists. Results or Your Money Back. K-R-O Company, Springfield, O.

K-R-O KILLS RATS ONLY

FACTORY TO YOU

NEW REMINGTON NOISELESS PORTABLE

AT LAST! The famous Remington NOISELESS Portable is yours for only ten cents a day. Brand new. Not rebuilt. Standard keyboard and every modern feature. Free carrying case and typing course. 10-Day free trial. You don't risk a penny. WE PAY ALL SHIPPING CHARGES. Act now! Write Remington Rand Inc., Dept. 152-3, 315 Fourth Ave., New York, N. Y.



10c A DAY



BRASS TAPPING

Get this big outfit for metal tapping. Make artistic Book-ends, Desk Racks, What-Not Racks and Plaques. Equipment includes plywood, special non-tarnishable metals, tapping hammer, 2 tapping tools, supply of nails, and design patterns, packed in attractive carton. See your dealer or send \$2.00 for complete outfit making Pair of Bookends, What-Not Rack and large Twin Plaques. State choice of Copper or Brass, "Gold" or "Silver" \$2.50.

FREE CATALOG

RAPAPORT BROS., 703 W. Ohio St., Chicago

PIONEER non-sinkable BOATS

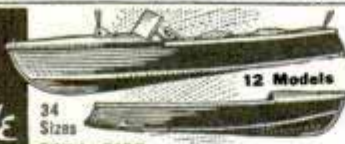

34 Sizes \$23 to \$155

America's outstanding values in Row Boats, Fishing, Hunting, Outboard Motor and Sail Boats! Will not sink! Low Cost! No work, worry or upkeep cost! Always ready to use! Preferred by leading summer camps and resorts! Send post card for 34-page catalog! It's Free!

PIONEER MFG. CO., 413 Perry St., Middlebury, Ind.

GAS MOTORS Ready-to-Run



FREE — finished, mounted fly-wheel with every motor!

\$12.50

Never in the history of gas engines was a motor ever offered at so low a price. All America has acclaimed this engineering triumph—accomplished by outstanding G.H.Q. designers and engineers after years of exhaustive, scientific, aerodynamic research. Has a broken record for amazing performance. Flies model planes up to 10 ft. wingspread. Also used for boats. And look at all these extra features! Easy starting—just a twist of the wrist. Steady running—runs 27 minutes on ounce of gas. Precision, replaceable parts. Cylinder and Piston Lapped. Longest crank shaft ever made on miniature motor. Chrome nickel steel shaft with 1 1/4" bearing surface. Connecting rod of high speed bronze. 1/5 horse power at 300 to 8000 R.P.M. This famous motor complete, entirely assembled on a stand. Tested and run before shipment—performance guaranteed. No oil, gas or batteries included. Only \$12.50. Send 3c for illustrated catalogue.

G. H. Q. MODEL AIRPLANE CO.

854-B East 149th St.

New York, N. Y.

759

The Thrill Hunters

(Continued from page 351)

auto roll. He has cracked up several hundred cars and has been in the hospital twenty-two times as a result of some of his stunts which include driving a car through a flaming fence, rolling a car over at sixty miles an hour, jumping a car over a truck and crashing head on into another car. Teter went to automobile races but paid more attention to the crowds than to the cars. He saw that they were morbidly interested in accidents.

"Here," he decided, "is a show to which more people can be attracted, if you can guarantee there will be some accidents."

So he determined to go into the business of providing intentional accidents and thrills. He began by experimenting with a car, driving two wheels up an inclined ramp until the car would roll over. He practiced this until he could get it to roll over while driving at high speed. The first time he tried the stunt before an audience it rolled over twice and the awestruck crowd thought he had been killed. He crawled out and said disappointedly: "I hoped to make it roll over three times."

But even the careful inspection he makes before each stunt is no proof there will not be some unforeseen accident. Last season he made the longest jump in a sedan over a truck that he had ever attempted, moving the truck away from the ramp until the far edge was thirty-four feet away. But he didn't land right. The hose connection tore loose from the radiator of the car and scalded him with hot water.

Most high divers become thrill providers deliberately, too. Among the leading performers are Sol Solomon, Frank Cushing, Kenneth Blake and Arthur Holden. Holden, who has been high diving for nearly forty-five years says he became one because "it's an easy way to make a living." Even the high divers are constantly adding new thrills to their acts. Cushing, for example, has added glass crashing. Blake, called the "Human Skyrocket," now dives ninety feet into a shallow tank of water which extinguishes the flames of his gasoline soaked coat which he ignites before he jumps.

Some thrill providers enter their profession by chance. As routine performers

(Continued to page 142A)

NEW 14-in BAND SAW

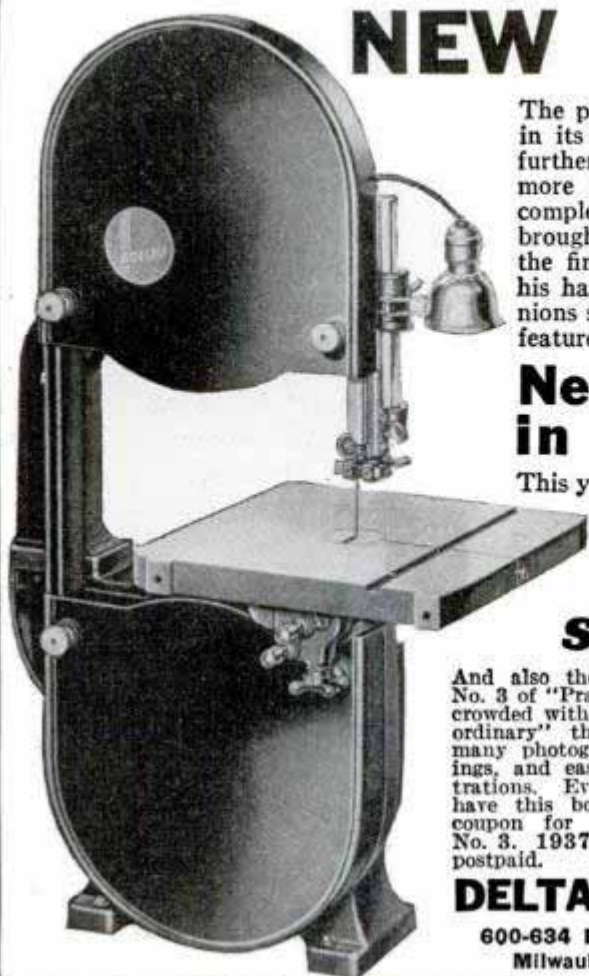

The previous Delta 14-inch Band Saw was a revolutionary new tool in its field. Now, Delta offers a new 14-inch Band Saw with still further improvements and refinements making it still more convenient, more rigid and safer to use. In this new model, both wheels are completely enclosed. Controls for the lower guide adjustments are brought out to the front of the table, so that the operator can make the final adjustments while the machine is running without having his hands anywhere near the blade. There are new heavy duty trunnions spaced far apart to give utmost rigidity to the table (a patented feature). For the full details see the 1937 Delta Catalog.

New Tools—New Improvements in 1937 DELTA LINE . . .

This year Delta offers many new tools and features of interest including: A remarkable **NEW Belt Sander**; Revolutionary **NEW 17" Drill Presses**; a **NEW Precision 4" Jointer**; a **NEW Precision 11" Drill Press**; Improved **14" Drill Presses**; Improved **Combination Units**; **NEW Tapping Attachments**; **NEW Shaper Cutter-head**; **NEW Tenoning Collars**; **NEW Belt-Drive Buffer**; **NEW Belt Guards** and Improved **Safety Features**.

Send for 1937 CATALOG!

And also the New 32-page book No. 3 of "Practical Delta Projects" crowded with new and "out of the ordinary" things to make—with many photographs, working drawings, and easy-to-understand illustrations. Every craftsman should have this book. Send 10c with coupon for Delta Project Book No. 3. 1937 Delta Catalog mailed postpaid.

DELTA MFG. CO.

600-634 E. Vienna Avenue
Milwaukee, Wisconsin

DELTA MANUFACTURING CO. Dept. A337
600-634 E. Vienna Ave., Milwaukee, Wis.

I enclose 10c (stamps or coin) for which please send me one copy of the new 1937 Book No. 3 of "Practical Delta Projects." Also place me on your mailing list to receive 1937 Delta catalog of quality motor-driven tools. I am interested in Delta Tools for:

Home Shop Industrial Use School Shop

Name

Address

City..... State.....

() Check here if you are a Delta user now.



FINDS BURIED TREASURE! NEW GOLDAK RADIOSCOPE

Most efficient metal and mineral ore locator ever known. Absolutely guaranteed to detect buried GOLD, SILVER, or any other metal. Extremely powerful new models; very simple to operate; light in weight. Put your prospecting on a scientific basis. If you know of buried treasure, find it with the new Goldak. Write world's largest manufacturer of successful mineral locators for interesting information.

THE GOLDAK CO., Dept. P
1031 South Broadway, Los Angeles, Calif.

KNEE ACTION TRAILER AXLES

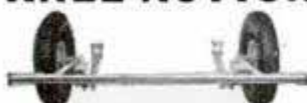

Knee action, drop center, & straight axles available in 56", 62", 68" & 72" treads, detailed circular upon request.

TOELLEN MFG. CO.
Box 4, Strathmoor Sta., Detroit, Mich.



FREE ELECTRICITY From Wind Power

For Lights, Power, Radio, from Auto Generators. New Copyright Book with over 100 Facts about Wind Chargers. Wind-Propellers—Generators—Plants—Batteries. Answers all questions you should know. Including plans for 6 or 32 V. Plant. Send 25c for plans, facts and catalog.

CURRIER MFG. CO.
421 Terminal
Minneapolis, Minn.



HOME AUTOMATIC CIGARETTE MACHINE

Have YOUR OWN Monogrammed Cigarettes. Put tobacco and block of papers on machine, TURN THE CRANK—PRESTO—CIGARETTES. Easy—simple. All metal construction. Guaranteed. No cloth ribbons; no special tube or gummed papers required. **ASK FOR FREE ILLUSTRATED FOLDER.** AUTOMATIC CIGARETTE MACHINE WKS., PM-2, 1055-57 Devon Ave., Chicago, Ill.

RAISE GIANT FROGS

MUFOND GIANTS WEIGH UP TO 3 LBS. EACH



SELL UP TO \$5 PER DOZEN!

A New Industry! Millions used yearly! Markets waiting. Prices Steady. Pleasant, outdoor work. Easy to ship to any part of the country. Nation-wide market at your command. A SMALL POND is all you need to start with five pairs of "Nufond Giant Breeders." Expand with the increase. **WE BUY!** As originators of *Canned Frog Legs*, we are developing one of the world's largest frog markets. In addition to other markets, frog raisers can also ship to us. **MEN & WOMEN!** Investigate this interesting, new work. See for yourself what others are already doing. Send for our illustrated, **FREE** book explaining our offer in detail. Write today. **AMERICAN FROG CANNING COMPANY**
Dept. 133-CC, New Orleans, La.

FREE BOOK



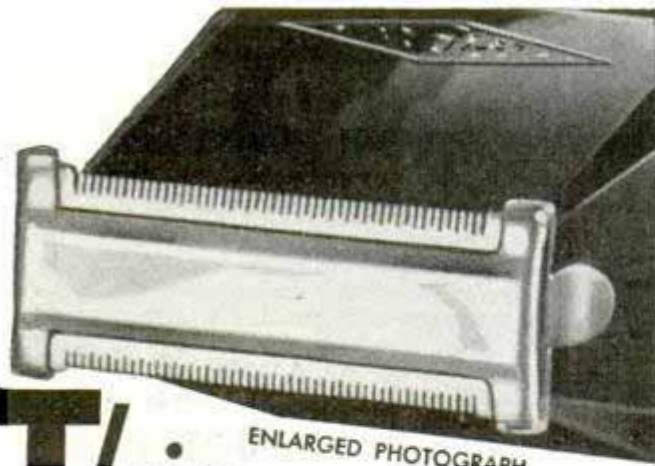

ENLARGED PHOTOGRAPH

This FLAT, TWO-SIDED SHEARING HEAD IS THE SECRET OF SMOOTH, CLOSE SHAVES

Why does CLIPSHAVE give you a quicker, smoother, closer shave? The answer lies in the scientific construction of the shearing head...with its flat surface, its shearing edges on the outside instead of the center, and the V-shaped slots which permit every type of hair—fine or coarse, long or short, to enter with equal ease and be shaved off *instantly and smoothly*.

The simplified CLIPSHAVE shearing head needs no oiling. It is self-cleaning and clog-proof because the hairs are ejected from the instrument and not *into* it. Operates economically on AC or DC. CLIPSHAVE costs only

Get one at your dealer's today, or use the coupon below.

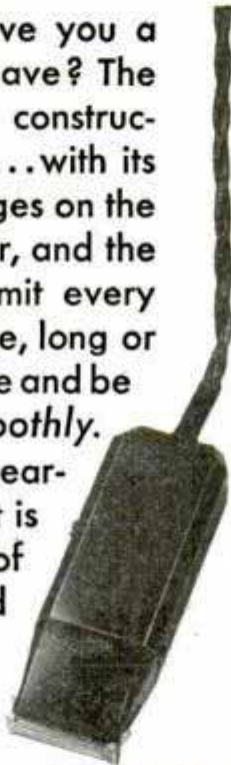

\$10

HANLEY
Clipshave

CLIPSHAVE, INC.,
DEPT. B2, PORT CHESTER, N. Y.

Please send me a Clipshave in payment for which \$10 is enclosed. It is understood that should I return it in good condition within 30 days, my money will be refunded.

NAME _____

STREET _____

CITY _____ STATE _____

I 159
(Continued from page 140A)

they find that they have plenty of nerve and gradually apply it to make more money. In Hollywood, a few years ago, four girls were despondent because they could not get jobs in the movies. A manager suggested jokingly that acrobats made money. The girls took him seriously and developed an "iron-jawed" act in which they were whirled through the air hanging to straps by their teeth. As they developed confidence, they decided the difference between doing their act twenty feet in the air and 120 feet was only one of nerve. Financially, however, it meant a difference of a great many dollars. Today they are doing their thrill act from the top of two ladders 120 feet high.

There is another type of thrill merchant of the "bridge-jumper" type of whom the entire thrill profession is wary. This is the desperate young man or woman who is inexperienced but who offers to do the impossible in the hope of getting much needed money. They are not given the slightest encouragement.

"It takes more than sheer courage to become a daredevil," states Mr. Hamid. "It takes plenty of practice and hard work and there is always present the danger of over-confidence."

Mr. Hamid says the number of American-born daredevils is increasing. One reason for this is that fewer European performers are coming to this country because they today command good salaries abroad. Another reason is that the crowds now prefer the American-type thrills of diving and crashing. When a new daredevil appears on the horizon, he is not left long without work if he can really thrill the crowd. Each year new attractions are needed. For 1937 Mr. Hamid expects to import three or four dozen new foreign thrill merchants and add about seventy-five American daredevils to the thrill circuit. Throughout the world scouts are actively hunting for new stunt sensations which will thrill American audiences.

"Americans like their thrills," states Mr. Hamid. "They want them fast, furious and sensational and they're willing to pay more for them than ever before."

Our Bureau of Information will answer questions regarding articles in this magazine, if accompanied by return postage.

D I G



in the
deep, dark
water...

Load up your duffle, some grub and an axe. Strike out for sport in the wilds. Follow the ribbons of water with ease . . . with the stroke-stroke-stroke of an Old Town. It's an Indian craft that's brought up to date! Light and responsive and tough.

See all the different models in the new catalog. Write for a free copy. Models for paddling, sailing or kicker. Prices start at \$73. Also a fine fleet of outboard boats, including large, seaworthy types for the family. Rowboats. Dinghies. Write today: Old Town Canoe Company, 333 Main Street, Old Town, Maine.

"Old Town Canoes"

a real MICROMETER BARGAIN!

Genuine, American made, six piece micrometer set, in velvet lined leather case. Special price, only \$11.95, a fourth off regular price and a fraction of the cost of other sets on the market.

These micrometers are precision machined for accuracy in one thousandths of an inch, up to 4 inches outside and 3 3/4 inches inside measurements. Guaranteed accurate, easy to read and adjust. Built to stand hard wear and give satisfaction.

Every mechanic, apprentice, garage and repair shop needs these accurate and dependable micrometers. This is your opportunity to get one at a Bargain Price if you act now. Shipped prepaid on receipt of remittance. On C.O.D. shipments, send deposit of \$2.00.

Money back if not satisfied

MICRO PRODUCTS 529 E. Jefferson Ave. DETROIT, MICH.

MICROMETERS • INDICATORS • PRECISION TOOLS

MAKE GLAZED CONCRETE PRODUCTS

Beautiful, colored, glazed concrete pottery made from sand and cement without molds or costly tools. Tiles, novelties, wall glazing, waterproofing. No experience needed. Money-making employment. Send 10c for booklet, color plate, details. NATIONAL POTTERIES CO., 13 West 26th Street Room 21 Minneapolis, Minn.



Sell Improved Leather Ties!

DON'T waste effort on second raters. Sell fast and repeat on handsomest improved ties. Rich colors, embossed like silk. Fullest cut; long wear; wrinkle-free. Wipe clean like new with damp cloth. Send 50c for sample tie (65c value) and Big Free Sales Kit of new season's smartest patterns. Money back plan. Free premiums.

NU-MODE TIE CO., Dept. 20
1333 N. 12th Street Milwaukee, Wis.





TRAILER

SEND 25c TODAY

for this big 64 page book that tells how to build Tops, Beds, Cabinets, etc. All about Electric Light and Water Systems, Floor Plans, etc. Pages full of valuable information, ideas, suggestions that save time and money for trailer builders, buyers and users. Catalog of parts and equipment includes everything you want—Axles, Hitches, Pumps, Stoves, Lights, Windows, Sinks, Toilets, Mattresses—over 200 items exclusively for building and equipping a trailer. Rush 25c (coin) today—satisfaction positively guaranteed.

TRAILER SUPPLY CO., Box 438-A, Wausau, Wis.

★ BUILDERS

★ BUYERS

★ OWNERS

NOW—A Genuine 7-Inch BLACK & DECKER ELECTRIC SANDER



FOR ONLY
\$39.50

THE NEW 7-INCH JUNIOR SANDER saves hours of slow, hard work with sandpaper, emery, files, etc. Makes quick work of such jobs as cleaning and smoothing wood or metal surfaces; removing paint and rust; grinding and smoothing welds and casting ridges; rubbing down new lacquer with felt rubbing pad; polishing metal, etc. Universal motor operates on A. C. or D. C. A great tool. A great value. Only \$39.50.

LOW-PRICED B. & D. DRILLS, TOO

1/2-INCH JUNIOR DRILL: (Illustrated). Drives twist drills for drilling up to 1/2" holes in steel; augers for drilling up to 1" holes in wood. Also drives Black & Decker Hole Saws for cutting clean, round holes from 3/4" to 3 1/2" diameter in any material a hacksaw will cut. Universal motor. Only \$35.00.



1/4-INCH JUNIOR DRILL: Drives twist drills for drilling up to 1/4" holes in metal; augers for drilling up to 1/2" holes in wood. Also drives light wheels for grinding, buffing, polishing, etc. Universal motor. ONLY \$19.50.

MAIL THE COUPON TODAY for complete information and name of nearest dealer where you can see the Junior Sander, Drills and other Black & Decker Tools.

BLACK & DECKER

World's Largest Manufacturer of
PORTABLE ELECTRIC TOOLS

MAIL THIS COUPON NOW

The Black & Decker Mfg. Co.,
603 Pennsylvania Ave., Towson, Md.

Please send me Free Literature describing new low-priced Black & Decker Tools and the address of my nearest B. & D. dealer.

Name

Occupation

Address

City State

Snow Fighters Clear the Way

(Continued from page 357)

only to look back and see the banks crumble and the shifty snow fill the new cut level under the lash of a sub-zero wind. It took one plow eighteen hours to open a lane through a snowbank twenty-five feet deep and 800 feet long near Lawler, Ia. Eighteen-foot drifts trapped a passenger train near Jackson, Wis., and then caught fast the special train sent to its rescue. A crew of 100 men with shovels was sent to dig a path to town a mile away for the eighty-nine marooned passengers. Plows finally extricated the trains, but to keep the lines clear workmen had to terrace the sides of the cuts, sometimes passing up buckets of snow by hand. When a coal train with one cattle car was snowbound in Illinois the crew tramped to town in twenty-eight below zero weather and obtained tar paper to wall the car and protect the livestock. Signal lines along the ground must be dug clear, and switches must be thawed. Failure to remove all the snow from one switch last winter caused the derailment of a freight train and blocked the line for hours.

In the cities it is not merely a problem of opening lanes for automobiles and street cars and pedestrians, but the snow must be removed entirely. Sewers must be kept open, fire hydrants cleared. Streetcars, buses and municipal trucks equipped with rotary brushes and drags shove the snow toward the curb, but this only builds up a wall along the side of the street.

Tractor plows and mechanical loaders today are taking the places of the shovel brigades. Wedge plows and drags start out when the storm begins. Propelled by heavy-duty motor trucks, they push the snow aside and keep the center of the street clear for vehicles. Meanwhile small tractor plows patrol the sidewalks, adding to the pile along the curb.

As the huge bank accumulates on the curb, automatic snow loaders go into action. Rotating, tooth-edged disks cut six-foot swath in the heaps flanking the street, feed the snow to a conveyor which carries it up to be funneled into a convoy truck. These loaders methodically eat up great ridges of snow and ice, dumping ten cubic yards to fill an oversized truck in fifteen to thirty seconds.

What to do with a few hundred thousand cubic yards of snow is still another problem. If you live on a river, a lake or an ocean the answer is simple enough. Some cities use vacant lots or sewers for snow dumps, which is not always satisfactory, for there is the danger of clogging the sewer, and the spring run-off to consider. In old Quebec, snow collected in "upper town" is dumped over the edge of the cliff into tremendous heaps that are still melting when summer tourists come. A novel method of ridding itself of snow was evolved at Westmount, a Montreal suburb. The snow is given a bath at the public incinerator. Until recently the Westmount garbage disposal plant developed a large portion of the city's electricity, and huge cooling basins were built to handle the flow of hot water from the turbines. Part of these basins has now been partitioned off and filled with hot water from the incinerator; solid buffers have been placed along the edge of the pool and the trucks, loaded with snow, back up to the pool and tip over their cargo. In short order the snow is turned to slush and then sluiced into the city sewers. In nine weeks of heavy snows the city disposed of 209,000 cubic yards in this giant melting pot.

Thousands of dollars may be invested in elaborate street-cleaning equipment, yet if the winter's snow is not put safely out of the way the coming of spring may bring more thousands of dollars' loss in flooded buildings and damaged sewers and pavements.

Ship's Propeller Worn Away by Friction of Water

In service only five years, one blade on the starboard propeller of a Panama-Pacific liner was found to have been reduced in weight two hundred pounds by water friction when it was removed recently. A new blade was installed, but it had to be made especially because its weight could not be different from the one which it replaced.

Our Bureau of Information will answer questions regarding articles in this magazine, if accompanied by return postage.

1519

Paul
Lalonde
J. Am. Lalonde
R. A. Anderson
W. W. Whentley

1651

Checking piston-ring widths on extremely accurate dial gage.

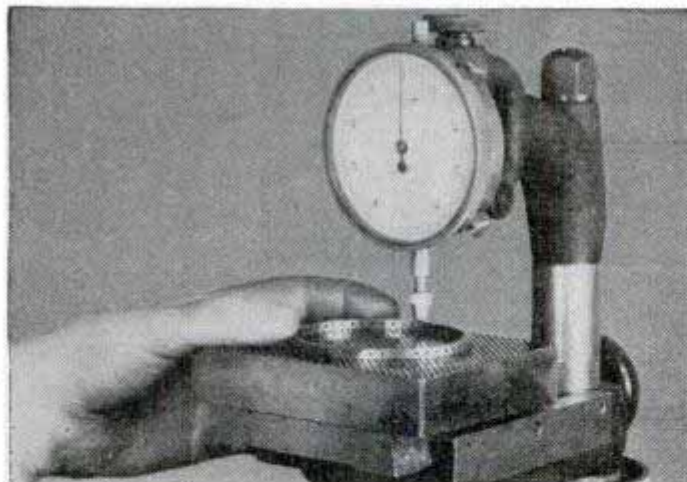

Inspecting Ford Pistons for accurate diameter and roundness on quick-reading amplifying type of gage.



Genuine Ford Piston Rings insure a perfect fit in cylinder bores.



Genuine Ford Pistons are of light-weight cast-alloy steel.



Genuine Ford Piston Pins withstand hard use, and fit accurately in piston-pin holes.

This machine automatically inspects Genuine Ford Piston Pins and sorts them with precision and accuracy into three groups that vary in diameters only one ten-thousandth of an inch.

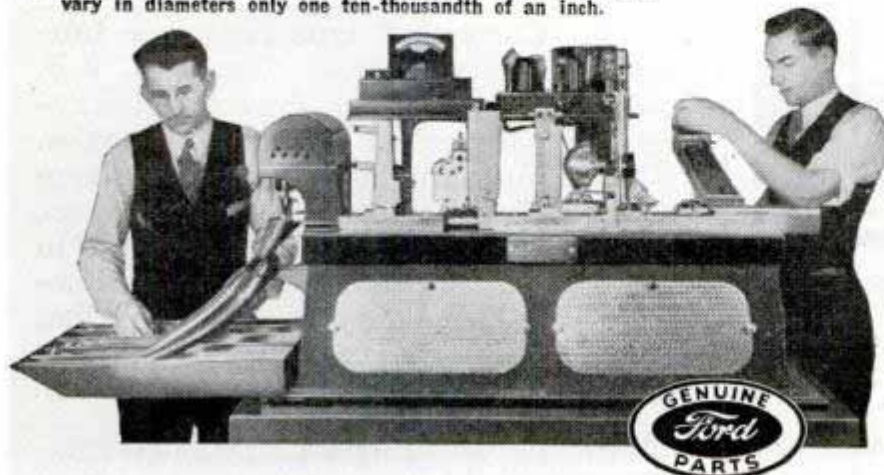

WHAT MAKES GENUINE FORD PARTS "GENUINE"?

FORD PRECISION manufacturing, materials that must meet Ford requirements in quality, Ford rigid tests and inspections — standards of a manufacturer genuinely interested in the performance and economy of his cars over the years . . . these make Genuine Ford Parts "Genuine."

Thirty-six kinds of steel, for example, are necessary to fulfil the many exacting requirements in the making of Genuine Ford Parts. And as to precision manufacturing — consider Genuine Ford Pistons, Piston Rings and Piston Pins, which are typical.

In manufacturing Genuine Ford Pistons, the diameter is held to a limit of variation of two-thousandths of an inch. Ring-groove widths are held to one-thousandth of an inch. Piston-pin holes must not vary more than three ten-thousandths of an inch (.0003") — one-tenth the thickness of a human hair. And Genuine Ford Piston Rings are held within limits of five ten-thousandths of an inch. That's the

kind of accuracy you want when you buy parts for your Ford V-8. It's the kind you will get if you buy from the Ford dealer or the garage that displays the sign: "Genuine Ford Parts."

FORD MOTOR COMPANY,
Dearborn, Michigan

Please send me a FREE copy of your booklet, "Reasons Why It Pays to Use Genuine Ford Parts."

Name _____

Address _____

City _____ State _____

FORD MOTOR COMPANY, DEARBORN, MICHIGAN

When writing to advertisers please mention Popular Mechanics



WORKSHOP FANS!

CARBORUNDUM BRAND
ABRASIVES ARE SPECIALLY
DESIGNED TO HELP YOU DO
A NEATER AND BETTER JOB

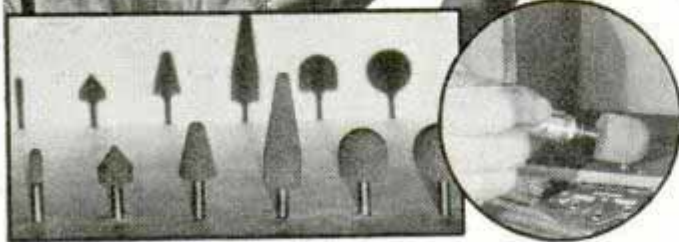

MOUNTED POINTS GET HARD-TO-REACH PLACES

Use these miniature grinding wheels in high speed portable grinders. Wide variety of shapes and sizes. At right: Removing end of wood screw with mounted point without damaging wood surface.

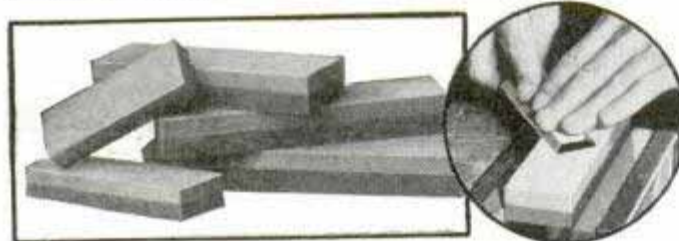

COMBINATION STONES KEEP TOOLS RAZOR-SHARP. Improve your workmanship with sharp tools. A few strokes brings chisel, gouge, draw knife or plane to a keen cutting edge. Coarse and fine side. Right: Sharpening chisel on Carborundum Brand Silicon Carbide stone.

SEND FOR 90-PAGE ILLUSTRATED BOOK AND FREE SHARPENING STONE.

Mail coupon today for free sharpening stone and useful handbook. Shows how hundreds of jobs can be done faster and better with abrasives.



CARBORUNDUM BRAND ABRASIVE PRODUCTS

The Carborundum Co., Dpt. PM-7-3, Niagara Falls, N.Y.

I enclose 20c (coin or stamp) for your new book, "Carborundum Brand Products for the Home Craftsman"; and FREE Pocket Sharpening Stone.

Name _____

Street _____

City _____ State _____

(Carborundum and Alloxite are registered trade-marks of the Carborundum Company.)

Little Giant Portable Receiver

(Continued from page 419)

The new "Triad" 25B5 "triple twin" output tube delivers twice the volume of the type-43 formerly used in this simple t.r.f. circuit. Tuning from 550 down to 70 meters, it now includes two of the amateur bands and all police broadcasts. All diagrams are simplified so that anyone who can use a soldering iron should be able to build the set. It is housed in a modern "lay-down" type of cabinet which is eas-

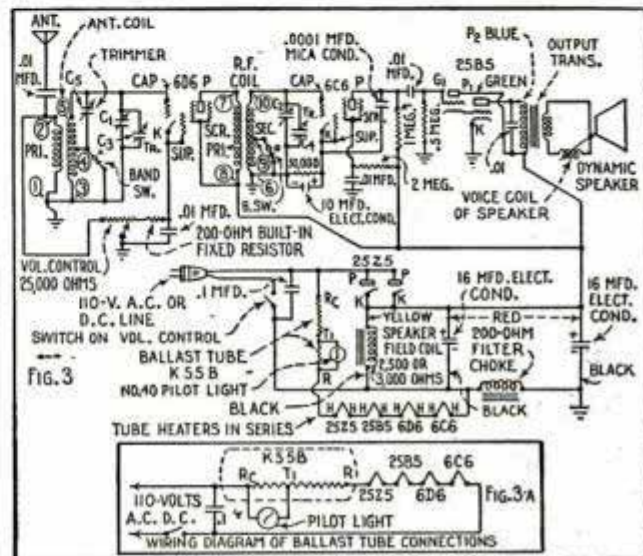

ily portable for tourists, summer homes and individual room use.

The chassis dimensions are given in Fig. 1 for those who wish to make their own; however, this metal base is available from several radio supply houses, formed and drilled. These ready-made bases are cadmium-plated for easier soldering.

A simplified wiring diagram, showing all connections below and above the base, appears in Fig. 2; the schematic circuit diagram is given in Fig. 3. The diagram Fig. 3-A merely repeats the main connections to the "Champion" type resistance tube K55B for convenience. Figs. 2-A, 2-B, 2-C, 2-D and 2-E show the completed receiver photographed from various angles.

When mounting the sockets on the base arrange them so that the heater prongs, indicated by the large black dots, are in the positions shown in Fig. 2 when viewing the base from the underside. Note that an octal-type socket is used for the ballast tube. The RCA 25Z5, 6C6 and 6D6 tubes are all standard glass types.

Although the drilled base and all parts

(Continued to page 148A)

**IDEAL 24. in. Model
of the Clipper Ship
CUTTY
SARK**



A beautiful, perfect Model of this famous, fast sailing Vessel. IDEAL Construction Kit contains Fully Carved Hull, Stamped Wood Decks, Lifeboats, Anchors, Bits, Chocks, Chains, Masts and Spars, Sail

Steering Wheel (all Cast Metal), Cloth, Rigging, Cement, Colored Lacquer, including Full Size Plans.

Complete Kit, \$2. Plus 15c Postage or Order Direct. Send for Catalog Model Ships, Model Airplanes, Parts, Supplies. 5c. IDEAL AEROPLANE & SUPPLY COMPANY, Inc.

26 West 19th Street, New York, N. Y.

New Low Prices
Cast Metal DEAD EYES
3/32 in. 10c doz.
1/8 in. 12c doz.
3/16 in. 15c doz.
1/4 in. 18c doz.
Postpaid.

WHIZ ELECTRIC TOOL

Does a real professional job of Drilling, Grinding, Polishing, Carving, Sanding, Buffing and Sawing.



\$6.95 Postpaid

POWERFUL—SPEEDY—DEPENDABLE. Speeds up hundreds of jobs for shop and home. Needed by every home craftsman, mechanic and carpenter. Full size chuck, 3/4 inch capacity. Triple geared to extra powerful motor. Self-enclosed fan prevents over-heating. Ball-bearing thrust. Pistol grip with thumb switch. Universal motor for A. C. and D. C. Money back guarantee.

—accessory outfit, including set of drills, mounted grinder, sanding discs, mandrel, etc., sent free with each WHIZ tool ordered now. Complete outfit for only \$8.95 postpaid.

PARAMOUNT PROD. CO. Dept. 4A, 245 Broadway, New York, N. Y.

Combination — Wood and Metal Lathe



CLAUSING MFG. CO. Dept. 537 OTTUMWA, IOWA

UNIVERSAL TRACTOR

Plenty of Power at Low Cost



Plows, discs, seeds, cultivates, digs potatoes, landscape work, Swivel trailer wheels and cultivator lift for easy turning. Over 4 h.p. on belt work. Moving parts fully enclosed. Write

Pioneer Mfg. Co., Dept. V-337, West Allis, Wis.

30 Days' Trial

On all Mead bicycles. New RANGER models now ready for delivery direct to rider. Many recent improvements. Astonishing new prices and terms. buys a genuine Mead bicycle. Rangers cost a few dollars more.

*\$19.95 Tires lamps, horns, wheels, parts, equipment, and repairs at half usual price. Established 44 years.

Mead CYCLE COMPANY DEPT C-116 CHICAGO



Write us today for free catalog

GERSTNER TOOL CHEST!

Extra Value in Every . . . Machinists, Tool, Die and Pattern Makers may choose from Free Catalog. GERSTNER TOOL CHESTS 463 Columbia St., Dayton, Ohio

ONE-MAN SAWMILL

Makes lumber, shingles, lath, ties, crates, boxes, cases, all forms lumber. **TURN TREES INTO MONEY WITH A BELSAW** Three capacities: 10, 14 and 20 ft. Accurate set works positive dogs. Full or one way type power feed runs on low power—Many owners use old auto engine. Pays for itself quickly—thousands in commercial service, everywhere. Write for free lumber handbook and catalog of mills, supplies, tools, saw tables, and woodworking equipment. Belsaw Machinery Co., 811-B Davidson Bldg., Kansas City, Mo.

FARM MODEL \$49.00

When writing please mention Popular Mechanics

Sensational BARGAINS

Guaranteed \$102.50 Model

Now Only

\$44.90 Cash or

On Easy Terms

Small Carrying Charge

10 Day Trial No Money Down



Fully Guaranteed

Positively the greatest bargain ever offered. A genuine full sized \$102.50 office refinished model Underwood No. 5 for only \$44.90 (cash) or on easy terms. Has up-to-date improvements including standard 4-row keyboard, backspacer, automatic ribbon reverse, shiftlock key, 2-color ribbon, etc. The perfect all purpose typewriter. Completely rebuilt and FULLY GUARANTEED.

Learn Touch Typewriting

Complete (Home Study) Course of the Famous Van Sant Speed Typewriting System—fully illustrated, easily learned, given during this offer.

Money Back Guarantee

Send coupon for 10-day Trial—if you decide to keep it pay only \$3.00 a month until \$49.90 (term price) is paid. Limited offer—act at once.

INTERNATIONAL TYPEWRITER EXCHANGE
231 West Monroe St., Chicago, Ill., Dept. 301.
Send Underwood No. 5 (F. O. B. Chicago) at once for 10-days trial. If I am not perfectly satisfied I can return it express collect. If I keep it I will pay \$3.00 a month, until I have paid \$49.90 (term price) in full.
For quick shipment give references and occupation.

Name.....Age.....
Address.....
Town.....State.....

HANDEE TOOL OF 1001 USES

Grinds - Drills - Cuts - Polishes
Carves - Routs - Saws - Sands
Sharpens - Engraves

A whole shop full of tools in one for work on all metals, alloys, bone, resins, glass, stone, wood, etc. Uses 200 accessories. Saves hours of tedious work. 13,000 r.p.m. AC or DC, 110 volts. \$10.75 and up, postpaid. 3 Accessories Free.



Plug in any Socket

DE LUXE MODEL

For constant service, nothing compares with this easy-to-handle production tool. Saves time and labor. Fastest, smoothest, most powerful tool for its type and weight. 25,000 r.p.m. \$18.50 postpaid, 6 Accessories Free.



Get a Demonstration at Your Dealer's or Order Either Model on 10-Days Money-Back Trial. Catalog Free.

CRAFTSMAN'S PROJECT BOOK

"Pleasure and Profit with a Handee" Easy working plans for making many interesting and unusual projects, 25c stamps or coin.

CHICAGO WHEEL & MFG. CO.
1101 W. Monroe St., Dept. Q. Chicago, Illinois

Send Catalog Project Book \$10.75 Handee De Luxe Model

Name.....
Address.....

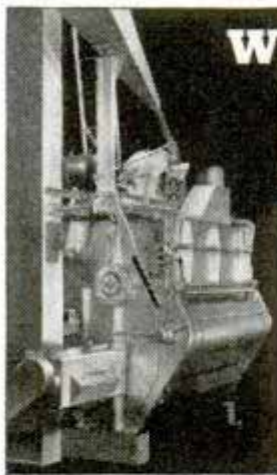

WHAT IS THIS *Revolutionary* METAL CLEANING MACHINE?

The American WHEELABRATOR, original *airless* abrasive cleaner—installed in over 300 shops and plants since its introduction three years ago—is the most important development in the metal cleaning field in the last decade.

It challenges comparison, because of its record-breaking cleaning speed, dividend-paying production savings, effective cleaning action and wide adaptability.

A list of work now being WHEELABRATED reads like a directory of U. S. industrial products. In addition to cleaning castings, forgings, heat-treated parts, stampings, steel strip, sheets, bars, tubes, etc., WHEELABRATOR is being used for many unusual operations, such as renovating steel barrel interiors, burnishing brass, etc.

If you want definite proof that your metal cleaning costs can be cut or if you have an unusual cleaning problem, it will pay to investigate WHEELABRATOR. It is made in a variety of sizes and types for every requirement. Write us on your *business letterhead* for further information.

The American Foundry Equipment Co.
579 S. Byrkit St. Mishawaka, Indiana

STRIPE YOUR OWN CAR

Anyone can stripe a car with a ROLL-A-STRIPE. You can save the price of your striping job and earn money doing others. Specially knurled roller and dependable gauge. Paint, lacquer, enamel or varnish may be used. Stripe signs, furniture, models, etc. See any Duce Dealer today or send direct. Postpaid \$1.50.

MODCRAFT INDUSTRIES, Dept. P23, 2908 N. Nordica Ave., CHICAGO, ILL.



GIVE AWAY FREE RCA LIC. RADIOS

MAKE \$10.00 ON EVERY DEAL.

Send 10c for sample salescard and plan. Many making up to \$150 weekly—why not you?

Buy Wholesale—Resell at 100% Profit! Get into radio business. 1937 catalog FREE. 25 new models for farms, homes and autos. 5 to 15 tubes. FOREIGN Reception. New "MAGIC-EYE" tuning. ONE YEAR guarantee. FREE home trial. MONEY-BACK if not 100% satisfied. SILVER MFG. CO. 606 N. Michigan Ave., Chicago, Ill.



American and Short Wave

Honeymoon Days Again

ALL-VEGETABLE
CORRECTIVE
Makes Them
Feel So Alive

FOLKS just can't believe what an

amazing difference there is in the way they feel after using a natural, all-vegetable laxative that really cleanses their system the way nature intended. But all around you people, millions of them, know how Nature's Remedy (NR Tablets) rids them of drabby headaches, colds, upset stomach, when caused by sluggish bowels. See for yourself. Know what it means to use a purely vegetable laxative. See how gently and naturally it works, leaving you feeling refreshed and alive. Get a box of NRs—25 tablets only 25 cents at any drugstore.

NR TO-NIGHT
TOMORROW ALRIGHT

FREE: Beautiful Six-color 1937 Calendar-Thermometer. Also samples of NR and Turns. Send stamp for packing and postage to A. H. Lewis Co., Desk 113C-16, St. Louis, Mo.

(Continued from page 146A)

cost only about \$8.50, less tubes and cabinet, they must be as specified for maximum results. The cabinet includes the dial and is available for about \$2.50. An original list of all parts used can be ob-

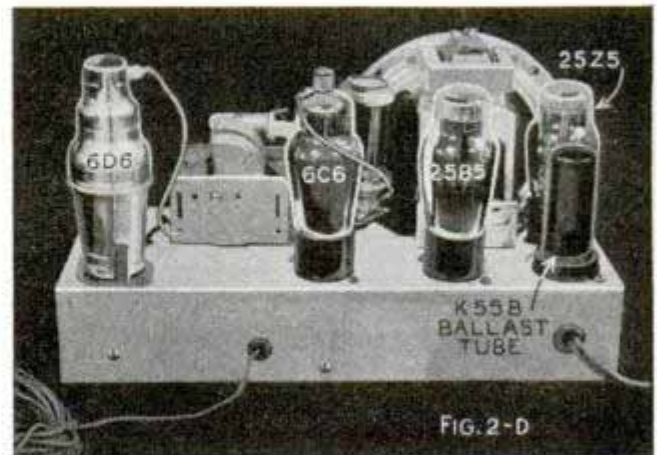

FIG. 2-D

tained upon application to Popular Mechanics radio department without charge.

It is important that the filter choke should not have more than 200 ohms d.c. resistance or the plate voltage to the 25B5 tube will be materially reduced. This also applies to the speaker output transformer. The primary should not exceed 200 ohms d.c. resistance and the plate load should be 2,000 ohms for best results; ordinary a.c.-d.c. set speakers with 43 or 38-tube output transformer will not work. To line up the receiver, tune in some station at about 1,400 k.c.; tune slightly off this sta-

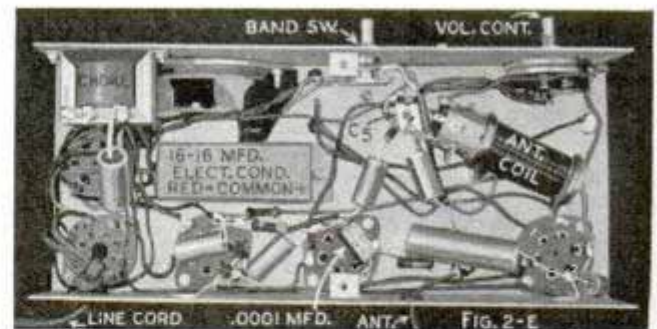

FIG. 2-E

tion and adjust trimmers (Tr.) C-3 and C-4 with a small screwdriver, to maximum noise. Next turn the band switch to the left (short-wave position) and set the 2-gang condenser so that the rotor plates will be $\frac{3}{4}$ out; now adjust (C₅) to maximum noise and the set is in balance. A 20-ft. antenna gives best results on broadcast band in crowded localities; for the short-wave band a 75-ft. length is better and may be used for both bands in areas remote from broadcasting stations.

Wired his news dealer but all copies were sold



This Issue Will Tell You:

Why the study of moons is restricted.

About man's capacity for protecting himself against harmful environments.

How the spectrograph aids the chemist and metallurgist.

The last survival in the belief in pre-natal maternal impression.

The main scientific accomplishments of 1936.

How a plant "wakes up."

Who is the true criminal.

How laboratory knowledge helps in the study of stars.

Among letters ordering subscriptions to Science Digest one from Canada told the above story. And the writer added he was interested in all branches of science.

Science Digest will serve and stimulate that interest. For busy men and women, in the professions or business, Science Digest presents pertinent news of scientific progress, in all parts of the world, in concise, clear, easy-to-read form.

The March issue of Science Digest is on thousands of newsstands today. Get your copy before they are sold out. If more convenient use the coupon below.

But get a copy. It is, as the table of contents shows, full of scientific articles of interest to business, technical, and professional men.

SINGLE COPY 25¢

A YEAR'S SUBSCRIPTION \$2.50

USE THE COUPON

Science Digest, Inc.

631-643 St. Clair St., Chicago, Ill.

Gentlemen: I enclose

25c for March Science Digest

\$2.50 check or money order for a year's subscription beginning with March issue.

Please bill me for year's subscription.

Name.....

Street.....

City.....State.....

What a Moment
FOR A **SNAPSHOT!**



TAKE IT easily with G-E MAZDA Photo lamps

What a moment for a snapshot! Chances are that you have said this about some indoor scene. Now you can snap precious indoor pictures with your camera . . . thanks to G-E MAZDA Photo lamps.

It's easy. If your camera has a fast lens—F/6.3 or faster—use supersensitive film and several G-E MAZDA Photo-flood lamps No. 1. Good for dozens of pictures. 25 cents list.

If your camera has a slow lens, open it wide, use supersensitive film and G-E MAZDA Photoflood lamps No. 2. Twice the light of the No. 1 and three times the life. 50 cents list.

Here's what you need

Put two G-E MAZDA Photoflood lamps in A and one in B. Place the lamps at the distances indicated. Tip shades to concentrate the light or use inexpensive paper reflectors. Then, when ready, click the shutter.



FOR FAST CAMERAS

FOR SLOW CAMERAS

FOR ACTION SHOTS, or with a box camera, set camera for "time" and use a G-E MAZDA Photoflash lamp. Each lamp gets one picture. 15 cents list. Your druggist or camera dealer can supply you.

LOOK FOR THE MARK 
to get dependable light for picture-taking



FREE FOLDER

Send for "How to Snap Pictures at Night." Write General Electric Co., Dept. 166, Nela Park, Cleveland, Ohio.

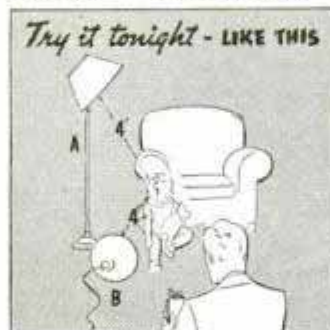

**GENERAL  ELECTRIC
MAZDA PHOTO LAMPS**

Harnessing Radio's 'Baby Waves'

(Continued from page 372)

straight lines and are reflected from objects such as buildings, leaving "radio shadows" behind the buildings. One queer condition is the "chattering tree effect" which makes a conversation seem to chatter when the receiver is among trees.

An advantage of the micro-waves is that they can be concentrated into narrow beams. This is true for all wave lengths up to ten meters, making it possible to reduce station-to-station operating costs, but among the centimeter waves the beam effect is most pronounced.

A ten-centimeter conversation can be transmitted as a beam of not more than a yard in cross section, assuring absolute secrecy in point-to-point communication. An outsider who located the beam and placed apparatus in its path to listen in would reduce the signal strength at the receiving station, giving himself away.

How far down the wave-length scale can we go? For ordinary communication the limit appears to be around ten centimeters, although messages on a four-and-one-half centimeter beam have been transmitted six miles.

Below three or four centimeters is a shadowy band that separates radio and heat and about which practically nothing is known. Exploring into this band, Dr. G. W. Potapenko, of the California Institute of Technology, has generated and studied waves only one centimeter long, by far the shortest radio waves known.

Such extremely short waves require tiny radio tubes and Dr. Potapenko has had to devise tubes that make ordinary "acorn" and midget tubes look like monsters. Made by hand by C. Y. Meng, each tube has a plate only .07 centimeter long. The wire used in the grid is .0025 centimeter in diameter and the finished grid spiral is .08 centimeter long. The whole assembly is smaller than a housefly.

Aside from the power supply, five tubes are all that is used in the one-centimeter transmitter, there being no external coils or resistances. To simplify matters Potapenko inclosed the tiny units in a five-fingered "radio tree" vacuum tube.

No one can say what strange uses will be found for these waves. So far they

(Continued to page 152A)

NEPTUNE TOPS 'EM ALL!



From the NEPTUNE Single at \$49.50 to the 16 H.P. "Master Twin" at \$149.50 - you simply can't buy more power, speed and downright dependability for equal money!

The new NEPTUNE line was the sensation of the Boat Shows - and these motors will be the sensation of every body of water they churn up this coming season. By all means - see them before you buy!

Exclusive Features!

- All Neptunes have . . .
- New type, sensational magneto
 - Automotive float-feed carburetor
 - Monel metal shafts
 - Underwater exhaust
 - Carburetor controls in steering handle

WRITE FOR ILLUSTRATED CATALOGUE

\$49⁵⁰ UP

2 H. P. FAMOUS SINGLE

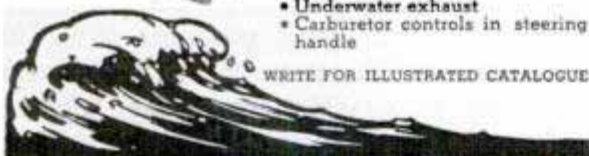

MUNCIE GEAR WORKS Inc.

DEPT. PM MUNCIE, INDIANA



are the finest
that money can buy

NO. 22 'CV' TAPPET WRENCH SET

3 pairs of Bonney double-ended 'CV' Steel Tappet Wrenches fitting most passenger cars and trucks. Longer, thinner, easier to handle. Send postcard for Catalog 'M', Bonney Forge & Tool Works, Allentown, Penna.



RADIO BARGAINS



Lafayette
**5 TUBE
TWO BAND
SUPERHET**

AMAZINGLY LOW!
ONLY \$14⁵⁰

COMPLETE WITH TUBES, CABINET, Etc.

MODEL GD-13

NOTHING ELSE TO BUY - READY TO OPERATE

Your home needs a smart-looking radio like this LAFAYETTE 1937 model GD13! 5 latest type tubes, airplane dial, short and standard American wave bands, dynamic speaker. YOU DON'T RISK A PENNY! Hear what this set can do . . . not in a showroom . . . but RIGHT in your own home, on our 30 DAY FREE TRIAL OFFER. Use Coupon for Radio Order Blank.

SPECIAL Lafayette 10 TUBE SUPERHET CATHODE RAY EYE 12" DYNAMIC SPEAKER TELL-TIME TUNING



ONLY \$42⁵⁰

If you want to cruise the radio lanes like an aristocrat, Model GMB6 is the set for you! It gets American, European, police and amateur broadcasts!! And tell - time tuning makes tuning simple as ABC. Why hesitate? Think it over on our 30 day FREE TRIAL OFFER . . . then decide!

COMPLETE WITH CABINET, TUBES, ETC., NOTHING ELSE TO BUY. READY TO OPERATE

FREE GREAT 156 PAGE CATALOG

156 pages . . . BARGAINS THROUGHOUT! Check 'em. You'll find everything you need in radio at unbelievable savings. Parts, Tubes, Test Equipment, etc. etc. **SEND COUPON IN AT ONCE** Only the world's largest distributor of radio parts could offer you these super bargains! Always remember . . . **WHOLESALE WILL NOT BE UNDERSOLD.**

WHOLESALE RADIO SERVICE CO., Inc.
CHICAGO, ILL. NEW YORK, N.Y. ATLANTA, GA.
901 W. JACKSON BLVD. 100 SIXTH AVENUE 430 W. PEACHTREE ST., N.W.

USE COUPON FOR ORDER BLANK **WHOLESALE RADIO SERVICE CO., INC.**
100 SIXTH AVENUE NEW YORK CITY
OR 901 W. JACKSON BLVD. CHICAGO, ILL.
Please Send me FREE Catalog No.

65-7C7. Enclosed is check money order for model GMB6 model GD13

Name
Address
City State

**BE
OIL WISE**



**These wise birds never
Have to prove
That Pennzoil makes
All motors smooth.
Streamliner trains
And airlines, too
Have shown you what
Is best to do.
For longer mileage—
Less to pay,
Just lubricate
The Pennzoil way.**



**USE
PENNZOIL**



HANDY Taps and Dies

Why Handy? Handy to use (easy cutting). Handy to own (10 cents each). Accurate (precision cut threads). Lasting (carefully hardened and tempered).



**Made by HENRY L. HANSON
Worcester, Massachusetts
At Your Local 5 and 10 Cent Store**

(Continued from page 150A)

have been used chiefly for studying magnetic properties of metals and for learning more about molecular structure. Molecules seem to absorb or reflect the waves according to their sizes.

One use that holds promise is that of hardening metals. Soft steel acquires an extremely hard surface when held in the high-frequency beam for a few minutes. The hardening effect is only a few molecules deep, the depth depending upon the length of the exposure.

Hand in hand with the development of short waves have come improvements that permit packing a radio circuit with many messages similar to the way that dozens of conversations can be handled over the same telephone wires. In opening up a commercial three-meter circuit between New York City and Philadelphia last summer David Sarnoff, president of the Radio Corporation of America, declared:

"Now we find that the short-wave part of the radio spectrum gives us a medium of almost unbelievable possibilities. We not only can send messages in facsimile as fast as present equipment will allow, but we can send two pictures simultaneously, and on the same radio wave we can add two automatic typewriter channels and a telegraph channel."

By installing other equipment and additional automatic typewriters it would be possible to transmit 12,000 words per minute each way over the three-meter radio circuit. Direct communication between New York and Philadelphia would be unreliable on three meters, so two untended automatic repeater stations are used en route, one located at New Brunswick, N. J., and the other near Trenton.

The circuit is opened by transmitting a musical note. When this note is received by the first repeating station it automatically goes on the air, relaying the note to the next station and putting that one in operation. Incoming messages on one wave length are rebroadcast on a slightly different wave length so there will be no interference either way. Six wave lengths all close to the three-meter frequency are used in the circuit. "Christmas tree" and turnstile types of directional antennas are used to reduce the spread of the beams between stations, hence messages over the circuit are practically secret.

For..BIG Money-Making..Doing ALL Work

Use *The* EIFEL-GEARED PIERRENCH KITS

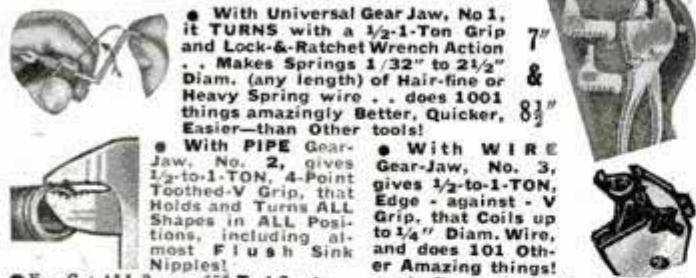

- With Universal Gear Jaw, No. 1, it TURNS with a 1/2-1-Ton Grip and Lock-& Ratchet Wrench Action. Makes Springs 1/32" to 2 1/2" Diam. (any length) of Hair-fine or Heavy Spring wire... does 1001 things amazingly Better, Quicker, Easier—than Other tools!
- With PIPE Gear-Jaw, No. 2, gives 1/2-to-1-TON, 4-Point Toothed-V Grip, that Holds and Turns ALL Shapes in ALL Positions, including almost Flush Sink Nipples!
- With WIRE Gear-Jaw, No. 3, gives 1/2-to-1-TON, Edge - against - V Grip, that Coils up to 1/4" Diam. Wire, and does 101 Other Amazing things!

● You Get ALL 3... a \$50 Tool Service... at the Price of ONE Good tool in the 8 1/2"(20-Oz.) KIT; or, in the 7" (12-Oz.) KIT; and, the 2 KITS give you 9 Different Super-2-Tool Combinations!

● WHAT'S MORE..These "Miracle KITS" are making \$30 to \$85 WEEKLY for AGENTS and DISTRIBUTORS, and We Need More..

● MAIL this Part of Ad TODAY with your Address (on a Postcard will do). Get FREE—this 7-Edge-End-&Angle SCREWDRIVER (It Turns Screws in ALL Positions and does many useful things)... and 101-PICTURE MANUAL of MECHANICS, with User Offers; or, with... **DISTRIBUTOR**, Territory and Free Kit Offers!

FREE

AMERICAN PIERRENCH CORP'N C.P.M. 4809N. Ashland Ave. CHICAGO, ILL.

HANDY GRINDER Complete Only \$2.95



Powerful 110 volt variable speed motor which originally sold for \$7.00. Has lever on side to adjust speed from 1000 to 10000 revolutions per minute. Can be used for routing, drilling, grinding, polishing and a multitude of other uses. INCLUDED FREE — 30 piece arbor tool set which consists of extra mandrels, routing burrs, all shapes, sizes and types of grindstones, mounted points, polishing brushes, buffing wheels and various grades of sand paper and emery discs. These accessories alone have a retail value of \$8.00 elsewhere.

Rush \$1.00, balance C. O. D. PHILADELPHIA MACHINERY CO., 603 Arch St., Philadelphia, Pa.

MEN—MAKE MONEY

Get into something for yourself, where your income is practically unlimited—The American Electric method of floor surfacing gives you that opportunity. Large profits—Work easy to get—No previous experience necessary—Small amount starts you—Write quick—No obligation.

The American Floor Surfacing Machine Co. 323 So. St. Clair St. Toledo, Ohio

Vest Pocket ADDING MACHINE



IDEAL FOR INCOME TAX! Adds, Subtracts, Multiplies, Divides. Does work of more costly machine. Not a toy. Million dollar capacity. Simple and accurate. Guaranteed 5 years.

— FREE TRIAL —
SEND NO MONEY \$2.50 Total Cost

Just name and address. We will ship Calculator immediately. On delivery pay postman \$2.50 (plus few cents postage). (If outside U. S. send cash.) 10c additional in Leatherette Case. If not satisfied after 10 days' trial you get your money back. THOUSANDS OF SATISFIED USERS. Write for Agents' Proposition. CALCULATOR MACHINE CO. (Mfrs.) P. O. Box 1118 Chicago, Illinois

PARTS for the POPULAR MECHANICS FAMILY TRAILER

Everything you need! Axle, Tongue, Hitch, Wheel Housings, Wood Parts, Tank, Sink, etc. Send for price list. Include 25c (coin) for our big Catalog and Trailer Builders' Manual. Satisfaction guaranteed!

TRAILER SUPPLY CO., Box A, Wausau, Wis.

NEW BOOK CRAFTSMEN SHOULD HAVE 100 Pages—No. 9

10c REBATED ON FIRST ORDER —MAKE BEAUTIFUL FURNITURE

at a fraction of store cost. USE THE CRAFTSMAN new process of inlaying, using our new process ART INLAY GLUE, needing no clamps for the finest work. Hard to find rare grains for all wood, including foreign, hard-to-find cabinet hardware. Lists and illustrates 76 blue-prints of scroll patterns, inlay table tops—Kits for inlaid art boxes, plaques, trays, book ends, etc., that anyone can make—22 pages in color. VENETIAN BLINDS for one-third of usual price. All material requiring only a saw, screw driver, a tack hammer and paint to assemble.

CRAFTSMAN WOOD SERVICE CO. 2722 MARY STREET CHICAGO

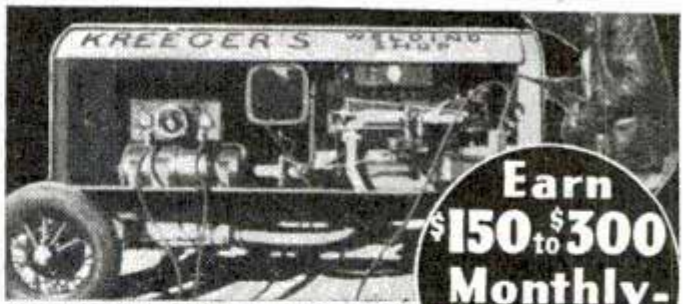

Earn \$150 to \$300 Monthly—Let PROFITS Pay for it

START BIG PAYING BUSINESS "Simplified" 40 VOLT ARC WELDING

New low prices on modern 40 Volt "Simplified" Arc Welders make this big pay business available to shops that never before could afford it. It opens the doors to the bigger profit jobs. The new Hobart is easier to operate, much faster. This is today's opportunity. Don't miss it.

Build Your Own
Portable Welder with Hobart Generator unit and auto engine or chassis. Lets you operate any place, especially on the profitable outside jobs. Easily saves you \$300 to \$500.

Portable Electric
New low cost on small sizes as well as large. The most profitable arc welder your shop can own. Welds faster, better, easier, saves current.

Easy to Operate
Hobart Welders have "Simplified" operation. This means faster welding—with the right current for every job. Hobart is simplified, so any of your men can weld easily and successfully. The mystery and uncertainty of obtaining correct welding current settings are removed.

60% Extra Capacity
Over old style 25 Volt Welders—necessary for welding with the new coated rods. Automatic reactance lets you handle light welding work without losing the arc. Users don't understand how they got along with the old style welders after using this new Hobart.

Remote Control
at no extra cost with Hobart. Think of being able to control your welder from any working point. Saves time, temper, and eliminates the need for a helper on overhead or concealed work.

"Pays-For-Itself" Terms
Extra earnings and savings make it easy for you to own a Hobart without expense to you. You can even rent a new Hobart—and later purchase it without loss of rent. Check Rental Purchase Plan.

GET THIS VALUABLE MANUAL

Sent Free if you will tell us the welding you plan doing.



30 DAYS TRIAL at Our Risk to Prove it Pays Mail Coupon for further Details

HOBART BROS., Box M-37, Troy, Ohio

Tell me more about—
 Building My Own Portable Welder
 Complete Gas Engine Drive Welder
 Electric Drive Welder
 30 Days' Trial—Easy Terms
 Rental Plan Privilege of Purchase
 Send FREE Manual on Welding. Attached letter tells about the work we want to do.

Name.....
 Address.....
 Interested in 30 DAYS' TRIAL EASY TERMS

HOBART ONE OF THE WORLD'S LARGEST BUILDERS OF ARC WELDERS

Sensational New Cork Plunger PEN



Writes like higher priced pens. Sample 35c Pre-paid Agents Wanted Write for price list and Sales Plans. BENSON PEN CO. 348 Plymouth Bldg. Minneapolis, Minn.



only 10c

Files Are Made Far Differently Now



USE THE NEW TYPE FOR YOUR WORK

NICHOLSON FILES are far different in construction than any old style files you have been using.

"Controlled Irregularity" — an entirely new principle of tooth design and construction gives these files increased filing speed in the hands of the user, greater stock removing capacity, ability to stay on the line of work, and longer cutting life.



Get the newest and best files for your shop at your hardware dealer's. You can do better filing with these new style files. Nicholson File Company, Providence, R. I., U. S. A.

A FILE FOR EVERY PURPOSE

Scrambled Voices

(Continued from page 343)

standard, or the declaration of an embargo, a boycott, or a bank holiday, immediately shows a rise in telephone calls.

The overseas service also has proved valuable to the press. It is now an established practice for London papers to call American sources for interviews or comments about events in the news. American reporters also frequently get scoops by telephone interviews with celebrities traveling on ships.

The overseas telephone is, of course, necessary for picking up foreign programs. In this wise, the voices of the world's foremost statesmen have come into American homes. Concerts, prize fights, earthquakes and speeches have also been wafted back and forth across the ocean. The flexibility of the overseas service was demonstrated by a recent program arranged by the National Broadcasting company for "Amos and Andy," famous radio stars, who separated for a vacation. "Amos" went to San Francisco, "Andy" went to London, and the announcer remained in New York. In order to broadcast on a simultaneous program, it was necessary for "Amos" to be in the San Francisco studio right after lunch, while "Andy" had to stay home until midnight, but for the announcer it was the usual evening broadcast hour.

Without leaving American soil, you can now reach more than 32,000,000 telephones, about ninety-three per cent of all the instruments in the world. Radio and wires have been combined to form the voice channels. American calls to Europe first pass through a central station in New York City, thence over a long wave and three short wave channels. The radio circuits connect with land-wire lines in Europe. If you make a call to Vienna, your voice travels over an invisible radio bridge to London, by submarine cable under the English Channel, and then by land-wire to Vienna. There are a number of important radio bridges leading from London. From this central station you can reach Iceland, Australia, Siam and South Africa. All of these connecting circuits are in the short-wave band.

Over the Atlantic, there are no convenient islands on which to locate repeater

(Continued to page 156A)

New-TYPE Cheap OIL BURNER INVENTED Sweeping the Country!

COOK and HEAT Without Coal or Wood
 In Your Present Stove or Furnace—
HOTTER—CHEAPER—No
 Dirt or Ashes—Twice the
 Heat Quick at **HALF THE COST.**

COOKS A MEAL for LESS

Beats any oil burner ever gotten out for low cost, perfect performance. Burns cheap oil a new way, without pre-generating or clogging up. Quick intense heat by Simple Turn of Valve.

Try At Our Risk
30 DAYS' TRIAL

Prove it ends drudgery and dirt of coal or wood; cuts fuel bills in half, pays for itself quickly by what it SAVES.

FREE SAMPLE FOR AGENTS

offered to one energetic man or woman in each locality who will demonstrate and take orders. Write quick, be first to learn how to make REAL MONEY right now, spare or full time—mail 1c postcard today. **UNITED FACTORIES, G-751 Factory Bldg., Kansas City, Mo.**

AGENTS
Salesmen
BIG MONEY

Drop Everything for this Quick Seller. Clark of Ind., sold 33 in 20 days. Get YOUR OWN oil burner FREE and make REAL Money. Write now.



Slips into Any STOVE RANGE or FURNACE

Quick HEAT at Turn of Valve!

"R & W ENGINEERED"

- Wheels
- Axles
- Hubs
- Springs
- Brakes
- Hangers
- Hitches



SEND FOR CATALOG

RIM & WHEEL SERVICE CO. 5132 Third Ave., DETROIT, MICH.
 147 Weston Street S. E., GRAND RAPIDS, MICHIGAN

MIDGET Electric RADIO

World's Smallest Loudspeaker Radio

Just a handful—Wt. only 1 1/4 lbs. Size only 3 1/4 x 5 x 2 1/4. Has two multi-purpose hi-gain tubes, hi-efficiency coil and precision parts—BUILT IN AERIAL! Midget BUILT IN speaker operates with beautiful clear tone and clarity on all stations on broadcast band and ALSO police calls! Actual four tube performance with real distance and punch for so tiny a radio. ALL ELECTRIC (Battery model available). Easily carried in any large pocket or tucked in suitcase. Ideal sound or personal radio. Colors to match any room—beautifully finished brook-proof cabinets. Only hi-grade parts used—a truly trouble proof midget. Late improvements. Users report wonderful reception in ALL PARTS OF THE WORLD. Uses 110 volt AC or DC current—any cycle. Kit of parts with tubes and diagram, \$6.48. COMPLETELY WIRED and factory checked, 50c extra or \$6.98 as shown. Send only \$2.00—pay postman balance. Guaranteed to operate anywhere. Colors: White, Black, Brown, Blue, Green. (Battery model same as above available; complete with self-contained batteries 99 cents extra.) Order Now. **TINYTONE RADIO CO. Dept. P-3 Kearney, Nebr.**

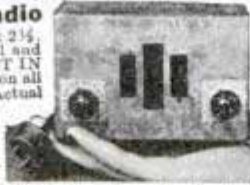

PORTABLE ELECTRO-PLATING OUTFIT

Retails for **\$3.75** Does Work of Big Outfit

New patented invention. GUARANTEED to PERMANENTLY electroplate Nickel, Copper, Zinc or Cadmium WITH A BRUSH—As easy to apply as a coat of paint. A NON-LIQUID process, always ready for use, quickly applied, and equal to any commercial electroplating. Used in factories, homes, home work shops, garages, stores, art studios, etc. Operates from dry cells, automobile battery, or battery charger. Does work of big outfit. Retails \$3.75. Specify metal finish wanted when ordering or write for full particulars. Agents wanted.

RAPID ELECTROPLATING PROCESS
 2135 No. Cicero Ave., Dept. 22, Chicago, Ill.

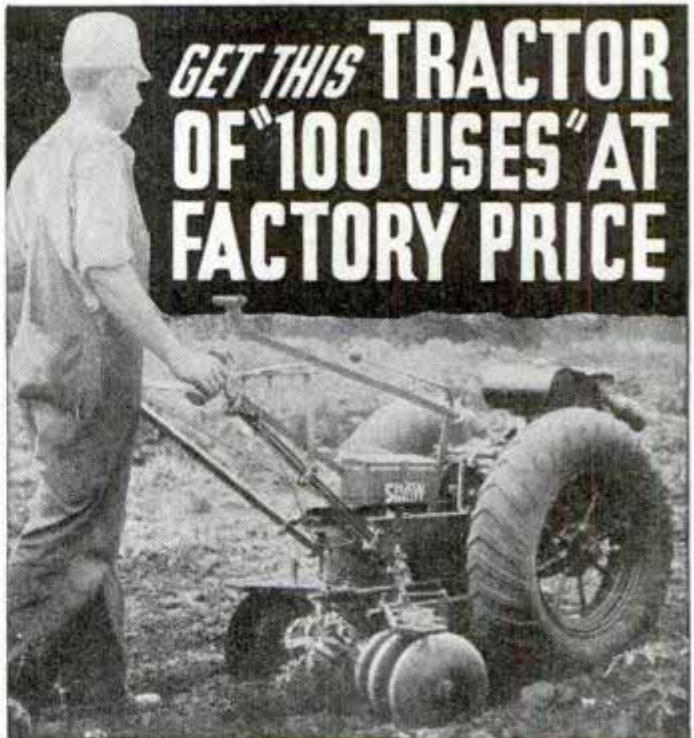

GET THIS TRACTOR OF "100 USES" AT FACTORY PRICE

DOES WORK OF MANY MEN OR 2 HORSES!

Here's untiring speed and power—that gets field and belt work done on time! Smallest size does work of many men—saving wages. Larger sizes do work of 2 horses or mules—quicker, cheaper, more efficiently—saving costly animal keep. **Runs all day for 33c.** Greatest time, labor and money-saver made!

"Tractor of 100 Uses"—Does all field, road, belt work. Plows, discs, harrows, furrows, seeds, cultivates, harvests, mows, rakes, cuts tall weeds, hauls. Runs washing machines, feed grinders, corn shellers, light plants, saws, concrete mixers, water pumps, lathes, other belt machinery. Does deep mold-board plowing, other heavy work. **Amazing money-maker** for farms, truck gardens, nurseries, orchards, suburban homes, golf courses, parks, etc.

SHAW GARDEN TRACTOR

New 1937 Model Has 3 Speeds Forward, and Reverse. Special to Order, 6 Speeds Forward—runs from 1/4 mile to 15 miles per hour. New Power Turn enables Shaw to turn in its tracks with no lifting or pushing. Reverse Gear makes it easy to work among rocks, roots, in close quarters. Tool Attachments for different uses. Convenient Jiffy Hitches. Improved Tool Control gives tools a wider range of movement - - increases tractor's usefulness. Briggs & Stratton air-cooled, 4-cycle engine. 4 Models, 2 to 5 H. P., Walking and Riding Types. Available With Air or Steel Tires. Air tires save 25% fuel. Enable Shaw to do more work in a day. Provide better traction.

LOW FACTORY PRICE!! Mail Coupon for details of price and terms today!



PLOWING



CULTIVATOR RIDING ATTACHMENT



SAWING WOOD



NEW POWER TURN SMALL BOY CAN OPERATE ALL SIZES

AGENTS—wanted. Liberal proposition. Mail Coupon for full information.

10-DAY TRIAL FREE BOOK!

OFFER! Use on your own work for 10 days. Explains everything about Shaw. Tells what enthusiastic owners say. Shows photos of tractors in use. Gives LOW Factory Prices on 4 different size models—with different attachments. **MAIL COUPON** for details 10-DAY TRIAL OFFER today! | Mail Coupon today!

FREE BOOK COUPON

THE SHAW MFG. CO. (Address Nearest Office)
 4503 Front St., Galesburg, Kans.; 5812-G Magnolia Street, Chicago, Ill.; 130-G West 42 St., New York, N. Y.; 668-G No. Fourth St., Columbus, Ohio.

Send me FREE information at once about the Shaw "Du-All" Garden Tractor as checked below:

- FREE Book and Low Factory Prices 10-Day Trial Offer Liberal Agent's Proposition

Name.....

Address.....

Town.....State.....

World's Lowest Priced Quality Homes

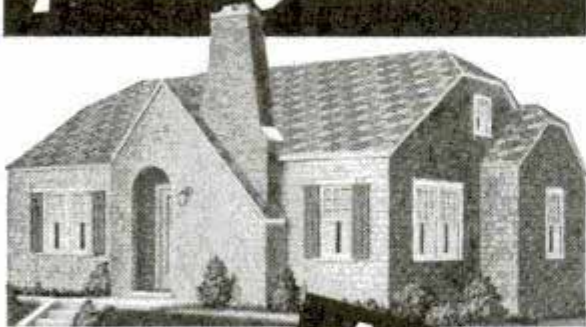

BUILD YOUR HOME BY THE MODERN READI-CUT WAY

Now you can own a fine, 4 to 10 room modern home—the world's lowest priced quality home—and save \$200 to \$800.

Buy direct from the big Aladdin Mills. Save 18% material waste. Save 30% labor—or build it yourself with our easy to follow plans. Our prices include all lumber *Readi-cut*, aluminum protected siding, millwork, windows, doors, interior woodwork, flooring, roofing, hardware, nails, paints, stains, varnish—and we pay freight!

4 to 10 ROOMS
\$495 and up
WE PAY FREIGHT



Learn about **ALADDIN'S** famous "DOLLAR A KNOT" GUARANTY.

SUMMER COTTAGES \$230 up. Write today for catalog No. 275. Send coupon or postcard to nearest address.

ALADDIN CO. BAY CITY, MICHIGAN
 PORTLAND, OREGON

Send me Free Catalog No. 275.

Name _____

Address _____

City or Town _____ State _____

\$1200.00 CASH
FOR DOG OWNERS
33 Monthly Prizes



At last an **easy** letter-writing contest **just for dog owners.** 33 cash prizes each month for letters about Miller's Dog Foods. Get rules and helpful winning suggestions from your dog food dealer or write us for complete information, FREE samples, and FREE Dog Book.

B. C. Dog Food Co.,
 346 State St.
 Battle Creek, Mich.



BATTLE CREEK HEALTH FOODS for DOGS

F1598

(Continued from page 154A)

stations. The amplification of your voice must be supplied at the transmitting and receiving stations. This necessitates enormous amplification of radio power. Thirty water-cooled vacuum tubes, each with a power capacity of ten kilowatts, are employed in the final stage of the long-wave transmitter at Rocky Point, Long Island. The power behind your voice, whether you shout or murmur, is just a few milliwatts. When the transmitters get your voice they convert it into waves of energy which, if suddenly converted into sound waves, would shatter windows for miles around. Despite the punch given to your voice by the power tubes, it is a bare whisper of energy when it reaches a receiving station 3,000 miles away. While the amplification at the transmitter may have been a million times, the receivers amplify the signal more than a billion times. Diamond-shaped antennas are used at both transmitting and receiving short-wave stations. This simple arrangement of wires gives the same results as antenna arrays much larger and more complex.

Scrambling is one of the devices employed to protect telephone subscribers against radio eavesdroppers. A device in the central control room in the New York long-distance building can scramble your voice so it is undecipherable to eavesdroppers. There are various types of scrambling. One of the methods now used is an upside-down "scramble"—with this, the high note sounds low and the low note sounds high. In the case of music, for instance, the shrill fife sounds like thunder, while the kettle drums sound like squeaky machinery. The eavesdropper hears vowels and consonants utterly strange to any human ear, and it is this gibberish that travels the voiceways overseas.

The steadily increasing volume of overseas telephone traffic has resulted in a gradual decline in toll charges. When the New York-to-London service was opened, the charge for a three-minute conversation was \$75, with \$25 for each additional minute. The present price of a call between New York and England is \$21 for three minutes during week days and \$15 for three minutes during nights and on Sundays. From New York you can now speak to Japan for \$35. The same toll charge applies to the Union of South Africa.

WHOLESALE CATALOG
of 4000 FAST SELLERS

FREE

SPURS WHOLESALE CATALOG

Hot off the press. Opportunity to make up to \$15 a day. Shows fast sellers of every description from many parts of the world, at rock bottom wholesale prices. 256 pages chock full of the biggest bargains you ever saw, many new items just being introduced, articles for every member of the family, office necessities, etc. One of the most complete lines in America. The 15 proven money making plans are fully explained in the catalog and may increase your earnings a hundred fold. This catalog is FREE—Send for it, today.

SPURS CO.
1-37 Main St. Le Center, Minn.

WHOLESALE IMPORTERS AND MANUFACTURERS
LE CENTER, MINNESOTA

BUILD IT YOURSELF

You can build this Trailer with ordinary tools easily from our step-by-step constructional sheets and largesized blueprints. Finest designed Trailer in existence, sleeps 4. Toilet, Shower, Electric Light, etc. Save 75% of the cost by building it yourself. Send 25c for plans sheet, illustrations and details.

THE PLAN SHOP, 507 Palmolive Bldg. Chicago, Ill.



BATTERY METER

\$4.85 Now you can know your battery charge

3575 BEVERLY, LOS ANGELES

GROVER PRODUCT

3402 ADDRESS-O-LITE Illuminated House Number

Easy to read from street, day or night. Shipped ready to install. Durable, handsome, weather-proof. Operates from door bell transformer. No switch. Tiny 3-CP 6-V bulb. 3c a mo. current. Money-Back Guarantee, \$1.25, plus 25c for each number. Order from ad (send house number) or ask for Free Folder.

DEALERS: Write for Spt. Offer! Unique Mfg. & Mach. Co., 4807-9 N. 31 Ave. Omaha, Nchr.

MEN—KILL for MONEY Weekly as a Professional Exterminator.

Your Own Business. Work everywhere. Our Easy Method Quickly Starts You. Exterminate roaches, bedbugs, rats, mites, termites, ants, etc. Free details. Write today.

D. L. THOMAS, Manager, 2650-P CARMEN AVENUE, CHICAGO, ILL.

BE YOUR OWN BOSS! Operate quality used and new clothing business from your own store, home or auto. Make 200% to 300% profit. No selling experience required. Everything furnished. Catalogue FREE. write for it today.

PORTNOY & SONS, 566 Roosevelt Road, Dept. 106, Chicago, Ill.

SHIP MODEL FITTINGS

SEND FOR DIE CAST—BOXWOOD—BRASS PARTS at NEW LOW PRICES! CATALOGS 5c. Largest and most complete range of QUALITY FITTINGS.

SELLEY MFG. CO., Dept. 803, 1377 Gates, Brooklyn, N.Y.

PAINT SPRAY OUTFITS

Electric Paint Spray Units complete \$14.50 and up. 1-30 H.P. Universal Motors; G.E. Phonograph Motors, Electrical Tools for Home Workshops. Send for free Catalog.

NATIONAL ELECTRIC TOOL CO., Dept. 02, 560 W. Washington Blvd., Chicago, Ill.

BUILD CLOCKS with our help

Cash in on the demand for Mantel, Banjo, GRANDFATHER'S CLOCKS. Ask about new, low-priced Clock and Special Blue Print Offer. Send dime for illustrated working drawing. Catalogue FREE.

AMERICAN CHIME CLOCK CO.
1674 Ruffner St. Philadelphia, Pa.

Men & Women Earn Cash at Home!

We paid M. M. \$267 in 3 weeks for exceptional "cellar crop" patented mushrooms! Big free picture book tells if your cellar, shed, barn suitable. We buy all crops thru ten branches. Write today.

Est. 1908. UNITED CO., 3848 Lincoln Ave., Dept. 74, CHICAGO

Earn Money Re-stringing TENNIS BADMINTON and SQUASH RACKETS!

AT HOME

Make big profits restringing rackets for tennis, badminton, squash players — and save money on your own tennis cost. Work at home in spare time. We show you how and supply equipment, instructions. **Everybody's** playing tennis and badminton! **CASH IN!** Write quick for free details and



WILLS' Free 1937 TENNIS BARGAIN BOOK listing **everything** for tennis players and re-stringers at money-saving prices. **Send coupon now!**

TENNIS BARGAIN BOOK FREE!

TENNIS STRINGS For 1937

RESTRINGING SUPPLIES H. E. WILLS CO.

JUST OUT!

DON'T buy any racket, silk or gut strings, re-stringing equipment, or tools — till you see **WILLS'** marvelous new tennis bargain book—just out. Here's a real opportunity for you to pick up some easy cash this season and to save money on your own tennis supplies.

Buy Gut Direct and Save!

Buy quality gut strings direct from manufacturer and save! Save on Silk strings too! Prompt service. Satisfaction guaranteed! Rush coupon for your free Tennis Bargain Book before they're all gone!

H. E. WILLS CO.

1047 W. 47th St. Chicago Dept. 1353



Un-Strung Racket Frames for Badminton, Tennis and Squash!



Rubber Handle Grip! Pure gum rubber, red or black colors. Priced low.



MAIL COUPON NOW!

H. E. WILLS CO. 1047 W. 47th St., Dept. 1353 CHICAGO, ILL., U. S. A.

Gentlemen: Please rush me your Special Money-Making Plan, and new, 1937 TENNIS BARGAIN BOOK, without cost or obligation on my part.

NAME.....
St. & No.....
CITY.....STATE.....

BROADCAST and AMAZE Your Friends!

Put on your own broadcast with the WALCO MIKE, most entertaining radio device yet produced. Sing, laugh, talk, crack jokes from another room and your radio will produce every sound as though you were miles away at a regular broadcasting station.

Marvelous Fun at Parties

Imitate the big radio stars and crooners. Do a "Ben Bernie" or "Rudy Vallee." No end of pleasure for grown-ups or kiddies. Excellent training in elocution. "Amateur Hour" practice, or broadcast announcing. Special cut-out button allows you to switch from home broadcasting to regular radio reception in an instant. Can not injure your radio in any way.

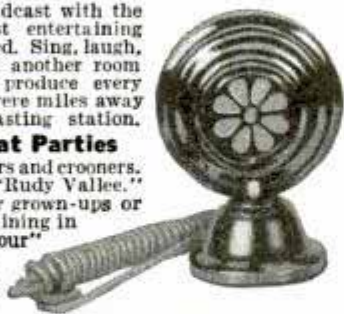

Send No Money

5 Days Trial at Our Risk!

Merely mail the coupon. On delivery pay postman \$1 plus few cents postage. If not delighted, will return in 5 days for \$1 refund.

THE WALCO MIKE

In handsome black metal. Long cord. Less than a minute to attach to any radio without tools. Fully guaranteed.

\$1

**ELECTRICAL LABORATORIES, Dept. 73,
49 East 21st St., New York, N. Y.**

Send Walco Mike, with complete instructions. Will pay postman \$1, plus few cents postage. If not delighted, will return in 5 days for \$1 refund.

Check here if ENCLOSING \$1—thus saving postage charge. Same refund guarantee applies.

Name

Address

Check here if you prefer chromium plated De Luxe model. Price \$1.39.

Neon Truck Signs

-- NOW Possible with Amazing New TRANSFORMER and Novel Method of Tube Installation!

**DISTRIBUTORS
WANTED**

Old, established factory wants financially responsible business executives - to handle distribution in exclusive territories. Signs fill long-felt Advertising need! Enable any advertiser to have brilliant, colorful, attention-getting Neon Advertising message on trucks, both day and night. Expected to quickly sweep country! Easily installed on top driver's cab. Amazing NEW TRANSFORMER enables Sign to operate on any truck's standard 6-volt auto storage battery—using only about same amount current as an extra tail light. Novel method tubing installation protects against breakage. Reasonable capital handles exclusive Distributorship Contract. Big Profits. No sign experience necessary. We furnish entire product. **FREE LITERATURE** gives details, explains liberal proposition. Write today! **E. E. SOUTHER IRON CO. - 1952-A-19 Kienlen Ave., St. Louis, Mo.**

JEWELLED WRIST WATCHES



New attractive Swiss Watches for the man or woman; guaranteed; excellent gift item in gift box.

\$3⁹⁵



Catalogue on request.
PLYMOUTH OUTFITTING CO.
163 Canal St. New York City

LEATHERCRAFT

These Winter Days. Profit and Pleasure with an EASCO complete Leathercraft Set. Leather, tools, dyes, accessories, work block and easily understood instructions for making beautiful belts, billfolds, key cases, etc. Ask for Easco at your department or sporting goods store or send direct and pay postman \$2.00 for complete set on arrival.

E. A. SWEET COMPANY, Inc., Dept. L, BINGHAMPTON, N. Y.

Smashing Atoms

(Continued from page 325)

segregated is with a mass spectrometer. Briefly, in this machine an element such as potassium is heated in a vacuum chamber. The absence of air permits a sort of evaporation of atoms from the surface of the potassium sample and these flying atoms are boosted to a speed of about one million centimeters per second by passing them through an electrical field. The speeding particles then enter a magnetic field that curves their lines of flight. Obviously, the radius of the curve depends upon the weight of the atom, since a light atom will be affected by the magnetic pull more than a heavy atom. That means all the potassium atoms having the same weight will land in one spot, while atoms of a greater weight will land in another.

Actual transmutation is done similarly. Positive ions are employed to bombard the atoms of an element. The ions themselves are merely unbalanced atoms of some other element, the choice depending upon the material being bombarded and the product desired. The ions are evaporated from a heated source and worked up to a terrific speed by using an electrical field of one million volts or more. Flying at top speed, the ions are directed at a target consisting of a small amount of the material to be transmuted. Some ions make direct hits on some of the nuclei on the target and when this occurs the nuclei join, thus forming the nucleus of a new element that gathers around it enough electrons to become a complete atom.

So far, transmutation is strictly a phenomenon of the laboratory. Changing one element into another is accomplished atom by atom instead of pound by pound. Enough material can be transmuted, however, to enable physicists to prove the transmutation. In one case enough helium was created out of atoms of another element to permit spectroscopic analysis.

From their study of the atom physicists have concluded there are not ninety-two basic elements after all, or even several hundred. Actually, the true building blocks of matter number less than half a dozen. At present these are thought to be the proton and neutron that compose the nucleus, the electron, and another minute electrical charge known as the positron.

F1660

450 Miles In a Gallon of Gas! Potential Gasoline Mileage

ACCORDING to an article by the president of the world's largest motor research corporation, there is enough energy in a gallon of gasoline if it were converted 100% in mechanical energy to run a four cylinder car 450 miles.

NEW GAS SAVING AND TOP-OILING INVENTION Astonishes CAR OWNERS

A Marvelous Device has accomplished wonders in utilizing a portion of this waste energy. It saves gasoline, gives better mileage, reduces carbon formation, creates more power, gives quicker starting, snappy pick-up and a smoother running motor. Saves many repair bills.

Big Profits and Free Offer! ... To obtain national distribution quickly, men are being appointed everywhere to help supply the tremendous demand. Free samples furnished to workers. Write today for this free sample and big money-making offer.

Diamond Fuelizer, Dept., 155, 600 High St., Akron, Ohio

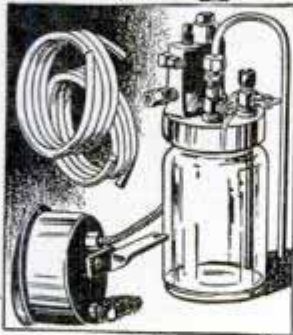

ONAN A. C. ELECTRIC PLANTS

FOR THOSE WHO MUST PROVIDE THEIR OWN ELECTRICITY

ONAN ELECTRIC PLANTS furnish the same current as supplied by power lines—110 volt, 60 cycle, ALTERNATING CURRENT. Operate Radio, Water System, Washing Machine, Electric Iron and all Electric Appliances.

Run from gasoline or gas and generate electricity for Farms, Lake Cottages, Oil Stations, Commercial Places. A woman or child can operate it.

SIZES 350 WATTS AND UP

Each ONAN PLANT is a complete Unit, ready to run. No battery used except to start the engine. Easy to install. Available from stock. 32 volt, Direct Current Models also available. Write for details.

D. W. ONAN & SONS

1001 Royalston Ave.

MINNEAPOLIS, MINN.

Home Craftsmen, Schools, Hobbyists METAL CASTINGS



produced in your own workshop allow you to design and build your own GASOLINE ENGINES, STEAM ENGINES, STATUARY, ART OBJECTS, SPECIAL TOOLS, NEW INVENTIONS, ETC. You can also make forgings and case harden steel. Your shop is not complete without a FOUNDRYETTE. Three sizes are available capable of making bronze castings of 1 1/2, 3, and 6 pounds weight, aluminum, copper, brass, etc., in proportion to specific gravity. Clean scrap metal suitable for use.

Domestic gas supply and 110 volt Electric energy required for operation.

Size	Crucible Capacity	Shipping Wt.	Price Complete
351	6 cu. in.	25 lbs.	1 1/2 lbs. \$13.50
352	12 cu. in.	40 lbs.	3 lbs. 19.00
353	24 cu. in.	65 lbs.	6 lbs. 27.50

Above price includes Universal high speed blower. For low speed blower good on

110 volt 60 cycle only, deduct \$4.00. Aluminum Casting Alloy 30c per lb. Prices f. o. b. K. C. Check or money order acceptable, express charges C. O. D. Write for circular.

KANSAS CITY SPECIALTIES CO.

P. O. Box 6022

Kansas City, Mo.

HIGH POWERED TELESCOPE

GENUINE AMERICAN MADE BROWNSCOPIES

Most powerful made for the money!
15 power long range telescope. Can see moon's craters or time on pocket watch a block away. 5 sections. Approx. 3 ft. long. Fine lenses. Brass bound. Can be used as powerful microscope.
Vol. magn. 52X. Only \$1.69 postpaid. C. O. D. 24c extra.

\$1.69



\$1.98

Special Super-Power 30X Telescope.

Similar to above but more powerful.

Guaranteed to see 900 times larger in surface and 30 times closer, 31 mm. objective 4 powerful lenses. Large field. Includes powerful microscope feature. 5 day money back guarantee. Only \$1.98 postpaid.

BROWNSCOPE CO., Dept. 43, 234 Fifth Ave., New York, N. Y.

INVENTORS Be Sure to See Page 23A

Trailer Parts and Plans

Drop center axle undercarriage, \$25, complete less tires. Utility trailer plans, 50c. Cabin trailer plans, \$1. Trailer parts at bargain prices. Write for free catalog of parts.

SHAMROCK TRAILER PARTS, 12321 Turner, DETROIT, MICH.



BUILD DUTCH WINDMILLS

And other Craftsman home workshop projects. Easy and fascinating with our blueprints. F-100 Cape Cod Lawn Chairs, 50c. B-10 Windmill 30 in. high, 75c. M-15 Martin House, 12 family, tower style. Flying goose weather vane mounted on top. Blueprint, 75c. M-10 Mart n House 8 family, castle style, 50c. Lf-20 Fairy Tale Lawn Figure patterns 35c each. 5 for \$1.00. Send 10c for catalog illustrating many home workshop projects.

CRAFTSMAN'S MODEL COMPANY, Dept. P-4, 2030 41st Street, Milwaukee, Wis.

EARN money

STRINGING TENNIS RACKETS

Build up a business of your own stringing tennis rackets. Pays up to 140% profit per racket. String your own racket and save money. No experience needed—we teach you how. Tennis players need new strings in their rackets two or three times yearly . . . every stringing means profit for you. See how simple it is to get in this business. Costs practically nothing to start. Easy work! **Get started NOW!**



FREE Write Today and we will send you free our new 1937 descriptive literature including new low prices of TOMGUT "Court-Tested" Tennis and Badminton Strings. Restringing Equipment and a complete line of Tennis and Badminton Rackets.

THOMPSON MFG. CO., 4535 Packers Ave., CHICAGO, U. S. A.
TOMGUT "Court-Tested" Tennis Strings and Restringing Equipment.

Please send new Tennis and Badminton String Price List and Catalog of Tennis and Badminton Rackets and Racket Restringing Equipment.

Name

Address

City..... State.....

GO INTO BUSINESS MAKE 100% TO 300% PROFIT!

Sell new and used clothing direct from your home, auto or store. Undercut all competition. **EASY SALES—FAST REPEAT ORDERS!** We furnish everything and show you how. Handsome profits every day in the year. No selling experience necessary. Write at once for our Big Money Catalog—It's FREE!
Liquidation Merchandise Co., 550 E. 43rd St., Dept. D-16, Chicago, Ill.

Manheim POCKET SLIDE RULE

With A-B-C-D Scales. Multiplies, divides, squares, takes square root, finds circumference and area of circles. 6 inches long—thin construction. **NO WOOD OR CELLULOID.** Fits in vest pocket. Send \$1 in cash, money order or check and receive slide rule with genuine leather case and instructions. Box M-5.

M. MANHEIM COMPANY, Inc.

15 E. 26th St.

New York, N. Y.



See the **NEW**
Sea Gull **OUTBOARD**
MOTORS!

Quiet and swift as a bird in flight
• with plenty of power • the new Sea Gulls establish an entirely **new** standard of value in outboard motors! Prices range from \$39.50 up—the lowest prices, we're sure, that have ever bought motors of such outstanding quality! 2-4-6 and 16 H. P. models.

\$39.50 UP

All Sea Gulls Have:

- ✕ Automotive float-feed carburetor
- ✕ Monel metal shafts
- ✕ Underwater exhaust
- ✕ New type sensational magneto
- ✕ Carburetor controls in steering handle

And • the smartest line of steel boats on the market! For rowing or outboard motors. Sturdy, seaworthy, safe • and **very** low-priced. Also **quality** elm and maple oars. Write for **FREE** illustrated literature.

Steel Boats

\$24.50 UP



NATIONAL OUTBOARD MOTOR CO.
DEPT. PM MARSHALL, MICHIGAN



WIND CHARGER RADIO
SAVE UP TO 1/2 Usual Price

Amazing invention by old established company FURNISHES ELECTRIC LIGHTS and OPERATES RADIO FROM FREE WIND POWER. Mighty twin speaker farm radio equal to the finer city sets. NO "B" or "C" batteries. **SENT ON 30 DAYS TRIAL.** AGENTS—Big Money Maker. New plan shows how to **GET YOURS FREE** by helping to introduce. Be first in your locality—write quick.
PARKER-McGRORY MFG. CO., Pioneers in Radio—Est. 1923
C-751-2609 Walnut St. Kansas City, Mo.

LOW COST POWER

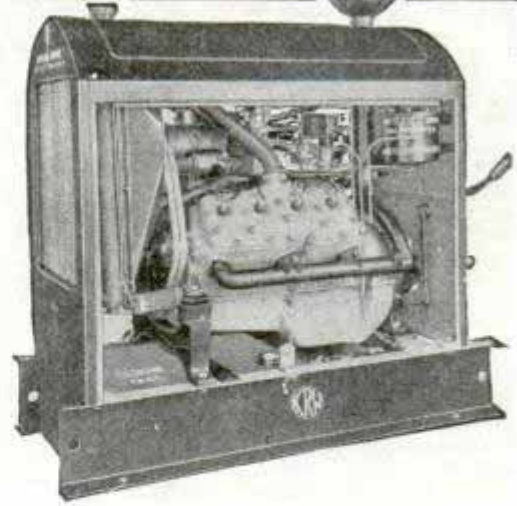

with this KRW-FORD V-8 unit

Here's dependable, low-cost power up to 60 H.P.—complete, compact, portable. Ideal for line shafts, welders, compressor, hoists, pumps, amusement devices, well drillers, agricultural, oil field and contractors' equipment, etc., etc. The most complete industrial power plant built. Uses gasoline or natural gas.

Assembled with brand new heavy duty Ford V8 Truck engine. Large capacity radiator protected by heavy screen. Engine rubber mounted—outfit complete with governor, gas tank, 17-plate battery, instruments and louvered side panels to thoroughly enclose the engine.

Write for complete information, price, and data showing how this unit will **pay for itself out of savings** in a few weeks, whether operated on gasoline or natural gas. You can buy thru your Ford Dealer and benefit by local service and low-cost Ford engine replacement feature.

K. R. WILSON 17 Lock St. BUFFALO, N.Y.
EXCLUSIVE BUILDER OF APPROVED FORD SHOP EQUIPMENT SINCE 1916

BIG PROFITS SHOWING TANNERS
NEW SPRING SHOE LINE
COMPLETE LINE FOR MEN, WOMEN, CHILDREN

Make fast easy sales! Unsurpassed quality assures steady repeats. \$10,000 Gold Bond guarantees absolute satisfaction. Outstanding line Men's Work and Dress Shoes, Women's modish footwear, Children's sturdy shoes. Newest leathers. Newest colors. Newest styles. Full range of sizes. Famous self-adjusting inbuilt steel arch-support. **GET FREE SHOES** for yourself and family by our liberal bonus plan.

YOUR OWN SHOES FREE
AMAZING GROFLEX SHOES
NEED NO BREAKING IN!



This wonderfully flexible shoe gets immediate attention from prospects. Special exclusive features. Most comfortable shoe ever built for work or play. Long wearing—economical. Greatest shoe value available!

FREE SHIRTS, TIES, HOSIERY OFFERS TO CUSTOMERS bring large orders and increased earnings. Big selling season on! No experience needed. We furnish all equipment **FREE** including \$30 outfit of shoes. We pay postage. Send **TODAY** for **FREE Sales Kit**.
TANNERS SHOE COMPANY 554 C STREET BOSTON, MASS.

MORE PROFIT—MORE PLEASURE—WITH BOICE-CRANE TOOLS



New 10 Inch Tilting-Arbor Saw is big and heavy. Accurate. Refined details. Easiest to use. Gives greater production. Investigate its greater safety, too.

Write for Catalog

Get full details... Twenty different Tools... New designs... Ahead of field... High quality... Dependable... Accurate machines of low cost.



Only ONE motor (not 2) needed to drive both this Tilting-Arbor Saw and Jointer. That saving of \$5 (impossible on most other saws) pays for your Boice-Crane Jointer.

6 Inch Jointer. Extra long tables. Very long fence guidance for accuracy. Fence locks rigidly at front, and at rear. Is spring-proof. Cutterhead 3 inch diameter.

BOICE-CRANE CO. Dept. PM.3-M. Toledo, Ohio



Do You Want a WATCH or DIAMOND?

Thousands have found it easy to own America's finest diamond rings, watches, silverware or jewelry by the Santa Fe Plan. Bulova, Hamilton, or Elgin watches—brilliant blue-white diamonds—silverware from world-famous companies, and the great Santa Fe Specials—offered to you at startling cash prices on confidential liberal credit terms.

A Few Cents a Day is the Santa Fe Way

That watch or diamond you've always wanted, longed for—you needn't wait any longer for it. The Santa Fe will trust you—let you wear the watch or diamond you want while you pay only a few cents a day.



TURN PIN MONEY INTO DIAMONDS

Gifts for Every Occasion

Don't Pay Extra For Credit!

No honest person should pay extra to have someone trust him. The Santa Fe trusts you the way you want to be trusted—straight from the shoulder without any extra charges, extra fees, or taxes. You pay only the low advertised cash price in small monthly payments. Send for 1937 Catalog NOW!

FREE to Adults—Send for this beautiful book today. Sent ABSOLUTELY FREE to adults. Send your name and address, and the beautiful catalog will come to you by return mail. Do it now while you think of it.

SANTA FE WATCH COMPANY
Dept. 36, Thomas Bldg., Topeka, Kans.



GET INTO AVIATION with a New CUB!

The new Silver Cub offers you your big chance to get into aviation—for here, at last, is a man-sized airplane almost everyone can own—just like Frank Hawks, America's Speed King, flies. It is America's Safest Airplane! And it is easier to fly than driving a car. In fact, one Cub pilot is only 11 years old. As for economy, it uses less than 3 gallons of gas per hour and almost no oil! The new Silver Cub costs only \$1270 F.A.F. Bradford, Pa. However, labor and material costs are mounting daily. So get YOUR Silver Cub now. You need pay only \$425 down and the balance in easy monthly instalments.

Free!

Write for our free, illustrated Cub folder and name of your nearest Cub dealer. Use coupon below if you wish.



GET YOUR WINGS NOW!

Enclose 10c in coin or stamps and we will send you this beautiful "wings" insignia pin.



TAYLOR AIRCRAFT COMPANY,
37 M Street, Bradford, Pa.

Please send me your free illustrated Cub folder and name of my nearest Cub dealer. Enclosed find 10c for my "wings" insignia pin.

NAME

ADDRESS

CITY..... STATE.....

WELDERS



Bottled gas cost six times as much as generated gas. THIS GENERATOR SELLS FOR ONE THIRD THE USUAL PRICE. You need to know more.

JOHNSON PORTABLE GENERATOR CO., Brookfield, Mo.

LISTEN!

If you think a black, tarry, sludge-filled oil will do the same lubricating job as the clean high-grade oil you originally put in your crankcase, you're an optimist.

Those manufacturers who protect their engines with a Purolator Oil Filter don't think so, and if you have an oil filter on your car you should keep it in service.

For thousands of miles the Purolator keeps the oil stream so clean and effective that it even retains its color. But in time the Purolator becomes filled with the sludge and grit and dirt and hard carbon that finds its way into every engine. It must be renewed... and every service garage is prepared to attend to this for you in a very few minutes.

Don't neglect this important matter. Check the condition of your oil with your favorite station attendant. He'll know. Motor Improvements, Inc., Newark, N. J., makers of Purolator, the oil filter on your motor car.

WORLD WIDE ALL WAVE RADIO \$1.55 POST PAID



A sensational Radio! Thousands now in use. Can actually bring in foreign stations, police calls, aeroplanes, amateurs, etc., as well as local broadcast! Short and Long Wave. Ace Radios give guaranteed results!

For only \$1.55 we send you the complete kit containing an attractive metal chassis panel and every part needed to build a powerful one-tube receiver, AMAZING VALUE! Works for months on two inexpensive dry batteries. Our clear diagrams make it simple to hook up. Not a feeble crystal set!

TWO TUBE KIT (More volume)—\$2.00.
ALL-ELECTRIC two tube house current set. No batteries! Complete kit \$3.00.

(Sets laboratory assembled and wired 75c extra.)
Enjoy NEW thrills! Send for your ACE Radio today!

Ace Radio Laboratories, 70 Barclay St., Dept. P-3, N.Y.C.

DEVELOP & PRINT YOUR OWN SNAPSHOTS



COMPLETE OUTFIT \$2.95

Save One Half!

Save money developing, printing your own pictures! No experience needed. Send only \$2.95 cash (or \$2.95 C. O. D. plus postage) for professional outfit including electric ruby lamp, developing and fixing trays, chemical, photograph paper, complete directions. Unless perfectly satisfied, return outfit within 10 days and your money will be refunded! Order now! Write for Free Barvain Book of cameras and supplies.

CENTRAL Camera Co. (Est. 1899)
230 S. Wabash, Dept. K-3, Chicago, U.S.A.

HALF AND HALF MAKES ONE SWELL SMOKE!

BUILD YOURSELF OR HAVE Carpenter or Garageman BUILD
A RITZY CABIN TRAILER. COST \$150 UP



USE AUTO AXLE OR RICHMAN TRAILER AXLE. ALL THREE PLANS \$15.00

SIMPLE PLANS AND SPEC BY REG. ENGINEER. SIZES 8' WIDE & HIGH. 14 AND 24' LONG. EASY TO CHANGE LENGTH AND WIDTH. MAIL \$1.00 BILL TODAY FOR ALL THREE PLANS TO RITZY CABIN TRAILER, BOX 2513, WAPAKONETA, OHIO

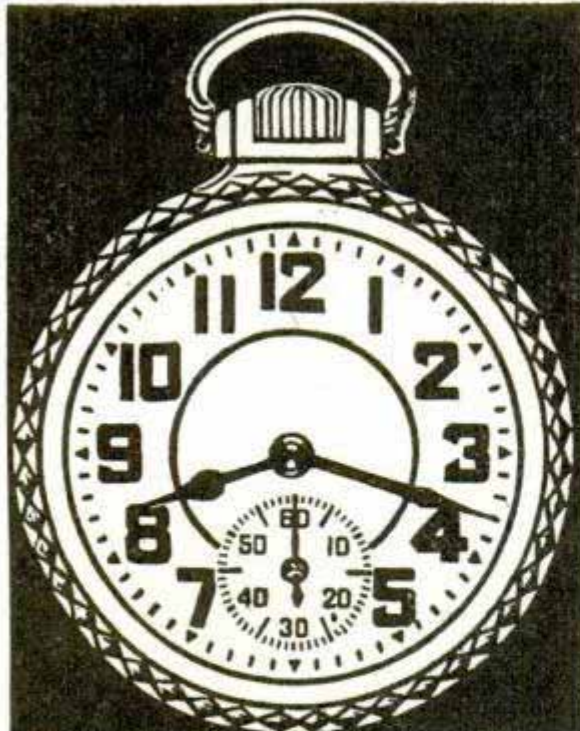

ON APPROVAL...

WE defy you to tell this 1937 R. R. Engineers Watch from one costing \$20.00. To prove it to you we'll send it on for 25 cents to cover cost of packing, shipping, etc. Pay 2 monthly \$2.25 payments (Total only \$4.50). You can't lose. Money back if not delighted. Genuine Waldemar Knife and Chain included FREE and shipped with Your Watch by RETURN MAIL. Compare with \$20.00 watches. If you are not thrilled with its solid gold effect, richly designed case, and if you are not amazed at its accuracy, guaranteed by 100-year-old million dollar FACTORY, we'll return your money. Wear it at our risk. Rush 25 cents stamps or coin. Watch, knife and chain shipped same day.

GOLD STANDARD WATCH CO., Dept. 683, Newton, Mass.
Copyright 1937 Gold Standard Co.

Make up to \$150 Weekly GIVING AWAY FREE RADIO

RCA LICENSED RADIOS

We offer this and other money making plans to all salesmen, distributors, cardmen, punch board men and agents with our new full 1937 line consisting of 30 beautiful and exclusive Radio Models for home, auto, and farm use. Make up to \$150 cash in a week for yourself. Every dealer and sub-agent, home, car owner, store, office, factory, lodge, club or individual wants these marvelous new plans for giving away FREE WORLD FAMOUS RCA LICENSED DE LUXE RADIOS. WRITE TODAY FOR OUR NEW STARTING OFFERS. Start at once making money with our unique sales plans. Write for full information how you can secure any or all of these plans FREE.

DELUXE MFG. CO., Dept. 307, 173 W. Madison St., Chicago, Ill.

Send FOR THIS 112 PAGE GUIDE ON FISHING!

IF YOU LIKE FISHING You'll Want This Book FREE! 14th edition of "Fishing—What Tackle and When." All new — revised. Articles by Rex Beach, Corey Ford, and Courtney Ryley Cooper. Identifies fish in colors. Casting lessons. Facts anglers want. Free! Write today. South Bend Bait Co. 567 High St., South Bend, Ind.

SOUTH BEND

Trindl ELECTRIC ARC WELDER

375

Works Off Any Storage Battery or Ordinary Light Socket

This new electric arc welder is made possible by the invention of a low voltage carbon. Auto batteries may be used without removing from car. Uses about same current as four headlight bulbs. Broken parts are simply melted together by the white hot electric arc, in just a few seconds. Produces about 7000 degrees heat.

Hottest Flame Known

Melts iron and steel instantly. Welds fenders, radiators, holes in bodies, milk cans, tanks, brazes broken castings. Works on anything iron, steel, brass, copper, tin or galvanized metal. Permanent repairs made for almost nothing. Used by factories in many operations. Positive money back guarantee by a responsible firm.

AGENTS
Men with cars to sell mechanics, repairmen, farmers, radio and battery shops, factories. Five minute demonstration makes sales. Up to 150% profit. Write today.

TRINDL PRODUCTS 2229-EK Calumet Av. CHICAGO, ILL.

BUILD YOUR OWN DODGE ARC-WELDER
25-200 AMPS.

from old North East automobile generators. Certified instructive plans \$1.00—C. O. D. \$1.12. Order at once!

WELDERS' CLUB OF AMERICA Box 3432-H
Merchandise Mart Chicago, Illinois

PRECISO RELIABLE MICROMETER

YOU NEED AN EXTRA MICROMETER

1 Inch Adjustable. Measures in Thousandths of Inch. Rustless Body. Mailed for \$1.00. Money refunded in five days on request.

SAFE HOLDER CO., 104 W. 42nd, New York City

NEW BIG TRAILER PARTS CATALOG

Shows 329 valuable trailer items. Build your own trailer or recondition the one you have. Wholesale prices for quality merchandise. Send 10c for this money saving catalog today.

C. M. Hoof Company, 1736 S. Michigan Ave., Dept. P-3, Chicago, Ill.

AGENTS 500% Profit GOLD LETTERS

For Store Fronts and Office Windows. Anyone can put them on. Free samples. Liberal Offer to general agents.

METALLIC LETTER CO., 438 N. Clark St., Chicago

NEW POPULAR MECHANICS BOOK CATALOG

1937 edition "A Billion Ideas" just issued. Thousands of useful books on practical subjects described and illustrated. Will be sent upon receipt of three cents in stamps to cover postage.

Address
Popular Mechanics Press 200 E. Ontario St. Chicago

New POCKET RADIO

MUSIC SPORTS ENTERTAINMENT

FITS POCKET EASILY—Take it with you!

All one unit—just like the big sets, but weighs only 6 oz. Carry it with you. Nothing to adjust. No batteries, tubes, or electric socket connections required.

Costs Nothing to Operate! Guaranteed!

Brings in stations with fine tone quality. Tunes broadcast band. Accurately made, precisely assembled, rigidly tested, assures excellent performance. Should last for years. Tuning knob is the only moving part. Comes with built-in phone, with easy instructions for use in camps, office, picnics, home, bed, etc. Listen to music, sports, prize fights, radio entertainment, etc. Thousands have been sold all over the United States and foreign countries. Comes all ready to connect and tune in.

SEND NO MONEY! You should be delighted with the enjoyable radio entertainment that you get out of the "Cathedral"—the radio that combines performance and economy, employing Hi-Powered fixed crystal. Get yours today. Pay postman on arrival only \$2.99 and postage or send \$2.99 (we pay postage). Order now. Makes an ideal gift.

LITTLE GIANT RADIO CO., 3959 Lincoln Ave., Dept. 704, Chicago, Ill.

STUCCO SPRAYING MASONRY SURFACES NOW OFFERS BIG EARNINGS



This new machine and process fuses a waterproofed plastic mixture on any masonry. It beautifies and weatherproofs both old or new buildings, walls, etc., at low cost. It fills all cracks and can be applied in any thickness desired and in 30 colors and shades. Fully proven by over twelve years actual use under all conditions and every climate.

LARGE WAITING MARKET

Owners everywhere want to enhance present values and make their buildings more attractive and livable. The better builders are striving for greater permanence, beauty and salability in their new construction. With Colocrete stucco spraying you can supply this waiting market and can offer permanent colorful surfacing at amazingly low cost. Many operators report costs of 2c to 4c per sq. ft. and sell at from 4½ to 7c. Some have paid for their equipment from first couple of jobs. Machine capacity up to 1000 sq. ft. per hour.

Get the facts. The new Colocrete books tell the whole story. Write today. It may mean business independence for you.

COLORCRETE INDUSTRIES, Inc., 570 Ottawa Ave., Holland, Mich.



BE ACCURATE AND POSITIVE

To examine diamonds, coins, machine parts, ores, specimens, and paintings use this fine double lens diamond eyeglass. Diamond experts, jewelers, watch repairers, and engravers use this very same kind of glass. Small defects, flaws, names, and details cannot be found with the naked eye. Therefore this powerful double-lens glass will be an amazing help to anyone. Price \$1.00 postage prepaid.

Security Jewelry Co., 742 So. Hill St., Los Angeles, Calif.

WIND CHARGER EARN

Genuine DUNN CHARGER for supplying 6-volt radio and house lighting current operating at less than one cent a week. Guaranteed. Be first in your community to make quick money showing world's best windcharger using the famous patented Dunn governing principle to friends and neighbors, and own yours FREE. Mail post card today.
Parris-Dunn Corp., Dept. 10, Clarinda, Iowa



27" QUEEN MARY, \$2.50 plus post.

Others \$1.00 to \$6.00. Completely finished hulls, and parts of wood; sails, wires, rigging, and all parts included. Also entirely new Beginner's Line, at \$1.00 each. Coach models, too. Rush 3c stamp for illustrated Ship and Coach catalog.

MINIATURE SHIP MODELS, Dept. RT, Perkaspie, Pa.



"TRAILER PARTS"

Save 70% on cost of trailer, build it yourself from parts. Family, express or freight trailer parts. Capacity 1000 lbs. to ten tons. **SPECIAL BARGAIN NOW** on Wheel chassis with axle, wheel housing, wheels, tires and hitch for only \$60.00 while they last.

South Bend Trailer Mfgs. 208 N. Main St. South Bend, Indiana

BUILD CLOCKS for PLEASURE - PROFIT



Hall clocks are high priced in stores—you can make good money building them or electrifying spring clocks. Dime brings "HOW" Book pricing banjo, desk, mantel, RADIO, spring, ELECTRIC, chime, BATTERY from \$1.40. Brass weight movements from \$16.95 with drawing of easily built Grandfather Case—start now.
KUEMPEL CHIME CLOCK CO., Bldg. 2, Gulfport, Iowa

Here's why these 1937 "speed model" Coronas are "going to town"...

Faster, easier to operate, the most complete portable typewriters we've ever made... and remember, we've made nearly two million! Exclusive Corona "Floating Shift," and such special features as Touch Selector, Speed Booster, Piano Key Action. Free carrying case and touch typing lessons included!



CORONA

America's finest portable typewriter

If you've ever wanted to "own a Corona" now's the time! School or literary work, business, or home correspondence... Corona handles it all. You can pay for it as you use it—as little as \$1.00 a week takes a Corona home with you. Ask your dealer—or write for free booklet. Four models to choose from.

MAIL COUPON TODAY

L C Smith & Corona Typewriters, Desk 3
723 E. Washington St., Syracuse, N. Y.

I'm thinking of buying a Corona. Please send free booklet showing models and prices.

Name.....
Street.....
City..... State.....

INVENTORS

BE CAUTIOUS Before You Make A Move — Get These Facts!

Invention, like everything else, is a business—you must know what you are doing. First, you must know how to obtain patent—then, how to market your invention. Don't move in the dark—get the complete story of Patents and the Inventive Field before proceeding.

Over 100 illustrations are in this book. Entire chapters are devoted to the value of a patent in promoting the final success of your invention.



HOW TO PROCEED

Our FREE 48-Page Book takes you from the first step in obtaining patent to the last step in commercializing your invention. Everything you need to know is in this book—prepared by experts with years of training in the patent field. We have served thousands of inventors in the United States and we can serve you very reasonably on liberal terms. Don't delay—learn what you must do today—Send for our FREE Book, "Patent Guide" and "Record of Invention" Blank.

HERE IS WHAT YOU MUST KNOW!

CLARENCE A. O'BRIEN & HYMAN BERMAN

19-V Adams Building, Washington, D. C.
Registered Patent Attorneys Before U. S. Patent Office
Please send me your FREE BOOK, "Patent Guide for the Inventor" and your "Record of Invention" form, without any cost or obligation on my part.

NAME.....
ADDRESS.....
(Important: Write or print name plainly)

**Water Sprayed on Auto Wheel
Prevents Shock from Static**

F1574



Picture. one.
Water spraying on wheels of cars approaching bridge tollhouse releases static electricity charge

When toll collectors on New York's Tri-borough bridge reached for the fare, both the tollman and the car driver were annoyed by the discharge of static electricity produced by cars moving over the bridge. The problem now has been solved by installing a water spray which spouts onto the wheels of cars approaching the tollhouse, releasing the static charge before the cars reach the tollkeeper.

**Agitator for Developing Tank
90s Shaken with a Finger**

F1690

Instead of shaking the film developing tank by hand, an agitator recently put on



the market requires only a slight finger motion. It is a metal disk about four inches in diameter, rubber-coated on one side to keep the developing tank from slipping, and fitted with a small convex dome on the other side. The tank is placed on

the flat side and rocked with a finger in a circular motion which distributes the developing solution uniformly over the film.

*The Central Camera Co
230 S. Wabash. Cheap*

**F1668.
Tower with "Eternal Light"
to Honor Edison**

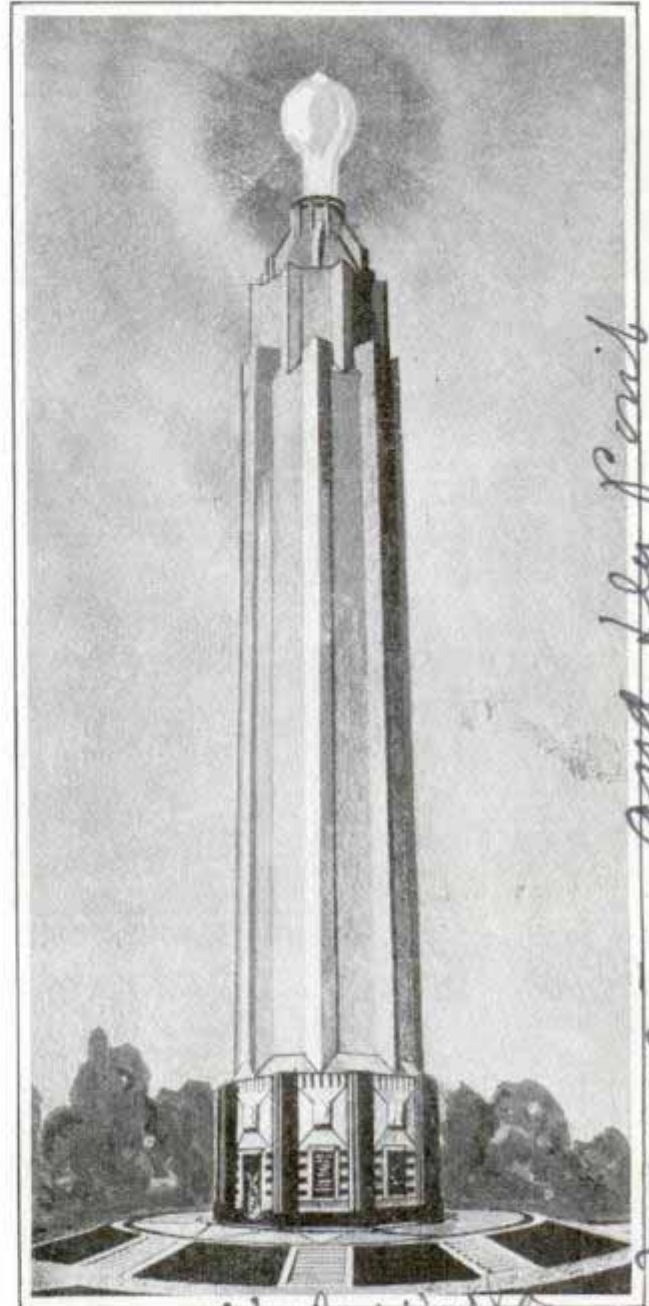

Wide World
Design of memorial shaft, topped by "eternal light," which will honor Thomas Edison

Topped by an "eternal light," a giant shaft is proposed as a memorial to Thomas A. Edison. The memorial will be erected by the Edison foundation and the Edison Pioneers. A design of the proposed light tower has just been completed by a firm of Wilmington, Del., architects.

Popular Mechanics Magazine does not publish the name of the maker of, or dealer in, any device described in its pages, but this information will be furnished by our Bureau of Information upon request, accompanied by stamped envelope.

Maschinen und Holzfabrik

*"I'd forget your
age, Old Boy—*

**...if you had a
Barbasol Face"**

It takes more than a clean, smooth shave to make a lovely lady yearn to draw her hands along your manly jaw.

It takes a "Barbasol Face"—a soft, firm skin, kept young and handsome looking by the soothing, after-shaving effects of Barbasol.

Throw away old shaving methods. Try a tube of Barbasol for two solid weeks and see how the years appear to roll off your face.

Barbasol is a cream—no harsh alkalis in it to dry and tighten the skin, to hurry on the wrinkles long before your time.

No brush, no lather, no rub-in

—Barbasol gives the quickest, easiest shave you ever had, and your skin feels sweet sixteen. Ask your druggist for a tube of Barbasol today. You'll love it.

And so will the ladies; that is, we mean, the wonderful effect it has on *your* face. Large tube, 25¢; giant size, 50¢. And for 15¢ five scalpel-sharp Barbasol Blades.



For modern shaving



No Brush—No Lather—No Rub in

PRIZES FOR GOOD GUESSERS

Are you good at guessing? If you are you may win any one of the valuable prizes given away every week—a new automobile, big money prizes, hundreds of \$3 Barbasol Razors. Absolutely free to enter, takes only a few seconds to do. Simply guess a number, that's all. For details, tune in Singin' Sam (NBC Blue Network) every Friday evening. See your paper for time.

When writing to advertisers please mention Popular Mechanics

FILE 88

Meter Analyzes Colors of Cloth in Five-Minute Test

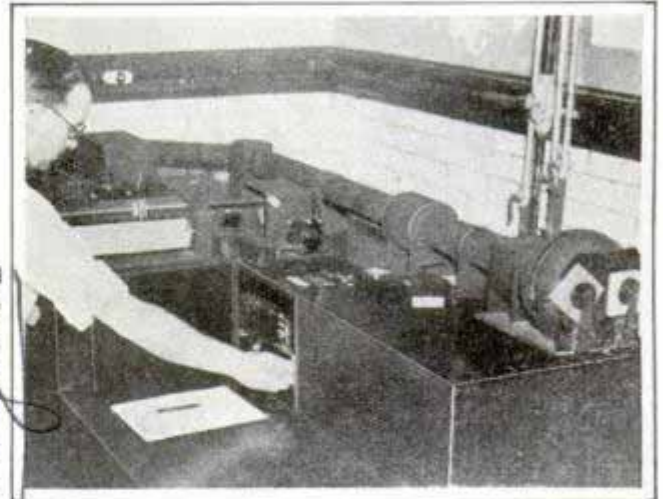

© Harris & Ewing
Analyzing the color of a bit of cloth with the spectrophotometer at the Bureau of Standards

It used to take a man a half day to test the colors in a piece of cloth. Today the same work is done by a spectrophotometer at the U. S. Bureau of Standards in just five minutes. The meter records the percentage of light transmitted or reflected at various wave lengths in the visible spectrum.

Washington, D.C.

Keegan

new EVINRUDE

"Scout"

15 POUNDS \$44

F. O. B. Milwaukee

Here is the lightest, handiest slickest little motor that any fisherman, cottager, vacationist ever dreamed about . . . and, complete, ready to go, it costs only \$44! Drives good sized boats up to 5½ miles an hour! Uses only a single quart of fuel in 1½ hours . . . 100 miles of carefree water motoring for less than 60 cents!

Write today for catalog on the 15 lb. Scout and brilliant new Evinrude Streamflow models for 1937. Address, EVINRUDE MOTORS, 5015 N. 27th St., Milwaukee, Wisconsin.



EVINRUDE SEND FOR CATALOG

The TRUE EXPERIENCE of PAUL SHEA

OF SPRINGFIELD, N. J.

I HATE TAKING



645 Atlantic Ave. Rochester, N.Y.

Safety Signal Worn on Hand Reflects Auto Lights

Worn on the wrist or hand, the latest safety signal for pedestrians, cyclists and drivers reflects automobile lights and is visible for 1,000 feet. The device has a canary-yellow reflector, which is visible to approaching traffic, and a red reflector, visible to traffic from the rear, which are connected by a tension spring. Spring tension can be increased by pressing the reflectors together, thus insuring a better fit on the wrist or hand. The signal may be worn over gloves.

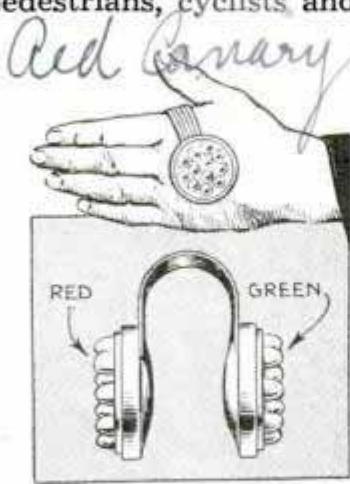

Saw-Filing

PAYS BIG!

An opportunity to earn up to \$2 to \$3 an hour in your own cash business. Start in spare time at home. No experience required. You can do expert work... easily, quickly, without eye-strain, with a



FOLEY AUTOMATIC SAW FILER

"I have filed 650 saws in spare time and have earned \$850.00 in carpenter work due directly to my saw filing contacts," says Louis P. Wadowick, Ohio. "Am still operating my Foley Filer after 5 years. Business better than ever this year," writes J. W. Veith, Pa.

The Foley files ALL kinds of hand saws, band saws and cross-cut circular saws BETTER than expert hand filing—every tooth exactly uniform in size.

FREE PLAN shows you how to start—no canvassing. Send coupon now—no obligation, no salesman will call.

FOLEY MANUFACTURING CO.
316-7 Foley Bldg., 11 Main St., N.E., Minneapolis, Minn.
Send me FREE PLAN, for starting my own business in spare time filing saws on the Foley Automatic Saw Filer, without obligation to me.

NAME.....
ADDRESS.....

THIS FACE ANYWHERE!



"THE WAY I LOOKED BEFORE I took Fleischmann's Yeast. I hated going anywhere, my face was so broken out."

PAUL NOW - PIMPLES GONE. "Fleischmann's Yeast sure cleared up my skin fine," he says.

I'm mighty glad to tell others about what a small pimple chaser Fleischmann's Yeast is. Every boy that wants to get rid of pimples ought to eat it.

Paul She



CLEAR UP ADOLESCENT PIMPLES—After the start of adolescence, important glands develop. This disturbs the entire system. The skin gets oversensitive. Waste poisons in the blood irritate this sensitive skin. Pimples appear. Fleischmann's Yeast helps to clear up pimples by clearing these skin irritants out of the blood.

Eat 3 cakes a day—a cake about one-half hour before each meal—plain, or in a little water.

New 1937 SOUTH BEND Back-Geared Screw Cutting PRECISION LATHES

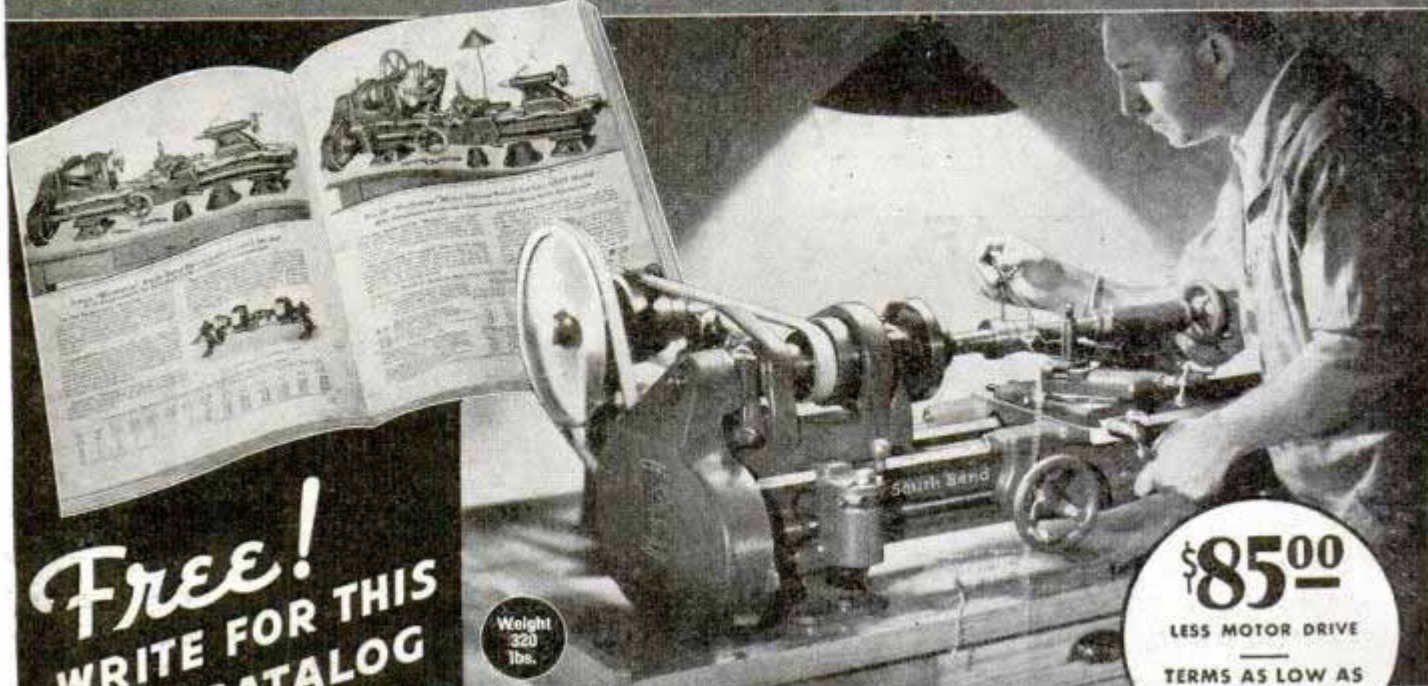

Free!
WRITE FOR THIS
NEW CATALOG
15 K

Weight
320
lbs.

\$85⁰⁰
LESS MOTOR DRIVE
TERMS AS LOW AS
\$7⁰⁰
A MONTH

No. 415-YA 9 1/8" swing by 3' bed Workshop Bench Lathe with Horizontal Motor Drive, 1/4 h.p. Reversing Motor, Switch and belt tension countershaft as shown above **\$116**
(\$29 Down, \$8 a month for 12 months)

THE new 1937 model 9-inch Workshop Lathe is a Back-Geared Screw Cutting Precision Lathe, with Twin Gear Reverse to lead screw, Ball Thrust Bearing on Spindle, Longitudinal Screw Feed to Carriage, Precision Lead Screw for cutting screw threads—and scores of other important features.

Especially recommended for fine accurate work in the plant, shop and toolroom. Used by all important industries in this country and abroad. Takes 38 practical attachments for milling, grinding, draw-in collet chuck work, and many other manufacturing jobs.

Write for Catalog 15K, illustrating and describing the new 1937 Model Workshop Lathe in 8 different drives—4 bed lengths. Shows the 38 attachments for use with this lathe. A valuable booklet to anyone interested in metal working lathes.

Use coupon below.

**SOUTH BEND
LATHE WORKS**
615 E. Madison Street
South Bend, Ind., U.S.A.

5 OTHER SIZES
9", 11", 13", 15", 16"
SWING.
IN ALL BED
LENGTHS
PRICED
\$87 to 1200.

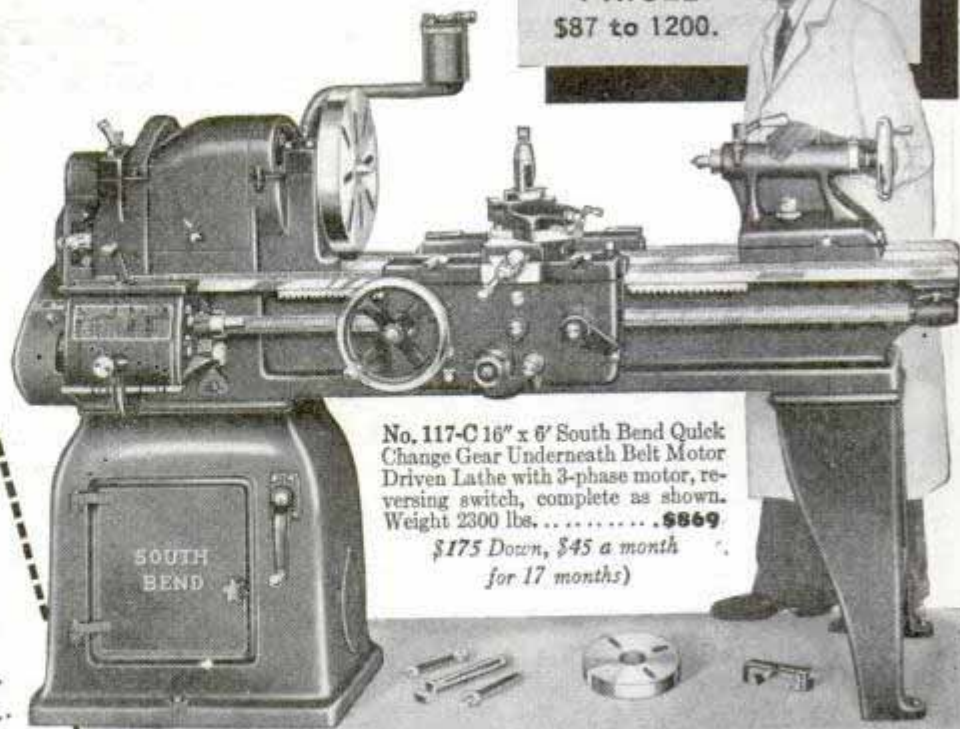

No. 117-C 16" x 6" South Bend Quick Change Gear Underneath Belt Motor Driven Lathe with 3-phase motor, reversing switch, complete as shown. Weight 2300 lbs. **\$869**
\$175 Down, \$45 a month
for 17 months)

South Bend Lathe Works,
615 E. Madison St.,
South Bend, Ind. U.S.A.
Please send me your new 1937 Catalog
15-K.
Size of lathe interested in
Class of work
Name
Address
City State

SOUTH BEND Precision LATHES

CHAMPIONS AT 1936 VANDERBILT CUP RACE

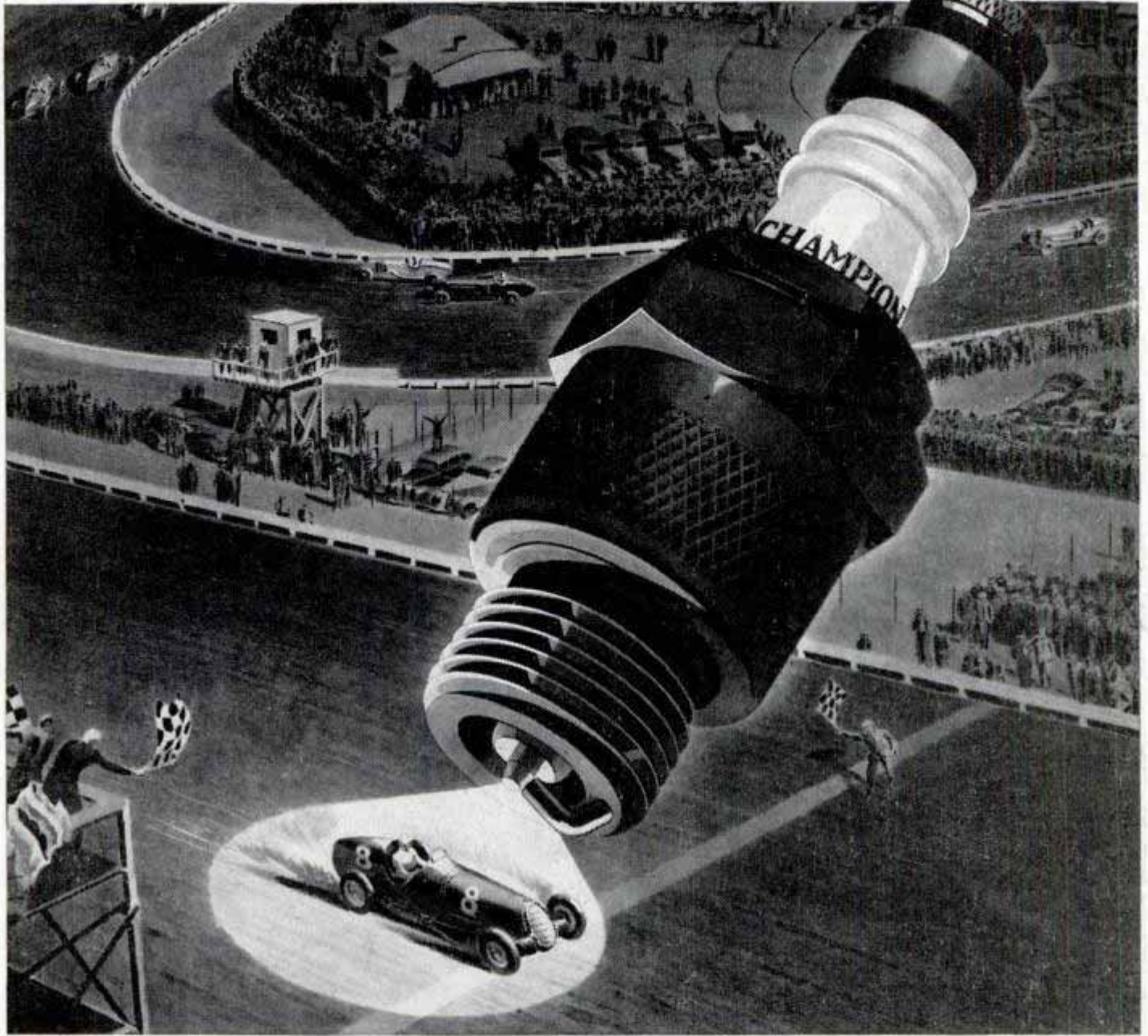

ACCELERATION DEPENDS ON SPARK PLUGS

YOU CAN DEPEND ON CHAMPIONS

● Buying the best spark plugs and keeping them always in good condition, is cheap insurance of dependable acceleration. You can depend on Champions to give your engine faster acceleration, more power, speed and dependability. Champions have a unique record in this respect, having equipped the winning engines of practically every racing event throughout the world for the last 13 years. The recently revived Vanderbilt Cup Race inaugurating the new Roosevelt Raceway, pictured above, was won by Nuvolari, Italy's premier race driver. Acceleration was the determining factor and the winner, as well as eight out of the first ten, relied on Champions. Demand Champions for your car.

THE

SPARK PLUGS

CHAMPIONS USE



CHECK AND CLEAN SPARK PLUGS WHEN YOU CHANGE OIL



For Digestion's Sake.. Smoke Camels

"I'll back that to the limit," says Miss Dorothy Kilgallen, spunky globe-circling girl reporter

AROUND THE WORLD IN 24 DAYS. "It was a breathless dash," said Miss Dorothy Kilgallen, famous girl reporter, back at work (*above*) after finishing her assignment to circle the world by air in record-breaking time. (*Right*) Her exciting arrival at the Newark Airport. "I snatched meals anywhere," she says, "ate all kinds of food. But Camels helped me keep my digestion tuned up. Camels set me right. I'll back them anytime for mildness and flavor."



IN every job—reporter or housewife, explorer or laborer—tension and upsets are to be expected. Healthy nerves and good digestion enable you to glide over trying incidents and get the full enjoyment out of working, eating, and playing. No wonder that so many who make their mark in the world today are steady Camel smokers!

At mealtimes—enjoy Camels for the aid they give digestion. By speeding up the flow of digestive fluids and increasing alkalinity, Camels contribute to your sense of well-being. Between meals—get a "lift" with a Camel. They don't get on the nerves, or irritate the throat. Camels set you right!



COSTLIER TOBACCOS

Camels are made from finer, **MORE EXPENSIVE TOBACCOS**—Turkish and Domestic—than any other popular brand.

Copyright, 1937, R. J. Reynolds Tobacco Company
Winston-Salem, North Carolina