

AROUND THE WORLD BY AIR

POPULAR MECHANICS



MAGAZINE

YOU CAN UNDERSTAND

REG'D. TRADE

REG. U.S. PAT. OFF.

FEB.
25 CENTS

SEE PAGE 200

PROF. H.

New 6 in. Sander

A New Delta Unit—The last word in an all-purpose surfacing machine



For the first time—here is a **correctly engineered** belt sander and finisher of 6-inch capacity. Equipped throughout with self-sealed New Departure ball bearings lubricated for the life of the bearing. **Completely enclosed and guarded**, which means safety and permits practically **complete removal of dust** by suction system. May be equipped with a fence, back stop or tilting table to suit any sanding or finishing operation. May be operated vertically or horizontally. Priced unusually low for such fine quality. Get the full story in the New Delta Catalog.



Complete Line of Efficient Low-Cost Tools

Be sure to see ALL the new Delta tools: the revolutionary new 17" Drill Presses, new precision 4" Jointer and 11" Drill Press, new 10" Band Saw and improved 14" Drill Presses and 14" Band Saw, in addition to many new and improved accessories.

Send for 1937 CATALOG

It is crowded with interesting illustrations and descriptions of the complete Delta line. Points out in detail the important features of Delta design. And also the new 32-page book No. 3 of "Practical Delta Projects" crowded with new and "out of the ordinary" things to make—with many photographs, working drawings, and easy-to-understand illustrations. Simple, complete instructions make every project easy to follow. Every craftsman should have this book. Send 10c with coupon for Delta Project Book No. 3. 1937 Delta catalog mailed postpaid.

New Practical Instruction Books

Up-to-the-minute, carefully written, liberally illustrated with especially prepared photographs and diagrams, easy to understand and thoroughly practical.



- No. 1. Making Money with Delta Tools—What to make, how to make it, where to sell it..... 10c
- No. 2. Getting the Most Out of Your Shaper. A complete Shop manual of latest shaper practice with over 200 photographs and line drawings..... 25c
- No. 3. Getting the Most Out of Your Band Saw. Full instructions for using band saw to best advantage..... 25c
- No. 4. Getting the Most Out of Your Drill Press. Covering all phases of Drill Press operation..... 25c
- No. 5. Getting the Most Out of Your Lathe. Covering wood-turning, metal turning, metal spinning—over 200 photographs and line drawings..... 25c

HOW TO ORDER

Just clip this portion of the advertisement, check books desired, enclose proper remittance in coin or stamps and mail in with signed coupon.

DELTA MFG. COMPANY
600-634 East Vienna Avenue
MILWAUKEE, WISCONSIN

Important: Outside of Canada, United States and its possessions, Delta Tools are known as "Tauco" Tools. Tauco tools are identical in every respect to Delta Tools.

Delta Manufacturing Co. Dept. A237
600-634 E. Vienna Ave., Milwaukee, Wis.

I enclose 10c (stamps or coin) for which please send me one copy of the new 1937 Book No. 3 of "Practical Delta Projects." Also place me on your mailing list to receive 1937 Delta catalog of quality motor-driven tools. I am interested in Delta Tools for:

Home Shop Industrial Use School Shop

Name.....

Address.....

City..... State.....

() Check here if you are a Delta user now.

"MAKING ROOM" NEW ACHIEVEMENTS IN SPACE ENGINEERING



HUGE TRUNK—so roomy, two full-grown young ladies actually climbed in.

Engineers find New Ways to Provide More Room for Restful Comfort

WEIGHT equally divided between front and rear axles gives smoother riding. Widening "tread" distance between rear wheels makes it hold the road better. And *both* these improvements make possible a lot more interior roominess.

Thus, Plymouth engineers, in perfecting ride and roadability, were able at the same time to contrive new inches of room.

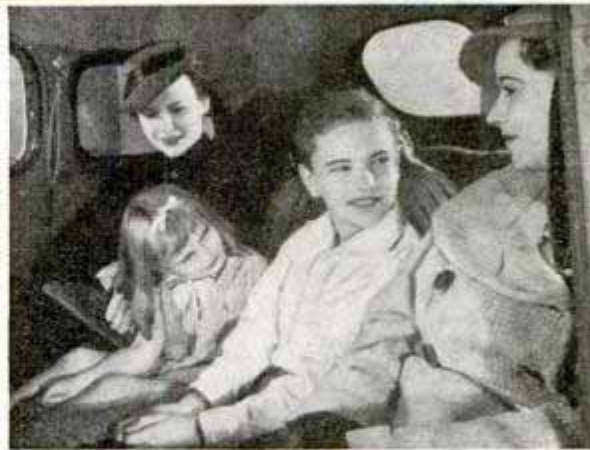

A REALLY BIG CAR... in each seat, ample shoulder, elbow, leg and head room for three large adults!



ROOM TO STRETCH! (above)—Interior measurements are amazing... because every inch is turned into comfortable room. "Chair-height" seats correctly support the body... low floors (no "hump" in rear floor).

(Right)... **MORE ROOM** around pedals, gear shift and steering wheel in the new Safety Interior... in which every detail has been designed for safety and comfort.



2½" WIDER IN REAR (above)—The biggest Plymouth ever! 3" wider in front... 3" added leg room... 1" added head room... windshield is 3" wider, for greater vision.

Drive this new Plymouth... learn how much more it gives for your money! It's priced at \$510 and up; *all prices list at factory, Detroit (special equipment extra).
PLYMOUTH DIVISION OF CHRYSLER CORP.

(Below) De Luxe 4-Door Touring Sedan, \$680 list.*

SENSATIONAL "RIDE-COMFORT"

- ★ **SILENT!** Sound-proofed like a radio studio.
- ★ **NO BUMPS OR JOLTS!** They're swallowed by shock-absorbers like giant air-liners use.
- ★ **NO VIBRATION!** Shut out by rubber body mountings and Floating Power engine mountings.
- ★ **SAFEST BRAKES!** Plymouth's double-action hydraulics... smooth, sure!

EASY TO BUY

Commercial Credit Company offers low terms through Chrysler, De Soto and Dodge dealers.

NEW FINGER-TIP STEERING
—NO "WANDERING"

SCIENTIFICALLY SOUND-PROOFED
—ALL-STEEL BODY

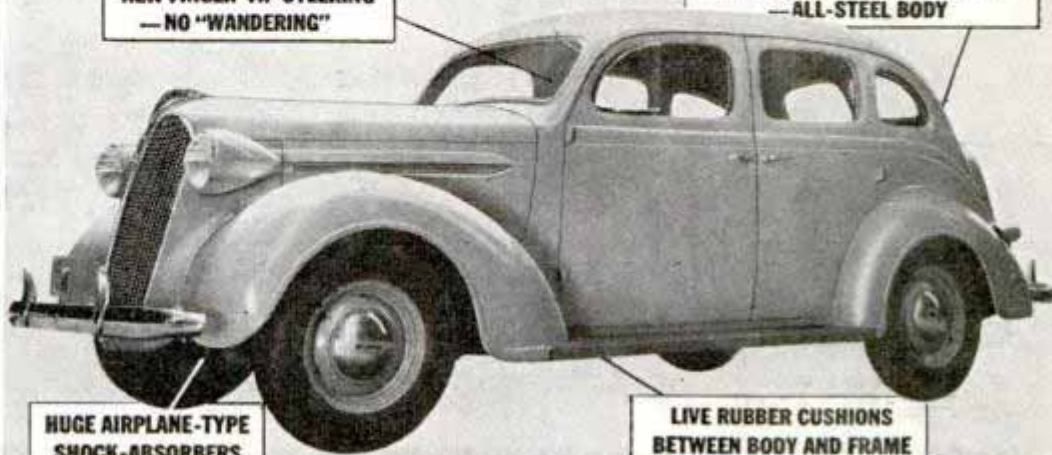

HUGE AIRPLANE-TYPE SHOCK-ABSORBERS

LIVE RUBBER CUSHIONS BETWEEN BODY AND FRAME

This One



A Happy New Year for

Kathryn

Dear Warner: You can toss away the memorandum of that other phone number now as we have one of our own! And if you don't think I feel swell about it, you're not the smart brother I think you are. I get a kick every time I pass that telephone in the living room.

Kathryn

The number is Exchange 2376.



THAT'S a real letter—written by a real Kathryn—to her brother. You can read her happiness in every line. She's mighty glad to have the telephone back.

And so are a great many other men and women these days. About 850,000 new telephones have been installed in the past year.

That means more than just having a telephone within reach. It means keeping the family circle unbroken—contacts with people—gaiety, solace, friendship. It means greater comfort, security; quick aid in an emergency.

There's a lot more happiness for everybody when there's a telephone in the home.

BELL TELEPHONE SYSTEM

When writing to advertisers please mention Popular Mechanics



Popular Mechanics Magazine

H. H. WINDSOR, Founder

H. H. WINDSOR, Jr., Editor and Publisher

February, 1937

Vol. 67, No. 2

Special Features

The Buried Treasure Racket	161
Around the World by Air	Coloroto
Gunsmith Seeks Smallest Bore	180
Noise Fighters Battle for Quiet	188
Harbor Pirates on the Run	194
Tuna Fleets Battle for Supremacy	204
Conquering Death after Dark	212
Wooden Ships and Iron Men	218
Racing the Man-Made Meteors	226
"Tuning In" on the Stars	234
Home That Runs Itself—Part II	242
The Master Man of Radio	250

(Continued on next page)

Sawdust Solves Crimes

A WISCONSIN woman opened a Christmas package addressed to her husband and was killed when the parcel, containing a crude bomb, exploded as she removed the wrapper. A few remnants of the bomb, including some wood debris, were the only clues. There was a suspect but no evidence—until a wood detective unearthed minute scraps of shavings and grains of sawdust from behind the leg of a workbench in the suspect's shop and, under the microscope, matched particles of the sawdust with bits of wood from the bomb. That evidence sent the suspect to prison for life. This is just one of many cases in which the wood sleuth, by the microscopic examination and identification of wood species, solves seemingly baffling mysteries involving not only crimes but many other forms of litigation. Watch for the article describing the work of this modern Sherlock Holmes in the March issue.

Next Month

ILLUSTRATED with eight pages of Coloroto pictures, the second part of "Around the World by Air," in the March issue, describes the journey over the Pacific in one of the "China Clippers" and the trip across this continent in a modern sleeper plane, both impossible feats only a few short months ago.

Wings to the Rescue

OVER land and over sea, wherever men fly the commercial air lanes today, they have written a new chapter in the traditional rescue code of the sea." Thus does Dr. Hugo Eckener, veteran commander of the dirigible, "Hindenburg," pay tribute to the skippers of the air lines who almost daily risk their own lives to speed aid to the stricken and helpless. Their heroic feats form the basis for the true adventure story, "Air Liners to the Rescue," in the March issue.

Let's Go Fishin'

NOW that there are a couple of feet of ice on the lake, and every stream is frozen solid—let's go fishin'. There's no need to wait until spring to get out rod and reel. The fish are ready to bite in mid-winter. First, you chop a hole in the ice. With what? Bob Becker tells you just how to go about it next month in "Fishing Through the Ice."

ON THE ODDEST RACE COURSE IN THE WORLD

"Used Pyroil
in my car,
finishing first
place. Pyroil
played its
part great in
this 300 mile
road race."

(Signed)
Tazio Nuvolari

To revive the Vanderbilt Cup Race, the most twisting, hazardous auto race course conceived by man was recently built at Westbury, New York. On this, the Italian racing star, Tazio Nuvolari, beat out 44 rivals to win the 300 mile Classic held there October 12. A great feat. Forty-three of the forty-five entrants in this race, including the winner, used famous Pyroil!

Auto aces the world over use Pyroil. So do millions of everyday motorists who continue to be amazed at the performance of this unusual lubrication process.

IMPORTANT IN COLD WEATHER

In cold weather Pyroil is doubly important. In starting, it safeguards vital mechanisms until regular lubricants circulate. It effects easier starting; with less battery drain.

Pyroil multiplies efficient operating life. It overcomes compression losses—increases power. Reduces serious ring wear. Stops dangerous corrosive attack.

Protect your auto investment. Add Pyroil regularly (by mere ounces) to crankcase and fuel tank. Sold everywhere. Mail coupon for interesting facts. Manufactured and Guaranteed by Pyroil Company, W. V. Kidder, Founder, 52 Pyroil Bldg., La Crosse, Wisconsin, U. S. A.

PYROIL HAS BEEN TESTED BY POPULAR MECHANICS AND IS USED BY POPULAR MECHANICS' PRESSES AND EQUIPMENT.

DISTRIBUTORS:

NEW PYROIL PREMIUM PLAN NOW IN EFFECT GIVES NATIONALLY ADVERTISED MERCHANDISE OF HIGH VALUE ABSOLUTELY FREE. CHECK COUPON FOR FULL DETAILS, AND FACTS OF BUSINESS OPPORTUNITY.



Genuine Pyroil
bears this signature on every can

W. V. Kidder
Founder

**PYROIL COMPANY,
52 Pyroil Bldg., LaCrosse, Wis., U. S. A.**

- Please send Free facts on Pyroil's money saving features.
 Send details of Premium Plan and Business Opportunity for me.

Name.....
Address.....
City.....County.....State.....

(Contents—Continued)

AUTOMOTIVE

Third wheel for trailers built in turntable	177
Streamline furniture van trimmed with gold leaf.....	179
Lighted sign warns of wide truck approaching.....	202
Armored motorcycle is police machine-gun nest.....	209
"Stunt" flying carburetor adapted to auto	209
Movie of highway tests drivers' steering skill.....	217
Transmission key to defeat of racing cars	222
Spare ignition coil for car	223
Post office built on wheels	225
Engine heat regulator for auto	230
Age of average auto nearly five years	231
Pedestrian lane markers flash traffic signals	232
Revolving floor displays cars in showroom	232
Queer-shaped racing auto sets speed records	238
Wavy lines on road warn driver	238
Auto parking meters tested by artificial weather.....	249
Gasoline flow stops when tank is full	254
Trailer pushed by auto to haul wood	255
Truck hauls old coaches to new site	256

AVIATION

Airplane motor develops one horsepower per pound.....	178
Clipper passengers see Philippines through clouds.....	179
Plane with folding wings stored in garage	184
Television screen helps pilot land in fog	185
Megaphone sends bugle call across air field	217
Wind indicator aids pilots miles away	223
Explorers pierce jungle in camouflaged seaplane.....	230
Big dirigible's steel skeleton takes shape	231
Super-speed plane "eye" of British army	239

CONSTRUCTION

Roof protects power plant from rock falls	186
Sheathing solves air-conditioning problem.....	187
Prefabricated homes to cost less	192
Latest U. S. mint built on rock	198
Garage door lifted without leaving car	240
Roofing nail anchored by shank rings	247

HOUSEHOLD

Full-recipe cookie press	193
Towel rack capacity tripled by bar	198
Framed mirror fastened on door with screws.....	210
Mantelpiece with radio set for the home	215
Electric light easily installed in refrigerator	232
Piano with tubes for strings always in tune	238
Equal cuts of pie by notched pan	241
Instant fire alarm plugs into light socket	246
Orange peeler speeds preparation of fruit	256

MOVIES AND PHOTOGRAPHY

Night parties hunt latest idea for parties	191
Sound pictures of auto races seen in hoods	192
Architects test model buildings with movies	199
Self-adjusting camera set by photocell	211
Fingerprints alike only once in undecillion.....	222
Daylight developing tank for miniature film	224
Automatic self-timer for cameras	118A

RADIO AND ELECTRICITY

Dust trap uses electricity for bait	183
Electric plug wedges self in socket	202
Stainless steel ignition cable starts motor quickly.....	217
Talking gas mask has built-in microphone	223
Electromagnet removes needles from man's hand.....	225
Television programs broadcast daily in London.....	233
Ultra s.w. receiver has built-in noise silencer.....	257
Hurricane emergency receiver operates on 6 volts.....	258
Helpful radio hints	261
Crystal receiver built from junk-box parts	260
Car-top antenna easily installed	262
Crystal "mikes" for sound and vibration pick-up.....	262
Frequency-control unit for amateur transmitters.....	262
Rotary clock gives world time	262

SCIENCE AND INDUSTRY

Flexible plastic glass can be molded	187
Vanilla to be made from wood pulp	191
Riddle of cellulose solved by woman scientist	200
Ear is an imperfect microphone	238
Electric pump replaces oil derrick	240

(Continued to page 6A)

FEBRUARY - 1937.

Airplane		
British bomber has revolving gun turret		167
Clipper sights Philippines from clouds		179
explorers fly camouflaged into jungle		230
folds wings like bird for storage		184
landing gear tested	Feb.	142a
largest land		164
motor yields one horsepower per pound		178
racing		226
super-speed for British army		239
Alarm, steel ball guards building from fire and 'quake		254
Animal ambulance		201
Apricot pits furnish explosive		225
Architects test model buildings with movies		199
Atom smasher may give secret of structure of matter		256
Automobile		
Age of Average Five Years		231
driving, movie of highway tests steering skill		217
driving, students steer dummy cars		165
painted in brilliant colors to cut accidents		167
racing, car transmission reason of defeat		222
racing sets speed records		27
shown on revolving floor		

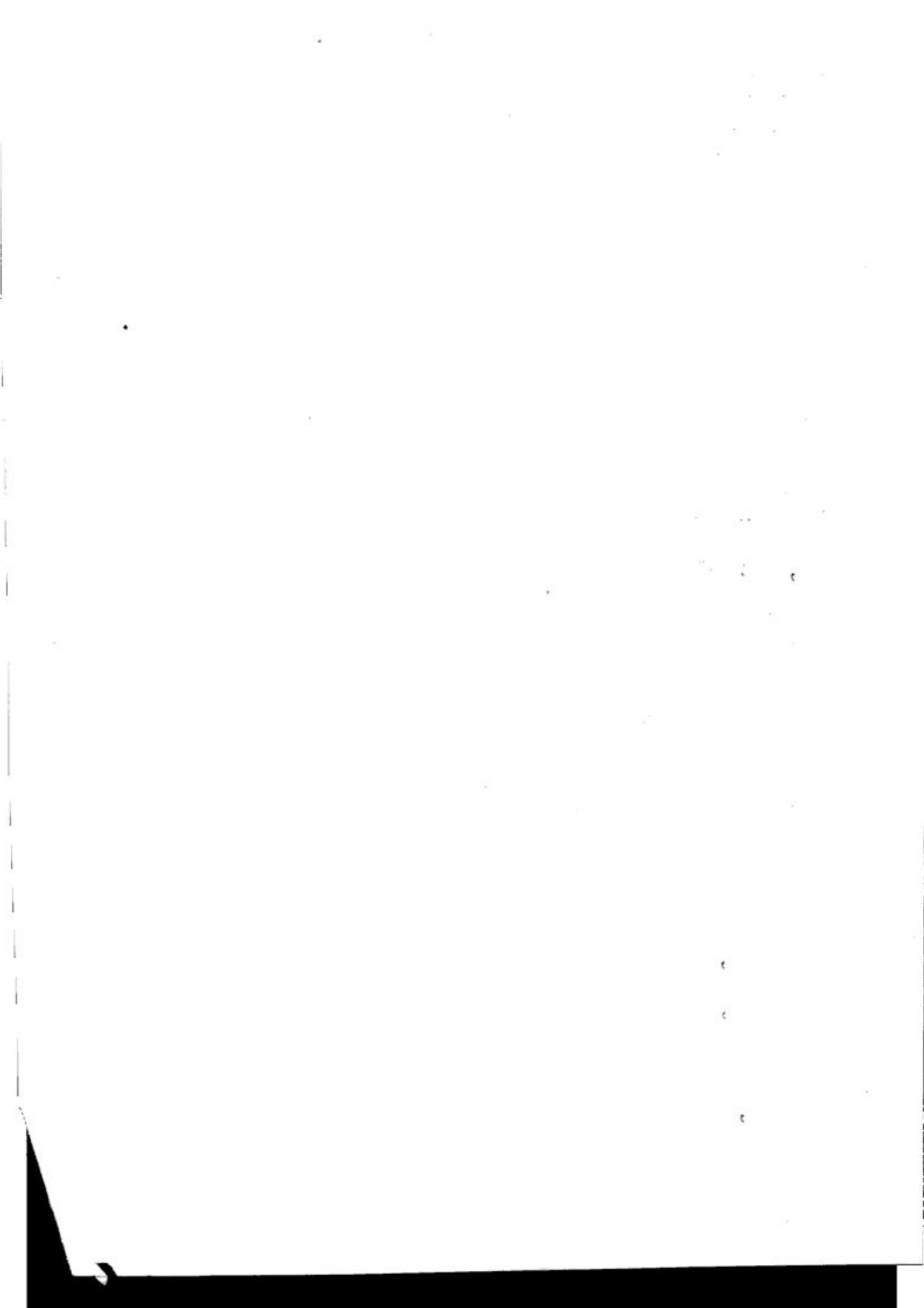

NO USE MURPH THAT'S ONE OF THOSE NEW HUDSONS WITH SEALED POWER PISTON RINGS.

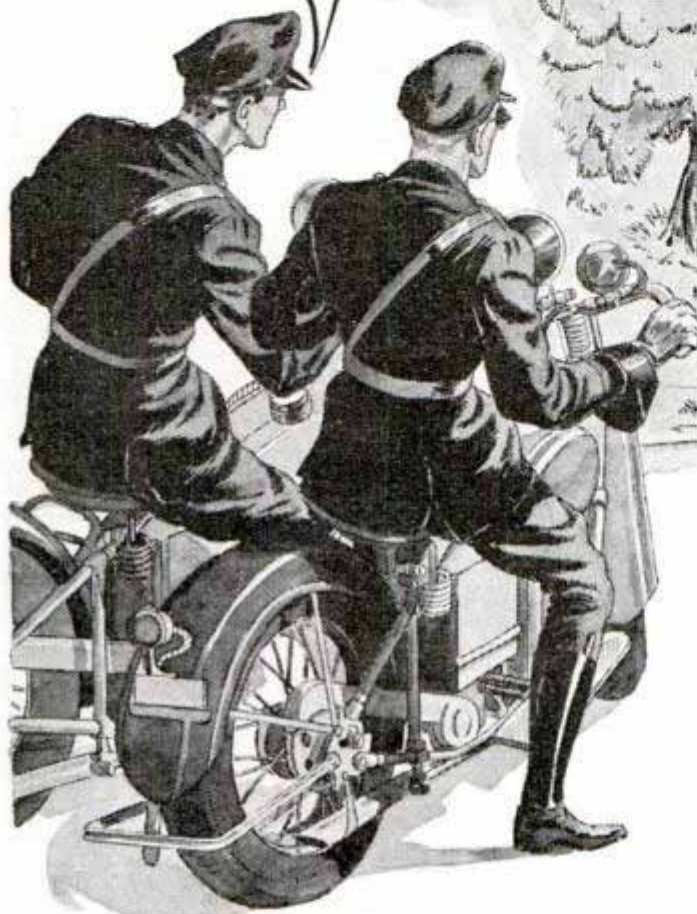

SEALED POWER PISTON RINGS

Best in new cars!

Best in old cars!



SEALED POWER PISTON SKIRT EXPANDER

When piston skirts collapse, they must be expanded if power and economy are to be reestablished. The Sealed Power Piston Expander is remarkable because it has spring tension yet is entirely adjustable to compensate for variations in piston and cylinder wall wear. America's ace repairmen endorse it. Use it for best results.

In 1937—as for many, many years—Hudson's great engineers again specify Sealed Power Piston Rings as standard equipment! Like the engineers of the Pontiac, Oldsmobile, LaFayette, Cord and other great cars and trucks, Hudson engineers recognize that Sealed Power Rings are designed *right*. That they *seal* power properly!

Get New Car Oil Economy

Now, no matter what make or model or how old your present car is . . . you can enjoy the thrilling oil economy and performance that Sealed Power Rings bring. For Sealed Power engineers have developed an expander-type ring with pat-

ented features that absolutely cure the "between-meal" oil hunger of the worst oil gluttons!

These great rings feature inner springs of imported Swedish steel which without excess tension create a perfect seal against blow-by—saving gas and oil, restoring new car power.

But before you have these new rings put in, ask your Sealed Power repairman to check your car. You may need Lo-Ex Ebonite Pistons installed, your valves reground or main bearings taken up to get 100% oil economy. Meanwhile, write for our new booklet "New Low Cost Way to Save Gas and Oil and Increase Pep".

You'll like it!

SEALED POWER CORPORATION

Dept. 272, Muskegon, Michigan

Canadian Factory at Walkerville, Ont.

Manufacturers of Piston Rings, Pistons, Piston Expanders, Piston Pins, Valves, and Cylinder Sleeves.



When writing to advertisers please mention Popular Mechanics



Now-Enjoy Teamwork Shaving

*Use Gillette Blades in
your Gillette Razor!*

SEE how easily stubborn bristles are removed when you use a Gillette Blade in your Gillette Razor. That's because *they are made for each other*. Both were designed as a unit by the same engineers. Both are made in the same great factory. Here millions of dollars' worth of special equipment is employed to produce the perfect blade for your razor—a blade that is tempered, ground, honed and stropped in the exact way required to give best results with the Gillette Razor. Buy a package of Gillette Blades today—enjoy the thrill of “*teamwork shaving*.”

Reputable merchants never offer substitutes for Gillette Blades. Always ask for them by name.

Tune in Gillette's “Original Community Sing” with Milton Berle and other stars Sundays 10 P.M., E.S.T., CBS Network, Coast to Coast.



Gillette Blades

Precision-made for the Gillette Razor

(Contents—Continued)

Anti-silicosis helmet of rubberized silk	246
Index reference file is floodlighted	246
Sensitive paint detects water in gasoline tank	248
Government baker tests bread for texture	249
Recording dough-mixer tests baker's flour	254
Five-million volt generator to bombard atom	256

SHIPS

Propeller changes reduce liner's vibration	184
Steamer broken in two caught by camera	186
Automatic lung aids rescue from submarine	201
“Old Ironsides” air conditioned	240
Lifeboats freed automatically upon touching water	255

MISCELLANEOUS

San Francisco fair painting shows exhibit palaces	177
Telescope kept aimed at star by guider	178
Water fans disperse poison gas after raid	178
Century-old pipe found in good condition	184
Giant bay bridge opened to auto traffic	185
Heart more efficient than steam engine	187
Plate glass resists impact of steel ball	192
From motorcycle to glider at mile a minute	193
Shovel-nosed wheelbarrow speeds work	200
War tanks conquer obstacles in tests	200
Ambulance for dogs and cats on motorcycle	201
“Electric therapy” makes straw flowers everlasting	202
Gas-driven submarine safer under water	203
Diamonds found in many parts of U. S.	208
Dresses tested for wear	208
Upholstery dry cleaner run by electricity	208
Concrete self-healing under certain conditions	210
Heating speaker's stand for outdoor meetings	210
Paint for insulating board requires no sizing	210
Meter shows amount of dust in air	211
Model boat “sails” on road with wind	211
Dart board flashes light to score hits	215
“Document glass” prevents deterioration of papers	215
Museum built as home for polar ship	216
Paper knights scale walls of model castle	216
Oxyacetylene tool cuts through ten-inch steel	224
Rubber poncho for writing in rain	224
Apricot pits yield explosive useful for war	225
Illusion of headless woman draws crowds	231
Experts scale giant stacks on repair jobs	241
Baby rides in bicycle trailer with cover	247
Night thermometer has radium numbers	247
Billiards and bowling combined in game	248
Glass brain shows how human brain works	248
Steel ball guards building from fire and quake	254

Craftsman and Shop Notes

AUTOMOTIVE

Single-cylinder engine from car motor	316
Auto short cuts	317
Bearing ram with grease fitting easily filled	318
Improving generator brushes	318
Portable floodlight for the garage	318
Shield protects tire cover	318
Avoiding kinks in gas line	319
Eliminating brake chatter	319
Filling gas tank during rain	319
Mirror substituted for trouble light	319
Grease-pit guide aids driver	320
Installing grease fittings	320

FARM

Tightening loose wagon tires	304
“Aerial” cold frame grows vigorous seedlings	269
Bobsled from car frames	306
Separating milk in cold weather	306

FURNITURE

Step-saving tea and beverage cart	266
Bathroom cabinet has self-contained lighting	273
Large table folds into small unit	275
Nested tables in modified Chinese design	277
Monkey wrench serves as webbing stretcher	283

(Continued to page 8A)

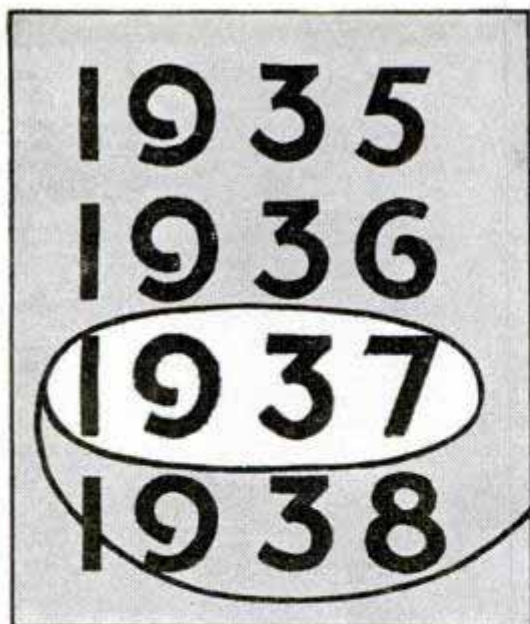

Now is the time!

Business is Searching for YOU, if

RIGHT now, in many lines, there is a search for really *good* men—managers, leaders—men who can take charge of departments, businesses, branch offices, and get things humming.

As always, there are not enough ordinary jobs to go 'round—but rarely before, in the history of American business, has there been so much room at the *top!* New jobs are being created by the business pick-up in almost all lines—jobs that pay splendidly and that open the way to lifetime success.

Ordinarily, there would be plenty of men to fill these jobs—men in junior positions who had been studying in spare time. But most men have been letting their training slide during these dark years of depression . . . “What’s the use?”—You have heard them say. Perhaps there has been some excuse for sticking to any old kind of a job one could get the past few years—but the door is wide open for the man with ambition and ability *NOW!*

And don’t let anyone tell you that “Opportunity Only Knocks Once”—that’s one of the most untruthful sayings ever circulated. Op-

portunities flourish for *every* American every day of his life.

Far more to the point is to be ready—to be *prepared*—to make yourself *interesting* to the big-time employer—and LaSalle offers you a short-cut method of qualifying for opportunity jobs in accounting, law, traffic, executive management, and kindred occupations.

LaSalle Extension University is 28 years old—averages 40,000 enrollments a year—60 American firms each employ 500 or more LaSalle-trained men—surveys show that LaSalle students attain 40% average salary increase after graduation—10% of all C. P. A.’s in the U. S. A. are LaSalle-trained.

Why not find out what LaSalle has done and is doing for men in *your* position? Send and get the facts; see what LaSalle can do for you, personally!

There’s no question about it—business is picking up—jobs are looking for *men*—the time has come for you to *qualify* for prosperity. Mail this coupon today!

LA SALLE EXTENSION UNIVERSITY, Dept. 264-R, Chicago

I am in earnest about my success and I would like to have your special booklet—without any cost or obligation to me—about my opportunities and your success training in the business field I have checked.

- | | |
|--|--|
| <input type="checkbox"/> Business Management | <input type="checkbox"/> Industrial Management |
| <input type="checkbox"/> Higher Accountancy | <input type="checkbox"/> Modern Foremanship |
| <input type="checkbox"/> Traffic Management | <input type="checkbox"/> Business Correspondence |
| <input type="checkbox"/> Modern Salesmanship | <input type="checkbox"/> Business English |
| <input type="checkbox"/> Commercial Law | <input type="checkbox"/> Effective Speaking |
| <input type="checkbox"/> Law: Degree of LL. B. | <input type="checkbox"/> Office Management |
| <input type="checkbox"/> Expert Bookkeeping | <input type="checkbox"/> Stenotypy |
| <input type="checkbox"/> C. P. A. Coaching | |

Name.....Age.....

Position.....Address.....

LaSalle Extension University

Ask for one of these booklets—or a similar one on your own field of business. They are free!



When writing to advertisers please mention Popular Mechanics

(Contents—Continued)

HAND TOOLS

Handy tools from old speed wrenches	268
Turning chisels stored under lathe	268
Notched chisel cuts rivets quickly	276
Self-feeding soldering iron	277
Clamp for gluing cylindrical work	291
Disk sander from bench grinder	292
Screw-gauge set with one handle	304

HOME IMPROVEMENTS

Water tank heated by waste gases	273
Locating stovepipe damper accurately	282
Sagging doors braced with concealed dowels	282
From coal bins to play rooms	284
Corrosive gases kept out of downspouts	292

HOUSEHOLD

Wash tubs held snugly on wall	265
Scraps of paraffin molded for future use	268
Sewing basket from small keg	274
Clock feet padded to protect furniture	276
Loosening tight screw caps	276
Making better coffee	297
Easy solutions for your home problems	298
Cabinet humidifier fits over radiator	307

METAL WORKING

Electric pencil to write on sheet metal	263
Iron scrollwork bent on rotating jig	305
Air cleaning cutting tools	309

OFFICE

Mimeographing heavy black lettering	268
Multiple rubber stamp saves time	304
Lettered disk identifies rubber stamps	309

PHOTOGRAPHY

Vertical enlarging easel is adjustable	274
Bellows patching clamp	282
Projection stand has adjustable tilting top	283
Handy container for sensitized paper	291
Darkroom clock seen through peep hole	305

POWER TOOLS

Cutting disks and washers in a lathe	265
Sanding blades for the jig saw	274
Grinder illuminated by desk lamp	281
Lathe headstock for car generator	300
Power-driven table saw	301
Avoiding breakage of band saws	315
How to figure pulley sizes	315

STORE AND SHOP

Bolts of cloth dispensed from rack	306
Neckties modeled by balloon manikins	309
Printer uses small sandbags for paperweights	309

MISCELLANEOUS

Guide to band-saw true circles	276
Non-slip gloves for glaziers	276
"Trip 'em"—a home pin ball game	278
Giving wood a rough finish	281
Walking stick serves as folding seat	281
Drawer for jig-saw blades	282
Mitering without a gauge	292
Putty knife aids amateur glazier	292
Gas-driven model plane	293
Ladder has flexible rung to climb trees	297
Soldering seams neatly with aid of paper	297
Emergency holder for ball bearings	304
Artist's color tray held on tumbler	306
Electric temperature indicators	310
Detachable handle for rock drill	316
Jewelry chains stored in soda straws	116A
Lady's glove has window for wrist watch	130A

JACK IS CERTAINLY A POPULAR GUY — GETS INVITED TO ALL THE PARTIES

WE WANT JACKIE
WE WANT JACKIE
WE WANT JACKIE

SURE, EVERYONE WANTS HIM TO PLAY HIS HARMONICA

NEXT DAY

JACK HOW DID YOU LEARN TO PLAY THE HARMONICA SO WELL?

WHY IT'S EASY, I GOT A FREE INSTRUCTION BOOK FROM HOHNER. IF YOU EACH SEND FOR A COPY WE'LL FORM A SWELL HARMONICA BAND

THOSE YOUNGSTERS CERTAINLY HAVE A GRAND TIME — THEY GET INVITED EVERYWHERE



MAIL COUPON FOR
New FREE

HARMONICA INSTRUCTION BOOK

**HOHNER
HARMONICAS**

M. HOHNER, Inc.
351 FOURTH AVE.
NEW YORK CITY

M. HOHNER, Inc., Dept. 20B, 351 Fourth Ave., New York City.
Please send me your new Instruction Book.

Name

Address

City

State

Address Canadian inquiries to Hough & Kohler, Ltd., 468 King St., W., Toronto

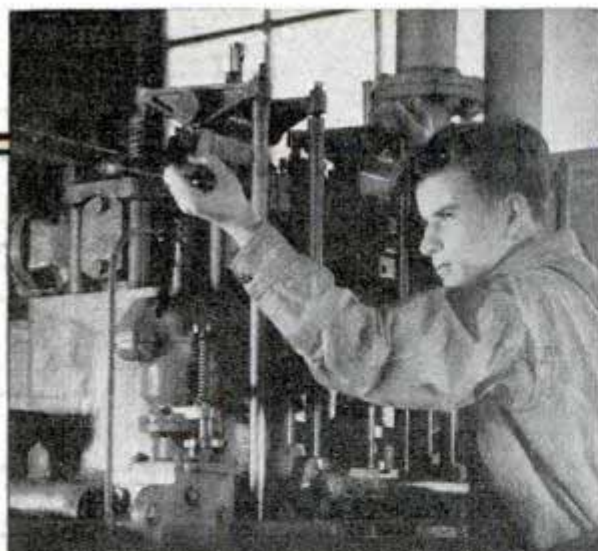

HERE'S THE WAY TO
BECOME AN EXPERT
ON
**DIESEL
ENGINES**



● If you work in industrial power and lighting plants; in small community power and light plants; in municipal pumping stations for water supply; in construction work, including trucks, tractors, hoists, graders and power shovels; in transportation, with special reference to buses, rail buses, locomotives; in marine service, including ocean liners, freighters, river and lake vessels, yachts and small cabin cruisers—

You should become an expert on Diesel Engines!

Your future depends on it. And the time to insure your future is—to-day. In your spare time, by study of the I.C.S. Diesel Power Course, you can become an expert. Mail the coupon for free information.

INTERNATIONAL CORRESPONDENCE SCHOOLS

BOX 5654-H, SCRANTON, PENNA.

★ Without cost or obligation, please send me a copy of your booklet, "Who Wins and Why," and full particulars about the subject *before* which I have marked X: ★

TECHNICAL AND INDUSTRIAL COURSES

DIESEL POWER

- Architect
- Architectural Draftsman
- Building Estimating
- Contractor and Builder
- Structural Draftsman
- Structural Engineer
- Management of Inventions
- Electrical Engineer
- Electric Lighting
- Welding, Electric and Gas
- Reading Shop Blueprints

- Boilermaker
- Heat Treatment of Metals
- Sheet Metal Worker
- Telegraph Engineer
- Telephone Work Radio
- Mechanical Engineering
- Mechanical Draftsman
- Machinist Toolmaker
- Patternmaker
- Aviation Engines
- Automobile Mechanic

- Refrigeration
- Plumbing Steam Fitting
- Heating Ventilation
- Air Conditioning
- Steam Engineer
- Steam Electric Engineer
- Marine Engineer
- R. R. Locomotives
- R. R. Section Foreman
- Air Brakes R. R. Signalmen
- Highway Engineering

- Civil Engineering
- Surveying and Mapping
- Bridge Engineer
- Bridge and Building Foreman
- Chemistry Pharmacy
- Coal Mining
- Mine Foreman Navigation
- Cotton Manufacturing
- Woolen Manufacturing
- Agriculture Fruit Growing
- Poultry Farming

BUSINESS TRAINING COURSES

- Business Management
- Office Management
- Industrial Management
- Traffic Management
- Accountancy
- Cost Accountant

- C. P. Accountant
- Bookkeeping
- Secretarial Work
- Spanish French
- Salesmanship Advertising
- Service Station Salesmanship

- First Year College
- Business Correspondence
- Stenography and Typing
- Civil Service
- Mail Carrier
- Railway Mail Clerk

- Grade School Subjects
- High School Subjects
- College Preparatory
- Illustrating Cartooning
- Lettering Show Cards Signs
- Apartment House Management

Name.....Age.....Address.....

City.....State.....Present Position.....

If you reside in Canada, send this coupon to the International Correspondence Schools Canadian, Limited, Montreal, Canada

When writing to advertisers please mention Popular Mechanics

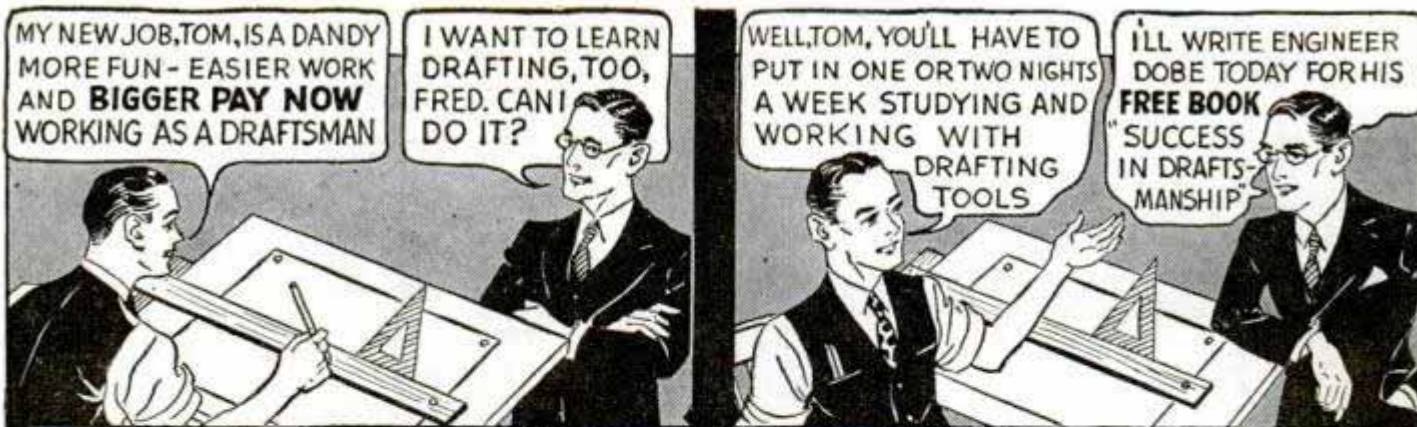

Then Tom, too, learned by mail at home

Illustrating assumed case.

THE boom in building and other industries now seems well on the way!

Who is always needed first of all? The draftsman who draws the plans. *After* that, the steel mills, lumber mills, brickyards and others make their sales.

Government efforts to help are making things hum. In one factory town, a shortage of draftsmen is already reported. Many trained draftsmen will be needed—at better pay and shorter hours.

Who'll get those good jobs? Of course, the men who have prepared—so, prepare now!

Prepare, for

Better Jobs Now

are ready and more expected soon in auto work, aviation, electricity, machinery and certain building lines.

For those who learn drafting now!

It's the way for a quick start to a better paying, much bigger job. Send *at once* for Engineer Dobe's Book.

Free Book

HERE is an opportunity that's open to those who know how to grasp it:—

At a few dollars a month, students get complete training in drafting by mail in surprisingly few months—Engineer Dobe teaches his students until thoroughly trained and until placed in a good paying job. Trained Draftsmen enjoy good salaries. If you don't get a satisfactory job:—all your money back. That's Engineer Dobe's guarantee.

With Engineer Dobe's method no previous experience is necessary. High School education not needed. Everything made plain. Practical work right from the start until you're in position.

If you're a mechanic, a knowledge of draftsmanship may make you a superintendent in short order. Get out of overalls and draw the pay of a boss. If you *are* a boss, learn draftsmanship; a *foundation* stone of many a line of business.

In every walk of life, practical training in draftsmanship will prove valuable. Even if you never accept a job as a draftsman, will you not be *money ahead* by taking Engineer Dobe's course?

You'll be amazed at the speed with which you can learn in your spare time by Engineer Dobe's *practical method*. Send coupon **TODAY** for free book entitled "Success in Draftsmanship".

For **MORE PAY** Learn **DRAFTING** FROM AN ENGINEER
LEARN BY MAIL AT HOME

Time is money. Learn drafting in your spare time. It's high time now to prepare. Don't wait another day. *Send coupon for Dobe's free book.*

ENGINEER DOBE, Div. 33-72, Libertyville, Ill.

Send me your free book, "Successful Draftsmanship" and please explain how you assist your graduates to good positions as draftsmen.

Name

Address

Town

State Age

These **TOOLS** and Other **EQUIPMENT** Given When You Start

For 34 years (since 1900) Engineer Dobe has taught drafting by mail. Thousands of students, aged 16 and 18 to past 50, have won **SUCCESS!**



Write **NOW** while this offer lasts.

Here's a valuable set of tools—sent *at once* (also a drawing table), all without extra charge the day you enroll.

ENGINEER DOBE, Division 33-72, Libertyville, Ill.

When writing to advertisers please mention Popular Mechanics

TELEVISION AND RADIO •• ARE YOUR OPPORTUNITY

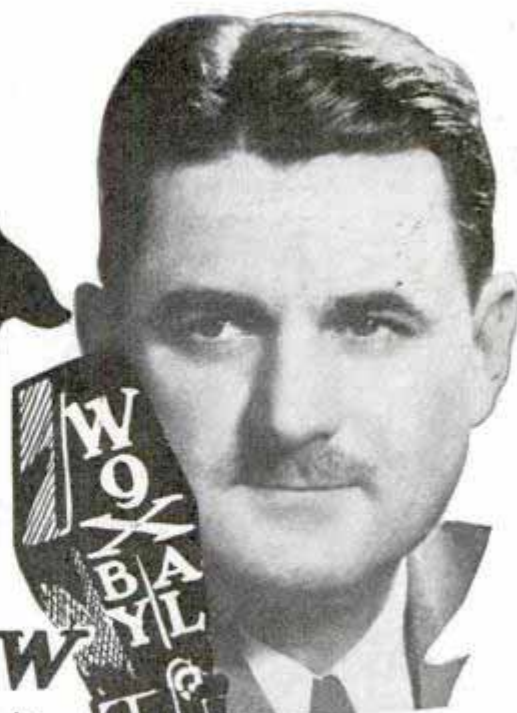

...if you *Act Now*

Bigger opportunities than ever before are open to trained men in new fields of radio. Television broadcasting is now a reality and leaders of industry predict immediate commercialization will put thousands of sets in homes; thousands of new jobs for trained men will be created as Television sweeps the nation.

"Get in on the ground floor! . . . Start now to train for this amazing new industry. Its opportunities are boundless," says S. Q. Noel, President of First National Television, Inc.

Learn TELEVISION WITH RADIO

in "First National's" huge laboratories and studios, where young engineers are trained on the job—to fit the job—graduates qualify for First Class Government License—which is the "ticket" it takes to get a job—and are First National graduates getting the jobs? I'll tell the world they are.

only 6 months Training required

to qualify for your Government License. Then you are assigned to active duty in broadcasting, immediately getting valuable experience "on the job". You actually handle the control and transmitter of High-Fidelity Station W9XBY and Television Station W9XAL while training—

WRITE FOR FREE BOOK OF FACTS—Telling of big, genuine opportunities for First National Trained men—

FIRST NATIONAL TELEVISION
INCORPORATED
TRAINING DIVISION . . . KANSAS CITY, MO.

Get Experience

"On-The-Job" in
CONTROL ROOM
TRANSMITTER
TELEVISION
BROADCASTING
CAMERA-ACTION
STATION OPERATION



FILL OUT AND MAIL THIS COUPON TODAY

S. Q. NOEL, Pres., First National Television, Inc.
Dept. AA-2, Power & Light Bldg., Kansas City, Mo.

Please send me immediately, without charge or obligation, your big, new book on Television—"Pictures On the Air"—completely illustrating Television methods, and giving full facts about big, new money-making opportunities in this career. I am ___ yrs. old.

NAME _____

STREET _____

TOWN _____

STATE _____



Arrest Him, Officer!

I'LL HAVE COMPLETE FACTS ON THE OTHER FELLOW TONIGHT!



Follow This Man!

SECRET Service Operator No. 38 is on the job... follow him through all the excitement of his chase after the counterfeiter gang. See how a crafty operator works. Tell-tale finger prints in the murdered girl's room that help him solve the great mystery! BETTER than fiction because every word is TRUE. No obligation. Just mail me the coupon and get—

FREE The Confidential Reports No. 38 Made to His Chief

And the best part of it all is this—it may open your eyes to the great opportunity for YOU as a well paid Finger Print Expert. This is a young, fast-growing profession. The kind of work you would like. Excitement! Thrills! Travell! A regular monthly salary. Reward money. And remember: graduates of this school HEAD 47% of all Identification Bureaus in the U. S. Quick! Mail the Coupon NOW and I'll send you these Free Confidential Reports!

INSTITUTE OF APPLIED SCIENCE
1920 Sunnyside Ave., Dept. 1352, Chicago, Illinois

Institute of Applied Science
1920 Sunnyside Ave., Dept. 1352 Chicago, Illinois

Gentlemen:—Without any obligation whatsoever, send me the Reports of Operator No. 38, also your illustrated Free Book on Finger Prints and your low prices and Easy Terms Offer. Literature will NOT be sent to boys under 17 years of age.

Name

Address

Age

When writing please mention Popular Mechanics

DON'T BUY

Mandolin
Guitar,
Banjo or
Drums



Don't buy Guitar Mandolin, Banjo, Electric Guitars, Ukuleles, or Drums, until you have tried the Slingerland May-Bells. Guaranteed More for your Money. Wonderful, snappy, powerful, pleasing tone. No equal in price. Sold on easy payments and 5 days free trial by all leading music dealers.

Send for free catalog. Mention instrument wanted.

Write today:

Slingerland Musical Instrument Mfg. Co.,
1325 Belden Ave., Chicago, Illinois

Cut This Adv.
Out — Good
for \$1.00
Credit

ENGINEERING DEGREE IN TWO YEARS

B.S. Degree in Electrical, Civil, Chemical, Radio, Mechanical or Aeronautical Engineering in two years. Located in an industrial center with that Engineering atmosphere. Earn board. Low tuition. Preparatory Department. Enter Mar., June, Sept., Dec. Catalog.

INDIANA TECHNICAL COLLEGE
229 East Washington St., Fort Wayne, Indiana

RADIO ENGINEERING

RCA Institutes offer an intensive course of high standard embracing all phases of Radio. Practical training with modern equipment at New York and Chicago schools. Also specialized courses and Home Study Courses under "No obligation" plan. Catalog Dept. PC-37.

RCA INSTITUTES, Inc.

75 Varick St., New York 1154 Merchandise Mart, Chicago
Recognized Standard in Radio Instruction Since 1909.

LEARN WATCH REPAIRING



AT HOME You can learn by our modern and original system of instruction every part of the Watch Repairing Trade at home. You can earn money while learning and prepare yourself for a well paying position or start in business after completing our course of instruction. Good watch repairers are in demand and generally earn very good salaries. For particulars apply to the Wisconsin School of Watch Repairing 524 E. Mason St., MILWAUKEE, WIS.

AVIATION APPRENTICES



Ambitious, air-minded young men, interested in entering the well paid field of Aviation, write immediately, enclosing stamp, to

Mechanix Universal Aviation Service, Incorporated
Strathmoor Station Dept. E Detroit, Mich.

To help you answer these **3** questions:



1 What are today's opportunities in Drafting?

2 Will I like the work?

3 Can I learn Drafting readily?

2 Beginning Lessons in Drafting Free

Drafting Opportunities Growing Daily

Before anything can be made or built, the Draftsman *first* must draw it. Building trades, transportation, manufacturing — ALL depend on him. That is why *any* pickup in *any* line means *first call for the Draftsman!*

Fit Yourself for a Job with a Future

Drafting welcomes ambitious men — offers good pay to start, with splendid opportunities for promotion. One of the *stadiest* of all lines. Right from the start, the beginner works side by side with experienced men — inking in their drawings, making tracings, constantly profiting by his contact with seasoned engineers. The "higher ups" see his work. If it is good, advancement is sure and steady.

Pleasant, well-lighted offices are the Draftsman's work-room. He keeps regular hours, with congenial, high grade fellow workers. The work is fascinating — embraces not just *one* line, but *hundreds*.

Drafting Experience NOT Necessary

You can master Drafting readily by home study because you learn and advance *exactly* as professional Draftsmen work — with T-square, dividers and drawing board. *Actual* working conditions are duplicated to the final detail. *Thousands* of successful graduates enthusiastically endorse American School methods, nowhere better exemplified than in our Drafting course.

We want you to see for yourself — before you come to ANY decision — exactly what Drafting is like. We want you to judge your own interest in the work — and our ability to teach you. So we make this 2 Free Lesson Offer.

American School, Drexel Ave. at 58th St., Chicago, Ill.

Prove That You Can Qualify

The 2 lessons will be absolutely without obligation. In the privacy of your own room, look them over. See how simply you start — how gradually you are led step by step — how thoroughly you master each point — how, as time goes on, you can pass from a raw beginning to complete *mastery* of Drafting — able to get and hold a pleasant, profitable, steady job. Such a future is well worth looking into **RIGHT NOW**, so . . . just mail the coupon!



Mail Coupon for 2 Lessons FREE

American School, Dept. DD-245

Drexel Ave. at 58th St., Chicago

Without the slightest obligation, send 2 beginning Drafting Lessons and free Bulletin. I am not to return them.

Name.....Age.....

Address.....

City.....State.....

HOW A "TIP" GOT TOM A GOOD JOB

I HAVEN'T HAD A RAISE IN YEARS -- GUESS I NEVER WILL -- I'M READY TO GIVE UP

BUCK UP, TOM, WHY NOT TRY AN INDUSTRY THAT'S GROWING -- WHERE THERE'S MORE OPPORTUNITY

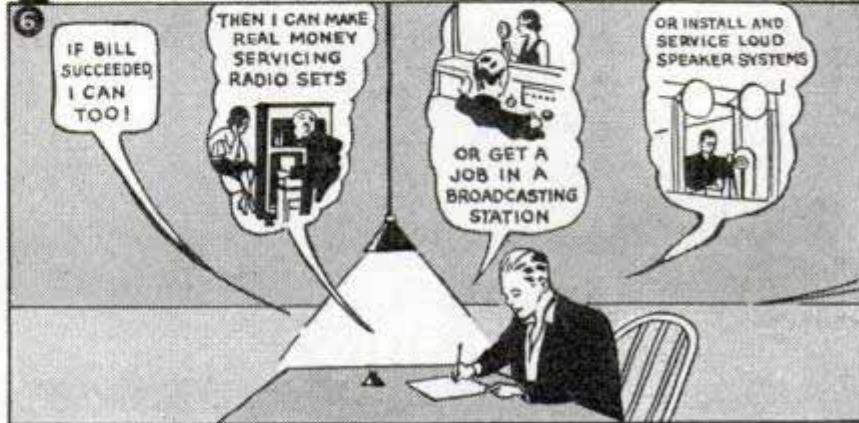

J. E. Smith, President National Radio Institute
The man who has directed the home study training of more men for the Radio Industry than any other man in America.

I will train YOU too at Home in Spare Time for Good Jobs in Radio

HERE'S PROOF THAT MY TRAINING PAYS



\$80 Monthly in Spare Time

"I work on Radio part time, still holding my regular job. Since enrolling five years ago, I have averaged around \$80 every month."
JOHN B. MORISSETTE, 773 Silver Street, Manchester, N. H.

Makes \$50 to \$60 a Week

"I am making between \$50 and \$60 a week after all expenses are paid and I am getting all the Radio work I can take care of, thanks to N. R. I."
H. W. SPANGLER, 368 Walnut St., Knoxville, Tenn.



Operates Public Address System

"I have a position with the Los Angeles Civil Service, operating the Public Address System. My salary is \$153 a month."
R. H. ROOD, R. 136, City Hall, Los Angeles, Calif.



Do you want to make more money? Radio offers you many opportunities for well-paying spare time and full time jobs. And you don't have to give up your present job or leave home and spend a lot of money to become a Radio Expert.

Many Radio Experts Make \$30, \$50, \$75 a Week

Radio broadcasting stations employ engineers, operators, station managers and pay up to \$5,000 a year. Spare time Radio set servicing pays as much as \$200 to \$500 a year—full time jobs with Radio jobbers, manufacturers and dealers as much as \$30, \$50, \$75 a week. Many Radio Experts operate their own full time or part time Radio sales and service businesses. Radio manufacturers and jobbers employ testers, inspectors, foremen, engineers, servicemen, paying up to \$6,000 a year. Radio operators on ships get good pay and see the world besides. Automobile, police, aviation, commercial Radio, and loud speaker systems are newer fields offering good opportunities now and for the future. Television promises to open many good jobs soon. Men I have trained are holding good jobs in these branches of Radio. Read their statements. Mail the coupon.

There's a Real Future in Radio for Well Trained Men

Radio already gives jobs to more than 300,000 people. In 1935 over \$300,000,000 worth of sets, tubes and parts were sold—an increase of 20%

Get Facts about **THE TESTED**



over 1934! Over 1,100,000 auto Radios were sold in 1935, 25% more than in 1934! 22,000,000 homes are today equipped with Radios, and every year millions of these sets go out of date and are replaced with newer models. Millions more need servicing, new tubes, repairs, etc. Broadcasting stations pay their employees (exclusive of artists) more than \$23,000,000 a year! And Radio is a new industry, still growing fast! A few hundred \$30, \$50, \$75-a-week jobs have grown to many thousands in less than 20 years.

Many Make \$5, \$10, \$15 a Week Extra in Spare Time While Learning

Practically every neighborhood needs a good spare time serviceman. The day you enroll I start sending you Extra Money Job Sheets. They show you how to do Radio repair jobs that you can cash in on quickly. Throughout your training I send you plans that made good spare time money—\$200 to \$500 a year—for hundreds of fellows. My training is famous as "the Course that pays for itself."

I Give You Practical Experience

My Course is not all book training. I send you special Radio equipment and show you how to conduct experiments and build circuits which illustrate important principles used in modern Radio receivers, broadcast stations and loud speaker

installations. I show you how to build testing apparatus for use in spare time work from this equipment. Read about this 50-50 method of training—how it makes learning at home interesting, quick, fascinating, practical. Mail coupon.

Money Back Agreement Protects You

I am so sure that I can train you successfully that I agree in writing to refund every penny you pay me if you are not satisfied with my Lessons and Instruction Service when you finish. I'll send you a copy of this agreement with my Free Book.

Find Out What Radio Offers You

Act Today. Mail the coupon now for "Rich Rewards in Radio." It's free to any fellow over 16 years old. It describes Radio's spare time and full time opportunities and those coming in Television; tells about my training in Radio and Television; shows you actual letters from men I have trained, telling what they are doing and earning. Find out what Radio offers YOU! MAIL THE COUPON in an envelope, or paste it on a penny post card NOW!

**J. E. SMITH, President
Dept. 7BP
National Radio Institute,
Washington, D. C.**



THIS FREE BOOK HAS HELPED HUNDREDS OF MEN MAKE MORE MONEY

Rich Rewards in Radio

WAY TO BETTER PAY

This Coupon is Good for One FREE Copy of My Book

J. E. SMITH, President, Dept. 7BP, National Radio Institute, Washington, D. C.

Dear Mr. Smith: Without obligating me, send "Rich Rewards in Radio," which points out the spare time and full time opportunities in Radio and explains your 50-50 method of training men at home in spare time to become Radio Experts. (Please Write Plainly.)

NAME.....AGE.....

ADDRESS.....

CITY.....STATE.....



High School Course at Home

Many Finish in 2 Years

You can complete this simplified High School Course as rapidly as your time and abilities permit. Equivalent to resident school work—prepares you for entrance to college. Standard H. S. texts supplied—Diploma. Credit for H. S. subjects already completed. Single subjects if desired. High School education is very important for advancement in business and industry and socially.

College Entrance

During the past 14 years, our High School graduates have been admitted to 531 different Universities, Colleges, Junior Colleges and Normal Schools—80% of them without entrance examination. Course also prepares for teachers' certificate and pre-professional examinations.

Business—Industry

To get and hold a good position in Business today you must be able to write clear, accurate letters and reports—do figuring involving Algebra and Geometry—talk intelligently on matters requiring a knowledge of Geography, History, and Economics.

In Industry—Mechanical and Engineering lines—you must have at least an elementary knowledge of Physics and Chemistry—be able to figure quickly and accurately—know something of Mechanical Drawing and blueprints—and be able to talk and write accurately and clearly on both your work and ordinary topics of conversation.

Our High School course meets the preparatory educational requirements for Business and Industry.

An Educational Institution

The American School was chartered in 1897 as an educational institution, not for profit—and is exempt from paying Federal income tax, like the best resident colleges and universities.

Don't Be Handicapped—Complete Your Training Now

Be a High School Graduate! Prepare yourself for promotion in Business and Industry—

20 Other Courses

Over 150 noted Educators, Engineers, and Business Men helped prepare our special instruction material, which is used by many resident schools and colleges, U. S. Navy, and Province of Manitoba, Canada. We offer you quality training at home for the best-paying lines of Industry and Business, as listed in the coupon.

—for the Professions, College Entrance and social success. No matter what line you may select, High School training will prove invaluable to you! Our moderate fees cover all instruction, standard textbooks and Diploma. Easy monthly terms. Get ahead in life. Start your training NOW!

Mail coupon for information about line that interests you
American School, Drexel at 58th, Chicago

American School, Dept. H-245, Drexel at 58th, Chicago

Tell me how to train for success in line checked. No obligation.

- | | |
|--|--|
| <input type="checkbox"/> Accounting & Auditing | <input type="checkbox"/> Diesel Engineering |
| <input type="checkbox"/> Architecture & B'ldg | <input type="checkbox"/> Drafting & Design |
| <input type="checkbox"/> Automotive Engin'ring | <input type="checkbox"/> Liberal Arts |
| <input type="checkbox"/> Business Management | <input type="checkbox"/> Private Secretary |
| <input type="checkbox"/> Com'ercial Aeronautics | <input type="checkbox"/> Hi'er Ac't'g (C.P.A.) |
| <input type="checkbox"/> Electrical Engineering | <input type="checkbox"/> Highway Engin'ring |
| <input type="checkbox"/> Electrical Refrigerat'n | <input type="checkbox"/> Mechanical Eng'ring |
| <input type="checkbox"/> Air Conditioning | <input type="checkbox"/> Radio & Television |
| <input type="checkbox"/> Civil Engineering | <input type="checkbox"/> Salesmanship |
| <input type="checkbox"/> Complete Law | <input type="checkbox"/> Steam Engineering |

Name.....
Address.....

When writing please mention Popular Mechanics

Start a POTATO CHIP BUSINESS

IN YOUR KITCHEN and MAKE MONEY!

Buy Potatoes for 2c A POUND
Sell Them as Vita-Seald Chips for 35c A POUND



THERE'S big money in potato chips for any man or woman who wants a business capable of paying as much as \$23.50 a day in profits. Just think of it. You can install the wonderful new machine in your kitchen—just manufacture and sack a sensational new kind of "Greaseless" Potato Chip—and let the stores sell them for you. Only \$2.50 invested in raw materials brings back \$10.00 in cash.

EVERYTHING FURNISHED You don't have to have a lot of money to start this business. A small investment in the machine puts you in a big profit business of your own. I send you everything including speed-slicer, cooker, oil-extractor (for making new "GREASELESS" chip), a big supply of printed bags and free advertising material. No experience is needed as I send complete, simple instructions showing how to make a profit the first day. Prices, pictures, and complete plans will be sent free for the asking.

DON'T BUY ANYTHING Just send your name and address on a post-card for all this Free information including the "Secret of Making Greaseless Potato Chips." No obligation, but hurry, and you may become independent as so many others have done with these fast selling new "Greaseless" Chips. Address your card to

G. H. Hardt, 325 W. Huron St., Dept. C-52, Chicago, Illinois

ENGINEERING



TECHNICAL AND APPLIED COURSES. Nonesentential omitted. TIME AND MONEY SAVED. Degree in 2 yrs., diploma in 1 yr. Electrical, Mechanical, Architectural, Structural, Aeronautical, Civil, Highway. Short intensive courses in Diesel-Electric, Electricity, Power Plant, Drafting. All courses include Refrigeration, Diesel, and Air-Conditioning. Low tuition. Extensive modern equipment. Part-time work for room and board. 37th year. Thousands of successful graduates in U. S. and foreign lands. Approved by industry, endorsed by educators and alumni. One and two year courses begin in Sept. Short courses open the year round. Catalogue free.

FINLAY ENGINEERING COLLEGE
1001 Indiana Avenue Kansas City, Mo.

CARTOONING PAYS WELL

Develop your ability with personal instruction from an internationally-known cartoonist. His exclusive, successful method of drawing and creating ideas makes it easy to attain success. Write for details of this exceptional home-study course.

National School of Cartooning, 437 Penton Building, Cleveland, Ohio



WHY NOT spend spring, summer, fall, gathering butterflies, insects. I buy hundreds of kinds for collections. Some worth \$1 to \$7 each. Simple outdoor work with my instructions, pictures, price list. Profit or pleasure. Send 10¢ (not stamps) for Illustrated Prospectus, terms, before sending butterflies.
MR. SINCLAIR, DEALER IN INSECTS
Dept. G, Box 1424 San Diego, Calif.

GOV'T. JOBS

SALARY TO START \$90 to \$175 MONTHLY MEN WOMEN Age Range 18 to 50

- | | |
|---|--|
| <input type="checkbox"/> Railway Mail Clk. | <input type="checkbox"/> POSTMASTER |
| <input type="checkbox"/> P. O. Laborer | <input type="checkbox"/> Stock Clerk |
| <input type="checkbox"/> R. F. D. Carrier | <input type="checkbox"/> Auditor |
| <input type="checkbox"/> Special Agent | <input type="checkbox"/> Stenographer |
| <input type="checkbox"/> Customs Inspector | <input type="checkbox"/> U.S. Border Patrol |
| <input type="checkbox"/> City Mail Carrier | <input type="checkbox"/> Telephone Opr. |
| <input type="checkbox"/> P. O. Clerk | <input type="checkbox"/> Watchman |
| <input type="checkbox"/> Elevator Conductor | <input type="checkbox"/> Meat Inspector |
| <input type="checkbox"/> Special Investigator | <input type="checkbox"/> Secret Service Opr. |
| <input type="checkbox"/> Typist | <input type="checkbox"/> File Clerk |
- OZMENT INSTRUCTION SERVICE**
Dept. 111 St. Louis, Mo.
Send me FREE particulars "How to Qualify for Government Positions" marked "X". Salaries, locations, opportunities, etc. ALL SENT FREE.
Name.....
Address.....

Train at Home...Under Factory Engineers for **GOOD PAY** Spare-Time and Full-Time Jobs in **RADIO**



APPOINTED BY RADIO MANUFACTURERS TO SUPERVISE R-T-I TRAINING

This is the R-T-I Advisory Board—Engineers and Executives of large Radio firms—appointed by these firms to supervise and direct R-T-I Training. Put your future in their hands. 50 great radio manufacturers now endorse this Training.

Trained Men Needed in All Branches

If you're dissatisfied with small pay—lay-offs and an uncertain future—here's an opportunity that's too good to miss. At the cost of only the time it takes you to mail the coupon, you can get my big FREE book, "RADIO'S FUTURE AND YOUR OPPORTUNITY." This book tells how you can learn at home under the supervision of factory engineers, to make more money almost at once in Radio—whether you want to make Radio your life's work, or use it to pick up an extra \$5 to \$20 a week in your spare time.

More Opportunities Than Ever Before

Radio is still forging ahead. 1936 beats all other years. Over 6 million new sets sold. Over 30 million dollars paid for service alone this year. Where only a few hundred men were employed a short time ago, thousands are employed today. And where a hundred jobs paid up to \$75 a week—there are thousands of such jobs today—many paying even more. And new jobs are being created all the time—full time jobs and spare time jobs. Get my book and see how easy it is to learn at home for this good-pay work.

"Shop Training" for the Home

R-T-I Training is different than any training you ever heard about. It comes to you right from the heart of the Radio Industry—right out of the factories where Radio sets and other vacuum-tube devices are made. It was planned and prepared and is supervised by big radio engineers IN these factories—by men appointed for the purpose. This means that trained the R-T-I way, you'll be trained as the Radio Industry wants you trained—just as the Radio Industry, itself, would train you if it was doing the job.

Television, Photo Electric Cells, Public Address Systems Included

Radio service work is only the starting point in R-T-I Training. From there it will take you through the whole field of Radio and Electronics. You will learn about every new development, including Television so you'll be ready when Television breaks. You'll also learn the big money subjects such as Aviation and Auto Radio; Public Address Systems; how to handle Photo Cells; Sound Picture Recording, Etc.

4 Working Outfits Furnished

Start almost at once doing part time radio work. I furnish 4 outfits of apparatus that you build into test equipment with which you can do actual jobs and earn extra money. My Training pays its own way and you get your money back if not satisfied.

Age or Lack of Experience No Handicap

You don't have to be a high school graduate, nor even have finished the grades. My Training is so simple, easy, and practical, that the average man, regardless of age, education, or previous experience can master it. It offers the chance you have wanted to get out of a small-pay, no-future job, into good pay work with a future, in Radio and all its branches.

Get My Free Book

INVESTIGATE! Learn why R-T-I Training is different. Find out why R-T-I Trained men get "Quick Results" and "Big Results." Send for your copy of "Radio's Future and Your Opportunity" today. It tells you about Radio's amazing opportunities. It describes my approved training. It tells what R.T.I. students are doing and making. It gives the names of my Advisory Board and 50 endorsing manufacturers. It's FREE. Clip, sign and mail coupon RIGHT NOW!

RAY D. SMITH, President



RAY D. SMITH,
President R-T-I,
who has directed
training of 100,000
men. Read what a
few students say.

"Made my first spare time money after finishing four lessons. Over \$500 spare time money in 10 months. R-T-I is O.K."

Delmer Grote, Route 5, Greenville, Ohio

"I made \$14.25 in first 11 days of my training following your instructions."

C. E. Head, 431 Third St., Alexandria, La.

"Before finishing my training I was made Manager of a Department Store's radio section."

Howard N. Lents, 123 W. Alexander St., Buchanan, Mich.

"My job paid me \$18 a week before taking your training. Shortly after starting was averaging \$60 a week. Have made as high as \$250 in single week."
Wm. T. Ridd, 3452 Evelyn St., Verdun, P.Q., Canada

LEARN TO EARN
UP TO \$75 A WEEK

(MANY R-T-I TRAINED MEN EARN MORE)
MAIL COUPON BELOW



Big Money in Auto and Police Radio Work

W. H. Carr, 402 N. 16th St., Kansas City, Kansas, an R.T.I. student, has charge of 35 radio equipped cars for the Kansas City Police and Fire Departments. His salary is \$230.00 a month and he is furnished with an automobile, gas, oil, etc. He says, "If I had not taken your course I would not be able to hold this job."

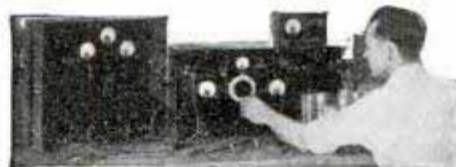

Makes \$600 in One Month

Herbert B. Thomson, Gorman, Texas, formerly an oil well driller, borrowed \$170.00 to start a spare time radio business after completing 12 R-T-I lessons. He made money from the start. In two years his shop was worth \$3500. He says, "Because of my R-T-I Training I made \$450 in September and over \$600 in October 1935. It pays to be R-T-I Trained."

MAIL FOR FREE BOOK

Ray D. Smith, President,
RADIO AND TELEVISION INSTITUTE
(R-T-I),

2130 Lawrence Ave., Dept. 12, Chicago, Ill.

Without obligation, send me a copy of "Radio's Future and Your Opportunity." I am interested in your training and the opportunities in the great field of Radio for the R-T-I Trained Man.

Name.....

Address.....

City.....State.....



RADIO AND TELEVISION INSTITUTE
PRACTICAL SHOP TRAINING FOR THE HOME

Dept. 12

• 2130 Lawrence Avenue

• CHICAGO

When writing to advertisers please mention Popular Mechanics

There's Quicker, Bigger MONEY for YOU in POULTRY RAISING!



Wherever You Live —
Whatever You Do Now —
\$1000 to \$3000 a Year
Can Be Yours!

Spare Time or Full Time YOU Can Cash-In BIG

Instead of knocking at your door, Opportunity is waiting for you in your back yard! Thousands have turned to Poultry Raising for PART TIME EXTRA MONEY or FULL TIME BIG PAY. Many start off in just a small way—with a back-yard or vacant lot flock. My profit-producing methods will make only a few hens pay. No matter what you're doing now—I will show you how to start and keep going successfully. Eggs and poultry meat are commanding high prices—prices that mean a handsome margin of profit on every egg or bird you can produce. There's not a doubt about it—YOU CAN CASH-IN BIG. I'LL PROVE that I can put YOU AMONG the big money makers—QUICK.

My Proved Methods Assure Success Right from START

All the "mystery and guess work" are taken out of poultry raising by my sure, tested, proved methods. My home study course, produced by eighteen famous experts and endorsed by thirty leading Agricultural Schools, puts in your hands the success-secrets of leaders. Satisfaction absolutely guaranteed, if you follow our methods. Decide now to get into this fascinating, healthful, profitable business. Be your own boss—make \$1.00 to \$3.00 for every hour of your spare time—or qualify for a fine salary in one of the big established poultry plants. From now on, let the other fellow pay YOU the fancy prices—Become depression-proof.

FREE BOOK EXPLAINS

My big, new, free book, "How to Raise Poultry for Profit" will amaze you! Brings absolute proof of what my course and training have done for thousands of others. My 44 years' experience as Commercial Poultryman and former Senior Poultryman in the U. S. Dept. of Agriculture is yours to use and profit by. Get in line for QUICKER, BIGGER MONEY. Don't delay a day. Get this coupon into the very next mail.

YOU Can Do What They Have Done

"You have opened up to me a pleasant and profitable way of gaining an independent living." Seldon Anderson, R. I.
"When I enrolled for your course, I knew nothing about poultry keeping. I am now successfully operating a commercial poultry farm." W. J. Warthen, Gona.
F. O. Anderson, Phoenix, Ariz., writes: "Thanks to N. P. L. I got a job even before I finished your course."

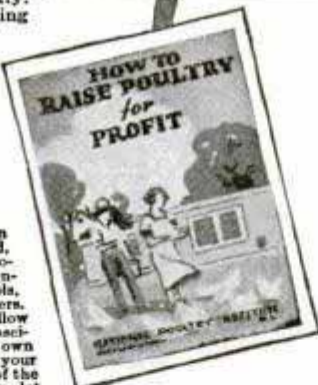

32 Pages
of Money-
making FACTS

Get this FREE Book NOW!

Harry M. Lamon, President,
The National Poultry Institute,
Adams Center, N. Y. Dept. 36-B.

I want to know how to make big money raising poultry. Send me your FREE book explaining your home-study course and PROVED methods.

Name

Address

City State

BRING YOUR RADIO UP TO DATE

ADD-A-TUBE



Get Rid of Static, Distortion,
Strong Local Interference. A "New Radio"
For Only.....

Tune out strong local stations—tune in Los Angeles, Canada, Mexico! Increase selectivity, improve tone, cut out static, distortion, interference, with amazing new ADD-A-TUBE. Uses no extra current, fits any radio, electric or battery, works on inside or outside aerial, all waves. Anyone can install in few minutes. GUARANTEED! Use 5 days. If not delighted, return within 10 days from date shipped and your dollar will be refunded instantly!

\$1
Send No Money
Pay nothing now. Just send name and address on postcard. Pay postman only \$1 plus few cents postage on delivery. Send your order today!

R-E ENGINEERS, Dept. L-511, Marburg Ave., & B. & O. R. R., Cincinnati, Ohio

Improves Handwriting In 3 Hours

Marvelous invention. Corrects poor writing in few days. Amazing results guaranteed. No failures. Positive proof and complete outline mailed FREE. Write quickly.

OZMENT INSTRUCTION SERVICE, Dept. 34, St. Louis, Mo.

CONDON'S GIANT EVERBEARING TOMATO



"Queen of the Market." Big Money Maker. Large Solid Fruit—Excellent Canner. To introduce to you our Vigorous Northern Grown "Pure Breed" Garden, Farm and Flower Seeds, Bulbs, Strawberry Plants, Fruits and Nursery Items we will mail you 125 Seeds of Condon's Giant EVERBEARING Tomato and our big 1937 Catalog, Most complete Seed and Nursery Book—180 pages—600 pictures. Bargain Prices. Write today.
Send 3c stamp to cover Postage.

CONDON BROS. SEEDSMEN **BOX 194**
Rockford, Illinois

CREDIT Given on FRUIT TREES, SHRUBS VINES, BULBS, Etc....

Small down payment books order. Easy terms on balance. Apple & Peach trees, low as 5c. Grapevines 3c. Ornamental shrubs 10c. Evergreens 25c. Garden Seed and Vegetable Plants. Write for FREE Catalog and bargain prices. Benton County Nursery Co., Box 621, Rogers Ark.

DO PEOPLE know that thousands of Royal squabs are wanted weekly in N. Y., Chicago, other cities by very best leading marketmen whose names we give you? Cash for you when these birds are only 25 days old, at prices much higher than chickens. Start breeding now. Free White Kings for prompt order. Send stamp for informing picture book and full facts. P. R. CO., 837 H. St., Melrose, Mass.

ROYAL

RAISE RABBITS FOR US

WE PAY YOU UP TO \$5.00 EACH. ALSO PUT YOU IN TOUCH WITH MARKETS EVERYWHERE. Large illustrated book and catalog, also copy of the AMERICAN RABBIT FARMER and monthly market bulletin showing names of buyers in various parts of America who continuously buy all rabbits offered them. All for 10 cents. Address OUTDOOR ENTERPRISE CO., 101 Main Street, NEW CITY, N.Y.

Best Poultry Paper 6 BIG ISSUES 10¢

Helps increase Poultry Profits. Send coin or stamps, 50 cents for 3 years or 10 cents for 6 months trial. Agents wanted. American Poultry Journal 532 So. Clark Street Chicago, Illinois

LOOK! Baby Chicks THOUSANDS WEEKLY ALL YEAR

Finest quality & Layers in 40 breeds. Hybrid Baby Pullets and Cockerels, B. W. D. Tested. 25 lbs. feed FREE with each 100 chicks. Ducklings, Goslings, Baby Turkeys, Guinness, Mature Breeders priced right. In business 27 years, Catalog free. Nabob Hatcheries, Box M, Gambier, Ohio.

BERRY'S New POULTRY BOOK

BERRY'S Hand-Selected BABY CHICKS, Pullets or Cockerels. Also HYBRIDS, STARTED CHICKS, Baby Turkeys, Mature Fowls. 52 Breeds, all low inspected, Fullorum tested. Best Service, LOW PRICES. Wonderful Poultry Book FREE, stamps appreciated. BERRY'S POULTRY FARM, Bx 29, CLARINDA, IOWA

WHAT INSTRUMENT DO YOU WANT TO LEARN TO PLAY?



QUICK WAY TO LEARN MUSIC

Thousands have learned to play at but a fraction of the old way costs

Simplified, quick method brings amazing results—over 700,000 students

Have you ever dreamed of the fun you'd have playing some musical instrument? Pictured yourself doing all the popular hits, movie theme songs, even classical numbers?

Then here's grand news for you! It's news of an easy, fascinating, simplified method whereby *anyone* can learn to play real music *by notes* in a *remarkably short time!* And what's more, you won't need a private teacher. You'll learn all by yourself—right in your own home. And best of all, the cost is only a small fraction of what it used to cost by old-fashioned methods.

No Special "Talent" Needed

If you can just hum or whistle a tune, you can learn to play quickly—easily—with the aid of this wonderful U. S. School of Music system of instruction. You learn

to read regular notes—and to play them—just as any real musician does. You start right in playing real little tunes almost from the very start. Gradually you master more and more difficult ones until—sooner than you ever expected—you find yourself entertaining your friends—playing at parties—and having the best times you ever had in your whole life.

Easy as A-B-C

The success of this U. S. School method of musical instruction is due to two things. One is the fact that it makes

everything so simple—so crystal clear—so easy to understand. First it *tells* you how to do a thing. Then it *shows* you in pictures how to do it. Then you do it yourself and *hear* it. What could be simpler?

The second reason for the success of this system is that it is so fascinating. Learning music this way is like playing a game. Practicing becomes real fun instead of a bore as it used to be with the old way.

Free Booklet and Demonstration Lesson

In order to show how easy—how simple—how pleasant this course is, the U. S. School of Music has prepared for you a free Demonstration Lesson and Explanatory Booklet. No matter what instrument you select to play the Free Demonstration Lesson and Booklet will show you at once the amazingly simple principles around which this method is built. And how it will enable you to become a popular musician in a surprisingly short time—at an average cost of only a few cents a day.

If you really want to learn music—if you want to win new popularity—if you want to enjoy musical good times galore—fill in and mail the coupon below. Don't delay—act at once. You'll not be obligated in any way. Instruments supplied when needed, cash or credit. U. S. School of Music, 72 Brunswick Bldg., New York City.

What Instrument for You?

- Piano
- Violin
- Organ
- Cornet
- Trombone
- Piccolo
- Flute
- Hawaiian Steel Guitar
- Trumpet
- Piano Accordion
- Italian and German Accordion
- Voice and Speech Culture
- Harmony and Composition
- Drums and Traps
- Banjo (Plectrum, 5-String or Toner)
- Guitar
- Saxophone
- Mandolin
- Ukulele
- Harp
- Clarinet
- Cello

START NOW TO MUSICAL GOOD TIMES

U. S. SCHOOL OF MUSIC
72 Brunswick Building, New York City

Please send me your free book, "How You Can Master Music in Your Own Home," with inspiring message by Dr. Frank Crane. Free Demonstration Lesson, and particulars of your easy payment plan. I am interested in the following course:

Have you
Instr. ?

Name

Address

City..... State.....



Magic Box!

TURN SPARE HOURS INTO CASH!

UP TO \$40 Weekly
In Your Own Home



No soliciting! No canvassing! We show you how to make big money decorating fast-selling Giftwares. We start you with the big \$10 Artist's Outfit shown above. We supply you with \$150 worth of Giftwares free of extra charge and show you how to dispose of them without leaving your home. We give you 29 Tested Plans for making money. One Fireside Member says, "I made \$100 on furniture in one week." Another writes, "My sales were \$500 for 5 weeks. This is my first year." R. M. P., of Ill., says, "I did \$3,500 worth of business last year and over \$12,000 this year." D. W., New Mexico, reports, "I would not take \$1,000 for my Course."

No Experience Needed

You too may have a guaranteed income opportunity with Fireside. No tiresome study. You learn by doing. No artistic ability necessary. Our easy 3-Step Method makes the work easy to learn and easy to do and fits you to make good money practically from the start.

Quick Sales in Your Home

No need to leave the house to dispose of everything you make. Our new automatic salesman does all the selling for you. Designed to quickly find cash buyers for all the Giftwares you can turn out.

No Cost Plan

Send coupon for details of new plan that pays for your Fireside Course besides putting big cash profits in your pocket. Mail coupon now while openings for new members are still being offered.

FIRESIDE INDUSTRIES
Dept. 66-B

Adrian, Mich.

Fireside Industries
Dept. 66-B, Adrian, Mich.
Send me FREE Book on Home Decorating for a big steady income. Also details of plan that will pay for my Course and give me big profits besides.

FREE!

Book on decorating at home for big money. Tells how to get big assortment of Giftwares free of extra charge.

NAME
ADDRESS
CITY STATE

When writing please mention Popular Mechanics

Turn JUNK
IN TO Cash!

TIRES
START AT HOME

The Most Sensational Business Opportunity Since 1929

Like turning lead into gold, here is a business with gigantic possibilities. Factories, Clubs, Stores, Schools, Homes, spend millions every year for rubber mats. Think of your profit when a

HAND MACHINE
and

5¢ TIRE
MAKES \$2.00 MAT

Brand new. Fully patented. Few men already started report unprecedented success. Wm. Eagle writes: "Can't make mats fast enough. First week brought over 200 orders for \$1.00 to \$10.00 each." Flash from Harris says: "Orders enough to keep 15 men busy all the time." Gunter got big order from County Commissioners and now reports: "Just signed up order for all Grade Schools and High Schools." No wonder responsible men are throwing everything else aside to establish local FABRIX factories.

COSTS NOTHING to get complete facts. Just send name and address. We'll send description of simple hand machine that quickly slices old tire into strips; show you how patented method forms strips into thick, springy, long-wearing FABRIX Mats—how five cents worth of Junk Tires makes a \$2.00 Mat; how you can start on a reasonable investment and build a business so big, so fast, that it will take your breath away. Don't delay a minute. Write or wire today. All information is free.

FABRIX, Inc., 325 W. Huron St., Dept. 72, Chicago, Ill.

Would You WEAR
this All-Wool SUIT

If We Send It FREE of Cost?

Here's an amazing opportunity to get a guaranteed all-wool suit, tailored-to-measure FREE of cost. No experience—no money necessary. No canvassing, either just call on a few friends during your spare time—we show you how to get your Suit quickly, EASILY! Also how you can turn spare time into BIG MONEY. Samples sent FREE. Write: **FAIRBANKS TAILORING CO., 2208 Wabansia, Chicago, Ill.**



Print Your Own

Cards, stationery, circulars, tags, labels, advertising, etc. Save money. **Print for Others; Big Profits;** easy rules sent. Will do popular Raised Printing like Engraving. Junior press \$5.90, job presses, \$11 up, power \$140. Send for free catalog and all details. **THE KELSEY COMPANY, R-37, MERIDEN, CONN.**

SPECTROSCOPE and book of 120 experiments... \$2.50
TELESCOPE clearly showing moon craters... 1.00
STROBOSCOPE with motor, neon lamp and book... 1.00
ELECTRIC FUN book, 200 stunts with 110 volts... 1.00
MAGIC ROD glows in six colors in the dark... 1.00
CUTTING & SONS 27 M St. Campbell, Calif.

NOW—Make These Attractive
Ornaments and Gifts at Home
and EARN BIG PROFITS!

RUBBER MOLDS
AS LOW AS 6c EACH!

Amazing rubber mold-making outfit makes perfect molds of plaques, medallions, statues, busts of famous men and women, ash trays, bookends, etc., from 6c to 25c each. One mold makes dozens of novelties and gifts to sell for \$1.00 or more apiece! No experience necessary. Everything furnished—complete instructions. Start profitable business in your home... sell to stores, friends, neighbors, by mail. **Make BIG MONEY** full or spare time with **SO-LO GO-MA**. Write for complete FREE details and sensational introductory offer.

SO-LO GO-MA MOLD CO.
Dept. L-827, Cincinnati, O.





STOP worrying about the future. **LOOK** at these students and **LISTEN** to what graduates of the Hemphill Diesel Schools have to say:

"In charge of a Diesel plant for a large dredging company." ✓ —Oden Rost

"I landed a Diesel job which tripled my former income." ✓ —B. V. Miller

"First pay check was \$350 more than my tuition." ✓ —Harold Ikemura

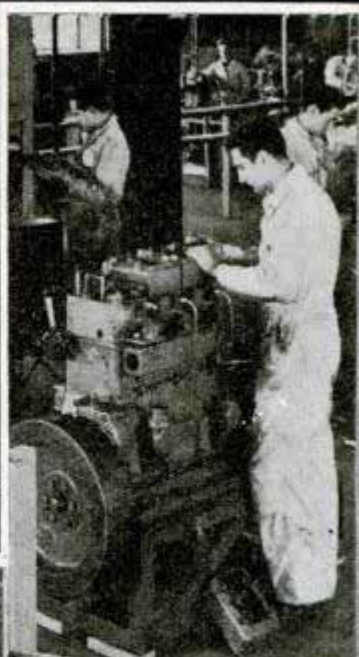

"I am now in line for a higher salary because of my training." ✓ —Roy Pike

"Since I have completed the course my earning power doubled." ✓ —Eldon Traylor

"Thanking you for placing me as port engineer." ✓ —Charles Cole

"Money I spent with Hemphill Schools is paying me dividends 100% per month." ✓ —Robert Lohheit

Similar opportunities are open to you. Can you afford to let them go-by? The book "March of Diesel" is now ready for distribution. Shows many types of Diesel applications and fully describes the growth of the industry since its inception over 40 years ago. Prepared after years of survey—your copy is ready for you. Send coupon today.

HEMPHILL DIESEL SCHOOLS

America's Original Exclusive Diesel training institution, located only at addresses shown

BOSTON, 114 Brookline Avenue
 NEW YORK, 31-26 Queens Blvd., L. I. City
 DETROIT, 2341 W. Lafayette Blvd.
 CHICAGO, 2014 Larrabee Street
 MEMPHIS, 417 Monroe Avenue
 LOS ANGELES, 2120 San Fernando Road
 SEATTLE, 501 Westlake North
 VANCOUVER, B. C., 1363 Granville Street

HEMPHILL DIESEL SCHOOLS

(use nearest address)

Please send me free copy of 32-page book, "March of Diesel," and full information on your Diesel courses.

Name _____ Age _____

Street _____

City _____ M-14-B

HEMPHILL TRAINING PAYS

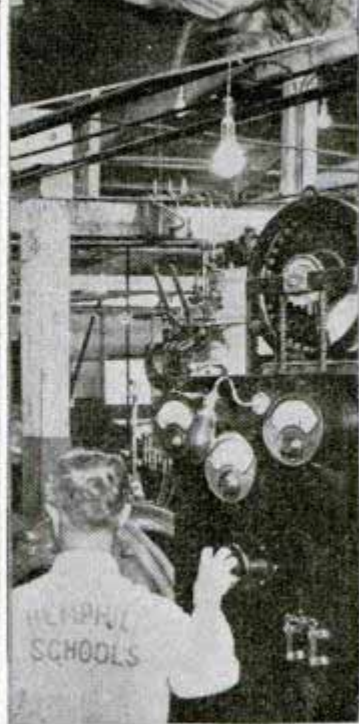

Mr. J. E. Owen 2 1/2 h. Pack

INVENTORS'

FOR THE YEAR

Square, Asheville N.C.



Here's the famous new electric organ, patented by John Hays Hammond, Jr. Contains no pipes. Creates musical tones electrically. Connects to ordinary light socket. Smaller and lighter than an upright piano. Said to produce more than two hundred and fifty million different musical effects.



This combination thread-cutter and needle-holder, recently patented, may prove a boon to busy housewives, and it clearly shows what a field there is for handy household inventions. With this device, the needles are always right where you want them, and the thread is easily cut off without tangling or raveling.

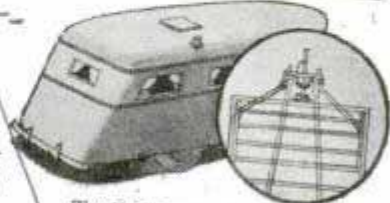

Trailer construction has boomed. Predictions are that soon millions will be living and travelling in trailers. Inset shows a special type of trailer brake mechanism. (Manufactured by Wood-Owen Trailer Co.) When driver of automobile applies brakes, brakes are automatically applied to trailer.



Numerous inventions relating to the home, simple gadgets for everyday use, are constantly being improved. Even such a commonplace article as the can opener affords room for improvement in construction. Shown is one patented this past year by Melvin Higgs, Pomona, California.



Many advances have been made in tire construction. Shown is a new Life Guard Tube introduced by Goodyear. Has a secondary tube within the main tube. Many other developments in tire construction have taken place.



Great strides made in television with several practical sets for home reception demonstrated in New York and elsewhere.

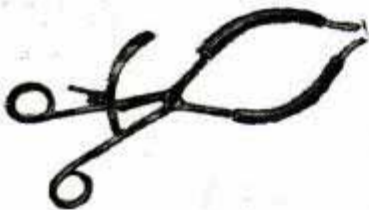

Advancement has been made in the field of first aid and medical equipment. Here is a simple operating tourniquet which can be instantly applied to stop the flow of blood from an injured member of the body. Permits application of pressure and may be released instantly or gradually.

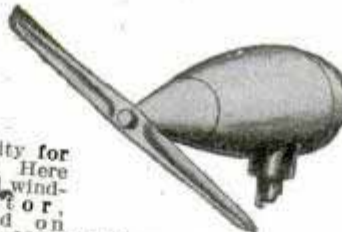

Electricity for the farm: Here is a novel wind-generator, patented on October 27, 1936, which may have the effect of bringing cheap electric power to thousands of isolated farms and homes. It heads into the wind automatically and has an automatic governor.



Numerous patents have been taken out in Air Conditioning. It is predicted that homes, office and factory buildings and all forms of travel conveyances will be air conditioned.

Dr. J. C. Plucker, 11201 Walnut St. Asheville, N.C.

FROM 1898



TO 1937



THESE INVENTIONS HELPED MAKE THE HISTORY OF 1936-1937 WILL WELCOME AND REWARD THE SAME SPIRIT OF PROGRESS

Television and trailers—simple household devices—all helped make inventive history during 1936. Invention marches on in every field, in every sphere of human life. Hard times are leaving, prosperity returning. Men are going back to work. Times are changing—getting better. We believe that

1937 will be a good year for worth while inventions. Look Around—Look Ahead At the recent Centennial Celebration of the American Patent System an old letter of Andrew Carnegie's was reproduced, in which he spoke of his 1905 Winton Automobile. Mr. Carnegie said: "There may be improvements yet to come, but it is difficult to see room for them." Think of it! Difficult to see any room for improvement on a 1905 "chuggamobile." The truth is the 1937 automobile contains more than 100,000 patented improvements. There is always room for improvement. Men who look around, then look ahead can help the world and help

themselves by developing worthwhile inventions.

Your Idea May Be a Good One

If you have been looking around—looking ahead—you may have a worthwhile idea. It may be for the house, the farm, the shop; for some new method or some new composition. And if it is worthwhile—if it is practical and new—it may be worth patenting.

Our Service to Inventors

Since 1898 we have helped inventors protect their rights. The law is designed to protect you, provided you take certain definite steps—and we tell you what these steps are, show you how to take them, render prompt, efficient service. If you have a worthwhile invention, or an idea for one, the facts in the booklets shown

When writing to advertisers please mention Popular Mechanics

CALENDAR

What will the inventions of 1937 be?

O F 1936

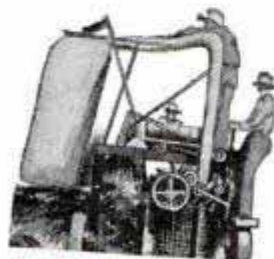

A startling inventive development brought to light this year is the famous Rust Cotton Picker said to do the work of seventy-five to one-

hundred men at one-sixth the cost. Will this prove as revolutionary in the cotton industry as Eli Whitney's famous cotton gin? Some say it will.

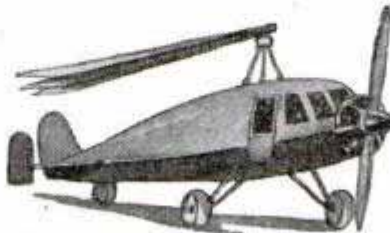

Aviation is, of course, a fertile field for inventive ingenuity. Important steps have been made to bring about the plane which average Mr. American man and woman can fly. Shown is an improved type of autogyro designed to land in any convenient spot. Then wings fold back and the plane serves as an automobile. Just one of the many unusual aeronautical developments during the past year.

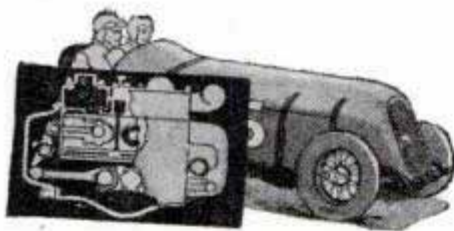

Diesel motors have commanded widespread attention. Shown is a racing car powered by Diesel. The car did 137.195 miles per hour. Inset shows a new Hill Diesel engine exhibited last year at New York Motor Boat Show. Its designer was R. E. Olds, pioneer in the automobile industry.

READ THESE FREE BOOKS

We helped hundreds of inventors during 1936—perhaps we can help you now. If you have a useful invention, if you have a good idea in mind you should read these two free books—64 pages of **FACTS** for inventors. They answer your questions: What can be patented? How does the law protect me? What is my first step? How much will it cost? When can I wisely take steps to sell my invention? They answer these and many more. Receive these facts. Mail the coupon today.



ACT-MAIL *this coupon to* 

VICTOR J. EVANS & Co.

REGISTERED PATENT ATTORNEYS

MAIN OFFICE: 200-B, VICTOR BUILDING,
WASHINGTON, D. C.

Other Offices: 1007-N, Woolworth Bldg., New York; 1445-N, Monadnock Bldg., Chicago; 514-N, Empire Bldg., Pittsburgh; 1040-N, Hobart Bldg., San Francisco; 736-N, Security Bldg., Los Angeles.

Send me FREE copies of your books, "Patent Protection" and "When and How to Sell an Invention." (Note: Same books supplied by any of branch offices listed above.)

Name.....

Street and No.....

City or Town.....

on this page will be interesting to you. With them, we also send you our Evidence of Invention form which will assist you in making a proper disclosure of your invention. These booklets were prepared to answer the questions which from long experience we know the average inventor has in mind. They tell you what to do, when and how to do it. We have endeavored to make them both informative and interesting. They explain the purpose of the patent laws, how they protect an inventor, what factors to consider when selling an invention, how to take steps to secure financial assistance, and much more. There are many illustrations, numerous interesting sidelights on inventive history. We believe that you will welcome this literature. There is no charge or obligation. Simply mail the coupon on this page, or if you prefer, write us with the understanding that all correspondence is absolutely confidential.

When writing to advertisers please mention Popular Mechanics

NOW FIX ANY MAKE OF

AUTO

SIX BIG AUTO BOOKS ALL SHIPPED FREE

on approval; whether you want to qualify as garage owner, auto repair expert or merely wish to know how to keep your own car 100% efficient, look at these books—they are sent to you for free examination. This brand new edition has been prepared by a large group of America's greatest automotive engineers. Anybody who can read will understand them, for this great automobile encyclopedia is a veritable

gold mine of valuable facts. Take advantage of this offer now; send in the coupon for FREE examination. You don't pay us a penny, you don't obligate yourself to pay anything unless you decide to keep the books. Just tell us you want to see them and the full set of 6 great volumes, just off the press, will be sent to you! Read them, look them over and prove to your own satisfaction that one fact alone, which you will find in them, may save you an expensive repair, or help you to a better job.

**DIESEL ENGINES
AVIATION MOTORS
MOTORCYCLES
OUTBOARD MOTORS
MARINE ENGINES
TRACTORS
AUTOMOBILE RADIOS
ALL COVERED**

Very Latest Edition

Imagine books which are so new that every page is right up to date—wiring diagrams, construction details, service problems—are all right up to the minute. Nowhere else can you get as complete and timely information. Over a million dollars of resources have enabled us to give you the most authoritative books on the subject ever published. Everybody interested in automobiles in any way will welcome these books published by the world's largest publishers of Technical Cyclopedia (est. 1897) with agencies all over the world.



Can You Fix It?

Can you take out "play" in differentials? Can you kill the "shimmy" in steering? Can you reset TIMING? Can you put your finger on engine trouble without guessing or tinkering? Can you pull the starter off and fix it? Can you adjust and repair transmission, engine, rear axle, bearings?

These Books Tell How and tell you how to do any and every auto job right, the first time.

6 Big Volumes

Nearly 3,000 pages, over 2,000 illustrations, wiring diagrams, equipment charts, etc. De Luxe edition with gold-stamped flexible binding. Sent FREE for 10 days' use. If not wanted return express collect. If kept, send only \$2.00 after 10 days, then \$3.00 a month until low advertising price, \$24.80 is paid.

A Year's Consulting Membership FREE!

Privilege of consulting engineers of million-dollar American Technical Society for one year if you mail coupon immediately. We also include 2 extra books, "Service Shop Management" and loose leaf book of new diagrams without extra charge.

SEND NO MONEY

AMERICAN TECHNICAL SOCIETY,
Drexel Ave at 58th St., Dept. A219, Chicago, Illinois.

I would like to see the brand new 6-volume edition of your automobile books but without any obligation to buy. I will pay the few cents delivery charges only and will examine the books and return them at your expense in 10 days unless I like them, in which case I will send you \$2.00 then and only \$3.00 per month until the total price of only \$24.80 is paid. You are to include free, consulting membership certificate in the American Technical Society and the two extra volumes mentioned above.

Name.....
Street.....
City..... State.....
Employer's Name.....
Employer's Address.....

Please give us, in addition, the name and address of one business man as reference.

When writing please mention Popular Mechanics

LEARN in 10 EVENINGS

You'll learn more quickly and easily to play a P-A Sax, Trumpet, Clarinet, or Trombone, because P-As are easier to blow and have such beautiful tone. Thousands in use. Strongest guarantee backed by old, reliable manufacturer. Moderate prices. Home trial. Easy terms. See your music dealer or write for beautiful free book. Mention instrument. 1248

PAN-AMERICAN
203 P-A Bldg., Elkhart, Ind.



TRI-STATE COLLEGE



B. S. Degree in 2 years. World famous for technical 2-year courses in Civil, Electrical, Mechanical, Chemical, Radio, Aeronautical Engineering; Business Administration and Accounting. Equivalent in technical hours to 4-year course. Those who lack

high school may make up work. Low tuition. Low living costs. Located in picturesque hill and lake region. Students from every state and many foreign countries. 54th year. Enter March, June, September and January. Write for catalog.

427 COLLEGE AVE.,

ANGOLA, IND.

VOICE

100% Improvement Guaranteed

We build, strengthen the vocal organs—not with singing lessons—but by fundamentally sound and scientifically correct silent exercises... and absolutely guarantee to improve any singing or speaking voice at least 100%... Write for wonderful voice book—sent free. Learn WHY you can now have the voice you want. No literature sent to anyone under 17 years unless signed by parent.

PERFECT VOICE INSTITUTE, Studio 1352
64 E. Lake St., Chicago



WILL YOU WEAR THIS SUIT

and Make up to \$12 in a Day!

Let me send you this fine all-wool tailored suit FREE OF COST. Just follow my easy plan and show the suit to your friends. Make up to \$12 in a day easily. No experience—no canvassing necessary.

Send for Samples—FREE OF COST
Write today for FREE details, ACTUAL SAMPLES and "sure-fire" money getting plans. Send no money.
H. J. Collin, Progress Tailoring Co., Dept. P-216
500 S. Throop St. Chicago, Ill.



AGENTS UP TO \$14 A DAY

Everybody needs food. My plan gives you opportunity for amazing profits at once. Make up to \$14.00 in a day. I'll give you a New Ford Tudor Sedan as a bonus in addition to your cash earnings. No experience required. 250 Famous Products—all fast sellers. I send everything. You don't risk a penny. Write quick for Free Facts.



ALBERT MILLS, 3781 Monmouth Ave., Cincinnati, O.

MAIL FOR FREE INFORMATION

BEDFORD YMCA TRADE SCHOOL

1117 Bedford Ave., Dept. PM-45
Brooklyn, New York City, N. Y.

- Auto Mechanic Talking Pictures
 Aviation Mechanic Welding
 Aeronautical Engineering
 Refrigeration Machine Shop
 Oil Burner Diesel Engineering
 Air Conditioning Sign Painting
 Electrical Window Display
 Radio and Television Mechanic
 Architectural-Mechanical Drafting
 Armature Winding
 Diesel Engines

Name.....
Address.....

Be An ARTIST



It's Fun to Learn this Way

Can YOU Do THIS?

Just a few plain, quickly sketched lines—and you have the "framework" of a drawing. These first lines give you the rough proportions and lines of action.



Then YOU Can Do THIS . . .

Next we show you exactly how to apply the rules for developing the outlines and "blocking in" the areas to be shaded. Then you erase the first "framework" lines and presto!—you have this!



...and THIS!

Now you are shown how to give your drawing shape, depth and form by shading and high-lighting. In every single step you are guided by proven rules which correct your mistakes and skillfully direct your hand!



BIG ARTIST'S OUTFIT GIVEN!

This full-size professional Artist's Outfit comes with your very first lessons—at NO EXTRA COST. It contains everything you need to start. Mail coupon now for complete details of this remarkable offer.

Learn to Draw at Home This Simple, Practical Way!

YOU have always longed for it—this fascinating ability to draw. Now it can really be yours! Illustrating, Rapid Sketching, Decorative Designing, Commercial Art, Cartooning—you can now learn all of this right in your own home. Many of our graduates never studied art before, yet today are successful artists with good incomes.

Our simple, proven, practical method makes it fun to learn, in your spare time. And now, with just a few hours' pleasant practice each week, you, too, may learn to make drawings that have a real commercial value—just as those whose reports are given below are doing! Get into this interesting, profitable field NOW! Mail coupon for FREE BOOK, "Art for Pleasure and Profit" at once!

Made \$125 a Week!

Joe Rinaldi of New York writes: "Since completing your course I have earned as high as \$125 a week."

\$3,000 for W.R.K.

"Just signed 2 contracts that will bring me \$3,000. Earned \$250 while taking course. Have more orders than I can accept."—W. R. Kent, Newark, N. J.

\$3,000 a Year and More!

M. A. Kraykovic writes: "... salary averages \$2,000 to \$3,000 a year and more. It is a pleasure to recommend your course."

\$100 for 8 Hrs. Work

"Have received for some of my paintings as much as \$100 for 6 to 8 hours' work."—D. P. Harris, N. Car.

\$50 for One Drawing

"Got \$50 for a simple idea, expressed in a pen and ink drawing. Have made over \$200 so far."—G. Bartolomi, Oregon.

\$76 a Week

—that's what our student, H. J. Algeldinger, of Penna., averages. Has made over \$1,200 in spare time.

Commercial Art, Cartooning and Designing, ALL in ONE Course!

It's like an enjoyable game when you learn to draw with this simple method. You study right at home, yet every bit of your work receives the individual attention and criticism of a real art teacher. It's almost as though you had your instructor standing at your elbow while you work.

With this training you progress in easy stages. Starting with straight lines and curves, you learn action, perspective and all the more advanced principles of drawing. You get a sound, complete, all round art training based on our 22 years of successful teaching experience. See (at the left) the money others have made even before they finished the course!

Our big FREE Book describes the latest developments and opportunities in this fascinating, good income field—and gives full details of this simple practical method. Tells about our graduates—their successes—what they say about our course—shows actual reproductions of their work—and tells how they earned good money even while learning. Mail coupon or postcard today. (No salesman will call.) Please state age. Studio 122, Washington School of Art, 1115—15th St., N. W., Washington, D. C.

Get this FREE BOOK



Free Book shows how

WASHINGTON SCHOOL OF ART, Studio 122, 1115—15th Street, N. W., Washington, D. C.

Without obligation, please send me a FREE copy of your Book, "Art for Pleasure and Profit."

Name.....Age.....

Address.....

City.....State.....

When writing to advertisers please mention Popular Mechanics



DRAFTING

BOOKS SENT FREE!

ON APPROVAL

5 VOLUMES BRAND NEW EDITION

Only 15 minutes a day with these WONDER BOOKS will prepare you for a good drafting job in less than a year. Mechanical and architectural drafting from simple straight lines to important complex plans. A step at a time! Built especially for beginners, for men with only grammar schooling. Drafting room practice, PLUS ENGINEERING, made easy and clear. Includes complete course in blue-print reading.

Big Field Big Demand Big Pay

Competent draftsmen are urgently needed right now in all building and manufacturing lines at \$30.00 to \$75.00 a week. That's just the beginning—FOR DRAFTSMEN HAVE THE BEST CHANCES FOR ADVANCEMENT. Pleasant, fascinating work, easy to learn and do. Learn quickly with these books—send coupon for a set and see for yourself.

A year's consulting membership in the American Technical Society now given to all readers of this famous cyclopedia of drafting. Many say that it is worth more than the cost of the books.

Complete set of drawing instruments if you send for these drafting books NOW. These instruments are made of the finest of German silver, are absolutely accurate and are packed in velvet lined leatherette pocket case. Real \$10 value, but included with these books.

AMERICAN TECHNICAL SOCIETY
Dept. D219, Drexel at 58th St., Chicago, Ill.

For Beginners

Written, so you can understand every word, by 22 famous engineers and architects. Deluxe flexible binding, nearly 2,000 pages, 1546 blueprints, charts and diagrams; prepares you for a good drafting job in mechanical or architectural lines. Sent for 10 days' free use if you mail coupon immediately.

These Instruments Included



American Technical Society, Dept. D219, Drexel at 58th St., Chicago, Ill.

Send for 10 days' free use New 5 volume set of drafting. I will pay the few cents delivery charge. If I wish, I may return books in 10 days and owe you nothing but if I decide to keep them, I will send \$2.00 after 10 days, then only \$5.00 a month until \$24.50, the introductory price, is paid. Send latest edition and include drawing instruments.

Name.....
Address.....
Attach letter stating age, occupation, employer's name and address and that of at least one business man as a reference.

Electricity at your finger ends

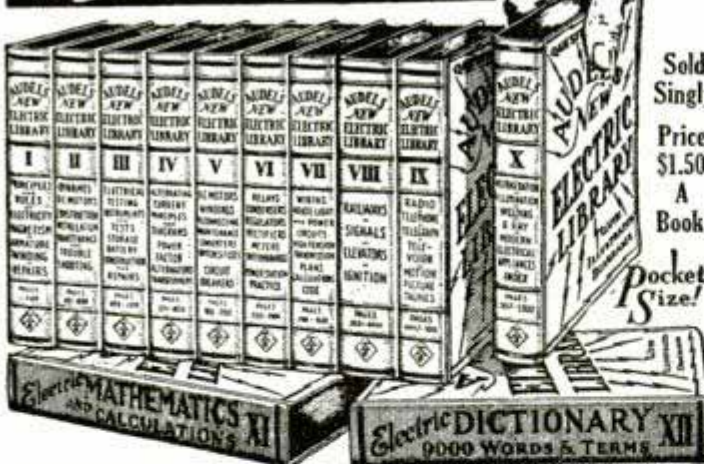

Sold Singly
Price \$1.50
A Book

Pocket Size!

AUDELS NEW ELECTRIC LIBRARY—A progressive Home Study and Reference Course in applied electricity. Easy to understand. Questions and answers plainly written for a complete working knowledge of modern electrical practice, necessary to every electrician, engineer, mechanic and student.

LEARN THE AUDEL WAY! You ask the question—Audels New Electric Library gives the answer—9500 simplified outlines, graphic illustrations and precise explanations covering Construction, Operation and Machine Maintenance.

BOOK A MONTH PLAN—Order the volume that interests you—today! We will send that volume on 7 days' free trial. If the book helps you, send us \$1.50. If it does not help you, mail book back to us. On receipt of your first payment, we will send your second book. We allow 30 days to pay for this and for each following book until you complete the Series.

If you are not satisfied, you may cancel your subscription at any time.

FREE EXAMINATION COUPON
Theo. Audel & Co., 49 W. 23rd St., New York City
Mail Vol. I, Electric Library on 7 days' free trial. If O. K. I will remit \$1.50, otherwise I will return it. I also request you to mail one book each month on same terms. No obligation unless I am satisfied.

Name.....
Address.....
Occupation.....PM

When writing to advertisers please mention Popular Mechanics

Cheaper HEAT Without COAL



New Invention Fits Any Stove or Range — 30 Days Free Trial
Remarkable invention burns 96% air, 4% of a cheap variety of oil obtainable everywhere. Does away with coal, wood, ashes, dirt and drudgery. Clean, silent, quick, like gas heat. 3 times hotter than coal and cheaper. Temperature controlled. No more getting up on bitter cold, wintry mornings. Many automatic features. No gas or electricity needed. Safe as any ordinary kitchen range. Easy to install—no damage to stove—simply sits in firebox of any stove, range, heater or furnace. Costs just a few cents a day to operate. TRY 30 DAYS AT OUR RISK. Low introductory price and 30-day trial. Write for FREE CATALOG. AGENTS and spare time workers: Oil heat saves money this year; people buy to save. Write for free burner offer that starts you in business for yourself. Act NOW! Listed as approved by Nat'l. Board of Fire Underwriters. BRIGHAM OIL BURNER CO., 2927-B Clark Ave., St. Louis, Mo.

EARN \$60 A WEEK!
Write for FREE Burner offer and protected territory.



ADVICE TO ACCORDIONISTS and Magnante PHOTO-CHART

Free Charles Magnante, famed Radio Accordionist, reveals secrets of Accordion playing. Explained with photo chart of large pictures. Send your name, address, make of Accordion you play, **EXCELSIOR** 333 SIXTH AVENUE, NEW YORK DEPT. PM

TECHNICAL BOOKS

Over 1500 Technical books of all publishers available to you at half price or less! Chemistry, Electricity, Physics, Astronomy, Technology, Research, Engineering and other subjects. Send for handsome big new catalogue. It will save you many dollars. Just mail 10c in stamps or coin to cover shipping and mailing.

at 1/2 price or less

Chemical Publishing Co. of New York, Inc.
148 Lafayette Street, (Dept. P) New York City



Learn to Write

Begin Today. Write for our Free Book, "How to Become a Good Penman." It contains specimens and tells how others learned to write in spare time. Your name elegantly written on a card if you enclose stamp for postage. Write today. **F. W. TAMBLIN**, 418 Ridge Bldg., Kansas City, Mo.

MAKE MONEY AT HOME!
Learn to color photos and miniatures in oil. No previous experience needed. Good demand. Send for free booklet, "Make Money at Home" and requirements. **NATIONAL ART SCHOOL** 3601 Michigan Ave. Dept. 1382 Chicago

NEW YORK SCHOOL OF MECHANICAL DENTISTRY
Make more money as a DENTICIAN. We show you how! Oldest school. Real Laboratory Training. Day, Eve. Easy terms. Tools FREE. Ask for Catalog P. N. Y. SCHOOL of MECHANICAL DENTISTRY, 125 W. 31 St., N. Y. C.

Photography for



PLEASURE or PROFIT

Prepare for profitable business or fascinating hobby, at home under guidance of qualified instructors. No previous experience necessary, common school education sufficient. Many earn while learning. Our practical studio methods also qualify for well-paying positions upon graduation. Send coupon below at once for free booklet "Opportunities in Modern Photography", particulars and requirements.

AMERICAN SCHOOL OF PHOTOGRAPHY
3601 Michigan Avenue Dept. 1352 Chicago, Illinois
Send booklet, "Opportunities in Modern Photography", full particulars and requirements.
Name.....
Address.....
City.....State.....

DIESEL

Gives Big - Pay Jobs to Adcox Graduates

Operating the big Diesels on the Streamliner "City of Portland" is Adcox Graduate James Haydon.

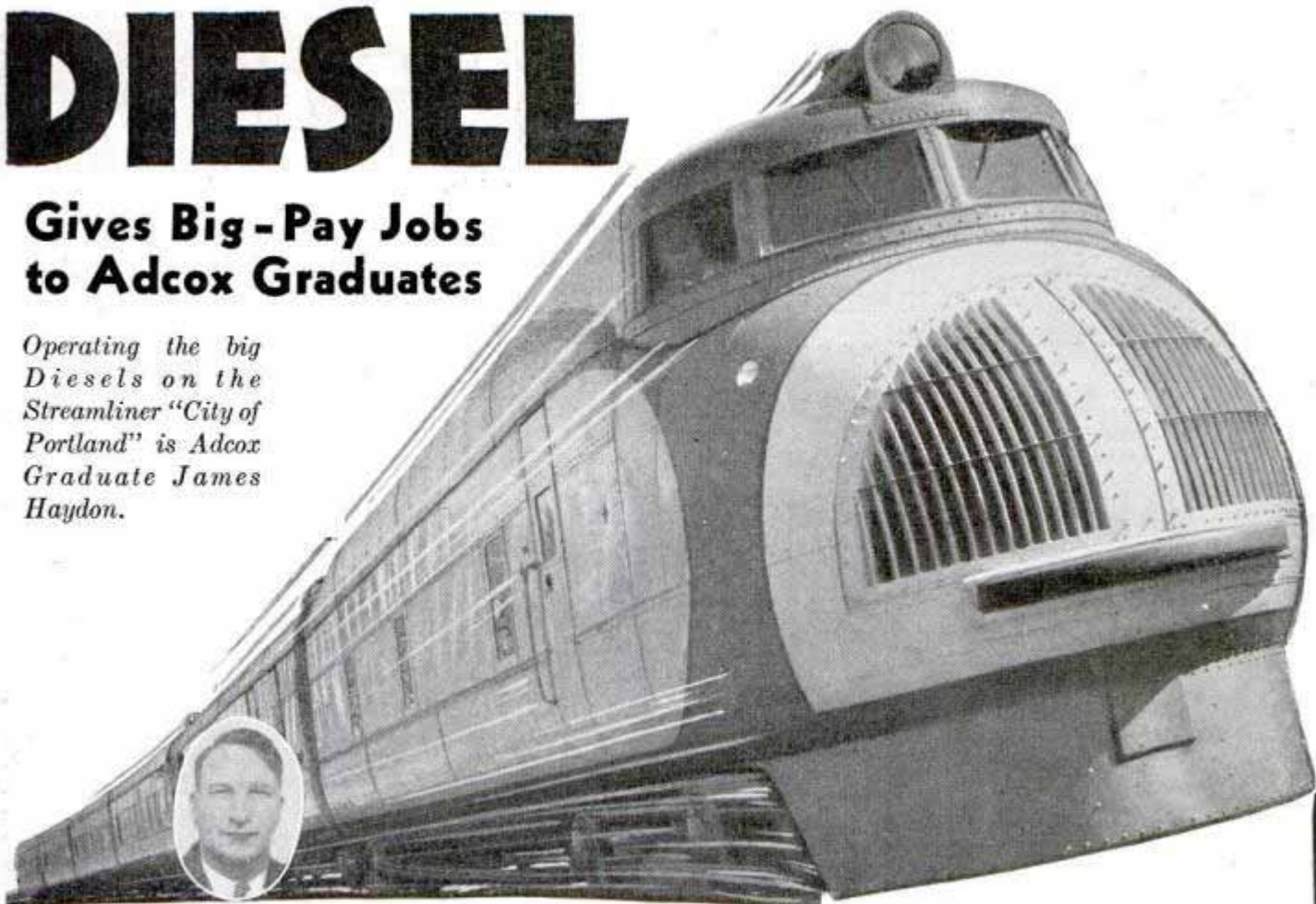

How would you like a big-pay Diesel job like James Haydon's—like countless other successful Adcox Graduates hold down? They are in the fascinating, fast-growing Diesel industry **RIGHT**—the **special advantages** of Adcox Training put them there! Isn't that exactly what **YOU** are looking for?

Let me put my 27 years' experience to work for **YOUR** success, just as I have done for James Haydon and many others. Send at once for my new, big, **FREE**, 40-page catalog. It tells you frankly *why* you should study in the thrilling Pacific Northwest, home of the Adcox School and a "hotspot" of Diesel

activity and employment—straight-from-the-shoulder facts you should know before choosing *any* trade or *any* school.

You owe it to yourself, your future happiness, your ambition for success in life to learn, first hand, of the exceptional opportunities before **YOU** as an Adcox Graduate. Earn board and room while learning. Get my valuable Catalog without further delay—

Send This Coupon NOW!

**I'LL HELP YOU
LAND A
WELL PAID
DIESEL
JOB -
GET MY
FREE BOOK
NOW!**

BIG 40 PAGE DIESEL SCHOOL CATALOG FREE

Mr. L. L. Adcox, President,
L. L. Adcox Trade School,
Portland, Ore.

Without obligation, please send **FREE** Diesel Catalog No. 18-H. I am interested in attending school. Home study.

Name..... Age.

Address.....

Town..... State.....



When writing to advertisers please mention Popular Mechanics



STEP NO. ONE

Make a rough pencil sketch of your invention, describe it fully, and send it to us for preliminary search through United States Patents in the U. S. Patent Office.



STEP NO. TWO

Our trained searchers will then make a preliminary search of the pertinent U. S. patents to determine if your invention is probably patentable.



STEP NO. THREE

Our complete report of search and opinion on patentability will be mailed to you with copies of U. S. Patents that we consider nearest to your invention.



STEP NO. FOUR

If you decide to make patent application, for customary fees explained in our booklet, our draftsmen will make drawings and proper papers will be prepared for presentation of your invention to the Patent Examiner in U. S. Patent Office.

INVENTORS

KNOW HOW TO START KNOW EACH STEP TO TAKE *Before Going Too Far With Your Inventions*

Very often, the patent procedure is what we call a "simple" one—as illustrated here. Our FREE BOOK, "Patent Guide for the Inventor," describes what to do and how to go about it. Send for it by all means—let us urge, however, that you take the first step (Step No. 1 to left) without further delay. It will prevent wasted work, mis-steps, and going ahead "in the dark"—your whole patent procedure depends upon the first step.

If you have an invention that is patentable—and want to secure for yourself your inventor's sole right to profit from the invention—you can't afford to lose time in securing the protection of a U. S. Patent. Other inventors may be working on the same thing right now. Should they develop this invention and file patent application before you do—the burden of establishing priority will be upon you. Our Big Book—"Patent Guide for the Inventor"—will tell you the quickest possible way to secure Patent Protection for your invention. SEND FOR IT TODAY!

Immediate Search Necessary

A search at the U. S. Patent Office will disclose one of three things: That you have hit upon an entirely original invention—that you have suggested patentable improvements upon an existing invention—or that your invention has been anticipated throughout, and you should drop it. You should have this information at once. The next steps (the whole procedure of obtaining a patent) will be thoroughly explained to you in our FREE BOOK.

Our FREE BOOK tells everything you need to know about patents. We will mail this book upon receipt of your letter requesting search—or if you want to read it before having search made, simply fill out the coupon on opposite page.

FREE RECORD OF INVENTION

This FREE Record of Invention Form enables you to make in convenient form a sketch of your invention and have it witnessed in a manner of value to you should the occasion for evidence arise. MAIL THE COUPON TODAY and obtain our FREE BOOK and Record of Invention Form.

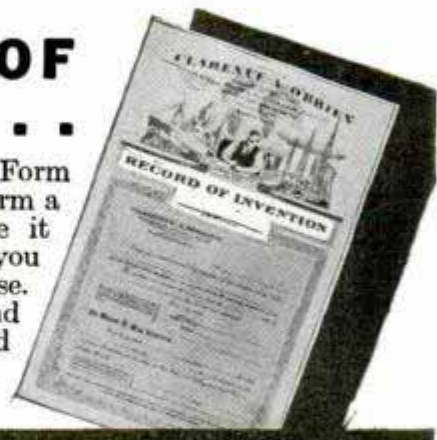

CLARENCE A. O'BRIEN & HYMAN BERMAN

701 Adams Bldg.

Washington, D. C.

Registered Patent Attorneys Before U. S. Patent Office

PATENT YOUR INVENTIONS *Act Now!*

DELAYS ARE DANGEROUS IN PATENT MATTERS

The Free Book shown here was prepared for inventors, to show them exactly what steps they must take to secure a PATENT. If you have an invention, you should send for this book AT ONCE. It will tell you exactly how an application for a Patent is made, what information you must furnish your attorney, and what steps he must take in order to protect your interests. Remember, inventing an article is one thing—securing the exclusive right to manufacture it, use it, or sell it is another. Without a U. S. Patent, you cannot expect to reap the profits that your invention may make possible. Send at once for this book. After you get that, you'll know exactly what to do to protect yourself.

WHAT A PATENT DOES FOR YOU

Every year thousands of Patents are granted. Very few, however, represent the discovery of entirely new principles. Most of them provide new methods of doing some everyday thing in a better way—changes for greater efficiency, usefulness, adaptability, or beauty in some previously Patented thing. These IMPROVEMENTS are Patentable if new, and actually represent new inventions. These improvement Patents offer large chances for profit if commercially useful. The business world wants improved products and services.

WE SERVE YOU QUICKLY AND SECRETLY

Anything you write us or send us is strictly confidential between us. All letters and drawings are kept in strong, steel, fireproof files, which are open only to ourselves or authorized members of our staff. We have secured patents for inventors located in every state in the Union. Our organization is a large and efficient one. Our practice is confined entirely to Patents, Trade-Marks, and Copyrights. We have had years of experience in Patent Matters. When you place your invention in our hands, we are in position to proceed at once to secure protection for you. Our fees are reasonable, and, if you desire, we can arrange convenient terms of payment.

IMPORTANT!

Please understand that you are not under the slightest obligation in sending for this book. We will mail it, together with the Record of Invention Form, the same day we receive your request. Use the coupon to save yourself time and trouble. After that, you will be in position to proceed or not as you choose, to make your application for a patent.

THIS FREE BOOK ... Tells How!

How your Patent Application is made; what kind of sketches or drawings are necessary; what other papers must be made out; how the Patent Laws protect you; why it is important to avoid loss of time in getting your application filed; and many other important points. Even a very simple invention, if new and useful, may prove very valuable. You may have much to gain and nothing to lose by sending for this book TODAY.



CLARENCE A. O'BRIEN & HYMAN BERMAN

701 Adams Building

WASHINGTON, D.C.

REGISTERED PATENT ATTORNEYS
BEFORE U.S. PATENT OFFICE

Please send me at once your Big Free 48-Page Book, "Patent Guide for the Inventor" and your Specially Prepared "Record of Invention" form. This request does not obligate me.

NAME

ADDRESS

(Please write or print plainly.)

PATENTS

Booklet Free Highest References
Promptness Assured Best Results

Send drawing or model.

ALL BUSINESS GIVEN PROMPT AND PROPER ATTENTION

Listed Patent Lawyer in the latest editions of the Rand-McNally Directory of Bankers and Bank-Recommended Attorneys, published by Rand-McNally & Co., Chicago, Ill.; The Baggott & Ryall Directory of Guaranteed Attorneys, published by Legal Directory Corporation, Boston, Mass.; American Lawyers Annual, Cleveland, Ohio; Bankers Service Legal Directory, published by Bankers Service Co., Boston, Mass.; Eyre's Law List, 9 Park Place, New York City; Snow-Church Directory Co. Lawyers List, published in New York City, and the Central Guarantee Co., Bankers and Lawyers Directories, 630 Fifth Avenue, New York City.

WATSON E. COLEMAN, Victor Building, 724 Ninth Street, N. W.
REGISTERED PATENT LAWYER **WASHINGTON, D.C.**

INVENTORS PATENT YOUR IDEAS SEND FOR FREE BOOK

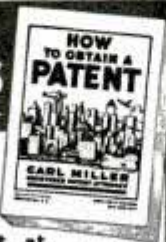

HOW TO OBTAIN A PATENT

Written by a Former Member of the Examining Corps (1922-24) of the U.S. Patent Office. If you want to profit by your idea, you should take steps to apply for a U. S. Patent at once. Your first step is to get this Free Book. This interesting illustrated book contains valuable information you should have. It tells you fully how to obtain a patent on your idea in the quickest way. With this Free Book you will also receive a "Record of Invention" form on which you can easily record your idea. Personal and Confidential Service: Your case will be personally handled only by a Registered Patent Attorney who is also a Former Member of the Examining Corps of the U. S. Patent Office. All communications confidential.

MAIL COUPON TODAY for FREE PATENT BOOK and RECORD OF INVENTION Form.

CARL MILLER

REGISTERED PATENT ATTORNEY
FORMER MEMBER EXAMINING CORPS U. S. PATENT OFFICE

1638 Woolworth Bldg., Dept. 27A, New York City
MILLER BUILDING, Dept. 27A, WASHINGTON, D. C.
Please send me your Free Book, "How to Obtain a Patent," and your "Record of Invention" form.

NAME.....

ADDRESS.....

ALBERT E. DIETERICH

REGISTERED PATENT ATTORNEY
512 B Colorado Building, WASHINGTON, D. C.
Booklet on Patents sent free

STOP Scratching

RELIEVE ITCHING In One Minute

Even the most stubborn itching of eczema, blotches, pimples, athlete's foot, rashes and other skin eruptions, quickly yields to Dr. Dennis' cooling, antiseptic, liquid **D. D. D. PRESCRIPTION**. Its gentle oils soothe the irritated skin. Clear, greaseless and stainless—dries fast. Easy to use. Stops the most intense itching instantly. A 35c trial bottle, at drug stores, proves it—or money back.

NEURITIS

Relieve
Pain In 9
Minutes

To relieve the torturing pain of Neuritis, Rheumatism, Neuralgia or Lumbago in 9 minutes, get the Doctor's Prescription **NURITO**. Absolutely safe. No opiates, no narcotics. Does the work quickly—must relieve your worst pain in nine minutes or your money back at Druggist's. Don't suffer. Use guaranteed **NURITO** today.

In answering advertisements always write name and full address clearly.

PATENTS—TRADE MARKS

All inventions submitted held confidential and given personal attention by members of the firm.

Form, "Evidence of Conception" and instructions, "How to Establish Your Rights"—FREE!

LANCASTER, ALLWINE & ROMMEL
Patent Law Offices

412 Bowen Bldg. Washington, D. C.

Inventions Wanted

Patented or Unpatented

We have been successfully selling inventions, patented and unpatented, since 1924. Write for proof, and tell us what you have for sale.

Chartered Institute of American Inventors
Dept. 4, Barrister Building, Washington, D. C.



G E A R S

In Stock—Immediate Delivery

Gears, speed reducers, sprockets, thrust bearings, flexible couplings, pulleys, etc. A complete line is carried in our Chicago stock. Can also quote on special gears of any kind. Send us your blueprints and inquiries.

Write for Catalog No. 10
CHICAGO GEAR WORKS
769-773 W. Jackson Blvd., CHICAGO, ILL.

INVENTORS who derive largest profits know and heed certain simple but vital facts before applying for patents. Our book, Patent-Sense, gives those facts; sent free. Trade Marks—Copyrights.
LACEY & LACEY, Est. 1869, 635 F St., N. W., Dept. 5, WASHINGTON, D. C.

To PROTECT YOUR INVENTION—Use this coupon, NOW

Delays are dangerous and may be very costly. My personal service assures prompt action, strict confidence, and a minimum of expense. I suggest that you send me a model or drawing, or sketch and description of your invention, and \$5.00. I will make a search and report

promptly as to its patentability and send you a copy of my 72-page booklet. Or, if you prefer to read my booklet first, mail the attached coupon at once. I will also send my "Record of Invention" form. (Over 38 years experience as a Registered Patent Attorney.)

L. F. Randolph, 302-D Victor Bldg., Washington, D.C.

Please send me at once, free of charge, your 72-page booklet and "Record of Invention" form.

Name.....

Address.....

A PERSONAL CONFIDENTIAL PATENT SERVICE—

When writing to advertisers please mention Popular Mechanics

**Learn
This
Profitable,
Fascinating**

Large Incomes FROM Swedish Massage



Profession in 90 Days, at Home

Hundreds of Men and Women have found Independence this way

If you are looking for a *new and better* way to make a living, take up *Swedish Massage*, a **DIGNIFIED, FASCINATING, PROFITABLE PROFESSION**, and one of the few still open to men and women without college training. Hundreds of graduates of our *home study* course, either have fine positions or a private practice of their own. Many report minimum earnings of \$50.00 per week, while H. C. Crittendon, who received his diploma January 1st, 1930, reports averaging \$60.00 *per day*.

Plenty of Opportunities Open

This interesting, big pay profession was for years available only to a few. Its secrets were guarded jealously and fabulous prices were paid for instruction. This same instruction is now available to you at a mere fraction of the former price, and you need not leave your present work until you have qualified as an expert and can command an expert's pay. There is a big demand for National College of Massage trained men and women from beauty shops, hospitals, sanitariums, clubs, doctors and private patients. Prepare for this profitable profession **now**.



A Dignified Profession

The expert in Swedish Massage is recognized as a professional of the highest type, commanding the respect of everyone in his community. Here is a profession, now open to you, which makes you a public benefactor; for the skill we teach you is of great aid in many human ailments as well as in building beauty—it offers you position, both professional and social, it offers you independence, freedom from worry and the respect and admiration of your neighbors and friends.

YOU Can Learn at Home

Turn spare hours into money. Use spare time at home to master a profession which has made thousands of dollars yearly for ambitious men and women. Many graduates have completed this training in just a few months, but you can take your own time. It need not interfere with your other work or pleasure. All instruction has been prepared by the teachers in our well known resident school—the same material is used and a diploma is awarded upon graduation.

Experts in Reducing

Many of our students become **specialists in reducing**. Thousands of men and women pay huge sums to take off fat. Enroll now—get the benefit of instruction by the teachers in our famous resident school. This course includes lessons in Dietetics, Reducing Diets, Hydro-Therapy, Anatomy, Medical Gymnastics, in fact everything you need to know to qualify for a Diploma (same as given by our Resident School).



Miss E. A. Childs, Md.



D. H. Beam, Calif.



Miss H. Swain, Ariz.

These photographs are representative of hundreds received with letters of praise and recommendation. Send the coupon and we will include a booklet of names and photographs of graduates.

Large Incomes from Doctors,

hospitals, sanitariums, clubs and private patients are bound to come to those of our graduates who profit by the thousands of opportunities available to make money. Mr. Charles Romer, Wisconsin, writes, "At times I have had to turn away people; I have been so busy the depression never touched me." Miss Childs, Baltimore, Maryland, says, "I already have over 40 patients. I hope many others take your course and profit financially and socially as I have." Hundreds and hundreds of graduates have written similar letters. Get into Swedish Massage and Physio-Therapy through our "Right in Your Own Home" Plan.

Regular Diploma Awarded

When you have completed our home study course (high school training not needed), you will be awarded the National College of Massage and Physio-Therapy Diploma. This diploma is a badge of honor, a warranty to the public that you have qualified as an expert and should be accepted by them as proof of your proficiency in your chosen profession. Enroll now, before it becomes necessary to spend years in intensive training to qualify for a permit to practice.

Anatomy Charts and Supplies Included

Many earn **BIG MONEY** while learning. Enroll now and we will include anatomy charts, medical dictionary, patented reducing roller and Hydro-Therapy supplies without extra cost. The reducing course alone may be worth many times the modest tuition fee. Send coupon for special reduced price offer. Complete details with list of successful graduates will be sent **FREE**.

NATIONAL COLLEGE of MASSAGE and PHYSIO-THERAPY

Dept. 264, 20 N. Ashland Ave., Chicago, Illinois

Use this Coupon for FREE information

NATIONAL COLLEGE OF MASSAGE AND PHYSIO-THERAPY
Dept. 264, 20 N. Ashland Ave., Chicago, Ill.

You may send me **FREE** and Postpaid your illustrated catalog, list of successful graduates and complete details of your offer.

Name.....
Address.....
City.....State.....



Amazingly Easy Way to get into **ELECTRICITY**

**Learn to Earn More
Money Every Week
—or Go Into Your
Own Business**

Whether your age is 16 or 40. Let us train you to prepare for positions that lead to good salaries in Electricity — NOT by correspondence, but by an amazing modern method right here in the great Coyne Shops that gives you a practical Training in 90 days! Getting into Electricity is easier than you imagine if you choose the right method. You don't need previous experience or need a lot of book learning. Start any time after you have enrolled.

Easy Payment Plan

Mail the coupon below and I'll send you all details of my monthly tuition plan. Under this plan you can get your training first and then pay for your tuition later in small monthly payments extending over an 18-month period, starting 5 months after you start school.

LEARN BY DOING—IN 90 DAYS IN THE GREAT COYNE SHOPS

I don't care if you don't know an armature from an air brake — I don't expect you to! We give you 12 weeks of practical Shop work in the Big Coyne Shops. . . . Practical work on real Electrical equipment.

MANY EARN WHILE LEARNING

If you need part time work to help pay your expenses we may be able to help you if you will write and tell us your problems. When you graduate you can get lifetime employment service.

DIESEL, REFRIGERATION AND AIR CONDITIONING

Right now we are including instruction in Diesel Engines, Electric Refrigeration and Air Conditioning without extra cost so your training will be more valuable to you.

GET MY BIG FREE BOOK! Coyne is your great chance to get into Electricity. This school is 37 years old—Coyne training is reliable. You can find out everything absolutely free. Simply mail the coupon and let us send you the big, free Coyne book with photographs . . . facts . . . opportunities. Tells you how many earn expenses while training and how we assist our graduates in the field. No obligation to you. So act at once. Just mail coupon.

H. C. Lewis



COYNE ELECTRICAL SCHOOL
500 S. PAULINA ST., Dept. 27-72, CHICAGO, ILL.

SEND NOW FOR FULL DETAILS!

H. C. LEWIS, President, COYNE ELECTRICAL SCHOOL
500 S. Paulina St., Dept. 27-72, Chicago, Ill.
Dear Mr. Lewis: Without obligation send me your big, free catalog with facts about Coyne Training and details of your Monthly Tuition Payment Plan.

Name.....
Address.....
City.....State.....

Mail in envelope or paste on a postcard

1,500 NEEDED INVENTIONS

1936 Edition of this remarkable source book for inventors by R. F. Yates tells what to invent, what inventions manufacturers are looking for, what will pay most money. Also gives new scientific discoveries important to inventors. Enables you to work on inventions that pay. Simple, practical ideas. Large cloth-bound book, 250 pages. Don't waste time. Send \$2.50 today, or send \$4.00 for this great book and **INVENTORS' SELLING GUIDE** which tells you where and how to sell safely your patented or unpatented inventions to its list of nearly 1000 buyers. Everything you must know about Selling Methods, Law, Royalty Contracts, Financing, Finding Buyers. 224 pages, cloth \$2.00. Send no money if you prefer C. O. D. shipment. Money back if not satisfied.

Write for FREE catalog of valuable books for inventors and sample pages of above books.

Donley Publishing Co., 609 Fifth Ave., Dept. P-2, New York, N.Y.

Be a DENTICIAN

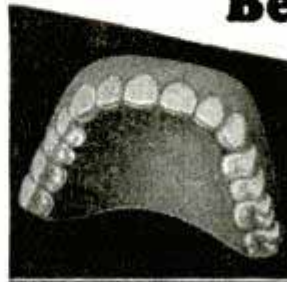

Learn at home to make Crowns, Plates, Bridgework, etc., for Dentists. Easy, practical way to learn mechanical dentistry at home in spare time. **Full Equipment of Tools and Materials included with Course.** Low tuition. Easy terms. Write for **FREE BOOK** about this money-making profession that is not affected by "machine age."

**McCARRIE SCHOOL
OF MECHANICAL DENTISTRY**
207 N. Broad St., Dept. 718 Philadelphia, Pa.

BE AN ARTIST

**WE CAN TEACH
YOU DRAWING** in your own home during your spare time. Thirty-five years of successful teaching proves our ability. Artists receive large salaries.

Write today for Art Year Book
SCHOOL OF APPLIED ART

Dept. 127, 10 E. Huron St., Chicago, Ill.



BE A RAILWAY WRITE TRAFFIC INSPECTOR TODAY

**THERE'S A PLACE FOR MEN WITH
THIS TRAINING**

RELIABLE, ACTIVE MEN—19 to 50—make good as Railway and Bus Passenger Traffic Inspectors. Our short, home-study course trains you quickly, and upon completion, we help place you at up to \$135 per month, plus expenses, to start, or refund tuition. Experience brings rapid advancement. Interesting work in a growing field with constant demand. Free Booklet. **STANDARD BUSINESS TRAINING INSTITUTE**
Div. 202 Buffalo, N. Y.

You Can Regain Perfect Speech, if you

STAMMER

Send today for beautifully illustrated book entitled "DON'T STAMMER," which describes the Bogue Unit Method for the scientific correction of stammering and stuttering. Method successfully used at Bogue Institute for 36 years—since 1901. Endorsed by physicians. Full information concerning correction of stammering sent free. No obligation. Benjamin N. Bogue, Dept. 175, Circle Tower, Indianapolis, Indiana.

REFINISHES AUTOS Like NEW!



PAYS UP TO \$7.00 AN HOUR!

KAR-NU refinishes any color automobile easily, quickly and economically without polishing, waxing, rubbing or painting. **JUST WIPE IT ON WITH A CLOTH!** Magic-like fluid covers old paint with tough, elastic coat. Absolutely transparent, self-leveling, self-polishing. Guaranteed. Lasts 8 to 12 months. Equal in beauty to repaint job costing \$10 to \$35. Write for Free Sample to prove our claims and Territory offer. **KAR-NU CO.** Dept. L-30, Oakley Sta. Cincinnati, O.

When writing please mention Popular Mechanics

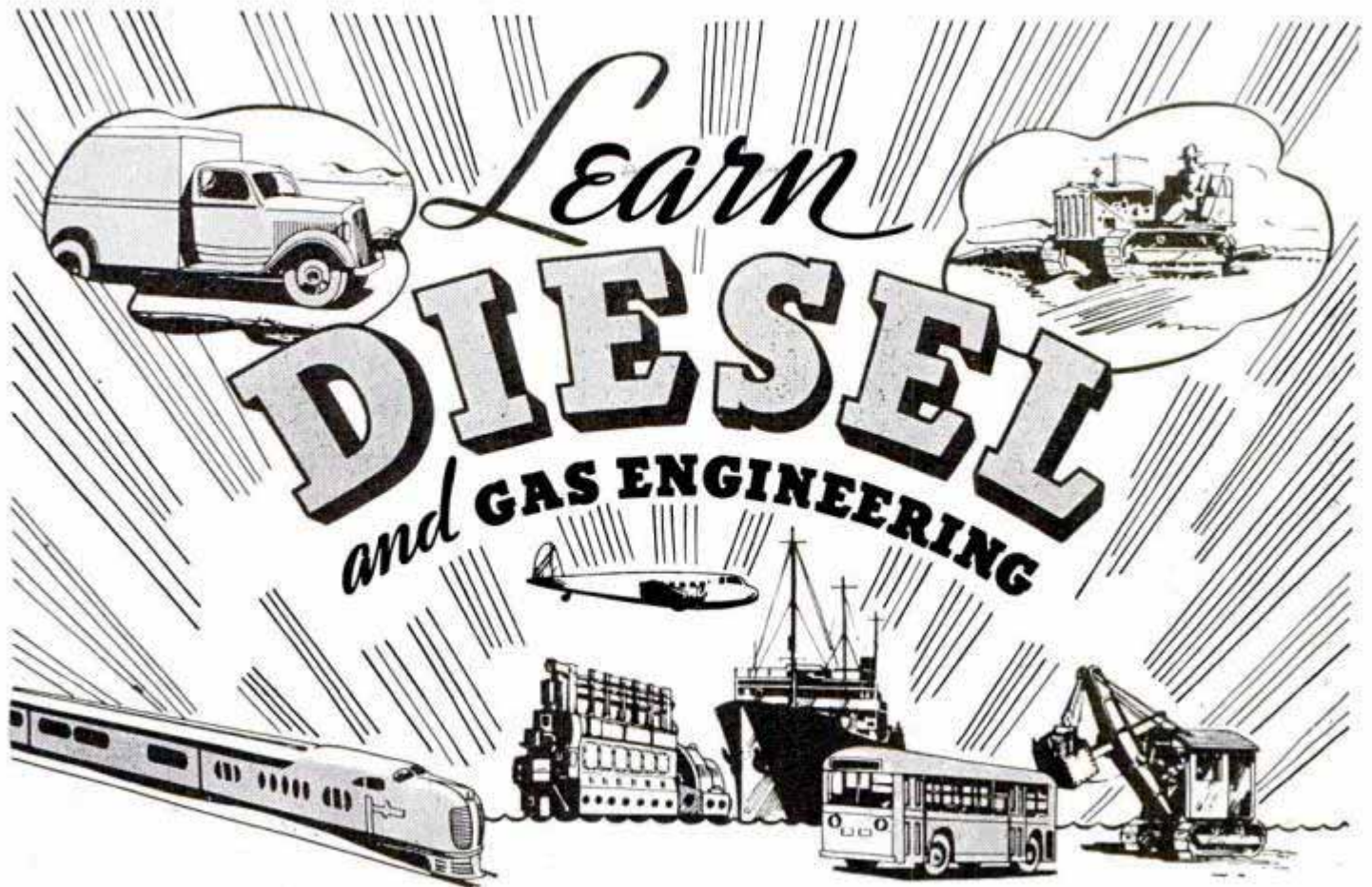

TESTED SYSTEM OF DIESEL AND GAS ENGINE TRAINING

To qualify for a good Diesel job you must receive training in an institution that can offer you **practical** instruction. At National Schools you actually work on the latest equipment, including practically every approved make of Diesel engine. You get the kind of instruction that serves your every day needs in the Diesel field after you have graduated. It's the type of training you can "cash in" on. You are trained under the direct, personal supervision of licensed Diesel Engineers. You learn Diesel and gas engine operation, repair, trouble-shooting, theory.

Easy-to-Learn Master Training

National Schools' training is complete in every respect. It includes all phases of Diesel engines, fuel injection, gasoline, butane, propane and natural gas engines, also Auto-Diesel electrics, machine shop practice, batteries and other essentials that must be learned in order to give you well rounded-out training.

Learn in Los Angeles

The most delightful place to learn—Los Angeles—the playground of America. Fascinating surroundings. Your coach railroad fare will be allowed to Los Angeles from any point in the U. S.

Earn Room and Board

We help students obtain part-time jobs to earn room and board while learning. This service only for residents of U. S.



Partial Room, Diesel Engine Dept.

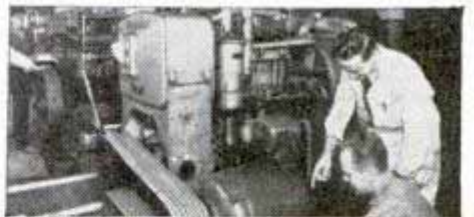

Student Servicing Diesel Electric Unit



Diesel Generating Unit. Diesel Converted Ford Auto

NATIONAL SCHOOLS

Special Added Feature
DIESEL ELECTRIC POWER GENERATION

A new feature essential to the complete training of Diesel experts. Completely covers power generation. This extra course is now presented to all Diesel students without extra tuition.

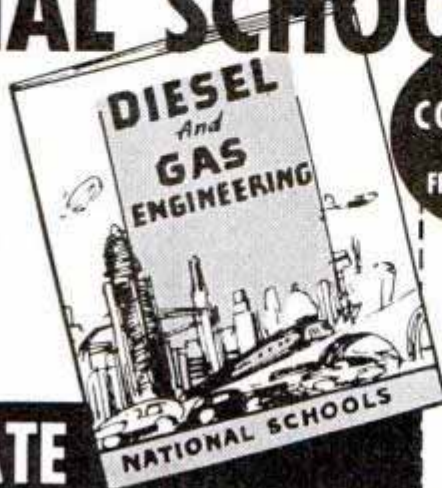

MAIL COUPON for FREE BOOK

National Schools, Dept. 2-PMA
4000 So. Figueroa St., Los Angeles
Send Free Diesel Book of Details.

Name..... Age.....
Address.....
City..... State.....

INVESTIGATE



What Are YOUR Mistakes in English?

They may offend others as much as these offend you

IF some one you met for the first time made the mistakes in English shown above, what would you think of him? Would he inspire your respect? Would you be inclined to make a friend of him? Would you care to introduce him to others as a close friend of yours?

These errors are easy for you to see. Perhaps, however, you make other mistakes which offend other people as much as these would offend you. How do you know that you do not mispronounce certain words? Are you always sure that the things you say and write are grammatically correct? To you they may seem correct, but others may know they are wrong.

Unfortunately, people will not correct you when you make mistakes; all they do is to make a mental reservation about you. "He is ignorant and uncultured," they think. So you really have no way of telling when your English offends others.

FREE—Book on English

Sherwin Cody, perhaps the best known teacher of practical English, has perfected and patented a remarkable device which will quickly find and correct mistakes you unconsciously make. Correct English soon becomes a HABIT.

Mr. Cody's remarkable new invention, the 100% Self-Correcting Method, has already improved the English of more than 100,000 people. No useless rules, no tedious copying, no hard study. Only 15 minutes a day required. You learn by creating the HABIT of using correct English. Nothing like Mr. Cody's method has ever been used before!

A new book, "How You Can Master Good English in 15 Minutes a Day," is ready. It explains Mr. Cody's surprisingly easy method. Get a copy free and learn how to stop making embarrassing errors. You do not want others to judge you unfairly. Merely mail the coupon or a postal card, SHERWIN CODY SCHOOL OF ENGLISH, 52 Searle Building, Rochester, N. Y.

SHERWIN CODY SCHOOL OF ENGLISH
52 Searle Building, Rochester, N. Y.

Please send me your free book, "How You Can Master Good English in 15 Minutes a Day."

Name.....
Address.....
Town..... State.....

If 18 years or under, check here for Booklet A.

NEW models EASIER TO PLAY

Find out about these sensational new Conn Band Instruments. Many wonderful, exclusive features! Today, more than ever, Conns are the "choice of the artists." You'll advance faster and take more pride in a genuine Conn—made by the world's largest manufacturer. See your dealer or write us for Home Trial, Easy Payment offer. Mention instrument.

C. G. CONN, LTD.
231 Conn Bldg., Elkhart, Ind.

CONN
SAX AND INSTRUMENTS

WRITE FOR FREE BOOK

ELECTRICAL ENGINEERING

A BROAD, basic, intensive course complete in one school year. Includes fundamentals of Refrigeration, Air-conditioning, Electronics. Approved by educators, endorsed by industry. 45th year. Catalog.

BLISS ELECTRICAL SCHOOL
132 TAKOMA AVE., WASHINGTON, D. C.

SEND FOR STUDENTS ART

Magazines for Artists, Art Students! Fine drawings, photos, Animals, Birds, Scenery, Human Figure, etc. Over 200 lessons in Cartooning, Chalk-talking, Lettering, Retouching, Figure, etc. Etc. Satisfying 44 all different back issues, 1856 pages, with big Cartoon Book and 3 books "Successful Artists" ALL FOR ONLY \$3. (12 for \$1.) Express. A gold-mine of Art and Inspiration! Student writes—"I would not buy mine if I couldn't replace." You'll like them, too. None free—but YOU CAN'T LOSE—as we guarantee satisfaction or refund.

CUT THIS OUT. Send with order today. Don't wait, supply limited!
LOCKWOOD ART STUDIO, Dept. 370, Kalamazoo, Mich.

LEARN to SELL STOP being a Failure!

Secrets of Successful Salesmen making \$4,000 to \$10,000 a year now available in fascinating Salesmen's Home Training Plan. Coming business boom bound to make good salesmen wanted everywhere at top salaries. **Get into the BIG PAY GROUP** of Master Salesmen through "KNOWING HOW." Two books, "The Key to Master Salesmanship" and "Mistakes Commonly Made in Selling" sent FREE to men who want to get ahead. Write for them today. **NATIONAL SALESMEN'S TRAINING ASSOCIATION, Dept. 109-B, 21 W. Elm St., CHICAGO**

TRAIN FOR Radio 12 Weeks SHOP TRAINING

EASY PAYMENT PLAN
GET DETAILS of MY AMAZING OFFER!

Prepare for Jobs in Radio-Broadcast, Talking Pictures, Television, by twelve weeks of practical shop work in the great Coyne Radio Shops, on real machinery and equipment. You don't need advanced education or experience. Free Employment Service for life. Many earn while learning. Mail coupon today for free book which tells you how hundreds have become successful Radio men after getting a training and all details of my "Pay Tuition After Graduation" Plan.

H. C. LEWIS, Pres., COYNE RADIO SCHOOL
500 S. Paulina Street., Dept. 27-3H, Chicago, Ill.
Send Free Radio Book and facts. Tell now I can pay for my course on easy payment plan after getting my 12 weeks' training.

Name.....
Address.....
Town..... State.....

When writing please mention Popular Mechanics



J. H. McSweeney
Founder and
President

READ What a Few McSweeney-trained men have to say:

Works for the I. H. C.

Been busy since I came back from your school. I am working here for the International Harvester Company at good wages. I like it fine. Nothing like learning a good mechanical trade and getting a good job.—Ardel Sims, Oklahoma City, Okla.

Pays Income Tax Now

Just got through writing check for income tax. Hope to have a place of my own soon. Am happy, pleased with my job and have everything that could make a person contented. The money I spent at your school was the best I ever invested.—Lee Grant, Ravenna, O.

Now Has Steady Job

Have been working for the past 18 months in a garage. I don't find any job I can't handle and I sure don't regret what I spent in your shops.—Hubert Erwine, Marlington, W. Va.

LEARN AUTO MECHANICS

in 8 weeks!

REAL JOBS ARE OPEN for trained men. The automobile business has come back with a rush. Jobs are waiting everywhere—but only for the man who has had **practical training**. Get into the great, thriving automobile industry. Earn \$35 to \$75 a week. McSweeney fits you in just eight weeks to hold down a good high-pay job, or to open your own repair shop. Don't look for a job—**TRAIN** for it!

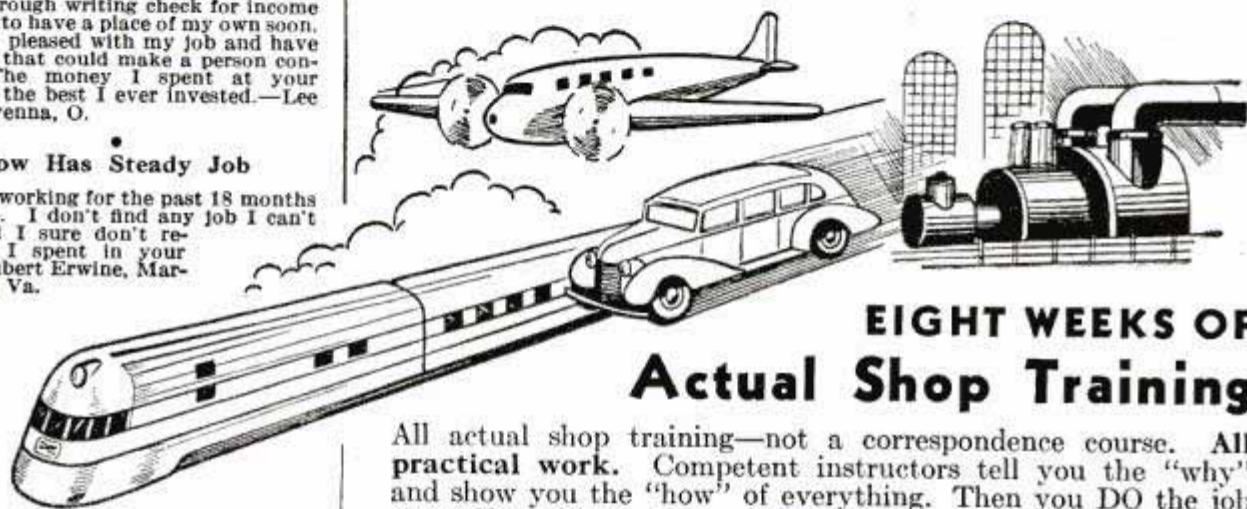

EIGHT WEEKS OF Actual Shop Training

All actual shop training—not a correspondence course. All **practical work**. Competent instructors tell you the "why" and show you the "how" of everything. Then you **DO** the job yourself, working with real tools on real equipment and machines. Complete rounded out training that makes you an experienced and practical mechanic. Read what a few trained McSweeney men have done. Hundreds of others can tell you similar facts. In eight short weeks, you are **TRAINED**, ready for a permanent job at Good Pay. Any man 16 to 50 can learn. Write today for our Free Book and Low Tuition Offer.

Diesel, Aviation and Welding

Here are three important fields. Prepare now for opportunities that lie ahead.

McSWEENEY

TRADE SCHOOL

AUTO—DIESEL—AVIATION—WELDING
DETROIT, MICH. WRITE THE SCHOOL NEAREST YOU KANSAS CITY, MO.

GUARANTEED TRAINING

Eight weeks of intensive shop training, the McSweeney way, fits you for a real job at good pay. If not satisfied, your tuition will be refunded.

FREE

This big illustrated Book will be sent you free. Get the facts about jobs and our Low Tuition Offer. Mail coupon right now.



MAIL COUPON AT ONCE FOR FREE BOOK

McSweeney Auto and Aviation School,
Dept. 10-38, Detroit, Mich., or Kansas City, Mo.
Without cost or obligation, send me your Big FREE Book; also full information about your Low Tuition Offer.

Name.....

Street.....

Town..... State..... Age.....

When writing to advertisers please mention Popular Mechanics

THE ONLY MAN



WHO COULD TALK TO THE SUPERINTENDENT

"SOON after I began studying," a student wrote to us the other day, "we had a change in management at our plant. I certainly was glad then that I had decided to study in my spare time. For, thanks to my I. C. S. Course, I was the only man in the organization who could talk to the Superintendent in his own language. As a result, I was promoted over men who had been here many years longer than I."

That's a true story of what just one I. C. S. student has done. This is proved by letters from satisfied students telling of promotions and increases in salary due directly to spare-time study.

One hour a day, spent with the I. C. S. in the quiet of your own home, will help prepare you for success in the work you like best. *Yes, it will!* Put it up to us to prove it.

INTERNATIONAL CORRESPONDENCE SCHOOLS

Box 5658-H, Scranton, Penna.

Without obligation, please send full particulars about the subject before which I have marked X:

TECHNICAL AND INDUSTRIAL COURSES

- | | |
|--|---|
| <input type="checkbox"/> Architect | <input type="checkbox"/> Diesel Engines |
| <input type="checkbox"/> Architectural Draftsman | <input type="checkbox"/> Aviation Eng. <input type="checkbox"/> Auto Mechanic |
| <input type="checkbox"/> Building Estimating | <input type="checkbox"/> Plumbing <input type="checkbox"/> Heating |
| <input type="checkbox"/> Contractor and Builder | <input type="checkbox"/> Air Conditioning <input type="checkbox"/> Refrigeration |
| <input type="checkbox"/> Structural Draftsman | <input type="checkbox"/> Steam Engineer |
| <input type="checkbox"/> Structural Engineer | <input type="checkbox"/> Steam Electric Engineer |
| <input type="checkbox"/> Electrical Engineer | <input type="checkbox"/> Marine Engineer |
| <input type="checkbox"/> Electric Lighting | <input type="checkbox"/> Civil Engineer <input type="checkbox"/> Highway Engineer |
| <input type="checkbox"/> Welding, Electric and Gas | <input type="checkbox"/> Bridge Engineer |
| <input type="checkbox"/> Reading Shop Blueprints | <input type="checkbox"/> Bridge and Building Foreman |
| <input type="checkbox"/> Telegraph Engineer | <input type="checkbox"/> Surveying and Mapping |
| <input type="checkbox"/> Telephone Work <input type="checkbox"/> Radio | <input type="checkbox"/> R. R. Locomotives <input type="checkbox"/> Air Brakes |
| <input type="checkbox"/> Mechanical Engineer | <input type="checkbox"/> R. R. Section Foreman |
| <input type="checkbox"/> Mechanical Draftsman | <input type="checkbox"/> R. R. Signalmen |
| <input type="checkbox"/> Machinist <input type="checkbox"/> Toolmaker | <input type="checkbox"/> Chemistry <input type="checkbox"/> Pharmacy |
| <input type="checkbox"/> Patternmaker | <input type="checkbox"/> Coal Mining |
| <input type="checkbox"/> Foundry Practice | <input type="checkbox"/> Navigation |
| <input type="checkbox"/> Sheet Metal Worker | <input type="checkbox"/> Cotton Manufacturing |
| <input type="checkbox"/> Boilermaker | <input type="checkbox"/> Woolen Manufacturing |
| <input type="checkbox"/> Heat Treatment of Metals | <input type="checkbox"/> Agriculture <input type="checkbox"/> Fruit Growing |
| <input type="checkbox"/> Management of Inventions | <input type="checkbox"/> Poultry Farming |

BUSINESS TRAINING COURSES

- | | |
|--|--|
| <input type="checkbox"/> Business Management | <input type="checkbox"/> Lettering Show Cards <input type="checkbox"/> Signs |
| <input type="checkbox"/> Industrial Management | <input type="checkbox"/> Stenography and Typing |
| <input type="checkbox"/> Traffic Management | <input type="checkbox"/> Civil Service <input type="checkbox"/> Mail Carrier |
| <input type="checkbox"/> C.P. Accountancy | <input type="checkbox"/> Railway Mail Clerk |
| <input type="checkbox"/> Bookkeeping | <input type="checkbox"/> Grade School Subjects |
| <input type="checkbox"/> Secretarial Work | <input type="checkbox"/> High School Subjects |
| <input type="checkbox"/> Cost Accountant | <input type="checkbox"/> College Preparatory |
| <input type="checkbox"/> Salesmanship <input type="checkbox"/> Advertising | <input type="checkbox"/> First Year College Subjects |
| <input type="checkbox"/> Service Station Salesmanship | <input type="checkbox"/> Illustrating <input type="checkbox"/> Spanish |
| <input type="checkbox"/> Business Correspondence | <input type="checkbox"/> Cartooning <input type="checkbox"/> French |

DOMESTIC SCIENCE COURSES

- | | |
|---|--|
| <input type="checkbox"/> Professional Dressmaking and Designing | <input type="checkbox"/> Millinery |
| <input type="checkbox"/> Home Dressmaking | <input type="checkbox"/> Foods and Cookery |
| <input type="checkbox"/> Advanced Dressmaking | <input type="checkbox"/> Tea Room and Cafeteria Management, Catering |

Name.....Age.....

Address.....

City.....State.....

Present Position.....

If you reside in Canada, send this coupon to the International Correspondence Schools Canadian, Limited, Montreal, Canada

When writing please mention Popular Mechanics

DANCE IN 5 HOURS

A whole family can learn from one set!



Realize your ambition—become a good dancer quickly, easily, at home! Arthur Murray, world-famous dance authority, with his new picture course teaches you popular Fox Trot, Waltz steps, poise, balance, correct following, self-assurance. No music or partner needed. Write today for 10 Lesson Introductory Course. Pay postman \$1.98 when he brings Course or send \$2 with order and save 24c postage. Try it 5 days. If not delighted with results money promptly refunded.

ARTHUR MURRAY, Studio 298, 7 E. 43 St., N.Y.C., N.Y.



BE A CARTOONIST

AT HOME IN YOUR SPARE TIME under personal supervision of the famous cartoonist NORMAN MARSH creator of "DAN DUNN" appearing every day in big papers. Success—Fame—Real Money may be Yours when you learn Marsh's easy simple methods and secrets. Send name and six cents—stamps or coin—for details of MARSH'S Personal course. ACT TODAY! MARSH CARTOON SCHOOL Chicago Daily News Bldg., Dept. B-1, Chicago, Ill.

IF YOU WANT

a new easy-to-learn business-profession and all the business you can take care of... BE A NEW KIND OF FOOT SPECIALIST! Good money after few weeks of spare time reading at home. New system. No Medicine or surgery. No expensive equipment needed. Low cost training on easy terms. Earn while you learn. Chartered 1915 by State of Illinois. Write D. N. Higbe, AMERICAN COLLEGE, Dept. C-2, 54 W. Illinois St., Chicago

NOT ALL BEAUTIFUL VOICES ARE GOD-GIVEN

More often it is the divinely inspired DETERMINATION to develop and perfect the gift that accounts for the rich beauty of a fine voice. One of the men who has done most to help earnest students is a master in this inspiration. His method of developing both speaking and singing voices (without the use of scales or singing lessons) has been so successful that he guarantees 100% improvement—or therein no cost for his simple instructions. Scores have found his Perfect Voice System the stepping stone to fame and fortune in opera, radio, concert stage and public speaking. His 120-page book, fully illustrated, will be sent free to anyone interested in developing a beautiful and magnetic voice for singing or speaking. Just send a postcard with your name and address to Prof. Eugene Feuchtinger, 64 East Lake Street, Studio 1352, Chicago, Illinois.

CRIME DETECTION
SECRET SERVICE
AND
FINGER PRINTS

SECRET SERVICE BOOK
FREE

Sent to you For 30 Days Reading

No Money Down—Actual Crime Cases—
If You Act Quick!—We will send you this stirring book on Crime Detection, Secret Service and Identification Work for 30 days free reading. Send no money. If you decide to keep it then send only \$1.00. If not, return it. WRITE TODAY. Not sent to boys under 17 years of age.

T. G. Cooke, Dept. 1352, 1920 Sunnyside Ave., Chicago

PLAY GUITAR

We Guarantee to teach you for 2c a day. Full particulars FREE.

Write today.

HAMANN INSTITUTE, 3015 N. 24 Place, Milwaukee, Wisconsin

RADIO ENGINEERING

broadcasting, aviation and police radio, servicing, marine and Morse telegraphy taught thoroughly. Nine months' engineering course equivalent to three years' college radio work. School established 1874. All expenses low. Catalog free.

Dodge's Institute, Ada St., Valparaiso, Ind.



Minstrels

Unique First Parts for complete show with special songs and choruses. Make-up. Catalog free.

T. S. Denison & Co., 623 S. Wabash, Dept. 19 Chicago



Lend Me Your Body for 7 Days...

and I'll Give You **PROOF**
I Can Make **YOU**
a **NEW MAN!**



**WIN THIS
STERLING SILVER CUP
BEING GIVEN AWAY BY**

Charles Atlas

**Holder of Title "World's
Most Perfectly Developed
Man"**

This valuable cup, made of solid sterling silver, stands about 14 inches high on a black mahogany base. I will award it to my pupil who makes the most improvement in his development within the next three months.

**Get my free
book by mail-
ing coupon
below.**



**48-PAGE
BOOK
FREE**

It tells you all about my **Dynamic-Tension** method, and how it has made big muscled men out of run-down specimens. It shows you, from actual photos, how I have developed my pupils to the same perfectly balanced proportions of my own physique. What my system did for me and hundreds of others it can do for you too. Don't keep on being only half the man you CAN be! Find out what I can do for you.

Where shall I send your copy of "Everlasting Health and Strength"? Put your name and address on the coupon, or a postcard. Mail it today. **CHARLES ATLAS**, Dept. SP, 115 East 23rd Street, New York, N. Y.

NECK
17 IN.

FOREARM
14½ IN.

BICEPS
17 IN.

CHEST
NATURAL
47 IN.

WAIST
32 IN.

THIGH
23¼ IN.

CALF
16 IN.

WEIGHT
178 lbs.

HEIGHT
5 ft. 10 in.

NOTE!
This is the latest photo of Charles Atlas showing how he looks today. This is not a studio picture but an actual untouched snap-shot.

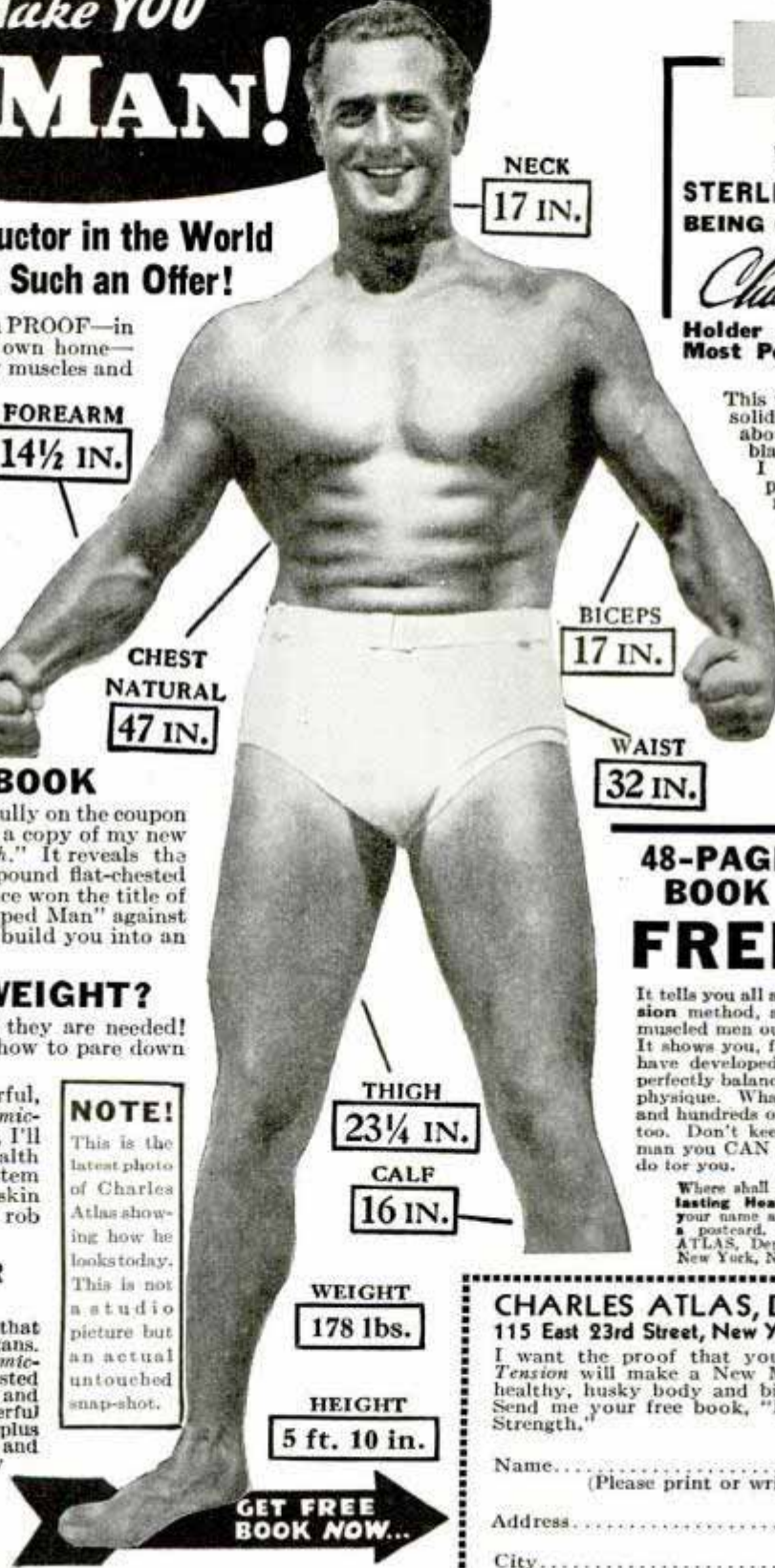

**No Other Physical Instructor in the World
Has Ever DARED Make Such an Offer!**

ALL I want is a chance to give you **PROOF**—in just 7 days, and right in your own home—that I can give **YOU** the mighty muscles and boundless energy you want! Right in the first week under my guidance you will see and feel the improvement! Then as my weekly instructions arrive in your home you continue to re-build, renew and "overhaul" your body. By the end of three months you are the owner of a powerful body that you will be proud to display.

People will notice the ruddy glow of health in your face, the sparkle in your clear eyes, your broad shoulders, and they will seek your company. You will be the fellow who walks off with the prettiest girl and best job while others wonder how you did it!

GET MY FREE BOOK

Write your name and address carefully on the coupon below. I'll send you, absolutely free, a copy of my new book, "Everlasting Health and Strength." It reveals the secrets that changed me from a 97-pound flat-chested weakling into a husky fellow who twice won the title of "The World's Most Perfectly Developed Man" against all comers! And it shows how I can build you into an "Atlas Champion" the same way.

ARE YOU UNDERWEIGHT?

I'll add pounds of muscles where they are needed! Are you fat in spots? I'll show you how to pare down to fighting trim.

And with the big muscles and powerful, evenly-developed body that my **Dynamic-Tension** method so quickly gives you, I'll also give you through-and-through health—health that digs down into your system and banishes constipation, pimples, skin blotches and similar conditions that rob you of the good things of life.

I'VE GOT NO USE FOR CONTRAPTIONS

I haven't any need for contraptions that may strain your heart and other vital organs. I don't dose you or doctor you. **Dynamic-Tension** is all I need. It's my natural tested method for developing real men inside and out. It distributes added pounds of powerful muscles over your body, gets rid of surplus fat, and gives you the vitality, strength and pep, that win you the admiration of every woman and the respect of any man.

Get my free book. "Everlasting Health and Strength!" Mail my coupon today. Gamble a stamp to prove I can make **YOU** a new man!

**GET FREE
BOOK NOW...**

**CHARLES ATLAS, Dept. 8P
115 East 23rd Street, New York, N. Y.**

I want the proof that your system of **Dynamic-Tension** will make a New Man of me—give me a healthy, husky body and big muscle development. Send me your free book, "Everlasting Health and Strength."

Name.....
(Please print or write plainly)

Address.....

City.....State.....

This MACHINISTS' Home-Study Course



helps men get ahead

Newly assembled—specially priced—these five recent books give you the practical facts on modern machines, up-to-date methods, you need to advance in machine shop work. Take advantage of the other man's experience as found in books, to solve your problems, increase your efficiency, with the new

Library of MODERN MACHINE SHOP PRACTICE

5 volumes—2000 pages—1600 illustrations

(A combined home-study course and reference library)

This library of machine shop practice was written for practical men. It gives you the best methods for every kind of machine shop work. It fully explains lathes, drills, and other machine tools and their operation, automatic screw machines, speeds and feeds, gear design and production, punch and die work, metal finishing, etc., etc. Plainly written—completely illustrated—the best kind of help to the machine-shop man who wants to advance himself.

No money down—special price—easy payments.

FREE EXAMINATION COUPON

McGRAW-HILL BOOK CO., 330 W. 42nd St., New York

Send me for ten days' free examination the Library of Modern Machine Shop Practice. If satisfactory I will send you \$1.50 in 10 days and \$3.00 monthly until the price of \$16.50 is paid. If not wanted, I will return the books postpaid. (To insure prompt shipment write plainly and fill in all lines.)

Name
Home Address.....
City and State.....
Position
Name of Company..... PM-2-37

INVENTORS

WE OFFER YOU 61 YEARS OF
PATENT EXPERIENCE

FREE THESE VALUABLE GUIDES FOR INVENTORS

C. A. Snow & Co., Registered Patent Attorneys, are specialists in obtaining all classes of patents, trademarks and copyrights. We have served tens of thousands of inventors. Our clients include many large National Corporations as well as individuals. Yet our fees are standard.

We invite you to take advantage of our long years of experience in patent matters and we offer you absolutely free our "Certification Of Invention", a document originated by us. In addition we will give you our complete handbook on patent procedure, "How We Protect You" and "Suggestions On How To Commercialize Your Invention".

Deferred payment on request. Mail the Coupon Today!

-----Cut Coupon On Dotted Line-----

Dept. A-14, Snow Bldg., Washington, D. C.

Gentlemen: Please send me absolutely free and without obligation on my part, your free guides for inventors.

Name _____

Address _____

City _____ State _____

C. A. SNOW & CO.

Registered Patent Attorneys Since 1875



Make Big MONEY!

as a Salesman

Train in your spare time for the best-paying profession in the world. Pick your field—control your income—be independent! LaSalle-trained salesmen in every section report promotions and advancement. Low cost; easy terms. Write now for valuable 64-page book, "The Modern Salesman"—FREE.

Dept. 264-S

LaSalle Extension University, Chicago

Learn to Draw

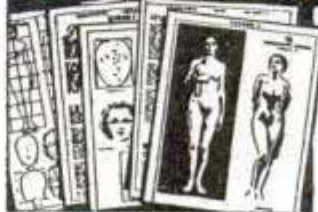

for pleasure and profit. At home—by mail. No experience necessary. You study from photos of artist's models just as they pose in the life class.

FIRST LESSON FREE

Send name and address and only 10c to cover mailing cost to—

TOWERTOWN STUDIOS, Dept. 236
520 N. Michigan Ave., Chicago, Ill.

JOBS FOR THOUSANDS



New opportunities open. Calls are increasing for men trained in **Drafting, Air Conditioning, Electricity, Housing, Engineering or Radio.** Choose your position if you have C. T. C. training. Free help to job when ready. No time to lose—start training now. B. S. Degree or shorter courses. 34th year, accredited. Send post card for 80 pg. "Blue Book." Mailed FREE.

CHICAGO TECHNICAL COLLEGE
B75 Tech Bldg., 118 East 26th St. Chicago, Ill.



Learn Public Speaking

At home—in spare time. Many overcome "stage-fright," gain self-confidence, and increase their earning power, through ability to sway others by effective speech. Write for free booklet, *How to Work Wonders With Words* and requirements.

NORTH AMERICAN INSTITUTE, Dept. 1352
3601 Michigan Avenue Chicago, Illinois

BECOME A VENDING MACHINE OPERATOR!

Own a "chain" of 10 peanut and chewing gum vending machines. Large, steady profits, as people eat peanuts and chew gum daily. Start with \$100. Write for details today!

D. ROBBINS & CO.

1141P DeKalb Ave. BROOKLYN, N. Y.

PLAY GUITAR!



FREE Gibson BOOK

Win popularity and bigger income with a Gibson Guitar, Banjo or Mandolin. Easy to play, beautiful in tone, exclusive features. You learn quickly. Free Book gives valuable facts. Send coupon now for your copy and details of trial offer, easy payment plan.

GIBSON, INC., 7203 Parsons St., Kalamazoo, Mich.

Without obligation please send me free book showing the quick way to popularity and success, and details of trial offer on [] Guitar [] Banjo [] Mandolin.

Name _____

Street _____

City _____ State _____

When writing please mention Popular Mechanics

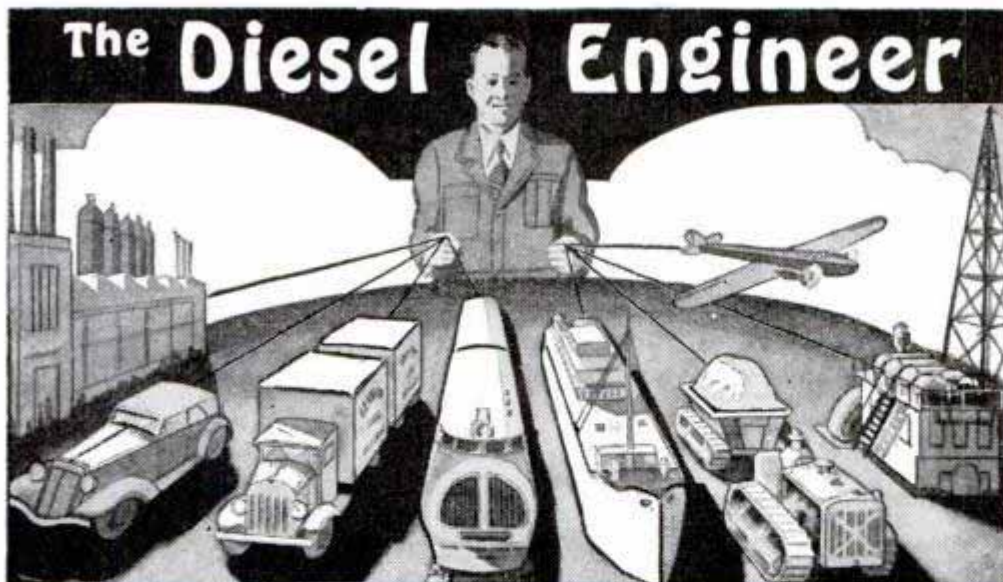

The Diesel Engineer

Is Your Job Safe?

Just as the gasoline engine changed or wiped out the jobs of thousands who depended on horse-drawn vehicles for their living—just as electricity changed the entire set-up in the fields of light and power—so now the Diesel engine is fast invading both the power and transportation fields, and threatening the present jobs of thousands of workers.

If jobs in your line are steadily growing scarcer, you owe it to yourself to investigate this new, progressive, uncrowded line, that in our opinion will offer good openings for the next 25 years.

2 Beginning Lessons in Diesel Engineering Free

Diesel—The New, Fast-Growing Power

Diesel engines—because of their high efficiency, dependability, and economy of operation—are fast replacing steam and gasoline engines in power plants, motor trucks and busses, locomotives and ships, aircraft, dredges, drills, pumps, etc.—opening up an increasing number of well-paid jobs for Diesel-trained men. The field of Diesel Engineering is on the upgrade and continually expanding. It will provide steady employment, advancement and good pay for those properly trained in this new industry.

What This New Field Offers You

Now is your chance to get into a big new industry and grow up with it to an important position. Today there is practically no competition in the Diesel field, but the increasing use of Diesel engines will result in keen competition for jobs in the near future. By starting your training now, you can keep ahead of such competition.

American School, Dept. D-245, Drexel at 58th Street, Chicago, Illinois

You get complete information on all the latest Diesel developments—two- and four-stroke cycles; low- and high-speed and heavy duty types; Diesel-electric generating systems, etc.—in our course. Includes all text material—with special diagrams for quick understanding of this new power.

Get 2 Lessons FREE to Prove Your Own Possibilities in Diesel

Can you learn Diesel? We want to give the opportunity of finding out. So, *without cost or obligation on your part*, we will send you 2 beginning lessons. In the quiet of your own home, look them over. See how clearly all is explained—how thoroughly you grasp every point—how definitely you progress step by step—so that your knowledge of Diesel grows constantly. Making this simple trial may be the turning point in your life—so write to us **TODAY!**

Turn Your Spare Time into Dollars

ARTISTS MAKE MONEY

Find out your ability. Send name, age, occupation and address for Free Vocational Art Test.
Federal Schools, Inc., 2137 Federal Schools Bldg., Minneapolis, Minn.

Be a GUNSMITH

Learn this fascinating, big pay profession at home. Repair, restock, blue, check, refinish, make new parts, etc. Write for Prospectus.

GUILD SCHOOL OF GUNSMITHING, Dept. A-2, Newark, O.

LEARN WATCHMAKING AND ENGRAVING

BY OUR PROFIT-SHARING PLAN
OUR GRADUATES SUCCEED

One of our Iowa students started in a very small way—now doing over \$30,000 a year. Another in Wisconsin, over \$10,000 the first year. Day or night classes. Call or write for FREE BOOK.
Chicago School of Watchmaking, Dept. 4801, 155 N. Clark St., CHICAGO.

Correspondence Courses in RADIO and ELECTRICAL ENGINEERING

SPECIAL Only \$25
ELECTRICAL ENGINEERING covers complete electrical field. Most modern course. Very understandable.
RADIO ENGINEERING. Ultra-modern course in radio, public address, photo-electric work. Trains you to be super-service man, real vacuum tube technician. Tuition ONLY \$25, either course. Deferred payment plan. WRITE TODAY for free copies of school catalogs, student magazines, etc.
LINCOLN ENGINEERING SCHOOL

931-9 So. 37th St., Lincoln, Nebr.

AUDELS MATHEMATICS AND CALCULATIONS FOR Mechanics

\$2

A
HANDY
BOOK

Good News!

MATHEMATICS AND CALCULATIONS FOR HOME STUDY AND REFERENCE

PRACTICAL MATHEMATICS ILLUSTRATED. How to figure correctly. EVERY MECHANIC can use the new, correct, easy methods, covering a complete review of practical arithmetic—with examples including mensuration—plane and solid geometry—trigonometry—algebra—calculus—ELECTRICAL and MECHANICAL SHOP CALCULATIONS—practical tests—reference tables and data—how to use the slide rule—700 pages—550 illustrations—pocket size.

Highly endorsed. Let us mail you copy for free trial. Price \$2, postpaid.



FREE
EXAMINATION
COUPON

THEO. AUDEL & CO.
49 W. 23rd St., N. Y. C.

Mail Audel's Mathematics on 7 days' free trial. If O. K. I will remit \$2, otherwise I will return it.

Name
Address
Occupation P. M.

When writing to advertisers please mention Popular Mechanics

✓ How to make MONEY WITH YOUR CAMERA

**Big Demand for Photos YOU Can Take!
Learn at Home—in Spare Time**

DO you realize how many photographs are in this ONE issue of this ONE magazine? Multiply that by the thousands of publishers who buy photographs. THAT gives an idea of the pictures being bought EVERY MONTH!

WHO GETS the money paid for these pictures? YOU can get your share, no matter where you live or what you are doing NOW! Many of these pictures are supplied by amateur photographers—ordinary non-professionals who have learned how to take pictures THAT SELL!

Turn Your Hobby into a Profitable Profession

You don't have to be an expert to make money in this fascinating field! You don't have to live amidst the whirl of exciting daily news events. You don't even need a special camera, or expensive equipment. It is NOT technical ability that publishers pay for. It's the knack of knowing WHAT to photograph, HOW to photograph it, and WHERE to sell it, that brings in the money! It's SALABLE and MARKETABLE pictures—full of human interest and popular appeal—that you must learn how to produce . . . not technically beautiful examples of photographic genius! Send for FREE BOOK which tells all about the simple training which quickly prepares you, right at home, to make the kind of pictures that SELL.

FREE BOOK

Get your copy of "How to Make Money with Your Camera." Page 1 shows you the vast scope of the field. Page 7 tells the kind of snapshots that can bring you a good income. And on pages 12, 13, 14 and 15 are printed the pictures and letters of others who, even 4 or 5 weeks after enrollment, are already making good money.

This is The Age of Photographs. Your own eyes tell you that! Your own Camera can cash in on it! Read the reports here—from ordinary people who have always liked to do a little snapshot work—and who have NOW discovered a way to turn their hobby into money.

There's money in YOUR camera too! Mail coupon at once for this FREE BOOK telling you how easy it is to get it out! UNIVERSAL PHOTOGRAPHERS, Dept. 72, 10 West 33rd Street, New York City.

CLIP-SIGN-MAIL NOW

**UNIVERSAL PHOTOGRAPHERS,
Dept. 72, 10 West 33rd St., New York City.**

Send me without cost or obligation, booklet, "How to Make Money with Your Camera."

Name.....

Address.....

City..... State.....

(No Salesman Will Call)

When writing please mention Popular Mechanics



\$50 for His VERY FIRST WORK!

A famous magazine paid L. D. Eldridge, of St. Paul, Minn., \$50.00 for the very first work he submitted.

Made \$237.00 WHILE LEARNING

That's what O. Hastings, of Dunstable, Mass., earned while learning "how to take pictures that sell."

3 CHECKS IN 1 WEEK

York McClary, of Belviders, Ill., another of our members, writes: "Received three checks this week. I owe you a lot for starting me on this path."

AMATEUR CARTOONISTS WIN \$25.00

Wanted—Amateurs with humorous ideas. No drawing ability necessary. The amateurs of today are the professional cartoonists of tomorrow. Ideas judged and prizes awarded by Applause-O-Meter test before movie audiences. Everyone has an equal chance. 26 cash prizes in all. Rush name on post card for "Valuable Tips on How to Make Money With Simple Cartoons and Humorous Ideas," Cash Prize Entry Blank and Rules—Send No Money.

CARTOONISTS' EXCHANGE, Dept. 92-A, Pleasant Hill, Ohio

PRACTICAL ELECTRIX

This new and unique publication is written for the man who wants to KNOW, BUILD, REPAIR, and READ about electrical APPARATUS and MACHINERY. It explains the theory and actual work in simple words, drawings, and illustrations. Chock-full of IDEAS THAT can be used in the SHOP, HOME and FARM. 25c a copy postpaid. S. W. Duncan, Publisher, Desk 2, 408 S. Hoyne Ave., Chicago



BULL DOG Trailer HITCH



CHEAPEST TRAILER INSURANCE in the world. DROP FORGED Bull Dog Hitch NEVER LETS LOOSE! GUARANTEED AGAINST BREAKAGE. Certified tensile strength up to 52,400 lbs. Unfastens easily at any angle BUT ONLY when desired. Wear compensator prevents back lash, lost motion, noise. A type for every trailer. Used EXCLUSIVELY by Biggest Trailer Manufacturers. WRITE TODAY for FREE details. (Include only 50c for latest Guaranteed Trailer Builder's Guide.) HAMMER BLOW TOOL CO. Dept. BD-2 WAUSAU, WIS., U. S. A.

HOME STUDY COURSES

Home-Study Courses, leading to Degrees in Arts and Sciences; Education; Writing; Psychology; Chemistry; Business and Commerce; Law; Theology; Agriculture; Engineering; also courses in Business Training; Accounting; Advertising; Sales Management; Public Speaking; Radio. Many others. Low Cost; Easy Terms. McKinley-Roosevelt College of Arts and Science, 4247 Clarendon Ave., Chicago

Learn ADVERTISING at Home

Greater opportunities now in advertising. Learn easily and quickly in spare time. Practical work. No text books. Old established school. Low tuition—Easy terms. Send for free booklet of interesting information.

Page-Davis School of Advertising
Dept. 1352, 3601 Mich. Av., Chicago

STOP Your Rupture Worries!

Why suffer with that rupture? Learn about my Appliance for reducible rupture. Automatic air cushion assists Nature to close the opening—has relieved thousands of men, women and children. No obnoxious springs or hard pads. No salves or plasters. Sent on trial to prove it. Beware of imitations. Never sold in stores. Write today for confidential information sent free in plain envelope. Brooks Company, 111-G State Street, Marshall, Michigan

How To Secure A Government Position

Why worry about strikes, layoffs, hard times? Train now for a Government job. Increased salaries, steady work, travel, good pay. Let me help you become a Railway Postal Clerk, Post Office Clerk, City Mail Carrier, Rural Carrier—or help you get any position in government Classified Service you want. I was a Secretary Examiner of Civil Service Commission for 8 years. My coaching has helped thousands. My 32-page book tells about Government jobs—and how my instruction helps to qualify you to get the one you want. Send for a free copy TODAY.

A. R. Patterson, Civil Service Expert
PATTERSON SCHOOL, 82 Case Bldg., Rochester, N. Y.
Send, without obligation, free book "How to Secure Government Position."

Name.....

Address.....



**"THOUSANDS OF
NATURALLY SKINNY"
WEAK, RUNDOWN, NERVOUS
FOLKS HAVE MADE THIS
AMAZING DISCOVERY!**

How New Sea Plant Concentrate from the Pacific Ocean by Feeding IODINE-STARVED GLANDS, Has Quickly Renewed Energy, Built Glorious NEW STRENGTH for Thousands. Gains of 5 to 25 Lbs. Reported Regularly!

Here's new hope and encouragement for thousands of thin, tired, weak, worn-out, haggard-looking men and women whose energy and strength have been sapped by overwork and worry, who are nervous, irritable, always half-sick and ailing. Science has at last placed its finger on what is often one of the principal causes of this dangerous, rundown condition—IODINE-STARVED GLANDS. When these glands don't work properly, all the food in the world can't help you. It just isn't turned into flesh. The result is you stay skinny, rundown, ailing.

The most important gland—the one which actually controls body weight and strength building—needs a definite ration of iodine all the time—NATURAL ASSIMILABLE IODINE—not to be confused with chemical iodides which often prove toxic. Only when the system gets an adequate supply of iodine can you regulate metabolism—the body's process of converting digested food into firm flesh, new strength and energy.

To get this vital mineral in convenient, concentrated and assimilable form, take Seedol Kelpamalt—now recognized as the world's richest source of this precious substance.

Make This Test!

Make this test with Seedol Kelpamalt. First weigh yourself and see how long you can work or how far you can walk without tiring. Then take 3 Seedol Kelpamalt Tablets with each meal for 1 week and again weigh yourself and notice how much longer you can work without tiring, how much farther you can walk. Notice how much better you feel, sleep and eat. Watch flattering extra pounds appear in place of scrawny hollows.

Money-Back Guarantee

If you are not absolutely satisfied with the results of even the first week, the trial is free and your money will be refunded. Seedol Kelpamalt costs but little to use. Your own doctor will approve this way. 100 Jumbo size Seedol Kelpamalt Tablets—four to five times the size of ordinary tablets—cost but a few cents a day to use. Get Seedol Kelpamalt today. Seedol Kelpamalt is sold at all good drug stores. If your dealer has not yet received his supply, send \$1.00 for special introductory size bottle of 65 tablets to the address below.

SEEDOL Kelpamalt Tablets

● Manufacturer's Note:—Inferior products imitating the genuine Seedol Kelpamalt are being offered as substitutes. Don't be fooled. Demand genuine Seedol Kelpamalt Tablets. Results guaranteed or money back.

SPECIAL FREE OFFER

Write today for fascinating instructive 50-page book on How to Add Weight Quickly. Build Strength, Energy, Weight, Strong Nerves and Rich Red Blood. Mineral contents of Food and their effects on the human body. New facts about NATURAL IODINE. Standard weight and measurement charts. Daily menus for weight building. Absolutely free. No obligation. Kelpamalt Co., Dept. 1092, 27-33 West 20th St., New York City.



**IT'S THIS TINY
GLAND STARVING
FOR IODINE THAT
OFTEN KEEPS YOU
WEAK, RUNDOWN,
NERVOUS & SKINNY**

**3 Steps in
the Building
of Good Solid
Flesh, Rich
Blood, New
Strength.**

1. Ordinary food enters stomach and is partially digested.
2. Digestion completed in intestines and flesh and strength-building material absorbed in blood stream.
3. Metabolism, when regulated, by glands kept healthy with iodine, should assure conversion of material into firm, new flesh, rich, red blood, rugged strength and day-long energy.

*Posed by
professional
model.*

When writing to advertisers please mention Popular Mechanics



STAMPS



... and Collecting

F 158¹⁹

By Richard McP. Cabeen
 R. 900, 333 N. Michigan, Chicago

THE beginner at stamp collecting will find stamps in a large packet which he cannot classify. Some do not give the country of origin, others give it in the strange characters of oriental lands. To sort such stamps, consult a standard catalog or an experienced collector.

Many types of stamps will be memorized for no collector has time to learn what the characters and inscriptions really mean.

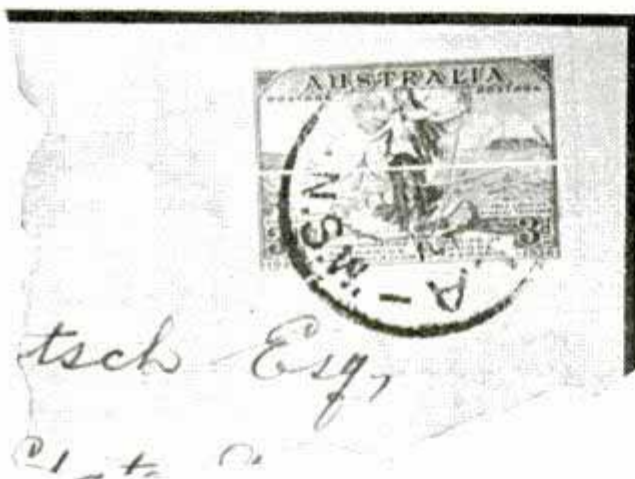

Australian stamp issued to celebrate establishment of submarine telephone service between Tasmania and Australia

Flags and coats of arms often assist in determining the country which issued stamps, and the currency unit sometimes gives a clue. With all the stamps sorted according to countries, you begin to arrange your stamps in sets by placing all of a single design together.

Colors usually differ for the various values. Some countries cannot be sorted in this manner for there are no standard designs or sizes and all denominations differ in color, size and in the picture itself. The standard catalog shows pictures of all of the types and designs issued by foreign countries. Even though you arrange a very presentable sorted collection, you need a catalog to separate the different issues of a country.

Many nations have used a single design

many years, perhaps changing the entire series of colors one or more times, but more often changing the paper upon which the stamps are printed or the size and spacing of perforations. The catalog lists such changes. Variations in the gauge of perforations may be neglected by beginners when more than one gauge was in use at the same time. A change in paper may be due to several causes. There may be danger of counterfeiting, or it may be necessary to distinguish new stamps from those which have been counterfeited. The quality of paper may be altered, due to a change in printing, or it may be desired to improve the paper in some cases and cheapen it in others, or it may be impossible to obtain a further supply of certain kinds of paper. Important changes in paper usually are listed in the catalog as a complete new issue.

The stamp papers most important to the beginner are those known as wove paper, laid paper and granite paper. Nearly all commercial paper is of the first variety, including newspapers and magazines. When held before a strong light this paper presents a uniformly even appearance in some cases, while in others a mesh of fine, uniformly spaced dots is evident. Laid paper, when given the same test, shows a series of parallel lines. These lines may be spaced very close or far apart and may be crossed at intervals by similar lines. Granite or Silurian paper usually appears colored slightly due to the presence of fine unbleached fibers.

It may be necessary to use a magnifying glass to determine whether the specimen is on granite or ordinary colored or toned paper. This granite paper may be either wove or laid, although nearly all such paper used for stamps is wove.

Watermarks are designs which cause the paper to appear more transparent where they occur. They are impressed in the

(Continued to page 50A)

New Invention! WITH SUPERCHARGE PRINCIPLE SAVES GAS

MORE SPEED
MORE POWER
NEW MOTOR LIFE
QUICKER STARTING
UP TO 30% GAS SAVINGS



Guaranteed Gas Savings

VACU-MATIC proves itself on every car. It is guaranteed to give worthwhile gas savings, quicker pick-up, and more power or it costs you nothing. You can instantly tell the difference in added power and motor performance — you quickly notice the cash savings on gasoline.

Fits All Cars

VACU-MATIC is constructed of six parts, assembled and fused into one unit, correctly adjusted and sealed at the factory. Nothing to regulate. Any motorist can attach VACU-MATIC in ten minutes. Once in, its only reminder is the surge of instant power and speed it gives to the motor and the savings it affords your pocketbook.

Free Details

You owe it to yourself to know all about this remarkable discovery. Mail the coupon below. Start saving gas with VACU-MATIC and enjoy a new driving thrill! There's no obligation—so get the facts now! Write today!

USERS REPORT
3 TO 7 MILES MORE PER GALLON
MOTORIST SAVES
\$180⁰⁰ A YEAR

"On an International truck on a round trip to Cleveland, 385 miles, it saved 19 gallons of gas."—James Seely, N. Y.

"On my V-8 Ford, it works miracles. Its added power, acceleration and top speed has sold me. The results are unbelievable."—Ralph Fields, Mass.

"Very glad to say, the Buick showed an increase of 5 miles more per gallon."—A. V. Grove, Washington.

"On my Plymouth, I obtained an average of 22 miles per gallon, an increase of 7 miles. This means a saving of \$15 a month or \$180 a year."—F. S. Peck, Calif.

"It saves me one gallon a day. I had to buy 5 gallons each day—now only 4 gallons."—L. V. Sweet, Pa.

"My Chevrolet certainly runs smoother, has more power and snap to it since I put the Vacu-Matic on."—J. H. Nelson, Minn.

"On my Dodge 8 I am getting 6 more miles per gal., with more power and pick-up, which is all anyone could ask."—Lee D. Esty, Calif.

"I have twelve Vacu-matics on cars now, and they all show an increase in mileage. The car owners are very well pleased."—Fred Taylor, Okla.

"I averaged 25 miles per gallon on a trip with a model A Ford at 40 miles per hour, where before I only averaged 20. Also better pickup and smoother running."—Wm. Lyons, Calif.

"I have been placing Vacu-matics on expert mechanics' cars. All are well pleased."—J. W. Donahue, W. Va.

VACU-MATIC

the Carburetor Control that "BREATHES"

AT LAST! Automotive engineers have smashed down the barriers to perfected combustion! The new VACU-MATIC solves the secret of greater power! With almost magical action, this amazing invention instantly puts new life and pep in any motor. It adds mileage to every gallon of gasoline . . . produces split-second pick-up, sensitive accelerator response, quicker starting, greater speed and smoother running.

Automatic — Nothing Like It!

The self-starter—four wheel brakes—knee action—stream-lining . . . and now VACU-MATIC! The sensational money-saving invention! With it, engineers have achieved a practical means of balancing air and gasoline automatically for all speeds.

Vacu-matic is entirely different! It operates on the super charger principle by automatically adding a charge of extra oxygen, drawn free from the outer air, into the heart of the gas mixture. It is entirely AUTOMATIC and allows the motor to "breathe" at the correct time, opening and closing automatically as required. No idling troubles—no carburetor adjustments necessary. It is so simple it will amaze you—so practical it will save you many dollars on gas costs.

Agents and Salesmen

VACU-MATIC offers a splendid opportunity for unusual sales and profits. Every car, truck, tractor and motorcycle owner a prospect. Valuable territories now being assigned. Check and mail coupon.

— — — FREE OFFER COUPON — — —

THE VACU-MATIC COMPANY

7617-277 W. State St., Wauwatosa, Wis.

Gentlemen: Please send me full particulars concerning the Vacu-matic and details of your Free Offer. This of course does not obligate me in any way.

Name

Address

City State.....

Check here if interested in selling proposition.

The VACU-MATIC Co.

Wauwatosa, Wis.

When writing to advertisers please mention Popular Mechanics

Snap out of it!

The

depression's over

● THE question is, are you over the depression? Tough? You bet it was — it was the toughest depression this country ever had. But listen: *The future is the brightest that ever beckoned a man.* Opportunity calls from every side — calls to ambitious and trained men! If you have the ambition, the International Correspondence Schools can supply the training. Get going! Snap out of it! Hurry this coupon along to Scranton.

INTERNATIONAL CORRESPONDENCE SCHOOLS

Box 5655-H, Scranton, Penna.

Without obligation, please send full particulars about the subject before which I have marked X:

TECHNICAL AND INDUSTRIAL COURSES

- | | |
|--|---|
| <input type="checkbox"/> Architect | <input type="checkbox"/> Diesel Engines |
| <input type="checkbox"/> Architectural Draftsman | <input type="checkbox"/> Aviation Eng. <input type="checkbox"/> Auto Mechanic |
| <input type="checkbox"/> Building Estimating | <input type="checkbox"/> Plumbing <input type="checkbox"/> Heating |
| <input type="checkbox"/> Contractor and Builder | <input type="checkbox"/> Air Conditioning <input type="checkbox"/> Refrigeration |
| <input type="checkbox"/> Structural Draftsman | <input type="checkbox"/> Steam Engineer |
| <input type="checkbox"/> Structural Engineer | <input type="checkbox"/> Steam Electric Engineer |
| <input type="checkbox"/> Electrical Engineer | <input type="checkbox"/> Marine Engineer |
| <input type="checkbox"/> Electric Lighting | <input type="checkbox"/> Civil Engineer <input type="checkbox"/> Highway Engineer |
| <input type="checkbox"/> Welding, Electric and Gas | <input type="checkbox"/> Bridge Engineer |
| <input type="checkbox"/> Reading Shop Blueprints | <input type="checkbox"/> Bridge and Building Foreman |
| <input type="checkbox"/> Telegraph Engineer | <input type="checkbox"/> Surveying and Mapping |
| <input type="checkbox"/> Telephone Work <input type="checkbox"/> Radio | <input type="checkbox"/> R. R. Locomotives <input type="checkbox"/> Air Brakes |
| <input type="checkbox"/> Mechanical Engineer | <input type="checkbox"/> R. R. Section Foreman |
| <input type="checkbox"/> Mechanical Draftsman | <input type="checkbox"/> R. R. Signalmen |
| <input type="checkbox"/> Machinist <input type="checkbox"/> Toolmaker | <input type="checkbox"/> Chemistry <input type="checkbox"/> Pharmacy |
| <input type="checkbox"/> Patternmaker | <input type="checkbox"/> Coal Mining |
| <input type="checkbox"/> Foundry Practice | <input type="checkbox"/> Navigation |
| <input type="checkbox"/> Sheet Metal Worker | <input type="checkbox"/> Cotton Manufacturing |
| <input type="checkbox"/> Boilermaker | <input type="checkbox"/> Woolen Manufacturing |
| <input type="checkbox"/> Heat Treatment of Metals | <input type="checkbox"/> Agriculture <input type="checkbox"/> Fruit Growing |
| <input type="checkbox"/> Management of Inventions | <input type="checkbox"/> Poultry Farming |

BUSINESS TRAINING COURSES

- | | |
|--|--|
| <input type="checkbox"/> Business Management | <input type="checkbox"/> Lettering Show Cards <input type="checkbox"/> Signs |
| <input type="checkbox"/> Industrial Management | <input type="checkbox"/> Stenography and Typing |
| <input type="checkbox"/> Traffic Management | <input type="checkbox"/> Civil Service <input type="checkbox"/> Mail Carrier |
| <input type="checkbox"/> C.P. Accountancy | <input type="checkbox"/> Railway Mail Clerk |
| <input type="checkbox"/> Bookkeeping | <input type="checkbox"/> Grade School Subjects |
| <input type="checkbox"/> Secretarial Work | <input type="checkbox"/> High School Subjects |
| <input type="checkbox"/> Cost Accountant | <input type="checkbox"/> College Preparatory |
| <input type="checkbox"/> Salesmanship <input type="checkbox"/> Advertising | <input type="checkbox"/> First Year College Subjects |
| <input type="checkbox"/> Service Station Salesmanship | <input type="checkbox"/> Illustrating <input type="checkbox"/> Spanish |
| <input type="checkbox"/> Business Correspondence | <input type="checkbox"/> Cartooning <input type="checkbox"/> French |

DOMESTIC SCIENCE COURSES

- | | |
|---|--|
| <input type="checkbox"/> Professional Dressmaking and Designing | <input type="checkbox"/> Millinery |
| <input type="checkbox"/> Home Dressmaking | <input type="checkbox"/> Foods and Cookery |
| <input type="checkbox"/> Advanced Dressmaking | <input type="checkbox"/> Tea Room and Cafeteria Management, Catering |

Name.....Age.....
 Address.....
 City.....State.....
 Present Position.....
 If you reside in Canada, send this coupon to the International Correspondence Schools Canadian, Limited, Montreal, Canada

From **SALESMAN**
 To
HOTEL EXECUTIVE
 In **4 Months**



Delmas Richardson, Former Salesman, Tells How He Became Hotel Manager Through Lewis Course

"Before going to Washington to take the Lewis Hotel Training Course, I was just a salesman earning a small salary. I was discouraged and very unsettled as to my life's work. Hotels had always interested me, so, seeing an advertisement in a magazine, I decided to take the course. Since graduating I have never been unemployed and am very much satisfied with my work. A year ago I took over the management of this hotel and made good. The Lewis Course did it all."

COME TO WASHINGTON

Delmas Richardson is typical of the many Lewis Resident School graduates who have won success from coast to coast in the hotel and institutional field. In four months they were qualified for the position of their choice in this fascinating industry. You have the opportunity to make Delmas Richardson's story YOUR story—if you make the same decision TODAY he made a short time ago. Day Classes start Feb., Sept., Oct., Jan. FREE book gives full details—tells how you are registered. FREE of extra cost, in Lewis Nationwide Placement Service. Write for it TODAY!

LEWIS HOTEL TRAINING SCHOOLS

Div. RPB-308

Washington, D. C.



Learn CHALK TALKING

Entertain for all occasions. Send \$1.00 for Laugh Producing Program of 23 Trick Drawings with Instructions. Catalog of Chalk Talk Supplies Free. BALDA ART SERVICE, Dept. K, Oshkosh, Wis.

DENISON'S PLAYS

Musical Comedies, Operettas, Vaudeville Acts, Minstrels, Comedy Songs, Make-up Goods.

Catalog Free

T. S. Denison & Co, 623 S. Wabash, Dept. 9, Chicago

60 YEARS OF HITS

NO JOKE TO BE DEAF



—Every deaf person knows that—
 Mr. Way made himself hear his watch tick after being deaf for twenty-five years, with his Artificial Ear Drums. He wore them day and night. They stopped his head noises. They are invisible and comfortable, no wires or batteries. Write for TRUE STORY. Also booklet on Deafness.

Artificial Ear Drum

THE WAY COMPANY
 729 Hofmann Bldg. Detroit, Michigan



New POCKET RADIO

MUSIC SPORTS ENTERTAINMENT

FITS POCKET EASILY—Take it with you!

Brings in stations with beautiful clear loud tone! Incorporates such features as direct reception from radio—no dangling phones to bother with—single centralized tuning which is the only moving part—covers broadcast band, etc. You should be thrilled with its excellent performance. Complete in one unit, just like the big sets—but weighs only 6 ozs. Requires no batteries, tubes or electrical connections.

Costs Nothing to Operate—Nothing Else to Buy! Comes to you complete, all ready to listen, with simple instructions for use in hotel, camps, office, home, picnics, bed, boats, etc., and take it with you while traveling, in autos, bicycles, etc. Works immediately. Nothing to adjust. No difficult hook-ups. Should last for years. A GUARANTEED Radio.

SEND NO MONEY! Sent C. O. D. or send money with order. Get the performance—economy—and practicability. Comes in beautiful walnut color with built-in phone and attractive tone grille in upper part of radio. Order now! Be the first to have one. Pay postman on arrival only \$2.99 and few pennies postage. Little Giant Radio Co., 3959 Lincoln Avenue, Dept. 703, Chicago, Ill.



What Strange Powers Did the Ancients Possess?



EVERY important discovery relating to mind power, sound thinking and cause and effect, as applied to self-advancement, was known centuries ago, before the masses could read and write. Much has been written about the wise men of old. A popular fallacy has it that their secrets of personal power and successful living were lost to the world. Knowledge of nature's laws, accumulated through the ages, is never lost. At times the great truths possessed by the sages were hidden from unscrupulous men in high places, but never destroyed.

Why Were Their Secrets Closely Guarded?

Only recently, as time is measured; not more than twenty generations ago, less than 1/100th of 1% of the earth's people were thought capable of receiving basic knowledge about the laws of life, for it is an elementary truism that knowledge is power and that power cannot be entrusted to the ignorant and the unworthy.

Wisdom is not readily attainable by the general public; nor recognized when right within reach. The average person absorbs a multitude of details about things, but goes through life without ever knowing where and how to acquire mastery of the fundamentals of the inner mind—that mysterious silent something which “whispers” to you from within.



Fundamental Laws of Nature

Your habits, accomplishments and weaknesses are the effects of causes. Your thoughts and actions are governed by fundamental laws. Example: The law of compensation is as fundamental as the laws of breathing, eating and sleeping. All fixed laws of nature are as fascinating to study as they are vital to understand for success in life.

You can learn to find and follow every basic law of life. You can begin at any time to discover a whole new world of interesting truths. You can start at once to awaken your inner powers of self-understanding and self-advancement. You can learn from one of the world's oldest institutions, first known in America in 1694. Enjoying the high regard of hundreds of leaders, thinkers and teachers, the order is known as the Rosicrucian Brotherhood. Its complete name is the “Ancient and Mystical Order Rosae Crucis,” abbreviated by the initials “AMORC.” The teachings of the Order are not sold, for it is not a commercial organization nor is it a religious sect. It is a non-profit fraternity, a brotherhood in the true sense.

Not for General Distribution

Sincere men and women, in search of the truth—those who wish to fit in with the ways of the world—are invited to write for complimentary copy of the sealed booklet, “The Secret Heritage.” It tells how to contact the librarian of the archives of AMORC for this rare knowledge. This booklet is not intended for general distribution; nor is it sent without request. It is therefore suggested that you write for your copy to the Scribe whose address is given in the coupon. The initial step is for you to take.

use
coupon
for free
copy of
booklet

Scribe: S. N. V., Rosicrucian Brotherhood, San Jose, California. Please send copy of sealed booklet, “The Secret Heritage,” which I shall read as directed.

Name

Address

City

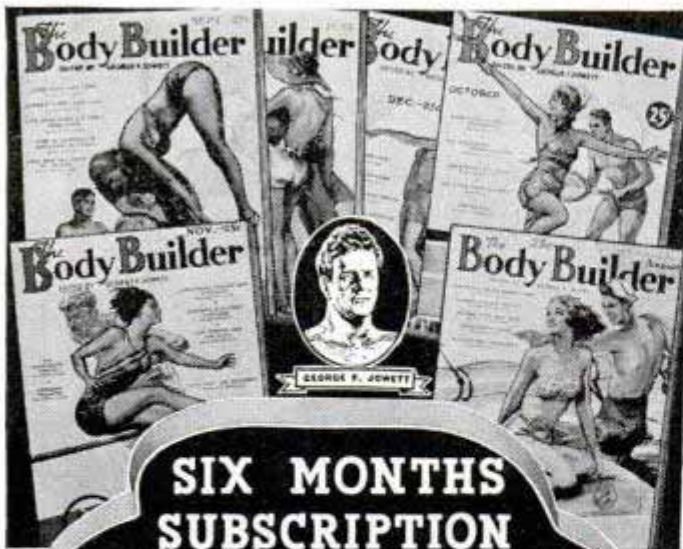

**SIX MONTHS
SUBSCRIPTION
to the
"BODY BUILDER"
included FREE...**

**... If You Send For These Famous
BODY BUILDING COURSES
NOW ALL 6 FOR ONLY \$1.00**

THIS is your chance to get that thrilling, new magazine "The Body Builder" edited by George F. Jowett... FREE for six months! Athletes, trainers, strength fans begged for a magazine like this for years. All the newest discoveries in the field of training... stories of famous strong men... advice on body building for the modern man and girl. This live magazine is yours, absolutely FREE, with every order for these 6 famous body building courses!

BUILD YOUR BODY THE CHAMPIONSHIP WAY!

You want to train your muscles to do things and show their power. There is no place today on the ladder of success for the weakling. Don't let a physical handicap stop you! Many of today's champions were once puny and sickly. THEY knew how to train the right way! Send for these 6 books by George F. Jowett, champion of champions! Learn how to develop those muscles the quickest, surest way!

A \$3 VALUE FOR ONLY \$1

Each book is sold separately for 25c, but we offer you all 6 for only \$1.00. In addition you get FREE a 6-months subscription to "The Body Builder", regularly \$1.50! A \$3.00 value for only \$1.00!

YOU ALSO GET "NERVES OF STEEL" FREE!

Mail your order now and "NERVES OF STEEL, MUSCLES LIKE IRON" will be included FREE! Full of pictures and information. Reach out... Grasp This Special Offer... Rush the Coupon TODAY!



**FREE BOOK WITH PHOTOS
OF FAMOUS STRONG MEN**

**JOWETT INSTITUTE
OF PHYSICAL CULTURE
DEPT. 4 Pd., 422 POPLAR ST., SCRANTON, PA.**
I am enclosing \$1.00 for which send by return mail, postpaid, 6 Book STRONG MAN'S LIBRARY. Subscription to BODY BUILDER, a copy of "NERVES OF STEEL"!
A \$3.00 VALUE, all for \$1.00

Name _____ Age _____
Address _____

PLASTIC RUBBER



BOOTS-SHOES



AUTO TIRES

Hundreds of OTHER USES

Every handy man needs So-Lo! Mends holes in shoes, boots, galoshes, only 1c a repair. Fills cracks and worn places in everything of rubber, leather and cloth. WEARS—and won't come off!

So-Lo Spreads on Like Butter
Dries Tough Overnight
WATERPROOF-FLEXIBLE-NON SKID

Big 25c can contains enough for 25 repairs! Satisfaction guaranteed or money back. Tear out this ad as a reminder to get So-Lo at Kresge's, Woolworth's, Gamble's, Grant's, Green's, Kress', McLellan's, McCrory's, Morris', Murphy's, Neilsner's, Newberry's, Sears', Ward's or at your nearest 10c or hardware store.

Save Your Feet

When all else fails end your suffering with the flexible "no metal" Heelner ARCH SUPPORT



Write for Free Booklet

HEEFNER ARCH SUPPORT CO., 654 Commercial Bldg., LOUISVILLE, KY.

PENNY EACH ! !

Beautiful Window Sign Letters. Lowest Price in America. Finest Quality. 5 Year Guaranteed. New styles. Tremendous Demand. Big Profits. Easily Applied. Record Breaking Offer. FREE Samples and Working Equipment. Hurry!

Atlas Sign Works, 7943 Halsted, Chicago, Ill.



BUCHSTEIN'S FIBRE LIMB



is soothing to your stump—strong, cool, neat, light. Easy payments. Braces for all deformities. Agents wanted.
D. BUCHSTEIN CO.
610 3rd Ave., So., MINNEAPOLIS, MINN.

Get Rid of PIMPLES

Acne, Blackheads, Oily Skin, etc.

Write at once for Great News about Sensational Home Treatment for clearing skin of unsightly Pimples, Acne, Blackheads, Enlarged Pores, Oily Skin and other blemishes. Discovery of Famous Skin Specialist used privately for years with marvelous success. Sent on Trial. You Risk Nothing. **FREE** Send for Free Booklet At Once. Don't suffer embarrassment any longer. **WRITE TODAY.**
SEBOLINE CO., Dept. 31 Box 2408, Kansas City, Mo.

New Pocket Radio

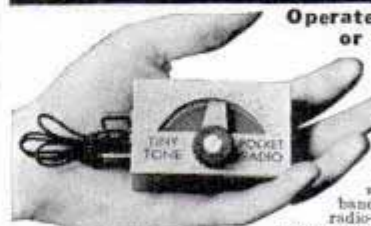

Operates Without Tubes, Batteries or Electric Connections

Amazing midget radio fits in pocket or purse. NEW MODEL weighs only 2 ozs. as shown in ACTUAL photo! Smaller than a cigarette package! Operates and receives stations with beautiful clear tone. Range to 50 miles—MUCH GREATER under good conditions—no noise! Employs Hi-efficiency fused crystal. Not to be confused with cheap imitations. Tunes broadcast band. NOT A TOY, but an unusual practical radio—a sensation everywhere—a delight to anyone every way. Comes in several beautiful colors (state yours). ABSOLUTELY COMPLETE ready to listen with midget phone and instructions to use in hotels, offices, autos, trains, camps, at home, in bed, on bicycles, on sea or wherever you may be. TAKES ONLY A SECOND TO CONNECT—no messy hookups. THOUSANDS OF SATISFIED OWNERS—many report wonderful service in ALL PARTS OF THE WORLD! THESE ARE FACTS! Carry one with you always and be assured of many hours of entertainment AT NO COST! Can be used by ANYONE—even a child! Send only \$1.00—pay postman balance or send \$2.99 (M. O., Cash Check). WE PAY POSTAGE. GUARANTEED. A most unusual value. Foreign orders 75c extra.

TINY TONE RADIO CO., Dept. P-2, Kearney, Nebr.



TO YOUNG MEN — STENOTYPY THE WAY TO SUCCESS!

Stenotypy, the new profession, offers unusual opportunities to ambitious young men. It's a man's way of recording speech in this machine age—a silent little machine that types plain print letters faster than any one can talk. It opens up preferred jobs now—leads to executive careers later. One of the surest, quickest ways to get into Business on the right basis.

Now you can learn Stenotypy at home in your spare time. Low cost—easy terms. Get full details. Write for valuable, free booklet, "Stenotypy, the New Profession," describing the unusual opportunities for young men in this growing field and telling how you may enter it successfully. Write Dept. 204-ST



THE STENOTYPE COMPANY
4101 S. Michigan Ave., Chicago, Ill.

PHOTO-ENGRAVING LEARN IT AT HOME



We Furnish all equipment and materials including large photo-engraving camera complete with lamps, lens and screen. When you have finished the course you can establish a good paying independent business with the equipment furnished or work for others at a big salary. Photo-Engraving offers greater opportunities today than any other industry. Every picture in this issue of Popular Mechanics was engraved by the process we teach you. Earn good money while learning. Write today for our new illustrated catalog which was engraved on equipment such as we furnish. You will not be obligated in any way by writing Aurora School of Photo-Engraving. Dept. 127. Aurora, Mo.

A copper plate to print above picture size 8 by 10 inches sells for \$15.37.

New York Electrical School Established 1902
Ask for free booklet
44 West 17th St., N. Y. C.

CARTOON YOUR WAY TO SUCCESS!



DON'T COPY — LEARN TO ORIGINATE!

RAYE BURNS will teach you HOW to CREATE ORIGINAL CARTOONS at home that you can SELL! Course contains 26 lessons and over 600 illustrations. All for Only **\$2.85**
Send name and address for free details.

RAYE BURNS SCHOOL, Dept. M-X, BOX 2194, Cleveland, Ohio

BARBERING OR BEAUTY CULTURE OLDEST, LARGEST SCHOOLS. Est. 1893. **EARN** while LEARNING. Day, Night classes. Free National employment bureau. Prize winning teachers. Big pay. Professions. Low rates. Easy terms. Free booklet "B."
MOLER SYSTEM, NEW YORK, N. Y., 112 W. 42nd St.

GO TO HIGH SCHOOL AT HOME

MAKE up the education you missed. Study at home in spare time. Your choice of subjects. Expert instruction. Personal service. You make quick progress because you are in a class by yourself. Diploma. Mail coupon today for interesting **FREE BOOKLET.**



INTERNATIONAL CORRESPONDENCE SCHOOLS
Box 5660-H, Scranton, Pa.
Without cost or obligation, please send me full particulars about the course I have checked—

English High School Course
 Civil Service Bookkeeping Accounting
 Salesmanship Advertising

Name.....
Address.....



U.S. GOVERNMENT JOBS

START \$1260 to \$2100 YEAR
MANY 1937 APPOINTMENTS

Railway Postal Clerks

Railway Postal Clerks get \$1,900 the first year regular, being paid on the first and fifteenth of each month. (\$79.17 each pay day.) Their pay is automatically increased yearly to \$2,450. Advance may be had to Chief Clerk at \$2,700 a year. (\$112.50 each pay day.)

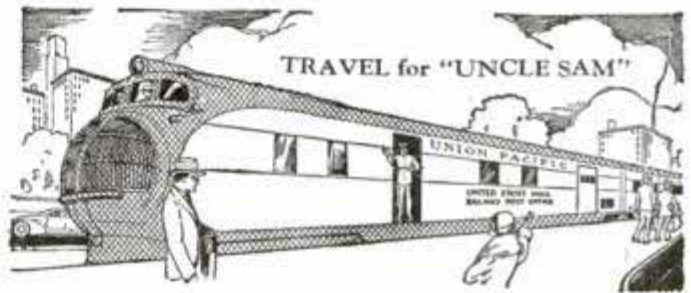

3 Days On—3 Days Off—Full Pay

Railway Postal Clerks on long runs usually work 3 days and have 3 days off duty or in the same proportion. During this off duty their pay continues just as though they were working. They travel on a pass when on business. When they grow old, they are retired with a pension.

City Mail Carriers, Post Office Clerks

Clerks and Carriers now get \$1,700 the first year on regular and automatically increase \$100 a year to \$2,100 and \$2,300.

Customs Inspector

Salary \$2,100 to start. Men 23 to 45. Work connected with examining baggage and merchandise entering the country from foreign parts covering boats, trains, roads, automobiles, etc.

Many Other Positions

Many other positions are obtainable. Those wishing these positions should qualify at once.



Get Free List of Positions

Fill out the following coupon. Tear it off and mail it today—now, at once. This investment may result in your getting a big-paid government job.

FRANKLIN INSTITUTE, Dept. W-173, Rochester, N. Y.

Rush to me, entirely free of charge (1) a full description of U. S. Government Jobs; (2) Free copy of illustrated 32-page book, "U. S. Government Positions and How to Get Them"; (3) List of U. S. Government Jobs; (4) Tell me what to do to get a U. S. Government Job.

Name.....

Address.....

Use This Coupon Before You Mislays It. Write or Print Plainly

When writing please mention Popular Mechanics

JUST OUT!

AUDEL'S DIESEL ENGINE MANUAL
QUESTIONS AND ANSWERS

\$2

If you are interested in the construction, operation and maintenance of modern Diesel engines, you will want this new timely book of practical, useful information.

"AUDEL'S DIESEL ENGINE MANUAL" with Questions and Answers explains in simple, concise language the Fundamental Diesel Principles—Operating Principles—Engine Starting—Air Starting Valves—Fuel Spray Valves—Inlet and Exhaust Valves—Valve Timing—Fuel Pumps—Fuel Injection Compressors—Starting Air Compressors—Scavenging Air Compressors—Pistons and Piston Rings—Cylinders—Lubrication—Cooling Systems—Fuel Oil—The Engine Indicator—Governors—Engine Reversing—Semi-Diesel Engines—High Speed Diesel Engines—Answers on Operation—Horse Power Calculations.

The illustrations and texts are clear and easy to understand. All details are plainly brought out. This book is of extreme value to engineers, operators, students and all who desire a knowledge of the Diesel engine. A handsome book, flexible, with gilt edges. 300 pages—illustrated.

Send for free Diesel folder today.

FREE EXAMINATION COUPON

THEO. AUDEL & CO., 49 W. 23rd St., New York

Please mail a copy of AUDEL'S DIESEL ENGINE MANUAL. If satisfactory, I will remit \$2 on its safe arrival, otherwise I will return the book.

\$2

Name

Address

Occupation PM

AUTO-MECHANICS & WELDERS

GOOD JOBS and Mighty GOOD PAY

Do you want to earn big money? If so let us know which of the following trades you prefer. You learn by doing. Practical work. Expert teachers. Low tuition. Personal attention. It will pay you to investigate **AT ONCE**. Just check the courses you'd like to take and mail today. You will receive full information, absolutely without cost or obligation. But don't delay.

Check the Trade You'd Like to Learn

- Auto Mechanics
- Welding
- Auto Collision
- Spray Painting
- Metal Finishing
- Torch Soldering

Ask about our **"Pay After Graduation Plan"**

Name

Address

Mail the above to

MICHIGAN TRADE SCHOOL

3758 Woodward Avenue DETROIT, MICH.

Write for FREE CIRCULAR

When writing please mention Popular Mechanics

AVIATION Offers the Better Pay Jobs to LINCOLN-Trained Men

Airline Pilots Earn Up to \$700 a Month Licensed Mechanics Up to \$200 a Month

Airlines are adding millions of miles to their Flight Schedules. Airplane factories are crowded with orders for new airplanes. This means thousands of new jobs for men with Lincoln training.

Government Approved School—Now in 27th year, 17 years teaching aviation. A fleet of twelve modern training planes with Government Licensed Flight Instructors trains you for Pilot's License up to Transport License. Modernly equipped Mechanics School with Government Licensed Mechanic Instructors trains you for your Government Mechanic's License. **Make Aviation Your Career.** Unlimited opportunities for promotion. Prepare yourself now at Lincoln with complete training under Government Supervision. We assist Graduates in locating positions as fast as they are qualified. Write for catalog. Please state age.

LINCOLN AIRPLANE & FLYING SCHOOL
Division of Lincoln Aeronautical Institute (Inc.)
205G Aircraft Bldg., Lincoln, Nebraska

AUTOMOBILE RACING New Book
(FOURTH EDITION)

Nine Chapters—66 illustrations of dirt, midget and championship cars and drivers. How to build cars and bodies—14 plates working drawings. Converting stock cars to 135 m.p.h. racers. Answers all questions on speeding up cars, balance, speed, revs., rules, specifications, track records, etc. Postpaid \$1.00, C.O.D. \$1.12. Order NOW. Ray Kuns, Dept. B-2, Madisonville, Cincinnati, Ohio.

LEARN CARTOONING

by the method that has developed hundreds successfully. Send name, address and age for free chart to test your ability.

The Landon School, 1738 National Bldg., Cleveland, Ohio

ARMY AND NAVY SUPPLY CO.

Bargains—Army, Sport Goods, Firearms, Clothes, Shoes, etc. Send 10c for new catalog, to be redeemed on first order

Army & Navy Supply Co., 4772 Lester St., Richmond, Va.

STEP INTO THE Spotlight

FREE LESSONS... A YEAR TO PAY

Banish Boredom... Earn Extra Money START TO PLAY VERY FIRST DAY

Picture the joy of playing a snappy foxtrot, dreamy waltz or mellow old favorite on the Xylorimba. No reason why you shouldn't! Xylorimba is **easiest** of instruments to play and yet the most spectacular. In constant demand by orchestras, radio stations, at lodge meetings and parties. Marvelous opportunity to increase popularity, make big spare-time money. No bothersome practice or exercises. With Free easy lessons you actually **Start to Play Very First Day.**

BIG FREE BOOK tells all about Deagan line, liberal trial offer and easy payments. Send coupon today for your free copy.

J. C. Deagan, Inc., Dept. 1452, 1770 Berceau Ave., Chicago

Send me, without obligation, full details of Free Trial offer and easy-payment plan on the Deagan Xylorimba.

Name

Address

FUN - PROFITS LEARN TAXIDERMY

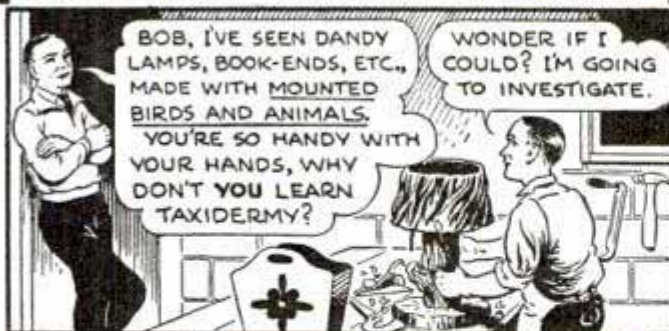

Mount Birds and Animals

Exciting hobby. Easily, quickly learned at home. Fun, fascinating, profitable. Rush Coupon for Free Book.

SPORTSMEN: Save your trophies. Game is growing scarcer—every specimen is valuable—keep them. Have your own museum. Mount for other sportsmen: **Birds—Animals—Game-heads—Fish.** Simple instructions—use your spare time. No experience necessary.

WILD GAME NOT NEEDED Use common, even domestic specimens. Mount in humorous poses, squirrels, frogs, rabbits, owls, mice, pigeons, many other kinds. Taxidermy has a thousand new interests—work them out at your work bench. You will be amazed and delighted with this New Hobby.

TAN skins and furs. Make all kinds of leathers for all purposes. **Genuine Simple Rapid Chrome Methods**, superior to All other home methods ever used. This Tanning alone, is a trade, a home-business.

EXTRA MONEY from spare time. Sell your mounted specimens. Rent them for window displays. Sell to schools. All sportsmen Now desire to have their trophies mounted. With wild-game diminishing, Taxidermy is in greater demand. Many students report \$30 to \$75 a month from Spare Time—and have Big Fun at the same time.

FREE BOOK Now Free. Mail Coupon or postal Today. This marvelous and unique Book tells all about Taxidermy, how you can learn at home, how to make your own museum, how to develop a profitable side-line business, how to make your Spare Time and Work Bench Pay Fine Cash Profits. It will bring you Fun—Fascination—Profits. Clip the coupon this Minute. You will always be Glad that you did. State your Age.



Free Book Coupon

NORTHWESTERN SCHOOL OF TAXIDERMY,
3372 Elwood Building, Omaha, Nebraska
Gentlemen: Please send at once, your free 48-page book on Taxidermy without any obligation on my part. Tell me how I can learn Scientific Taxidermy at home.
Name _____ Age _____
Address _____

FREE BOOK

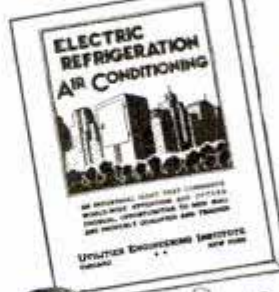

HERE'S PROOF U. E. I. TRAINING HELPS MEN GET JOBS

"Got job with Mr. H., one of the men to whom you wrote letters . . . signing up to take your course was one of the wisest things I ever did."
L. E. C., Calif.

"Called on Mr. W. of the Ideal Refrigeration Company and the fact I had training with U. E. I. got me job. Mr. W. is a U. E. I. graduate."
W. F. L., Mich.

"Secured employment with C. & S., one of firms to which you referred me . . . taking full charge of Service Departments."
R. K. W., Ill.

"Am now employed by Frigid-aire in charge of assembly of self-contained room coolers . . . would never have made it without your training."
J. S. S., Ohio.

"Commenced your course in March. It is now November and through your recommendation I obtained position with S. & M. of this city . . . and have already been promoted to field work."
F. C. M., Neb.

"I had no trouble locating job paying better than expected, thanks to U. E. I. training and opportunity you extended."
O. I. B., Okla.

The Same Opportunity May be Yours
MAIL COUPON TODAY

TELLS HOW TO EARN UP TO \$30-\$50 and more WEEKLY!

ELECTRIC REFRIGERATION AIR CONDITIONING

Think of it, Man! Here are two new rapidly growing industries that offer the very opportunity you are looking for. Big Pay, Fascinating Work and an extremely bright Future. Here's what one of America's best-known engineers says about YOUR opportunity. He states, "The greatest demand today is for specially trained men and the big question facing the industry is how these men are to be found." Here's a condition that spells O-P-P-O-R-T-U-N-I-T-Y for you—in great big capital letters.

Where would you be today if you had been able to cash in on one of the opportunities offered by the Radio and Automobile Industries when they were new? Think how men's salaries soared—how "beginners" were skyrocketed into permanent prosperity. RIGHT NOW the opportunities offered in Refrigeration and Air Conditioning are just as big as they ever were in the Radio or Auto fields. And they're getting BIGGER every day.

MEN NEEDED NOW

RIGHT NOW there are new jobs for thousands in Electric Refrigeration and Air Conditioning. Prepare for your opportunity at home in spare time by U. E. I.'s low-cost, easy-pay plan. Learn EVERYTHING—Engineering, Estimating, Installation and Servicing under a highly successful system that has brought outstanding results during the past TEN YEARS. Then get practical experience in one of our large, completely equipped Laboratories where you'll learn by doing.

LET US HELP YOU PREPARE FOR A BIG PAY JOB

Decide now to prepare for a big-pay, full time or spare time position in Electric Refrigeration and Air Conditioning—as we have helped hundreds of others. U. E. I. trained men are now employed by leading manufacturers, distributors and service organizations throughout the United States, Canada and elsewhere. U. E. I. Employment Service is offered you FREE of extra cost. What it has done for others it can do for you. Mail the Coupon for Book of Facts about your opportunity.

UTILITIES ENGINEERING INSTITUTE

Established 1927

400-410 N. Wells St., Dept. 127, Chicago, Ill.

Utilities Engineering Institute, Dept. 127, 400-410 N. Wells St., Chicago, Ill.
Please send me your Free Book telling about MY opportunity in Air Conditioning and Electric Refrigeration. I have marked the one that interests me most.
 Air Conditioning. Electric Refrigeration.
NAME.....
ADDRESS.....
CITY.....STATE.....

"I have **REDUCED**
MY WAIST 8 INCHES
WITH THE WEIL BELT!"

... writes *George Bailey*

**Wear the WEIL BELT for
10 days at our expense!**

YOU will appear many inches
slimmer at once and in 10 days
if your waist line is not 3 inches smaller
it will cost you nothing. "I reduced 8 inches"
... writes Geo. Bailey. "Lost 50
lbs.," writes W. T. Anderson ... Hun-
dreds of similar letters.

If you do not

**REDUCE Your WAIST
3 INCHES in 10 DAYS**

... it will cost you nothing!

**NO DIET, DRUGS OR
EXERCISES**

You will be completely comfortable
as the massage-like action and
gentle pressure of your Weil Belt
persistently eliminate fat with
every move! Gives an erect, ath-
letic carriage ... supports ab-
dominal walls ... keeps diges-
tive organs in place ... and
with loss of fat come increased
pep and vigor.

Fat endangers your health. In-
surance Companies know the dan-
ger of fat accumulations. So don't
wait any longer ... act TODAY!



SEND FOR 10 DAY FREE TRIAL OFFER

THE WEIL COMPANY, INC., 562 HILL ST., NEW HAVEN, CONN.

Gentlemen: Send me FREE, your illustrated folder describing The Weil Belt and full details of your 10 DAY FREE TRIAL OFFER.

Name

Address

City State

Use coupon or send name and address on penny postcard

Diesel... *the NEW POWER*

The amazing performance of the Diesel powered Burlington Zephyr trains has opened a new era of power efficiency. Airplanes, automobiles, great industrial plants will soon be using these marvelously efficient engines. This means a new profession, a new trade for thousands of men. Learn Diesel operation, construction and repair NOW through our brand new quick reference cyclopedia.

5 Big Books Shipped FREE

for examination. If you want to get into the most promising new field of the century, the liveliest, most up-to-date, most talked of profession, send for these books on our amazing free shipment offer. Over a thousand pages profusely illustrated and right up to the minute. Examine these books, read them, test them and if not thoroughly satisfied return them at our expense and you won't owe us one cent.

➔ Consulting Membership Included

Send now and we will include without extra charge a one year consulting membership in the American Technical Society with privilege of consultation with our engineers on any difficult problem.

AMERICAN TECHNICAL SOCIETY
Drexel at 58th Street, Dept. 0219, Chicago, Illinois.

You may send me the new 5 volumes on Diesel Engineering for ten days free examination. I will pay the few cents express only. Will examine the books and return them in ten days unless I decide to keep them, in which case I agree to send you \$2.00 in ten days and \$3.00 a month until the introductory price of only \$15.00 is paid.

Name

Address

City State

Please attach a letter giving age, occupation and the name and address of your employer and that of at least one business man as reference.

STAMPS and COLLECTING

(Continued from page 42A)

pulp during manufacture, and may be used in both wove and laid paper. All the papers may be colored by dye. A few stamp papers are "surface colored," by applying a thin coating of color upon the finished paper. Silk paper has a few silk fibers scattered through it and some varieties of safety thread paper have continuous silk threads imbedded in them.

Army and Navy Heroes Issues

The first values of the much advertised sets of stamps to commemorate national heroes of the army and navy are appearing. These issues were originally announced last May. The one-cent values were finally placed on sale on December 15. The one-cent stamp for the army shows the portraits of George Washington and Nathaniel Greene, on either side of a view of Mount Vernon. The one-cent value for the navy shows John Paul Jones and John Barry flanking a view of naval vessels of their time. The two-cent stamps will show Andrew Jackson and Zachary Taylor for the army, and Thomas MacDonough and Stephen Decatur for the navy. The three-cent values show U. S. Grant and W. T. Sherman, and David G. Farragut and David D. Porter. Robert E. Lee and Stonewall Jackson are scheduled for the four-cent army stamp, while Admirals Dewey, Sampson and Schley will adorn the four-cent navy stamp. The five-cent values have been given over to views of the military and naval academies at West Point and Annapolis. These latter will have their first-day sales at the cities mentioned, but all others have been or will be placed on first-day sale at Washington.

The Lesser Gold Coins

Although a pattern piece of a one-dollar gold coin was struck in 1836, regular minting did not begin until 1849. One-dollar gold pieces were minted at Philadelphia from 1849 until 1889; at Charlotte, N. C., from 1849 until 1855 and again in 1859; at Dahlonega, Ga., from 1849 until 1860; at New Orleans from 1849 until 1853 and also in 1855; at San Francisco in 1854, and from 1856 until 1860, and again in 1870. Since 1902 the Philadelphia mint has coined eleven varieties of commemorative

(Continued to page 74A)

Earn Cash at Home!

RAISE NEW GIANT PATENTED MUSHROOMS

WE BUY ALL CROPS AT GUARANTEED PRICES* THRU 25 COAST-TO-COAST BRANCHES

*Backed by \$5000 Guarantee Bond!



BIG BOOK and PICTURES FREE!

USE CELLAR, SHED, BARN, ETC.

We paid Rev. Schuster, Mich., \$286 in two weeks. Mrs. M. McDonald, Texas grower, received \$238 for three-week cellar crop! Exceptional? Yes, but wasted space of your home may bring moderate income. Why not find out?

AMAZING GUARANTEE ON NEW "BLENDED" SEED

Secret process produces fastest-growing seed in United's 29-year history. Must grow profitable crops—or new seed free! Novel "Movie Book" directions show every step in pictures—end guesswork—**increase profits.**

SEND NO MONEY

Full details furnished in plain wrapper; no cost, no obligation, no solicitor will call. Postcard will bring you big book and photos.

UNITED MUSHROOM CO.
3848 Lincoln Ave., Dept. 72,
Chicago, Ill.

SPECIAL OFFER: While they last! Free copies of "Handy Hints," mushroom growers' newspaper, sent with book and photos. Write today!

More GOOD JOBS in DRAFTING NOW!

Calls for Draftsmen Are Increasing! Want-ads prove it. Steel mills—railroads—buildings—all are "on the up" . . . all are calling for Draftsmen. New fields like Air Conditioning and Diesels join in the call—"Give us more trained DRAFTSMEN." Some who read this advertisement will do nothing. Others, smart enough to realize this means Opportunity, will Send A Post Card or Mail The Coupon for Free Trial Lesson.



This Complete Drawing Outfit, Tools and table sent to Chicago Tech Home-Study students in Drafting.

The draftsman's work comes first. When business improves . . . and it is improving . . . there is new construction work, new buildings, new machines, repairs and reconstruction work. All these must first be laid out on paper. So the FIRST man that must be hired is the DRAFTSMAN.

Drafting is Well-Paid Work

Drafting is clean, interesting professional-type work. It pays good to start . . . offers real opportunities for promotion. You need no previous training or experience . . . no special talent—to learn Drafting. It is one of the steadiest employment fields. No machine ever did the Draftsman's work . . . and no machine can be invented. So your job is always secure.

Learn at Home in Spare Time

(or at the College in Chicago,) by the fascinating, easy, step-by-step plan originated by this 34-year old school for Draftsmen. This is the way thousands of successful men started their careers. Begin yours without delay . . . terms are low . . . and we help you to a job when ready. Send now for



AMAZING NEW BUSINESS Sell to Stores

Get Set for Life!

MAKE up to \$65 WEEKLY

In new kind of wholesale business. Place famous line 5c-10c goods with stores. Merchants grab our FREE GOODS Deals. 200 fast-selling products—all on salesmaking Counter Displays. Up to 140% profit for you and merchant. No experience or investment to start. Big catalog and facts FREE. World's Products Co., Dept. 2810, Spencer, Ind.

CHEMISTRY

A CAREER OF SERVICE AND PROFIT

No FIELD of human endeavor offers greater possibilities today than chemistry. All progress is dependent upon this fascinating science. And right at home, in spare time, you can learn the fundamentals by study of the International Correspondence Schools modern course. Send for booklet.

...INVENTION—a field of opportunity for men with ideas

If you have an inventive turn of mind, this new International Correspondence Schools Course in inventing and patenting will teach you all the basic knowledge you must have in order to earn real money from your talents. Mail the coupon today.



INTERNATIONAL CORRESPONDENCE SCHOOLS

Box 5659-H, Seranton, Penna.

Explain fully about your course in the subject marked X:

- | | |
|--|---|
| <input type="checkbox"/> CHEMISTRY | <input type="checkbox"/> INVENTION |
| <input type="checkbox"/> Radio | <input type="checkbox"/> Air Conditioning |
| <input type="checkbox"/> Aviation | <input type="checkbox"/> Architecture |
| <input type="checkbox"/> Refrigeration | <input type="checkbox"/> Accountancy |
| | <input type="checkbox"/> Advertising |
| | <input type="checkbox"/> Electrical Engineering |
| | <input type="checkbox"/> Drafting |
| | <input type="checkbox"/> Show Card Lettering |

Name.....Age.....

Address.....

FREE TRIAL LESSON in DRAFTING



Sample this easy-lesson system of learning Drafting. Send post card or this coupon. No charge now or later for this FREE LESSON. Prove to yourself how easy it is to learn Drafting by the CTC Method.



Chicago Technical College

B208 Tech Bldg., 118 E. 26th St., Chicago, Ill.

Send me FREE BOOK as checked below. No obligations.

DRAFTING—in Spare Time—AT HOME.

DRAFTING, at Chicago Tech—IN CHICAGO.

Name..... Age.....

Address.....

P. O..... State.....

Other C.T.C. money-making training by home-study shown below. Check one of these if you prefer it to Drafting.

- | | |
|--|--|
| <input type="checkbox"/> Air Conditioning and Refrigeration. | <input type="checkbox"/> Builders' Course for Carpenters and Builders. |
|--|--|

When writing please mention Popular Mechanics

Why Trained Accountants Command High Salaries

—and how ambitious men are qualifying by the LaSalle Problem Method

GET this straight.

By "accountancy" we do not mean "bookkeeping." For accountancy begins where bookkeeping leaves off.

The skilled accountant takes the figures handed him by the bookkeeper, and *analyzes* and *interprets* them.

He knows how much the costs in the various departments should amount to, how they may be lowered.

He knows what profits should be expected from a given enterprise, how they may be increased.

He knows, in a given business, what per cent of one's working capital can safely be tied up in merchandise on hand, what per cent is safe and adequate for sales promotion. And these, by the way, are but two of *scores* of percentage-figures where-with he points the way to successful operation.

He knows the intricacies of government taxation.

He knows how to *survey* the transactions of a business over a given period; how to show in cold, hard figures the progress it has made and where it is going. He knows how to *use* these findings as a basis for constructive policies.

In short, the trained accountant is the *controlling engineer* of business—one man business cannot do without.

Small wonder that he commands a salary two to ten times as great as that of the bookkeeper. Indeed, as an independent operator (head of his own accounting firm) he may earn as much as the president of the big and influential bank in his community, or the operating manager of a great railroad.

Some Examples

Small wonder that accountancy offers the trained man such fine opportunities—opportunities well illustrated by the success of thousands of

LaSalle accountancy students.* For example—one man was a plumber, 32 years old, with only an eleventh grade education. Today he is auditor for a large bank and his income is 325 per cent larger.

Another was a drug clerk at \$30 a week. Now he heads his own very successful accounting firm with an income many times as large.

A woman bookkeeper—buried in details of a small job—is now auditor of an apartment hotel, and her salary mounted in proportion to her work.

A credit manager—earning \$200 a month—moved up quickly to \$3000, to \$5000, and then to a highly profitable accounting business of his own which nets him better than \$10,000 a year.

And What It Means to You

Why let the other fellow walk away with the better job, when right in your own home you can equip yourself for a splendid future in this profitable profession?

Are you really *determined* to get ahead? If so, you can start at once to acquire—by the LaSalle Problem Method—a thorough understanding of Higher Accountancy, master its fundamental principles, become expert in the practical application of those principles—this without losing an hour from work or a dollar of pay.

Preliminary knowledge of bookkeeping is unnecessary. You will be given whatever training, instruction or review on the subject of bookkeeping you may personally need—and without any extra expense to you.

If you are dissatisfied with your present equipment—if you recognize the opportunities that lie ahead of you through home-study training—you will do well to send at once for full particulars. The coupon will bring them to you without any obligation, also details of LaSalle's convenient payment plan.

Check, sign and mail the coupon NOW.

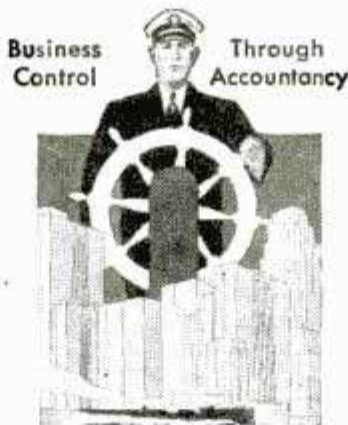

Business Control Through Accountancy

LaSalle Extension University

DEPT. 264-HR CHICAGO

Opportunities in Accountancy—Check below and we will send you a copy of "Accountancy, the Profession that Pays," without obligation.

Higher Accountancy:

Other LaSalle Opportunities: If more interested in one of the other fields of business indicated below, check here:

- | | |
|---|---|
| <input type="checkbox"/> Business Management | <input type="checkbox"/> Modern Foremanship |
| <input type="checkbox"/> Modern Salesmanship | <input type="checkbox"/> Personnel Management |
| <input type="checkbox"/> Traffic Management | <input type="checkbox"/> Expert Bookkeeping |
| <input type="checkbox"/> Law: Degree of LL. B. | <input type="checkbox"/> C. P. A. Coaching |
| <input type="checkbox"/> Commercial Law | <input type="checkbox"/> Business English |
| <input type="checkbox"/> Industrial Management | <input type="checkbox"/> Stenotypy |
| <input type="checkbox"/> Business Correspondence | <input type="checkbox"/> Effective Speaking |
| <input type="checkbox"/> Credit and Collection Correspondence | <input type="checkbox"/> Railway Accounting |

Name

Present Position

Address

*Names available on request.

When writing to advertisers please mention Popular Mechanics

**WORLD'S
BEST
WANT AD
MEDIUM**

CLASSIFIED Advertisements



Advertisements in this section, 35 cents per word, each insertion, minimum 10 words, payable in advance

To be inserted under proper classification in March issue, copy should be in our office January 8th

March issue on sale February 1st

Popular Mechanics Magazine, 200 East Ontario Street, Chicago, Illinois

YOU'LL PROFIT

By reading and answering the classified ads in this section. Hundreds of opportunities to make and save money.

Mr. F. W. Johnson, Manager, Classified Advertising,
Popular Mechanics Magazine, Chicago.

Dear Sir: I have been a constant advertiser in the classified columns of Popular Mechanics Magazine for some time and I am very glad to say that the results obtained from my ad have been entirely satisfactory, in fact they have exceeded my expectations and your magazine stands at the head of a list of over 30 different publications I am now using. It produces more cash orders and more inquiries leading to cash orders than others costing me much more and with a larger circulation. I have received inquiries lately from ads run over two years ago in Popular Mechanics. I shall continue to be a constant user of your classified columns as long as I am in the mail order business. Thanking you, I am

(Original letter on file in our office)

Yours very truly, H. T. DANIEL.

AUTOMOBILES

MIDGET Racing book; facts for fans, builders, drivers; track sizes, regulations; pictures, specifications, working drawings. Also stock car conversions for fastest cars. \$1.00 postpaid. \$1.12 C.O.D. Ray Kuns, Dept. 22, Cincinnati, Ohio.

MIDGET Racers, parts, engines. Catalogue dime. "Kirby's Midgets," Box 213, Winnboro, Texas.

MIDGET Powered car plans. Full size patterns and dimensions. Best design. Free consulting service during construction. Postpaid \$1.00. Free circular. Derby Midget Car Co., Woodstock, Ill.

ECONOMY! Performance! Mileage! Semi-diesel conversions for all gasoline motors, \$12.00 up. Unconditional written guarantee. Special complete units for Ford and Chevrolet. Learn basic facts. Illustrated literature free. Des-A-Gas, 1719 Addison, Berkeley, California.

PHOTOGRAPHS, World's costliest, speediest automobiles, Rolls, Hispano, Duesenberg, Mercedes, Bugatti, Maybach, etc. Quarter-plate size, 15c each, 12 for \$1.00. Motor Photos, Box 329, St. Cloud, Minnesota.

REBUILD Ford T or A motor into fast pumping air compressor. Plans \$1.00. Tuck's Garage, 73 Shirley, Pontiac, Michigan.

R & R Mfg. Co., Anderson, Indiana. Racing cars and midgets. Catalogue 25c.

REFINISH Your own car. New instruction book treats all phases of painting and refinishing autos and trucks. Written for the man who wants to renew his own car, but covers also the business end of refinishing for the professional. \$1.65 postpaid. Popular Mechanics Press, Room (C36), 200 E. Ontario St., Chicago.

SPECIAL! Factory prices on genuine Desogas fuel-oil converters. Two year demonstrated superiority. Standard unit \$4.75. (Ford V8, \$15.00). Prettie Desogas, 1618 6th, Berkeley, Calif.

STEERING Post watch holder 50c. Complete with guaranteed watch \$1.50. Powers, Winsted, Conn.

PAINT Stripping tool—Automobiles, furniture, everything. Guaranteed, \$1.00. C. Carlson, 2212 Grand Ave., Omaha, Nebraska.

MIDGET Car plans, parts, engines. Circulars dime. Storms, 13 Southside, Asheville, N. C.

AUTO SUPPLIES AND EQUIPMENT

GROWLER Armature tester, \$3.45 postpaid. Circular free. Troughton, Aurora, Missouri.

IGNITION Supercharger. Easy starting wet or cold. More mileage, pep, less carbon. \$1.25. Agents wanted. E. G. Sales Co., 321 Broadway, New York City.

MECHANICS And garage men. Now! Guaranteed, permanent repair operation, cracked valve seats, cylinder blocks, etc. (No welding.) Only one dollar to learn this moneymaking business. Send for it today. C. Thayer, Boone, Iowa.

DEMONSTRATORS. Compressor, test bench, 8-hour battery charger—are welder. Guaranteed. Trial and terms. Ken's Equipment Exchange, Box M-271, Troy, Ohio.

PLATING Outfits for automobile parts. Connect to battery. No tanks used. Free particulars and proofs. Gunmetal Co., Ave. J, Decatur, Ill.

TURN Scrap into money. Convert old auto generators into A.C. generators for auto radio, camp and home lighting, power and other uses. Complete instructions \$1.00 postpaid. Popular Mechanics Press, Room (C36), 200 E. Ontario St., Chicago.

A. C. GENERATORS

PRACTICAL Changes for automobile generators. See our advertisement at bottom of page 135A. Autopower, Inc.

AUTO TRAILERS

BUILD The famous Jim Dandy cabin trailer—thousands on the road! A roomy, good looking trailer easy to build at low cost by anyone handy with tools. Complete plans and instructions—only 50c—give every detail of chassis, body, top, beds, cabinets, refrigerator, electric light and water systems and where to buy all parts. Can be built in any size to accommodate 2 to 4 people. Send 50c for these practical plans. Rush your order today to Jim Dandy, Box 1125, Wausau, Wis.

MODERN Streamlined trailer easily built. Information, plans, parts list, \$1.00. Can furnish 1/2" plywood parts, etc. Eck-O Trailers, Sharp's Corners, Altamont, New York.

SAVE Better than half building your own trailer coach. We supply everything including plans. Free catalog. National Trailer Equipment Co., Welsh Building, Milwaukee, Wis.

DO You like to hunt or fish week ends? Go in a Fold-A-Way and be comfortable. Fold-A-Way Trailer Co., Box 642, Davenport, Ia.

\$1.00 COMPLETE Building plans; attractive California house trailer, sleeps 4. Can be built for \$100.00. Trailer Designers, Box 885, San Diego, Calif.

PARTS For the Popular Mechanics "Family Trailer" featured in the February, March and April issues. Everything you need—Axle, hitch, wheel housings, water tank, pump, toilet, sink, stove, wood parts, windows, screens lights, cushions, etc. Send for price list. Include 25c for our big catalog and Trailer Builders' Manual. Tra Supply Co., 419 Grand Ave. Wausau, W

TRAILER Axles, wheels, springs, equipment. Roberts Trailers, 11429 Forest Ave., Chicago.

MOTORCYCLES, BICYCLES AND SUPPLIES

MOTORCYCLE Tires \$3.00, magnetoes \$5.00, belts \$5.00, chains \$2.00, wheels \$1.00. Parts (bicycles \$11.00.) bicycle for two \$34.50. Send 12c. Deninger, Rochester, N. Y.

POWER Your bike with low priced Speed-bike motor. Attach in one hour. Eighty miles to gallon. Thirty miles an hour. Free folder. Guaranteed. Outboard Motor Corp., 4046 N. 28th St., Milwaukee, Wis.

BOYS, Girls, men, women, we pay the return freight. Bicycle wheels straightened, \$1.50 each; broken pedal arm ends made like new, \$1.00 each end. Complete bicycle repairing. Parts for any make. Ed. Krause's Bicycle Service, St. Clair Shores, Mich.

SEND 15c For illustrated used motorcycle catalog. Bargains. Largest stock genuine Indian parts and motorcycles. Indian Motorcycle Sales, Kansas City, Mo.

SEND 10c For Handbook of Information listing new and used parts, for Indian, Harley, Excelsior, Henderson; accessories, tires, batteries. Bootz, 622 East Grand, Des Moines, Iowa.

GENUINE Harley Davidson parts, accessories, repairs. Prompt service. Send 10c for used motorcycle bulletin. Bill Knuth, 2491 Fondulac Ave., Milwaukee, Wis.

CLOSING Out large stock new Indian parts, all models. Discounts to repair shops. Many used parts, all makes. No catalogs. Indian Agent, 3681 Archer, Chicago, Ill.

MOTORCYCLE Bargains, lowest prices, bargain sheets for stamp. Motorcycle accessories. Rochester Harley Davidson Corp., 129 West Main St., Rochester, N. Y.

HENDERSON, Excelsior, Harley, Indian, used parts, alloy pistons, catalogue and wings pin 10c. Ballak, 1115 Chestnut Street, St. Louis, Mo.

MOTORCYCLES—Direct to you at rock-bottom wholesale prices. Rebuilt, roadtested and guaranteed Indians, Harleys, etc. Send 10c today for "Bargain Bulletin 43." Crandall Hicks Co., 780 Commonwealth Avenue, Boston, Mass.

BOOKS Covering hundreds of subjects. Big catalog for 3c postage. Popular Mechanics Press, Room (C36), 200 E. Ontario St., Chicago.

RECONDITIONED Motorcycles. New and used parts for all makes. Complete service. Whitman Motorcycle & Supply Co., 405-9 Southwest Blvd., Kansas City, Mo.

REBUILT Motorcycles, all makes, new and used. Harley Davidson parts. Send 10c for bulletin. Western, 914 E. 15th, Kansas City, Mo.

AVIATION

PROPELLERS, Sled-lightplane, lowest prices. Literature 6c. Woodcraft Propeller Co., Hillside Station, Wichita, Kans.

PROPELLERS For airplanes, ice sleds, snow sleds. Catalog dime. Lorenzen Propellers, Niles, Michigan.

DON'T Buy anything until you get Ort's Aviation Material Catalogue. Prices are lower. Send thin dime today. (Canada 20c.) Karl Ort, 634 W. Poplar, York, Pa.

WANT To get into aviation? Train at home in spare time. Complete, practical up-to-the-minute home study course trains you to fill many different types of ground jobs. Write for free book. Aviation Institute of America, Dept. A10D, 1115 Connecticut Ave., Washington, D. C.

AIRPLANES \$75 Up, terms. Motors, crackups salvage. Complete directory 25c postpaid. Aircraft Directory, Athens, Ohio.

YOUNG Men interested in entering aviation under apprentice plan see ad on page 12A.

MAKE Money in aviation. Special mechanics training course—Finest instructors and equipment—Located at aviation center. Write Robertson Aviation School, Lambert-St. Louis Airport, Robertson, Missouri.

TUITIONS Reduced. Information dime. School of Aeronautics, Fort Dodge, Iowa.

GET Into aviation. Air transport pilots get up to \$7,000 per year; mechanics, \$2,500. Learn at this government approved school. Write for complete information. State age. Lincoln Flying School, 200½ Aircraft Building, Lincoln, Nebr.

QUALITY Propellers, 4 ft. Harley \$1.95, 4½ ft. Henderson \$5.00, Fordchev \$7.50. Literature free. Standard Propellers, Fort Worth, Tex.

NEW Airplanes, \$98.00. Terms. Motors, propellers, air-wheels. Send 25c for information. Hibbs, Fort Worth, Texas.

BOOKS Covering hundreds of subjects. Big catalog for 3c postage. Popular Mechanics Press, Room (C36), 200 E. Ontario St., Chicago.

BATTERIES, GENERATORS, ETC.

EDISON Storage batteries will save you money. Replace your lead with the Edison. Non-acid. Odorless. Fifteen year life. Liberal unconditional guarantee. Bargains in complete generating plants, motor, etc. Free illustrated literature. "See Jay Battery Company," 82 Sterling Avenue, Yonkers, New York.

DATA—Auto generators to slow speed wind-chargers, welders, etc. 5 types 50c. We also rewind to specifications. Armature Service, Concordia, Kansas.

BUILD Powerful electric plant from washer engine, automobile generator. Instructions 50c. Electric Manufacturing, St. Paul, Minnesota.

ELECTRIC Lights—Wind driven—You build them. Write Wind Motor Electric, Brainerd, Minnesota.

EDISON Storage batteries for light-power plants. Non-acid, non-sulphating. Long life. Fully guaranteed. Low priced. Also attractive bargains in power-light plants, generators, motors, etc. T. Hawley Smith Company, Croton Falls, N. Y.

GENERATOR Propellers, expertly designed at factory prices. Hibbs, Ft. Worth, Texas.

ELECTRICAL SUPPLIES—EQUIPMENT

HUNDREDS Of new and rare items. replacement parts and supplies. Send 10c for new, 60-page wholesale catalog. Autopower, 410-K S. Hoyne Avenue, Chicago.

REPAIRING Electrical appliances and 350 other money making shop kinks in Vol. 31, Shop Notes, only 50c postpaid. Popular Mechanics Press, 200 E. Ontario St., Chicago.

WELDING AND SOLDERING

DODGE Arc-welder, 25-200 amperes. Build it yourself. Certified plans \$1.00. Welders' Club of America, Box 3432-A Merchandise Mart Station, Chicago.

SOLDERING Iron operates on automobile battery. \$1.25 postpaid. Agents opportunity. Great Lakes Metal Specialty Mfg. Co., 1450 W. North Ave., Chicago.

REPAIR Fenders, braze, solder. New arc-welding outfit, \$1.00. Dickerson Manufacturing, Springfield, Missouri.

ARC Welder only \$39.25. Professional type—110-220 volt. Delivers 110 amperes. Easy to use. Details free. Commonwealth, Dept. R-11, Cincinnati, Ohio.

DEMONSTRATORS, Electric arc welders. Money-saving prices. Used by the government. Trial and terms guaranteed. Hobart Welders, M-272, Troy, Ohio.

LEARN Arc-welding or oxy-acetylene. Qualified school. Particulars, stamp. Welders' Club of America, Box 3432-A Merchandise Mart Station, Chicago.

ACETYLENE Welding equipment, new and used. Pricelist free. 1299 Michigan, Grand Rapids, Mich.

GOOD 200 Amp. welder can be made from Delco plant, ideal for average shop. Blueprints, specifications, \$5.00. City Electric Shop, Snyder, Okla.

IS There money in welding? New book gives valuable information showing welding is a growing field offering opportunity to anyone looking for a trade. \$1.00 postpaid. Popular Mechanics Press, Room C37, 200 E. Ontario St., Chicago.

ACETYLENE And electric welding equipment. Box 331, Hamilton, Ohio.

REBUILT Electric arc welders, all sizes, a.c.—d.c. Service Co., 3732 Cedar Ave., Cleveland, Ohio.

300 AMPERE Welding generator. Fine condition \$150.00. Wilmot Auto Supply, 1970 Wilmot St., Chicago.

ARC-WELDING Outfit \$1.25. Weld fenders, braze, solder. Lavrow, 4368-W. Warren, Detroit. Stamp appreciated.

ENGINES, MOTORS, DYNAMOS

NEW!! Our book of motor end connection data covering single phase two to eight pole, three phase two to twelve pole in Star and Delta. Postpaid in United States—\$3.00. Washington Electric & Armature Works, 2211 Main Street, Vancouver, Washington.

GOVERNORS Control speed of any make of auto engine, regardless of load changes, when used for stationary or portable power production. Read our ad on page 126A. Man'gs Candee-Smith Governor.

"PEPY" Gasoline engine governor \$7.50 postpaid. Automobile engines made into controlled power plants. Guaranteed. Agents wanted. Harris Machinery, Minneapolis, Minn.

ELEVEN—½ Hp. a.c. motors, 60 cycle, 1 phase, 110 volt, like new, guaranteed, \$10.50. Send check to Erie Electric Motor Co., 120 Church St., Buffalo, N. Y.

WINDING Data, 225 motors, single and three phase. Price \$1.00. Motor Data Co., Box 7631, Kansas City, Mo.

ELECTRIC Motors; new, rebuilt. Electric clocks. Air condition indicators. Exceptional bargains. Pricelist free. Mallorcer Electric Co., 1718 So. Michigan, Chicago.

TO Close out. Slightly used ½ horse, 110 volt, alternating motors \$8.50. Wilmot Auto Supply, 1970 Wilmot St., Chicago.

SMALL Elect. motors, high speed, 1/10 horsepower, 110 volts, universal. Reworked, \$1.50 postpaid. L. McConnell, 1619 Edgewood Ave., Racine, Wis.

NEW One horsepower motors \$32.50; 32v. Delco light plants \$60.00. AC and DC generators. Queen City Electric, 1736 Grand Avenue, Chicago.

MACHINERY, TOOLS AND SUPPLIES

EVERY Tractor owner needs Irving's 60 page 1937 tractor replacement parts catalog. Absolutely free. Thousands parts, all makes; tremendous price savings. Irving's Tractor Lug Co., 134 Knoxville Road, Galesburg, Illinois.

EXCEPTIONAL Values—Flexible shaft screwdrivers, flexible drive socket wrench sets, self-adjusting flat wrenches, slide rules, micrometers, and miscellaneous precision tools. Write for catalog and prices. Sevan Company, Dept. 101, 7 East 42 Street, New York City.

MACHINISTS, Tool makers chests at bargain. Circular free. Cepader, 3602 Wesley, Berwyn, Ill.

FREE Catalog all shapes brass, copper, steel, aluminum, Dowmetal, monel, stainless steel, gears. Hobby Supply House, Box 2014, Pittsburgh, Penna.

BARGAINS, Demonstrators, electric arc welders, guaranteed, 30 days trial and terms. Write Ken's Equipment, Box M-273, Troy, Ohio.

GRIND Your circular saws perfectly by shaping your emery wheels with our New Smooth-Side Dresser. Free catalog. Thompson Mfg. Company, Meadville, Pa.

SPRING Winder, best on the market. Circular 10c. John Blauer, Box 163, Sharon, Pa.

¼ HORSE, 110 Volt, Universal motors with 14 to 1 gear reduction \$3.50. Wilmot Auto Supply, 1970 Wilmot St., Chicago.

15" x 6" SOUTH Bend screw cutting engine lathe, \$175.00. 14" Steptoe crank shaper \$125.00. All sizes of machine tools. Cincinnati Machinery & Supply Company, 27 West Second St., Cincinnati, Ohio.

HOMEMADE Drill press, belt sander, forge and 328 other practical shop articles in Shop Notes, Vol. 31, only 50c postpaid. Popular Mechanics Press, 200 E. Ontario St., Chicago.

BOATS, OUTBOARD MOTORS, ETC.

FORD Marine conversion parts and kits. Models A, B, V8 (domestic or foreign). Catalogue 25c (coin). Osmithson, 3101 C St., Philadelphia, Pa.

BOAT Designers are highly paid professionals. Complete course by mail. Catalog. Westlawn, Montville, N. J.

OUTBOARDS, All makes, bought, sold, exchanged. Used parts and accessories. Outboard Headquarters, No. 305 Atlantic Avenue, Boston, Mass.

ASSEMBLE A boat. Use Welch ready cut parts. Simple; interesting; inexpensive. Send 25c for 32 page catalog with material lists; prices and full information. Welch Boat & Supply Company, Station K-1, Milwaukee, Wisconsin.

PROPELLERS, Gear pumps, stuffing boxes, bearings, etc. Wm. Baker, Pond St., Quincy, Mass.

BOATS, Camps, motor camping, trailers, outdoor sports, etc. Send for list of special books on. It's free. Popular Mechanics Press, Room (C36), 200 E. Ontario St., Chicago.

BUILD Your own boat. Save two thirds, use our ready cut semi-assembled materials. Send 25c for catalog. Brooks Boat Co., Inc., G. 20, Saginaw, Michigan.

12-FOOT Flat bottom rowboat—complete plans 25c. Free bottombuilding catalog. The Rudder, 15 Murray Street, New York.

OUTBOARDS—Save ½. Good used parts, all makes and models. Bargains rebuilt motors. Crandall Hicks Co., 780 Commonwealth, Boston, Mass.

SPORTING GOODS, GUNS, FISHING TACKLE, ARCHERY

FISHERMEN! Finest stock of hooks, gut, leaders, tools and materials in America. List free. Write Paul H. Young, 8065-3 Grand River Ave., Detroit, Mich.

FREE—1937 Fishing tackle catalogue. Work Fly Company, Pueblo, Colorado.

FLYTYERS 3 Squirrel tails, fox or gray, 25c. Free 68 page illustrated Fly Tying, Rod Building and Fishing Tackle catalogue. Tack-L-Tyers, 1414-GS Dempster Street, Evanston, Illinois.

HUDSON Bay blankets, Indian pack baskets, camp stoves, knives, compasses, outdoor equipment. Free catalog. Howe Fur Co., Box P, Coopers Mills, Maine.

OUTDOOR Sports for everyone—Enjoy them all year round with aid of book published by Popular Mechanics. Hundreds of ideas for new and popular sports for every season; complete instruction for making necessary equipment at small cost. 350 pages and 650 illustrations. \$2 postpaid. Popular Mechanics Press, Room (C36), 200 E. Ontario St., Chicago.

FIELD GLASSES, TELESCOPES AND MICROSCOPES

GET Our lowest prices on telescopes, microscopes, movie cameras and hundreds of other items. Catalog free. G. Winn, 124 W. 23 St., New York.

ALUMINIZE—Aluminum applied to telescope mirrors and other optical surfaces. Replaces silver. High reflectivity, and very durable. Prices reasonable. Leroy Clausung, 5509 Lincoln Ave., Chicago.

TELESCOPES, Microscopes, binoculars. Lowest prices. Optical catalog free. Brownscope Company, 234 Fifth Avenue, New York.

MINERAL Sets, microscopes, etc. Catalog free. Teeko, BL515, Evanston, Illinois.

FREE Literature—Amateur Telescope Makers Supply Company, 24 West 20 Street, New York.

BUILD Reflecting telescopes; catalog free. Instructions 10c. Optical Laboratories, Larchmont, N. Y.

ANTIQUES, RELICS, INDIAN GOODS

14 ARROWHEADS, Lancehead, spearhead, gempoint \$99. 120,000 bargains. Firearms. Photolist 10c. Museum, Rutland, Illinois.

WORLD War relics, for club house or den. Vickers aircraft machine guns, rendered unserviceable without marring, \$7.75 each. Marlin aircraft machine guns, rendered unserviceable, \$7.75 each. Send money order, check or draft, \$1.00 deposit on C.O.D. orders. Fiala Outfits, 10-C Warren St., New York.

5 ARROWHEADS 20c. 3 Birdpoints 18c. Knife, birdpoint, scraper, spearhead 45c. Catalogue. Coins, Minerals, Curios. Lemley Curio Store, Northbranch, Kansas.

100 GOOD Arrowheads \$3.00. Catalog 5c. H. Daniel, Dardanelle, Ark.

TAXIDERMY

TAXIDERMY Supplies—Quality artificial eyes, teeth, genuine Jonas head forms. Tools, materials, etc. Everything for the progressive taxidermist. Send 10c for big illustrated catalogue. Jonas Bros., 1049 Broadway, Denver, Colorado.

I GUARANTEE To easily teach you by mail to mount animals, birds, tan hides. Have taught thousands. My famous seven-book, complete course, diploma, formerly \$15.00, now only \$1.00. Limited offer. Order now. Schmidt School, G-12-2, Memphis, Tenn.

FREE—Official catalogue. Big values. Eyes. Head forms. Everything, direct from manufacturer. Taxidermic Manufacturers, Memphis, Tenn.

UNCLAIMED Specimens, eyes, scalps, supplies. Hofmann Studio, 992 Gates Ave., Brooklyn, N. Y.

GLASS Eyes. Taxidermists', furrers' supplies. Lowest prices. Forty page catalogue, free. Write today. Elwood Supply Co., 222 Smith Building, Omaha, Nebraska.

PROFIT And pleasure in taxidermy. Complete guide for the preparing and mounting of animals, birds, fish, reptiles, etc., for home, den, or office. \$1.65 postpaid. Popular Mechanics Press, Room (C36), 200 E. Ontario St., Chicago.

DOGS, BIRDS, PETS

JUMBO, Pedigreed Newfoundland puppies. Baby's companion. Earl Thurston, Hartsville, Indiana.

SAINT Bernards—the kind you've wanted! Dime brings photographic prospectus. No duty. Royal Kennels, Napierville, Que.

BEAUTIFUL Pure white police dogs. Ansonia Kennels, Mose, N. Dak.

POULTRY AND SUPPLIES

52 BREEDS—Baby chicks, started chicks, baby turkeys, hybrids, pullets, cockerels; hand-picked, Iowa inspected. Beautiful book free. Mrs. Berry's Farm, Rt. 23, Clarinda, Iowa.

POULTRY Tribune—America's leading poultry magazine. Five years \$1.00; one year trial 25c. Poultry Tribune, Dept. 93-C, Mount Morris, Illinois.

BOOKS Covering hundreds of subjects. Big catalog for 3c postage. Popular Mechanics Press, Room (C36), 200 E. Ontario St., Chicago.

FARMS AND FARM LANDS

FARMS That pay in the Great Northern Railway agricultural empire—Minnesota, North Dakota, Montana, Idaho, Washington, Oregon—Fertile black soil, high producing crops, grain, fruit, vegetables, feed and livestock. Many kinds of farms for selection. Write for lists and Zone of Plenty book. E. C. Leedy, Dept. 257, Great Northern Railway, St. Paul, Minnesota.

BEST Virgin grasslands, covered with primeval sod and tall grass; 76,900 acres, suitable grazing, hunting or dry farming, at 50 cents the acre. Located in Coahuila State, Northern Mexico. Directly from owner. M. Hernandez, Donato Guerra 12, Mexico City, Mexico.

MONEY-SAVING Farm catalog, farm bargains many states. Free. Strout Ag'y, 255-P 4th Ave., New York City.

FINE Sixteen hundred acre irrigated ranch and farm. Fully stocked. Closing estate. Write Minnie Doherty, Saratoga, Wyo.

CANADIAN Tax sale lands for a dollar an acre and up. Small monthly payments. Farms, timber, hunting and fishing camps, minerals. Limited number of properties. Write at once for free illustrated booklet. Tax Sale Service, Room 613, 72 Queen St., W., Toronto, Canada.

NEW Farm opportunities! Washington, Idaho, Montana, North Dakota, Oregon, Minnesota. Farm income is up. Good land still at rock bottom prices. Literature. Specify state. J. W. Haw, 119 Northern Pacific Ry., St. Paul, Minn.

40 ACRES, Near White River, unimproved, poultry land, \$100, \$5 down, \$5 monthly. Free list and literature. Hubbard, 216 Grossman Bldg., Kansas City, Kansas.

TREES, SHRUBS, ROOTS, HERBS

BOYSENBERRY! World's largest vine-berrie. Taste resembles raspberry. Stood 17° below zero. Free pictorial pamphlet giving quantity price, dealer's affidavit making \$300 from city lot. Plants prepaid from Va., Okla., Calif. original plantings 10—\$2.00, 100—\$12.00. Rancho Verdad, Mentone, Calif.

JUST Out! World's greatest "Herbalist Almanac." Beautifully illustrated in natural colors. Contains over 200 old-fashioned herb medicine recipes for home use. 10c postpaid. Worth dollars! Botanics, 145 West 112th Street, Chicago.

PROFITABLE OCCUPATIONS

MRS. M. Earned \$267, three weeks, raising mushrooms in cellar! Exceptional, but your cellar, shed perhaps suitable. We buy crops. Book free. United, 3848-A66 Lincoln Ave., Chicago.

FREE Booklet describes 107 plans for making \$20-\$100 weekly, in home or office, business of your own. Elite Co., 214 Grand St., New York.

"RAISE Giant Frogs!" We buy! Start small pond. Free frog book. American Frog Canning, (153-B), New Orleans, Louisiana.

MEN—Kill for money! Make up to \$75 weekly as professional exterminator. Your own business. Work everywhere. Our easy method quickly starts you. Exterminate roaches, bedbugs, rats, ants, etc. Free details. Exterminating Industries, 2650-A Carmen, Chicago.

MAKE Money—Quickly and honestly. Our books and plans teach you how. Details free, if you mean business. Home City Specialties, Box P1273M, Springfield, Mass.

RAISING Jumbo frogs. Interesting. Big future. Females lay 10,000 eggs. Free literature. American Frog Industries, Box 338, Rayne, Louisiana.

INVESTIGATE Frog raising—a profitable side line. New book explains and illustrates every phase of subject. Covers very latest developments such as plans of constructing ponds, combination frog feeder and fly traps, getting other live food electrically, also the roly poly, a new mechanical feeder. \$2.00 postpaid. Popular Mechanics Press, Room (C36), 200 E. Ontario St., Chicago.

OLD BOOKS WANTED

\$100—\$200—\$500—\$1000 EACH And even \$5000 cash will be paid for certain old books! We buy thousands of dollars worth annually. We also pay big cash prices for certain old magazines, letters, newspapers. Books even recent as 1931 wanted. A single school book, story book, old bible, travel book, poetry book, etc. in your home may bring you \$10—\$50—\$100 or more in cash! Send 10c for latest list of books wanted. Act now! American Book Mart, 140 S. Dearborn, Dept. 1313, Chicago.

BOOKS, PERIODICALS, PICTURES, POSTCARDS

FREE—Send for list of new technical books at sensational discounts. E. Winn, 124 West 23 St., New York.

YOUR Favorite magazines—Half price. Catalog, 10c. Magazine Exchange, Baseline, San Bernardino, Calif.

FREE! Big catalog describing hundreds of books on various subjects. Franklin Publishing Company, 800 North Clark Street, Dept. 2208, Chicago.

EGYPTIAN Dream book explains what 968 dreams mean. Prepaid, 10c. Franklin Publishing Company, 800 North Clark Street, Dept. 2207, Chicago.

GAMES AND ENTERTAINMENT

CHALK Talks. Laugh producing program, \$1.00. Catalog free. Balda, The Cartoonist, Oshkosh, Wis.

FORTUNE Telling by cards, 10c. Latest methods; entertain your friends. Franklin Publishing Company, 800 North Clark Street, Dept. 2206, Chicago.

40 MODERNIZED "Old-fashioned" parlor games, 35c. Demonstrators, 1741 Harrison, Chicago.

PLAYS, Operettas, musical comedies, complete minstrel first-parts with song programs, blackface skits, vaudeville acts, monologs, dialogs, recitations, juvenile plays and songs, musical readings, entertainments, make-up goods. Catalog free. T. S. Denison & Co., 623 So. Wabash, Dept. 11, Chicago.

MAGIC TRICKS, PUZZLES, JOKER NOVELTIES

A PASTIME For the whole family. Try your skill, the results will amaze you. One thousand problems, figure puzzles, price 25c, 5 for \$1. Stamps not acceptable. Watchman's Puzzle, 105 Brookview Ave., Troy, N. Y.

LEARN Ventriloquist art. Easy. Low cost. Free details. Apex, 221 E. 31, New York.

FREE Tricks! Join Magicians' Fraternity! Monthly magazine, sample, 10c. International Magicians, Mt. Morris, Ill.

VENTRILQUISM Course 50c. Results guaranteed. Ledesky, Box 123, Ernest, Pa.

AMAZING Hindu mystery trick vanishes money! Together with complete catalog of magic tricks, novelties, jokers, mind reading items, etc., for only 5c! National Magicians, 5710 Woodlawn, Dept. 150, Chicago.

SAMPLES Catalog, novelties, photos, 25c. Box 468-P, New Haven, Conn.

BE A Magician. Send 20c mailing fee for our large catalog. Chicago Magic Co., 2300 N. Mason Ave., Chicago.

EARN Money in any crowd. Call names of strangers, tell unspoken questions. Professional course mind reading, spirit writing, etc., \$1. Henderson, Box 341, San Bernardino, Calif.

MAGIC Catalogue 20c. Lynn, Midland and Albradt Ave., Paramus, N. J.

LARGE Professional magic catalogue, 25c. Holden, 220 W. 42nd St., New York.

LEARN Ventriloquism, 3c stamp brings particulars. Smith, 125 North Jefferson, Peoria, Ill.

MAGICAL Apparatus, illusions, catalog 3c. McKwade, 609 Martinique, Dallas, Tex.

200 TRICKS You can do—Mystify your friends; have loads of fun. This collection of tricks has been selected by Thurston for the average person. Neither unusual skill nor elaborate apparatus required. 200-page illustrated book. \$1 postpaid. Popular Mechanics Press, Room (C36), 200 E. Ontario St., Chicago.

RARE COINS

OLD Money wanted. Do you know coin collectors pay up to \$100.00 for certain U. S. cents? High premiums for all rare coins? I buy all kinds. Send 4c for large coin folder. May mean much profit to you. B. Max Mehl, H Mehl Bldg., Fort Worth, Texas.

1909 CENT \$10—We buy certain coins, common and rare—Others worth to \$6000; 1864-1865 Indian head cents \$100 each; dimes before 1893, \$450; Liberty head nickels before 1914, \$300; large pennies, \$2000; encased postage stamps, \$13; half cents, \$275; half dimes, \$175; quarters, \$300; fractional currencies; paper money; gold dollars \$1,500; colonial coins, \$300; silver dollars, \$4,000; 1933, 50c, \$4.00; foreign coins \$165, etc. Send 15c today for illustrated 1937 coin book, before sending coins. National Coin Corporation (80), Springfield, Massachusetts.

25 NICE Coins, 25c; 100, \$1.00. 1852 bill free with order. Coin Exchange, Box 2544, Kansas City, Missouri.

COIN Cleaner. Guaranteed, 50c; sample 10c. Atlas Leve, Syracuse, N. Y.

STAMP & Coin catalog illustrated! 25c. Gives prices paid! Bauer Coin Co., Rochester, N. Y.

COMMEMORATIVE 1/4s, Illinois, Stone Mountain, Oregon, Texas, Long Island, \$1.50 each. California gold quarter size and illustrated catalogue 25c. Auction catalogue 50c. Norman Shultz, Salt Lake, Utah.

FREE—California $\frac{3}{4}$ gold token with each large illustrated 50c coin book, Bay Bridge $\frac{3}{4}$ \$2.50. Send 10c for buying book, large coin folder 6c. Coinshop, 2510 Chester, Alameda, California.

25 COINS, Bills, tokens 25c; 100 for \$1.00. Otto Oddehon, Box 101, Springfield, Missouri.

ANCIENT Coins, all United States series and foreign always carried in stock. Write us your wants. United States premium booklet 20c. New Netherlands Coin Company, Suite P, 95 Fifth Ave., New York.

UNITED STATES commemorative half dollars. Lincoln \$1.19; Lexington \$1.75; Texas \$1.69; Arkansas \$1.69. Bargain selling price list and California 50c gold token 25c. Arcy, Box 3507-A, Cleveland, Ohio.

\$3.00 EACH For certain Lincoln pennies dated between 1911 and 1923. Keep posted. Send 15c for complete 28 page buying book. American Coin Company, Box 3507-A, Cleveland, Ohio.

LARGE Copper cent and bargain lists for dime. Acorn Stamp & Coin Co., South Norwalk, Conn.

UNITED STATES. Large cent, 2c bronze, 3c nickel and bargain list, 25c. Eleven dates large cents, \$1.00. George P. Coffin Company, Augusta, Maine.

\$5.00 TO \$500.00 Each paid for old coins. Keep all old money. Send 10 cents for illustrated coin value book. 4x6. Guaranteed prices. Buying and selling. Coin Exchange, Box 5, Le Roy, N. Y.

FREE! Foreign coin, banknote, and large illustrated coin catalogue. Send 4c postage. Coin approvals sent. Tatham Coinco, Springfield-125, Mass.

RARE United States, foreign coins, war medals. Catalogue 10c. Mengelle, Colorado Springs, Colorado.

U. S. COIN BOOK—Guide to values, just issued. Many special features. Order Burt's, the leader among American coin books, only 50 cents postpaid. Popular Mechanics Press, Room (C36), 200 E. Ontario St., Chicago.

STAMP COLLECTING

SETS—That satisfy. New 1936 issue of Bolivia, 9 varieties complete. 30c value only 5c to approval applicants. Charles Cleveland, 806 North Humphrey Avenue, Oak Park, Illinois.

QUEEREST Stamp packet. Receive world's smallest stamp; Vatican City; scarce Liberia triangle (value 15c); 1935 Greek Red Cross picturing coiled snake in Garden of Eden; Australian Bushman; new Spanish Morocco; Japan 'quake stamp; Manchukuo; many others. Only 5c to approval applicants. R. M. Stamp Co., P. O. Box 230P, Port Chester, N. Y.

SCARCE Airmail and triangle. Beautiful Uruguay "flying horse" airmail and scarce Guatemala triangle (smallest in the world) are included in our big packet of 60 different stamps from Alouites, Grand Liban, Venezuela, British and French Colonies, etc. All for 5c to approval applicants. Big illustrated lists free with each order. Write today! Mystic Stamp Co., (Dept. 80), Camden, New York.

TRIANGLE Map stamps, jubilees, old U. S. and 100 different others, all for 10c to approval applicants. Jones Stamp Company, Box 146, Norristown, Pa.

A SNAP—300 Different foreign and 60 different U. S. stamps, including \$1 value, for only 30c. Free with each order, our pamphlet telling "How To Make A Stamp Collection Properly," together with our price lists of albums, supplies and hundreds of bargains in sets, packets, etc. Queen City Stamp Co., Room 36, 604 Race St., Cincinnati, Ohio.

EXTRAORDINARY Free offer—Turks Caicos, \$5 U. S., Caymans, Western Samoa (native girl), genuine Baden. Everything free to approval applicants enclosing 3c postage. Viking Stamp Co., 1-Z Hanson Place, Brooklyn, N. Y.

NEW Chile pictorials, set King Edwards, triangle, set Epirus, mourning stamps, Armenia, Lebanon, money stamp, etc. 10c with profit-sharing approvals. Brownell, 1608 Tenth Street, Niagara Falls, N. Y.

100 DIFFERENT Portugal 25c. Packet bargain list free. Approvals on request only. LC Trading Company, Box 38A, Bellerose, N. Y.

FREE!! Abyssinia, Iceland, Liberia, Nyassa, Mongolia, Palestine, airmails, jubilee, triangle, pictorial stamps, 25 different to approval applicants after first purchase 25c. O.K. Stamps, 1340 Danforth, Toronto, Canada.

RARE Diamond-shaped stamp, two different Tannou Touva triangles, pictorials, colonials, others. Everything 3c. Approvals included. Laffal, 91-01F 102nd St., Richmond Hill, New York.

WORLD'S Smallest air mail, \$2.00 U. S. stamp, animals, bird, train, Indian, airplane, commemoratives, special issues with scarce stamps from 25 different countries only 5 cents with approvals. Capital Stamps, 413G Roosevelt, Little Rock, Arkansas.

25 DIFFERENT Canada 2c. Approvals sent. Maynard Sundman, M2, Bristol, Conn.

PRODIGIOUS Gift! Negri Sembilan, scarce Perak, bi-colored airport, cheery French colonies, gorgeous Trinidad pictorial, Siberia. Absolutely free with approvals! Postage 3c. Saxon Stamp Co., Dept. 65, Albee Bldg., Brooklyn, N. Y.

UNITED STATES and foreign approvals. References. McClay, 814 Mar Vista, Pasadena, California.

JUNGLE Packet 3c with approvals. Monjar, 1542 Waverly, Cincinnati, Ohio.

ILLUSTRATED Album. Spaces 4000 stamps; to approval applicants 20c. Swan Stamps, 604 Swan, Dunkirk, N. Y.

WORLDWIDE Variety approvals that satisfy. McKee, 925 Main, Covington, Ky.

35 AIRMAILS, Etc., 10c. (Approvals). Star Supply Company, Lima, Ohio.

UNPICKED! 100 U. S. revenues on original documents—10c. Vanvoorhis, Hyndman, Pennsylvania.

COLOMBIA—25 Different, rare, beautiful \$1.00. Ovidio Monroy, Santamarta, Colombia.

WHOLESALE Approvals. References. Fuld, 3155 So. Grand, St. Louis, Missouri.

89 DIFFERENT United States 25c. Chas. Reitter, 111 Jackson, Chicago.

ALBUMS—Send 3c for sample page and circular. Progressive Stamp Albums, St. Davids, Penna.

U. S. Post mark collectors—35 different post marks with stamps attached 15 cents. Armour Organization, Flushing, New York.

SUPERIOR "New Issues" collection, airmails, commemoratives, jubilees, pictorials, triangle, etc., with approvals only 10c. Katharine Crane, Stamps, Applegate, Calif.

MINT Tipex sheet 40c. Free list. Stamp Fair, 125 Lenox Rd., Brooklyn, N. Y.

50 **BRITISH** Colonies, jubilees, commemoratives, airmails, pictorials, 10c. Sachse Stamp Co., London, Canada.

No. 1 **STAMPS!!** First stamps 10 different countries 5c. Approvals. Zegel Stampco, Box A, Windham, N. Y.

FREE—6 Different silver jubilees, with approvals. Send 3c postage. Berg, Box 259, Ann Arbor, Michigan.

FREE! 10 Mint stamps to approval buyers only. Barton Battaille, West Second, Lexington, Kentucky.

CANADA—35 Different including silver jubilees, pictorials, commemoratives. 10c with approvals. Crescent Stamps, Box 653, London, Canada.

KING'S Silver jubilees, 25 different 85c. Quality mixtures foreign: 500 45c, $\frac{1}{2}$ lb. bag \$1.00, 550 Scandinavia 75c. Mixture catalog 3c. Pade Stampco, Denver, Colo.

FREE! Odd set; big-value general approvals. Exchanges? Vallette, Declo, Idaho.

\$1.00 **POSTAGE** Due free. Unbeatable United States. Approvals. Nelson, 658 Laurel, St. Paul, Minn.

50 DIFFERENT United States 10c coin. Box 458, Elgin, Texas.

20 DIFFERENT Foreign commemoratives and airmails only 3c. Approvals. Mensch, 1956 Clinton, Bronx, N. Y.

FREE—Send 3c postage for generous package British colonials, pictorials, jubilees. Swan Trading, 1002 St. Joseph, Montreal, Canada.

HALF Pound United States mixture, 30c. 2 pounds \$1.00. Halay, 452 West 58th, New York.

ENGLISH Jubilee set 3c. Approvals, references. Evalco, 12 Vine, Corona, N. Y.

PACKET Tannou Touva, large price list, dime. A. Thorington, Vacaville, California.

FREE. 40 Page clearance list collections. U. S. A. Jersey Stamp Co., 164 Percy Rd., Twickenham, England.

CEYLON Jubilees, pictorials, etc. 200 mixed \$1 bill. Fernando, Box 272, Colombo.

1000 U. S., including precancelled, commemoratives, etc., 15c. Auburn Stamp Co., Bridgeport, N. Y.

ZANZIBAR—Also Sudan, Somaliland, Tiger stamps, Togoland, Caribbean, Archer, Algerian, Central American, British Colonials. This magnificent collection free for 5c postage. Gray Stamp Shop, Dept. PM, Toronto, Canada.

UNITED STATES, Canada, Newfoundland, Mexico! Where? Our "Four Star" approvals. Nothing like them! Write today. Kessels, Box 808, Tucson, Arizona.

TRADING Proposition and 100 different, 10c. No approvals. Traders Club, 16152 Snowden, Detroit, Michigan.

\$1 **PACKET** British colonials free to all approval applicants. Superb colonials of all periods my specialty. References or \$1 deposit please. E. Wislin, Island Falls, Ontario, Canada.

OLD Stamps and envelopes wanted. Will pay \$300.00 for 1911 Vinfix stamp. Spot cash paid for all rare stamps. Send 5c today for large illustrated stamp folder showing amazing prices paid. Vernon Baker, 444-PM, Elyria, Ohio.

GIGANTIC Collection, containing rare triangle, air mail, Abyssinia, Andorra, Barbados, Camerouns, Cape Verde, Dahomey, Kouang-Teheou and other scarce stamps. Only 10c with approvals. Stamp Supply, Redondo Beach, California.

LIQUIDATING 20 Country accumulation. Hundreds of varieties. 3,000, \$2. Hunt Moffat, 379 Grand Ave., Brooklyn.

SENSATIONAL! Arabia (scarce), assortment triangles, old United States, and large packet others. Everything only 10c to approval applicants. Daniels, 66 Bradley St., Burlington, Vermont.

CANADA—Special mixture since 1869. Five, 25c; ten, 50c, twenty, \$1.00. Sege Stamps Exchange, Box 100, Waterloo, Que.

AHOY!! 56 Different, world, 3c. Approvals included. Dealing, Mound, Minnesota.

COMPLETE Country 6c, approvals. Hazett Stamp Shop, 701P Fourth, Bay City, Mich.

LINDBERGH Stamps, covers, commemorating tenth anniversary Paris landing, next May. Prudhomme, 1516 Masonic, San Francisco.

SCARCE Six-sided stamp (found in very few collections) and 60 different stamps; including Cape Verde, Soudan, Honduras, Hyderabad, Brazil, \$2 U. S. All for only 5c to approval applicants. Lennott Stamp Company, Dept. 4, Claiborne, Maryland.

ROMAN States. Seven different copies cataloging \$18.25! Only 10c. Approvals sent. National Distributors, 1140 Gower, Los Angeles.

OBSOLETE!! \$1.00 Abyssinia elephant, catalogs 50c, and thirty scarce stamps all totaling \$1.35 sent approval applicants for 3c. Kumlur, King, Lancaster, Ohio.

DENMARK—25 Different, 8c; 150 different, \$1.00. Stamps accepted. Eisea, Bowling Green, Ohio.

EXCHANGE Stamps! Over 2,000 members in over 125 countries. Club magazine 10c; prospectus free! Stamp Collectors' Exchange Club, Seaforth, Ontario, Canada.

107 DIFFERENT, Congoand, Gabonese, Algeria, Newzealand, Guinea, etc., 5c to approval applicants. Extra—Packlette of scarce airmails free!! Hunziker, Box 225K, Minneapolis, Minnesota.

ATTRACTIVE United States, Canada, Newfoundland—approvals. Raymond Peterson, 391 Minnesota, St. Paul, Minnesota.

SILVER Jubilee 15 different 25c, 30 different \$1.00. 18 Canada commemoratives 25c. Werner, Alton, Ontario.

SEA-GODDESSES, Ships, Britannia pictorials from Barbados, British Guiana, Trinidad—sixteen varieties only 9c to approval applicants. Douglas, Hawkesbury, Ontario.

LINDBERGH Airmail, triangle, perforation gauge, worldwide packet, only 10c, approvals and premiums. Whitmer, 438 S. Terrace St., Columbus, Ohio.

AMAZING Offer! Army and navy commemoratives, imperforate Chicago, packet of 23 North American stamps from U. S., Canada, Mexico, Newfoundland. Catalogue value over 65c—all for 5c to approval applicants. Illustrated pricelist free. Curhan Stamp Co., Dept. P, Gloucester, Mass.

WHOPPER Packet 5c. Jubilees, ships, triangle, map, diamond, airmail, Vatican, Jhind, Siam, Iran, Iraq, Iceland, etc. 33 stamps, only 5c with approvals. Dominion Stamp Company, Dept. M, Arlington, Virginia.

FREE—Mint Canal Zone stamp with General Gorgas portrait given together with rare South Australia stamp, Cape of Good Hope King Edward stamp, Western Australia swan stamp, Siamese Garuda bird stamp, Southern Rhodesia King George stamp, obsolete Prussian stamp and many others, all for 10c to approval applicants. First 200 answers receive special prize. Lorwin Stamp Company, 1327 Roosevelt Boulevard, Philadelphia, Pa.

25 DIFFERENT South American for only 10c, no approvals. Burkhart Stamps, Sandwich, Ill.

CLEARANCE! U. S. commemoratives, British Colonies, sets, mystic Orient, all 5c! Huge commemoratives collection 25c! Scarce mourning collection (U. S. included) 25c! Approvals! Corsa, 9018 91 Avenue, Woodhaven, N. Y.

SELECTED Approvals by country. Stamps numbered; priced to please. Reference. Leinert, 851 Marcy Ave., Brooklyn, New York.

SCARCE Nyassa triangle; giant Belgium balloon; Egypt and Lebanon airmails; packet British Colonies including rare Borneo, Congo, San Marino, Brazil, China, Mexico; perf. gauge; watermark detector. 6c to approval applicants. Eureka Stamps, Burbank, Calif.

NEWFOUNDLAND, 15 Different 5c with approvals. Frederick Brown, Plainfield, N. J.

FOLD-A-WAY The perfect container for first day covers. Write for literature. Fold-A-Way Company, Milwaukee, Wis.

COLOSSAL: New Bermuda, Cuba Mantanzas, Cuba Gomez monument, Sweden tercentenary, airmails and jubilees. All only 10c to approval applicants. Taylor, 261 Hawthorne, Haddonfield, N. J.

U. S.—57 Different (commemorative, airmail, etc.) with approvals 9c. Moseley, 4932 Forestpark, St. Louis, Mo.

30 U. S. Commemoratives 25c. Holmes Stamp Co., New Albany, Ind.

TEN Lots only 10c. Include lot each old U. S., airmails, Zanzibar, British Colonies and six others. Everything for 10c to approval applicants. John Perry, Bramwell, W. Va.

NINE Different British jubilees for dime with choice approvals. Killbuck Exchange, Wooster, Ohio.

WORLD'S Best penny approvals. Gilger, 576 S. Reys, Columbus, Ohio.

100 DIFFERENT United States postage—63 cents. Charles I. Watson, Greenville, Illinois.

UNITED States, all different, 55—15c; 75—25c, 200—\$1.00. Thousand assorted 40c. Thousand foreign 35c, with approvals. Illinois Stamp Co., Rockford, Ill.

225 VARIETIES. Catalogue \$12.00. 25c to approval applicants. Timor, B-589, Pasadena, Calif.

UNITED States covers; 30 mixed 1873-1912, \$1.00. Warner Bates, 657 Hudson Avenue, Albany, N. Y.

15 FREE Sweden, Peru, Chile, Guatemala, 3c with approvals. Arrow, 5228 South Paulina, Chicago.

UNITED States mixtures, 50c lb., 5 lbs. \$2.00. Canada 75c. Japan \$2.00. Mexico \$2.00. Magazine, 4512 North Racine, Chicago.

FREE—Dollar packet to approval applicants. Harlan, 5307 S. Marshfield, Chicago.

UNITED States and foreign approvals. Huber, Three South Eighth, Minneapolis.

SCARCE New giant sized, diamond-shaped Russian "sports" stamp; Nyassaland "leopard"; Morocco; Tanganyika, and other scarce countries included in our big packet of new and recent issues—stamps most collectors have never seen! Get this valuable packet today. 5c to approval applicants. Reimers, 115 Flatiron, Fort Worth, Texas.

GIANT Spain triangle and bi-colored Persia airmail (both illus.); big packet 25 diff. Russia (cat. nearly \$1); pkt. British Colonies including Egypt, Travancore, Ireland, Malay, Silver Jubilee, etc. All for only 5c to approval applicants. Fidelity Stamp Co., Dept. 20, Earle Bldg., Washington, D. C. Free: Large U. S. list.

MONTHLY Stamp magazine; six months and 25 foreign stamps, 25c. American Stamp Journal, Cedar Rapids, Iowa.

200 MIXED 8c, 1000 Hinges 10c. Bargains galore. Approvals. Harvey Teeple, Decatur, Indiana.

200 DIFFERENT 10c. Big 50% approval. Covert Stamp, 39 State, Rochester, N. Y.

"GOYA Nude Stamp" \$0.05 to approval applicants. Jewells, Tamaqua, Penna.

FREE—25c Packet given approval buyers. Lincoln Stampmart, Shelbyville, Illinois.

FREE—Beautiful airmails, including new Mozambique to approval applicants. Green & Co., Norwood, Ohio.

50 STAMPS Free, Manchukuo, etc. Postage 1c. Approvals not necessary. Album 3c. Bullard, 268 Northampton, Boston.

300 DIFFERENT Stamps, 10c to approval applicants. R. Sherman, 47 Central Avenue, Hartsdale, New York.

1000 HINGES 3c. Bargain approvals included. V-J Sales, 2729 N. Summit, Milwaukee, Wis.

\$5.00 U. S. Postage due, No. 2284, fine copy 5c with general approvals. Hudson Company, 116 Nassau St., New York City.

300 DIFFERENT 20c; 1,000, \$1; 2,000, \$3.00. Fred Onken, 630 79th St., Brooklyn.

ILLUSTRATED U. S. list, price 50c, large complete U. S. price list free. Send postage. Stanley Gibbons, 38P Park Row, N. Y.

PENNY Approvals that please. Haywood, 395 Adams St., Pomona, Calif.

ABSOLUTELY Free! Scarce mint United States telegraph stamp, cataloging 50c, and our big 56-page illustrated catalog, "United States, British North America and Foreign Stamps." Write today! H. E. Harris & Co., 137-G Transit Building, Boston, Mass.

AIRMAIL Triangles from Liberia and Mozambique, 3 British silver jubilees, new King Edward stamp and packet 25 different stamps from Azerbaijan, China, Ukraine, etc. All for 5c to approval applicants. Clipper Stamp Co., Dept. 7, Gloucester, Mass.

FREE—15 Different Peru to approval applicants enclosing postage. Ranson, 3555 Fullerton, Chicago.

ASK For our wonderful one cent approvals. Prospect Stamp Co., 225 Broadview, Toronto, Canada.

50 VARIETIES U. S. 12c. Approvals sent. Elmer's, 196A Washington St., Boston, Mass.

MIDGET Airmail (½ in. tall), Szechuen, Kouang-Teheou, Mozambique, etc., 30 stamps—5c Depraw, Ocean Park, California.

CANNON! Set of stamps showing cannon, firing squad, cavalry charge and 200 other different stamps only 10c to approval applicants. Paramount Stamp Co., 4225 Broadway, Chicago, Ill.

RARE Mint Newfoundland commemorative, 23 different Russia, Poland's astronomical commemorative, Yugoslavian war horror, Denmark 1921 issue, United States telegraph set, all complete; 42 stamps cataloging \$2.93 only 25c. Friendly Filatelists, 3615 N. Sydenham, Philadelphia, Penna.

WHOLESALE—Send 3c for large wholesale catalogue. Stamp Importers, Palms Station, Los Angeles, Calif.

SILVER Jubilees—15 different 25c. World specials—500 different 35c, 1000 different \$1.00, 2000 different \$3.00. These offers to approval applicants only. List free. Victoria Stamp Co., London 4, Canada.

STAMPS: A splendid selection sent on approval. Quality at low prices. Scarce and high value stamps are included in our approval books. Fred Herzberg, Box 91-P, Elmhurst, Ill.

UNITED States—Elaborate pricelist free. 45 different 10c, 75 different 30c. Seidenberg, Baroda, Mich.

STAMP Dealers, your ad here will bring wonderful returns. Ask me for proof. F. W. Johnson, Manager, Classified Advertising, Popular Mechanics Magazine, 200 E. Ontario St., Chicago.

GIANT-SIZED Russian Zeppelin stamp (cat. val. 20c!) and beautiful Lithuania airmail triangle; also big packet of 53 diff. stamps including Azerbaijan, Epirus, new Martinique, etc. and illustrated lists—all for 5c to approval applicants! World-Wide Stamp Co., Box 600, Camden, New York.

FREE—\$1.00 U. S. stamp, our choice, with request for 52 page price list of United States and foreign stamps. Stamps on approval. References necessary. 1000 U. S. no current \$1.50. New Hussman Stamp Co., 1122 Pine Street, St. Louis, Mo.

FREE! Rare airmail! Jubilee! Pictorials! Extraordinary packet 65 different stamps from strange countries (no Europe), 5c postage to approval applicants. Bargain Co., Box 39P, Station H, New York.

UNITED States approvals only. Write for selection. Positively no foreign. Jack Daub, Wabash Bldg., Pittsburgh, Pa.

WEEKLY Stamp magazine, thirteen weeks, 10c. Stamp Journal, Kalamazoo, Mich.

WHOLESALE Catalog for dealers. Illustrated. Postage 5c. Frank Co., 4900 Chalmers, Baltimore, Md.

PENNY Approvals, that satisfy. Nell Gronberg, Box 5441-P, Philadelphia, Pa.

44 DIFFERENT United States including \$5 stamp, or complete set United States bicentennials, or 30 different obsolete Canada, 13c postpaid with approvals. C. A. Lennan Co., Box 322, City Hall Annex, New York, N. Y.

\$5.00 U. S. Red and blue liberty, present postage value, Scott No. 573 cat. \$1.25 (retails as high as \$1.00 net by some dealers) only 5c to approval applicants. Giant U. S. pricelist free! Tatham Stamp Company, Springfield-5, Mass.

ANNUAL Wholesale catalogue—Illustrated and enlarged. Free upon application. Empire Stamp, Department 5, Toronto, Canada.

25 UNITED States, including \$4 and \$5 stamps free to approval applicants. 3c postage. Brownie Stamp Shop, Flint, Michigan.

DIAMOND-SHAPED Stamp, Liberia gunboat triangle, two other triangles, silver jubilee, 27 others, 5c. Crowder Company, 127E North, Baltimore, Md.

FREE!!! King George memorial packet, 15 varieties. Postage 3c. Roberts 901F Fourth, Baycity, Michigan.

LIBERIA Snake triangle, giant Spanish ship triangle, 50 other stamps, 5c. Abell Company, 2527 Guilford, Baltimore, Md.

PHOTO FINISHING

ROLL Developed, 8 fadeproof Velox prints and a Photo-file 25c. Reprints 3c. 1937 Photo Calendar from your negative 10c. Professional 8x10 enlargement 25c. Beautiful premiums. Young Photo Service, 405B, Albany, N. Y.

ENLARGEMENTS 4x6, Five for 25c, 5x7 three for 25c, 8x10 three for 35c. Hand colored and framed each 4x6 25c, 5x7 30c, 8x10 40c. Send film negatives. Enlargers, Maywood, Illinois.

FILMS Developed, 2 prints of each 25c; 20 reprints 25c. Pine Photo, M-5134 Nevada, Chicago.

DEVELOP And print your own pictures. Save time, money with our complete \$1.49 outfit postpaid, or pay postman \$1.55 C.O.D. Includes electric ruby lamp, printing frame, photo paper, chemicals and equipment. One of hundreds of amazing bargains in our free, newest, money-saving bargain book. Send for it today! Central Camera Co., 230 So. Wabash, Dept. K-22, Chicago.

IMMEDIATE Service! No delay! Roll developed, carefully printed and two beautiful 5x7 double weight professional enlargements or one tinted enlargement or six reprints—all for 25c coin. The expert's choice. Reprints 3c each. The Photo Mill, Box 629-12, Minneapolis, Minn.

MAIL Your rolls to The Kodak City. 8 guaranteed glossy Velox deckle-edged prints, 25c coin. Two professional enlargement coupons free! Photo Finishing Shop, Est. 22 yrs., 411-E Genesee Valley Trust Bldg., Rochester, N. Y. "The Kodak City."

"**HOLLYTINTS** Mean better prints." Two Hollywood professional enlargements with trial roll—25c. Handsome premium coupons free. Unequaled service. Hollytints, P-168, Hollywood, California.

ROLLS Developed, two sets dated Velox prints 25c. Hench Studios, 1814 Chestnut, Harrisburg, Penna.

ROLL Developed, two prints each, two enlargement coupons 25c. Summers' Studio, Unionville, Mo.

20 REPRINTS 25c—Films developed, 16 prints 25c. Enlargements 8x10—25c; 5x7—10c. Low Photo, M-2657 Neva, Chicago.

FINER Photos guaranteed! Rolls developed professionally—8 Velox prints, 2 bromide enlargements—25c coin. Finerfotos, Box D-898, Minneapolis, Minnesota.

BEAUTIFUL Kodak album (premium) free. One roll 16 prints for 25c. Fifco, Yale, Okla.

ROLLS Developed, 16 guaranteed prints, two coupons on plain or colored enlargement 25c. Smart Photo, Winona, Minnesota.

SUPERIOR Enlargements at low cost, plain, hand-painted, framed. Cut-rate price list free. Beauty Pictures, Dept. 54B, 408 Manhattan Ave., New York.

IDEAL Finishing. Your roll developed and printed, 25c. Snapshot folder and enlargement coupon with each order. Ideal Photo Service, Box 2235, Paterson, N. J.

FASCINATING! Easy! Beginner's developing-printing equipment. Electrobull, paper, chemicals, instructions, \$1.30 postpaid. Film-O-Print, 2019 North Kedzie, Chicago.

FRAMLETTE—Wooden, easel back, sizes 120, 116, 10c each; \$1.00 per dozen. Coin. Fotofram, Riverhead, N. Y.

LALJAGRAPH Reprints: (5x7), five 25c. Cardinal Photos, Berkeley Heights, N. J.

IMMEDIATE Service! No delay! Roll developed, carefully printed and two beautiful 5x7 double weight professional enlargements or one tinted enlargement or six reprints—all for 25c coin. The expert's choice. Reprints 3c each. The Photo Mill, Box 629-Z, Minneapolis, Minn.

TWO Beautiful Nuborder enlargements, eight guaranteed Nuborder prints, 25c. Giant Snapshots, Inc., B667A, Greenbay, Wis.

ROLLS Developed, remarkable quality, two master enlargements, eight gloss prints 25c. Reprints 3c. World Famous Johnson Studio, Eau Claire, Wisconsin.

ROLLS Developed, 116 size or smaller, eight beautiful enlargements, no small prints, 25c (coin). LaCrosse Photo Works, LaCrosse, Wis.

TWO Glossy enlargements, 1 colored, with roll 25c. Arbor Service, 10 Joliet, Ill.

FOR The discriminating amateur—roll developed and printed on super gloss Velox paper 25c, reprints 2c. Quality instead of quantity, same day service. Paramount Co., 403 E. 92nd St., New York City.

KODAK Enlargements 5x7, 10c; 3 for 25c coin. Send best negatives (film). Dept. 5, Xint Photo Lab., Cedar Rapids, Iowa.

FINE Finishing. Rolls developed and printed, with one colored enlargement, or two professional enlargements. All for 25c (coin). Genuine, nationally known, Moentone superior quality. Moen Photo Service, La Crosse, Wis.

ROLLS Developed. Two beautiful double-weight professional enlargements and 8 guaranteed Never Fade Perfect Tone prints. 25c coin. Rays Photo Service, LaCrosse, Wisconsin.

QUALITY Counts—Two double weight gloss enlargements and eight prints guaranteed not to fade from each roll, 25c. Prompt service. Excel Photo, Box D, Dubuque, Iowa.

ROLLS Rushed! Developed and printed with two supertone enlargements 25c. Four 4x6 enlargements 25c. Newton, Maywood, Illinois.

20 REPRINTS 25c, 100 Reprints \$1.00. Rolls developed with 16 prints 25c. Nordskog, 4, Maywood, Ill.

ROLL Developed and 8 beautiful Velox glossy prints 25c coin or stamps. Reprints 3c each. Fotoprint Service, Box E, Roanoke, Virginia.

20 REPRINTS 25c. Films developed, two prints each negative, 25c. Skrudland, 6970-8 George, Chicago.

ROLL Developed with 16 prints and two professional enlargements 30c, 100 reprints \$1.00, 16 reprints and 2 enlargements 30c. Dependable, RiverGrove, Illinois.

DAILY Service—Roll developed, 16 guaranteed prints, 25c. Valuable enlargement coupon; 16 reprints 25c. Modern Finishers, Box 3537-L, St. Paul, Minnesota.

COMPARE The difference! Roll developed, two professional double weight enlargements, 8 guaranteed prints, 25c coin. Excellent service. Nationwide Photo Service, Box 3333, St. Paul, Minnesota.

GET The best. Roll developed, beautiful hand colored enlargement, 8 neverfade border prints, 25c coin. Prompt service. Sun Photo Service, Drawer T, St. Paul, Minn.

TWO Prints each with every roll developed, 25c. Very finest quality. Reprints 2c each. Brown Photo Company, 2209-34 Lowry, Minneapolis, Minnesota.

MAKE Money with your camera. New book tells how. 113 pages illustrated. \$1.50. Popular Mechanics Press, 200 E. Ontario St., Chicago.

CAMERAS, PHOTO SUPPLIES

MAKE Money in photography. Learn quickly at home. Spare or full time. Easy plan. Previous experience unnecessary. Common school education sufficient. Write for full information and requirements. American School of Photography, 3601 Michigan Avenue, Dept. 3431, Chicago.

CAMERAS And supplies. Free illustrated catalog listing everything photographic—still and movie cameras, films, lenses—at tremendous savings. Hundreds of bargains, new and used. All guaranteed. We take your old camera or equipment in trade. Write now for your free copy of our newest money-saving bargain book—just out! Limited edition. Hurry! Central Camera Co., (Photographic Headquarters since 1899), 230 So. Wabash, Dept. K-2, Chicago.

MAKE Money selling snapshots. Complete instructions, 1800 markets, 10c. Photo Markets, 201-P Barrister Bldg., Washington, D. C.

INTERESTING Sample copy of 25c photographic magazine for 10c. Photographic Digest, 1666 Linden Street, Brooklyn, New York.

GET Inside! Fire lines; parade lanes; courts. Photographer's Press Card (like reporters) 25c each. Emery Service, Adam St., Pittsfield, Mass.

35% DISCOUNT On films. Write Paramount Photo Division, 403 E. 92nd St., New York.

INCOME From your camera instead of expense. Low cost home course teaches you to make photographs for magazines, newspapers, advertisers. Tremendous demand. Earn good money wherever you live. Free book. Universal Photographers, Dept. 104, 10 West 33rd St., New York.

HAVE You a camera? Send ten cents for recent number of our big magazine, showing how to make better pictures and earn money. American Photography, 116 Camera House, Boston, 17, Mass.

BASS Will postpay to you the Argus Candid Camera with f:4.5 lens, speeds to 1/200th of a second, \$12.50. New Argus enlarger at \$12.50. Daylight Pan film, all speeds, 36 shots, 85c. Weiti Precision Candid camera with genuine Carl Zeiss Tessar f:2.8 lens in Compur shutter, \$48.50. Voigtlander Duo Bessa 2 1/4 x 3 1/4 or 16 Vest Pocket, with f:4.5 Anastigmat lens, speed shutter, \$27.50. Write for free Bargaingram 227 now ready. Largest stock of new and used apparatus in America. Dept. AG, Bass Camera Company, 179 West Madison Street, Chicago.

MOTION PICTURES AND SOUND EQUIPMENT

DE VRY Sound film 35 projector, amplifier, speaker, complete \$185.00. 35mm silent 1,000 ft. films shorts complete \$1.00. Features \$5.00, 16mm F1.9 kodak camera \$45.00 like new, 16mm silent films \$1.00 per 100 ft. \$2.85 per 400 ft. Sound odd \$2.00, 400 ft. \$8.00. Collapsible screen 22"x30" spring roller, map case with adjustable tripod \$4.50 complete. Leica camera F3.5 perfect, \$45.00. Send for film lists. 8mm, 9 1/2, 16, 35 silent, soundlist, soundfilm. America's largest film library, rentals sent anywhere. Bargaingram full with used, new equipment, parts, repairs. Trades accepted, bought. Victor sound 16mm projector complete with amplifier \$79.50. Stewart Warner 500 watt fan-cooled projector, \$69.50. Mogull's 1944-J Boston Road, New York.

TALKIE Specials, silents \$5.00, projectors. Simpson, 1275 So. Broadway, Dayton, Ohio.

HOME Movies cost less than snapshots. Automatic \$9.95 camera takes 2400 pictures with 60c film and shows in \$12.50 motor projector. Order now! Send no money. Pay postman. Free lists. Home Movies, Box 32, Easton, Pennsylvania.

8MM—16MM ART Films. New series 25c for 8 Art film samples, \$1.00 for 20 ft. Art screen test. 16mm projectors \$3.50. 8mm projectors \$12.50, cameras \$9.95. Send 3c for Art film catalogues and complete 8mm and 16mm lists. Hollywood Cine Film Distributors, 1431-33 No. Highland, Hollywood, Calif.

CENTRAL'S Free, new, money-saving bargain book explains latest movie developments, offers money-saving bargains in cameras, lenses, projectors, films. Used equipment taken in trade. Write for free copy. Central Camera Company, (Photographic Headquarters since 1899), 230 So. Wabash, Dept. K-32, Chicago.

SMASH! 16mm Talkie units \$10.00, 35mm films 75c. Lists free. Visual Products, 459 West 22 Street, New York.

16MM FILMS "All subjects," bargains, exchanges made. Free illustrated catalogue (with sample art film 10c) 25 ft. Art \$1.00, 100 ft. \$3.50, 400 ft. \$13.00. Garden Film, 800 8th Ave., New York.

READY For you—No. 224—the latest and greatest Bass Bargaingram of Cine apparatus. Acknowledged leadership in the cinema field. A few of the fine values: Cine Kodak Model B, f:1.9 lens and case, \$54.50. 8 mm. Stewart-Warner camera with f:3.5 lens, \$15.00. 100 ft. DeVry 16 mm. camera, f:3.5 lens, \$22.50. RCA sound on film projector complete, \$85.00. Willo Cinemeter with case, \$3.75. Write today to Cine Headquarters and start to save now. Bass Camera Co., Dept. A, 179 W. Madison St., Chicago, Ill.

DIME Brings 3 free 16mm end titles and catalogs. 8mm and 16mm films exchanged. Big bargains in new and used films. 8mm art test, 50c or 16mm \$1.00. Generous art samples 25c. Illustrated art catalog 10c. Pacific, 1040 North McCadden, Hollywood, California.

8—16MM TITLES 2c Word Catalogue. Cineshop, 1560 Jackson, Charleston, West Virginia.

16MM BARGAIN Bulletin free! Acme Cine, Box 794, Lima, Ohio.

16MM FILMS. Our big catalogue and two usable "end" titles, 10c. Eastin Pictures, Davenport, Iowa.

FILMS, Cameras, projectors, lists 6c. BiCamex, 1451-P Broadway, New York.

35MM FILMS—Lists free. Superior, 126 Fourth Avenue, Paterson, N. J.

FILMS Exchanged free. Bargains cameras, projectors, films. National Service, Box 125, West Springfield, Mass.

WORLD-FAMOUS Movies forty-years old. 16mm "Great Train Robbery," \$12. Two locomotives crash, 69c. Catalogs dime. Exclusive distributors. Peerless, 6801 Carpenter, Chicago.

35MM FEATURES \$1.00 Reel. Shorts, \$1.25. Lists. Calderaro, 5119 South St. Louis, Chicago.

ANNIVERSARY Sale. Everything cinematic. Arts, samples 10c. Box 2133, Paterson, N. J.

LEARN Motion picture theatre business. Home-study training: Management, advertising, projection. Established nine years. Low tuition. Easy to learn. Free catalog. Theatre Institute, Elmira, N. Y.

BARGAINS! 8mm, 16mm. Catalogue free. Elder, Dept. B-31, Chelsea, Mass.

16MM BELL Movie camera \$7.50. Complete outfits \$19.50 up. 16mm film (including processing) \$1.89. Projectors. Circular free. Bytom, Dept. B, Park Ridge, Ill.

35MM TWO Reels \$1.75. Projectors. Bergen, Woodliff Lake, New Jersey.

WESTERN Thrillers, 500 feet 75c. Jersey Filmco, 2075 Richard, Lakewood, Ohio.

LOOK! "The World's Greatest Passion Play." Seven reels, (new) 16 mm. Superior than the Oberammergau stage play. Rent or purchase. Write Hemenway Film Co., 37 Church St., Boston, Mass.

35MM FILMS. Bargain lists 3c. Hoffman Film Service, 57 Broad, Albany, N. Y.

BASS Now exclusive distributor for Radio Corp. of America 16mm. R.C.A. Sound on Film Cameras. Anyone can record sound pictures. New low price. News reporter model was \$350.00, now \$210. Send for complete details. Bass Camera Co., Dept. AK, 179 W. Madison St., Chicago, Ill.

8MM FILMS: Cartoons, travel. List. Lincoln Film Service, Box 293-A, Saginaw, Mich.

16MM SILENTS. Free "60% reduction" catalog. Deutsch, 509 Pine, Chattanooga, Tenn.

16MM FILMS. List. Sam's Cine Films, 804 St. Charles Ave., New Orleans, La.

RADIOS, SUPPLIES, INSTRUCTION

NEW Style custom built personal radio. Ideal for child's room, den, bedroom, kitchen, office. Full rich tone. Dynamic speaker. Six tube performance from four new type dual purpose tubes. Handsome walnut finish console cabinet 8 1/2" x 5 1/2" x 4 1/2". Tone control. A.C.-D.C. Illuminated dial. Guaranteed. Five day trial. \$9.85 complete. Mail check or money order. Myradio, Room 2305, General Electric Building, 570 Lexington Ave., New York.

TWENTY Lesson radio course for beginners. New easy method. Remit one dollar bill to Henderson Radio Service, Expanse, Saskatchewan, Canada.

SAVE Money on radios and parts. Send for our money saving bulletin. United Radio Co., Newark, N. J.

1937 MODEL Farm radio \$2.95. Send dime for illustrated copy "Radio Millions Been Waiting For." Western Radio Corporation, Wichita, Kansas.

FREE—"Pocket Radio" with order. Particulars, catalogue, 10c. American Business Service, Shamokin, Pennsylvania.

CONDENSERS: Bypass metal encased, transmitting and diathermic. Super Tel. Labs., Oconomowoc, Wisconsin.

RADIO Experimenters and set builders; parts and kits of parts for Six Tube long and short wave, Pre-Amplifier, Portable Superhet battery, Improved Little Giant Four and Five tube and Economy Three sets described by Popular Mechanics. Guaranteed specified parts. Lund Manufacturing Co., 43 East Ohio, Chicago.

RADIO. What everyone should know about it. "The Beginner's Story," 100 pages, many illustrations, leatherette cover, written in simple language. Price 40c. Radex, Conneaut, Ohio.

SW CRYSTAL Set—4250 mile record. Instructions 18 distance models; "Radiobuilder" year; 25c. Laboratories, 151-C Liberty, San Francisco.

TEST Tubes yourself, accurately! Simple instructions, 10c. Tomalino Radio Service, Glendive, Mont.

RADIO Engineering, broadcasting, aviation and police radio, servicing, marine and Morse telegraphy taught thoroughly. All expenses low. Catalog free. Dodge's Institute, Ames St., Valparaiso, Ind.

RADIO. All phases. Amateur, shortwave, experimenting, set building, broadcasting, servicing, etc. Complete list recommended books free. Popular Mechanics Press, Room (C36), 200 E. Ontario St., Chicago.

MUSIC AND MUSICAL INSTRUMENTS

REBUILT Band and orchestra instruments. Honestly rebuilt—fully guaranteed. Catalog of new instruments on request. Weymann Company, Dept. M-2, 1613 Chestnut St., Philadelphia.

LEARN Piano accordion. Quick method by mail. Stamped envelope for particulars. Gigey, 5201 Bernard, Chicago.

SONGPOETS. Music guaranteed. Lessons 25c. National Songland, "PM," Thomaston, Maine.

ENTER Monthly song contest. Send lyrics, melodies. Write to Superior Song Studios, Passaic, N. J.

SONGPOEMS Set to music—10 copies with "Modern Marketing Guide," \$2.00. Newald Music Co., Kitchel, Ind.

SONGWRITERS! Outstanding proposition. Inquire. Hibbeler, D1, 2157 No. A-ers, Chicago.

SONGWRITERS Fifty-fifty Magazine, ten cents. Lee Ice, Marietta, Ohio.

ORCHESTRATIONS—10, \$1.00. Sheet-music, 25, \$1.00. Silverman, 3303 Lawrence, Chicago.

BUILD 3 1/2 Octave marimba—xylophone. Beautiful tone. I tell you how. Melody Mallet Shop, Dept. C, 808 So. Division St., Kellogg, Idaho.

SONG Poems, complete songs wanted, instruction book sent free. Song Bureau, Salem, Indiana.

MUSIC Composed to song poems. Our published songs endorsed and featured by stage, radio, screen celebrities. Adelman Bros. Music House, Dept. 601, Washington, D. C.

EARN Your own musical instrument. Get free details and free attractive savings bank at your music store, or write Fred Gretsch Mfg. Co., 521 1/2 So. Wabash, Chicago.

SONGS—Composed, revised, published. Get our 100 copies offer. Melodymart, Box 160, Independence, Kansas.

SONG Poems wanted—Home, love, sacred, comic, any subject. Send poem today for offer. Richard Bros., 24 Woods Bldg., Chicago.

VIOLINS—Handmade. Best since Stradivarius days. (Curious don't bother.) John Lehto, San Pedro, Cal.

SONGS Published, arranged and composed, royalty basis. W. Coast Music Pub., 942 Market, San Francisco.

SONGWRITERS—Send for free copy of booklet revealing Secrets of Successful Songwriting, free rhyming dictionary and market information. If you write poems or melodies, send for our offer today. MMM Publishers, Dept. E1, Studio Bldg., Portland, Ore.

MUSIC Composed to words. Wonderful proposition. Bauer Bros., Oshkosh, Wis.

WRITE Songs. Big money and reputation. Write for information. J. Gordon Pub. Co., 201 N. Hoyne Ave., Chicago.

ORIGINAL Music composed to your words \$5. Reginald Belcher, Chatham, New Jersey. 25 years church organist, musical director.

SONG Writers. Send for our "Publishing Agreement." McKinley Music Printers, 1501 E. 55th St., Chicago.

BUSINESS OPPORTUNITIES

SUCCESSFUL Brains, the guide to a full pocketbook. New ideas, plans, money making secrets and valuable information. Particulars free. Edward Johnson, Dept. P, West Creek, New Jersey.

FORMULAS—Fast selling products. Guaranteed. Laboratory tested. Lowest prices. Catalog free. Kemico, 55B, Park Ridge, Ill.

MECHANICALLY Inclined salesman. Sell, install new gas station signal. Choice territory open. Air-O-Call, Box 2757, Cleveland, Ohio.

INVENTION Finance Magazine, 80-G Wall Street, New York. Year subscription 60c entered upon promise to pay on receipt of first copy.

OPERATE A collection business. Be a credit-collection manager. Short course quickly teaches both. Fine income assured. Write Cole Associates, Syracuse, New York.

"THE Schemer," Alliance, Ohio, prints schemes, ideas, business starters, formulas—big winners: \$10,000 to \$50,000 reported. 39th year; \$1.00. Special—Trial six months only 30c.

INVENTORS—Small ideas may have large commercial possibilities. Write us for free book, "Patent Guide for the Inventor" and "Record of Invention" form. Delays are dangerous in patent matters. Free information on how to proceed. Clarence A. O'Brien & Hyman Berman, 58-S Adams Building, Washington, D. C.

MRS. M. earned \$267, three weeks, raising mushrooms in cellar! Exceptional, but your cellar, shed perhaps suitable. We buy crops. Book free. United, 3848-A65 Lincoln Ave., Chicago.

COLOR Any concrete surface with cheap chemical solutions. Dandy new business. Particulars free. Hollywood Cementcraft, 8527 Wonderland Ave., Hollywood, Calif.

START Mail business—Plans; free help. General Publishing Co., Peekskill, N. Y.

PRACTICAL Mailorder plans. Details free. Fred Rothe, 3949 Ontario, Chicago.

FREE Details for earning at home. Write Healy, 48 Washington Bridge Station, New York.

"17 WAYS To make money with pigeons." 15c postpaid. Mrs. Johnnie Jeffers, Okaloosa, Iowa.

MAIL Business. Start small. Everything furnished. Free details. Metromails, P-2, Cincinnati.

START Profitable mailorder business. Shoestring capital. Monroe Rinehart, Hanover, Pa.

START Your own circulating library. We furnish and exchange your books. Fireside Rental Library, 210 Crosby Bldg., Buffalo, N. Y.

FREE Instruction resilvering mirrors with 75 cowboy songs 25c. Empire Novelties, Peterboro, Canada.

ATTENTION: Make money collecting accounts with letters that retain customers. Write Commercial Station, Box 925, Springfield, Missouri.

MARBLEIZING; Porcelain enamel finish. Cement prepared, mix with water, applied to wood, wall-board, concrete, etc. Filinlike hardness, brilliant. Cheap as white portland cement. See our 85c liquid rubber for mold making. Sets solid in four hours. Any thickness. Send dime for assorted samples, both rubber and porcelain. Cowell Institute, Grayling, Mich.

WHERE To buy at lowest wholesale prices, information free. Yorena, Box P-132, Bayonne, N. J.

1000 SURE-FIRE Moneymaking opportunities! 25c postpaid. Rayburt, 100 Genesee, San Francisco, California.

WE Promote business transactions of all kinds. Cole Syndicate, Bryant Pond, Maine.

HEALTH Food products, easiest and safest. Mail sellers. Vegetable concentrates, tablets, powders, vitamins. Your own labels. Samples, dime. Gardena, 128B, Station "S," Los Angeles, California.

SELL By mail. "The Key to Business Opportunities" is a secret that will make you independent. Free. R. Edmondson, 50 Whitehall, Atlanta, Ga.

OPPORTUNITY!! Learn outdoor profession. Make \$1.50 hour. Details 3c. Clough Institute, Grayling, Michigan.

BED Bugs. Our new formula kills them every time without danger or trouble. You can start good business selling product or using it for exterminating. All details including secret formula \$1. Particulars free. Stamp appreciated. Benton Company, 29 Buckley, Liberty, New York.

OFFICE-SUPPLY Salesmen sell Tough-Tape-Binder to strengthen edges of papers, drawings, blueprints, photos. Steady income. Repeat orders. Attractive proposition. Write: Vertex Co., 5 Great Jones St., New York.

67 PROVEN Moneymaking plans, 25 cents. Frank Turack, 127 Starr Bldg., Export, Pa.

GIGANTIC Mails year, 10c. Copies, maildealers. National News, Winchester, Ohio.

PLASTEX Industries offer industrious men an opportunity to start a business of their own, manufacturing art goods, novelties and utility products in Plastex and marble imitation. 1/2c material makes regular 10c store sellers. Rubber moulds furnished for speed production. Small investment brings big returns. Since the crash, low priced goods are needed and this line meets the demand. Interesting booklet mailed free. Plastex Industries, Dept. A, 1085 Washington Avenue, New York.

NEWEST Mechanical merchandiser sells 36 different confections. Big money maker. Sold on exclusive franchise. Write for details to 209 United Bldg., Louisville, Ky.

START Your own business. Be independent. Proven income \$300-\$400 monthly. Can start as part time. Protected A1 merchandise (trade mark). Retail \$3.90, cost you 75c. Act quickly for this rare opportunity. Details. Beyer Mfg. Co., 4655 Lincoln Ave., Chicago, Ill.

MAKE Artificial marble, glossy tiles, un-canny. Tabletops, plaques, floors, whetstones, novelties. Inexpensive, hard, fireproof, cement secrets. Brilliant tile and liquid rubber samples 3c. John A. Payu, 945 Grande Vista Avenue, Los Angeles, Calif.

NEW Method—Mail order business. Big money in spare time. Experience unnecessary. Baker, 5509 Winthrop, Chicago.

AGENTS—To mail our literature. Good profits. Home business. Maywood, 149 Fifth Ave., New York.

24 SELECTED Opportunities to start a business of your own. \$1.00 postpaid. Particulars free. Act now! Kubelka, 58 East 106th, New York, N. Y.

OBTAIN Capital needed for any purpose. Particulars free. Capital Service, Jefferson City, Missouri.

SELL By mail: 10 complete copyrighted plans, 25c coin. Pricerite, 58 N. 14th, Hawthorne, N. J.

INVEST In your future—New folio tells how to make money quickly and honestly. Details free. Morrison, Pontotoc, Miss.

CORRESPOND For newspapers: Profitable, interesting. Easily learned. Write Publishers' Service Bureau, 4258-F Drexel, Chicago, Ill.

DOLLARS Daily! Start home! Mailorder business. Details, Duffy, Covington, Ky.

PROFIT With new products. Make, sell, repeat. Analysis, Research. Guaranteed formulas. Biggest catalog free. Special prices, leads. Gibson Laboratory, Chemists, BD-1142 Sunnyside, Chicago.

COMPLETE Money making plans free! National Service, 7026 Normal, Chicago.

DISTRIBUTOR For new products and appliance line. Liberal commission. Walters, 326 Monterey, Detroit, Michigan.

BARGAINS—Paint spray outfit, gasoline engine drive. Terms—trial. Helmick Paint Spray Exchange, M-274, Troy, Ohio.

MAKE Walkiesnaps—A new business. Write for details on this fascinating new money-making business. Bass Camera Company, 179 W. Madison St., Chicago, Ill.

WE Start you in business, furnishing outfits and instructions, operating "Specialty Candy Factory" home. Men and women, earn \$25.00 up to \$60.00 weekly, all or spare time. Booklet free. W. Hillyer Ragdale, Inc., Drawer 4, East Orange, N. J.

10 CENTS Brings copy of mail dealer, and big mail. Guilford Service, Aurora, Nebr.

HOW And where to obtain capital fully explained, free particulars. Star Service, Wapakoneta, Ohio.

GET Lots of mail. Your name in 10,000 opportunity directories, 25c. Roseco, 4627 Glenshade, Cincinnati.

EARN Money acting as rent collector. All or part time. Also fine side line for real estate men. Modern method gets results. Circular free. Slocan, 2038 Obeas, St. Louis, Mo.

FREE Circulars describing hundreds of money making opportunities selling by mail. Build your own business. Write now. Progress Publishing Co., Box 1936-H, Milwaukee, Wisconsin.

BIG Malls 10c. 20,000 directories service. Norton Wynn, Lamar, Mo.

"1,000 WAYS To Make \$1,000.00." You can do it—others have. This new amazing book will startle you. 475 pages only \$2.50. Popular Mechanics Press, Room (C36), 200 E. Ontario St., Chicago.

BUSINESS Of your own. No capital required. Details. Wun Service, California, Pa.

BOOK Contains 700 formulas. 50c postpaid. Illinois Universal, 3112 Madison, Chicago, Illinois.

CONSULT Miller free regarding any manufacturing problem, newest specialty, formula, process, analysis you're interested in. Get my interesting literature describing newest discoveries, modern recognized products. All lines. 38 years of unequalled service. Miller, Analytical Chemist, Miller Building, Tampa, Fla.

BE A Perfumer, retail, or mail order. Hardly any capital. Free instructive booklet gives plans of operation. Call-Blossom Perfume Syndicate, Alhambra, Calif.

FREE Literature—Hundred business ideas. Merritt Co., 14 Steuben St., East Orange, N. J.

BRINK'S Trade Directory—The most complete ever published for salesmen, agents and mail order dealers. Price 50c. M. Devine, 820-M, Wrightwood Ave., Chicago, Ill.

500—1936 NAMES Of opportunity seekers 50c. Trial hundred 10c. Carl Edquist, Odessa, Minn.

SUCCEEDED With your products. Make-sell them. Formulas, Processes. Accurate analyses. Catalog free. B. Thaxly Company, Washington, D. C.

NO Boss! Sure cash! Silvering mirrors, autographs, reflectors. Combination outfit. Write Sprinkle, Piater, 127, Marion, Ind.

CHEMICAL Expert furnishes manufacturing formulas with complete working directions. Reliable individual services. Charges reasonable. Dr VanHeeden, 1410 East 54th, Chicago.

SELL By mail. Books, novelties. Bargains! Big profits! Particulars free. B. Elfcio, 438 North Wells, Chicago.

CHARTERS: Delaware; best, cheapest; free forms. Colonial Charter Co., Wilmington, Del.

MANUFACTURE Polishpuffs. Amazing proposition 10c. Particulars free. Hickorydell, Glenbeulah, Wisconsin.

ARTIFICIAL Marble sanitary flooring, instructions covering wood or cement flooring ½ inch thick, fireproof, all colors, low cost, ornamental casting, concrete, plaster, papier-mache, garden furniture, statuary, flexible molds, particulars free. Chris Mahler, Elmont, N. Y.

MAIL Order business is your opportunity. Many began small, now earn thousands yearly. No personal contact. Boundless opportunities. Have had over 30 years experience; will help you succeed. Send 25c for valuable booklets, none free. B. Breniser, 257 South 21st, Philadelphia.

I WANT To send you proof of the wonderful pulling power of Popular Mechanics Magazine's classified pages. What's your proposition? Write me today. F. W. Johnson, Manager Classified Advertising, 200 E. Ontario St., Chicago, Ill.

FREE Booklet describes 107 plans for making \$20-\$100 weekly, in home or office, business of your own. Elite Co., 214 Grand St., New York.

COMPLETE Chemical service, analysis, formulas, processes, trade secrets. Particulars free. W. L. Cummings, 228 Gordon Avenue, Syracuse, N. Y.

POPCORN, Crispette, earmelcrisp, potato chip, salted nut machines. Long Eakins, 1960 High St., Springfield, Ohio.

MAIL Order and local business. All of fee. No canvassing; no stock; no shipping. Part of national chain. All instructions given. Shoestring capital. Circular free. Harrigan, P.O. Box 97, Drexel Hill, Pa.

START Little business anywhere. Everything furnished. No canvassing. Maywood, PM-923 Broadway, New York.

YOUR Old plans—regardless of original cost—taken in exchange for my new, original 1000-In-One-Plan. Details free. Write at once. National M. Agency, 2045 Snyder Avenue, H. Philadelphia, Pa.

MONEYMAKING OPPORTUNITIES

MONEYMAKING Projects for woodworkers. Two for 30c coin. Interesting circular free. Woodcraft Service, Plainview, Minnesota.

"20th CENTURY Business Encyclopedia." Book full of money making plans, formulas, manufacturing processes. One plan brought \$250,000.00 business in one year. 144 pages. Postpaid \$1.00. Richard Supply Co., Dept. B, 2514 Mt. Auburn St., Augusta, Georgia.

BIG Winter profits with the new Champion Electric Skate Sharpener. Circular free. Carl Jamer, 75 Walker Street, New York, N. Y.

"FINANCIAL Independence"—New dollar copyrighted book money making opportunities, formulas, ideas. Sample, with wholesale prices, quarter. Self-Help, Twin Peaks, California.

PULL In the dollars with the "Money by Mail" system. Particulars free. R. Bowen Company, American Bank Building, Portland, Oregon.

1,000,000 ARTICLES Wholesale. Latest directory, 10c. Jelsmith, 163 Myrtle, Waltham, Mass.

107 PLANS For making \$20-\$100 weekly in home or office business of your own. Descriptive booklet free. Elite Co., 214 Grand Street, New York.

NATIONWIDE Profitable propositions. Details, stamp. Evers, Box 66PB, Elmhurst, N. Y.

"PROFITABLE Ideas" Magazine, 6 North Dearborn, Chicago. 50 moneymaking pages. 10c. "Mail Dealers Wholesale Directory," 25c.

NEW "By Mail" distributing business. Free details. Dollar plan, "Building Mailing Lists" 10c. Merchants Sales, 617M North Second, Milwaukee, Wis.

FIFTY Money-making opportunities, 25c. Carl Greiner, 5112 N. Oakley Avenue, Chicago, Illinois.

MAKE Your telephone pay. Inst. 25c. Phone-guide, 3105 32 Ave. So., Minneapolis, Minn.

10c BRINGS Copy National Mail Order News, Box 1773PM13, Roanoke, Virginia.

DOLLARS Daily by mail. Bulletins free. Write now. Tell Service, P1451 Broadway, New York.

FREE! Profitable circular mailing instructions. Mallservice, 2231 McKinley, Berkeley, Calif.

FREE Particulars! Exceptional money-making opportunities. Sinclair, Box 861, Hollywood, Calif.

TREMENDOUS Money making opportunities in new 1937 Mail Promotion Bureau. Particulars free. Sawyer Specializations, Newton Highlands, Mass.

FREE!! New, unusual, spare-time money-making business. Including samples printed matter. Flescher, 4 W. Huron, Chicago.

TO Win success you must do something different; particulars free. Publishers Sales Company, Box A-76, Nelson, Georgia.

BUILD New batteries from old. Latest achievement. Cost \$1.58. Battery Laboratories, St. Paul, Minnesota.

OPPORTUNITIES For money making. Summit Press, Box 123, Jackson, Mich.

\$250.00 BUYS Neon sign plant complete. Illustrated glass blowing book teaches you the trade. Learn the easy way. Earn big profits in neon signs. Details free. Wholesale Neon Supply, Sheboygan, Wisconsin.

FREE Circulars describing hundreds of money making opportunities selling by mail. Build your own business. Write now. Progress Publishing Co., Box 1936-G, Milwaukee, Wisconsin.

FORTUNES In home manufacturing. Booklet free. Ogg Laboratories, Tampa, Florida.

1000 MONEYMAKING Ideas, book 50c; literature free. Harvey Teeple, Decatur, Ind.

MILLIONS Jobless! Get dollars in mail daily, like we do, for amazing employment information (got man 76 jobs). Keep money; we fill your orders free. Stamp brings details. Co-Operative Service, 77 Swan, Buffalo.

BIG Money at home plating auto parts, reflectors, mirrors, chandeliers, by late method. Experience unnecessary. Free particulars. Gunmetal Co., Ave. N, Decatur, Ill.

FORMULAS, PLANS, ETC.

67 PLANS, 29 Formulas 25c. Jelsmith, 163 Myrtle, Waltham, Mass.

MAKE A real stone cleaner. Guaranteed. Formula 50c. F. Schuller, 1928 University Ave., Bronx, New York.

SOLDERING Aluminum. Formula \$1. Simple, inexpensive, permanent. Gerwin, Shawnee, Oklahoma.

GUARANTEED Formulas—New fast sellers. None better. Lowest prices. Catalog free. Kemico, 49B, Park Ridge, Ill.

SUCCEED As your own boss. Manufacture fast selling products paying good profits. Details. VG Chemical, Box 4651, Pittsburgh, Pa.

FORMULAS—Money-making ideas. Literature free. Hoy Service, Valley Junction, Iowa.

TESTED Formulas. Free consultation; details. Kaplan, 13 S. Eden, Baltimore.

FORMULAS—Newest, profitable, unexcelled. Write for unequalled special offers. Philarst, Jefferson City, Missouri.

550 MONEYMAKING Formulas 20c. Ideal Book Shop, 178, Park Ridge, Ill.

FORMULAS And analysis. Modern, all types created. Gallagher, % Goods Drug Store, Allentown, Penna.

ANALYSIS. Research. Newest guaranteed formulas. Biggest catalog free. Special prices, leads. Gibson Laboratory, Chemists, BD-1142 Sunnyside, Chicago.

FORMULAS—Latest best sellers. List free. Persian Laboratories, Bay City, Mich.

MAGIC Soap, cleans everything. Money maker. Formula 30c coin. Fair Deal Agency, Amarillo, Texas.

CERTIFIED Formulas, best science can produce for making popular, biggest-selling specialties. All lines. Before buying formulas, get my valuable "Eye-Opening" literature, including free subscription to Miller's Monthly Messenger. Miller, Chemist, 1706-A, Tampa, Fla.

SUCCEED With your products. Make-sell them. Formulas, Processes. Accurate analyses. Catalog free. B. Thaxly Company, Washington, D. C.

FORMULAS—Latest money makers. Literature free. Belfort, 4042 N. Keeler, Chicago.

10,000 MONEY-MAKING Formulas. Tells you how to make and sell almost everything under the sun; cosmetics, mucilage, anti-freeze solutions, battery solution, beverages, cheese, chewing gum, cleaning preparations, extracts, hair preparations, inks, bluing, leather polish, mirrors, perfumes, polishes, typewriter ribbons, carbon paper, washing powders, liquid soap, and hundreds of other profitable articles. \$4 postpaid. Popular Mechanics Press, Room (C36), 200 E. Ontario St., Chicago.

CHEMISTRY

FREE Chemistry catalogs. Supplies at 5c! Equip complete laboratory. Send 10c (returnable) for postage and handling. Kemkit Scientific Corp., 135P Johnson Street, Brooklyn, New York.

SUPPLIES For chemistry students. Catalogue 5c. Book catalogue free. Handbook for chemical experimenters, hundreds of instructive experiments, 50c. Reading Scientific Company, Reading, Penna.

SEND 25c For new illustrated chemical experiment book with over 300 formulas and tests. Also receive 32 page illustrated catalog of apparatus, microscopes, telescopes and chemicals free. F. Winn, 124 West 23 St., New York.

RESEARCH. Experiments, magic—three months subscription—15c. Spencers Chemistry Magazine, 100 Forsyth, New York.

CHEMICALS. Laboratory glassware, apparatus. Send 3c for catalog CP. Biological Supply Company, 1176 Mt. Hope Avenue, Rochester, New York.

CHEMICALS In 5c quantities. Catalog 5c. Flescher's Laboratories, Everett, Massachusetts.

HELP WANTED

ENJOY Good weekly pay while learning landscape work. No money or experience needed—we train you free. Work in home county full or part time. Old reliable company. Brown Brothers Nurseries, Dept. 161, Rochester, New York.

LOCAL Agents wanted to wear and demonstrate free suits to friends. No canvassing. Up to \$12 in a day easy. Experience unnecessary. Valuable demonstrating equipment, actual samples free. H. J. Graves, Pres., 1300 Harrison, Dept. P-817, Chicago.

IF You want to get groceries and household supplies at wholesale, and a wonderful chance to make up to \$15 in a day besides, send me your name immediately. No experience necessary. New Ford sedans given to producers as bonus. Albert Mills, 2246 Monmouth, Cincinnati, Ohio.

CASH Paid for butterflies, insects. See Sinclair Display Advertisement on page 16A.

EARN \$10.00 Daily commission selling absolutely finest, guaranteed, specially constructed shoe; garages, mechanics, delivery men; free samples. Dura-Tex Shoe, 1010 Center, Brockton, Mass.

USE \$500.00? Raise canaries for us. Free particulars. Canary Guild, 3741-B, 60th Street, Woodside, N. Y.

AGENTS WANTED

"SNAP-UP" Gas tank locks. Electric, push button control, compact, attractive, reliable. Price \$4.00. Agents wanted. Steele Brothers Co., 445 Winchester, Ashland, Kentucky.

MEXICAN Feather pictures. Unusual novelty. 50c (stamps) bring \$2.00 worth samples, details. Refunded if unsatisfied. Mexican Art, Apartado 1593, Mexico City.

MONUMENTS, Markers, beautiful enduring granites \$8 up. Free catalog, samples. Agents wanted. Mihelich Monument Co., St. Cloud, Minn.

STRANGE Ironing cord. Saves electricity. Abolishes scorching and kinking. For telephones also. 150% profit. Sales guaranteed. Big free offer. Neverknot, Dept. 2A, 4525 Ravenswood, Chicago.

450% PROFIT In new automatic gas lighter. No flint or flame. Lights gas instantly. Retail 25c. Costs you \$1.00 a dozen or 15 dozen for \$8.00 postpaid. Sample 10c. New Method Co., Box PMG-50, Bradford, Pa.

NEW Cleaner—Amazes everybody. Cleans everything. Washes clothes snow-white quickly. Spots, stains removed like magic. Startling demonstrator. Free samples make fast sales. Quick repeater. Immense profit. Write quick for "free sample." Super-X Cleaner Co., 11, Berwyn, Illinois.

MEXICAN Curios. Free particulars, samples 10c stamps. Apartado 1176, Mexico City, Mexico.

SEND 50c For false-tooth brush that does not soften, recommended by dentists. One each household and mechanics' brush included. Postpaid. Money back guarantee. Agents wanted. Palm-ett Brush Co., Umatilla, Fla.

WHOLESALE Catalog free. 500 best sellers. Paty Co., 1167 Broadway, Somerville, Massachusetts.

500% PROFIT Selling new "20-in-1" kitchen utensil. Retail 25c. Costs you \$1.00 a dozen. \$7.20 a gross. Sample 10c. New Method Co., P.M.M.-50, Bradford, Pa.

NEW Discovery—Liquid window shade cleaner. Trial pkg. 25c. Porter Advertising Service, Box 3123, Knoxville, Tenn.

ROUTE Men wanted. Local grocery routes paying up to \$45 in a week. Automobile given producers as bonus. Write Albert Mills, 2249 Monmouth, Cincinnati, Ohio.

AGENTS! Dresses 33c. Men's suits \$1.50-\$2.00, shirts 46c, ties 6½c, chifon hose 42c. Amazing prices. Big profits. Catalogue free. Acme, AB-558 W. Roosevelt, Chicago.

\$6.00 HOURLY. Amazing Karnu refinishes auto like new without rubbing, polishing, waxing or painting. Wipes on with cloth. Lasts 8 to 12 months. Free sample. Karnu, Dept. L-8, Cincinnati, Ohio.

300% PROFIT In new self-starting no-flint cigar lighter. Retail 50c. Sample 25c. Get details quick on wonder seller. New Method Co., Box PM-50, Bradford, Pa.

AMAZING Iron-So-Ezee-Ironing switch. Saves electricity! Prevents scorching! Makes ironing easy. Needed in homes. Big seller. Iron-So-Ezee Company, Mt. Washington, Ohio.

PROFIT With new products. Make, sell, repeat. Analysis. Research. Guaranteed formulas. Biggest catalog free. Special prices, leads. Gibson Laboratory, Chemists, BD-1142 Sunnyside, Chicago.

CASH Paid for butterflies, insects. See Sinclair Display Advertisement on page 16A.

FREE Clothing, big money daily selling quality raincoats, jackets, overcoats. Lowest prices! Samples free! Goodwear, 712-AC Roosevelt, Chicago.

BIG Profits selling powdered hand cleaners, get our low bulk prices. Sell under your own name. Kleenslick Co., 1992 E. 5th, St. Paul.

5c WILL make you 75c profit. Free sample of product. Free literature. Stanley Products, Lansing, Mich.

LINDBERGH Stamps, covers, commemorating tenth anniversary Paris landing, next May. Prudhomme, 1516 Masonic, San Francisco.

SELL Slogan signs. New catalog free. Special. Kut, Sidney, Ohio.

SELL Air cushion insoles. Sample 35c. Hanlan, 2911 Van Buren, Los Angeles, Calif.

BUY Wholesale 1000 bargains. Catalog free. Products Company, Gary, Indiana.

MEN—Women \$3 to \$6 daily. Selling 25c household necessity that repeats. Three to ten sold in every home. Free sample. Write Puro Company, 3107 Pine St., Dept. B-2047, St. Louis, Mo.

BIG Money and fast sales. Every owner buys gold initials for his auto. You charge \$1.50, make \$1.45. Ten orders daily easy. Write for particulars and free sample. American Monogram Company, Dept. 40, Dunellen, N. J.

AGENTS: Smash go prices. Santos coffee 12c lb., 4-oz. vanilla 8½c. Razor blades 10 for 8½c. 100 sticks chewing gum 12c. 150 other bargains. Premiums. Experience unnecessary. Carnation Co., PO, St. Louis, Mo.

500% PROFIT! Gold reflecting letters for store windows. Large sizes 1c. Free samples. Modernistic Sign, B-3004 Lincoln Ave., Chicago.

SELL Neon signs. Big profits. Sample—\$3.95. Free details. Wholesale Neon Supply, Sheboygan, Wisconsin.

SELL—Blade conditioners—Smoother shaving, millions being sold. Marvellous. Order sample, details quick. Twenty-five cents. Charlton Corporation, Chicago.

NO Boss! Sure cash! Silvering mirrors, autoproducts, reflectors. Combination outfit. Write Sprinkle, Plater, 128, Marion, Ind.

SUCCEED With your products. Make-sell them. Formulas. Processes. Accurate analyses. Catalog free. B. Thaxty Company, Washington, D. C.

WHY Work for others? Make and sell your own goods. Formulas, toilet articles, perfumes, extracts. Valuable book free. Scientific Laboratories, 1950W Broad, Richmond, Va.

ENGRAVED Name plates, numbers, signs, etc., easily sold, profits large. Brett Bros., Winthrop, Mass.

MAN In each town to plate auto parts, reflectors, bathroom fixtures, refinish beds, mirrors, chandeliers, by late method; experience unnecessary. Simple plan of manufacturing at home starts you in big money making business. Free particulars and proofs. Gunmetal Co., Ave. H, Decatur, Ill.

GENUINE Gold letters for store windows. Easily applied. Free samples. Liberal offer to general agents. Metallic Letter Co., 438-B North Clark, Chicago.

BIG Money applying gold initials on automobiles. Easiest thing today. No experience needed. Free samples. "Balco," 1084 Washington, Boston, Mass.

FREE Sample—Amazing cleaner; sells homes, taverns, everywhere. Big profit—fast repeater. Betco, 5007 Irving Park, Chicago.

SELL Novelty fun cards, novelties, etc. Samples 10c. National, Box 500M, Cincinnati.

AGENTS: Stamping names on pocket-key protectors. Sample check with your name, address, 25c. Stamping outfits. Emblem checks, check-fobs, name plates. Hart Mfg. Co., 303 Degraw St., Brooklyn, N. Y.

AGENTS—Opportunity to make money; book containing 107 successful business plans; home or office; send for free introductory booklet. Elite Co., 214 Grand St., New York.

WANTED—District purchasing agents. No experience or money required. Write Purchasing Manager, 174 N. Halsted, Chicago.

COSTS 1c—Sells 25c. Make non-explosive cleaner from benzene crystals. 1c gallon. Sample 10c. Literature free. Western Reserve Laboratories, 6615 Denison Ave., Cleveland, Ohio.

DO You want agents for your proposition? Your ad in this space will place your message before hundreds of men seeking fast-selling products. My folder "How to Secure Agents" is filled with proof. I'll gladly send you a copy free. F. W. Johnson, Manager Classified Advertising, Popular Mechanics Magazine, 200 E. Ontario St., Chicago.

PROFITABLE Home business. Legitimate. No canvassing. Maywood Publishers, P-923 Broadway, New York.

GOLD Reflecting letters for store windows. Easily applied. Large sizes, penny each, free samples! Atlas Sign Works, 7941 Halsted, Chicago.

HIGH-GRADE SALESMEN

SELL Only (4) all wool suits to get yours without cost. No limit to number of suits you may earn. Prices \$14.95 to \$26.95. Zipper leather carrying case. Sample line free. No experience needed to make big money. All suits individually cut and tailored to measure. Satisfaction or money back guarantee. Three Star Clothes, Dept. 36F, 330 So. Franklin, Chicago.

IMMEDIATE Openings for ambitious men! Wear, introduce "Fairbanks" tailored-to-measure clothes, make up to \$10 in a day. Experience unnecessary. Free suit offer. Low prices. Quick sales. Free outfit. Permanent! Fairbanks Company, 2243-A Wabansia, Chicago.

MAN Wanted—by shoe manufacturer established 34 years, for sales work. Ready cash daily and extra bonuses to producers. No experience needed. Your own shoes at factory prices. Sales outfit sent free. Write Mason Shoe Manufacturing Company, Dept. A110, Chippewa Falls, Wis.

YOU Get paid first. Take orders for 20 home necessities. Pay after you collect. Big profits. Write Ho-Ro-Co, 2791-R Dolder St., St. Louis, Mo.

BIG Money selling advertising book matches. Amazing low prices. Wonderful full time or sideline. Liberal commissions paid daily. Free elaborate outfit. Regal Match Co., Dept. 52, Hamilton & Gladys, Chicago.

SELL Celluloid and cardboard pricing tickets, steel shelf moulding, changeable signs, menu covers. Every store prospect. P. Pricing Press, 124 White St., New York.

SALESMEN: Sell advertising novelties, calendars, fans, thermometers, etc., for nationally known firm. Liberal commissions. Stanwood Hillson Corp., 21 Station St., Brookline, Mass.

WE Need experienced salesmen for a real money making article. Wide sales field with exclusive territory. Richmond Chemical Company, Silver Spring, Maryland.

NEW Punchboard line. Free 32 page full color catalog. Nothing to carry. Larger cash commissions daily. Season now! Lea-Moore Co., 180 Adams, Chicago.

STRANGE Chemical sponge cleans wallpaper like magic. Banishes housecleaning drudgery. Women amazed. Hustlers cleaning up. Details free. Kristee, Dept. 251, Akron, Ohio.

MAN Wanted to supply Rawleigh's household products to consumers. We train and help you. Good profits for hustlers. No experience necessary. Pleasant, profitable, dignified work. Write today. Rawleigh's, Dept. B-53-PPM, Freeport, Ill.

SELL Nothing! \$95.00 weekly. \$500.000 punchboard firm announces new, no investment plan. Season starting. K&S, Dept. C122, 4329 Ravenswood, Chicago.

DISTRIBUTORS, Responsible salesmen. Loud-speaker and inter-call systems for business places, restaurants, etc. This is a package proposition requiring no specialized knowledge. Quality equipment at attractive prices. Excellent opportunity for above the average type man. Electro-Vox, 75 Pearl St., Hartford, Conn.

BEAUTIFUL Kid furs, rugs sell quickly. Gonzalez, Penasur 810, Monterrey, Mex.

LINDBERGH Stamps, covers, commemorating tenth anniversary Paris landing, next May. Prudhomme, 1516 Masonic, San Francisco.

LARGE Illustrated coin books cost you 25c, sell for 50c; send 35c for sample. Coinshop, 2510 Chester, Alameda, California.

BRAND New guaranteed business stimulator—all merchants. Big cash commission. Repeats. Sales outfit free. Merchants, 18 South Clinton, Chicago.

CHANCE To get free tailored-to-measure suit right away! Wear it! Show friends how to save up to \$10. Take orders. Make up to \$7 per suit including free suit and cash bonus. Every suit hand cut—custom tailored—100% all wool. Money back guarantee. No limit to number of free suits given you. Fine traveling case—large samples free. O. K. Tailoring Company, 325 S. Market, Dept. 122, Chicago, Ill.

SALESMEN: Everybody now buying book matches, labels, salesbooks, garage forms, blotters, calendars, pricing sets, business stationery, etc. Free deals. Wonderful sideline. Comm. daily. Sales portfolio free. Willens, Dept. RB, 2130 Gladys, Chicago.

EXCLUSIVE! Large advertising book match factory wants salesmen: full or part time. G. G. made \$278 in 1 week. Big comm., amazing repeats. Permanent, dignified business. Free kit. Match Corp. of America, Dept. E-2, 6041 Grand, Chicago.

PRINTING Salesmen—100 salesbooks for \$4. Advance commission \$1. Quick delivery. Every merchant a prospect. Free outfit. Harrison Salesbook, Inc., 290 Broadway, Boston, Mass.

POIRER Earned \$127 one week. Wilbur \$37.10 in 9 hours. Wonderful opportunity. Introduce startling guaranteed hosiery service. Hosiery free as bonus, send size. Write quick. Wilknit, Desk 2B37, Greenfield, O.

PROFITABLE Selling Quintuplet mail boxes. Prospect every house. Send \$1 for sample, sales plan. Extra Quintuplet first dozen. Satisfaction guaranteed. Walfred Mfg. Co., Racine, Wis.

CLEAR-VIEW: New winter product for auto glass. Tested and proven to 20 below zero. Guaranteed. Cellulose Products Co., Enid, Okla.

MEN—\$500.00 Weekly selling fur coats. Rimer-Dicker, 282 7 Ave., New York.

NEW Specialty—Sells every business and professional man. Four \$15 sales daily pay \$280 weekly. Ferrell cleared over \$1,000.00 monthly. Write, F. E. Armstrong, President, Dept. PM, Mobile, Ala.

TRUCK Covers. Complete line waterproofed canvas. Thousands of trucks in your state constantly buying. Open price line. No competition. Michigan Tarpaulin Co., Grand Rapids, Mich.

EXCLUSIVE Territory for established auto route jobbers. Steady profitable demand for every store counter. Bur-Lite, Hudson, Ohio.

BE Your own boss. Make the largest commissions selling our complete line of brushes. Write for sales plan. Wire Grip Sanitary Brush Corp., 220 Southern Boulevard, N. Y.

BRUSH Salesman—If you ever sold brushes write for our money making proposition. Donald Brush Co., Camden, New Jersey.

FREE Booklet describes 107 plans for making \$20-\$100 weekly, in home or office, business of your own. Elite Co., 214 Grand St., New York.

SALESMEN—New deal guarantees stores \$10 for one. Two \$15 sales net you \$20 daily. Sayers, 2801-123 Sheffield, Chicago.

SOMETHING New in fire extinguishers—Red Comet Automatics. Proved in west five years. Exclusive territory. Low price opens pocketbooks. Write, Red Comet, 404 Comet Building, Littleton, Colorado.

EDUCATIONAL AND INSTRUCTION

TIMESTUDY. New practical home training. Rapidly growing field for conscientious workers, with mechanical experience, ambitious for advancement into executive positions. Dix-Staunton School of Timestudy, Rochester, N. Y.

BE A radio expert—Many make \$30, \$50, \$75 a week. Learn at home in spare time. Radio's big growth making many good full time and spare time jobs. Write for free copy of 64-page book. National Radio Institute, Dept. 7BPA, Washington, D. C.

HOME Study courses leading to degrees: Arts and sciences, philosophy, education, law, letters, theology, psychology, engineering, chemistry, business and commerce. Many others. McKinley-Roosevelt College of Arts and Sciences, Chicago.

SECRET Service. Particulars free. Write immediately. George Wagner, M-2640 Broadway, New York.

GOVERNMENT Jobs. Start \$105-\$175 month. Men-women. Prepare now for next examinations. Many Social Security jobs. Full particulars free. Write today sure. Franklin Institute, Dept. W3, Rochester, N. Y.

BIG Bargain catalogue educational matter 10c. Hanfling, Y-799 Broadway, New York.

BECOME Business investigator. Earn \$1.00 hourly, upwards—spare time. Experience unnecessary; we teach you. Details free. Business Detective System, 1009 Oak, Elmira, N. Y.

BECOME An investigator—Secret service agent. New "Test Problem Method." Develops your ability. Particulars free. International Secret Service Institute, (PM27), Hoboken, N. J.

WIN High rating Civil Service position through intensive training. English, grammar, letter writing, quick figuring. Easy, interesting. No contract. Ten sections. Send \$1.00 for Section A. The Five Tutors, 4 Myrtle Street, Dover, N. H.

NATURAL Method speech correction at home. Particulars. Dowden, 509 Fifth Ave., New York.

LEARN Arc-welding or oxy-acetylene. Qualified school. Particulars stamp. Welders' Club of America, Box 3432-A Merchandise Mart Station, Chicago.

HOME Study courses leading to degrees: arts, literature, sciences, psychology, engineering, philosophy, chemistry, English, education, languages, law, business. Many others. Low cost; easy terms. Catalog on request. Thomas Jefferson University, 749 Independence Boulevard, Chicago.

REFRIGERATION And air conditioning. Invest in a future in these industries. Resident or extension courses. Write for information. Detroit School of Refrigeration and Air Conditioning, 4125 Grand River, Detroit, Mich.

LAW, Cartoon courses, educational books. List. Moorfield-Shannon, Nutley, New Jersey.

LEARN To dance—Waltz, fox trot, tango, continental, Puccolino, truckin', collegiate steps by new chart method at home. Information free! Franklin Publishing Company, 800 North Clark Street, Dept. 2209, Chicago.

PERSONALITY. An attractive, distinguished personality guaranteed. Complete directions \$1.00. Success Studios, 1930 N. Madison, Pasadena, California.

BUSINESS And technical books for sale. Money-back guarantee. Bargain catalogue free. Nelson Co., 361 Wrigley Bldg., Chicago.

GET A government clerk job. File clerk, P. O. clerk, statistical clerk—all good jobs. Men-women, age 18-50. Want to qualify for next entrance test? Details free. Write, Ozment Instruction Service, Dept. 101, St. Louis, Mo.

HEALTHIANA Scientific divine healing. Wonderful proposition. Healthiana, 3137 Tiffin, Toledo, Ohio.

SHORTHAND Brings opportunities. Free catalogue. Shorthand Institute, 6330 Clayton, St. Louis.

MASSAGE, Hydrotherapy, dietetics, drugless therapeutics, chiropody, taught by mail. Evans Correspondence School, Montgomery, Ala.

BE An investigator. Earn big money—Travel. Crime detection newspaper and particulars free. National System, 425-G, Fremont, Nebraska.

LEARN Machinist trade, tool, die making. Automatic and hand screw machines. Modern shop methods. Actual work. Jobs open for trained men. Employment help. Illustrated booklet free. Allied Screw Machine Company, 601 Lake Street, Chicago.

LEARN Auto mechanics, body, repairing, welding, electricity, refrigeration. Diesel. Stevinson's, 2008A Main, Kansas City, Mo.

LEARN Latest methods solving arithmetical problems quickly. Frederick A. Smith, 2410 Smalley Court, Chicago.

BOOKS Covering hundreds of subjects. Big catalog for 3c postage. Popular Mechanics Press, Room (C36), 200 E. Ontario St., Chicago.

STAMMERING, Stuttering corrected. Write Lewis Institute, 12052 Woodward, Detroit, Michigan.

U. S. GOVERNMENT Positions. \$1700-\$1900 and up a year. Let our expert (former government examiner) prepare you for a position in the railway mail service, rural carrier, post office, customs and other branches. Write today for free booklet. Dept. 8, Patterson School, Rochester, N. Y.

PLAYS—STORIES—MANUSCRIPTS

MANUSCRIPTS Wanted. Plays, sketches. Manuscript Plays, 1110 N. Dearborn, Chicago.

STORIES Wanted for sales dept. Also arranging, typing, etc. Crown Service, 917 Shreve Bldg., San Francisco.

STORIES Revised, typewritten, and placed on the market. Details free. Hursh Service, Box 1013, Harrisburg, Penna.

FOUR Smart radio monologues, \$1.00. Manuscript Plays, 1110 N. Dearborn, Chicago.

CARTOONING—COMMERCIAL ART

AMATEUR Cartoonists—Win \$25.00. No drawing ability necessary to win. 26 prizes in all. Rush name on postcard for valuable tips on "How to Make Money With Simple Cartoons," cash prize entry blank and rules. Send no money. Cartoonists' Exchange, Dept. C-92, Pleasant Hill, Ohio.

NEW Chalk talk ideas. \$1. Truman Cartoon Service, Perrysville, Ohio.

18 LESSON Sign course \$1.00. Chalk talking 50c. "Vocational," 3555 Aberdeen, Alton, Ill.

SELL Drawings. Read Art Advisor Monthly, Parkville, Missouri. Samples 29c.

NATIONAL Cartooning Magazine free, sales tips, prizes. Cartoon Publishers, West Springfield, Mass.

AMATEUR Cartoonists can earn \$35.00 weekly, spare time, duplicating cartoon advertisements. 3-M Syndicate, Argyle, Wis.

CARTOONING Course—30 lessons, over 500 illustrations, drawing pens and pencils, \$1.00 complete. Scovell Studios, Box 748-P, Hollywood, Calif.

CARTOONING, Sketching, etc.—46 lessons, 600 illustrations, including practice sheets, pens, pencils, \$1.00 complete. Fraba Service, Cashton, Wisconsin.

ADVERTISING AGENCIES

LEARN Advertising quickly at home. Easy practical plan. No text books. Common school education sufficient. Interesting booklet and requirements free. Page-Davis School of Advertising, 3601 Michigan Avenue, Dept. 3431, Chicago.

ADVERTISE: 24 Words in 250 newspapers \$10. Lists free. Advertising Service Bureau, 4258-C Drexel, Chicago.

ADVERTISING Placed anywhere. Helpful, free service. Rate guide book free. Baker Advertising Agency, 189 W. Madison, Chicago. Successors to Ankrum Advertising Agency. Established 27 years.

ADVERTISE Profitably: \$15 reaches 6,000,000 Sunday newspaper readers with 24 word ad. Newspaper, magazine rate-guide, free. Chicago Union Agency, 20 West Jackson, Chicago.

FREE—New Advertisers Rate Guide, 44 pages. Includes everything. Lowest rates. E. H. Brown Advertising Agency, 140 S. Dearborn, Chicago.

FOR ADVERTISERS

24 WORDS, 45 Newspapers \$2.00. Write, Goodall, 742 Market, San Francisco.

NAMES From new cash orders, 100—10c, 1000—50c. Center Mailing Service, Centralia, Ill.

25 WORDS, 25 Magazines, three months \$1.50. Empire, Shawano, Wis.

ADVERTISE—3c Word. Meriden Magazine, Des Moines, Iowa. 10,000 circulation. Sample 10c.

ADVERTISING And printing cuts cheap. Big illustrated catalogue 10c. Ermil Cut Co., Hika, Wisconsin.

BUSINESS SERVICE

BOSTON Business—personal mail address, \$1.00 month. Service, 315 Atlantic Ave., Boston, Mass.

WE Specialize in obtaining hard to get articles. Try us. Universal Salesman, Research Dept., Box 3, No. Tarrytown, N. Y.

TEXAS Mail address. Send \$1.00 for February. Balance January free. United, 607 Jennings, Fort Worth.

COLLECT Your outstanding accounts. System guaranteed. Government income tax record free. Order direct. Price \$10.50. Modern Business Kit, Box 183, Salina, Kansas.

INFORMATION Where to buy anything!! Correct addresses of reliable manufacturers, wholesalers. 25c (per-item). King Buyers' Service, 564 Delaware, Buffalo, N. Y.

QUESTIONS Answered on art, science, nature, history and miscellaneous subjects \$1.00 per question. Business Research Bureau, 1312 East 29th Street, Kansas City, Missouri.

CHICAGO! Business-personal mail address, representation, forwarding; \$1.00 month. Established 1919. General Business Service, 56 West Washington.

DELAWARE Charters: Complete incorporating and organizing service \$35. Submitted forms. Chas. G. Guyer, Inc., Wilmington, Delaware.

ALL International legal matters. Lic. Victor Prieto, Mexican Attorney at Law, P. O. Box 122 M. Juarez, Mexico.

RUBBER STAMPS AND OFFICE SUPPLIES

NAME, Address, 2 lines 25c; 3 lines 35c. Stamp Works, Auburn, Nebr.

OFFICE Supplies—rubber stamps. Premiums. Catalog. Sylco, Downers Grove, Ill.

2 LINES 25c, 3 Lines 35c. Stamprite, FP43, Springfield, Mass.

CUSHION Mounted, one-two lines 25c, three 35c. Signatures \$1.50. Stamp Works, 814 Bradley, Peoria, Ill.

2 LINES 25c, 3 Lines 35c. Stamp Works, Centerport, N. Y.

TYPEWRITERS, DUPLICATORS, OFFICE DEVICES

NEW Improved portable Simplex typewriters, \$3.00. Catalog 3c. Dimeo, 114 Ford, Providence, R. I.

PRINT Your circulars, bulletins, etc., in attractive colors with the Vari-Color duplicator, \$29.75 complete. Single color duplicators, \$14.50 and up. Illuminoscopes (great aid for preparing stencils), \$3.95. Vari-Color Duplicator Co., Ottumwa, Iowa.

TYPEWRITERS, Duplicators, multi-graphs. Write for free list office machine bargains. Save half. Pruitt, 518 Pruitt Bldg., Chicago.

INCREASE Business. "Excellograph" rotary stencil, clay and film duplicators \$3.85 to \$37.50. Prints anything. Typewritten, penned, drawn, traced. Colors. Folder free. Pittsburgh Typewriter Supply, Suite 518, Pittsburgh, Pa.

PRINTING, MULTIGRAPHING, MIMEOGRAPHING, GUMMED LABELS

500 TWO-COLOR Howard bond letterheads \$3.75; 500 6x9 bills \$2.50; 500 6x envelopes \$2.50. Prepaid. Office forms, booklets, folders. Small town modern shop. Press, Jamestown, Ind.

1000 BUSINESS Cards \$1.50. Olsen, 1551 Southeast Powell, Portland, Oregon.

500 ENVELOPES And 500 whitebond letterheads, \$3.00. Webpress, Farmland, Ind.

BUSINESS Cards printed, 70 cents 1000; \$3.00, 5000. McBride Printery, 646 McBride Ave., Los Angeles, Calif.

PRINTING—Lowest prices in America. Samples free. Pitz, Middle, Iowa.

QUALITY Stationery, 300 sheets, 150 envelopes \$1.00. Morey's Press, 87 Somerset St., Springfield, Mass.

ENGRAVURE Printing. Lowest possible prices. Samples free. Sunko, Mohawk, N. Y.

BARGAINS—100 8½x11 Heavy bond letterheads, 100 envelopes. Both \$1.00 prepaid. Evans Print, 44PM North Tenth, Reading, Pa.

1000 6x9 COLORED Circulars \$1.50. Samples. Tribune Press, Fowler, Indiana.

PRINTED, Mailed, 1000 3x6 circulars, \$2.00. Clark, Box 121, Oshawa, Canada.

ARTISTIC Printing—Priced right. Business stationery, circulars. Price list, samples free. Square Deal, Gordonsville, Virginia.

FREE!! 205 Address stickers! 5c postage. Extraordinary values! Main Press, Greenwood, R. I.

LABELS—High quality, quick service, low price. Tompkins' Label Service, 3210 Amber Street, Philadelphia, Pa.

2000 BUSINESS Cards neatly printed \$1.50. Quick service. Free samples. Atlas Distributing Co., 1814 Bedford Ave., Pittsburgh, Pa.

\$1.85—1000; LETTERHEADS, Envelopes, circulars, statements, shipping tags. Midwest Printing, Northfield, Minn.

ECONOMY, Quality—Distinctive printing. Get our prices, samples. CPress, Box 103, Station W, Brooklyn, N. Y.

250 BUSINESS Letterheads or envelopes, \$1.00 postpaid. Cameron Press, 56 Montgomery, Bloomfield, N. J.

KEEP With prosperity with Hall's distinctive stationery!! Samples! Hall's Printing, Dalton, Massachusetts.

EXPERT Printing—\$2.40 per 1000. Letterheads, envelopes, etc. Samples. Laporte Printing, 4011 Vernon, Long Island City, New York.

LABELS—All kinds. Write, samples, JBSCO, Box 93, Holyoke, Mass.

5000 6x ENVELOPES \$7.00. Samples. Specialty Sales, 3065 Fifth, Chicago.

QUALITY Printing, lowest prices, free samples. Excel, 6325 Maxwell, Detroit, Mich.

SUPERIOR Printing priced low. Free samples. Sibley Press, Rahway, N. J.

LABEL Value headquarters. Samples free. Labels, 6618D Quimby, Cleveland, Ohio.

BUSINESS Cards printed, 70 cents 1000; \$3.00, 5000. McBride Printery, 646 McBride Ave., Los Angeles, Calif.

500 LETTERHEADS, Envelopes, statements \$1.10; 1,000, \$2.00. Samples. Raymond's, Newport, New York.

\$1.00 EACH—250 Envelopes, 250 letterheads, 250 statements. Postpaid. Hustler, Advance, Indiana.

1000 LETTERHEADS, Envelopes, postcards, 6x9 circulars—\$2.95; 2000, \$4.95. (Envelope slips, \$1.75; 2000, \$2.50 prepaid.) Samples. Goodprint, Harrisonburg, Va.

GOOD Printing. Reasonable. Samples. Harmon Company, 318 South Tenth, Philadelphia, Pennsylvania.

500 GUMMED Stickers, ½x2½, 4 lines, 30c. Catalog, 10c. Lambing, 6457P Eggleston, Chicago.

PRINT Your own. Bargains, presses, type. List 3c. Exchange D-14, 22 Orient, Meriden, Conn.

1000 BUSINESS Cards, card case, \$1.50. Miller, Printer, Ambler, Pa.

CUTS 2x3, \$1.10, from drawings and photos. Joe Rek, 118 Gazette Ave., Lexington, Ky.

PRINTING OUTFITS AND SUPPLIES

SUPPLIES For the small shop. O. L. Livingston, North, South Carolina.

TYPE Bargains; list free. G. House, Box 1072, Dallas, Texas.

PRINTERS—Do your own die-cutting. Estimates gladly furnished. Central Steel Rule Die Co., Room 2000, 176 W. Adams St., Chicago, Ill.

NEW Type 29c font. Catalog dime. National Type Co., Jackson, Michigan.

HAND Press, type and complete printers' supplies. Advise equipment you need and we quote prices; or send stamp for catalog. P. Peiffer, 5 B; 6 Columbia St., Newark, N. J.

PAPER—Wholesale prices 3c. Samples 10c. VanDorn Paperstocks, Ottawa, Illinois.

PRINTING Presses, supplies. Long established. Lists 3c. Landis, Richland, Pa.

PRINT Your own cards, stationery, circulars, advertising, etc. Save money. Easy rules furnished. Print for others, big profits. Junior press, \$5.90; job presses, \$11, power \$149. Write for details. Kelsey Co., A-11, Meriden, Conn.

BARGAINS—Presses, type, supplies. Send stamp. 159 Harvard, Cambridge, Mass.

PRINTING Outfits—Presses, type, supplies, type novelties. Send 20c for card case samples. Catalog free. Model Press, York, Pa.

BARGAINS, Presses, type. List 3c. Exchange D-15, 22 Orient, Meriden, Conn.

PATENT ATTORNEYS

INVENTORS—Small ideas may have large commercial possibilities. Write us for free book, "Patent Guide for the Inventor" and "Record of Invention" form. Delays are dangerous in patent matters. Free information on how to proceed. Clarence A. O'Brien & Hyman Berman, 58-S Adams Building, Washington, D. C.

INVENTORS: Send immediately for your copies of our new free books, "Patent Protection" and "Suggestions on Selling an Invention." Sixty-eight pages of interesting facts. They tell how patent laws protect you; kind of sketch or model needed; simple steps to take without cost; how successful inventors have secured financial assistance; show interesting inventions; illustrate important mechanical movements. With books we also send free Evidence of Invention form to help establish date of disclosure. Prompt service, reasonable fees, special deferred payment plan. Strictest secrecy. Thirty-six years' experience. Highest references. Write us today. The facts in our books are worth money to the man with a good invention. Address: Victor J. Evans & Co., Registered Patent Attorneys, 900-B Victor Building, Washington, D. C.

SELL Your unpatented ideas. We tell you how; help you make the sale. Particulars free. Write W. T. Greene, 976 Barrister Bldg., Washington, D. C.

PRACTICAL Inventions now salable before patenting. What have you? Write Chartered Institute of American Inventors, Dept. 4B, Washington, D. C.

PATENTS—Proper service for manufacturers and individual inventors. Established 1895. Reasonable charges. Consult Chandiee & Chandiee, Patent Attorneys, 902 F. Street, Washington, D. C.

PATENTS—Personal, confidential services for protection of your invention at reasonable cost. Preliminary information and approximate cost of patent furnished without obligation. John B. Thomas & Co., 902 F Street, N. W., Washington, D. C.

OREL Z. Burdick, Registered Patent Attorney and Chemist, Hart, Michigan.

PATENTS—Trade marks—Personal service, reasonable charges. Preliminary advice, book and disclosure form free. Irving L. McCathran, 1060 International Bldg., Washington, D. C. Registered Patent Attorney.

INVENTORS—Send for free booklet "Patent-Sense." Information based on 64 years experience. Lacey & Lacey, Dept. 5A, 635 F St., Washington, D. C.

L. F. RANDOLPH, 302-B Victor Building, Washington, D. C. Low cost. Book and information free.

PATENTS. Protect your idea by securing free "Proof of Invention" folder. Exceptional personal service. Established 1906. E. E. Vrooman, 871 Woodward Building, Washington, D. C.

PATENTS. Instructions "How to Establish Your Rights" and form, "Evidence of Conception"—sent free! Lancaster, Allwine & Rommel, 411 Bowen Building, Washington, D. C.

PATENTS. Booklet free. Highest references. Best results. Promptness assured. Watson E. Coleman, Patent Lawyer, 724 Ninth St., Washington, D. C.

"**INVENTOR'S** Guide," 100 mechanical movements, free; advises on patenting, selling inventions. Frank Ledermann, Tribune Bldg., New York.

THEODORE H. Rutley, Registered Patent Attorney, 512 Colorado Bldg., Washington, D. C.

FOR INVENTORS

INVENTORS—Small ideas may have large commercial possibilities. Write us for free book, "Patent Guide for the Inventor" and "Record of Invention" form. Delays are dangerous in patent matters. Free information on how to proceed. Clarence A. O'Brien & Hyman Berman, 58-S Adams Building, Washington, D. C.

PERPETUAL Motion experiments. Blue prints and data for one experiment, send \$1.00, four experiments \$3.00. My own original motions, I think nobody has ever conceived them. E. Tillert, 1012 Albert St., Racine, Wis.

INVENTIONS Illustrated \$3.00. Serio, 1827 E. Elmdale Ct., Milwaukee.

ADVICE To inventors in the field of aviation. Box 2110, Wichita, Kansas.

FIVE Day inventors meeting and exhibit of new inventions and new products at Chicago, March 29 to April 2. For details, write Albert G. Burns, Blum Building, Chicago.

SCORES Of tested money making ideas for home, shop, farm. Send for list. It's free. Popular Mechanics Press, Room (C36), 200 E. Ontario St., Chicago.

PATENT Protection—Know what you need. Get "Advice to Amateurs" before you apply for a patent on your invention. 25c coin. Box 151, Orosi, Calif.

INVENTORS: Send immediately for your copies of our new free books, "Patent Protection" and "Suggestions on Selling an Invention." Sixty-eight pages of interesting facts. They tell how patent laws protect you; kind of sketch or model needed; simple steps to take without cost; how successful inventors have secured financial assistance; show interesting inventions; illustrate important mechanical movements. With books we also send free Evidence of Invention form to help establish date of disclosure. Prompt service, reasonable fees, special deferred payment plan. Strictest secrecy. Thirty-six years experience. Highest references. Write us today. The facts in our books are worth money to the man with a good invention. Address: Victor J. Evans & Co., Registered Patent Attorneys, 901-B Victor Building, Washington, D. C.

TO Inventors: We are in the market to purchase a good patent, preferably in the automobile accessory line. Will purchase outright or on royalty basis. Purchasing Agent, 241 Front St., New York, N. Y.

INVENTORS: "Making Inventions Pay," our 32-page illustrated book, mailed upon receipt of 3c postage. Crescent Tool Company, Dept. Z, Cincinnati, Ohio.

INVENTORS—Send for 72-page book on patents. Reasonable terms. Conscientious treatment to inventors. L. F. Randolph, Registered Patent Attorney, 302-E Victor Bldg., Washington, D. C.

UNPATENTED Ideas can be sold. We tell you how and help you make the sale. Particulars, with list of manufacturers and wanted inventions sent free on request. Write W. T. Greene, 944 Barrister Building, Washington, D. C.

I SELL Patents. Established in 1900. Charles A. Scott, 773PM Garson Ave., Rochester, N. Y.

SELL Your patent through a small classified ad in Popular Mechanics. Many inventors have found buyers in this way. Ask me for proof—I'll gladly send it to you. F. W. Johnson, Manager, Classified Advertising, 200 E. Ontario St., Chicago.

FREE Information about new magazines for inventors who want more profit from their ideas. Write "Successful Inventions," 800 Barrister Bldg., Washington, D. C.

HAVE You a sound, practical invention for sale, patented or unpatented? If so, write Chartered Institute of American Inventors, Dept. 4A, Washington, D. C.

INVENTOR'S Universal Educator; contains 900 mechanical movements; 50 perpetual motions; instruction on procuring and selling patents and selecting an attorney, etc. Suggests new ideas. Price \$1.00 postpaid in U.S.A. Address: Albert E. Dietrich, 511-B Colorado Bldg., Washington, D. C.

INVENTIONS WANTED

SMALL Inventions wanted by manufacturers. I'll help you sell your invention. Stanley Hull, K-7829 Euclid Ave., Cleveland, Ohio.

WE Successfully sell inventions, patented and unpatented. Write for proof, and tell us what you have for sale. Chartered Institute of American Inventors, Dept. 4-C, Washington, D. C.

INVENTORS—Small ideas may have large commercial possibilities. Write us for free book, "Patent Guide for the Inventor" and "Record of Invention" form. Delays are dangerous in patent matters. Free information on how to proceed. Clarence A. O'Brien & Hyman Berman, 58-S Adams Building, Washington, D. C.

SMALL Inventions wanted. Ten cent store items or auto accessories line on royalty basis. Master Mfg. Co., Litchfield, Ill.

INVENTIONS Wanted—Patented or not. H. Wendell, 810 No. 27th Ave., St. Petersburg, Fla.

INVENTIONS Wanted—Patented, unpatented. If you have an idea for sale, write Hartley's, Inc., Box 928-E, Bangor, Maine.

PATENTS FOR SALE

REVOLUTIONARY Copy holder; rides typewriter carriage; synchronized with platen roller; automatic spacing. Detachable for desk stand. Cast aluminum; weight complete about ten ounces. Every office prospective buyer. Released on royalty only. J. S. Wheeler, Phoenix National Bank Building, Phoenix, Arizona.

LOG Splitting device. U. S. 2042401. Lawrence Hull, 462-25, Redondo Beach, Calif.

GLARE Stop polarized rays. Material 6 cents. Proven seller. Royalty. Write Max Koehler, 3637 13 St., Washington, D. C.

PATENTED Directional signal for cars and trucks, outright or royalty. Unlike others. Cheap, ornamental. Market for millions. Mfrs. Address James M. Lee, Newton Grove, N. C.

PRACTICAL, Economical, single prong appliance plug. Connections established any rotary position. Earl Allabach, Box 133 Treviso, Bucks, Co., Pa.

NEWLY Invented hoe, every gardener needs. Will sell patent. J. R. Blocher, Box 608, Oklahoma City, Okla.

AUTOMOBILE Body invention for sale. Floyd Weaver, R. 2, Rockford, Ill.

MANUFACTURING

LET Us figure on your patent, developing, stamping and light manufacturing work. Fully equipped plant, under economic management. Master Mfg. Co., Litchfield, Ill.

CORPORATION, Amply financed having excess facilities for manufacturing heavy metal specialties in Illinois, Ohio and New York will contract production your specialties; especially interested in new devices. Van Auken-Ragland, Inc., Room 1130, 20 N. Wacker Drive, Chicago, Ill.

MANUFACTURING, Dies, machinery, models, brasswork, white metal casting moulds. Catalog 3c. Baum's Metal Specialties, Kansas City.

INVENTIONS Manufactured in any quantity at low cost. Stampings, dies, models, etc. Estimates and free catalog. Crescent Tool Co., Dept. X, Cincinnati, Ohio.

MODELS AND MODEL SUPPLIES

BUILD Radio controlled model ship. 2 detailed drawings, 9 photographs. \$2.00 postpaid. Felix La Vallee, Hugo, Minnesota.

UNIQUE Injection engine, blueprints one dollar. Art Egolf, Westville, Indiana.

POWER Modelers—Read Modelmaker Magazine. Current sample 15c. Special big buy, 25 assorted back issues, \$1.00. Model steam locomotives, gas engines, power boats, stationary engines. Box 196-P, Wauwatosa, Wis.

MODELS, Stampings, and special machinery. Send for catalog of brass gears and model supplies. The Pierce Model Works, Tinley Park, Ill.

INVENTIONS—Small ideas may have large commercial possibilities. Write us for free book, "Patent Guide for the Inventor," and "Record of Invention" form. Delays are dangerous in patent matters. Free information on how to proceed. Clarence A. O'Brien & Hyman Berman, 58-S Adams Building, Washington, D. C.

MODEL Airplane supplies! Free introductory gift and catalog. Stamp required. Models, 4802P Clarendon, Brooklyn, New York.

3/4" SCALE Locomotive easily built by "Step" method. Latest catalog of castings, boiler fittings, track material, etc. 25c (coin). (Returned on first order). Little Engines, Box B15, Wilmington, Calif.

FREE! Illustrated circular. Listing 40 engines. Locomotive castings. Supplies. Stamp required. Howardo, A-2417 N. Ashland, Chicago.

EXPERIMENTERS Materials and supplies catalog postpaid 20c. Free particulars on 96 page engine catalog. Eray Mechanics Supply Company, 28 N. Clinton, Chicago.

SHIPS—18" Flying Cloud, Constitution or Galleons. All materials including easy plans only \$1.50. Catalog 15c. Hancock, 323 Douglass Ave., Portsmouth, Virginia.

MODEL Of modern passenger locomotive—size, unfolded 10x48 in. Here, accurately shown in colors, are all the intricate parts of a modern giant of the rails, complete with tender. Invaluable for study. Of great interest and fascination to boys and others interested in railroads. \$1.00 postpaid. Popular Mechanics Press, Room (C36), 200 E. Ontario St., Chicago.

1937 MODEL Railroad catalog, locomotives, cars and parts, 25c. Refunded first order. Rollin L. Lobough, 1179 Howard Street, San Francisco, Calif.

POWER Models, locomotives, steam, gasoline engines, accessories. 80 page catalog 35c. Chas. Cole, Ventura, Calif.

RAILWAY Models. Catalog handbook 25c. Walthers, 1564 West Pierce, Milwaukee.

MODELS—Your ideas developed into practical working models. 30 years' successful experience; thousands of satisfied customers. Confidential service guaranteed. Bank references. Send 3c postage for 32-page book—"Making Inventions Pay." Crescent Tool Company, Dept. Y, Cincinnati, Ohio.

HOME CRAFTSMEN

BUILD Bird houses. Make your workshop pay. Literature free. Albert Publishing Company, 14, Barrington, Illinois.

KNO WOOD, Wood study kit. 24 wood pieces, 24 plates, descriptions, \$1.00 postpaid. Springer, 402 E. Wisconsin, Milwaukee, Wis.

20 FULL-SIZED Lawn ornament patterns 25c. Catalog and sample patterns 10c. Modern Woodcraft, Saginaw, Michigan.

"MODERN Wood sculpture." Complete instruction book on carving statues \$1.00. Lee, Wood Art Studio, Centerville, Ia.

LEATHERCRAFTSMEN—Write for free instructions and price list of leather, tools and beginners' kits. Send 5c for sample cards. Address Wilder & Company, Dept. F, 1038 Crosby St., Chicago, Ill.

WOOD Carving. Complete chip carving kit contains gumwood box with design ready to carve, special chisel of finest steel, step by step instructions and other designs. Only \$1.75 postpaid. Karv-Kit Company, Columbiaville, Michigan.

HEAVY-DUTY Jigsaw, home workshop shaper, drum sander and 458 other practical articles in Vol 28 Shop Notes only 50c postpaid. Popular Mechanics Press, 200 E. Ontario St., Chicago.

OLD GOLD, WATCHES, JEWELRY, PRECIOUS STONES

AUSTRALIA. The land of beautiful opals. Opal catalogue free. Norman Seward, Melbourne, Australia.

LEARN Watchmaking, instructions free with tools. Bargain tool, material, movement catalog 5c. Stewart's, Carleton Building, St. Louis, Mo.

ANY Watch rebuilt \$1.00 (parts extra). Guaranteed. Holmes Watch Co., Washington, Kansas.

GOLD \$35.00 Ounce. Ship old gold teeth, crowns, jewelry, watches—receive cash by return mail. Satisfaction guaranteed. Free information. Dr. Weisberg's Gold Refining Company, 1593 Hennepin, Minneapolis, Minn.

CASH For old gold, teeth, watches, jewelry. 100% full cash value mailed day shipment received. Satisfaction guaranteed or articles cheerfully returned. Information free, or ship today. Chicago Gold Smelting Company, 300P Champlain Building, Chicago.

HOW To identify and determine value of old precious metals. Where to buy. To whom to sell. Reliable and up-to-date information. Complete instructions only \$1.00 postpaid. Popular Mechanics Press, Room (C36), 200 E. Ontario St., Chicago.

FOR THE HOME

ARTISTIC Glass tube bud vases. Beautiful colors. Glastube Products, Box 5446, Los Angeles, California.

SENSATIONAL Offer! Hand-engraved name plates. Free circular. Acme Engraving Shoppe, 211 Roby Avenue, East Syracuse, N. Y.

MAKE It Yourself. Hundreds of practical and useful devices described in our big book. Plain instructions and illustrations show you how to make them. Save money on things for yourself or make profit selling to others. 900 articles of great variety. 480 pages. 823 illustrations. \$3 postpaid. Popular Mechanics Press, Room (C36), 200 E. Ontario St., Chicago.

TOBACCO

CHEWING, 4 Pounds, \$1.25. Subac smoking with burley, Turkish tobacco, 3 pounds \$1.10 postpaid. Belmont Farms, Chatham, Va.

10 POUNDS Old Hillside chewing or smoking tobacco, guaranteed good, \$2.00 postpaid. Allen Ford, Dresden, Tenn.

BUY At wholesale prices by mail—cigarettes, cigars, tobaccos. All brands. No tax. Postal naming your favorite brands brings low wholesale prices. Moberly, Box 1016, Owensboro, Kentucky.

HIGHER Quality! Milder, golden yellow smoking or rich ripe chewing, four pounds, postpaid, \$1.00. Riverside Ranch, Hazel, Kentucky.

FREE Cigars and pipe with 5 pounds guaranteed cigarette, pipe or chewing tobacco \$1.00, ten \$1.75. Send no money. Reves Tobacco Co., Paducah, Ky.

SURVEYING INSTRUMENTS

GUARANTEED Factory rebuilt transits and levels for rent (with purchase option) or sale (cash or terms). Order now before prices advance. We will repair, trade in, or buy your old instruments. Ship prepaid for estimate and valuation. Write for List M-22 and complete information to Warren-Knight Co., 136 N. 12th St., Philadelphia, Pa.

FOR SALE OR EXCHANGE

SELL Or trade anything for you. 10% commission. Big list 10c. Traders Exchange, 190 North Wells, Chicago.

WANTED—MISCELLANEOUS

MUZZLE-LOADING Colt revolver with 9" barrel or folding trigger. Armory, Montevideo, Minnesota.

CASH For used microscopes, binoculars, slide rules, drawing sets, cameras, surveying, medical and scientific instruments, tools, marine equipment. Highest prices paid day shipment received. Satisfaction guaranteed or shipment promptly returned. Elman's, 2302 Van Buren, Chicago.

WANTED—An agency for some kind of a new service invention to promote in state of Minnesota. Will advertise and promote in the best way possible. Box 747, Minneapolis, Minn.

PERSONAL

YOU Can have health, happiness, success. Complete psychology course tells how. Now only \$1.00. Individual Efficiency Service, Box 653, Hollywood, Calif.

MISSING Persons located. Attorneys Service Bureau, 70 Chapel Street, Albany, New York.

PERSONAL Success easily attained. Individual requisites explained. Age, occupation, complete address requested. Edw. Johnston, 257 North Washington St., Tiffin, Ohio.

AUTHENTIC Lists. Missing heirs to enormous fortunes, 25c. Duffy, Covington, Ky.

NEW, Enlarged edition, "The Secret Place." Personal power, confidence, health, banish fear, nervousness, win friends, prosper. 1,000 sold. 64 pages. money back guarantee, 50 cts. M.O. Dr. Smith, Box 71, Stoneham, Mass.

CASH'S Woven names. For marking men's, women's, children's clothing. Free sample. Oulmette's, 907A Brook, New Bedford, Mass.

MISCELLANEOUS

DEEP Sea shells (3), many uses, bridge prizes, ash trays, etc. Fifty cents stamps. Capt. Bill, 1571 Marine Parkway, Brooklyn, N. Y.

AMATEUR Tattooing outfits, illustrated catalog 6c. "Tattoo," 651A South State, Chicago.

FORD Funny stories 10c. 25 volumes Encyclopedia Britannica \$10.00. Jos. Cherry, 406 East Philadelphia, Detroit, Mich.

HOBBY—Picture scrapbooks. Fascinating, profitable hobby. Scrapbooks bought. Interesting folder, lists, samples 10c. Mulligan, 255 W92, New York.

CUTS Anything can make. Zinc etching process. Specimens, particulars, testimonials for stamp. J. C. Day, Windfall, Ind.

17"x22" HANDWRITING (Graphochart) enables analysis of any handwriting! 50c; stamps, coin. No cards. Route 2, Box 87, Alpha, Minn.

PERFECT Eyesight without glasses. No drugs. Send dime for valuable booklet, "Eye Weaknesses." Arthur Jacobson, Alexandria, Minnesota.

LOCATE Buried treasure, ore veins, meteorites, etc., by radio and electricity. Diagrams and instructions \$1.00. Neal Brown, Richland Springs, Texas.

CASH Paid for butterflies, insects. See Sinclair Display Advertisement on page 16A.

NOW You can really enjoy your pipe. Latest proven methods for a dime. Chaiten Enterprises, 1502 East 4th St., Brooklyn, N. Y.

THE Earth's magnetic phenomena. 25 cent (no stamps) for booklet. F. Kern, Bennett Ave., Wildwood, New Jersey.

POCKET Goods—Five special samples, 35c coin. Frank Shilling, 1017-P Dueber, Canton, Ohio.

HOW To live 150 years. Particulars free. 800 Cowles, Joliet, Ill.

SEND 25c For beautiful Ozark ash tray, made of native cedar and shell, also 50c size. Other novelties. Dealers take notice. Make ideal gifts. Ozark Novelties, Arcadia, Mo., Box 5.

HAWAIIAN Caress perfume, no oily bottle \$1. Lei sachet 25c. Box 2273A, Honolulu.

COCOONS, Butterflies, collectors' supplies, butterfly art materials. Free lists. Maynard, 1192 Lewiston, Rochester, New York.

TATTOOING Outfits, supplies. Illustrated list. "Waters," 965 Put-nam, Detroit.

SIGNS—By new method. Particulars 10c. Straley, 13 1/2 Main, Springfield, Ohio.

NO Boss! Sure cash! Silvering mirrors, autoparts, reflectors. Combination outfit. Write Sprinkle, Plater, 288, Marion, Ind.

WANTED—Hear from parties interested gold or silver ores, buried or hidden treasures. Bergman's instrument \$5.00. Particulars free. Henry Bergman, Box 398P, Springfield, Missouri.

BRONZE Tablets, desk plates, wall plates, memorials, grave markers. Bronze, brass and aluminum casting. Wandkey Pattern & Foundry Co., Anderson, Ind.

SWAPPER'S Friend, Rt. Saline, Michigan. Interests swappers, collectors, sportsmen. 50c year, sample 10c.

FREE—13 Screamingly funny letters with 75 popular cowboy songs, 25c. Empire Novelties, Peterboro, Canada.

LEARN TO PAINT SIGNS AND SHOW CARDS

THE MONEY IS IN IT

BIG PROFITS

We teach you quickly, by mail or at school. Enormous, steady demand. Big future. Interesting. Write for full information. **DETROIT SCHOOL OF LETTERING** 5737-A Second Blvd. DETROIT, MICH.



Forms to cast Lead Soldiers, Indians, Trappers, Hunters, Wild and Farm Animals. 239 different forms to select from. Every form guaranteed to cast perfect figures. Send 5c stamp for illustrated catalogue.

HENRY C. SCHIERCKE Spencer Rd. GHENT, N. Y.



LAW HIGH-GRADE INSTRUCTION BY CORRESPONDENCE

College, Post Grad. and Bar Ex. Rev. Courses. Law has attracted more keen, brainy men than any other calling. Send today for catalog. Low cost, easy terms. Standard texts. Degrees.

Chicago School of Law Dept. 801, Reaper Block CHICAGO, ILL.

ELECTRICITY!

RADIO REFRIGERATION DIESEL ELECTRIC POWER

Learn Quickly in Spare Time at Home -by Practical Shop Methods

New easy way to prepare for jobs leading to salaries of \$30, \$40, \$50 a week. Opportunities to earn \$5-\$10 a week and more while training. Learn by doing actual jobs in your own home electrical shop. Electrical Equipment and Apparatus supplied at no extra cost to make training practical. No previous experience or advanced education necessary. Money back if not satisfied. Write for **FREE BOOK of Facts and Opportunities for you as a trained Electrical Man.**

ELECTRIC INSTITUTE Dept. 67B

H. W. PETERSEN, President Hinsdale, Illinois

NAME _____ AGE _____

STREET _____

CITY _____ STATE _____

PARKS AIR COLLEGE

Offers COLLEGE AND PROFESSIONAL TRAINING Majoring in Aviation

FOUR two-year courses (96 weeks) lead to Bachelor of Science degrees in Professional Piloting, Aviation Operations, Aviation Mechanics and Aeronautical Engineering.

THIRTEEN TRAINING PLANES are on the flight line. They range from the Kinner Sportster to the high speed twin-engined Monocoach equipped with retractable landing gear, air brakes, two-way radio, radio direction finder, and blind flight instruments.

58,000 hours flight instruction have been given, 650 hours now being flown monthly. THE FACULTY of 33 is composed of specialists in the various fields of aviation. AN ENROLLMENT of 260 resident students for the 1936 Fall term. On its 100-acre airport, Parks has 14 buildings with a total floor area of 2 3/4 acres, devoted to school purposes exclusively.

DORMITORIES AND DINING HALL ON THE FIELD.

1344 graduates.

All graduates of the last two classes were placed prior to graduation.

63 per cent of graduates enter air transport operations in North and South America.

At Parks you train for aviation in aviation. Parks is recognized as the training division of the industry. Ask any one who is in aviation. You can expect more at Parks and still be agreeably surprised when you come.

The 60-page catalog gives complete information. Send for it. It is FREE. It is packed full of valuable information. A letter or post card will bring it to you.

PARKS AIR COLLEGE
237-M Cahokia Rd. East St. Louis, Illinois



**YOU CAN REPEAT ALMOST
EVERY EXPERIENCE IN LIFE**

—EXCEPT

life - itself



Today is life. Tomorrow is a hope. Yesterday is a dream. Nothing is so dead as a day that has passed. Only the trailing clouds of memory remain.

One *today* upon another *today*—how quickly a decade is built! Youth approaches manhood in high heart, embraces maturity as the period of his conquest, then “remembers with a sigh the days that are no more.”

So life goes—like that. NOW is the only opportunity. NOW is the moment of success. NOW men decide—NOW men win or fail.

Are you one of the men who are wondering today what will happen to them tomorrow? Then remember this: *If you take care of today, tomorrow will take care of itself.* And one of the most important safeguards you can take is to be certain your *training* is modern . . . that you are adequately equipped to master the problems of 1937. Today, in almost every line of human endeavor, ambitious men are modernizing their training by spare-time study of International Correspondence Schools Courses. Their action is a guide to you—and NOW is the time to act! Complete information on any subject in which you are interested will be sent without cost or obligation. The coupon is for your convenience. Return it today.

INTERNATIONAL CORRESPONDENCE SCHOOLS

Box 5657-H, Scranton, Penna.

Without obligation, please send full particulars about the subject before which I have marked X:

TECHNICAL AND INDUSTRIAL COURSES

- | | |
|--|---|
| <input type="checkbox"/> Architect | <input type="checkbox"/> Diesel Engines |
| <input type="checkbox"/> Architectural Draftsman | <input type="checkbox"/> Aviation Eng. <input type="checkbox"/> Auto Mechanic |
| <input type="checkbox"/> Building Estimating | <input type="checkbox"/> Plumbing <input type="checkbox"/> Heating |
| <input type="checkbox"/> Contractor and Builder | <input type="checkbox"/> Air Conditioning <input type="checkbox"/> Refrigeration |
| <input type="checkbox"/> Structural Draftsman | <input type="checkbox"/> Steam Engineer |
| <input type="checkbox"/> Structural Engineer | <input type="checkbox"/> Steam Electric Engineer |
| <input type="checkbox"/> Electrical Engineer | <input type="checkbox"/> Marine Engineer |
| <input type="checkbox"/> Electric Lighting | <input type="checkbox"/> Civil Engineer <input type="checkbox"/> Highway Engineer |
| <input type="checkbox"/> Welding, Electric and Gas | <input type="checkbox"/> Bridge Engineer |
| <input type="checkbox"/> Reading Shop Blueprints | <input type="checkbox"/> Bridge and Building Foreman |
| <input type="checkbox"/> Telegraph Engineer | <input type="checkbox"/> Surveying and Mapping |
| <input type="checkbox"/> Telephone Work <input type="checkbox"/> Radio | <input type="checkbox"/> R. R. Locomotives <input type="checkbox"/> Air Brakes |
| <input type="checkbox"/> Mechanical Engineer | <input type="checkbox"/> R. R. Section Foreman |
| <input type="checkbox"/> Mechanical Draftsman | <input type="checkbox"/> R. R. Signalmen |
| <input type="checkbox"/> Machinist <input type="checkbox"/> Toolmaker | <input type="checkbox"/> Chemistry <input type="checkbox"/> Pharmacy |
| <input type="checkbox"/> Patternmaker | <input type="checkbox"/> Coal Mining |
| <input type="checkbox"/> Foundry Practice | <input type="checkbox"/> Navigation |
| <input type="checkbox"/> Sheet Metal Worker | <input type="checkbox"/> Cotton Manufacturing |
| <input type="checkbox"/> Boilermaker | <input type="checkbox"/> Woolen Manufacturing |
| <input type="checkbox"/> Heat Treatment of Metals | <input type="checkbox"/> Agriculture <input type="checkbox"/> Fruit Growing |
| <input type="checkbox"/> Management of Inventions | <input type="checkbox"/> Poultry Farming |

BUSINESS TRAINING COURSES

- | | |
|--|--|
| <input type="checkbox"/> Business Management | <input type="checkbox"/> Lettering Show Cards <input type="checkbox"/> Signs |
| <input type="checkbox"/> Industrial Management | <input type="checkbox"/> Stenography and Typing |
| <input type="checkbox"/> Traffic Management | <input type="checkbox"/> Civil Service <input type="checkbox"/> Mail Carrier |
| <input type="checkbox"/> C.P. Accountancy | <input type="checkbox"/> Railway Mail Clerk |
| <input type="checkbox"/> Bookkeeping | <input type="checkbox"/> Grade School Subjects |
| <input type="checkbox"/> Secretarial Work | <input type="checkbox"/> High School Subjects |
| <input type="checkbox"/> Cost Accountant | <input type="checkbox"/> College Preparatory |
| <input type="checkbox"/> Salesmanship <input type="checkbox"/> Advertising | <input type="checkbox"/> First Year College Subjects |
| <input type="checkbox"/> Service Station Salesmanship | <input type="checkbox"/> Illustrating <input type="checkbox"/> Spanish |
| <input type="checkbox"/> Business Correspondence | <input type="checkbox"/> Cartooning <input type="checkbox"/> French |

DOMESTIC SCIENCE COURSES

- | | |
|---|--|
| <input type="checkbox"/> Professional Dressmaking and Designing | <input type="checkbox"/> Millinery |
| <input type="checkbox"/> Home Dressmaking | <input type="checkbox"/> Foods and Cookery |
| <input type="checkbox"/> Advanced Dressmaking | <input type="checkbox"/> Tea Room and Cafeteria Management, Catering |

Name.....Age.....

Address.....

City.....State.....

Present Position.....

If you reside in Canada, send this coupon to the International Correspondence Schools Canadian, Limited, Montreal, Canada

Ruptured?

Save yourself the misery of wearing leg-straps and cutting belts. Learn about the famous Cluthe Comfort Truss positively guaranteed to hold—a condition absolutely necessary for possible improvement or recovery. Water and perspiration proof; wear it in bath; Automatic Pad insures safety; hips left free. Made to your order for your individual requirements by mail on a liberal 60 days trial plan. Send for FREE 100-page Book of Advice and endorsements (publication permitted) from grateful patrons in your own neighborhood. No obligation. Write today.
Dept. 31, CLUTHE SONS, Bloomfield, New Jersey
(Serving the Ruptured Since 1871)

DRAW-O-MATIC DRAFTING BOARD

ALWAYS READY—ALWAYS SQUARE

ACCURATE, SELF-ALIGNING, SLIDING PARALLEL-BAR



Handy. Speeds up drawing. Eliminates the Old-Fashioned T Square. Ideal for Draftsmen, Students, Artists, Architects, Engineers and Designers.

Sturdy Construction: Board made of specially treated heavy smooth hard fiber composition. Will not Warp, Crack or Chip. Attractively finished. Metal parts are plated. No sharp edges.

No Thumb-Tacks necessary. Fool-Proof Mechanism. Rubber Feet prevent scratching or slipping. Easy action. Handy to carry.

Three sizes: 12"x16", \$1.75; 16"x20", \$2.75; 20"x24", \$3.95

Plus Postage. Send Money-Order or write for Circular.

ROLLIN PRODUCTS CO., Dept. PM2, 222 W. Aushin Ave., Chicago, Illinois

Men Needed Quick!—Not hundreds—but thousands!

Learn NOW—at home, in spare time—(or at our School in Chicago.) Qualify for steady work and big profits in Everybody's air conditioning.

AIR CONDITIONING and REFRIGERATION

GET Free PROSPERITY BOOKLET
Get in on ground floor. Send for "Prosperity Booklet."
CHICAGO TECHNICAL COLLEGE 34th Year
9 301 Tech Bldg. 118 East 26th St., Chicago, Ill.

Music Lessons

A Complete Conservatory Course by Mail under master teachers. Piano, Harmony, Voice, Public School Music, Violin, Cornet, Trumpet, Mandolin, Guitar, Banjo, Organ, Accordion, Saxophone, Clarinet. Lessons amazingly easy, complete. Mention instruction desired. Low cost; terms. Catalog free.

University Extension Conservatory, Dept. S-12. 1525 E. 53rd St., Chicago



PLAY A SAW!

Produce wonderful music in 5 days...quickly play popular and classical numbers. No notes to read, no dreary practice—success guaranteed. Since 1924 thousands of my students have amazed friends, starred in shows and broadcasting orchestras. Without obligation, write for 5 DAY TRIAL OFFER now.

MUSSEHL & WESTPHAL
110 W. Water St., Fort Atkinson, Wis.

QUICK WAY to make money in

TRAIN WITH R.T.A. NOW **RADIO** Modern receivers are demanding men with modern training for service work. New training method and service equipment offer starts you earning almost at once. Up to \$3 an hour easy in a short time. Write today for FREE book of details.
Radio Training Association of America
Dept. PM. 72, 4525 Ravenswood Ave., Chicago

LEARN TO PLAY \$1
Sax, Trumpet, Clarinet, Flute
Play an instrument for pleasure and profit. Learn quickly, easily. Simplified picture-methods contain 30 lessons. Send dollar bill. No more to pay. Mention which instrument you wish to learn.
Selmer Dept. 13X, Elkhart, Indiana

1000 LIGHTS FROM 1 MATCH!



CAN-O-LITES! An amazing new breath-taking invention, with a market running into the millions. CAN-O-LITES banishes lighters and matches forever—gives 1,000 lights with this one mysterious new kind of match. Sure as a match, it strikes like a match and replaces the match, YET there are no burnt out matches strewn around. Instantly you have a big, giant flame that will light a pipe, cigar, cigarette, gas stove, and serves the thousand and one uses a match has. NEVER NEEDS TO BE REFILLED. And CAN-O-LITES sells for the astounding low price of 25c each complete—with whopping big profits.

One Salesman SOLD OVER 15,000 in Three Months!

Does CAN-O-LITES sell? J. C. Ball sold over 15,000 in only 3 months! Sells quick as a flash on demonstration, to every home, office, factory, restaurant, club, college, cigar store, hotel. Everybody who sees CAN-O-LITES is completely captured by its novelty and usefulness. You sell from 6 to 6 dozen at a crack, your repeat business alone can reach a staggering weekly figure.



J. C. BALL

RETAILS

For Only 25c

What is the mysterious scientific principle that makes source of 1,000 lights from 1 match? What strange power lies hidden in the little container which, hundreds and hundreds of times, day after day, as easily as you strike a match, instantly produces a giant-size flame many times bigger than a match-flame? Turn CAN-O-LITES upside down—nothing pours out. Shake it—nothing rattles. You don't see any wheels or moving parts. No wicks, no gears. Don't use CAN-O-LITES for weeks—then pick it up and strike, and a big live flame appears, instantly! Yet you NEVER put anything into it to re-fuel or re-fill. Sells in VOLUME—and at 25c, your profits are enormous!

Millions Want This New Light!

CAN-O-LITES combines all the good features of matches and mechanical lighters and banishes all the bad ones. No sparks. No cinders, no danger of burnt clothes or fingers. No untidy burnt-out match sticks. Works better. Surer than most expensive lighters. Never fails. Absolutely safe. No competition. You can be at the receiving end of the lion's share of the thousands of dollars now being spent for matches in your Community, you can create a sensational, profitable business overnight!

THIS IS A WINNER!

CAN-O-LITES has already chalked up unbelievable sales and profit records. Rush this coupon fast for FREE details and big-profit news. Send no money! Mail this coupon NOW.

CAN-O-LITES Mfg. Corp., 1455 South Ave.
Dept. D-12, Youngstown, Ohio

Yes, I want to know more about CAN-O-LITES. Please rush me free sample offer, free plans and money-making details.

Name

Address

City State

CAN-O-LITES Mfg. Corp.
1455 South Ave. Dept. D-12 Youngstown, Ohio

When writing to advertisers please mention Popular Mechanics

INVENTORS PATENT YOUR IDEAS

Get this **FREE** Book

SMALL IDEAS ARE OFTEN VERY VALUABLE. If your idea is new and useful, no matter how small or inexpensive to produce, you should take prompt steps to secure protection. Write immediately for a copy of MY NEW FREE BOOK and my "Record of Inventions" form. Protect the future profits from your idea by securing a United States Patent. Your first step is to communicate with a competent, Registered Patent Attorney and learn the essential facts about Patents without a day's delay. My FREE BOOK gives you these vital facts . . . how to proceed, different kinds of patents, importance of protection and much more. Also explains my Convenient Payment Plan.



PERSONAL ATTENTION

Every case that comes into my office receives my PERSONAL ATTENTION in every step of the road to protection. If you have faith in your invention, then take care to select the lawyer who will PERSONALLY represent you before the United States Patent Office, a registered Patent Attorney and a Graduate Engineer in whom you can feel the utmost faith, and know that he will give your case his PERSONAL attention and not turn it over to an assistant or subordinate. Mail This Coupon TODAY!

L. EDWARD FLAHERTY REGISTERED PATENT ATTORNEY

70-A International Building WASHINGTON, D. C.

Please send immediately your FREE book and Record of Invention Form.

Name

Address

City State

STOP THAT! SLAM!

AMAZING INVENTION
STOPS SLAMMING DOORS

KANT-SLAM closes heaviest doors silently, positively, automatically. Prevents slamming or leaving doors open. Works in oil. Lasts lifetime. Easily installed. LOW PRICED. Real Demonstrator Furnished. We supply actual KANT-SLAM on easily-carried miniature door. You make big money on quick sales to stores, offices, factories—every building can use 1 to 20! Free Demonstrator to workers. Write! Get free details. KANT-SLAM CO., Dept. P-53, Bloomfield, Ind.

PAYS BIG PROFITS DAILY!



WHOLESALE CATALOG of 4000 FAST SELLERS



Hot off the press. Shows fast sellers of every description from many parts of the world, at rock bottom wholesale prices. 256 pages chock full of the biggest bargains you ever saw, many new items just being introduced, articles for every member of the family, office necessities, etc. One of the most complete lines in America. The 15 proven money making plans are fully explained in the catalog and may increase your earnings a hundred fold. This catalog is FREE—Send for it, today.

SPURS CO.
12-36 Main St. Le Center, Minn.

New Oil Burner Heats Cheaper

Saves 25% Fuel Cost



New perfected oil burner! All the best features combined in one burner—LACO's patented "Mineral-Wick" gives hotter gas flame from cheap fuel oil—extremely simple—only one moving part—nothing to cause trouble. Underwriters Lab. 35,000 in use.

WRITE! Free booklet gives complete details of oil burners for your present heating plant—complete oil burning heating plants—oil burning circulating room heaters, all at amazing low prices. LACO will ship any model to a new dealer subject to examination without costing you a cent. SEND NOW!

LACO OIL BURNER CO.
127 Union Ave., Griswold, Iowa

Look Here, DEALERS! LACO sales doubled this year! LACO has a most profitable dealer's proposition—you can fill any order for oil heat from a small cafe hamburger griddle up to a large industrial plant, I mean what I say, LACO is the best money-maker for the dealers.

AMAZING-NEW INVENTION! BIG EARNINGS QUICK! WITH THIS NEW MONEY MAKER



No Experience Needed. Sells easy to amazing big market. Combination **BLOW TORCH AND SOLDERING IRON**. No pressure system. No pumps. No stove. No charcoal. Operates with 100% satisfaction. Neat, complete, compact. Guaranteed by 30 year old company. Write quick for New Agents' Plan and Exclusive territory offer. Hurry!

JUSTRITE MFG. CO.
Dept. 52, 2061 Southport, Chicago

RAISE GIANT FROGS

NUFOND GIANTS WEIGH UP TO 3 LBS. EACH



A New Industry! Millions used yearly! Markets waiting. Prices Steady. Pleasant, outdoor work. Easy to ship to any part of the country. Nation-wide market at your command. A SMALL POND is all you need to start with five pairs of "Nufond Giant Breeders." Expand with the increase. WE BUY! As originators of Canned Frog Legs, we are developing one of the world's largest frog markets. In addition to other markets, frog raisers can also ship to us. **MEN & WOMEN!** Investigate this interesting, new work. See for yourself what others are already doing. Send for our illustrated, FREE book explaining our offer in detail. Write today. **AMERICAN FROG CANNING COMPANY**
Dept. 133-B, New Orleans, La.

SELL UP TO \$5 PER DOZEN!

FREE BOOK



SWEET OR SWING BUESCHER'S THE THING



Easy to Play FOR FUN OR PROFIT

Quickly, easily, you'll learn to play a Buescher True-Tone saxophone, cornet, trombone—any band instrument. Exclusive Buescher features mean faster progress—you join a band or orchestra in a few weeks—win pleasure and profit.

FREE TRIAL: Easy Payments. Send now for details, no obligation. Mention instrument which interests you.

Buescher Band Instrument Company
210 Buescher Bldg., Elkhart, Ind.

BUESCHER True Tone

Hal Kemp
leader, and many players in his popular Radio band, use Buescher True-Tones.

MAN IN EACH TOWN To Plate Auto Parts,
Reflectors, Mirrors, etc., by late method. Experience unnecessary. Free particulars and proofs. Write today.
GUN METAL CO., Ave. M, Decatur, Ill.

MIDGET Electric RADIO

World's Smallest Loudspeaker Radio

Just a handful—Wt. only 1 1/4 lbs. Size only 3 1/2 x 5 x 2 1/4. Has two multi-purpose hi-gain tubes, hi-efficiency coil and precision parts—**BUILT IN AERIAL!** Midget **BUILT IN** speaker operates with beautiful clear tone and clarity on all stations on broadcast band and ALSO police calls! Actual four tube performance with real distance and punch for so tiny a radio. **ALL ELECTRIC** (Battery model available). Easily carried in any large pocket or tucked in suitcase. Ideal second or personal radio. Colors to match any room—beautifully finished break-proof cabinets. Only hi-grade parts used—a truly trouble proof midget. Late improvements. Users report wonderful reception in ALL PARTS OF THE WORLD. Uses 110 volt AC or DC current—any cycle. Kit of parts with tubes and diagram, \$6.48. **COMPLETELY WIRED** and factory checked, 50c extra or \$6.98 as shown. Send only \$2.00—pay postman balance. Guaranteed to operate anywhere. Colors: White, Black, Brown, Blue, Green. (Battery model same as above complete with self-contained battery, same price.) **ORDER NOW.**

TINYTONE RADIO CO. Dept. P-2 Kearney, Nebr.

MECHANICAL ENGINEERING



Pays Big NOW!

Less than 20 minutes a day with these 7 big mechanical engineering books entitled "Modern Shop Practice," will prepare you for a better job and bigger pay. Machine hands become foremen and superintendents, helpers become experts, foremen become managers. Any machinist, helper or factory employee can benefit QUICKLY and can command more money.

Your Opportunity Don't miss this chance to qualify for promotion, don't put off for one minute this Big Opportunity which is yours almost for the asking. Seven Big Books chockful of important mechanical facts told so simply and clearly that any one can understand them. Over 2600 pages, nearly 2700 illustrations cover every subject fully, including Tool Making, Pattern Making, Foundry Work, Mechanical Drawing, Forging, in fact anything you need to know.

Everything Sent FREE for examination. Yes ALL of these books will be sent to you for examination. Decide in your own home or place of business whether or not you want to keep them, check up on any facts you want to. Note their great MONEY MAKING value, then, if you want them, pay on the easiest kind of payments.

These Instruments Included

Complete set of drawing instruments if you send for these books NOW. These instruments are made of the finest of German silver, are absolutely accurate and are packed in velvet lined leatherette pocket case. Real \$10 value but sent to you with these books without extra charge.

American Technical Society, Dept. M219, Drexel at 58th St., Chicago

You may send me the 7 big NEW books for free examination. I will pay the few cents delivery charges only unless I decide to keep them in which case I will send \$2.00 in ten days and \$3.00 per month until the total price of only \$29.80 is paid. If I return them in 10 days I will owe you nothing. Because I send now, you agree to give me a membership in the American Technical Society entitling me to Free consultation privileges with any of your experts for one year and set of drawing instruments.

Name.....
Address.....
Address.....

Please attach a letter stating age, occupation, employer's name and address and that of at least one business man as reference.

WORK FOR THE GOVERNMENT START



\$1260 to \$2100 YEAR

Many 1937 Appointments

Social Security Work Means Many Jobs as Clerks, Stenographers, etc.

City Mail Carriers, City Post Office Clerks

Clerks and carriers now get \$1,700 the first year regular and automatically increase \$100 a year to \$2,100 and \$2,300. Open to men—women 18 to 45.



Railway Postal Clerks

Railway Postal Clerks get \$1,900 the first year regular, being paid on the first and fifteenth of each month. (\$79.17 each pay day.) Their pay is automatically increased yearly to \$2,450. Advance may be had to Chief Clerk at \$2,700 a year. (\$112.50 each pay day.) Open to men, 18 to 35.

Customs Inspector

Salary \$2,100 to start. Men 23 to 45. Work connected with examining baggage and merchandise entering the country from foreign parts covering boats, trains, roads, automobiles, etc.

File Clerk—Clerk

Open to Men—Women 18 to 50. Entrance salary \$1260 — \$1440 Year. Appointments as File Clerks and Clerks in the Departments at Washington, D. C., are made from this examination.



Many Other Jobs

Many other positions. Experience is usually unnecessary and political influence is not permitted. Let us show you how to get a government job.

Free List of Positions

Fill out the following coupon. Tear it off and mail it today—now, at once. This investment may result in your getting a big-paid government job.

FRANKLIN INSTITUTE, Dept. W195, Rochester, N. Y.

Gentlemen: Rush to me, FREE of charge, list of U. S. Government big pay jobs. Send me FREE 32-page book describing salaries, vacations, hours, work, and full particulars telling how to get one of these jobs.

Name.....
Address.....
Address.....

When writing please mention Popular Mechanics

Get the FREE Book of opportunity

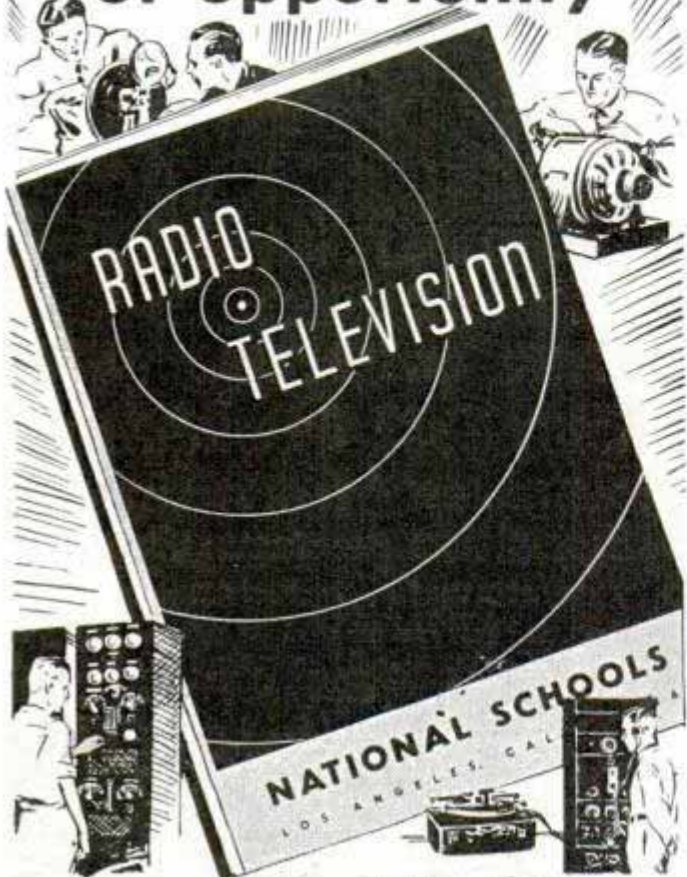

Brimful of terse instructive facts about

TELEVISION

RADIO

SOUND RECORDING

ELECTRICITY

Note These Interesting Contents

Written in plain, understandable language, this free book gives facts you want to know about the best-paying trades and opportunities. 95 illustrations. Major subjects include Television Theory and Construction, Pick-up Systems, Amplifiers, Transmitters, Receivers, Cathode Tubes; Radio in all its branches, Receiving, Broadcasting, Trouble-shooting, Construction and Theory; Sound-recording on Disc; Loud Speakers, Talking Picture Projection, Radio Communication, Laws, etc. This book also tells how you can qualify for these good pay trades by training at NATIONAL SCHOOLS. Send coupon now for free book.

National Schools is the oldest trade Institution in the West. Est. 1905. More than 30,000 graduates. You can earn room and board while learning. Coach railroad fare allowed to Los Angeles. This service only for residents of U.S.



NATIONAL SCHOOLS

LOS ANGELES

NATIONAL SCHOOLS, Dept. 2-PMR,
4000 So. Figueroa St., Los Angeles, Calif.

Name..... Age.....
Address.....
City..... State.....

PLAY IN THE BAND



You can join a band or orchestra quickly, playing an easy-to-learn Elkhart instrument. Free Chart pictures and tells uses of all band and orchestra instruments—cornet, saxophone, trombone, etc., helps you choose the one for your talent. **FREE TRIAL; EASY PAYMENTS.** Write now for details and Free Chart, without obligation.

ELKHART BAND INSTRUMENT CO., 210-A JACKSON ST., ELKHART, IND.

ELKHART

NEW SCIENTIFIC WONDER



10c
3 for
25c

BOYS BIG FUN. You apparently see thru clothes, Wood, Stone, any object. See Bones in Flesh. **FREE PACKAGE** radio picture films, take pictures without camera. "You'll like 'em." 1 package with each 25c order.
MARVEL MFG. CO., Dept. 80 — NEW HAVEN, CONN.

AGENTS 500% Profit GOLD LETTERS

For Store Fronts and Office Windows. Anyone can put them on. Free samples. Liberal Offer to general agents.
METALLIC LETTER CO., 438 N. Clark St., Chicago

AUDELS Carpenters and Builders Guides

4 vols. \$6



Inside Trade Information for Carpenters, Builders, Joiners, Building Mechanics and all Woodworkers. These Guides give you the short-cut instructions that you want—including new methods, ideas, solutions, plans, systems and money saving suggestions. An easy progressive course for the apprentice and student. A practical daily helper and Quick Reference for the master worker. Carpenters everywhere are using these Guides as a Helping Hand to Easier Work, Better Work and Better Pay. To get this assistance for yourself, simply fill in and mail the **FREE COUPON** below.

Inside Trade Information On:

How to use the steel square—How to file and set saws—How to build furniture—How to use a mitre box—How to use the chalk line—How to use rules and scales—How to make joints—Carpenters arithmetic—Solving mensuration problems—Estimating strength of timbers—How to set girders and sills—How to frame houses and roofs—How to estimate costs—How to build houses, barns, garages, bungalows, etc.—How to read and draw plans—Drawing up specifications—How to excavate—How to use settings 12, 13 and 17 on the steel square—How to build hoists and scaffolds—skylights—How to build stairs—How to put on interior trim—How to hang doors—How to lath-lay floors—How to paint.



THEO. AUDEL & CO., 49 W. 23rd St., New York City

Mail Audels Carpenters and Builders Guides, 4 vols., on 7 days' free trial. If O.K. I will remit \$1 in 7 days, and \$1 monthly until \$6 is paid. Otherwise I will return them. No obligation unless I am satisfied.

Name.....
Address.....
Occupation.....
Reference..... P.M.

When writing please mention Popular Mechanics

MIDWEST...

THE RADIO THAT CAUGHT A NATION'S FANCY!

HALF the Cost..
(FACTORY-TO-YOU SAVES 50%)

TWICE the Performance
(14 TUBES FOR THE PRICE OF 8)

Only \$ **39.95** BUYS A
NEW 1937
MIDWEST
30 DAYS FREE TRIAL!

**FACTORY-TO-YOU,
EASY-PAY PLAN!
SAVES YOU 50%!**

This great new Midwest has caught the nation's fancy, because scores of marvelous new features like Dial-A-Matic Tuning*, Elektrik-Saver* (optional*) give magnificent world-wide reception and glorious crystal clear realism. America OK's Midwest radios because they out-perform ordinary sets on a point-for-point comparison. Not a cut-price set, but a more powerful super performing radio in a big, exquisitely designed cabinet of matched walnut! You are triply protected with Foreign Reception

Guarantee... One-Year Warranty and Money-Back Guarantee Now, you can roam the world in a flash... switching instantly from American programs to police, amateur, commercial, airplane and ship broadcasts... to the most fascinating foreign programs. When you buy the Midwest factory-to-you way, you deal directly with the factory that makes radios—instead of paying extra profits to wholesalers, distributors, retailers, etc. Remember! Nothing of value is added to a radio just because it is handled many times. You have a year to pay... terms as low as 10c a day... you secure the privilege of 30 days FREE trial in your own home.

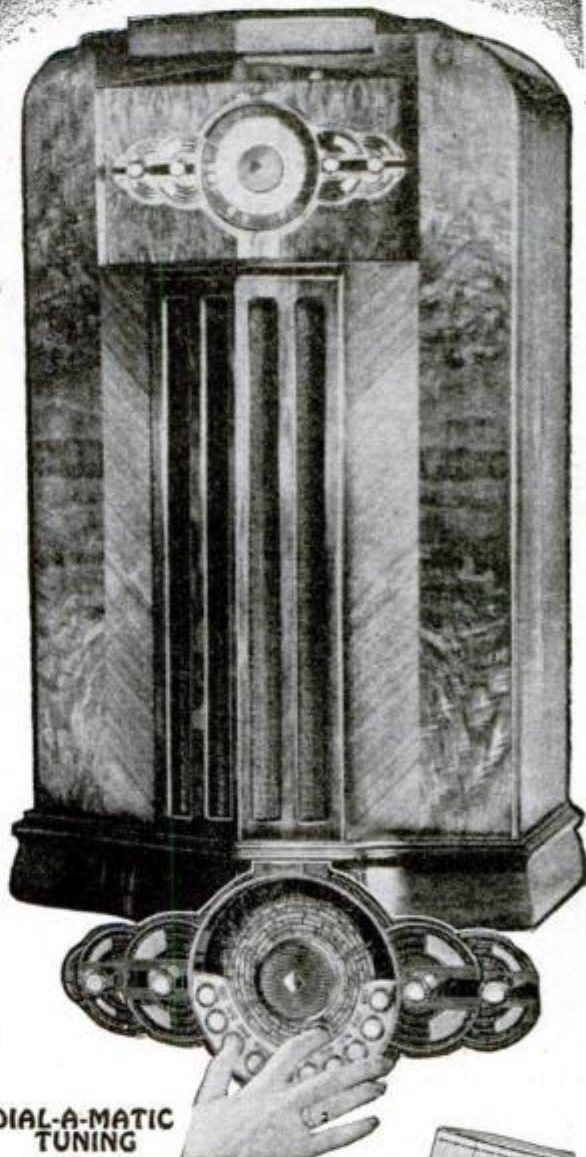

DIAL-A-MATIC TUNING

Your radio enjoyment is doubled with Dial-A-Matic Tuning, the amazing new Midwest feature that makes this radio practically tune itself. Zip!... Zip!... Zip!... stations come in instantly, automatically, perfectly... as fast as you can push buttons. Exclusive Midwest Elektrik Saver cuts radio wattage consumption 50%, enables Midwest radios to use no more current than ordinary 7-tube sets.

Only **MIDWEST RADIOS** Offer
DIAL-A-MATIC TUNING • **ELEKTRIK-SAVER** •
DUAL-AUDIO PROGRAM EXPANDER • **AUTOMATIC**
AERIAL TUNING • **6 WAVE BANDS (4 1/2 to 2400 METERS)**
AND SCORES OF OTHER FEATURES AT SAVINGS UP TO 50%!
RUSH COUPON FOR FREE 40-PAGE CATALOG!

Why be content with an ordinary 6, 8, 10 or 12-tube set when you can buy a 14-tube deluxe Midwest for the same money! The extra power brings in those distant stations without tone distortion.

MIDWEST RADIO CORP.

DEPT. H-15 CINCINNATI, OHIO, U.S.A.
Established 1920 Cable Address MIRACO...All Codes

PASTE COUPON ON 1¢ POSTCARD...OR WRITE TODAY!

MIDWEST RADIO CORPORATION
Dept. H-15 Cincinnati, O.
Send me your new FREE catalog and complete details of your liberal 30-day FREE trial offer.
(Special offer and prices prevail only when dealing direct with factory by mail.)

Name.....

Address.....

Town..... State.....

User-Agents Make Easy Extra Money Check Here for details.

NOW—IT'S SCIENTIFIC CRIME DETECTION



that PAYS BIG REWARDS

New Easy Training Endorsed by Experts Prepares You For
BIG EARNINGS

The Nation's cry these days is for *scientifically* trained investigators. Never before has there been such an opportunity for young men scientifically trained as at the present time.

Study At Home—Advanced Education Or Previous Experience Not Necessary

This new training is not difficult. No deep book or technical data. Anyone 17 to 70 eligible. A little time each day qualifies you for big earnings in most fascinating profession on earth. Course includes every important branch of crime detection. Only course in existence that offers combination of the Science of Finger Prints, Secret Service and Private Investigation, Identification of Handwriting, Secrets of Defense and Attack, and Police Photography, ALL IN ONE GREAT COURSE!

Easy Terms—Big Regulation Outfit Free To Students

Write for easy terms policy enabling you to secure this scientific training with practically no sacrifice. You train with regulation police equipment and employ methods used in finest equipped bureaus of identification. Internationally famous leaders in police world endorse this training. Instructor a nationally known expert in scientific crime detection. Private industry also now demanding scientifically trained experts. Now is your opportunity to get into this new fascinating field.

FREE TO ANY YOUNG MAN 17 OR OVER

Send today for big new book, "Get Into Scientific Crime Detection," including 14 famous scientifically solved cases. This free book tells how and why you can earn big money in this great profession. Fill in coupon—mail today sure.



SCIENTIFIC CRIME DETECTION INSTITUTE of AMERICA, Inc.

Dept. 2B37 Chesapeake and Ohio Bldg.
Huntington, West Virginia
J. T. BURDETTE, President

SCIENTIFIC CRIME DETECTION INSTITUTE of AMERICA, Inc.

Chesapeake and Ohio Building
Huntington, West Virginia

Dept. 2B37

Gentlemen: Without any obligation whatsoever, please send me your big book containing 14 famous scientifically solved cases, together with full particulars on how I can get into SCIENTIFIC Crime Detection.

Name.....

Address.....

Age.....

When writing please mention Popular Mechanics

Own a CHEEZE-KIST Popcorn Route



BIG PROFITS MANUFACTURING AND SELLING AT WHOLESALE

Imagine fresh, crisp popcorn flavored with golden yellow liquid cheese. That's CHEEZE-KIST—the newest food sensation that is sweeping the country. We furnish outfit enabling you to make this tasty food product. Large production capacity of outfit **MAKES BIG EARNINGS POSSIBLE**. Make CHEEZE-KIST in your own home and sell your entire output at wholesale to stores, taverns, road houses, cigar stands, restaurants, etc. **STARTLING PROFITS**. Experience not important.



NEW LOW PRICE OPENS FIELD FOR ORDINARY MAN

Complete manufacturing equipment furnished at price so unbelievably low that even the man of limited means can start. Everything supplied, including formula, manufacturing and selling instructions. Operation made as simple as A B C. Raw material plentiful and cheap.



WE TRUST YOU

Equipment shipped on credit to honest, deserving persons. All particulars furnished free. Simply send name today and get all the facts.

CHEEZE-KIST COMPANY
228 High St., Springfield, Ohio

CIVIL SERVICE

VALUABLE INFORMATION

COLUMBIAN CORRESPONDENCE COLLEGE
WASHINGTON, D. C.



Know Electricity as Experts Know It—and Get an Expert's Pay!

Recovery has begun! The months ahead are charged with significance and expectation. What will you do to get the jump on the other fellow?

Thousands of men have used

The Croft Library of Practical Electricity

The Croft Library is a complete electrical educator. It is founded on practice—on 20 years of shirt-sleeve experience—on work as it is actually done. It is jammed from cover to cover with the kind of hard-headed facts you want. Written so that the beginner can easily understand it, yet so sound, so thorough, that it is the daily guide of 50,000 highly paid electrical workers and engineers. Croft tells you the things you need to know about motors, generators, armatures, commutators, transformers, circuits, switchboards, distribution systems—electrical machinery of every type—wiring for light and power—wiring of finished buildings—underwriters' and municipal requirements—illumination in its every phase—the most improved methods of lighting—lamps and lamp effects, etc.—how to do a complete job, from estimating it, to completion.

No money down—easy payments

Fill in and mail the coupon attached and we will send you the entire set of seven volumes for ten days' Free Examination. We take all the risk—you assume no obligation. If you decide to keep the books, send \$1.50 in ten days and the balance at the rate of \$2.00 a month. Send the coupon NOW and see the books for yourself.

FREE EXAMINATION COUPON

McGRAW-HILL BOOK CO., 330 W. 42nd St., New York

Send me for ten days' free examination the Croft Library of Practical Electricity. If satisfactory I will send you \$1.50 in 10 days and \$2.00 monthly until the price of \$19.50 is paid. If not wanted, I will return the books postpaid. (To insure prompt shipment write plainly and fill in all lines.)

Name.....

Home Address.....

City and State.....

Position.....

Name of Company.....

PM-237

How Does a Ship Captain Plot His Course with the Sextant?



Surprising as it may seem, you will find the method of determining latitude clearly described in the New Merriam-Webster! The wide scope of this greatest single volume of information is shown by hundreds of illustrated encyclopedic articles on scientific operations. Every other field is also covered with the same unprecedented thoroughness in

WEBSTER'S NEW INTERNATIONAL DICTIONARY Second Edition



The Supreme Authority. 3,350 Pages. 600,000 entries—122,000 more than any other dictionary. Edited by 207 authorities. See it at your bookdealer's.

Write for illustrated new booklet, "Through Wonderland with Webster"

G. & C. MERRIAM CO.
Dept. 710 Springfield, Mass.

SIGNS and Show Cards

Big demand! Steady work! New Picture-

Way Teaching Method trains you in three months, at home, on actual work. Professional outfit FREE to students. Personal supervision of D. Rogers Stewart, the noted artist-instructor. For free lesson and particulars write at once to the

STEWART SCHOOL of Sign Painting, Dept. P-2, 3555 Aberdeen, Alton, Ill.



WITHOUT GLASSES

The NATURAL EYESIGHT SYSTEM Gives Your Eyes a New Deal

If you wear glasses, or think you should, our FOUR MONTHS' TRIAL OFFER—containing the inspiring story of glasses discarded for Nearsight, Farsight, Astigmatism, Old Age Sight, Eyestrain, Weak Eyes, Eye Muscle Trouble, Etc., as told by USERS AT HOME of this Revolutionary System—will be mailed FREE upon request.

NATURAL EYESIGHT INSTITUTE, INC.
Dept. 72-C Los Angeles, Calif.

In answering advertisements always write name and full address clearly.

OLD FACES MADE YOUNG



MEN you can look 10 to 15 years younger. 5 Minutes a Day Keeps Wrinkles Away and erases age lines. This new sensational home method Sent on Trial—You Risk Nothing. Lifts sagging muscles, fills up hollows. No Cosmetics.

Men, Women, all ages write for thrilling book and Facial Analysis Chart—both sent FREE in plain wrapper.

PAULINE PALMER, 1461B Armour Blvd., Kansas City, Mo.

When writing to advertisers please mention Popular Mechanics



ALL EYES ARE ON THE MAN WHO LOOKS AHEAD

● A MAN cannot conceal ability. And the man who is determined to go some place and is doing something about it cannot conceal that either. His associates feel it and his superiors recognize it. The man who looks ahead knows the importance of training, and other men who have looked ahead and gone some place know that I. C. S. offers the right kind of training. Look ahead — mail this coupon!

INTERNATIONAL CORRESPONDENCE SCHOOLS

Box 5656-H, Scranton, Penna.

Without obligation, please send full particulars about the subject before which I have marked X:

TECHNICAL AND INDUSTRIAL COURSES

- | | |
|--|---|
| <input type="checkbox"/> Architect | <input type="checkbox"/> Diesel Engines |
| <input type="checkbox"/> Architectural Draftsman | <input type="checkbox"/> Aviation Eng. <input type="checkbox"/> Auto Mechanic |
| <input type="checkbox"/> Building Estimating | <input type="checkbox"/> Plumbing <input type="checkbox"/> Heating |
| <input type="checkbox"/> Contractor and Builder | <input type="checkbox"/> Air Conditioning <input type="checkbox"/> Refrigeration |
| <input type="checkbox"/> Structural Draftsman | <input type="checkbox"/> Steam Engineer |
| <input type="checkbox"/> Structural Engineer | <input type="checkbox"/> Steam Electric Engineer |
| <input type="checkbox"/> Electrical Engineer | <input type="checkbox"/> Marine Engineer |
| <input type="checkbox"/> Electric Lighting | <input type="checkbox"/> Civil Engineer <input type="checkbox"/> Highway Engineer |
| <input type="checkbox"/> Welding, Electric and Gas | <input type="checkbox"/> Bridge Engineer |
| <input type="checkbox"/> Reading Shop Blueprints | <input type="checkbox"/> Bridge and Building Foreman |
| <input type="checkbox"/> Telegraph Engineer | <input type="checkbox"/> Surveying and Mapping |
| <input type="checkbox"/> Telephone Work <input type="checkbox"/> Radio | <input type="checkbox"/> R. R. Locomotives <input type="checkbox"/> Air Brakes |
| <input type="checkbox"/> Mechanical Engineer | <input type="checkbox"/> R. R. Section Foreman |
| <input type="checkbox"/> Mechanical Draftsman | <input type="checkbox"/> R. R. Signalmen |
| <input type="checkbox"/> Machinist <input type="checkbox"/> Toolmaker | <input type="checkbox"/> Chemistry <input type="checkbox"/> Pharmacy |
| <input type="checkbox"/> Patternmaker | <input type="checkbox"/> Coal Mining |
| <input type="checkbox"/> Foundry Practice | <input type="checkbox"/> Navigation |
| <input type="checkbox"/> Sheet Metal Worker | <input type="checkbox"/> Cotton Manufacturing |
| <input type="checkbox"/> Boilermaker | <input type="checkbox"/> Woolen Manufacturing |
| <input type="checkbox"/> Heat Treatment of Metals | <input type="checkbox"/> Agriculture <input type="checkbox"/> Fruit Growing |
| <input type="checkbox"/> Management of Inventions | <input type="checkbox"/> Poultry Farming |

BUSINESS TRAINING COURSES

- | | |
|--|--|
| <input type="checkbox"/> Business Management | <input type="checkbox"/> Lettering Show Cards <input type="checkbox"/> Signs |
| <input type="checkbox"/> Industrial Management | <input type="checkbox"/> Stenography and Typing |
| <input type="checkbox"/> Traffic Management | <input type="checkbox"/> Civil Service <input type="checkbox"/> Mail Carrier |
| <input type="checkbox"/> C.P. Accountancy | <input type="checkbox"/> Railway Mail Clerk |
| <input type="checkbox"/> Bookkeeping | <input type="checkbox"/> Grade School Subjects |
| <input type="checkbox"/> Secretarial Work | <input type="checkbox"/> High School Subjects |
| <input type="checkbox"/> Cost Accountant | <input type="checkbox"/> College Preparatory |
| <input type="checkbox"/> Salesmanship <input type="checkbox"/> Advertising | <input type="checkbox"/> First Year College Subjects |
| <input type="checkbox"/> Service Station Salesmanship | <input type="checkbox"/> Illustrating <input type="checkbox"/> Spanish |
| <input type="checkbox"/> Business Correspondence | <input type="checkbox"/> Cartooning <input type="checkbox"/> French |

DOMESTIC SCIENCE COURSES

- | | |
|---|--|
| <input type="checkbox"/> Professional Dressmaking and Designing | <input type="checkbox"/> Millinery |
| <input type="checkbox"/> Home Dressmaking | <input type="checkbox"/> Foods and Cookery |
| <input type="checkbox"/> Advanced Dressmaking | <input type="checkbox"/> Tea Room and Cafeteria Management, Catering |

Name.....Age.....

Address.....

City.....State.....

Present Position.....

If you reside in Canada, send this coupon to the International Correspondence Schools Canadian, Limited, Montreal, Canada

STAMPS and COLLECTING

(Continued from page 50A)

F1589



Recent foreign stamp issues, including some by Great Britain for nationals in Morocco, and several air-mail stamps issued by various countries

gold dollars. Most of the regular gold dollars of the Philadelphia mint are priced at about six dollars for uncirculated copies, but there are a few scarce dates, one of which is listed at \$150. All coins of the Charlotte mint list above ten dollars and one date is priced at \$2,500 for a copy listed only as very fine. Those of the Dahlonega mint range from six dollars to about \$350 for uncirculated copies. Those minted at New Orleans are priced at from five to fifteen dollars and those from San Francisco at from fifteen to \$150. The commemorative gold dollars are worth from four or five to twenty-five dollars.

Recent Foreign Stamp Issues

Recent foreign stamp issues include several of more than passing interest. At the top of the illustration are examples of four sets of stamps which Great Britain provides for the use of her nationals in Morocco. The stamp inscribed "Tangier" is

for use in that city. The stamp inscribed "Morocco Agencies" is one of a set for general use throughout the region, and the next two examples are for use in the French and Spanish zones. The stamp at the upper left is a Panama air mail. At the upper right is an example of the set issued by the commonwealth of the Philippine islands in honor of the aviators, Antonio Arnaiz and Juan Calvo. The second row includes three German stamps, two of which are samples of the Winter Help semi-postal issue. At either end of this row are stamps of Bulgaria and Finland.

The third row contains two examples of air-mail stamps. The first is the ten-franc value of the French issue commemorating the aerial conquest of the South Atlantic. The other is a more recent stamp of the Dominican republic. The remaining four stamps show the four designs of a new long series issued for the French colony of French Western Africa.

THIS COMPLETE, SIMPLE, PRACTICAL COURSE FOR SELF-INSTRUCTION WILL QUICKLY GIVE YOU
A Complete Mastery of MATHEMATICS



Prepare now to advance yourself to an important job by *Mathematics Training*. Mathematics is the foundation of all mechanical and scientific work, and of all business or industry based on science. Without this essential knowledge even the most capable man is left behind while others forge ahead to better jobs, bigger contracts, more money. You need mathematics to solve technical problems and to improve, speed up and check on your work and the work of others.

Now you can learn mathematics by an easy, inexpensive and time-saving method. A very simple and extremely interesting course in book form has been prepared for you by an expert who has devoted a lifetime to teaching practical men the fundamentals of this important subject.

MATHEMATICS FOR SELF-STUDY

By **J. E. Thompson, B.S., A.M.,**
 Dept. of Mathematics,
 Pratt Institute

These books start right from the beginning with a review of arithmetic that gives you all special short-cuts and trick methods that save countless hours of your time. Then they go right into higher mathematics and show you how simple it is when an expert explains it for you. In no time at all you will be tackling with ease the most difficult questions on this subject.

An Expert's Simplified Methods

Mr. Thompson, the author of these books, has had many years' experience in mathematical training. He

presents each practical method and problem in the clearest, simplest way. He gets right down to the kind of information that you need in your daily work.

Send No Money—Mail This Coupon for FREE EXAMINATION

D. Van Nostrand Co., Inc., 250 Fourth Ave., New York
 Send me MATHEMATICS FOR SELF-STUDY in 5 volumes. Within 10 days I will either return the books or send you \$2.95 as first payment and \$2.00 per month for 3 months—total \$8.95 (5% discount for cash). (P.M. 2-37)

Name.....
 Address.....
 City and State.....
 Reference.....

Address.....
 FOR FREE CATALOG of best books of practical instruction and technical information, check here. If you do not want Mathematics for Self-Study cross out paragraph above.

Every Needed Fact, Figure, Formula, Every Shortcut and Special Method
 in the
WHOLE FIELD of MATHEMATICS
 Now in ONE Handy Volume

For the first time you can have this wealth of practical mathematical information, covering every trade and business, condensed into one handy book for quick reference. This volume puts right at your finger tips instant facts and formulas for making every kind of mathematical calculation. From hundreds of different sources, this priceless information has been gathered together, boiled down into brief, simple language, and applied to actual problems. Every man in business, every man in the mathematical trades, every man who ever uses a tool or has to make calculations or estimates in office, shop, or home, will find here a treasury of money-making, money-saving ideas.



THE HANDBOOK OF APPLIED MATHEMATICS

No previous knowledge of mathematics is needed. No study is required. The specific information you want is easy to find, by looking it up in the index. The

Entirely NEW Greatly ENLARGED

Revised throughout, greatly extended in scope, with a wealth of NEW MATERIAL in all sections. The subjects of pulleys, gears, the use of the slide rule, and weights and measures have been greatly lengthened. Valuable new sections deal with the topics of strength of materials, papering, glazing, and radio. Ample new material has been furnished on machine shop practice and sheet metal work. Finally, an entirely new treatment covers exhaustively the great field of business mathematics. In its new form, more than ever before, this book will simplify your most important and puzzling problems.

No Increase in Price
 754 Pages. Lavishly illustrated.
 Strong Cloth Binding. Page Size 5 1/2 x 8 inches.

book takes up every trade and gives you practical methods, easily-worked formulas for solving every problem. Thousands of specific examples show you just how to make your calculations. If your work involves mathematics in any way this complete reference handbook is an indispensable part of your equipment. It is an amazing time saver for any one concerned with engineering, architecture, electricity, mechanics, construction, automobiles, machinery, printing, or any other industrial work; or with accounting, auditing, manufacturing, costs, taxes, or any other

business mathematics. No practical man, no house owner who makes an occasional repair, no one who has a home work-shop can afford to be without the valuable information quickly found in this book. A few of the subjects covered:

- | | | | |
|-----------------------------------|-----------------------------|-----------------|-----------------------------|
| Arithmetic (including Slide Rule) | Excavations and Foundations | Mechanics | Sheet Metal Work |
| Algebra | Concrete | Painting | Radio |
| Geometry | Brickwork | Plumbing | Electricity (D.C. and A.C.) |
| Trigonometry | Carpentry and Building | Glazing | Print Shop |
| Weights and Measures | Lathing and Plastering | Paper Hanging | Business Mathematics |
| | | Heating | Accounting |
| | | Machine Shop | |
| | | Automotive Shop | |

EXAMINE THIS BOOK FREE
Send No Money—Mail This Coupon

D. VAN NOSTRAND CO., 250 Fourth Ave., New York
 Send me on approval THE HANDBOOK OF APPLIED MATHEMATICS. Within 5 days after I receive the book, I can return it and owe nothing. If I keep it, I will send you \$2.00 as first payment and I will pay \$2.00 monthly thereafter for 2 months—\$6.00 in all. (5% discount for cash.)

Name..... (P.M. 2-37)
 Address.....
 City..... State.....
 Reference.....

Address.....
 FOR FREE CATALOG of best books of practical instruction and technical information check here. If you do not want The Handbook of Applied Mathematics cross out paragraph above.

OL' JUDGE ROBBINS

POLYNESIAN PIPE

I'VE SEEN PIPES FROM ALL PARTS OF THE WORLD, JUDGE, BUT NONE FROM THE POLYNESIAN SOUTH SEA ISLAND GROUPS

FRANKLY, THE SOUTH SEAS ARE A POOR HUNTING GROUND FOR A PIPE COLLECTOR

SMOKING IS A FAIRLY RECENT INNOVATION THERE. LET ME FILL MY PIPE AND I'LL TELL YOU ABOUT IT

CAPTAIN COOK, THE EXPLORER, WAS THE FIRST EUROPEAN TO DISCOVER MANY OF THE ISLANDS. NATURALLY, THE BRITISH SEAMEN CARRIED PIPES AND TOBACCO ASHORE



THE NATIVES TRIED SMOKING - LIKED IT - AND TODAY MAKE A RATHER CURIOUS PIPE ALL THEIR OWN

HERE IT IS - A SOUTH SEA PIPE MADE FROM A SEA-SHELL. IT MAKES A SURPRISINGLY COOL SMOKE

IT ALWAYS SMOKED HOT BEFORE, BUT WITH PRINCE ALBERT EVERY PUFF IS AS GENTLE AS A SUMMER BREEZE

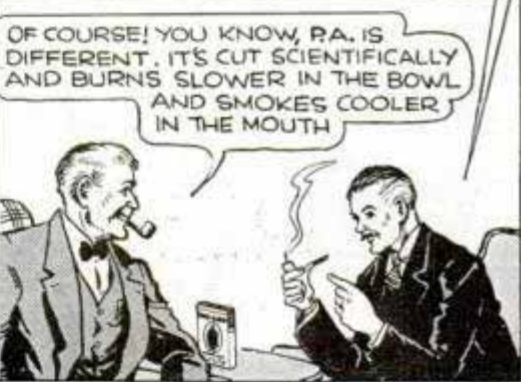

Copyright, 1936, R. J. Reynolds Tobacco Co.



MEN, TAKE UP P.A.'S 'GET-ACQUAINTED' OFFER

PRINCE ALBERT MONEY-BACK GUARANTEE
SMOKE 20 FRAGRANT PIPEFULS OF PRINCE ALBERT. IF YOU DON'T FIND IT THE MELLOWEST, TASTIEST PIPE TOBACCO YOU EVER SMOKED, RETURN THE POCKET TIN WITH THE REST OF THE TOBACCO IN IT TO US AT ANY TIME WITHIN A MONTH FROM THIS DATE, AND WE WILL REFUND FULL PURCHASE PRICE, PLUS POSTAGE.
(Signed) R. J. Reynolds Tob. Co., Winston-Salem, N. C.

PRINCE ALBERT THE NATIONAL JOY SMOKE!

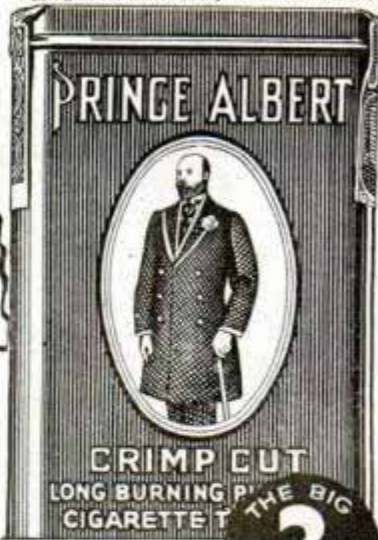

YOU CAN'T BEAT PRINCE ALBERT FOR TASTY SMOKIN'



BEING 'CRIMP CUT' P.A. GIVES ME A COOLER, Milder SMOKE



PRINCE ALBERT'S MY TOBACCO. IT DOESN'T BITE MY TONGUE

50 pipefuls of fragrant tobacco in every 2-oz. tin of Prince Albert

When writing to advertisers please mention Popular Mechanics

Popular Mechanics Magazine

REGISTERED IN U. S. PATENT OFFICE AND CANADA

WRITTEN SO YOU CAN UNDERSTAND IT

Vol. 67

FEBRUARY, 1937

No. 2

The BURIED TREASURE RACKET

PROBABLY you have heard of magical devices supposed to lead you directly to buried treasure. Recently investigators decided to test one.

They arranged six covered boxes on a table. In one they placed a few gold coins, the rest were filled with various kinds of vegetables. Then they called in the owner of a "scientific gold

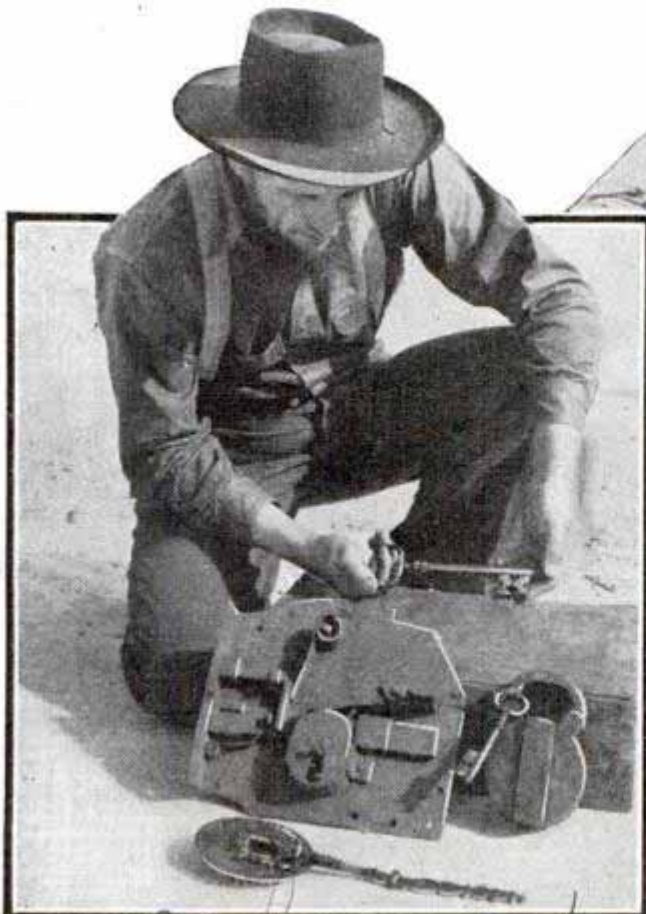

Top, diver adjusting air hose before descending to hunt sunken treasure. Bottom, early locks and keys taken from treasure chests and old safes

compass" supposed to point unerringly to precious metals. After a few exploring trips up and down the line of boxes he picked the fourth one.

"That box," he announced, "contains the gold." The box contained a tomato.

In another case, the owner of a "gold magnet" wanted to demonstrate his instrument to a skeptical business man. The owner of the magnet pulled out a large gold watch and left the office while the skeptic hid it. The business man wrapped the watch in thick paper and placed it far back in a desk drawer. Then he raised

A. Lincoln

Embress Museum

*Thomas E. Timmon, Jr. 10555
Hollywood Blvd. Los Angeles*

1031 S Broadway
Los Angeles Calif

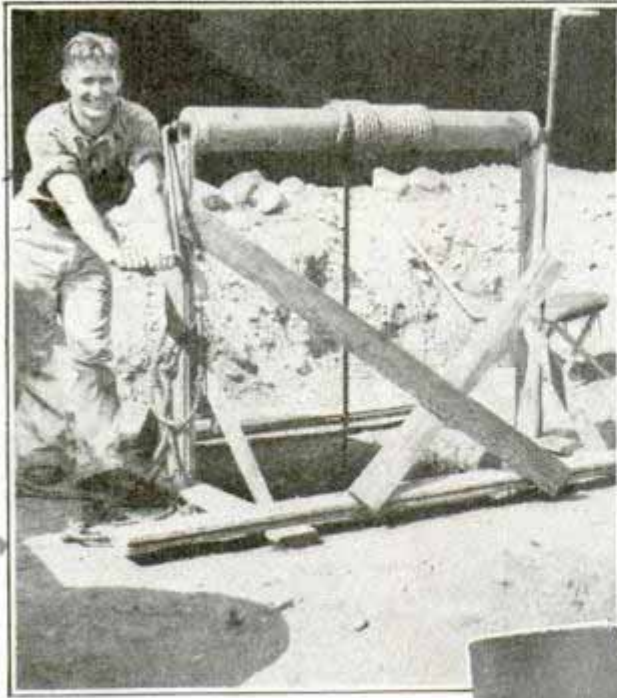

Top, left, raising dirt from deep shaft in vain hunt for treasure. Center, "doodle bug" made of aluminum wire is supposed to point out buried treasure. Right, ship's strongbox of early days. Bottom, swivel gun found aboard sunken pirate ship

stead of with that stick," the business man told him. "I raised one of the windows to let in a little traffic noise to prevent you from hearing the watch. That made you suppose the only hiding place was inside that closet with its thick walls."

Dozens of useless and

fake machines are being sold for finding buried treasures. People who think there is a fortune just beyond their grasp pay from twenty-five dollars to several hundred dollars for strange looking devices that are worthless. Selling such

one of his windows a few inches. The gold hunter prowled around the room, holding his queer device before him. He finally announced the watch was hidden in a supply closet. His "magnet" pulled him toward the closet every time, he declared. Then the business man showed him where the watch really was.

"You locate this watch by its ticks in-

struments is a racket based mainly on the persistent superstition that precious metals give off "vibrations" that can be picked up with so-called divining rods or forked sticks. Science knows of no such vibration that can be detected and the willingness of people to buy and use "doodle bugs" seems to rest in the fact that they believe what they want to believe.

Handwritten notes on the left margin: 2220 15...
Handwritten notes at the bottom: ...



*Left, ruined walls of adobe building where treasure hunters have dug many holes.
Right, early Spanish cannon found by treasure hunters*

In its simplest form, a doodle bug is a forked willow stick, at the fork of which is placed a sample of the material being sought. This "bait" is supposed to be attracted by the buried treasure and to dip toward it when the operator walks over the cache. No matter if you are looking for gold, oil, silver or a lost box of matches, you are supposed to be able to find it with the proper bait. You can buy doodle bugs

of any size or shape to suit your fancy. Magic pendulums, gold detectors, Spanish needles, cylinders containing magnetic sand swinging from six inches of chain, "high-pressure" treasure hunters attached to small batteries to increase the mystery, and "double-strength" divining rods with special compasses to point out gold, all are peddled to gullible purchasers. All of them are equally worthless. One instrument has a special dial with a pointer that you may turn to sections marked "gold," "silver," and so on, depending upon the kind of treasure you want.

Magnetic dip needles have had a wide sale for treasure hunting although gold and other nonmagnetic metals have no effect on such needles. A novice would have trouble in locating even a buried locomotive with the device although magnetic needles have actually been used for such purposes by trained men. When postal authorities stopped one firm from selling mineral rods guaranteed to locate gold 400 feet away, the company began offering the rods free to purchasers of a high-priced book on treasure hunting.

Even if you should see treasure found by some magic device with your own eyes you should still be skeptical. Old coins can be bought by anyone, and it is no trick to "plant" treasure in the ground and then,



Successful inductive electrical apparatus that indicates buried metallic materials

(Continued to page 156A)

Students Steer Dummy Cars in Driving Class

With drivers' seats and dashboards for classroom desks and a motion-picture screen for their highway, students in a Chicago high school are learning how to drive a car safely. Twelve weeks of "skull work" in the classroom is followed by six weeks of actual driving on a practice field. Police furnished obsolete cars for the indoor study, and these were stripped down to a front seat, steering wheel, clutch and brake pedals, gearshift lever and instrument board. The controls were linked to electric lamps in a panel mounted in front of the class, and with each control movement a lamp is lighted. Movies of traffic situations are projected on the screen and the student's reaction is shown instantly on the light panel. The outdoor practice

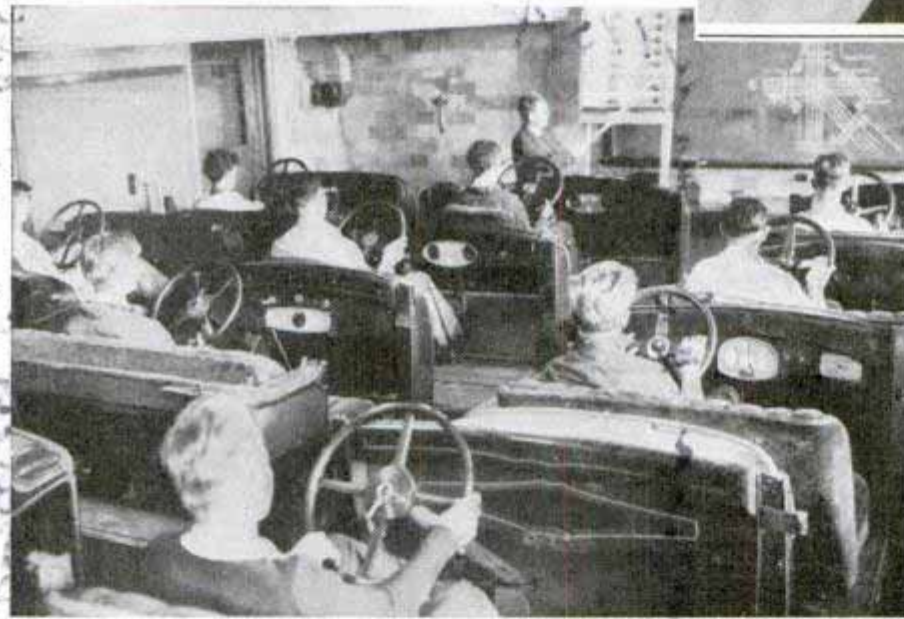
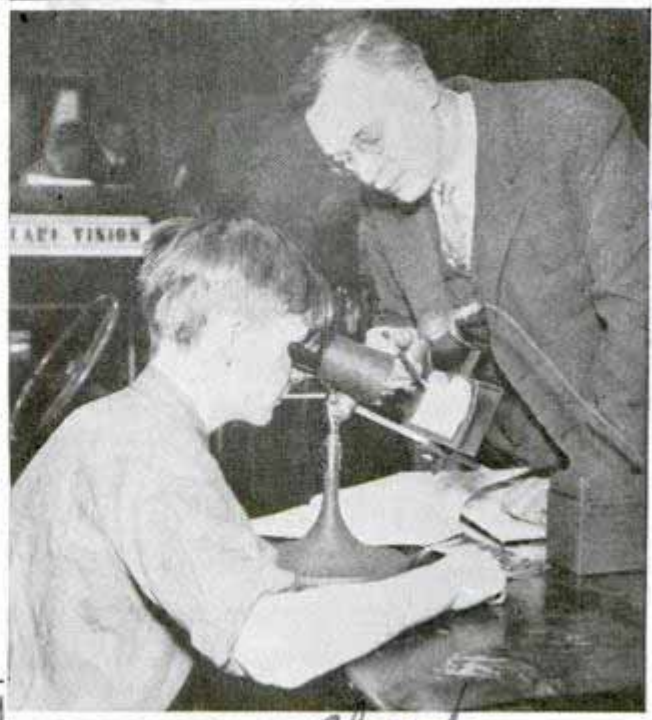

Left, driving class in a Chicago high school. Controls of each dummy car are wired to panel of lights in front of room and student's reaction to traffic situation pictured on a screen is instantly recorded by the lamps. Above, traffic instructor administers a vision test

clut
Lane Tech drive comprises one mile of hard-surface roadway twenty feet wide, with "S" curves and intersections at various angles, grades simulating a railway crossing, and a backing lane for an imaginary one-car garage.

Revival of Electrocution Victims Is Hope of Research

Revival of human victims of industrial electrocution may be made possible through the research of Drs. William T. McNiff and Leonard J. Piccoli of Fordham University. The experimentation is founded on the theory that most deaths resulting from low-voltage electric shocks are caused by suspension of the customary muscular activity of the heart. The experiments prove, the professors assert, that by sending a sixty-five cycle alternating current, constituting a counter shock, through the heart of an animal apparently dead of electric shock, the heart muscles

are restored to normal activity, reviving the animal. The experimenters have not had opportunity to try this method on electrocuted persons, but they believe it practical. The electrodes of the counter-shock apparatus can be applied in a few seconds time to the chest and back of the victim without surgery. According to the investigators, the apparatus was effective in reviving forty out of sixty animal subjects. The counter shock must be applied within four minutes. Where the original shock passed through the head, the method was not successful.

Fordham

See page 164

Aerial Map of State Read with Field Glasses

Aerial Surveys
300 Madison Ave
New York

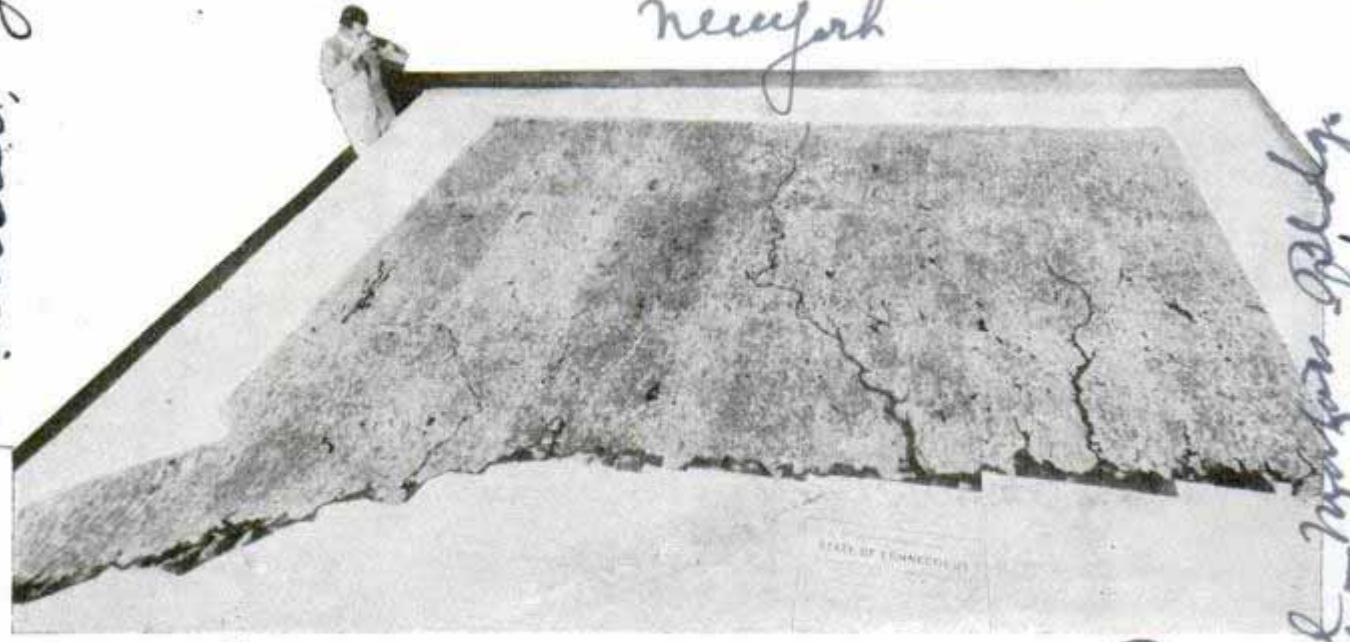

More than 10,000 aerial photographs were pieced together to form this map of Connecticut, so large and detailed that even small houses, hedges and trails can be seen with aid of binoculars

So vast that it must be examined with field glasses to see details, an aerial photographic map of the entire state of Connecticut was pieced together of 10,479 individual pictures. It is eighteen feet by thirteen, and so perfect in detail that with binoculars the observer can pick out trails and streams, hedges and chicken houses. Aerial survey planes flying at an altitude of 11,400 feet covered the 5,004 square miles of the state and brought down the thousands of photographs. These were fitted into thirty-four "composites," each a mosaic view of a section of the state, and finally into the gigantic state map which is being exhibited at Hartford.

Automatic Auto Top Opened and Folded with Switch

Sudden showers hold no terrors for the driver of a convertible car if it is equipped with an automatic top which can be



Pressing switch releases compressed air and causes this auto top to fold back out of sight

Yeast Is Made from Waste

Waste liquid at a Canadian paper mill is being converted into yeast, thus utilizing the sugar contained in wood. The process consists of putting the yeast cells to work devouring all the sugar in the waste. Eleven pounds of yeast cells grow into sixteen tons of yeast. Vast quantities of clean air and filtered water keep the yeast free from poisoning and from turning into alcohol. Then the water is pressed out and the yeast is packed in the conventional manner. At present the mill produces 20,000 pounds per week.

opened or folded by pressing a switch inside the car. The opened top is held in place by compressed air. Pressing the switch releases the air and causes the top to fold back out of sight.

Eastman Kodak Co
Rochester, N.Y.
Decentenary Industrial
Exhibition
Toronto 3
Can. Canada

F1518
Automatic Auto Top Opened and Folded with Switch
Wid Wid
Pressing switch releases compressed air and causes this auto top to fold back out of sight
Best Yeast Corp.
Yeast Is Made from Waste
at Paper Mill
F1541
Waste liquid at a Canadian paper mill is being converted into yeast, thus utilizing the sugar contained in wood. The process consists of putting the yeast cells to work devouring all the sugar in the waste. Eleven pounds of yeast cells grow into sixteen tons of yeast. Vast quantities of clean air and filtered water keep the yeast free from poisoning and from turning into alcohol. Then the water is pressed out and the yeast is packed in the conventional manner. At present the mill produces 20,000 pounds per week.
Best Yeast Corp.
Yeast Is Made from Waste
at Paper Mill
F1541
Waste liquid at a Canadian paper mill is being converted into yeast, thus utilizing the sugar contained in wood. The process consists of putting the yeast cells to work devouring all the sugar in the waste. Eleven pounds of yeast cells grow into sixteen tons of yeast. Vast quantities of clean air and filtered water keep the yeast free from poisoning and from turning into alcohol. Then the water is pressed out and the yeast is packed in the conventional manner. At present the mill produces 20,000 pounds per week.
opened or folded by pressing a switch inside the car. The opened top is held in place by compressed air. Pressing the switch releases the air and causes the top to fold back out of sight.

General Motors Corp.
Detroit, Mich.
Pressed from waste Co.

James Montague
F17

F152⁶

Wolverhampton, England

British Bomber Has Revolving Gun Turret

Gunners aboard the latest type of British bomber have little to do except pull the trigger. The gun turret and everything inside it operates automatically. The turret is turned by a compressed-air motor operated in unison with the turning of the gun, power being supplied by an engine-driven, six-cylinder air compressor which maintains pressure at 200 pounds per square inch. This turret also serves as a station for dropping bombs. The gunner plays a game of seesaw with his weapon. He sits on a stool connected to a hydraulic ram which, in turn, is linked to the gun so that the weight of the gunner just balances the weight of the gun. As the gun goes down, the gunner's seat goes up or when the gun is raised the

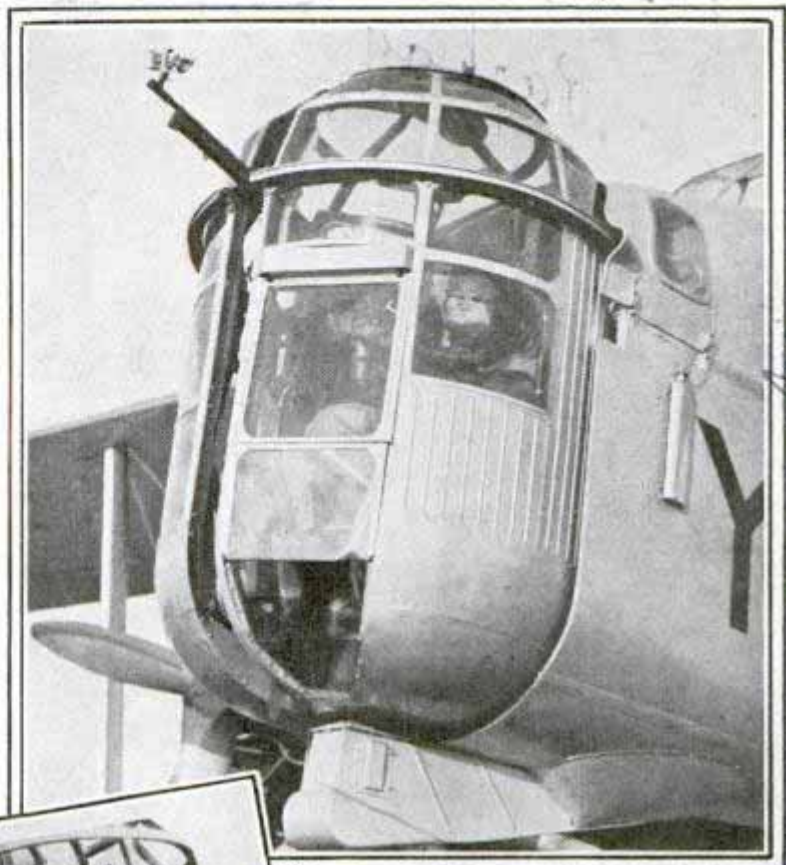

Revolving gun turret of bomber with gun protruding through "zipper." Left, zipper closed and gunner's balanced seat

© Charles E. Brown

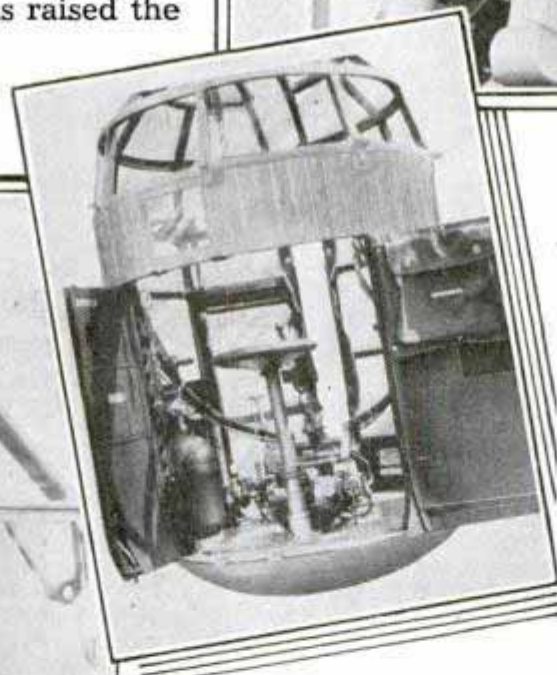
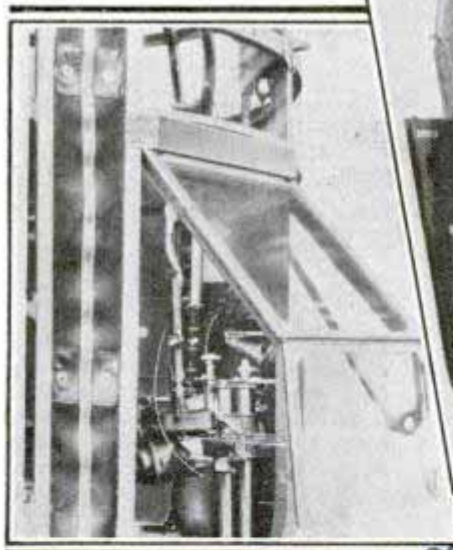

seat is lowered. Both gun and seat can be locked in any position and the seat can be adjusted to the weight of the gunner. A roller bearing at the base of the gun makes it possible to point the weapon vertically and the slot through which the gun protrudes can be closed with a "zipper" fastener.

F1582

Painting Autos in Brilliant Colors Might Cut Accidents

If automobiles were painted in brighter hues there would be fewer traffic accidents, Dr. Miles A. Tinker of the University of Minnesota, a psychologist, believes. The colors commonly used today—black, dark blue, dim gray, horizon green, dark green and tan—have low visibility, and cars painted these colors are difficult to see against the gray tone of the highway,

especially at dusk or on a dark, foggy day. The colors most easily visible against a dark background in daylight are respectively white, yellow, green, orange, gray, blue, violet and red. Against a gray background, the best contrast is provided by red, blue, yellow and green. When daylight begins to fail green is the brightest. Maroons and browns lack contrast.

Minneapolis

Mr. Williams
 Gunner's seat
 zipper
 F1582

Hardwood Parquet Floor Made Ready to Lay



Parquet flooring of real hardwood is now available in sections ready to lay, and a room can be floored or recovered with it in a morning. The cost is no more than that of an imitation wood floor covering. The mosaic sections, shipped in cartons, are prefabricated and prefinished at the factory. They are made of individual blocks of hardwood, five-sixteenths inch thick, assembled in basket-weave pattern and imbedded in a semi-pliable grill in two by six foot sections. Light and dark oak, walnut and teak are available in various finishes. A layer of felt is first cemented to the sub-floor, then the hardwood mosaic is fastened over the felt with a special adhesive. There is no sawing, hammering nor dust in laying the floor. Being genuine hardwood, these floors resist wear and the imprinting of heels and furniture.

Parquet floor in room shown above was made of two by six foot sections, one of which is illustrated below as it came from factory, prefinished and ready for laying with special adhesive

Canary Champion Develops Soft Voice in Darkened Cage

Has your canary a championship repertoire? The "roller" canary sings the classic repertoire. The "chopper" is a jazz singer, unable to execute the smooth, soft "tours" the champion must learn to sing. To be a champion, the bird must have in its repertoire at least eight of the thirteen tours a canary can sing. Rollers begin their voice lessons when very young, usually starting in September. They are placed in the company of a good singer and their

cages are gradually darkened over a two-week period. The darkness helps them develop soft, sweet tones essential to a good rating. A piercing trill is bad form; the best voice is soft and low. The "hollow roll," one of the most prized tours, can be executed in ascending or descending pitch and brings twelve points toward championship. The "bass roll" also takes twelve. Perfect execution requires singing with the beak shut.

Wood. Mosaic by eye. Beachland Park Smerville, Ky
 F1465
 Parkay
 F1593
 Reginald Hermanns
 for here N.Y.



SERVING early morning tea on one of the 200-mile-an-hour Empire seaplanes. Above, promenade saloon with reclining chairs on one of the new Empire seaplanes. These flying boats carry a crew of five, are eighty-eight feet long and have a wing span of 114 feet.

F1155
1947
 world in less than nine days. But, spectacular as this was, their trip actually was a breathless dash around the top of the globe, blazing an uncharted trail without the benefit of any but the simplest navigational and flying aids.

Now, only five years later, we see circumnavigation of the world by air actually accomplished by regular, scheduled commercial transport services. You or anyone else now can fly around the world, covering 24,000 miles in three weeks or less, making almost the entire trip by conventional day flights. Except for Wiley Post's record, you can beat the best time ever made by globe-girdlers, and it is quite likely you may be able to equal Post's time before long because the present time can be cut in half by day-and-night service whenever

Patented by Imperial Airways

the traffic warrants.

Let's assume you are stretching your two weeks' vacation to three to make what you laughingly refer to at the office as a "little trip." Your air road to adventure starts at New York. A short plane trip to Lakehurst, N. J., and you board the German Zeppelin "Hindenburg." Two or two and one-half days later you land at Frankfort, Germany, 4,000 miles from home.

In Europe you have a choice of German Lufthansa and British Imperial Airways, Dutch K. L. M. or Air France. The French line extends to Saigon and the British and Dutch to Java via Singapore. As this is written, there still remains an 850-mile water voyage out to Manila, but by the time you go, it is quite likely that one or all of the European

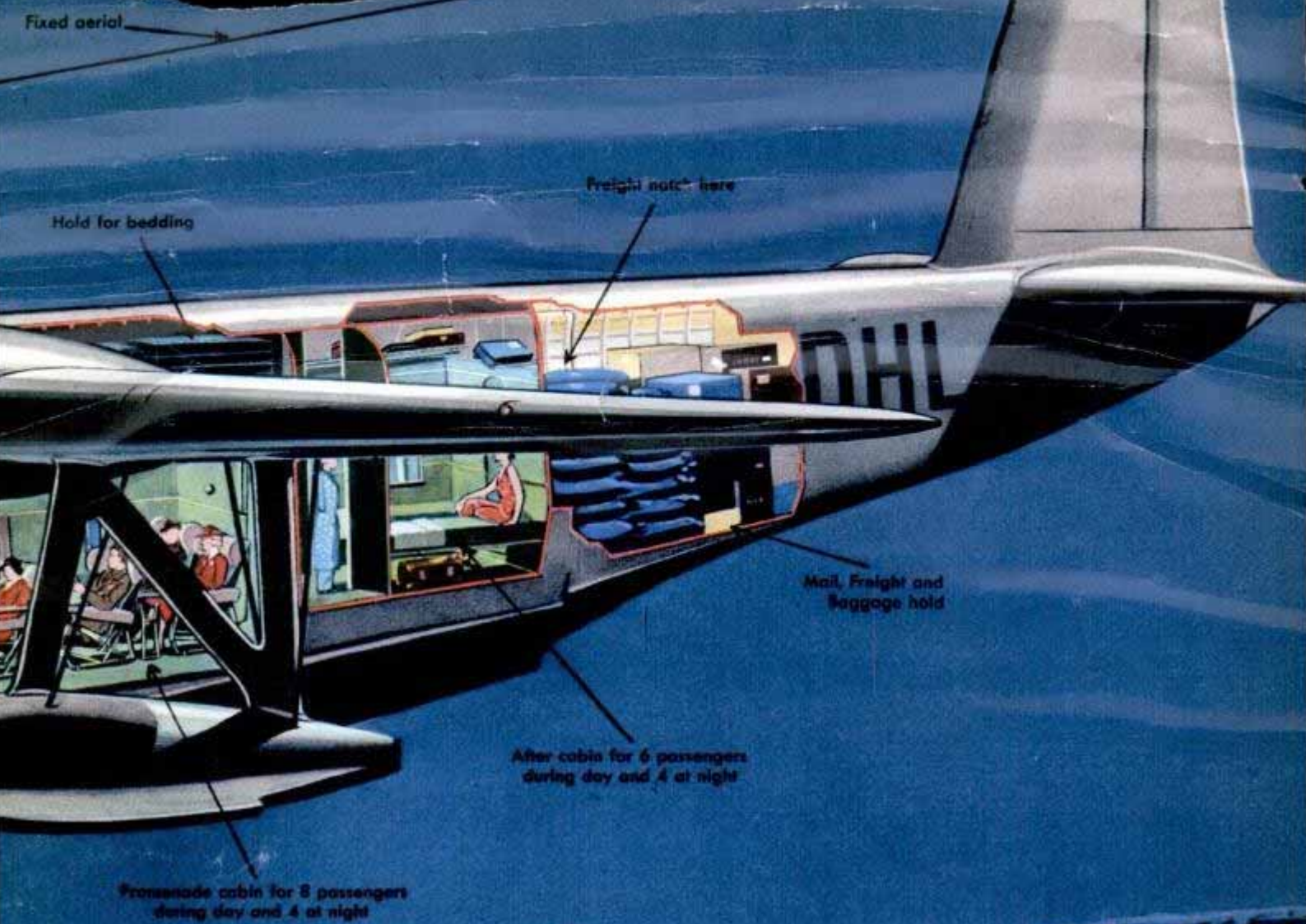

Frontside cabin for 8 passengers during day and 4 at night



Atalanta

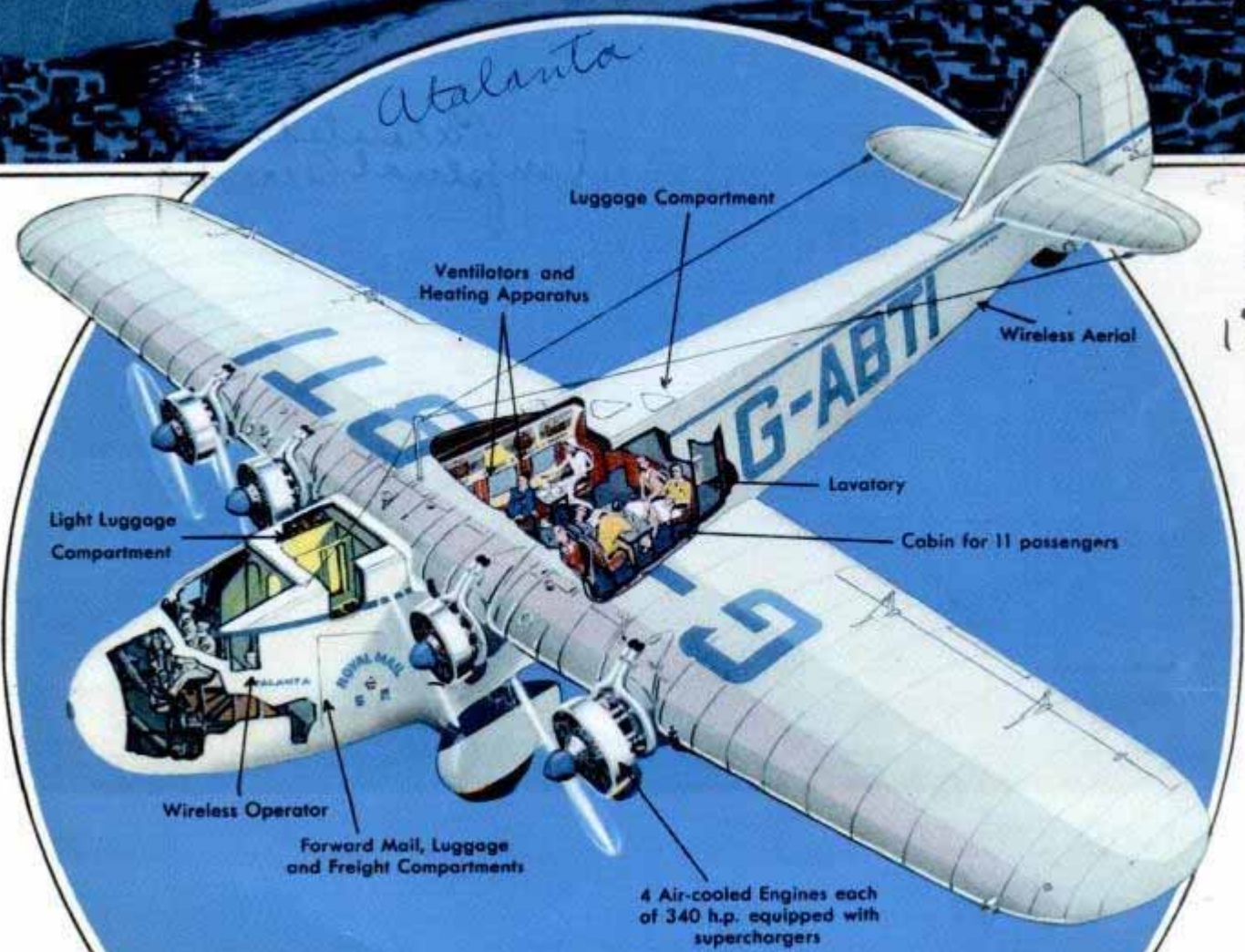

*Fl 55
1977*



SLEEPER plane of American Airlines with upper and lower berths arranged like those of a Pullman coach.

AROUND
the WORLD
by AIR

F1155

169

F1155

170



ENJOYING tea aboard an American Airlines flagship and, below, passengers boarding sleeper for a night journey across a continent. One lap of your journey around the world by air can be made on a luxury liner of this type.



By H. W. MAGEE

PART I

IF you've ever considered making an air trip around the world as a short cut to fame and fortune, you might as well forget it and concentrate on a rocket journey to the moon.

Because there's nothing spectacular today about flying around the world. In fact, it's on the verge of becoming commonplace—like making a motor trip to California or a boat trip to Bermuda. Your friends may be envious, but they

won't hail you as a hero any more just because you've flown around the world.

Anyone with the price—and the necessary passports—can girdle the globe by air now. And if you're in a big hurry, you can do it in about three weeks, or even a bit less if you happen to be lucky in making connections. And the cost? Well, roughly, it's about \$3,000—not much when you consider that only a few years ago the fare to cross the Atlantic on the "Graf Zeppelin" was \$2,250. At present you can cross on the "Hindenburg" for \$400.

Ever since Columbus proved the earth is round, circumnavigation of the globe

*James Montagnes, 517 Harbour
 P. ... Olds Toronto 2 Ont*



Photos courtesy Deutsche Zeppelin Reederei

ACROSS the Atlantic, you travel on the "Hindenburg," the world's largest Zeppelin. Above is the radio room of this giant dirigible and at the right, above, is the writing room. The diagram below shows the layout of the passenger quarters and the public rooms on the "Hindenburg."

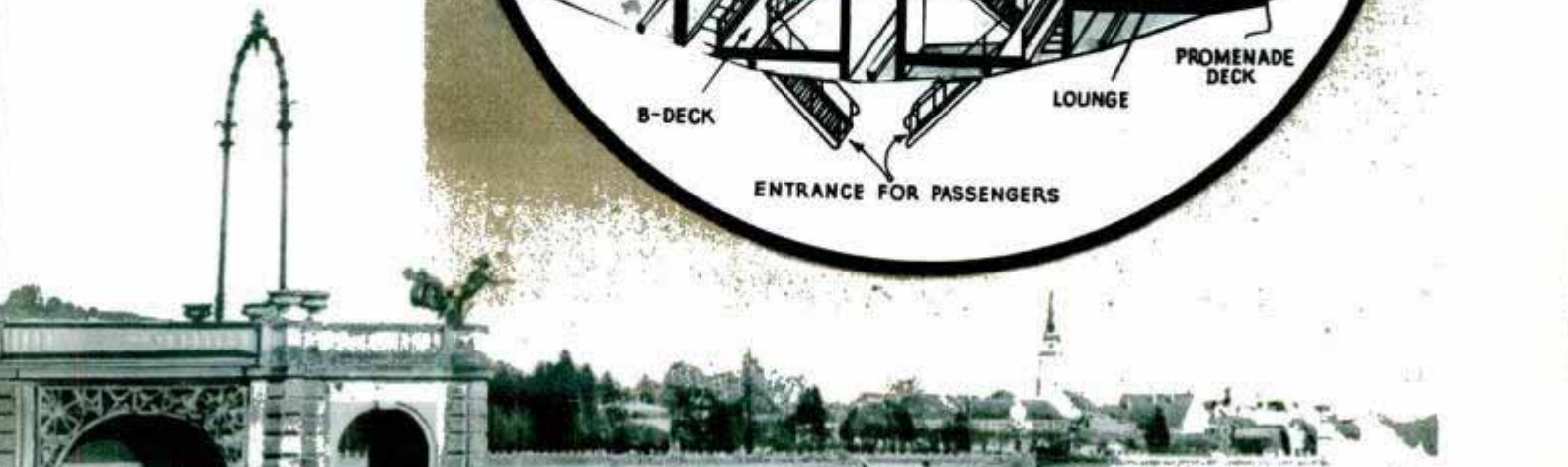
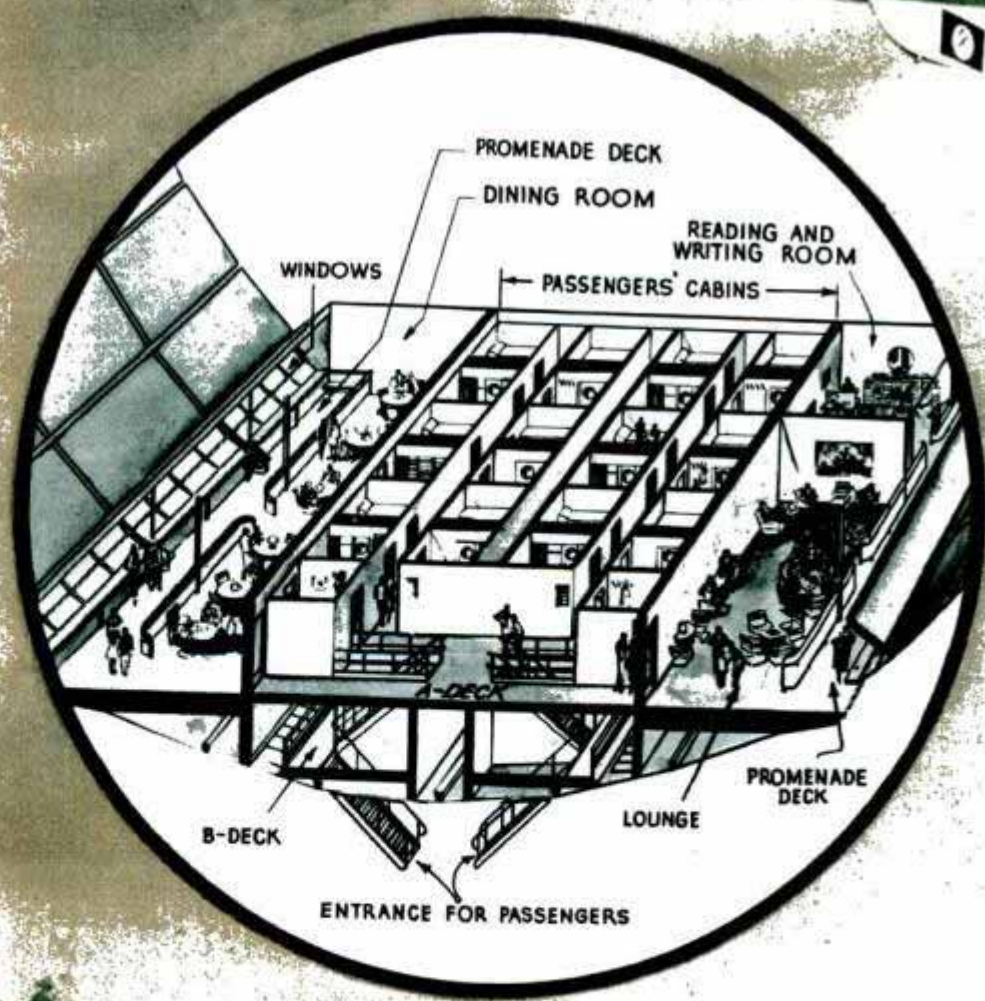
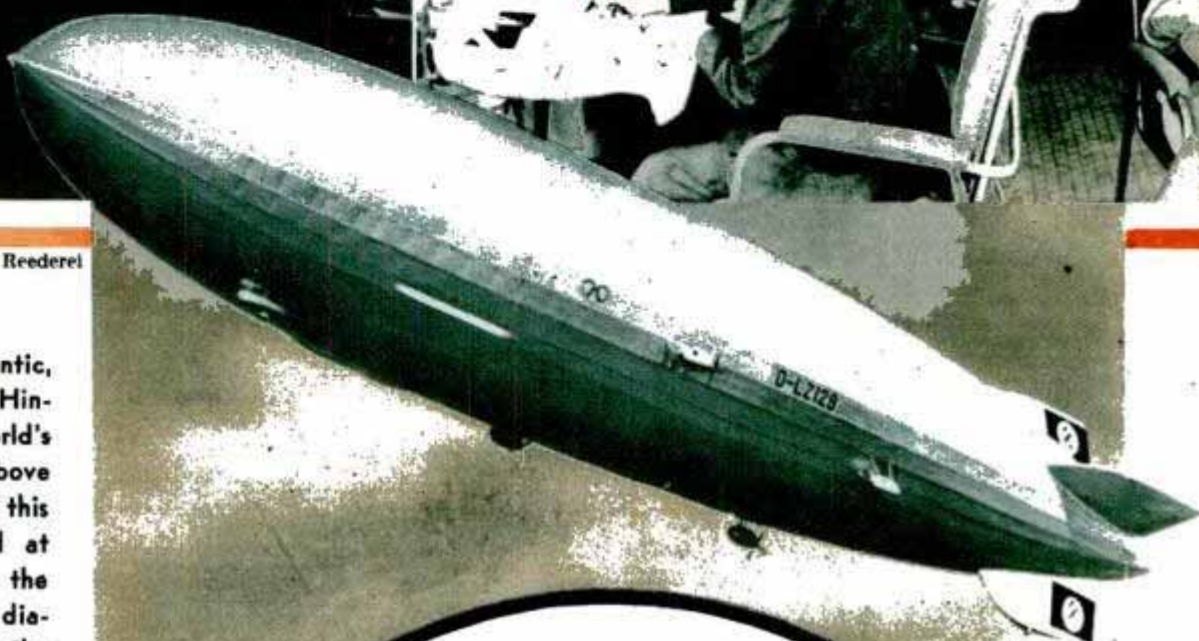

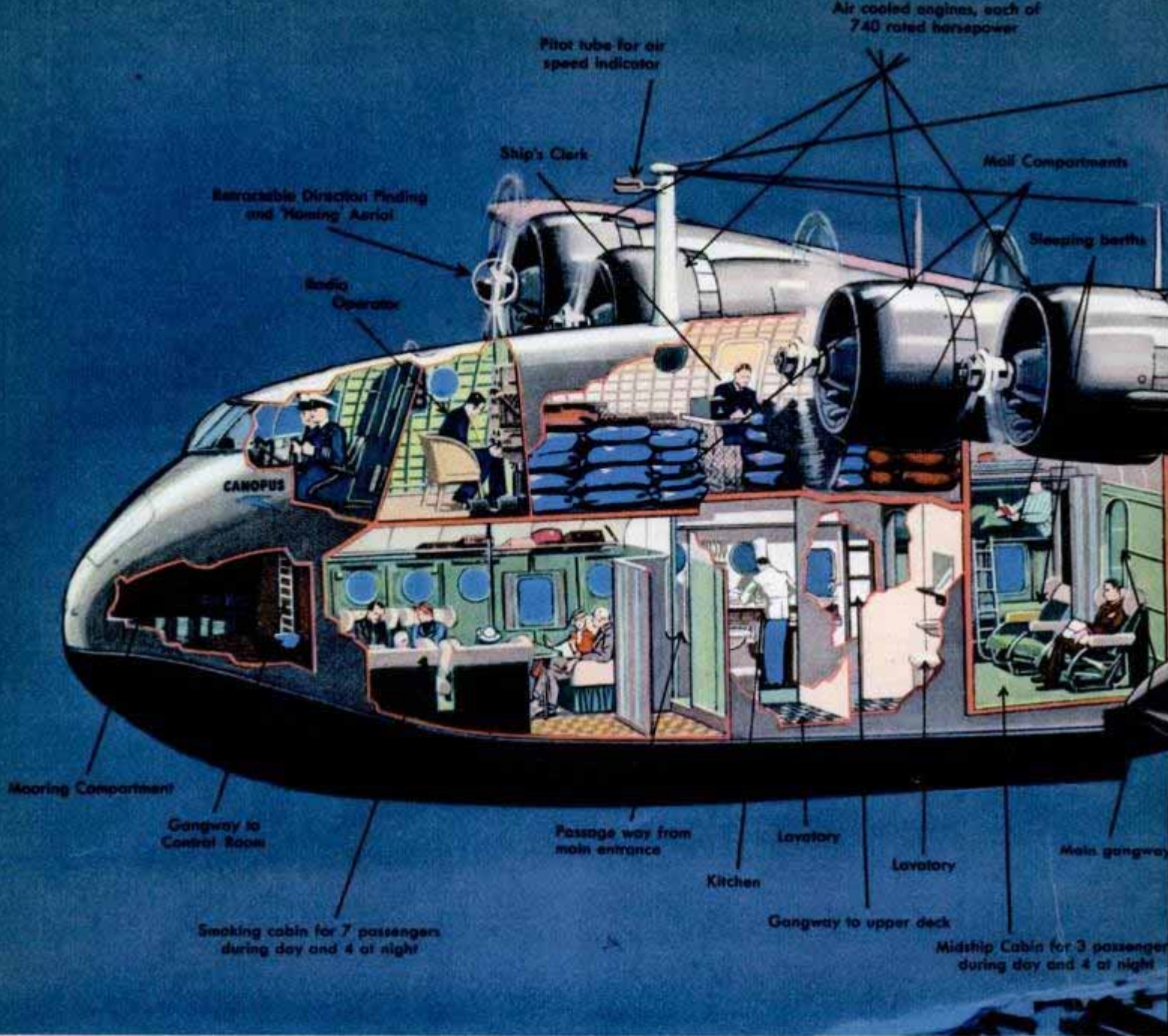

FLYING boat of Imperial Airways, above, with accommodations for twenty-four passengers by day and sixteen at night. It weighs eighteen tons. On opposite page is a smaller type of Imperial Airways plane.

F1155
192

has been a challenge and a goal for adventurous man. Magellan's little flagship, "Trinidad," accomplished it first in 1522. It took 1,083 days—three years. In 1580 Sir Francis Drake started the business of breaking records. He cut a month from the "Trinidad's" time. Since then, with a steadily increasing tempo through the centuries, globe-girdlers have been chopping years, months and finally, weeks, days and hours from the time. In 1874 Jules Verne wrote "Around the World in Eighty Days." People laughed and called it a fantastic dream. Fifteen years later Nellie Bly electrified the world by actually beating

Verne's "dream time" with her seventy-two-day journey by rail and boat. Fourteen years after that, John Mears made it in thirty-five days. Then came the airplane to speed travel in a new element and the globe-girdlers really started to get dizzy. In 1926 Edward S. Evans and Linton Wells, using airplanes, boats, trains and automobiles, got around and home again in twenty-eight days. A couple of years later Mears and C. B. D. Collyer cut the time to less than twenty-four days. And then, in 1931, Wiley Post and Harold Gatty climaxed all these feats with their brilliant flight around the

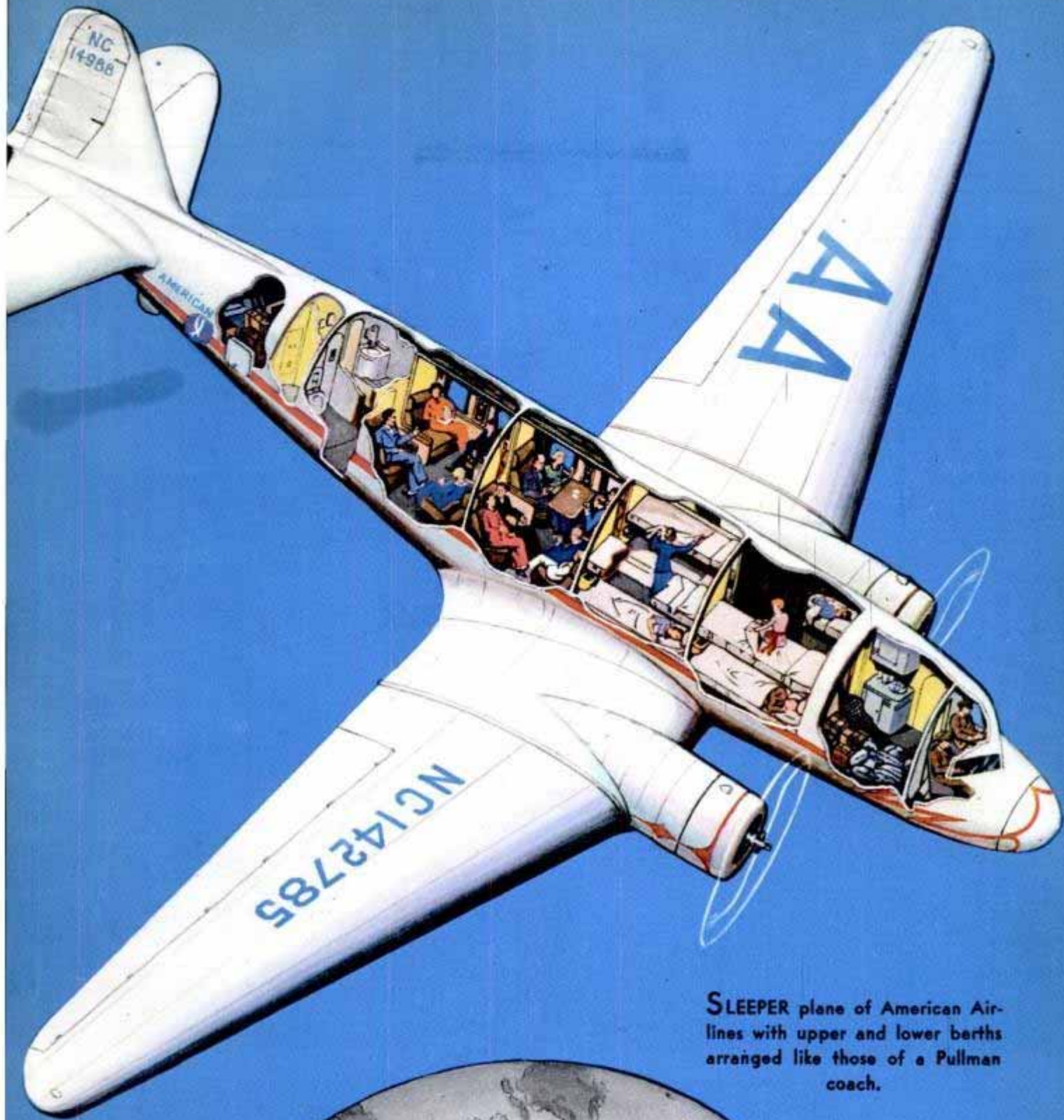

SLEEPER plane of American Airlines with upper and lower berths arranged like those of a Pullman coach.

AROUND
the WORLD
by AIR

F1155

169



SERVING early morning tea on one of the 200-mile-an-hour Empire seaplanes. Above, promenade saloon with reclining chairs on one of the new Empire seaplanes. These flying boats carry a crew of five, are eighty-eight feet long and have a wing span of 114 feet.

F1155
1947
 world in less than nine days. But, spectacular as this was, their trip actually was a breathless dash around the top of the globe, blazing an uncharted trail without the benefit of any but the simplest navigational and flying aids.

Now, only five years later, we see circumnavigation of the world by air actually accomplished by regular, scheduled commercial transport services. You or anyone else now can fly around the world, covering 24,000 miles in three weeks or less, making almost the entire trip by conventional day flights. Except for Wiley Post's record, you can beat the best time ever made by globe-girdlers, and it is quite likely you may be able to equal Post's time before long because the present time can be cut in half by day-and-night service whenever

Patented by Imperial Airways

the traffic warrants.

Let's assume you are stretching your two weeks' vacation to three to make what you laughingly refer to at the office as a "little trip." Your air road to adventure starts at New York. A short plane trip to Lakehurst, N. J., and you board the German Zeppelin "Hindenburg." Two or two and one-half days later you land at Frankfort, Germany, 4,000 miles from home.

In Europe you have a choice of German Lufthansa and British Imperial Airways, Dutch K. L. M. or Air France. The French line extends to Saigon and the British and Dutch to Java via Singapore. As this is written, there still remains an 850-mile water voyage out to Manila, but by the time you go, it is quite likely that one or all of the European

Painting Gives Preview of Golden Gate Fair



This is how one artist expects the San Francisco fair to look when it is completed. Note the causeway which will connect the exposition island with the new San Francisco-Oakland bridge

How the Golden Gate International Exposition will appear at San Francisco, Calif., in 1939, is shown by a painting from the brush of a Berkeley artist. In the foreground of the painting is the 110-foot causeway which will connect the island on which the fair will be built and the recently completed San Francisco-Oakland bay bridge. At the right is Exposition

harbor. The first building at the right of the roadway will be the administration building, which will become an air terminal after the fair. Exhibit palaces dot the painting, giving the observer an idea of what the exposition will be. The fair will be constructed upon an island now being created by pumping out the shallows of San Francisco bay.

Third Wheel for Auto Trailers Is Mounted in Turntable

Mounted on springs in a steel turntable capable of a 360-degree turn, a third wheel for auto trailers can be attached as a permanent unit to conventional two-wheel trailers or built into the framework of new models. The extra wheel facilitates steering, the triangular frame imparting additional solidity and stability. The third wheel removes all weight of the trailer from the tow car, eliminates the need for balancing trailer furniture and makes hitching and unhitching easy.

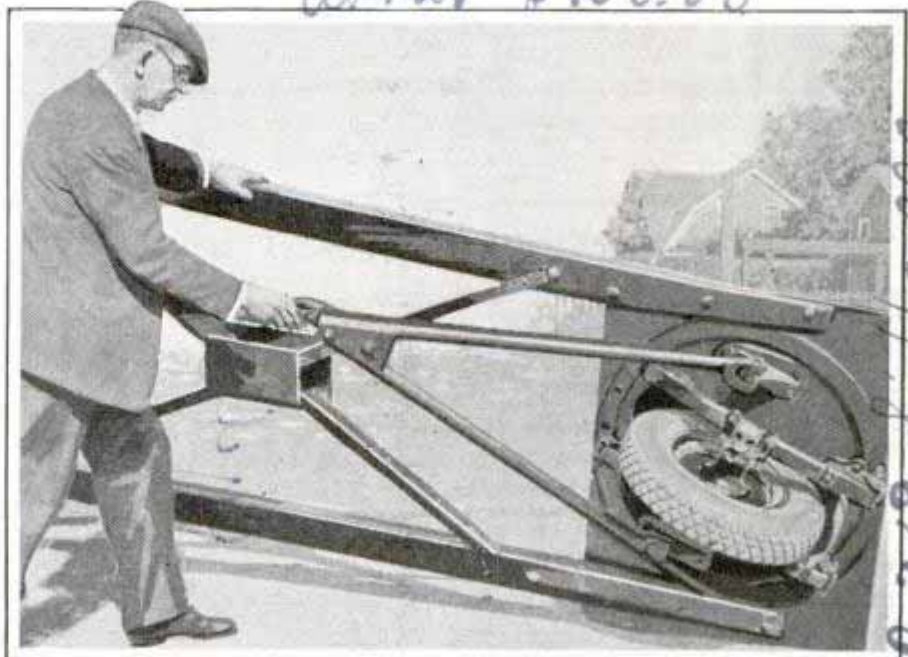

Third wheel for auto trailer mounted on springs in a steel turntable removes weight of trailer from tow car

Acme
about \$100.00
2318 D. Powell
San Francisco

Chas. August and Art Newman
San Francisco Garage

11/12/36

Water Fans Flush Buildings After Wartime Gas Attack

*178
I 1489.
A. Carnwell Larries, Ltd
Watford West. Herts England*

U. of Wisconsin



dent.
Fan-shaped sprays of water shooting in all directions disinfect street, air and walls after poison-gas attack upon city in London.

Evolution processes have turned the old-fashioned water wagon into an instrument of defense from wartime gas attacks. Instead of spraying the streets, the tank car in its new guise is equipped with nozzles which throw fan-shaped sprays of water, cleansing the air and purging the walls and roofs of buildings of poison gas. A masked operator rides the tank trailer and manipulates the sprays. The driver rides in an inclosed cab mounted, with the engine, over a single wheel.

Telescope Kept Aimed at Star 1510 by Automatic Guider

Designed to relieve the astronomer of the exacting task of keeping a giant telescope trained on a star during the long hours required to make a photograph, an automatic guider is being tested in Washburn Observatory in Wisconsin. A photoelectric cell does the work. The astronomer picks up a star that is to serve as guide. Its light is divided into two beams by a reflecting knife edge and the two beams are made to shine alternately on

Cyclone

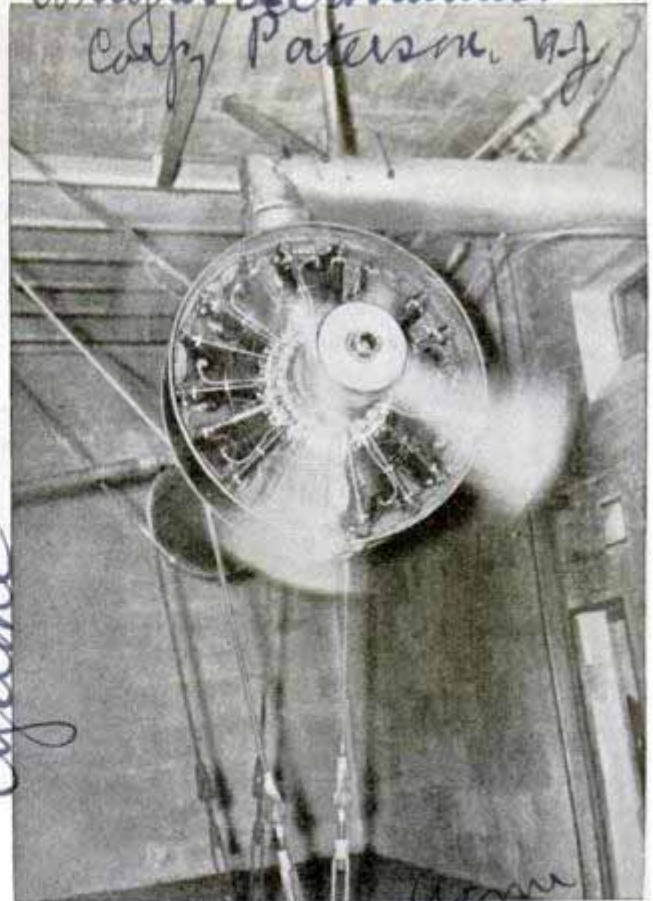

Engine designed for sky liners develops 1,205 horsepower and weighs only 1,275 pounds

the light-sensitive surface of the photocell. If the star is not perfectly centered, one beam will be brighter than the other, causing a flicker. This flicker, suitably amplified, controls a motor which makes the proper corrections.

I 1494 Plane Motor Yields One Horsepower per Pound

Ten years of development have resulted in the production of an airplane engine which yields nearly one horsepower per pound. It is rated at 1,205 horsepower and weighs 1,275 pounds. Its builders, who spent \$2,500,000 to develop the engine, call it the most powerful in the United States.

Wright Aeronautical Corp. Paterson, N.J.

Douglas Aircraft Co. Torrance, Calif.

Madison (I) ... like the old

Clipper Sights Philippines through the Clouds



As the "China Clipper" neared harbor in the Philippines at the end of its first westward trans-Pacific flight with passengers, this picture of the islands was taken by a passenger holding Clipper ticket No. 1

Here is the spectacular view that greeted the first passengers to reach the Philippine islands from America on the "China Clipper." The islands lay partly hidden

under a great cloud bank that billowed up as if from some ocean volcano. This photograph was taken by Richard Bradley, holder of Clipper ticket No. 1.

Streamline Van for Furniture Is Trimmed with Gold Leaf

All the furniture for a twelve-room house can be shipped in a huge streamline van built for a New Jersey store. First tractor-trailer of its type ever constructed, it has a steel exterior and is padded inside to protect the furniture. Bands of fourteen-carat gold leaf along the sides, a gold-bronze top finish and gold-leaf radiator trim add to its attractive appearance. The van is of the cab-forward type, weighs eight tons and is thirty-nine feet long.

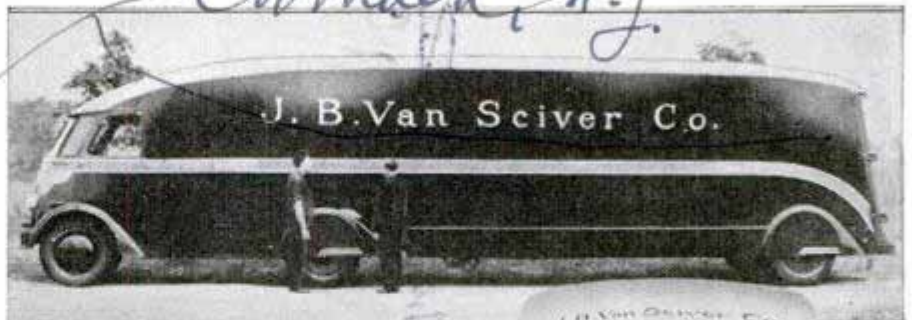

Brookside and head-on views of mammoth tractor-trailer van large enough to carry furniture for a twelve-room house. It is decorated with fourteen-carat gold leaf bands and radiator trim is also gold leaf



Studebaker Corp. South Bend

F 1463

Camden, N.J.

MASTER GUNSMITH *Seeks*

"Listening in" on trigger action in "tuning up" a rifle. Below, sporting rifle made from Springfield model 1903 army rifle, and muzzle-loader made from 1873 Springfield and barrel of twenty-gauge shotgun. Bottom, Mr. Howe at work

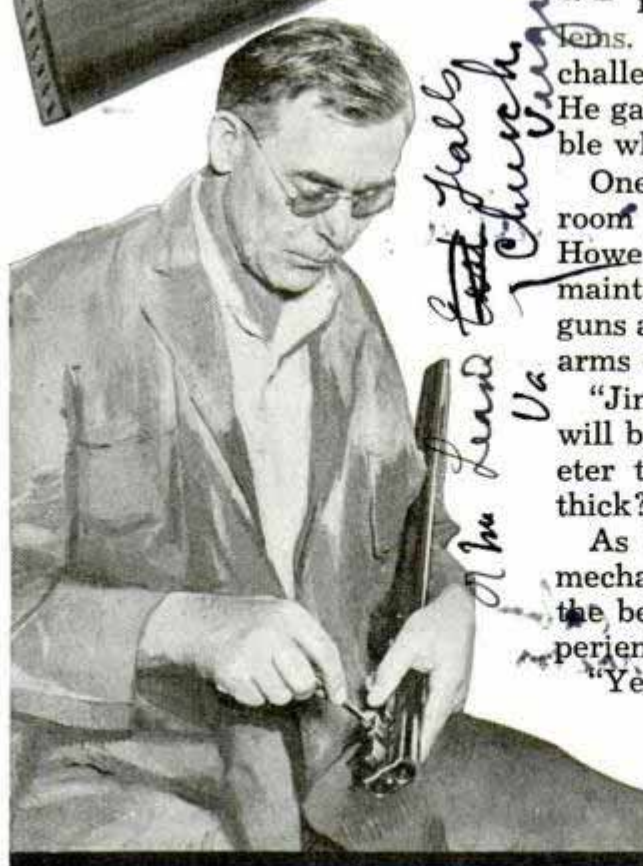

HENRY FORD, a master craftsman himself, is intrigued and fascinated by mechanical problems. Nothing is more enticing to him than the challenge of one of those "can't-be-done" enigmas. He gains great pleasure in demonstrating as possible what most of us would term impossible.

One day Mr. Ford dropped in at the gunsmithery room of his Dearborn Museum where James V. Howe, then in charge of the reconditioning and maintenance of the 1,600 historical rifles and shotguns and the 1,800 pistols and revolvers in the fire-arms collection, was at work.

"Jim," he inquired, "can you make a drill which will bore a hole one-sixteenth of an inch in diameter through a block of steel thirty-four inches thick?"

As Mr. Howe considered the problem and its mechanical complexity, Mr. Ford announced that the best foremen in his shops, even the most experienced gauge makers, said it was impossible.

"Yes," responded Howe, one of the few remaining masters of gunsmithing, "I think I can do it."

"Get busy, then," admonished his employer.

Knowing from experience that no steel of the quality needed for the drill which

*Letter was returned. 4/29/17
no the address.*

At the Land Hall Church Va

Mr. ...
Montgomery Ave
Bellemead, Ind
F134

World's SMALLEST BORE

he had contracted to make—a feat which would exemplify the wizardry of skilled shop work if successful—was procurable in the United States, Mr. Howe ordered the high-speed steel needed from England. When this high tungsten steel of extreme hardness arrived, the gunsmith started making the almost incredibly small drill, subjecting the metal to temperatures as high as 2,200 degrees Fahrenheit in hardening and yet simultaneously protecting it against blisters.

One-sixteenth of an inch is about equivalent to the diameter of the lead in an ordinary pencil. It was an amaz-

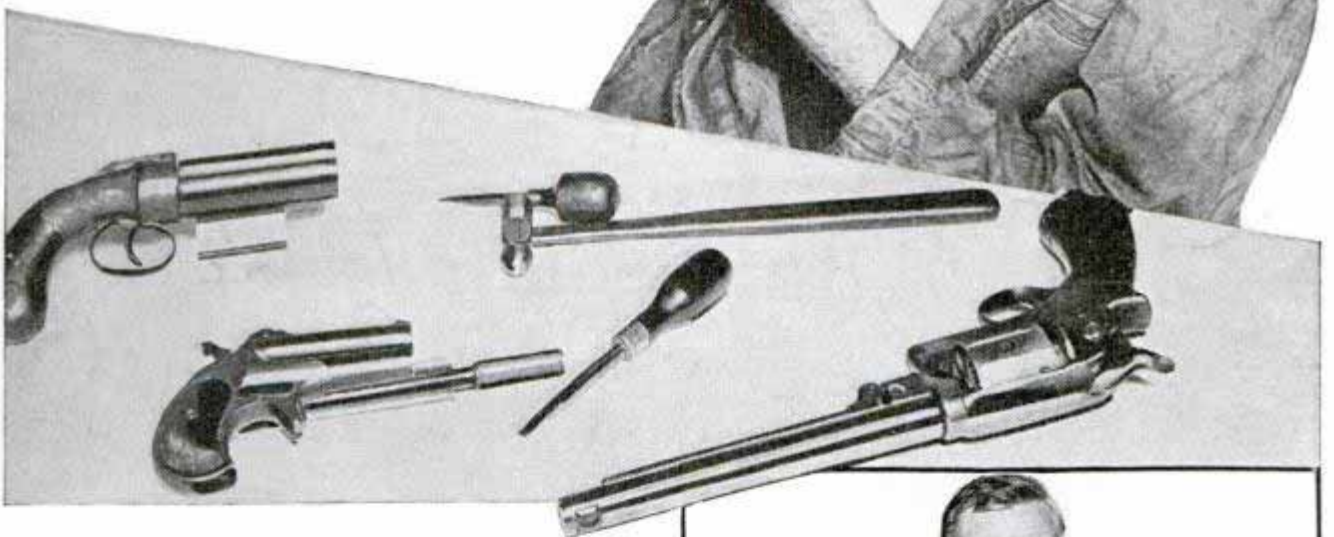
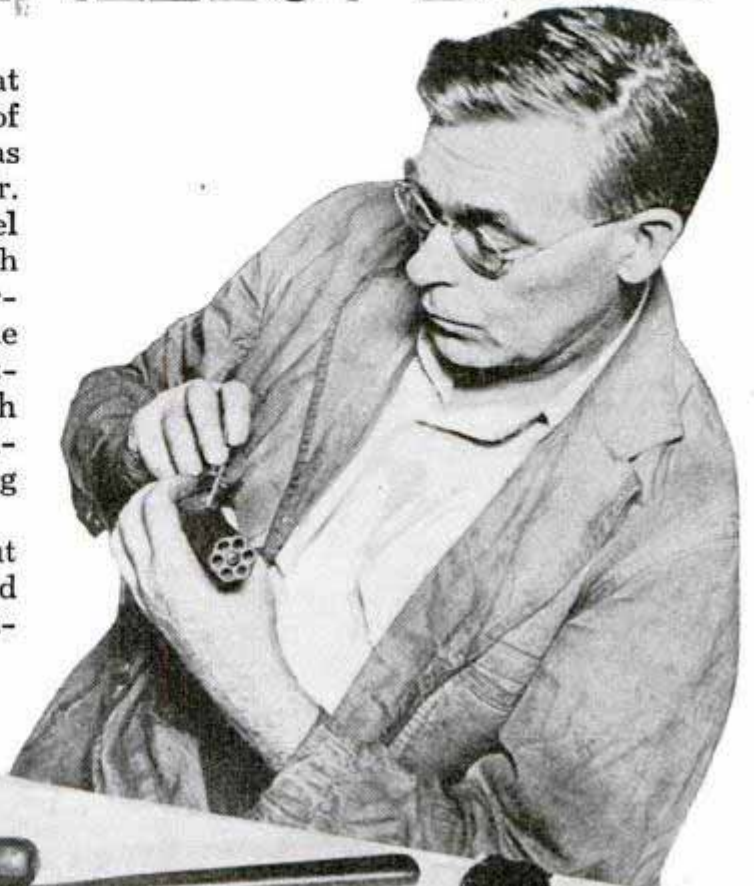

Gunsmith Howe "tuning up" small arms and, at right, testing the results of his work

ing accomplishment merely to make a drill of such midget dimensions but to produce one which actually would bore a hole through a solid block of steel almost one yard thick verged on the miraculous. This bore had to be both straight and concentric. Never before in the history of mechanics had such a feat been done. Yet Gunsmith Howe turned the trick, a trick, incidentally, which cost Mr. Ford \$30,000.

The drill as completed was provided with a core aperture through which lard oil was forced to lubricate the drill point during its prolonged drive through the steel block. This aperture also served as the chip groove or channel through which the steel filings and debris were removed by the back flow of the oil. As you may





10,000 feet per second. This is a bullet speed approximately two and one-sixth times faster than the maximum which has been attained up to this time. H. Gerlich, a German, using a gun and bullets of special construction, has demonstrated bullet speeds up to 4,600 feet per second. Those results were calibrated by using special chronographs. The test bullet discharged from the muz-



surmise, extremely high temperatures were developed during the boring process which was continued for seven days before the little drill finally came through the steel. The steel block was mounted on a special framework which rotated 2,400 turns per minute against the tiny drill held in a fixed position.

The story of that \$30,000 hole does not end with the mere accomplishment of the feat. Mr. Ford was satisfied with the performance of the "impossible." In secret, probably, he had the laugh on his experienced gauge makers and shop experts. But to Mr. Howe, the gunsmith, the boring of that diminutive opening through the big steel blank tapped a new field of gunsmithery research. To him, the aperture represented the actual bore of a tiny rifle, a test boring of remarkable experimental possibilities. The demand of the present sportsman is for firearms capable of higher velocities than were possible with the weapons formerly used against big game animals. Greater bullet speed would result from smaller bores and the adaptation of new types of cartridges to these small-diameter bores.

So Mr. Howe, now located near Washington, D. C., where he is continuing his studies of firearms and ballistics in addition to writing technical books and treatises on those subjects, aspires to make a rifle with a bore between one-eighth and one-sixteenth of an inch in diameter. He believes that with such a gun and the development of cartridges suitable for use in it, he could produce bullet velocities of



Top, adjusting telescopic sights on modern rifle. Center, this rifle killed seven lions in Africa. Bottom, repairing small arms

zle of the experimental gun severed a recording wire which in turn struck a plate. The setup was such that the recorders registered the muzzle velocity of the various discharges. Instrumental velocity was a stepping-stone in this research to the final determination of muzzle velocity. Pressure gauges were used to determine the breech pressure produced in the gun by the explosion of the powder charges. Pressures as high as 50,000 pounds per square inch are developed in the breeches of large guns during such firing tests as compared with pressures only one-fourth

(Continued to page 120A)

Falls Church, Va., Sean, Va.
or

Century-Old Cast-Iron Pipe Found in Good Condition



Officials examining old water main which had been in service for a century

When it was removed recently for installation of a larger main, a section of the 109-year-old iron pipe which has been serving Lynchburg, Va., as a water main was found in good condition. It is believed to be the second oldest cast-iron pipe in America. The pipe has been presented to the city's museum.

Vibrations in Liner Overcome by Propeller Changes

During early voyages of the French liner, "Normandie," in 1935, uncomfortable vibration was found in the aft part of the vessel, especially on the upper deck. How this vibration was overcome was revealed recently in a paper read before the World Power Conference in Washington. Various alterations were attempted during a trial run some months after the maiden voyage. Changing the direction of rotation of the two outside propellers reduced the vibration by twenty per cent, it

was found, but synchronizing the four propellers was of no value and impracticable. Expansion joints in the decks reduced vibration on sun and boat decks by as much as sixty per cent but "brake stanchions" intended to absorb the vibration energy by creating frictional resistance action were of little or no value. Shaft bearings and thrust blocks, which take the end pressure of the propellers, were stiffened up as well as part of the structure around the stern. Four-bladed propellers whose blades had a backward rake of fifteen degrees were used and revolutions were reduced from 200 to 180 per minute at twenty-eight knots. The changes reduced vibration for the vessel as a whole to twenty per cent of its former intensity.

Plane Folds Wings Like a Bird for Storing in Garage

Wings that fold back against the fuselage permit a Los Angeles flyer to store his plane in an ordinary garage. The ship, built by the aviator himself, has a forty-foot wing spread and is twenty-four feet long from motor to tail. A 125-horsepower engine is installed, capable of 10,000-foot altitudes and a speed of 120 miles per hour. There are attachments for pontoons.

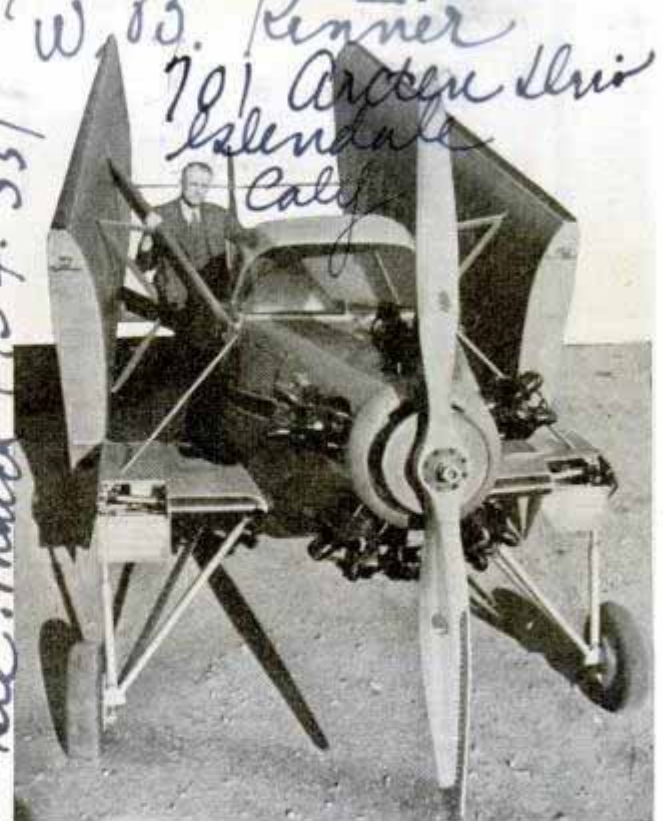

With its wings folded back, this small monoplane can be stored conveniently in an ordinary garage.

F1594

see March 1934. 351

W. B. Kenner
701 Arden Drive
Escondido
Calif

The Sphere (London)

Giant Bridge over Bay Is Opened to Traffic

Accommodating eleven traffic lanes on its two decks, the giant San Francisco-Oakland bay bridge has been opened to automobile traffic. Its upper deck carries lanes for autos, the lower, three truck lanes and two railway tracks. At Yerba Buena island the traffic passes through a huge double-deck bore to a cantilever span reaching Oakland and Berkeley. The tunnel through the island is seventy-six feet wide, fifty-eight feet high and 540 feet long.

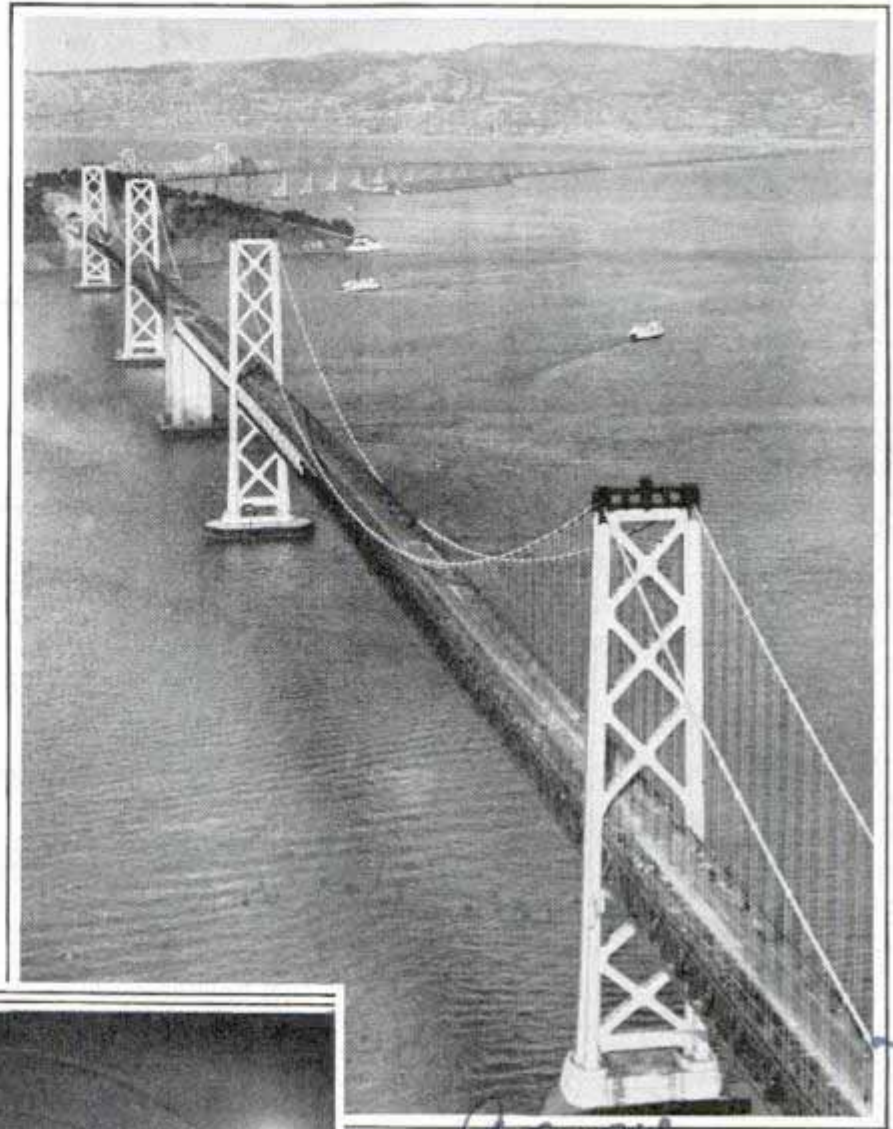

Air view of the San Francisco-Oakland bay bridge as it appeared just before being opened to traffic. Below, night view of tunnel through Yerba Buena island, connecting the San Francisco span with that on the Oakland side. The tunnel is seventy-six feet wide



Television Screen Shows Pilot How to Land Plane in Fog

With television for a fog-piercing eye, the airplane pilot soon may be able to land his ship safely in the thickest weather. Under a plan devised by the Marconi company two radio transmitters at the airport would send signals to two receivers and a

television screen in the pilot's cockpit. An all-direction transmitter on nine-meter wave length would give the name of the airport; wind direction and other information reproduced on the right side of the television screen. The other transmitter on an ultrashort wave of fifty centimeters would send a sharply directional beam swinging through an arc vertically. This transmitter is modulated by tone frequencies varying with the degree of inclination of the beam. Its signals are reproduced as a pattern of black bars on the left side of the pilot's television screen. The number and arrangement of these bars can be so standardized for given positions that the pilot, watching the pattern as he circles near the airport, can determine the direction and the proper angle of glide for landing.

Handwritten notes:
 F1535
 The sphere London!
 11/19/31
 The sphere London!
 11/19/31

11/12/36

cushions, interspersed with waterproof layers. The roof, 180,000 square feet in area, can withstand a terrific blow from rock tumbling from the canyon rims.

F1509

Heart Is Found More Efficient Than Gas or Steam Engine

In fuel economy, the Mammalian heart has been found twice as efficient as modern steam or gasoline engines. A healthy heart can convert twenty per cent of the energy latent in its food supply into useful work. The fuel efficiency of the best steam engine is about ten to eleven per cent. A good gasoline engine has a theoretical efficiency of twenty per cent, but under usual working conditions, its actual output drops to about half that. The high mechanical efficiency of the heart is pointed out by Prof. Maurice B. Visscher of the University of Minnesota, who has isolated living hearts of laboratory animals in such a way that he could measure the oxygen going in and the carbon dioxide going out.

Minneapolis

New Insulating Sheathing Solves Air-Conditioning Problem

Designed to solve one problem encountered in air conditioning, new insulating sheathing resists moisture and reduces damage to walls. Air conditioning introduces additional moisture into the home or other building so equipped, a condition against which the product is protected by a coating of asphalt on both sides and on the edges. In addition, one side is specially treated to give even greater protection.

F1454

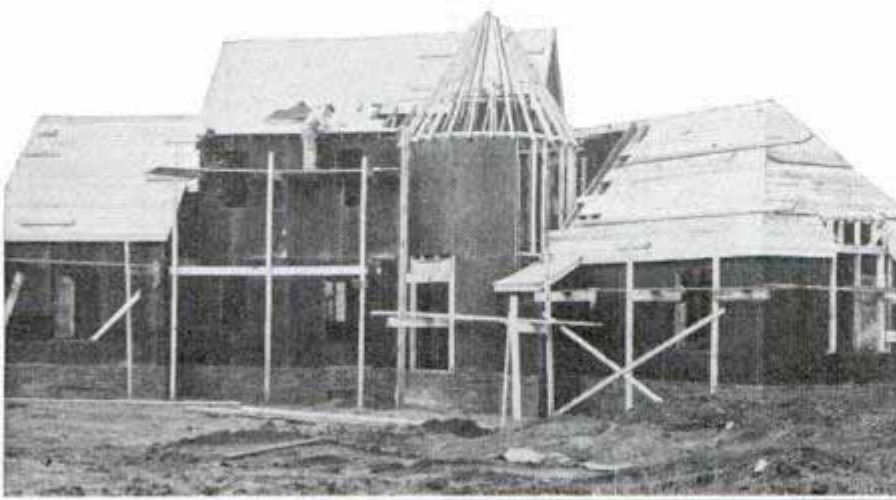

Insulating sheathing being applied to house in process of construction. It absorbs excess moisture and prevents wall damage

The Celotex Corp.

Crystal-Like Plastic Glass Can Be Molded

F1505



Looking into a crystal that is not glass but plastic, a light, strong material that is nonshatterable

Glass that is not glass, yet clear as crystal, lightweight yet sturdy and non-shatterable and easily molded, is being introduced to American industry. It is a plastic known to the chemist as methyl methacrylate polymer, so transparent that you can see through several inches of it without distortion. Softer than glass and only half as heavy, it is flexible and in liquid form can be poured into molds and hardened, or used to impregnate wood, paper, stone and fabrics to render them resistant to water and chemicals. Dropped on the floor, it will bounce without damage, and will resist a tension of four to five and one-half tons per square inch. Ultraviolet rays pass through this plastic with little resistance, and sunlight does not affect it. Pigments can be worked in to give it color. It can be drilled, cut, sawed or polished.

furnished in

Remond Co. Plastics Div.

Plastics Div. I du Pont de Nemours & Co.

NOISE FIGHTERS

modern community, people are willing to pay handsomely for its benefits. In more ways than one, silence is golden. When you work in quiet surroundings you safeguard your health and temper and you can maintain top efficiency for a greater number of hours of the working day. This increases your earnings.

Any undesired sound is noise. And noise is a pain, a menace, and an annoyance. The noise-conditioned home may be the next great development in modern living. In it you will enjoy the quiet of the country in the middle of the city; you will not be bothered by your neighbor's radio, his piano practice, or his midnight parties.

Another likely development in noise abatement is the sound-conditioning of trans-

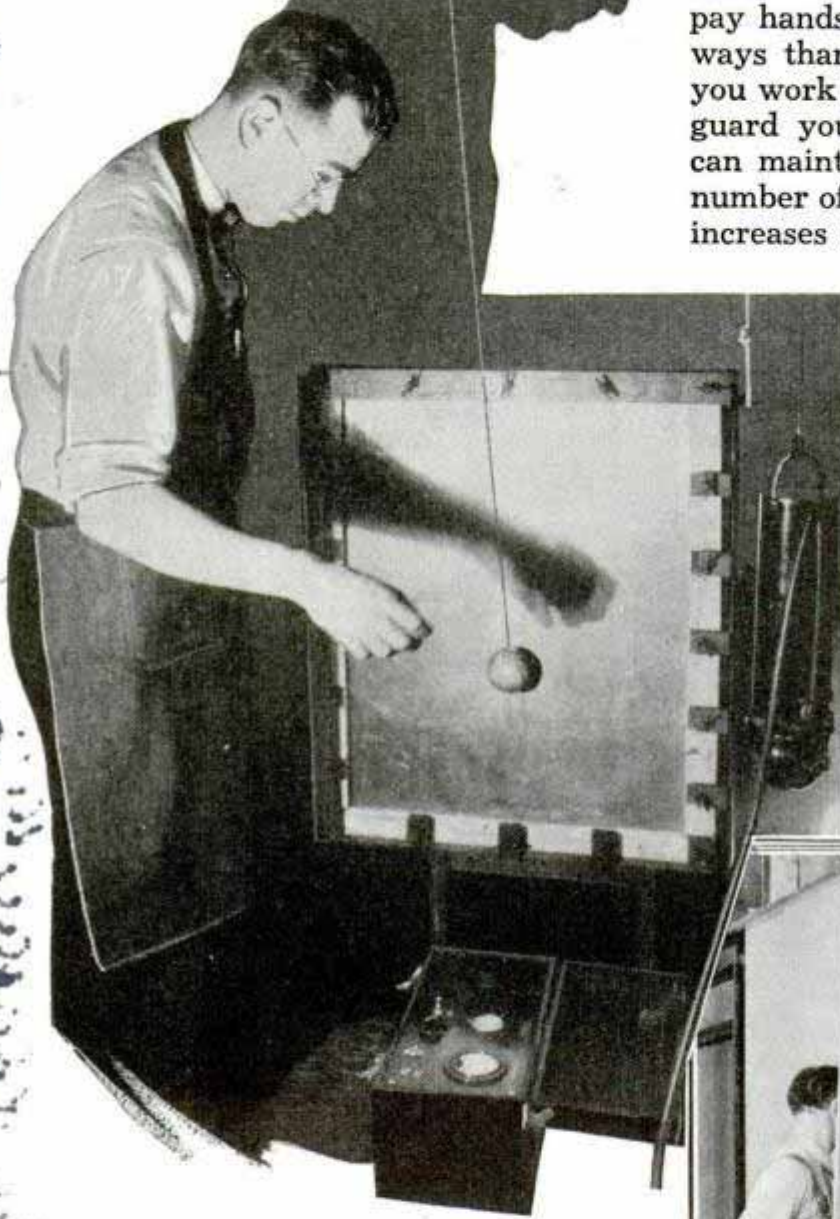

THE demand for quiet in homes, offices, transportation vehicles and the great outdoors has given rank to a new profession—the noise fighter.

Noise fighters study sound and its unique properties, investigate the effects of noise on human efficiency and endurance, devise methods for deadening sound, test sound-insulating materials and conduct a vast experimental program in the new field of "sound conditioning."

The possibility of creating quiet in homes, workshops and transports presents a golden opportunity to industry because if quiet can be created and maintained amid all the noise-making devices in a

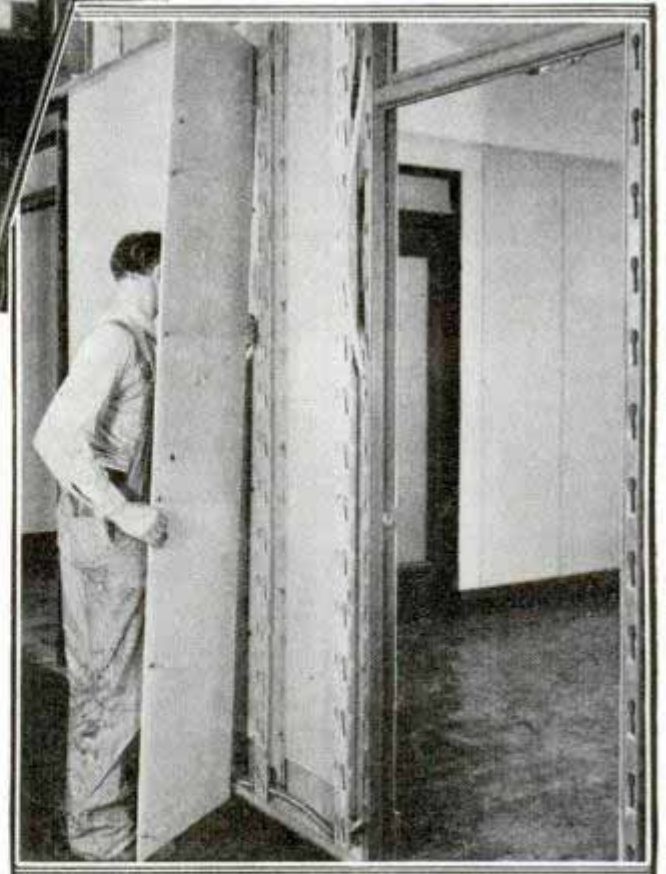

Top, measuring vibrations of steel panels under impact of the swinging ball which acts as pendulum. Below, installing noiseproof panels in office

22 E. 40th, New York. F1482

Battle for QUIET

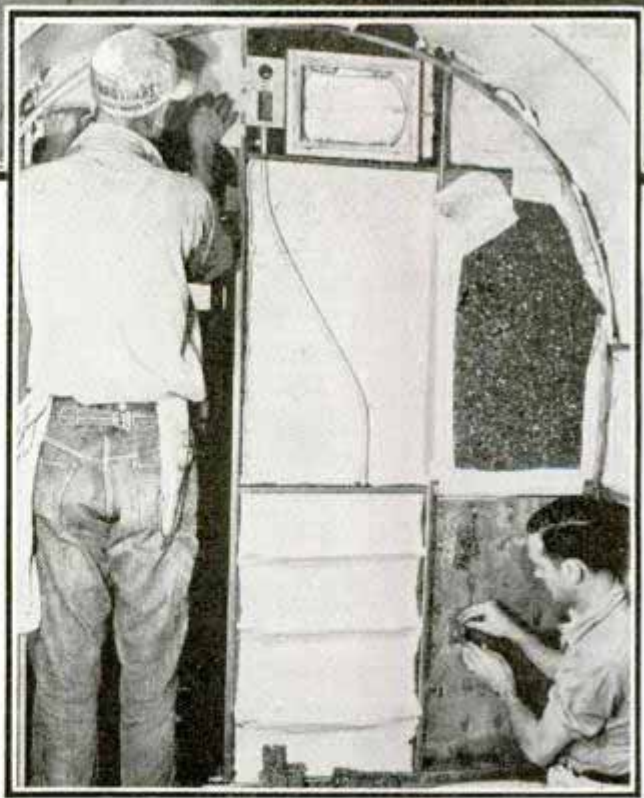
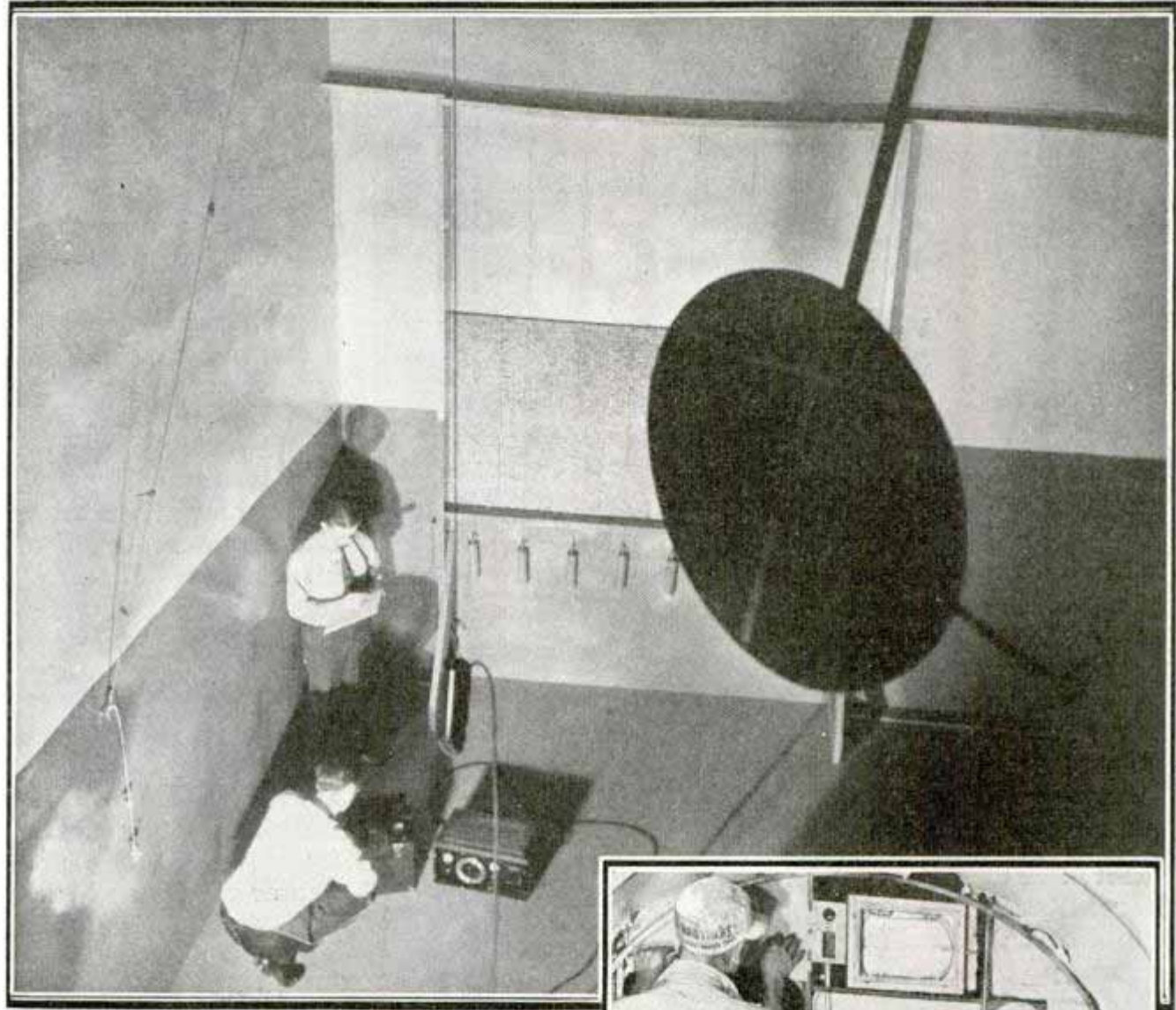

Soundproofing airplane cabin and, above, reverberation chamber for measuring sound absorption with scientific precision

ports. Trains, airplanes, subways, ships and private cars cause much unnecessary fatigue through noise and vibration. The protection of passengers against noise is one of the chief considerations of airplane and train builders. Tremendous improvements have been made, especially in modern airplane cabins, where it is now possible to carry on a conversation without raising the voice, irrespective of whether ventilators are open or closed.

The technique of noise fighters has improved tremendously in the last few years. For instance, in the measurement of noise absorption in a bare room, the old method at the Johns-Manville Research Laboratory was like this: The noise fighter tiptoed into a bare room and closed the door behind him softly. Then he waited a few



minutes until the air was absolutely dead. Raising an organ pipe to his lips, he blew a note, at the same instant pressing his thumb on a stop watch. Straining his ears to catch the last dying sound, he pressed his finger on the stop watch the moment his ears could no longer detect it. After averaging the results of similar tests with different sound frequencies, he arrived at his conclusions.

The modern technique for obtaining the same information eliminates every possibility of error. The operation takes place in a bare room, but nobody is present. Instead of a man, there is a pendulum swinging from the ceiling. Instead of a crude organ pipe, there is a dynamic speaker mounted on the pendulum. The man's lungs are supplanted by a vacuum-tube oscillator which actuates the loudspeaker to give off an accurately controlled "warble tone"—an eerie sound similar to



the haunting note of a hoot owl in a lonely countryside.

Instead of using his ear, the noise fighter employs a dynamic microphone, far more sensitive. It, too, is mounted on the swinging pendulum. Wires, corresponding to a man's nervous system, lead from the microphone to an adjoining room where they connect with relays, corresponding to a man's brain, and with an electromagnet, which corresponds to a man's thumb on the button of a stop watch. This indicates how the modern noise fighter goes about his business. Nothing is haphazard or left to chance; he eliminates the factor of human error wherever possible.

The reverberation chamber, described above, is but one of a number within a "fortress" where the noise fighter carries on his experiments. It is literally a room within a room and

(Continued to page 144A)

Top, noiseproof wall withstands fire for an hour. Center, taking outside temperature of wall. Below, soundproofing an airplane cabin

Night Picture Hunt Latest Idea for Parties

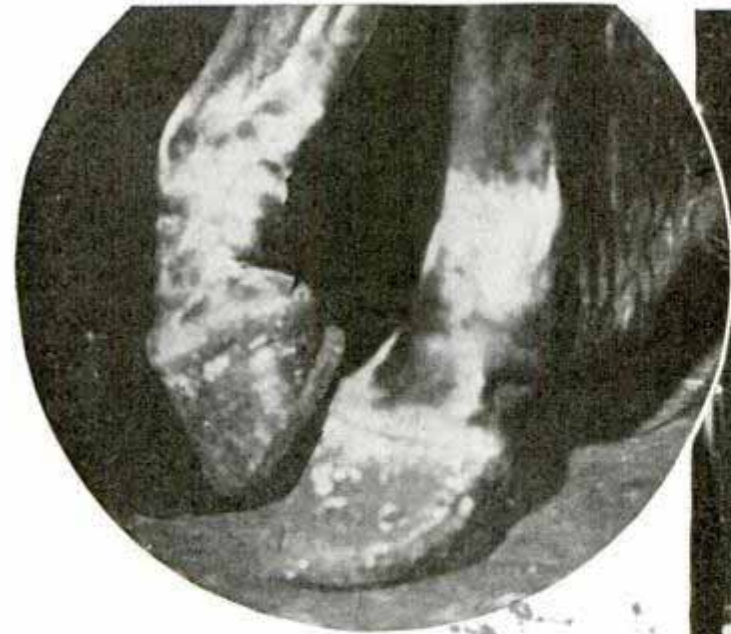

Circle, prize photo, tired feet of a horse. Right, another outstanding picture, night view of the "Queen Mary" at dock



Introduced recently at a society function, the night picture hunt is a new idea for the hostess who desires to deviate from the conventional party. The hunt is organized as a contest, with guests formed into teams and equipped with cameras and photo flashlamps. Each team is given instructions to search for the most interesting subjects to be photographed at night and is supplied with a list of clues or suggestions for pictures. Typical suggestions include "a man sleeping in the doorway of a tenement house," "an actress making up in her dressing room," "a scene in a newspaper office," "the traffic officer on night duty," and so on. In the original hunt, three hours were allowed for the picture quest. Then the guests returned to have their pictures developed and judged for prizes. Several excellent photographs were submitted, though all the contestants were amateurs with the camera.

F1444

Vanilla Made from Wood Pulp

Vanilla flavor is to be extracted from wood in a plant at Cornwall, Ontario. Vanillin is obtained naturally from vanilla beans and made synthetically from coal tar, and is used in perfumes and flavoring. The Canadian plant will manufacture it from sulphite liquor, one of the by-products of the paper industry.

Raised Letters Made of Wax Written with Electric Pen

Depositing letters of colored plastic wax, an electric pen writes raised characters on any surface. The wax is melted on contact with an electrically heated element and is emitted from the feed point upon the card or other surface where it hardens almost



Electric pen set which writes raised characters of colored wax on any smooth surface

immediately, leaving an elevated letter which does not chip, fade or break loose. By regulating the heat, the width and size of the lettering can be controlled.

General Electric
570 Atlantic Ave. New York
570 Lexington Ave. New York
F1532
Plastic - Rite Pen
Advertising Plastic. New York
480 Lexington Ave. New York

Dept. of Commerce

From Motorcycle to Glider at Mile a Minute

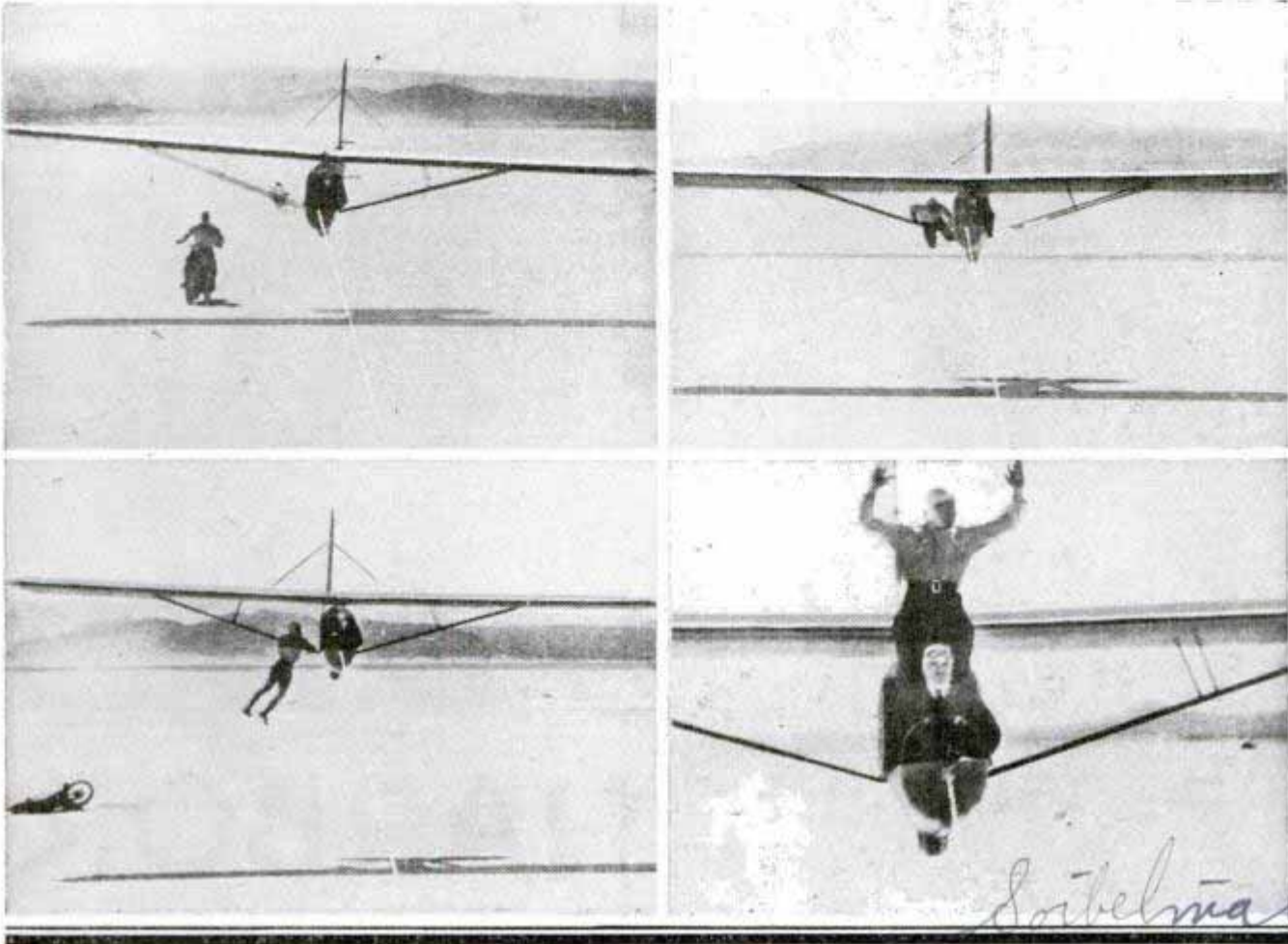

Top, left, motorcycle and glider attain same speed. Bottom, a moment after rider transfers to glider. Top, right, climbing up on the glider. Bottom, safe aboard the glider and the stunt's success

While speeding sixty miles an hour, a daring motorcycle rider transfers to a glider in the latest death-defying stunt. The glider pilot keeps his plane on an even keel while the motorcyclist rides along beneath.

At the moment when speeds of glider and motorcycle are the same, the motorcyclist releases the handlebars and grabs the glider. Cautiously he pulls himself up until he reaches a safe position behind the pilot. Meanwhile the riderless motorcycle falls to the ground.

Franklin Wolcott

Don Stevens

71369

Twist of the Wrist Forms a Cookie in Full-Recipe Press

Cookies thick or thin, plain or fancy, are turned out in fast time by a full-recipe aluminum cookie press just introduced. It makes sixty cookies with one filling; a simple twist of the wrist forms a perfect cookie. Gauges are supplied for various sizes and thicknesses, and there are twelve different forming plates for fancy shapes.



Making a big batch of cookies with the press. Forming plates for fancy shapes are seen in foreground

One of the world's shortest railroads is the Chicago Short Line, operating ten engines, fifty-three freight cars and a caboose on 1.12 miles of track in the steel-mill district.

Railway Age

Aluminum Presses mfg. Co. Maintained by



HARBOR

PIRATES still live. Not the freebooters of old, but wharf rats, slippery criminals in high-powered boats who slink out at night to plunder the world's richest harbor, the New York docks. And, more often than not, they would succeed except for the efforts of the harbor patrol—a little army of marine policemen entrusted with the task of guarding New York's water front within the three-mile limit.

The harbor patrol selects men with a hankering for boats and water, with iron in their constitution and adventure in their blood. This work demands endurance, courage, seamanship, and not a little detective skill. The wharf rats, freebooters, traders in stolen goods, and pirates with whom the marine division of the police deals operate under cover of the night, resort to homicide if necessary and have no check but the harbor police.

Word has gotten around the water front that the marine cops can take, and they can give. The ideal condition for piracy along the world's richest harbor is a black foggy night and stormy weather—the stormier, the better for the pirates. On

Top, harbor policeman operating machine gun. Below, harbor officer boarding vessel for inspection

Harbor policeman shouting traffic orders to a freighter. Handling the water traffic along New York's congested water front constitutes part of the work of the harbor patrol

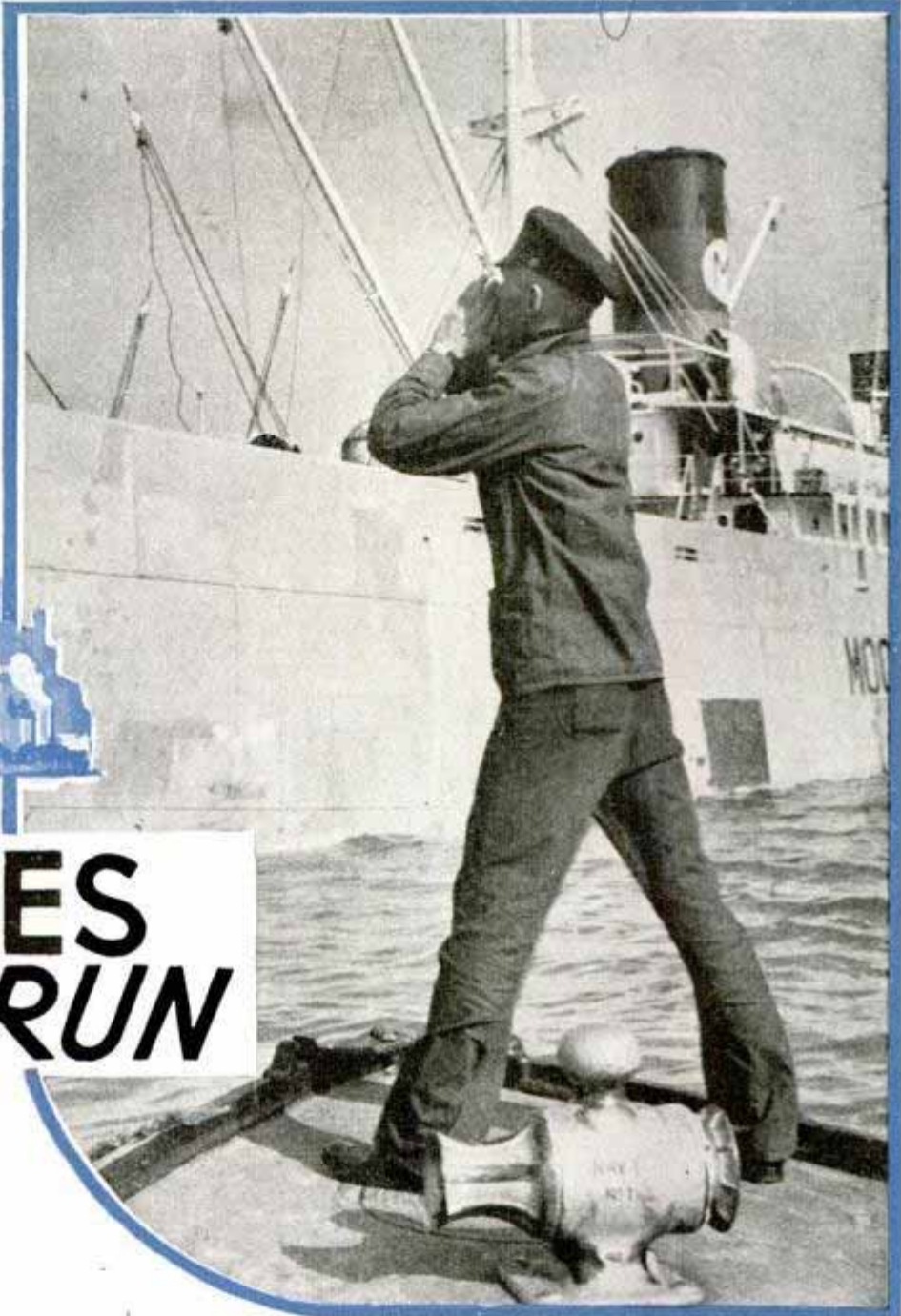

PIRATES *on the RUN*

bright moonlit nights, the pirates do not venture forth and the marine division takes it easy. But when the eerie mists creep over the docks and cut down visibility to a few feet, when rain, sleet, and wind cut loose, the harbor patrol prepares for action.

On a pitch-black night, you cannot see the big sign that marks the South African docks. There is no noise but the gurgle of water around the supporting piles. At 2 a.m. the watchman makes his rounds and finds everything in order. Ten minutes later, he lies in a corner tied to a post and gagged. The pirates work swiftly.

The pirate craft is a long sleek cabin boat with an ample hold. Hardly a word is spoken among the freebooters as they roll 150-pound bales of crude rubber across the dock floor and heave them over. Rubber sells at seventeen cents a pound.

Figure out the possible profit if the pirates make off with fifty bales of this stuff. After the boat is loaded, they cast off and back out of the slip. Not a light on board. The only noise is the muffled motor, purring softly as the craft creeps cautiously into the river, leaving no visible trail.

Soon an alarm goes out over the police teletype and all harbor precincts assign detectives. The clues are slim. The water front stretches for 580 miles, and there are thousands of places where the booty might be landed, or transferred to another vessel. The harbor patrol has its own secret method of tracing the movements of suspicious craft. Often just when the free-

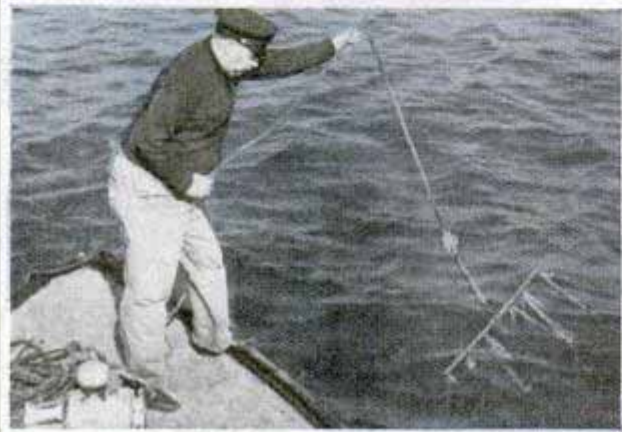

Top to bottom, harbor policemen demonstrating how a lifebuoy is tossed to person in water, marine policeman grappling for a body, hurling a tear-gas bomb such as the harbor police use in quelling mutinies and riots on boats in the harbor, and the pilothouse of one of the speedy police launches which guard the water front

booters think they have made a haul and escaped, they fall pell-mell into the hands of the waiting police.

The police launches are low and black-hulled to render them inconspicuous. They have trim lines in the water, and they can travel at a thirty-mile clip. Few pirate vessels can go faster. If speed launches can't overtake a pirate, a well-aimed machine gun will. And there is good reason to dread the aim of harbor patrolmen. About 150 men are necessary to man the fleet of eight launches in the harbor patrol. The work is supervised by one captain, three lieutenants and eight sergeants. Their watch never lets up for one minute in the entire year.

Chasing pirates is but one of the harbor patrol's many duties. Much of the work is not directly concerned with law enforcement. For instance, the harbor patrol aids small boats in distress, grapples for dead bodies, directs traffic during regattas, and performs errands of mercy. The immense harbor frontage and the countless activities thereon leave little time for idleness. On an average of once a day, the harbor patrol picks up a floating body and transfers it to an ambulance. About 400 bodies are picked up in the course of a year, and a large percentage of them are never identified. People jump from bridges, sometimes unnoticed. Others slip from boats and are drowned. Still others are murdered and thrown into the water. When the bodies are picked up a report is filed with the bureau of missing persons. Of about 200 boats a year reported stolen or missing from their stations, about half are recovered.

Recently a harbor patrolman displayed great courage in the face of adversity. One night with a half moon smiling, the tide rip at Little Hell Gate caught the thirty-five-foot cabin cruiser "Nordic" and hurled her upon the treacherous rocks between Randall's island and Ward's island. Little Hell Gate earns its name when the tide rips through the forty-foot channel. Many a small vessel has cracked up on the shallow rocks. When a police launch arrived, the "Nordic" was in a bad way, with her skipper begging for a rescue.

Unable to buck the tide in the police launch, the sergeant sent Patrolman Michael Grecula out in a small rowboat.

A cross-current upset the boat and threw Grecula overboard. Swimming in darkness in that mad tide, Grecula gained inch by inch until he reached a half-submerged rock. And there he clung grimly for three hours until the searching spotlights of half a dozen police launches found him, 400 yards from the spot where he went under. After he was rescued, he refused medical attention, and returned to duty as if nothing out of the ordinary had happened. As for the "Nordic," she was safely towed out with her skipper vowing never to sail near Little Hell Gate again.

Part of the harbor patrolman's education consists in learning the geography of the harbor. Although it may not appear larger than a pinhead on the map, the busiest harbor in the world has a shore line that winds in and out for 580 linear miles, cut up by rivers, bays, canals, inlets, and miniature harbors. Dutch Hills creek, Buttermilk channel, Princess island, Kill Van Kull, and the Narrows are definite localities which the harbor cops must know as you know the streets around your home.

In winter, the hazards and dangers besetting the patrol are multiplied. The river ice moves into the bay with the tide and buffets the police boats about mercilessly. Large steel-hulled ice-breakers can buck the river, but the small wood-hulled launches must proceed cautiously. From outlying sections come distress calls telling of small craft caught in the ice pack, of boys floating out to sea on floes, and of barges cast adrift. Recently patrolmen on board the police boat "Sinco" risked their lives to rescue a dog whose legs were frozen to a cake of ice drifting out to sea.

Harbor collisions between large ships often involve loss of life and property. An excursion steamer's boilers exploded in the East river and scattered people helter-skelter. The harbor patrol boats rushed to the scene and fished more than forty persons out of the cold water within an hour.

During prohibition days the harbor patrol led many a stiff chase after the speedy rum runners. The exploits of one police

(Continued to page 138A)



Top, hand signaling from a police boat. Each harbor policeman must know how to send and receive such messages. Center, every harbor policeman is a good shot with pistol, rifle and machine gun. Here two policemen are practicing from the deck of a pitching police launch. Bottom, the helmsman of a police boat in New York harbor

Latest U.S. Mint Built on Rock to Resist Fire, Quake and Theft

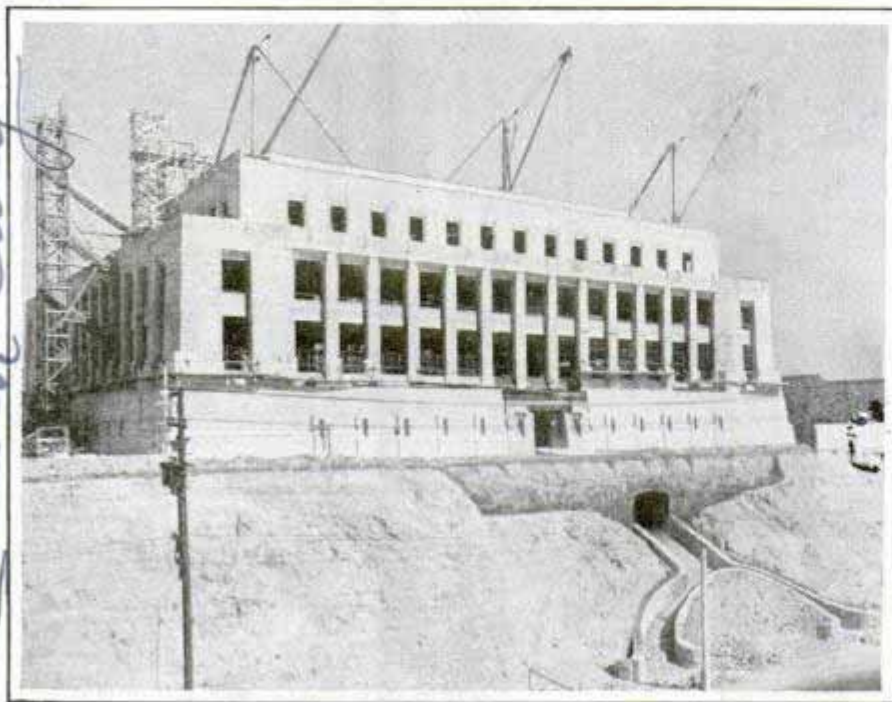

Latest view of mint, showing approach from street level. The foundation is rock. Note resemblance to a fortress

Rising from foundations deep in solid rock, surrounded by steep cliffs and built 100 feet above the pavement at the entrance, the new San Francisco mint is designed to resist fire, earthquakes and attempts at robbery. It is more impregnable than many fortresses and contains two alarm systems, a watchmen's report system and a radio communication system. Should thieves tamper with the regular lighting equipment, a self-starting power generator automatically would begin operating to frustrate attempts to darken the building. A gun tower covers all approaches and the whole place can be flooded with tear gas almost instantly through a network of pipes. The front and rear entrances both have two electrically controlled steel doors, only one of which can be opened at a time. Defense lights will illuminate the outer walls at night. Safety for the government's gold and silver is provided by the storage, melting and refining vaults with reinforced concrete walls two feet thick. The mint is five stories high. The first floor has a marble lobby, large storage and melting vaults, vaults for nickel and copper, a carpenter shop, plumbing shop, blacksmith shop,

boiler room, emergency generator room and locker rooms. On the second and third floors are offices, minting rooms, assay laboratory, and women's lunch room. The fourth floor will house a system which will recover metallic particles from the vapor given off by the furnaces. This equipment consists of a series of tubes in which the air is electrified with 75,000-volt current. As the discharged vapors pass through the tubes, the electricity will ionize the metallic particles, causing them to cling to the sides of the tubes. A pistol range for guards and machinery to operate elevators occupy the fifth floor

F137

Towel-Rack Capacity Tripled by Attachable Bar

For extra space on which to hang guest towels or laundered clothing, an attachable bar which fits over the present towel rack is available. It adds two full lengths to the rack. The installation calls for no drilling of holes, the bar simply gripping the rack firmly.

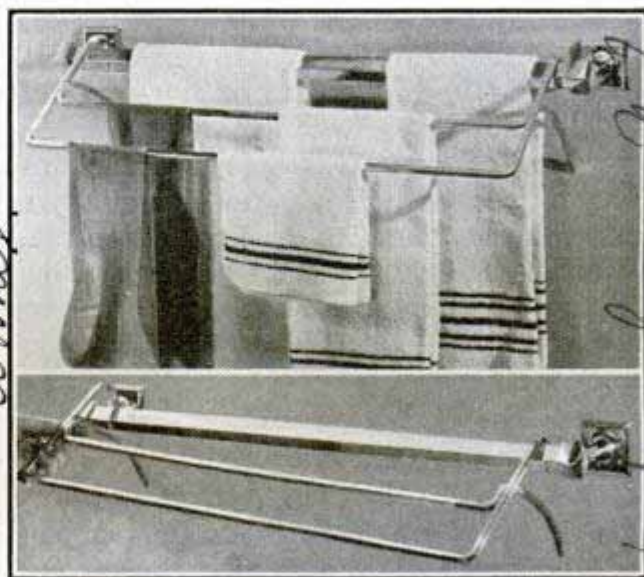

Top, rack in place. Bottom, how it is attached to conventional towel bar

Doegger, Inc.
5.3.2

cont. M.A. Waller 210 Spencer
Cassady, Calif.

Ames

Webbaker's

F1363

Architects Test Model Buildings with Movies

Blod
July

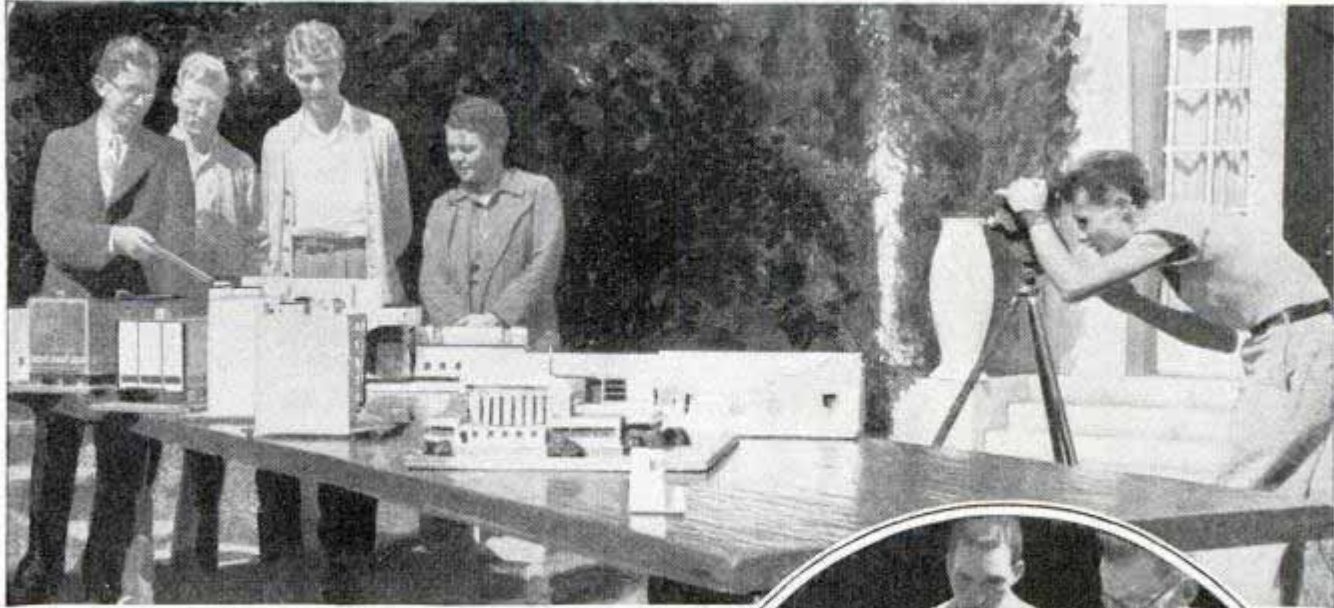

Architectural students, above, are grouping model buildings to be filmed with amateur movie camera



Above, focusing camera on model for a closeup. When this is projected on the movie screen it creates the illusion of a full-size building

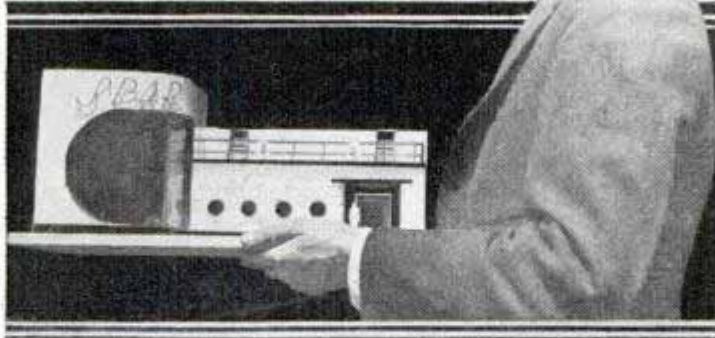

At the left is a scale model of a modern shop, and above, designers are finishing another store model to be filmed for study of perspectives

Architects and students of building design are using the motion-picture camera to translate scale models into seeming reality. From their blueprints they build tiny models. Then, from every angle of approach and under varied lighting arrangements they film the models with amateur movie cameras. Projected upon a screen, the picture seems to transform

the model into a full-sized house, affording a dramatic test of its architecture and emphasizing both beauty and error of line. Students at the University of Southern California make their lessons in perspective graphic with this use of a camera.

Los Angeles

Twenty-five billion telephone calls were made in the United States last year.

Emd. Maxwell Glend. variant. Blod
546 1/2 Sole Indace
200 copies

Monthly

War Tanks Conquer All Obstacles in Tests

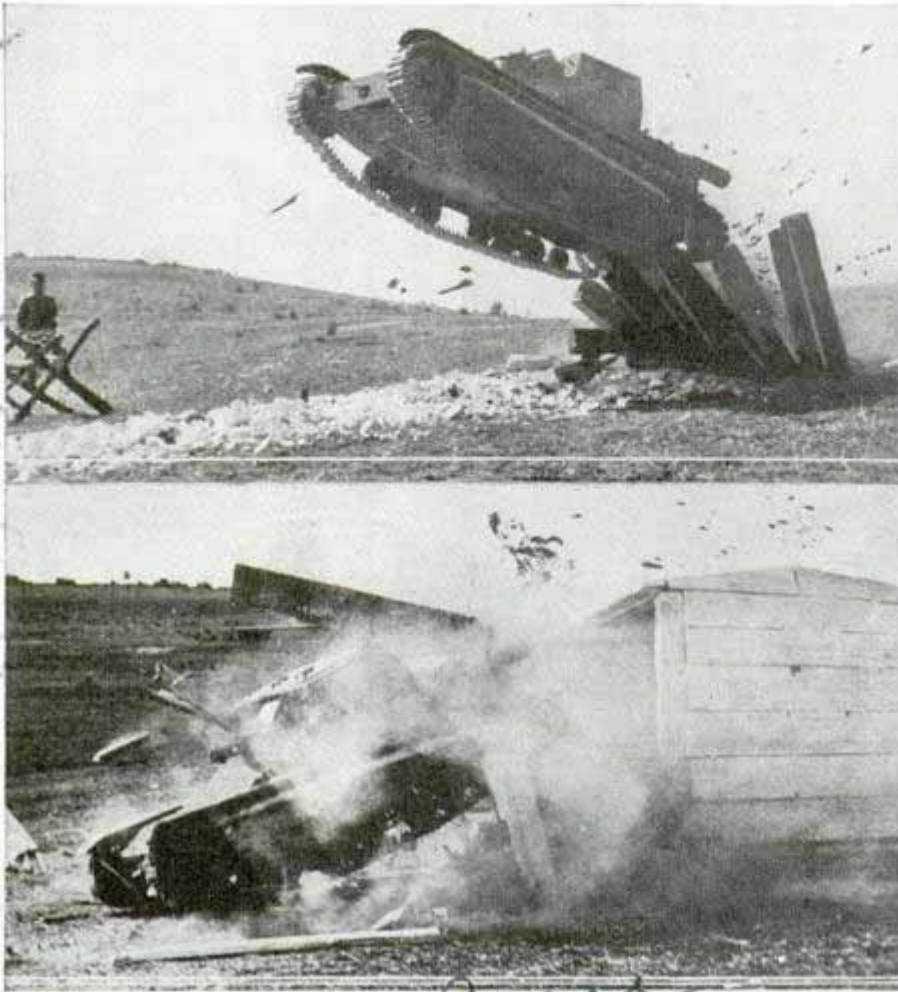

Top, army tank going over the top in test of hill climbing. Bottom, smashing through wooden building during maneuvers

Climbing over or smashing through obstacles of the kind which might be encountered in actual warfare, army tanks demonstrated their effectiveness in the recent Austrian maneuvers at Bruck. One of the tanks, after climbing at high speed over an obstacle, hurtled into the air and landed several feet beyond, yet continued on its way after crashing to the earth. Another battered through a wooden structure, sending boards flying in all directions. Under conditions of modern warfare, these high-speed "fortresses" might be expected to smash through barb-wire entanglements, leap narrow trenches and perform innumerable other duties as their crews man guns from the interior.

Shovel-Nosed Wheelbarrow Speeds Loading and Hauling

So constructed that it serves as a shovel and a wheelbarrow, a new means of manual transportation speeds up loading and hauling. To fill the shovel-barrow, the op-

erator digs its shovel nose into the pile of sand or dirt. Downward pressure on a treadle throws the load into the body, then a second thrust of the shovel loads the barrow and it is wheeled away. Pressing a foot lever tips the body to discharge the load. Packages, castings, forgings, bolts, kegs and many other items may be transported easily by this means. The shovel-barrow also is handy for the home, since it handles any loose materials, gravel, sand, coal and ashes, as well as being adapted to shoveling and hauling away snow from paths and roads.



Workman loading the shovel-nosed wheelbarrow

Riddle of Cellulose Is Solved by Woman Scientist

Radical changes in the textile and laundering industries may result from the discovery of a woman scientist, Dr. Wanda

F1263
2-4-11
1000.000 of 1000.000

F1409

2,026 3/0

Steel wheel - 17.50

Multi wheel \$20.00

Shovel-Barrow

The Lanyard Sales Co.

Crew Saved from Submarine by Wearing Automatic Lung

Chicago Trib. 11/6/36

K. Farr that most of the artificial fibers and dyes believed to have come from cellulose are actually derived from a cement-like coating over the cellulose. This coating has been partly identified as pectin, the substance which makes fruit juices jell. Cellulose is used for structural material in cotton, flax, rayon, newsprint and paper industries. Dr. Farr found that it can be separated into the cement and a white powder which is the real cellulose and which does not respond to the chemical treatments in making rayon. It is the cement, containing pectin, which reacts to the chemical treatment.

F1396

Sick Dogs and Cats Ride Motorcycle Ambulance

Consisting of one large and one small cage mounted on the sidecar chassis of a motorcycle, a dog and cat ambulance carries stray and sick animals to the shelter of a Maryland unit of the Humane Society. The equipment is the very latest for transportation of animal patients.

Baltimore



Dog rides in big cage, cat in small one



Crew emerging from wrecked submarine, wearing automatic lungs which permit regular breathing. Diagram of apparatus shown in inset

To aid in the rescue of men from wrecked submarines, an automatic lung has been developed in Germany. It has its individual oxygen supply which is fed through a mouth tube. Tight goggles protect the eyes and a nose clip prevents inhaling water. Respiration goes on with its normal, uniform rhythm, the apparatus furnishing just as much air as is desired without superfluous pressure or any danger to the human lungs. Enough air is carried to permit two hours' work under water or in a gas-filled room.

Dr. Kutschbaer
Cmdr. Hays

Germany
Suebeck
Dr. Kutschbaer

Electric Oven for Flowers Makes Beauty Last

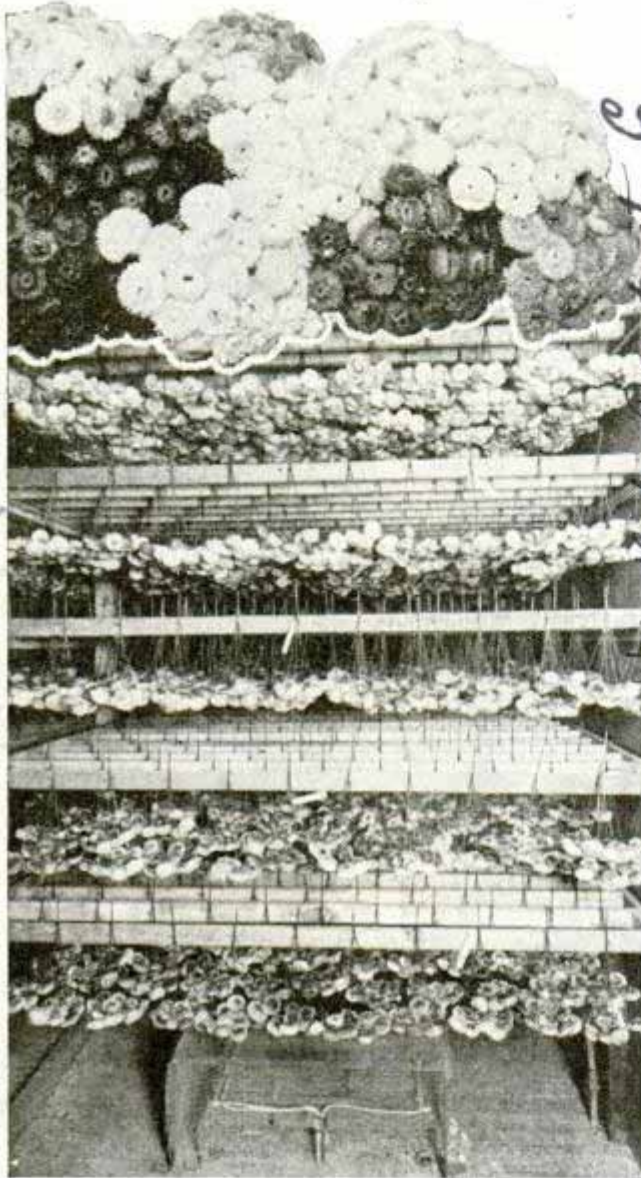

Thousands of "everlasting" flowers mounted on wire stems are hung heads downward in ovens to dry

Twenty million flowers were given a "permanent" beauty treatment last year. Harvested from seventy acres in California, they were dried—chiefly by electricity—in their natural colors and shipped with synthetic stems to be used for decorations and floral pieces. When this industry was started, not so long ago, the natural stems were left on, but they were brittle when dried and did not last. Now the blossoms are cut without stems and mounted immediately on fine wires, then hung in bunches of twenty-five in dehydration chambers, sometimes as many as 50,000 blossoms in the chamber. They remain from thirty-six to forty-eight hours in temperatures of 130 to 200 degrees, heated by electricity; some have long

strip-heaters on the chamber floor, others blow heat down through the flowers from units on the roof. The so-called "everlasting" straw flowers thus treated will retain their natural beauty for years.

Electric Plug Wedges Itself in Outlet Socket

Equipped with double prongs that act as a wedge, an electric plug now available grips the socket firmly and will not slip out. After inserting the plug in the outlet, a rubber ram is pressed and the auxiliary prongs slide along the regular contact prongs into the socket, wedging it tight.

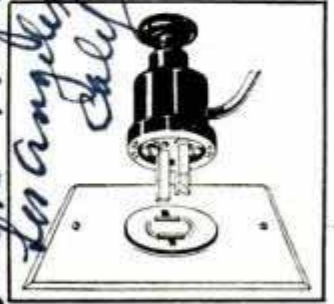

Lighted Sign Warns Motorist of Wide Truck Approaching

To guard against sideswiping other cars, a trucking concern in Germany equips its freight carriers with a distinctive sign that means: "Wide truck coming!" When motorists see it they keep to their own side of the road. The sign is illuminated at night.



Yellow triangle set in a blue square above windshield gives night and day warning of wide truck

R.R. Wagner
Montana Calif

Toy Study Products Co

F 14 35

F 138 3

San Angeles
Calif

Handwritten notes on the right margin.

Gas-Driven Submarine Safer under Water

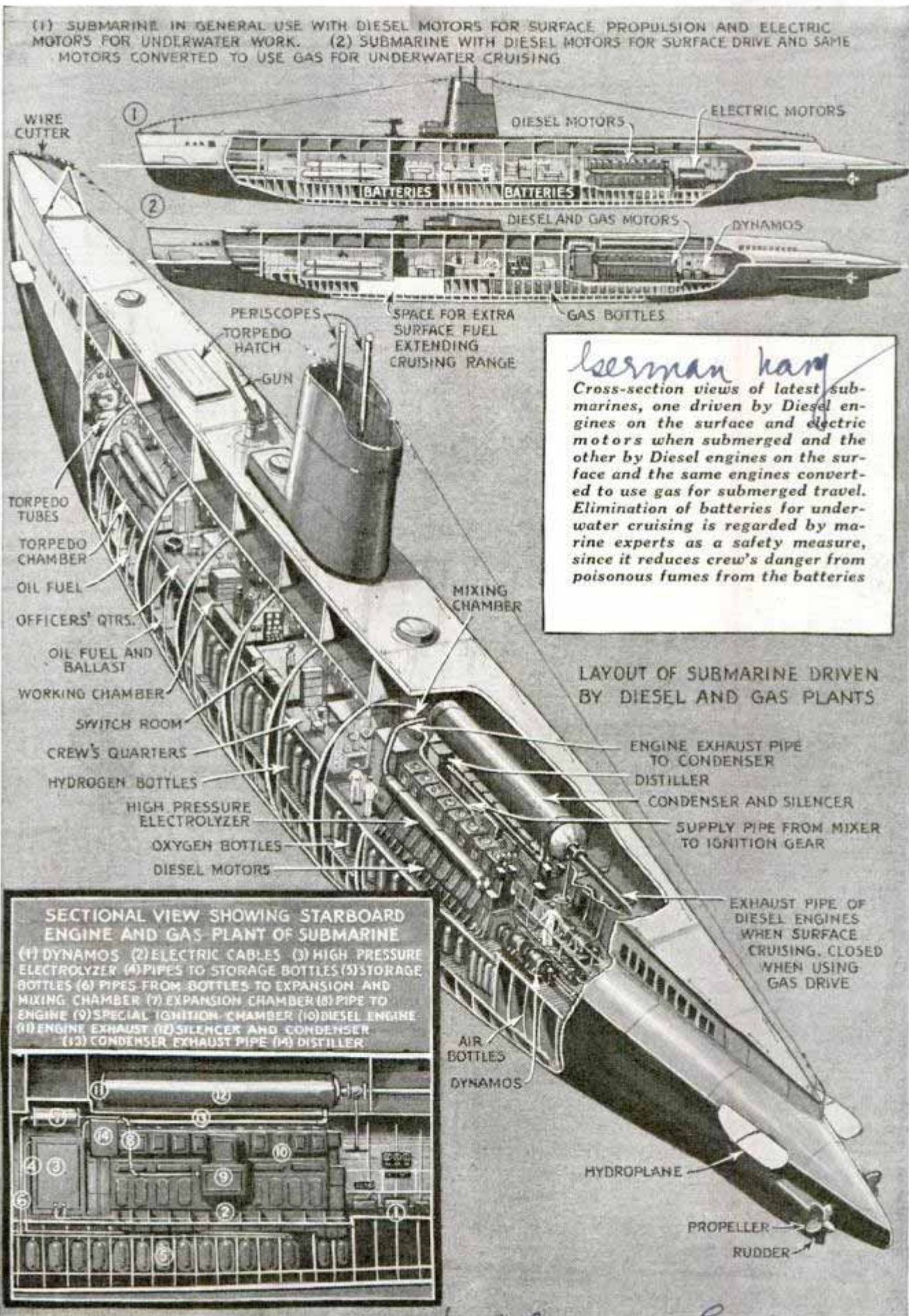

Capt. George H. Davis Esq. Esq. Esq.

F1293

1144 S. Grandview St
Los Angeles, Calif

TUNA FLEET Battles

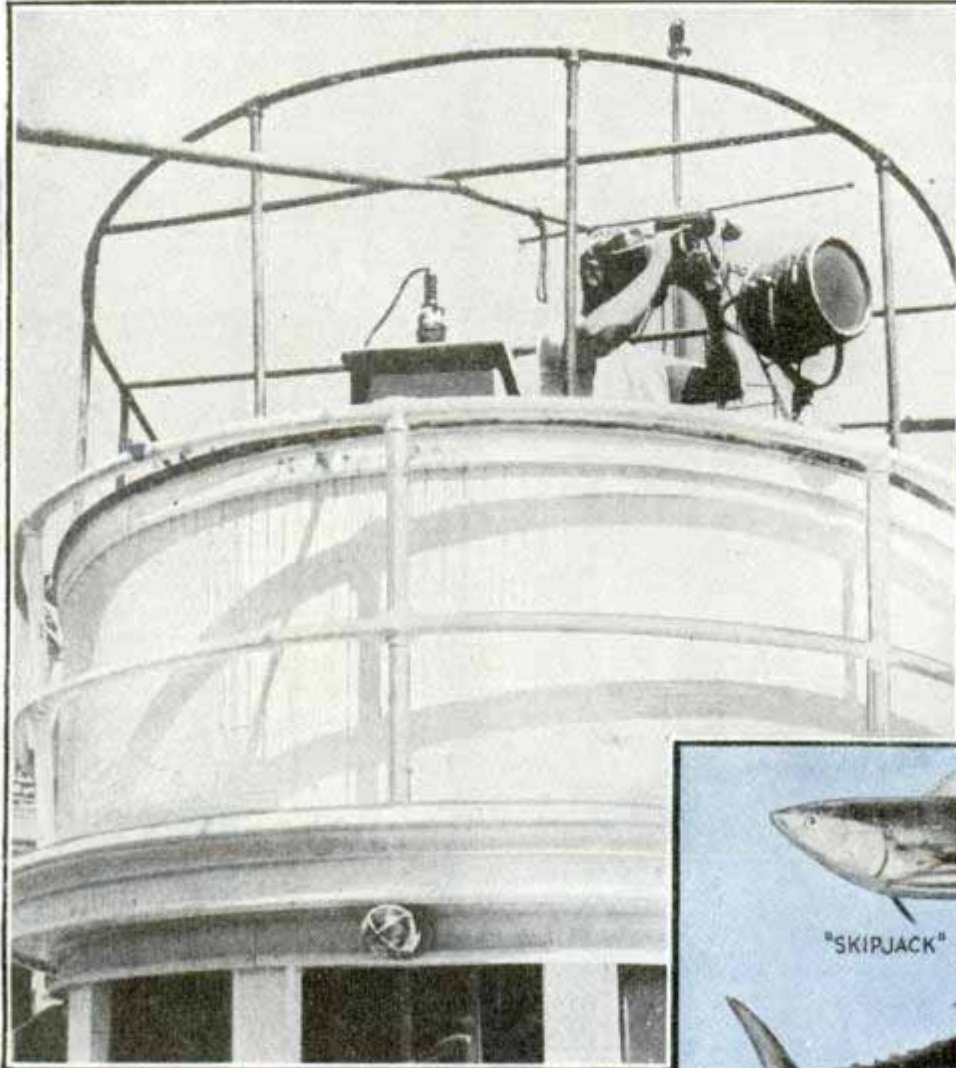

Through his binoculars, the skipper of a tuna boat searches the sea for the flashing fins of tuna. Below, the tuna fisherman must learn to distinguish the four different kinds of tuna at a glance

LOS ANGELES and San Diego harbors are echoing today to the sound of calking mallets and riveting hammers as the southern California fishing industry girds to meet the competition of Japanese commercial tuna craft in western Pacific waters.

For more than twenty years California fishermen have monopolized the famous tuna banks off the western coast of Mexico and Central America, and the Galapagos grounds astride the equator, 600 miles west of Ecuador. No nation controls this "no man's land" of tuna. And now, suddenly, giant craft from the far ports of Japan, fueled and provisioned for twenty weeks at sea, are sailing into these tuna grounds, precipitating a struggle for supremacy of the industry which will be won by the nation with the most efficient ships and methods.

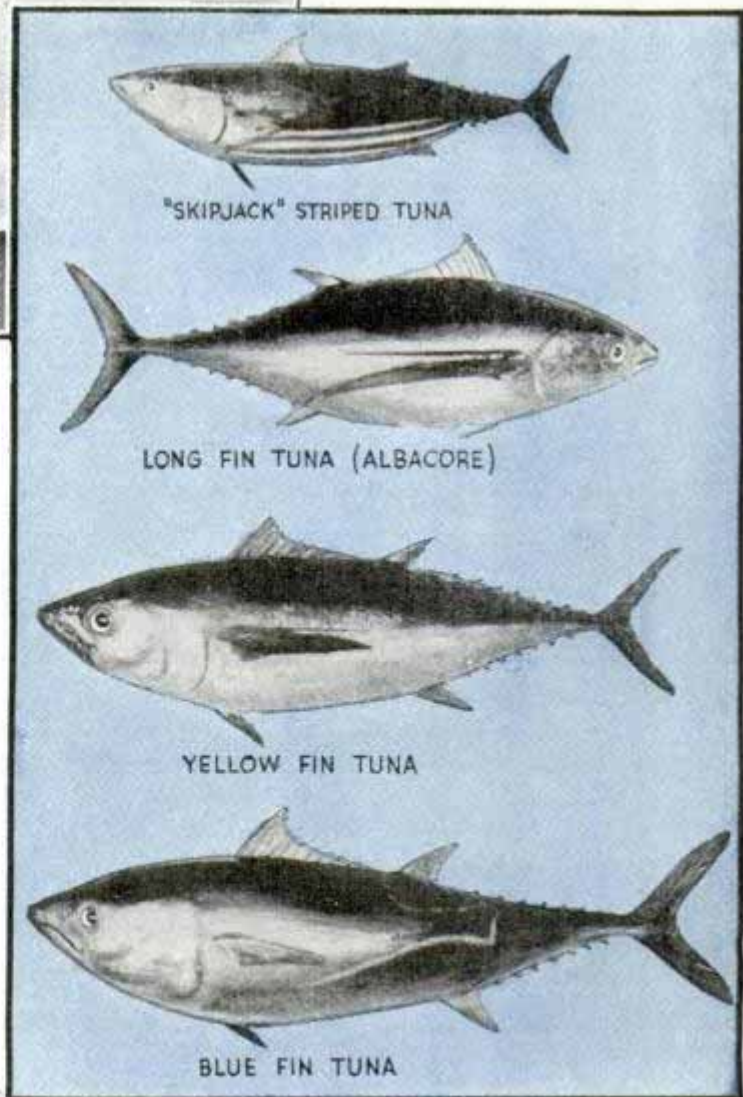

"SKIPJACK" STRIPED TUNA

LONG FIN TUNA (ALBACORE)

YELLOW FIN TUNA

BLUE FIN TUNA

for "NO MAN'S LAND"

New clipper ships are being rushed to completion in American yards in the greatest expansion program in the history of the fleet and \$1,000,000 are being spent on ships, machinery and equipment. The largest of these pine-hulled vessels are 140 feet long, carry twenty-two officers and men, and can stow a payload of 420 tons of fish valued at \$40,000 in their refrigerated, insulated holds. The new clippers are fitted with radio compasses to aid in better navigation, and some have sounders for telling automatically, by the rebound of radio "echoes," the depth of water under keel.

The modern tuna fleet has gone completely Diesel. Their 350 to 550-horsepower directly reversible engines give

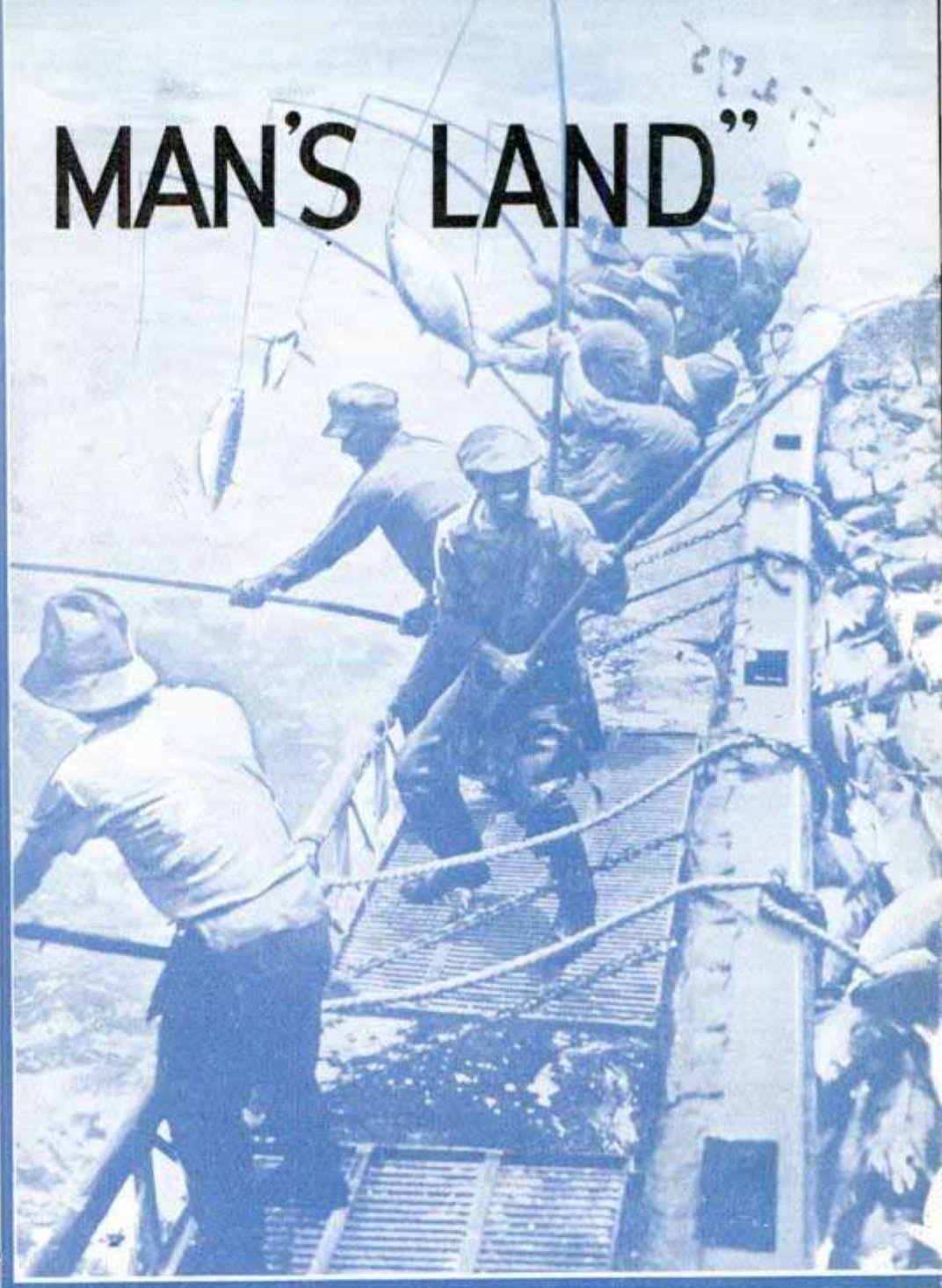

A new tuna clipper bound for the Galapagos. Above, the tuna fishermen in action on the grating outside the rail—and there's a fish on every line

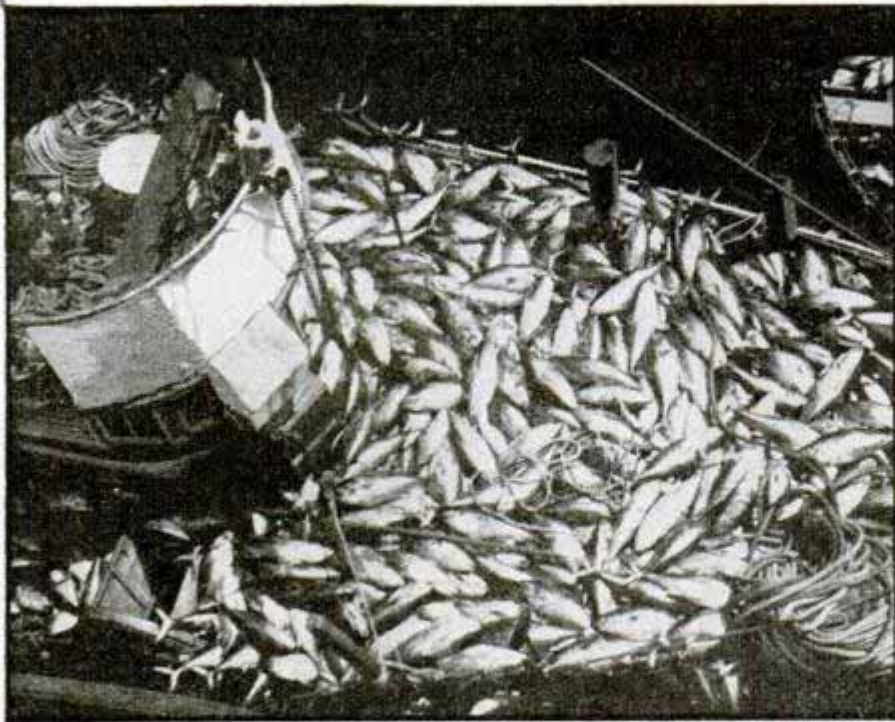

to resist most effectively the strain they must endure during the breathless, furious moments on "live" tuna grounds. From the moment the lookout on the bridge sights the flying gulls wheeling overhead and the flash of fins in the water that indicates a tuna school, and yells "fish ahead!" life on a tuna clipper is action intensified. Atop the bait box—a wooden aquarium filled with salt water and live sardines on the aft deck—the "chummer" awaits his call with a

these boats a cruising speed of twelve knots, with auxiliary Diesels to provide power for refrigeration, and coupled to generators, electricity for light, pumps and winches. No former tuna fleet has been so considerate of crews. Cold sea-water coils circulate cool brine in every room where men live and assemble on voyage, reducing inside temperatures from twelve to eighteen degrees so the men may be comfortable no matter how hot it is outside. Ice cream, frozen dainties and chilled drinks, are now enjoyed on the fishing clippers, just as on the most palatial liners.

These long-range craft, capable of carrying enough fuel and provisions for the 10,000-mile round trip to the Galapagos, are scheduled to make seven or eight such voyages yearly. Whereas previous wireless equipment was short range, the short-wave apparatus carried by the tuna boats can circle the globe. The home base is now continually informed of operations, and knows days in advance the date of return of its fishing craft, so canning forces may be assembled the moment of arrival. This radio equipment also is used to flash information in code to other craft operating for the same concern, so they may be advised instantly of where tuna are running.

On the long trips south, the crews are taught to file their barbless hooks to needle sharpness, to clean piano wire leaders, and where to tape the stout bamboo poles



Decks on a tuna boat loaded clear to the bridge with one day's catch. Below, the "no man's land" where the tuna bite

fine-mesh net on a pole. Quickly the boat noses her prow into the midst of the school. The engine-room and navigating officers quit their posts and the craft rolls free as every man snatches a pole and rushes to take his stand with others of the crew on metal-slatted gratings held horizontally over the ocean outside the railing.

"Chum 'em up," orders the fishing chief and the chummer casts scoops of live sardines into the sea to entice the tuna. The

result is electric. Swish! A fish has struck. Timing his tug with pole and pencil-thick cotton line to a nicety, a man whisks the tuna overhead and in a twinkling it lies writhing on deck. The barbless hook rolls free from its mouth and the lure which, when wet, looks invitingly like a squid is returned to the foaming waters, the work continuing until darkness, or the fish cease biting.

Thirty tons are frequently caught by hook and line during the daylight hours of a day. But when the fish don't bite, what then?

Heretofore when food and fuel ran low, the boats were forced to run for home base, taking financial losses. But recent maneuvers of American interests are circumventing these losses. An ice plant,

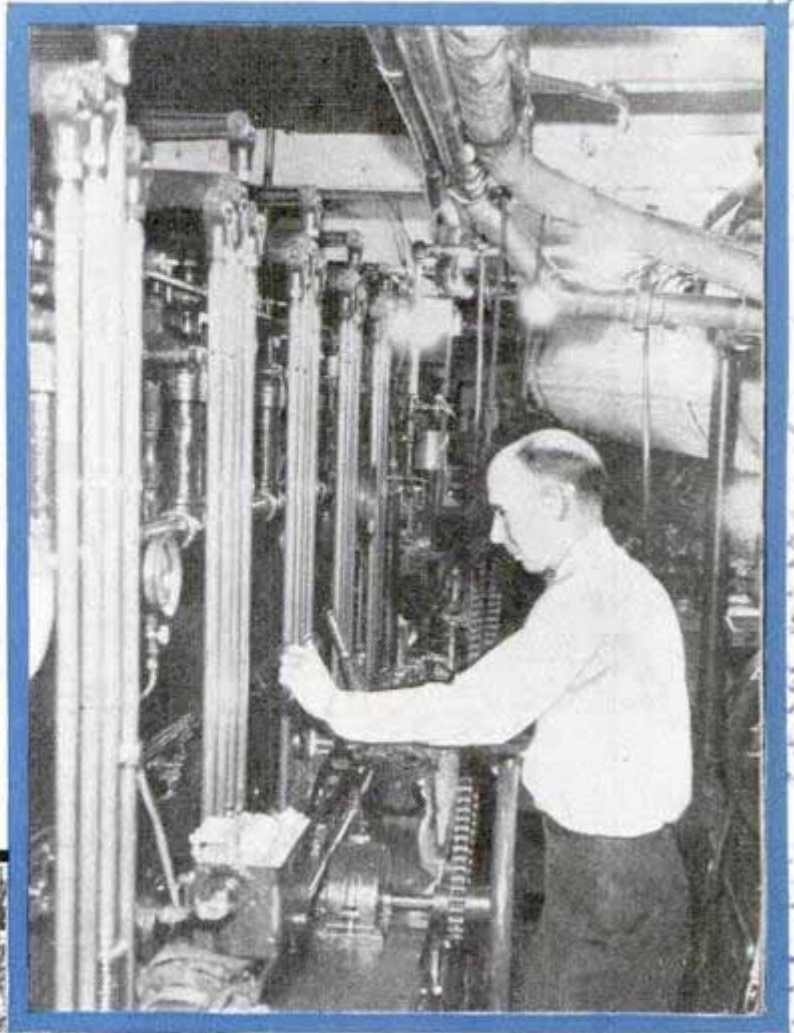

Diesel engines of a tuna clipper and, below, a tuna fishing boat at her pier at San Pedro

refrigerator and Diesel fuel base are being constructed at Puntarenas, Costa Rica, where a California clipper, short of supplies, may slip in, disgorge its partial load

for transfer to a northbound boat and return quickly to the tuna grounds. With 5,000-mile trips back to packing bases with light payloads thus made needless, American tuna fisheries believe a large part of the pending battle for supremacy of this market already is won.

But why this long journey for tuna, once so prolific off the western coast of the United States and Mexico? Old salts who remember when every cannery need was met with fish caught a few miles off San Diego or Los Angeles, declare the detonations of the big guns of the American navy in target practice in the vicinity have frightened them away.

"All bosh," says W. L. Scofield, in charge of the fish harbor office of the California State Fisheries Laboratory. "The equator-ward parade of the clipper fleet is due entirely to the increased

(Continued to page 130A)

Upholstery Dry Cleaner Run by Electricity

\$325.00



Covering upholstery with dry suds from cleaner. Inset, removing the suds

Portable and electrically operated, an upholstery cleaning machine is on the market. Dry air-blown suds are sprayed on the fabric through a blower and tube from the machine. No moisture penetrates the fabric, thus assuring even cleaning on delicate coverings. Head stains, mildew and grease spots are removed quickly. Coverings of the machine are made of molded rubber to deaden sound and to protect furniture. A special cleaning fluid to be used with cold water, is available. Fabrics dry in a few hours. The machine operates on alternating or direct current, twenty-five to sixty cycles.

Diamonds Found in Many Parts of the United States

Diamonds are found in many parts of the United States, instead of being confined to the single diamond mine in Pike County, Ark. Samuel G. Gordon, of the Academy of Natural Sciences, Philadel-

phia, points out that one of the largest diamonds ever found in this country was picked up at Manchester, Va. It weighed almost twenty-four carats in the rough and eleven and one-half when cut, with a value of \$4,000. Diamonds may be found along the eastern slope of the Appalachian mountains from Virginia to Alabama, along the western slope of the Sierra Nevada on the Pacific coast and in Wisconsin, Michigan, Indiana and Ohio. While most of them are small, the diamonds found in America are not inferior to those taken from South African mines.

Dresses Undergo Wear Tests in Hunt for Standard

Possibility of evaluating dress fabrics by performance tests and of setting up standards for serviceability is indicated in the national bureau of standards tests of women's dresses. How much wear may be expected, color fastness, breaking strength and aging characteristics are some of the questions which the bureau answers by means of a machine which subjects fabrics to severe tests. The machine is a recent development of government experts.

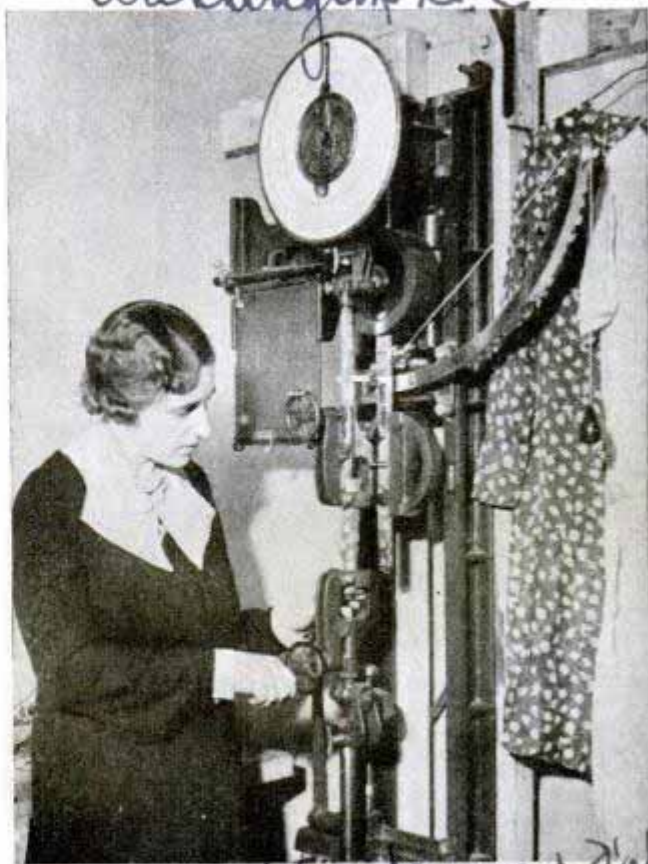

Subjecting dress to latest testing machine which measures life of the fabric

Vertical handwritten notes on the left margin:
Schroeder Mfg. Co.
Standard Function (see) U.S.
Philadelphia
1488

Horizontal handwritten note at the bottom:
Curatorial minerals

Motorcycle Police Man Machine-Gun "Nest"

Veritable machine-gun nests on wheels are the armored motorcycles recently supplied to the police at Rome, Italy. Both the driver and the gunner in his sidecar are protected by metal shields. The entire fleet participated in a demonstration of modernized police equipment at the Italian capital.



© Planet News, Ltd.
Motorcycle police of Rome, Italy, on review in their armored "bikes" with machine gunner riding in sidecar behind metal shield

Although camera film usually is "dated" for use within a year or two after manufacture, pictures have been made successfully with twenty-six-year-old film.

Kodak magazine Club 1936

acme

F14 55

"Stunt-Flying" Carburetor Adapted to the Automobile

Taking a tip from airplane engineers, one automobile manufacturer is equipping latest models with a carburetor which provides unfailing flow of gasoline to the motor under all driving conditions. The carburetor is designed to prevent "starving" the engine when the car is climbing steep grades, attempting a quick get-away, when turning corners and while stopping quickly. Of the dual down-draft type, the carburetor has two fuel nozzle tips located in the center of the bowl so that an unfailing supply of

comparable to that which permits a plane to fly in any position without affecting the operation of the motor.

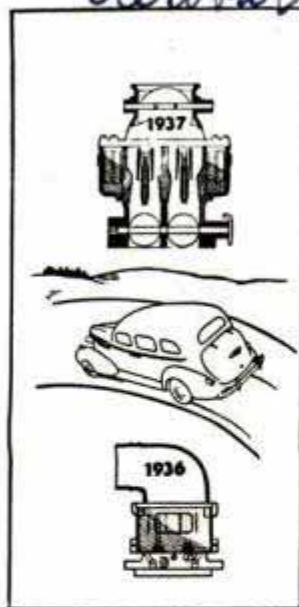

fuel flows in. The bowl is separated by a wall at the forward end and by baffles at the base of the nozzles which prevent the jets from being robbed of fuel or flooded, as in conventional carburetors, under fast turns and sudden stops. The equipment is

Corrosion in Pipe Line Stopped by Deaerating Water

Corrosion that was seriously reducing the capacity of a huge water line at a Gulf Coast mine was conquered by deaerating the water by vacuum. Rust could not be prevented by a protective coating because the pipe was of welded steel, nine miles long. In four months corrosion cut its volume by twenty-two per cent. Engineers found that by drawing the water from its reservoir with vacuum pumps into a high tank they could remove about ninety-five per cent of the dissolved oxygen, and the remaining five per cent could be removed chemically at small expense. After three months' experiments with this method no rust was found.

Names and addresses of manufacturers and dealers in articles described in this magazine will be furnished by our Bureau of Information upon request accompanied by stamped, self-addressed envelope.

Freeport Sulphur Co
Freeport, Ark
1936

Freeport Sulphur Co

Freeport Sulphur Co

124-9th St. Wilmette, Ill.
7138 8. Grant Bldg
Full-Length Door Mirror

Mounted with Screws
Pittsburgh, Pa



Hanging a full-length mirror, which not only adds to the appearance of the room but is very useful

Full-length mirrors on hall or bedroom door are not only decorative but practical. A framed mirror can be had, ready to be fastened to the door with four screws.

Paint for Insulating Board Requires No Sizing



Requiring no sizing and no sealers, a paint made for application to insulating board bonds completely with the surface, yet does not penetrate. It bridges the spaces between the fibers to form an evenly distributed film, so

that in many types of finishes and colors only one coat is necessary on boards once considered difficult to paint because of their tendency to absorb great quantities of liquid paint. Drying rapidly, a board painted with the new product may be put into service within a few hours. Scrubbing with soap and water improves its appearance and wearing quality.

71500

Concrete Found Self-Healing under Certain Conditions

Broken concrete will heal under proper conditions, it has been found by investigators. A number of test cases showed that complete fractures of concrete culvert pipes had become self-welded and in some cases the weld was stronger than the original culvert. This self-healing action is the result of calcium hydroxide, which is exuded by concrete, being converted into calcium carbonate in the presence of moisture. Dampness or long-continued high humidity is required for the reaction.

71499

Heating of Speaker's Stand Latest for Outdoors

Heating the air around the speaker's stand at outdoor meetings is the latest accomplishment of Detroit engineers. At a recent gathering in Navin Field, complete

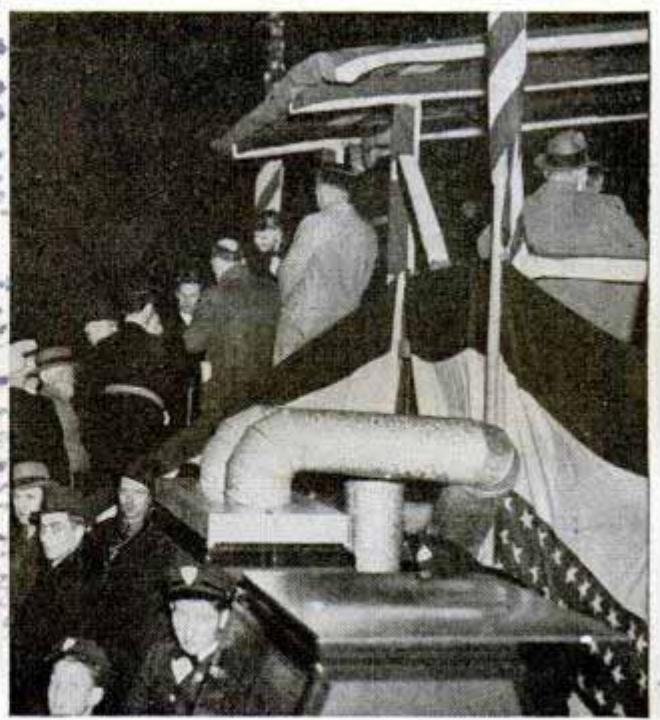

Heating equipment in place beside speaker's stand at an outdoor gathering

wood, stone, brick, paper.

124-9th St. Wilmette, Ill.

Mitchell & David
Murray

heating equipment supplied warm air through two ten-inch pipes to the platform, one on each side of where the speaker stood. The heat was generated by oil burner and blower. Fuel oil was conducted from a fifty-gallon drum to the burner by copper tubing. So efficient was the arrangement that the speaker was able to appear without overcoat or hat, though the temperature was near freezing point. The unit was installed by Gar Wood engineers. Possibility of the idea being adapted to other winter gatherings such as ice carnivals, was expressed by observers.

Model Boat 'Sails' on Road When the Wind Is Favorable



Photographer catches "master" of model ship when there's no wind and he must push the craft along the highway

Meter Shows Amount of Dust in Air You Breathe

Devised as a means of determining the amount of dust that may be in the air, a handy meter has been tested successfully in Boston. The device takes a sample of air and analyzes it, showing quickly the percentage of dust.



Taking a sample of air with meter which analyzes it and shows amount of dust

When the wind is favorable, a model barquentine constructed by a New Zealand man may "sail" along the highway. It was built to make a trip by road from Auckland to Wellington to raise funds for a new gospel ship to replace one destroyed by fire when nearly completed. When there is no wind, the builder pushes the boat along on the small wheels with which it is equipped.

Camera Sets Itself for Exposure with Aid of Photocell

Judging the proper aperture and exposure time for a photograph may soon be left to the camera itself. Dr. Albert Einstein, noted scientist, and Dr. Gustav Bucky of New York have patented a camera equipped with a photoelectric cell arrangement which automatically adjusts the camera for the existing light. An auxiliary lens receives the light from the scene to be photographed and transmits it to the "electric eye." A screen of varying transparency mounted in the main lens system is adjusted according to the degree of light falling on the photoelectric cell, admitting the proper amount of light to the photographic plate when the shutter is snapped.

Mr. Stuck at camera

L. Davis, Submarine

5 2 7 6-4th M

7515 11/25/32

Low Philips 03

Available for Advanced

F1005

Conquering

DEATH



and dawn than in the daytime. Truly, there's a sinister meaning for motorists today in the words of that old refrain, "I'm Afraid to Come Home in the Dark." Going home—or anywhere else—becomes dangerous business after dark if you drive a car.

Improved highways, safer cars, better traffic regulations and other safety measures actually are decreasing daytime accidents. But the night accident trend is moving upward despite all preventive measures. And darkness—lack of visibility, inability to see—constitutes the major difference be-



254
253
ARE you afraid of the dark? Probably not, but cold figures prove you should be, if you drive a car. You should cultivate a healthy fear of the night because darkness is the ally of death on our highways.

Traffic accidents are snuffing out human lives in America at an average rate of about 100 a day, 3,000 a month, 36,000 a year. And when the sun goes down, the death toll goes up. Statistics indicate that from three-fourths to four-fifths of all automobile traffic is by day. But more than half the fatal accidents and almost half the non-fatal ones occur at night. The average accident hazard per vehicle mile by night is three or four times that by day.

And the fatality rate per accident is sixty-four per cent greater between dusk

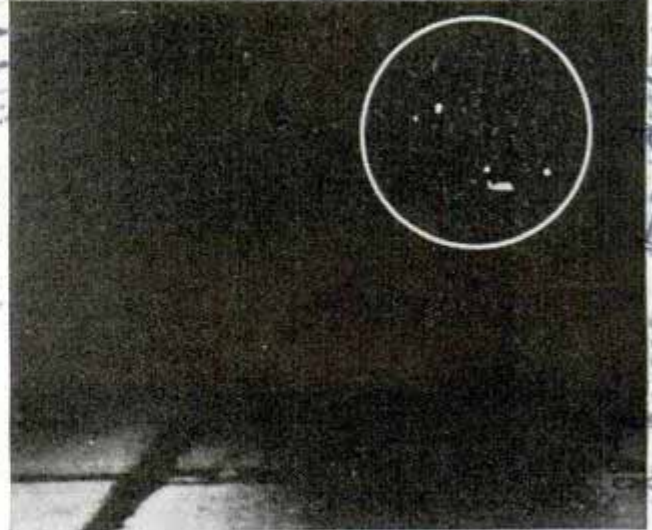

Photos Courtesy General Electric Co.
Top, left, road lighted at night and same view by day. Below, same road, same car, same man on lighted and unlighted highway

7-1305
0811

AFTER DARK

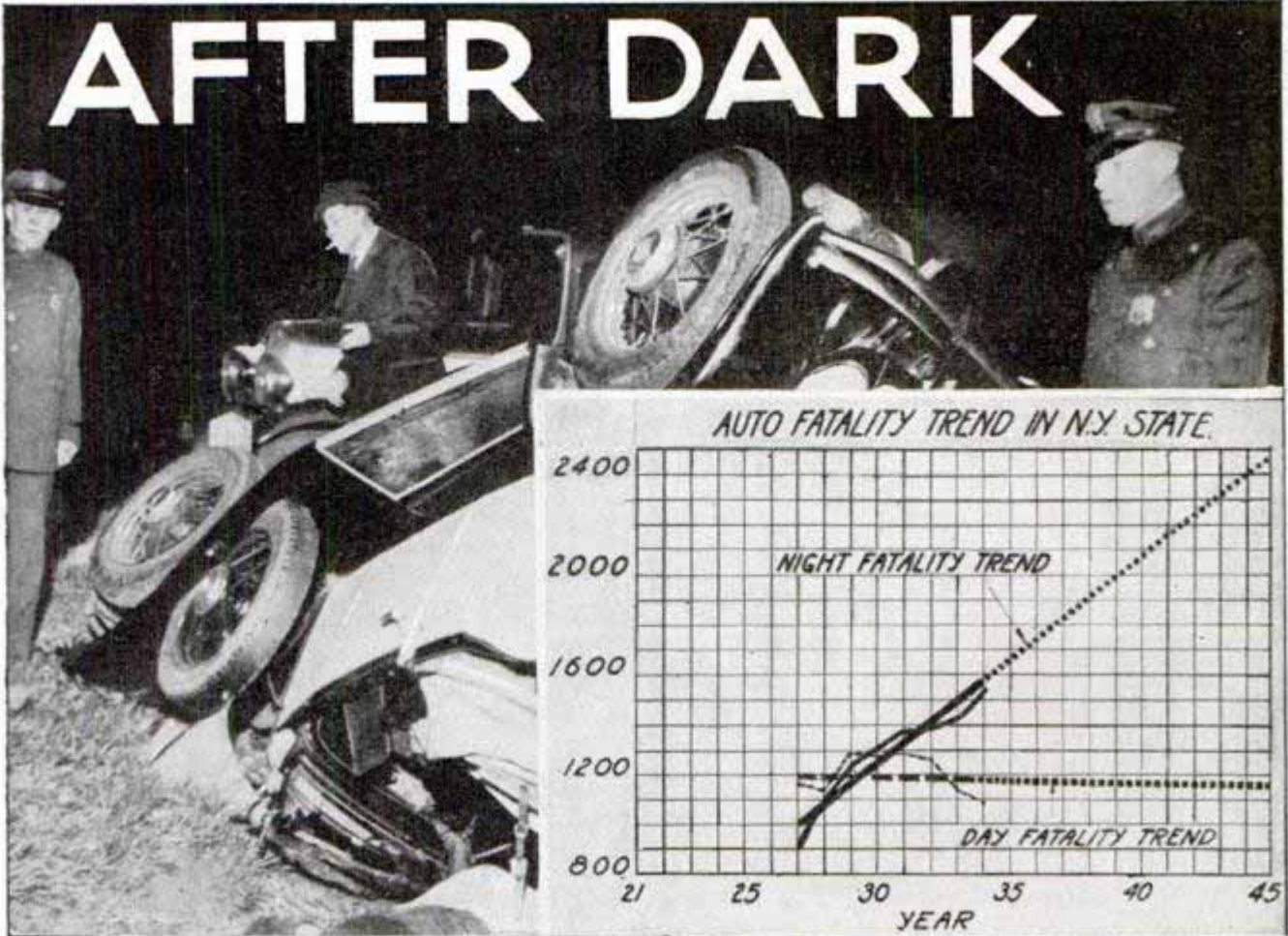

tween day and night driving. Modern automobiles are equipped with the best headlamps engineers have been able to design, but even the greatly improved lights in use today cannot approximate the visibility offered by daylight. Powerful lights could be produced which would flood a road with light but they could not be used without blinding approaching drivers by their glare. Glare has been defined as "light out of place" and it has been virtually impossible, thus far, to keep all the light from powerful lamps "in place"—that is, focused on the road ahead—when the lamps themselves are attached to a swaying, pitching car. A method was devised for depressing beams in passing, but not all drivers utilize this safety device. So engineers have been forced to compromise between illumination and glare in designing car lamps because it was found that too much glare was just about as dangerous as not enough illumination. Some investigators believe the problem eventually may be solved by using a special glass to polarize the headlight beams.

Speeds at night of forty, fifty or sixty

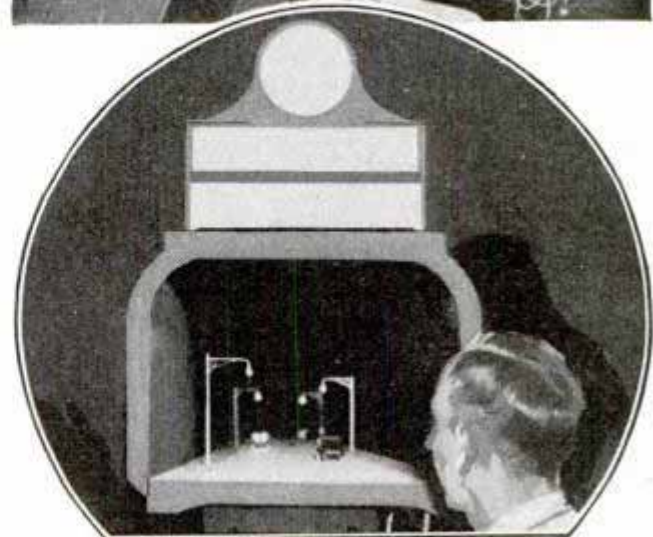

Top, night fatalities are going up. Center, modern highway lighting unit. Bottom, model highway used for light experiments

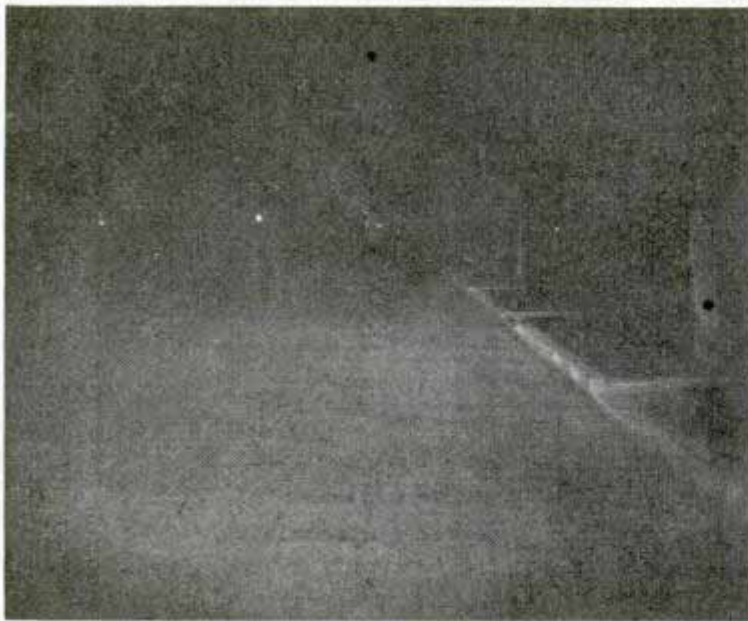

Top, man in dark clothes seen with low car lights and street lights. Center, high headlights, no street lights, man in gray. Bottom, same conditions, man in dark clothes

miles an hour are not uncommon. If your brakes are in average condition and the road surface is good, you require about 165 feet to stop at forty miles an hour, including the time it takes you to think—the interval between the time you see something and the time you decide to do something about it. And at fifty miles an hour you need 243 feet to stop, while at sixty you require 330 feet. But if your brakes are poor or your tires are worn or the pavement is slippery, you may need 600 feet. How many headlamps offer such visibility?

Since solution of the problem of making the highways safer at night seemed to involve some method of providing better visibility, road and safety officials sought the advice of lighting engineers. And it did not take the lighting engineers long to supply the answer.

"Light your highways rather than your cars," was their verdict. And they demonstrated that good visibility can be obtained and maintained on any road by properly arranged fixed lighting which reduces glare to a minimum while greatly increasing the ability to see clearly. Highway officials ridiculed the idea. Think of the cost, they said, of lighting our 3,250,000 miles of roads.

Then the lighting engineers did some research work. And here is what they found. There is a limited mileage—about 50,000 miles for the whole United States, and less than 1,000 miles in most states—where the hazard per vehicle mile by night is six times that by day instead of the average of three or four. And the fatality hazard on this heavily traveled mileage is ten times that by day. Though but a small percentage of all improved roads, about three-fourths of all rural highway accidents at night occur on this mileage.

Illuminate this 50,000 miles of

F1303

road and there would be an annual saving of 5,000 lives at least, plus 10,000 personal injuries, plus 100,000 cases of property damage!

But, you meditate, lighting even a 50,000-mile stretch of road would cost a lot of money—millions of dollars. Well, here's one answer to that. How much are 5,000 human lives worth, or, projected over ten years, how much are 50,000 human lives worth? But that's not the real answer. The real answer is that the lighting program would pay for itself three times over by the economic loss it prevented. Here are the figures, supplied by Kirk M. Reid, lighting engineer of the General Electric company:

"The installation cost of the 50,000 miles of lighting is estimated at \$125,000,000 to

(Continued to page 128A)

Merleyville
Walsingham
Dart Board Flashes Light
to Score Hits
F1304



When dart strikes target a light flashes below to show number of points scored

F1403
"Document Glass" Saves Papers by Filtering Out Light Rays

Historical documents and valuable manuscripts can be placed on public exhibition under a special glass which prevents



Examining historical papers in display case under glass which stops damaging light rays

their deterioration from light. This "document glass" filters out the ultraviolet rays which cause ink and paper to fade and discolor. Important records which have always been sealed against light are now being shown in display cases made of this glass. The New York Historical Society has built a special case for General Burgoyne's Articles of Surrender at Saratoga, Washington's acceptance of the freedom of the city of New York, and the record of Nathan Hale's execution.

When a player throws a dart at a game board introduced in London recently, the number scored flashes on the board. When the dart strikes the board it causes a short circuit which directs electric current to the lamp located at the number.

F1378
Mantelpiece with Radio Set Latest for the Home

Combining a mantelpiece and a radio is the achievement of one exhibitor at the recent biennial Building Exhibition in London. Called the "radiomant," the accessory for the home has the double appeal of utility and decoration. The radio may be removed for servicing.



Installing radio receiving set in mantelpiece

Pittsburgh Plate Glass Co.

170 Central

at 12th International
no further information

Museum Built as Last 'Haven' for Polar Ship

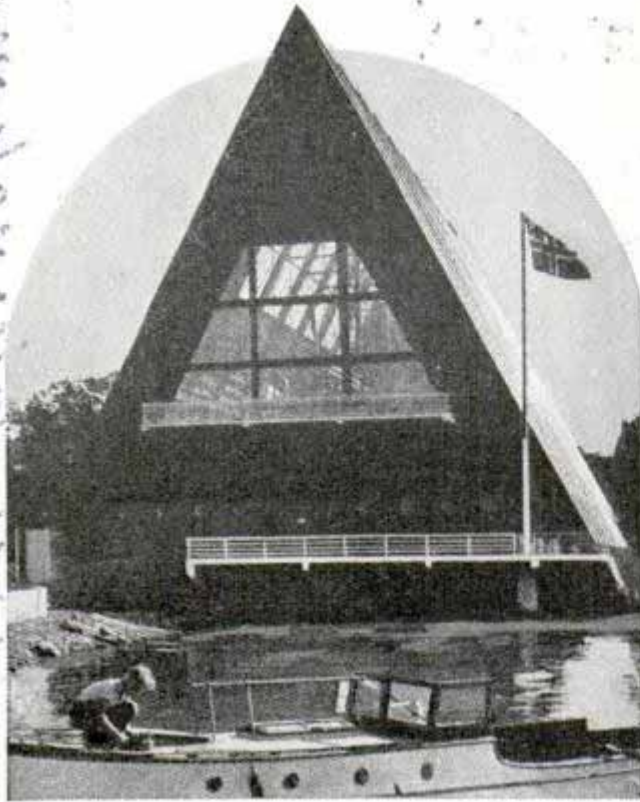

Its polar adventures over, the research ship "Fram" in which Nansen and Amundsen explored both Arctic and Antarctic seas has found a final resting place. A museum has been built around the vessel at Bygdøenes, near Oslo, Norway, and it is enshrined there as a permanent national memorial. The "Fram" was built by Nansen for his voyage into the polar ice fields north of Siberia in 1893 and withstood terrific pressure from the floes. In 1910 Amundsen used the "Fram" to take his men and supplies on his race to the south pole. The famous vessel is now high and dry in the triangular building overlooking the fjord.

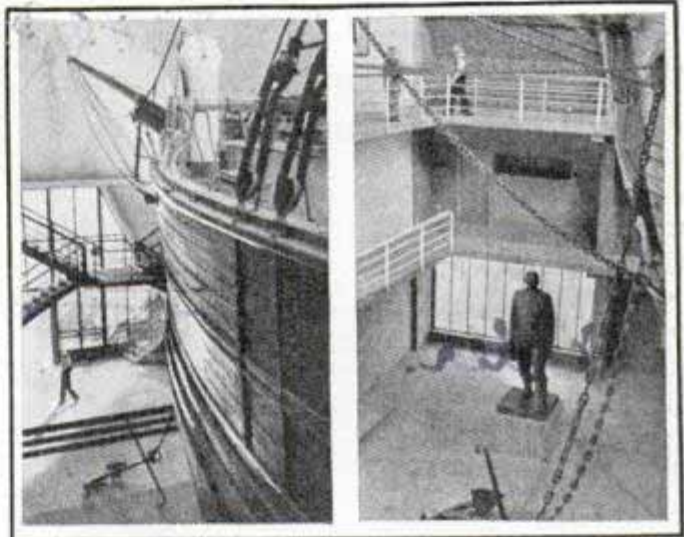

Triangular museum, above, was built around the famous ship "Fram" in which Nansen and Amundsen explored the polar seas. At the right is a view of the vessel in its permanent home, a Norwegian national memorial, and the statue of Roald Amundsen. The museum overlooks the fjord at Bygdøenes, near Oslo, Norway

1453

Paper Knights Scale Walls of a Model Medieval Castle

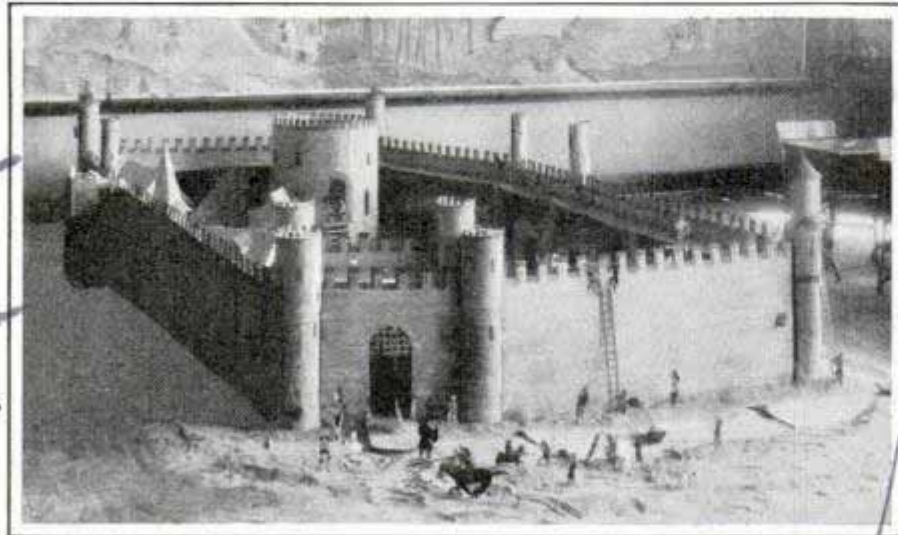

Cardboard knights joust on horseback and scale the walls of a medieval castle modeled in faithful detail by school children of Albany, Calif. The manor house is surrounded by castellated walls manned by feudal soldiers. Tiny boats cross an imitation moat, and the gate is guarded by portcullis and movable drawbridge. Towers and shields, too, are movable. The entire model is of cardboard, colored with

School children built this cardboard castle with its drawbridge, portcullis and feudal knights. It is colored with chalk

Museum of Science and Industry
 Chicago
 Albany, Calif.
 1936

Albany School

chalk to harmonize with a mural in the background which depicts a landscape typical of the middle ages. The class spent two months constructing the model.

Megaphone Sends Bugle Call to Far Corners of Air Field

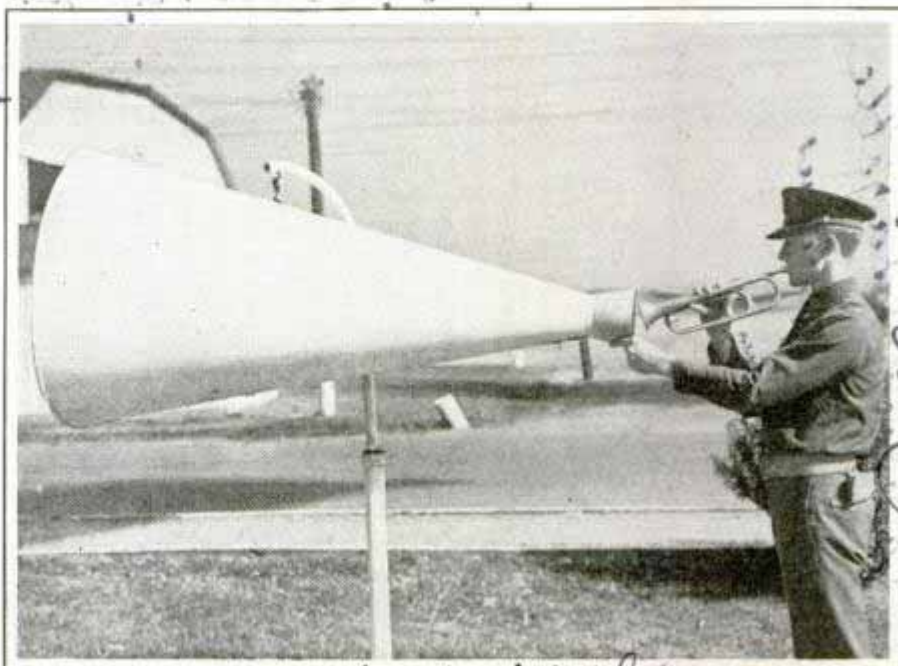

Bugler's call is carried to every part of air field by means of this big megaphone installed at Scott Field, Ill.

Movie of Highway Tests Driver's Steering Skill

If you can keep the "cut-out" hood of the car where it belongs while the road wanders at random in a moving background, you rate 100 per cent at the steering wheel. To test the motorist's steering skill and alertness in reacting to visual stimuli, an accident insurance company has developed a recording mechanism. The driver sits in an automobile seat facing a small window through which he sees a moving highway and the cut-out nose of his car. As he maneuvers the steering wheel to follow the meandering road and avoid its obstacles, the cut-out hood responds to the wheel and at the

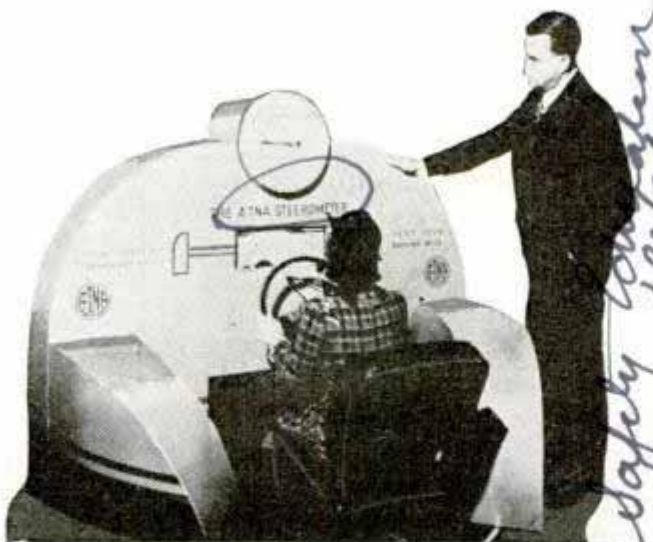

As driver manipulates steering wheel, "cut-out" nose of car follows moving road on rectangular screen

same time the driver's accuracy in steering is recorded on a paper disk. The test lasts forty-five seconds. The average driver rates about ninety per cent in keeping the car on the right side of the road.

Bugle calls are carried to every part of the airplane landing field at Scott Field, Ill., by means of large megaphones. When the bugler sounds mess call, for instance, he steps to one of the megaphones, places the bell of the bugle to the megaphone mouthpiece and sends the call roaring across the field.

Ignition Cable of Stainless Steel Starts Cold Motor Quickly

Much quicker starting of cold motors in winter weather is possible with an ignition cable of stainless steel for which a patent has been granted to government engineers. A much higher voltage potentiality can be gained since the flow of electricity through ferrous metals such as stainless steel is impeded less than in copper. Ferrous wirings, too, are stronger and cause less radio interference, making them ideal for use in airplanes, and their resistance to corrosion gives them another advantage over copper in seaplanes.

Boys and girls under sixteen are the entire executive and operating staff of a complete railroad in Russia operated between stations two miles apart.

F1452

F1486

Pat # 2,058,619

Aetna Casualty and Surety Co.

Railway Age
Nov. 21, 1936

Vertical handwritten notes on the right margin, including "Bureau of Standards" and "Bell Telephone".

Vertical handwritten note: "Safety Recording Mechanism"

49

F1219.

Illustrated newspapers, etc.
Averech House,

WOODEN SHIPS

346 Strand, London, W.C.2

England

Commander J. E. Capstick, R.A.N.
Retired ops Editor, Chief
of Planters Gazette
Mauritius

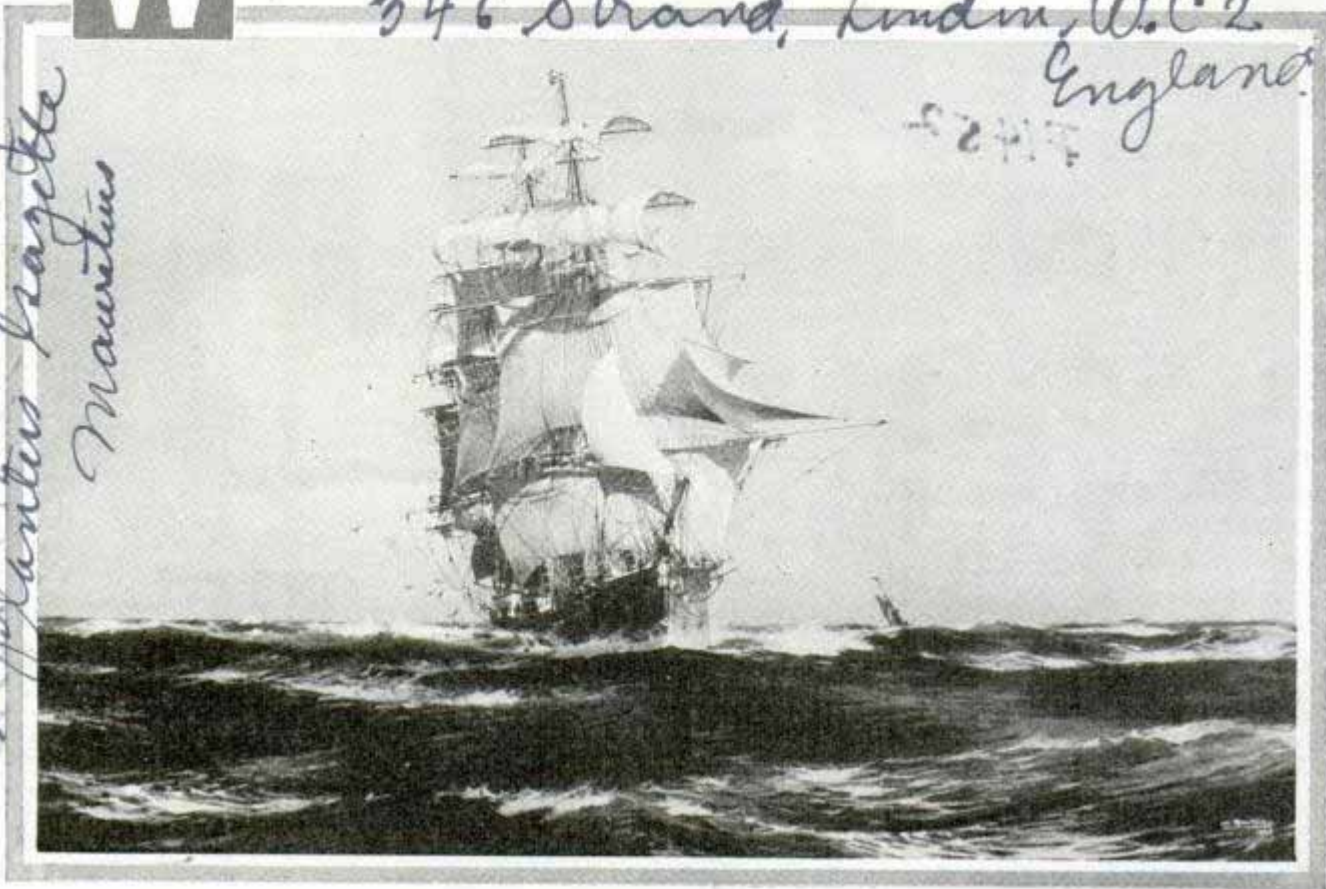

The "Red Jacket," one of the most beautifully proportioned clippers ever built. Her figurehead represented a Seneca chief for whom the vessel was named

By Cappy Ricks

THERE have been few works of man around which has settled such a definite halo of affectionate regard as that evoked by the memory of the old-time clipper ship, the stately and intriguing product of America's designers who alone on earth were responsible for the birth of ocean speed.

These magnificent ships—perfect instruments for their purpose to the last detail—for a generation and more carried in their bellying sails the ocean supremacy of the world, and held in their spacious holds the cream of all ocean-borne traffic. They were, of course, of wooden construction, and in themselves they represented the highest peak of the woodworker's craft ever attained by man. They were not, however, as often erroneously supposed, built of soft wood; instead, all the flyers were built of American oak, often internally bound with iron in an intricate and exceedingly skillful manner, never quite

imitated by any other nation's builders. They were, though, lightly built with plenty of "give" in their construction, and it was this elasticity which gave to them their entirely unique and supreme sea-kindliness and rendered them so speedy that no other wind-driven ships in history ever came up to their achievements; no other ships ever built attained twenty knots or over, nor did 400 miles in a day, as did these queenly clippers which in their day held every ocean record.

The first "extreme" clippers were built for the China tea trade, the sea-trade par excellence, but the noble type really arrived at its peak during the Californian gold rush of forty-nine and the fifties of last century, and the contemporaneous Australian rush in which American-built clippers carried half a million gold-seekers to the land of the Southern Cross, and took to Europe millions of ounces of gold dust and bullion alone.

Handwritten notes at the bottom of the page, including "The Red Jacket" and other illegible scribbles.

Illustrations from Book entitled
Sail
and IRON MEN F1219



All pictures © The Blue Peter Magazine, London

12 St. Mary Ave,
 "Flying Cloud," built in 1850. On her maiden voyage she traveled from Boston to San Francisco
 in eighty-nine days, a record never broken by any other clipper

The first clipper to prove a success was "Coquette," a small ship of but 420 tons, sailed by that magnificent seaman and skillful navigator, Elridge the elder. She astonished the world by making on her maiden voyage, in 1843-4, the passage from Boston to Hong Kong in ninety-nine days, a performance eclipsing by several days anything previously accomplished.

A later clipper, "Rainbow," of 720 tons, the first ship to be given "hollow" bows, made the outward passage, to Canton, in ninety-two days, and returned to Boston in eighty-eight, a most remarkable achievement for so small a vessel. This ship, though, was considered to be too "extreme"; she was early in her career named a "coffin ship," with a reputation for "losing men overboard when no one was looking." She disappeared with all hands on her fourth voyage, considered to have been sailed right under.

This swift vessel's record was soon beaten. In 1846, Waterman the elder took the new "Sea Witch" from Canton to New

London, Eng.
 York in eighty-one days, and, it was said, never once left the deck of his ship for more than a wash during the long passage. In one day this ship reeled off 361 miles, an average of fifteen knots, easily a record for a day's run. It was Waterman's practice to padlock his chain topsail and topgallant sail sheets, and keep the keys on his person, to insure that no one but himself could reduce sail. Only one other man was ever known to adopt this practice, the indomitable Forbes of "Marco Polo."

"Surprise" was another wonderful ship, finest of her day and fastest; she went from New York to San Francisco, 16,000 miles, in ninety-six days, under that prince of ship captains, Dumaresq. On many occasions during the passage she logged seventeen knots, the highest ever attained to that date by any ship, sail or steam.

"Staghound," a truly noble ship, was the next to attain seventeen knots, but she was driven to desperation to attain it.

marine pictures - suggest - see also



"Sovereign of the Seas," first clipper to attain a speed of twenty knots. She made 413 knots in one day's run, an average speed of seventeen and one-half knots

Then came the wonderful "Flying Cloud," well ahead of anything in the world then afloat. Built in 1850 by the Boston ship-building wizard, Donald Mackay, she went on her maiden voyage to 'Frisco in eighty-nine days, a record which was never broken. In five successive California voyages her average passage was 100 days, when the average ship's passage lay around 140. Her tonnage was 1,783, and she was the loftiest ship of her day.

This noble ship put up many records, some of which still exist; she did 374 miles in a day, and reached eighteen and one-half knots on many occasions. In 1858 she covered 1,501 miles in four days.

The first of the "large" clippers over 2,000 tons, was the "Oriental," built in 1849 to be the first ship to take tea from China to London upon the repeal of the navigation laws, and she made the passage from the Pagoda Anchorage, Foochow, to the London docks in ninety-six days, beating the fastest British ship by no less than thirteen days.

The flight of clippers during the gold rush amounted to some thousand, all magnificent ships and the finest fleet the world

has ever seen. Over 200 were being built annually, for these were stirring times in the sea trade. They were, by far, the largest, and swiftest ships afloat at the time and they were handled and sailed in faultless manner. One of the first was the noted "N. B. Palmer," which on her maiden voyage crossed the North Pacific, port to port, in twenty-seven days, taking five off the record, doing 396 miles one day, an average of sixteen and one-half knots. "Swordfish," a product of the same Maine yard, beat this passage by a day in 1856, reeling off 6,000 miles on a passage from California to Swatow, a record for the west-bound passage.

In the same year the noble "Sovereign of the Seas," 2,684 tons and the largest of the Mackay built clippers, having 109 in her crew and commanded by Laughlan Mackay, brother of the builder, attained the phenomenal speed of twenty knots, with 413 for the day's run, an average of seventeen and one-half. This stupendous feat, unique in that it was made to the westward in a region given over almost wholly to westerly winds and mountainous seas, was achieved off Cape Horn.

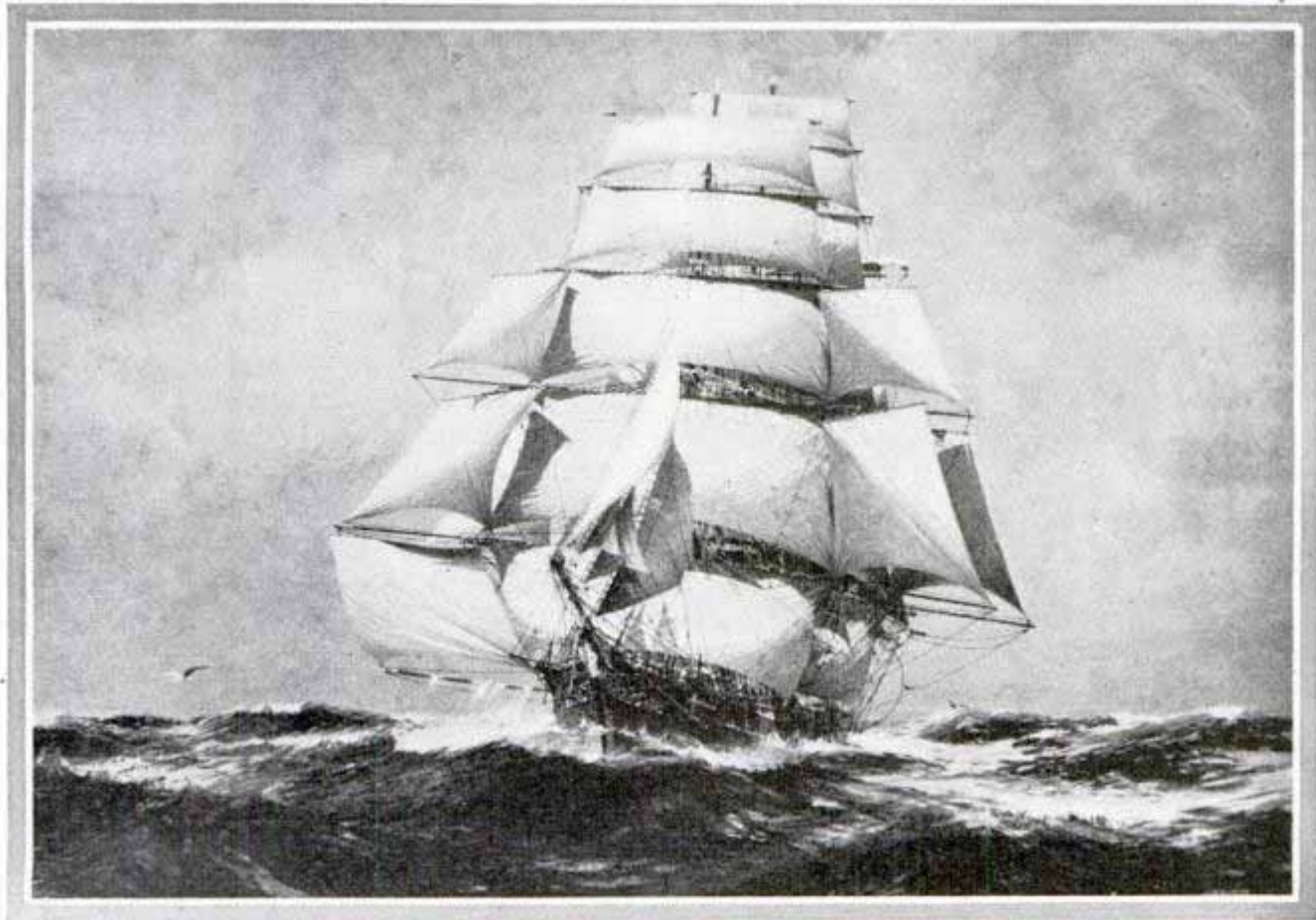

"Lightning," a clipper that came honestly by her name for she sailed 436 miles in one day, a record for all time, and several times attained a speed of twenty-one knots

Once this great ship went from Melbourne to London in sixty-eight days, with half a crew, the remainder being in irons. Mutiny had reared its head, but happily, it had been nipped in the bud. The ship at the time had nearly 400,000 ounces of bullion and gold dust on board, and half her crew were the sweepings of the goldfields.

There were many thrilling and resonant names in the great gold fleet; "Romance of the Seas," "Phantom of the Sea," "Witchcraft," "Winged Racer," "Contest," "Witch of the Wave," an exceedingly lucky ship that carried at the bow a sculptured witch of Salem, with lampblack locks and stovepipe hat, pipe in mouth, and forefingers crossed to bring good luck; "Tornado," "White Squall," "Neptune's Car," "Nightingale," with the human nightingale Jenny Lind at the stem-head; "Pocahontas," "Herald of the Morning," and "Chanticleer," all have their high place in the annals of America's golden era of sail.

It was left to an American clipper, "Golden Age," to put up the highest hourly speed known to history, twenty-two knots, thirty-three miles in an hour and thirty minutes. This is the best run ever

made by a ship under canvas. This ship, too, was unlucky in that she never in her career of but eight years received strong winds over any length of time to show what she really could do. There are indications that even twenty-two knots was not her maximum, for it is known that when this epochal run was being made, the watch below was left undisturbed in their bunks, a thing unheard of when records were being attacked.

It was the Australian racecourse that witnessed the highest speeds over long distance achieved by the clipper ships, for, whether outward or homeward bound, around the Horn, there lay 6,000 miles or more of the track in the region of strong fair wind, the roaring forties, and here the wooden clipper by reason of her extreme sea-kindliness was supreme both for comfort and speed.

Special and large ships were built to cope with this gold-rush traffic over two or more decades, and the three most successful of all, among a hundred others, "Lightning," "James Baines," and "Red Jacket," were products of Maine yards,

(Continued to page 164A)

Fingerprints Alike Only Once in Undecillion



tograph of a right index finger and subjected its enlargement to a microscope to determine various identifiable points in an area less than one-fourth inch in diameter. Next he took a print of the same finger with dark powder and photographed the print which was enlarged 100 diameters and then 200 diameters. Ruling off each picture in squares he counted the identifying points in each. In the larger picture he finds as many as twelve points peculiar to that finger alone. Each square in the picture represented an area of less than one-sixteenth of an inch in diameter. In a full print there are more than 3,072 such points and a minute difference in any one proves the print came from another finger: Colored powders and ultraviolet light reveal prints once invisible to the camera.

Capt. Andrew G. Boone,
 1157 S. Broadway,
 Los Angeles Calif.

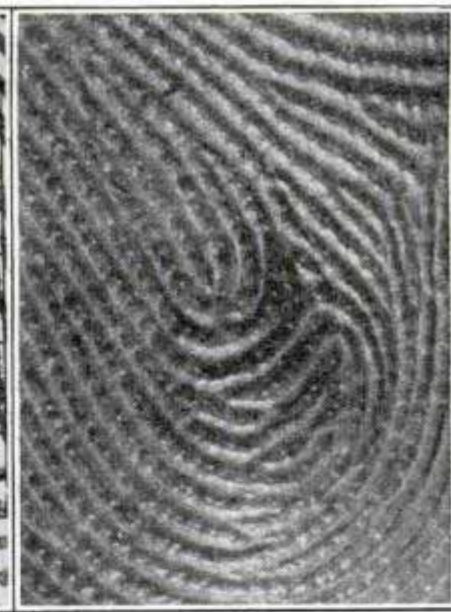

Top, photographing finger. Bottom, left, 200-diameter enlargement shows within each square how ridges would appear under microscope. Center, 100-diameter enlargement. Right, classification area of finger

If a fingerprint is found at the scene of a crime, there is only one chance in an undecillion, many times the population of the world, that it belongs to more than one person. The undecillion is written 1,000,000,000,000,000,000,000,000,000,000. Supported by statisticians, J. Edgar Hoover, chief of the G-men, federal bureau of identification, points out that there is practically no chance for an innocent person to be convicted of a crime. Fletcher Gould, a California photographer, has proved with pictures the remoteness of identical fingerprints. First he took a closeup pho-

F1481

Transmission Is Key to Defeat of American Racing Cars

Why foreign racing cars won the Vanderbilt Cup run on Roosevelt Raceway last fall may be traced to the superiority of their transmissions over those on American cars. Foreign entries were equipped with a special gear set, usually with four speeds, mounted in conjunction with the differential on the rear axle unit, and shifted electrically by hand buttons, preset to give the selection when the driver depressed the foot lever. In contrast,

Police Dept.

Phone Built in Mouthpiece of "Talking" Gas Mask



Microphone fitted inside this gas mask permits the wearer to talk over the telephone

To permit communication during a gas attack or while working at a hazardous occupation, a gas mask developed in France has a microphone built into it. An ordinary handset telephone is held to the ear and the wearer's voice is carried outside the mask by the microphone attached.

Day-and-Night Wind Indicator Aids Pilots Miles Away

Visible five miles away, a forty-foot indicator at Scott Field, Illinois, shows pilots the direction of the wind, enabling them to land properly. The indicator is lighted with red and green electric lights

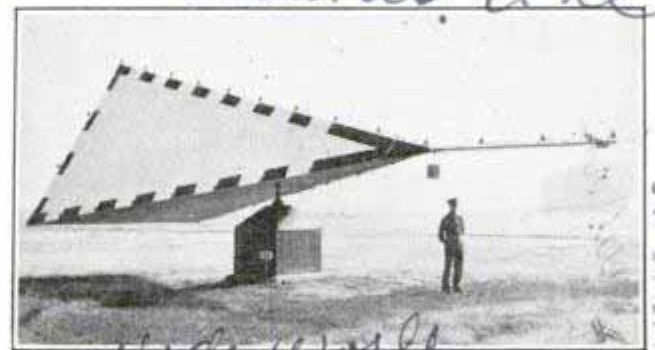

Giant wind indicator installed recently at Scott Field, Ill., to aid pilots

to make it visible at night. It replaces several smaller indicators formerly used at the flying field which could be seen from only a short distance.

American cars used rear drive with conventional three-speed forward transmission and rear axle gear ratios of dirt-track specifications. American transmissions were too fast on the turns and too slow on the straightaways and American drivers drove the entire race in high gear while foreign drivers shifted gears quickly up or down, for turns or straightaways, utilizing every ounce of speed and power when and where needed. With the electric gear shift, foreign drivers came out of turns in third speed and then shifted into high. Their best speeds on straightaways were around 150 miles per hour.

Spare Ignition Coil for Car Saves Delay on Road

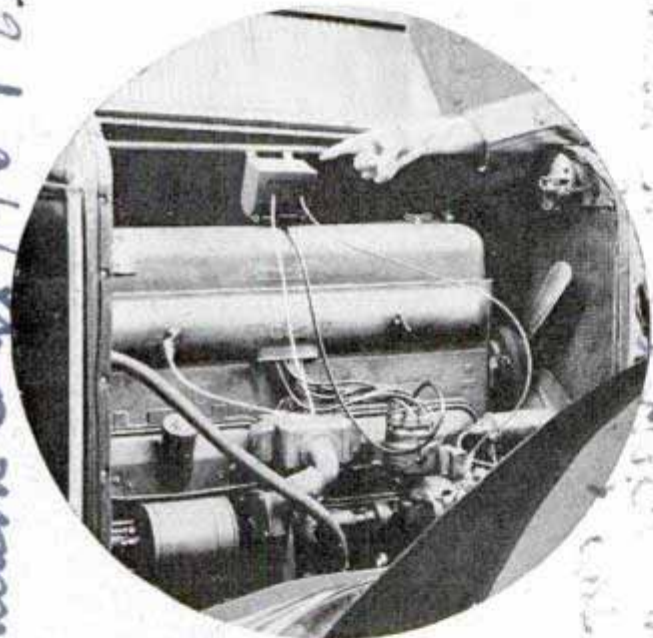

Spare ignition coil shown in place, ready to operate motor stalled on road

When the regular ignition system fails from such causes as defective contact points, unsynchronized points, burned-out coil, defective condenser or damp motor, an emergency ignition coil now on the market will start and drive the car. It can be installed in less than one minute by clipping it to the radiator tie-rod and connecting its cables to the distributor, the generator and to a convenient ground.

In thirteen states requiring automobile brake inspection, traffic deaths were reduced six per cent in the first seven months of 1936 compared with a one per cent reduction in other states.

no. 1936
K. W. d. quinton Cars 1767 E. 27th Cleveland Ohio

at Way the James es. July 2
at the ...

found not given

Oxyacetylene Shaping Tool Cuts Ten-Inch Steel

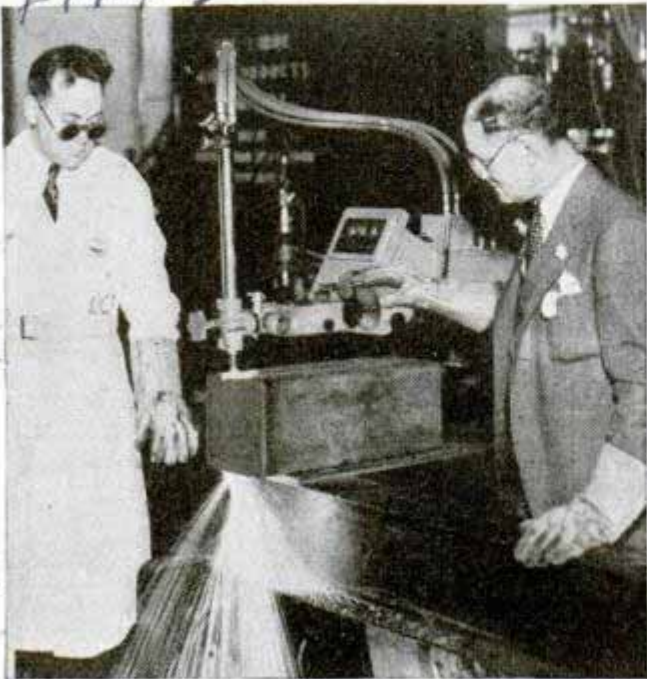

Block of steel ten inches thick being sliced by oxyacetylene machine in a demonstration at metal show

Cutting through ten inches of steel is an ordinary job for an oxyacetylene tool demonstrated recently at a metals exposition. This automatic shape-cutting machine severed a ten-inch steel billet in quick time.

Daylight Photo Developing Tank For Miniature Films

Development of thirty-five millimeter photographic film without a darkroom is made possible by a light-tight tank in which the film can be immersed without removing it from its daylight-loading magazine. After taking pictures, the film

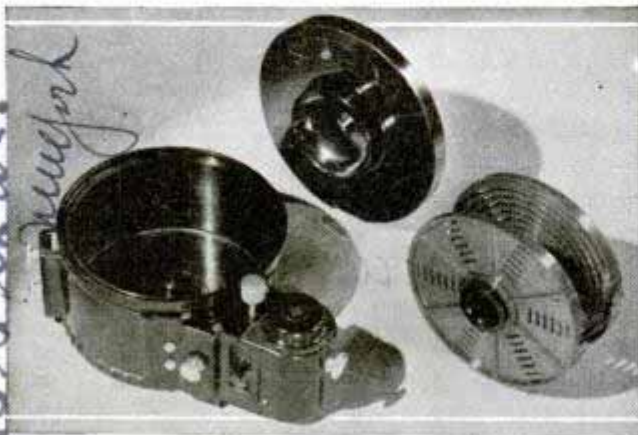

Film in daylight-loading magazine is placed in small chamber and wound into light-tight developing tank

is rewound in the camera until about two inches remain outside the magazine. Then the magazine is slipped into a small antechamber of the developing tank, the projecting film end engaged by sprockets and, with the cover on tight, fed into the tank proper by winding a knob. The various solutions can be poured in and drained without exposing the film to light.

Rubber Poncho Has a Window for Writing in the Rain

Policemen writing "tickets," reporters covering a story, drivers making deliveries in the rain could benefit by a rubber poncho



You can write notes in a rainstorm and keep your paper dry if the poncho has a window in front

cho recently placed on the market. It has an eleven by twelve inch celluloid window in the front, at just the right height for writing notes, visibly, under cover. The poncho is of lightweight rubber with a head hole, draping over the shoulders to allow full freedom for the arms in driving.

Aerial pictures taken from army planes can be developed in a flying darkroom and dropped by parachute within fifteen minutes to aid the ground forces.

Minrosa American Corp
455 5th Ave.
New York

of Consolidated
Gas & Electric Co.
San Diego Calif

Book: J. of Photography

Electromagnet Draws Needles Out of Finger

Electromagnet and compass came to the aid of the doctor when a Providence, R. I., mill-worker was injured in a textile plant and had several needles imbedded in his finger. The finger became infected and physicians feared it would be permanently stiffened by the steel pieces which lay close to the middle joint. The injured man was taken to an electric research laboratory and a small compass was used to determine the direction of the imbedded needles. Then the patient moved his finger between the poles of a strong electromagnet, and felt the needles creep to the surface.

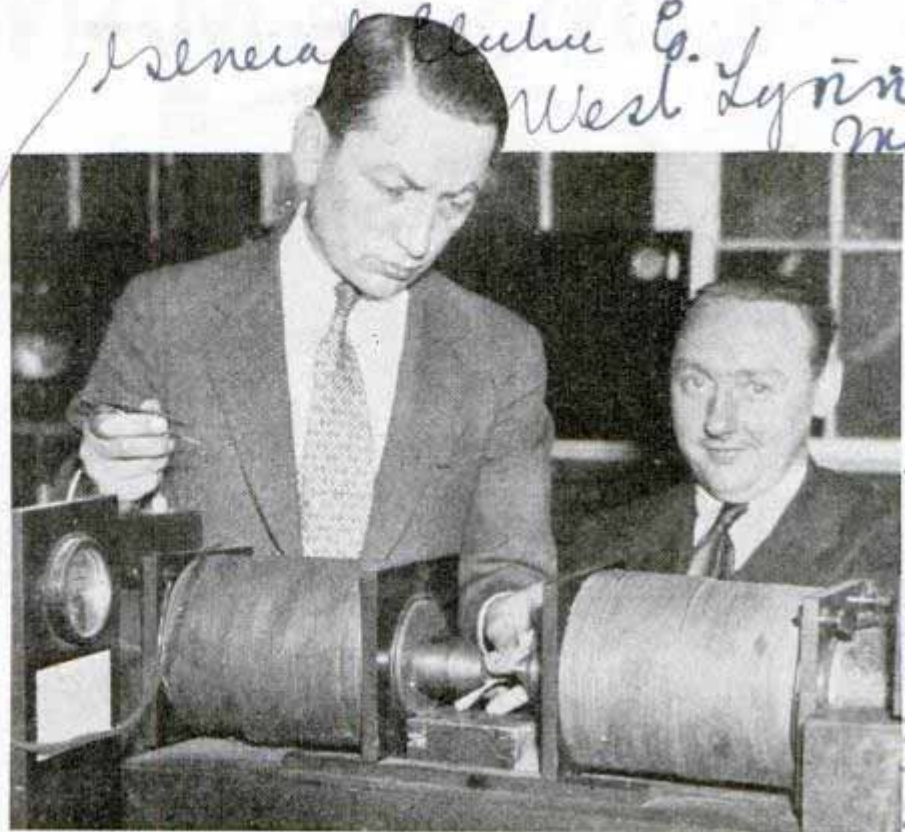

Injured man inserts hand between poles of a powerful electromagnet and feels the magnet draw out fragments of steel needle imbedded in finger

General Electric Co. West Lynn Mass

British Post Office Built on Wheels Travels to the Public

Mounted on wheels and propelled by motor, the latest British post office travels to the public. It is intended for use at race meetings, cattle shows and similar gatherings. It is equipped with two telephone

booths and telegraph printers which will transmit photos of messages in facsimile to all parts of the world. Letters also may be mailed in the ordinary manner, a drop slot being provided in the vehicle.

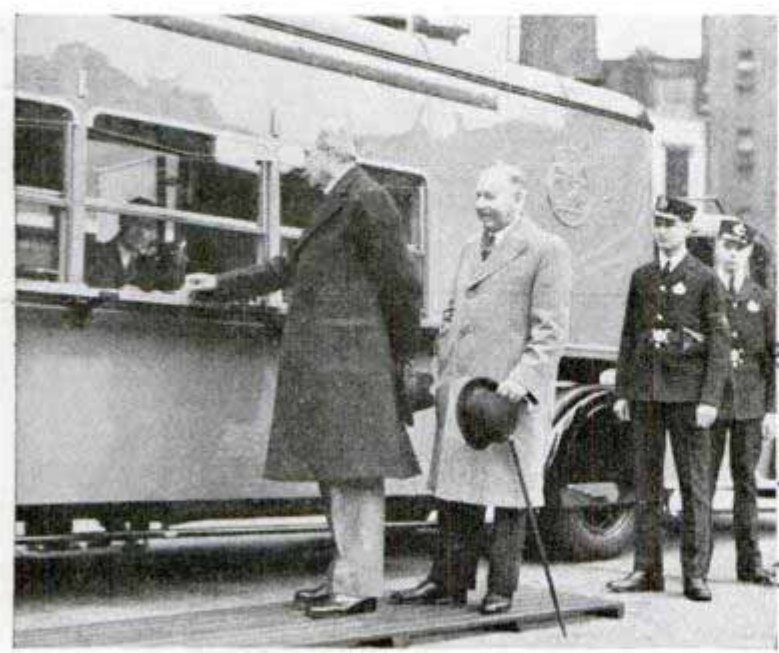

Post office on wheels pictured as it served the public at English race meeting

Explosive in Apricot Pits in Great Demand

Material for high explosives has been discovered in apricot pits, resulting in a demand much greater than the supply at Sydney, Australia. The production of dried apricots and apricot jam in Australia is now a mere by-product business in comparison with the more profitable business of producing apricot pits for war industries in other countries.

It costs two and one-half times as much to transmit electricity a hundred miles as it does to ship coal by rail the same distance.

F1359
 F1511
 Con. H. G. ...
 Western Camera and Photo Service
 Editor, Electrical World

RACING *the* MAN-MADE

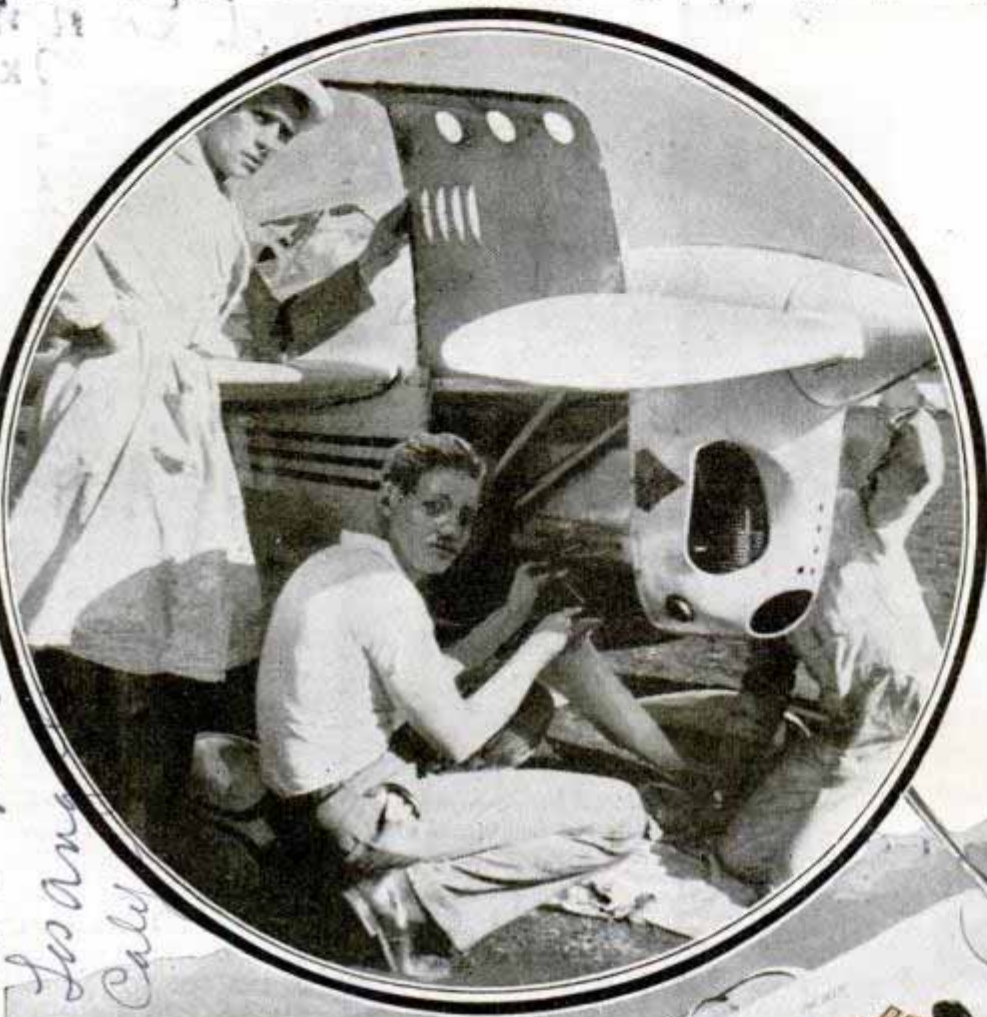

Left, mechanics tuning the engine of a racing plane just before the start of a closed-course contest. Below, the racing plane has speed in every line. Note how the engine is cowled in

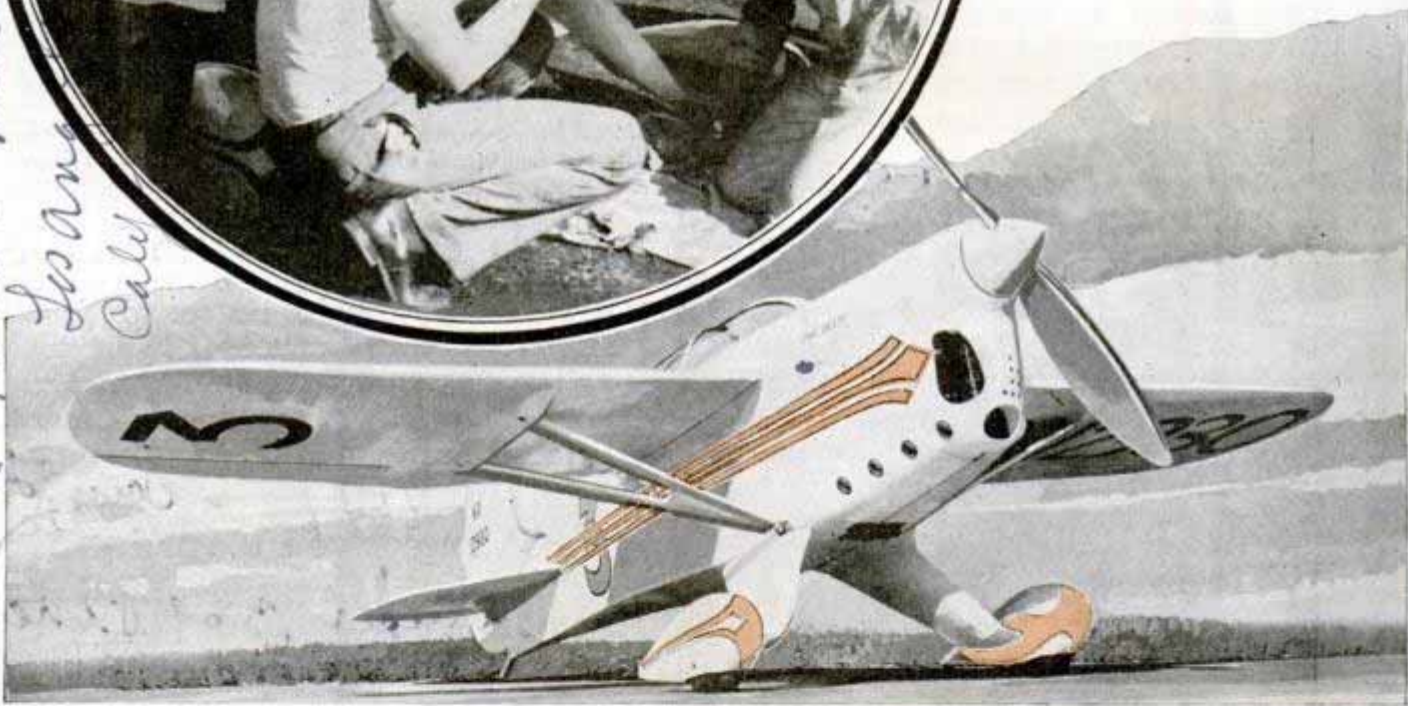

IF THERE were room in the tiny cockpit of a racing plane for you to squeeze in beside the pilot, you would get a thrill to last the rest of your life. And the chances are one ride would be enough.

A race is a terrifying nightmare to anyone except a trained pilot. The nerve-racking roar of the heavy engine a foot or so in front, the shattering jars as the plane smashes through rough air and the sickening swoop of a pylon turn make closed-course racing a sport for only the hardiest pilots. Dodging trees and some-

times flying under high-tension power lines at 250 or 300 miles per hour takes more than sheer nerve. One slight misjudgment of time or distance is the end.

From the cockpit the ground below looks like a liquid smear. Objects ahead are visible but they zip toward you at terrific speed. Pilots select their own altitude to fly around a course and racers such as Earl Ortman, second place winner in the 1936 Thompson trophy classic, like to do their racing twenty or thirty feet off the ground. It's more dangerous so low and

Capt. Thomas E. Stinson, Jr.
10555 Dolman Ave.
Los Angeles
Calif.

Hangar # 5
Aurora

*Harry Crosby F1287
Menasco plane*

METEORS

the plane and pilot take a beating from the rough atmosphere that's as bad as bumping over concrete, but the blanket of thick air close to the ground allows more supercharging and speed.

Making a tight turn around a pylon, with the plane tipped on its side to reduce skidding, tends to crush a pilot down into the floor of the cockpit. Imagine making a ninety-degree turn in an automobile at 250 miles per hour. A pylon turn is almost as hard on a pilot as pulling out of a terminal velocity dive, the difference being that a test pilot needs to dive a new airplane only once while a racing pilot may make sixty pylon turns in a 150-mile race. Ortman prepares for his races by taping his body tightly from hips to shoulders to reduce the strain. That leaves only his chest unprotected and by the end of a race it is covered with black and blue marks. The reason is that in a fast turn his chin is crushed down into his chest and bruises the flesh in spite of all his efforts to hold his head erect.

Besides taping his body, Ortman tapes his helmet to his head because he likes to use a semi-enclosed cockpit instead of one entirely housed over

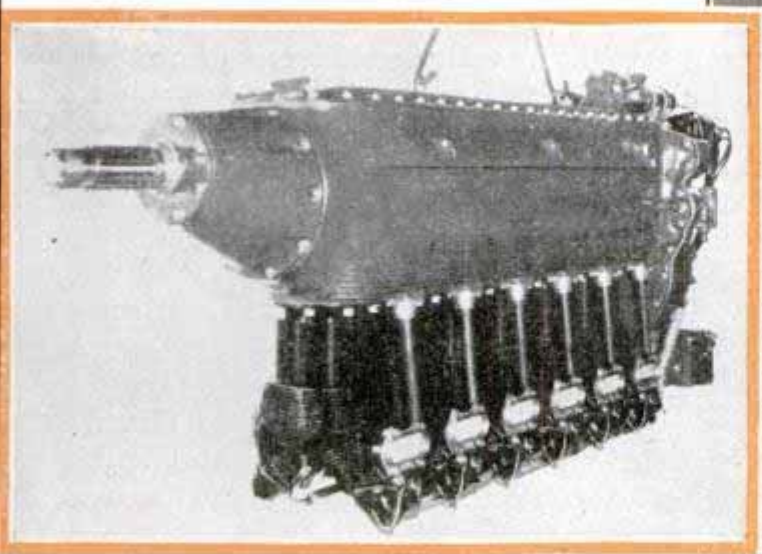
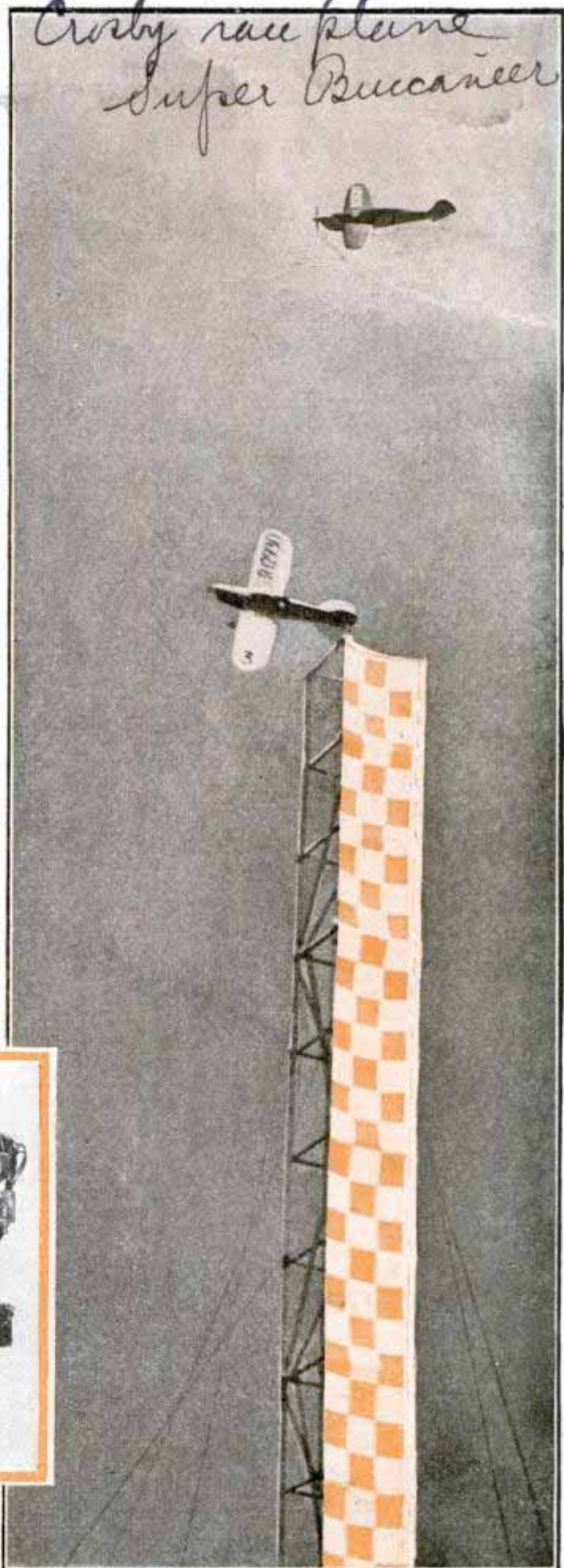

A 250-horsepower in-line racing engine and, at right, two racing planes rounding a pylon together. Both the pilot and the plane take a beating in this maneuver

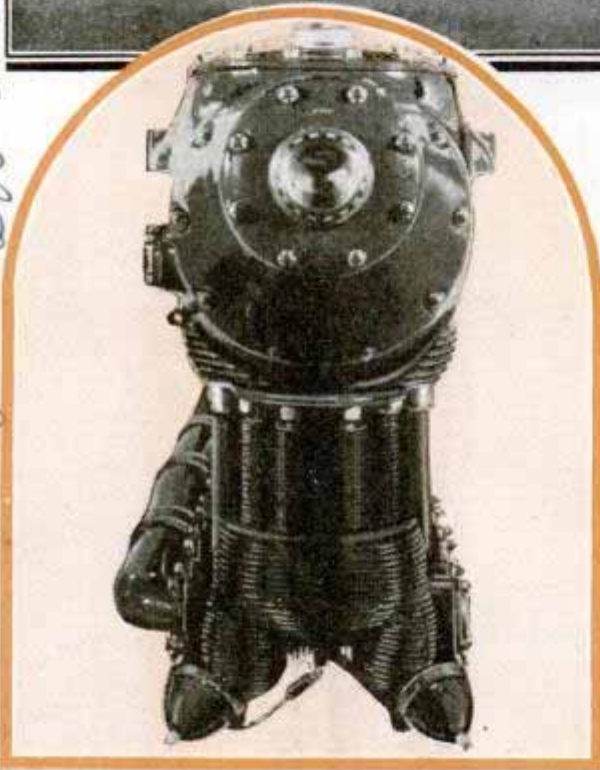
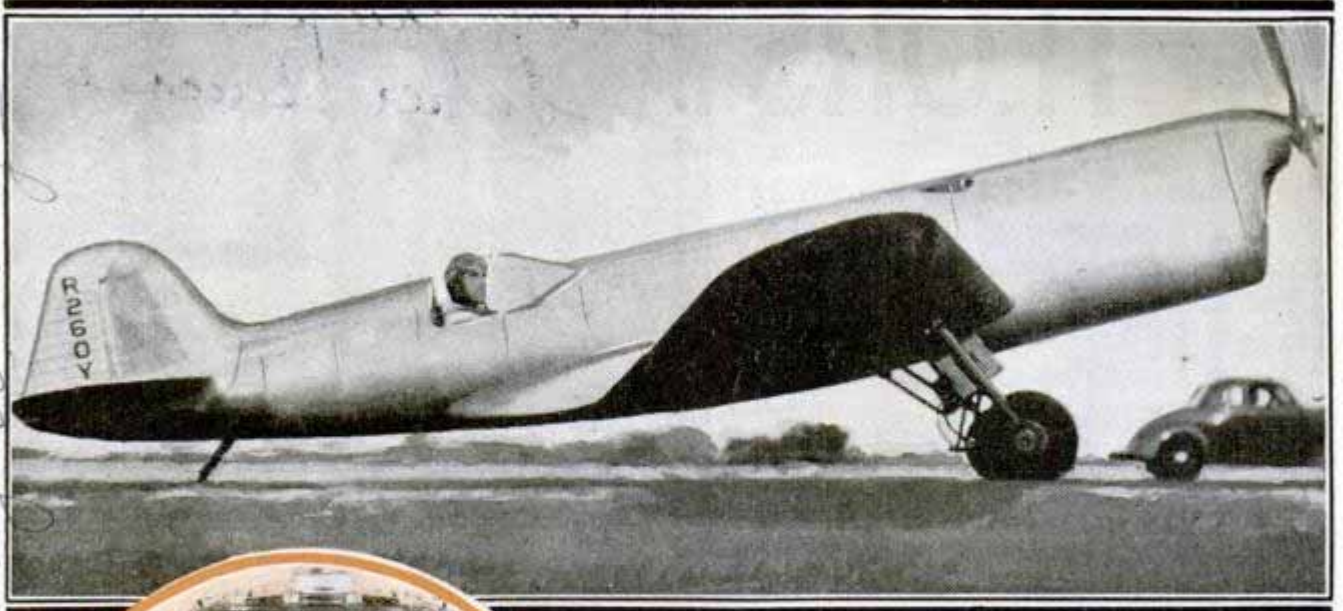

Modern racing plane and a 250-horsepower, in-line, air-cooled airplane racing engine

with transparent Pyralin. A heavy bounce is apt to throw his head half an inch above the cowling and without the tape the wind would rip the helmet from his head. Ortman lost a wrist watch that way a few years ago when he put one hand out to wipe away an oil smear on the windshield.

"The touchiest part of a contest is the 'racehorse start,'" says Ortman. "In this the planes line up across the field with engines idling and the pilots ready with one hand on the throttle. Then, at the drop of the flag, the planes roar down the field and into the air. The danger is that with the planes only a few yards apart one of them might veer from its course and crash into another. Once in the air it

is a free-for-all scramble to get around the first pylon. From that point the planes string out according to their speeds.

"The first few laps are usually the fastest since by the end of that time the leader has discovered how much faster he is than the next man and begins to throttle down so he will still have the lead but not strain his motor more than necessary.

"You might think that, once he gets into the air, a pilot can sit back and give all his attention to the race. It would be a lot easier if that were so. While jockeying through the traffic toward the first pylon his job is to get his retractable landing gear up. This may take a dozen manual operations, throwing switches, working the hydraulic hand pump, turning valves, and testing the gear to make sure the wheels are actually up. During the rest of a race the pilot keeps one hand busy adjusting the fuel mixture and occasionally switching from one fuel tank to another to keep the plane in balance. In between he must watch the different temperature-indicating instruments and turn a selective switch that shows the head temperatures of the individual cylinders."

The real racing occurs between planes with approximately the same speed. Then it is up to the pilots to cut corners and whip their planes around the pylons as close as they dare. With the planes equally matched, it is the pilot who flies the straightest lines and makes the fastest turns who wins. In one close race Ortman actually flew under a bridge that hap-

Menasco Mfg. Co. 6714. Mc Kenley Ave. Los Angeles Calif. 712

pened to be on the course just to avoid the delay of zooming over it.

Staying on the course is one of the hardest things that confronts a pilot. The checkered pylons are hard to see from a distance of several miles especially if oil wells or similar structures are in the vicinity. Sometimes a pilot who is busy banking his plane around a turn and at the same time keeping clear of other planes heads for the next pylon by compass, depending on the degree to which he changes course to point him accurately at the next marker.

Race rules say an overtaking plane must clear one being passed by at least 100 feet but in the heat of a

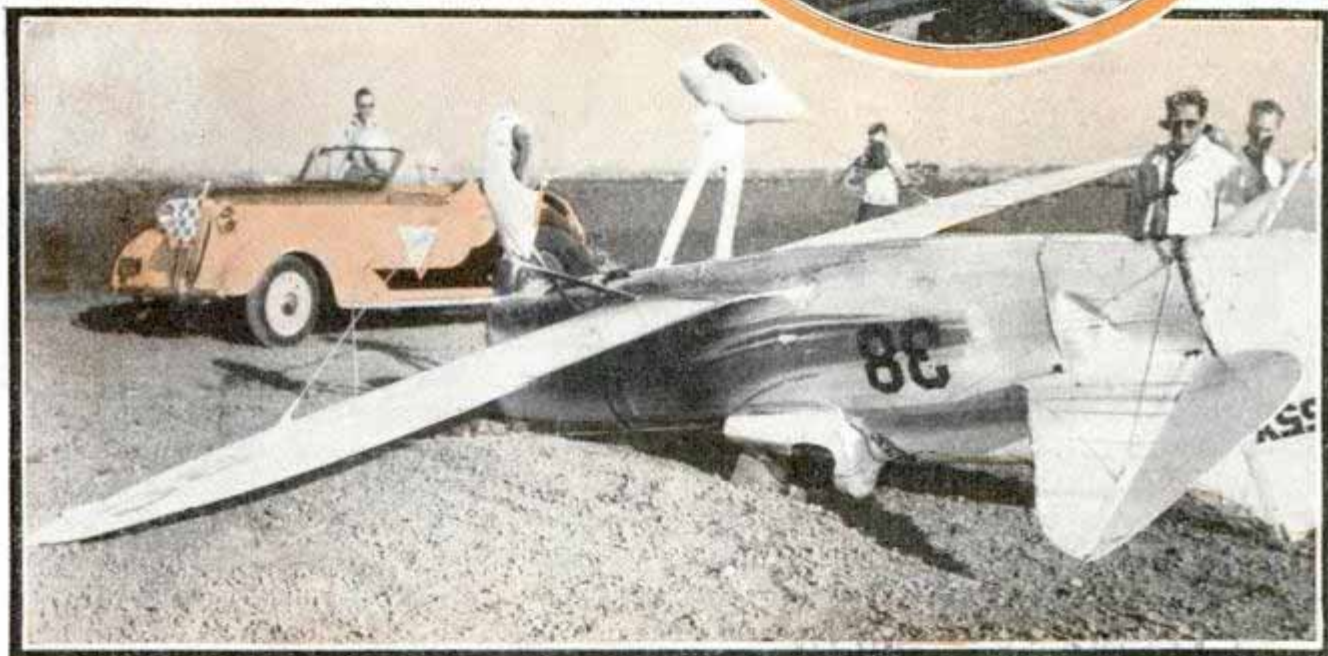
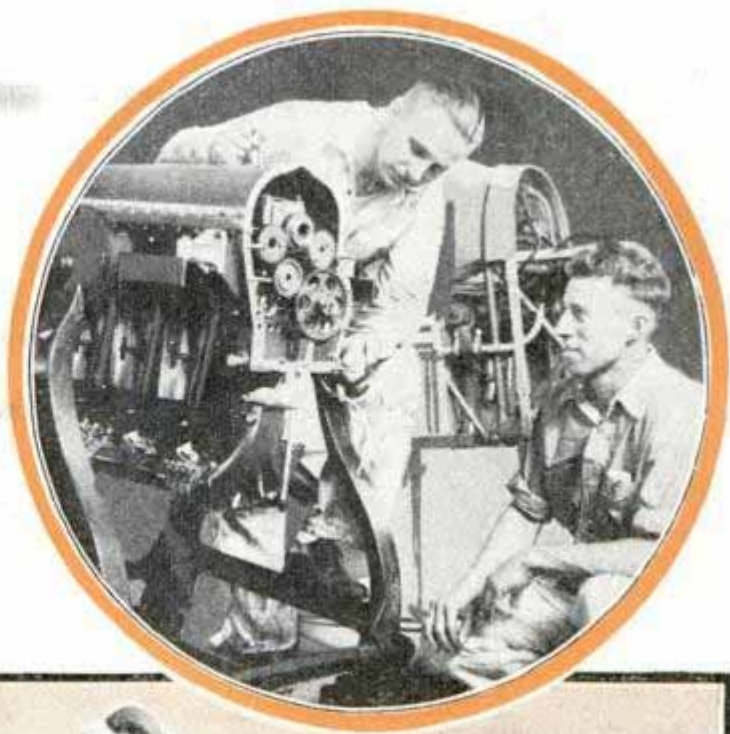

Top, inspecting air-cooled, in-line inverted racing engine and, below, wreck of a racing plane which turned over as it was landing at high speed

race one may pass within ten feet of another. When two pilots battling it out for the lead roar by, a slower pilot dodges out of the way if he sees them in time. He knows that at close quarters the revolving stream of air from one of their propellers may turn him flat on his back and possibly cause him to dive before he can regain control.

In the straightaways a pilot "freezes" onto the stick. To correct for every bump and lurch of the plane is difficult because at high speed a slight correction results in over-control. To prevent this the pilot locks the controls as much as possible. The control stick is adjusted so its top is only

half an inch under the instrument panel. The pilot holds the stick at its top with his hand squeezed under the bottom of the instrument board. This braces him against the tendency of the stick to kick around in rough air. With the stick held like this a pilot can perform any maneuver without moving his hand more than a quarter of an inch. Racing planes are so sensitive that a movement of a fraction of an inch on the controls is enough to make a tight turn or a steep climb.

Most pilots use the right hand to guide the plane. The throttle, fuel mixture adjustment, hydraulic hand pump, and me-

(Continued to page 116A)

Explorers Fly Camouflaged Plane into Jungle



but
Natives swiftly paddle their canoes out of the way as Mr. and Mrs. Martin Johnson pilot their flying boat, its cabin spotted like a leopard, just above the surface of a river in central Borneo

Their flying boat roaring down over lakes and rivers like some giant bird, Mr. and Mrs. Martin Johnson startled the natives of Borneo on their recent trip into

the jungle. The ship was camouflaged with painted spots like a leopard's. The Johnson's, noted hunters and explorers, gathered a cargo of wild animals in Borneo.

Engine Heat Regulator Gives More Warmth in Auto

Thermo. O. Sward

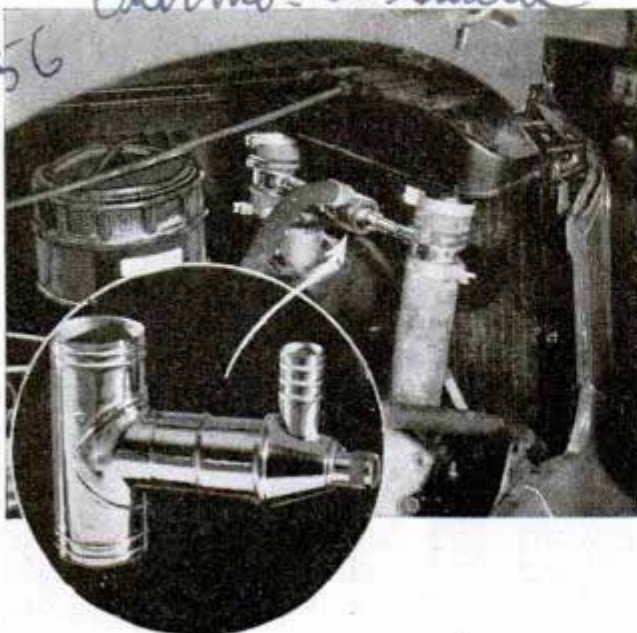

*Inset, heat regulator for straight "8" engine.
Above, V-eight installation*

Devised to warm up the motor faster and to supply more warmth to the interior of the automobile through the car heater, a thermostatic guard which operates automatically is on the market. Installed in the water circulation system, it cuts off the flow of cold water from radiator to motor and places the water pump in direct circuit with the heating system, thus circulating the water over and over from the motor through the car heater until the temperature is quickly brought to the proper intensity. When sufficient quick heat has been generated the thermostatic chamber in the device automatically becomes a safety valve and prevents overheating by releasing small quantities of cool water from the radiator at necessary intervals through the circulating pump

F1456

D. B. 6/30/38

Automotive Services Co.

direct to the motor. This in turn displaces a similar amount of hot water which flows out of the motor to the top of the radiator where it is cooled. The guard is made in two models, one for V-type and the other for in-line motors. No tapping or drilling is necessary.

F140

Giant Dirigible's Steel Skeleton Takes Shape

Slightly larger than the "Hindenburg," the German dirigible designated as the LZ-130 is taking shape in the Zeppelin works at Friedrichshafen. The huge steel framework of the craft, which is a sister ship to the "Hindenburg," is in place and soon the "skin" will be applied to the outside of the skeleton.

"Headless Woman" Illusion Is Latest in Crowd Thriller

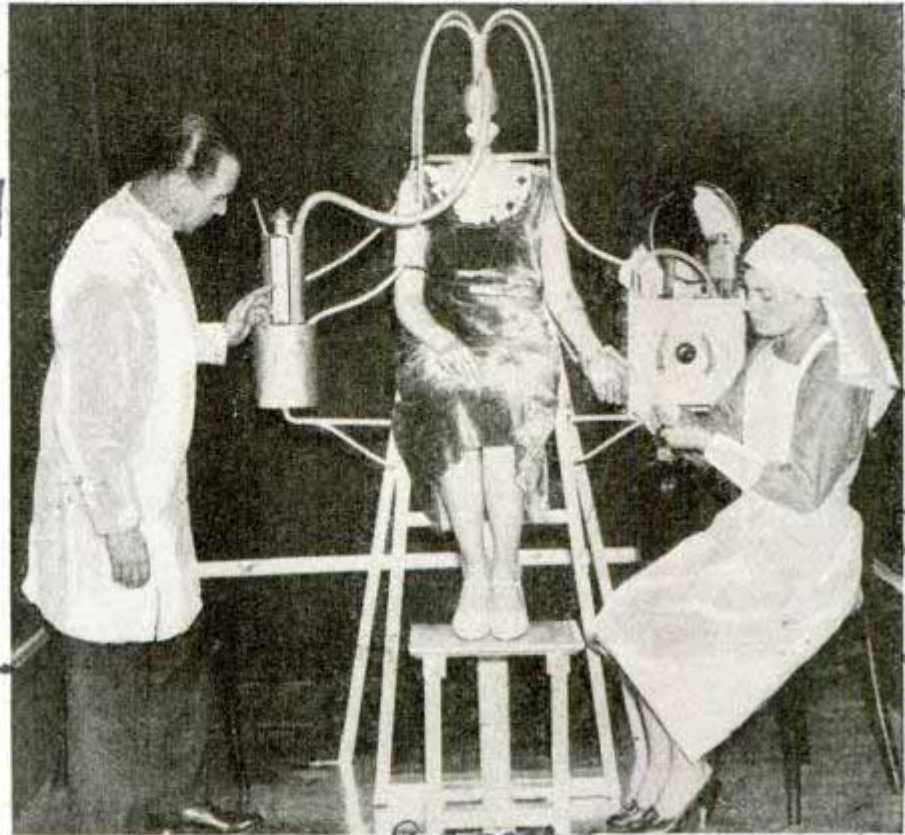

Doctor and assistant checking amount of nourishment and pulse of "headless" woman. Can you detect how this illusion is created?

Handwritten notes on the right margin:
The woman is...
The camera...
The illusion...
The amount of nourishment...
The pulse...
The amount of nourishment is indicated on dials. The camera fails to reveal the trick, but it appears to be similar to the head-without-a-body illusion featured in circus side shows for many years, which is accomplished with the aid of mirrors.

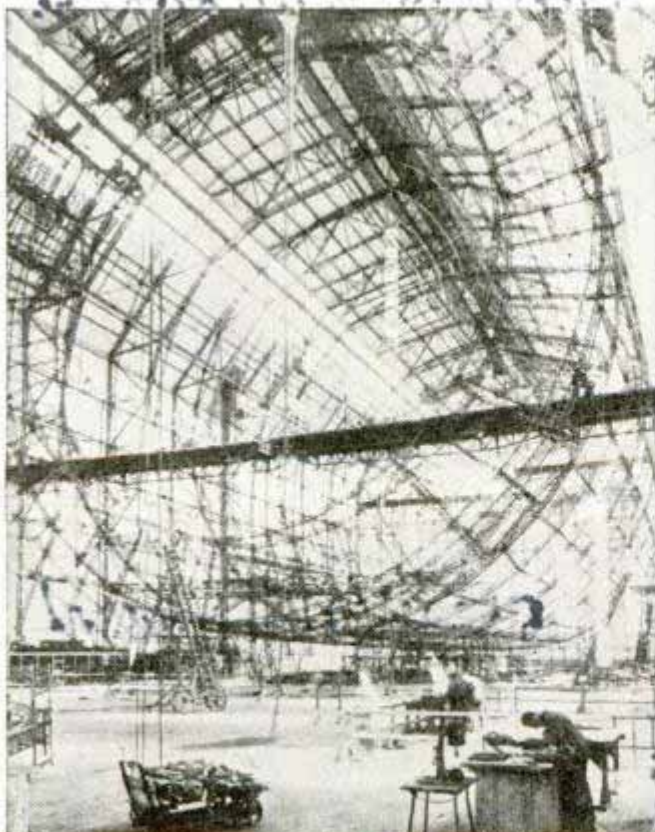

Framework of the "Hindenburg's" sister ship as it appeared recently in construction hangar

Crowds gather at a London store in the window of which is an apparently headless woman. The effect is heightened by a tube leading to the throat. Through this tube goes the food which the woman is supposed to consume and the amount of nourishment is indicated on dials. The camera fails to reveal the trick, but it appears to be similar to the head-without-a-body illusion featured in circus side shows for many years, which is accomplished with the aid of mirrors.

F1467

Age of Average Automobile Is Nearly Five Years

By analyzing passenger-car registrations, engineers have found that the average motor car now in use is 4.71 years old. Since the survival life of an automobile is 8.4 years, the average car is now well past "middle age." Sixty per cent of all the cars in use at the end of 1935 consisted of the three low-priced makes, 10,845,295 out of 17,896,616 cars.

Handwritten notes at the bottom:
Scene Service 11/4/36

Pedestrian Lane Markers Flash Traffic Signals



Pedestrians may cross when stud in street shows green light like traffic signal

Illuminated from within, studs marking pedestrian lanes at some of the busier intersections in Paris flash red, amber or green to match the traffic lights. Thus, when the traffic lamp tells the pedestrian to stop, a line of red dots extends across the street. A line of green dots tells the pedestrian when he may cross. The studs which are made of metal, have a glass window on the side toward the walker, through which the lights are visible.

Electric Light Easily Installed in Any Refrigerator



If your refrigerator is not equipped with light, you can install in a minute a unit which automatically makes contact when you open the door and floods the interior

with light. It is easily fastened to the refrigerator shelf, bulb pointed inward, and a plunger shuts off the light when the door closes upon it. Dry cells are used. It is rustproofed and fully protected against contact with liquids.

F1476

Revolving Floor Displays Cars in Modern Showroom

Among the features of the modern automobile showroom are a revolving floor for displaying the cars, scientifically designed display lighting to eliminate glare, invisible glass windows, escalators, a motion-picture room, air conditioning and scientific acoustical characteristics. A showroom of this type recently was opened in New York by the Chrysler corporation. The circular revolving floor, fifty-one feet in diameter, is set flush with the floor and moves around an "island." It turns silently on roller bearings at a speed of four revolutions per hour, being powered by electric motors beneath the floor. Rising from the island in the center are two escalators which carry visitors to a large salon on the second floor. Both the escalators and the big turntable are controlled from a central electric panel on the first floor

Machinery Builders, Inc.



Pointing to separation between floor and revolving platform in auto showroom

and by convenient emergency buttons. Lighting of the first floor consists of one-color illumination arranged to obtain one-half or full intensity. Duplex fixtures in the room provide spotlights and special lighting effects. The interiors and undersides of the cars on the revolving floor are illuminated from receptacles on the floor.

55 W. 16th Street New York

Bates and Gates, etc. etc.

M. B. Early, Inspector General, 9. Place de l'Hotel de Ville, Paris

Inter-national Automobile Salon

Designed and installed by

London Broadcasts Daily Television Program

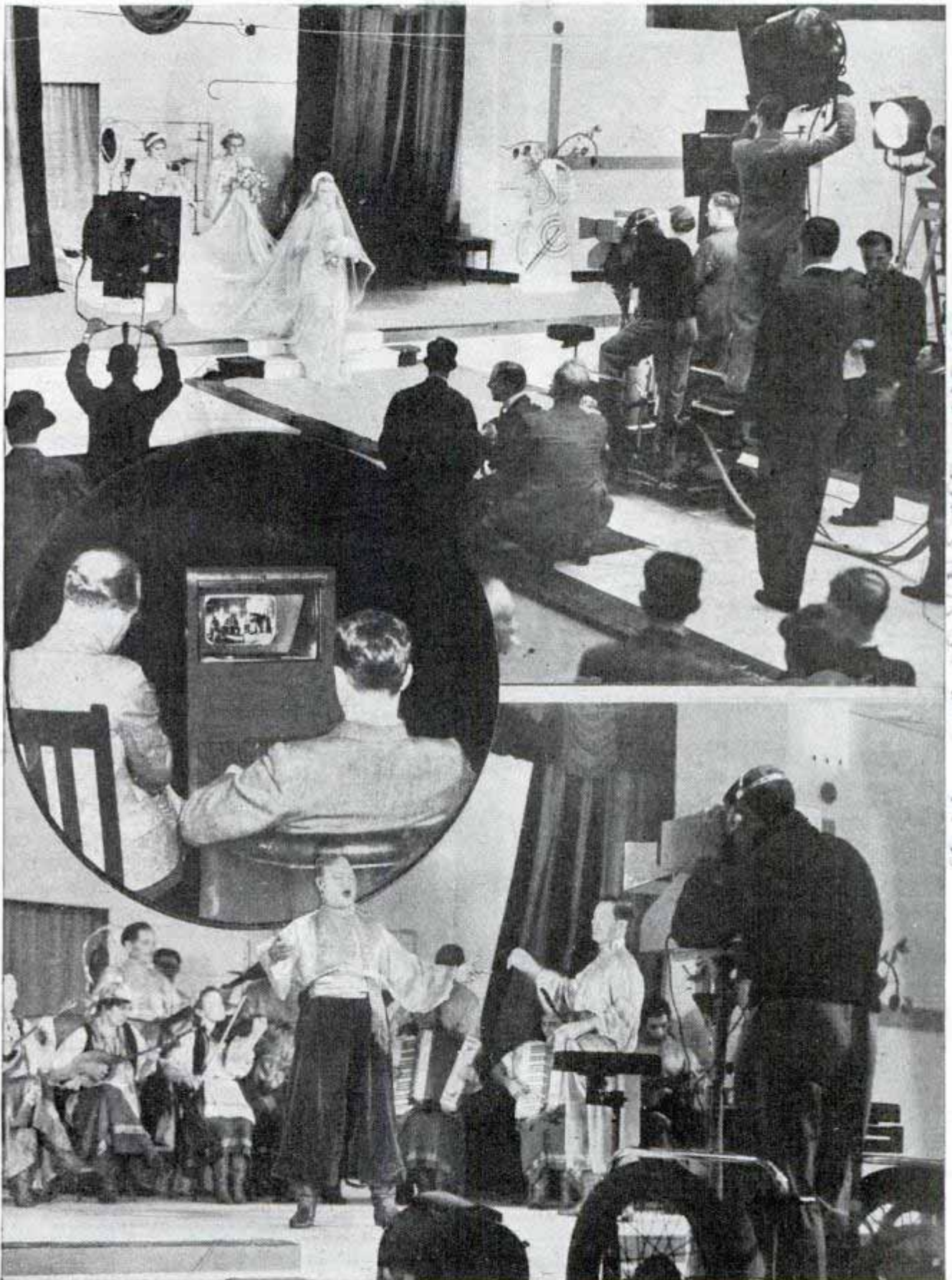

Photos © Harris & Ewing

Television programs now are being broadcast each day in London, both the direct and film process being used. Top picture shows television camera being employed for direct transmission by Marconi system and, in circle, watching the broadcast on cathode-ray receiver. Bottom, using television camera to broadcast image of singer

E. M. J.

F1462

Carl Thomas & Stinson Jr. 10555 Holman
Cen. Los Angeles Calif

... "TUNING IN"



are all exceedingly color blind and can see only a little of the light the stars radiate," remarks one of the astronomers of the Carnegie Institution. "Our eyes are tuned to receive only a small segment of the whole light spectrum. They might be compared to a radio receiver that tunes across a narrow band and misses the rest of the broadcasts that are on the air. The stars radiate a great deal of invisible light that we



Picture of stars as seen in telescope and, above, metal plate ruled with 15,000 parallel lines to inch, used for studying visible and invisible light in spectroscope

BEAMS of invisible light, short-wave radio messages and "atom-smashing" rays are the latest tools of astronomy. Starlight alone tells only part of the story of the heavens and now scientists are fingering radio dials and operating weird "cosmic-ray telescopes" in their study of the stars.

"You might say that in a broad sense we

cannot see without some special means."

Light itself is only a narrow section of the entire electromagnetic spectrum. Energy on many other wave lengths aside from light is being radiated by the stars and today the problem is to "tune in" on the stars on as many wave lengths as possible. One of these wave lengths happens to be radio.

7/14/62

on the STARS

For several years radio research men have been puzzled by mysterious signals in the form of a steady hiss received on 14.6 meters, along with static from local and distant thunderstorms. There is nothing secret about the signals and you can listen to them yourself if you have a powerful enough receiver and can get away from local interferences.

Sweeping the skies with

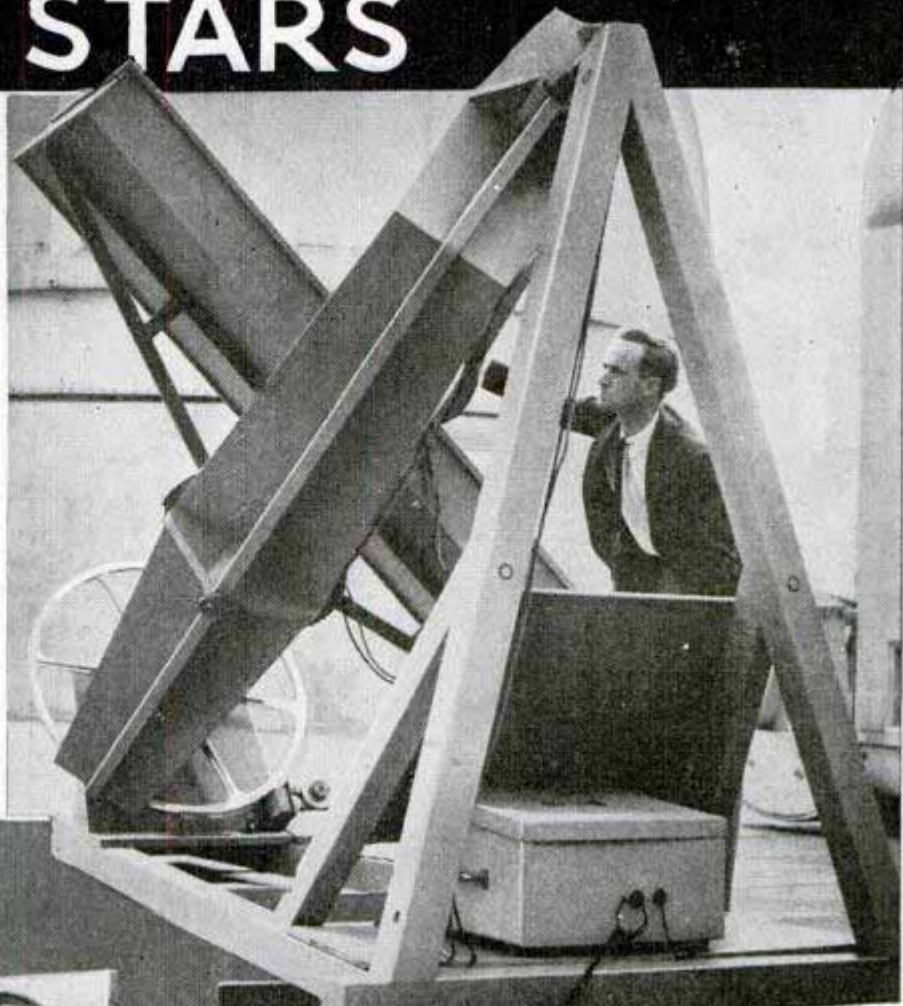

Top, cosmic-ray telescope which "rings up" incoming rays on counter. Below, using cathode-ray tube as sensitive voltmeter to measure the strength of radio signals from space in an effort to determine their source

a directional type of antenna to learn where the signals were coming from led to the discovery that the hiss originated at some point away from the earth. At first it was thought that the sun was acting as a giant broadcasting station because no matter in what part of the sky the sun

happened to be, the signals seemed to be coming directly from it. But later the direction of the signals shifted and started to precede the sun. Then a new source had to be found. After a year of patient listening the origin of the strange static was traced to a fixed area in space near the center of the Milky Way system.

Last summer at the California Institute of Technology the signals were studied with the aid of one of the most powerful receiving stations ever built. The ignition of an automobile half a mile away or static from a vacuum cleaner or electrical refrigerator at that distance is enough to blast in the earphones. The sensitive fifteen-tube set can pick up a thunderstorm half way around the world. To escape from man-made interference the station was set up in the Mojave desert and the "messages from the universe" were measured with a sensitive vacuum-

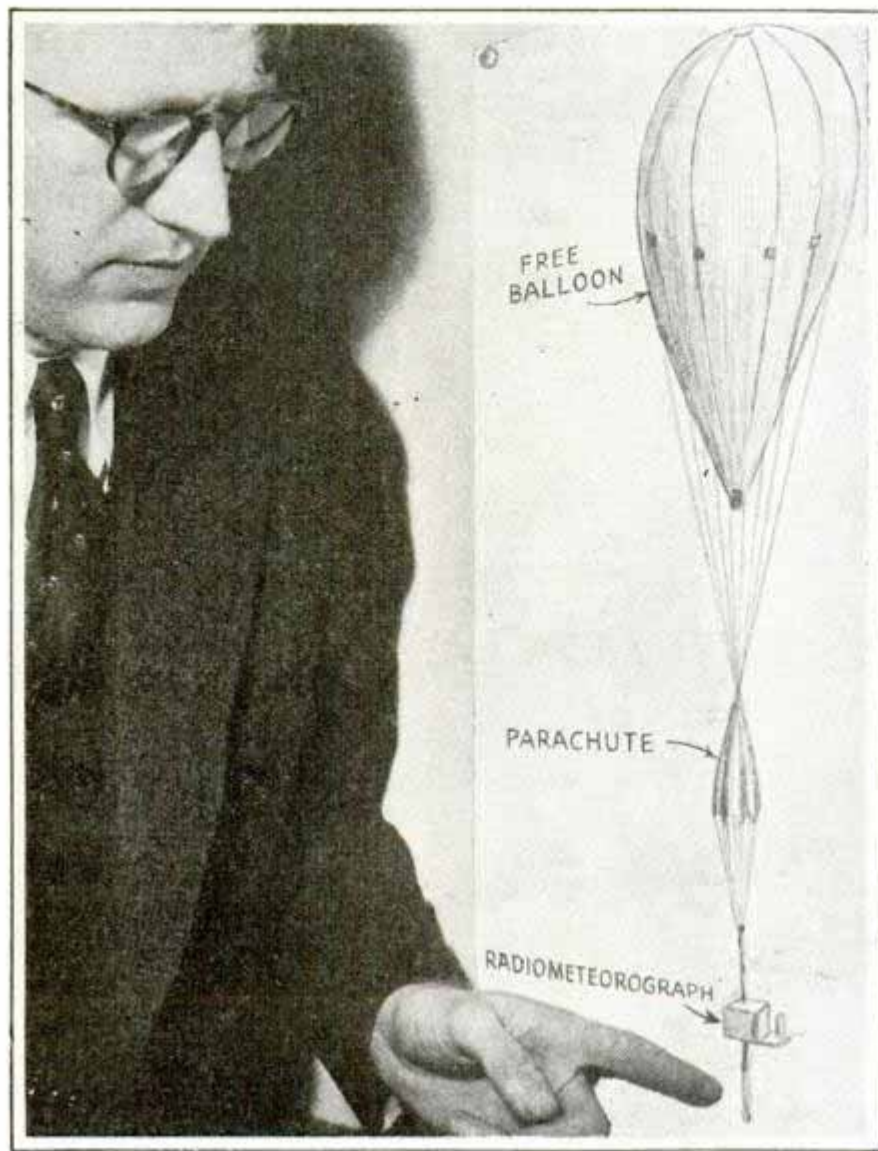

picked up by other dust particles that have lost some of their own electrons. The re-absorption of the electrons leads to the radiation of electromagnetic waves. The frequency of the wave depends upon the size of the dust particle and it happens that the average size results in a broadcast on 14.6 meters. At least, this is what the scientists think.

An example of wavelength change something like this happens when sunlight strikes a black pavement in the summer. The light is reflected back as heat, which is still the same kind of energy as light. In this case the pavement acts as the transformer that changes the wave length.

You may think of radio waves as extremely low-frequency light waves, if you like. At the other end

tube type of volimeter. So far the identity of the celestial broadcasting station remains a mystery. The latest idea is that instead of originating on some distant star the radio waves are actually created by dust particles in space. Space is usually thought to be devoid of all matter but it is estimated that the earth picks up something like a pound of meteor dust and other material every hour as it moves around the sun. Throughout limitless space an average of one dust particle possibly one-millionth of an inch in diameter may occupy every 100 cubic miles. The theory is that these particles act as transformers and change light waves into radio waves.

What happens, the scientists think, is that light from a star strikes a dust particle and causes it to emit electrons. These shoot through space and eventually are

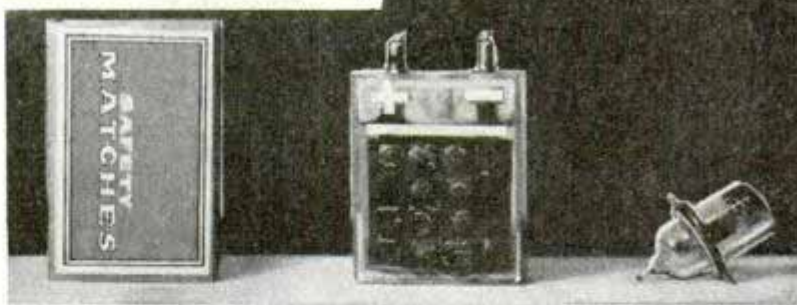

Drawing of stratosphere balloon and parachute carrying instruments for studying cosmic rays and, below, size of storage battery and radio tube carried by balloon compared with matchbox

of this energy scale, in which light waves are about at the middle, are the high-frequency waves called cosmic rays. In between radio and light are heat waves and infrared waves, and between light and cosmic rays are the ultraviolet, X-rays, and Gamma rays.

The stars radiate ultraviolet light and there is no doubt that they also give off X-rays, although the earth's atmosphere effectively screens out most of them. Cos-

mic rays, however, are able to pierce the atmosphere and in these the scientists have available another wave length for star study. Like the radio signals, the cosmic rays are thus far a perplexing puzzle. No one as yet has found out how or where they are created. If they could be "manufactured" artificially like light or radio they might be easier to understand.

Recently research workers at the California



Quartz crystals, above, before they are ground, and finished natural quartz lens for studying invisible starlight. Below, movable chart of Milky Way used in finding direction of radio signals from the heavens

scope seems to have deepened the mystery. Day after day, the report was: "The rays are coming from directly overhead." The signals were strongest when the telescope was pointed at the zenith and faded in intensity when it was turned toward the horizon. The trouble is that "directly overhead" means nowhere in particular. It represents a different point in the heavens every day in the year. The signals are strongest from overhead, it seems, because there is less air directly above to weaken the rays.

If an ordinary star is responsible for cosmic rays the sun should be a strong near-by source. Scientists have had to rule this out because reception of the rays

Institute of Technology built a "cosmic-ray telescope" with which they hoped to find out where the rays come from. The strange device was placed in an equatorial mounting so that it could be pointed toward any part of the sky. The telescope consists of four vacuum chambers in which the rays are detected, arranged so that the recording apparatus "rings up" the reception of a wave only when the ray passes through all four tubes. This means that the telescope should work best only when it is pointed directly at the source of the rays.

Instead of solving anything, the tele-

seems to be constant night and day, no matter where the sun happens to be.

One theory is that cosmic radiation is released during the vast explosion that occurs when a normal star "blows up" into a super nova, increasing its brilliance many hundreds of times. This only happens about once in 700 years in every galaxy of stars like the Milky Way. Since the explosion may last only a few weeks, and cosmic-ray reception seems to be constant year after year, the theory suggests a universe tremendously larger than can ever be surveyed with telescopes.

(Continued to page 118A)

Los Angeles, Calif
Symphonic.

Piano Kept Always in Tune with Tubes for Strings



Tones are produced on this piano by striking metal tubes instead of strings. Notice its curved keyboard

Instead of strings, a piano recently invented by a Californian has metal alloy tubes which produce a tone similar to that of a small piano or harp. A practical element is that these tubes are always in tune. The keyboard is slightly curved and has a four-octave span. The instrument is quite compact and weighs only 150 pounds.

Queer-Shaped Racing Auto Sets Speed Records

Speeding over the new Frankfort highway in Germany, Rudolf Caracciola recently established two new records, one for the kilometer and one for the mile.



German racing car is shown as it sped along highway on record trials

The car in which he established the marks is odd looking. Its rounded shovel-like nose has an opening resembling the air scoop used on another racing car to aid in cooling the engine.

Wavy Lines on Road Warn Driver of Intersection

Wavy lines for 200 feet on each side of a dangerous intersection on a road in Los Angeles constitute a new method of warning motorists that they are approaching the corners. The lines are expected to be

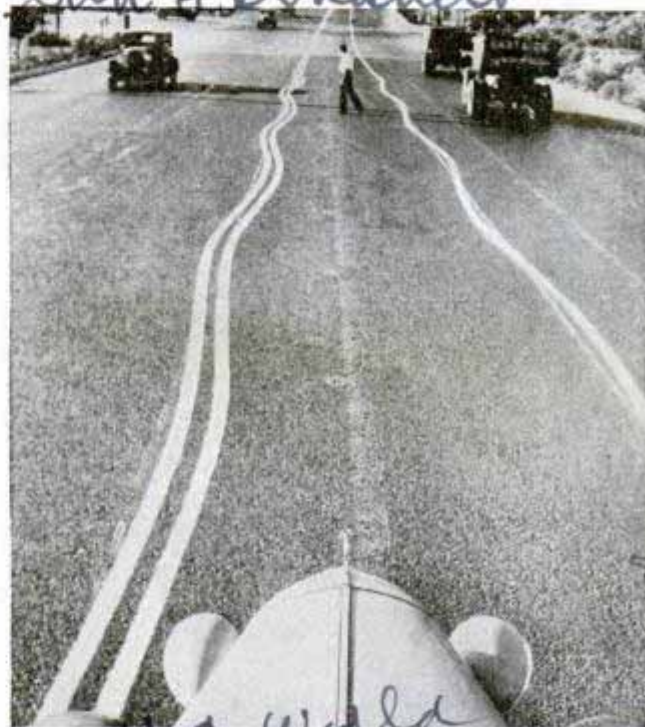

Wavy lines defining traffic lanes warn driver of dangerous intersection ahead

especially helpful to the driver following the straight white traffic lines on foggy and rainy nights, warning him before he enters the intersection.

Ear Is an Imperfect Microphone Adding to What It Hears

From the scientist's point of view the human ear is an imperfect microphone which adds harmonics to the notes it hears. Actually, physicists say, it is difficult to prevent any sound-detecting device from adding overtones which were not present in the original sound. The ear does not pass sound vibrations on to the brain exactly as they were received, but adds other higher tones.

Harry F. Noakes 585
Phonograph, Air
Sheira
Madre
Calif

Mercedes-Benz

F1448
German law driver
Mr. S. S. Newman
Calleres

Super-Speed Plane Is "Eye" of British Army

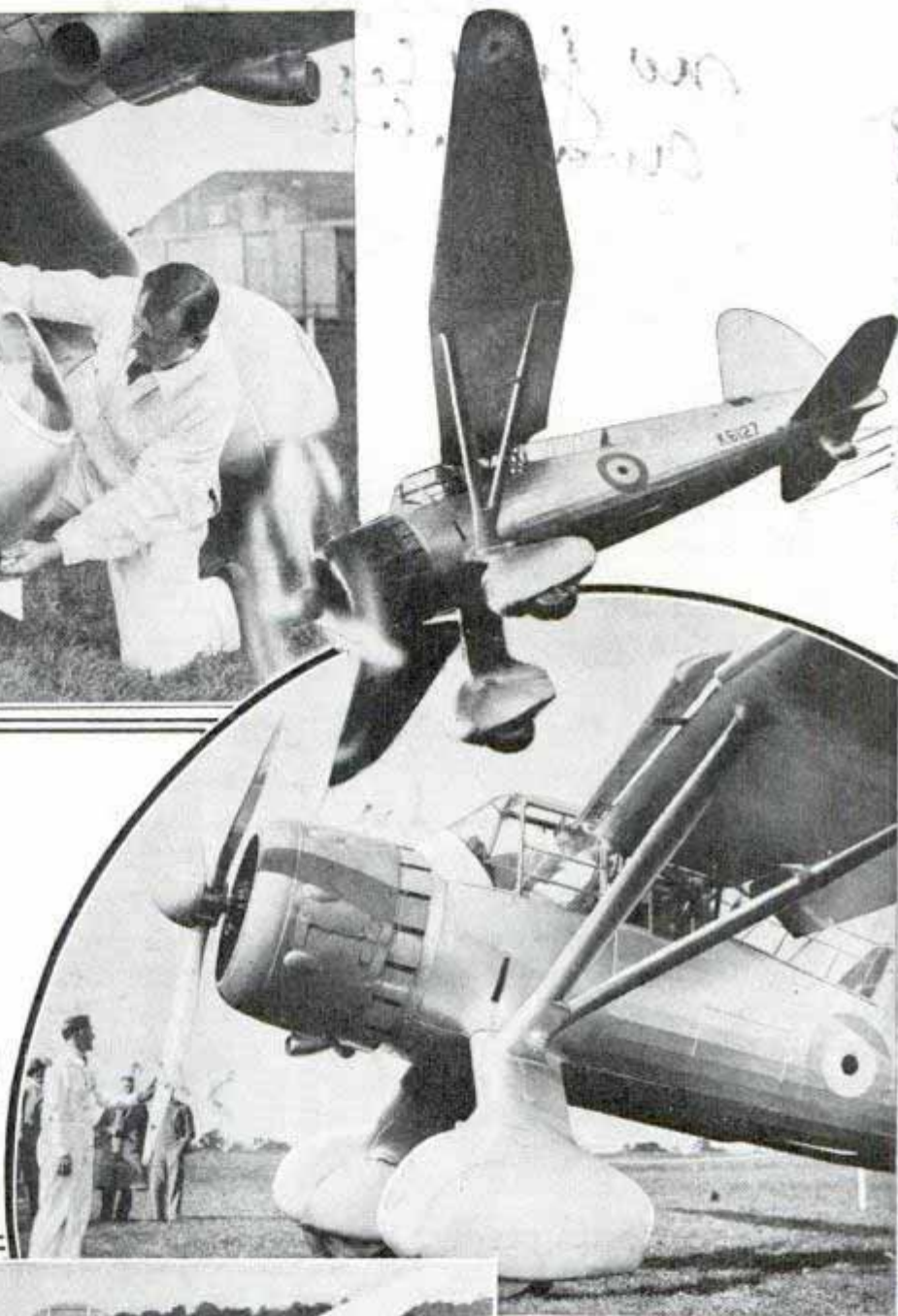
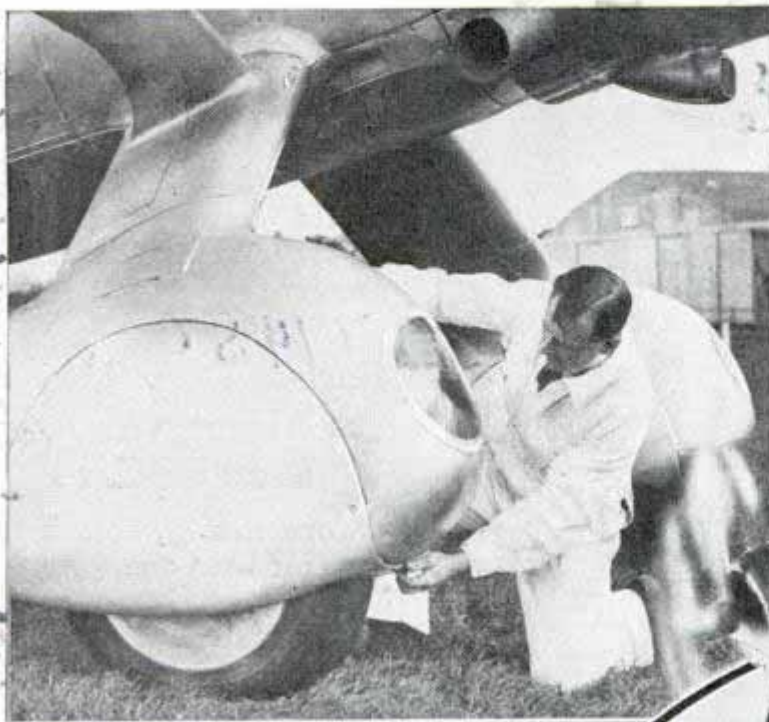

Photos © Planet News, Ltd.

Its speed has been kept a close secret, but this British army ship is understood to be one of the fastest fighting planes built. Known as the Westland army cooperation plane, it is to be the "eye" of the land troops, its duties including artillery spotting, aerial photography and reconnaissance work. In the picture above are seen the removable "spats" which enclose the landing wheels and the headlights for night landings

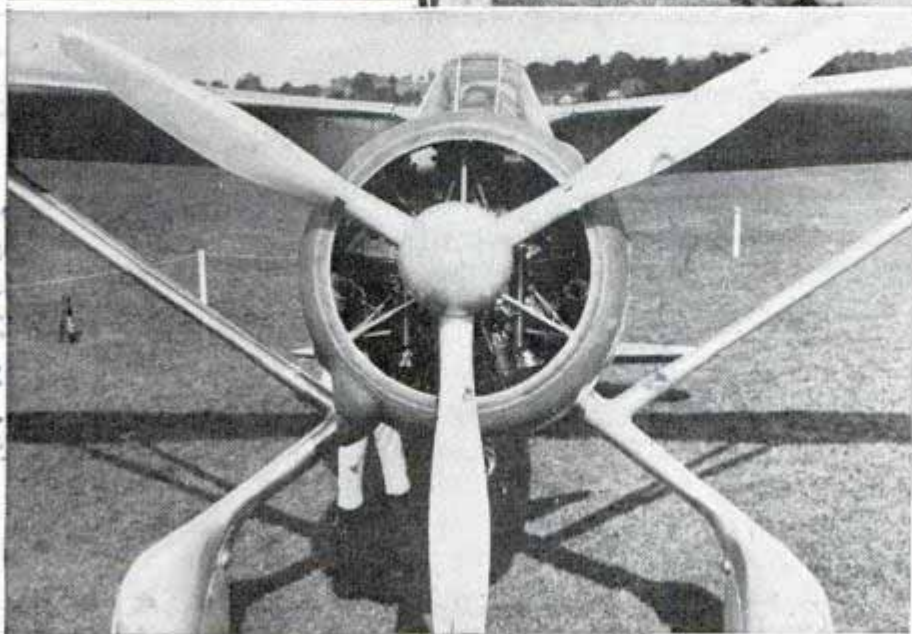

Acme

In the space of twelve months this high-wing monoplane was designed, built and put through demonstration tests. The top picture shows the speedy ship on a test flight, and in the middle it is on the line ready for inspection. Notice its rugged bracing and the long, glass-covered cabin. At the left is a head-on view revealing its unusual landing gear, bullet-shaped body and three-bladed propeller. This is the first of a fleet of super-speed planes of similar design destined for aerial liaison duty

Electric Pump for Oil Well Replaces Familiar Derrick

*Democratized by C. L. Bush
Los Angeles, Calif.*

*No further data
available*

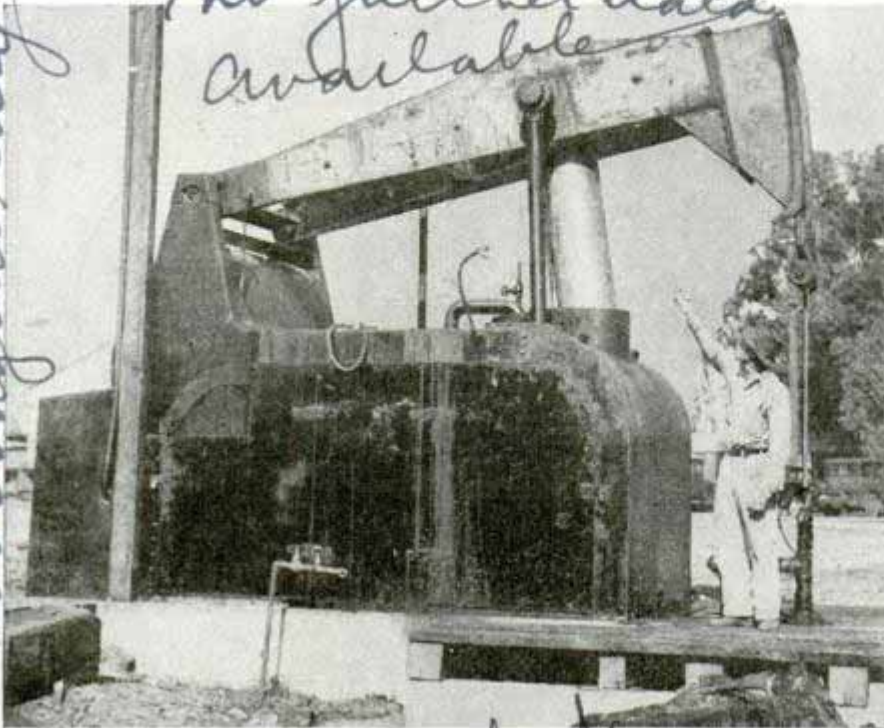

This heavy duty hydraulic pump, operated by electricity, has taken the place of the traditional derrick in a Los Angeles oil field

Landmark of the oil field since the industry was born, the trelliswork oil derrick may be outmoded by the latest hydraulic pump. Electrically operated, it is designed for heavy duty and is already in service in the Los Angeles oil fields. The new pump is said to work faster and more quietly than the derrick.

out the timbers, resulting in excessive shrinkage and checkage, so engineers determined the best atmospheric conditions for the wood and installed an air-conditioning system to circulate clean air heated for the comfort of visitors and humidified to preserve the wood.

~~F1450~~ Garage Door Lifted by Motor without Leaving Car

Turn a key, touch a button and the garage door rolls up. It is as easy as that to open or shut the rolling steel doors recently placed on the market. Since they are the lifting type, they are unaffected by winter snow and ice, and being steel they do not warp and

jam. Beside the driveway is a post in which you can insert a key without leaving the car, unlock it, then press the button operating a magnetic switch and a motor hoists or lowers the door.



Motorist opening his garage door by pressing electric button after turning key in post beside driveway

Air Conditioning Helps Save Timbers of "Old Ironsides"

F1519

Air conditioning has been installed on the historic old frigate, "Constitution," as part of the precautions being taken to preserve the wood in the gun and berth decks. Many of the original timbers in "Old Ironsides" deteriorated and were renewed, years being spent in searching for replacement wood of the proper quality and seasoning. The yellow pine originally was obtained in South Carolina and Georgia while Massachusetts and Maine provided the white oak. During the winter, the gun and berth decks are heated for the comfort of visitors to this old ship. Installation of a simple heating system would reduce the air's relative humidity and dry

*\$42.50 } job
47.50 }*

*Carrier Corp.
850 Franklin Street
New York, N.Y.*

*Columbus, Ohio
Friedrich Co.
3000
Jannet City Co.*

71426

914 S. Answorth Ave

Tacoma, Wash

Experts Scale Giant Stacks on Repair Jobs

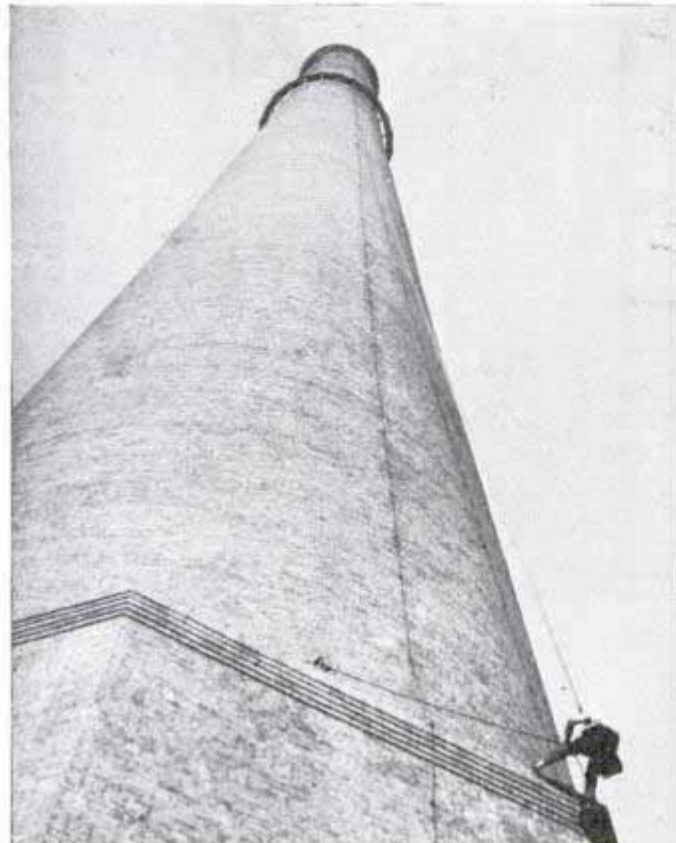

Stack worker on the job. This particular stack is more than 500 feet high. Right, worker preparing to ascend. Note small seat on which he sits to repair brickwork hundreds of feet in the air

Repairing the giant stacks of smelters is an occupation which keeps a small group of experts busy in the Rocky Mountain region, as far south as Mexico and out to the Pacific coast. The work is surrounded by danger, the men sitting on boatswains' chairs or big galvanized buckets filled with cement attached to a rope sometimes 500 feet long. The wind swings the repairmen into the air, then back against the rough brick of the stack. The men also work on a platform set on brackets tied to the stack by a steel cable. Although there is no guard rail or rope the workers walk around the platform without thought of their danger. Smelter stacks grow old in twenty-five to thirty-five years, due to the chemical action of fumes in the stack. The chemicals deposit on the inside of the stack and then become sulphated from sulphur fumes and expand, causing cracks. Windstorms and lightning are other causes of stack failure. The repairmen's job is to remove crumbling brick and mortar and put in new brick with a special plastic cement. Steel bands to strengthen the stacks are installed frequently. Concrete also is used

Tacoma

in the construction of stacks. It is cheaper than brick, but does not last as long and repairs are difficult. Lightning and windstorm cracks were repaired recently in Tacoma, Wash., on a 575-foot stack. Thirty-nine feet in diameter at the inside of the base and twenty-five feet at the top, the stack contains 2,400,000 bricks.

71432

Equal Cuts of Pie Are Marked by Notched Rim of Pan

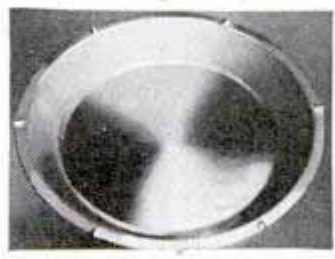

Making it easier for the housewife to serve equal cuts of pie, the rim of a new pan is notched. Prior to baking, the pie-crust is pressed

down over die-formed V-humps halfway across the rim of the pan. The hump or notch is made only half way so covered pies may be sealed as effectively at the notch as elsewhere. During the baking, the pie shrinks away from the humps and the resulting notches mark the line of cut even after the pie is removed from the pan.

Washington S. Culver, chd

W. W. Mutton Cloth

Runs Itself

efficiently, effortlessly. An electric oil furnace keeps the house at an even temperature, an electric range turns itself off when food is cooked, an electric refrigerator makes ice without attention, an air conditioner, a room cooler, a dishwasher, a washing machine, an ironer, a dryer, a garbage preventer and a score of other tools used by Annie operate with a minimum of supervision. To transform his house into an all-electric home, Mr. Ripley in a period of about nine years has acquired electrical household equipment

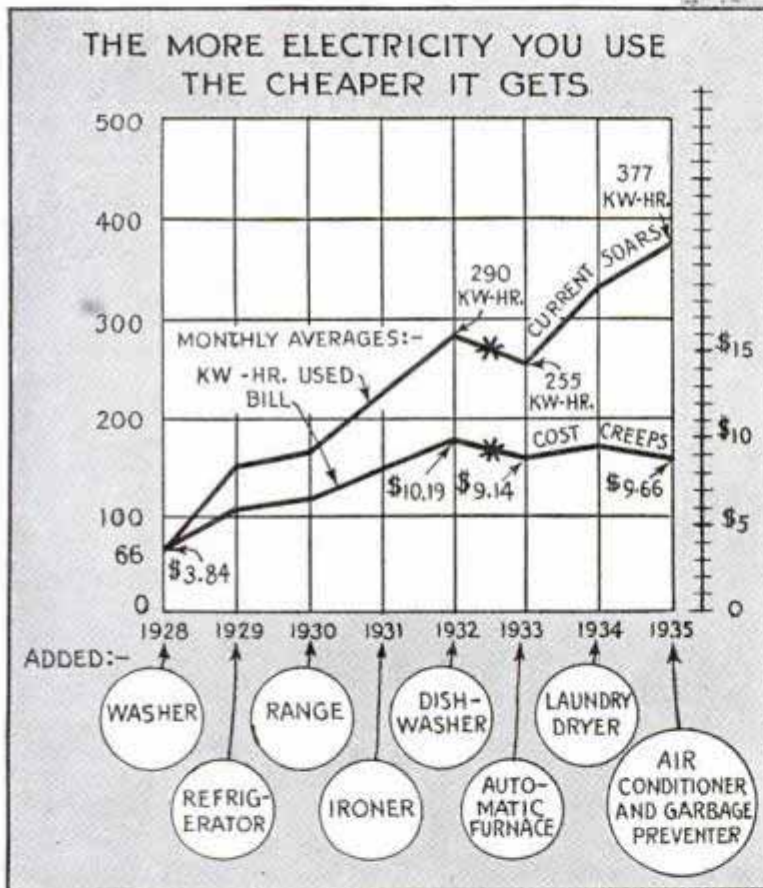

Photos Courtesy General Electric Co.

Chart showing how cost per kilowatt-hour goes down as consumption goes up. Top, light under lily pad which illuminates fish pool so it can be enjoyed after dark.

which is valued at more than \$2,000.

"Ah, hah!" you exclaim, "I knew there was a joker somewhere. So you need \$2,000 worth of machinery to do all this?"

Well, the joker isn't where you think it is. It's true that Annie, the electrical maid, can't work without tools and it's also true

that she uses equipment in Mr. Ripley's home which he estimates is worth more than \$2,000. But here's the joker. Mr. Ripley says this \$2,000 worth of equipment didn't cost him a cent and he supplies figures to prove it! Let's allow him to do his own arithmetic.

"It's like this," says Mr. Ripley. "A washwoman used to come to our house every Monday. We paid her three dollars, lunch and carfare—\$15 a month. We didn't need the laundress after we bought the electric washer—terms, \$10 down and \$14 a month. In less than a year we owned a \$165 washer, paid for with money which otherwise would have gone to the washwoman. The 'juice' to run it cost \$1.25 a year, also paid out of the laundress' wages we saved.

"Well, once we owned the washer, that \$15 a month we had been paying the laundress began burning a hole in my pocket. So we bought a refrigerator for \$250—terms, \$10 down and \$20 a month. We paid for that with the \$15 a month saved on our washing plus about \$6.50 a month saved on ice and food formerly spoiled. The refrigerator made the electric bill go up \$1.25 a month. This too, was paid out of savings.



see Jan. mags.

which we couldn't measure in dollars, but there was another angle too.

"For every bright, shiny, new appliance that came into our home, half a dozen old-fashioned, unhandy and often unsanitary things went out. Consider for a moment what we got rid of. Our cellar used to be shunned. It was cluttered up with coal, ash cans, kindling, papers, pokers, shovels and a big coal bin which took up one end.

"By the end of the second year, we owned both a washer and a refrigerator, paid for out of what we had been paying the washwoman and for ice and spoiled food. Our plan certainly was working. We decided to keep on going, using the money saved by the present appliances to buy the next. The third year we bought a \$250 electric range. Our old stove was turned in for the down-payment. All the other payments of \$20 a month each could have been made with the money saved by the refrigerator and washer. But in addition, we saved the gas bill for cooking and we found we saved on our meat bills. The electric bill for the range averaged \$2.28 a month.

"At the end of the third year we had a \$250 range, a \$250 refrigerator and a \$165 washer, all paid for by savings these machines effected for us. We bought everything else the same way, using the money saved by all the previous appliances to buy the next one, and never buying the next one until the last one was paid for. Of course, we were enjoying better food and many comforts, conveniences and services

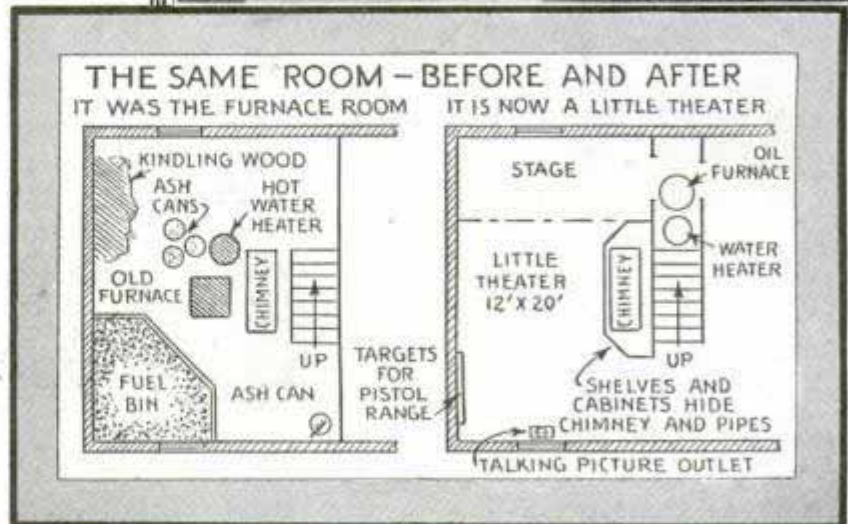

Top, getting a morning workout in the electrified home. Center, sun lamp mounted over bath tub. Bottom, the basement of the electric home before electrification and afterward

The electric oil furnace got rid of all of them and the cellar is now a recreation room. We got rid of dish washing and drying, sooty pots and pans, scrub boards, dishpans, garbage cans, rug beaters—we even got rid of matches.

"Now let's recapitulate. The entire elimination of some expenses and the reduction of others under the old system, saved enough cash to buy all the modern appliances we use today. Here are the figures. Before we had the automatic furnace we used two fuels—coal and gas—which cost \$14.13 per month. The new furnace uses one fuel—oil—which costs \$9.29 per month, or a saving of \$4.84 per month. The washer saved \$15 a month paid out for a laundress. The refrigerator saved \$6.50 previously paid for ice and lost in spoiled food. That's a decrease of \$26.34 a month."

"But," you shout triumphantly at this point, "what about your light bill? If you're running the whole house with electricity, someone has to pay for all the extra 'juice.' How about the light bill?"

"Ah, yes," replies the man whose home runs itself, "the light bill. I had almost forgotten that. Well, when we began our program of electrification our light bill averaged \$3.84 per month. Now that we have finished, we find that we are using six times as much electricity as we used to. But we don't pay six times as big a light bill. We pay about two and one-half times as much as we did when we started. Our average bill now is \$9.66. Deduct the difference, \$5.82, from the \$26.34 we saved by electrification, and you have a net decrease per month of \$20.52. That's \$246.24 a year—almost five per cent interest on \$5,000. I'm glad you mentioned that light bill."

When you buy electricity, you buy work. You can't see the current that does your work but it can be measured far more accurately

(Continued to page 124A)

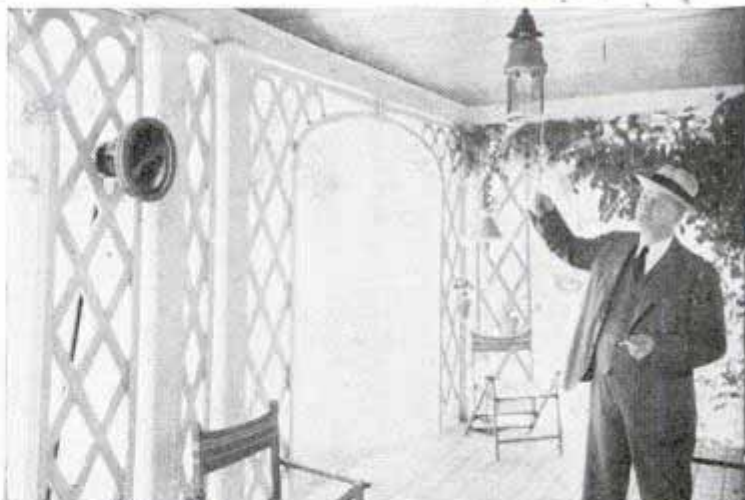

Mr. Ripley pointing out the bug killer on his porch. At left is a colored light which illuminates the porch when there is a party



Putting on a trick lighting entertainment in the basement of the Ripley home. Kindling and ash cans used to occupy the space where this little theater is

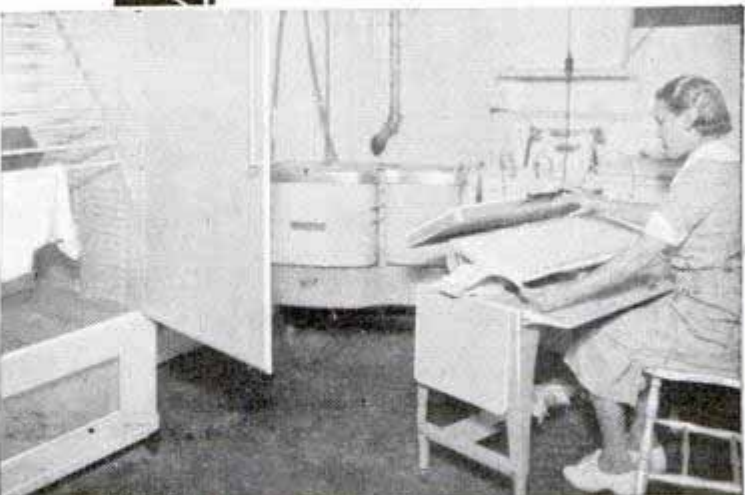

Wash day in the electric home. The electric ironer is in the foreground, the electric washing machine in the background and the electric clothes dryer at the left

F1342
Silk Hood for Sandblaster
 Prevents Inhaling Dust



Did work
 Dangerous dust is excluded by this rubberized silk hood, protecting the sandblaster from silicosis

Weighing only forty-three ounces, a rubberized silk hood invented by a navy safety engineer gives complete protection from dust while sandblasting. Inhaling sand and dust frequently causes silicosis, a dangerous industrial disease, but with this hood slipped over the head and shoulders, extending to the waist, the worker is safe. The helmet weighs about half as much as most previous protective masks.

F1399
Instant Fire Alarm for Home
 Plugs into Light Socket



Valerm
 Within a few seconds after fire breaks out in your home the household can be warned by a howling alarm which is simply screwed into a light socket. This detector utters an unmistakable

\$14.50

Newton, Mass
 shriek if the temperature in the room rises at a sustained rate of fifteen or twenty degrees per minute. This "rate-of-rise" thermostat will catch the fire before it has reached dangerous proportions, yet will not cause false alarms from ordinary changes in room temperature due to weather or winter heating of the building. Plugged into a ceiling socket in basement, attic or closet—danger spots for fires in the home—it will detect any sudden surge of heat almost instantly. The rate-of-rise feature is operated by a small air-expansion chamber with an extremely sensitive diaphragm which bellows out when the temperature rises in the air chamber and closes an electrical contact. There is an additional thermostat which, in the event a smoldering, slow fire has not actuated the alarm, will sound the howler when the room temperature reaches 150 degrees. The signal operates on alternating current, and uses about eight watts. A tiny neon lamp consuming four-tenths watt shows that the current is on. The detector readjusts itself after the fire is extinguished and need not be replaced. Extension howlers and detectors can be connected for remote alarms.

F1418
Reference File Is Floodlighted
 by Lamp Attached to Base



Record file mounted at angle for quick reference and easy reading, and lighted to save eyestrain

Eyestrain in index reference work can be reduced to a minimum by using a file floodlighted by a lamp which is part of the

Chicago 407 S Dearborn. William P. Roberts. Washington D.C. Mar 7 465

Art Metal Construction

unit. The record file is slanted at an angle convenient for reading, and its pages are designed for inserting and changing any kind of typewritten index matter. The lamp has an opal glass bowl, a reflector and a special shade to protect the reader's eyes, and when its hundred-watt bulb is turned on, the index is flooded with fifty foot-candles of light.

F1333

Night Thermometer Has Radium Numbers

Designed especially for easy reading at night, the latest thermometer has radium-painted numbers and pointer on its face. The instrument is mounted on a swivel for tilting to any convenient position. The case is of baked black enamel and the crystal is unbreakable. The thermometer is guaranteed for commercial accuracy. Installed just outside the window, it may be read in daylight or darkness.

Tel. 17me

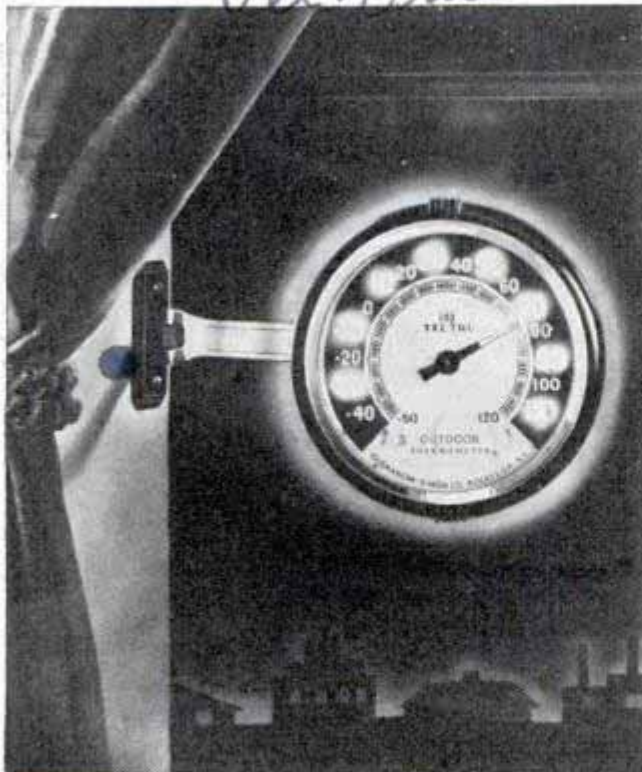
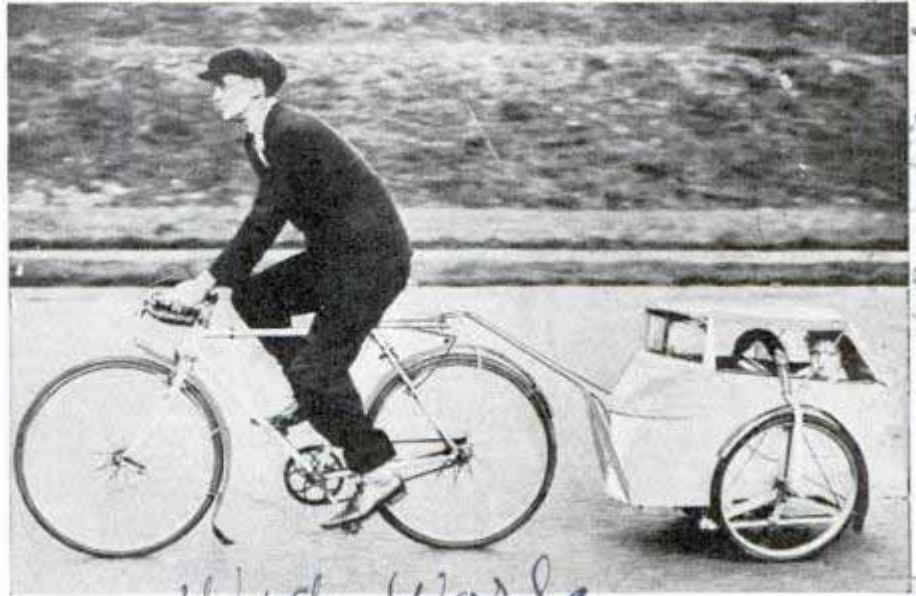

Photo shows radium-dial thermometer attached to outside window frame

*Armanow Dixon
P. 448 H. Paul*

Baby Rides in 'Bike' Trailer with a Windshield and Cover



Wide World

Father pumps the bicycle pedals and braves the weather, but son rides comfortably in a homemade trailer protected by windshield and top

East Lancashire

Old bicycle parts were used by an English bicyclist to build a two-wheeled trailer in which his son rides. It is streamlined, and has both windshield and folding top to protect the baby from sun or rain. The homemade bicycle trailer cost less than ten dollars.

F1405

Roofing Nail with a Lead Head Is Anchored by Shank Rings

Lead-headed roofing nails which cannot work loose have just been introduced. Built on the principle of the anchor, they have rings around the shank to prevent the nail pulling out or twisting out like a screw. They are especially useful for galvanized roofs.

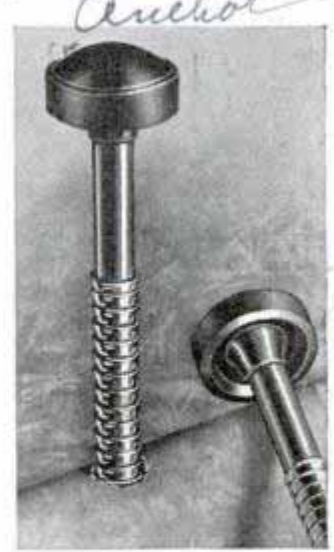

Anchor

Of the 250,000 or more plants known to man, only a few hundred are grown agriculturally and only a few score are food plants basic to civilization.

*Science Monthly
Vol 143*

Vertical text on the right margin, including 'H. Mage Co. Penn' and other illegible words.

Billiards and Bowling Combined in New Game

Woodcraft Cleveland Ohio

National Sales Rep. Shay Product Corp. 1616 S. Michigan Ave. Cheery Cue Bowl

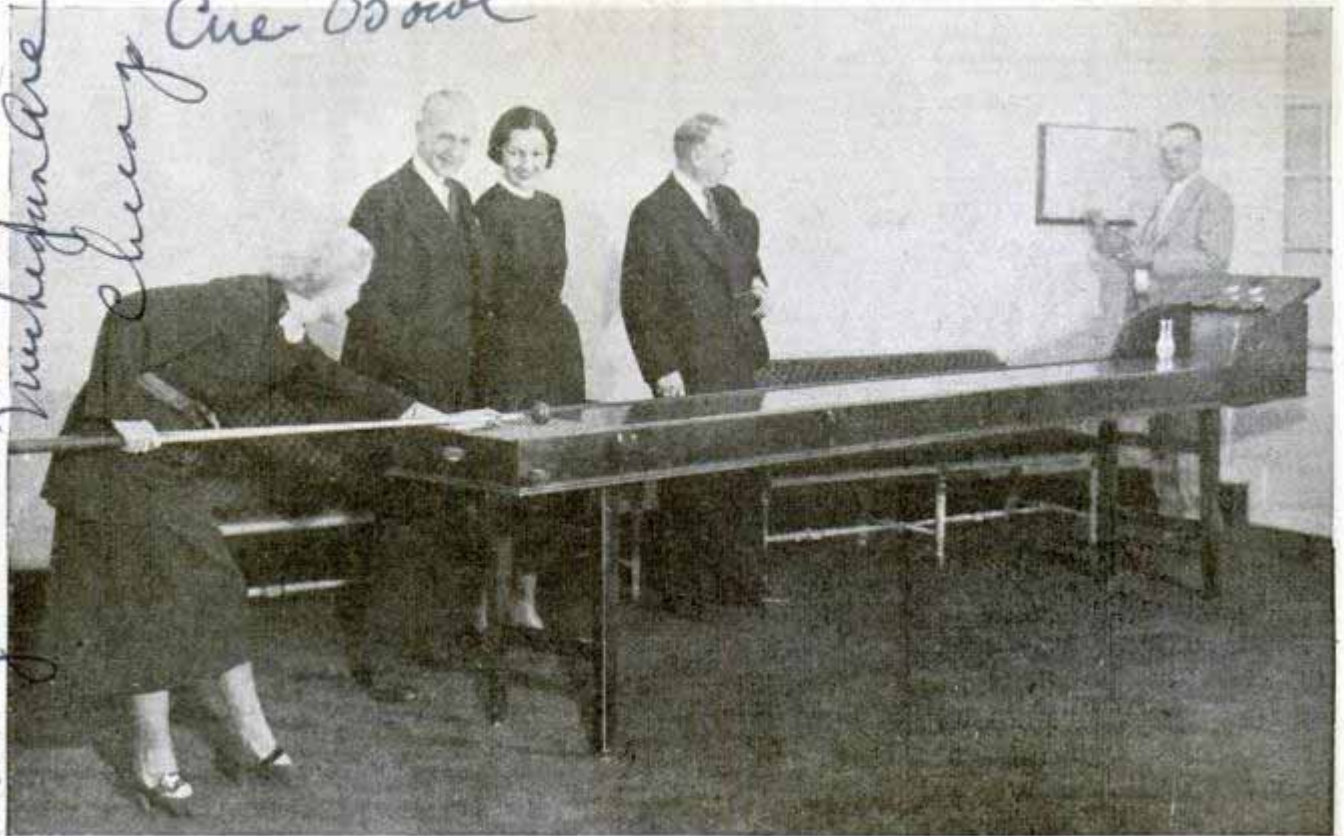

Playing the "cue-bowl" game, a standard billiard cue taps a billiard ball down a table alley against small pins, scoring as in ordinary bowling. This alley can be set up in the home recreation room

Billiards and bowling join forces in the latest home game. Ten maple pins are set up as in bowling at the foot of an alley twelve feet eight and one-half inches long. Instead of rolling a big ball, the player taps a standard two and one-quarter inch black billiard ball with a standard billiard cue, and scores as in bowling. The

alley, sturdy enough to support 1,000 pounds weight, is built to the scale of the bowling alley, being twenty-two inches wide and mounted three and one-half feet high. As many as ten persons can play. A built-in templet makes pin adjustments a matter of seconds, and the balls are automatically returned as in bowling.

Glass Brain Is Used to Show How Human Brain Works

Dr. Temple Fay, Prof. of Radiology, and Mr. W. E. Chynoweth, Dept. of Neurology

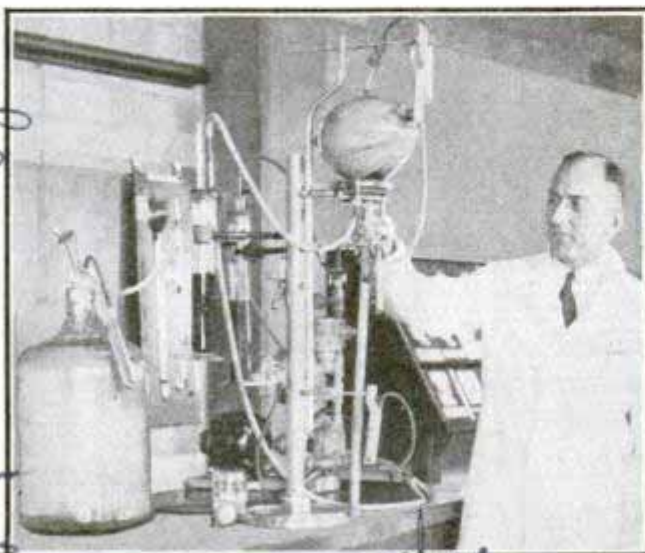

Demonstrating the glass brain

Capable of performing all the functions of the brain except think, a glass brain perfected by Dr. Temple Fay shows how a human brain works. It was demonstrated before the American College of Surgeons.

Dept. of Neurology

Sensitive Paint Indicates Water Present in Gasoline Tank

Red paint which is sensitive to water is being used in testing gasoline tanks for their water content. The red coating is applied to one side of the measuring stick used to sound the tank. When it is dry, the stick is lowered to the bottom of the tank and then removed ten seconds later.

Temple Fay

If there is water in the tank it will turn the red paint a chalky white. When the stick dries, the paint becomes red again and the same coating can be employed several times for the water test before it is necessary to repaint.

71387

Auto Parking Meters Tested by Artificial Weather

Severe tests of automobile parking meters designed for installation at the street curbing are conducted in a Minnesota city by creating artificial weather, dust and rain storms, heat and cold waves. The meters, made by competing companies, are placed in a hot oven until the heat reaches 120 degrees. Then they are transferred to an ice-cream manufacturer's refrigerator where the temperature is ten degrees below zero. To duplicate dust-storm conditions the meters are sand-blasted. Finally rain-making apparatus, consisting of a perforated pipe through which water is forced under pressure, is set up and "rain" falls on the meters, simulating a four-inch rainfall. At fifteen-minute intervals the meters are given a quarter turn so that the water may strike the instruments at different angles, thus revealing flaws. Meters which withstand these tests are selected to control parking on city streets. Upon dropping a coin into the meter, the motorist may park his car for a certain period without interference.

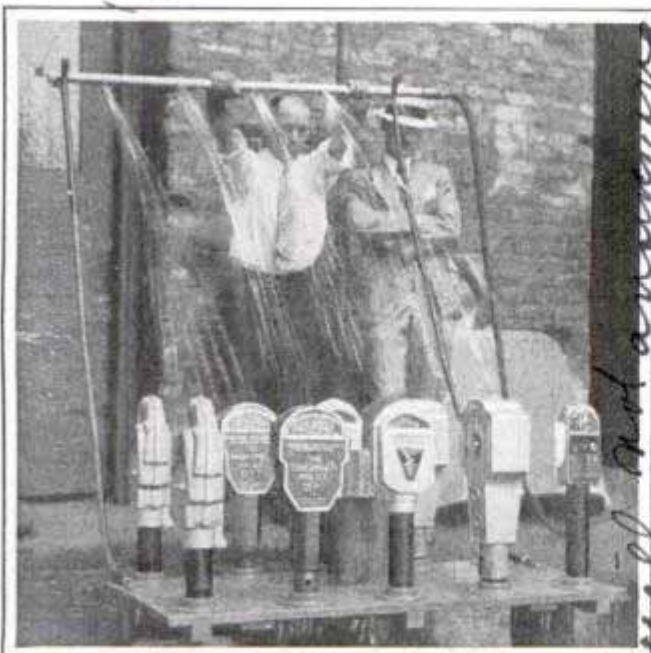

Rain-testing the parking meters before they are placed in service on city streets

Minneapolis Waffle

Official Baker Tests Bread for Looks and Texture



Inspecting loaves of bread baked in government ovens for experimental and grading purposes

Baker for the sake of science, Lorin H. Bailey for twenty years has been turning out cakes and cookies, biscuits and pies and bread in the laboratory of the Bureau of Chemistry and Soils in the Department of Agriculture. He grades every loaf of bread carefully, allotting thirty per cent for external appearance, evenness and color of crust, symmetry and volume; seventy per cent for internal texture. Results of his baking experiments are reported in papers that become guidebooks to bakers throughout the country. In making bread, Mr. Bailey weighs ingredients and places them in an electric mixer. Then the dough goes into a glass-enclosed "proofing cabinet" where the yeast ferments, the temperature being kept at eighty-six degrees and humidity at seventy-five. Next he kneads the dough—he calls it "punching"—and replaces it in the cabinet, and after repeating this process several times the dough is baked at 450 degrees.

Whenever you find that you wish to know more about any article in this magazine, write our Bureau of Information, inclosing return postage.

Washington, D.C.

F1281. *Conn. Rem. Masterman*
4 W. 70 3rd. New York

The MASTER MAN

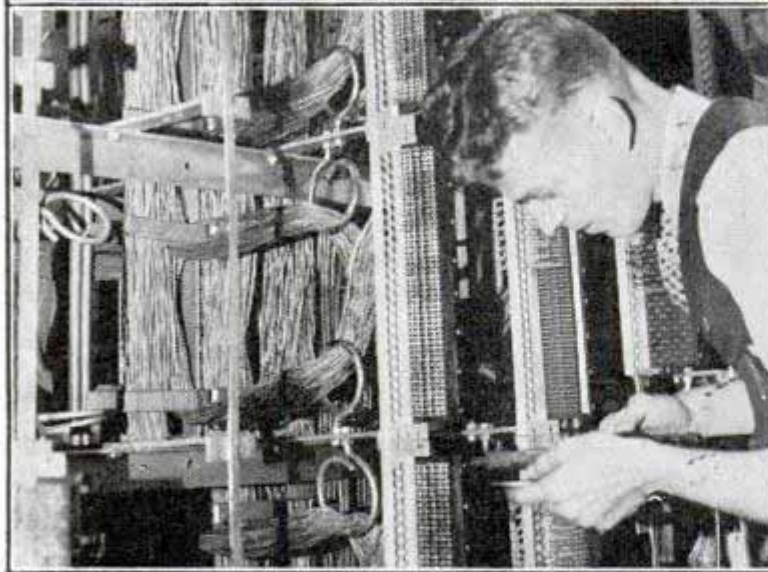
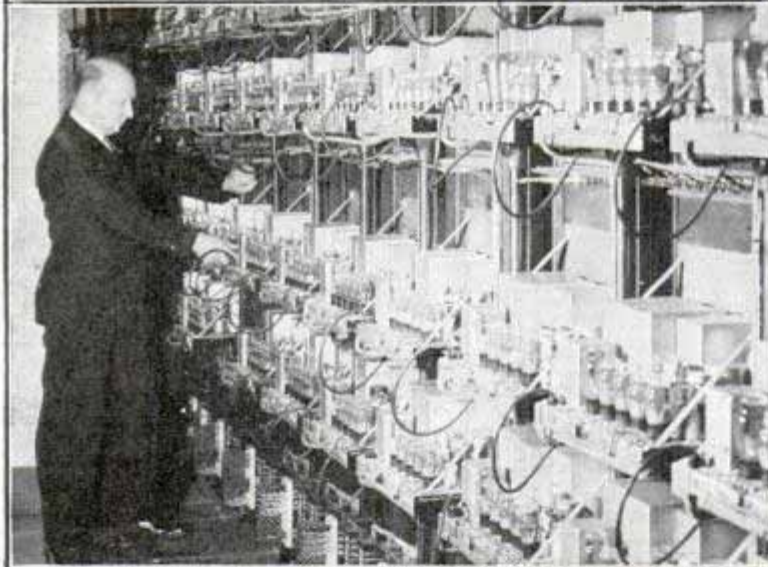

Top, left, engineer of the power supply board in Radio City. Right, broadcasting over the 100-watt "cue channel" which is used for communicating with the portable auto-truck transmitting stations. Center, amplifiers used for the many loudspeakers scattered throughout the N.B.C. offices. Bottom, part of the maze of wires behind the master control board

IN a little niche of Radio City is a man who holds every program emanating from there in the palm of his hand.

He bosses two great radio networks and makes his headquarters at the central desk of the master control board in the world's greatest broadcasting center. Here are the heart, brains, and nerve centers of a great radio system, all manipulated by thin strands of wire through which speed electric pulsations that make possible the wonders of network broadcasting.

The boss of N.B.C.'s Red and Blue network sits at the center of a board twenty-seven feet long, the most flexible and elaborate bit of telltale mechanism that has ever been set up. Telephones, telegraph, teletype, loudspeakers, buzzers, bells, and 3,700 colored light signals are attached to the master control board. In effect, the master control room is nothing more than a signal station from which one man can control the

T 1288,

of RADIO

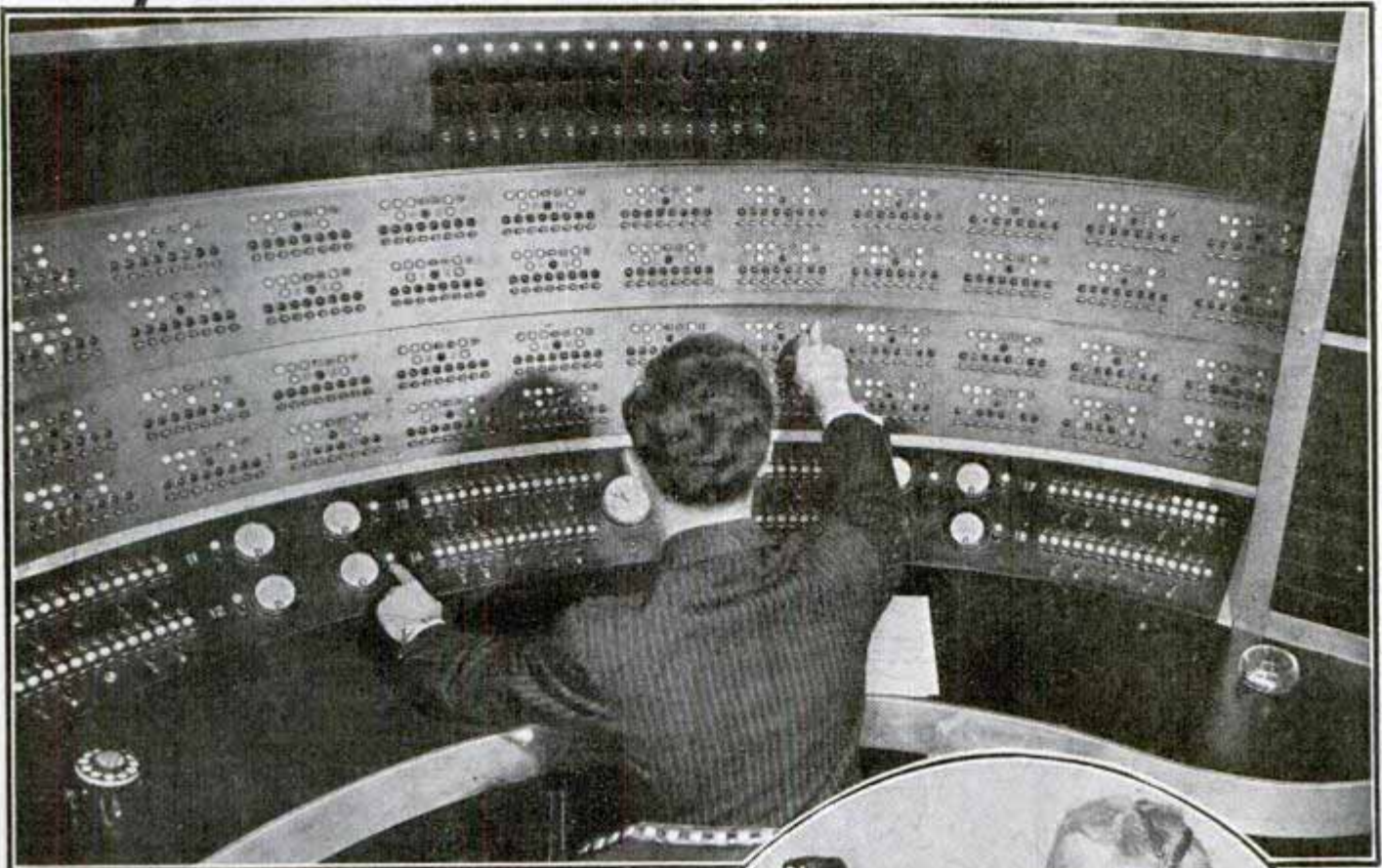

operations of two great radio networks and a big broadcasting center. He corresponds to the railroad dispatcher; but instead of utilizing "tracks," the master control supervisor utilizes "channels." He gives the final check to each radio program before it is fed to the long-distance telephone lines that carry it from coast to coast.

The control board makes known to the supervisor at a glance what is taking place at dozens of strategic points. There is a constant change of colored lights, a ringing of bells and chimes, a drone of buzzers, and a cross-talk of loudspeakers, an army of invisible lightning-speed "messengers" rushing to and fro, conveying last-minute news to the master control board. If the supervisor had to depend upon human messengers to carry this same information, the direction of network programs would involve thousands of people.

As he pauses for a moment, the super-



Switchbank operator, above, changing studio channel hook up. Below, making "spot news" announcement

visor meditates over a flash that has just been telephoned from Delaware.

"Three hundred men are reported at sea in fishing boats off the Delaware coast," reads the message.

The weather bureau had posted warnings about a tropical hurricane that was



Studio engineer at controls during rehearsal of air program. Below, lead-coated cables laid beneath the floor connect control room with broadcasting studios throughout Radio City

running a high fever while speeding up the Atlantic coast and overtaking shipping that had failed to head for home. The coast guard was standing by. The supervisor opens communication with a dozen different places. Broadcasting does not wait for a disaster; it anticipates emergencies. The Washington office of N.B.C.

dispatches a crew of men to a possible trouble spot in Chesapeake bay; a portable broadcasting outfit is rushed to the Delaware coast. Arrangements are made with local "ham" operators to stand by in case telegraph and telephone lines are disabled.

Fifteen minutes elapse. No word about the 300 fishermen tossing in a mad sea. The supervisor 'phones N.B.C.'s regional offices. Still no news. He solicits information up and down the coast on the teletype machine, meanwhile keeping an eagle eye on the traffic control of regular radio programs. At length, comes a flash.

"Fishermen just pulled off boats by coast guard," it says.

"I was getting worried for a while," the supervisor confessed.

The technique of broadcasting a flash news announcement without the waste of precious seconds is a development but a few months old. The most recent installation on the master control board is a "news flash" control panel. This is essentially an operating link between N.B.C.'s chief announcer and the master control room. If an important news flash arrives in the course of a scheduled program, the spot news announcement does not wait the completion of that program; with a single movement of his wrist, the chief announcer can cut in on a network program and make his brief announcement. Nobody in the studio knows the scheduled

program is temporarily off the air. No sooner is the news flashed, than the chief announcer fades the scheduled program back into its proper channel. Thus, nobody in the studio is disturbed by what has taken place. The "news flash" panel saves much running back and forth between the master control room and the chief announcer's station.

A novel method is also used for picking up a program from a distant point. If Los Angeles is scheduled to feed the network for an eight o'clock program, the master control supervisor notifies the telephone operator by teletype.

"Please connect me with LA585 at 7:56 p. m.," says his message.

At 7:56 p. m. the operator's bell rings.

"Ready with LA585."

"Go ahead, please."

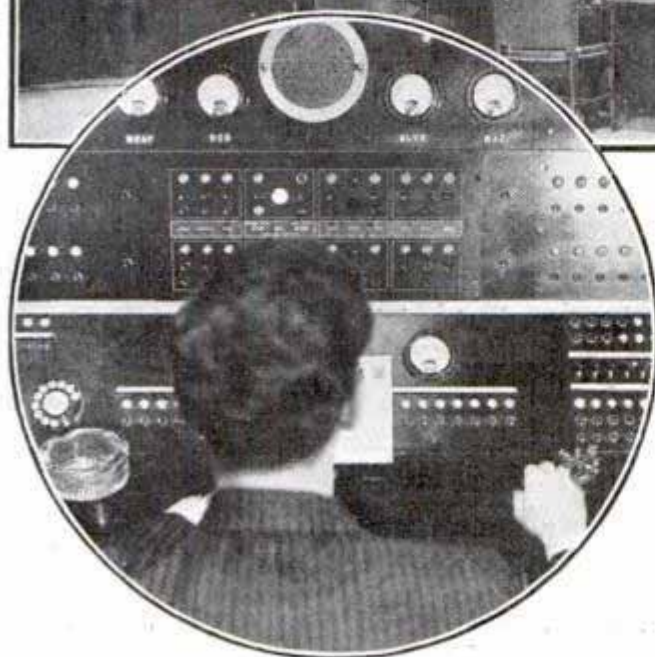
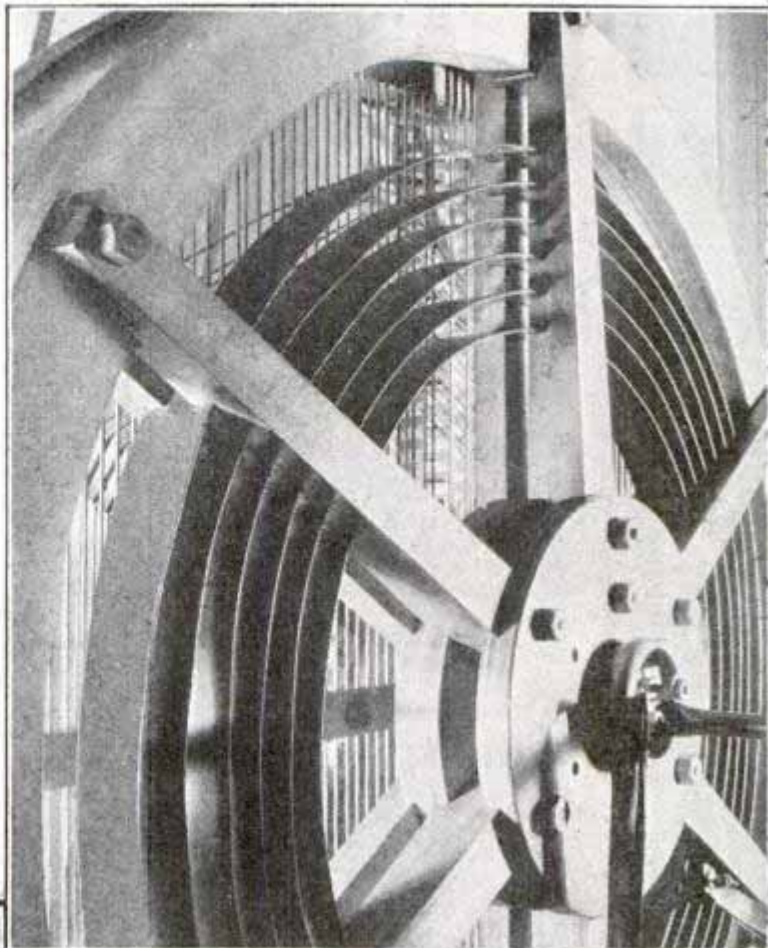

Top, part of transmitting apparatus. Center, master control board. Left, supervisor of control board at central position

If Los Angeles was not on the previous network program and, hence, has not heard Radio City's chimes, the master control supervisor "cues" the distant station with a teletype signal, "gagagaga..." which means "go ahead."

Since modern broadcasting is virtually on a twenty-four hour basis, the supervision of the master control board is carried on by three watches, two or three men on

(Continued to page 136A)

Flour Is Given a Written Test on Recording Dough-Mixer

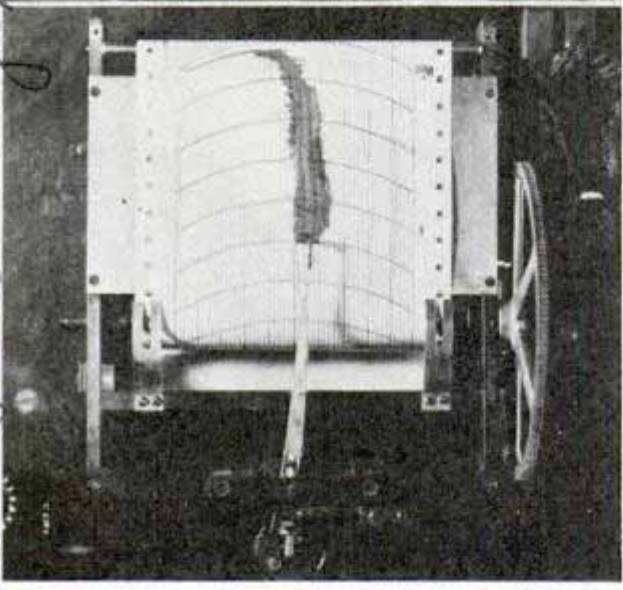
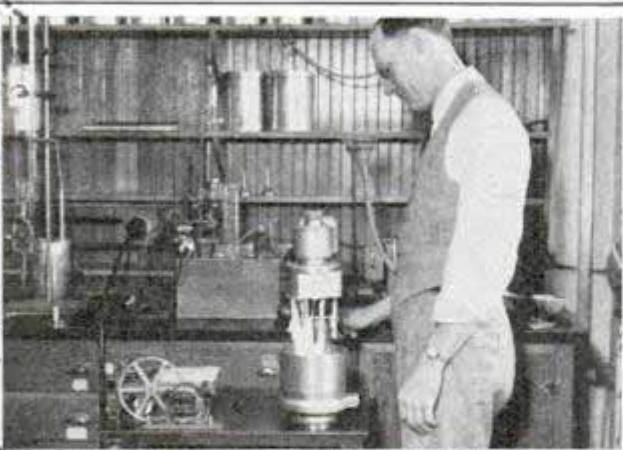

Top, testing dough made from a sample of flour. Below, the record written on the graph

Mixing bread dough has been reduced to an exact science, all the guesswork and experiment over proper time and proper flour obviated. The dough is made to analyze itself on a graphic record. From this record the baker can tell exactly how long dough should be left in the mixer, and whether the flour being tested has adaptability and stability for making good bread. The ingredients are placed in a small aluminum mixing bowl in the bottom of which are four stationary steel fingers. Over the bowl is placed a mixing head with four rotating fingers, and as the head itself revolves these fingers move around the stationary ones. As the mixing proceeds, the slightest movement of the aluminum bowl is transmitted to a delicate balance arm; a rod leading down from the bowl to a horizontal bar transmits the pressure exerted on the bowl by the moving dough, and a pen draws a

graph of the movement on a moving paper marked in three-minute periods. As the dough stiffens, the pen shows resistance in the wider and higher lines on the graph. At maximum consistency, good flour dough would hold at the same level on the graph for some time, whereas poor flour might show a sharply rising curve and then fall rapidly. The width of lines indicates stiffness or elasticity and the baker would know from the widest line the exact minute for removing the dough.

Valve Stops Flow of Gasoline When Auto Tank Is Full

Designed to automatically cut off the flow of gasoline when the automobile tank is full, a sensitive valve for filling-station hose prevents overflow. The valve shuts off when the gasoline reaches the end of the nozzle, operating by suction. It also may be used in handling other liquids.

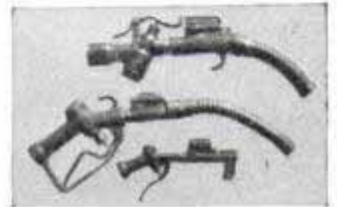

Steel Ball Guards Building from Fire and 'Quake

Designed to protect homes and other buildings against fire and against the danger of broken gas lines in earthquakes, a

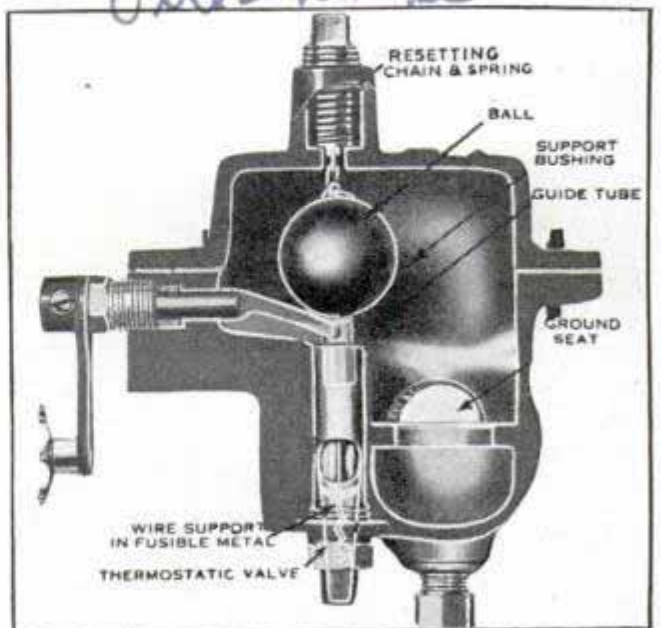

When the steel ball is dislodged from its seat, gas flow is cut off

American Safety

Dr. C. D. Swanson and Mr. Carl B. Working
pulling up Kansas State College
Manhattan, Kan.

Los Palos Calif

F1401

F1328

new device has been approved by underwriters. A steel ball, perched on a slender column, is unseated either when an earth tremor of a given intensity shakes the ground or when the temperature where the device is located reaches 160 degrees. Toppling of the ball from its place cuts off the gas and sounds an alarm, thus affording fire and earthquake protection. At San Francisco and at Tokyo, the earthquake caused only five per cent of the total damage, fire accounting for the rest.

Lifeboat Freed from Ship When It Touches the Water

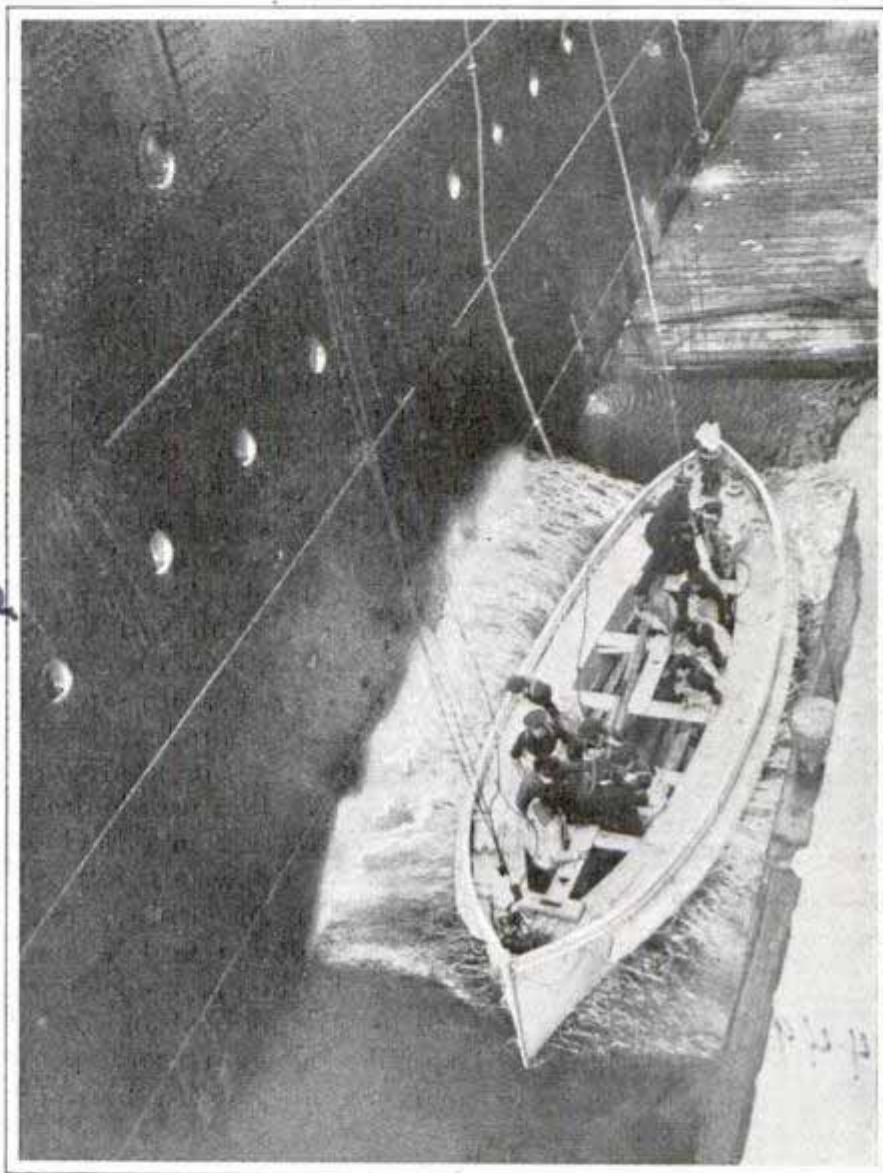

Showing lifeboat at moment of touching the water. This action causes lowering lines to be released and the boat to float free

F 1402

Trailer Is Pushed by Automobile to Haul Wood

By hitching a trailer in front of his automobile and pushing it onto uncleared land, one man has found a way to speed up wood hauling. It has been found easier to push the trailer and to haul out wood faster by this method than by hitching it to the rear of the car. By using a double hitch, both front and rear, greater ease in maneuvering the trailer is provided.



Auto pushing trailer into the woods

When lifeboats from the modern liner touch the surface of the water, they may be automatically released from the ship by a device tested recently in New York. The device is designed for safety, to prevent swamping and overturning of lifeboats entangled in the gear by which they are lowered. In marine disasters, many lives have been lost because the lifeboats could not be released from the ship, due to the tangling of lines or failure of the crew to operate the gear properly.

☐ Dogs trained as companions for the blind are treated as human passengers on the Baltimore and Ohio railroad. They are the first dogs permitted in passenger cars.

Edman Overland

Railway Age

Old Coaches Moved by Truck to Lunch-Stand Sites

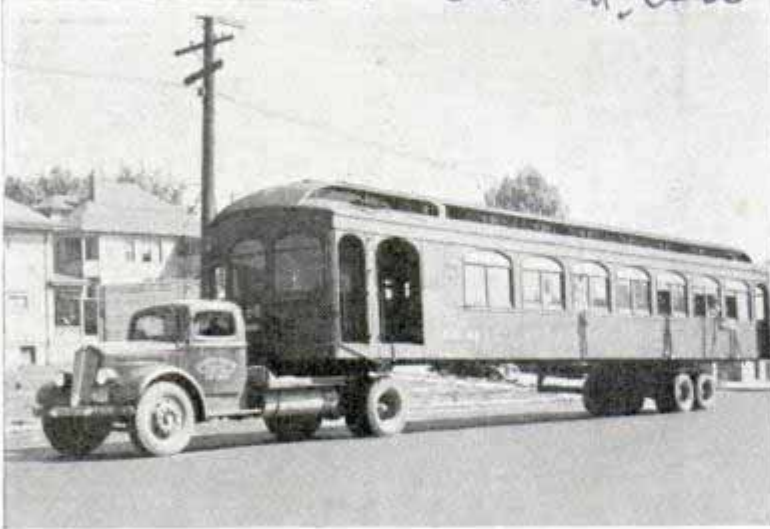

Here is how old railroad coaches are hauled away by purchasers to be used as lunch stands and sometimes as homes

Old wooden railway coaches, sold to be wrecked or to be used as lunch stands or even homes, are moved to their purchasers' sites by truck. The coach is set upon rubber-tired wheels and hauled away by the powerful engine mounted in the forward end of the truck. The wooden equipment is sold to make way for steel coaches.

Atom Smasher May Give Secret of Structure of Matter

Some of the mystery surrounding the structure of matter may be revealed by a powerful atom smasher with whose aid research engineers of the Westinghouse Electric and Manufacturing company expect to embark on a scientific journey into the unknown. Since it is recognized that the application of steady high voltages is necessary to provide information in the field of nuclear research beyond that already revealed, an electrostatic generator offering direct-current potentials of 5,000,000 volts is now being designed to attain the high velocities necessary for atomic bombardment. It is hoped eventually to go beyond that peak. Little is known about such high direct-current voltages because nearly all previous research has been in the field of alternating current high voltage. The apparatus contemplated for the generation of such high direct-current voltage includes a pear-shaped

vessel thirty feet in diameter and forty-seven feet long, built for air pressures of 150 pounds per square inch. The project involves the building of apparatus to withstand the high voltages sought, the designing of units to withstand terrific air pressures and high degrees of vacuum and the development of a vacuum tube, in which the atomic bombardment will take place, capable of withstanding voltages of 5,000,000 or more. This is the first time that a large industrial concern has entered the field of atomic research and, while no one can foresee the ultimate results, it is pointed out that most fundamental knowledge gained by science is put to some practical use. Thus, when science learned to control electrons, the radio industry

was developed; and knowledge about control of electron streams made it possible to develop circuit breakers capable of interrupting high voltage as easily as turning off the water in a kitchen faucet. Science previously has found a way to strip off the electrons that surround the particles of matter, leaving only the nucleus or core of the atom. In it may be hidden other nuggets of pure scientific gold waiting to be mined if a way can be found to their hiding place.

Simple Orange Peeler Speeds Preparation of Fruit

Simple in construction and automatic in operation, an inexpensive orange peeler has been invented. It has three main parts and one spring. The device can peel six oranges per minute, the work being done by a knife with two cutting edges.

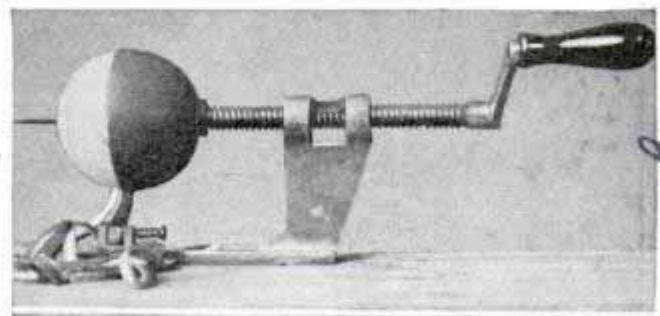

Turning the handle causes this device to strip the skin from an orange quickly

Earl Pittsburgh Pa

F1449

415 Raleigh Bldg. Portland, Ore.

Habana, Cuba
Vedado
Ernesto

Handwritten scribbles at the bottom of the page.

Radio



ULTRA S-W RECEIVER

HAS
BUILT-IN *Noise Silencer*

INCREASING interest in the 5 and 10-meter bands has encouraged radio engineers to develop special receivers for these ultrahigh frequencies. Although the receiver illustrated is designed primarily for these bands, it actually tunes from 3.76 to 53 meters. This range, of course, also covers the amateur 20 and 40-meter bands as well as the 19 and 49-meter foreign broadcasts.

Ultramodern as well as ultra short-wave, it includes a built-in Lamb noise silencer which brings the background noise level to a new low. There

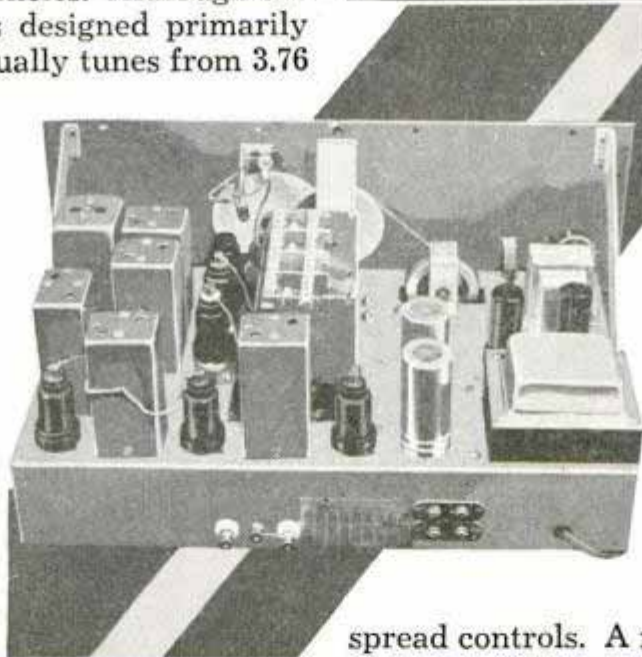

are a number of controls on the front panel as will be noted in the upper photo. These controls are necessary for tone, audio gain, R.F. gain, noise silencer, band switch, crystal phasing condenser, I. F. expander, crystal switch, AVC switch, "send" and "receive" switch, main tuning and band-

spread controls. A rear view of the chassis is given in the center photo. Provision has been made for a 5,000-ohm speaker, and either a doublet or regular single lead-in antenna. Headphones may be plugged into a jack connected in the first audio stage. This jack is so arranged that the speaker is shorted out when the headphones are being used.

The following metal tubes are employed in the circuit: 6K7, R.F. amplifier; 6C5 oscillator; 6L7, first detector; 6K6 first I.F.; 6L7, second I.F.; 6J7, noise silencer amplifier; 6Q7, noise silencer and first audio; 6R7, second detector and beat oscillator; 6F6, power amplifier and a 5Z4 rectifier.

The lower photo shows the receiver in operation in the shielded testing room of Popular Mechanics radio laboratory.



Hallicrafters

HOW *to* BUILD a

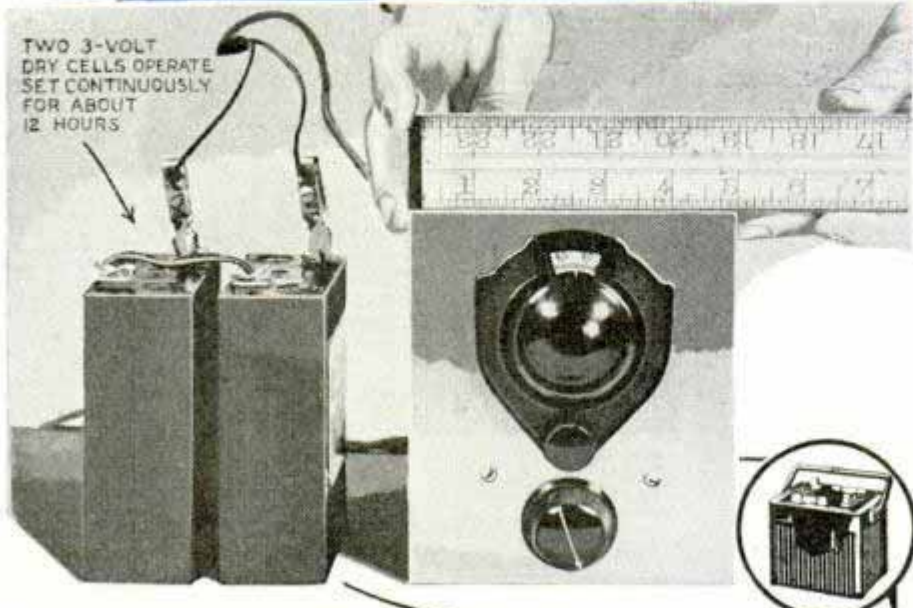

Fig. 1

ONLY a handful of inexpensive parts is required to build this little ultracompact broadcast receiver which is designed to work from a single d.c. source. No B-batteries, power pack, transformers, dynamotor, rectifiers or other expensive parts are necessary for its operation.

The primary idea behind the design is to provide a simple, rugged portable receiver that will work from a 6-volt storage battery, or a few dry cells, when other sources of power fail. When floods, hurricanes or other natural catastrophes occur and all ordinary means of communication go out, it is satisfying, and sometimes vitally important, to be able to learn from outside radio stations just what is going on. As a portable knockabout set, it also has other useful applications in the home, boat or camp.

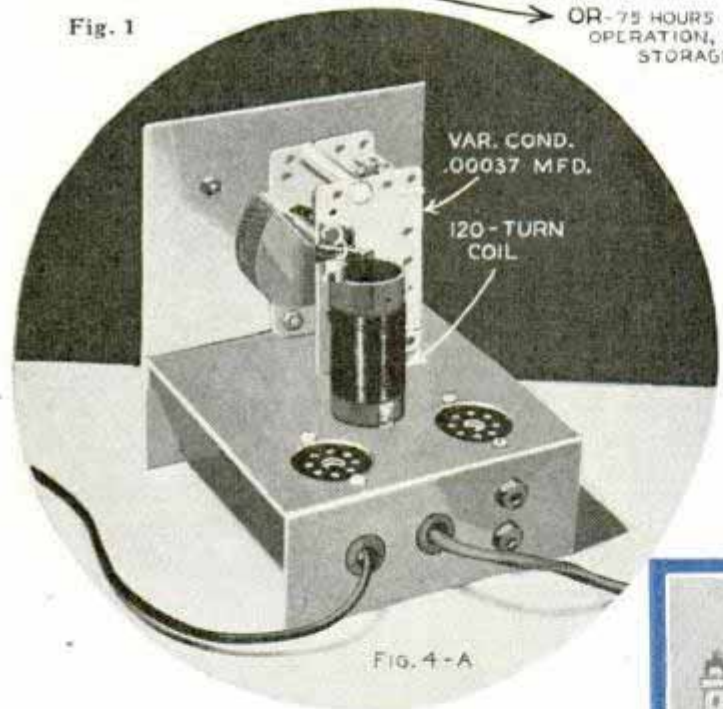
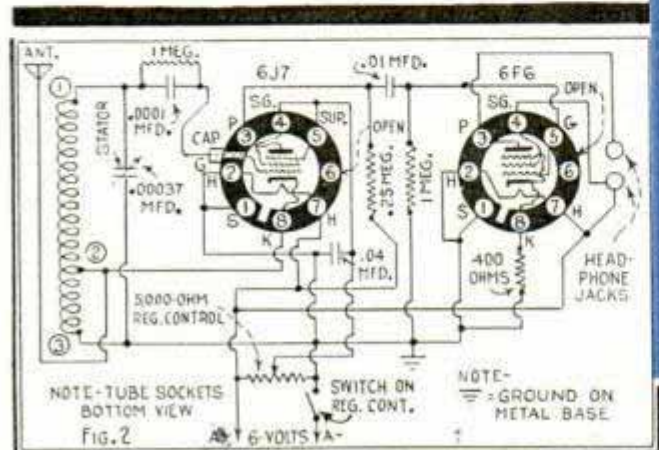

FIG. 4-A



HURRICANE *Emergency* RECEIVER

With only 6 volts available for the plates of the tubes, the circuit design provides sensitivity sufficient for satisfactory reception of medium or high-power stations within a range of about 500 miles; headphones are, of course, required. The set draws a total of 1 amp., therefore two midget 3-volt portable A-batteries, or four 1½-volt No. 6 dry cells in series, will operate the set continuously for about 12 hours. A 6-volt storage battery extends this time to approximately 75 hours.

Photos Figs. 1, 4-A, 4-B and 4-C, show various views of the completed receiver. The schematic circuit diagram is given in Fig. 2 and the coil-winding details are clearly shown in Fig. 3; cardboard or Bakelite tubing may be used for the coil form. Fig. 4 shows a simplified diagram of the wiring under the base and all parts in their relative positions; the metal base and panel details appear in Fig. 5.

Non-critical antenna coupling permits the use of various lengths of antenna without seriously affecting the tuning of

(Continued to page 152A)

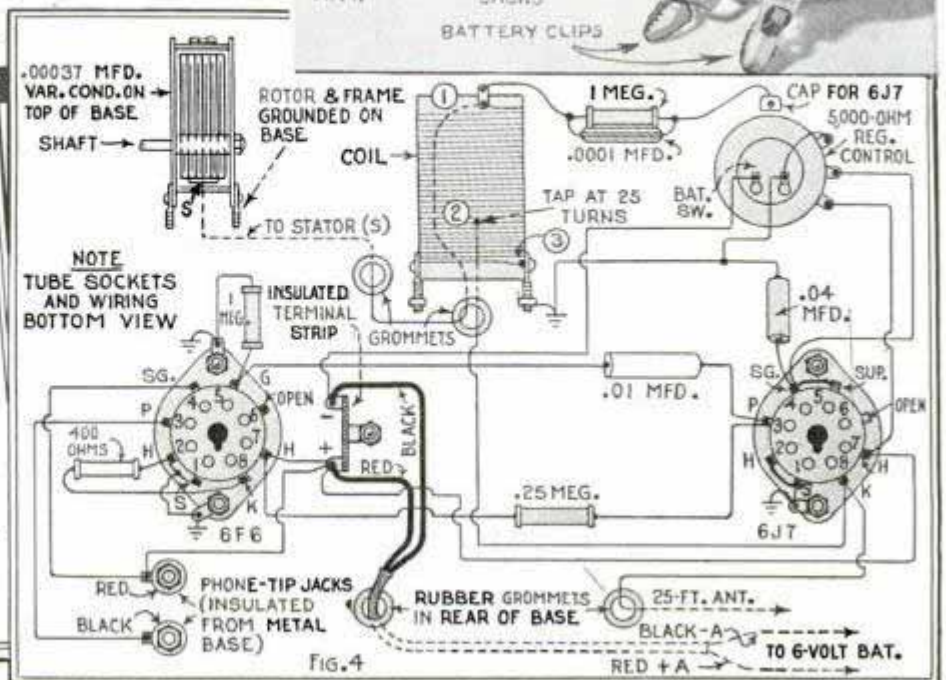
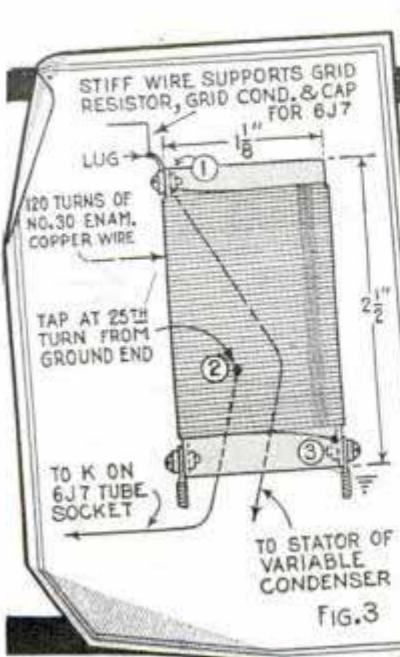
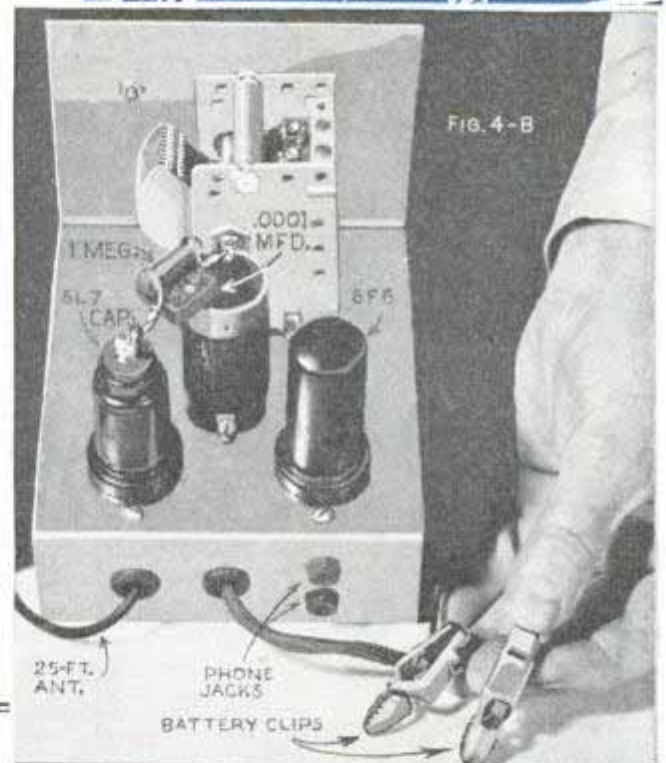

Crystal Receiver Built from Junk-Box Parts

By Arthur Wildhagen



ALTHOUGH built from odds and ends commonly found in the average experimenter's junk box, this is a practical crystal receiver that will do everything that any well-designed crystal set should do. It is selective enough to separate most of the powerful broadcasting stations in metropolitan areas, bringing in local programs with the excellent clarity characteristic of a good crystal detector.

It is housed in a homemade wooden cabinet 10½ in. long, 7¾ in. deep and 7½ in. high, and looks

something like a regular tube-type receiver. The coil is wound on a cardboard tube 4 in. in diameter and 5 in. long. It consists of 40 turns of ordinary insulated bell wire close-wound in a single layer and tapped at the 10th, 20th and 30th turns as shown in Figs. 1 and 2. The beginning and ending coil leads are anchored through holes punched in the cardboard form and are left long enough to reach the terminals of the variable condenser. This condenser is an ordinary 23-plate type commonly used in older models of standard receivers.

The 4-point induction switches, crystal detector and phone jack are mounted on the plywood front panel which is ¼ by 7½ by 10½ in. Regular 4-point inductance switches may be used, or the cheaper switch levers and contact points as shown in the front view of the completed set, Fig. 2-A. The contact points and stops cost about 10 cents a dozen; they are inserted through holes drilled in the panel

(Continued to page 148A)

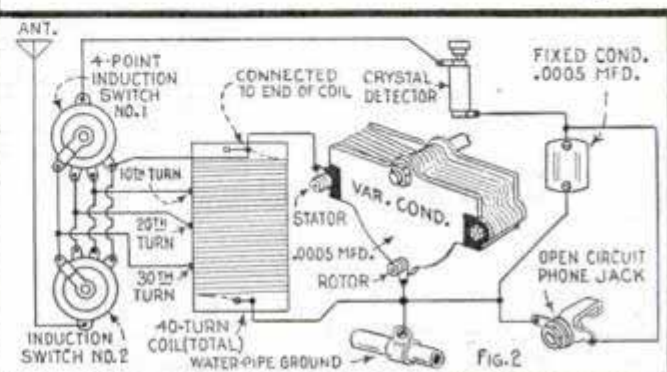
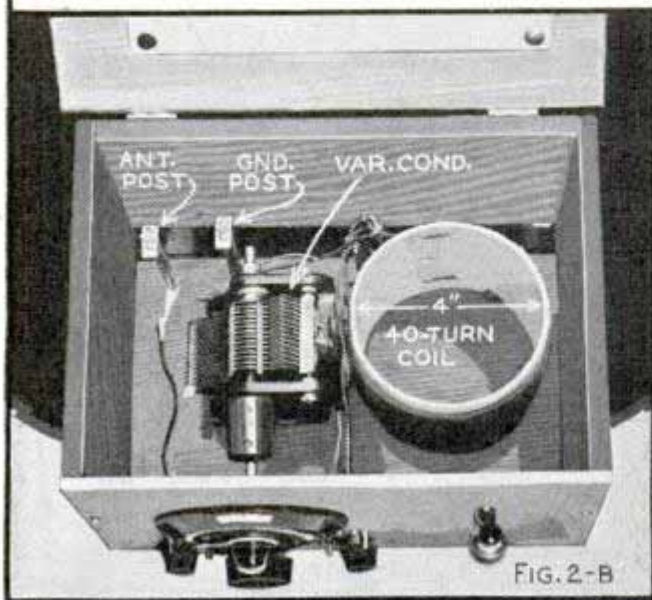
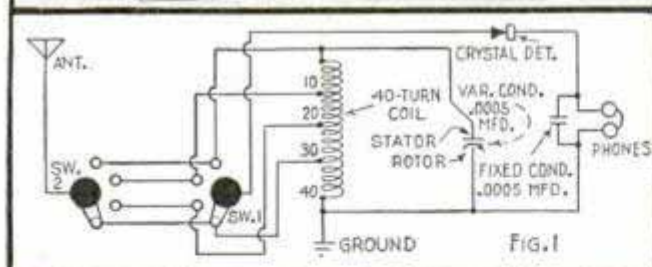
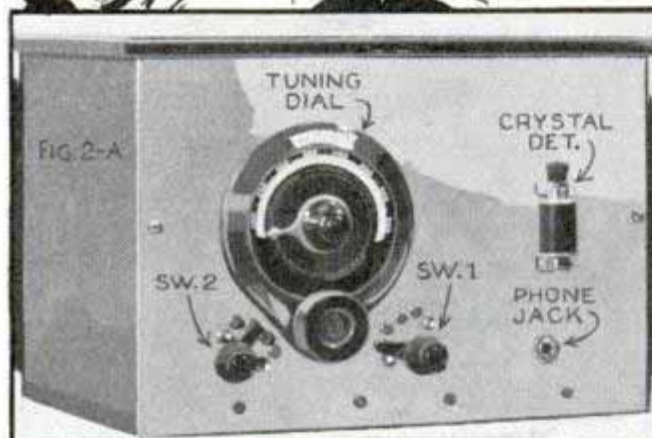

Helpful RADIO HINTS

Right, spare tubes inserted in sockets on narrow wood or Bakelite shelf mounted inside radio console. Sockets are provided so that a spare for each type of tube in the set is available for immediate replacement. A chart showing when each tube was last changed is posted under the shelf for convenient reference

Below, acorn-type super-control r.f. amplifier now sold. A companion tube to acorn 954 and 955

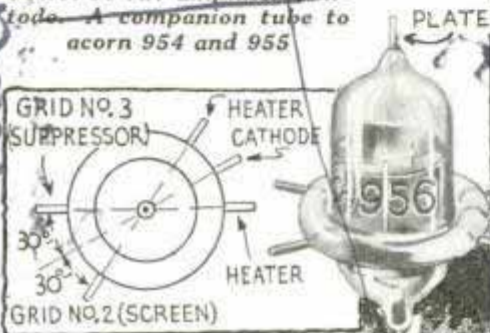

Below, noise-reducing self-selecting all-wave antenna kit, wired and soldered ready for installation wherever a 60-ft. span is available

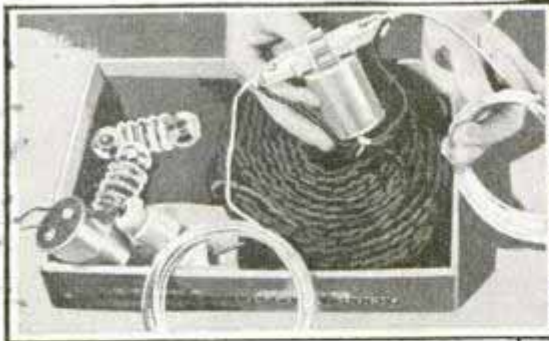

Headphone trouble shooter locates auto-ignition noises and sources of man-made static near home receiver. Choke on stick is wound with 100 turns No. 30 enamel wire



EXPLORING COIL

WALL

LOCATING INTERFERENCE

R.F. CHOKE COIL

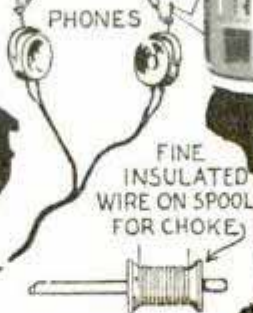

Left, two coffee cans with "twist-lock" tops provide service men with a safe method for carrying spare tubes in a car. Covers are placed back to back and four top-of-panel sockets are mounted on each side by means of machine screws. Photo shows completed assembly



SINGLE CIRCUIT FIL. CONTROL JACK

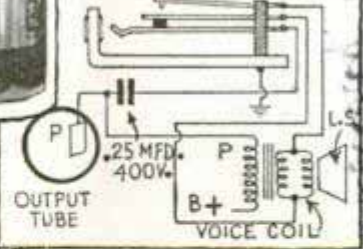

Jack for using headphones with any set. Closed-circuit "filament control" contacts short out voice coil in speaker when phone plug is inserted. Below, control grid cap made from end of old amperite or burned-out resistor

WIRE SOLDERED THROUGH HOLE IN CAP

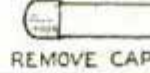

REMOVE CAP



USED AS A GRID CAP



Rotary Clock Gives World Time



K and J Sales Co.

43 25 Pleasantwood

When it's 10:00 a.m. in Chicago, New York or San Francisco, what time is it in Berlin, Hawaii or the Azores? This clock-globe gives you the answers on a 24-hour rotary time band.

Amateur Frequency Control Unit

F 3601



When properly monitored, this electron-coupled oscillator unit offers a convenient method for remotely controlling the frequency of an amateur transmitter from the operating position. Powered with a separate unit, it will excite a low-power stage such as RK-20, 802, 210

All Electric. che. 6431

Broadway Chicago

or equivalent tubes, directly. By means of a band-spread control, the operator can shift frequency within reasonable limits to a point of minimum interference.

Special Purpose Crystal "Mikes"

Designed for sound and vibration pick-up, the small contact-type unit at lower right is used to study machine problems; it is also suitable for stringed musical instrument reproduction. The larger unit is a piezo-electric crystal device for picking up heart and chest sounds for reproduction and recording.

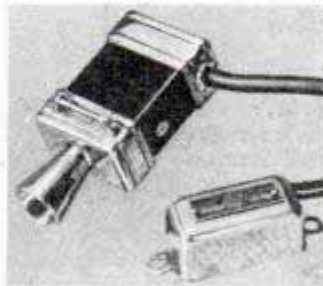

Car Antenna Easily Installed

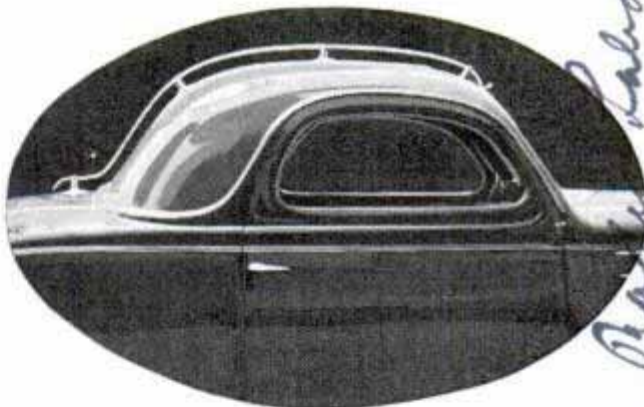

Mounted on rubber vacuum-cup stand-off insulators to avoid drilling holes, this car-top antenna consists of a length of aluminum tubing which is easily bent to conform with the streamlined tops of modern coupes and sedans. It is intended principally for all-steel turret-top cars.

Blueprints covering radio construction articles in past issues are available for 25 cents each; original material lists and additional information can be obtained from our Radio Department without charge upon receipt of postage.

Radio Laboratory
Fullerton Ave
Norwood 3454

NEXT MONTH—How to Build the 1937 Little Giant Portable A.C.-D.C. Receiver. The improved model of this popular a.c.-d.c. midget set tunes from 70 to 550 meters, has twice the volume of the original, uses new tubes and is easier to build. Also **Phono-Oscillator**, for playing records through any receiver.



Electric PEN and PENCIL

to write and draw on sheet metal

by Byron M. Taylor

AS THIS electric pencil utilizes an electric arc to burn inscriptions into metal, it is practical for marking tools. It is made of standard-size fiber, copper tubing and iron rod. The bulk of the weight and the heat from the winding are above the hand as in Fig. 1. The electrode may be lengthened as it burns down by pulling it out of the copper tubing.

A 1/2-in. fiber tube (see detail of Fig. 2) is slotted and fitted with a fiber disk. The outside of the tube is roughened just above the slot and the disk glued on. A second fiber tube, 4 3/8 in. long, is fitted with a 1/4-in. steel rod, 3/8 in. long, drilled to receive a 1/8-in. tube. The rod is glued in place at the end of the tube after which both are ground to a point.

Now the armature, electrode and core: The former is a piece of soft iron with a 1/8-in. hole drilled in one end to receive a 1/8-in. copper tube, 5 1/2 in. long, which is soldered in place. The other end of the tube has a slit, 1/4 in. long, so the tube can be slightly pinched to hold the electrode, No. 16-ga. copper wire. One end is locked in a vise and the other in a hand drill, after which the wire is pulled while turning the drill so that the wire will



Electric pen -
 Post Electric Co.
 7 E. 44th Street
 New York, N.Y.
 P.O. 121
 P.O. 110

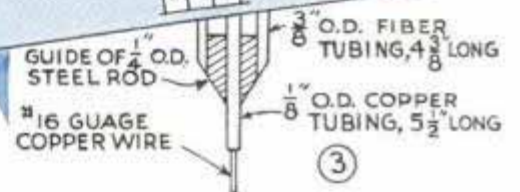
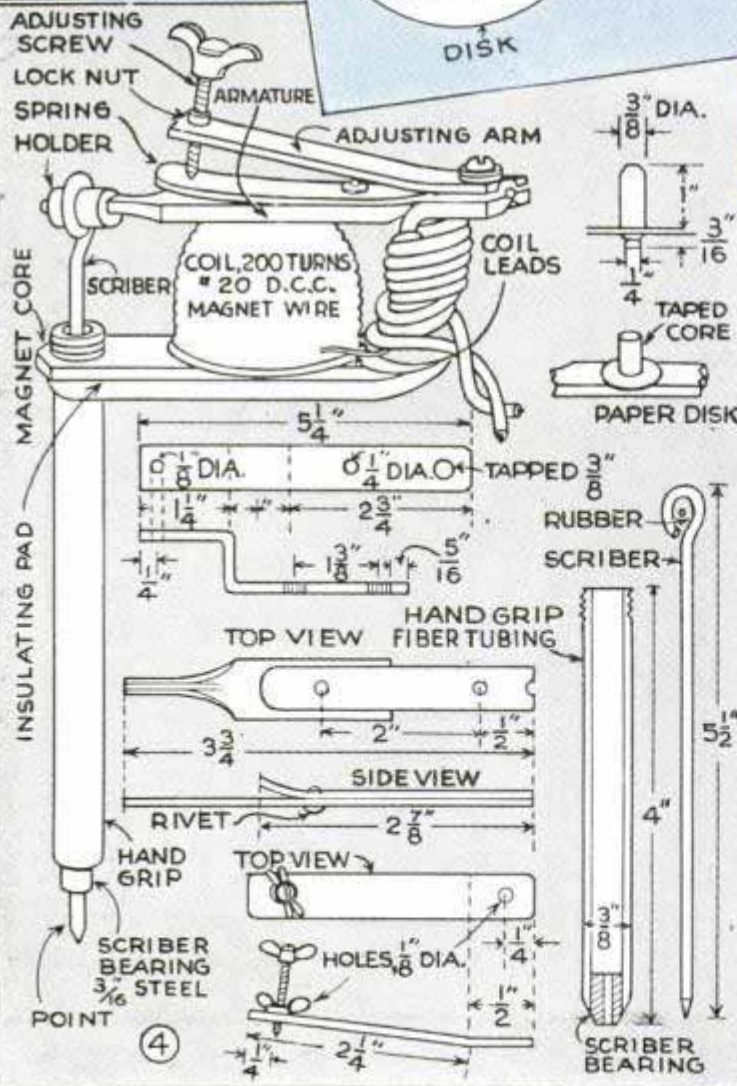
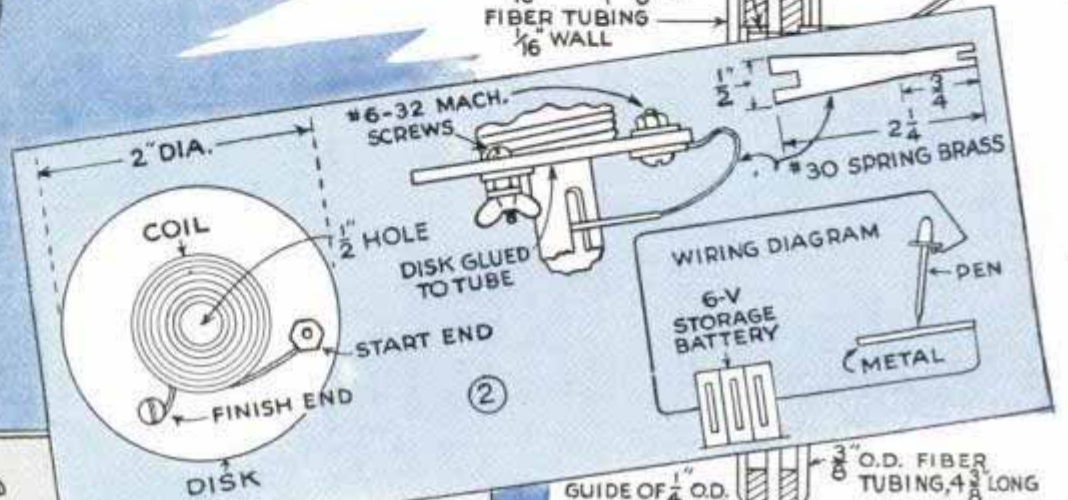
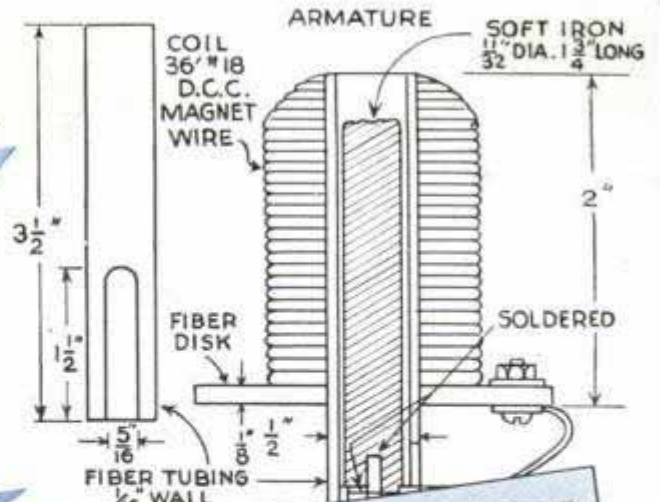
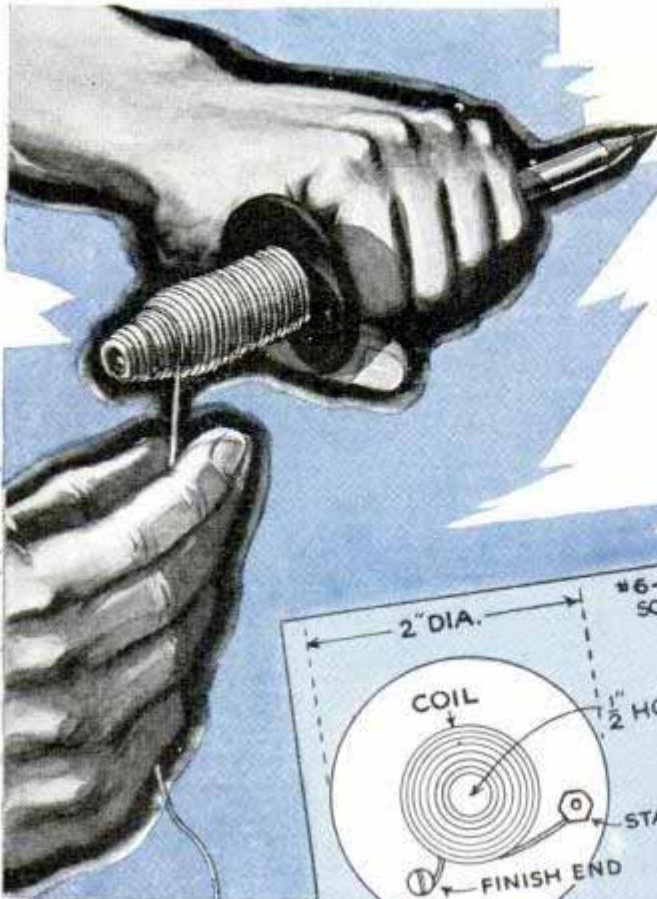

be hardened and stiffened. It is cut to size, inserted in the copper tube and the slotted end is compressed. The core is wound with a 36-ft. length of No. 18-ga. d.c.c. magnet wire. Wind neatly in compact layers. Start and finish ends are connected as shown.

The armature is supported in the fiber tube by a flexible piece of No. 30-ga. spring brass. The blank for this is shown in Fig. 2. Having cut the blank, one end is turned over parallel to the other end to form the spring. The slotted end of the spring straddles the copper tube of the armature, is brought up against the iron, and soldered. The spring passes through a slot in the tubing and is attached to the machine screw holding the finish end of the core. Now the hand grip is slipped over the armature point and the open end is glued in the coil tube. To

operate, wires are connected as shown in the wiring diagram, using either a 6-volt storage battery or a 6 to 8-volt transformer of not less than 50 watts. When you press the pencil electrode lightly on the work a series of arcs will result.

The engraving pen, which has a vibrating scriber, is detailed in Fig. 4. The frame, which supports the armature and coil, is a piece of $\frac{1}{8}$ by $\frac{3}{4}$ by $5\frac{1}{4}$ -in. flat iron, bent and drilled as shown. The $\frac{3}{8}$ -in. hole is tapped for the fiber-tube hand grip. The $\frac{3}{8}$ by $1\frac{3}{16}$ -in. core for the coil is filed or turned at one end to fit the $\frac{1}{4}$ -in. hole in the frame. The projecting end is peened over. Before winding the coil, a disk of thick, oiled paper or thin fiber is slipped over the core, after which the latter is wrapped with friction tape. The completed coil is covered with a single wrapping of tape and is then thoroughly tested to make sure that it is not grounded to the frame.

The vibrating armature is made from a piece of $\frac{1}{8}$ by $\frac{1}{2}$ -in. flat iron to which a piece of old hacksaw blade is riveted. Top and side views of the armature are detailed in Fig. 4. Note how one end is tapered to take a rubber sleeve on which the end of the scriber is fastened. Both the extending end of the hacksaw blade on the armature and the adjustment arm of $\frac{1}{8}$ -in. metal are held by a machine screw to the frame, a thumbscrew being used to control the up-and-down movement of the armature.

The fiber-tube hand grip is threaded at one end to screw into the frame. The other end is fitted with a bearing for the scriber, similar to the one in Fig. 3. The scriber is formed from a 7-in. length of $\frac{1}{8}$ -in. drill rod. The eye at one end fits a rubber bushing on the armature. The other end of the rod is pointed. When assembled, the scriber should move freely in the bearing at the lower end. The armature spring, the adjusting arm and the frame are each indented with a cold chisel so that the two top pieces will not shift. Solder a length of lampcord to the coil ends and tape well. When the line wires are connected to a 50-watt, 6 or 8-volt transformer and the proper spring adjustment is made, there should be a strong and steady vibration of the scriber point. Some variation in adjustment will be necessary.

Sheet-Metal Disks and Washers Quickly Cut in a Lathe



Disks and washers of light sheet metal are easily turned out in quantities with this tool

It's a simple matter to cut small disks from light sheet metal in a lathe with this tool. A block upon which the metal is mounted is backed up by a wood pad on the tailstock, and the shank of the cutting tool is held in the chuck. The tool may be made in one part if only one size of disk or washer is to be cut. Or, it may consist of an externally threaded shank to receive internally threaded cutters of various sizes. Sawing off the end of the tool obliquely and grinding this surface, after hardening, produces a sharp working point.

—John E. Hyler, Peoria, Ill.

Wash Tubs Held Snugly on Wall

If you hang your wash tub on the exterior wall of an outbuilding and it "bangs around" in the wind, a couple of empty thread spools will quiet it. One end of each spool is cut off and they are screwed to the wall on each side of the tub.

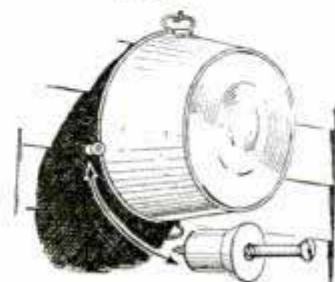

Step-Saving TEA and

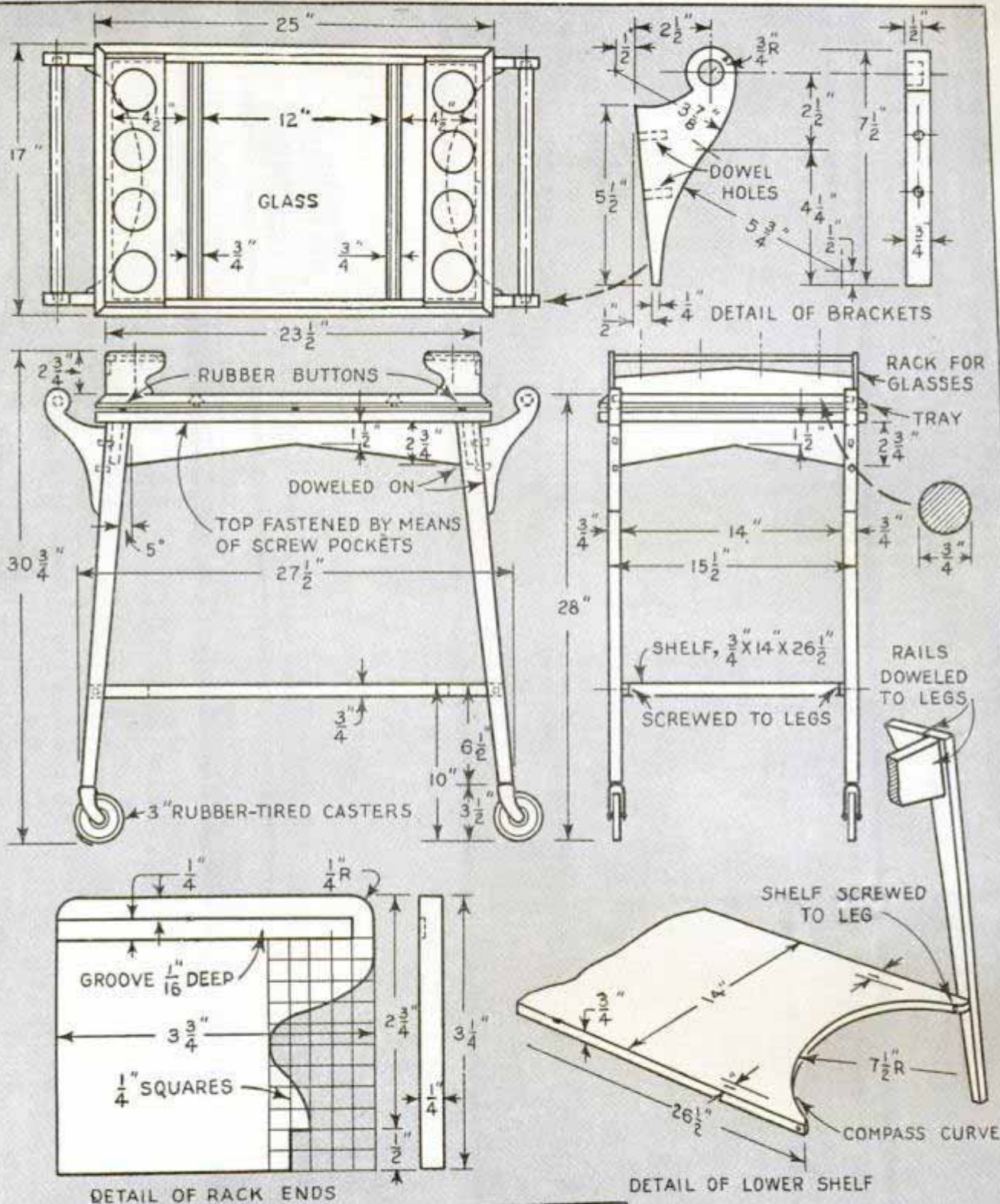

Styled for simplicity of line and easy construction, this beverage cart has a glass-bottom tray fitted with racks for holding a refreshment set. Due to the small size of most of the parts you'll find it economical to build this project of selected solid wood. If you study the joinery closely you will see that the whole job can be done with hand tools

**POPULAR
MECHANICS
MAGAZINE**

Wood-Turning Chisels Stored in Pockets under Lathe

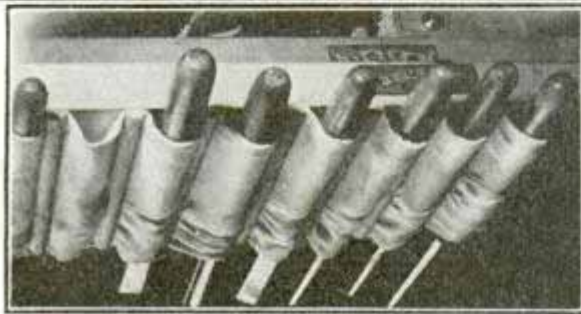

Turning chisels stored in these pockets are not likely to be damaged and are always at hand

Tacked to the underside of the bench or table supporting a wood lathe, a strip of canvas 5 or 6 in. wide, divided into a series of pockets with wood cleats, as shown, provides a handy place to store your wood chisels. They are always at hand when needed and there is little possibility of them getting dulled or nicked.

—L. C. Ferguson, Manteca, Calif.

Cutting Mimeograph Stencils to Get Heavy Printing

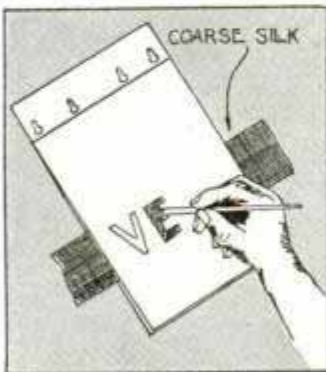

By rubbing over the area to be shaded with the point of a loop stylus, much of the stencil coating will be absorbed by the silk without injury to the gauze or tissue which

If you want to print heavy, black lettering with a mimeograph machine, cut the stencil over a piece of coarse silk instead of the usual fine screen wire. By rubbing over the area to be shaded with the

forms the foundation of the stencil. Thus, when placed on the machine, the ink will come through this treated portion more freely, producing a heavy black tone. Stencils treated in this manner must be handled carefully, and will not stand up under long runs.

Screwdrivers and Valve Grinders from Old Speed Wrenches

Old speed wrenches with broken sockets are readily converted to a screwdriver or a valve grinder.

The latter is made by sawing off the socket, slotting the end of the wrench to take the tip, which is pivoted in place with a cotter key. The tip is made from a steel washer as shown. In making a screwdriver, the end of the wrench is merely ground to shape and hardened.

—Robert E. Davy, Represa, Calif.

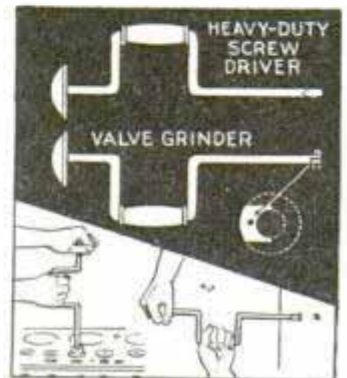

Paraffin Scraps Molded into Cakes

Scrap pieces of paraffin, left over after a job of fruit preserving, may be molded easily into cakes and stored for future use.



Just melt the scraps and pour the liquid into a rubber soap tray, first cooling the tray in water and wiping it dry. When the paraffin hardens, the tray may be bent as shown to release the cake. While

melted paraffin is not dangerously explosive, it is easily ignited. Therefore, care should be taken to see that it does not come in contact with a flame.

ⓁIf strong alkaline soaps are used in washing decorated china, they will cause gold bands and other decorations to deteriorate and ultimately disappear.

"Aerial" COLD FRAME

Grows Vigorous Seedlings

by
Clarence Robert Stahler

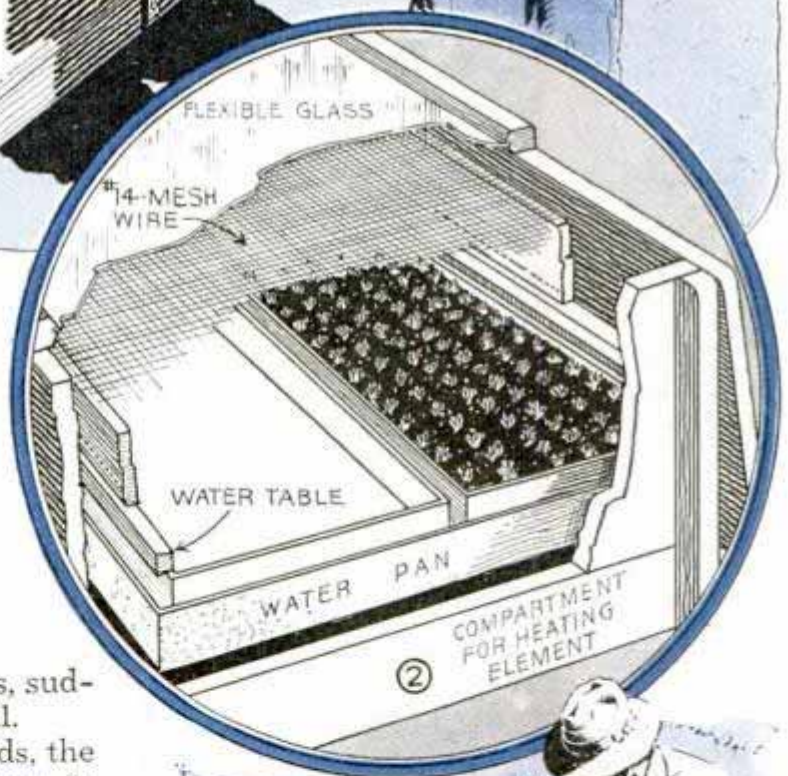
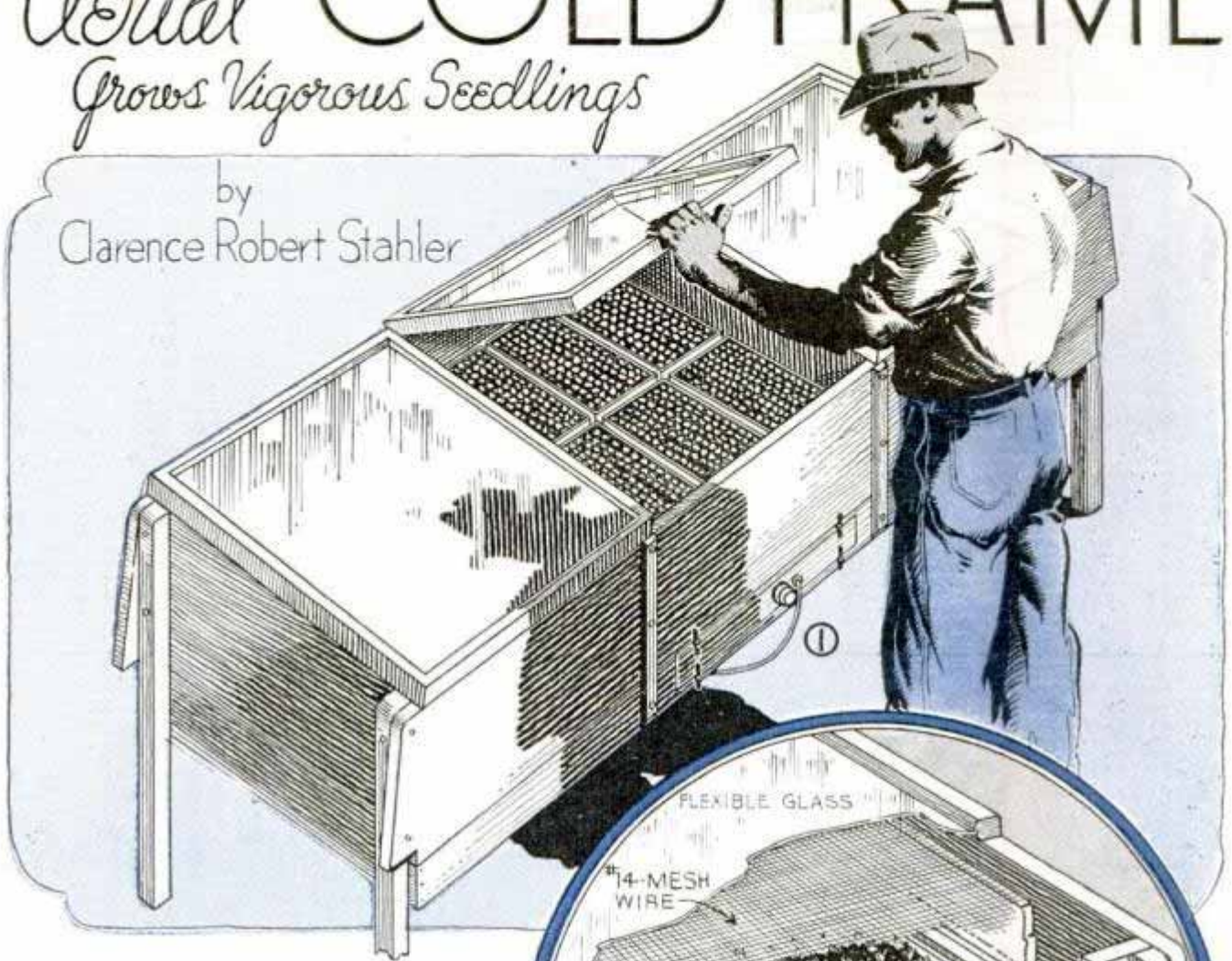

MANY are the hazards besetting cold-frame and hotbed culture of seedlings. Manure-heated beds often cool prematurely and subject the plantlets to ammonia-fume injury. Care and watering methods are tedious in both the cold frame and hotbed, and often there occurs complete destruction of the seedlings by "damping-off." Cutworms, cats, dogs, sudden beating rains—all take their toll.

Designed to eliminate these hazards, the "aerial" cold frame and hotbed shown in Fig. 1 will accommodate approximately 720 seedlings spaced 2 in. apart in eighteen flats. The frame length may be shortened, if desired. Use a good grade of decay-resistant lumber such as cypress, sound and free from knots, priming all parts of the frame before assembling. The construction is shown in Fig. 2, from which you will note several advantages over the regular type of cold frame. There are a



The cutaway view above lets you in on the secret of uniform success with this cold frame. Seedlings are watered by natural capillary action and a screen gives the desired "dappled" shade

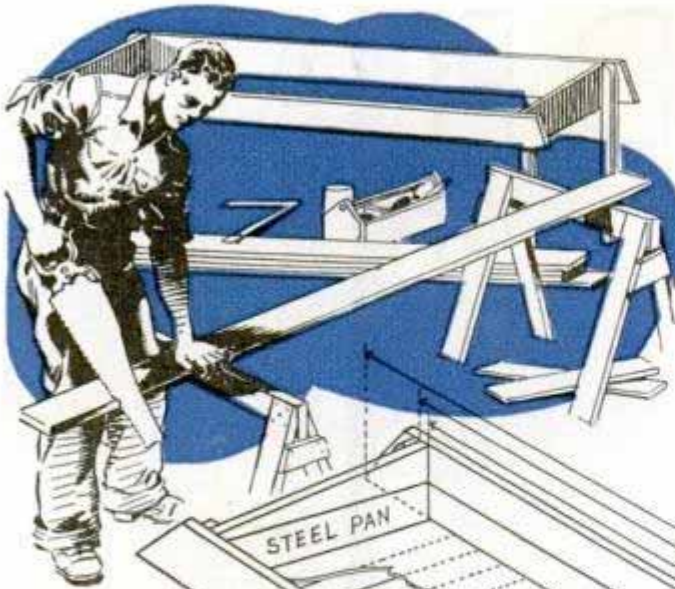

After getting out the front, back and end rails from 1 1/4-in. stock to the finish size, the parts are bolted to the legs, then nailed together and squared ready for the floor. The front legs are 30 in. and the rear legs, 33 in. in length, over-all. After adding the floor, you bore a hole for a 1/2-in. pipe nipple in the right-hand corner about 3 in. from the front and end-rail joint. Now you can make up the water pan of galvanized iron as in Figs. 7 and 8. When you place it in the frame, space it evenly all around and tack thin blocks of wood to the rails so that the pan cannot shift its position. Next you nail a water table to the frame as in Figs. 2 and 5, keeping in mind the im-

13" T.&G. FLOOR
16 IF FRAME
HAS NO ARTI-
FICIAL HEAT

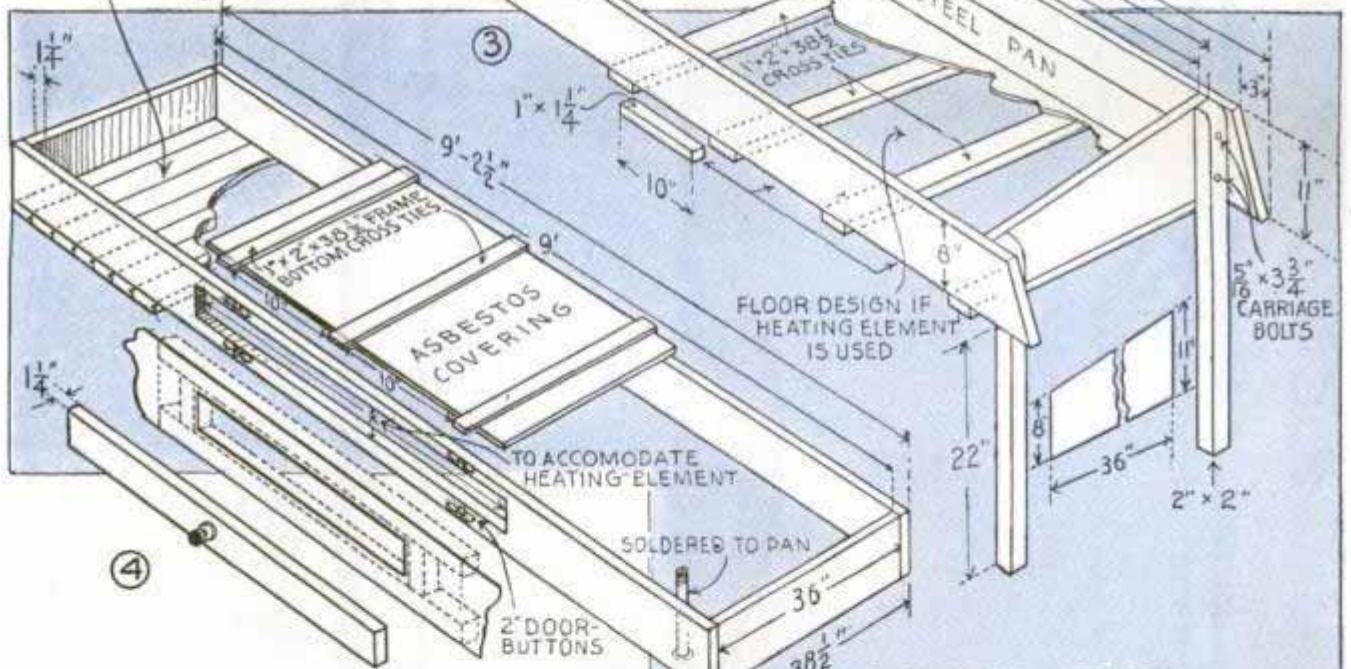

number of parts that fit inside and as the wood may warp slightly, they should be made and fitted with care. The frame may be made for use without artificial heat, and the heating compartment added later, with slight alterations. When the frame is made for use without a heating element you have to depend on sash adjustment, uniform watering, and a southern exposure for proper growing conditions.

Now to begin construction. Figs. 3, 4 and 5 give the details. Notice particularly the variations in the floor in Fig. 3.

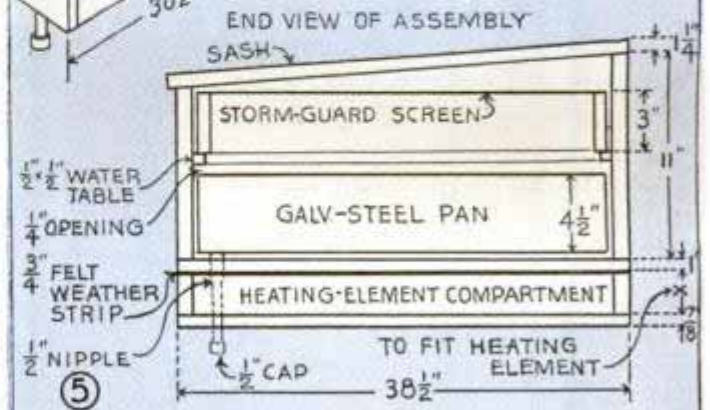

5
You can build the frame either with or without a heater compartment. Cypress is the lumber to use for the frame as it resists decay. The material should be primed before assembling it

portant $\frac{1}{4}$ -in. air space between the top edge of the pan and the water table. Though a somewhat permanent fixture, the pan may be removed by prying off the water table, the main purpose of which is to direct rain falling, while frame is open, into pan.

The flats, which are built to fit inside the water pan, have drainage holes about 3 in. apart. As the flats must be elevated slightly above the bottom of the pan, $\frac{1}{4}$ by 1 by 1-in. blocks of wood are tacked to the bottom corners and one in the center. The purpose of this is threefold: It permits rapid entrance of water through drainage holes, positive drainage and air circulation between bottom of flats and pan. One flat is made 4 in. shorter than the others. It is placed in the lower right-hand corner of the pan, thus leaving the drainage hole open to



Water reaches the seedlings from the water pan in which the flats are placed. When moisture shows on the surface of the flats, excess water is drained from the pan

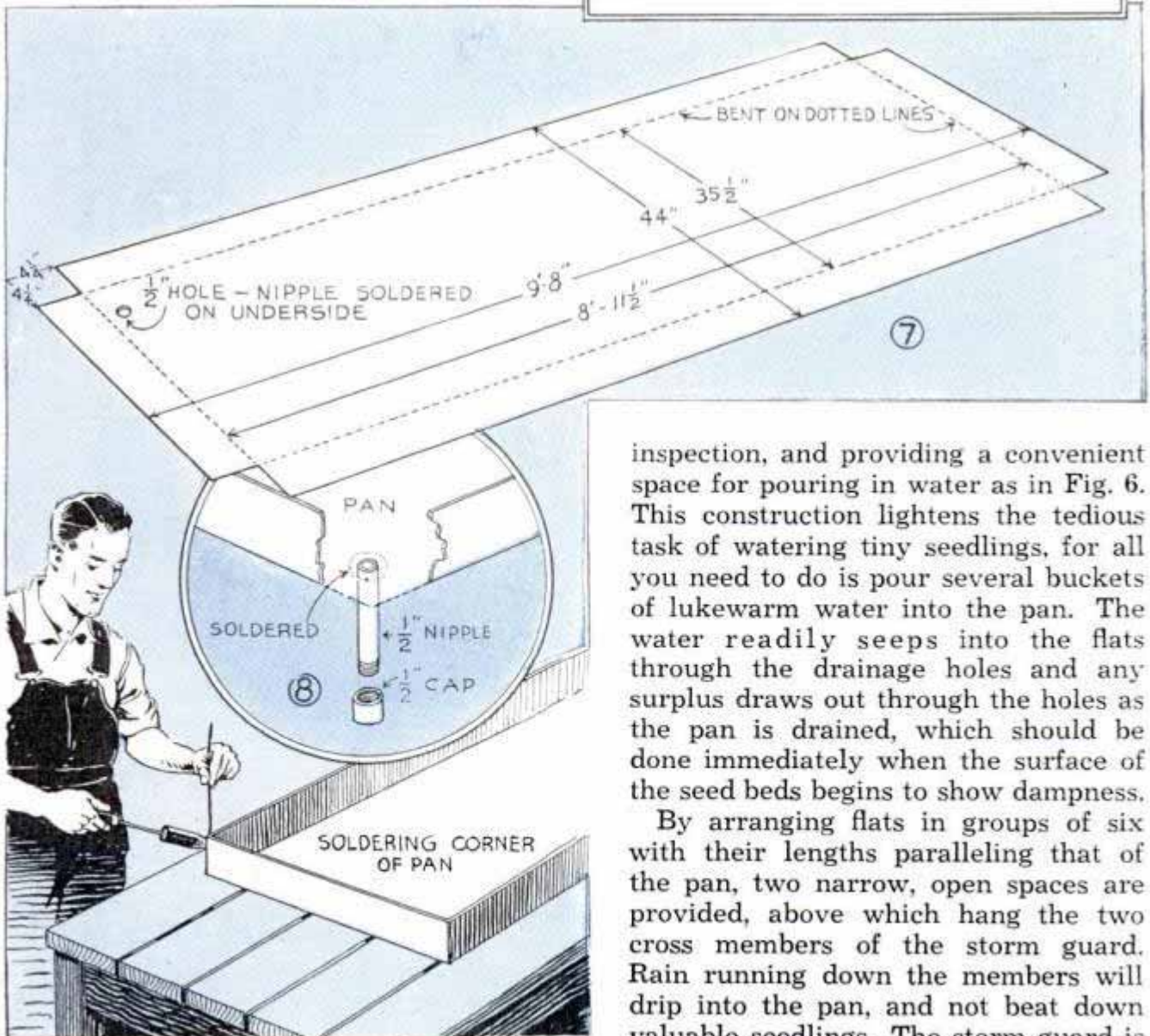

inspection, and providing a convenient space for pouring in water as in Fig. 6. This construction lightens the tedious task of watering tiny seedlings, for all you need to do is pour several buckets of lukewarm water into the pan. The water readily seeps into the flats through the drainage holes and any surplus draws out through the holes as the pan is drained, which should be done immediately when the surface of the seed beds begins to show dampness.

By arranging flats in groups of six with their lengths paralleling that of the pan, two narrow, open spaces are provided, above which hang the two cross members of the storm guard. Rain running down the members will drip into the pan, and not beat down valuable seedlings. The storm guard is

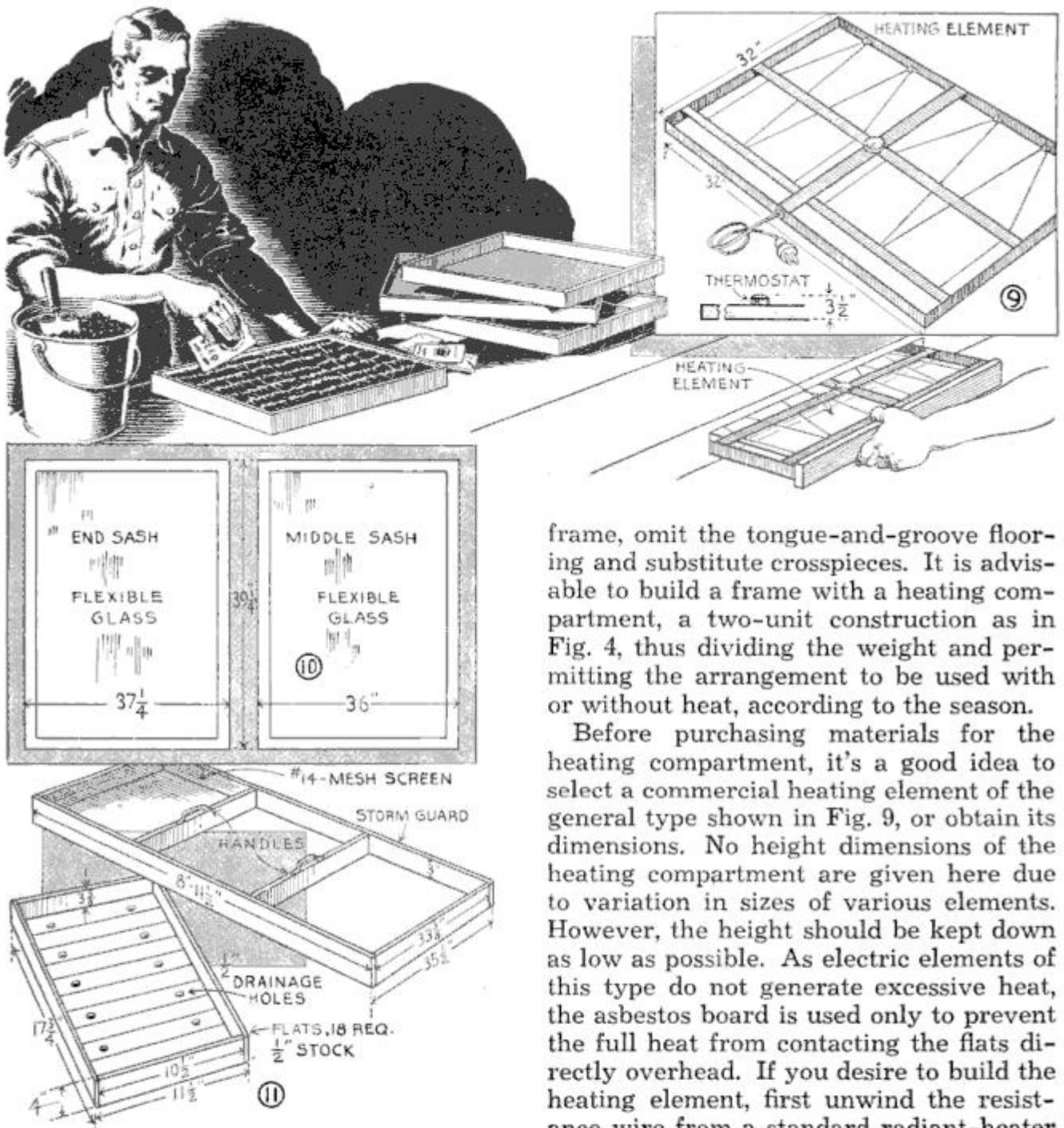

an important part of the whole arrangement. It should always be in place, with its fine wire mesh ready to break up large raindrops and deliver them to the seedlings as mist. The guard furnishes the desirable "dappled" shade, which may be increased by using No. 14 mesh wire and building up the wire diameter with a coat of heavy paint. The guard also breaks drying winds.

Any substantial method of sash-corner joining may be used, providing it permits the sash to rest snugly on the frame rails. Flexible glass, which is more nearly unbreakable, is preferable to ordinary glass. If you add a heating compartment to the

frame, omit the tongue-and-groove flooring and substitute crosspieces. It is advisable to build a frame with a heating compartment, a two-unit construction as in Fig. 4, thus dividing the weight and permitting the arrangement to be used with or without heat, according to the season.

Before purchasing materials for the heating compartment, it's a good idea to select a commercial heating element of the general type shown in Fig. 9, or obtain its dimensions. No height dimensions of the heating compartment are given here due to variation in sizes of various elements. However, the height should be kept down as low as possible. As electric elements of this type do not generate excessive heat, the asbestos board is used only to prevent the full heat from contacting the flats directly overhead. If you desire to build the heating element, first unwind the resistance wire from a standard radiant-heater element, pull the wire straight and then arrange it on a wood frame. Porcelain knobs should be used to hold the element. The ends of the resistance wire are twisted to the bared ends of a length of a flexible waterproof cable, which supplies current. A suitable thermostat, mounted in the center of the heater frame, is cut in one of the supply lines.

Select an accurate thermometer whose frame at top and bottom is bent back at right angles. The bottom projection is bent up so that it can be fastened in sloping position at one end of a flat. The thermometer is located in the center of the frame so that the sun strikes the bulb.

Bathroom Cabinet Has Self-Contained Light

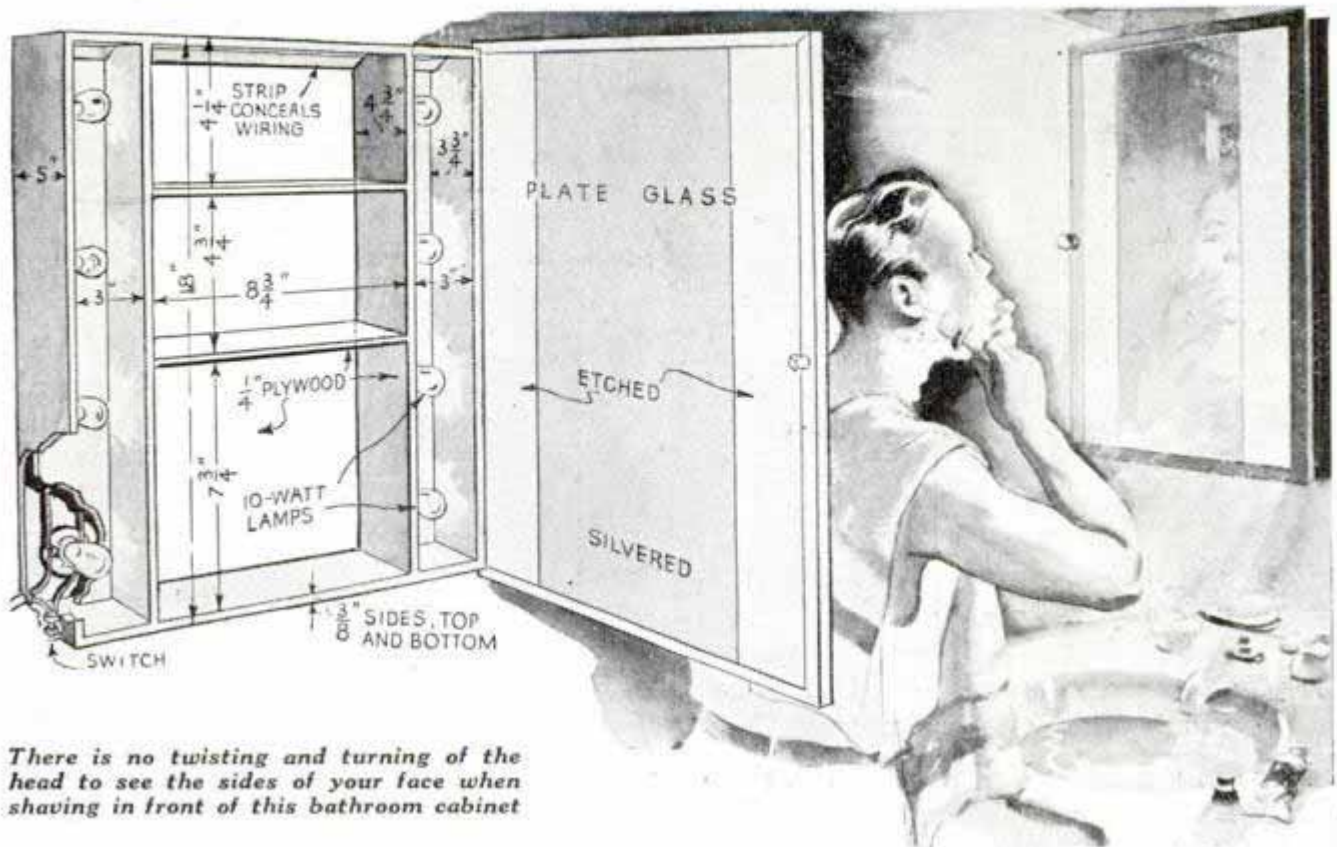

There is no twisting and turning of the head to see the sides of your face when shaving in front of this bathroom cabinet

Combining neatness and compactness with modern diffused lighting, this bathroom cabinet not only illuminates both sides of the face for shaving, but it floods the bathroom with non-glaring light. Recessed into the wall in the conventional manner, the cabinet differs from the usual flush, mirror-faced type in that narrow wells at the ends of the shelves house electric bulbs. The portions of the mirror covering the bulbs are unsilvered and are etched or frosted to diffuse the light. By

having the silvered area and the etched areas on the same piece of plate glass, a maximum of strength with a minimum of over-all size is obtained. The lamps are accessible for cleaning and replacement without the necessity for separate framing of the etched panels. The cabinet is constructed of plywood. Glass may be etched by rubbing with fine emery powder, gummed paper first being pasted along the edges of the center area to protect the silvering.

Home Water Tank Heated by Waste Gases in Smoke Pipe

As the distance between my furnace and hot-water tank could not be reduced easily, I found it practical to install a water-heating unit in the smoke pipe as shown. In my case, this installation has proved more satisfactory than the usual type of water back in the furnace as it eliminated long feed pipes with a resulting reduction in wasted heat radiation.

—R. K. Beal, Marion, Ohio.

☐ If your doorbell is fastened to the underside of one of your hot-air furnace registers, it can be heard in the basement.

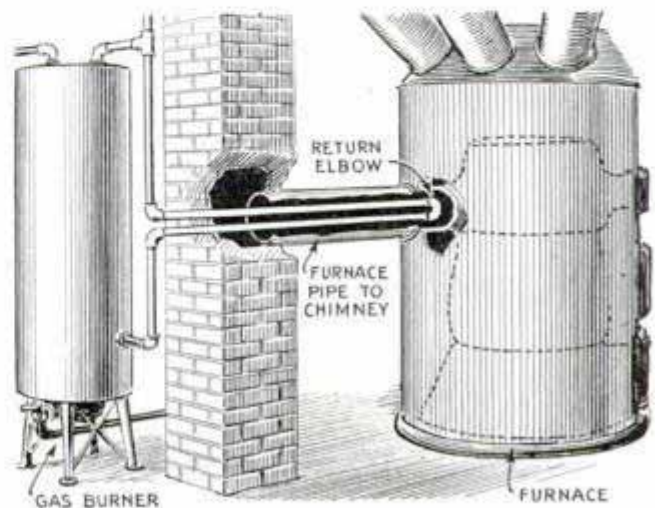

Sewing Basket from Small Keg Resembles a Large Wood Cup

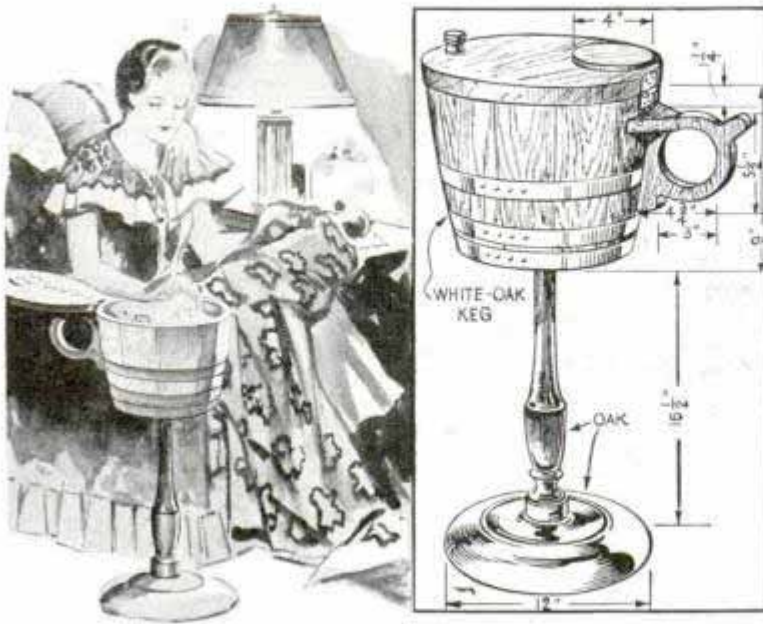

Very little work is required to convert a keg, which can be purchased cheaply, into this novel sewing basket

Here is a sewing basket which is simplicity itself, yet it is unusually attractive in any surroundings. Made from one half of a small white-oak keg about 19 in. high, the basket is supported by a standard and base turned from oak to match the keg. The lid and handle are solid oak, the sole purpose of the latter being to support the lid when open and to carry out the cup resemblance. The interior of the basket can be finished as desired. In this case, a half-moon tray, which lifted out, was attached to the side of the basket to hold thread, buttons, etc., and the underside of the lid was fitted with felt holders for scissors and other accessories.

Sanding Blades for the Jig Saw

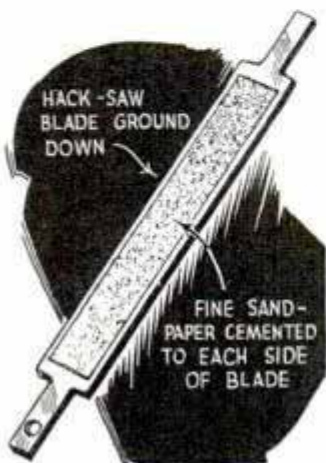

For sanding intricate scrolls and similar work where the job would be tedious if done by hand, you can do it quite easily by using these improvised sanding blades in your jig saw. They are made by grinding pieces of

hack-saw blades to the shape shown, and then cementing abrasive paper to both sides of them. I find that bicycle-rim cement is best for this purpose as it sets quickly and is inexpensive.

—H. R. Hearn, Greenville, S. C.

Vertical Enlarging Easel Is Adjustable in Height

A useful addition to your dark-room, this vertical enlarging easel is readily constructed from scraps of wood. The dimensions, of course, will vary with the focal length of your particular enlarging lens, the degree of enlargement desired and the height of the lens from the floor. The standard of the easel slips inside of a U-shaped sleeve to which is screwed 1 by 5-in. supporting members securely attached to the base as shown, flat-iron braces being used. When the standard has been adjusted for height,

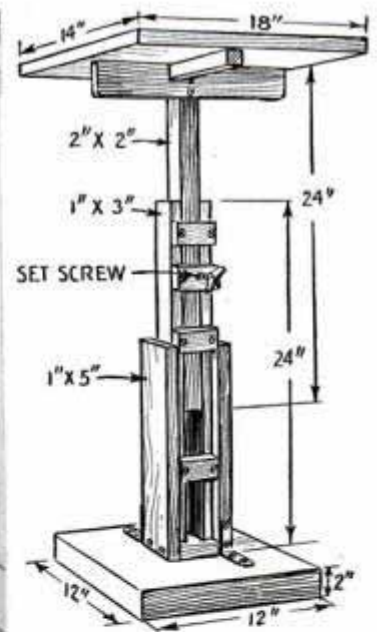

Be sure that the easel is perfectly level, otherwise the image will be distorted

a thumbscrew holds it in place. The thumbscrew is fitted to a cleat across the open side of the sleeve, while similar cleats serve to strengthen the assembly.

☐ Green bananas will ripen quickly if they are placed in a paper bag and stored in a dark place.

LARGE TABLE

folds into small unit

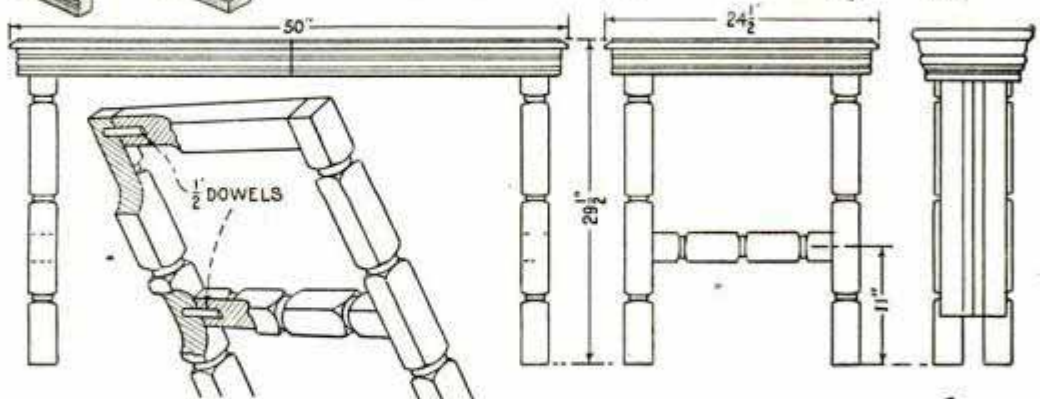
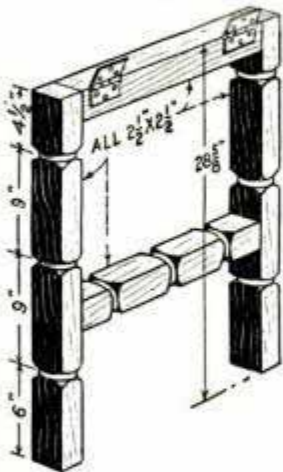
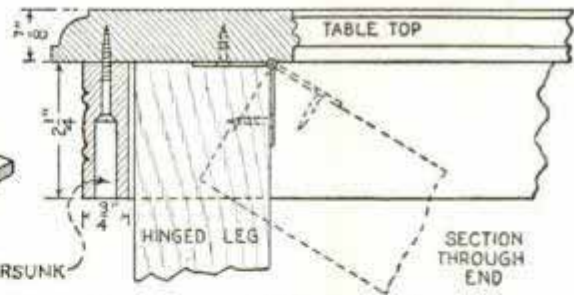
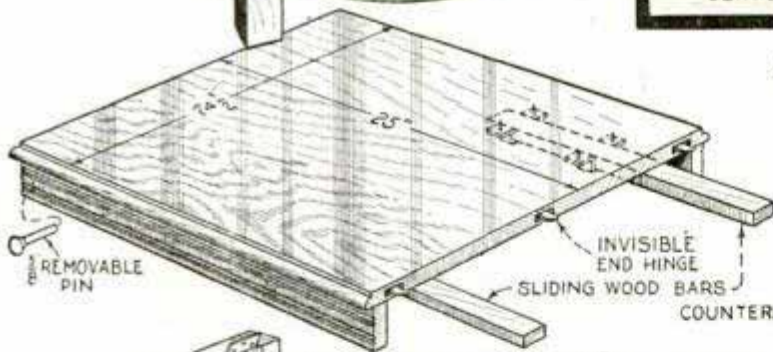
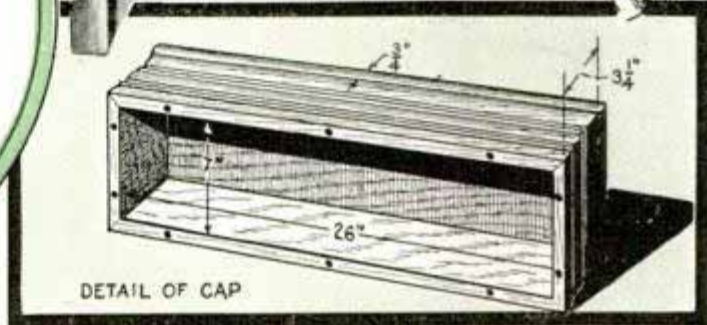
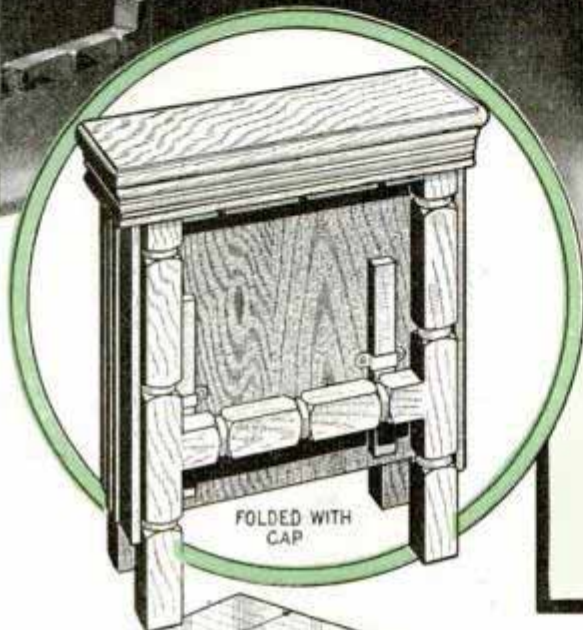
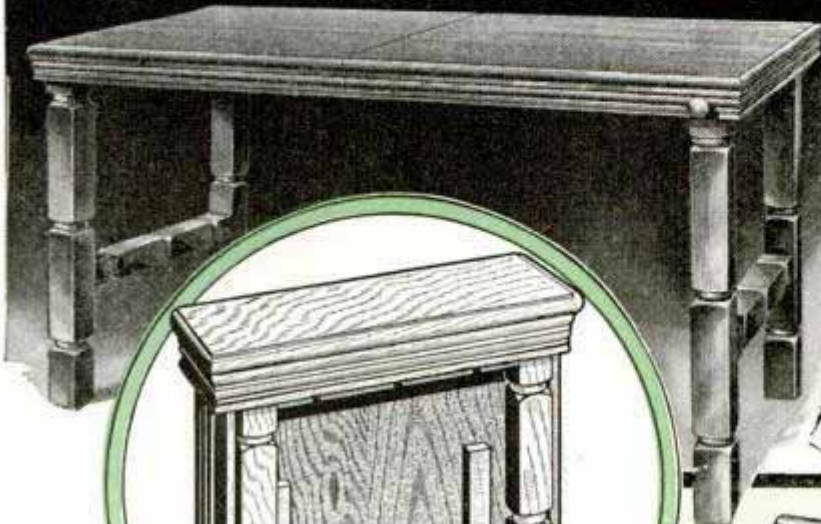

Slide back two bars beneath the top, pull a couple pins and this 50-in. table collapses into a small unit but a fraction of its original size. When folded, a neatly molded cap fitting over the legs makes it look just like an ordinary occasional table

Glazier's Gloves Have Fingers That Won't Slip



Glass panes are less likely to slip out of your hands when these patches are applied to tips of gloves.

Canvas gloves, which are often worn by glaziers, may be made more convenient for lifting and carrying large panes of glass if the fingers are rubber tipped. Simply use inner-tube patches, applying them to the gloves in the regular way, using two liberal coatings of rubber cement on the canvas. The cement should be allowed to dry between coatings and before applying the patch.

Jig for Band-Sawing True Circles

Cutting true disks on a band saw is accurately done with the aid of this simple guide. It consists of an arrangement as shown, which has a pointed pivot to swing the work. The pivot must be directly on a line at right angles with the line of cut and neither ahead nor back of the cutting

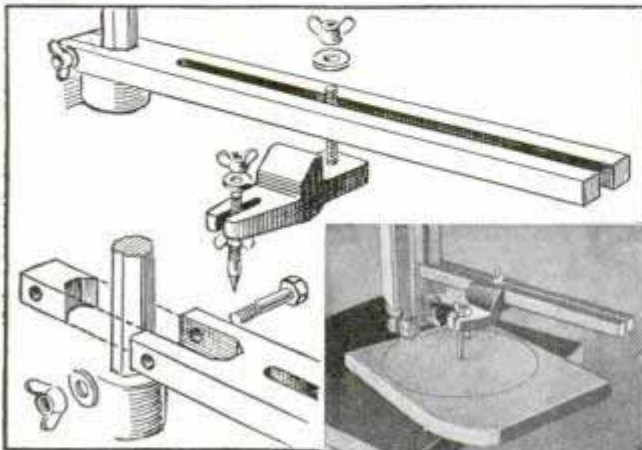

This adjustable guide will handle disks up to a radius equal to one half the table width

edge of the saw blade. The block that holds the pivot is adjustable for different diameters.—Brooks Hill, Neosho, Mo.

Rubber Feet on Alarm Clock Protect Table Top

Fitted over the legs of your alarm clock, small penny pencil erasers of the type shown will prevent scratching the top of a table. If the openings in the erasers are too large, you can shim them with paper.

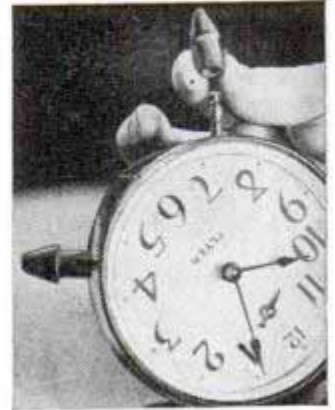

Rivets Rapidly Sheared Off When Chisel Is Notched

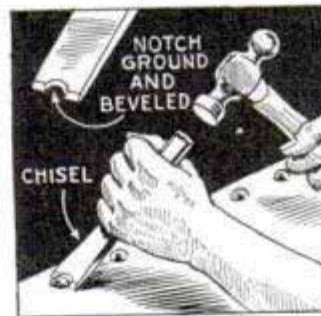

When a cold chisel used for cutting rivets has a half-circular notch in the cutting edge, the job goes much faster than with an ordinary edge as any tendency to slip

off the rivet is prevented. The notch, of course, is ground to a bevel to match the rest of the cutting edge of the chisel.

Loosening Tight Screw Caps

If you are unable to grip a screw cap on a can or bottle tight enough to loosen it, try looping a rubber band around it. This will help provide a non-slip surface, which can be gripped easily, especially if the hands are a little wet or greasy.



⚠ Cutlery which has bone, ivory or pearl handles should not be permitted to remain in water for more than an instant, if at all.

Nested Tables in a Modified Chinese Design

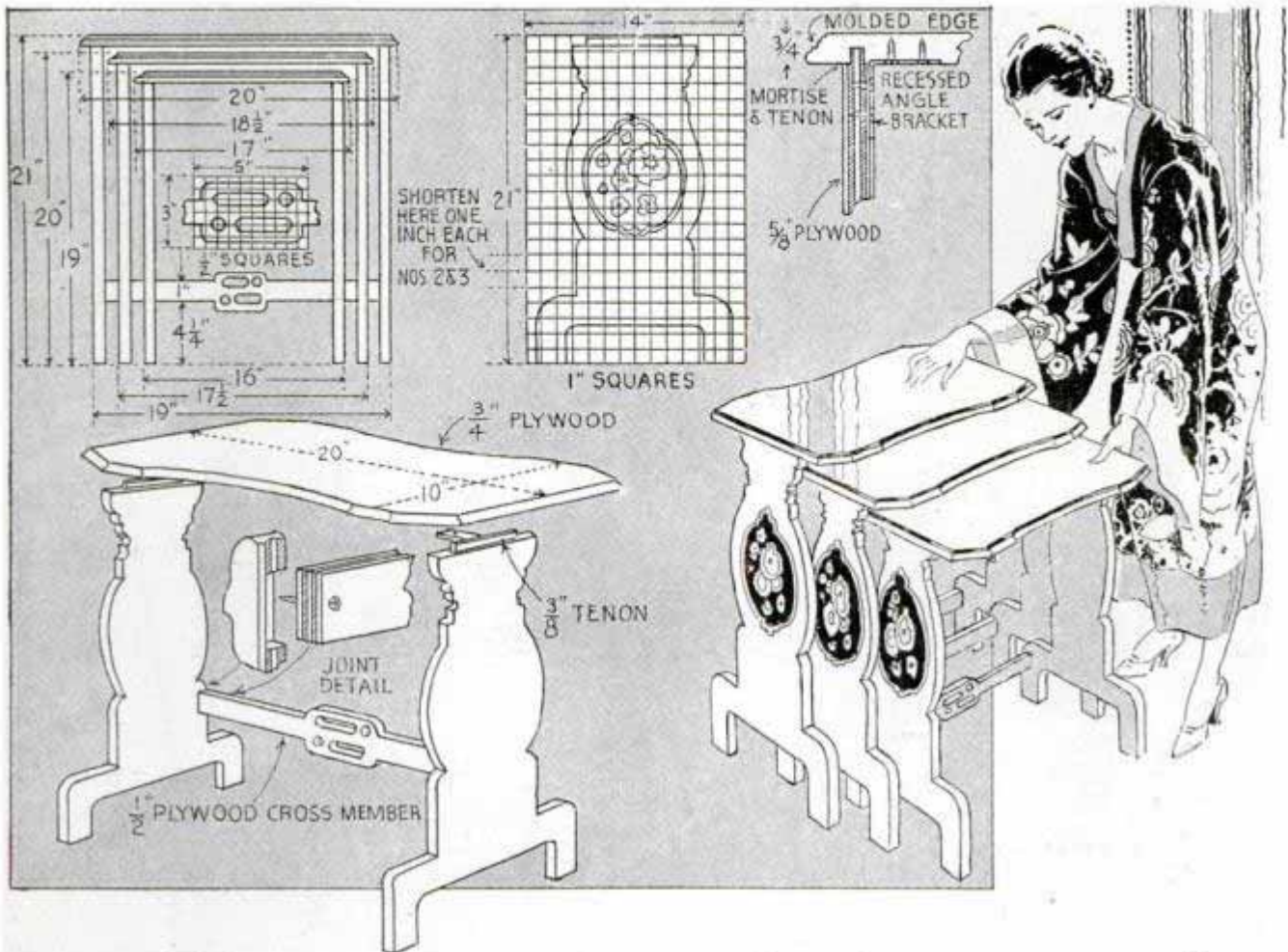

As a modified American adaptation of a Chinese design, these nested tables are unusually attractive if finished in white and "Chinese" red. Plywood is used throughout and each table is 1 in. lower and 1½ in. shorter in length than the one above it, although the widths may be equal. Tops and legs have mortise-and-tenon joints and are reinforced with angle brackets concealed under the tops and set flush with the wood surface, while the cross members are merely mortised and screwed into the leg pieces. All screw holes and finished joints are filled with plastic wood which, when dry, is sanded down. The tables are finished with brushing lacquer over a suitable ground coat, the decorations on the leg pieces being hand-painted or stenciled to suit. The edges of the tops are finished in a contrasting color.

☐ When washing glass vessels in hot water, dip the open end into the water first. If the bottom touches the water first, the sudden expansion is apt to break the glass.

Self-Feeding Iron Saves Solder and Speeds Large Jobs

One tinsmith who has many jobs which require soldering long seams, uses a self-feeding iron like the one shown. He claims that the iron enables him to do neat jobs and save solder as it flows evenly over the seams. Wire solder is fed into the hole in the copper end where it is melted and flows out of the hole at the tip.

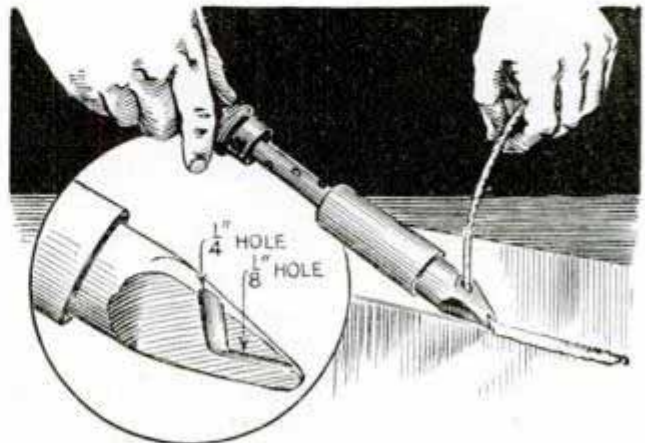

Long seams in sheet metal are neatly and quickly soldered with this altered iron

“TRIP 'EM”

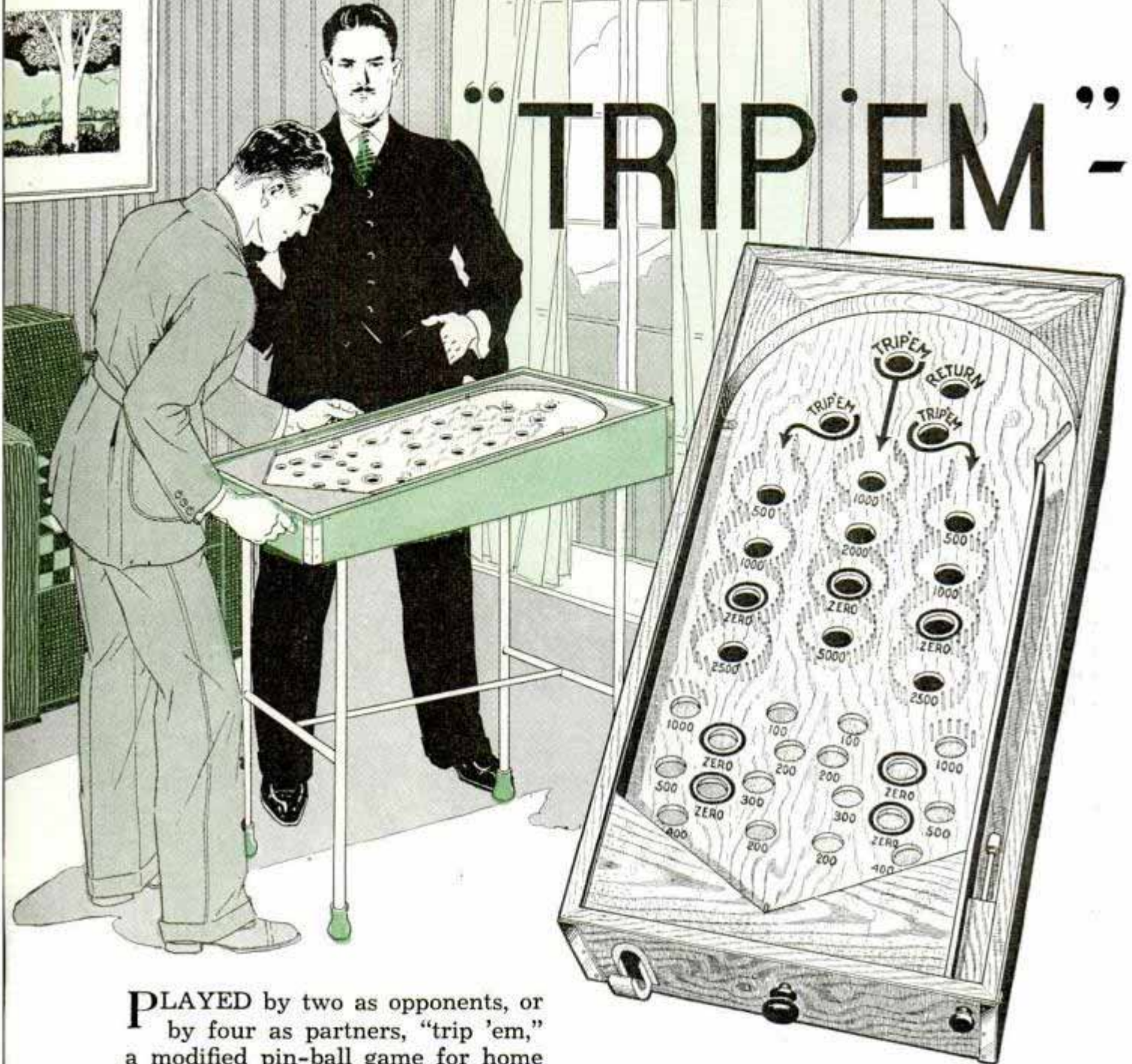

PLAYED by two as opponents, or by four as partners, “trip 'em,” a modified pin-ball game for home entertainment, will prove a highly competitive pastime, as it is possible for a player to reduce his opponent's score by getting one of his balls in the right trip-'em hole, which will cause all the balls in the holes below it to be returned for re-playing. A magnetic trip or kicker adds further interest by automatically kicking balls that reach the front of the board back over the scoring surface until they drop into a hole. In the early stages of the game, the objective of each player is to put his balls in the center “corral” until “zero” is reached. If a player sees that he has two or more consecutive balls to shoot, he may play for the zero in hopes of getting the 5,000 hole on the next shot. When a player has several balls in any of the three corrals, his opponent will play for the respective trip-'em hole to dump the

balls out. The trip 'em feature contributes an uncertainty to the game which sustains interest until the final ball has found a pocket.

Consisting of a number of scoring holes, seven zero or non-scoring holes, three trip 'em holes and one return, the game is played with thirteen $\frac{7}{8}$ -in. balls, two sets of six being of different colors with the odd ball a third color. The odd ball with its score goes to the player whose ball precedes it in the ball cup at the lower left, the same being true if the odd ball has already been tripped out of one of the corrals.

The game-board cabinet, Figs. 4, 7 and 10, is $\frac{3}{8}$ -in. plywood. The ball-return tray is $\frac{1}{2}$ -in. plywood and, as it fits snugly within the sides of the cabinet, it is braced

A home pin-ball game for two players

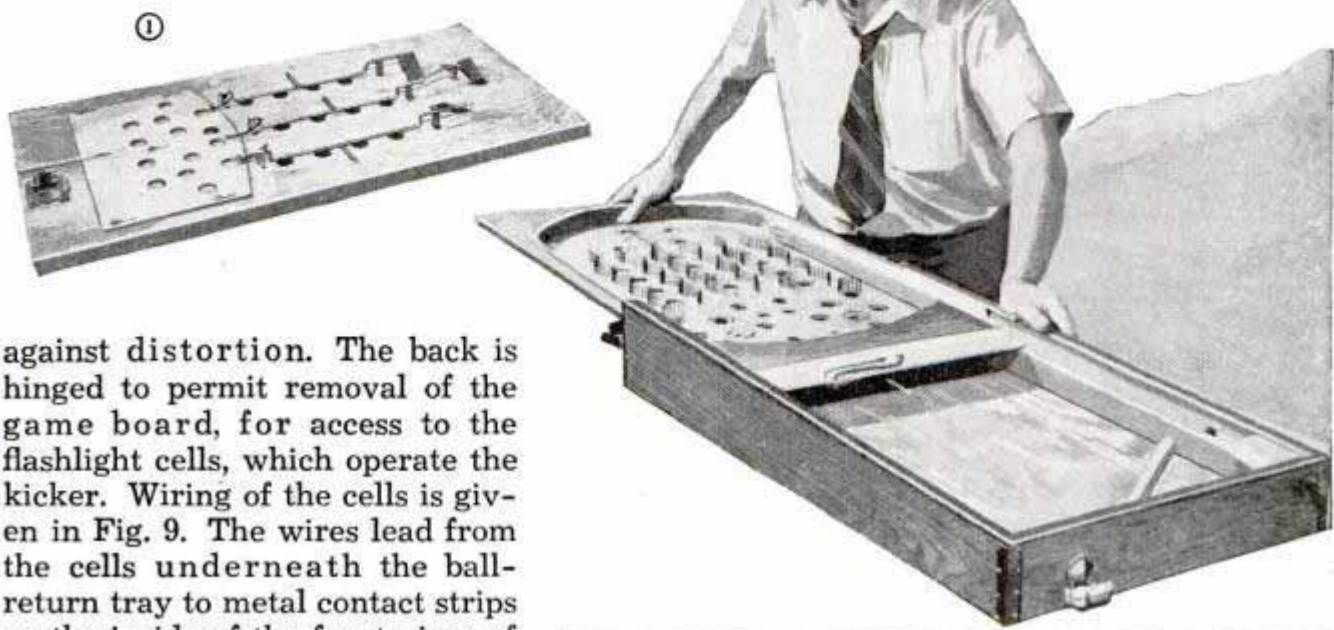

against distortion. The back is hinged to permit removal of the game board, for access to the flashlight cells, which operate the kicker. Wiring of the cells is given in Fig. 9. The wires lead from the cells underneath the ball-return tray to metal contact strips on the inside of the front piece of the cabinet. These, in turn, contact screw heads on the game board when it is in place. The spring-plunger block, Fig. 6, is a permanent fixture of the cabinet. The tension on the spring itself is reasonably soft so that a player can control the speed of the ball. When pulled back fully, the ball should rebound from the rebound spring back to the "gate," Fig. 3, and then back to about the center of the board. The ball-return cup, Fig. 8, is No. 24-ga. galvanized iron, and permits the player to see two balls, which, with one in the shooting trough, shows him the order of play for three shots. Baffle strips on the ball-return tray lead the balls to the cup.

Details of the game board are shown in Figs. 1, 2 and 3. It is $\frac{3}{8}$ -in. plywood on which is mounted the 1-in. ball rail and base block. Next, the sliding board or "shuffle" board is fitted in place as in Fig. 3. The "trip 'em" and the "return" holes are $1\frac{1}{8}$ in. in diameter, all the others being 1 in. in diameter. The "corral" fences around the holes are $1\frac{1}{2}$ -in. finishing nails spaced about $\frac{1}{8}$ in. apart.

Next is the tripping mechanism, which is shown fitted on the underside of the

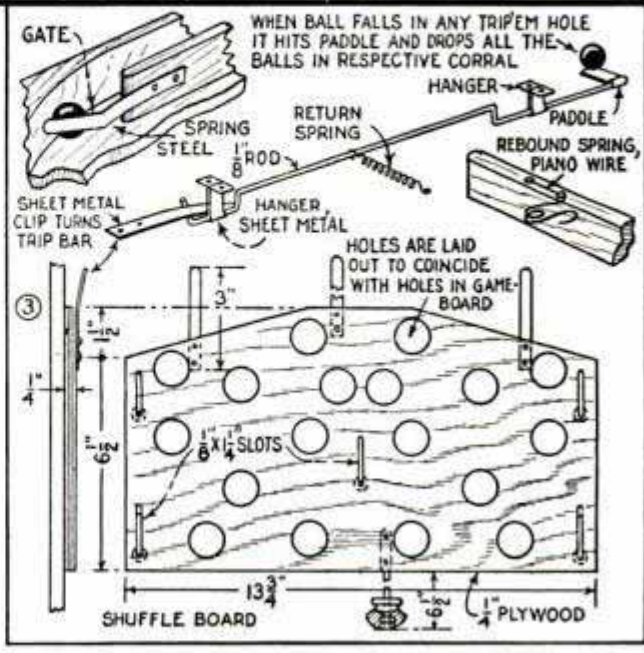
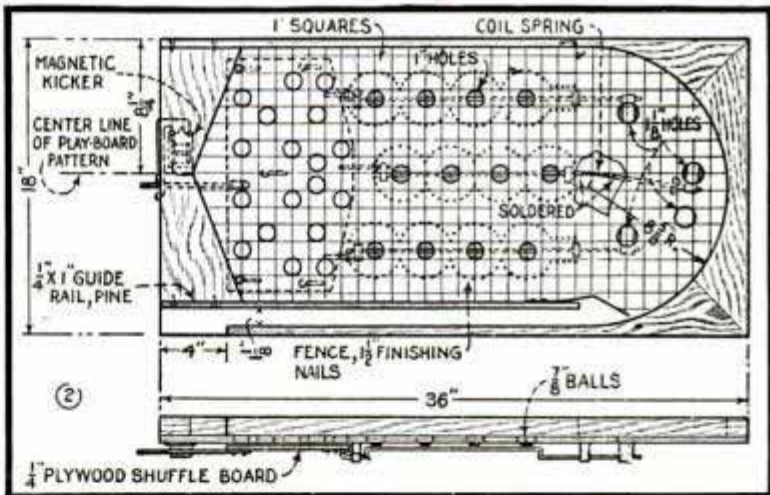

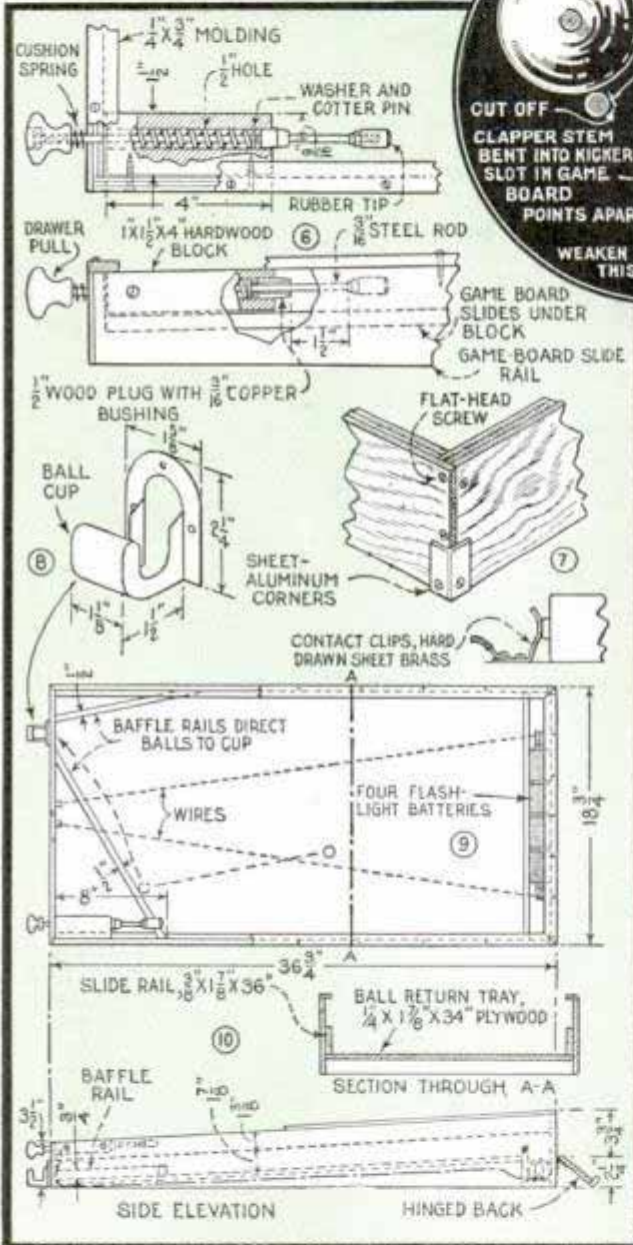
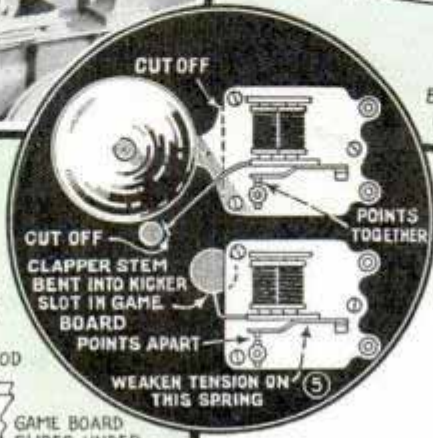
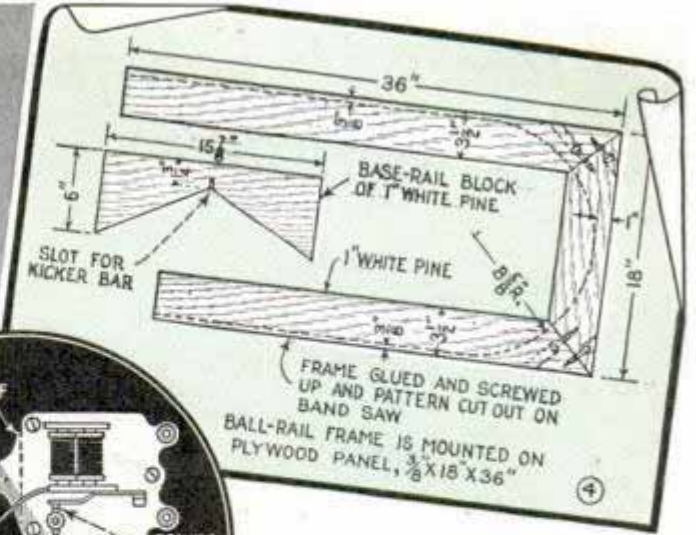
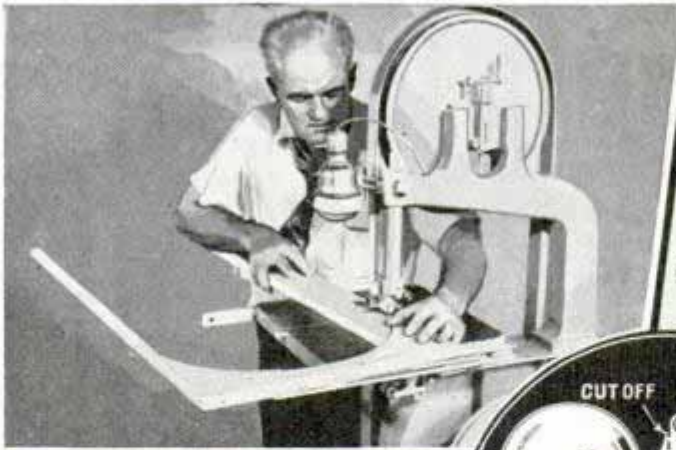

pulled out, sheet-metal tongues on the latter tilt the trip racks, dropping all balls in the corrals.

An altered electric doorbell with the bell and supporting arm removed, forms the kicker as shown in Fig. 5. The clapper shaft is bent at right angles to fit through a slot in the game board and the kicker is mounted so that the weight of a ball pressing against the vibrator points closes them and causes the clapper to vibrate. Careful adjustment of the kicker gives it just the right action.

Screwdriver Altered for Use in Tight Places

One workman who had some screws to drive in a tight place where he couldn't reach with his fingers, altered an old screwdriver as shown, so that it would grip the screws to start them. The flattened part was sawed off, after which the shank was split back a couple of inches with a hacksaw and one side ground down to provide a blade. Then, the other side of the split portion was curved inward slightly.

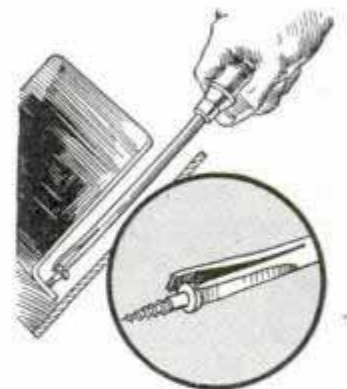

shuffle board in Fig. 1. The trip rack is a 1 1/8-in. rod and the hangers are of sheet metal. It will be seen that when a ball drops in a trip-'em hole, it strikes a tongue, or paddle, which turns the trip rack and drops all the balls in the corresponding corral onto the ball-return tray. When the game is over, and the shuffle board is

☛ A little starch added to calcimine before brushing it on a wall will make it adhere firmly and help prevent streaking.

Novel Walking Stick Serves as Folding Seat

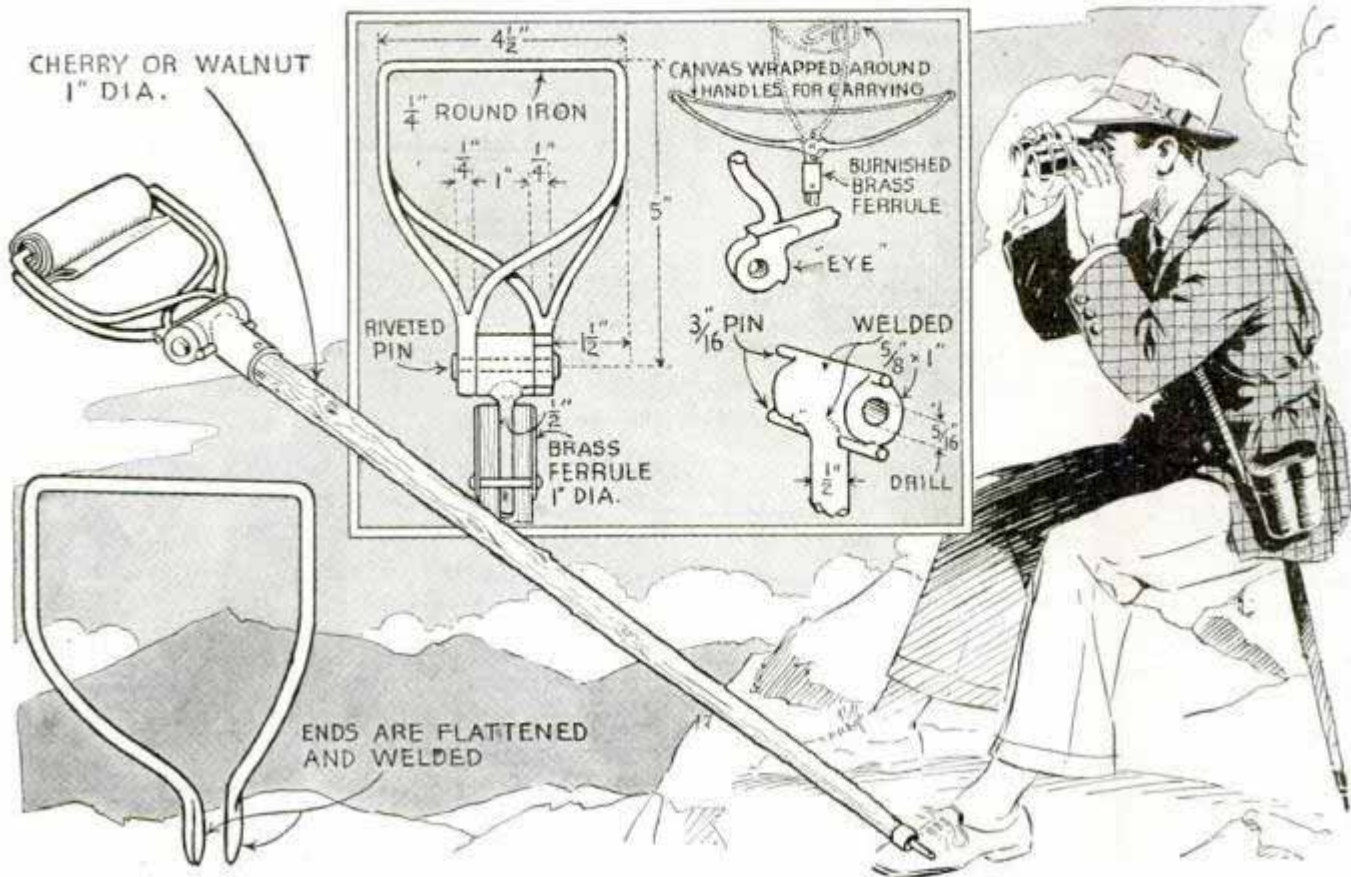

Patterned after a folding seat used by some British sportsmen, this novel walking stick unfolds into a seat, which is very useful at sporting events. It consists of a pair of hinged or pivoted brackets mounted on a substantial walking stick of cher-

ry, walnut or other hardwood. The brackets are shaped like stirrups. They are of 1/4-in. iron rod with the ends flattened and welded together, stop pins being welded to the bearing to prevent the brackets from rocking on the axis.

Light on Your Power Grinder Can Be Adjusted to Needs

Mounted on your home-shop power grinder with a flat-iron bracket, a desk lamp having a flexible shank permits quick adjustment to throw light where it is needed most. The lamp may be wired into the motor circuit so that it is turned on or off with the grinder. The wiring diagram shows the hookup for either a single-pole or a double-pole switch.

—Thomas Trail, Baltimore, Md.

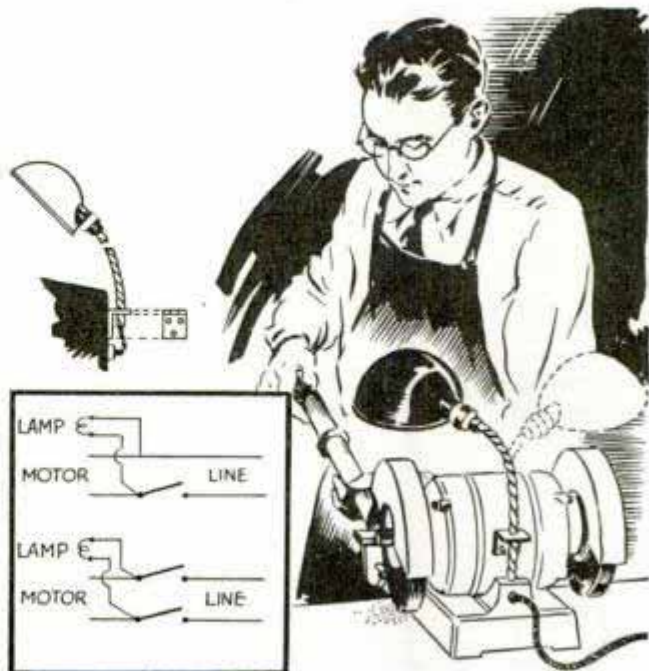

Easily raised, lowered or turned from side to side, a desk lamp illuminates work at a grinder

Giving Wood a Rough Finish

Rough finishes on wood can be made with a rotary wire brush, which tends to cut away the softer portions and leave the harder ones standing out in relief. The brush can be attached to any machine which will rotate it, such as a grinder or, it can be fitted to a flexible shaft.

Stovepipe Damper Set Accurately with a Pattern

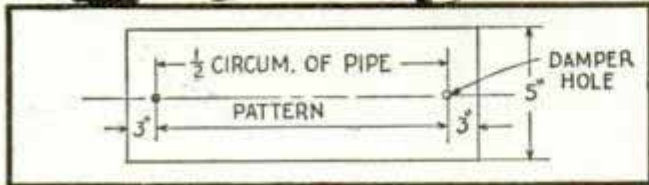

Paper pattern equal in length to one half of pipe circumference locates damper holes accurately

The problem of getting the holes for a damper in a stovepipe exactly opposite each other so that the damper will work freely, is solved by locating them with a pattern equal in length to one half the circumference of the pipe. To make the pattern, fold a strip of heavy paper around the pipe and cut it off just so that the ends come together. Then fold the strip in the center and cut it at the fold. When one of these strips is folded around the pipe and the damper holes drilled at its ends, in line with the centerline of the strip, they will be exactly opposite each other.

—L. H. Georger, Buffalo, N. Y.

Sagging Doors Are Strengthened by Concealed Braces

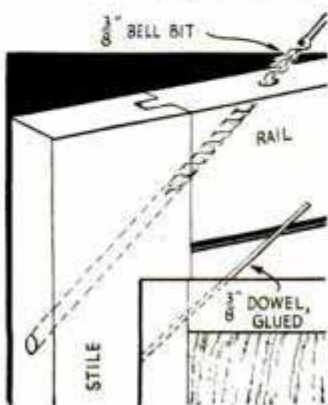

Doors that have a tendency to sag can be braced by doweled them at the corners as shown. When drilling the dowel holes, try to avoid damaging the door tenons as much as possible. Spiral

dowels are best for this work, as they can be fitted tightly into the holes without forcing out an excessive amount of glue when driving them in place.

—C. Serborg, De Motte, Ind.

Jig-Saw Blades Stored in Drawer Made from Curtain Rod

To keep jig-saw blades handy, a small drawer can be made from a flat, telescoping curtain rod. Cut two pieces of the rod and bend the narrow one in the manner indicated to form the sides and ends of the drawer. A wooden knob should be attached at the end. The wider section of the rod is then nailed to the underside of the bench in a convenient place.

—G. E. Hendrickson, Argyle, Wis.

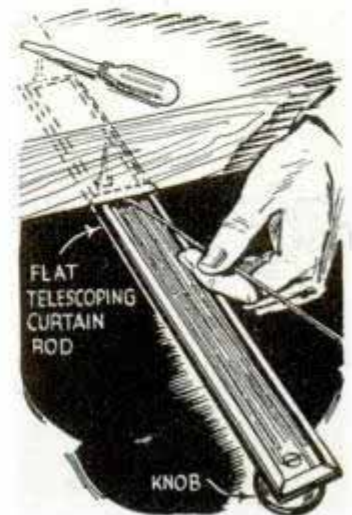

Clamp Aids in Repairing Camera Bellows That Leak Light

The job of patching a leaky camera bellows with strips of rubberized cloth to

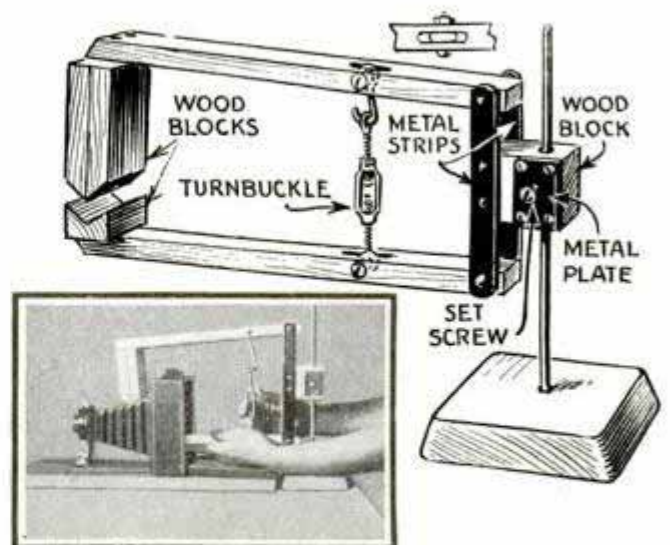

This clamp fits into the folds of a camera bellows and holds patching strips until glue dries

keep out light is simplified with this clamp, which has jaws that fit snugly into the folds of the bellows. The clamp consists of

two wooden arms which are pivoted at one end to a pair of parallel metal strips. The jaws are screwed to the other end of each arm. A small turnbuckle, engaging a hook pivoted to the upper arm, affords a means of setting the clamp in place and tightening the jaws on the work. The whole assembly can be raised or lowered on a vertical rod mounted on a wood base. A set screw holds the clamp at any height.

Upholstery Webbing Is Stretched with Monkey Wrench

If you have a small job of upholstering to do and have no webbing stretcher at hand, a monkey wrench will serve the purpose. It is used in a manner similar to that of a regular stretcher. The jaws are tightened up on the webbing, which is then run back along the handle and is gripped with the fingers to prevent slipping. A pad of felt or similar material should be placed under the end of the wrench to avoid marring the furniture.

—A. H. Waychoff, Tempe, Ariz.

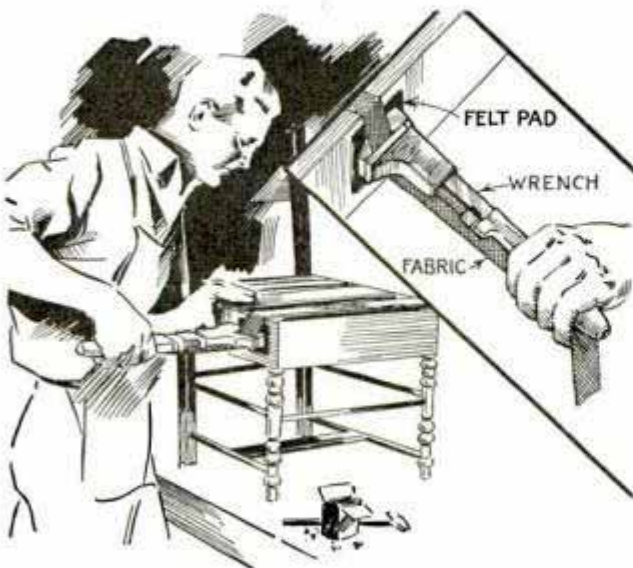

In the absence of a webbing stretcher for an upholstering job, try using a monkey wrench

Home-Movie Projection Stand Has Adjustable Tilting Top

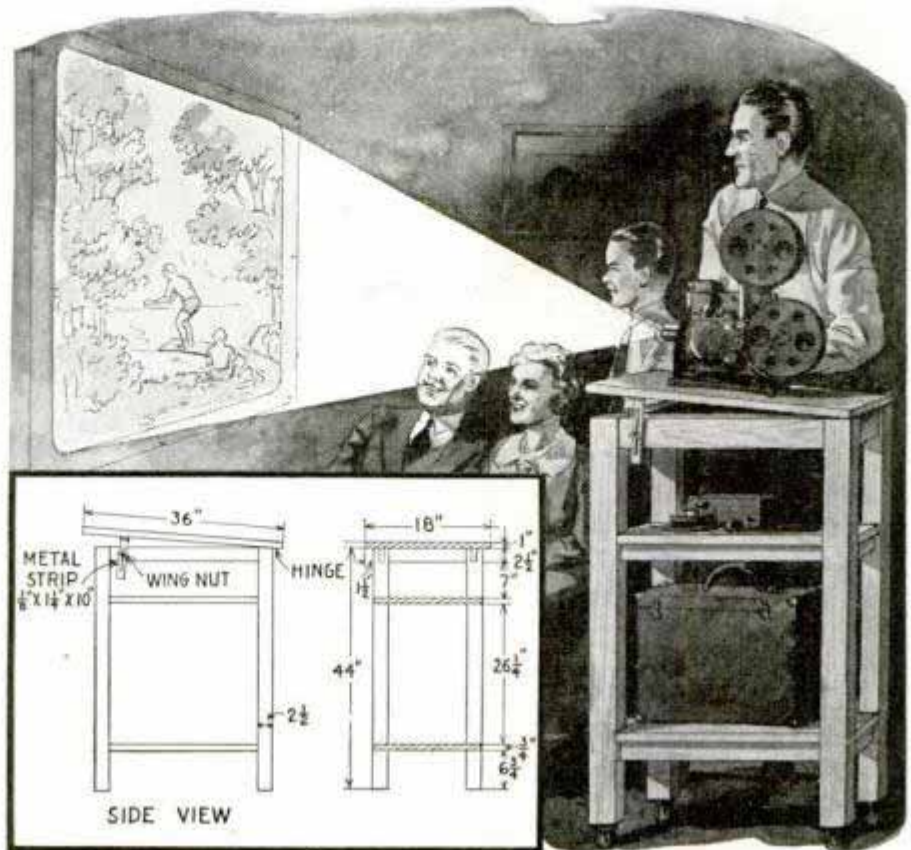

Fitted with rubber-tired casters, this projection stand is easily moved about or stored in a closet when not in use

This sturdy stand may be used equally well for home movie, lantern slide, strip film or opaque projection and, with the projecting apparatus still on top, it can be pushed into a closet. The top tilts to provide adjustments in the heights of the pictures, two lower shelves being provided for holding apparatus, slides, reels, etc. Tight tenon joints well glued make for strength, and soft wood can be used for the framing, but the top should be constructed from hardwood or heavy plywood to withstand warping. If desired, it can be covered with two strips of auto running-board rubber, which will help prevent the projector from slipping. Two strips of flat steel are used for holding the top when raised. One end of each is bent at right angles for screwing to the underside of the top, and the long arm is slotted for a bolt and wing nut to secure it in varying positions to the side of the frame. The rear end of the top is hinged to the frame. Four large rubber-tired casters complete the job.

—Gilbert Brighthouse, Iowa City, Ia.

from Coal Bins

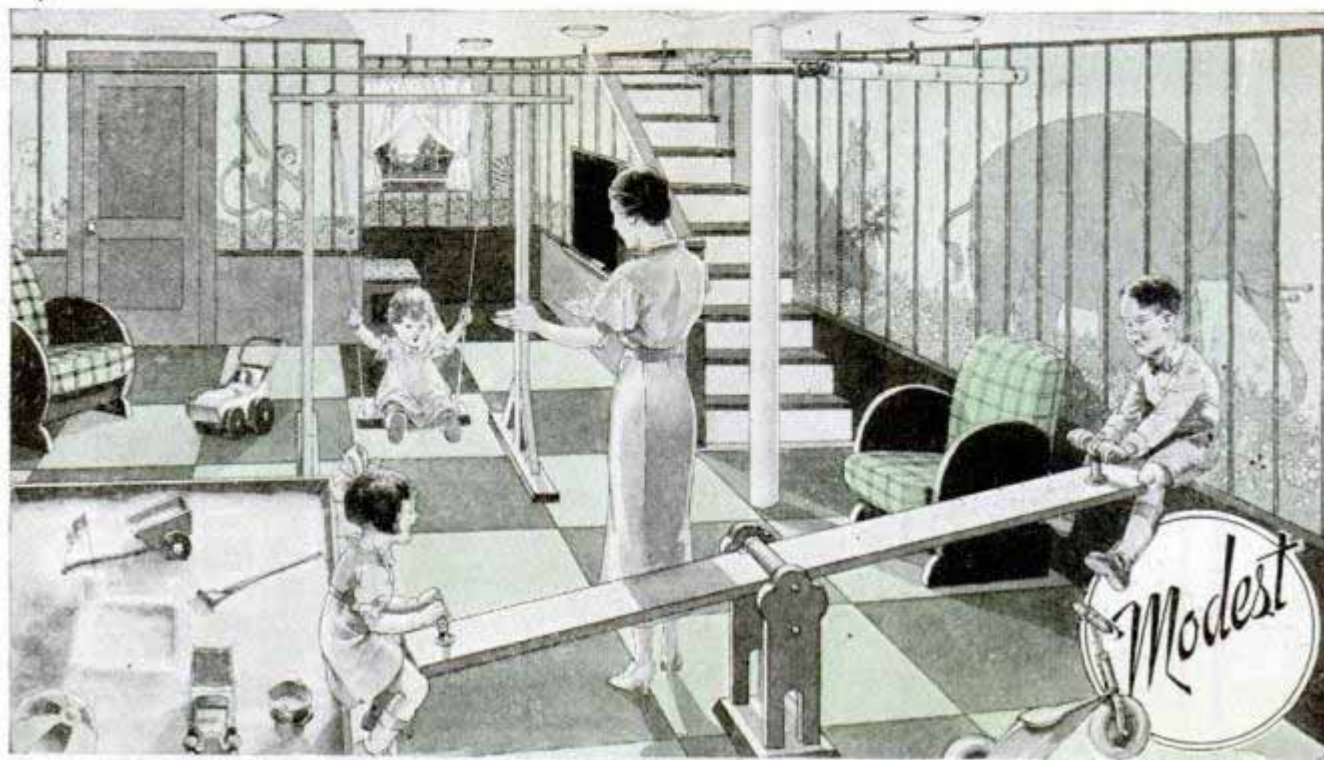

By R. O. Buck

PART I—Ceiling, Wall and Floor Treatments; also Painting and Ventilating

ONE of the first steps in planning a recreation room is to determine just how much of the basement space you can devote to the purpose and where partitions may be placed to greatest advantage. Unless the basement is small you will probably plan to finish up only a part of it and thus avoid too great an expenditure. The dryness of the basement must be considered also. If the floor and walls are inclined to leak or if water backs up through the drain after a heavy rain, steps must be taken to have these defects remedied before anything in the way of improvements can be undertaken.

Wall Treatments: In most basements the poured foundation is thicker than the wall above ground, resulting in a set-back near grade level. A wainscot effect can be made by finishing up to this line with paint and filling out the depression above with some sheet material. Fig. 1 shows how this can be done on different types of walls. If the walls are smooth they may be finished with paint or calcimine. For ce-

ment or brick walls, a cement-bearing paint is recommended. The steps in applying this material are shown in Fig. 2. Two coats are generally required for good coverage. Paints of this type bond themselves to the wall, thus coloring, waterproofing and preserving in one operation. Cracks must be patched and any oil paint removed with lye or tri-sodium phosphate before painting. Cement paint will not adhere to smooth surfaces such as wood or plaster board. Stains, washable calcimine, plastic paint or the new casein paints are suggested for smooth surfaces. Ordinary inside oil paint is also suitable, of course.

Before proceeding with any wall finish, all openings around pipes, where the ceiling and walls meet, etc., should be closed up with wood or plaster. Unfinished places like this not only spoil the appearance but are causes of heat loss as well. In many cases a complete covering of the walls is more desirable. There is a wide choice of suitable materials to choose from: Plaster

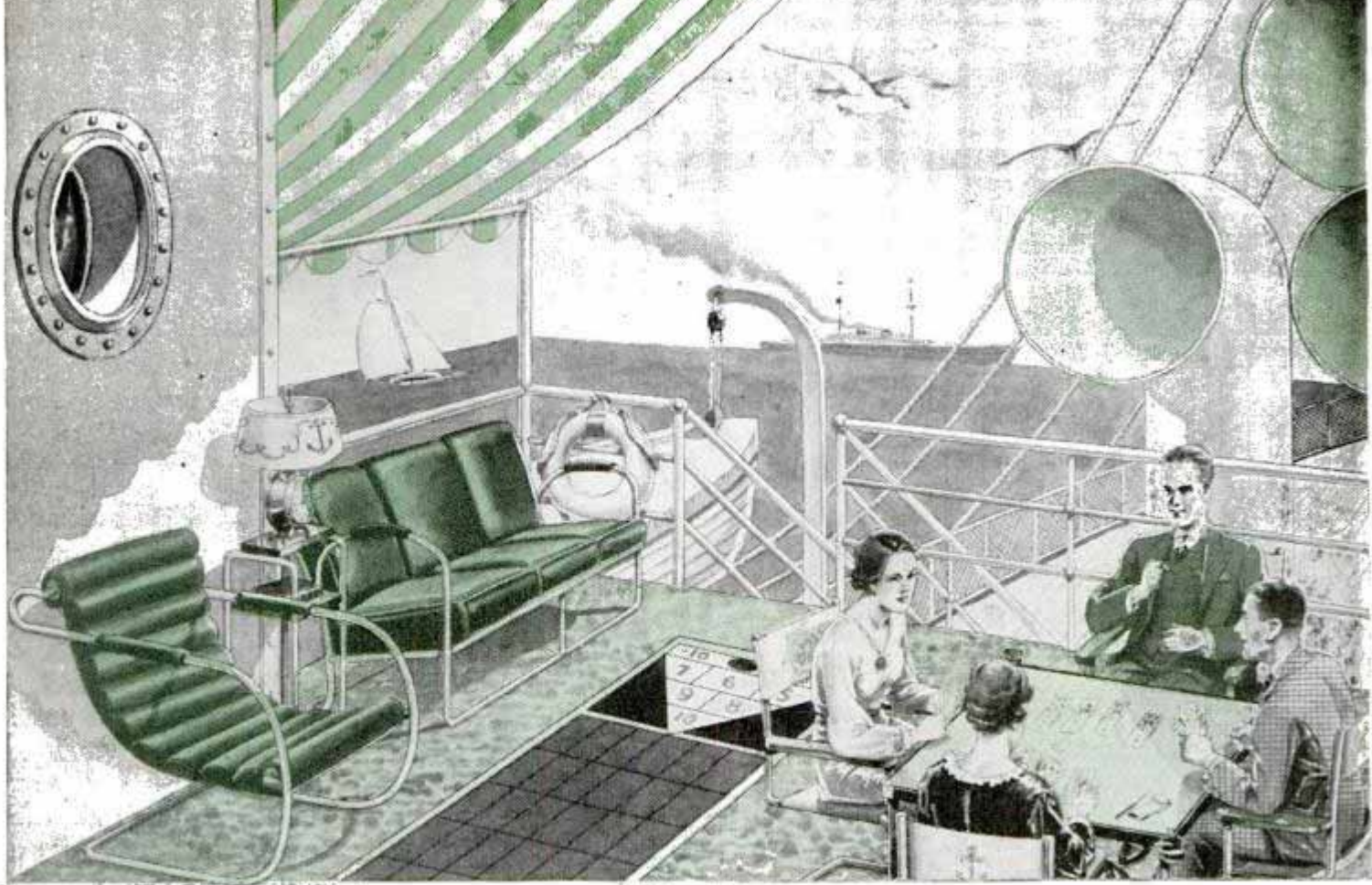

to Play Rooms

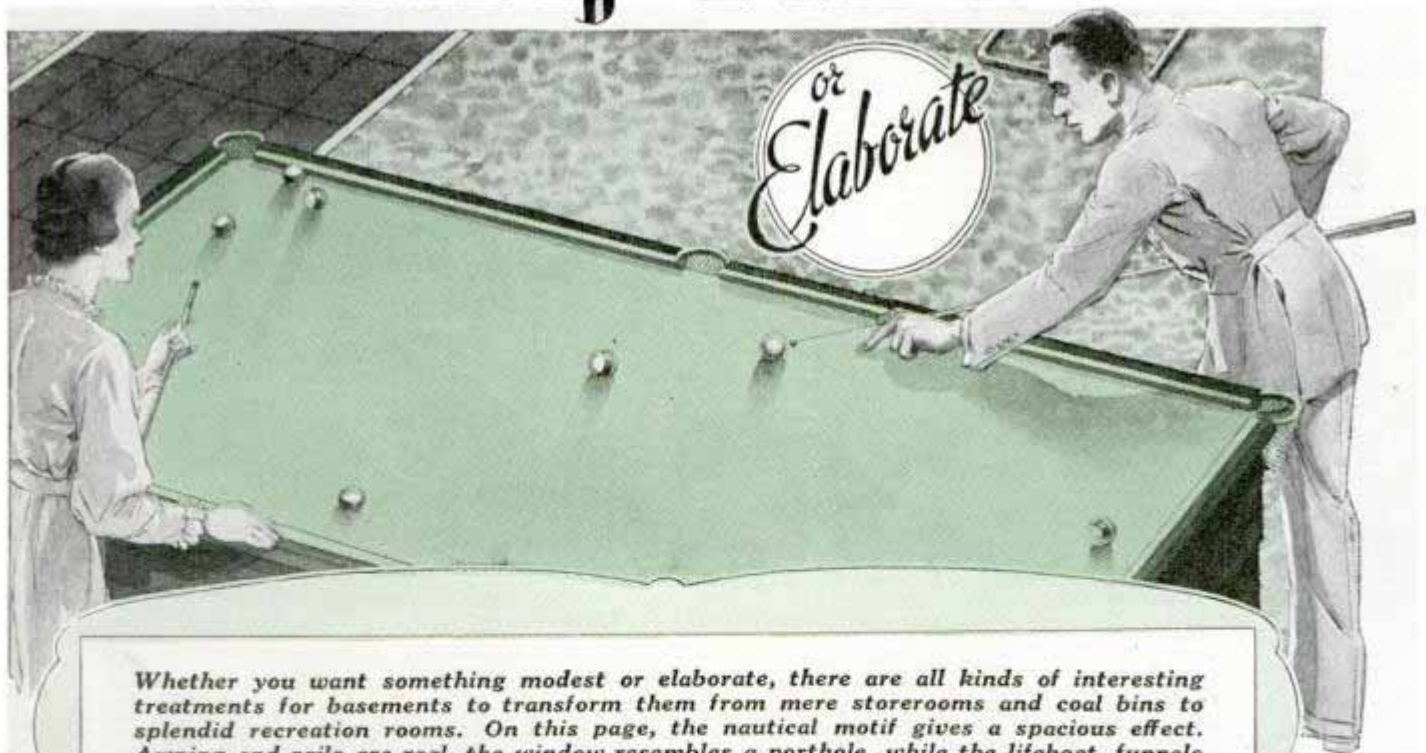

Whether you want something modest or elaborate, there are all kinds of interesting treatments for basements to transform them from mere storerooms and coal bins to splendid recreation rooms. On this page, the nautical motif gives a spacious effect. Awning and rails are real, the window resembles a porthole, while the lifeboat, funnels and background are painted on the walls. Basements, heated and ventilated to dispose of dampness, make ideal playrooms for the children too, providing plenty of space for miniature swings, seesaws, sand boxes and other playground equipment. For scenic effect you can paint animals on the walls and nail on molding strips to represent a cage

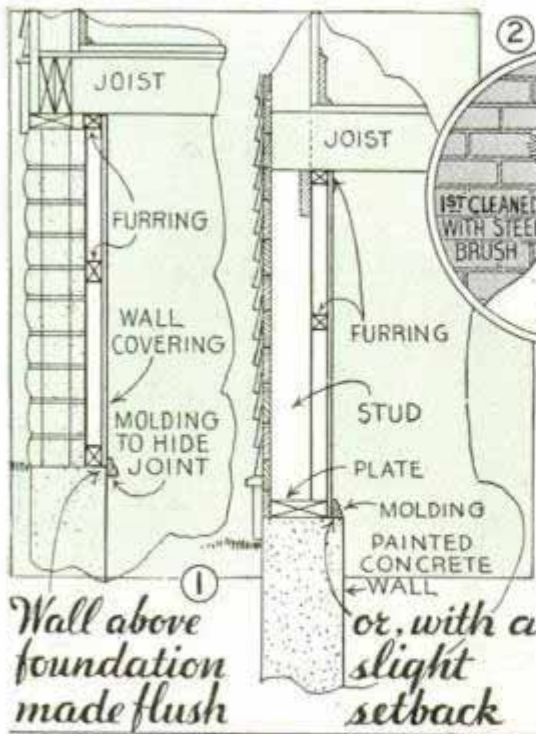

board in plain and wood-grained effects, soft and hard boards in sheets, tile and plank, real knotty pine, slab wood for log-cabin effects, and plywood. If real wood, such as knotty pine or plywood, is used, it is advisable to first cover the masonry walls with sheets of soft board nailed to furring strips. A lining of this sort serves the double purpose of finishing and insulating. It is

advisable, however, in using any of the material, with the exception of hard-pressed board, to start the sheets an inch above the floor and not less than $\frac{3}{4}$ in. from the wall. Walls which are difficult to nail to are furred in the manner shown in Fig. 3. It is excellent practice to paint the entire wall behind the board with asphaltum or tar if it is at all porous. Either of these materials is inexpensive and easily applied. Wall panels may be set either vertically or horizontally. The former accentuates the height of the ceiling and the latter gives an air of spaciousness. You need only decide which effect you desire. Large sheets of wall material are readily nailed into place as in Fig. 4.

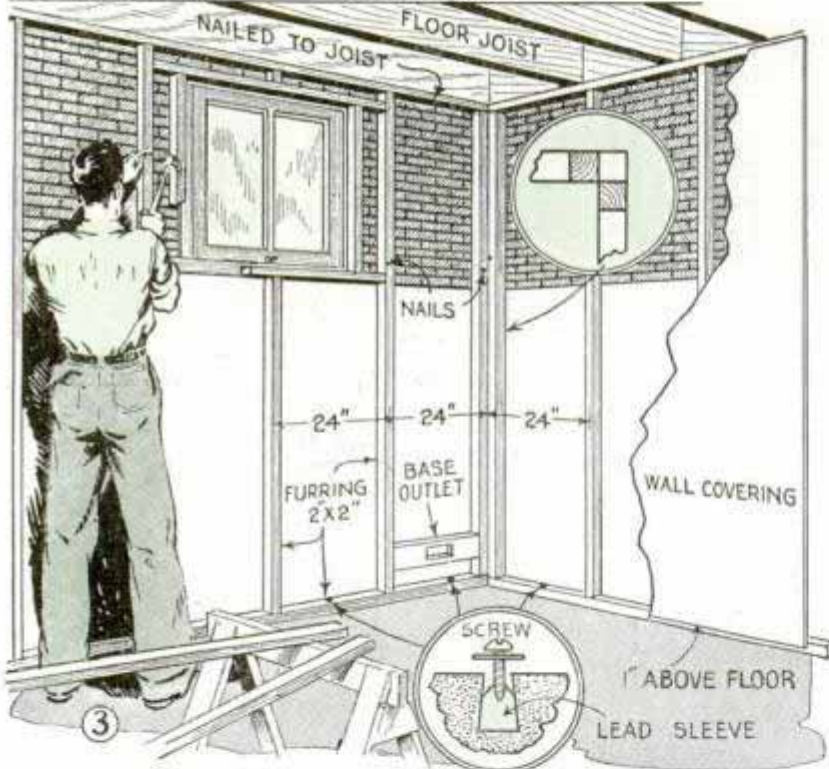

Complete covering of walls on furring

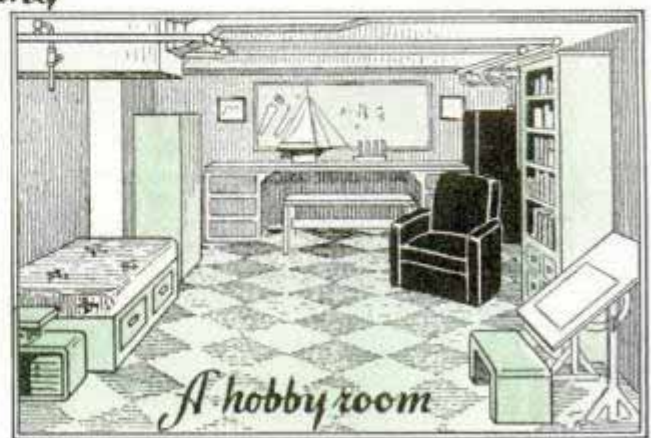
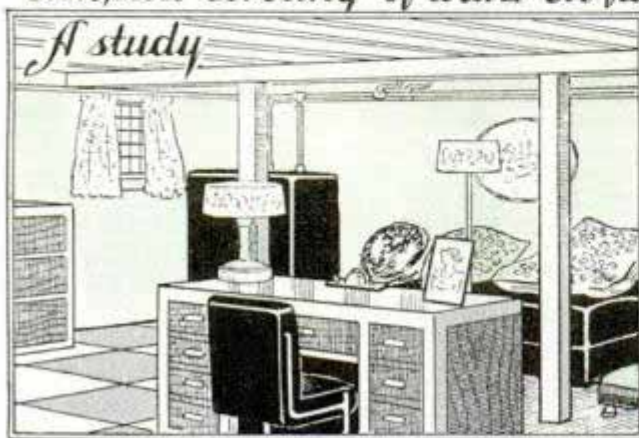

Right here it's well to remember that if you plan on a ceiling covering, this should be applied first. Partitions must be framed solidly to prevent undue vibration when doors are closed. Heavy framing also prevents the joints between the wall sheets from opening. Fig. 12 shows a typical example of partition framing. The installation of wiring and boxes for light outlets should not be overlooked before finishing walls and ceilings as these are much easier to locate beforehand. The four standard methods of covering joints between sheets of wall-covering material are shown in Fig. 6. Choose the one that fits in best with the type of room contemplated. Boards come with plain edges and lapped and V-lapped joints. The latter two types are shown in Fig. 5.

Ceiling Treatments: If your basement ceiling is plastered, it will require only calcimining or painting. For exposed floor joist a number of treatments are possible, depending on the type of room you want and the amount of expense you wish to go to. For ship deck or exterior motifs, striped canvas may be hung from the ceiling to conceal the joist and carry out the scheme in the manner shown in Fig. 11. Soft-pressed board in one of the stock patterns shown in Fig. 8 makes an unusually attractive ceiling and one easily applied. It is simply nailed to furring strips as shown

Covering with large sheets, or ----



with narrow vertical strips

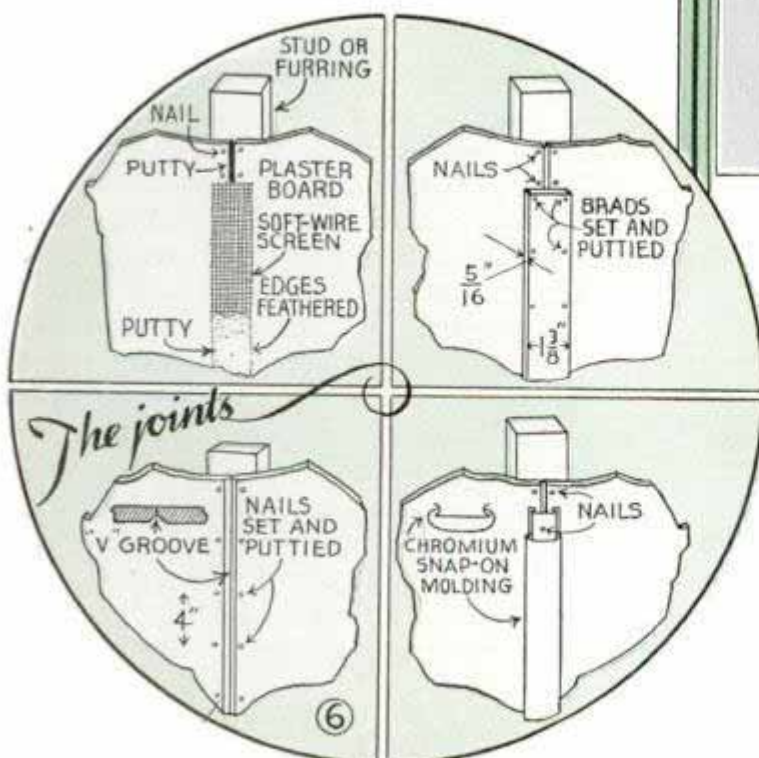

in Fig. 7. A variety of stock moldings, made of the same material as the soft-pressed board, are available to produce panel effects, cover joints, round corners, etc. Ornaments to use as medallions for light fixtures and head caps on pilasters may be selected from these materials. As an example, an attractive room in the nautical vein is shown in the heading. Here large sheets of hard board are nailed to the ceiling and walls and the joints covered with 5-in. strips of the same material. Imitation rivet heads of wood (screw-

9/19/21 Chicago

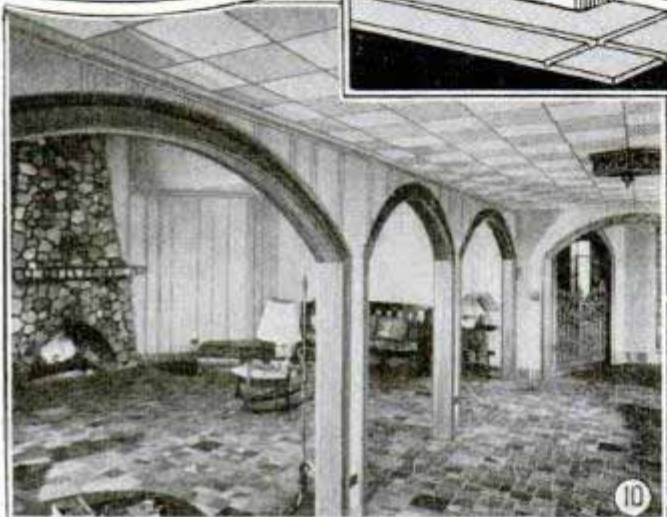
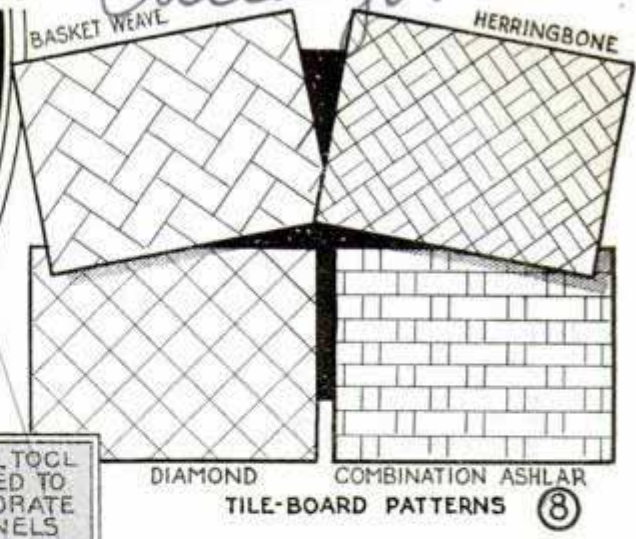

Tile ceiling with arched partition

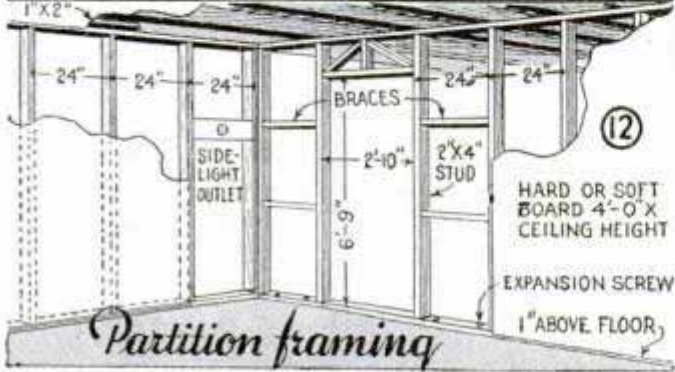
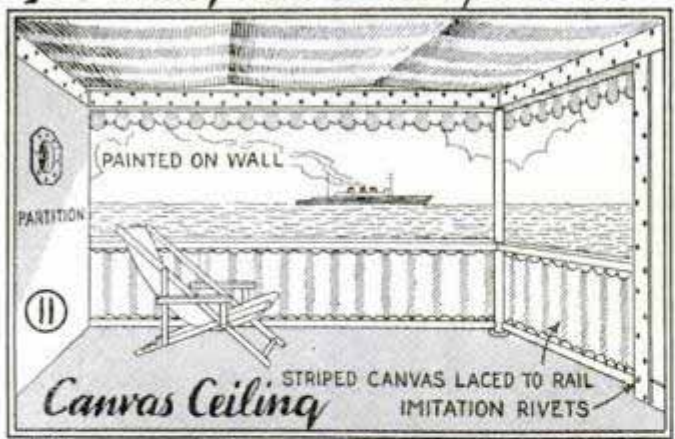

hole buttons will do) are nailed or glued to the strips at intervals. The entire walls and ceiling are painted white. Most wall-covering materials can be used either unfinished or decorated with paints, calcimine or varnishes. Soft board may be decorated in a variety of patterns by means of a special tool which can be purchased or borrowed from dealers in this material. An inexpensive type of this tool, equipped with a V-cutter, is shown in use in Fig. 9. Cutters to make reeds, flutes and bevels are also available. The ceiling illustrated in Fig 10 is one example of decoration by means of this type tool.

A novel and inexpensive method of covering an unsightly ceiling or wall is produced by using poultry netting and muslin. The wire is simply stretched over the joist or furring, then covered with yard-square pieces of a cheap grade of muslin which has been soaked in a thick solution of laundry starch. The material is fastened to the netting with thread and when the starch has started to set, pushed in or raised between the mesh to produce a rough wall effect. A little experimenting may be necessary to get just the effect desired. When the material becomes rigid, it may be calcimined or painted with casein paint, then highlighted with a lighter shade. Though not essential, a spray gun will be found very convenient for this work.

Floor Treatments: Now, with the walls and ceiling finished, the next problem is to find a way to make the floor attractive. Painting, if correctly done, with proper materials and preparation, is a

Finally the floor -----

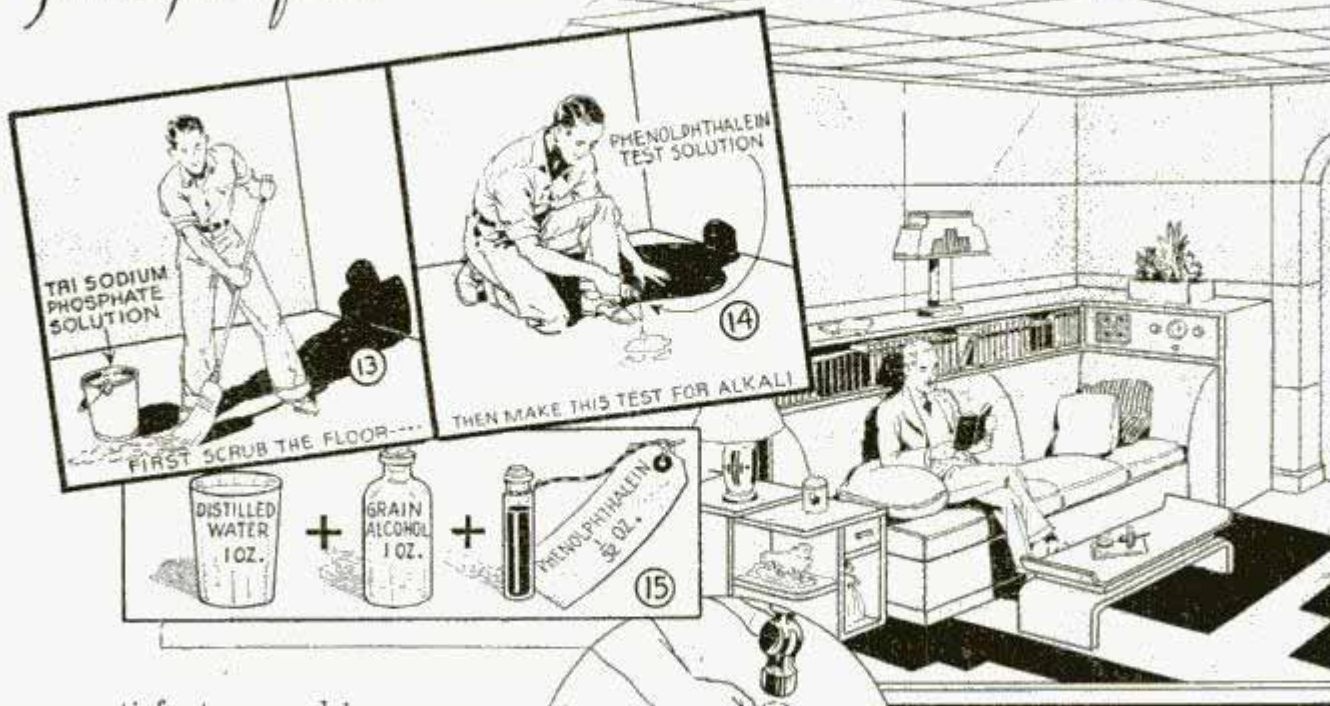

very satisfactory and inexpensive way of finishing the floor. Unfortunately, however, many painted floors turn out badly, due to dampness and alkali in the cement, which softens and discolors the paint. Grease from soapy water, generally found around laundry tubs, is also a frequent cause of paint failure. The floor must be cleaned thoroughly before painting. Flushing off with water alone is not sufficient. The surface must be scrubbed thoroughly with a grease-dissolving compound, such as tri-sodium phosphate, until all grease and paint are removed, as in Fig. 13. Follow the scrubbing with a final rinse of hot water. Cleaning and filling the cracks is next. The larger cracks should be chipped back and undercut, as shown in Fig. 16. All cracks are filled with a mortar consisting of cement, 1 part, sharp sand, 2 parts. After the surfaces of the crack have been thoroughly wet, the mortar is pressed into the opening and leveled with a small trowel.

The presence of active alkali can be determined by making a simple test with the solution shown in Fig. 15. Pour a few drops on the dry floor in several places as in Fig. 14. If the spots turn pink, alkali is present. However, if the above test is negative, any of the paints that are especially made for concrete floors may be used safely, if applied according to the manufacturer's directions. Remember that

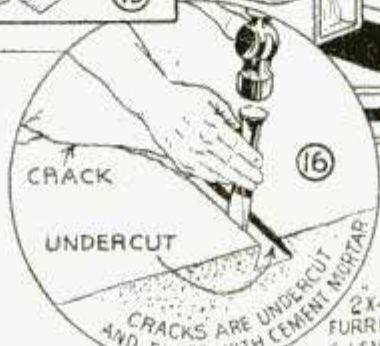

Furring strips are leveled with blocks



no floor paint can be applied over a damp surface. Painting during the season when the heating plant is in operation, is strongly recommended. Painting floors less than a year old is not advisable, but color may be added when a floor is laid, or a topping of colored cement may be applied where the floor remains damp or is in poor condition. On the other hand, if alkali is indicated a primer must be used to seal the floor against dampness and alkali. Several suitable primers are available. A solution of magnesium fluosilicate crystals dissolved in water and painted over the floor two or three times, is effective and inex-

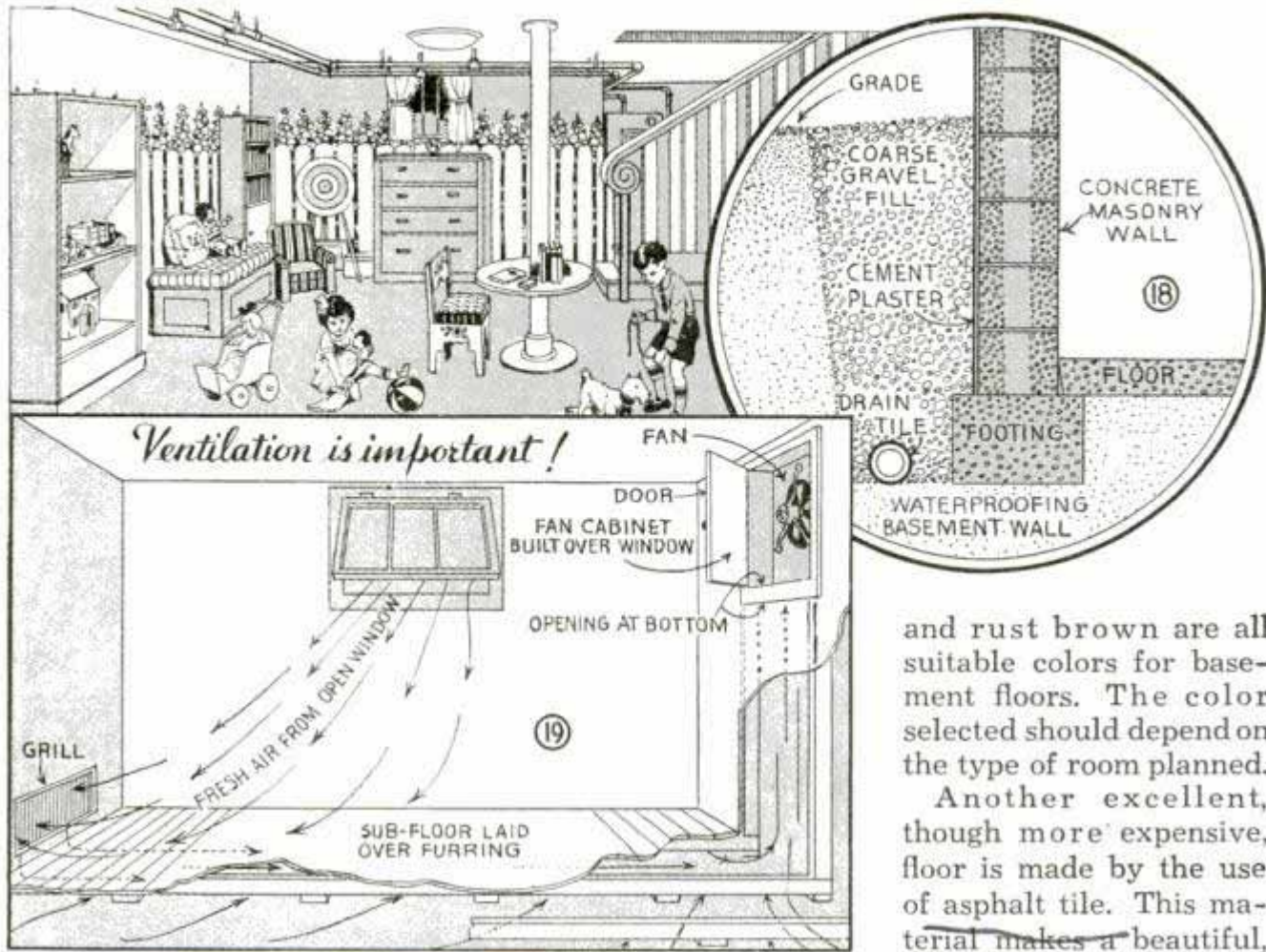

expensive. Mix $\frac{1}{2}$ lb. of the crystals with a gallon of water for the first application, then increase the quantity of the crystals to 2 lb. for succeeding coats. Copper-bearing primers make an effective seal and may be followed with two coats of an especially prepared phenol-formaldehyde paint which produces an extremely hard surface having exceptional wearing qualities. Powder types which mix with water are also good. A mixture containing an iron compound is often used but must be followed by a coat of shellac or aluminum paint before applying the color coats, to prevent the iron from "bleeding" through. Floor paints consisting principally of rubber hydro-carbon produce extremely hard and long-wearing surfaces that are unaffected by alkali. When applying this material, the floor must be cleaned thoroughly, as previously described, and in addition washed with a 10-per-cent solution of muriatic acid, which is allowed to remain on the floor for 15 min. before rinsing off with water. Cement paints are available in a great many pleasing colors. Neutral gray, tile red, hunter's green, navy blue

and rust brown are all suitable colors for basement floors. The color selected should depend on the type of room planned. Another excellent, though more expensive, floor is made by the use of asphalt tile. This material makes a beautiful, waterproof floor that will withstand hard usage. The tile is available in a variety of colors and sizes so that very attractive color combinations can be worked out. An idea of the effect produced by alternate dark and light tile is shown in the illustration at the right of Fig. 14. The material is cemented directly to the concrete floor, which must be dry and free from paint and grease, then rolled and weighted down with sandbags until the adhesive has set. Now a wood floor has a decided advantage if the room is to be used by small children who enjoy playing on the floor, for it is always warm and dry. Also children are less likely to be seriously hurt from falls. Excessive pitch on the cement floor often makes a wood floor desirable, as the latter provides a level surface. The cost of a wood floor is not excessive, especially if the room is small, and wood gives the whole room that warm "up-stairs" feeling. A single thickness, matched pine or fir floor is recommended. The floor should be laid over stringers which may be either 2 by 4 in. or 2 by 2 in., depending on the amount of pitch to the floor. Starting at one corner,

"Asphalte" Armstrong
 Care Co. 2' long 11" wide

level up a stringer by blocking, as shown in Fig. 17, and the illustration above. A variety of blocks of varying thicknesses will be required. The blocks are fastened by toenailing through the sides of the stringers. Now lay a straightedge on the stringer at the corner and at right angles to it, as shown. Block this piece up until it is perfectly level. This establishes the level at which all of the pieces are to be laid. On single-thickness flooring, all joints must occur over a stringer.

Provision must be made for ventilation under a wood floor. This is accomplished by leaving the ends of the stringers open on the outside of the partition. As the stringers are blocked up from the floor, cross ventilation is also provided. If moisture condenses on the foundation wall, Fig. 19 suggests a method of eliminating this source of dampness by accelerating the normal movement of air with a fan placed in a hood or cabinet built over a window. The cabinet is so constructed that the fan draws out the air under the floor and from between the walls. This displacement sets up a slow movement of air from the room, the air being drawn through grills at the baseboard and down under the floor. Grills are placed on three sides of the basement and about 4 in. above the floor. The arrangement does not produce objectionable drafts when in operation and need be run only at intervals during the summer months when the heating plant is not in operation.

Lastly, if you're troubled with water seeping into the basement due to pressure built up outside the wall, Fig. 18 shows a remedy. Care must be taken to assure ample fall of the drain tile to the storm sewer. The gravel fill should be uniformly coarse, should be at least double the thickness of the wall, and should come clear up to the grade level. In this way both surface water and rising levels of water below grade will be carried away before sufficient pressure can be built up to cause seepage.

(To be continued)

☞ When painting iron railings, grills and similar work where you cannot get at both sides, a hand mirror, when held under or behind the work, will enable you to see if any spots have been left unpainted.

Column Work Clamped Tightly with Hand Screw and Rope

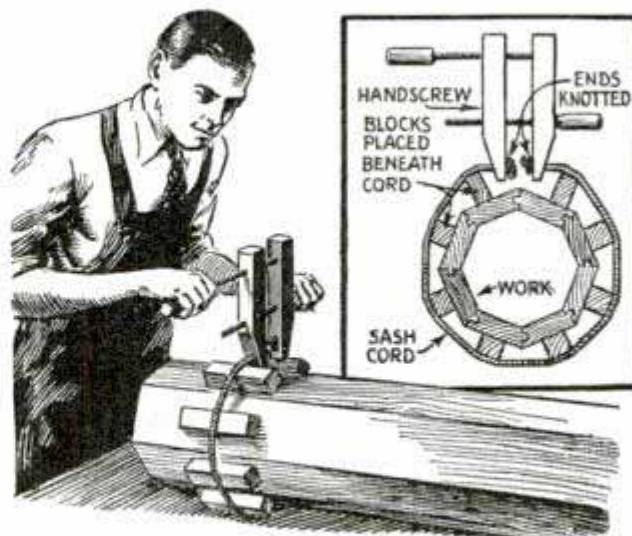

Columns and similar work are easily glued together with this simple clamp

An efficient clamp for use on cylindrical work can be improvised from a common hand screw and a length of sash cord. Holes are drilled in the ends of the clamp jaws through which the cord is inserted and knotted. Tightening the hand screw exerts sufficient pressure on the rope to draw the work firmly together. Blocks of equal size must be placed between the rope and work, of course, to get an even pressure all around.

Container Protects Photo Paper

This self-closing container to keep sensitized photographic paper lessens the possibility of accidentally exposing it to light in the darkroom. Made of cardboard, the container should be of a size to take the largest paper you use. The two halves of the box are hinged together at the bottom, and a piece of gummed paper is placed over the hinged part on the inside as further protection against entrance of light. Rubber bands run through holes near the bottom of the back and near the top of the lid provide tension to keep the box closed.

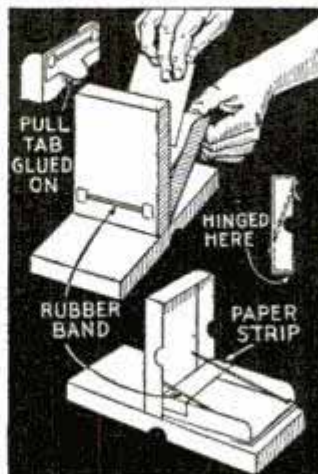

Hand-Operated Bench Grinder Converted to Disk Sander

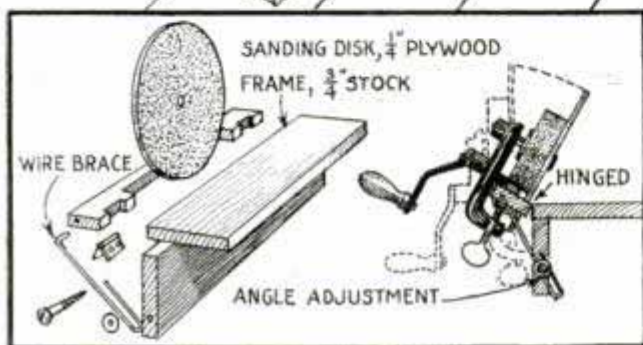
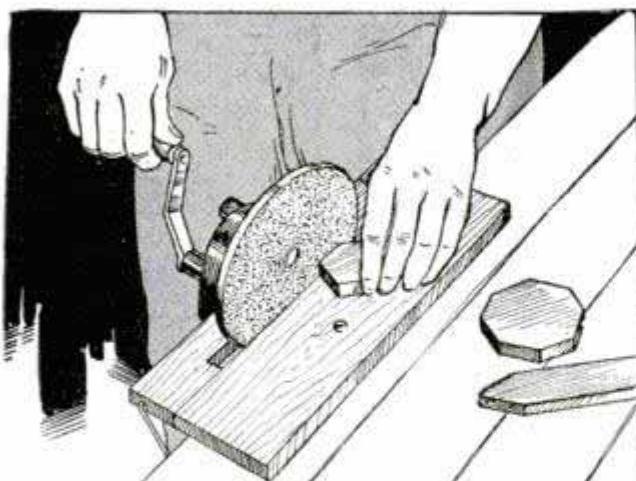

Light materials such as trimmings and model work are readily handled by this simple sander

A disk sander for small jobs is easily improvised from a bench grinder. It has been found especially suitable for sanding all kinds of trimmings and for model work. No alteration of the grinder is necessary as a plywood sanding disk is merely substituted for the grinding wheel. A right-angle frame is made up as indicated and a recessed strip, to which the grinder is clamped, is hinged to it. The hinged strip is adjustable by means of a heavy wire or rod brace to set the sander at various angles. The assembly is attached to the edge of the workbench with a heavy screw.

Gases Kept Out of Downspouts

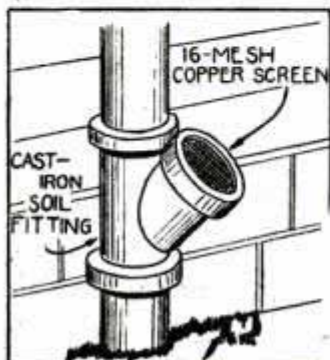

In case there is no trap in the sewer drain at the point where conductor pipes connect to it, the escape of corrosive sewer gases often results in rapid deterioration of

the conductor pipe. To overcome this trouble, I installed a Y-fitting of the soil pipe at the lower end of the downspout, which allowed the gas to escape at this point. The opening in the fitting is covered with copper screen to prevent the entrance of anything that might clog the pipe.—L. H. Georger, Buffalo, N. Y.

Angle Putty Knife Aids Amateur in Glazing Windows

Here is a simple tool that will enable the amateur glazier to do a good job of puttying windows. Made of sheet steel not heavier than No. 16 gauge, it can be shaped easily in a bench vise, the edges ground a little to remove roughness and the end of the blade inserted in a file handle. With this knife, you can apply the putty uniformly, do good corner work and complete the job neatly in much less time than it usually takes.

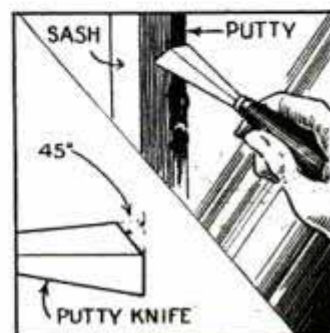

Mitering without a Gauge

Two boards may be jointed at a 45° angle with an ordinary hand plane by using the set-up shown. The boards are clamped in a vise with the top edge of one projecting above the other a distance equal to exactly the thickness of one board. Then a guide line is drawn at the end of the work from the rear edge of the projecting board down across the inner edge of the other one. When the stepped edges of the boards have been planed down flush with the guide line, the bevel on each board will be exactly 45 degrees.

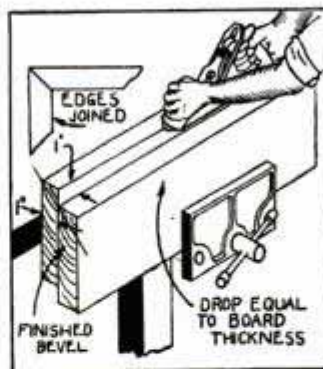

Ⓛ Rag rugs will not curl up or slip on waxed floors so easily if they are dipped in a medium starch solution and dried.

no blueprints



Gas-Driven

MODEL PLANE

PART II

Rudder—Wings—Covering Motor Installation

TAKING up the fin and rudder next, you sketch a full-size layout of the parts in Fig. 11, leaving a $\frac{1}{8}$ -in. space between the rudder and the bottom part of the tapered fuselage section. To do this, you can refer back to the plan view in Part I. Vertical members of the rudder and fin are tapered from the 1-in. width at the bottom to $\frac{3}{16}$ in. at the top. The leading and trailing edges are assembled first. Then the ribs are put in one at a time and fitted, starting at the bottom and working toward the top, small pins being used to hold the ribs in place until the cement sets. To keep the rudder square, a cross brace is placed from the upright of the second rib to the bottom rib near the trailing edge. After assembling, the parts are sanded to their proper streamlined shape. The rudder and fin are hinged at three points equally spaced with small strips of tin, $\frac{1}{64}$ in. thick and $\frac{1}{4}$ in. wide. These pieces are forced

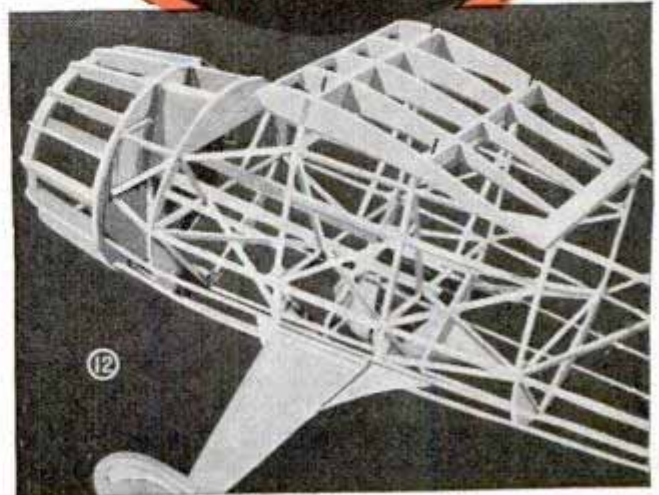
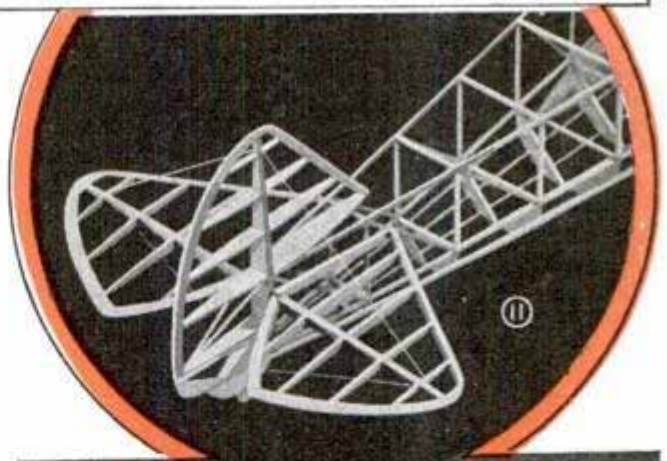



It's a good idea to make full-size layouts on heavy paper of the fin, rudder, ribs and wing panels before cutting the stock. Then you build the rudder and wing panels right over the layout

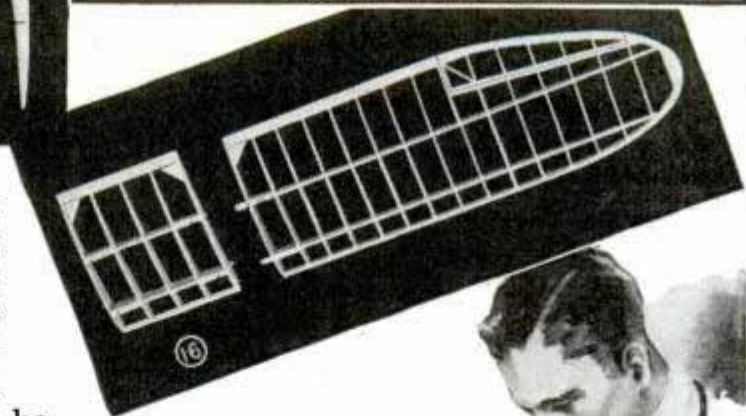
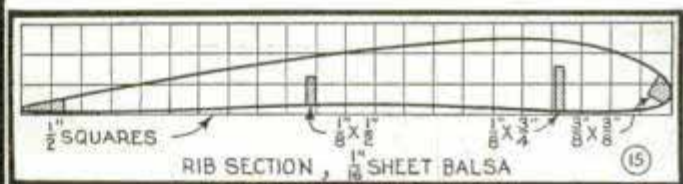
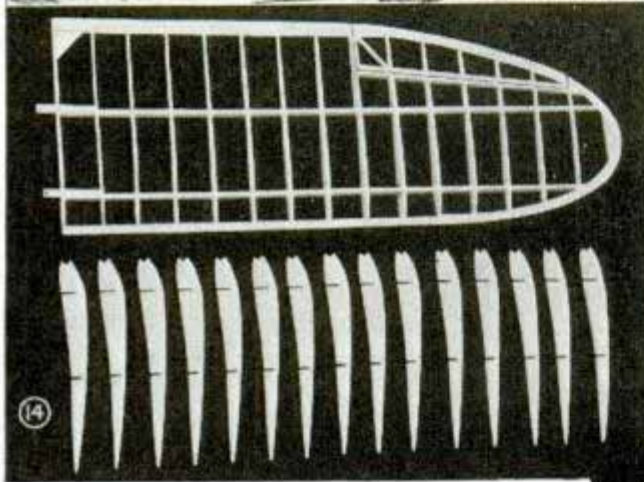

through the uprights, bent over on the inside and cemented. They are flexible enough to permit bending the rudder either way. The hinge construction of the stabilizer and elevators is the same. The fin, rudder, stabilizers and elevators are covered before they are attached to the body permanently with cement.

Wings and Center Section: A full-size layout of the wing rib should be sketched as in Fig. 13, and this pattern cemented to a block of balsa wood which in turn is sawed to shape, Fig. 15, including the notches for the leading edge, the spars and a part of the trailing edge. A block, 3½ to 5 in. high, will be sufficient. After the outline has been formed, the ribs are sliced off as in Fig. 17. Allow ten extra ribs to cover possible breakage. The center section, Fig. 12, should be constructed first, the end ribs being double thickness, or ¼

in. The center section, upon completion, is cemented in position against the top longeron on which a cross brace ½ in. high has been cemented to give the wing the correct angle of incidence.

Construction of the wing is similar to the center section and should be assembled over a full-size layout made from the plan view in Part I. Thirteen ribs are used in each panel, Figs. 14 and 16, and are spaced equally with the exception of the last one. The wing tips are cut from flat sheets and assembled in three sections. The front part is cut from ⅜-in. stock and the two rear parts from ⅜-in. stock. The two ribs near the wing tips are less in height and are tapered to fit when placed in position. Also, the last five ribs are a trifle shorter. When constructing the wing pan-

RIBS ARE CUT FROM SHAPED BLOCK ON THE CIRCULAR SAW



els, be sure to make a left and a right-hand unit. Now, when the parts have all dried, you cut out a section for the aileron, adding a few extra parts to complete this unit. These consist of two additional end ribs and a spar for the front part of the aileron, also a small spar cemented to the wing. The ailerons are attached at three points with small bands of tin, $\frac{1}{64}$ by $\frac{1}{4}$ in.

Wing Struts: The wing struts are made of pine. A 3° dihedral at the wing tips equals about 2-in. inclination for each tip. Although the length of the struts is given, it is advisable to cut and fit the parts with the model partly set up. The metal pieces that hold the wings to the center section are cut from

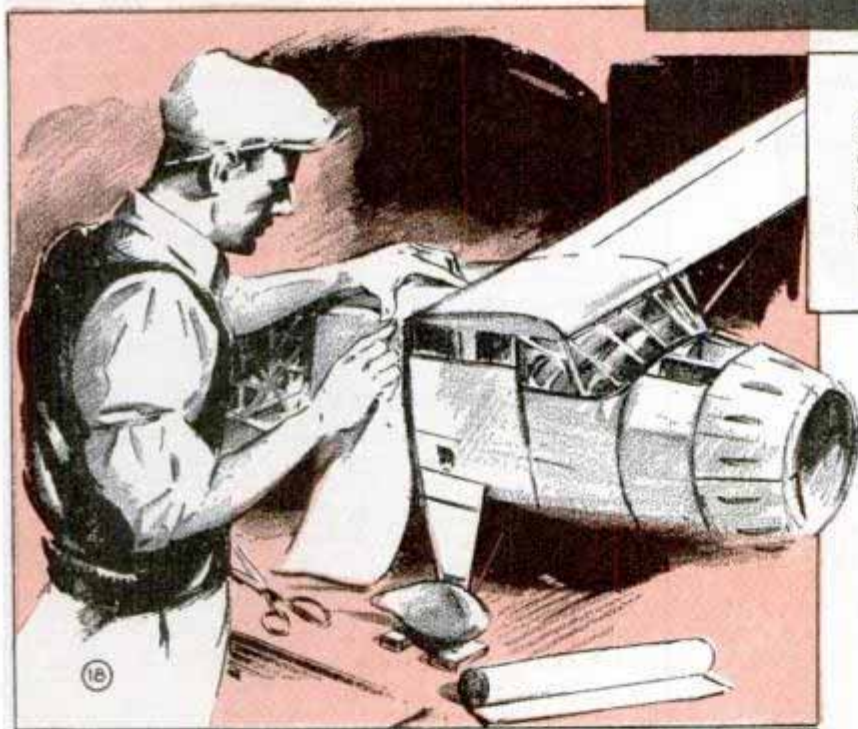

After covering fuselage and wings, the parts are sprayed with water, allowed to dry thoroughly, then given two coats of airplane wing dope. When dry this is followed with a coat of white lacquer applied with a camel's-hair brush

lage when the model is being transported.

Mounting the Motor: Now, before continuing, it's best to mount the motor and test it. With the motor in place, the tiny gasoline tank and spark coil are mounted on the body bulkhead as in Fig. 23. Because of the probability of breaking wire connections,

$\frac{1}{32}$ -in. sheet metal, $\frac{1}{4}$ in. wide and $1\frac{1}{2}$ in. long. Bolts are attached to the center section and are both cemented and tied, the threaded ends projecting upward $\frac{1}{2}$ in. Two bolts in each wing project on the underside $\frac{1}{2}$ in. below the wood parts. Triangular blocks of balsa forced against the spar and the rib hold them in place securely. Lugs for strut bolts on the body are attached first to a piece of balsa running across the inside of the fuselage at station 6. This piece is fitted in advance, the bolts attached with lugs which are wrapped with thread and cemented as in Fig. 21. The whole arrangement allows the wings to be detached from the fuse-

make small pig tails leading from the spark plug to the high-tension side of the coil. As three volts are required for operation, two small $1\frac{1}{2}$ -volt flashlight cells are soldered together in series with long wire leads soldered on. The leads go through the body and to the outside between stations 4 and 5 where a midget radio jack is used to break the circuit. The dry cells are located to the rear of station 8 in a balsa-wood box, made sufficiently large to permit wedging the batteries firmly in place. A trap door allows entry to the battery box as in Fig. 20. Positive and negative leads should be marked on the fuselage for connecting

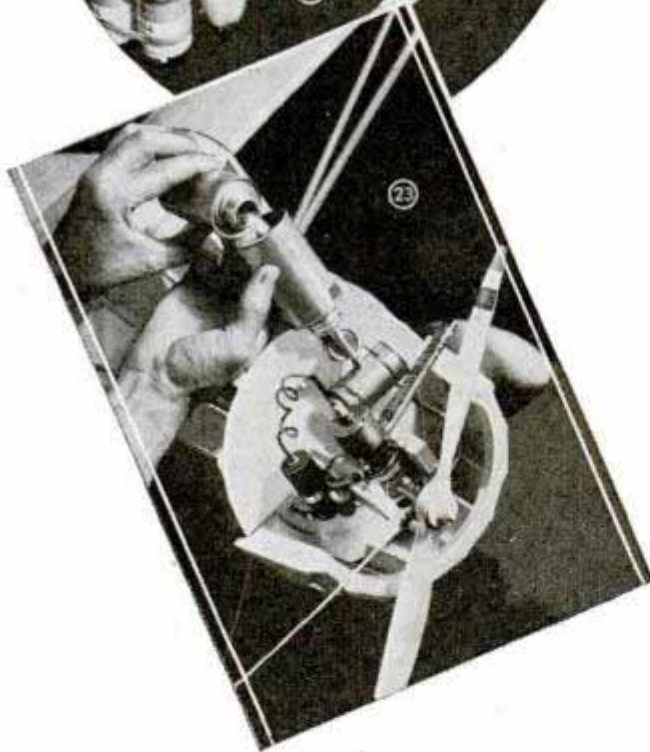
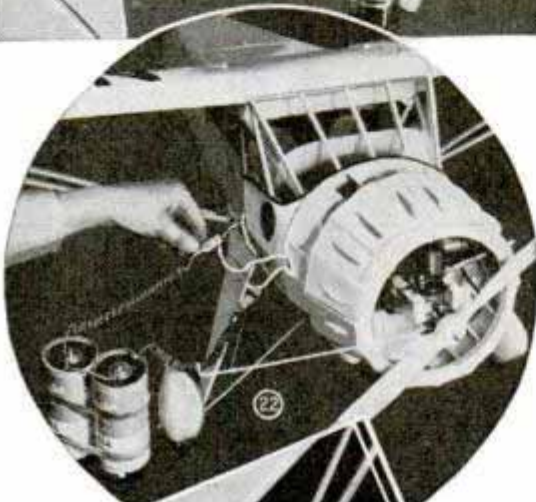
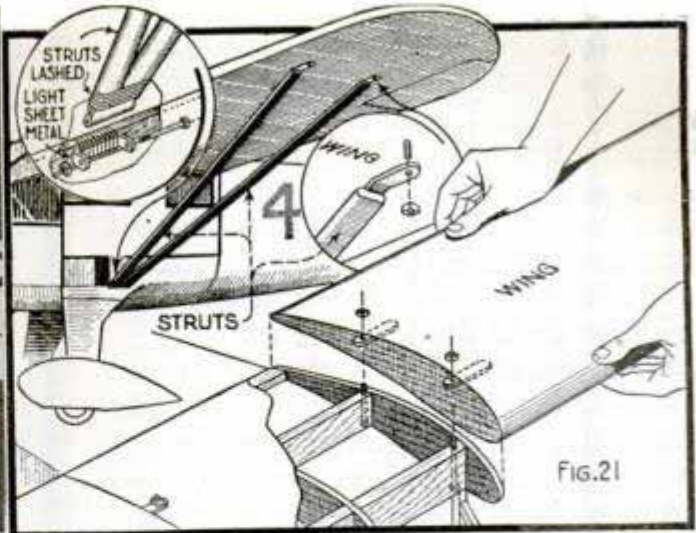

it reaches through to the outside of the motor cowl. The motor should be thoroughly checked, using both the external dry cells and the small ones. All of these small motors are of the two-cycle variety.

Material List

STABILIZER AND RUDDER

- 4 Spars, balsa, $\frac{1}{8} \times \frac{3}{4} \times 24$ in.
- 4 Ribs, balsa, $\frac{1}{16} \times 2 \times 24$ in.
- 2 Leading Edge Spars, balsa, $\frac{3}{8} \times \frac{3}{8} \times 24$ in.
- 2 Trailing Edge Cut to Curve, balsa, $\frac{3}{16} \times \frac{3}{8}$ in.

WING MATERIAL

- 3 Leading Edge Spars, balsa, $\frac{3}{8} \times \frac{3}{8} \times 24$ in.
- 3 Front Spar, balsa, $\frac{1}{8} \times \frac{3}{4} \times 24$ in.
- 3 Rear Spar, balsa, $\frac{1}{8} \times \frac{1}{2} \times 24$ in.
- 3 Trailing Edge, balsa, $\frac{3}{16} \times \frac{5}{8} \times 24$ in.
- 2 Wing Tips, Front, balsa, $\frac{3}{8} \times \frac{3}{8}$ in., cut to curve
- 2 Wing Tips, Rear, balsa, $\frac{3}{16} \times \frac{5}{8}$ in., cut to curve
- 30 Ribs, balsa, $\frac{1}{16} \times 1\frac{1}{2} \times 11$ in.
- 10 Sets Bolts and Nuts, iron, $1 \times 2/56$ in.
- 10 Lugs, iron, $\frac{1}{32} \times \frac{1}{4} \times \frac{3}{4}$ in.
- 4 Struts, pine or basswood, $\frac{1}{4} \times \frac{1}{2} \times 24$ in.

MISCELLANEOUS

- 1 Windshield, heavy celluloid, 12×12 in.
- 1 Battery Box, balsa, $\frac{1}{16} \times 3 \times 12$ in.
- $\frac{1}{2}$ pt. White Lacquer
- $\frac{1}{2}$ pt. Quick-Drying Model Airplane Cement
- $\frac{1}{2}$ pt. Dope
- 12 Sheets heavy bamboo fiber paper, 15×20 in.
- Black Tissue for numbers and control outlines, cut to size
- 1 Motor and 15 in. Propeller, small bore, less than 1 in.
- 1 Ignition Coil, 3 volt, 3 oz.
- $\frac{1}{2}$ oz. 400-volt Condenser

large dry cells, which are used for starting. The dry cells are connected to the leads with clips and the circuit to the small flashlight cells is so arranged that after the motor has been started, the small cells are cut in the circuit. Then the clips to the large cells are removed and the motor will continue to run. The exhaust pipe is lengthened with thin sheet metal so that

Covering: Heavy bamboo-fiber paper is used for covering. Between five and ten sheets are required, the number depending on the size of the sheets. The paper is fastened in place as in Fig. 18, with model airplane cement. All the separate units are

covered and sprayed with water, allowed to dry and then given two light coats of standard airplane "dope," followed with a coat of white lacquer as in Fig. 19. Hand-holes are arranged on each side of the hot-air vent behind the motor cowling on the top side of the fuselage or directly in front of the celluloid windshield. This is the best place to hold the model while starting. The rudder and stabilizers are braced with heavy thread. Decorations such as No. "40" placed on the fuselage sides and "NR-273Y" placed one underneath the left wing and another on top of the right wing as in Fig. 19, help to complete the job. Black tissue paper, $\frac{1}{8}$ in. wide, is used to outline the controls. This is also carried around the windows and windshield and a $\frac{1}{16}$ -in. strip is cemented around the body at stations 4, 5 and 7.

Preparing the Model for Flight: After checking all the parts and having the motor in running condition, a suitable field is selected for the first trial flights. The weather should be perfectly calm, early morning or late evening being the best time. Fill the tank with $\frac{1}{2}$ oz. of gasoline as in Fig. 23, attach the external dry cells, crank the motor, and select a hard runway. It is advisable to have an assistant on hand so that when the model is started, the two persons can follow along with the model near the wing tips to see that it is in perfect balance before allowing it to continue on its first flight. Gas models are not as a rule launched by hand. They are permitted to run along a runway just as the large ships. If the balance does not appear to be correct, adjustments can be made before the model gets out of hand.

Percolator Improved with Ball



One woman claims that by serrating the top of her percolator tube with a three-cornered file and placing a $\frac{1}{2}$ -in. steel ball on top of it, she can improve the coffee. The ball deflects the rising hot water over the coffee uniformly so that all of it is wetted at the same time, thus none is wasted.

Slip-Proof Ladder for Climbing Poles and Trees



The upper rung of this ladder adjusts itself to the curvature of a tree to prevent slipping

When a ladder is used to climb poles and trees it can be made safe by substituting a length of hose-covered chain for the top rung. The chain fits around the curve of the pole and the rubber hose prevents it from slipping.

—Vernon Tracy, Centreville, N. B., Can.

Tape Aids in Soldering Seams

If you are an amateur at soldering, a couple strips of removable, gummed tape will help you do a neat job of seam soldering. Just place the strips on each side

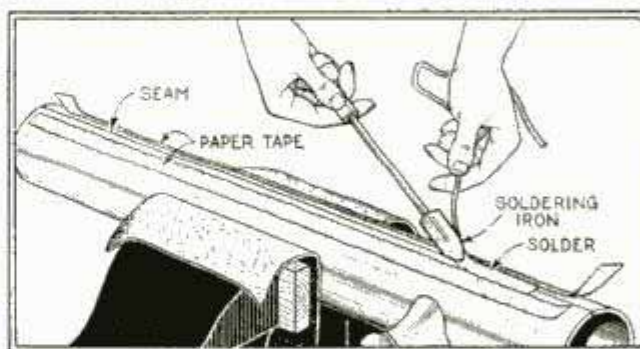

of the seam, leaving the metal bare where the solder is to be applied. This will confine the flow of solder to the bare portion, leaving a neat, straight seam when the paper is removed.

—Richard A. Scott, Kansas City, Mo.

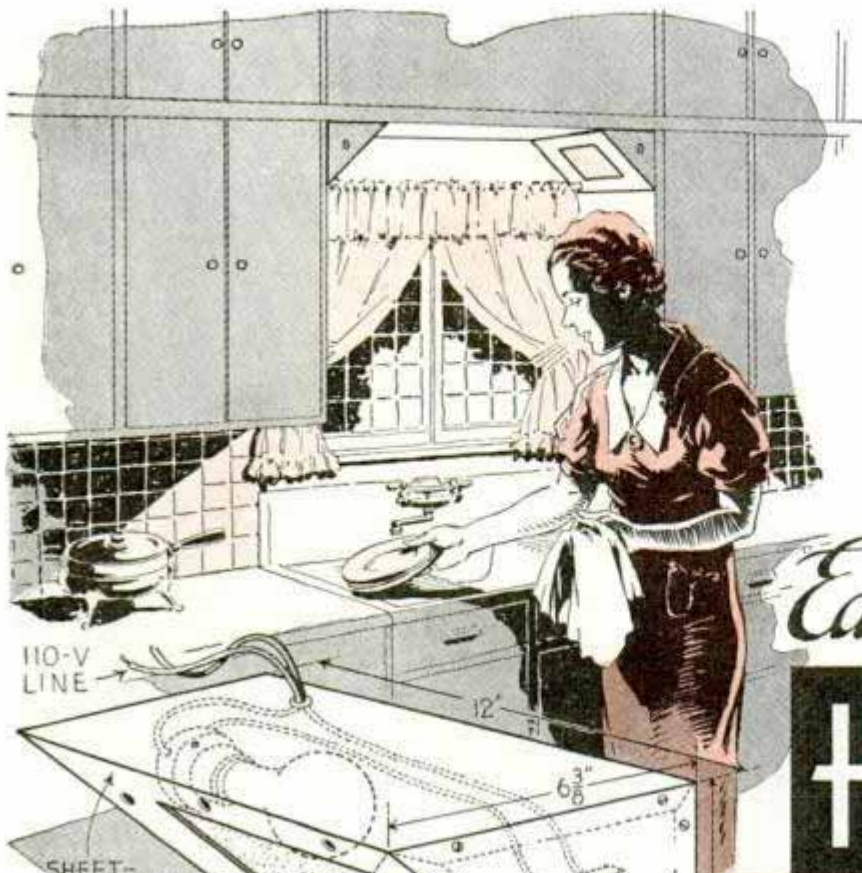

Utilizing corners of the alcove above your kitchen sink and painted to match the woodwork, these fixtures give a diffused light which is easy on the eyes. For replacing the 40-watt bulb, the outer end of each fixture should be removable. The ends may be fastened in place with "drive" screws or with small machine screws and nuts. Place a sheet of asbestos between the fixture and the cabinet. If desired to have one switch control both lights, wire the lamp sockets in parallel. Vent holes in the housings allow the heat to escape

Easy Solutions

HOME

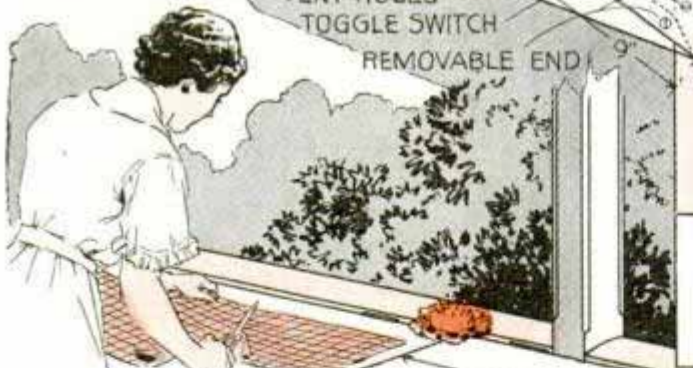
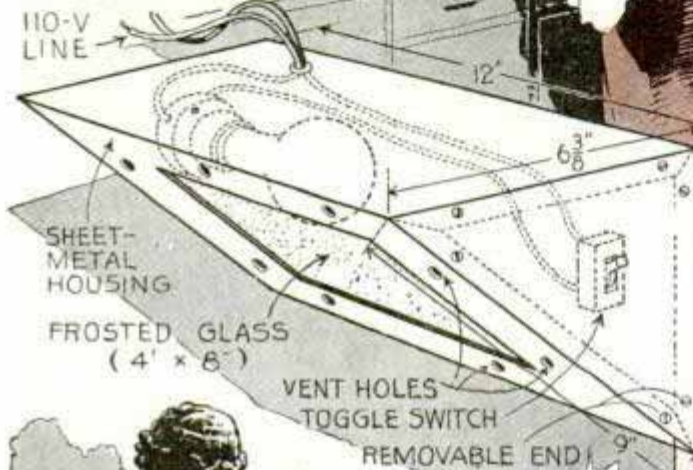

SMALL DOOR BOLT LOCKS THE TOP SECTIONS

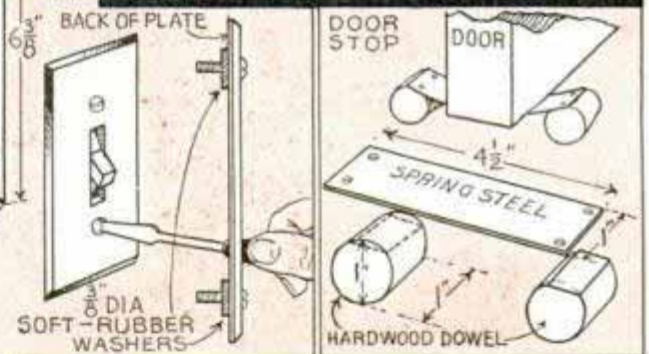

Tightening glass switch plates on rubber washers prevents breakage. A piece of spring steel screwed to short lengths of dowel makes a non-slip doorstop

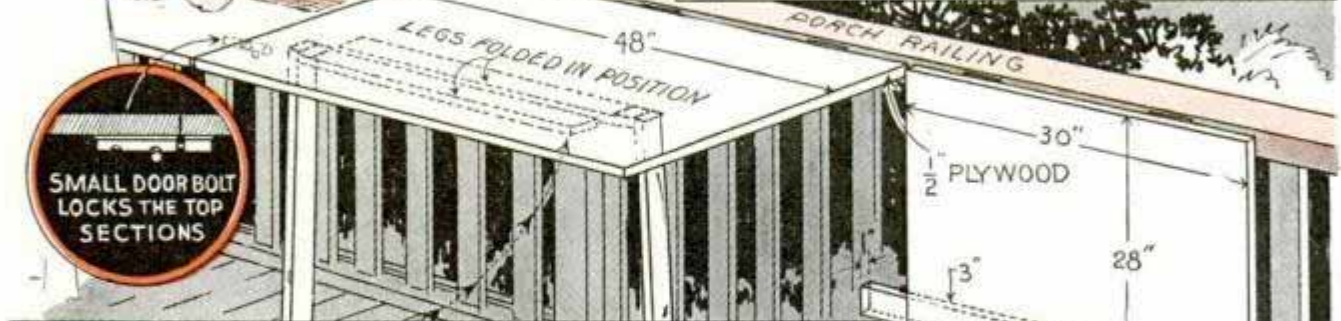

You'll use this "table" all summer long. It hinges to the porch railing, can be built in as many sections as you need, and best of all, it's rigid. It folds down against the railing, taking up no more space than the thickness of the top and can be set up in an instant, ready for use. The top is made of 3/4-in. plywood

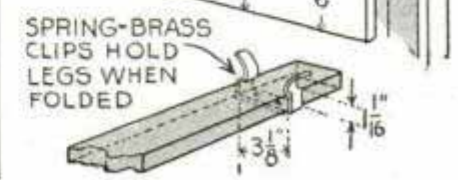

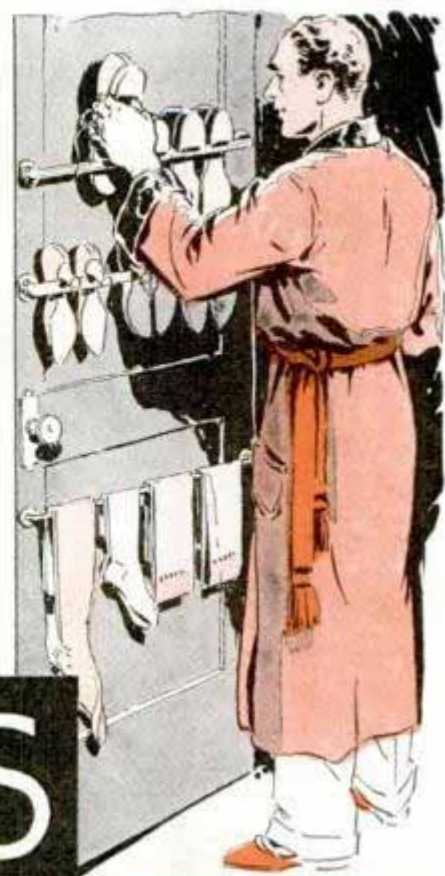

Here's Junior's "place for everything," a long, shallow box on rubber-tired wheels, the right height to roll under the bed. Right, handy racks for shoes and hosiery, by screwing curtain rods to the closet door

for Your

PROBLEMS

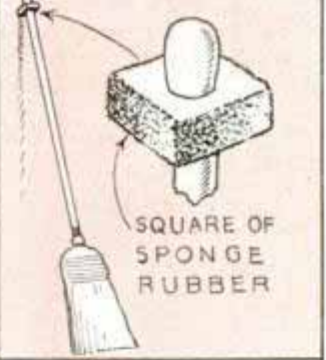
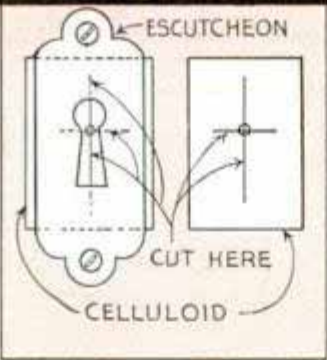
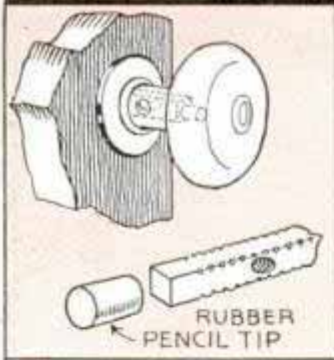

Left to right above—a rubber pencil tip will silence a loose doorknob and a thin sheet of celluloid, slit as shown and placed under the escutcheon, keeps the key in place. To have the soap handy in the shower, sew a pocket to the curtain. A square of sponge rubber keeps a broom upright

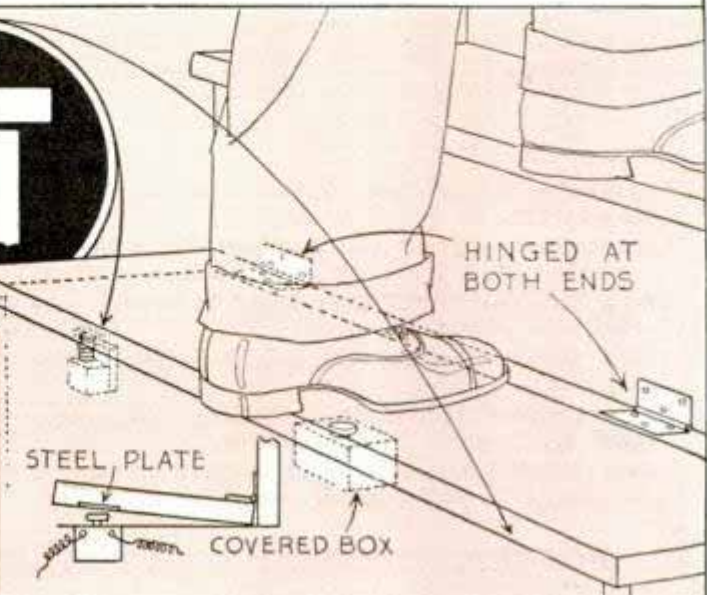
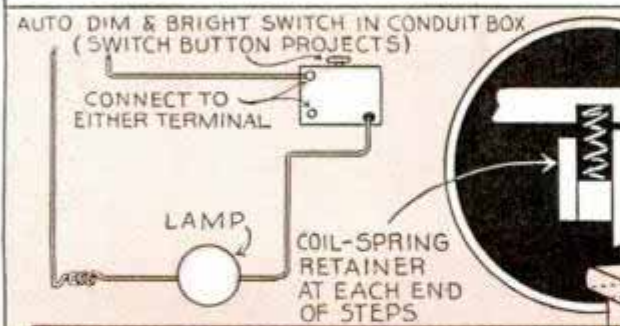

You won't forget to turn off the basement light when you install this switch. The hinged step, when depressed, operates a switch which puts the light on and off. Notice particularly that the switch is mounted inside a conduit box and must be adjusted for proper action

Ball-Bearing Headstock for Lathe from Old Car Generator

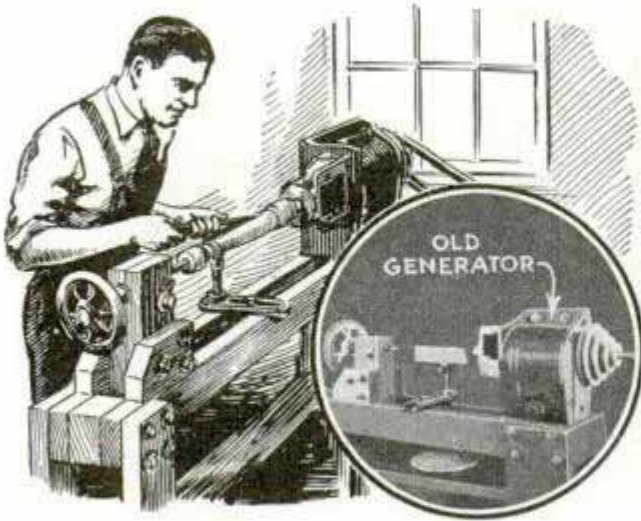

If you want to assemble a homemade woodturning lathe, an old Delco-Buick

combination starting motor and generator will solve the problem of obtaining a good headstock. See that the bearings are in good condition and then remove the pinion, brush holders and field coil. It is also a good idea to remove the armature windings and commutator unless a flywheel effect is preferred. One end of the motor shaft is turned down to take a spur center and faceplate, and the other end is fitted with a 4-step pulley. It will be necessary to purchase a bearing to take the end thrust of the work. The ball bearing at one end of the headstock is packed with grease before assembling and an oil hole is drilled through the casting to lubricate the roller bearing at the other end. The top of the generator is already flat so that it needs only to be clamped to the lathe bed to complete the job.

—Ralph L. Kunau, Sabula, Ia.

BUILD YOUR BOAT THIS WINTER

so it will be ready to launch next spring when the boating season opens. The photo shows "Hi-Ho," a 14-ft. family runabout, driven by a 11 to 22-hp. outboard, or converted model-T Ford motor. Six prints giving complete constructional details will be sent postpaid for \$1.00.



OTHER BOATS

- "Roamer"—765 to 770: Outboard cabin cruiser; two berths. Six prints \$1.00.
- "Sea Saucer"—893: 9½-ft. sail boat. Deck, bottom and sides are 3/16-in. plywood. 25c.
- 17-Ft. Kayak—928 and 929: Light framework covered with canvas. Two prints 50c.
- 12-Ft. Utility Rowboat—707: Flat bottom. Four seats. Sturdy design. 25c.
- 16-Ft. Canoe—811 and 812: Cedar planking covered with canvas. Two prints 50c.
- "Arrowhead" Sloop—944 to 951: Fast sailboat 21 ft. long, 5 ft. 11 in. beam. Set of 8 prints \$1.50.

1937 "WHAT TO MAKE"

This 96-page Craftsman's Guide is just crammed full of practical information and valuable reference data for workshop owners. It not only suggests hundreds of items that you can make, but also tells where to purchase hard-to-get supplies. Will be sent postpaid on receipt of 15c, in U. S. stamps or money order.



POPULAR MECHANICS MAGAZINE, 200 East Ontario Street, Chicago



*Power
Driven*

TABLE SAW *you can build*

By Ralph L. Kunau

AT FIRST glance you'd think this table was a commercially built machine, but it isn't; it's a homemade job throughout, except, of course, the motor and saw mandrel. The large table raises and lowers with a threaded hand screw as in Fig. 1, giving you a fine dado and depth adjustment. The full-length rip fence can be set true with the saw blade and locked at both ends. An automatic blade guard operates in the conventional manner. Fig. 2 shows how the table swings up off the frame, giving access to the mandrel for chang-

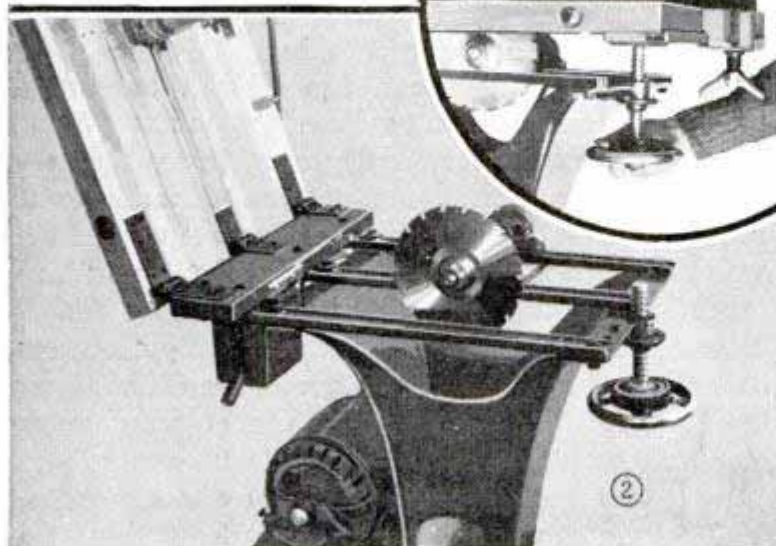
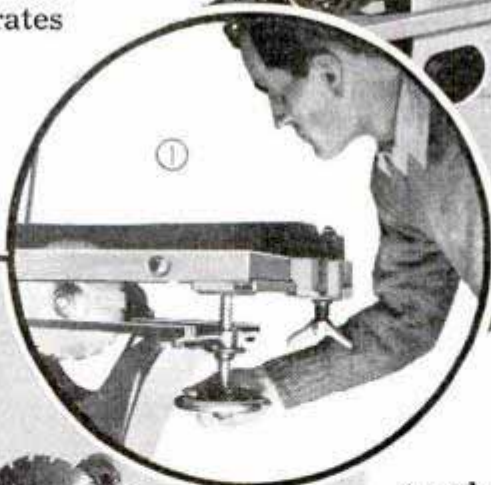

ing the blade. Now let's see how easy it is to build it. The pedestal consists of two bases of old cream separators, only the lower half of each separator base being used. Both the halves must be from the same make of separator so that when the top half is inverted as in Fig. 4, the bolt holes will register. When you have the base castings, the first thing to do is saw off the

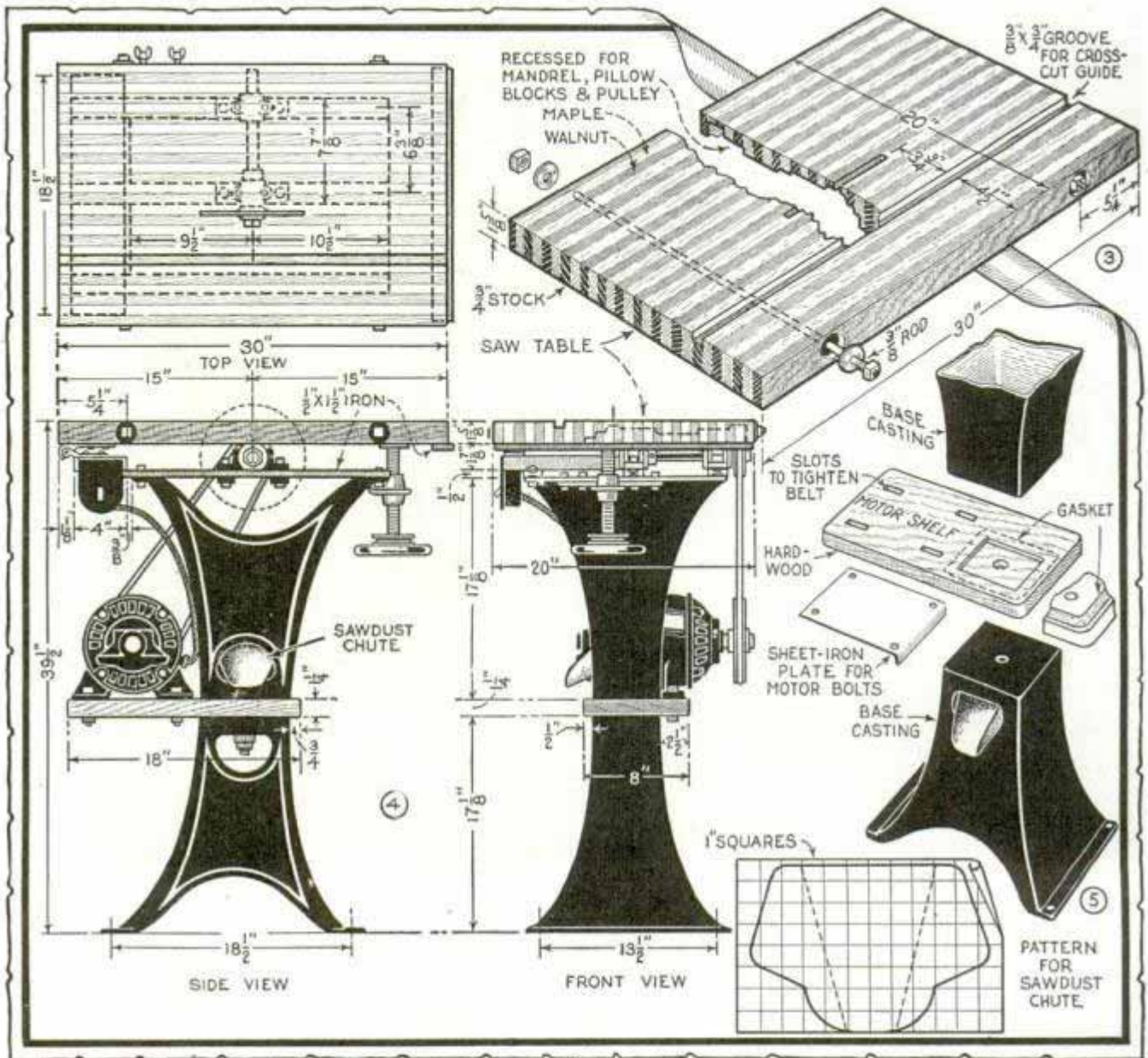

lugs or other projections and then make a shelf for the motor out of hardwood as in Fig. 5. Notice that the motor shelf is recessed for the ends of the castings and a gasket provides the necessary flexibility between the parts when they are bolted together. A sawdust chute is made of sheet metal and fitted in the opening of the upper casting, Fig. 4. As you will see from Fig. 5, the motor bolts pass through a sheet-iron plate

Holes in the separator base casting provide an easy means of bolting on a simple structure to support the hinged top and the saw mandrel. Figs. 2 and 5 show how the three bars of iron are bolted to the base. These bars can be either flat iron or channels of the same sectional dimension. A hardwood crosspiece is bolted to the projecting ends of the bars as in Fig. 2,

the thickness depending on the type of mandrel you use. For this reason, it's a good idea to decide this before you bolt the crosspiece permanently in place.

Now, before you get any further, the table should be built. There are several ways of building a table of this type. For example, you can use 1 3/16-in. hardwood flooring, planing off the tongue and groove on each piece, and gluing the pieces together with the edges up. Another, and better, method is to rip an equal number of strips from maple and walnut, and glue them together alternately as in Fig. 3. There is an important point in getting out the stock. You can avoid the difficulty of cutting the groove for the crosscut guide by planing one of the 1 3/16-in. strips back to a uniform thickness of exactly 3/4 in. and ripping it 3/8 in. narrower than the

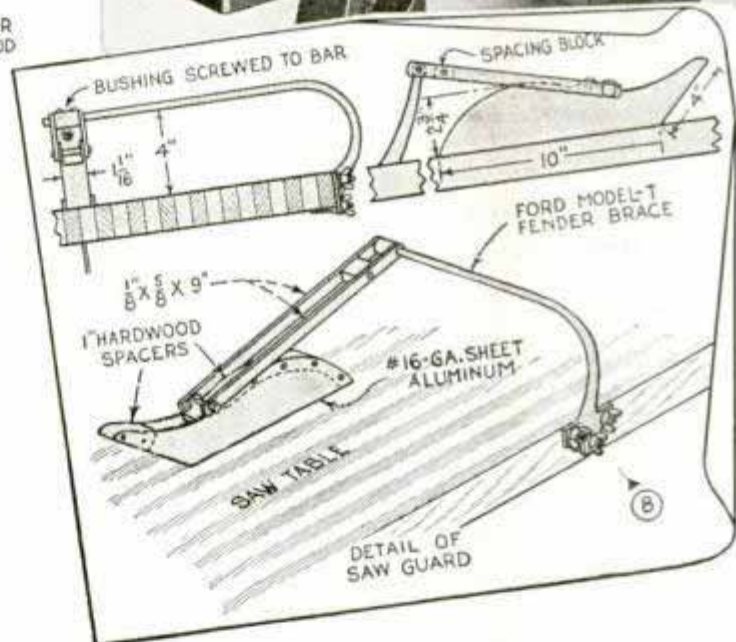
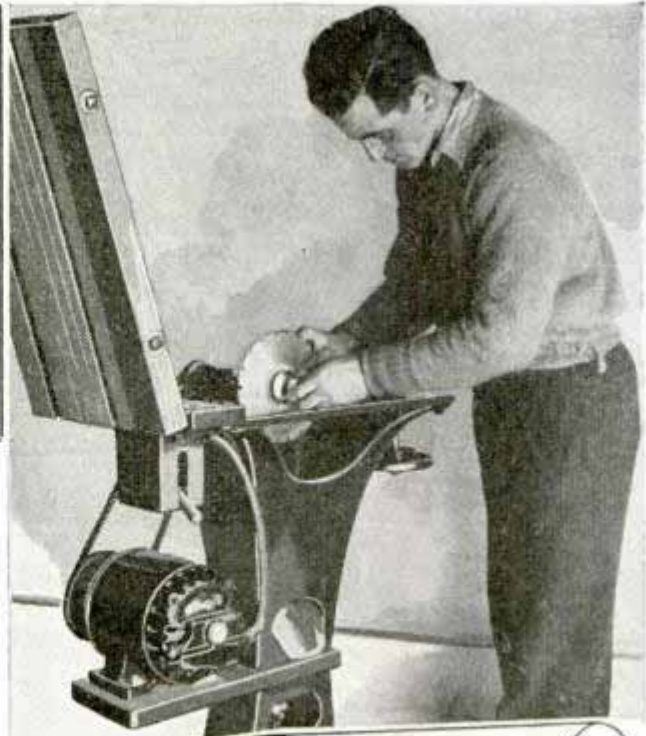
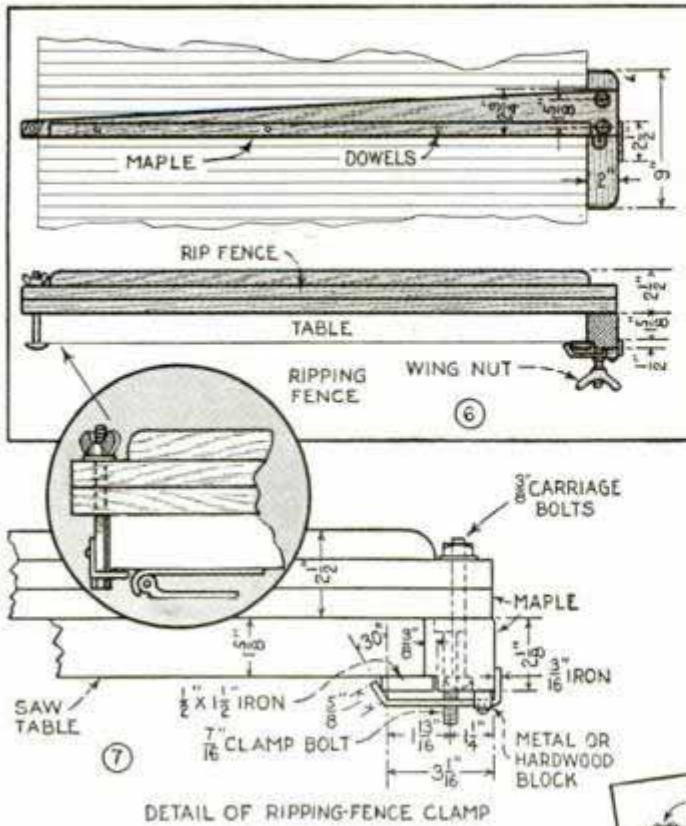

others. When gluing up, this strip is inserted in the proper place. Due to the strains to which a wood saw table is subjected, it is best to bolt the strips together as in Fig. 3, using two $\frac{3}{8}$ -in. rods, each threaded at both ends, the nuts and washers being recessed in the edges of the table. Then both sides of the table are finished smooth, and waxed.

Three old auto door hinges are just the thing for hinging the table to the frame. If the hinges are loose from wear, you can usually tighten them by peening the ends of the pins. The hand screw that you see in Figs. 1 and 2 was made from a sewing-machine hand-wheel and a screw taken from an old piano stool. If you can't use the nut, you can easily make one by coating the screw with graphite and then pouring babbitt around it in a suitable form. A bracket, bolted to the frame, supports the hand screw, which should have at least a $4\frac{1}{4}$ -in. vertical movement. When level, the top of the table should be approximately $2\frac{1}{2}$ in. above the center of the mandrel. To get this distance it probably will be necessary to recess the bottom of the table for the mandrel bearings.

With this much done, you can mount the motor, belt it to the mandrel, then, with

the blade in place, start the motor and lower the table carefully onto the revolving blade, letting the latter cut its own slot. If you use a dado head, do the same thing to widen the slot. The ripping fence and the blade guard, Figs. 6, 7 and 8, finish up the job. The fence, Figs. 6 and 7, is made of hardwood, the arrangement for locking at both ends being shown in the details. The guard, of course, is optional.

☐ A mixture of cement, fine sand and wood-fiber plaster, with the fiber sifted out, produces a lasting, almost glazed surface on stone and concrete and it is impervious to moisture; it is ideal for pointing jobs and for finishing basement floors.

Detachable Screw-Gauge Handle Fits Entire Set



Merely removing a lock pin permits this handle to be switched from one screw gauge to another

When making up a set of heavy screw gauges, the detachable handle shown was used which not only saved time and material, but it also saved a great deal of weight and enabled a small box to be used for carrying the set. The handle was knurled on the outside as usual with a plain part at one end, after which it was drilled and reamed at an angle, and then used as a jig to drill each of the gauges, which were counterbored to receive it. A lock pin to fit this hole was made with one end knurled and a short portion in the center turned down so that a stop pin driven in the handle would hold it in place. To remove the handle, just push out the lock pin.—H. Moore, Hamilton, Ont., Can.

Tightening Loose Wagon Tires

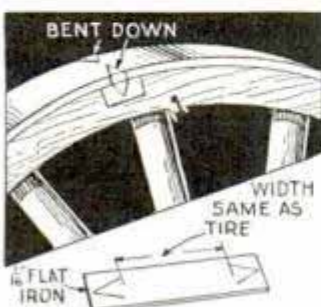

The strips are an inch or so longer than the width of the tire, and V-notches are

Instead of wiring the tires of his farm wagon when dry weather causes them to loosen, one farmer uses strips of flat iron as shown, which makes a neat, lasting job.

cut near each end. When the strips are slipped under the tire, the V-shaped tabs are bent over it and the ends of the strip are bent down over the felly of the wheel.

Four-in-One Rubber Stamp Saves Time

In offices where three or four stamps are often used on one paper, much time can be saved by assembling the related stamps in one unit as shown. This is done by removing the rubber type from the smaller ones and cementing it to the sides of the largest stamp.



The small type is brought into use by simply tipping the stamp to one side, thus making it unnecessary to pick up a stamp for each operation.

Emergency Holder for Balls of a Bearing

When dismantling a ball bearing around a piece of machinery where there is no holder for the balls, just pull out a few

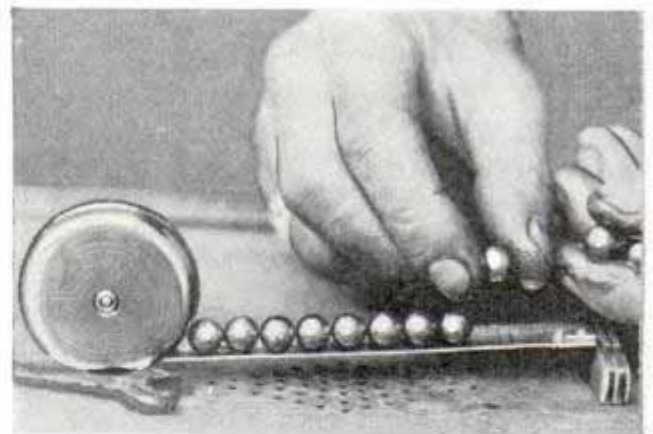

The curved inner surface of a flexible pocket rule makes a dandy holder for ball bearings

inches of a flexible pocket rule and you have a dandy one. The hooked end of the rule can be supported with a pocketknife and a wrench or other tool will prop up the other end as shown.

☐ A piece of inner tube, 2 in. square, makes an excellent squeegee, when folded, for spreading an even film of glue.

Darkroom Clock Is Seen Through Peep Hole

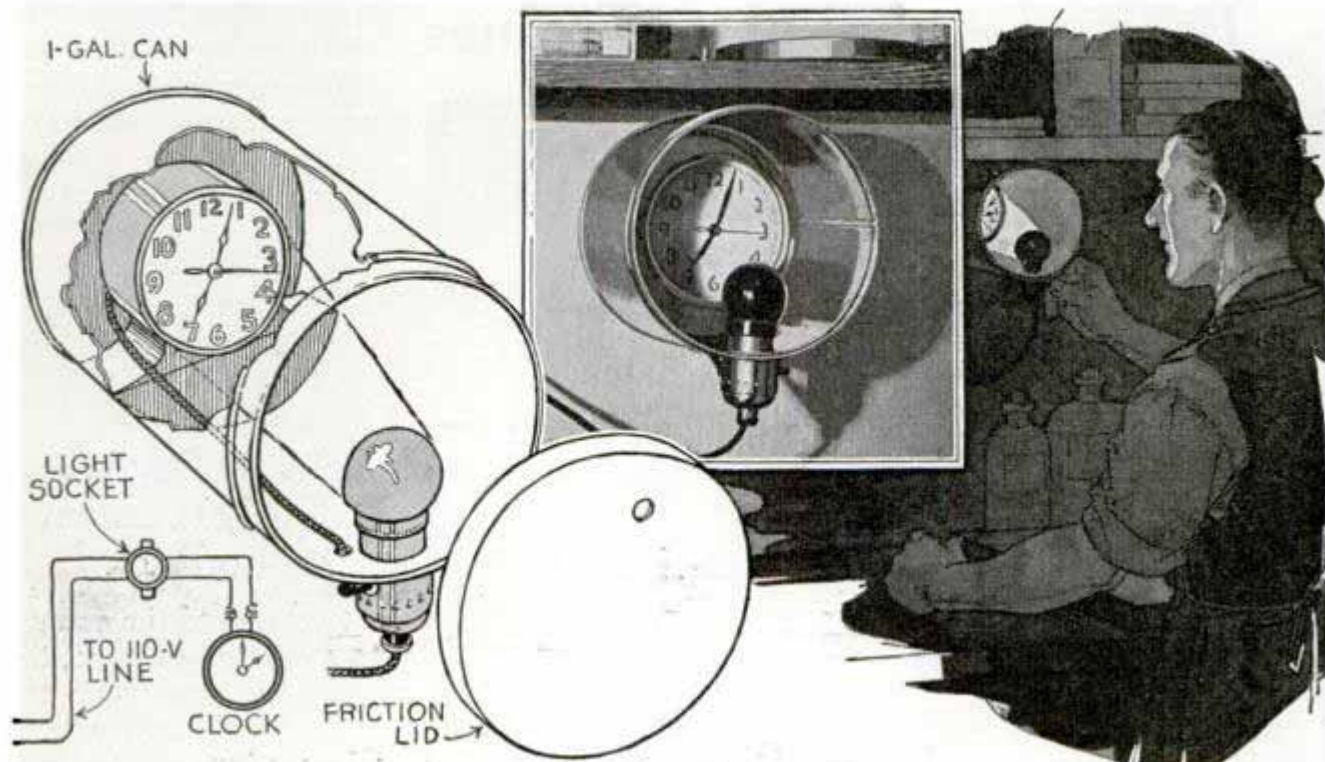

Made especially for use when handling panchromatic films, which must be developed in total darkness, this timing clock is viewed through a peep hole in its light-tight cover. Illuminated by a shielded, ruby lamp inside the cover, the clock is easily read at a glance. The parts required are a 1-gal. can with a friction lid, cheap electric clock with sweep second hand, push switch socket with extra wire hole, small red bulb, reflector for same, wire,

plug, and a bolt with nut and washers for mounting the clock under a convenient shelf. The socket is soldered into a hole cut in the box, the clock set in and connections made so that the light is independent from the clock, and may be turned off when not in use. The lid in which is drilled the $\frac{1}{2}$ -in. peep hole is left in place when handling films and plates, but it may be removed for printing and general timekeeping.

Iron Scrollwork Is Easily Bent on This Rigid Rotating Jig



Handling practically any bends necessary in making ornamental scrollwork, this inexpensive bending jig consists of two pipe flanges and a nipple. One flange is bolted to the bench and the nipple, which is slotted at the upper end, is screwed into it. The other flange is reamed to a snug, sliding fit over the nipple, and is drilled to take steel pins, which, in use, are set at various locations to form the desired bend when the flange is turned.

Indelible ink marks may be removed often by applying equal parts of turpentine and ammonia.

Sturdy Lightweight Bobsled Built of Automobile Frames

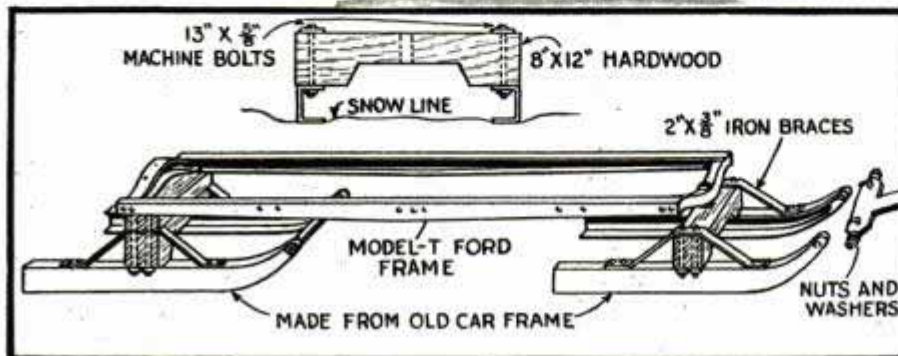

Ordinary hand tools are all you need to make this lightweight bobsled from two old car frames, one of which is cut in two to provide the four runners, the other one serving as a strong frame to tie the bobs together. A hardwood crosspiece braced with heavy flat iron ties the runners of each bob and provides rigid construction that will stand up under heavy loads.—Theodore A. Hodgdon, Whitingham, Vt.

Separating Milk in Cold Weather

Farmers and dairymen who experience difficulty in getting the usual amount of cream from their milk in cold weather, will find that the trouble is often caused by a tendency of the cream to stick to the metal disks in the separator. To avoid such trouble, run a half-gallon or so of warm water through the separator before turning on the milk.

—Frank Ward, Canyon, Tex.

Artist's Paint-Mixing Tray Held on Tumbler



By making up this simple paint tray to fit over a tumbler, an artist has both together so that the brush can be wetted and touched to the colors almost with one sweep of the

hand. The copper or tin tray is circular in shape, is $\frac{5}{8}$ in. deep and has several partitions. The wall of the opening in the center extends below the bottom to form a flange, which fits inside the tumbler to keep the tray from slipping. The entire job can be done with a pair of tinner's shears and a soldering iron.

Bolts of Dry Goods Easily Handled on Rack

Screwed to the counter in a dry-goods store, this simple wood rack will save the clerk's time when dispensing cloth from bolts. When showing a customer cloth, the bolt is simply laid in the rack where it is quickly unrolled by the clerk for the customer's inspection. Large wood screws, driven into the wood plugs in the ends of the bolt of cloth, serve as an axle to support it in the rack.

—Opie Read, Jr., Chicago.



Customers quickly inspect cloth in this rack, which permits the bolt to rotate freely.

CABINET HUMIDIFIER

fits over radiator

By H. G. LaBrant

HAVE you ever felt chilly and uncomfortable in a steam-heated room during cold weather even though the thermometer indicated an inside temperature of 68 to 70°? That's because the moisture from your skin is rapidly evaporated and absorbed by the extremely dry air, which has a cooling effect. To overcome this, water should be evaporated so that the air will be kept humid. In the average small home, it is necessary to evaporate from 10 to 20 gal. of water every 24 hrs. in order to maintain the needed humidity, while individual rooms require only a few gallons. If you have a steam-heating system, the cabinet humidifier and circulator shown here will do the work. One unit takes care of a large room or two smaller ones.

The unit consists of a cabinet, which houses a water pan over the radiator, has a deflector to control the amount of air contacting the surface of the water, and an electric fan to accelerate the air movement. Dimensions of the cabinet will vary, of course,

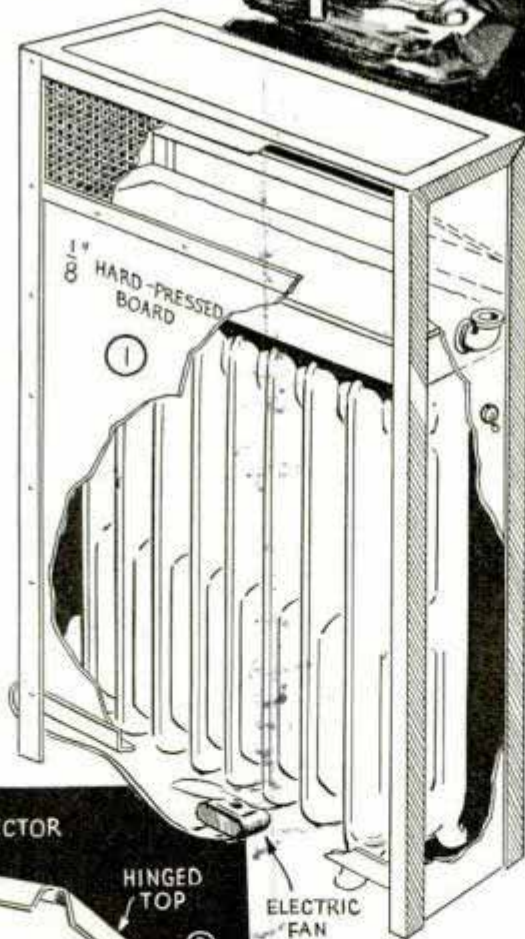
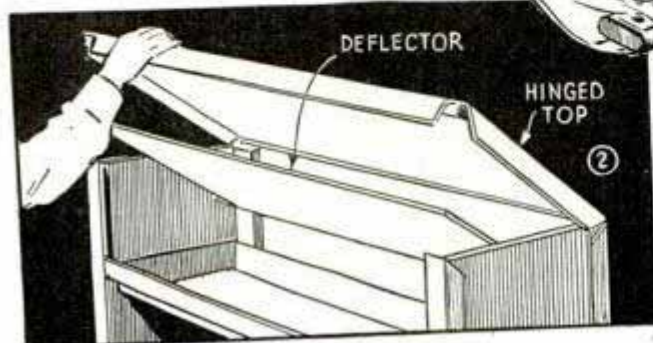

with the size of the radiator on which it is to be used. It can be made of hard-pressed board or sheet metal and should be about 10 in. higher than the radiator as shown in Fig. 1. At the corners, the construction shown in Fig. 7 is followed. An opening in the front, near the top, should be about 5 in. wide and is covered with a neat screen, while the lower opening is about 3½ in. wide. A hinged top provides ready access to the galvanized sheet-iron water pan, although, if desired, the pan may be fitted with a street elbow extending outside of the cabinet to permit filling. Details on bending the water pan to shape are given in Fig. 6. The pan, which rests

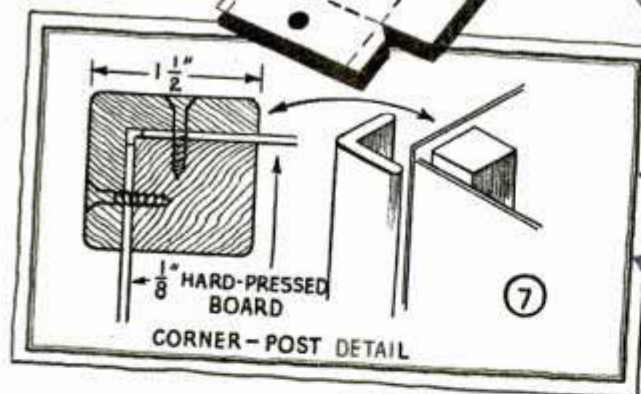
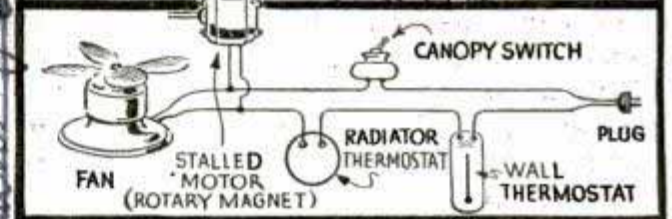
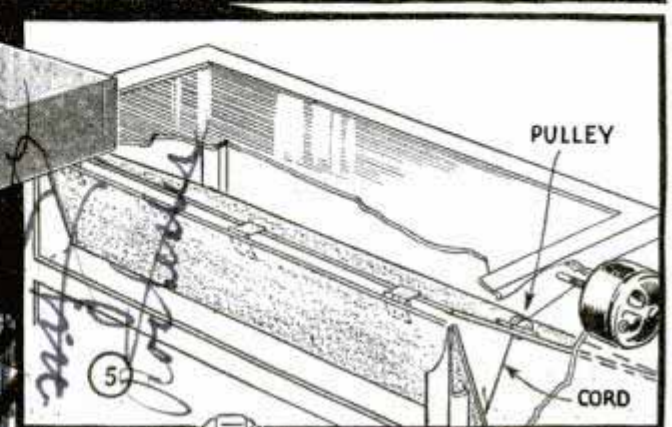
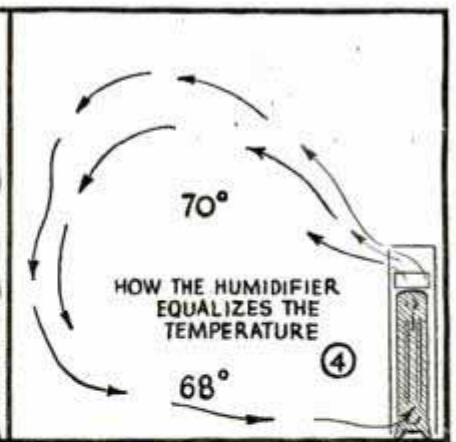
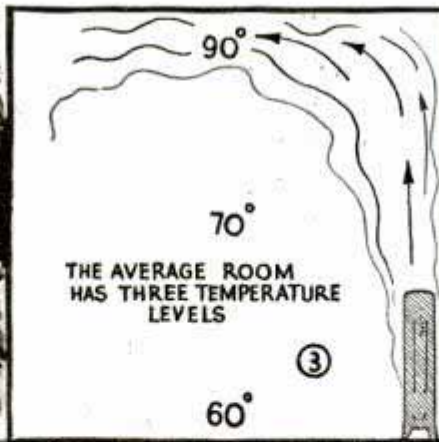

on crosspieces of the cabinet frame, should have the largest possible evaporating area and therefore it should extend the full length of the radiator, but should have a 2-in. clearance between front and back of the cabinet to permit free circulation. One should keep in mind that evaporation of water increases with its temperature, area exposed to air and the velocity of air passing over the water. A small 6 or 8-in. fan placed under the radiator to direct air upward, can be switched on to warm up the room quickly. The deflector directs the warm air into a room at a much lower level

than is the case with an ordinary radiator and thus provides more heat where it is needed. See Figs. 3 and 4.

Besides having a thermometer in the room, you should also have a humidity indicator. Humidity should be maintained at 35 per cent or more if it does not involve excessive "sweating." For simplest operation, both the fan and deflector may be manually controlled and the water pan filled each day. To make the device automatic in operation, the fan circuit may be connected to a wall thermostat and, if desired, the deflector can be made to open at the same time that the fan starts by means of a shaded-pole induction motor, which winds up a cord attached to the deflector as in Fig. 5. When the deflector is up and the cord wound tight, this motor will stall. (Stalling will not injure a shaded-pole motor.) When the wall thermostat cuts off the current, the fan will stop and the weight of the deflector will cause it to close again. A wiring diagram is shown directly below Fig. 5.

Russell Electric Co.
370 W. 1st St. N. Minneapolis

Air-Cleaning Cutting Tools

It is recommended that cutting tools such as taps, dies, drills, etc., be cleaned with air instead of knocking them against some solid object to jar off metal chips and filings. With this method, there is no danger of bending or checking the tools. Compressed air is ideal where available, but a small syringe or similar rubber bulb with a nozzle can be used.

—A. H. Waychoff, Tempe, Ariz.



Balloon "Manikins" Model Ties in Store Window

Simple and effective, this display for neckties is made by fitting toy rubber balloons with paper cutouts to represent features and mounting them on cardboard-tube standards. The balloons should be blown up to about 10 in. in diameter and tied. From a piece of white paper, make the cutouts to form the eyes, nose and mouth, and use rubber cement to fasten them in place. Roll sheets of cardboard into tubes about 5 in. in diameter and 2 ft. long and cover them with tissue paper. Place the balloons on top of the cardboard tubes and fit the figures with collars and ties.—F. M. Mix, Chicago.

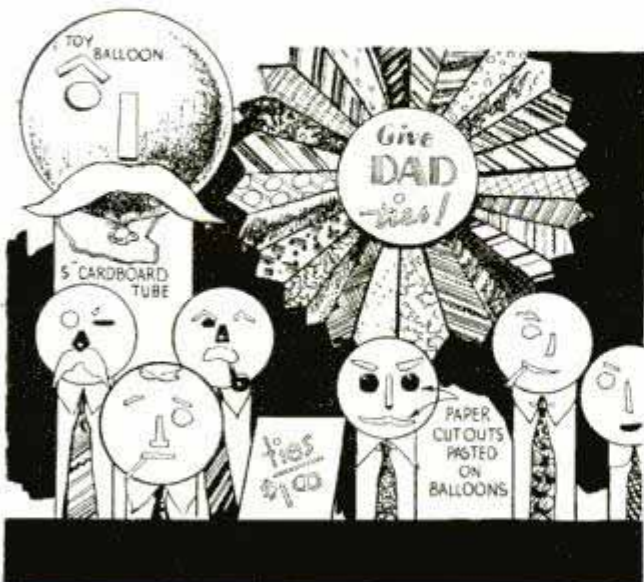

These grotesque balloon "faces" are sure to attract the attention of passing shoppers

Printer Uses Small Sandbags for Paperweights



If a number of small sacks are filled with sand, they make paperweights which are easy to handle

Filled with coarse sand, cloth tobacco sacks were found handy for paperweights by one printer for weighting stacks of paper stock and printed matter when the windows were opened for ventilation on windy days. The sacks are tied securely at the top, small rings being fastened to the ends of the tie strings so that the weights can be suspended from nails when they are not being used.

Rubber Stamps on Rotary Holder Identified by Paper Dial

For quick selection of any stamp on a rotating holder, a clerk glued a paper disk to the latter and printed the facsimile of each stamp on the paper. The lettering on the disk should be large enough to be read easily at a glance.



☐ A cheap vacuum-filler type fountain pen is a convenient oil container for carrying in the pocket.

Electric Temperature

HOW TO MAKE THERMOCOUPLE PYROMETERS
TEMPERATURES OF MOLTEN METALS, ETC., AS

THERMOCOUPLE

by C.A. Crowley



of all necessary to decide upon the type of metals which should be used in the couple itself. Fig. 2 shows the maximum working temperature which can be used with seven different types of thermocouples. The first type of couple shown in Fig. 2, Chromel-Alumel, can be used for measuring temperatures as high as 2,500° F. It is impractical to build thermocouples

MILLIVOLTS CORRESPONDING TO TEMPERATURES

TEMPERATURE (°F)	CHROMEL-ALUMEL	NICHROME IV-NICKEL	NICHROME-NICKEL	NICHROME ADVANCE	NICHROME IV ADVANCE	IRON ADVANCE	COPPER ADVANCE
2500°	54.85						
2400°	52.95						
2300°	51.00						
2200°	49.01						
2100°	46.97	48.72					
2000°	44.89	46.40					
1900°	42.77	44.08					
1800°	40.62	41.76	29.52				
1700°	38.43	39.44	27.88				
1600°	36.20	37.12	26.24	54.40	65.44	47.52	
1500°	33.94	34.80	24.60	51.00	61.35	44.55	
1400°	31.65	32.48	22.96	47.60	57.26	41.58	
1300°	29.33	30.16	21.32	44.20	53.17	38.61	
1200°	26.98	27.84	19.68	40.80	49.08	35.64	
1100°	24.62	25.52	18.04	37.40	44.99	32.67	
1000°	22.25	23.20	16.40	34.00	40.90	29.70	
900°	19.88	20.88	14.76	30.60	36.81	26.73	
800°	17.52	18.56	13.12	27.20	32.72	23.76	
700°	15.18	16.24	11.48	23.80	28.63	20.79	
600°	12.85	13.92	9.84	20.40	24.54	17.82	13.38
500°	10.56	11.60	8.20	17.00	20.45	14.85	11.15
400°	8.31	9.28	6.56	13.60	16.36	11.88	8.92
300°	6.09	6.96	4.92	10.20	12.27	8.91	6.69
200°	3.82	4.64	3.28	6.80	8.18	5.94	4.46
100°	1.52	2.32	1.64	3.40	4.09	2.97	2.23
TO METER -	0-60	0-50	0-30	0-60	0-70	0-50	0-15

TWO pieces of wire of different metals or alloys, welded or brazed together at one end, and connected to a d.c. millivoltmeter at the other end form a thermocouple pyrometer. The welded end is inserted where temperature is to be measured. Heat at this end causes a difference in electric potential which is shown on the millivoltmeter, the scale of the instrument having been calibrated in degrees. The millivoltmeter is simply a voltmeter which is sufficiently sensitive to read as low as .001 of a volt, or less in certain cases. These are available from instrument manufacturers and, unless the pyrometer is to be used for extremely accurate work, the inexpensive kind will serve the purpose admirably.

In designing a thermocouple, it is first

Technical Service Bureau 6805 N. Clark Chicago

*nichrome wire }
Pure nichel wire }*

W. A. ...

W. A. ...

Western Electric Instrument Corp

Indicators

FOR MEASURING
HIGH AS 2500° F.

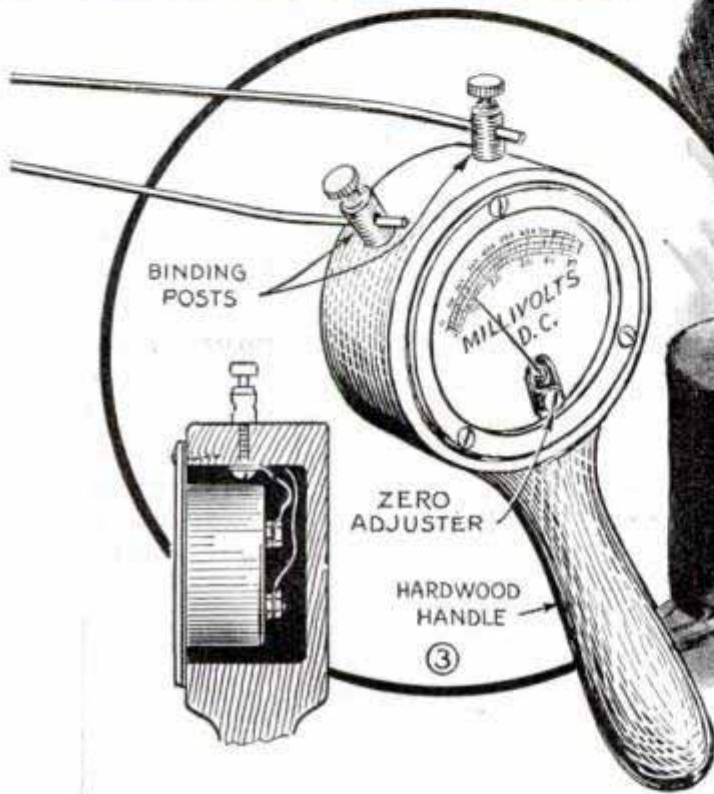

for measuring temperatures higher than 2,500° F. because all thermocouple metals, with the exception of platinum and extremely expensive alloys, melt or cease to be sensitive at about this temperature. If it is not necessary to measure temperatures this high, one of the other couples shown in Fig. 2 may be selected for the job. A couple made from Nichrome IV and Advance wires, is the most sensitive of all of the couples described. Thermocouples made from these metals may be used up to 1,600° F.

After deciding which metals will serve the purpose at hand, it will be necessary next to decide upon the form of couple and pyrometer which are to be constructed. If the couple is to be used for measuring the temperature of molten metals in a crucible, the design shown in Fig. 3 is extremely practical. This type of pyrometer consists of a millivoltmeter mounted in a handle turned from wood. The ends of the thermocouple wires are attached to the

binding posts of the millivoltmeter as shown. If rigid No. 8 or 10-ga. wire is used, this arrangement is quite handy around the shop. If the thermocouple required must be permanently installed for indicating the temperature inside a furnace or other inaccessible place, a unit such as shown in Figs. 8 and 9 is more satisfactory. With this type of installation, the millivoltmeter is mounted on the wall as in Fig. 8, at a suitable location where it can be read easily and the wires run to the thermocouple which is permanently installed in the furnace or other equipment as in Fig. 9. If you wish a rugged portable pyrometer, Fig. 10 shows the most convenient method of construction. In this case, a section of steel tubing is welded closed at one end and the thermocouple junction inserted and sealed in place. The lead wires from the couple to the instrument should be well insulated and may be made as long as required, provided a sufficiently large size of wire is used. To

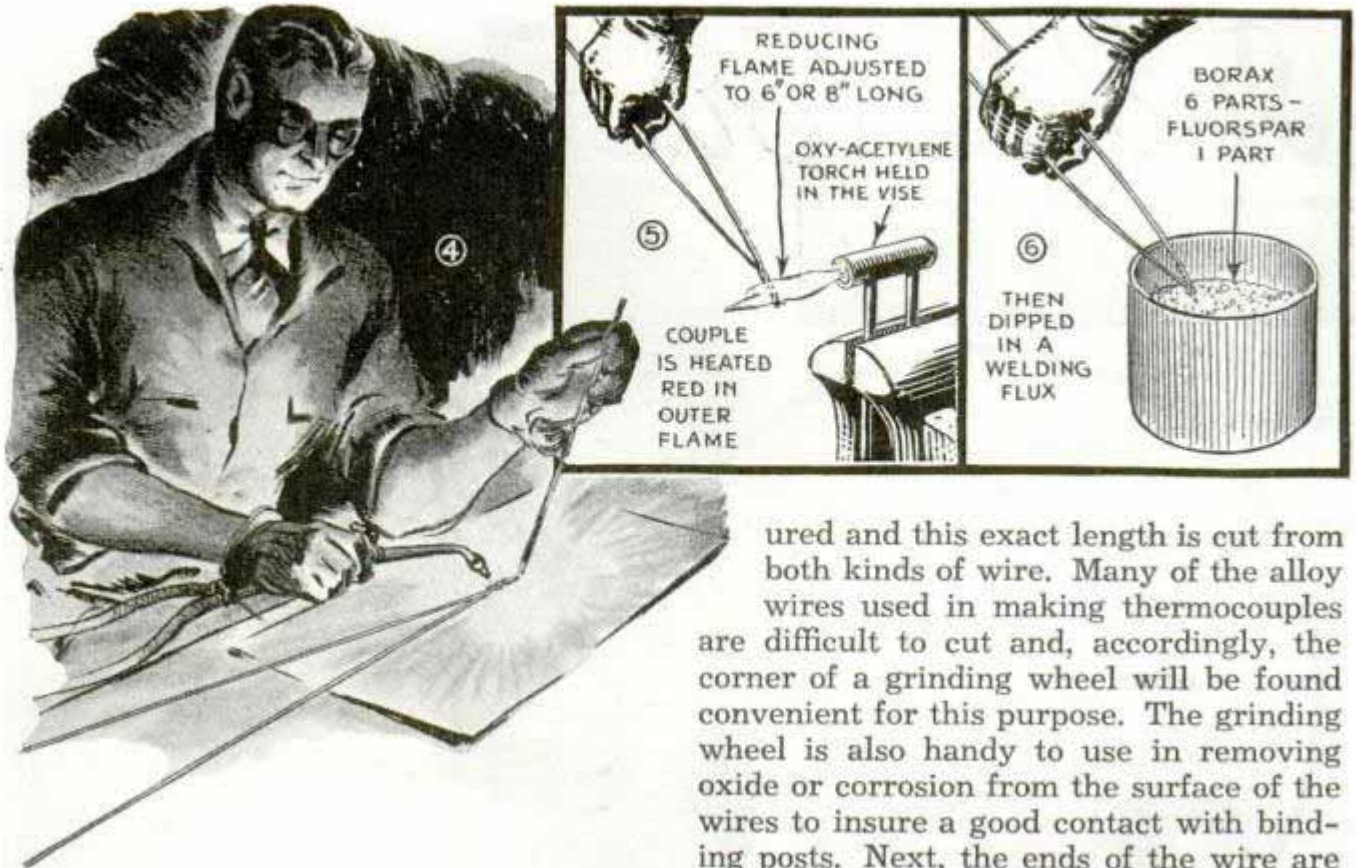

use this type of pyrometer, the instrument is set at any convenient location and the thermocouple tube inserted into the furnace or other location at which it is desired to read the temperature. This type of pyrometer is particularly desirable when the unit is to be used for metallurgical work. Many metals and alloys when in contact with thermocouples, will alloy with them and therefore change the instrument reading.

After selecting the particular thermocouple metals, which will operate at the maximum temperature which the unit is to be used on, from Fig. 2, and after you have decided upon the form of unit which will be the most serviceable for your purposes, the next step is to procure the material needed and start construction. In the case of all of the instruments, it is desirable to use as large a wire size as possible for the construction of the couple in order to prevent losses and to make the instrument as accurate as possible. Thermocouples which are to be operated at high temperatures particularly, should be constructed of at least No. 10-ga. wire. For intermittent use and when short leads are used, No. 12, 14 or even 18-ga. wire may be selected. The exact length of thermocouple wire required to reach from the couple location to the instrument is meas-

ured and this exact length is cut from both kinds of wire. Many of the alloy wires used in making thermocouples are difficult to cut and, accordingly, the corner of a grinding wheel will be found convenient for this purpose. The grinding wheel is also handy to use in removing oxide or corrosion from the surface of the wires to insure a good contact with binding posts. Next, the ends of the wire are fastened side by side in the jaws of a vise as shown in Fig. 1. The ends of the wires should protrude above the vise jaws about an inch. They are then twisted together as shown, with a pair of pliers. The twists should be made regular and firm to insure good contact. If the thermocouple is to be operated at a temperature below the melting point of silver solder or brazing spelter, the junction may be brazed neatly by heating it in the torch, Fig. 4, sprinkling with borax and applying just enough silver solder or brazing spelter to flow into the junction and insure good contact. For high-temperature work where brazing would not be satisfactory, an oxyacetylene torch should be used to weld the ends of the wires together. In making thermocouple welds, it is convenient to hold the torch in the vise so that the flame will be horizontal, as in Fig. 5. The gas valves are then adjusted to produce a slightly reducing flame about 6 or 8 in. long and so that the inner cone is between $1\frac{1}{4}$ and $1\frac{1}{2}$ in. long. A reducing flame is produced when a slight excess of acetylene is being fed to the flame. Now, the twisted junction is held in the flame until both wires become red hot. The junction is then withdrawn and dipped into a good welding flux as in Fig. 6. The flux will stick to the wire due to its being melted by the heat.

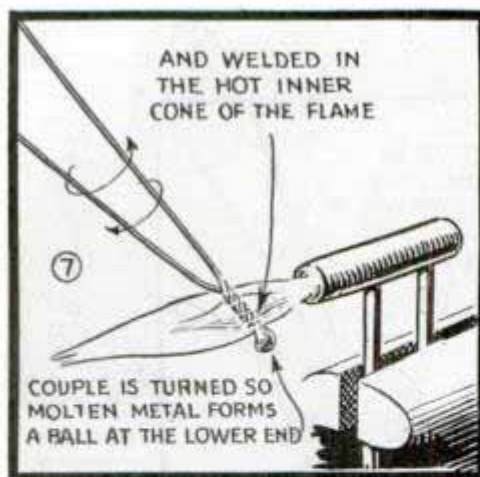

The wire junction is now returned to the hottest part of the flame and kept moving to insure even heating as in Fig. 7. In all cases, one of the wires making up the junction will tend to melt before the other and some care will be required to prevent it from flowing before the other wire comes to its melting temperature. Careful manipulation in the flame will easily overcome this and insure a good neat weld. When both wires have just reached their melting points, rotate the couple carefully so that the metal from both wires flows together and forms a ball of molten metal at the tip. If the job has been handled satisfactorily, this ball of metal which will flow to the end of the couple will consist of an intimate mixture of both metals. In welding a thermocouple by this method, care should be taken to avoid overheating and burning. A burned junction will be weak and in addition will not give accurate temperature readings when connected to the millivoltmeter. It is important that the weld be completed at the first attempt, inasmuch as repeated heating and cooling is likely to bring about certain changes in the alloys which would prevent them from functioning properly. If the first weld is unsuccessful, the joint should be cut off and a new junction prepared. After a little practice, the job can be handled quite easily.

Having completed the junction, the other ends of the thermocouple wires are filed or ground clean and bright to insure good contact and connected to the terminals of the millivoltmeter. To test the instrument for polarity, and also to check the effectiveness of the weld, the thermocouple

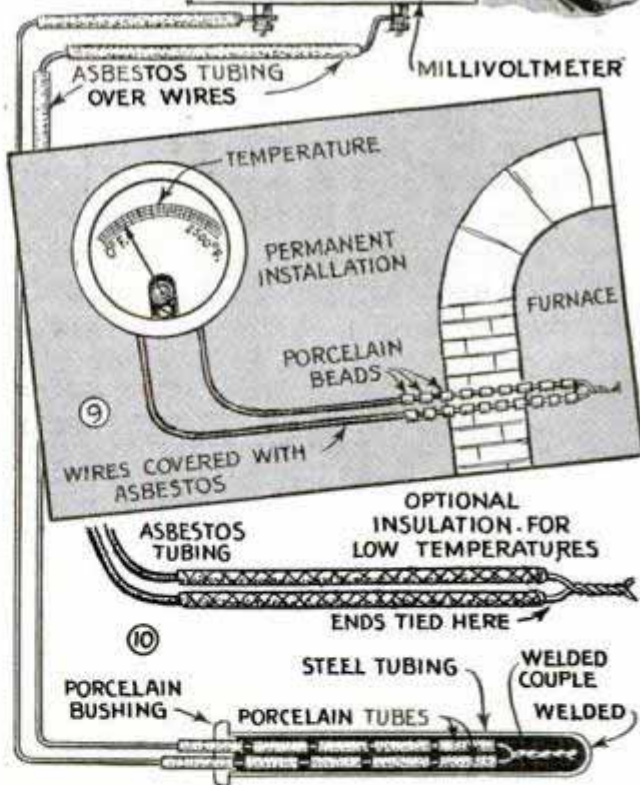

may be placed in the flame of a burner while watching the voltmeter needle as in Fig. 11. If the needle tends to move in the wrong direction, this indicates that the couple was connected wrong and then, the connections to the instrument should be reversed at the meter terminals. If heating in the flame produces a regular de-

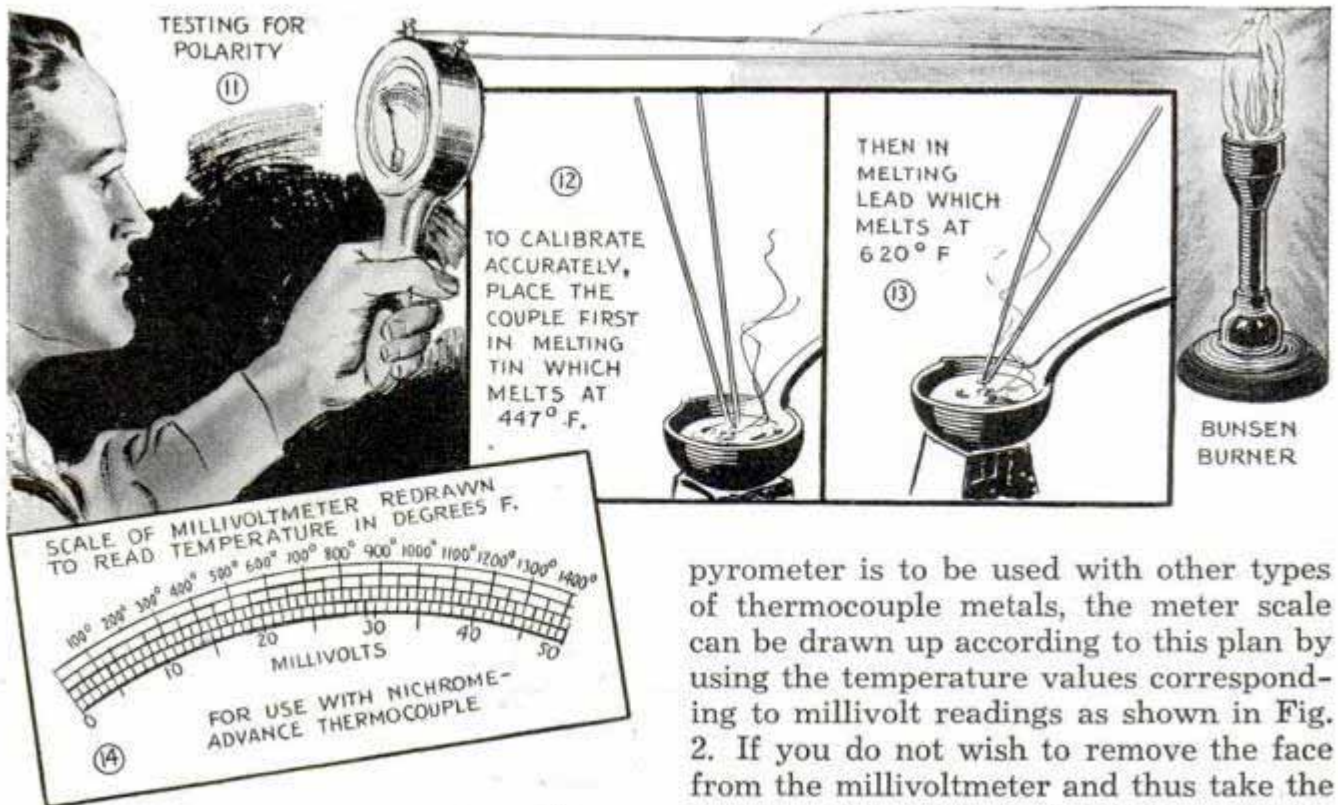

flection of the millivoltmeter, you are ready to assemble the pyrometer according to the plan which has been decided upon. If the unit is to be built according to the plan shown in Fig. 3 the wires will need to be bent carefully to the proper shape so that the ends can be fastened tightly in the binding posts of the millivoltmeter. After this, the wires may be formed so that they are of convenient shape for inserting into the furnace while holding the handle of the instrument in such a position as to facilitate reading. If the unit is being built along the lines indicated in Figs. 9 and 10, porcelain beads or glass beads, if the temperature to which the pyrometer is to be exposed is not high enough to melt them, should be slipped over the wires as shown to prevent their coming in contact with each other and with the metal case. If bare thermocouple wire is used, it may be insulated by slipping sections of asbestos tubing over the entire length of each wire. A convenient plan which produces a neat job is to place asbestos tubing over the wires and to encase the two jointly in a length of rubber tubing. This will effectively prevent contact between the wires.

Fig. 14 shows a millivoltmeter scale to which has been added figures giving corresponding temperatures for use with a Nichrome Advance thermocouple. If the

pyrometer is to be used with other types of thermocouple metals, the meter scale can be drawn up according to this plan by using the temperature values corresponding to millivolt readings as shown in Fig. 2. If you do not wish to remove the face from the millivoltmeter and thus take the chance of impairing its accuracy, it is quite satisfactory simply to prepare a chart which gives temperatures corresponding to millivolt readings. A chart of this type can be placed on the wall near the pyrometer for instant reference.

To use the pyrometer thus altered, adjust the zero adjuster on the millivoltmeter until the needle points to the millivolt reading corresponding to room temperature. This should be done with the couple out of the heat. Upon inserting the couple into the furnace the needle will then read correctly. For more accurate work the couple should be calibrated by placing it in melting tin and then in melting lead, Figs. 12 and 13. As the metals are heated the millivolt reading will rise gradually until the melting point is reached, then the reading will hold constant for a few seconds. The reading at which the temperature holds constant is the melting point. To check this value let the hot molten metal cool while watching the millivoltmeter. Here again the needle will hold at the melting point.

¶ When mixing paints, an accurate method of assuring that each batch will be identical in color, is to put a sample of each one on a clean paddle and let them run together by inclining the paddle. If a blend is noticeable when the two samples mix, the colors are not identical.

Getting Pulley Sizes Right for Correct Speeds

As most workshop machines should be run within limits of certain definite speeds to make them most efficient for use, often varying with the particular stock used and with the job, the problem becomes one of selecting the right size pulleys. Speed of a driven machine depends on three variables, namely, the speed of the motor, the size of the motor pulley and the size of the pulley on the machine to be driven. As the speed of motors used for this type of work is generally about 1,750 r.p.m., speed regulation depends mostly on the pulley sizes. Increasing the diameter of the drive pulley increases the speed, and

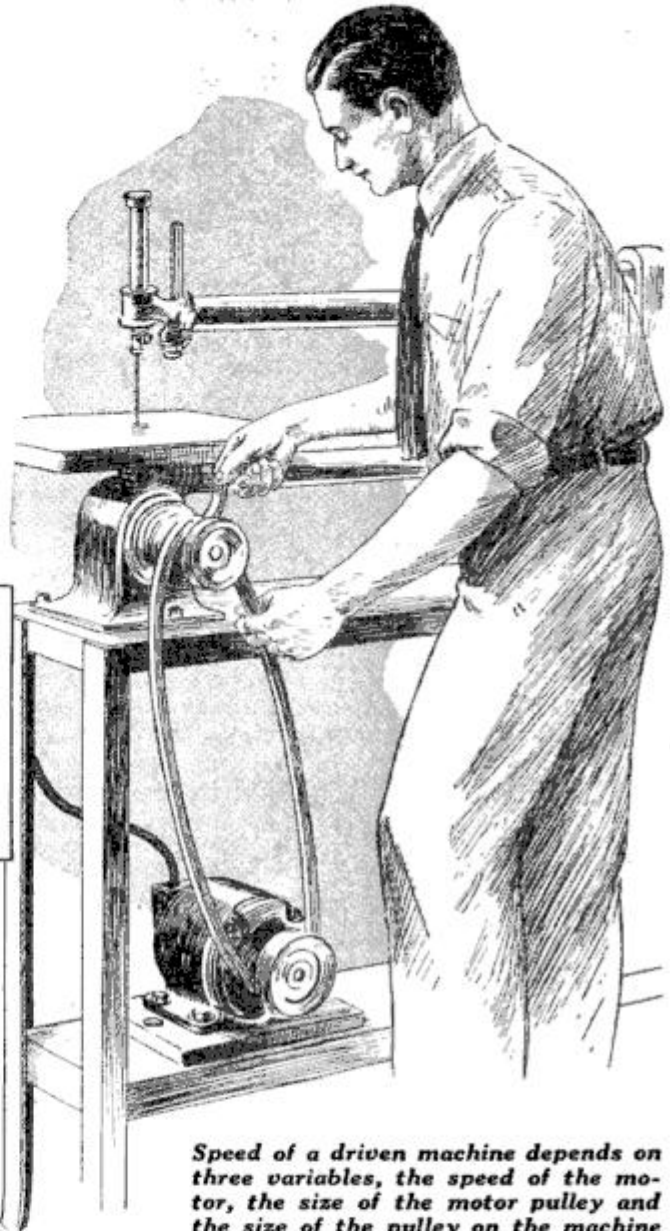

Speed of a driven machine depends on three variables, the speed of the motor, the size of the motor pulley and the size of the pulley on the machine to be driven

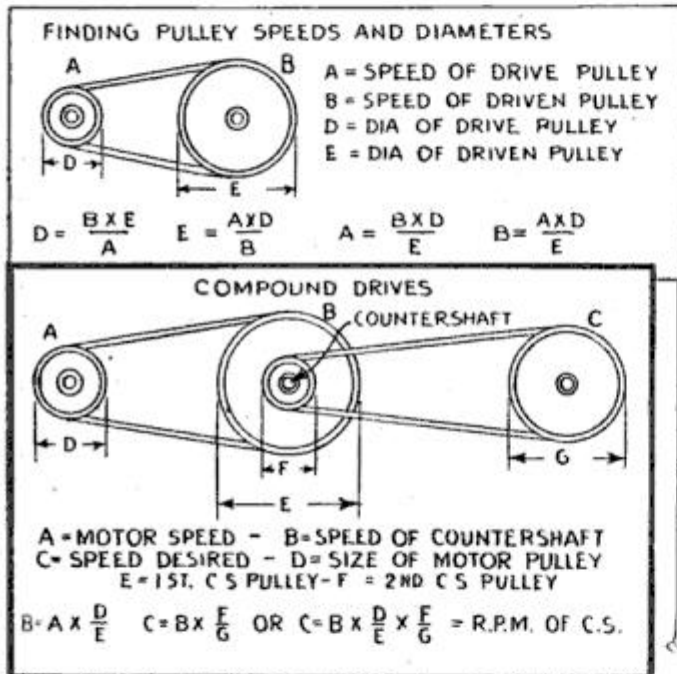

increasing the diameter of the driven pulley decreases the speed of the machine. The use of V-pulleys is advised and these can be obtained in sizes varying from 1½ to 12 in., the sizes increasing by ¼ in. on the smaller pulleys and by 1 in. on the larger pulleys. The formulas given here will enable you to figure out your requirements quickly. Should the increase or decrease in speed be so great that too large or too small pulleys are required, a countershaft carrying a pair of pulleys or an assembly of cone pulleys is used. If this method is followed, do not fail to take into consideration that considerable power is used to operate this shaft. Therefore, a motor which is adequate to operate the machine directly may be overloaded. Rec-

ommended speeds for various machines are usually given in the manufacturer's instructions. If one machine has several recommended speeds, cone pulleys may be used on both motor and machine.

Avoiding Breakage of Band Saws

When band saws break after they have been in use a while, probably the trouble is caused by friction between them and the guide. This heats the blade and often tends to caseharden the edge, making the metal very brittle. Such breakage can be reduced by removing a small amount of the metal with a soft-grained emery stone held lightly against the back of the blade while it is running.

Long Rock Drill Operated Easily with Detachable Handle

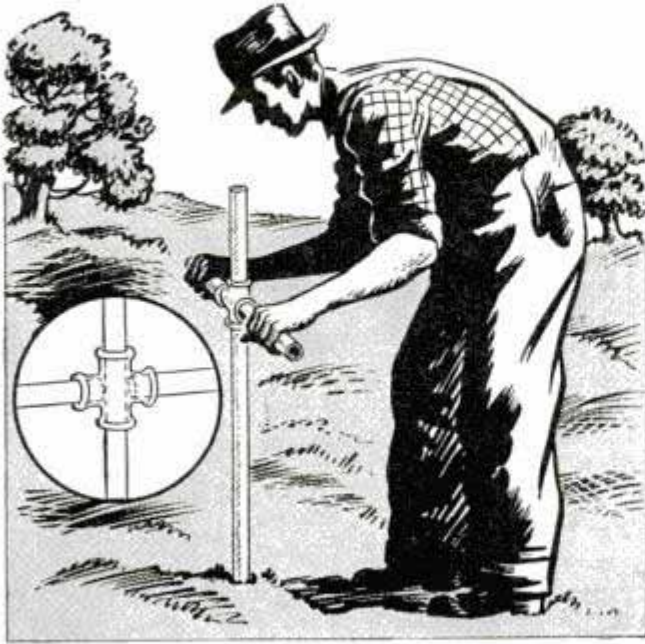

This simple handle permits a rock drill to be twisted to remove it from a crevice

When a long drill is used to make holes in rocky ground for blasting, it may be operated more easily if a simple assembly of two pipe nipples and a 4-way fitting are used as a detachable handle. The nipples are screwed tightly against the drill. This arrangement permits the drill to be twisted and extracted easily when it becomes wedged in a crevice.

—G. E. Hendrickson, Argyle, Wis.

Single-Cylinder Engine from Car Motor

Anyone who needs a one-cylinder engine of the utility type can make one from an old auto motor at small cost. First dismantle the motor and cut the block in half with a hack saw as indicated in the upper left-hand detail, being sure to cut behind the center main bearing and the side hose connection. Then saw the head casting to match the block. Next, cut the oil pan, the front half being used, and, from a piece of sheet metal, cut out an end for the pan, leaving $\frac{3}{4}$ -in. flanges at the edges by means of which this piece is welded or soldered to the rest of the pan. Be sure to remove a piece

from the back of the pan so that it fits snugly over the rear main bearing. When assembling, use a felt strip to seal the opening. Plug up the water-jacket openings in the block and head where they have been cut. This can be done by either welding or soldering pieces of sheet metal over them. Then comes the cutting of the crankshaft, the rear half of which is used. By carefully studying the lower left-hand detail, you will see where this is done. Be sure to cut as far in front of the center main bearing as possible. On the end opposite the flywheel flange, the timing gear is mounted. Now, cut the timing gear shaft with a chisel, as it is too hard to saw. The front half of this is used and it is cut just behind the center main bearing. Assemble the front half of the engine, being sure that the timing gear is in the same position as it was before the motor was dismantled. Only the first cylinder is used, which means that only one connecting rod and one piston are needed. One half of the intake port and chamber is plugged with lead to prevent gas leakage into the idle cylinder. The carburetor is mounted directly against the intake port with two studs. One coil connected to a 6-volt battery and the proper place on the timer will work satisfactorily. The Ford flywheel is mounted in its regular place and a pulley may be attached with the same bolts that hold the flywheel.

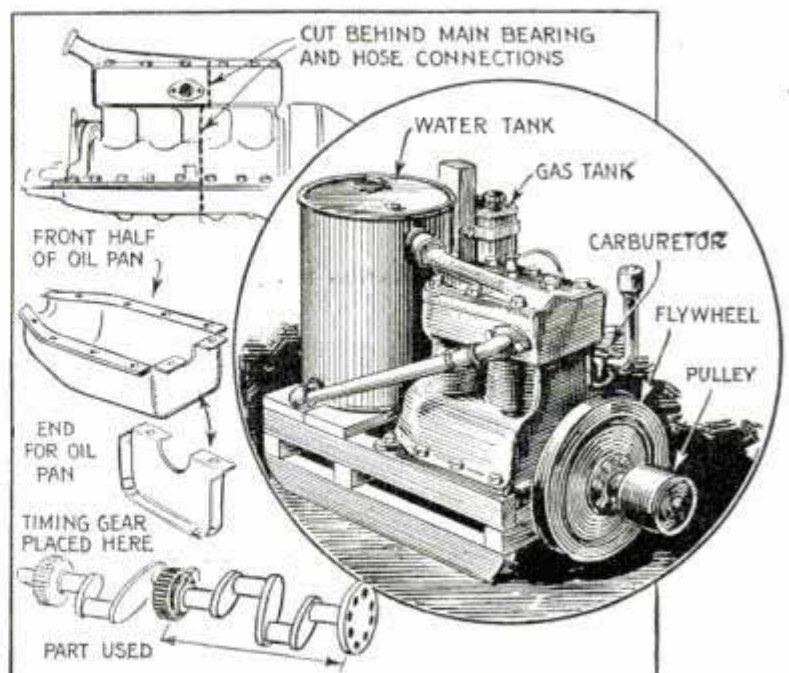

Economical to operate, this converted motor will do the work of the average small gas engine of 1 or 2 hp.

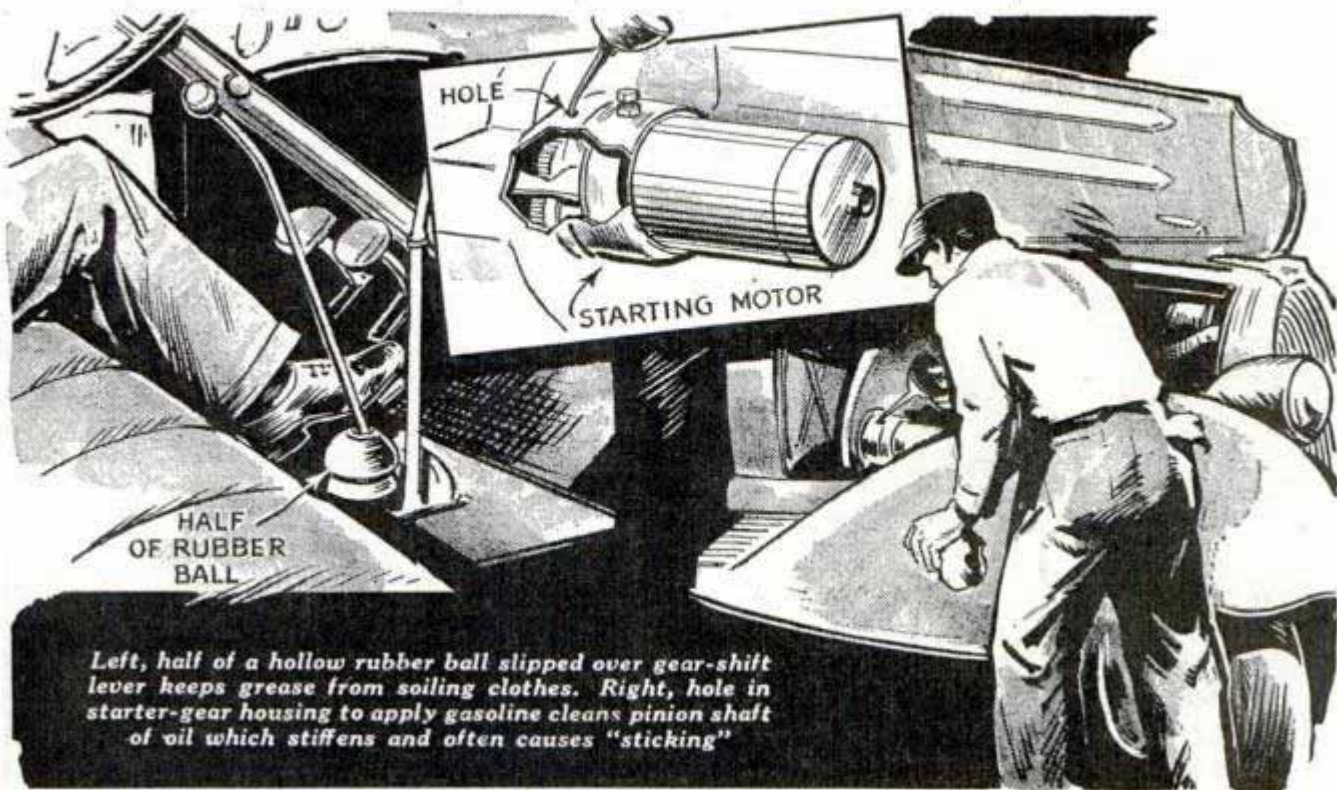

Left, half of a hollow rubber ball slipped over gear-shift lever keeps grease from soiling clothes. Right, hole in starter-gear housing to apply gasoline cleans pinion shaft of oil which stiffens and often causes "sticking"

AUTO Short-Cuts

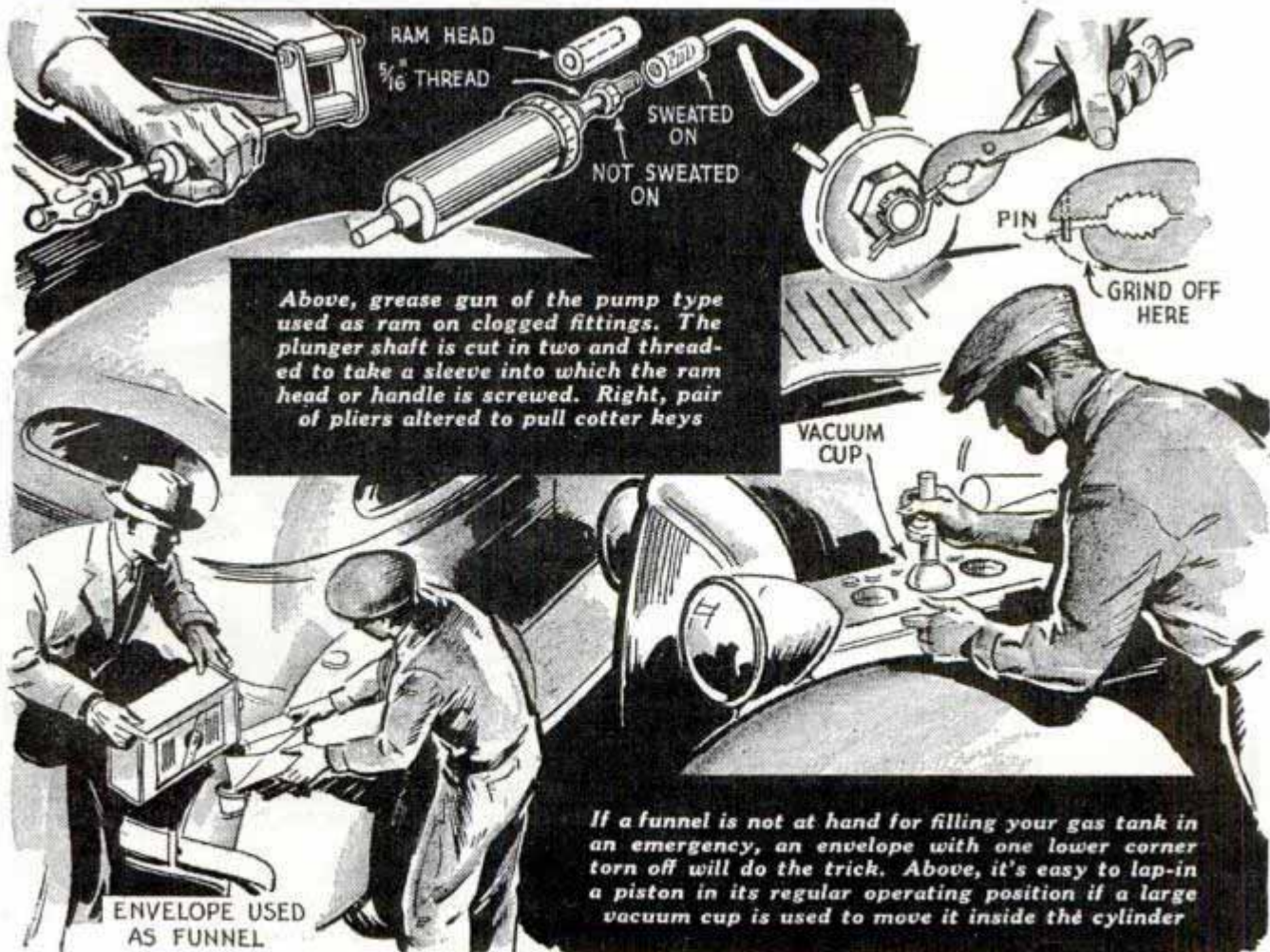

Above, grease gun of the pump type used as ram on clogged fittings. The plunger shaft is cut in two and threaded to take a sleeve into which the ram head or handle is screwed. Right, pair of pliers altered to pull cotter keys

If a funnel is not at hand for filling your gas tank in an emergency, an envelope with one lower corner torn off will do the trick. Above, it's easy to lap-in a piston in its regular operating position if a large vacuum cup is used to move it inside the cylinder

Portable Floodlight in Garage Illuminates Your Work

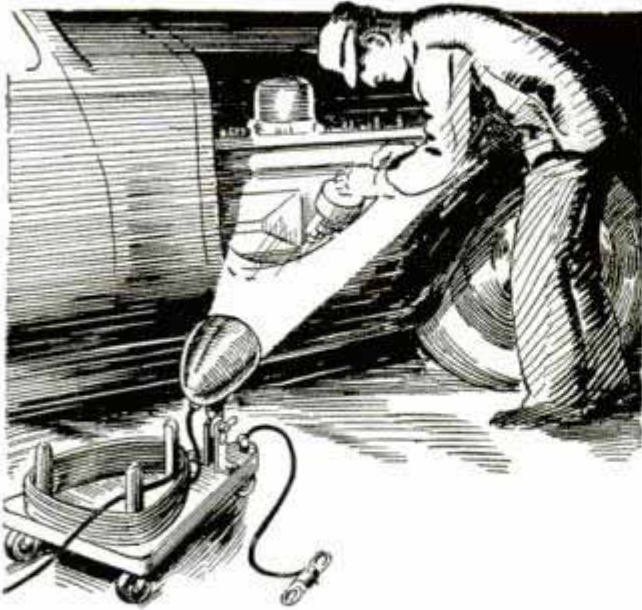

This floodlight is easily moved to any part of the garage to brightly illuminate work

The problem of getting plenty of light where it was most needed in a garage was solved by one mechanic who used a portable floodlight. It consists of an old auto headlight or spotlight which is mounted on a three-wheel dolly, using a long bolt and wing nut so that the lamp can be adjusted instantly to any angle. This idea is especially handy in small, rural garages where electricity is unavailable, as the dolly can be made large enough to accommodate a storage battery. If the light is used on a 110-volt line, however, it will be necessary to cut away part of the rear of the headlight so that a socket and 110-volt lamp can be installed. Hardwood dowels projecting from the dolly provide a reel for the extension cord.

Ram to Open "Frozen" Bearings Has Grease Fitting

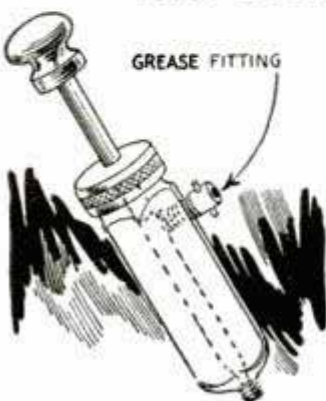

The job of filling a ram, used to open plugged bearings, is simplified if a grease fitting is installed as shown. The fitting permits the ram to be filled with a regular grease gun, in-

stead of taking it apart and forcing grease in with a paddle. The fitting should be located on the side so that it will be below the plunger when the latter is pulled back.

—R. Mooney, Erie, Pa.

Shaping Generator Brushes to Improve Operation

If the commutator of your car generator or starting motor gets dirty quickly, the trouble is sometimes due to carbon particles worn or chipped off the brushes.

When replacing one or more of them, after sanding the contacting surfaces to the exact arc of the commutator, take a file and round off the sharp edge of each brush facing the direction of rotation of the commutator. This will eliminate any tendency of the commutator segments to chip off particles. The portions of the brush filed off should be as small as possible as good commutation depends greatly on a maximum contact between the brushes and segments.

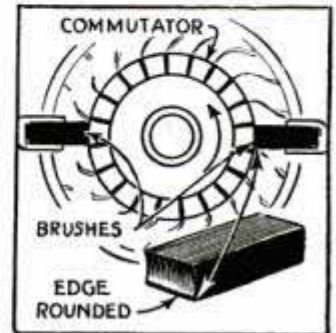

Metal Tire Cover Protected by Rubber Shield

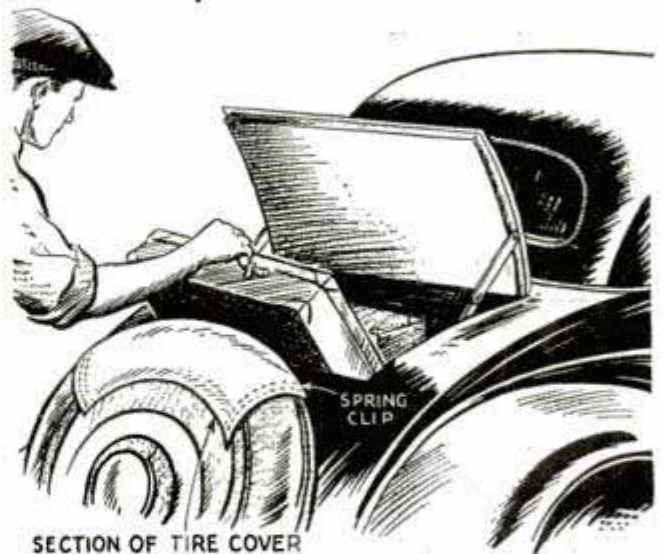

Shield clips over tire cover to protect it when removing heavy articles from the luggage compartment

On cars where the spare tire is carried directly behind the luggage compartment, a rubber or fabric shield clipped over the

metal cover will protect it against scratches when removing heavy suitcases, boxes, etc. The ends of the shield are folded over spring-brass or steel clips and cemented to hold the latter in place and to keep them from touching the tire cover.

Eliminating Brake Chatter



I find that brake chatter is sometimes caused by loose rivets in the lining, and can be eliminated in such cases by removing the brake shoes and resetting the rivets. After this has been done, of

course, the brakes should be readjusted carefully.—James W. Clift, Columbus, O.

Mirror Serves as Trouble Lamp

If you have motor trouble at night, and there's no flashlight at hand, remove your rear-view mirror and have someone hold it to reflect light from the head or cowl



If a flashlight isn't at hand for motor trouble at night, try using a mirror

lamps onto the motor. If you are alone, prop the mirror on a fender or some other part of the car so that it will catch the light from one of the cowl lamps.

¶To find a crack in a cylinder block, rub it with machine oil and dry; then rub the oiled surface with powdered chalk, and any cracks will become visible.

Rain Kept Out of Gasoline Tank by Shield on Pump Hose



Water running down gas hose during rain deflected from car tank by rubber cap on nozzle

In order to keep water from running down the pump hose into gas tanks, when filling the latter during a rainstorm, one gasoline-station attendant put half of a hollow rubber ball over the hose nozzle so that it would cover the filler hole as shown. The opening in the ball is a tight, slip fit over the nozzle so that it can be removed easily when not needed.

Gas Line Prevented from Kinking with Small Coil Springs

Owners of the newer cars that have the motors mounted on rubber, often experience difficulty by having the flexible sections of the gas and oil lines where they connect to the motor, pinch together, causing sluggishness or perhaps total in-operation. This trouble can be avoided to a certain extent by removing the flexible sections and inserting coil springs inside at points where they have a tendency to kink. Bronze coil springs used on electric-motor brushes were found suitable for the purpose.



Vertical Standard Guides Driver onto Lubricating Pit

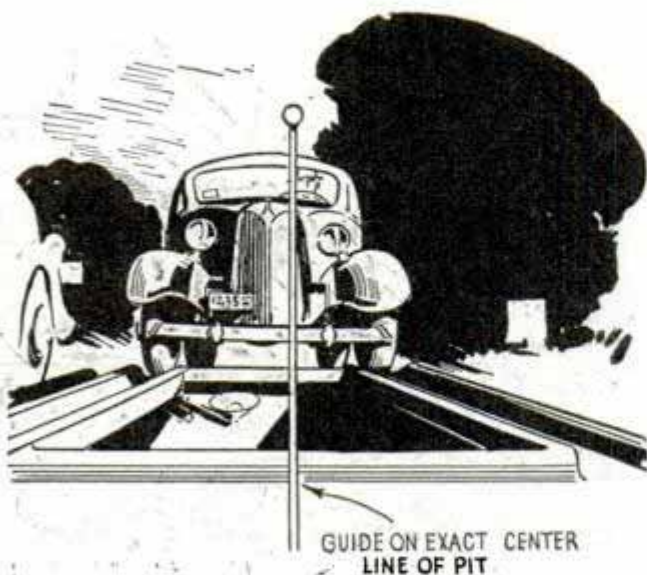

By lining up the radiator cap with this standard, you can drive straight onto the grease pit

Set at the end of a grease pit, this standard serves as a guide for a driver when lining up his car to come onto the wheel treads. When approaching the pit, the driver merely lines up the radiator cap

with the standard, which assures him that the wheels are headed straight for the treads on each side of the pit.

—Opie Read, Jr., Chicago.

Installing Grease Fittings

A simple method of installing grease fittings of the drive-in type without special tools is to use the barrel of the grease gun as a driver. The end of the gun, which slips over the fitting, is exactly the same shape, so there is no danger of damaging it. To use the gun for this purpose, remove the plunger and put a wooden disk or block of the shape shown over the end to protect the edges and the threads from the hammer blows. As only a little force is necessary to drive the fittings home, the blows will not damage the end of the barrel in any way.—W. C. Wilhite, Edelstein, Ill.

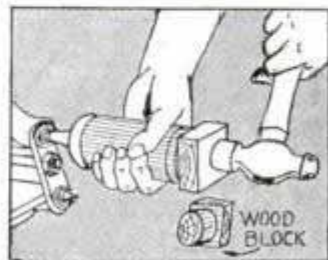

The Next Issue

ALL ABOUT CORROSION AND HOW TO CHECK IT

Corrosion, from which no metal is wholly immune, may result from acid, from electrolytic action or from oxidation. Although it cannot be prevented completely, much can be done to minimize its action and effects, in the plumbing or heating system, in the car, or elsewhere.

MODERN TELEPHONE STAND AND BENCH COMBINED

Completely upholstered, this bench and telephone-stand combination, with its concealed bell box, makes a striking piece of furniture for an alcove.

FLEXIBLE MOLDS TO CAST PLASTIC ORNAMENTS

How to make flexible molds, and prepare imitation marble compositions, including magnesite cement in color, for casting plastic ornaments.

SUCCESS WITH SEEDS AND SEEDLINGS

Information on sterilizing soil, preparing and seeding hotbeds and cold frames to assure strong, vigorous growth of seedlings for transplanting.

PAINT THAT SHINES IN THE NIGHT

You'll find many uses for luminous paint, which you can make right in your workshop by following the simple instructions given in this story.

FOR
LOW COST

SPORT

RIDE A 1937

HARLEY-DAVIDSON

Harley-Davidsons have always been easy on the pocketbook—but the new 1937 models take mileage costs to new low levels!

The answer is in the new improved Harley-Davidson motors with their many advanced features. Circulating pressure oiling—roller bearings throughout—improved cooling—four speeds forward—external ignition timer—all spell increased gas and oil mileage.

Greater economy, SURE — but that's only the beginning! You have to see and ride one of the 1937 Harley-Davidsons to get the real thrill of their classy lines, snappy colors—their double loop trussed frames, welded steel saddle-type tanks—and built-in instrument panel with its 120 M.P.H. speedometer dial!

See your nearest Harley-Davidson dealer NOW—take a FREE ride on one of the new models—ask about his Easy Pay Plans. And send in the coupon.

Los Angeles, Oct. 9th—News Flash—Bill Connelly and Fred Dauria cross continent from New York City in fastest time ever made by motorcycle. Their record—69 hours 46 minutes—beats former sidecar record by 17 hours 9 minutes. Exceeds best previous solo time by 1 hour 34 minutes. Their sidecar outfit—a Harley-Davidson—of course!



Ride a

HARLEY- DAVIDSON

HARLEY-DAVIDSON MOTOR CO.
Dept. P, Milwaukee, Wis.

Interested in motorcycling. Send illustrated literature. Postage stamp is enclosed to cover mailing cost.

Name.....

Address.....

My age is 16-19 years, 20-30 years, 31 years and up, under 16 years. Check your age group.

"For Digestion's Sake Smoke Camels!"

"MIGHTY GOOD ADVICE," SAYS THIS HARD-RIDING TEXAS COW PUNCHER

AFTER riding herd from sun-up to sun-down, the chuck-wagon looks mighty good to me," says Fred McDaniel (*right, also below*). "But I'm sure I wouldn't enjoy my 'chuck' half as much without the pleasure I get from smoking Camels with my meals and afterwards. After a good meal and Camels I feel plenty O. K. Camels set me right! They're throat-easy, and they never get on my nerves." What Fred McDaniel says about Camels is backed up 100% by baseball's "Iron Man," Lou Gehrig —by Frank Buck, of "Bring 'Em

Back Alive" fame—by Eleanor Tennant, outstanding woman tennis coach—and by millions of other Camel smokers in all walks of life.

Smoking Camels, you enjoy a sense of ease while you're eating, and afterwards too!

Enjoy Camels at every meal. They speed up the flow of digestive fluids. Increase alkalinity. Help you enjoy food. Camels set you right! They're *the* cigarette for steady smoking. Light up a Camel any time and get an invigorating "lift."

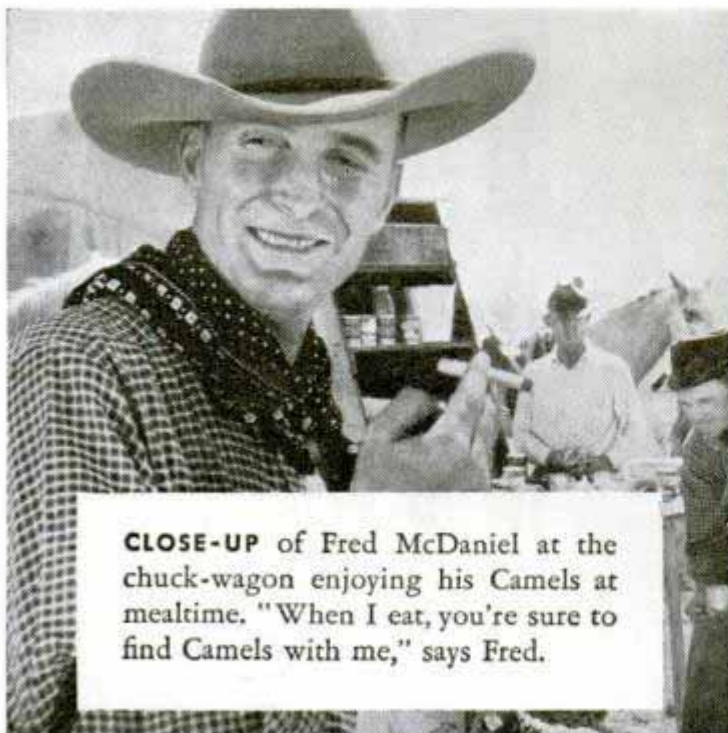

CLOSE-UP of Fred McDaniel at the chuck-wagon enjoying his Camels at mealtime. "When I eat, you're sure to find Camels with me," says Fred.



BUSY SECRETARY. "I smoke Camels," says Joselyn Libby. "Camels put more fun into eating and smoking too. So many girls smoke Camels."

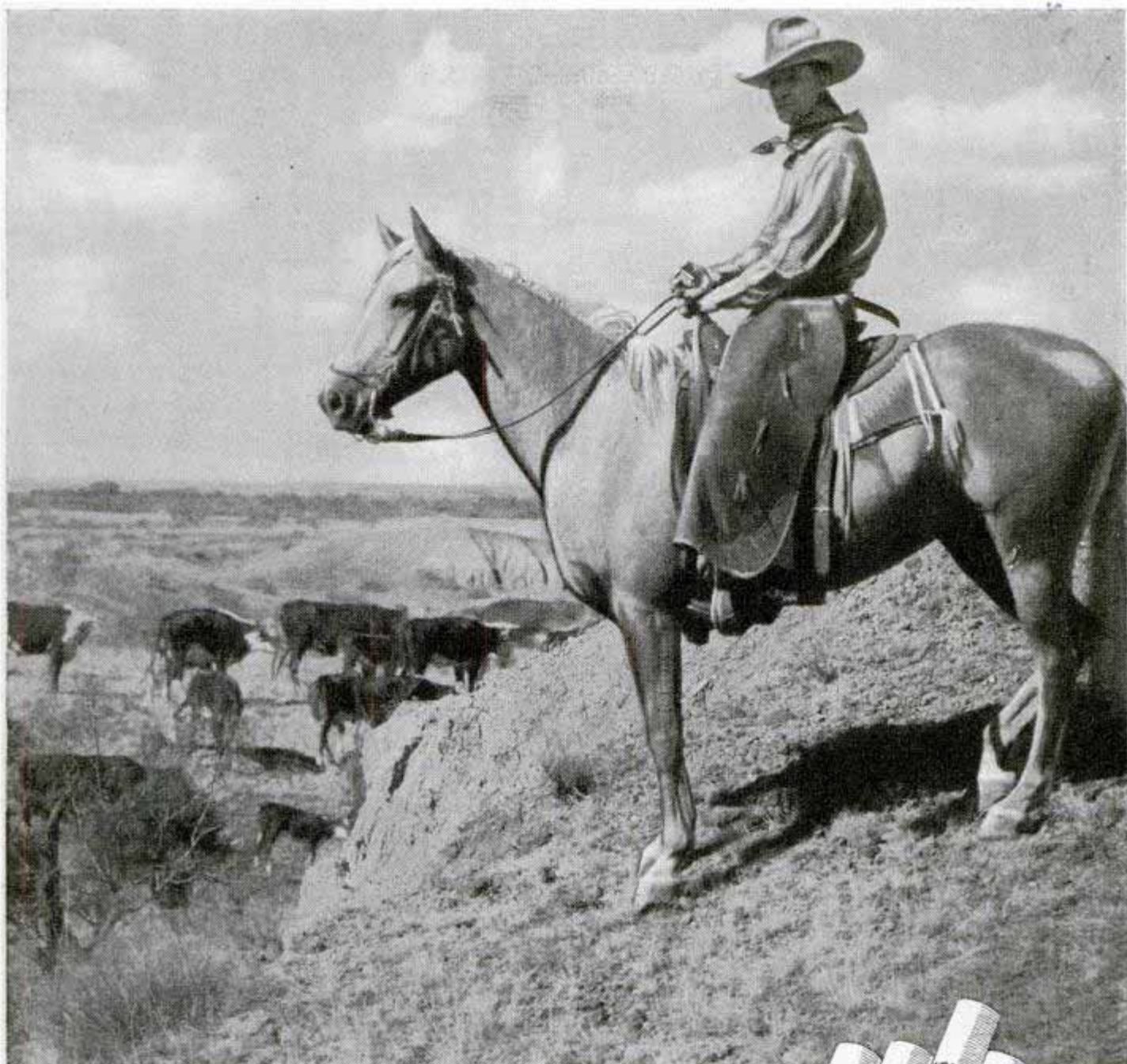

Copyright, 1936, R. J. Reynolds Tobacco Company, Winston-Salem, N. C.

COSTLIER TOBACCOS

Camels are made from finer,
MORE EXPENSIVE TOBACCOS
...Turkish and Domestic...than
any other popular brand.



When writing to advertisers please mention Popular Mechanics

Racing the Man-Made Meteors

(Continued from page 229)

chanical wheel lock are at the left of the instrument board. On the right side are the wing-flap and landing-gear switches, stabilizer controls, and hand gasoline pump, arranged so the pilot can reach across with his left hand to operate them.

Pilots try to fly a level course all through a race but some of them climb sharply while making a pylon turn. This is because unless the plane is banked vertically for the turn it tends to skid uphill. Ortman's plane has its engine pointed one degree to the right of center line to offset engine torque. This makes the plane fly level on the horizontal, but when it is banked to the left in a turn the engine tries to climb and the pilot must fight to keep from getting more altitude.

Pilots start their turns long before they actually get to the corners. They slowly start to roll the plane while approaching, planning to have the left wing tip pointed at the ground just as the pylon is reached. Then they can whip around the marker, clearing it by from ten to 100 feet, without sliding sideways. As they straighten out they roll back to the horizontal at the same slow speed.

Horsepower alone is not enough to win a race. In the Thompson contest Ortman was beaten by a French racing plane with about half as much horsepower. Another contestant with an engine only a quarter as powerful as Ortman's 850-horsepower radial averaged only fifteen miles per hour slower than Ortman. This was because the radial engine has a large frontal area while most racing planes are equipped with in-line engines that offer less wind resistance. The frontal area of an in-line engine is about one-fifth that of a radial, resulting in a saving of eighty per cent in head resistance. Radial engines give poor visibility ahead and frequently Ortman must dive his ship for a few feet to see whether he is approaching another plane.

In-line racing engines are air-cooled and are mounted upside down in the planes. This inverted position keeps the crankshaft high so propellers with long blades may be used and at the same time places the engine low enough to provide good visibility. Instead of remaining in the crankcase and flowing down into the

cylinders, oil is kept in a separate reservoir and pumped in and out of the engine. Most racing planes land on tiny high pressure tires ten and one-half inches in diameter. Touching the ground at ninety miles per hour or more, the landing speed of most racing airplanes even when equipped with air brakes, is hazardous.

Pilots now are concentrating on newer, faster airplanes. In the last Thompson race an average speed of 264 miles per hour was established, although the winner, Lieut Detroyat of France, flew one lap at better than 300 miles per hour. Ortman is at work on a super-speed plane he hopes will have a top speed of from 380 to 400 miles per hour. The plane will cost \$50,000 or \$75,000, depending upon research not yet finished. It will resemble most racing airplanes of today, being planned as a low-wing monoplane with retractable landing gear, small control surfaces, and fitted with a 1,000-horsepower in-line, air-cooled engine weighing about one pound per horsepower. The fuel tank will hold just enough gasoline to finish a 150-mile race with enough to spare for circling the field before landing.

In the past, most racing airplanes have been financed by private persons and were often owned by the pilots who flew them. Soon some of the larger airplane companies may enter the racing field with specially built speed craft.

Fine Chains Are Protected in Soda Straws

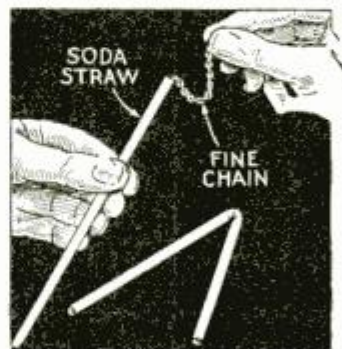

Strings of small beads and fine gold and platinum chains will be well protected from dust and grease if they are stored in ordinary soda straws. The straws may be bent or curved around in

any desired shape to fit a jewel box.

Loaded with putty, a cake decorator makes a good tool for filling cracks.



Load your camera
with Kodak "SS" Film

1

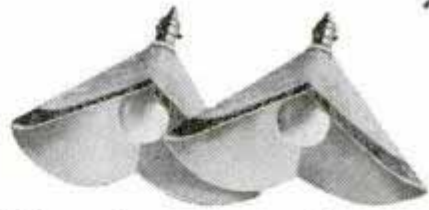

Use two or three
Photoflood Lamps
and Reflectors

2

All you do to make snapshots at NIGHT

HERE'S GOOD NEWS for every camera fan who's keen to get snapshots at night, but hasn't had a fast enough lens.

Now, even a simple Brownie makes snapshots (instantaneous pictures) indoors after dark.

Just use Kodak "SS" Film, and two or three of the new No. 2 Mazda Photoflood lamps, which last for hours, and Model B Kodak Handy Reflectors.

If your camera has an *f.6.3* or faster lens, No. 1 Photoflood lamps are powerful enough.

FREE BOOKLET... Contains all you need to know about *both kinds* of night pictures—snapshots with Photoflood lamps, *fast exposures* with Photoflash lamps. (You can use Photoflash lamps, each good for one picture, if your camera can be set for "time.") The booklet's pictures and diagrams show how to arrange your lights... how to place your subject... and it even suggests a variety of picture opportunities. Get a copy at your dealer's... Eastman Kodak Co., Rochester, N. Y.



"Tuning in" on the Stars

(Continued from page 237)

71462
The atmosphere is a shield that prevents all except the strongest of these rays from reaching the earth. Stratosphere balloons carrying electroscopes to an altitude of 85,000 feet, released by Dr. Robert A. Millikan, have recorded about 200 times as many rays as reach the surface of the earth. On the ground the rays are strongest during periods of low barometric pressure. Cosmic rays have an electrical potential of as much as twenty billion volts and are able to pierce lead plates three feet thick, although X-rays are stopped by one inch of lead. The rays have been picked up also by apparatus lowered 200 feet below the surface of the sea.

Much of what is known about the rays has been learned by observing their action in a "cloud chamber." Such a chamber contains a saturated atmosphere of water vapor. When the atmosphere is expanded the water vapor condenses as fog on the trail of ions left by the passage of a cosmic ray through the chamber. By this device the paths of cosmic rays may be photographed and a few things may be learned about them. Among other interesting things, it has been found that when a cosmic ray makes a direct hit on an atom of matter, the atom is smashed into bits and its parts are sprayed around. Some people have suggested that this destruction is responsible for many of the world's ills, but scientists find it impossible to draw any such conclusions. They point out that about twelve cosmic rays per second zip through the human body, hence any effect that such a ray has on one person must also have the same effect on everyone else.

Most progress in studying the stars is being made in the regions just outside the range of human eyes. Two bands of invisible light, consisting of infrared rays and ultraviolet rays, are being caught by means of photographic filters and special films, enabling astronomers to learn much more about the stars than could be found out by means of visible light alone. The average eye is sensitive to light ranging from 3,800 to 7,000 Angstrom units. Today "invisible" light down to 2,900 Angstrom units in the ultraviolet region and up to 13,500 units at the heat end can be studied.

The importance of this is that every element emits characteristic colors or "lines" when studied with a spectroscope and now that spectroscopic studies of the stars can be carried on beyond the limits of visible light, much guesswork is removed from charting the elements that make up the stars. In some cases recognition of an element depends upon finding spectral lines that lie outside the visible light band. For a long time no one could be certain that the sun contained carbon atoms because the most characteristic part of the carbon spectrum was within the infrared band and could not be seen. Infrared photography opened up this field and showed that carbon is present in the sun.

Studying the stars from many fronts, scientists are beginning to suspect that there may be other wave lengths of energy aside from those now known, and that temporary elements not yet listed may exist on some of the stars.

"Four things account for everything in the objective universe. These are matter, energy, time, and space," says one of the scientists. "All of these things are interrelated and one cannot be studied without considering the others. In some cases they are interchangeable.

"One of the questions we are trying to answer today is, 'What is the universe made of?' No one can say what new forces mankind will be able to control when we get the answer to that."

71514
Automatic Timer for Camera



Any camera with a cable release can be equipped with a self-timer which can be set for long exposures. Automatic time exposures ranging from one-half second up to ten seconds are possible. The self-timer also can be used to

delay shutter action, permitting the photographer to take his own picture.

Heinr. Klapproth,
Bismarckstr. 62

no. 15, Isesman
Jamburg.

FREE TO HOMECRAFTERS!

NEW, EXCLUSIVE PROJECTS BY FAMOUS DESIGNERS

● Big news! For the third successive year, Casein Company, makers of CASCO, famous heatproof and waterproof glue, offers a Free Project Service to homecrafters. And for 1937 it's bigger and better than ever before!

Here is the kind of projects homecrafters have asked for. We know because we asked them—thousands who built from Free Casco plans in 1935 and 1936.

We didn't stop there! We retained famous authorities to design these "request" projects, assuring originality of design and genuine usefulness. And we put these projects in simple, compact form... easy to follow... a pleasure to build... a joy to possess.

Twenty-four exclusive projects in all—sailboat, kayak, surfboard, modern tables and cabinets, inlaid card table, colonial desk, etc. Some for hand tools... others for power tools... some simple... others more challenging to your skill. In this enlarged service you're sure to find something you want to build.



HOW YOU GET FREE PLANS

Fill out and mail the coupon below. You get by return mail an illustrated folder picturing and describing all 24 of these interesting and useful projects. Take your choice. Then mark that choice on the green ticket which is in every 25c (or larger)



A New Class "Plover" Sailboat. One of a series of water projects designed by William Crosby, Editor of Rudder Magazine.



Modern End Table Radio Cabinet. One of a group of eight modern tables, desks and cabinets by Gilbert Rhode, internationally famous furniture designer.

can of CASCO. Each ticket entitles you to one FREE plan. Plans come complete—not merely blue-prints, but all-inclusive instructions. This Free Project Service is designed for you. Get your can of CASCO today.

Hardware, Paint and Lumber Dealers Sell CASCO

FREE!

● Save 2c. Stick this coupon on pennypostcard to get FREE folder describing 24 CASCO Projects.



CASEIN COMPANY OF AMERICA, Inc.
350 Madison Ave., Dept. PM237, New York, N. Y.
Please send folder about FREE Project Service.

Name _____

Address _____

IMPORTANT!

Unlike ordinary glues and pastes which set merely by evaporation, **CASCO sets chemically like concrete.** Heat, moisture and rough usage will not affect it.

For permanence, use CASCO on your next project.

When writing to advertisers please mention Popular Mechanics



3-IN-ONE OIL IS A BLEND OF THREE FINE OILS

BEST FOR CLEANING AND OILING TOOLS, EASING ACTION POINT OF TOOLS, LIGHT MOTORS, GUNS, WATERPROOFING LEATHER, CLOCKS, HINGES, LOCKS, ETC.

LUBRICATES • CLEANS • PREVENTS RUST

RE-STRING RACKETS AT HOME



• **EARN MONEY** •

It's easy, pleasant, profitable work. No experience required. Learn in a FEW MINUTES. I supply everything needed. Earn \$50 to \$100 cash in your spare time. Act QUICK—write for details FREE.

SPECIAL
Set Permatex Silk Strings, 50c with instructions, postpaid.

W. A. BICKEL, Dept. A-2, 809 W. Madison St., Chicago, Ill.



TRAILER

- ★ BUILDERS
- ★ BUYERS
- ★ OWNERS

SEND 25c TODAY

for this big 64 page book that tells how to build Tops, Berds, Cabinets, etc. All about Electric Light and Water Systems, Floor Plans, etc. Pages full of valuable information, ideas, suggestions that save time and money for trailer builders, buyers and users. Catalog of parts and equipment includes everything you want—Axles, Hitches, Pumps, Stoves, Lights, Windows, Sinks, Toilets, Mattresses—over 200 items exclusively for building and equipping a trailer. Rush 25c (coin) today—satisfaction positively guaranteed.

TRAILER SUPPLY CO., Box 438-A, Wausau, Wis.

INVENTORS Be Sure to See Page 23A

NEW SCREW FEED LATHE



No. 355-6 x 18-inch METAL TURNING LATHE WITH LONGITUDINAL SCREW FEED. Length overall 30 inches. Machined semi-V ways. Threaded hollow spindle No. **ONLY \$10⁹⁵**

6 MORSE TAPER CENTERS. BRONZE TAPERED TAKE-UP BEARING. 1/4 inch tailstock set-over. Compound carriage travels on semi-V ways gibbed for take-up. Included: Two 60° centers, tool post assembly and 4 inch face plate.—3 inch four jaw chuck \$3.50; 4 inch chuck \$4.50; adapter bushing 50 cents. Send \$2.00 with order, balance C.O.D. Shipping weight 30 lbs.

FREE—32-page catalog



BALKO ELECTRIC MOTOR & SUPPLY COMPANY
Dept. A12 10 S. Clinton St. Chicago, Ill.

Gunsmith Seeks World's Smallest Bore

F1346

(Continued from page 182)

or one-fifth as great produced at the muzzle. That is why the thickness of the barrel wall at the muzzle of a gun is sometimes no greater than that of the strap which holds your wrist watch in place.

Mr. Howe has gone so far as to make a tiny needle-point cartridge suitable for firing in a dwarf experimental gun of the type which he ultimately hopes to produce. It is the smallest bullet of its kind ever made, too small even to photograph unless it be magnified. This experimental cartridge is three thirty-seconds of an inch in diameter, its caliber being .09, and is approximately thirteen-sixteenths of an inch long. The bullet is made of pure silver instead of lead because bullets of the precious metals offer more satisfactory ballistics tests and the experimenter may best determine the proper center of form for such tiny projectiles. The cartridge shell is made of brass. It would require about three grains of a fast-burning powder like that used for a pistol or shotgun to cause the silver bullet to be belched from the tiny gun—when and if completed—at a speed never before even remotely approached. Mr. Howe estimates that it will cost more than \$100,000 to produce a satisfactory experimental midget gun and test ammunition of extreme technical accuracy for the high-velocity firing research which he eventually intends to make. It may be that he will have to develop a sub-caliber rifle, a large chamber within a small bore to produce the velocity which he seeks.

This maker of all kinds of small arms, who for fourteen years was in charge of the small-arms experimental department of the Philadelphia arsenal and whose many patents have been used by both American and foreign armies, predicts that within the next decade the American doughboy will be armed with a gun which loads and fires automatically. It will resemble a machine gun, and a clip of cartridges will be good for twenty shots before reloading. This automatic rifle is now in production but it will require nine or ten years to produce an adequate supply

71346
for American troops to replace their present small arms.

Mr. Howe also predicts just as radical a change in the style of rifle used by the average sportsman. Automatics now rule the roost among sporting guns. The future trend, he thinks, will be to eliminate the automatics and revert to the single-shot rifle or shotgun. The idea will be to play fair with our rapidly diminishing wild life, to make the strife between the hunter and the hunted a better sporting proposition.

This Washington gunsmith reports that more guns used by sportsmen in this country are made in the home basement or shop than in the professional gunsmithery. Nowadays, American riflemen and shotgun users have also turned tinkers in large numbers. They reap as much fun from remodeling and repairing their firearms as other amateur craftsmen gain from carving or cabinetmaking and spend their spare time in home gun shops adjusting sights, decorating gunstocks, bluing and browning barrels, altering triggers to finer pull, engraving locks and barrels, carving wooden stocks and striving to improve the "hang" of their guns for maximum accuracy.

Most of these amateurs work with rifles as there is little chance for tinkering with shotguns which are designed for special shot loads. About all that can be done with shotguns in the way of alteration is to change the stock or engrave the barrel. The home tinkers, however, enjoy revising rifles and pistols. For example, the pistol enthusiast can alter the grips and sights, speed up the lock timing, stone down the trigger pull and otherwise subject his guns to "face-lifting" operations.

If you are a member of the National Rifle Association you can purchase either used or new army rifles of former types and patterns at ridiculously low prices. The model 1917 Enfield rifle costs \$7.50 for a used gun or \$20 for a new one. You can buy a Springfield 30-06 for \$34, the actual production price. The tinkers disassemble such rifles and fit them with barrels of other calibers. They also change the army rifle sights which are unsuitable for hunting purposes. Mr. Howe recommends the use of rear as well as peep sights for such made-over rifles. The military rifles generally have poor trigger pulls for the

(Continued to page 122A)

FOR THE FIRST TIME IN MOTORCYCLE HISTORY



F. O. S. FACTORY
\$195.
FULLY
EQUIPPED

A *Twin*
CYLINDER

Indian JUNIOR SCOUT

NOW, you can have the machine you've been waiting for—a real, twin-cylinder motorcycle at the lowest price in American History—and it's an Indian, of course!

The new Indian Junior Scout is easy to handle—starts with the kick of the starter—packs plenty of power and pep to whizz you along up with the leaders. And it's as economical to run as it is to buy. You'll get 70 miles to the gallon easily.

Why wait? Enjoy the fun and thrills of soaring over the open road on your own motorcycle. Visit your Indian dealer today. Look at this magnificent engineering triumph. Your dealer will tell you how easy it is to buy the Junior Scout, or any of the many other Indian models, on easy payments and how you can get a fine RIDER'S HELMET and INDIAN PIN absolutely FREE when you order.



FREE



**MAIL
COUPON
TODAY!**

INDIAN MOTORCYCLE CO., Springfield, Mass.
Please send me at once, and without obligation, Illustrated Folder describing the new Indian Motorcycles and
CERTIFICATE of VALUE entitling me to **FREE Rider's**
Helmet and Pin as illustrated when I place my order. **PM2**

Name.....
Address.....
Please be sure to check your age group:
 16-19 years
 20-30 years
 31 years and up
 under 16 years

INDIAN MOTORCYCLE CO., Springfield, Mass.

Can You Equal This Home for **\$845**

Shipped
Direct
from Our
Mill

Save 30% to 40%
on Your New Home..

WE PAY
FREIGHT

Don't pay several hundred dollars more than necessary when you build a home! Buy it direct from our mill at our low factory price. We ship you the materials—lumber cut-to-fit, ready to erect. Paint, glass, hardware, nails, etc., all included in the price—no extra charges. We pay the freight. Plans furnished—also complete building instructions. No wonder our customers write us that we saved them 30% to 40%, compared with builder's prices. Easy terms—3 years to pay.

Handsome Big **FREE**

Pictures wonderful homes in colors at money-saving prices. Designs to suit everyone.

Write for your catalogue today.

LEWIS MANUFACTURING CO.

Dept. 1272 Bay City, Michigan

Send for
FREE
BOOK
of Liberty
Homes

600 POWER MICROSCOPE \$8.50
Triple Objective Brownscope "Professional"



The new super-power 100X to 600X Brownscope. Substantially and precisely made. Heavy tilting base. Large concave mirror. Rack and pinion focusing with two adjusting wheels. Power 100X to 600X in six steps. Dustproof 3 objective revolving nosepiece. Chromium plated tube and machined parts. Comes complete with wood carrying case, slides, instructions, and elaborate 6 piece set of dissecting instruments mounted in carrying case. Only \$8.50 postpaid.

BROWSCOPE CO. Dept. 42, 234 Fifth Ave. NEW YORK, N. Y.

TURN SNAPSHOTS INTO
'HUMANETTES'



Sensational invention. Almost human in appearance. A life-like cut out figure. Any snapshot, photograph or picture can be "immortalized" by this strange new process. Surface covered with moisture-proof transparent PORCELITE. Will not peel, tear, crack, or soil. Looks like porcelain bas-relief.

BIG MONEY FOR AGENTS

Low prices make HUMANETTES big sellers. We furnish list of prospects in your neighborhood who will pay from \$1.00 to \$2.50 for showing samples of LIFETIME HUMANETTES. If you want to make money fast, send name for free sample proposition at once.

AL SCHULER, 1037 Evans Street, Dept. 10-B, Cincinnati, Ohio

CHEAP FARM POWER
PULLFORD
MAKES ANY FORD CAR
INTO A TRACTOR



**Powerful...
Economical**

Plows 5 acres a day. Discs, cultivates, harvests. Does the work

of 3 or 4 horses, faster and better. The PULLFORD unit is quickly attached to Model T or A Ford. It's simple, strong, built to last. Use your old Ford or buy one cheap, and get the advantages of power farming.

WRITE
for FREE Catalog

Pictures . . . letters from users . . . details and LOW FACTORY PRICES.

PULLFORD CO., 2947 Cedar St., Quincy, Illinois

F1346
sportsman and if he is well versed in rifle mechanics he may readjust the triggers, although ordinarily that is a job only the professional gunsmith can perform.

The present fad for muzzle-loaders is bringing much "artillery" of this type into use again. Many are making such weapons in the home shop. Mr. Howe received an order recently from a California sportsman who, as a youth in Kentucky, had hunted with a muzzle-loader. He wished a duplicate of that gun and offered some crude sketches. Howe used the action of a 45-70, a Springfield model of 1873, and fitted it with the barrel of a Winchester twenty-gauge shotgun. The gun as completed was technically accurate in all particulars. Amateurs should use the same high quality and demonstrated materials in their efforts. Mr. Howe warns sportsmen about the danger of overloading remodeled guns made of inferior metal. Many old-time guns were made of ordinary wrought iron. They are not qualified to withstand an overcharge even of black powder.

An over-and-under gun, one with one barrel directly above the other in vertical formation as contrasted to the pair of barrels mounted side by side in horizontal position, is superior to an automatic, believes Mr. Howe. It can be fired almost as rapidly as an automatic while it offers no visual obstruction even for a split second as does the ordinary double-barreled shotgun. One set of sights on the over-and-under gun serves for both barrels.

F1540
Automatic Humidifier for Room
Fits on Steam Radiator



Performing the double duty of moistening the air and acting as a noiseless vent for a steam radiator, an automatic humidifier can be installed simply by screwing it in place of the radiator valve. With steam pressure at one pound it discharges a pint of water vapor into the atmosphere every hour, enough to keep a large room at proper humidity.

\$3.95
Maid O. Night June
180 N. Wacker Drive

ELECTRIC ARC WELDER



Only
\$39.25
WITH DELUXE
ACCESSORIES

Licensed
Under Basic
U. S. Patent
R. E. 16012.
Other Patents
Pending.

Amazing Machine with Efficiency of Arc
Welders Selling for \$150 to \$800 Now
Offered at Breath-taking Low Price

Now You Can Own Complete Full-Size Electric ARC WELDER



Think of it! A big, full-size, heavy duty, Electric Arc Welder—only \$39.25—less than one-third of any other equipment of its kind! Now for the first time every inventor, laboratory, home work shop, repair and machine shop, garage, and factory, dairy, farm, etc., can own a powerful, efficient Electric Arc Welder that handles all kinds of welding—everything from fenders and light sheet metal to motor blocks and heavy castings. Big opportunity for PROFITS in starting your own Welding Shop. Just plug the Aladdin into a 110 or 220-Volt 50 or 60-cycle A. C. socket and do practically any welding job right on the spot. Ideal for all kinds of maintenance, production and experimental welding jobs.

For
Personal
Or Shop
Use —
Or Go Into
Welding
Business
For Yourself



EXTRA PROFITS!

Reliance Electric Pipe Thawer

Sensational! Thaws any frozen pipe in 1 minute without tearing out plaster, woodwork or digging frozen ground! Absolutely SAFE. Clean up big profits this winter with Reliance Pipe Thawer—costs only \$39.25 complete—does work of machines costing up to \$300.00. Make \$2.50 to \$15.00 per job. Check coupon for details.

Big Practical Machine—The Aladdin is a big, 100-lb., sturdily-built tool that welds iron, steel, aluminum, bronze and their alloys, and does electric soldering and brazing. Uses standard welding rods. Current controls instantly adjustable. Costs only a few pennies an hour to use. Often returns its cost on first two or three jobs. Easily carried to outside jobs in auto, truck or side-car. Rolls on steel casters. No experience or training needed to operate. Simple, complete instructions for doing all kinds welding jobs included.

AMAZING DETAILS FREE! Send today for amazing details about Aladdin Electric Arc Welder at \$39.25 with DeLuxe Accessories. At last every metal-working and repairing establishment can obtain a highly efficient Arc Welder—**GUARANTEED IN EVERY WAY**—at a saving that may amount to several hundred dollars. Mail Coupon NOW for full facts.

12-BATTERY-CAPACITY
BATTERY CHARGER

A big, professional, 12-battery-capacity, 6-ampere charger—only \$19.75—only half the cost of old-fashioned chargers! Cash in on BIG PROFIT battery charging business. WONDER Charger is a big, sturdy, welded-steel-construction machine. New scientific principle; (Patents Pending) makes low price possible. Operates from 110 to 125 Volt 50 or 60 cycle A. C. socket. Weighs 35 lbs. Charges one to 12 batteries in 18 hours. Makes money for you day and night. Check coupon for details.

Only
\$19.75



Commonwealth Mfg. Corp.,
3785 Beechmont Ave., Dept. R-12,
Cincinnati, Ohio

Please rush me at once, without obligation, full facts about Aladdin Electric Arc Welder at only \$39.25 with DeLuxe Accessories—and also about the machines I have checked below.

Reliance Electric Pipe Thawer Wonder Battery Charger

Name.....

Address.....

Town..... State.....

A BIG LEAGUE PITCHER TAUGHT ME TO "Carry TUMS"

THIS IS THE
**FAST WAY TO
RELIEVE ACID
INDIGESTION
(GAS... SOUR STOMACH)**

"Big League baseball players can't be bothered with a fussy stomach out on the diamond. They need relief quick. When a Big League pitcher told me more and more ball players were carrying Tums right in their pockets all the time, I started carrying them myself as a regular thing. Now I get relief, minutes and sometimes hours, quicker."

Millions have switched to Tums because they bring such quick relief. Just the thing after you eat, drink or smoke too much. So handy. The roll fits right into your pocket or purse. And they taste just like candy. Best of all, Tums are harmless and non-habit forming. Contain no harsh, water soluble alkalies—can never over-alkalize the stomach. And Tums are so economical—just 10 cents a roll—or 3 rolls in convenient 25 cent ECONOMY PACK.

TUMS FOR THE TUMMY
TUMS ARE
ANTACID...
NOT A LAXATIVE
HANDY TO CARRY

FREE: Beautiful Six-color 1937 Calendar-Thermometer. Also samples of Tums and NR. Send stamp for packing and postage to A. H. Lewis Co. Dept. 32B-76, St. Louis, Mo.



PHOTO ENLARGEMENTS

Is Photography your hobby? Do you want a profitable easy business at home? Make **PHOTO ENLARGEMENTS** for yourself and others. Your cost 5c each and less. The Ideal Photo Enlarger is **AUTOMATIC**. No experience required. Also **COPIES** any picture. **\$5.94 COMPLETE**. Interesting circular **FREE**.

IDEAL-O, 122 East 25th Street, New York City

5¢
ANY
SIZE

New HULL AUTO COMPASS

Saves miles of travel in wrong direction. This handsome, **STREAMLINE** Airplane Type Compass keeps you on the right road. Easily installed. 3 1/4 inches high. Bakelite case, sapphire bearing. Built-in compensator. Only **\$2.95 POSTPAID**. **SATISFACTION GUARANTEED**.

MODEL A

Airplane Type. 1 1/4-inch diameter. Sticks to windshield. Guaranteed. With separate compensator, only **\$1.95 POSTPAID**.

If your dealer cannot supply you, order direct.

HULL MFG. CO., Box 246-D, WARREN, OHIO



The Home that Runs Itself

(Continued from page 245)

than gasoline or oats or lumber. The unit of measure is the kilowatt-hour and a kilowatt-hour will do more mechanical work than thirteen men can do in one hour.

Electrical rates generally are established on a sliding scale, so that the more "juice" you use, the cheaper it becomes. And that is the secret of Mr. Ripley's \$9.66 bill per month for about 400 kilowatt-hours of work as compared with a bill of \$3.84 he used to pay for an average of sixty-six kilowatt-hours. As he made fuller use of the Handy Annie he was employing in his home, he began buying electricity in wholesale quantities at bargain prices. He explains it like this:

"You don't get all the economies until you are all-electric, but the more electric equipment you use in your home, the lower the average rate per kilowatt-hour. So just remember that costs don't increase equally with consumption. Power is cheaper than light, and power—or work—is what I am buying.

"Here's the way my electric bill begins to creep instead of race as I increase consumption in a typical city like Schenectady. The first dollar of my bill buys seventeen kilowatt-hours, enough to run a washer with the strength of four women, a vacuum cleaner, a radio, a hand iron, clock and toaster.

"My second dollar buys twenty-two kilowatt-hours and that's enough to light the house fairly well. My third dollar buys twenty-five kilowatt-hours, enough to run a coffee-maker, waffle iron, cooker, grill, hot plate, fan, another clock and some more and better lighting.

"And right here is where most people stop—just at the point when they are ready to get a big bargain. The average electric bill for 21,000,000 American homes is about three dollars a month. Few know what happens after the third dollar. Well, in Schenectady the fourth dollar buys not seventeen, but thirty-five kilowatt-hours—more than twice as much as I got for the first dollar. And this is enough to run a good refrigerator, chafing dish, another fan, a vacuum cleaner upstairs, four more clocks and still more and better lights.

"The fifth dollar buys thirty-six kilowatt-hours and the sixth buys thirty-six

1223
more. And that's about enough, in our small family, to run the electric range and a kitchen ventilating fan, particularly as we do much cooking right on the dining-room table. The seventh dollar buys forty-three kilowatt-hours, two and one-half times what the first dollar bought, enough 'juice' to run an automatic oil or gas furnace that also heats our water.

"And now take notice. My eighth dollar buys sixty-six kilowatt-hours, almost four times as much work as my first dollar bought. That would be enough to run four washers, four vacuum cleaners, four irons, four clocks, four radios and four toasters. But to be practical, I added an ironing machine, another radio and a dishwasher in the kitchen, a clock in every room, a vacuum cleaner for each floor, more fans and more lamps.

"You are now really beginning to live electrically. You have an electric kitchen and an electric laundry. After this you will look into air conditioning and will investigate a room cooler. You will light your garden. You will begin to burn small lights all night and put 100-watt bulbs in modern efficient lights to save your eyes.

"And all of a sudden, you'll discover that you actually are using electricity like water—even more freely than water, perhaps, because while you don't let water run all night, you are using electricity twenty-four hours a day. Handy Annie is working while you sleep. And when you begin living electrically, you'll really find that you are living better at less cost because you're buying electric power—work—at bargain rates and using the money formerly spent in doing things the old-fashioned way to provide the tools for your Annie to do things the modern way.

"Based on my average rate of two and one-half cents, I can buy the mechanical work that an average farm hand would do in a month for about fifty cents.

"And, once you're completely electrified, you'll find your home actually does run itself. I know, because we went on a Caribbean cruise one winter and left our home to its own devices for eighteen days. We returned to find the automatic furnace still holding the temperature at sixty and the food in the refrigerator as fresh as when we departed. If that home didn't run itself, who ran it?"

(Continued to page 126A)

Now You can use

**GENUINE
23-KARAT
GOLD LEAF**

*In Your Home
Workshop*



The Hastings Home-Workshop

GOLD LEAF KIT

\$5.00 POSTPAID

Here it is—just what you have wanted to add that "finishing touch" to the many things you make in your home workshop: A practical, complete, low-cost Kit of Hastings Genuine 23-karat Gold Leaf, with full, easy-to-follow instructions for gilding on wood, metal, or any surface that will take paint—and 101 suggested uses. Made and guaranteed by Hastings & Co., America's oldest gold leaf manufacturers.

Give your models and miniatures that professional finish. Decorate them with genuine gold leaf. Unlike so-called "gold" paint or bronze powder, gold leaf never tarnishes because it is made from genuine 23-karat solid gold, beaten so thin that one ounce of gold will cover an area of 200 square feet! It's fascinating to work with. So thin and delicate, you have to handle it with your breath. So brilliant and permanent, you'll want to put it on everything in sight! On your Fisher Body Guild coaches, your canoe, your book ends, your radio cabinet—on any of the 101 different useful articles and novelties that you make.



You can make money with the Hastings Home-Workshop Gold Leaf Kit, too—for the art of gilding is profitable. But buy the Kit for your personal satisfaction and as a long-needed accessory for your own workshop. No shop is complete without it. And look what this Kit contains:

- 25 Sheets of Transfer Gold Leaf (Genuine 23-Karat; 3 $\frac{3}{8}$ " x 3 $\frac{3}{8}$ ")
- 25 Sheets of Loose Gold Leaf (Genuine 23-Karat; 3 $\frac{3}{8}$ " x 3 $\frac{3}{8}$ ")
- 1 Can of Oil Size (Slow Drying)
- 1 Can of Japan Size (Quick Drying)
- 1 Lettering Brush
- 1 Striping Brush
- 1 Gilder's Tip
- 6 Paint Cups
- 1 Easy-to-Follow Instruction Book

MONEY-BACK GUARANTEE: If you are not entirely satisfied that the Hastings Home-Workshop Gold Leaf Kit can be useful to you, return it within five days of its receipt and your money will promptly be refunded. These Kits are sold only by Hastings & Company and only by mail. So—

MAIL THIS COUPON TODAY

(Or order by letter)

HASTINGS & CO.,
819 Filbert Street Philadelphia, Pa.

I enclose \$5.00, for which please send me, postpaid, The Hastings Home-Workshop Gold Leaf Kit with full instructions and 101 suggested uses. If I am not entirely satisfied, I shall return the Kit within five days and my money will be refunded.

(PRINT PLAINLY PLEASE)

Name _____

Address _____

City & State _____

Check Here if you prefer C. O. D. \$5.00 plus postage)

HOW TO MAKE JOINTS LAST FOREVER

In the first place see that the surfaces to be joined, fit together as perfectly as possible, and that they are clean and dry. Then apply a thin coating of LePage's Liquid Glue. Let this dry a bit, then apply another coat. Place joints together evenly, using clamps if convenient. You needn't worry about those joints ever separating again. They're glued for life! Ideal for veneering and inlaying. LePage's Liquid Glue comes in tubes, bottles or cans. All are economical. All are on sale at your favorite hardware or drug store. LePage's Adhesives, Laboratories and Factory, Gloucester, Massachusetts.



NEW BENJAMIN AIR PISTOLS

Powerful—Accurate—Economical—Practical—Adjustable Shooting Force—Amazing Maximum Velocity—cal. 177 or 22 and BB—For Target and Small Game—the only Genuine Compressed Air Pistol on the market—Single Shot with Bolt Action—Hammer Fire—Hair Trigger—Safety. Price \$7.50. Also 177 and 22 Single Shot Air Rifles \$7.50—Single Shot BB Air Rifle \$9.00—25 Shot BB Repeater Air Rifle \$7.50—at Dealer or Direct—No license required—Safe for indoor use. FULL DETAILS—TARGETS—FREE—WRITE TODAY. Benjamin Air Rifle Co., 691 N. Broadway, St. Louis, Mo.

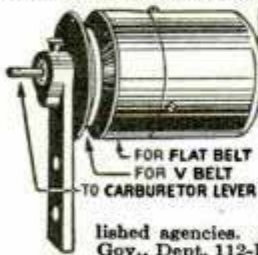

AUTO ENGINE SPEED CONTROL GOVERNORS

To control speed of any make of auto or truck engine, regardless of load changes, when used as a stationary or portable power plant. Fully guaranteed. No cash down. Governor speed range from 400 to 3000 R.P.M. Fine opportunity for established agencies. Send for free circulars. Mrs. Candee-Smith Gov., Dept. 112-B 215 No. L. A. St., Los Angeles, California.

LEATHERCRAFT

Make money this easy way. Hand-tooled Cigarette and Key Cases, Billfolds, Belts and many other useful articles quickly made. Complete EASCO Leathercraft Kit contains tools, leathers, lacings, work block, tinting dyes, patterns, EVERYTHING. Easy instructions. Ask for EASCO at Department and Sporting Goods Stores or order direct. Two Dollars complete. Pay Postman on arrival. Satisfaction guaranteed.

E. A. SWEET COMPANY, Inc., Dept. P-M, BINGHAMTON, N. Y.

(Continued from page 125A)

And that's about all, except that this Handy Annie which runs Mr. Ripley's home so efficiently is employed on a part-time basis in more than 21,250,000 other homes. In 1935 the average housewife paid her sixty-six cents a week wages, but in that year she did forty-three per cent more work in American homes than in 1929 and twice as much as ten years ago, but got only fifty per cent more pay.

Imagine, if you can, the work Annie may be called upon to do some day when all these millions of homes begin using electricity as freely as water. That day, says Mr. Ripley, is near. It will arrive when others begin to find out what he has already proved—that electricity can run a home efficiently, easily and economically, and do a better job than the most capable of human hands.

"The part Annie will play in our homes in the future staggers the imagination," says the proud owner of the first all-electric home. "I believe that long before 1950 her work in homes will equal in usefulness—kilowatt-hours—all the work now done by electricity in all our mills, mines and factories."

Motorcycle Built Like a Coupe

Is Inexpensive to Drive

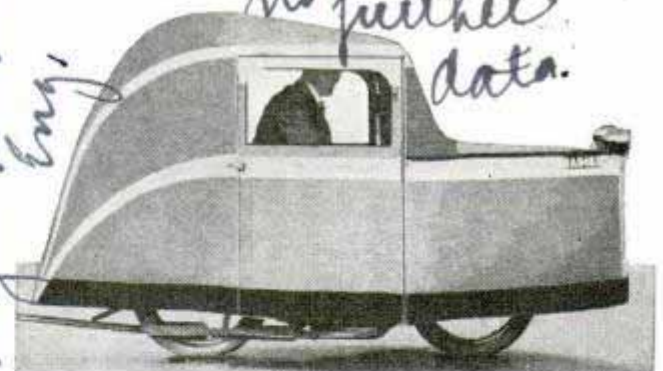

© Planet News, Ltd.

No need to fear wet weather when your motorcycle has a coupe body like this English model

Is it motorcycle or automobile? A two-wheeled car built in London, England, has the lines of a coupe but the "works" of a motorcycle. The rider is protected by the inclosed body, and the vehicle maneuvers in traffic with the ease of a motorcycle.

Our Bureau of Information will answer questions regarding articles in this magazine, if accompanied by return postage.

ALL PURPOSE
MOTO-TOOL



10 DAY MONEY BACK TRIAL

for Home-Shop-School-Profession

Grinds, drills, engraves, routes, carves, sharpens, polishes and does hundreds of jobs quicker, better and with greater precision. Handles easily as a pencil—weight only six ounces, and is amazingly powerful. 110-Volt Universal Motor—about 20,000 r.p.m.—oilless self-aligning ball thrust bearings. Handy built-in switch. Easily replaceable brushes. Universal Collet Chuck. Bakelite housing. You must see and use it to appreciate its tremendous value.

Order on 10-day trial. Money refunded if not more than satisfied. **Booklet Free.** 20-piece Craftsmans Tool Set for all types of Moto-Tool work, \$5.75.

ONLY \$9.85

DREMEL MFG. CO.
2814-CT., Racine, Wis.

SENT POST PAID

SENSATIONAL NEW SAW TABLE



20 x 26 TABLE

Now! A real heavy duty saw table that is practical, accurate and dependable at a remarkable direct factory - to - you price. Large 20x26 table. Blade raises and lowers, also tilts 45 degrees. Price includes 8" blade, fence, miter gage, guard, splitter knife, motor base and V belt on arbor.

Net weight without motor 110 pounds. Write today for New Catalog.

Scrollsaw — Jointer — Saw Table — Band Saw

Write for the new FREE Blue Star catalog describing and pricing complete line modern heavy duty equipment. Remember factory-to-you prices, no agents, no dealers. Factory guarantee. Act at once.

BLUE STAR PRODUCTS 354 Penn Street FAIRFIELD, IOWA

BURN YOUR NAME ON TOOLS WITH THE ARKOGRAF



PROTECT YOUR TOOLS FROM THEFT

Write with electricity any name or design on the hardest and finest tools and instruments, or any metal, like writing on paper with pen or pencil.

Complete Outfit \$3.50—Prepaid Anywhere

Interesting illustrated circular free. Write today. Agents wanted.

ARKOGRAF PEN CO., 3927 S.E. Stark St., Portland, Ore.

ONE-MAN SAWMILL



TURN TREES INTO MONEY WITH BELSAW

Three capacities: 10, 14 and 20 ft. Accurate set works positive dogs. Full or one way type power feed runs on low power—Many owners use old auto engine. Pays for itself quickly—thousands in commercial service, everywhere. Write for free lumber handbook and catalog of mills, supplies, tools, saw tables, and woodworking equipment.

Belsaw Machinery Co., 811-A Davidson Bldg., Kansas City, Mo.

FARM MODEL \$49.00

The NEW KINKADE GARDEN TRACTOR and Power Lawnmower



A Practical Power Plow and Cultivator for Gardeners, Suburbanites, Florists, Truckers, Nurserymen, Fruit Growers.

Low Prices—Easy Terms

AMERICAN FARM MACHINE CO.
1058 33rd Ave. SE., Minneapolis, Minn.

Catalog Free

One Quality Only—the Finest!

GERSTNER Tool Chests for Machinists and Toolmakers. Free Catalog.

GERSTNER TOOL CHESTS
462 Columbia St., Dayton, Ohio



MOTORISTS WISE

SIMONIZ

YOU NEED THIS FREE HOME REPAIR BOOKLET

Contains diagrams and simple instructions for emergency and routine repairs that every home and auto owner can and should make himself. Revised



edition, greatly enlarged and completely rewritten. Get a copy for your workshop.

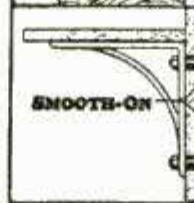
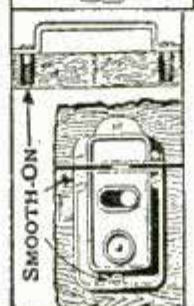
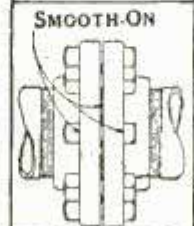

Be thrifty — do your own work—and keep the money otherwise paid to plumbers, repair men and for new parts.

With Smooth-On No. 1, you can stop leaks at joints, seams and cracks in pipes, boilers, heating systems, tanks, pails, auto radiators, water jackets and crank cases, tighten loose parts, reset stripped screws, bolts and nuts, and make dozens of other equally practical repairs—all at almost no cost, and in emergencies without the delay of waiting for outside help.

Smooth-On No. 1 is applied without heat or special tools, hardens into metallic iron and holds permanently under any pressure and on any metal, masonry, wood and tile. Leading power and industrial plants have used it for 35 years, and with this new booklet as a guide, you can make equally successful applications.

When you know where and how to apply Smooth-On No. 1, you will make constant savings. Be prepared. Ask us for the booklet and buy Smooth-On No. 1 in 7-oz., 1-lb. or 5-lb. can from your hardware store.



Do it with SMOOTH-ON

SMOOTH-ON MFG. CO., Dept. 37
574 Communipaw Ave., Jersey City, N. J.

Please send the free Smooth-On Repair Book.

Name.....

Address.....

2-37.....

Conquering Death After Dark

(Continued from page 215)

\$150,000,000," he says. "This is five or six per cent of the investment in these highways, assuming \$50,000 a mile the average cost. The annual cost of operating the 50,000 miles of safety lighting, exclusive of investment charges, is estimated at \$30,000,000 to \$50,000,000. The total lighting cost, based upon the claim experience of casualty underwriters, is less than one-third of the losses, from the accidents which would be prevented by the lighting!"

Let's take the top figure for installation and the top one for operation. Operating the lights for ten years would cost \$650,000,000. In that period there would be saved at least 50,000 lives—the cost per life \$13,000. But we would also save 100,000 personal injuries and 1,000,000 cases of property damage costing millions of dollars in economic loss.

Here's another way of looking at it. New York state authorized a bond issue of \$300,000,000 for the elimination of grade crossings. At three per cent interest and amortized over fifty years, that involves an annual expenditure of \$12,000,000. Now in 1935 New York had 156 grade-crossing accidents and an estimated 10,000 night highway accidents which could have been prevented by spending \$12,000,000 for lighting. So the cost of preventing one accident by eliminating grade crossings is more than \$75,000, compared with an estimated cost of \$1,200 for preventing one accident involving a fatality or personal injury by highway lighting.

This opportunity for conserving life, limb and property by highway lighting has stimulated research into light sources and their application. Three main light sources are being employed today as a result of this research—incandescent lamps specially designed for the purpose, sodium-vapor lamps with an efficiency of light production nearly three times that of the incandescent, and the high-efficiency mercury-vapor lamp, giving nearly twice as much light per watt as the incandescent.

The lighting studies also have involved such factors as the reflecting value of various road surfaces, the best height for light standards and the proper spacing between them, and the most efficient reflectors. It has been found, for instance, that

as a general rule, light coming to the pavement and reflected toward the driver is the effective light in building pavement brightness. Pavement brightness is important since most of what we observe when driving at night is seen in silhouette.

Where demonstration sections of safety lighting have been installed for observation and study, amazing decreases in night accidents have resulted. Two installations in New York state decreased night accidents more than thirty-six per cent although day accidents increased more than nine per cent, along with increasing traffic. On the Bay Shore highway in California, night accidents decreased forty per cent after lighting. The accident rate on one of sixty lighted sections in New Jersey was less by night than by day; on adjacent unlighted roads the rate at night was three times that by day. On two New York installations, night accidents increased thirty-seven per cent when lighting was reduced, and after lighting was discontinued on the Mt. Vernon Memorial highway near Washington, night accidents increased two and one-half times.

Due to the great improvement in seeing provided by the newest developments in highway lighting, not available when the early installations were made, lighting engineers estimate that fully one-half of all night highway accidents could now be prevented by safety lighting.

Since about one-half of all highway accidents occur at night and about seventy-five per cent of all night accidents occur on about 50,000 miles of heavily traveled highways, a reduction of one-half the night accidents on this 50,000 miles would represent a reduction of about eighteen per cent in the total highway accidents.

And that, in turn, would mean a saving of about 6,500 lives a year, or 65,000 lives in a period of ten years. Based on 1935 accident figures, it would also represent an annual saving of more than 18,000 cases of permanent disability, more than 100,000 cases of temporary disability and more than 1,000,000 cases of property damage.

Our Bureau of Information will answer questions regarding articles in this magazine, if accompanied by return postage.

Half & Half Makes ONE Swell Smoke!

Your pipe will bat a thousand with Half & Half. Cool as two strikes with three men on base. Smooth as the hit that brings in four runs. . . . Fragrant, friendly, full-bodied tobacco that won't bite the tongue . . . in a tin that won't bite the fingers. Made by our exclusive modern process including patent No. 1,770,920. Cool and smooth. Smells good. Makes your pipe welcome anywhere. Tastes good. Your password to pleasure!

Copyright 1937, The American Tobacco Co.



No Bite!

No Bite!

Still no Bite!

Not a bit of bite in the tobacco or the Telescope Tin, which gets smaller and smaller as you use-up the tobacco. No bitten fingers as you reach for a load, even the last one.

HALF ^{AND} HALF
The Safe Pipe-Tobacco
FOR PIPE OR CIGARETTE

F1275

Tuna Fleet Battles for "No Man's Land"

(Continued from page 207)

demand for tuna as food. And as long as catches are made with hook and line, I predict these fish never will become extinct."

Meanwhile the first boats of a fleet of six Japanese fishing cruisers, each equipped with facilities for canning tuna aboard, have appeared in western Pacific waters. These big craft, several times the size of the clippers, are initiating a type of competition heretofore unknown to the American tuna industry. Although the exact details of the foreign boats are not made public by the Japanese, it is known they plan to make only two round trips a year.

American tuna clipper owners believe the efficiency of their new fleet will enable them to withstand any competition from other nations. Plans are maturing for a commercial tuna fishing school—a ship where student fishermen will be taken on a test cruise for several weeks while they learn to recognize the different kinds of tuna on sight, and are taught the technique of fishing, how to care for gear and gain some knowledge of seamanship. It is believed this scheme will create a reservoir of trained tuna fishermen upon which the industry in the United States may draw, thus adding another spoke in the wheel of efficiency with which California fisheries hope to maintain supremacy.

"Window" in Lady's Long Glove to Read Wrist Watch

One woman solved the problem of reading her wrist watch while wearing long gloves by providing a small opening in the glove. If desired, a piece of celluloid may be sewed in, and, of course, the edge of the opening should be hemmed to provide a neat appearance.



Special Article on Photography FREE Each Month!

Each month an outstanding author writes a special photographic article for our Bargain Book. Get your name on our mailing list NOW (send coupon) for FREE copy of Bargain Book with article, as issued. Hurry!

Limited Edition—Get Yours Quick—Free!

Now ready—Central's sensational new, money-saving BARGAIN BOOK of Cameras and Supplies—FREE on request while the supply lasts! Illustrates latest developments in photography—offers hundreds of still and movie cameras, films, lenses, chemicals—everything photographic—all at tremendous savings. All guaranteed. Send coupon quick!

Most Complete Stock!

Central offers you the most complete, varied stock of photographic merchandise! Always first with the latest at money-saving prices! A few world-renowned lines we carry in stock: Zeiss, Korona, Graflex, Eastman Kodak, Leica, Foth, Bell & Howell, Geveart, Deardorf, Graf, Bausch & Lomb, Agfa, Etc. All orders shipped same day received on SATISFACTION-OR-MONEY-BACK GUARANTEE! DON'T buy any camera or supplies till you've seen Central's latest BARGAIN BOOK. Remember . . . Central has been America's Photographic Headquarters for Amateurs and Professionals since 1899. Send coupon or postal for Free Bargain Book NOW.

We Take Your Old Camera and Equipment in Trade!

Have you a Camera, Kodak, Lens or equipment you want to exchange for some other outfit? Write us! We can offer you a reasonable sum for any saleable apparatus.

Mail Coupon!

Send coupon or postal today—now—for our newest money-saving Bargain Book! Limited supply printed. Don't be too late! SAVE on Central's cameras and supplies whether you take pictures for fun or profits! Mail Coupon quick! (A post-card will do.)

CENTRAL CAMERA CO.
230 S. Wabash, Dept. K-2, Chicago, U.S.A.

CENTRAL CAMERA COMPANY
230 S. Wabash, Dept. K-2,
Chicago, Ill., U. S. A.

Gentlemen: Send me FREE money-saving Bargain Book of Cameras & Supplies containing Special Photographic Article. This obligates me in no way.

Name

St. and No.

City State

PHOTOGRAPHIC HEADQUARTERS since 1899



CAMERAS

\$1 to \$500.00!
Tremendous stock of Zeiss, Graflex, Leica, Eastman Kodak, Voigtlander, Korona, etc. New and used. Save at Central!



DEVELOPING AND PRINTING SETS

Complete outfits: supplies, chemicals, trays, lamps. \$1 up. Save on Film! Movie, still, roll, cut, plates. Fresh stock, Low prices!



LENSES—FILTERS

Zeiss, Bausch & Lomb, Wollensak, Gundlach, Schneider . . . new and used.



MOVIE

Cameras—Projectors \$15.75 to \$175.00 Including Bell & Howell, Eastman Cine, Ampro, Keystone, Victor, De Vry. New and used.

Send for FREE PHOTOGRAPHIC BARGAIN BOOK

Write name, address on margin if you need more space or send postal.

My night see letter

6 WEEKS AGO SHE SAID: "HE'S TOO SKINNY!"

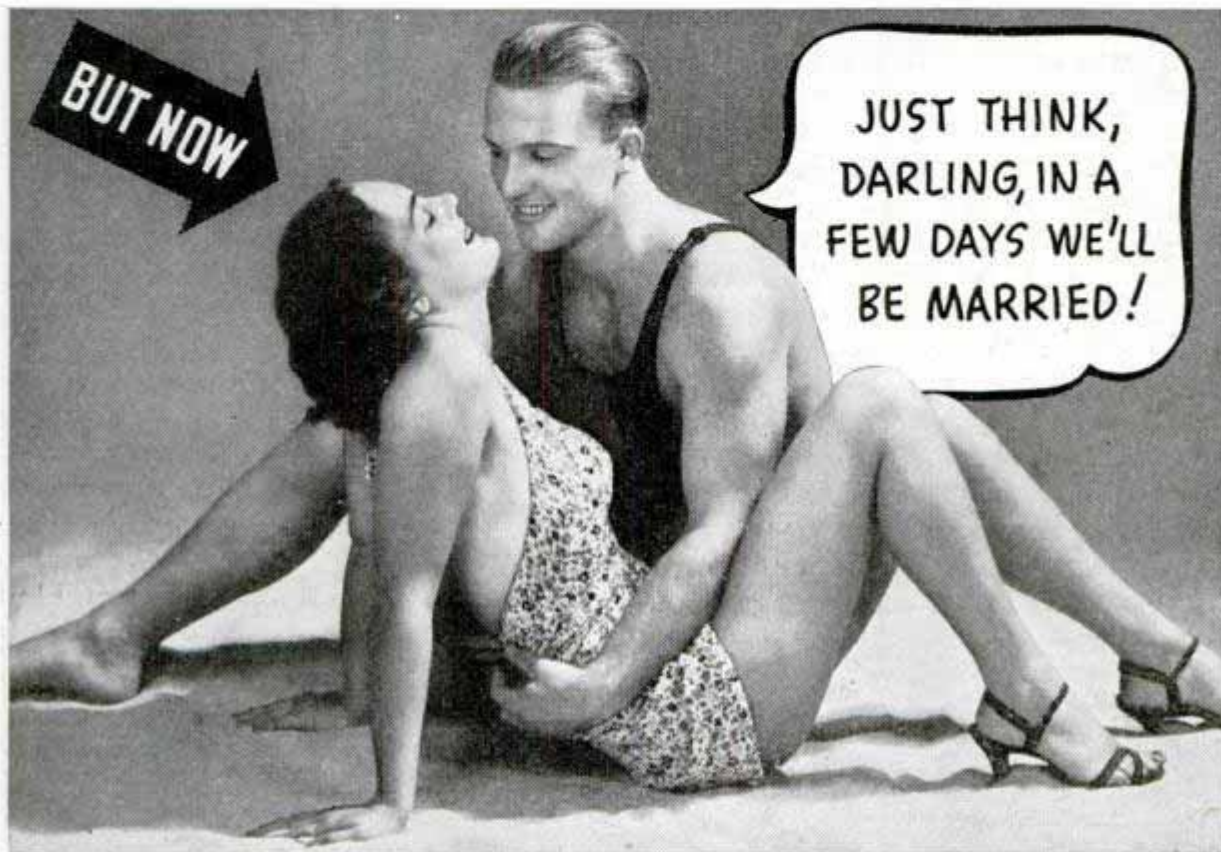

Posed by professional models

NEW DISCOVERY GIVES THOUSANDS 10 TO 25 POUNDS - *in a few weeks!*

If you seem "born to be skinny"—if you've tried everything to gain weight but with no success—here's a new scientific discovery that has given thousands of happy men just the pounds and solid heftiness they wanted—and so quickly they were amazed!

Not only has this new easy treatment brought solid, naturally attractive flesh, but also normal color, new pep, and the many new friends these bring.

Body-building discovery

Scientists recently discovered that thousands of people are thin and rundown for the single reason that they do not get enough Vitamin B and iron in their daily food. Without these vital elements you may lack appetite, and you don't get the most body-building good out of the food you eat.

Now one of the richest known sources of Vitamin B is cultured ale yeast. By a new process the finest imported cultured ale yeast is now concentrated 7 times, *made 7 times more powerful*. Then it is combined with 3 kinds of iron, pasteurized whole yeast and other valuable ingredients in pleasant tablets.

If you, too, need these vital elements to aid in building you up, get these new Ironized Yeast tablets from your druggist today. Note how quickly they increase your appetite and help you get more benefit from the body-building foods that are so essential. Then day after day watch flat chest develop and skinny limbs round out to natural attractiveness. See better color and natural good looks come to your cheeks. Soon you feel like an entirely new person, with new charm, new personality.

Money-back guarantee

No matter how skinny and run-

down you may be from lack of sufficient Vitamin B and iron, these new "7-power" Ironized Yeast tablets should aid in building you up in just a few weeks, as they have helped thousands. If not delighted with the benefits of the very first package, your money instantly refunded.

Only be sure you get genuine Ironized Yeast. Don't let anyone sell you some perhaps cheaper yeast and iron tablet, which is not the original Ironized Yeast that has been so successful. Look for "IY" stamped on each tablet.

Special FREE offer

To start thousands building up their health right away, we make this FREE offer. Purchase a package of Ironized Yeast tablets at once, cut out the seal on the box and mail it to us with a clipping of this paragraph. We will send you a fascinating new book on health, "New Facts About Your Body." Remember, results with the very first package—or money refunded. At all druggists. Ironized Yeast Co., Inc., Dept. 532, Atlanta, Ga.

F 1155 Around the World by Air

(Continued from Coloroto Section)

"Where did you go?" they ask.

"Oh, just around the world," you reply airily. "Europe, Asia, the Atlantic, the Pacific—all those places."

You'll get your "air legs" under you on the first leg of your trip, that jump across the Atlantic on the "Hindenburg." From spring to fall its schedules across the north Atlantic are maintained with almost clocklike precision. After October you can cross until December by taking the "Graf Zeppelin" from Rio de Janeiro and utilizing a Clipper ship of Pan American for the trip south. In a year or so, you will probably be able to cross the Atlantic as well as the Pacific by plane. Two or three airplane routes across the Atlantic already are being surveyed. But at present the "Hindenburg" offers you the fastest transportation.

Traveling on this dirigible is like taking a trip on an ocean liner supported by air instead of water. In size alone it compares favorably with an ocean greyhound. It is the biggest Zeppelin ever built, more than 800 feet long, is powered by four Diesel motors of 1,200 horsepower each, has a cruising range of 8,750 miles, carries a crew of forty and has accommodations for about seventy passengers. A sister ship as big will be ready next summer.

The passenger quarters on the "Hindenburg" are confined to one section entirely within the ship's hull and constructed on two levels. There are twenty-five state-rooms in the main section, each containing two berths; four public rooms including a large dining room, lounge, writing room and smoking room; two promenades, kitchen, officers' and crew's mess rooms, bar, shower bath and lavatories. Windows along the promenades on each side of the vessel provide ample visibility for all public rooms in the daytime but the cabins have no outside exposure. The quarters are supplied with heating and air-cooling systems, walls are insulated with aluminum foil and exhaust gases of the motors are used to preheat fresh air carried into the passenger rooms.

The walls of the smoking room are covered with a veneer of pear wood which, like asbestos, does not burn. All other rooms are covered with balloon cloth. The

furniture is made mostly of duralumin and there's an all-metal piano. Besides the berths, cabin furnishings include a washstand with mirror and hot and cold running water, writing ledge, chair and clothes closet. Washbasins can be folded back against the wall when not in use and the upper berth also is of the disappearing type to provide extra room in the daytime. All cooking and refrigeration is electrical, the current for the ship being supplied by two generators driven by two fifty-horsepower Diesel engines.

And when you ride the "Hindenburg," don't think for a minute that you're doing anything unusual. Up to late 1936, the "Graf Zeppelin," similar but smaller dirigible, had made 557 trips, including 125 ocean crossings and a voyage around the world, carrying nearly 13,000 persons, 5,500,000 pieces of mail and many tons of cargo. The trips of these German airships to the United States are just about as routine as the passages of surface liners.

Once at Frankfort, you're ready to begin going places in a big way—if you have passports, visas and other credentials in order. Be sure you have, because many of the countries are fussy about strangers without credentials and you may find your journey ended unexpectedly if your passports are not in order.

From Frankfort you can go by plane to London, Paris or Rome, according to the air line you intend to follow across Europe. If you travel by Imperial Airways, for instance, you can pick it up in London and be in Singapore eight and one-half days later, going by way of Paris, Brindisi, Alexandria, Bagdad, Delhi and Calcutta. You end this leg of your journey at Saigon, Penang, Singapore or Hongkong, depending on the eventual connection made with Pan American Airways at Manila. At present, of course, there is an 850-mile trip by boat but this gap in the air service is almost sure to be closed soon.

Over Imperial Airways you'll probably fly one of its double-deck air liners. Most of these great ships are powered by four engines and carry from a dozen to forty passengers, depending on the particular type used on the route you happen to se-

(Continued to page 134A)

FORD OWNERS ALONE ENJOY THIS MONEY-SAVING FEATURE Engine and Parts Exchange Plan

You may never need to have your Ford V-8 engine overhauled. But if you should, after thousands of miles, you'll appreciate the time and money-saving advantages of the Ford Engine and Parts Exchange Plan.

Through this plan you can exchange your Ford engine for a factory-reconditioned engine at a big saving over the cost of an engine overhaul. A complete engine overhaul usually costs well over \$85. A Ford factory-reconditioned engine may be installed for \$56 (slightly more west of the Rocky Mountains). This includes reboring of the cylinders, new pistons, piston pins, piston rings, bearings and valve springs. Crankshaft, camshaft, valve lifters, valves, retainers, timing gears and oil pump are either rebuilt or replaced with new ones as needed.

Many other reconditioned Ford parts, too, are available at remarkable savings to Ford owners—savings made possible by Ford mass

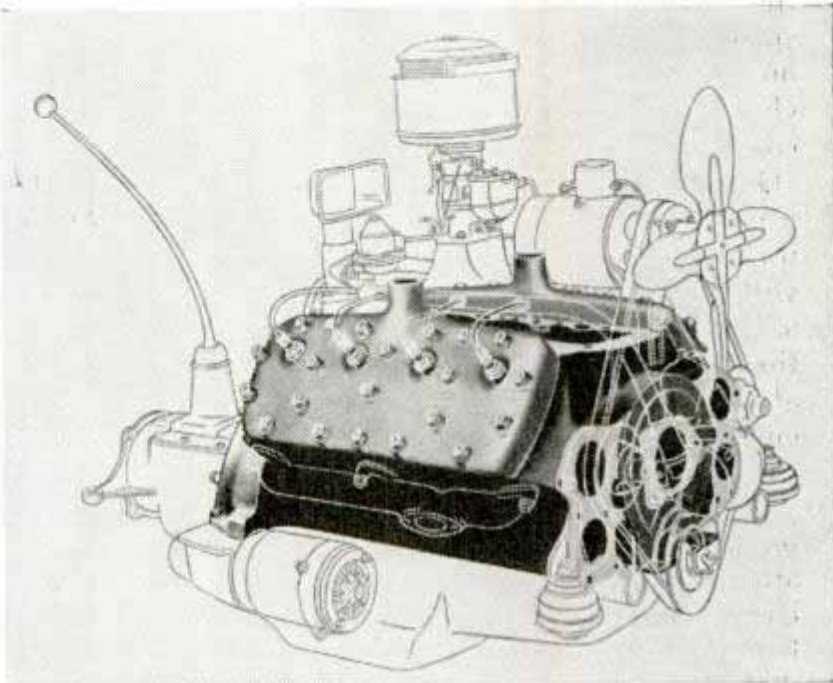

Phantom view of Ford V-8 engine, showing parts included in Engine Exchange Plan in solid black.



(Above) Reconditioned engines are block-tested and given the same rigid inspections as new engines.



All reconditioned parts are subjected to final tests on performance and adjustments. Photo at right shows a reconditioned distributor receiving final test.

Parts used in reconditioning the engine are tested and inspected with the same care as parts used in new engines. Photo at left shows inspector checking weight of connecting-rods on sensitive balance.

production methods. In the case of all Ford reconditioned engines and parts, experienced workmanship, quality materials, precision manufacturing methods, rigid tests and inspections are the same as in the building of new Ford engines and parts.

Ask any Ford dealer or any garageman who displays the sign, "Genuine Ford Parts," to give you complete details of the Ford Engine and Parts Exchange Plan.

FORD MOTOR COMPANY
DEARBORN MICHIGAN

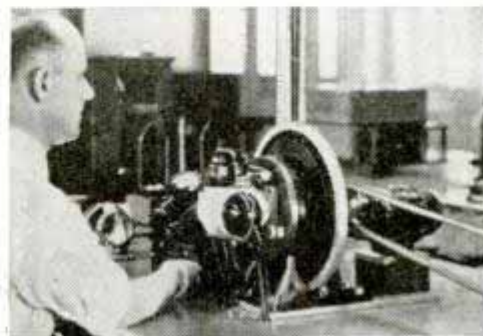

When writing to advertisers please mention Popular Mechanics

**REPAIRS
FURNITURE**



MAKES 1001 HOUSEHOLD REPAIRS

- | | |
|--------------------------------|--------------------|
| Loose Bathroom Fixtures | Damaged Furniture |
| Loose Drawer Pulls | Countersunk Screws |
| Loose Casters | Repairing Linoleum |
| Old Nail and Screw Holes | Loose Tiles |
| Replacing Wood Rot | Cracked Porcelain |
| Modeling: Amateur—Professional | |

Genuine Plastic Wood makes household repairs so easily yet permanently—this wood in putty form dries to hard wood—when dry it can be sanded, sawed, carved; will hold nails and screws perfectly without chipping or cracking. Genuine Plastic Wood is waterproof and weatherproof and will adhere to any clean, dry surface—wood, metal, stone, glass or porcelain.

Keep it handy. Sold at all paint and hardware stores in cans and tubes.

Use Genuine
**PLASTIC
WOOD**



HOME AUTOMATIC CIGARETTE MACHINE

Have YOUR OWN Monogrammed Cigarettes. Put tobacco and block of papers on machine, TURN THE CRANK—PRESTO—CIGARETTES. Easy—simple. All metal construction. Guaranteed. No cloth ribbons; no special tube or gummed papers required. ASK FOR FREE ILLUSTRATED FOLDER. AUTOMATIC CIGARETTE MACHINE WKS., PM-1, 1055-57 Devon Ave., Chicago, Ill.

NEVERSLIP PULLEY

Transmits more power with less belt wear; unaffected by weather. No pulley covering, no belt dressing required. Replace troublesome pulleys with NEVERSLIPS. All sizes. Money-back guarantee. Ask for NEVERSLIP Pulleys on ALL power machinery you buy. Write for folder and prices. **ROSENTHAL CORN HUSKER CO.** Box 16 Milwaukee, Wisconsin



F 1155

(Continued from page 132A)

lect. You'll find these European planes as spacious as a Pullman car.

And from the time you start from New York, don't worry about where to eat. Meals are included in your fare on the "Hindenburg" and over virtually every air line you will fly. For the most part, you will fly by day and sleep on the ground, and hotel accommodations also are generally included with your air transportation. And there are no tips. Your air fare covers virtually everything.

(Concluded next month)

F 1493

**"Pillbox" for Executions by Gas
Replaces Noose in Wyoming**

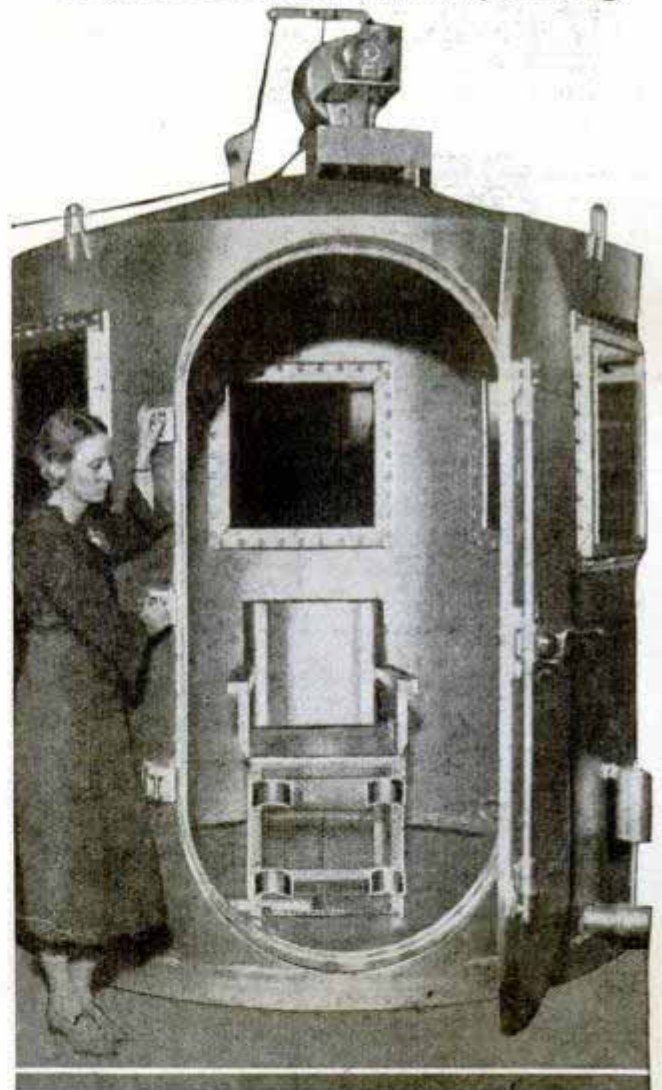

Death chamber showing chair in which prisoner is strapped before lethal gas is turned on

Since lethal gas has replaced the gallows as the legal method of executing criminals in Wyoming, an airtight death chamber has been built for the state. The doomed man is strapped in a chair in the metal "pillbox," the door is latched and the chamber flooded with gas.

made by Lewis



DIESEL ENGINES

**LIGHT ON
LOWER
POWER COSTS**

**Produce ELECTRICITY for LESS
than ONE CENT per KILOWATT
A.C. or D.C. Current**

Be your own boss and independent of the power company. Cut your power bill 75% or more with a WITTE Dieselelectric Plant, 3000 or 6000 watts. Makes electricity for **less than one cent per kilowatt**. Smooth, flickerless current—close voltage regulation. Generators are engineered to the engine they serve. Alternating or direct current. Uses non-explosive fuel. Also **WITTE Stationary Diesel Engines**, 5 and 10 H-P. Standard units in stock. Immediate Delivery.

LOG SAWS



Used by U. S. Gov't



2 to 10 H-P

Type "J" on Wood Skids

3000 and 6000 Watts
A.C. or D.C.

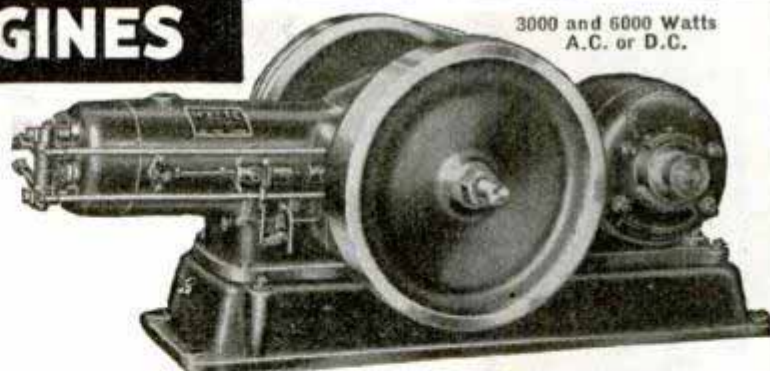

LOG SAWS AND GASOLINE ENGINES

Recognized as standard for Quality and Economy for half a century, WITTE Engines and Combinations offer you power in its most economical form. Operate on gas, gasoline, kerosene or distillate. The WITTE Log and Tree Saw and Type "J" Enclosed, Self-Oiling, Roller Bearing Engines are two outstanding units. 42 styles and sizes. Get an outfit designed especially for your work. Users agree "You Can't Go Wrong with a WITTE." Free Catalog.

USE OUR 6% FINANCE PLAN—2 YEARS TO PAY

WITTE ENGINE WORKS

1742 Oakland Ave. Kansas City, Mo.

TYPEWRITER 1/2 Price

**Easy Terms
Only 10c a Day**

Save over 35% on all standard office models. Also portables at reduced prices.

SEND NO MONEY

All late models completely refinished like brand new. **FULLY GUARANTEED**. Big free catalog shows actual machines in full colors. Lowest prices. Send at once.

Free course in typing included.

INTERNATIONAL TYPEWRITER EXCHANGE
231 W. Monroe St. Dept. 201, Chicago



10-day Trial

RADIOS

ALL NEW 1937 MODELS!

**SAVE
UP TO
50%**

**DEAL DIRECT—
FACTORY PRICES!** Iron-Clad Written Guarantee!

A penny post card brings you our new, full-color 16-page **BARGAIN CATALOG** free. Many models to choose from: 4 to 19 tubes! AC-DC, All-Wave and new Farm sets that operate like city radios!

30-DAY NO-RISK HOME TRIAL
Send post card or coupon below for full details of our 30-day no-risk trial and Agent-User proposition!

AGENTS! \$6.98 NOW - MAIL COUPON

A real money-making offer. Write at once for territory.

**GOLDENTONE RADIO CO., DEPT. E,
Dearborn, Mich.**
Without obligation, send me new 1937 Catalog and 30-day trial plan.
Name
ADDRESS

Free Catalog

DRILL-INDEX Keep your drills in a **DRILL-INDEX**. Works like a card index. A flip of the wrist opens the case. Six sizes. Ask your dealer or write to

Huot Mfg. Co., Foot Schulze Bldg., St. Paul, Minn.

KNEE ACTION TRAILER AXLES



Knee action, drop center, & straight axles available in 56", 62", 68" & 72" treads, detailed circular upon request.

TOELLEN MFG. CO.
Box 4, Strathmoor Sta., Detroit, Mich.

BUILD YOUR OWN

Wind Driven Light Plant

from old auto generator. We show you how. Make money building for others. Light your buildings, play radio, operate washing machine and other motors. Dime brings complete plans and 1937 catalog. Over 50 other changes for 6-12-32 and 110 volt plants.

LEJAY MFG. CO., 1447 W. Lake St., Minneapolis, Minn.

FREE Lights

TURN SCRAP INTO MONEY



AUTOPOWER tells you how in plain, easy, simple, and illustrated instructions that anyone can follow. Change auto generators into useful, practical A C and D C generators and motors with voltage from 2 to 1,000 volts, for power, light, welding, radio, sound, etc. No previous experience nor special tools needed. Generators can be driven by wind, water, fan belt, etc. Already used and endorsed by thousands. Send today for your copy, and also receive **FREE** a copy of **PRACTICAL ELECTRIX**, the new publication for the man who wants to **KNOW, BUILD, REPAIR and READ** about electrical apparatus and machinery. Book and magazine postpaid only \$1.00.

AUTOPOWER, INC., Dept. K 410 S. Hoyne Ave., Chicago

**AUTO
POWER**

LIMITED OFFER FREE COPY OF PRACTICAL ELECTRIX WITH EACH ORDER FOR THE AUTOPOWER BOOK.

When writing to advertisers please mention Popular Mechanics



Amazing Values \$1.20 to \$2.00

Cross-cut, Rip, Combination

6" (1/2" hole) \$1.20 8" (1/2", 5/8", 3/4" hole) \$1.60
7" (1/2" hole) \$1.40 10" (5/8", 3/4" hole) . . . \$2.00
Also Hollow Ground, \$3.00 to \$5.00

Keystone Disston-made Circular Saws are specially designed by the world's foremost sawmakers, for good craftsmanship in home workshops. They fit your machine, suit your work, stay sharp. • Keystone BAND Saws—set, sharpened, joined by Disston, ready for your use, \$1.00, \$1.05, \$1.10, \$1.20 each. In Canada, prices slightly higher.

Ask your dealer for Keystone Home Workshop Saws and Tools—Made-By-Disston. Or write us and we will see that you are supplied.

LET DISSTON HELP

Disston makes fine Saws, Tools, Files, to give work speed and accuracy . . . to help you excel in craftsmanship. All

about these fine tools—how to use them, care for them, illustrated from home workshop photographs, is told in this Disston Manual. Sent FREE, with special pointers on getting the most out of your motorized home workshop equipment.



MAIL COUPON

TO: HENRY DISSTON
& SONS, INC.
211 Tacony
Philadelphia, U. S. A.

Send me free copy of "Disston Saw, Tool and File Manual."

Name.....

Address.....

The Master Man of Radio

(Continued from page 253)

each watch. They are rated as the senior control supervisor, junior control supervisor, and the switchbank operator.

As an adjunct to the master control board, there is a short-wave transmitter used for "cue" channeling. This transmitter is useful for talking back and forth when a portable short-wave broadcasting truck is dispatched to pick up some special event at a remote point. The special events director in Radio City carries on a running conversation with the field force while the remote pick-up is going out on W.E.A.F.'s regular channel. This conversation takes place on a seven-meter wave. Without this short-wave arrangement, it would be difficult to transmit "go ahead" cues to the portable transmitter.

The master control room's most common function is the routing of channels from studio to studio. This is accomplished by means of relay switchbanks, of which there are sixteen in all. Each switchbank set has fourteen keys, above each of which is a white light representing one of the fourteen available channels for every program. Above the switchbanks are sections of keys and lights pertaining to each studio. Each key and light corresponds to a switchbank.

Both switchbank and channel are "pre-set" by the operator. That is, if a program is scheduled to go off at seven o'clock, the switchbank operator sets his keys at 6:55 o'clock so the shift from one studio to the next takes place automatically at seven p.m. What actually happens is this. At seven o'clock sharp, the announcer in the studio to "go off" pushes a release button which drops all channels. Simultaneously, the announcer in the studio to "go on," receives a green light signal. He presses a set-up button which automatically picks up the switchbank which has been pre-selected.

Although it is usually carried out by the switchbank operator, the master control supervisor can carry out the same sequence from his central position. So far as dropping and setting up channels are concerned, the master control desk and the announcer's control panel in the studio are in parallel. Hence two points of control are provided for each program.

SHOW YOUR GANG SOME REAL SKIING ON NORTHLAND SKIS

Write for FREE Booklet on "How to Ski"



You'll be out in front every time on Northland Skis. Choiceest long wearing woods are worked by master craftsmen into perfectly proportioned "matched-pair" skis. Absolutely uniform in grain, weight, balance and limberness. Experts, champions, even your gang know that Northlands are faster, better performing skis. Identified by the Northland Deer-head trademark in better sporting goods shops.

NORTHLAND SKI MFG. CO.
World's Largest Ski Manufacturers
95 Merriam Park,
St. Paul, Minn.

JIG SAW \$1.50
COD or outside U.S.A. \$1.25



Including 12 assorted blades, Adapters, Illustrated Manual, and roller Saw Guide formerly found on expensive machines only. All metal, 15" long, 8" high, 6 1/2" table. A swift and easy cutter—best ever made for the money.

"The Jigmaker" cuts wood up to 2" thick

FREE Catalog illustrating complete power tool line: Shaper, Circular Saw with oilless bearings, \$3 each; Drill Press, \$2.50; completely equipped Lathes, \$2 & \$3; Sander, \$1, etc. All practical tools for real work. Order today or send card for catalog.

J & H Metal Products Co. 5 Commercial St. Rochester, N. Y.

Rider Agents Wanted

Select from many styles, colors and sizes of Mead Bicycles. Many recent improvements. Ride and exhibit sample RANGER and make money.

Direct to Rider: We ship on approval for 30 Days' Trial—genuine Mead bicycles from \$19.95 up. Get our marvelous offers and terms. Lamps, horns, wheels, parts, equipment, and repairs at half usual price. Established 39 years.

Mead CYCLE COMPANY
DEPT B-116 CHICAGO

Write us today for free catalog



OTTAWA LOG SAW



GREATEST OFFER EVER MADE

only \$39

PUTS THIS OTTAWA TO WORK FOR YOU

Make Money! Wood is valuable. Saw 15 to 20 cords a day. Does more than 10 men. Ottawa easily operated by man or boy. Falls trees—saws limbs. Use 4-hp. engine for other work. Write today for FREE book.

OTTAWA MFG. CO., 213 Wood St., Ottawa, Kansas

DO YOU

WANT a new business profession of your own, with all the trade you can attend to? Then become a foot correctionist, and in a few weeks earn big income in service fees,—not medical nor chiropody—easy terms for home training, no further capital needed, no goods to buy, no agency. Established 1894. Address Stephenson Laboratory, 1 Back Bay, Boston, Mass.

BUILD IT YOURSELF PLANS \$1.00



JIM DANDY CABIN CRUISER
The Trailer that has Everything

With my plans you can build this beautiful coach with ease and save money. Plans show every detail of building body, chassis, beds, cabinets, drawers, refrigerator, top, electric light and water systems and where to buy all parts. The Jim Dandy Cabin Cruiser can be built in any size to accommodate 2 to 4 people. Send \$1.00 for these plans today—get started now!

COMPLETE BUILDING PLANS \$1.00

MAIL DOLLAR BILL TO JIM DANDY, Box 125-A, WAUSAU, WIS.

When writing please mention Popular Mechanics

COMPLETE PLANS

FOR A PERMANENT PROFITABLE BUSINESS OF YOUR OWN—free

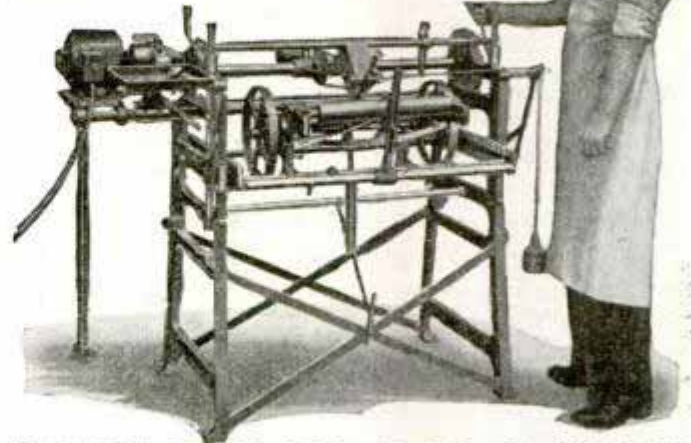

MAKE \$30 TO \$40 A WEEK

Our free plans show you how to build a successful business of your own sharpening lawnmowers. Positively no experience necessary. Most men average from \$30 to \$40 a week. J. B. Van Dien writes: "Some weeks I earned \$40 a week with my Ideal just as a side line." H. Greenlau writes: "In May I sharpened over 200 mowers at \$1.00 each." Niles C. Race writes: "I have sharpened 785 mowers at \$1.00 each."

THE IDEAL LAWNMOWER SHARPENER

Makes old, dull lawnmowers cut like new. Mowers run easier, stay sharp longer—customers come back year after year. Start right at home. Attach the Ideal to your lamp socket. Sharpens any make of mower in 15 to 20 minutes—you get \$1.00 to \$1.50. Attachments for grinding skates, grass shears, hedge shears, sickles, scythes, axes, etc.



Send Post Card for FREE CATALOG and Complete Plans

THE FATE-ROOT-HEATH CO.
437 Bell St., Plymouth, Ohio



EARN MONEY EVERY DAY

More than 2,000 men and women are building a secure business for themselves by servicing customers monthly with our paper necessities. Our merchandise is reasonably priced; changes with the seasons; and is quickly used up. No investment necessary. A car will increase your profits.

Our 1937 NEW MERCHANDISE RELEASES will themselves make you a fine income. If you are serious about wanting a permanent connection that has promotion possibilities, it will pay you to write for details.

HOUSEHOLD PAPER PRODUCTS CO.
1310 E. Woodbridge Street, Detroit, Michigan

WRITE TODAY

Sensational New Auto-Glide ONLY



World's Cheapest Motor Transportation \$125

Newest Ride Thrill—Sweeping the Nation. Easy to ride—easy to park. Wonderful for pleasure—school—deliveries—business. 140 miles on a gallon of gas—30 miles per hour. Safe—Economic and lowest priced motor transportation. Reliable, powerful Cushman Engine, balloon air wheels, drum brake clutch, cushion seat, channel iron frame, parcel carrier, lights and horn.

FREE INFORMATION—Send at once for full details—NOW!

DEALERS: Going like wildfire! Write for Special Offer!

CUSHMAN MOTOR WORKS
Dept. 27 Lincoln, Nebr.

FACTORY TO YOU

NEW REMINGTON NOISELESS PORTABLE



10¢
A DAY

FAMOUS Remington Noiseless Portable that speaks in a whisper, only

10c a day, direct from factory. Standard Keyboard. Automatic ribbon reverse. Variable line spacer and all the conveniences of the finest portable ever built. PLUS the NOISELESS feature. Act now. Send coupon TODAY for details.

You don't RISK a Penny. We send you a Remington Noiseless Portable for 10 days' free trial. If not satisfied, send it back. We pay all shipping charges.

FREE typing course and carrying case. You will receive FREE a complete simplified home course in Touch Typing. Also FREE, a handsome, sturdy carrying case. No obligation. Mail coupon for full details—NOW.

Remington Rand Inc., Dept. 152-2
315 Fourth Ave., New York, N. Y.

Tell me, without obligation, how to get a new Remington Noiseless Portable, plus Free Typing Course and Carrying Case, for 10c a day. Send Catalogue.

Name

Address

City..... State

FREE! HAMMARLUND 25th YEAR RADIO CATALOG

Including a profusely illustrated Special Bulletin describing the famous 16-tube HAMMARLUND SUPER-PRO RECEIVER. Address Dept. PM-2.

HAMMARLUND MFG. CO.
424-438 W. 33rd St. New York



DEAFNESS IS MISERY



Many people with defective hearing and Head Noises enjoy Conversation, Movies, Church and Radio, because they use Leonard Invisible Ear Drums which resemble Tiny Megaphones fitting in the Ear entirely out of sight. No wires, batteries or head piece. They are inexpensive. Write for booklet and sworn statement of their inventor who washed himself deaf.



A. O. LEONARD, Inc., Suite 699, 70 5th Ave., New York

BABY CALCULATOR
CHICAGO, U.S.A.
PATENT APPLIED FOR

VEST POCKET ADDING MACHINE

Adds, Subtracts, Multiplies, Divides. Does work of more costly machines. Not a toy. Million dollar capacity. Simple and accurate. Guaranteed 5 years.

FREE TRIAL \$2.50
—SEND NO MONEY— Total Cost

Just name and address. We will ship Calculator immediately. On delivery pay postman \$2.50 (plus few cents postage). (If outside U. S. send cash.) 10c additional in Leatherette Case. If not satisfied after 10 days' trial you get your money back; THOUSANDS OF SATISFIED USERS. Write for Agents' Proposition. CALCULATOR MACHINE CO. (Mrs.) P. O. Box 1118, Dept. 31, CHICAGO, ILLINOIS.

Harbor Pirates on the Run

(Continued from page 197)

boat, the "Gypsy," are famous around the water front. The "Gypsy" outsmarted the rum runners often and engaged them in many a running battle. The rum smugglers never obeyed orders to heave to but would jettison their cargo if overtaken,



Harbor police boat cruising along the New York water front on the lookout for pirates

and fight to the last ditch. Present-day harbor pirates usually do not care to risk a gun battle with the police. They try to escape at the first alarm because they would rather run than risk a fight with the special patrol organized and trained to combat modern freebooters.

Copper and Asphalt "Sandwich" Forms Self-Healing Roof

Thin sheets of copper sandwiched between layers of asphalt form a durable

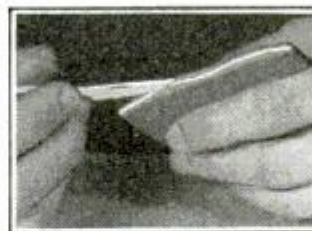

material for roofing, or lining refrigerators or shower stalls. The asphalt is impervious to moisture and protects the copper from corrosion. In addition,

the asphalt has a self-healing tendency, its surface closing together after being punctured and thus preventing leaks. This type of construction material is made possible by development of pure copper sheets so thin they are as flexible as sturdy cloth.

Our Bureau of Information will answer questions regarding articles in this magazine, if accompanied by return postage.

Mitchell Brand Mfg. Co.

Because THEY ARE ENGINEERED

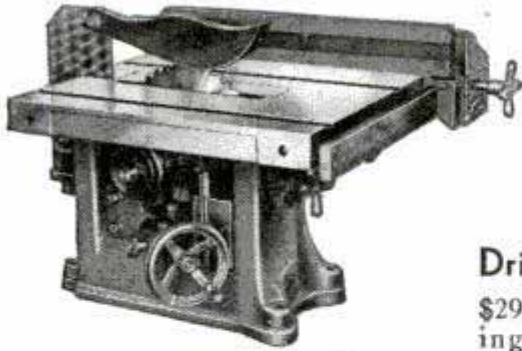

Driver B735 8" Bench Saw

\$24.95 as shown, with self-setting Mitre Gauge and 72 page Instruction Book.

The biggest and best \$24.95 worth of tool value to be found anywhere. 16"x13" machine ground iron table tilts to 45° angle. SKF ball bearings. Saw blade raised by precision worm gear. Max. depth of cut 2 1/4". Geared, self-indexing mitre gauge furnished at no extra cost. An unbeatable value—it's Driver Engineered.

ASK YOUR DEALER ABOUT THE DRIVER EASY PAYMENT PLAN

DRIVER *Engineered* POWER TOOLS

—the 1937 Driver Power Tools offer far greater values for the money. Features ordinarily found only in more expensive equipment are incorporated in these models.

Perhaps you are buying your first power tool, or enlarging your workshop. In either case you owe it to yourself to study carefully the many points of superiority that characterize Driver Engineered Tools for 1937.

See them at your dealer's or write for free copy of the colorful 1937 folder.

Driver P715 Jointer

\$29.95 as shown, including 72 pg. Instruction Book. Driver Engineering has lifted this Jointer out of the usual 4" jointer class. It is longer, heavier, more accurate and far more durable. 28" overall length. Machine ground table. SKF sealed, dust-tight ball bearings. Geared tilting fence 24" long. From the standpoint of convenience, utility and dependability it has no equal—it's Driver Engineered.



Other Driver Engineered Tools—Band Saws, Jig Saws, Lathes, Drill Presses, Motor Grinders, Flexible Shafts. Three Complete Lines in Three Price Ranges.

USE THIS COUPON

Walker-Turner Co., Inc.
127 South Ave.,
Plainfield, N. J.

Gentlemen: Please send me copy of the colorful folder on 1937 Driver Tools.

Name.....

Address.....

SOFT WATER

MAGIC WORDS—that are bringing big profits to Webb Salesmen! The Webb Portable Water Softener brings to every housewife, soft water in an endless flow for washing dishes, laundry, bath, shampoo and every home purpose. Softens hardest water instantly at the turn of the faucet. Sell at popular prices. Greatest capacity at the price.

Distributors FREE SALES PLAN

Quick easy sale—and 100% profit—simple home demonstration sells it instantly! Write today for free literature and full details of the Webb NO RISK TEST OFFER and FREE Sales Plan.

WEBB MFG. CO., Dept. P-27, 1813 Baltimore Ave., Kansas City, Mo.



NO RISK TRIAL OFFER!

Printing Offers BIG PROFITS

Cards, stationery, circulars, etc. Easy rules sent. Does raised printing like engraving. **Print for others, Big Profits.** Save money. Junior press \$5.90; job press \$11; power, \$147. Sold direct from factory only. Send for free catalog and all details. **THE KELSEY CO., P-37, MERIDEN, CONN.**

UNIVERSAL TRACTOR

Plenty of Power at Low Cost



Plows, discs, seeds, cultivates, digs potatoes, landscape work. Swivel trailer wheels and cultivator lift for easy turning. Over 4 h. p. on belt work. Moving parts fully enclosed. Write

Pioneer Mfg. Co., Dept. V-237, West Allis, Wis.

AMATEUR CARTOONISTS WIN \$25.00

Wanted—Amateurs with humorous ideas. No drawing ability necessary. The amateurs of today are the professional cartoonists of tomorrow. Ideas judged and prizes awarded by Applause-O-Meter test before movie audiences. Everyone has an equal chance. 26 cash prizes in all. Rush name on post card for "Valuable Tips on How to Make Money With Simple Cartoons and Humorous Ideas," Cash Prize Entry Blank and Rules—Send No Money.

CARTOONISTS' EXCHANGE, Dept. 92-B, Pleasant Hill, Ohio

HANDICRAFT Canning and weaving materials, chair frames, basketry materials—reed, rattan, raffa, grass, rush, fibre. Leather raft. Cotton, Yarn, Wool, Warp. Send 10c for Catalog. Instructions free.

AMERICAN REEDCRAFT CORPORATION
Dept. P 130 Beekman Street New York City



COMPLETE ELECTRIC PLANTS

ONAN ALTERNATING CURRENT PLANTS furnish same as city current anywhere. Operate on gasoline. Run Radio, Water System, Refrigerator, all Appliances.

SIZES 350 WATTS UP

Easy to install. Available from stock. Ideal for Farms, Camps, Lake Homes, Commercial use. Sizes for any purpose. Write

D. W. ONAN & SONS

1000 Royalston Ave. Minneapolis, Minn.

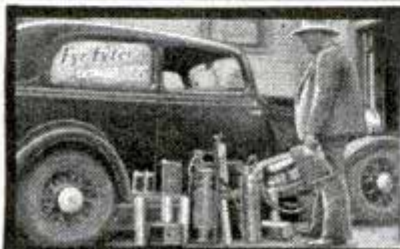

START A BUSINESS *at home*

—like J. R. Sammons of Billings, Mont. Started a Fyr-Fyter Dealership in his home a few years ago. **MADE PROFITS OVER \$6,900 IN 1935.** Business in 1936 will exceed 1935 record. Inspect, Service and Re-fill all types of Approved Fire Extinguishers. Previous experience unnecessary. We train and advance you to Dealership for complete line of Fyr-Fyter Extinguishers. Schools, stores, homes, auto and truck owners, farmers, warehouses, churches, factories, filling stations, public utilities, etc., are your prospects. Use your home as headquarters. No stock investment required. Real opportunity for men past middle age as well as younger men. Write a letter giving full information about yourself and past work to **THE FYR-FYTER COMPANY, Dept. 90-14, DAYTON, OHIO**

RAISE GIANT FROGS

NUFOND GIANTS WEIGH UP TO 3 LBS. EACH



SELL UP TO \$5 PER DOZEN!

A New Industry! Millions used yearly! Markets waiting. Prices Steady. Pleasant, outdoor work. Easy to ship to any part of the country. Nation-wide market at your command.

A SMALL POND is all you need to start with five pairs of "Nufond Giant Breeders." Expand with the increase. **WE BUY!** As originators of **Canned Frog Legs**, we are developing one of the world's largest frog markets. In addition to other markets, frog raisers can also ship to us.

MEN & WOMEN! Investigate this interesting, new work. See for yourself what others are already doing. Send for our illustrated, **FREE** book explaining our offer in detail. Write today.

AMERICAN FROG CANNING COMPANY
Dept. 133-BB, New Orleans, La.

FREE BOOK



STOP SUFFERING

From Abdominal Weakness, Backaches, Headaches . . .



nervousness and other symptoms caused by bad posture.

Welcome relief from such ills and discomforts has come to thousands after wearing the light, comfortable **Natural Body Brace**, as the brace gently helps return the vital organs to a more normal position.

SUPPORTS-STRENGTHENS STRAIGHTENS-Comfortable, easy to wear. Thousands of users, men and women.

30-Day Trial Offer

Write today for free booklet, "Health, Strength and Perfect Figure" and details of 30-Day Trial Offer. (c)

The Natural Body Brace Co.
302 Rash Bldg., Salina, Kans.



PARTS for the POPULAR MECHANICS FAMILY TRAILER

Everything you need! Axle, Tongue, Hitch, Wheel Housings, Wood Parts, Tank, Sink, etc. Send for price list. Include 25c (min) for our big Catalog and Trailer Builders' Manual. Satisfaction guaranteed! **TRAILER SUPPLY CO., Box A, Wausau, Wis.**

FREE TREASURE BOOK **RINGS \$1.50**

PINS 30¢ Write for Big FREE Catalog of Pins, Rings, Emblems, Medals, Trophies, Etc.

Class Pins, any letters, numerals, colors. Silver Plate, 25 or more, 30 ea.; 7 to 24, 35¢ ea.; 1 to 6, 40¢ ea. Gold Plate, add 10¢ ea. to above. Star, 88¢, add 20¢ ea. Star, 88¢ Ring shown, 26 or more, \$1.50 ea.; 12 to 25, \$1.60 ea.; 1 to 11, \$1.75 ea.

4254 METAL ARTS CO., INC., FACTORY 44, ROCHESTER, N.Y.

MAKE YOUR OWN VENETIAN BLINDS

Complete instruction book shows how easy you can make them in your own home shop. Postpaid only 25c. We furnish hardware, ladder-tape and cord at amazing direct-to-you low prices. Cost of book applied against hardware cost (\$5.00 or more) if purchased from us. Write To-day.

HESTON & ANDERSON 602 PINE STREET FAIRFIELD, IOWA

CATCH 'em ALIVE! MINK, MUSKRAT, SKUNK, etc. also FISH, with our Folding Gelatinized **STEEL WIRE TRAPS**. Made strong and durable. Sent Parcel Post. Write for Free Trap Offer and descriptive Catalog. \$1 Box of FISH or ANIMAL BAIT Free to introduce our traps. **WALTON SUPPLY CO., 3507-B Junata Street, St. Louis, Mo.**

MONUMENT **BIG FREE CATALOG** Freight Paid or Erected

Lettered, Guaranteed. 30% savings. Thousands sold. Write for Big Free catalog.

\$9 UP. WORLD'S BEST MARBLE or GRANITE. Direct from factory. **U. S. MARBLE & GRANITE CO.** Dept. A-18, ONECO, FLA.



BUILD WITH DOENUTS

Build with the original patented Musselman Doenut Cord Tires and Wheels. Tire requires only 12 to 15 lbs. air pressure for loads up to 200 lbs. per wheel. No springs needed. Musselman Doenut Cord absorbs surface obstructions, eliminates jolts and reduce effort 50% on the same loads. Wheels cadmium plated with adjustable ball-bearings. Doenuts are ideal for building, hand trucks, push carts, bicycle trailers, midget autos, coasting wagons, scooters, grass guns, spraying equipment, wheel barrows, etc.

Write today for literature and prices.

THE MUSSELMAN PRODUCTS CO.
6247-P ST. CLAIR AVE. CLEVELAND, OHIO



Balance as above with 1-50; 1-20; 2-10; 1-5 and 2-2 gram weights base 6 3/4" x 3 1/2" - \$4.75. Catalog with 3000 illustrations of laboratory apparatus sent for 50c. Catalog listing 10,000 chemicals, drugs, flavors, etc. and 1700 scientific books sent for 25c; Wholesale Price List 1000 ill. 10c.

Laboratory Materials Company, 639 E. 71st St., Chicago, Ill.

Sani-Flush **SAFE, NOT CAUSTIC**

KEEPS AUTOMOBILE RADIATORS CLEAN

FREE! 1937 BOICE-CRANE CATALOG



Write today!

Get full details . . . Twenty different Tools . . . New designs . . . Ahead of field . . . High quality . . . Dependable . . . Accurate machines of low cost.

Only ONE motor (not 2) needed to drive both this Tilting-Arbor Saw and Jointer. That saving of \$5 (impossible on most other saws) pays for your Boice-Crane Jointer.



New 10 Inch, Tilting-Arbor Saw is big and heavy. Accurate. Refined details. Easiest to use. Gives greater production. Investigate its greater safety, too.

6 Inch Jointer. Extra long tables. Very long fence guidance for accuracy. Fence locks rigidly at front, and at rear. Is spring-proof. Cutterhead 3 inch diameter.

43 inches Overall

BOICE-CRANE CO. Dept. PM.2-M. Toledo, Ohio

He Got \$1000 for ONE OLD COIN

B. Max Mehl paid Mr. Brownlee of Georgia \$1000.00 for this coin that he found while digging—

DO YOU WANT BIG MONEY for OLD COINS-BILLS-STAMPS?

POST YOURSELF! It Pays!

I paid \$400.00 to Mrs. Dowty of Texas, for one Half Dollar; J. D. Martin of Virginia \$200.00 for a single Copper Cent, Mr. Manning of New York, \$2,500.00 for one Silver Dollar, Mrs. G. F. Adams, Ohio, received \$740.00 for a few old coins. I will pay highest cash prices for all kinds of old coins, medals, bills and stamps.

I WILL PAY \$100.00 FOR A DIME!

1894 'S' Mint; \$50.00 for 1913 Liberty Head Nickel (not Buffalo) and hundreds of other amazing prices for coins. Send 4c for Large Illustrated Coin Folder and further particulars. It may mean much profit to you. Write to **B. MAX MEHL, 165 Mehl Bldg., FORT WORTH, TEXAS** (Largest Rare Coin Company in U. S. A.) Established 36 Years.

GET THIS TRACTOR OF "100 USES" AT FACTORY PRICE

Thompson BEATS the World on BOATS

Better Built Lower Prices

Only Boats With Full Length Spray Rails

Keep passengers perfectly dry—even at high speeds. Catalog also shows today's five most popular models of sailboats. Two big factories. Prompt shipment. CATALOG FREE

Write for your copy. State kind of boat in which you are interested.

THOMPSON BROS. BOAT MFG. CO. (79)
 213 Ann St., PESHTIGO, WIS. (Write to either place) 113 Elm St., COKLAND, N. Y.

Canoes \$54 and up
 Rowboats \$42 and up
 Outboards \$42 and up
 Very fast utility model

BIG 1937 LEADER GENUINE LEATHER TIES.

4-in-Hands and Bows:—Men's and Boys'. Beautiful new stripes and plaids. Look like silk. Cleaned with a damp cloth. Durable; won't wrinkle. Each tie wrapped in Cellophane. **SELL ON SIGHT.** Big profits; repeat orders. Be independent; have your own business. Young man sold 23 one night after school. No sales ability needed. Let us show you how you can **MAKE \$5 up A DAY.** Send 50c cash or stamps for sample and kit.

Information FREE

Write Today

CENTURY TIE CO.
 Dept. A, 2345 W. Grand Blvd., Detroit, Mich.

New Adding Machine Fits Vest Pocket!

Adds, subtracts, divides, multiplies as accurately as \$100 machines. Weighs only 4 ounces. Not a toy—strong guarantee. Absolutely accurate, lightning fast. Sells on sight to offices, stores, homes—all who use figures. Write quick for **FREE AGENTS** sample offer and Money-Making Plan.

C. M. Cleary, Dept. 61, 303 W. Monroe St., Chicago

Costs only \$2.95

a real MICROMETER BARGAIN!

Genuine, American made, six piece micrometer set, in velvet lined leather case. Special price, only \$11.95, a fourth off regular price and a fraction of the cost of other sets on the market.

These micrometers are precision machined for accuracy in one thousandths of an inch, up to 4 inches outside and 3 3/4 inches inside measurements. Guaranteed accurate, easy to read and adjust. Built to stand hard wear and give satisfaction.

Every mechanic, apprentice, garage and repair shop needs these accurate and dependable micrometers. This is your opportunity to get one at a Bargain Price if you act now. Shipped prepaid on receipt of remittance. On C.O.D. shipments, send deposit of \$2.00.

Money back if not satisfied

MICRO PRODUCTS 529 E. Jefferson Ave. DETROIT, MICH.

MICROMETERS • INDICATORS • PRECISION TOOLS

DOES WORK OF MANY MEN OR 2 HORSES!

Here's untiring speed and power—that gets field and belt work done on time! Smallest size does work of many men—saving wages. Larger sizes do work of 2 horses or mules—quicker, cheaper, more efficiently—saving costly animal keep. Runs all day for 33c. Greatest time, labor and money-saver made!

"Tractor of 100 Uses"—Does all field, road, belt work. Plows, discs, harrows, furrows, seeds, cultivates, harvests, mows, rakes, cuts tall weeds, hauls. Runs washing machines, feed grinders, corn shellers, light plants, saws, concrete mixers, water pumps, lathes, other belt machinery. Does deep mold-board plowing, other heavy work. **Amazing money-maker** for farms, truck gardens, nurseries, orchards, suburban homes, golf courses, parks, etc.

SHAW GARDEN TRACTOR

New 1937 Model Has 3 Speeds Forward, and Reverse. Special to Order, 6 Speeds Forward—runs from 1/2 mile to 15 miles per hour. **New Power Turn** enables Shaw to turn in its tracks with no lifting or pushing. **Reverse Gear** makes it easy to work among rocks, roots, in close quarters. **Tool Attachments** for different uses. Convenient Jiffy Hitches. **Improved Tool Control** gives tools a wider range of movement - - Increases tractor's usefulness. Briggs & Stratton air-cooled, 4-cycle engine. 4 Models, 2 to 5 H. P., Walking and Riding Types.

Available With Air or Steel Tires. Air tires save 25% fuel. Enable Shaw to do more work in a day. Provide better traction.

LOW FACTORY PRICE!! Mail Coupon for details of price and terms today!



10-DAY TRIAL FREE BOOK!

OFFER! Use on your own work for 10 days. Know how Shaw makes you much more money—with less work and trouble! Mail Coupon for details 10-DAY TRIAL OFFER today!

Explains everything about Shaw. Tells what enthusiastic owners say. Shows photos of tractors in use. Gives **LOW Factory Prices** on 4 different size models—with different attachments. Mail Coupon today!

FREE BOOK COUPON

THE SHAW MFG. CO. (Address Nearest Office)

4502 Front St., Galesburg, Kans.; 5812-G Magnolia Street, Chicago, Ill.; 130-G West 42 St., New York, N. Y.; 668-G No. Fourth St., Columbus, Ohio.

Send me **FREE** information at once about the Shaw "Du-All" Garden Tractor as checked below:

FREE Book and Low Factory Prices 10-Day Trial Offer Liberal Agent's Proposition

Name.....
 Address.....
 Town..... State.....

OH!
for a **SNAPSHOT NOW!**

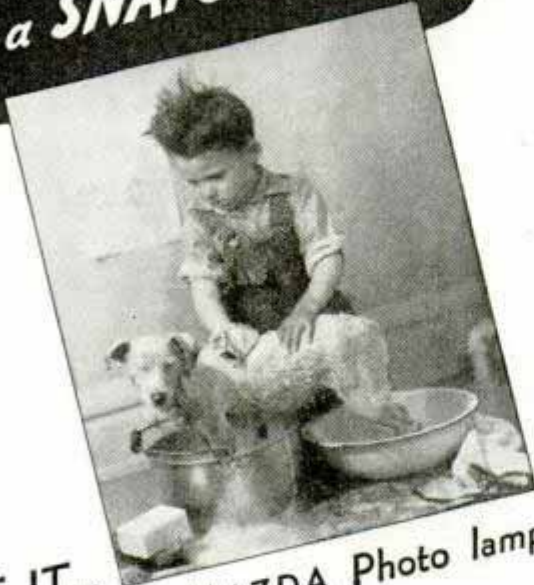

TAKE IT..
easily with **G-E MAZDA Photo lamps**

Haven't you often wished for a picture of some precious indoor scene, such as that above? Get out your camera and take it now, day or night, with G-E MAZDA Photo lamps.

It's easy. If your camera has a fast lens—F/6.3 or faster—use supersensitive film and G-E MAZDA Photo flood lamps No. 1. Good for dozens of pictures. 25 cents list.

If your camera has a slow lens, open it wide, use supersensitive film and G-E MAZDA Photo flood lamps No. 2. Twice the light, three times the life. 50 cents list.

Here's What You Need

Put two G-E MAZDA Photo flood lamps in A and one in B. Place the lamps at the distances indicated. Tip shades to concentrate the light or use inexpensive paper reflectors. Then click the shutter as for a snapshot outdoors.

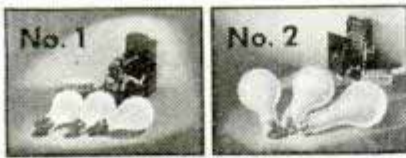

No. 1 For Fast Cameras **No. 2 For Slow Cameras**

FOR ACTION SHOTS, or with a box camera, use G-E MAZDA Photo flash lamps. Each lamp gets one picture. 15 cents list. Your drug store or camera dealer can supply you.

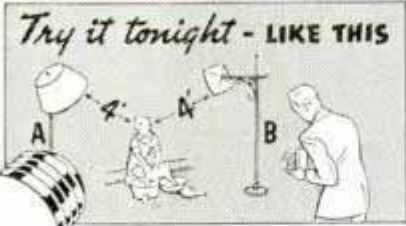

FOR PICTURES AT NIGHT

FREE FOLDER

Send for "How to Snap Pictures at Night." Write General Electric Co., Cleveland, Ohio.

LOOK FOR THE MARK  **for dependable light for picture-taking**

GENERAL  ELECTRIC MAZDA PHOTO LAMPS

F1527
Airplane Landing Gear Tested on Friction Wheel and Rig

Emb. Charles T. Bauer, 90 Dayton Blvd, Dayton, Ohio

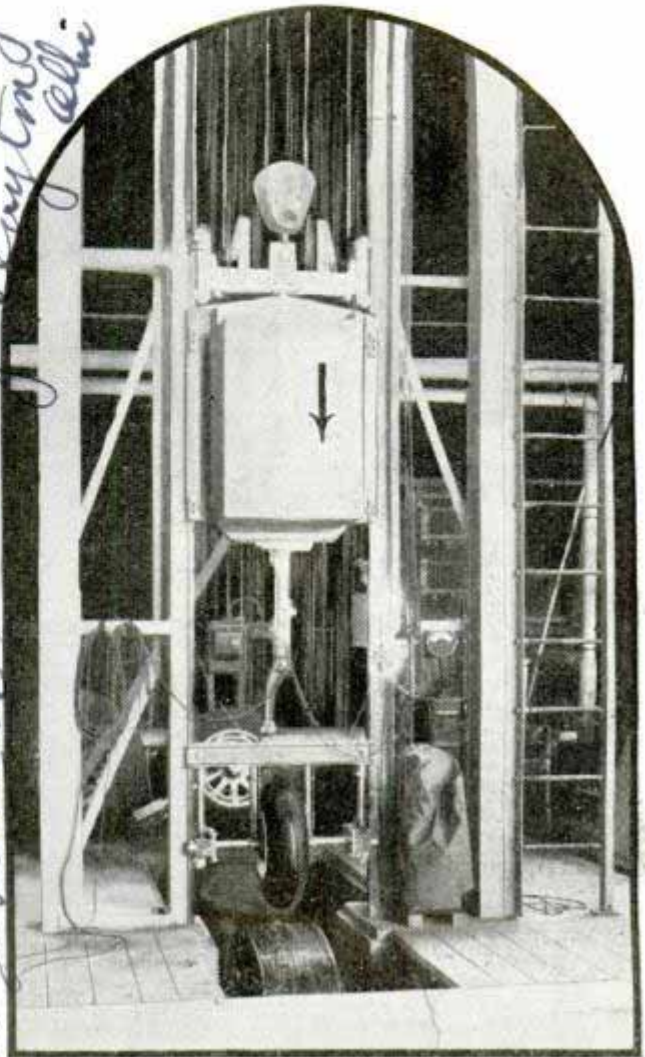

Conditions encountered by an airplane on landing are duplicated with an ingenious rig and friction wheel in the laboratory at Wright Field, Dayton, O., where tires and shock absorbers for bombing planes are tested. A revolving wheel is built into the floor to simulate the "rolling" effect of the ground on an airplane landing gear. Dynamic test rigs for landing gear previously could duplicate only the general effect of landing, and not the added stresses imposed by the "roll" of the ground. The friction-driven wheel in the test rig can be rotated at speeds up to sixty miles an hour, the fastest landing speed of the bombers. A steel box suspended from a crane is loaded with lead blocks equal to half the weight of the airplane. One shock absorber, wheel and tire unit are fitted in a special frame under the load which is raised and dropped on the revolving wheel. A recording mechanism shows the load taken up by the shock absorber and the stresses on the tire.

NEW 1937 *Atlas* SHOP TOOLS

DRILL PRESSES
\$16.45 to \$42.45

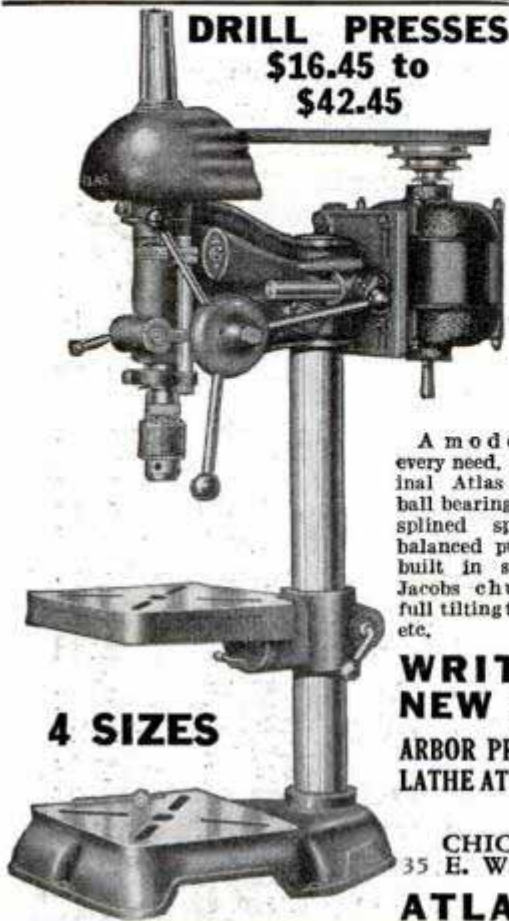

4 SIZES

A model for every need. Original Atlas SKP ball bearing head, splined spindle, balanced pulleys, built in switch, Jacobs chucks, full tilting tables, etc.

WRITE FOR THIS NEW 1937 CATALOG FREE

ARBOR PRESSES, WOOD TURNING TOOLS, DRILL PRESS & LATHE ATTACHMENTS, VISES, DISC SANDERS & SMALL TOOLS

DISPLAYS AT
CHICAGO 35 E. Wacker Dr. NEW YORK 130 W. 42nd St. PHILADELPHIA 113 No. 3rd St.

ATLAS PRESS CO. 243 NO. PITCHER ST. KALAMAZOO, MICH.

METAL WORKING LATHES

Atlas

\$39.75 to \$112.50



A complete line of precision built metal cutting lathes. Back geared models start at \$87.50. Attachments available for all machine shop operations. Guaranteed accuracy—modern design and many exceptionally outstanding features.



Sell Improved Leather Ties

DON'T waste effort on second raters. Sell fast and repeat on handsomest improved ties. Rich colors, embossed like silk. Fullest cut; long wear; wrinkle-free. Wipe clean like new with damp cloth. Send 50c for sample tie (65c value) and Big Free Sales Kit of new season's smartest patterns. Money back plan. Free premiums.

NU-MODE TIE CO., Dept. 20
1333 N. 12th Street Milwaukee, Wis.

BUILD THIS 6' YAWL MODEL, ONLY \$1.50

Everything furnished including semi-shaped hull of white pine and mahogany with black water line. All rigging material, airports, pedestal, base, plans and instructions. Mailed postpaid for \$1.50 in U.S.A., \$1.65 Canada. No C.O.D. orders. Our 44 page illustrated catalog listing kits and separate fittings mailed on receipt of 15c.

A. J. FISHER, 1002-1 Etowah Ave., Royal Oak, Mich.

POPULAR MECHANICS FAMILY TRAILER PARTS

Available from Hammerblow Tool Company—the original.

Don't build until you get Hammerblow facts. Save money, time, wasted labor. Hammerblow guarantees a rugged, non-sway, perfect trailer! BLUEPRINTS FREE WITH PARTS. Hammerblow parts are world's best. Used by nationally known mfrs. and engineers who know. Send only 50c for 64-page Trailer Builder's Guide and Free 40 page supplement. Immense value. Or write for Free Literature.

HAMMERBLOW TOOL COMPANY, Dept. 102, Wausau, Wis.

Learn to Re-Seat Your Chairs

Have you a chair, stool or bench that you would like to re-seat? We will teach you how to do it. Use either Cane, Rush, Reed, Splints, Fibre Rush, Cane Webbing or Grass.

Instruction Book Only 10c

Send 10c today for our illustrated Instruction Book and price list explaining how to do Seat Weaving.

The H. H. PERKINS CO., 252 Shelton Av., New Haven, Conn.

FINDS BURIED TREASURE! NEW GOLDAK RADIOSCOPE

Most efficient metal and mineral ore locator ever known. Absolutely guaranteed to detect buried GOLD, SILVER, or any other metal. Extremely powerful new models; very simple to operate; light in weight. Put your prospecting on a scientific basis. If you know of buried treasure, find it with the new Goldak. Write world's largest manufacturer of successful mineral locators for interesting information.

THE GOLDAK CO., Dept. P
1031 South Broadway, Los Angeles, Calif.

MEN—MAKE MONEY

Get into something for yourself, where your income is practically unlimited—The American Electric method of floor surfacing gives you that opportunity. Large profits—Work easy to get—No previous experience necessary—Small amount starts you—Write quick—No obligation.

The American Floor Surfacing Machine Co.
523 So. St. Clair St. Toledo, Ohio

Stoves AT FACTORY PRICES!

Sale Catalog—FREE

200 Styles and Sizes of Stoves, Ranges, Furnaces at Factory Prices, Easy Terms—as little as 18c a day. More Bargains than in 20 Big Stores. New styles, new features, new colors, Year to Pay—30 days' free trial—360 days' approval test—24-hour shipments. Over 1,100,000 Satisfied Users. 37 Years in Business.

Write for FREE Catalog.
THE KALAMAZOO STOVE CO. MFRS.
391 Rochester Avenue
Kalamazoo, Michigan

"A Kalamazoo Direct to You"

When writing please mention Popular Mechanics

Noise Fighters Battle for Quiet

(Continued from page 190)

has no structural connection with the surrounding building. The floors, walls and ceiling are of concrete, and the whole room "floats" on a bed of dry sand underlaid with gravel.

Another field of inquiry for the noise fighter is the measurement of sound transmission and sound isolation properties of walls, floors, and partitions. On the third floor of Johns-Manville's laboratory, any type of wall or panel can be built to order. By producing vibrations and sounds on the third floor and picking them up on the second floor, or vice versa, a complete study can be made of the sound-isolating value of various floor constructions.

Noise fighters call the sound boundary between comfort and discomfort the "psychological boundary." This term is now used commonly in the sound-conditioning of transports. Investigators of the Sperry Gyroscope company have determined that the comfort level for airplane passengers lies below eighty-five decibels. The discomfort range lies between eighty-five and 120 decibels. Beyond 120 decibels noise is no longer a discomfort, but a positive pain, unbearable to the average person and injurious to his health.

Uncomfortable vibrations are commonly associated with noise. Vibrations, therefore, come under the jurisdiction of the noise fighter. It is not difficult to cushion an airplane chair seat, but it is equally important to cushion the armrests, the sides, and all other parts with which the occupant comes in contact. Vibrations of more than eight-thousandths of an inch—tissue paper thickness—may cause a passenger to hold his muscles tense, making it impossible to relax.

Five years ago, the interior of an airplane cabin was like a boiler factory. The passengers were given cotton to place in their ears, and conversation at ordinary levels was impossible. The modern air transport has cabin walls covered with a synthetic, washable, and fireproof fabric. Window glass is flexible and fits into the openings snugly. The lowest noise level in an airplane cabin is probably inside the new Wibault transports, built for Air France by the French Air Ministry. The sound-conditioning of these planes was

placed in the hands of an American engineer. At 200 miles per hour the noise in the Wibault cabin is not above sixty-four decibels; it is seventy-two in the cockpit and seventy-six in the bar.

The time when all noise will be eliminated from an airplane cabin seems remote because the difficulties are great. But at the lower noise levels, obtainable in modern air transports, passengers feel perfectly comfortable.

The noise fighters begin their job while airplanes are still in the blueprint stage. They now have much to say about the location and thickness of partitions, and even the location of motors. The old aircraft motor was fastened to a solid base. This method of construction transmitted engine vibrations to every part of the ship. Today motors are cushioned and placed as far from the cabin as practicable.

The old cabin walls made of metal or paneled wood became huge diaphragms or sounding boards under the influence of motor vibrations. The present cabin walls are carefully insulated with "kapok," a vegetable fiber from Java. It is non-hydroscopic, and when combined with a small percentage of paper can be suspended inside a wall. It weighs only one-tenth of a pound per square foot. Three layers of kapok usually form the soundproofed walls and ceilings of an airplane. The first layer is stuck fast to the cabin walls, the second suspended about two inches away, and the third about the same distance from the second.

Fast Lens Sees Rubber Band Rebound Four Times

Stretch a rubber band between your fingers until it breaks. Your eye is too slow to see what happens, but ultra-fast motion pictures show that the ends of the broken band snap back to your fingers and bounce out again not once, but four times. Speed cameras developed to study industrial processes can record 2,000 to 3,000 pictures per second. Instead of speeding up the mechanical shutter to that pace, an intense light which can be switched on and off 3,000 times in a second is used.

*Mr. Eschman J.
Eschman, Boston*

F1482

Eschman, Boston

F1561

Here are the most dependable brakes ever built—
PERFECTED HYDRAULIC BRAKES

(WITH DOUBLE-ARTICULATED BRAKE SHOE LINKAGE)

.. and it was Chevrolet that perfected them!

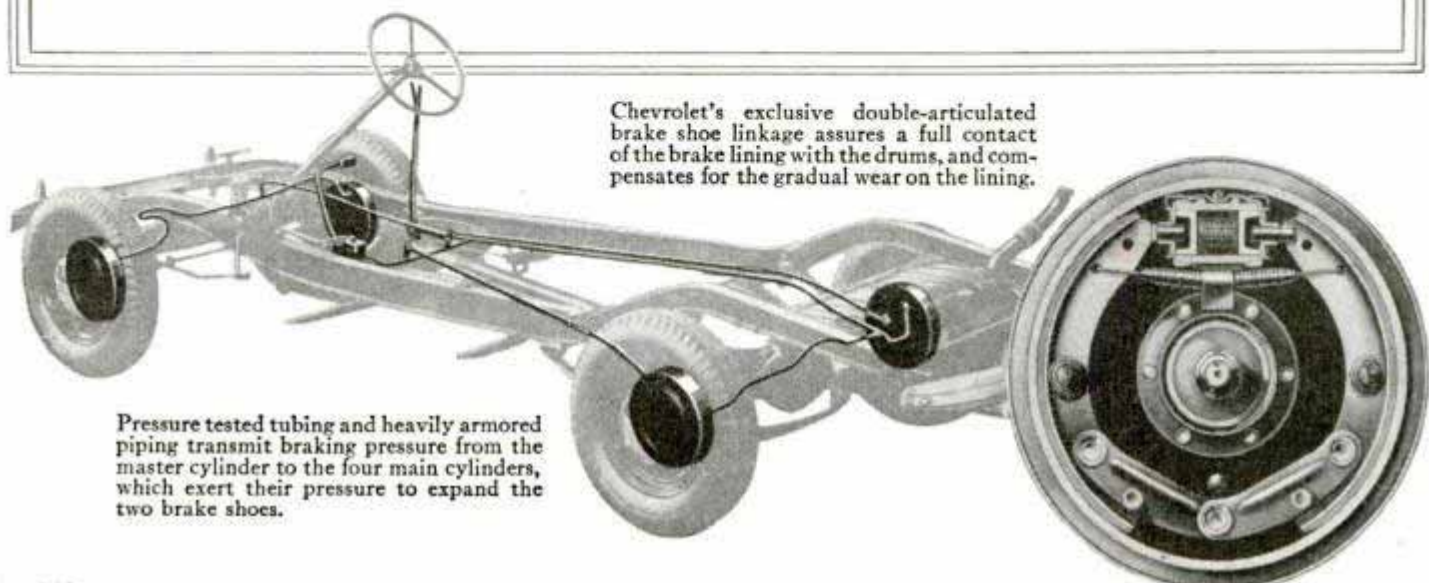

Chevrolet's exclusive double-articulated brake shoe linkage assures a full contact of the brake lining with the drums, and compensates for the gradual wear on the lining.

Pressure tested tubing and heavily armored piping transmit braking pressure from the master cylinder to the four main cylinders, which exert their pressure to expand the two brake shoes.



Of all the braking systems ever developed for motor cars, the soundest and most dependable is the Hydraulic braking system; and of all Hydraulic brakes, the most thoroughly efficient are Perfected Hydraulic Brakes—built by Chevrolet!

These brakes have been built into the chassis of more than 1,300,000 Chevrolet cars to date. They are hailed by owners and engineers alike as the greatest safety factor in modern motoring. They are absolutely positive in action. They are velvety smooth. They give the highest degree of quick, straight-line stops under the lightest pedal pressure—braking that is instantly effective, braking that is always under exact control.

Your Chevrolet dealer will be glad to demonstrate these brakes, as well as Chevrolet's New Valve-in-Head Engine, Improved Knee-Action Ride*, New All-Silent, All-Steel Body, and many other features found only in this one low-priced car—the complete car, completely new.

CHEVROLET MOTOR DIVISION, General Motors Sales Corporation, DETROIT, MICHIGAN

*Knee-Action and Shockproof Steering on Master De Luxe models only.
 General Motors Installment Plan—monthly payments to suit your purse.

CHEVROLET

The Complete Car - Completely New

When writing to advertisers please mention Popular Mechanics

The hydraulic brake master cylinder and the clutch and brake pedal bracket form a single sturdy unit attached directly to the chassis frame. Perfect alignment thus is maintained, and pedals are stabilized.

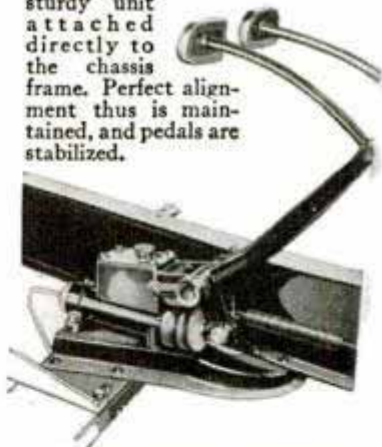

The hand-operated emergency brake, connected by flexible cables, operates both brake shoes in each rear wheel, as shown below.

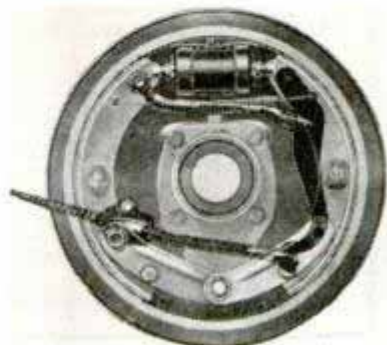

At these Low Prices Anyone can Afford a Genuine BLACK & DECKER DRILL



**1/4 INCH
Junior
Drill**
ONLY
\$19.50

Here's a light, powerful drill that makes quick work of a thousand and one jobs around the workshop, garage or home. Drives twist drills for drilling up to 1/4-inch holes in metal; wood augers up to 1/2 inch in wood; light grinding and wire-brush wheels; carbon-cleaning brushes; and many other attachments. Powerful Universal motor; 3-jawed Jacobs chuck.



**1/2 INCH
Junior
Drill**
ONLY
\$35.00

Here's the most popular sized drill for any shop or workbench—at a price almost any shop can afford. It handles more jobs, drives more accessories, than any other sized drill. Drives twist drills for drilling up to 1/2-inch holes in metal; wood augers up to 1 inch in wood; B. & D. Hole Saws for cutting clean round holes up to 3 1/2 inches in diameter in any material a hacksaw will cut; also drives wheels for light grinding, wire-brushing, etc. So powerful you can't stall it even when working up to capacity in steel. Universal motor; 3-jawed Jacobs chuck. A great tool for only \$35.00.

MAIL THE COUPON TODAY for complete information and name of nearest dealer where you can see the B. & D. Junior Drills and other B. & D. Tools.

BLACK & DECKER

World's Largest Manufacturer of
PORTABLE ELECTRIC TOOLS

MAIL THIS COUPON NOW

The Black & Decker Mfg. Co.,
602 Pennsylvania Ave., Towson, Md.

Please send me Free Literature describing new low-priced Black & Decker Tools and the address of my nearest B. & D. dealer.

Name

Occupation

Address

City State

When writing please mention Popular Mechanics

FOR Real FUN Play. A Soprani ACCORDION



● If you want to be really popular, have all the fun, the center of attraction everywhere, just learn to play this thrilling instrument from Italy. A complete band or orchestra in itself, and so easy to learn to play. You'll master this easier Soprani in no time, and you'll have real fun from the start. Don't delay. Big future. Send postal for beautifully illustrated literature. No obligation. Easy terms. Write today sure. 122

SOPRANI, INC.

DEPT. 229, 630 S. WABASH AVE.
CHICAGO, ILL.

Neon Truck Signs

-- NOW Possible with Amazing
New TRANSFORMER and Novel Method
of Tube Installation!

**DISTRIBUTORS
WANTED**

Old, established factory wants financially responsible business executives—to handle distribution in exclusive territories. Signs fill long-felt Advertising need! Enable any advertiser to have brilliant, colorful, attention-getting Neon Advertising message on trucks, both day and night. Expected to quickly sweep country! Easily installed on top driver's cab. Amazing NEW TRANSFORMER enables Sign to operate on any truck's standard 6-volt auto storage battery—using only about same amount current as an extra tail light. Novel method tubing installation protects against breakage. Reasonable capital handles exclusive Distributorship Contract. Big Profits. No sign experience necessary. We furnish entire product. **FREE LITERATURE** gives details, explains liberal proposition. Write today! **E. E. SOUTHER IRON CO.** - - 1952-A-8 Kienlen Ave., St. Louis, Mo.



BRASS TAPPING

Get this big outfit for metal tapping. Make artistic Book-ends, Desk Racks, What-Not Racks and Plaques. Equipment includes plywood, special non-tarnishable metals, tapping hammer, 2 tapping tools, supply of nails, and design patterns, packed in attractive carton. See your dealer or send \$2.00 for complete outfit making Pair of Bookends, What-Not Rack and large Twin Plaques. State choice of Copper or Brass, "Gold" or "Silver" \$2.50.

**FREE
CATALOG**

RAPAPORT BROS., 703 W. Ohio St., Chicago

STANDARD GARDEN TRACTORS

Plow Powerful Gas Tractors for Small Farms, Gardeners, Florists, Nurseries.
Seed Fruit Growers & Poultrymen.
Cultivate 1 & 2 Cylinders
Mow Hay Walk or Ride-Do Belt Work
and **Lawns** High Wheels--Free Catalog

STANDARD ENGINE CO.
Minneapolis, Minn. Philadelphia, Pa. New York, N. Y.
3221 Como Ave 2546 Market St. 290 Cedar St.

NEW!



IMPROVED!

DUAL RAY HEALTH LAMP

**TWO SEPARATE LAMPS IN ONE
ULTRA VIOLET—INFRA RED RAY**

Health giving. Prevents Rickets. Gives **SUN-TAN**. Vitamin "D." Automatic safety control. 110 Volt AC-DC current. Also experimental work. Free Details.

Beyer Mfg. Co. 4655 Lincoln Ave., Dept. PM-2
CHICAGO, ILL.



BUILD YOUR OWN!:

Make one of the most exciting games ever invented—a Big League Electric Baseball Game. Have the **THRILL OF BUILDING** this NEW marvel YOURSELF! Free Catalog illustrating games and other special parts.

ELECTRIC GAME CO. Upper High
Holyoke, Mass.

\$200 My First Week



... Now in my OWN Business.

Would you, too, like to own a business where you could take in \$200 your first week as did L. A. Eagles in Madison, Wisconsin?

We want a reputable, honest man in each county. This man need not have any special experience or more than ordinary ability, but he must be honest and courteous.

Such a man we will start in business for himself. You can make far above average profits in the rug-cleaning business—a high-grade business all your own. Many earn \$125 to \$200 per week—some considerably more.

NO SHOP NECESSARY

The rug-washer finishes rugs like new on the customer's floor. Anyone can run it. Electricity does the work. A quick, thorough and highly-efficient method that restores the natural beauty of floor coverings.

There are hundreds of customers—in your vicinity and nearby towns. The business grows steadily. Simply clean a few rugs or carpets. These customers tell others and also give you their future work. Soon you will have a prosperous year-around business. Send coupon for booklet explaining everything.

"Profits Pay for Home"

Harry Hill built and paid for a home from rug-washer profits. His first day's business was \$86. Another man writes, "Made \$70 in 13 hours." A. L. Miller says, "Have had rug-washer 6 years—have earned as high as \$92 a day." M. O. Malmin earned 3 times the cost of his machine the first two months. You, too, can enjoy a large income.

VON SCHRADER MFG. CO., 102 PL., RACINE, WIS.

Free Book!
MAIL COUPON now

VON SCHRADER MFG. CO.
102 Pl., Racine, Wis.

Send at once (no obligation) your free booklet illustrating rug-washer and telling how I can own my own permanent business; how I can earn large profits at prices below other methods; how I can become financially independent in a short time; and how I can pay on easy terms.

Name.....

Address.....

City..... State.....



"Never a Complaint"

C. J. White says: "\$100 business in six days—never a complaint." That is the nicest part of this business—every customer is more than satisfied. Stains and blotches disappear and vivid colorings and freshness in faded floor coverings come back.

EVERY MACHINE GUARANTEED

You take no risk. These machines have been manufactured since 1918 and are used by the United States Government and by Statler and other leading hotels. They are fully GUARANTEED.

EASY TERMS

The complete equipment is inexpensive. A reasonable down payment brings everything to you and the balance is paid monthly. From the start, you have your own business—one that is profitable and of which you can be proud.



MAIL COUPON Today

FREE ELECTRICITY From Wind Power



For Lights, Power, Radio, from Auto Generators. New Copyright Book with over 100 Facts about Wind Chargers. Wind-Propellers—Generators—Plants—Batteries. Answers all questions you should know. Including plans for 6 or 32 V. Plant. Send 25c for plans, facts and catalog.

CURRIER MFG. CO.

421 Terminal Minneapolis, Minn.

WANTED MEN

OPERATE POTATO CHIP STORES

We furnish equipment, supplies and instructions. Our equipment is efficient, good looking and low in price. Get our finance plan. Unusual profits. We help start you in business. Rush name for Booklets, today.

LONG-EAKINS COMPANY

228-5 High Street, Springfield, Ohio



HANDY Taps and Dies

Why Handy? Handy to use (easy cutting). Handy to own (10 cents each). Accurate (precision cut threads). Lasting (carefully hardened and tempered).



Made by **HENRY L. HANSON**
Worcester, Massachusetts
At Your Local 5 and 10 Cent Store



BIG NEW 100 PAGE BOOK No. 9

10c REBATED on FIRST ORDER—MAKE BEAUTIFUL FURNITURE

at a fraction of store cost. USE THE CRAFTSMAN new process of inlaying, using our new process ART INLAY GLUE, needing no clamps for the finest work. Hard to find rare grains for all wood, including, foreign, hard-to-find cabinet hardware. Lists and illustrates 76 blueprints of scroll patterns, inlay table tops—Kits for inlaid art boxes, plaques, trays, book ends, etc., that anyone can make—22 pages in color. VENETIAN BLINDS for one-third of usual price. All material requiring only a saw, screw driver, a tack hammer and paint to assemble.

CRAFTSMAN WOOD SERVICE CO.,

2721 MARY STREET,

CHICAGO



only 10c

THE WORLD'S FINEST RADIO CATALOG FREE!

Paste the coupon on a penny post card TODAY! You will be amazed at the SAVINGS shown on the 156 pages of the LATEST 1937 Radio Catalog! Ten thousand Bargains in Parts—Tubes—Testers—Kits—Tools. Custom Built Lafayette Radios at prices which cannot be beaten. Remember—WHOLESALE will not be undersold. Don't wait! Clip the coupon and mail it right away!

BUILD YOUR OWN!

Build any of the circuits described in this magazine! We can supply parts for all of them. Write for FREE parts list.

MAIL THIS COUPON NOW

Wholesale Radio Service Co., Inc.
901 W. Jackson Blvd.
Chicago, Illinois

Please rush me your BIG, FREE Radio Catalog 65B7.

Name.....

Street.....

City..... State.....



New—Speedy BELT SANDER

Five times faster than hand plane—electrically driven sanding belt surfaces wood, metal or stone. Get details on the—

AMERICAN SANDERPLANE

Price and catalog sent free upon request—no obligations. Write today to—
The American Floor Surfacing Machine Co.
524 So. St. Clair St. Toledo, Ohio



Latest MARIGOLD DWARF ROYAL SCOT ALL DOUBLE

Striped French Marigold, rich mahogany and gold in uniform stripes, 100% absolute doubleness.

Special pricing, per pack . . . 15c

Write for New Free Golden Anniversary Seed Book and free Packet of Seeds

L. L. OLDS SEED CO.
Dept. 23 Madison, Wis.

FASTER - SAFER - CLEANER

7200 Strokes per Minute
Electric Operation

No Motor Required

Astounding performance! Cuts up to 1" or more, with smooth, clean edges. No sanding required. Accurate, sturdy, efficient—a revelation to skilled craftsmen in handling both intricate designs and heavy work. Ideal for cutting light metals, veneers and plastics. Operates on 60 cycle, 110 volt AC, without motor or any reciprocating parts. Requires no oiling. 10" square table; 13 1/2" throat; adjustable guide; variable stroke. Complete with underwriters approved cable and rubber plug. Built for years of continuous service.



New SYNCRO JIG SAWS

GET FREE LITERATURE TODAY

Ask your dealer to show you the models now available. Or send your name for full information and illustrated literature, FREE

SYNCRO DEVICES, INC.

511 Boydell Building Detroit, Mich.

**FREE
FOLDER**

Receiver from Junk-Box Parts

(Continued from page 260)

and held in position by means of 6-32 nuts. The switch levers can be purchased in the 5-and-10-cent stores, or made from the sliding arm of an old variable resistor unit.

No. 18 or 20 double-cotton covered wire, or the bell wire used for the coil, may be employed for the various circuit connections. When tapping the coil, lift the turn to be tapped with an ice pick or similar pointed instrument and insert a short length of match stick under the turn to hold it up while removing the insulation preparatory to making the soldered connection. It will be noted that one switch lever is connected to the antenna and the other goes to one side of the crystal.

Fig. 2-B shows the arrangement of the coil and tuning condenser in the cabinet. The antenna and ground posts are extended on brass bushings to place the clips within easy reach. However, the terminal clips may be screwed directly to the wood bottom of the cabinet if preferred. These spring clips were salvaged from an old B-battery. Mount the variable condenser on the wood base and extend the shaft through the wood front panel. The shaft of the condenser shown in the photo was not long enough to reach through the panel therefore a connector bushing and a short length of 1/4-in. brass rod were used to bring it out to the dial. Almost any type of tuning dial may be used.

To place the receiver in operation, use a good long antenna from 100 to 200 ft. in total length. No. 14 enameled-copper wire is easily obtained and recommended for best results. A ground clamp on a cold-water pipe completes the installation. Switch No. 1 acts as a selectivity control, while switch No. 2 places the antenna and ground circuit across different portions of the coil. This switch and the variable condenser regulate the wave length of the receiver. A good pair of 2,000-ohm headphones is necessary with any crystal set. A complete material list, including construction details for the cabinet, can be obtained from Popular Mechanics radio department upon application without charge.

During tests with this set, programs from powerful local stations could be heard across the room when the phones were placed on the operating table.

FISHING TACKLE at LOW PRICES

Send today for our Big 100 Page Catalog listing hundreds of bargains in Fishing Tackle, Baseball, Basket Ball, Golf, Tennis, Archery Equipment, Guns, Sporting Goods and Clothing of all kinds. Here are some typical bargains:

- \$17.50 Fly Rod with Aluminum Case & 2 tips **\$8.95**
- 4.00 One Piece Casting Rod Offset Handle **1.89**
- 6.00 Level Wind Casting Reel **2.69**
- 4.00 Automatic Fly Reel **2.79**
- 1.50 English Snelled Trout Flies per doz. **.49**
- 6.50 Hagen Registered Wood Golf Clubs **3.45**
- 5.00 Hagen Registered Matched Steel Shafted Irons **2.25**
- 8.50 Golf Bag, 7 in. 2 large Zipper Pockets **5.75**

All merchandise guaranteed. You'll save if you join thousands of sportsmen who purchase all their requirements at the Gateway. Free Catalog—Yours for the asking. Invaluable to every sportsman. Contains the famous 'Fisherman's Calendar.'

GATEWAY SPORTING GOODS CO.
1330 PM MAIN ST. KANSAS CITY, MO.



TURN
THEM
INTO
MONEY

BUILD THESE PROJECTS

Easy to build. Easy to sell. Beautify your lawn or garden. Note the special low prices on BLUEPRINTS ORDERED FROM THIS AD.

- ACTUAL BLUEPRINTS (Fully detailed and dimensioned.)
- Model B-25 DUTCH WINDMILL, 24 in. high (girl churning butter)..... \$0.50
 - Model B-30 DUTCH WINDMILL, 24 in. high (farmer using butter)..... .55
 - Model B-10 DUTCH WINDMILL, 32 in. high (Hexagon style)..... .75
 - Model OM60 OLD MILL, 30 in. high (16 inch diameter water wheel)..... 1.00
 - Model F-100 CAPE COD LAWN CHAIRS..... .50
 - Model M-10 MARTIN HOUSE (8 family Castle Style)..... .50



SPECIAL: ANY 3 OF ABOVE PRINTS ONLY \$1.00.
LAWN-FAIRY TALE FIGURES, PATTERNS (Approx. 20" high)
Dutch Schoolboy, Holland Pair, Sunbonnet Girl, Dutch Tulip Girl, Jack and Jill, Little Bo-Peep, Puss-in-Boots, Red Riding Hood, Peter, Peter, Tom The Piper's Son, each 35c.

(Note: Color arrangement included on all patterns. Trace direct to wood.)
SPECIAL: ANY 5 OF THE ABOVE PATTERNS, \$1.00.
Dutch Schoolboy Doorstop pattern FREE with each order. For CATALOG illustrating many models, kits and supplies, SEND 10c.

CRAFTSMAN'S MODEL CO., Dept. P-2, 2030 N. 41st St., Milwaukee, Wis.

DON'T Be Hand-capped for Want of CLAMPS

Plenty of clamps is true economy and good craftsmanship—assure firm joints when gluing, accurate drilling and sawing, for clamps hold work rigidly. From 40 types we furnish industry, these 3 clamps are best for the home shop. If your dealer hasn't genuine "Jergensen" and "Pony" Clamps, order direct.

Genuine "Jergensen" Handscrews grip at all angles, never slip, split or loosen. All Sizes. Send \$3.20 plus postage (7 lbs.) for 2 No. 1 Handscrews—open 6".

Pony Miniatures 9 types—1" to 2 1/4" cap. Not toys but fine tools with 100 uses.

Pony 500 Fittings go on ordinary 3/4" pipe. Any length. Send \$2.00 (new low price) plus postage (6 lb.) for fittings for 2 Pony 500 Clamps.

CAT-ALOG FREE

Adjustable Clamp Co.
"THE CLAMP FOLKS"
421 N. Ashland Ave., Chicago, U. S. A.

Home Craftsmen, Schools, Hobbyists METAL CASTINGS



produced in your own workshop allow you to design and build your own GASOLINE ENGINES, STEAM ENGINES, STATUARY, ART OBJECTS, SPECIAL TOOLS, NEW INVENTIONS, ETC. You can also make forgings and case harden steel. Your shop is not complete without a FOUNDRYETTE. Three sizes are available capable of making bronze castings of 1 1/2, 3, and 6 pounds weight, aluminum, copper, brass, etc., in proportion to specific gravity.

Domestic gas supply and 110 volt 60 cycle energy required for operation.

Size	Crucible Capacity	Shipping Wt.	Price Complete
351	6 cu. in.	25 lbs.	1 1/2 lbs. \$ 9.50
352	12 cu. in.	40 lbs.	3 lbs. 15.00
353	24 cu. in.	65 lbs.	6 lbs. 23.50

For 110 volt D. C. or 25 cycle Universal motor instead of 60 cycle motor add \$4.00. Aluminum Casting Alloy 30c.

Prices f. o. b. K. C. Check or money order acceptable, express charges C. O. D. Write for circular.

KANSAS CITY SPECIALTIES CO.
P. O. Box 6022 Kansas City, Mo.

Here's why
MASONITE
TEMPERED
PRESWOOD
is the leader in
trailer materials



MANY of today's finest trailers are made almost entirely of MASONITE TEMPERED PRESWOOD—because this material answers the three vital problems in trailer construction:

STRENGTH—Grainless, moisture-resisting, MASONITE TEMPERED PRESWOOD withstands constant stress, strain and exposure to the elements without warping or cracking.

LIGHT WEIGHT—Since these boards are made of natural wood fibers, held together only by natural lignin, their weight is much lower than other, less durable materials.

BEAUTY—As illustrated above, the natural finish of TEMPERED PRESWOOD is ideal for interior walls and ceilings. Requires no special treatment for exterior surfaces. Can be varnished, painted, enameled if desired.

For achieving extra satisfaction in building trailers, or other articles requiring hard, smooth surfaces, be sure you know the advantages of MASONITE TEMPERED PRESWOOD. Mail coupon for FREE samples and further details.



MASONITE CORPORATION, Dept. PM-2
111 W. Washington St., Chicago, Ill.

Please send FREE sample and more information about MASONITE TEMPERED PRESWOOD.

Name _____
Address _____
City _____ State _____

THE PROFESSIONALS CALL THEM

"Sweet Cutting Files"

In the plants where a man's filing ability determines his income, they call Nicholson Files "sweet cutting".



And in YOUR WORKSHOP, where a file's cutting determines the quality of what you make you'll find these files are the sweetest you ever used.



Nicholson Files are made according to the principle of "controlled irregularity." It's a special arrangement of tooth points that removes far more metal, corrects the tendency to side-slip, accounts for the high cutting speed of Nicholson Files.

Sold by alert hardware dealers everywhere. Nicholson File Company, Providence, Rhode Island, U. S. A.

PATENTS PENDING

A FILE FOR EVERY PURPOSE

FOR YOUR HOME WORKSHOP

Stanley Plan Book giving step-by-step instructions for building 16 useful articles. • Stanley Tool Guide shows how to use and care for all common woodworking tools. • "How To Work With Tools and Wood" is a 185 page book showing how to use tools, how to select materials, plan your work and finish it. More than 150 illustrations.

Things to make in your HOMEWORKSHOP



16 complete plans

10¢

STANLEY PLAN BOOK 16 complete plans 10¢ per copy.

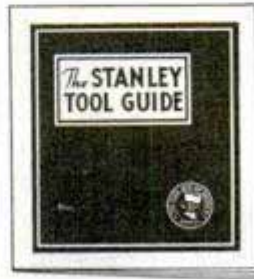

STANLEY TOOL GUIDE 32 big pages of information 25¢ per copy.

STANLEY BOOK "How To Work With Tools and Wood" 185 pages \$1.00 per copy.

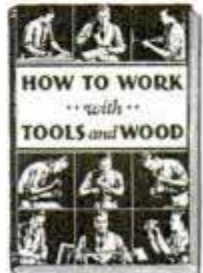

Send check, money order or stamps for your copies to



STANLEY TOOLS

105 Elm Street, New Britain, Conn.

In answering an advertisement with a coupon, be sure to write name and complete address clearly. Sometimes advertisers are unable to respond to inquiries due to lack of complete information.

GO INTO BUSINESS MAKE 100% TO 300% PROFIT!

Sell new and used clothing direct from your home, auto or store. Undercut all competition. EASY SALES—FAST REPEAT ORDERS! We furnish everything and show you how. Handsome profits every day in the year. No selling experience necessary. Write at once for our Big Money Catalog—It's FREE! Liquidation Merchandise Co., 550 E. 43rd St., Dept. D-16, Chicago, Ill.

EXTRA \$5 in SPARE TIME PRINT at HOME

Letterheads circulars, billheads, cards, Printing jobs BIG. Easy, interesting, educational. PRINTING PRESS BARGAINS \$12. Types and Supplies, lowest prices. Send stamp for catalog. PEIFFER Co., 6-B, 6 Columbia St., Newark, N. J.

NEW Light Weight Paint Sprayer—Only \$29.50
 1/4 H.P. Motor AC110 Volts. 60 Cycles—COMPLETE
 Quick, easy way to paint screens, furniture, radiators, machinery—anything—in homes, Factories, Stores, Schools, Hospitals, Office Buildings, etc. Small, compact. Carry anywhere. Weight 44 lbs. Complete with Spray Gun; 15 ft. Hose. FULLY GUARANTEED. Only \$29.50 f.o.b. Chicago. \$5.00 Deposit, Balance C. O. D., or see your dealer. Free Circular. Ideal Pump Co., Dept. P-2, 801 Washington St., Chicago, Ill.

Make Hundreds Fascinating Electric-Radio Experiments

29 PIECES—FREE INST. MANUAL
 110-volt A.C. power motor, microphone, transformer, many other pieces genuine commercial apparatus. Wire up thief detector, extension phone, electric welder, radio code set, electro-plating, arc furnace, circuit tester, 110-volt rectifier, 110-volt motor, etc. Build arc light 4,000-ft. range, secret service phone (listen in private conversation), generate health rays, make electric stove, etc. Original cost of parts \$3.99 (\$18.50.) SPECIAL.....

25 Pc. Radio Exp. Kit
 Free Instruction Manual

Almost a "University in itself!" Finest apparatus. All the parts necessary to make scores of radio hook-ups. Contains variable low-loss condensers, polarized test receiver, crystal detector, many special resistors, condensers, sockets, test clips, coil form, form, enamel wire, aerial wire, bolts, screws, nuts, test sheet, etc. \$3.99 (Retail price \$15.) SPECIAL.....

6 BOOKS FREE! Value \$5.50! Given with order for either kit. "Short Course in Electricity," "Short Course in Radio," "Electricity Are Mankind," "Motor-Transformer Manual," "Fun with Electricity," "Plans for Exper. Lab." ORDER NOW! 3¢ stamp brings Electrical Radio, Tool and Kit bargain catalog.

ELECTRICAL SALVAGE CO., Box 524-A16, Lincoln, Nebr.

America's Most Amazing Radios!

WITH
THE

AND

MAGNA-SPAN DIAL VITA-TONE SPEAKER



Astonishing
tuning
speed



Thrilling
new beauty
of tone

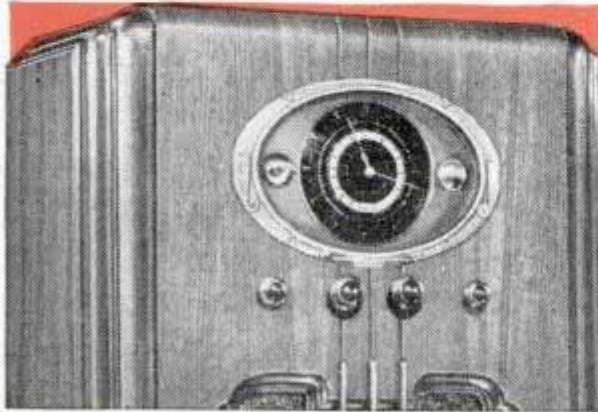

NEW *Knight* RADIOS

38 Models to choose from—As low as \$8.45!
5-19 Tubes—See them in ALLIED's Catalog

1937 Knights—the marvels of the radio industry—bring you sensational new developments in radio—new Giant Magna-Span Dials, and mighty "Vita-Tone" super-dynamic speakers, plus perfected metal tubes, Flywheel Tuner, "Electric Eye", Visual-Wave Band Indicator, etc. Their tone quality, sensitivity, selectivity, volume capacity, all-around performance at such amazingly low prices again prove that only **ALLIED** is able to offer such tremendous values. All-Wave, Dual-Wave and Short-Wave—5-19 tubes—AC, AC-DC, 6-volt, 32-volt battery and auto sets—a set for every purse and purpose.

1937's GREATEST VALUE! Knight 11 Tube All-Wave Superhet

Tunes 3 full bands—brings you the world—powerfully, dependably. Metal tube circuit—RCA and Hazeltine licensed—gives fullest sensitivity—reaches out farther—perfect reception, powerful performance on every band. New 12" Vita-Tone Speaker. New 11" Magna-Span Dial with every new and exclusive device for simplified tuning. Beautiful rolled-top console cabinet. See full description on pages 8-9 of **ALLIED's Free Catalog**.

A SENSATION!

Knight 5-Tube AC Superhet

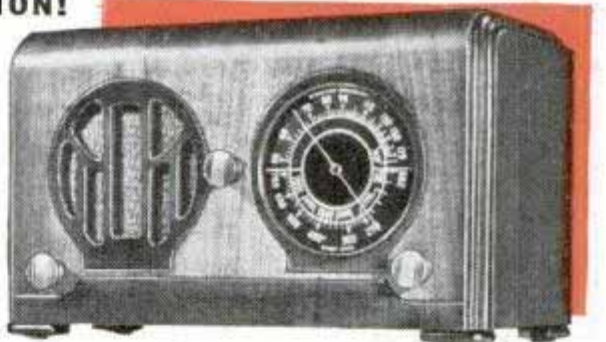

An amazing 5 Tube Dual-Wave Value—actually achieves 8-tube efficiency! Tunes 2 Full Bands—Short Wave, police, aviation, amateur 'phone—and Foreign 49-meter Reception, besides standard Broadcasts. Latest RCA licensed circuit—rubber-floated tuning condenser; 8 tuned circuits, Automatic Volume Control. 5 1/2" Vernier dial, 6" Electro-dynamic speaker. Beautiful cabinet. 1937's Radio Sensation—see Back Cover of **ALLIED's Free Catalog**.



FREE PARTS LISTS for Radio Builders!

Write for Free parts lists covering P. M. 1 Tube Portable (R209); 2 Tube AC-DC (R211); Beginners' 3 Tube All-Wave (R224); 1 Tube Flashlight Cell Set (R227); 18 Watt Amplifier (R230); 150 Watt X'mitter (R231); "A-B" Power Unit for 6 Volt Sets; Beginners' S-W 2 Tuber (R232); 6 Tube AC-DC 2-Band Super (R233), and many others. **ALSO**—see pages 125-6-7 of your **ALLIED Catalog** for other new, low-priced Build-Your-Own Kits.

10,000 RADIO PARTS-TOOLS-AMATEUR GEAR-SOUND SYSTEMS-BOOKS
AT LOWEST PRICES

You need **ALLIED's Free Catalog**, whether you sell, service or build radios, install P. A. Systems or operate a "ham" station. It shows Everything in Radio. Besides amazing new Knight Radios, its 152 pages include over 10,000 exact duplicate and replacement radio parts. Test Equipment, latest Public Address Equipment for every Sound need, Amateur Transmitting and Receiving gear, dozens of new Build-Your-Own kits, Rurlpower units and Winchargers, etc.

Faster Service—Lower Prices—Highest Quality

We buy in vast quantities, get lower prices, and sell for less, passing the resulting savings on to you. Our complete stocks are located under one great roof—central location for faster shipping; and real, personal service. Every item tested and approved by **ALLIED** expert engineers. See all these great radio values in the new 1937 **ALLIED Catalog**. If you don't have a copy, send coupon now!

FREE
Catalog



ALLIED RADIO CORP.,
833 W. Jackson Blvd., Chicago, Ill., Dept. 5-B

Rush me a Free copy of your 152-page 1937 Catalog showing the 38 new Knight sets and complete Radio Supplies.

Send me Free Parts List for Kit No.

Name.....

Address.....

City..... State.....

ALLIED RADIO CORP.

833 WEST JACKSON BLVD. CHICAGO, ILL.

NEW-TYPE BATTERY

**GUARANTEED AS LONG
AS YOU OWN YOUR CAR**

STRONGEST BATTERY GUARANTEE EVER WRITTEN

No matter how long you own your passenger car—no matter how far you drive it—if the Goodrich Kathanode Electro-Pak you buy for it fails to give satisfactory service in that car, The B. F. Goodrich Company will replace it without charge, as clearly stated in the written guarantee.



SPUN GLASS RETAINER MATS LIGHT AS A FEATHER . . . Feather-light spun glass retainer mats give long life to this new Electro-Pak, assuring steady flow of current—preventing the loss of active power-producing materials in the plates.



THE ONLY BATTERY WITH THIS POWER-SAVING TOP COVER . . . This exclusive Top Cover shields all exposed points—protects against acid spray, dirt, corrosion, short circuits. It keeps Electro-Pak's extra power locked in. Get one today at your Goodrich Tire and Battery dealer's.

Goodrich
KATHANODE
Electro-Pak BATTERY

Portable 2-Tube Emergency Set

(Continued from page 259)

the set. Note that the antenna is fastened directly to the cathode of the detector tube instead of through a condenser into the grid as in common practice. This permits maximum coupling without the usual loading or damping effect.

Assuming that the builder already has a set of headphones, this little set can be built for about \$5.00, including tubes. A list of the original parts used can be obtained from Popular Mechanics radio de-

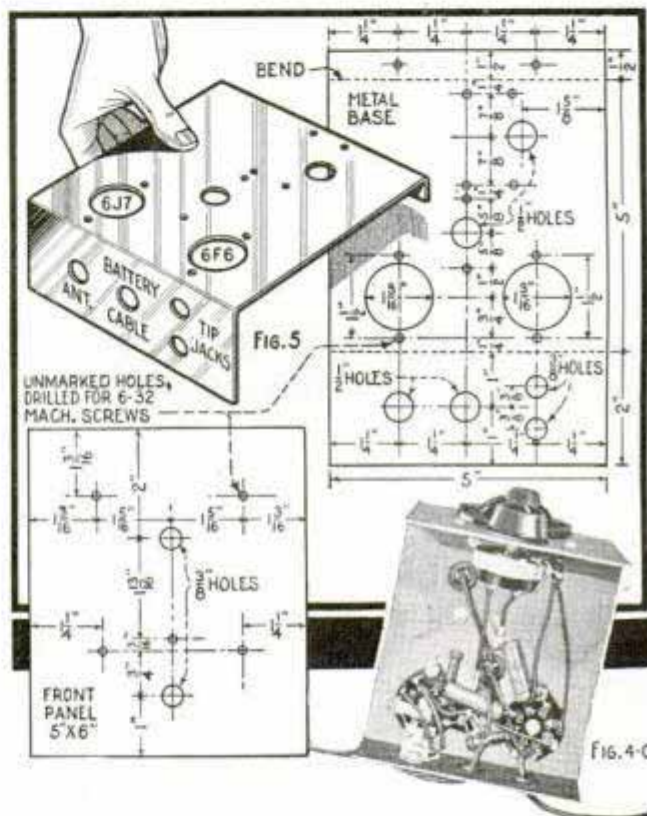

partment upon application, without charge. The blueprint number is R-234. To place the receiver in operation, clip the battery leads across the 6-volt battery as shown in Fig. 1, turn on the switch which is combined with the regeneration control and throw the attached 25-ft. flexible rubber-covered antenna out the window, or support it in any convenient manner. A 50-ft. antenna is best for distance but tunes broad on locals. Adjust the regeneration control about half-way in, and tune over the dial until you pick up a whistle which indicates a station. Now back off the regeneration control to a point where the station comes in clearly. Extremely weak distant signals will be heard best with the regeneration control set where it is just ready to spill over into oscillation.

3150
Metal Plating Easy as Painting
 with Electric Brush

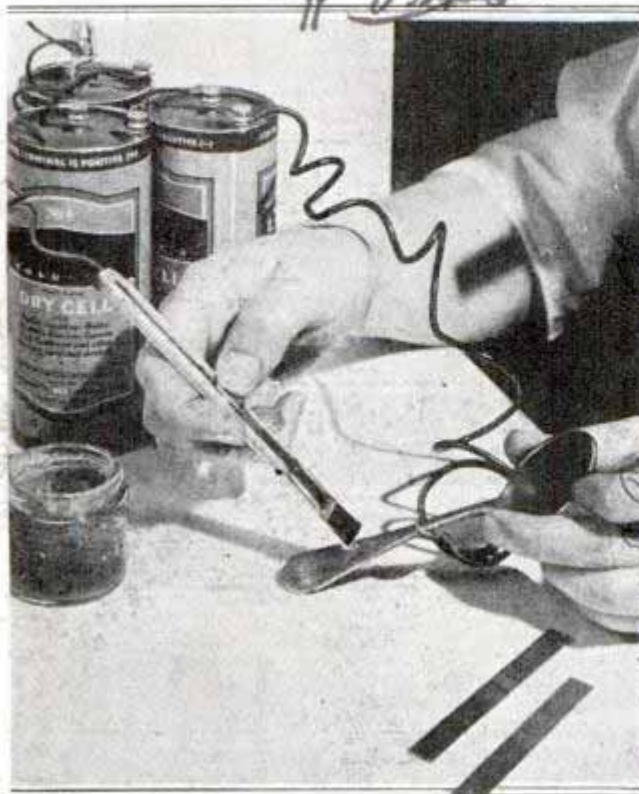

Replating a spoon with electric brush which has been dipped in jar of metal "paste"

Electroplating has been made as simple as painting by a recently patented process which consists of an electric brush and a non-liquid electrolyte. The metal compound, available in various common and precious metals, is merely spread with a brush to which direct current is fed by a thumb-pressure control in the brush handle. Dry cells, storage battery, or any convenient source of direct current ranging from three to twelve volts can be used. The brush is attached to the positive terminal, and the surface being plated to the negative. It is useful not only for plating entire surfaces, but for touching up worn spots or stenciling free-hand designs. Dense deposits can be produced where desired by instant control of current. Plating is quick and positive. Since the compound is non-liquid, it can be worked in overhead positions or on machine parts without danger of dripping. It is essential to clean the surface thoroughly before plating.

Whenever you find that you wish to know more about any article in this magazine, write our Bureau of Information, inclosing return postage.

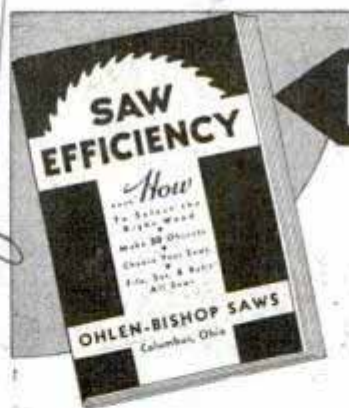

FREE BOOK

INVALUABLE TO EVERYONE WHO WORKS WITH WOOD!

HUNDREDS of pointers for your home workshop! 60 pages, over 200 illustrations and diagrams. Learn about—Woods, their various characteristics, tensile strengths, and uses; how to make 50 objects; how to joint, set, file, and refit all saws; and other facts. Get the benefit of methods proven throughout Ohlen-Bishop's 85 years' experience in master saw making.

KNOW YOUR SAWS MAIL TODAY

THE OHLEN-BISHOP CO.

905 Ingleside, Columbus, Ohio

Send my copy of "Saw Efficiency."

Name

Address

City

WHIZ ELECTRIC TOOL

Does a real professional job of Drilling, Grinding, Polishing, Carving, Sanding, Buffing and Sawsing. **\$5.95 Only Postpaid**

POWERFUL—SWIFTY—DEPENDABLE
 Speeds up hundreds of jobs for shop and home. Needed by every home craftsman, mechanic and carpenter. Full size chuck, 1/2 inch capacity. Triple geared to extra powerful motor. Self-enclosed fan prevents over-heating. Ball-bearing thrust. Pistol grip with thumb switch. Universal motor for A. C. and D. C. Money back guarantee.

FREE a set of drills plus your choice of mounted grinder or drum sander with each WHIZ tool ordered now. Complete outfit only \$5.95 postpaid.

Paramount Products Co., Dept. 3A, 245 Bd'y, New York, N. Y.



MANUFACTURING OPPORTUNITIES



IN BUILDING INDUSTRY—with machine and process producing permanent construction with savings of 1/3 labor, 1/2 mortar, and 1/3 material costs—ashlar, hollow, veneer or solid walls—plain or 40 colors.

WE EQUIP YOU with Automatic Machinery—large production only one or two men. Equipment costs but fraction of other processes with equal capacity.

INVESTIGATE—let us show you why building today offers you the greatest opportunity for growth, expansion and profit in a business of your own, using raw materials available in your territory. Write today.

W. E. DUNN MFG. CO.

600 West 24th St. Holland, Michigan

NO BOSS! SURE CASH! SILVERING MIRRORS

Autoparts, Reflectors. Combination outfit. Write **SPRINKLE, Plater, 129, Marion, Indiana**



With A-B-C-D Scales. Multiplies, divides, squares, takes square root, finds circumference and area of circles, 6 inches long—thin construction. **NO WOOD OR CELLULOID.** Fits in vest pocket. Send \$1 in cash, money order or check and receive slide rule with genuine leather case and instructions. Box M-4.

M. MANHEIM COMPANY, Inc. 15 E. 26th St. New York, N. Y.

Taken over by

360 N. Michigan

Wash. St. Plater

The New Simplified 40 Volt Arc Welding

Earns \$150 to \$300 Extra Profit Monthly Pays for itself

WITHOUT COST TO YOU Hobart pays its own way out of profits in a short time, without a cent of cost to you. The Hobart payment plan is the most liberal offer ever made.

HOBERT PORTABLE ARC WELDER

30 DAYS TRIAL at Our Risk to Prove it Pays
Mail Coupon for further Details

START BIG PAYING BUSINESS "Simplified" 40 VOLT ARC WELDING

New low prices on modern 40 Volt "Simplified" Arc Welders make this big pay business available to shops that never before could afford it. It opens the doors to the bigger profit jobs. The new Hobart is easier to operate, much faster. This is today's opportunity. Don't miss it.

Build Your Own
Portable Welder with Hobart Generator unit and auto engine or chassis. Lets you operate any place, especially on the profitable outside jobs. Easily saves you \$300 to \$500.

Portable Electric
New low cost on small sizes as well as large. The most profitable arc welder your shop can own. Welds faster, better, easier, saves current.

Easy to Operate
Hobart Welders have "Simplified" operation. This means faster welding—with the right current for every job. Hobart is simplified, so any of your men can weld easily and successfully. The mystery and uncertainty of obtaining correct welding current settings are removed.

60% Extra Capacity
Over old style 25 Volt Welders—necessary for welding with the new coated rods. Automatic reactance lets you handle light welding work without losing the arc. Users don't understand how they got along with the old style welders after using this new Hobart.

Remote Control
at no extra cost with Hobart. Think of being able to control your welder from any working point. Saves time, temper, and eliminates the need for a helper on overhead or concealed work.

"Pays-For-Itself" Terms
Extra earnings and savings make it easy for you to own a Hobart without expense to you. You can even rent a new Hobart—and later purchase it without loss of rent. Check Rental Purchase Plan.

GET THIS VALUABLE MANUAL
Sent Free if you will tell us the welding you plan doing.

HOBERT BROS.,
Box M-27, Troy, Ohio

Tell me more about—

() Building My Own Portable () Complete Gas Welder () Engine Drive Welder () 30 Days' Trial—Easy Terms

() Rental Plan Privilege of Purchase.

() Send FREE Manual on Welding. Attached letter tells about the work we want to do.

Name.....

Address.....

Interested in 30 DAYS' TRIAL EASY TERMS

HOBERT ONE OF THE WORLD'S LARGEST BUILDERS OF ARC WELDERS

READY CUT HOMES

Prices start at \$416, freight paid; save \$500 or more. Designs are all modern, practical, distinctive. Ready-cut houses complete ready for cut, quick, easy assembly. Includes lumber, insulation material, spring bronze weather stripping, built-in ironing board, medicine cabinet. Attractive l-panel doors and latest hardware. Also, complete plans, nails, lath, paint, varnish, shingles, etc. Range of 100 homes, summer cottages, garages, etc. Full color catalog and complete descriptions sent for 25c coin or stamps to help cover costs.

INTERNATIONAL MILL and TIMBER CO.
Dept. P-27, Bay City, Mich.

FULL COLOR CATALOG FOR ONLY 25c

FACTORY TO YOU

WRITE for FREE CATALOG

KITSELMAN FENCE

Heavier, tougher, pure zinc galvanizing. Stronger, tougher Copper-Bearing Steel. Same low Factory Prices. WE PAY FREIGHT. 160 styles and heights Farm, Poultry and Lawn Fence; Steel Posts, Gates, Barb Wire, Paints, Roofing. Write today.

KITSELMAN BROTHERS
BOX 94 Muncie, Indiana

Ask for FREE Catalog

ITALIAN ACCORDIONS

OF ALL TYPES. Hand-made, best quality. Buy direct from our factory and save 1/3. Satisfaction guaranteed. Used musical instruments taken in trade. FREE accordion lessons.

ITALIAN ACCORDION CO.
323 W. Polk St., Dept. P-4, Chicago

WORLD WIDE ALL WAVE RADIO \$1.55 POST PAID

A sensational Radio! Thousands now in use. Can actually bring in foreign stations, police calls, aeroplanes, amateurs, etc., as well as local broadcast! Short and Long Wave. Ace Radios give guaranteed results! For only \$1.55 we send you the complete kit containing an attractive metal chassis panel and every part needed to build a powerful one-tube receiver, AMAZING VALUE! Works for months on two inexpensive dry batteries. Our clear diagrams make it simple to hook up. Not a feeble crystal set!

TWO TUBE KIT (More volume)—\$2.00.
Complete kit \$3.00.
(Sets laboratory assembled and wired 75c extra.)
Enjoy NEW thrills! Send for your ACE Radio today!

Ace Radio Laboratories, 70 Barclay St., Dept. P-2, N. Y. C.

In answering an advertisement with a coupon, be sure to write name and complete address clearly. Sometimes advertisers are unable to respond to inquiries due to lack of complete information.

TECHNICAL BULLETINS

Technical Data Simplified for the Practical Man

A New and Valuable Popular Mechanics Service • \$1.00 Each

Here is a valuable, inexpensive service for mechanics, inventors, technical specialists and practical craftsmen of all kinds. Popular Mechanics Technical Bulletins give the needed basic and practical information on a wide variety of subjects—briefly, concisely and simply presented—yet complete in every detail. No advanced mathematics, chemistry or physics needed to understand them. Material never before in print, now specially prepared in bulletin form. Postpaid \$1 each or sent C.O.D. in United States. Ask for list of complete bulletin service.

- D-101—Using Nichrome Resistance Wire.—Features electrical appliance repairs.
- D-102—Cleaning Products for all Purposes.—Includes ten formulas for making.
- D-103—Automobile Specialty Chemical Products.—Complete instructions for making wide-selling products.
- D-104—Silver Soldering and Brazing.—Includes data, methods and materials needed.
- D-105—Latest Gas-Welding Practice.
- D-106—Rewinding Electric Motors.—A difficult subject made simple and easy.
- D-107—Electro-Plating with Copper, Nickel and Chromium.
- D-108—Electro-Plating with Gold and Silver.
- D-109—Electro-Plating with Zinc and Cadmium.
- D-110—Electro-Plating Non-Metallic Objects and Electro-Forming.
- D-111—Designing and Building Transformers.
- D-112—Designing Electro-Magnets.
- D-113—How to Design Solenoids and Plunger Magnets.
- D-114—Designing Thermostats for Air Conditioning and Heat Control Purposes.
- D-115—Flexible Molds for Casting Small Objects.
- D-116—Printing Photos on Cloth, Paper, Etc.
- D-117—The A B C of Air Conditioning.

POPULAR MECHANICS PRESS
Room 236B 200 East Ontario Street Chicago

When writing please mention Popular Mechanics

Save with this low-cost KRW-FORD V8 EQUIPMENT

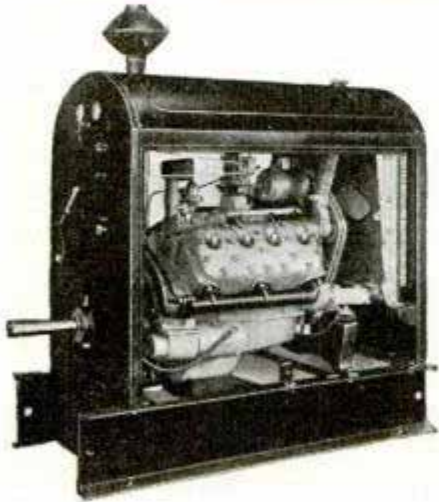

PORTABLE POWER PLANT

Up to 60-H. P., compact, portable—for welders, compressors, hoists, pumps, amusement devices, well drillers, agricultural, oil field and contractors' equipment, etc., etc. The most complete industrial power plant built. Uses gasoline or natural gas. Will pay for itself out of savings in a few weeks.



ELECTRIC PLANT

Produce your own electric power at a fraction of present cost. Eliminate peak load and stand-by charges. The most complete plant ever devised—both 110 and 220 volts at same time—every protective device — 20,000 watts. Runs on gasoline or natural gas.

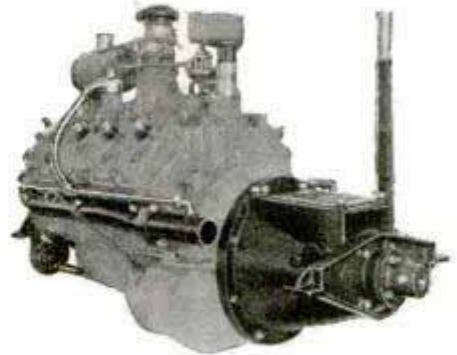

MARINE CONVERSION

The 1937 KRW-FORD V8 conversion, with its new full-lubricated, ball-bearing water pump, surpasses anything on the market. No hose—all copper-bronze connections. Paragon Reverse Gear. For speed boats, runabouts, cruisers, work boats. Conversion Kit only also available.

Also ARBOR PRESSES, AIR COMPRESSORS CAR WASHERS, BRAKE MACHINES, BATTERY CHARGERS

and complete garage and shop equipment

You can buy KRW-FORD V8 equipment thru *your local Ford Dealer*. We are exclusive builders of approved Ford Tools and Shop Equipment. New tools for servicing 1937 Fords and Lincoln-Zephyr now ready. If you buy Genuine Ford Parts you can purchase tools and equipment from us at same low cost as Ford dealers. Bulletins describing KRW-FORD V8 money-saving equipment will be mailed on request. Also bulletin describing Garage Equipment for service stations and repair shops. Get the facts—compare price, quality and performance—use the coupon.



HYDRAULIC and SENSITIVE ARBOR PRESSES
No. 37 - 35 ton \$150.00
No. 37E - 50 ton 180.00
No. 37F - 70 ton 300.00
Prices F. O. B. Factory, Arcade, N. Y.



BENCH TYPE
ARBOR PRESS

No. 37D - \$28.50

F. O. B. Factory, Arcade,
N. Y.

Shipping wgt. 140 lbs.

K. R. WILSON, 17 Lock St., Buffalo, N. Y.

Send information on the following:

Power Plant _____ Marine Conversion _____

Electric Plant _____ Bench Press _____

Arbor Press _____ Air Compressor _____

Garage Equipment as follows: _____

My local Ford Dealer is _____

(Write your name and address in margin and mail)

K. R. WILSON - BUFFALO, N. Y.

Exclusive Builder of Approved Ford Shop Equipment Since 1916

Do You Want a WATCH or DIAMOND?



Thousands have found it easy to own America's finest diamond rings, watches, silverware or jewelry by the Santa Fe Plan. Bulova, Hamilton, or Elgin watches—brilliant blue-white diamonds—silverware from world-famous companies, and the great Santa Fe Specials—offered to you at startling cash prices on confidential liberal credit terms.

A Few Cents a Day is the Santa Fe Way

That watch or diamond you've always wanted, longed for—you needn't wait any longer for it. The Santa Fe will trust you—let you wear the watch or diamond you want while you pay only a few cents a day.



TURN PIN MONEY INTO DIAMONDS

Gifts for Every Occasion

Don't Pay Extra For Credit!

No honest person should pay extra to have someone trust him. The Santa Fe trusts you the way you want to be trusted—straight from the shoulder without any extra charges, extra fees, or taxes. You pay only the low advertised cash price in small monthly payments. Send for 1937 Catalog NOW!

FREE to Adults—Send for this beautiful book today. Sent ABSOLUTELY FREE to adults. Send your name and address, and the beautiful catalog will come to you by return mail. Do it now while you think of it.

SANTA FE WATCH COMPANY
Dept. 26, Thomas Bldg., Topeka, Kans.

GAS MOTORS

Ready to run. Easy Starting. Steady running—runs 27 minutes on ounce of gas. Precision, replaceable parts. Longest crank shaft made on miniature motor. Connecting rod high speed bronze. 1/5 horse power at 300 to 8000 R.P.M. Complete, entirely assembled on stand. Tested and run before shipment—performance guaranteed. No oil, gas or batteries included. Only \$12.50. FREE—finished, mounted flywheel with every motor! Send 3c for illustrated catalogue.

G. H. Q. Model Airplane Co., 854-B E. 149th St., New York

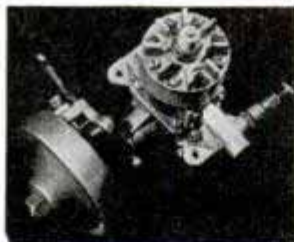

For..BIG Money-Making..Doing ALL Work

Use The EIFFEL-GEARED PIERENCH KIT



● With Universal Gear-Jaw, No. 1, it Turns with a 1/2-to-1-TON, Automatic LOCK-&-Ratchet Action. Makes Springs 1/32" to 2 1/2" Diam. (any length) of Hairline or Heavy Spring wire, and, does 1001 other things amazingly Quicker, Better, Easier!



● With PIPE Gear-Jaw, No. 2, gives 1/2-to-1-TON, 4-Point Toothed-V Grip, that Holds and Turns ALL Shapes in ALL Positions, including almost Flush Sink Nipples!



● With WIRE Gear-Jaw, No. 3, gives 1/2-to-1-TON, Edge - against - V Grip, that Coils up to 1/4" Diam. Wire, and does 101 Other Amazing things!

● You Get ALL 3... a \$50 Tool Service... at the Price of ONE Good tool in the 8 1/2" (20-Oz.) KIT; or, in the 7" (12-Oz.) KIT; and, the 2 KITS give you 9 Different Super-2-Tool Combinations!

● WHAT'S MORE... These "Miracle KITS" are making \$30 to \$85 WEEKLY, for AGENTS and DISTRIBUTORS, and We Need Many More...

● MAIL this Part of Ad TODAY with your Address (on a Postcard will do). Get FREE—this 7-Edge-End-&-Angle SCREWDRIVER... it Turns Screws in ALL Positions and does many useful things... and 101-PICTURE MANUAL OF MECHANICS, with User Offers; or, With... DISTRIBUTOR, Territory and FREE KIT Offers!

AMERICAN PIERENCH CORP. B.P.M. 4809 N. Ashland Ave. CHICAGO, ILL.



71588.

The Buried Treasure Racket

(Continued from page 163)

in front of witnesses, go directly to it with the aid of a divining rod and dig it up. The makers of such instruments cleverly avoid guarantees by which they can be held. One company states its device is "designed to locate buried treasures," instead of asserting it is actually capable of finding them. Another announces "this machine works on psychological principles and is governed by the same natural laws as the original divining rods." In this statement psychology is nothing but a big word. The only physical law that has any influence on divining rods is gravity, a force that acts equally well on peanuts. Another maker states the exact way to hold his rods for best results depends upon the personal magnetism of the user, while another qualifies his literature with the statement that his equipment "just won't work for everyone."

One treasure racketeer impressed prospective customers with a weird assembly of copper helixes and electrical instruments carried in the back of his car. This super-power detector, he asserted, was able to point directly to precious metals fifty miles away. His racket was fairly safe because he had nothing to sell. He worked on a fee basis, contacting people who believed they had treasure on their land and promising to locate it for a certain sum. He demanded half the fee as a down payment, the balance to be paid when he pointed out the hiding place of the gold, without waiting for it to be dug up. That was the catch.

He learned from a client the approximate locality where the treasure was supposed to be buried, then sent an accomplice to learn from neighbors the position the client believed the treasure was buried. After that he put on his act. Adjusting his instruments every few miles, he would drive an impressive zigzag course that finally led to where the treasure was supposed to be. Then he would order all out of range of his "powerful rays" and with rubber gloves would turn switches to operate his apparatus. Sparks and buzzing noises would emanate from the back of his car. Finally, he would announce the treasure certainly was within fifty feet

(Continued to page 158A)

HUSBAND WISES UP WIFE ON CARS



"FRANK, LOOK AT THOSE GOOD-LOOKING USED CARS. LET'S PRICE THEM!"

"NOT AT THAT PLACE. EVERY CAR HAS AS MANY PRICES AS A DOG HAS FLEAS!"



"WELL, ISN'T THAT HOW YOU DO WITH ALL USED CARS... JUST HAGGLE?"

"NO INDEED! THE STUDEBAKER DEALER UP THE STREET HAS A ONE-PRICE POLICY"



"DOES THAT HELP? HIS USED CARS AREN'T ANY BETTER ARE THEY?"

"YES THEY ARE BETTER AND HIS STUDEBAKER PLEDGE STANDS BACK OF EVERY USED CAR HE SELLS!"

BUY your used car from a Studebaker Pledge dealer. Choose from all the popular makes and pay the rock-bottom price that's marked on the car in plain figures. The Studebaker Pledge five day guarantee allows you to return the car within that time for any reason and apply the deposit on any other car, new or used, in the dealer's stock. Certified cars sold under the Studebaker Pledge carry a certificate assuring thirty days free service.

STUDEBAKER PLEDGE

... YOUR PROTECTION
WHEN BUYING USED CARS

DISTRIBUTORS RADIO CARDMEN AGENTS ATTENTION! 40 NEW 1937 MODELS



This CONSOLE Superheterodyne Floor Model

for American Regular and low wave
PLUS FOREIGN
BROADCASTS.
Only

\$19⁹⁵
AC and AC-DC
Table and Con-
sole Models

\$8⁹⁵
and up.
Special battery
operated sets
with built-in
"B" supply

\$16⁸⁵
and up.

Order **NOW**

10 DAY MONEY BACK Guarantee

A DELTA radio set for every price and purpose. BUY THESE EXCEPTIONAL RADIOS DIRECT FROM FACTORY at a big saving. Also sell direct to dealers, sub-agents, service men and consumers everywhere. Big profit for you on every sale. Build a permanent business of your own. Repeat orders and recommended customers from users will make you an exceptional income. Write at once for complete, illustrated descriptive folder, prices and FREE RADIO SALES CARD PLANS.

DELUXE MFG. CO., Dept. 302

173 W. Madison St.,

Chicago

WHAT TO MAKE *and how* to make it ON A LATHE

WRITE for these books: (1) The Home Workshop, free; (2) What to Make on the Lathe, 10c; (3) How to Run a Lathe, 160 pages, 25c. Coin or stamps accepted. Any South Bend Screw Cutting Lathe on easy terms. Priced from \$85 up.



Ask
for
Catalog
No. 15
Sent
FREE!

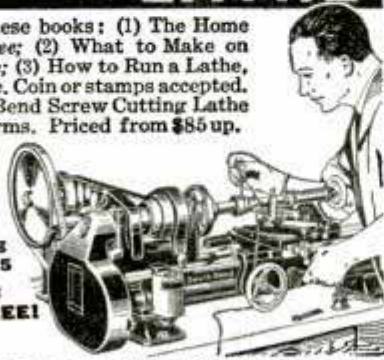

SOUTH BEND LATHE WORKS

981 E. Madison Street

South Bend, Indiana, U. S. A.

(Continued from page 156A)

but it was so big its powerful vibrations made it impossible for him to trace it closer. All the client got for his money was a good show.

Most authorities believe many treasure troves are still buried in the United States although they think most of the caches amount to only a few hundred or a few thousand dollars. They are mostly the savings of individuals who buried them for safekeeping. Nearly all the stories of vast treasures amounting to millions of dollars are mere hoaxes, they believe. Another thing they point out is that the average person, in burying treasure, would likely dig only a foot or so into the ground. Some have been buried five or six feet but many that have been found were located only a foot or so below the surface. Nevertheless, disappointed treasure hunters are apt to keep on digging long after they have passed a reasonable depth.

"You can break your neck tumbling into deep holes treasure hunters have dug around old ruins in the southwest and in Mexico," an archaeologist declares. "Common sense should have told the hunters no one needs to burrow so deeply."

In California two treasure hunters, spurred on by the actions of a magic gold detector, dug a twenty-foot shaft, then a sixty-five-foot shaft in a fruitless hunt for pirate gold. It took them several years, working part time, and all they got out of it was the exercise. In another instance, following the quivering of a gold needle, hunters dug a group of shafts twenty-five feet deep and ran cross-tunnels like a regular mine. The gold is still there, if there ever was any. In a third case hunters honeycombed the top of a hill with a maze of galleries. In all these cases there was no real reason to think that treasure had been buried so deeply.

During the last few years electrical instruments working on the inductive principle have been put on the market. Some of these have real merit in indicating the presence of metallic objects or ore close to the surface, but none is able to distinguish between metals. An inductive machine operates by flooding the adjacent earth with high-frequency radio waves thrown off by a loop aerial, with another aerial a few feet away to receive the waves. A

(Continued to page 160A)

Trindl ELECTRIC ARC WELDER



Works Off Any Storage Battery or Ordinary Light Socket

This new electric arc welder is made possible by the invention of a low voltage carbon. Auto batteries may be used without removing from car. Uses about the same current as four headlight bulbs. Broken parts are simply melted together by the white hot electric arc, in just a few seconds. Produces about 7,000 degrees heat.

Hottest Flame Known

Melts iron and steel instantly. Welds fenders, radiators, holes in bodies, milk cans, tanks, brazes broken castings. Works on anything—iron, steel, brass, copper, tin or galvanized metal. Permanent repairs made for almost nothing. Used by factories in many operations. Positive money-back guarantee by a responsible firm. Send for yours today.

TRINDL PRODUCTS
2229-BV Calumet Ave., Chicago, Ill.

AGENTS

Men with cars to sell mechanics, repairmen, farmers, radio and battery shops, factories. Five-minute demonstration makes sales. **Up to 150% PROFIT.** Write Today—Now!

NEW FREE TRAILER PARTS CATALOG

Shows 329 valuable trailer items. Build your own trailer or recondition the one you have. Wholesale prices for quality merchandise. Send for free money saving catalog today.
C. M. Hoof Company, 1736 S. Michigan Ave., Dept. P-2, Chicago, Ill.

PAINT SPRAY OUTFITS

Electric Paint Spray Units complete \$14.50 and up. 1-30 H.P. - Universal Motors G. E. Phonograph Motors, Electrical Tools for Home Workshops. Send for free Catalog.

Dept. 01

NATIONAL ELECTRIC TOOL CO.
560 W. Washington Blvd., Chicago, Ill.

MAKE GLAZED CONCRETE PRODUCTS
Beautiful, colored, glazed concrete pottery made from sand and cement without molds or costly tools. Tiles, novelties, wall glazing, waterproofing. No experience needed. Money making employment. Send 10c for booklet, color plate, details.
NATIONAL POTTERIES CO., 13 West 26th Street Room 21
Minneapolis, Minn.

BUILD CLOCKS
for
PLEASURE - PROFIT



Hall clocks are high priced in stores—you can make good money building them or electrifying spring clocks. Dime brings "HOW" Book pricing banjo, desk, mantel, RADIO, spring, ELECTRIC, chime, BATTERY from \$1.40. Brass weight movements from \$16.95 with drawing of easily built Grandfather Case—start now
CHIME CLOCK COMPANY, Bldg. 1, Guiltsberg, Iowa

SELLEY SHIP MODEL FITTINGS

SEND FOR DIE CAST-BOXWOOD-BRASS PARTS at NEW LOW PRICES! CATALOGS 5c. Largest and most complete range of QUALITY FITTINGS.

SELLEY MFG. CO., Dept. 802, 1377 Gates, Brooklyn, N.Y.

VENETIAN BLIND MATERIALS

You can make fine blinds for your own home at low cost, also go into the business. All parts supplied. Send 10c for circular and samples of ladder tape, cord, slats and rails.

R. A. Peterson, 6900 North Ashland Blvd., Chicago, Ill.

INVENTORS Be Sure to See Page 23A

When writing please mention Popular Mechanics

Start This Business in Your Spare Time at Home.

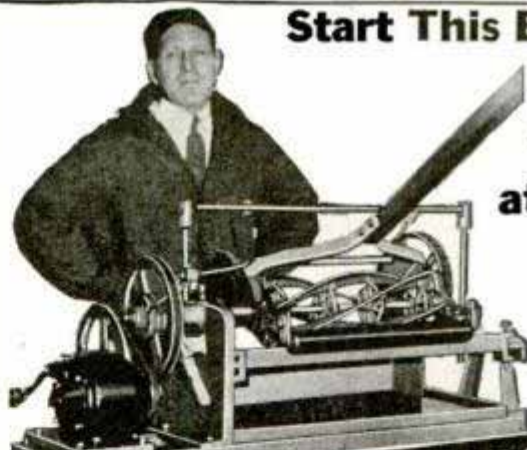

This Is the Way! To Make MONEY!

That is what hundreds are saying about the Foley Electrakeen Lawn Mower Sharpener business. J. LeVert, N. Y., made up to \$104.50 a week clear profit last season. J. W. Anderson, Texas, reports increasing business for each of last 3 years.

No Canvassing Necessary Free plan tells you how to start. The Foley Electrakeen Lawn Mower Sharpener turns out perfect work quickly and easily, no experience needed. Simply put the mower in the machine and turn on the power. Uses same system as lawn mower factories. Sharpens all sizes and types in 15 or 20 minutes. You get \$1.00 or more for each job.

Special Offer: Attachment for grinding axes, hatchets, knives, etc., included FREE with Foley Lawn Mower Sharpener on our Special Offer, brings you business the year around. Best season just ahead. Send postcard today—no salesman will call.

FOLEY MFG. CO. 207-7 Foley Bldg., 11 Main St. N.E., Minneapolis, Minn.

We also make the **FOLEY Automatic SAWFILER**

Files hand, band, circular saws. Saves eyestrain—does perfect work. Used by over 3000 repair shops.

(Continued from page 158A)

change of resistance in the ground such as would be caused by the presence of metal objects or rich metallic ore helps to conduct the current with less resistance and the change may be detected with sensitive meters or earphones. Portable inductive apparatus is reliable only for shallow depths and merely indicates the presence of buried current-conducting bodies, whether treasure trove, meteorite, or a collection of old tin cans.

Successful treasure hunters have had good results with this type of equipment although not all types of inductive equipment are suitable for amateur use. Some types, for instance, are not compensated for body or ground capacity and may react to streaks of wet soil or moist grass roots. To be worthwhile, such a machine should not react to such conditions even when lowered to within a few inches of the ground. Even the best equipment of this sort is useless on an ocean beach that contains much black magnetic sand. It is likewise incapable of locating metallic objects under a few feet of water. The best way to find submerged outboard motors or underwater treasure chests, the experts declare, is to go down and look for them.

There are also various other ways of conducting underground explorations. These are used in the science of geophysics, are highly technical and require long training. The best any of these methods can do is to indicate the presence of some foreign mass below the surface. The most widely used method is that of electrical resistivity. In this, two or more electrodes connected to a power source are planted some distance apart in the ground. Then, with two prods connected to a sensitive meter, an expert makes an electrical survey of the surface. He plots the lines of current flow between the electrodes. If some conducting mass such as a ledge of rich ore is hidden below the surface, the lines of force are attracted toward it and the expert is able to locate the body. This method is said to be useful for exploring down as far as 1,500 feet.

Another way of using electricity is the self-potential method in which natural currents in the earth, generated by certain minerals in the presence of underground moisture, are measured. Depths down to about 500 feet can be explored this way.

Nonelectrical methods include the use of the torsion balance in determining the gravitational pull of underground masses. This is a highly specialized and difficult field but is a well recognized way of locating salt domes and large bodies of certain heavy ores.

The seismic method, in which artificial earthquakes are generated by explosions close to the surface, is one kind of exploration used in hunting for new oil fields. The elapsed period from the time of the explosion until the wave bounces back from underground strata allows the depth and contours of the strata to be measured. Seismic exploration, however, does not indicate the presence of oil, but merely makes it possible to locate domed formations under which oil might be found.

In the magnetic method, a magnetometer is used for pointing out changes from the normal position of magnetic lines of force. This is valuable in determining the presence and position of bodies of magnetic ore but is worthless in hunting for nonmagnetic kinds. Radioactive materials such as ores containing minute amounts of radium can be detected by means of Geiger tubes. These are tools of the geophysicists. All of them, however, are practical only for studying comparatively large masses and are no good for finding a small chest, even if there were a million dollars inside it.

F1601 Miter Guides Hack-Saw Blade and Guards Its Teeth

Preventing the blade from wiggling and its teeth from breaking, a handy miter is available for hack saws. It enables the saw operator to make square and diagonal cuts.

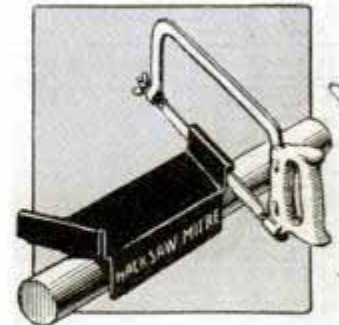

Popular Mechanics Magazine does not publish the name of the maker of, or dealer in, any device described in its pages, but this information will be furnished by our Bureau of Information upon request, accompanied by stamped envelope.

Hanson Mfg. Co.
Blvd.
Los Angeles, Calif.

Well of the Padres His Living Tomb

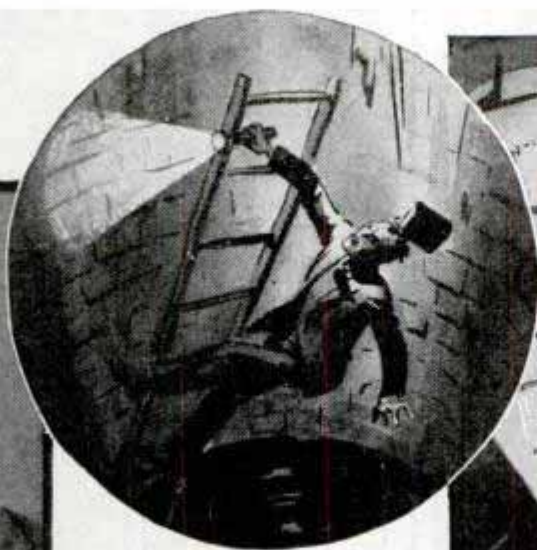

San Diego Reporter, Weak from Loss of Blood, Cheats Death in Ancient Shaft

"For nearly two hundred years this death-trap had awaited its human prey... that was the grisly thought uppermost in my mind, as I fought for life in the ancient crumbling mission well of San Diego de Alcala," writes E. P. Lyle III.

"First, as I was climbing down to explore an opening at the water level, a loose tile struck me on the head; then the rickety ladder slipped, plunged me dazed and bleeding into the water.

"But I had clung to my flashlight and as the cold water cleared my senses, I

could see it shining under the surface. Paddling to keep afloat, I swung the light as best I could around the well. A rusted old pipe attached to the wall offered a hand hold, and was stout enough to hold me as I fought off growing dizziness from loss of blood, and climbed hand over hand to where my companions could reach me.

"They would have pulled a corpse out of that well if it hadn't been for the DATED Eveready batteries in my flashlight—batteries that were really *fresh* when I bought them months before. I would certainly have lost consciousness and drowned before my friends could have reached the mission (a quarter mile away) and returned with rope and a *E. P. Lyle III* light."



← **EVEREADY BATTERIES ARE FRESH BATTERIES**

NATIONAL CARBON CO., INC., 30 East 42nd St., New York, N. Y.

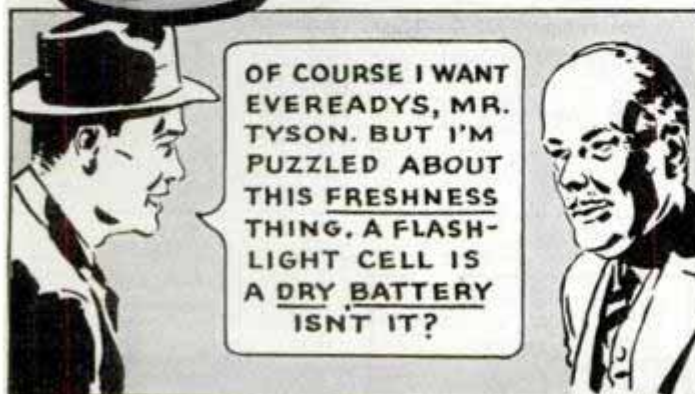

BIG MONEY!

ASSEMBLING MEAD'S

New PORTABLE KI-YAK

IN A FEW DAYS AT HOME!



—from Complete Cut-To-Fit Construction Kit!

Weigh as little as 20 LBS.

Use with PADDLE! OARS! SAIL! MOTOR!

Assemble for PROFIT or Personal FUN! NO Experience Needed!

MEAD'S perfected, patented, aluminum-ribbed Cut-To-Fit Construction Kit GUARANTEES successful assembly easily, quickly, *INEXPENSIVELY*—in a few days at home with simple hand tools without previous experience. Build yours for personal sport use, or sell at splendid profit! Mead's quality KI-YAKS (available in 4 models, kits or factory assembled) are beautiful and PORTABLE. Take yours anywhere by hand or car for paddling, sailing, rowing, outboarding, touring, fishing, camping, hunting. Leak-proof. Seaworthy. Durable. THOUSANDS in use. Strong as a giant—light as a feather! More fun at less cost! \$6.00 Double-Blade Paddle GIVEN with your CR Ki-Yak—if you hurry! Mail 10c and Coupon below for Giant Colored Circular, Money-Making Plan, special offer, Low Introductory Prices!



OK-2

Weights only 50 lbs. Takes ANY Outboard 4 1/2 H. P. or less!

AMAZING LOW COST!

Don't buy any boat until you see the amazing Low Introductory Prices on MEAD KI-YAK Construction Kits and Factory-Built jobs. (You can even Pay As You Build, on our special Progressive Group plan!) EARN money assembling, selling! Remember, Mead KI-YAKS are unsurpassed... the lightest, strongest, most portable boats of their kind! Join in the FUN—and PROFITS being made. Rush Coupon and dime NOW for Free details BEFORE prices go up!

Mail Coupon NOW!



OK-2 as rowboat



OK-2 as motor boat. Convertible in 10 minutes into fast sailboat.



OK-2 as sailboat

\$6 PADDLE GIVEN

with your CR-KI-YAK—if you hurry!

Gentlemen: I enclose 10c as handling, postage charge. Please rush your New Colored KI-YAK Circular, Low Introductory Prices, Money-Making Plan and \$6 Gift Paddle Offer. (Please Print Plainly.)

NAME.....
STREET & NO.....
CITY..... STATE.....

RUSH ME WITH 10c TO

MEAD GLIDERS
15 S. MARKET ST. DEPT. B-27 CHICAGO, U.S.A.

New-TYPE Cheap OIL BURNER INVENTED

Sweeping the Country!

COOK and HEAT Without Coal or Wood

In Your Present Stove or Furnace—HOTTER—CHEAPER—No Dirt or Ashes—Twice the Heat Quick at HALF THE COST.

COOKS A MEAL for LESS

Beats any oil burner ever gotten out for low cost, perfect performance. Burns cheap oil a new way, without pre-generating or clogging up. Quick intense heat by Simple Turn of Valve.

Try At Our Risk 30 DAYS' TRIAL

Prove it ends drudgery and dirt of coal or wood; cuts fuel bills in half, pays for itself quickly by what IT SAVES.

FREE SAMPLE FOR AGENTS

offered to one energetic man or woman in each locality who will demonstrate and take orders. Write quick, be first to learn how to make REAL MONEY right now, spare or full time—mail 1c postcard today.

UNITED FACTORIES, B-751 Factory Bldg., Kansas City, Mo.

AGENTS Salesmen BIG MONEY

Drop Everything for this Quick Seller. Clark of Ind., sold \$3 in 20 days. Get YOUR OWN oil burner FREE and make REAL Money. Write now.



Slips into ANY STOVE RANGE or FURNACE

Quick HEAT at Turn of Valve!

DEAF? AMAZING NEWS!

You may hear like normal again! Amazing new instrument releases deaf from misery and embarrassment.

The Godsend, new Scientific, Electrical Hearing Aid, is guaranteed to give you same strain-free power to hear as instruments selling for \$50, \$75, \$100, and more. PRICED AT ONLY \$19.75, complete! Backed by \$1,000.00 Money-Back Guarantee. Now you may enjoy sermons from back of church, lectures, conversations, radios, movies. Complete with Microphone, powerful Amplifier, Batteries, and TWO Appliances for BONE or AIR CONDUCTION, both for less than the usual price of only ONE. Music and words heard distinctly from all directions at close range or from distances. No distortion—no head noises. Instrument is lightweight, easily concealed in clothing, no more noticeable than a pair of glasses. Write quick for FREE DETAILS, sent in plain envelope. Godsend Company, Dept. R-418, 3785 Beechmont, Cincinnati, Ohio.



BUILD CLOCKS with our help

Cash in on the demand for Mantel, Banjo, GRANDFATHER'S CLOCKS. Ask about new, low-priced Clock and Special Blue Print Offer. Send dime for illustrated working drawing, Catalogue FREE.

AMERICAN CHIME CLOCK CO. Philadelphia, Pa. 1673 Ruffer St.

IDEAL 24. in. Model of the Clipper Ship

CUTTY SARK

A beautiful, perfect Model of this famous, fast sailing Vessel. IDEAL Construction Kit contains Fully Carved Hull, Stamped Wood Decks, Lifeboats, Anchors, Bits, Chocks, Steering Wheel (all Cast Metal), Chains, Masts and Spars, Sail Cloth, Rigging, Cement, Colored Lacquer, etc., including Full Size Plans. Complete for \$2. Plus 15c Postage. Ask Your Dealer, or Order Direct.



Send 5c for Catalog Model Ships, Model Airplanes, Parts, Supplies.

IDEAL AEROPLANE & SUPPLY COMPANY, Inc. 26 West 19th Street New York N. Y.

New Low Prices	
3 1/2 in.	10c doz.
1 3/8 in.	12c doz.
3 1/8 in.	15c doz.
1 1/4 in.	18c doz.

Cast Metal DEAD EYES Postpaid.

For Everybody Interested In Science



This Issue Will Tell You:

What accounts for the differences between European and American automobiles.

Why 75 million families buy co-operatively.

How our weather forecasters are studying the stratosphere.

When our calendar will be off a full day.

What industries use tung oil.

What insect makes elaborate provision for the care of its young that it will never see.

SINGLE COPY 25¢

A YEAR'S SUBSCRIPTION \$2.50

USE THE COUPON

Among first day buyers of the first issue of Science Digest at one newsstand were a manufacturer, an army officer, an executive of a large corporation, a university professor, and a dentist. Within a day many newsstands sold out, and within a few days subscriptions began to come in—as many as three from a single reader.

And now the second issue—February—is on the stands—full of articles of scientific interest to business, technical and professional men.

Get your copy today. From the scientific publications of the world Science Digest selects the important features and condenses them, for busy men, into concise, clear, time-saving, easy-to-read articles.

You can buy the February Science Digest at your newsstand today or send the coupon below if that's more convenient to you.

Science Digest,

631-643 St. Clair St., Chicago, Ill.

Gentlemen: I enclose

25c for February Science Digest

\$2.50 check or money order for a year's subscription beginning with February issue.

Please bill me for year's subscription.

Name.....

Street.....

City.....State.....

STRONGEST PADLOCK ever built!



NO. 1 SECRET SERVICE '51

Laminated like a bank vault door!

ONLY Master PADLOCKS
protect you with patented laminated security!

Sold by dealers everywhere.
MASTER LOCK COMPANY
916 W. Juneau Ave., Milwaukee
World's Largest Exclusive Padlock Manufacturers

OVER 52,800,000 IN USE



ACE Set

Tools for every operation on metal-cutting lathes
\$14.50

Insist on ACE Tool Holders Drop forged by ARMSTRONG, makers of cutting tools used by 96% in industry. ACE TOOL HOLDERS with Cutters and Wrenches in fitted steel case — Turning, Boring, Knurling, Threading and Cutting off.

Write for Circular
ARMSTRONG BROS. TOOL CO.
"The Tool Holder People"
360 N. Francisco Ave., CHICAGO, U.S.A.



Trailer Travel Magazine

If interested in trailer lore, as owner, builder, buyer or prospect, you want the only magazine devoted exclusively to trailer news, stories, features, designs and plans; touring and camping; laws, and directory. Profusely illustrated. The Trallerite's guide. 10c

For 12 issues mail \$1, or for sample copy 10c

TRAILER TRAVEL, PM2, 35 E. Wacker Drive, Chicago, Illinois

'2 to '3 An Hour

Make Big Money in Saw Filing Business!

NO EXPERIENCE NEEDED to file hand, band and circular saws with FOLEY Automatic Saw Filer. J. W. Anderson, Texas, writes: "My fourth year with Saw Filer and third with FOLEY Lawn Mower Sharpener as side line. Business has increased until it is about full time."

Used by Leading Saw Makers

Atkins, Disston, Simonds and by industrial plants and repair shops all over U. S. Cash work. No canvassing. No eye strain. Postcard brings FREE PLAN. No obligation. FOLEY MFG. CO., 216-7, Foley Building 11 Main St. N. E., Minneapolis, Minn.



File 19 Wooden Ships and Iron Men

(Continued from page 221)

built for Baines of Liverpool by the Boston "wizard," Donald Mackay. Before these clippers appeared upon the scene, history had been made by British-built ships. The famous "Marco Polo" was the best and fastest of these. She made two round-the-world voyages in eleven months and ten days, setting a pace for this greatest of all ocean racecourses, some 30,000 miles in length, that was never subsequently beaten. In harbor this ship flaunted a large canvas sign, extending from mast to mast, on which was displayed the legend "Fastest Ship in the World," and at her main truck she flew the "Cock in his Triumph." This ship with her record passage of sixty-seven days to Melbourne was the one the Maine clippers had to beat. Their work was cut out for them.

"Lightning" was built in 1854, and Forbes came across the Atlantic to take her over from the builders' yard. Laughlan Mackay sailed in the ship as passenger and builders' representative, and he must have proved a tower of strength to Forbes; when the latter on an occasion remarked to Mackay that it appeared inevitable that the "sticks" would be taken out of the ship by the gale then blowing, Mackay replied, "Don't worry, captain, you couldn't drive the masts out of her if you tried, my brother built the ship."

On this maiden passage the ship broke all records, she crossed, port to port, in 299 hours. In one day she sailed 436 miles, a record for all time, and several times did twenty-one knots. At that date no steamer had ever approached that great day's run within 150 miles.

"James Baines" was a larger "Lightning" by 430 tons and she followed her sister in 1855. On her maiden voyage she crossed to Liverpool in two hours less time than had her sister, so there was little to choose between them. She then went out to Melbourne in sixty-three days, with 702 passengers and 365 sacks of mail. In one day she sailed 423 miles and several times reached twenty-one and one-half knots, and during this phenomenal run every stitch of canvas was set, even to the lightest "gossamer." Such a feat was unique, and proves she was a truly noble vessel.

(Continued to page 166A)

Increase Your Earning Power

Apply time and labor-saving kinks to your work. Your efficiency will soon be recognized and you will be in line for advancement.

If you do machine shop work of any kind, sheet-metal work, painting, carpentry, auto repairing, farming, concrete work, plumbing, electrical work, welding, building-glass work, general repairing, tool-making, poultry raising, masonry or home repair work, get this

LIBRARY OF 2000 TIME AND LABOR SAVING IDEAS FOR SHOPMEN AND HANDYMEN

JUST OUT

SHOP NOTES for 1937

357 Articles
703 Illustrations
224 Pages
Price 50c
See partial list
of
contents below

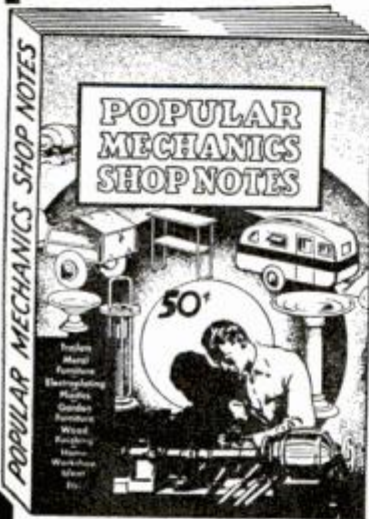

Including the new 1937 issue illustrated above, there are five volumes in the Shop Notes Library of 2000 easily understood short cuts to every-day jobs. Here are just a few of the subjects taken from the latest issue:

Alloys, Electroplating With	Fly Chaser for Door Folding Bed in Auto	Sawhorse for Uneven Floors
Belt Sander	Fruit-Picker's Ladder	Shop Heating Unit
Cesspools, Repairing	Gold, Finding	Soldering Aluminium
Concrete Garden Furniture	Humidifier for Furnace	Thermistats, Designing
Dovetails, Making	Magnet Recharger	Tools from Drill Rod
Dowel Making	Metal Awnings	Trailer, Contractor's
Efficient Farm Weeder	Metal Furniture	Truck Lift, 3 Speed
Electric Motors, Servicing	Oil Finishing	Universal Tripod for Camera
Electrical Test Board	Photo Enlarger	Window Displays, Novel
Electroplating Non-Conductors	Photo "Spot" Light	Window Sign "Flasher"
Family Auto Trailer	Plastics, Working With	Winter Starting Aids
Fence Posts, Pulling	Pottery, Concrete	Wood Lathe Used for Metal Turning
	Resilvering Mirrors	Wooden Bowl Forming
	Rewinding Auto Generators	

Each volume contains approximately 400 articles and 700 illustrations and has 200 or more pages. This unrivaled library of shop helps may be secured for a limited time only. After the present supply of books is exhausted the offer must be withdrawn.

* **Send No Money**

POPULAR MECHANICS PRESS,
200 E. Ontario St., Room 236, Chicago, Ill.

Send me, as per your offer, the following books. I will pay postman price and small amount of postage. My money will be refunded if I am not satisfied. (Check what you want.)

- 1937 Shop Notes and Lathe Handbook (Metal Working), both for 98c.
 Shop Notes Library (5 vols.) \$2.50.

Name.....

Street and No.....

City..... State.....

* C. O. D. applies to U. S. and possessions only. If you reside elsewhere, remittance must accompany order.

BONNEY TOOLS are the *finest* that money can buy



BONNEY D3 SOCKET WRENCH SET
Compact set of 16 plated and polished 'CV' Chrome-Vanadium steel double-hexagon Sockets, $\frac{1}{8}$ " to $1\frac{1}{4}$ " and 15" Hinge Handle with cross handle, in enameled metal box. Ask your Jobber, or send postcard for Catalog M. Bonney Forge & Tool Works, Allentown, Penna.

Combination — Wood and Metal Lathe

12 in. over bed
36 in. between centers
TIMKEN BEARINGS
Back geared screw cutting .001" accurate
50 to 3200 r.p.m.
Write for catalogue
CLAUSING MFG. CO. Dept. 527 OTTUMWA, IOWA

INVENTORS

BE CAUTIOUS Before You Make A Move — Get These Facts!

Invention, like everything else, is a business—you must know what you are doing. First, you must know how to obtain patent—then, how to market your invention. Don't move in the dark—get the complete story of Patents and the Inventive Field before proceeding.

Over 100 illustrations are in this book. Entire chapters are devoted to the value of a patent in promoting the final success of your invention.

HERE IS
WHAT YOU
MUST
KNOW!



MAIL
COUPON
NOW!

HOW TO PROCEED

Our FREE 48-Page Book takes you from the first step in obtaining patent to the last step in commercializing your invention. Everything you need to know is in this book—prepared by experts with years of training in the patent field. We have served thousands of inventors in the United States and we can serve you very reasonably on liberal terms. Don't delay—learn what you must do today—Send for our FREE Book, "Patent Guide" and "Record of Invention" Blank.

CLARENCE A. O'BRIEN & HYMAN BERMAN

19-T Adams Building, Washington, D. C.

Registered Patent Attorneys Before U. S. Patent Office

Please send me your FREE BOOK, "Patent Guide for the Inventor" and your "Record of Invention" form, without any cost or obligation on my part.

NAME.....

ADDRESS.....

(Important: Write or print name plainly)

File 19

(Continued from page 164A)

HANDEE TOOL OF 1001 USES

**Grinds - Drills - Cuts - Polishes
Carves - Routs - Saws - Sands
Sharpens - Engraves**

A whole shop full of tools in one for work on all metals, alloys, bone, resins, glass, stone, wood, etc. Uses 200 accessories. Saves hours of tedious work. 13,000 r.p.m. A C or D C, 110 volts. \$10.75 and up, postpaid. 3 Accessories Free.



Plug in any Socket

DE LUXE MODEL

For constant service, nothing compares with this easy-to-handle production tool. Saves time and labor. Fastest, smoothest, most powerful tool for its type and weight. 25,000 r.p.m. \$18.50 postpaid, 6 Accessories Free.



Get a Demonstration at Your Dealer's or Order Either Model on 10-Days Money-Back Trial. Catalog Free.

CRAFTSMAN'S PROJECT BOOK

"Pleasure and Profit with a Handee" Easy working plans for making many interesting and unusual projects, 25c stamps or coin.

CHICAGO WHEEL & MFG. CO.
1101 W. Monroe St., Dept. Q. Chicago, Illinois

Send Catalog Project Book \$10.75 Handee De Luxe Model PM3

Name

Address

In 1857 the ship was taken for trooping to India. "Lightning" was also taken and she beat all the steam transports not by hours or days but weeks. Later editions of "James Baines" were "Champion of the Sea," "Chariot of Fame," "Donald Mackay," "Pharaoh's Daughter," and "Blue Jacket," all built for, or early sold to, Britain, and all true clipper ships.

The last-named vessel was lost by fire off the Falkland Islands, and two years and nine months afterward her figurehead, a blue-jacketed seaman of pre-Civil War times, was washed on shore at Rottneest Island, West Australia, to stand on the lawn of the Governor's summer residence there for many years, and then be chopped up for firewood by a cheerful vandalistic idiot who knew no better.

The clippers have now gone from the surface of the Seven Seas; they remain but a legend and a name. The stately sea-queens, each with her grace, her glory, paid toll of fire, storm, reef, and leak, to perish on the rocky coasts of Anno Domini and find a last resting-place from their labors in Dead Man's bay. "Sleepe after toyle. Porte after stormie seas."



E. J. Pegram London W.C. England.
Electric Clock Runs for a Year

Fl 470 on Flashlight Battery
will be a gent man

Run by a battery instead of alternating current, an electric clock manufactured in England is said to operate for a year on a flashlight battery. The "works" consist of a balance wheel and hair spring with an additional weight to even up any irregularities; a small catch on the balance staff makes a contact on every return of the balance system, and this energizes an electromagnet to give an impulse to the system. At the same time the clock hands are moved forward. The contact is maintained for only one-twentieth of a second, so power consumption is small.

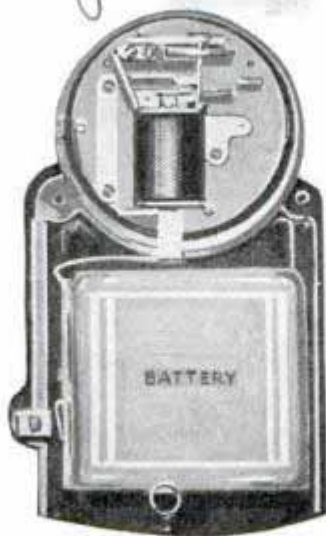

GET INTO ELECTRIC WELDING—MAKE \$150 TO \$300 EXTRA MONTHLY!

Low Investment . . . Liberal Time Payments . . . Easy to buy the New Guaranteed FlexArc Welder.

Hundreds of shops are now taking in new high-profit jobs by providing customers with the big savings of electric welding. YOU can do the same with low investment. But make sure you get a wide-range, high-capacity set. Don't make the mistake of buying a welder that can only handle small jobs. The New FlexArc is the one machine that does all types of welding at lowest cost. Revolutionary new-type design; easiest to use on the market today; makes welding completely safe.

Backed by Written Guarantee—Westinghouse, a company that has made electrical history for 50 years, is the only manufacturer that has dared put its guarantee in writing.

Build Your Own—All you need is an auto engine, chassis and the FlexArc Generator. Make your own Portable Welder and easily save \$300 to \$500.

Electric-Driven FlexArc—Portable or stationary types available. If you have electric power this is most profitable FlexArc for you.

Gas Engine Driven—Portable or stationary models, Dodge truck engine, with electric starter.

Earn While You Buy—New Easy-Payment Plan enables you to pay for your FlexArc out of monthly profits. Send coupon NOW for details. J 20248



30-Day Trial
 Easy Payments
 Priced Right!

Westinghouse Electric, Room 5N1, East Pittsburgh, Pa.
 Without obligation send your new "1937 Catalog of Popular FlexArc Models." I am interested in: Building my own Electric Driven FlexArc Gas-Engine Driven 30-Day Trial Easy Payment Plan.
 Name _____
 Address _____

Westinghouse Flexarc Welder

FASTEST SELLING WELDER ON THE MARKET TODAY

— JIM'S PIMPLY FACE MADE HIM BALKY ABOUT GOING PLACES

➔
READ STORY



Don't let Adolescent Pimples keep YOU from making new friends

Countless boys and girls shun company and avoid "dates," because they hate to be seen with a pimply face.

After the start of adolescence—from about 13 to 25, or even longer—important glands develop and final growth takes place. The whole body is disturbed. The skin gets oversensitive. Waste poi-

sons in the blood irritate this sensitive skin. Pimples result.

Fleischmann's fresh Yeast is helping thousands of young people to overcome adolescent pimples. It clears these skin irritants out of the blood. Pimples go. Eat 3 cakes daily—one before each meal—plain, or dissolved in a little water—until skin clears. Start today!



— clears the skin
by clearing skin irritants out of the blood

New 1937

SOUTH BEND Back-Geared Screw Cutting PRECISION LATHES

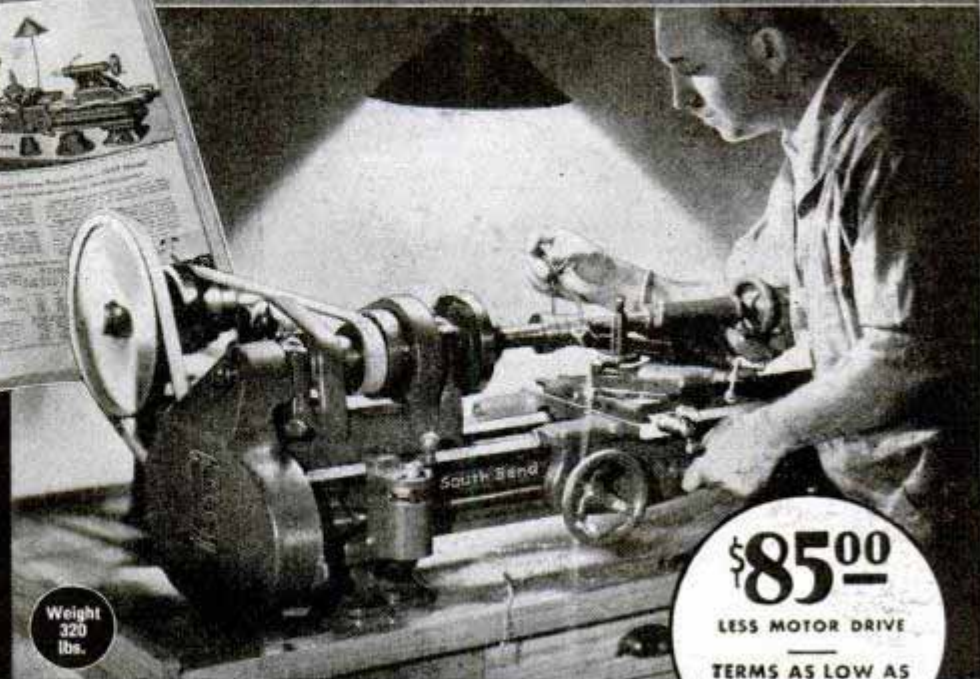
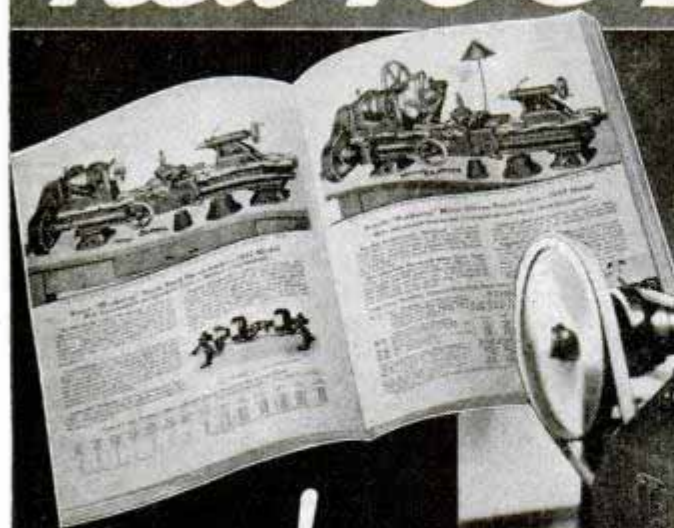

Free!
WRITE FOR THIS
NEW CATALOG
15 K

Weight
320
lbs.

\$85⁰⁰
LESS MOTOR DRIVE
TERMS AS LOW AS
\$7⁰⁰
A MONTH

No. 415-YA 9 1/8" swing by 3' bed Workshop Bench Lathe with Horizontal Motor Drive, 1/4 h.p. Reversing Motor, Switch and belt tension countershaft as shown above **\$116**
(*\$29 Down, \$8 a month for 12 months*)

THE new 1937 model 9-inch Workshop Lathe is a Back-Geared Screw Cutting Precision Lathe, with Twin Gear Reverse to lead screw, Ball Thrust Bearing on Spindle, Longitudinal Screw Feed to Carriage, Precision Lead Screw for cutting screw threads—and scores of other important features.

Especially recommended for fine accurate work in the plant, shop and toolroom. Used by all important industries in this country and abroad. Takes 38 practical attachments for milling, grinding, draw-in collet chuck work, and many other manufacturing jobs.

Write for Catalog 15K, illustrating and describing the new 1937 Model Workshop Lathe in 8 different drives—4 bed lengths. Shows the 38 attachments for use with this lathe. A valuable booklet to anyone interested in metal working lathes.

Use coupon below.

SOUTH BEND LATHE WORKS

614 E. Madison Street
South Bend, Ind., U.S.A.

5 OTHER SIZES
9", 11", 13", 15", 16"
SWING.
IN ALL BED
LENGTHS
PRICED
\$87 to 1200.

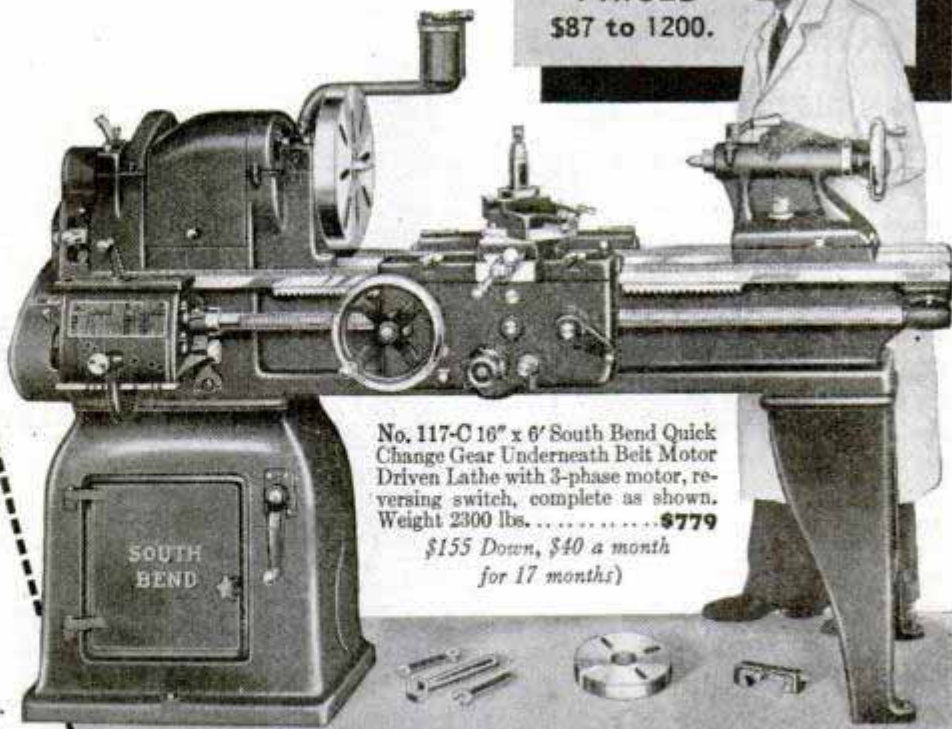

No. 117-C 16" x 6' South Bend Quick Change Gear Underneath Belt Motor Driven Lathe with 3-phase motor, reversing switch, complete as shown. Weight 2300 lbs. **\$779**
\$155 Down, \$40 a month for 17 months

South Bend Lathe Works,
614 E. Madison St.,
South Bend, Ind. U.S.A.

Please send me your new 1937 Catalog
15-K.

Size of lathe interested in
Class of work
Name
Address State
City

SOUTH BEND Precision LATHES

TO EARN MORE MONEY • HAVE MORE FUN

Invest in PRACTICAL PROFITABLE Books



Whatever your interest—whatever your need—here are books that will help you. Popular Mechanics experts have selected them for you. Books to help you on your job . . . to help you to a better job . . . to help you earn extra money in spare-time work . . . to profitably develop a hobby . . . to gain advancement through home study. Other books for entertainment and recreation.

Successful businesses . . . profitable sidelines . . . doubled incomes . . . have resulted from a single idea. Popular Mechanics Books are filled with money-making ideas. Select from the list on this page. Profit with the latest and best-proven facts—ideas and information.

SELECT FROM THIS LIST

AUTO POWER: A fine, practical book on winding auto generators and converting "Model T" and other units into 110 and higher voltages. \$1.00.

EASY-TO-MAKE TOYS: 67 varied and novel designs. Just the thing for the home workshop or a guide to an interesting small business. \$1.50.

BOAT BOOK: Just published! New edition with six additional boats. Build your own boat. Full directions and details for all types small pleasure craft. 312 pages. Illustrated. \$3.00.

DYKE'S AUTO ENCYCLOPEDIA: World's Greatest Auto Book. New 17th edition just out. Now more than ever before the only book for auto and shop mechanics. 1396 pages. 4,600 illustrations. Cloth. \$6.00.

MODERN RADIO SERVICING: This radio man's "Book of Knowledge," by Ghirardi, covers every phase of radio servicing today. 1,300 pages. 706 illus. \$4.00.

AIR CONDITIONING: By Riesbeck. The book of the hour in this big new field. Get started in America's next big industry with this new, authoritative work. 369 pages. Illustrated. \$3.50.

DIESEL HANDBOOK: By J. Rosbloom. The standard book on modern Diesel practice. Adopted everywhere for instructions in land, marine, locomotive, automotive, aero and portable services. 544 pages. Illustrated. \$5.00.

OUTDOOR SPORTS: The one book for out of doors folks. Covers everything, including homemade equipment. For young and old. 352 pages. 650 Pictures. Cloth. \$2.00.

SHIP MODEL: Build finest ship model of them all. Sovereign of the Seas. A real masterpiece. Detailed instructions, plans, etc. Authentic design. 180 Pictures. \$1.00.

REWINDING SMALL MOTORS: Details of repair shop practice for rewinding all fractional horse power motors. \$2.50.

FURNITURE DESIGN AND CONSTRUCTION: Shows how to design and make tables, chairs, desks, lamps, shelves, candlesticks, etc. \$2.50.

COLONIAL FURNITURE: The finest Colonial furniture adapted for home and school shop reproduction. An excellent book for the home furniture maker. Illustrated. \$3.50.

WOOD TURNING: A real course of instruction in this fascinating art. Starts with simple operations. Includes spiral turning and complete jobs. \$1.50.

PROSPECTOR'S HANDBOOK: Tells what minerals to look for and where. How to locate, sample, test, appraise, mine and market; also prices. \$3.00.

HIGH SPEED DIESEL ENGINES: New practical book includes fuel injection, combustion systems, frames, cylinders, running gear, construction details. Clearly written. \$2.50.

200 TRICKS YOU CAN DO: By famous Magician Thurston. Explains 200 tricks the average person can easily learn and do. \$1.00.

STEEL SQUARE POCKET BOOK: A complete, practical and handy treatise on best methods of using carpenter's steel square. Pocket size. \$1.00.

PRACTICAL MECHANICAL DRAWING: For individual study, shop classes, trade and high schools. \$1.00.

MODERN ELECTRIC AND GAS REFRIGERATION: By Althouse and Turnquist. Covers entire field of installation, service and repair. 850 pages. 368 illustrations. \$5.00.

THE BOY MECHANIC: A Four Volume Library Every Boy Should Have. Think of it—4,000 things boys can and want to make. Single volumes (each complete in itself). \$2.00. Four volumes \$7.00.

BIRD HOUSES: Build to sell; easy designs, standard types, houses for many kinds of birds. \$1.00.

BUILT-IN FURNITURE: Take orders, make money! Practical, popular furniture. Fits waste spaces in homes. \$2.00.

CHEMISTRY, PRACTICAL EVERYDAY: Make hundreds things daily use. 2300 formulas and recipes. New, practical, commercial. \$2.00.

DOG TRAINING: Home, stage, movies, etc. Dog lovers! Learn the experts' methods of training. Train your dog. \$1.50.

SHEET METAL WORKERS' MANUAL: A complete book of 15 sections covering every phase of sheet metal work. \$2.00.

V-8 FORDS: Also "A" and "B" Models. Construction, operation and repair. 715 pages. Illustrated. \$2.50.

FORMULAS: 10,000 money making processes you can use right at home to make quick selling products. \$4.00.

LATHE WORK (Metal): Drilling, threading. 2 volumes, comprising hundreds of valuable shop kinks. Illustrated. \$1.00.

LOG CABINS: Easy plans; build for profit. Value! Complete building instructions. Covers fireplaces. \$2.50.

POULTRY: Breeding, management. For those interested in making Poultry pay. Develop phenomenal layers. \$2.00.

ELECTRONIC TELEVISION: New, non-technical book of the hour. Get the "inside" on a new industry. 200 pages. Illustrated. \$2.50.

RADIO PHYSICS COURSE: New edition. 992 pages. 500 illustrations. All about radio explained step by step. \$4.00.

ELECTROPLATING: Practical book of modern methods. Includes zinc, cadmium, and chromium plating. Also copper, gold, alloys, other metals and metal coloring. \$2.25.

SHOP NOTES LIBRARY: 5 vol. 2000 Wonderful shop ideas. Volumes reprinted annually from Shop Notes section Popular Mechanics. \$2.50.

WIRING: Approved economy methods for homes, buildings. Standard up-to-date book meets every requirement. \$2.50.

2000 WAYS TO MAKE MONEY

A THOUSAND WAYS TO MAKE \$1,000: Tried and Tested Methods that Work — That You Too, Can Use. How hundreds of men made their first \$1,000 in their own business. \$2.50.

MONEY MAKING IDEAS: 1000 spare time ways to make money. Practical guide for young and middle aged men and women, students, boys, girls. \$1.00.



SEND NO MONEY—BOOKS SHIPPED C. O. D. IN U. S.

Select books from list above. Help yourself to more profitable—more enjoyable days. Send No Money. Pay postman above prices plus postage. (C.O.D. in U. S. and possessions only). Add ten cents for each book for postage if remittance is sent with order. Act Now.

POPULAR MECHANICS PRESS

Room 237—200 East Ontario St., Chicago, Ill.





...one of the first pleasures of 1937

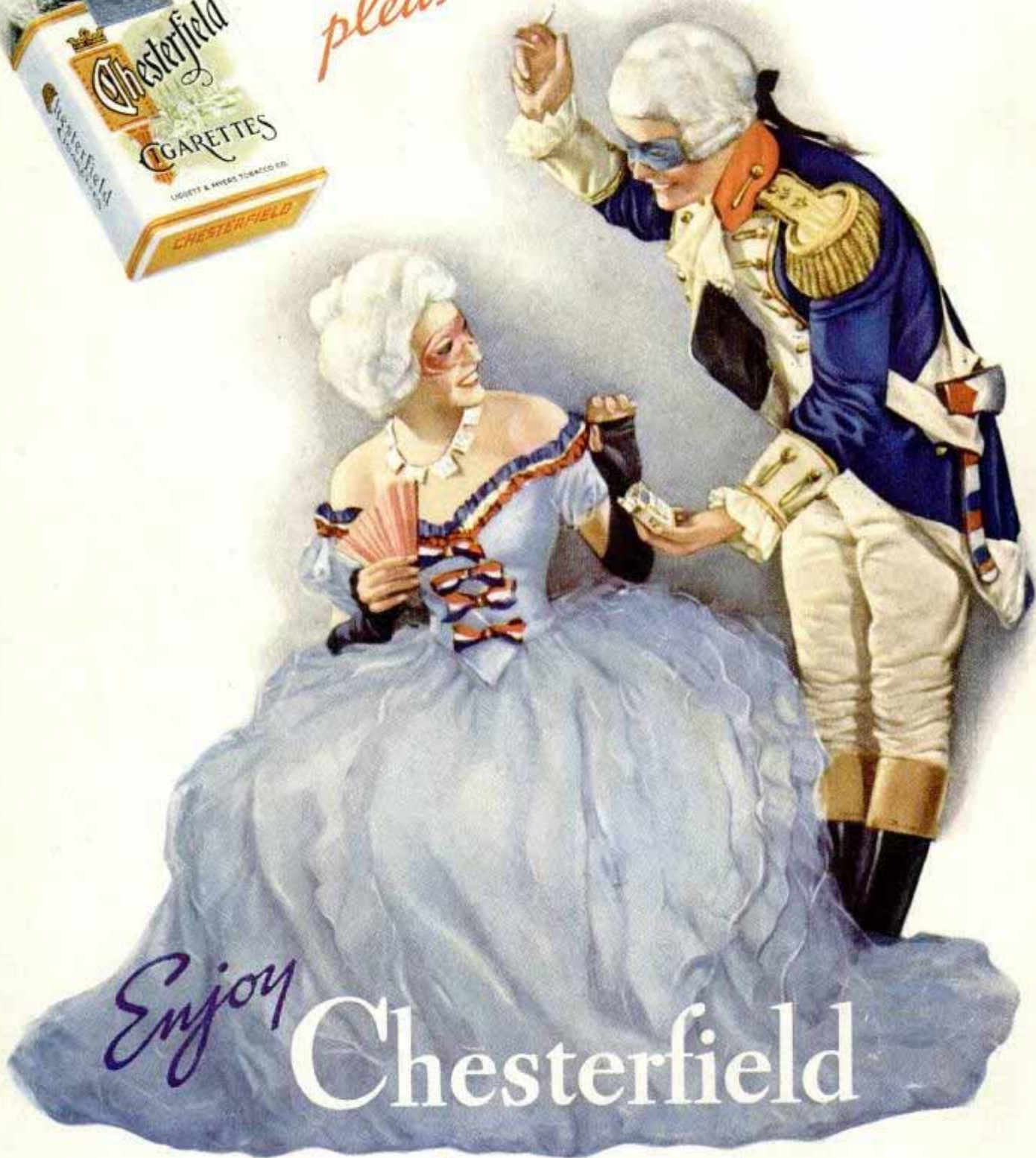

Enjoy

Chesterfield

*for the good things
smoking can give you*