

ELECTRIC HOME RUNS ITSELF

POPULAR MECHANICS



MAGAZINE

WRITTEN SO YOU CAN UNDERSTAND IT

REG'D. TRADE MARK, GREAT BRITAIN 404

REG. U.S.

**JAN.
25 CENTS**



SEE PAGE 86

New 1937 DELTA Low-Cost Quality Tools



**New 10-Inch
Band Saw**

Has balanced enclosed disk wheels, running on New/Departure double-seal ball bearings, patented table swinging on widely-spaced double trunnions, micrometer adjustment guides and ball-bearing blade supports above and below the table, with the lower-guide adjustments brought out to the front of the table for convenience and safety—and a full 6" capacity under the blade guide—where you need capacity in a band saw.



**New 17-Inch
Drill Press**

The greatest drill press value ever offered. Has scores of unusual features. Get the full story in the 1937 Delta catalog.

**New 6-Inch
Belt Sander**

Has numerous new features including complete double-sealed ball-bearing equipment, full 6 inches of sanding width. Operates in both vertical and horizontal positions.



NEW 4-INCH JOINTER

It has the patented fence that insures sure, free action and unvarying accuracy of the settings, patented swinging stop with its individually adjusted stop screws, swinging dual-control handle that makes control of the fence so convenient. Double-seal ball bearings, of course, and dovetailed ways for the tables. The ideal tool for the man who wants the best and who requires only 4-inch capacity.

Many New Tools—New Improvements

The 1937 Delta line incorporates many new tools, new improvements, new accessories—of interest to every man who works with tools. The complete Delta line includes Drill Presses, Circular, Band, Scroll Saws, Lathes, Shapers, Sanders, Grinders and full line of accessories.

SEND FOR 1937 CATALOG

It is crowded with interesting illustrations and descriptions of the complete Delta line. Points out in detail the important features of Delta design. And also the new 32-page book No. 3 of "Practical Delta Projects" crowded with new and "out of the ordinary" things to make—with many photographs, working drawings, and easy-to-understand illustrations. Simple, complete instructions make every project easy to follow. Every woodworker should have this book. Send 10c with coupon for Delta Project Book No. 3, 1937 Delta catalog mailed postpaid.

Delta Manufacturing Co. Dept. A 137
600-634 E. Vienna Ave., Milwaukee, Wis.

I enclose 10c (stamps or coin) for which please send me one copy of the new 1937 Book No. 3 of "Practical Delta Projects." Also place me on your mailing list to receive 1937 Delta catalog of quality motor-driven tools. I am interested in Delta Tools for:

Home Shop Industrial Use School Shop

Name..... Age.....

Address.....

City..... State.....

() Check here if you are a Delta user now.

DELTA MFG. CO.

600-634 E. Vienna Ave., Milwaukee, Wis.

IMPORTANT: Outside of the United States and its possessions, Delta Tools are known as "TAUCO" Tools. Tauco tools are identical in every respect to Delta Tools.

**BILLIONS OF DOLLARS
WORTH OF NEW AUTOMOBILES
HAVE RELIED UPON**

SEALED POWER PISTON RINGS



1937 CARS
featuring
SEALED POWER
PISTON RINGS

Buick
Cord
Hudson
LaFayette
Oldsmobile
Pontiac
Terraplane
Willys
and others

**SEALED
POWER
MOTOR
PARTS**

ENGINE power, engine economy, engine life depend on piston rings. During 25 years the world's greatest automotive engineers and leading car manufacturers have used hundreds of millions of Sealed Power Piston Rings as original equipment because of their superior design, fine materials and expert craftsmanship.

*Follow the lead of great engineers
in re-powering your car*

Sealed Power engineers have developed a marvelous patented ring of exclusive design for use when cylinder walls have been worn out of round or tapered by long, hard service. Springs of the finest imported Swedish alloy steel hold these thin, flexible rings against the cylinder walls—firmly but without excessive tension, creating a perfect seal against blow-by, saving gas, restoring new car performance, paying for themselves over and over by stopping the expensive "between meals" oil hunger of your car.

Piston rings won't fix your carburetor

Be sure to get the advice of a Sealed Power ace mechanic before you spend money for any type of engine overhaul. Possibly the electrical system is at fault or leaky gaskets or worn bearings or you may need new Lo-Ex Ebonited pistons as well as rings. Ask a Sealed Power ace mechanic. Take his advice.

Write for booklet "How to cut the cost of re-powering my car"—valuable—money-saving—sent free on request.

SEALED POWER CORPORATION
Dept. 271, Muskegon, Michigan

Manufacturers of Piston Rings, Pistons, Piston Expanders, Valves, Piston Pins and Cylinder Sleeves

When writing to advertisers please mention Popular Mechanics

"How I Threw the World's Strongest Pipe"

By **MATT McGRUNT**, Champ Wrassler

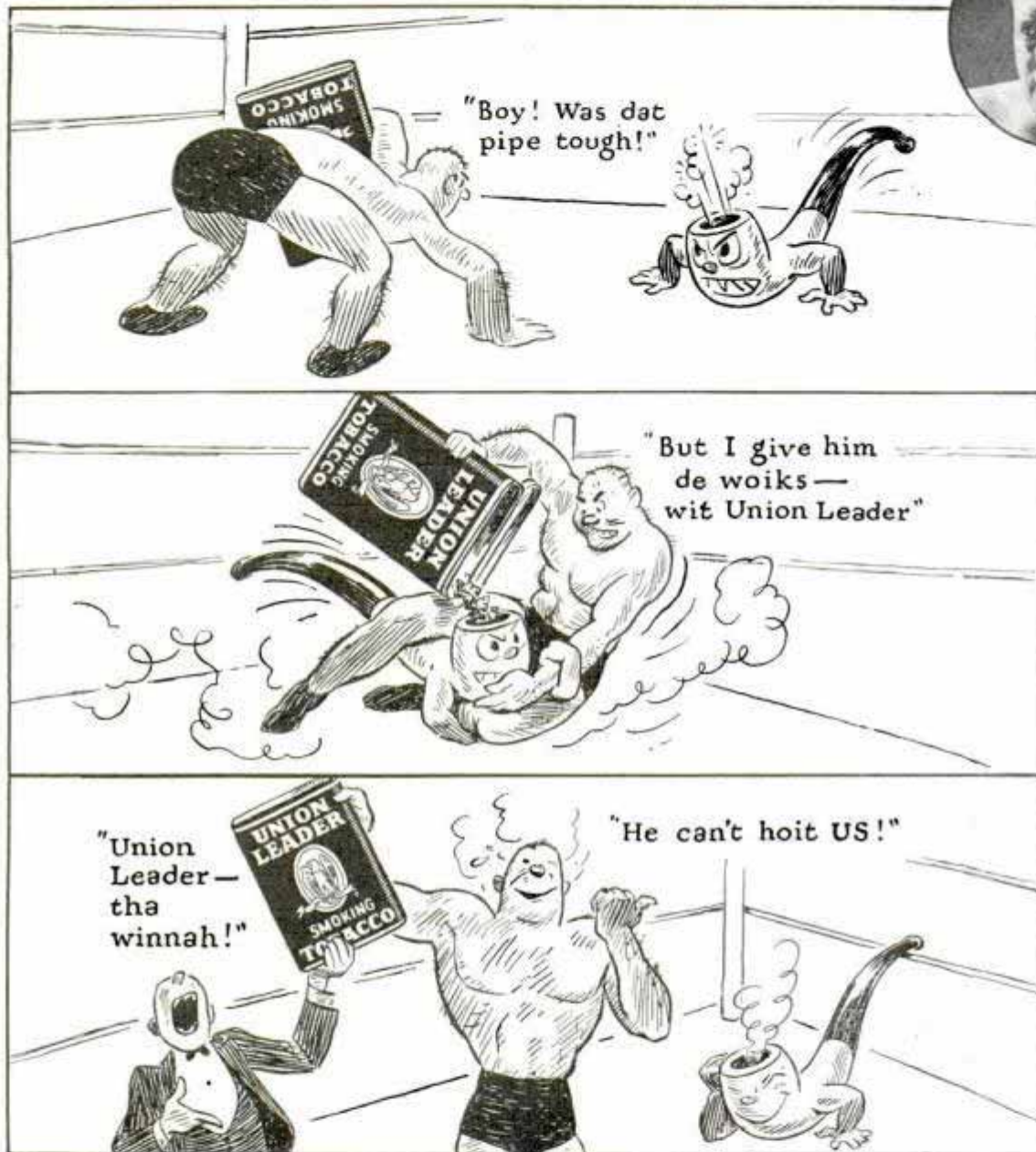

You too, can subdue Strong Pipes

THIS EASY, INEXPENSIVE WAY! Don't be bullied by an overpowering pipe! Union Leader makes *any* pipe behave. Nature flavors the finest Kentucky Burley for Union Leader; ripens it to fragrant mellowness. But the extra "class" that makes champions is trained into Union Leader by patient curing and *aging in wood*. For a cool, comfortable, clean-tasting tongue, even if you smoke all day—

UNION LEADER
THE GREAT AMERICAN SMOKE

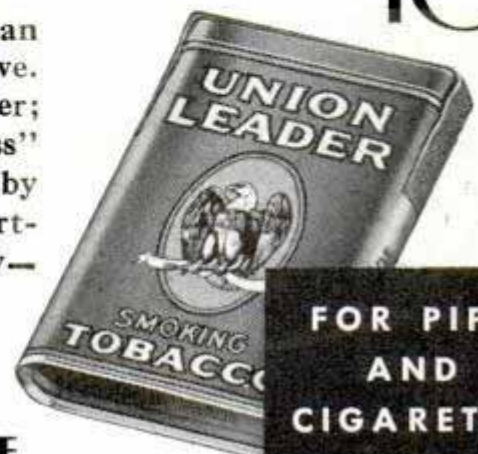

FOR PIPE
AND
CIGARETTE

Copyright, 1937, by P. Lorillard Co., Inc.

10¢

Popular Mechanics Magazine

H. H. WINDSOR, Founder

H. H. WINDSOR, Jr., Editor and Publisher

January, 1937

Vol. 67, No. 1

Special Features

Easier Motoring for 1937	1
Hitch Your Wagon to a Car - Coloroto	
Asleep in the Clouds	18
Breaking Speed Records on Salt	26
Engineer Casey Jones Turns Motorman	34
Giant Bombers Guard Nation's Gates	42
The Home That Runs Itself—Part I	50
Trouble Shooter for a Railroad	58
The Flying Penman	66
Cutting Capers on Ice	74
Docking the Big Fellows	82
Motoring on Skis	86
Gold Farmers of the West	90

(Continued on next page)

Around the World by Air

EVER since Columbus proved the earth is round, circumnavigation of the globe has been a challenge and a goal for adventurous man. Magellan's little flagship did it first and it took three years. Since then, with a steadily increasing tempo through the centuries, globe-girdlers have been whittling down the time. Wiley Post and Harold Gatty made a breathless dash around the top of the globe in less than nine days. Today, anyone with \$3,000 can fly around the world, covering more than 24,000 miles in three weeks or less, and traveling on regular, scheduled commercial aircraft. Watch in the February issue for the first of two articles describing an air trip around the world. You'll find it illustrated with eight pages of Coloroto pictures.

Next Month

SQUEEZE into the tiny cockpit of a racing plane beside the pilot and you'll get enough thrills in a few minutes to last you the rest of your life. A race around a closed course is a terrifying nightmare to anyone except a trained "pylon polisher." An article in the February issue takes you for a ride by proxy in the cockpit of a racer.

Pirates Still Live

PIRATES today? Sure there are. When the eerie mists creep over the New York waterfront, pirates set forth to plunder the world's richest harbor. And, more often than not, they would succeed were it not for the harbor police who wage unremitting warfare against these modern freebooters. Watch for the article, "Harbor Pirates on the Run," next month.

Afraid of the Dark?

ARE you afraid of the dark? You should be, if you drive a car because darkness is the ally of death on our highways. More than three-fourths of our automobile traffic is by day, yet more than half the fatal accidents occur at night. Now science has found a way to prevent about half these night fatalities, and at comparatively low cost. Read how it can be done next month in "Conquering Death after Dark."

Published monthly by POPULAR MECHANICS CO., 200 East Ontario Street, Chicago, U. S. A. Single copy in United States, 25 cents; \$2.50 a year, \$4.00 for two years, \$5.00 for three years in United States and possessions, Canada, Newfoundland, Labrador and countries of the Americas and Spain. To all other countries add \$1.00 a year extra for overseas postage. Changes in address must be reported to us immediately to eliminate delay. Entered as Second Class Matter, Sept. 15, 1903, at the Post Office at Chicago, Illinois, under Act of March 3, 1879. Entered as Second Class Matter at the Post Office Department *Canada*. Copyright 1936, by Popular Mechanics Co. in the United States, Australia and France.

This One



Why YOUR CAR NEEDS PYROIL

**NEW 12-OUNCE SIZE
TAMPER-PROOF
SEALED CON-
TAINER FOR ALL 5,
6 AND 7 QUART
CRANKCASES.**



**Overcomes Compression Losses
Reduces Serious Ring Wear
Multiplies Efficient Operating Life**

One of the most outstanding features of Improved Pyroil (both "A" and "B" grades) is its ability to *stop corrosion*. Corrosive attack—formed chiefly during combustion—is generally responsible for serious power losses. Corrosion sets up wear on rings, cylinders, bearings and gears. Improved Pyroil defeats corrosion. It keeps harmful wear from occurring!

Improved Pyroil has many unusual qualities. It keeps valves free. Stops valve chatter. Frees away sludges and gums. Reduces carbon formation. *Your new car needs Pyroil right from the start!* Pyroil Company will show you laboratory and field facts proving how improved Pyroil protects your car—new or old. How it saves you money. Mail coupon for this. Then, try Pyroil today. Sold the world over at service stations, garages, other dealers. Manufactured and guaranteed by Pyroil Company, W. V. Kidder, Founder, 51 Pyroil Building, LaCrosse, Wis., U.S.A.

**IN COLD WEATHER, PYROIL EFFECTS EASIER
STARTING, SAVES BATTERY DRAIN, PRO-
TECTS THE METAL UNTIL OIL CIRCULATES.**

**PYROIL HAS BEEN TESTED BY POPULAR ME-
CHANICS AND IS USED BY POPULAR MECHANICS'
PRESSES AND EQUIPMENT.**

**DISTRIBUTORS: NEW PYROIL PRE-
MIUM PLAN NOW IN EFFECT GIVES
NATIONALLY ADVERTISED MER-
CHANDISE OF HIGH VALUE, ABSOLU-
TELY FREE. CHECK COUPON FOR FULL
DETAILS, AND FACTS OF BUSINESS
OPPORTUNITY.**

Genuine Pyroil
bears this signa-
ture on every can

W. V. Kidder
Founder

**PYROIL COMPANY,
51 Pyroil Bldg., LaCrosse, Wis., U. S. A.**

- Please send Free facts on Pyroil's money saving features.
 Send details of Premium Plan and Business Opportunity for me.

Name.....

Address

City.....County.....State.....

Genuine
PYROIL
LUBRICATION PROCESS

(Contents—Continued)

AUTOMOTIVE

Streamlined hood on motorcycle boosts speed.....	17
Windshield defroster fan with rubber blades.....	24
Tire chain for dual-wheel trucks.....	41
Car atop building latest in advertising.....	46
Speeding up metal hardening.....	48
Auto driven by centrifugal ejection of air.....	56
Car with rudderlike tail.....	71
Automobile driven by hands alone.....	73
Small racer goes ninety miles an hour.....	78
Alaska street car built of odd parts.....	88
Bus carries baby's buggy on hooks at rear.....	95
Three-wheel teardrop car has rear engine.....	95

AVIATION

Radio signal replaces bomb in target practice.....	48
Record set for plane for high flying.....	55
"Flying boxcar" hauls freight on fast schedule.....	63
Laboratory plane tests flight above weather.....	65
Sleeper flying boats carry sixty passengers.....	70
"Flying laboratory" to do six miles a minute.....	72
De-icers protect air liners in winter.....	85
Plane takes off from railway handcar.....	88

CONSTRUCTION

Cafe walls move to vary seating capacity.....	24
Leaning towers of Boulder dam.....	39
Burning off paint speeded by flame spreader.....	46
Asphalt roads reinforced with cotton.....	47
Spheroid gasoline tank holds 100,000 barrels.....	72
Acidproof cement bricks resist weather.....	81

FARMS AND GARDENS

Orange-lemon, giant mango among late fruits.....	30
Lactic acid made from whey.....	71
"Delicious monster" latest fruit from tropics.....	80
Generator on wheels works for farmer.....	89
Persian lambs to be raised on American farms.....	96

HOUSEHOLD

Automatic stoker also empties ashes.....	17
Aluminum salt-pepper shakers marked "S" or "P".....	32
Gutters cleared of ice by chemical "brick".....	33
Measuring dial on coffee jar.....	41
Portable gas lighter kindles furnace fire.....	46
All-glass table for home.....	48
Locked drain lid on utensil.....	63
Vacuum pump for canning prevents food spoilage.....	94

MOVIES AND PHOTOGRAPHY

Spanish galleon built for motion picture.....	47
Lifelike color for movie forecast.....	80
Pigeons speed film to city papers.....	81
Film sorting case for amateur movies.....	96

RADIO AND ELECTRICITY

Hurricane-hunting radio hangs from balloon by aerial.....	31
Inter-office phone uses light circuit.....	47
Light beam changed into musical chords.....	57
Electric eyes count vehicles but ignore pedestrians.....	64
Million-volt generator for X-ray tube.....	79
Human tissue photographed by radio.....	81
Shower bath in electric sparks.....	94
Goggles for short-wave treatments.....	96
Television system of advanced design.....	97
Six-tube a.c.-d.c. super for long and short waves.....	98
How to build a five-meter pocket receiver.....	100
Practical radio suggestions.....	101
Battery converter operates a.c. receiver in car.....	102
Crystal holder controlled from panel.....	102
Radio desk set has inkwell and clock.....	102

SCIENCE AND INDUSTRY

Japanese discards theory that heart pumps blood.....	17
Workers chip ribs of giant mirror.....	33
Rat's leg transplanted to another rat.....	41
South land of opportunity for the chemist.....	46
Rotating frame for 200-inch "eye".....	57
Powerful gun's bullets tap new oil pockets.....	62
Age of invention still in infancy.....	63
Gas passes through hot metal.....	78
Lost city soon to vanish again.....	95

SPORTS

Red golf balls for Arctic ocean course.....	17
Safety swing for playground.....	23

(Continued to page 6A)

TO EARN MORE MONEY • HAVE MORE FUN

Invest in PRACTICAL PROFITABLE Books

Whatever your interest—whatever your need—here are books that will help you. Popular Mechanics experts have selected them for you. Books to help you on your job . . . to help you to a better job . . . to help you earn extra money in spare-time work . . . to profitably develop a hobby . . . to gain advancement through home study. Other books for entertainment and recreation.



Successful businesses . . . profitable sidelines . . . doubled incomes . . . have resulted from a single idea. Popular Mechanics Books are filled with money-making ideas. Select from the list on this page. Profit with the latest and best-proven facts—ideas and information.

SELECT FROM THIS LIST

AUTO POWER: A fine, practical book on winding auto generators and converting "Model T" and other units into 110 and higher voltages. \$1.00.

EASY-TO-MAKE TOYS: 67 varied and novel designs. Just the thing for the home workshop or a guide to an interesting small business. \$1.50.

BOAT BOOK: Just published! New edition with six additional boats. Build your own boat. Full directions and details for all types small pleasure craft. 312 pages. Illustrated. \$3.00.

DYKE'S AUTO ENCYCLOPEDIA: World's Greatest Auto Book. New 17th edition just out. Now more than ever before the only book for auto and shop mechanics. 1396 pages. 4,600 illustrations. Cloth. \$6.00.

MODERN RADIO SERVICING: This radio man's "Book of Knowledge," by Ghirardi, covers every phase of radio servicing today. 1,300 pages. 706 illus. \$4.00.

AIR CONDITIONING: By Riesbeck. The book of the hour in this big new field. Get started in America's next big industry with this new, authoritative work. 369 pages. Illustrated. \$3.50.

DIESEL HANDBOOK: By J. Rosbloom. The standard book on modern Diesel practice. Adopted everywhere for instructions in land, marine, locomotive, automotive, aero and portable services. 544 pages. Illustrated. \$5.00.

OUTDOOR SPORTS: The one book for out of doors folks. Covers everything, including homemade equipment. For young and old. 352 pages. 650 Pictures. Cloth. \$2.00.

SHIP MODEL: Build finest ship model of them all. Sovereign of the Seas. A real masterpiece. Detailed instructions, plans, etc. Authentic design. 180 Pictures. \$1.00.

REWINDING SMALL MOTORS: Details of repair shop practice for rewinding all fractional horse power motors. \$2.50.

FURNITURE DESIGN AND CONSTRUCTION: Shows how to design and make tables, chairs, desks, lamps, shelves, candlesticks, etc. \$2.50.

COLONIAL FURNITURE: The finest Colonial furniture adapted for home and school shop reproduction. An excellent book for the home furniture maker. Illustrated. \$3.50.

WOOD TURNING: A real course of instruction in this fascinating art. Starts with simple operations. Includes spiral turning and complete jobs. \$1.50.

PROSPECTOR'S HANDBOOK: Tells what minerals to look for and where. How to locate, sample, test, appraise, mine and market; also prices. \$3.00.

HIGH SPEED DIESEL ENGINES: New practical book includes fuel injection, combustion systems, frames, cylinders, running gear, construction details. Clearly written. \$2.50.

200 TRICKS YOU CAN DO: By famous Magician Thurston. Explains 200 tricks the average person can easily learn and do. \$1.00.

2000 WAYS TO MAKE MONEY

A THOUSAND WAYS TO MAKE \$1,000: Tried and Tested Methods that Work—That You Too, Can Use. How hundreds of men made their first \$1,000 in their own business. \$2.50.

MONEY MAKING IDEAS: 1000 spare time ways to make money. Practical guide for young and middle aged men and women, students, boys, girls. \$1.00.



RADIO PHYSICS COURSE: New edition. 992 pages. 500 illustrations. All about radio explained step by step. \$4.00.

ELECTROPLATING: Practical book of modern methods. Includes zinc, cadmium, and chromium plating. Also copper, gold, alloys, other metals and metal coloring. \$2.25.

SHOP NOTES LIBRARY: 5 vol. 2000 Wonderful shop ideas. Volumes reprinted annually from Shop Notes section Popular Mechanics. \$2.50.

WIRING: Approved economy methods for homes, buildings. Standard up-to-date book meets every requirement. \$2.50.

SEND NO MONEY—BOOKS SHIPPED C. O. D. IN U. S.

Select books from list above. Help yourself to more profitable—more enjoyable days. Send No Money. Pay postman above prices plus postage. (C.O.D. in U. S. and possessions only). Add ten cents for each book for postage if remittance is sent with order. Act Now.

POPULAR MECHANICS PRESS
Room 137—200 East Ontario St., Chicago, Ill.



When writing to advertisers please mention Popular Mechanics



THAT'S
a snapshot WE WANT!

HERE'S WHAT YOU
NEED TO TAKE THEM



With fast F/6.3 lens cameras, use SS pan film, and G-E MAZDA Photoflood lamps No. 1. Good for dozens of shots. 25c list.



With a box camera or for action shots, use G-E MAZDA Photoflood lamps. Each lamp gets one picture. 15c list.



With many inexpensive folding cameras, use SS pan film, and new G-E MAZDA Photoflood lamps No. 2. 50c list.

FOR
PICTURES
AT NIGHT

FREE FOLDER "How to take snapshots at night." Write for a copy. Dept. 168, General Electric Company, Nela Park, Cleveland, Ohio.

GENERAL ELECTRIC
MAZDA PHOTO LAMPS

...And you can get it
indoors at night with G-E
MAZDA Photoflood lamps

Catch that look of delight when Santa comes... get scores of other precious pictures, too! It's easy with G-E MAZDA Photoflood lamps.

They screw into regular light bulb sockets to provide a flood of brilliant light, which helps you get snapshots indoors at night as readily as outdoors in sunlight. Good for dozens of shots.

Just load your camera with SS pan film. Direct the light on your subjects by tilting the lamp shades or by means of reflectors. (Handy cardboard reflectors come 2 for 25c.) Then click the camera shutter to get your snapshot.

Your drug store or camera dealer can supply you.

(Contents—Continued)

Overnight tent pitched on top of auto	40
"Water ball" played with fire hoses	47
Tent in stands for rainy-day game	56
Electric scoreboard flashes race results	70
Spring frame on bike gives softer ride	73

MISCELLANEOUS

Masked rescuers sweep city after gas raid	23
Metal "traffic cop" guards school zone	24
Electric log shows "Queen Mary's" speed	25
Telegrams by facsimile latest wire service	30
Air rudder helps steer 150-mile speedboat	31
Ice thinner in sub-zero temperature	32
Metal sled built like plane	32
Twin Diesels drive submarine in tests	32
Plywood figure directs tourists to camp	33
Marine amphitheater to feature 1939 world's fair	38
Billion-gallon water siphon	39
Steam turbine locomotive powered like ocean liner	39
Craftsmen of old on modern liner	40
Self-sustaining refuge for wartime gas attack	40
Latest Australian locomotive streamlined for speed	49
Lathe cuts grooves with spindle gripper	49
Mississippi river modeled in coal	49
Warships fire at radio-controlled planes	56
Fireworks etching of King Edward for coronation	64
Uses for wood increasing	64
Streamline trailer for bike has radio	70
Sailors cling to rigging as ship sinks	71
Model shows moon phases as spotlight moves	73
Racket restrainer keeps tension uniform	79
Dentist's office in trailer serves needy	80
Wooden horses join museum of relics	89
Noiseless furniture leg tip saves floor wear	94

Craftsman and Shop Notes

AUTOMOTIVE

Bench depressing tool removes valve springs	158
Bumper step simplifies removing luggage	158
Keeping chamois skin damp for cleaning	158
Repairing stripped threads in a crankcase	158
Detachable armrest for driver	159
Running board shoe scraper for truck cab	159
"Saw-tooth" loading platform handles many trucks	159
Snow short circuits spark plugs	159

ART AND DRAFTING

Complete drawing kit	103
Holder for artist's brush	126
Plans on drafting table rack	140
Rack on drafting table for plans	140
Hairs tightened in cheap art brushes	144
Sign writer holds cloth taut for signs	149

FARM

Adjustable holder keeps mouth of sack taut	105
Gas bailed from wells	105
Utility buckets from 5-gal. oil cans	160

FURNITURE

Pembroke table by Hepplewhite	108
Two attractive wastebaskets	111
Bedroom suite built with hand tools	120
Child's closet of plywood	127

HAND TOOLS

Tool molds filler between wallboard joints	104
Small drills carried in spectacle case	106
Improving a calking tool	106
Workman's chest cushioned against bit brace	106
Calibrated punch measures holes	107
Miter box has clamp for small work	107
Wrecking bar to remove old flooring	110
Bench hardy from cold chisel	112
Boring tool to lay pipe under sidewalks	112
Flue cleaner shaves off corrosion	112
Self-centering marking punch for screw holes	112
Holder for small tools fits inside toolbox	126
Pressure gun for filling cracks with plastics	128
Gauge spaces siding boards equally	135
Wire winder for forming springs	136
Adjustable vise handle speeds jobs	137

(Continued to page 8A)

Are you, too, up against life's big question— "How Can I Make More Money?"

Every bill to be paid, every need to be met, every dream still unfulfilled—demands the answer to this question. For on its answer hang all the other answers of life: how you live, what you wear, where you go, what you do, the position you hold, the one you hope to hold in future!...

MORE than anywhere else, this question haunts you daily on the job. You want a bigger salary; more pleasant and interesting work to do; more advantages for your loved ones—recreation, travel, social activities. And so, as you keep plodding on, in between the little thoughts comes this big one, again and again: "How can I make more money?"

Well, how can you? . . . By working harder than ever, so as to attract more attention to your industry? Thousands of people are working harder than ever, these days; employers have no worries on that score. By trying to "get a stand-in" with somebody of influence? Plenty of people have tried that, too—only to fall down because they couldn't deliver. By getting "outside work" to do? Sooner or later, your regular job suffers—and then what?

Out of the corner of your eye you can see a long line of folks just waiting for the job you have now. Any time you're "out," a dozen others are ready to step in. So it's dangerous to resign and look elsewhere, isn't it? Besides, jobs in your same line elsewhere are bound to pay about what you're earning now.

What's Wrong, Anyway?

Let's be quite serious for a moment about this "money" question. Who, as you glance around the business world, are the money-makers in it? Are they the filing clerks, typists, stenographers, bookkeepers, timekeepers and routine clerical people? Or are they the expert salesmen, the accountants and C. P. A.'s, the attorneys, the traffic managers, the personnel directors, the sales correspondents, the sales managers, and other executives who give orders for other people to execute?

And how did these money-makers, with their enviable jobs and opportunities, "get that way"? Was it simply by working hard—having a "pull"—changing jobs till they found the fat salaries they wanted?

Experience says no! . . . They make more money than the rank-and-file in business for just one reason: they



have *trained* for the better-paid specialized functions that Tom, Dick and Harry, the rank-and-file, cannot discharge.

Their Answer is Yours

That is their answer to life's biggest question. It is *your* answer as well. And LaSalle Extension University has made it possible for YOU—granted a real purpose and adequate education—to train for the field in which you would prefer to earn more money. Without leaving your job, you can do what more than 800,000 men and women have done already: utilize your spare time for home study that definitely equips you to get your money question *answered*.

The coupon below lists a number of specialized vocations which today offer the interesting work, attractive opportunities, gratifying incomes—all the rewards that go with "bigger responsibilities." Pick out the one that most appeals to you, check it, and add your name and address. Find out the interesting facts about it which your inquiry will bring you promptly, without obligation. Send your request along NOW, and learn how to get the one right answer to this biggest of life's questions—the question of "more money."

Don't act on this advertisement unless you're really in earnest.

LASALLE EXTENSION UNIVERSITY, Dept. 164-R, Chicago

I would like to have your special booklet—without any cost or obligation to me—about my opportunities and your success training in the business field I have checked.

- | | | |
|--|--|---|
| <input type="checkbox"/> Business Management | <input type="checkbox"/> Expert Bookkeeping | <input type="checkbox"/> Business English |
| <input type="checkbox"/> Higher Accountancy | <input type="checkbox"/> C. P. A. Coaching | <input type="checkbox"/> Effective Speaking |
| <input type="checkbox"/> Traffic Management | <input type="checkbox"/> Industrial Management! | <input type="checkbox"/> Office Mgm't |
| <input type="checkbox"/> Modern Salesmanship | <input type="checkbox"/> Modern Foremanship | <input type="checkbox"/> Stenotypy |
| <input type="checkbox"/> Commercial Law | <input type="checkbox"/> Personnel Management | |
| <input type="checkbox"/> Law: Degree of LL. B. | <input type="checkbox"/> Business Correspondence | |

Name..... Age.....

Address.....



LaSalle Extension University

When writing to advertisers please mention Popular Mechanics



Every Shave Is Cleaner, Smoother when blade and razor match

WITH precision teamwork, the Gillette Blade and Gillette Razor whisk off stubborn bristles quickly, comfortably. That's because these two were made for each other. Both were designed as a unit by the same engineers. Both are produced in the same great Gillette factory where equipment costing millions of dollars assures flawless coordination of blade and razor. Every step in their manufacture is directed to making them the perfect shaving combination. Buy a package of Gillette Blades. Slip one into your Gillette Razor and enjoy the matchless shaving comfort of the world's most scientifically matched shaving combination.

Reputable merchants never offer substitutes for Gillette Blades. Always ask for them by name.

Tune in on Gillette's "Original Community Sing" program every Sunday night at 10 P.M. E. S. T.—C B S Network—Coast to Coast



Gillette Blades

Precision-made for the Gillette Razor

(Contents—Continued)

Angle-handle knife cuts without wrist strain.....	137
Soldering-iron handle kept cool by turnbuckle.....	149
Handle to use short solder bars	131A

HOME IMPROVEMENTS

Storm sash with double vents provide ventilation...	118
Picture lighting by footlight reflectors	135
Shingle siding improved with furring strips.....	136

HOUSEHOLD

Leaky radiator valve kept from marring walls.....	106
Bed lamp gives direct and indirect light	113
Hanging plate-glass mirrors	116
Tin lugs keep pot cover from slipping	116
Shield under knife sharpener to protect wall.....	126
Shopping list kept on shopping bag	126
Furnace poker serves as clinker hook	137
Simple methods of solving home problems.....	138
Coil spring supports funnel	140
Spiral drain cleaner with ball tip ends	145

OFFICE

Stencil cut in typewriter without wrinkling	106
Typewriter platen has ruled lines	119
Typewriter ruler saves time for stenographer.....	150

PHOTOGRAPHY

Developing tray improved with small drain holes...	107
Table on exposure meter avoids ruined photos.....	128
Tripod head swings camera to vertical position.....	129

PLUMBING

Damp oakum used for leading pipe joints	110
Flushing clogged soil pipes	128
Check valves improvised from pipe fittings.....	144

POWER TOOLS

Chips kept out of lathe shaft	136
Drive your hack saw electrically	141
Emery-belt polisher saves hand work	151
Auto motor runs arc welder	152

STORE AND SHOP

Sweeping compound from sawdust	104
Signs painted on wire with aid of board	118
Window display operated from street	144
Flashing window sign has no moving parts	145
Finger grips for handling blueprints	149
Welder's eye shield hinged to wall	160

WOODWORKING

Bench stop made from half of hinge	113
Doll house built of plywood	114
Glue pot from oil can	116
Fasteners for rubber-band clamps	118
Workshop operations on a shaper	146

MISCELLANEOUS

Glassware etched with a stencil	105
Wheel chair has mudguards	107
Eyes for animal cutouts	110
Safety beacons for ice skaters	110
Cleaning buckskin shoes	113
Disk scraper cleans sidewalks	116
Emergency microscope-slide mounting	116
Table-top Christmas trees	117
Cutting patterns from thin cloth	118
"Cage" holds ball of knitting yarn	119
Simple thermostat from pipe fittings	126
Handy pocket oilers from shells	128
Winter hot-dog stand like Arctic igloo	129
Gas-driven plane is speedy flyer	130
Disconnecting copper tubing	136
Drop oiler from can and tire valve	136
Flexible-brush combination cleans curved surfaces...	137
Brick cleaner from spring leaf	143
Handy roller for material yard	144
Loose lock held by turnbutton	148
Sand hoisted in canvas bags	149
Putty kept warm with heated brick	150
Trackwalker's grease bucket supported on legs...	150
Watches wound on rubber strip on desk edge.....	150
Combination ear muffs and sun glasses	151
An improvised glue pot	119A
Hillside trees protected by rock walls	134A
Belt dressing from rubber	146A

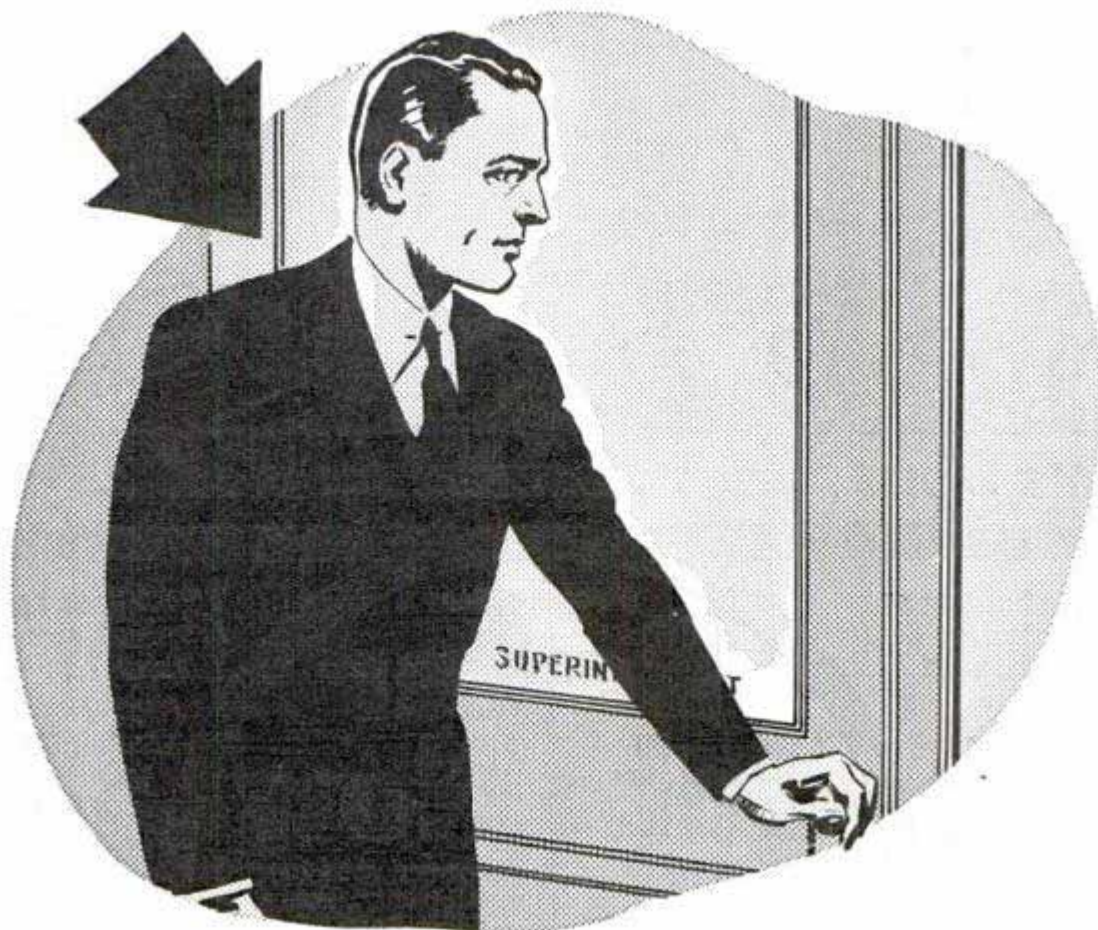

GO AHEAD, ASK YOUR BOSS WHAT HE THINKS OF YOU!

● **TELL HIM** you really want to know, from his point of view, what he thinks about your work. How are you doing now and what are your chances for the future? Can he offer any suggestions for the improvement of your work? ● **Go ahead, ask him!** If he refers to your lack of qualification for a more important job, what he means is your lack of training. Well, you can acquire this training in your spare time! All over this country men are getting this training *right now*, by mastering International Correspondence Schools Courses. They realize what training means—and are getting it! Their first step toward better things was mailing this coupon to Scranton.

INTERNATIONAL CORRESPONDENCE SCHOOLS

BOX 5649-H, SCRANTON, PENNA.



Without cost or obligation, please send me a copy of your booklet, "Who Wins and Why," and full particulars about the subject *before* which I have marked X:



- | | | |
|---|---|--|
| TECHNICAL AND INDUSTRIAL COURSES | | |
| <input type="checkbox"/> Architect | <input type="checkbox"/> Sheet Metal Worker | <input type="checkbox"/> Plumbing |
| <input type="checkbox"/> Architectural Draftsman | <input type="checkbox"/> Boilermaker | <input type="checkbox"/> Heating |
| <input type="checkbox"/> Building Estimating | <input type="checkbox"/> Telegraph Engineer | <input type="checkbox"/> Air Conditioning |
| <input type="checkbox"/> Contractor and Builder | <input type="checkbox"/> Telephone Work | <input type="checkbox"/> Steam Fitting |
| <input type="checkbox"/> Structural Draftsman | <input type="checkbox"/> Mechanical Engineering | <input type="checkbox"/> Ventilation |
| <input type="checkbox"/> Structural Engineer | <input type="checkbox"/> Mechanical Draftsman | <input type="checkbox"/> Steam Engineer |
| <input type="checkbox"/> Management of Inventions | <input type="checkbox"/> Machinist | <input type="checkbox"/> Steam Electric Engineer |
| <input type="checkbox"/> Electrical Engineer | <input type="checkbox"/> Patternmaker | <input type="checkbox"/> Marine Engineer |
| <input type="checkbox"/> Electric Lighting | <input type="checkbox"/> Diesel Engines | <input type="checkbox"/> R. R. Locomotives |
| <input type="checkbox"/> Welding, Electric and Gas | <input type="checkbox"/> Aviation Engines | <input type="checkbox"/> R. R. Section Foreman |
| <input type="checkbox"/> Reading Shop Blueprints | <input type="checkbox"/> Automobile Mechanic | <input type="checkbox"/> Air Brakes |
| <input type="checkbox"/> Heat Treatment of Metals | <input type="checkbox"/> Refrigeration | <input type="checkbox"/> R. R. Signalmen |
| | | <input type="checkbox"/> Highway Engineering |
| | | <input type="checkbox"/> Civil Engineering |
| | | <input type="checkbox"/> Surveying and Mapping |
| | | <input type="checkbox"/> Bridge Engineer |
| | | <input type="checkbox"/> Bridge and Building Foreman |
| | | <input type="checkbox"/> Chemistry |
| | | <input type="checkbox"/> Pharmacy |
| | | <input type="checkbox"/> Coal Mining |
| | | <input type="checkbox"/> Mine Foreman |
| | | <input type="checkbox"/> Fire Bosses |
| | | <input type="checkbox"/> Navigation |
| | | <input type="checkbox"/> Cotton Manufacturing |
| | | <input type="checkbox"/> Woolen Manufacturing |
| | | <input type="checkbox"/> Agriculture |
| | | <input type="checkbox"/> Fruit Growing |
| | | <input type="checkbox"/> Poultry Farming |
| BUSINESS TRAINING COURSES | | |
| <input type="checkbox"/> Business Management | <input type="checkbox"/> Bookkeeping | <input type="checkbox"/> Service Station Salesmanship |
| <input type="checkbox"/> Industrial Management | <input type="checkbox"/> Secretarial Work | <input type="checkbox"/> First Year College Subjects |
| <input type="checkbox"/> Traffic Management | <input type="checkbox"/> Spanish | <input type="checkbox"/> Business Correspondence |
| <input type="checkbox"/> Accountancy | <input type="checkbox"/> French | <input type="checkbox"/> Stenography and Typing |
| <input type="checkbox"/> Cost Accountant | <input type="checkbox"/> Salesmanship | <input type="checkbox"/> Civil Service |
| <input type="checkbox"/> C. P. Accountant | <input type="checkbox"/> Advertising | <input type="checkbox"/> Mail Carrier |
| | | <input type="checkbox"/> Railway Mail Clerk |
| | | <input type="checkbox"/> Grade School Subjects |
| | | <input type="checkbox"/> High School Subjects |
| | | <input type="checkbox"/> College Preparatory |
| | | <input type="checkbox"/> Illustrating |
| | | <input type="checkbox"/> Cartooning |
| | | <input type="checkbox"/> Lettering Show Cards |
| | | <input type="checkbox"/> Signs |
| DOMESTIC SCIENCE COURSES | | |
| <input type="checkbox"/> Home Dressmaking | <input type="checkbox"/> Advanced Dressmaking | <input type="checkbox"/> Millinery |
| <input type="checkbox"/> Professional Dressmaking and Designing | | <input type="checkbox"/> Tea Room and Cafeteria Management, Catering |
| | | <input type="checkbox"/> Foods and Cookery |

Name..... Age..... Address.....

City..... State..... Present Position.....

If you reside in Canada, send this coupon to the International Correspondence Schools Canadian, Limited, Montreal, Canada

When writing to advertisers please mention Popular Mechanics

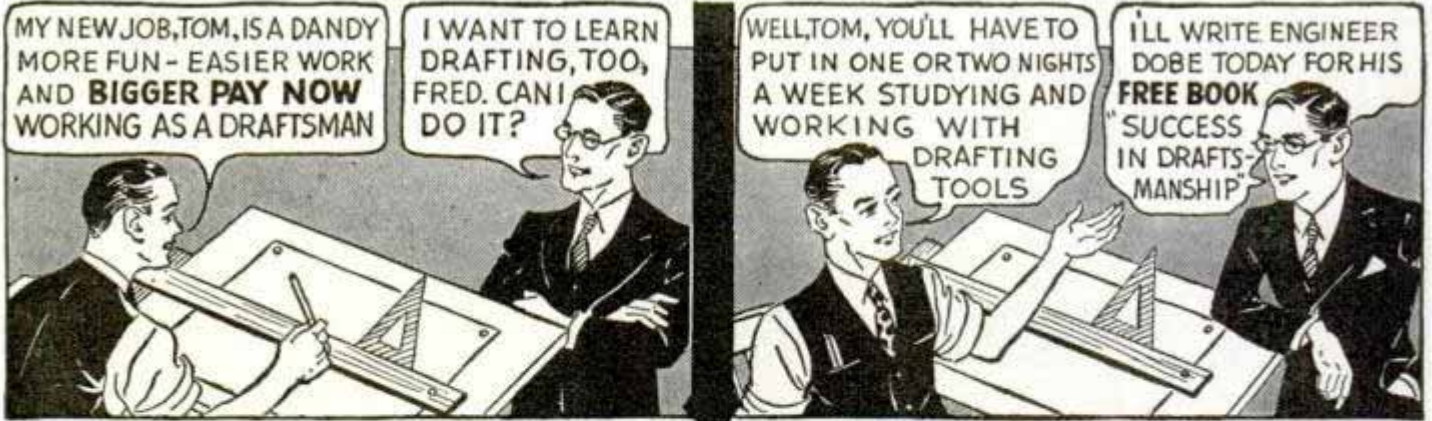

Then Tom, too, learned by mail at home

Illustrating assumed case.

THE boom in building and other industries now seems well on the way!

Who is always needed first of all? The draftsman who draws the plans. After that, the steel mills, lumber mills, brickyards and others make their sales.

Government efforts to help are making things hum. In one factory town, a shortage of draftsmen is already reported. Many trained draftsmen will be needed—at better pay and shorter hours.

Who'll get those good jobs? Of course, the men who have prepared—so, prepare now!

Prepare, for
Better Jobs Now

are ready and more expected soon in auto work, aviation, electricity, machinery and certain building lines.

For those who learn drafting now!

It's the way for a quick start to a better paying, much bigger job. Send at once for Engineer Dobe's Book.

Free Book

HERE is an opportunity that's open to those who know how to grasp it:—

At a few dollars a month, students get complete training in drafting by mail in surprisingly few months—Engineer Dobe teaches his students until thoroughly trained and until placed in a good paying job. Trained Draftsmen enjoy good salaries. If you don't get a satisfactory job:—all your money back. That's Engineer Dobe's guarantee.

With Engineer Dobe's method no previous experience is necessary. High School education not needed. Everything made plain. Practical work right from the start until you're in position.

If you're a mechanic, a knowledge of draftsmanship may make you a superintendent in short order. Get out of overalls and draw the pay of a boss. If you are a boss, learn draftsmanship; a foundation stone of many a line of business.

In every walk of life, practical training in draftsmanship will prove valuable. Even if you never accept a job as a draftsman, will you not be money ahead by taking Engineer Dobe's course?

You'll be amazed at the speed with which you can learn in your spare time by Engineer Dobe's practical method. Send coupon TO-DAY for free book entitled "Success in Draftsmanship".

For **MORE PAY** Learn **DRAFTING** FROM AN ENGINEER LEARN BY MAIL AT HOME

Time is money. Learn drafting in your spare time. It's high time now to prepare. Don't wait another day. Send coupon for Dobe's free book.

ENGINEER DOBE, Div. 33-71, Libertyville, Ill.

Send me your free book, "Successful Draftsmanship" and please explain how you assist your graduates to good positions as draftsmen.

Name

Address

Town

State Age

These **TOOLS** and Other **EQUIPMENT** Given When You Start

Outfit 20x25 in.

For 34 years (since 1900) Engineer Dobe has taught drafting by mail. Thousands of students, aged 16 and 18 to past 50, have won **SUCCESS!**



Write NOW while this offer lasts.

Here's a valuable set of tools—sent at once (also a drawing table), all without extra charge the day you enroll.

ENGINEER DOBE, Division 33-71, Libertyville, Ill.

2 Beginning Lessons in Diesel Engineering Free

Test Yourself Without Cost See how readily you, too, can Learn Diesel

At your leisure in your own home, read these 2 Diesel lessons carefully. Judge for yourself our ability to teach—and your ability to learn—this fast-growing new line of work.

No Previous Experience Necessary

See for yourself how *practical* American School training is—how clearly every fact is presented—how *thoroughly* you can master Diesel through home study.



Diesel — the New, Fast-Growing Power

Is Your Job Safe?

Just as the gasoline engine changed or wiped out the jobs of thousands who depended on horse-drawn vehicles for their living—just as electricity changed the entire set-up in the fields of light and power—so now the Diesel engine is fast invading both the power and transportation fields, and threatening the present jobs of thousands of workers.

If jobs in your line are steadily growing scarcer, you owe it to yourself to investigate this new, progressive, uncrowded line, that in our opinion will offer good openings for the next 25 years.

Diesel engines—because of their high efficiency, dependability, and economy of operation—are fast replacing steam and gasoline engines in power plants, motor trucks and busses, locomotives and ships, aircraft, dredges, drills, pumps, etc.—opening up an increasing number of well-paid jobs for Diesel-trained men. The field of Diesel Engineering is on the upgrade and continually expanding. It will provide steady employment, advancement and good pay for those properly trained in this new industry.

What This New Field Offers You

Now is your chance to get into a big new industry and grow up with it to an important position. Today there is practically no competition in the Diesel field, but the increasing use of Diesel engines will result in keen competition for jobs in the near future. By starting your training now, you

can keep ahead of such competition.

You get complete information on all the latest Diesel developments—two- and four-stroke cycles; low- and high-speed and heavy duty types; Diesel-electric generating systems, etc.—in our course. Includes all text material—with special diagrams for quick understanding of this new power.

Real Opportunities for Trained Men

Get our Free Diesel Booklet and learn all about this new, fast-growing line—its opportunities and requirements. Find out what the Diesel field offers you—how rapidly the Diesel industry has developed during the last three years—the large number of Diesel engines and accessories being manufactured today—how quickly you can obtain a complete understanding of Diesel engine principles and operation by home study during your spare time! ... at your own pace—without interfering with your regular work.

American School, Dept. D-145, Drexel Avenue at 58th Street, Chicago

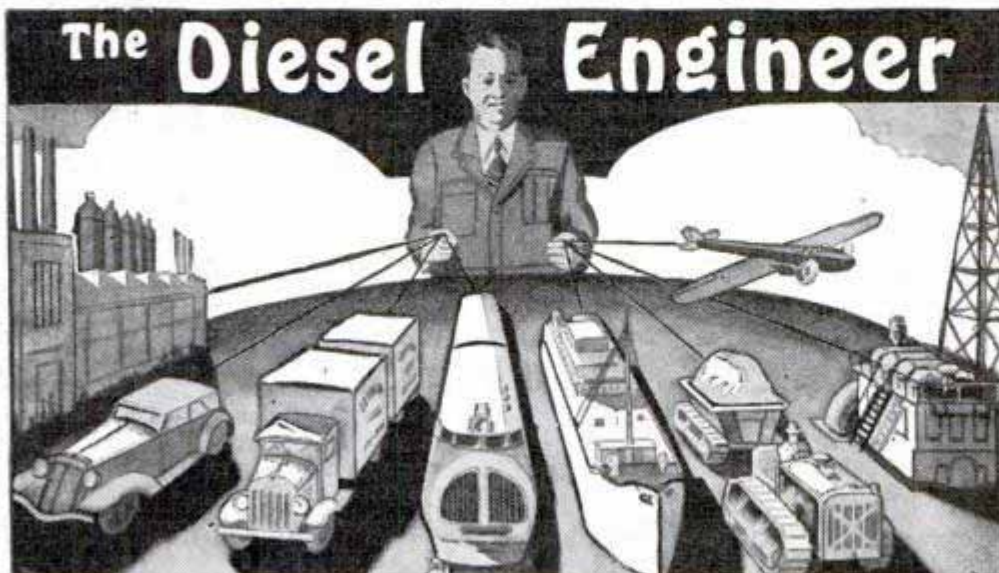

Get These 2 Diesel Lessons

When you learn what worthwhile opportunities Diesel offers and how readily you can cash in on them through American School training, it may mark the turning point in your life. Asking for full information involves NO obligation—so write TODAY for FREE lessons and FULL information.

Free Lesson Coupon

American School, Dept. D-145
Drexel Ave. at 58th St., Chicago

WITHOUT obligation, please send me 2 beginning lessons in Diesel Engineering FREE. They are to be mine, to keep. Also send FREE Diesel booklet.

Name.....

Address.....

When writing to advertisers please mention Popular Mechanics

Learn to Make \$30 \$50 \$75 a Week!



J. E. SMITH, Pres., National Radio Institute. The man who has directed the home study training of more men for the Radio Industry than any other man in America.

I will Train You at Home for good spare time and full time JOBS IN RADIO

DO you want to make more money? Radio offers you many opportunities for well-paying spare time and full time jobs. And you don't have to give up your present job or leave home and spend a lot of money to become a Radio Expert.

Here's Proof
THAT MY TRAINING PAYS

**Many Radio Experts
Make \$30, \$50, \$75 a
Week**

Radio broadcasting stations employ engineers, operators, station managers and pay up to \$5,000 a year. Spare time Radio set servicing pays as much as \$200 to \$500 a year—full time jobs with Radio jobbers, manufacturers and dealers as much as \$30, \$50, \$75 a week. Many Radio Experts operate their own full time or part time Radio sales and service businesses. Radio manufacturers and jobbers employ testers, inspectors, foremen, engineers, servicemen, paying up to \$6,000 a year. Radio operators on ships get good pay and see the world besides. Automobile, police, aviation, commercial Radio, and loud speaker systems are newer fields offering good opportunities now and for the future. Television promises to open many good jobs soon. Men I have trained are holding good jobs in these branches of Radio. Read their statements. Mail the coupon.

000 worth of sets, tubes and parts were sold—an increase of 20% over 1934! Over 1,100,000 auto Radios were sold in 1935, 25% more than in 1934! 22,000,000 homes are today equipped with Radios, and every year millions of these sets go out of date and are replaced with newer models. Millions more need servicing, new tubes, repairs, etc. Broadcasting stations pay their employees (exclusive of artists) more than \$23,000,000 a year! And Radio is a new industry, still growing fast! A few hundred \$30, \$50, \$75-a-week jobs have grown to thousands in less than 20 years!

**Many Make \$5, \$10, \$15
a Week Extra in Spare
Time While Learning**

Practically every neighborhood needs a good spare time serviceman. The day you enroll I start sending you Extra Money Job Sheets. They show you how to do Radio repair jobs that you can cash in on quickly! Throughout your training I send you plans that made good spare time money—\$200 to \$500 a year—for hundreds of fellows. My training is famous as "the Course that pays for itself."

**There's a Real Future
in Radio for
Well-Trained Men**

Radio already gives jobs to more than 300,000 people. In 1935 over \$300,000,-

WORKS FOR STATE OF ILLINOIS

"If I had not taken your Course I would still be digging ditches. I just started to work for the State of Illinois, operating their 1,000 watt transmitter. If anyone wants to write me about your Course, I shall be glad to answer." R. S. LEWIS, 126 E. Ashe St., Springfield, Ill.



PICKED UP \$1800 WHILE LEARNING

"I picked up \$1800 while studying and I call that easy money—the time I gave my Radio work did not interfere with my other business." OTIS DENTON, 14105 Lorain Avenue, Cleveland, Ohio.



MADE UP TO \$400 A MONTH

"I was working in a garage with no future in sight. My wife and I decided to put aside enough to pay for your Course. We have not regretted it. I have made as high as \$400 a month in Radio." E. G. WOLFE, 1202 Eden St., Elkhart, Ind.



\$10 TO \$25 A WEEK IN SPARE TIME

"I am making from \$10 to \$25 a week in spare time while still holding my regular job as a machinist. I owe my success to N. R. I."—WM. F. RUPP, 130 W. 6th St., Conshohocken, Pa.



The tested way to Better Pay



BE A RADIO EXPERT

Broadcasting Stations

Employ managers, engineers, operators, installation and maintenance men for fascinating jobs and pay up to \$5,000 a year.

I Give You Practical Experience

My Course is not all book training. I send you special Radio equipment and show you how to conduct experiments and build circuits which illustrate important principles used in modern Radio receivers, broadcast stations and loud speaker installations. I show you how to build testing apparatus for use in spare time work from this equipment. This 50-50 method of training makes learning at home interesting, fascinating, practical.

You Get a Money-Back Agreement

I am so sure that I can train you successfully that I agree in writing to refund every penny you pay me if you are not satisfied with my Lessons and Instruction Service when you finish. I'll send you a copy of this agreement with my Free Book.

Find Out What Radio Offers

Act Today. Mail the coupon now for "Rich Rewards in Radio." It's free to any fellow over 16 years old. It describes Radio's spare time and full time opportunities and those coming in Television; tells about my training in Radio and Television; shows you actual letters from men I have trained, telling what they are doing and earning. Find out what Radio offers YOU! MAIL THE COUPON in an envelope, or paste on a postcard—NOW!

J. E. SMITH, Pres.,
National Radio Institute,
Dept. 7AP,
Washington, D. C.

THIS FREE BOOK
HAS HELPED HUNDREDS OF MEN MAKE MORE MONEY



Set Servicing
Spare time set servicing pays many \$5, \$10, \$15 a week extra while learning. Full time servicing pays as much as \$30, \$50, \$75 a week.

Loud Speaker Systems
Building, installing, servicing and operating public address systems is another growing field for men well trained in Radio.



Automobile Radio
Another new Radio field—selling, installing, servicing. One million or more auto owners will install radio sets within the next year.



Mail to get 64 page Book FREE

Mr. J. E. SMITH, President, Dept. 7AP
National Radio Institute, Washington, D.C.

Dear Mr. Smith: Without obligating me, send "Rich Rewards in Radio," which points out the spare time and full time opportunities in Radio and explains your 50-50 method of training men at home in spare time to become Radio Experts. (Please Write Plainly.)

NAME..... AGE.....
ADDRESS.....
CITY..... STATE.....

NOW FIX ANY MAKE OF AUTO



SIX BIG AUTO BOOKS ALL SHIPPED FREE

on approval; whether you want to qualify as garage owner, auto repair expert or merely wish to know how to keep your own car 100% efficient, look at these books—they are sent to you for free examination. This brand new edition has been prepared by a large group of America's greatest automotive engineers. Anybody who can read will understand them, for this great automobile encyclopedia is a veritable

gold mine of valuable facts. Take advantage of this offer now; send in the coupon for FREE examination. You don't pay us a penny, you don't obligate yourself to pay anything unless you decide to keep the books. Just tell us you want to see them and the full set of 6 great volumes, just off the press, will be sent to you! Read them, look them over and prove to your own satisfaction that one fact alone, which you will find in them, may save you an expensive repair, or help you to a better job.

**DIESEL ENGINES
AVIATION MOTORS
MOTORCYCLES
OUTBOARD MOTORS
MARINE ENGINES
TRACTORS
AUTOMOBILE RADIOS
ALL COVERED**

Very Latest Edition

Imagine books which are so new that every page is right up to date—wiring diagrams, construction details, service problems—are all right up to the minute. Nowhere else can you get as complete and timely information. Over a million dollars of resources have enabled us to give you the most authoritative books on the subject ever published. Everybody interested in automobiles in any way will welcome these books published by the world's largest publishers of Technical Cyclopedias (est. 1897) with agencies all over the world.

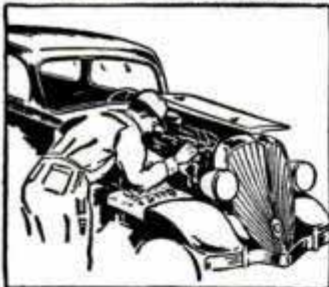

Can You Fix It?

Can you take out "play" in differentials? Can you kill the "shimmy" in steering? Can you reset TIMING? Can you put your finger on engine trouble without guessing or tinkering? Can you pull the starter off and fix it? Can you adjust and repair transmission, engine, rear axle, bearings?

These Books Tell How and tell you how to do any and every auto job right, the first time.

6 Big Volumes

Nearly 3,000 pages, over 2,000 illustrations, wiring diagrams, equipment charts, etc. De Luxe edition with gold-stamped flexible binding. Sent FREE for 10 days' use. If not wanted return express collect. If kept, send only \$2.00 after 10 days, then \$3.00 a month until a total of only \$24.80 is paid.

A Year's Consulting Membership FREE!

Privilege of consulting engineers of million-dollar American Technical Society for one year if you mail coupon immediately. We also include 2 extra books, "Service Shop Management" and loose leaf book of new diagrams without extra charge.

SEND NO MONEY

AMERICAN TECHNICAL SOCIETY,
Drexel Ave. at 58th St., Dept. A119, Chicago, Illinois.

I would like to see the brand new 6-volume edition of your automobile books but without any obligation to buy. I will pay the few cents delivery charges only and will examine the books and return them at your expense in 10 days unless I like them, in which case I will send you \$2.00 then and only \$3.00 per month until the total price of only \$24.80 is paid. You are to include free, consulting membership certificate in the American Technical Society and the two extra volumes mentioned above.

Name.....
Street.....
City..... State.....
Employer's Name.....
Employer's Address.....

Please give us, in addition, the name and address of one business man as reference.

DON'T BUY

Mandolin
Guitar
Banjo or
Drums



Cut This Adv.
Out — Good
for \$1.00
Credit

Don't buy Guitar, Mandolin, Banjo, Electric Guitars, Ukuleles, or Drums, until you have tried the Slingerland May-Bells, Guaranteed More for your Money. Wonderful, snappy, powerful, pleasing tone. No equal in price. Sold on easy payments and 5 days free trial by all leading music dealers.

Send for free catalog. Mention instrument wanted.

Write today:

Slingerland Musical Instrument Mfg. Co.,
1325 Belden Ave., Chicago, Illinois

ENGINEERING



TECHNICAL AND APPLIED COURSES. Nonesentials omitted. TIME AND MONEY SAVED. Degree in 2 yrs., diploma in 1 yr. Electrical, Mechanical, Architectural, Structural, Aeronautical, Civil, Highway. Short intensive courses in Diesel-Electric, Electricity, Power Plant, Drafting. All courses include Refrigeration, Diesel, and Air-Conditioning. Low tuition. Extensive modern equipment. Part-time work for room and board. 37th year. Thousands of successful graduates in U. S. and foreign lands. Approved by industry, endorsed by educators and alumni. One and two-year courses begin in Sept. Short courses open the year round. Catalogue free.

FINLAY ENGINEERING COLLEGE
1001 Indiana Avenue Kansas City, Mo.

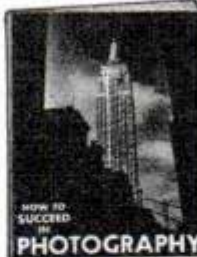

BIG OPPORTUNITIES AS AN EXPERT PHOTOGRAPHER

You can have a fascinating, profitable career in the World's newest, big profession. Become a Commercial, News, Portrait or Advertising Photographer, or Movie Cameraman. Big money-making opportunities. Personal Attendance or Home Study training. Individual, practical instruction. 27th year. Write for FREE Booklet.

NEW YORK INSTITUTE OF PHOTOGRAPHY
10 West 33 Street (Dept. 49) New York, N. Y.

CARTOONING

PAYS WELL Develop your ability with personal instruction from an internationally-known cartoonist. His exclusive, successful method of drawing and creating ideas makes it easy to attain success. Write for details of this exceptional home-study course. National School of Cartooning, 437 Penton Building, Cleveland, Ohio

NEW YORK SCHOOL OF MECHANICAL DENTISTRY

★ Make more money as a DENTICIAN. We show you how! Oldest school. Real Laboratory Training. Day, Eve. Easy terms. Tools FREE. Ask for Catalog P. N. Y. SCHOOL OF MECHANICAL DENTISTRY, 125 W. 31 St., N. Y. C. ★



WHY NOT spend spring, summer, fall, gathering butterflies, insects. I buy hundreds of kinds for collections. Some worth \$1 to \$7 each. Simple outdoor work with my Instructions, pictures, price list, Profit or pleasure. Send 1¢ (not stamps) for Illustrated Prospectus, terms, before sending butterflies. **MR. SINCLAIR, DEALER IN INSECTS** Dept. 6, Box 1424 San Diego, Calif.

TRAIN NOW FOR TOP JOBS

in *Radio*

R-T-I Advisory Board of leading Radio Engineers in regular conference with members of staff.



Big-Money in Police Radio

Student W. H. Carr, 402 N. 16th St., Kansas City, Kansas, has charge of 35 radio equipped police and fire department cars. Earns \$230.00 a month, plus free automobile, oil, gas, etc. Gives R-T-I credit for his success.



Makes \$600 in One Month

Herbert B. Thomson, Gorman, Texas, former oil well driller, borrowed \$170 to start own radio shop now worth \$3,500. Made as high as \$450 in one month. Says, "It pays to be R-T-I trained."



Starting Salary in Radio Most Money Ever Earned

Harold Apley, 2639 Brookside, Indianapolis, made \$30 extra weekly in spare time radio work then went to work for big firm starting with bigger pay than he ever earned before. Says, "Glad to recommend R-T-I."

Learn to EARN up to \$75 Weekly

[MANY R-T-I STUDENTS GET MORE]

Trained Men Needed in All Branches

If you're dissatisfied with small pay—lay-offs and an uncertain future—here's an opportunity that's too good to miss. At the cost of only the time it takes you to mail the coupon, you can get my big FREE book, "RADIO'S FUTURE AND YOUR OPPORTUNITY." This book tells how you can learn at home under the supervision of factory engineers, to make more money almost at once in Radio—whether you want to make Radio your life's work, or use it to pick up an extra \$5 to \$20 a week in your spare time.

More Opportunities Than Ever Before

Radio is still forging ahead. 1936 beats all other years. Over 6 million new sets sold. Over 30 million dollars paid for service alone this year. Where only a few hundred men were employed a short time ago, thousands are employed today. And where a hundred jobs paid up to \$75 a week—there are thousands of such jobs today—many paying even more. And new jobs are being created all the time—full time jobs and spare time jobs. Get my book and see how easy it is to learn at home for this good-pay work.

"Shop Training" for the Home

R-T-I Training is different than any training you ever heard about. It comes to you right from the heart of the Radio Industry—right out of the factories where Radio sets and other vacuum-tube devices are made. It was planned and prepared and is supervised by big radio engineers IN these factories—by men appointed for the purpose. This means that trained the R-T-I way, you'll be trained as the Radio Industry wants you trained—just as the Radio Industry, itself, would train you if it was doing the job.

Television, Photo Electric Cells, Public Address Systems Included

Radio service work is only the starting point in R-T-I Training. From there it will take you through the whole field of Radio and Electronics. You will learn about every new development, including Television, so you'll be ready when Television breaks. You'll also learn the big money subjects such as Aviation and Auto Radio; Public Address Systems; how to handle Photo Cells; Sound Picture Recording, Etc.

4 Working Outfits Furnished

Start almost at once doing part time radio work. I furnish 4 outfits of apparatus that you build into test equipment with which you can do actual jobs and earn extra money. My Training pays its own way and you get your money back if not satisfied.

Age or Lack of Experience No Handicap

You don't have to be a high school graduate, nor even have finished the grades. My Training is so simple, easy, and practical, that the average man, regardless of age, education, or previous experience can master it. It offers the chance you have wanted to get out of a small-pay, no-future job, into good pay work with a future, in Radio and all its branches.

Get My Free Book

INVESTIGATE! Learn why R-T-I Training is different. Find out why R-T-I Trained men get "Quick Results" and "Big Results." Send for your copy of "Radio's Future and Your Opportunity" today. It tells you about Radio's amazing opportunities. It describes my approved training. It tells what R. T. I. students are doing and making. It gives the names of my Advisory Board and 50 endorsing manufacturers. It's FREE. Clip, sign and mail coupon RIGHT NOW!

RAY D. SMITH, President

Mail Coupon for my FREE BOOK that shows how Factory Engineers will Prepare You at home for Good Pay Spare Time or Full Time Radio Jobs



Ray D. Smith, President R-T-I, who has helped more than 100,000 men succeed.

These Engineers Supervise Your Training

Kendall Clough, Chief Engineer, Clough-Brengle Co.
E. E. Gramer, Chief Engineer, Standard Transformer Corp.
Karl E. Hassel, Chief Engineer, Zenith Radio Corp.
F. H. Schneff, Radio Engineer, General Household Utilities (Grunow).
Dr. C. M. Blackburn, Asst. Factory Mnggr.; P. K. Mallory & Co., Mfrs. of Radio Apparatus.

Endorsed by 50 Radio Concerns

AMERICAN TELEVISION
ARCTURUS TUBES
CLOUGH-BREngle
CROSLY • DeFOREST • FADA
HAMMARLUND • HOWARD
MAJESTIC • PHILCO
STEWART-WARNER
SILVER-MARSHALL
STANDARD TRANSFORMER
STROMBERG-CARLSON
ZENITH
—and Others

MAIL FOR FREE BOOK

Ray D. Smith, President,
RADIO AND TELEVISION INSTITUTE
2150 Lawrence Ave., Dept. 11, Chicago, Ill.

Without obligation, send me a copy of "Radio's Future and Yours." I am interested in your training and the opportunities in the great field of Radio for the R-T-I Trained Man.

Name.....

Address.....

City.....State.....



RADIO AND TELEVISION INSTITUTE
PRACTICAL SHOP TRAINING FOR THE HOME

Dept. 11

2150 Lawrence Avenue

CHICAGO

When writing to advertisers please mention Popular Mechanics



High School Course at Home

Many Finish in 2 Years

You can complete this simplified High School Course as rapidly as your time and abilities permit. Equivalent to resident school work—prepares you for entrance to college. Standard H. S. texts supplied—Diploma. Credit for H. S. subjects already completed. Single subjects if desired. High School education is very important for advancement in business and industry and socially.

College Entrance

During the past 14 years, our High School graduates have been admitted to 531 different Universities, Colleges, Junior Colleges and Normal Schools—80% of them without entrance examination. Course also prepares for teachers' certificate and pre-professional examinations.

Business—Industry

To get and hold a good position in Business today you must be able to write clear, accurate letters and reports—do figuring involving Algebra and Geometry—talk intelligently on matters requiring a knowledge of Geography, History, and Economics.

In Industry—Mechanical and Engineering lines—you must have at least an elementary knowledge of Physics and Chemistry—be able to figure quickly and accurately—know something of Mechanical Drawing and blueprints—and be able to talk and write accurately and clearly on both your work and ordinary topics of conversation.

Our High School course meets the preparatory educational requirements for Business and Industry.

An Educational Institution

The American School was chartered in 1897 as an educational institution, not for profit—and is exempt from paying Federal income tax, like the best resident colleges and universities.

Don't Be Handicapped— Complete Your Training Now

Be a High School Graduate! Prepare yourself for promotion in Business and Industry—for the Professions, College Entrance and social success. No matter what line you may select, High School training will prove invaluable to you! Our moderate fees cover all instruction, standard textbooks and Diploma. Easy monthly terms. Get ahead in life. Start your training NOW!

20 Other Courses

Over 150 noted Educators, Engineers, and Business Men helped prepare our special instruction material, which is used by many resident schools and colleges, U. S. Navy, and Province of Manitoba, Canada. We offer you quality training at home for the best-paying lines of Industry and Business, as listed in the coupon.

Prepare yourself for promotion in Business and Industry—for the Professions, College Entrance and social success. No matter what line you may select, High School training will prove invaluable to you! Our moderate fees cover all instruction, standard textbooks and Diploma. Easy monthly terms. Get ahead in life. Start your training NOW!

Mail coupon for information about line that interests you
American School, Drexel at 58th, Chicago

American School, Dept. H-145, Drexel at 58th, Chicago
Tell me how to train for success in line checked. No obligation.

High School Course

- | | |
|--|--|
| <input type="checkbox"/> Accounting & Auditing | <input type="checkbox"/> Diesel Engineering |
| <input type="checkbox"/> Architecture & B'lding | <input type="checkbox"/> Drafting & Design |
| <input type="checkbox"/> Automotive Engin'ring | <input type="checkbox"/> Liberal Arts |
| <input type="checkbox"/> Business Management | <input type="checkbox"/> Private Secretary |
| <input type="checkbox"/> Com'ercial Aeronautics | <input type="checkbox"/> Hi'er Ac't'g (C.P.A.) |
| <input type="checkbox"/> Electrical Engineering | <input type="checkbox"/> Highway Engin'ring |
| <input type="checkbox"/> Electrical Refrigerat'n | <input type="checkbox"/> Mechanical Eng'ring |
| <input type="checkbox"/> Air Conditioning | <input type="checkbox"/> Radio & Television |
| <input type="checkbox"/> Civil Engineering | <input type="checkbox"/> Salesmanship |
| <input type="checkbox"/> Complete Law | <input type="checkbox"/> Steam Engineering |

Name.....

Address.....

Unaccustomed as I am—er—



Do **YOU** get "platform paralysis"? At dinners, lodge nights, conferences, do you tremble because you **may** be called on to "say a few words"? Words that **COULD** make you a leader—if you only knew how to **say** them!

FREE BOOK—"Talking for Results"

Write for this revealing book on how to develop a strong, confident voice; an instant flow of clinching words; self-assurance, compelling presence. No foolishness about "elocution." Real facts about Grenville Kleiser's practical, new method of Public Speaking, Personality Development. Address: **FUNK & WAGNALLS CO.**, Dept. 1653, 354-4th Ave., New York, N. Y.

LEARN WATCH REPAIRING



AT HOME You can learn by our modern and original system of instruction every part of the **Watch Repairing Trade** at home. You can earn money while learning and prepare yourself for a well paying position or start in business after completing our course of instruction. Good watch repairers are in demand and generally earn very good salaries. For particulars apply to the **Wisconsin School of Watch Repairing**
524 E. Mason St., MILWAUKEE, WIS.

FREE 25,000 BARGAINS CATALOG in BOOKS

Our 42nd Annual 320-Page Bargain Catalog of new Books of all Publishers lists 25,000 titles—Fiction, Juvenile, History, Scientific, etc. Illustrated, Indexed. Used by schools, colleges, libraries, and thousands of individuals. Write today for this new 1937 catalog, "Bargains in Books."
THE BOOK SUPPLY COMPANY, Dept. 132
564-566 West Monroe Street - - Chicago, Illinois

BE A PASSENGER Traffic Inspector

Increasing Traffic Means More Men Are Needed

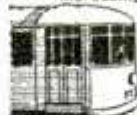

A GOOD POSITION is ready for you upon completion of our simple, home-study course. We place you as a **Railway and Bus Passenger Traffic Inspector** with salary up to \$135 per month, to start, plus expenses, or refund tuition. Interesting, healthful work; travel if you like. Free Booklet gives our 18-yr. record of placing students.

STANDARD BUSINESS TRAINING INSTITUTE Div. 201, Buffalo, N. Y.

VOICE

100% Improvement Guaranteed

We build, strengthen the vocal organs—not with singing lessons—but by fundamentally sound and scientifically correct *silent exercises*... and absolutely guarantee to improve any singing or speaking voice at least 100%... Write for wonderful voice book—sent free. Learn WHY you can now have the voice you want. No literature sent to anyone under 17 years unless signed by parent.

PERFECT VOICE INSTITUTE, Studio 1351
64 E. Lake St., Chicago



Improves Handwriting In 3 Hours

Marvellous invention. Corrects poor writing in few days. Amazing results guaranteed. No failures. Positive proof and complete outline mailed FREE. Write quickly.

OZMENT INSTRUCTION SERVICE, Dept. 34, St. Louis, Mo.

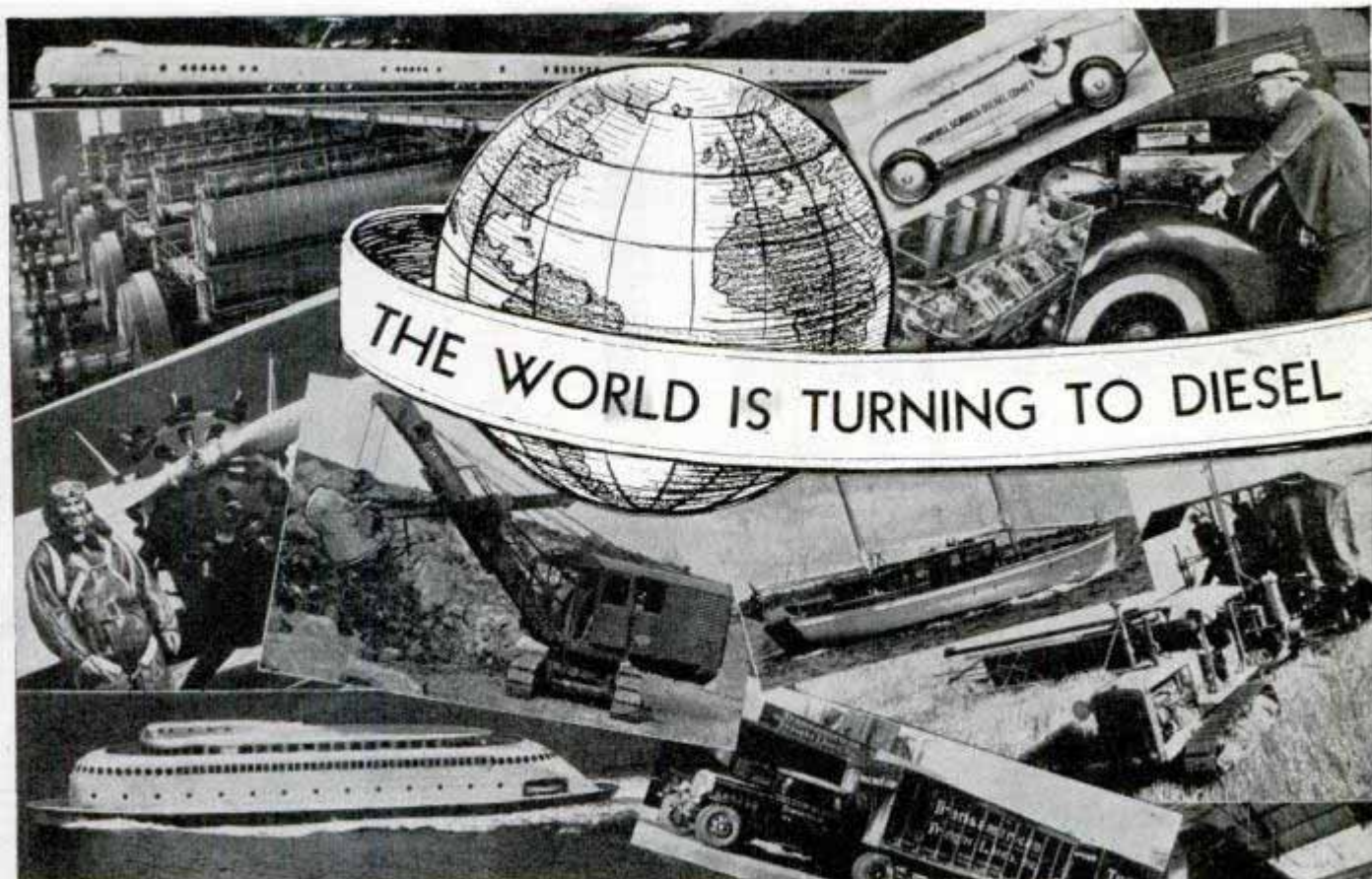

THINK OF YOUR FUTURE - YOUR SUCCESS

Are you preparing yourself for this world-wide change in power producers? Are you equipping yourself with the knowledge required of men who will be the leaders in the Diesel field? The opportunity is here . . . you should be acting now. Hemphill Diesel Schools, America's Original Exclusive Diesel training institution, can qualify you for the opportunities in this gigantic field.

HEMPHILL DIESEL SCHOOLS

are located at addresses shown below and in no way connected with any other schools.

BOSTON, 114 Brookline Avenue
NEW YORK, 31-26 Queens Blvd., L.I. City
DETROIT, 2341 W. Lafayette Blvd.
CHICAGO, 2014 Larrabee Street
MEMPHIS, 417 Monroe Avenue
LOS ANGELES, 2120 San Fernando Road
SEATTLE, 501 Westlake North
VANCOUVER, B. C., 1363 Granville Street

"March of Diesel" now ready for distribution. Shows many types of Diesel applications. Fully describes the growth of the industry.

Day and Night Resident Courses, also a proven Combination Home Study Course with later shop practice are offered. . . .

Read this letter from Hemphill graduate, Lewis Jensen . . . "I am now sales engineer of one of the largest boat and engine distributors on the Great Lakes. I wish to thank you for helping me the way you have, and for the interest you have always shown in my success." (Signed) Lewis Jensen. The large number of employed Hemphill graduates proves the value of Hemphill Diesel training.

HEMPHILL DIESEL SCHOOLS (use nearest address)
I would like a free copy of 32-page book, "March of Diesel," and full information on your Diesel courses.

Name _____ Age _____
Address _____
City _____

M-13-B

MAIL COUPON TODAY

**HEMPHILL
TRAINING PAYS**

Snap out of it!

The depression's over

● THE question is, are you over the depression? Tough? You bet it was — it was the toughest depression this country ever had. But listen: *The future is the brightest that ever beckoned a man.* Opportunity calls from every side — calls to ambitious and trained men! If you have the ambition, the International Correspondence Schools can supply the training. Get going! Snap out of it! Hurry this coupon along to Scranton.

INTERNATIONAL CORRESPONDENCE SCHOOLS

Box 5652-H, Scranton, Penna.

Without obligation, please send full particulars about the subject before which I have marked X:

TECHNICAL AND INDUSTRIAL COURSES

- | | |
|--|---|
| <input type="checkbox"/> Architect | <input type="checkbox"/> Diesel Engines |
| <input type="checkbox"/> Architectural Draftsman | <input type="checkbox"/> Aviation Eng. <input type="checkbox"/> Auto Mechanic |
| <input type="checkbox"/> Building Estimating | <input type="checkbox"/> Plumbing <input type="checkbox"/> Heating |
| <input type="checkbox"/> Contractor and Builder | <input type="checkbox"/> Air Conditioning <input type="checkbox"/> Refrigeration |
| <input type="checkbox"/> Structural Draftsman | <input type="checkbox"/> Steam Engineer |
| <input type="checkbox"/> Structural Engineer | <input type="checkbox"/> Steam Electric Engineer |
| <input type="checkbox"/> Electrical Engineer | <input type="checkbox"/> Marine Engineer |
| <input type="checkbox"/> Electric Lighting | <input type="checkbox"/> Civil Engineer <input type="checkbox"/> Highway Engineer |
| <input type="checkbox"/> Welding, Electric and Gas | <input type="checkbox"/> Bridge Engineer |
| <input type="checkbox"/> Reading Shop Blueprints | <input type="checkbox"/> Bridge and Building Foreman |
| <input type="checkbox"/> Telegraph Engineer | <input type="checkbox"/> Surveying and Mapping |
| <input type="checkbox"/> Telephone Work <input type="checkbox"/> Radio | <input type="checkbox"/> R. R. Locomotives <input type="checkbox"/> Air Brakes |
| <input type="checkbox"/> Mechanical Engineer | <input type="checkbox"/> R. R. Section Foreman |
| <input type="checkbox"/> Mechanical Draftsman | <input type="checkbox"/> R. R. Signalmen |
| <input type="checkbox"/> Machinist <input type="checkbox"/> Toolmaker | <input type="checkbox"/> Chemistry <input type="checkbox"/> Pharmacy |
| <input type="checkbox"/> Patternmaker | <input type="checkbox"/> Coal Mining |
| <input type="checkbox"/> Foundry Practice | <input type="checkbox"/> Navigation |
| <input type="checkbox"/> Sheet Metal Worker | <input type="checkbox"/> Cotton Manufacturing |
| <input type="checkbox"/> Boilermaker | <input type="checkbox"/> Woolen Manufacturing |
| <input type="checkbox"/> Heat Treatment of Metals | <input type="checkbox"/> Agriculture <input type="checkbox"/> Fruit Growing |
| <input type="checkbox"/> Management of Inventions | <input type="checkbox"/> Poultry Farming |

BUSINESS TRAINING COURSES

- | | |
|--|--|
| <input type="checkbox"/> Business Management | <input type="checkbox"/> Lettering Show Cards <input type="checkbox"/> Signs |
| <input type="checkbox"/> Industrial Management | <input type="checkbox"/> Stenography and Typing |
| <input type="checkbox"/> Traffic Management | <input type="checkbox"/> Civil Service <input type="checkbox"/> Mail Carrier |
| <input type="checkbox"/> C.P. Accountancy | <input type="checkbox"/> Railway Mail Clerk |
| <input type="checkbox"/> Bookkeeping | <input type="checkbox"/> Grade School Subjects |
| <input type="checkbox"/> Secretarial Work | <input type="checkbox"/> High School Subjects |
| <input type="checkbox"/> Cost Accountant | <input type="checkbox"/> College Preparatory |
| <input type="checkbox"/> Salesmanship <input type="checkbox"/> Advertising | <input type="checkbox"/> First Year College Subjects |
| <input type="checkbox"/> Service Station Salesmanship | <input type="checkbox"/> Illustrating <input type="checkbox"/> Spanish |
| <input type="checkbox"/> Business Correspondence | <input type="checkbox"/> Cartooning <input type="checkbox"/> French |

DOMESTIC SCIENCE COURSES

- | | |
|---|--|
| <input type="checkbox"/> Professional Dressmaking and Designing | <input type="checkbox"/> Millinery |
| <input type="checkbox"/> Home Dressmaking | <input type="checkbox"/> Foods and Cookery |
| <input type="checkbox"/> Advanced Dressmaking | <input type="checkbox"/> Tea Room and Cafeteria Management, Catering |

Name.....Age.....
 Address.....
 City.....State.....
 Present Position.....

If you reside in Canada, send this coupon to the International Correspondence Schools Canadian, Limited, Montreal, Canada

When writing please mention Popular Mechanics

WANTED: TRAINED PILOTS and MECHANICS for BIG PAY JOBS IN AVIATION

Aviation Needs and Must Have Thousands of Newly Trained Men for new positions as Pilots and Airplane Mechanics. Airlines adding millions of miles to their flight schedules. Factories crowded with huge private and Government orders for new airplanes.

This Lincoln Government Approved School trains you for good pay positions as Pilot or Government Licensed Airplane and Engine Mechanic. School now in 26th year; 16 years teaching Aviation.

Good Salaries paid to properly trained men. Airline Pilots get up to \$700 a month; Co-Pilots \$250 a month. Licensed Mechanics get up to \$200 a month—wonderful opportunities for promotion.

Make Aviation YOUR Career. Supervised by U.S. Government, Aviation offers you unlimited opportunities for promotion. Prepare yourself at this Lincoln Government Approved School. Graduates now employed by leading Airlines, Factories and in Foreign Service. We assist Graduates in locating positions when qualified. Write for catalog. Please state age.

LINCOLN AIRPLANE & FLYING SCHOOL, 204-G Aircraft Bldg., Lincoln, Nebraska

ELECTRICAL ENGINEERING

A BROAD, basic, intensive course complete in one school year. Includes fundamentals of Refrigeration, Air-conditioning, Electronics. Approved by educators, endorsed by industry. 45th year. Catalog.



BLISS ELECTRICAL SCHOOL
 131 TAKOMA AVE., WASHINGTON, D. C.



Learn Public Speaking

At home—in spare time. Many overcome "stage-fright," gain self-confidence, and increase their earning power, through ability to sway others by effective speech. Write for free booklet, *How to Work Wonders With Words* and requirements.

NORTH AMERICAN INSTITUTE, Dept. 1351
 3601 Michigan Avenue Chicago, Illinois

FREE! LABORATORY APPARATUS BIOLOGICAL SUPPLIES MICROSCOPES TELESCOPES CHEMICALS

New complete 32 page catalog lists hundreds of items of interest to amateur and professional experimenters. Save Money—Buy Direct. Send now! It's FREE and crammed full of bargains and valuable information.



J. H. WINN MFG. CO., Dept. 401, 124 W. 23 St., New York

FENCING World's Finest Sport Exciting Fun—Harmless



Boys! Become the best swordsmen in your neighborhood. Develops both body and mind. Harmless, because the spring-steel 3 ft. long foils are equipped with rubber buttons. Cup shaped hand guards. Complete set of two foils (swords) and free instruction booklet only \$1.98 postpaid. Order Now.

INDUSTRIAL PROD. CO., Dept. 12 M, 274 Madison Ave., NEW YORK, N. Y.

How To Secure A Government Position

Why worry about strikes, layoffs, hard times? Train now for a Government job. Increased salaries, steady work, travel, good pay. Let me help you become a Railway Postal Clerk, Post Office Clerk, City Mail Carrier, Rural Carrier—or help you get any position in government Classified Service you want. I was a Secretary Examiner of Civil Service Commission for 8 years. My coaching has helped thousands. My 32-page book tells about Government jobs—and how my instruction helps to qualify you to get the one you want. Send for a free copy TODAY.



A. R. Patterson, Civil Service Expert
 PATTERSON SCHOOL, 81 Case Bldg., Rochester, N. Y.
 Send, without obligation, free book "How to Secure Government Position."

Name.....
 Address.....

Learn **DIESEL** and **GAS ENGINEERING**



Partial view of Diesel-engine operating room—one of the important Departments at National Schools.



Students servicing Fairbanks-Morse Diesel power generating unit.

YOU WORK ON FINEST and LATEST EQUIPMENT AVAILABLE IN AMERICA

National Schools' course of Diesel Training is the outgrowth of years of successful development. The instruction is **PROVEN**. Over 30,000 graduates have received National Training. Now, National offers the most comprehensive training—actually three complete courses for the price of one—Gas and Diesel Engineering, and Electric Power Generation—all of which are absolutely essential to qualify for best jobs.

Easy, Fascinating "Shop-Practice" Method

The day you begin your training at National you start right in with a practical job on the most modern Gas and Diesel equipment, including Caterpillar, Cummins, McCormick-Deering, Hercules, Venn-Severin, Fairbanks-Morse, Enterprise, and many others. The work is actually a pleasure for students—easy to understand—ever fascinating. You learn in a few months what would ordinarily take far longer.

Complete, Modern Equipment Actually Used by Students

The vast installation of modern Gas and Diesel equipment here is all used by you in learning your trade. You learn to assemble and disassemble all parts, learn trouble-shooting; operating and all essentials to qualify you for big-pay Gas and Diesel opportunities. Your instruction is personalized under direct supervision of a large staff of experts.

LEARN IN LOS ANGELES, Playground of America RAILROAD FARE ALLOWED EARN ROOM AND BOARD

For a limited time, coach R. R. fare allowed to L. A. from any part of the U. S.

We help students obtain part-time jobs to earn room and board while learning.

NATIONAL SCHOOLS, LOS ANGELES

ESTABLISHED 1905



Electrical trouble-shooting in gas engine department.

QUALIFY FOR GOOD PAY JOBS

NATIONAL'S

Master Training
Includes

All Phases of
Diesel Engines
Fuel Injection
Gas Engines
Butane Engines
Propane
Natural Gas
Auto-Diesel Electrics
Also Diesel Power
Generation
Machine Shop
Batteries

Special Added Feature!

DIESEL ELECTRIC POWER GENERATION

In keeping with National Schools' progressive policy of offering the most complete Course, we announce this added feature, made available to you by an investment on our part of thousands of dollars. Full instruction includes:

Alternating and Direct Current Power Stations

Switchboards and Instruments

Station and Motor Wiring Motors and Controls

Distribution Lines, Transformers, etc.

This specialized training enables our graduates to expertly handle Diesel equipment in power plants, mines, public buildings and utilities, boats, trains, etc. Knowledge of Diesel Electrics is just as essential as the fundamentals of Diesels. This school is the only one in the U. S., to our knowledge, offering this extra, yet necessary, specialized training.

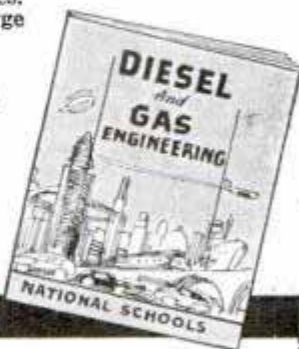

MAIL THIS COUPON

NATIONAL SCHOOLS, Los Angeles, Calif.
Dept. 1-PMA, 4000 So. Figueroa St.
Please send Catalog

NAME.....AGE.....

ADDRESS.....

CITY.....STATE.....



START \$1260 to \$2100 YEAR
MANY 1937 APPOINTMENTS

Railway Postal Clerks

Railway Postal Clerks get \$1,900 the first year regular, being paid on the first and fifteenth of each month. (\$79.17 each pay day.) Their pay is automatically increased yearly to \$2,450. Advance may be had to Chief Clerk at \$2,700 a year. (\$112.50 each pay day.)

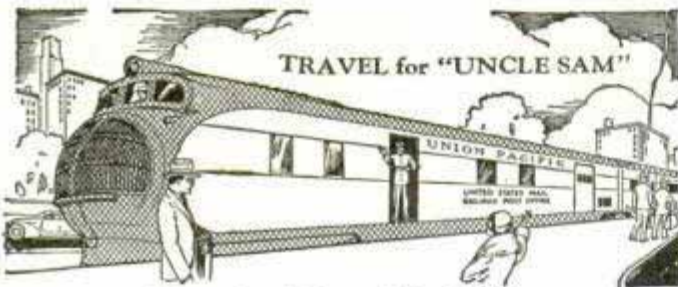

3 Days On—3 Days Off—Full Pay

Railway Postal Clerks on long runs usually work 3 days and have 3 days off duty or in the same proportion. During this off duty their pay continues just as though they were working. They travel on a pass when on business. When they grow old, they are retired with a pension.

City Mail Carriers, Post Office Clerks

Clerks and Carriers now get \$1,700 the first year on regular and automatically increase \$100 a year to \$2,100 and \$2,300.

Customs Inspector

Salary \$2,100 to start. Men 23 to 45. Work connected with examining baggage and merchandise entering the country from foreign parts covering boats, trains, roads, automobiles, etc.

Many Other Positions

Many other positions are obtainable. Those wishing these positions should qualify at once.

Get Free List of Positions

Fill out the following coupon. Tear it off and mail it today—now, at once. This investment may result in your getting a big-paid government job.

FRANKLIN INSTITUTE, Dept. T-173, Rochester, N. Y.

Rush to me, entirely free of charge (1) a full description of U. S. Government Jobs; (2) Free copy of illustrated 32-page book, "U. S. Government Positions and How to Get Them"; (3) List of U. S. Government Jobs; (4) Tell me what to do to get a U. S. Government Job.

Name.....

Address.....

Use This Coupon Before You Mislaid It. Write or Print Plainly.

When writing please mention Popular Mechanics

Easy free book

● You'll learn more quickly and easily to play a P-A Sax, Trumpet, Clarinet, or Trombone, because P-As are easier to blow and have such beautiful tone. Thousands in use. Strongest guarantee backed by old, reliable manufacturer. Moderate prices. Home trial. Easy terms. See your music dealer or write for beautiful free book. Mention instrument. 1247

PAN-AMERICAN
 103 P-A Building Elkhart, Indiana

BE AN ARTIST

WE CAN TEACH YOU DRAWING in your own home during your spare time. Thirty-five years of successful teaching proves our ability. Artists receive large salaries.

Write today for Art Year Book
SCHOOL OF APPLIED ART
 Dept. 117, 10 E. Huron St., Chicago, Ill.

ENGINEERING DEGREE IN TWO YEARS

B.S. Degree in Electrical, Civil, Chemical, Radio, Mechanical or Aeronautical Engineering in two years. Located in an industrial center with that Engineering atmosphere. Earn board. Low tuition. Preparatory Department. Enter Mar., June, Sept., Dec. Catalog.

INDIANA TECHNICAL COLLEGE
 229 East Washington St., Fort Wayne, Indiana

You Can Regain Perfect Speech, if you

STAMMER

Send today for beautifully illustrated book entitled "DON'T STAMMER," which describes the Bogue Unit Method for the scientific correction of stammering and stuttering. Method successfully used at Bogue Institute for 36 years—since 1901. Endorsed by physicians. Full information concerning correction of stammering sent free. No obligation. Benjamin N. Bogue, Dept. 174, Circle Tower, Indianapolis, Indiana.

CRIME DETECTION SECRET SERVICE AND FINGER PRINTS

SECRET SERVICE BOOK FREE

For 30 Days Reading No Money Down—Actual Crime Cases—If You Act Quick!—We will send you this stirring book on Crime Detection, Secret Service and Identification Work for 30 days free reading. Send no money. If you decide to keep it, then send only \$1.00. If not, return it. WRITE TODAY. Not sent to boys under 17 years of age.

T. G. Cooke, Dept. 1351 1920 Sunnyside Ave., Chicago

MAIL FOR FREE INFORMATION

BEDFORD
 1117 Bedford Ave., Dept. PM-44
 Brooklyn, New York City, N. Y.

YMCA TRADE SCHOOL

- Auto Mechanic
- Talking Pictures
- Aviation Mechanic
- Welding
- Aeronautical Engineering
- Refrigeration
- Machine Shop
- Oil Burner
- Diesel Engineering
- Air Conditioning
- Sign Painting
- Electrical
- Window Display
- Radio and Television Mechanic
- Architectural-Mechanical Drafting
- Armature Winding
- Diesel Engines

Name.....
 Address.....

Be An ARTIST



It's Fun to Learn this Way

Learn to Draw at Home This Simple, Practical Way!

YOU have always longed for it—this fascinating ability to draw. Now it can really be yours! Illustrating, Rapid Sketching, Decorative Designing, Commercial Art, Cartooning—you can now learn all of this right in your own home. Many of our graduates never studied art before, yet today are successful artists with good incomes.

Our simple, proven, practical method makes it fun to learn, in your spare time. And now, with just a few hours' pleasant practice each week, you, too, may learn to make drawings that have a real commercial value—just as those whose reports are given below are doing! Get into this interesting, profitable field NOW! Mail coupon for FREE BOOK, "Art for Pleasure and Profit" at once!

Can YOU Do THIS?

Just a few plain, quickly sketched lines—and you have the "framework" of a drawing. These first lines give you the rough proportions and lines of action.



Then YOU Can Do THIS . . .

Next we show you exactly how to apply the rules for developing the outlines and "blocking in" the areas to be shaded. Then you erase the first "framework" lines and presto!—you have this!



...and THIS!

Now you are shown how to give your drawing shape, depth and form by shading and high-lighting. In every single step you are guided by proven rules which correct your mistakes and skillfully direct your hand!



BIG ARTIST'S OUTFIT GIVEN!

This full-size professional Artist's Outfit comes with your very first lessons—at NO EXTRA COST. It contains everything you need to start. Mail coupon now for complete details of this remarkable offer.

Made \$125 a Week!

Joe Rinaldi of New York writes: "Since completing your course I have earned as high as \$125 a week."

\$3,000 for W.R.K.

"Just signed 2 contracts that will bring me \$3,000. Earned \$280 while taking course. Have more orders than I can accept."—W. R. Kent, Newark, N. J.

\$3,000 a Year and More!

M. A. Kraykovic writes: "... salary averages \$2,000 to \$3,000 a year and more. It is a pleasure to recommend your course."

\$100 for 8 Hrs. Work

"Have received for some of my paintings as much as \$100 for 6 to 8 hours' work."—D. P. Harris, N. Car.

\$50 for One Drawing

"Got \$50 for a simple idea, expressed in a pen and ink drawing. Have made over \$200 so far."—G. Bartoloni, Oregon.

576 a Week

—that's what our student, H. J. Algeldinger, of Penna., averages. Has made over \$1,200 in spare time.

Commercial Art, Cartooning and Designing, ALL in ONE Course!

It's like an enjoyable game when you learn to draw with this simple method. You study right at home, yet every bit of your work receives the individual attention and criticism of a real art teacher. It's almost as though you had your instructor standing at your elbow while you work.

With this training you progress in easy stages. Starting with straight lines and curves, you learn action, perspective and all the more advanced principles of drawing. You get a sound, complete, all round art training based on our 22 years of successful teaching experience. See (at the left) the money others have made even before they finished the course!

Our big FREE Book describes the latest developments and opportunities in this fascinating, good income field—and gives full details of this simple practical method. Tells about our graduates—their successes—what they say about our course—shows actual reproductions of their work—and tells how they earned good money even while learning. Mail coupon or postcard today. (No salesman will call.) Please state age. Studio 121, Washington School of Art, 1115—15th St., N. W., Washington, D. C.

Get this FREE BOOK

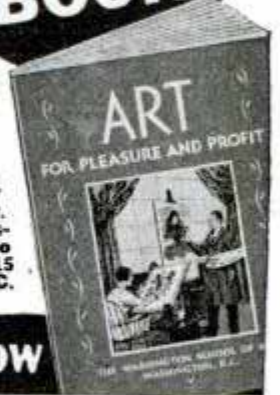

Free Book shows how

WASHINGTON SCHOOL OF ART, Studio 121, 1115—15th Street, N. W., Washington, D. C.

Without obligation, please send me a FREE copy of your Book, "Art for Pleasure and Profit."

Name.....Age.....

Address.....

City.....State.....

*David
Sarnoff
says:*

David Sarnoff, once a poor lad and now the famous President of the Radio Corporation of America, in an article in Liberty Magazine states: "Civilization means elimination of unnecessary labor. The sewing machine and the vacuum cleaner save millions of women from backbreaking toil. The tractor makes the farmer's life bearable. The automobile lends wings to us all. The airplane is our magic carpet. It would be madness to slow up invention because our trouble is not that mechanical science moves too speedily, but that the governmental and social sciences move too slowly . . . In a world reorganized to vibrate within certain wave bands, human intelligence will be able to distribute equitably nature's bounties from above and below, and make princes of paupers."

INVENTIONS

Send for Valuable Facts *about*



Since the "Horseless Buggy" Days, We Have Helped Inventors

Perhaps you have already heard about our firm, because one client tells another—and we have served men in every state in the Union, and in nearly every foreign country. We have been working with inventors since 1898. If you have a good invention—or an idea for one—and don't know what Victor J. Evans & Co. can do for you, NOW is the time to find out.

How We Can Help You

Both the Patent Office and the U. S. Supreme Court have made it clear that the inventor needs the assistance of a competent patent lawyer when it comes to protecting an invention. It is one thing to think up a good invention—it is another to get effective patent protection on it.

For more than a third of a century—it has been our business to give sound advice and counsel to inventors. Our free books (described on the opposite page) tell what steps to take first, how to protect yourself, how the laws protect you, what you must do, when to offer your invention for sale, how others have succeeded, and much more. You need this information.

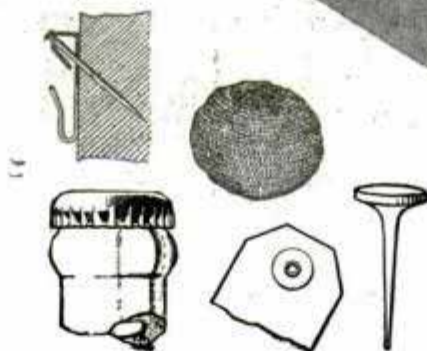

Simple Inventions May Have Excellent Commercial Possibilities

Frequently inventors confuse the size or the complication of a device with the question of commercial value and patentability. These two factors, of course, have no relation to each other. Most of our present-day complicated machines represent a process of evolution, a series of inventions. On the other hand, every so often some inventor comes along with a very simple "gadget" which possesses the elements of broad utility and is patentable. Some of the most profitable inventions have been of this latter class. Shown above are a few such examples. Whether a device is simple or complex, if it represents a forward step to save manufacturing costs, to save labor, or to add enjoyment to human life, it may prove patentable and profitable. This subject is more fully discussed in the booklet entitled "Patent Protection" shown on the opposite page.



What Will Be Next?

Ever since George Washington signed the first patent, America has led the world in inventions. It may be said that not a year has gone by without some important inventions being patented and commercialized. David Sarnoff, president of the Radio Corporation of America, sees a big future ahead for science and invention. Just as sure as the sunrise, 1937 will see new inventions come out—new wealth made from patents. Your idea may be one of them. You never can tell. For this reason you should send for our books today and get the facts about patents and inventions.

**Learn How Our Patent Laws
Protect You**

The U. S. has liberal patent laws, and much of our national wealth is based on patents. In fact, a Japanese commission decided that American progress was mainly due to our patent laws. These laws are made to protect you. Find out about them now. This is for your own good.



**These FREE
Books Tell You**

Get the answers to your questions: How can I protect my invention? When can I show my invention to manufacturers? When can I offer it for sale? How should I go about selling it? Can I get protection without a patent? What are my employer's rights? These and other important questions are fully answered.

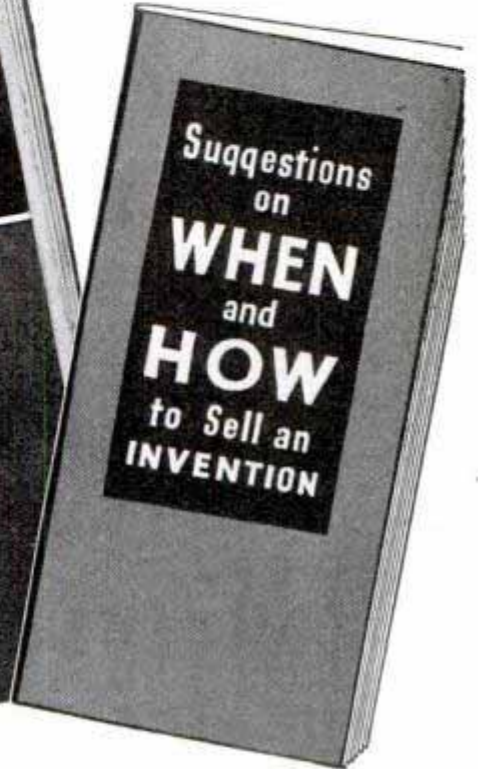

PATENTS
and Selling
Inventions

Mail Coupon Today

Delays are dangerous. If you have a good invention you should get protection for it just as soon as possible. Don't turn this page until you have clipped and mailed this coupon—you will hear from us by return mail.

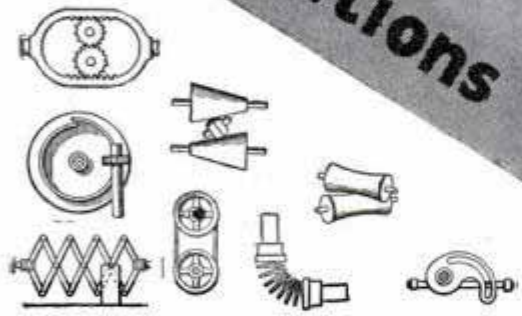

115 Mechanical Principles Shown

Request the book "Patent Protection" (sent free to inventors). Not only does it tell you what to do for protection, and how to do it—it also shows you 115 different mechanical movements that you may use in developing your own inventions. Inventors tell us they have found these useful.

**VICTOR J.
EVANS & Co.**
REGISTERED PATENT ATTORNEYS

MAIN OFFICE: 200-A, VICTOR BUILDING,
WASHINGTON, D. C.
Other Offices: 1007-N, Woolworth Bldg., New York; 1445-N,
Monadnock Bldg., Chicago; 514-N, Empire Bldg., Pittsburgh;
1010-N, Hobart Bldg., San Francisco; 736-N, Security Bldg.,
Los Angeles.

Send me FREE copies of your books, "Patent Protection" and
"When and How to Sell an Invention." (Note: Same books
supplied by any of branch offices listed above.)

Name

Street and No.

City or Town



Amazingly Easy Way to get into **ELECTRICITY**

**Learn to Earn More
Money Every Week
—or Go Into Your
Own Business**

Whether your age is 16 or 40. Let us train you to prepare for positions that lead to good salaries in Electricity—NOT by correspondence, but by an amazing modern method right here in the great Coyne Shops that gives you a practical Training in 90 days! Getting into Electricity is easier than you imagine if you choose the right method. You don't need previous experience or need a lot of book learning. Start any time after you have enrolled.

Easy Payment Plan

Mail the coupon below and I'll send you all details of my monthly tuition plan. Under this plan you can get your training first and then pay for your tuition later in small monthly payments extending over an 18-month period, starting 5 months after you start school.

LEARN BY DOING—IN 90 DAYS IN THE GREAT COYNE SHOPS

I don't care if you don't know an armature from an air brake—I don't expect you to! We give you 12 weeks of practical Shop work in the Big Coyne Shops. . . . Practical work on real Electrical equipment.

MANY EARN WHILE LEARNING

If you need part time work to help pay your expenses we may be able to help you if you will write and tell us your problems. When you graduate you can get lifetime employment service.

DIESEL, REFRIGERATION AND AIR CONDITIONING

Right now we are including instruction in Diesel Engines, Electric Refrigeration and Air Conditioning without extra cost so your training will be more valuable to you.

GET MY BIG FREE BOOK!

Coyne is your great chance to get into Electricity. This school is 37 years old—Coyne training is reliable. You can find out everything absolutely free. Simply mail the coupon and let us send you the big, free Coyne book with photographs . . . facts . . . opportunities. Tells you how many earn expenses while training and how we assist our graduates in the field. No obligation to you. So act at once. Just mail coupon.

H. C. Lewis



COYNE ELECTRICAL SCHOOL

500 S. PAULINA ST., Dept. 17-72, CHICAGO, ILL.

SEND NOW FOR FULL DETAILS!

H. C. LEWIS, President, COYNE ELECTRICAL SCHOOL
500 S. Paulina St., Dept. 17-72, Chicago, Ill.
Dear Mr. Lewis: Without obligation send me your big, free
catalog with facts about Coyne Training and details of your
Monthly Tuition Payment Plan.

Name.....

Address.....

City..... State.....

Mail in envelope or paste on a postcard

TO YOUNG MEN— **STENOTYPY** THE WAY TO SUCCESS!

Stenotypy, the new profession, offers unusual opportunities to ambitious young men. It's a man's way of recording speech in this machine age—a silent little machine that types plain print letters faster than any one can talk. It opens up preferred jobs now—leads to executive careers later. One of the surest, quickest ways to get into Business on the right basis.

Now you can learn Stenotypy at home in your spare time. Low cost—easy terms. Get full details. Write for valuable, free booklet, "Stenotypy, the New Profession," describing the unusual opportunities for young men in this growing field and telling how you may enter it successfully. Write Dept. 164-ST.

THE STENO TYPE COMPANY
4101 S. Michigan Ave., Chicago, Ill.



RADIO ENGINEERING



RCA Institutes offer an intensive course of high standard embracing all phases of Radio. Practical training with modern equipment at New York and Chicago schools. Also specialized courses and Home Study Courses under "No obligation" plan. Catalog Dept. PC-37.

RCA INSTITUTES, Inc.

75 Varick St., New York 1154 Merchandise Mart, Chicago
Recognized Standard in Radio Instruction Since 1909.

VOICE

89 PAGE BOOK
- ILLUSTRATED -
SENT FREE
(NO OBLIGATION TO BUY)

If you act quick!—we will send postpaid—for 30 days free reading—new 89 page Voice Book disclosing startling VOICE FACTS that may save hundreds of dollars to every man or woman seeking a strong, rich voice for either singing or speaking. 30 days free reading—then send \$1.00. Otherwise, return it—that's all! Prof. E. Feuchtinger Studio 1351 64 E. Lake St., Chicago

LEARN CARTOONING

by the method that has developed hundreds successfully. Send name, address and age for free chart to test your ability.

The Landon School, 1738 National Bldg., Cleveland, Ohio



SPECTROSCOPE and book of 120 experiments. . . \$2.50
TELESCOPE clearly showing moon craters. . . . 1.00
STROBOSCOPE with motor, neon lamp and book. 1.00
ELECTRIC FUN book, 200 stunts with 110 volts. 1.00
MAGIC ROD glows in six colors in the dark. . . . 1.00

CUTTING & SONS 17 M St. Campbell, Calif.



Minstrels

Comedy
Stunts
Plays
Songs

Unique First Parts for complete show with special songs and choruses. Make-up. Catalog Free.

T. S. Denison & Co., 623 S. Wabash, Dept. 19 Chicago

Full Size Professional ARC WELDER

Only
39.25
With Deluxe
ACCESSORIES

Full size, heavy duty Aladdin Electric ARC WELDER only \$39.25 with De Luxe Accessories! Has efficiency of machines costing \$145.00 to \$800.00. Welds all metals and alloys from heavy motor block and castings to fenders and light sheet metal. Also fine for soldering and brazing. Fully guaranteed. Approved by Automotive Test Laboratories. Easily portable on casters.

WORKS FROM 110-V SOCKET. Simply plug into 110 Volt or 220 Volt light socket—costs only few pennies an hour to use. Has complete heat controls. Anyone can use easily. Full instructions included. AMAZING DETAILS FREE! Write today for sensational facts about Aladdin Arc Welder for \$39.25 including De Luxe Accessories!

COMMONWEALTH MFG. CORP.
3785 Beechmont Ave.
Dept. P-12 Cincinnati, Ohio

More Than

47%

of ALL Identification Bureaus in the United States are in Charge of GRADUATES of THE INSTITUTE OF APPLIED SCIENCE!

While some of these graduates had previous police experience, it is equally true that many of them had *no previous police or identification experience whatever.*

In addition to the graduates who are in charge of all these bureaus, **MANY** others are working as assistants on regular monthly salaries.

If you are over 18 years of age—if you are ambitious—if you are willing to study and learn—if you like travel, excitement, thrills and if you are willing to study at home to fit yourself for a good position at a regular steady monthly salary in a permanent, fast-growing profession—**THEN** send in the coupon below for complete free details. *Do this now while you are thinking about it.* In just a few days you will receive complete facts on Institute of Applied Science training, and the Confidential Reports Secret Service Operator No. 38 made to his chief! All sent absolutely **FREE** of Charge!

THE INSTITUTE OF APPLIED SCIENCE 1920 SUNNYSIDE AVENUE
DEPT. 1351, CHICAGO, U.S.A.

THE INSTITUTE OF APPLIED SCIENCE,
1920 Sunnyside Ave., Dept. 1351, Chicago, Illinois, U.S.A.

Gentlemen:

Without obligation to me in any way whatsoever, please mail me the free details on Institute of Applied Science training, together with the free book, "Operator No. 38."

Name..... Street and No.....

City..... State.....



Know Electricity as Experts Know It!

— and get an expert's pay

Recovery has begun! The months ahead are charged with significance and expectation. What will you do to get the jump on the other fellow? Thousands of men have used

The Croft Library of Practical Electricity

A combined home-study course and reference library of master electrical practice.

7 VOLUMES, 3000 PAGES, 2100 ILLUSTRATIONS

THE Croft Library is a complete electrical educator. It is founded on practice—on 20 years of shirt-sleeve experience—on work as it is actually done. It is jammed from cover to cover with the kind of hard-headed facts you want. Written so that the beginner can easily understand it, yet so sound, so thorough, that it is the daily guide of 59,000 highly paid electrical workers and engineers. Croft tells you the things you need to know about motors, generators, armatures, commutators, transformers, circuits, switchboards, distribution systems—electrical machinery of every type—wiring for light and power—wiring of finished buildings—underwriters' and municipal requirements—illumination in its every phase—the most improved methods of lighting—lamps and lamp effects, etc.—how to do a complete job, from estimating it, to completion.

FREE—if you act now

Kushlan's HANDBOOK OF INDUSTRIAL ELECTRICITY

As soon as you decide to accept the Croft Library, we will give you absolutely free, a copy of this handy manual. Kushlan's Handbook is a regular 500-page McGraw-Hill book, compact enough to fit in your tool kit or pocket, that gives a wealth of practical, how-to-do-it information for those engaged in electrical construction, maintenance, testing, inspection and contracting.

No money down — easy payments

Fill in and mail the coupon attached and we will send you the entire set of seven volumes for 10 days' Free Examination. We take all the risk—you assume no obligation. If you decide to keep the books, send \$1.50 in 10 days and the balance at the rate of \$2.00 a month, and get Kushlan's useful Handbook free, in addition. Send the coupon NOW and see the books for yourself.

FREE EXAMINATION COUPON

McGraw-Hill Book Co., 330 W. 42nd St., New York.

Send for 10 days' free examination the Croft Library of Practical Electricity. If satisfactory I will send you \$1.50 in 10 days and \$2.00 monthly until the price of \$19.50 is paid. If not wanted, I will return the books postpaid. Upon receipt of my first payment of \$1.50 you are to send me a copy of Kushlan's Handbook of Industrial Electricity, absolutely free. (To insure prompt shipment, write plainly and fill in all lines.)

Name.....

Address.....

City and State.....

Position.....

Company..... PM-1-37

FOR Real FUN Play. A Soprani ACCORDION



● If you want to be *really* popular, have *all* the fun, the center of attraction *everywhere*, just learn to play this thrilling instrument from Italy. A complete band or orchestra in itself, and so easy to learn to play. You'll master this *easier* Soprani in *no time*, and you'll have real fun from the start. Don't delay. Big future. Send postal for beautifully illustrated literature. No obligation. Easy terms. Write today sure. 122

SOPRANI, INC. DEPT. 129, 630 S. WABASH AVE. CHICAGO, ILL.

EARN MONEY AT HOME



Developing Pictures

Pay for this professional Home Developing Printing Outfit with your PROFITS on first job! NO experience needed! 150% profit. We furnish complete outfit containing everything needed, directions, and Profit-Making plan. Send \$1.95 or pay postman \$1.95 plus postage. (Regular \$2.65 value.) Satisfaction or money back. Write for FREE BARGAIN BOOK of Cameras and Supplies!

CENTRAL CAMERA COMPANY (Est. 1899)
230 S. Wabash, Dept. K-21, Chicago

CARTOON YOUR WAY TO SUCCESS!



DON'T COPY—LEARN TO ORIGINATE!

RAYE BURNS will teach you HOW to CREATE ORIGINAL CARTOONS at home that you can SELL! Course contains 26 lessons and over 600 illustrations. All for Only . . .

\$2.85

Send name and address for free details.
RAYE BURNS SCHOOL, Dept. M-X, BOX 2194, Cleveland, Ohio



BULL DOG Trailer HITCH

CHEAPEST TRAILER INSURANCE in the world. DROP FORGED Bull Dog Hitch NEVER LETS LOOSE! GUARANTEED AGAINST BREAKAGE. Certified tensile strength up to 52,400 lbs. Unfastens easily at any angle BUT ONLY when desired. Wear compensator prevents back lash, lost motion, noise. A type for every trailer. Used EXCLUSIVELY by Biggest Trailer Manufacturers. WRITE TODAY for FREE details. (Include only 50c for latest Guaranteed Trailer Builder's Guide.)

HAMMER BLOW TOOL CO. Dept. BD-1 WAUSAU, WIS. U. S. A.

New Remarkable! MIDGET POCKET RADIO

BEAUTIFUL CLEAR LOUD TONE
DIRECT FROM POCKET RADIO!

No Dangling Phones to Bother With. All one unit—just like the big sets, but weighs only 6 ozs. Fits pocket easily. Take it with you—listen to music, sports, radio entertainment, etc. No batteries, tubes or electrical connections required. A Guaranteed Pocket Radio, EASY TO USE—WORKS IMMEDIATELY

Beautiful reception and tone. Accurately made, precisely assembled, rigidly tested, assures excellent performance. Tunes broadcast band. Costs nothing to operate and should last for years. Tuning control is the only moving part. Nothing to adjust. No difficult hook ups. Comes complete with built-in phone, ready to tune in, with easy instructions for use in camps, office, boats, picnics, home, hotel, bed, etc., and take it with you while traveling, in auto, bicycle, etc.

SEND NO MONEY! Write for yours today. Play it as soon as you get it. Pay postman only \$2.99 and a few cents postage. State color wanted (Silver, Brown, Black, White, Blue). An ideal gift. Amaze your friends!

Little Giant Radio Co., 3959 Lincoln Avenue, Dept. 702, Chicago, Ill.

To help you answer these **3** questions:



1 What are today's opportunities in Drafting?

2 Will I like the work?

3 Can I learn Drafting readily?

2 Beginning Lessons in Drafting Free

Drafting Opportunities Growing Daily

Before anything can be made or built, the Draftsman *first* must draw it. Building trades, transportation, manufacturing — ALL depend on him. That is why *any* pickup in *any* line means *first call for the Draftsman!*

Fit Yourself for a Job with a Future

Drafting welcomes ambitious men — offers good pay to start, with splendid opportunities for promotion. One of the *stadiest* of all lines. Right from the start, the beginner works side by side with experienced men — inking in their drawings, making tracings, constantly profiting by his contact with seasoned engineers. The "higher ups" see his work. If it is good, advancement is sure and steady.

Pleasant, well-lighted offices are the Draftsman's work-room. He keeps regular hours, with congenial, high grade fellow workers. The work is fascinating — embraces not just *one* line, but *hundreds*.

Drafting Experience NOT Necessary

You can master Drafting readily by home study because you learn and advance *exactly* as professional Draftsmen work — with T-square, dividers and drawing board. *Actual* working conditions are duplicated to the final detail. *Thousands* of successful graduates enthusiastically endorse American School methods, nowhere better exemplified than in our Drafting course.

We want you to see for yourself — before you come to ANY decision — exactly what Drafting is like. We want you to judge your own interest in the work — and our ability to teach you. So we make this 2 Free Lesson Offer.

American School, Drexel Ave. at 58th St., Chicago, Ill.

Prove That You Can Qualify

The 2 lessons will be sent absolutely without obligation. In the privacy of your own room, look them over. See how simply you start — how gradually you are led step by step — how thoroughly you master each point — how, as time goes on, you can pass from a raw beginning to complete *mastery* of Drafting — able to get and hold a pleasant, profitable, steady job. Such a future is well worth looking into **RIGHT NOW**, so . . . just mail the coupon!



Mail Coupon for 2 Lessons FREE

American School, Dept. DD-145
Drexel Ave. at 58th St., Chicago
Without the slightest obligation, send 2 beginning Drafting Lessons and free Bulletin. I am not to return them.

Name..... Age.....

Address.....

City..... State.....

When writing to advertisers please mention Popular Mechanics



*Small
Inventions*
**THAT HAVE
BUILT BIG
BUSINESSES**

INVENTIONS do not have to be complicated to be profitable when Patented. The 5c and 10c stores flourish on simple Patented products which are commercially successful. The zipper, safety pin, thumb tack, paper clip, collar button—all simple, yet familiar inventions—brought their inventors rich rewards. If you have a Patentable invention—act to protect it. Many of the most useful, widely popular, greatly profitable, and ex-

tremely successful inventions have been very simple ones. You have only to look at the devices we have pictured here to realize how a simple invention may become a utility bought by a hundred thousand or a million people soon after it is produced. Don't be afraid that the simplicity of your invention makes it valueless. The thing that you find so simple that you wonder why a thousand other people haven't already done it is often the invention worthwhile.

HOW OTHER INVENTORS GOT STARTED



The list of men who succeeded in invention with only a poor boy's start is a very long and noble one. Poverty, hardships, lack of friends, distance from the market—these could not hold back Bell, Edison, Eastman, McCormick, Whitney and others. Everyone cannot succeed. But every man can try. Courage, sacrifice, and hard work may bring you a measure of the success these men had. Lack of mechanical ability is not a serious drawback. You can always get someone able to build a model, draw a detailed design, or otherwise materialize your invention for you. The big drawback is discouragement.

Your invention of a practical article or an improvement upon an old one should be

patented NOW. Frequently many of the thousands of applications filed in the U. S. Patent Office each year are for the same or almost the same invention. In such a case, the burden of proof rests with the last application filed. Sometimes a delay of even a few days in filing the application means the total loss of the patent. **LOSE NO TIME.**

The entire time of this large and experienced organization is devoted exclusively to patent and trade-mark cases. We know the rules and requirements of the Patent Office. We understand the technicalities of Patent Law. We can proceed in the quickest and safest ways in preparing an application for a patent covering your invention.

FREE THE BIOGRAPHY OF GEORGE EASTMAN
Views of the man who used Patent Protection to amass millions and give perfection to a new art—*Photography*—itself one of the greatest inventions.

CLARENCE A. O'BRIEN & HYMAN BERMAN

70-Z ADAMS BUILDING

WASHINGTON, D. C.

Registered Patent Attorneys Before U. S. Patent Office

When writing to advertisers please mention Popular Mechanics

Send For This FREE BOOK

TORS

If you have an invention that is patentable—and want to secure for yourself your inventor's sole right to profit from the invention—you can't afford to lose time in securing the protection of a U. S. Patent. Other inventors may be working on the same invention right now. Should they develop this invention and file patent application before you do—the burden of establishing priority will be upon you. Our Big Book—"Patent Guide for the Inventor"—will tell you the quickest possible way to secure Patent Protection for your invention. **SEND FOR IT TODAY!**

The **FIRST IMPORTANT STEP** in **SECURING A PATENT**—is to obtain the services of a Registered Patent Attorney. The U. S. Patent Office advises that you secure the aid of an experienced Registered Patent Attorney to prepare your statements. Establish the date of your invention as explained in our book and disclose your invention to him in correct form. He then makes a **SEARCH** of the Patent Office Records and reports to you on existing U. S. Patents which might bear on your invention, giving his opinion on the advisability of proceeding and filing formal application.

REASONABLE FEES—CONVENIENT TERMS. Don't worry about finances. Our fees are very reasonable—we can arrange convenient terms of payment. It is our custom to permit clients to pay for our services in installments as the application progresses in our office. See our Big Book for fees in obtaining Patent. It explains our arrangements clearly. Send for it **NOW!**

FREE RECORD OF INVENTION FORM—Use our **FREE** "Record of Invention" form to assist you in recording the descriptive outline of your invention and to establish the date of your invention. With it you can make a rough sketch of your invention and have it witnessed in a manner of value to you as evidence should occasion arise.

**TEAR OFF AND
MAIL NOW!**

**CLARENCE A. O'BRIEN
& HYMAN BERMAN**
70-Z Adams Building
WASHINGTON, D.C.
REGISTERED PATENT ATTORNEYS
BEFORE U. S. PATENT OFFICE

Please send me at once your Big Free 48-Page Book, "Patent Guide for the Inventor" and your Specially Prepared "Record of Invention" form. Also George Eastman Biography, "Inventor and Business Man." This request does not obligate me. (Please write or print plainly)

NAME.....

ADDRESS.....

**PROTECT YOUR
INVENTIONS
WITH U.S.
PATENTS**



PATENTS

Booklet Free Highest References
Promptness Assured Best Results

Send drawing or model.

ALL BUSINESS GIVEN PROMPT AND PROPER ATTENTION

Listed Patent Lawyer in the latest editions of the Rand-McNally Directory of Bankers and Bank-Recommended Attorneys, published by Rand-McNally & Co., Chicago, Ill.; The Baggott & Ryall Directory of Guaranteed Attorneys, published by Legal Directory Corporation, Boston, Mass.; American Lawyers Annual, Cleveland, Ohio; Bankers Service Legal Directory, published by Bankers Service Co., Boston, Mass.; Eyre's Law List, 9 Park Place, New York City; Snow-Church Directory Co. Lawyers List, published in New York City, and the Central Guarantee Co., Bankers and Lawyers Directories, 630 Fifth Avenue, New York City.

WATSON E. COLEMAN,
REGISTERED PATENT LAWYER

Victor Building, 724 Ninth Street, N. W.
WASHINGTON, D. C.

INVENTORS PATENT YOUR IDEAS SEND FOR FREE BOOK



HOW TO OBTAIN A PATENT

Written by a Former Member of the Examining Corps (1922-24) of the U. S. Patent Office. If you want to profit by your idea, you should take steps to apply for a U. S. Patent at once. Your first step is to get this Free Book. This interesting illustrated book contains valuable information you should have. It tells you fully how to obtain a patent on your idea in the quickest way. With this Free Book you will also receive a "Record of Invention" form on which you can easily record your idea. Personal and Confidential Service: Your case will be personally handled only by a Registered Patent Attorney who is also a Former Member of the Examining Corps of the U. S. Patent Office. All communications confidential.

MAIL COUPON TODAY for FREE PATENT BOOK and RECORD OF INVENTION Form.

CARL MILLER
REGISTERED PATENT ATTORNEY
FORMER MEMBER EXAMINING CORPS U. S. PATENT OFFICE

1638 Woolworth Bldg., Dept. 17A, New York City
MILLER BUILDING, Dept. 17A, WASHINGTON, D. C.
Please send me your Free Book, "How to Obtain a Patent," and your "Record of Invention" form.

NAME.....

ADDRESS.....

ALBERT E. DIETERICH
REGISTERED PATENT ATTORNEY
512 B Colorado Building, WASHINGTON, D. C.
Booklet on Patents sent free

ITCH

...STOPPED IN ONE MINUTE...

Are you tormented with the itching tortures of eczema, rashes, athlete's foot, eruptions, or other skin afflictions? For quick and happy relief, use Dr. Dennis' cooling, antiseptic, liquid **D. D. D. PRESCRIPTION**. Its gentle oils soothe the irritated skin. Clear, greaseless and stainless—dries fast. Stops itching instantly. A 35c trial bottle, at any drug stores, proves it—or money back.

PATENTS—TRADE MARKS

All inventions submitted held confidential and given personal attention by members of the firm.

Form, "Evidence of Conception" and instructions, "How to Establish Your Rights"—FREE!

LANCASTER, ALLWINE & ROMMEL
Patent Law Offices

412 Bowen Bldg.

Washington, D. C.

New Ideas now Salable Before Patenting

Practical, useful inventions may now be safely marketed without patenting expense. Write for proof that we successfully sell both patented and unpatented inventions.

Chartered Institute of American Inventors
Dept. 4, Barrister Building, Washington, D. C.



G E A R S

In Stock—Immediate Delivery

Gears, speed reducers, sprockets, thrust bearings, flexible couplings, pulleys, etc. A complete line is carried in our Chicago stock. Can also quote on special gears of any kind. Send us your blueprints and inquiries.

Write for Catalog No. 10

CHICAGO GEAR WORKS

769-773 W. Jackson Blvd., CHICAGO, ILL.

INVENTORS who derive largest profits know and heed certain simple but vital facts before applying for patents. Our book, Patent-Sense, gives those facts; sent free. Trade Marks—Copyrights. **LACEY & LACEY, Est. 1869, 635 F St., N. W., Dept. 5, WASHINGTON, D. C.**

No JOKE TO BE DEAF

—Every deaf person knows that—

Mr. Way made himself hear his watch tick after being deaf for twenty-five years, with his Artificial Ear Drums. He wore them day and night.

They stopped his head noises. They are invisible and comfortable, no wires or batteries. Write for TRUE STORY. Also booklet on Deafness.



THE WAY COMPANY

729 Hofmann Bldg.

Detroit, Michigan

Books on all subjects are sold by Popular Mechanics Press, 200 East Ontario Street, Chicago, Illinois

To PROTECT YOUR INVENTION Use this coupon, NOW

Delays are dangerous and may be very costly. My personal service assures prompt action, strict confidence, and a minimum of expense. I suggest that you send me a model or drawing, or sketch and description of your invention, and \$5.00. I will make a search and report

promptly as to its patentability and send you a copy of my 72-page booklet. Or, if you prefer to read my booklet first, mail the attached coupon at once. I will also send my "Record of Invention" form. (Over 38 years experience as a Registered Patent Attorney.)

L. F. Randolph, 302-D Victor Bldg., Washington, D. C.

Please send me at once, free of charge, your 72-page booklet and "Record of Invention" form.

Name.....

Address.....

A PERSONAL CONFIDENTIAL PATENT SERVICE

When writing to advertisers please mention Popular Mechanics



I'll bet real money you can learn to play — *this easy fascinating way*

YES, I mean actually play real music—classical numbers or jazz—so that you'll be able to entertain your friends—to be popular everywhere.

And what's more, you won't need a private teacher. You'll learn all by yourself—right in your own home. And best of all the cost is only a small fraction of what it used to cost by old-fashioned methods.

Why am I so sure? Simply because more than 700,000 other men and women, boys and girls—no more clever—no more gifted than you—have studied music by this modern system.

No Special Talent Required

Learning to play this U. S. School of Music way is easy as A-B-C. No special talent is required—no previous musical training. If you can whistle a tune you can learn to play by this simple method—quicker than you ever dreamed possible. There's nothing tricky about it—no complicated theories—nothing to memorize.

You learn to play from real notes—the same as those used by accomplished musicians.

And with this shortcut system you have the fun of playing real tunes—right from the very beginning. And almost before you realize it you are able to pick up any piece of music and play it.

Clear as Crystal

The best part of it all is that it is so simple—so crystal clear—so easy to understand. It's all right before you in print and

pictures. First you are told how to do a thing. Then a picture shows you how to do it. Then you actually do it yourself and hear it. It's fascinating fun, too—practicing becomes a real interesting pastime instead of a wearisome task.

Free Demonstration Lesson

So that you may see for yourself how easy, how pleasant it is to learn by this modern, simplified method, the U. S. School of Music has prepared an Illustrated Booklet and typical Demonstration Lesson which are yours for

the asking. They explain fully the principles of this remarkable method and how it enables you to become a popular musician in a surprisingly short time, at a cost of only a few cents a day.

If you are really serious about wanting to learn music—if you honestly want to become popular—to have the pleasure of entertaining your friends—take this first step *today*—send for this Free Booklet and Free Demonstration Lesson. Don't put it off. Mail the coupon below and they will be sent to you promptly. No obligation. Instruments supplied where needed, cash or credit. U. S. School of Music, 71 Brunswick Building, New York City.

U. S. SCHOOL OF MUSIC 71 Brunswick Bldg., N. Y. C.

Please send me your free book, "How You Can Master Music in Your Own Home," with inspiring message by Dr. Frank Crane, Free Demonstration Lesson and particulars of your easy payment plan. I am interested in the following course:

Have you
.....Instrument?....

Name.....

Address.....

City.....State.....

PICK YOUR INSTRUMENT

- | | |
|--------------------------|-------------------------------------|
| Piano | Guitar |
| Violin | Saxophone |
| Organ | Mandolin |
| Cornet | Ukulele |
| Trombone | Harp |
| Piccolo | Clarinet |
| Flute | 'Cello |
| Hawaiian Steel Guitar | Trumpet |
| Piano Accordion | Italian and German Accordion |
| Voice and Speech Culture | Harmony and Composition |
| Drums and Traps | Banjo (Plectrum, 5-String or Tenor) |

AUDELS Carpenters and Builders Guides 4 vols. \$6



Inside Trade Information for Carpenters, Builders, Joiners, Building Mechanics and all Woodworkers. These Guides give you the short-cut instructions that you want—including new methods, ideas, solutions, plans, systems and money saving suggestions. An easy progressive course for the apprentice and student. A practical day helper and Quick Reference for the master worker. Carpenters everywhere are using these Guides as a Helping Hand to Easier Work, Better Work and Better Pay. To get this assistance for yourself, simply fill in and mail the FREE COUPON below.

Inside Trade Information On:

How to use the steel square—How to file and set saws—How to build furniture—How to use a mitre box—How to use the chalk line—How to use rules and scales—How to make joints—Carpenters arithmetic—Solving mensuration problems—Estimating strength of timbers—How to set girders and sills—How to frame houses and roofs—How to estimate costs—How to build houses, barns, garages, bungalows, etc.—How to read and draw plans—Drawing up specifications—How to excavate—How to use settings 12, 13 and 17 on the steel square—How to build hoists and scaffolds—skylights—How to build stairs—How to put on interior trim—How to hang doors—How to lath—lay floors—How to paint.



THEO. AUDEL & CO., 49 W. 23rd St., New York City

Mail Audels Carpenters and Builders Guides, 4 vols., on 7 days' free trial. If O.K. I will remit \$1 in 7 days, and \$1 monthly until \$6 is paid. Otherwise I will return them. No obligation unless I am satisfied.

Name.....
 Address.....
 Occupation.....
 Reference..... P.M.

Be a Civil Engineer!
 Learn—Quick Reference Way

It's Paying Big Right NOW



Cyclopedia of Civil Engineering
 7 great volumes.
 2,800 pages.
 1,600 illustrations.
 New revised edition by twelve of America's greatest engineers.
 Includes: Surveying, bridges, railroads, steel structures, municipal engineering, water supply, road building, etc.
 Spanish Grain Flexible Covers Gold Stamped

Earn \$3000 with these books a Year—and Up!

"Civil engineers are wanted NOW. Enormous amounts are being spent in all kinds of public works and not a dime is spent until the Engineer has prepared plans. Then He must direct the work. It's a big job and there are not enough men to go around. Everywhere you go you see road work going on—water and sewer systems being built—vast projects of all kinds. Here is Your Opportunity to get the necessary training right at home. These books are complete and simply written so anyone can understand them. Start now on our FREE examination plan. Mail the coupon without obligation.

American Technical Society
 Dept. C119, Drexel at 58th St., Chicago

American Technical Society
 Drexel at 58th St., Dept. C119, Chicago
 I want to examine the CIVIL ENGINEERING Cyclopedia for 10 days FREE. I will gladly pay the few cents express, but I am to pay nothing for the 7 big volumes if I return them within 10 days. If I wish to keep them I will send you \$2 after the 10 days, then \$3 a month until special advertising price \$29.80 is paid. Send latest Edition and Slide Rule.

Shipped Free

Slide Rule
 Be prompt and we will include a brand new, circular slide rule to carry in coat pocket. Invaluable in solving all kinds of problems.

Name.....
 Address.....
 (Attach letter stating age, occupation, employer's name and address and that of at least one business man as reference.)

Law!

LEARN AT HOME

Are you adult, alert, ambitious, willing to study? Investigate LAW! We guide you step by step—furnish all texts, including 14-volume Law Library. Training prepared by leading law professors and given by members of bar. Degree of LL. B. conferred. Low cost, easy terms. Send NOW for Free, 64-page "Law Training for Leadership."
 LaSalle Extension University, Dept. 164-L, Chicago

LEARN MECHANICAL DENTISTRY

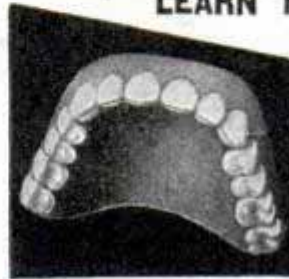

A profession offering unlimited opportunities. Most modern and complete course embracing every branch from Plate to Porcelain Work, which prepares you to work for Dentists or start your own business. Individual instruction—practical training in day or night school. No books—no classes. Catalog upon request.

Dept. 717
McCARRIE SCHOOL OF MECHANICAL DENTISTRY
 207 N. Broad St. Phila., Pa.

TRI-STATE COLLEGE



B. S. Degree in 2 years. World famous for technical 2-year courses in Civil, Electrical, Mechanical, Chemical, Radio, Aeronautical Engineering; Business Administration and Accounting. Equivalent in technical hours to 4-year course. Those who lack high school may make up work. Low tuition. Low living costs. Located in picturesque hill and lake region. Students from every state and many foreign countries. 53rd year. Enter Sept., Jan., March and June. Write for catalog.

417 COLLEGE AVE., ANGOLA, IND.

LEARN WATCHMAKING AND ENGRAVING BY OUR PROFIT-SHARING PLAN OUR GRADUATES SUCCEED

One of our Iowa students started in a very small way—now doing over \$30,000 a year. Another in Wisconsin, over \$10,000 the first year. Day or night classes. Call or write for FREE BOOK, Chicago School of Watchmaking, Dept. 4701, 155 N. Clark St., CHICAGO.

Learn ADVERTISING at Home

Greater opportunities now in advertising. Learn easily and quickly in spare time. Practical work. No text books. Old established school. Low tuition—Easy terms. Send for free booklet of interesting information.
 Page-Davis School of Advertising
 Dept. 1351, 3601 Mich. Av., Chicago

MAKE MONEY AT HOME!

Learn to color photos and miniatures in oil. No previous experience needed. Good demand. Send for free booklet, "Make Money at Home" and requirements.
NATIONAL ART SCHOOL
 3601 Michigan Ave. Dept. 1351 Chicago

GOV'T. JOBS

SALARY TO START \$90 to \$175 MONTHLY MEN WOMEN
 Age Range 18 to 50

() Railway Mail Clk.	() POSTMASTER
() P. O. Laborer	() Stock Clerk
() R. F. D. Carrier	() Auditor
() Special Agent	() Stenographer
() Customs Inspector	() U.S. Border Patrol
() City Mail Carrier	() Telephone Opr.
() P. O. Clerk	() Watchman
() Elevator Conductor	() Meat Inspector
() Special Investigator	() Secret Service Opr.
() Typist	() File Clerk

OZMENT INSTRUCTION SERVICE
 Dept. 111 St. Louis, Mo.
 Send me FREE particulars "How to Qualify for Government Positions" marked "X". Salaries, locations, opportunities, etc. ALL SENT FREE.
 Name.....
 Address.....

SAVE UP TO 50% DIRECT FROM MIDWEST FACTORY!

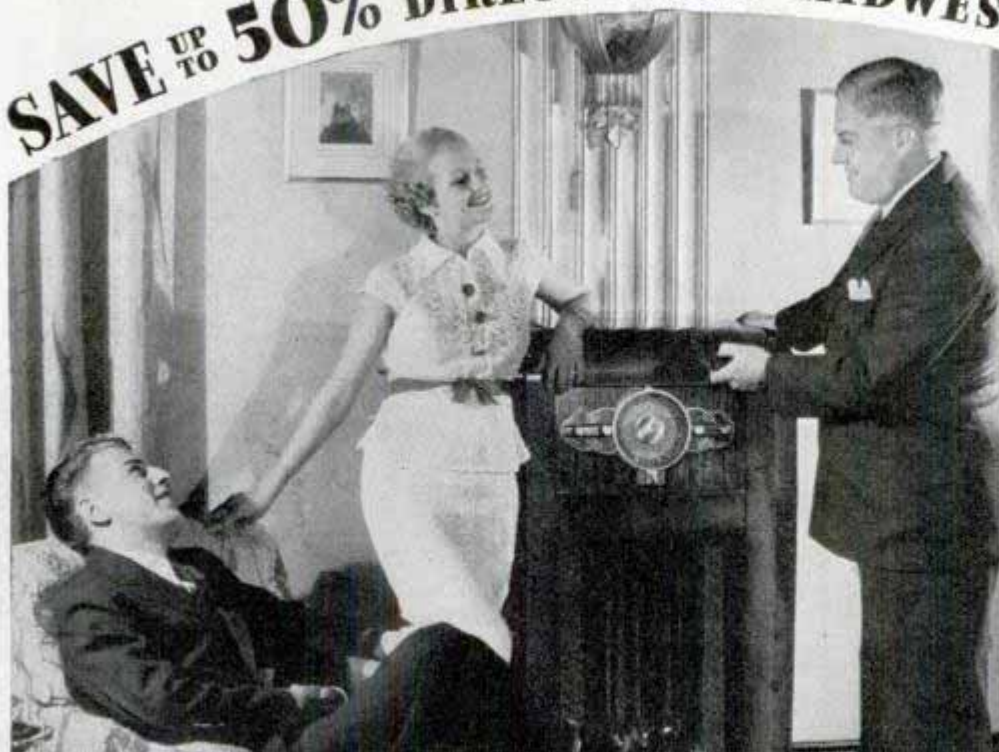

"I REMEMBER WHEN RADIO FIRST STARTED...
EVEN THEN MIDWEST WAS KNOWN FOR ITS
Power AND Beauty!"

MAIL COUPON *Now* FOR NEW
FREE 40-PAGE CATALOG

Mail coupon today for new, FREE 40-page catalog...and learn how you can save up to 50% by buying direct from Midwest factory. See for yourself that Midwest offers today's greatest radio values, and scores of exciting features, like Dial-A-Matic Tuning, plus Elektrik-Saver. With the sensational Dial-A-Matic Tuning feature, for example, even a child can bring in ten perfectly tuned programs in ten seconds. Zip!... Zip!... Zip!... stations come in instantly, automatically, perfectly... as fast as you can push buttons. The exclusive Midwest Elektrik-Saver cuts radio wattage consumption 50%, enables Midwest radios to use no more current than ordinary 7-tube sets.

ONLY IN MIDWEST DO YOU GET
DIAL-A-MATIC TUNING *plus* ELEKTRIK-SAVER



DIAL-A-MATIC TUNING

Now, even a child can bring in ten perfectly tuned programs in ten seconds! It's a big thrill to whirl the dial... and then hear the station you want... come in instantly, automatically... as fast as you can press buttons!



ELEKTRIK-SAVER

This exclusive Midwest feature cuts radio wattage consumption 50%... results in Midwest radios using no more current than ordinary 7-tube set... enables you to operate on voltages as low as 80 volts.

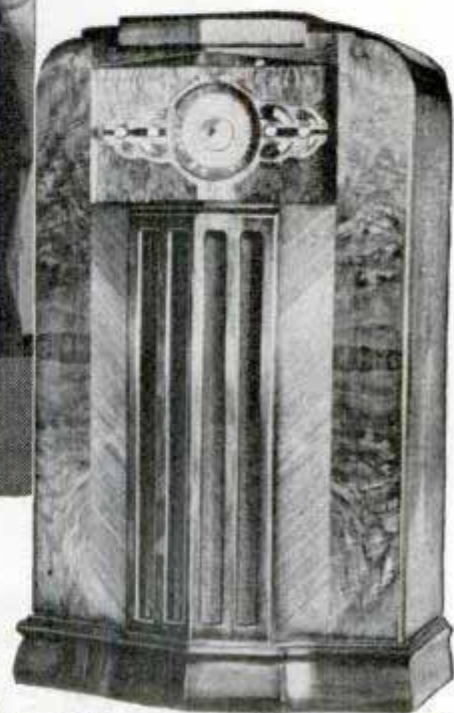

18 TUBES
SIX WAVE BANDS
4½ to 2400 METERS

Bigger, better, more powerful, more beautiful, this super deluxe Midwest out-performs \$150 sets on a point-for-point comparison. Amazingly selective, delicately sensitive, it brings in distant foreign stations with full loud speaker volume on channels adjacent to powerful locals. You'll thrill over its marvelous super-performance...glorious crystal-clear "concert realism"... magnificent world-wide foreign reception. Powerful Triple-Twin tubes (two tubes in one) give 22-tube results. You can switch instantly from American programs... to Canadian, police, amateur, commercial, airplane, ship broadcasts... to the finest and most fascinating foreign programs. Never before so much radio for so little money. Why pay more? Save up to 50% by buying at wholesale... direct from factory... preferred by thousands of careful radio purchasers since 1920.

Only
\$59.50 COMPLETE
with
GIANT
THEATRE-SONIC
SPEAKER
(18 TUBES)
TERMS
AS LOW AS
10¢ A DAY



**30
DAYS
FREE TRIAL**

You have a year to pay...terms as low as 10¢ a day...you secure privilege of 30 days' FREE trial in your own home. In addition, you are triply protected with Foreign Reception Guarantee, One-Year Warranty and Money-Back Guarantee.

MAIL COUPON TODAY FOR **FREE 30-DAY TRIAL OFFER AND 40-PAGE FOUR-COLOR FREE CATALOG**

MIDWEST RADIO CORPORATION
Dept. G-15
Cincinnati, Ohio

Without obligation on my part, send me your new FREE catalog and complete details of your liberal 30-day FREE trial offer. This is NOT an order.

Name.....

Address.....

Town..... State.....

(Special offer and prices prevail only when dealing direct with factory by mail.)



MIDWEST RADIO CORP.

DEPT. G-15 CINCINNATI, OHIO, U.S.A.
Established 1920 Cable Address MIRACO...All Codes



Attention

MEN WHO WANT TO GET MARRIED!

Most likely your income has been reduced. And yet —

You and that girl of your dreams have the precious hope of facing life together!

The obstacle is money — more money.

Listen: Thousands of men, even in these times—men who faced the same problem that now troubles you—have learned the secret. They're making themselves more valuable on their present jobs, preparing themselves for the bigger opportunities ahead!

They're doing it by devoting a portion of their spare time to study—by mastering International Correspondence Schools Courses that are modern and practical in their training. Many of today's business leaders started this very way.

You can do the same thing—and realize that hope you hold so dear. It takes work and sacrifice—what worth-while thing doesn't? The coupon will bring you good news—mail it today!

INTERNATIONAL CORRESPONDENCE SCHOOLS

Box 5653-H, Scranton, Penna.

Without obligation, please send full particulars about the subject before which I have marked X:

TECHNICAL AND INDUSTRIAL COURSES

- | | |
|--|---|
| <input type="checkbox"/> Architect | <input type="checkbox"/> Diesel Engines |
| <input type="checkbox"/> Architectural Draftsman | <input type="checkbox"/> Aviation Eng. <input type="checkbox"/> Auto Mechanic |
| <input type="checkbox"/> Building Estimating | <input type="checkbox"/> Plumbing <input type="checkbox"/> Heating |
| <input type="checkbox"/> Contractor and Builder | <input type="checkbox"/> Air Conditioning <input type="checkbox"/> Refrigeration |
| <input type="checkbox"/> Structural Draftsman | <input type="checkbox"/> Steam Engineer |
| <input type="checkbox"/> Structural Engineer | <input type="checkbox"/> Steam Electric Engineer |
| <input type="checkbox"/> Electrical Engineer | <input type="checkbox"/> Marine Engineer |
| <input type="checkbox"/> Electric Lighting | <input type="checkbox"/> Civil Engineer <input type="checkbox"/> Highway Engineer |
| <input type="checkbox"/> Welding, Electric and Gas | <input type="checkbox"/> Bridge Engineer |
| <input type="checkbox"/> Reading Shop Blueprints | <input type="checkbox"/> Bridge and Building Foreman |
| <input type="checkbox"/> Telegraph Engineer | <input type="checkbox"/> Surveying and Mapping |
| <input type="checkbox"/> Telephone Work <input type="checkbox"/> Radio | <input type="checkbox"/> R. R. Locomotives <input type="checkbox"/> Air Brakes |
| <input type="checkbox"/> Mechanical Engineer | <input type="checkbox"/> R. R. Section Foreman |
| <input type="checkbox"/> Mechanical Draftsman | <input type="checkbox"/> R. R. Signalmen |
| <input type="checkbox"/> Machinist <input type="checkbox"/> Toolmaker | <input type="checkbox"/> Chemistry <input type="checkbox"/> Pharmacy |
| <input type="checkbox"/> Patternmaker | <input type="checkbox"/> Coal Mining |
| <input type="checkbox"/> Foundry Practice | <input type="checkbox"/> Navigation |
| <input type="checkbox"/> Sheet Metal Worker | <input type="checkbox"/> Cotton Manufacturing |
| <input type="checkbox"/> Boilermaker | <input type="checkbox"/> Woolen Manufacturing |
| <input type="checkbox"/> Heat Treatment of Metals | <input type="checkbox"/> Agriculture <input type="checkbox"/> Fruit Growing |
| <input type="checkbox"/> Management of Inventions | <input type="checkbox"/> Poultry Farming |

BUSINESS TRAINING COURSES

- | | |
|--|--|
| <input type="checkbox"/> Business Management | <input type="checkbox"/> Lettering Show Cards <input type="checkbox"/> Signs |
| <input type="checkbox"/> Industrial Management | <input type="checkbox"/> Stenography and Typing |
| <input type="checkbox"/> Traffic Management | <input type="checkbox"/> Civil Service <input type="checkbox"/> Mail Carrier |
| <input type="checkbox"/> C.P. Accountancy | <input type="checkbox"/> Railway Mail Clerk |
| <input type="checkbox"/> Bookkeeping | <input type="checkbox"/> Grade School Subjects |
| <input type="checkbox"/> Secretarial Work | <input type="checkbox"/> High School Subjects |
| <input type="checkbox"/> Cost Accountant | <input type="checkbox"/> College Preparatory |
| <input type="checkbox"/> Salesmanship <input type="checkbox"/> Advertising | <input type="checkbox"/> First Year College Subjects |
| <input type="checkbox"/> Service Station Salesmanship | <input type="checkbox"/> Illustrating <input type="checkbox"/> Spanish |
| <input type="checkbox"/> Business Correspondence | <input type="checkbox"/> Cartooning <input type="checkbox"/> French |

DOMESTIC SCIENCE COURSES

- | | |
|---|--|
| <input type="checkbox"/> Professional Dressmaking and Designing | <input type="checkbox"/> Millinery |
| <input type="checkbox"/> Home Dressmaking | <input type="checkbox"/> Foods and Cookery |
| <input type="checkbox"/> Advanced Dressmaking | <input type="checkbox"/> Tea Room and Cafeteria Management, Catering |

Name.....Age.....

Address.....

City.....State.....

Present Position.....

If you reside in Canada, send this coupon to the International Correspondence Schools Canadian, Limited, Montreal, Canada

When writing please mention Popular Mechanics

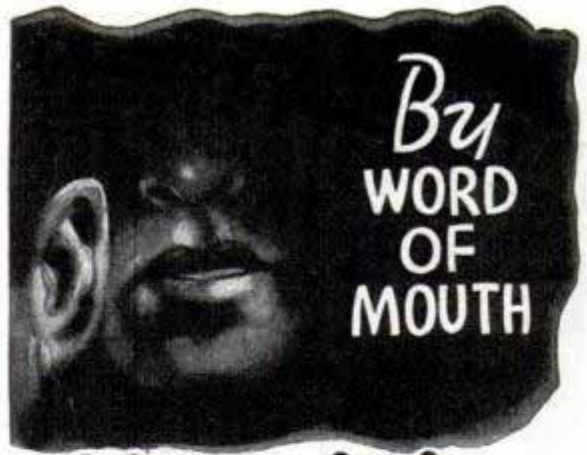

A Message No Man Dared to Write!

Furtive glances. Whispered words. Concealed remarks. Who ever would have been so foolhardy as to commit them to writing would have signed his own death warrant. What were these communications which for generations could only be transmitted from mouth to ear? It was the rare wisdom of the ancients; age-old truths which tyrants and selfish rulers sought to suppress, knowledge which they knew would give man power, independence, mastery of life and the ability to attain his highest ideals. Today, these secret principles, once withheld from the masses, are available to the sincere, to you if you seek the fullness of life.

SEND FOR FREE BOOK

The Rosicrucians have for centuries, in distant lands, preserved this knowledge, kept it in secret archives. They have always made it available to men and women who sought progress in life by making the utmost of their natural talents and abilities. They offer you a free copy of "The Secret Heritage," which explains how you may receive these startling facts. Address:

Scribe K.H.Y.

The ROSICRUCIANS

[A M O R C]

San Jose

California

(Not a religious organization)



Forms to cast Lead Soldiers, Indians, Trappers, Hunters, Wild and Farm Animals. 239 different forms to select from. Every form guaranteed to cast perfect figures. Send 5c stamp for illustrated catalogue.

HENRY C. SCHIERCKE Spencer Rd. GHENT, N.Y.



WILL YOU WEAR THIS SUIT

and Make up to \$12 in a Day!

Let me send you this fine all-wool tailored suit FREE OF COST. Just follow my easy plan and show the suit to your friends. Make up to \$12 in a day easily. No experience—no canvassing necessary. Send for Samples—FREE OF COST. Write today for FREE details, ACTUAL SAMPLES and "sure-fire" money getting plans. Send no money. H. J. Collin, Progress Tailoring Co., Dept. N-216, 500 S. Throop St. Chicago, Ill.

BIG PAY DIESEL JOBS OPEN



Practical training all types Diesel engines



Diesel - electric and Diesel-hydraulic training

The Pacific Northwest, home of the Adcox School, is the "hot spot" of Diesel activity and a center of Diesel employment, offering countless opportunities for Diesel Experts. Every branch of Diesel industry is represented here—including trucks, tractors, Diesel shovels, Diesel donkeys, Diesel motors in mines, large and small boats—it is probably unequalled by any other Diesel center in the world.

The Adcox School has been in business 27 years and is the most prominent school of its kind in the United States. Recommended by leading educational authorities as one of the finest practical trade schools in the world. Students from virtually every state including Alaska.

Study in the matchless climate of the Pacific Northwest. Enjoy numerous outdoor recreations such as fishing, hunting, hiking, sight-seeing, mountain climbing, swimming and other thrilling, healthful diversions.

Earn board and room while learning. You will find us friendly people here with a personal interest in your welfare and success, and fair treatment at all

times. Adcox graduates located in all parts of the world. Remember, the best training pays best—Adcox has NO branch schools.

Before you choose a Diesel school carefully read valuable Adcox Diesel School Catalog No. 18G—free on request while the present supply lasts.

DIESEL BOOK FREE

MR. L. L. ADCOX, President
L. L. ADCOX TRADE SCHOOL
237 N. E. Broadway, Portland, Ore.

Without obligation, please send FREE Diesel School Catalog No. 18G.

Name.....

Address.....

Town..... State.....



New York Electrical School

Established 1902

Ask for free booklet

44 West 17th St., N. Y. C.



Learn CHALK TALKING

Entertain for all occasions. Send \$1.00 for Laugh Producing Program of 23 Trick Drawings with Instructions. Catalog of Chalk Talk Supplies Free. BALDA ART SERVICE, Dept. K, Oshkosh, Wis.



Printing Offers BIG PROFITS

Cards, stationery, circulars, etc. Easy rules sent. Does raised printing like engraving. Print for others, Big Profits. Save money. Junior press \$5.90; Job press \$11; power, \$147. Sold direct from factory only. Send for free catalog and all details. THE KELSEY CO., P-37, MERIDEN, CONN.

TRAIN FOR Radio 12 Weeks SHOP TRAINING

EASY PAYMENT PLAN
GET DETAILS of MY AMAZING OFFER!

Prepare for jobs in Radio Broadcast, Talking Pictures, Television, by twelve weeks of practical shop work in the great Coyne Radio Shops, on real machinery and equipment. You don't need advanced education or experience. Free Employment Service for life. Many earn while learning. Mail coupon today for free book which tells you how hundreds have become successful Radio men after getting a training and all details of my "Pay Tuition After Graduation" Plan.

H. C. LEWIS, Pres., COYNE RADIO SCHOOL
500 S. Paulina Street., Dept. 17-3H, Chicago, Ill.

Send Free Radio Book and facts. Tell how I can pay for my course on easy payment plan after getting my 12 weeks' training.

Name

Address

Town..... State.....

PARKS AIR COLLEGE

Offers COLLEGE AND PROFESSIONAL TRAINING Majoring in Aviation

FOUR two-year courses (96 weeks) lead to Bachelor of Science degrees in Professional Piloting, Aviation Operations, Aviation Mechanics and Aeronautical Engineering.

THIRTEEN TRAINING PLANES are on the flight line. They range from the Kinner Sportster to the high speed twin-engined Monocoach equipped with retractable landing gear, air brakes, two-way radio, radio direction finder, and blind flight instruments.

Accredited by the Illinois Superintendent of Public Instruction. Government approved as a Transport Ground and Flying School and Mechanic's School.

58,000 hours flight instruction have been given, 650 hours now being flown monthly. THE FACULTY of 33 is composed of specialists in the various fields of aviation. AN ENROLLMENT of 260 resident students for the 1936 Fall term. On its 100-acre airport, Parks has 14 buildings with a total floor area of 2 3/4 acres, devoted to school purposes exclusively.

DORMITORIES AND DINING HALL ON THE FIELD.

1344 graduates.

All graduates of the last two classes were placed prior to graduation.

63 per cent of graduates enter air transport operations in North and South America.

At Parks you train for aviation in aviation. Parks is recognized as the training division of the industry. Ask any one who is in aviation. You can expect more at Parks and still be agreeably surprised when you come.

The 60-page catalog gives complete information. Send for it. It is FREE. It is packed full of valuable information. A letter or post card will bring it to you.

PARKS AIR COLLEGE

137-M Cahokia Rd.

East St. Louis, Illinois





STAMPS



..... *and* **Collecting**



By Richard McP. Cabeen

Re 900 333 & Hutchinson Chicago

F1346



Some recent stamp issues including sets to commemorate the three hundredth anniversary of the colonization of the Antilles

IN a previous issue the process of soaking and drying stamps was explained. This slow drying while the stamps are subjected to moderate pressure insures flat stamps without the humps or waves present if wet paper is dried in open air.

When properly hinged, the smooth, flat stamps will retain their shape and lie flat on the album page, but if hinges are not carefully applied, the stamps will warp and stand up from the page whenever the

album is opened, resulting in an untidy collection, difficult to show on account of the varying surfaces which the stamps present to the light. Although several novel stamp hinges have been invented, the old-fashioned variety continues to serve the majority of collectors. These are of various sizes, but for ordinary purposes a hinge about one-half inch wide and three-quarters of an inch long will be

(Continued to page 39A)

VACU-MATIC SCORES AGAIN!

BOB McKENZIE
 TRANSCONTINENTAL AUTOMOBILE CHAMPION
 COAST TO COAST

WESTERN UNION
 TIMED
 NEW YORK
 TO
 LOS ANGELES
 24 hrs. 40 min.

LOS ANGELES
 TO
 NEW YORK
 27 hrs. 28 min.

CANADA
 19,000 MILES
 18 DAYS

LOS ANGELES
 TO
 NEW YORK
 AND RETURN
 121 hrs. 52 min.

WASHINGTON, D. C.
 TO
 MEXICO CITY
 82 hrs. 27 min.

LOS ANGELES
 TO
 PHOENIX
 8 hrs. 18 min.

MURKIN OYLAKE
 1887 M. IN 21 DAY

LOS ANGELES
 TO
 EVANSTON, ILL.
 28 hrs. 27 min.

ALPAC, ARIZ.
 TO
 OGDEN, W. V.
 100 hrs. 21 min.

Vacu-matic Carburetor Co.
 7617 W. State St.
 Wauwatosa, Wisconsin

Dear Sirs:

Having just completed a new speed record between Los Angeles and Chicago, driving a 1936 Chevrolet equipped with a Vacu-matic carburetor control, I thought you might be interested in knowing some of the facts and the important part Vacu-matic played in the success of the run.

The distance covered was 2322 miles in thirty nine hours and forty-two minutes, officially timed by Western Union, which gave me an average speed of 59.7 M.P.H. based on elapsed time and with the Vacu-matic averaged 18 1/2 miles per gallon on gasoline.

Before leaving Los Angeles, we made several test runs both with and without the Vacu-matic, and the tests proved that Vacu-matic increased my gas mileage 3 1/2 miles per gallon at the driving speed of 60 M.P.H. and also very noticeable increase in both acceleration and power.

After this experience with Vacu-matic, you can depend that on my future speed runs across country that I will be depending on Vacu-matic to give me the same added performance it has proven on this last record breaking drive.

Yours very truly,



Sets New
 Coast-to-Chicago
 Record

New Supercharge
 Principle
SAVES GAS

MORE POWER - MORE SPEED
 FASTER PICK-UP - NEW LIFE

ESTABLISHING new mileage records on cars in all sections of the country, the Vacu-matic again scores in a new speed record established by Bob McKenzie transcontinental automobile champion. Los Angeles to Chicago—2,322 miles in 39 hours and 42 minutes—driving 75 and 80 to maintain a speed average of 59.7 miles per hour!

Here is speed—a gruelling grind—where quick acceleration, greater top speed—and less stops for gasoline mean those precious moments saved that make new speed records possible. The same Vacu-matic that helped Bob McKenzie establish this speed record and gave him such fine gas savings is now available for all car owners. It is positively automatic—simple to install—inexpensive—and pays for itself many times over in gas savings.

Automatic • • Nothing Like It!

Vacu-matic is *entirely different!* It operates on the supercharge principle by automatically adding a charge of extra oxygen, drawn free from the outer air, into the heart of the gas mixture. It is entirely AUTOMATIC and allows the motor to "breathe" at the correct time, opening and closing automatically as required. No idling troubles—no carburetor adjustments necessary. It is so simple it will amaze you—so practical it will save you many dollars on gas costs.

Fits All Cars

VACU-MATIC is constructed of six parts, assembled and fused into one unit, correctly adjusted and sealed at the factory. Nothing to regulate. Easily attached in ten minutes.

Agents and Salesmen

VACU-MATIC offers a splendid opportunity for unusual sales and profits. Valuable territories now being assigned. Check and mail coupon.

The VACU-MATIC Co. Wauwatosa, Wis.

Guaranteed Gas Savings

VACU-MATIC must prove itself on every car. It is guaranteed to give worthwhile gas savings, quicker pick-up and more power, or it costs you nothing. "On my V-8 Ford it works miracles", says Ralph Fields. James Seeley—"On an International Truck on a round trip to Cleveland, 385 miles, it saved 19 gallons of gas." A. V. Grove—"On the Buick it showed 5 miles more per gallon." F. S. Peck—"I average 22 miles per gal. on my Plymouth, an increase of 7 miles, for a saving of \$15.00 a month, or \$180.00 a year." Wm. Lyons—"Averaged 25 miles on a gal. with a Model A Ford at 40 miles per hour."

Free Details

You owe it to yourself to know all about this remarkable discovery. Mail the coupon below. Start saving gas with VACU-MATIC and enjoy a new driving thrill! There's no obligation—so get the facts now! Write today!

--- **FREE OFFER COUPON** ---

THE VACU-MATIC COMPANY
 7617-272 W. State St., Wauwatosa, Wis.

Gentlemen: Please send me full particulars concerning the Vacu-matic and details of your Free Offer. This of course does not obligate me in any way.

Name

Address

City State.....

Check here if interested in selling proposition.

Electricity at your finger ends



Sold Singly
Price \$1.50 A Book

Pocket Size!

AUDELS NEW ELECTRIC LIBRARY—A progressive Home Study and Reference Course in applied electricity. Easy to understand. Questions and answers plainly written for a complete working knowledge of modern electrical practice, necessary to every electrician, engineer, mechanic and student.

LEARN THE AUDEL WAY! You ask the question—Audels New Electric Library gives the answer—9500 simplified outlines, graphic illustrations and precise explanations covering Construction, Operation and Machine Maintenance.

BOOK A MONTH PLAN—Order the volume that interests you—today! We will send that volume on 7 days' free trial. If the book helps you, send us \$1.50. If it does not help you, mail book back to us. On receipt of your first payment, we will send your second book. We allow 30 days to pay for this and for each following book until you complete the Series.

If you are not satisfied, you may cancel your subscription at any time.

FREE EXAMINATION COUPON

Theo. Audel & Co., 49 W. 23rd St., New York City
Mail Vol. I, Electric Library on 7 days' free trial. If O. K. I will remit \$1.50, otherwise I will return it. I also request you to mail one book each month on same terms. No obligation unless I am satisfied.

Name

Address

OccupationPM

AUTO-MECHANICS & WELDERS

GOOD JOBS and Mighty GOOD PAY

Do you want to earn big money? If so let us know which of the following trades you prefer. You learn by doing. Practical work. Expert teachers. Low tuition. Personal attention. It will pay you to investigate **AT ONCE**. Just check the courses you'd like to take and mail today. You will receive full information, absolutely without cost or obligation. But don't delay.

Check the Trade You'd Like to Learn

- Auto Mechanics
- Welding
- Auto Collision
- Spray Painting
- Metal Finishing
- Torch Soldering

Name

Address

Mail the above to

MICHIGAN TRADE SCHOOL

Write for FREE CIRCULAR

3758 Woodward Avenue DETROIT, MICH.

When writing please mention Popular Mechanics

AMATEUR CARTOONISTS WIN \$25.00

Wanted—Amateurs with humorous ideas. No drawing ability necessary. The amateurs of today are the professional cartoonists of tomorrow. Ideas judged and prizes awarded by Applause-O-Meter test before movie audiences. Everyone has an equal chance. 26 cash prizes in all. Rush name on post card for "Valuable Tips on How to Make Money With Simple Cartoons and Humorous Ideas," Cash Prize Entry Blank and Rules—Send No Money.

CARTOONISTS' EXCHANGE, Dept. 91, Pleasant Hill, Ohio

PHOTO-ENGRAVING LEARN IT AT HOME



We Furnish all equipment and materials including large photo-engraving camera complete with lamps, lens and screen. When you have finished the course you can establish a good paying independent business with the equipment furnished or work for others at a big salary. Photo-Engraving offers greater opportunities today than any other industry. Every picture in this issue of Popular Mechanics was engraved by the process we teach you. Earn good money while learning. Write today for our new illustrated catalog which was engraved on equipment such as we furnish. You will not be obligated in any way by writing Aurora School of Photo-Engraving, Dept. 117, Aurora, Mo.

A copper plate to print above picture size 8 by 10 inches sells for \$15.37

AUTOMOBILE RACING New Book

(FOURTH EDITION)

Nine Chapters—66 illustrations of dirt, midget and championship cars and drivers. How to build cars and bodies—14 plates working drawings. Converting stock cars to 135 m.p.h. racers. Answers all questions on speeding up cars, balance, speed, revs., rules, specifications, track records, etc. Postpaid \$1.00, C.O.D. \$1.12. Order NOW. Ray Kuns, Dept. B-1, Madisonville, Cincinnati, Ohio.





Learn to Write

Begin Today. Write for my Free Book, "How to Become a Good Penman." It contains specimens and tells how others learned to write in spare time. Your name elegantly written on a card if you enclose stamp for postage. Write today. F. W. TAMBLIN, 418 Ridge Bldg., Kansas City, Mo.

BARBERING OR BEAUTY CULTURE OLDEST, LARGEST SCHOOLS. Est. 1893. EARN while LEARNING. Day, Night classes. Free National employment bureau. Prize winning teachers. Big pay. Professions. Low rates. Easy terms. Free booklet "B." **MOLER SYSTEM, NEW YORK, N. Y., 139 E. 23rd St.**

BECOME A VENDING MACHINE OPERATOR!
Own a "chain" of 1c peanut and chewing gum vending machines. Large, steady profits, as people eat peanuts and chew gum daily. Start with \$100 Write for details today!
D. ROBBINS & CO. BROOKLYN, N. Y. 1141P DeKalb Ave.

Men & Women Earn Cash at Home!
We paid M. M. \$267 in 3 weeks for exceptional "cellar crop" patented mushrooms! Big free picture book tells if your cellar, shed, barn suitable. We buy all crops thru ten branches. Write today. Est. 1908. **UNITED CO., 3848 Lincoln Ave., Dept. 71, CHICAGO**

NOW—Make These Attractive Ornaments and Gifts at Home and EARN BIG PROFITS!

RUBBER MOLDS AS LOW AS 6c EACH!

Amazing rubber mold-making outfit makes perfect molds of plaques, medallions, statues, busts of famous men and women, ash trays, bookends, etc., from 6c to 25c each. One mold makes dozens of novelties and gifts to sell for \$1.00 or more apiece! No experience necessary. Everything furnished—complete instructions. Start profitable business in your home . . . sell to stores, friends, neighbors, by mail. Make **BIG MONEY** full or spare time with **SO-LO GO-MA**. Write for complete **FREE** details and sensational introductory offer.

SO-LO GO-MA MOLD CO.
Dept. K-827, Cincinnati, O.



STATUES \$2.00



SCOTTIE \$1.00



BOOK ENDS \$1.50



PLAQUE \$1.75

STAMPS and COLLECTING

(Continued from page 36A)

found convenient. They are made of thin tough paper gummed on one side with a superior grade of mucilage.

A collector often tries to provide his own hinges by cutting up strips of gummed paper, labels or flaps from envelopes, but much of this gum may stain stamps, or change the color where hinged, and often it will be almost impossible to soak off the stamps when remounting the collection. The better grades of hinges are double-gummed, so the hinge may be peeled off the stamp without damage to its surface. A few kinds are too "peelable," with the result that the stamps fall off the page. These are even less desirable than a hinge which sticks to the end.

To apply the hinge so the stamp will not change shape, moisten only enough of the hinge so it will stick tightly to the stamp. It will be necessary to mount several stamps before you learn the strength of the gum, but rarely does any hinge require that more than one-eighth of an inch of its surface be applied to the stamp.

In practice, it is well to learn to use your tongs for mounting stamps. Begin by holding a stamp hinge between the thumb and forefinger of the left hand, gummed side down. With the tongs, fold up one-eighth inch of the hinge, moisten this folded end and apply to the back of the stamp with the folded line even with the top of the stamp. Now moisten about one-eighth inch at the other end of the hinge, and carefully place the stamp in a predetermined space in your album, pressing it firmly into place. The general appearance of the collection will be judged by the neatness displayed in mounting, rather than by the condition of the stamps.

Albums with printed boxes for each stamp are easier to use than blank albums, for the black lines of the box will cause the rows to appear lined up even though the stamps are not centered in each box. Stamps mounted on plain white pages must be very carefully lined up for any variation is noticeable. At one time there was a fad for mounting stamps on blank pages in intricate geometrical and artistic designs. This system has largely gone out of style in favor of pages mounted in strict

(Continued to page 43A)



ART is necessary IN MODERN INDUSTRY

Nearly everything worn or used must first be designed. Color and style influence their sale. Industry knows the importance of good looks in its products. In addition, magazines, newspapers, publishers and advertisers spend millions yearly for illustrations. The artist has become an important factor in industry.

Do you like to draw? If so, train your talent to serve industry. Drawing may be your surest road to success.

The Federal Schools, affiliated with a large art, engraving and printing organization, has trained many young men and women now capable of earning \$1,000 to \$5,000 yearly as designers and illustrators. Its Home Study courses in Commercial Art, Illustrating and Cartooning, contain exclusive illustrated lessons by many famous artists. Practical instruction by experienced men is the reason for its many years of outstanding success. Courses sold on easy monthly payments.

Send today for Free Book, outlining present opportunities in Art, describing the training and showing reproductions of students' work. Just fill out and mail the coupon below.

FEDERAL SCHOOLS, INC.

1137 Federal Schools Bldg.
Minneapolis, Minnesota

Send me your free book explaining Federal School Art Training.

Name.....

Address.....

Age..... Occupation.....

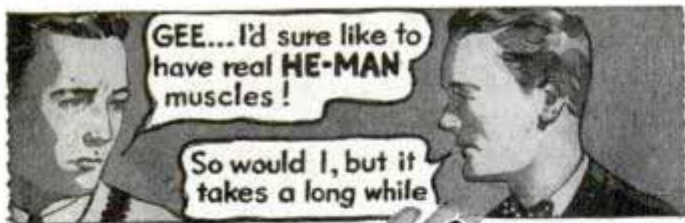

—says Charles Atlas
Holder of title, "World's
Most Perfectly Developed
Man" won in national and
international contests.

"Bunk!"

**I'll Prove in
the first 7 days
YOU can have a
Body like Mine!"**

DON'T get the idea that it takes a lot of time and hard work for you to get smashing strength and powerful muscles! Don't think you need dumbbells, springs or any other contraptions!

Both these ideas are all bunk—and I have PROVED it. All I need is 7 days to prove what I can do for you! And I don't need any apparatus either. In fact, I don't believe in artificial methods that may strain your vital organs for life!

NATURAL Methods Are All I Need

Above you see an actual photo of how I look today. No muscles have been "painted on." This is the camera's honest proof of what I did for MY body. I'm ready to prove what my secret of Dynamic Tension can do for YOURS!

A few years ago I was a physical wreck, a 97-pound weakling—flat chested, arms and legs like pipestems. I was worried. I studied myself. Then I found a new way to build myself up. A way that was simple, natural, quick, and sure! "Dynamic Tension" is what I called it. In a short time I had the body that has twice won the title of "The World's Most Perfectly Developed Man."

Get MY FREE Book

Thousands of others now know from their own personal experience what Dynamic Tension has done for them. My interesting booklet, filled with pictures tells my story—and theirs.

This little coupon brings you my free book, which tells all about it. No cost or obligation.

I just want to give you proof that I can do for you what I have done for so many others: give you broad, powerful shoulders, biceps that bulge with smashing strength, a chest which stands out solid and muscular, and an evenly developed body that will make others look like dwarfs next to you. Mail this coupon TODAY! CHARLES ATLAS, Dept. 8N, 115 East 23rd Street, New York, N. Y.

**CHARLES ATLAS, Dept. 8N
115 East 23rd Street, New York, N. Y.**

I want the proof that your system of Dynamic Tension will make a New Man of me—give me a healthy, husky body and big muscle development. Send me your free book, "Everlasting Health and Strength."

Name.....
(Please print or write plainly)

Address.....

City..... State.....

When writing to advertisers please mention Popular Mechanics

New JOBS FOR THOUSANDS

Calls are increasing. Good draftsmen are scarce. Get ready now for a real money-making opportunity in Drafting. Send for our

Free TRIAL LESSON in DRAFTING



Prove at our risk that you can learn Drafting at home in spare time. Same training as given in our Chicago school. See just how you can prepare quickly for one of these new jobs. Valuable drawing outfit and table furnished our students; also free help to secure job.

Send post-card today for FREE LESSON.

CHICAGO TECHNICAL COLLEGE

A208 Tech Bldg., 118 East 26th St., Chicago, Ill.

If you prefer to go to College to learn Drafting, Engineering, Air Conditioning, Architecture, Electricity or Radio, send for our 80 page "Blue Book." Mailed free.

EVERY TOM, DICK and HARRY WILL BE WORKING for YOU!

WHATTA LIFE—you have the gas station attendants, the waitresses, garage men, laborers, railroad men, as a matter of fact, every Tom, Dick & Harry telling your story and everybody's interested. It's really fun! And do you collect profits!!—we mean *Big Money!* Your helpers are well paid too—but not by you—we take care of that. *Better write for this interesting big money plan today—right now so you will be first.*

C. A. STODDARD

4325 Ravenswood Ave.,

Chicago

HOME STUDY COURSES

Home-Study Courses, leading to Degrees in Arts and Sciences; Education; Writing; Psychology; Chemistry; Business and Commerce; Law; Theology; Agriculture; Engineering; also courses in Business Training; Accounting; Advertising; Sales Management; Public Speaking; Radio. Many others. Low Cost; Easy Terms.

McKinley-Roosevelt University, 4247 Clarendon Ave., Chicago

LEARN TO PAINT SHOW CARDS
SIGNS AND

BIG PROFITS
We teach you quickly, by mail or at school. Enormous, steady demand. Big future. Interesting. Write for full information. **DETROIT SCHOOL OF LETTERING**
5737-A Second Blvd. DETROIT, MICH.

Learn PHOTOGRAPHY at Home

Splendid opportunities. Prepare in spare time. Easy plan. No previous experience needed, common school education sufficient. Send for free booklet "Opportunities in Photography", particulars and requirements.

**American School of Photography
3601 Michigan Ave., Dept. 1351, Chicago, Ill.**

don't WORRY

Why put up with years of needless discomfort and worry? Try a Brooks Automatic Air Cushion. This marvelous appliance permits the opening to close, yet holds reducible rupture securely, comfortably—day



and night. Thousands report amazing results. Light, neat-fitting. No hard pads or stiff springs to chafe or gouge. Made for men, women and children. Durable, cheap, **Sent on trial** to prove it. Never sold in stores. Beware of imitations. Write for Free Book on Rupture, no-risk trial order plan, and proof of results. All correspondence confidential.
BROOKS COMPANY, 111-H State St., Marshall, Mich.

FREE BOOK
Gamble a stamp today. Mail coupon for free copy of my new book, "Everlasting Health and Strength." It shows you from actual photos how I have developed my pupils to my own perfectly balanced proportions. Where shall I send your copy?



EASY
to play

With an easy playing Conn band instrument, you can be ready for band or orchestra in 4 to 6 weeks. A sure road to popularity if you start on a Conn. Choice of the world's greatest artists. Magnificent tone. Many exclusive features—yet they cost no more.

Ask to see the marvelous new models now being displayed by Conn dealers.

WRITE FOR THIS NEW FREE BOOK

Home trial. Easy payments. Write us for free book on whichever instrument interests you most. Mention instrument.

C. G. CONN, LTD., 131 CONN BLDG. ELKHART, IND.



CONN

BAND INSTRUMENTS

New POCKET RADIO
MUSIC SPORTS ENTERTAINMENT

FITS POCKET EASILY—Take it with you!

Brings in stations with beautiful clear loud tone! Incorporates such features as direct reception from radio—no dangling phones to bother with—single centralized tuning which is the only moving part—covers broadcast band, etc. You should be thrilled with its excellent performance. Complete in one unit, just like the big sets—but weighs only 6 ozs. Requires no batteries, tubes or electrical connections.

Costs Nothing to Operate—Nothing Else to Buy! Comes to you complete, all ready to listen, with simple instructions for use in hotel, camps, office, home, picnics, bed, boats, etc., and take it with you while traveling, in autos, bicycles, etc. Works immediately. Nothing to adjust. No difficult book-ups. Should last for years. A GUARANTEED Radio.

SEND NO MONEY! Send C. O. D. or send money with order. Get the "Cathedral" Radio today—the radio that combines performance—economy—and practicability. Comes in beautiful walnut color with built-in phone and attractive tone grille in upper part of radio. Order now! Be the first to have one. Pay postman on arrival only \$2.99 and few pennies postage. **Mighty Midget Radio Co., 1951 Irving Park Blvd., Dept. 701, Chicago**



Trailer Travel Magazine

Keep abreast of trailer travel and trailer life!

If interested in trailer lore as owner, builder, buyer or prospect, you want the only magazine devoted exclusively to—

- News, articles and stories on all phases of trailer life.
- Current events in the trailer world.
- Official announcements of all trailer conclaves.
- Trailer tours and trailer camp information.
- Lists of national, state and local trailer parks.
- Developments in the trailer industry.

- New features in trailer construction and equipment.
- Helps for the trailer home-builder.
- Federal, state and local laws and regulations.
- Hunting, fishing and other sports via trailer.
- Housekeeping on wheels by the trailer wife.
- Advertisements—a directory in themselves of the field.

For 1 year monthly mail, \$1, or for sample copy.....10c
TRAILER TRAVEL Magazine, PM1, 180 N. Michigan Ave., Chicago

**“GET ON”
“Uncle Sam’s”
PAYROLL**

**START
\$1260 to \$2100
YEAR**

MANY 1937 APPOINTMENTS

**Common Education Usually Sufficient
Influence Not Needed**

**City Mail Carriers, City
Post Office Clerks**

Clerks and carriers now get \$1,700 the first year regular and automatically increase \$100 a year to \$2,100 and \$2,300. Open to men—women, 18 to 45.



Railway Postal Clerks

Railway Postal Clerks get \$1,900 the first year regular, being paid on the first and fifteenth of each month. (\$79.17 each pay day.) Their pay is automatically increased yearly to \$2,450. Advance may be had to Chief Clerk at \$2,700 a year. (\$112.50 each pay day.) Open to men, 18 to 35.

Customs Inspector

Salary \$2,100 to start. Men 23 to 45. Work connected with examining baggage and merchandise entering the country from foreign parts covering boats, trains, roads, automobiles, etc.



File Clerk—Clerk

Open to Men—Women 18 to 50. Entrance salary \$1260—\$1440 Year. Appointments as File Clerks and Clerks in the Departments at Washington, D. C., are made from this examination.

Many Other Positions

Many other positions are obtainable. Experience is usually unnecessary and political influence is not permitted. Let us show you how to get a government job.

Free List of Positions

Fill out the following coupon. Tear it off and mail it today—now, at once.
This investment may result in your getting a big-paid government job.

FRANKLIN INSTITUTE, Dept. T-195, Rochester, N. Y.

Gentlemen: Rush to me, FREE of charge, list of U. S. Government big pay jobs. Send me FREE 32-page book describing salaries, vacations, hours, work, and full particulars telling how to get one of these jobs.

Name.....

Address.....



There's Quicker, Bigger MONEY for YOU-in POULTRY

Earn \$1,000 to \$2,500 a Year or Have a Business of Your Own!



Whether you want a job at good pay or a highly profitable business of your own—the Poultry Industry offers you more than any other. There's a shortage of poultry meat and eggs — a shortage of trained poultrymen. I'll train you quickly at home—to fill a good job in Poultry—and our FREE Students' Employment Dept. will help you get one!

See How Easy It Is To Start—Cash In QUICK

Modern "factory" method—using a brooder—make it easy for you to raise poultry in limited space. Start in your garage, basement or barn. Raise fliers and broilers—they're ready for the cash market without ever being taken out of the battery brooder. No farm needed. City folks can make \$1,000 to \$2,500 a year. I'll show you how to make a tiny investment grow automatically. What I've done for thousands of others I can do for you.

FREE Book Shows the Way to Big Pay and BIG Profits

Mail coupon below TODAY—for my Big NEW FREE Book, "How to Raise Poultry for Profit." My forty years of experience are yours. The Poultry Industry needs YOU. You need my book. Get it—and get in line for the BIG Money that's waiting for you in POULTRY.



Mail NOW for FREE Book

NATIONAL POULTRY INSTITUTE, Dept. 35-B, Adams Center, N.Y., Att'n: Harry M. Lamson, Pres.

Dear Mr. Lamson: Send me your FREE Book, "How to Raise Poultry for Profit." I want to know more about my opportunity to make \$1,000 to \$2,500 a year, spare or full time.

Name

Address



DRAFTING

BOOKS SENT FREE!

ON APPROVAL 5 VOLUMES BRAND NEW EDITION

Only 15 minutes a day with these WONDER BOOKS will prepare you for a good drafting job in less than a year. Mechanical and architectural drafting from simple straight lines to important complex plans. *A step at a time!* Built especially for beginners, for men with only grammar schooling. Drafting room practice, PLUS ENGINEERING, made easy and clear. Includes complete course in blue-print reading.

Big Field Big Demand Big Pay

Competent draftsmen are urgently needed right now in all building and manufacturing lines at \$30.00 to \$75.00 a week. That's just the beginning—FOR DRAFTSMEN HAVE THE BEST CHANCES FOR ADVANCEMENT. Pleasant, fascinating work, easy to learn and do. Learn quickly with these books—send coupon for a set FREE and see for yourself.

A year's consulting membership in the American Technical Society now given free to all readers of this famous cyclopedia of drafting. Many say that it is worth more than the cost of the books.

Complete set of drawing instruments if you send for these drafting books NOW. These instruments are made of the finest of German silver, are absolutely accurate and are packed in velvet lined leatherette pocket case. Real \$10 value, but free to you with these books.

AMERICAN TECHNICAL SOCIETY Dept. D119, Drexel at 58th St., Chicago, Ill.



American Technical Society, Dept. D119, Drexel at 58th St., Chicago, Ill. Send for 10 days' free use New 5 volume set of drafting. I will pay the few cents delivery charges. If I wish, I may return books in 10 days and owe you nothing but if I decide to keep them, I will send \$2.00 after 10 days, then only \$3.00 a month until \$24.80, the introductory price, is paid. Send latest edition and include drawing instruments.

Name

Address

Attach letter stating age, occupation, employer's name and address and that of at least one business man as a reference.

For LOTS of HEAT

Buy this NEW LACO Oil-Burning HEATER

New Type Heating Unit Develops REAL Heat with Little Fuel —



Now, keep your home cozy and warm in severest weather, at little cost.

It's that famous LACO burner (see below) that does it. Same principle burner we have used for 11 years in our furnace oil-burners (60,000 in use). Gets every atom of heat from low-priced oil. Delivers all into the room, none wasted up the chimney.

4 sizes. Largest is positively the only "really big" stove on the market—delivers 120,000 B.T.U. of heat—wonderful for large home, store, etc.

Clean. Automatic temperature control. Humidifies and circulates the air. Built of finest extra-heavy copper-bearing steel. Handsome as the finest furniture.

For 10 years we have built a full line of quality Oil Burners. Prices lowest known!

SAVE! LACOs are the Lowest Priced Quality Oil Burners you can buy. You save because factory is located where all overhead expenses are below usual.

WRITE! Get free copy of new details book, many photos, full details. Low Prices, SEND NOW.



Here's the Burner Unit that Produces Extra Heat
Built for extra heavy heating Spring suspension—full floating—self cooling—powerful enough for extra large heaters. Sizes for all oil burning room heaters.

LACO OIL BURNER CO., 117 Union St., Griswold, Iowa

Correspondence Courses in RADIO and ELECTRICAL ENGINEERING **SPECIAL Only \$25**

ELECTRICAL ENGINEERING covers complete electrical field. Most modern course. Very understandable. **RADIO ENGINEERING.** Ultra-modern course in radio, public address, photo-electric work. Trains you to be super-service man, real vacuum tube technician. Tuition ONLY \$25, either course. Deferred payment plan. **WRITE TODAY** for free copies of school catalogs, student magazines, etc. **LINCOLN ENGINEERING SCHOOL 931-6 So. 37th St., Lincoln, Nebr.**

SIGNS Big demand! Earn \$100 a week. New Picture-Way teaching method. Train on actual work at home, quickly. You receive the personal attention of D. Rogers Stewart, noted artist-instructor, which makes this the finest instruction obtainable. Low tuition. Free placement service. **FREE** sign outfit. For **FREE** lesson, criticism, and information (no obligation), write to: **STEWART SIGN SCHOOL, Dept. P-1, 3555 Aberdeen, Alton, Ill.**



FREE Squab Book for 1937. (Send 3-cent U. S. stamp for mailing expense.) Quick cash for these **ROYAL** baby birds; orders waiting for hundreds of thousands from N. Y., Chicago and other city firms whose names we give you. Make money breeding them; sold only 25 days old; easy to raise. We ship breeders everywhere. See any bank about our responsibility. For full details write **PR COMPANY, 636 Howard St., Melrose, Massachusetts, 37th year.**



LOOK! Baby Chicks THOUSANDS WEEKLY ALL YEAR

Finest quality & Layers in 40 breeds. Hybrid Baby Pullets and Cockerels, B. W. D. Tested. 25 lbs. feed **FREE** with each 100 chicks. Ducklings, Goslings, Baby Turkeys, Guinea's. Mature Breeders priced right. In business 27 years. Catalog free. Nabob Hatcheries, Box M, Gambier, Ohio.



Best Poultry Paper 6 BIG ISSUES 10¢

Helps increase Poultry Profits. Send coin or stamps. 50 cents for 3 years or 10 cents for 6 months trial. Agents wanted. **American Poultry Journal 532 So. Clark Street Chicago, Illinois**

RAISE RABBITS FOR US

WE PAY YOU UP TO \$5.00 EACH. ALSO PUT YOU IN TOUCH WITH MARKETS EVERYWHERE. Large illustrated book and catalog, also copy of the **AMERICAN RABBIT FARMER** and monthly market bulletin showing names of buyers in various parts of America who continuously buy all rabbits offered them. All for 10 cents. Address **OUTDOOR ENTERPRISE CO., 101 Main Street, NEW CITY, N.Y.**

STAMPS and COLLECTING

(Continued from page 39A) F 1436

gridiron fashion. Here the stamps are arranged in horizontal and vertical rows, spaced rather widely apart, and any notes or descriptive matter should be subdued. The stamps are the important part of the display, and fancy borders or intricate arrangements detract from the stamps themselves say those favoring a simple arrangement although many fine collections have been made in which the stamps were purely incidental to a display of chirography, or hand painting upon the pages.

Recent Stamp Issues

Historically interesting sets of stamps have been issued for the French colonies in America, Guadeloupe, Martinique, and French Guiana, to commemorate the three hundredth anniversary of the colonization of the Antilles. Those illustrated picture Belain D'Esnambuc taking possession in the name of France, on the forty-centime Martinique; Schoelcher and the Abolition of Slavery in 1848, on another Martinique; Richelieu, founder of the Company of the Antilles, on the fifty-centime Guadeloupe; Victor Hugues and his corsairs, on a second Guadeloupe; the Capture of Cayenne, by D'Estrees in 1676, on the fifty-centime French Guiana, and a native and the products of the colony on another.

A new French series of stamps has been issued to advertise the International Exposition to be held in Paris in 1937. The lower values especially are difficult to decipher. The new semi-postal stamp of New Zealand is an interesting example, and is known as the "keyhole" stamp. The vignette is shaped like a keyhole and shows a boy playing on the beach. These stamps were sold at two pence, half being for postage and half for charity. Brazil has issued stamps in connection with the First National Juridical Congress. The design pertains to justice and shows the balance and the tablets containing the ten commandments. An unusual set issued by Hungary in connection with the two hundred fiftieth anniversary of the recapture of Buda from the Turks is printed in photogravure. Another photogravure stamp is that issued by Jugoslavia for semi-postal purposes. It is one of a set picturing the

(Continued to page 45A)

LEARN AUTO MECHANICS

in 8 weeks!

Earn \$35 to \$75 a week as an Auto Mechanic. Never in the history of the automotive business has there been such a demand for TRAINED men. 8 weeks training fits you for a job that's waiting for you or to open your own repair shop. Read what two McSweeney trained men have done. Hundreds of others can tell you facts equally interesting. Don't look for a job! TRAIN for it!

Farrell, Pa.

Dear Mac: Please forward me your catalog. I want it to add to my traveling souvenirs. I am working in a modern garage although I have been out of school only four weeks, thanks to McSweeney Training. My best regards to all. M. Klushauk

Rector, Ark.

Dear Mac: Just a few lines which might interest you. I left your school two years ago last May. Since I left I have not seen a day I could call "hard times." I have been working ever since I left and have averaged in my earnings \$173.00 a month, in spite of the hard times. Many thanks. Thos. J. Sharp

EIGHT WEEKS of Actual Shop Training

No books or lessons the McSweeney way. First you learn the "why" of everything you do; then under competent instructors, you DO the job. You work on real equipment and machines, with the real tools of the auto expert. In eight short weeks you are TRAINED to hold down a permanent BIG PAY job. Any man 16 to 50 can learn. Write today for New Low Tuition Offer.

Diesel Engines and Aviation Ground Course!

Diesel and Aviation coming fast! Prepare now for the wonderful opportunities of the future.

MONEY BACK GUARANTEE!

Eight weeks of intensive training, actual shop work with real tools on real equipment, qualifies you for a Big Pay Job. If not satisfied, your tuition will be refunded.

FREE Write today for Big Free Book on AUTOS. Get the facts about jobs; and Low Tuition Offers. Mailing the coupon does NOT obligate you. It obligates ME to tell YOU how you can train for Big Money in eight short weeks. Address Dept. 10-37.

McSWEENEY SCHOOLS

AUTOMOBILE—DIESEL—AVIATION

DETROIT, MICH. or KANSAS CITY, MO.

Write Our School Nearest You

McSweeney Auto and Aviation School,
Dept. 10-37, Detroit, Mich., or Kansas City, Mo.

Without cost or obligation, send me your Big FREE Book on Autos; also full information about your Low Tuition Offer.

Name.....

Street.....

Town.....State.....Age.....

Be a TELEVISION EXPERT

LEARN TELEVISION with RADIO—NOW!

Great opportunity for experts in this amazing new industry. Recent developments in radio make television a certainty NOW. We teach you by our "on the job" method Radio and Television from beginning to end in our marvelously equipped labs and studios. You actually operate thousands of dollars worth of expensive equipment. You get expert instruction and skilful guidance by radio-television specialists.

Demand for Television Experts

Television now perfected and ready for the market ON THE NEXT BIG BUYING WAVE. Business leaders predict new system television will require thousands of relay and broadcasting stations. Ultra-short waves will permit eighty thousand television stations in America alone.



FREE BOOK

GET IN NOW and "build up" with the world's next billion-dollar industry.

6 MONTHS THOROUGH, PRACTICAL TRAINING

Qualifies for radio-phone license (1st Class). Complete up-to-the-minute training on modern "workable" television equipment including the new cathoderay. Practical experience in studio, control room. Transmitter operation of Television Station W9XAL. Employment aid while training and upon graduation. Write for free book "Pictures On the Air" NOW!

BIG FUTURE USE COACH

S. Q. NOEL, Pres. First National Television, Inc.
Dept. AA-1 Power & Light Bldg., Kansas City, Mo.

Without obligation, send me postpaid FREE Illustrated Book—"Pictures On the Air", telling about new opportunities in television. I am 17 years or older.

Name _____

Address _____

INVENTORS all PATENTS ARE NOT GOOD PATENTS

Free

There Are Many Degrees Of PATENT PROTECTION

You want to make money from your invention, therefore, you want the best patent you can possibly get. But a good patent depends not only on the invention itself, but upon the skill and interest of your patent attorney in drawing up the claims and specifications and in following your case to a successful conclusion. C. A. Snow and Company have had over 61 years of specialized patent experience. We know the difference between strong patents and weak ones. We won't promise you something we can't get for you.

Write today for our free document: "CERTIFICATION OF INVENTION" and our two free booklets: "HOW WE PROTECT YOU" and "SUGGESTIONS ON HOW TO COMMERCIALIZE YOUR INVENTION". Fill out the coupon below NOW.

Cut Coupon On Dotted Line

DEPT. A-13 SNOW BUILDING, WASHINGTON, D. C.

Gentlemen: Please send me absolutely free and without obligation on my part, your original document, "Certification of Invention", together with your two guides for inventors, "How We Protect You" and "Suggestions On How To Commercialize Your Invention."

NAME _____

ADDRESS _____

(PLEASE PRINT NAME CLEARLY)

C. A. SNOW & CO.

Registered Patent Attorneys Since 1875



MARVELOUS INVENTION! "All-in-one" Combination Blow Torch & Soldering Iron

Now garage men, plumbers, mechanics, engineers can cut cost and time—with this new Justrite Combination Blow Torch and Soldering Iron! Supplies its own pressure—without pumps of any kind. Generates its own heat—without charcoal or stove. Light, convenient, portable, foolproof gives 100% customer satisfaction. SELLS ON DEMONSTRATION.

AGENTS' SAMPLES: A special proposition for new, fast-working agents who can start now—and produce!

Exclusive Territories are open for agents who know how to sell this PROVED MONEY MAKER. Thousands of Justrite Torches are in use now. This success is ready for YOU! Write today!

JUSTRITE MFG. CO.

2061 Southport, Dept. 51, Chicago

Save Your Feet

When all else fails end your suffering with the flexible "no metal"

Heefner ARCH SUPPORT

Write for Free Booklet



HEEFNER ARCH SUPPORT CO., 653 Commercial Bldg., LOUISVILLE, KY.



BUCHSTEIN'S FIBRE LIMB

is soothing to your stump—strong, cool, neat, light. Easy payments. Braces for all deformities. Agents wanted.

D. BUCHSTEIN CO.

610 3rd Ave., So., MINNEAPOLIS, MINN.

Send for Catalog Today

In answering advertisements always write name and full address clearly.



U.S. Manufacturers desire men to learn Electric Arc Welding and get practical experience under actual production conditions in the laboratories of the School of Engineering. Moderate training Fee. Accepted applicants will be fully trained until ready to pass rigid test and assisted in securing employment.

ARC WELDING presents one of the outstanding opportunities for steady income and future success. Welding is growing rapidly, replacing large and intricate castings, rivets, nuts, bolts, screws. It is commonly used in assembling cranes, hoists, bridges, structural steel work, etc. No limit to the application of welding to industry, increasing durability and reducing manufacturing costs. There is a decided shortage of properly trained Welding Operators, Technicians, and Welding Engineers. Why be content with ordinary work, hit and miss jobs and low pay when in a short time you can become a trained Specialist in Welding?

MILWAUKEE SCHOOL of ENGINEERING

Institute of Electrotechnics

Dept. PM-1-A, Broadway & E. State, Milwaukee, Wis.

Without obligation send Free Booklet "The Dawn of a Gigantic Industry and its Outstanding Opportunity." Also tell me How to Become a

- | | |
|----------------------------|-----------------------------------|
| Welding Operator (3 mo.) | Refrigeration and Air |
| Welding Technician (6 mo.) | Conditioning Technician (3 mo.) |
| Welding Engineer (1 yr.) | Radio and Television |
| Electrical Engineer | Service Man (6 mo.) |
| B.S. Degree (4 yrs.) | Commercial Radio Engineer (1 yr.) |
| Student Loan Plan | Earn Part Expense Plan |

Name _____ Age _____

City _____ State _____ (PM-1 A)

When writing please mention Popular Mechanics

STAMPS and COLLECTING

(Continued from page 43A)

queen mother of that country. Poland's most recent contribution is a pair of values to mark the holding of the Gordon-Bennett balloon races in that country.

Christmas Seals

Each year finds more people collecting Christmas seals, and many confirmed stamp collectors have added this as a side line. The publishers of the specialized United States catalog have listed the regular American Red Cross and National Tuberculosis Association seals. There is the same incentive in making a collection of seals as in making one of stamps, for the seals are issued under authority, their sale is closely supervised and there is only one seal or set of seals each year. Some of the early dates of American seals are scarce and it may require much searching to complete a collection of dates without including any varieties. If the collection is not large enough to suit the individual, he may include seals issued by state and local organizations, and by foreign lands.

Coin Notes

Coin collectors and dealers have been spurred to activity by the offer of a Chicago dealer to pay full list price for certain United States twenty-five cent pieces minted between 1916 and 1924. This offer stated he was prepared to pay the full price in any coin list published prior to 1936. The quarters show a flying eagle on the reverse, a type which was only superseded in 1932 by the new design bearing the profile bust of Washington. The first of these coins was minted in 1916 and 1917 and was replaced in the latter year by a second type with three stars between the eagle and the words denoting the value. In 1925 the die was altered so the date is less liable to wear, thus removing the reason for the scarcity of the previous coins. In searching through quarters of this design you will be surprised at the number without any trace of a date. These are the coins minted between 1916 and 1924. To be of any value to a collector, the coin must show a fairly legible date, and to command a good premium, it must be uncirculated or nearly in that condition.

I'LL GIVE YOU THIS BEAUTIFUL NEW FORD SEDAN

AS A
BONUS



besides A WONDERFUL
OPPORTUNITY TO MAKE UP TO

\$60
IN A WEEK

If you are out of work or on part time and need cash at once to pay your bills and live on, you are just the person I am looking for. I have a good offer for you right now—a wonderful opportunity to start right in making up to \$10.00 in a day and quickly advance your earnings as you become established.

I Send Everything You Need

Experience or previous training is unnecessary. I send you everything you need to make big earnings from the very first day. You will act as Local Distributor for my million-dollar company. You will look after your customer's orders, fill them, and handle the money. A big part of every dollar you take in you keep as your pay. Once started I'll give you credit and you can build on my capital. Even starting part time you can enjoy earnings up to \$27.50 in a week; up to \$60.00 in a week for full time. In addition to your cash earnings, I'll give you a brand-new Ford Tudor Sedan as a bonus for producing.

\$96.00 in a Week

You may wonder at making so much money in such a pleasant, simple manner. Clare C. Wellman, N. J., reported that he cleared \$96.00 in a week. Hans Coordes, Nebr., stated he made \$27.95 in a day; \$96.40 in a week. Ruby C. Hannen, W. Va., reported \$73.00 in a week. I have scores of reports of exceptional earnings like these as positive evidence of the amazing possibilities of my offer to you.

Send No Money—Just Name

I need more men and women at once. Send me your name so I can lay the facts before you, then you can decide if the earning possibilities are satisfactory. Don't miss this chance. It doesn't cost you anything to investigate. You can't lose by mailing the coupon or a penny postcard for free details. Do it today—NOW.

ALBERT MILLS, President
3732 Monmouth Ave. Cincinnati, Ohio

MAIL COUPON—NOW

ALBERT MILLS, Pres.,
3732 Monmouth Ave., Cincinnati, Ohio

Send me the free facts about your Local Distributor offer. Tell me how I can make up to \$60.00 in a week and get a brand-new Ford Tudor Sedan as a bonus in addition to my cash earnings.

Name.....

Address.....

(Please print or write plainly)

DIESEL

**THE
New Power**



The whole world gasped at the amazing performance of the Diesel Powered Burlington R. R. Zephyr train. It opens a new era of power efficiency. Aeroplanes, automobiles, great industrial plants may soon be using these marvelously efficient engines. It means a new profession, a new trade for thousands and thousands of men. Learn Diesel operation, construction and repair NOW. Use our magical quick reference method. Find out all you need to know through these books, "Diesel and Other Internal Combustion Engines"—"Diesel Engines, Operation and Maintenance"—"Diesel Electric Plants," which we send free for examination. This combination offer brings you the latest and most authoritative information obtainable. Over 300 illustrations.

3 BOOKS ALL SHIPPED FREE

for examination. There are no strings to this offer, if you really want to get into the most promising new field of the century—the liveliest—most up-to-date—most talked of profession, send for these books on our amazing free shipment offer. Read them, examine them, test them in any way and then if you are not sold 100% send them back at our expense and you won't owe one cent.

American Technical Society, Dept. O-119
Drexel at 58th Street, Chicago, Illinois.

Send me the 3 Volumes on Diesel Engines, listed above for 10 days FREE examination. I will pay the few cents express but don't owe you a cent unless I keep the books, in which case I agree to send \$2.00 in 10 days and \$3.00 a month until the introductory price of only \$9.80 is paid.

Note: If you prefer you may send only \$8.80, cash or money order (you save \$1.00) in full payment, and we will send the 3 books prepaid. We agree to return your money if you are not satisfied and return them in 10 days.

Name

Address

City..... State.....

Please attach a letter giving age, occupation and the name and address of at least one business man as reference.

JOBS FOR THOUSANDS



New opportunities open. Calls are increasing for men trained in **Drafting, Air Conditioning, Electricity, Housing, Engineering or Radio.** Choose your position if you have C. T. C. training. Free help to job when ready. No time to lose—start training **now.** B. S. Degree or shorter courses. *33rd year, accredited.* Send post card for 80 pg. "Blue Book." Mailed FREE.

CHICAGO TECHNICAL COLLEGE
A75 Tech Bldg., 118 East 26th St. Chicago, Ill.

RADIO ENGINEERING, broadcasting, aviation and police radio, servicing, marine and Morse telegraphy taught thoroughly. Nine months' engineering course equivalent to three years' college radio work. School established 1874. All expenses low. Catalog free.
Dodge's Institute, Ada St., Valparaiso, Ind.

DANCE IN 5 HOURS



A whole family can learn from one set!

Realize your ambition—become a good dancer quickly, easily, *at home!* Arthur Murray's new picture course teaches you popular Fox Trot, Waltz steps, poise, balance, correct following, self-assurance. No music or partner needed. Write today enclosing \$2 for Ten-Lesson Course. Try course 5 days. If not delighted with results money promptly refunded.

\$2.00

ARTHUR MURRAY, Studio
285, 7 E. 43 St., N.Y.C., N.Y.

LAW HIGH-GRADE INSTRUCTION BY CORRESPONDENCE

College, Post, Grad, and Bar Ex. Rev. Courses. Law has attracted more keen, brainy men than any other calling. Send today for catalog. Low cost, easy terms. Standard texts, Degrees.

Chicago School of Law Dept. 801, Reaper Block CHICAGO, ILL.

Hand Out FREE CIGARETTES

EARN UP TO \$95 WEEKLY introducing NEW WAY TO SMOKE. We furnish you Free Cigarettes. Ask any man to have a Free Smoke. Hand him LIGHTED Cigarette from beautiful pocket-size "Magic Case." Just touch button. Presto! Out comes Lighted Cigarette automatically. No batteries or electricity. Get Magic Case for 15 days' trial at our risk. State favorite brand cigarettes.

MAGIC CASE MFRS., Dept. A-371
4234 Cozens Ave. St. Louis, Mo.



New Pocket Radio



Operates Without Tubes, Batteries or Electric Connections

Amazing gadget radio fits in pocket or purse. NEW MODEL weighs only 2 ozs. as shown in ACTUAL photo! Smaller than a cigarette package! Separates and receives stations with beautiful clear tone. Range to 50 miles—MUCH GREATER under good conditions—no noise! Employs Hi-efficiency fixed crystal. Not to be confused with cheap imitations. Tunes broadcast band. NOT A TOY, but an unusual practical radio—a sensation everywhere—a delight to anyone every way. Comes in several beautiful colors.

(state yours). ABSOLUTELY COMPLETE ready to listen with midget phone and instructions to use in hotels, offices, autos, trains, camps, at home, in bed, on bicycles, on sea or wherever you may be, TAKES ONLY A SECOND TO CONNECT—no messy hookups. THOUSANDS OF SATISFIED OWNERS—many report wonderful service in ALL PARTS OF THE WORLD! THESE ARE FACTS! Carry one with you always and be assured of many hours of entertainment AT NO COST! Can be used by ANYONE—even a child! Send only \$1.00—pay postman balance or send \$2.99 (M. O., Cash, Check). WE PAY POSTAGE, GUARANTEED. A most unusual value. Foreign orders 75c extra.
TINYTONE RADIO CO., Dept. P-1, Kearney, Nebr.

SEND ONLY \$1.00

RAISE GIANT FROGS

MUFOND GIANTS WEIGH UP TO 3 LBS. EACH



SELL UP TO \$5 PER DOZEN!

Pair of breeders may lay 10,000 Eggs Yearly! Prices steady. Markets waiting. Millions used yearly! Easy to ship to any part of the country. Nation-wide market at your command.

START BACKYARD! Small pond in your backyard is all you need for five pairs of breeders. Expand with increase. **WE BUY!** As originators of **Canned Frog Legs**, we are developing one of the world's largest frog markets. In addition to other markets, frog raisers can also ship to us.

MEN & WOMEN! Investigate this interesting, new work. See for yourself what others are already doing. Send for our big **FREE** frog book explaining our offer in detail. Write

AMERICAN FROG CANNING COMPANY
Dept. 133-A, New Orleans, La.

FREE BOOK



For FUN and PROFIT learn to MOUNT BIRDS



AND ALL KINDS OF ANIMALS

SPORTSMEN, SAVE YOUR TROPHIES! Learn at home in spare time to mount all kinds of birds and animals. Decorate your den with trophies of field and stream. We teach you this **FASCINATING SPORTSMEN'S HOBBY**. Quickly, easily learned. Wild game is growing **scarcer**. Trophies now more valuable than ever! Shoot **FEWER** and **MOUNT** them true to life. **IT'S PROFITABLE!** Many report earning \$25 to \$75 a month mounting specimens for hunters. Why not **YOU!** Learn to make **USEFUL** articles from mounted specimens such as book ends, lamps, etc., etc. (See squirrel lighter to left.)

WILD GAME NOT NEEDED. If you ^{don't} hunt you can mount **COMMON** specimens: Owls, crows, pigeons, hawks, rabbits, even frogs. **Real FUN.**

LEARN TANNING We also teach you to tan furs soft and pliable and new method to **TAN GENUINE LEATHER** from all kinds of hides. Great spare time money maker.

FREE BOOK Send right now for beautiful free 48-page booklet, illustrated, telling how easily **YOU** can learn to be a Taxidermy Artist. Contains many fine pictures. Intensely interesting. Get **YOUR** copy today. No cost or obligation. **Send now!** State **AGE**. N. W. SCHOOL of TAXIDERMY, 3371 Elwood Bldg., Omaha, Neb.



STEP INTO THE Spotlight

FREE LESSONS... A YEAR TO PAY



Banish Boredom ... Earn Extra Money START TO PLAY VERY FIRST DAY

Picture the joy of playing a snappy foxtrot, dreamy waltz or mellow old favorite on the Xylorimba. No reason why you shouldn't! Xylorimba is **easiest** of instruments to play and yet the most spectacular. In constant demand by orchestras, radio stations, at lodge meetings and parties. Marvellous opportunity to increase popularity, make big spare-time money. No bothersome practice or exercises. With Free easy lessons you actually **Start to Play Very First Day.**

BIG FREE BOOK tells all about Deagan line, liberal trial offer and easy payments. Send coupon today for your free copy.

J. C. Deagan, Inc., Dept. 1451, 1770 Berceau Ave., Chicago

Send me, without obligation, full details of Free Trial offer and easy-payment plan on the Deagan Xylorimba.

Name.....

Address.....

NOW-IT'S SCIENTIFIC CRIME DETECTION

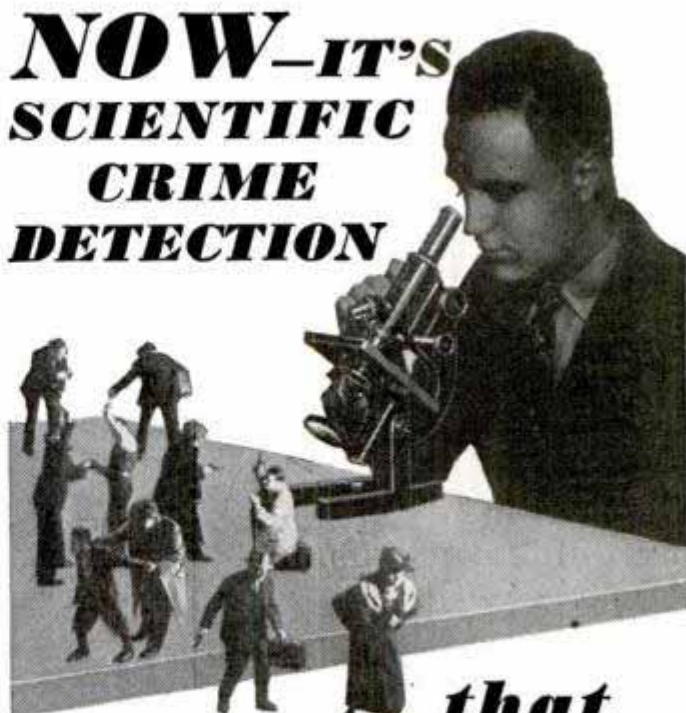

that PAYS BIG REWARDS

New Easy Training Endorsed by Experts Prepares You For BIG EARNINGS

The Nation's cry these days is for *scientifically* trained investigators. Never before has there been such an opportunity for young men scientifically trained as at the present time.

Study At Home—Advanced Education Or Previous Experience Not Necessary

This new training is not difficult. No deep book or technical data. Anyone 17 to 70 eligible. A little time each day qualifies you for big earnings in most fascinating profession on earth. Course includes every important branch of crime detection. Only course in existence that offers combination of the Science of Finger Prints, Secret Service and Private Investigation, Identification of Handwriting, Secrets of Defense and Attack, and Police Photography, **ALL IN ONE GREAT COURSE!**

Easy Terms—Big Regulation Outfit Free To Students

Write for easy terms policy enabling you to secure this scientific training with practically no sacrifice. You train with regulation police equipment and employ methods used in finest equipped bureaus of identification. Internationally famous leaders in police world endorse this training. Instructor a nationally known expert in scientific crime detection. Private industry also now demanding scientifically trained experts. Now is your opportunity to get into this new fascinating field.

FREE TO ANY YOUNG MAN 17 OR OVER

Send today for big new book, "Get Into Scientific Crime Detection," including 14 famous scientifically solved cases. This free book tells how and why you can earn big money in this great profession. Fill in coupon—mail today sure.



SCIENTIFIC CRIME DETECTION INSTITUTE of AMERICA, Inc.

Dept. 2A37 Chesapeake and Ohio Bldg. Huntington, West Virginia
J. T. BURDETTE, President

SCIENTIFIC CRIME DETECTION INSTITUTE of AMERICA, Inc.

Chesapeake and Ohio Building Dept. 2A37 Huntington, West Virginia

Gentlemen: Without any obligation whatsoever, please send me your big book containing 14 famous scientifically solved cases, together with full particulars on how I can get into SCIENTIFIC Crime Detection.

Name.....

Address.....

Age.....

When writing please mention Popular Mechanics

JUST OUT!

AUDEL'S DIESEL ENGINE MANUAL
QUESTIONS AND ANSWERS

\$2

If you are interested in the construction, operation and maintenance of modern Diesel engines, you will want this new timely book of practical, useful information.

"AUDEL'S DIESEL ENGINE MANUAL," with Questions and Answers explains, in simple, concise language the Fundamental Diesel Principles—Operating Principles—Engine Starting—Air Starting Valves—Fuel Spray Valves—Inlet and Exhaust Valves—Valve Timing—Fuel Pumps—Fuel Injection Compressors—Starting Air Compressors—Scavenging Air Compressors—Pistons and Piston Rings—Cylinders—Lubrication—Cooling Systems—Fuel Oil—The Engine Indicator—Governors—Engine Reversing—Semi-Diesel Engines—High Speed Diesel Engines—Answers on Operation—Horse Power Calculations.

The illustrations and texts are clear and easy to understand. All details are plainly brought out. This book is of extreme value to engineers, operators, students and all who desire a knowledge of the Diesel engine. A handsome book, flexible, with gilt edges. 300 pages—illustrated.

Send for free Diesel folder today.

FREE EXAMINATION COUPON

THEO. AUDEL & CO., 49 W. 23rd St., New York **\$2**
Please mail a copy of AUDEL'S DIESEL ENGINE MANUAL. If satisfactory, I will remit \$2 on its safe arrival, otherwise I will return the book.

Name

Address

Occupation PM

Learn this Profitable Profession



in 90 Days at Home

Hundreds of men and women of all ages 18-50 are making \$10.00 to \$20.00 a day giving scientific Swedish Massage and Hydro-Therapy treatments. There is a big demand from Hospitals, Sanitariums, Clubs, Doctors and private patients as well as opportunities for establishing your own office.

Learn this interesting money-making profession in your own home by mail through our college extension course. Same instructors as in our **NATIONALLY KNOWN** resident school and a diploma is awarded. Course can be completed in 3 to 4 months. No High School training necessary. Many earn big money while learning.

Anatomy Charts & Supplies Included

Enroll now and we will include anatomy charts, medical dictionary, patented reducing roller and Hydro-Therapy supplies without extra cost. The reducing course alone may be worth many times the modest tuition fee. Send coupon for reduced price offer. Complete details with booklet containing photographs and letters from successful graduates will be sent free.

National College of Massage & Physio-Therapy
Dept. 164—20 N. Ashland Boulevard, Chicago

You may send me **FREE** and postpaid, your illustrated catalog and details of your special offer, also booklet containing photographs and letters from successful graduates.

Name

Address

City

State

QUICK HELP FOR TIRED OUT, NERVOUS, RUNDOWN MEN!

How a Simple Change—Correcting IODINE STARVED GLANDS—Quickly Builds Rich Red Blood, Rugged New Strength, Calm Nerves

If you wake up in the morning exhausted, can't enjoy the sound sleep that gives you rest and energy . . . if you go around weak, half sick and ailing, nervous, irritable, easily upset, the chances are your blood is thin, pale and watery, and your system is failing to get certain particular types of nourishment so vitally needed.

Now, however, science claims that by making one simple change—correcting **IODINE STARVED GLANDS**—you can quickly correct these dangerous, rundown conditions and often, in an amazingly short time, build up the strength, endurance and solid pounds of extra flesh you need to feel fine. That's because these tiny, hidden glands which promote assimilation and control metabolism, the body's process of converting ordinary food into muscle, bone, flesh and energy) require a definite ration of iodine regularly.

When food fails to nourish you, you're bound to be rundown—sure to be weak, tired, nervous and a prey to every disease that comes along. The quickest and simplest way to provide your system and glands with a generous ration of **NATURAL PLANT IODINE** (don't confuse this with ordinary liquid iodine which is frequently toxic) is **Seedol Kelpamalt**, the astonishing new mineral concentrate from the sea.

Try **Seedol Kelpamalt** for a single week. Notice how much better you feel, how well you sleep, how your appetite improves, color comes back into your cheeks. And if it doesn't add 5 lbs. of good, solid flesh the first week, the trial is free. **Seedol Kelpamalt** costs but little. Sold at all good drug stores.

Learn in Los Angeles
**TALKING PICTURE PROJECTION
SOUND RECORDING
TELEVISION-RADIO**

QUALIFY FOR GOOD JOBS

Learn the best-paying technical trades by most modern training methods right in the heart of **filmdom**—**LOS ANGELES**. **National Schools** is the oldest, largest trade school in West—30,000 graduates. Latest equipment. Complete instruction in Talking Picture operation, Radio Transcription, Recording, Broadcasting, Television and complete Radio training.



NATIONAL SCHOOLS

Unlimited opportunities for properly-trained men. Earn room and board while learning. Coach R. R. fare allowed to L. A.

Send for Free Book

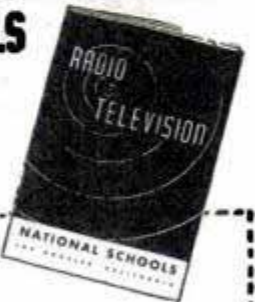

REQUEST FOR BOOK

NATIONAL SCHOOLS,
Dept. 1-PMR, 4000 So. Figueroa St.,
Los Angeles, Calif.

NAME..... AGE.....

ADDRESS

CITY..... STATE.....

AMAZING NEW ELECTRIC ARC WELDER



HOOK UP TO ANY BATTERY! \$

RETAILS Only **95** Complete

Just invented! Amazing new Comet ELECTRIC ARC WELDER—hooks up to any storage battery—generates tremendous heat to weld all metals. PRICE, ONLY \$1.95, complete. Repairs fenders, auto bodies, galvanized cans, radiators, castings, machinery parts, etc. Fuses broken parts permanently, stronger than before. Low power consumption. Take the Comet anywhere to the job, operate from auto battery. Sturdily built of finest materials to last years. FULLY GUARANTEED BY BIG MANUFACTURER.



SEND NO MONEY! You'll find a thousand uses for the Comet around your home, garage, and work shop. Thousands of garages need the Comet Welder. Also factories, repair shops, mechanics, farmers, inventors, tin shops, plumbers, etc. Order a Comet now. Send no money. We'll rush one to you, complete with rods. Pay postman only \$1.95 plus few cents postage. If not delighted, return Comet in 5 days from receipt and money you paid for it will be refunded instantly. Rush your order NOW. Comet Welders, Dept. P-17, Cincinnati, Ohio



CANS JARS and BOTTLES Fly Open!

AT A TOUCH! NEW KITCHEN DEVICE

Amazing discovery. Let us send one on trial and show you how to make big profits. Works like magic. Show housewives how it INSTANTLY opens any size can, round, square or oval. Leaves smooth edges. No cut fingers. Opens tightest Jar and Bottle Tops. Low priced. Startling demonstration makes housewives buy. Get Free Sample Offer.

AGENTS Make up to \$9 in a Day

FREE SAMPLE OFFER Just send Name and Address
MAGIC PRODUCTS COMPANY
 1418 Pendleton Ave. Dept. CA-371 ST. LOUIS, MO.

CIVIL SERVICE

VALUABLE INFORMATION
 COLUMBIAN CORRESPONDENCE COLLEGE
 WASHINGTON, D. C.

INVENTORS PATENT YOUR IDEAS...

Send for Free Book and record of Invention Form today. Personal service.
L. EDWARD FLAHERTY Registered Patent Attorney—
 Electrical Engineer
 709-International Bldg. WASHINGTON, D. C.

BRING YOUR RADIO UP TO DATE

ADD-A-TUBE



Get Rid of Static, Distortion, Strong Local Interference, A "New Radio"
For Only \$1

Tune out strong local stations . . . tune in Los Angeles, Canada, Mexico! Increase selectivity—cut out static, distortion, interference, with amazing new ADD-A-TUBE. Uses no extra current, fits any radio, electric or battery, works on inside or outside aerial, all waves. **GUARANTEED!** Use 5 days. If not delighted, return within 10 days from date shipped and your money will be refunded instantly!

Send No Money! Pay nothing now. Just send name and address on postcard. Pay postman only \$1.00 plus few cents postage on delivery. Send your order today!

R-E ENGINEERS, Dept. K-511, Marburg Ave., & B & O. R. R., Cincinnati, Ohio

This Magic Box



Turns Spare Time into Money! Up to **\$40 a Week!** without Leaving the House

We show you how to make big money decorating fast-selling Giftwares and start you off with the big complete \$10 Artist's Outfit shown above. Also Free Idea Book that has started hundreds of men making big, easy money. One Fireside Member says, "I made \$100 on furniture in one week." Another writes, "My sales were \$500 for 5 weeks. This is my first year." R. M. P. of Illinois, says, "I did \$3500 worth of business last year and over \$12,000 this year." D. W., New Mexico, reports, "I would not take \$1000 for my Course." If you really want to make big money, a *guaranteed income* opportunity is now ready for you with Fireside. No tiresome study. You learn by doing. You make good money practically from the start. Our FREE Book tells you how. Send the coupon for it.

NO SOLICITING—NO CANVASSING

It's easy to dispose of everything you make. Our new "Automatic Salesman" does all the selling for you. This vendor is designed to quickly find cash buyers for all the Giftwares you can turn out! No soliciting or house to house canvassing required under this method. Nor do you need any artistic ability in order to succeed. Simple "3-Step Method" makes the work easy to learn and easy to do. Under new Plan your membership need not—**should not**—cost you a penny. Get full details. Coupon brings everything.

FREE Book on Decoration

FREE! of extra cost. Send coupon for details of amazing new Plan that tells how to get a big assortment of beautiful giftwares that you can decorate.

Mail the coupon NOW for the beautiful new Book on decorating at home for big money. A new plan that gives you a quick start included free. Mail coupon now while openings for new members are still being offered.

FIRESIDE INDUSTRIES
 Dept. 66-A Adrian, Michigan

Fireside Industries,
 Dept. 66-A, Adrian, Michigan.
 Send me FREE Book on Home Decorating for a big steady income. Also how to get the big Artist's Outfit.

Name.....
 Address.....
 City.....State.....



1938 1939 1940 1941 1942 1943 1944 1945 1946 1947



The leaders of the next ten years will largely be determined in the next ten months. Will you be one of them?

Will You Be Clerk or Manager Ten Years from Now?

"SURELY, this could never happen to me," you say—"that I should be sitting at the same desk—be doing the same work—for ten straight years!"

But wait a minute—

Exactly that same thing has happened to thousands upon thousands of men. It has probably happened to men right in the company you now are working for. And—unless you fit yourself for a better job—there is a very good chance that it may happen to you!

Unthinkable? That's what J. N. Dixon of Columbus, Ohio, said to himself. Yet lack of training kept him slaving away at low wages for a long time.

TRIPLES INCOME

Here is Mr. Dixon's own story—"Just after I returned from the war, one of your representatives found me plugging away at a bookkeeper's job in Marietta, Ohio. He performed a real service and explained to me the need of further training, and induced me to take the LaSalle training in Higher Accountancy. After a few months of study, I secured a position with the Trust Department of a National Bank. This was the stepping stone I needed to various responsible positions including handling of receiverships and other important duties. That quickly boosted my income several hundred percent."

ANOTHER AMAZING SUCCESS STORY

If you think Mr. Dixon's success story unusual, please read what J. H. Krouse of Memphis, Tennessee, says. "When I decided to take your training in Higher Accountancy, I was a clerk. Today I am Chief Consultant Accountant for the U. S. Engineer's Office in Memphis, Tenn. Whatever success or recognition I have had, I owe to your training. I have had no other specialized training along this line. Your method of teaching is not only instructive but highly engaging. I have observed other courses, but firmly believe LaSalle has the best to be had anywhere."

Another bit of proof is Mr. R. P. Barthalow's experience. Mr. Barthalow is Chief of the Sales Tax Section of the Tax Commission of Ohio. A department which handles over \$50,000,000 a year. Mr. Barthalow attributes much of his success to LaSalle training.

SEND FOR These Two Books and Start Toward Bigger Success

Need you hear more before you investigate the opportunities in Accountancy?

Or will you face the problem of your future NOW—and send to LaSalle and get further facts and particulars?

Without cost or obligation, the coupon will bring you two interesting books—one a 64-page book entitled, "Accountancy, the Profession that Pays"; the other "Ten Years' Promotion in One."

How about those next ten years—will you wait or will you START TODAY to realize the tremendous opportunities that lie ahead of you through sound and practical home-study business training?

Measure your grit and ambition by what you do with this coupon—NOW.

LaSalle Extension University

LASALLE EXTENSION UNIVERSITY,

Dept. 164-HR

CHICAGO

Opportunities in Accountancy—Check below and we will send you a copy of "Accountancy, the Profession that Pays," also copy of "Ten Years' Promotion in One," all without obligation.

Higher Accountancy: Leading to position as Auditor, Comptroller, Certified Public Accountant, Cost Accountant, etc.

Other LaSalle Opportunities: If more interested in one of the other fields of business indicated below, check that.

- Business Management
- Expert Bookkeeping
- C. P. A. Coaching
- Modern Salesmanship
- Traffic Management

- Law: Degree of LL. B.
- Industrial Management
- Personnel Management
- Modern Business Correspondence

- Stenotypy
- Business English
- Commercial Law
- Effective Speaking



Name

Present Position Address

When writing to advertisers please mention Popular Mechanics



CLASSIFIED Advertisements



Advertisements in this section, 35 cents per word, each insertion, minimum 10 words, payable in advance
To be inserted under proper classification in February issue, copy should be in our office December 8th
February issue on sale January 1st
Popular Mechanics Magazine, 200 East Ontario Street, Chicago, Illinois

YOU'LL PROFIT

By reading and answering the classified ads in this section. Hundreds of opportunities to make and save money.

AUTOMOBILES

MIDGET Race cars, midget motorcycles, motorscooters, handbook catalog, parts, plans, motors. 79 illustrations, 20c coin. Bates Midget Motor Engineers, 4877 Armitage, Chicago.

SPECIAL! Factory prices on genuine Desogas fuel-oil converters. Two year demonstrated superiority. Standard unit \$5.00, (Ford V8, \$15.00). Pretti Desogas, 1618 6th, Berkeley, Calif.

PAINT Stripping tool—Automobiles, furniture, everything. Guaranteed, \$1.00. C. Carlson, 2212 Grand Ave., Omaha, Nebraska.

MIDGET Racing book: facts for fans, builders, drivers; track sizes, regulations; pictures, specifications, working drawings. Also stock car conversions for fastest cars. \$1.00 postpaid. \$1.12 C.O.D. Ray Kuns, Dept. 21, Cincinnati, Ohio.

REBUILD Ford T or A motor into fast pumping air compressor. Plans \$1.00. George Tuck, 73 South Shirley, Pontiac, Michigan.

R & R Mfg. Co., Anderson, Indiana. Robert M. Roof, Chief Eng. Speed equipment Fords, Chevrolets and other cars. Midget engines and parts. Catalogue 25c.

PRACTICAL Changes for automobile generators. See our advertisement at bottom of page 125A. Autopower, Inc.

GUARANTEED Semi-Diesel conversions for gasoline motors, \$12.00. Enclose stamp for illustrated literature. Des-a-gas, 1719 Addison, Berkeley, California.

MIDGET Race cars powered with Knuth's specially tuned Harley Davidson motors win. We specialize in speed. Let us soup-up your motor. Send 10c for list of Knuth's Super-Tuned Harley Davidson racing motors, parts, fuel, accessories, etc. Bill Knuth, 2491 W. Fondulac Ave., Milwaukee, Wis.

NEW Book covering every detail of auto electric system, including magneto ignition. Step by step trouble shooting. Questions and answers. One dollar postpaid. Satisfaction or money refunded. Allen Electric Manual, Box 83, Detroit, Michigan.

MIDGET Car plans, parts, engines. Circulars dime. Storms, 13 Southside, Asheville, N. C.

NOW! A money-back guaranteed Diesel converter for automobiles, trucks, tractors, boat engines; complete with fittings only \$7.75. (V type engine \$10.00.) 5 days trial. Saves up to 70% fuel cost. Easy to install. Send \$7.75 money order or \$2.00 and pay balance when delivered. Groat Diesel Co., Dept. C, 516 Morgan Bldg., Portland, Oregon.

AUTO SUPPLIES AND EQUIPMENT

PLATING Outfits for automobile parts. Connect to battery. No tanks used. Free particulars and proofs. Gunmetal Co., Ave. J, Decatur, Ill.

Popular Mechanics, Chicago, Ill.

When we first started to use your publication some 15 years ago, we used only classified space and our appeal was for customers who were buying clock movements from \$5.00 to \$20.00. Our present appeal is for clocks ranging from \$1.65 to \$350.00. I recall right now two instances where classified space in Popular Mechanics brought us one customer who bought a \$200.00 movement and another customer, an amateur craftsman (incidentally a minister), who for six or eight years has been buying from us an average of \$1,500.00 worth of clocks.

(Original letter on file in our office)

Yours truly,

AMERICAN CHIME CLOCK CO.

PEDESTRIANS! Motorista! Send \$1.25 for our new Model J-81 Nite-Safety Wrist Reflector Belt. Wonderfully effective in protecting the night pedestrian against approaching cars on dark streets and highways. An excellent left-hand turn signal for the night motorist. Reflector Belt Company, Baltimore, Ohio.

GOVERNORS: Genuine Universal for auto engines. Roby Governor Company, Turo, Iowa.

SURE Starter will positively start your automobile easily in zero weather, installed in few minutes. \$1.95 postpaid. Trico windshield wiper repair kit, all new parts, 50c postpaid. Globe Specialty Company, Century Building, Pittsburgh, Pa.

IGNITION Supercharger. Easy starting wet or cold. More mileage, pep, less carbon. \$1.25. Agents wanted. E. G. Sales Co., 321 Broadway, New York City.

DEMONSTRATORS. Compressor, test bench, 8-hour battery charger—arc welder. Guaranteed. Trial and terms. Ken's Equipment Exchange, Box M-171, Troy, Ohio.

USED Auto parts, 3/4 price. Tires \$2.50, all sizes. Cash with order. Klondyke's, 2605-2601 Fort St. West, Detroit, Michigan.

DEALERS. Service station owners, automobile water temperature gauges repaired \$1.50. Send all parts. United Speedometer Repair Co., 436 West 57th St., New York City.

USED Auto parts at half price for all cars. Century Parts Co., 1712 Lafayette Ave., St. Louis, Mo.

AUTO TRAILERS

HUNDREDS Subscribing to Western Trailer Trails, the new house-trailer magazine of the West. Filled with trailer news, pictures, Western Trailer Trails is going places. You must read Western Trailer Trails to keep posted on Western trailer activities. You'll be coming West sometime, so wise up about the greatest trailer territory in the world. Send a postcard with name and address for six-months trial subscription for 50 cents. Bill will not be sent to you until you receive the first issue. Write now. Circulation Manager, Western Trailer Trails, 830 Market Street, San Francisco, Calif.

IT'S Different—A trailer for the week end. Trails easy. Folds away. Cool and airy. Write today. Fold-A-Way Trailer Co., Box No. 642, Davenport, Iowa.

PARTS For the Popular Mechanics "Family Trailer" featured in the February, March and April issues. Everything you need—Axle, hitch, wheel housings, water tank, pump, toilet, sink, stove, wood parts, windows, screens lights, cushions, etc. Send for price list. Include 25c for our big catalog and Trailer Builders' Manual. Trailer Supply Co., 410 Grand Ave., Wausau, Wis.

TRAILER Axles, wheels, springs, equipment. Roberts Trailers, 11429 Forest Ave., Chicago.

TRAILER Builders send 10 cents for "National Trailer News" and big catalog on parts and equipment. Free plans. National Trailer, Welsh Bld., Milwaukee, Wis.

MOTORCYCLES, BICYCLES AND SUPPLIES

SEND 10c For Handbook of Information listing new and used parts, for Indian, Harley, Excelsior, Henderson; accessories, tires, batteries. Bootz, 622 East Grand, Des Moines, Iowa.

GENUINE Harley Davidson parts, accessories, repairs. Prompt service. Send 10c for used motorcycle bulletin. Bill Knuth, 2491 Fondulac Ave., Milwaukee, Wis.

POWER Your bike with low priced Speedbike motor. Attach in one hour. Eighty miles to gallon. Thirty miles an hour. Free folder. Guaranteed. Outboard Motor Corp., 4045 N. 28th St., Milwaukee, Wis.

CLOSING Out large stock new Indian parts, all models. Discounts to repair shops. Many used parts, all makes. No catalogs. Indian Agent, 3661 Archer, Chicago, Ill.

MOTORCYCLE Bargains, lowest prices, bargain sheets for stamp. Motorcycle accessories. Rochester Harley Davidson Corp., 129 West Main St., Rochester, N. Y.

HENDERSON, Excelsior, Harley, Indian, used parts, alloy pistons, catalogue and wings pin 10c. Ballak, 1115 Chestnut Street, St. Louis, Mo.

MOTORCYCLES—Direct to you at rock-bottom wholesale prices. Rebuild, roadtested and guaranteed Indians, Harleys, etc. Send 10c today for "Bargain Bulletin 43." Crandall Hicks Co., 780 Commonwealth Avenue, Boston, Mass.

RECONDITIONED Motorcycles. New and used parts for all makes. Complete service. Whitman Motorcycle & Supply Co., 405-9 Southwest Blvd., Kansas City, Mo.

REBUILT Motorcycles, all makes, new and used. Harley Davidson parts. Send 10c for bulletin. Western, 914 E. 15th, Kansas City, Mo.

AVIATION

AVIATION Photographs, postcard size, 1936 Beechcraft or Cessna in flight 10c. Also others. Ideal for your aviation album. Barnes Photos, 638 Pattie, Wichita, Kansas.

PROPELLERS For airplanes, ice sleds, snow sleds. Catalog dime. Lorenzen Propellers, Niles, Michigan.

GET into aviation. Air transport pilots get up to \$7,000 per year; mechanics, \$2,500. Learn at this government approved school. Write for complete information. State age. Lincoln Flying School, 2004 Aircraft Building, Lincoln, Nebr.

BROTHER. Can you spare a dime? If you can, send it to me and I'll send you my low-priced aviation material catalog. (Canada 20c.) Karl Ort, 635 W. Poplar, York, Pa.

RACY R.O.G. flying model kits—1500 foot flights. Catalogue free. Air-King Model Company, 3262 N. E. Dunckley, Portland, Oregon.

YOUNG Men interesting in entering aviation under apprentice plan see ad on page 67A.

BECOME An airplane mechanic in ten weeks at one dollar per week! Send for catalog correspondence courses. United Air School, Box 528, Elgin, Ill.

QUALITY Propellers, 4 ft. Harley \$1.95, 4½ ft. Henderson \$5.00, Fordehev \$7.50. Literature free. Standard Propellers, Fort Worth, Tex.

AIRPLANES \$75 Up, terms. Motors, crackups, salvage. Complete catalogue 25c postpaid. Aircraft Directory, Athens, Ohio.

PROPELLERS. Sled-lightplane, lowest prices. Literature 6c. Woodcraft Propeller Co., Hillside Station, Wichita, Kans.

NEW Airplanes, \$98.00. Terms. Motors, propellers, air-wheels. Send 25c for information. Hibbs, Fort Worth, Texas.

BATTERIES, GENERATORS, ETC.

ELECTRIC Lights—Wind driven—You build them. Write Wind Motor Electric, Brainerd, Minnesota.

EDISON Storage batteries for light-power plants. Non-acid, non-sulphating. Long life. Fully guaranteed. Low priced. Also attractive bargains in power-light plants, generators, motors, etc. T. Hawley Smith Company, Croton Falls, N. Y.

GENERATOR Propellers, expertly designed at factory prices. Hibbs, Ft. Worth, Texas.

EDISON Storage batteries will save you money. Replace your lead with the Edison. Non-acid. Odorless. Fifteen year life. Liberal unconditional guarantee. Bargains in complete generating plants, motor, etc. Free illustrated literature. "See Jay Battery Company," 82 Sterling Avenue, Yonkers, New York.

ELECTRICAL SUPPLIES—EQUIPMENT

HUNDREDS Of new and rare items, replacement parts and supplies. Send 10c for new, 60-page wholesale catalog. Autopower, 410-J S. Hoyne Avenue, Chicago.

ELECTRICIANS: It is easy to install electrical circuits, when you follow our wiring diagrams and instructions. Send for blueprint No. E. 103. The price is only 30c postpaid. H. Henrichsen, Engineering Service, 140 West 42nd Street, New York.

VACUUM Cleaners, twenty-five standard makes and types. Guaranteed like new \$4.00 up. Send for list. Union Electric Co., 955 Park Ave., Union City, N. J.

WELDING AND SOLDERING

ARC Welder only \$29.50. Professional type—110-220 volt. Delivers 110 amperes. Easy to use. Details free. Commonwealth, Dept. P-11, Cincinnati, Ohio.

60 AMPERE, 110-Volt arc welding transformer \$8.00. 100 ampere, 110-220 volt, \$16.00. Welding supplies. Literature. Arcmaster, 1936 Lyndale, South Minneapolis, Minnesota.

DEMONSTRATORS. Electric arc welders. Money-saving prices. Used by the government. Trial and terms guaranteed. Hobart Welders, M-172, Troy, Ohio.

OXY-ACETYLENE Welding equipment at discount. Circular free. 1299, Michigan, Grand Rapids, Mich.

OXY-ACETYLENE Apparatus repairs—guaranteed. Perfection, 1315 Marlowe, Lakewood, Ohio.

ACETYLENE And electric welding equipment. Box 331, Hamilton, Ohio.

ARC-WELDING Outfit \$1.00. Repair fenders, braze, solder. Dickerson Manufacturing, Springfield, Missouri.

REBUILT Electric arc welders, all sizes, a.c.—d.c. Service Co., 3732 Cedar Ave., Cleveland, Ohio.

300 AMPERE Welding generator. Fine condition \$150.00. Wilmot Auto Supply, 1970 Wilmot St., Chicago.

DODGE Arc-welder, 25-200 amperes. Build your own from old North-East automobile generators. Certified instructive plans \$1.00, C.O.D.'s \$1.12. Welders' Club of America, 3432 Drake, Chicago.

WELDING—Special training in qualified school. Arc or acetylene. Day or evening courses. Satisfaction guaranteed. Welders' Club of America, 3432 Drake, Chicago.

ARC-WELDING Outfit \$1.25. Weld fenders, braze, solder. Lavrow, 4368-W. Warren, Detroit. Stamp appreciated.

ENGINES, MOTORS, DYNAMOS

SEVEN—½ Horsepower General Electric motors, 60 cycle, 1 phase, 110 volts, like new, \$9.50. Send check to Erie Electric, 120 Church, Buffalo, N. Y.

WINDING Data, 225 motors, single and three phase. Price \$1.00. Motor Data Co., Box 7631, Kansas City, Mo.

ELECTRIC Motors; new, rebuilt. Electric clocks. Air condition indicators. Exceptional bargains. Pricelist free. Mailorder Electric Co., 1718 So. Michigan, Chicago.

GOVERNORS Control speed of any make of auto engine, regardless of load changes, when used for stationary or portable power production. Read our ad on page 129A. Man'gs Candee-Smith Governor.

12 VOLT Dodge generators \$4.50. N. P. & M. Wks., 1367 Niagara St., Buffalo, N. Y.

NEW One horsepower motors \$32.50; 32v. Delco light plants \$60.00. AC and DC generators. Queen City Electric, 1736 Grand Avenue, Chicago.

NEW!! Our book of motor end connection data covering single phase two to eight pole, three phase two to twelve pole in star and delta. Postpaid in United States—\$3.00. Washington Electric & Armature Works, 2211 Main Street, Vancouver, Washington.

TO Close out. Slightly used ½ horse, 110 volt, alternating motors \$8.50. Wilmot Auto Supply, 1970 Wilmot St., Chicago.

SMALL Elect. motors, high speed, 1/10 horsepower, 110 volts, universal. Reworked, \$1.50 postpaid. L. McConnell, 1619 Edgewood Ave., Racine, Wis.

MACHINERY, TOOLS AND SUPPLIES

RELANCE Electric pipe thawing machine—price \$39.25, complete! Thaws out frozen pipes in 1 minute. Goldmine this winter! Write! Commonwealth, Dept. P-708, Cincinnati, Ohio.

FREE Price list all shapes brass, copper, steel and aluminum. All orders postpaid. Hobby Supply House, Box 2014, Pittsburgh, Pa.

BARGAINS, Demonstrators, electric arc welders, guaranteed, 30 days trial and terms. Write Ken's Equipment, Box M-173, Troy, Ohio.

SPRING Winder, best on the market. Circular 10c. John Blauer, Box 163, Sharon, Pa.

"PEPY" Gasoline engine governor. Use automobile engines for power. \$7.50 postpaid. Agents wanted. Harris Machinery, Minneapolis, Minnesota.

MACHINISTS. Tool makers chests at bargain. Circular free. Cepader, 3602 Wesley, Berwyn, Ill.

¼ HORSE, 110 Volt, Universal motors with 14 to 1 gear reduction \$3.50. Wilmot Auto Supply, 1970 Wilmot St., Chicago.

15" x 6" SOUTH Bend screw cutting engine lathe, \$175.00. 14" Steptoe crank shaper \$125.00. All sizes of machine tools. Cincinnati Machinery & Supply Company, 27 West Second St., Cincinnati, Ohio.

BOATS, OUTBOARD MOTORS, ETC.

BUILD Your own boat. Save two thirds, use our ready cut semi-assembled materials. Send 25c for catalog. Brooks Boat Co., Inc., G. 20, Saginaw, Michigan.

BARGAINS In rebuilt outboard motors. Send stamp for list. Murray Boat Shop, Traverse City, Mich.

WANTED:—Outboard motors and parts. We pay cash. Outboard Headquarters, 305 Atlantic Avenue, Boston, Mass.

ATTENTION Builders—Our fabricated boat frames save 75% and costly mistakes. Send requirements for quotation. Illustrated catalog 100 boats, 10c. Bay City Boats, Inc., 1532 Adams St., Bay City, Michigan.

ASSEMBLE A boat. Use Welch ready cut parts. Simple; interesting; inexpensive. Send 25c for 32 page catalog with material lists; prices and full information. Welch Boat & Supply Company, Station K-1, Milwaukee, Wisconsin.

12-FOOT Flat bottom rowboat—complete plans 25c. Free boatbuilding catalog. The Rudder, 15 Murray Street, New York.

OUTBOARDS—Save ½. Good used parts, all makes and models. Bargains rebuilt motors. Crandall Hicks Co., 780 Commonwealth, Boston, Mass.

ROCKET MOTORS. Just out. How to experiment on boat, car, cycle, rocket. Win fame and fortune. 25c (coin). J. D. Shepherd, Morrow, Ohio.

FORD Marine conversion parts and kits. Models A, B, V8 (domestic or foreign). Catalogue 10c. Osmithson, 3101 C St., Philadelphia, Pa.

SPORTING GOODS, GUNS, FISHING TACKLE, ARCHERY

FENCING Equipment. Fells, swords, masks, etc. Low prices. Free catalog. Industrial Products, 274 Madison Ave., New York.

FISHERMEN—Complete specifications finest ice chisel. Send dime. Fishcrafters, Box 804, Worcester, Mass.

ARCHERY Christmas presents! Catalogue free. Instruction book 25c. Archery Sales Co., 439 So. Wabash Ave., Chicago.

GUNSMITH'S Secrets! Bluing! Checkering! Engraving! Etc. 25c. Duffy Co., Covington, Ky.

FREE List, fly and leader makers materials. Also big catalog needed by every fisherman. Write today. Paul H. Young, 8065 Grand River, Detroit, Michigan.

TENTS: Factory to you. Catalog free. Willis Co., Everett, Mass.

HUDSON Bay blankets, Indian pack baskets, camp stoves, knives, compasses, outdoor equipment. Free catalog. Howe Fur Co., Box P, Coopers Mills, Maine.

FIELD GLASSES, TELESCOPES AND MICROSCOPES

GET Our lowest prices on telescopes, microscopes, movie cameras and hundreds of other items. Catalog free. A. Winn, 124 W. 23 St., New York.

FREE Literature—Amateur Telescope Makers Supply Company, 24 West 20 Street, New York.

USED Microscopes, binoculars, astronomical telescopes, surveying instruments—Bought, sold, repaired. Send 10c for list. Rasmussen, P. O. Box 294, Amsterdam, N. Y.

FREE! Bargain catalog. Telesopes, microscopes, binoculars. Teeko, 515BL, Evanston, Illinois.

6" TO 12" Parabolic mirrors ground and polished. Plate \$2.50. Pyrex \$3.00 per inch diam. Lutts, Norwalk, Ohio.

TELESCOPES, Microscopes, binoculars. Lowest prices. Optical catalog free. Brownscope Company, 234 Fifth Avenue, New York.

BUILD Reflecting telescopes; catalog free. Instructions 10c. Optical Laboratories, Larchmont, N. Y.

ANTIQUES, RELICS, INDIAN GOODS

MODEL Indian teepees. For information inclose stamped, self-addressed envelope. Wallace Larkey, Crow Agency, Mont.

PREHISTORIC Indian relics. Arrow, list, 10c. List free. Kenneth Mayhall, Belmont, Mississippi.

WORLD War relics, for club house or den. Vickers aircraft machine guns, rendered unserviceable without marring, \$7.75 each. Marlin aircraft machine guns, rendered unserviceable, \$7.75 each. Send money order, check or draft. \$1.00 deposit on C.O.D. orders. Makes an ideal Xmas gift. Fiala Outfits, 10-C Warren St., New York.

14½ ARROWHEADS, Spearhead, lancehead, wampum \$98. Firearms, trophies, 120,000 bargains. Photolist 10c. Museum, Rutland, Illinois.

5 ARROWHEADS 20c. 3 Birdpoints 18c. Knife, birdpoint, scraper, spearhead 45c. Catalogue. Coins, Minerals, Curios, Lemley Curio Store, Northbranch, Kansas.

100 GOOD Arrowheads \$3.00. Catalog 5c. H. Daniel, Dardanelle, Ark.

TAXIDERMY

LEARN Taxidermy complete \$1.00. Glass eye catalog free. Schoepper Eyes, 134 West 32 St., New York.

TAXIDERMY Supplies—Quality artificial eyes, teeth, genuine Jonas head forms. Tools, materials, etc. Everything for the progressive taxidermist. Send 10c for big illustrated catalogue. Jonas Bros., 1049 Broadway, Denver, Colorado.

FREE—Official catalogue. Big values. Eyes. Head forms. Everything, direct from manufacturer. Taxidermic Manufacturers, Memphis, Tenn.

STEER Horns for sale. Seven feet spread. Lee Bertillon, Mineola, Texas.

BIGGEST \$1.00 Buy. Schmidt 7 Book Home Study Taxidermy. See our ad page 67A.

UNCLAIMED Specimens, eyes, scalps, supplies. Hofmann Studio, 992 Gates Ave., Brooklyn, N. Y.

GLASS Eyes. Taxidermists', furriers' supplies. Lowest prices. Forty page catalog, free. Write today. Elwood Supply Co., 222 Smith Building, Omaha, Nebraska.

DOGS, BIRDS, PETS

SPORTSMEN: 200 Pointers, Setters, Straight Cooners, Combination Hunters, Rabbit and Fox Hounds. Cheap. List free. Ramsey Creek Kennels, Ramsey, Ill.

SAINT Bernards—the kind you've wanted! Dime brings photographic prospectus. No duty. Royal Kennels, Napierville, Que.

SAINT Bernard puppies, massive beauties, lowest prices. Paramount Kennels, North Hatley, Quebec.

FREE! Pictures of our St. Bernards. Manitou Kennels, Watrous, Saskatchewan.

BEAUTIFUL Pure white police dogs. Ansonia Kennels, Mose, N. Dak.

POULTRY AND SUPPLIES

BABY Chicks for immediate delivery. Barred, Buff, White Rocks, Reds, White Wyandottes, White, Buff Minorcas, Orpingtons \$7.95—100. English White, Buff, Brown Leghorns, Anconas \$7.45—100. Heavy mixed \$6.75. Assorted \$5.50. Write at once for the Seymour big surprise offer and free catalog. Seymour Hatchery, Box 39, Seymour, Indiana.

POULTRY Tribune—America's leading poultry magazine. Five years \$1.00; one year trial 25c. Poultry Tribune, Dept. 93-C, Mount Morris, Illinois.

FARMS AND FARM LANDS

FARMS That pay in the Great Northern Railway agricultural empire—Minnesota, North Dakota, Montana, Idaho, Washington, Oregon—Fertile black soil, high producing crops, grain, fruit, vegetables, feed and livestock. Many kinds of farms for selection. Write for lists and Zone of Plenty book. E. C. Leedy, Dept. 157, Great Northern Railway, St. Paul, Minnesota.

NEW Farm opportunities! Washington, Idaho, Montana, North Dakota, Oregon, Minnesota. Farm income is up. Good land still at rock bottom prices. Literature. Specify state. J. W. Haw, 119 Northern Pacific Ry., St. Paul, Minn.

VILLAGE Farm on hard road, 32 acres, short drive to city, easy walk to fishing, good neighbors handy; dandy 8-room house, electricity; basement barn, spring water, well and creek; sacrificed to settle affairs, \$1300 including cow, lot potatoes, vegetables, etc.; easy terms, page 44 big free catalog. Strout Ag'y, 255-P 4th Ave., New York City.

CANADIAN Tax sale lands for a dollar an acre and up. Small monthly payments. Farms, timber, hunting and fishing camps, minerals. Limited number of properties. Write at once for free illustrated booklet. Tax Sale Service, Room 613, 72 Queen St., W., Toronto, Canada.

FOR Quick liquidation we offer 2½ acre farms \$45, total, \$5 down, \$2 month. 5-10-20 acres in proportion. Near St. Petersburg and gulf beaches. Ideal for poultry and small farming. No city taxes but near city limits and schools. Write for folders. Liquidator, 806 Florida Theatre Building, St. Petersburg, Fla.

40 ACRES. Near White River. unimproved, poultry land, \$100, \$5 down, \$5 monthly. Free list and literature. Hubbard, 216 Grossman Bldg., Kansas City, Kansas.

TREES, SHRUBS, ROOTS, HERBS

BOYSENBERRY! World's largest vine-berri. Taste resembles raspberry. Immense profit. Very hardy. Thrive where blackberries grow. Prepaid from Virginia, Oklahoma, or original acreage. 10—\$2.00, 100—\$12.00. Free pictorial pamphlet. Quantity price. Dealers wanted. Rancho Verdado, Mentone, California, Box 700.

JUST Out! World's greatest "Herbalist Almanac." Beautifully illustrated in natural colors. Contains over 200 old-fashioned herb medicine recipes for home use, 10c postpaid. Worth dollars! Botanics, 145 West 112th Street, Chicago.

PROFITABLE OCCUPATIONS

BEEKEEPING Pays. Adds healthful sweet to home larder. Learn modern way. Interesting. Instructive. Send dime for sample copy, 25c four months subscription. Beekeepers Item, Box 838, San Antonio, Texas.

DUPLICATE Building stone with cement mortar on stucco walls. Illustrated instruction \$1.00. Hollywood Cementcraft, 8527 Wonderland Ave., Hollywood, Calif.

REMARKABLE Opportunities in mail order business. Write! Jay, 6054-P Kenwood, Chicago.

"RAISE Giant Frogs!" We buy! Start backyard. Free book. Write. American Frog Canning Company, (153-A) New Orleans, La.

RAISE Guinea pigs, add to your income. We supply breeding stock at reasonable prices and marketing plan for all you raise. Particulars 5c. Acorn Cavy Farm, Box 104, Lemoyne, Pa.

MAKE Money—Quickly and honestly. Our books and plans teach you how. Details free, if you mean business. Home City Specialties, Box P1273M, Springfield, Mass.

MRS. M. Earned \$267, three weeks, raising mushrooms in cellar! Exceptional, but your cellar, shed perhaps suitable. We buy crops. Book free. United, 3848-A64 Lincoln Ave., Chicago.

RAISE Frogs, ginseng, girasol. Instructions free. Specialty Farm, Rockford, Minn.

RAISING Jumbo frogs. Interesting. Big future. Females lay 10,000 eggs. Free literature. American Frog Industries, Box 336, Rayne, Louisiana.

OLD BOOKS WANTED

WE Pay up to \$5,000 each for old books; also high cash prices for old magazines, letters, newspapers. A single story book, school book, old Bible, travel book, almanac, etc., that looks worthless may bring you \$50, \$100, \$500 or more cash. Thousands wanted! A small town barber discovered a valuable edition of "Pilgrim's Progress" and sold it for \$4000. Two boys playing in an old barn found a valuable edition of "Venus and Adonis" for which we pay \$5000. Send 10c now for big price list. American Book Mart, 140 S. Dearborn, Dept. 1213, Chicago.

BOOKS, PERIODICALS, PICTURES, POSTCARDS

FREE—Send for list of new technical books at sensational discounts. Y. Y. Winn, 124 West 23 St., New York.

SINGLE Picture stereoscope. Beauty mirror. Nu-Mirror Co., Bridgeport, Conn.

STUPENDOUS Xmas value! Super-fine 21 piece box assorted Christmas cards, latest designs, colors, \$1.00 postpaid. Anhel, 1044 Buckingham, Toledo, Ohio.

HOW To live 150 years. Particulars free. 800 Cowles, Joliet, Ill.

GAMES AND ENTERTAINMENT

PLAYS, Operettas, musical comedies, complete minstrel first-parts with song programs, blackface skits, vaudeville acts, monologs, dialogs, recitations, juvenile plays and songs, musical readings, entertainments, make-up goods. Catalog free. T. S. Denison & Co., 623 So. Wabash, Dept. 11, Chicago.

MAGIC TRICKS, PUZZLES, JOKER NOVELTIES

BE A Magician. Send 20c mailing fee for our large catalog. Chicago Magic Co., 2300 N. Mason Ave., Chicago.

"MARVELOUS Magic tricks"—Hoo coins 25c, multiplying balls 25c, Aladdin's matches 25c, Hindu cross 25c, Okito box 35c, shell game 50c, card tricks 10c each, six 50c. Browns, 1401 Washington, Cairo, Ill.

SAMPLES—Catalog, novelties, photos 25c. Box 290-P, New Haven, Conn.

A PASTIME For the whole family. Try your skill. The results will amaze you. One thousand problems, figure puzzles, price 25 cents, 5 for \$1. Stamps not accepted. Order now. Watchmans Puzzle, 105 Brookview Ave., Troy, N. Y.

MYSTIFY Your friends—be a mind reader! Amazingly clever trick and catalog sent for 10c. National Magicians, 5712-H Woodlawn, Chicago.

EARN Money in any crowd. Call names of strangers, tell unspoken questions. Professional course mind reading, spirit writing, etc., \$1. Henderson, Box 341, San Bernardino, Calif.

THE Mathematical-Wizardry. Astonish your friends with amazing feats of mental arithmetic. Complete equipment 50c postpaid. No stamps. National Syndicates, P.O. Box 1443, Indianapolis, Ind.

MAGIC Catalogue 20c. Lynn, Midland and Albradt Ave., Paramus, N. J.

MAGIC Tricks, joke novelties, puzzles, at lower prices. South's largest line. My famous catalogue, "Book 1000 Wonders" and "50 Mysteries Magic" postpaid 10c. Write today. You will be surprised! Lyle Douglas, Station A-5, Dallas, Texas.

LARGE Professional magic catalogue, 25c. Holden, 220 W. 42nd St., New York.

LEARN Ventriloquism, 3c stamp brings particulars. Smith, 125 North Jefferson, Peoria, Ill.

BE A magician. Large professional magic catalogue of latest tricks 25c. Cash paid for complete Tarbell magic courses. Write. Ireland, 804 Wesley, Oak Park, Ill.

MAGICAL Apparatus, illusions, catalog 3c. McKwade, 600 Martinique, Dallas, Tex.

RARE COINS

OLD Money wanted. Will pay fifty dollars for 1913 Liberty head nickel (not buffalo). I pay cash premiums for all rare coins. Send 4c for large coin folder. May mean much profit to you. B. Max Mehl, H. Mehl Bldg., Fort Worth, Texas.

1909 CENT \$10—We buy certain coins, common and rare—Others worth to \$6000; 1864-1865 Indian head cents \$100 each; dimes before 1895, \$450; Liberty head nickels before 1914, \$300; large pennies, \$2000; encased postage stamps, \$13; half cents, \$275; half dimes, \$175; quarters, \$300; fractional currencies; paper money; gold dollars \$1,500; colonial coins, \$300; silver dollars, \$4,000; 1933, 50c, \$4.00; foreign coins \$165, etc. Send 15c today for illustrated 1937 coin book, before sending coins. National Coin Corporation (81), Springfield, Massachusetts.

BARGAIN Coin folder 6c. Large new illustrated 96 page book 50c. San Diego, Monroe, Oregon, Illinois \$1.40 each. California Jubilee, New Bridge \$2.50 each. Coinshop, 2510 Chester, Alameda, California.

LARGE Cents at bargain prices. Large cent and list 10c. L. D. Gibson, B-115, Bandana, North Carolina.

UNITED States commemorative half dollars. Lincoln \$1.19; Lexington \$1.75; Texas \$1.69; Arkansas \$1.69. Bargain selling price list and California 50c gold token 25c. Arcy, Box 3507-A, Cleveland, Ohio.

50,000 COINS, Medals, papermoney. Lists free. Nagy, 8P South 18th, Philadelphia, Pa.

\$3.00 EACH For certain Lincoln pennies dated between 1911 and 1923. Keep posted. Send 15c for complete 28 page buying book. American Coin Company, Box 3507-A, Cleveland, Ohio.

25 COINS, Bills, tokens, 25c, 100 for \$1.00. Otto Oddehon, Box 101, Springfield, Mo.

25 NICE Coins, 25c, 90, \$1.00. Coin Exchange, Box 2544, Kansas City, Missouri.

LARGE Copper cent and bargain lists for dime. Acorn Stamp & Coin Co., South Norwalk, Conn.

COINS For every type of collector always carried. U. S. gold, commemoratives, silver and minor coins. Fine stock of ancients, foreign coins, old and new issues. Your correspondence and want list invited. New Netherlands Coin Co., Suite P, 95 5th Avenue, New York.

UNITED States. Large cent, 2c bronze, 3c nickel and bargain list, 25c. Eleven dates large cents, \$1.00. George P. Coffin Company, Augusta, Maine.

COMMEMORATIVE \$½; Illinois, Monroe, Oregon, Long Island, Texas \$1.50 each. Illustrated catalogue 25c. Norman Shultz, Salt Lake, Utah.

\$5.00 To \$500.00 Each paid for old coins. Keep all old money. Send 10 cents for illustrated coin value book. 4x6. Guaranteed prices. Buying and selling. Coin Exchange, Box 5, Le Roy, N. Y.

FREE! Foreign coin, banknote, and large illustrated coin catalogue. Send 4c postage. Coin approvals sent. Tatham Colnco, Springfield-125, Mass.

RARE United States, foreign coins, war medals. Catalogue 10c. Mengelle, Colorado Springs, Colorado.

STAMP COLLECTING

A BIG Bargain—All for only 55c. Stamp album, providing spaces for 2200 stamps with 700 illustrations, packet of 500 different stamps, 500 hinges, and millimetre measure. Free with each order our pamphlet which tells "How To Make A Stamp Collection Properly," and our price list of albums, supplies and hundreds of bargains in sets and packets. Queen City Stamp Company, Room 36, 604 Race Street, Cincinnati, Ohio.

SCARCE Airmail and triangle. Beautiful Uruguay "flying horse" airmail and scarce Guatemala triangle (smallest in the world) are included in our big packet of 60 different stamps from Alouites, Grand Liban, Venezuela, British and French Colonies, etc. All for 5c to approval applicants. Big illustrated lists free with each order. Write today! Mystic Stamp Co., (Dept. 80), Camden, New York.

QUEER Diamond-shaped stamp and 60 different stamps including Cape Verde, Soudan, Inhi, Honduras, St. Thomas, Hyderabad, Ivory Coast, Brazil, \$2 U. S. All for only 5c to approval applicants. Lennott Stamp Company, Claihorne, Maryland.

SCARCE New giant sized, diamond-shaped Russian "sports" stamp; Nyassaland "leopard"; Morocco; Tanganyika, and other scarce countries included in our big packet of new and recent issues—stamps most collectors have never seen! Get this valuable packet today. 5c to approval applicants. Reimers, 115 Flatiron, Fort Worth, Texas.

GIANT Spain triangle and bi-colored Persia airmail (both illus.); big packet 25 diff. Russia (cat. nearly \$1); pkt. British Colonies including Egypt, Travancore, Ireland, Malay, Silver Jubilee, etc. All for only 5c to approval applicants. Fidelity Stamp Co., Dept. 20, Earle Bldg., Washington, D. C. Free: Large U. S. list.

PLENTY! Jubilees, British Colonies, U. S. commemoratives, sets, mystic Orient, others 10c. Approvals. Valuable stamps free. Prospectus 10c. Corsa, 9018 91 Ave., Woodhaven, N. Y.

LARGE Columbus triangle and fine packet of 55 different stamps including New Guinea airmail (former German colony); interesting Turks Island and Leeward Islands, birds, ships, etc. Only 5c to approval applicants. Potomac Stamp Co., Dept. 101, Washington, D. C.

UNITED States mixture 25c, 1000. Commemoratives appreciated. Schiffermuller, Bellerose, Long Island, N. Y.

WORLD'S Smallest air mail, \$2.00 U. S. stamp, animals, bird, train, Indian, airplane, commemoratives, special issues with scarce stamps from 25 different countries only 5 cents with approvals. Capital Stamps, 413E Roosevelt, Little Rock, Arkansas.

WORTHWHILE British Colonies including Jubilees, 10c to approval applicants. Tipton's, 86 Penn. Denver, Colorado.

1000 WORLDWIDE Surprise mixture 25c. Moniar, 1542 Waverly, Cincinnati, Ohio.

75 MEXICO, Peru, Ecuador, etc., 5c. Clark, 3024 Lakeview, Dayton, Ohio.

WANTED Stamps, coins, tokens. Premium list 10c. Walter Allgeyer, Box 192, Newark, N. J.

TIPEX, Byrd, 3 British jubilee, 10c. Approval applicants. Brumbaugh, 111-M Bell, Altoona, Penna.

SET Yugoslavia mourning, set Netherland and 2 South Africa, 10c approvals. Rock Stamp Shop, 378P Avon Ave., Newark, N. J.

APPROVALS Of value at 50% discount. Barnaby Stamp Co., 6000 Fulton, San Francisco, Calif.

U. S. SECONDS At 1/2th cat. in dollar lots mounted. Park Stamp Co., 589 Beacon St., Boston.

CAYMAN Island free with approvals. Herget, Kensington, Buffalo, New York.

UNITED States price list, complete free. Olson, 3621-17 Avenue, Minneapolis, Minn.

SET World's largest airmails. 5c. Request approvals. Supreme, 573 Stone, Brooklyn, New York.

FIRST Postage stamp ever issued. Great Britain. 1840-1d black, \$1.00. R. H. A. Green, 707 Linden Ave., Wilmette, Ill.

FREE—Mint Papua and Niue to approval applicants. Edward Szabo, 202 West 88th Street, Los Angeles, Calif.

GIANT Netherlands commemorative triangle, jubilee, airmails, pictorials in mammoth collection—10c with double premium approvals. Free airmail collection given regular customers. Tru-Value Stamp Service, Box P1412, Hartford, Connecticut.

FIVE Complete sets 5c to approval customers. Meyers, 5738 Drexel, Chicago.

10 LARGE Italy commems., gauge, 3c. Approvals. Corn Belt, Marion, Iowa.

MONTHLY Stamp magazine; six months and 25 foreign stamps, 25c. American Stamp Journal, Cedar Rapids, Iowa.

ONE Pound world wide stamps (about 3,000) for \$1.50 postpaid. Sandles, 1967 Summit Street, Columbus, Ohio.

UNITED States; 50 different 10c with approvals, 75 different foreign 10c. Nebraska Stamp Co., Bruning, Nebraska.

200 MIXED 8c, 1000 Hinges 10c. Bargains galore. Approvals. Harvey Teeple, Decatur, Indiana.

5 DIFFERENT Mongolia with approvals 5c. Delbert Auten, Cedar Rapids, Iowa.

CASH For stamp collections and accumulations. C. E. Bocker, Geneva, N. Y.

200 DIFFERENT 10c. Big 50% approvals. Covert Stamp, 39 State, Rochester, N. Y.

MONGOLIA, Eritrea, Persia, U. S. memorial and 125 different 10c. Approvals. Bedford, 31 Stockton, Dayton, Ohio.

WORLDWIDE Variety approvals that satisfy. McKee, 925 Main, Covington, Ky.

UNITED States, off paper, precancels, commemoratives, etc., 250, 10c. Clift, Waymart, Pa.

"GOYA Nude Stamp" \$0.05 to approval applicants. Jewells, Tamaqua, Penna.

25 DIFFERENT Norway 3c. Approvals. Daywin's, Atlantic Way, Miami Beach, Florida.

THIRTEEN Exceptional 5c sets 10c. Shelley, 5th, Asbury Park, N. J.

10 POUND Sacks of Australian mixture, \$11. (1 lb. parcels \$1.50.) Price lists free. H. Wheeler, Boronia P. O., Victoria, Australia.

FREE—25c Packet given approval buyers. Lincoln Stampmart, Shelbyville, Illinois.

ZANZIBAR, Kelanton, Sudan, triangle, fifty others, dime, approvals included. Stutzenstein, Valley Stream, N. Y.

DISGUSTED. Try my approvals, 1/2c up. Bargains galore. Viscusi, 4, Scotia, N. Y.

QUEEN Astrid, 3 var., 8c to approval applicants. Hawthorne Stampeo, 3221 So. 53 Court, Cicero, Ill.

THREE 10c Sets free!! Beauties that every collector wants. Sent to applicants for unsurpassed bargains on approval. 3c postage. Kumler, King, Lancaster, Ohio.

CHOOSE Your premiums! Jungle stamps! Animal! Bird! Airmail! Triangle and map stamps! Pick any ten from our big approval selection. Absolutely free. Stamp Importers, Akron, Ohio.

WORTHWHILE—Jubilees, commemoratives, airmails, pictorials, 10c with approvals. Clatworthy, Upland, Calif.

125 FINE Jubilees postpaid with parks—\$1.00. Plymouth Importers, Plymouth, Michigan.

FREE—Beautiful airmails, including new Mozambique to approval applicants. Green & Co., Norwood, Ohio.

1000 MIXED U. S., 15c. Foreign approvals. Auburn Stamp Co., Bridgeport, N. Y.

555 FINE Foreign! Send dollar. Philatelic Exchange, Edgewood, Rhode Island.

FREE! Brunel River set to applicants for approvals. Sets that satisfy. Charles Cleveland, 806 North Humphrey Avenue, Oak Park, Illinois.

TRIANGULAR Netherland jubilee, 3 cents, penny approval applicants. Jones, 208 21st Avenue, San Francisco.

SPECIAL! 50 Jubilees, airmails, commemoratives, pictorials, 10c. Sachse Stampco, London, Canada.

FREE! Bulletin, tremendous bargains. Rolke, 309 Greylock, Belleville, New Jersey.

20 ARGENTINE, 50 Others, 10c, approval applicants. Fountain City Stamp Co., Fond du Lac, Wis.

ARGENTINE, 60 Diff. 10c with bargain approvals. Davis, Silver Lake, Ind.

EXTRAORDINARY. All different, 100 Portugal, 100 French Colonies, 100 Netherlands, three triangles, one dollar. Approval applicants only. LC Trading Company, Box 38, Bellerose, N. Y.

BEAUTIFUL Utrecht triangle—scarce—2c with approvals. Tobiasen's, Murdo, S. Dak.

CHINA—15 Different, 10c (stamps accepted.) Eisea, Bowling Green, Ohio.

FREE! English Jubilees complete to approval applicants enclosing postage. Box 118, Stamford, Conn.

TURKS—Calicos, jubilees, swan—sets. 110—10c. Brooks, 373C Fifth Avenue, New York.

QUEEN Astrid stamp—3c with approvals. Stamp Company, 5301 South Hermitage, Chicago.

JUBILEE Set, scarce Chicago imperforate, rare Tipex stamp; scarce Netherland triangle; everything 10c; approvals included. Taflaw, 302 East 56th St., New York City.

BRITISH Turkislands—Also Congo's, Montecarlo, Nigercoast, Uganda, Djibouti, Ecuadorian, Ivorycoast, Ubangi, countries collectors need. Free for 5c postage. Empire Stamp Shop, Dept. PM, Toronto, Canada.

BASUTOLAND Crocodile, magnificent pictorial, with packet 50 different; approval applicants 5c. Topmost, 3155 So. Grand, St. Louis, Mo.

50 STAMPS Free, Manchukuo, etc. Postage 1c. Approvals not necessary. Album 3c. Bullard, 268 Northampton, Boston.

EXCHANGE Stamps! Over 2,000 members in over 125 countries. Club magazine 5c; prospectus free! Stamp Collectors' Exchange Club, Seaforth, Ontario, Canada.

SELECTED Approvals by country. Stamps unnumbered; priced to please. Reference. Leinert, 851 Marcy Ave., Brooklyn, New York.

50 DIFFERENT Canada 15c to approval applicants. Mantle Stamp Company, London, Canada.

U. S. MIXTURE, 3 Pounds \$1.00, Holmes Stamp Co., New Albany, Ind.

LOOK No farther. Approvals that please. Barton Battalle, 427 West Second Street, Lexington, Kentucky.

\$1 TO \$10 U. S. free, with packet of 35 different—25c. Regal Stampco, 1224 North 19 St., Philadelphia, Penna.

FREE—Zwirko-Wigura airmail to approval buyers. Reference. Hicks, 1007 Reed, Joliet, Ill.

NEW Airmails complete! Philippines 25c. Liberia triangles 40c. Riedell, Greensburg, Pa.

300 DIFFERENT 20c; 500—45c; 1,000—95c; 2,000—\$2.75. Daywin's, Atlantic Way, Miami Beach, Florida.

NEGRI Sembilan, Siberia, bicolored Columbian airmail, cheery French Colonies, beautiful Trinidad pictorial, scarce Perak. Everything 5c with approvals! Saxon Stampco, Dept. 65, Albee Bldg., Brooklyn, N. Y.

300 DIFFERENT Stamps, 10c to approval applicants. R. Sherman, 47 Central Avenue, Hartsdale, New York.

100 U. S. Commemoratives \$1.00, sets of parks, bicentennials, Olympics, Chicago included. Satisfaction or money refunded. Bee Stamp Mart, Chamber Commerce, Newark, N. J.

20 INTRIGUING Stamps, ten Newfoundland, bicolored Guatemala, Ecuador air, Greece, St. Demetrius, etc. 10c to approval applicants. Premier Stamps, Box 18, Stn. K, New York.

75 DIFFERENT U. S. 25c, 200 different \$1.00, thousand assorted 40c with approvals. Illinois Stampco, Rockford, Ill.

166 U. S. Commemoratives, etc., 10c; 500, 25c. Box 457, Newark, New Jersey.

1000 HINGES 3c. Bargain approvals included. V-J Sales, 2729 N. Summit, Milwaukee, Wis.

SELLING Collection colonials, pictorials, fraction catalogue. Packets 25c. I. Killam, Box 587, Saint John, Canada.

VALUE! 100 Different U. S. 30c, 250 foreign 10c. Stamp House, Wenatchee, Washington.

CANADA Commemoratives, complete 25c. Jubilee 25c; 1935, 45c. 3439 St. Andrew, Montreal.

HINGES Free with approvals. Wollaston Stampco, Wollaston Station, Boston, Mass.

55 DIFFERENT United States 15c with approvals. 200—\$1.00. Thousand mixed 35c. Tricity Stampco, Davenport, Iowa.

FRENCH Colonies, fascinating, always current, better than stocks, buy them cheap for pleasure and profit. Philatelic, 1516 Masonic, San Francisco.

25 DIFFERENT Mint commemoratives \$1.00, used 25c. Howard Weaver, Waynesboro, Pa.

\$5.00 U. S. Postage due, No. 2284, fine copy 5c with general approvals. Hudson Company, 116 Nassau St., New York City.

MAKE Extra money. Sell stamps in your spare time. Write for free illustrated wholesale catalogue. Fordham Co., 152 W. 42 St., New York.

THE Most historic issue in existence. "The Bosnian Assassination, the Spark that Set the World Afire." We include this complete set; also a complete Denmark Ancient-Ship set; 2 complete Russian sets; 3 stamps over 50 years old, and Italy's Mussolini stamp, all for 10c! Pearson Brothers, 68 Nassau Street, Department 19, New York.

TRIANGLES!! Five different—5c, with bargain approvals! One packet to a customer. Midwood Stamp Company, Dept. 5P, Midwood Station, Brooklyn, New York.

UNBELIEVABLE—Suriname, Panama, British Honduras, Jubilee, airmail, triangle. Complete collection every country from Straits Magellan to Arctic. 10c. Approval applicants only. Mutual Stamp Service, Box 666PD, Ventura, Calif.

300 DIFFERENT 20c; 1,000, \$1; 2,000, \$3.00. Fred Onken, 630 79th St., Brooklyn.

ILLUSTRATED U. S. list, price 50c, large complete U. S. price list free. Send postage. Stanley Gibbons, 33P Park Row, N. Y.

NEWFOUNDLAND, 15 Different 5c with approvals. Hudson Company, Plainfield, N. J.

UNITED States mixtures 50c pound. 5 pounds \$2.25. Mission, 4512 No. Racine, Chicago.

TEN Canadians, \$1 postpaid. J. Pinard, 30 Drummond, Sherbrooke, Que.

1000 UNITED States good mixture, actual count, 25c. Seifert Stamp Shop, 1352 Buttonwood, Reading, Pa.

ECUADOR Bargain list free, 1000 mixed \$3.00, 75 different \$1.00, 100 different \$2.00. Peru, Lima airmails 5c to 10 Soles \$7.00. Perrone & Campana, Box 749, Guayaquil, Ecuador.

RARITIES!! Afghanistan beauty! Dominican bridge stamp; large Greece charity; mint Cayman bicolor; scarce Syrian airmail; three jubilees; packet old U. S. revenues; all for 5c with approvals. Trident Company, 2017 McKean Avenue, Baltimore, Maryland.

PENNY Approvals that please. Haywood, 395 Adams St., Pomona, Calif.

UNITED States on approval. Sullivan, 391 Minnesota, St. Paul, Minn.

ABSOLUTELY Free! Scarce mint United States telegraph stamp, cataloging 50c, and our big 56-page illustrated catalog, "United States, British North America and Foreign Stamps." Write today! H. E. Harris & Co., 137-G Transit Building, Boston, Mass.

AIRMAIL Triangles from Liberia and Mozambique, 3 British silver jubilees, new King Edward stamp and packet 25 different stamps from Azerbaijan, China, Ukraine, etc. All for 5c to approval applicants. Clipper Stamp Co., Dept. 7, Gloucester, Mass.

BADEN, (Scarce German state), Mongolia, Georgia, \$5 U. S., Azerbaijan, Caymans, Transcaucasian Federated Republic—everything absolutely free to approval applicants enclosing 3c. Viking Stamp Co., 1-Z Hanson Place, Brooklyn, N. Y.

FREE—15 Different Peru to approval applicants enclosing postage. Ranson, 3555 Fullerton, Chicago.

FREE, 25 Different Italy to approval applicants. Harlan, 5307 S. Marshfield, Chicago.

ASK For our wonderful one cent approvals. Prospect Stamp Co., 225 Broadview, Toronto, Canada.

50 VARIETIES U. S. 12c. Approvals sent. Elmer's, 196A Washington St., Boston, Mass.

MIDGET Airmail (1/2 in. tall), Szechuen, Kouang-Tcheou, Mozambique, etc., 30 stamps—5c Depraw, Ocean Park, California.

FREE—6 Different silver jubilees, with approvals. Send 3c postage. Berg, Linwood Station, Detroit.

7 IMPERFORATE U. S. commemoratives including Chicago, Byrd, Farley reissue and 23 North American stamps. Retail value over 75c—all for 25c to approval applicants. Illustrated pricelist free. Curhan Stamp Co., Dept. P, Gloucester, Mass.

CANNON! Set of stamps showing cannon, firing squad, cavalry charge and 200 other different stamps only 10c to approval applicants. Paramount Stamp Co., 4225 Broadway, Chicago, Ill.

WORLD'S Largest triangle! Giant Spain triangle and bi-colored Persia airmail; big packet 25 different Russia (catalog value nearly \$1.00); packet British Colonies including Egypt, Travancore, Ireland, Malay, etc. Big United States list. All for only 5c to approval applicants. Fidelity Stamp Co., 920 Earle Bldg., Washington, D. C.

FREE! Metal perforation gauge to approval buyers. Buckey, 208 Ludlow Bldg., Dayton, Ohio.

RARE Mint Newfoundland commemorative, 23 different Russia, Poland's astronomical commemorative, Jugoslavian war horror, Denmark 1921 issue, United States telegraph set, all complete; 42 stamps cataloging \$2.93 only 25c. Friendly Philatelists, 2615 N. Sydenham, Philadelphia, Penna.

WHOLESALE—Send 3c for large wholesale catalogue. Stamp Importers, Palms Station, Los Angeles, Calif.

25 DIFFERENT South American for only 10c, no approvals. Burkhart Stamps, Sandwich, Ill.

SILVER Jubilees—15 different 25c. World specials—500 different 35c, 1000 different \$1.00, 2000 different \$3.00. These offers to approval applicants only. List free. Victoria Stamp Co., London 4, Canada.

STAMPS: A splendid selection sent on approval. Quality at low prices. Scarce and high value stamps are included in our approval books. Fred Herzberg, Box 91-P, Elmhurst, Ill.

FREE—20 Different Canada to approval applicants. Fort Dearborn, 5439 Aberdeen, Chicago.

UNITED States—Elaborate pricelist free, 45 different 10c, 75 different 30c. Seidenberg, Baroda, Mich.

STAMP Dealers, your ad here will bring wonderful returns. Ask me for proof. F. W. Johnson, Manager, Classified Advertising, Popular Mechanics Magazine, 200 E. Ontario St., Chicago.

GIANT-SIZED Russian Zeppelin stamp (cat. val. 20c!) and beautiful Lithuania airmail triangle; also big packet of 53 dif. stamps including Azerbaijan, Epirus, new Martinique, etc. and illustrated lists—all for 5c to approval applicants! World-Wide Stamp Co., Box 600, Camden, New York.

FREE—\$1.00 U. S. stamp, our choice, with request for 52 page price list of United States and foreign stamps. Stamps on approval. References necessary. 1000 U. S. no current \$1.50. New Hussman Stamp Co., 1122 Pine Street, St. Louis, Mo.

FREE! Rare airmail! Jubilee Pictorials! Extraordinary packet 65 different stamps from strange countries (no Europe), 5c postage to approval applicants. Bargain Co., Box 39P, Station H, New York.

UNITED States approvals only. Write for selection. Positively no foreign. Jack Daub, Wabash Bldg., Pittsburgh, Pa.

40 UNITED States, commemoratives, airs, etc., 10c with approvals. Stamp Shop, Mabel Hoehn, Holland Bldg., St. Louis, Mo.

107 DIFFERENT: Algeria, Gabon, New Zealand, Guinea, Congo, etc., 5c to approval applicants. Extra—Airmail packet free!! Hunziker, Box 225H, Minneapolis, Minnesota.

44 DIFFERENT United States including \$5 stamp, or complete set United States bicentennials, or 30 different obsolete Canada, 13c postpaid with approvals. C. A. Lennan Co., Box 322, City Hall Annex, New York, N. Y.

\$5.00 U. S. Red and blue liberty, present postage value, Scott No. 573 cat. \$1.25 (retails as high as \$1.00 net by some dealers) only 5c to approval applicants. Giant U. S. pricelist free! Tatham Stamp Company, Springfield-5, Mass.

ANNUAL Wholesale catalogue—Illustrated and enlarged. Free upon application. Empire Stamp, Department 5, Toronto, Canada.

25 UNITED States, including \$4 and \$5 stamps free to approval applicants. 3c postage. Brownle Stamp Shop, Flint, Michigan.

DIAMOND-SHAPED Stamp, Liberia gunboat triangle, two other triangles, silver jubilee, 27 others, 5c. Crowder Company, 127E North, Baltimore, Md.

FREE!!! King George memorial packet, 15 varieties. Postage 3c. Roberts 901F Fourth, Bayville, Michigan.

LIBERIA Snake triangle, giant Spanish ship triangle, 50 other stamps, 5c. Abell Company, 2527 Guilford, Baltimore, Md.

UNITED States, Canada, Newfoundland. Where? Our "Four Star" approvals. Nothing like them! 300 mixed U. S. 10c to applicants. Kessels, Tucson, Arizona.

WEEKLY Stamp magazine, thirteen weeks, 10c. Stamp Journal, Kalamazoo, Mich.

WHOLESALE Catalog for dealers. Illustrated. Postage 5c. Frank Co., 4900 Chalmers, Baltimore, Md.

PENNY Approvals, that satisfy. Nell Gronberg, Box 5441-P, Philadelphia, Pa.

PHOTO FINISHING

IMMEDIATE Service! No delay! Roll developed, carefully printed and two beautiful 5x7 double weight professional enlargements or one tinted enlargement or six reprints—all for 25c coin. The expert's choice. Reprints 3c each. The Photo Mill, Box 629-Z, Minneapolis, Minn.

MAIL Your rolls to The Kodak City. 8 guaranteed glossy Velox deckle-edged prints, 25c coin. Two professional enlargement coupons free! Photo Finishing Shop, Est. 22 yrs., 411-D Genesee Valley Trust Bldg., Rochester, N. Y. "The Kodak City."

FILMS Developed, 2 prints of each 25c; 20 reprints 25c. Pine Photo, M-5134 Nevada, Chicago.

DEVELOP And print your own pictures. Save time, money with our complete \$1.49 outfit postpaid, or pay postman \$1.55 COD. Includes electric ruby lamp, printing frame, photo paper, chemicals and equipment. One of hundreds of amazing bargains in our free, newest, money-saving bargain book. Send for it today! Central Camera Co., 230 So. Wabash, Dept. 21K, Chicago.

PHOTOGRAPHIC Christmas cards, 20 for \$1.00. Send your negative. Sample 10c. Seascout Service, Box 52, Chelsea, Mass.

5x7 ENLARGEMENT, Dime. Send negative. Albert's, Box 76, Easton, Pa.

20 REPRINTS 25c—Films developed, 16 prints 25c. Enlargements 8x10—25c; 5x7—10c. Low Photo, M-2657 Neva., Chicago.

ENLARGEMENTS 8"x10" Hand colored in oils. Price 98c. Send photo or film. A Klein, 3312 Hull Ave., New York City, N. Y.

12 PHOTOGRAPHIC Christmas cards and beautiful gift calendar from your photo, \$1.00. Films finished 25c. Pocket album and enlargement coupon with first order. Ideal Photo Service, Box 2255, Paterson, N. J.

50 COPIES Size 2 3/4 x 3 3/4 from any good photo or drawing \$1.00; gummed \$1.25. Niles Studio, Wayland, New York.

SIXTEEN Prints, two enlargements with roll—25c. Truefoto, 671A—37th, Des Moines, Iowa.

SPECIAL—4x6 Enlargement, colored, golden oak frame. Send negative. 50c coin. Fotofram, Riverhead, N. Y.

TWO Beautiful Nuborder enlargements, eight guaranteed Nuborder prints, 25c. Giant Snapshots, Inc., B667A, Greenbay, Wis.

ROLLS Developed, remarkable quality, two master enlargements, eight gloss prints 25c. Reprints 3c. World Famous Johnson Studio, Eau Claire, Wisconsin.

QUALITY You can see at a glance. Rolls 25c, reprints 3c. Mead's, Box 811, Station H, Los Angeles, Calif.

PHOTOGRAPHIC Christmas cards, 20 for \$1.00. Send your negative. Sample 10c. Seascout Service, Box 52, Chelsea, Mass.

SENSITIZED Xmas cards in colors all ready to print a photo on. The latest idea, ten for dollar, assorted. The only colored Xmas cards on market. Leroproducts, 1612 Neptune, Brooklyn.

BEAUTIFUL Photographic Christmas cards, envelopes included, 75c dozen, 25 for \$1.50. Sample 10c. Hensch Studios, 1814 Chestnut, Harrisburg, Penna.

ROLLS Developed, 116 size or smaller, eight beautiful enlargements, no small prints, 25c (coin). LaCrosse Photo Works, LaCrosse, Wis.

ENLARGEMENTS 4x6, Five for 25c, 5x7 three for 25c, 8x10 three for 35c. Hand colored and framed each 4x6 25c, 5x7 30c, 8x10 40c. Enlargers, Maywood, Illinois.

SOLEX Sensitizer reproduces any negative on fabrics, Xmas cards, etc. No dark room or experience required. Permanent, washable. Trial size 25c. Lynmore Company, Gravesend Station, Brooklyn, New York.

TWO Glossy enlargements, 1 colored, with roll 25c. Arbor Service, 10 Joliet, Ill.

FOR The discriminating amateur—roll developed and printed on super gloss Velox paper 25c, reprints 2c. Quality instead of quantity, same day service. Paramount Co., 403 E. 92nd St., New York City.

KODAK Enlargements 5x7, 10c; 3 for 25c coin. Send best negatives (film). Dept. 5, Xint Photo Lab., Cedar Rapids, Iowa.

FINER Finishing. Rolls developed and printed, with one colored enlargement, or two professional enlargements. All for 25c (coin). Genuine, nationally known, Moentone superior quality. Moen Photo Service, La Crosse, Wis.

TRIAL Roll developed and 8 prints 25c. Reprints 3c. Hand colored, embossed photo Christmas cards or photo greeting calendars from your negatives 10c each, 12 for \$1.00 with envelopes. 8x10 enlargement 25c. Young Photo Service, 405 Bertha St., Albany, N. Y.

ROLL Developed and 8 guaranteed prints including two enlargements, 25c coin. Super Snapshot, Winona, Minn.

ROLLS Developed. Two beautiful double-weight professional enlargements and 8 guaranteed Never Fade Perfect Tone prints. 25c coin. Rays Photo Service, LaCrosse, Wisconsin.

HAND Colored enlargement with each roll 25c. 40 reprints 50c. Colorgraph, Dunning Station, Chicago.

ROLL Developed, two prints each, two enlargement coupons 25c. Christmas cards 60c dozen. Summers' Studio, Unionville, Missouri.

QUALITY Counts—Two double weight glossy enlargements and eight prints guaranteed not to fade from each roll, 25c. Prompt service. Excel Photo, Box D, Dubuque, Iowa.

ROLLS Rushed! Developed and printed with two supertone enlargements 25c. Four 4x6 enlargements 25c. Newton, Maywood, Illinois.

20 REPRINTS 25c. 100 Reprints \$1.00. Rolls developed with 16 prints 25c. Nordskog, 4, Maywood, Ill.

ROLL Developed and 8 beautiful Velox glossy prints 25c coin or stamps. Reprints 3c each. Fotoprint Service, Box E, Roanoke, Virginia.

20 REPRINTS 25c. Films developed, two prints each negative, 25c. Skrudland, 6970-8 George, Chicago.

ROLL Developed and 16 prints 25c. Smart Photo, Winona, Minn.

ROLL Developed with 16 prints and two professional enlargements 30c. 100 reprints \$1.00. 16 reprints and 2 enlargements 30c. Dependable, RiverGrove, Illinois.

DAILY Service—Roll developed, 16 guaranteed prints, 25c. Valuable enlargement coupon; 16 reprints 25c. Modern Finishers, Box 3537-L, St. Paul, Minnesota.

COMPARE The difference! Roll developed, two professional double weight enlargements, 8 guaranteed prints, 25c coin. Excellent service. Nationwide Photo Service, Box 3333, St. Paul, Minnesota.

GET The best. Roll developed, beautiful hand colored enlargement, 8 neverfade border prints, 25c coin. Prompt service. Sun Photo Service, Drawer T, St. Paul, Minn.

TWO Prints each with every roll developed, 25c. Very finest quality. Reprints 2c each. Brown Photo Company, 2209-34 Lowry, Minneapolis, Minnesota.

PHOTOGRAPHIC Christmas cards from your own kodak negatives. Mail negative and five cents for sample and quantity prices. Send something different this Christmas—a card nobody else can duplicate. The Photo Mill, Box 629-12, Minneapolis, Minnesota.

CAMERAS, PHOTO SUPPLIES

CAMERAS And supplies. Free illustrated catalog listing everything photographic—still and movie cameras, films, lenses—at tremendous savings. Hundreds of bargains, new and used. All guaranteed. We take your old camera or equipment in trade. Write now for your free copy of our newest money-saving bargain book—just out! Limited edition. Hurry! Central Camera Co., (Photographic Headquarters since 1899), 230 So. Wabash, Dept. 1-K, Chicago.

MAKE Money in photography. Learn quickly at home. Spare or full time. Easy plan. Previous experience unnecessary. Common school education sufficient. Write for full information and requirements. American School of Photography, 3601 Michigan Avenue, Dept. 3431, Chicago.

INTERESTING Souvenir free! Amateur. Postfach 20, Porzellangasse, Vienna, Austria.

CHRISTMAS Cards—New, patented item. Turn any snapshot immediately into a very effective Christmas card. Made for size print No. 127, No. 120, and No. 116 only. Sample 5c. Sole American distributor: Paramount Co., 403 E. 92nd St., New York City.

OPERATE And carry your Argus or Leica in a rich, heavy brown leather, Eveready case. Only \$3.75 postpaid. Dealers write. QuentIn Products Company, West Salem, Illinois.

XMAS Cards in colors, photographically sensitive, handled like azo. Be first. Dollar for ten assorted. Patented, exclusive. Leroproducts, 1612 Neptune, Brooklyn.

BASS Will postpay to you the Argus Candid Camera with f4.5 lens, speeds to 1/200th of a second, \$12.50. New Argus enlarger at \$12.50. Daylight Pan film, all speeds, 36 shots, 85c. Weltl Precision Candid camera with genuine Carl Zeiss Tessar f:2.8 lens in Compur shutter, \$48.50. Voigtlander Duo Bessa 2 1/4x3 1/4 or 16 Vest Pocket, with f:4.5 Anastigmat lens, speed shutter, \$27.50. Write for free Bargaingram 227 now ready. Largest stock of new and used apparatus in America. Dept. AG, Bass Camera Company, 179 West Madison Street, Chicago.

FREE—New booklet, "60 New Discoveries in Photography," 50 pages. Send stamped envelope. International Laboratories, 1612 Neptune, Brooklyn.

35% DISCOUNT On films. Write Paramount Photo Division, 403 E. 92nd St., New York.

INCOME From your camera instead of expense. Low cost home course teaches you to make photographs for magazines, newspapers, advertisers. Tremendous demand. Earn good money wherever you live. Free book. Universal Photographers, Dept. 104, 10 West 33rd St., New York.

HAVE You a camera? Send ten cents for recent number of our big magazine, showing how to make better pictures and earn money. American Photography, 116 Camera House, Boston, 17, Mass.

MOTION PICTURES AND SOUND EQUIPMENT

DE VRY Sound film 35 projector, amplifier, speaker, complete \$185.00. 35mm silent 1000 ft. films, shorts, complete \$1.00. Features \$5.00. 16mm F 1.9 Kodak camera \$45.00, like new. 16mm silent films \$1.00 per 100 ft. \$2.85 per 400 ft. Sound odd \$2.00, 400 ft. \$8.00. Collapsible screen 22"x30" spring roller, in map case with adjustable tripod \$1.50 complete; biggest bargain ever offered. Leica camera F 3.5 perfect, \$45.00. Send for film lists—8mm, 9 1/2, 16, 35 silent, sound, sound-film—one of America's largest film libraries; rentals sent anywhere. Just issued, Xmas Bargaingram full with used, new equipment, parts, repairs. Trades accepted, bought. Victor sound 16mm projector, complete with amplifier, \$79.50. Stewart Warner 500 watt fan-cooled projector, \$69.50. Brand new 8mm movie camera \$9.95. Motor projector \$12.50. Mogul's, 1944-J Boston Road, New York.

ART Films. Another new series of Hollywood art featurettes in 16mm and 8mm. Just produced with new models and new stories. Send 25c for 8 Art film samples or \$1.00 for a 20 ft. Art screen test. 3c brings our illustrated 16mm or 8mm catalogues. Hollywood Cine Film Distributors, 1431-33 No. Highland, Hollywood, Calif.

SPRING Motor 16mm cameras takes snapshots, book movies, motion pictures, \$5.95, brand new. Uses \$1.00 films. Automatic 8mm movie cameras \$9.95 new. Uses 60c film. 200-ft. 8mm motor projectors \$12.50 new. Send no money. Pay postman. Free lists. Home Movies, Box 32, Easton, Pennsylvania.

16MM FILMS—400 Ft. art, \$17.50. Remnants 10c foot. Popeye—Betty Boop, any star 35c up. Features rented \$5.00. Projectors, cameras \$3.75 up. New 16mm talkies \$15 reel. Latest talkie projector \$175, 1000 ft. 35mm \$1.00. Features \$7.50. Serials \$35. Cine Supply, Box 524, Cincinnati.

BUILD 16mm Projector. Complete double claw projector mechanisms for motor drive, with sprocket, guide rollers, adjustable gate, reel arms, lens holder. Not a toy. Brand new. Worth \$25.00. Special clearance, \$5.95. S.O.S., 1600-G Broadway, New York.

LEARN Motion picture theatre business. Home-study training; Management, advertising, projection. Established nine years. Low tuition. Easy to learn. Free catalog. Theatre Institute, Elmira, N. Y.

35MM PROJECTOR \$10. 15mm camera. Exchanges, Box 505, Pekin, Ill.

TALKIES \$15.00; Silents \$5.00. Simpson, 1275 So. Broadway, Dayton, Ohio.

TITLES 8-16mm, 2e Word. Catalogue. Cineshop, 1560 Jackson, Charleston, West Virginia.

PROJECTORS, Cameras, accessories, films. Substantial discounts. Listings, Box 2133, Paterson, N. J.

16MM MOVIE Camera \$9.95, projector \$12.50. Free illustrated catalogue (with sample art film 10c.) 25 ft. art film \$1.00, 100 ft. \$1.00. Garden Film, 800P 8th Ave., New York.

READY For you—No. 224—the latest and greatest Bass Bargaingram of Cine apparatus. Acknowledged leadership in the cinema field. A few of the fine values: Cine Kodak Model B, f:1.9 lens and case, \$54.50. 8 mm. Stewart-Warner camera with f:3.5 lens, \$15.00. 100 ft. DeVry 16 mm. camera, f:3.5 lens, \$22.50. RCA sound on film projector complete, \$85.00. Willo Cinemeter with case, \$3.75. Write today to Cine Headquarters and start to save now. Bass Camera Co., Dept. A, 179 W. Madison St., Chicago, Ill.

WANTED: 35MM Acme model S.V.E. silent projectors. State price and condition. Uhler, 1323 Trumbull, Detroit.

CENTRAL'S Free, new, money-saving bargain book explains latest movie developments, offers money-saving bargains in cameras, lenses, projectors, films. Used equipment taken in trade. Write for free copy. Central Camera Company, (Photographic Headquarters since 1899), 230 So. Wabash, Dept. 31-K, Chicago.

1937 FREE Catalogue ready. Projectors, cameras, films. Kay, 40 Linden Street, Brooklyn, New York.

FREE Lists! 35mm silent. Features. Shorts. Bargains! Complete! One reels \$1.25. Albert, 5119 South St. Louis, Chicago.

BARGAINS! 8mm, 16mm. Catalogue free. Elder, Dept. B-31, Chelsea, Mass.

8MM CAMERA \$9.95. Projector \$12.50. Bleamex, 1451-p Broadway, New York.

16MM BELL Movie camera \$7.50. Complete outfits \$19.50 up. 16mm film (including processing) \$1.89. Projectors. Circular free. Bytom, Dept. B, Park Ridge, Ill.

16MM FILMS. Our big Christmas catalogue and two usable "end" titles, 10c. Eastin Pictures, Davenport, Iowa.

EXCHANGE—16mm Films, 25c per 100', all subjects. American Anilinated Pictures, 270 - 92nd Street, Brooklyn, N. Y.

GREAT Train robbery \$11.99. Magic heads \$1.69. Building Panama Canal \$12.00. 16mm catalogue 10c. Scholefield, 6801 Carpenter, Chicago.

TALKIES: 35mm Odd reels \$7.75. Features \$10.00. Shernco Film Ex., 3501 W. 60 St., Cleveland, Ohio.

DIME Brings 3 free end titles and catalogues. 8mm and 16mm films exchanged. Big bargains in new and used films. 8mm art test 50c or 16mm \$1.00. Generous art samples 25c. Pacific, 1040 N. McCadden, Hollywood, California.

35MM TWO Reels \$1.75. Projectors. Bergen, Woodcliff Lake, New Jersey.

BARGAINS, 16mm Cameras and projectors. Catalog. Rosien Movies, 245-M Broadway, New York.

WESTERN Thrillers, 500 feet 75c. Jersey Filmco, 2075 Richland, Lakewood, Ohio.

LOOK! "The World's Greatest Passion Play." Seven reels, (new) 16 mm. Superior than the Oberammergau stage play. Rent or purchase. Write Hemenway Film Co., 37 Church St., Boston, Mass.

35MM FILMS. Bargain lists 3c. Hoffman Film Service, 57 Broad, Albany, N. Y.

BASS Now exclusive distributor for Radio Corp. of America 16mm. R.C.A. Sound on Film Cameras. Anyone can record sound pictures. New low price. News reporter model was \$350.00, now \$210. Send for complete details. Bass Camera Co., Dept. AK, 179 W. Madison St., Chicago, Ill.

8MM FILMS: Cartoons, travel. List. Lincoln Film Service, Box 293-A, Saginaw, Mich.

16MM EXCEL Motor driven projector, 100-ft. reel \$3.95. Pop-Eye, Betty Boop, Hal Roach, "Our Gang" comedies and others. 3c stamp for catalogue. Excel Home Movies, 622 Madison, Toledo, Ohio.

FILMS Exchanged free. Bargain new 400 ft. 16mm film \$10. Cameras, projectors. National Service, 36 New Dwight, Springfield, Mass.

RADIOS, SUPPLIES, INSTRUCTION

RADIO Experimenters and set builders; parts and kits of parts for portable Superhet Battery. Improved Little Giant four and five tube. Economy three, 32 volt, and Pre-Amplifier described by Popular Mechanics. Lund Manufacturing Co., 43 East Ohio, Chicago.

CONDENSERS—Bypass, metal encased, mounting feet, heat resisting, made of best nonhygroscopic material. All capacities. Write for list. Super Television Labs, Oconomowoc, Wisconsin.

MATCH Box pocket size crystal radio, amazing reception. Complete for 50 cents (coin). Sannipetro's Shop, 104 1/2 Balbo Avenue, Providence, R. I.

CRYSTAL Experimenters. Radio beginners. Free magazine. Hulet, Keansburg, New Jersey.

SW CRYSTAL Set—4250 mile record. Instructions 18 distance models; "Radiobuilder" year; 25c. Laboratories, 151-C Liberty, San Francisco.

FARM Radio—\$7.95. Save 60%. Sensation. Catalog. Esco-J, Kansas City, Mo.

TEST Tubes yourself, accurately! Simple instructions, 10c. Tomalino Radio Service, Glendive, Mont.

FARM And city radios \$6.95 up. Save over half. Power plants. Windchargers. Catalog. Agents free offer. Marco Company, 244-D East 14th, Kansas City, Mo.

RADIO Engineering, broadcasting, aviation and police radio, servicing, marine and Morse telegraphy taught thoroughly. All expenses low. Catalog free. Dodge's Institute, Ames St., Valparaiso, Ind.

RADIO. All phases. Amateur, shortwave, experimenting, set building, broadcasting, servicing, etc. Complete list recommended books free. Popular Mechanics Press, Room (C36), 290 E. Ontario St., Chicago.

MUSIC AND MUSICAL INSTRUMENTS

REBUILT Band and orchestra instruments. Honestly rebuilt—fully guaranteed. Catalog of new instruments on request. Weymann Company, Dept. M-1, 1613 Chestnut St., Philadelphia.

POEMS Wanted. Work guaranteed. We publish. Great Eastern Song Bureau, Dept. 27, Thomaston, Me.

MUSIC. Lyric writing "Taught correctly." \$1.00. Gornston, 9030 - 148th, Jamaica, New York.

SONG Poems wanted. Free examination and details on request. Radio Song Service, Hutchinson, Kan.

EARN Your own musical instrument. Get free details and free attractive savings bank at your music store, or write Fred Gretsch Mfg. Co., 521 1/2 So. Wabash, Chicago.

SONGS—Composed, revised, published. Get our 100 copies offer. Melodymart, Box 160, Independence, Kansas.

SONGWRITERS! Poems—melodies. Free examination. Studio PM, Guaranty Bldg., Hollywood.

PLAY Piano, professional style, by ear or note in two months. Booklet free. Joe Boucher, Box 12-A, Ottawa, Canada.

SONG Poems wanted—Home, love, sacred, comic, any subject. Send poem today for offer. Richard Bros., 24 Woods Bldg., Chicago.

SONGWRITERS. Our piano parts guaranteed. National Songland, "PM," Thomaston, Maine.

AMAZING Bargains. Rebuilt, nationally known instruments and musical accessories. Get facts. Old reliable company. Tom Brown Music Co., 315 So. Wabash, Chicago.

VIOLINS—Handmade. Best since Stradivari's days. (Curious don't bother.) John Lehto, San Pedro, Cal.

SONGS Published, arranged and composed, royalty basis. W. Coast Music Pub., 942 Market, San Francisco.

SONG-WRITERS. Professional phonograph record of your song. Musical arrangements. Free information. Paramount Song-Recording Studio, J-8, Box 190, Hollywood, California.

SONGWRITERS—Send for free copy of booklet revealing Secrets of Successful Songwriting, free rhyming dictionary and market information. If you write poems or melodies, send for our offer today. MMM Publishers, Dept. EI, Studio Bldg., Portland, Ore.

SONG Poems wanted, 50-50 plan, instruction book sent free. Song Bureau, Salem, Indiana.

MUSIC Composed to words. Wonderful proposition. Bauer Bros., Oshkosh, Wis.

WRITE Songs. Big money and reputation. Write for information. J. Gordon Pub. Co., 201 N. Hoyne Ave., Chicago.

SONGS! We compose, arrange, publish, sell. Superior Song Studios, 211 Hope Ave., Passaic, N. J.

ORIGINAL Music composed to your words \$5. Reginald Belcher, Chatham, New Jersey. 25 years church organist, musical director.

SONG Writers. Send for our "Publishing Agreement." McKinley Music Printers, 1501 E. 55th St., Chicago.

BUSINESS OPPORTUNITIES

MAKE Walkiesnaps—A new business. Write for details on this fascinating new money-making business. Bass Camera Company, 179 W. Madison St., Chicago, Ill.

COLOR Any concrete surface with cheap chemical solutions. Dandy new business. Particulars free. Hollywood Cementcraft, 8527 Wonderland Ave., Hollywood, Calif.

SWEETMEATS. A book of choice recipes by Eunice B. Rogers. Make your own jams, jellies, sweet meats, pickles and relishes. Keep your table supplied the year round with these homemade dainties, or can for others and earn money. Price \$2.00. E. Guncelle, Westhampton, Long Island, N. Y.

WE Start you in business, furnishing outfits and instructions, operating "Specialty Candy Factory" home. Men and women, earn \$25.00 up to \$60.00 weekly, all or spare time. Booklet free. W. Hillyer Ragsdale, Inc., Drawer 4, East Orange, N. J.

SALES Opportunities, mail trade, Paramount, Progressive, Verity—mailorder magazines, 1-10c; any 3-25c. Miles, 35-30 Mapledeil, Springfield, Mass.

WE Buy and sell business propositions of all kinds. No books, nothing to pay in advance. Let us aid you in selling or buying. Send us your problems. Cole Syndicate, Bryant Pond, Maine.

1,000 ADDRESSES Of parents who have children born during 1936. Birth date given. Neatly typewritten. Price \$10. Ref. Linden State Bank, Thomas Wilson, Linden, Indiana.

10 CENTS Brings copy of mail dealer, and big mail. Guilford Service, Aurora, Nebr.

FORMULAS—Fast selling products. Guaranteed. Laboratory tested. Lowest prices. Catalog free. Kemico, 55, Park Ridge, Ill.

HOW And where to obtain capital fully explained, free particulars. Star Service, Wapakoneta, Ohio.

PLASTEX Industry needs manufacturers on small scale and for big production of Xmas tree ornaments, crib sets, art goods, novelties, etc., in Plastex and marble imitation. Cheaply and easily made in our guaranteed rubber moulds. We cooperate in selling goods. Since crash, low priced goods are needed and this line meets demand. Interesting booklet mailed free. Plastex Industries, 1085 Washington, Ave., Dept. A, New York, N. Y.

50 WAYS To make money for 25c. R. B. Martin, 528 North Third St., Marshalltown, Iowa.

HEALTH Products easiest to sell by mail. But they must be "safe"! Many violations made unknowingly. New Monograph "Avoiding Fraud Orders, Cease and Desist Orders and Federal Citations" 35c (quarter and dime). G. M. Institute, Drawer 128B, Station "S," Los Angeles, Calif.

GET Lots of mail. Your name in 10,000 opportunity directories, 25c. Roseco, 4627 Glenshade, Cincinnati.

SUCCEED As your own boss. Manufacture fast selling products paying good profits. Details. VG Chemical, Box 4651, Pittsburgh, Pa.

MAIL Business. Start small. Everything furnished. Free details. Metromails, P-1, Cincinnati.

SHUFFLE-BOARD—This sport, an opportunity for enterprise of scope throughout U. S. and Canada, on land and sea, controlled with its new fascinating improved chart, disk and cue. Patents, copyright. Theo. Reichard, 724 Central, Alameda, California.

MONEY For you making window boxes and selling supplies to all who raise plants in house. Easy, pleasant, profitable. Steady work for all or part time; can grow to large proportions if desired. Free information. A Decorative Sales, 63 Baumer, Johnstown, Pa.

EARN Money acting as rent collector. All or part time. Also fine side line for real estate men. Modern method gets results. Circular free. Sicoan, 2038 Obeas, St. Louis, Mo.

BARGAINS—Paint spray outfit, gasoline engine drive. Terms—trial. Helmick Paint Spray Exchange, M-174, Troy, Ohio.

FREE Circulars describing hundreds of money making opportunities selling by mail. Build your own business. Write now. Progress Publishing Co., Box 1936-H, Milwaukee, Wisconsin.

WHERE To buy at lowest wholesale prices. Information free. Yorena, Box P-312, Bayonne, N. J.

START Home business. We furnish (free) secret mold instructions. Equals best rubber. Experience unnecessary. Full line best selling molds furnished. 300% profit. Practically no capital needed. Any cements make casts. Dime brings sample mold and marbled cast, assorted samples, Cowell Institute, Grayling, Michigan.

BIG Mails 19c. 20,000 directories service. Norton Wynn, Lamar, Mo.

MRS. M. earned \$267, three weeks, raising mushrooms in cellar! Exceptional, but your cellar, shed perhaps suitable. We buy crops. Book free. United, 3848-A63 Lincoln Ave., Chicago.

MAKE Artificial marble, glossy tiles, uncanny. Tabletops, plaques, floors, whetstones, novelties. Inexpensive, hard, fireproof, cement secrets. Brilliant tile and liquid rubber samples 3c. John A. Payn, 945 Grande Vista Avenue, Los Angeles, Calif.

BUSINESS Of your own. No capital required. Details. Wun Service, California, Pa.

FREE Details for earning at home. Write Healy, 48 Washington Bridge Station, New York.

BOOK Contains 700 formulas. 50c postpaid. Illinois Universal, 3112 Madison, Chicago, Illinois.

WHERE And how to obtain capital, any purpose, explained fully. Particulars free. Capital Service, 12, Jefferson City, Missouri.

WANT To earn \$5000 yearly? Nationally known motor oil business. Write Franklin, 1326A Beldale Street, Pittsburgh, Pa.

CONSULT Miller free regarding any manufacturing problem, newest specialty, formula, process, analysis you're interested in. Get my interesting literature describing newest discoveries, modern recognized products. All lines. 38 years of unequalled service. Miller, Analytical Chemist, Miller Building, Tampa, Fla.

MAKE Money at home. Bulletin free. Tell Service, 1451 Broadway, New York.

FREE Imprint catalog. Postage, 5c. Leader, 7341 S. Marshfield, Chicago.

BE A Perfumer, retail, or mail order. Hardly any capital. Free instructive booklet gives plans of operation. Call-Blossom Perfume Syndicate, Alhambra, Calif.

INCORPORATE In Delaware. Sell shares. Raise capital. Free details. Corporation Fiscal Co., Wilmington, Delaware.

QUICK Profits daily! Sell famous brands typewriter supplies. Special \$2.75 combination costs \$1.00; sells for \$1.50 up. Repeats. Merchandise investment \$25 upwards. (Guaranteed.) Particulars free. Kaye Supply, 1457P Broadway, New York.

THE Collection business offers profit and opportunity. Quickly learned. Sure income. Write Cole Associates, Syracuse, New York.

\$1.00 MONTHLY, Maintains New York office. Co-operative Mail Service, 126-B Lexington Avenue.

SELL By mail. "The Key to Business Opportunities" is a secret that will make you independent. Free. J. R. Edmondson, 503 Atlanta National Building, Atlanta, Georgia.

500-1936 NAMES Of opportunity seekers 50c. Trial hundred 10c. Carl Edquist, Odessa, Minn.

MAKE Products yourself. Tested formulas. Catalog free. Grinstead Laboratories, Edwardsville, Illinois.

DIME Brings Mail Sale Advertiser, opportunities galore. Hemphill, Kenilworth, Illinois.

START Home mailorder business. Write, Dixie Mailers, King, North Carolina.

FREE Literature—Hundred business ideas. Merritt Co., 14 Steuben St., East Orange, N. J.

BRINK'S Trade Directory—The most complete ever published for salesmen, agents and mail order dealers. Price 50c. M. Devine, 820-M, Wrightwood Ave., Chicago, Ill.

PROFIT With new products. Make, sell, repeat. Analysis. Research. Guaranteed formulas. Biggest catalog free. Special prices, leads. Gibson Laboratory, Chemists, BD-1142 Sunnyside, Chicago.

MAILORDER Men: Where to buy wholesale over 500,000 items. Plan to make \$25.00 a day. Old coin given. Send \$1.00. Little Willie Mail Order Co., Madera, Calif.

START Practical small mail order business. Complete instructions, 25c. Clenco, Box 17, Verdun, Que.

DOLLARS Daily resilvering mirrors. 24 money-making plans 25c. Parker Publications, Peterboro, Canada.

OPPORTUNITIES And money making plans galore. Join International Literary Club. Make new friends everywhere. Free books. Bi-monthly bulletin, free. Send postage. International Literary Club, 705 Railway Exchange Bldg., Montreal, Canada.

FREE Booklet describes 107 plans for making \$20-\$100 weekly. No house to house selling. H. S. Linscott, P. O. Box 181, Harberton, Ohio.

MONEY Making business. Stock, dies, \$7,000. Patent gratis. Write H. Spiess Co., Saginaw, Mich.

FREE Literature of latest plans. Kurtz, 35-41 94th Street, Jackson Heights, N. Y.

30 MONEY Making propositions 10c. Donahoo, 3848 Hammel, Los Angeles, Calif.

SUCCEED With your products. Make-sell them. Formulas. Processes. Accurate analyses. Catalog free. B. Thaxly Company, Washington, D. C.

NO Boss! Sure cash! Silvering mirrors, autographs, reflectors. Combination outfit. Write Sprinkle, Plater, 127, Marion, Ind.

MAILING Service supreme. Will mail 10,000 circulars six by nine and up to opportunity seekers, etc., for \$5.00 per month. Guaranteed to please. Armour Organization, Flushing, New York.

WE Teach you new business, then buy your product. Write Superior Specialties, Springfield, Illinois.

CHEMICAL Expert furnishes manufacturing formulas with complete working directions. Reliable individual services. Charges reasonable. Dr VanHeeden, 1410 East 54th, Chicago.

SELL By mail. Books, novelties. Bargains! Big profits! Particulars free. B. Elfco, 438 North Wells, Chicago.

"TURN Ideas into Cash." Free details. Martinez-PM, San Bernardino, Calif.

LIQUID Marble—Anyone can make! Colorful, glazed! Moulded, brushed, sprayed. Rubberlastic moulds. Composition flooring. Big money in these! Particulars free. Marbleizing Service, Edwardsville, Illinois.

BUSINESS For yourself starting part time. Fully established in one year. Write NC Company, Leominster, Mass.

TO Win success you must do something different; particulars free. Publishers Sales Company, Box A-76, Nelson, Georgia.

CORRESPOND For newspapers. Profitable. Interesting. Easily learned. Write Publishers' Service Bureau, 4258-F Drexel, Chicago, Ill.

OPERATE Amazing new vending machine business. Big profits. Wonderful opportunity. Propell-O-Lite Company, Mt. Washington, Ohio.

CHARTERS: Delaware; best, cheapest; free forms. Colonial Charter Co., Wilmington, Del.

STOP Squealing—Start crowing!! Work mornings home—drive to country—"movies"—afternoons!! Unusual "plans." No canvassing! Prepare for surprise! National Folio-A, Station "D," Los Angeles.

MANUFACTURE Polishpuffs. Amazing proposition 10c. Particulars free. Hickorydell, Glenbeulah, Wisconsin.

ARTIFICIAL Marble sanitary flooring, instructions covering wood or cement flooring 1/2 inch thick, fireproof, all colors, low cost, ornamental casting, concrete, plaster, papier-mache, garden furniture, statuary, flexible molds, particulars free. Chris Mahler, Elmont, N. Y.

MAIL Order business is your opportunity. Many began small, now earn thousands yearly. No personal contact. Boundless opportunities. Have had over 30 years experience; will help you succeed. Send 25c for valuable booklets, none free. B. Breniser, 257 South 21st, Philadelphia.

BIG Mail 10c. Milton Boss, 2007M 34th St., Rock Island, Ill.

I WANT To send you proof of the wonderful pulling power of Popular Mechanics Magazine's classified pages. What's your proposition? Write me today. F. W. Johnson, Manager Classified Advertising, 200 E. Ontario St., Chicago, Ill.

FREE Booklet describes 107 plans for making \$20-\$100 weekly, in home or office, business of your own. Elite Co., 214 Grand St., New York.

COMPLETE Chemical service, analysis, formulas, processes, trade secrets. Particulars free. W. L. Cummings, 228 Gordon Avenue, Syracuse, N. Y.

POPCORN, Crispette, caramelcrisp, potato chip, salted nut machines. Long Eakins, 1960 High St., Springfield, Ohio.

OPERATE Chain world's finest money making vending machines. Sells four products—same time. Instant success! Small capital—profits immediately. No curiosity seekers. Penny King, 1233 Chouteau, St. Louis.

MAIL Order and local business. All office. No canvassing; no stock; no shipping. Part of national chain. All instructions given. Shoestring capital. Circular free. Harrigan, P.O. Box 97, Drexel Hill, Pa.

"SCHEMER Magazine." Alliance, Ohio, prints schemes, ideas, business starters, formulas—big winners; \$10,000 to \$50,000 reported. 38th year; \$1.00. Trial special: six months only 30c.

START Little business anywhere. Everything furnished. No canvassing. Maywood, PM-923 Broadway, New York.

MONEYMAKING OPPORTUNITIES

WHEAT, Rice, corn puffing business. General information \$1.00. William Haffner, Clearwater, California.

10c BRINGS Copy National Mail Order News, Box 1773-PM12, Roanoke, Virginia.

NEW Business. No canvassing. Sell by mail. Merchants Sales, 617M North Second, Milwaukee, Wis.

\$250.00 BUYS Neon sign plant complete. Illustrated glass blowing book teaches you the trade. Learn the easy way. Earn big profits in neon signs. Details free. Wholesale Neon Supply, Sheboygan, Wisconsin.

96-GUARANTEED Money-making secrets—25c. Free examination. Schumacher, P1592 Monticello, Chicago.

"HOME-WORKER," 52 Page magazine for opportunity seekers. Sample dime. Year \$1.00, with valuable premium free. Order today. Alf Lyhuann, 5623 So. Flores, San Antonio, Texas.

TRIAL Lesson free. Oil painting over photographic reproductions. Big money. Home study. Request instructions. Savigny's Studios, 2033 Park Ave., Detroit, Mich.

CARICA Papaya (meat tenderer). Benzene crystals (amazing chemical cleaner). Powerpex Exzontite (strange expanding mineral). Free opportunity bulletins. Waldo, Box 266, Dallas, Texas.

SPLENDID Opportunity to gain independence. Free bulletin. C. Makeenco, 1633 Burling, Chicago.

FREE Circulars describing hundreds of money making opportunities selling by mail. Build your own business. Write now. Progress Publishing Co., Box 1936-G, Milwaukee, Wisconsin.

FORTUNES In home manufacturing. Booklet free. Ogg Laboratories, Tampa, Florida.

BED Bugs. Plenty people bothered. Will pay big prices for article to exterminate. We have it, give complete formula and many sales pointers for \$1. Particulars free. Guaranteed. Benton Co., 28 Buckley, Liberty, New York.

DOZENS Nationwide profitable offerings. Homework and outside. Stamp brings them. Evers, Box 66PA, Elmhurst, N. Y.

FREE Particulars about money-making opportunities. Sinclair, Box 861, Hollywood, Calif.

67 PLANS, 29 Formulas 25c. Jelmsmith, 163 Myrtle, Waltham, Mass.

"PROFITABLE Ideas" Magazine, 6 North Dearborn, Chicago. Fifty money-making pages. 10c.

\$50.00 A WEEK. Even in spare time. 5c brings details and sample. Triborough Novelty Manufacturer, 213 Cypress Ave., New York City.

MILLIONS Jobless! Get dollars in mail daily, like we do, for amazing employment information (got man 76 jobs). Keep money; we fill your orders free. Stamp brings details. Co-Operative Service, 77 Swan, Buffalo.

TURN Your home workshop into a factory and spare time into cash. Small woodturning lathe only power tool required. Actual photo, pattern with complete dimensions and manufacturing instructions for ideal novelty gift article which finds ready market at dept. stores and gift shops sent you post-paid for 25c coin and 6c in stamps. Order now. Don't delay. H. R. Oliverson, Woodcraft Service, Plainview, Minnesota.

WISE Home worker and spare time money makers will send immediately for free details of new "Silent System" business. No canvassing. Harry Julius, Amarillo, Texas.

FREE Booklet describes 107 plans for making \$20-\$100 weekly, in home or office, business of your own. Elite Co., 214 Grand St., New York.

BIG Opportunities waiting. Why worry about strikes, lay offs, or no money. You can have all now at once. Spare time, full time, Sunday work. The first 500 who send us full details about themselves together with 25 cents, get a special big surprise gift free, when we send you your big opportunity bundle. Money back if dissatisfied. Particulars free. Armour Organization, Flushing, New York.

1000 MONEYMAKING Ideas, book 50c; literature free. Harvey Teepie, Decatur, Ind.

BIG Money at home plating auto parts, reflectors, mirrors, chandeliers, by late method. Experience unnecessary. Free particulars. Gunmetal Co., Ave. N, Decatur, Ill.

BIG Profits from ordinary ashes! Finished product in great demand. Raw material found everywhere. Write for details of money-making secret. Adolph Ringle, 12524 Moran, Detroit, Mich.

PROSPERITY For home workers, 52 page magazine. Sample, dime. Sizemore, 4917 N. Kostner, Chicago.

FORMULAS, PLANS, ETC.

MAKE A real stove cleaner. Guaranteed. Formula 50c. F. Schuller, 1928 University Ave., Bronx, New York.

GUARANTEED Formulas—New fast sellers. None better. Lowest prices. Catalog free. Kemico, 49, Park Ridge, Ill.

FORMULAS, Analysis, literature free. Herstein, Chemist, 222 Ransom, Grand Rapids, Mich.

MAGIC Soap, cleans everything. Money maker. Formula 30c coin. Fair Deal Agency, Amarillo, Texas.

EXTRAORDINARY—Wealth using formulas. Large catalogue free. Brown's Formula, 212 East Waters, Tampa, Florida.

ANY Formula 30c or money back. Catalog free. Ogg Laboratories, Tampa, Florida.

NU-BEAUTEE Face cream formula \$1.00 guaranteed. Sanquist Mfg. Co., Pomeroy, Iowa.

MAKE Own products, more profit. Latest guaranteed formulas, trade secrets, plans. Catalog, special offers free. C. Philarst, Jefferson City, Missouri.

CERTIFIED Formulas, best science can produce for making popular, biggest-selling specialties. All lines. Before buying formulas, get my valuable "Eye-Opening" literature, including free subscription to Miller's Monthly Messenger. Miller, Chemist, 1706-A, Tampa, Fla.

TEN Good formulas \$1. Geo. W. Van Pelt, Madison, Ohio.

ANTI-MIST; Anti-freeze! Genuine guaranteed formulas, both 25c. Duffy, Covington, Ky.

500 MONEYMAKING Formulas, 25c. Womble Co., Siler City, N. C.

ANALYSIS, Research. Newest guaranteed formulas. Biggest catalog free. Special prices, leads. Gibson Laboratory, Chemists, BD-1142 Sunnyside, Chicago.

ANYTHING Analyzed. Guaranteed formulas. Process for tenderizing meats. Associated Chemists, Indianapolis, Indiana.

SUCCEED With your products. Make-sell them. Formulas, Processes. Accurate analyses. Catalog free. B. Thaxly Company, Washington, D. C.

ANY Formula \$.50, three \$1.00. Cole Laboratories, Bryant Pond, Maine.

FORMULAS—Latest money makers. Literature free. Belfort, 4042 N. Keeler, Chicago.

CHEMISTRY

SEND 25c For new illustrated chemical experiment book with over 300 formulas and tests. Also receive 32 page illustrated catalog of apparatus, microscopes, telescopes and chemicals free. Z.Z. Winn, 124 West 23 St., New York.

FREE Chemistry catalogs. Supplies at 5c. Equip complete laboratory. Send 10c (returnable) for postage and handling. Kemkit Corporation, 135P Johnson Street, Brooklyn, New York.

CHEMICALS, Laboratory glassware, apparatus. Send 3c for catalog CP. Biological Supply Company, 1176 Mt. Hope Avenue, Rochester, New York.

RESEARCH, Experiments, magic—three months subscription 15c. Spanners Chemistry Magazine, 100 Forsyth, New York.

EXPERIMENT With Latex. Dime brings literature. Xmas special. Eastern Latex Labs., Box 64, Norfolk Downs, Mass.

THRILLING Miniature chemical laboratory and instruction book, complete, \$3.00. Safe-Chem, New Haven, Conn.

25 CHEMICALS With experiments, 50c. Kayare Chemical, 5522 P Ft. Hamilton Parkway, Brooklyn, N. Y.

CHEMICALS In 5c quantities. Catalog 5c. Fleischer's Laboratories, Everett, Massachusetts.

HELP WANTED

MAN Wanted—Manufacturer established 46 years will finance responsible man with complete stock of guaranteed food, farm and household necessities—you pay when sold. Mighty attractive proposition. Good living right from start with steady increase for industrious man. Big value combination deals, premiums and fast-selling specials now in effect. Jacob Van Dyke of Michigan sold \$441.21; Maurice Vander Haar of Michigan sold \$376.15; and B. M. Anderson of Utah sold \$530.55 in one recent week. Pleasant outdoor work. Experience not necessary. No slack seasons or layoffs. Write today for "No-Investment" offer. McCannon and Company, Room 66MS, Winona, Minnesota.

USE \$500.00? Raise canaries for us. Free particulars. Canary Guild, 3741-B, 60th Street, Woodside, N. Y.

GO Into wholesale business without investment. Call on stores with biggest line self-selling counter displays: Aspirin, razor blades, handkerchiefs, breathlets, household cement, 79 different items. Up to 125% profit for you. Experience unnecessary. Write for catalog and plans. Procopax, Dept. 36-H, 1936 S. Troy, Chicago.

LOCAL Agents wanted to wear and demonstrate free suits to friends. No canvassing. Up to \$12 in a day easy. Experience unnecessary. Valuable demonstrating equipment, actual samples free. H. J. Graves, Pres., 1500 Harrison, Dept. N-817, Chicago.

CASH Paid for butterflies, insects. See Sinclair Display Advertisement on page 14A.

MAN And wife—to run local coffee agency. Earnings up to \$240 in a month. New Ford sedan given you as bonus. I send complete outfit. You don't risk a penny. Details free. Albert Mills, 2245 Monmouth, Cincinnati, Ohio.

MECHANICALLY Inclined men to demonstrate. Specialty Sales, 4303 Roscoe, Chicago.

BECOME A business investigator. Make money in your spare time. Pleasant work. Good fees. Details free. Business Detective System, 1009 Oak Street, Elmira, N. Y.

AGENTS WANTED

AGENTS—Lowest prices—Top profits on carded aspirin, razor blades, handkerchiefs, laxatives, shoe laces, etc. Details free. Better Products Co., Dept. 2718, Marion, Ind.

AGENTS. 90% Profit on \$1.00 sales. Cleaner for autos, metal and glass. Your name on labels. Free sample. Instant Kleen Lab., Dept. E, Dayton, Ohio.

300% PROFIT In new self-starting no-flint cigar lighter. Retails 50c. Sample 25c. Get details quick on wonder seller. New Method Co., Box PM-49, Bradford, Pa.

STRANGE Ironing cord. Saves electricity. Abolishes scorching and kinking. For telephones also. 150% profit. Sales guaranteed. Big free offer. Neverknot, Dept. 1A, 4525 Ravenswood, Chicago.

BIG Money and fast sales. Every owner buys gold initials for his auto. You charge \$1.50, make \$1.45. Ten orders daily easy. Write for particulars and free sample. American Monogram Company, Dept. 40, Dunellen, N. J.

AMAZING New product plates with real silver. Fast sales to housewives—big profits—one minute demonstration. Write quick for details. Puritan Laboratories, 1612P Summit, Akron, Ohio.

\$6.00 HOURLY. Amazing Karnu refinishes auto like new without rubbing, polishing, waxing or painting. Wipes on with cloth. Lasts 8 to 12 months. Free sample. Karnu, Dept. K-8, Cincinnati, Ohio.

AGENTS For new metal cleaner. Send for sample and proposition. Story-Johnson, 119 Federal, Pittsburgh, Pa.

AGENTS: Smash go prices. Santos coffee 12c lb. 4-oz. vanilla 8½c. Razor blades 10 for 8½c. 100 sticks chewing gum 12c. 150 other bargains. Premiums. Experience unnecessary. Carnation Co., PO, St. Louis, Mo.

SELL Leading mechanics hand soap, good profit, repeat business. Write Radium Compound Co., Phoenix, N. Y.

BUSINESS Opportunities. Flavor bargains. Chemical service. Free literature. Herstein, 222 Ransom, Grand Rapids, Mich.

NEW Cleaner—Amazes everybody. Cleans everything. Washes clothes snow-white quickly. Spots, stains removed like magic. Startling demonstrator. Free samples make fast sales. Quick repeater. Immense profit. Write quick for "free sample." Super-X Cleaner Co., 11, Berwyn, Illinois.

BE Your own boss! Operate used-new clothing business from store, home, auto. 200%-300% profit. Everything furnished. Catalogue free. Portnoy, 566-G Roosevelt, Chicago.

500% PROFIT Selling new "20-in-1" kitchen utensil. Retails 25c. Costs you \$1.00 a dozen. \$7.20 a gross. Sample 10c. New Method Co., PMM-49, Bradford, Pa.

DRIVING Master shows miles per gallon when driving. Analyzes motor. Described page 369 September Popular Mechanics. Driving Master Company, Sioux City, Iowa.

\$6.85 HOURLY! Amazing No-Flatz fixes punctures without patching; makes tires puncture-proof! Instantly—permanently seals holes made by nails, etc. Big seller. Free sample offer. No-Flatz, Dept. K-172, Cincinnati, Ohio.

CASH Paid for butterflies, insects. See Sinclair Display Advertisement on page 14A.

AGENTS Wanted selling new patented article. Write, Richards Rubber Co., Dept. 5, 288 Valley St., Providence, R. I.

FREE Clothing, big money daily selling quality raincoats, jackets, overcoats. Lowest prices! Samples free! Goodwear, 712-AB Roosevelt, Chicago.

450% PROFIT In new automatic gas lighter. No flint or flame. Lights gas instantly. Retails 25c. Costs you \$1.00 a dozen or 15 dozen for \$8.00 postpaid. Sample 10c. New Method Co., Box PMG-49, Bradford, Pa.

500% PROFIT! Gold reflecting letters for store windows. Large sizes 1c. Free samples. Modernistic Sign, B-3004 Lincoln Ave., Chicago.

SILHOUETTE Pictures. Entirely new. Fast, profitable sales guaranteed. Write for illustrated literature. Vandrey Service, Truman, Minnesota.

LEATHER Necktie 50c prepaid. (Agents.) Washable, durable, beautiful. Anderson-Simplex Co., Anderson, Indiana.

WHOLESALE Catalog free. 500 best sellers. Paty Co., 1167 Broadway, Somerville, Massachusetts.

MEXICAN Feather pictures. Christmas novelty. 50c (stamps) bring \$2.00 worth samples, details. Refunded if unsatisfied. Mexican Art, Apartado 1593, Mexico City.

SELL Neon signs. Big profits. Sample—\$3.95. Free details. Wholesale Neon Supply, Sheboygan, Wisconsin.

NEED Money quick? Here's a genuine opportunity to make up to \$42.50 in a week. Operate grocery business from your own home. Supply friends, neighbors, others. I send complete outfit on 30-day trial; no money risk. Details free. Albert Mills, 2248 Monmouth, Cincinnati, Ohio.

SPARKLING Tinselled Christmas signs—5c. Retails 25c. Sample free! Boxed, 21 Christmas cards 35c—retails 85c. Make Christmas money. Department 679, L. Lowy, 8 West Broadway, New York.

MAKE More money selling shirts, ties, underwear, dresses, hosiery, raincoats, jackets, pants, uniforms. Sales outfit free. Nimrod Company, Department 8, 4922-28 Lincoln Avenue, Chicago.

NEW Fountain brush uses 6 colors. Makes signs without skill. Every merchant buys. 250% profit. Vandrey Signs, Truman, Minnesota.

SELL—Blade conditioners—Smoother shaving, millions being sold. Marvelous. Order sample, details quick. Twenty-five cents. Chariton Corporation, Chicago.

MEN—Women, tremendous profits. Sell famous Eldore perfumes—beauty products to women who demand the best; popular prices. Write for details. Eldore, 299 Madison Ave., New York.

AGENTS! Dresses 53c, men's suits \$1.50-\$2.00, shirts 46c, ties 6½c, chiffon hose 42c. Amazing prices. Big profits. Catalogue free. Acme, AB-558 W. Roosevelt, Chicago.

\$1.00 MONTHLY. Maintains New York office. Co-Operative Mail Service, -126-H Lexington Avenue.

PROFIT With new products. Make, sell, repeat. Analysis. Research. Guaranteed formulas. Biggest catalog free. Special prices, leads. Gibson Laboratory, Chemists, BD-1142 Sunnyside, Chicago.

DOLLARS Daily. Start manufacturing, mail order businesses. Details. Duffy, Covington, Ky.

\$6.00 A WEEK. Even in spare time. 5c brings details and sample. Triborough Novelty Manufacturer, 213 Cypress Ave., New York City.

"THERMOLITE Re-Power." Brand new motor compression seal. Fast-seller! Big profits! Guaranteed! Write quick. Free sample. Electro-Thermolite Works, Peoria, Ill.

AGENTS Wanted. Every car owner prospect for Sta-Charg, adds life and pep to car battery, money back guarantee. Thousands satisfied users. Send fifty cents for sample. Amasco, 6715 Hollywood Blvd., Los Angeles, Calif.

AGENTS—200% Profit. Selling collection system \$1.50 complete. Results guaranteed. Every merchant extending credit needs one. Samples on request. Send 10c for mailing and packing. Hill Agency, 8777 Violetlawn, Detroit, Mich.

LEGITIMATE Spare-time income opportunities. Free literature. Charlton, Box 6310 West Market St., Philadelphia, Pa.

NO Boss! Sure cash! Silvering mirrors, autoparts, reflectors. Combination outfit. Write Sprinkle, Plater, 128, Marion, Ind.

WANTED—Monument salesmen. Men, ladies make good money. Outfit free. Write Factory Manager, A-23, Oneco, Florida.

SUCCEED With your products. Make-sell them. Formulas. Processes. Accurate analyses. Catalog free. B. Thaxly Company, Washington, D. C.

WHY Work for others? Make and sell your own goods. Formulas, toilet articles, perfumes, extracts. Valuable book free. Scientific Laboratories, 1950W Broad, Richmond, Va.

ENGRAVED Name plates, numbers, signs, etc., easily sold, profits large. Brett Bros., Winthrop, Mass.

MAN In each town to plate auto parts, reflectors, bathroom fixtures, refinish beds, mirrors, chandeliers, by late method; experience unnecessary. Simple plan of manufacturing at home starts you in big money making business. Free particulars and proofs. Gunmetal Co., Ave. H, Decatur, Ill.

GENUINE Gold letters for store windows. Easily applied. Free samples. Liberal offer to general agents. Metallic Letter Co., 438-B North Clark, Chicago.

BIG Money applying gold initials on automobiles. Easiest thing today. No experience needed. Free samples. "Ralco," 1084 Washington, Boston, Mass.

FREE Sample—Amazing cleaner; sells homes, taverns, everywhere. Big profit—fast repeater. Betco, 5907 Irving Park, Chicago.

STOP Squealing—Start crowing!! Drive to country—"movies"—afternoons. Work mornings—home. No canvassing! National Folio-A, Station "D," Los Angeles.

SELL Novelty fun cards, novelties, etc. Samples 10c. National, Box 500M, Cincinnati.

AGENTS: Stamping names on pocket-key protectors. Sample check with your name, address, 25c. Stamping outfits. Emblem checks, check-fobs, name plates. Hart Mfg. Co., 303 Degraw St., Brooklyn, N. Y.

AGENTS—Opportunity to make money; book containing 107 successful business plans; home or office; send for free introductory booklet. Elite Co., 214 Grand St., New York.

COSTS 1c—Sells 25c. Make non-explosive cleaner from benzene crystals. 1c gallon. Sample 10c. Literature free. Western Reserve Laboratories, 6615 Denison Ave., Cleveland, Ohio.

WANTED—District purchasing agents. No experience or money required. Write Purchasing Manager, 174 N. Halsted, Chicago.

DO You want agents for your proposition? Your ad in this space will place your message before hundreds of men seeking fast-selling products. My folder "How to Secure Agents" is filled with proof. I'll gladly send you a copy free. F. W. Johnson, Manager Classified Advertising, Popular Mechanics Magazine, 200 E. Ontario St., Chicago.

SALESBOARD Men—New put and take jars. Details, samples free. Tom Thumb, Dept. PM, Nauvoo, Ill.

GUARANTEED Double-edged blades 50c hundred up. If there's anything else you want, write us; we have it. Samples sent. Steven Sneider, 412 E. 51, Brooklyn, N. Y.

PROFITABLE Home business. Legitimate. No canvassing. Maywood Publishers, P-923 Broadway, New York.

AGENTS, Distributors—Why constantly seek new territory? Sell new improved Dutch-Maid. Non-competitive monthly repeater. Cleans toilet tank bowl and trap. Unusual profits. Home Helpers Co., Dept. P, 321 Virginia St., Buffalo, N. Y.

BIG Profits eyeglass necessity. Cleans, polishes, prevents steaming. Sample ten cents. Shurberg Chemical, Hartford, Conn.

GOLD Reflecting letters for store windows. Easily applied. Large sizes, penny each, free samples! Atlas Sign Works, 7941 Halsted, Chicago.

HIGH-GRADE SALESMEN

SALESMAN—To contact industrial concerns; profitable, fast-selling line essential to all shippers; full or part time; immediate results; yearly renewals. Write Official Motor Freight Guide, 732 Van Buren, Chicago, Illinois.

BRAND New grab-bag deal. Going big everywhere—big profits—swift sales—fast repeats. No restrictions. All dealers buy. Act! K&S, 4347-D Ravenswood, Chicago.

DISTRIBUTOR: For nationally advertised non-poisonous liquid raticide, insecticides, soap, etc. Small investment, exclusive territory. Address Drawer C, Towson, Maryland.

NEW Specialty—Sells every business and professional man. Four \$15 sales daily pay \$280 weekly. Ferrell cleared over \$1,000.00 monthly. Write, F. E. Armstrong, President, Dept. PM, Mobile, Ala.

NEW Drycleaning clothes brush. Revolutionary invention. Cleans clothes like magic. Homes, offices buy instantly. Phenomenal profits. Outfit free. Kristee, Dept. 262, Akron, Ohio.

NEW Punchboard line. Free 32 page full color catalog. Nothing to carry. Larger cash commissions daily. Season now! Lea-Moore Co., 180 Adams, Chicago.

NEW Chemical fluid—Prevents blur. Keeps store windows, windshields and all glass surfaces clear in cold weather. Just what merchants are looking for. Send 25c for sample. Morgan Chemical Company, 425 Strawberry Street, Harrisburg, Penna.

DRAWING Account to acceptable experienced broom salesman. Acme Broom, Sedalia, Mo.

GOOD Seller. Pickle, olive, cherry fork. Nickel plated. Sample ten cents. Kubik & Sons, Michigan City, Indiana.

CAN You sell? We have it to sell. Let's get together and sell it. Peachy Novelties, Poplar Bluff, Missouri.

MAKE \$100 Weekly presenting unique guaranteed "Prosperity Plan" for stores. National, 1451 Broadway, New York.

DON'T Be a job hunter—Start your own business on our capital. No hard times; no lay-offs; always your own boss. Hundreds average \$3,000 to \$5,000 annual sales year after year. We supply stocks, equipment on credit. 200 home necessities. Selling experience unnecessary. Wonderful opportunity to own pleasant, dignified, profitable business backed by world wide industry. Write Rawleigh's, Dept. A-U-PPM, Freeport, Ill.

SELL Only (4) all wool suits to get yours without cost. No limit to number of suits you may earn. Prices \$14.95 to \$26.95. Zipper leather carrying case. Sample line free. No experience needed to make big money. All suits individually cut and tailored to measure. Satisfaction or money back guarantee. Three Star Clothes, Dept. 36E, 330 So. Franklin, Chicago.

MAKE More money selling shirts, ties, underwear, dresses, hosiery, raincoats, jackets, pants, uniforms. Sales outfit free. Nimrod Company, Department 65, 4922-28 Lincoln Avenue, Chicago.

TRUCK Covers. Complete line waterproofed canvas. Thousands of trucks in your state constantly buying. Open price line. No competition. Michigan Tarpaulin Co., Grand Rapids, Mich.

MAKE Money and give protection against fire at the same time—Firex—Automatic Fire Extinguisher and Alarm assures double protection. Recommended by fire chiefs, insurance men, etc. Unlimited prospects—good commissions. Write for territory and testimonials. Firex Corporation, Dept. A-103, 516 South Broadway, St. Louis, Missouri.

EXCLUSIVE Territory for established auto route jobbers. Steady profitable demand for every store counter. Bur-Lite, Hudson, Ohio.

NEW 3rd Hand holds your flashlight. Sell to dealers. Sample and proposition, 25 cents. McMasters, Groton, New York.

AMAZING Invention! New electric hot water heater. Sells on 60 second demonstration. Needed in every home. Makes up to 133% profit each sale. Exclusive territory to right man. Write today. Industrial Laboratories, Dept. 200, Des Moines, Iowa.

EXCLUSIVE! Advertising book match factory wants salesmen: full or part time. G. B. made \$77 in 1 day. Big comm., amazing repeats. Permanent, dignified business. Samples free. Write Match Corp. of America, Dept. E-1, 6041 Grand, Chicago.

FREE Suits and cash profits. Earn cash profits, prizes and free suit for selling five all-wool tailored-to-measure suits. No limit on free suits you may earn. No experience necessary. Free sample outfit. Prices from \$17.50. Money-back guarantee. Frank Knight Tailoring Co., Not Inc., 316 W. Van Buren, Dept. C1, Chicago, Illinois.

BOOK Match salesmen cleaning up! No dull season. Cash commission with order. Free kit. Full or part time. Gem Match Co., Dept. 51, 72 W. Washington, Chicago.

BE Your own boss. Make the largest commissions selling our complete line of brushes. Write for sales plan. Wire Grip Sanitary Brush Corp., 220 Southern Boulevard, N. Y.

SALESMEN-AGENTS. Free. Join Direct Selling Legion, world's largest organization of salespeople. Founded to raise standards of direct selling and afford full service and protection. Button, Gold Seal identity card and monthly magazine free. No fees, dues or assessments at any time. Send name and address today for membership application. Direct Selling Legion, Dept. AD, 307 N. Michigan Ave., Chicago, Ill.

BRUSH Salesman—If you ever sold brushes write for our money making proposition. Donald Brush Co., Camden, New Jersey.

FREE Booklet describes 107 plans for making \$20-\$100 weekly, in home or office, business of your own. Elite Co., 214 Grand St., New York.

SALESMEN—New deal guarantees stores \$10 for one. Two \$15 sales net you \$20 daily. Sayers, 2801-123 Sheffield, Chicago.

SOMETHING New in fire extinguishers—Red Comet Automatics. Proved in west five years. Exclusive territory. Low price opens pocketbooks. Write, Red Comet, 404 Comet Building, Littleton, Colorado.

BE Independent. Own your business; experience unnecessary. selling \$10,000 accidental death, \$50 accident; \$25 sick weekly benefits—\$10.00 yearly. Other amounts proportionate. Guaranteed steady renewal income. \$726,415.63 securities deposited. Universal Policy, 716-A Lefcourt Bldg., Newark, New Jersey.

EDUCATIONAL AND INSTRUCTION

BE A radio expert—Many make \$30, \$50, \$75 a week. Learn at home in spare time. Radio's big growth making many good full time and spare time jobs. Write for free copy of 64-page book. National Radio Institute, Dept. 7APA, Washington, D. C.

"SHORTHAND Simplified" (complete) \$1.00. Free lesson. Erskine Simmons, Cromwell, Conn.

BIG Bargain catalogue educational matter 10c. Hanfling, Y-799 Broadway, New York.

WORK For "Uncle Sam." \$105-\$175 month. Men-women. Many 1937 appointments. Try next examinations. Common education sufficient. Qualify now. Influence unnecessary. Full particulars, list jobs and sample tests—free. Write today sure. Franklin Institute, Dept. T3, Rochester, N. Y.

SECRET Service. Particulars free. Write immediately. George Wagner, M-2640 Broadway, New York.

GET A government clerk job. File clerk, P. O. clerk, statistical clerk—all good jobs. Men-women, age 18-50. Want to qualify for next entrance test? Details free. Write, Ogment Instruction Service, Dept. 101, St. Louis, Mo.

BECOME An investigator—Secret service agent. New "Test Problem Method." Develops your ability. Particulars free. International Secret Service Institute, (PM-17), Hoboken, N. J.

HEALTHIANA Scientific divine healing. Wonderful proposition. Healthiana, 3137 Tiffin, Toledo, Ohio.

SHORTHAND Brings opportunities. Free catalogue. Shorthand Institute, 6330 Clayton, St. Louis.

DOUBLE Entry bookkeeping mastered 60 hours with keys. (Diplomas.) International Bookkeeping Institute, Springfield, Mo.

SHORTHAND In 30 days. Wonderful Boyd system. Free catalog. Chicago Home Study Schools, 801 Reaper Block, Chicago.

IF You like to draw, sketch or paint—Write for talent test (no fee). Give age and occupation. Federal Schools, Inc., Dept. P17, Minneapolis, Minn.

MATHEMATICS, Drafting, architectural, mechanical, structural, surveying, engineers licenses. Tutored days, evenings. Mondell, 112 West 42nd, New York.

HOME Study courses offering degrees: arts, literature, sciences, psychology, engineering, philosophy, chemistry, English, education, languages, law, business. Many others. Low cost; easy terms. Catalog on request. Thomas Jefferson University, 749 Independence Boulevard, Chicago.

BOAT Designers are highly paid professionals. Complete course by mail. Catalog. Westlawn, Montville, N. J.

AUCTIONEERING. 1000 Men wanted to become auctioneers. Few weeks training prepares you for big money. Business and real estate booming, will increase auction sales. Rochester Correspondence School of Auctioneering, 34 Atkinson, Rochester, New York.

BLUE-PRINT Reading taught by short easy home course. Prepare yourself now for boom and higher wages. Write today for details. Muffler's Blueprint Reading Institute, Box 5662 Metropolitan St., Los Angeles.

LEARN Broad-pen lettering. \$1.50. Smith, 3608 Hazelhurst, Toledo, Ohio.

GREAT Strength easily obtained. Particulars. Prof. Dryer, Box 1850, Chicago.

LEARN Welding. Special training, qualified school. Read ad under Welding.

JOB-SEEKERS: The names and addresses of the personnel officers for 42 government agencies, (24 of these under Civil Service), sent you for 25c coin. John Mudd, Box 225, Farmington, Mo.

MASSAGE, Hydrotherapy, dietetics, drugless therapeutics, chiropody, taught by mail. Evans Correspondence School, Montgomery, Ala.

ELECTRICIANS. Big money in maintenance. We teach you. Earn from start. Wilaway Institute, 5796 Metropolitan Station, Los Angeles, Calif.

CIVIL Service examination questions! 7 stickers adapted from city, state, government tests free. Helpful. Write Lincoln Institute, 10 Tremont Street, Boston, Mass.

13 KNOCKOUT Blows without fists, by internationally known police instructor. Send 15 cents, coin or stamps. S. J. Jorgensen, 400 Maritime Bldg., Seattle, Wash.

AIR Conditioning and refrigeration. Learn these trades that know no depression. Resident or extension courses. For opportunities in these lines write to Detroit School of Refrigeration and Air Conditioning, 4125 Grand River, Detroit, Mich.

BE An investigator. Earn big money—Travel. Crime detection newspaper and particulars free. National System, 425-G, Fremont, Nebraska.

LEARN Machinist trade, tool, die making. Automatic and hand screw machines. Modern shop methods. Actual work. Jobs open for trained men. Employment help. Illustrated booklet free. Allied Screw Machine Company, 601 Lake Street, Chicago.

LEARN Auto mechanics, body, repairing, welding, electricity, refrigeration. Diesel. Stevinson's, 2008A Main, Kansas City, Mo.

LEARN Latest methods solving arithmetical problems quickly. Frederick A. Smith, 2410 Smalley Court, Chicago.

STAMMERING. Stuttering corrected. Write Lewis Institute, 12052 Woodward, Detroit, Michigan.

HOME Study courses leading to degrees: Arts and sciences, philosophy, education, law, letters, theology, psychology, engineering, chemistry, business and commerce. Many others. McKinley-Roosevelt University, Chicago.

U. S. GOVERNMENT Positions. \$1700-\$1900 and up a year. Let our expert (former government examiner) prepare you for a position in the railway mail service, rural carrier, post office, customs and other branches. Write today for free booklet. Dept. 8, Paterson School, Rochester, N. Y.

NEW Fascinating business—Repair, adjust typewriters, adding machines. Learn easily at home from factory expert. Earn up to \$25.00 daily. Complete instructions covering all makes \$3.00. Adding Machine Equipment Co., 222 W. Adams, Chicago.

CARTOONING AND COMMERCIAL ART

ATTENTION Professional artists and art students. The mystery of drawing solved. Twenty lessons producing immediate results. Entirely new system. Write Henri Seville Schools, 1530 North Western, Hollywood, California.

CARTOONING Course—Complete with equipment, magazine and correction service \$1.00. National Service, 36 New Dwight, Springfield, Mass.

MAKE Money at home painting cartooned and lettered signs. Send \$1.00 for five samples, 10 sheets (12x18) and instructions. Dobbie's Sign Shop, 1210 Bryn Mawr Ave., Chicago.

CARTOONISTS! Markets, syndicates, professional secrets—10c. Cartoon Studios, LaCrosse, Wisconsin.

LEARN Cartooning by easy method, circulars free. Matthews, 3627 Finney, St. Louis, Mo.

ART Course. Study cartooning, illustrating, advertising under professional guidance, 50c lesson. First lesson free. Victor Hundgen, 2130 Tiebout Ave., New York City.

AMATEUR Cartoonists can earn \$35.00 weekly, spare time, duplicating cartoon advertisements. 3-M Syndicate, Argyle, Wis.

CHALK Talks. Laugh producing program, \$1.00. Catalog free. Balda, The Cartoonist, Oshkosh, Wis.

CARTOONING Course:—30 lessons, over 500 illustrations, drawing pens and pencils, \$1.00 complete. Scovell Studios, Box 748-P, Hollywood, Calif.

CARTOON Entertainment course—for schools, churches, stage. Amateur, professional, 50c. National Service, 36 New Dwight, Springfield, Mass.

CARTOONING, Sketching, etc.—46 lessons, 600 illustrations, including practice sheets, pens, pencils, \$1.00 complete. Fraba Service, Cashton, Wisconsin.

BOOKS Covering hundreds of subjects. Big catalog for 3c postage. Popular Mechanics Press, Room (C36), 200 E. Ontario St., Chicago.

ADVERTISING AGENCIES

LEARN Advertising quickly at home. Easy practical plan. No text books. Common school education sufficient. Interesting booklet and requirements free. Page-Davis School of Advertising, 3601 Michigan Avenue, Dent, 3431, Chicago.

INCH Display advertisement, 30 magazines, year, \$24. Wood's Popular Services, Atlantic City, (N. J.)

ADVERTISING Placed anywhere. Helpful, free service. Rate guide book free. Baker Advertising Agency, 189 W. Madison, Chicago. Successors to Ankrum Advertising Agency. Established 27 years.

ADVERTISE Profitably: \$15 reaches 6,000,000 Sunday newspaper readers with 24 word ad. Newspaper, magazine rate-guide, free. Chicago Union Agency, 20 West Jackson, Chicago.

FREE—New Advertisers Rate Guide, 44 pages. Includes everything. Lowest rates. E. H. Brown Advertising Agency, 140 S. Dearborn, Chicago.

FOR ADVERTISERS

500 **PENCILS** With your advertising \$10.50. Samples 10c. Ad-Craft, Lacrosse, Wis.

ADVERTISE: 24 Words, 45 newspapers \$2.00. Goodall Advertising Agency, 230 Bankers' Investment Building, San Francisco.

SIGNS—Attractively painted in 3 colors, lengths to 25 feet, yard wide, \$1.50 postpaid. "Edwards," Galena, Ill.

ADVERTISE: 24 Words in 250 newspapers \$10. Lists free. Advertising Service Bureau, 4258-C Drexel, Chicago.

BUSINESS SERVICE

IF You are looking for a representative in the Far-East, apply with full particulars to Mr. United Agencies, 244 Route Maresca, Shanghai, China.

SKIPPED Debtors located fifty cents. No charge unless successful. Nation wide service. Write today for free literature. United Inheritance Bureau, 1278 Jefferson Ave., Buffalo, N. Y.

PERSONAL Or business address, \$1.00 monthly. Master Services, 222 W. 4th Street, Cincinnati.

CHICAGO! Business-personal mail address, representation, forwarding; \$1.00 month. Established 1919. General Business Service, 56 West Washington.

ANY Information desired, anywhere. Reasonable rates. Fred Klotz, Reading, Pa.

WHERE To buy anything! Manufacturers, wholesalers, 25c (coin). King, 564 Delaware, Buffalo, N. Y.

MAINTAIN Office for \$1.00 monthly. Business-personal mail address. Fields, Box 1102, Waco, Texas.

CHOICE New York City mail address—Broadway 1472 or 147 West 42nd St., Suite 612. Long established, capable secretaries in attendance. Mail forwarded daily. Cost only \$2.00 monthly.

REAL Live opportunity seekers names, copied from original letters, 1000 for \$3.00. Guaranteed 100% correct. Armour Organization, Flushing, New York.

DELAWARE Charters: Complete incorporating and organizing service \$35. Submitted forms. Chas. G. Guyer, Inc., Wilmington, Delaware.

ALL International legal matters. Lic. Victor Prieto, Mexican Attorney at Law, P. O. Box 122 M. Juarez, Mexico.

RUBBER STAMPS AND OFFICE SUPPLIES

NAME, Address, 2 lines 25c; 3 lines 35c. Stamp Works, Auburn, Nebr.

2 LINES 25c, 3 Lines 35c. Stamprite, FP43, Springfield, Mass.

CUSHION Mounted, one-two lines 25c, three 35c. Signatures \$1.50. Stamp Works, 814 Bradley, Peoria, Ill.

2 LINES 25c, 3 Lines 35c. Stamp Works, Centertown, N. Y.

METAL Pocket case self-inking name, address stamp 60c. Fehlberg, Lacrosse, Wis.

TYPEWRITERS, DUPLICATORS, OFFICE DEVICES

BUY Direct from manufacturer prepaid. Typewriter or cash register ribbons 50c each. Carbon paper \$1.00 box. Multigraph ribbons \$1.50. Ribbon Ink Company, Cicero, Illinois.

TYPEWRITERS Bought, sold, swapped. Typery, 3941 Shaker Square Station, Cleveland, Ohio.

NEW \$4.75 Automatic adding machine. Fully guaranteed. Bassett, Box 302A, Altadena, California.

PRINT-O-PRESS, World's lowest priced rotary duplicator. See advertisement page 67A.

TYPEWRITERS, Duplicators, multigraphs. Write for free list office machine bargains. Save half. Pruitt, 518 Pruitt Bldg., Chicago.

INCREASE Business. "Excellograph" rotary stencil, clay and film duplicators \$3.85 to \$37.50. Prints anything. Typewritten, penned, drawn, traced. Colors. Folder free. Pittsburgh Typewriter Supply, Suite 518, Pittsburgh, Pa.

PRINTING, MULTIGRAPHING, MIMEOGRAPHING, GUMMED LABELS

500 **MIMEOGRAPHED** Circulars \$2.75; 1000, \$4.50. Free samples. Merchants' Mutual Service, Siren, Wisconsin.

500 **LETTERHEADS**, Envelopes, statements \$1.10; 1,000, \$2.00. Samples. Raymond's, Newport, New York.

QUALITY Printing, lowest prices, free samples. Excel, 6325 Maxwell, Detroit, Mich.

ENVELOPES, Cards, statements \$2.75 1000. Wolverine Envelope, Grand Rapids, Michigan.

PERSONAL Printed stationery, 100 sheets, 100 envelopes \$1.00. Cott's Press, Sufekard, Mo.

BETTER Printing—Attractive prices—Reorder profit-sharing. 500 Hammermill letterheads, envelopes \$1.75. Circulars, etc. Croydson Press, 100 4th Ave., New York.

SELF Seal envelopes 100 for 50c. Morey's Press, 87 Somerset Street, Springfield, Mass.

\$1.00 **EACH**—250 Envelopes, 250 letterheads, 250 statements. Postpaid. Hustler, Advance, Indiana.

PRINTED Quality stationery. Samples. Triangle, 601 West 137th Street, New York.

1000 **LETTERHEADS**, Envelopes, postcards, 6x9 circulars—\$2.95; 2000, \$4.95. (Envelope slips, \$1.75; 2000, \$2.50 prepaid.) Samples. Goodprint, Harrisonburg, Va.

250, \$1.00—**LETTERHEADS**, Envelopes, statements, cards. Howard Weaver, Mechanicsburg, Pa.

LABEL Value headquarters. Samples free. Labels, 6618D Quimby, Cleveland, Ohio.

GIVE Distinctive stationery for Christmas gifts! Samples! Write, Hall's Printing, Dalton, Massachusetts.

300 **ENVELOPES** Or letterheads, 99c. Leader, 7341 S. Marshfield, Chicago.

FLASHY Two color business stationery. Snappy designs. Lowest prices. Samples, Acme, 406 N. Second, Elkhart, Indiana.

PHOTO Engravings—Zinc line cuts made, 10 square inches, \$1.00 up; halftones; electro; artist; speedy; free price list. Riteway Engraving, 1457P Broadway, New York.

CARDS, Envelopes \$2.00 per 1000. Statements, letterheads \$3.00 per 1000. Skulnick's Printing Service, 205 Broome Street, New York.

LETTERHEADS, Envelopes, 500, \$1.60. 2000 3x6 envelope slips, \$2.00. 1000 enameled blotters, 3 1/4 x 6 1/4, \$4.00. BPress, Box 103, Station W, Brooklyn, N. Y.

1000 **BUSINESS** Cards \$1.25 postpaid. W. A. Hall, 1505 E. 52nd St., Los Angeles.

BARGAINS—100 8 1/2 x 11 Letterheads, 100 envelopes \$1.00, 250, \$1.98. Personal, 125 each, \$1.00. Evans, 44PM North Tenth, Reading, Pa.

5000 **BOND** Letterheads, 8 1/2 x 11, \$7.00. E. K., 254 Elmwood Ave., E. Orange, N. J.

GOOD Printing. Reasonable. Samples. Harmon Company, 318 South Tenth, Philadelphia, Pennsylvania.

500 **GUMMED** Stickers, 1/2 x 2 1/2, 4 lines, 30c. Catalog, 10c. Lambing, 6457P Eggleston, Chicago.

5000 8 1/2 x 11 **LETTERHEADS** \$8.45. Envelopes \$7.45. Midwest Printing, Northfield, Minn.

PRINT Your own. Bargains, presses, type, List 3c. Exchange D-14, 22 Orient, Meriden, Conn.

5000 3 1/4 x 6 **CIRCULARS** \$3.25; 250 noteheads, 100 envelopes \$1.00. Abbott Press, Oswego, Kansas.

1000 **BUSINESS** Cards, card case, \$1.50. Miller, Printer, Ambler, Pa.

BETTER Grade printing, reasonable priced. Free samples. Economic Press, Leonia, N. J.

CUTS 2x3, \$1.10, from drawings and photos. Joe Rek, 118 Gazette Ave., Lexington, Ky.

"1,000 **WAYS** To Make \$1,000.00." You can do it—others have. This new amazing book will startle you. 475 pages only \$2.50. Popular Mechanics Press, Room (C36), 200 E. Ontario St., Chicago.

PRINTING OUTFITS AND SUPPLIES

HAND Press, type and complete printers' supplies. Advise equipment you need and we quote prices; or send stamp for catalog. P. Peiffer, 4 B; 6 Columbia St., Newark, N. J.

NEW Type 29c font. Catalogue dime. National Type Company, Jackson, Mich.

WHOLESALE Paper (all kinds). Also envelopes, cards, blotters, tags, labels. Price lists, 3c. Sample assortment 10c. VanDorn Paperstocks, Ottawa, Illinois.

PRINT Your own circulars, envelopes, with home made press costing less than \$1.00. Illustrated instructions 10c. Carl Edquist, Odessa, Minn.

TYPE, Printing supplies. Lists stamp. Lawrence, Box 11, Wichita, Kansas.

PRINTING Presses, supplies. Long established. Lists 3c. Landis, Richland, Pa.

PRINT Your own cards, stationery, circulars, advertising, etc. Save money. Easy rules furnished. Print for others, big profits. Junior press, \$5.90; job presses, \$11, power \$149. Write for details. Kelsey Co., A-11, Meriden, Conn.

BARGAINS—Presses, type, supplies. Send stamp. 159 Harvard, Cambridge, Mass.

PRINTING Outfits—Presses, type, supplies, type novelties. Send 20c for card case samples. Catalog free. Model Press, York, Pa.

BARGAINS, Presses, type, List 3c. Exchange D-15, 22 Orient, Meriden, Conn.

BOOKS Covering hundreds of subjects. Big catalog for 3c postage. Popular Mechanics Press, Room (C36), 200 E. Ontario St., Chicago.

PATENT ATTORNEYS

INVENTORS: Send immediately for your copies of our new free books, "Patent Protection" and "Suggestions on Selling an Invention." Sixty-eight pages of interesting facts. They tell how patent laws protect you; kind of sketch or model needed; simple steps to take without cost; how successful inventors have secured financial assistance; show interesting inventions; illustrate important mechanical movements. With books we also send free Evidence of Invention form to help establish date of disclosure. Prompt service, reasonable fees, special deferred payment plan. Strictest secrecy. Thirty-six years' experience. Highest references. Write us today. The facts in our books are worth money to the man with a good invention. Address: Victor J. Evans & Co., Registered Patent Attorneys, 900-A Victor Building, Washington, D. C.

INVENTORS—Small ideas may have large commercial possibilities. Write us for free book, "Patent Guide for the Inventor" and "Record of Invention" form. Delays are dangerous in patent matters. Free information on how to proceed. Clarence A. O'Brien & Hyman Berman, 58-R Adams Building, Washington, D. C.

SELL Your unpatented ideas. We tell you how; help you make the sale. Particulars free. Write W. T. Greene, 976 Barrister Bldg., Washington, D. C.

PRACTICAL Inventions now salable before patenting. What have you? Write Chartered Institute of American Inventors, Dept. 4B, Washington, D. C.

PATENTS—Proper service for manufacturers and individual inventors. Established 1895. Reasonable charges. Consult Chandiee & Chandiee, Patent Attorneys, 902 F. Street, Washington, D. C.

PATENTS—Personal, confidential services for protection of your invention at reasonable cost. Preliminary information and approximate cost of patent furnished without obligation. John B. Thomas & Co., 902 F. Street, N. W., Washington, D. C.

OREL Z. Burdick, Registered Patent Attorney and Chemist, Hart, Michigan.

PATENTS—Trade marks—Personal service, reasonable charges. Preliminary advice, book and disclosure form free. Irving L. McCathran, 1060 International Bldg., Washington, D. C. Registered Patent Attorney.

INVENTORS—Send for free booklet "Patent-Sense." Information based on 64 years experience. Lacey & Lacey, Dept. 5A, 635 F. St., Washington, D. C.

L. F. RANDOLPH, 302-B Victor Building, Washington, D. C. Low cost. Book and information free.

PATENTS. Protect your idea by securing free "Proof of Invention" folder. Exceptional personal service. Established 1906. E. E. Vrooman, 871 Woodward Building, Washington, D. C.

PATENTS. Instructions "How to Establish Your Rights" and form. "Evidence of Conception"—sent free! Lancaster, Allwine & Rommel, 411 Bowen Building, Washington, D. C.

PATENTS. Booklet free. Highest references. Best results. Promptness assured. Watson E. Coleman, Patent Lawyer, 724 Ninth St., Washington, D. C.

"INVENTOR'S Guide," 100 mechanical movements, free; advises on patenting, selling inventions. Frank Ledermann, Tribune Bldg., New York.

THEODORE H. Rutley, Registered Patent Attorney, 512 Colorado Bldg., Washington, D. C.

FOR INVENTORS

INVENTORS: Send immediately for your copies of our new free books, "Patent Protection" and "Suggestions on Selling an Invention." Sixty-eight pages of interesting facts. They tell how patent laws protect you; kind of sketch or model needed; simple steps to take without cost; how successful inventors have secured financial assistance; show interesting inventions; illustrate important mechanical movements. With books we also send free Evidence of Invention form to help establish date of disclosure. Prompt service, reasonable fees, special deferred payment plan. Strictest secrecy. Thirty-six years' experience. Highest references. Write us today. The facts in our books are worth money to the man with a good invention. Address: Victor J. Evans & Co., Registered Patent Attorneys, 901-A Victor Building, Washington, D. C.

INVENTORS—Small ideas may have large commercial possibilities. Write us for free book, "Patent Guide for the Inventor" and "Record of Invention" form. Delays are dangerous in patent matters. Free information on how to proceed. Clarence A. O'Brien & Hyman Berman, 58-R Adams Building, Washington, D. C.

EXPERT Drafting: Blueprinting, estimating, engineering. Valuable information, stamp. Westerfield, South Bound Brook, New Jersey.

INVENTOR'S Hand-book on Patents, by Albert E. Dieterich, L.L.B., up-to-date edition; mailed on receipt of 10c, stamps or coin. Dieterich Co., Publishers, 512B Colorado Bldg., Washington, D. C.

SAMPLE Copy monthly magazine The Inventor free. Albert G. Burns, Blum Building, Chicago, Ill.

SAVE Money on drawings and specifications. Guaranteed work. You'll like my price. Write E. W. Holmes, 918 F St., Washington, D. C.

ATTENTION Inventors! My book "Valuable Hints to Inventors" is your guide describing how to invent, obtain patents, and marketing. Recommended by U. S. Patent officials. Price \$1.00 post paid. A. F. Gillet, 4747 Capitol Ave., Omaha, Nebr.

INVENTION Finance Magazine, 80-G Wall Street, New York. Year subscription 60c entered upon promise to pay on receipt of first copy.

TO Inventors: We are in the market to purchase a good patent, preferably in the automobile accessory line. Will purchase outright or on royalty basis. Purchasing Agent, 241 Front St., New York, N. Y.

INVENTORS: "Making Inventions Pay," our 32-page illustrated book, mailed upon receipt of 2c postage. Crescent Tool Company, Dept. Z, Cincinnati, Ohio.

INVENTORS—Send for 72-page book on patents. Reasonable terms. Conscientious treatment to inventors. L. F. Randolph, Registered Patent Attorney, 302-E Victor Bldg., Washington, D. C.

UNPATENTED Ideas can be sold. We tell you how and help you make the sale. Particulars, with list of manufacturers and wanted inventions sent free on request. Write W. T. Greene, 944 Barrister Building, Washington, D. C.

I SELL Patents. Established in 1900. Charles A. Scott, 773PM Garson Ave., Rochester, N. Y.

WE Make models and manufacture inventions. Send 3 cents stamps for catalog. Pierce Model Works, Tinley Park, Ill.

SELL Your patent through a small classified ad in Popular Mechanics. Many inventors have found buyers in this way. Ask me for proof—I'll gladly send it to you. F. W. Johnson, Manager, Classified Advertising, 200 E. Ontario St., Chicago.

FREE Information about new magazines for inventors who want more profit from their ideas. Write "Successful Inventions," 800 Barrister Bldg., Washington, D. C.

HAVE You a sound, practical invention for sale, patented or unpatented? If so, write Chartered Institute of American Inventors, Dept. 4A, Washington, D. C.

INVENTOR'S Universal Educator; contains 900 mechanical movements; 50 perpetual motions; instruction on procuring and selling patents and selecting an attorney, etc. Suggests new ideas. Price \$1.00 postpaid in U.S.A. Address Albert E. Dietrich, 511-B Colorado Bldg., Washington, D. C.

INVENTIONS WANTED

SKILL And science: Have you an idea for a new game of skill or science for either public or home use? We will buy outright or finance marketing of meritorious presentation. No gambling devices. Will H. Wade & Co., (Investment Bankers), 134 So. LaSalle, Chicago.

INVENTORS—Small ideas may have large commercial possibilities. Write us for free book, "Patent Guide for the Inventor" and "Record of Invention" form. Delays are dangerous in patent matters. Free information on how to proceed. Clarence A. O'Brien & Hyman Berman, 58-R Adams Building, Washington, D. C.

INVENTIONS Wanted—Patented, unpatented. If you have an idea for sale, write Hartley's, Inc., Box 928-E, Bangor, Maine.

LIST Your invention in our marketing file for attention of interested manufacturers. Brezina & Holzinger, Patent Counsel, 201A North Wells, Chicago.

SMALL Inventions wanted by manufacturers. I'll help you sell your invention. Stanley Hull, 7829 Euclid Ave., Cleveland, Ohio.

WE Successfully sell inventions, patented and unpatented. Write for proof, and tell us what you have for sale. Chartered Institute of American Inventors, Dept. 4-C, Washington, D. C.

PATENTS FOR SALE

AUTOMOBILE Body invention for sale. Floyd Weaver, R. 2, Rockford, Ill.

MANUFACTURERS, For sale. Rope tension reading device. Indispensable to elevator owners. C. J. Lester, 4207 Franklin Blvd., Cleveland, Ohio.

PATENT For sale. (Fresh air) gas heater. First of its kind. Sell outright or with royalty. Wm. H. Juhnke, 1226 E. 77 Place, Los Angeles, Calif.

MANUFACTURERS, Capitalists, attention. Patents. Metal assemblage research problems solved. Publicity sign advertising complete. General assemblage, without bolts, screws, straps, snaps. Sectional, adjustable, interchangeable, knockdown. Open, Outright. Royalties. Services. Isenhour, Display Specialist, Inventor, Geneva, New York.

TELEPHONE Directory hanger, good advertising medium, outright or royalty. E. E. O'Connor, 831 Colborne St., London, Canada.

PATENT For sale. Comb cleaner and sterilizer for beauty and barber shops. \$10.00 seller. Sample machine for \$6.00 deposit. S. Thiesen, 1220 Washington St., Hoboken, N. J.

AIROPLANES No. 1917561. Another new patent. Triplice Streamaircraft No. 2054610. Vito Loreto Volpicelli, 1260 Reynolds St., Scranton, Pa.

MANUFACTURING

CORPORATION, Ample financed having excess facilities for manufacturing heavy metal specialties in Illinois, Ohio and New York will contract production your specialties; especially interested in new devices. Van Auker-Ragland, Inc., Room 1130, 20 N. Wacker Drive, Chicago, Ill.

MODELS, Light manufacturing, inventions perfected. H. Hathorn, Mason City, Iowa.

ECONOMICAL Manufacturing. Models, dies, special machinery. Swanberg, 5124 N. Kildare Ave., Chicago.

BALL Bearing hangers. Experimental work. Patents. Simplex Co., 414 Fowler, Waterloo, Iowa.

WOOD Patterns made to order. Benj. Nortved, P. O. Box 181, Denver, Colorado.

DIES, Stampings, light manufacturing, development engineering. Hagstrom Model & Tool Works, Kansas City, Mo.

MANUFACTURING, Dies, machinery, models, brasswork, white metal casting moulds. Catalog 3c. Baum's Metal Specialties, Kansas City.

INVENTIONS Manufactured in any quantity at low cost. Stampings, dies, models, etc. Estimates and free catalog. Crescent Tool Co., Dept. X, Cincinnati, Ohio.

MODELS AND MODEL SUPPLIES

SHIPS—18" Flying Cloud, Constitution or Galleons. All materials including easy plans only \$1.50. Catalog 15c. Hancock, 323 Douglass Ave., Portsmouth, Virginia.

INVENTIONS—Small ideas may have large commercial possibilities. Write us for free book, "Patent Guide for the Inventor," and "Record of Invention" form. Delays are dangerous in patent matters. Free information on how to proceed. Clarence A. O'Brien & Hyman Berman, 58-R Adams Building, Washington, D. C.

MODEL Cement, waterproof, trial 10c. Stay-Tite Products Co., Cleveland, Ohio.

FREE: Illustrated circular. Listing 40 engines. Locomotive castings. Supplies. Stamp required. Howardeo, A-2417 N. Ashland, Chicago.

1937 CATALOG Ready, 3c stamp. Thompson, Box No. 24, Waterloo, Iowa.

MODEL Makers—Brass, copper, fibre, steel and aluminum in all shapes. Also castings, gears, screws, fittings. Catalog 10c. Experimenters Supply House, Dept. P, Box 10, Station Y, New York.

1937 MODEL Railroad catalog, locomotives, cars and parts, 25c. Refunded first order. Rollin L. Lobaugh, 1179 Howard Street, San Francisco, Calif.

JUST Out—Three new catalogs. Engines, models, supplies. Each 20c postpaid. All three 50c. Refunded first order. Particulars free. Erraymesco, PM-28 N. Clinton, Chicago.

3/4" SCALE Steam locomotive easily built by "Step" method. Latest catalog of castings, boiler fittings, track material, etc. 25c (returned on first order). Little Engines, Box B15, Wilmington, Calif.

POWER Models, locomotives, steam, gasoline engines, accessories. 80 page catalog 35c. Chas. Cole, Ventura, Calif.

RAILWAY Models. Catalog handbook 25c. Walthers, 1564 West Pierce, Milwaukee.

YACHT Model fittings, for Zip, Vanja and others. Send for illustrated list. A. J. Fisher, 1002-1 Etowah Ave., Royal Oak, Mich.

MAGAZINES, Books for modelmakers. Write for free list. 25c brings sample Modelmaker and Model Railroader. Modelmaker Corp., Wauwatosa, Wis.

MODELS—Your ideas developed into practical working models. 30 years' successful experience; thousands of satisfied customers. Confidential service guaranteed. Bank references. Send 3c postage for 32-page book—"Making Inventions Pay." Crescent Tool Company, Dept. Y, Cincinnati, Ohio.

BRASS Gears, models and model supplies. Send 3 cents stamps for catalog. Pierce Model Works, Tinley Park, Ill.

HOME CRAFTSMEN

DRILL Glass easily, quickly. New method and drill 50c M.O. Mason, 14 N. Walnut St., E. Orange, N. J.

"MODERN Wood sculpture". Complete instruction book on carving statues \$1.00. Lee, Wood Art Studio, Centerville, Ia.

MAKE Your own hollow spindle Timken bearing lathe. We furnish parts. Wahl Machine Co., Kalona, Ia.

LEATHERCRAFTSMEN—Write for free instructions and price list of leather, tools and beginners' kits. Send 5c for sample cards. Address Wilder & Company, Dept. F, 1638 Crosby St., Chicago, Ill.

BUILD Birdhouses. Make your workshop pay. Literature free. Albert Publishing Company, Barrington, Illinois.

WOODCARVING Set. Swedish steel tools, and instructions. \$2.00 postpaid. Hagstrom Tool Works, Kansas City, Mo.

4 FULL-SIZED Shelf bracket patterns 20c. Modern Woodcraft, Saginaw, Michigan.

IMPORTED Swedish spring steel, Swiss files, oilstones. Mittermeier, 3577 Tremont, New York City.

ENLARGE Diagrams instantly. Abolish squares. \$1.35 postpaid. Details stamp. Pantographs, Escanaba, Michigan.

OLD GOLD, WATCHES, JEWELRY, PRECIOUS STONES

AUSTRALIA'S Lovely opals. Beautifully illustrated opal catalogue post free. Norman Seward, Melbourne, Australia.

AVERAGE Watch rebuilt, guaranteed, \$1.50. Holmes Watch Co., Washington, Kansas.

GOLD \$35.00 Ounce. Ship old gold teeth, crowns, jewelry, watches—receive cash by return mail. Satisfaction guaranteed. Free information. Dr. Weisberg's Gold Refining Company, 1593 Hennepin, Minneapolis, Minn.

5000 HUNTING Waltham, Elgin watches! New chromium, engraved, open face cases. Make big money! 12 size, 7 jewel \$3.25, 16 size, 17 jewel, \$4.75. Sample watch 25 cents extra. Ask for free catalogue, new plan. The New York Jobbers, Dept. M, 74 Bowery, New York.

LEARN Watchmaking. Lessons, practice, movement \$1.00. Catalog 5c. Stewarts, Sixth & Olive, St. Louis, Mo.

CASH For old gold, teeth, watches, jewelry, 100% full cash value mailed day shipment received. Satisfaction guaranteed or articles cheerfully returned. Information free, or ship today. Chicago Gold Smelting Company, 300P Champlain Building, Chicago.

FOR THE HOME

BEAUTIFUL Glass bud vase, hand made, 35c. Glasure Products, Box 5446, Los Angeles, California.

SENSATIONAL Offer! Hand-engraved name plates. Free circular. Acme Engraving Shoppe, 211 Roby Avenue, East Syracuse, N. Y.

RED-TOP Oil burner, used anywhere coal is used, guaranteed 5 yrs. Established 1923. F.O.B. Chicago and Pacific Coast. Red-Top Oil Burner Mfrs., 742 Market St., Room 230, San Francisco, Calif.

WEBSTER Oil burners. Wholesale and retail. Webster Oil Burner Co., Barrington, N. J.

FIREPLACES—New principle traps waste heat. Warm large room or small home. Materials inexpensive. Anyone handy with trowel can build new ones or convert old ones. Rare business opportunity for artisans. Complete, copyrighted instructions \$1.00 postpaid. Stringham, Technician, Bountiful, Utah.

MAKE It Yourself. Hundreds of practical and useful devices described in our big book. Plain instructions and illustrations show you how to make them. Save money on things for yourself or make profit selling to others. 900 articles of great variety. 480 pages. 823 illustrations. \$3 postpaid. Popular Mechanics Press, Room (C36), 200 E. Ontario St., Chicago.

TOBACCO

HIGHER Quality! Milder, golden yellow smoking or rich ripe chewing, four pounds, postpaid, \$1.00. Riverside Ranch, Hazel, Kentucky.

BUY At wholesale prices by mail—cigarettes, cigars, tobaccos. All brands. No tax. Postal naming your favorite brands brings low wholesale prices. Moberly, Box 1016, Owensboro, Kentucky.

FREE Cigars and pipe with 5 pounds guaranteed cigarette, pipe or chewing tobacco \$1.00, ten \$1.75. Send no money. Reves Tobacco Co., Paducah, Ky.

GOLDEN Burley, 25 hands \$1.00; 60—\$2.00, postpaid. Graylodge, Alvarado, Va.

POSTPAID: 5 Pounds very best, bulk sweetened, Red Leaf chewing or mild smoking \$1.00. Mellofarms, Martin, Tenn.

SURVEYING INSTRUMENTS

GUARANTEED Factory rebuilt transits and levels for rent (with purchase option) or sale (cash or terms). Order now before prices advance. We will repair, trade in, or buy your old instruments. Ship prepaid for estimate and valuation. Write for List M-21 and complete information to Warren-Knight Co., 136 N. 12th St., Philadelphia, Pa.

FOR SALE OR EXCHANGE

TRADE Rags, raw wool for new wool blankets. Write for details. Adams-Clark, 3539-A Fifth Ave., Chicago.

WANTED—MISCELLANEOUS

WANTED—Slightly used South Bend workshop with long bed, cheap. A. B. Conklin, 2255 Calder Avenue, Beaumont, Texas.

CASH For used microscopes, binoculars, slide rules, drawing sets, cameras, surveying, scientific instruments, tools, marine equipment, sporting goods. Highest prices paid day shipment received. Satisfaction guaranteed or shipment promptly returned. Elman's 2302 Van Buren, Chicago.

PERSONAL

DON'T Stammer! New, revolutionary speech control system assures permanent correction. Normal Speech Mail Course, 236 Palmer St., Grand Rapids, Mich.

"KILZKOFF" Syrup is unequalled for coughs from colds, sore throats. Ingredients anywhere. Formula 50 cents. Drawer 309, Canon City, Colorado.

HAIR Getting thin? Then investigate my "No Hair—No Pay" offer. No obligation. Paul Downing, 625 Sweetland Bldg., Portland, Oregon.

NEW, Enlarged edition, "The Secret Place." Personal power, confidence, health, banish fear, nervousness, win friends, prosper. 1,000 sold, 64 pages, money back guarantee, 50 cts. M.O. Dr. Smith, Box 71, Stoneham, Mass.

"BOULWARE'S Skin Lotion"—Relieves skin irritations, 50c. Box 364, Rock Hill, S. C.

CASH'S Woven names. For marking men's, women's, children's clothing. Free sample. Outmette's, 907A Brock, New Bedford, Mass.

STUTTERING And stammering corrected at home. Descriptive booklet free. Paul J. Wolfe, Box 52, Pittsburgh, Penna.

MISCELLANEOUS

SEND 25c For beautiful Ozark ash tray, made of native cedar and shell, also 50c size. Other novelties. Dealers take notice. Make ideal gifts. Ozark Novelties, Arcadia, Mo., Box 5.

BEAUTIFUL Carved wood figures. 21" high, cheap. Motyka, 2237 N. Monitor, Chicago.

USED PA Amplifiers, mikes, accessories, parts, cheap. Rauschenberg, Titusville, Pa.

DINOSAUR Specimens for the finest collections get yours now. Write M. Lieske, Nucia, Colorado.

HAWAIIAN Caress perfume, no elty bottle \$1. Lel sachet 25c. Box 2273A, Honolulu.

ASH Trays made from large fresh water shells. Price 25c. Posters, Tallulah, La., Box 891.

BLADES—50 Double edge 50c, single 75c. Kramer, 413 Sixth St., Brooklyn, N. Y.

MAKE Basement walls, floors waterproof. Inexpensive. Permanent. Gerwin, Shawnee, Oklahoma.

CASH Paid for butterflies, insects. See Sinclair Display Advertisement on page 14A.

POCKET Goods. Circulars free. Frank Shilling, 1017-J Dueber, Canton, Ohio.

PREVENT Sweating, steaming, filmy eye glasses—Crystallike Compound pocket compact. Guaranteed one year supply. Send 25c silver. Crystallike, 3034 Holland Avenue, Bronx, N. Y.

STORIES Wanted for sales dept. Also arranging, typing, etc. Crown Service, 917 Shreve Bldg., San Francisco.

COCOONS, Butterflies, collectors' supplies, butterfly art materials. Free lists. Maynard, 1192 Lewiston, Rochester, New York.

TATTOOING Outfits, supplies. Illustrated list. "Waters," 965 Put-nam, Detroit.

SCRAPBOOK Hobby. Scrapbooks bought, sold, materials supplied. 5c brings folder telling how to make a collection. Mulligan, 255 W. 92, New York.

LOCATE Buried treasure, ore veins, meteorites, etc., by radio and electricity. Diagrams and instructions \$1.00. Neal Brown, Richland Springs, Texas.

MEXICAN Curios. Christmas novelty. Particulars free. Samples 10c stamps. Apartado 1176, Mexico City, Mexico.

AMATEUR Tattooing outfits, illustrated catalog 6c. "Tattoo," 651A South State, Chicago.

CHRISTMAS Perfumes. One bottle fragrant bouquet 25c coin. Addison Laboratories, Pawling, New York., Dept. B.

SECURE Applications new fraternity. Oviatt, 878 E. Third, Pomona, California.

SINGING Canary novelty. Imitates canary perfectly. 50c. A. J. Ledesky, Box 123, Ernest, Pa.

\$1.00 MONTHLY Maintains New York office. Co-operative Mail Service, 126-F Lexington Ave.

TREASURE Finding and metal locating devices galore. Thirty-two names and addresses to obtain scientific devices and plans from. Complete information \$1.00. Piltz, Box 603, St. Petersburg, Florida.

BOY Mechanic—Famous library of 4 volumes covers the building of almost everything a boy might want to make. A great boon to parents and teachers. Actually covers 4,000 different articles. Each volume 460 pages, fully illustrated. Cloth. Price \$2.00 each or set of 4 vols.—\$7.00 postpaid. Popular Mechanics Press, Room (C36), 200 E. Ontario St., Chicago.

SIGNS—By new method. Particulars 10c. Straley, 13 1/2 Main, Springfield, Ohio.

NO Boss! Sure cash! Silvering mirrors, autoparts, reflectors. Combination outfit. Write Sprinkle, Plater, 288, Marion, Ind.

MONUMENTS \$9 Up delivered, erected, guaranteed. Thousands sold. Catalog free. Marble Granite Factory, A-17, Oneco, Fla.

WANTED—Hear from parties interested gold or silver ores, buried or hidden treasures. Bergman's instrument \$5.00. Particulars free. Henry Bergman, Box 398P, Springfield, Missouri.

TREASURE Seekers—Make your own gold finders. Wyss, 104 1/2 Frances, St. Joseph, Missouri.

BRONZE Tablets, desk plates, wall pates, memorials, grave markers. Bronze, brass and aluminum casting. Wandkey Pattern & Foundry Co., Anderson, Ind.

SWAPPER'S Friend. R4. Salline, Michigan. Interests swappers, collectors, sportsmen. 50c year, sample 10c.

DIESEL POWER

A Coming American Industry



Courtesy "Diesel Progress"

The internal-combustion engine represents man's supreme triumph of machine power. Diesel engineers are in great demand. Many are acquiring necessary knowledge through spare-time study of this modern I. C. S. Course on Diesel engines. Free booklet—use coupon!

RADIO

holds great rewards for trained men



Almost in a decade radio has become a giant industry. The opportunities created will be enjoyed by trained men. The International Correspondence Schools Radio Course, prepared by leading authorities and constantly revised, will help make you a trained man! A fascinating book — FREE.

MECHANICAL ENGINEERING

—A Field with a Future



This course has meant advancement to hundreds of ambitious men, mechanics, draftsmen, blacksmiths, foundrymen, patternmakers, apprentices, and mechanical engineers — men who wanted to get ahead and to earn more money. You will find, as they have found, that enrolling for an I. C. S. Course is an investment in a Bigger Future. Use the coupon! No obligation.

AIR CONDITIONING

today's big opportunity!

Air Conditioning is the next big industry. Mark that prediction! Its opportunities are as big in winter as in summer. Plumbing and heating engineers must know Air Conditioning — the field in its broader aspects invites ambitious men. And a new, up-

to-the-minute course on Air Conditioning now offered by the International Correspondence Schools is a golden avenue for success. Full information — free!

INTERNATIONAL CORRESPONDENCE SCHOOLS

Box 5651-H, Scranton, Penna.

Without obligation, send me full information on subject checked below:

- | | |
|---|---|
| <input type="checkbox"/> DIESEL POWER | <input type="checkbox"/> RADIO COURSE |
| <input type="checkbox"/> MECHANICAL ENGINEERING | <input type="checkbox"/> AIR CONDITIONING |
- | | | |
|--|---|--|
| <input type="checkbox"/> Architecture | <input type="checkbox"/> Drafting | <input type="checkbox"/> Accounting |
| <input type="checkbox"/> Concrete Construction | <input type="checkbox"/> Good English | <input type="checkbox"/> Salesmanship |
| <input type="checkbox"/> Reading Shop Blueprints | <input type="checkbox"/> Advertising | <input type="checkbox"/> Show Card Lettering |
| <input type="checkbox"/> Civil Engineering | <input type="checkbox"/> Civil Service | <input type="checkbox"/> High School Subjects |
| <input type="checkbox"/> Diesel Engines | <input type="checkbox"/> Electrical Engineering | <input type="checkbox"/> Inventing and Patenting |
| <input type="checkbox"/> Gas Engine Operating | <input type="checkbox"/> Aviation Engines | |
| <input type="checkbox"/> Refrigeration | | |
| <input type="checkbox"/> Chemistry | | |
| <input type="checkbox"/> Highway Engineering | | |
| <input type="checkbox"/> Poultry Farming | | |

Name _____

Address _____

TELEVISION

Get Ready for
Nation-Wide Activity

is Here!

"Electronic Television" Gives all Facts and Practical Working Information. Only \$2.50

Get this newly published non-technical book. Prepare for Television's big opportunities. Covers everything, including methods, apparatus, wiring diagrams. Authorized by R. C. A. and Farnsworth, leaders in Electronic Television development. Material never before in print. Flexible binding, 182 pages. Illustrated. Postpaid only \$2.50. Money back if not satisfied. Order Electronic Television today and ask for catalogue FREE.



New, Authorized, Authentic.

Tells about cathode ray, incolescope, kinescope, and other new Television developments.

THE GOODHEART-WILCOX COMPANY, INC.

(Publishers of Deke's Auto Encyclopedia)

Dept. PM

2009 Michigan Avenue, Chicago

Write and Speak

MASTERLY ENGLISH



Learn correct English with Sherwin Cody's new invention. No rules to memorize. Like a fascinating game. Spare-time study, 15 minutes each day, quickly gives you command of English. Send for free book, "How You Can Master Good English in 15 Minutes a Day." Write today. SHERWIN CODY SCHOOL OF ENGLISH
51 Searle Bldg. Rochester, N. Y.

LEARN to SELL STOP Being a Failure

Secrets of successful salesmen making \$4,000 to \$10,000 a year now available in fascinating salesmen's home training plan. Coming business boom bound to make good salesmen wanted everywhere at top salaries. Get into the BIG PAY GROUP of master salesmen through "knowing how." Two books, "The Key to Master Salesmanship" and "Mistaken Commonly Made in Selling" sent FREE to men who want to get ahead. Write for them today.

NATIONAL SALESMEN'S TRAINING ASSOCIATION
Dept. 109A—21 W. ELM ST., CHICAGO

KNOCK-EM-COLD!

THE BIGGER THEY ARE, LEARN JIU JITSU!

13 secret knock-out blows copyrighted by world famous Police Jiu-Jitsu Instructor

A little jab with tip of fingers or strike with edge of hand to the right spot and the tough guys go out like a light. The world famous Northwest Mounted Police use his method in part of their training. Send now for this illustrated booklet. Full price 15c postpaid. Also learn how you may defend yourself against any man regardless of size or strength whether he is armed with gun, knife or club.

S. J. JORGENSEN, 789 Maritime Building, Seattle, Washington



In answering advertisements always write name and full address clearly.

THAWS FROZEN PIPES IN 1 MINUTE!

Only \$39.25 COMPLETE

Big, Quick Money-Maker for Plumbers! Money Saver for Municipalities, Building Operators, Etc.

Amazing new Reliance Electric Pipe Thawer.—thaws out frozen pipes easily, quickly, economically, and safely. No danger of bursting pipes or causing fires; no need for carpentry or digging. Ends ripping out walls, tearing up floors, or digging through frozen ground to get at hidden or buried pipes. Simply attach cables of the Reliance to faucets, meter, or shut-off valves; plug into nearest electric socket, and IN ONE MINUTE the water flows freely. Sensational low price—only \$39.25 complete with accessories — yet does work of machines costing \$165.00 to \$3000.00. Works on 110 or 220 Volt, 50 or 60 cycle alternating current. Easily portable; weighs only 90 lbs. A money Details FREE! Make big profits or save money thawing frozen pipes in one minute without fuss, muss or bother of old-fashioned, dangerous methods. Write today for full details of Reliance Pipe Thawer at only \$39.25

RELiance PIPE THAWER CO.
3785 Beechmont Ave., Dept. P-706, Cincinnati, Ohio

Professional Efficient
12 BATTERY CHARGER Only \$ **19**⁷⁵—



Get Your Share Of Easy, Quick Battery Charging Profits

Yes, it's true! A big, professional, 12-battery-capacity 6 ampere charger—only \$19.75!—only HALF the cost of old-fashioned Chargers. Now every garage, filling station, repair shop, tire and accessory shop can cash in on BIG PROFIT battery-charging business. The WONDER

Battery Charger is a full-sized, sturdy, welded-steel-construction machine. Built on new, scientific principle, fully patented, that makes sensational low price possible, yet assures greatest charging efficiency at lowest power cost. Operates from 110-Volt to 125-Volts, 50 or 60 cycle A. C. Socket. Measures 11" by 11" by 12 1/2". Weighs 35 pounds complete.

Completely charges up to 12 batteries in 18 hours—giving you PROFITS up to \$8.00 a DAY. Has accurate ammeter and embodies every feature of higher priced chargers.

FREE DETAILS! Battery charging service is almost ALL PROFIT! Stop sending good money out of your shop. Makes money for you while you sleep! Write today for sensational facts and full details and specifications. No obligation.

WONDER BATTERY CHARGER CO.
3789 Beechmont Ave., Dept. P-205, Cincinnati, Ohio

New **JOBS for THOUSANDS in**
AIR CONDITIONING
and REFRIGERATION

If you want steady work—all year 'round—good pay, or a business of your own, prepare NOW. Such ground-floor opportunities are rare. Learn at low cost right in your own home (or at our school in Chicago). Write for FREE "Prosperity Booklet."
CHICAGO TECHNICAL COLLEGE
A 301 Tech Bldg., 118 E. 26th St., Chicago

33rd Year Get Free "Prosperity Booklet"

MAN IN EACH TOWN To Plate Auto Parts,
Reflectors, Mirrors, etc., by late method. Experience unnecessary. Free particulars and proofs. Write today.
GUN METAL CO., Ave. M, Decatur, Ill.

ARMY AND NAVY SUPPLY CO.
Bargains—Army, Sport Goods, Firearms, Clothes, Shoes, etc. Send 10c for new catalog, to be redeemed on first order
Army & Navy Supply Co., 4772 Lester St., Richmond, Va.

S **AGENTS** 500% Profit **GOLD LETTERS**
For Store Fronts and Office Windows. Anyone can put them on. Free samples. Liberal Offer to general agents.
METALLIC LETTER CO., 438 N. Clark St., Chicago

5c TIRE MAKES \$2.00 MAT
Make springy, long-wearing Rubber Mats out of old auto tires. Any length or width. BIG sale to schools, factories, stores, homes. Think of the profit. Brand new business, fully patented. Field untouched. Reasonable investment and simple hand machine starts your local plant. Write quick for free information. Don't lose a minute—this is BIG!
FABRIX, Inc. Dept. 71 325 W. Huron St., Chicago, Ill.

Join THE BAND WITH A
BUESCHER
True Tone

● Top flight radio artists, like Hal Kemp, pictured above, choose Buescher instruments for their beautiful tone and easy playing qualities. You will learn quickly—take your place in a band or orchestra in a short time with a Buescher True-Tone. **FREE TRIAL; Easy Payments.** Write now for details. Mention which interests you: saxophone, cornet, trombone, any instrument for band or orchestra.
BUESCHER BAND INSTRUMENT CO.
110 Buescher Bldg. Elkhart, Indiana

EASY TO PLAY

MEN WANTED
for Big Pay Jobs
in Air Conditioning

Get into the big pay jobs in one of the world's fastest growing industries—AIR CONDITIONING-REFRIGERATION. This new field is rapidly becoming one of the country's foremost industries. LEARN NOW. Train in our shops and laboratories under actual working conditions. DIESEL POWER-UNITED ENGINEERING SCHOOLS, one of the world's largest systems of Air Conditioning-Refrigeration, Diesel Schools. Trained men are in demand all over the country. Homes, offices, trains, factories, stores are rapidly installing Air Conditioning. GET STARTED TODAY! Tear out the coupon and send it in. Do it NOW!

DIESEL ENGINEERS
IN DEMAND!

Diesel motors are rapidly replacing all other types of power plants on land, sea and air. Learn how to maintain, install and operate, these motors by actual motor practice in our big shops and laboratories.

EARN BOARD and ROOM

We assist you in securing part time work to help defray your expenses while in practical training. Also FREE National Lifetime Employment Service upon graduation.

MAIL COUPON TODAY

Mail the coupon today for FREE copy of latest developments in Diesel and Air Conditioning-Refrigeration. See for yourself the undreamed of opportunities now open in these fields.

DON'T BE MISLED—Diesel Power-United Engineering Schools are located only at the addresses shown below.

KANSAS CITY, MISSOURI 1520-22 McGee Street	CLEVELAND, OHIO 1124 Carnegie Ave.
MINNEAPOLIS, MINN. 5 North 15th Street	SAN FRANCISCO, CALIF. 3320 Twentieth Street

Diesel Power-United Engineering Schools
(Use nearest address above)

Gentlemen: Dept. PM-1
Please send me without obligation, information about the subject which I have checked below.

Air Conditioning-Refrigeration Training
 Diesel Training

NAME..... AGE.....
ADDRESS.....
CITY..... STATE.....

When writing please mention Popular Mechanics

This MACHINISTS' Home-Study Course



helps men get ahead

Newly assembled—specially priced—these five recent books give you the practical facts on modern machines, up-to-date methods, you need to advance in machine shop work. Take advantage of the other man's experience as found in books, to solve your problems, increase your efficiency, with the new

Library of MODERN MACHINE SHOP PRACTICE

5 volumes—2000 pages—1600 Illustrations
(A combined home-study course and reference library)

This library of machine shop practice was written for practical men. It gives you the best methods for every kind of machine shop work. It fully explains lathes, drills, and other machine tools and their operation, automatic screw machines, speeds and feeds, gear design and production, punch and die work, metal finishing, etc., etc. Plainly written—completely illustrated—the best kind of help to the machine-shop man who wants to advance himself.

No money down—special price—easy payments.

FREE EXAMINATION COUPON

McGraw-Hill Book Co., 330 W. 42nd St., New York

Send me for ten days' free examination the Library of Modern Machine Shop Practice. If satisfactory I will send you \$1.50 in 10 days and \$3.00 monthly until the price of \$16.50 is paid. If not wanted, I will return the books postpaid. (To insure prompt shipment write plainly and fill in all lines.)

Name

Home Address

City and State

Position

Name of Company

PM-1-37

FREE BOOK Tells How to Earn UP TO \$30-\$50 and more WEEKLY

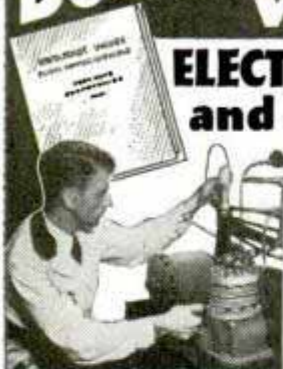

ELECTRIC REFRIGERATION and AIR CONDITIONING

Think, Man! Two new, rapidly growing industries offer the very opportunity you are looking for. Big Pay. Fascinating Work—a bright Future. Where would you be today if you had been able to cash in on the opportunities offered by the Radio and Automobile Industries when they were new? Think how men's salaries soared—how "beginners" were skyrocketed into permanent prosperity.

MEN NEEDED NOW

RIGHT NOW there are new jobs for thousands in Electric Refrigeration and Air Conditioning. Prepare for your opportunity at home in spare time by U. E. I.'s low-cost, easy-pay plan. Learn Engineering, Estimating, Installation and Servicing, under a system that has brought outstanding results for TEN YEARS. Get practical experience in one of our large, completely equipped Laboratories where you'll learn by doing.

LET US HELP YOU PREPARE FOR A BIG PAY JOB

U. E. I. trained men now employed by leading manufacturers, distributors and service organizations. U. E. I. Employment Service offered FREE of extra cost. What it has done for others it can do for you. Write for Book of Facts about your opportunity.

UTILITIES ENGINEERING INSTITUTE

Established 1927

400-410 N. Wells St., Dept. 117
CHICAGO, ILL.

U. E. I. TRAINING HELPS MEN GET JOBS

"Got job with Mr. H., one of the men to whom you wrote letters . . . taking your course was wisest thing I ever did." L. E. C., Calif.

"Called on Mr. W. of the Ideal Refrigeration Company and the fact I had training with U. E. I. got me job. Mr. W. is a U. E. I. graduate." W. F. L., Mich.

"Secured employment with C. & S., one of firms to which you referred me . . . taking full charge of Service Departments." R. R. W., Ill.

"Am now employed by Frigid-air in charge of assembly of self-contained room coolers . . . would never have made it without your training." J. S. S., Ohio.

Music Lessons

A Complete Conservatory Course

by Mail under master teachers. Piano, Harmony, Voice, Public School Music, Violin, Cornet, Trumpet, Mandolin, Guitar, Banjo, Organ, Accordion, Saxophone, Clarinet. Lessons amazingly easy, complete. Mention instruction desired. Low cost; terms. Catalog free.

University Extension Conservatory, Dept. S-2. 1525 E. 53rd St., Chicago

Ask for
FREE
Catalog



ITALIAN ACCORDIONS

OF ALL TYPES. Hand-made, best quality. Buy direct from our factory and save 1/2. Satisfaction guaranteed. Used musical instruments taken in trade. FREE accordion lessons.

ITALIAN ACCORDION CO.
323 W. Polk St., Dept. P-3, Chicago

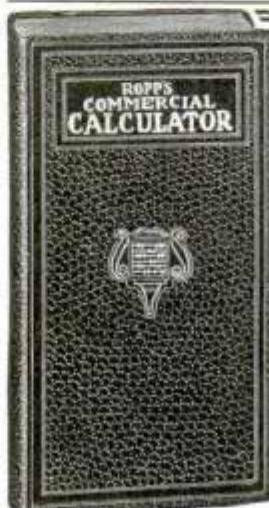

Mathematics Made Easy by ROPP'S CALCULATOR AND SHORT-CUT ARITHMETIC

Shows the Answer as Quickly as a Watch shows the Time to all Problems likely to occur in the Office, Store, Shop, Bank, Farm, or Factory.

Over 2,000,000 Sold

Explains and simplifies every principle in Arithmetic, Mechanics, and Mensuration.

PRICES POSTPAID

Desk Size, Flexible Keratol Binding \$2.00

Pocket Size, Art Leather Binding \$1.00

Pocket Size, Cloth Binding \$0.50

POPULAR MECHANICS PRESS

Room P-1 200 E. Ontario St. CHICAGO



Build a BOAT FOR PLEASURE OR PROFIT



Shows EXACTLY HOW TO BUILD 15 DIFFERENT BOATS

This is the new edition with 42 added pages, 6 new boats, and conversion of Ford motor for marine use. Full directions and details for cabin cruiser, racing, hydroplane, outboard runabout, sail boats, kayak, sled type—15 boats in all. Also sectional boat to carry on car.

SEND NO MONEY

Write for new edition of Boat Book today! Sent anywhere. Pay postman \$3.00 plus few cents postage. Outside U. S. and possessions remit with order. Money refunded if not satisfied.

POPULAR MECHANICS PRESS—Room 137A
200 East Ontario St., Chicago

EASY—LOW COST
with

POPULAR MECHANICS

BOAT BOOK

Build a boat at home! You can do it. Just the kind you've wanted—power, sail, or row boat. The "Boat Book" shows you how in simple step-by-step directions. Specially prepared for those with limited tools, little skill and money. Build boats to sell for profit too. Book tells how.

GIVES PLANS, METHODS AND MATERIALS

Actual working plans and photos of real boats under construction makes building easy. Shows materials needed and rock-bottom costs. Hundreds of pictures. No chance for mistake. Includes also, navigation and pilot rules, handling sailing craft, boat kinks, boating terms. Everything a boat enthusiast should know. Size 7x10 inches. 312 pages. Fine cloth binding.

"4 Months In WASHINGTON"



Won Me A Well Paid HOTEL POSITION"

Delmas Richardson, Former Salesman, Tells How He Became Hotel Manager Through Lewis Course

"Before going to Washington to take the Lewis Hotel Training Course, I was just a salesman earning a small salary. I was discouraged and very unsettled as to my life's work. Hotels have always interested me, so, seeing an advertisement in a magazine, I decided to take the course. Since graduating I have never been unemployed and am very much satisfied with my work. A year ago I took over the management of this hotel and made good. The Lewis Course did it all."

Delmas Richardson is typical of the many Lewis Resident School graduates who have won success from coast to coast in the hotel and institutional field. In four months they were qualified for the position of their choice in this fascinating industry. You have the opportunity to make Delmas Richardson's story YOUR story—if you make the same decision TODAY he made a short time ago. FREE book gives full details—tells how you are registered, FREE of extra cost in Lewis Nation-wide Placement Service. Write for it TODAY!

LEWIS HOTEL TRAINING SCHOOLS
Div. RPA-308 Washington, D. C.

AVIATION



APPRENTICES

Ambitious, air-minded young men, interested in entering the well paid field of Aviation, write immediately, enclosing stamp, to

Mechanix Universal Aviation Service, Incorporated
Strathmoor Station Dept. E Detroit, Mich.

BIGGEST BUY EVER OFFERED — ALL \$1



COMPLETE TAXIDERMAY COURSE NO OTHER COST

WITH LIFE MEMBERSHIP—DIPLOMA
SCHMIDT'S original \$15.00 Complete Professional Training in Taxidermy. NOW only \$1.00 postpaid. This marvelous Home Course has easily and quickly taught thousands to mount birds, animals, fish; make novelties, tax hides... among the 218 subjects. All comes at once—start mounting first day—anyone can do. Send only \$1.00 with order or pay postman \$1.00 PLUS postage. Guaranteed.
SCHMIDT SCHOOL OF TAXIDERMAY, Dept. G-1-1, Memphis, Tenn.

PRINT-O-PRESS TYPELESS PRINTER



Professional Model Does the Work of

Equipment Costing Up to \$200, only \$7.95
Amazing new fast Rotary Universal Printer. Prints letters, advertising, etc., for stores, offices, factories, churches, restaurants, home work. Factory-precision-built; has advanced features; does color work; portable. Simple—anyone can use it. Opens four big profit sources. Order direct. Rush \$7.95 for yours complete. Guaranteed.

Write for Free Sample of work. Write for Free details
The Professional Products Corp. Dept. 110 Silverton, Ohio

MECHANICAL ENGINEERING

—A Field with a Future



This course has meant advancement to hundreds of ambitious men, mechanics, draftsmen, blacksmiths, foundrymen, patternmakers, apprentices, and mechanical engineers—men who wanted to get ahead and to earn more money. You will find, as they have found, that enrolling for an I. C. S. Course is an investment in a Bigger Future. Use the coupon!

ELECTRICAL ENGINEERING

—A Great Industry with a Great Future



The new course in Electrical Engineering covers this fascinating field thoroughly. If you are just starting or are partly on the way to a real paying position in this industry, this new course brings the broader knowledge necessary for advancement. The coupon brings complete information.

DIESEL POWER

A Coming American Industry



Courtesy "Diesel Power"

The internal-combustion engine represents man's supreme triumph of machine power. Diesel engines are in great demand. Many acquire necessary knowledge through spare-time study of this modern I. C. S. Course on Diesel engines. Free booklet!

AUTOMOBILE EXPERTS

are always in demand

The rapid progress in manufacture and service of the modern automobile brings new opportunities to thousands of ambitious and forward-looking men. There's always a demand for trained men. The new I. C. S. Automobile Course will make you a trained man! The time to act is now. Use the coupon.



INTERNATIONAL CORRESPONDENCE SCHOOLS

Box 5650-H, Scranton, Penna.

Without obligation, send me full information on subject checked below:

- | | |
|--|--|
| <input type="checkbox"/> MECHANICAL ENGINEERING | <input type="checkbox"/> MECHANICAL ENGINEERING |
| <input type="checkbox"/> ELECTRICAL ENGINEERING | <input type="checkbox"/> DIESEL POWER |
| <input type="checkbox"/> DIESEL POWER | <input type="checkbox"/> AUTOMOBILE COURSE |
| <input type="checkbox"/> Architecture | <input type="checkbox"/> Drafting |
| <input type="checkbox"/> Concrete Construction | <input type="checkbox"/> Accounting |
| <input type="checkbox"/> Reading Shop Blueprints | <input type="checkbox"/> Good English |
| <input type="checkbox"/> Civil Engineering | <input type="checkbox"/> Salesmanship |
| <input type="checkbox"/> Diesel Engines | <input type="checkbox"/> Advertising |
| <input type="checkbox"/> Gas Engine Operating | <input type="checkbox"/> Show Card Lettering |
| <input type="checkbox"/> Refrigeration | <input type="checkbox"/> Civil Service |
| <input type="checkbox"/> Chemistry | <input type="checkbox"/> High School Subjects |
| <input type="checkbox"/> Highway Engineering | <input type="checkbox"/> Air Conditioning |
| <input type="checkbox"/> Poultry Farming | <input type="checkbox"/> Inventing and Patenting |
| | <input type="checkbox"/> Aviation Engines |

Name _____

Address _____

t. s. = 200 000 #/□"

No Wonder GENUINE FORD SPRINGS STAND UP!

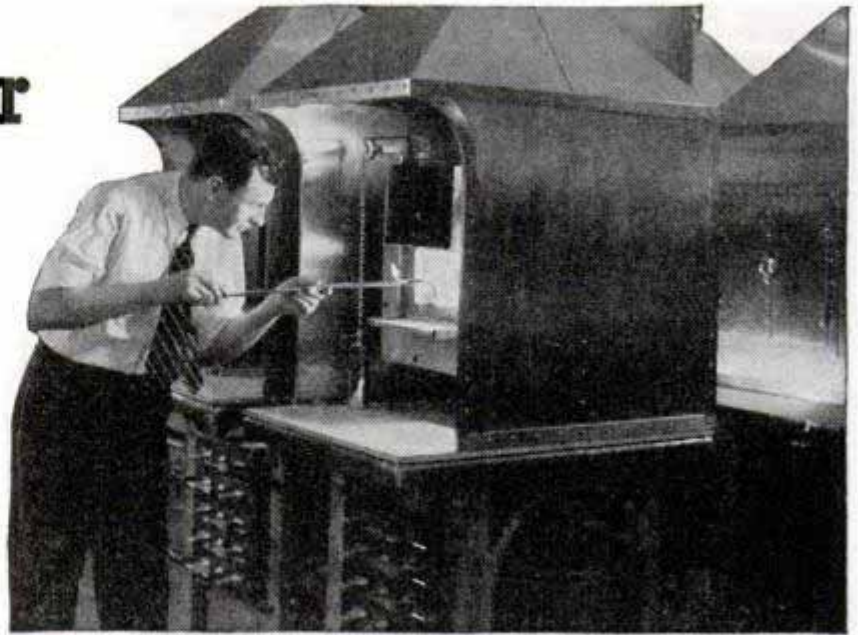

TWO HUNDRED THOUSAND pounds per square inch! That's the tensile strength of the steel in a Genuine Ford Spring. It's an example of the standards of quality to which Genuine Ford Springs are built.

Every batch of steel used in making Ford Springs is carefully analyzed. It must meet rigid specifications established by Ford engineers. Only a high-grade oil-hardened chromium steel is used.

Test springs made up of leaves from the various batches of steel are being constantly subjected to rigorous tests on one of five machines built exclusively for spring testing. And an

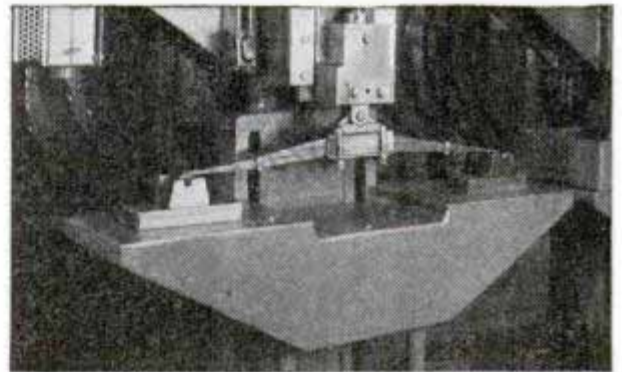

(Above) Heating steel sample in electric furnace at Ford Testing Laboratories. (Below) Fatigue Test equivalent to more than 10 years of usual service.



Springs for 1937 Ford V-8s are provided with an oil groove for interleaf lubrication as shown at left.

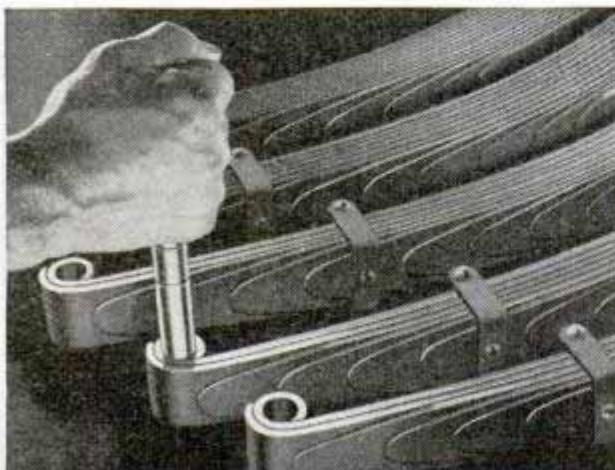

Plug gage inspection of Ford Spring eyes.

example of the precision used in manufacturing Genuine Ford Springs is the fact that the inside diameter of spring eyes is held within limits of two thousandths of an inch.

Quality materials, uniformity of materials, precision manufacture, rigid tests and careful inspections — these are the things that insure Ford quality in Genuine Ford Springs as well as all other Genuine Ford Parts. These are the things that mean you get full value when you buy Genuine Ford Parts.



FORD MOTOR COMPANY

DEARBORN • MICHIGAN

Popular Mechanics Magazine

REGISTERED IN U. S. PATENT OFFICE AND CANADA

WRITTEN SO YOU CAN UNDERSTAND IT

Vol. 67

T-1355

JANUARY, 1937

No. 1

EASIER MOTORING *for* 1937

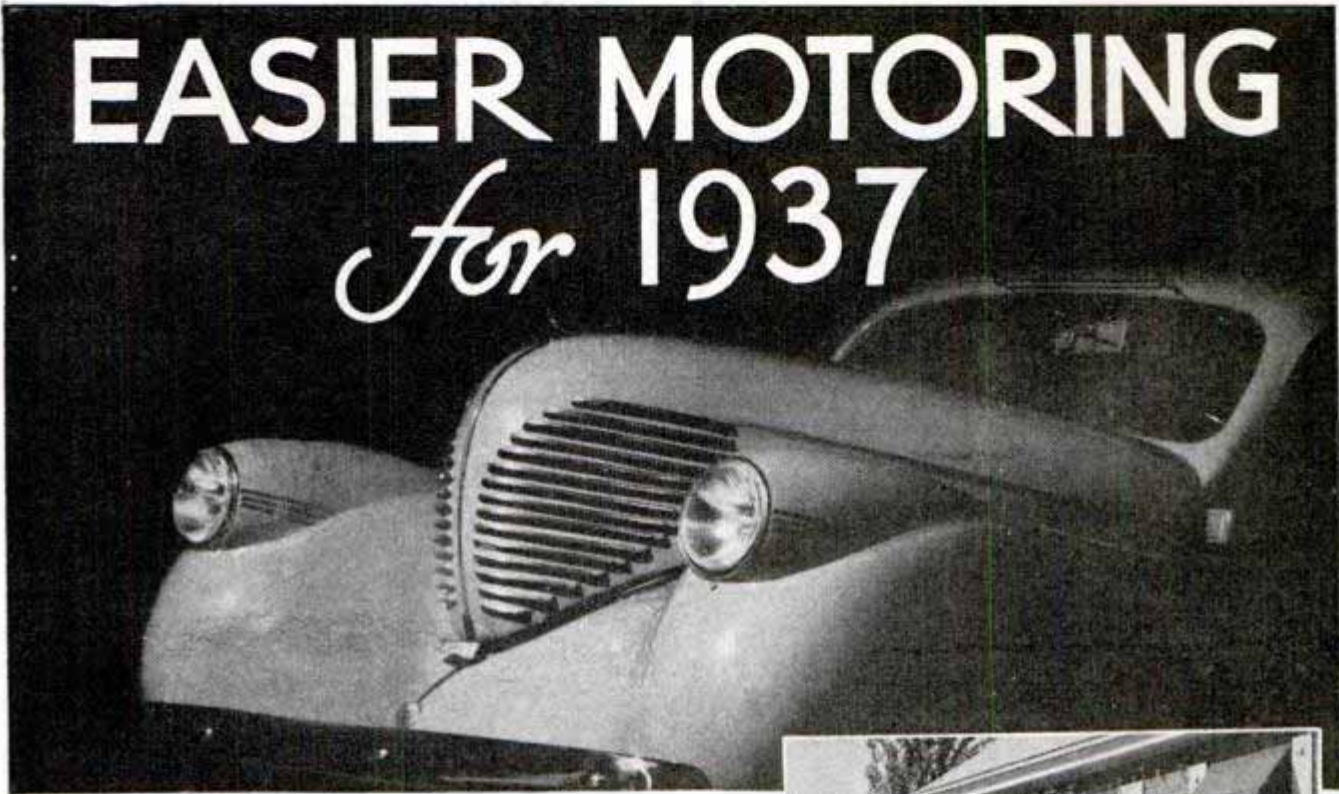

By Julian Leggett

IF ALL the 1937 models could be condensed into one automobile, the owner would find it more economical, more powerful, roomier, safer and considerably more comfortable than its 1936 counterpart. And this hybrid would contain many hints of what the future holds for the American motorist. Better streamlining, more

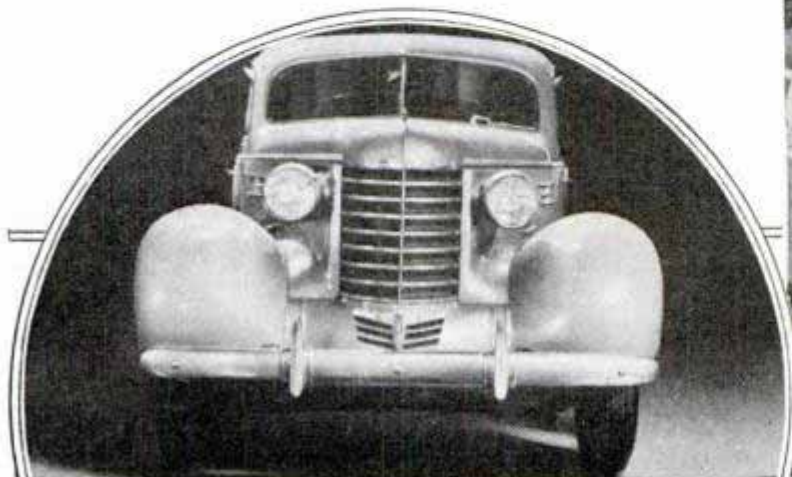
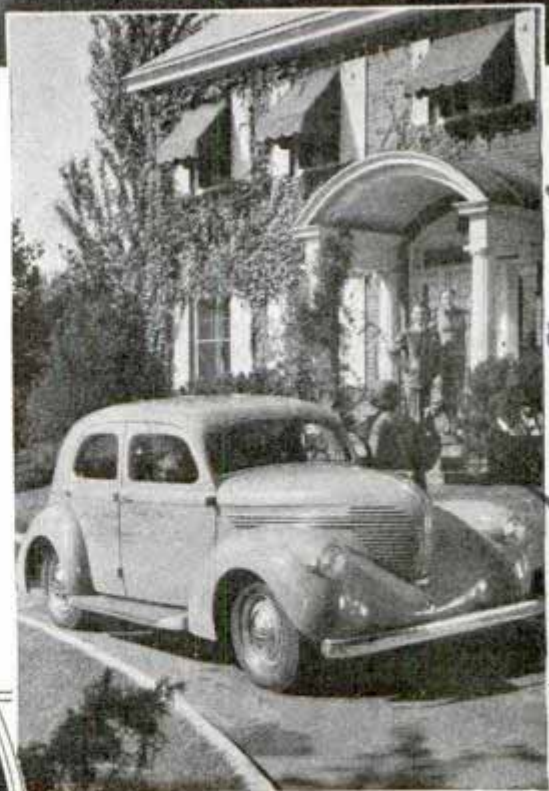

Top, striking photo of new Willys. Right, full-car view of Willys. Left, distinctive front end of the Oldsmobile "6," showing unusual grille distinguishing it from the eight-cylinder car

Willys - Overland Co. Toledo, Ohio

FI 355

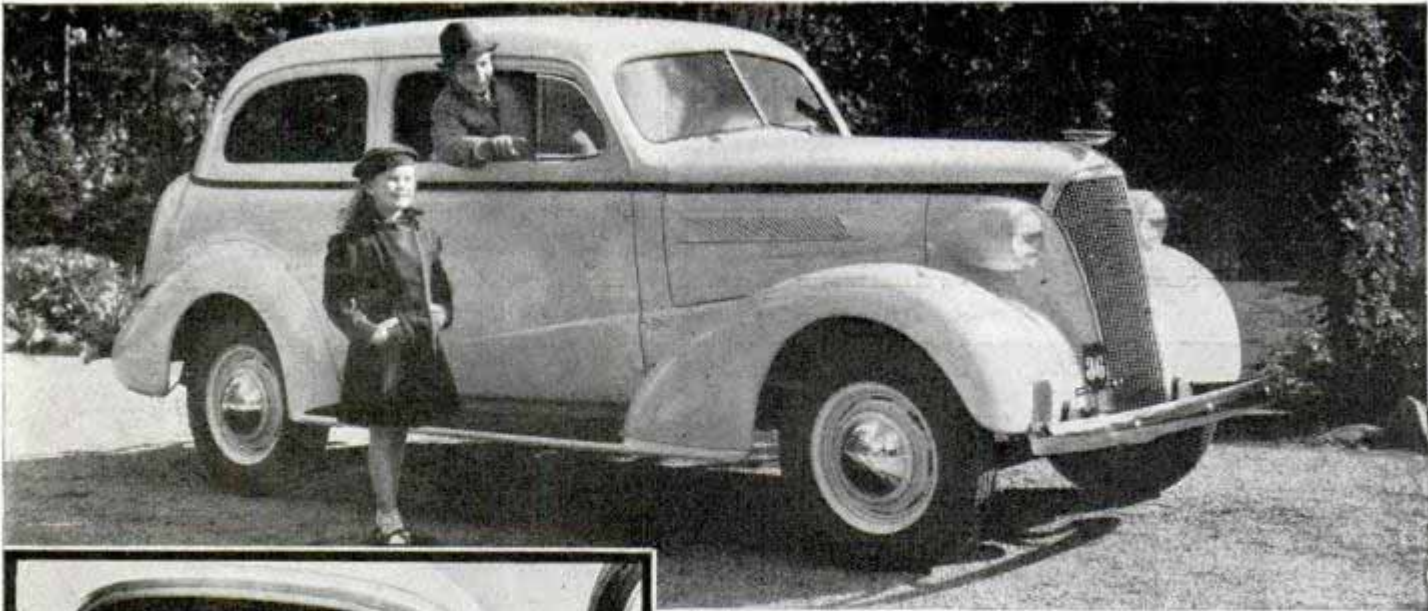

with a heater and foot warmer



nearly automatic regulation of controls, better gas and oil mileage and drastic reduction and simplification of service mark the new cars. Just around the corner is the automatic transmission. A new system, said to be free from objections which resulted in the discard of earlier transmissions, is scheduled for introduction on a car in the class just above the low-price field. This transmission has been tested for hundreds of thousands of miles without major repair, engineers report.

One manufacturer, in the 1937 models, offers the "electric hand," which was introduced sometime ago, an automatic clutch and a selective automatic shift as optional equipment. Nearest thing to the automatic transmission, this combination system has entirely automatic clutch action and a governor which limits coasting or free wheeling to sixteen miles per hour or less. Gear changes are made when the driver's foot is lifted from the accelerator and the engine is idling. The driver is free to select the gear he desires.

Almost universal adoption of certain features marks the 1937 models. These include: roomier bodies and larger baggage compartments; wider windshields set at a sharper angle; defrosting vents built into the instrument panel for connection to the heater; hypoid rear axle which permits lowering the over-all height of the car without the inconven-

Top, fleet-appearing Chevrolet. Center, interior of Plymouth, showing chair-height seats and instrument panel with recessed controls. Bottom, heater and defroster in supercharged Graham

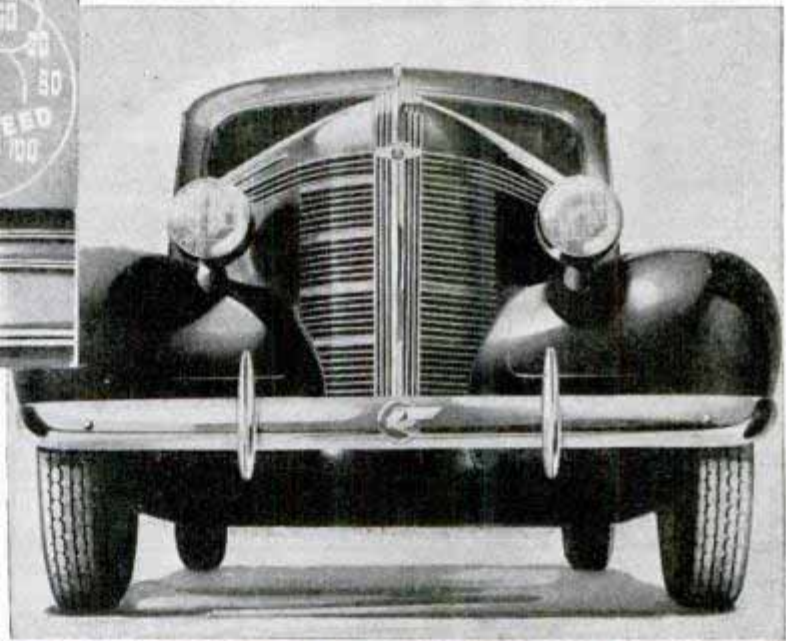
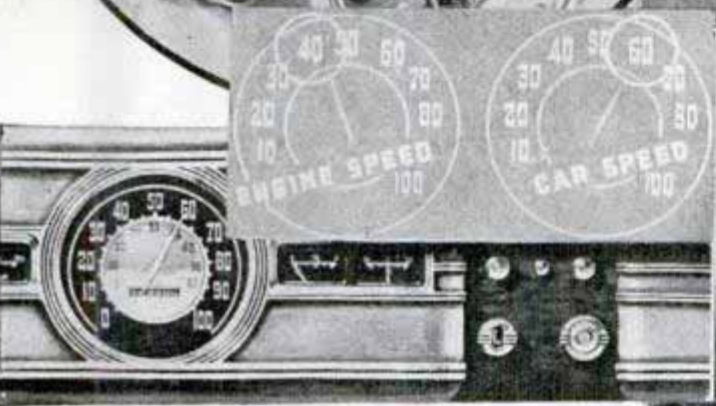
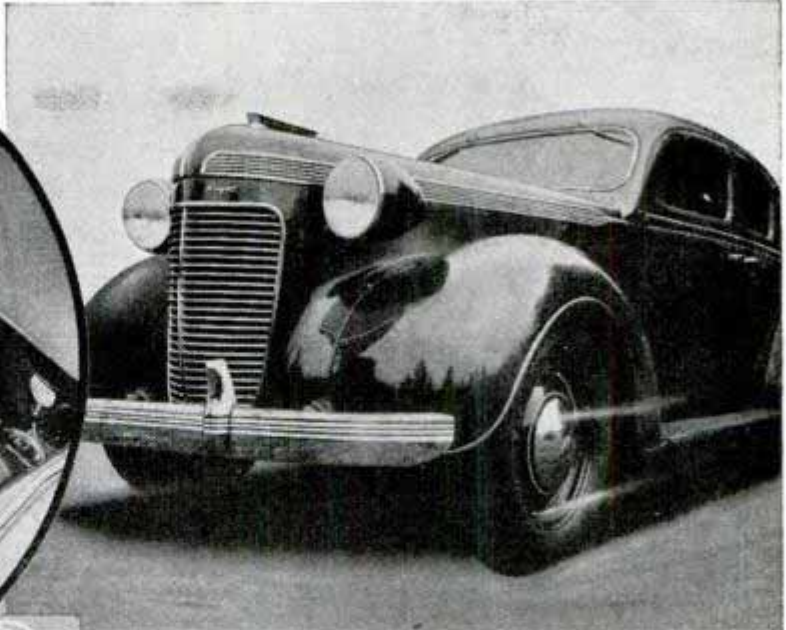
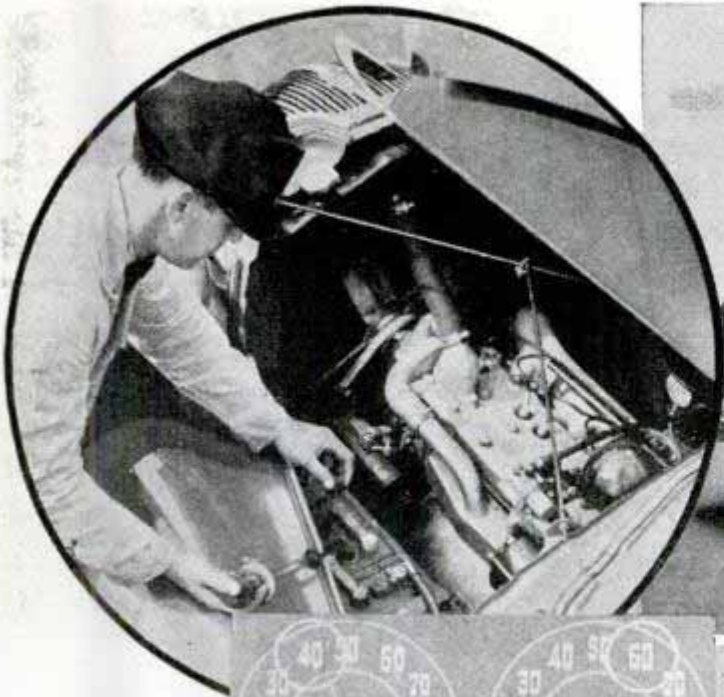

Top, circle, servicing Hudson-Terraplane battery under hood. Below, speedometer on Nash with cruising gear shows car speed and engine speed in miles per hour

ience of a tunnel through the rear compartment; relocation of the license-plate brackets at the rear center instead of at the side; longer wheelbase and more horsepower with lower gear ratios to attain driving speed more quickly; higher compression and improved carburetion for better engine performance and economy, and steel wheels, either with large hubs and short spokes, or disk.

Occupying a prominent position in the new car parade is the Ford, available in de luxe models with an eighty-five horsepower engine and in standard models with either the eighty-five or a sixty-horsepower engine. Both are V-eights. The sixty-horsepower motor, offered for the first time, is designed to meet the public demand for economy without sacri-

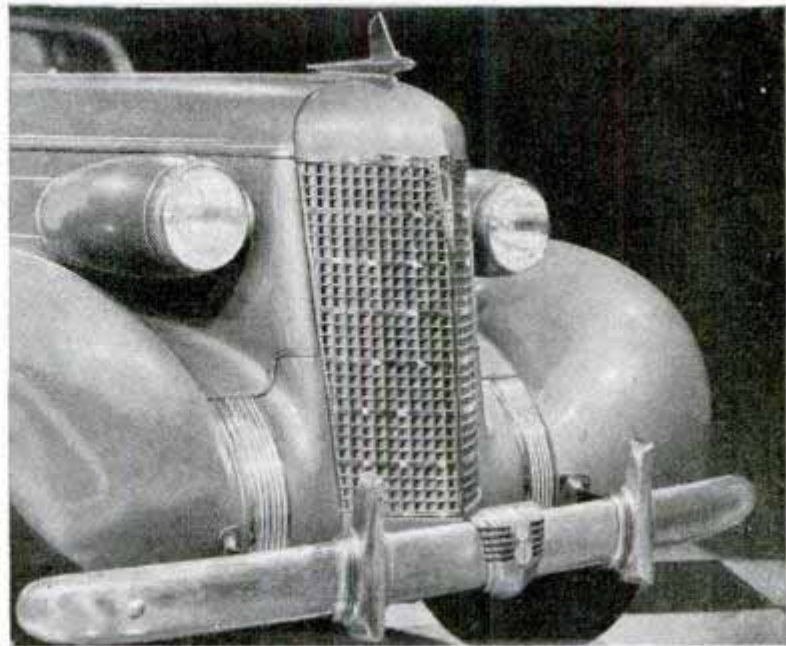

Top, unusual appearance of new Chrysler Royal. Center, head-on view of Pontiac "8." Bottom, Oldsmobile "8." Note novel headlamps and grille

(Handwritten note, partially illegible)

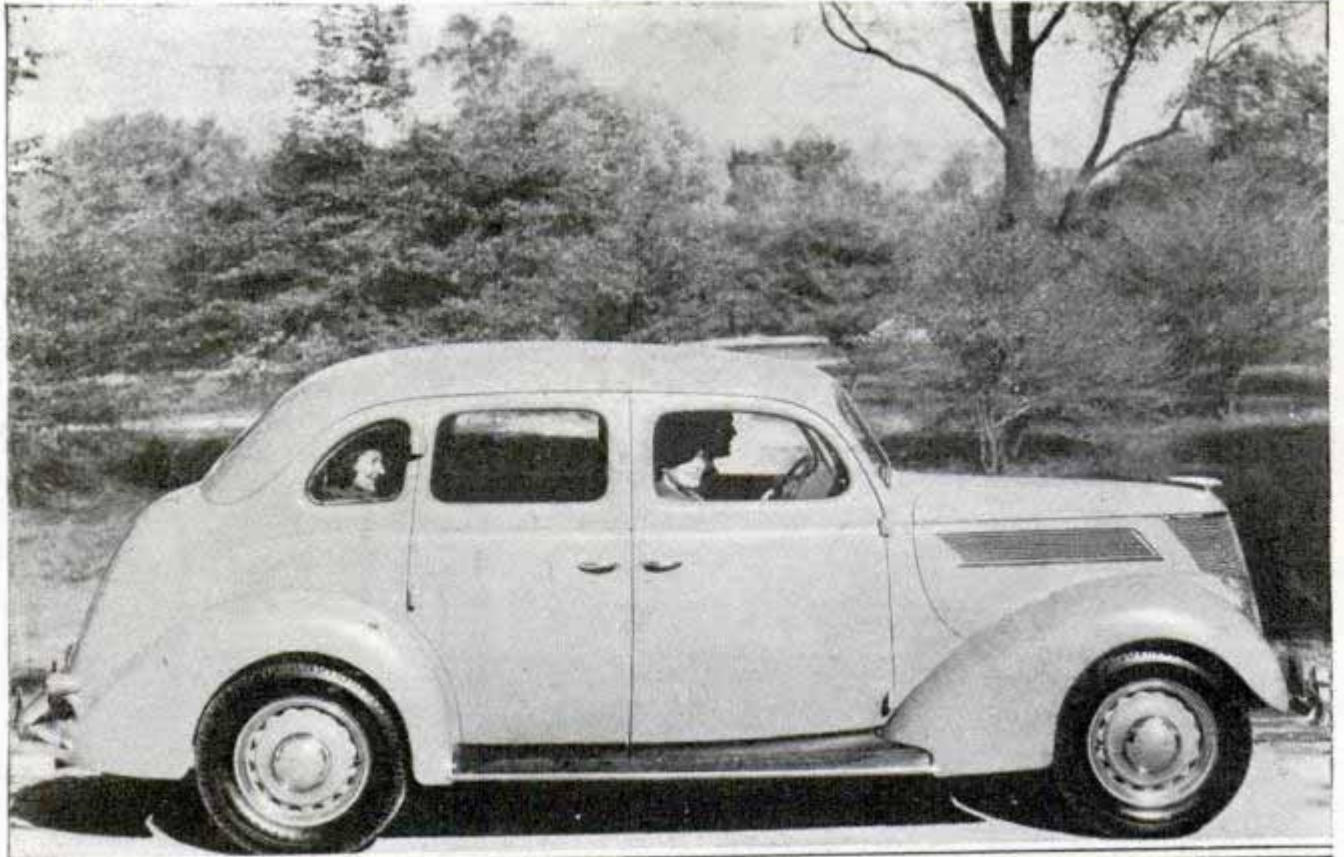

ficing too much in performance and in car size.

Ford also offers an all-steel body with one-piece steel top and new brakes which are actuated through a cable-and-conduit system and have controlled self-energizing action. Styling closely resembles that of the Lincoln-Zephyr.

The new Willys returns to standard tread and offers ultra-modern styling, all-steel body and top and a forty-eight horsepower engine which tests up to thirty-five miles per gallon of gasoline under normal operating conditions. Wheelbase is 100 inches but the body is longer than in 1936.

Claims of forty-five to fifty miles per gallon are made for the twenty-horsepower engine of the American Bantam, a new-comer. While the Bantam replaces the midget Austin in the field, it differs from that car in that it was engineered for American highways. Harry Miller, builder

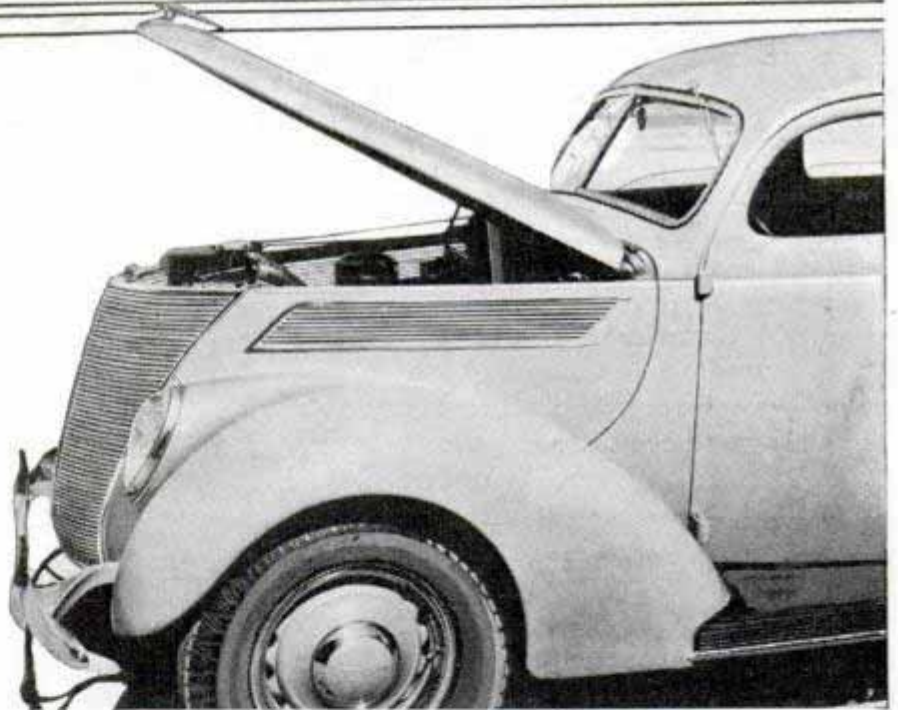

Top, photo of the new Ford. Note resemblance to Lincoln-Zephyr. Bottom, showing how hinged hood raises at front for servicing

of racing-car engines, is understood to have designed the Bantam's four-cylinder motor which has a speed above sixty miles per hour. Operating costs are said to be three-fourths of one cent per mile for gas, oil and tires.

Unusual treatment of body lines gives the new Chevrolet an appearance of fleetness which is ably borne out by the redesigned valve-in-head engine. Develop-

American Bantam

ing eighty-five horsepower, the motor has higher compression than the 1936 power plant and gives greater gasoline mileage and increased acceleration. Combustion chambers and piston heads are slightly dome-shaped to improve performance, the crankshaft has four bearings instead of three to assure smoothness, and the manifolding system has been revamped to assist carburetion.

The body is all steel from roof to floor, welded together to form a silent unit. Not a bolt, nail, rivet or screw is used and even the doors are steel. Safety glass all around is standard equipment. Use of the hypoid rear axle has lowered over-all height and the center of gravity to give greater road stability. The car is roomier, being five inches wider at the floor line in the front compartment. In keeping with the universal trend more space is provided for baggage.

Hypoid rear axle, safety interior, air-plane-type shock absorbers, improved insulation against noise and dirt, higher engine compression, and a new method of mounting the body on rubber cushions are features of the Plymouth, the Dodge, DeSoto and the Chrysler Royal.

The safety interior introduced on Chrysler-built cars, except the Airflow, includes an instrument panel with recessed controls, padded roll at back of the front seat, top door handles curved inward to prevent snagging the clothing, windshield wiper control and armrests of soft rubber, silk cord instead of metal robe rail and smoothly rounded surfaces—the objective being prevention of injury to occupants.

In the Royal, Chrysler offers a new entry for the lower-price field. Powered with a ninety-three horsepower engine and equipped with independently sprung front wheels, this car has the distinctive Chrysler front end. Its motor is serviced by raising the front of the hood. Chrysler Imperial is propelled by a 110-horsepower eight-cylinder engine and the Custom Imperial by a 130-horsepower engine with automatic overdrive. The Airflow also has the high-power motor and overdrive.

(Continued to page 143A)

First Trans-U. S. Telegraph Is Seventy-Five Years Old

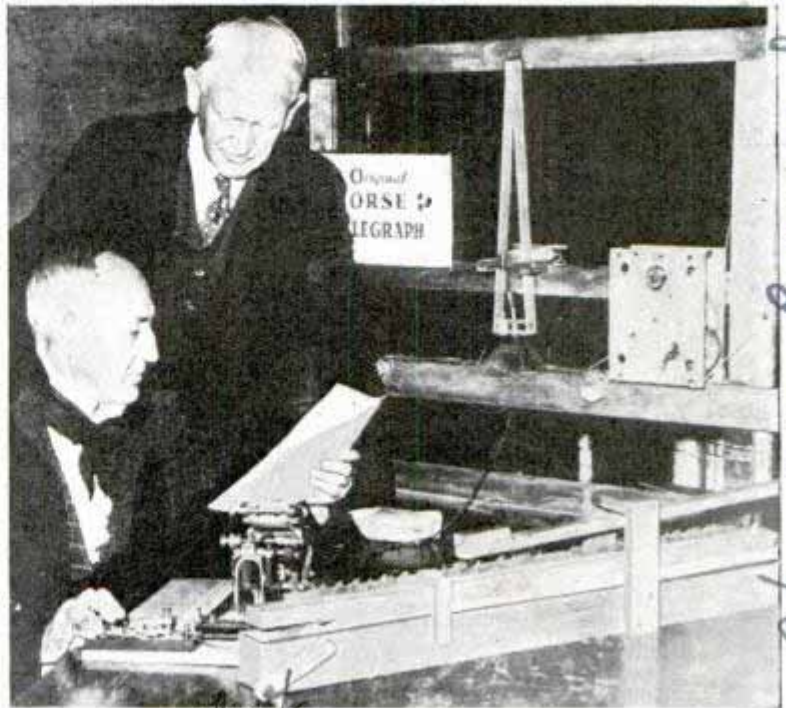

ant.
Sending original message on telegraph instrument used seventy-five years ago to send first trans-U. S. telegram

Mr. Howard DeLuigo
Members of the Oregon Trail Memorial association recently celebrated the seventy-fifth anniversary of the completion of the first transcontinental telegraph line. The links linking the two coasts were brought together at Salt Lake City and the first message was transmitted from San Francisco to the White House in Washington in 1861. The celebration was marked by re-transmission of the first message, the same instrument used in 1861 again being used. Replicas of the first telegraph instruments invented by Samuel F. B. Morse in 1836 were also displayed during the anniversary celebration.

F1417

Hone for Fishhooks Sharpens Barbs and Points



As an addition to the tackle box, a small hone for fishhooks is available. It is made of fast-cutting electric furnace abrasive and may be used wet or dry. One curved side is used for sharpening the barbs and the flat side for the points.

Wisconsin Abrasive

Operator - Edmond Brewster

Wisconsin Abrasive

71370

Smoke Clouds Test Masked Troops for War



Top, officers wearing gas masks "advance" through smoke clouds in training course intended to familiarize them with war conditions. Bottom, creating smoke cloud with portable chemical guns. These projectors depend upon the wind to carry the smoke

cal agents. These cylinders are dependent upon the direction of the wind as the smoke must be freed at the place of installation to be blown by the wind to the target.

Students of the army chemical warfare service school, located in Maryland, are given practical training in the use of smoke and chemical agents. The students, who are officers of the army, navy and marine corps, travel through smoke-filled air to familiarize themselves with conditions of actual warfare. Masks are worn by the officers to prevent harmful effects. Across the training ground may be found another group of students engaged in creating the smoke cloud, releasing the smoke from portable chemical cylinders which are used to project non-persistent chemi-

Acme 7/427

Electricity Kept in Cold Storage in Wire Near Absolute Zero

Electricity can be "bottled" in a wire at a temperature near absolute zero and kept in cold storage without noticeable loss of energy. Turn a current through a short loop of wire at 458 degrees below zero Fahrenheit for eighteen hundredths of a second and the current will remain in the wire for days, like water in a hose, if maintained at that low temperature. Hooked up to a circuit, it will then flow out without appreciable loss due to stor-

at Edgewood

93/10/30/36
Chicago Tribune

Essential Electric Co. Schenectady

How Worn-Out Ship Sinks N.Y. Is Caught by the Camera

age. Scientists hope this laboratory development will prove to be the first step toward actual efficient storage of power and long-distance transmission at low cost. Lead, tin, mercury and certain other metals become super-conductors at low temperatures, losing their resistance to electricity. Physicists express the belief that a thread of lead no greater than the strand of a spider's web would, if kept near absolute zero, carry all the power developed at Niagara Falls to San Francisco without loss. The problem is either to find metals which are super-conductors at higher temperatures, or to find cheaper methods of maintaining low temperatures.

F1384

Midget Car Has Three Wheels

With a two-horsepower motor under its tiny hood, a three-wheeled French automobile operates economically on a basis of about eighty miles to the gallon of gasoline. It seats only the driver, and travels about thirty-one miles an hour. The car weighs only 264 pounds.

No information



One-passenger French car with single rear wheel goes eighty miles on a gallon of gasoline

Wide World

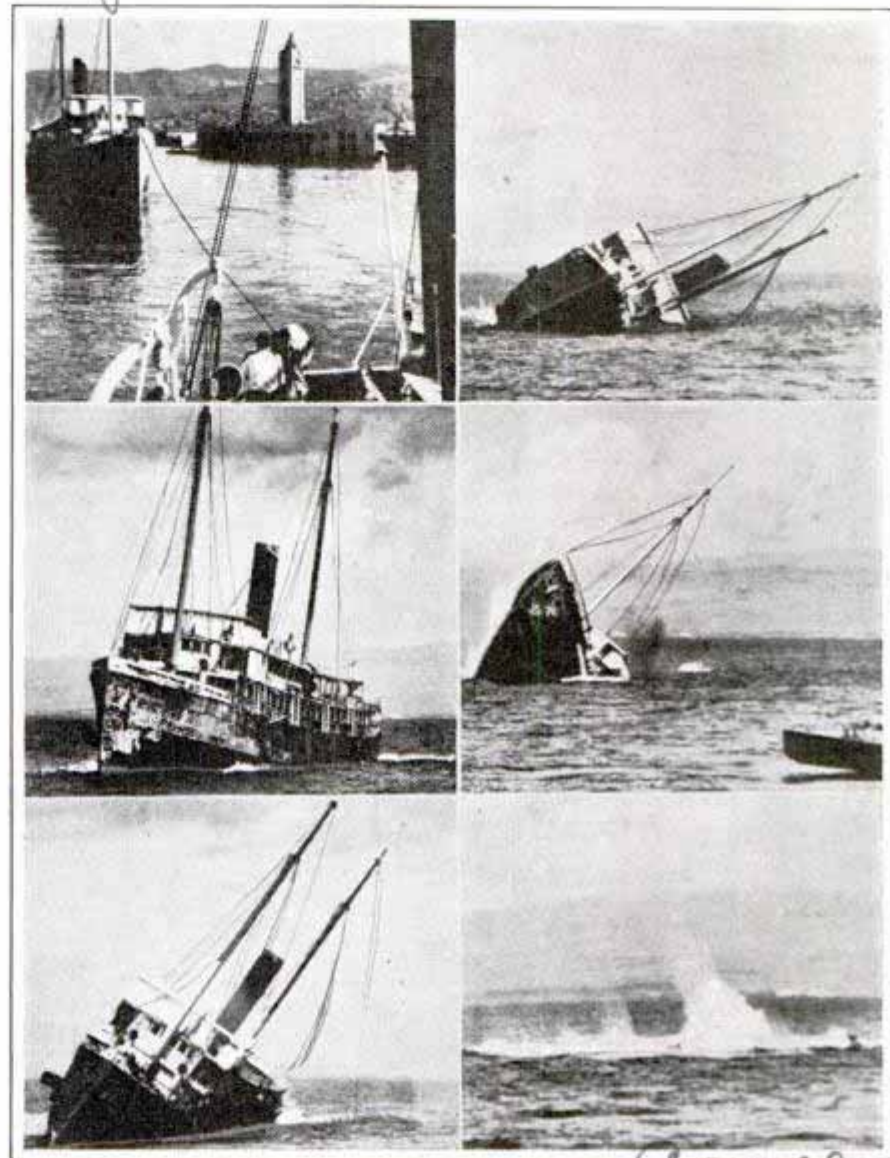

Top, left, towing condemned ship to sea. Center, ship settling after opening of seacocks. Other photos show stages in ship's sinking

When the owners of a worn-out ship scuttled it recently off Honolulu, a photographer made a pictorial record of the sinking. The craft was the steamer "Mauna Kea," one of the first mail boats to ply the islands of the Hawaiian group. The photographer snapped his first picture as the ship was started on its last trip, in tow, out of Honolulu. In succession came photographs of the ship as the seacocks were opened, letting in the water, the gradual settling of the craft and then the final plunge, with one end in the air, as the mail steamer sank to the bottom three miles out at sea. The Pacific at that point is so deep that the sunken craft will not interfere with surface travel.

Silver-Sided Luxury Train Is Speed Champion

71394



Twelve-Car "Denver Zephyr" on its record-making speed run, and interior views showing alternating-current outlet and individual radio in bedroom

Inter-car telephones, wall outlets for alternating current in the men's and women's dressing rooms, individual radios in every bedroom, drawing room and compartment and an "air curtain" that shuts out all kitchen odors from the dining room are some of the luxuries introduced by the Burlington railroad on its "Denver Zephyrs." The twelve-car stainless steel train, hauled by 3,000-horsepower Diesel-electric

locomotives, was recently placed in overnight service between Denver and Chicago. One of the twin trains established a long-distance speed record on its first run, covering the 1,017 miles in twelve hours, twelve minutes and twenty-seven seconds for an average of eighty-three and four-tenths miles per hour, and touching a top speed of 116 miles per hour, sustained for one mile.

HITCH *your* WAGON to a CAR



STREAMLINE trailer which adds little to the fuel bill. Roger Babson says more than half of us will be living in trailer homes in a few years.

nomad 16 foot.

Hollywood Trailers, 1315 Wilshire

1998
10.
Woburn
Boston
San Fernando, Calif

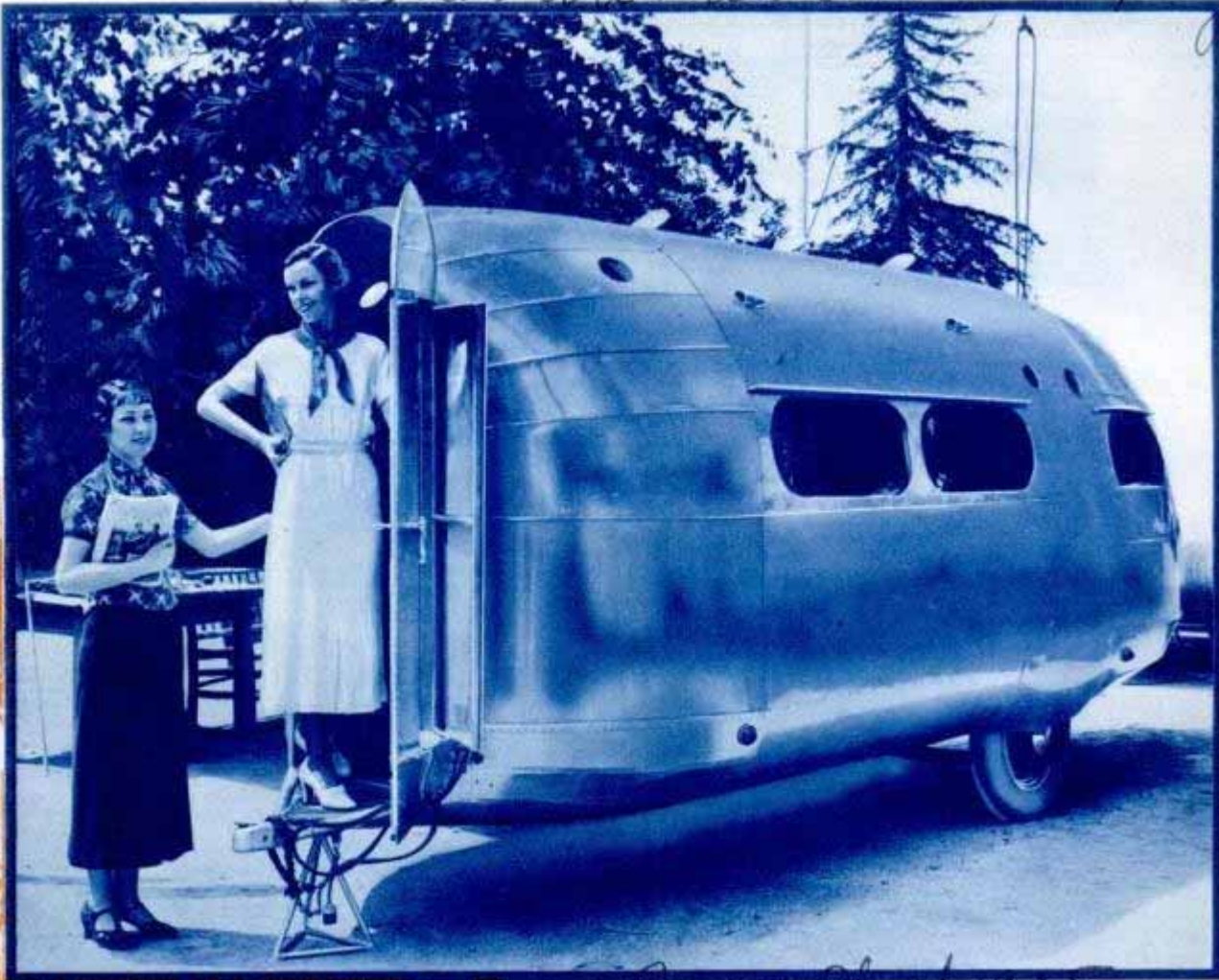

Road Chief 1935.

ANOTHER type of streamline trailer of metal construction. Note the front door entrance over the parking stand and the large windows.



By H. W. MAGEE
PART II

WE are getting ready to live on wheels. The exodus from the American home is under way by a tax-ridden population clamoring for independence and freedom of movement.

That is the astonishing conclusion of no less an authority than Roger W. Babson, statistician and economist. Following an extensive survey, Mr. Babson a few months ago made an amazing prediction.

"Within twenty years," he said, "more than half the population of the

United States will be living in automobile trailers."

In other words, if Mr. Babson is right, you have more than an even chance of calling a trailer coach your home within two decades. Uprooting half the people of the country and starting them out in rolling homes within the space of a few years seems preposterous until we take a look at this trailer business—perhaps the fastest growing industry in America today.

Five years ago a trailer coach was a novelty. The man who owned one had no privacy because curious throngs hammered on his door, peeked in his windows and demanded information on costs, upkeep, comfort, ventilation, miles per gallon and a hundred other subjects. That should have been a

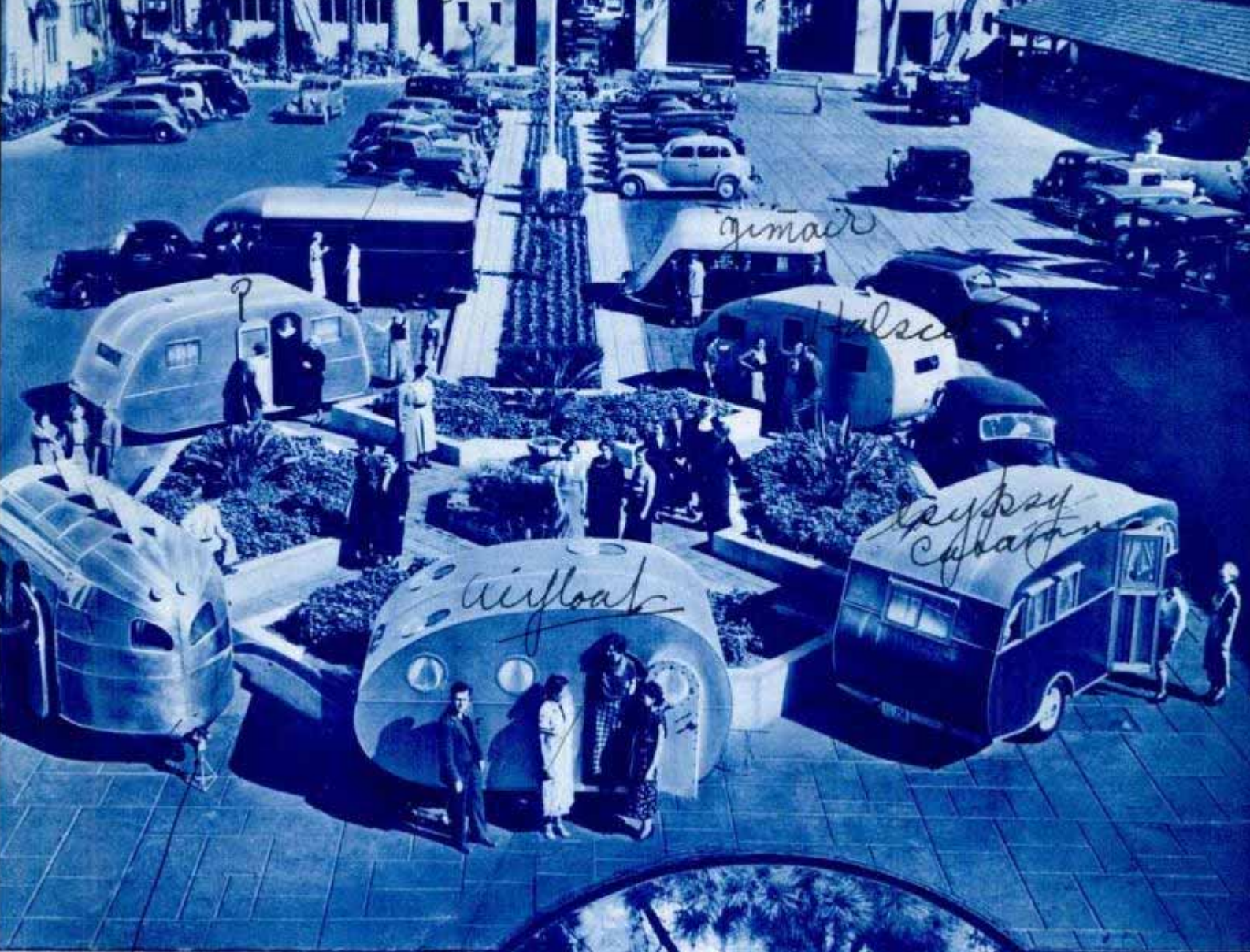

*Streamliner
Clipper.*
 MODERN trailers come in just about every size and shape, as indicated by the group above. Right, stream-line trailer built of plywood which is light and sturdy.

\$395.00 up

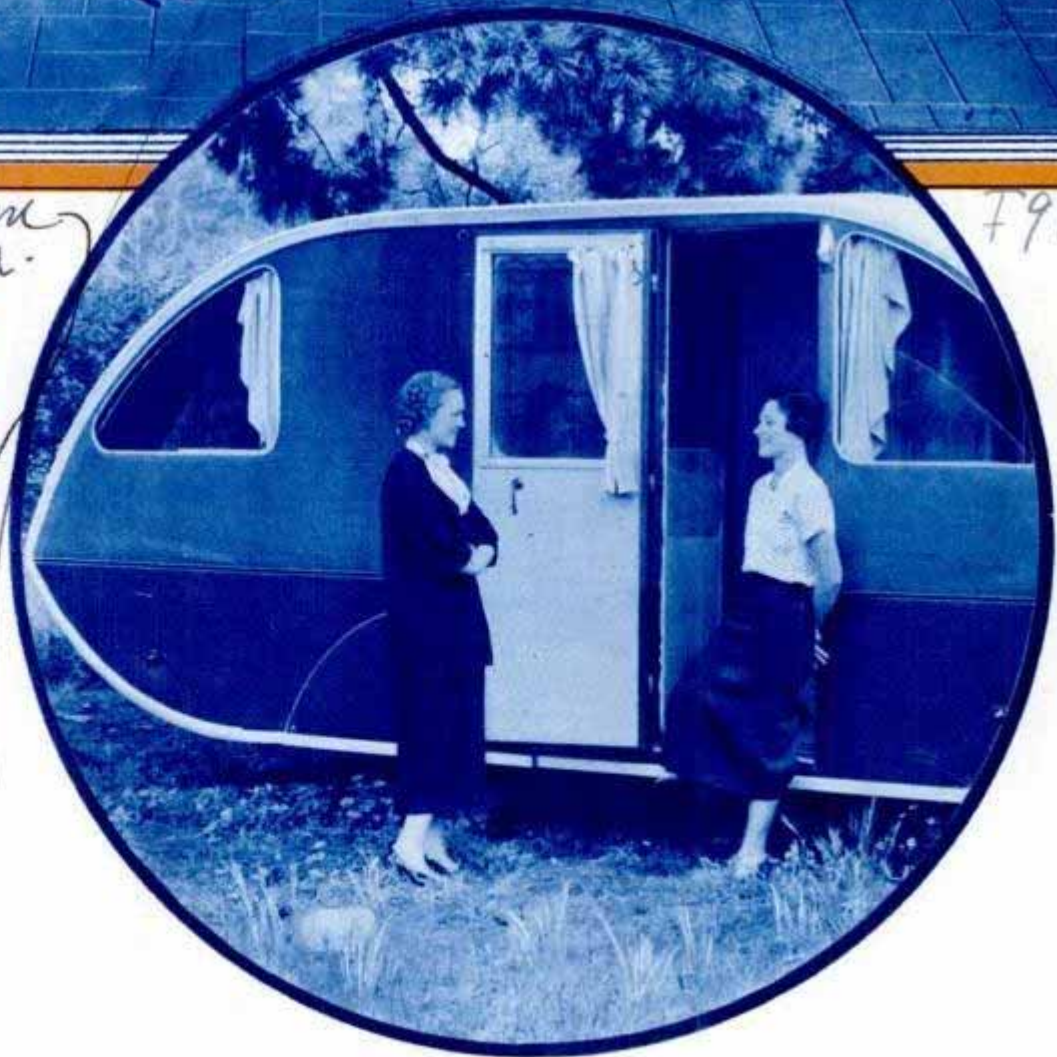

*7980
11.*

Cherid. Wang

1980

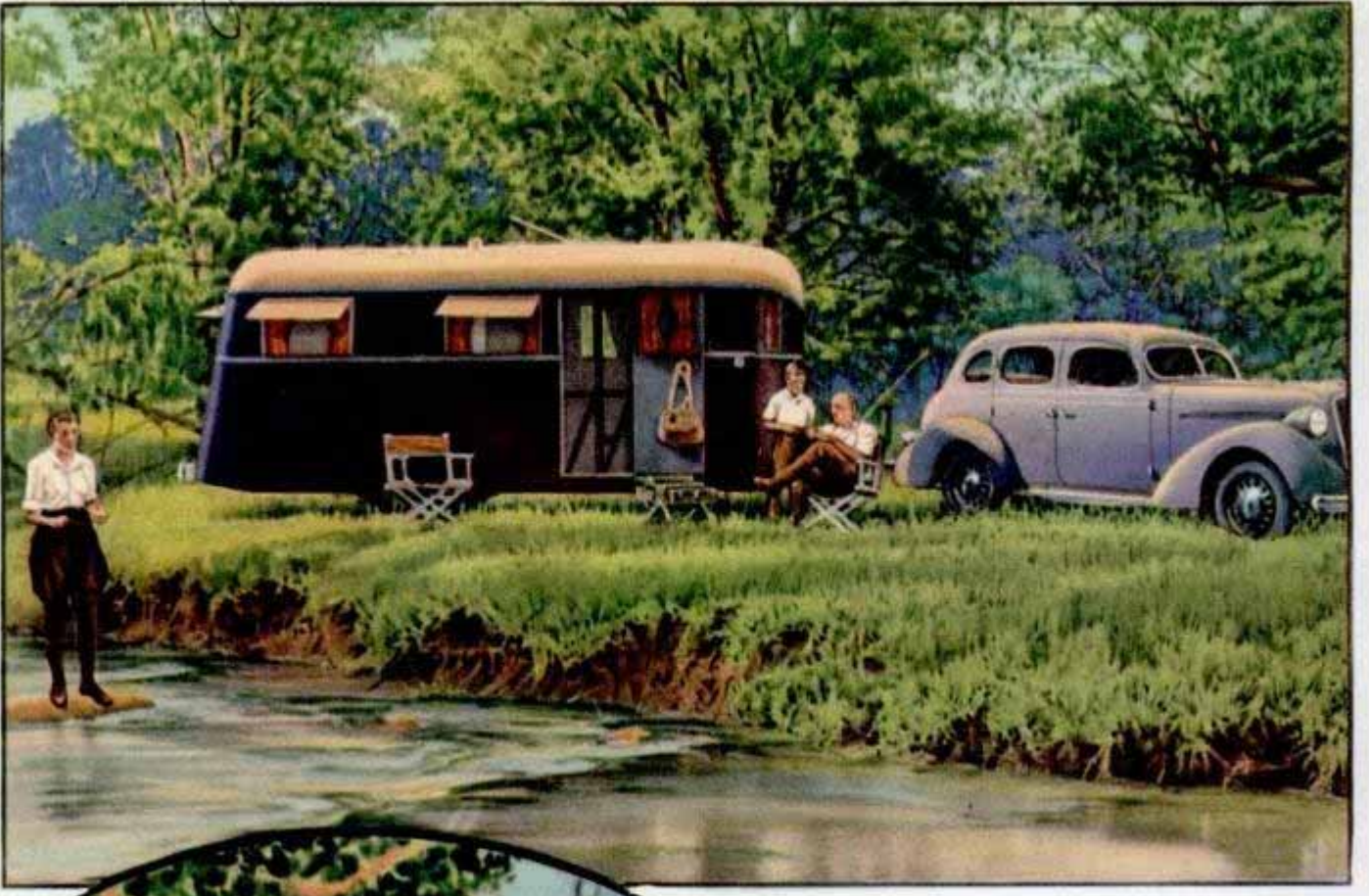

12



Airstream
Clipper
395.00 up

A TRAILER family, above, enjoying city conveniences in a rural setting miles from the nearest village. Left, vacation time has become trailer time for thousands of people today.



Bonbus Road Chief 1936

COMMODIOUS interior of a large trailer home. Note the yacht-like arrangement of furnishings to take advantage of every inch of space.

F980

warning of what was to come, but no one heeded except a few canny individuals who now are swamped with orders for trailers.

Today it is estimated there are on the road about 100,000 homemade and outmoded trailers owned and still used enthusiastically by the pioneers of modern nomading who built their own. It is also estimated there are 200,000 or 250,000 of the newer type coaches, the majority of them factory-produced. That makes an estimated 300,000 or 350,000 trailers of all types rolling over our highways today. But that's only part of the picture. Trailer manufacturers say they could have sold 300,000 trailers in 1936 if they could have built that many. But the industry, even though growing mushroom-like, could hardly supply one-fourth that number. Even so, conservative manufacturers estimate that 400,000 trailers will be produced and sold annually by 1940.

By then, if not before, there probably will be 1,000,000 rubber-tired "cottages" on our roads.

(3)

Who is using or trying to buy all these trailers? Most trailer owners at present fit into one of three classes—vacationers or campers, retired couples too restless to sit still and people who live in trailers permanently. There are said to be 100,000 of the latter class today, couples and families who move with the climate and call home wherever they park. Their number is increasing every day.

At present the majority of trailer owners use them for vacations, week-ends and camping trips. These people have found the trailer offers them the advantages of a summer cottage at a fraction of the cost—and in addition, the rolling home is not anchored to one spot. While these people do not live in trailers permanently, they do utilize them for part-time living.

F980
Highway
Pullman
Co.

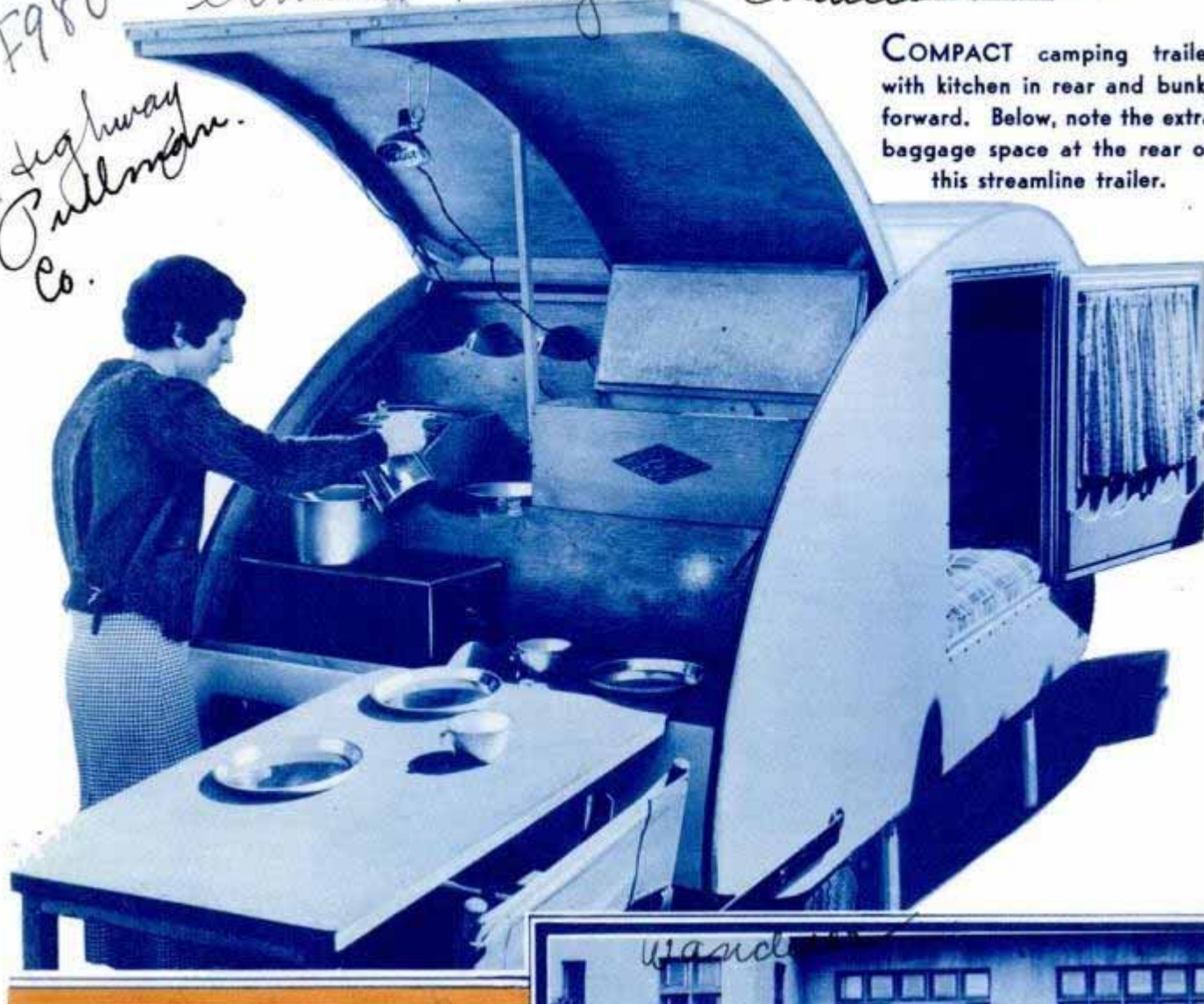

COMPACT camping trailer with kitchen in rear and bunks forward. Below, note the extra baggage space at the rear of this streamline trailer.



14.

Real estate and housing are affected by another angle of this trailer business. Modern trailer coaches are finding favor as permanent homes with many types of people. A rolling home is not plastered with real estate taxes, the original cost is lower than even a modest dwelling, the upkeep is low and the retired couple or those whose professions are in general demand are free to move about, following the sun, their professions or just plain fancy.

No less remarkable than the trailers themselves are the new arrangements for accommodating trailer tourists. Trailer colonies and camps are springing up everywhere, notably in Florida and California. The large ones are laid out in streets and have complete water and electric service carried right to the door of the trailer. Many have community buildings with baths, laundries, stores and clubrooms. Fees are as low as a dollar a week for the whole family.

The tax collector is taking notice of the trailer, but as yet trailer taxes are confined to license fees which, in most states, are considerably less than a dollar per 100 pounds of weight. Trailer coaches are finding a wide appeal for commercial purposes, and the traveling salesman now travels by trailer, living in the coach at night and using it as a display and sample room to demonstrate his wares by day.

Cramming Room 1900

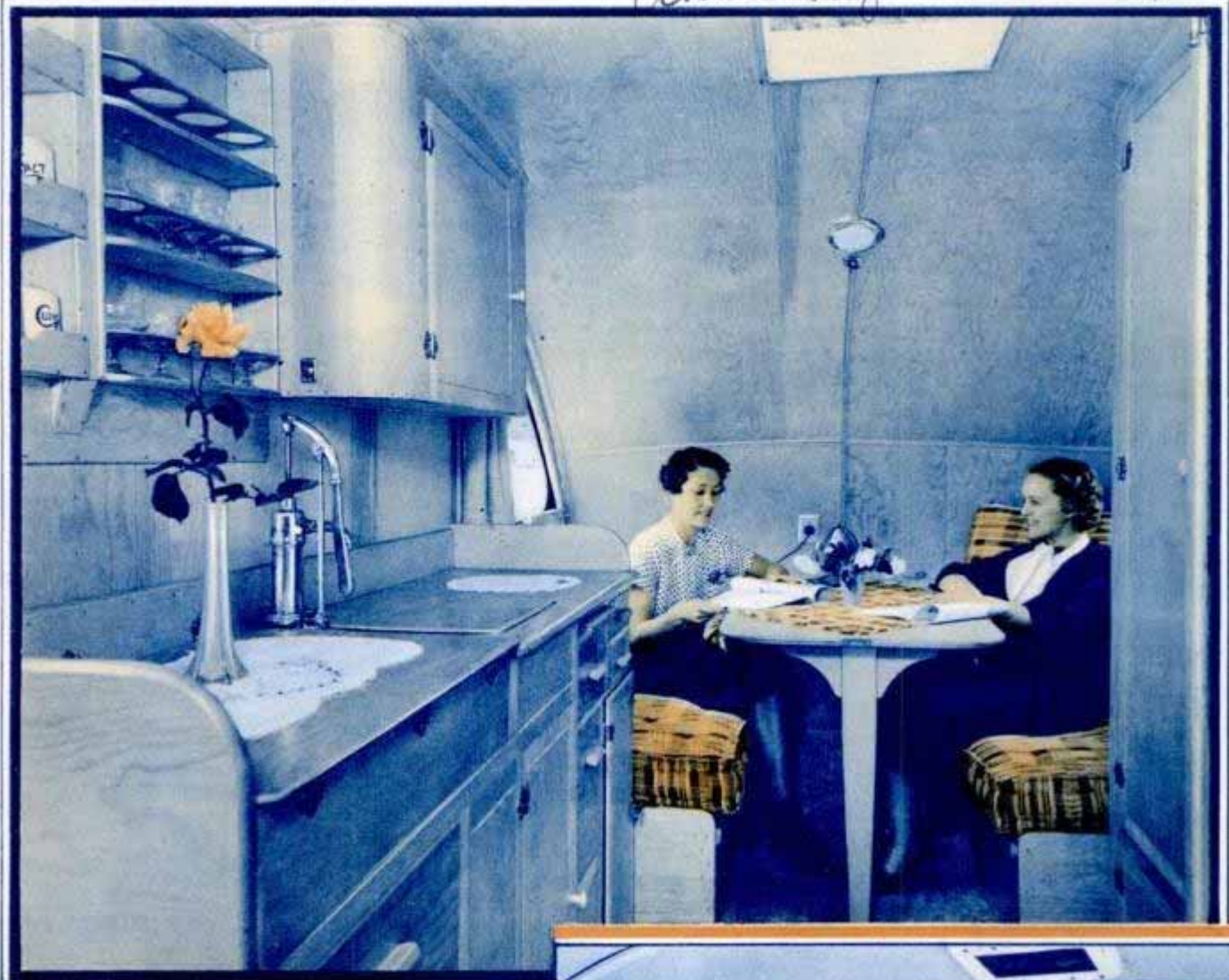

There are two organizations of trailerites and other auto campers and tourists, the Tin Can Tourists of the World whose annual winter meetings at Sarasota, Fla., attract upward of 1,000 trailers and trailer owners, and the more recently formed Automobile Tourists' Association.

Your money buys a lot of conveniences when you buy a modern trailer. In the low-priced range, from about \$350 up to \$900, you can get a camp coach for four people. It probably will be about twelve feet long, more than six feet wide and have inside headroom of about six feet. Construction probably will be partly of wood and partly of metal with leatherette exterior finish and equipment might include two double beds serving as settees in the daytime, a folding



old model

GALLEY of modern trailer, complete even to an electric fan and a stack for carrying off cooking fumes and heat from the gasoline stove. Top, trailer interior, showing the many built-in fixtures.

South Los Angeles Transportation Co



FOLDING camp furniture carried in this trailer makes an outdoor living room for the family when the weather is comfortable.

table, cupboards, an ice box, a sink, two-burner stove using gasoline as fuel, a bath basin built in the floor, a ten or twelve gallon water tank and perhaps a radio.

If you have \$1,000 or so to spend, you can get a trailer about twice as large and with more elaborate furnishings. Construction may be all-metal or nearly so. Above \$1,500 you run into the de luxe, custom built coaches and in the \$15,000 field you will find the land-yachts, luxuriously equipped and constructed to distribute all stresses in the sides and provide maximum strength with minimum weight. Trailers in any of the price classes can be purchased on time-payment plans like cars are sold, and fire, theft and other forms of insurance are being written for them. Many states are preparing to pass trailer laws dealing with maximum length and width, and types of lights and brakes to be required, but as yet there are comparatively few regulations.

Virtually every trailer manufacturer adds his own individual touches to his product, and many ingenious devices are found in these rolling homes to make them more
(Continued to page 132A)

Automatic Stoker Handles Coal and Ashes

Not only can you let an automatic "hired man" shovel coal on your furnace fire, but he will carry out the ashes as well. A mechanical stoker which feeds fuel and removes ashes without raising dust through the house was exhibited recently at a trade exposition in Chicago. An enclosed screw acts as feeder.



Pointing out the screw-feed on the automatic stoker which loads coal mechanically and also empties the ashes

Chicago Blade News 10/28/36

Global Fuel

9636 South Park Ave

Theory of Heart as Pump Discarded by Japanese

Denying the 300-year-old theory that the heart pumps blood, Dr. Katsuzo Nishi of Japan advances the contention that blood circulates largely through capillary action. He believes that the heart is no pump but merely an elastic tank which helps regulate and control the blood stream. His theory is the basis for a health system which claims a million adherents in Japan.

F1415

Streamline Hood on Motorcycle Used to Boost Speed

In attempts to establish a new world's speed record, a German rider is using a streamline hood on his motorcycle. The

hood is expected to reduce wind resistance and increase speed considerably. The driver awaits head or tail winds on his trial runs because the hood offers too much resistance to cross winds.



Protecting the rider from the windstream, this hood gives motorcycle more speed

Ernest Henne

F1425

Red Golf Balls to Be Used on Arctic Course

Golf on the Arctic ocean with the midnight sun and the northern lights to illuminate the course is the plan of the hardy "sourdoughs" in the Point Barrow region of Alaska. They would drive red golf balls over this all-ice course, and its nine holes would have plenty of natural hazards—icebergs and polar bears, and now and then a water hole during the summer thaw. Dr. R. W. Maurer, government physician at Barrow, a golf enthusiast, says he has found an ideal spot to lay out a course.

The average depth of the ocean is estimated at two and one-third miles.

Emb. Francis S. Burke

Motorboating Oct. 1936

F1340. Oemore

ASLEEP

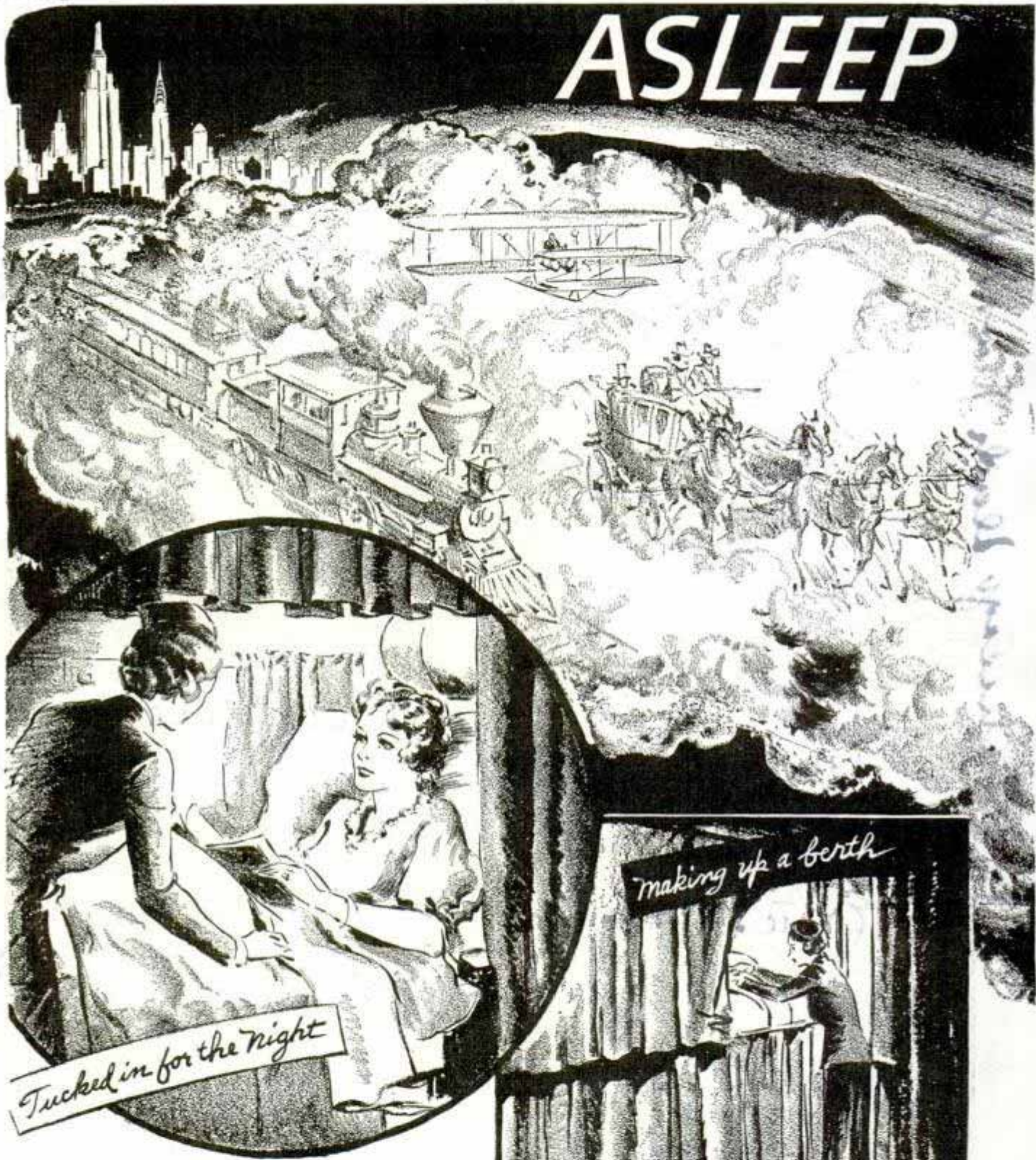

High above the trail the stagecoach and pony express used to travel, a flying palace nightly wings its way from New York to Los Angeles. It's the "American Mercury," fourteen-passenger sleeper plane of American Airlines which crosses the continent from dusk to dawn—speeds you from ocean to ocean while you sleep. From the "sky room," a private drawing room up front, to the six semi-private sections in its spacious cabin, it is the height of luxury—and no pun intended. Riding a sleeper plane is a novel experience for most persons, and believing you might enjoy an overnight journey by proxy, we told one of our staff artists to make the trip and do a little sketching between naps. He

boarded the flying Pullman at Newark and before he was long in the air, saw the stewardess making up the "uppers" and "lowers" and tucking in her sleepy passengers. When he himself turned in, he found an individual ventilator and did his own air conditioning before falling asleep in the clouds

in the CLOUDS

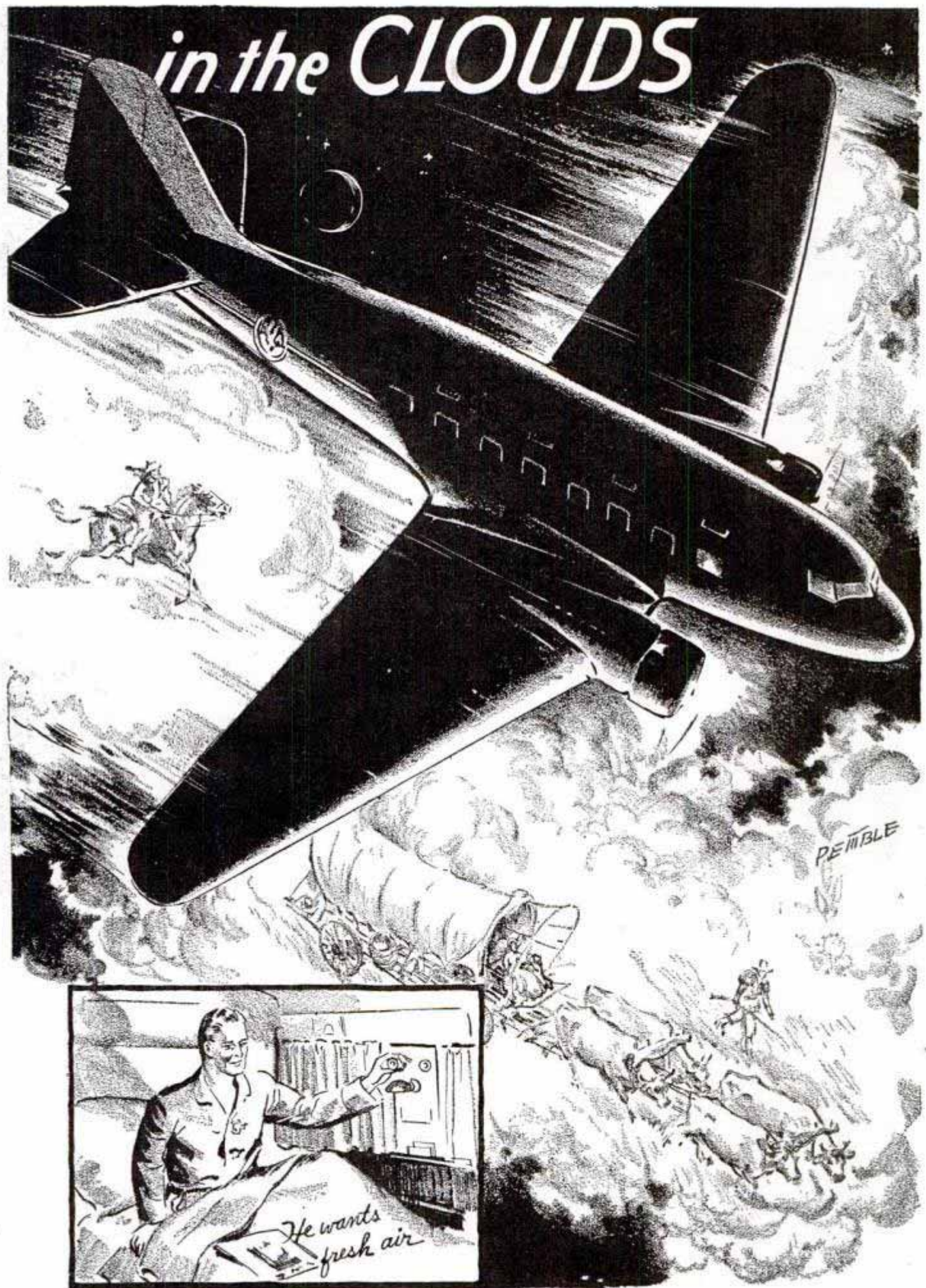

He wants fresh air



Chicken Dinner in the Clouds

fastening Safety belt for take-off

The flying kitchen

refueling at Memphis

There's no "box lunch" on the flying sleeper. Instead it's a six-course chicken dinner served piping hot from the flying kitchen—and there's real china and silverware



This twelve-ton "Leviathan" of the skies boasts separate dressing rooms for men and women. You can read, smoke, sleep, eat, write letters, play cards or just view the scenery

F1340

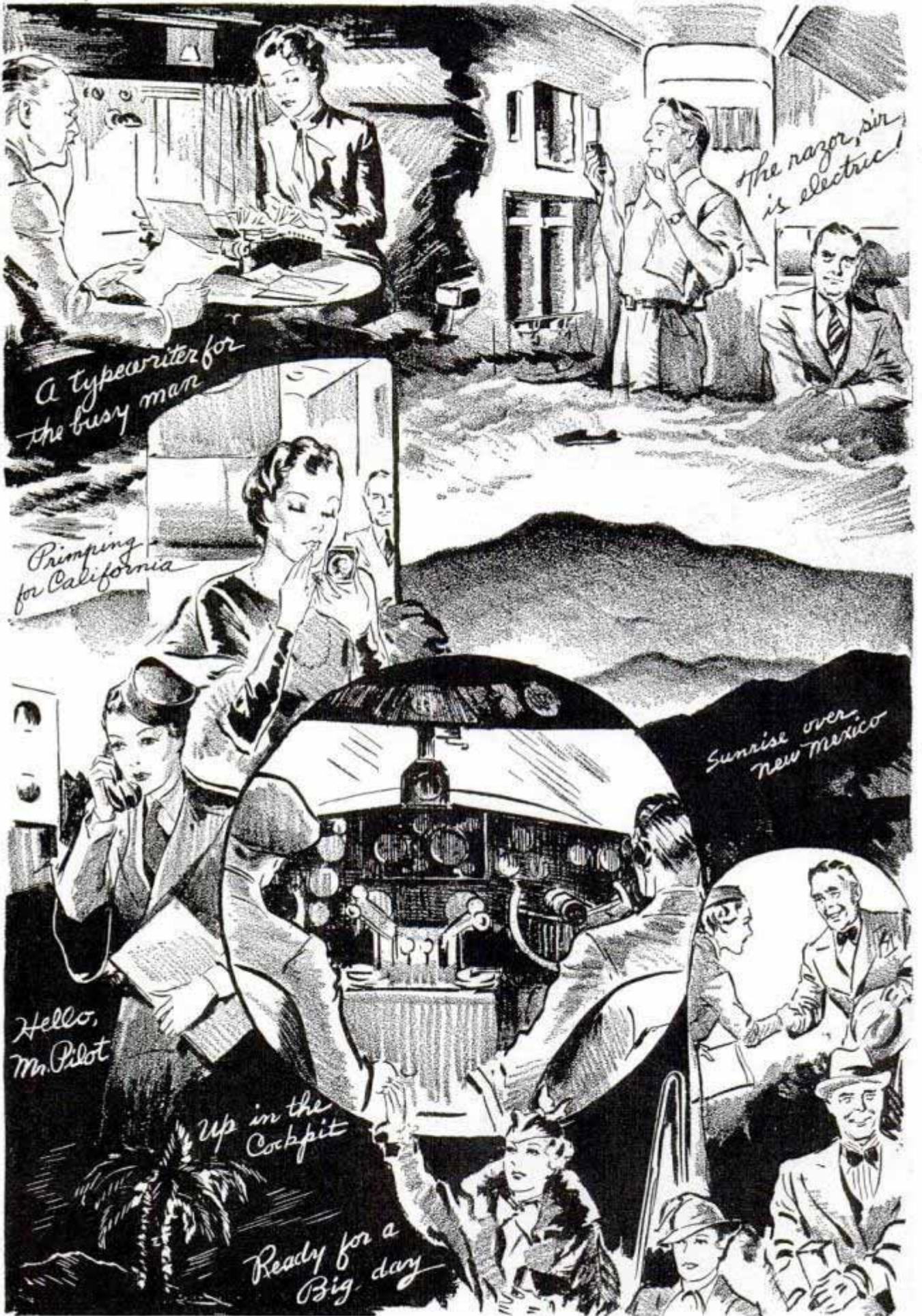

A typewriter for the busy man

The razor, sir is electric!

Primping for California

Sunrise over New Mexico

Hello, Mr. Pilot

Up in the Cockpit

Ready for a Big day

Over her private telephone the stewardess hears the pilot announce you're nearing Glendale, and sixteen hours after leaving New York, you land in California

Masked Rescuers Sweep City After Gas Raid



Parisians carry out their peacetime war drills with grim reality. Here is a squad of rescue workers cleaning up gas-infested streets after a mock bombardment by "enemy" planes

Rescue crews held a "full-dress" rehearsal after a recent mock air raid on Paris by night. Wearing masks and gas-resistant suits, they went about the darkened city "mopping up" and disinfecting

the supposedly gas-drenched streets and effecting mimic rescues. During the practice attack all the lights in the city were extinguished except the eternal flame on the tomb of the unknown soldier.

F1352
Safety Swing for Playground Has Space for More Riders

Constructed so that it never rises more than three feet from the ground, a new safety swing for playground or school basement is on the market. It is hung on roller bearings, therefore is easily operated when loaded to capacity. One feature is that the swing will carry more children than the conventional rope or chain swing. The seat of the device moves horizontally through twenty-four feet of space, utilizing the body movement of a rowing machine in its operation.



Never rising more than three feet from the ground, this safety swing has space for about twelve children

Alert - Spindane Swing Co

*Curplane Swing Co
 mainte J. C. H.*

Metal 'Cop' for School Zone Removed When Classes End

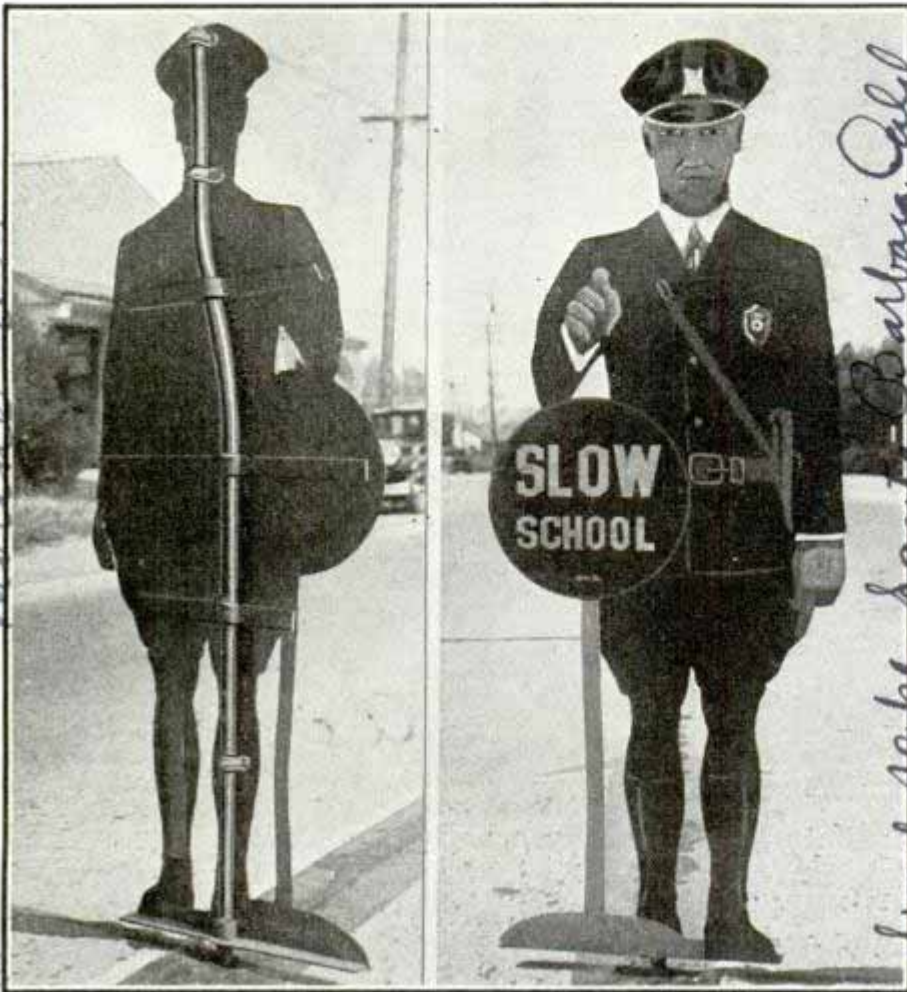

Rear and front views of the sheet-metal "traffic cop" who stands in front of school during sessions and is stored away at end of day

So realistic is the figure of a policeman standing in the middle of the street in front of a school that motorists apply the brakes before they are near enough to discover it is a sheet-metal "traffic cop." The figure is five feet six inches high, of sixteen or eighteen gauge sheet metal reinforced by a three-quarter inch pipe that extends through the base into a hole in the pavement five or six inches deep. When school is over for the day the safety sign is lifted out of the hole and stored away.

Cafe Walls Move Electrically to Vary Seating Capacity

Instead of hanging up the "Standing Room Only" sign when every table is taken, the proprietor of a San Francisco restaurant merely presses a button and presto! the walls move, and there is another dining room ready for patrons. With movable

walls he can accommodate his cafe to varying crowds. Each wall is operated by a one-fourth horsepower motor. Lowering one wall he can add a room seating 125 persons, and supplied by its own kitchen. Raising a wall he adds another room seating ninety, also with its own kitchen. Farther back is another disappearing wall that reveals a third room accommodating sixty more diners.

Rubber Bladed Fan for Auto Window Is Safe and Quiet

Blades of rubber make the windshield defroster fan safe and silent. A wire guard is unnecessary, for the blades would not injure a finger even if touched at top speed. The smooth, mauve finish of the rubber dissipates light and eliminates any eyestrain caused by reflections on ordinary metal blades. The six-volt fan operates on the automobile battery.



Flexible rubber blades on windshield fan cannot injure a finger, but they provide plenty of wind

Chicago-Fields

*Clifford B Paul 2111-13th St
F1344
F1414
78 Ellis St.*

*Barbara Caley
Properly
United*

*Rockwell, N.Y.
Properly
United*

Electric Log Records "Queen Mary's" Speed

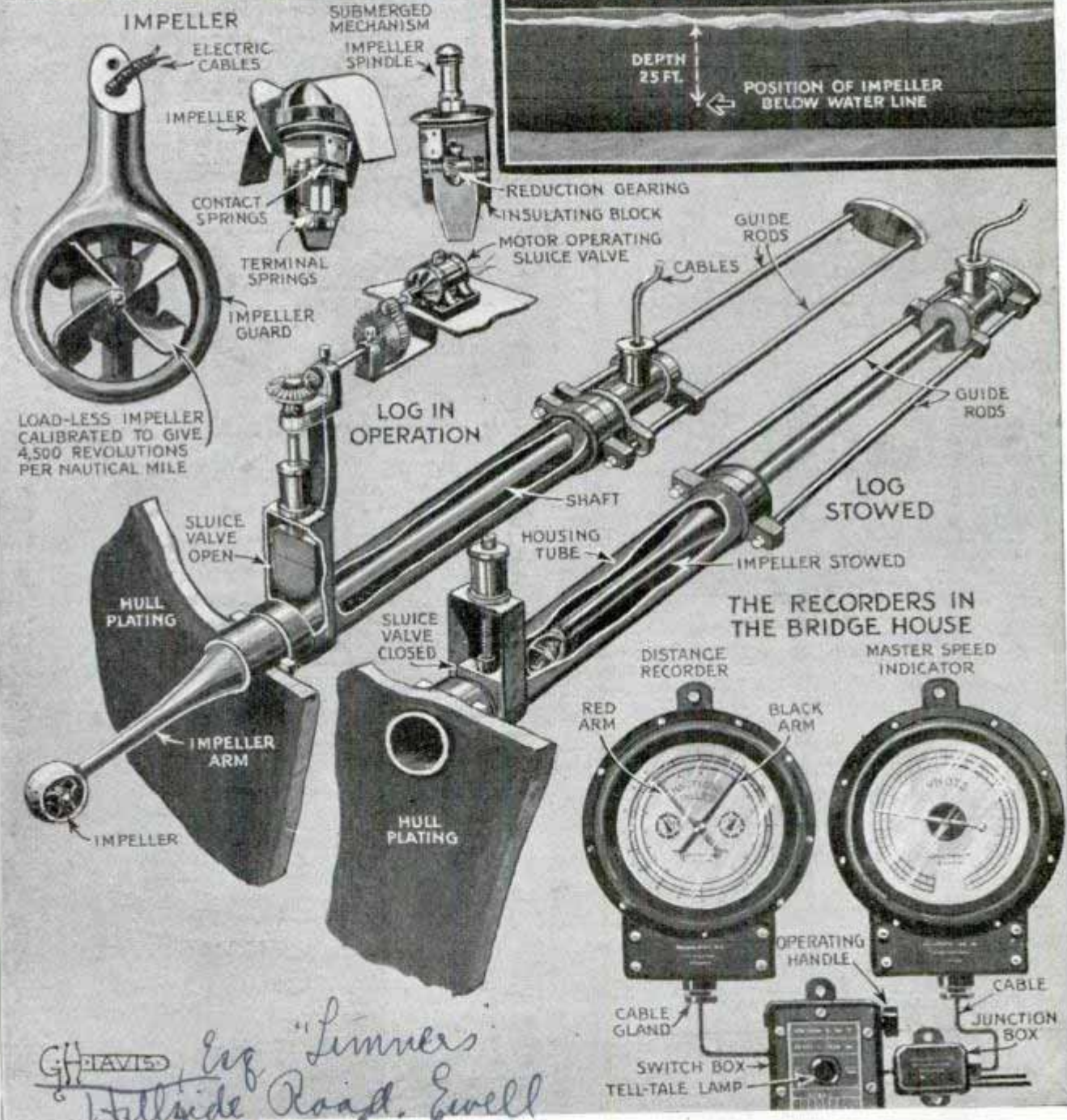
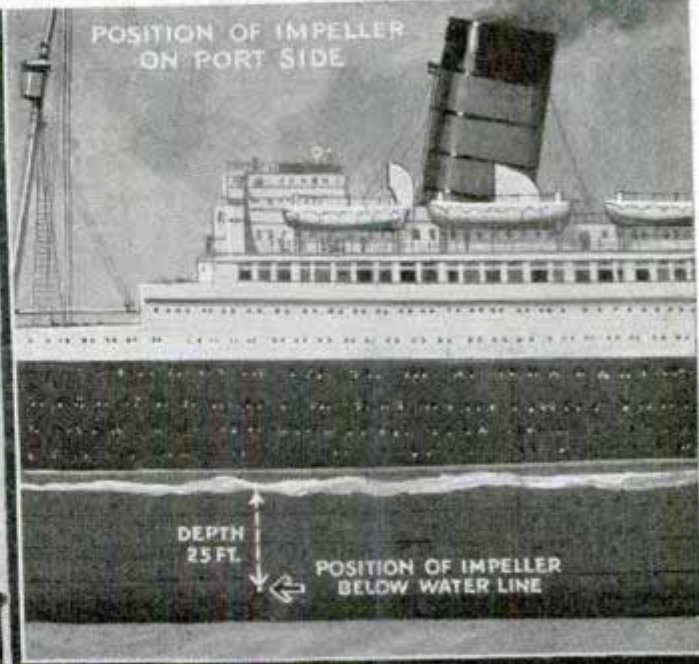
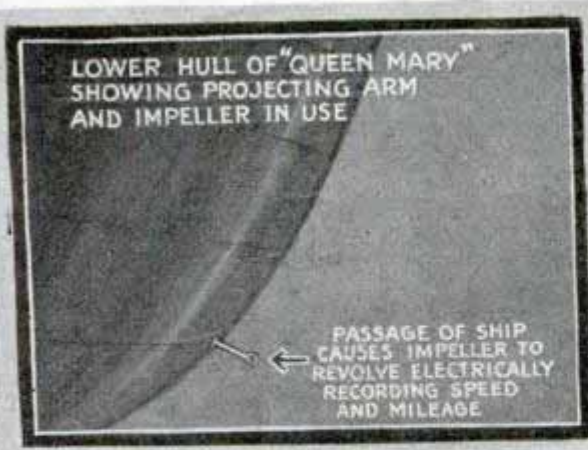

G. H. HAVIS
 Exp. "Limmers"
 Hillside Road, Ewell
 Surrey, England.

Racing across the ocean or crawling in thick weather, an electric log tallies accurately "Queen Mary's" mileage and speed. A frictionless screw extended from the hull, calibrated for 4,500 revolutions per mile, makes and breaks electric contacts actuating dials which help the navigator chart his progress

Cherzikeel & Co. Ltd.

F127) Mr. Leavin R. Mann
Box 282, Ogden, Utah

Breaking SPEED RECORDS



John Cobb, have written automotive history in fast succession on the Utah Salt Flats during the past several months and the stories of their exploits are a climax to man's constant fight to conquer speed and mechanical limitations.

The speed laboratory of all motor-dom, the mecca of speed enthusiasts from every land, and the probable testing ground for motor-powered vehicles of the future, is located on the dry salt bottom of ancient Lake Bonneville, 125 miles west of Salt Lake City. This great level body of

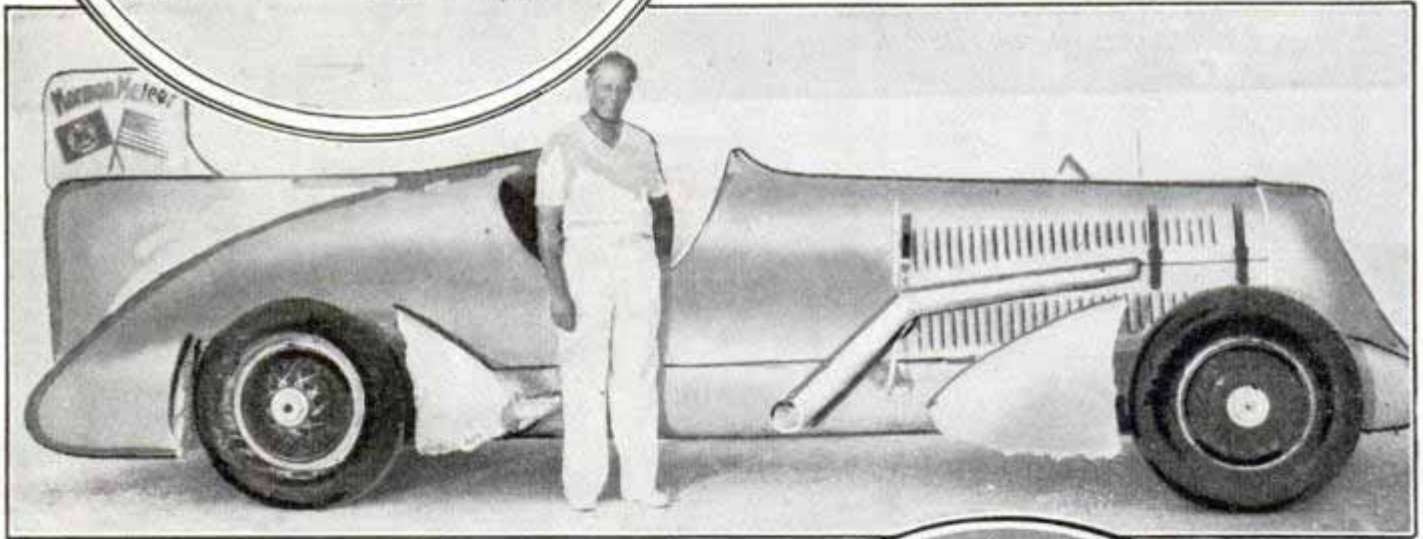

EARLY seekers of automobile speed records were limited in their efforts to outdistance time by problems of motor, transmission and tires. Speed courses offered no serious problems because any open road or commercial racetrack answered the purpose.

With the increase in recent years in motor refinements, the use of blowout-proof tires and streamlining, mechanical problems no longer present so many serious difficulties to the seeker of high-speed records. The problem now is to find a course which offers no physical limit to speed.

Four speed drivers have found a satisfactory answer. Ab Jenkins, American, and three British drivers, Sir Malcolm Campbell, Captain George Eyston and



Top, trying to drive nails into the salt flats. Center, Ab Jenkins and his "Meteor." Bottom, streamlining cowling of "Meteor"

on the **SALT FLATS**

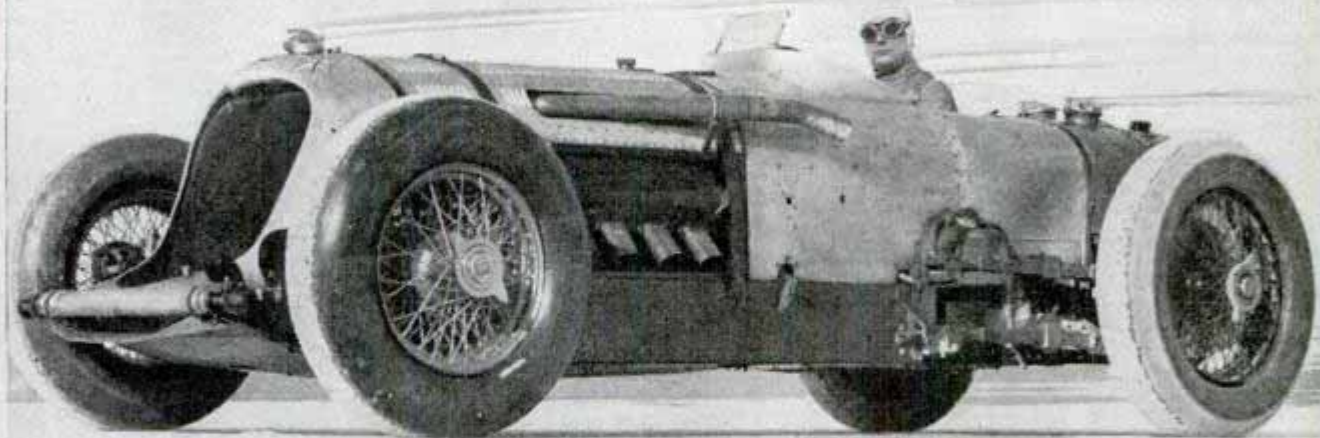

smooth, hard salt formed by the drying of the ancient lake is fifteen by thirty miles with an average depth of four feet. The salt flats are as white and dazzling under the noonday sun as new snow. The salt has the consistency of ice and is almost as hard as concrete. It crunches under tires like snow, is ninety-five per cent pure and needs only a slight treatment for human consumption. The flats accommodate many ten and twelve-mile circular speed courses and Sir Malcolm Campbell's 301-mile-an-hour straight-away was thirteen miles long.

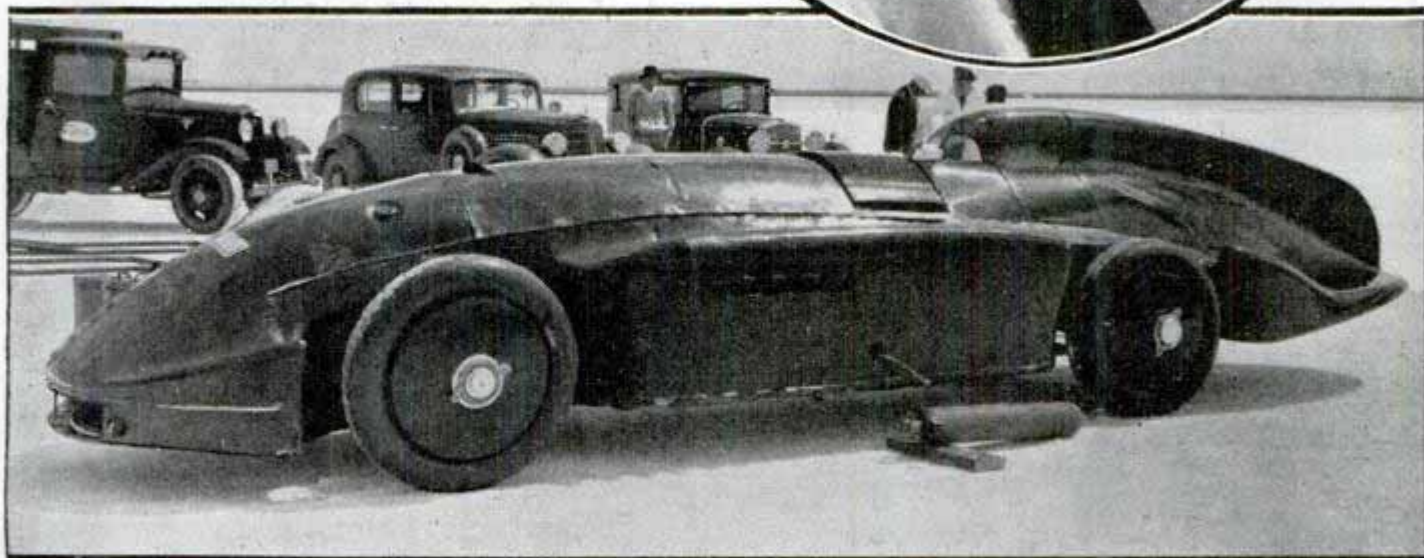

Top, John Cobb, British driver, and his 600-horsepower speedster. In circle, broadcasting speed trial at the flats over a mobile short-wave transmitter. Bottom, the "Flying Spray," Diesel-powered car of Capt. George Eyston

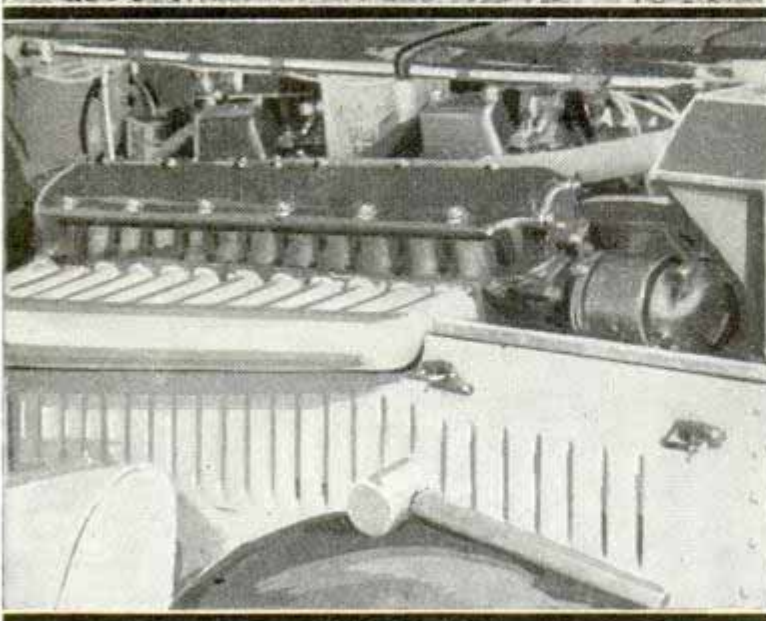
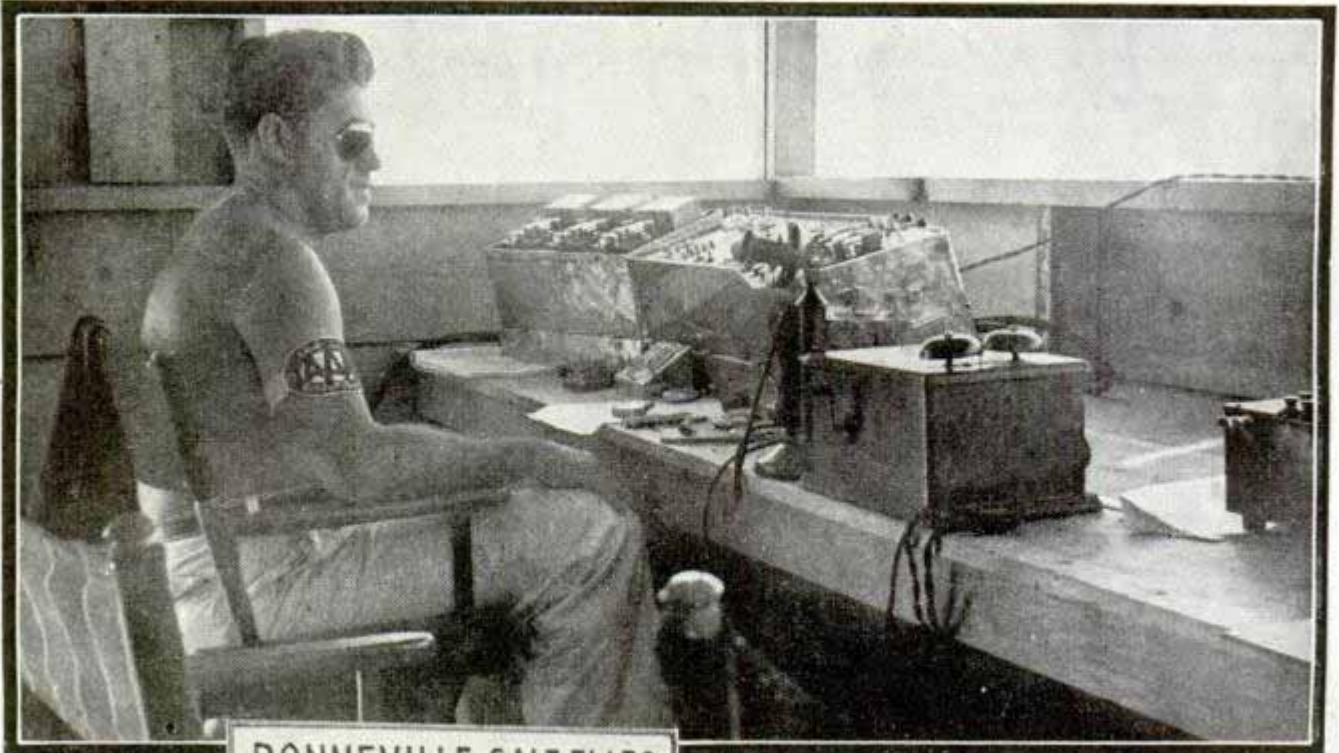

Top, timer watching speed trial. Center, sign near speedway. Bottom, twelve-cylinder motor of "Meteor"

America returned with a rush last September to world dominance in the realm of speed on land when Ab Jenkins roared to a new world's record of 153.76 miles per hour for twenty-four hours on the Bonneville Salt Flats in his \$40,000 twelve-cylinder "Mormon Meteor" powered with an airplane motor. Continuing on, Jenkins established a new world record for forty-eight hours of 148.626 miles per hour with a total distance covered of 7,134.08 miles. During his September runs, Jenkins established seventy-two new world records in all, including the one-hour speed of 170.99 miles per hour.

Thrills aplenty popped up during the speed tests. After running eighteen hours on a ten-mile circular track the great cream monster threw a tire while going 172 miles per hour, when the key pin in the rim lock broke.

"She's on fire," went up the shout from the pit camp, for the "Meteor" could be seen two miles distant with a great white smoke trailing behind her, salt dust thrown up by the wheel rim. The car limped into the pits at 100 miles an hour on the rim with

the right rear wheel streamline cowling smashed and trailing. This was torn away and nine minutes later the car thundered away. The same day, oil trouble developed and a fourteen-minute check disclosed the lock nut on the oil pipe into the oil reservoir all but off. It was loosened by the jarring when the wheel was thrown. During this stop it was discovered the driver had powder puffs on his ears under his helmet to help

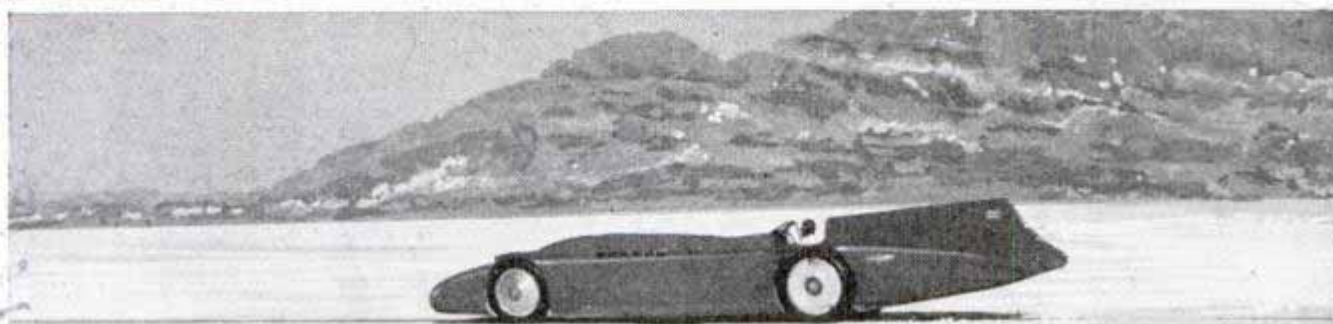

keep out the noise. At two different times the driver lost control and the car skidded away in an 800-foot arc but remained upright.

At night the track was lighted by flares and the driver grew sick from the smoke. The car, capable of 200 miles an hour, required all the driver's attention as he had a continual fight with centrifugal force. So perfectly streamlined was the speedster that notes dropped by the driver as he passed the pit camp would drift to the ground directly at the point they were let loose.

Jenkins' car consists of a twenty-two-foot Duesenberg chassis powered with a salvaged Lycoming airplane motor. The car has a high tail fin and adjustable rudder as a stabilizer. The weight is 5,140 pounds with a 142-inch wheel base. It has a special transmission and the clutch locks at 100 miles an hour. The car has three speeds and an electric starter. The motor alone weighs 900 pounds and, with the transmission, 1,200 pounds. It develops 700 horsepower at 2,400 revolutions per minute with a speed of 180 miles per hour. It is a V-12, has two updraft carburetors,

(Continued to page 148A)

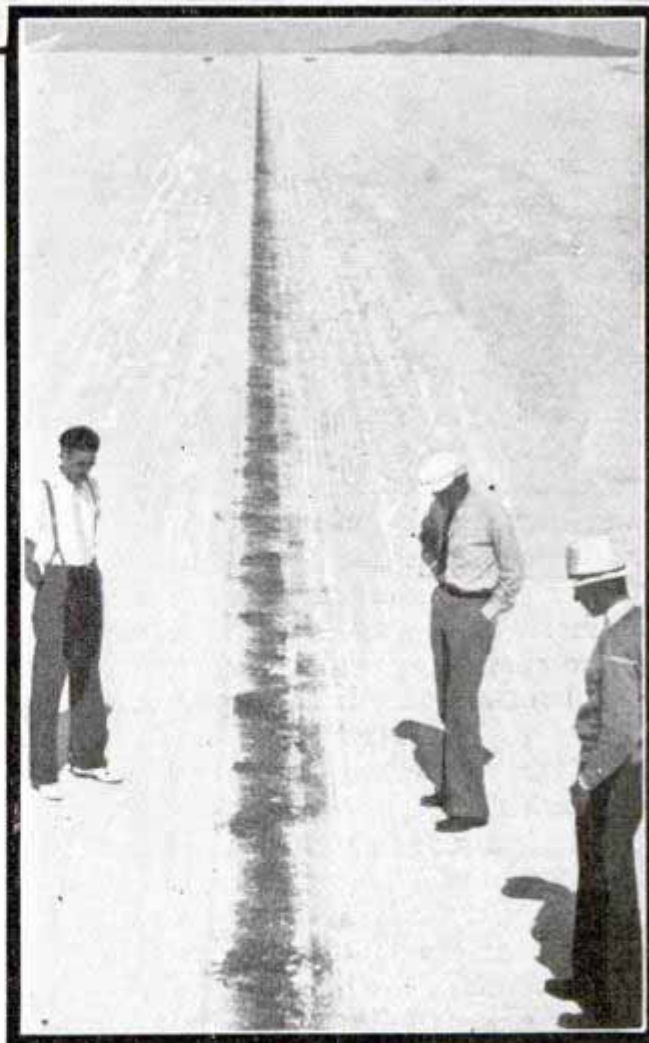

Top, "Meteor" making pit stop. Center, "Bluebird" traveling 300 miles an hour. Bottom, black line on salt to guide driver

flowers in the last two years, including a combination of the orange and lemon, a giant mango which can be shipped successfully, a white raspberry without thorns, an early variety of the York imperial apple and an improved freestone peach. The orange-lemon is described as a sort of citrus fruit shaped like a lemon, colored like an orange and tasting like both. Until recently the mango could not be placed on northern markets, due to the rapidity with which it deteriorated, but a horticulturist at Naples, Fla., has developed a variety resistant to decay which may be shipped. Its size, formerly that of a pear, has been increased to almost a foot in length and more than seven inches in diameter. In addition, it has a bearing period of three months, the first crop being harvested the middle of May. The improved York apple matures two to three weeks earlier than its parent, while the new freestone peach tree produces only marketable grade-A fruit.

Hurricane-Hunting Radio Set Hung to Balloon by Its Aerial

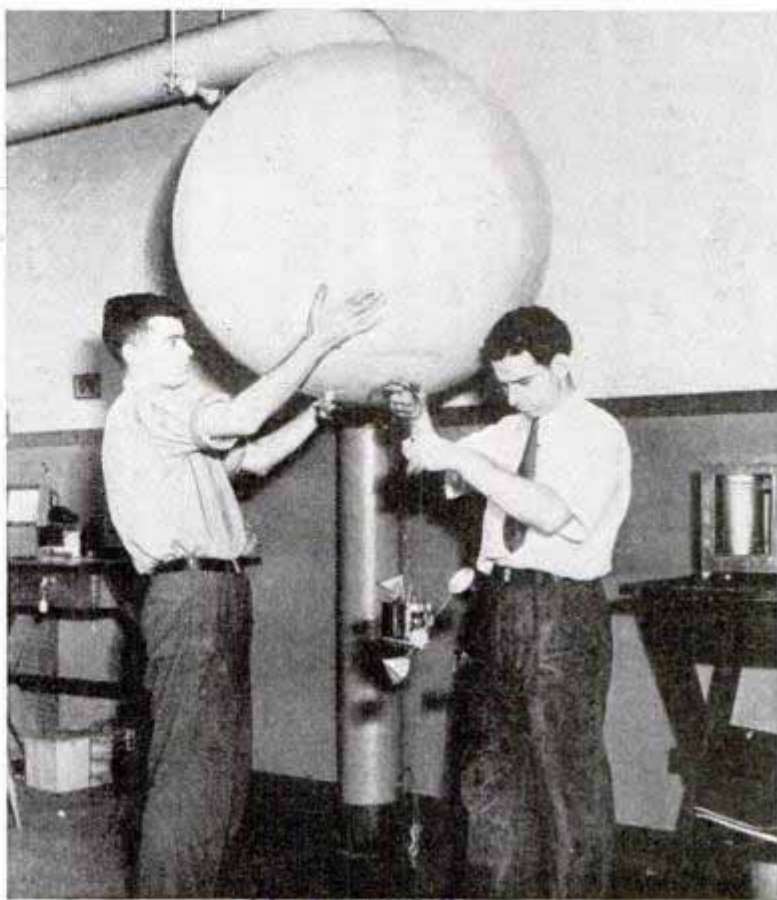

Wire by which weather instruments and radio transmitter are suspended from balloon acts as antenna for the radio set

F1322

Air Rudder Helps Pilot Steer 150-Mile-an-Hour Boat

Candidate for the title of "world's fastest boat" of unlimited class is the "Miami Queen," a power boat equipped with an air rudder to facilitate steering at high speeds. Twin twelve-cylinder motors drive this racer with belts instead of the usual water-cooled gear box.



Designer expects this boat to develop 150-mile-an-hour speed

Robot weather reporters trail hurricanes right to the stratosphere and send back news of temperature, humidity and atmosphere pressure in the heart of the storm zone. These reporters are tiny radio transmitters and observation instruments, harnessed to balloons that will carry them as high as fifteen miles above the earth. The radio set is hung to the balloon on a wire that also serves as antenna. The meteorological staff of Massachusetts Institute of Technology plans to study weather in the hurricane belt of the Caribbean region and the southern states by releasing these weather balloons in the path of the storms.

Ⓜ A mountain-top airport is being built on Mt. Palomar, Calif., so astronomers may fly to and from their work.

*Designed by Louis
Lupton, Miami, Fla.*

California Institute of Technology

Cambridge, Mass

Twin Diesels Drive Submarine in Proving-Ground Tests

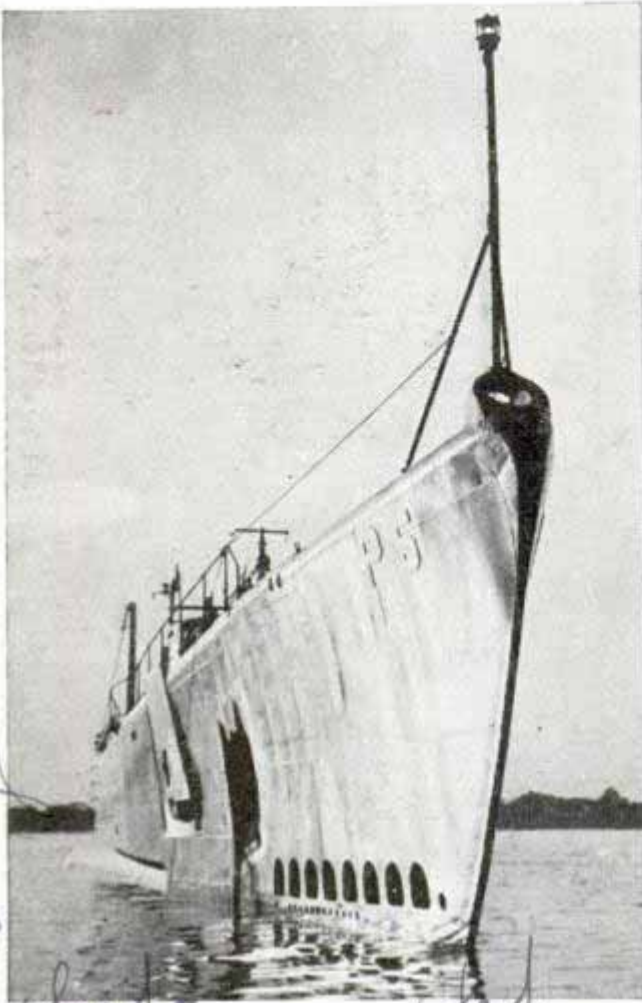

This odd-angle photograph makes submarine appear as large as an ocean liner

Propelled by twin Diesel engines, the latest submarine in the U. S. navy has been undergoing proving-ground tests off Provincetown, Mass. Known as the P-5, the underwater craft is 306 feet long, displaces 1,300 tons and is armed with a six-inch gun and the usual torpedo tubes.

The Lower the Temperature the Thinner the Ice

Ice grows thicker and quicker at zero than at severe sub-zero temperatures. This paradox has long been recognized by sailors, but science now has an explanation for it. Dr. W. J. Humphreys of the U. S. Weather Bureau points out that ice grows fastest when its upper surface is coldest, and the surface temperature varies according to weather above. If snow covers the ice, or foggy air insulates it, the escape of heat from the underside or

growing surface of the ice is retarded and it thickens slowly. Usually in zero weather there is little fog, and sufficient wind to blow the ice clear of snow and thus promote rapid freezing. In sub-zero weather "frost smoke" drifting from the deep water often spreads over the surface, acting as an insulator and sometimes depositing fine snow which retards ice formation.

Aluminum Salt-Pepper Shakers Have "S" or "P" in Top

Made of heavy-gauge aluminum with spun-ray finish, the latest salt and pepper shakers have "S" or "P" punched in the top. The shakers have Bakelite bases, and are inexpensive, but distinctive enough to match fine table appointments.



Metal Sled Built Like Plane Lightens Dogs' Load

Constructed on the same principle as the modern airplane, the latest dog sled is made of duralumin, reducing the weight to sixty pounds, compared to 120 pounds for the old type. The runners are shod with very hard, thin stainless steel. The new freight sled is as light as a passenger sled, yet withstands loads of a ton or more.



Tubing framework of latest sled. Weight has been reduced fifty per cent

Handwritten notes on the left margin: "F1386", "Taylor, Chittenden, Westover, Ames, Rochester, N.Y.", "Washington", "F1424", "Rochester", "designed by".

Handwritten notes on the right margin: "Mantoway, Wis.", "Mammath, Lakeland", "designed by".

Expert Workers Chip Ribs of Giant Mirror

Just a fraction of an inch at a time, skilled glass workers are chipping the reverse side of the giant 200-inch mirror being prepared for high-power telescopic observation of the heavens. The workers are removing the heavy ribs which were left on the mirror so that it could be handled safely in shipping to California Institute of Technology for final preparation. The job of removing the ribs is entrusted only to experts. The mirror will be installed in an observatory atop Palomar mountain near San Diego.



Experts at their job of cutting away the heavy ribs from the giant mirror which will be installed in observatory

Plywood Figure Directs Tourists to Camp

Made from plywood and painted in gay colors, the figure of a happy-looking old man directs tourists to a Minnesota camp. The figure is constructed with wooden thumb jauntily inviting the motorist to turn into the grounds.



This jovial figure isn't thumbing a ride; it's directing tourists to campground

House Gutters Kept Ice-Free by Chemical "Hot Brick"

Packed in cartons complete with fasteners for slate or shingle roofs, a special chemical for preventing water from freezing in the gutters and downspouts of the house is on the market. The chemical compound, called "hot brick," is held in a porous container and is fitted with a wick. When the container becomes wet, a continuous flow of non-freezing fluid is delivered through the wick. When the wick becomes dry, the flow stops automatically. The compound is designed to last one winter. Its function is to prevent freezing, thus forcing the water to leave the building as a liquid and without the damage frequently caused by ice-clogged gutters.

Popular Mechanics Magazine does not publish the name of the maker of, or dealer in, any device described in its pages, but this information will be furnished by our Bureau of Information upon request, accompanied by stamped envelope.

Owner - A. E. Lovejoy
Bureau of Information
Post Office

Factory north Adams, Mass.

Pat. March 24, 1936

Lyberty Booth

F1224.

ENGINEER Casey Jones

Chicago
Blauy
Blauy
Chicago
Chicago
Chicago

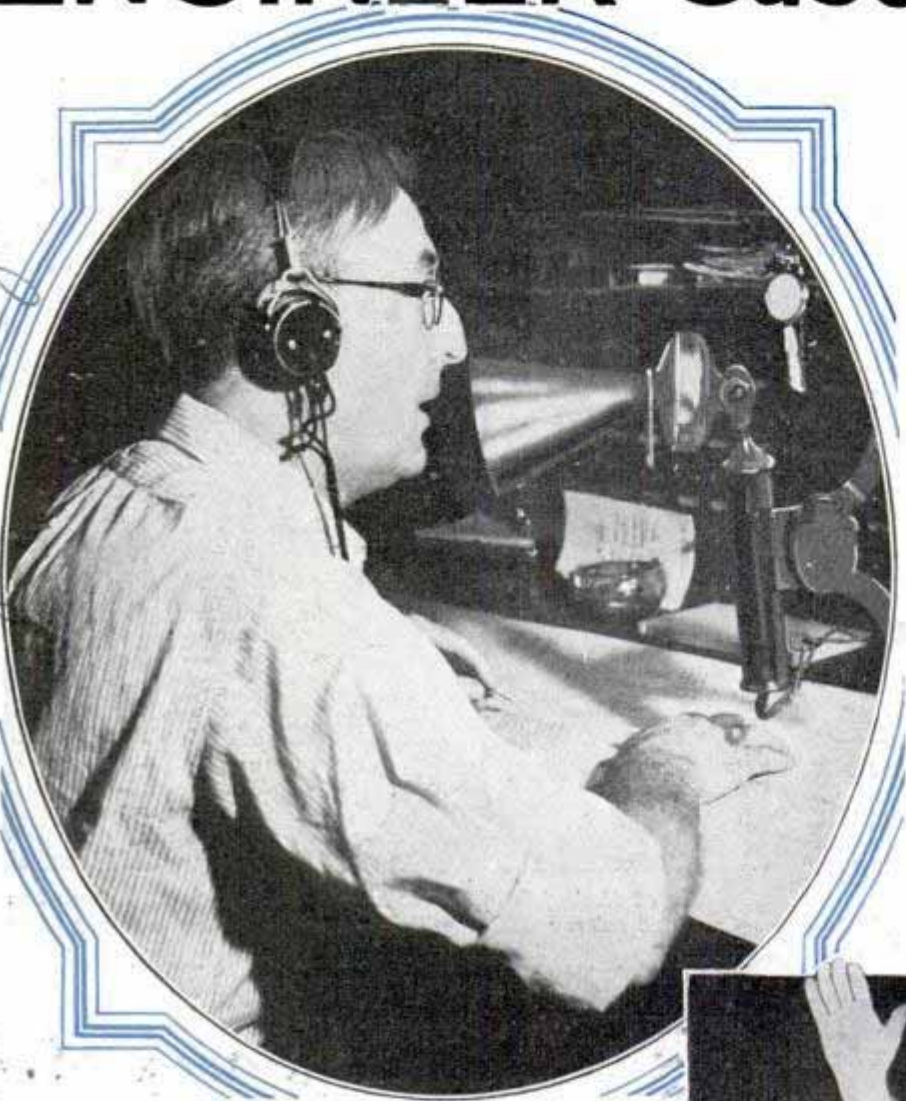

the terminal yards in Chicago and swinging gracefully around the curve onto the main line toward the west.

When the "City of Denver" "takes off," either from Chicago or on the eastward trip from Denver, it is still an "event." It is like the sailing of an ocean liner, although there is little swank about it on the railroad's part. The real excitement of the trip is in what is still called the engine "cab," although it is more like the front platform of a modern street car. So let's get back with George and take a ride.

Take a look first at the cab itself. Did you ever

By William H. Fort

h-w.

YOU are sitting behind George Reid, skipper of the "City of Denver," who is waiting for the starting signal from Frank Greenway, the conductor of this amazing streamliner. It comes as a single sharp-toned note from an overhead valve.

George's face, weatherbeaten by sun and rain and wind through the forty-odd years spent leaning out of steam-cab windows, breaks into a grin. He grasps the throttle bar with both hands and slowly eases it toward him a notch or two. Behind, from the door leading to the engine powerhouse, the Diesels, which until then have sounded much like a huge idling automobile engine, roar into a steady, powerful whine like a buzz saw in a logging mill. The "City of Denver" is on its way, rolling down the maze of tracks through



Dispatcher listening to progress report of "City of Denver" and conductor giving "high ball"

+ 12 29

TURNS MOTORMAN



see the inside of the control section of a steam engine? Ahead, a boiler with its yawning firepot door blazing with a roaring flame whenever it is opened, with gauges showing the temperature of the water, the mount of steam pressure. Behind, with no room to spare, the coal chute, a huge scoop shovel along with firepot implements, coal dust on the iron floor. On each side a high, uncomfortable seat, one for the fireman and one for his engineer. Craning half out the cab window is the only way anything like a clear view of the road ahead can be obtained. Boiling hot in the summer, cold in the winter and slopping wet during a storm.

In the "City of Denver" a rounded window of safety glass—the whole train is equipped with it—gives an unobstructed view both straight ahead and to each side. The prow of the train extends forward from the "windshield" like the hood of an



Power plant of the "City of Denver" and engineer at controls of this modern streamliner

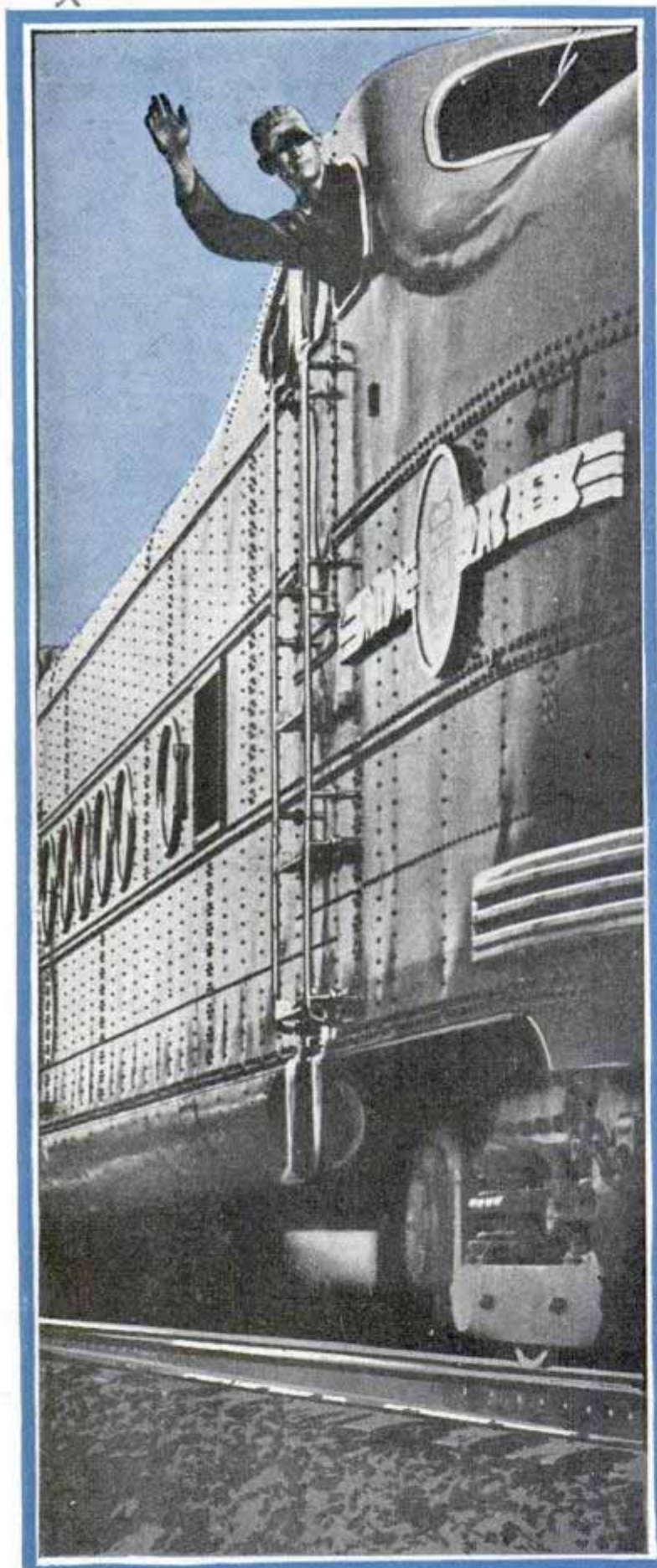

Easing the streamliner through the Chicago yards preparatory to making its run to Denver. Old-time engineers are divided in their opinions about these modern trains. Some of them object to being converted into "street-car motormen" but applications to drive the new trains outnumber the available jobs

automobile. Behind this windshield are three leather-upholstered seats, one for the engineer, the other two for his assistant and whoever else may be there. The engineer's chair is deeply cushioned, with arms, and is set on a swivel. The only difference, so far as comfort is concerned, between it and the private chair of the president of the railroad is that it can't roll across the floor. The windows roll down like those of an automobile. There is plenty of leg room in front of the seats. In front of the engineer on the dashboard are six gauges or indicators. One indicates the speed, another shows the heat of the engine and the others indicate air pressure of the brakes. To the left of these are three round disks of ground glass, set in a row and shaded by separate metal visors.

These, Claude Lewis, foreman of engines for the North Western explains, represent the most important development in railroading during recent years. They are the silent watchmen of the railroad's automatic train control system. If the track is all clear ahead, a green light shows in one of them. If there is some obstruction, the green disappears and two smaller spheres, red over orange, appear. At the same time a whistle blows, in case the engineer might have his eye on something else. When that red-and-orange signal appears—and with it the sound of the whistle—the engineer has exactly ten seconds to apply forty-five pounds of air on his brakes. If he should fail to do this, automatically the emergency brakes would be thrown on and the train brought to a stop.

As the engineer sits in his chair, his right foot rests continuously on a pedal, the springs of which are so delicately adjusted that only the weight of his foot is necessary to hold it down. Railroad men call it the "dead man's foot." If, inadvertently, the engineer

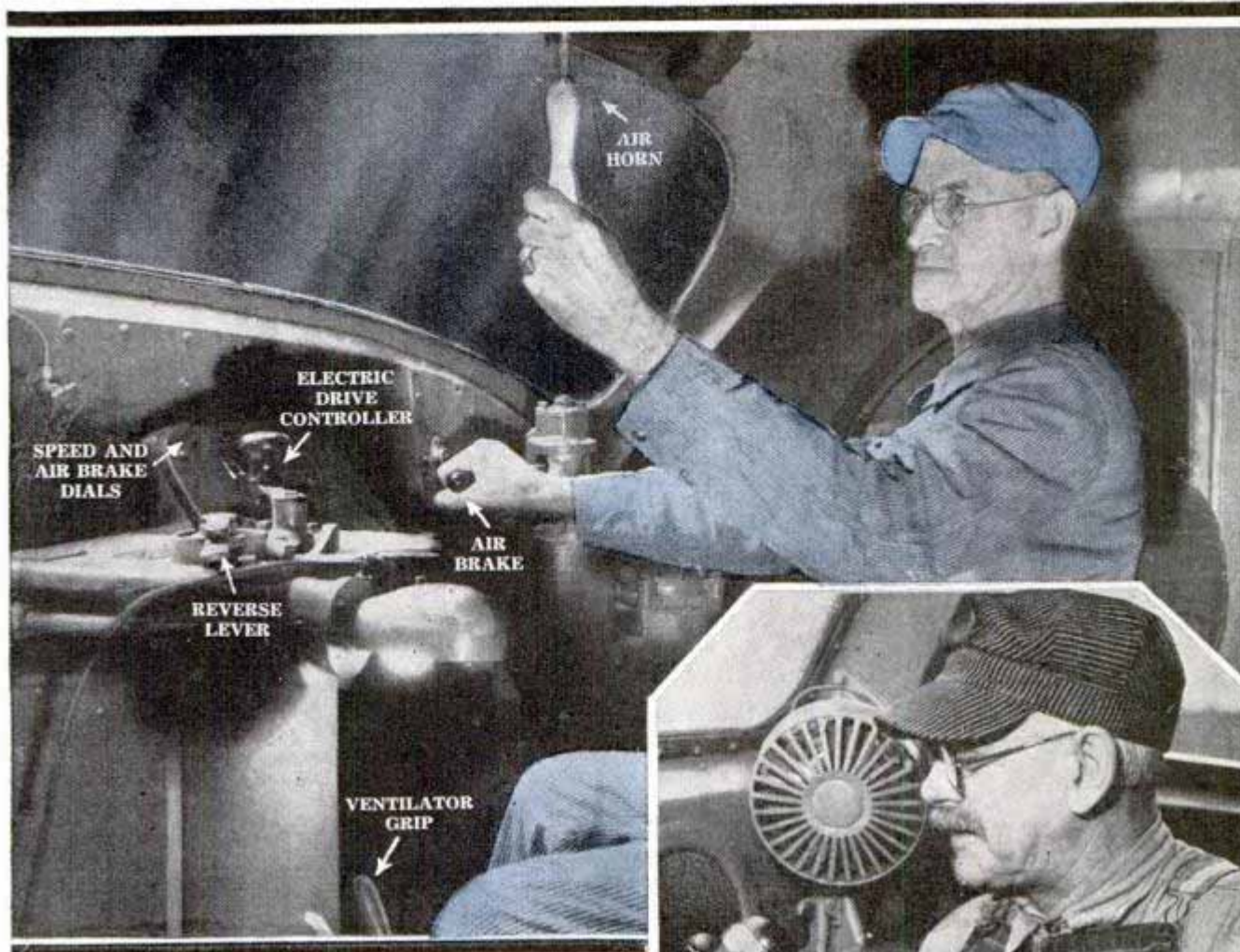

should move his right foot, the train would immediately come to a stop. This, it was explained, is to avert the possibility of an accident if the engineer is suddenly stricken with a heart attack or for some reason should be thrown from the control seat. Instead of careening down the tracks with no one at the controls, the train would stop itself. At the left of the engineer is an adjustable lever like the emergency brake on an automobile. This regulates the shutters on the outer hood which form part of the cooling system. The engines are water cooled with air vents to cool the water system. Watching the temperature gauge, the engineer regulates the heat of the engine by opening or closing the shutters. There is even a loudspeaker through which the train crew can talk to the engine from five different points on the train, should anything go wrong. A miniature "mike" in a niche on top of the control box enables the engineer and the train crew to hold a two-way conversation.

It is dusk as the train pulls out. Clouds scudding overhead reflect flashes of crim-

(Continued to page 128A)

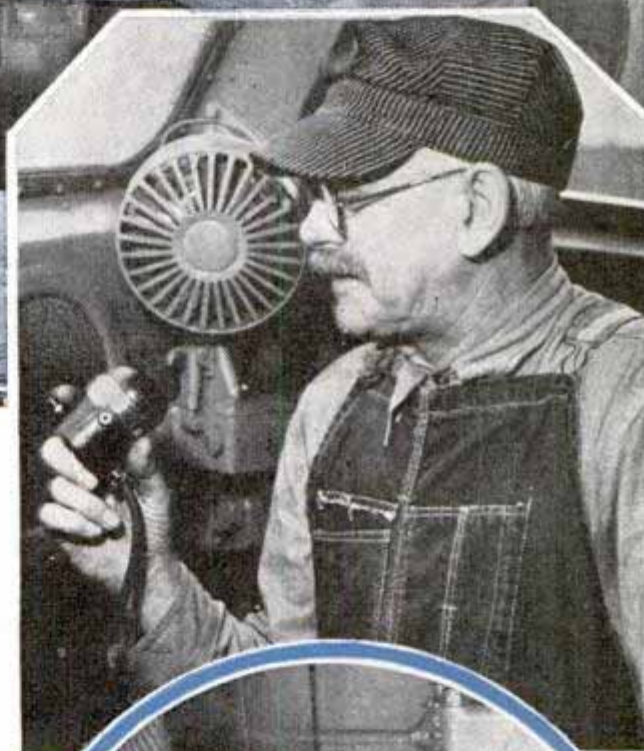

Engineer at controls of the "City of Denver." Center, engineer conversing with train crew by "telephone." Bottom, the "dead man's" throttle which stops train if pressure of foot is released

7-1501

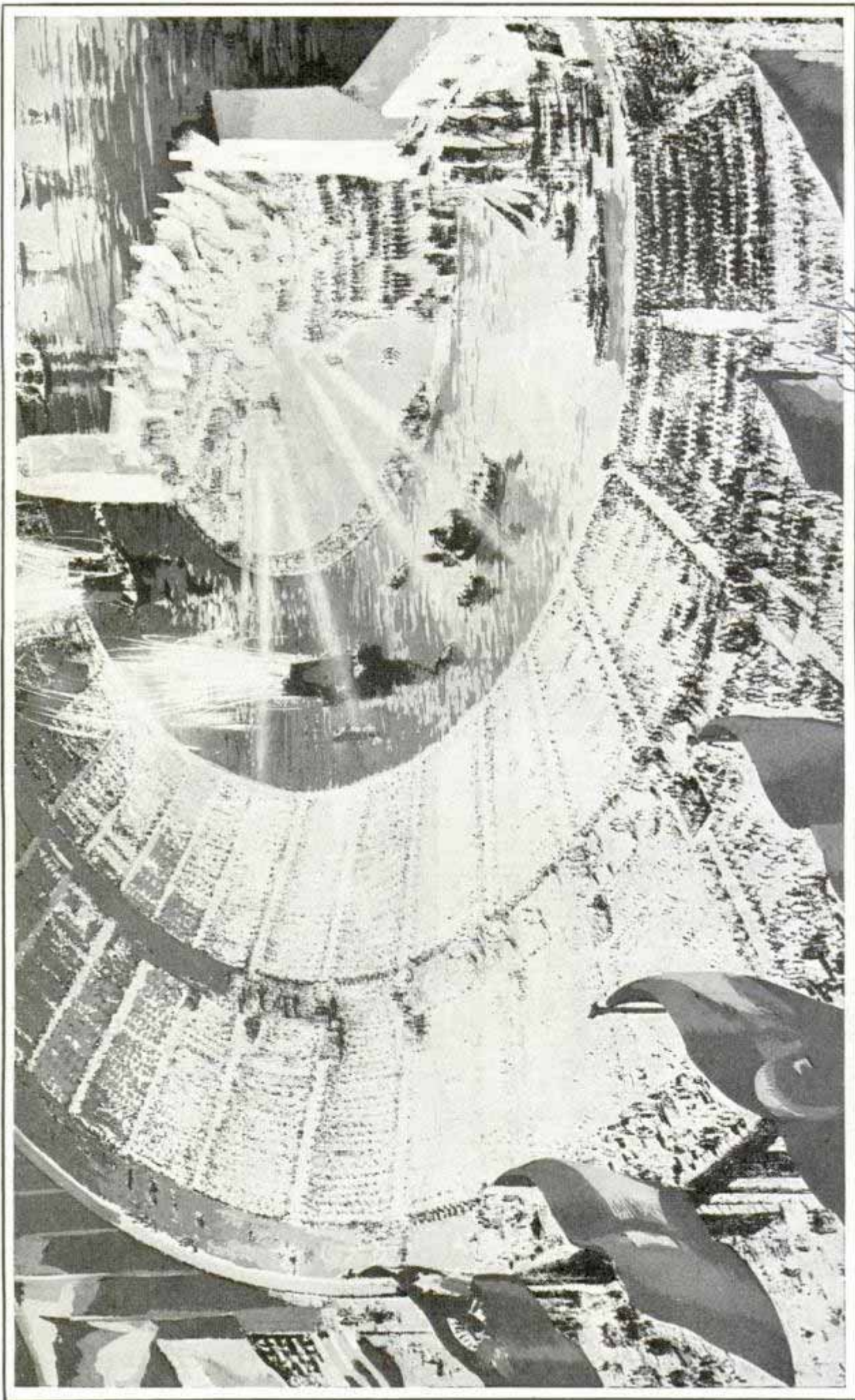

In this vast amphitheater thousands will gather during the New York world's fair in 1939 to witness water sports and pageants, fireworks, concerts and operas on an island stage 100 feet from the lagoon shore. Beneath the stadium the architect plans a great promenade hall flanked by exhibition rooms

Leaning Towers Start Power Line from Dam

Modern versions of the ancient "Leaning Tower of Pisa" are the rigid steel transmission towers that overhang Boulder canyon. They are the first of a chain of towers that carry the 266-mile line of hollow copper cables bringing electric power across desert and mountain from Boulder dam to Los Angeles and other cities of the Southern California coast.

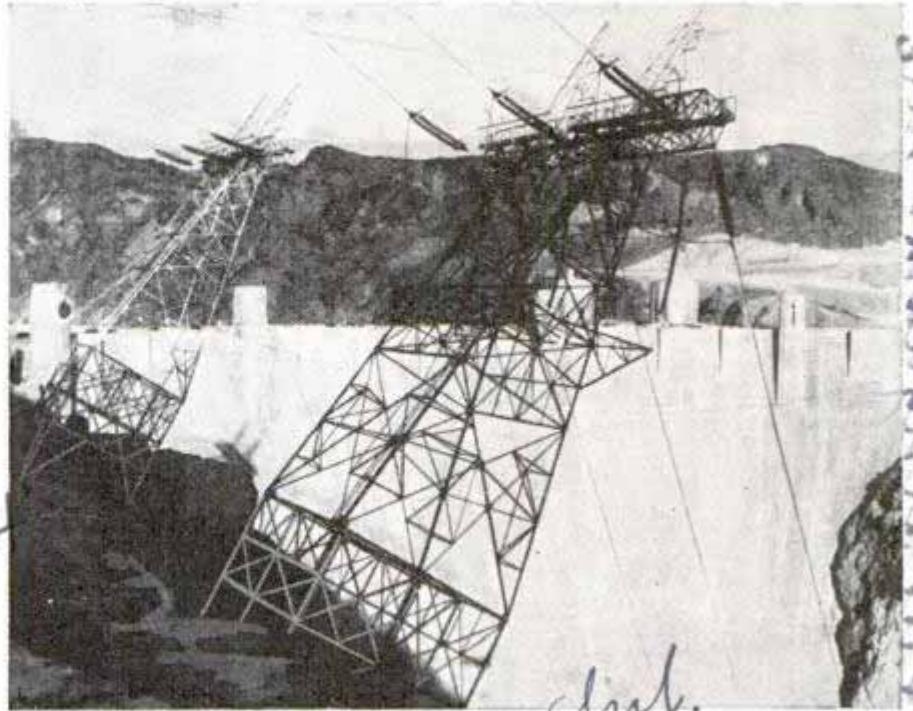

These leaning towers of steel perched over the brink of Boulder canyon shoulder the cables that start power flowing from dam to metropolis

Siphon to Handle Billion Gallons Each Day

Spanning California for 390 miles a giant aqueduct which will supply thirteen cities, including Los Angeles, with water is under construction. It will carry water from the Colorado river. Included in the great system is a huge siphon made of steel bars and concrete. It is large enough to handle one billion gallons of water per day.

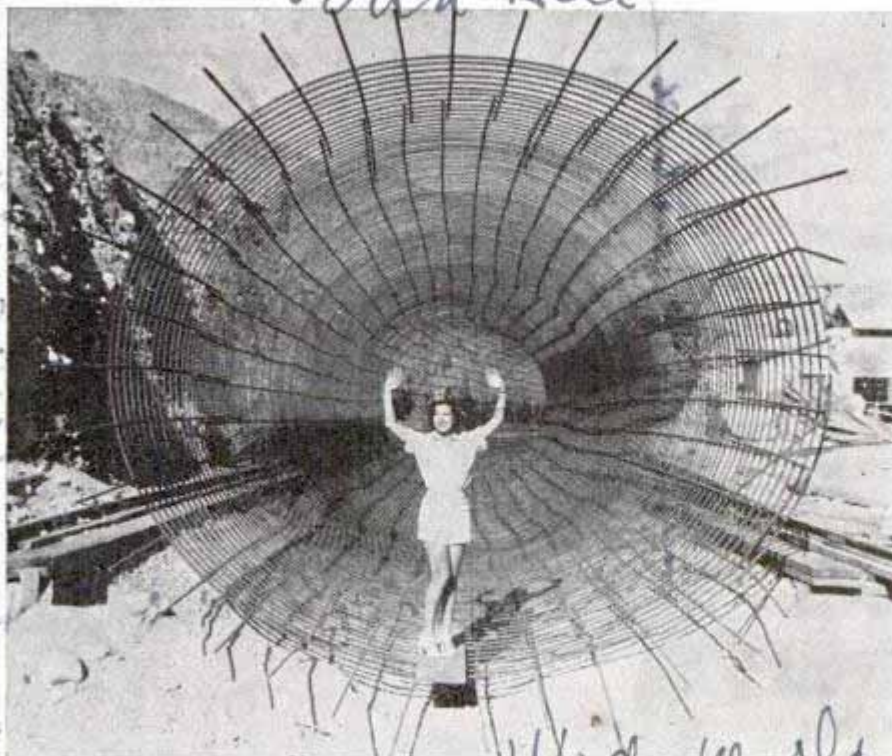

Figure of the girl helps to illustrate the size of iron-ribbed core of siphon which handles billion gallons of water per day

Steam Turbine Rail Locomotive Powered Like Ocean Liner

With virtually the same power plant that drives an ocean liner, a steam-turbine locomotive will make its debut this year on the Union Pacific railroad. From the traditional steam engine the railroads have turned to electric locomotives, gasoline motor cars, Diesel-electric power cars and now the steam turbine drive, in which steam is employed to turn the generators furnishing power to the driving motors. Lighter than the Diesel locomotive of corresponding power, this Union Pacific driver will be able to haul a 1,000-ton train at 110 miles an hour. It is expected to be more efficient than conventional steam engines.

There are more than 190,000 miles of streets in American cities of 2,500 or more population.

Wide World
marjory Isage

American City
Oct. 1936

General Electric Co.

Wartime Gas Attack Refuge Has Radio, Food and Water



Self-sufficient chamber built by London concern to shelter employees during gas attack. It has oxygen, food, and water

Forehanded London firms are planning protection for their employes from the threat of gas attacks on the city in the event of another outbreak of war. One company has installed a self-sustaining refuge which is proof against every known form of deadly gas and has not only air filters but first-aid equipment, food lockers and a water supply. Thus its occupants could withstand a prolonged gas attack. The shelter has telephone and radio for communication with the outside world.

Craftsmen of Old in Crew of Modern Liners

Modern ocean liners, like the giant "Queen Mary," carry in their crew such craftsmen of ancient days as a lamptrimmer and a sailmaker. The lamptrimmer's job on the windjammers of old was to keep wicks trimmed and lamps filled with oil. On the modern liner he performs the same duties because all ships are required to carry a set of oil navigating lamps to sup-

plement the electric lamps. The sailmaker, now that sails are not used on big liners, fashions canvas covers for lifeboats, ventilators and hatches. He is now called the storekeeper and is responsible for seamen's stores, such as rope, paint, wire and canvas. The ship's carpenter deserves the name of shipwright because he is an expert worker in metal and wood. Any major repairs that are necessary while the ship is at sea are handled by the carpenter and he also transfers the water ballast and water supply from tank to tank to keep the ship "trimmed" and pumps in water ballast to replace the oil as it is consumed by the engines. The "Queen Mary" also has her ordinary seamen, who find plenty to do keeping decks scrubbed, metal polished, hatches battened down and a thousand and one other tasks. Also in the crew are electricians, plumbers, engineers, boilermakers, joiners, stewards, bellhops and even policemen, called masters-at-arms.

Overnight Tent on Top of Auto Is Tourists' "Upper Berth"



Tourists camping for the night on top of their car. Tent is supported by ladder-like prop in front

Ten minutes after you have parked the car in an ideal camping spot you can have the tent pitched for the night on the roof. This "upper berth" for campers was in-

Office of Carriage Engineering Co. 1315. Duncraigham Road

Levallois, Seine 71, Seine Rue de, 20, Sarcote Subano

Ad information

F1 217

Coyard while you

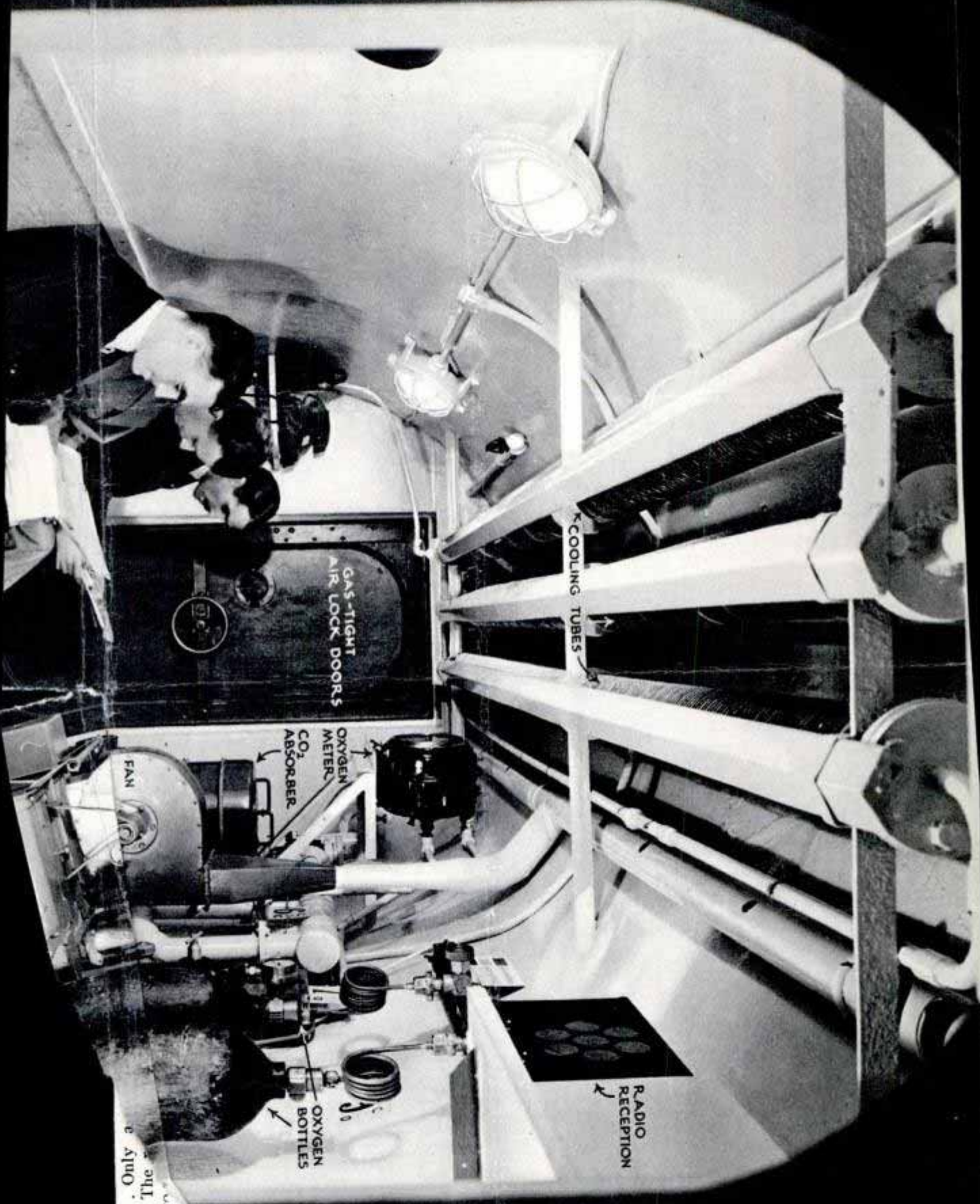

their own areas. . . . Only a
loved what he did. The
Lawrence managed to
b cause after

GAS-TIGHT
AIR LOCK DOORS

COOLING TUBES

OXYGEN
METER
CO₂
ABSORBER

FAN

OXYGEN
BOTTLES

RADIO
RECEPTION

... we must control or reconcile. We have tried it, with
ing results, in Ireland, in India, and in South Africa.
we are faced with a similar problem in Palestine.
ral of my books this week touch on this question, from
rent points of view. Some of them also allude incident-
to Lawrence of Arabia, of whom we were reminded
n recently by Mr. Churchill's masterly address when
giving a memorial tablet to him at the High School, Oxford.

It must not be thought that these matters constitute
whole interest of "THREE DESERTS." By C. S. Jarvis,
Governor of Sinai. Illustrated by Frank Lee (Murray;
6d.), a work recommended by the Book Society. The
author has had eighteen years' experience as an adminis-
trator of Arab countries, including thirteen in Sinai as
governor. He therefore writes with authority concerning
Arabs, but his book has not the slightest trace of
social *hauteur*. It is, in fact, a delightfully entertaining
account of his personal activities and journeyings, per-
meated through and through with wit and humour. At
the same time, it possesses a solid core of historical value
—a picture of people and places and a record of events.
"Three deserts" are those in which his administrative
career was successively located—in Libya; the region
surrounding the Kharga oasis; and the wilderness of Sinai,
of the most curious episodes is the great campaign
against locusts. Very interesting, too, are the passages
describing how, as gardener and agriculturist, Major Jarvis
conquered the desert to blossom like the rose. Perhaps the
most charming part of the book, however, is that devoted
to his canine friends. In its humour and sympathy it is
one of the best things about dogs that I have ever read.

Major Jarvis heads his chapter on Lawrence and the
Arab Revolt with Antony's tribute to Brutus: "And say
all the world, 'this was a man.'" Mr. Churchill recalled
Lawrence's distress at "what he deemed the ill-usage of
Arab friends and allies," to whom he had pledged the
aid of Britain and his own. Major Jarvis apparently
considers that the Arabs were unworthy of Lawrence's
attention. "There is no questioning the fact," he writes,
that Lawrence was a great man and that he will go down
in posterity as the finest guerrilla commander that has
ever existed. . . . The Arabs were only interested in the
solution for three objects, in the following order of
importance—gold, loot, and the satisfactory clearing up
of the race, the work of

"The Jews," says Lord Melchett, "do not wish the land
that was allotted them as a National Home to become a
perpetual battle-ground. They definitely do wish to live
in peace and goodwill with the Arab community." Here
and elsewhere the author seems to suggest that the whole
of Palestine is to be the Jews' National Home. This goes
rather beyond the words of the Balfour Declaration, which



SACRILEGE IN THE SPANISH CIVIL WAR: A STATUE OF THE CHILD CHRIST DRESSED TO REPRESENT A GOVERNMENT MILITIAMAN AND GIVEN A REVOLVER AND A RED

to eke out a meagre existence, is so much more. The standard of life of the Palestinian Arab is the highest among the native population of the East. This is a reversal of the pre-war conditions. Palestine was the most backward State of all. No nation is placed on the immigration of Arabs from Transjordan, and their large influx is at once a refutation of the claim that Arabs are being forced into the country. It is estimated that since 1922 no less than 200,000 Arabs have immigrated into Palestine. There was a time when Europe was plunged in the Ages, and when the torch of culture and knowledge kept alight only by the harmonious co-operation of Arab. Why should not this erstwhile trust and ship be restored? The two peoples together could do things for the world. Why shall not Israel and the live once more in amity in the field as in the town Jerusalem shall once more become the 'city of God' and 'be full of boys and girls playing in the thereof'? (Zechariah viii. 5.)"

Another expression of the Zionist standpoint from an American Jewess who has gone to live in Palestine. She relates her experiences with fervour, and pictures (sometimes unpleasant) detail, in "Spring Up, O Viper" By Dorothy Ruth Kahn. Illustrated. With an introduction by Henry W. Nevins (Cape; 10s. 6d.). The author strikes a hopeful note when she says: "For Arab and the Jew it may be only a matter of time these two Semitic mentalities are able to re-orientate themselves to each other." The fact that Mr. Nevins considered this book worthy of commendation will be less win for it many readers. His own early interest in Jewish history, he recalls, sprang from a Victorian religious education, laying stress on Old Testament stories tending to make British children identify themselves with the Chosen People. "How much greater that identification must be," he proceeds, "to every Jew who approaches Palestine for the first time. Mr. Balfour's Declaration of 1917 has made the phrase 'National Home' familiar to a Jew Palestine is far more than a National Home. It is a Spiritual Home. Ever since the Roman legions destroyed his city and laid waste the heritage of his heart the Jew has turned to his spiritual home. Christians have turned to the site of Calvary, and Moslems to Mecca. The author of the present book shows irresistibly the attraction, even to a Jew who was reared in the Jewish faith or custom."

Colonial Times

...two years of close...
in their failings and weaknesses and their total...
personal feeling were daily brought home to him."

Again, Major Jarvis suggests that the Arabs, after all, have a little cause for complaint. "I cannot see, considering things," he writes, "that we failed to honour our bond to any great extent. The Iraqians, who took no part in the struggle, have their independence, and the Sudan, or Saudi Arabia has it also. The British Mandate has a very modified form of independence. . . . The great fault of the Syrian people did absolutely nothing beyond hold secret meetings and talk. The inhabitants of Palestine are rather less than this, and yet it is in the educated *effendiya* of the Syrian towns that one hears all the talk of Arab independence and Great Britain's perfidy. In the first place these people took no part whatsoever in assisting the Allies to drive out the Turks from their country, and secondly they are not Arabs. An Arab must of necessity be of Arabian birth, and neither Palestine nor Syria is in Arabia proper. These countries are inhabited by a race of cultivators and townfolk who undoubtedly descended from the ancient Syrians, Jebusites, Canaanites, Philistines or others that occupied these lands before the days of Christ. True, they were conquered by the Arabs of Arabia in the seventh century, but that does not make the inhabitant of the country to-day an Arab any more than the conquest of Great Britain in A.D. 43 makes the Englishman an Italian."

As in all international questions, the general reader, unacquainted with the locality concerned, is bewildered by divergent opinion among those who profess that special knowledge. I remember, for example, a recent article in *Observer* by Professor John Garstang, the famous archaeologist, in which he contended that the "establishment in Palestine a National Home for the Jewish people," and the subsequent British Mandate, practically ignored the fact that the country was "already the home of another people," and that "for more than 1000 years an Arab people has dwelt

This photograph, which, a correspondent states, was taken on the road to Cordoba, shows a statue of the Child Christ taken out of a church and placed as a warning to drivers entering the village of Bailen to stop and have their papers examined.



AN ORGY OF WANTON DESTRUCTION BY "RED" PARTISANS AT VICH, A TOWN NEAR BARCELONA: A PILE OF ECCLESIASTICAL STATUES AND TREASURES TORN FROM THE BISHOP'S PALACE READY TO BE BURNED IN THE MARKET PLACE.

According to a description sent with this photograph, not only were paintings and sculptures destroyed on this occasion, but archives containing documents of historical and archaeological value of the fourteenth, fifteenth, and sixteenth centuries and a collection of old Mass books were burnt. Certainly the Museo Episcopal in the Bishop's palace contained a number of artistic treasures. Whether these have all perished is not known. Photographs of church-wrecking in Andalusia are on the opposite page.

proposed establishing such a home "in Palestine." There is a slight distinction between the two ways of putting it.

Lord Melchett traces the history of Zionism and offers practical suggestions for a settlement. Among other things he suggests that the future of the Arabs should be to develop the vast territories of Arabia, and, discussing

though not so military, are related in "THE BLACK OF ARABIA" (My Life Among the Bedouins). By Raswan. Illustrated (Hurst and Co.; 3s. 6d.). This is a new addition to the Paternoster Library, and apparently from an earlier edition. The book drew high praise from Mr. Cunningham Graham. It sets before you a picture of Arab life and point of view as something seen in a flash of lightning. The author is a man who had already spent time among the Arabs when the Dardanelles were then served at the Dardanelles and on the Suez Canal. After the war he eventually returned to England. He expresses deep admiration for Lawrence, and of the late Doughty's classic "Arabia Deserta." His own purpose in revisiting Arabia was mainly to study the Arab mind and its breeding. His book contains valuable information on this

The author attributes his knowledge of the Arabs, and their traditions, to the fact that he refrained from meddling in their politics. In an appendix, however, he provides an interesting commentary on political conditions in Arabia and on the genius of Ibn Sa'ud. "Perhaps Great Britain," he concludes, "is destined to be the god-father to this new Islamicism. Great Britain may be the world of Islam, and the same rôle of protector and co-protector she has done, and will do, in the federation of Indian States, and further be called upon to devote her power to securing everlasting peace between both the Arab and Abraham—Israel and Ishmael. This would end the Arab question. In my opinion, it can only come to pass if the British Empire stands for an Arab Empire as it stands for an Indian Empire and embraces within this Arab-Indian Empire the State, as a stout ally of all Arab States." Surprisingly, he is justified of his saying—"What should the rôle of England who only England know?"

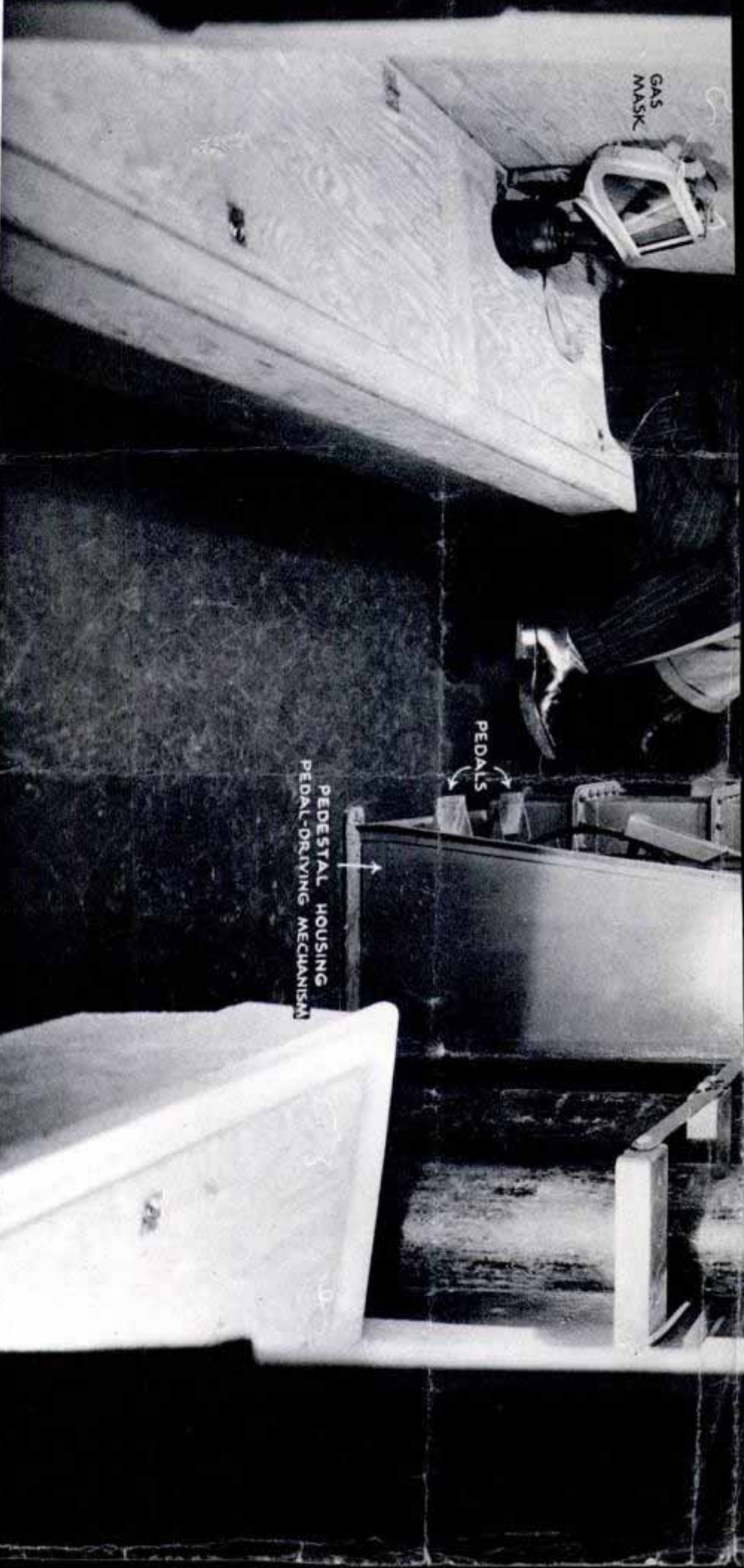

GAS-MASK PRINCIPLE APPLIED TO A SHELTER: AN UNDERGROUND ROOM BENEATH A GASPROOF OFFICE WHICH IS SO DEvised AT IT COULD RECEIVE ONLY PURIFIED AIR DURING A GAS ATTACK, THUS ENABLING THOSE WITHIN IT TO REMAIN IN SAFETY.

anti-gas shelter, built underground, has been installed at the offices of the Engineering Co., in Buckingham Gate. It has alternative entrances, each of two doors forming an air-lock. Thus people can be admitted without which draws gas-laden air from outside through an anti-gas filter proofed any known form of gas, and then discharges the purified air through into the interior. Should the inlet be destroyed, a valve inside the can be closed, shutting off the outside supply. A continual circulation through a chemical CO₂ absorber then takes place, while oxygen is from bottles in order to maintain the air at the proper oxygen The fan used for drawing the air from outside, or circulating air inside,

the shelter is driven by an electric motor; but, should the power supply fail, the fan can be operated by means of a pedal attachment. The walls are treated with a special coating in order that the shelter may be as air-tight as possible. The equipment is very extensive—including a wireless set, so that bulletins can be received, a telephone, first-aid necessities, gas-masks, food lockers, and drinking water. The four-storey building above has been fitted with gas-filtration plant so that the staff can remain at work during a gas raid. This plant takes the air from outside through a poison-gas filter and discharges it into the various rooms in pure form by ducts normally used for conveying air from an air-conditioning plant. Steel shutters are fitted to the windows for protection against bomb splinters and flying debris.

Illustrated London News Oct. 12, 1930

roduced to motorists in France. The overnight tent, compactly packed on the top during the day, is quickly unfolded, and is entered from the front by a ladder which serves also as a frame for the tent floor. The flap has zipper fasteners.

Tire Chain for Dual Wheels Has Easily Detached Lugs



Notice the broad lugs attached by a single chain to dual tires. A truck equipped with these successfully navigated the sticky mire at right

Coffee Measured by Dial on Glass Jar

Helping to maintain uniform strength in coffee, a measuring dial attached to a glass coffee jar permits only the exact number of spoonfuls to be dropped into the pot. The dial has three letters, "L," "M" and "S." Manipulation of the dial at "L" produces a perfectly measured large spoonful of ground coffee; "M" a medium and "S" a small spoonful. Thus is eliminated all guesswork. Coffee in the jar remains fresh.



Measuring coffee into the pot with aid of device on latest glass container

Detachable lugs made to fit the dual wheels of motor trucks assure good traction whether on icy pavements or in hub-deep mire. A single chain between the tires holds the tough, long-wearing lugs in place, and they can be installed without jacking up the vehicle even if the wheels are axle-deep in gumbo or sand. The lugs are made of drop forgings, heat treated and case hardened, and the chains are of heavy steel, electric-welded links.

Rat's Leg Grafted to Another without Loss of Function

Without loss of muscle or nerves, a rat's leg has been transplanted to another rat. The grafted leg not only remained healthy but its new owner can control the muscles and flex the toes. Dr. J. V. Schwind of Chicago accomplished this by transplanting the right hind leg of a white rat, including all bones and muscles below the knee, to the back of a second rat, giving it five legs. The sciatic nerve of the leg was joined to a branch of the rat's sciatic nerve so that when its own right hind leg moves, the transplanted leg also moves. Until satisfactory blood vessel connections were made, the leg was left partly attached to its original owner.

Dr. William D. Warriner
Dr. J. V. Schwind
Professor
60 - 11th Ave. N.E., Minneapolis, Minn.
School of Medicine
Loyola Univ.
measur. dial
F1300
F1341
since 10/15/36

Dr. W. & wife; M. K. Geigel

F108

GIANT BOMBERS



bombers are considered ideal for defense against any enemy air attack which might be launched against Gotham, the treasure house of the United States.

The defensive work of the bombardment planes would be in the form of a fierce attack on the enemy air bases, which probably would be the decks of airplane carriers. Guided to their objective by the radio of a naval vessel or the buzzing antennas of scouting planes, these bombers could carry enough T.N.T. to put out of commission any airplane carrier now afloat.

Each of these planes can carry

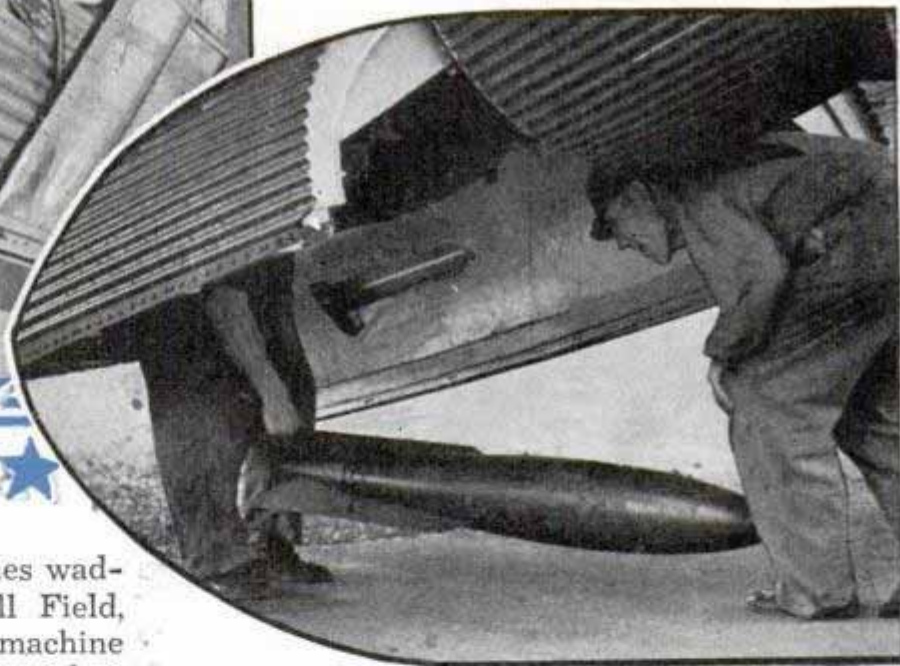

FROM dawn to dusk, giant planes waddle from hangars at Mitchell Field, Long Island, these days as pilots, machine gunners and bombers learn to manipulate Uncle Sam's latest birds of death, monster bombardment ships intended to protect New York City's millions from enemy air attack.

Thirty of these flying death-machines, B10b Martin bombers, each capable of carrying a ton of bombs, have been delivered as a part of the new plan of the General Headquarters Air Force to convert the former observation unit into the most deadly bombardment group on American soil. Capable of a cruising speed of more than 210 miles an hour, these long-range

All photos by Harris and Ewing
Loading bomb into Martin bomber, and machine gunner demonstrating mobility of his weapon

350 Madison Ave N.Y.C.
a ton of destruction ranging from 100-pound demolition bombs to 2,500-pound high-explosive bombs, one of which would wreck a shipyard, freight terminal or a fair-sized city. In defensive action, perhaps, some of the planes would carry smoke bombs, to help our fleet screen its defensive maneuvers. Other bombardment planes would carry bombs heavy enough to disable or destroy a battleship, and still

71088

Guard NATION'S Gates

Weighing ingredients going into aerial bomb. Below, the "egg sack" of a bomber open and the demolition bombs beginning their earthward flight. Bottom, inserting chemical into smoke bomb

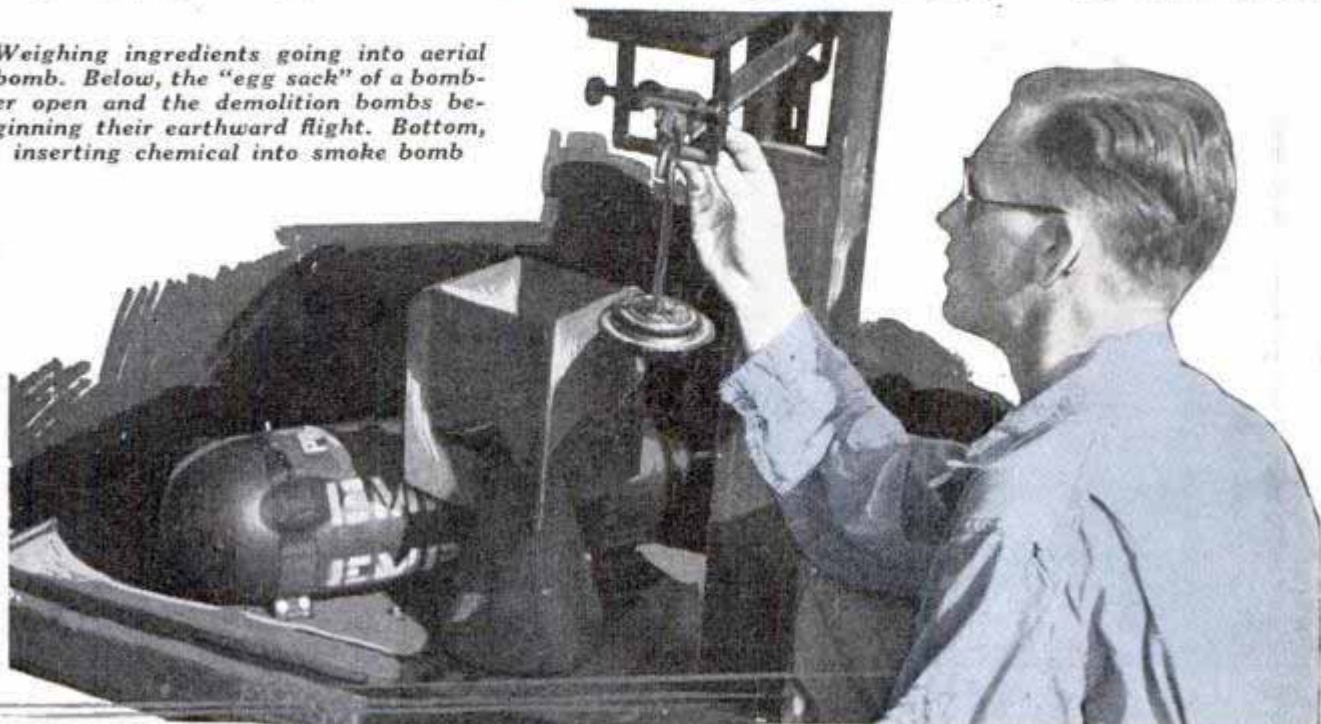

others would carry 100-pound demolition bombs. Direct hits from three of these would create such havoc on the flying deck of any enemy carrier that it would be unfit as a base for many days.

But it is not with their bombs alone that these flying fortresses would prove invaluable defenders of America's greatest city. Taking off without a burdensome load of bombs, these planes have a straightaway flying speed as high as any planes likely to attempt the bombardment of New York City. Spread fanwise over the ocean, their chattering machine guns could make a formidable ring of death through which an enemy would have to fly before



"laying eggs" on Manhattan. Besides the dashing young pilots, machine gunners and bombers who go sky-side, hundreds of ground men must keep the planes in the air and provide the bombs for them to drop. Drivers nurse their lumbering trucks onto the field loaded with T.N.T., and chemicals. Others bring in empty steel bomb cases. Hundreds of others load bombs in isolated tents, far from hangars.

Some of the men measure the amount of T.N.T. which goes into the 100-pound demolition bombs. Others work on the "big fellows," ranging from the 300-pounders up to the 2,500-pound giants. Still others insert the chemical cartridges which give smoke bombs their potency.

The "big Berthas" among the bombs are not intended for the destruction of a mobile enemy. In the first place, a miss costs too much. And second, very few enemy objectives deserve the dignity of being blown entirely into oblivion. These bombs are intended for objectives similar to New York City, railroad yards, dry docks, ammunition factories and shipyards. It is estimated that three of these 2,500-pound bombs, one landing in the down-

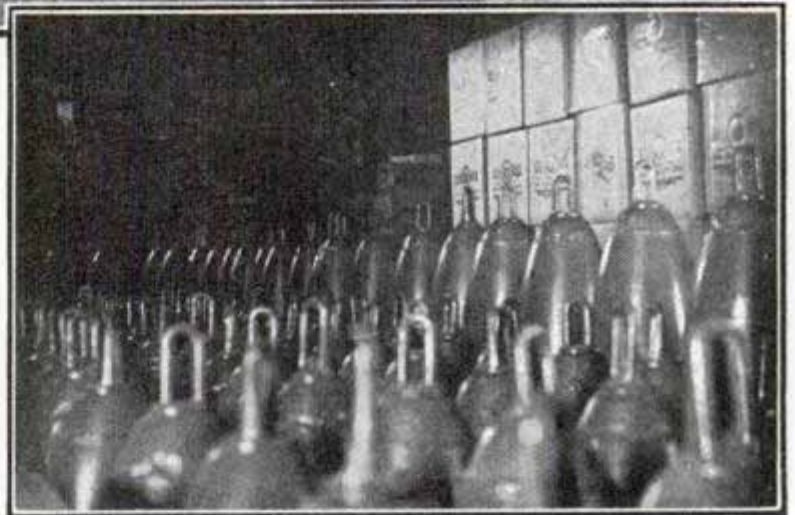

Army bombardment plane, poised for flight, and rows of reserve aerial bombs in storage

town financial district of New York City, another in midtown and the third in the uptown section, not only would put Manhattan Island out of commission, but would destroy residential houses a considerable distance away.

The development of Mitchell Field into a bombardment base is in keeping with a broad plan devised at the time the General Headquarters Air Force was created and the young officer, Maj. Gen. Frank M. Andrews, was placed in command. At Mitchell Field are the headquarters of the Ninth bombardment group composed of the First, Fifth and Ninety-Ninth bombardment squadrons and the Eighth photo section. In addition to these, there are the Ninety-Seventh observation squadron and

the Fourteenth photo section. Mitchell Field is a part of the Second wing of the air force organization. The wing includes the Second bombardment group and Eighth pursuit groups at Langley Field, Va., and the First pursuit group at Selfridge Field, Mt. Clemens, Mich. Of the other two wings, the first is located in the far west, the third in the south.

Units of the various wings are coordinated by a new system of "flying flagships." Each of these is equipped with radios powerful enough so that Maj. Gen. Andrews at Langley, for example, can maintain communication with Col. Walter H. Frank, commanding officer at Mitchell Field, and either or both of these officers can communicate with the commanding officer at Selfridge while all three are in

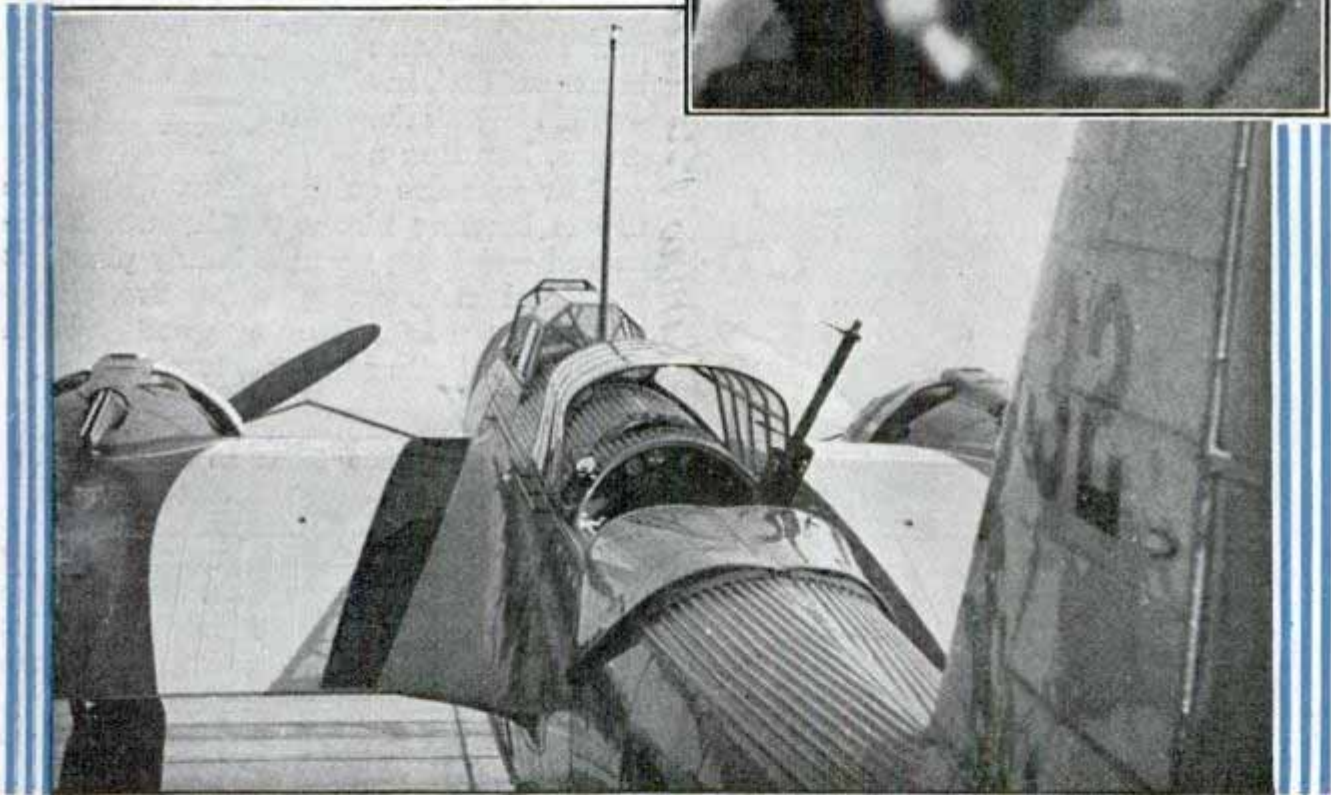
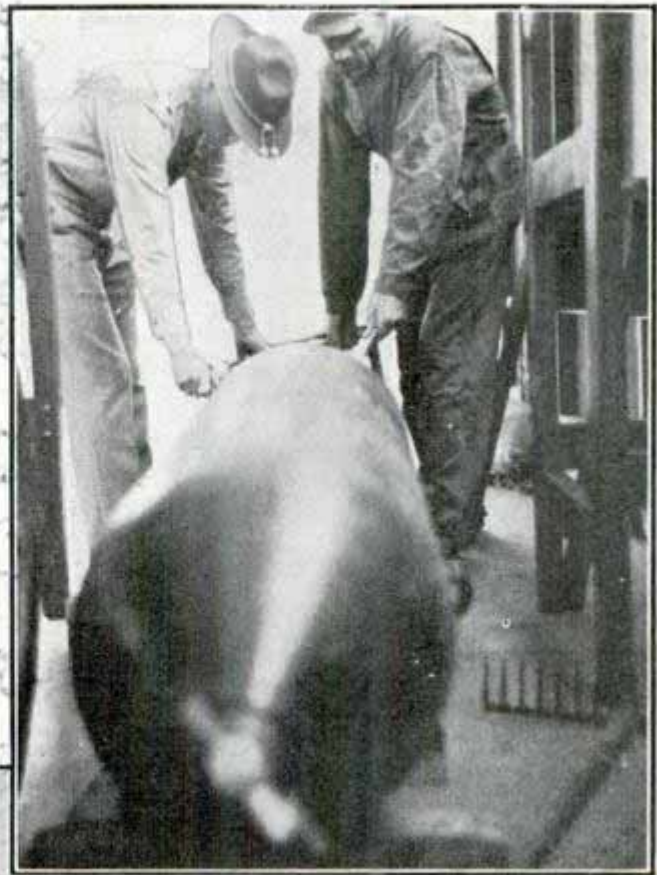

Rear machine gunner's cockpit in a bombardment plane and, above, fitting the wings to a 2,500-pound "angel of death," preparatory to loading it on bomber

the air directing their commands.

This development has changed the type of work done by commanding officers in the air force from that of the protected officer sitting in a bombproof dugout to that of a "Lord Nelson" moving into battle with his brother officers and men aboard the dreadnaughts of the sky. And although the B10b Martin bombardment plane is the largest, fastest and most for-

midable ship of its type now in service, orders for a super-dreadnaught fighter have been placed with the Boeing company. One of these ships was delivered, but it was destroyed. Additional ones will be in service shortly, and it is understood that a few will be commissioned to Mitchell Field where they will help other bombers, the new pursuit ships and scouting planes protect New York City.

F1295
46

12465 Luddarva.
Detroit Mich

Car Atop Dealer's Building Latest in Advertising

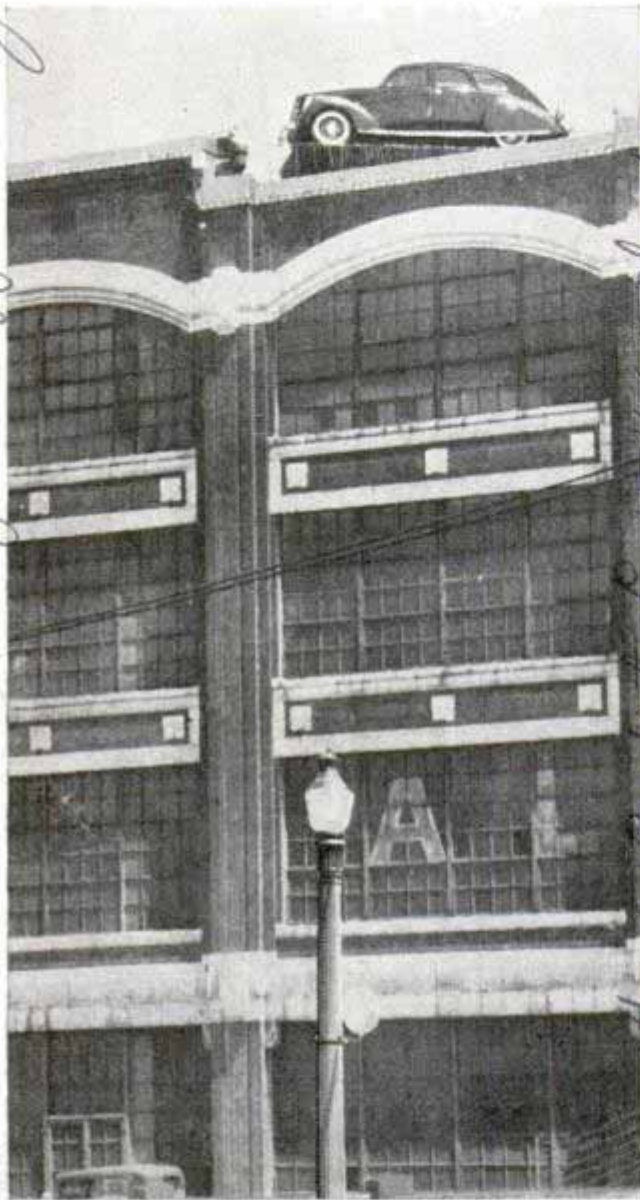

Note the full-size automobile perched on top of this building as advertisement

Putting a new automobile atop the building in which he maintains a sales office is the latest wrinkle in advertising. An automobile dealer at Buffalo, N. Y., has attracted considerable attention to his merchandise by installing the car at one corner of the roof.

Chemical Land of Opportunity Seen for Industry in South

Today's land of opportunity for the chemical industries — soap, paper, glass, alcohol and resins—is the southland. Chemists foresee a southward trend as industries discover the abundance of raw materials, fuel and power, labor, and the

favorable climatic conditions of that region. Soap is not produced in great quantities in the south, yet the requisite fats, oils, alkalis, sodium silicate and resin are available there. Southern pines promise the pulp for paper industries. Raw materials for glass invite that industry. Synthetic resins may be made from sugar. Glycerin, ethyl alcohol and vegetable casein may be manufactured from southern rice, and the Gulf coast petroleum field may develop synthetic chemicals.

F1265

Fire Kindled in Coal Furnace by Portable Gas Lighter

Starting the furnace fire with a gas flame is a quick and easy method. A portable furnace lighter recently developed can be connected with a gas line in the basement and, inserted beneath the grates, kindles a

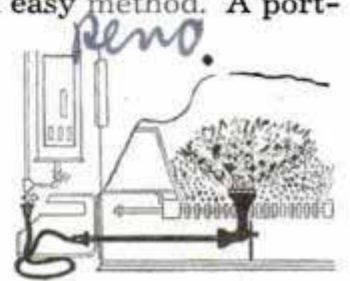

coal or coke fire quite rapidly. When the fire is burning nicely the lighter is removed and hung up in a handy place. It is helpful in "boosting" a low fire, eliminates the need for kindling wood and can also be used as a soldering torch.

F1327

Burning Off Paint Is Speeded by Flame Spreader

Constructed to fit the nozzle of any standard blowtorch, a new type flame spreader speeds up the removal of paint by burning. The device causes the flame to emerge from the torch in a flat plane, covering a four-inch area. Sweeping the

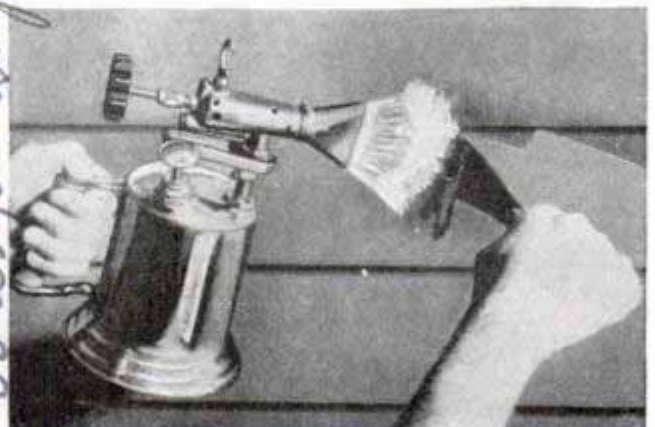

Burning paint with flame spreader on blowtorch

Lincoln Sales Building, Buffalo, N.Y.

Thomas Products Co. 1547 65 Cherriman Ave. Detroit Mich

Science Service
10/10/36
F1295

James A. Lee, Editor
Physics and Metallurgy

Summer Brass Works

71256
Corp. 117 West St. New York

flame across a painted surface loosens the paint so that it may be removed easily with a putty knife. The spreader also is handy for removing grease from motors.

Huge Spanish Galleon Built for Use in Motion Pictures

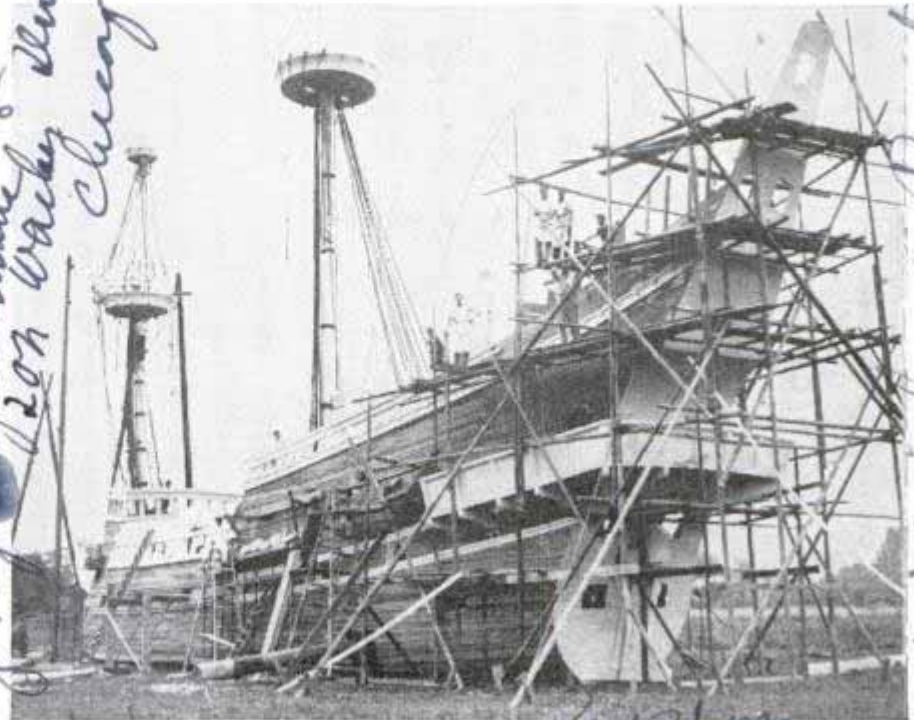

Here is the "dry-land" galleon being constructed on a motion-picture lot. It is a duplicate of craft used many years ago by the Spanish

Inter-Office Phone Plugs into Any Socket

You can telephone from the bedroom to the kitchen over the electric-light wires, or plug into your office desk lamp and talk to the shipping room. A two-way portable telephone system that utilizes the house wiring circuit has just been demonstrated by a radio inventor. The speaker merely plugs in his portable set at any socket in the building and converses with another person plugged into any other socket.

Firemen Play "Water Ball" with Fire Hoses

Played with a huge rubber ball and streams of water from fire hoses, a new game has been developed by Berlin firemen. The rules forbid touching the ball by hands, feet or any part of the body. Only the streams from the hoses can be used to propel the ball through the goal.



Trying to push ball over goal with streams from hose during game of "water ball" played by Berlin firemen

For use in a motion picture, "Fire over England," a huge model of a Spanish galleon was constructed in a field beside the studio. The model, a duplicate of craft used many years ago by the Spanish, is large enough for actors to go through their roles aboard the dry-land ship.

Ditches Reinforced with Cotton Resist Weeds and Erosion

Cotton membrane is being widely used to reinforce the asphalt lining of ditches, making them resist erosion, cracking and breakdown by weeds. Roadside drainage ditches, soil erosion control ditches, irrigation and malaria control ditches are all being built with cotton-reinforced asphalt lining. Five hundred miles of secondary dirt roads have also been surfaced with asphalt reinforced by cotton fabric, and the same method is being applied to airport runways.

and Sol Levy

7129
Chicago High School
207 Wacker Drive
Chicago

at Lenham's Books Engle

320 Broadway New York
C. K. Coyle

Radio Signal Replaces Bomb in Target Practice for Pilots

*30th Bombardment Squadron
March Field
Riverside Calif.*

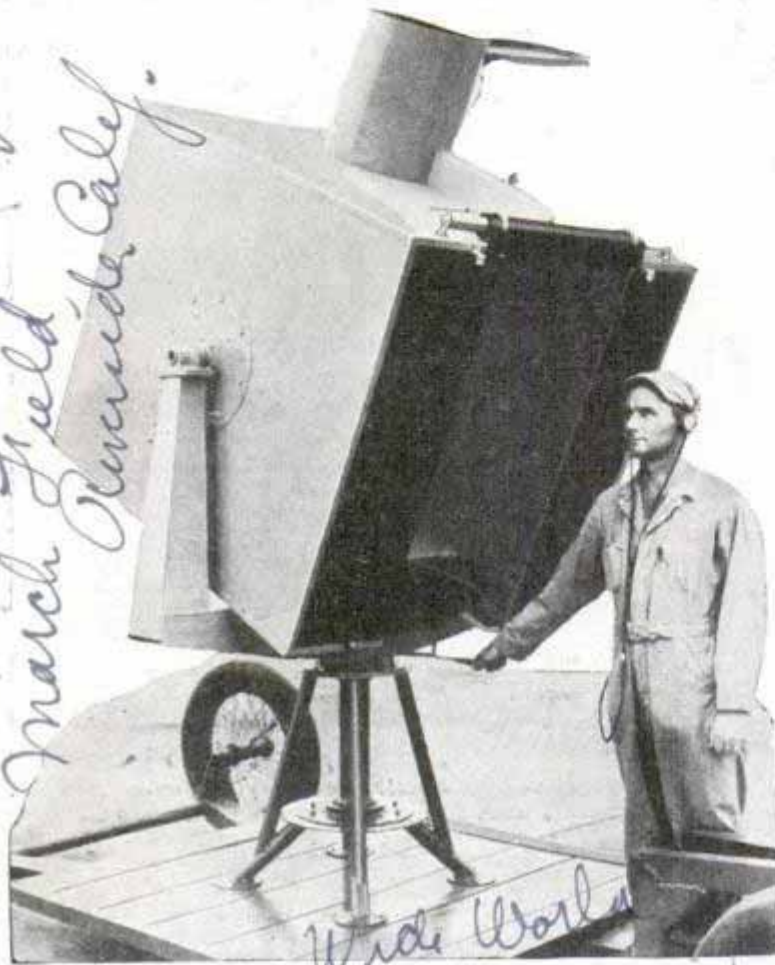

Camera obscura pointed at bombing plane in sky records its position when radio signal tells of missile dropped at target

Instead of dropping actual bombs, army pilots in bombing practice at March Field, California, send a radio impulse at their target. A huge camera obscura mounted on wheels is the target. Sighting it from the sky, the pilot sends a radio signal which is recorded by the camera operator on the ground. He marks the position of the plane and the spot where the imaginary missile would hit. This method trains the army flyers in accuracy without wasteful expense for real explosives.

F1311 Speeding Up Metal Hardening Aids Auto Industry

Development of a revolutionary process for hardening metal surfaces by electrical induction is hailed by the automobile industry as an advancement which will speed up production methods and improve the quality of crankshafts for all kinds of engines. The method reduces hours of sur-

Welds

face-hardening time to seconds and produces a regulated, exact result, superior in many ways to the surface produced by furnace hardening. For the new treatment, a high-frequency current at high voltage is transformed into low voltage with high amperage. This current passes into inductor blocks which surround, but do not touch, the bearing surface desired to harden. The inductor block current induces a current in the surface of the metal and this induced current is the heating factor. When the area to be heated has been subjected to the controlled high-frequency current for the correct length of time the electrical circuit is opened and the heated surface is quenched with spray from a water jacket built into the inductor block. When all the main, intermediate and pin bearings are hardened, the entire crankshaft is drawn at a low temperature to remove strains.

*Auto Crankshaft
6600 Cleveland Ave.
Cleveland, Ohio*

F1330 Glass Table for Home Is Decorative Touch

Made entirely of glass, the latest table enhances the beauty of the modern home without clashing with decorative schemes. It has a circular top which rests on three glass supports.

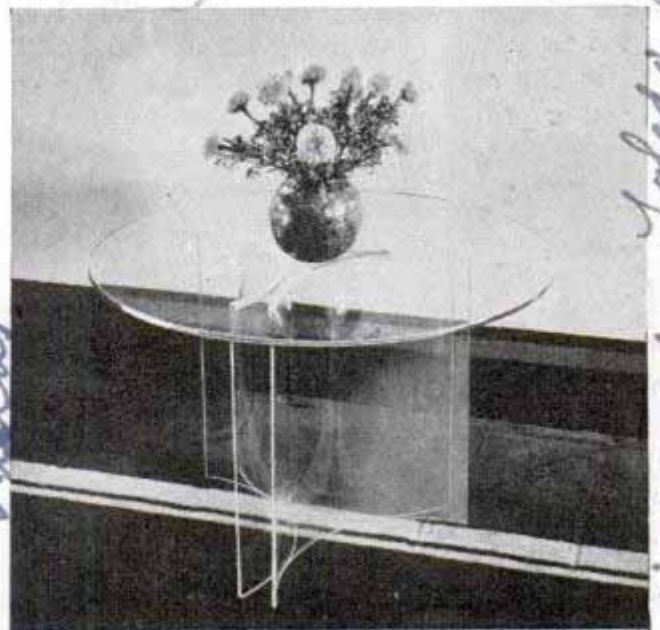

This is the latest touch in home decoration—a table made entirely of glass

Warman, Toledo, Ohio

Lobby Owens, Ford

The HOME that



what a kilowatt-hour will do for you

PART I

THIS is the story of a humble, hard-working household drudge, a maid-of-all-work employed by a family in Schenectady, N. Y. They call her Handy Annie and pay her only \$2.41 a week.

Despite her low wages, Annie is an ideal maid—quiet, efficient, tireless, a regular bundle of energy. She never heard of a forty-hour week or Thursdays off. She never asks for a vacation or a raise. In fact, Annie works twenty-four hours a day and does as much as eighteen men could accomplish if they labored eight hours a day and seven days a week.

Among a lot of other things, this family expects Annie to tend the furnace and hot-water heater, turn the clothes washer, dry the clothes in bad weather and run the ironer, cook the food and see that it is kept fresh and edible, wash and dry the dishes, dispose of the garbage, vacuum clean the rugs, keep the house at a comfortable temperature summer and winter, run the sewing machine, wake the family and provide healthful exercise and sun baths, get rid of flies and insects, discourage burglars, help nurse the sick by supplying hot or cold pads as required, help tend the goldfish and provide music and entertainment.

That's a big order for one \$2.41-a-week maid. Almost any family



13 people working one hour

Work, in the electrified home, is interpreted in kilowatt-hours, and here's the work a kilowatt-hour will do—the combined efforts of thirteen servants for one hour

F124

Runs Itself



could afford a servant who would do all that work—and a lot more—for such wages. But where, you inquire rather enviously, could you find another Annie, even if you were heartless enough to work such a simple-minded girl to death?

Well, servants like Annie make just one demand. They won't work in unwired homes. But if you light your lamps by flipping a switch instead of a match, then there's an Annie ready to go to work for you too. As a matter of fact, she's already working for you. The difference between you and the people in Schenectady is that they're working their Annie

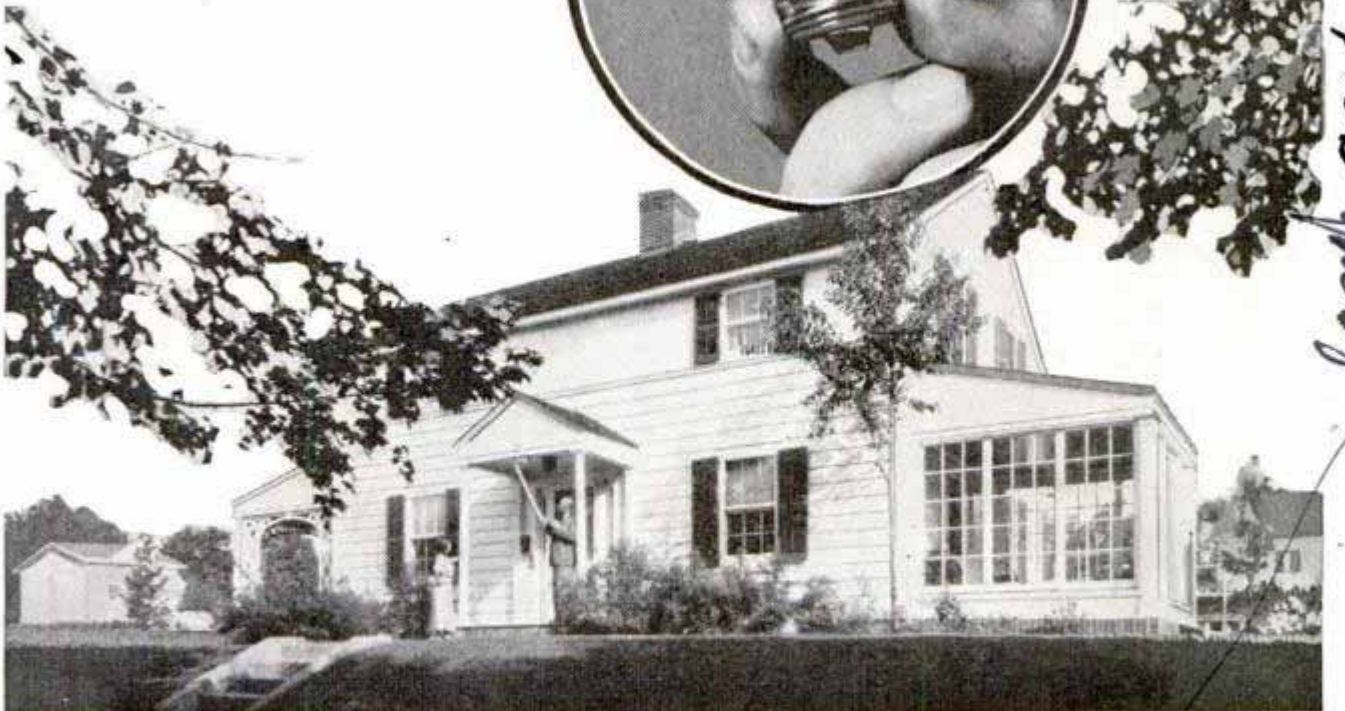
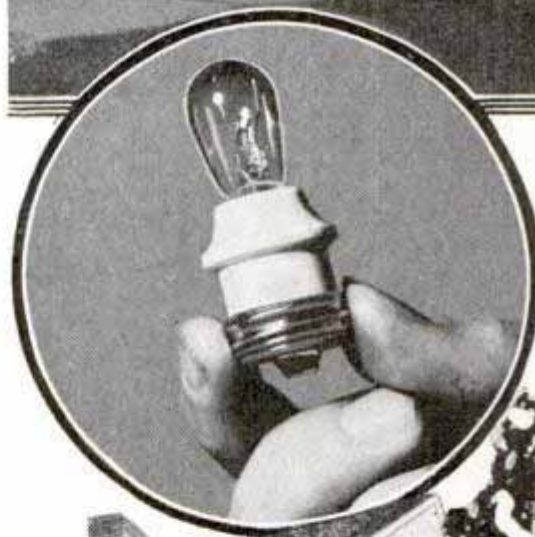
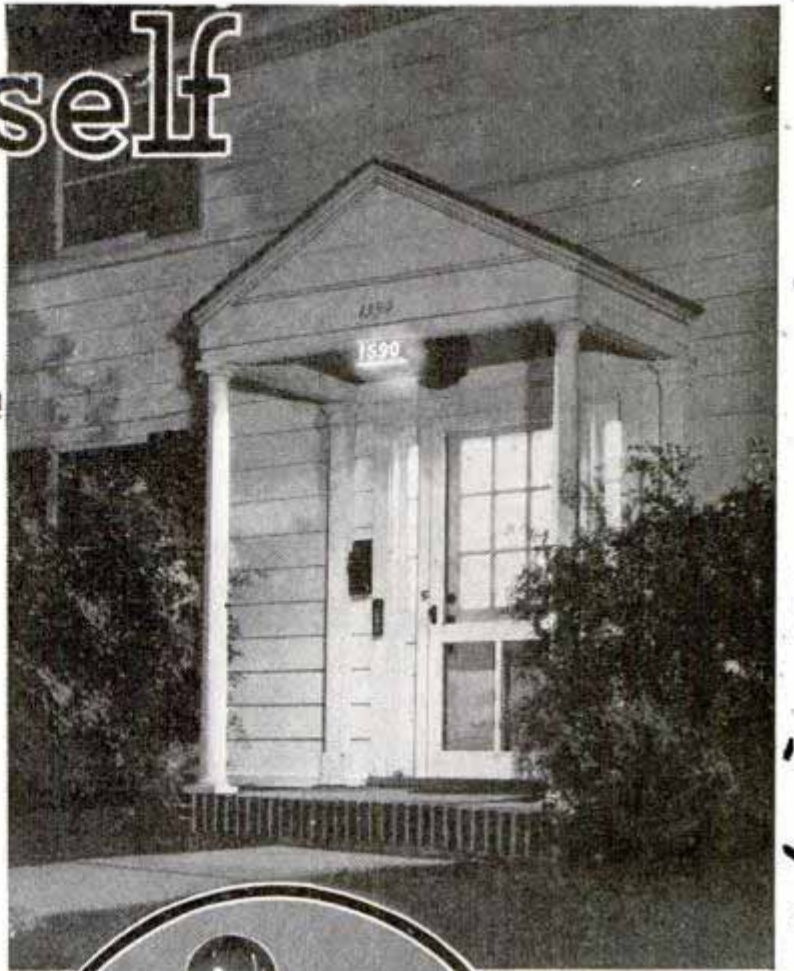

Photos Courtesy General Electric Co.

Electricity is the Handy Annie which does the work in this home that runs itself. Mr. Ripley is pointing out the illuminated house number. Above, the lighted entrance and the little lamp and reducer that do the trick

lamp and reducer - Annie store.

Edm. & Publishers Dept.



Mr. and Mrs. Ripley enjoying an electric breakfast—and if you don't think the dining-room table is electrified, glance at the picture to the left. The reels wind up the cords automatically so no unsightly wires are exposed

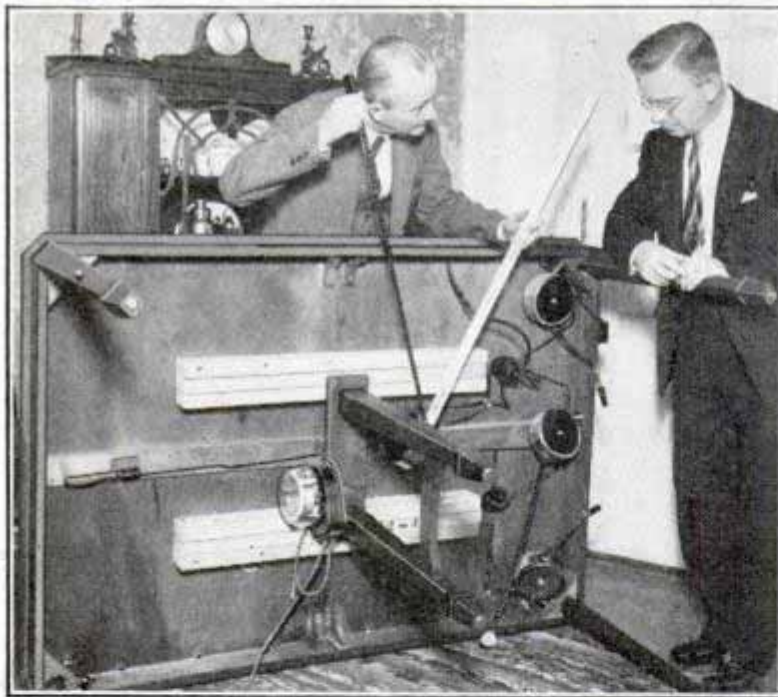

more freely than it uses water—and with amazing results. Nothing in this home is done by hand if it can be done by electricity. That's why Annie has so much work to do.

It all started more than eight years ago. Charles M. Ripley, his wife and young son lived in a neat, six-room, two-story colonial cottage on a quiet residential street. Days Mr. Ripley wrote copy designed to help sell big turbines, generators, and motors,

twenty-four hours a day while you probably work yours only three or four. The Handy Annie each of you employs is electricity and her tools are electrical household appliances.

More than twenty years ago, Dr. Charles P. Steinmetz, the electrical wizard, predicted that some day we would use electricity as freely as water. That day has not yet arrived for us as a nation, but it has for one family. This Schenectady family actually uses electricity in the home

which do the work of hundreds of men. His evenings were occupied with home work—stoking the coal furnace, carrying out ashes, disposing of garbage, helping with the dishes.

These chores irked Mr. Ripley. Why, he meditated one evening, didn't someone supply equipment to run a home as efficiently as a factory? Then it occurred to him that there were plenty of electrical home appliances on the market, machines to do the very work he was doing. Why



The electrified kitchen with its range, dishwasher, garbage preventer, food mixer, flour mill, radio, clock, fan, lights and many other appliances

wasn't he using some of them? He guessed they cost too much, or would run his light bill way up. But he decided to investigate.

He went about it rather timidly. What he needed most of all, he figured, was an electric washer. Finally he bought one on the installment plan and paid for it with the \$15 a month he had been paying a laundress. The "juice" to run

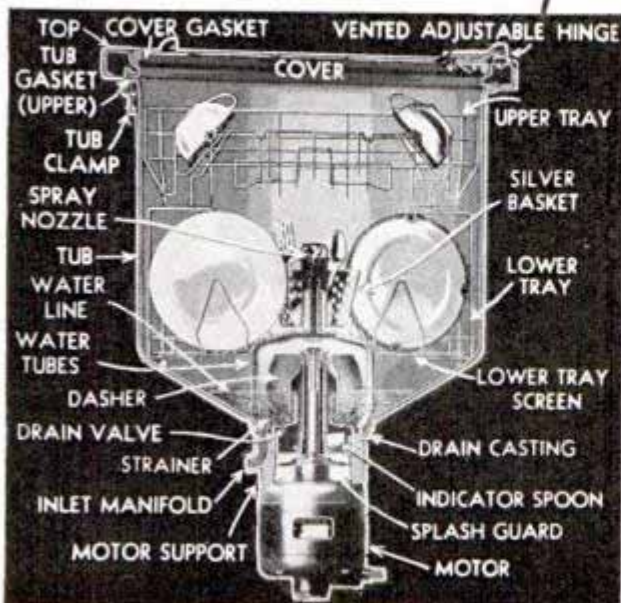

Diagram of the electric dishwasher. Put the dishes in, turn on the water and the "juice," and Handy Annie does the rest

RIPLEY SAYS:

Whatever we need, we pay for, whether we buy it or not.

It costs less to live better.

A good electric washer has the strength of four women, yet the current to run it costs only about \$1.25 a year.

The bathroom was the invention of the last generation, the electric kitchen and laundry were creations of this generation.

The all-electric home will be next.

Then a recreation room for radio, movies, television.

it cost \$1.25 a year. When the washer was paid for, he wondered what to do with the \$15 a month he had been paying the laundress. So he bought a refrigerator, using the \$15 and the money he saved on ice and food to pay for that. The refrigerator cost \$1.25 a month to operate, but he paid that too with money saved on ice and laundress bills.

Then he really got into the spirit of the thing. Why worry, he asked himself, if you can buy electrical home equipment and pay for it out of what the equip-

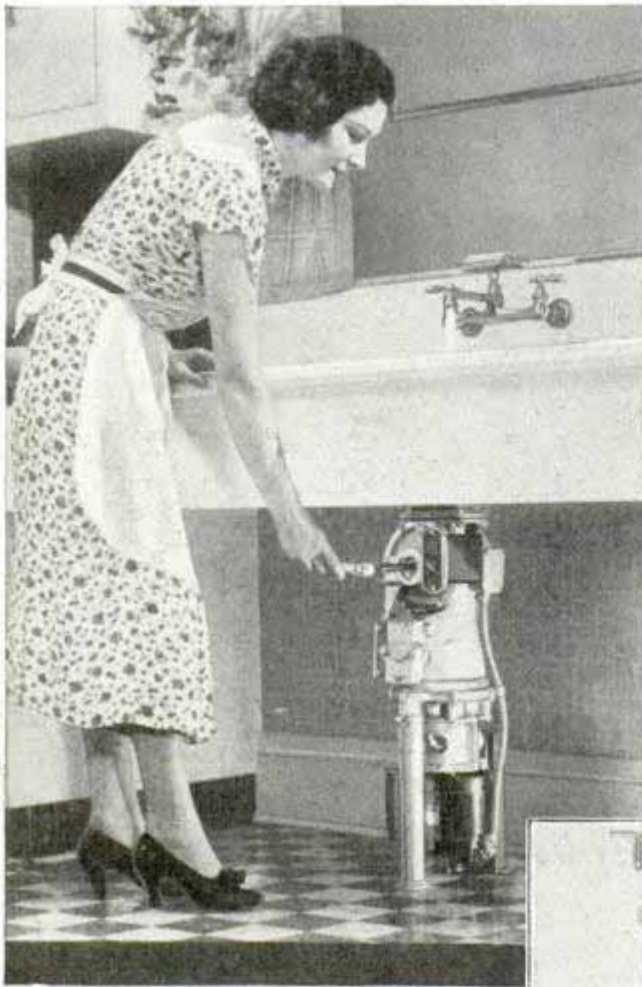

Garbage preventer such as is employed in the electric home and diagram showing working parts. Dump the garbage in, turn on the motor and Handy Annie does the rest

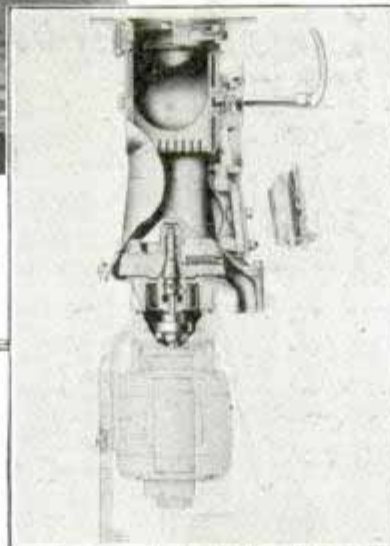

ment saves? So, one at a time, he added other appliances. Year by year, he bought an electric range, an ironing machine, a dishwasher, an oil furnace electrically controlled, a laundry dryer, an air conditioner and an electric garbage preventer. In between, he purchased dozens of smaller appliances—door chimes, bug killers, vacuum cleaners, clocks, a room cooler, sun lamps, heating pads, fans, an exerciser, toaster, coffee maker, egg cooker, electric double boiler—anything which would save work or add health and comfort to his home.

Today the life of Reilly has nothing on the life of Ripley. This family lives in a home that virtually runs itself. Annie does the work, much of it automatically, without supervision or attention. Let's pay the Ripleys a visit and see just how an electric home runs itself.

Over the door you'll find a glass plate

with the house number on it. Back of the plate is a seven-watt bulb that burns all night. No striking matches hunting for this home, even on the darkest night. Press the doorbell and you hear the tinkle of chimes. Press again and you get another tune. The doorbell has a repertoire of six melodies and doubles as a dinner gong by virtue of a set of keys inside the house connected to the same chimes. In the garden is another chime to soothe the ears. Yes, it's electric too.

Four floor and table lamps in the living room shed a soft glow without shadows and without glare, although each of those lamps contains a 100 or 150-watt bulb. The light is diffused by frosted-glass globes and by reflection from the ceiling. There's probably twice as much light here as in the average living room, but there's no sense of brilliant illumination. A room cooler augments the air conditioner in the basement and a radio plays softly.

"Watch the smoke from this cigar," directs Mr. Ripley. He puffs rapidly. The smoke curls upward, drifts back of a bookcase and vanishes.

"An air vent back there does the trick," he explains. "It's part of the air-conditioning system."

(Continued to page 144A)



One of the features of the electric home is an electric floor polisher—no crawling about on hands and knees here

Record Set by Plane Designed for High Flying

Harborough England

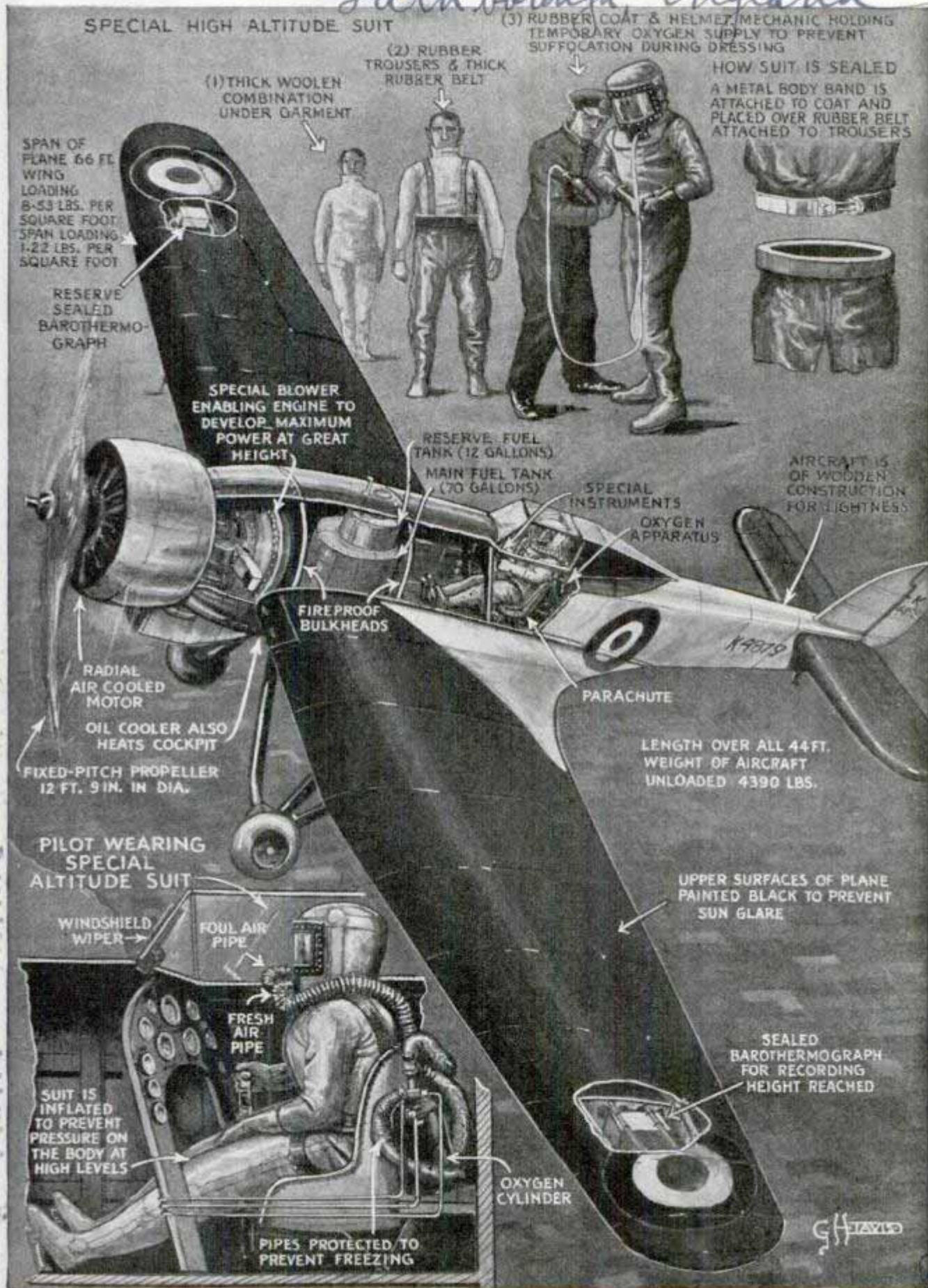

British monoplane which set altitude record of 49,967 feet recently is shown, in sketches and cross-section views, to have been designed especially for high flying. Note special suit worn by the pilot

Distal Aeroplane Co. Ltd.

DeGasus Engine

High Altitude

Battleships Fire at Radio-Controlled Plane

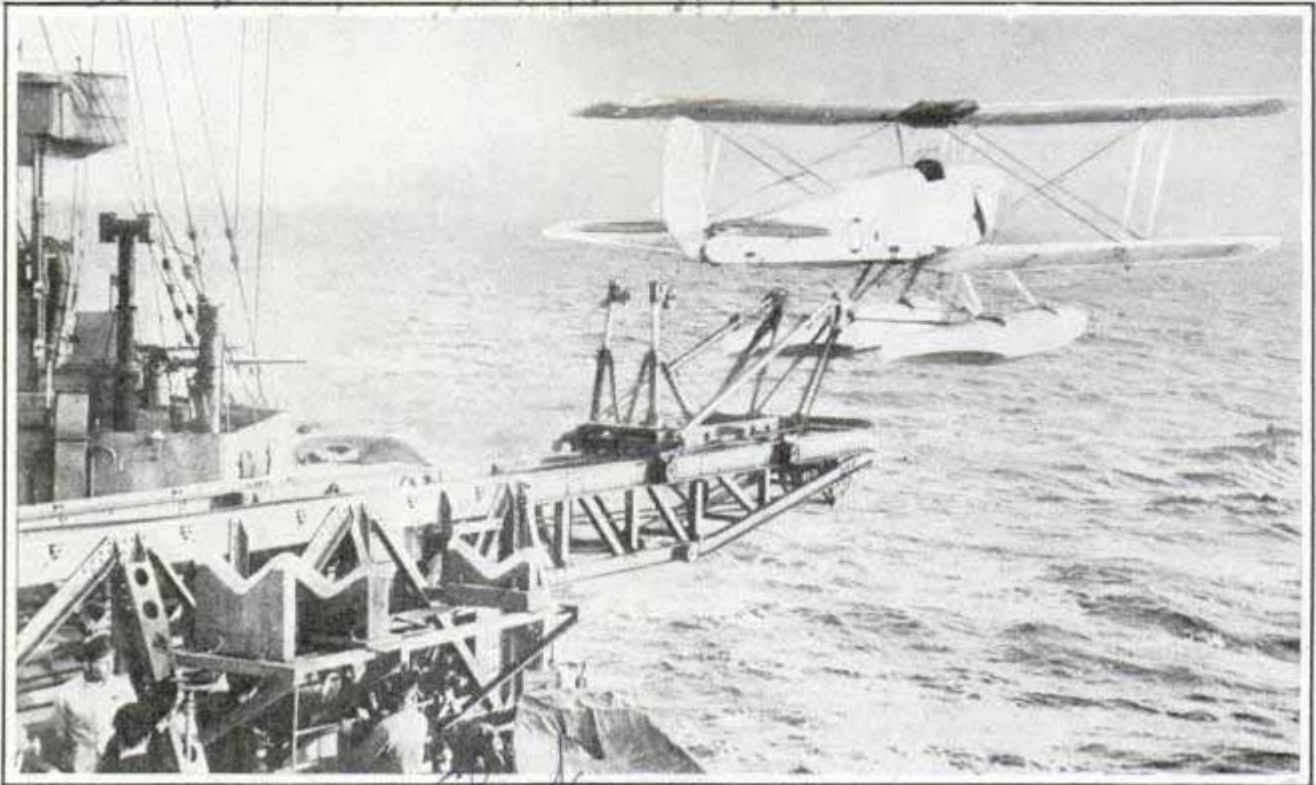

Here is the radio-controlled plane at the moment it was launched from British battleship by catapult. Note that the pilot is missing from the cockpit. Anti-aircraft fire failed to damage the robot craft

While an officer on the bridge of one warship operated an unoccupied plane by radio, gunners of this and another ship fired numerous shots at their flying target in recent maneuvers of the British fleet. At the end of the test, the plane made a perfect landing and was safely hoisted on

board, untouched by the anti-aircraft fire of two of Britain's most powerful battleships. The plane was launched by catapult from one of the ships. Every movement of the flying target was in response to manipulation of controls on the switchboard at which the "pilot" stood.

F1334

Small Tent Is Rigged in Stands for Rainy-Day Games



High and dry in their shelter at football game while other spectators sit in rain

University Stadium
 For protection from rain while they witnessed a football game, one couple rigged up a small tent in the stands at Columbia, S. C. The shelter consisted of a piece of canvas stretched over sections of light iron pipe which were attached to the stands and which held the top of the tent in place. The canvas extended down to seat level at the back to keep the occupants dry. The shelter covered only the two seats occupied by the enterprising couple.

F1356

Automobile Driven Like Rocket by Ejecting Air Centrifugally

Without any connection between power plant and wheels, an automobile invented by a French engineer is driven by throw-

al routes.

Sept. 4 Commerce memo 10/14/36

*Consult J. & Cooke
Hantes France*

ing air centrifugally toward the rear. The inventor holds that centrifugal ejection is fifty per cent more efficient than the use of a propeller. His car is a three-wheeled, low hung vehicle seating one person, and with a nine-horsepower gasoline engine driving its air-expulsion system it is said to have traveled fifty miles an hour. The engineer is studying methods of propelling boats and airplanes by centrifugal ejection of air and water.

F1362

Light Beam Stopped by Whirling Disk Plays Chords

Producing music from light is one of the feats of electrical magicians. Shining a hand flashlight beam through perforations in a revolving disk upon an amplifier, a California electrician caused major and minor chords and bugle calls to be played. The light rays were changed into controlled sound vibrations.

Kenneth Strickfadden



As electrician focuses light on amplifier, interruptions by perforated disk cause musical chords

Rotating Frame for Big 'Eye' Is Built Like Five-Story Kite

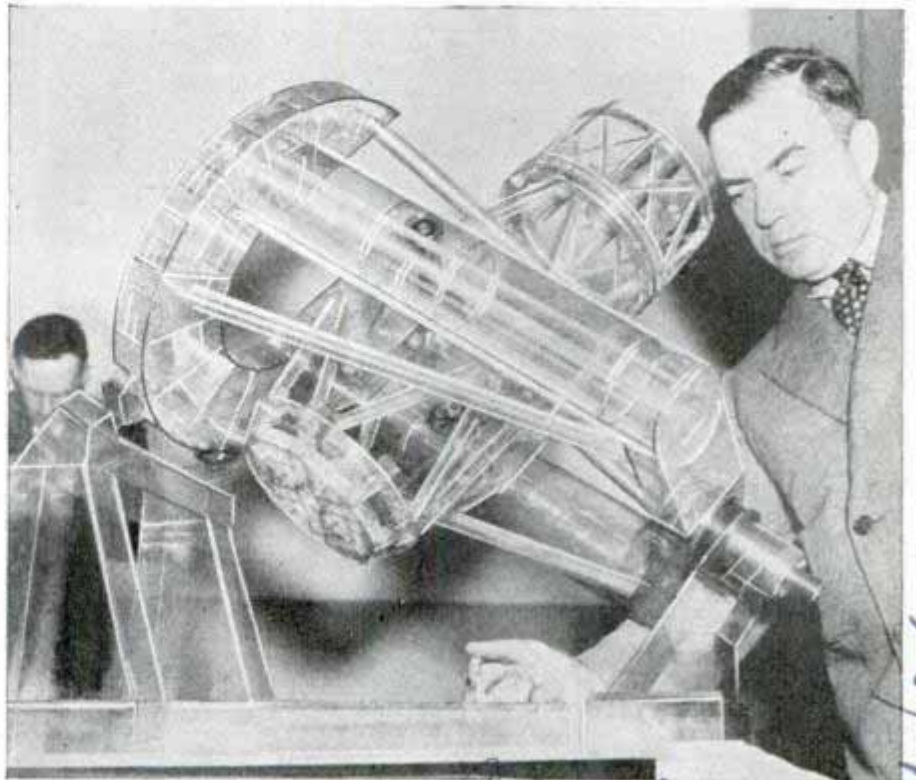

Scale model, made of glass, of the revolving frame for the world's largest telescope. The actual frame will be of steel, five stories high

Five-story steel structures fitted together like sticks crossed to make a kite will form the body of the \$6,000,000 telescope which, when installed on Mt. Palomar in California about 1940, will be the world's largest "eye." This frame for the 200-inch glass mirror consists of a steel tube or barrel five stories high by twenty-two feet in diameter; a yoke shaped like a tuning fork, and a horseshoe. The tube will be hung at its middle on an axle lying between the two sides of the fork. This steel skeleton fork will lie parallel to the earth's axis, at an angle of about thirty-three degrees to the earth's surface. A five-story steel horseshoe will support the upper end of the fork, the top, open end of the horseshoe bolted to the fork. The telescope thus can be swung in all directions and pointed to any spot in the sky. The 500-ton mass will float on a thin film of oil under a pressure of 200 pounds to the square inch.

Chicago Tribune 10/16/36

When North Sea gales exert a pressure of more than twenty-eight pounds per square inch against a railroad bridge in England a bell warns trains not to cross.

Santa Monica The Sphere

F1250 Mr. W. 103 ed receipt

TROUBLE SHOOTER

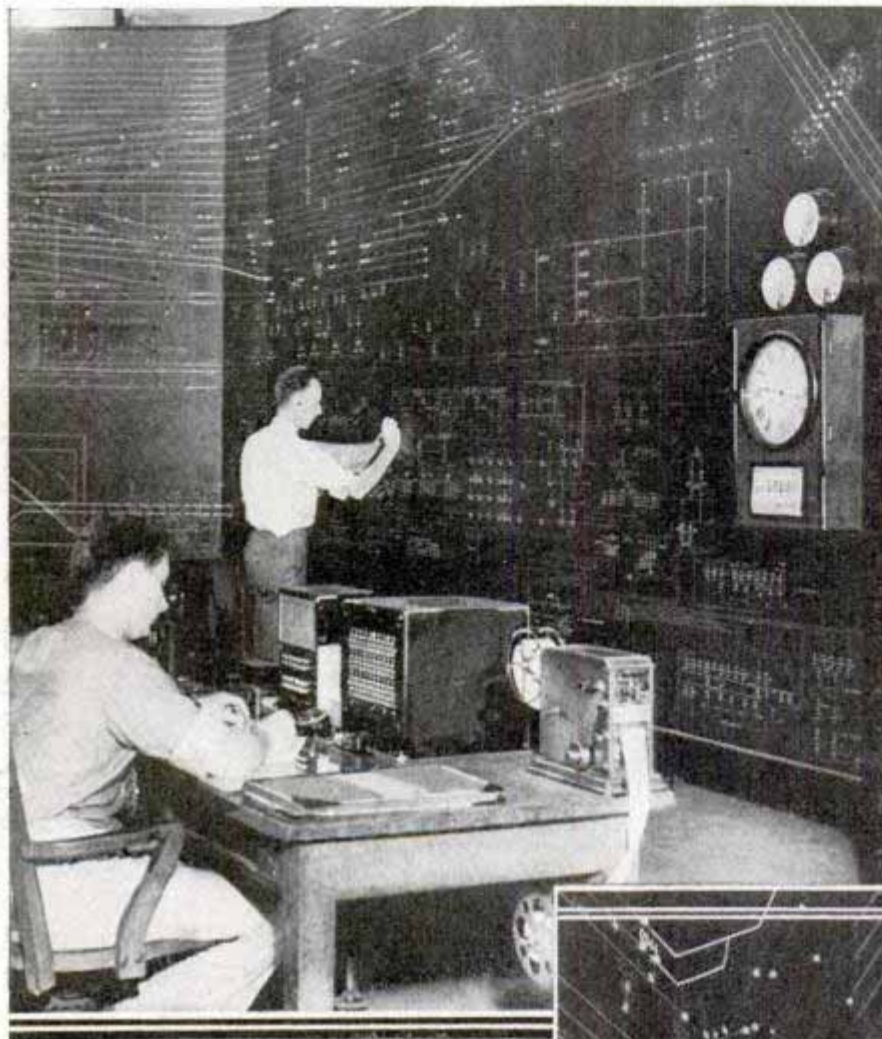

kilowatt hours. The man who maintains this system at top efficiency, who supervises the repair of breaks, whose orders are obeyed to the letter, is the power director. He sits beside his telephone and switches. Before him is the huge model board of the New York terminal area, an elaborate hand-painted chart showing the 541 miles of overhead trolley in the world's busiest railroad zone. Dozens of tiny red, green, and white lights blink and twinkle. The power director seems to be taking it easy most of the time, but his senses are alert to every new situation. Preparedness is in his

201101

"TRAINS must run!"

That's the eternal slogan before a Pennsylvania railroad power director. Trains can't run without power, and the maintenance of scheduled service against all odds is what makes this one of the most thrilling and responsible jobs in railroading.

Almost any minute of the day, a train heads east or west from Pennsylvania station in New York and dives under a deep river. The westbound trains are hauled by mammoth ninety-mile-an-hour locomotives, 230-ton "juice eaters." The annual consumption of power for the entire single-phase operation between New York and Washington is stupendous. The present traffic movement consumes approximately 563,000,000



Top, model board of New York terminal area. Below, drawing circuits on power director's model board

for a RAILROAD

eyes. Ask him what he would do in a hundred different emergencies and his answers are ready.

When the telephone bell drones, the power director hunches over the mouthpiece.

"Short circuit on Track nine," says a voice. "Train from Pittsburgh stopped."

"Stand by," replies the director.

Without pause he summons the sub-station operator and directs him to manipulate the controls that will restore service on Track nine.

Why did the circuit breakers trip to cause the

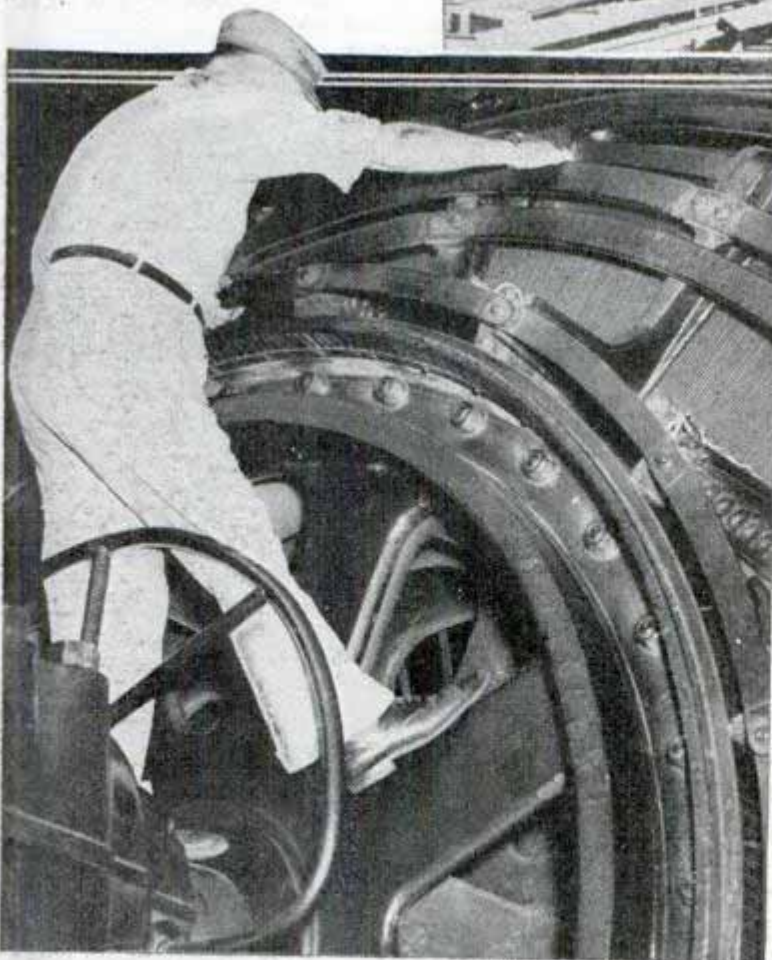
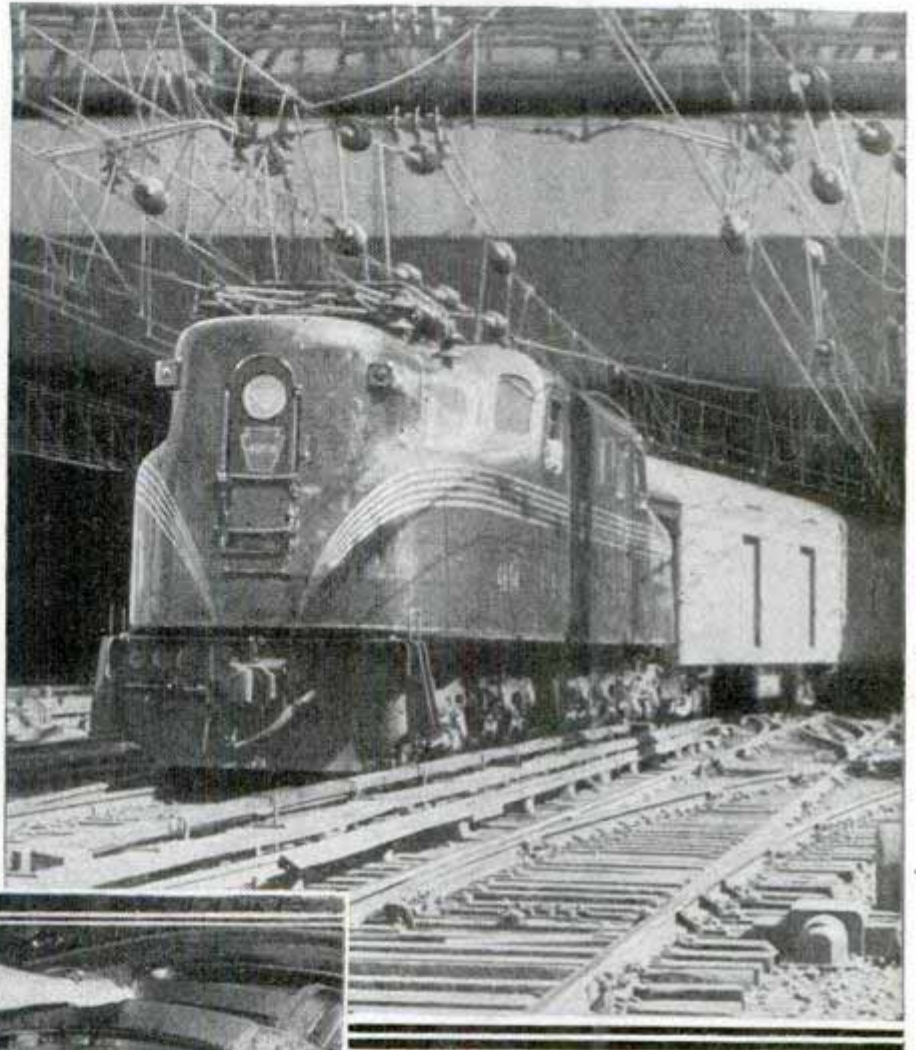

Rotary converter in power sub-station, and electric locomotive leaving New York terminal

short circuit? Nobody seems to know at the moment. No matter what the cause, the first duty of the power director is to energize that train from Pittsburgh. Not until after he closes the circuit does he inquire into the reason for the power break.

Short circuits are possible from numerous causes. In fact, nothing would surprise a power director. Once a live snake found its way into Pennsylvania station and stopped several trains with a short circuit. Mr. Pigeon is a notorious short circuiter. If he alights on a messenger wire and flaps his wings against the overhead structure, the contact trips the circuit breakers. Then, with a report like a twelve-inch naval gun, and a blue lightning flash as



Load dispatcher's office in the Pennsylvania station, Philadelphia, and, above, throwing a switch in a power sub-station

big as a man, the poor pigeon turns to charcoal, and the trains stop running. Service must be restored by orders from the power director.

Creatures smaller than pigeons and snakes can also put an electric railroad temporarily out of commission. A sparrow or a canary bird have in this fashion stopped a mighty steel locomotive.

The weather is something else that worries the power director. In winter, icicles fall from overhead structures and quite frequently ground a trolley wire. To prevent short circuits, men walk along the tracks with long poles and break off the icicles. These poles have been treated with paraffin and insulating varnish. As added precaution, the men wear rubber gloves tested for 10,000 volts.

Major trouble has never occurred since the Pennsylvania railroad was electrified. The power director is mostly concerned with routine work, such as repairing broken circuits and granting permits to work trains to put a grinding device on a circuit. But there are dramatic moments. Ticklish situations arise when fire

breaks out along an electrified right of way. The local fire chief usually calls the power director and requests that the power be shut off along a certain section of track. The power director finds the spot on the map and gives his orders.

Firemen are cautioned to exercise great care around a railroad power line. An electric current can actually travel along

a stream of water and kill the man who holds the hose. Kites are no less dangerous in wet or damp weather. If a kite merely touches the railroad power line, the current can travel down at lightning speed and electrocute the person standing on the ground.

The power director stands at the nerve center of a traffic control system so ingeniously interlocked that it can handle about 650 scheduled trains every twenty-four hours without delays or confusion. About 200,000,000 kilowatt hours are consumed by the direct-current third rail in this single zone in a year. More than one-third of the electrified trackage of America's standard railroads lies between New York and Washington. In all, the Pennsylvania operates 1,345 trolley miles.



Interior of the main signal tower in the Pennsylvania station, New York City, and, above, the power director at work

The load dispatcher in Philadelphia has centralized control over power on the 132,000-volt circuits, which supply power to all the trains. In each sub-station, the main power transformers step down the voltage from 132,000 to a mere 11,000, which is then distributed to the overhead trolleys. Third-rail operation is supplied with direct current of 675 volts.

Only one load dispatcher is necessary for handling the immense river of electric current needed to keep the heavy steel trains running. But it takes seven power directors and their assistants to maintain the operation. The load dispatcher's duties keep him in contact only with the power-generating stations, but the power

(Continued to page 126A)

Powerful Gun's Bullets Tap New Oil Pockets

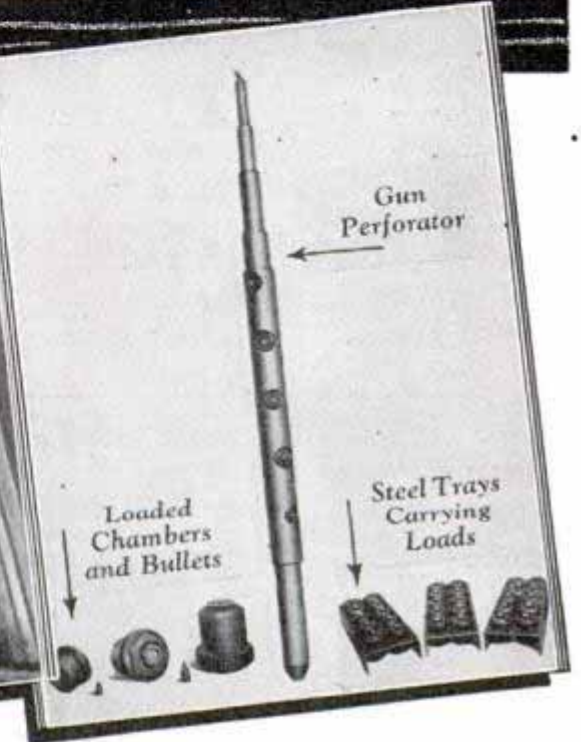
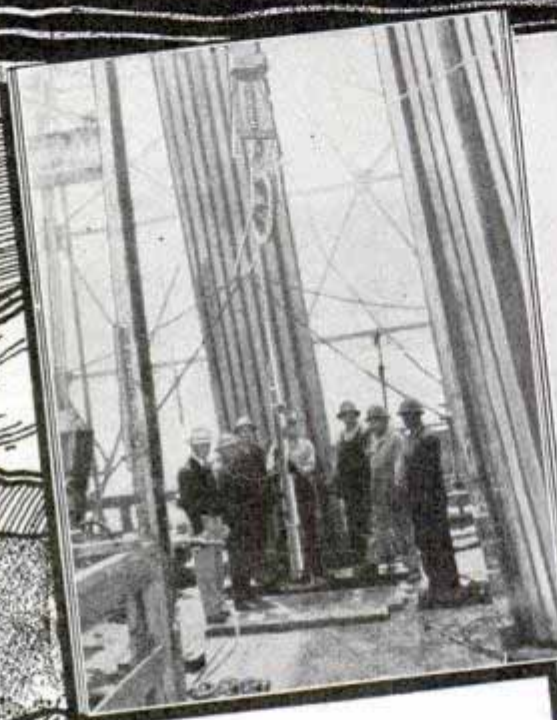
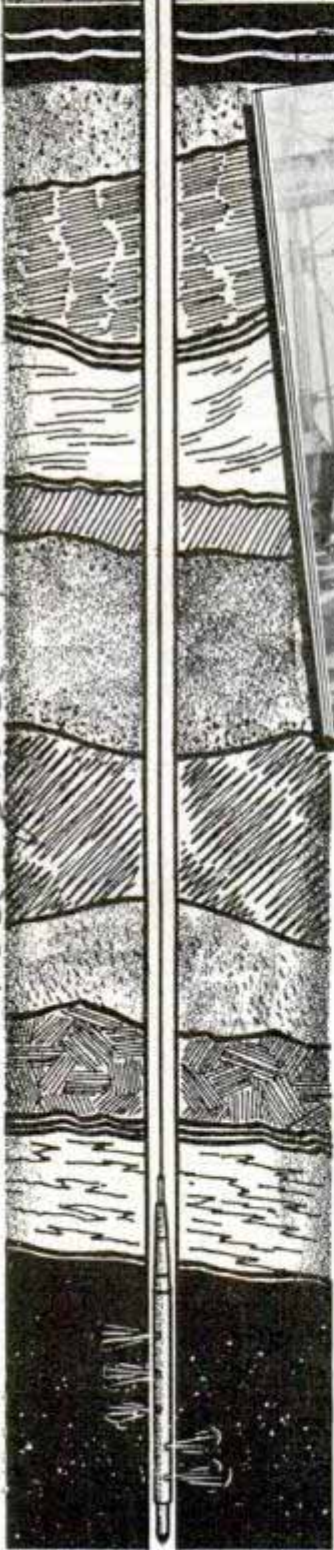
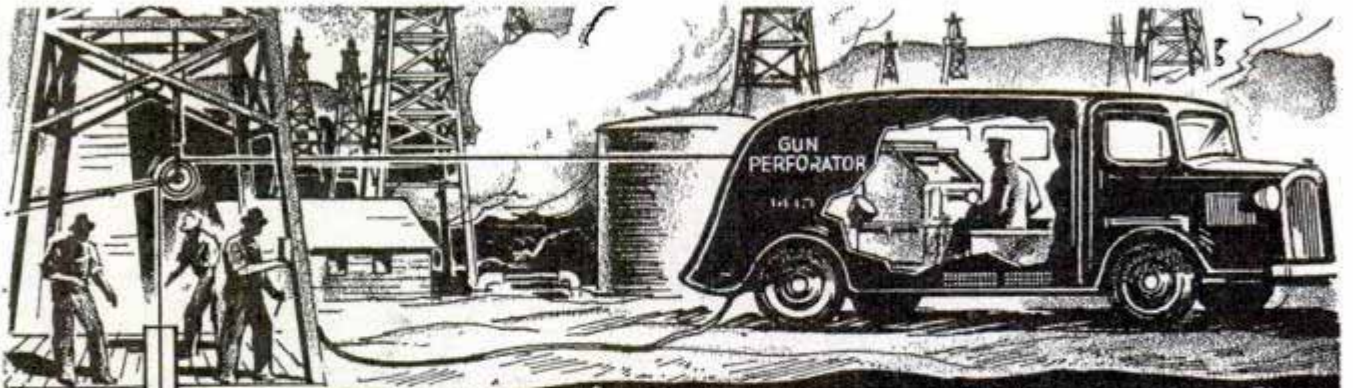

Sketch shows how bullets are fired from gun in well by remote control in truck. Photo, left, shows gun ready for lowering. Right, parts of the oil-well gun

Shooting into the depths of the earth with a powerful gun is the latest means of tapping new pockets of oil. The gun perforator, as the device is known, consists of a solid shaft of steel into which are recessed ten to fifteen firing chambers for discharging forty-five caliber high-test steel bullets. This bullet is powerful enough to penetrate three steel casings of the type used in oil wells and the intervening layers of cement, without mushrooming or breaking. The casings are a total of three-fourths of an inch in thickness, the cement several inches. The gun is used to advantage in oil wells which were rushed to completion into a certain formation, to the neglect of all others. If the exact thickness of each stratum is known from coring, each can be shot for new production by lowering the gun to the proper depth and discharging bullets through the casings into the sand. The gun also may be used to help deepen wells. Another use is the rejuvenation of wells where gas pressure has run low. With the gun a single shot is fired into stratum likely to contain gas. Other shots may be discharged at other favorable depths until gas is found. A "shooter" sitting in the control department of a perforator truck fires the gun electrically after

4439 Santa Fe
 Los Angeles Calif
 Aug. 1940. 240.
 See June 1940. 872.

1 up 1 1936
sheet # 957

Fireworks Etching of King

F138 Ready for Coronation Show

features of King Edward VIII will blaze in fireworks when this big set piece is lighted at coronation celebration

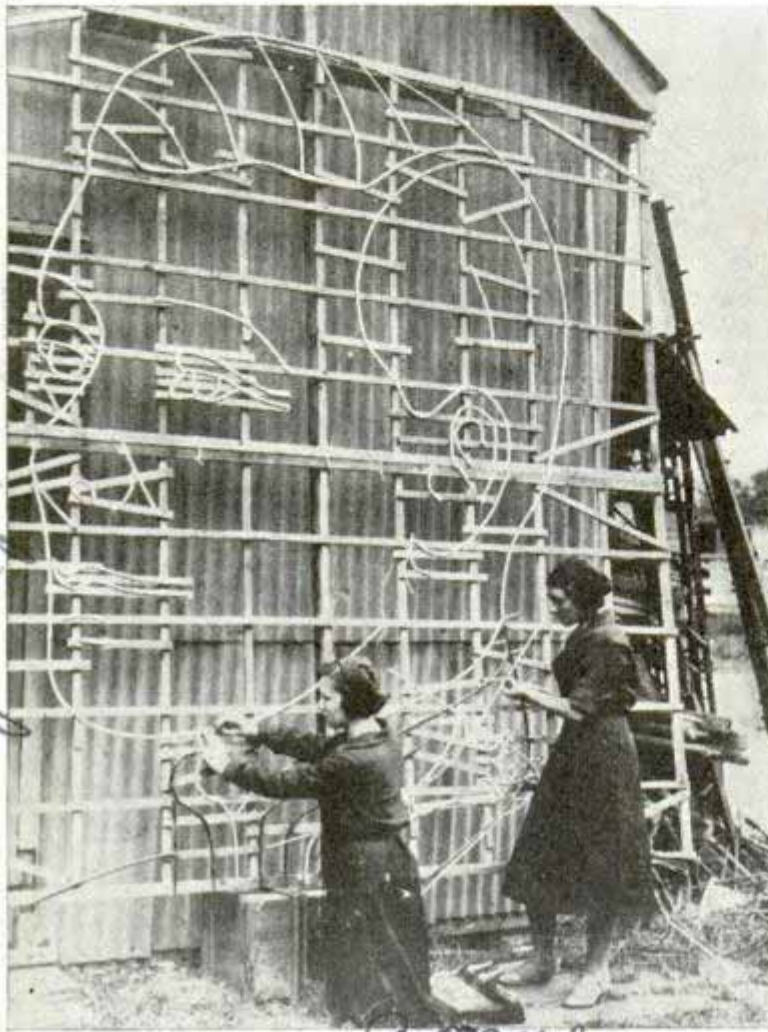

Features of King Edward VIII will blaze in fireworks when this big set piece is lighted at coronation celebration

King Edward's coronation at London this year will be the signal for a spectacular fireworks display. Aerial bombs will be exploded, rockets and star-bursts will brighten the night skies, and elaborate set pieces will be lighted at celebrations on the ground. Manufacturers are busy preparing for the big show. One of the set pieces portrays the head of the king.

Era of Wood Is Just Arriving

F142 as Uses for It Increase

Most of us probably think we are emerging from the era of wood. Not so the United States Forest Service. We are just growing into the age of wood, says this bureau of the government. At the Forest Products Laboratory at Madison, Wis., scientists are testing the practicability of prefabricated houses of wood to be built

Washington, D.C.

by mass production in factories and erected complete in a week or less. The laboratory also is improving methods of making joints and fastenings so timbers can be used more efficiently for bridges, arched halls and hangars. One advantage of wood is that it is renewable because we can grow successive crops. About 50,000,000,000 board feet of wood are used in the United States annually, enough to build a boardwalk forty feet wide and an inch thick from the earth to the moon. More than one-half this wood goes into building construction. The second largest use is for fuel and experts predict that by 1950 we will be using 25,000,000 tons of wood pulp each year, which is twice our present consumption.

F1389

Twin 'Eyes' Count Vehicles but Ignore Pedestrians

Pedestrians can walk unnoticed past the electric traffic counter posted at a roadside in southern Illinois. But the twin "eyes" never miss an automobile! Two "electric eyes" are mounted on the ends of the crossbar of a T-shaped post set in a concrete base, and any vehicle long enough to cut off the two beams of light focused on both photocells from across the road is counted.

Highway Dept

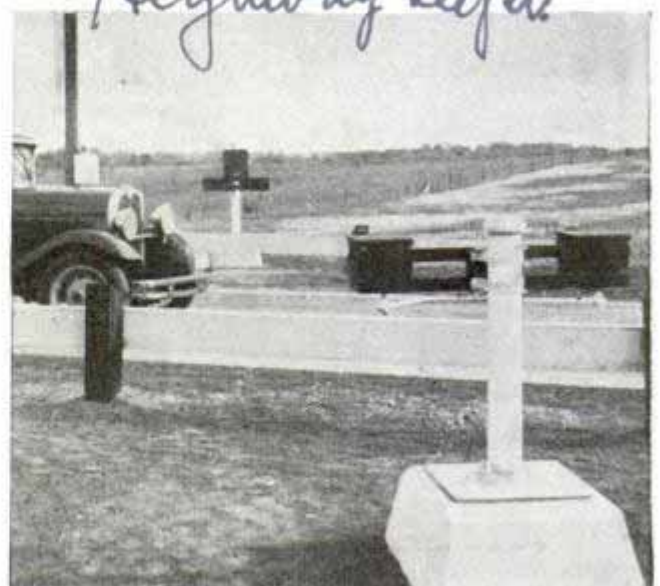

Passing vehicles are counted as they interrupt light beam focused on photo-cells on arms of post

Experimental Plane Tests Overweather Flight

Blazing the "overweather" trail that giant air transports of the future may follow, a flying laboratory is testing the performance of men, motor and plane six miles above the earth for Transcontinental & Western Air, Inc. Airmen prophesy that intercity and intercontinent planes of tomorrow will cruise at superspeeds high above the earth's weather,



Flying laboratory ready to try air lanes above earth's weather. Above at right, pilot talking into microphone. Below, observer with oxygen tube in mouth watches instruments in closed forward cockpit

ignoring the storms and winds below. In the TWA experimental ship D. W. Tomlinson, pilot, and James Heistand, observer, have tried altitudes above 30,000 feet, encountering temperatures eighteen below zero but wearing only summer clothing because their cabin is heated, the pilot's cockpit having a sliding glass hood framed with metal. For helmet, Tomlinson wears only a knotted handkerchief to shield his head from the brilliant sun. A radio microphone fastened in front of his mouth permits him to communicate with ground stations, leaving his hands free for the controls. Both men breathe oxygen at high altitudes through a mouth tube, but it is expected that when sub-stratosphere passenger service begins the cabins will be supplied with air pressure, and oxygen tubes to individual passengers will not be necessary. While the observer jots notes concerning the performance of the plane, photographic records of the instruments



are made at every thousand-foot level. A camera is mounted at the rear of the observer's compartment, focused on the instrument panel, which is illuminated by two special lights for photographic purposes. The low-wing monoplane is powered by the same 715-horsepower engine used on the twin-motored passenger ships.

Traps with rubber jaws which do not break bones nor even injure the fur are being used to catch mink and muskrat.

Cash. In Leap
Charles H. Duddell
Chas. P. ...

7/15 saw.

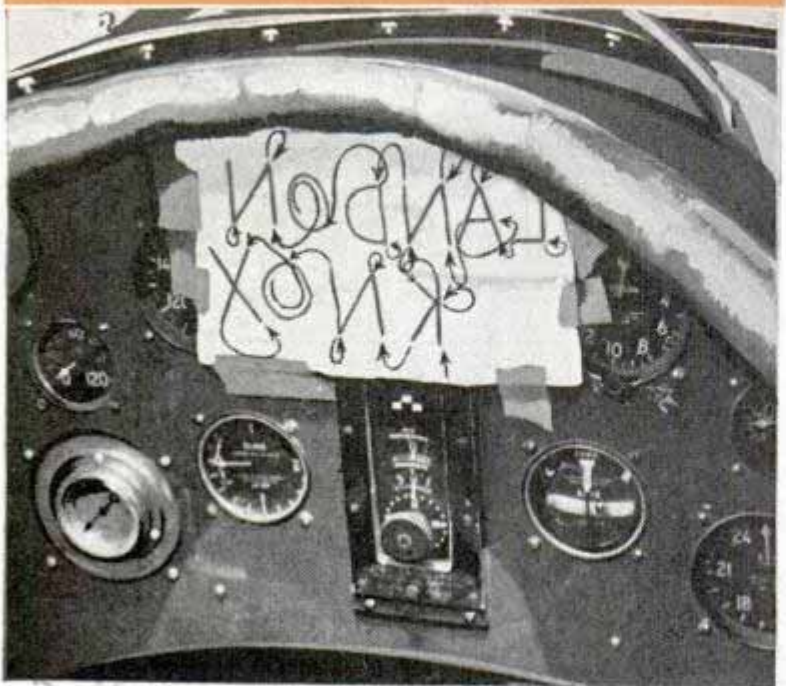

HANGING out smoke signs on the blue sky looks easy. You stand there on solid ground watching the flying penman a mile or so above the city spell out in leisurely fashion the big block letters of an advertising slogan. You'd like to try it yourself. It looks simple enough. But it isn't.

You can count the skywriters on your fingers. Jimmy Rose, "pro" at the little Elmhurst, Ill., airport, knows but three men in this specialized branch of aviation. Art Goebel, who flew to fame in a Honolulu derby several years ago, is one of them. Jim Rose, himself, is another.

There is more to this skywriting business than climbing up on a nice day and blowing smoke rings out of the exhaust. You may sign your name beautifully on the back of a check and print the most artistic letters with your pencil, using the art gum to correct any lines off center. It's quite something else to dash off a mes-

Blue sky over a big city is the skywriter's billboard. In circle, Jim Rose. Below, flight chart on instrument board, printed backward because he flies above and "behind" his letters

7.11.32
22.11

Flying Penman

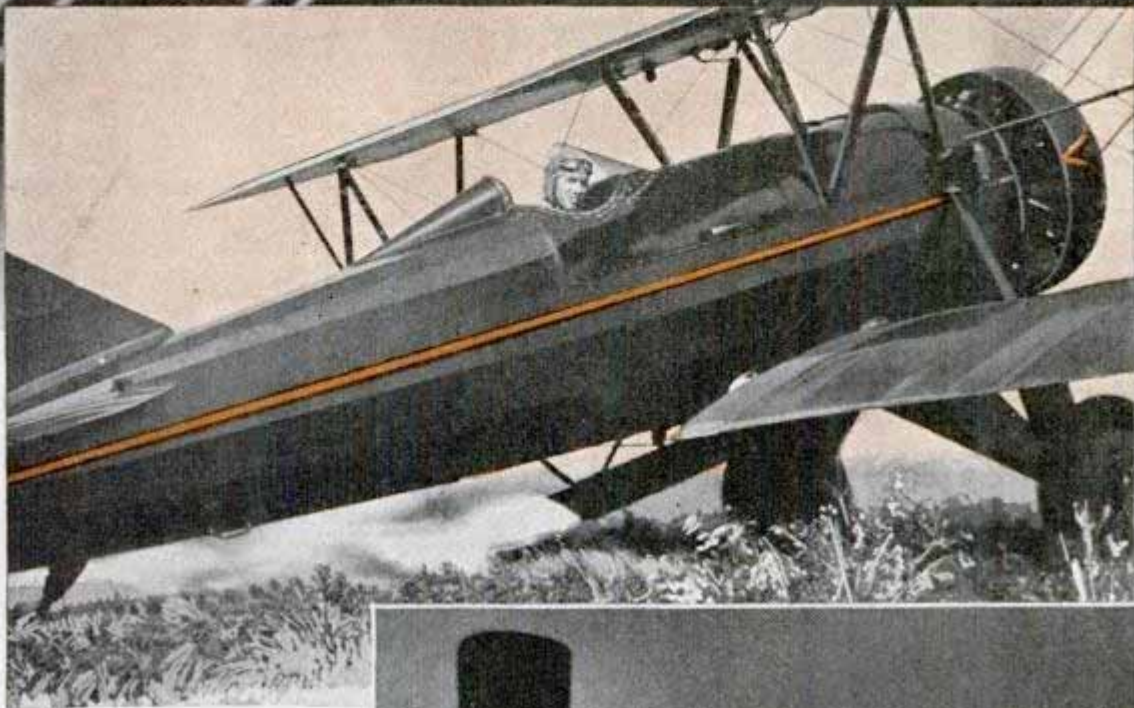

sage three miles long in letters a half mile high, while you're roaring through thin air at two and one-half miles a minute, remembering to write backward and not drop out any vowels because if you misspell you're done for. There's no erasing.

One reason why there are so few skywriting experts in the land today is equipment required. Any old crate won't do. You need a hill-climbing ship with plenty of engine up in the nose, one that won't cough and gasp when it gets into the rarified atmosphere where smoke letters don't blow away. Jim Rose flies a two-seater Travelair biplane with a 330-horsepower Wright Whirlwind motor, a trim little ship



Top, the flying penman ready to climb up three miles and hang out signs. Notice the oversized exhaust, heavily swathed in asbestos to hold its heat. Below, the same plane leaving its trail of white smoke

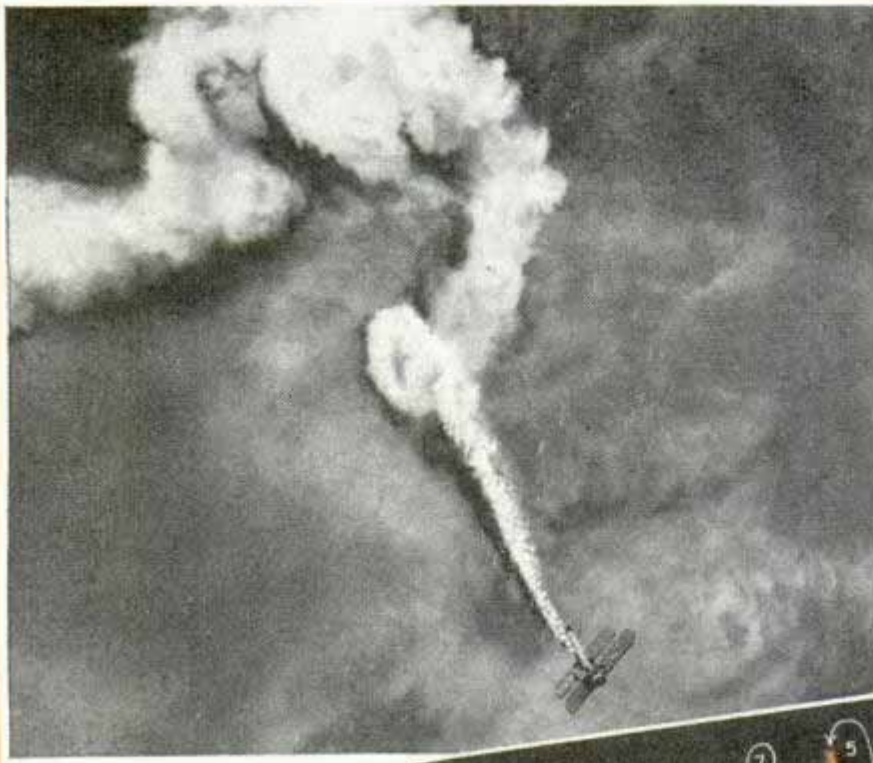

also break clean when the smoke throttle is shut," the flyer explains.

"Molasses would make smoke, but not the right kind. The secret chemical is what does the trick."

This oil compound is pumped with an engine pump under forty pounds pressure through a three-eighths inch pipe into the exhaust pipe below the motor, where the heat of the burned gas converts it into white smoke. A grip on the pilot's stick

able to get up there in a hurry. He lifts it off the dirt in a matter of seconds, seems to stand it on its tail in climbing 2,000 feet per minute for the first 6,000 feet and then gathers 800 feet altitude every minute until he finds a spot from 10,000 to 17,000 feet high where, if you were a cook, you'd say you had reached the "soft-ball stage." The smoke hangs together like hot fudge dropped in cold water.

Ask Jim Rose for his recipe for skywriting. He won't tell you all of it. He'll tell you this: you need a body, a brain and a ship that can "take it" two or three miles up; a good memory; paper, pencil and a mirror; an exhaust pipe that will keep you from coming home a cinder; plenty of experience and—the trade secret—a formula for sticky smoke.

Jim takes the back seat in his plane. That formula takes the front seat. Installed in the forward cockpit is a special tank full of a light paraffin oil for smoke making. There is a chemical added to this oil to hold the smoke together, and what that chemical is, is the flying penman's private affair.

"It must be a dense smoke, but it must



Skywriter above is stunting. His smoke is not holding well enough for lettering. The chart shows how a flyer would maneuver to write "Popular Mechanics" in block letters, which are easier to line up than script

controls the oil flow, and he must remember to allow for a twenty-foot trail of smoke after he shuts the valve. The exhaust pipe itself is especially built, eight feet long and six inches in diameter, with welded joints to withstand vibration, and wrapped in plenty of asbestos. Even with that fireproof sheath, Jim Rose sometimes wonders why he and his ship haven't turned into a blazing rocket, for that oil is dangerous stuff. Its flash point is 280 degrees Fahrenheit, and Rose himself has found 1,000-degree temperatures at the mouth of his exhaust. There are good reasons for that oil-smoke to burst into flame as it leaves the exhaust; but it hasn't yet, perhaps because of the cold that strikes the smoke as it emerges, the high speed, the thin atmosphere. Being sane, the flying penman plays no pranks

in the air and takes no unnecessary chances. His only serious mishap has been a rocky landing in a sudden gusty storm that flipped him on his nose as he hit the earth. Practically every "bone" in the plane's body was broken but his own were intact.

Like a navigator, the skywriter's first task is to chart his flight. That is where paper, pencil and mirror come in. He draws his words on paper as if writing from the back of a billboard, for, when he is in the air, he is flying above and behind his sign and it must be read from below. He holds the completed drawing in front of a mirror to check it for spelling and appearance. Then, starting with the first letter, he sketches in arrows to guide his flight in the quickest course, memorizes that course, posts his chart on the instrument board with adhesive tape, tanks up with plenty of gasoline, lubricant and smoke-oil and is ready to hop.

Grey days are holidays. Smoke-writing is useless without a blue background. Wind may ruin your penmanship, so you must seek a level of calm, cold air. Jim Rose prefers to fly around 17,000 feet high. At that altitude you may encounter horizontal winds, but these do not necessarily spoil your day, for in the air you are a part of the air, your plane drifts just as the letters drift and you can disregard wind. Convection currents, however, are another thing. These rising and falling currents of hot and cold air can tear your sign apart and make it unreadable before you have crossed the final "t." If you run into vertical currents you must either climb above them or forget the whole business until tomorrow.

Block letters are easier to line up. Script is not difficult to chart, but hard to write and uses more oil, for you must write the connecting links and that costs money.

(Continued to page 124A)

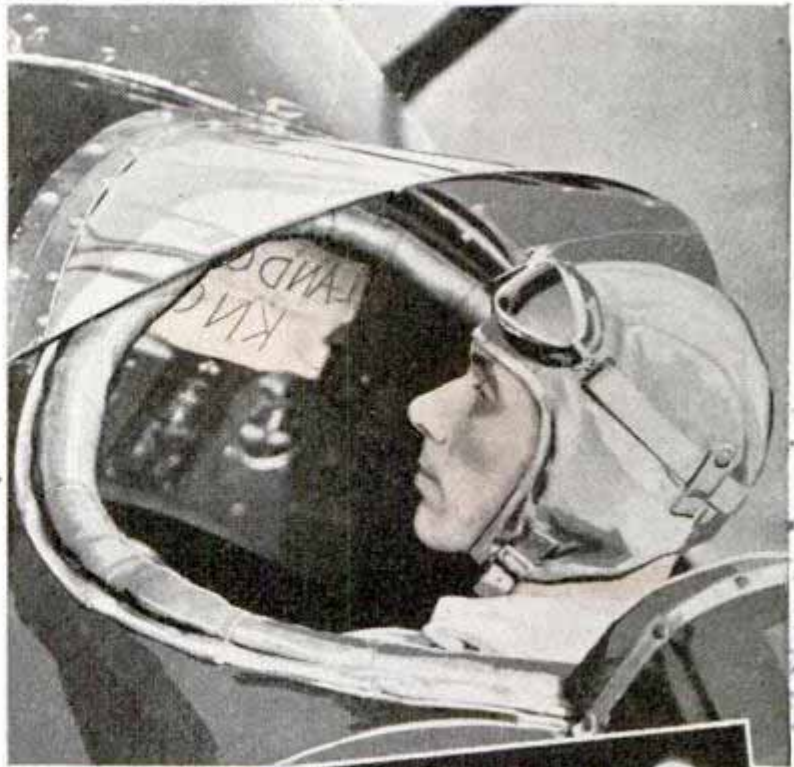

ARROWS AND LINES DENOTE POINTS WHERE SMOKE IS SHUT OFF, AND SUBSEQUENT POSITIONING OF PLANE BEFORE WRITING IS RESUMED



It takes more oil to write script, for the letters are all connected and smoke is shut off for only a few swift turns, indicated by light lines with arrows in chart drawn by Skywriter Jim Rose. In bottom picture can be seen the pilot's stick with the grip, attached, which controls a smoke-oil flow

FI 284

Silent Announcer

Electric Scoreboard Flashes Results of Races



Numbers of first, second, third, fourth and fifth place horses are flashed in electric lights on a large scoreboard installed recently at a Maryland race track. In addition the board shows whether a foul claim is entered after a race and whether the finish is close enough to be declared a dead heat, two or more horses crossing the line together. The scoreboard is operated by remote control from a switchboard on which are several rows of push buttons.

Laurel Park Track



Top, operator at control board of race track announcer scoreboard. Bottom, how the board appears with numbers of horses in one, two, three and four positions

*30 Unaired, 31.5 w. 47th
New York City*

FI 280

Streamline Trailer for Bicycle Has Lights and a Radio

Equipped with battery-operated taillights and radio, a streamline trailer for bicycles has been patented. Its length is

five feet. Bullet-shaped and dustproof, the trailer has a double-door hinged top to permit easy removal of its contents. A storage battery anchored in the rear helps to balance the load and provides sufficient current to operate the dual taillights and the radio controlled from the handlebars. The vehicle was designed for picnickers, campers and delivery purposes.



Trailer, with top open for loading, attached to bike. Note the smart appearance.

*William George Mally
3033 Lyndale Ave. S.
Minneapolis, Minn.*

+1349

Giant Ocean "Sleeper" Planes to Carry Sixty Passengers

Clipper ships of tomorrow, six great Boeing flying boats now in the engineering stage of development, will be double-decked liners capable of carrying more than sixty passengers across the sea. The first of the fleet will be ready for Pan-

*Boeing Aircraft Co
200 W. Michigan*

Seamen Cling to the Rigging as Whaler Plunges to Bottom



© Planet News, Ltd.

Awaiting rescue as their whaling ship goes down, several members of the "Sol Hagen's" crew can be seen clinging to the rigging

Acme

American Airways late in 1937. Sleeping accommodations will be available for forty passengers on night flights over the ocean. On the upper deck will be an elaborate control cabin, cabins for the crew and baggage compartment; the lower deck will house passenger quarters, galley, lavatories and dressing rooms. Passageways through the wings will permit servicing and inspection of the engines during flight. For the comfort and enjoyment of sky cruises between continents, the cabins will be soundproof, heated and ventilated, and provided with reading lamps and broad windows. With gross weight of more than 82,000 pounds, wing spread of 152 feet and length of 109 feet, the flying boats will be true giants of the air. Of the high-wing monoplane type, they will ride the water on short stub-wing hydro stabilizers instead of the conventional wing-tip floats.

Car with Rudderlike Tail Resembles Airplane

Among the new automobiles introduced recently at the Paris show is one with a rudderlike tail. The car, a Peugeot, bears a striking resemblance to an airplane. Stability at high speed is claimed as one advantage of the rear end structure.

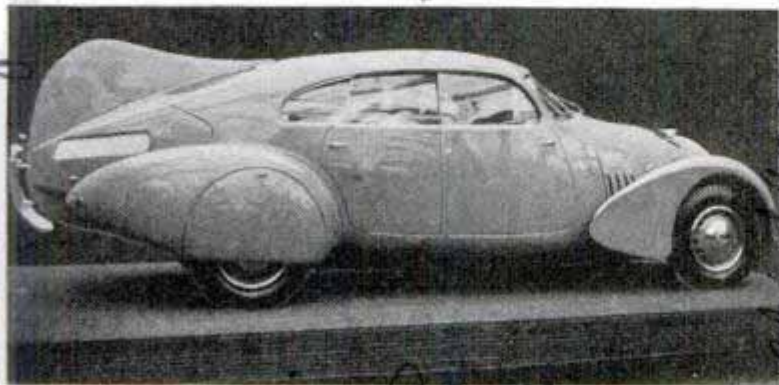

Latest streamliner in Europe has odd tail which is designed to stabilize the car at high speed

Acme

One of the tragedies of the sea was caught by the camera as the Norwegian whaler "Sol Hagen" plunged to the bottom in Table bay, South Africa. Several sailors can be seen clinging for their lives to the mast and the rigging as the vessel slips under the waves. Six of the crew of twelve men lost their lives when the ship was wrecked off Robben island.

Chemicals Made from Whey Open New Field for Dairy

Whey, once a troublesome waste product of skim milk, is now being turned to profitable use in the making of lactic acid.

In the past lactic acid has been made from molasses, cornstarch and other fermentable sugar sources, but the use of surplus milk for this purpose opens a new source of income for dairymen. Whey is a by-product of the manufacture of casein from skim milk. Lactic acid is used in the textile industry, in baking, in hardening pickles, soda-fountain beverages, medicines, lacquers, and in the leather industry to neutralize lime used to remove hair from hides.

Soixante Annyme des Automobiles Peugeot, 32 Quai de Passy, Paris, France

F1312.

F1333

U.S. Bureau of Washington, D.C.

1240

H. Hornum and Chicago

F1285

pressure of ten pounds. More than 1,000 cubic yards of concrete were poured to form its base. It is painted aluminum to reduce temperature and resultant evaporation, and a "blending spider" mixes the gasoline to a uniform consistency.

F1245

Spring Frame on Latest Bike Gives Softer Ride

Built-in spring frame construction on the latest bicycle is designed to give a softer ride. It consists of three spring leaves installed in the rear crank hanger and two parallel bars running directly from the head in a curve to the rear axle. The other parts of the bicycle are in keeping with the sweeping lines of the spring frame, resulting in a trim, fast appearance.

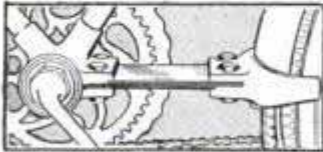

running directly from the head in a curve to the rear axle. The other parts of the bicycle are in keeping with the sweeping lines of the spring frame, resulting in a trim, fast appearance.

F1244

Model Shows Moon's Phases as Spotlights Move

Every phase of the moon is shown on a papier-mache model as spotlights mounted on small carriages move in accordance with automatic controls installed on the lecture desk at Franklin Institute, Philadelphia. The apparatus is covered in front by a black curtain with a window cut in it and the effect is the same as when one gazes on the moon in the sky.

By Arnold N. Skitz

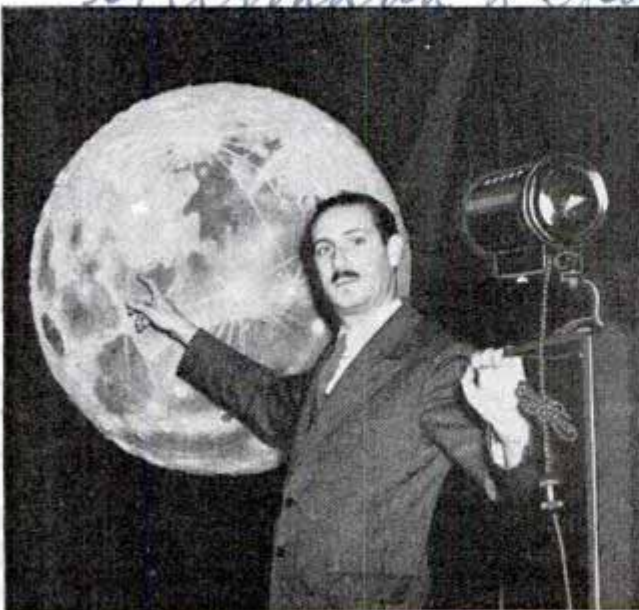

Model of moon with lecturer pointing out topographical feature brought out by spotlight

Cml. Eckhardt

Auto Driven by Hands Alone Controlled by Extra Wheel

pat up

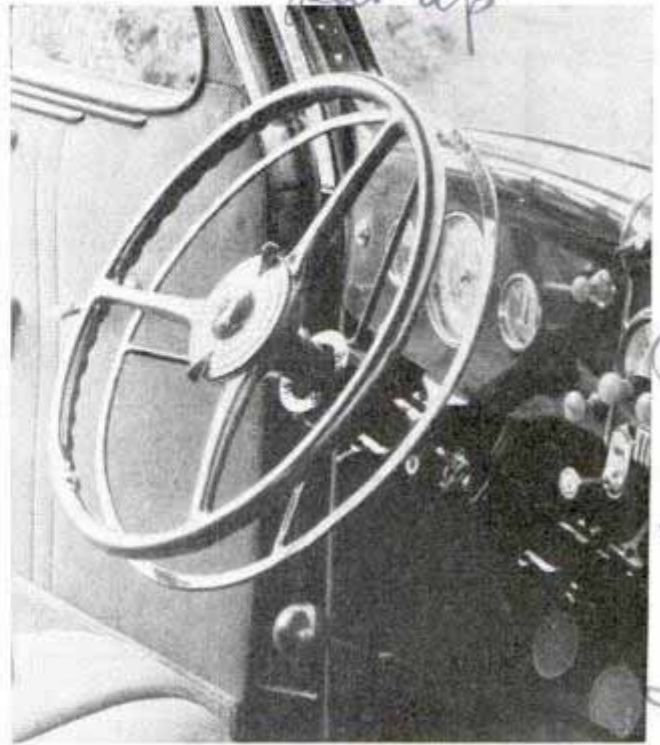

Top wheel is for steering; lower wheel slides down to engage clutch and accelerate, up to apply brakes

Driving an automobile entirely by hand is made practicable by a special control system which can be installed on any car. Fingertip pressure applied to an extra wheel mounted on the post just below the steering wheel operates brake, clutch and accelerator. Foot pedals are unnecessary, but they can be used if desired by locking out the hand control mechanism. When driving by hand, full power brakes, clutch and throttle are operated by vacuum cylinders controlled by valves, and these valves are controlled by the second wheel. This is mounted on a collar, rotating freely on the steering post and sliding up and down. About two inches below the steering wheel it is in "neutral," to which position it returns when pressure is withdrawn. Press the wheel down and the clutch is engaged, the throttle advanced and the car moves forward, accelerating as the control wheel moves downward. As the control wheel is raised, speed is reduced; in neutral position the clutch disengages and the throttle closes; above neutral, brakes are applied. If it is desired to keep the clutch engaged for braking, there is a dashboard button to lock it. The system was invented by a man who had lost the use of his legs by illness.

Stone Controls, Inc. Box 302

F1024

CUTTING CAPERS



Correct position of partners for waltzing on skates, and position of feet at conclusion of pivot



the most absorbing of all the forms, but there are no short cuts to its mastery. Some skaters take a fancy to some curlicue and work at it until they can do the one stunt fairly well. If they would apply the same time to the study of the underlying principles of figure skating, they would soon be capable of doing dozens of stunts.

The essence of figure skating is embodied in forward skating, backward skating, left and right turns, skating on the outside forward edge, outside backward edge, the inside forward edge, and the inside backward edge.

The meaning of the word "edge" should first be explained. In ordinary backward or forward skating, the width of the skate blade rests flat upon the ice. Figure skating is different, however. When cutting a

By Jack Smalley

Professional, Minneapolis Arena

FIGURE skating is done with the mind as well as the feet. Headwork is what distinguishes a good skater from a mediocre one.

The first rule is not to go fancy until you have schooled yourself thoroughly in fundamentals. Figure skating is, perhaps,

No address necessary
10/10/37

Mr. James H. ...
 20 W. Hartman Road,
 Kansas City, Mo

ON ICE

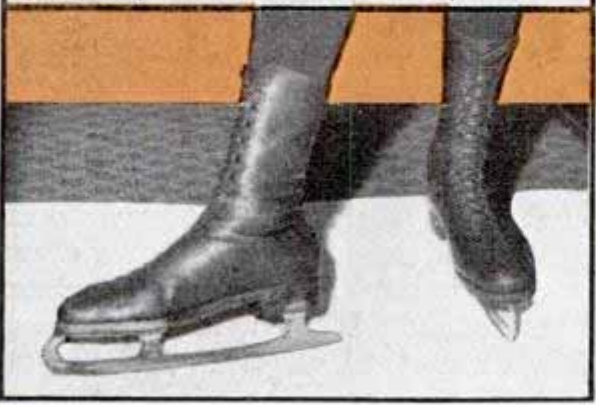
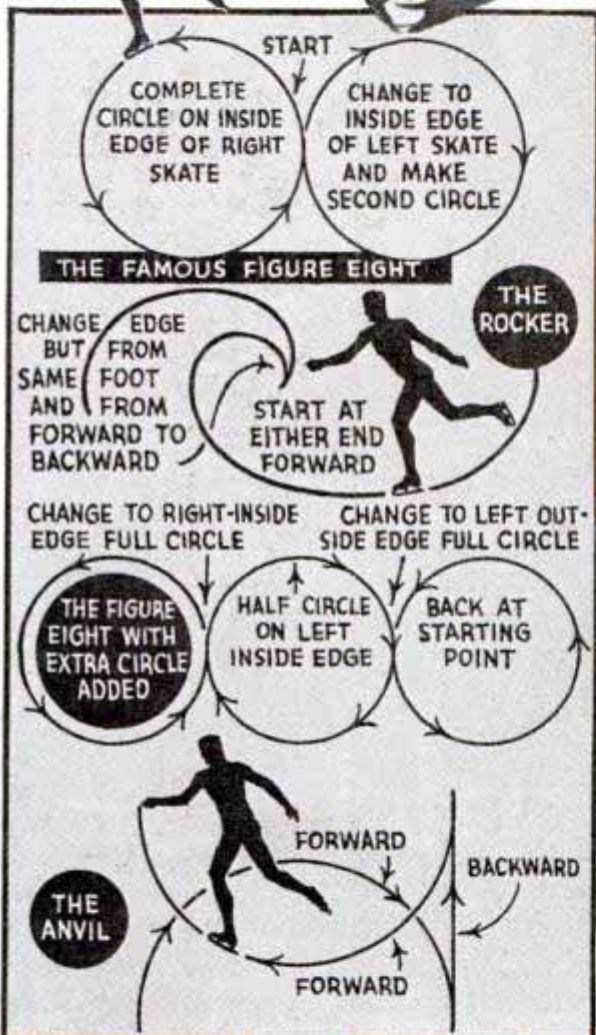

Diagrams showing execution of the figure "eight," the rocker, the "eight" with extra circle and the anvil. Above, right way to execute the outer forward "edge." Bottom, the "strike-off"

circle, the skater leans his body in one direction and does the same with his skate. Thus, the blade runs on an edge instead of being flat on the ice. If the body and skate weren't tilted, it would not be possible to etch figures and circles.

There are two edges on each skate, the inside edge being on the inner side of the foot and the other on the outer side. A skater going on the right foot in a curved direction to the right is on the outside edge. When gliding on the right foot in a curved direction to the left he is on the inside edge. You become a figure skater when you learn these four movements as they are virtually figures in themselves.

F10.24

Don't attempt this stunt until you have mastered a few of the fundamentals. Below, right way to skate on the inner forward "edge"



The inside forward edge is the first to learn. You move across the ice just as in regular forward skating except that every mark on the ice is made with the inner edge of the skate. Suppose the left foot supplies the "strike-off," or the power with which the movement is made. This comes from the edge of the skate not employed in describing the circle. Remember, al-



ways from the edge of the blade, not the toe. The right skate starts to cut a half circle inward toward the left and on the inside edge of the blade from the force of the strike-off. The left shoulder is brought forward, the body leans toward the inside of the circle, and the left foot is carried behind.

Gradually, you bring your left foot forward and when the half circle is completed, place it on the ice, shifting the body weight. On the left skate's inner edge another half circle is cut. It is the right shoulder that is brought forward this time.

The outside forward edge is the same in many respects except that the marking is made with the outer edge of the skate. The left foot again supplies the strike-off, and the right skate, leaning on its outer edge, starts to cut a half circle to the right. The body weight is thrown forward on a slightly bent right leg. While this is being done, the body should be leaning toward the inside of the half circle being described. This time, the right shoulder is forward and the left foot behind.

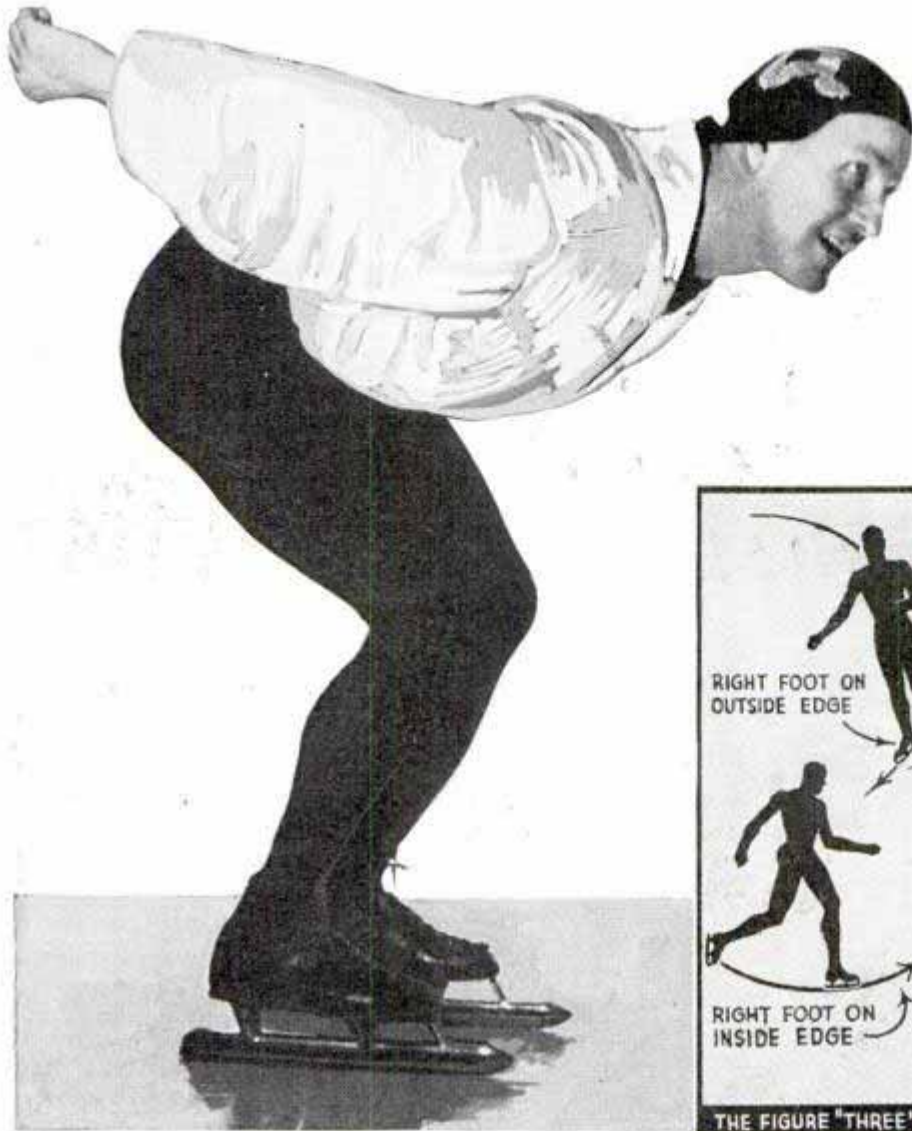

Effortless speed, one of the fascinating thrills of skating. Below, diagrams showing how outside "edge" forward, inside "edge" forward and figure "three" are executed

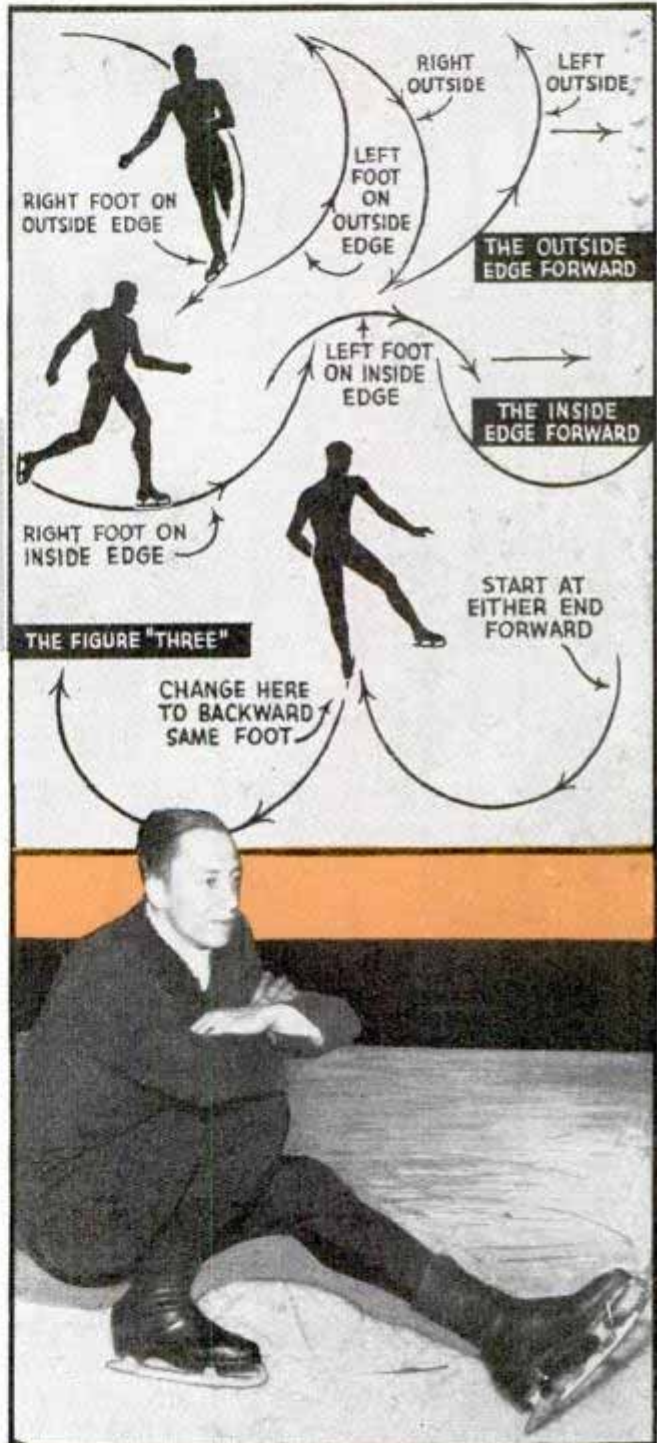

As the routine progresses, the left foot should be brought forward so when the half circle is completed, the weight of the body can be shifted to the left foot, this skate proceeding on its outer edge to cut another half circle off to the left. Here, of course, the position of the body and shoulders is reversed, the left side of the body leaning toward the inside of the circle with the left shoulder forward. The right foot is behind. When the second half of the circle is reached the right foot is again set on the ice and the movements are repeated. You can alternate from the right outside edge to the left outside edge as long as you wish. The same is true of the other edges. The outside and inside backward edges are executed in the same way except they are effected backward. These can be picked up by the skater who has grounded himself in the forward movements.

Faults should be corrected as soon as

(Continued to page 140A)

One nice thing about "shoot the duck" is that you don't fall so far when you do fall. Any skater can learn this simple stunt

'Baby' Racer Built as Hobby Hits a Fast Pace

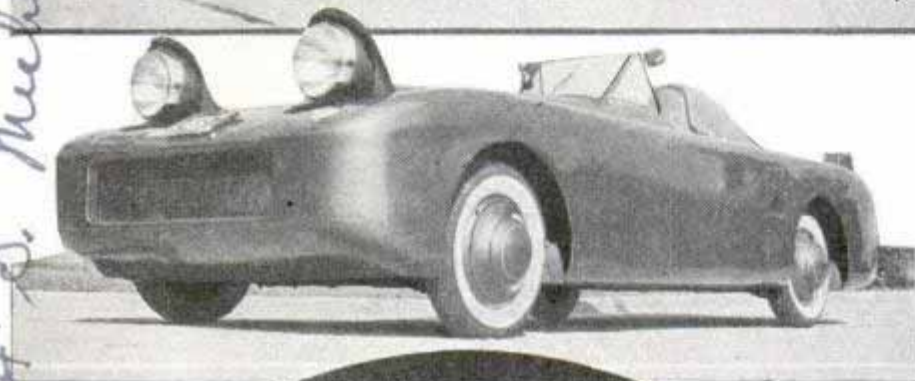
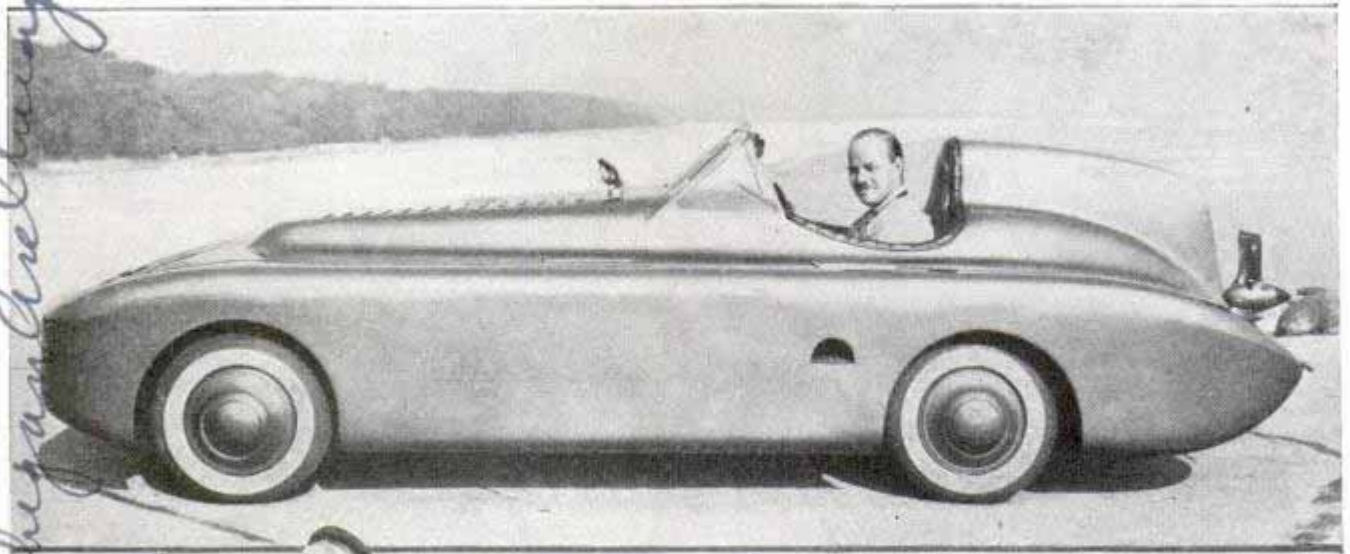

Notice the clean design of this ninety-mile-an-hour racing car. Its headlights are retractable, and the exhaust vent is a narrow slot in the tail "fin"

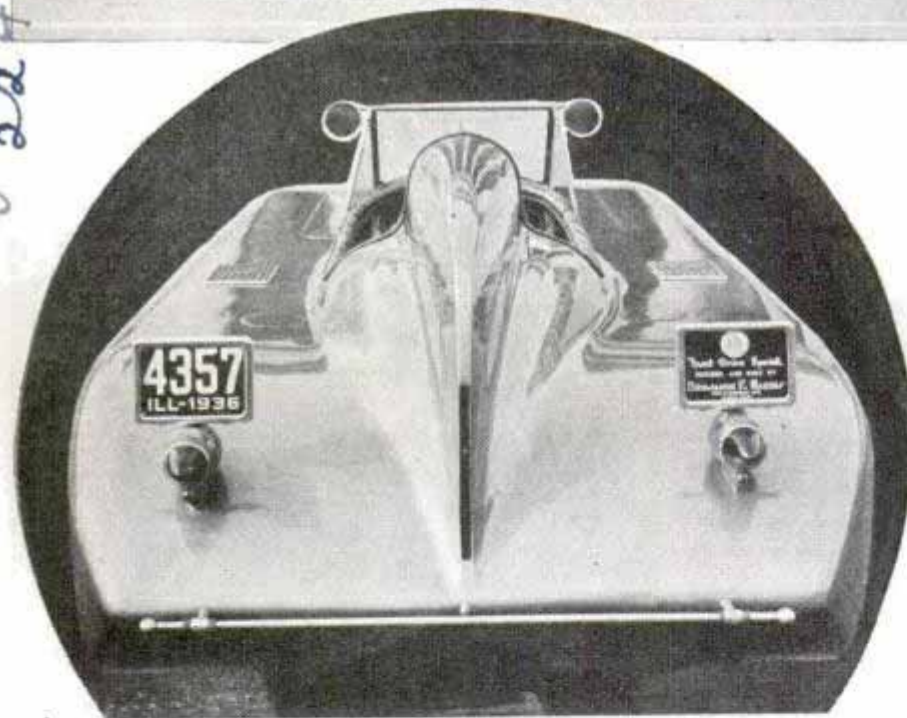

disappear into the body, spare wheel, tools and baggage are all carried inside, and even the exhaust aperture is built in as a narrow slot in the tail "fin" that extends from the driver's seat to the back of the car. The motor is a specially built V-8 with two carburetors. Over-all length of the car is twelve feet, width fifty-nine inches and height forty-three inches, with six-inch road clearance. The filler caps for gas tank and radiator are remotely controlled.

F1348
Gas Seeps Through Red Hot Metal as It Expands

With a wheelbase of only eighty-six inches, a front-drive car built as a spare-time hobby by a Chicago engineer is geared for ninety-mile-an-hour speed yet achieves the economical performance of thirty miles on a gallon of gasoline. Trim and clean of design, it has no external "gadgets" to mar its appearance: hood latches and locks are concealed, headlights

Metal is not always solid. Proof of this was given by Dr. W. R. Ham of the physics department at Pennsylvania State College when he passed hydrogen gas through red hot metal plates. Metal is composed of crystals, molecules and atoms with vacant spaces between them, and as its temperature is raised the crystals change their structure. In his demonstration,

State College P.A.

*Built and owned by B. J. Barrio 1111
 224 S. Michigan Ave. Chicago*

10/18 7/36

Dr. Ham heated a metal plate slowly, and at first no hydrogen went through the plate; but as it reached a critical temperature more and more hydrogen passed through the vacant spaces in the expanding metal. By studying metals in this way the scientist learns to predict the points at which changes in the physical nature of the metals occur, such as elongation, tensile strength, magnetic permeability, conductivity and crystal structure.

F1297
**Racket Restringer
 Keeps Tension
 Uniform**

Stringing tennis rackets with an automatic tensionizing stringer which uses no awls saves the gut and frame from bruising and strain. The tensionizer is set by turning an indicator to the number of pounds tension desired, and thus both lateral and cross strings are uniformly taut. A multiple disk clutch prevents pulling the strings tighter than the set tension. One turn of the gut on a special rubber-covered drum of the tensionizer pulls it to the maximum tension.

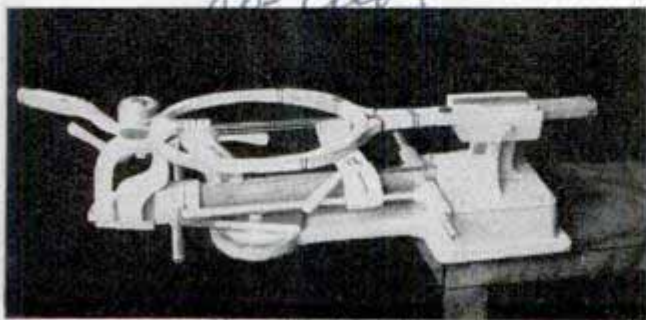

Racket is strung equally taut in both directions

Million Volts for X-Ray Tube Flow from Giant Generator



To develop curative rays which will penetrate deep into the human body, electrostatic generator will supply a million volts for X-ray tube

Rays more penetrating than all the radium in the world are to be developed in a huge X-ray tube designed for a Boston hospital. To supply the power for this tube, a million-volt electrostatic generator has been built. Medical authorities hope that when this electric plant begins its beneficent work, the X-rays will have a curative influence on malignant growths in the human body so deep-seated that treatment has hitherto been impossible.

Model makers are being offered a kit of gold leaf with tools for applying it.

Mass. Institute of Technology
 Technology
 strung
 strung

Tennis machines, Inc.
Hastings & Co.
210 N. York

10-5/4-1936

10/9/36

Tropical 'Delicious Monster' Is New Fruit for Your Table

F.1293

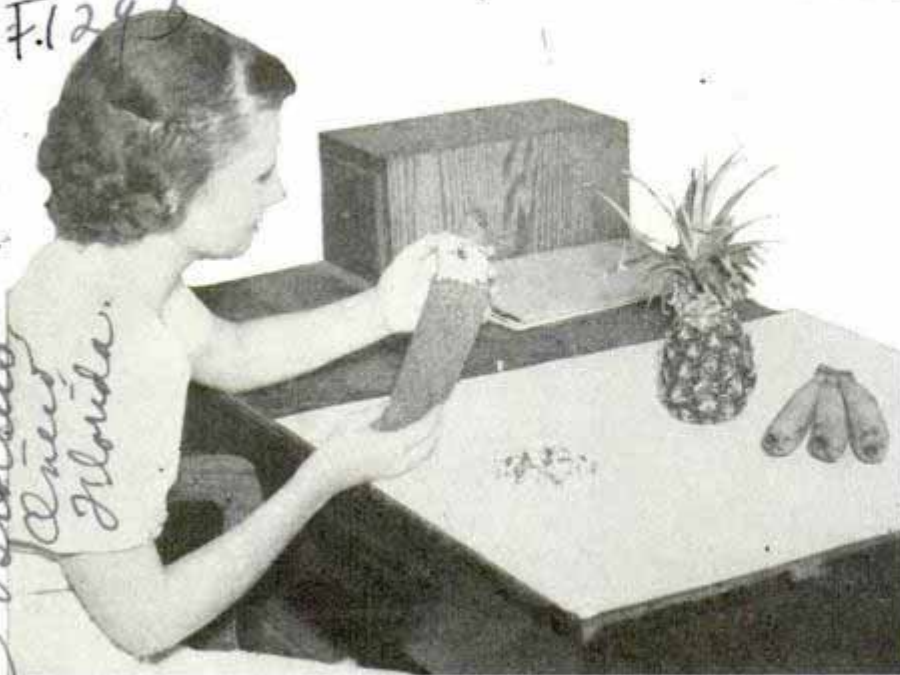

Conelike, the ceriman bears luscious, meaty kernels, seen on the table in foreground. It looks like a cross between banana and pineapple

Like a banana in shape, like a pineapple in external markings, and a little like both in flavor, the "delicious monster" from the tropics is being introduced to North American tables. Despite its resemblance to these fruits, the ceriman, or *Monstera deliciosa* as botanists know it, is not a close relative of either banana or pineapple. A native of Central America and Mexico, and grown now in Florida, it is borne on a large-leaved climbing plant. When the cone-like fruit ripens, the small hexagonal sections of the rind burst off and reveal kernels of white meat somewhat like an ear of corn, delicious in flavor.

F.1318

Lifelike Movie Colors Seen by Engineers

Motion-picture engineers, in a recent convention, predicted that color, brilliantly true to life, will be the next widespread change in the film industry. The engineers said that the day is not far off when theatrical talkies will use color film almost entirely. They pointed to the recent development of amateur color film that in about one year has made black-and-white movies virtually obsolete. The difficulty in applying the same process to the theater is that it

has not become possible to make prints by the color process most widely used for home movies. More color in professional pictures is forecast by reports that the lenticular type of color film is adaptable to larger theater projection. Present color movies are produced by a more complicated and costly method which has prevented wider use.

F.1276

Dental Trailer Serves Needy of State

Dental equipment of the latest design has been installed in a trailer which the state of Indiana will send out to treat needy children. The trailer contains one dental chair, a divan, hot and cold running water, sterilizer and other apparatus. Services include prophylaxis, cement and amalgam fillings, and extractions.

Board of Health



Interior of the dental-office trailer which will serve needy children in all parts of Indiana

Plants from Royal Palm, Florida
Society of...
Researcher: Arthur...
Dinner Florida

Indiana people. dated

Hotel Pennsylvania
New York

Wide World

220 South St. New York
Aesne Photo Service

Pigeons Speed Story and Film to City Papers

When minutes count in getting stories and photographic film back to the newspaper office, reporters save time by using carrier pigeons instead of a human messenger who may be delayed by heavy traffic in city streets. Recently one New York publication and a photo service syndicate inaugurated the carrier pigeon means of delivering material to the home office, thereby scoring a "beat" over rival reporters and cameramen using motorcycles and automobiles. Cameramen use a portable darkroom or lightproof changing bag to unload the film into an aluminum capsule in broad daylight. After being sealed, the capsule is taped to the pigeon's leg and the bird is released, to wing its way straight to the newspaper office. Important stories are written on very thin paper and sent in the same way. From one to three hours may be saved on assignments in and near New York. The pigeons proved successful for transmission of film and copy when the liners "Queen Mary" and "Normandie" arrived.



Reporter ready to release carrier pigeon with pictures and news story. Inset, capsule containing film is attached to bird's leg

F1250

Weather-Resistant Bricks Made of Acidproof Cement



Samples of acidproof bricks which are impervious to effects of weather

Sulphuric cement manufactured in blocks which must be melted for use is the basis of a construction material which promises long life. Bricks made with this cement are impervious to weather and resist attacks by acid and gases found in chemical plants, tunnels and sewers.

F1307

Radio Peers into Human Body Taking Picture without Light

Photography of human tissues and organs by radio waves instead of X-ray or visible light is being developed in a California laboratory. The method is based on the theory that heart, lungs, brain, muscles all have their individual electromagnetic vibrations. A radio receiving set is tuned to receive the emanations from the muscle or organ and a small wire connected to the set is touched to the body over the tissue for a short period. The wave received is amplified and sent through a photo-electric cell, then transmitted to photographic film.

Atlas Mercantile Products Co.
Merby Lumber Co.
U.S. patents granted
Dr. B. Brown, Brown Laboratories, Inc.
Dr. B. Brown, Brown Laboratories, Inc.

Atlas Mercantile Products Co.

F1209

D DOCKING

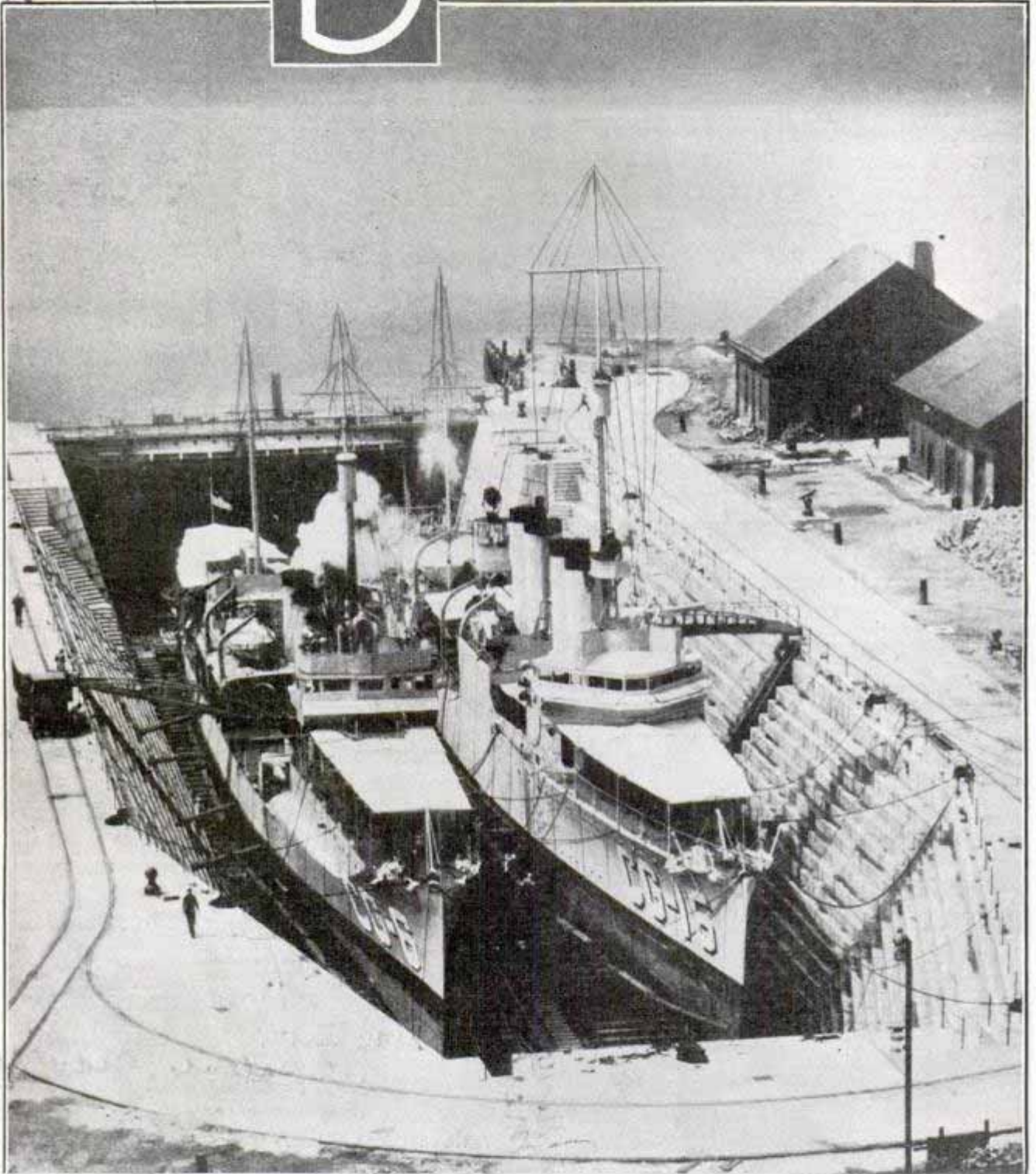

The size of a modern dock is indicated by this photograph showing two destroyers docked side by side at a navy yard

By Commander W. Mack Angas

Captain of Corps of Civil Engineers, U.S.N.

WHEN a big ship is planned, her designer must consider the problem of getting her out of the water, even before taking up the difficult and often critical problem of getting her into it.

Steel ships require dry-docking at regular intervals of from six to twelve months for the cleaning and painting of the bottom plating and routine repairs. Dry-dock design and construction must, therefore,

29 W. Eldridge St.

Handwritten notes on the left margin, including 'F1209' and other illegible text.

Commander, Corps of
Civil Engineers, U.S.N.

the BIG FELLOWS

29 Weldwood St.
Worcester, Mass

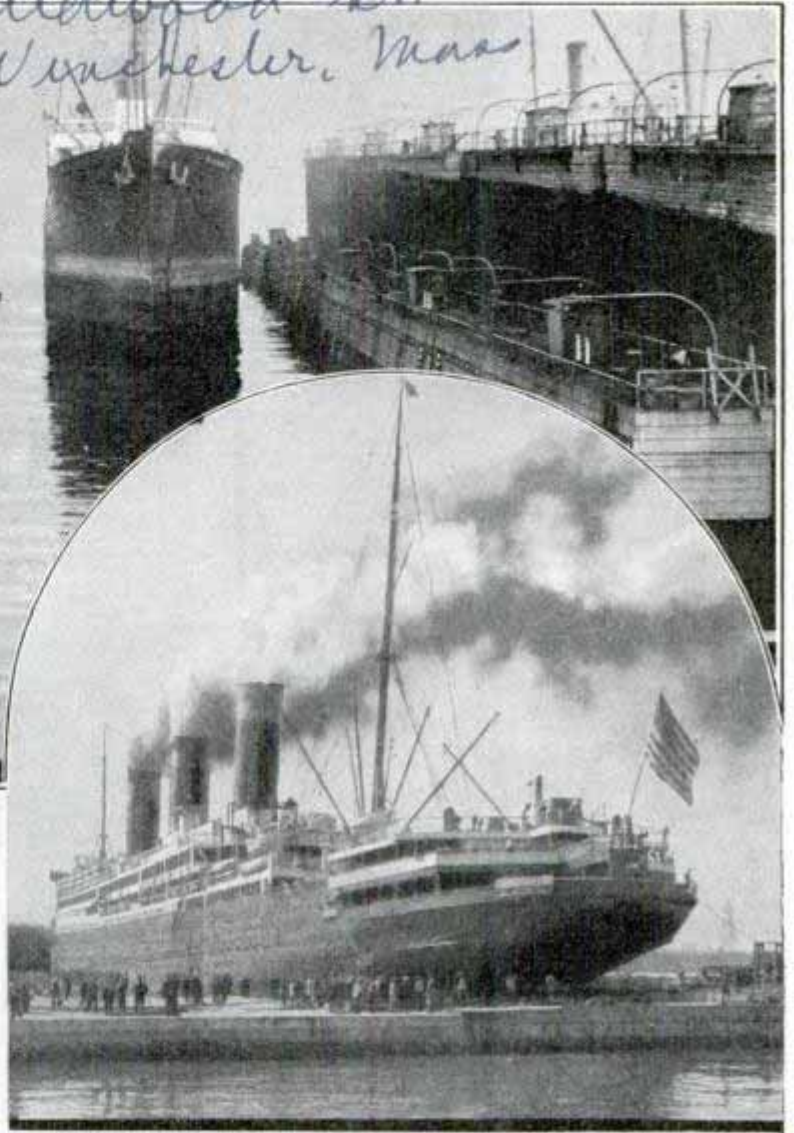

keep ahead of ship building. The size of the great ships of today is in general limited by the size of the dry docks of yesterday. The civil engineer of today is, therefore, estimating the size of the ships of tomorrow and designing and building dry docks to accommodate them.

Although dry docks are among our largest engineering structures, they attract little attention despite their vital necessity to the ocean transport system of the age of steel and steam, largely due to invariably being located in some out-of-the-way shipyard not open to the general public and also because the docking of a ship is far less spectacular than the launching of the same vessel.

But to lovers of ships there is a fascination about seeing a great vessel out of her usual element, with the beautiful symmetry of her hull and the great bronze propellers which drive her exposed to view. The methods used to get the floating cities out of the water

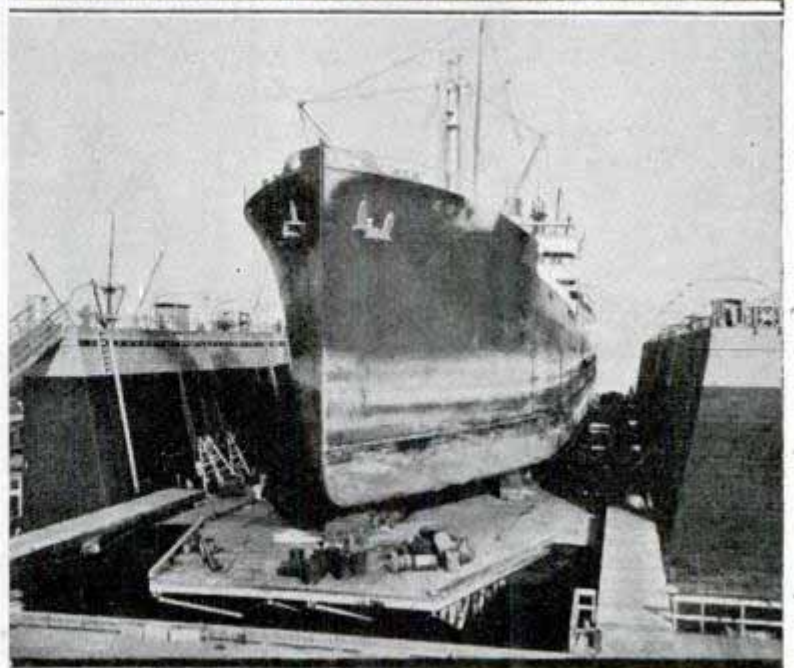

Top, ship entering floating dock. Center, docking the "Leviathan." Bottom, ship in floating dock

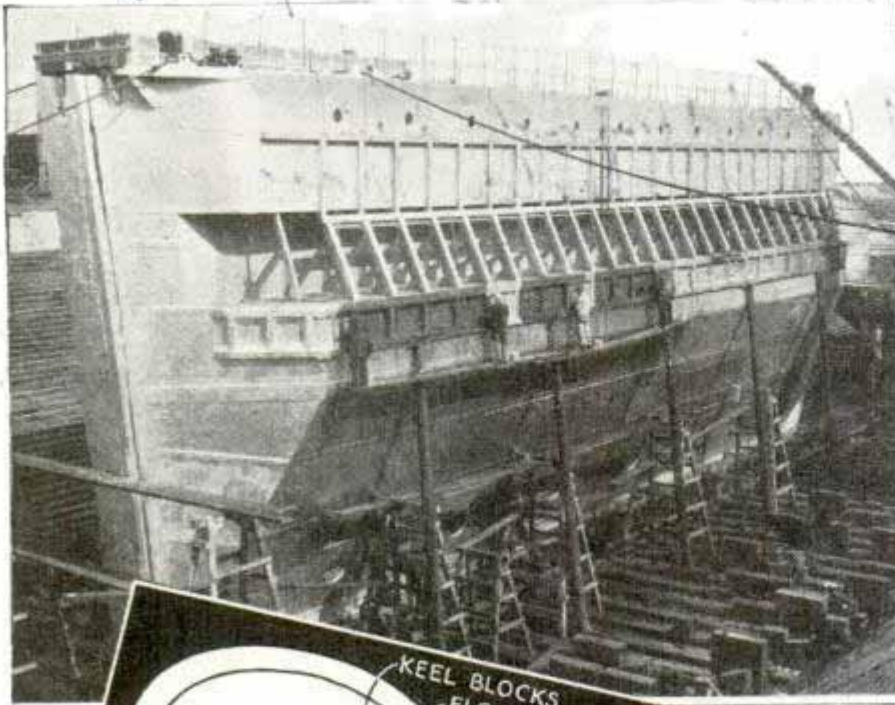

possible before the next high tide refloated the ship. The operation was usually repeated to get at the other side of the hull.

To improve the accessibility of careened vessels the "gridiron" was developed. This was merely a heavy timber platform upon which the receding tide left the vessel. The gridiron greatly increased the accessibility of the ship's bottom, but did nothing to extend the short interval between tides which was available for underwater work. When extensive underwater repairs became necessary, it was a natural step in the evolution of the dry dock to build a dike around a gridiron, and after the ship was deposited on it

(Continued to page 120A)

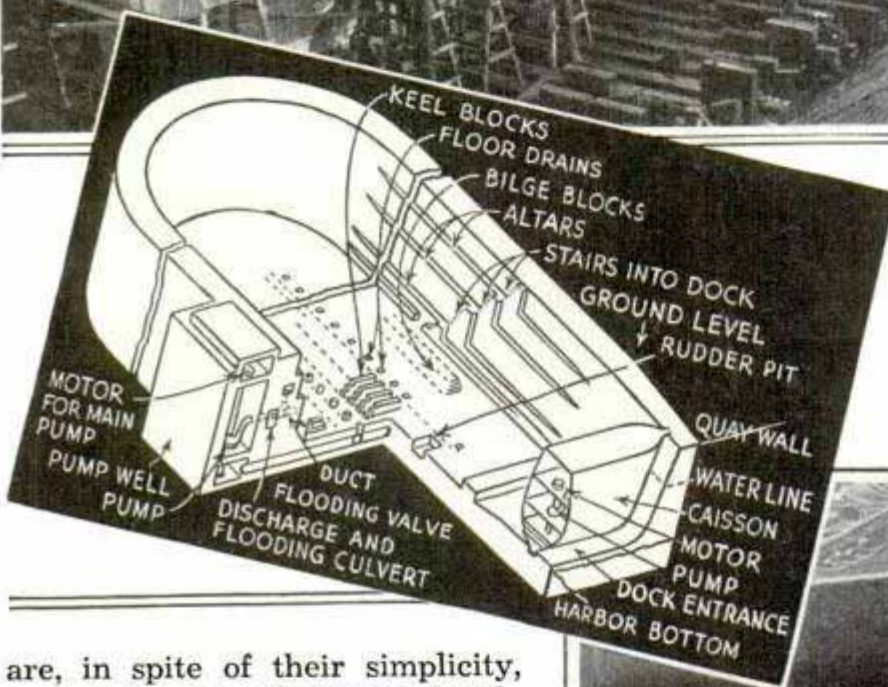

are, in spite of their simplicity, among the more ingenious developments of science and industry. Two basic methods are used. These are taking the water away from the ship in a graving dock or lifting the ship bodily out of the water in a floating dock.

A graving dock, a basin into which a ship can be floated, and from which the water may subsequently be pumped, is a logical development of the crude methods used to make underwater repairs to the first boats and ships too large to be drawn out of the water by man power or draft animals. It was usual to run such vessels ashore at high tide on a clean sandy beach, careening them onto one side as the tide fell and doing such underwater work as was

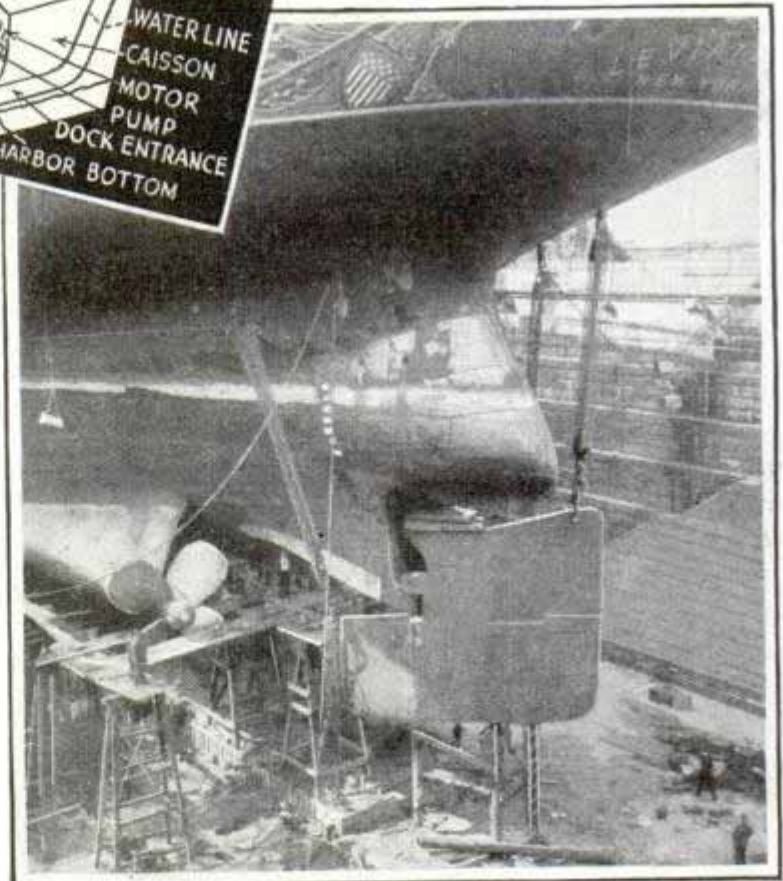

Top, docking a dry-dock caisson for repairs. Center, diagram of graving dock. Below, stern of the "Leviathan" in dock where the vessel is being repaired

De-Icers Protect Air Liners on Winter Flights

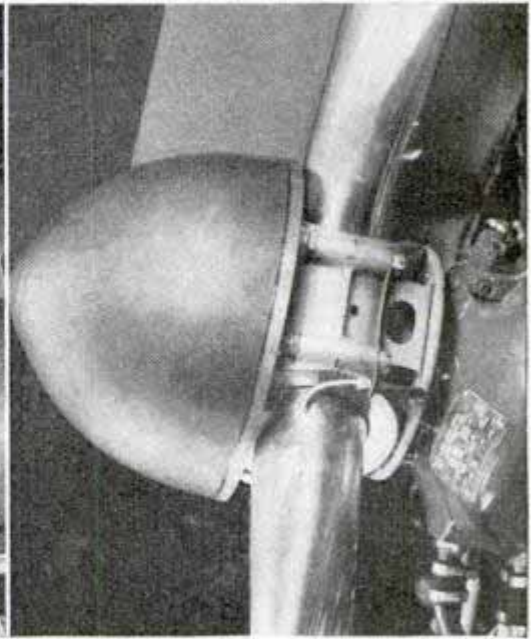

Left, three views of rubber overshoes attached to edge of wing, fin and stabilizer. Right, propeller guarded by cone-shaped spinner and by ring which distributes oil on blades to prevent ice formation

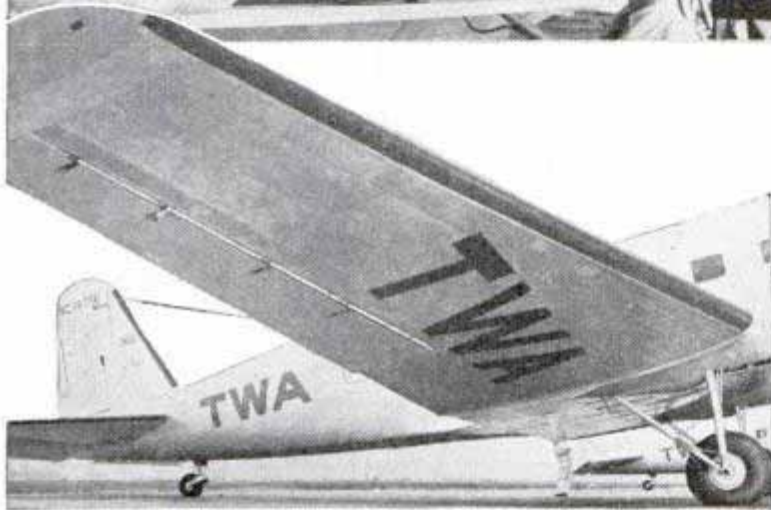

ber sheeting into which are built three tubes. Inflating the tubes results in a violent breaking action on ice adhering to that particular part of the plane. By keeping the leading edge free, the possibility of ice forming over the balance of the plane's surface is minimized. The pull cord on the radio antenna shakes free any ice accumulated on wire and insulators when pulled and released. The oil slinger ring is attached to the back of the propeller hub. Special glycerin solution is fed from the interior of the plane to a groove in the ring, which in turn distributes it over the entire propeller blade area by centrifugal force. The solution prevents ice formation but does not interfere with performance of the propeller.

For protection against excessive accumulation of ice on transport planes de-icing equipment is installed with the approach of winter. Transcontinental and Western Air, Inc., uses rubber overshoes on the leading edges of wings, fin and stabilizer; spinners and oil slinger rings on the propeller, and pull cords on the radio antenna. The overshoes are made of rub-

The spinner is a cone-shaped attachment made of metal and coated with rubber. Bolted to the front side of the propeller hub, it protects the adjustable mechanism of the variable pitch hub which is not guarded by the oil slinger. Before the transport leaves the ground, the spinner surface is coated with castor oil which prevents adhesion of ice.

B. F. Goodrich Rubber Co.

F1306

19 I marked

see ad - 145a

Chicago

MOTORING on SKIS

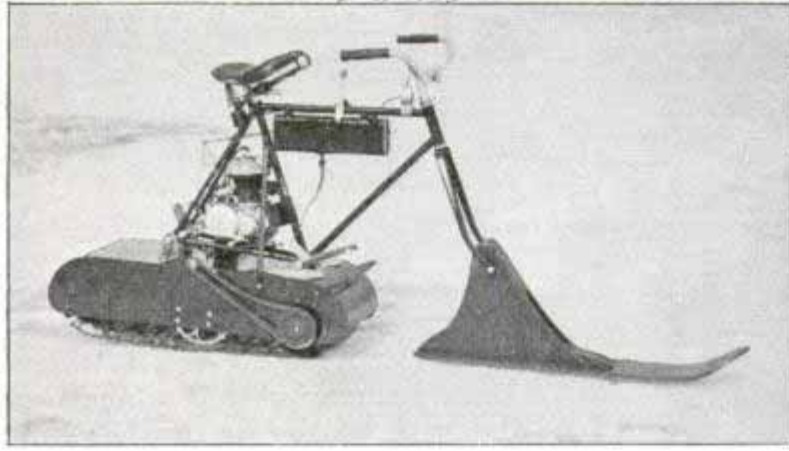
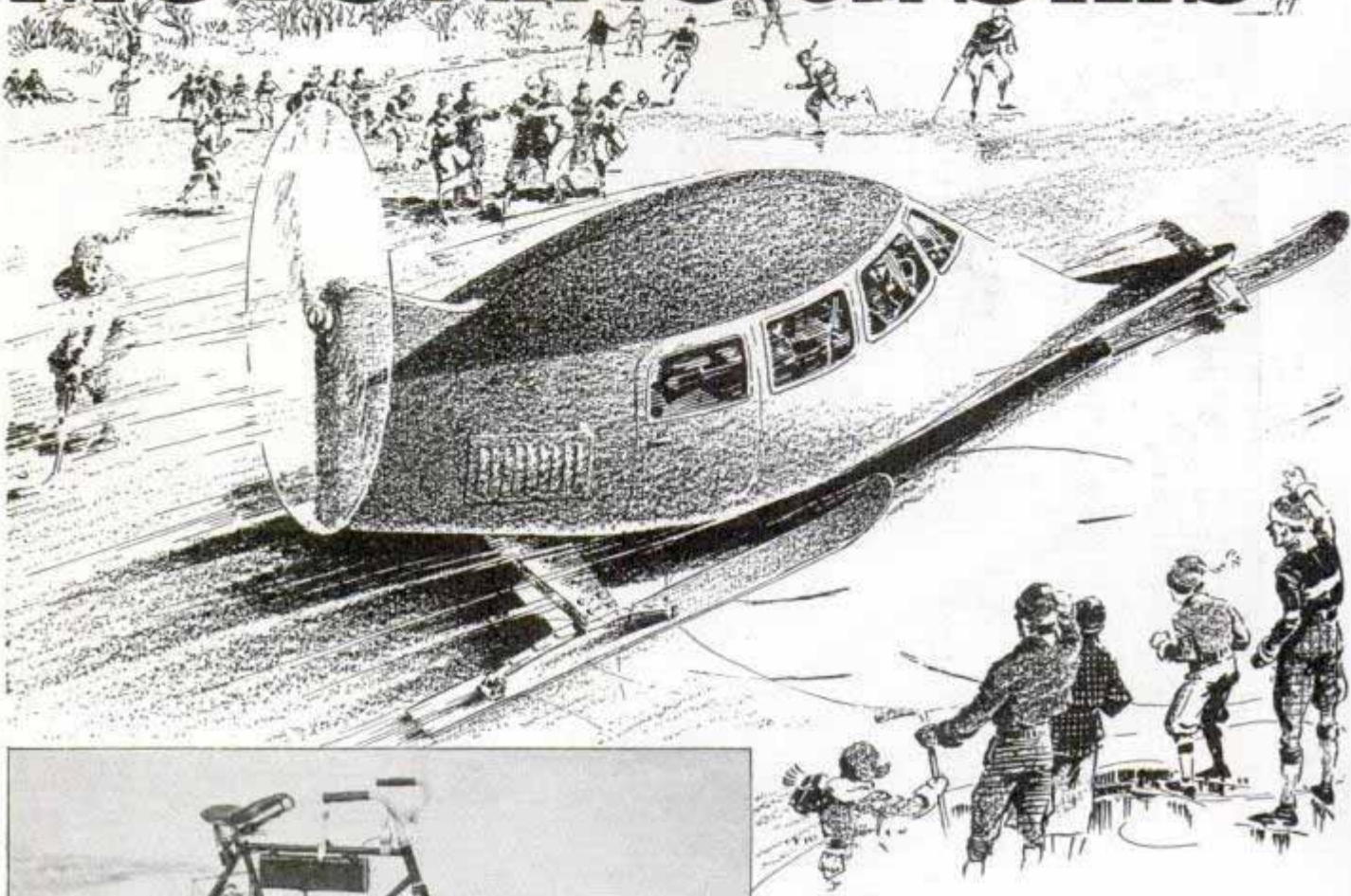

Top, drawing of the snow sedan as it would appear on winter sports course. Center, the "bronco," a motor bike equipped with tractor tread at rear and runner at front. Bottom, driver's compartment of the speedy power sled which is capable of 150 miles per hour on ice. Its steering wheel controls the front runner

By T. E. Mead

ROARING like an airplane and moving so fast that it is hardly more than a blur against the blue-white of ice and snow, a strange-looking craft speeds along the surface of a frozen lake near the Illinois-Wisconsin line. Down a course marked by tiny flags it races, then makes a sweeping turn at the far end as the driver throttles the engine. A final burst from the motor is followed quickly by silence as the ignition is cut off and it comes gliding to a stop.

Spectators hurry from shore to get a closer view. They see what appears to be the body of a carefully streamlined racing car or the cockpit of an airplane, mounted on three skis, one in front and two attached to wing-like outriggers on either side.



winter's latest sport



Almost a foot wide and shod with steel blades like ice skates, the runners give a sure footing on ice and hard-packed or loose snow. Just ahead of the single-seat driving compartment is the power plant, a forty-horsepower aircraft engine which drives a two-blade propeller mounted in the nose.

Capable of 140 to 150 miles per hour on smooth ice and 100 on hard-packed snow, this racing sled's full speed has never been reached, the driver tells us, because a sufficiently long, clear course has not been available. Only for a few seconds at a time has it been possible to apply all the power and that on a marked course surveyed in advance.

Bumps and depressions, though ever so small, in the ice and snow tend to upset the balance of the plane-on-skis at high speed, so the driver carefully picks his road when he wants to "open 'er up." But at slower pace, the craft rides easily and sure-footedly and can travel over almost any surface coated with ice or snow. The rougher the road, the slower the speed, of course.

Flaps built into the sides of the body help to stop the sled. Except at unusually high speeds, the flaps can be opened from the driving compartment to act as air-resistance brakes. An attractive instrument panel is equipped with ta-

(Continued to page 118A)

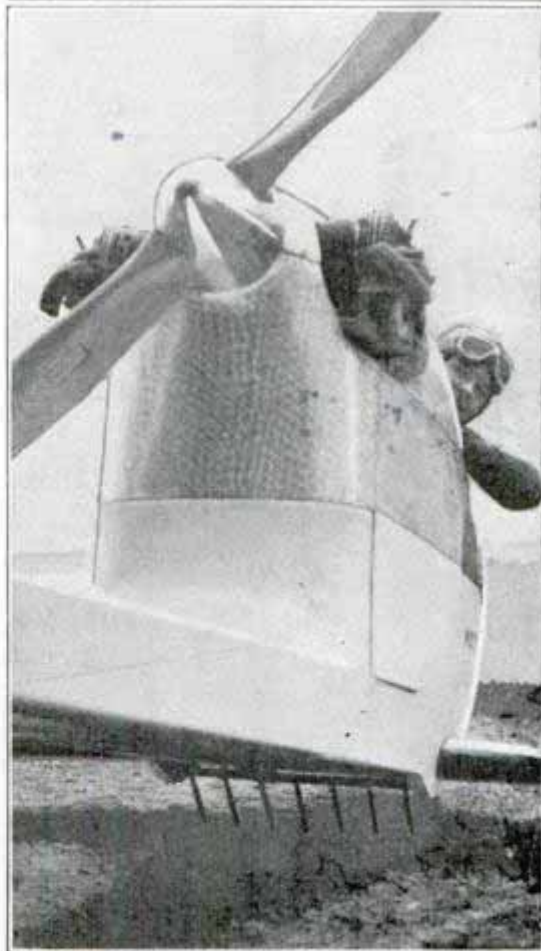

Top, power sleds on the line for fast jaunt down the frozen lake. Bottom, closeup of the super-sled

Alaska Street Car Has "Mummy" Conductor

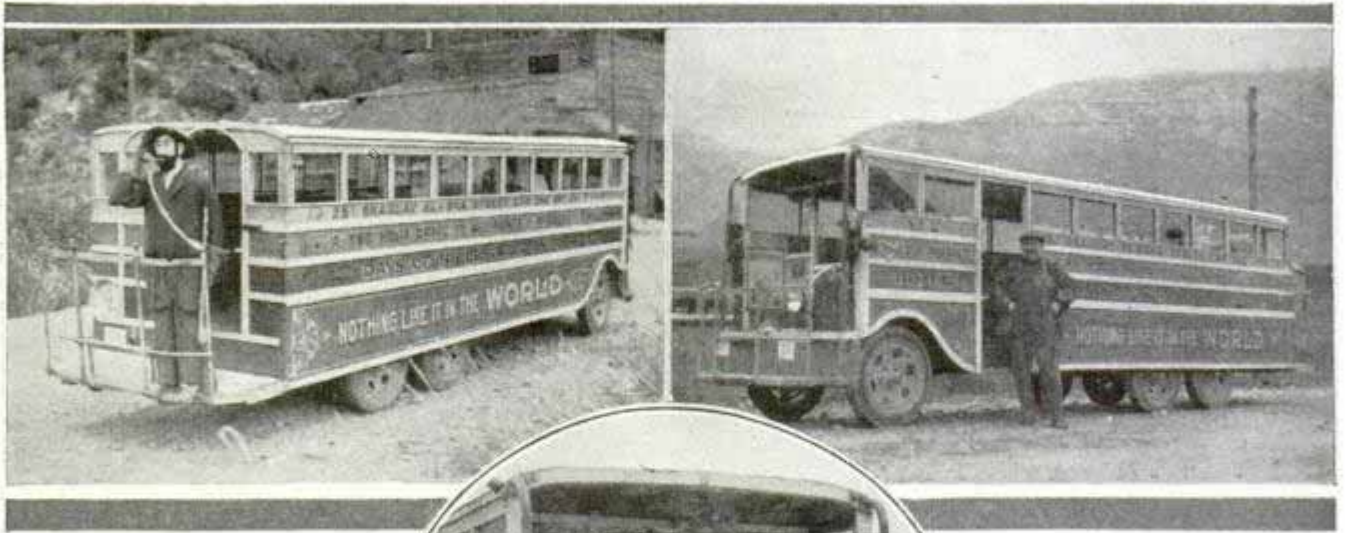

Built of odd parts by a sixty-seven-year-old Alaskan sourdough, a street car riding on a six-wheel motor-truck chassis rambles through the streets of Skagway with a "mummy" conductor on its rear platform. Martin Itjen, builder and driver, equipped his thirty-five passenger conveyance with a collection of picturesque attachments: a stuffed brown bear cub that rides in a front seat and flashes its electric eyes and opens its jaws when the driver presses the horn; a blue-



Top, left, image of "bad man" salutes passengers of odd street car. Right, driver beside car. Bottom, stuffed bear in driving compartment

uniformed image of "Soapy" Smith, pioneer Alaskan bad man, which stands on the open platform raising the right arm in salute to tourists. The bear also grasps a cord, ringing the gong when the car approaches a crossing. Stuffed arms drop down to indicate left or right turn. Brass rails from "Soapy's" old tavern

provide a handhold for passengers stepping aboard. The car is twenty-four feet long and six feet wide and is mounted on a standard truck with two extra wheels.

Plane Uses a Rail Handcar for Its Runway in Takeoff



After run of 400 feet the plane takes off from the handcar. The plane's propeller drives handcar until the takeoff

Riding a handcar seems a novel method of catapulting a plane into the air. A test pilot at San Diego, Calif., proved it could be done safely. His biplane was mounted on a railway handcar rebuilt for the purpose, the plane wheels in a groove to prevent the ship sliding off. A supporting frame under the fuselage held the plane level for flight when the proper speed

was attained. The plane's propeller started handcar and ship rolling down a straight stretch of track near the airport, gathered speed, and after a four-hundred-foot ride on the rails the pilot flipped the plane up into the air and zoomed away.

F12 48

Small Generator on Wheels Works for Farmer

Handy for operating machines which will clip hedges, mow grass, shear sheep, saw wood, light the house and do many other jobs, a generator mounted on rubber-tired wheels produces 110-volt electric current for the farmer or camper. The 400-watt dynamo is driven by a one-cylinder gasoline engine which runs eight hours at full load on one gallon of fuel. The generator is driven directly off the engine by means of a flexible coupling. An automatic electric governor controls the speed and output of the generator. If desired the engine can be used alone.

Wooden Horses Pull Coach in Museum of Frontier West

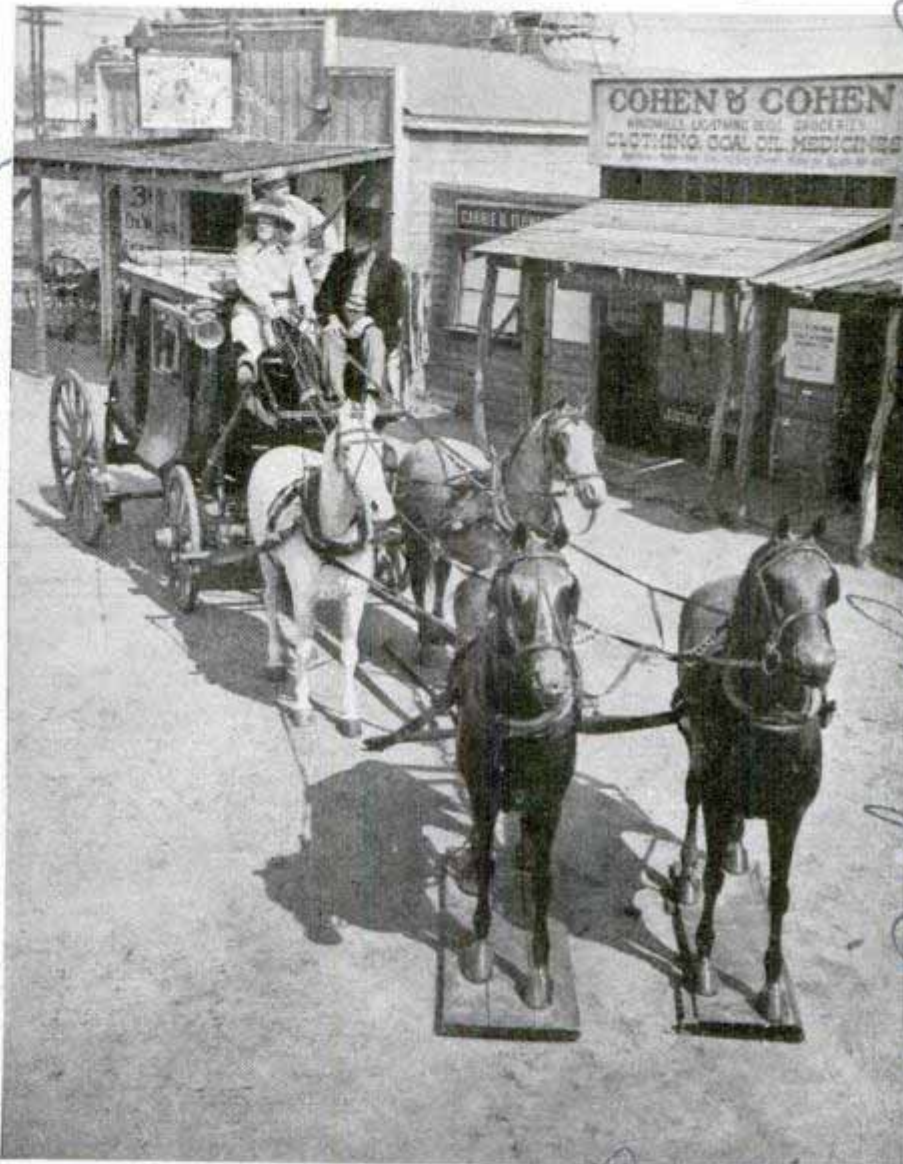

Museum setting in which wooden horses are shown harnessed to stage-coach of the Old West, preserving memories of frontier days

W. Parkes Lynn. Arcades Early

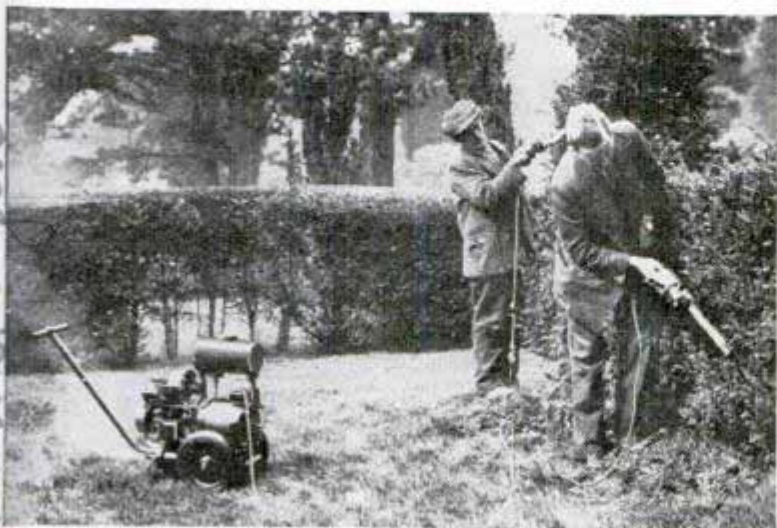

Small portable generator and motor being used to drive electric hedge clippers. The equipment has many other uses

Wooden horses, like wooden Indians, are fast becoming extinct, but four of the artificial steeds have been saved for coming generations by joining a museum of relics in California. These equine "models" once displayed the latest style in harness. Now, in a frontier west setting, they display the ancient style of travel, being harnessed to a stage coach on a street of the "pony express" museum in Arcadia.

There is no "zero" year on our calendar, the year 1 A. D. having begun at the close of 1 B. C.

No U.S. and

San Luis Rey, N.M.

The San Luis Rey & Indicate, N.M.

10555 Halman Ave
Los Angeles, Calif

GOLD FARMERS



Relics recovered from old gold diggings being reworked today. Above, gold miner of today operating a sluice box

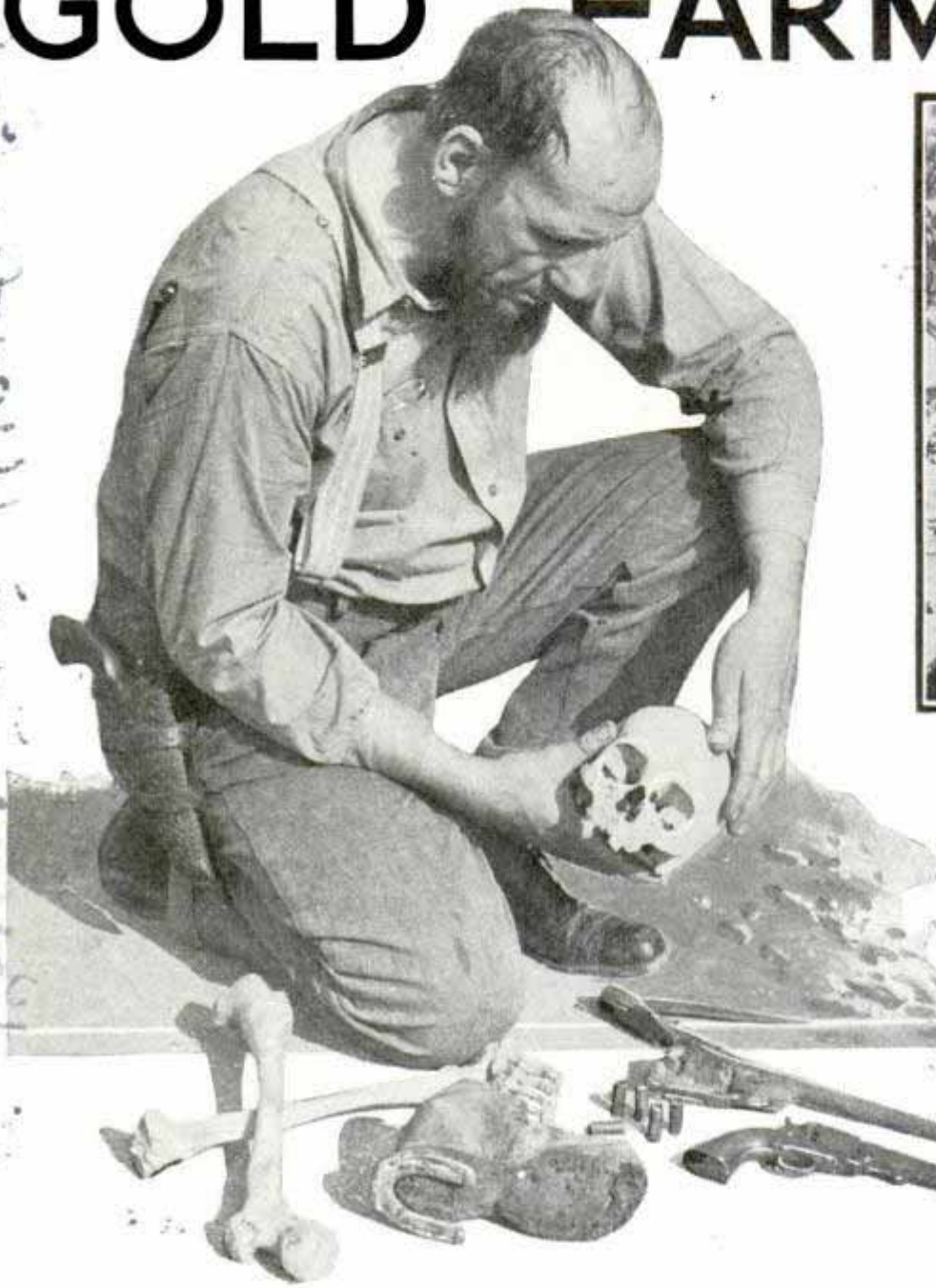

IN SOME parts of the west gold "grows" like any ordinary vegetable and men operate gold farms on which they dig up regular crops of the yellow metal. The gold farmers don't worry about fertilizing or irrigating and it's not even necessary to plant new seed each spring. In this strange agriculture they merely wait until the right time of year and then harvest a crop which they can exchange for dollar bills at the nearest assay office.

These lucky men own canyons located below districts rich in gold. Each season rain and snow water wash some of the gold down out of the hills, concentrate it, and deposit it in natural traps in the can-

yons. Then the gold farmers come along to harvest their crop.

"Typical of the gold farms is a small canyon north of Tonopah," says Roy L. Cornell, Los Angeles mining engineer. "The slopes of the hills beyond contain many small stringers of ore that carry gold but none are large enough to make mining them worth-while. So the owners simply sit back and let nature do the milling and concentrating. Each winter and spring the heavy rains sweep down some of the ore, grind it up, and drop the concentrates on the floor of the narrow canyon.

"The lighter sands and dirt are swept

1429 Santa Fe

of the WEST

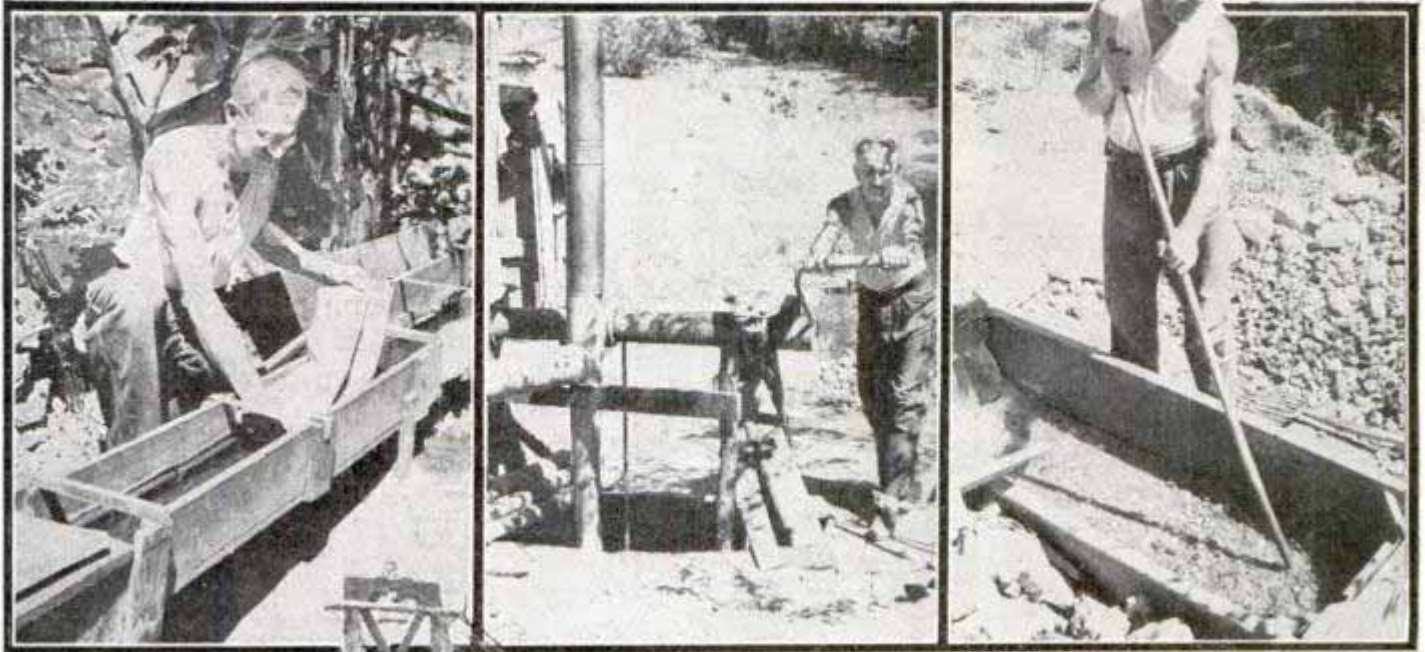

Top, placing burlap sack in sluice box, shaft leading to gravel bed rich in gold, and sluice box which traps gold in gravel

away by the floods but the heavy particles of gold are left behind in a natural sluice box about 400 yards long on the floor of the canyon. That's where the crop is harvested. The owners gather \$500 or \$600 worth of gold every year in exchange for two weeks work or less. But don't expect to find a bonanza farm for yourself. There are not many places where large amounts of gold can be harvested every year and all known locations have been taken up."

Almost every stream in the gold country, however, produces gold in small quan-



Giant gold dredge and sample of black ocean sand from which gold is obtained

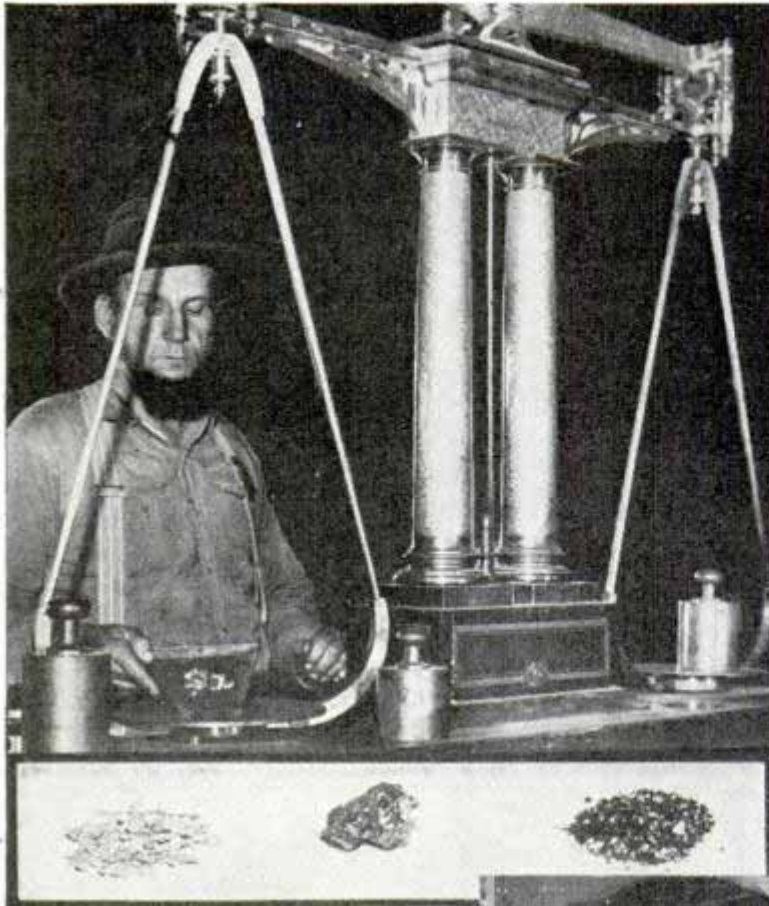

depression. The amounts of gold recovered are not great but the streams can be depended upon to supply some gold for centuries to come. In nearly any part of the Mother Lode country in California a miner with a gold pan or sluice box can count on earning a dollar or two a day, with the chance that he might happen to uncover a pocket of richer gravel or even stumble across a stratum of original stream bed overlooked by the first miners.

Occasionally modern miners find real gold pieces in their sluice boxes instead of the thin yellow flakes they are looking for. One miner found four \$20 gold pieces and other coins worth \$170 one day in his regular "cleanup." The coins were dated 1875 and probably had been lost or buried by

tities. When the forty-niners first worked these streams they recovered large amounts of heavy nuggets and coarse dust that had been accumulating for centuries. Later, the Chinese reworked the same gravel and gleaned quantities of fine gold the original prospectors overlooked. Since then the streams have started the accumulation process all over but there will never be another tremendous crop of coarse gold because no one wants to wait a dozen centuries for it. Instead, itinerant prospectors are continually hunting for small deposits of flake gold that have concentrated since the streams were last worked. Sometimes the same prospector works the same stream each spring, skimming off a thin layer of pay dirt deposited at the places where the current slows down and allows the fine gold to drop to the bottom.

In a depression thousands of unskilled miners gather along the streams, many of which have not been worked since the last

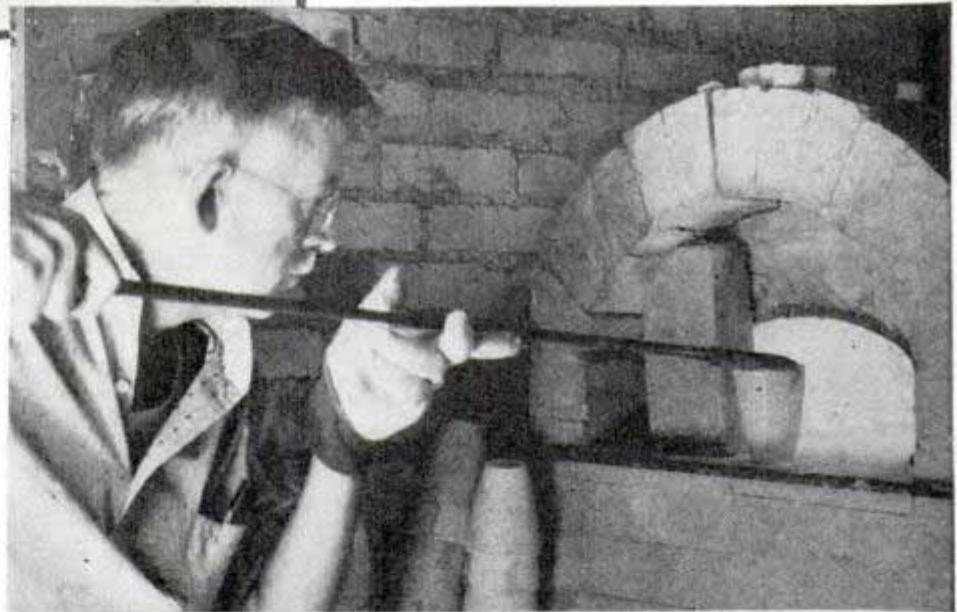

Gold scales of early days, samples of real gold, "fool's gold" and "cat" gold, and placing sample of gold in the assay furnace

some early miner who had worked the same district. Another miner was surprised to find nearly a pint of brass Chinese coins, some jade jewelry, and a powder horn in the dirt. Old American and Chinese coins are found nearly every month in the diggings being reworked. In some parts of California a gold pan is a regular item in a trout fisherman's outfit. In the middle of the day when fishing is poor he pans for gold and sometimes recovers enough to pay for the day's outing.

Along some ocean beaches of northern California and southern Oregon, gold is a regular winter crop. After a big storm or an unusually high tide the beaches may be crowded with people shoveling over a top layer of black sand cast up by the sea. They gather as much as possible before the next high tide carries the deposit back to sea. The layer may be one-half to six inches thick. After it is carried above high-tide line, sluice boxes are built, water is pumped from the ocean, and the black sand is run through the sluices. Fine gold in varying quantities is recovered by this

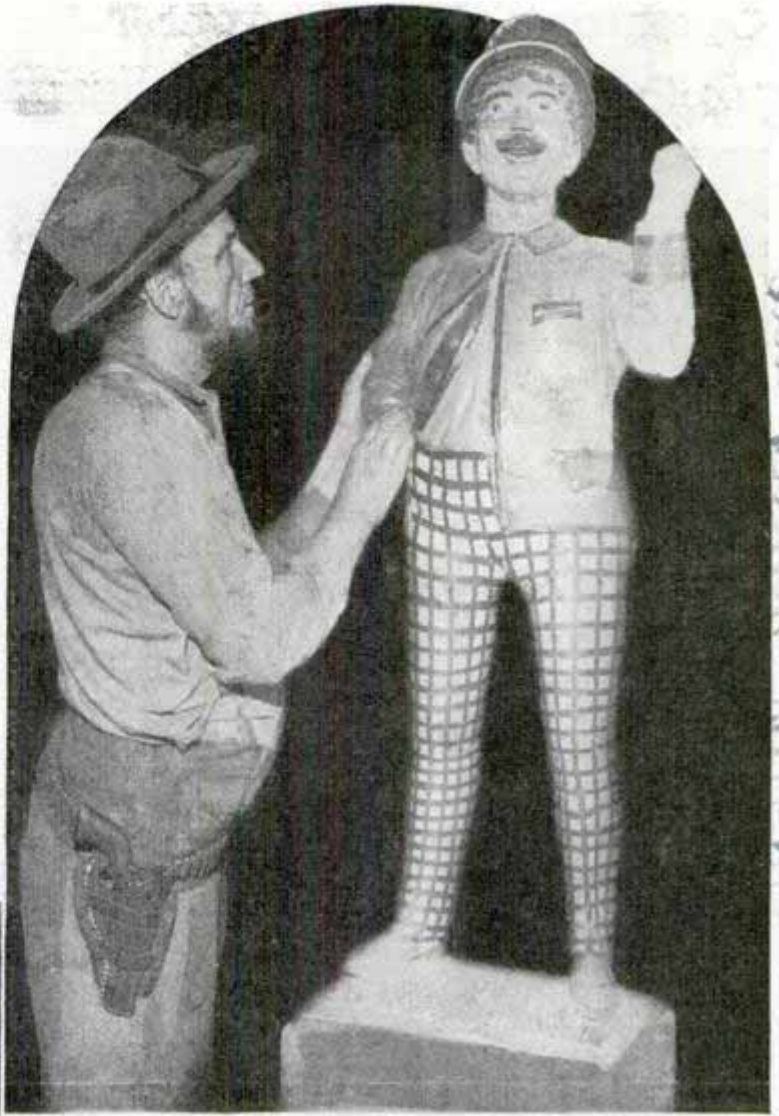

method. Ordinary white beach sand contains little gold and it is only when a rich deposit is swept up on the beach that the gold harvesters go to work.

For hundreds of centuries, small amounts of gold in near-by hills and mountains have been scoured out by the streams. Some of the finest material was carried to sea

(Continued to page 116A)



Left, high-temperature furnace which melts gold dust. Top, sign found in California "ghost town." Bottom, gold wet-washing outfit

Operator Takes a Shower in Spray of Electric Sparks



Here is a photograph of what happens when you connect two arcs. The demonstrator seems not to mind the electric shower

For a dry shower bath, try electric arcs. An electrical demonstrator, well protected by goggles and gloves, showed how it was done by contacting two arcs, the resultant spray of sparks enveloping him like a shower of light. The power for the display flowed from Boulder dam generators.

the furniture are on the market. The tips absorb noise on hard floorings and reduce floor wear. Use of the glides on metal furniture is recommended by the makers because of the noise caused by moving this type of furniture. One model of the glide has a sharp nail with which the device may be attached to the furniture by a few blows of a hammer. For metal furniture, the glide is furnished with a threaded stem.

Vacuum-Pump Canning Prevents Spoilage

Food canned by a new vacuum-pump method will remain fresh in its container for years, due to the exhaustion of air from the container. Bacteria which cause fermentation, spoilage and decay cannot exist in the vacuum created by a few strokes of the pump. After cherries, pickles, jam, jelly, meat or any other foods have been placed in the jar by the cold pack or other method, a rubber ring is inserted in a metal top placed over the mouth of the jar. Next a small rubber cap is placed over a hole in the metal top and the vacuum pump's mouth is set over the rubber cap. A few strokes of the plunger extract the air and the pump is removed, leaving the rubber cap firmly



Equipment for vacuum canning, including pump, rubber band, metal top and tiny rubber seal

Noiseless Furniture-Leg Tips Also Save Floor Wear

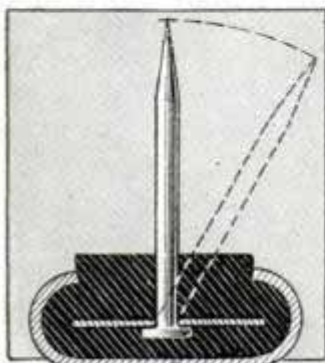

Desirable for use on light furniture, such as school and restaurant chairs, stools, small tables and radio cabinets, noiseless tips or glides for attaching to the legs of

Keneth Brief address Santa Monica Calif

Alvin Beach Calif

325 W. Huron Chicago J.B. 6/2/47

Harnell Corp Ltd

Los Angeles Calif

sealing the jar. Pressure of the outside air holds the cap against the hole. The cap seal can be removed by lifting one edge with the fingernail, permitting air to rush in and then the metal top can be taken off for removal of the jar's contents. If desired, the jar can be resealed after part of the food has been taken out, and there is no danger of spoilage after the second sealing. Fresh food can be preserved for many days in the same manner, without refrigeration, thus solving the problem of keeping leftovers, milk, butter, cream, the baby's food and even coffee and tobacco. All may be kept fresh by vacuum.

Three-Wheel Teardrop Car Has Engine Mounted at Rear

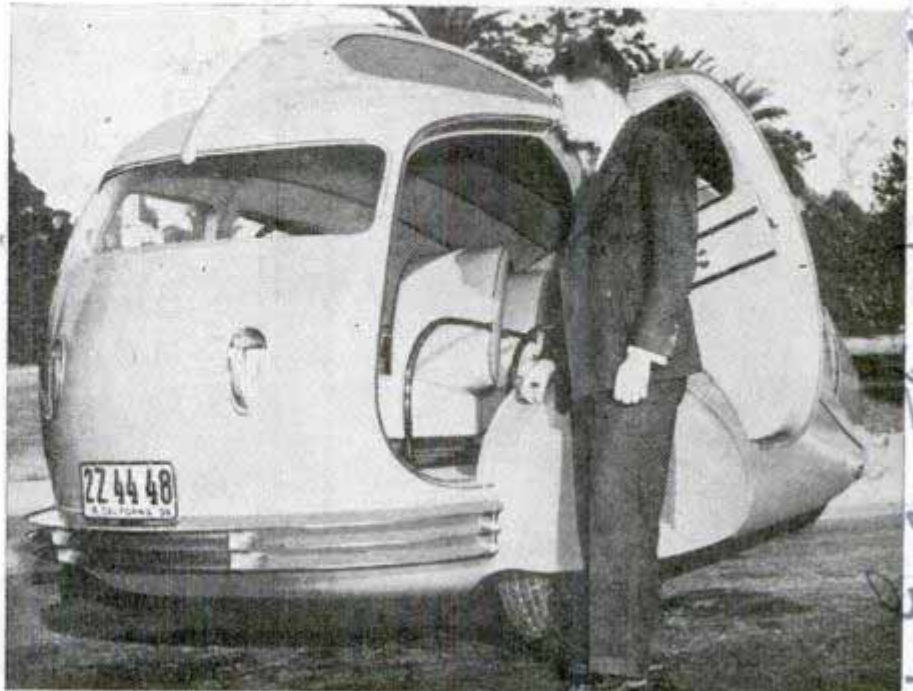

Here is the latest version of the streamline auto. Seats are located forward, with engine in rear compartment

Bus Carries Baby's Buggy on Hooks at Rear

Motor coaches in Australia have been equipped with hooks at the rear for transporting baby carriages, thus solving an old problem. The perambulator is hung on one of the hooks by its handle while mother and baby board the bus, ready for long or short trip.

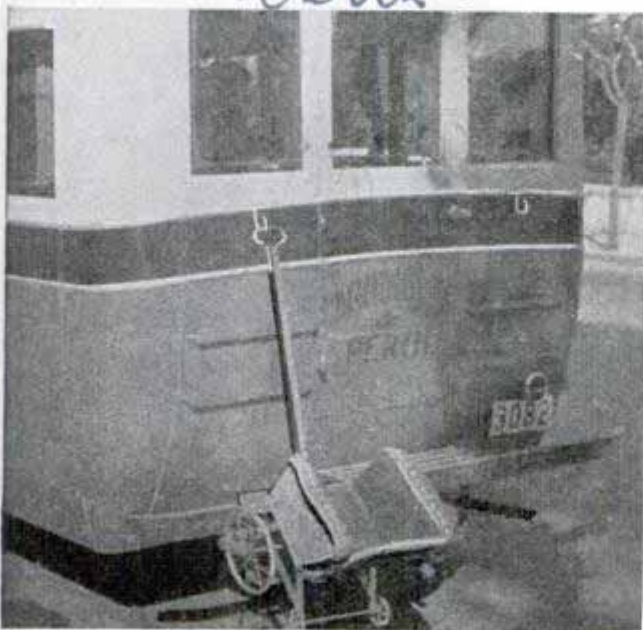

This is how Australian bus companies solved problem of where to carry baby's buggy

Passengers ride in front, engine in the rear of a "teardrop" car built by a Los Angeles engineer. It is a three-wheeled automobile for three passengers, who enter doors opening above the forward wheels and sit in pigskin-covered seats with chromium trimmings. All three wheels have hydraulic brakes. The car is powered by an eight-cylinder motor.

Lost City Soon to Vanish Again Beneath Boulder Dam Lake

Nevada's Lost City, discovered after perhaps fifteen centuries of oblivion, soon will vanish again—this time beneath the waters of the man-made lake behind Boulder dam. Archaeologists already have recovered many relics of pottery, shell and turquoise ornaments, broken clay dolls, paints, arrow and spear points from the Pueblo Indian city that flourished about 1,500 years ago. They are still working against time to study this early American culture before the rising lake engulfs the ruins, which extend nearly five miles along the Muddy river. Sand dunes covered the ancient city until twentieth century archaeological explorers dug into it.

Scene Service 10/2/36

Miller

Biological Survey, Washington DC

F1234
Patient in Goggles and Headset Given Short-Wave Therapy



at Michigan State Medical Faculty Conference

Wide World
With her eyes protected by goggles, the patient dons ear pieces for electrical treatment

Weird masks are worn by patients undergoing electrical treatment for their ills. A headset resembling radio earphones is worn when heat therapy is administered, but instead of being a radio receiver the ear pieces contain electrodes which radiate heat energy. Goggles must be worn when the patient is placed under the quartz mercury ultraviolet lamp.

F1320
Persian Lambs for Fur Market Raised on American Farms

American farmers may soon be producing the broadtail, Persian lamb and caracul furs for which the American fur trade paid more than \$2,000,000 last year. All three furs come from the Karakul sheep, chiefly raised in soviet Russia, southwest Africa and Roumania. Only a few pure-bred Karakul sheep have been brought to America from their native home in central Asia, and further importations are practically impossible due to quarantine regulations. Instead, the government is experimenting in crossbreeding Karakul rams with Blackface Highland ewes from Scotland and Corriedale ewes from New

Dept. of Agriculture Releases 10/18/30

Zealand. It is hoped that a valuable fur stock which could be supplied to American farmers will be produced. Broadtail, most valuable of the three, is taken from prematurely born Karakul lambs and is a flat, lustrous, light fur with water-wave pattern; Persian lamb, taken from Karakul lambs three to ten days old, has a tight curl; Caracul is the trade name for the wavy, moire fur taken from Karakul lambs about two weeks old.

F1283

Editing Movie Film Simplified by Pigeon-Hole Sorting Case

Chaos and confusion in the editing of amateur movie film are reduced to neatness and order by a pigeon-hole sorting case recently devised. Transposition of scenes in a long reel of eight or sixteen millimeter film becomes systematic and simple. The case consists of two trays, hinged but detachable, divided by partitions into five horizontal compartments in which eighty different strips of film can be filed in orderly fashion in small boxes. The film in each box is plainly identified by notation on blanks which fit in the box. These boxes are readily moved from one position to another in the trays, facilitating the editing of film in desired sequence. Once arranged in order, it is easy to splice the entire series together. Further, the work may be laid aside at any time and picked up later, still in order. A flexible rubber spool is supplied with the case to wind the film strips into short rolls for disposition in the sorting boxes. The case accommodates 800 feet of film.



This pigeon-hole sorting case is handy for the amateur editing movie film

Ralph H. Eno



TELEVISION SYSTEM of Advanced Design

AFTER eight years of experimenting, the Philco Radio and Television Corporation recently have demonstrated their television apparatus. While this system uses principles that have been the basis of research work of the two pioneers in the electronic television field, their engineers claim to have developed them into instruments of a high degree of per-

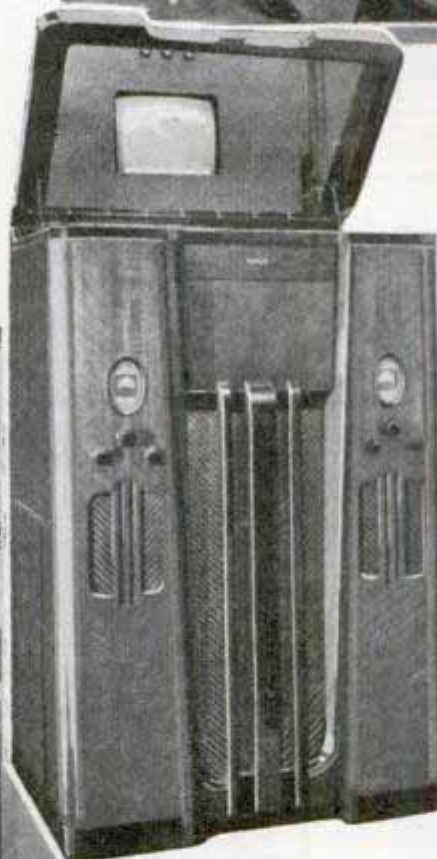
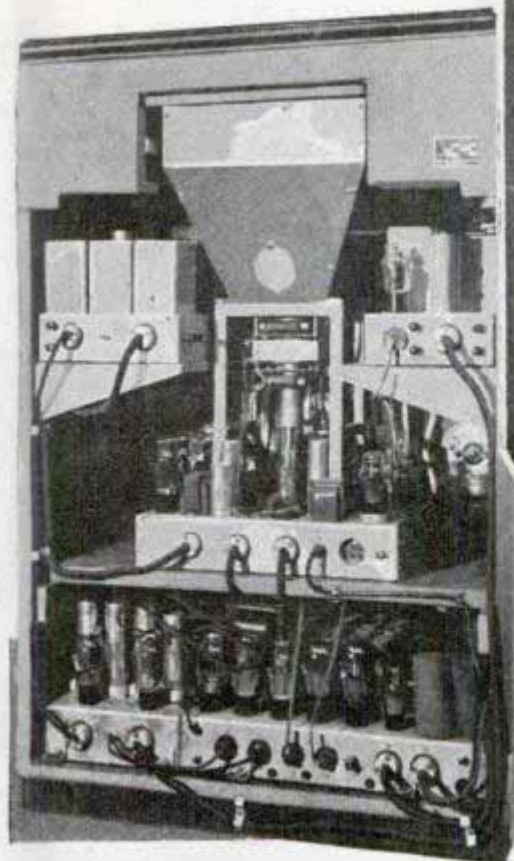

fection. The pick-up camera, shown above, uses a tube known as the "electric eye"; the extremely feeble television signal is amplified about 10,000 times in the control room until it has sufficient strength to modulate the ultrahigh-frequency transmitter.

A cathode-ray tube, 19 in. long and 12 in. in diameter, is employed in the receiver console, front and rear views of which are given. This tube is mounted in the cabinet in a vertical position, hence the moving

images appear on a mirror set in the half-opened lid of the console. This picture is about 8 by 10 in. and has sharp definition with good contrast.

All power-supply units are located in the bottom of the cabinet. The total number of tubes used in this combined sight and sound receiver is thirty-six.

SIX-TUBE

A.C.-D.C.

long and

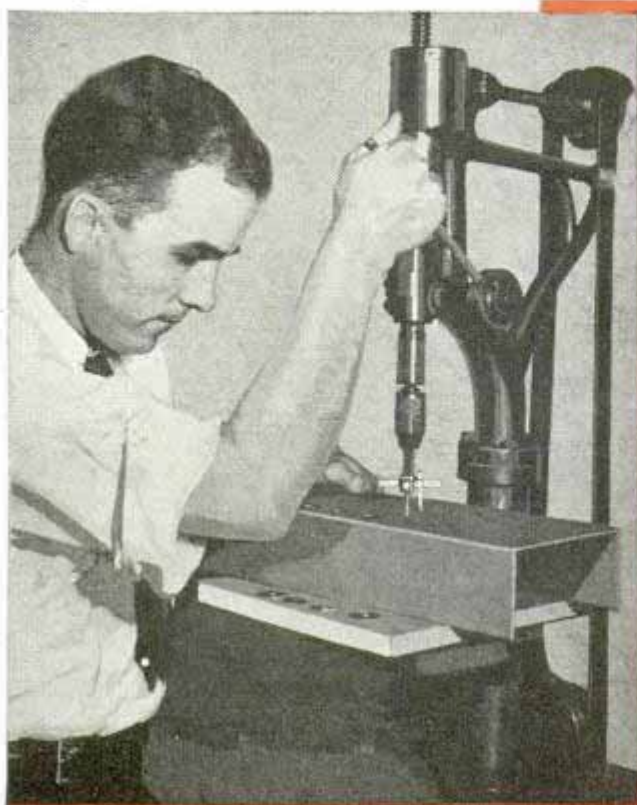

By F. M. Lund

HERE is a dual-band a.c.-d.c. superheterodyne receiver that can be built with few tools. Excellent results have been obtained with this original model which can be duplicated by any careful experimenter at low cost.

It includes a number of features that make it of special interest to all members of the family. Operating on either direct or alternating current, it covers the regular program band and all police broadcasts. In addition, it gets ships at sea,

exciting airplane calls, amateurs, and foreign reception in the 49-meter band, which is the best night band for foreign stations. It can be installed in a small mantel-type cabinet, or used to replace an obsolete receiver in a console.

A ballast tube is used to eliminate the line-cord resistor commonly employed in a.c.-d.c. sets; it also protects the tubes from overloads. In common with all good superheterodyne receivers, this one is sensitive and selective. Automatic volume control and tone control are, of course, included in the circuit. Although the parts are not expensive, they are of good quality, therefore, in order to obtain maximum results, the builder should insist that they be exactly as specified. The large 6-in. airplane-type dial used in the model, is calibrated in kilocycles and megacycles. This dial costs about \$1.75 but it is complete with bracket and two pilot-lamp sockets.

A detailed sketch of the sheet-metal base is given in Fig. 1. This base is available, formed and drilled, if you do not wish to make your own. Fig. 2 shows the simplified wiring diagram, with the parts in their relative positions and each lead carefully indicated to avoid errors in wiring. Photos, Figs. 2-A, 2-B, 2-C and 2-D,

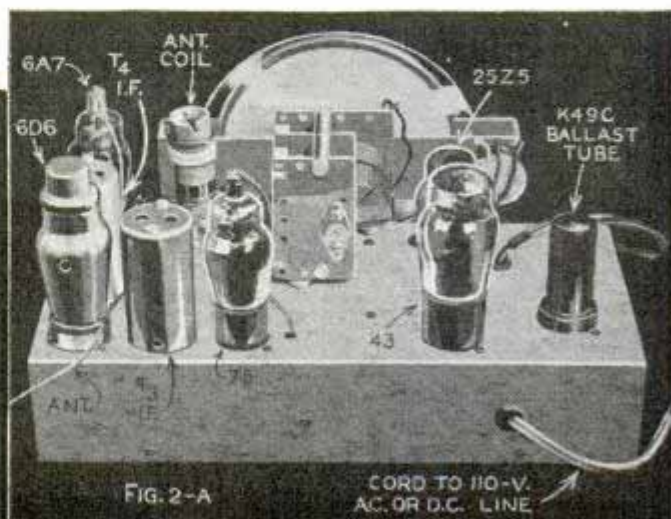
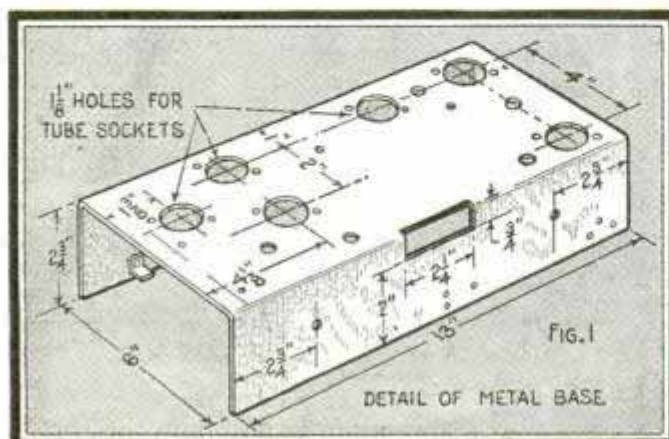

SUPER for *short waves*

show the completed set from various angles, each part being labeled to aid the builder. A schematic circuit diagram appears in Fig. 3. Although you may prefer the simplified diagram for wiring the set, it is a good idea to check each lead with the schematic diagram as you proceed. Key letters and numbers identify the same parts in both diagrams. A complete list of the original parts used, and detailed balancing data, can be obtained

(Continued to page 136A)

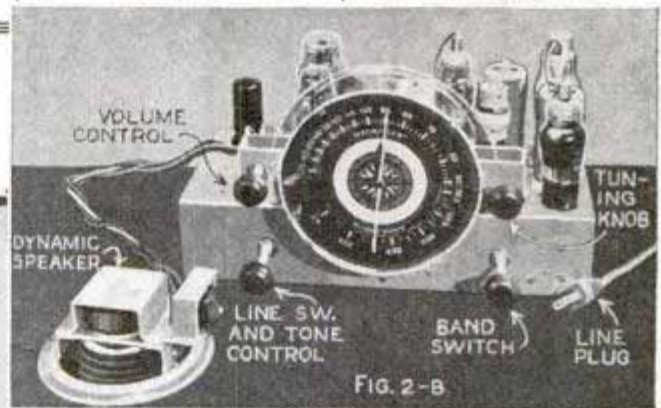
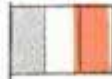
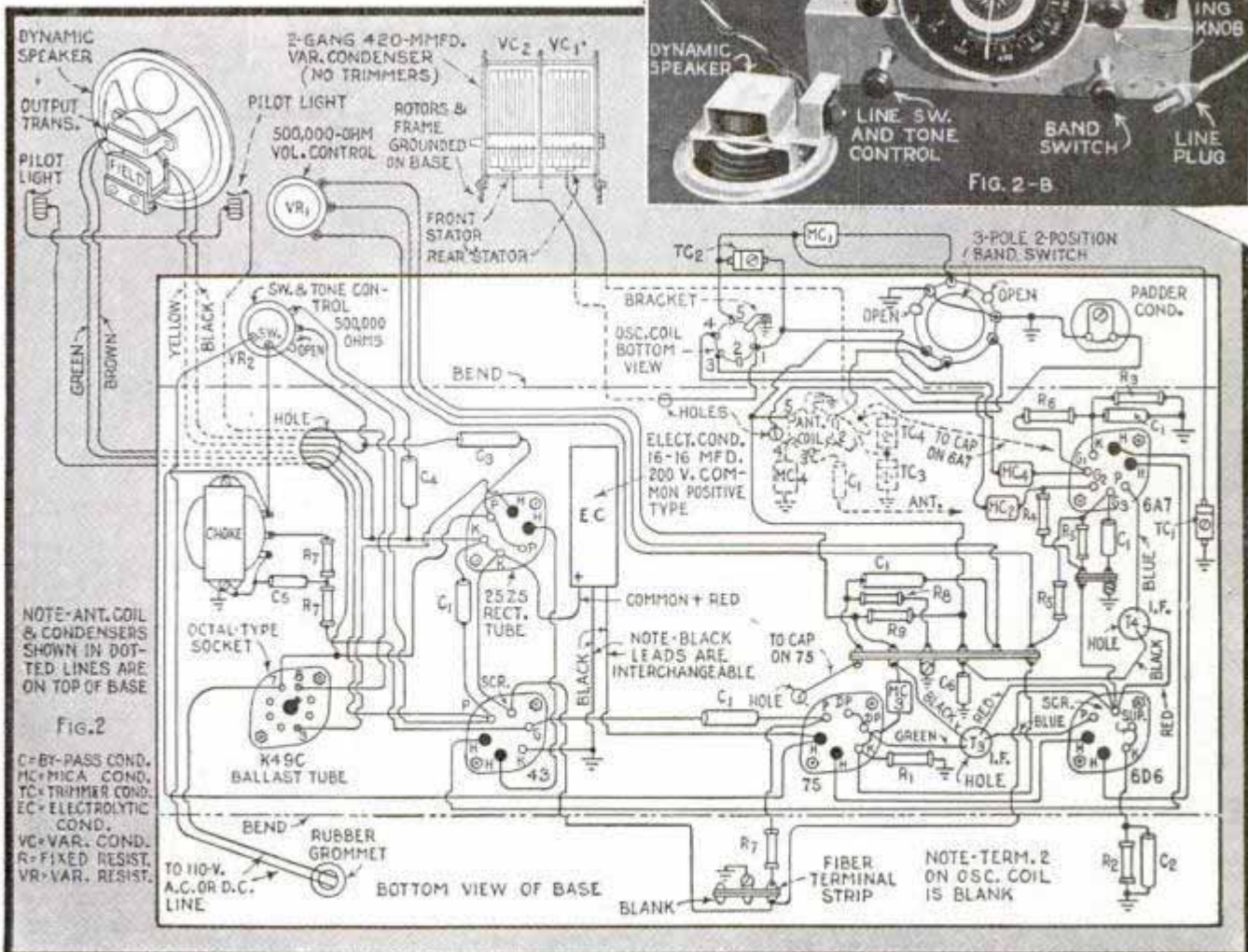

FIG. 2-B



Practical RADIO SUGGESTIONS

F 3580

Right, radio chassis racks for workbench aid experimenters and service men in checking receivers. Doing away with the usual blocks used to support the set in various positions while working on the circuit, these racks are clamped to each end of the chassis and permit the receiver to clear the bench on all sides

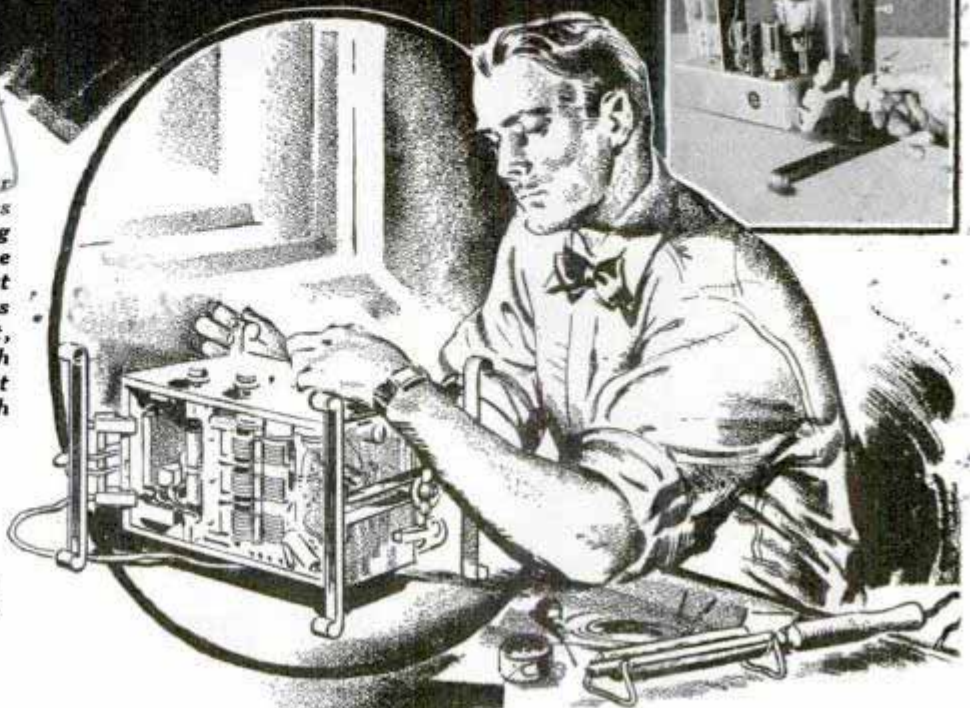

Inset, photo above shows adjustable rack clamp fastened to one side of metal chassis

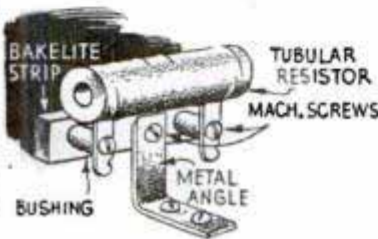

Above, rigid mounting for tubular resistor made with angle bracket and strip of scrap Bakelite. This mounting keeps resistor away from the metal chassis and permits air circulation to dissipate heat. Right, main line noise filter blocks line noise before it reaches the house wiring system. It may be connected between the main line fuse plugs and the individual circuit fuse plugs, or, it can be coupled into the line near interfering motors, refrigerators or oil-burner ignition systems

F 3613

Below, emergency connection to storage battery made with machine screw and large hex nut. This provides a good electrical connection for battery-operated receivers when battery-terminal clips are not available

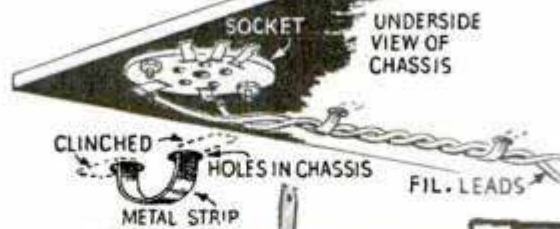

Left, simple method for supporting twisted filament leads or other long conductors under receiver bases. Several of these tin clips applied in this manner will hold the wiring firmly in place

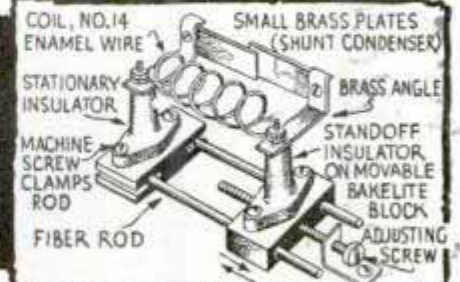
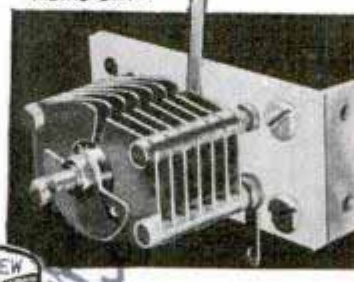
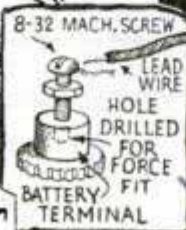

F 3612

Above, low-loss midget condenser designed with two stators, for use in ultrahigh-frequency sets. Right, homemade tuning unit for ultrashort-wave receiver, assembled with two porcelain standoff insulators and scrap parts. Capacity and inductance may be varied simultaneously by adjusting the long screw which moves one of the standoff insulators

Confidential Carbon Co.

National Company, Inc.

D.C. to A.C. Battery Converter



Small unit operates your 110-volt home set in car

No elaborate installation is necessary to use this midget 6-volt d.c. to 110-volt a.c. converter in any location. Connected across a 6-volt storage battery, it will operate a small a.c. home receiver in your car or boat. Designed for continuous service, the output is 40 watts.

Crystal Controlled from Panel

Amateurs operating crystal-controlled transmitters in the crowded short-wave bands are now provided with a simple

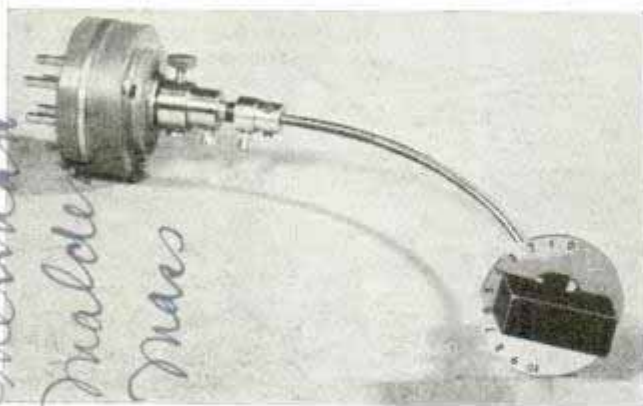

NEXT MONTH—How to Build a Hurricane Emergency Receiver. No power pack, vibrator unit, dynamotor or B-batteries are necessary to operate this 2-tube receiver designed for use during floods, hurricanes or similar emergencies; works on 6-volt storage battery or dry cells. Also, **A Good Cabinet-Type Crystal Set.**

means for quickly shifting their crystal frequency a few kilocycles to avoid interference from other stations. This adjustable-gap crystal holder is provided with a flexible shaft drive and dial plate for panel mounting. A mere twist of the control knob will vary the crystal frequency up to 6 kilocycles in the 80-meter band. When operating on harmonics the frequency spread is proportionately greater; for example, 24 kilocycles in the 20-meter band. A locking device is provided for fixed-frequency operation. Special A-cut crystals are used with this holder.

Radio Desk Set Is Compact

Why clutter up your desk with numerous gadgets when you can have them all in one modern unit only 15 in. long? This individual radio desk set consists of a clock, self-closing inkwell and a 3-tube

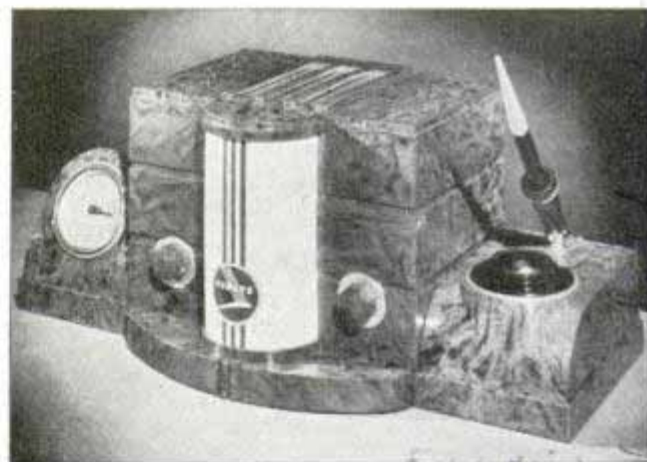

receiver that keeps you informed of the news, market reports and other daily programs of interest. The molded cases are available in four colors and are provided with an illuminating unit complete with a 30-watt bulb. A model with temperature and humidity indicator, instead of the pen set, can be obtained if preferred.

Blueprints covering radio construction articles in past issues can be obtained for 25 cents each; material lists are available without charge on receipt of postage.



Complete DRAWING KIT



*carried in
typewriter case*

FITTED to the original clamps of a typewriter case, this drawing board provides ample working space for sketching right on the job. Its compactness and portability make it convenient to use in motorcar, railway coach or plane. Spring clips, screwed to plywood base, hold pencils, triangles and other drawing instruments which are conveniently reached by raising the hinged top. Wings, providing extra board area and a tracing glass, may be attached or detached quickly by means of telescoping rod-and-tube supports.

The dimensions given will be found suitable for building the board to fit carrying cases of the larger size portable typewriters, which leaves extra space over drawing board for storing paper, books, and other drawing material that is usually carried to the job. Straps, bent from thin sheet metal, are used to fasten tube sections of the wing supports in place. Tubing of inside diameter slightly greater than outside diameter of rod, making a loose telescopic fit,



SLIDING WING-SUPPORTS, $\frac{1}{4}$ " STEEL RODS IN TELESCOPING TUBING

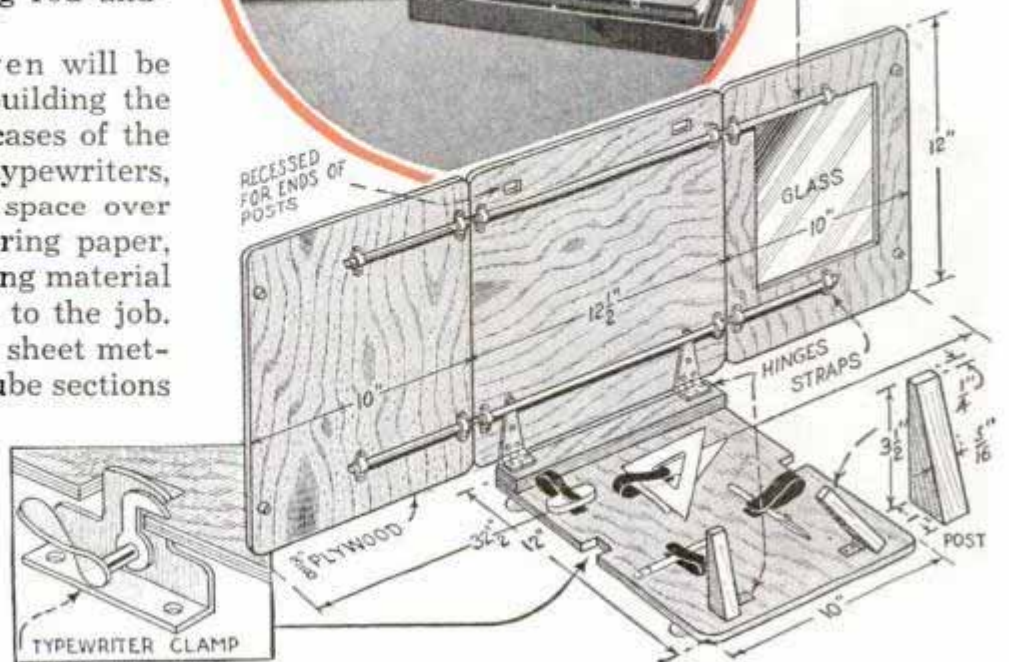

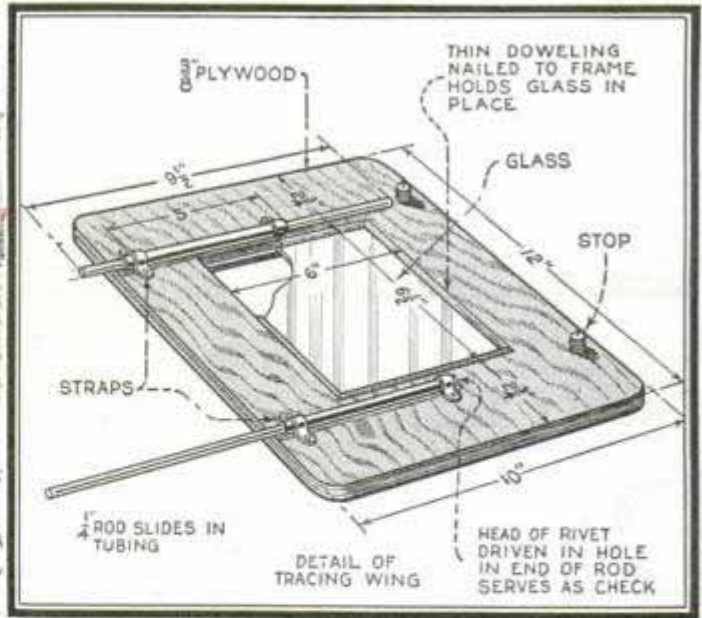

will serve the purpose. It is only a matter of slightly offsetting tubes on the wings with those on main board to provide sufficient tension for keeping the rods from sliding out of the main tubes. Stops keep the rods from sliding completely out of wing tubes in one direction, while heads of rivets, driven in holes drilled in ends of rods, serve as stops in the other direction. A piece of frosted glass, under which a light bulb may be placed for tracing photos and drawings, is fastened in left wing by strips of thin doweling or small quarter-round nailed into frame on both

sides of glass. Rubber vacuum cups, screwed on the bottom of the base, serve as feet, raising the base to proper height for fitting over clamps and protecting table tops when board is used out of the case. Carefully filing all rough edges off rods, tubes, straps and spring-steel clips will prevent injury to hands and drawing instruments. When finished, the board should be sanded smooth with succeeding finer grades of paper and then waxed in the natural color of the wood. Chrome or brass-plating the metal parts will enhance the appearance of the job.

Simple Tool for Molding Filler Between Wallboard Joints



With this tool, it's easy to press filler firmly into joints between wallboard panels

As it is necessary to apply filler to joints between panels of wallboard in two coats if a neat job is to be done, this simple tool will be found ideal for pressing the first, or rough, coat in place. The tool is nothing more than a short length of tongue-and-groove stock. You'll find that the tongue on a piece of $\frac{7}{8}$ -in. stock of this type is just the right size to fit snugly into the wallboard joint.

Sawdust Sweeping Compound

Utilizing the accumulation of sawdust in your home workshop, the following mixture makes a good sweeping compound for the floor. Melt paraffin wax, 2 oz., in paraffin oil, 2 qts., over a water bath. Then add coarse salt, 6 oz., fine, white sand, 5 lbs., sawdust, 10 lbs., and oil of eucalyptus, 1 oz.

Monograms Neatly Stenciled on Glassware

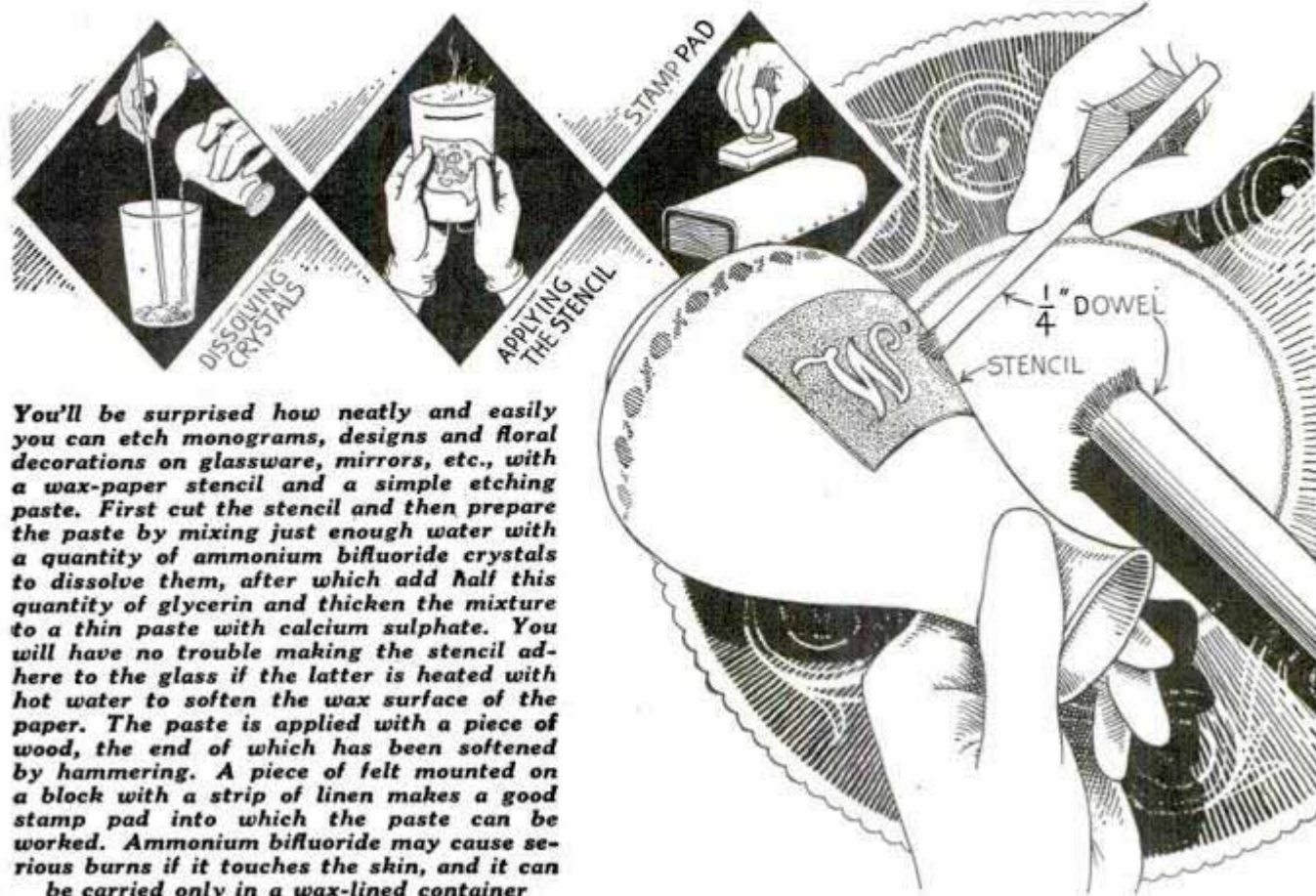

You'll be surprised how neatly and easily you can etch monograms, designs and floral decorations on glassware, mirrors, etc., with a wax-paper stencil and a simple etching paste. First cut the stencil and then prepare the paste by mixing just enough water with a quantity of ammonium bifluoride crystals to dissolve them, after which add half this quantity of glycerin and thicken the mixture to a thin paste with calcium sulphate. You will have no trouble making the stencil adhere to the glass if the latter is heated with hot water to soften the wax surface of the paper. The paste is applied with a piece of wood, the end of which has been softened by hammering. A piece of felt mounted on a block with a strip of linen makes a good stamp pad into which the paste can be worked. Ammonium bifluoride may cause serious burns if it touches the skin, and it can be carried only in a wax-lined container

This Adjustable Holder Keeps Mouth of Sack or Bag Taut

For keeping bags and sacks open while filling them, it's hard to beat this simple holder. Adjustable in height, it has two hinged, hardwood arms which carry sharp-pointed nails bent upward to engage the mouth of a sack. Strong rubber bands attached to the arms and to the post pull the arms outward to keep the sack mouth taut. The table or base, post and arm-carrying block are made of any stock available. A peg inserted through a hole in the block and post takes care of the height adjustment.

—H. Aprahamian, Dunnville, Ont., Can.

Gas "Bailed" from Wells

Carbonic-acid gas which forms in the lower parts of wells can be removed by an opened umbrella let down and rapidly hauled up a number of times in succession. The gas being heavier than air, is simply dipped up by the inverted umbrella and brought to the surface much the same as water is lifted in a bucket.

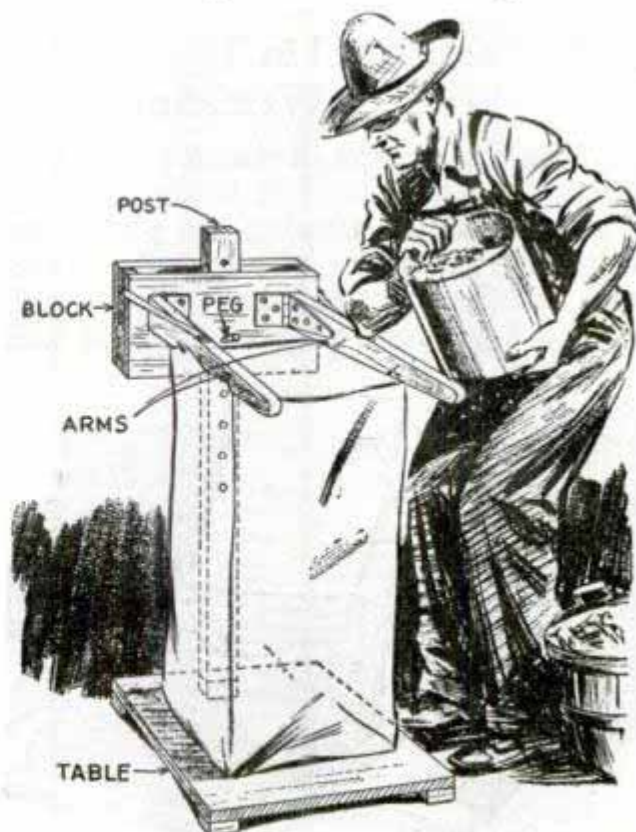

Filling sacks single-handed is easy when this holder is used

Pressure of Bit Brace on Chest Eased by Rubber Pad



You can use a brace and bit for hours without bruising your chest if this pad is provided

One workman who had to use a brace and bit considerably put a sponge-rubber pad in a pocket sewed to the bib of his overalls to cushion the end of the brace where it pressed against his chest. The pad fit loosely in the pocket, and was quickly removed and stored in his tool chest when not in use.

Cutting Stencil in Typewriter Without Wrinkling

When a mimeograph stencil is being cut on a typewriter, and it tends to crease while repeatedly turning the platen, try fastening the lower edges of the stencil and backing sheet together with a couple strips of gummed paper. This will hold

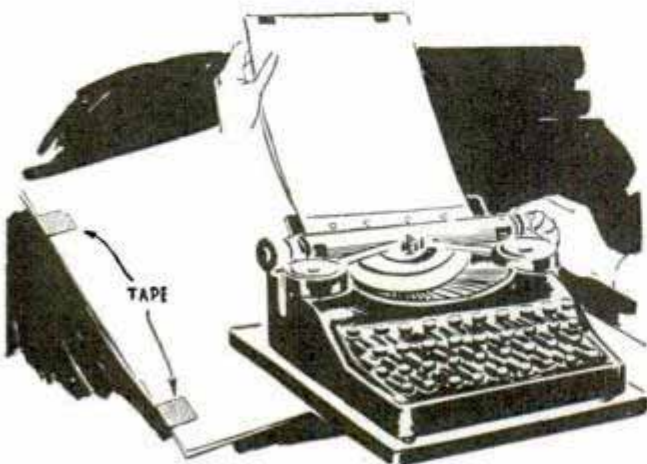

Mimeograph stencil taped together at bottom to prevent wrinkling in the typewriter

the wax sheet smoothly throughout the typing, and a sharp knife may be inserted between the strips to cut them, when finished.—G. E. Hendrickson, Argyle, Wis.

Leaky Air Valve on Radiator Kept from Marring Wall

If one of the air valves on your steam radiator begins to leak and spatters water over the wall, cut an opening in a fair-sized hollow rubber ball and slip it over the valve.



This will catch the water that leaks out and will protect the walls and floor until a new valve can be installed.—Opie Read, Jr., Chicago.

Calking Tool with Fish-Tail End

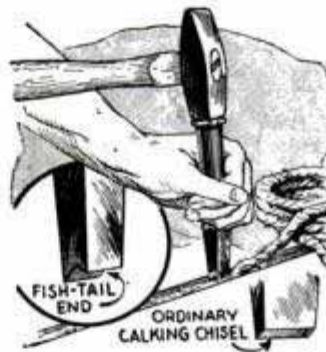

When calking cracks with oakum and similar materials, file the end of the tool to an inverted V-shape or fish tail and you will find that a better job can be done than when the tool is used with a square end. Filed to such a shape, the tool tends to force the calking material tightly in the crack.

Preventing Loss of Small Drills

To avoid loss of small drills from an open tool box, one carpenter screwed a discarded spectacle case to the inside surface of the box to hold them as shown. To permit



ready removal of very small drills, the recess provided under the front edge of the case was filled with wood so that the drills could not work under the overhanging edge where they would be hard to get out.

Calibrated Punch Measures Holes

Turned from a short piece of steel rod, this tapered punch enables you to determine quickly the diameter of a hole. To

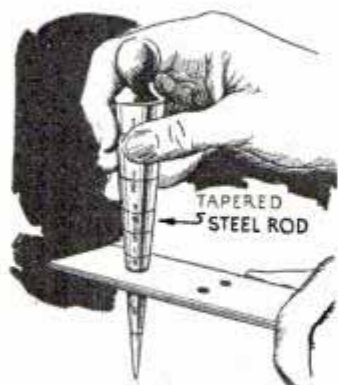

calibrate the punch, it is inserted into holes of various known diameters, and lines are scribed around it at the top of each hole, after which the diameter is stamped in the metal at each of the lines.

Miter Box Has Spring Clamp for Holding Small Molding

When cutting strips of small molding in a miter box, try using this simple spring to keep the work from moving under pressure of the saw. Just insert a length of clock spring into a hardwood block, slotted as shown. In use the block is attached to the miter box with a C-clamp so that the end of the spring bears against the side of the box. The work is then inserted with the end of the spring resting against it.

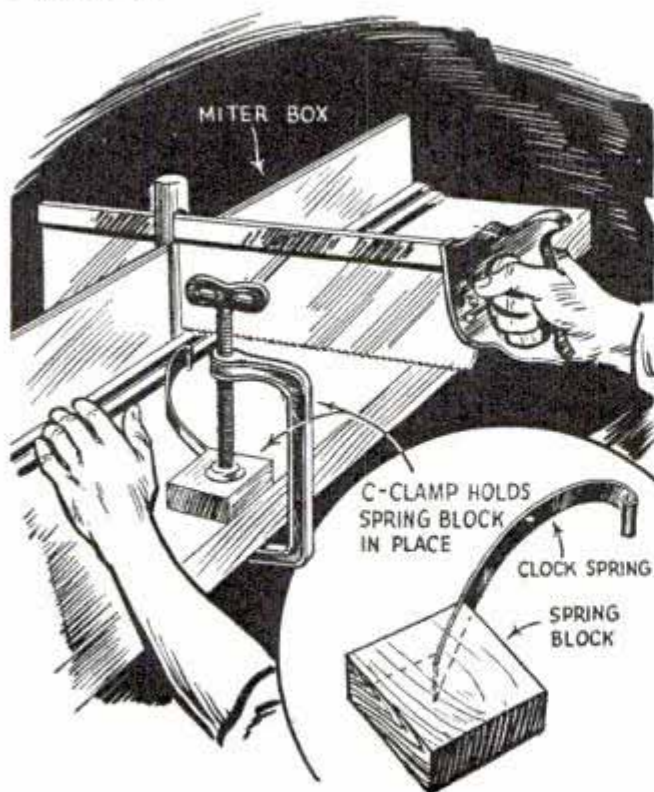

Small work is handled easily in a miter box without "jumping" when this spring is used

Wheel Chair Has Mudguards to Protect Patient's Sleeves

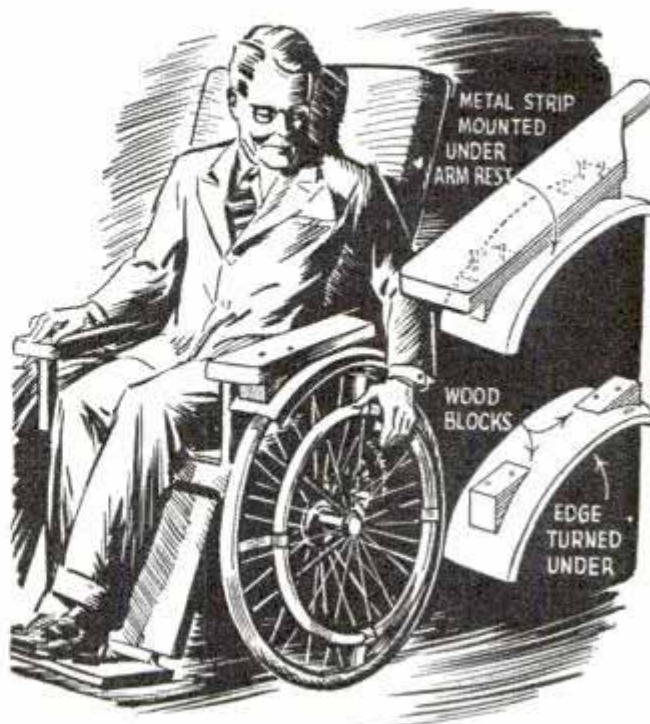

By using these guards, a patient in a wheel chair can operate it without soiling his sleeves

To avoid soiling his sleeves on the tires of his wheel chair when traveling on wet sidewalks, one patient had sheet-metal mudguards put on the underside of the chair arms as shown. The edges are turned down at right angles and are attached to the arms with wood blocks and screws. The guards are not wide enough to interfere with the hands when moving the chair.

Drain Holes in Washing Tray Keep Prints in Place

By merely drilling a number of small holes about $\frac{1}{2}$ in. below the rim of my photo-washing tray so that the water will drain off before it reaches the top of the pan, I overcame the tendency of the prints to be washed over the edge of the pan. This arrangement permits the prints to be washed in a short time as a stronger stream of water can be used.



—Wayne C. Leckey, Aurora, Ill.

PEMBROKE TABLE

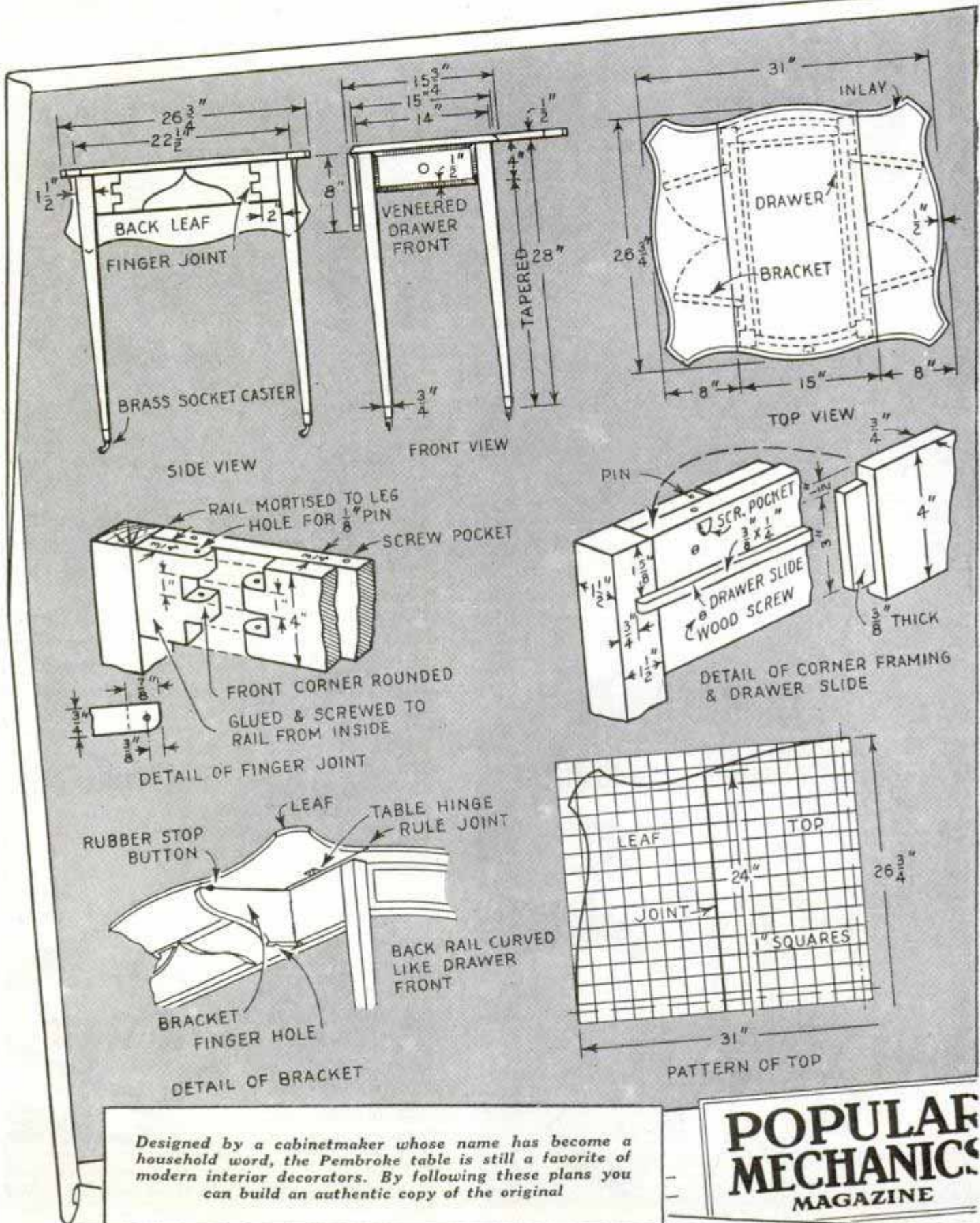

Designed by a cabinetmaker whose name has become a household word, the Pembroke table is still a favorite of modern interior decorators. By following these plans you can build an authentic copy of the original

POPULAR MECHANICS
 MAGAZINE

by Hepslewhite

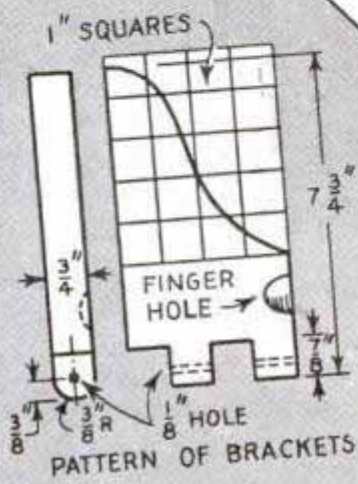
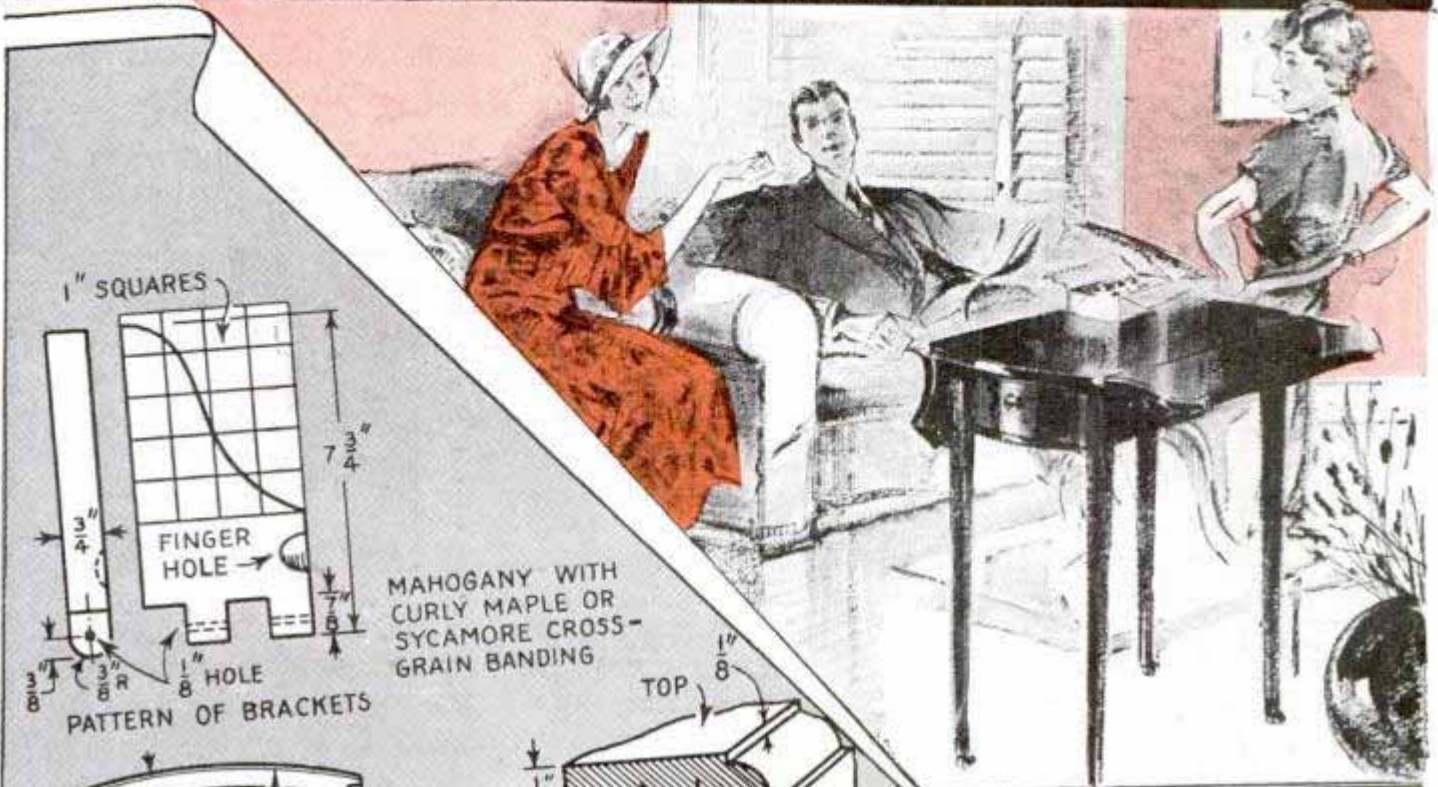

MAHOGANY WITH CURLY MAPLE OR SYCAMORE CROSS-GRAIN BANDING

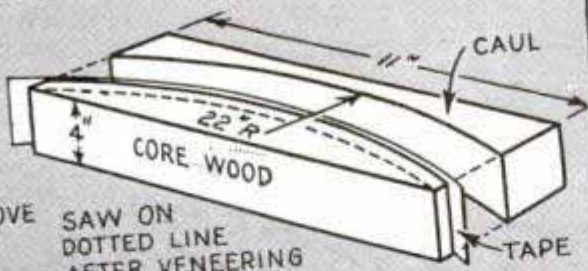
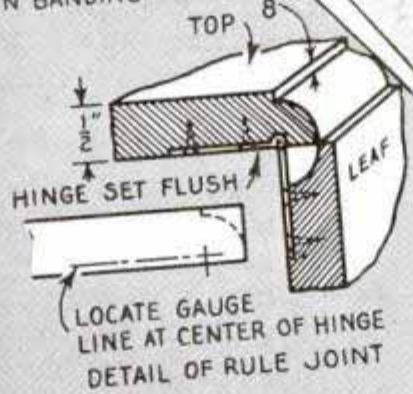
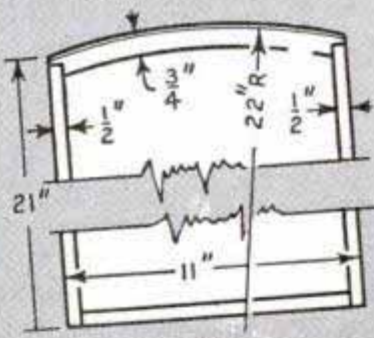

SAW ON DOTTED LINE AFTER VENEERING
SET-UP FOR VENEERING DRAWER FRONT & BACK RAIL

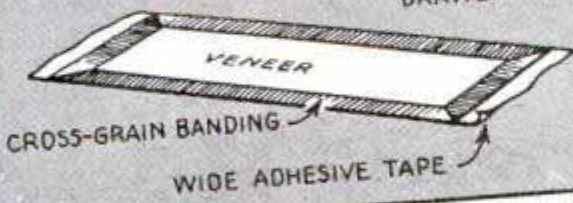
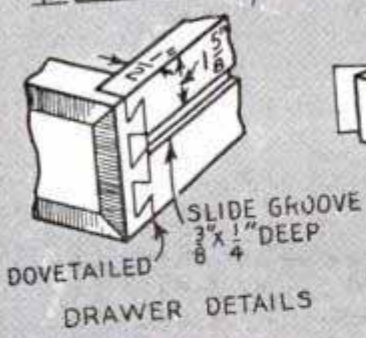

NOTE - VENEER AND BANDING ARE ASSEMBLED ON TAPE FACE DOWN BEFORE VENEERING

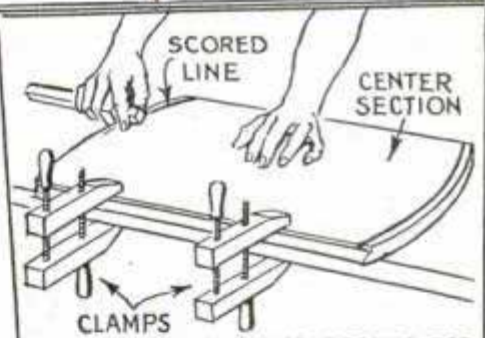

THE EDGE IS SCORED FOR BANDING WITH A STEEL CUTTER - THEN FINISHED WITH A CHISEL

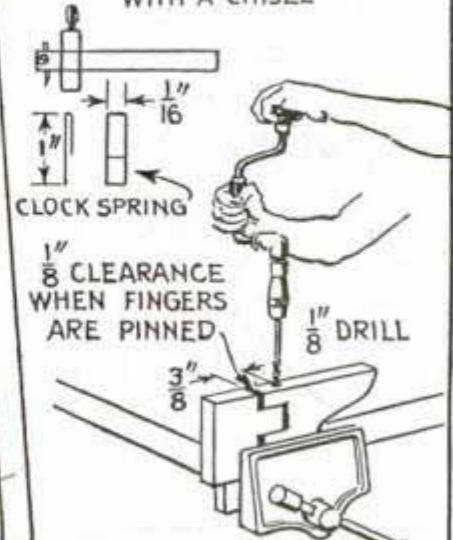

THE TWO MEMBERS OF EACH BRACKET SHOULD BE DRILLED TOGETHER

SHEET NO. 1 ISSUE
POPULAR MECHANICS MAGAZINE
200 E. ONTARIO ST. CHICAGO

BLUEPRINT No. SN 956

Old Flooring Removed Quickly with This Wrecking Bar



This simple tool solves the problem of removing old flooring for the inexperienced workman

By bending a piece of $\frac{1}{2}$ by 2-in. flat steel to a U-shape and welding it to a length of $\frac{3}{4}$ -in. iron rod, you have a dandy tool for removing old flooring. In use, the bar is slipped over a floor board near a joist and the handle is pulled toward the workman. This pries the board away from the joist and, at the same time, tends to pull the tongue from the groove of the adjoining board without splitting it off.—C. H. Wilson, San Antonio, Tex.

Eyes for Animal-Cutout Toys

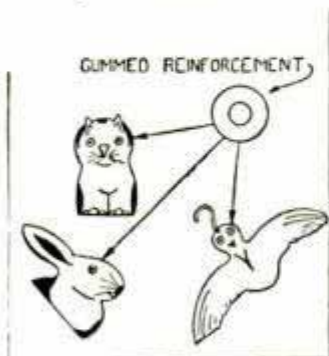

When adding the features to animal cutouts a clever method of representing the eyes can be had by utilizing gummy notebook reinforcements. These little circular pieces of cloth

or paper provide a neat appearance on a dark background as the center of the re-

inforcement simulates the pupil of the eye. Where a number of figures are being finished this method speeds up the work and assures uniform results.

Damp Oakum Soaked in Oil Before Leading Pipe Joints

If there is no dry oakum at hand when leading pipe joints, and you have to use some that is damp, pour a small quantity of oil over it after it has been tamped in place. The oil will help prevent the formation of steam when the hot lead touches the damp oakum, thus preventing the molten lead from being thrown on the worker by hot vapors suddenly building up a pressure under it.

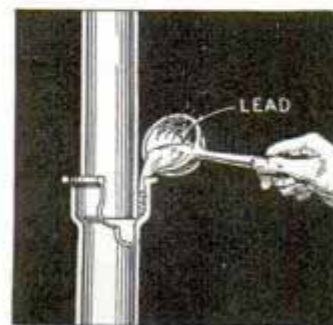

Safety Beacons for Ice Skaters

To avoid accidents while skating at night on a lake or pond where ice is being harvested, or where there are open spaces of water, a number of these flares will mark off the danger zones. They are simply auto-cushion springs holding cotton waste which is saturated with used crankcase oil and ignited.



When saturated with used auto crankcase oil, these flares will burn for a long time

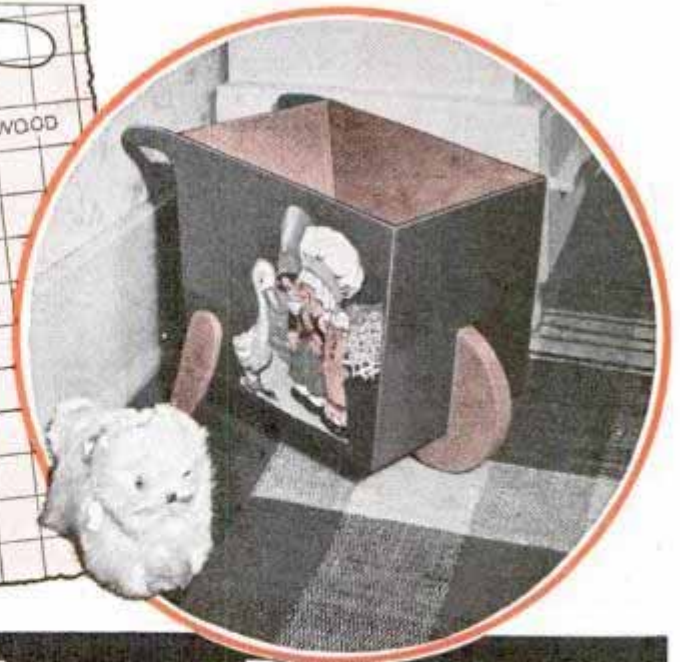
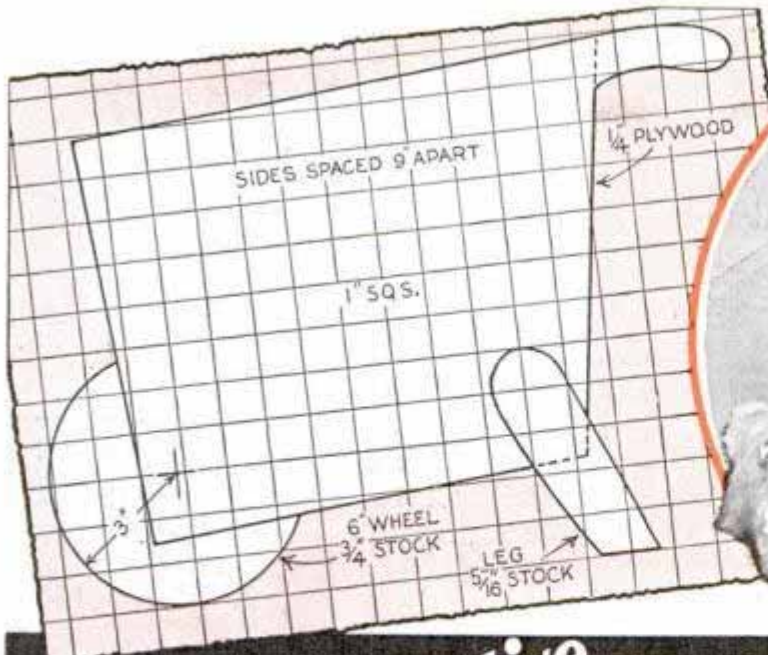

TWO ATTRACTIVE WASTE BASKETS



A "wheelbarrow" basket makes an ideal unit for a child's room, but it is not out of place if used elsewhere. Stock is $\frac{1}{4}$ -in. plywood, all joints being butted and nailed. The "wheel" is cut from $\frac{3}{4}$ -in. stock and is screwed to the front of the basket. Legs are sawed from $\frac{5}{16}$ -in. stock and are nailed in place in the position shown. The width of the basket should be about 9 in. for pleasing proportions. Pictures can be cut from a magazine or a discarded ten-cent picture book, and pasted to the sides.

The basket shown below is a dandy companion piece for a modern desk. Construction starts with the two sides, which are sawed to shape and then rabbeted on the shaper or circular saw to take the bottom. The latter is either composition board or heavy cardboard and is nailed to the sides. If composition board is used, it can be bent to shape around a hot furnace pipe. A center ornament for each side is made from hardwood, and fluted on the shaper or drill press. The ornaments are finished natural, the rest in color.

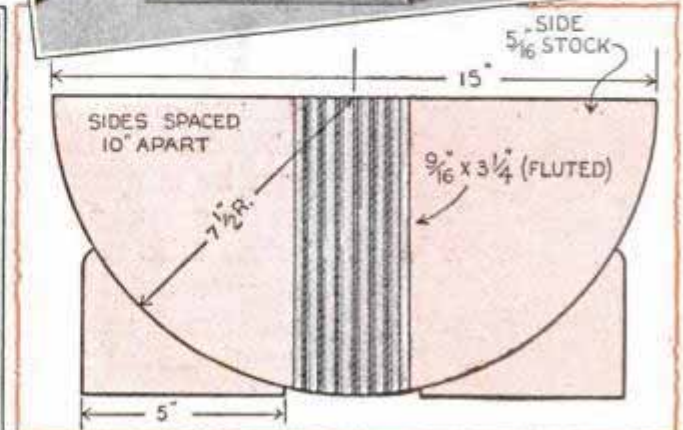
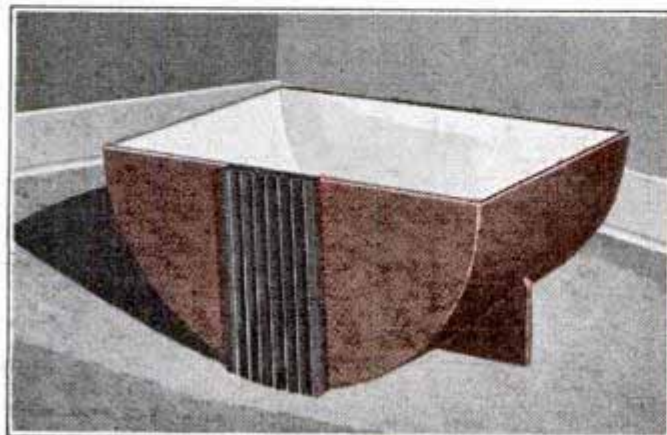
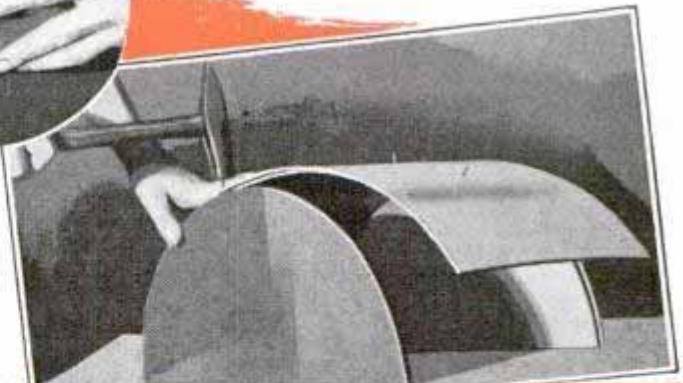

Simple Boring Tool to Lay Pipe under Sidewalks

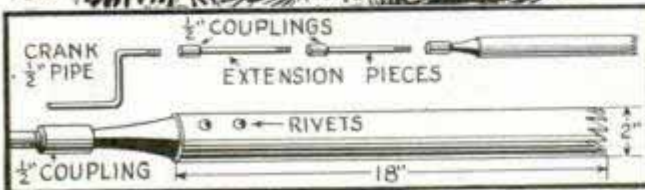

This tool will bore a hole quickly under a sidewalk for laying pipe or conduit

Having a job of laying electrical conduit under some sidewalks and driveways, I made this boring tool to get under the walks without breaking up the concrete. The tool is nothing more than an 18-in. length of 2-in. pipe having teeth sawed on one end and a yoke riveted to the other end. The yoke is threaded to take a 1/2-in. coupling so that a handle and extension pieces can be added as needed. The teeth are shaped so that they tend to cut into the ground when the tool is rotated toward its user's right.

—L. S. Landmichl, Riverton, Wyo.

Bench Hardy for the Home Shop



Projecting through your workbench top at one corner, a large cold chisel provides a serviceable hardy that can be slipped in place quickly when it is necessary to cut light material such as small metal rods and sheet stock. The lower end of

the chisel rests on an angle-iron bracket screwed to the bench leg. When not in use, the chisel is removed and kept in a bench drawer or cabinet.

Self-Centering Marking Punch Locates Screw Holes

Made from a piece of brass or soft steel, this marking punch assures accuracy in locating screw holes for hinges and other hardware which is mounted on wood. The tool is drilled lengthwise through the center to take a pointed steel punch, and the end is beveled at a 60° angle to fit in the countersunk holes of the hardware.

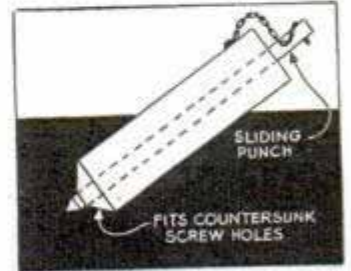

—E. T. Gunderson, Jr., Humboldt, Ia.

Flue Cleaner Made from Pipe and Fittings

Two pieces of pipe and a reducing coupling can be converted into an efficient cleaner for boiler flues and rusted water pipes. Get a coupling and a nipple that will slip inside the flue easily. Assemble them, and then, with a hack saw, cut slots in the end of the nipple 2 in. deep and 3/4 in. apart. Bend the resulting segments outward slightly at the end and sharpen them on a grinder, to make the cutting end of your cleaner. Now screw a length of pipe into the other end of the coupling for a handle. This cleaner has been found more efficient and longer-lasting than many brushes used for this work.

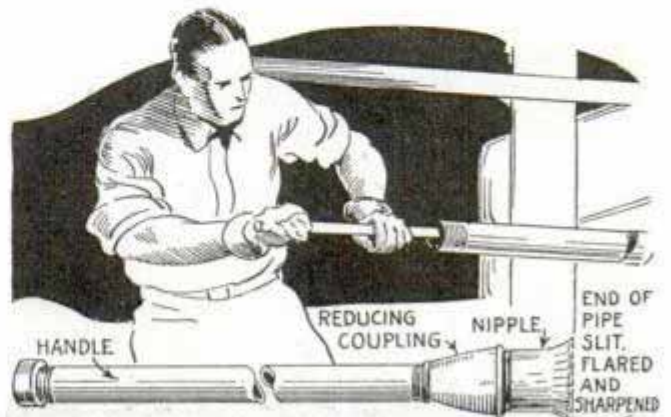

This flue cleaner "shaves" rust and corrosion from the pipes instead of scraping

Bed Lamp Gives Direct and Indirect Light

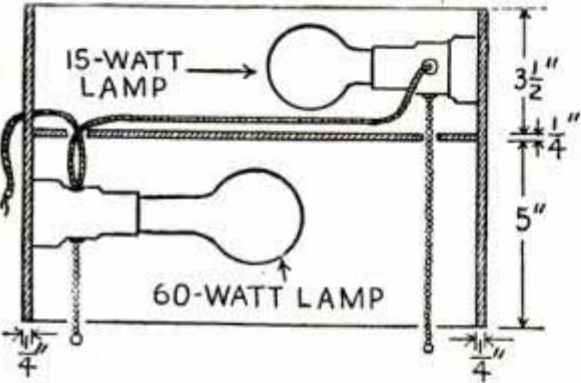
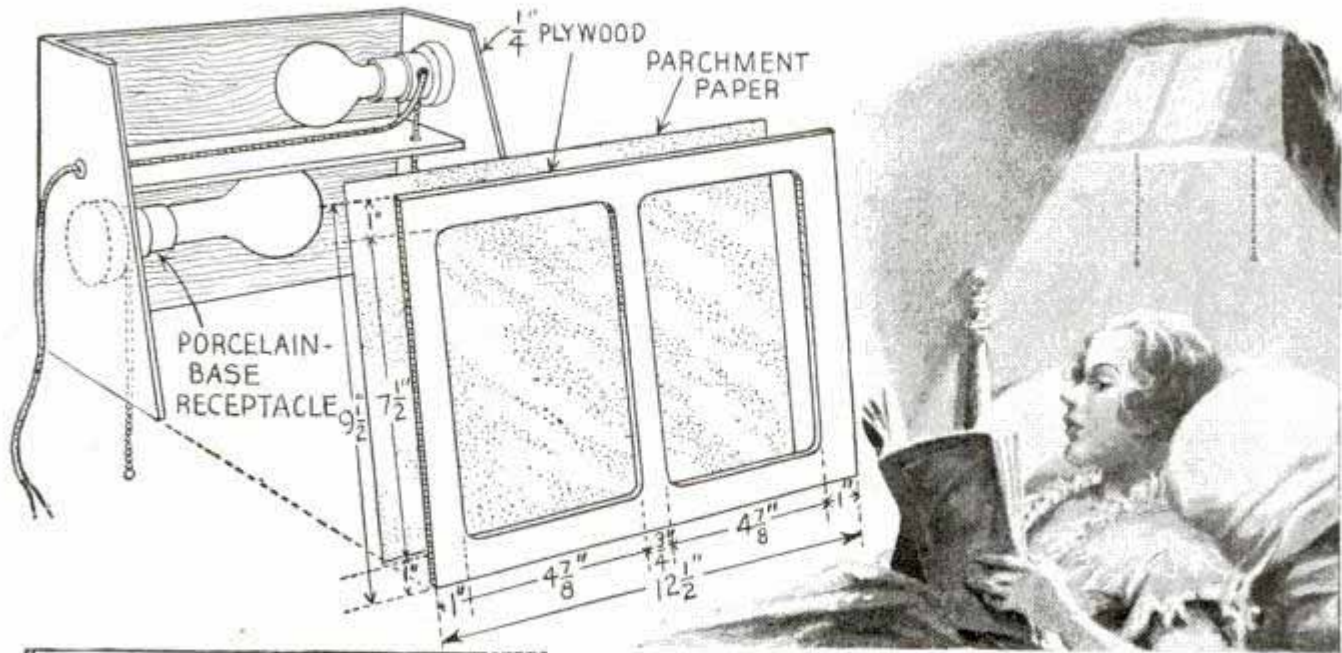

If you like to read in bed here's just what you want. It differs from most bed lamps in that there are two lights, one above the other, thus serving the two-fold purpose of giving a soft, indirect light in the room or a direct light for reading. The whole thing is made of 1/4-in. plywood, the outside finished as you choose, the interior with aluminum paint or "eggshell" enamel. The partition between the lights is faced on both sides with asbestos paper. Porcelain pull-chain sockets are wired as indicated at the left. The front section of the shade is cut out to form a grill and a piece of colored parchment paper is placed under it when assembling

Pivoted Bench Stop Made from Butt Hinge Is Adjustable

Made by recessing half of a door butt hinge in a workbench top and pivoting the hinge pin with staples, this stop is adjustable in height. Adjustment is obtained by a long stove bolt over which a coil spring is slipped between the stop and the bench top as shown in the circular detail. A large hole part way through the bench accommodates the spring when it is compressed to bring the stop flush with the bench top.

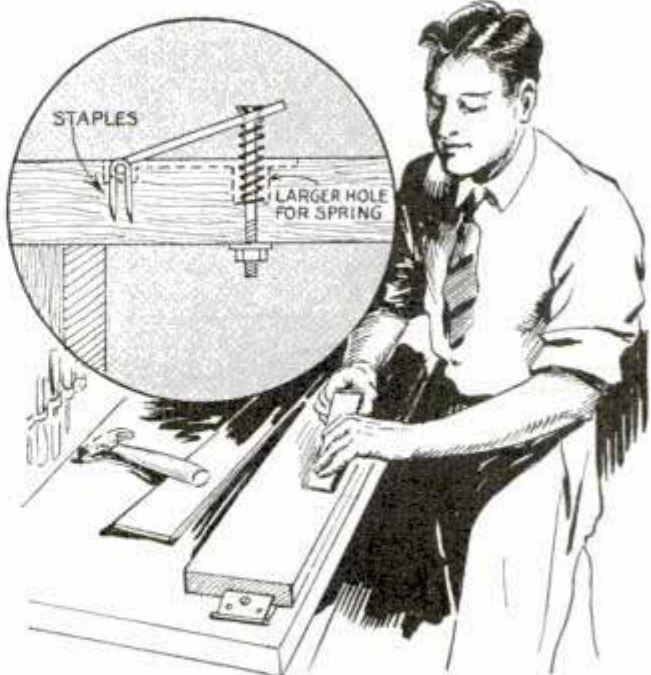

This bench stop is rapidly adjusted with a screw-driver by driving the bolt in or out of a nut on the underside of the bench

Cleaning Buckskin Shoes

Soiled shoes made with the flesh side of the leather exposed can be cleaned on a fine-wire buffing wheel. The shoe should be held lightly against the rotating wheel, taking care not to damage the leather. This should not be done excessively, of course, as the cleaning is accomplished by the rotating wheel removing the soiled leather fibers and raising new ones.

You Can Build this DOLL

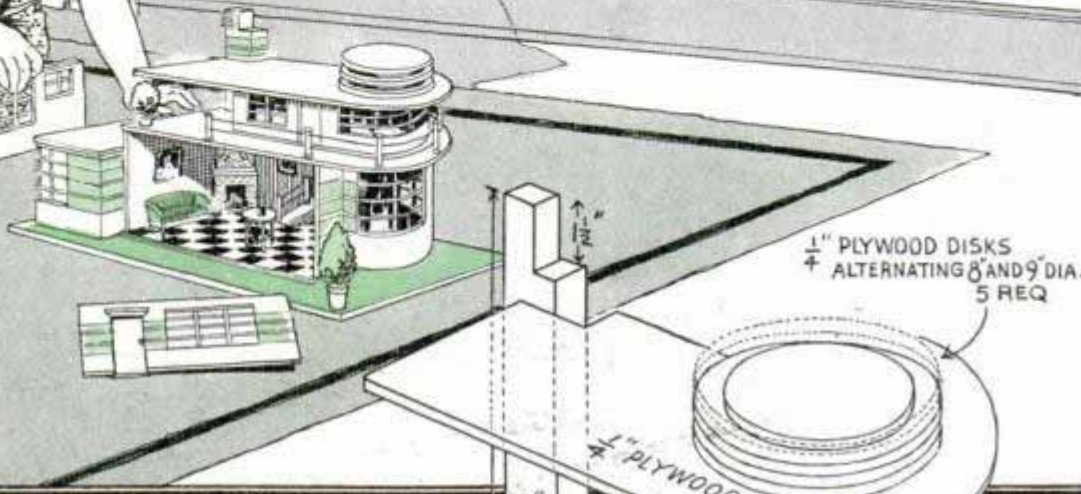

Just think of the pleasure the youngsters will get from this modern doll house! Up-to-the-minute styling makes it easy to build, for simplicity is always a feature of modern design. A jig saw comes in handy for cutting the curved parts, but for the balance you can get along nicely with hand tools and glue

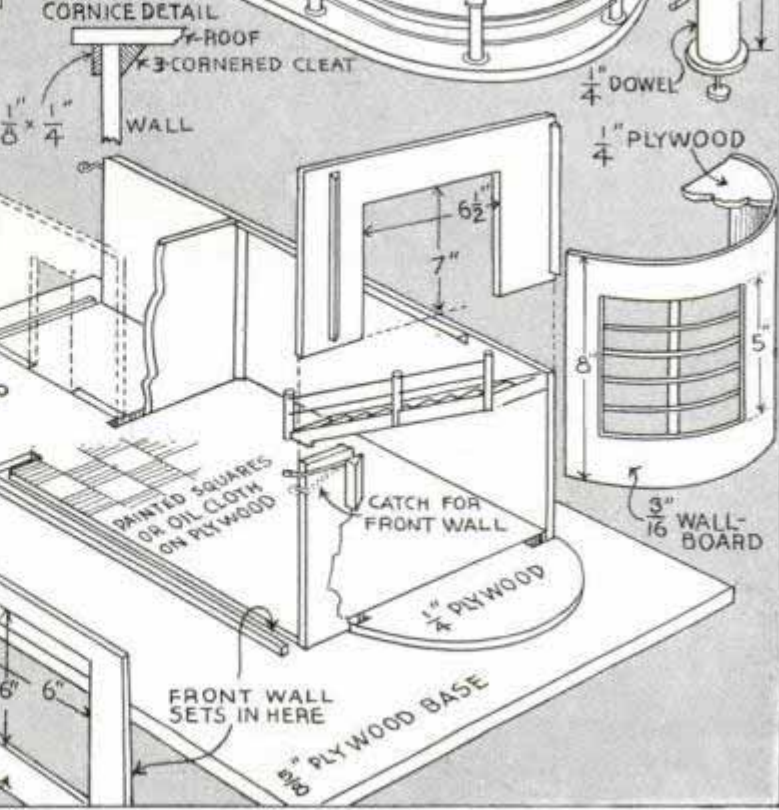
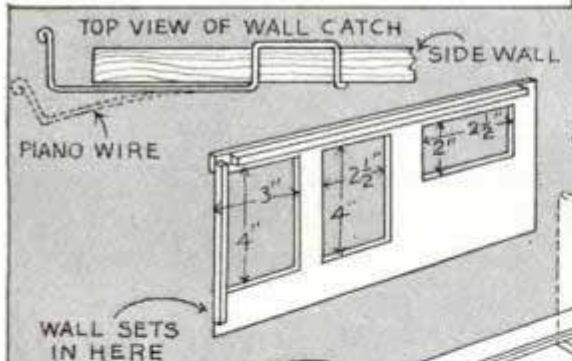
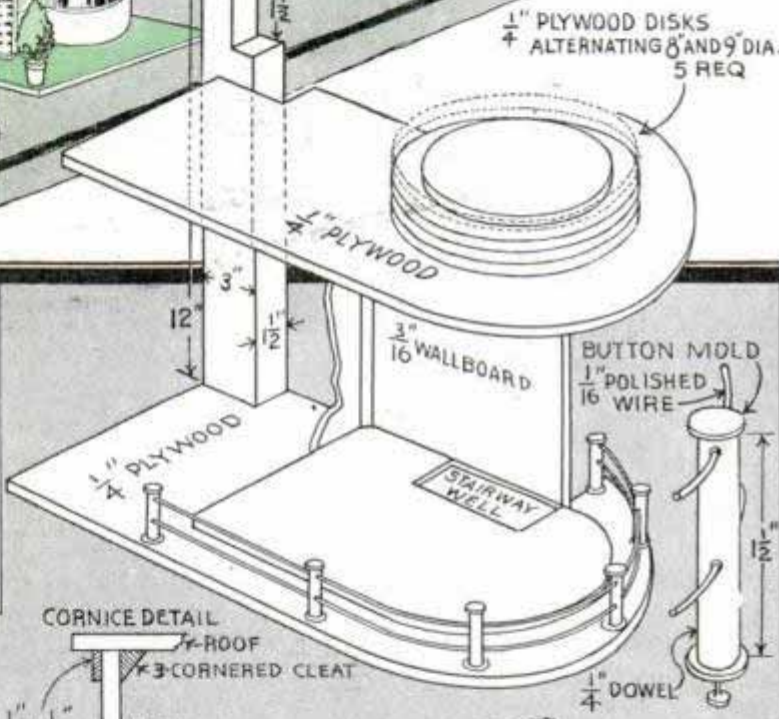

HOUSE

of Plywood

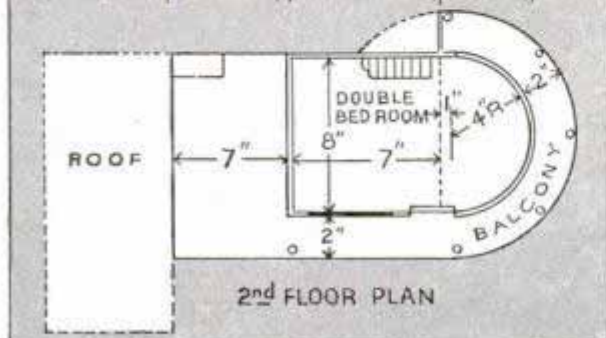
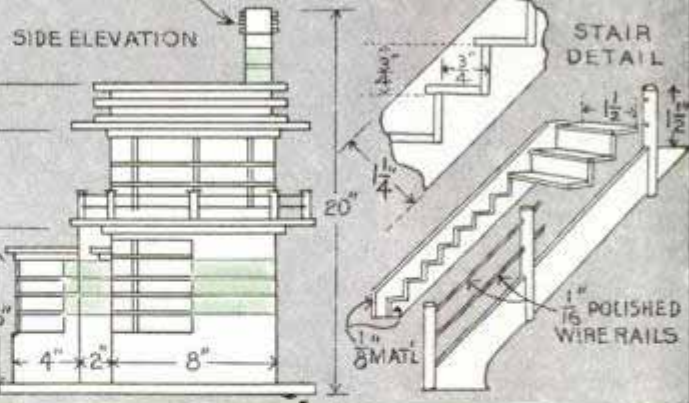
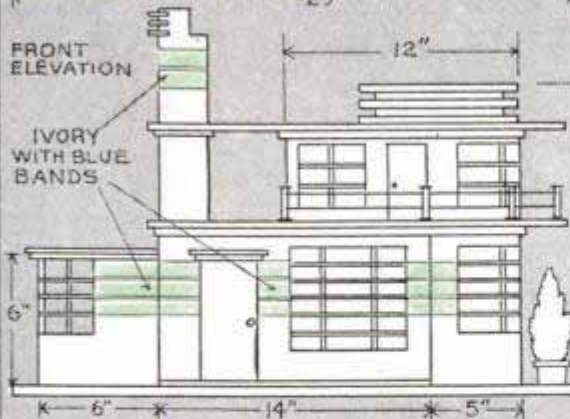
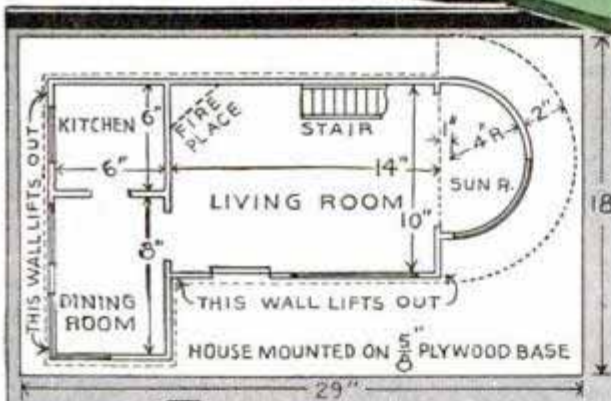
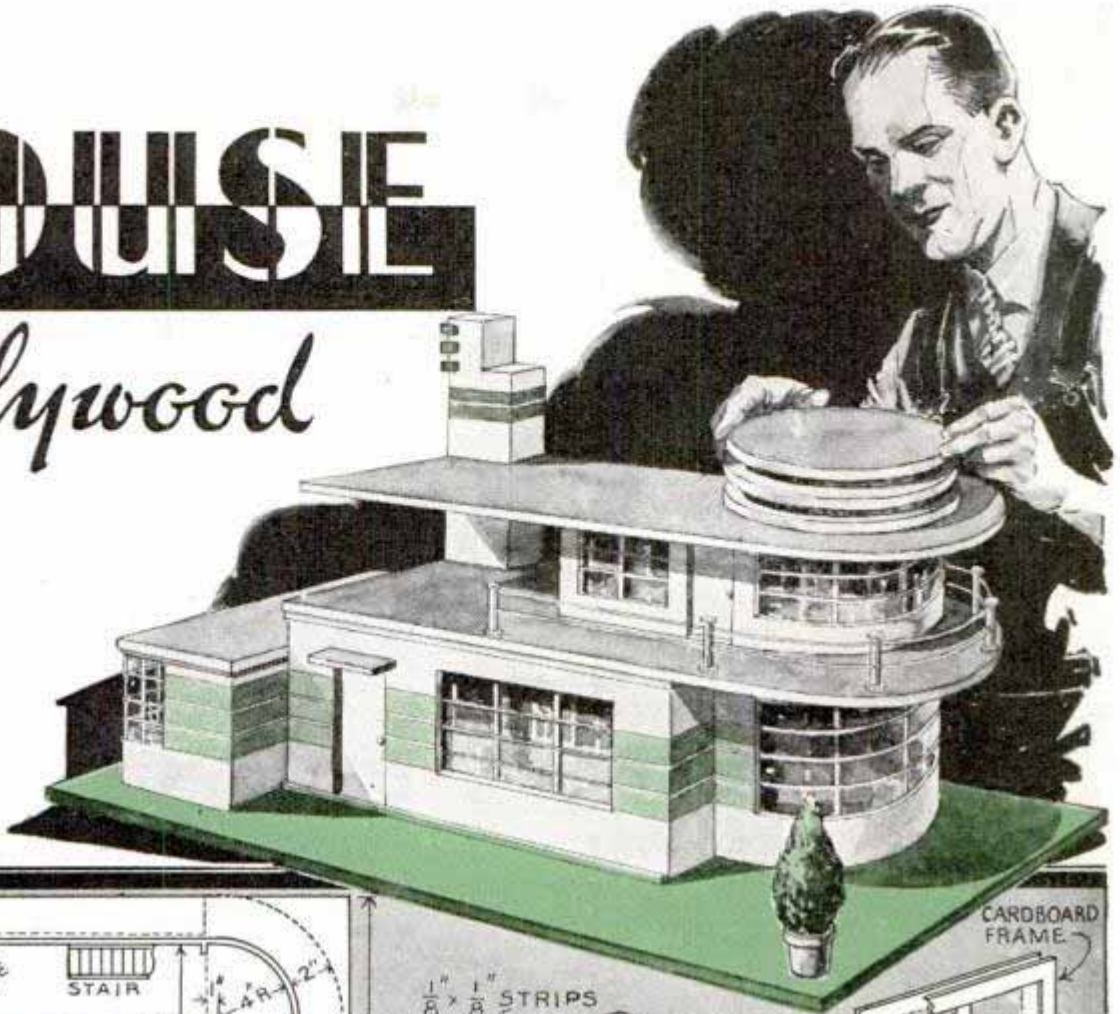

Practically the whole thing is made of plywood and wallboard. Windows are of transparent celluloid. Two walls are made so that they can be lifted out to give easy access to the interior. Plan views are given on this page and at the left a perspective shows the assembly. Only general dimensions are given, this being done so that you can make the house larger if you wish. The trickiest parts to make are the curved ends. After bending the wallboard over a form, glue the celluloid windowpanes in place with strips of cardboard on the inside as in the upper right detail

Disk Scraper Makes Quick Work of Cleaning Sidewalks



Removing ice, snow and hard mud from sidewalks is no problem when this disk scraper is used

Cleaning sidewalks, driveways and floors is simplified with this scraper, which literally "shaves" off ice, packed snow and grease, dried mud, etc. The scraper is made by pivoting a long, stiff handle to a disk from an old disk harrow.

Lugs Hold Pan Cover in Place While Draining Vegetables

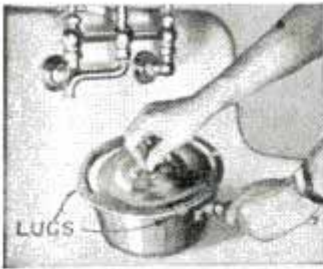

Have you ever had a pot cover slip, when draining vegetables, and let escaping vapor burn your arm? If so, you can avoid a recurrence by simply

soldering three equally spaced strips of tin to the edge of the cover so that when bent downward, they project down over the sides of the pot.

Oil Can Makes Dandy Glue Pot

You can make a handy glue, shellac or cement container from a small oil can such as fine, high-grade oils come in. Just remove the spout and cut it off so

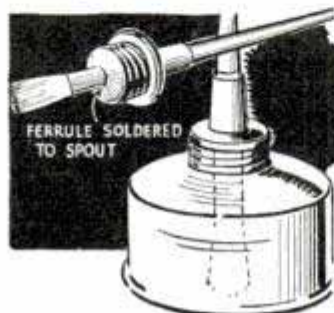

that the handle of an artist's cheap brush can be inserted into it. Push the brush into the spout so that the bristles just clear the bottom of the can when the spout is in place. Then solder the ferrule of the brush to the top end of the spout to make the can air-tight.

Plate-Glass Mirror Is Hung with Anti-Rattler Hooks

Faced with the problem of hanging a large plate-glass mirror, which had no frame nor any provision for holding it, I did the job quite easily with anti-rattler assemblies often used on auto-brake rods. These were hooked over the bottom and sides of the mirror as shown, which was then hung up with

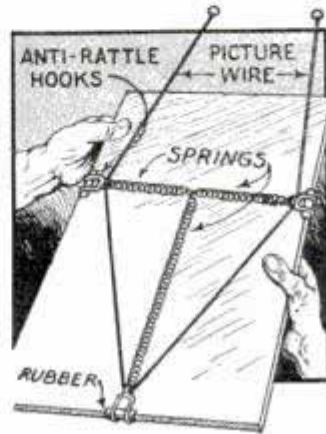

strong picture wire. Strips of rubber were folded over the edges of the mirror where the hooks of the anti-rattlers touched it to prevent chipping the glass.

—D. Harold Hammond, Richmond, Ind.

Specimens on Microscope Slides Held by Gummed Eyelets

Amateur microscopists who use low-power microscopes will find that gummed eyelet reinforcements of the type used on loose-leaf note books, are handy for mounting specimens on the glass slides. To do this, a Cellophane disk slightly smaller in diameter than the eyelet is placed over the specimen, after which the eyelet is dampened and pressed over the assembly. Such a mounting will work well on microscopes of less than 250 power.

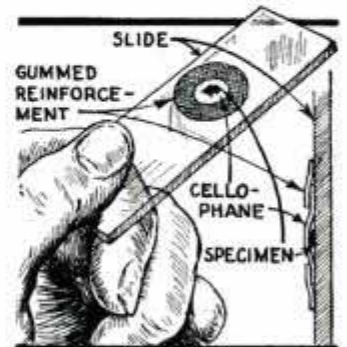

—Paul L. Ambelang, Chicago.



Table-Top CHRISTMAS TREES

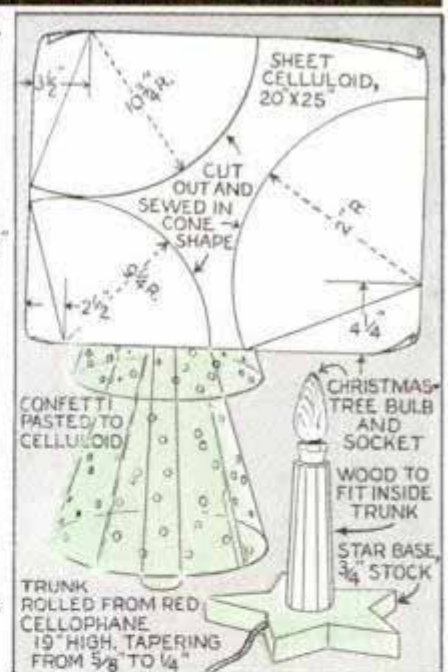
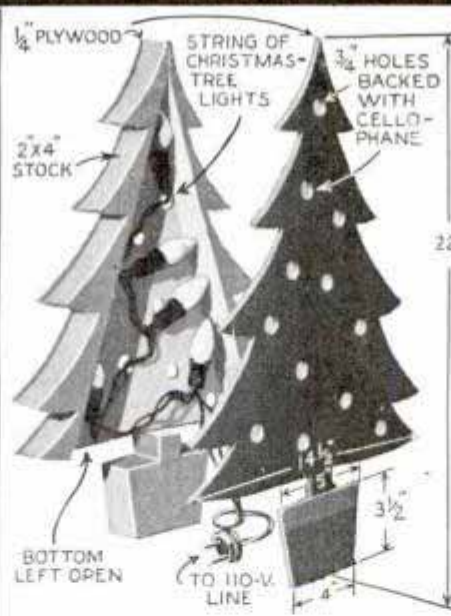
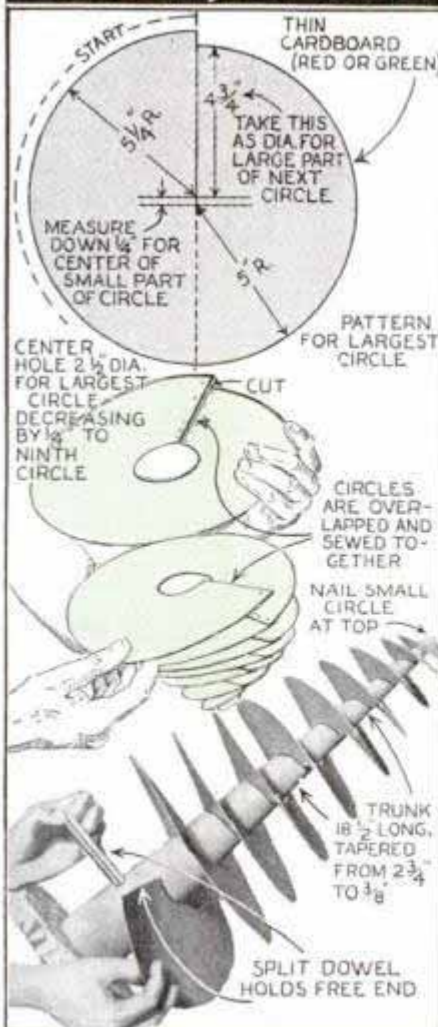

Cut ten circles from thin cardboard according to the plan shown at the left, sew them together and pull the whole thing down over a hardwood cone, fastening the free end with a split dowel. Add a sprinkling of artificial snow, and there's your Christmas tree. The cutout tree, center, above, is always popular. Holes in the plywood facing pieces are backed with tinted Cellophane to color the light furnished by a string of lamps. The third design requires a half sheet of celluloid. Three "cones" are cut from this sheet, each cone being rolled up and sewed. The conical "trunk" of the tree is red Cellophane. Cones are fastened to the trunk with pins. The base is star-shaped and supports a wood column and socket for Christmas-tree light

Thin Cloth Given Paper Backing to Cut True Patterns



Light, thin cloth backed with heavy paper to keep it from "creeping" in front of scissors

Unless light, thin cloth is stiffened in some way when cutting patterns from it, it is likely to "creep" ahead of the scissors, so that an irregular cut is made and the piece of goods ruined. A good way to stiffen cloth is to baste a heavy piece of paper to the underside and then cut through both the cloth and paper.

Double Vents in Storm Sash Improve Ventilation

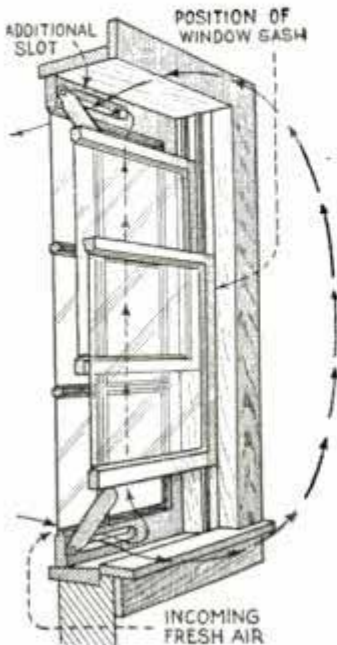

If you object to using storm sash on your bedroom windows because of inadequate ventilation during sleeping hours, air vents in the top and bottom of the sash will solve the problem. When the window sash are raised from the bottom and lowered from the top slightly as shown, fresh air enters through

the lower vent, circulates through the room and out at the top vent at a surprisingly rapid rate, completely changing the air in the room at frequent intervals. During waking hours, the window sash and vent covers are closed, giving you a tight storm protection.

Hooks for Rubber-Band Clamps

When wide rubber bands, which have been cut from old inner tubes, are used to hold bundled material, or for clamps on light work, the simple wire fastener shown will solve the problem of attaching the ends of the band. The fastener is made of strong wire, and consists of one straight length and one length bent to a wide U-shape with hooks on the ends.

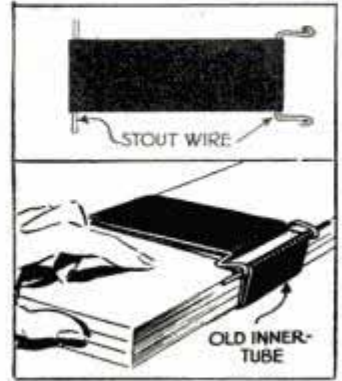

Signs Painted on Screen Wire over Backing Board

The difficulty of neatly painting signs on screen wire is easily overcome by first outlining the lettering on a board, which is then fastened against the wire with thumbtacks on the side opposite that from which the lettering is to be done. Besides serving as a guide, the board backing holds the wire smoothly.



Lettering outlined on board is easily copied on screen wire with paint

Novel "Cage" Holds Ball of Knitting Yarn

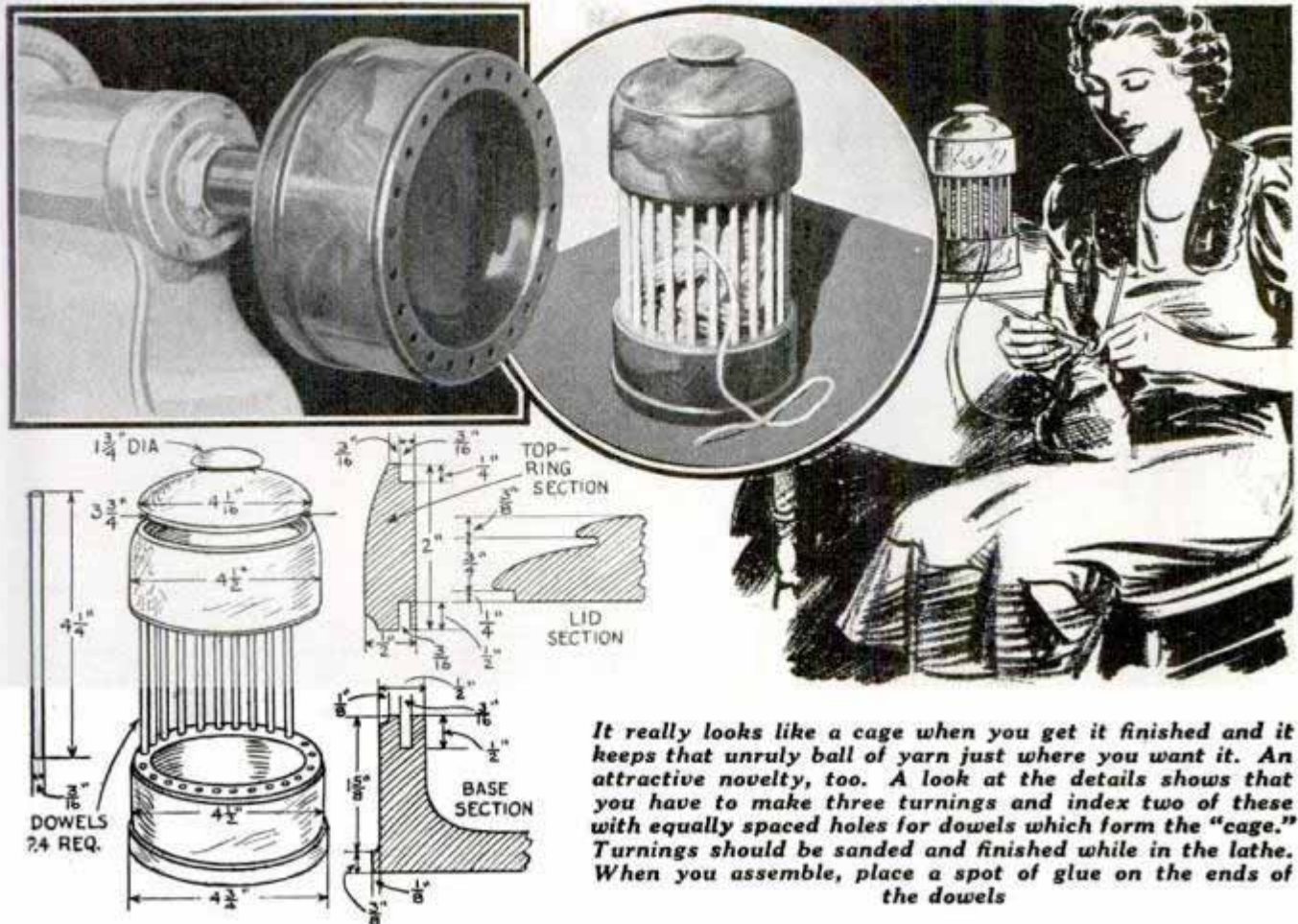

It really looks like a cage when you get it finished and it keeps that unruly ball of yarn just where you want it. An attractive novelty, too. A look at the details shows that you have to make three turnings and index two of these with equally spaced holes for dowels which form the "cage." Turnings should be sanded and finished while in the lathe. When you assemble, place a spot of glue on the ends of the dowels

Typewriter Platen Has Ruled Lines to Aid in Alining Work

Ruled in a true horizontal plane across your typewriter platen, a number of equally spaced parallel lines will aid greatly in alining work, especially cards and shipping tags, which are difficult to aline in the usual manner. To rule the lines, leave the platen in the typewriter and set it to single space. Then, get a ruling pen and regular ink of good quality, the color being yellow or red. Use any straightedge. Lay it on the platen and rule the lines. Be sure that the ink is dry before turning the platen so far that the wet lines will rub the portions of the carriage that come in contact with the platen. If a ruling pen is not at hand, a regular fountain pen will serve the purpose, being sure that all the black ink has been washed out of the rubber reservoir before filling it with the yellow ink.—Paul Erickson, Laurel, Nebr.

☐ Newly plastered walls should not be painted or papered for eight to ten weeks and, not even then if the weather is damp.



Small work is easily alined with the aid of these parallel lines

Hand Tools Built this

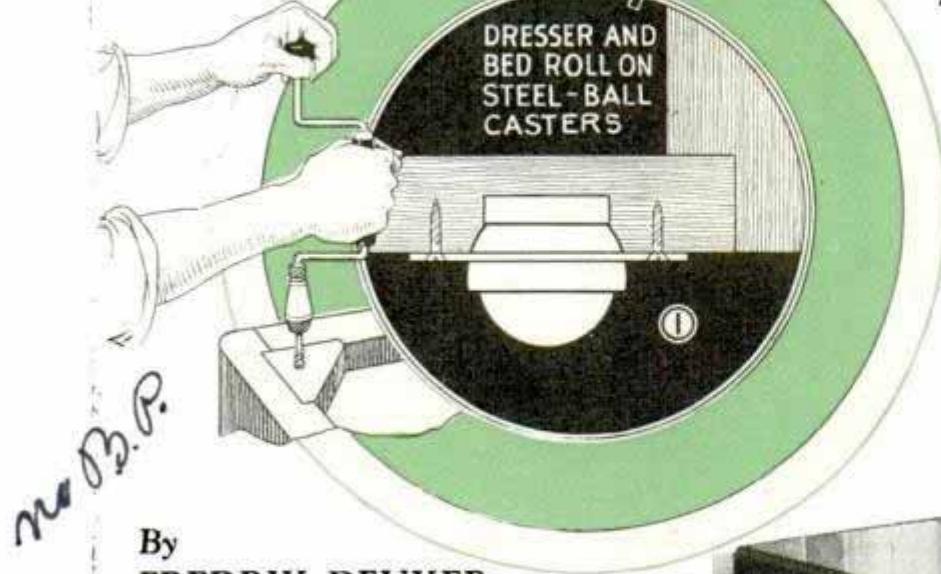

By
FREDRIK DEUKER
and **JOHN MODROCH**

BUILT after modern "skyscraper" design, these compact twin vanity cabinets and dresser, together with the octagonal vanity seat, full-length mirror and double bed, make up the essential furniture around which the outfitting of a distinctive modern bedroom can be planned. Due to the simple lines and adaptable proportions of these essential pieces, little difficulty will be experienced by the builder or planner when selecting whatever up-to-date fabric, wallpaper, floor covering and lamps might be desired to complete the decoration of the room.

Since the modern cabinet construction employed departs from the traditional style, joining has been simplified so that the tools found in the average home workshop will be ample for the job. In the cabinets there are no false panels or waste compartments to collect dust. Except for the divan base and drawers, $\frac{3}{4}$ -in. lumber is used throughout, with $1\frac{3}{16}$ -in. plywood for doors. Any close-grained wood, hard or soft, that will take a smooth coat of enamel, may be used with good results.

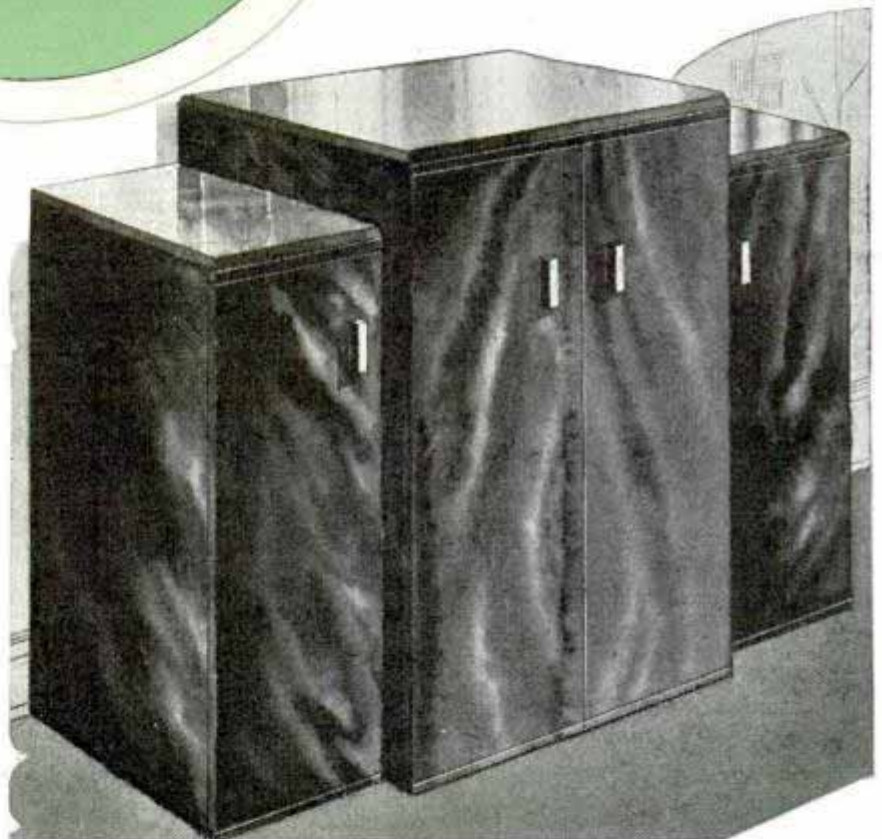

Or, if you wish, you can use walnut plywood, finishing the wood in the natural color.

Unless you use plywood throughout, gluing up stock for the sides and shelves of the two vanity cabinets and dresser is the first step. Before gluing, the pieces should be doweled or splined if full strength is desired. Dimensions for the dresser will be found in Fig. 3. First, cut the bottom and shelves to size, noting that the shelving runs the full length of the dresser. After grooving the side pieces, and rabbeting the ends to fit into the spe-

BEDROOM SUITE

*Compact twin vanity
cabinets and dresser,
octagonal vanity seat
and double bed ----
all in the
Latest Modern Styling.*



cial cut of the front corners of the bottom and tops as shown at A, Fig. 3, glue together the bottom, sides, shelves and $\frac{1}{4}$ -in. plywood back. The back fits in rabbets, with the exception of its bottom edge which overlaps. Next, glue together the pieces that go to make up the terrace top, joining the parts as in the cross-section drawing, Fig. 2. It is a good idea to include the drawer slide in this assembly, for purposes of rigidity. Dowels or splines may be used to join the pieces of the drawer

slide, which is then screwed up against the bottoms of the risers and lower terrace tops. The two front stiles, B, Fig. 3, had best be inserted in place, after fitting and gluing the terrace-top assembly to the lower section. The stiles, B, are grooved to take the edges of the shelves, and are also joined to the front corners of the terrace top as at A, in Fig. 3, this joint being employed at the front corners of both dresser and vanity cabinets.

Building up the vanity cabinets is a simpler job. Dimensions and details for the right-hand cabinet are given in Fig. 5. It will be necessary to reverse these dimensions, side for side, when laying out parts for the left-hand cabinet. In each, there are two drawers that slide on guides nailed on the top shelf. The drawers pull

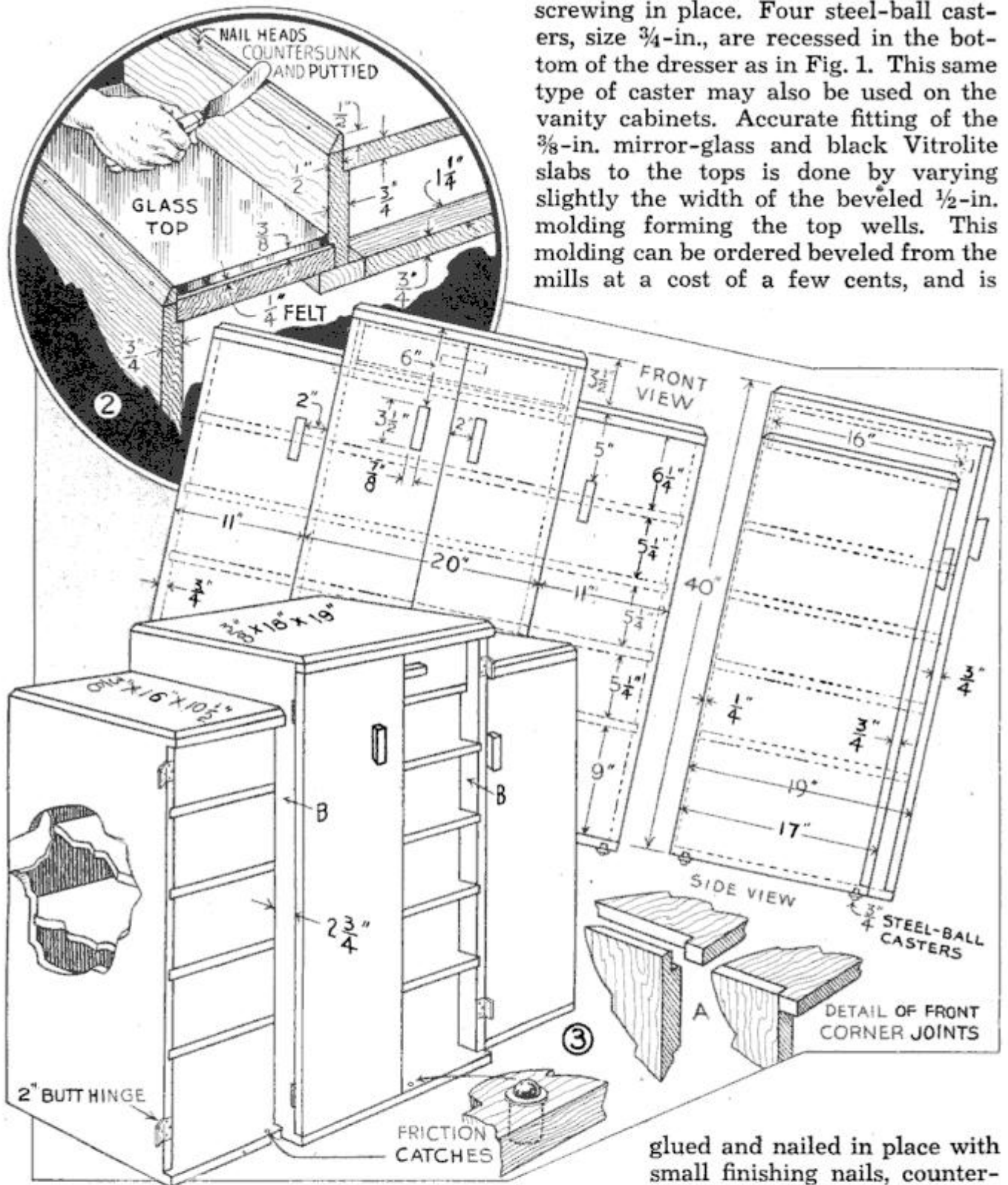

screwing in place. Four steel-ball casters, size $\frac{3}{4}$ -in., are recessed in the bottom of the dresser as in Fig. 1. This same type of caster may also be used on the vanity cabinets. Accurate fitting of the $\frac{3}{8}$ -in. mirror-glass and black Vitrolite slabs to the tops is done by varying slightly the width of the beveled $\frac{1}{2}$ -in. molding forming the top wells. This molding can be ordered beveled from the mills at a cost of a few cents, and is

out of the fronts and inner sides of the cabinets. Fig. 5 gives dimensions for making the inside drawers of the vanity cabinets. Varying the dimensions to suit, this same construction can be followed in making the front drawers of the cabinets, and the one for the top terrace of the dresser. The drawer and door handles are cut to the shape shown in the upper right detail, Fig. 5. After being fitted, the handles should be sanded and finished before

glued and nailed in place with small finishing nails, countersunk and puttied as in Fig. 2. It is advisable to specify "finished edges" when ordering the mirror-glass and Vitrolite slabs, to avoid chipping in handling. Finished edges will also permit the slabs to be dropped out of the wells without sticking. A layer of felt, $\frac{1}{8}$ in. thick, is laid under each slab to build them to the $\frac{1}{2}$ -in. level, and to serve as a cushion. The backboard of the bed is a rectangular frame made of $1\frac{3}{4}$ -in. square stock, and is covered, back and front, with $\frac{1}{4}$ -in.

3-ply veneer as in Fig. 7. The front board and side rails are cut from 1 $\frac{3}{4}$ -in. stock to the dimensions given. In order that the bed can be set up or taken down at will, the corners are locked together with 6-in. wrought-steel bed fasteners, the halves of the fasteners being mortised in the ends of the side rails, and the back and front boards. Fig. 8 gives dimensions for the corner pieces. In each a hole is drilled to take a 1-in. steel-ball

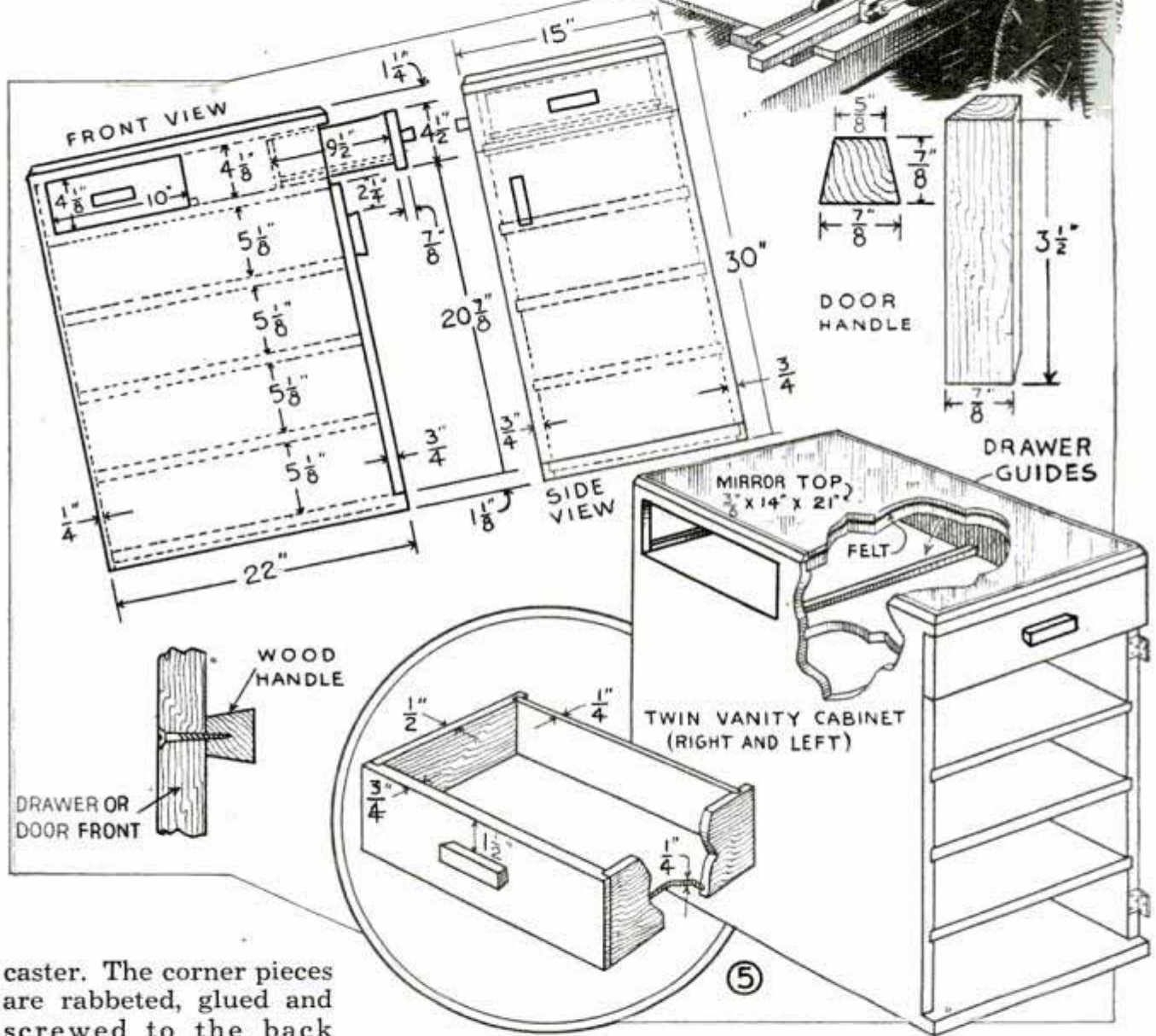
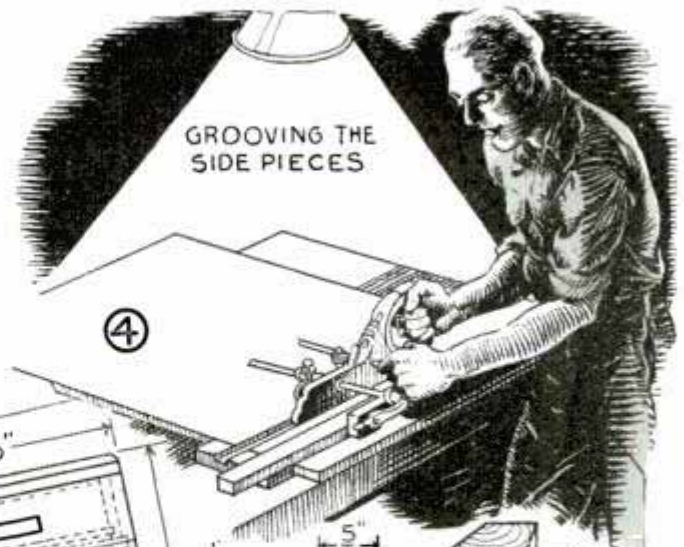

caster. The corner pieces are rabbeted, glued and screwed to the back board and the front board, and serve as ledges on which the side rails rest. As dimensioned the frame will take a standard full-size box spring, of the type having a wood frame which lowers between the rails of the bed as in Fig. 6.

The $\frac{3}{8}$ -in. beveled plate-glass mirror is mounted on a lap-jointed frame having a center rail added for rigidity. Details and dimensions are shown in Fig. 10. It is wise

not to attempt to drill the holes necessary for mounting the mirror, as this job requires the skill and special equipment of an experienced glass worker. When mounting the mirror, extreme care should be exercised in drawing up the nuts on the bolts, lest they be drawn too tightly and crack the mirror. The two hanger brackets are fastened to the top rail of the frame on 16-in. centers, so that when the frame

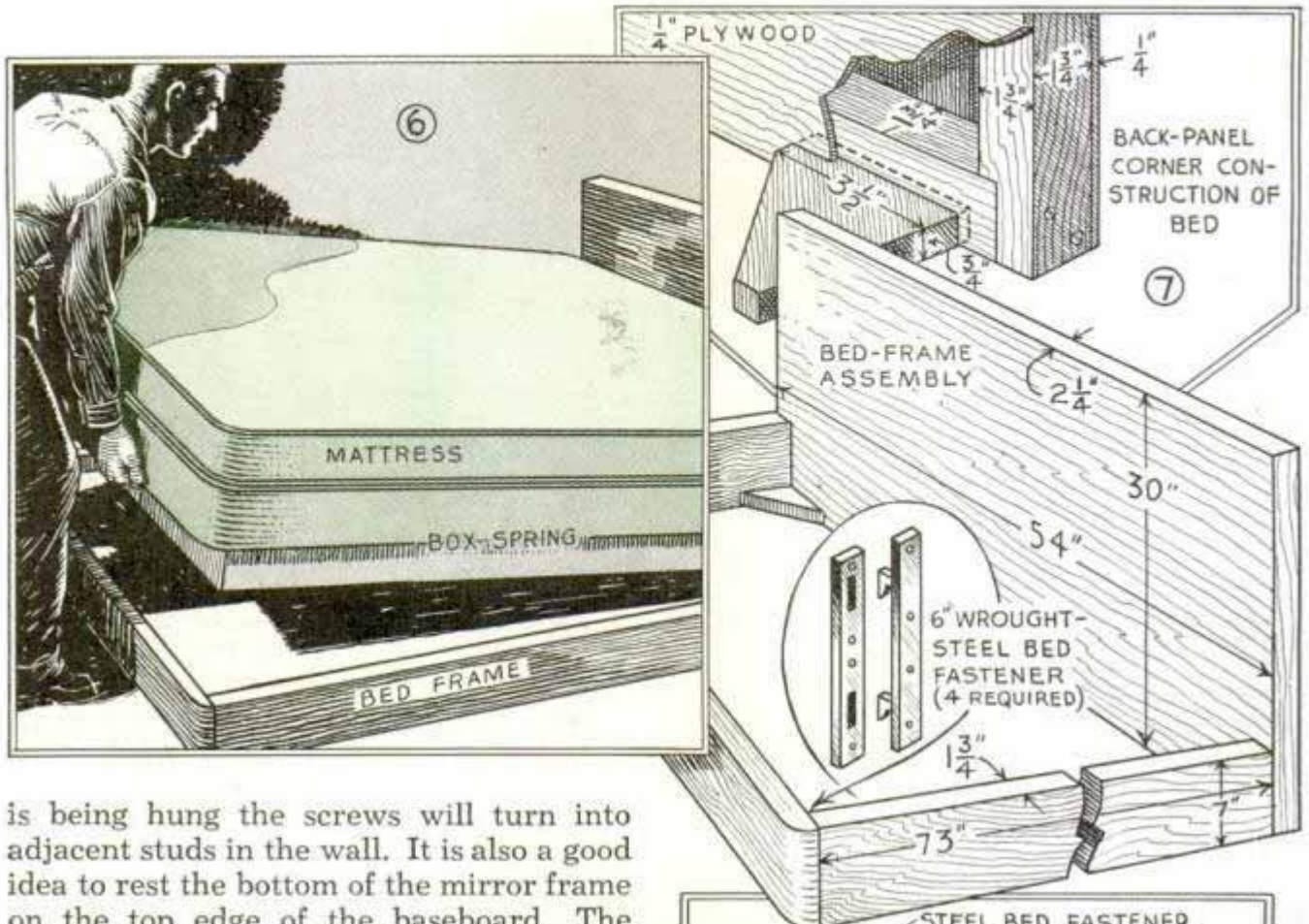

is being hung the screws will turn into adjacent studs in the wall. It is also a good idea to rest the bottom of the mirror frame on the top edge of the baseboard. The mirror hanger bracket and ornamental bolts can be bought from any dealer handling cabinet hardware.

The octagon seat completes the vanity ensemble. First, cut out the eight side pieces from 3/4-in. lumber to the dimensions given in Fig. 11. These are rabbeted at both ends to receive the top and bottom. To glue together the eight sides, begin by first gluing and nailing the lower ends into the bottom. Then, with the removable seat cover serving as the internal top form, apply glue to the edges of the sides and clamp the assembly together using the arrangement shown in Fig. 9. This clamping arrangement consists of two loops of stout rope drawn tightly around the octagonal assembly, to which tension is applied with C-clamps. The base of the seat is built up of two additional octagons of graduated size, forming an offset. Holes, providing a grip for the hand, are cut through the removable cover of the seat, the interior of which makes a handy storage space. An octagonal cushion stuffed with kapok and covered with the same material used to make the bed-spread and drapes finishes off the seat. Gliders may be driven into the base, to

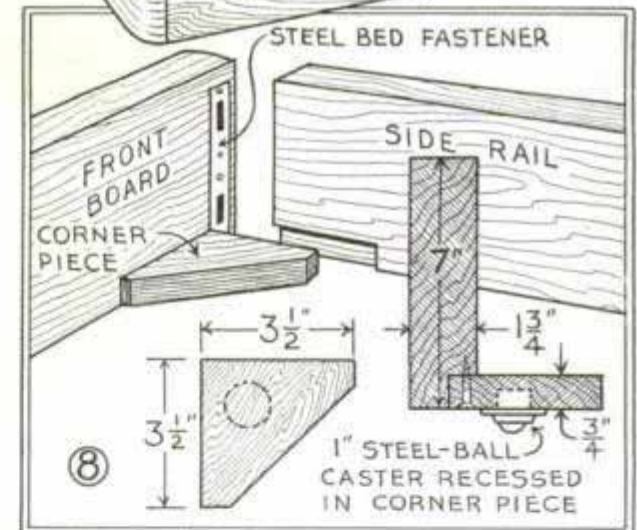

make it easy to slide the seat over the floor.

To put a smooth finish on the completed pieces, all surfaces should be dampened slightly by wiping with a moist cloth. Then while the grain of the wood is raised, rub down with fine sandpaper until all ripples are gone. This should be followed by two sanded coats of shellac, followed by a third which is left unsanded. This is followed by a coat of black brushing lacquer or black varnish which, when dry, is rubbed down with pumice and water. Follow this with two more coats of the same finish, rubbing down the final coat with a mixture of rottenstone and rubbing oil.

Hinged Holder for Small Tools Fits inside Regular Box



Small tools are always right where you can reach them if this holder is hinged to your toolbox

Hinged between the lid and top of your toolbox, this holder solves the problem of a place to carry small tools where they can be reached readily. The holder is made by cutting grooves in facing sides of two hardwood strips to take the tools and then gluing and nailing the strips together. The holder is hinged to the rear side of the toolbox, the partitions being recessed so that it will lie flush with the top of the box when closed.

—William Ferrary, New York City.

Mercury Thermostat for Home

For controlling small motors, fans and warning bells by temperature, you can make a simple thermostat from pipe and fittings. It is especially handy to install in the bonnet of a manually controlled furnace to sound a bell when the temperature gets too high. The thermostat is set to close an electrical circuit at any temperature by raising or lowering the $\frac{1}{8}$ -in. iron electrode at the top. If the thermostat is used where

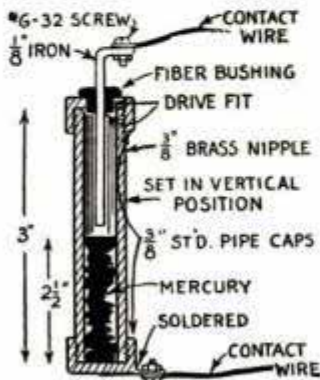

it is necessary to change its adjustment frequently, you can put it in a heated oven with a thermometer and scribe lines on the electrode to indicate the various temperatures at which it will operate.

Shield under Knife Sharpener Protects Woodwork

If you have a knife sharpener screwed to the woodwork near your pantry or kitchen stove, probably the wood is marred by having the knife slip off the sharpener.

To avoid this take a piece of linoleum or heavy celluloid and tack it under the sharpener as shown.



Shopping Bag Has Extra Pocket to Keep the "Want List"



To avoid loss or misplacement of her shopping list, and to keep it at hand when making small purchases, which she intends to carry home, one woman glued a paper pocket to the side of her shopping bag. The pocket

is of a depth that will leave the folded list projecting slightly for easy removal.

Artist's Brushes Held by Jacks

Amateur artists and card writers who haven't suitable holders for their small brushes when laid down temporarily, will find that two or three jacks, such as children play with, solve the problem. One leg of each jack is cut off as shown.

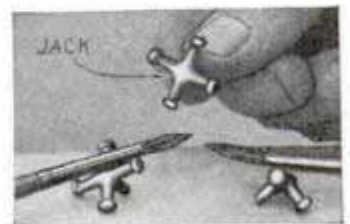

CHILD'S CLOSET

of plywood

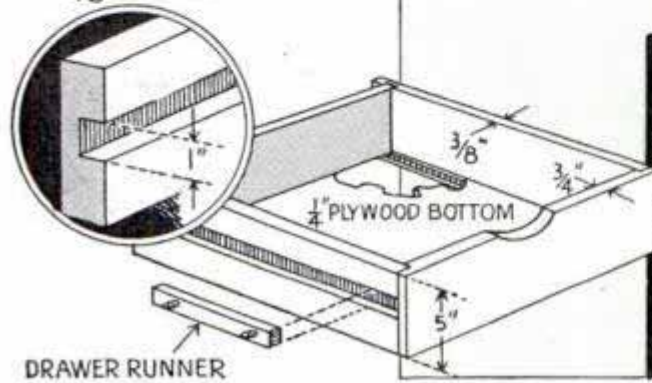
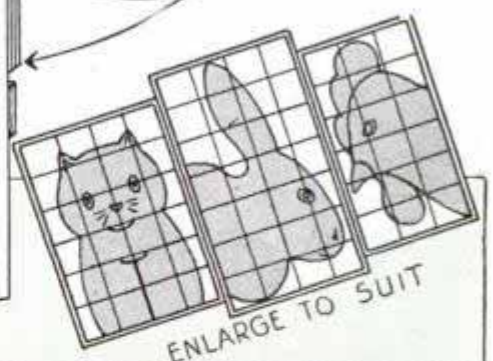
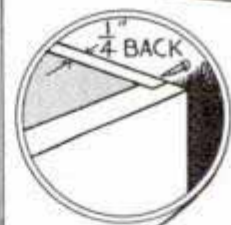
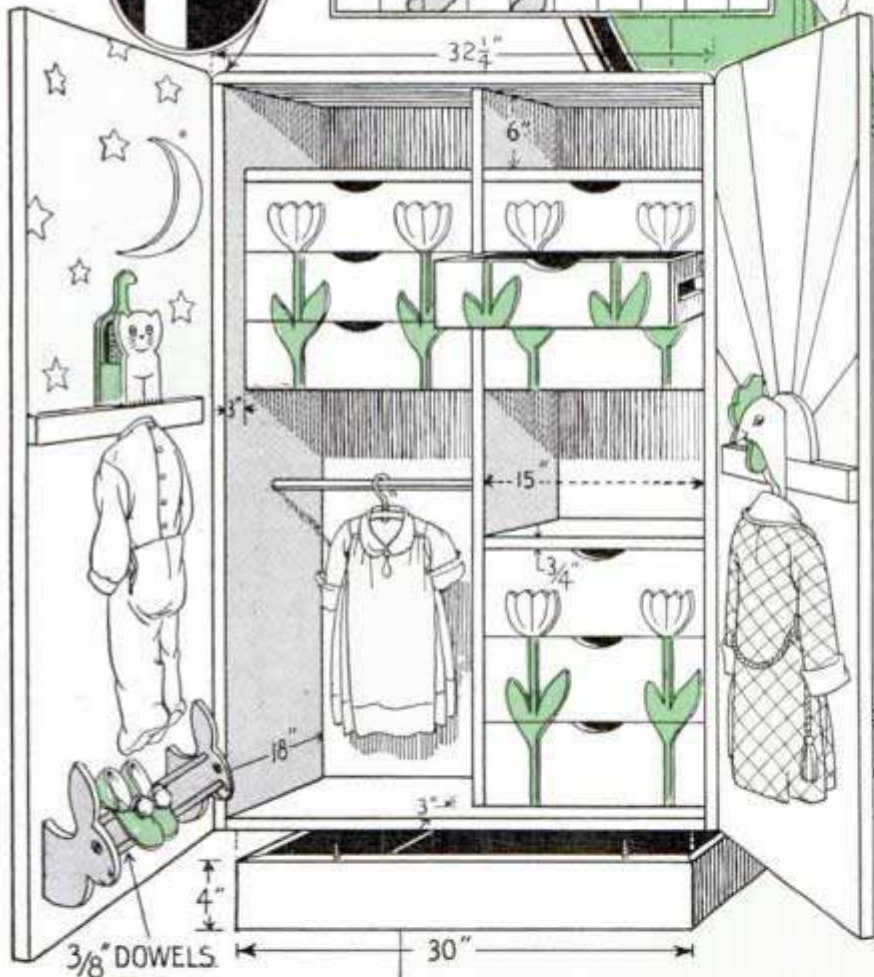
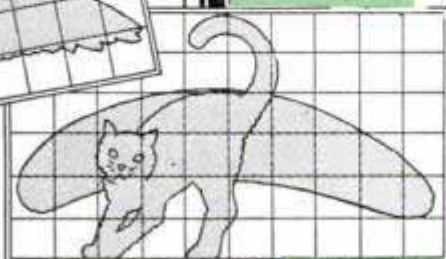
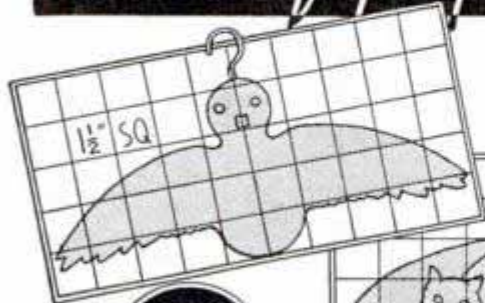

Youngsters "brought up" with this cabinet learn early habits of neatness and order. Simple to build, too, for it's made of plywood. Only the width and depth are given—the height is left to the builder's discretion. This can range from 52 to 60 in. The drawers are of the "flush" type, sliding on concealed runners. The drawer fronts are decorated with "tulip" overlays cut from 1/4-in. plywood. Other suggestions for decorative cutouts are shown on 1 1/2-in. squares

Pressure Gun for Filling Cracks with Glue or Plastics

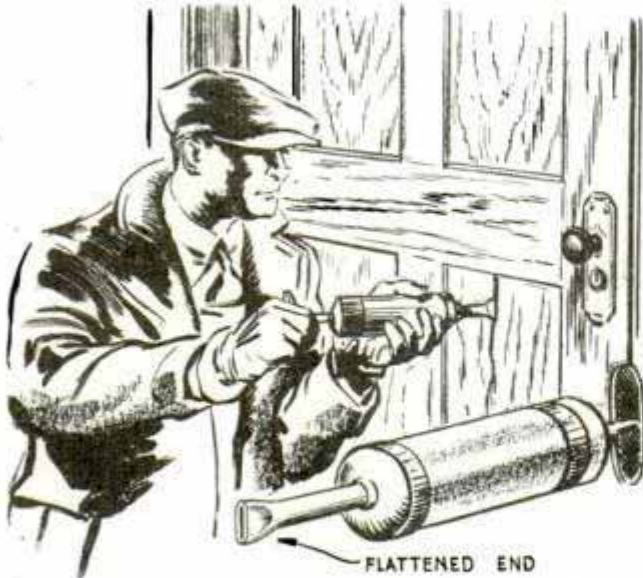

Cracks in wood and masonry filled completely with this gun to avoid undue shrinkage

By substituting a nozzle with a flattened end for the regular nozzle on an Alemite grease gun, you have a tool that will give a high pressure for filling cracks in wood with glue, for filling cracks in masonry with thin cement and for applying paste calking and flashing materials. If nozzles of different shapes are provided, you can apply plastics in almost any form desired.

Handy Pocket Oilers from Shells

Handy pocket oilers for use on guns, typewriters, fishing reels, etc., are readily made from metallic cartridge cases that have been fired.



Two good combinations are to use a .32-cal. automatic shell over the end of a .30-cal. U. S. army shell. Another is to use fired cases from a .45-cal. automatic over a .30-cal. U. S. army

shell that has been cut off at the enlarged portion just above the neck. Remove the primer from the short case and in the hole solder a finishing nail with the lower end flattened and pointed. The nail should be long enough to just clear the bottom of the long shell when the oiler is assembled.

—Earl B. Powell, Hollywood, Calif.

Flushing Clogged Soil Pipes

The problem of flushing soil pipes that have been clogged by leaves and trash from the eave troughs is solved by soldering a short section of pipe to the downspout as shown, so that a garden hose can be used. If you do not wish to do the soldering job, get a Y-shaped piece of downspouting from your dealer and install it at the top of the soil pipe. The open end of the pipe, of course, must be fitted with a removable cap to keep out dirt and leaves.



Table Printed on Exposure Meter Avoids Ruined Photos

Having an exposure meter calibrated to the "F" system and a camera with U. S. stops, I often forgot to convert the meter reading to U. S. equivalent, which resulted in ruined photos. To avoid this trouble, I typed a conversion table on a slip of paper and glued it around the exposure meter as shown below. The table not only served as a reminder to make the conversion, but I could tell at a glance where to set the camera.

—Wilbur Ennis, Los Angeles, Calif.



F.	U.S.
4	1
5.6	2
8	4
11	8
16	16
22	32
32	64

Conversion table on exposure meter serves as reminder and shows at glance setting for camera

Winter Hot-Dog Stand Resembles Arctic Igloo

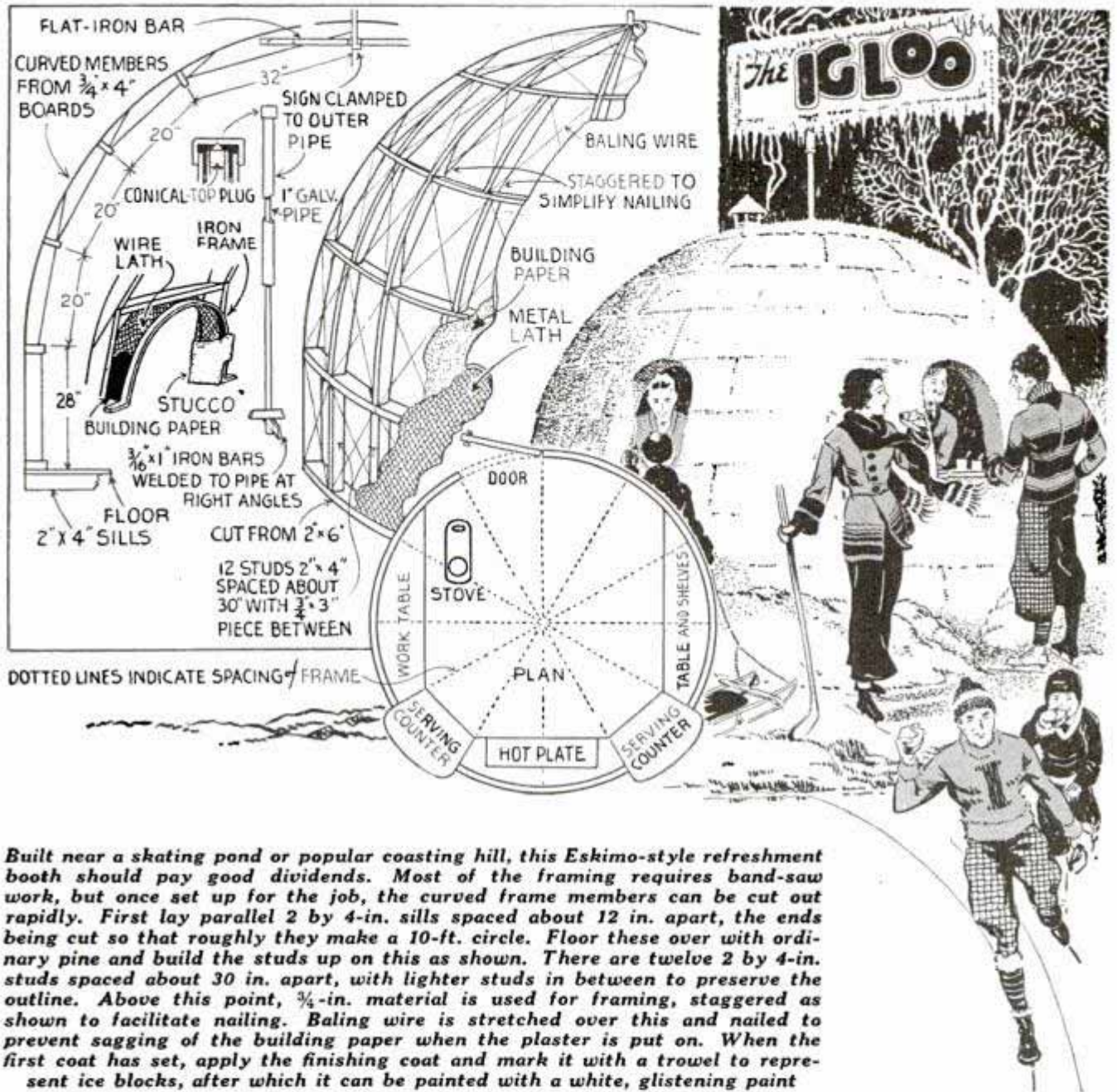

Built near a skating pond or popular coasting hill, this Eskimo-style refreshment booth should pay good dividends. Most of the framing requires band-saw work, but once set up for the job, the curved frame members can be cut out rapidly. First lay parallel 2 by 4-in. sills spaced about 12 in. apart, the ends being cut so that roughly they make a 10-ft. circle. Floor these over with ordinary pine and build the studs up on this as shown. There are twelve 2 by 4-in. studs spaced about 30 in. apart, with lighter studs in between to preserve the outline. Above this point, $\frac{3}{4}$ -in. material is used for framing, staggered as shown to facilitate nailing. Baling wire is stretched over this and nailed to prevent sagging of the building paper when the plaster is put on. When the first coat has set, apply the finishing coat and mark it with a trowel to represent ice blocks, after which it can be painted with a white, glistening paint

This Tripod Head Swings Camera to Vertical Position

In addition to the usual features of a tilting tripod head, this one has the advantage of permitting the camera to be tilted to a vertical position. The head is made of well-seasoned maple, which is amply strong even for tapping a hole in the bottom to take the tripod screw. The pivot, which is a $1\frac{1}{4}$ -in. ball bearing, works in circular recesses in the sides. Attachment is made to the camera by means of a headless machine screw brazed to the ball. A nut soldered on the screw to leave five or six threads exposed, keeps it from entering the camera too far.

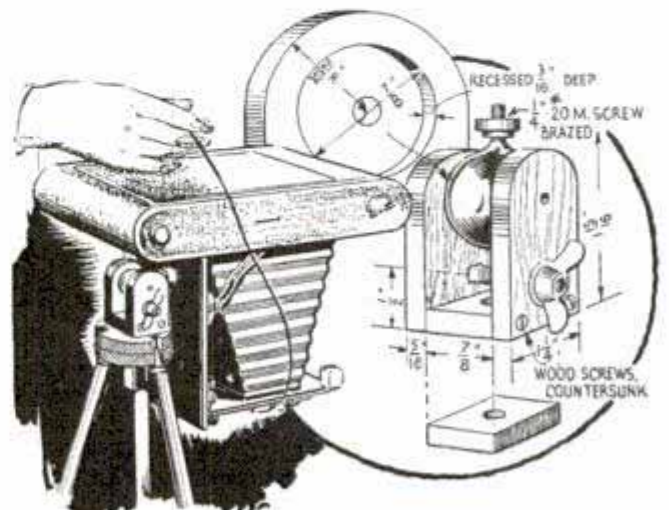



Model GAS-DRIVEN



by JOE OTT



Here's an exact scale model of a famous racing monoplane, "Mister Mulligan," winner of the Bendix Trophy and the Thompson Trophy races at the 1935 National Air Races. Recently the original speed plane set a new record in flying from Chicago Airport to Floyd Bennett Field on Long Island in 2 hours, 45 minutes. The model is scaled down to a wingspread of 66 in., and is driven by a tiny single-cylinder gasoline motor swinging a 15-in. propeller at 3,000 r.p.m. Under good flying conditions the model will attain a speed of approximately 18 m.p.h. The total weight of the model ship ready to fly is 3½ lbs., or 56 ounces

Part I—Fuselage Framework and Landing Gear

ALTHOUGH it was a great thrill to fly your first rubber-band model plane, it's nothing compared to the realism of flying a gas-driven model! Midget gasoline motors that develop from $\frac{1}{8}$ to $\frac{1}{2}$ hp. will fly readily a 5 to 8-ft. plane weighing up to 5 lbs. The average cost of the motor is about \$15.00 and all the materials needed to build the model of "Mister Mulligan" cost around \$3.00.

Before proceeding with any of the details, it's a good idea to become familiar with the entire general construction of the model. When the actual construction is

started, go thoroughly and completely in detail over the particular unit being assembled. Then lay out in single lines a full-size drawing of the fuselage, landing gear and tail wheel as in Fig. 1.

Fuselage: Looking at Figs. 2, 3, 4, and 8, begin with the center line which is the bottom longeron and which is the main longitudinal member in the body. One body height is given in the cross sections at station 5. This height continues through stations 6 and 7. From here through to station 12 there is a gradual taper above the center line. The top longeron tapers

No blueprints

PLANE ..

is speedy flyer

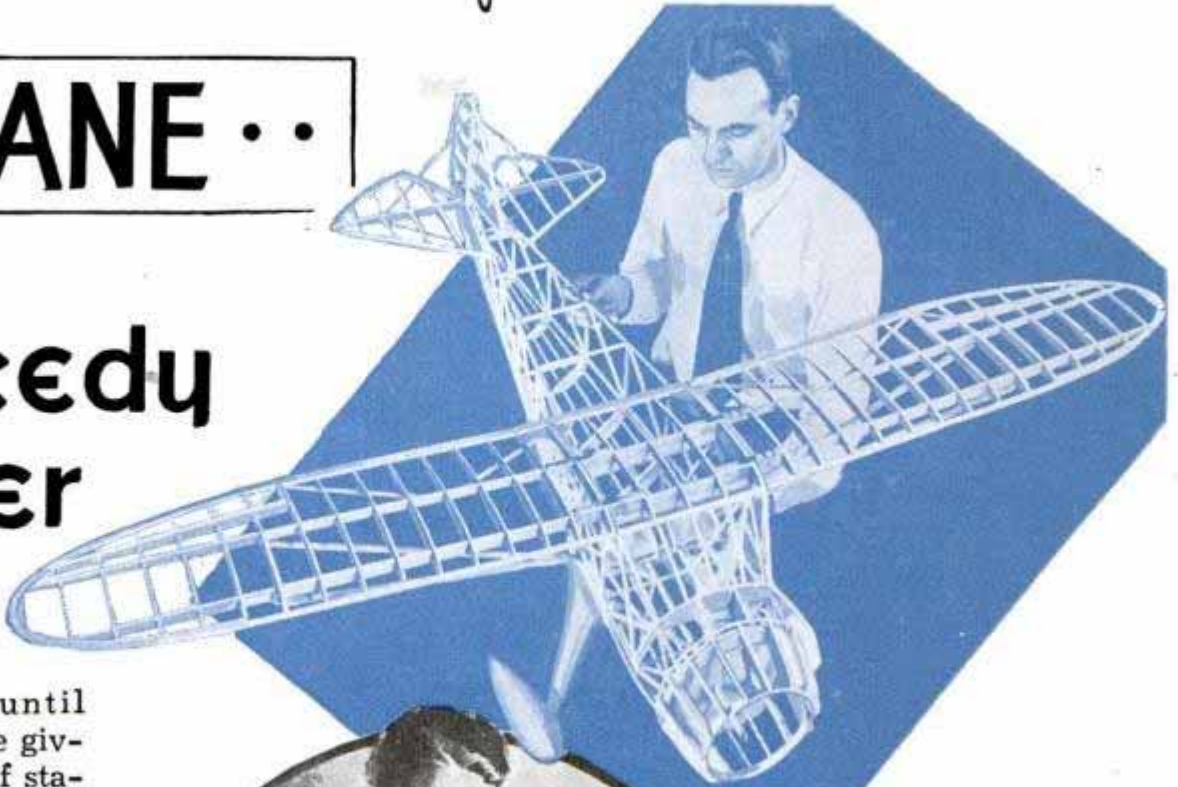

downward until it meets the given height of station 12. The distances between stations are given in the side view, Fig. 8. After the side view has been drawn, the construction can be started and the parts are placed directly over the drawn lines as in Fig. 7. Note that the heights for sections from stations 8 to 11 incl., are not given but must be checked on the full-size layout. The top and bottom longerons are placed in position, working directly over the center of the lines. Pin the longerons in place. When the uprights are fitted between the longerons they will tend to force the longerons against the pins, firmly holding them in position. Two sides exactly alike are constructed, one directly over the other, and separated with wax paper. This done, you make a full-sized layout of the top of the fuselage. Check the top dimensions at stations 5, 7 and 12. Draw the lines tangent to these dimensions, permitting the rest to fall in line. After the two sides are dry, place them right side up and pin in a similar manner to the board as specified for the side view. The cross



braces are cut and fitted first at the points dimensioned and then at those not marked. After the top and bottom cross braces have been cemented in, the main part of the fuselage is complete. When constructing a part be sure to refer to the parts list so that the proper materials

are used. The body so far should have been constructed entirely from bass wood or sugar pine. Sand all pieces before cutting to exact length. Balsa wood can be used throughout for the construction, but for the additional few ounces of weight, pine or bass wood gives greater strength and resiliency. From the bottom longeron to the extreme bottom of the fuselage the construction will be $\frac{1}{16}$ -in. sheet balsa and $\frac{1}{8}$ -in. balsa bracing, with a center piece of pine or bass running the full length from station 4 to 12. Note that a triangular section is built up underneath each station and small semi-circular pieces are added to complete the circular shape of the underside. At points not dimensioned, check the distance across the lower cross brace, then draw a circle equaling this diameter

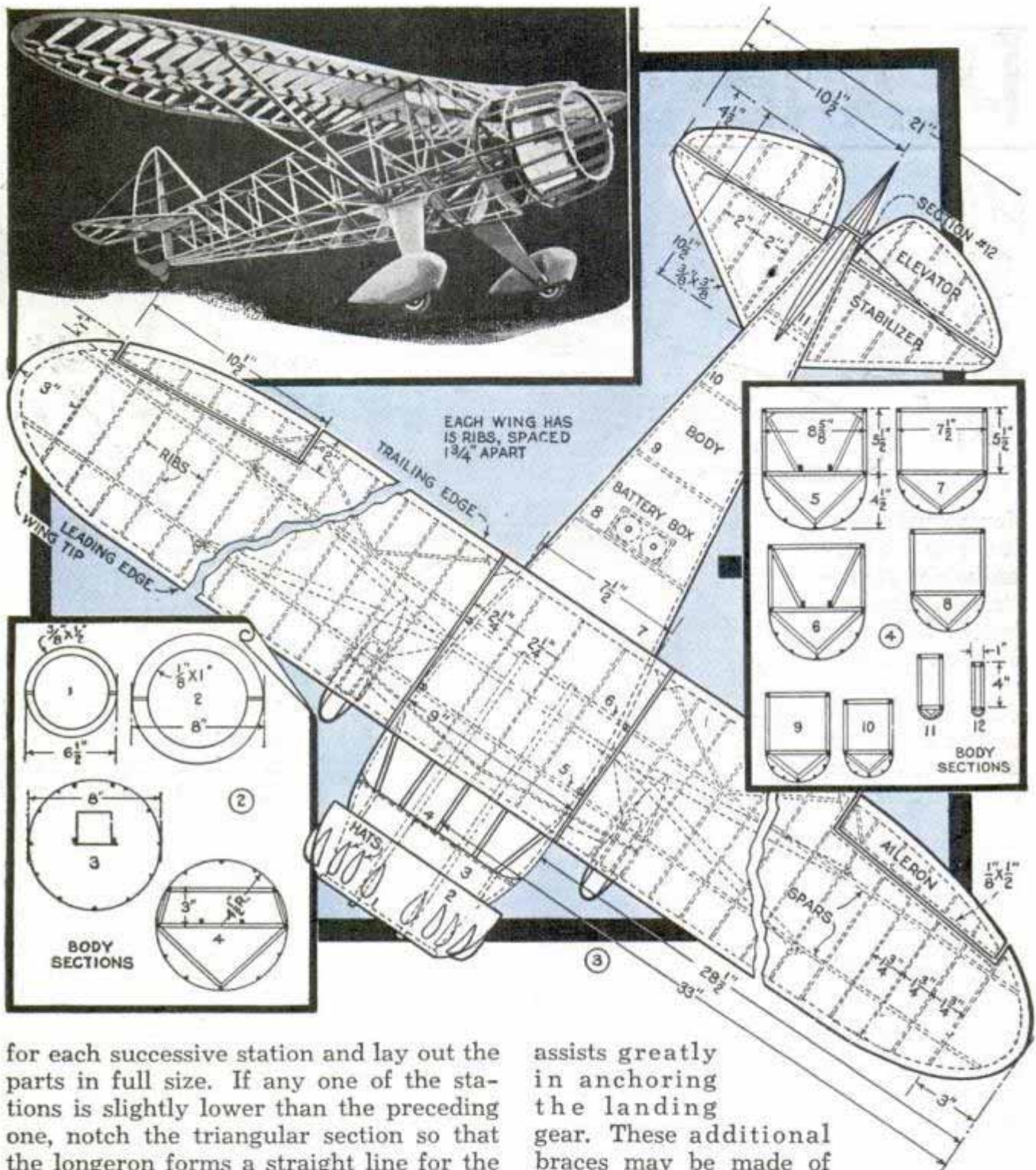

for each successive station and lay out the parts in full size. If any one of the stations is slightly lower than the preceding one, notch the triangular section so that the longeron forms a straight line for the greater part of the distance between stations 6 and 12 and a slight gradual curve between stations 4 and 6. The motor supports, which are $\frac{1}{4}$ by $\frac{1}{2}$ -in. pine, should be fitted in on top of the bottom cross braces between the two lower longerons. The distance between these supports will depend entirely upon the motor selected. After the motor mounts have been placed, check the views of the model and note that the triangular braces from the top station 5 to the motor brace are added on each side. An additional triangular brace is placed between stations 4 and 5, which

assists greatly in anchoring the landing gear. These additional braces may be made of balsa. A similar triangular brace is also placed on each side of the fuselage from the top down at station 6. This brace helps to eliminate side sway when the wings are in place. Additional bracing can be added by cementing small gussets in the corners on the main longerons at stations 4 to 7 inclusive. A gusset is a small flat triangular piece of balsa usually joining an upright, a cross brace and a longeron.

Motor Cowl: The small wooden streamlined sections cemented on top of the motor-cowl covering are hats and on the

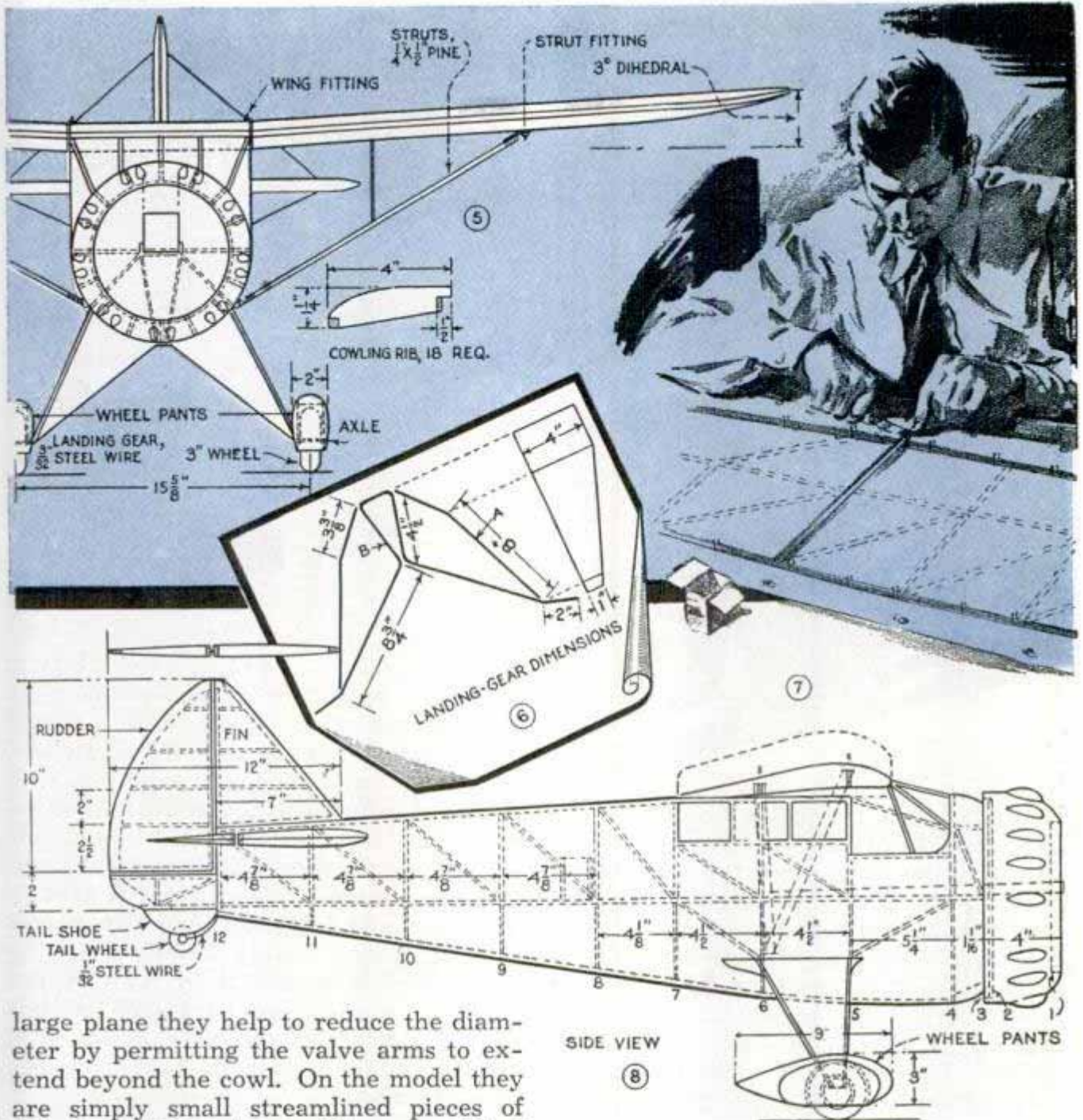

large plane they help to reduce the diameter by permitting the valve arms to extend beyond the cowl. On the model they are simply small streamlined pieces of balsa sanded to shape. There are 18 of these, equally spaced in pairs.

Stations 1 and 2 give the diameters and the cross-sectional sizes of the rings required for the motor cowl. Note in Figs. 9 and 10 that the front part of the body at stations 2 and 3 has a wall completely constructed of balsa wood. There is a small opening leading directly from station 3 to station 4 under the front of the windshield as in Fig. 2. This is a hot-air vent and is covered with balsa on all sides except the top. When the motor is entirely enclosed the hot air escapes through this vent. The motor cowl is constructed of two rings which are sawed from large flat sections of balsa, cemented together and assembled with 18 cowlings ribs. The cowlings is as-

sembled in two halves. The lower half is firmly cemented in position and is a part of the body. The top half is loose and is held in place by rubber bands and removes in a jiffy, permitting complete examination and checking of the motor, the gas tank and the spark coil.

Landing Gear: The landing gear, Figs. 5 and 6, is constructed of $\frac{3}{32}$ -in. steel wire. The unit visible in the side view, Fig. 8, is made in one piece, but note that you must have a right and left unit. The center section is also made in one piece and continues through the wheel pants. The landing-gear frame is filled with $\frac{1}{8}$ -in. balsa sheeting and is attached to the motor mounts between stations 5 and 6, where it

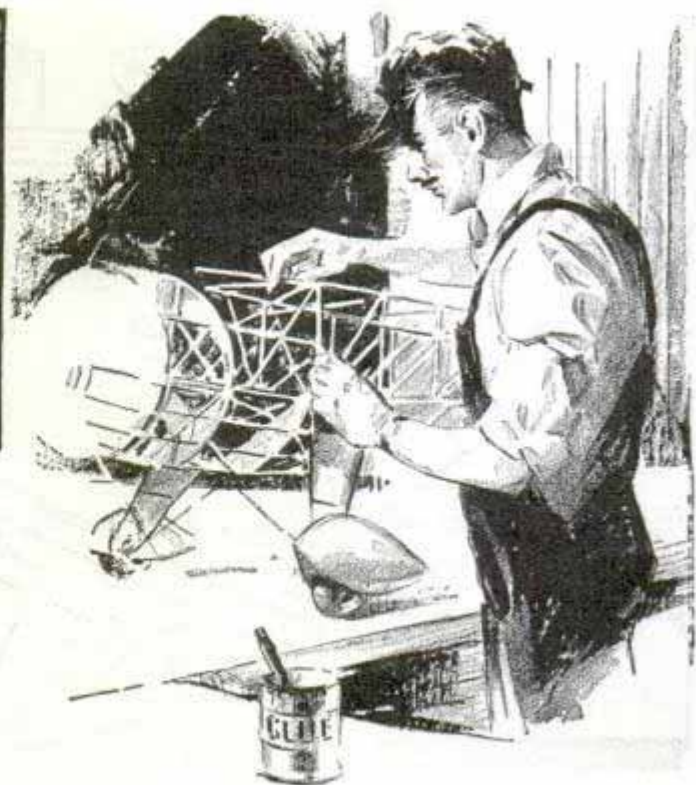
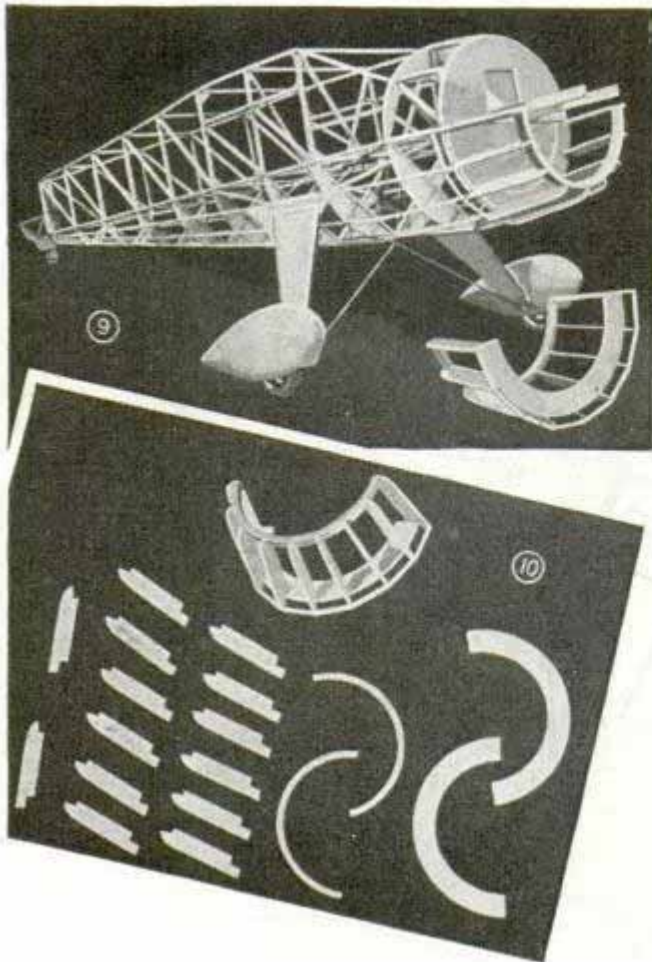

is braced in a triangular fashion to the front and rear of the longerons. The braces run from the motor mount to the landing gear at station 5 on both sides. At the rear they run between stations 6 and 7. The center piece fitted directly underneath the fuselage is held together by a rubber band, the strength of which may be increased or decreased until the proper spring action is secured. Wheel pants are carved from balsa to the size given in Figs. 5 and 8. The wheels used are 3 in. in di-

ameter, and from $\frac{1}{2}$ to 1 in. wide. You can use either pneumatic or solid wheels.

Rear Fuselage: The tail wheel is placed in a small shoe at the rear of the fuselage, the mounting being constructed from two pieces of balsa cemented to the rear of the body. A $\frac{1}{32}$ -in. wire passes through the center of the wheel and back to the upright at station 12. The wheel is 1 in. in diameter and is turned from hardwood. The small rigid section directly above the tail wheel is cemented in position and conforms to the general shape of the rudder. The width of the body at station 12 is 1 in., and the rudder rib at the lower end should conform.

(To be continued)

MATERIAL LIST

FUSELAGE	DIMENSIONS	NO. PIECES
Longerons, cross braces and uprights.....	$5/32 \times 5/32 \times 42$ in.....	12 pine or basswood
Cross braces	$5/32 \times 5/32 \times 42$ in.....	12 balsa
Motor supports	$1/4 \times 1/2 \times 18$ in.....	2 pine or basswood
Body formers	$1/16 \times 2 \times 24$ in.....	6 balsa
Stringers	$1/8 \times 1/8 \times 42$ in.....	12 balsa
MOTOR COWL		
Circular ring—front cut to shape.....	$3/8 \times 1/2$ in.....	1 set balsa
Circular ring—rear cut to shape.....	$1/8 \times 1$ in.....	1 set balsa
Cowling ribs	1/16-in. sheet 3 x 24 in.....	1 balsa
LANDING GEAR		
Bracing and axle	10 ft. of 3/32-in. piano wire.....	1 steel
Wheels	$1/2 \times 3$ in. diameter.....	2 hardwood
Tail wheel	$3/16 \times 1$ in. diameter.....	1 hardwood
Wheel pants (cores)	$3/4 \times 4 \times 10$ in.....	2 balsa
Wheel pants (covers)	$1/8 \times 3 \times 7$ in.....	4 balsa
Landing-gear struts	$1/8 \times 4 \times 7$ in.....	2 balsa

Footlight Illuminates Painting over Mantel

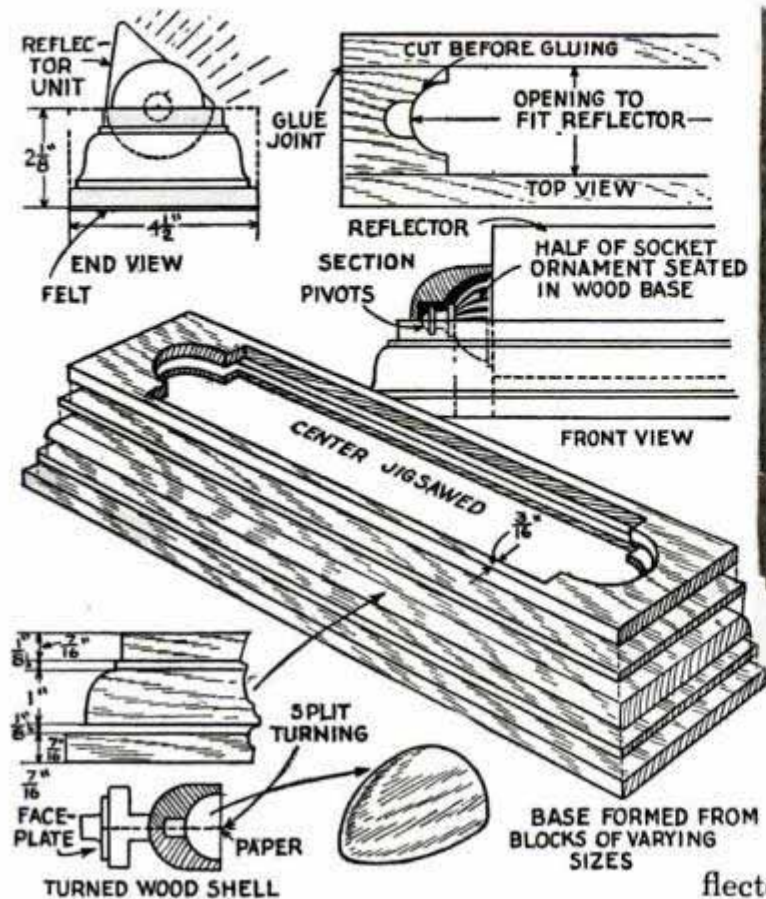

Bathed in a flood of soft light, a picture or painting above your mantel stands out beautifully when illuminated by this decorative footlight reflector

Footlight reflectors, the latest innovation in picture illumination above a mantel, can be improvised easily by fitting the reflector from an old overhead type of picture lamp into an appropriate base of molded wood. Construction of the latter is more or less dependent upon the particular reflector at hand and must be made to fit accordingly. Double-bulb type re-

flectors generally have ornamental shells which cap the sockets at each end, and these are made to pivot in the base to permit proper angle adjustment. The base can be made by molding a roughly shaped, glued-up block on a shaper. Where such a tool is not available, appropriate moldings can be worked out by gluing together pieces of varying shapes and sizes. Lathe turned shells of wood are used to hide the partly visible ends of the reflector.

Siding Applied with Aid of This Gauge Is Equally Spaced

To assist in correctly spacing siding boards while applying them single-handed, one man used this homemade gauge. It consists of a short length of spring steel bent to the shape shown and riveted to a regular kitchen knife. The points at which the steel is bent will depend on the width of the siding being applied. In use, the knife blade is pushed under the last board nailed on, with the steel strip resting on top. Then the next board is put on, with the lower edge resting against the gauge.

☐ A few cheesecloth bags filled with moth balls and hung where sparrows are nesting will usually cause them to leave.

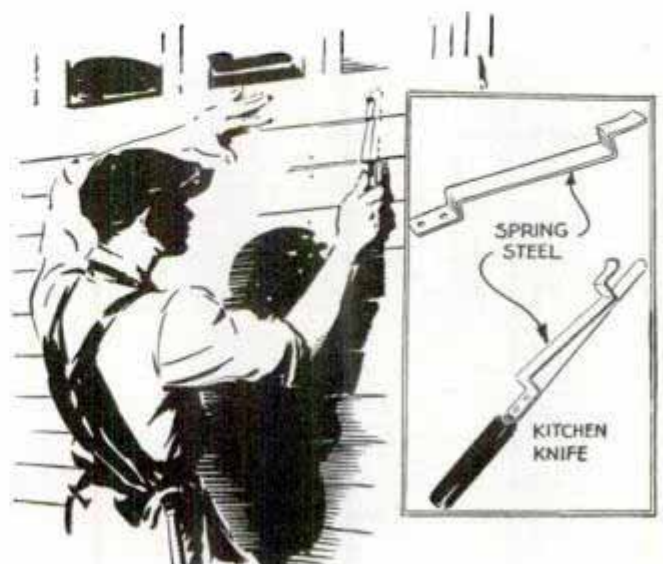

Coil Springs Are Quickly Made with This Wire Winder



You can do a neat job with this winder, which has an adjustment to gauge the tension on the wire

To wind coil springs by hand, this simple winder will save work and enable you to do a neat job. Made from a length of flat iron, the winder is curved at one end to fit the contour of the mandrel on which the wire is being coiled, the wire being fed through two U-bolts, which are tightened to adjust the tension on the wire.

Life of Shingle Siding Increased by Use of Furring Strips

Instead of nailing shingle siding directly to the sheathing as is customarily done, it is claimed that a better method is to use 1-in. furring strips between them as shown. When shingles rest against the sheathing, soaking rains sometimes penetrate them

and wet the building paper, and, there being no air space between the shingles and sheathing, drying is slow and not uniform, which tends to cause the shingles to curl and even rot out quickly. With the fur-

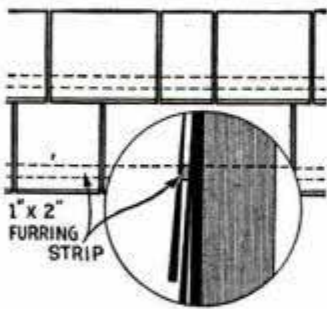

ring strips, however, a 1-in. air space is provided which prevents moisture from reaching the paper and permits quick, uniform drying.

Disconnecting Copper Tubing

When copper tubing of 1/2-in. diameter or larger is threaded and screwed into a fitting, the job of unscrewing the joint may be accomplished without marring or crushing it by using a leather strap and a pair of pliers. The strap is wrapped around the tubing a few turns in the direction that the tube must be turned, and then the free end is grasped with the pliers as indicated. By resting the jaw of the pliers on the leather and applying steady pressure, considerable torque can be applied.

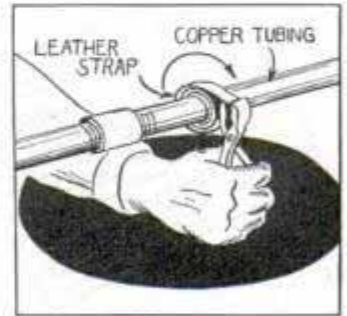

Chips Kept Out of Lathe Shaft



When doing chuck work and also some face-plate work in a lathe where the headstock center is removed, it is a good idea to plug the end of the lathe shaft to keep fine chips from entering the center hole. Such a plug is easily provided by turning a piece of wood to the same taper as the center.

Improved Drop Oiler

For lubricating delicate machinery, guns, clocks, typewriters, etc., you can easily make an oilcan that will accurately release one drop of oil at a

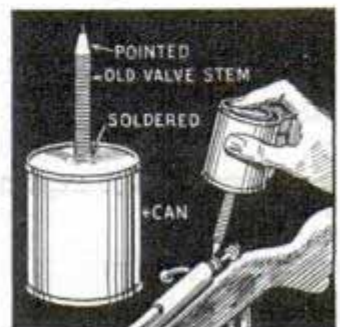

time. Remove the case from an old tire valve, and file down the end so that the core will project slightly when it is replaced. Then solder the valve in a hole in the bottom of a small can with a screw top or press-fit lid. When the can is filled with oil, just press the projecting core lightly against the part to be lubricated.

Handle of Vise Is Adjustable to Speed Opening of Jaws

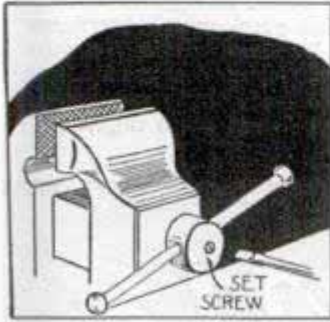

On many vise jobs which require repeated opening and closing of the jaws, you will find that a handle which can be locked and spun around saves time.

To make the handle on the vise adjustable, just drill and tap a hole in the end of the vise screw to take a large set screw, which can be driven in to engage the handle.

Angle-Handle Knife Cuts Steaks without Wrist Strain

For greater convenience in cutting steaks, one butcher finds that a knife with the handle bent to the angle shown is more practical than a straight one. Besides bringing the full length of the blade parallel to the cutting block, the angle of the handle prevents the knife from twisting in one's hands, thus relieving considerable strain on the wrist.



A knife with the handle bent to an angle gives full use of the entire cutting edge

Flexible-Brush Combination Cleans Curved Surfaces

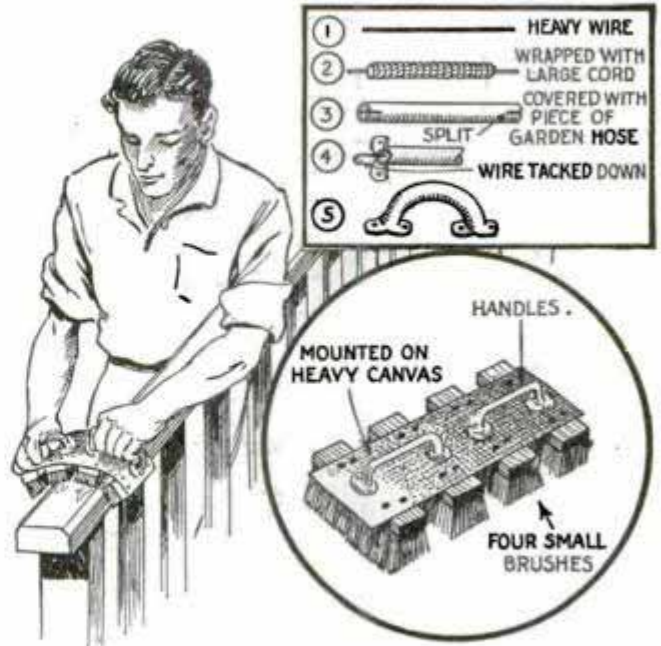

Porch and stair railings, round columns and similar work can be cleaned quickly with this assembly

In cleaning railings and similar curved work, this flexible brush assembly readily adjusts itself to almost any irregular surface. It is made by tacking a heavy canvas back to four or more equally spaced scrub brushes and providing the assembly with two flexible handles, made as shown in the insert. By substituting steel-wire brushes and making the back and handles of heavier material, you have an assembly for cleaning large pipes and similar work.

Furnace Poker Converted to Tool for Removing Clinkers

By simply drilling his furnace poker to take two metal rings through which a folded length of spring wire could be slid, one home owner made his poker serve the dual purpose of stirring the fire and removing the clinkers. Small hooks were bent on the ends of the wire, which was then curved upward a little to form open jaws. When the poker was slipped over a clinker, the wire was pulled back through the rings, which caused the jaws to grip the clinker.

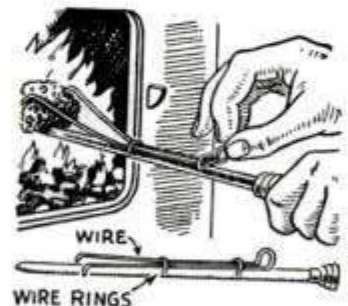



SHALLOW RECESS IN UNDER SIDE OF TABLE

WOOD GRIP

TO TURN OVER HOT STEAKS

Food choppers won't slip if the swivel disk fits in a shallow recess and if the screw is tightened with a removable grip, which increases leverage. To turn sizzling steaks without splattering hot grease, use tongs made from two meat forks; the spring keeps them together

Simple Methods of Solving Your

Home

1/16" FIBER

NARROW SLOT

WIDE SLOT

Wash ties can be pressed without wrinkling or stretching out of shape by inserting a fiber form which holds the material taut. Clothespins with narrow slots at right angles to the regular ones permit fastening thin fabric on the line securely without wadding the material to make the pin hold it. The edges of the slots should be sanded smooth. Splinters from basement stair rails are avoided if the rails are covered with rubber from old inner tubes. When stuffing a fowl, try the neat, simple lacing method on the right; run meat skewers through the flesh and loop cord over the ends, after which the cord is tied. The lower right detail shows envelope corners glued to a calendar to prevent the pad from curling

SKEWERS

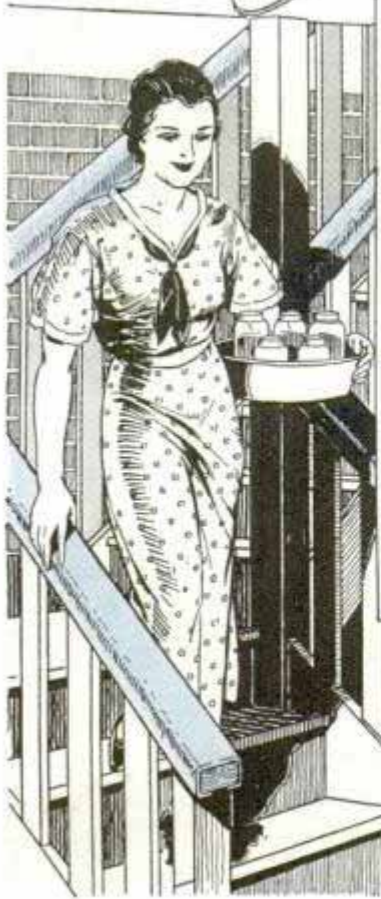

INNER TUBES FOR COVERING HAND RAILS

ENVELOPE CORNER



JANUARY

1	2	3	4	5	6
7	8	9	10	11	12
13	14	15	16	17	18
19	20	21	22	23	24
25	26	27	28	29	30
31					

For closing the crack between French doors and windows that connect to an unheated porch or have direct outside exposure, use strips of gummed sponge rubber. Both doors are then closed together. This material is also ideal to seal storm sash tightly

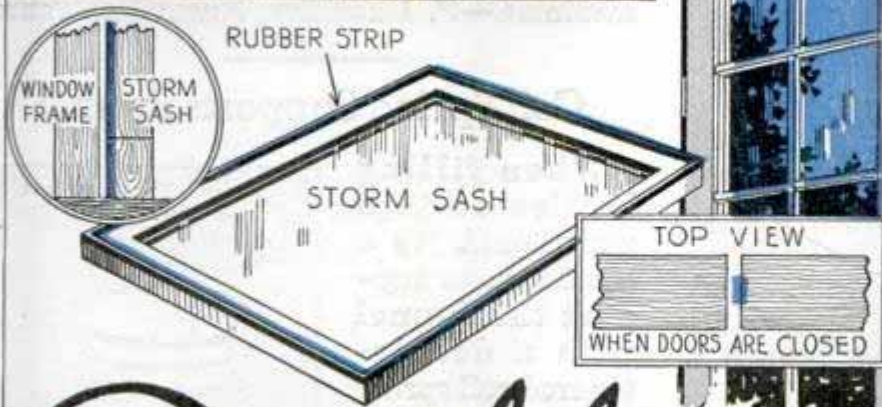

SPONGE-RUBBER STRIP



Problems

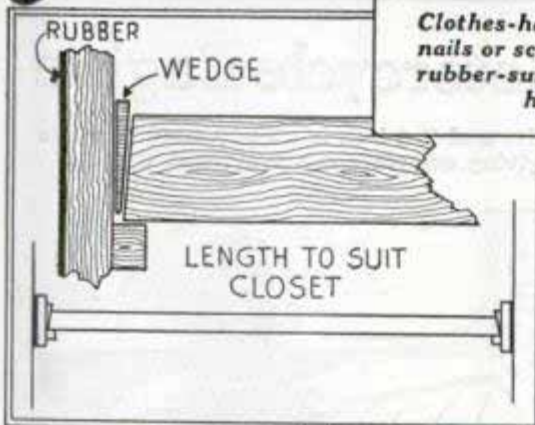

Clothes-hanger poles installed without nails or screws by wedging them between rubber-surfaced plates having cleats to help support the poles

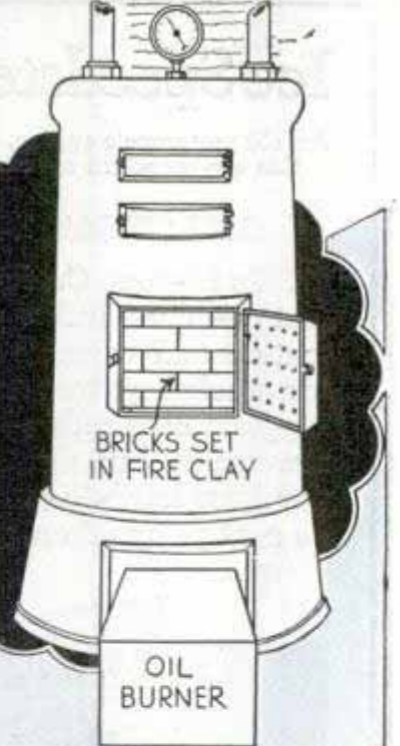
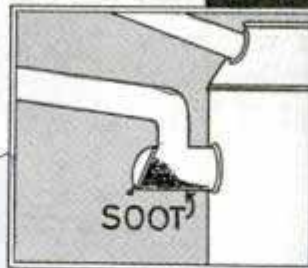
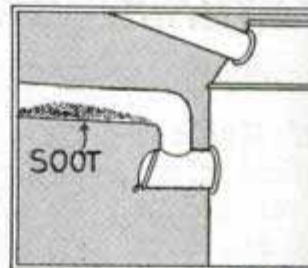

If you can't keep paint on the door of a furnace fired with a flash heat, erect a heat baffle of bricks just inside of the door frame, setting the bricks in fire clay. This keeps the door cooler and the paint won't burn off. The center detail shows how increasing the pitch of a furnace smoke flue, where coal is fired, will prevent soot from accumulating in the flue, which obstructs draft and accelerates corrosion. And, if you are troubled with chimney down drafts, make a sheet-metal hood—perhaps an old 5-gal. oil can will fit—and cut it as shown in the lower left detail. Air currents will be deflected upward and out of the top, drawing the smoke up with them

Plans on Drafting-Table Rack Are Easy to Read

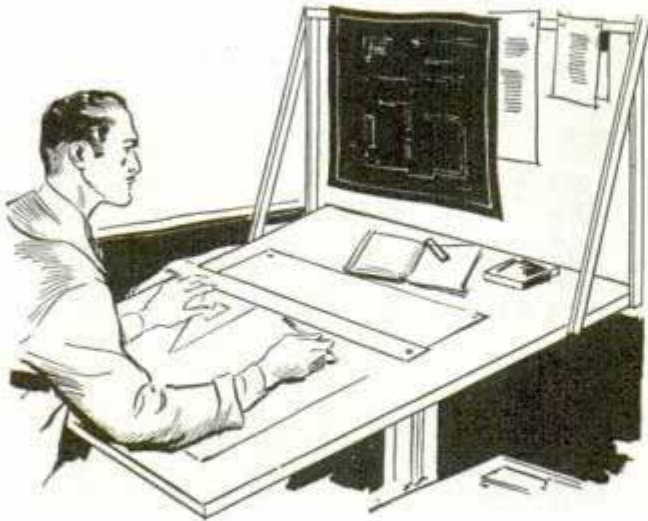

This rack holds blueprints and data sheets in front of the artist where they are easy to read

When copying details from architectural plans, and it is inconvenient to keep the latter on the drawing table, a wooden rack

rising from the rear edge of the table will support them so that they are easy to see. The rack can be made from four strips of wood and a dowel rod as shown. Tables of data and other material may be hung on the rack where they are instantly available.—P. Chandler, Nashville, Tenn.

Coil Spring Supports Funnel

When filling bottles or jugs with liquid, it's a good idea to support the funnel with a double-tapered coil spring from an old auto-seat cushion. This keeps the funnel from tipping and allows the escape of air.



Ice Speedster Driven by Motorcycle Engine

An old motorcycle engine, a few dollars worth of lumber, bolts and flat iron is all you need to make this air-propelled speedster. Send 25c for blueprint 785 giving complete constructional details.

1937 "WHAT TO MAKE"

This 96-page Craftsman's Guide is just crammed full of practical information and valuable reference data for workshop owners. It not only suggests hundreds of items that you can make, but also tells where to purchase hard-to-get supplies. Will be sent postpaid on receipt of 15c.



Air-Propelled Ice Boat

OTHER SPORTCRAFT

- 18-FT. ICE BOAT—774: Roomy cockpit seats four people. 14-ft. mast, main sail and jib. 25c.
- FRONT STEERING ICE BOAT—786: 13-ft. cockpit. Single sail on 18-ft. mast. Safe. 25c.
- COASTING TOBOGGAN—657: 7½ ft. long by 16 in. wide. Includes data on bending slats. 25c.
- 8-FT. BOBSLED—632: Auto-type steering gear. Runner supports made from pipe fittings. 25c.
- HOMEMADE SNOWSHOES—796 and 797: Prints show how to bend frames, and string rawhide. Two prints 50c.

POPULAR MECHANICS MAGAZINE

200 E. Ontario St., Chicago



SHOP NOTES

Drive Your HACKSAW *Electrically*

ANY ordinary hack-saw frame with the handle removed can be fitted to this simple drive unit, making an efficient power hack saw that will handle all kinds of light and medium work.

Fig. 1 shows side and end views of the table and gives you a general idea of the assembly. You don't have to be particular about the dimensions of the table. The main thing is rigidity and sufficient weight to absorb vibration of the reciprocating parts. A 1/4-hp. motor supplies the power through two sets of reducing pulleys, which brings the speed of the saw down to about 90 strokes per minute. The length of 3/4-in. shafting which

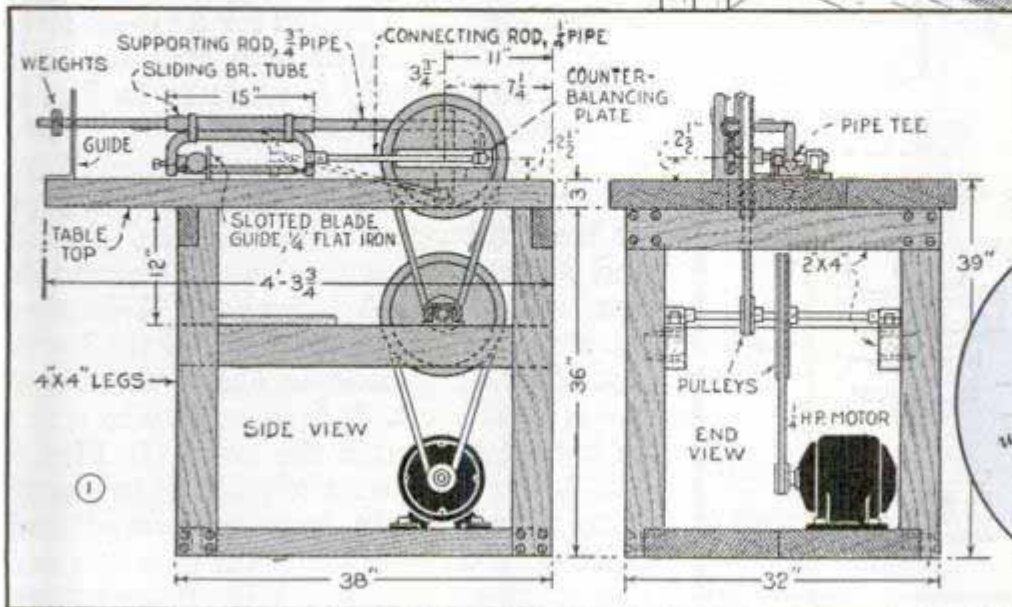
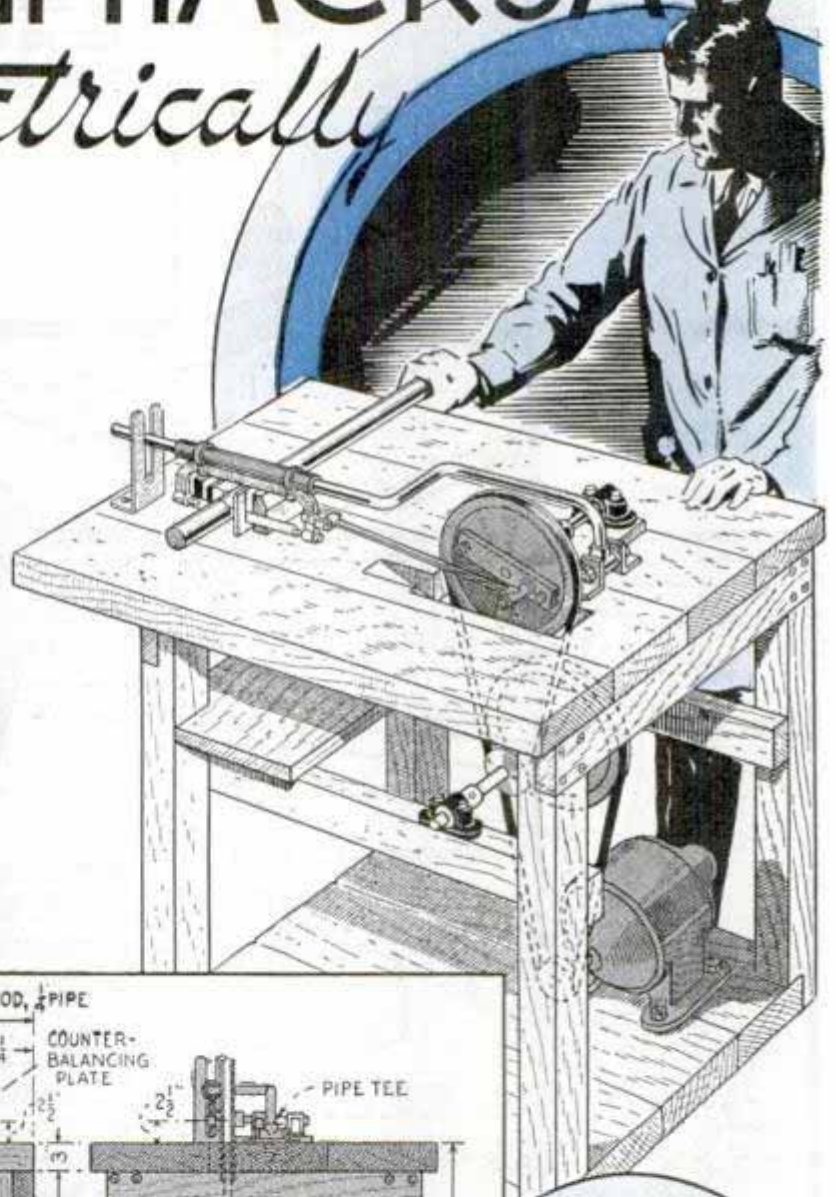

Any ordinary hand hacksaw can be used with this simple power drive. The saw frame is clamped to support arm, which is weighted.



supports the intermediate and top pulleys turns in sets of $\frac{3}{4}$ -in. babbitted split bearings. Note that setscrew collars are used on each shaft. One face of the top or driving pulley is fitted with a counterbalancing steel plate as in Figs. 2 and 3. The counterbalance is bolted to the pulley. Construction of the crankpin is shown in Fig. 3, the lower right detail. A section of $\frac{1}{2}$ -in. brass rod is threaded on both ends and screwed into a tapped hole in one end of the counterbalance and through the pulley. This crankpin is secured with a nut at the back of the pulley. A $\frac{1}{4}$ -in. pipe tee which has been reamed to fit

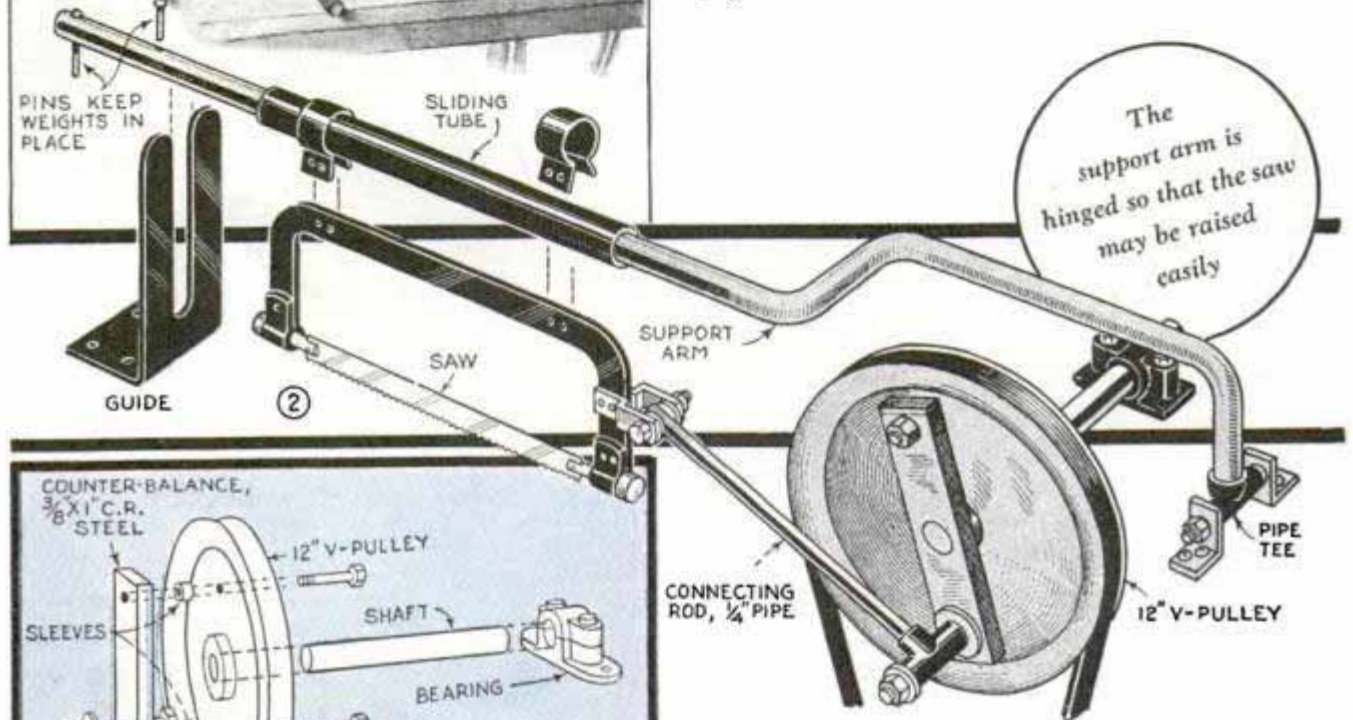

The support arm is hinged so that the saw may be raised easily

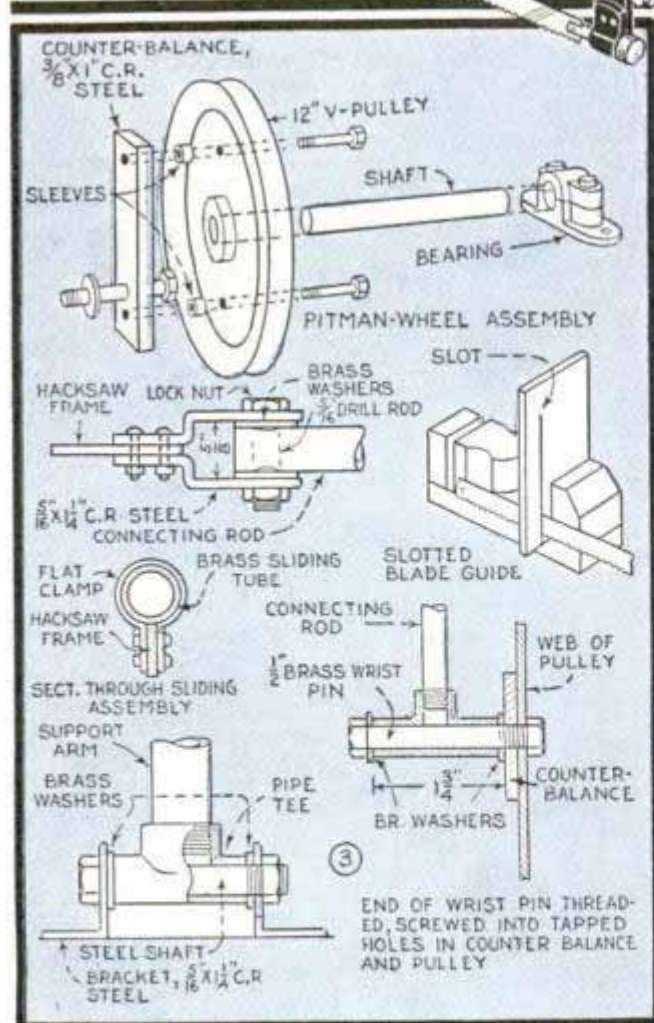

serves as a driver for the connecting rod which is made from a length of $\frac{1}{4}$ -in. standard pipe. The forward end of the connecting rod is drilled for a $\frac{5}{16}$ -in. steel wrist pin threaded at both ends for lock nuts. The assembly is made as in Fig. 3. To guide the hack saw in a straight path, it is necessary to make a supporting arm either of $\frac{3}{4}$ -in. inside diameter iron pipe or brass tubing of the same size. Figs. 2 and 3 show the method of fastening this arm to the table. A $\frac{1}{4}$ by $\frac{1}{4}$ by $\frac{3}{4}$ -in. pipe tee is used as the moving part of the bearing. The tee is reamed out to fit over a $\frac{1}{2}$ -in. steel shaft. It is necessary to make an S-shaped bend in the arm as in Figs. 2 and 3. The best way of making the bend is to fill the $\frac{3}{4}$ -in. pipe with sand and place caps on each end, heat to a dull red and bend carefully in a vise. Brass tubing

can be bent cold. The surface of the pipe which supports the hack-saw guide should be polished smooth. The slide is a length of brass tubing which will telescope over the polished section of the supporting arm. The hack-saw frame is fastened to the guide with the aid of clamps as in Fig. 2. These can be riveted to the saw frame or held with small bolts.

The pressure applied to the blade when cutting is regulated by weights on the outer end of the supporting arm as shown in Fig. 1. These weights can be made by drilling a hole in cold-rolled steel plate of such a size that the piece will slip easily over the pipe. Setscrews or pins can be

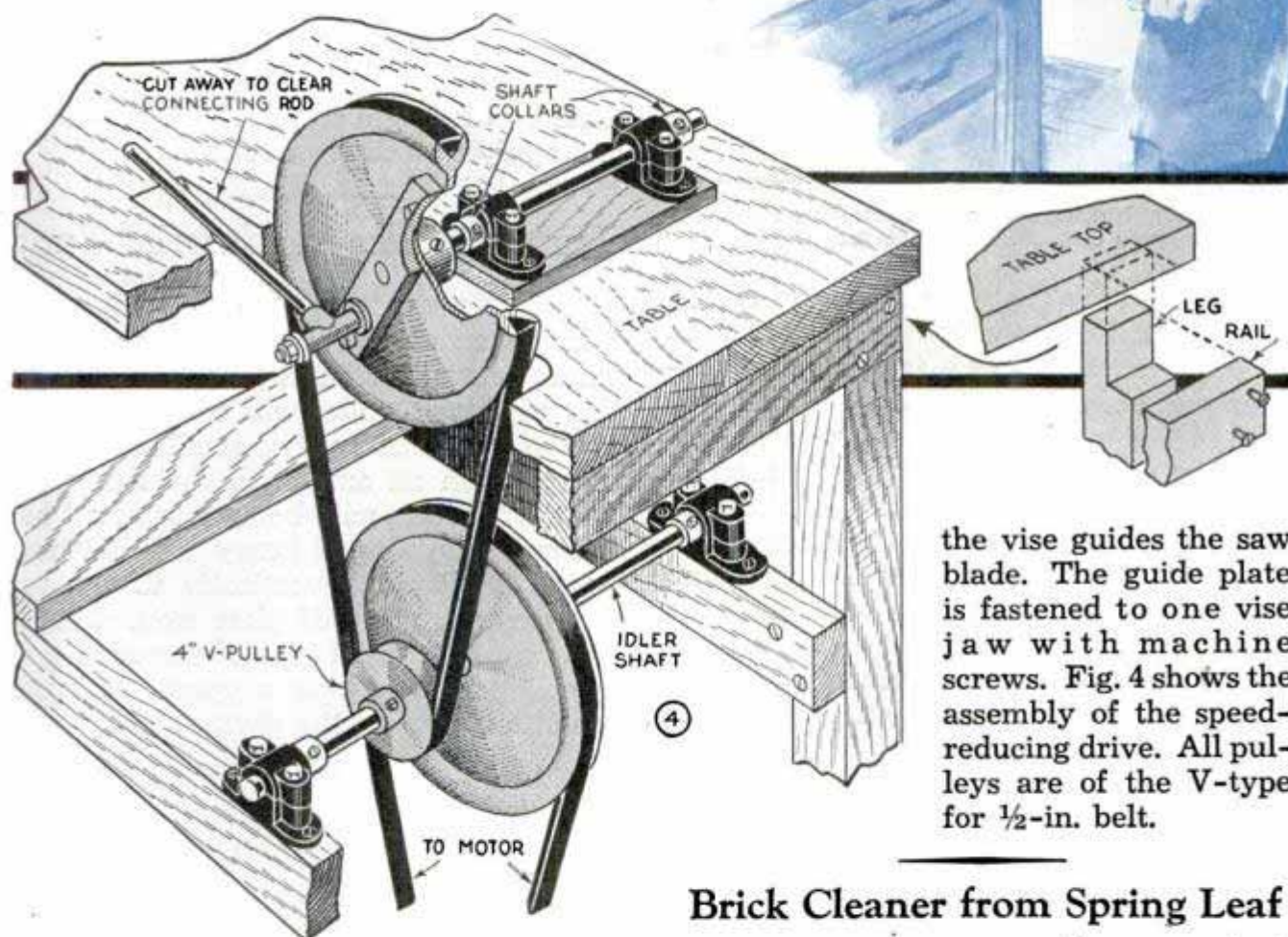

used to hold the weights in place. Different materials require slight variations in blade pressure for the best cutting action. The support-arm guide, Fig. 3, can be made from $\frac{1}{4}$ -in. flat iron, the slot being of the same width as the diameter of the pipe. If necessary, the guide should be blocked up on the bench, so that the arm will reach the bottom of the slot just as the saw breaks through the work.

A standard toolmakers' vise can be used to hold the work. A slotted plate fitted in

By filling the tubing with sand and plugging the ends you can bend it easily

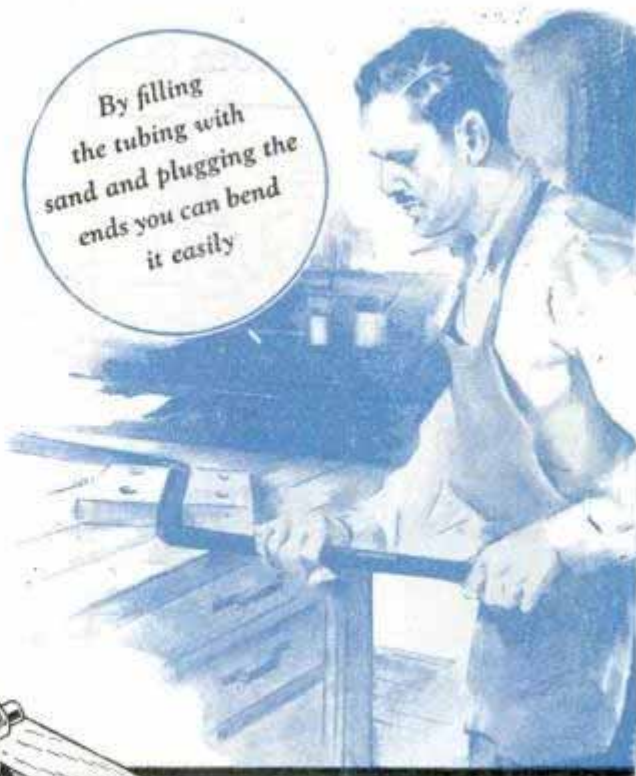

the vise guides the saw blade. The guide plate is fastened to one vise jaw with machine screws. Fig. 4 shows the assembly of the speed-reducing drive. All pulleys are of the V-type for $\frac{1}{2}$ -in. belt.

Brick Cleaner from Spring Leaf



Sharpened at opposite edges near one end, a short leaf taken from an old auto spring will provide a convenient tool for removing mortar from old bricks. Taping the unsharpened end provides a comfortable handle.

Window Display Is Operated by Shoppers from Street

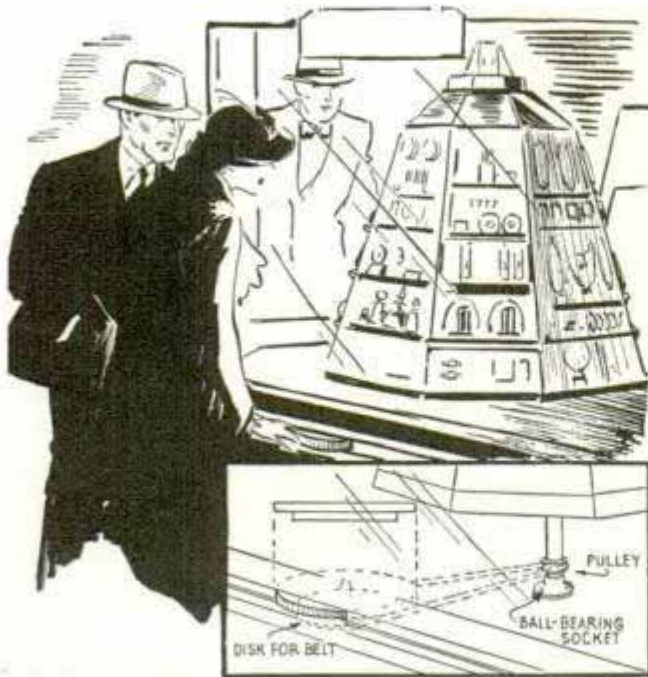

By turning a wood disk projecting from the wall, shoppers can rotate this window display

Operated by shoppers from the street, this pivoted cone, which displays articles in a show window of a jewelry store, attracts considerable attention. The lower end of the cone standard rests in a ball-bearing socket, and is belted to a wood disk set horizontally in the wall so that the edge projects within easy reach of the shoppers. A disk of smaller diameter than the one projecting from the wall, takes the belt and is screwed to the side of the larger one. The entire mechanism is hidden under the floor of the show window.

Making Emergency Check Valves

On a rush job of installing a compressed-air outfit where check valves for the air line were not available, some were

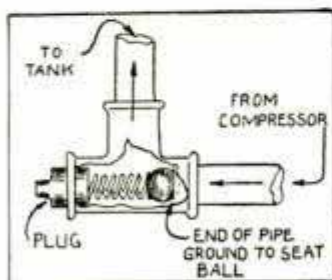

quickly assembled from pipe fittings, ball bearings and small coil springs. A wrought-iron tee served as the body of each valve. The end of the pipe against which the ball rests between strokes was ground to a perfect seat with a ball having a shank brazed on to it to fit a hand drill. A glue-

and-emery mixture was used for grinding. As the valves were made of $\frac{3}{8}$ -in. pipe, balls of $\frac{7}{16}$ -in. diameter were obtained for the checks. A length of spiral spring and a pipe plug completed the assembly.

Tightening Hairs of Art Brushes

Sign and show-card writers who use cheap brushes for some of their rough work, can keep the hairs from coming out by cementing them tightly inside the brush ferrule. This is done by drilling a small hole in the latter and applying a drop of collodion.



Handy Roller in Material Yard to Move Heavy Work

In material yards and other places where heavy pipe, shafts, etc., are handled, this adjustable roller will come in handy. The roller consists of two small car wheels mounted on an axle with the flanges to the outside, the axle being supported between two pieces of heavy channel iron, which are welded vertically to the top surface of a piece of plate iron. This is welded to the usual type of threaded post screwing into a pipe support. A large, round base makes the device stable.

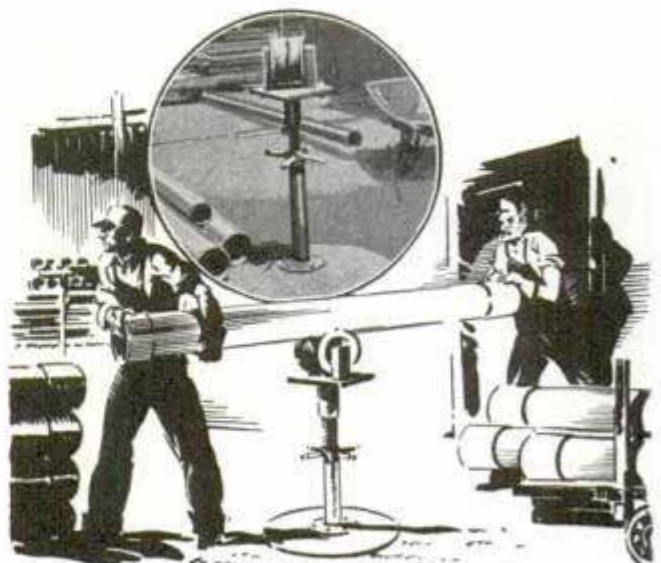

This roller is readily adjustable to any height to assist in piling or unloading heavy work

Flashing Window Sign Has No Moving Parts

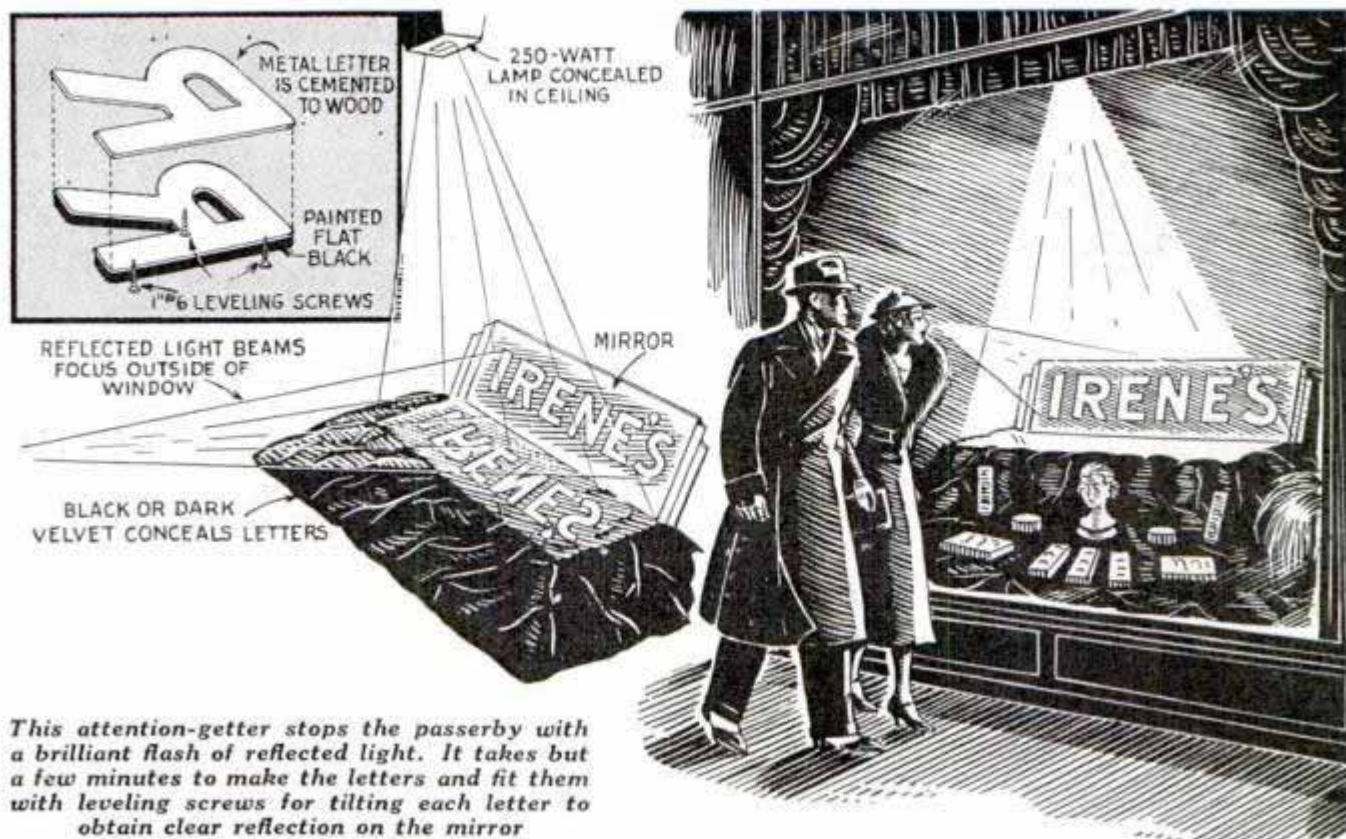

This attention-getter stops the passerby with a brilliant flash of reflected light. It takes but a few minutes to make the letters and fit them with leveling screws for tilting each letter to obtain clear reflection on the mirror.

Prospective customers will be sure to stop in front of your store to figure this one out. Large letters in reverse are jigsawed from hardwood, are faced with chrome-plated sheet metal and then each letter is fitted with three leveling screws. The letters, spelling your own name or that of some special product, are arranged on a base in the center of the window and

hidden from the street by folds of velvet. Back of this is placed a mirror. The light from a 250-watt bulb concealed in the ceiling shines on the letters which are placed so that the reflection is cast onto the mirror and from there to a point outside the window. The attention of the passerby is arrested by a brilliant flash of light from the letters.

Spiral Drain Cleaner with Ball Tip Feeds into Pipe Easily

If you have had difficulty in getting a spiral drain cleaner to feed into a drain pipe, the trouble was probably caused by the end of the cleaner catching on the edges of the pipe at the joints. This trouble can be eliminated quite easily by drilling and tapping a $\frac{1}{2}$ -in. hole in a brass ball so that the end of the cleaner can be screwed into it and then soldered. The ball will offer a smooth, rounded point so that the cleaner can be inserted easily regardless of turns and angles of the drain.

☞ If an electric radiant heater is focused on work to be put together with hot glue, the heat will prevent the glue from chilling quickly and allow slow, careful joining.

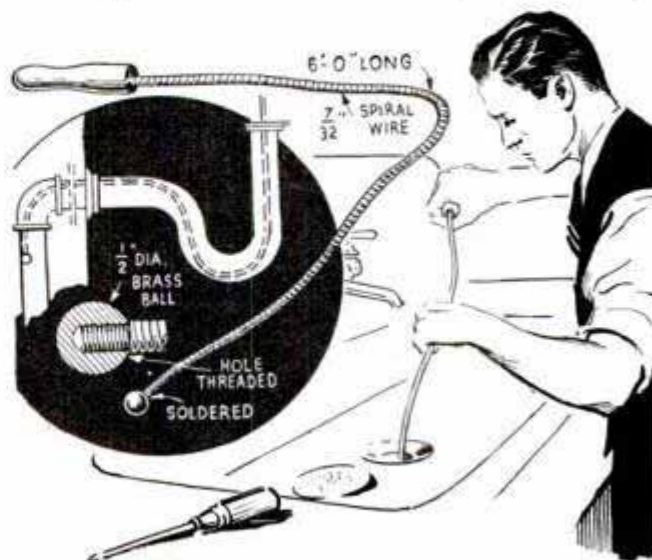

Your spiral drain cleaner won't catch on pipe walls when a ball is put on the end

Try These

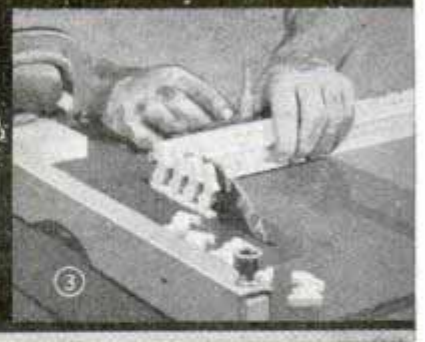
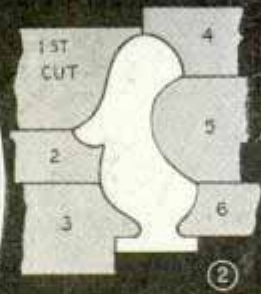
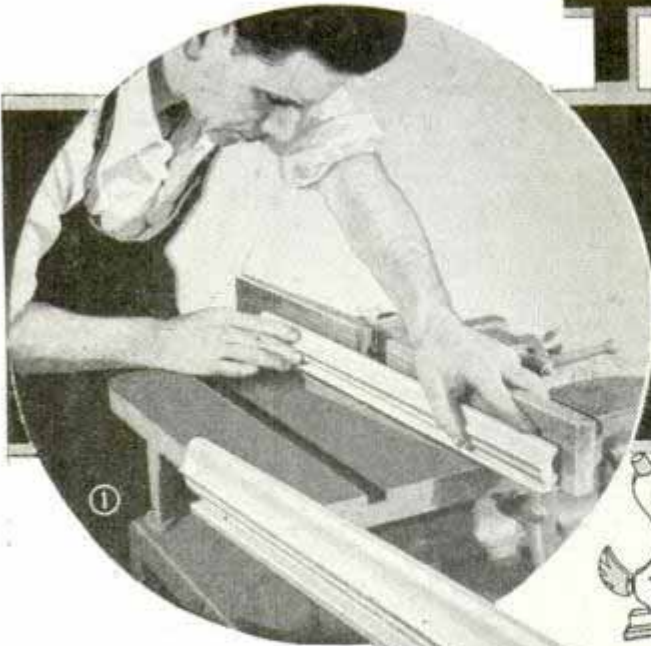

THERE are many workshop operations that can be accomplished conveniently on a shaper. A typical example is the making of small cutout figures for toys and novelties, a sample figure being the duck shown in Fig. 4. This novelty is worked on the shaper in a long strip, as in Fig. 1, blank knives being ground to the prop-

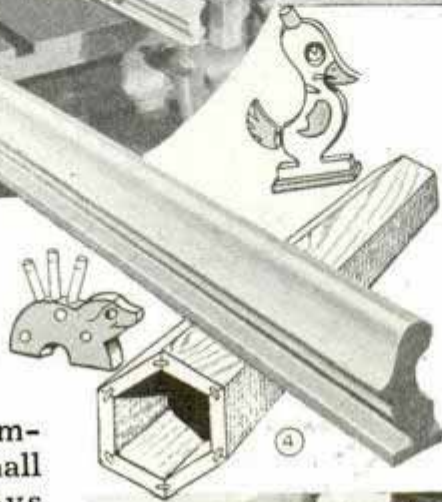

er contour to make the cut, as in Fig. 2. However, very good results can be obtained with standard knife shapes, the figure used in the example being cut in ten passes, using six standard shaper knives. After shaping, you saw off the pieces to the required thickness, as in Fig. 3. Figures up to about 6 in. square can be worked readily in this manner.

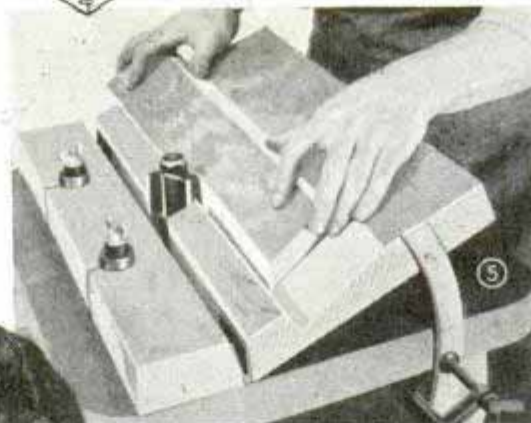

Using a straight knife and the simple bevel jig shown in Fig. 5, any form of column work can be done easily on a shaper. The jig consists of a fixed base which is slotted to permit fastening to the table studs. The movable portion is hinged to the base, and fitted with an index arm so that it can be clamped at any angle. While the cut shown is simply a straight bevel, tongue-and-groove work can be done by using the proper cutters.

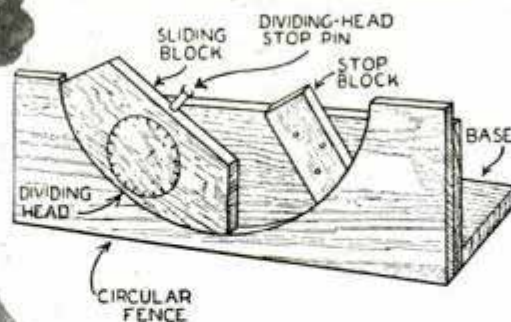
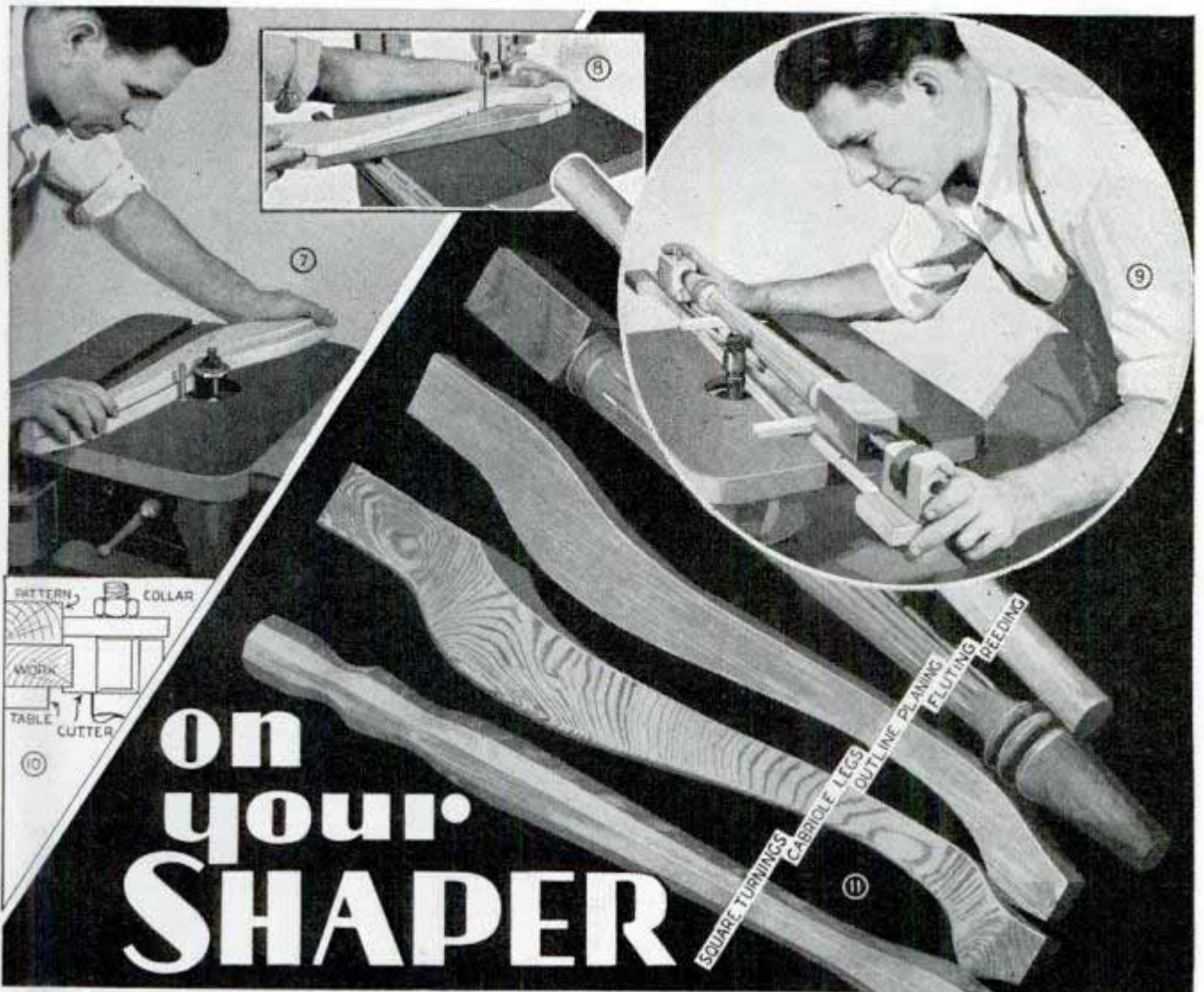

Fig. 6 shows a radial rosette and also pictures the shaper operation and the dividing head. The jig consists of a circular fence fitted onto a suitable base. On the fence is a sliding block, and housed in the sliding block is a simple dividing head. In operation, the work is fastened to the dividing head, and successive radial cuts



at the various settings are made. You use a reeding cutter on the spindle for this work.

The shaper is also adapted to the fashioning of a variety of furniture legs, as in Figs. 8 to 11. One of the most popular is the cut-out leg, made from flat stock. A pattern of this leg is first made up and carefully sanded. This pattern is then bradded to the wood stock and the surplus lumber cut away on a band saw, as in Fig. 8. Now, with a straight cutter on the shaper spindle and a collar of the same diameter as the cutter to ride the pattern, the rough-sawed work can be shaped quickly to a perfectly smooth-edged duplicate of the pattern, as shown in Fig. 7. The edge requires no sanding.

Fluting, reeding and chamfering are done with a simple fluting jig, as in Figs. 9 and 12. In use, the work is centered in the jig, and a form of the same contour as

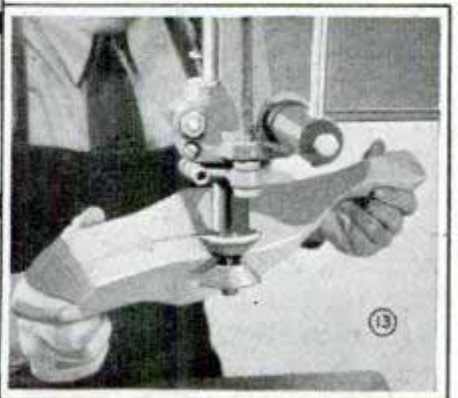
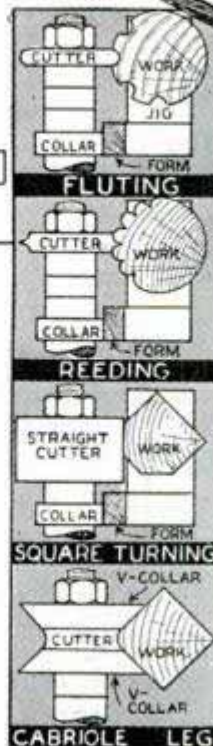
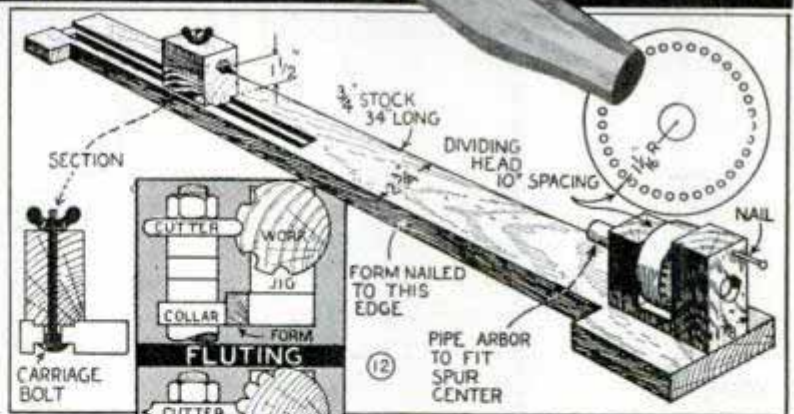

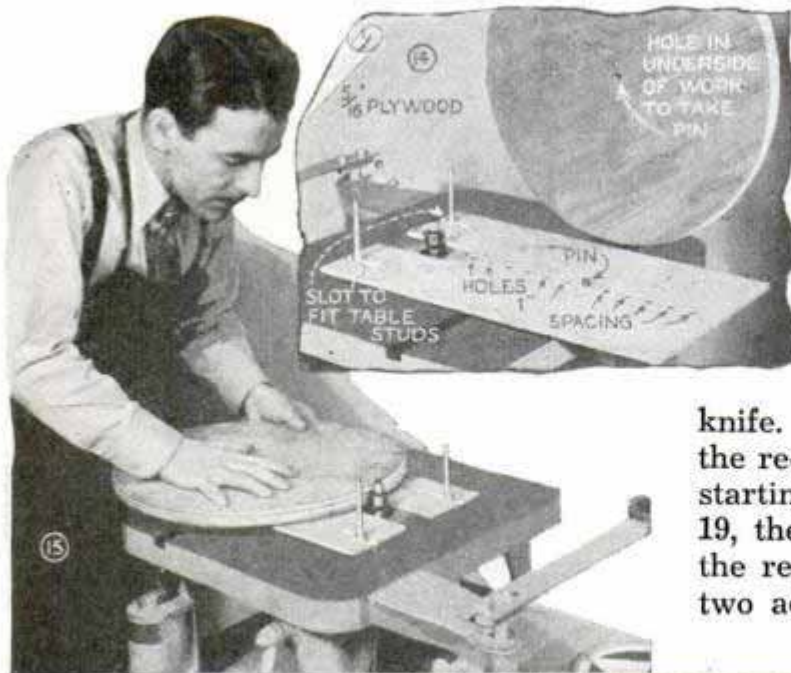

the leg is bradded to the edge of the base. A shaper collar rides on the form, adjustments being made to give the proper depth of cut. The dividing head spaces the cuts accurately.

Referring back to the paragraph on outline planing, you will see that the compound cutting of a cabriole leg can be done quite well on the shaper by mounting the leg in the fluting jig and using a suitable pattern. Fig. 13 and the detail at the left show another cabriole leg operation—the rounding of the outer corner. This is done by using hardwood V-collars on either side of the cutter, and feeding the work freehand as in Fig. 13 where the cutter is mounted on the drill press. A standard shaper operation with a simple jig is the molding of circular work, as in Figs. 14 and 15. With this jig, the work need only be roughly sawed to shape, after which it can be mounted at the required position on the jig and swung into the cutter from the fixed pivot point. Another shaper job is routing, as shown in Figs. 16 and 17. The general practice is the same as in the familiar drill-press method of routing, except that the pattern is above the work. This is an advantage in routing intricate

work, making it unnecessary to “feel” for the opening as is required when routing is done on the drill press with the pattern below the work.

One of the most useful standard operations which can be done on the shaper is taper jointing. A straight knife is placed on the spindle, and the rear fence is set even with the cutting circle of the knife. The front fence is then set back the required amount of taper, and, from a starting position, as shown in Figs. 18 and 19, the work is pushed through to make the required taper cut. This method has two advantages over the similar method of cutting tapers on the jointer. The fence extension can be fitted more easily, and cuts up to 1 in. taper can be made with one pass.

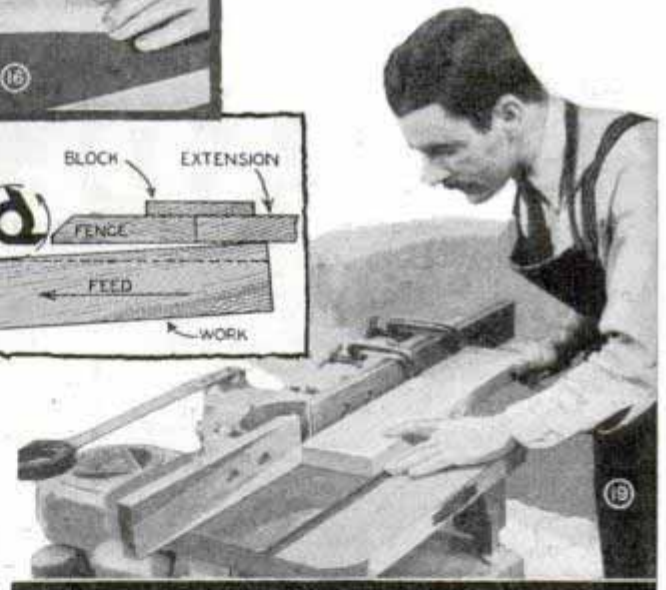
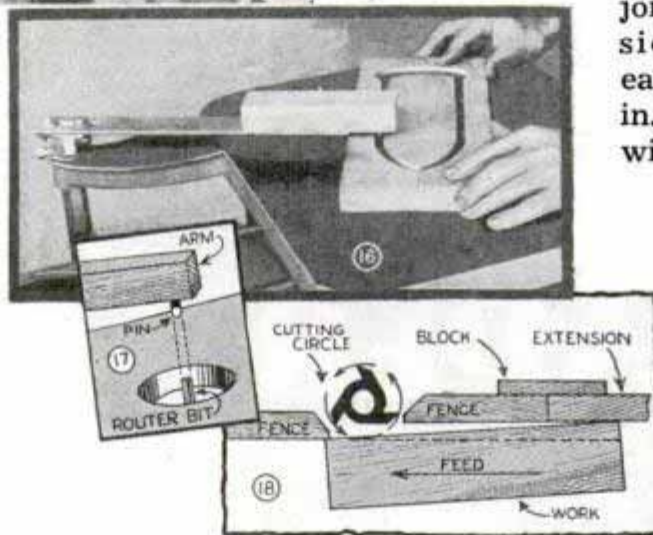

Hasp Held Flat by Turnbutton

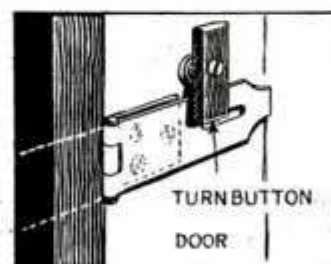

After catching my clothing on a swinging lock hasp on a storeroom door, I installed a wood turnbutton above the hasp as shown, so that it could be folded

back and held out of the way. Washers were used to space the button from the door so it could be turned over the hasp.

—Edward Hartel, Jamaica Plain, Mass.

Clips Keep Blueprints Clean

To avoid soiling blueprints in a shop where they had to be picked up frequently with dirty hands, one foreman made a number of simple spring clamps to slip over the corners to serve as finger grips for the workmen. Each clamp was made by cutting a piece from a window-shade roller containing four coils, which were opened between the second and third coil and bent to the shape

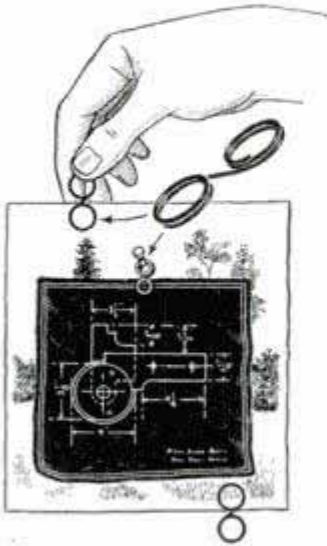

shown. The edge of the blueprint then slips easily between the two coils of either end, yet they grip the paper firmly.

The edge of the blueprint then slips easily between the two coils of either end, yet they grip the paper firmly.

Sign Writer Uses Spring Spreader to Hold Cloth Taut

Draftsmen and other artists who do much hand lettering on cloth or paper are often inconvenienced by having the fabric buckle at that point. Although it is customary to spread the fabric smoothly with the finger and thumb of the left hand, while the right hand operates the pen, perspiration marks may remain to leave the drawing messy, if not soiled. To eliminate this trouble, get a length of spring wire and loop the ends around two rubber erasers, which are usually purchased with automatic pencils. Bend the wire in the center so that the double point, or bend, may be inserted into a small hole drilled in the end of any convenient wooden handle. In use, the rubber tips of the device are placed upon the fabric, over the portion upon which the lettering is to be done. Pressure applied will spread the rubber tips and smooth the surface of the cloth.

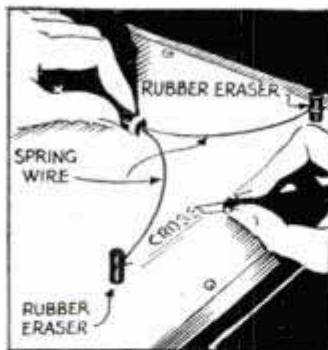

Pressure applied will spread the rubber tips and smooth the surface of the cloth.

Building Construction Speeded with Canvas Hoisting Bags



False canvas bottoms on wheelbarrows hold sand to be hoisted without delaying workmen

To eliminate much of the labor and time ordinarily consumed in transporting sand and similar materials to the upper floors of a building in the course of construction or repairs, one contractor uses a number of canvas squares, which are provided with steel rings securely attached to the four corners. In use, the workman spreads one of these squares over the bottom of his wheelbarrow, fills it with sand and wheels it to the hoisting rope. The rings of the canvas are drawn together and slipped over the hoist hook.

Soldering-Iron Handle Kept Cool by Small Turnbuckle

One tinsmith cuts the shaft of his soldering irons, threads the severed ends and screws them firmly into small turnbuckles, such as commonly used for tightening bucksaws. He

claims that the turnbuckles prevent the shafts from becoming hot enough to burn the handles of the irons.

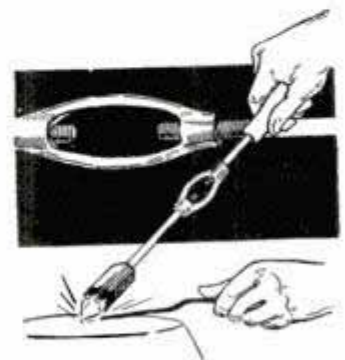

Trackwalker's Grease Bucket Supported on Legs



Legs keep trackwalker's grease bucket level when it must be set on inclined roadbed

One trackwalker whose job is to lubricate switches and the rails at cross-overs has his grease bucket fitted with folding legs. These are pointed so that they are easily pushed into the ground to hold the bucket level when it must be set on an incline. Also, the legs hold the bucket at a height within easy reach of the worker. When not in use, the legs are folded up against the side of the bucket where they are held by a wire ring as shown.

Typewriter Ruler Saves Time

Typed on a strip of heavy paper, this simple ruler was found very handy by one stenographer. It is useful in taking true copies of material already typed in which the copies must be the same as the original in headings, margins, spacing of paragraphs, etc.

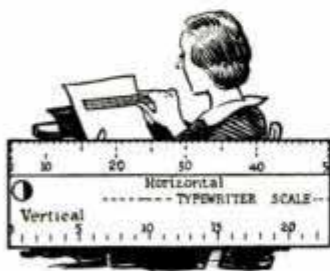

It is a simple matter to center lines, determine margins and the number of spaces indented for paragraphs, as the ruler reads

the same as the scale on the typewriter. The vertical lines give the number of spaces to be turned on the platen. Also, the ruler is handy for filling in blanks on report forms as you can determine how many letters can be placed in each blank and how numbers or other information must be crowded in order to get them in one blank space.—A. Dakon, Weeping Water, Nebr.

Jeweler Winds Watches on Desk

Jewelers and watch repairmen who have several watches to wind daily will find that a strip of rubber cemented to the top of a desk or counter at the edge simplifies the work. To wind a watch, the stem is passed over the rubber with enough pressure to cause it to turn. Very little practice is needed to determine when the watch is wound sufficiently.

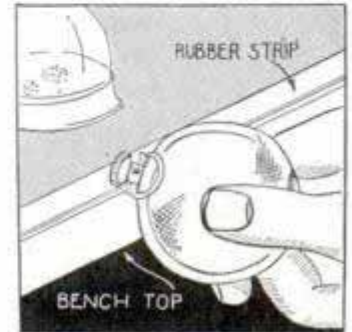

Putty Kept Soft in Winter by Heated Brick

When a number of broken windowpanes are to be replaced in cold weather, and it is inconvenient to bring the sash to the shop, the putty may be kept warm and soft by putting it on a heated brick. This should be wrapped in oilpaper, which will prevent the putty from sticking.



Glazier keeps putty soft on cold days with the aid of a heated brick

This Emery-Belt Polisher Saves Hand Work

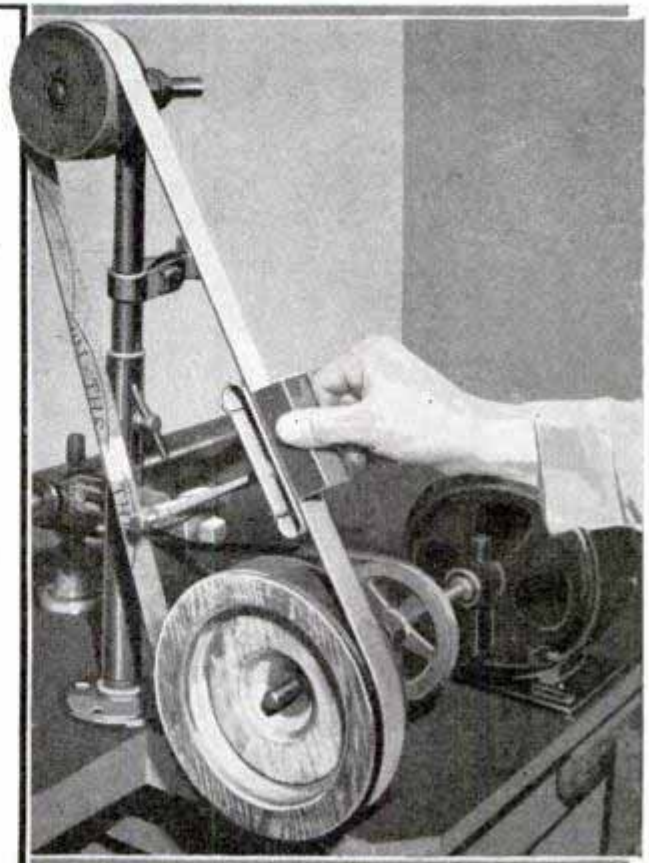
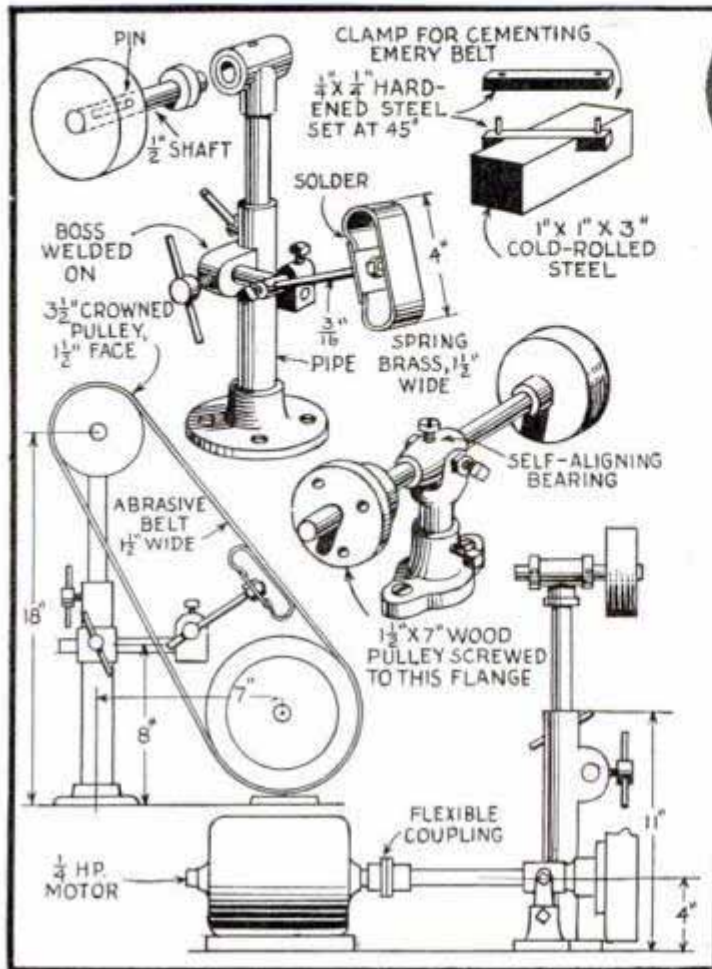

It's no trick to get a fine, uniform polish on metal with this machine, which also serves as a light grinder

This belt polisher does many jobs which cannot be handled accurately on a buffer, or by hand, and a spring plate against which the work is pressed, with the belt between, assures an even polishing all over. Emery belts for the polisher are easily made with the aid of the belt-cementing clamp shown. The ends of emery cloth are cut off at a 45° angle, belt cement applied, the ends lapped 1/4 in., and placed in the clamp, which is set in a vise. The pressure thus applied almost "welds" the ends of the belt together, forcing the grit into the fabric. As shown in the drawing, the various parts require little machine work, pulleys being of wood and the standard of pipe. The universal arm, which supports the spring plate, is made of cold-rolled steel with bosses welded on, and set screws located where required. The spring plate itself consists of a strip of spring brass bent as shown and soldered to a steel piece to which the extension arm is bolted. By the use of a self-aligning bearing, purchased for a small sum, and a coupling or universal to the armature

shaft of the motor, the polisher can be driven direct. If a belt drive is desired, two bearings should be used on the driven shaft to keep it in alinement.

Ear Muffs Fastened to Sun Glasses



If you attach ear muffs to your sun glasses, you will have a good combination for bright, wintry days. Just make a tiny opening in the cloth covering of each muff to take the temples of the glasses and sew them in. Worn in this manner, the temples are removed from behind the ears so that pressure from the muffs does not cause pain if worn for several hours at a time.

behind the ears so that pressure from the muffs does not cause pain if worn for several hours at a time.

Auto Motor Runs

by C.A. Crowley

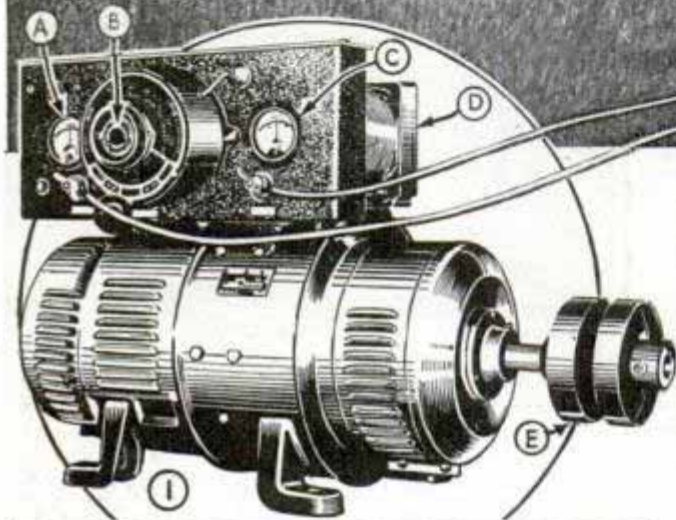
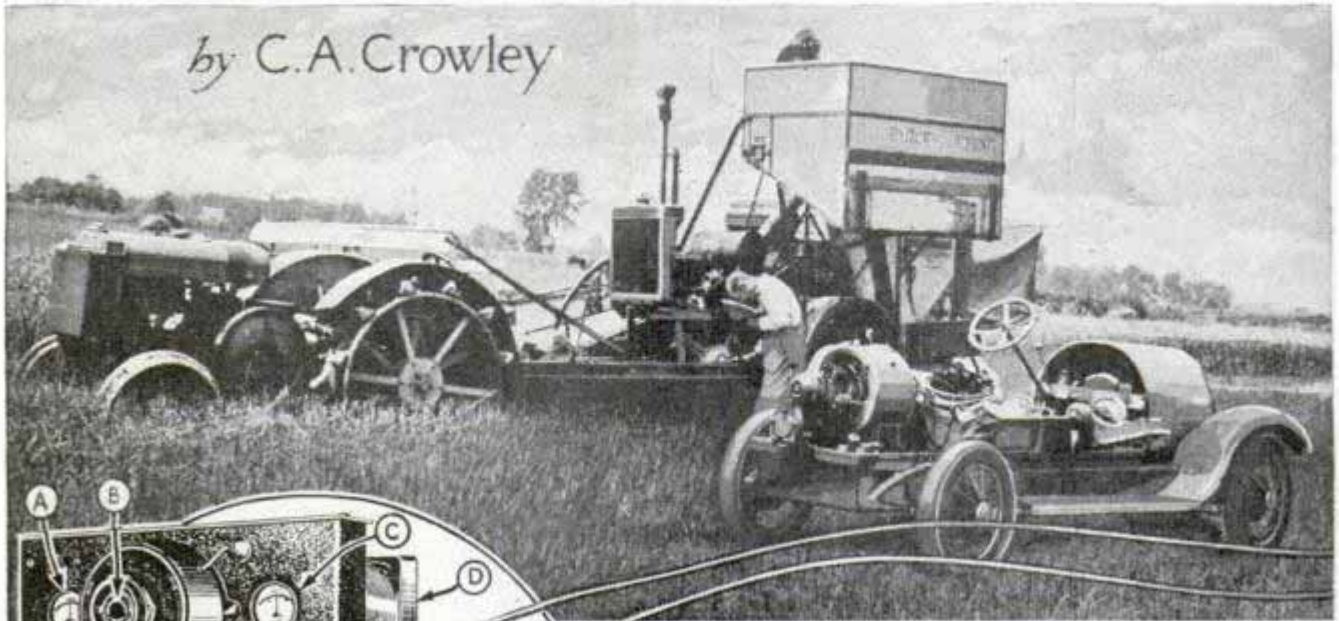

TYPICAL ARC-WELDING GENERATOR

(A) AMMETER (B) FIELD RHEOSTAT CONTROL (C) VOLTMETER
(D) ARC CONTROLLING REACTOR (E) COUPLED TO GAS ENGINE

IF YOU are interested in an electric-arc welding business, there is nothing like a portable outfit with the welding generator driven by an old auto motor. You can tow it directly to the job and do the welding in less time than a customer could dismantle his machine and bring the broken part to your shop, thus saving him costly time delays. Outfits of this type will handle almost any job, including the welding of steel, cast iron, stainless steel, manganese steels, aluminum, copper and numerous other alloys in common use. The same equipment may also be used for carbon arc welding and for cutting steel and cast iron. While there are various types of portable outfits, including the type where the motor is used both as motive power and to drive the generator, the simplest and most practical is the trailer type with

the motor coupled directly to the generator, one of which is pictured in Fig. 2.

The generators used in electric-arc welders are of special design and construction to meet the exacting requirements imposed by welding. It is, therefore, not practical to rebuild generators which were originally designed for other purposes. It should also be noted that automobile generators and starters cannot be converted into satisfactory welding machines. There are many welding generators on the market which can be purchased for a nominal sum, one of which is shown in Fig. 1. First, determine the size needed. The table in Fig. 3 gives four standard sizes of welding generators and the horsepower rating of the motors which should be used as a drive. For ordinary repair work, including auto and farm-machinery repairing, a 200-amp. generator will be satisfactory. However, if you feel that a generator of a larger capacity might be needed, then the 300-amp. unit should be selected.

In order to make clear the highly specialized design of welding generators, an exploded view of a popular type is given in Fig. 4, together with a wiring diagram indicating the internal circuit connections for both generator and controlling devices in Fig. 5. You will notice that the generator really consists of two generators. The small one is the exciter, and its purpose is to generate the voltage which is

ARC WELDER

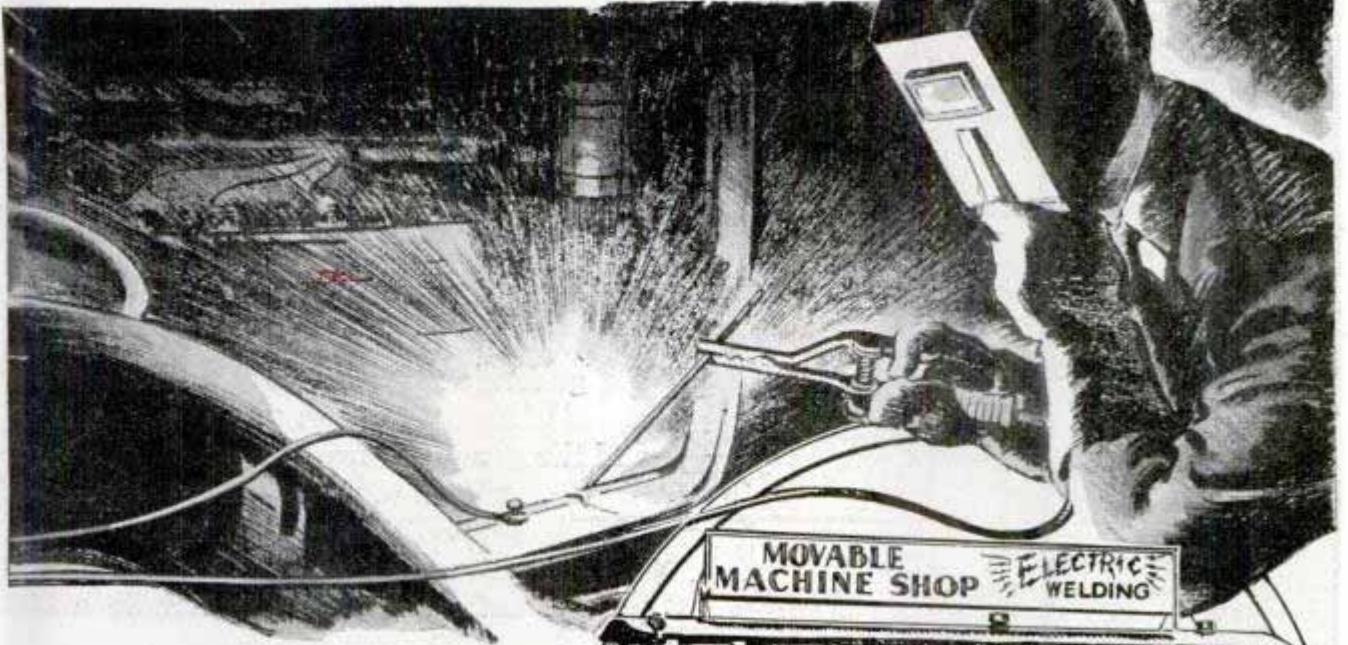

applied to the second or welding-current generator to regulate the output. The welding generator proper is constructed with split-pole field coils in addition to the regular field coils. The field rheostat is used to control the voltage and amperage across the arc.

Having obtained the generator, the trailer is next. Almost any standard chassis will do, and very little alteration is necessary. Two

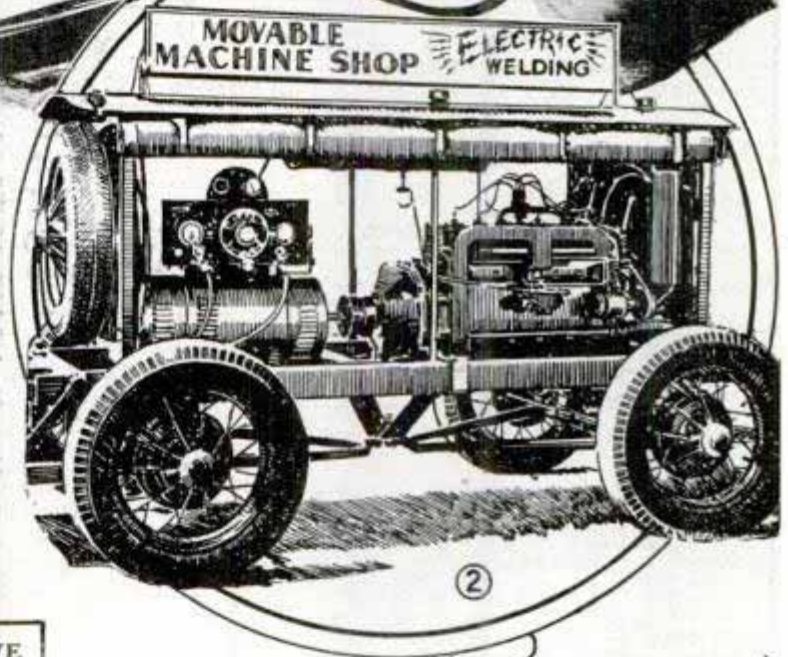

SIZE OF ENGINES REQUIRED TO DRIVE WELDING GENERATORS

Welding-Current Range	Horsepower Rating of Gasoline Engine Required
30 to 200 amp.	20 HP.
40 to 300 amp.	25 HP.
50 to 400 amp.	35 HP.
60 to 600 amp.	60 HP.

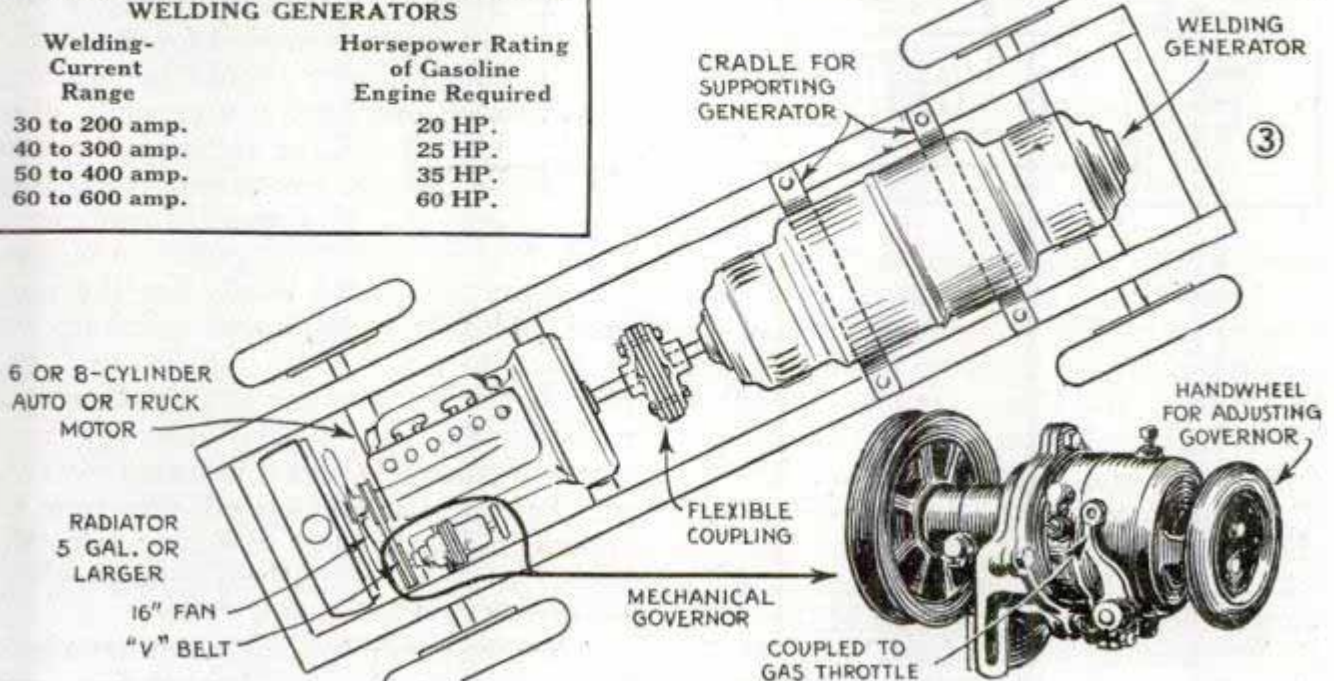

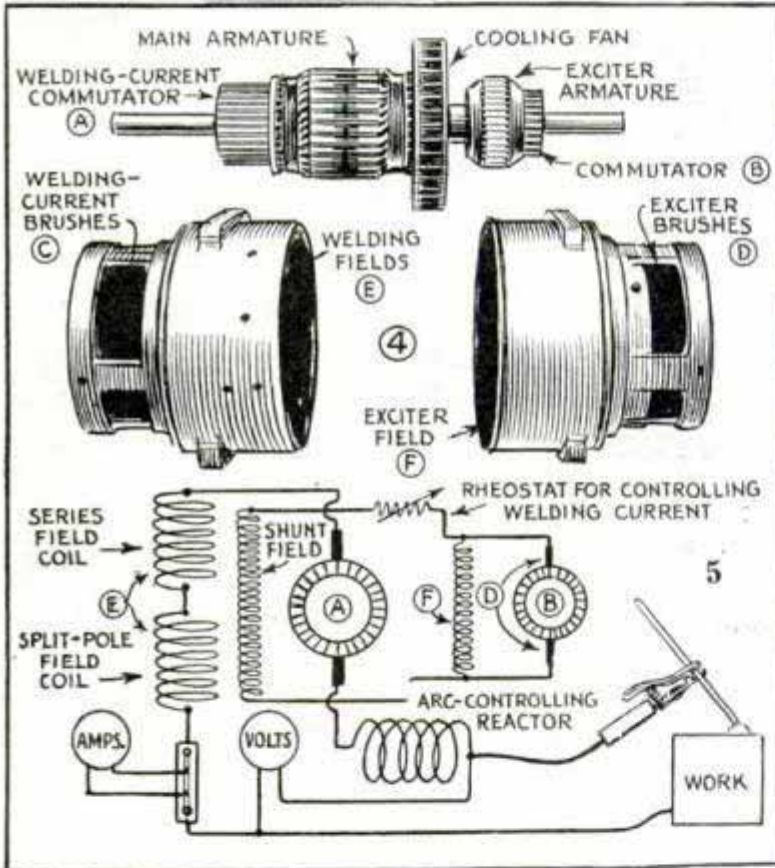

front-wheel assemblies are frequently used and heavy steel cross members are riveted across the frame for mounting the generator. These must be strong enough to eliminate vibration as much as possible. Mountings for both a belt drive and a direct drive are given in Figs. 7 and 8. Figs. 3 and 6 show the hook-ups and Fig. 9 shows a completed job. Note that the transmission has been removed from the motor, thus exposing the end of the drive shaft extending from the flywheel. On this end of the shaft a flexible coupling is in-

stalled, the motor side of the coupling being bored out to a diameter to fit the shaft. Couplings of this type may be obtained already bored out so that one half of the unit will fit the shaft of the generator and the other half cast in blank for drilling to suit. If you have access to a lathe, it is a simple matter to center up the motor half of the coupling and drill it to a size corresponding with that of the flywheel shaft. If it is inconvenient to couple the generator directly to the shaft of the motor with a flexible coupling, it can be driven with a belt from the motor shaft. In this case, the generator is supported on top of the chassis frame and both the flywheel shaft and the generator are equipped with 6-in. pulleys of the standard steel-core type. These pulleys and a belt of corresponding width will transmit sufficient power to handle a 200 or 300-amp. generator.

Selection of a motor to drive the generator requires a little more care, however, as the success of your venture depends largely on it. Any 6 or 8-cylinder motor of the popular cars will deliver enough power to operate a 200 or 300-amp. generator. Lack of smoothness in the running of 4-cylinder motors makes them less satisfactory for the purpose. Having obtained the motor, it should be overhauled and put in good condition to operate at maximum efficiency. Only a few changes are needed for the motor. The radiator should be replaced with one having a capacity of at least 5 gal., as stationary operation of the motor may cause it to overheat if a smaller radiator is

used. Secondhand truck radiators in good condition, will serve nicely for the purpose. Also, it is advisable to equip the motor with a fan at least 16 in. in diameter. To hold the motor at a steady speed, a governor will be needed. This, of course, can be homemade, but it is usually best to purchase a variable-speed governor as shown in Fig. 3. For ordinary jobs, the governor is set so that the generator will be driven at 1,500 r.p.m.

After the generator and motor have been assembled on the trailer chassis, and

standard-type welding cables, an electrode holder and a ground clamp have been installed, the unit is ready for service. Figs. 10 and 11 show the final connections. In addition, a frame should be constructed over the entire assembly so that a removable canvas or other covering may be placed over the unit to protect it against rain as in Fig. 9. In no case should the welding generator be allowed to become damp as this would short circuit the windings and render it unfit for further service until dried out. Welders should never be operated with the motor and generator covered as a considerable amount of heat is generated in both.

When the unit has been assembled completely, the owner should give close attention to the practice of welding in order to gain the skill required of an efficient welder. The accessory equipment should include a welding shield or helmet, equipped with a window of special glass capable of filtering out ultraviolet light, which is injurious to the eyes.

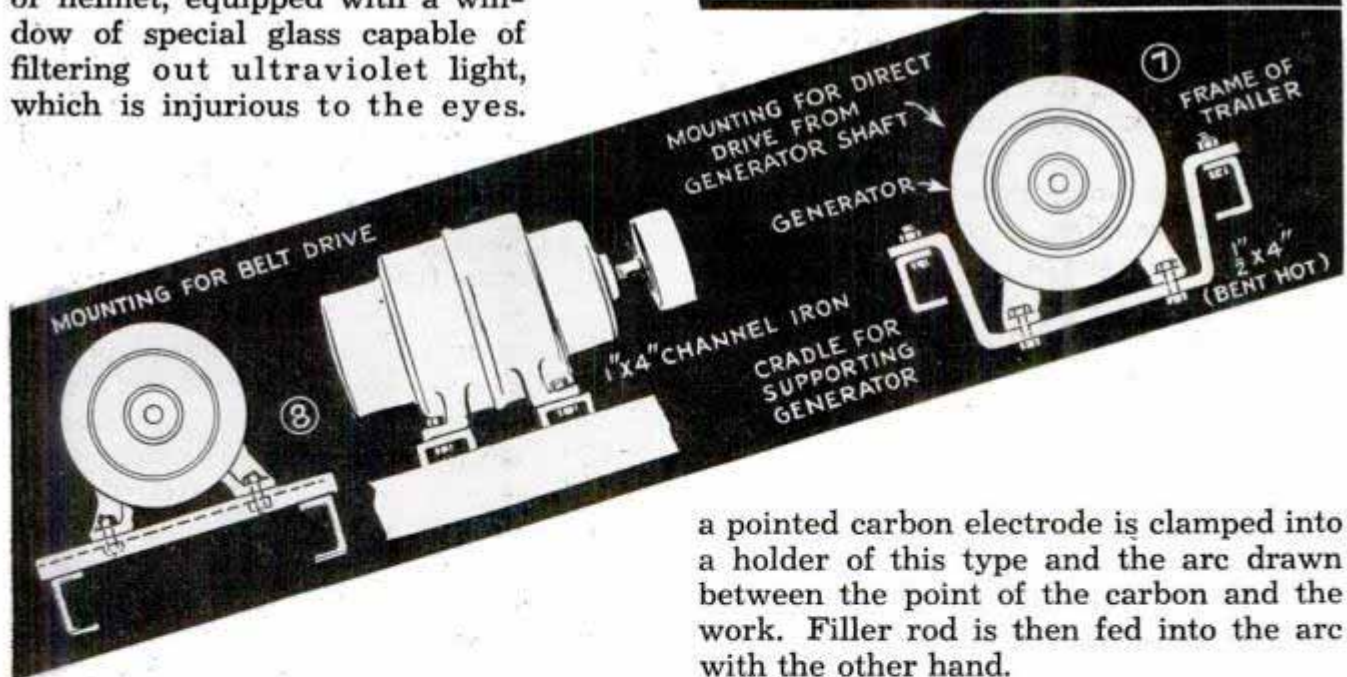
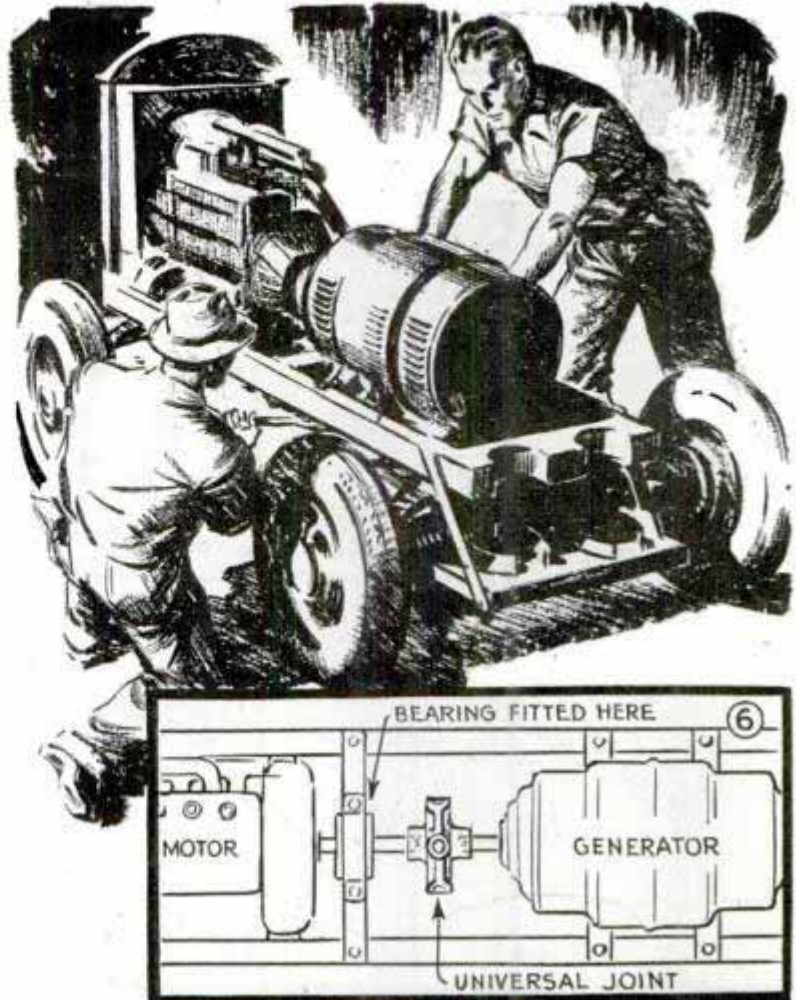

Gloves, jackets and other clothing which will prevent sparks from getting into contact with the body and causing burns should also be provided.

An electrode holder of the type shown in Fig. 10 is used for all-around work with metal electrodes. For carbon-electrode work, a holder of the type shown in Fig. 11 will be needed. In carbon-arc welding,

a pointed carbon electrode is clamped into a holder of this type and the arc drawn between the point of the carbon and the work. Filler rod is then fed into the arc with the other hand.

Special welding cables are used to connect the various types of electrode holders and ground clamps to the welding machine. These cables should be of the type made particularly for electric arc welding and should be large enough to carry the maximum current developed by the machine. The cable leading from the generator to the electrode holder should be 30 ft. long and should be equipped with a heavy

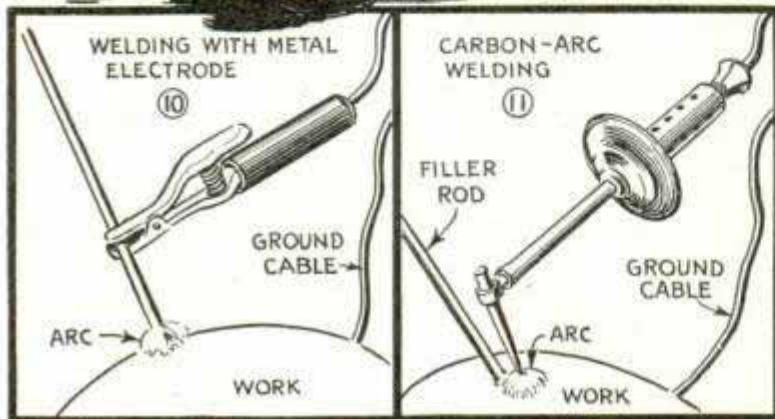
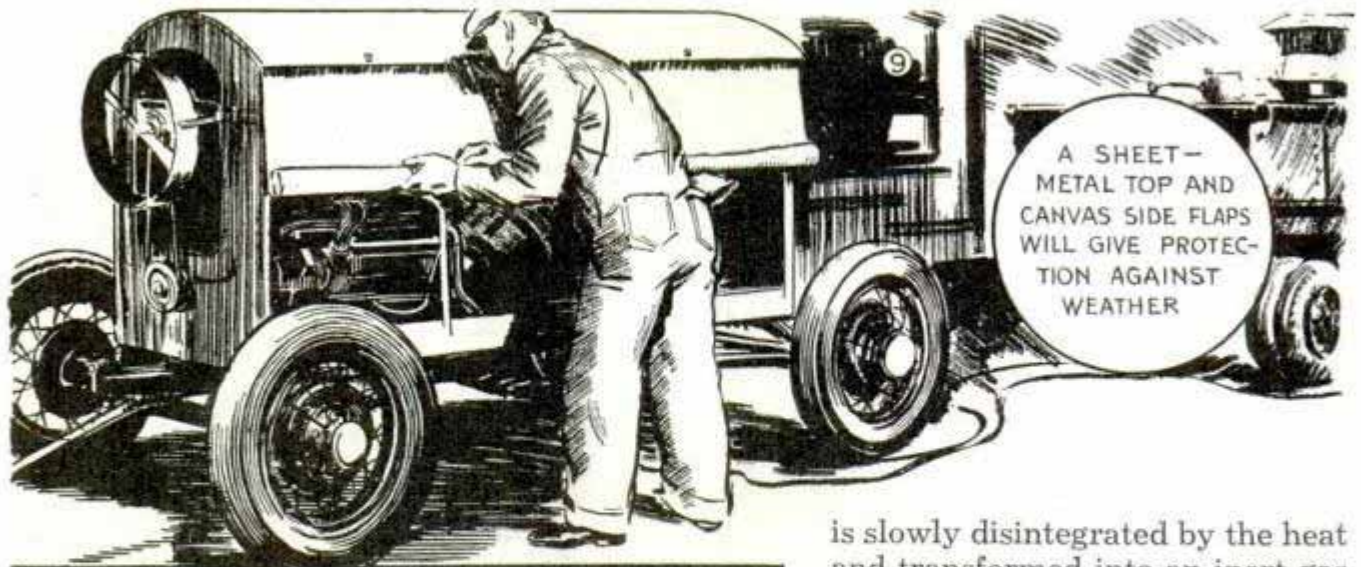

lug for connection to the generator as well as with a standard type of ground clamp. A stiff brush for removing scale and corrosion before welding, Fig. 12, should be a part of the standard equipment.

To make a weld, the ground clamp is securely fastened to the work, the generator started, and the electrode brought into contact with the metal surface to be welded. The electrode is immediately withdrawn a distance approximately equal to the diameter of the welding rod being used. This causes an arc, and metal from the electrode will be deposited on the work if the electrode is connected to the negative side of the generator. For ordinary work with metallic electrodes, this connection is used. It should be noted that electric current causes the transfer of metal from the electrode to the work. Therefore, electric welding may be effected overhead. Fig. 14 shows a diagram of what takes place when the electrode is being used. The coating

is slowly disintegrated by the heat and transformed into an inert gas which completely surrounds the hot arc, thus preventing the metal from being oxidized, which makes possible the production of a strong weld. It should be noted that the metal from the electrode is transferred to the surface being welded more rapidly than the heavy coating is destroyed. It is by this means that the arc may be directed accurately so that its maximum intensity is available at the spot where the metal is to be applied.



Special types of electrodes are available for welding copper, aluminum, stainless steel, manganese steel and cast iron. In addition, there are also available general-purpose electrodes which may be used for welding the grades of steel encountered.

To use the electric-arc equipment for

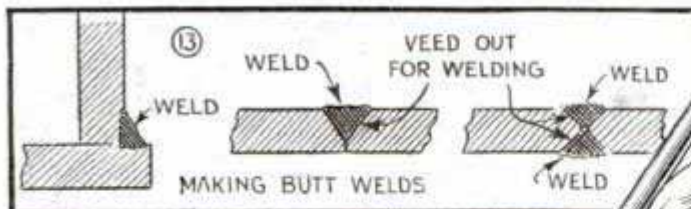

To correctly prepare the work for butt welds adjoining surfaces should be "veed" out so that the molten flux will run between them

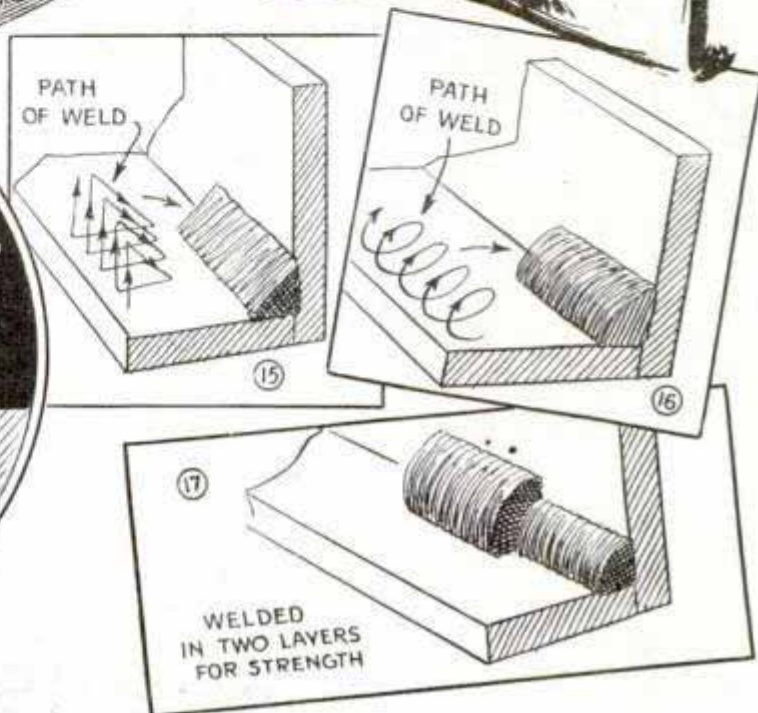
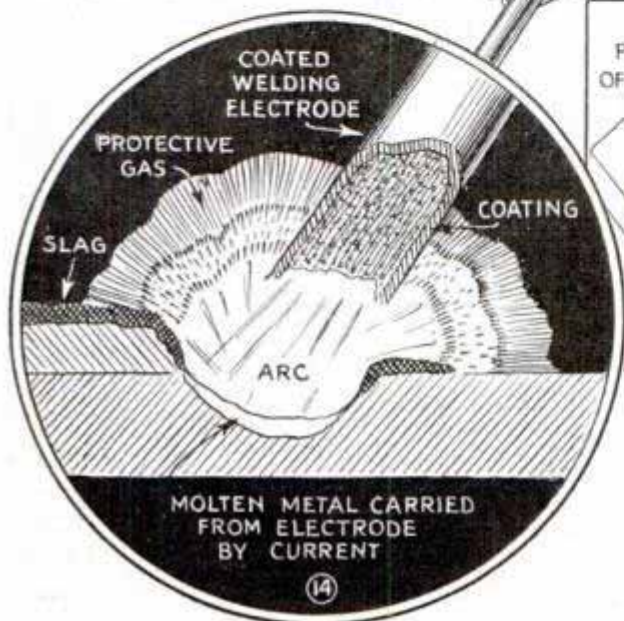

certain classes of welding where it is desirable to feed special filler rod into the weld, the carbon electrode should be used. The carbon electrode is used in the same manner as the metal electrode, except that

brazing rods and rods of other alloys are fed into the hot arc formed between the carbon and the work. Figs. 13, 15, 16 and 17 show methods which have been found satisfactory for making butt welds.

Rubber Stamps on Springs Save Time for Shipping Clerk

To speed up the work of stamping packages in his office, one shipping clerk suspended the rubber stamps from the wall above his desk with lengths of spring brass. The springs keep the stamps raised out of the way when not in use, yet permit them to be brought down against the ink pads and onto the packages with one swing of the hand. The pads, which are screwed to the wall by the lids, are set at an angle corresponding to that of the stamps when the latter contact them. Thin wood blocks attached to the springs show the lettering of their respective stamps.

Expand a spool of wire by heating it before winding a coil and you'll have a snug job when the windings contract.

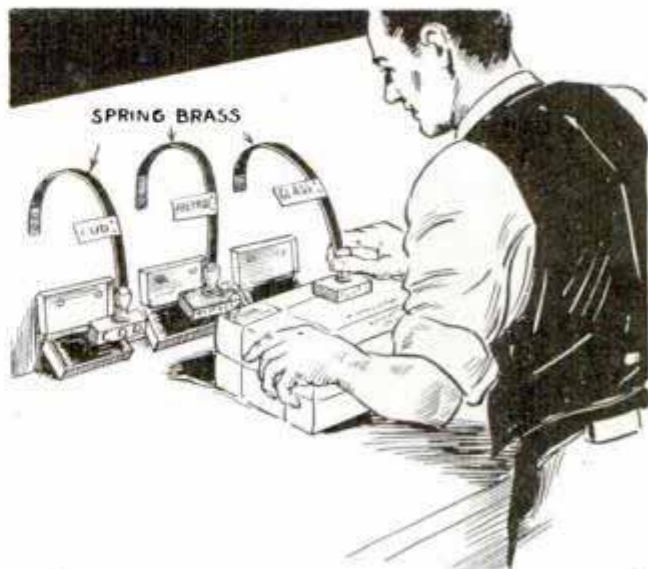

These spring-mounted stamps save lost arm motion in busy shipping clerk's office

Removable Step on Rear Bumper to Get Luggage from Trunk



Block slotted to fit on bumper makes handy step when lifting luggage from trunk

To simplify removing luggage from the trunk, one car owner carries a hardwood block notched to fit over the upper edge of the rear bumper. It makes a dandy step to stand on when lifting out the luggage, and takes little room in the trunk or tool compartment when not in use.

Repair for Stripped Threads in Aluminum Crankcase

If you have the misfortune to strip the threads from a bolt hole in an aluminum crankcase, a repair can be made by pinning the lower end of the stud in the hole.

To do this, substitute a headless bolt or a stud threaded at both ends for the regular stud or cap screw, and drive it firmly in place. Then drill through both the crankcase and stud, and insert a long, slender machine screw. Use a screw large enough

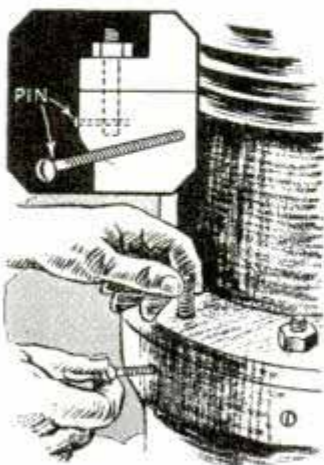

case and stud, and insert a long, slender machine screw. Use a screw large enough

to cut shallow threads in the aluminum as it is driven into the hole. The projecting end of the stud or bolt can be fitted with a nut.—Paul Sikson, Cicero, Ill.

Keeping the Chamois Skin Damp for Cleaning Windshields

One filling-station operator who had difficulty in keeping his chamois skin damp enough to clean windshields, yet not too wet, solved the problem in the following manner:

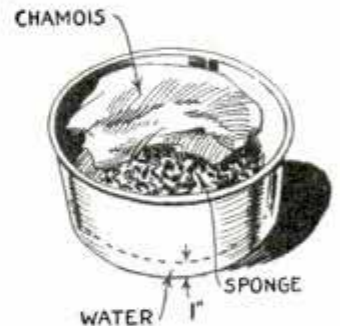

He put a large sponge in a shallow container with about 1 in. of water in the bottom, and placed the chamois on top so that it would absorb just enough water from the sponge to keep it moist and always ready for instant use.

—Paul A. Ruddell, Fort Scott, Kan.

Valve-Removing Tool on Bench Speeds Up Grinding Jobs

Mounted on a workbench as shown, this tool of pipe and fittings simplifies the job of removing springs from valve-in-head

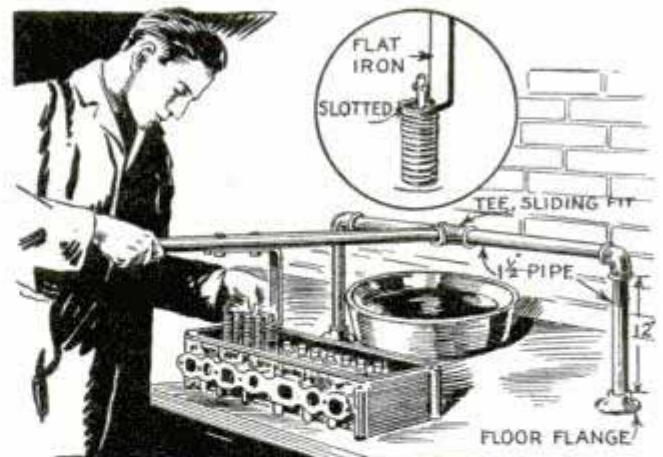

Springs are rapidly removed from valve-in-head motors with this simple depressing tool

motors. The handle or pressure arm, which is pushed progressively along the pipe support as the valves are removed, carries a depressing lever of flat iron notched at the lower end to straddle the valve stem. When working on a motor head having recessed valves, a board with a number of

equally spaced wood blocks screwed to it, is slipped under the head to support the valves while depressing the springs.

—Jos. C. Coyle, Tucson, Ariz.

Driver's Detachable Armrest Hooks over Door Frame

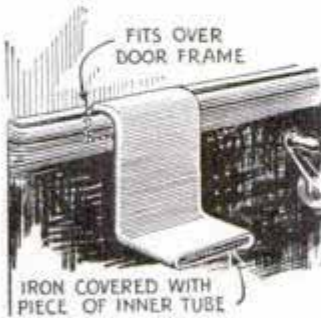

Bent from a piece of heavy sheet iron or steel, this armrest can be moved in a horizontal plane to meet the requirements of different drivers, and when not needed,

it can be lifted off the door and stored under the seat. A section of inner tube is slipped over the rest to serve as a cushion.

"Saw Tooth" Loading Platform Aids Truck Drivers

Built with the front side resembling a huge saw, this loading platform enables trucks to be backed in at an angle, thus saving time in "spotting" them. Also, it permits plenty of room for other trucks to pass when the loading platform is in a narrow alley, and accommodates more trucks at one time for a platform of given length than when the front is straight.

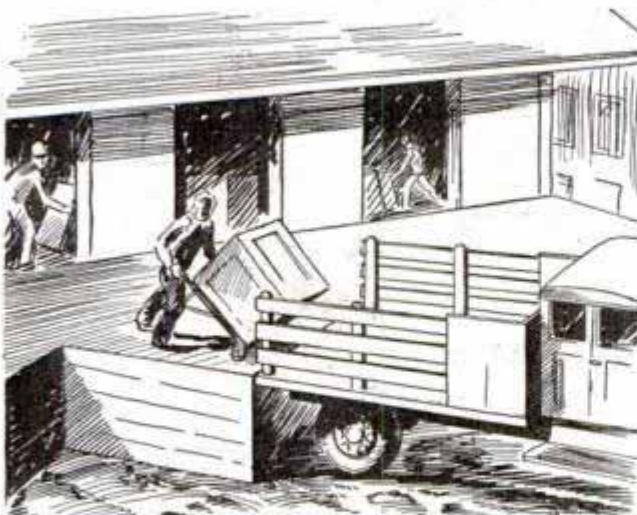

TOP VIEW OF LOADING PLATFORM



The staggered front of this loading platform accommodates more trucks than one with a straight front

Shoe Scraper on Running Board Keeps Cab Clean

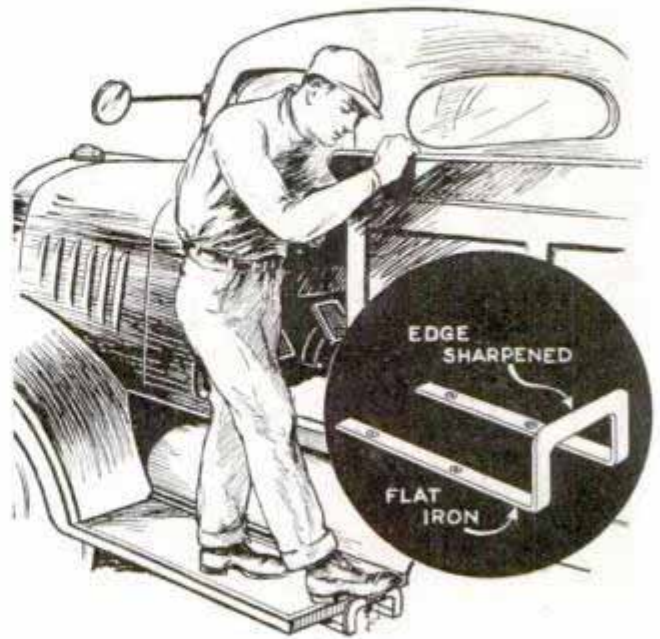

Conveniently located on the stub running board, this shoe scraper is always at hand

Truck drivers who dislike to enter their cabs with muddy shoes will find that this scraper, which is screwed to the end of the stub running board, solves the problem. It is out of the way yet always at hand when needed.

Snow "Shorts" Spark Plugs

One owner of a popular eight-cylinder car who experienced considerable trouble with the motor missing badly during a snowstorm, found that the snow blowing in through the hood louvers short-circuited the spark-plug wires. To avoid this, he bent the wires so that they would be as far as possible from the inner edge of the cylinder head and then wrapped them with tape as shown.



The same trouble can also be caused by rain blowing through the hood louvers. Also, after a car has been standing in a snowstorm, lift up the hood and remove any deposit of snow from the spark plugs.

Welder's Eye Shield on Wall Replaces Goggles

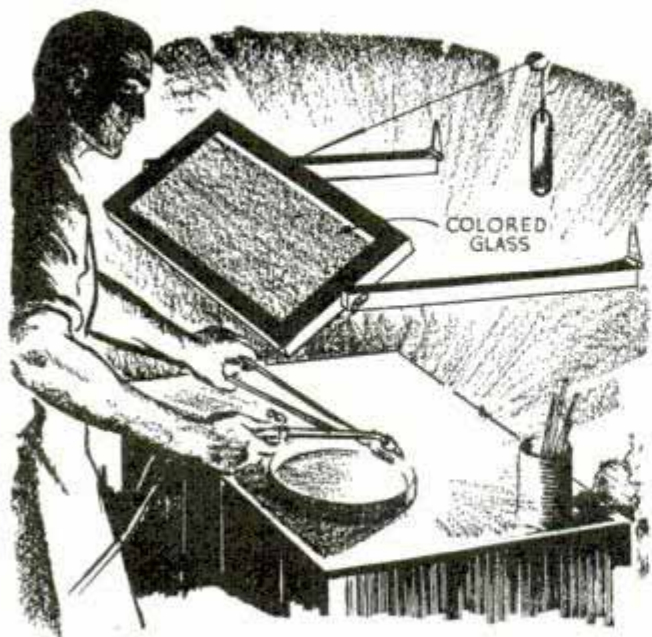

This welder's eye shield is always at hand, and is brought into use by merely pulling it over the work

Because some of his mechanics neglected to wear colored goggles when doing a welding job, one shop foreman took a framed pane of colored glass, pivoted it

between two arms and hinged them to the wall so that the shield could be held between the workman's face and the work as shown. A rope and small counterweight permitted the shield to be adjusted at various heights.

Buckets Made from Oil Cans

Buckets that are handy for carrying water and various materials are easily made from discarded 5-gal. oil cans. To provide a handle, take a pair of tinner's shears and cut out the top, leaving a strip of the metal about 1 or 1½ in.

wide uncut at the center. Then roll the metal from opposite sides toward the center. This will provide a handle which is strong and easy to grip.

—A. H. Waychoff, Tempe, Ariz.

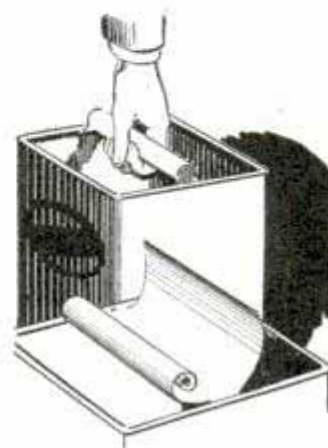

The Next Issue

FROM COAL BINS TO RECREATION ROOMS

How wasted basement space can be converted into recreation rooms for parties and games by utilizing materials available in any locality. Specific information on damp-proofing concrete walls and floors, framing partitions, covering ceilings, enables the home handy man to do a first-class job.

HIGH TEMPERATURES READ BY ELECTRIC INDICATOR

Reading temperatures of molten metal, hot bearings, etc., up to 2,500° F. by means of homemade thermocouples which are easily built and calibrated.

STURDY PEDESTAL-TYPE CIRCULAR SAW FOR \$10.00

With its pedestal of two cream-separator bases, adjustable hardwood table, miter gauge and ripping fence, this 8-in. saw handles most jobs.

COMBINATION COLD FRAME AND HOTBED

Can be used either as a cold frame or an electrically heated hotbed. The frame stands 30 in. above ground and will accommodate about 700 seedlings.

"TRIP 'EM" GAME FOR THE HOME

Simplified pin-ball game, played by two, or four as partners. Has magnetic trips in certain holes which must operate to get a high score.

FINAL WARNING TO MOTORISTS!

MAP SHOWS WINTER OIL-CHANGE PAST DUE IN 40 STATES

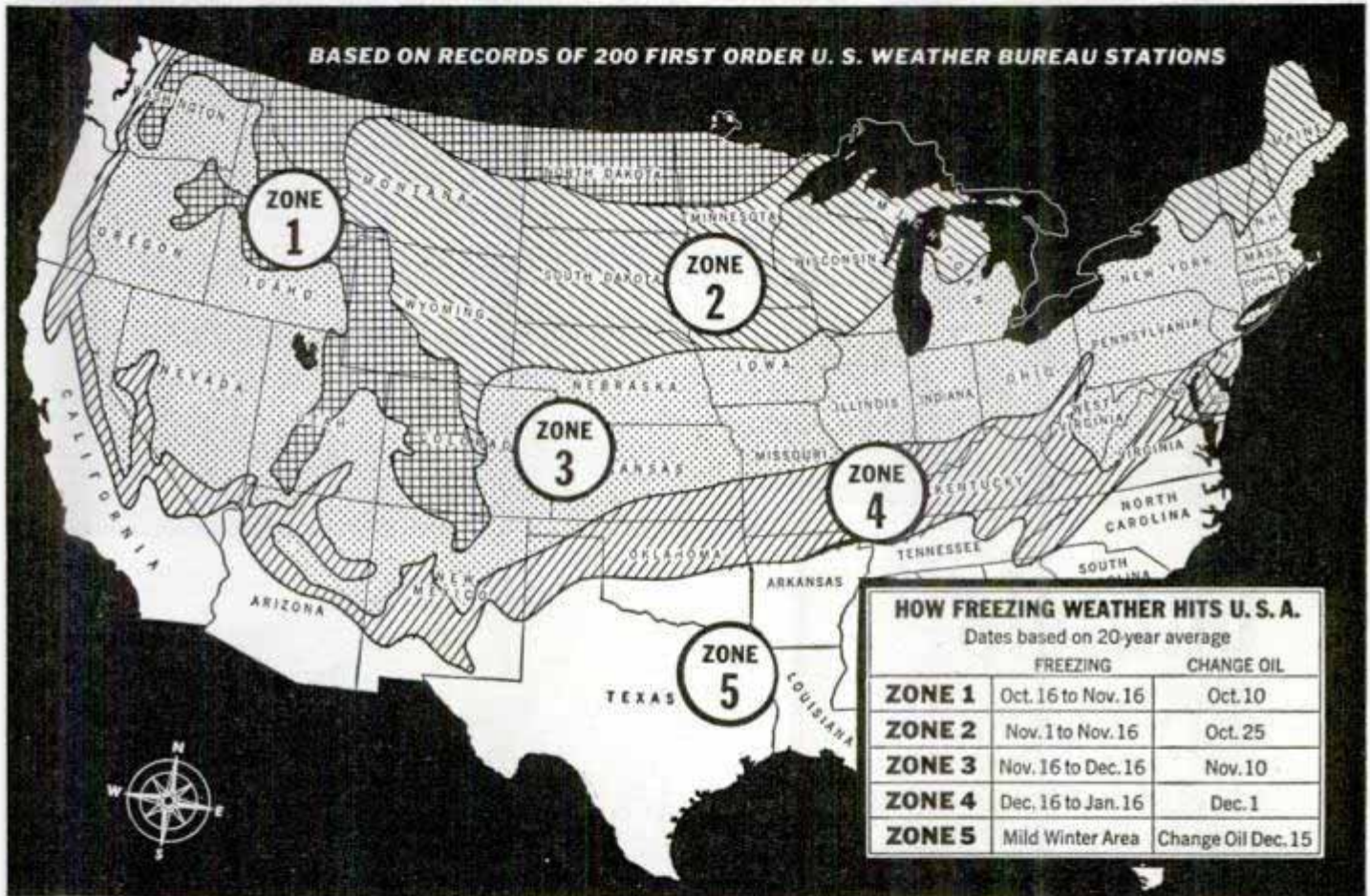

YOUR CAR'S in danger if you still have summer-grade oil in your engine and gears. Get winter protection now!

Millions know that Mobiloil dealers do this job best! Through two of the hardest winters on record, these motorists have proved that Mobiloil Arctic makes starting quicker and easier — protects engines better — gives longer mileage. They've

learned that Mobiloil Winter Gear Oil makes shifting safe and easy.

Stop today at the familiar Mobiloil sign, or the Sign of the Flying Red Horse. Protect your engine with Mobiloil Arctic or (for *extreme* cold conditions) Mobiloil Arctic Special. And protect your gears 100% with Mobiloil Winter Gear Oil.

SOCONY-VACUUM OIL COMPANY, INC.

CHANGE TODAY Mobiloil Arctic

Season's Greetings

FROM
R. J. REYNOLDS TOBACCO COMPANY
 MAKERS OF CAMEL CIGARETTES AND
 PRINCE ALBERT SMOKING TOBACCO

Camels

There's no more acceptable gift in Santa's whole bag than a carton of Camel cigarettes. Here's the happy solution to your gift problems. Camels are sure to be appreciated. And *enjoyed!* With Camels, you keep in tune with the spirit of Christmas. Enjoy Camels at mealtime for their aid to digestion. Camels set you right! They're made from finer, **MORE EXPENSIVE TOBACCOS**...Turkish and Domestic...than any other popular brand.

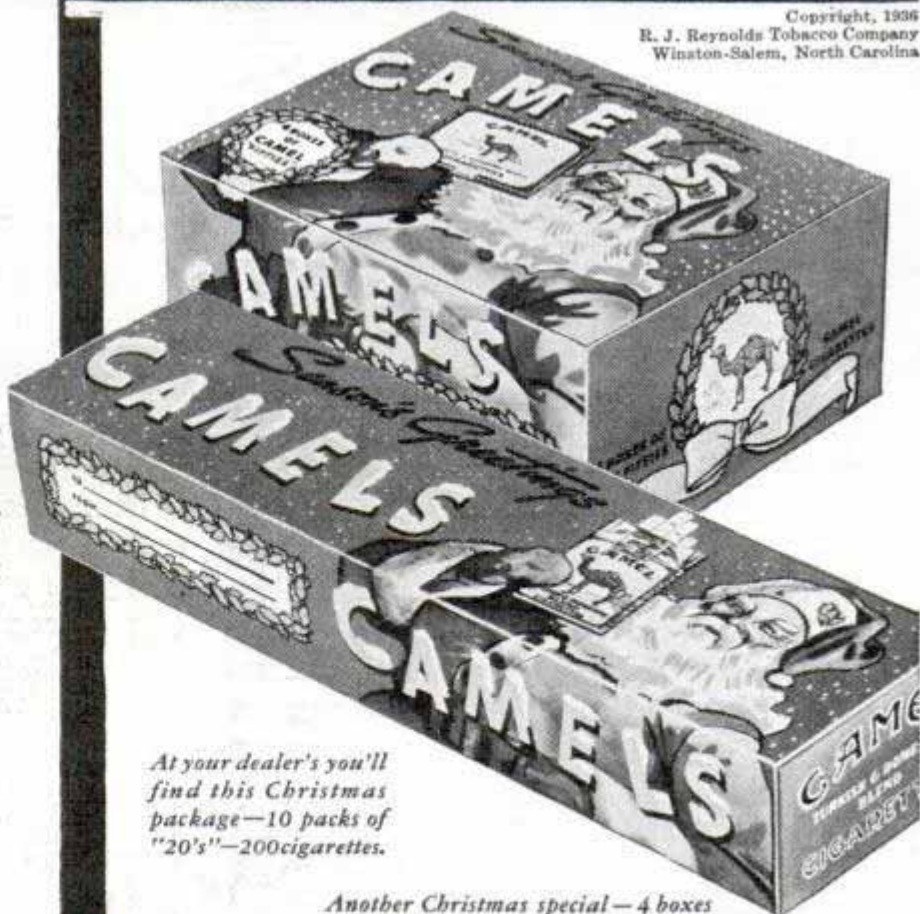

Copyright, 1936
 R. J. Reynolds Tobacco Company
 Winston-Salem, North Carolina

At your dealer's you'll find this Christmas package—10 packs of "20's"—200 cigarettes.

Another Christmas special—4 boxes of Camels in "flat fifties"—wrapped in gay holiday dress. (Right, above)

When writing to advertisers please mention Popular Mechanics



Prince Albert

It's easy to please all the pipe-smokers on your list. Just give them mellow, fragrant Prince Albert—the National Joy Smoke—the Prince of Pipe Tobaccos. "P.A." is the largest-selling smoking tobacco in the world. Prince Albert does not "bite" the tongue. Have bright Christmas packages of Prince Albert to wish your friends and relatives the merriest Christmas ever.

(Right) A full pound of Prince Albert, in a real glass humidor that keeps the tobacco in perfect condition and becomes a welcome possession.



(Left) One full pound of mild, mellow Prince Albert—the "biteless" tobacco—packed in the cheerful red tin and placed in an attractive Christmas gift package.

Gold Farmers of the West

F1208 (Continued from page 93)

by the rivers and dropped offshore where the river currents were slowed down. From these points ocean currents scattered the gold particles up and down the beaches. This material makes up the black sand, which, being heavier than ordinary sand, is not washed up by normal tides. It rests on the bottom of the ocean offshore until wave action during very stormy weather sweeps it up.

The black sands run from a few cents to as much as five or six dollars per cubic yard in gold. The yellow metal sometimes forms the smallest part of the crop. One sample of concentrate recovered from a sluice box assayed at the rate of \$76,000 per ton and was found to contain about fifty per cent of the value in iridium, thirty per cent in platinum, and twenty per cent in gold. Both iridium and platinum bring higher prices than gold. By working hard a man can usually count on making \$10 a day or more when the black sand is available. Then he must wait until a new storm throws up another deposit.

Thousands of dollars worth of gold and other minerals have been mined from the beaches of Klamath, Gold Beach, Crescent City, and other points, but not enough black sand can be counted on to warrant working it on a large scale. A number of companies have tried to work the beaches with drag lines and large gold-recovery plants but nearly all these ventures have failed.

It has been suggested that tremendous quantities of the rich black material must lie in natural riffles on the ocean floor right off the beaches but so far no one has ever explored the ocean bottom or attempted to suck the material up on barges. One theory is that the immensely rich Rand deposit in South Africa was at one time an ocean placer deposit that was subsequently raised above sea level, and a similar concentration of placer gold might exist off the west coast.

It is estimated that billions of dollars worth of gold are still untouched in the ground in California. Much is so scattered that ordinary mining methods are too expensive and not until after it has slowly been collected by the streams can it be

(Continued to page 150A)

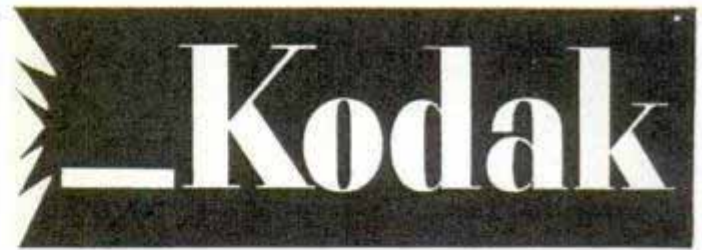

FOR THOSE WHO LIKE THEM SMALL

★ *Miniature Kodaks*



\$5750

KODAK DUO SIX-20

A true "miniature"; compact, finely built, yet it takes 16 album-size pictures (1 $\frac{5}{8}$ x 2 $\frac{1}{4}$ inches) on a roll of Kodak Film (four types available). Negatives are sharp; give big, clear enlargements. Shutter, 1/500 Compur-Rapid. Lens, Kodak Anastigmat f.3.5. Price, \$57.50.



\$5750

KODAK RETINA

Concentrated photographic versatility... lens, anastigmat f.3.5; shutter, Compur-Rapid—9 speeds up to 1/500 second. Loads with any of five different Kodak Film Magazines (including new Kodachrome for full-color transparencies). Negative size approximately 1 x 1 $\frac{1}{2}$ inches. Price, \$57.50.

KODAK BANTAM SPECIAL



\$110

This exquisitely made "miniature" fits the hand. Lens, Kodak Anastigmat EKTAR f.2.0. Shutter, 1/500 Compur-Rapid. Military-type range finder, coupled with focusing mechanism. Makes sharp negatives for superb enlargements (low-cost size, 2 $\frac{3}{4}$ x 4 inches); or Kodachrome transparencies. Price, \$110.

Calif

Oregon
Calif

Christmas Guide

FOR THOSE WHO LIKE THEM LARGER

★ *Precision Kodaks*

KODAK SIX-16 (f.4.5)

Smallest folding camera taking $2\frac{1}{2}$ x $4\frac{1}{4}$ -inch pictures. f.4.5 lens; 1/400 Compur-Rapid shutter. Price, \$40. (With f.6.3 lens, \$20; with Doublet lens, \$16.)



\$40

KODAK RECOMAR 18

Advanced amateurs delight in its f.4.5 lens, 1/250 Compur shutter, self timer, ground-glass focusing back. Loads with film packs, cut film, plates. $2\frac{1}{4}$ x $3\frac{1}{4}$. Price, \$54.



\$54

KODAK DARKROOM OUTFIT NO. 1

Contains trays, chemicals, developing clips, safe-light, printing frame, thermometer, instruction booklet—everything necessary for first-class work. Also includes the book, "How to Make Good Pictures." Price, complete, \$8.75.



\$875

FOR THOSE WHO WANT MOTION

★ *Ciné-Kodaks*

CINÉ-KODAK EIGHT

Movies at "10 cents a shot"! The "Eight" makes it possible. A roll of Ciné-Kodak Eight Panchromatic Film costs only \$2.25, finished, ready to show. Good for 20 to 30 black-and-white movie "shots," each as long as the average scene in the news-reels. Price, \$34.50.



\$3450

CINÉ-KODAK "K"

Most widely used 16 mm. home movie camera—it's so simple, yet so fine. Makes clear, brilliant movies at the touch of a button. And as the user's skill increases, responds to every exacting demand. Loads with full 100 feet of 16 mm. film. With f.1.9 lens, \$112.50.



\$11250

MAGAZINE CINÉ-KODAK

Loads in 3 seconds. Slip in the magazine, close camera cover, and shoot. And you can switch to another film in a jiffy, even when but part of the 16 mm. film has been exposed. Effortless loading is only one of six new features. With f.1.9 lens, \$125... Eastman Kodak Company, Rochester, N. Y.



\$125

ALL CINÉ-KODAKS MAKE FULL-COLOR MOVIES
ON KODACHROME FILM

FREE!

PLANS FOR THESE AND 18 OTHER CASCO PROJECTS



● Card Table with inlaid top. Portable Bar. Expensive? Not to make! And what satisfaction to make it yourself! These

are only two of 20 prize-winning projects in the favorite project service of homecrafters. Free to users of famous waterproof, heatproof CASCO Glue.

Here's How You Get FREE Plans

Fill out and mail coupon below. You get, by return mail, illustrated folder picturing and describing these 20 interesting, practical projects. Take your choice. Then mark that choice on the green ticket which is in every 25c (or larger) can of CASCO. That entitles you to FREE plans. No extras to buy. Plans come complete with exact working directions and list of materials needed. This FREE project service is designed for you. Take advantage of it. Fill out this coupon and get your can of CASCO today, at any Hardware, Paint or Lumber Dealer.

● **SAVE 2c.** Stick this coupon on penny postcard to get FREE folder describing 20 CASCO Prize Projects.



CASEIN COMPANY OF AMERICA, Inc.
350 Madison Av., Dept. PM137, New York, N.Y.
Please send folder about FREE Project Service.

Name.....

Address.....

CROSMAN SILENT .22 RIFLE



Adjustable peep sight

NO CLEANING ADJUSTABLE POWER LOW COST AMMUNITION

Grooves inside barrel make the Crosman a real rifle with all the hair-splitting accuracy this term implies. Shoots bullet (pell) same diameter as .22 powder rifle, but silently, powerfully, with no recoil, using the terrific force of compressed air—same force U. S. Navy uses to drive 2000 lb. torpedoes. Marvelous for target, small game. Single and 20 shot repeater models. No license required.

SuperPells 

Best for all .22 cal. air rifles. Heavier, longer, more perfectly formed (secret process), thus harder hitting and more accurate. Made to American standards by American workmen. Write for folder.

FREE BOOK

Containing important target and game shooting facts; also Crosman Catalog. Write. Ask Your Dealer to Show You a Crosman.

CROSMAN ARMS CO., Inc., 430 St. Paul St., Rochester, N.Y.

Motoring on Skis

(Continued from page 87)

chometer, oil, water and gasoline gauges and compass. An air speed indicator attached to the front of the "backbone" causes a dial in the cockpit to show how fast the craft is traveling.

The sled is steered by the front runner. Stability at all speeds is insured by the rudderlike tail which finishes off the sleek-appearing body. Constructed to produce high speed, the entire job looks the part and it is the pride of a small group of winter sports enthusiasts who have formed a club with quarters on the lake shore.

This "super-sled" is the flagship of a fleet of motorized and sail-propelled craft designed for winter use. There are five two-seater power sleds, similar to the high-speed job but driven by less powerful motors. Their speed, with only the driver, is around ninety on smooth surfaces. With two persons in the cockpit, a speed of sixty produces plenty of thrills. Commercially assembled, these sleds may be fitted with outboard or motorcycle engines.

But the clown of the motor fleet is the "bronco," which consists of a small motor mounted in a bicycle frame and geared to an endless track in place of the rear wheel, with a ski in front. The beginner finds the "bronco" considerably harder to ride than appears at first glance and plenty of spills are sure to accompany his first attempt to master it.

For the 1936-1937 season, the club members also have a sailing fleet of fifteen ice yachts which develop high speed with a favorable wind. Most of these boats are of the popular "E" class. The chief difficulty with this type of sports craft is that a six-inch snow prevents travel, whereas the power sled operates over ice or snow.

As a matter of fact, there are many weeks of the winter in the northern United States and Canada when a power sled is the only practical means of transportation. Doctors, postmen, telephone service crews and many others are using this type of craft in their business when heavy snowfall halts railroads, grounds airplanes and blocks highways. Particularly is the low-speed two-seat sled useful for travel under such conditions.

The builders of the super-sled began

F1306

work last fall on a "snow sedan" powered with a fifty-horsepower automobile engine, to serve the same purpose, as well as to prevent families in rural districts from becoming snowbound. The first model has a pusher propeller at the back, connected to the engine which also is located at the rear. It has seats for four persons and is enclosed like an automobile. Weighing only 300 pounds without the motor, it is capable of traveling over loose, deep snow at fifty miles per hour. The body, constructed of wood and canvas to keep down the weight, is streamlined and mounted on three wide runners, like the racing sleds. It has front steering. The radiator which cools the engine also acts as a heater for the passenger compartment. The propeller is mounted on a countershaft above the motor, permitting installation of the motor in a low-set compartment where it is protected from the weather.

Assembly of snow sedans by the purchaser is planned by the designers. Suitable automobile engines can be obtained at secondhand dealers and put into good condition with a little work. Instructions for installing the engine and propeller will be supplied with parts for the body.

Racing drivers and racing cars have been the means of bringing the automobile to its present state of perfection. The winter sports club and the super-sled may be the means of introducing an entirely new type of vehicle which will solve the problem of transportation for any area subject to heavy snow.

An Improved Glue Pot



The home mechanic who does not have a pot for melting glue can improvise an efficient one from a can, a length of wire and a stewing pan. Just get a can of the required size, insert the wire through holes drilled from opposite sides near the top and set the can in a stewing pan as shown. The pan is filled with water and should be of sufficient depth to keep the can from touching the bottom.

—A. H. Waychoff, Tempe, Ariz.



Everybody who tinkers around the home—man, woman or boy, wants this amazing NEW

"YANKEE" Handyman Spiral SCREWDRIVER

for \$1

Drives screws like magic—simply by pushing on handle. Boresholes, too—if you add "Yankee" Chuck and Drill.

Long has it been said that "Yankee" Tools Make Better Mechanics. Handyman Screw-driver is "Yankee" Quality! Same as famous "Yankee" Tools used the world over—to do better work . . . save time, labor.

Handyman No. 33-H.
—At your dealer's, \$1.00

For boring small holes for screws or other purposes around the home, buy "Yankee" Chuck and 3 Drills, 39c set.



Fit in Place of Blade



"Yankee" Chuck & 3 Drills

-----INTRODUCTORY OFFER-----
North Bros. Mfg. Co., Philadelphia, U. S. A.



NEW TOOL! If not at dealer's, send us \$1 with this coupon. Receive *postpaid* this ingenious "Yankee" Handyman that drives or draws screws at a push on the handle.

"Yankee" Tool Book, included FREE

Name.....

Address..... (PM1)

MESSY GLUE POTS THING OF THE PAST

Men who know their wood-working ... experienced craftsmen ... have discovered that mixing glue in messy old-fashioned glue pots is a waste of time. The modern way, the *sensible* way is to buy LePage's Liquid "all purpose" Glue in handy cans. LePage's guarantees lasting strength. LePage's joints practically "weld" the wood. Ideal for veneering and inlaying. Makes snug joints, reinforces nails and screws, fills small cracks and nail holes. Use LePage's—and the job is permanent. All hardware and drug stores sell LePage's Liquid Glue in the tube, bottle or can. There is no need for any homecraftsman to be without it. LePage's Adhesives, Laboratories and Factory, Gloucester, Massachusetts.

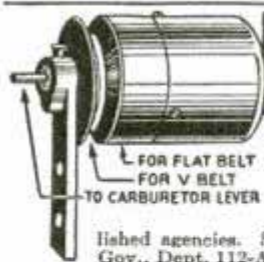

AUTO ENGINE SPEED CONTROL GOVERNORS

To control speed of any make of auto or truck engine, regardless of load changes, when used as a stationary or portable power plant. Fully guaranteed. No cash down. Governor speed range from 400 to 3000 R.P.M. Fine opportunity for estab-

lished agencies. Send for free circulars. Mfrs. Capdee-Smith Gov., Dept. 112-A 215 No. L. A. St., Los Angeles, California.

New Adding Machine Fits Vest Pocket!

Adds, subtracts, divides, multiplies like \$300 machines. Weighs only 4 ounces. Not a toy—strong guarantee. Absolutely accurate, lightning fast. Sells on sight to offices, stores, homes—all who use figures. Write quick for **FREE AGENTS** sample offer and Money-Making Plan.

C. M. Cleary, Dept. 53, 303 W. Monroe St., Chicago



RCA LIC. RADIOS

BUY at FACTORY PRICES as low as **6.95** Save 1/2

FREE HOME TRIAL
Money-Back Guarantee
NEW 1937 CATALOG FREE!

Twenty beautiful models for farms and homes. 4 to 11 tubes. **Save 50%**. One year guarantee on every set. Agents: Send 10c for plan—give away radios FREE—make \$100 a week.

WORLD-WIDE RADIO CO.
2868 Elston, Dept. A, Chicago

EUROPE Guaranteed
"Electric-Eye" Radio
7 Tubes—3 Bands. Powerful superhet. Send \$3 deposit. Pay bal. C.O.D. **\$17.95**

Docking the Big Fellows

(Continued from page 84)

by the tide, exclude the return of the water at high tide. A ship thus "docked" on a gridiron could be worked on whether the tide was low or high, provided pumps capable of ejecting such water as might leak through the dikes were available. The vessel was undocked by cutting the dike at low tide, allowing it to fill as the tide rose, and floating the vessel out at high tide.

This gridiron inclosed in a dike was in fact a crude tidal dock. Substituting a masonry lined basin for the gridiron and dike, and fitting it with some form of watertight gate and with drainage pumps of sufficient capacity to handle leakage gave us the tidal dock as it existed before the development of the large capacity pumps which made possible the graving dock as it is known today.

The graving dock is a basin into which a vessel can be floated through an opening capable of being closed with a gate, and furnished with large pumps to remove the water. We have such a dock at the Brooklyn Navy Yard, which was finished in 1841 and which is still in excellent condition. The original gates of this dock which were of the canal lock type have been replaced with a boat-type caisson and the old steam pumping engine and drainage pump have given way to motor-driven centrifugal pumps, but otherwise the dock is much as it was when built, nearly a century ago.

The other method of docking large vessels is to lift them bodily out of the water with a floating dock. The floating dry dock is a development of an English sea captain whose ship was damaged in the harbor of Cronstadt over 200 years ago. There being no dock available, the captain purchased an old hull considerably larger than his damaged ship, removed the spars and decks, cut a large opening in the stern and fitted it with a watertight gate. He then flooded the hulk, floated his ship into it through the opening, closed the watertight gate behind her and pumped out the hulk so it floated with the damaged ship inside it. After repairs were completed, the hulk was flooded, the stern gate opened, and the ship floated. This type of

(Continued to page 122A)

WITTE DIESEL ENGINES

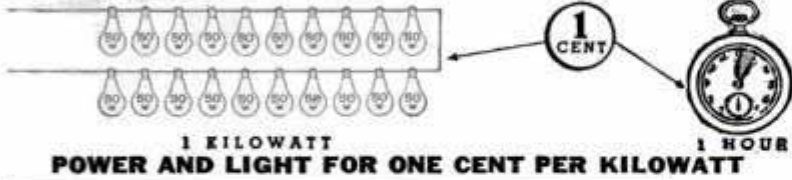

EVERY
MODERN
IMPROVEMENT

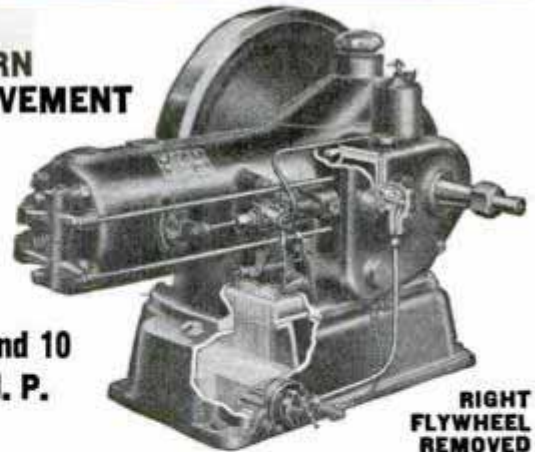

3.5-7.5 KVA
A. C.
3-5 KW
D. C.

DIESELECTRIC PLANTS

Good news for Electric Light and Power Users whose electric bills approach \$50 per month. In factories, on farms and under various conditions, WITTE Dieselectric Plants are producing light and power for less than 1c per kilowatt. No peak load or standby charges. Money saved every hour of operation. When not running expense stops! Smooth flowing current—no flicker—close voltage regulation. Generators engineered to the engines they serve.

2 to 10
H. P.

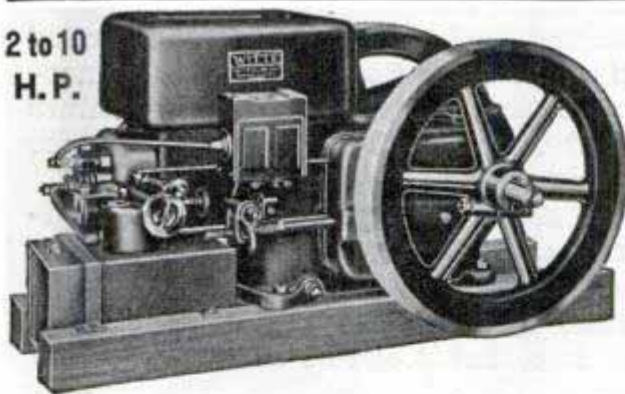

WITTE GASOLINE ENGINES TYPE "J" ON WOOD SKIDS

Where the amount of power used does not warrant a Diesel Engine our Type "J" on wood skids or Type "K" on iron base is recommended. They are Enclosed, Self Oiling and have Timken Roller Bearings. Operate on gas, gasoline, kerosene or distillate. Lubrication is automatic. Run smooth as an electric motor. Consume less oil and fuel and deliver more power. Pronounced by experts years ahead in design and construction. Buy your power equipment from power specialists. Try a WITTE and profit.

WITTE LOG AND TREE SAWS

"Saws 'em down and cuts 'em up." There is money for you to make with a WITTE, timber to be cleared, logs to be cut, wood supplied for fuel. WITTE outfits have safety lever clutch control, saw guide, automatic force feed, human arm swing and other exclusive features. Portable as a wheelbarrow. Engine may be used for belt power the year around. Buy from reputable manufacturers.

FREE CATALOG—CASH or TERMS—QUICK DELIVERY



The WITTE cuts logs into fire wood, cord wood, fence posts, cross ties and shingle butt lengths. It is the best sawing outfit ever built. There is no other saw like it.

215-A So. 2nd St.
HARRISBURG, PA.

WITTE ENGINE WORKS

1741 Oakland Avenue
KANSAS CITY, MO.



TAKE it from one who knows . . . there's no thrill like that "lift" you get when you bring in radio programs from far away corners of the earth on a radio you've built yourself. There is no age limit in this fascinating, instructive and profitable game. Lads from 8 to 80 indulge in this interesting outlet to their mechanical inclinations.

Build one of the circuits described in this magazine. **WHOLESALE** can supply parts and tubes for any of them. For everything in radio—go to **WHOLESALE**.

CUSTOM BUILT RADIOS

Described in the Big, Free 1937 Catalog is the complete line of custom-built Lafayette radios, together with many other makes of short wave and all-wave receivers—all at prices which cannot be beaten. Remember—**WHOLESALE** cannot be undersold. **GIVE ELECTRICAL GIFTS THIS XMAS**—they are lasting! Our Special Xmas Catalog contains hundreds of unheard of values. Latest models of **RADIOS, ELECTRICAL TRAINS, TOYS, HOUSEHOLD APPLIANCES,** etc. Send for this catalog **TODAY! IT'S FREE!**

**SEND NOW
FOR FREE
CATALOG**

**WHOLESALE RADIO
SERVICE CO., INC.**

100 Sixth Avenue, New York, N. Y.

Rush Free Blue Ribbon Radio Catalog 65-A7

Rush Free Xmas Electrical Catalog 67-A7

Check

()

()

Name

Street

City

State

WHOLESALE RADIO SERVICE CO., INC.

CHICAGO, ILL.
301 W. JACKSON BLVD.

NEW YORK, N.Y.
100 SIXTH AVENUE

ATLANTA, GA.
430 W. PEACHTREE ST. NW

BRONX, N.Y.
142 E. FORDHAM RD.

NEWARK, N.J.
216 CENTRAL AVE.

SOFT WATER

MAGIC WORDS—that are bringing big profits to Webb Salesmen!

The Webb Portable Water Softener brings to every housewife, soft water in an endless flow for washing dishes, laundry, bath, shampoo and every home purpose. Softens hardest water instantly at the turn of the faucet. Sell at popular prices.

AGENTS NEW SALES PLAN FREE

Quick easy sale—and 100% profit—simple home demonstration sells it instantly! Write today for free literature and full details of the Webb **NO RISK TEST OFFER** and **FREE** Sales Plan.

WEBB MFG. CO., Dept. P-17, 1813 Baltimore Ave., Kansas City, Mo.



**NO RISK
TEST OFFER!**

PHOTOGRAPHIC BARGAIN BOOK

of Cameras & Supplies

FREE

Explains latest inventions, methods in Photography and Home Movie Making, for fun and profits. Offers hundreds of amazing, money-saving Bargains in still and movie Cameras, Lenses, Films, etc. Used equipment accepted in trade. Satisfaction guaranteed! **WRITE!**

**CENTRAL
CAMERA CO.**

230 S. Wabash, Dept. K-1, Chicago, U. S. A.

PHOTOGRAPHIC HEADQUARTERS SINCE 1899

(Continued from page 120A)

dock was known as a "Camel," the name of the Cronstadt hulk.

The next step was to substitute for a hulk a specially built hull with a large watertight double bottom and watertight double side walls. A cross section of such a dock was like a flat bottomed "U," both the bottom and the side walls being double. Both ends of the dock were open. There were no gates. By flooding the double bottom and side walls the dock could be submerged almost completely. A ship could then be floated into the dock between the arms of the "U," and by pumping out the side walls and double bottom, the dock was made to float with the ship in it.

Self-docking floating docks are of two general types, rigid docks which are bolted, or otherwise fastened together to form a single rigid dock which acts as a unit when raising a vessel, and non-rigid sectional docks in which no attempt is made to connect the sections firmly together. The rigid dock makes little or no demand on the vessel being docked for longitudinal strength and stiffness. In this respect it approaches the graving dock. Its disadvantage is the difficulty of providing connections between the sections capable of taking the heavy stresses to be carried and at the same time having the connections between sections of such a nature that it is practical to separate them for docking and readily reassemble them.

The non-rigid dock consists of a number of short floating docks, each with its own pumping equipment, each separate section or short dock being of such dimensions that it can be docked in two or more of the other sections. The sections are not rigidly connected when used to dock a long ship, each section being so pumped that it lifts and supports its proper proportion of the total weight of the ship.

Docking a ship in a floating dock undoubtedly requires more care than docking in a graving dock. The keel blocking and bilge blocking which are of the same general type as those used in a graving dock are prepared to receive the ship. The dock sections are flooded so the dock sinks low enough in the water to permit the ship to float over the blocking and the ship is then carefully warped into the dock and

centered over the blocking. Power-driven spur shores are used in some large docks, notably the 60,000-ton floating dock at Southampton, to hold the ship centered, and the dock sections are then pumped out to float the dock high enough out of the water to lift the ship and the dock floor clear of it. The pumping must be done carefully with due regard to the weight distribution of the ship if straining of the dock and vessel is to be avoided. Undocking is accomplished by flooding the sections, thus lowering the dock and the ship until the latter is refloated and may be warped out.

For docking relatively small vessels, marine railways remain popular because of the relatively low first cost and low cost of operation. These consist of a sloping runway extending into the water down which a cradle travels on rollers. The cradle is fitted with keel blocks and bilge blocks and may be lowered down the runway into the water or hauled out by means of heavy chains and a power-driven winch or windlass. A vessel is docked by lowering the cradle down the runway into the water, centering the vessel on the blocking and hauling the cradle up the runway with the vessel on it. Marine railways are used at a number of shipyards for docking vessels up to about 2,000 tons displacement, but have not been built for handling larger ships.

To a sailor "docking" means placing a ship in a dry dock, not "berthing" her at a pier. A man-of-war was recently going up the North river to one of the piers near Forty-Second street. She was the flagship of an admiral. The ship was berthed while the admiral was at lunch. An ensign reported to him that "The ship has been docked, sir."

"Go and take another look, my boy," was the reply. "I was at the foot of Forty-Second street two weeks ago and although New York is the city of miracles I don't think they could build a dock in two weeks. Take another look and let me know if the ship has been docked without my orders or berthed in accordance with my orders."

☐ Whenever you find that you wish to know more about any article in this magazine, write our Bureau of Information, inclosing return postage.

A GIFT OF SOLID GOLD

Fully-Equipped, Low-Cost Kit of

GENUINE 23-KARAT GOLD LEAF



With Easy-to-Follow
Instructions

AND 101 SUGGESTED USES ONLY \$5.00 POSTPAID

Put the "finishing touch" on your locomotive, airplane, ship, and stagecoach models with Genuine 23-karat Gold Leaf. Add that "professional finish" to your book ends, treasure chests, clock cases, jewel boxes, and picture frames. Initial your canoe, gun, pipe, tool handles with solid gold. Make dollhouse furniture fit for a queen. Experience the thrills of true craftsmanship with the Hastings Home-Workshop Gold Leaf Kit—practical, fully-equipped, inexpensive. Complete, easy-to-follow instructions with every Kit—and 101 suggested uses for gold leaf.



Gold Leaf is lasting. Unlike so-called "gold" paint or bronze powder, it retains its brilliance and won't tarnish because it is made from solid gold. And the gold leaf in this Kit is beaten by Hastings & Co., America's oldest gold-leaf manufacturers.

This isn't a toy. It's a new creative thrill. It's a home-workshop "tool" for American hobbyists. It's fascinating, practical, and profitable. Don't be without your Kit another day. It's as essential to the workshop as paint and varnish. And here's what the Kit contains:

- 25 Sheets of Transfer Gold Leaf (Genuine 23-Karat; 3 3/8" x 3 3/8")
- 25 Sheets of Loose Gold Leaf (Genuine 23-Karat; 3 3/8" x 3 3/8")
- 1 Can of Oil Size (Slow Drying)
- 1 Can of Japan Size (Quick Drying)
- 1 Lettering Brush
- 1 Striping Brush
- 1 Gilder's Tip
- 6 Paint Cups
- 1 Easy-to-Follow Instruction Book

MONEY-BACK GUARANTEE: If you are not entirely satisfied that the Hastings Home-Workshop Gold Leaf Kit can be useful to you, return it within five days of its receipt and your money will be refunded at once. These Kits are sold only by Hastings & Co., and only by mail, direct from the manufacturer.

MAIL THIS COUPON TODAY

(Or order by letter)

HASTINGS & CO.

819 Filbert Street Philadelphia, Pa.

I enclose \$5.00, for which please send me, postpaid, your Home-Workshop Gold Leaf Kit with full instructions and 101 suggested uses. If I am not entirely satisfied, I shall return the Kit within five days and my money will be refunded.

(Print Plainly Please)

Name _____

Address _____

City & State _____

Check Here if you prefer C. O. D. (\$5.00 plus postage)

WHAT TO MAKE *and how* to make it ON A LATHE



WRITE for these books: (1) The Home Workshop, free; (2) What to Make on the Lathe, 10c; (3) How to Run a Lathe, 160 pages, 25c. Coin or stamps accepted. Any South Bend Screw Cutting Lathe on easy terms. Priced from \$75 up.

Ask for Catalog No. 15 Sent FREE!

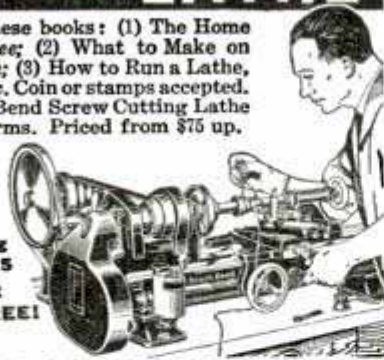

SOUTH BEND LATHE WORKS

398 E. Madison Street

South Bend, Indiana, U. S. A.



HANDY Taps and Dies

Why Handy? Handy to use (easy cutting). Handy to own (10 cents each). Accurate (precision cut threads). Lasting (carefully hardened and tempered).



Made by HENRY L. HANSON
Worcester, Massachusetts

At Your Local 5 and 10 Cent Store

HAVE YOU A CAMERA?

Send 10c for recent number of our big magazine, showing how to make better pictures and earn money.

AMERICAN PHOTOGRAPHY

144 Camera House, Boston, Mass.

DO YOU

WANT a new business profession of your own, with all the trade you can attend to? Then become a foot correctionist, and in a few weeks earn big income in service fees,—not medical nor chiropody—easy terms for home training, no further capital needed, no goods to buy, no agency. Established 1894. Address Stephenson Laboratory, 1 Back Bay, Boston, Mass.

Stoves AT FACTORY PRICES!



Sale Catalog—FREE

200 Styles and Sizes of Stoves, Ranges, Furnaces at Factory Prices. Easy Terms—as little as 18c a day. More Bargains than in 20 Big Stores. New styles, new features, new colors. Year to Pay—30 days' free trial—360 days' approval test—24-hour shipments. Over 1,100,000 Satisfied Users. 37 Years in Business.

Write for FREE Catalog,
THE KALAMAZOO STOVE CO. MFRS.
391 Rochester Avenue
Kalamazoo, Michigan

"A Kalamazoo"
Trade Mark Registered
Direct to You

The Flying Penman

(Continued from page 69)

Figure it out for yourself. Jim Rose writes his block letters 2,500 to 3,500 feet high, which means they are about a quarter mile or more in width. It takes a gallon of oil to smoke up one letter. Writing two words for one advertiser costs him twenty-five gallons of oil and he burns thirty-five gallons of aviation gasoline in the hour it takes to hang up those two words, and come down to earth. Rose estimates that sixty dollars just about covers the operating expense of an average sky-writing job.

Unfortunately you cannot check up on your handwriting until the job is done. The fellow who looks like a microbe three miles below can see your letters scattering, see your lopsided figures and upslanted lines but you are scooting along at 150 to 175 miles an hour on a level with what you have just written and it is merely a wall of smoke to you.

If the wind is blowing from the west, Jim Rose starts spelling from the east; flying into the wind helps hold the word together. He lines up that first letter with some landmark, perhaps a city street, and keeps the rest of the word lined up with the foregoing letters—wind drift takes care of itself.

One thing the flying penman must remember: he has an eraser, but he must never use it. His eraser is the whirling propeller. If he forgets about propeller wash, the first time he swoops around to hang the tail on an "R" he will blow the top of his letter, previously written, into a meaningless cloud. He must never cross his own trail, and so, to dodge it, the sky-writer climbs constantly, each letter fifty feet higher than the last. Hanging up a ten-letter word you'd finish 500 feet higher than you started. Think about that when you start skywriting a three or four-word slogan in air so thin that you and your supercharged engine find breathing a job in itself.

Popular Mechanics Magazine does not publish the name of the maker of, or dealer in, any device described in its pages, but this information will be furnished by our Bureau of Information upon request, accompanied by stamped envelope.

\$200 My First Week



... Now in my OWN Business.

Would you, too, like to own a business where you could take in \$200 your first week as did L. A. Eagles in Madison, Wisconsin?

We want a reputable, honest man in each county. This man need not have any special experience or more than ordinary ability, but he must be honest and courteous.

Such a man we will start in business for himself. You can make far above average profits in the rug-cleaning business—a high-grade business all your own. Many earn \$125 to \$200 per week—some considerably more.

NO SHOP NECESSARY

The rug-washer finishes rugs like new on the customer's floor. Anyone can run it. Electricity does the work. A quick, thorough and highly-efficient method that restores the natural beauty of floor coverings.

There are hundreds of customers—in your vicinity and nearby towns. The business grows steadily. Simply clean a few rugs or carpets. These customers tell others and also give you their future work. Soon you will have a prosperous year-around business. Send coupon for booklet explaining everything.

"Profits Pay for Home"

Harry Hill built and paid for a home from rug-washer profits. His first day's business was \$86. F. E. Bonner writes, "Made \$70 in 13 hours." A L. Miller says, "Have had rug-washer 6 years—have earned as high as \$92 a day." M. O. Malmin earned 3 times the cost of his machine the first two months. You, too, can enjoy a large income.

VON SCHRADER MFG. CO., 110 PL., RACINE, WIS.

Free Book!
MAIL COUPON now

VON SCHRADER MFG. CO.
110 PL., Racine, Wis.

Send at once (no obligation) your free booklet illustrating rug-washer and telling how I can own my own permanent business; how I can earn large profits at prices below other methods; how I can become financially independent in a short time; and how I can pay on easy terms.

Name.....
Address.....
City..... State.....

"Never a Complaint"

C. J. White says: "\$100 business in six days—never a complaint." That is the nicest part of this business—every customer is more than satisfied. Stains and blotches disappear and vivid colorings and freshness in faded floor coverings come back.

EVERY MACHINE GUARANTEED

You take no risk. These machines have been manufactured since 1918 and are used by the United States Government and by Statler and other leading hotels. They are fully GUARANTEED.

EASY TERMS

The complete equipment is inexpensive. A reasonable down payment brings everything to you and the balance is paid monthly. From the start, you have your own business—one that is profitable and of which you can be proud.



MAIL COUPON Today



BUILD YOUR OWN \$1

TRAILER DESIGNERS' GUIDE BOOK—3 different designs, with floor plans. Complete working plans of one model, balancing instructions, etc. All for \$1 postpaid.

D. Van Oostveldt, Dept. 55, 111 Marston, Detroit, Mich.

FREE—25¢ Gilbert Thrills Magazine

—A gold mine of scientific news. 36 big pages jam full of exciting pictures. Free if you write now.

The A. C. Gilbert Co., 660 Erector Square, New Haven, Conn.

27" QUEEN MARY, \$2.50 plus post.

Others \$1.00 to \$6.00. Completely finished hulls, and parts of wood; sails, wires, rigging, and all parts included. Also entirely new Beginner's Line, at \$1.00 each. Coach models, too. Rush 3c stamp for illustrated Ship and Coach catalog.

MINIATURE SHIP MODELS, Dept. RT, Perkasie, Pa.

RADIOS

ALL NEW 1937 MODELS! **SAVE UP TO 50%**

DEAL DIRECT—FACTORY PRICES! Iron-Clad Written Guarantee!

A penny post card brings you our new, full-color 16-page BARGAIN CATALOG free. Many models to choose from: 4 to 19 tubes; AC-DC, All-Wave and new Farm sets that operate like city radios!

30-DAY NO-RISK HOME TRIAL

Send post card or coupon below for full details of our 30-day no-risk trial and Agent-User proposition!

AGENTS! \$6.98 **NOW - MAIL COUPON**

A real money-making offer. Write at once for territory.

GOLDENTONE RADIO CO., DEPT. E, Dearborn, Mich.

Without obligation, send me new 1937 Catalog and 30-day trial plan.

Name.....
ADDRESS.....

Free Catalog

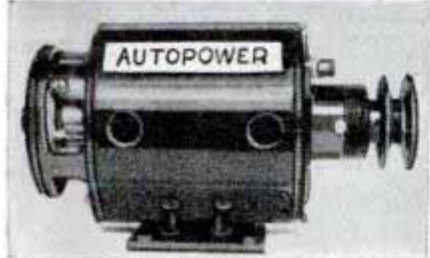

TURN SCRAP INTO MONEY

The new "1936" edition of "AUTOPOWER" with all the original specifications and many new ones is now off the press. The book is plainly written and illustrated—the instructions easy and simple. Change auto generators into practical A. C. and D. C. generators and motors, with voltage from 2 to 1,000 volts, for power, light, welding, radio, sound, etc. No experience nor special tools needed to make these economical changes. Generators can be driven by wind, water, fan-belt, etc. Already used and endorsed by thousands. Send for your copy today. Price only \$1 postpaid.

AUTOPOWER, INC. Dept. J. 410 S. Hoyne Ave., Chicago



REAL LIFE STORY

**TIRED ALL
THE TIME**



**SHE TOLD HIM
WHAT TO DO**

**FEELS LIKE NEW!
THANKS TO CLEVER WIFE..**

HE wasn't himself. Had too many restless nights, too many tired days. Seemed to lose his ambition. But his clever wife was too smart to let this go on. She insisted that he try Nature's Remedy (NR Tablets) and he found out what a surprising difference it made to use a laxative of entirely vegetable origin. He didn't mind taking NRs at all, they were so gentle, and non-habit forming. They simply made him feel like a new man. Get a 25c box at any drugstore today.

**NR TO-NIGHT
TOMORROW ALRIGHT**

FREE Beautiful Six-color 1937 Calendar-Thermometer. Also samples of NR and Turns. Send stamp for packing and postage to A. H. Lewis Co., Desk 113A-15, St. Louis, Mo.

**NEW
BENJAMIN AIR PISTOLS**

Powerful—Accurate—Economical—Practical—Adjustable Shooting Force—Amazing Maximum Velocity—cal. 177 or 22 and BB—For 12gauge and Small Game—the only Genuine Compressed Air Pistol on the market—Single Shot with Bolt Action—Hammer Fire—Hair Trigger—Safety. Price \$7.50. Also 177 and 22 Single Shot Air Rifles \$7.50—Single Shot BB Air Rifle \$5.00—25 Shot BB Repeater Air Rifle \$7.50—at Dealer or Direct—No license required—Safe for indoor use.

FULL DETAILS—TARGETS—FREE—WRITE TODAY.
Benjamin Air Rifle Co., 691 N. Broadway, St. Louis, Mo.



\$7.50



**PARTS FOR THE POPULAR MECHANICS
FAMILY TRAILER**

Everything you need! Axle, Tongue, Hitch, Wheel Housings, Wood Parts, Tank, Sink, etc. Send for price list. Include 25c (coin) for our big Catalog and Trailer Builders' Manual. Satisfaction guaranteed!

TRAILER SUPPLY CO., Box A, Wausau, Wis.



**PHOTO
ENLARGEMENTS**

Is Photography your hobby? Do you want a profitable easy business at home? Make **PHOTO ENLARGEMENTS** for yourself and others. Your cost 5c each and less. The Ideal Photo Enlarger is **AUTOMATIC**. No experience required. Also **COPIES** any picture. \$5.94 COMPLETE. Interesting circular **FREE**.

IDEAL-O, 122 East 25th Street, New York City

**5¢
ANY
SIZE**

WILD HAIR

Quickly tamed with our highly processed vegetable oil

**LUCKY TIGER
HAIR DRESSING**

... and Dandruff Remover

Beautifies without matting and enables you to dress hair in any style. Scientifically compounded to combat ravages to the hair of modern outdoor life. **At Druggists, Barbers.**



Trouble Shooter for a Railroad

F 1258 (Continued from page 61)

director has direct contact with all the maintenance forces in the field. The system between Washington and New York is divided into seven zones, each presided over by a power director.

One of the power director's functions is to maintain the power for signal operation. With trains moving in and out of this terminal, light signals must work properly, or serious accidents may result. On both sides of the eight-acre Pennsylvania station are water bodies. Trains approach from east and west through deep tunnels bored beneath the Hudson and East rivers. Often separated by intervals of less than one minute, these trains are controlled by a signal system that keeps them from colliding in the near-total darkness.

When a trolley line is de-energized a telltale light appears on the power director's model board. A red light indicates a switch is closed, a green light that it is open, and a white light indicates power is on. So thorough-going is the communications system in the modern rail terminal that it is never necessary for a power director to appear on the scene of a power break. His telltale lights and his staff of "reporters" furnish him with all the necessary information.

Without remote-control devices, visual signals, and telephones, it would be impossible to run hundreds of trains on accurate schedules. Operators in the various signal stations do not see the trains they direct, nor would they have time to watch if the trains ran before their eyes. It all appears uncanny. Practically nothing is seen to move in the control rooms. Electric currents are the only ties between the central offices and the trains in the field. The four signal stations in Pennsylvania station have 344 levers. They are simply traffic stations in a highly congested area—but no congestion or traffic can be seen.

In signal station "A," one of the busiest in the world, there is a track model with indicator lights and movable switch points. Between 600 and 700 scheduled trains per day are handled in this one room. Train directors give orders direct to levermen who, because of the heavy traffic, have time only to manipulate the levers.

MORE SPEED, MORE THRILLS ON

Write for
FREE Booklet
on "How to Ski"



NORTHLAND SKIS

The smooth, hard running surfaces of Northland Skis increase your speed greatly. Absolute uniformity of grain, weight, balance and limberness make for better control. You can have a lot of fun and thrills on a "matched-pair" of Northland Skis. Built expertly of select woods to withstand rough usage. A pair of Northlands makes a swell Christmas gift. Identify Northlands by the Deer-head trade-mark.

NORTHLAND SKI MFG. CO.
World's Largest Ski Manufacturers
95 Merriam Park,
St. Paul, Minn.

Models for
Touring, Down-hill
Slalom, Racing and Jumping

OTTAWA LOG SAW



GREATEST OFFER
EVER MADE

only \$**39**

PUTS THIS
OTTAWA
TO WORK FOR YOU

Make Money! Wood is valuable. Saw 15 to 20 cords a day. Does more than 10 men. Ottawa easily operated by man or boy. Falls trees—saws limbs. Use 4-hp. engine for other work. Write today for **FREE** book.

OTTAWA MFG. CO., 113 Wood St., Ottawa, Kansas

BUILD IT YOURSELF PLANS \$1.00



JIM DANDY CABIN CRUISER

The Trailer that has Everything

With my plans you can build this beautiful coach with ease and save money. Plans show every detail of building body, chassis, beds, cabinets, drawers, refrigerator, top, electric light and water systems and where to buy all parts. The Jim Dandy Cabin Cruiser can be built in any size to accommodate 2 to 4 people. Send \$1.00 for these plans today—get started now!

COMPLETE BUILDING PLANS \$1.00

MAIL DOLLAR BILL TO JIM DANDY, Box 125-A, WAUSAU, WIS.

BURN YOUR NAME ON TOOLS

WITH THE ARKOGRAF

PROTECT YOUR TOOLS FROM THEFT

Write with electricity any name or design on the hardest and finest tools and instruments, or any metal, like writing on paper with pen or pencil. Complete Outfit \$3.50—Prepaid Anywhere. Interesting illustrated circular free. Write today. Agents wanted.

ARKOGRAF PEN CO., 3927 S.E. Stark St., Portland, Ore.

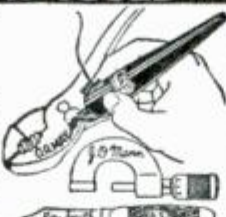

DEAFNESS IS MISERY



Many people with defective hearing and Head Noises enjoy Conversation, Movies, Church and Radio, because they use Leonard Invisible Ear Drums which resemble Tiny Megaphones fitting in the Ear entirely out of sight. No wires, batteries or head piece. They are inexpensive. Write for booklet and sworn statement of their inventor who washed himself deaf.



A. O. LEONARD, Inc., Suite 699, 70 5th Ave., New York



SAFEGUARD good TOOLS!

Use a Gerstner Chest. Made for Machinists, Tool, Die and Pattern Makers. Free Catalog.

GERSTNER TOOL CHESTS

461 Columbia St., Dayton, Ohio

Print Your Own

Cards, stationery, circulars, tags, labels, advertising, etc. Save money. Print for Others; Big Profits; easy rules sent. Will do popular Raised Printing like Engraving. Junior press \$5.95, job presses, \$11 up, power \$149. Send for free catalog and all details. **THE KELSEY COMPANY, R-37, MERIDEN, CONN.**

When writing please mention Popular Mechanics

BROADCAST and AMAZE Your Friends!

Put on your own broadcast with the **WALCO MIKE**, most entertaining radio device yet produced. Sing, laugh, talk, crack jokes from another room and your radio will produce every sound as though you were miles away at a regular broadcasting station.

Marvelous Fun at Parties

Imitate the big radio stars and crooners. Do a "Ben Bernie" or "Rudy Vallee." No end of pleasure for grown-ups or kiddies. Excellent training in elocution. "Amateur Hour" practice, or broadcast announcing. Special cut-out button allows you to switch from home broadcasting to regular radio reception in an instant. Can not injure your radio in any way.

Send No Money

5 Days Trial at Our Risk! Merely mail the coupon. On delivery pay postman \$1 plus few cents postage. If not delighted return it in 5 days and your \$1 refunded at once.



THE WALCO MIKE

In handsome black metal. Long cord. Less than a minute to attach to any radio without tools. Fully guaranteed. **\$1**

ELECTRICAL LABORATORIES CO., Dept. 71,
49 East 21st St., New York, N. Y.

Send Walco Mike, with complete instructions. Will pay postman \$1, plus few cents postage. If not delighted, will return in 5 days for \$1 refund.

Name

Address

Check here if **ENCLOSING \$1**—thus saving postage charge. Same refund guarantee applies.

SENSATIONAL NEW SAW TABLE



20 x 26
TABLE

Now! A real heavy duty saw table that is practical, accurate and dependable at a remarkable direct factory - to - you price. Large 20x26 table. Blade raises and lowers, also tilts 45 degrees. Price includes 8" blade, fence, miter gage, guard, splitter knife, motor base and V belt on arbor.

Net weight without motor 100 pounds. Write today for New Catalog.

Scrollsaw — Jointer — Saw Table — Band Saw

Write for the new **FREE** Blue Star catalog describing and pricing complete line modern heavy duty equipment. Remember factory-to-you prices, no agents, no dealers. Factory guarantee. Act at once.

BLUE STAR PRODUCTS 343 Penn Street FAIRFIELD, IOWA

MAKE YOUR OWN VENETIAN BLINDS

Complete instruction book shows how easy you can make them in your own home shop. Postpaid only 25c. We furnish hardware, ladder-tape and cord at amazing direct-to-you low prices. Cost of book applied against hardware cost if purchased from us. Write To-day.



HESTON & ANDERSON 601 PINE STREET FAIRFIELD, IOWA

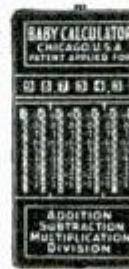

VEST POCKET ADDING MACHINE

IDEAL XMAS GIFT! Adds, Subtracts, Multiplies, Divides. Does work of more costly machine. Not a toy. Million dollar capacity. Simple and accurate. Guaranteed 5 years.

FREE TRIAL —SEND NO MONEY— \$2.50
Total Cost

Just name and address. We will ship Calculator immediately. On delivery pay postman \$2.50 (plus few cents postage). (If outside U. S. send cash.) 10c additional in Leatherette Case. If not satisfied after 10 days' trial you get your money back. **THOUSANDS OF SATISFIED USERS.** Write for Agents' Proposition. **CALCULATOR MACHINE CO. (Mfrs.) P. O. Box 1118, Dept. 31, CHICAGO, ILLINOIS.**

Casey Jones Turns Motorman

(Continued from page 37)

son from the sun which has just set. The mists and smoke of the city are tinted by the afterglow. The western section of Chicago seems to speed past for there is little noticeable motion in the engine. Then come the suburbs. It is dark now. The long hood of the train looks longer than ever in the darkness. Ahead, the endless ribbons of steel flash and glisten in the glare of the powerful headlight.

A glance at George's face shows he is enjoying it. There is a half smile around his mouth. He looks over and winks. Reaches up and pulls the whistle cord for crossings—two longs, two shorts.

"Just like the one on the 'Queen Mary' only not so big," he boasts, and pulls it again to give another sample of its tone. "You can hear it for five miles."

Out in the open country George opens the throttle wide.

"We're good for eighty-three miles an hour now." Claude Lewis, the engine foreman, explains. "Can't go faster between Chicago and Omaha because of the train control system. Go above that and the red light comes on to make us slow down."

As the throttle bar moves forward the whine of the motors increases in volume. The needle of the speedometer creeps up, slowly at first, then, as the tip passes sixty, more quickly, until it hovers around seventy-nine. When it hits eighty, George shifts the throttle back a notch and takes a "bite" of air—"to offset the momentum."

It was just about then that the fun started. Storm clouds filled the sky to the north and west. They could be seen sweeping in from the horizon, silhouetted in gray-black blotches as fingers of lightning, dozens of them at one time, stabbed swiftly to earth. Then the rain commenced.

"Doesn't look so good," remarks George, taking a quick squint at the sky, then pulling out his watch, estimating the time made thus far and wondering how badly the storm will disrupt his schedule.

He had hardly spoken when, in a sudden burst of sound, the warning whistle went on. At the same instant the green sphere disappeared and the red-and-orange flashed. George grabbed the air bar with both hands. The ominous sound

of the whistle blended with the hiss of rushing air and the rumbling grind of brakes as the twelve-car train slackened speed and slowed finally to a stop.

Passengers behind probably wondered what it was all about during the next hour or so, but only vaguely. The lights were bright back there. The seats were comfortable and, after all, rain is only rain to a passenger. They couldn't know what was going on up forward in that engine cab. Time after time the red-and-orange danger signal would flash. The journey, usually accomplished at a smooth eighty-mile-an-hour pace, became a series of intermittent stops. The rain came down in torrents, accompanied by a high wind which whistled even through the close-sealed windows. In the glare of the powerful searchlight it was impossible to see more than a few feet ahead of the engine's giant nose.

"Worst I've seen in years," said George. He had to yell to make himself heard. Yet when the green signal permitted, he drove ahead—seventy-eight, eighty miles an hour. He knew the road. Traveling along those rails through the night meant nothing more to him than for the average householder to walk through his own home in the dark. George could "feel" his run. Automatically his arm reached up at just the proper time to blast the whistle at crossings.

Benny Neuman, assistant engineer, came into the cab from the engines and slammed the door behind him. He was dripping, soaked to the skin.

"Bad time closing the side ventilators," he yelled. "Closed now, but don't keep out the rain. Might as well try to stop Niagara. Two inches of water on the floor."

The red danger signal came on again. The warning whistle tooted and kept on tooting even after the train had come to a stop.

"Something wrong," Lewis said. He jumped up and disappeared into the engine room again. The whistle, added to the pounding of the rain and the wind gave an eerie spine-tickling sensation as George gave four deep-throated blasts to warn the rear-end brakeman to hop off

(Continued to page 130A)



HOW COULD YOU AFFORD THAT FINE CAR? STRIKE OIL?

IT SURE HAS BEAUTY, POWER, COMFORT AND QUALITY— BUT IT COST ME LESS THAN THE CHEAPEST NEW CAR. IT'S A USED CAR.



I'D BE AFRAID TO BUY A USED CAR. YOU MIGHT GET A BARGAIN—BUT YOU MIGHT GET STUNG.

NOT IF YOU BUY UNDER THE STUDEBAKER PLEDGE. THAT GIVES REAL PROTECTION.



HOW COME?

WHEN YOU BUY A CAR UNDER THE STUDEBAKER PLEDGE YOU HAVE FIVE DAYS IN WHICH TO DRIVE IT, TEST IT, HAVE IT CHECKED BY YOUR OWN MECHANIC.



BUT SUPPOSE THERE IS ANYTHING WRONG? SUPPOSE YOU JUST DON'T LIKE THE CAR?

RETURN IT AND APPLY YOUR DEPOSIT ON ANY OTHER CAR IN THE DEALER'S STOCK—NEW OR USED.



THAT SOUNDS FAIR.

IT IS FAIR. AND ALL PLEDGE-BACKED CARS ARE MARKED WITH ROCK-BOTTOM PRICES IN PLAIN FIGURES. NO JUGGLING ON PRICE.



I'D SURE LIKE TO BUY A GOOD USED CAR ON THAT BASIS. WHERE DO THEY SELL THEM?

AT STUDEBAKER DEALERS. AND REMEMBER THAT CERTIFIED CARS CARRY 30-DAY FREE SERVICE. BUY A USED CAR UNDER THE STUDEBAKER PLEDGE IF YOU WANT A BARGAIN—AND SAFETY.

BUY USED CARS UNDER THE *Studebaker Pledge*

When writing to advertisers please mention *Popular Mechanics*

**C'MON YOUSE GUYS
GET A REAL
MOVIE BARGAIN**



SPECIAL OFFER
Projector as described below with two fifty-foot films of Charlie Chaplin and Tom Mix.

All For **\$7** Post-Paid

FREE!

Projector is motor driven for 110 volts A. C. with double 2 inch lens. Shows pictures 30 inches wide at 12 feet from screen. Takes 100 feet of standard 16mm. film. (Sold separately at \$4.50).
Send NOW for our **BIG, FREE Catalogues of Movie Supplies and films including POPEYE, BETTY BOOP, MICKEY MOUSE, etc.**

PARAMOUNT MFG. CO.
Dept. G-83 BOSTON, MASS.

Latest book on **ASTRONOMY. IF YOU ACT NOW.** Learn to tell all the stars. Mystify your friends.

Patent Copyright, King Features Syndicate, Inc., 1935

NEW SCREW FEED LATHE

No. 255-6 x 18-inch METAL TURNING LATHE WITH LONGITUDINAL SCREW FEED. Length overall 39 inches. Machined semi-V ways. Threaded hollow spindle No. **ONLY \$10⁹⁵**



O MORSE TAPER CENTERS. BRONZE TAPERED TAKE-UP BEARING. 1/2 inch tailstock set-over. Compound carriage travels on semi-V ways gibbed for take-up. Included: Two 60° centers, tool post assembly and 4 inch face plate.—3 inch four jaw chuck \$3.50; 4 inch chuck \$4.50; adapter bushing 50 cents. Send \$2.00 with order, balance C.O.D. Shipping weight 30 lbs.

FREE—32-page catalog



BALKO ELECTRIC MOTOR & SUPPLY COMPANY
Dept. A11 10 S. Clinton St. Chicago, Ill.

New HULL AUTO COMPASS

Saves miles of travel in wrong direction. This handsome, STREAMLINE Airplane Type Compass keeps you on the right road. Easily installed. 3 1/2 inches high. Bakelite case, sapphire bearing. Built-in compensator. Only \$2.95 POSTPAID. SATISFACTION GUARANTEED.

MODEL A
Airplane Type. 1 3/4-inch diameter. Sticks to windshield. Guaranteed. With separate compensator, only \$1.95 POSTPAID.

If your dealer cannot supply you, order direct.

HULL MFG. CO., Box 246-D, WARREN, OHIO



'2 to '3 An Hour

Make Big Money in Saw Filing Business!

NO EXPERIENCE NEEDED to file hand, band and circular saws with FOLEY Automatic Saw Filer. J. W. Anderson, Texas, writes: "My fourth year with Saw Filer and third with FOLEY Lawn Mower Sharpener as side line. Business has increased until it is about full time."

Used by Leading Saw Makers
Atkins, Disston, Simonds and by industrial plants and repair shops all over U. S. Cash work. No canvassing. No eye strain. Postcard brings FREE PLAN. No obligation.

**FOLEY MFG. CO., 116-7, Foley Building
11 Main St. N. E., Minneapolis, Minn.**



with his lantern and red light. A five-minute stop this time, while Diesel expert and electrician searched feverishly for the trouble. The engine room door opened.

"Try the shut-off again."

"Nope. Won't work." George sat calmly in his chair. No responsibility of his.

Lewis examined things for himself, tried tossing the shut-off lever over. The whistle continued its maddening toot. Minutes were precious. Eight or ten are all that can be made up between Chicago and Omaha with the train control system in operation. Then, as suddenly as it blared into sound, the whistle stopped, the green light showed again on the dash. Everyone breathed easier. George grabbed another hasty look at his watch and advanced the throttle, picking up speed. As before, the train whistle moaned at crossings, the rain continued, illumined by revealing displays of lightning.

To ride like this, blind, at eighty miles an hour through a cloudburst; to feel the close contact with danger, the roll and lurch of the train; to hear the rumble of the wheels, the whine of the motors; to wonder what, and how bad it is, ahead; to sit tense, speeding swiftly into the unseen and, to you, unknown, with telephone poles flashing past like so many gray ghosts—that is adventure!

The Mississippi at last. Clinton, Ia., a "division" stop and time for the engine crew to change. The engine crews change eight times between Chicago and Denver. Not until then did George Reid manifest any part of the tension he had been under. He stood up, flexed his arms and legs.

"Well," he said as he disappeared through the side door of the cab and down the ladder, "here we are at last—and me, I'm glad of it."

Do the streamline skippers like their new work? Two or three months ago old-time engineers were still bemoaning the creation of streamliners as "sure death" for the romance of railroading.

"When I have to sink to driving a street car," one old-timer said, "I'll quit."

Well, it is like running a street car, so far as the mechanics of it are concerned. On the Union Pacific division, in fact, they refer to the pilots as "motormen." They have no responsibility for the motors; all they have to do is know how to

operate them. A Diesel expert is always on hand to take care of trouble. Yet there must be the "feel" of the old-time engineer; a confidence that comes only with years of experience.

"How do I like 'em?" exclaimed George Reid. "I think they're great. On a night like this, I'd be soaking wet, along with my fireman, from leaning out the cab trying to see ahead. Steam cabs are regular sieves. Tonight—it's been a long time since I saw a worse one—I was dry and comfortable."

On the return run from Denver to Chicago the next night, Engineer C. G. "Dad" Peacock, gave the same sort of answer. "Dad" Peacock is sixty-four years old and has been running an engine for thirty-seven years.

"You couldn't drag me off this run," he said. "I work two hours every other day and get paid by the mile. Why shouldn't I like it? All the time in the world to myself and I'm comfortable even when I'm working."

"Ollie" Mitchell, superintendent of engineers for the Union Pacific, reported there are more applications from old-time engineers for streamliner runs than can be accommodated.

Claude Lewis, engine foreman for the North Western, represents the third generation in his family who have "lived with engines."

"My father was an engineer," he said, "and so was my grandfather. I wish my dad could have lived to ride like this. He wouldn't believe it. Sometimes I almost don't believe it myself."

Handle to Use Short Solder Bars

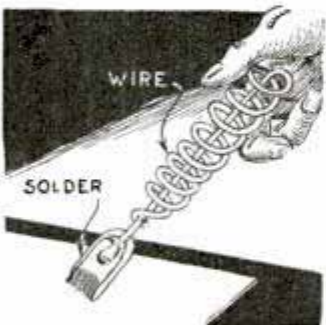

When working with bar solder, and a piece becomes too short to hold without burning the fingers, one tinsmith solders a coiled wire handle to the short piece so that

he can hold it comfortably. He claims that this is better than soldering the short piece to a new bar, as the handle is always cool and does not increase the weight of the solder appreciably.

**I CAN PATCH
THIS TOP with
PLASTIC WOOD**



Damaged or leaky tops or rotted posts are repaired by applying Plastic Wood firmly into cracks or holes—allow to harden—sandpaper smooth. Fabric patch can be cemented over Plastic Wood.

Make 1001 Household Repairs

Genuine Plastic Wood is actual wood in putty form—when dry it is hard wood that can be worked with any wood-working tools—sawed, planed, turned on lathe, carved—will hold nails and screws perfectly without chipping, cracking or crumbling. Adheres to any clean, dry surface—wood, metal, glass or porcelain—is waterproof and weatherproof—can be painted, varnished or lacquered perfectly.

Genuine Plastic Wood is also used to repair broken furniture, reset loose bathroom fixtures, loose casters; fill old screw holes, baseboard cracks, shelving cracks, replacing wood rot; fill holes around pipes, wiring, boat and canoe repairs, etc.

Get your can or tube at any leading paint, hardware or variety store.



PLASTIC WOOD

GO INTO BUSINESS MAKE 100% TO 300% PROFIT!

Sell new and used clothing direct from your home, auto or store. Undersell all competition. **EASY SALES—FAST REPEAT ORDERS!** We furnish everything and show you how. Handsome profits every day in the year. No selling experience necessary. Write at once for our Big Money Catalog—It's FREE!

Liquidation Merchandise Co., 550 E. 43rd St., Dept. D-16, Chicago, Ill.



**Manheim
Pocket
Slide Rule**

\$1

With A-B-C-D Scales. Multiplies, divides, squares, takes square root, finds circumference and area of circles. 6 inches long—thin construction. **NO WOOD OR CELLULOID.** Fits in vest pocket. Send \$1 in cash, money order or check and receive slide rule with genuine leather case and instructions. Box M-3.

M. MANHEIM COMPANY, Inc., 15 E. 26th St., New York, N. Y.

Consider this fact
before you buy



Prices from
\$510 UP
f. o. b. factory

You will have no difficulty today in finding a tourist-trailer which delights your eye and which offers nearly every conceivable comfort and convenience. Any of the better makes will satisfy you on this score.

But bear this fact in mind: A tourist-trailer in reality is an automotive vehicle. As such it presents problems with which only automobile engineers are fully familiar—problems of frame structure . . . of materials . . . of spring suspension . . . of riding qualities . . . of braking control.

The Pierce-Arrow Travelodge is the only trailer in the field today designed by automobile engineers, built by automobile men.

That is why the 1937 Pierce-Arrow Travelodge offers all that other trailers offer—PLUS basic and exclusive structural and design advantages which are the direct result of 37 years of engineering leadership in the highly specialized automotive field.

The price of a Pierce-Arrow Travelodge is no more than that of any good trailer; the *ultimate cost* is far less, for its all-steel frame and its outer armor of airplane-type aluminum are built to outlast by years, by additional thousands of miles, the ordinary wooden construction which now becomes obsolete.

Commercial Units Also Available

**THE 1937
PIERCE-ARROW
TRAVELODGE**

FREE—Send for this booklet.

Use this coupon ----->

TRAILER DIVISION
PIERCE-ARROW MOTOR CORPORATION, BUFFALO, N. Y.

Please send me your booklet which shows HOW Pierce-Arrow engineers have built strength, safety, long life and luxury into the 1937 Pierce-Arrow Travelodge.

Name _____

Address _____

City _____ State _____

Hitch Your Wagon to a Car

(Continued from Coloroto Section)

comfortable or to utilize the limited space to the utmost. One sleeps four in two compartments and has its own air conditioning system. Outside air enters through a wind scoop, is cleaned in steel wool and oil air strainer and is cooled in a Dry Ice unit. Several coaches have shower baths, one has a bathtub, and the larger ones have chemical or flush type toilets with septic tanks.

One telescoping model can be extended in width and height when parked and another has a floor which is lowered when parked to increase the headroom. An inexpensive unit consists essentially of two streamlined beds on wheels and a tiny kitchenette, all contained in a compact little unit not much larger than a big trunk. There are a host of collapsible tent trailers and one outfit which really is not a trailer but serves the purpose of one, roosts on top of your car by day and forms an enclosed second-story lean-to at night. Some of the more swanky trailers have tile galleys, others boast Venetian blinds and one make, at least, has a telephone between the tow car and the coach. Some interiors are mahogany, some are leatherette and some are plywood, but one maker went a step further and has his car lined with stucco.

One manufacturer is turning out a line of trailers with pre-shaped body panels like an automobile and with a welded steel frame. Several others have duralumin or other metal for frames and the more expensive ones are likely to have all-metal bodies. Some of the custom-built coaches are actually palaces on wheels. One man has a thirty-five foot trailer weighing 5,900 pounds. It has a real living room, forward observation windows set high enough to command a view of the road ahead, a bedroom, shower bath and galley, and separate quarters for the chauffeur. There is a telephone, windows are of shatterproof glass and equipped with disappearing screens and the luxuries include an electric outlet at every washbasin for operating electric razors or other electric toilet appliances.

Trailer and permanent cottage are combined in one mobile home which is towed

(Continued to page 134A)

OF CLAR MECHANICS ADVERTISING SECTION 1937

HERE ARE THE NEW 1937 *Atlas* SHOP TOOLS

DRILL PRESSES

\$16.45
to
\$42.45

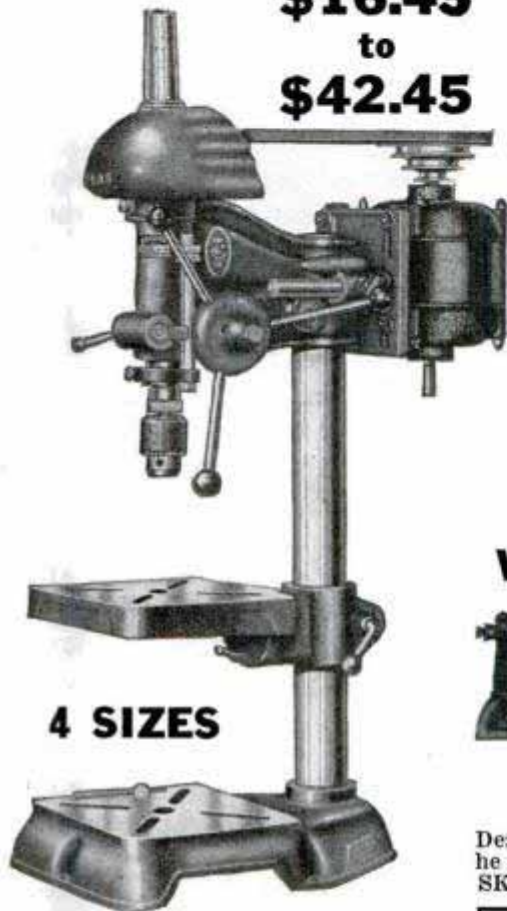

4 SIZES

A model for every need. Original Atlas SKF ball bearing head, spline spindle, balanced pulleys, built in switch, Jacobs chucks, full tilting tables, etc.

MOTORS AND GRINDERS \$8.75 UP

Real values in motors and grinders. A size and price for every need—grinders in both floor and bench models.



ALSO A COMPLETE LINE OF
ARBOR PRESSES, WOOD TURNING
TOOLS, DRILL PRESSES AND LATHE
ATTACHMENTS, VISES, DISC SANDERS
AND SMALL TOOLS

DISPLAYS AT
CHICAGO NEW YORK PHILADELPHIA
35 E. Wacker Dr. 130 W. 42nd St. 113 No. 3rd St.

25th
ANNIVERSARY



Atlas METAL WORKING LATHES

\$39.75 to \$112.50

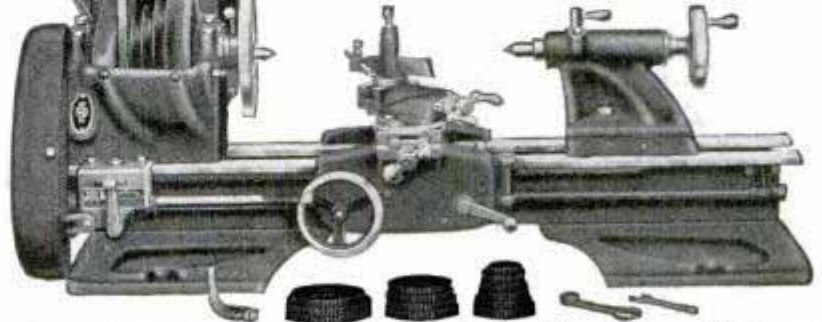

A complete line of precision built metal cutting lathes. Back geared models start at \$87.50. Attachments available for all machine shop operations. Guaranteed accuracy—modern design and many exceptionally outstanding features.

WOOD WORKING LATHES



\$22.95 to \$29.95

Designed for the user who wants the best possible lathe he can obtain for this type of work. Deep grooved SKF Ball bearings.

**THESE TOOLS MAKE IDEAL
CHRISTMAS GIFTS**

**FREE
NEW
1937
CATALOG**

*Send
Today*



Ten minutes with this big new 52-page catalog will save you many dollars in equipment costs this Fall. It's our 25th Anniversary. We're offering the greatest values in our history. Mail the coupon below for your copy.

Please send me your new 1937 Catalog.

I AM INTERESTED IN

METAL LATHES DRILL PRESSES SHOP
 WOOD LATHES ARBOR PRESSES TOOLS

NAME

ADDRESS

CITY

STATE

ATLAS PRESS COMPANY
143 No. Pitcher St., Kalamazoo, Michigan

When writing to advertisers please mention *Popular Mechanics*

THE LAY OF THE LAST MINSTREL!



...then he switched to the
brand of grand aroma



WE insist that a pipe is the world's sweetest smoke if regularly cleaned and fed a certain mixture of Kentucky Burleys. And *that*, we blushing admit, is Sir Walter Raleigh Smoking Tobacco. Folks, we've discovered a combination of fragrant leaf that is raised, cured, well-aged, and secretly blended to smoke several degrees milder. Try this kingly tobacco. Life will seem brighter, the air clearer, and your circle of friends will widen.



TUNE IN JACK PEARL (BARON MUENCHAUSEN)
NBC BLUE NETWORK, MONDAYS 9:30 P. M., E. S. T.

(Continued from page 132A)

behind the car to wherever the owner wishes to live for a while. There he un-hooks it, jacks it up on cement blocks and unfolds it into a four-room bungalow until he decides he doesn't like his neighbors or tires of the scenery. Then he moves on.

So it makes little difference whether you want a trailer to call home the year round or one for vacations, there's a rolling home to fit your purse and there certainly are enough from which to select, so you should have little difficulty picking one with the particular features that appeal most to you. If you can't buy one, you can still live in a trailer. In many places today you can rent a modern trailer by the day, week or month from dealers specializing in this business.

And if, as Mr. Babson predicts, half of us are going to be living on wheels in a few years, you might as well become accustomed to a portable home, even if you have to rent one. The only trouble is that, according to trailer "addicts," once you live in a home on wheels, you're never satisfied to be anchored to a permanent one again.

Trees on Hillside Protected by Rock Walls

In localities where fruit and shade trees are located on a hillside, half circular walls of stone or brick built as shown will be highly effective in checking erosion and in retaining moisture. The walls should be fairly thick and should be set well into the ground.



Half-circular walls on the downhill-side of these trees check erosion and help hold moisture

FASTER - SAFER - CLEANER

7200 Strokes per Minute
Electric Operation

No Motor Required

Astounding performance! Cuts up to 1" or more, with smooth, clean edges. No sanding required. Accurate, sturdy, efficient—a revelation to skilled craftsmen in handling both intricate designs and heavy work. Ideal for cutting light metals, veneers and plastics. Operates on 60 cycle, 110 volt AC, without motor or any reciprocating parts. Requires no oiling. 10" square table; 13½" throat; adjustable guide; variable stroke. Complete with underwriters approved cable and rubber plug. Built for years of continuous service.



New
**SYNCRO
JIG SAWS**

**FREE
FOLDER**

GET FREE LITERATURE TODAY
Ask your dealer to show you the models now available. Or send your name for full information and illustrated literature, FREE.

SYNCRO DEVICES, INC.
511 Boydell Building Detroit, Mich.

LOW COST FUN!

1937 improvements give greater horsepower, longer life, increased mileage. Send for catalog on new models. The classiest motorcycles you ever saw. Color options at no extra cost.

Write today.
HARLEY-DAVIDSON MOTOR CO., Dept. P, Milwaukee, Wis.

HARLEY-DAVIDSON
Motorcycles

**BUILD YOUR OWN**

Wind Driven Light Plant

from old auto generator. We show you how. Make money building for others. Light your buildings, play radio, operate washing machine and other motors. Dime brings complete plans and 1937 catalog. Over 50 other changes for 6-12-32 and 110 volt plants.

LEJAY MFG. CO., 1447 W. Lake St., Minneapolis, Minn.

FREE
Lights

**Sell Improved Leather Ties**

DON'T waste effort on second raters. Sell fast and repeat on handsome improved ties. Rich colors, embossed like silk. Finest cut; long wear; wrinkle-free. Wipe clean like new with damp cloth. Send 50c for sample tie (65c value) and Big Free Sales Kit of new season's smartest patterns. Money back plan. Free premiums.

NU-MODE TIE CO., Dept. 20
1333 N. 12th Street Milwaukee, Wis.

**COMPLETE ELECTRIC PLANTS**

ONAN ALTERNATING CURRENT PLANTS furnish same as city current anywhere. Operate on gasoline, Run Radio, Water System, Refrigerator, all Appliances.

SIZES 350 WATTS UP

Easy to install. Available from stock. Ideal for Farms, Camps, Lake Homes, Commercial use. Sizes for any purpose. Write

D. W. ONAN & SONS
999 Royalton Ave. Minneapolis, Minn.

**ONE-MAN SAWMILL**

Makes lumber, shingles, lath, ties, crates, boxes, cases, all forms lumber

TURN TREES INTO MONEY WITH A BELSAW

Three capacities: 10, 14 and 20 ft.

Accurate set works positive dogs. Full or one way type power feed runs on low power—Many owners use old auto engine. Pays for itself quickly—thousands in commercial service, everywhere. Write for free lumber handbook and catalog of mills, supplies, tools, saw tables, and woodworking equipment.

Belsaw Machinery Co., 811-Z Davidson Bldg., Kansas City, Mo.



FARM
MODEL
\$49.00

**TRAILER**

SEND 25c TODAY

for this big 64 page book that tells how to build Tops, Beds, Cabinets, etc. All about Electric Light and Water Systems, Floor Plans, etc. Pages full of valuable information, ideas, suggestions that save time and money for trailer builders, buyers and users. Catalog of parts and equipment includes everything you want—Axles, Hitches, Pumps, Stoves, Lights, Windows, Sinks, Toilets, Mattresses—over 200 items exclusively for building and equipping a trailer. Rush 25c (coin) today—satisfaction positively guaranteed.

TRAILER SUPPLY CO., Box 438-A, Wausau, Wis.

★ BUILDERS
★ BUYERS
★ OWNERS

NOW—A Genuine 7-Inch BLACK & DECKER ELECTRIC SANDER

No. 17 JUNIOR



FOR ONLY

\$39.50

THE NEW 7-INCH JUNIOR SANDER saves hours of slow, hard work with sandpaper, emery, files, etc. Makes quick work of such jobs as cleaning and smoothing wood or metal surfaces; removing paint and rust; grinding and smoothing welds and casting ridges; rubbing down new lacquer with felt rubbing pad; polishing metal, etc. Universal motor operates on A. C. or D. C. A great tool. A great value. Only \$39.50.

LOW PRICED B & D DRILLS, TOO

½-INCH JUNIOR DRILL: (Illustrated). Drives twist drills for drilling up to ½" holes in steel; augers for drilling up to 1" holes in wood. Also drives Black & Decker Hole Saws for cutting clean, round holes from ¼" to 3 ½" diameter in any material a hacksaw will cut. Universal motor. Only \$35.00.



¼-INCH JUNIOR DRILL: Drives twist drills for drilling up to ¼" holes in metal; augers for drilling up to ½" holes in wood. Also drives light wheels for grinding, buffing, polishing, etc. Universal Motor. ONLY \$19.50.

MAIL THE COUPON TODAY for Black & Decker Catalog and name of nearest dealer where you can see these and other Black & Decker tools.

BLACK & DECKER
World's Largest Manufacturer of
PORTABLE ELECTRIC TOOLS

MAIL FOR FREE CATALOG

THE BLACK & DECKER MFG. CO.,
601 Pennsylvania Ave., Towson, Md.

Please send Free Catalog showing Junior Sander, Drills and other tools, and address of nearest B & D Dealer.

Name.....
Occupation.....
Address.....
City..... State.....

When writing please mention Popular Mechanics



The Marvel of the Radio Industry!

NEW MAGNA-SPAN DIAL and VITA-TONE SPEAKER

in the 1937

Knight RADIOS

38 Models to choose from
AS LOW AS \$8⁴⁵—5-19 TUBES
See them in Your ALLIED CATALOG

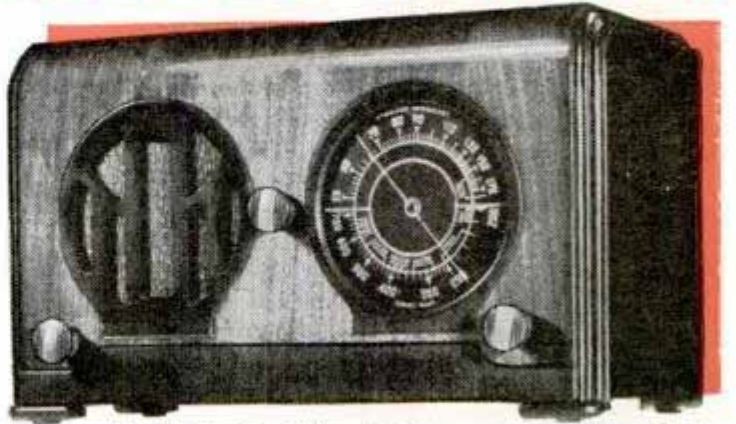

1937 Knights—America's most amazing radios—bring you sensational new developments in radio—new Giant Magna-Span Dials, and mighty "Vita-Tone" super-dynamic speakers, plus perfected metal tubes, Flywheel Tuner, "Electric Eye," Visual-Wave Band Indicator, etc. Their tone quality, sensitivity, selectivity, volume capacity, all-around performance at amazingly low prices again prove that only **ALLIED** is able to offer such tremendous values. All-Wave, Dual-Wave and Short-Wave—5 to 19 tubes—AC, AC-DC, 6-volt, 32-volt, battery and auto sets—a set for every purse and purpose.

An amazing 5 Tube Dual-Wave Value—actually achieves 8-tube efficiency! Sensationally low-priced. Tunes 2 Full Bands—43-150 meters for Short Wave, police, aviation, amateur 'phone—also Foreign, 49-meter Reception; second Band 175-550 meters—upper police channel and standard Broadcasts. Latest RCA licensed circuit—rubber-floated tuning condenser; 8 tuned circuits, Automatic Volume Control. Big 5½" Vernier dial makes tuning easy and accurate. Full size 6" Electro-dynamic speaker reproduces with flawless fidelity. Beautiful "Lay-Down" cabinet. 1937's **Radio Sensation**—see Back Cover of **ALLIED'S Free Catalog**.



1937'S WONDER RADIO
Knight 19 TUBES
MASTERBILT A. C. SUPERHET

TUNES THE WORLD! 3 full bands cover **everything broadcast!** Amazing new circuit—Dual Dreadnaught chassis (2 chassis)—Giant 30-Watt output, handled with remarkable tonal beauty by two 12" Vita-Tone speakers. 11" Magna-Span Dial with five exclusive features: The "Electric Eye," Flywheel Tuning, Wave Band Indicator, "Tell-Time" Scale, 340 deg. concentric calibration. America's First Luxury Radio at a popular price! For full description, see pages 12-13 of **ALLIED'S Free Catalog**.

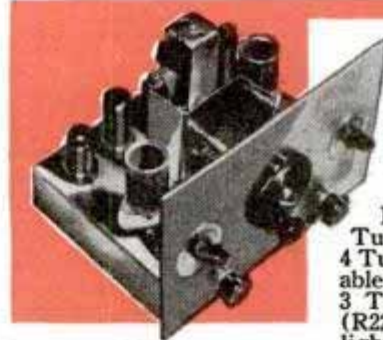

FREE!
Parts Lists for
Radio Builders

Write for Free parts lists covering P. M. 1 Tube Portable (R209); 2 Tube AC-DC (R211); 4 Tube Battery Portable (R223); Beginners' 3 Tube All-Wave (R224); 1 Tube Flash light Cell Set (R227);

18 Watt Amplifier (R230); 150 Watt Transmitter (R231); "A-B" Power Unit for 6 Volt Sets; Beginners' S-W 2 Tuber (R232); and many others. **ALSO**—see pages 125-6-7 of your **ALLIED Catalog** for other new, low-priced Build-Your-Own kits.

EVERYTHING IN RADIO AT LOWEST PRICES!

You need **ALLIED'S Free Catalog**

whether you sell, service or build radios, install P. A. Systems or operate a "ham" station. It shows **Everything in Radio**. Besides amazing new Knight Radios, its 152 pages include over 10,000 exact duplicate and replacement radio parts. Test Equipment, latest Public Address Equipment for every Sound need, Amateur Transmitting and Receiving gear, dozens of new build-your-own kits. Rurpower units and Windchargers, etc.

Faster Service—Lower Prices—Highest Quality

We buy in vast quantities, **get** lower prices, and sell for **less**, passing the resulting savings on to you. Our complete stocks are located under one great roof—central location for faster shipping; and real, personal service. Every item tested and approved by **ALLIED** expert engineers. See all these great radio values in the new 1937 **ALLIED Catalog**. If you don't have a copy, send coupon now!

FREE
Catalog



Allied
Radio
CORP.

ALLIED RADIO CORP.,

833 W. Jackson Blvd., Chicago, Ill. Dept. 5-A.

- Rush me a Free copy of your 152-page 1937 Catalog showing the 38 new Knight sets and complete Radio Supplies.
- Send me Free Parts List for Kit No.

Name

Address

City..... State.....

ALLIED RADIO
CORPORATION
833 W. JACKSON BLVD. • CHICAGO, ILL.

When writing to advertisers please mention *Popular Mechanics*

(Continued from page 136A)

HANDEE TOOL OF 1001 USES

**Grinds - Drills - Cuts - Polishes
Carves - Routs - Saws - Sands
Sharpens - Engraves**

A whole shop full of tools in one for work on all metals, alloys, bone, resins, glass, stone, wood, etc. Uses 200 accessories. Saves hours of tedious work. 13,000 r.p.m. A C or DC, 110 volts. \$10.75 and up, postpaid. 3 Accessories Free.



Plug in any Socket

DE LUXE MODEL

For constant service, nothing compares with this easy-to-handle production tool. Saves time and labor. Fastest, smoothest, most powerful tool for its type and weight. 25,000 r.p.m. \$18.50 postpaid, 6 Accessories Free.



Get a Demonstration at Your Dealer's or Order Either Model on 10-Days Money-Back Trial. Catalog Free.

CRAFTSMAN'S PROJECT BOOK
"Pleasure and Profit with a Handee"
Easy working plans for making many interesting and unusual projects, 25c stamps or coin.

CHICAGO WHEEL & MFG. CO.

1101 W. Monroe St., Dept. Q. Chicago, Illinois

Send Catalog Project Book \$10.75 Handee De Luxe Model

Name _____ PM1

Address _____

UNIVERSAL TRACTOR

Plenty of Power at Low Cost



Plows, discs, seeds, cultivates, digs potatoes, landscape work. Swivel trailer wheels and cultivator lift for easy turning. Over 4 h.p. on belt work. Moving parts fully enclosed. Write

Pioneer Mfg. Co., Dept. V-137, West Allis, Wis.

Combination — Wood and Metal Lathe

12 in. over bed 36 in. between centers

TIMKEN BEARINGS

Back geared screw cutting .001" accurate

Write for catalogue 50 to 3200 r.p.m.

CLAUSING MFG. CO. Dept. 517 OTTUMWA, IOWA

NEW Light Weight Paint Sprayer—Only \$29.50



1/4 H.P. Motor AC110 Volts. 60 Cycles—COMPLETE
Quick, easy way to paint screens, furniture, radiators, machinery—anything—in homes, factories, stores, schools, hospitals, office buildings, etc. Small, compact. Carry anywhere. Weight 44 lbs. Complete with Spray Gun; 15 ft. Hose, FULLY GUARANTEED. Only \$29.50 f.o.b. Chicago. \$5.00 Deposit, Balance C. O. D., or see your dealer. Free Circular. IDEAL PUMP CO., 801 Washington St., Chicago, Ill.

WORLD WIDE ALL WAVE RADIO \$155 POST PAID



A sensational Radio! Thousands now in use. Can actually bring in foreign stations, police calls, airplanes, amateurs, etc., as well as local broadcast! Short and Long Wave. Ace Radios give guaranteed results!
For only \$1.55 we send you the complete kit containing an attractive metal chassis panel and every part needed to build a powerful one-tube receiver, AMAZING VALUE! Works for months on two inexpensive dry batteries. Our clear diagrams make it simple to hook up. Not a feeble crystal set!
TWO TUBE KIT (More volume)—\$2.00.
ALL-ELECTRIC two tube house current set. No batteries! Complete kit \$3.00.
(Sets laboratory assembled and wired 75c extra.)
Enjoy NEW thrills! Send for your ACE Radio today!
Ace Radio Laboratories, 70 Barclay St., Dept. P-1, N.Y.C.

example, WGES, 1,360 k.c. Next adjust the broadcast oscillator trimmer (TC₁) while following the station by retuning the dial until the pointer on the dial indicates the correct frequency. Now adjust trimmer TC₃ for loudest signal, then tune slightly off the station and adjust TC₃ for loudest noise. The next step is to tune the set to about 600 k.c. and adjust the

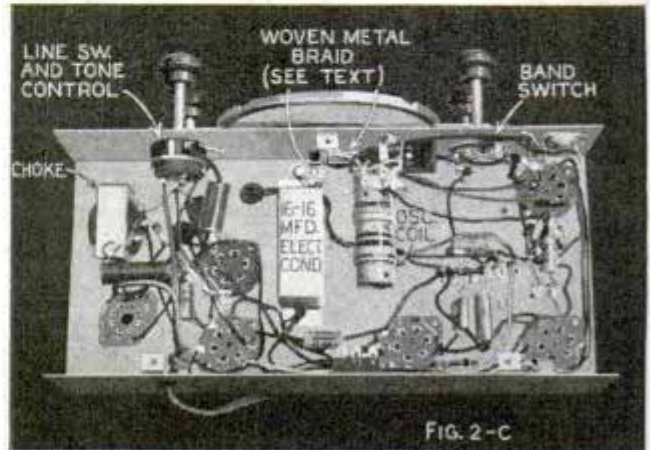
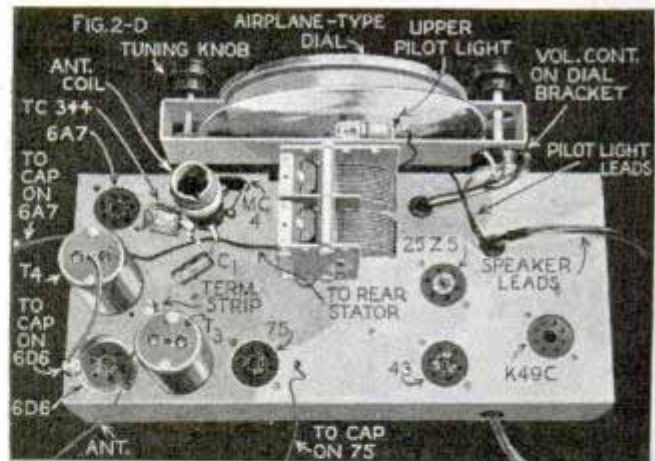

FIG. 2-C

padder condenser for maximum noise. Now go back to 1,400 k.c. and reset TC₁ to correct reading, as this will have shifted when the padder was adjusted.

The best time to balance the short-wave band is in the evening. With band-chang-



ing switch in short-wave position, tune in the amateur phones around 4 megacycles (4,000 k.c.). Adjust oscillator condenser TC₂ until the top of this phone band comes in at exactly 4 megacycles on the lower scale of the dial. The 75-meter phone band extends from 3,900 to 4,000 k.c. Now tune to about 6 megacycles and adjust TC₄ for loudest noise. The padder condenser on the short-wave band is fixed. This is MC₁ which must be exactly 1,900 mmfd., plus or minus not more than three per cent.

ALL PURPOSE
MOTO-TOOL



10 DAY MONEY BACK TRIAL for Home-Shop-School-Profession

Grinds, drills, engraves, routes, carves, sharpens, polishes and does hundreds of jobs quicker, better and with greater precision. Handles easily as a pencil—weight only six ounces, and is amazingly powerful. 110-Volt Universal Motor—about 20,000 r.p.m.—oilless self-aligning ball thrust bearing. Handy built-in switch. Easily replaceable brushes. Universal Collet Chuck. Bakelite housing. You must see and use it to appreciate its tremendous value.

Order on 10-day trial. Money refunded if not more than satisfied. Booklet Free. 20-piece Craftsmen Tool Set for all types of Moto-Tool work, \$5.75.

ONLY \$9.85
SENT POST PAID

DREMEL MFG. CO.
2813-Ct., Racine, Wis.

FACTORY TO YOU

NEW REMINGTON NOISELESS PORTABLE

10-Day Free Trial Offer



10¢ A DAY

AT LAST! The famous Remington NOISELESS Portable is yours for only ten cents a day. Brand new. Not rebuilt. Standard keyboard and every modern feature. Free carrying case and typing course. 10-Day free trial. You don't risk a penny. **WE PAY ALL SHIPPING CHARGES.** Act now! Write Remington Rand Inc., Dept., 152-1, 815 Fourth Avenue, New York, N. Y.

Sell Without Canvassing!



When you sell the Teeterbabe Jumper & Auto Seat, you don't have to waste time calling at every house. Just get a birth list—or each mother you call on will tell you right where to find another baby. You know where to call. Babies being born constantly all around you. Mail circulars to mothers. They'll keep you busy. We tell you how. Teeterbabe has no equal in the home and auto. Best quality. Sells at bargain price and big profit. Write today for Sample offer. Exclusive territory to those who qualify.

AGENTS WANTED

NATIONAL PRODUCTION CO.
1-4292 St. Jean Ave. Detroit, Mich.

BUILD YOUR OWN ELECTRIC OUTBOARD MOTOR



from old auto generator. We show you how. Variable Speed. Light weight and Silent. Operates from 8 to 12 hours on ordinary storage battery. Dime brings complete plans and catalog. Wind Driven Cottage Light Plants, Motors, etc.

LEJAY MFG. CO. 1847 W. LAKE ST. MINNEAPOLIS, MINN.

Trailers, Plans and Parts



Utility Trailers, 4' x 5', complete less tires, \$27.50. Utility trailer plans, 50c. Cabin trailer plans, \$1. Trailer parts at bargain prices. Write for free catalog of parts.

SHAMROCK TRAILERS, 11761 Grand River, Detroit, Mich.

Catch Fish!



Eels, Mink, Muskrats, with our new folding galvanized STEEL WIRE TRAP. Write for our FREE TRAP OFFER and Bargain Catalog. \$1 Box of our famous Fish Bait FREE to introduce our traps.

WALTON SUPPLY CO., 3509 JUNIATA AVE., ST. LOUIS, MO.

EXTRA \$5 in SPARE TIME PRINT at HOME



Letterheads, circulars, billheads, cards. Printing pays BIG. Easy, interesting, educational. **PRINTING PRESS BARGAINS \$12.** Types and Supplies, lowest prices. Send stamp for catalog.

PEIFFER Co., 3-B, 6 Columbia St., Newark, N. J.

When writing please mention Popular Mechanics

Sensational BARGAINS

Guaranteed \$102.50 Model
Now Only \$44.90 Cash or On Easy Terms
Small Carrying Charge
10 Day Trial No Money Down



Fully Guaranteed

Positively the greatest bargain ever offered. A genuine full sized \$102.50 office refinished model Underwood No. 5 for only \$44.90 (cash) or on easy terms. Has up-to-date improvements including standard 4-row keyboard, backspacer, automatic ribbon reverse, shiftlock key, 2-color ribbon, etc. The perfect all purpose typewriter. Completely rebuilt and FULLY GUARANTEED.

Money Back Guarantee

Send coupon for 10-day Trial—if you decide to keep it pay only \$3.00 a month until \$49.90 (term price) is paid. Limited offer—act at once.

Learn Touch Typewriting
Complete (Home Study) Course of the Famous Van Sant Speed Typewriting System—fully illustrated, easily learned, given during this offer.

INTERNATIONAL TYPEWRITER EXCHANGE
231 West Monroe St., Chicago, Ill., Dept. 101.
Send Underwood No. 5 (F. O. B. Chicago) at once for 10-days trial. If I am not perfectly satisfied I can return it express collect. If I keep it I will pay \$3.00 a month, until I have paid \$49.90 (term price) in full.
For quick shipment give references and occupation.

Name.....Age.....
Address.....
Town.....State.....

JIG SAW \$1.50
COD or outside U.S.A. \$1.75



POST PAID

Including 12 assorted blades. Adapters. Puzzle Instructions, and roller Saw Guide formerly found on expensive machines only. All metal, 15" long, 8" high, 6 1/2" table. A swift and easy cutter—best ever made for the money.

FREE Catalog illustrating complete power tool line: Shaper, Circular Saw with oilless bearings, \$3 each; Drill Press, \$2.50; completely equipped Lathes, \$2 & \$3; Sander, \$1, etc. All practical tools for real work. Order today or send card for catalog.

J & H Metal Products Co. 5 Commercial St. Rochester, N. Y.

Sani-Flush **SAFE, NOT CAUSTIC**

KEEPS AUTOMOBILE RADIATORS CLEAN

THE LIFELONG GIFT
A WOLLENSAK MICROSCOPE



425 Power Only \$18.50

Give him a gift that will open the door to Nature's endless wonders. A Wollensak Microscope lasts forever, unless abused. Defines minute details clearly, sharply—the scientific test of fine quality. Magnifies 425 diameters—and only \$18.50. Greatest magnification on the market at anywhere near that price.

Others: 150 diameters, \$12.50; 100 diameters, \$5.00. At stores or direct, postpaid (or C. O. D.), under money-back guarantee. Literature free.

Wollensak Optical Co., 895 Hudson Ave., Rochester, N. Y.

WOLLENSAK MICROSCOPES • TELESCOPES
RIFLESCOPES • BINOCULARS

Fun and BIG MONEY!
ASSEMBLING MEAD'S NEW
Portable
OUTBOARD BOAT!

Assemble at Home In a Few Hours From Cut-To-Fit Kits
 Easily Perfectly

Takes ANY OUTBOARD
 4 1/4 HP or less
 — also Sail, Row

PRICED LOW
 —and Pay as You Build!

A sensation! Build this tough, durable seaworthy, portable 50 lb. Mead Outboard Ki-Yak in a few hours at home—and save nearly half! Take it anywhere by hand, car, for sailing, out-boarding, rowing, touring, hunting, fishing, camping! Safe, leak-proof. More speed per horsepower. More miles per gallon. More boating per \$. Takes any outboard 4 1/2 hp. or less. Send 10c & Coupon for circular. Low Introductory Prices!



PATENTED CONSTRUCTION!
Weighs as Little as 20 Pounds!

Mead's perfected, exclusive, patented aluminum-ribbed, Cut-to-Fit Construction Kit **guarantees** successful assembly, easily, quickly—and **profitably** (if you build to sell to others). **Thousands** bought, built Mead Portable Ki-Yaks! CK-1 weighs 20 lbs.—CK-2, 30 lbs.—CK-3, 45 lbs. and OK-2 only 50 lbs. Amazing **LOW** Introductory Prices! RUSH dime and Coupon for Giant Color Circular, low prices, \$6 GIFT PADDLE Offer. *Hurry!*

\$6.00 Paddle GIVEN
 with your CK-Ki-Yak if you hurry



MEAD GLIDERS
 15 S. Market, Dept. B-17, Chicago, U.S.A.

Mr. T. E. Mead: I enclose 10c as postage, handling charge. Rush your Circular of Ki-Yaks, Low Introductory Prices, \$6 GIFT PADDLE OFFER.

NAME.....
 ST. & NO.....
 CITY..... STATE.....
 Rush me with 10c to:—

MEAD GLIDERS
 15 S. MARKET ST. DEPT. B-17 CHICAGO, U.S.A.

T1024
Cutting Capers on Ice

(Continued from page 77)

they are observed. It is well to have an experienced figure skater supervise your training until you have mastered the edges. The experienced figure skater must be capable of doing full circles on each of the four edges as well as half ones. There is little difference between the two except that one requires more push at the outset.

Approximately seventy-two recognized turns can be done from the four edges. For this reason it's a good idea for the young skater to spend time in polishing his movements in these before launching into the more subtle phases. The figure "eight" is easy for the "well-edged" skater. It is nothing more than two attached circles, performed on the same edge but



Robin Lee, national figure skating champion at the age of thirteen

with a change of feet. It also can be described on each of the four "edges."

On the inside forward edge, for example, the right skate cuts a circle on the inside edge with the left foot being carried behind. When this is three-quarters finished, the left foot comes forward and at the completion of the curve by the right foot, the left's inside edge makes a similar circle, thus completing the "eight."

The "eight" leads to the figure "three." This is skated on one foot and two edges, making it the direct opposite of the

(Continued to page 142A)

BOYS! MEN! Get This Wonderful XMAS GIFT!

25 PIECE ELECTRICAL EXPERIMENTAL KIT

WIRE UP thief detector, extension phone, electric welder, radio code set, electro-plating, arc furnace, circuit tester, 110-volt rectifier, 110-volt motor, hundreds of fascinating experiments.

CONSTRUCT arc light 4,000-ft. range, secret service phone (listen on private conversations), generate ultra violet (sun tan) health rays, make real electric stove, etc. Thrilling and educational experiments.



25 Pieces Genuine Commercial Apparatus

NOT TOYS—but real apparatus purchased from surplus and bankrupt stocks. Kit contains 110-volt A. C. power motor, sensitive microphone, transformer, polarized test receiver, arc carbons, electro-magnet, test compass, plating chemicals, condenser, secret service transmitter, powerful magnet, plating anodes, test socket, 110-volt power reducer, test cord and clips—12 other valuable pieces. Complete illustrated experimental manual furnished.

Original List Price of Parts.. \$18.50

Orders shipped same day received, only

FREE 3 manuals—1. Short Course in Electricity and Radio.

2. Blue Prints and Plans for Home Laboratory. 3. Fun with Electricity. Send stamp for Electrical, Radio and Tool Bargain Catalog. **Order Today!**
ELECTRICAL SALVAGE COMPANY
Box 524-A9 Lincoln, Nebr.



Arc Kit
4000 Ft. Range

Works from house light current. Weld iron or brass. Melt glass, metal. Make arc light (1-mi. range), arc furnace. Generate sun-tan rays. Consists of arc holder, stand, carbons, power coils, cord, plug, special goggles, etc. Exper. booklet free. (List price \$4.75.)
SPECIAL \$1.49

AMAZING VALUE!

Motor Transformer Kit

Make scores of thrilling A. C. experiments. Free book shows how. Make motor, transformer, elec. hammer, floating ring, step-down transformer, stroboscope, etc. 100 laminations, mounted rotor, pulley, wire, cord, plug, lamp, coils, etc. List \$6.
SPECIAL \$2.87



CUT POWER COSTS with this KRW FORD V-8 UNIT

60 H. P.—complete, compact, portable—for welders, compressors, hoists, pumps, amusement devices, well drillers, agricultural and contractors' equipment, etc. Will pay for itself out of savings in a few weeks. Write us or see your local Ford Dealer. \$8-31.

K. R. WILSON, 17 Lock St., BUFFALO, N. Y.

a real MICROMETER BARGAIN!

Genuine, American made, six piece micrometer set, in velvet lined leather case. Special price, only \$11.95, a fourth off regular price and a fraction of the cost of other sets on the market.



These micrometers are precision machined for accuracy in one thousandths of an inch, up to 4 inches outside and 3/4 inches inside measurements. Guaranteed accurate, easy to read and adjust. Built to stand hard wear and give satisfaction. Every mechanic, apprentice, garage and repair shop needs these accurate and dependable micrometers. This is your opportunity to get one at a Bargain Price if you act now. Shipped prepaid on receipt of remittance. On C.O.D. shipments, send deposit of \$2.00.

Money back if not satisfied

MICRO PRODUCTS 529 E. Jefferson Ave. DETROIT, MICH.

MICROMETERS • INDICATORS • PRECISION TOOLS

POPULAR MECHANICS FAMILY TRAILER PARTS

Available from Hammerblow Tool Company—the original.

Don't build until you get Hammerblow facts. Save money, time, wasted labor. Hammerblow guarantees a rugged, non-sway, perfect trailer! **BLUEPRINTS FREE WITH PARTS.** Hammerblow parts are world's best. Used by nationally known mfrs. and engineers who know. Send only 50c for 64-page Trailer Builder's Guide and Free 40 page supplement. **Immediate value.** Or write for Free Literature.
HAMMERBLOW TOOL COMPANY, Dept. 101, Wausau, Wis.



NOW, LEATHER TIES

In Cellophane Wrappers



These beautiful Century 4-In-Hands now come to you, each one in an individual, cellophane wrapper, AT NO EXTRA COST. Keeps ties neat and clean, attracts customers, increases profits. **CENTURY LEADS AGAIN!**

Four-In-Hands in Beautiful colors and designs. Cleaned with damp cloth. Young man sold 2 dozen one afternoon after school. Big profits. Repeat orders. Century Bows known from coast to coast for quality, workmanship and satisfaction. Big outlets: letter-carriers, policemen, firemen, gasoline stations, bus, bakery, laundry drivers, etc.

Send 50c for sample kit, including Bow and 4-In-Hand

Look Like Silk

Century Tie Co., Mfrs.

Dept. A, 2345 W. Grand Blvd., Detroit, Mich.

HIGH POWERED TELESCOPE

GENUINE AMERICAN MADE BROWNSCOPIES

Most powerful made for the money!

15 power long range telescope. Can see moon's craters or time on pocket watch a block away. 5 sections, Approx. 3 ft. long. Fine lenses. Brass bound. Can be used as powerful microscope. Vol. magn. 512X. Only \$1.69 postpaid. C. O. D. 24c extra.

\$1.69



\$1.98

Special Super-Power 30X Telescope. Similar to above but more powerful. Guaranteed to see 900 times larger in surface and 30 times closer, 31 mm. objective 4 powerful lenses. Large field. Includes powerful microscope feature. Only \$1.98 postpaid.

MICROSCOPES

Substantially and precisely made, with rack and pinion focusing, tilting base, slides, directions, etc. 75X to 510X—only \$3.95 postpaid. 100X to 600X triple objective revolving nosepiece "Professional," concave mirror, etc., including wood carrying case and set of dissecting instruments, only \$8.50 postpaid. 150X to 1400X new Delux 1400 power Super Brownscope with photographically corrected achromatic lenses, detachable base, concave mirror, etc., only \$18.75 postpaid.

BROWNSCOPE CO., Dept. 41, 234 Fifth Ave., New York, N.Y.



BUILD DUTCH WINDMILLS

and other popular projects. Easy and fascinating with our blueprints. B-10, 30-in. hexagon windmill. Blueprint 75c; A-2, 6-room doll mansion; Blueprint 50c, knockdown kit \$3.75. Illustrated catalog over 25 projects sent for 10c. Order today.

CRAFTSMAN'S MODEL CO., Dept. P-1, 2030 N. 41st St., MILWAUKEE, WIS.

FREE! 1937 BOICE-CRANE CATALOG



Write today!

New 10 inch Tilting-Arbor Saw is big and heavy. Accurate. Refined details. Easiest to use. Gives greater production. Invests its greater safety, too.

Only ONE motor (not 2) needs drive both this Tilting-Arbor Saw and Jointer. That saving of \$8 (impossible on most other saws) pays for your Boice-Crane Jointer.

6 Inch Jointer. Extra long tables. Very long fence guidance for accuracy. Fence locks rigidly at front, and at rear. Is spring-proof. Cutterhead 3 inch diameter.



43 inches Overall

BOICE-CRANE CO. Dept. PM.1-M. Toledo, Ohio

When writing to advertisers please mention Popular Mechanics

HOME OWNERS:— This was written for you and is sent



DO your own simple home, auto and motorboat repairing and be independent of outside repair men. You will avoid delays, save much money, and have the satisfaction of knowing that the work is well done.

The booklet contains clear diagrams and directions for correct procedure for hundreds of common jobs, and enables any home worker to get dependable results, *easily*, on any of the following:

Stopping leaks in pipes, heaters, boilers, tanks, radiators, air ducts, smoke pipes, pails, etc., at connections, seams, cracks, rivets or holes.

Tightening or anchoring loose hinges, locks, handles, screws, bolts, nuts, bases, stems, tops, casters, etc.

Making waterproof joints at skylights, roof cracks and flashing.

Making wet cellars dry from the inside, making concrete floors hard, water and oil proof, and non-dusting, making masonry walls waterproof.

On the car:—Stopping leaks in the radiator at hose connections, or in oil and gasoline lines, patching cracked water jackets, crank, gear and differential cases, tightening loose rivets, mud guards, lamp standards, hub caps and lubricator connections, loose moulding screws, etc.

Smooth-On Iron Cement with which this work is done is applied without heat, without special tools, and so easily and inexpensively that half a dollar to half a hundred dollars is saved in each instance. Smooth-On has been widely used in industrial work for over 35 years and its use is standard practice by power plant engineers and repair men.



Get the booklet by mailing the coupon and buy Smooth-On No. 1 in 7-oz., 1-lb. or 5-lb. can from your hardware store or if necessary from us.

Do it with SMOOTH-ON

SMOOTH-ON MFG. CO., Dept. 37

574 Communipaw Ave., Jersey City, N. J.

Please send the free Smooth-On Repair Book.

Name.....

Address.....

1-37.....

(Continued from page 140A)

"eight," which is skated on one edge and two feet. The "rocker" is another old standby skated on one foot only. The first portion is skated forward and the last half backward but both on the same edge.

The figure "eight" with another circle added can be accomplished by describing a half circle on the right outside forward edge and then carrying this into a full circle by switching to the inner edge of the same skate. When this circle is completed, switch to the left foot, skating for a half circle on its inside edge. Prolong this stroke into a complete circle by switching to the outer edge of the same skate. What has been said for single skaters also may be adapted for pair skating.

The fastest growing feature about figure skating in rinks where there is music, is the waltz. This graceful dance carries the bulk of its charm and grace to the ice, as it is performed in virtually the same manner as in a ballroom. After taking their positions as partners, the pair strike off on opposite feet. Then the man turns an outer forward "three" while the woman makes the same turn on the outer backward edge. Completing three turns apiece, they change direction so as to dance in a large imaginary figure "eight."

A livelier form of the waltz is the "ten step." It is composed of ten steps divided into four beats. The first beat includes steps one, two and three; four, five and six comprise the second beat, and seven, eight, nine and ten are the third and fourth beats. The partners take the usual position, and if the man's first three steps are left outside forward, right inside forward and left outside forward, the woman's will be right outside backward, left inside backward, and right outside backward. The change from three to four is made almost with a half turn and steps four and five complete it so the man is skating backward and his partner forward. On steps nine and ten the partners make their final turn, and then start all over.

Popular Mechanics Magazine does not publish the name of the maker of, or dealer in, any device described in its pages, but this information is kept on file and will be furnished by our Bureau of Information upon request, accompanied by stamped, self-addressed envelope.

Easier Motoring for 1937

(Continued from page 5)

1355

Starting at Pontiac and running through two models in the Cadillac line, General Motors features all steel body and top, longer wheelbase, larger power plant, and either the hypoid rear axle or propeller shaft specially designed to permit lowering the car floor. Pontiac "8" has a wheelbase of 122 inches, open-type independent wheel suspension and an inverted fuel pump located in the windstream below the engine pan to reduce vapor lock.

Oldsmobile is represented by a six-cylinder and an eight-cylinder car, each of which is individual in appearance. The 110-horsepower eight-cylinder engine is set into a larger chassis, 124-inch wheelbase, and its power is transmitted to the rear wheels by a two-piece propeller shaft with three universal joints. The fuel pump is located as in the Pontiac. Greater economy is claimed. Oldsmobile has located the body about six inches ahead, in relation to the rear axle, to improve the ride. A club coupe in which there are two folding seats behind the driver's seat is included in the group.

Buick follows the general pattern, with its small car powered by 100-horsepower engine set into a chassis with 122-inch wheelbase, and its second car, the Century, boasting 130-horsepower engine and 126-inch wheelbase. The hypoid rear axle is used on both models. An aviation-type carburetor assures full power operation under all driving conditions. LaSalle switches from eight-in-line to V-eight engine, rated at 125 horsepower, and employs a wheelbase four inches longer than the 1936 models. Cadillac "60," the smallest car in that line, is four inches longer and its engine is stepped up to 135 horsepower. It also uses the hypoid rear axle to permit lowering the over-all height, and to give more headroom. Cadillac adds a new car, the "65," which is set on a wheelbase of 131 inches and is priced just above the "60."

Lincoln-Zephyr is virtually unchanged in appearance, but it has an improved steering system, spare tire so mounted in the baggage compartment that it may be swung out of the way for loading or unloading, and an enclosed grille extending

(Continued to page 156A)

Amazing NEW LIGHT BULB gives SAFE filtered SUNSHINE

Read, Work, or Play by This Light and At the Same Time Get the Benefits of Mild Ultra-Violet Rays . . . Vitamin-D Producing Rays . . . From Every Light Socket!

A SENSATIONAL NEW KIND OF LIGHT BULB THAT CAN FLOOD EVERY HOME AND OFFICE WITH ULTRA-VIOLET RAYS THE YEAR 'ROUND. A genuine ULTRA-VIOLET MERCURY ARC sunlamp that everyone can afford. The Sperti Sunlamp is a self-contained mercury arc generator. No special transformers or fixtures needed. Use it in any lamp or light socket. Separate filament gives ample light for reading, etc., while your body



Use in any LAMP or LIGHT SOCKET

absorbs SAFE, FILTERED ULTRA-VIOLET RAYS producing VITAMIN-D.



The Sperti Sunlamp uses no more current than an ordinary light bulb.



SAFE Even for Infants!

This new sunlamp delivers only the beneficial ultra-violet rays. All harsh skin-shocking rays are positively filtered out. Over-exposure is absolutely impossible. Why be sunshine starved? Give the entire family the benefits of a Sperti Ultra-violet lamp.



Enjoy the Benefits of Safe Filtered "Sunshine" for only \$5.00. Simply check and mail the coupon below and we'll send you a Sperti Sunlamp (postpaid) by return mail. Pay the postman \$5.00 for each lamp when your order is delivered. EVERY LAMP GUARANTEED! For more proof mail the coupon for complete details and colorful book ABSOLUTELY FREE!



FREE BOOK TELLS ALL!

Science Laboratories, Inc. Dept. PM-137 424 E. Fourth St. Cincinnati, Ohio

SCIENCE LABORATORIES, INC. Dept. PM-137, 424 E. Fourth St., Cincinnati, Ohio.

- Gentlemen:
- Mail (postpaid) immediately Sperti Sunlamps @ \$5.00 each. I will pay postman \$ when he delivers my order.
 - I want more proof. Send me all the details, including your big colorful book ABSOLUTELY FREE!

My name is

Address

City State

GAS MOTORS

Ready-to-Run

\$1250

FREE — finished, mounted fly-wheel with every motor!

The thrill of a lifetime is yours this Xmas with a G.H.Q. super-power gas engine — actually one of the most powerful motors ever constructed! Never in the history of gas engines was a motor ever offered at so low a price. All America has acclaimed this engineering triumph — accomplished by outstanding G.H.Q. designers and engineers after years of exhaustive, scientific, aerodynamic research. Has broken records for amazing performance. Flies model planes up to 10 ft. wingspread. Also used for boats. And look at all these extra features! Easy starting — just a twist of the wrist. Steady running — runs 27 minutes on a ounce of gas. Precision, replaceable parts. Cylinder and Piston Lapped. Longest crank shaft ever made on miniature motor. Chrome nickel steel shaft with 11/8" bearing surface. Connecting rod of high speed bronze. 1/5 horse power at 300 to 8000 R.P.M. This famous motor complete, entirely assembled on a stand. Tested and run before shipment — performance guaranteed. No oil, gas or batteries included. Only \$12.50. Send 3c for illustrated catalogue including information on gas accessories.

The thrill of a lifetime is yours this Xmas with a G.H.Q. super-power gas engine — actually one of the most powerful motors ever constructed! Never in the history of gas engines was a motor ever offered at so low a price. All America has acclaimed this engineering triumph — accomplished by outstanding G.H.Q. designers and engineers after years of exhaustive, scientific, aerodynamic research. Has broken records for amazing performance. Flies model planes up to 10 ft. wingspread. Also used for boats. And look at all these extra features! Easy starting — just a twist of the wrist. Steady running — runs 27 minutes on a ounce of gas. Precision, replaceable parts. Cylinder and Piston Lapped. Longest crank shaft ever made on miniature motor. Chrome nickel steel shaft with 11/8" bearing surface. Connecting rod of high speed bronze. 1/5 horse power at 300 to 8000 R.P.M. This famous motor complete, entirely assembled on a stand. Tested and run before shipment — performance guaranteed. No oil, gas or batteries included. Only \$12.50. Send 3c for illustrated catalogue including information on gas accessories.

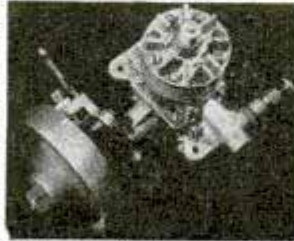

G. H. Q. MODEL AIRPLANE CO.

854-B East 149th St.

New York, N. Y.

CLAMPS

These finest clamps cost no more

Selected for the home work shop from 40 "Jorgensen" Types that are standard throughout industry. Have them for clamping, gluing, pressing, setting-up etc., etc. — for perfect joints, accurate drilling and sawing and press fits... for "100 uses" inset on genuine "Jorgensen" and "Pony" Clamps. If your dealer tries to substitute, order direct.

ADJUSTABLE CLAMP CO.

"THE CLAMP FOLKS"

421 N. Ashland Ave. Chicago

Pony Fittings

Pony 500 Fittings on ordinary 1/2" pipe. Make Clamps of any length. Send \$2.00 new low price plus postage (6 lbs.) for Fittings for 2 Clamps.



Jorgensen Handcrews

Genuine Jorgensen Handcrews grip at all angles, never slip, split or loosen. All sizes. Send \$2.50 plus postage (7 lbs.) for 2 No. 1 Handcrews open 6."



Pony Miniatures Standard

Fine quality clamps with a thousand uses. 7 sizes 1 in. to 2 1/2 in. esp. 12c each and up.

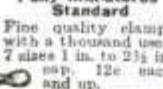

SHARPENS TOOLS Factory Way

CHARTIER TOOL HOLDER fits ANY GRINDER. You can put factory precision edge on twist drill bits, plane irons, lathe cutters. Grind inside and outside ground gouges, auto valves. Do any sharpening job at any angle, arc or combination. Saves re-sharpening coats or ruining expensive tools.

TRIAL OFFER! Send only \$15.00. Shipped postpaid. Or send \$3.00, balance C.O.D. Use for 10 days on most difficult jobs. Money Back if not satisfied. Or send for FREE literature.

E. B. DEKKER CO., 814 Clinton Ave., Dept. 17, Oak Park, Ill.

MAKE YOUR OWN ELECTRIC DRILL

\$17.85 MOTOR MADE from Model T Ford Generator. We furnish all other parts already assembled. Hones Cylinders, etc., like \$55 to \$65 DRILLS. Motor: fan cooled, continuous duty, extra power, 110 volts AC or DC or 32 volts. Many in use. Guaranteed to work. Get your Drill Kit now. Costs going up.

RAND CO., Dept. 100, 816 South 8th, Kansas City, Mo.

For..BIG Money-Making..Doing ALL Work

Use **The EIFEL-GEARED**

● 2 New Pocket Machine Shops .. 7" and 8 1/2" SPACE
● It Takes 7 SQ. FT. OF SPACE and 101 Pictures to show the astounding Working Power, Speed and Efficiency, and the AMAZING MONEY-MAKING Power..\$35 to \$100 Weekly.. of this Greatest Hand Tool Invention of ALL Time... so Don't expect us to tell the story Here; but... let us send you the MOST AMAZING Propositions, FREE!
● They will Please and Astound you!



PIERRECH KIT

● ACT TODAY, and get also Free .. "the world's Most Useful small tool." It has .. 2 End, 2 Side and 3 Angle Edges .. turns FREE Screws in All Positions .. \$1 worth of Uses.



● Mail this Part of Ad TODAY with your address (on a Postcard will do). Get FREE—101-Picture Manual of Mechanics, with .. User Offers. Or, With .. DISTRIBUTOR, Territory and FREE KIT Offers.

AMERICAN PIERRECH CORP'N APM-4809 N. Ashland Ave., CHICAGO, ILL.

The Home that Runs Itself

(Continued from page 54)

There's no stale smoke smell left here. And here's a card table. It's electric too. You plug in on the under side for a light, a cigarette lighter or the coffee maker after the game's over."

The dining-room table likewise is electrified. Reels attached to the under side carry cords which are pulled out and plugged into the coffee maker, the egg cooker, the waffle iron, the toaster or any of half a dozen other appliances for table cooking. Pull out the plugs and the cords are whisked out of sight by the reels. There's a timer at one end of the table to turn off the current when the coffee is cooked. A meter under the table measures the current used for cooking. The main line plugs into the floor under the table so all wires are concealed. From the opened doors of a built-in china closet flows a cooling breeze. It emanates from a vent above the top shelf.

"Comes from the air conditioner in the basement," explains Mr. Ripley. "On summer nights I close the doors of the china cabinet and the cool air goes up to my bedroom right above."

The dining-room light fixture has just one bulb, but it's a 100, a 200 and a 300-watt bulb all in one. One turn of the switch and you have 100 watts, three turns and you have 300, four turns and it's out. There's an electric clock in the living room, there's another in this dining room.

"You'll find 'em in every room in the house," explains Mr. Ripley. "We have a vacuum cleaner for each floor and fifteen all-night lights of five or seven watts each scattered about the house and garage. They discourage burglars."

Virtually everything in the kitchen runs by electricity and most of it is automatic. The electric range is equipped with a thermostat and a timer, the dishwasher operates with a simple control and the metal sink contains the garbage preventer. All waste from potato peelings to soup bones goes down the drain. A grinder operated by a quarter-horsepower motor converts the waste to a pulp which is flushed away through the sewer system.

An exhaust fan in a window carries away cooking odors. There's an elaborate mixer which also kneads bread dough. A

grinder grinds the wheat, the mixer kneads the dough, and the oven bakes the bread, each at the turn of a switch. There's a kitchen radio, the inevitable clock, an electric floor waxer and a cabinet full of smaller kitchen utensils, including a double boiler, all run by electricity.

The upstairs is just as electrified. Over the bath tub is the sun lamp. There are two others beside the mirror.

"If you don't like baths, you get your sunshine while shaving," explains Mr. Ripley.

In his bedroom is an exerciser mounted on a small table. There's a timer to turn it off when you have absorbed enough punishment. Mr. Ripley goes through his morning exercises on this machine, goes downstairs and starts his breakfast on the electrified dining-room table, goes upstairs and shaves, then comes back downstairs to find a hot breakfast waiting for him in the coffee maker, the egg cooker and the toaster.

The outside of this home is almost as electrified as the inside. There's a bug killer on a side porch and a marine lamp which casts a rosy glow over the side of the house when there's a party, and a sodium vapor lamp in the garden which gives a grotesque hue to the shrubbery. And Mr. Ripley, with the aid of electricity, has stripped the last vestige of privacy from 200 giant goldfish in a 3,000-gallon pool. Artificial lily pads form shades for underwater lights. Other colored lights and waterproof cords are sunk in the pool or shine down on it from above. At night, with the aid of the lights, you see every fish on parade. Above the pool is another bug killer. The fish gather in droves beneath it to watch for the spark which signals their next titbit is on the way down.

"These fish," says Mr. Ripley, "thrive on light. Some of them are more than a foot long. We feed 'em hamburger sandwiches—raw hamburger and crumbled bread."

There are more than 100 outlets in the house and more than a dozen outside. The Ripleys use them all. In the basement, besides the oil furnace, which fits under the stairs, the washer, ironer and dryer in the laundry, and the air conditioner, there's an electrified home workshop. One side of the basement is a recreation room. There's

(Continued to page 146A)

Mead WINTER SPORTCRAFT

New SNOW-SEDAN

Now Ready for Home Builders!

Mead's sensational new Snow-Sedan has been designed for residents of the "snowy" parts of the world to give them practical, economical transportation during the long, snow-bound winter! Adaptable for use with a Chevrolet or Ford A motor costing only a few dollars second-hand. Easily assembled at home from our blueprints, etc. Now you can go anywhere on snow or ice. Aeroplane type construction guarantees lightness, strength, superior performance. Send coupon and 10c for details.

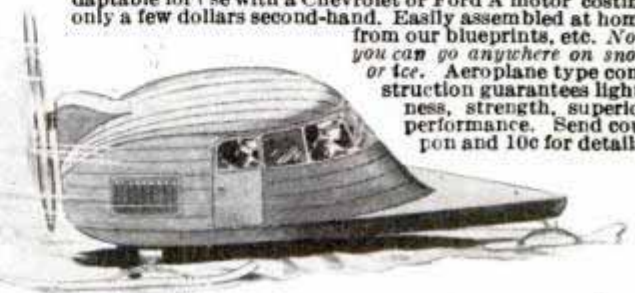

MOTOR SLEDS! Use Motorcycle or Outboard Engine!

Build your own motor sled easily and quickly using Mead drawings, parts or complete construction kits! A wonderful home workshop project. Inexpensive. Mead Motor Sleds are designed for use with outboard or motorcycle engines. Low cost. Amazing speed.



New "Dual-Control" ICE YACHT RACER!

Presenting the new Mead front-steering, dual-control, Class "E" ice yacht—available factory-built, ready to sail. Every detail reflects the fine quality and preeminent craftsmanship America's sportsmen have learned to expect in Mead products. Enjoy Old Man Winter in a Mead Ice Yacht!

Batwing



**Build
Batwing
at Home**

Mead Batwing Ice Yachts are available in low cost, cut-to-fit kits for quick home assembly!

Write!

MAIL COUPON!

Mr. T. E. Mead: I am enclosing 10c as postage handling charge. Rush me complete information on your Winter Sportcraft line.

Name.....

Street and No.....

City..... State.....

Rush me with 10c to:

MEAD GLIDERS
15 S. MARKET ST. DEPT. 17-B CHICAGO, U.S.A.

(Continued from page 145A)



NEW LEWIS 1937 Catalog
 —SHOWS ALL NEW UNITS
 —Loaded with information on tool building from castings

CASTINGS FOR MACHINE HOBBYISTS

—All items are now available with the larger castings machined. You don't need planers, shapers or mills to build Lewis project

Here's what two buyers say:

1. "Finished mill paid for self in six weeks."
 — Home Elevator Co., San Francisco.
2. "Built chain hoist in three hours worth \$60.00."
 — General Service & Engineering Co., San Francisco.

List of Lewis Tools: Bench Mill, 10" metal shaper, 16" band saw, 24" band saw, hack saw, turret attach., 6" jointer, 14" woodshaper, bench drill, floor drill, aero engine, steam engine, I T. chain hoist, 6" grinder, 11" wood lathe, 8" circular saw, centrifugal pump, 7" machine vise, 3 1/2" machine vise, drill vise, 4" bench vise, dividing center.

One of the "NEW UNITS," fully covered in the 1937 catalog. A real power hack saw with gears cut, slide milled, swivel cast in, and all necessary material \$14.50

Order your blueprints and catalog today.

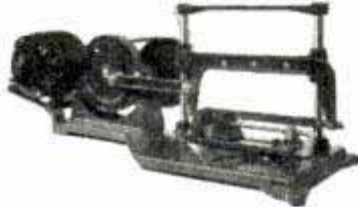

LEWIS MACHINE TOOL CO.
 544 FIFTH STREET—Dept. B • SAN FRANCISCO

AIR SCOUT JR. DOLLAR RADIO



A real radio capable of keen broadcast reception. For only \$1 you get every part needed to build the powerful radio shown, including tube. Parts mount on wood panel (not in kit) which you can make yourself. Uses inexpensive dry batteries. Full-size picture diagram and detailed instructions.

\$1.00 WITH TUBE

ALLIED ENGINEERING INSTITUTE, Dept. PM, 95 Park Place, NEW YORK

BUILD WITH DOENUTS



Build with the original patented Musselman Doer Nut Cord Tires and Wheels. Tire requires only 22 to 15 lbs. air pressure for loads up to 200 lbs. per wheel. No springs needed. Musselman Doer Nut Cords absorb surface obstructions, eliminates jolts and reduce effort 50% on the same loads. Wheels cadmium plated with adjustable ball-bearings. Doer nuts are ideal for building, hand trucks, push carts, bicycle trailers, nidget autos, coasting wagons, scooters, grease guns, spraying equipment, wheel barrows, etc.

Write today for literature and prices!

THE MUSSELMAN PRODUCTS CO.
 6247-N ST. CLAIR AVE. CLEVELAND, OHIO

In answering advertisements always write name and full address clearly.

When You Build the "SOVEREIGN" You Can Build Them All

Complete book on building Popular Mechanics Famous Museum Ship Model "Sovereign of the Seas." Price \$1.00 postpaid.

Popular Mechanics Press 200 E. Ontario St., Chicago

a shooting gallery with floodlights and frosted-tube lights to illuminate the target and there's a little theater where Mr. Ripley and young Charles, Jr., entertain their friends with their own private house of magic. The stage is equipped with neon, black ultraviolet, mercury vapor and sodium lights, all operated from a control box. With the aid of these lights and some fluorescent materials and color drawings, it requires only a few minutes to prove to anyone that you can't believe what you see as far as colors are concerned. And the stage has a piano—electric, of course.

Everywhere inside and outside this home you find electric appliances—a battery charger in the garage, an electric moth killer, a garage light which turns itself out, an electric hand dryer, a baby milk bottle warmer, curling irons, an electric speedboat to aerate the fish pool—you find Handy Annie's tools at every turn.

What happens, you wonder, when the electric home blows a fuse? That never occurs. The reason? There is not a fuse in the house. Circuit breakers do the job instead.

"Keeping house in a home that runs itself must be swell," you murmur enviously, "but think of the cost. Who could afford it?"

Well, Mr. Ripley says it didn't cost him a cent to electrify his home and presents figures to prove it. And Mr. Ripley's arithmetic is as amazing as his home. He shows you in black and white that six times one equals two and one-half when you begin using electricity like water and employing a maid like Annie—and that's a story all by itself.

(Concluded next month)

Belt Dressing from Rubber

I have found that a highly effective belt dressing, which doesn't dry out quickly, can be made by melting old inner tubes in used cylinder oil. We put the tubes and a quart of oil in a kettle and cook them over a slow fire until melted. If the dressing is too thick, it can be thinned by adding a little oil.—Tom Davidek, Boling, Tex.

☞ Liquid shellac, thickened with sealing wax, makes an excellent household cement that is waterproof.



Now
I CAN MAKE

ANYTHING — This Book Shows How

If you like to make things—if you want to get the most out of the home Work-Shop—if you want to give that "professional touch" to home made projects—get a copy of "MAKE IT YOURSELF." It's the only book of its kind for the young home mechanic and the advanced amateur craftsman. Stop puttering—Learn what to make and how best to make it. "Make It Yourself" is what you need and just one of its 900 different articles can easily be worth more than the entire cost of the book. Sent postpaid for \$3.00, or in U. S. and possessions sent C.O.D. You pay postman. Order now direct from publishers.

POPULAR MECHANICS PRESS
200 East Ontario Street

Room 137A
CHICAGO

900 DIFFERENT THINGS YOU CAN MAKE!

Large size book—7 x 10½ inches — 480 pages. 823 Illustrations. Cloth binding — 900 different articles including:

Toys, including mechanical
Model Making,
Methods, Plans,
Tools, etc.

Furniture, all kinds
Sports Equipment
Radio Apparatus
Work Shop Tools
and Machinery
Wood Working
Metal Work
Leather Work
Working with Glass
Modelmakers Helps
Home Repairs
Garden Equipment
Puzzle Games and
Amusement De-
vices
Bird Houses
Electric Wiring and
Devices

Altogether—900 different illustrated articles on things to make and how to make them.

TECHNICAL BULLETINS

TECHNICAL DATA SIMPLIFIED
FOR THE PRACTICAL MAN

[A New and Valuable Popular
Mechanics Service. \$1.00 Each]

Make use of this valuable technical bulletin service. It's something new for mechanics, inventors, technical specialists and practical craftsmen of all kinds. Now for the first time you can get the needed basic and practical information on a wide variety of subjects in an inexpensive and easy-to-use form. Every bulletin covers its subject briefly, concisely, simply and complete in every detail. No advanced mathematics, chemistry or physics needed to understand them. Material never before in print now specially prepared in practical bulletin form. Postpaid \$1 each or sent C.O.D. anywhere in U. S. Ask for details of complete bulletin service.

D-101 — Using Nichrome Resistance Wire.—For repair men, shop owners, electricians, radio service men, experimenters and inventors, etc. Explains clearly and simply how to repair electric flat irons, toasters, rheostats, resistors and other electric heating devices that use resistance wire. Simplified methods of figuring exact lengths and sizes of wire for any job. Also contains tables and illustrations.

D-102—Cleaning Products for All Purposes.—Contains ten formulas for the manufacture of popular highly effective cleaning preparations of the type now enjoying popularity, together with complete instructions for the manufacture of the products described, and a list of chemical houses who sell the required raw materials.

D-103 — Automobile Specialty Chemical Products.—Contains formulas and complete instructions for making products used by automobile owners: Penetrating Oil, Chromium and Nickel Polish, Radiator and Cooling-System Cleaner, Anti-Dimming Paste—and a dozen others. Specially prepared with general market demand in view. Also a complete list of supply sources.

D-104 — Silver Soldering and Brazing.—Explains the latest and most practical methods of brazing, silver soldering, and hard soldering. Boiled-down, practical information enabling anyone to quickly become expert.

D-105—Latest Gas-Welding Practice.—Contains simplified instructions for using the modern oxyacetylene torch for welding and cutting metals. Includes special instructions enabling one to easily weld all materials.

D-106 — Rewinding Electric Motors.—Complete information, diagrams, sketches, tables, etc., enable any shop man, mechanic, electrician, experimenter, etc., to become an expert in rewinding A-C and D-C motors and generators of all types. For the man who wants to know "how" rather than "why."

D-107—Electro-Plating with Copper, Nickel and Chromium.—Latest methods, formulas, and trade secrets. Includes formulas for cleaning, directions for polishing, valuable data on buffing and numerous plating procedures.

D-108—Electro-Plating with Gold and Silver.—Latest formulas and instructions for electro-plating with gold and silver by a highly efficient process. Of value to the shop man, home shop worker, handy man, jeweler, etc.

D-109 — Electro-Plating with Zinc and Cadmium.—The use of these metals is becoming popular more and more for the protection of other metals against corrosion, rust, oxidation, etc. A complete treatise.

D-110—Electro-Plating Non-Metallic Objects and Electro-Forming.—How to prepare any non-conducting material so that it can be electro-plated with common metals such as copper, nickel, chromium, gold, silver, zinc, cadmium, lead, etc.

D-111 — Designing and Building Transformers.—Simple, non-mathematical methods, illustrations, tables and charts for designing transformers of all kinds. Also describes special transformers such as are used for ultra-violet lamps, Neon tubes, etc.

D-112—Designing Electro-Magnets.—Clearly explains so that anyone can design and build magnets for practically every purpose.

D-113 — How to Design Solenoids and Plunger Magnets.—Non-mathematical, simple and practical, written for the shop man, experimenter, inventor and home shop worker.

D-114—Designing Thermostats for Air-Conditioning and Heat-Control Purposes.—Gives complete information for designing and building thermostats of many types, such as are used for controlling temperature, etc.

D-115—Flexible Molds for Casting Small Objects.—Covers making flexible molds used in casting novelties, statuary, clock cases and other objects with plastic materials such as magnesite, dental plaster and cement.

D-116 — Printing Photos on Cloth, Paper, Etc.—Takes all the mystery out of this fascinating subject. Includes also enlargements on walls, screens, signs, etc.

D-117—The A B C of Air Conditioning.—Tells exactly what complete air-conditioning is, how it works, and describes the functions of the apparatus used. Information is in simple, non-technical language.

\$ MONEY-MAKING \$ OPPORTUNITIES

For those who need larger incomes or must seek new occupations. The following workable, tested plans are adaptable both to the needs of the country or city dweller either for part time development or principal income source.

Every idea set forth in these books has been used by others for profit. They are well worth your consideration.

Plan No. 1—1000 Ways to Make \$1,000. Practical new book of tried, tested methods that work that you too, can use. Price \$2.65.

Plan No. 2—Radio Servicing. Let an expert teach you how to engage in this money making business. Price \$4.15.

Plan No. 3—Refrigeration Service. Official manual covers all makes. Good service men are needed. Price \$5.00.

Plan No. 4—Automobile Refinishing. Start a lucrative business of your own. Fine possibilities here. Excellent new instruction book. Price \$1.50.

Plan No. 5—Outdoor Opportunities. The raising of small animals, birds and plants for profit. Price \$2.00.

Plan No. 6—10,000 Money-Making Formulas. Complete instructions for the making of commodities at small cost that may be sold at a handsome profit. Price \$4.00.

Plan No. 7—1000 Spare Time Money Making Ideas. A job for everybody. 146 page book tells how. Price \$1.00.

Plan No. 8—100 Civil Service Examinations. Covering steady Government jobs. All types of positions. Better business means thousands of new jobs. Prepare now by studying this new book. Price \$2.50.

Plan No. 9—Making Poultry Pay. The proper breeding and management of fowls for higher egg production. Price \$2.00.

Plan No. 10—A Living from the Land. Answers the question "How can I successfully get established in the country?" Price \$1.50.

Plan No. 11—Rabbits for Food and Fur. A complete guide to the successful rearing and breeding of rabbits. Price \$2.00.

Plan No. 12—The Frog Industry. Should be considered more as a side line than as a major means of income. Price \$1.00.

Plan No. 13—Is There Money in Welding? Factual information shows welding is a growing field offering opportunity to anyone looking for a trade. Price \$1.00.

Plan No. 14—Auto Service Shop Management. Money-saving and business-producing ideas by two men who know just what is essential to a profitable service shop business. Price \$1.50.

Any of the above mailed postpaid upon receipt of price or sent C.O.D. anywhere in U. S. Pay postman price and few cents postage.

POPULAR MECHANICS PRESS
Room 137 200 E. Ontario St. Chicago, Illinois

POPULAR MECHANICS PRESS—Room 137A
200 EAST ONTARIO STREET CHICAGO

FOR XMAS—A "CANDID" CAMERA



\$2.98
only **postpaid**

**5 Days Free Inspection—Ironclad
MONEY-BACK GUARANTEE**

Amazing Value. Adjustable focus, 1-meter to infinity. 16 pictures on No. 127 Vest Pocket film. Eye level finder. Lens f:8 and f:16; 1/25 and Bulb Exposures, cable release. Sturdy, compact. Only \$2.98, postpaid. 5 days Free Inspection. Money back, no questions, if you're not delighted.

Ask for folder

SUN TECHNICAL SUPPLY COMPANY

Dept. J, 505 Professional Bldg., Pittsburgh, Pa.

FREE

WHOLESALE CATALOG
of **4000 FAST SELLERS**

Hot off the press. Shows fast sellers of every description from many parts of the world, at rock bottom wholesale prices. 256 pages chock full of the biggest bargains you ever saw, many new items just being introduced, articles for every member of the family, office necessities, etc. One of the most complete lines in America. The 15 proven money making plans are fully explained in the catalog and may increase your earnings a hundred fold. This catalog is FREE—Send for it, today.

SPURS CO.
11-36 Main St. Le Center, Minn.



**31½ in. Perfect Scale
Model of the**

QUEEN MARY

Easy construction with Fully Carved, Hard Wood Hull, Turned Wood Parts, Stamped Wood Decks, Fibre Superstructure, Lifeboats, Davits, Winches, Stairways (all cast metal) Full Size Plan, Photos, Instructions—everything to build and decorate a beautiful 1/32nd in. Scale Model. **\$5.00**

(West of Denver, add 50c extra) Postpaid

Ask Your Dealer, or Order Direct
Send 5c for Catalog Model Ships, Supplies, etc.

Ideal Aeroplane & Supply Co., Inc., 26 W. 19th St., New York

Now!

IT'S HERE!

New, Remarkable
MIDGET
POCKET
RADIO

**MIGHTY MIDGET TUBE RADIO
CAN BE CARRIED WITH YOU!**
Beautiful Clear Loud Tone
Direct From Pocket Radio.

Fits pocket easily. All one unit—just like the big sets, but this LIGHTWEIGHT Radio measures only 5 in. x 3½ in. Take it with you—listen to music, sports, radio entertainment.

Easy To Use—Works Immediately
No Electrical Connections Required!

Beautiful reception and tone. Accurately made, precisely assembled, rigidly tested, assures excellent performance. Simplified, centralized tuning. Tunes broadest band. Comes complete with phone in set, with easy instructions, ready to listen, in hotels, camps, office, boats, home, picnics, beach, etc. and take it with you while traveling, in auto, bicycle, etc. **GUARANTEED.** Nothing to adjust. No difficult hook-ups. Beautiful walnut color and modernistic design.

SEND NO MONEY! Play the Mighty Midget Tube Radio as soon as you get it. Get yours today. Pay postman on arrival only \$5.49 and a few cents postage. Makes an impressive gift. Amaze your friends.

Mighty Midget Radio Co., 1951 Irving Park Blvd., Dept. 702, Chicago

Just a Handful!

Breaking Speed Records

(Continued from page 29)

overhead cam, twenty-four exhaust and intake valves. The block is aluminum with steel cylinder casings and aluminum pistons. The oil reservoir holds twenty-eight quarts and the gas tank ninety-five gallons. The "Meteor" was built with the aid of nine trained mechanics in two months. The dash carries the standard equipment plus a tachometer and dials to indicate the temperature of the transmission and differential.

All speed tests made on the Salt Flats are under the observation of the Automobile Association of America. A timer's shack on the speed course houses the instruments and two banks of stop watches which alternately time the lap of a car. An electric eye with a beam across the course governs the watches.

John Cobb, British driver, with his special Napier-Railton 600-horsepower, twelve-cylinder racer also established a host of new records on the flats, including the twenty-four-hour record of 150.16 miles per hour, but lost most of them a few days later to Jenkins. Streamlining was ignored in the construction of Cobb's car. The car, worth \$25,000, has old-fashioned high wheels and required two years to build. It weighs 5,000 pounds and has never been stopped by mechanical failure. The motor has three rows of four cylinders, in other words it is a V-motor with a row of four cylinders in between the V. It has two spark plugs to each cylinder, and an up-draft carburetor. It has a special three-speed transmission, cantilever springs and its starter is an electric motor, whose shaft, equipped with a roller, engages the rear wheel by friction, thus propelling the car to a start.

Captain George Eyston in July, 1936, established over sixty records to be lost later to Cobb and Jenkins. Eyston drove his "Speed of the Winds," a shark-nosed twelve-cylinder Rolls Royce to a new record of 149.16 for twenty-four hours and 135.35 miles per hour for forty-eight hours. The "Speed of the Winds" has a twelve-cylinder motor, dual ignition and a special selective transmission mounted ahead of the motor as the car is a front-wheel drive. The car, beautifully streamlined, is made largely of airplane tubing

and duralumin welded and bolted together. In April, 1936, Eyston established two records for a Diesel powered vehicle. He drove his "Flying Spray" over the Salt Flats at a speed of 158.87 miles per hour for the measured mile and 159 miles per hour for the kilometer. The old Diesel record was 137 miles per hour. The "Flying Spray" was powered with the same motor used in the big Diesel passenger buses in London.

The most spectacular event ever recorded on the flats occurred in September, 1935, when Sir Malcolm Campbell drove his six-ton "Bluebird" on a thirteen-mile straightaway to a new world's record of 301 miles per hour. That was a great day for those in the reviewing stand opposite the measured mile. Faintly they heard the oncoming juggernaut throbbing and pulsating as it roared over the horizon, a cloud of salt in its wake. Like the hum of a monster bumble bee, the noise increased. Then a higher key, a new pitch was heard as the car neared the measured mile. The howl of the motor reached an agonizing tempo that smote the ears with painful penetration as the "Bluebird" flashed past the reviewing stand in a blur of white salt dust. Then the rhythmic pulse of the "Bluebird's" power plant faded into a bumble-bee hum and the comet of steel became a black dot and disappeared over the horizon. The measured mile had been passed.

The driver had six miles in which to stop his car and make the return trip within an hour. The six-ton juggernaut was losing speed when, with an explosion, the left front tire blew out. The "Bluebird" swerved from its course and then back again. The iron-nerved Britisher held the car to the track marked with an eighteen-inch black line and had reduced speed to 175 miles per hour when the tire burst into flames. The car continued on to the end of the course, the tire a flaming pin wheel. Mechanics extinguished the flames, changed tires and turned the blue monster for the return trip. The car made the first lap at 304 miles per hour. The return trip was made at 298 miles per hour, an average of 301 miles per hour, a world's record. The "Bluebird's" engine was a supercharged twelve-cylinder Rolls Royce which at 3,200 revolutions per minute developed 300 miles per hour.

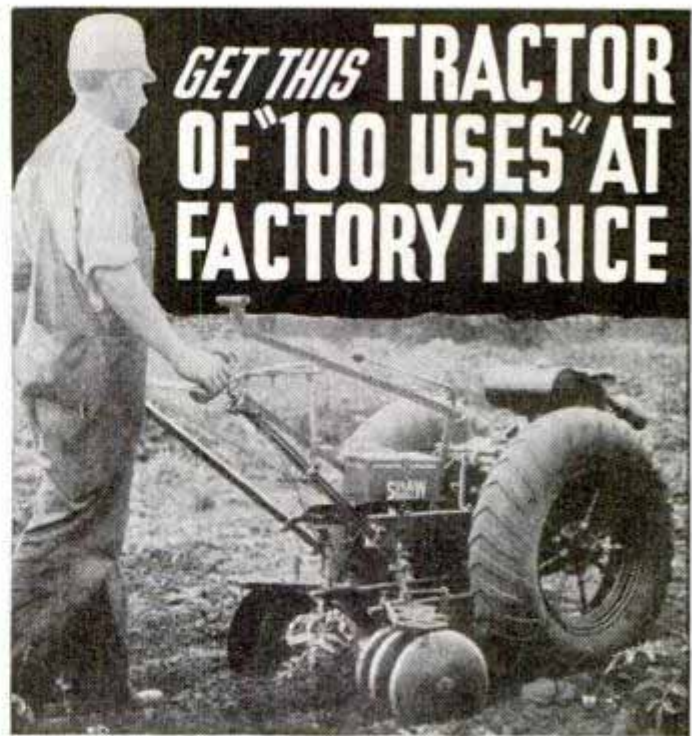

DOES WORK OF MANY MEN OR 2 HORSES!

Here's untiring speed and power—that gets field and belt work done on time! Smallest size does work of many men—saving wages. Larger sizes do work of 2 horses or mules—quicker, cheaper, more efficiently—saving costly animal keep. **Runs all day for 33c.** Greatest time, labor and money-saver made!

"Tractor of 100 Uses"—Does all field, road, belt work. Plows, discs, harrows, furrows, seeds, cultivates, harvests, mows, rakes, cuts tall weeds, hauls. Runs washing machines, feed grinders, corn shellers, light plants, saws, concrete mixers, water pumps, lathes, other belt machinery. Does deep mold-board plowing, other heavy work. **Amazing money-maker** for farms, truck gardens, nurseries, orchards, suburban homes, golf courses, parks, etc.

SHAW GARDEN TRACTOR

New 1937 Model Has 3 Speeds Forward, and Reverse. **Special to Order, 6 Speeds Forward**—runs from 1/4 mile to 15 miles per hour. **New Power Turn** enables Shaw to turn in its tracks with no lifting or pushing. **Reverse Gear** makes it easy to work among rocks, roots, in close quarters. **Tool Attachments** for different uses. Convenient Jiffy Hitches. **Improved Tool Control** gives tools a wider range of movement - - increases tractor's usefulness. **Briggs & Stratton air-cooled, 4-cycle engine, 4 Models, 2 to 5 H. P., Walking and Riding Types.**

Available With Air or Steel Tires. Air tires save 25% fuel. Enable Shaw to do more work in a day. Provide better traction.

LOW FACTORY PRICE!! Mail Coupon for details of price and terms today!

10-DAY TRIAL FREE BOOK!

OFFER! Use on your own work for 10 days. Know how Shaw makes you much more money—with less work and trouble! Mail Coupon for details 10-DAY TRIAL OFFER today!

Explains everything about Shaw. Tells what enthusiastic owners say. Shows photos of tractors in use. Gives **LOW Factory Prices** on 4 different size models—with 18 different attachments. Mail Coupon today!



AGENTS—wanted. Liberal proposition. Mail Coupon for full information.

FREE BOOK COUPON

THE SHAW MFG. CO. (Address Nearest Office)

4501 Front St., Galesburg, Kans.; 5812-G Magnolia Street, Chicago, Ill.; 130-G West 42 St., New York, N. Y.; 608-G No. Fourth St., Columbus, Ohio.

Send me **FREE** information at once about the Shaw "Du-All" Garden Tractor as checked below:

- FREE Book and Low Factory Prices
- 10-Day Trial Offer
- Liberal Agent's Proposition

Name.....

Address.....

Town.....State.....



Complete Line of TRAILER PARTS and SUPPLIES

Whether you are going to build a new trailer, or wish to modernize your old you should get our **FREE BOOK** of trailer parts. Axles: wheels, \$5.95 pr., roof canvas, jack, \$5.95; electric generators, hitches, heating stove, \$6.25; latest hardware, locks, windows, \$1.15; drip midg., 5c ft.; pumps, sink, \$2.95; insulation, dome lights, beds any size to order. Everything for trailer—no need to hunt for parts—we have all and at amazingly low prices.

Complete, large size working blue prints, of 16 ft. 4 passenger trailer-parts cost less lumber—\$230.00. Send \$1.00 to

KAR-A-VAN A. G. Industries, 308 W. Randolph St., Chicago, Ill.

DEAF ? AMAZING NEWS!

You may hear like normal again!
Amazing new instrument releases deaf from misery and embarrassment.

The Godsend, new Scientific, Electrical Hearing Aid, is guaranteed to give you same strain-free power to hear as instruments selling for \$50, \$75, \$100, and more. **PRICED AT ONLY \$19.75, complete!** Backed by \$1,000.00 Money-Back Guarantee. Now you may enjoy sermons from back of church, lectures, conversations, radios, movies. Complete with Microphone, Batteries, and TWO Appliances for BONE or AIR CONDUCTION, both for less than the usual price of only ONE. Music and words heard distinctly from all directions at close range or from distances. No distortion—no head noises. Instrument is lightweight, easily concealed in clothing, no more noticeable than a pair of glasses. Write quick for **FREE DETAILS**, sent in plain envelope. Godsend Company, Dept. P-418, 3785 Beechmont, Cincinnati, Ohio.

MAKE YOUR XMAS PRESENTS WITH A BRONZE FOUNDRY for Schools and Home Workshops



Complete Foundry Outfits are available in three sizes and make it possible for you to produce beautiful bronze, silver or aluminum castings in your home workshop from scrap metal. Presents such as book ends, ash trays, dishes, paper weights, letter openers, bottle openers, statuary, etc., can be quickly made by the sand casting process. Existing objects can be used as patterns, and sand moulds made in a few minutes' time. Previous experience unnecessary. Domestic gas supply and 110 volt 60 cycle energy required for operation.

Size	Crucible Capacity	Shipping Wt.	Price Casting Complete
351	6 cu. in.	25 lbs.	1 1/2 lbs. \$ 9.50
352	12 cu. in.	40 lbs.	3 lbs. 15.00
353	24 cu. in.	65 lbs.	6 lbs. 23.50

For 110 volt D. C. or 25 cycle set add \$4.00. Prices f. o. b. K. C. Check or money order acceptable, express charges C. O. D. Write for circular.

KANSAS CITY SPECIALTIES CO.

P.O. Box 6022

Kansas City, Mo.

WHIZ ELECTRIC TOOL

Does a real professional job of drilling, grinding, polishing, carving, routing, sanding, etc. **Powerful—Speedy—Dependable**

\$5.95 Only



Speeds up hundreds of jobs for shop, and home. Needed by every craftsman, mechanic and carpenter. Fits size chuck, 1/4" capacity, geared to extra powerful motor. Self-enclosed fan prevents overheating. Ball bearing thrust. Pistol grip with thumb switch. **Universal motor for A.C. and D.C.** Money-back guarantee. **FREE**—a grinder and drill set with each WHIZ tool. Complete outfit, postpaid, for only **\$5.95**. Order now.

Paramount Products Co., Dept. 2A, 245 Bway., New York

MEN-WOMEN EVERYBODY WANTS FREE GIFTS

A large 25 year old company has a unique plan of distributing free gifts. Right now they are giving away, under their plan, to you and your friends **WITHOUT COST** a beautiful gift of universal appeal. Really an ornament of necessity that will be cherished in any home. If you wish you can also make amazing big money telling others about this plan. Nothing to buy or sell. Get facts quick.

GARDEN CITY NOVELTY CO.

4318-F Ravenswood Ave., Chicago, Ill.

Gold Farmers of the West

F1208 (Continued from page 116A)

recovered. In some places there are deposits of rich ore but the ore is of such a complex nature that the cost of taking out the gold is prohibitive. In these cases, also, man must wait until nature grinds it down and frees the gold.

In some parts of the gold country small quantities of gold are scattered all through the ground. Hills and fields containing millions of dollars worth of metal are planted to orchards and farm crops because it costs too much to get the gold out. In an effort to get this gold at a profit, mining men are resorting again to hydraulic mining. Powerful streams of water are turned against the side of a hill, the force of the water tearing away the dirt and boulders. Then the dirt and water travel through sluice boxes where the gold is trapped. Hydraulic mining was a fast, cheap way of making a big fortune in the last century but the method was prohibited when it was found that the debris settled in the valleys and ruined thousands of acres of fertile ground. Now, under certain restrictions that include the building of retention dams for holding the debris, hydraulic mining is starting up again. Hydraulic mining costs about fourteen cents per cubic yard today and all the gold above that represents profit.

Another way low-grade gold deposits are worked is with gold boats, huge dredges equipped with endless chains of buckets that scoop up gravel at the rate of hundreds of yards per day. Each of the big boats moves in its own man-made lake, traveling up the course of some old stream and eating its way along the channel. The boom that carries the buckets can be lowered forty or fifty feet down to bedrock. From the buckets the gravel and sand are carried through sluice boxes and over recovery tables inside the barge. The material from which the gold has been extracted travels over another endless belt and is piled up behind the dredger.

Popular Mechanics Magazine does not publish the name of the maker of, or dealer in, any device described in its pages, but this information will be furnished by our Bureau of Information upon request, accompanied by stamped envelope.



Get Popular Mechanics Famous BOY MECHANIC Library

**4000 Ideas,
Plans, Thrills,
Including**

- Shooters
- Push-Motors
- Real Autos with
- Motorcycle
- Engines
- Wind Wagons
- Ferris Wheels
- Roller Coasters
- Merry-Go-Rounds
- Swings
- Giders
- Model Airplanes
- Model Ships
- Model Railways
- Water Wheels
- Pole Drivers
- Cableways
- Boats
- Shop Machinery
- Movie Cameras
- Ice Boats
- Toboggans
- Bob Sleds
- Bob Speedsters
- Etc. Etc. Etc.



This is it Fellows! Here's what you want! You know it's the fellow who can do things—make things that "work" and "go"—that's the kingpin in every school and neighborhood. Get the "Boy Mechanic" and enjoy that popularity yourself. These famous books give thousands of plans, kinks, and articles on everything the average boy wants to do and make for himself.

4 Big Books — 7x10½ Inches

A total of 4,000 wonderful ideas you can use at the workbench; in camp; on land or water; winter or summer. Something for every place—every time. Each book is different—has about 460 pages, hundreds of pictures. Anyone can understand and use them. Send \$2 for Book 1, 2, 3 or 4. Whole set for \$7.00. Sent C.O.D. if you live in U. S. or possessions. Just pay postman. Give yourself a thrill—Order at least one book—any one—today.

**POPULAR MECHANICS PRESS, Room 137A
200 East Ontario St. Chicago**

A Billion Ideas

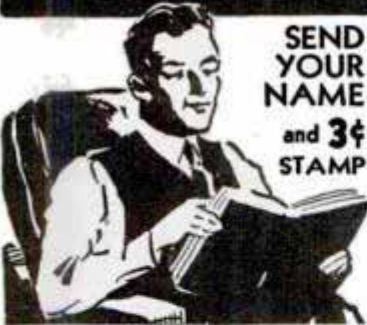

**SEND
YOUR
NAME
and 3¢
STAMP**

POPULAR MECHANICS BOOK CATALOG

Every man who reads Popular Mechanics will want this new big illustrated catalogue of practical, helpful and money making books.

It describes over 5,000 informative and authoritative books, alphabetically arranged under a thousand subjects—everything from ACCIDENT PREVENTION to X-RAYS. It's an amazing guide to the world's BEST practical books. You must see it to appreciate its value. Only limited edition printed. Send your name and address and three cent stamp to cover postage on your copy. Do it today.

**Popular Mechanics Press
200 E. Ontario St., Chicago**

900 WORKSHOP IDEAS!

How to Make Articles of Beauty and Utility that Sell

Get the most out of your hobby. Turn your Work Shop hours into profit. The "Make It Yourself" book shows you what to make and how to make it, with that "professional touch"—models—toys—useful decorative articles of all kinds. Newest edition—480 pages, 823 pictures, 7 x 10 inches. Sent postpaid for \$3.00 or in U. S. and possessions C.O.D.—you pay postman. Order Now.

**POPULAR
MECHANICS
PRESS.**

**Room 137B
200 East Ontario
Street, CHICAGO**

**"MAKE IT
YOURSELF"
INCLUDES:**

- Toys — Models — Furniture — Garden Equipment
- Home Repairs — Sports Equipment — Auto Kinks
- Radio Equipment — Workshop Tools and Machinery. Articles on Working: Wood, Metal, Leather, Glass, Etc., Etc., Etc.



Get into this PROFIT MAKING BUSINESS "Simplified" ARC WELDING



**EARN \$150 to \$300
EXTRA Profit Monthly**

New low prices on modern 40 Volt Simplified Arc Welding makes this money making service available to shops that up until now could not afford it. It opens the doors to hundreds of big paying jobs that carry a real profit for you. Hobart is far easier to operate, faster on each job—and guaranteed to bring quality welding to your shop. Don't miss today's opportunity to get into this most profitable business—extra profits will easily pay for your welder without expense to you.

"BUILD YOUR OWN"—Portable Welder with Hobart Generator unit and auto engine or chassis. Lets you operate any place, especially on the profitable outside jobs. Easily saves you \$300 to \$500.

"ELECTRIC DRIVE"—In new small sizes as well as large, the new Hobart 40 Volt Welder is the most profitable shop welder you can own. Welds faster, saves current.

EASIEST TO OPERATE
Hobart Welders are Simplified in operation. Weld faster. Your own men can use successfully. Uncertainty of obtaining correct welding current eliminated.

60% EXTRA CAPACITY
40 Volt Ratings mean easier welding with new coated rods. Automatic reactance handles light welding work without losing arc.

REMOTE CONTROL
No extra cost. Controls welder from any working point. Saves time and need for helper on overhead or congested work.

HOBART IS FASTEST SELLING WELDER TODAY—Used by U. S. Government, U. S. Navy, Ford Motor and going into hundreds of welding and repair shops each month.

**GET 30 DAYS TRIAL—
AT OUR RISK
NO INVESTMENT TERMS —
PROFITS PAY FOR IT**

Extra earnings and savings possible with Hobart Welders make it easy for you to own one without expense. You can even rent a new Hobart — and later purchase it without loss. Check Rental Purchase Plan.

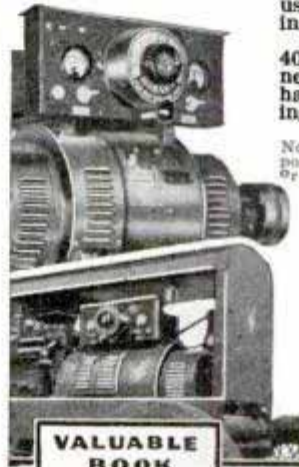

**VALUABLE
BOOK
FREE!**

HOBART BROS., Box M17 Troy, Ohio
Tell me more about

- Building My Own Complete Gas Engine
- Portable Welder Drive
- Electric Drive Welder 30 Days' Trial—Easy Terms
- Rental Plan Privilege of Purchase

Send FREE Manual on Welding. Attached letter tells about the work we want to do.

Name.....
Address.....

HOBART ONE OF THE WORLD'S LARGEST BUILDERS OF ARC WELDERS

MODEL BOAT PARTS

FINE DIE-CAST PARTS from STEM to STERN
THE MOST COMPLETE LINE EVER MADE.
Powerful Inboard and Outboard Steel Motors



Props, Vents, Cabins, Anchors, Controls, Windshields, Hulls, Assembly Kits and Every Conceivable accessory for Model Boat Building.

All Parts Sealed to Size
MAIL 10c IN STAMPS OR COIN FOR COMPLETE SET OF PLANS AND CATALOG.

Motors to Drive up to 4-ft. Models
Calcraft Corporation, Dept. M., 2732 Colorado Blvd., Los Angeles, Calif.

SAVE PRINTING COSTS



with the COPY-STAMP

Prints postcards, letters, menus, notices, etc., etc. Works like a mimeograph. Quick, clean, compact, instantly changeable.

Ask your stationer or write us direct.

**THE STENCIL-STAMP CO., Inc.
53 Park Row, New York, N. Y.**

SHOPPING GUIDE TO FAVORITE GIFTS

For A Man or Boy

DRIVER D925 DRILL PRESS

\$37.50 as shown, less motor, incl.
belt and motor pulley

A fine drill press is one of the ideal "first tools" for any home workshop. This Driver model is sturdy enough for heavy work, yet made with precision that fits it for the most accurate drilling. SKF ball bearings, Jacobs Key Chuck. True running, vibrationless. A high quality engineered tool in every respect.

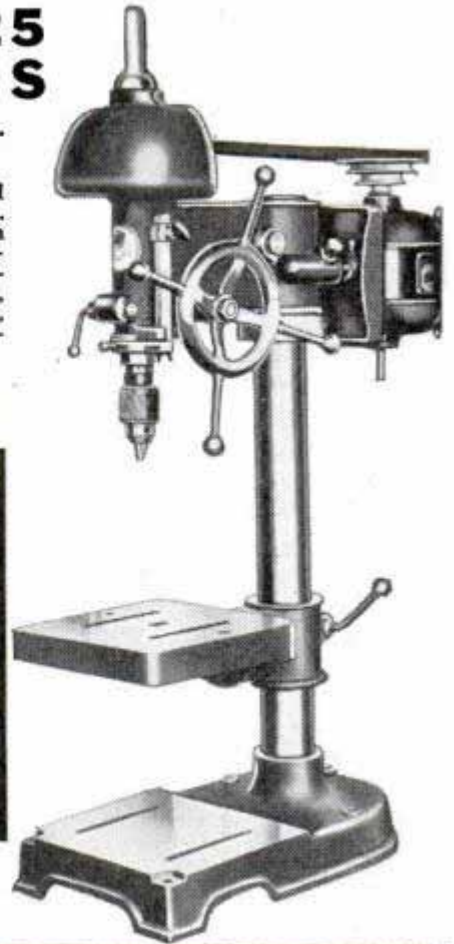

CHOOSE WISELY FROM THE DRIVER LINE!

- An 8"x30 1/2" Lathe for \$16.95
- A 14" Jig Saw for \$12.25
- A 7" Bench Saw for \$11.25
- A 10" Band Saw for \$19.95
- A 4" Planer (Jointer) \$13.50

Other Models Available at Slightly Higher Prices—ALL ENGINEERED—ALL RUGGED—ALL EASY TO OPERATE

Walker-Turner Co., Inc.
117 South Ave., Plainfield, N. J.

Send me your colorful descriptive folder on 1937 Driver Engineered Power Tools.

NAME

ADDRESS

**ASK YOUR DEALER ABOUT
THE EASY PAYMENT PLAN**

DRIVER *Engineered* POWER TOOLS

Neon Truck Signs

-- NOW Possible with Amazing
New TRANSFORMER and Novel Method
of Tube Installation!

Old, established factory wants financially responsible business executives - to handle distribution in exclusive territories. Signs fill long-felt Advertising need! Enable any advertiser to have brilliant, colorful, attention-getting Neon Advertising message on trucks, both day and night. Expected to quickly sweep country! Easily installed on top driver's cab. Amazing NEW TRANSFORMER enables Sign to operate on any truck's standard 6-volt auto storage battery—using only about same amount current as an extra tail light. Novel method tubing installation protects against breakage. Reasonable capital handles exclusive Distributorship Contract. Big Profits. No sign experience necessary. We furnish entire product. FREE LITERATURE gives details, explains liberal proposition. Write today!
E. E. SOUTHERN IRON CO. - 1952-A-7 Kienlen Ave., St. Louis, Mo.

**DISTRIBUTORS
WANTED**

**BUILD
CLOCKS
for
PLEASURE
—PROFIT**



Hall clocks are high priced in stores—you can make good money building them or electrifying spring clocks. Dime brings "HOW" Book pricing banjo, desk, mantle, RADIO, spring, ELECTRIC, chime, BATTERY from \$1.40. Brass weight movements from \$10.95 with drawing of easily built Grandfather Case—start now.
CHIME CLOCK CO., GUTTENBERG, IOWA

KNEE ACTION TRAILER AXLES

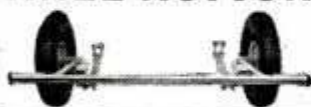

Knee action, drop center, & straight axles available in 56", 62", 68" & 72" treads, detailed circular upon request.

TOELLEN MFG. CO.

Box 4, Strathmoor Sta., Detroit, Mich.

G.E. PHONOGRAPH MOTOR

Variable speed induction type self-starting, 110 volt, 25 to 60 cycle, AC, with speed regulator. Plug and cord. Speed range from 30 to 200 RPM. Can be installed in place of old-fashioned, hand-winding speed motor. Also ideal for display turn table.



\$4.95
Only

and a hundred other uses. Regular \$15.00 value. Send check or Money Order plus Postage. Shipping weight 12 lbs. Money back guarantee.
National Electric Tool Co., 560 W. Washington Blvd., Dept. 31, Chicago, Ill.



BUILD THIS 6' YAWL MODEL, ONLY \$1.50

Everything furnished including semi-shaped hull of white pine and mahogany with black water line. All rigging material, airports, pedestal, base, plans and instructions. Mailed postpaid for \$1.50 in U.S.A., \$1.65 Canada. No C.O.D. orders. Our 44 page illustrated catalog listing kits and separate fittings mailed on receipt of 15c.

A. J. FISHER, 1002-1 Etowah Ave., Royal Oak, Mich.

BE YOUR OWN BOSS! Operate quality used and new clothing business from your own store, home or auto. Make 200% to 300% profit. No selling experience required. Everything furnished. Catalogue FREE, write for it today.

PORTNOY & SONS, 566 Roosevelt Road, Dept. 106, Chicago, Ill.



MONUMENT \$9 UP Freight Paid or Erected.

World's Best Marble and Granite. Direct from factory. Lettered. Guaranteed. 30% Savings. Thousands sold. Write for Free catalog. **U. S. Marble and Granite Co., Dept. A-18, Oneco, Florida.**

NO BOSS! SURE CASH! SILVERING MIRRORS

Autoparts, Reflectors. Combination outfit. Write

SPRINKLE, Plater, 129,

Marion, Indiana



MAKE GLAZED CONCRETE PRODUCTS

Beautiful, colored, glazed concrete pottery made from sand and cement without molds or costly tools. Tiles, novelties, wall glazing, waterproofing. No experience needed. Money making employment. Send 10c for booklet, color plate, details.
NATIONAL POTTERIES CO., 13 West 26th Street Room 21 Minneapolis, Minn.

PENNY EACH ! !

Beautiful Window Sign Letters. Lowest Price in America. Finest Quality. 5 Year Guaranteed. New styles. Tremendous Demand. Big Profits. Easily Applied. Record Breaking Offer. FREE Samples and Working Equipment. Hurry!
Atlas Sign Works, 7943 Halsted, Chicago, Ill.



MOTORISTS WISE SIMONIZ

When writing please mention Popular Mechanics

Increase Your Earning Power

Apply time and labor-saving kinks to your work. Your efficiency will soon be recognized and you will be in line for advancement.

If you do machine shop work of any kind, sheet-metal work, painting, carpentry, auto repairing, farming, concrete work, plumbing, electrical work, welding, building-glass work, general repairing, tool-making, poultry raising, masonry or home repair work, get this

LIBRARY OF 2000 TIME AND LABOR SAVING IDEAS FOR SHOPMEN AND HANDYMEN

JUST OUT

SHOP NOTES for 1937

357 Articles
703 Illustrations
224 Pages
Price 50c
See partial list of contents below

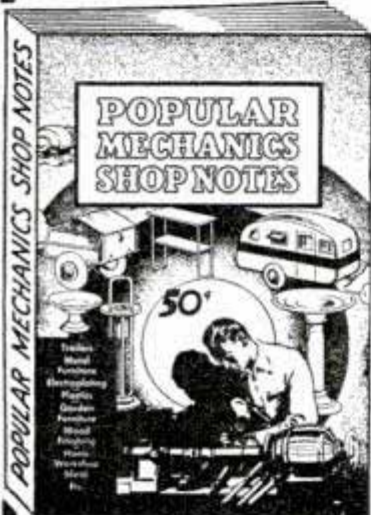

Including the new 1937 issue illustrated above, there are five volumes in the Shop Notes Library of 2000 easily understood short cuts to every-day jobs. Here are just a few of the subjects taken from the latest issue:

- | | | |
|-------------------------------|---|-----------------------------------|
| Alloys, Electroplating With | Fly Chaser for Door Folding Bed in Auto | Sawhorse for Uneven Floors |
| Belt Sander | Fruit-Picker's Ladder | Shop Heating Unit |
| Cesspools, Repairing | Gold, Finding | Soldering Aluminium |
| Concrete Garden Furniture | Humidifier for Furnace | Thermosets, Designing |
| Dovetails, Making | Magnet Recharger | Tools from Drill Rod |
| Dowel Making | Metal Awnings | Trailer, Contractor's |
| Efficient Farm Weeder | Metal Furniture | Truck Lift, 3 Speed |
| Electric Motors, Servicing | Oil Finishing | Universal Tripod for Cameras |
| Electrical Test Board | Photo Enlarger | Window Displays, Novel |
| Electroplating Non-Conductors | Photo "Spot" Light | Window Sign "Flasher" |
| Family Auto Trailer | Plastics, Working With | Winter Starting Aids |
| Fence Posts, Pulling | Pottery, Concrete | Wood Lathe Used for Metal Turning |
| | Resilvering Mirrors | Wooden Bowl Forming |
| | Rewinding Auto Generators | |

Each volume contains approximately 400 articles and 700 illustrations and has 200 or more pages. This unrivaled library of shop helps may be secured for a limited time only. After the present supply of books is exhausted the offer must be withdrawn.

* Send No Money

POPULAR MECHANICS PRESS, 200 E. Ontario St., Room 137, Chicago, Ill.

Send me, as per your offer, the following books. I will pay postman price and small amount of postage. My money will be refunded if I am not satisfied. (Check what you want.)

- 1937 Shop Notes and Lathe Handbook (Metal Working), both for 98c.
 Shop Notes Library (5 vols.) \$2.50.

Name.....

Street and No.....

City..... State.....

* C. O. D. applies to U. S. and possessions only. If you reside elsewhere, remittance must accompany order.



COOK and HEAT without COAL or WOOD in Your PRESENT STOVE

TWICE THE HEAT AT LESS COST—No Dirt or Ashes
QUICK HEAT AT TURN OF VALVE

An Amazing New-Type Oil Burner Which 25,000 Users Say BEATS ANY EVER GOTTEN OUT FOR LOW COST, PERFECT PERFORMANCE, Burns Cheap Oil a NEW WAY Without Pre-generating or Clogging Up, Cuts Fuel Bills and Pays for Itself Quickly by What It Saves. READ BELOW HOW YOU CAN TEST THIS REMARKABLE SUPER FLAME OIL BURNER in Your Own Home FREE OF RISK. Then Mail Coupon.

COOKS A MEAL for LESS

Why burn coal or wood with its dirt and drudgery of building and feeding fires? Why carry ashes and get uneven, slow-starting heat? Burn cheap oil a NEW WAY and get TWICE THE HEAT at LESS COST—and have QUICK HEAT regulated by a simple turn of a valve.

Thousands have acclaimed the HEAT KING the most perfect oil burner. Nothing like it—the lowest priced efficient oil burner—positively guaranteed NOT TO CLOG, NOT TO CARBON OR STOP UP. Has a record of over 11 years constant use without ever needing any cleaning. Simple—safe—economical—no electrical connections—no moving parts to wear out—does better work at less cost. Burns 95% air and 5% cheap oil—TWICE THE HEAT OF COAL by simply turning valve. **Engineer of National Reputation Says:** Combustion principles are simple, efficient, excellent—assures economical oil consumption and maximum heat. Tests made on burner with one year's hard service prove no evidence of dirt or residue or any carbon on interior parts. No nozzles or tips to "coke up" or stop up.—C. W. Lovelace—K. C., Mo.

USERS SAY: Fifteen oil burners of different kinds here but Heat King is cheapest, best.—J. R. Goldthorp—Washington.

I get more heat from your burner than I ever had from coal or anything burned in my furnace.—W. C. Nicholson—Ind.

Reduced coal bill fifty percent.—W. S. Collins—Pa.

SENT ON TRIAL

SENT ON TRIAL for 30 days. If you want to SAVE MONEY in cooking and heating you may try the "HEAT KING" AT OUR RISK—prove that it ends drudgery and dirt of coal or wood, cuts fuel bills in half, pays for itself quickly by what it SAVES. You must be satisfied under our liberal guarantee or YOU PAY FOR THE BURNER ABSOLUTELY NOTHING.

FREE SAMPLE to Agents

and salesmen offered to one in each locality who will demonstrate and take orders. Send no money—just sign and mail coupon (or 1c postcard will do). Mail coupon quick, be first in your locality to learn how satisfactory oil heat can really be and how you can MAKE REAL MONEY spare or full time. Mail Coupon or 1c postcard today—NOW.

UNITED FACTORIES

A-751 Factory Bldg. KANSAS CITY, MO.

MAIL COUPON

UNITED FACTORIES

A-751 Factory Bldg., Kansas City, Mo.

Without cost or obligation, rush generous TRIAL OFFER on wonderful "HEAT KING" Oil Burner sent WITHOUT RISK TO ME.

CHECK HERE

Name.....

Address.....

City..... State.....

if interested in NO COST SAMPLE and money-making offer.

When writing please mention Popular Mechanics



Slips into Any STOVE RANGE or FURNACE

AGENTS SALESMEN BIG MONEY

No wonder salesmen and distributors are breaking records in sales. They show how it gives QUICK HEAT, HOTTER, CHEAPER, WITHOUT DIRT AND ASHES, and how IT SAVES—then, reap BIG CASH PROFITS. Sells fast because low-priced, cheap to operate, efficient.

WHAT SALESMEN SAY:

Installed one when weather was 10 degrees below zero. Kept house well heated. I can dispose of 250.—F. Silver—Canada.

I am a plumber, installed all kinds of oil burners, but never knew such a thing to get that much heat out of oil. There is money in selling them.—W. C. Nicholson—Ind.

Get YOUR OWN OIL BURNER SAMPLE AT NO COST and CASH IN BIG. Be FIRST in your locality—MAIL COUPON or 1c postcard today—NOW.

WIND SPRINGS Yourself!

Machine Shops, Inventors, Small Lot Mfrs.—SAVE COST ON ONE PROJECT. **ROTO-TENSIONED MUSIC WIRE and TOOLS.** A new, rapid process (pat. pdg.) makes springs any diameter, length, open, closed—0.010 to 0.078 inch. Outfit includes 3 permanent tools and assorted sizes highest grade music wire, enough for 20 4" springs. Additional wire reasonable even in small quantities. Roto-Tension wire is non-snarling, non-waste.

\$1.95

Per Outfit
Postpaid

Send \$1.95 (M. O. or Check) for the outfit—POSTPAID.
ROTO-TENSION CO., 70 Fulton St., New York City

MODEL BUILDERS! CRAFTSMEN! big 64-page Catalog

Just off the press in time for Xmas!

Model R.R.'s, Ships, Airplanes, Gas and Steam Engines, Racing Cars, Supplies, Accessories. Hard-to-get parts, sheet metals, rods, wires, bolts, screws, etc., etc., (all very fine sizes). Thousands of tiny items. The catalog everyone has waited for. Supply limited. Send 10c (coin) today—no free copies.

Cleveland Model & Supply Co., Inc., 1866P W. 57th, Cleveland, Ohio, U.S.A.

100 PAGE BOOK No. 8

Make Beautiful Furniture

at a fraction of store cost. USE THE CRAFTSMAN new process of inlaying, using our new process **ART INLAY GLUE**, needing no clamps for the finest work. Hard to find rare grains for all wood, including foreign hard-to-find cabinet hardware. Lists and illustrates 76 blueprints of scroll patterns, inlay table tops—Kits for inlay art boxes, plaques, trays, book ends, etc., that anyone can make—22 pages in color.

**CRAFTSMAN WOOD SERVICE CO.,
2723 MARY STREET CHICAGO**

only
10¢

POPULAR MECHANICS TRAILER PARTS



Chassis and frame in Knock-Down form—easily and quickly erected, by one man, with only a few tools. Cooking cabinet—front "A" frame, roof and end curved pieces—complete window kits ready for assembly—everything for the Family Trailer. Send for **FREE** circular before building. **Eastern Trailer Supply, Box 98-R 1, Asbury Park, N. J.**

In answering an advertisement with a coupon, be sure to write name and complete address clearly. Sometimes advertisers are unable to respond to inquiries due to lack of complete information.

The NEW KINKADE GARDEN TRACTOR

and Power Lawnmower

A Practical Power Plow and Cultivator for Gardeners, Suburbanites, Florists, Truckers, Nurserymen, Fruit Growers.

Low Prices—Easy Terms

**AMERICAN FARM MACHINE CO.,
1058 33rd Ave. SE., Minneapolis, Minn.**



Catalog
Free

FREE TREASURE BOOK RINGS \$1.50



Write for Big
FREE Catalog
Of Pins, Rings,
Emblems, Medals,
Trophies, Etc.



Class Pins, any letters, numerals, colors. Silver Plate, 25 or more, 30c ea.; 7 to 24, 35c ea.; 1 to 6, 40c ea. Gold Plate, add 10c ea. to above. Ster. 811, add 20c ea. Ster. 811. Ring shown, 25 or more, \$1.50 ea.; 12 to 25, \$1.60 ea.; 1 to 11, \$1.75 ea.

4254 METAL ARTS CO., INC., FACTORY 44, ROCHESTER, N. Y.

A BILLION IDEAS FOR ONLY A 3¢ STAMP

Send today for the big Popular Mechanics Illustrated Book Catalogue—"A BILLION IDEAS." An interesting helpful guide to thousands of practical informative and money-making books. It describes many books of the kind you want to know about. Limited edition just published. Send three cent stamp to cover postage.

POPULAR MECHANICS PRESS 200 East Ontario Street, CHICAGO



Scale Measurements Transferred Accurately on Work

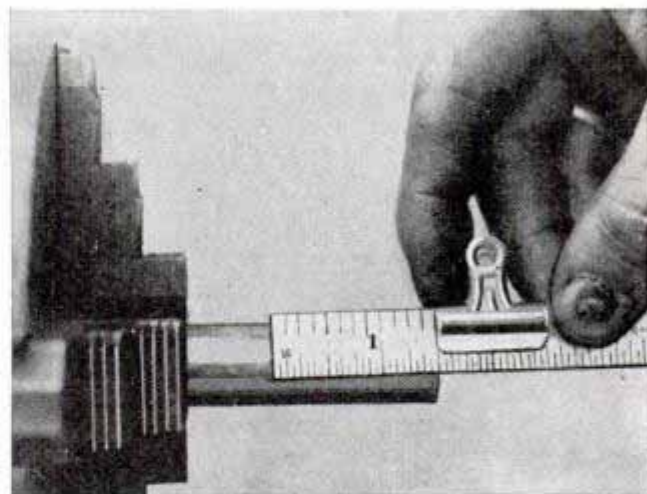

Duplicate lengths of work are quickly cut in your lathe by using this stop on a scale

When transferring measurements from one piece of work to another, or when cutting off duplicate lengths from pipe, tubing and rods in a lathe, a paper clamp on the scale will serve as a stop so that the correct length can be marked quickly. Paper clamps of this type have a strong spring, which causes the jaws to grip the scale tightly to avoid accidental slipping.

—Frank Bentley, Jr., Missouri Valley, Ia.

Rough "Field" Whirls Propellers of Tiny Model Planes

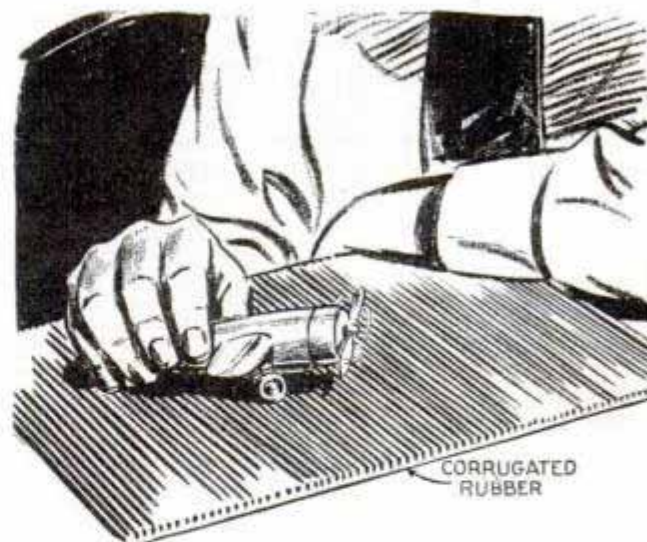

Vibration set up in the plane when it is pushed over corrugated rubber causes the propeller to whirl

Whirling props give tiny cast-lead planes a touch of realism. Vibration set up in the plane as it is pushed across a piece of corrugated rubber causes the propeller to turn.—Edward K. Packer, Chicago.



Dixon's "Junior" Graph-Air Gun, Flexophane—throw-away-when-empty Model, filled with Microfyne Graphite, about 900 applications. Individually carded with use-directions. **30¢**

Unlike plain oil or grease, powdered graphite never gums; stands 10 times more heat and lower sub-zero cold; does a far better, longer-lasting lubricating job at lower cost. Used by itself in powder form or as a co-lubricant wherever plain oil or grease is used, and in endless other applications where oil or grease fails, is ineffective or messy.

Dixon's "Junior" Graph-Air Gun when squeezed

PATENTED provides a quick, easy, clean way of blowing microscopically Powdered Microfyne Flake Graphite into and onto anything that SQUEAKS, RATTLES OR STICKS. **FOR STICKY LOCKS**

At stores selling hardware, automobile and marine supplies, firearms, sporting goods or sent postpaid in U. S. A. on receipt of price (Stamps) and your dealer's name if possible.

USED BY EVERYBODY IN SOME WAY, THE FOLLOWING GENERAL USES SUGGEST ENDLESS OTHER USES:

- | | | | | |
|--|---|--|--|--|
| <p>IN HOMES, OFFICES AND STORES</p> <ul style="list-style-type: none"> Locks, Clocks Household Machines, Gadgets, Bicycles Window, Furniture, Letter File, Show Case Slides Business Machines Cash Registers Change Making Machines, etc. | <p>IN AUTOMOBILES AND SERVICE STATIONS</p> <ul style="list-style-type: none"> Locks of Doors, Switch, Spare Tire and Compartments Door Dovetails, Door Checks Window Slides Crank Case Oil, Gear Boxes Upper Motor Cylinders (Blow into spark plug holes or manifold) Hood Latches Gaskets, Springs, etc. | <p>IN FACTORIES ON RAILROADS</p> <ul style="list-style-type: none"> Locks, Hand Tools Gaskets and Pipe Threads Power Machinery Bearings, Gears Chains, Slides Linotypes, Planos Coin Operated Machines Fire & Signal Alarm Boxes Car Seats and Window Slides, etc. | <p>IN SPORTS, ON SEAS IN THE AIR</p> <ul style="list-style-type: none"> Locks, Firearms Fishing Rod Reels Racing Boat Bottoms Blocks and Pulleys Gaskets and Stuffing Box Packings Airplane Landing Gear Quadrant Gasoline Motors see Auto Uses, etc. | <p>ON FARMS</p> <ul style="list-style-type: none"> Locks Coating Germicide-Treated Pen Seeds Gaskets, Pipe Threads Pump Packings Hand Tools, Power Machinery Bearings, Gears Chains, Slides Gasoline Motors see Auto Uses, etc. |
|--|---|--|--|--|

JOSEPH DIXON CRUCIBLE CO., Dept. 26 C-G, Jersey City, N. J.

Dixon's Graph-Air Gun, long-life rubber re-fillable model, filled with Microfyne Graphite, about 900 applications, individually wrapped with use-directions. **75¢**

DIXON'S "JUNIOR" GRAPH-AIR GUN
WITH MICROFYNE POWDERED GRAPHITE



Extra Money From Books

SEND NO MONEY • Books Sent C.O.D. Anywhere in U. S.

These famous Pay-Raising, Extra Money Books have helped thousands of others. Let them help you too. Check this list and mail with your

name and address. Pay postman on delivery plus few cents postage. Send 3c stamp to cover postage and ask for catalog of other books.



- SELECT FROM THIS LIST**
- ARMATURE WINDING** For A.C. and D.C. Machines... \$2.00
 - AUTO REFINISHING** Duco With Spray Gun... \$1.50
 - BLUEPRINT READING** For Machine Trades... \$1.50
 - BRICKLAYING** Plain and Fancy... \$1.50
 - CARBURETORS (All Makes)** New, Revised Edition... \$2.50
 - CHEVROLET SIX** Car, Truck, Operation Repair... \$2.00
 - COLONIAL FURNITURE** Making, 95 Pieces... \$3.50
 - DANCE** Learn at Home Without Music or a Partner... \$2.00
 - DIE CASTING** Machines, Dies, Alloys... \$3.00
 - ELEMENTS DIESEL** Engineering Questions and Answers... \$4.00
 - FOUNDRY WORK** Molding, Casting, etc... \$2.00
 - FURNITURE REPAIRING** Finishing and Decoration... \$3.00
 - HEATING, VENTILATING** Homes and Buildings... \$2.50

- HIGH-SPEED DIESELS** New, practical, non-technical... \$2.50
- INVENTIONS** 1500 Needed... \$2.50
- LEATHER MAKING** and Home Tanning... \$1.00
- MACHINE SHOP WORK** Tools and Methods... \$2.50
- MAGICIAN'S MANUAL** New, 100 Tricks for Amateurs... \$1.39
- METAL SPINNING** Practical New Book... \$1.00
- MONEY MAKING FORMULAS** 15,000 Practical... \$5.50
- MOTOR VEHICLE** Trouble Shooters' Handbook... \$2.00
- PLASTERING** Best Instruction Manual... \$1.25
- PLASTIC MOLDING** Production Basis... \$3.00
- RADIO PHYSICS COURSE** New edition. Everything about Radio... \$4.00
- SHEET METAL** Construction Work... \$2.00
- STEAM ENGINEER'S LICENSE** How to Obtain... \$2.00
- TAXIDERMISTRY, HOME** Mount Trophies Profit, Pleasure... \$1.50
- WROUGHT IRON WORK** Practical... \$1.35

\$15 Value BENCH SAW \$7.50

Size 12 in. x 14 in. Weight 33 lbs. Spring steel splitter, with adj. or remov. guard. Cuts up to 2 1/2 in. depth, raises & lowers. Graduated mitre gauge. Takes up to 8 in. saw, polished table top, tilts to 45°. Blade \$1.60 extra; Dixon's Combination, rip or crosscut. All prices F.O.B. Philadelphia. Send \$1.00 with order for each item desired, balance C.O.D. Canadian orders \$1.00 extra. Send 10c for illus. catalog showing screw cutting lathes, drill presses and hundreds of other tools, motors, etc.

Martin Electric T & S Co., 604 Arch St., Philadelphia, Pa.

BUILD CLOCKS with our help

Cash in on the demand for Mantel, Banjo, GRANDFATHER'S CLOCKS. Ask about new, low-priced Clock and Special Blue Print Offer. Send dime for illustrated working drawing. Catalogue FREE.

AMERICAN CHIME CLOCK CO., 1672 Ruffner St., Philadelphia, Pa.

BUILD YOURSELF OR HAVE Carpenter or Garageman BUILD

A RITZY CABIN TRAILER COST 1500 UP

USE AUTO AXLE OR REGULAR TRAILER AXLE

ALL TRIPLE PLANS \$1.50

Ritzy Standard, Ritzy Coupe Cruiser, Ritzy Air Cooled

SIMPLE PLANS AND SPEC. BY REG. ENGINEER. SIZES: WIDE 5 HIGH 22 AND 24 LONG. EASY TO CHANGE LENGTH AND WIDTH. MAIL 15¢ BILL TODAY FOR ALL TRIPLE PLANS TO RITZY CABIN TRAILER, BOX 253X, WAPAKONETA, OHIO.

SECURE THE WORLDS FINEST WOODS

100 KINDS OF WOODS

for all requirements available in small quantities in VENEERS, LUMBER, PANELS, INLAYS, INLAID BORDERS. Free Folder.

ALBERT CONSTANTINE AND SON, Inc. 793 E. 135th St. New York, N. Y.

CATALOG WITH CREDIT SLIP **25¢**

OLD FACES MADE YOUNG

MEN you can look 10 to 15 years younger. 5 Minutes a Day Keeps Wrinkles Away and erases age lines. This new sensational home method Sent on Trial—You Risk Nothing. Lifts sagging muscles, fills up hollows. No Cosmetics.

Men, Women, all ages write for thrilling book and Facial Analysis Chart—both sent FREE in plain wrapper.

PAULINE PALMER, 1461A Armour Blvd., Kansas City, Mo.

When writing please mention Popular Mechanics

POPULAR MECHANICS PRESS
Room 137A 200 E. Ontario St., Chicago

Trindl **ELECTRIC ARC WELDER**

375

Works Off Any Storage Battery or Ordinary Light Socket

This new electric arc welder is made possible by the invention of a low voltage carbon. Auto batteries may be used without removing from car. Uses about same current as four headlight bulbs. Broken parts are simply melted together by the white hot electric arc, in just a few seconds. Produces about 7000 degrees heat.

Hottest Flame Known

Melts iron and steel instantly. Welds fenders, radiators, holes in bodies, milk cans, tanks, brazes broken castings. Works on anything iron, steel, brass, copper, tin or galvanized metal. Permanent repairs made for almost nothing. Used by factories in many operations. Positive money back guarantee by a responsible firm.

AGENTS

Men with cars to sell mechanics, repairmen, farmers, radio and battery shops, factories. Five minute demonstration makes sales. Up to 150% profit. Write today.

TRINDL PRODUCTS 2228-T Calumet Av. CHICAGO, ILL.

MIDGET *Electric* RADIO

World's Smallest Loudspeaker Radio

Just a handful—Wt. only 1½ lbs. Size only 3¼ x 5 x 2¼. Has two multi-purpose big-in tubes, hi-efficiency coil and precision parts—BUILT IN AERIAL! Midget BUILT IN speaker operates with beautiful clear tone and clarity on all stations on broadcast band and ALSO police calls! Actual four tube performance with real distance and punch for so tiny a radio. ALL ELECTRIC (Battery model available). Easily carried in any large pocket or tucked in suitcase. Ideal second or personal radio. Colors to match any room—beautifully finished break-proof cabinets. Only hi-grade parts used—a truly trouble proof midget. Late improvements. Users report wonderful reception in ALL PARTS OF THE WORLD. Uses 110 volt AC or DC current—any cycle. Kit of parts with tubes and diagram, \$6.48. COMPLETELY WIRED and factory checked, 50c extra or \$6.98 as shown. Send only \$2.00—pay postman balance. Guaranteed to operate anywhere. Colors: White, Black, Brown, Blue, Green. (Battery model same as above complete with self-contained battery, same price. ORDER NOW.

TINYTONE RADIO CO. Dept. P-1 Kearney, Nebr.

"R & W ENGINEERED"

- Wheels
- Axles
- Hubs
- Springs
- Brakes
- Hangers
- Hitches

SEND FOR CATALOG

RIM & WHEEL SERVICE CO. 5132 Third Ave., DETROIT, MICH.
147 Weston Street S. E., GRAND RAPIDS, MICHIGAN

STRIPE YOUR OWN CAR

Anyone can stripe a car with a ROLL-A-STRIPE. You can save the price of your striping job and earn money doing others. Specially knurled roller and dependable gauge. Paint, lacquer, enamel or varnish may be used. Stripe signs, furniture, models, etc. See any Duco Dealer today or send direct. Postpaid \$1.50.

MODCRAFT INDUSTRIES, Dept. P21, 2908 N. Nordica Ave., CHICAGO, ILL.

NEW FREE TRAILER PARTS CATALOG

Shows 329 valuable trailer items. Build your own trailer or recondition the one you have. Wholesale prices for quality merchandise. Send for free money saving catalog today.

C. M. Hoof Company, 1736 S. Michigan Ave., Dept. P-1, Chicago, Ill.

AMAZING NEW BUSINESS
Sell to Stores

Get Set for Life!

MAKE up to \$65 WEEKLY

in new kind of wholesale business. Place famous line 5c-10c goods with stores. Merchants grab our FREE GOODS Deals. 200 fast-selling products—all on salesmaking Counter Displays. Up to 140% profit for you and merchant. No experience or investment to start. Big catalog and facts FREE. World's Products Co., Dept. 1810, Spencer, Ind.

Easier Motoring for 1937

(Continued from page 143A)

from the instrument panel to the top of the transmission housing. This grille is designed to house radio and heater. The Cord also has few changes. It is available with 125-horsepower or supercharged 170-horsepower engine. Nash joins the parade of all-steel bodies and tops, and features the folding bed introduced last year in the Lafayette. A special speedometer to be used in connection with the optional cruis-

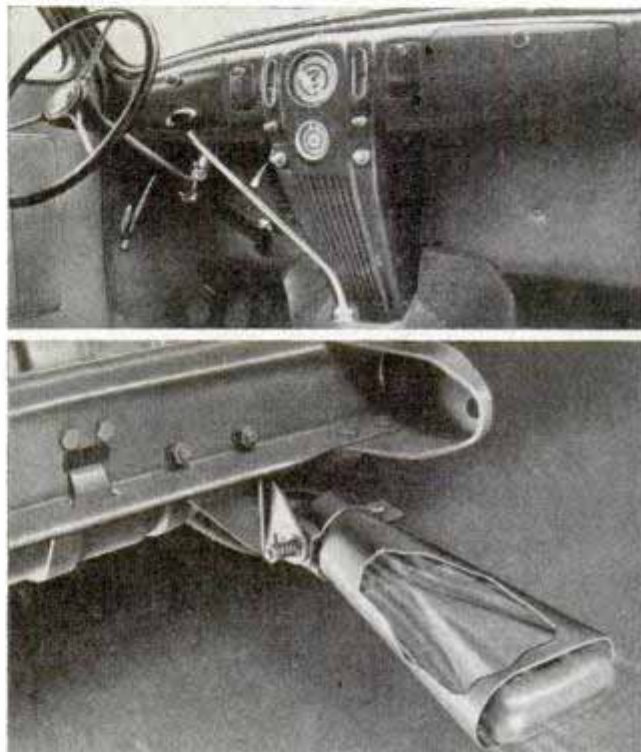

Top, grille extending from instrument panel to transmission housing in Lincoln-Zephyr. It houses radio and heater. Bottom, new exhaust pipe of Cadillac and LaSalle permits smooth flow of gases and reduces exhaust noise

ing gear shows car speed and also engine speed in miles per hour. Louver openings in the hood have been eliminated by Nash engineers.

Service-station attendants will welcome the new location of the battery under the hood, at the left-hand side, in Hudson, Terraplane and Willys. In Chevrolet, oil filler, radiator filler and gasoline filler pipes are all located on the right-hand side so that the car may be serviced without the attendant stepping off the curb into the path of traffic.

Ford, Chrysler and Studebaker join Lincoln-Zephyr in use of the hood top pivoted at the rear. Unlocked by manipu-

(Continued to page 158A)

ANNOUNCING

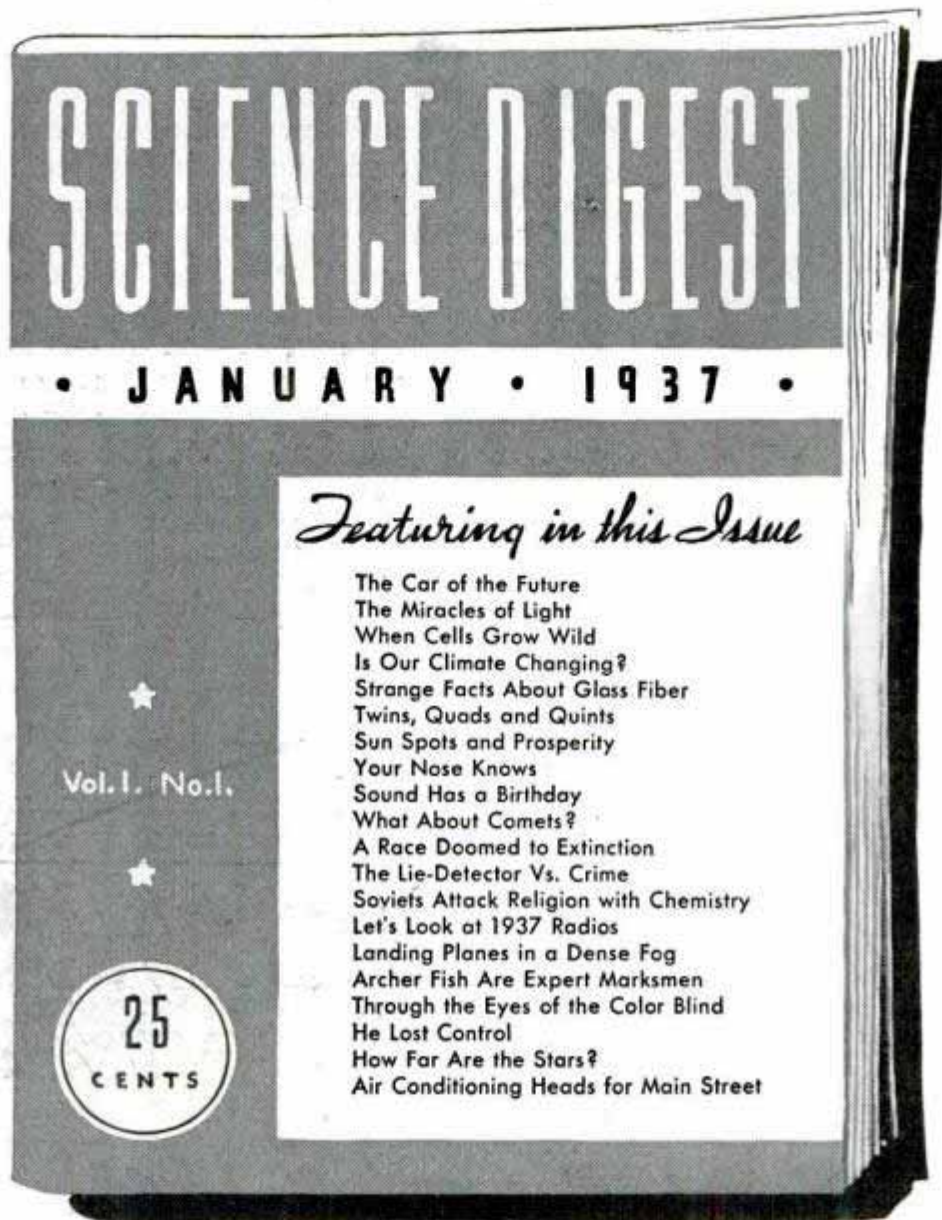

For busy men, in profession or business, Science Digest presents pertinent news of scientific progress, in concise, clear, easy-to-read form. It is a pocket-size monthly, a time-saver, a digest of the important articles from the world's scientific publications. Get Volume 1, Number 1, from your newsstand today. Price twenty-five cents. Subscription price \$2.50 per year. Mail your subscription now and start with the first issue.

SCIENCE DIGEST, INC.

631-643 St. Clair Street

Chicago, Illinois

When writing to advertisers please mention Popular Mechanics

DOUBLE A Power TOOLS

10-in.
Jig Saw
\$1.49



The **Champion**—America's outstanding power tool value. Cuts up to 1½". Has 8" table, 10" throat, sturdy frame, adjustable guides, enclosed top spring. V-belt pulley drive. Takes 5" plain end saw blade. Runs quietly. Shipping wt. 6 lb. Price, \$1.49. 6 all-purpose blades, 15c extra. 3 assorted blades, 15c extra.

WOODWORKER'S VISE, \$1.00

Strong, rugged, practical. Carefully and accurately finished. Jaws, 6" x 2 5-8". Open to 6". Shipping wt. 6 lb. Price, \$1.00.

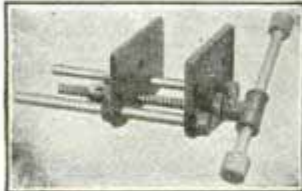

MOTOR-DRIVEN HACK SAW, \$7.95



The new, portable **Pioneer** is sturdy, built for hard use. Cuts 2" stock. Has 8" saw blade, strong vise, accurate gears, firm cast iron frame. Accurately machined. We recommend ¼ H. P. motor and 125-150 strokes per minute. Shipping wt. 10 lb. Only \$7.95. Six 8" blades, 45c extra.

DISC SANDER, \$1.20

Has 7"x3½" table and 6" sanding plate. Height, 7"; depth, 8"; length, 8". Shipping wt. 8 lb. Only \$1.20. Six standing discs, 30c extra.

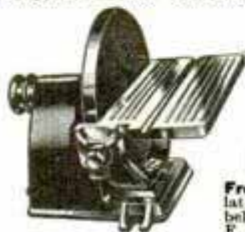

BELT SANDER, \$1.80

Includes fence. Shipping wt. 12 lb. Price, \$1.80. Sanding belts, coarse, medium or fine, 35c extra.

IDEAL CHRISTMAS GIFTS

Free literature describes full line of wood and metal lathes, grinders, spindle shapers, drills, motors, pulleys, belts, line shaft equipment and accessories. All prices F. O. B. Ann Arbor. 25% deposit, balance C. O. D.

DOUBLE A PRODUCTS CO., INC.

407 No. Fifth Avenue

Ann Arbor, Mich.

Easier Motoring for 1937

(Continued from page 156A)

lating the ornament, the front of the hood lifts for servicing.

An automatic hill-holding device, which prevents the car from rolling backward on inclines, is optional on Terraplane and Hudson. Operated hydraulically from the braking system, the device is released by stepping on the clutch.

On the oil pressure gauge in Hudson and Terraplane is an opaque panel in which flashes the word "No" when pressure drops. The word "Not" flashes on the ammeter panel when the generator is not charging. Thus the two devices quickly warn the driver of conditions which might cause trouble.

Production of Eggs Is Increased by Drip Water Fountain

Knowing that eggs contain a high percentage of water, one poultryman concluded that the production of his flock could be stimulated if the hens could be encouraged to drink more water than they did under ordinary conditions. Accord-



ingly, he constructed the water fountains in the pens so that the water would drip from a faucet of the tank into a pan be-

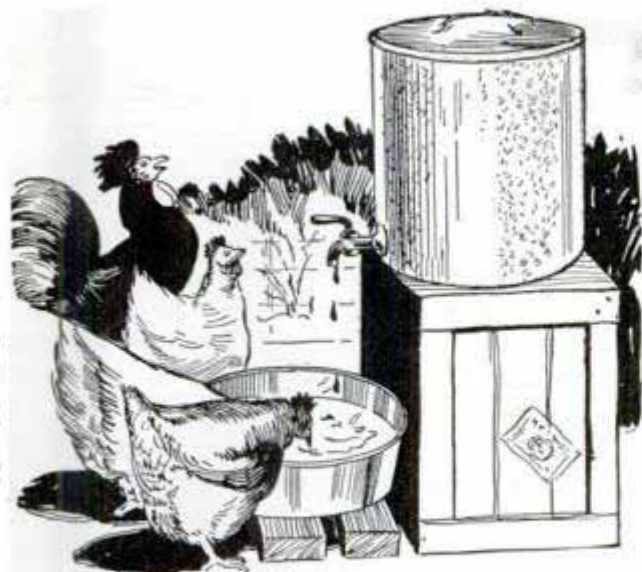

Chickens encouraged to drink plenty of water consume more mash, which increases egg production

low with an audible splash. The experiment proved that the fowls did not only consume more water, but also consumed more laying mash which resulted in an increase of eggs sufficient to bring a good profit on the investment.

COMPLETE Ready Made Business MANUFACTURES FOODS

OFFERS YOU 5 BIG PROFIT OPPORTUNITIES

Expert in foods and confections now sets up ambitious men and women in a sensational money-making business. Complete equipment furnished for making delicious potato chips, donuts, toasted nuts, and the nationally known Carmelcrisp and Crispette confections. Profits up to 300% and over. Peak season just ahead. Proved plans lead you to success. We show you how to manufacture and get stores, restaurants, bars, hotels, barbecue stands and confectioneries selling products as fast as you make them.

WE HELP FINANCE YOU

Begin in home or store. Good locations ready for immediate occupation. No previous experience required and only little money needed. Pay balance out of profits. Earnings come in almost first hour. Unlimited nationwide demand. Very little competition.

WE START YOU IN BUSINESS

Get into this dignified, year 'round business that offers unlimited profit opportunities. We will give you lifetime advisory service and free success plans that have been compiled by our staff of experts. All facts sent free. Rush name today. No obligation.



Complete 16-unit outfit includes new type vitreous white enamel ROUND Cooking Vat, Direct-to-fat high speed Slicer, centrifugal Grease Extractor, Thermometer—positively everything necessary to start—all at new low price

SEND FOR *Free* BOOK

LONG-EAKINS COMPANY

128-S High St., Springfield, Ohio



READ HOW LARRY'S PIMPLY FACE ALMOST MADE HIM QUIT THE SHOW

SAY - WHAT'S BITING YOU? YOU'RE NOT SERIOUS ABOUT NOT BEING IN THE SHOW, ARE YOU?

I CERTAINLY AM - WHAT D'YOU FELLOWS TAKE ME FOR? THINK I WANT TO GET UP AND PLAY IN FRONT OF A BUNCH OF PEOPLE WITH THIS PIMPLY FACE? NOT MUCH!

GOSH - WHY DIDN'T I THINK OF IT BEFORE - IF THOSE PIMPLES ARE ALL THAT'S HOLDING OFF LARRY - I KNOW WHAT I WILL FIX 'EM!

LARRY'S A WIZ WITH THAT SAX -

HE KNOWS HOW TO PANIC 'EM ALL RIGHT

-DARNED GLAD I SOLD HIM ON THOSE YEAST CAKES

Don't let Adolescent Pimples keep YOU from being a hit

Ugly pimples make any boy or girl want to steer clear of the spotlight. Yet many young people suffer this embarrassment after the start of adolescence—from about 13 to 25, or even longer.

During this period, important glands develop and final growth takes place. This causes disturbances

throughout the system. The skin becomes very sensitive. Waste poisons in the blood irritate this sensitive skin. As a result, pimples appear.

Fleischmann's Yeast clears these skin irritants out of the blood. Then, pimples go. Eat 3 cakes *daily*—one before each meal—plain, or in a little water—until skin clears.

—clears the skin
by clearing skin irritants out of the blood

New 1937 SOUTH BEND Back-Geared Screw Cutting PRECISION LATHES

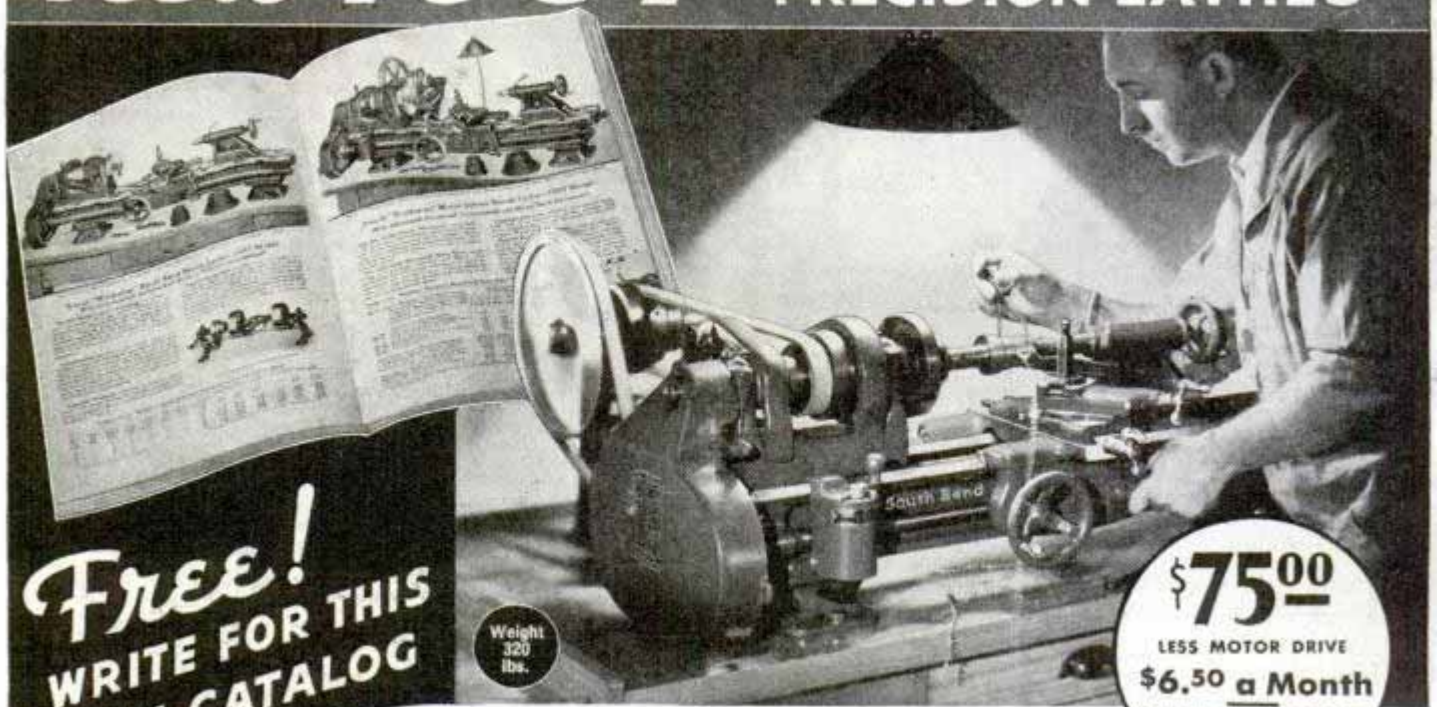

Free!
WRITE FOR THIS
NEW CATALOG
15 K

Weight
320
lbs.

\$75.00
LESS MOTOR DRIVE
\$6.50 a Month
AN IDEAL XMAS
GIFT

No. 415-YA 9 1/8" swing by 3' bed Workshop Bench Lathe with Horizontal Motor Drive, 1/4 h.p. Reversing Motor, Switch and belt tension countershaft as shown above **\$104**
(*\$28 Down, \$7 a month for 12 months*)

THE new 1937 model 9-inch Workshop Lathe is a Back-Geared Screw Cutting Precision Lathe, with Twin Gear Reverse to lead screw, Ball Thrust Bearing on Spindle, Longitudinal Screw Feed to Carriage, Precision Lead Screw for cutting screw threads—and scores of other important features.

Especially recommended for fine accurate work in the plant, shop and toolroom. Used by all important industries in this country and abroad. Takes 38 practical attachments for milling, grinding, draw-in collet chuck work, and many other manufacturing jobs.

Write for Catalog 15K, illustrating and describing the new 1937 Model Workshop Lathe in 8 different drives—4 bed lengths. Shows the 38 attachments for use with this lathe. A valuable booklet to anyone interested in metal working lathes.

Use coupon below.

SOUTH BEND LATHE WORKS

613 E. Madison Street
South Bend, Ind., U.S.A.

5 OTHER SIZES
9", 11", 13", 15", 16"
SWING.
IN ALL BED
LENGTHS
PRICED
\$87 to \$200.

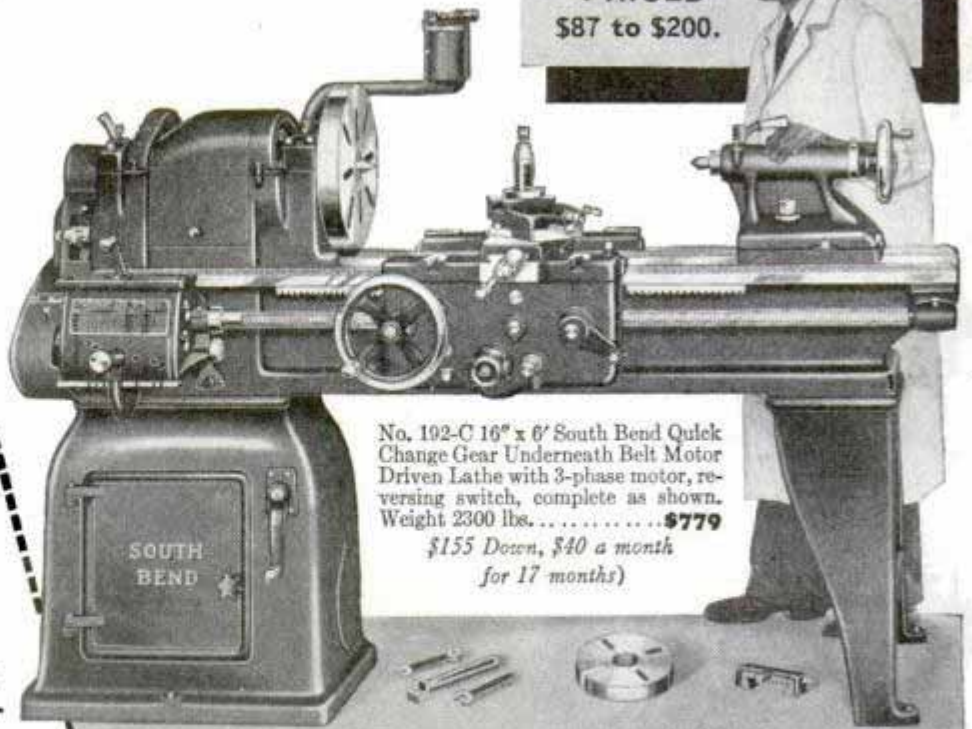

No. 192-C 16" x 6" South Bend Quick Change Gear Underneath Belt Motor Driven Lathe with 3-phase motor, reversing switch, complete as shown. Weight 2300 lbs. **\$779**
\$155 Down, \$40 a month for 17 months

South Bend Lathe Works,
613 E. Madison St.,
South Bend, Ind. U.S.A.

Please send me your new 1937 Catalog 15-K.

Size of lathe interested in

Class of work

Name

Address

City State

SOUTH BEND Precision LATHES

2 MONEY-MAKING METAL OUTFITS

RAP-A-TAP

**PROFIT!
FUN!**

Metalcraft



**THE
MODERN,
COMPLETE**

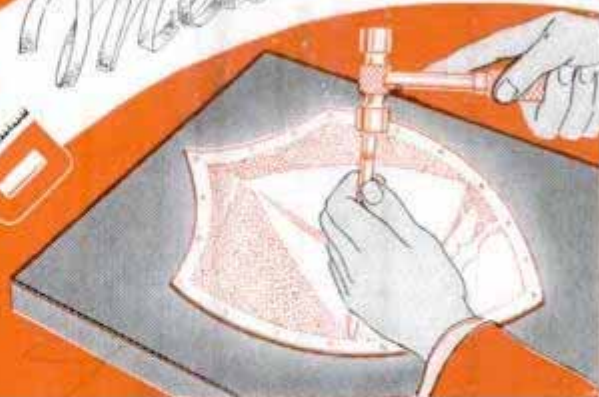

METAL TAPPING SETS

1 Get this fascinating new outfit! With these fine tools and materials you can "tap out" decorative designs and beautiful pictures in metal. Make valuable Bookends, Plaques, Desk Racks. All materials included. Special non-tarnishable metals, set of exclusive noiseless tapping tools, handsome art patterns, plywood backing ready cut, special mounting nails, emery cloth, etc. Your choice of copper, brass, "silver" or "gold." Price complete, \$2.00—\$2.50.



MAKE MONEY

Finished pieces are quickly made. Sell them at a big profit in your neighborhood or to stores. They are also ideal for gifts.

These outfits are on sale at all leading stores. Just ask for RAP-A-TAP or JUNIOR CASTER or mail coupon below.



JUNIOR CASTER

METAL CASTING OUTFITS



2 All the latest equipment for casting and coloring metal toys. Make all you want. Sell them at a big profit.

COMPLETE OUTFIT \$2.50

Includes moulds for making the largest, finest figures with clamps, handles, paints, brushes and large supply of casting metal. In its large 4 color carton makes handsome gift.

ELECTRIC OUTFIT \$3.00

Includes all the regular equipment and a special electric melting ladle for rapid casting.

225 FIGURES IN EXTRA MOULDS

Be sure to get the NEW Cannon and Gun-Truck with moving wheels.

**FREE
4
BIC
ILLUST.
FOLDERS**



SENIOR CASTER

A larger home workshop set for the advanced metal craftsman. Packed in attractive carton. Large moulds for decorative bookends 5 1/4" x 4" or ashtrays. Full casting equipment. A profitable set to own. Price \$4.95.

BUCK ROGERS and NEW 25TH CENTURY SOLDIERS



Buck Rogers Caster Sets also include full casting and painting equipment with special 25th Century character moulds and 4 color Buck Rogers box. Extra moulds at \$1.50 include Soldiers of Amphibian Squadron of Planet Neptune and Mars Stratosphere Patrol.

SEND THIS COUPON

Rapaport Bros., 703A W. Ohio St., Chicago, Ill.

Please send me items checked. Money order for enclosed.

RAP-A-TAP
Outfit for Pair Bookends, "What-Not" Rack, Twin Plaques.

Senior Caster \$4.95

Please send FREE folders on lower and higher priced outfits and extra equipment.

Brass or Copper \$2.00
 "Silver" or "Gold" \$2.50
 JUNIOR CASTER, \$2.50,
 Junior Caster Electric \$3.00
 Buck Rogers Electric Caster \$3.50

EXTRA MOULDS

Cannon and Gun Truck with moving wheels \$1.50
 U. S. Soldiers (3) 95c
 Buck Rogers Mars Stratosphere Soldiers \$1.50

Name:

Address:

City: State:

Free postage in U. S. A. on orders of \$2.00 and over. On orders less than \$2.00 include 25c for postage east of Rockies and 50c west of Rockies.

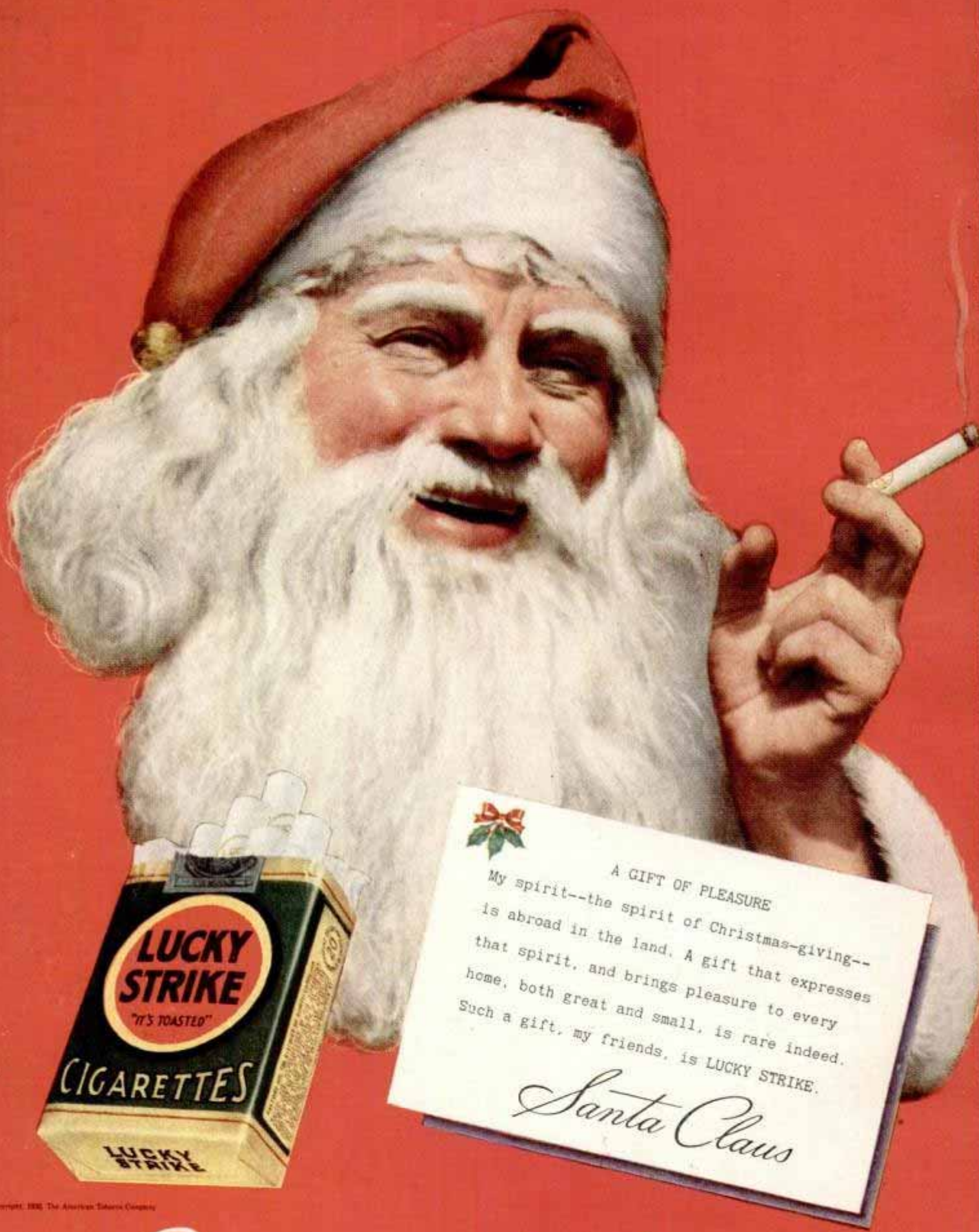

A GIFT OF PLEASURE
 My spirit--the spirit of Christmas-giving--
 is abroad in the land. A gift that expresses
 that spirit, and brings pleasure to every
 home, both great and small, is rare indeed.
 Such a gift, my friends, is LUCKY STRIKE.

Santa Claus



Copyright, 1930, The American Tobacco Company

Luckies - a light smoke

OF RICH, RIPE-BODIED TOBACCO - "IT'S TOASTED"