

THE WORLD'S RACE TO ARMS

POPULAR MECHANICS

MAGAZINE

WRITTEN SO YOU CAN UNDERSTAND IT

REG. U.S. PAT. OFF.

DEC.
25 CENTS



SEE PAGE 856

Change Now to America's Favorite Winter Oil!

Be Ready for Cold Weather Driving with an Easy Starting, Fully Protected Motor

DRIVE IN today for Mobiloil Arctic, the new winter oil that won millions last winter!

Made by Socony-Vacuum's remarkable Clearosol Process, Mobiloil Arctic was introduced last November to give easier starting, better engine protection, longer mileage.

Public acceptance came immediately. Sales far exceeded expectations. Positive proof that Mobiloil Arctic does all that is claimed for it.

Change now to Mobiloil Arctic (20W) or Mobiloil Arctic Special (10W), whichever your car requires. And get Mobiloil CW—for easy shifting gears.

SOCONY-VACUUM OIL COMPANY, INC.



STOP AT YOUR

Mobiloil Dealer

FOR AMERICA'S
FAVORITE WINTER OIL



- 1 EASY STARTING—** Mobiloil Arctic gives easy starting, instant lubrication at low temperatures.
- 2 FULL ENGINE PROTECTION—** Mobiloil Arctic resists heat, holds its body, protects at all operating speeds.
- 3 OIL ECONOMY—** Mobiloil Arctic lasts longer. Users report 25% to 50% greater oil mileage.

Mobiloil Arctic



It's the New '36 Plymouth — Now on Display!



40 Big Improvements—Great- est Plymouth Ever Built!

HERE IT IS!—the biggest, roomiest and most beautiful Plymouth we have ever presented.

Note a few of the 40 improvements:

Frame 100% more rigid... body newly reinforced at five main points... the silent riding-smoothness you'd expect.

New design steering ends the last trace of road-shock at the wheel... Plymouth's 100% hydraulic brakes stop you safely.

Evidence indicates you'll get 18 to 23 miles... *or more!*... per gallon of gas.

4 THINGS PEOPLE WANT:

1. **ECONOMY**—All evidence indicates 18 to 23 miles per gallon of gas.
2. **SAFETY**—Plymouth's body is Safety Steel... Brakes are 100% hydraulic.
3. **RELIABILITY**—Of all low-priced cars, Plymouth has most long-life features.
4. **COMFORT**—Plymouth's Floating Ride plus 11 new comfort improvements.

See your Chrysler, Dodge or De Soto dealer now. Ask about the official Chrysler Motors Commercial Credit Plan.

PLYMOUTH DIVISION OF CHRYSLER CORP.

PLYMOUTH BUILDS GREAT CARS



"I'M A telephone installer and I like to be busy. A good many people are calling up these days and saying they would like to have a telephone put in.

"Often they will make an appointment and it's my job to be there on the dot. The company is a stickler for that. More than 97% of the appointments made with subscribers are now met at the exact time requested. We're trying to do even better than that.

"Seems to me it's something worth while—putting in a telephone. People always seem happier when I tell them

they are connected and everything is O. K. Especially if they have been without the telephone for a little while. Most everybody says the same thing—'We missed it.'

"Well, I hope it keeps up. It means a lot to have a telephone in the house and it means a lot to us fellows who work for the telephone company."

The Bell System employs a total of 270,000 men and women. They are your friends and neighbors. Good business for the telephone company is a sign of prosperity in the country.

B E L L T E L E P H O N E S Y S T E M



When writing to advertisers please mention Popular Mechanics

Popular Mechanics Magazine

H. H. WINDSOR, Founder

H. H. WINDSOR, Jr., Editor and Publisher

December, 1935

Vol. 64, No. 6

Special Features

The 1936 Cars	801
Fun with Model Boats	Coloroto
Cutting Your Heating Costs	820
The World's Race to Arms	825
How to Play Table Tennis	834
Paint Magic	840
The Aladdin of the Movies	850
Romance of Locomotive Whistles ..	856
The Wonders of High Frequency ..	860
Wings over Four Continents	866
Fish Worth Their Weight in Gold ..	872
The Secrets of a Smooth Ride	876
Amusing Magic	882
What's It a Sign of?	888
Don'ts for Hunters	894

(Continued on next page)

The Land of Gold and Mystery

MEXICO, often called "the world's treasure house," contains vast mountain areas almost as wild and primitive as when Cortez invaded the land of the Aztecs. Here Indians still hunt with bows and arrows and maintain their tribal customs of centuries ago. Here gold is a common metal and wives and children of the native men wash it from the gravel in just sufficient amounts to satisfy their needs. There are stories of hidden mines containing fabulous riches. In the January issue a man who has spent years in the isolated sections of Mexico describes this land of gold and mystery for you. Eight pages of pictures in full color illustrate the article.

Next Month

HOW did a Kentucky farm boy dress in 1835? What type of blunderbuss did the Puritans use? These and hundreds of similar questions must be answered daily by those who supply the clothes for the movies. These costumers have in stock enough clothes to dress 500,000 actors, actresses and extras. Watch for the story about them next month.

Higher--and Faster

THE higher you go the faster you fly. Pilots have known that for years but they faced difficult problems in piloting aircraft in the rare atmosphere three miles or more above the earth. Factors like engine power and propeller efficiency had to be considered. An article in January explains how high altitude flying is being reduced to an exact science, with increased safety and increased speed as a result.

Pirates of the Air

PIRATES of the ether are at work "jamming" the air lanes to prevent you from listening to radio broadcasts—particularly international programs—for one reason or another. While science can trace an interfering station, no mechanical means have been found as yet to prevent intentional "jamming." An article next month describes the tricks of these air pirates.

Published monthly by POPULAR MECHANICS CO., 200 East Ontario Street, Chicago, U. S. A. Single copy in United States, 25 cents; \$2.50 a year, \$4.00 for two years in United States and possessions, and countries of the Pan American Postal Union; for Canada, Newfoundland and Labrador, add 50 cents a year extra for postage; to all other countries add \$1.00 a year extra for postage. Changes in address must be reported to us immediately to eliminate delay. Entered as Second Class Matter, Sept. 15, 1903, at the Post Office at Chicago, Illinois, under Act of March 3, 1879. Entered as Second Class Matter at the Post Office Department, Canada. Copyright, 1935, by Popular Mechanics Co. in the United States, Australia and France.

GIVES YOUR CAR Lasting Beauty

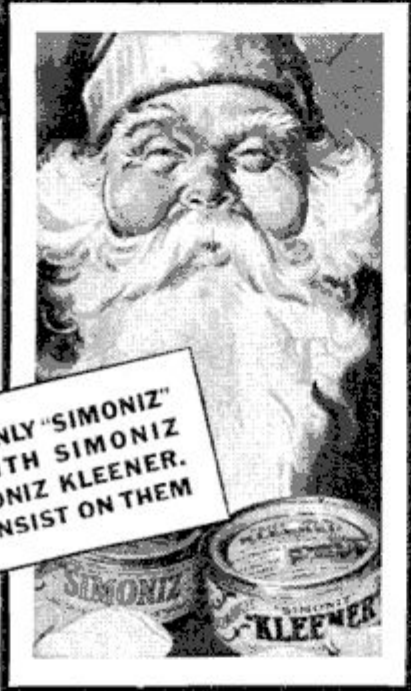

YOU CAN ONLY "SIMONIZ" A CAR WITH SIMONIZ AND SIMONIZ KLEENER. ALWAYS INSIST ON THEM

The Sooner Any Car Is Simonized the Better

Simoniz your car . . . and do it before Winter sets in! The finish needs Simoniz now more than ever. It keeps snow, sleet, mud and other destructive elements from getting at the finish; no chance for them to dull and ruin its beauty. So give your car this "beauty insurance"! If it is dull, first use Simoniz Kleener. It quickly restores the lustre. Then apply Simoniz. Although easy to put on, Simoniz is hard to wear off . . . perfect protection that makes the finish last longer and keeps your car beautiful for life.

MOTORISTS WISE
SIMONIZ

Bread began next fresh &

(Contents—Continued)

- Airplanes
 - "flying box car," for freight and passengers... 858
 - glider towed two miles aloft by balloon... 854
 - "Hindenburg," Diesel motors cut fuel costs... 893
 - "homing," two robots guide... 892
 - man-powered, pedaled like bicycle... 855
 - private planes, 2,000, fly the air lanes... 817
- Army, German—"hussar, motor," replaces caval-ryman... 887
- Automobiles—door handles, recessed for safety... 832
- Automobiles, Driving
 - brake applied in half second... 859
 - crosses on streets show danger spots... 832
 - "lid" on carburetor helps summer starting... 854
 - meter, reaction, shows ability of driver... 865
 - recorder, stationary, measures speed of... 845
 - shield, metal, for rear view mirror... 839
 - streamline, "back-seat" driving stopped by... 886
 - tire pressure kept up by air control on dash... 843
 - windshield, heater and defroster for... 887
- Automobiles, Racing—fuel, mixed, Campbell makes record with... 843
- Aviation—amphibian flies four miles a minute... 870
- Battery
 - corrosion guard prolongs life of... 849
 - power saved by cell connection... 858
- Bicycle—two-wheeler hauls a trailer... 864
- Blind—phonograph records for... 848
- Bomb, Powder—clipper drops on sea to measure drift... 871
- Bulb, Electric—sheds sunlight without burning... 838
- Burglar Alarm—bell rings when door is moved... 893
- Buses—Diesel engines save fuel for... 880
- Butterflies—birds and insects fought by... 848
- Camera
 - exposure meter measures light intensity... 886
 - photography through the microscope, camera for... 838
- Camera Tripod—carried in pocket when telescoped... 845
- Canaries
 - Paul Fodor's canary school... 881
 - tests show "horse sense" of... 865
- Cart—dump, one man handles one-ton load in... 869
- Chimes—brake drums of auto tuned for... 819
- Clock—hand, steeple jack puts on... 880
- Coast Guard—radio guides planes home... 875
- Cottage—summer, pilothouse of boat makes... 869
- Cutter—hand operated, cylinder ridges removed by... 870
- Dogs—"flying dog house" used in Russia... 892
- Doors, Office—dual, easy to open... 844
- Exposition—Texas, light and color magic at... 846
- Fortress—gold to be guarded in... 837
- Fruit—washer improves appearance and sales of... 891
- Gas—waste, home gas supply generated from... 892
- Household Devices... 898, 899
- Irodosmine—heaviest substance found in nature... 885
- Lightning—rug on floor more dangerous... 893
- Lily—X-ray produces an unusual... 900
- Malaria—rock-garden pools cause of... 869
- Motorcycle—engine has two pistons in each cylin-der... 843
- Paint and Painting—bridge, Oakland-San Francis-co, paint required for... 887
- Penholder—rubber, has two suction cups... 900
- Photography
 - stencil for posters, photo enlarged on silk is... 897
 - visible developer aids control of light values... 885
- Piston Ring—has non-friction bands... 900
- Plumbing—bathtub in auto helps sell ware... 875
- Radio
 - amplifier, 30-watt, money made with... 902
 - bridge, Wheatstone, for shop or laboratory... 906
 - code-practice set... 905
 - hints, practical, for experimenters... 904
 - inter-room, provides remote control for house... 863
 - lightship run by radio from shore... 833
 - "major disaster" station at Los Angeles... 831
 - man hunt guided from air by... 824

(Continued to page 6A)

3 REASONS why men who use Ingram's get better shaves



1 Ingram's direct wilting action strips the oily coating from whiskers; softens them thoroughly



2 Ingram's unique lubricating action tightens and tones your skin; makes the razor glide smoothly



3 Ingram's famous cooling action banishes burning and smarting, prevents irritation after shaving

Ingram's can promise and deliver better shaves because its three special ingredients help shavers these three ways

1. Whiskers are softened right down to the skin line. 2. Skin is conditioned before the shave, smoothed and toned to prevent scuffing razor strokes. 3. Every shave is cool—no burning or stinging, and no need for lotion!

Men who use Ingram's not only get better shaves, but pay less for them. Ingram's is concentrated; three months of shaving in each tube or jar. Any drug store, or try 10 cool shaves free.



TRY THE WORLD'S COOLEST SHAVE *free*

BRISTOL-MYERS CO., Dept. E-125
110 Washington St., New York, N. Y.

I want better shaves! Send me a



This One

INGRAM'S SHAVING CREAM

When writing to advertisers please mention *Popular Mechanics*

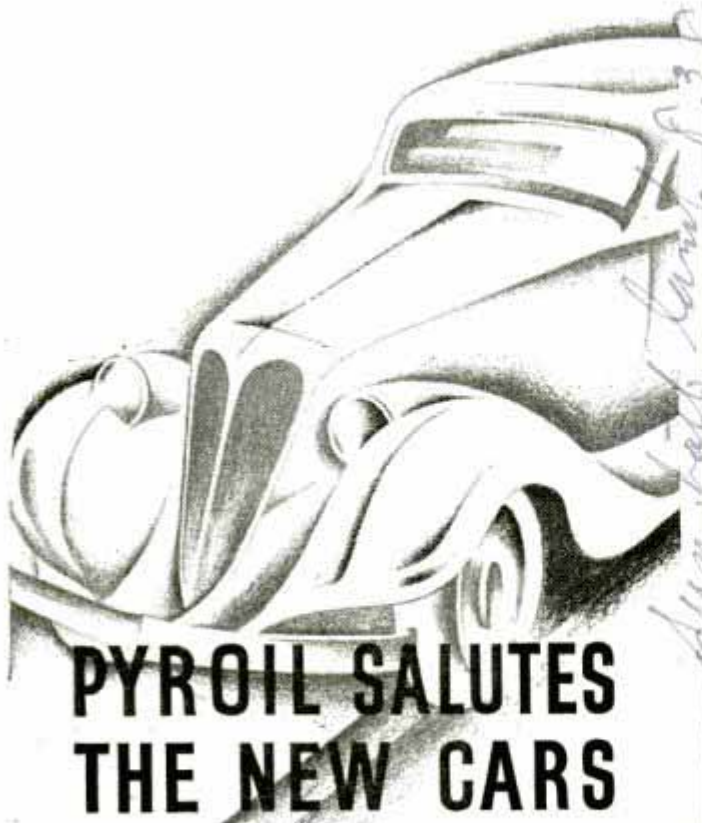

PYROIL SALUTES THE NEW CARS

On display! Those masterful creations of ingenious men—the new 1936 automobiles. Representing the maximum of scientific and engineering skill.

Vigilant research, hard work, make possible the development of such as alloy bearings, plated pistons, independent springing—many other progressive features of the new automobiles. Science keeps pace with public demand—and supplies this demand.

Pyroil, too, has kept pace. By supplying a lubrication process that takes unusual care of new car engines. That relieves and better the condition of old car engines. That will safeguard alloy metals—bearings and pistons—as it will babbit and other types of metals.

Safeguard your new car as you would any other investment of money. Get all of your money's worth from it in constant efficiency of operation. Use good oil. Use good gasoline. And add Pyroil.

Would you like to know how much good Pyroil will do toward protecting your automobile investment . . . increasing your motoring pleasure while saving you money? Mail the coupon below, and at no obligation you will receive a sheaf of interesting, important charts and reports, all recent and direct from the technical and metallurgical laboratory.

Manufactured and Guaranteed by Pyroil Company, W. V. Kidder, Pres., 512 LaFollette Ave., LaCrosse, Wis., U.S.A.

Pyroil has been tested by Popular Mechanics and is used by Popular Mechanics' Presses and Publishing Equipment.

Distributors — For an unusual Business Opportunity, check coupon below.

**Look for this Signature
on Every Can.**

W. V. Kidder
Pres.



PYROIL COMPANY
 512 Pyroil Bldg.
 LaCrosse, Wis., U.S.A.
 Please send charts and reports showing what Pyroil will do for my car.
 Send details of the Pyroil Sales Opportunity for me.
 Name.....
 Address.....
 City.....
 County..... State.....

Simply ADD TO GAS OIL AND GREASE

(Contents—Continued)

Radio—(continued)	
midget, mounted on portable stand	824
"Normandie" warned of obstacles in path by	844
oscillight television receiver	901
Radio, Receiver— all-wave super, has eighteen metal tubes	906
Radio, Tubes— electron-ray, for visual tuning	906
Railroads— wheel, movie shows faults in	900
Rays, Infrared— planes and boats miles away located with	818
Razors— glass blades, sharp as steel	839
Refrigerator— jacket on cold unit helps in defrosting	891
Rule— steel, pocket clip serves as depth gauge	887
Saws and Sawing— scrollwork patterns carved with hot wire saw	855
Sculpture— latex used to produce lifelike figures	854
Sewing Machine— wood cut with bit inserted as needle	824
Shovel— twin points "bite" into ground	863
Smoke Rings— drum blows for advertising purposes	839
Soil Erosion— beavers put to work to stop	864
Stars— "yardstick" measures position of	849
Stove— charcoal disks burned in	871
Telescope— college course in building	858
Temperature— hotter near pavement in summer	864
Timer, Electric— Howard Hughes' flight checked by	838
Torpedo— submarine can be blown up with	871
Truck	
sliding body for loading and unloading	891
streamline, has air-conditioned cab	859
Typewriter— Japanese, has 2,000 slugs	848
Vacuum Cleaner— cobblestones, Dutch housewives clean	832
Weather Strip— all-metal, is easily installed	880
Windshield— wiper, electric, clears of ice	833

THE CRAFTSMAN

Boots— laced to prevent pinching	910
Bottles— chain instead of shot used to clean	918
Camera	
platform on rumble seat elevates	909
tubing, repair with bicycle spoke nipple	919
Carvings— razor blades used for	930
Chair— maple wing of colonial days	932
Clothesline— post, adjustable, line raised out of way with	938
Crutches— arm pieces cushioned with rubber hose	912
Cupboard— corner, simple to construct	915
Drain Pipes— elbow on pipe prevents clogging	937
Electric Switch— clothespin, spring, converted into	918
Fan, Electric— basement, damp, dried with	924
Flower Garden— winter, fits your window	919
Football— toy, lively players give action to	931
Gambrel— animals held by, to skin	917
Games— "swing ball," table top action game of skill	925
Heating— furnace, waste heat from used	918
Lamp, Electric— cork used as socket	910
Leash— dog's, rubber band on absorbs shocks	939
Map— large rolled, tin clips hold	939
Markers— celluloid, guests glasses marked with	912
Microscopes	
mounts from glass slides, minerals viewed by	938
strength of increased	929
Mimeograph— time-savers for operator	917
Motor, Electric	
handle for carrying	909
operates in vertical position	914
Mud Scraper— clock spring used to make	922
Paints and Painting— paintbrush, tin sleeve protects	930
Photography	
air pad for photo-printing box	914
bathroom converted into darkroom	931
border masks, make your own	907
negatives, holders keep on drying line	930
trimmer knife cuts margins on shadow	939

(Continued to page 8A)

When jobs are looking for men -that's news!



..... NOW IS THE TIME!

RIGHT now, in many lines there is a search for really good men—managers, leaders—men who can take charge of departments, businesses, branch offices, and set things humming.

As always, there are not enough ordinary jobs to go round—but rarely before in the history of American business, has there been so much room at the top! New jobs are being created by the business pick-up in almost all lines.

Ordinarily, there would be plenty of men to fill these jobs—men in junior positions who have been studying in spare time. But most men have been letting their training slide during these dark years of depression . . . "What's the use?"—You have heard them say. Perhaps there has been some excuse for sticking to any old kind of a job one could get the past few years—but the door is wide open for the man with ambition **NOW!**

And don't let anyone tell you that "Opportunity Only Knocks Once"—that's one of the most untruthful sayings

ever circulated. Opportunities flourish for every American every day of his life.

Far more to the point is to be ready—be prepared—to make yourself interesting to the big-time employer—and LaSalle offers you a short-cut method of qualifying for opportunity jobs in accounting, law, traffic, executive management, and kindred occupations.

LaSalle Extension University is 27 years old—40,000 students enroll annually—60 American firms each employ 500 or more LaSalle-trained men—surveys show that LaSalle students attain 40% average salary increase after graduation—10% of all C. P. A's in the U. S. A. are LaSalle-trained—in two states over 60% of the C. P. A's are LaSalle-trained men.

Why not find out what LaSalle has done and is doing for men in your position? Send and get the facts; see what LaSalle can do for you, personally!

There's no question about it—business is picking up—jobs are looking for trained men—the time has come for you to qualify for prosperity. Mail this coupon today!

LaSalle Extension University, Dept. 1264-R, Chicago.

Kindly send me your free booklet on the business field I have checked—and tell me how your training in that field can help me.

- Business Management
- Business Correspondence
- Salesmanship
- Law
- Commercial Law
- Business English
- Traffic Management
- Accountancy
- Bookkeeping

Name..... Position.....

Address.....

LASALLE EXTENSION UNIVERSITY

When writing to advertisers please mention Popular Mechanics

TEST *Yourself*

How many of these questions about automobiles can you answer correctly?

1. How can you make your car ride safer at high speeds?
2. Do modern engines run at higher or lower winter temperatures than the old ones?
3. What should you be careful of when inflating front tires?
4. Why was last winter a severe test of anti-freezes?
5. What is the best way to drive out of deep mud or snow?
6. How can you find out how much anti-freeze your car requires for protection in zero weather?

ANSWERS

1. Have pressure in front tires a few pounds higher than the rear.
2. Modern engines run at much *higher* winter temperatures.
3. Be sure both tires carry the same pressure. Uneven inflation causes shimmy and hard steering.
4. The weather was as changeable as a seesaw. Warm one day... cold the next. Ordinary "cheap" anti-freezes boiled away during warm spells and didn't give protection when freezing weather returned. Eveready Prestone won't boil off or evaporate no matter how changeable the weather.
5. *Back* out, if possible. This pulls rear wheels *up* and out. Going forward tends to push wheels in deeper.
6. Turn to Page 15A and find *your* car on the chart. It shows how little—at the new low price—it will cost to have *guaranteed* Eveready Prestone protection in your car this winter.

SPECIAL OFFER...A "Weather Wheel" which will help you to forecast the weather. Also "Weather as a Hobby"—a 48-page illustrated book, prepared by weather experts. Full of fascinating weather facts. Send 10c (stamps or coin) to National Carbon Co., Inc., P. O. Box 600-4L, Grand Central Station, New York, N. Y.

(Contents—Continued)

Pictures—dust kept out of framed	914
Pie Tin—slits in, crust loosened through	912
Porch Columns—holes drilled in, prevent decay	910
Pry—can lids loosened with	938
Rack—wire, ice-box shelf used to make	924
Racks, Towel—animal cut-outs decorate	913
Ruler—typewritten, tenth of an inch measurements on	924
Sack—screw top in sack top for pouring contents ..	930
Saws and Sawing	
circular, silencing "sing" of	939
circular, spiral turnings on	911
fence, adjustable, for homemade circular saw ..	922
Shelf—pantry-door, folding, saves steps	912
Shelves—slides, corrugated, make adjustable	924
Skimmer—comb converted into	922
Smoker—smoke forced into animal dens with	929
Soldering—disk, grooved, waste prevented by	914
Sports—winter warrior, from arsenal of	923
Spotlight—photo, improvised from desk lamp	910
Stove—heat deflector hung on edge of	909
Surveying—carpenter's level makes instrument for ..	940
Tape Holder—steel tape on bench protected by	938
Trough—metal, moisture on window drained off with	922
Tubes, Collapsible—screw eyes in place of caps, for hanging	912
Veneer—paper-backed, uses for	920
Washboard—vacuum cups hold in sink	918
Woods—priming coat required for	929
Workbench—drawers, angle-iron slides hold	930

SHOP NOTES

Automobiles	
battery, how to locate shorted cell in	959
cotter key, right way to install	959
door, frozen, how to loosen	958
door handle, removable, theft foiled by	958
gaskets, ball bearing used to cut	959
gaskets, sticking, soapstone solves problem of ..	958
generator, pivoted cradle holds for repairing ..	960
inner tubes, finding slow leaks in	960
steering wheel cranks motor when adjusting bearings	958
tire, clothespin used to deflate	959
Automobiles, Repairing—Ford spring forced into position with turnbuckle	958
Barrels—wood, evaporation of water keeps from drying out	954
Cable—garden hose makes casing for	955
Chuck—three-jaw, increasing range of	954
Coil springs—scales test pressure of	955
Drill Press—teeth on a blank gear cut with	946
Egg Crate—hose, garden, used to cushion	956
Fire Doors—close when 170° Fahr. is reached	946
Flags—horizontal, keeping unfurled	946
Flashlight—operates on 110 volts	954
Furniture Legs—made on the jointer	957
Garage—stand to hold catalogues, revolving	958
Grain—stored, checking temperature of	944
Grinder—auto parts used to make	941
Heating—shop or garage, heat distributed evenly ..	946
Ladder—cleats nailed to sides to rest load	954
Lantern—brakeman attaches to arm	943
Lathe—auto transmission improves	945
Moistener—felt pad used as	956
Oil Can—spout, split, prevents end from clogging ..	944
Paper Trimmer—has waste box for trimmings	944
Potatoes—thaw out in dark place	956
Screw Hooks—tags held securely with	956
Skates—blade holder for grinding	947
Smoke Generator—air currents located safely with ..	953
Stains—finger nail, tartaric acid and water remove ..	947
Taboret—altered, artists find useful	956
Tool Drawer—handle folds for carrying	947
Tools—small veining, umbrella ribs used to make ..	954
Troughs—hog-feeding, wheels aid in moving	945
Welding—oxyacetylene outfit, method of using	948
Wrench—speed, plunger on expels nuts	944

IF MEN WORE PRICE TAGS



HOW WOULD YOU FEEL?

WELL, your boss thinks of you in terms of so much a week! You are worth this or that to him. How much you are worth depends upon—YOU! You decide the amount chiefly by your ability—by your

training. Why not increase the amount by increasing your training? Thousands of men have done it by spare-time study of I. C. S. Courses. You are invited to earn more money. Mail this coupon.

INTERNATIONAL CORRESPONDENCE SCHOOLS

BOX 5603-H, SCRANTON, PENNA.



Without cost or obligation, please send me a copy of your booklet, "Who Wins and Why," and full particulars about the subject *before* which I have marked X:



TECHNICAL AND INDUSTRIAL COURSES

- | | | | | |
|--|---|--|--|--|
| <input type="checkbox"/> Architect | <input type="checkbox"/> Heat Treatment of Metals | <input type="checkbox"/> Plumbing | <input type="checkbox"/> Steam Fitting | <input type="checkbox"/> Bridge Engineer |
| <input type="checkbox"/> Architectural Draftsman | <input type="checkbox"/> Sheet Metal Worker | <input type="checkbox"/> Heating | <input type="checkbox"/> Ventilation | <input type="checkbox"/> Bridge and Building Foreman |
| <input type="checkbox"/> Building Estimating | <input type="checkbox"/> Telegraph Engineer | <input type="checkbox"/> Air Conditioning | | <input type="checkbox"/> Chemistry |
| <input type="checkbox"/> Contractor and Builder | <input type="checkbox"/> Telephone Work | <input type="checkbox"/> Steam Engineer | | <input type="checkbox"/> Pharmacy |
| <input type="checkbox"/> Structural Draftsman | <input type="checkbox"/> Mechanical Engineering | <input type="checkbox"/> Steam Electric Engineer | | <input type="checkbox"/> Coal Mining |
| <input type="checkbox"/> Structural Engineer | <input type="checkbox"/> Mechanical Draftsman | <input type="checkbox"/> Marine Engineer | | <input type="checkbox"/> Mine Foreman |
| <input type="checkbox"/> How to Invent and Patent | <input type="checkbox"/> Machinist | <input type="checkbox"/> R. R. Locomotives | | <input type="checkbox"/> Navigation |
| <input type="checkbox"/> Electrical Engineer | <input type="checkbox"/> Patternmaker | <input type="checkbox"/> R. R. Section Foreman | | <input type="checkbox"/> Cotton Manufacturing |
| <input type="checkbox"/> Electric Lighting | <input type="checkbox"/> Gas Engines | <input type="checkbox"/> Air Brakes | <input type="checkbox"/> R. R. Signalmen | <input type="checkbox"/> Woolen Manufacturing |
| <input type="checkbox"/> Welding, Electric and Gas | <input type="checkbox"/> Aviation Engines | <input type="checkbox"/> Highway Engineering | | <input type="checkbox"/> Agriculture |
| <input type="checkbox"/> Reading Shop Blueprints | <input type="checkbox"/> Automobile Mechanic | <input type="checkbox"/> Civil Engineering | | <input type="checkbox"/> Fruit Growing |
| <input type="checkbox"/> Boilermaker | <input type="checkbox"/> Refrigeration | <input type="checkbox"/> Surveying and Mapping | | <input type="checkbox"/> Poultry Farming |

BUSINESS TRAINING COURSES

- | | | | |
|--|---|---|--|
| <input type="checkbox"/> Business Management | <input type="checkbox"/> C. P. Accountant | <input type="checkbox"/> Service Station Salesmanship | <input type="checkbox"/> Railway Mail Clerk |
| <input type="checkbox"/> Office Management | <input type="checkbox"/> Bookkeeping | <input type="checkbox"/> First Year College | <input type="checkbox"/> Grade School Subjects |
| <input type="checkbox"/> Industrial Management | <input type="checkbox"/> Secretarial Work | <input type="checkbox"/> Business Correspondence | <input type="checkbox"/> High School Subjects |
| <input type="checkbox"/> Traffic Management | <input type="checkbox"/> Spanish | <input type="checkbox"/> Lettering Show Cards | <input type="checkbox"/> College Preparatory |
| <input type="checkbox"/> Accountancy | <input type="checkbox"/> Salesmanship | <input type="checkbox"/> Stenography and Typing | <input type="checkbox"/> Illustrating |
| <input type="checkbox"/> Cost Accountant | <input type="checkbox"/> Advertising | <input type="checkbox"/> Civil Service | <input type="checkbox"/> Mail Carrier |
| | | <input type="checkbox"/> French | <input type="checkbox"/> Signaling |

Name.....Age.....Address.....

City.....State.....Present Position.....

If you reside in Canada, send this coupon to the International Correspondence Schools Canadian, Limited, Montreal, Canada

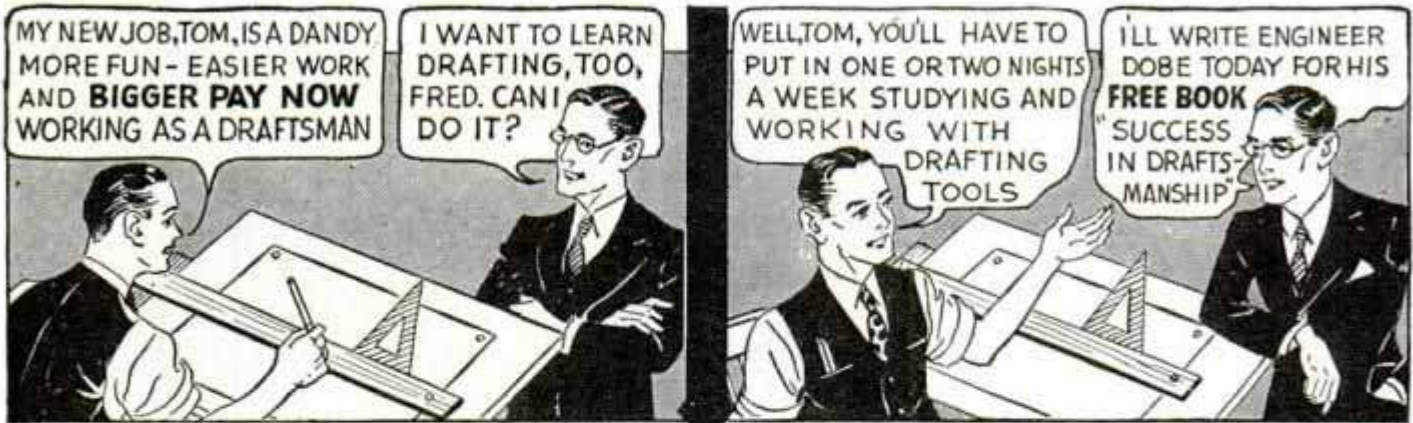

Then Tom, too, learned by mail at home
An assumed case illustrated

THE boom in building and other industries now seems well on the way!

Who is always needed first of all? The draftsman who draws the plans. After that, the steel mills, lumber mills, brickyards and others make their sales.

Government efforts to help are making things hum. In one factory town, a shortage of draftsmen is already reported. Many trained draftsmen will be needed—at better pay and shorter hours.

Who'll get those good jobs? Of course, the men who have prepared—so, prepare now!

For **MORE PAY** Learn **DRAFTING** FROM AN ENGINEER
LEARN BY MAIL AT HOME

Time is money. Learn drafting in your spare time. It's high time now to prepare. Don't wait another day. Send coupon for Dobe's free book.

ENGINEER DOBE, Div. 33-79, Libertyville, Ill.

Send me your free book, "Successful Draftsmanship" and please explain how you assist your graduates to good positions as draftsmen.

Name

Address

Town

State Age

Better Jobs Now

are ready and more expected soon in auto work, aviation, electricity, machinery and certain building lines.

For those who learn drafting now!

It's the way for a quick start to a better paying, much bigger job. Send at once for Engineer Dobe's Book.

Free Book

Outfit
20x25 in.

These **TOOLS** and Other **EQUIPMENT**
Given When You Start

For 34 years (since 1900) Engineer Dobe has taught drafting by mail. Thousands of students, aged 16 and 18 to past 50, have won **SUCCESS!**



Write **NOW** while this offer lasts.

Here's a valuable set of tools—sent at once (also a drawing table), all without extra charge the day you enroll.

HERE is an opportunity that's open to those who know how to grasp it:—

At a few dollars a month, students get complete training in drafting by mail in surprisingly few months—Engineer Dobe teaches his students until thoroughly trained and until placed in a good paying job. Trained Draftsmen enjoy good salaries. If you don't get a satisfactory job:—all your money back. That's Engineer Dobe's guarantee.

With Engineer Dobe's method no previous experience is necessary. High School education not needed. Everything made plain. Practical work right from the start until you're in position.

If you're a mechanic, a knowledge of draftsmanship may make you a superintendent in short order. Get out of overalls and draw the pay of a boss. If you are a boss, learn draftsmanship; a foundation stone of many a line of business.

In every walk of life, practical training in draftsmanship will prove valuable. Even if you never accept a job as a draftsman, will you not be money ahead by taking Engineer Dobe's course?

You'll be amazed at the speed with which you can learn in your spare time by Engineer Dobe's **practical method**. Send coupon **TODAY** for free book entitled "Success in Draftsmanship".

ENGINEER DOBE, Division 33-79, Libertyville, Ill.

Learn ELECTRICITY

**SEND TODAY FOR DETAILS OF MY
Pay-Tuition-after-
Graduation Plan!**

Get training in 90 days, right here in the big Coyne Shops — **not by correspondence** — but on real electrical machinery. **Mail the coupon below.** If you are short of money I'll send you all details of my finance plan and consider your application. If accepted, you won't have to start paying tuition back until **five months from the date you start school**, and then you'll have **over a year** to complete your payments.

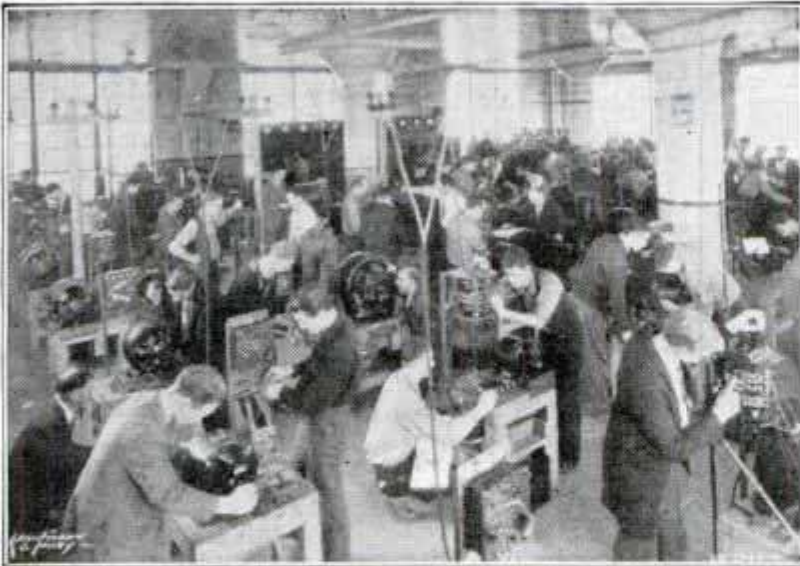

STUDENTS BUSY AT WORK IN LARGE COYNE SHOPS

Tremendous Developments Ahead in Electricity!

HERE is YOUR opportunity to cash in. Every day brings news of new developments in every branch of Electricity, with more opportunities, more jobs, and a greater future for the trained man than ever before. I consider the fellow who is ambitious enough to want to get ahead by taking my Training, worthy of my help. **MAIL THE COUPON BELOW** and you can prove to me that you are willing to spend just **THREE MONTHS** in the Coyne Training Shops Learning **ELECTRICITY**. Then, I'll tell you about my finance plan, which has enabled many to get complete Training and pay tuition back later. *H. C. Lewis*



Learn By Doing In 90 Days

Lack of experience or advanced education bars no one. I don't care if you don't know an armature from an air brake—I don't expect you to! It makes no difference! Don't let lack of money hold you back from getting all details of my amazing plan.

MANY EARN While LEARNING

If you need part-time work to help pay your living expenses and will tell us your problems we may be able to help you as we have thousands of others. Then in 12 brief weeks, in the great roaring shops of Coyne, we train you as you never dreamed you could be trained... on one of the greatest outlays of electrical apparatus ever assembled... real dynamos, engines, power plants, auto, switch-boards, transmitting stations... everything from doorbells to farm power and lighting... full-sized... in full operation every day!

TRAINING By Actual Work

No dull books... you get individual training... real actual work with only the theory you will need. Building seal batteries... winding real arma-

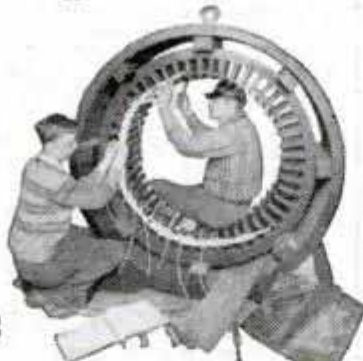

Prepare for Jobs Like These

Here are a few of hundreds of positions in the electrical field. Our free employment bureau gives you a lifetime employment service.
**ARMATURE EXPERT
 SUBSTATION OPERATOR
 AUTO ELECTRICIAN
 INVENTOR
 MAINTENANCE ENGINEER
 SERVICE STATION OWNER
 RADIO EXPERT**



Home of Coyne School

This is our fireproof modern home where-in is installed thousands of dollars' worth of Electrical equipment of all kinds. Every comfort and convenience has been arranged to make you happy and contented during your training.

tures, operating real motors, dynamos and generators, wiring houses, etc. That's a glimpse of how we help to make you a master electrician, and fit you to qualify for jobs leading to the biggest pay.

Jobs-Pay-Future

"I owe my Electrical success to your 12 week shop course," says R. B. Umbarger of Tennessee. "Two weeks after leaving school I took a wiring job," reports E. O. Berndt of Illinois, "and the profits from this one job alone more than paid for the entire course." A. C. Hoehnle of Ohio says "Received several raises in pay, due to the training I received at Coyne." And I could quote from hundreds of letters of successful Coyne Trained Men, *What they have done, you should be able to do!*

Electric Refrigeration — Air Conditioning

Right now I am including my new Electric Refrigeration and Air Conditioning course at no extra cost.

GET THE FACTS

Coyne is your one great chance to get into electricity. This school is 36 years old—Coyne training is tested—proven beyond all doubt—endorsed by many large electrical concerns. You can find out everything absolutely free. Simply mail the coupon and let me send you the big, free Coyne book with photographs... facts... jobs... salaries... opportunities. Tells you how many earn expenses while training and how we assist our graduates in the field. This does not obligate you. So act at once. Just mail coupon.

Get This
FREE
Book



**H. C. LEWIS, President
Coyne Electrical School, Dept. 95-72
500 S. Paulina St., Chicago, Ill.**

Dear Mr. Lewis:—Without obligation send me your big free illustrated catalog, with all facts about Coyne Training and details of your "Pay-Tuition-After-Graduation" Plan.

Name..... Age....

Address.....

City..... State.....

COYNE H. C. LEWIS, PRESIDENT FOUNDED 1899
ELECTRICAL SCHOOL
500 S. Paulina St., Dept. 95-72, Chicago, Ill.



Follow this Man

Secret Service Operator 38 is on the job

FOLLOW him through all the excitement of his chase of the counterfeit gang. See how a crafty operator works. Telltale finger prints on the lamp stand in the murdered girl's room! The detective's cigarette case is handled by the unsuspecting gangster, and a great mystery is solved. Better than fiction. It's true, every word of it. No obligation. Just send the coupon and get—

FREE!

The Confidential Reports No. 38 Made to His Chief

And the best part of it all is this—it may open your eyes to the great opportunity for YOU as a well paid Finger Print Expert. This is a young, fast-growing profession. This school has taken men and trained them for high official positions. This is the kind of work you would like. Days full of excitement. A regular monthly salary. Rewards.

Can you meet this test?

Are you of average intelligence? Are you ambitious? Would you give 30 minutes a day of your spare time preparing yourself for this profession? Answer "yes" and I'll show you how it is possible for you to attain all this. Send the coupon and I'll also send the Free Reports.

INSTITUTE OF APPLIED SCIENCE
1920 Sunnyside Ave., Dept. 13-59 Chicago, Illinois

Institute of Applied Science
1920 Sunnyside Ave., Dept. 13-59 Chicago, Illinois
Gentlemen:—Without any obligation whatever, send me the Reports of Operator No. 38, also your illustrated Free Book on Finger Prints and your low prices and Easy Terms Offer. Literature will NOT be sent to boys under 17 years of age.

Name

Address

Age

When writing please mention Popular Mechanics

NOW is the Time to Get Ready for the BIG PAY JOBS IN AVIATION



The governments of the world are spending hundreds of millions of dollars in aviation development. This means thousands of high salaried aviation jobs. Now is the time to let LINCOLN training prepare you for the wonderful future ahead in aviation.

\$500 a Month
That's the kind of big pay earned by airline pilots!
Airplane mechanics also earn good salaries!

LINCOLN Qualifies You for a Successful Career!

You should have the unexcelled Lincoln training if you want to qualify for these better pay positions in aviation. 14 years success teaching aviation and 25 years successful experience as a mechanics' trade school recommends this famous Government Approved School to you as the school better able to train you properly.

Finest Training—Best Equipment—Only modern, high class training planes with Dept. of Commerce approval are used. Training for government license as Transport, Limited Commercial, Private or Amateur Pilot. Complete training includes blind flying by instrument, cross country, aerobatics. High wing and low wing monoplanes, biplanes, cabin planes, etc., for complete experience. Both flight and ground training under Government Supervision. Thoroughly equipped ground and mechanics' school with high class, experienced instructors. Training qualifies you for Government Mechanics License.

WRITE now for further facts. Please state your age.

LINCOLN AIRPLANE & FLYING SCHOOL
201F AIRCRAFT BLDG. LINCOLN, NEBRASKA

ENGINEERING



INTENSIVE PRACTICAL TECHNICAL COURSES. Non-essentials omitted. TIME AND MONEY SAVED. Degree in 2 yrs. Electrical, Mechanical, Structural, Architectural, Civil, Aeronautical, Highway. Also shorter courses in Electricity, Radio, Electric Refrigeration, Power Plant, Drafting, Building, Low tuition. Extensive modern equipment. Part-time work for board and room. 34 yrs. experience producing successful men, located all over U. S. and foreign lands, holding responsible positions. Approved by industry, endorsed by graduates and educators. Catalog free.

FINLAY ENGINEERING COLLEGE
1001 Indiana Avenue Kansas City, Mo.



"BECOME A LIGHTNING TRICK CARTOONIST"

Send \$1.00 for Laugh Producing Program of 23 Trick Drawings with Instructions. Catalog of Chalk Talk Supplies Free. BALDA ART SERVICE, Dept. 1, Oshkosh, Wis.

DENISON'S PLAYS Musical Comedies, Operettas, Vaudeville Acts, Minstrels, Comedy Songs, Make-up Goods. Catalog Free

T.S. Denison & Co, 623 S. Wabash, Dept. 9, Chicago

HOW to GET a GOV'T JOB



— PAYING FROM \$1200 TO \$2700 A YEAR!

Railway Postal Clerks may earn \$155 first month. Customs Inspectors as high as \$3000 a year! No experience needed. Excellent opportunities for citizens 18 to 50. Increased salaries, steady work, travel, good pay. Let me train you NOW for a government position. I was Secretary Civil Service Examiner for 8 years.



FREE BOOK tells how I have helped thousands! Many examinations expected soon! Write or mail coupon TODAY.

A. R. PATTERSON, Civil Service Expert, 812 Case Bldg., Rochester, N. Y. Please send me your free book, "How to Secure a Government Position."

Name

Address

Learn at Home to Make More Money



I'll train You Quickly for Radio's GOOD spare time and full time Jobs . . .



Broadcasting Stations employ managers, engineers, operators, installation and maintenance men for jobs paying up to \$5,000 a year.



Set servicing pays many N. R. I. men \$200 to \$1,000 a year for their spare time. Full time men make as much as \$30, \$50, \$75 a week.



Making, installing and servicing Loud Speaker apparatus is another growing, money-making field for Radio trained men.

Some Other Jobs N.R.I. Trains Men For

- Broadcast Engineer.
- Operator in Broadcast Station.
- Aircraft Radio Operator.
- Operator of Airway Beacons.
- Government Radio Operator.
- Radio Operator on Ships.
- Serviceman on Loud Speaker Systems.
- Installation Engineer on Loud Speaker Systems.
- Sales Manager for Retail Stores.
- Service Manager for Retail Stores.
- Auto Radio Installation and Serviceman.
- Television Broadcast Operator.
- Television Engineer.
- Set Servicing Expert.

Mail Coupon for FREE Information

Why slave your life away in a no-future job? Why skimp, why scrape, trying to pay your bills? I'll train you quickly for a live-wire field with a future—**RADIO**. \$30, \$50, \$75 a week—that's what many Radio Experts make. \$5, \$10, \$15 a week extra money—that's what many of my students make in their spare time while learning. My free book tells you about Radio's spare time and full time opportunities—about my tested training—about my students and graduates—what they are doing and making. Get this book. Be a Radio Expert. The Radio field is big enough to absorb many more properly trained men.

Many Radio Experts Make \$30, \$50, \$75 a Week

Spare time and full time Radio Service, Installing, Operating, Maintaining Broadcast, Aviation Radio, Commercial, Ship and Television stations, a Radio service business of your own—I'll train you for these and other opportunities in the manufacture, sale and service of Radio, Loud Speaker and Television apparatus. My FREE book tells you about the many money-making opportunities in Radio. Get a copy. Mail Coupon today.

Save—Learn at Home in Your Spare Time

You don't have to leave home and spend \$500 to \$1,000 to learn Radio. I'll train you quickly and inexpensively right in your own home and in your spare time. You don't need a high school or college education. Many of my successful graduates didn't even finish grade school. My practical 50-50 method of training—half with lessons, half with Radio equipment—gives you broad practical experience—makes learning at home easy, fascinating, practical and rapid.

Many Make \$5, \$10, \$15 a Week Extra in Spare Time While Learning

My book shows how my special training, instruction material, plans, ideas, and my twenty years' experience training men for Radio careers has helped many students make \$200 to \$1,000 a year in their spare time. My Course is famous as "the one that pays for itself."

Your Money Back if Not Satisfied

I'm so sure you will be satisfied with my training that I agree in writing to refund every penny of your money if you are not entirely satisfied with my Lesson and Instruction Service when you finish.

Find Out What Radio Offers You

Act today. Mail the coupon. My 64-page book will be sent free to any ambitious fellow over 15 years of age. It tells about Radio's opportunities—explains the eighteen star features of my Course—shows letters of what others are doing and making. There is no obligation. Mail the coupon in an envelope or paste on 1 cent post card.

J. E. SMITH, President
National Radio Institute
Department 5NP
Washington, D. C.

Here's Proof

Made Up To \$400 a Month



"I was working in a garage with no future in sight. My wife and I decided to put aside enough to pay for your Course. We have not regretted it. I have made as high as \$400 a month in Radio."—**E. G. WOLFE**, 1202 Eden St., Elkhart, Indiana.

\$10 to \$25 Weekly in Spare Time

"I am making from \$10 to \$25 a week in spare time, while still holding my regular job as a machinist. I have earned enough to pay for your Course many times over. Only a trained man can service sets nowadays. I owe my success to N. R. I."—**WILLIAM F. RUPP**, R. F. D. No. 1, Conshohocken, Penna.



Chief Operator in Broadcasting Station

"When I had completed the first twenty lessons, I had obtained my license as a Radio Broadcast Operator and immediately joined Station WMPG where I am now Chief Operator. I do not hesitate to recommend N. R. I. Training to anyone."—**HOLLIS F. HAYES**, 85 Madison St., Lapeer, Michigan.



ACT TODAY

Dear Mr. Smith: Without obligation send me your free book about spare time and full time Radio opportunities, and how I can train for them at home in spare time. (Please Write Plainly)

NAME.....
ADDRESS.....
CITY.....
STATE.....

The Tested Way to BETTER PAY

DON'T GET CAUGHT IN

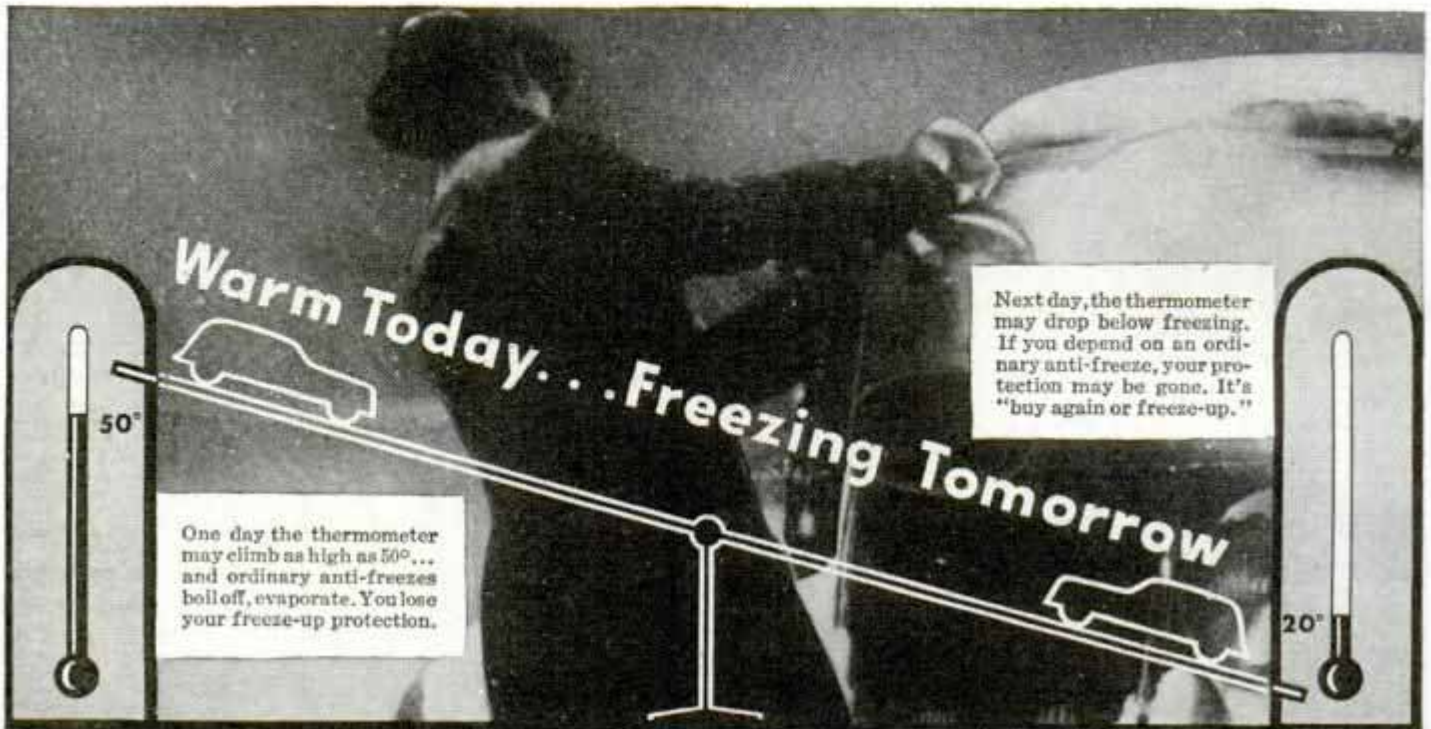

Put in EVEREADY PRESTONE

the GUARANTEED* ANTI-FREEZE

One shot, put in now, will guard your car against freeze-up and rust all winter. Eveready Prestone won't boil off no matter how warm the weather gets between the cold snaps. Has no odor. Specifically guaranteed.

Ask Your Dealer This One Question

Of more than 100 brands of anti-freeze on the market, most are based on alcohol—but are not plainly labeled as such. So ask your dealer this question about any anti-freeze you consider buying: "How much of this product is alcohol?" That is important, for alcohol, no matter how disguised or what it is called, is subject to evaporation, leaving you without adequate protection.

Your dealer will tell you that Eveready Prestone contains no glycerine, no alcohol... and that it will not boil off or evaporate. Back of every drop of Eveready Prestone is the following guarantee... your definite assurance of all-winter protection.

* A DEFINITE GUARANTEE

"National Carbon Company, Inc., specifically guarantees that Eveready Prestone, if used according to printed directions, in normal water cooling systems, will protect the cooling system of your car against freezing and clogging from rust formations for a full winter, also that it will not boil away, will not cause damage to car finish, or to the metal or rubber parts of the cooling system, and that it will not leak out of a cooling system tight enough to hold water."

Special Offer... A "Weather Wheel" which will help you to forecast the weather. Also "Weather as a Hobby"—a 48-page illustrated book, prepared by weather experts. Full of fascinating weather facts. Send 10¢ (stamps or coin) to National Carbon Co., Inc., Box 600, Grand Central Station, New York, N. Y.



UCC

Unit of Union Carbide and Carbon Corporation Address _____ (P. M.—12)

THE WINTER SEE-SAW

FIND YOUR CAR ON THIS CHART

IMPORTANT! The price per gallon of an anti-freeze means nothing unless you know how many gallons you will need during the entire winter. You can't get that information on a boil-away anti-freeze. But you can get it for Eveready Prestone...and here it is. See how reasonably you can get two-way protection all winter long against both freeze-up and rust with one shot of Eveready Prestone—one shot because it won't boil off, no matter how warm the weather gets between the cold snaps. If your car isn't on this chart, your dealer has a chart showing all cars; and amounts needed for temperatures to 62° below zero.

Find your car and read from left to right. The first figure shows the protection you get with one gallon of Eveready Prestone in the cooling system; the second with one and a half gallons—and so on. "+" means above zero. "-" means below zero. If your car has a hot water heater, add 1/4 gallon to the quantity called for.

	1 GAL.	1 1/2 GAL.	2 GAL.	2 1/2 GAL.
Auburn				
6-52, '34; 6-53, '35	+12	-4	-27	-59
8-100, '32; 6-101, 8-105, '33	+15	+2	-16	-42
8-95, '30; 850, '34; 851, '35	+17	+0	-9	-28
Buick				
40, '34, '35;	+6	-18	-54	
60, '32; 50, '33, '34, '35	+10	-8	-34	-62
80, 90, '32; 60, '33, '34, '35	+15	+2	-16	-42
80, 90, '33; 90, '34, '35	+19	+9	-3	-19
Cadillac				
340-D, '34, '35	+14	Zero	-21	-50
355-D, '34, '35	+16	+4	-12	-34
452-D, '34, '35	+19	+9	-3	-19
370-A, '31; 355-B, '32; 355-C, '33	+21	+13	+3	-9
Chevrolet				
Stand, '33, '34, '35	-12	-62		
Master, '33, '34, '35	-6	-47		
Master, '31, '32	Zero	-34	-62	
Chrysler				
6-, '32, '33, '34, '35	+12	-4	-27	-59
8-, '31, '32, AF, IMP, '35	+15	+2	-16	-42
Roy 8, Imp 8, '33; Air 8, '35	+16	+4	-12	-34
Imp, '30, '77, '30, '70, '31	+18	+8	-6	-23
De Soto				
6, '31, '32; '33; 8, '31	+10	-8	-34	-62
6, '34	+16	+4	-12	-34
Airflow, Airstream, '35	+12	-4	-27	-59
Dodge				
6, '32, '33, '34	+8	-12	-43	
See 6, '30; New Six, '35	+12	-4	-27	-59
8-'32, '33	+15	+2	-16	-42
Ford				
A, '30, '31; B, '32, '33	Zero	-34	-62	
V-8, '32, '33, '34	+18	+8	-6	-23
V-8, '35	+16	+4	-12	-34
Graham				
73-Spl 6; 72-8, '35	+14	Zero	-21	-50
6, 8, '33; 6, 8, '34; 75, '35	+16	+4	-12	-34
Hudson				
8, '31, '32, '33; 6, '35	+12	-4	-27	-59
8, '35	+17	+6	-9	-28
8, '34	+19	+9	-3	-19
Hupmobile				
18, '31; Cent. 8, '32; 321, '33	+10	-8	-34	-62
417, 421, '34; 521, '35	+10	-8	-34	-62
Hupmobile (cont)				
322, '33; 422, '34; 518, '35	+17	+6	-9	-28
326, '33; 426, '34; 527, '35	+19	+10	Zero	-15
La Fayette				
1934; 3510, '35	+15	+2	-16	-42
La Salle				
350, '34; 35-50, '35	+15	+2	-16	-42
345-B, '32; 345-C, '33	+21	+13	+3	-9
Lincoln				
136, '33, '34, '35; 145, '34, '35	+23	+17	+10	-2
Nash				
60, '31; 960, '32, '70, '31; 970, '32	+3	-25	-62	
1130, 1070, 1170, '33; 1220, '34	+12	-4	-27	-59
1280, '34; 3580, '35; 1080, 1180, '33	+17	+6	-9	-28
Oldsmobile				
F-30, '30; F-31, '31; F-35, '35	+3	-25	-62	
F-32, L-32, '32; F-33, '33, L '35	+12	-4	-27	-59
L-33, '33; L-34, '34	+15	+2	-16	-42
Packard				
120-'15	+12	-4	-27	-59
Sup. 8, '33, '34; 8, '33, '34, '35	+16	+4	-12	-34
Sup. 8, '35	+18	+8	-6	-23
745, '30; 845, '31; DeL '32	+21	+13	+3	-9
Pierce Arrow				
41, 42, 43, '31; 54, '32; 836-A, '34	+21	+13	+3	-9
840-A, '34; 845, '35	+22	+15	+6	-5
Plymouth				
30, '30; PF, PG, '34	+6	-18	-54	
PA, '31; PB, '32; PE, '34; PJ, '35	+10	-8	-34	-62
PC, PD, '33	+3	-25	-62	
Pontiac				
'30, '31; 6-'32, '35	+6	-18	-54	
8-'33, '34, '35	+8	-12	-43	
Reo				
6-21, 6-25, '32; FC '35; Roy, '35	+15	+2	-16	-42
8-25, '32; S-2, '33; S-6, '34	+16	+4	-12	-34
Studebaker				
Com 8, '31, '32, '33; Dict 6, '34, '35	+10	-8	-34	-62
Dict '31, Com 8, '34, Pres 8, '33, '34	+14	Zero	-21	-50
Pres 8, '31, '32, '35; Com 8, '35	+17	+6	-9	-28
Terraplane				
6, '32, '33; 6 Spec, '35	+3	-25	-62	
8, '33; 6 DeL., '35	+10	-8	-34	-62
6, '34	+14	Zero	-21	-50

PRICE REDUCED AGAIN

Eveready Prestone was used by a million more motorists last winter than the winter before. Thanks to by far the biggest volume in its history, the price has been reduced again to only \$2.70 a gallon.

\$2.70
A GALLON

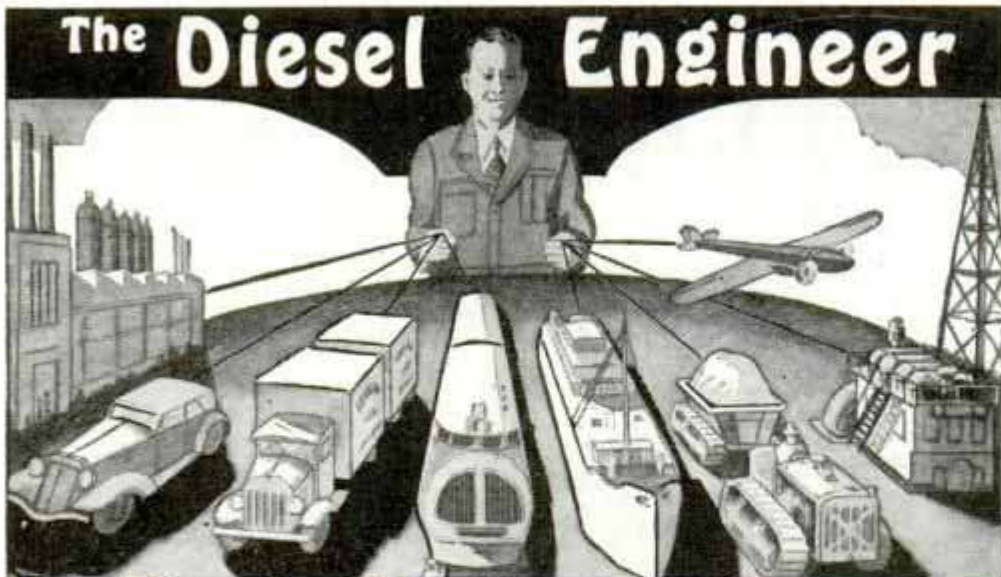

The Diesel Engineer

Is Your Job Safe

Just as the gasoline engine changed or wiped out the jobs of thousands who depended on horse-drawn vehicles for their living—just as electricity changed the entire set-up in the fields of light and power—so now the Diesel engine is fast invading both the power and transportation fields, and threatening the present jobs of thousands of workers.

If jobs in your line are steadily growing scarcer, you owe it to yourself to investigate this new, progressive, uncrowded line, that will offer good openings for many years to come.

Diesel—The Newest, Fastest-Growing Power

Diesel engines—because of their high efficiency, dependability, and economy of operation—are fast replacing steam and gasoline engines in power plants, motor trucks and busses, locomotives and ships, aircraft, tractors, dredges, drills, pumps, etc.—opening up an increasing number of well-paid jobs for Diesel-trained men. The field of Diesel Engineering is on the upgrade and continually expanding. It will provide steady employment and advancement for those properly trained in this new industry—as long as they need to work. You get complete information on all the latest Diesel developments—two- and four-stroke cycles; low- and high-speed and heavy-duty types; Diesel-electric generating systems, etc.—in our course. Includes all text material—with special diagrams for quick understanding of this new power.

Now is your chance to get into a big new industry and grow up with it to an important position. Today there is practically no competition in the Diesel field, but the increasing use of Diesel engines will result in keen competition for jobs in the near future. By starting your training now, you can keep ahead of such competition.

What This New Field Offers You

Get our Free Diesel Booklet and learn all about this newest, fastest-growing line—its opportunities and requirements. Find out what the Diesel field offers you—how rapidly the Diesel industry has developed during the last three years—the large number of Diesel engines and accessories being manufactured today—how quickly you can obtain a complete understanding of Diesel engine principles and operation by home study during your spare time—without interfering with your regular work.

Asking for information involves no obligation—but it may mark the turning point in your life. Write TODAY for full information.

American School, Dept. D-945, Drexel Avenue at 58th Street, Chicago, Illinois

Turn Your Spare Time into Dollars



There's Quicker, Bigger MONEY for YOU-in POULTRY

Earn \$1,000 to \$2,500 a Year or Have a Business of Your Own!



Whether you want a job at good pay or a highly profitable business of your own—the Poultry Industry offers you more than any other. There's a shortage of poultry meat and eggs—a shortage of trained poultrymen. I'll train you quickly at home—to fill a good job in Poultry—and our FREE Students' Employment Dept. will help you get one!

Spare Time or Full Time YOU CAN Cash-in BIG No matter where you live—city, town or country—or what you do now, my proved methods will assure your success right from the start. I'll help you make from \$1,000 to \$2,500 a year and UP! And, if you choose to start your own business, I'll show you how to make your tiny investment multiply itself automatically. What I've done for thousands of others—I can do for you.

FREE Book Shows the Way to Big Pay and BIG Profits

Mail coupon below TODAY—for my Big NEW FREE Book, "How to Raise Poultry for Profit." My forty years of experience are yours. The Poultry Industry needs YOU. You need my book. Get it—and get in line for the BIG Money that's waiting for you in POULTRY.



Mail NOW for FREE Book

NATIONAL POULTRY INSTITUTE, Dept. 32-A, Adams Center, N.Y., Att'n: Harry M. Lamon, Pres.

Dear Mr. Lamon: Send me your FREE Book, "How to Raise Poultry for Profit." I want to know more about my opportunity to make \$1,000 to \$2,500 a year, spare or full time.

Name

Address



TRI-STATE COLLEGE

B. S. Degree in 2 years. World famous for technical 2-year courses in Civil, Electrical, Mechanical, Chemical, Radio, Aeronautical Engineering; Business Administration and Accounting. Equivalent in technical hours to 4-year course. Those who lack high school may make up work. Low tuition. Low living costs. Located in picturesque hill and lake region. Students from every state and many foreign countries. 52nd year. Enter Sept., Jan., March and June. Write for catalog.

4125 COLLEGE AVE.,

ANGOLA, IND.

LEARN CARTOONING

by the method that has developed hundreds successfully. Send name, address and age for free chart to test your ability.

The Landon School, 1738 National Bldg., Cleveland, Ohio

RADIO ENGINEERING, broadcasting, aviation and police radio, servicing, marine and Morse telegraphy taught thoroughly. Nine months' engineering course equivalent to three years' college radio work. School established 1874. All expenses low. Catalog free. Dodge's Institute, Ada St., Valparaiso, Ind.

MAIL FOR FREE INFORMATION

BEDFORD

YMCA
TRADE
SCHOOL

1117 Bedford Ave., Dept. PM-31 Brooklyn, New York City, N. Y.

- Auto Mechanic
- Talking Pictures
- Aviation Mechanic
- Welding
- Aeronautical Engineering
- Refrigeration
- Machine Shop
- Oil Burner
- Commercial Art
- Air Conditioning
- Sign Painting
- Electrical
- Window Display
- Radio and Television Mechanic
- Architectural-Mechanical Drafting
- Armature Winding
- Diesel Engines

Name

Address

**IF YOU ARE WEAK, PALE,
RUNDOWN AND SKINNY
...MAKE THIS
SIMPLE TEST!**

**It's GLANDS STARVING for
IODINE That Keep You
Tired, Nervous and Worn-out**

Natural Iodine in Kelpamalt, New Mineral Concentrate, Must Correct Trouble With Tired, Careworn, Haggard-Looking Folks the First Week and Add 5 Lbs. of Solid, "Stay There" Flesh or the Trial Is

FREE!

As the result of tests covering thousands of weakened, run-down, nervous, skinny folks, science now claims that it is GLANDS STARVING FOR IODINE that keep you pale, tired-out, underweight and ailing. When these glands don't work properly, all the food in the world can't help you. It just isn't turned into "stay-there" flesh, new strength and energy.

The most important gland—the one which actually controls body weight—needs a definite ration of iodine all the time—NATURAL ASSIMILABLE IODINE—not to be confused with chemical iodides which often prove toxic. Only when the system gets an adequate supply of iodine can you regulate metabolism—the body's process of converting digested foods into firm flesh, new strength and energy.

To get this vital mineral in convenient, concentrated and assimilable form, take Kelpamalt—now recognized as the world's richest source of this precious substance.

It contains 1300 times more iodine than oysters, once considered the best source. 6 tablets alone contain more NATURAL IODINE than 486 lbs. of spinach or 1387 lbs. of lettuce.

Make this test with Kelpamalt. First weigh yourself and see how long you can work or how far you can walk without tiring. Then take 3 Kelpamalt Tablets with each meal for 2 weeks and again weigh yourself and notice how much longer you can work without tiring, how much farther you can walk. Notice how much better you feel, sleep and eat. Watch flattering extra lbs. appear in place of scrawny hollows. And if you don't gain 5 lbs. the very first week the trial is free.

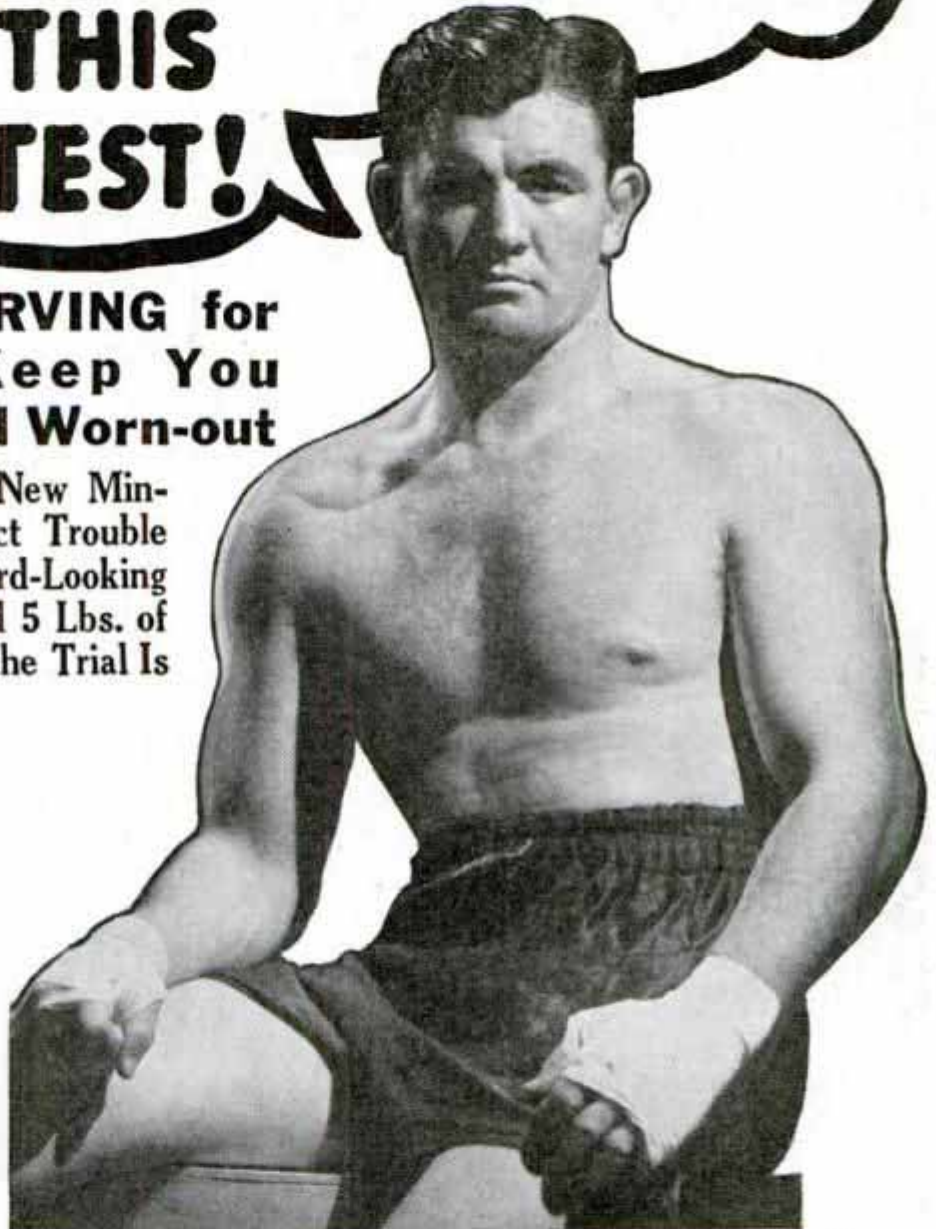

It Was Kelpamalt That in 6 Short Weeks Enabled World's Heavyweight Champion, "Jimmy" Braddock, to Add 26 Husky New Lbs. and Build the Shattering Strength and Tireless Energy That Won Him Victory! New World's Champion Urges All Weak, Pale, Rundown Men and Women to Try Kelpamalt!

100 jumbo size Kelpamalt tablets—four to five times the size of ordinary tablets—cost but a few cents a day to use. Get Kelpamalt today, Kelpamalt costs but little at all good drug stores. If your dealer has not yet received his supply, send \$1.00 for special introductory size bottle of 65 tablets to the address at right.

Kelpamalt
Tablets

**SPECIAL
FREE OFFER**

Write today for fascinating instructive 50-page book on How to Add Weight Quickly. Mineral Contents of Food and their effects on the human body. New facts about NATURAL IODINE. Standard weight and measurement charts. Daily menus for weight building. Absolutely free. No obligation. Kelpamalt Co., Dept. 620, 27-33 West 20th St., New York City.

NAME.....

ST.....CITY.....

6 Big AUTO BOOKS

including DIESEL engines

Just mail the coupon and we'll send you a set of these remarkable auto books, just off the press. Whether you want to qualify as garage owner, auto repair expert or merely wish to know how to keep your own car 100% efficient, look at these books—they are sent to you for free examination. This brand new edition has been prepared by a group of America's foremost automotive engineers and is written so anybody who can read will understand—a veritable gold mine of valuable facts.

Take advantage of this offer now; send in the coupon for FREE examination. You don't pay us a penny, you don't obligate yourself to pay anything unless you decide to keep the books. Just tell us you want to see them and the full set of 6 great volumes, just off the press, will be sent to you. Read them, look them over and prove to your own satisfaction that one fact alone, which you will find in them, may save you an expensive repair, or help you to a better job. Imagine books which are so new that every page is right up to date—wiring diagrams, construction details, service problems—are all right up to the minute. Nowhere else can you get as complete and timely information. Over a million dollars of resources have enabled us to give you the most authoritative books on the subject ever published.

Shipped FREE FOR EXAMINATION



6 BIG VOLUMES bound in gold stamped flexible binding, over 2600 pages, 2000 illustrations—fine paper—extra clear type, and double indexed for instant reference.

Practically Every Auto Fact Included

**DIESEL ENGINES
AVIATION MOTORS
OUTBOARD MOTORS
MOTORCYCLES
TRACTORS**

**WIRING DIAGRAMS
EQUIPMENT CHARTS
SUPERCHARGERS
KNEE ACTION & other up-to-date features all included**



Can You Fix It?

Can you take out "play" in differential? Can you kill the "shimmy" in steering? Can you reset TIMING? Can you put your finger on engine trouble without guessing or tinkering? Can you pull the starter off and fix it? Can you adjust and repair transmission, engine, rear axle, bearings? Can you take care of knee action faults, and do an expert job?

These Books Tell How and tell you how to do any and every auto job right, the first time, in the gigantic auto industry. **BIGGER PAY**—a chance to go into business for yourself and get a share of the huge profits even half tries to improve himself. Learn Auto Engineering with these wonder books a new way—without studying or memorizing. Simply use the JIFFY INDEX to look up the answer to any auto problem. Remember over 300 pages on DIESEL the new power.

A Better Job

are waiting for any man who are waiting for any man who himself. Learn Auto Engineering with these wonder books a new way—without studying or memorizing. Simply use the JIFFY INDEX to look up the answer to any auto problem. Remember over 300 pages on DIESEL the new power.

free [FREE! Privilege of consulting Automobile Engineers of American Technical Society for one year without cost if you mail coupon immediately. Write or wire for answer to any difficult problem, reply will be sent promptly at no cost.]

AMERICAN TECHNICAL SOCIETY

Drexel at 58th St. Dept. A-919 Chicago

SEND NO MONEY

AMERICAN TECHNICAL SOCIETY, Drexel Ave. at 58th St., Dept. A-919, Chicago, Ill.

I would like to see the new 6-volume edition of your AUTO BOOKS. I will pay the few cents delivery charges only, but if I choose to, I may return them express collect. If after 10 days use I prefer to keep them, I will send you \$2 and pay the balance at the rate of only \$3 a month, until \$24.80 is paid. Please include free consulting membership as per your offer above. Send brand new edition including DIESEL.

Name _____

Address _____

City _____ State _____

Attach letter stating age, occupation and name and address of employer and at least one business man as reference.

34 Lesson

Drawing Course \$2.98

The biggest value you ever saw advertised anywhere

Haven't you often wished that you could draw cartoons, illustrate some idea, sketch some pretty face, etc. You can do all of these things. One of America's most famous Cartoonists and Illustrators has developed a great, simple system for success in all branches of Commercial Art. This system has revolutionized the entire theory of drawing. It means that drawing can be as easy for you as writing—much simpler than learning shorthand, bookkeeping or typewriting. We are now placing this original system for learning Drawing, Art and Cartooning, consisting of 34 lessons with over 500 illustrations, within reach of every one. If you will devote a few hours each week to the Course WE ABSOLUTELY GUARANTEE that you will learn to draw and draw well before you have half finished the Course. If we fail to make this claim good, we will refund every cent paid us. By eliminating a large office force for answering correspondence, expensive catalogs, etc., we are enabled to make a price of \$2.98, the cheapest price ever known for a high-grade, home study course. Learn to draw. It is a big asset, no matter what field you are in.



Send No Money

Just order the course and on arrival \$2.98 pay postman

plus a few cents postage, payment in full for the entire Course and Drawing Outfit. If not entirely satisfied, return within five days and we will Refund Money. Address:

LEDERER SCHOOL OF DRAWING, Dept. 1148-E, Coalport, Tenn. Orders from outside the U. S. A. are payable \$3.28 cash with order.

Learn ADVERTISING at Home

Greater opportunities now in advertising. Learn easily and quickly in spare time. Practical work. No text books. Old established school. Low tuition—Easy terms. Send for free booklet of interesting information.

Page-Davis School of Advertising
Dept. 1359, 3601 Mich. Ave., Chicago



Minstrels

Unique First Parts for complete show with special songs and choruses. Make-up. Catalog free.

T. S. Denison & Co., 623 S. Wabash, Dept. 19 Chicago

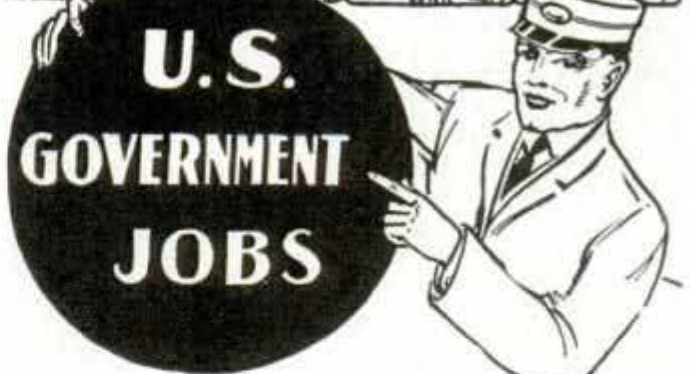

START \$1260 to \$2100 YEAR

MEN—WOMEN

GET READY Immediately

New 40 hour week means many Postal Appointments.

Mail Coupon Today—**SURE**

Franklin Institute Dept. D174 Rochester, N.Y.

Gentlemen: Rush to me, FREE of charge, list of U. S. Government big pay jobs. Send me FREE 32-page book describing salaries, vacations, hours, work and free sample coaching tests. Tell me fully how to get one of these jobs.

COUPON

Name _____

Address _____

LEARN RADIO FROM REAL RADIO ENGINEERS



HERE THEY ARE:

Kendall Clough, Chief Engineer, Clough-Bronze Company.
 E. E. Gramer, Chief Engineer, Standard Transformer Corporation.
 Karl E. Hassel, Chief Engineer, Zenith Radio Corporation.
 H. C. Tittle, Chief Radio Engineer, General Household Utilities (Group now).
 F. D. Whitten, Service Manager, Chicago Branch, Philco Radio & Television Corp.
 Dr. C. M. Blackburn, Radio Engineer, P. R. Mallory & Co., Indianapolis, Manufacturers of Radio Apparatus.

LET THESE ENGINEERS RIGHT FROM THE HEART OF THE BIG RADIO INDUSTRY Train You at Home for

GOOD PAY RADIO WORK

MANY R-T-I TRAINED MEN MAKE \$35 TO \$75 A WEEK

If you're dissatisfied with small pay—work that's getting you nowhere—lay-offs and uncertain income—here's an opportunity that's too good to miss. At the cost of only the time it takes you to mail the coupon, you can get my big FREE book, "RADIO'S FUTURE AND YOURS." This book tells how you can learn at home to make more money almost at once in Radio—whether you want to make Radio your life's work, or use it to pick up an extra \$5 to \$20 a week in your spare time.

"RADIO IS GROWING BY LEAPS AND BOUNDS"

says *Radio Craft Magazine*. It has forged ahead even in depression years. Where only a few hundred men were employed a short time ago, thousands are employed today. Where a few years ago a hundred jobs paid \$35 to \$75 a week—there are thousands of such jobs today. And more new jobs being created all the time—full time jobs and spare time jobs. Get my book and see how easy it is to learn at home for this good-pay work.

R-T-I TRAINING IS "SHOP TRAINING" FOR THE HOME

It comes to you right from the Radio Industry—right out of the factories where Radio sets and other vacuum-tube devices are made. It was planned and prepared for you by big radio engineers IN these factories, most of whom are the Chief Engineers of these great Radio plants. And NOW these same engineers are actually supervising R-T-I Training. Which means that trained the R-T-I way, you'll be trained as the Radio Industry wants you trained—just as the Radio Industry, itself, would train you if it was doing the job.

4 BIG WORKING OUTFITS INCLUDED

These are probably the biggest and most expensive Working Outfits ever included with a home-training Course. You use them to build up testing equipment—to experiment with—to do actual Radio work. It's Shop Training for the home.

SOUND PICTURES, P. A. SYSTEMS, PHOTO CELLS, TELEVISION, ETC. ALL INCLUDED

Radio service work is just the starting point in R-T-I Training. From there we take you up through the very latest developments in Radio, and then on into the new and larger field of Electronics—Sound Pictures, Public Address Systems, Photo Cells, and Television. This feature alone makes R-T-I the outstanding home training in Radio.

YOU GET "QUICK RESULTS"

C. E. Head, 431 Third St., Alexandria, La., says: "Made my first money 11 days after starting your training—cleared \$14.25."

Frank E. Klemann, Lisle, Ill., writes: "Doubled my pay in less than six months."

Harry L. Stark, Ft. Wayne, Ind., writes: "Now making three times as much money as I was when I started your training."

AGE OR LACK OF EDUCATION NO HANDICAP

You don't have to be a high school graduate. It isn't necessary that you should have finished the grades. My Training in Radio is so simple, so easy, and so practical, that it offers every man, regardless of age, education, or previous experience, the chance to get out of a small-pay, no-future job, into good pay, big future work in Radio.

YOUR MONEY BACK IF YOU ARE NOT SATISFIED

That's my way of doing business. And I'll give you that agreement in writing—an agreement to refund every penny of your tuition if, on completion of my Training, you are not entirely satisfied. INVESTIGATE! Learn why R-T-I Training is different. Find out why R-T-I Trained men get "Quick Results" and "Big Results." Send today for my big book "Radio's Future and Yours." The book is free.

When writing to advertisers please mention Popular Mechanics

50 GREAT RADIO CONCERNS

ENDORSE this TRAINING and RECOMMEND it to YOU

AMONG THEM ARE:

ARCTURUS TUBES
 CROSLLEY . PHILCO
 AMERICAN TELEVISION
 CAPEHEART . FADA
 STROMBERG-CARLSON
 STEWART-WARNER
 and 52 Others!



MAIL COUPON FOR MY FREE BOOK

Get your copy of "Radio's Future and Yours" today. It tells you about Radio's amazing opportunities. It describes my Course. It tells what R-T-I students are doing and making. It's FREE. Clip, sign and mail coupon RIGHT NOW!



Ray D. Smith, Pres.
 Radio & Television Institute,
 Chicago

Ray D. Smith, President
 RADIO AND TELEVISION INSTITUTE (R-T-I)
 2130 Lawrence Ave., Dept. 19
 Chicago, Ill.

Without obligation of any kind please send me a copy of "Radio's Future and Yours." I am interested in your home training and the opportunities you say exist in the great field of Radio for the R-T-I Trained men.

Name.....

Address.....

City..... State.....

Boys Look!

Free



THIS 24" WING SPREAD CABIN MONOPLANE. A genuine fast flying sport model. An exact duplicate of the plane that has flown over 2,000 feet.

10 OUTSTANDING FEATURES

1. Full size plans in every kit.
2. No tools needed.
3. Takes only 2 hours to assemble.
4. All parts ready cut.
5. Wire parts formed.
6. Strong wing tissue.
7. 8" shaped propeller.
8. Sturdy landing gear.
9. Record flight 2,000 feet.
10. Flies under own power.

Think of the Fun You Will Have

with this swell kit. You will be the envy of everyone in your neighborhood. This free kit contains printed fuselage sides and wing ribs, all strips cut to size, formed wire parts, tissue, finished 8" propeller, full size plans and instructions.

Takes Only Two Hours to Assemble

Two hours after you have received your kit, your plane should be ready to take the air. Get ready to show your friends a real model that will soar around and gain altitude in less time than it takes to write about it.

No Tools Needed

A pocket knife is all you need to assemble this fast flying model. The full size plans accompanying each kit make

assembly so easy that you will have as much fun building this model as flying it.

Stage an Air Race

Your sport model speed flyer will set new records that you will be proud of. Be the first in every air contest! Show your friends a real model that flies under its own power.

How to Get Your Kit By Return Mail

This genuine 24" cabin monoplane is given free with a 15 week subscription to YOUNG AMERICA. YOUNG AMERICA is a sparkling news weekly, crammed full of articles on aviation, sports, news, "How-to-Make-it"; chemistry, science and radio columns. Get your kit and a 15 week subscription all for \$1.00. Clip your check or money order for \$1.00 to the coupon below and mail today. Your kit will be sent you by return mail and your subscription will start immediately.

YOUNG AMERICA, Dept. P,
32 East 57th St., New York, N. Y.

Rush my 24" wing spread cabin monoplane to me. Start my subscription to YOUNG AMERICA for 15 weeks with the current issue. Enclosed is check—money order for \$1.00.

Name.....

Address.....

City..... State.....



High School Course in 2 to 4 Years

You can now complete your High School education—in 2 to 4 years—by homestudy. Course prepares for college entrance and teacher's certificate examinations—and advancement in business and industry. Standard H. S. texts used. Diploma awarded. Credit for H. S. subjects already completed.

Liberal Arts Course

Offers cultural advantages of college training at low cost, by home study. Uses standard texts, supplemented by special instruction and lectures. A real opportunity for H. S. graduates and you older people to overcome your handicap and enjoy the benefits of college training. Write TODAY for Free Bulletin, stating which course interests you. No obligation.

American School, Dept. H-945
Drexel at 58th, Chicago

Home Study Prepares You for the Better Job

CARTOON YOUR WAY TO SUCCESS!



DON'T COPY—LEARN TO ORIGINATE!

RAYE BURNS will teach you HOW to CREATE ORIGINAL CARTOONS at home that you can SELL! Course contains 26 lessons and over 600 illustrations. All for Only . . .

\$2.85

Send name and address for free details.

RAYE BURNS SCHOOL, Dept. M-X, BOX 2194, Cleveland, Ohio

VOICE

100% Improvement Guaranteed

We build, strengthen the vocal organs—not with singing lessons—but by fundamentally sound and scientifically correct silent exercises . . . and absolutely guarantee to improve any singing or speaking voice at least 100% . . . Write for wonderful voice book—sent free. Learn WHY you can now have the voice you want. No literature sent to anyone under 17 years unless signed by parent.

PERFECT VOICE INSTITUTE, Studio 13-59
64 E. Lake St., Chicago



How to Cash-In with Your CAMERA

Magazines, newspapers, advertisers BUY millions of photos a year from people who know how to take the kind of pictures wanted! Let us teach you how to take real human-interest pictures that SELL! Our personalized homestudy course—the most complete training in Journalistic Photography ever offered—prepares you to make good money in this fascinating field—quickly, at low cost, in spare time. Write now for FREE Book.

Learn at Home

UNIVERSAL PHOTOGRAPHERS, Dept. 712, 10 W. 33 St., N. Y. C.



SECRET SERVICE BOOK FREE

For 30 Days Reading
No Money Down—Actual Crime Cases—
If You Act Quick!—We will send you this stirring book on Crime Detection, Secret Service and Identification Work for 30 days free reading. Send no money. If you decide to keep it, then send only \$1.00. If not, return it. WRITE TODAY. Not sent to boys under 17 years of age.

T. G. Cooke, Dept. 1359, 1920 Sunnyside Ave., Chicago

GOV'T. JOBS

SALARY TO START \$90 to \$175 MONTHLY MEN.. WOMEN Age Range 18 to 50

- () Ry. Mail Clerk
- () P. O. Laborer
- () R. F. D. Carrier
- () Special Agent
- () Customs Inspector
- () City Mail Carrier
- () P. O. Clerk
- () Matron
- () Special Investigator
- () Typist
- () POSTMASTER
- () Seamstress
- () Auditor
- () Stenographer
- () U.S. Border Patrol
- () Telephone Opr.
- () Watchman
- () Meat Inspector
- () Secret Service Opr
- () File Clerk

OZMENT INSTRUCTION BUREAU Dept. 111 St. Louis, Mo.

Send me FREE particulars "How to Qualify for Government Positions" marked "X". Salaries, locations, opportunities, etc. ALL SENT FREE.

Name.....
Address.....

When writing please mention Popular Mechanics

Learn DIESELS

at AMERICA'S
ORIGINAL and FOREMOST
DIESEL SCHOOLS

W. O. Tatman, Operating Engineer of America's largest DIESEL municipal power and light plant at Vernon, Calif. He learned DIESELS at the HEMPHILL Schools.



HEMPHILL TRAINING QUALIFIES YOU FOR OUTSTANDING DIESEL POSITIONS

TO be a LEADER in the DIESEL Industry—get your training at the world's LEADING DIESEL Schools!

HEMPHILL Schools teach DIESELS exclusively on the largest assemblages of DIESEL Engines and TESTING Equipment available. Thousands of dollars-worth of latest type, high-speed DIESELS recently installed for student training. We teach you "from the ground up" to qualify for positions in DIESEL installation, operation, maintenance and sales. International Free

Employment Service. If you can meet our requirements, we want you to enroll in one of our proven courses.

Learn DIESELS at your nearest HEMPHILL Schools or at home with our thorough Combination Home-Study Course which includes later shop work. The Coupon below will bring you all the facts!

CAUTION: We operate Schools only at the locations shown below and are in no way connected with any other schools.

C. A. Madison, employed in the Engineering Dept. of Fairbanks-Morse Company is a HEMPHILL Graduate.



Lewis Jensen, Diesel Sales Engineer employed by Leonard Thompson, Inc., Detroit, Mich., is another HEMPHILL Graduate.



Many other HEMPHILL Graduates are occupying responsible positions in U. S. and foreign countries.

HEMPHILL DIESEL SCHOOLS



New York Schools
31-26 Queens Blvd.
Long Island City,
New York



Chicago Schools
2014 Larrabee Street



Los Angeles Schools
2120 San Fernando Rd.



Seattle Schools
501 Westlake North



Detroit Schools
2341 W. Lafayette Blvd.

Also Schools at 1363 Granville Street,
Vancouver, B. C.

"DIESEL NEWS" published by the HEMPHILL DIESEL SCHOOLS, contains latest facts and pictures about the amazing growth and possibilities of the DIESEL Industry. The Coupon at right will bring you this interesting publication absolutely FREE. Send for it!



MAIL COUPON TODAY

Hemphill Diesel Schools, Dept. PM (use nearest address shown above): I would like to have, without any obligation, full information about your Diesel training courses and a copy of "Diesel News."

Name _____

Street Address _____

City _____ State _____

WORLD'S FINEST AND MOST COMPLETE DIESEL ENGINE EQUIPMENT

When writing to advertisers please mention Popular Mechanics



Power Each year sees an ever-increasing demand for electric power for all purposes in manufacturing, lighting, transportation, and communication.



Light Whether at home, at work, or at play—on street or highway—life is made easier, pleasanter, and safer by Electric light.



Transportation Electric-powered trains—and for city use, the Electric elevated, subway, and street cars.



Communication Telephone, cable, radio, telegraph, teletype—all these swift messengers would be lost to us without Electricity.

Electricity

The Largest Employer

Think of the huge army of Electrical workers regularly employed in various industries—from those just starting at a modest salary, to highly-paid Engineers and Superintendents. Electricity offers wonderful employment opportunities—even when other lines are slowed up—because Electrical workers provide necessities and conveniences which the public demands night and day, at the throw of a switch.

And the present huge army of workers is constantly being increased by the discovery of new uses for Electricity—as well as by the growing adoption of Electric power by other industries. Directly or indirectly, Electricity is easily the largest employer.

Shut Off the Current for a Day —and What Would Happen?

Because Electricity has come into such general use, we are apt to forget how directly and vitally it affects our lives. Electricity furnishes our manufacturers with power and light—provides much of our population with light and transportation—makes possible communication far beyond the range of the human voice—helps drive millions of pleasure and commercial cars—brings us unlimited enjoyment and education over the radio—and puts a score of comforts and conveniences into our homes. It is absolutely essential to our present mode of living.

The Future of Electricity

You will be interested in the 24-page illustrated booklet "The Future of Electricity as Westinghouse Sees It." Sent free on request to show you the opportunities in Electricity. You don't have to know all about Electricity before you can get a job. It's not difficult to acquire the knack of wiring—to master the principles of the motor—to learn how to service Electrical equipment; and each step forward in knowledge, boosts you a step up in responsibility and pay.

Through spare-time home study you can prepare yourself, in a short time, for a good Electrical job. Write today for booklet and full information. No obligation.

American School

Dept. E-945

Drexel Avenue at 58th Street

Chicago, Ill.

**Turn JUNK
IN TO Cash!**

**TIRES
START
AT HOME**

The Most Sensational
Business Opportunity
Since 1929

Like turning lead into gold, here is a business with gigantic possibilities. Factories, Clubs, Stores, Schools, Homes, spend millions every year for rubber mats. Think of your profit when a

**HAND
MACHINE
and**

**5¢ TIRE
MAKES \$2.00 MAT**

Brand new. Fully patented. Few men already started report unprecedented success. Wm. Eagle writes: "Can't make mats fast enough. First week brought over 200 orders for \$1.00 to \$10.00 each." Flash from Harris says: "Orders enough to keep 15 men busy all the time." Gunter got big order from County Commissioners and now reports: "Just signed up order for all Grade Schools and High Schools." No wonder responsible men are throwing everything else aside to establish local FABRIX factories.

COSTS NOTHING to get complete facts. Just send name and address. We'll send description of simple hand machine that quickly slices old tire into strips; show you how patented method forms strips into thick, springy, long-wearing FABRIX Mats—how five cents worth of Junk Tires makes a \$2.00 Mat; how you can start on a reasonable investment and build a business so big, so fast, that it will take your breath away. Don't delay a minute. Write or wire today. All information is free.

FABRIX, Inc., 325 W. Huron St., Dept. 712, Chicago, Ill.



FREE BARGAIN CATALOG of BOOKS

25,000 books of all publishers listed in our 41st Annual Bargain Catalog of 320 pages. Old-time favorites—latest "best sellers." Reference, Fiction, Juvenile, History, Scientific, etc. Supplying schools, colleges, libraries and thousands of individual customers. Send postcard today for our new 1936 catalog, "Bargains in Books." **THE BOOK SUPPLY COMPANY, Dept. 146**
564-566 West Monroe St., Chicago, Illinois

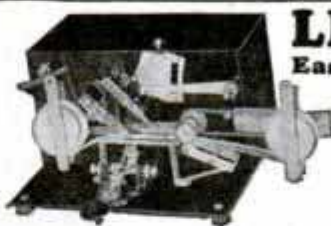

LEARN CODE

Easily and Quickly at Home

To get the most out of your S.W. Radio, you must know code. Thousands agree the easiest, quickest, surest way to learn code is with the Master Teleplex Code Teacher. Master Teleplex records your own sending in visible dots and dashes on copper tapes—then **SENDS BACK** your key work. We furnish complete course, lend you instrument, give personal service with a **MONEY BACK GUARANTEE** on a low monthly payment basis. Send for **FREE** catalog "P1." No obligation.

TELEPLEX CO. 76 Cortlandt St. NEW YORK, N. Y.

Come to WASHINGTON

Train for a Fine Hotel Position

Graduates earning substantial salaries
Good positions for trained men in hotel, restaurant and institutional field. Qualify in 4 months—learn on real hotel equipment. Placement Service **FREE** of extra charge. New day classes start Jan., Feb. Catalog **FREE!**
LEWIS HOTEL TRAINING SCHOOLS
Division RLW-398 Washington, D. C.

Learn Profitable Profession in 90 days at Home

Salaries of Men and Women in the fascinating profession of Swedish Massage run as high as \$40 to \$70 per week but many prefer to open their own offices. Large incomes from Doctors, hospitals, sanitariums, clubs and private patients come to those who qualify through our training. Reducing alone offers rich rewards for specialists. Anatomy charts and supplies are given with our course. Write for details

National College of Massage & Physio-Therapy, 20 N. Ashland Avenue, Dept. 964, Chicago, Ill.



When writing to advertisers please mention Popular Mechanics

SAVE UP TO 50% by BUYING YOUR RADIO *Direct from* MIDWEST LABORATORIES

Glorious Tone Realism.. World-Wide Entertainment Guaranteed!
with New 1936 SUPER *Deluxe*

METAL TUBE **MIDWEST**

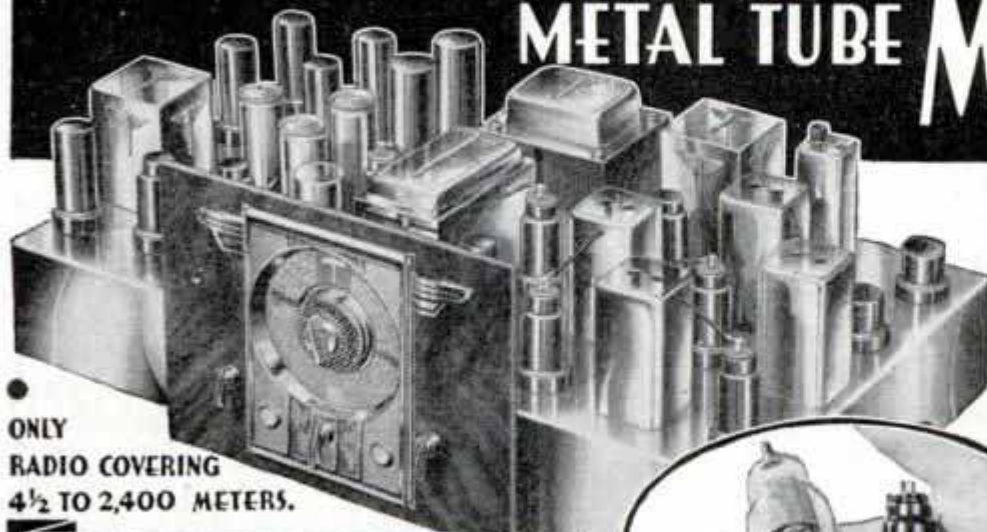

ONLY
RADIO COVERING
4½ TO 2,400 METERS.

30 Days FREE Trial!



PUSH-BUTTON TUNING
(Noises Suppressed)

Now, Push-Button Silent Tuning is offered for first time! Simply pushing Silencer Button hushes set between stations . . . suppresses noises. Pressing Station Finder Button automatically indicates proper dial position for bringing in extremely weak stations.

Acousti-Tone V-Spread Design
(Patent Pending)

...Establishes new radio style overnight! The V-Front Dispersing Vanes were developed by Midwest engineers as a result of a study of directional effect of the Midwest Full Scope High Fidelity Speaker. These Vanes spread the beautiful lacework of the "highs" throughout the entire room in a scientific manner... directing the High Fidelity waves uniformly to the ear. Send for new FREE 40-page catalog. It pictures the complete line of beautiful 1936 Acousti-Tone V-Spread consoles . . . and chassis . . . in four colors.

FULL SCOPE HIGH FIDELITY

Brilliant

Concert Tone
Now, get complete range of audible frequencies from 30 to 16,000 cycles, being transmitted by four new High Fidelity Broadcasting stations—WIXBS, W9XB, W2XR and W6XAL. Glorious new Acousti-tone is achieved... assuring life-like, crystal-clear "concert" realism.

V-FRONT

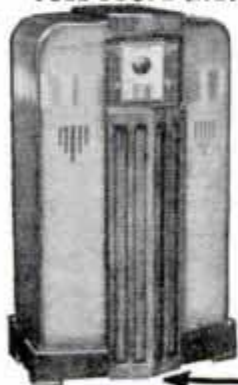

EVERYWHERE, radio enthusiasts are praising this amazingly beautiful, bigger, better, more powerful, super selective, 18-tube 6-tuning range radio. They say it is a tremendous improvement over Midwest's 16-tube set, so popular last season. It is sold direct to you from Midwest Laboratories at a positive saving of 30% to 50%. (This statement has been verified by a Certified Public Accountant who conducted an impartial survey among representative Ohio, Kentucky and Indiana radio retailers.) Before you buy any radio, write for FREE 40-page catalog. Never before so much radio for so little money. Why pay more? You are triple-protected with: One Year Guarantee, Foreign Reception Guarantee and Money-Back Guarantee! This super Midwest will out-perform \$200 to \$400 sets on a point-for-point comparison. That is why nationally known orchestra leaders like Fred Waring, George Olsen, Jack Denny, Ted Fio Rito, and others use Midwest sets to study types of harmony and rhythmic beats followed by leading American and Foreign orchestras.

80 ADVANCED 1936 FEATURES

Scores of marvelous features, many exclusive, explain Midwest super performance and thrilling world-wide all-wave reception . . . enable Midwest to bring in weak distant foreign stations, with full loud speaker volume, on channels adjacent to locals. Only Midwest offers so many features . . . only Midwest tunes as low as 4½ meters . . . only Midwest gives the sensational new Push-Button Tuning feature, etc. See pages 12 to 21 in FREE catalog for description of the 80 features. Read about advantages of 6 Tuning ranges . . . offered for first time: E, A, L, M, H and U. They make this Super De Luxe 18-tube set the equivalent of six different radios . . . offer tuning ranges not obtainable in other radios at any price!

DEAL DIRECT WITH LABORATORIES

No middlemen's profits to pay—you buy at wholesale price direct from laboratories

...saving 30% to 50%. Increasing costs are sure to result in higher radio prices soon. Buy before the big advance . . . NOW . . . while you can take advantage of Midwest's sensational values. You can order your Midwest 1936 Full Scope High Fidelity Acousti-Tone radio from the 40-page catalog with as much certainty of satisfaction as if you were to come yourself to our great radio laboratories. You save 30% to 10% . . . you get 30 days FREE trial . . . as little as \$5.00 puts a Midwest radio in your home . . . Satisfaction guaranteed or money back. Write today, for FREE catalog.

SAVE UP TO 50%



18 TUBE
RADIOS
6 TUNING RANGES

WORLD'S GREATEST
RADIO VALUE

59.50
with New
GIANT
THEATRE-
SONIC
(LESS TUBES) **SPEAKER**

TERMS AS LOW AS \$5.00 DOWN

Thrill to new explorations in sections of radio spectrum that are strangers to you. Every type of broadcast from North and South America, Europe, Asia, Africa and Australia is now yours. Send today for money-saving facts.

GEORGE OLSEN PRAISES LIFE-LIKE TONE REALISM

Long Island, N. Y.—After comparing many different makes, I finally decided upon Midwest. It out-performs other radios costing almost twice as much. The crystal-clear tone is so life-like that it sounds as though I am in the studios, actually hearing artists performing.



TODAY'S FINEST RADIO SAYS TED FIO RITO

My new Midwest is finest radio I have had pleasure of hearing. Base-Treble control is marvelous . . . enables one to hear every instrument in orchestra.



METAL TUBES

This Midwest is engineered from the ground up to see either the new METAL tubes or glass-metal counterpart tubes. Octal sockets and newest circuits permit use of either type . . . just as you desire.

MAIL COUPON TODAY! FOR FREE 30-DAY TRIAL OFFER and 40-PAGE FOUR-COLOR FREE CATALOG

MIDWEST RADIO CORP.,
Dept. 15-F, Cincinnati, Ohio

Without obligation on my part, send me your new FREE catalog, complete details of your liberal 30-day FREE trial offer, and FREE Miniature Roasting 18-tube Dial. This is NOT an order.

User-Agents
Make Easy
Extra Money

Check Here for details

Name _____
Address _____
Town _____ State _____
 Check here, if interested in a Midwest All-Wave Battery Radio

MIDWEST RADIO CORP.

DEPT. 15-F, CINCINNATI, OHIO U.S.A.

Established 1920 Cable Address MIRACO All Codes

DIESEL POWER

A COMING AMERICAN INDUSTRY



THE internal-combustion engine represents man's supreme triumph of machine power. Diesel engineers are in great demand. Many are acquiring necessary knowledge through spare-time study of this modern I. C. S. Course on Diesel engines. Free booklet

THE internal-combustion engine represents man's supreme triumph of machine power. Diesel engineers are in great demand. Many are acquiring necessary knowledge through spare-time study of this modern I. C. S. Course on Diesel engines. Free booklet

INTERNATIONAL CORRESPONDENCE SCHOOLS

Box 5604-H, Scranton, Penna.

Explain fully about your course in the subject marked X:

DIESEL POWER

<input type="checkbox"/> Mechanical Engineering	<input type="checkbox"/> Architecture
<input type="checkbox"/> Automobile Course	<input type="checkbox"/> Radio
<input type="checkbox"/> Concrete Construction	<input type="checkbox"/> Chemistry
<input type="checkbox"/> Civil Engineering	<input type="checkbox"/> Aviation Engines
<input type="checkbox"/> Gas Engine Operating	<input type="checkbox"/> Air Conditioning
<input type="checkbox"/> Electrical Engineering	<input type="checkbox"/> Refrigeration
<input type="checkbox"/> High School Subjects	<input type="checkbox"/> Civil Service

Name..... Age.....

Address.....

NEW ELECTRIC LIBRARY

\$ 1.50 A VOLUME

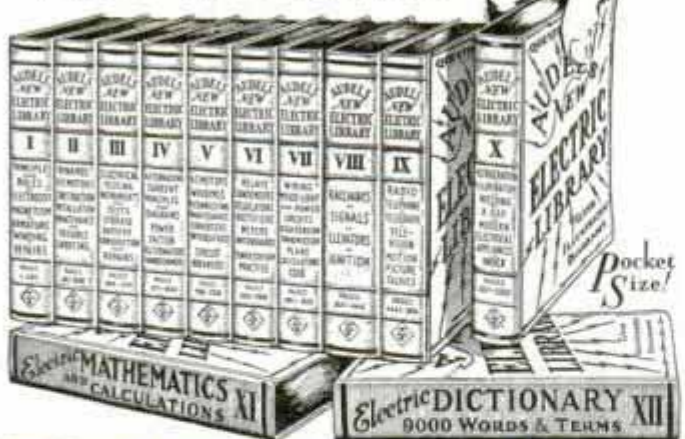

WHAT EVERY ELECTRICIAN WANTS TO KNOW!

is easily found in AUDEL'S NEW ELECTRIC LIBRARY. Electricity made simple as ABC. Up-to-date, trade dope for the expert and ALL electrical workers. Questions, answers, diagrams, calculations, underwriter's code; design, construction, operation and maintenance of modern electrical machines and appliances FULLY COVERED.

All available at small cost, easy terms. BOOK-A-MONTH service puts this NEW information in your hands for 6c a day. You can start your subscription with any volume. Write TODAY for electric Folder and FREE TRIAL offer.

THEO. AUDEL & CO., 65 W. 23rd St., New York City

Mail Vol. I, Electric Library on 7 days' free trial. If O. K. I will remit \$1.50, otherwise I will return it. I also request you to mail one book each month on same terms. No obligation unless I am satisfied.

Name.....

Address.....

Occupation..... PH

When writing please mention Popular Mechanics

FREE LESSON Home Art Craft

GOOD MONEY FOR SPARE TIME

A new easy way. Art novelties in big demand. Get free lesson and quickly learn to decorate Gifts, Bridge Prizes, Toys, etc. No experience necessary. Anyone can succeed with simple "3-step" method and you earn as you learn. Everything furnished, including supply of Novelties for you to decorate and Homecrafters' Outfit.

NO CANVASSING

Just sit at home and make up to \$50 a week spare time or full. Write today for big illustrated book and **FIRST LESSON FREE**. Absolutely not one cent to pay. Lesson is free. Openings in every locality. Write quick.

FIRESIDE INDUSTRIES
Dept. 66-W Adrian, Mich.

ENGINEERING DEGREE IN TWO YEARS

B.S. Degree in Electrical, Civil, Chemical, Radio, Mechanical or Aeronautical Engineering in two years. Located in an industrial center with that Engineering atmosphere. Earn board. Low tuition. Preparatory Department. Enter Dec., March, June, Sept. Catalog.

INDIANA TECHNICAL COLLEGE
229 East Washington St., Fort Wayne, Indiana

Learn to Dance

You can learn all the modern dances—the latest Tango steps, the new Fox Trots, dreamy Waltzes, smart Collegiate Steps, and popular Society Steps at home, easily and quickly. New chart method makes dancing as simple as A-B-C. No music or partner required. Don't be a wallflower. Learn to dance. Complete course—256 pages, 54 illustrations, sent on 5 Days' Free Trial. Equals \$20.00 course. Send no money. Pay postman only \$1.98, plus postage upon arrival. Money back if not delighted. Catalog Free.

Franklin Pub. Co., 800 No. Clark St., Dept. 9479, Chicago

NEW YORK SCHOOL OF MECHANICAL DENTISTRY

Makes more money as a DENTICIAN. We show you how! Oldest school. Real Laboratory Training. Day, Eve. Easy terms. Tools FREE. Ask for Catalog P. N. Y. SCHOOL OF MECHANICAL DENTISTRY, 125 W. 31 St., N. Y. C.

STICK EM UP!

Regardless of strength or size defend yourself and friends against any foul attack, from bullies or by gun, knife or club. Subdue with ease persons much stronger than yourself. A complete course on approved American Police Jiu-Jitsu by internationally known police instructor. 151 illustrations with detailed instructions pocket size. 13 knockout blows without using fists. Send One Dollar Full Price, or will send C. O. D.

S. J. JORGENSEN
787 Maritime Building Seattle, Washington

Learn Radio in 12 WEEKS

SEND TODAY FOR DETAILS OF MY "Pay-Tuition-After-Graduation" Plan

Prepare for jobs in Radio Broadcast, Talking Pictures, Television by 12 weeks of practical shop work in the great Coyne Radio Shops, on real machinery and equipment. You don't need advanced education or experience. Free Employment Service for life. Many earn while learning. Electric Refrigeration—Air Conditioning included. MAIL COUPON TODAY for free book which tells you how hundreds have become successful Radio Men after taking my training.

H. C. LEWIS, Pres., COYNE ELECTRICAL & RADIO SCHOOL
500 S. Paulina Street, Dept. 95-3H, Chicago, Illinois

Send Free Radio Book and facts. Tell me about your "Pay-Tuition-After-Graduation" Plan.

NAME..... AGE.....

ADDRESS.....

TOWN..... STATE.....

The 97-Pound Weakling...

who became "The World's
Most Perfectly
Developed
Man"



**"I'll Prove to You in 7 Days that YOU, too
Can be this NEW MAN!" — CHARLES ATLAS.**

WHEN I say I can make you over into a man of giant power and energy, I know what I'm talking about. I've seen my new system, *Dynamic-Tension*, transform hundreds of weaker, punier men than you into Atlas Champions.

Take myself, for instance, I used to weigh only 97 pounds. I was a sickly scare-crow. Then I discovered *Dynamic-Tension*. It gave me a body that twice won me the title "The World's Most Perfectly Developed Man." It'll work just as big a change in you, too! I'm so sure of it that I make you this amazing offer: At my own risk, I'll give you PROOF in even the first 7 days that I can make you over into the NEW MAN. I'll begin training you *on approval*. If you don't notice a marvelous change in yourself *within a week* you don't owe me a cent.

No "ifs," "ands," or "maybes." Just tell me where you want handsome, steel-like muscles. Are you fat and flabby? Or skinny and gawky? Are you short-winded, pepless? Do you hold back and let others walk off with the prettiest girls, best jobs, etc.? Give me just 7 days! I'll PROVE to you that I can make you a healthy, confident, powerful HE-MAN.

Dynamic-Tension is an entirely NATURAL method. No mechanical apparatus to strain your heart and other vital organs. No pills, special foods or other unnatural artificial contraptions. Only a few minutes of your spare time daily is enough to show amazing results—and it's actually fun! *Dynamic-Tension does the work.*

Send for FREE BOOK

Mail the coupon right now for full details and I'll send you my illustrated book, "Everlasting Health and Strength." Tells all about my "*Dynamic-Tension*" method. Shows actual photos of men I've made into Atlas Champions. Supplies the facts you need to know about your condition. It's a valuable Book! And it's FREE. Send for your copy *today*. Mail the coupon to me personally. CHARLES ATLAS, Dept. 812, 115 East 23d St., New York, N. Y.



NOTE:
No other Physical Instructor in the World has ever DARED make such an Offer!

**THIS STERLING SILVER CUP BEING
GIVEN AWAY BY**

This valuable cup stands about 14 inches high. I will award it to my pupil who makes the most improvement in his development within the next three months. Therefore, no matter what your measurements may be now, you have an equal chance to win this cup—with YOUR name engraved on it.

Charles Atlas

CHARLES ATLAS
Dept. 812, 115 E. 23rd St.
New York, N. Y.

I want the proof that your system of "*Dynamic-Tension*" will make a New Man of me—give me a healthy, husky body and big muscular development. Send me your free book, "*Everlasting Health and Strength*." This request places me under no obligation.

Name.....
(Please print or write plainly)

Address.....

City..... State.....

©1935, C. A. Ltd.



The Editor's MAIL BAG

The Safest Driver?

"In your article, Million Milers of the Air, you ask: 'Could you hope to drive an automobile forty times around the earth without denting a fender?'"



A friend, W. A. Orrell, has driven more than sixty-eight times around the world, 1,567,800 miles in fifteen years, without an accident on his St. Louis-Memphis

truck run. He says, 'In case of doubt, play it safe. There's no excuse for wrecks.'—**Mark A. Statler**, Cape Girardeau, Mo.

To Inventors

"As a suggestion to inventors: how about inventing a dial that would register the exact amount of charge left in the battery of an automobile? One half of the dial could be used as an ammeter and the other half as an electrometer. Installed on the dash of the new models, it would be a great talking point, aside from its help to the car owner."—**Jesse Rothman**, Detroit, Mich.

Builds Model Planes



model plane that I built, with the help of your magazine. I have been constructing

"I have every issue of Popular Mechanics since November, 1924, and I have received much valuable information from them. Enclosed is a picture of a scale

model planes for a number of years."—**Pete Summers**, Henrietta, Mo.

One-Tube Enough

"I am enclosing a photo of the One-Tube All-Wave Receiver that I built from Popular Mechanics. It has brought in many broadcast and short-wave stations and I am well pleased with its performance."—**John Colbert**, Scottsbluff, Nebr.



Flies His Homemade Glider



"Am enclosing picture of the 135-pound glider that I built. I have flown it a number of times and had some great sport."—**Robert Morse**, Los Angeles, Calif.

In Far Morocco

"I am in the French Foreign Legion in Morocco, having left the United States in March, 1922. When I recently got a chance to read a copy of Popular Mechanics, after



(Continued to page 58A)

New INVENTION

**3 TO 7 MILES MORE
PER GALLON**

**MOTORIST SAVES
\$180⁰⁰ a YEAR**



Saves up to Thirty Per Cent On Gas.
Provides Faster Pick-Up—More Power—
Greater Mileage and Smoother Running.

GET FREE INFORMATION

VACU-MATIC
the Carburetor Control
that "BREATHES"

AT LAST! Automotive engineers have smashed down the barriers to perfected combustion! The new VACU-MATIC solves the secret of greater power! With almost magical action, this amazing invention instantly puts new life and pep in any motor. It adds mileage to every gallon of gasoline . . . produces split-second pick-up, sensitive accelerator response, greater speed and smoother running

New—Automatic—Nothing Like It!

The self-starter—four wheel brakes—knee action—streamlining . . . and now VACU-MATIC! The greatest motor improvement of recent years! With it, engineers have achieved a practical means of balancing air and gasoline automatically for all speeds. Vacu-matic is *entirely different!* It is AUTOMATIC and allows the motor to "breathe" at the correct time, opening and closing automatically as required. No idling troubles—no carburetor adjustments necessary. Just put it on and forget it! Sharply cuts fuel wastes, saves dollars in gas costs, reduces carbon and gives your engine new pep, greater power and longer life.

Fits All Cars

VACU-MATIC is constructed of six parts, assembled and welded into one unit, correctly adjusted and *sealed at the factory*. Nothing to regulate. Any motorist can attach VACU-MATIC in ten minutes. Once in, its only reminder is the surge of instant power and speed it gives to the motor and the savings it affords your pocketbook.

Agents and Salesmen

If you are interested in earning unusual profits, check coupon. Exclusive territories are now being granted.

The VACU-MATIC Co.,

Wauwatosa, Wis.

When writing to advertisers please mention Popular Mechanics

SAVES GAS!

CHRYSLER

Have tried the Vacu-matic and it sure is fine. Better pick-up with a 30% gas saving.—John C. Martin, Pa.

PLYMOUTH

I am amazed at Vacu-matic performance. It's giving me 5 more miles per gallon.—Walter Zielinski, Ill.

FRANKLIN

With Vacu-matic I have increased my mileage from 10.1 to 14.2 miles per gallon. I figure I save over \$75.00 a year in gasoline.—R. K. Radtke, Wis.

ALL WELL PLEASED

Enclosed find order for 12 more. Everyone I have sold is giving from 4 to 6 more miles per gallon. I have 3 more orders for V8 Ford. Every body is well pleased.—J. O. Carll, Texas.

NASH

On my Advanced 6 Nash gained 17 1/2% in mileage. The car will idle down to 3 miles an hour and then take gas without a complaint.—J. Showalter, Mo.

DODGE

Just completed 2310 miles on 92 gallons in my 1933 Dodge 6. This figures 25 miles while before I averaged only 20 miles per gallon trips.—Al Fruzyna, Calif.

V-8 FORD

I installed both Vacu-matics and they work excellent. On my own V8 Ford I notice wonderful performance in pickup, get-away and gas saving.—Burt Burnett, Mich.

BUICK

Everything you claim about Vacu-matic is true. I now get 20 miles to the gallon. Before I was only averaging 15 1/2 miles.—C. Constantino, Fla.

CHEVROLET

Please send me a Vacu-matic for a Model A. The mileage on my 1933 Chevrolet jumped from 18 to 22 miles per gallon with Vacu-matic.—Paul P Haas, Mass.

MODEL A FORD

Have been using the Vacu-matic for a month. I used to get 20 to 22 miles per gallon. Now I get 30 to 33 miles. It is amazing the difference it makes.—James W. Barr, Canada.

OLDSMOBILE

I am well pleased with Vacu-matic on our Oldsmobile. A test proved it to give 18 miles per gallon. Before we considered 13 good.—Arthur Williams, N. Y.

Above are just a few of the many unsolicited letters received from Vacu-matic users.

Guaranteed Gas Savings

The VACU-MATIC proves itself on every car. It is guaranteed to give worth-while gas savings, quicker pick-up, and more power or it costs you nothing. "On a test I gained an average of 4 miles on a gallon," writes Alex Wertz. "Vacu-matic is the best I have ever tried." Clarence Rutzin—"I have tried the Vacu-matic on several tests and find that I get between 5 and 6 miles per gallon increase, have more mileage, have greater pickup."

Free Details

Learn about this remarkable device that so greatly affects the entire performance of your motor. Learn why your car is costing you extra money to operate without VACU-MATIC. See why your VACU-MATIC equipped car will leap away from traffic without sputter or hesitation. Discover a new driving thrill and enjoy the savings. Get the facts! Write today!

FREE OFFER COUPON

THE VACU-MATIC COMPANY
7617-137 W. State St., Wauwatosa, Wis.

Gentlemen: Please send me full particulars concerning the Vacu-matic and details of your Free Offer. This of course does not obligate me in any way.

Name.....

Address.....

City..... State.....

Check here if interested in selling proposition.

BE A TRAINED

AUTO-DIESEL

Expert

Diesel Power for trucks, busses, tractors, farm power and lighting plants opens rich, new fields of opportunity for Diesel-trained men.

Good jobs, at good pay, await those who prepare NOW to get in on the ground floor of this fast-growing industry. And with combined Auto-Diesel "Job-Way" Training, brought to your home by the pioneer *automotive home-study school*, you can train for success in this new field without leaving your present position while learning.

"Job-Way" Training is Practical, Complete, Modern

Our modern, revised Training covers every new development in the operation and repair of present day gasoline and Diesel automobiles, trucks, tractors, etc. And the same practical, easy-to-learn method that has started thousands of our graduates toward success, will qualify you in a few short months for a better job, or a profitable repair business of your own.

New Auto-Diesel Course Included at No Extra Cost

Students enrolling now for our regular Automotive course get our complete new Auto-Diesel course AT NO EXTRA COST. Send Coupon today for details of our "Earn as You Learn" Training plan, backed by fifteen years' success in the automotive training field.

Earn as You Learn—Two Motor Testers Free

Just now, we are also including complete, valuable motor testing equipment, to assist your training and enable you to begin earning extra spare-time money soon after you enroll.

AUTO-DIESEL BOOK FREE

Men without previous auto experience or special education quickly master "Job-Way" Training and become skilled experts in every branch of auto work. Mail the coupon today for Big FREE AUTO-DIESEL Book and complete facts about Free Employment and Consultation Service. No obligation!

MOTOR INSTITUTE OF AMERICA
2140 Lawrence Ave., Dept. MD-11, Chicago

MOTOR INSTITUTE OF AMERICA
2140 Lawrence Ave., Dept. MD-11-Chicago, Ill.

Without obligating me, send Free Auto-Diesel Book with all facts about "Job-Way" Home Training and Special Offer.

MAIL COUPON FOR FREE BOOK



Name.....
Address.....
City..... State.....

TELEVISION

has arrived



AMERICA'S First Complete TRAINING COURSE -now ready-

Students operate actual equipment in NATIONAL STUDIOS



RECEIVING
LEARN TELEVISION ELECTRICITY RADIO all branches

BROADCASTING
You can quickly qualify for big opportunities in the newest radio science—TELEVISION. Be a Radio expert. National Schools (est. 1905) offers several complete courses at price of one course. 30,000 graduates. Practical shop and studio instruction. Coach railroad fare allowed to Los Angeles. Earn room and board during enrollment. SEND COUPON FOR BOOK.

NATIONAL RADIO & ELEC. SCHOOLS

Dept. 12-PMR, 4000 So. Figueroa St., Los Angeles

NAME.....
ADDRESS.....
CITY..... STATE.....



When writing please mention Popular Mechanics



ACCOUNTING

the profession that pays!

Accountants command big income. Thousands needed. About 12,000 Certified Public Accountants in U. S. Many earn \$3,000 to \$20,600. We train you thoroughly at home in your spare time for C. P. A. examinations or executive accounting positions. Previous bookkeeping knowledge unnecessary—we prepare you from ground up. Our training is supervised by Wm. B. Castenholz, A. M., C. P. A., assisted by staff of C. P. A.'s. Low cost—easy terms. Write now for valuable 64-page book, "Accountancy, the Profession that Pays," free.

LASALLE EXTENSION UNIVERSITY
The school that has trained over 1,000 C.P.A.'s
Dept. 1264-HR Chicago, Ill.

BE A PASSENGER TRAFFIC INSPECTOR



A Better Job with this Special Training
WRITE for Free Booklet which explains our 17-yr. record in training and placing reliable active men—19 to 30—on Railway and Bus Passenger Traffic Inspector, interesting, profitable work with opportunity for advancement. Upon completion of simple home-study course, we help place you at up to \$133 per month, plus expenses, to start, or refund tuition.

Standard Business Training Institute, Div. 212, Buffalo, N. Y.

LEARN WATCH REPAIRING



AT HOME You can learn by our modern and original system of instruction every part of the Watch Repairing Trade at home as good or better than at a shop. You can earn money while learning and secure a well paying position or start in business after completing our course of instruction. Good watch repairers are always in demand and earn very good salaries. For particulars apply to the Wisconsin School of Watch Repairing
524 E. Mason St., MILWAUKEE, WIS.

NEON EXPERTS MAKE BIG MONEY

Learn at Home—in Few Weeks

Prepare quickly to enter this opportunity field. Cash in on fascinating NEON, "luminous-tube" industry! Today's most widely-used medium of lighted signs—tomorrow's greatest source of illumination. Trained men needed right now, in every locality. Selling—designing—manufacturing—installing. Splendid future awaits shrewd men who start NOW.

FREE LESSON EXCERPTS and Free Book describe America's foremost Neon home-study course. Teaches everything. Non-technical. Amazing low cost. Easy terms. Free employment service. WRITE!
COMMERCIALITE LABORATORIES Dept. 47 OMAHA, NEBR.

"Why VOICE Students Fail"

SENT FREE No Obligation to Buy

If you act quick!—we will send postpaid—for 30 days' free reading—new Voice Book discussing startling VOICE FACTS that may save hundreds of dollars to every man or woman seeking a strong, rich voice for either singing or speaking. 30 days' free reading—then send \$1.00. Otherwise, return it—that's all!
PROF. E. FEUCHTINGER Studio 93-59 64 East Lake Street Chicago



MAKE YOUR BOOTS LEAK-PROOF

WITH \$0-10 PLASTIC RUBBER!
Just spread on like butter—dries tough overnight. Flexible! Non-skid! Guaranteed! For holes in canoes, tents, bags... for straps, gun butts, etc. At any Hardware or 10c Store. ASK FOR \$0-10 PLASTIC RUBBER. You'll Save Money!

TAP DANCING

LEARN AT HOME NEW EASY WAY. Professional Stage Method. Surprise and entertain your friends. Be popular, earn extra money, develop hidden talent. No music or experience needed. Begin dancing first day. Beginner's fundamentals and complete Professional Tap Dance included. Equal to \$40 instruction. Easy way to reduce or build up figure. For ladies or men. Send only \$3.75 money order for Complete 17-Lesson Course. Or send no money (if in U.S.) and pay postman \$3.98 on delivery. No more to pay. Try 5 days. If not delighted, money refunded. Limbering exercises Free if you enroll now. THORNTON DANCE STUDIOS 827 Irving Park Blvd., Suite 135, Chicago, Ill.



STRANGE FACTS ABOUT MUSIC *— by Landron*



BEETHOVEN WAS DEAF WHEN HE COMPOSED HIS FAMOUS 9TH SYMPHONY

A NOTE ON THE ORGAN... CALLED THE VOX HUMANA... CAN NOT BE TOLD APART FROM THE HUMAN VOICE

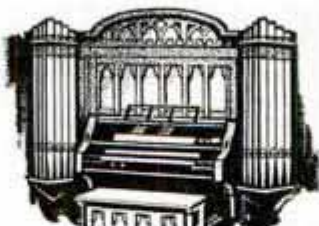

ANYONE CAN NOW LEARN TO PLAY MUSIC AT 1/3 THE COST — THE U.S. SCHOOL WAY AT HOME WITHOUT A TEACHER

New Easy Music-Teaching Method brings quick, sure results!

OVER 700,000 STUDENTS

Thousands who never played music until a few months ago are getting thrills of enjoyment from a talent they never knew they had. By a simple short-cut method you can actually learn to play any popular instrument without knowing one note from another! The secret of the U. S. School of Music system is simplicity. The lessons come to you by mail. They consist of complete printed instructions, simple diagrammatic pictures, and all the music you need. No grinding routine. Study when you feel like it—at home. In an almost unbelievably short time you find that you are actually playing! Jazz, musical comedy hits, movie theme-songs, even classics—you learn to play them all—as easily as you now whistle or sing them. If popularity and the joy of making your own music appeal to you—send today for FREE Demonstration Lesson with illustrated book

LEARN TO PLAY BY NOTE

- Piano
- Violin
- Organ
- Ukulele
- Guitar
- Saxophone
- Tenor
- Banjo
- Hawaiian
- Guitar
- Piano
- Accordion
- Or Any Other Instrument

describing the now famous U. S. School of Music "print-and-picture" method of learning.

FREE PROOF!

Just mail the coupon. Then judge for yourself when you receive free demonstration lesson and descriptive material. U. S. School of Music, 712 Brunswick Bldg., N. Y. C.

U. S. SCHOOL OF MUSIC
712 Brunswick Bldg., New York City

Send me your amazing free book, "How You Can Master Music in Your Own Home," with inspiring message by Dr. Frank Crane; also Free Demonstration Lesson. This does not put me under any obligation.

Name.....
Address.....
Instrument..... Have you Instr.?......

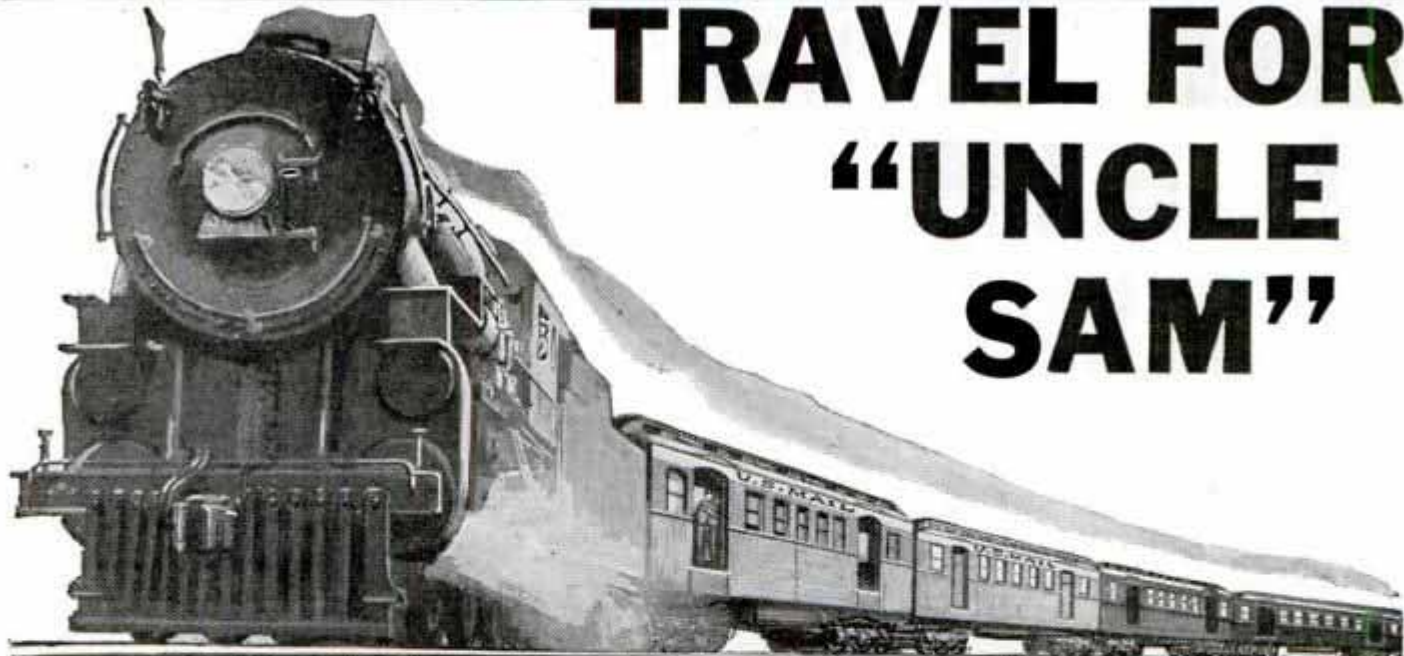

TRAVEL FOR "UNCLE SAM"

RAILWAY POSTAL CLERKS

\$1900 First Year Regular

EARLY EXAMINATION ANNOUNCEMENT EXPECTED

On Oct. 1, 1935—the Postal Service went on a 40 hour week—formerly 44. This should bring many Railway Postal Clerk—City Carrier—Postoffice Clerk appointments.

Many other Government Jobs. Mail coupon before you forget.

FRANKLIN INSTITUTE
Dept. D185, Rochester, N.Y.

Rush to me, entirely free of charge (1) a list and full description of U. S. Government Jobs; (2) Free copy of illustrated 32-page book, "U. S. Government Positions and How to Get Them" with free sample coaching tests; (3) Tell me how to qualify for a U. S. Government Job.

Name.....
Address.....

When writing to advertisers please mention Popular Mechanics

Drafting and Design

Offers Ambitious Young Men A Real Opportunity



As a starting job for the man who wants to get ahead in industry, Drafting offers more possibilities for rapid promotion than almost any other job. The Draftsman's work brings him into direct contact with all new developments.

Many of the highest-paid Architects, Engineers, Designers, and Superintendents got their start at the Drafting table, where they gained knowledge and experience that soon fitted them for bigger things.

Why are Draftsmen among the first to be hired—the last to be laid off? Why are there thousands of Draftsmen on the payrolls of architects and builders—consulting engineers—engineering and construction firms—mills and factories—railroad and street car systems—telephone and telegraph companies—electric light and power companies—shipbuilders—surveying and mapping companies—plumbing supply houses—electric wiring contractors—city sewer and water departments—subdivision development companies, etc.?

Because the Draftsman is the connecting link between engineer and mechanic. Every new machine or building—every improvement in a tool or machine part—starts on the Drafting table. On paper, the Draftsman works out the new idea in the lines and figures which speak the language common to engineers and mechanics; and his drawings and blueprints give the engineer's instructions to the skilled workers who do the job.

Draftsmen in Wide Demand

And Draftsmen are equally necessary in many other less familiar lines—thousands are employed by patent attorneys—cemeteries—golf course designers—testing laboratories—map makers—museums—educational institutions—city park systems—landscape gardeners—publishers of technical books—city planners—model makers—industrial research associations—furniture makers—stone cutters—large buildings, etc. In fact, there is hardly a business or industry of any size that does not employ Draftsmen.

Well-Paid Line with Real Future

Drafting is well-paid, interesting, necessary, high-grade office work along engineering lines—covers all types of construction and manufacturing—carried on in light, airy working quarters—brings you in touch with important men of the organization—and, because of the training and experience it gives, leads direct to very desirable positions in Engineering, Building, and Manufacturing. Write today for full information about the opportunities open to you. No obligation.

American School

Dept. DD-945

Drexel Avenue at 58th Street

Chicago, Ill.

Be An ARTIST



Make \$50 to \$100 a Week

Learn at Home This Amazingly Simple Way

More and more trained Artists are needed each year. 28,531 magazines, advertisers, newspapers, printing houses, etc., pay good money for art work. Our simple, proven, personalized method makes it fun to learn Commercial Art, Cartooning and Designing quickly, AT HOME, in spare time.

Big Artist's Outfit Given

Drawing board, paints, brushes and all materials you need to learn and earn come with very first lessons. Actual fun learning to draw this new way. Be an artist and make big money!

Send for FREE BOOK

Our big Free Book describes latest developments and wonderful opportunities in this fascinating field and gives full details of this quick, simple method. Tells all about our students—their successes—what they say—actual reproductions of their work—and how many earned big money even while learning. Mail coupon below or postcard today. State age. (No salesman will call.)



\$125 a Week!—that's what our graduate, Miss L. F. of Brighton, Ontario, is making—selling her work in Montreal.

\$3000 for W.R.K.—of Newark, N. J. He writes that just two contracts brought him that neat sum!

\$3380 a Year!—that's what our graduate R. K. K., of Michigan, is drawing as Art Director of a big engraving house.

Free Book shows how

Washington School of Art, Studio 1212
1115—15th St., N. W., Washington, D. C.
Please send me, without obligation, your Free Book, "Art for Pleasure and Profit."

Name.....Age.....

Address.....

City.....State.....

When writing please mention Popular Mechanics

Be a DENTICIAN



Learn at home to make Crowns Plates, Bridgework, etc., for Dentists. Easy, practical way to learn mechanical dentistry at home in spare time. Full equipment of tools and materials included with course FREE. Low tuition. Easy terms. Write for FREE BOOK about this money-making profession that is not affected by "machine age."

McCARRIE SCHOOL OF MECHANICAL DENTISTRY
207 N. Broad St., Dept. 704, Philadelphia, Pa.

ELECTRICAL ENGINEERING

A BROAD, basic, intensive course complete in one school year. Includes fundamentals of Refrigeration, Air-conditioning, Electronics. Approved by educators, endorsed by industry. 43rd year. Catalog.



BLISS ELECTRICAL SCHOOL
122 TAKOMA AVE., WASHINGTON, D. C.

You Can Regain Perfect Speech, if you

STAMMER

Send today for beautifully illustrated book entitled "DON'T STAMMER," which describes the Bogue Unit Method for the scientific correction of stammering and stuttering. Method successfully used at Bogue Institute for 34 years—since 1901. Endorsed by physicians. Full information concerning correction of stammering sent free. No obligation. Benjamin N. Bogue, Dept. 161, Circle Tower, Indianapolis, Indiana.



Learn to Write

Begin Today. Write for my Free Book, "How to Become a Good Penman." It contains specimens and tells how others learned to write in spare time. Your name elegantly written on a card if you enclose stamp for postage. Write today. F. W. TAMBLYN, 418 Ridge Bldg., Kansas City, Mo.

Law!

LEARN AT HOME

Are you adult, alert, ambitious, willing to study? Investigate LAW! We guide you step by step—furnish all texts, including 14-volume Law Library. Training prepared by leading law professors and given by members of bar. Degree of LL. B. conferred. Low cost, easy terms. Send NOW for Free, 64-page "Law Training for Leadership."

LaSalle Extension University, Dept. 1264-L, Chicago

JOBS FOR THOUSANDS



are opening in the live fields of **Air Conditioning, Drafting, Electricity, Housing, Engineering, Radio.** Don't delay. Start training now at this accredited 32 yr. old college. B. S. Degree or shorter courses. 80-Page Blue Book tells about opportunities.

CHICAGO TECHNICAL COLLEGE
R78 Tech Bldg., 118 East 26th St., Chicago, Ill.

Learn PHOTOGRAPHY at Home

Make money taking pictures. Photographs in big demand. Commercial Photography also pays big money. Learn quickly at home in spare time. No previous experience necessary. Write today for free new book, *Opportunities in Modern Photography.* American School of Photography, Dept. 1359, 3601 Michigan Ave., Chicago.

LES Correspondence Courses in RADIO and ELECTRICAL ENGINEERING

ELECTRICAL ENGINEERING covers complete electrical field. Most modern course. Very understandable.

RADIO ENGINEERING. Ultra-modern course in radio, public address, photo-electric work. Trains you to be super-service man, real vacuum tube technician. Run like a college. Tuition ONLY \$25, either course. Deferred payment plan. WRITE TODAY for free copies of school catalogs, student magazines, etc.

LINCOLN ENGINEERING SCHOOL 855-N So. 37th St., Lincoln, Nebr.

The Lost Word

THE KEY TO SECRET WISDOM

"Like a bolt from the heavens, the word was spoken and from the reverberations of its sacred syllables, came the creation of the Universe"—so relates an old, old legend. Through the ages men have searched in vain for this lost word. In its stead they found keys to a secret wisdom. They learned how to unlock the hidden possibilities slumbering within everyone—startling, unused powers that make for a greater life.

This Sealed Book—FREE

A sealed book by the Rosicrucians, reveals the plan whereby you may obtain this wealth of knowledge leading to the greater joys and rewards of living. For free copy without obligation, write Scribe E. H. Y.

The ROSICRUCIANS
SAN JOSE [AMORC] CALIFORNIA
NOT a religious organization

LEARN AUTO MECHANICS

in 8 weeks!

Earn \$35 to \$75 a week as an Auto Mechanic. Never in the history of the automotive business has there been such a demand for TRAINED men. 8 weeks training fits you for a job that's waiting for you or to open your own repair shop. Read what two McSweeney trained men have done. Hundreds of others can tell you facts equally interesting. Don't look for a job! TRAIN for it!

Farrell, Pa.
Dear Mac: Please forward me your catalog. I want it to add to my traveling souvenirs. I am working in a modern garage although I have been out of school only four weeks, thanks to McSweeney Training. My best regards to all. M. Klushauk

Rector, Ark.
Dear Mac: Just a few lines which might interest you. I left your school two years ago last May. Since I left I have not seen a day I could call "hard times." I have been working ever since I left and have averaged in my earnings \$173.00 a month, in spite of the hard times. Many thanks. Thos. J. Sharp

EIGHT WEEKS of Actual Shop Training

No books or lessons the McSweeney way. First you learn the "why" of everything you do; then under competent instructors, you DO the job. You work on real equipment and machines, with the real tools of the auto expert. In eight short weeks you are TRAINED to hold down a permanent BIG PAY job. Any man 16 to 50 can learn. Write today for New Low Tuition Offer.

Diesel Engines and Aviation Ground Course!

Diesel and Aviation coming fast! Prepare now for the wonderful opportunities of the future.

MONEY BACK GUARANTEE!

Eight weeks of intensive training, actual shop work with real tools on real equipment, qualifies you for a Big Pay Job. If not satisfied, your tuition will be refunded.

FREE Write today for Big Free Book on AUTOS. Get the facts about jobs; and Low Tuition Offers. Mailing the coupon does NOT obligate you. It obligates ME to tell YOU how you can train for Big Money in eight short weeks. Address Dept. 10-24

McSWEENEY SCHOOLS AUTOMOBILE—AVIATION CLEVELAND, OHIO or KANSAS CITY, MO.

Write Our School Nearest You

McSweeney Auto and Aviation School,
Dept. 10-24, Cleveland, Ohio or Kansas City, Mo.

Without cost or obligation, send me your Big FREE Book; also full information about your Low Tuition Offer.

Name.....

Street.....

Town..... State..... Age.....



If you like to draw, test your sense of design, color, proportion, etc., with our simple Art Ability Test. An opportunity to get a frank opinion, free, as to whether your talent is worth developing.

Magazines, newspapers, publishers and advertisers spend millions yearly for illustrations. Design and color influence the sale of most things we buy. Artists have become important to industry. Machines can not displace them. If you have talent, train it. Drawing may be your surest road to success.

The Federal Schools, affiliated with a large art, engraving and printing institution, has trained many young men and women now serving industry as designers or illustrators, capable of earning from \$1,000 to \$5,000 yearly. Its Home Study courses in Commercial Art, Illustrating and Cartooning, contain exclusive illustrated lessons by many famous artists. Practical instruction by experienced men is the reason for its many years' outstanding success. Courses sold on easy payments.

Send today for Art Test and Free Book explaining present opportunities in art. Just fill out and mail coupon below.

FEDERAL SCHOOLS, INC.
12135 Federal Schools Bldg.
Minneapolis, Minn.

Send me, without obligation, your Art Test and Free Book.

Name.....
Address.....
Age..... Occupation.....

Wrestling Book FREE

Learn at Home



Be an expert wrestler. Learn at home by mail. The greatest wrestlers of all, Frank Gotch and Farmer Burns, both world's champions have prepared the most wonderful course of lessons ever written on Physical Culture and Expert Wrestling. Be strong and healthy! Handle big men with ease. This great free book tells you how. Don't delay. Write now. State your age.
Farmer Burns School, 3379 Elwood Bldg., Omaha, Neb.



Learn Public Speaking

At home—in spare time. Many overcome "stage-fright," gain self-confidence, and increase their earning power, through ability to sway others by effective speech. Write for free booklet, *How to Work Wonders With Words* and requirements.
NORTH AMERICAN INSTITUTE, Dept. 1359
3601 Michigan Avenue Chicago, Illinois

RADIO ENGINEERING

RCA Institutes offers an intensive course of high standard embracing all phases of Radio. Practical training with modern equipment at New York and Chicago schools. Also specialized courses and Home Study Courses under "No obligation" plan. Illustrated Catalog on request



RCA INSTITUTES, Inc. Dept. PC-35
75 Varick Street, New York, N. Y.
1154 Merchandise Mart, Chicago
Recognized Standard in Radio Instruction Since 1909

AUTO-MECHANICS & WELDERS

Auto Mechanics and Welders are in big demand. Complete courses in arc and acetylene welding, body and fender bumping, spray painting and metal finishing. Pay while you learn. Enroll now at special low rates. Write today.
MICHIGAN TRADE SCHOOL
3758 Woodward Ave., Detroit, Mich.

Write for FREE CIRCULAR

LEARN WATCHMAKING AND ENGRAVING

BY OUR PROFIT-SHARING PLAN
OUR GRADUATES SUCCEED

One of our Iowa students started in a very small way—now doing over \$30,000 a year. Another in Wisconsin, over \$10,000 the first year. Day or night classes. Call or write for FREE BOOK.
Chicago School of Watchmaking, Dept. 3401, 155 N. Clark St., CHICAGO.

LEARN AVIATION MECHANICS!

Secure thorough training in airplane and engine mechanics. Complete flight training—modern equipment. Write for new low rates.
ROBERTSON AVIATION SCHOOL, St. Louis Municipal Airport, ROBERTSON, MO.

SHORTHAND IN 30 DAYS

Boyd, the wonderful easy system, 150 words a minute guaranteed. Send today for catalog and sample lesson.
CHICAGO HOME STUDY SCHOOLS
801 Reaper Block Chicago, Ill.

Government Jobs

EXAMINATIONS SOON
COLUMBIAN CORRESPONDENCE COLLEGE,
WASHINGTON, D. C.

MAKE MONEY at Home!

Exclusive new process. Bigger, better, quicker crops. More money for you! Big demand. We buy. Mushroom book free.
AMERICAN MUSHROOM INDUSTRIES, Ltd.
Dept. 473 Toronto, Ont.

Grow Mushrooms IN YOUR CELLAR OR SHED

EARN up to \$25.00 A WEEK or More

BIG PAY DIESEL JOBS OPEN



Practical training all types Diesel engine.



Diesel - electric and Diesel-hydraulic training

The Pacific Northwest, home of the Adcox School, is the "hot spot" of Diesel activity and a center of Diesel employment, offering countless opportunities for Diesel Experts. Every branch of Diesel industry is represented here including trucks, tractors, Diesel shovels, Diesel donkeys, Diesel motors in mines, large and small boats—it is probably unequalled by any other Diesel center in the world.

The Adcox School has been in business 26 years and is the most prominent school of its kind in the United States. Forty thousand square feet of floor space. Recommended by leading educational authorities as one of the finest practical trade schools in the world. Students from virtually every state including Alaska.

Study in the matchless climate of the Pacific Northwest. Enjoy numerous outdoor recreations such as fishing, hunting, hiking, sight-seeing, mountain climbing, swimming and other thrilling, healthful diversions.

Earn board and room while learning. You will find us friendly people here with a personal interest in your welfare and success, and fair treatment at all

times. Adcox graduates located in all parts of the world. Remember, the best training pays best.

Before you choose a Diesel school carefully read valuable Adcox Diesel School Catalog No. 18A—free on request while the present supply lasts.

DIESEL BOOK FREE

MR. L. L. ADCOX, President
L. L. ADCOX TRADE SCHOOL
237 N. E. Broadway, Portland, Ore.

Without obligation, please send FREE Diesel School Catalog No. 18-A.

Name.....
Address.....
Town.....State.....



BUTTER YOUR SOLES
WITH NEW SO-LO PLASTIC RUBBER!
Dries tough over-night! Out-wears leather!
Waterproof! Flexible! Non-skid! Guaranteed! Fix auto top, cuts in tires, etc. Take this ad to any Hardware or Shoe Store. ASK FOR SO-LO PLASTIC RUBBER.



Men & Women Earn Cash at Home!
Grow fancy giant mushrooms in cellar, attic, barn. Easy, odorless method. We show you how, furnish guaranteed materials and buy crops. Valuable big book, pictures free if you write quickly. (Est. 1908.) UNITED CO. 3848 Lincoln Ave. Dept. 128 CHICAGO



No JOKE TO BE DEAF

—Every deaf person knows that—

Mr. Way made himself hear his watch tick after being deaf for twenty-five years, with his Artificial Ear Drums. He wore them day and night. They stopped his head noises. They are invisible and comfortable, no wires or batteries. Write for TRUE STORY. Also booklet on Deafness.



Artificial Ear Drum
THE WAY COMPANY
729 Hofmann Bldg. Detroit, Michigan

don't WORRY

Why put up with years of needless discomfort and worry? Try a Brooks Automatic Air Cushion. This marvelous appliance permits the opening to close, yet holds rupture securely, comfortably—day and night.

Thousands report amazing results. Light, neat-fitting. No hard pads, metal girdle or parts to chafe or gouge. Patented in U. S. and 13 foreign countries. Try one 10 DAYS WITHOUT A PENNY'S RISK. You'll be delighted. Free book on Rupture and convincing facts mailed postpaid in plain sealed envelope. Address **BROOKS COMPANY, 111C State St., Marshall, Mich.**



Be an ELECTRICAL EXPERT



**NEW JOBS!
GOOD PAY!
For Trained Men**

Don't stick to a small-pay, no-future job. There's more money and bigger opportunities for you in Electricity—because it's a "Basic" industry and proved itself "depression-proof." All other businesses depend on Electricity, and on the "Trained" Electrical Expert. Get into this Big-Pay Field, yourself. Good jobs—good pay—big future for properly "trained" men.

NEW USES FOR ELECTRICITY—GOVERNMENT PROJECTS—MAKE MORE JOBS

Air Conditioning, Electric Refrigeration, Diesel-engine motor-power, stream-line trains, Photo-cells, Public Address Systems, Radio, and similar electrical devices, demand Specialists with electrical training. The Government housing program—Rural electrification—hydro-electric projects, such as Tennessee Valley and Boulder Dam developments will make thousands more jobs for trained men. America is on the verge of its biggest Electrical Boom. Get your Training now. Prepare for a big future in this gigantic field. Start today.

EARN EXTRA MONEY WHILE YOU LEARN

Learn at home with quick, easy, low-cost "pay it's own way." Cooke Training—now right up-to-date. Over 100,000 men successfully trained in the past 20 years. Many earn \$35 to \$75 a week and more. Big years ahead for Cooke Trained Men everywhere.

WORKING OUTFITS INCLUDED

Six practical working outfits and Special Spare Time training included. Consultation and Employment service given too. No experience needed. Write for Free Book and details of Money Back Agreement. Mail coupon now.

**L. L. Cooke School of Electricity, Dept. 19,
2154 Lawrence Ave., Chicago.**

Send me your FREE Book about Electricity and details of L. L. Cooke Training.

Name.....
Address.....
City.....State.....



When writing please mention Popular Mechanics

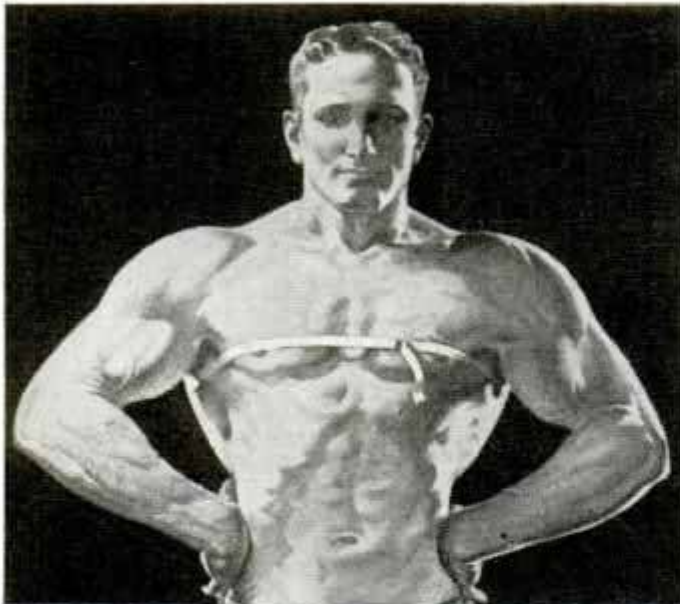

"IF YOU DO NOT ADD AT LEAST 3 INCHES To Your CHEST IT WON'T COST YOU ONE CENT!"

—Signed: GEORGE F. JOWETT

THREE SOLID INCHES of muscles added to your chest and at least two inches added to each of your biceps, or it won't cost you a penny. I know what I am talking about. . . I wouldn't dare make this startling agreement if I wasn't sure I could do it.

All I want is a chance to prove it! Those skinny fellows who are discouraged are the men I want to work with. I'll show them how to build a strong man's body . . . and do it quickly. And I don't mean cream-puff muscles either. Wouldn't you, too, like to get a he-man's chest like the idealized figure above? I will show you how to get real, genuine invincible muscles that will make your men friends respect you and women admire you!

So many of my pupils have gained tremendous development that I am willing to stake my reputation that you can do the same . . . REMEMBER . . . If I fail it will cost you nothing!

Send for "MOULDING A MIGHTY CHEST" A SPECIAL COURSE FOR ONLY 25c

I will not limit you to the chest; develop any part or all of your body. Try any one of my test courses listed below at 25c. Or try all six of them for only \$1.00. You can't make a mistake. The assurance of the strongest armed man in the world stands behind these courses.

RUSH THE COUPON TODAY AND I WILL INCLUDE A FREE COPY OF "Nerves of Steel, Muscles Like Iron."

It is a priceless book to the strength fan and muscle builder. Full of pictures of marvelous bodied men who tell you decisively how you can build symmetry and strength the Jowett way! Reach out—grasp this Special Offer!



FREE BOOK WITH PHOTOS OF FAMOUS STRONG MEN



GEORGE F. JOWETT
"Champion of Champions"

Winner of many contests for strength and physical perfection!

JOWETT INSTITUTE OF PHYSICAL CULTURE

Dept. 42c, 422 Poplar St., Scranton, Pa.

George F. Jowett: Send, by return mail, prepaid, the courses checked below for which I am enclosing.....

- Moulding a Mighty Arm, 25c
- Moulding a Mighty Back, 25c
- Moulding a Mighty Grip, 25c
- Moulding a Mighty Chest, 25c
- Moulding Mighty Legs, 25c
- Strong Man Stunts Made Easy, 25c
- All 6 Books for \$1.00.

Name Age.....

Address

BE A CARTOONIST



AT HOME IN YOUR SPARE TIME under supervision of NORMAN MARSH, creator of the famous comic strip "DAN DUNN, SECRET OPERATIVE 48," appearing in the big newspapers. Success—fame—real money may be yours when you learn the easy simple methods and secrets which make the MARSH cartoons so successful. Send name for free details of this personal course. Act Today!

MARSH CARTOON SCHOOL, Chicago Daily News Bldg., Dept. K-1, Chicago, Ill.

New York Established 1902

Electrical

Ask for free booklet **School**

44 West 17th St., N. Y. C.

SHOWCARD LETTERING

BY OUR NEW METHOD. We quickly teach you by mail in your spare time. A good profession. Easy to learn. Increase your earning power. Write now for complete information. EDBEN SERVICE, 521 Fifth Avenue, New York, N. Y.

FIXES PUNCTURES WITHOUT PATCHING



Pays YOU up to \$6.85 IN AN HOUR

NO-FLATZ—amazing new product fixes punctures air-tight INSTANTLY—PERMANENTLY without patching—without removing tire or even jacking up wheel. Just squirt into tube through valve stem, pump up tire and drive away. Makes tire puncture-proof besides. Ends changing tires in winter's snow and slush. Popular priced! Guaranteed!

FREE SAMPLE—Rush name and address for Free Sample Offer and money-making details. Pays up to 203% Profit. Act now!

NO-FLATZ COMPANY, Dept. T-171, Cincinnati, O.

Profit from Books

Popular Mechanics Press specializes in supplying books on any subject. Look over this list. Check the books you want, and mail this advertisement as your order blank. Write for information about books on any special subject you may be interested in.

- | | |
|--|--|
| AIR CONDITIONING SERVICE MANUAL
Small Unit Apparatus..... \$5.00 | LANDSCAPE GARDENING
Practical..... \$2.50 |
| ARMATURE WINDING and Motor Repair \$3.00 | LEATHER MAKING AND Home Tanning \$1.00 |
| AUTO RACING
How to Build Dirt Track Racers..... \$1.00 | LOCKSMITHING
Revised Edition..... \$2.00 |
| AUTO REFINISHING
Duo With Spray Gun..... \$1.50 | MONEY MAKING FORMULAS
15,000 Practical..... \$5.50 |
| BRICKLAYING
Plain and Fancy..... \$1.50 | MUSHROOMS
Raise for Market..... \$1.75 |
| CAMPS AND LOG Cabins (Building) \$2.00 | NEON SIGNS
Only book on. New... \$3.00 |
| CARBURETORS (All Makes)
New, Revised Edition.. \$2.50 | PATTERN MAKING
Excellent New Book... \$1.50 |
| CHEMICAL MAGIC
Experiment, Entertain, Mystify..... \$1.00 | PLASTERING
Best Instruction Manual..... \$1.25 |
| DANCE
Learn at Home Without Music or a Partner... \$2.00 | RADIO PHYSICS COURSE
New edition. Everything about Radio from A to Z..... \$4.00 |
| DRAWING
Freehand and Perspective..... \$1.50 | REFRIGERATION SERVICE Manual (All Makes) \$5.00 |
| DRY CLEANING (Practical) and Dyer \$3.00 | RUBBER ARTICLES
How to Make..... \$2.00 |
| ENGINEERS' VEST POCKET Reference Book \$1.50 | SHEET METAL
Construction Work... \$2.00 |
| FURNITURE REPAIRING
Finishing and Decoration..... \$3.00 | STAMP COLLECTING
Why and How..... \$1.50 |
| HYPNOTISM
How to Become an Expert..... \$2.00 | Steam Engineer's License
How to Obtain..... \$2.00 |
| INVENTION, YOUR
How to Protect and Merchandise..... \$1.50 | TAXIDERMY, HOME Mount Trophies Profit, Pleasure \$1.50 |
| | WROUGHT IRON WORK
Practical..... \$1.35 |

Books sent C. O. D. anywhere in U. S.

Just check the books you want, and mail the whole advertisement. It is your order blank. When postman hands you books, pay him the price and few cents postage. If you send remittance when ordering please include 10 cents per book extra for postage.

POPULAR MECHANICS PRESS, Room P-12, 200 East Ontario St., Chicago, Ill.

BE AN ARTIST

WE CAN TEACH YOU DRAWING in your own home during your spare time. Thirty-five years of successful teaching proves our ability. Artists receive large salaries.

Write today for Art Year Book
SCHOOL OF APPLIED ART
Dept. 195, 10 E. Huron St., Chicago, Ill.

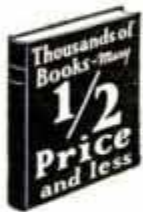

ANY BOOK IN PRINT

Delivered at your door. We pay postage. Standard authors, new books, popular editions, fiction, reference, medical, mechanical, children's books, etc.—all at guaranteed savings. Send card now for Clarkson's 1936 Catalog.

FREE Write for our great illustrated book catalog. A short course in literature. The buying guide of 300,000 book lovers. The answer to your Christmas gift problem. **FREE** if you write **NOW—TODAY!**

CLARKSON PUBLISHING COMPANY

1259 S. WABASH AVE.

CHICAGO, ILLINOIS

LOOK! MAGIC CASE

HANDS YOU A LIGHTED CIGARETTE

Take a beautifully enameled Case from your vest pocket. Press a magic button! Automatically there is a spark—a flame. A LIGHTED Cigarette—your favorite brand—is delivered to your lips. You PUFF and SMOKE. A revolutionary invention... guaranteed... amazingly low priced. Get a Magic Case for 15 Days' Trial at our risk. **AGENTS!** Get facts about Big Profits. **MAGIC CASE MFRS., 4234 Cozens Ave., Dept. W-370, St. Louis, Mo.**



BOYS MAKE YOUR OWN ELECTRIC TELEPHONE

one that really works. Build it and talk to your friends in the neighborhood. Can be made from odds and ends at low cost. Plans and instruction booklet 35c. Imell, Box 45, 144 West Diamond Lake Road, Minneapolis, Minn.



STEP INTO THE Spotlight



Banish Boredom... Earn Extra Money START TO PLAY VERY FIRST DAY

Picture the joy of playing a snappy foxtrot, dreamy waltz or mellow old favorite on the Xylorimba. No reason why you shouldn't! Xylorimba is easiest of instruments to play and yet the most spectacular. In constant demand by orchestras, radio stations, at lodge meetings and parties. Marvelous opportunity to increase popularity, make big spare-time money. No bothersome practice or exercises. With Free easy lessons you actually Start to Play Very First Day.

BIG FREE BOOK tells all about Deagan line, liberal trial offer and easy payments. Send coupon today for your free copy.

J. C. Deagan, Inc., Dept. 8459, 1770 Berneau Ave., Chicago

Send me, without obligation, full details of Free Trial offer and easy-payment plan on the Deagan Xylorimba.

Name.....

Address.....

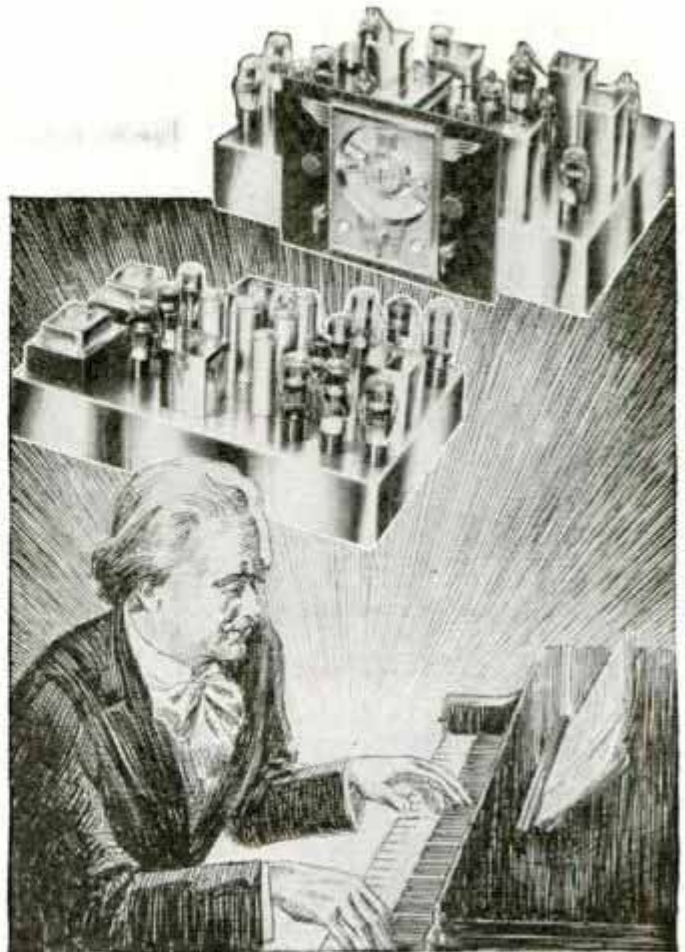

CUSTOM BUILT ROYALE 24-TUBE Radio

THIS super radio-musical instrument was created for those discriminating and exacting few who insist on the finest, most beautiful, most precisely built radio obtainable. A set of rare distinction, musically and artistically perfect, the Royale offers over 100 features... assuring a luxurious and idealized type of brilliant, sparkling, guaranteed world-wide performance... heretofore unattainable. It is today's only "aged" radio... offers 6 tuning ranges... 4½ to 2400 meters... etc.

This 24-tube achievement out-performs other receivers. Assures Unlimited Scope Full Fidelity. Audio range is 20 to 16,000 cycles per second... 40 watts undistorted output. Fully guaranteed for 5 years... absolute satisfaction assured.

The 30-day **FREE** Trial Offer enables you to try the Royale in your own home, without obligation. Write now for literature or mail coupon.



ROYALE RADIO CRAFTERS
(Division Midwest Radio Corporation)

Dept. 204-F, Cincinnati, Ohio.

Without obligation, send me literature describing Custom-Built, 24-Tube 6-Tuning Range, Royale Radio... and details of your 30-day Free Trial Plan.

Name.....

Street.....

Town..... State.....

When writing please mention Popular Mechanics

LEARN THE BEST PAY TRADES



Demand for Auto-Diesel Experts Increases



TRAIN AT NATIONAL SCHOOLS

Diesel operation and repairing calls for trained men. Everywhere you hear Diesels discussed and you can see the application of Diesels in trucks, tractors, trains, boats, busses, airplanes, power shovels, etc. To qualify for a good job you must first become trained. In the National Schools in Los Angeles you receive the most practical training under the guidance of expert instructors who teach you by proven methods.

Learn in Los Angeles

Not only do we instruct you in all branches of Diesel training, but also give you complete Auto Training, qualifying you for jobs in garages, service stations, factory branches and transportation departments. Here in Los Angeles you receive instruction in one of the most modern trade schools.



Opportunities for Good Jobs

National's method of training you is most comprehensive. You receive two complete courses for the price of one—Autos and Diesels. We offer full training in Auto Repair which is essential to all Diesel operators. Upon graduation you have a complete understanding of, and experience in, the operation of gas, gasoline, butane and Diesel engines and farm power tools.

A Fortune in Brand New Equipment

There is absolutely no dummy equipment at National. Tens of thousands of dollars have been recently invested in brand new equipment which you will actually work on during your training period. We have just completed enlargement of our Diesel School, tripling its capacity. Equipment includes Diesel and gas engines of most modern design, testing equipment, late model autos, machine tools, etc.

Oldest, Largest Trade School in West
Established 1905. More than 30,000 successful graduates. National Schools is a million-dollar institution, occupying a magnificent building in Los Angeles.

Earn Room and Board While Learning
The majority of National students earn room and board while learning. With limited finances you can enroll. We assist students to obtain part-time jobs. Cash R. R. fare allowed to L. A.

Mail Coupon for Free Book

This book gives full information regarding the combined Auto and Diesel Courses. Profusely illustrated.

NATIONAL AUTOMOTIVE SCHOOLS
Dept. 12-PMA, 4000 So. Figueroa St., Los Angeles

NAME _____

ADDRESS _____

CITY _____ STATE _____

Qualify for These Good Jobs

Diesel Mechanic; Fuel Injection Expert; Diesel Service Man; Diesel Trouble Shooter; Auto Mechanic; Auto Electrician; Battery Expert; Carburetor Expert, etc.



When writing please mention Popular Mechanics

NEW INDUSTRY NEEDS MEN

Is This YOUR Opportunity?

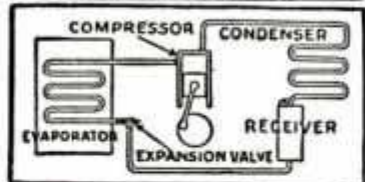

AIR CONDITIONING and ELECTRIC REFRIGERATION—two giant industries—have need for reliable and properly qualified men for servicing and installation work. . . . To meet this need, men who can meet requirements are being selected by the Utilities Engineering Institute and fully trained in spare time for the work involved. For **FREE BOOKLET** containing detailed information, write fully, giving age, experience, present occupation, etc.

UTILITIES ENGINEERING INSTITUTE
Box 1125, 400-410 N. Wells St., CHICAGO, ILL.

EARN More Money! Get a

Bigger Job—a better position. Big salaries are paid for **IDEAS**—and the ability to present them clearly—concisely—convincingly. Become a Master of Words. Increase your Vocabulary. Learn to express thoughts easily—effectively—forcefully. Know **WHAT** to say—**HOW** to say it. Make **WORDS** your servant. Enjoy the power of fluent speech. Get **WORD-OLGY**—The Vocabulary Builder. A simple, easy, fascinating method of word study anyone can understand. Mailed C. O. D. or postpaid—only \$2.00. Send **TODAY**. Get started **NOW!** Ask for folder.

WORDOLGY ASSOCIATES P. O. Box 82-B, Grand Cent. Sta., New York, N. Y.

60 ART LESSONS Only \$1.95 POST PAID

Become Talented Artist with Big Income
This thorough Course by Alexander Murray, famous Art School instructor, makes it easy to learn art in spare time. Teaches commercial art, cartooning, lettering, anatomy, perspective, adv. layout, etc., without bother or expense of corresponding. You get all 60 lessons at once—no waiting for next lesson. Over 215 instruction illustrations. 125 pages of drawing paper **FREE**. Send only \$1.95 for Complete Course postpaid—or pay postman plus postage. **MONEY BACK** if not delighted after inspecting. Start Now turning your spare time into **MONEY!**
EDUCATIONAL SUPPLY CO., Dept. A101-M, Racine, Wis.

50c VALUE FOR 19c! GUARANTEED

No. H5-Drexel blades. Finest blue steel blades made for Gillette type razors. Test one or two blades. If not the best you ever used, bar none, return unused blades and your money will be refunded. Guarantee with each package.

25 blades 19c. 100 blades 79c (Sent postpaid)

FREE Wholesale' catalog of 3500 fast sellers. Send for copy today.
Spors Co. 10-35 Main St. Le Center, Minn.

ARMY AND NAVY SUPPLY CO.
Bargains—Army, Sport Goods, Firearms, Clothes, Shoes, etc. Send 10c for new catalog, to be redeemed on first order.
Army & Navy Supply Co. 4772 Lester St. Richmond, Va.

Earn Money with this WONDERFUL NEW INVENTION!

Real Money Maker for Part or Full Time AGENTS!

Make quick PROFITS with new, patented invention—sells on "flash" demonstration. Main or side-line. Big, new market.

Soldering Iron and Blow Torch in ONE!
Light, portable. Eliminates pump, pressure system, stove, charcoal—ALL!

PROOF IT SELLS—Agent Rowland earned \$300 a month. —Ware sold 50 Irons while stopping in hotel! "Going like hot cakes," says Bailey.

WRITE quick—get established for EXCLUSIVE territory. A postal will do!

JUSTRITE MFG. CO., 2061 Southport, Dept. 13-59 Chicago



EASY to play

With an easy playing Conn band instrument, you can be ready for band or orchestra in 4 to 6 weeks. A sure road to popularity if you start on a Conn. Choice of the world's greatest artists. Magnificent tone. Many exclusive features—yet they cost no more.

Ask to see the marvelous new models now being displayed by Conn dealers.

WRITE FOR THIS NEW FREE BOOK

Home trial. Easy payments. Write us for free book on whichever instrument interests you most. Mention instrument.

C. G. CONN, LTD., 1231 CONN BLDG. ELKHART, IND.



CONN
BAND INSTRUMENTS



Here is my gift to mother! Made in three evenings. We had the lamp. Taxidermy material cost me 85¢.

WORK out your own ideas for lamps, book ends, clocks, etc., etc., decorated with stuffed specimen of squirrels, rabbits, white mice, pigeons, frogs, etc., etc.

Beautiful Decorations
for your own home or to sell to others.

Malcolm Greany made a squirrel lamp. Now he writes us that he has 15 orders for squirrel lamps. **Figure his profit!**

This case is invented to illustrate an interesting fact.

FUN!

For tired business men; for the older boys, too.

Wonderful hobby evening after evening. Easily learned. *Very* inexpensive. Act now! And **profits**, if you sell your handicrafts; start your own business. See coupon below.

Learn this art: Learn at home from instruction sheets mailed to you. After 4 or 5 evenings of practice in spare time you should successfully mount the simpler specimens of birds and fish. Thereafter practice makes perfect. (And Taxidermy supplies, some glass eyes, etc. cost **so** little.) Decorate your den! Send coupon for booklet.

If you fish or hunt the time is **now**, Mr. Sportsman, to learn taxidermy. With wild game scarce and scarce, you'll get more pleasure out of one specimen you personally mount than out of your former big bag. Prepare yourself **now**. Practice up on Taxidermy these Winter evenings!

mount pigeons, squirrels, frogs, etc.

OR And make money mounting the trophies of Sportsmen who did **not** learn the knack of Taxidermy. Send coupon below.



Humorous Taxidermy: For example, mount frogs playing fiddles, squirrels boxing, chipmunks in a fight, etc., etc.



Learn Tanning, Too Our simple instruction sheets show you the **Krome-Tan** process to make excellent water-proof and heat-proof leather from hides. Big savings for farmers—or make money selling your leather.

Learn Fur-work, Too We show you at the same time how to make up furs, to renovate furs, etc., etc.; for your family; for profits.



Complete Instructions on the knack of Taxidermy, tanning and fur-work, can be had by mail at a ridiculously small cost.

Free Book

To N. W. School of Taxidermy (Est. 1902)
3379 Elwood Bldg., Omaha, Neb.

Without any obligation send me (free) your illustrated book telling me how I can quickly learn the knack of Taxidermy through instruction sheets by mail.

Name.....

Address.....

Age.....
State your age!



Electric Arc Welding

Revolutionizes modern Industry

Milwaukee Manufacturers desire to contact earnest men to work and learn Electric Arc Welding in their laboratories at the School of Engineering. Small training Fee. Accepted applicants will be fully trained until ready to pass rigid test and assisted in securing employment.

Arc Welding presents one of the outstanding opportunities for steady income and future success. Welding is growing rapidly, replacing large and intricate castings, rivets, nuts, bolts, screws. It is commonly used in assembling cranes, hoists, bridges, structural steel work, etc. No limit to the application of welding to industry, increasing durability and reducing manufacturing cost. There is a decided shortage of properly trained welders. Why be content with ordinary work, hit or miss jobs and low pay when in a short time you can become a trained Specialist in Welding?

MILWAUKEE
SCHOOL of ENGINEERING
Institute of Electrotechnics

PM-1235 No. Broadway, Milwaukee, Wisc.

Without obligation send Free Booklet "The Dawn of a Gigantic Industry and Its Outstanding Opportunities."

Name..... Age.....

Address.....



CLASSIFIED

Advertisements



Advertisements in this section, 35 cents per word, each insertion, minimum 10 words, payable in advance. To be inserted under proper classification in January issue, copy should be in our office November 14th. Popular Mechanics Magazine, 200 East Ontario Street, Chicago, Illinois

YOU'LL PROFIT

By reading and answering the classified ads in this section. Hundreds of opportunities to make and save money.

Popular Mechanics Magazine,
200 East Ontario Street, Chicago, Illinois

Gentlemen: We thank you for your letter of January 16th in which you acknowledge receipt of our classified advertisement with remittance.

"Results from our small advertisement have been unusually satisfactory from 'Popular Mechanics Magazine'. Your magazine must penetrate every nook and corner of the United States for we received orders from all parts of the country. If we ever stopped advertising in 'Popular Mechanics Magazine', you can rest assured that we must be out of business for we'll advertise in your magazine as long as we are in business."

(Original letter on file in our office)

Yours very truly,
ATLAS DISTRIBUTING CO.

AUTOMOBILES

MIDGET Car, midget motorcycle headquarters. Full line, parts, plans, motors, wheels, rims, brakes, fenders. Completely illustrated catalog—10c. Bates Midget Motors, 4877 Armitage, Chicago.

MIDGET Racing. Get full details on this thrilling sport; facts for fans, builders, drivers; track sizes, regulations; car specifications, pictures, working drawings. Book tells all about Indianapolis cars, Miller-Fords and world's fastest car. Brand new Automobile Racing, fourth edition, \$1 postpaid, \$1.12 C.O.D.; 3c tax if you live in Ohio. Ray F. Kuns, Dept. 15, Madisonville, Cincinnati, Ohio.

DODGE Generator quickly changed to arc welder. Welds fenders, cylinder heads, etc. Plans, drawings \$1.00. Neal Brown, Richland Springs, Texas.

AUTO Owners drive 200 miles—46c. Fuel oil conversions \$12.00. Agents wanted. Stamps (3c) secure information. Desogas Company, 1719 Addison, Berkeley, Calif.

BUILD Airflow midget. Photograph 25c. Plans \$1.00. Lusk, 4841 Ogden, Cicero, Ill.

WINTER Coming—Don't drive blindly—Sleet, ice, snow kept off windshield by U-C-Clearly—50c. Agents, retailers, wholesaler wanted. High profits. Home Necessity, 902 West Prairie, Taylorville, Illinois.

SEMI-DIESELIZE Your car for \$5.00 and burn Diesel oil. Among greatest automotive improvements yet. Complete instructions \$1.00. Stamp brings literature. Earl Behling, Box 944, Los Angeles, Calif.

200 MILES 35c. Burn stove distillate in your car. Get parts in any junk yard. Complete detailed information and blueprint 50c (coin). C. C. Carmichael, 5013 2nd Ave., Los Angeles, Calif.

AUTO SUPPLIES—EQUIPMENT

AUTO Paint stripper, 1/16 inch. Guaranteed. \$1.00 C.O.D. Alexander, 1821 Leavenworth, Omaha, Nebr.

NEW—Auto owners—Quick starting cold, or wet. Extra mileage—pep. Easy attached \$1.25. E G Sales Co., 321 Broadway, New York City.

ANTI-FREEZE Formula \$1. Few cents protects you entire winter. Feller, Box 29, Arlington, New Jersey.

DEMONSTRATORS. Compressor, test bench, 8-hour battery charger—are welder. Guaranteed. Trial and terms. Ken's Equipment Exchange, Box M-1252, Troy, Ohio.

NON-SOLDERING Battery terminal. Saves buying new cable. Send 15c for sample. Hiawatha Sales Co., Atchison, Kansas.

NEW Old type auto pulse electric fuel pump \$2.75. A. Pendleton, 902 Hadley, Whitliff, Calif.

NICKEL Plating outfits, connect to your battery. No tanks used, thousands in use. \$3.00 prepaid. Gunmetal Co., Ave. J, Decatur, Ill.

A. C. GENERATORS

TWENTY New practical changes for automobile generators. See our advertisement at bottom of page 136A. Auto Power, Inc.

AUTO TRAILERS

\$1 VALUE For 50c. Get facts on trailer coach design. This 50-page book can save you 100 times its cost. Order direct from author. Money back if not satisfied. 2c tax in Ohio. Ray F. Kuns, Dept. 125, Madisonville, Cincinnati, Ohio.

BOOK Of camp trailer plans containing fifteen modern designs ranging from 8 to 16 feet. Copy sent postpaid for \$1.00. Toellen Coach Company, Box 25, College Park Sta., Detroit, Mich.

AUTO-TRAILER Bodies. Use Ferdico Waterproof Canvas Cement for attaching fabric to roof and sides. Send for information. L. W. Ferdinand and Company, Canton and Albany Streets, Boston, Mass.

REFINISH Your own car. New instruction book treats all phases of painting and refinishing autos and trucks. Written for the man who wants to renew his own car, but covers also the business end of refinishing for the professional. \$1.65 postpaid. Popular Mechanics Press, Room C35, 200 E. Ontario St., Chicago.

MOTORCYCLES, BICYCLES AND SUPPLIES

MOTOR Bicycles \$45.00, motorcycles \$40.00, tires \$3.95, all parts, wheels \$1.00, chains \$1.00, frames \$5.00. Bicycles \$11.50. Engines \$10.00 to \$75.00. Balloon wheels for boys automobiles. Send 10c. Price Cutter Deninger, Rochester, N. Y.

RECONDITIONED Motorcycles. New and used parts for all makes. Complete service. Whitman Motorcycle & Supply Co., 405-9 Southwest Blvd., Kansas City, Mo.

SEND 15c For illustrated used motorcycle catalog. Bargains. Largest stock genuine Indian parts and motorcycles. Indian Motorcycle Sales, Kansas City, Mo.

POWER Your bike with low priced Speed-bike motor. Attach in one hour. Eighty miles to gallon. Thirty miles an hour. Free folder. Guaranteed. Outboard Motor Corp., 4032 N. 28th St., Milwaukee, Wis.

DIME Secures sample Speedway Racing Magazine, catalog English motorcycles, crash helmets, speed books, supplies. Clymer, 434 W. Pico, Los Angeles, Calif.

BOYS—How to lace bicycle wheel. Instructions—quarter. Foreman's, Racine, Wisconsin.

MOTORCYCLES—Direct to you at rock-bottom wholesale prices. Rebuilt, roadtested and guaranteed Indians, Harleys, etc. Send 10c today for "Bargain Bulletin 43." Crandall Hicks Co., 780 Commonwealth Avenue, Boston, Mass.

HENDERSON, Indian, Super X and Harley Davidson parts, new and used. Cylinder welding and grinding. Indian Agency, 3661 Archer, Chicago, Ill.

HENDERSON, Excelsior, Harley, Indian, used parts, alloy pistons, catalogue and wings pin 10c. Ballak, 1115 Chestnut Street, St. Louis, Mo.

MOTORCYCLE Bargains, lowest prices, bargain sheets for stamp. Motorcycle accessories. Rochester Harley Davidson Corp., 129 West Main St., Rochester, N. Y.

AVIATION

PARACHUTES. Navy surplus new 18 ft. sizes \$4 each postpaid and insured. No C.O.D.'s. Remit with moneyorder. Thompson Bros., Balloon & Parachute Co., Aurora, Illinois.

WRITE For free model airplane samples. Aero Shop, 3050 Huribut, Detroit, Mich.

PROPELLERS For airplanes, icecleads, snowsleeds. Catalog dime. Lorenzen Propellers, Niles, Michigan.

QUALITY Propellers—Factory prices, for aeroplanes, sleds, boats, two and four blades, save 50%. Hibbs, Ft. Worth, Texas.

USED Airplanes \$85 and up. Literature 10c. Continental, Box 344, Dept. 2, Indianapolis, Ind.

HUNDREDS Airplane bargains. Fall directory 20c. Aircraft Directory, Athens, O.

TACHOMETERS 2400 r.p.m., Altimeters 2800 feet, 300 h.p. Stromberg carburetors, all new, guaranteed \$4.95 each. Air Transport, Garden City, N. Y.

GET Into aviation. Air transport pilots get up to \$7,000 per year; mechanics, \$2,500. Learn at this government approved school. Write for complete information. State age. Lincoln Flying School, 2004 Aircraft Building, Lincoln, Nebr.

BATTERIES, GENERATORS, ETC.

MODERN Propeller design for wind battery charger, large blueprint and instructions \$1.00. Clarence W. Trost, Rice, Kas.

DELCO Light plants. Rebuilt, guaranteed. M. Pilske, 2033 E. 69th, Cleveland, Ohio.

GENERATOR Propellers, expertly designed at factory prices. Hibbs, Ft. Worth, Texas.

EDISON Storage batteries for power and lighting systems. Especially adapted for all make plants. The ideal battery for wind driven generators. Replace your old batteries with Edisons. Rugged construction. Non-acid. No sulphation. Fifteen year life. Five year unconditional notarized guarantees. Complete generating plants. Free illustrated literature. "See Jay Battery Company." 82 Sterling Avenue, Yonkers, New York.

6-32 VOLT Wind electric plants. Kits \$10.00 up. Parts catalog, plans 25c. Currier Mfg. Co., Minneapolis, Minn.

ELECTRIC Lights—Wind driven—You build them. Write Wind Motor Electric, Ridgway, Mont.

EDISON Non-acid storage batteries for all types electric light plants. None of the acid battery diseases. Long life. Fully guaranteed. Attractive bargains in light plants, generators, motors, etc. D. Hawley Smith Company, Croton Falls, N. Y.

GENERATORS—32 Volt, 1000 watt. Brand new \$25.00. Victor Mfg. Co., Box 75, Adrian, Michigan.

ELECTRICAL SUPPLIES AND EQUIPMENT

ELECTRICAL Experimental laboratory kit—Contains alternating generator, small motor, microphone, transformer, polarized relay, condensers, electroplating chemical, carbons, electro magnets, etc. Contains 25 pieces commercial apparatus, weight 16 pounds. Laboratory makes arc furnaces, secret detectophone, search light, extension telephone, generates electricity, etc. Complete instructions. Educational, fascinating, useful. Original cost \$17.75. Special bargain \$2.79. Other bargains. Stamp for catalog. Electrical Salvage Company, Box 524-AJ, Lincoln, Nebraska.

INSULATION, Wire, varnishes—complete line of materials and parts. Send 10c for new, 60-page, wholesale catalog. Autopower, 408-B S. Hoyne Ave., Chicago.

FIRE Prevention; electrically operated, 75c. Herr Fire Alarms, Collinsville, Ill.

NEW 1000 Watt floodlights \$6.50. Surplus, 938 N. Homan, Chicago.

WELDING AND SOLDERING

300 AMPERE Welding generator. Fine condition, \$150.00. Wilmot Auto Supply, 1970 Wilmot St., Chicago.

DEMONSTRATORS, Electric arc welders. Money-saving prices. Used by the government. Trial and terms guaranteed. Hobart Welders, M-1253, Troy, Ohio.

WELDING, Soldering, brazing outfits \$6.00 to \$69.00. Superior Oxy-Acetylene Company, Hamilton, Ohio.

ARC-WELDING Outfit \$1.25. Weld fenders, braze, solder. Lavrow, 4368-W, Warren, Detroit. Stamp appreciated.

HOW To make efficient small electric spot welder, hundreds other useful devices in Shop Notes, Vol. 29, only 50 cents postpaid. Popular Mechanics Press, Room C 35, 200 E. Ontario St., Chicago.

ENGINES, MOTORS, DYNAMOS

ELECTRIC Motors. Bought, sold, exchanged, repaired, rewound. ¼ to 100 h.p. motors for sale. ¼ h.p. single phase \$12.50, ¾—\$18.50, 1—\$22.50. Three phase 1 h.p. \$16.00, 2—\$22.00, 3—\$27.00. Winding data supplied any motor \$1.00. Temps Bros. Motor Company, 797 Myrtle Avenue, Brooklyn, New York.

NEW Universal 110 volt motors, 1/12 h.p. long shaft. Suitable for experimental work. \$3.50 postpaid. Minerallac Electric Company, 25 N. Peoria Street, Chicago.

25 SLIGHTLY Used ½ horse alternating motors \$9.85. ¼ horse new General Electric \$5.90. ½ horse Universal motors \$1.95. Wilmot Auto Supply, 1970 Wilmot St., Chicago.

MOTORS, Supplies, motor repairing. Wholesale bargain pricelist free. Mailorder Electric Co., 153 North Desplaines, Chicago.

GOVERNORS Control speed of any make of auto engine, regardless of load changes, when used for stationary or portable power production. Read our ad on page 132A. Candee-Smith Governor Co.

THREE To ten KVA alternating generators. Motors, converters. Queen City Electric, 1736 Grand Avenue, Chicago.

FOR Sale—Small elec. motors, high speed. 1/10 h.p., 110 volts, universal. Reworked, \$1.50 postpaid. L. McConnell, 1619 Edgewood Ave., Racine, Wis.

WINDING Data, 100 AC motors, various horsepower and voltage, \$1.00. Motor Data Co., 3002 Monroe, Kansas City, Mo.

REWINDING Motors and 330 other valuable articles in Shop Notes for 1935—50 cents postpaid. Popular Mechanics Press, Room C35, 200 E. Ontario St., Chicago.

MACHINERY, TOOLS AND SUPPLIES

14" x 5' LODGE & Shipley lathe, quick change, good condition, price \$175.00. 14" x 5' Monarch, quick change, good condition, \$150.00. 14" Steptoe crank shaper, \$125.00. All sizes of machine tools. Terms to suit. Cincinnati Machinery & Supply Company, 27 W. Second Street, Cincinnati, Ohio.

KELLOGG Air compressors, excellent condition, \$6.00. Taylor, 103 East 102nd Street, New York.

ELECTRIC Drills. Brand new, \$5.95 up. Descriptions sent. Shaw, 31-A Winchester St., Boston, Mass.

BARGAINS, Demonstrators, electric arc welders, guaranteed, 30 days trial and terms. Write Ken's Equipment, Box M-1254, Troy, Ohio.

½" CHUCK Bench drill presses \$2.50. Lacquer sprayer \$2.00. Compressors, belting. Write Universal Electric Company, Indianapolis.

BOATS, OUTBOARD MOTORS, ETC.

BUILD Substantial 16½ foot cedar shell canoe. Particulars, stamp. Arbec, Bedford, Ohio.

SPECIAL Winter prices, cut-to-fit kayaks, \$5.00 up. Send dime for literature. James-town Specialty Co., Box 377P, Titusville, Penna.

BUILD Your own boat. Our fabricated frames save you ⅓. Describe requirements and let us quote. Illustrated catalog 100 boats 10c. Bay City Boats, Inc., 1552 Adams, Bay City, Mich.

12-FOOT Flat bottom rowboat—complete plans 25c. Free boatbuilding catalog. The Rudder, 15 Murray Street, New York.

OUTBOARD Parts—New or used—All makes—What do you need? Crandall-Hicks Company, 782 Commonwealth Avenue, Boston, Mass.

GUNS, FISHING TACKLE AND SPORTING GOODS

CUSTOM Tanning: on your small catch of furs. Hides for rugs, mounting game heads. Chokers, coats, Tanning buckskin. W. W. Weaver, Reading, Michigan.

SNOWSHOES, 12x48, \$7.00. Yours repaired, relaced \$2.50 up. Indian pack baskets, Hudson Bay blankets, etc. Catalogue ready. Howe Fur Company, Box P. Coopers Mills, Maine.

NEW Pocket weapon 40c! Kills game! Blue steel. Maple grip. Illustrated literature for stamp. Grant Sportgoods, B51, Detroit, Mich.

HICKORY Ski staves 70c each, archery and homecraft wood. Catalog free. Sportswood, Ironton, Mo.

GUNSMITHS' Secrets—Bluing, checkering, engraving, etc., 25c. International Agency, Cincinnati.

PROFIT And pleasure in taxidermy. Complete guide for the preparing and mounting of animals, birds, fish, reptiles, etc., for home, den, or office. \$1.65 postpaid. Popular Mechanics Press, Room C35, 200 E. Ontario St., Chicago.

FIELD GLASSES, TELESCOPES AND MICROSCOPES

DON'T Buy any microscope until you see our complete catalog and price list. Binoculars, telescopes, air guns, etc. Dwight-Carlson, Dept. C, 175 Fifth Ave., New York.

MICROSCOPES, Telescopes, binoculars. America's lowest prices. Optical catalog free. Brownson Company, 234 Fifth Avenue, New York.

BUILD Reflecting telescope. Catalog free. Optical Laboratories, Larchmont, New York.

ANTIQUES, RELICS, INDIAN GOODS

5 ARROWHEADS 20c. 3 Birdpoints 18c. Knife, birdpoint, scraper, spearhead 45c. 15 arrowheads, lancehead, scraper, spearhead 85c. Knife, fisharrow, gempoint, warpoint, pottery 80c. Tomahawk, wampum, fletcher 60c. 35 arrowheads 49c. Catalogue. Coins. Minerals. Curios. Lemley Curio Store, Northbranch, Kansas.

THOUSANDS Pieces old glass. List for stamp. Mrs. Don Hoover, 505 North Eighth, Quincy, Illinois.

INDIAN Costumes, curios and beadwork. Buying direct from Indian. Prices reasonable. Free catalogue. Pawnee Bill's Indian Trading Post, Pawnee, Oklahoma.

INDIAN Arrowheads—100 assorted, \$2.00. Bellson Company, Box 229, Marion, Ohio.

NOAH'S Ark buys most anything. 116 East First St., Tulsa, Okla.

15 ARROWHEADS, Spearhead, pottery, scraper 99c. Scapling knife, lancehead, gempoint, wampum, 99c. Photolist 10c. Robert Helke, Rutland, Illinois.

ANTIQUE Guns, Indian relics. List five cents. Elmer Ellis, Webster Groves, Mo.

TAXIDERMISTRY

PAPIER Mache, largest line of deer head forms, elk, moose, goat, sheep, rug head forms. Full line of taxidermist supplies. Papier Mache Specialties Co., Reading, Michigan.

TAXIDERMISTRY Supplies—Quality artificial eyes, teeth, genuine Jonas head forms. Tools, materials, etc. Everything for the progressive taxidermist. Send for big illustrated catalogue—Free. Jonas Bros., 1049 Broadway, Denver, Colorado.

SCHMIDT'S Seven-book taxidermy course, \$1. Free supply catalog. Taxidermic Manufacturers, Memphis, Tenn.

LEARN Taxidermy, complete \$1.00. 48 page supply catalog free. Taxidermy Studio, 134 West 32 St., New York.

LEARN Taxidermy. Five courses. Blue Beaver Taxidermy School, Lemont, Ill.

DOGS, BIRDS, POULTRY, PETS

XMAS Gifts that live! Woolly, warm Saint Bernard puppies! Write: Royal Kennels, Napierville, Que.

LABRADORs—All ages, ideal for children, the favorite with hunters. Mac's Kennels, Norton, Kans.

FLYING Squirrels. Christmas pets. \$3 pair. Shuler Horne, Charleston, S. C.

ST. BERNARD Puppies, beautiful Christmas gifts. Paramount Kennels, 5345M McKenna, Montreal, Canada.

POPULAR Poultry Magazine—Helped thousands to success and profits in poultry raising. Sample free. Twelve issues, 35c. Four years, \$1.00. The Poultry Item, Box 71, Sellersville, Pa.

POULTRY Tribune—Leading poultry magazine. Five years \$1.00; one year trial 25c in U. S. Poultry Tribune, Dept. C-93, Mount Morris, Illinois.

SPORTSMEN: 200 Pointers, Setters, straight cooners, combination hunters, rabbit and fox hounds, cheap, list free. Ramsey Creek Kennels, Ramsey, Ill.

BEAUTIFUL Pure white police dogs. Ansonia Kennels, Mose, N. Dak.

ROOTS, HERBS, TREES AND SHRUBS

FREE! Send for this amazing new "Herbalist Almanac." Interesting! Instructive! Educational! Contains over 200 valuable herb medicine recipes and Indian secrets for home use. Beautifully illustrated in natural colors. Needed every home. Dime covers postage and handling. Write today! Botanics, 145 West 112th Street, Chicago.

FARMS AND FARM LANDS

INSURED \$3000; Price \$1800. 11 acres on improved road, 4 miles small city; 9 rooms, hardwood floors, electricity and bath; cemented-basement barn, two 30-ft. hen houses, 55 fruit trees, 6 acres berries; almost given away at \$1800, good terms; pg. 52 big free fall-winter catalog. Strout Agency, 255-P 4th Ave., New York City.

\$5 DOWN, \$5 Monthly, 20 acres in Missouri Ozarks, \$100. Fishing, hunting, trapping. Hubbard, 216 Grossman Bldg., Kansas City, Kansas.

INDEPENDENCE, Security assured, North Dakota, Minnesota, Montana, Idaho, Washington, Oregon farms. Bargain prices, easy terms. Descriptive literature, impartial advice. Mention state. J. W. Haw, 119 Northern Pacific Railway, St. Paul, Minn.

NEW Deal in farms, Minnesota, North Dakota, Montana, Idaho, Washington, Oregon. Rents are cheaper, prices lower. New low rates. Write for free book. E. C. Leedy, Dept. 1257, Great Northern Railway, St. Paul, Minnesota.

PROFITABLE OCCUPATIONS

RAISE Rabbits for us. We pay up to five dollars each. Large book and copy of American Rabbit Farmer gives full details. Ten cents. Address Outdoor Enterprise, Box 4, Holmes Park, Missouri.

"**FROG** Raisers needed!" Start backyard. Write for free frog book. American Frog Canning Company, (153-W), New Orleans, Louisiana.

INDIAN Candy. New. Original. Gorgeous flash. Money maker. Recipe \$1.00. Lettie Rhodes, Queensborough Station, Shreveport, La.

FROG Raising—If interested, we guarantee to save you money. Send 10c for literature now. American Frog Industries, Rayne, Louisiana.

BOOKS AND PERIODICALS

WONDERFUL Gifts! Magazine subscription bargains. Save many dollars. List those wanted, enclose stamp. Douglass, Box 742, Hanover, N. H.

FREE—Catalog of 310 books on gas engines, electricity, carpentry, concrete work, taxidermy, letter writing, magic, occult sciences, ventriloquism, hunting, fishing, formulas, etc., with 25c credit certificate for 3c postage. Franklin Publishing Company, 800 North Clark Street, Dept. 2012, Chicago.

WILL ROGERS 300 Page book with 30 illustrations \$1.00. Clifford Hoffman, 57 Broad, Albany, N. Y.

BIG Mails, magazines, catalogues, samples. Your name in 10,000 directories, 25c. Anderson Press, Coral Gables, Fla.

HOW To win prize contests 10c. Walnut Specialty, Everett, Mass.

GAMES AND ENTERTAINMENT

EXOTIC Fortune telling formula entertainment \$1.00. Dobbelaar, 3433 Madera, Los Angeles, California.

PLAYS, Operettas, musical comedies, complete minstrel first-parts with song programs, blackface skits, vaudeville acts, monologs, dialogs, recitations, juvenile plays and songs, musical readings, entertainments, make-up goods. Catalog free. T. S. Denison & Co., 623 So. Wabash, Dept. 11, Chicago.

TABLE Football. All the thrills of the real game. Send 25 cents for complete instructions. Radco, 212 E. Third St., Beaver Dam, Wis.

MAGIC TRICKS, PUZZLES, JOKER NOVELTIES

AMAZE And mystify! Be popular entertainer. No skill required. Two new books explain, describe hundreds baffling tricks you can do. "50 Mysteries Magic" and "Book 1000 Wonders," marvelously illustrated, bound together, both postpaid 10c. None free. Send today! Lyle Douglass, Station A-5, Dallas, Texas.

BOYS—Like magic? 3c stamp brings clever card trick. Asco, Frankfort, Ohio.

250 **MAGIC** Tricks illustrated, explained, 25c. Two clever pocket tricks free. Raythe, 744 East 126, Cleveland, Ohio.

SIX Sensational professional card tricks with ordinary pack. Instructions 25c. Big catalog 10c. Becker, 22-D Hale Avenue, Brooklyn, N. Y.

NEW Wonderful trick. Hat-coin! \$1. Otis Collins, Eugene, Oregon.

BOOK Explaining 250 parlor tricks of magic, etc., easy to perform. Postpaid 25c. Brown, 1401 Washington, Cairo, Ill.

LEARN Ventriloquism, 3c stamp brings particulars. Smith, 125 North Jefferson, Peoria, Ill.

MAGIC Catalog 20c. Lynn, 105 Beach, Dept. 3, Jersey City, N. J.

JOIN Magicians' Fraternity! Monthly magazine, sample 10c (contains many tricks). International Magicians, Mount Morris, Ill.

NEW Professional catalogue, 10c. Frank Lane, Little Bldg., Boston, Mass.

LARGE Professional magic catalogue, 25c. Holden, 220 W. 42nd St., New York.

FOR BOYS

EARN Christmas money. Order 50 sets Christmas seals. Sell 10c each. When sold return \$3.00 keeping \$2.00. St. Nicholas Seals, 43-PMD, Brooklyn, N. Y.

STAMP COLLECTING

IMPERFORATE 1c And 3c Chicago commemoratives and 33 U. S., including early issues; high values; commemoratives, airmail; envelopes; special delivery; postage due; revenues cataloging over 75c. All for 5c to approval applicants. Illustrated price-list free. Curhan Stamp Co., Dept. F, Gloucester, Mass.

LONDON. Once again a magnificent bargain. Send dollar bill for beautiful large lot of scarce stamps worth eight times as much. Money back if unsatisfactory. I sell no junk. Bileski, 38 Myddleton Square, London, E.C-1, England.

FREE: Collectors handbook. The finest 1,000 variety stamp collection ever assembled: \$1.25. Satisfaction assured. Elmer Long, 511 Seneca, Harrisburg, Penna.

AMAZING Value—35 different U. S. early, commemoratives. Air mail, etc. 10c to approval applicants. Stamp Shop, 809 Holland Bldg., St. Louis, Mo.

MOURNING Stamps are the most popular of all commemoratives. These stamps are always issued in limited quantities, have a short life and are soon obsolete. Then they start to increase in value. We offer the following mourning stamps. Pilsudski (Poland), King Alexander (Jugoslavia), Hindenburg (Germany) and King Albert (Belgium) all for 10c to approval applicants. Globus Stamp Company, 268 - 4th Ave., Dept. 50, New York, N. Y.

SIXTY Attractive stamps from twelve different countries cataloging over \$1.50 to approval applicants—25c. Reference. Towson Stamp Shop, Towson, Md.

ZANZIBAR—Also Sudan, Somaliland, Tigerstamps, Togoland, Caribbean, Archer, Algerian, Centralamericans, Britishcolonials. This magnificent collection free for 5c postage. Graystampshop, Dept. PM, Toronto, Canada.

EXCELLENT Foreign approvals. 50 different British Colonial stamps 6c to approval applicants. H. Wilcox, Box 142, Torrington, Connecticut.

MYSTERIOUS Jungle packet: Abyssinia, Azerbaijan, Congo, Tanganika, Zanzibar, scarce triangle included. 5c. Approvals. Rosenberg, 3544 West 12th Place, Chicago.

PRESIDENT Murdered! King assassinated! Patriot hanged! Czar shot by firing squad! Beautiful woman burned at the stake! All above and more, included in horror packet—stamps picturing notable men and women who have horribly met violent death! Only 5c, approvals included. Thole, Box 86P, Jamaica, N. Y.

THE World in a packet—105 different stamps from 105 different countries, including Abyssinia, Afghanistan, Brunel, Falkland, Zanzibar, and others from Africa, Asia, South America, West Indies, etc. Our pamphlet which tells "How to Make a Stamp Collection Properly," together with our large bargain list of albums, packets, sets, etc., all for only 28c. Queen City Stamp Co., Room 36, 604 Race St., Cincinnati, Ohio.

SCARCE Iceland airmail triangle and fine packet of 60 different stamps, including Ubangi, Chad, Gabon, Inini, St. Pierre, Togo, Senegal-savages, ships and animal stamps. Only 5c to approval applicants. Potomac Stamp Co., Dept. 112, Washington, D. C.

200 **MIXED** 8c, 1000 Hinges 10c. Bargains galore, approvals. Harvey Teeple, Decatur, Indiana.

TWELFTH Wholesale Review—Greatly enlarged, sent free on application. Empire Stampco, Dept. MP, Toronto, Canada.

LIBERIA, Set eleven 1923, 20c to approval applicants. 35000 varieties available. Kelgwinco, Vineland, N. J.

OPPORTUNITY! Airmails from five countries, set Zanzibar, new triangles, St. Vincent, multitude others. Everything 10c to approval applicants. Krebs, Weirton, W. Va.

WANTED—Old letters, autographs, stamps and coins. Mathewson's, Jackson, Ga.

RARE Canadian coin booklets (dime). Park Coin Shop, Winnipeg, Canada.

NEW! Beautiful set! Ten Long Beach beconer stamps, 15c. Stamps accepted. Knipp, 1525 Rose, Long Beach, California.

GOYA Nude stamp \$0.10 to approval applicants. "Jewels," Tamaqua, Penna.

300 **DIFFERENT** Stamps 15c. Fascinating stamp stories free. Imperforate used for postage. Approvals included. Timberline Stampco, Box 1191, Denver, Colo.

FASCINATING Complete sets on approval. References. Bradys, 111 W. Jackson, Chicago.

U. S. 50 Different, gauge, millimeter scale, package hinges, magic square, price lists, for 15c. Hawkeye Stamp, Cedar Rapids, 39, Iowa.

POLAND Mourning, Greece charity set, 30 others, 5c with penny approvals. Lejac, Chowchilla, Calif.

INTENSIVE Approval service. Stamps by countries and airmails. Great assortment at 1/2c, 1c, 2c, etc. Application blank free. Stamp Studio, 68 Nassau St., New York City.

SHIP Stamp!! World's largest, free to approval applicants. Also 25 beautiful French, British colonials. Postage 3c. Kumler, King, Lancaster, Ohio.

FREE—Beautiful Egyptian air-mail set to applicants for approvals at 60% discount. Sets that satisfy. Charles Cleveland, 806 North Humphrey Avenue, Oak Park, Illinois.

UNITED States—Elaborate pricelist free. 45 different 10c, 75 different 30c. Seidenberg, Baroda, Mich.

CANADA Treasure packet. Fifteen cents. Frontenac Stamp Company, Kingston, Ontario.

APPROVALS. Penny up. Nice items. Priced right. Eldridge, Cassadaga, Florida.

500 **MIXED**, 20 Different Liechtenstein 10c! Approvals. Paul Baringer, Defiance, Ohio.

SPECIAL 750 Mixed stamps 35c, 1,000 mixed United States 30c. Frank Strosky, Box 53, Perth Amboy, New Jersey.

OLD Stamps wanted. Will pay \$100.00 for 1924, 1c green, Franklin (rotary, perforated eleven) \$1,000.00 if unused. Write before sending. Large illustrated folder 10c. Stamp Broker, 431 East Broad, Elyria, O.

GIVEN—6 Commemoratives Ecuador 1930 bicolors—5c to approval applicants. Von Muller, Doylestown, Pa.

"**QUALITY** Approvals"—Singles, sets. Priced right. Harry Tamer, Leonia, N. J.

200 **DIFFERENT** Beauties 10c. Approvals. Ide, Box 1875m, Milwaukee, Wisconsin.

U. S. Two sets 15c. Approvals. National Parks Stamp Shop, Gloucester, Mass.

50 **CHRISTMAS** Seals 15 cents. Salvatorian Fathers, St. Nazianz, Wis.

COMMEMORATIVE Album 50c, 100 selected quality stamps \$1.00. McGull, 2077 Wallace Avenue, Bronx, New York.

STAMP Collections bought! A. Kalber, 452 Ewing Court, Akron, Ohio.

TRIANGLE Stamps; 4 different 5c with approvals. Fort Dearborn Stampco, 5439 Aberdeen, Chicago.

JAPAN—25 Different only 2c with attractive approvals. Garcelon, Calais, Maine.

SPAIN, Set 5 airmails 10c. Approvals. References. Begin, 48, Sous-le-Fort, Quebec, Canada.

ATTRACTIVE Canada packet, commemoratives, scarce overprints, old and new issues. Only 3c with approvals. Raymond Peterson, 391 Minnesota, St. Paul, Minn.

SILVER Jubilee, Ethiopia, Italy, 25 different, 10c, approvals. Collectors', 166 High Street, Reading, Mass.

UNITED States: 15 commemoratives and pricelist 10c. We buy stamps. Doak, Fresno, Ohio.

GRAND Gift for approval applicants sending dime to Overbrook, 1719 Felton, Philadelphia, Pa.

APPROVALS! Price lists! Postage 3c. Ideal Stampco, 418 Maumee, Toledo, Ohio.

QUEEN Astrid memorial on cover, and packet Mozambique to approval applicants sending 10c. Henry Loufs, Dept. 81, Wetteren, Belgium.

BRITISH Silver jubilees from 3 different countries, imperforate 1c and 3c national parks—all included in marvel packet containing 25 different stamps from Azerbaijan, China, Ukrania, etc. All for only 5c to approval applicants. Clipper Stamp Co., Dept. 7, Gloucester, Mass.

SELL Stamps—8 sheets \$1.—Retail \$4. A. Kalber, 452 Ewing Court, Akron, Ohio.

MOST Notorious stamp ever issued! Famous Nude Spain (Goya's masterpiece), plus giant bicolor Caymans, \$5 U. S., imperforate "Park"—everything 10c to approval applicants. Viking Stamp Co., Dept. 816, Williamsburgh Bank Building, Brooklyn, N. Y.

UNPICKED Packet (20) stamps, 5c, 5c, 10c sets. Approvals. Elmer Gilmore, Box 1086, Butte, Montana.

1000 **MIXED** U. S., 25c. Rare Vatican commemoratives only 5c to collectors requesting foreign approvals. Lee, Bridgeport, N. Y.

YOU'VE Tried the rest, now get the best! "Challenge Collection" including Cape Goodhope, triangle, Thessaly octagonal, commemoratives, 10c with approvals. Free airmail collection, additional premiums given regular customers. Bargain Stamp Service, Box 5147, Los Angeles, California.

4 PESETA Goya Nude of Spain, No. 398, only 25c; 1 Peseta Nude, 10c; 10 Peseta Nude, 65c; complete Goya set, 18 values, \$1.35; approvals included. Paramount Stamp Company, 66-N Nassau Street, New York.

FREE—25 British colonies with approvals. Harlan, 5307 South Marshfield, Chicago.

PENNY Approvals by country! Hoerning Stamp Exchange, Kansas City, Kansas.

FREE! Philatelic parade. Stamps from everywhere including commemoratives, pictorials, air mails. Postage 3c. Request approvals. Grandstamps, 619½ South Spring, Los Angeles, California.

ALBUM Free—Spaces for 4,000 stamps, 2,000 illustrations, free to buyers of my approvals. R. F. Stern, 23-56P Crescent St., Long Island City, N. Y.

U. S.—300 Mixed 10c. To approval applicants. Kessels, Tucson, Arizona.

SILVER Jubilee packet. 25 varieties, 5c with approvals. Lincoln Stampco, 5535 May, Chicago.

COLLECTORS! Many buyers for your stamps listed in the guide. 50c postpaid. Royal Bookco, Balsden, W. Va.

40 GREECE 10c; 10 Epirus 10c; 40 Japan 10c; 25 Egypt 10c. To approval applicants. Anchor Stampco, Rutherford, N. J.

50 STAMPS 1c. Many obsolete. Album 3c. Bullard, 446 Tremont, Boston.

MAMMOTH Mystery packet rare stamps only 10c to serious approval applicants, also valuable free premiums with every selection afterwards. Our stamps are better, our service is different. Fair-Play Stamp Service, 1215 Browning Blvd., Los Angeles, Calif.

CONFEDERATE Bill, guaranteed genuine, 3c to approval applicants. Georgia Stamp Co., Decatur, Ga.

PENNY Approvals free from junk for serious collectors. Plenty of bargains at ½c up. Taylors Exchange, 6122 Woodlawn, Chicago.

200 DIFFERENT 10c. Approvals. Sachse Stampco, 1057 Trafalgar, London, Canada.

25 DIFF. Stamps, cat. \$1.00 for only 5c with approvals. T. Ahlquist, 1565 Nostrand Ave., Brooklyn, N. Y.

20 LEICHTENSTEIN .03c To approval applicants. Sodak Stamps, Sioux Falls, S. D.

WAR Declared! Abyssinia 5 diff. 10c; 15 diff. 45c. Scott's 1936 catalogue \$2.15 postpaid. Approvals. Victor Katzman, 630M West 141 Street, New York City.

WORLD'S Smallest triangle, 40 beauties, 10c. Demonstrators, 1743B Harrison, Chicago.

\$10 U. S. Plus 51 extrafine Newfoundland, Mexico, Canada, Salvador only 10c. Approvals and catalogues. Valuable premiums. Hart Stamp Company, St. Louis.

SCARCE Ceylon jubilee, 27 other British colonies, including jubilees, 6c with approvals. Killbuck Exchange, Wooster, Ohio.

MAKE Good money. Teachers, scoutmasters, clubmembers request our splendid agents' outfit. Substantial reference necessary. Hart Stamp Company, St. Louis.

100 DIFFERENT Postmarks 20c. Paul's, 2149 North Lamon Ave., Chicago.

50 SWEDEN, 50 Belgium, 50 Denmark, 10c each. Price lists free. John Graf, 1874 Loring Place, New York.

55 DIFFERENT United States commemoratives, Civil War revenues, airmails, etc. 15c with approvals; 120 different 50c; 200—\$1.00. Illinois Stampco, Rockford, Ill.

UNITED States mixtures 50c, Belgium 90c, Canada 75c lb. postpaid. Mission Co., 4512 North Racine, Chicago.

1000 STAMPS 10c, with approvals. Elbert Hale, Dept. P, Palestine, Texas.

MAGNIFIER, Stock book, stamp album, hinges, watermark detector, perforation gauge, millimetrescale, packet scarce stamps. Price 5c with approvals. Atlas Stampco, Box 4025, Culver City, California.

SCARCE Morocco airmail. Eritrea camel stamp, maps of stamp countries, watermark detector, hinges, perforation gauge, stamp album, many scarce stamps, 5c with approvals. Superior Stampco, Box 8276, Palms Station, Los Angeles, California.

FREE! 15 Different Peru to approval applicants, enclosing postage. Ranson, 3555 Fullerton, Chicago.

NEWFOUNDLAND, 15 Different 5c with approvals. Hudson Co., Plainfield, N. J.

KOREAN Red Cross stamp! Egyptian airmail 5c! Approvals. References. Stamp Center, Rt. 10, Sta. F, Milwaukee.

PACKET Of Guatemala 5c with approvals. Dunn, 2255 Winnemac, Chicago.

U. S. Mixture, 1000 for 50c, over 60 varieties. W. Keyser, Irvington, N. J.

25 DIFFERENT Canada 2c; 100 Germany 4c; 25 Italy 2c; 45 Hungary 3c; 25 Sweden 2c; 25 British colonials 3c; 25 Greece 5c; 25 Peru 6c; 25 Japan 2c to general foreign approval applicants. Penn Stamp Co., 5 Livingston, Binghamton, N. Y.

ALBUM Leaves—Looseleaf stamp stories, year \$1, 25 commemoratives, premium. National parks 10c. Reynolds, Flint, Mich.

5 BRITISH Jubilees 10c, with approvals. Seither, 1527 No. White, New Orleans.

120 DIFFERENT including United States commemoratives 10c with approvals. Tricity Stampco, Davenport, Iowa.

SILVER Jubilee, triangle, airmail. All included complete collection every western hemisphere country—Super value guaranteed. Only 10c with double premium approvals. Mutual Stamp Service, Box 666P, Ventura, Calif.

FREE!! Scarce triangle! Set 50-year old U. S.! Packet magnificent pictorials including English Silver Jubilee, famous Spain Goya and Newzealand Kiwi Bird! This \$\$\$ combination absolutely free with bargain approvals! Postage 3c. Midwood Stampco, (P6) Midwood Station, Brooklyn, N. Y.

UNITED States—89 different 25c. Chas. Reiter, Box 329, Chicago.

CHOOSE Your premium! Jungle stamps! Animal! Bird! Airmail!! Triangle and map stamps! Pick any ten from our big approval selection. Inclose 5c postage. Stamp Importers, Akron, Ohio.

10 ETHIOPIA 25c. Cat. at \$1.38 with approvals. Tulla, Box 76, Flatbush, Brooklyn, N. Y.

STAMP Collectors' Guide to profit producing results in modern stamp collecting. Price 30c. Lamp Mailing Co., Meriden, Conn.

FREE—Beautiful airmails from six countries, to approval applicants enclosing postage. Green & Co., Norwood, Ohio.

AUSTRALIAN Jubilee packet 5c with approvals. Ephraim Stampco, River Forest, Ill.

300 DIFFERENT 20c; 1,100, \$1; 2,000, \$2.50. Fred Onken, 630 79th St., Brooklyn, N. Y.

300 STAMPS 10c, Worldwide. Paul, 2070 Grand Ave., New York.

SILVER Jubilee! 6 different, only 5c. Approvals. Keating, 260 (P) Clinton, Jersey City, New Jersey.

JUBILEE—British silver jubilee set, only 8c to approval applicants. New Empire Stamp Co., 269M Jewett Ave., Jersey City.

FREE! Gorgeous packet including Spanish airmail, triangle, ship, animal, etc., to approval applicants enclosing 3c postage. Royale Stampco, South Pasadena, Calif.

FREE—100 Different stamps to approval applicants sending 3c postage. Yale Stamp Co., 226 W. Longwood, Detroit, Mich.

ILLUSTRATED U. S. list, price 50c, large complete U. S. price list free. Stanley Gibbons, 38P Park Row, N. Y.

FREE!!! Packet queer stamps from odd countries including Iraq, Rhodesia, Charkhari, Nigeria, with approvals. Postage 3c. Echostampco, P-1765 Ivar, Hollywood, Calif.

GIVEN! Liberal discounts on set approvals. Reference please. Oris Stampco, Kerrigan Av., Union City, N. J.

BIG Diamond Russian games set (5) 10c, approvals sent. Tonka Specialtyco, 3336 Ainslee, Chicago.

SILVER Jubilee mixture. 500 British colonies (125-150 different), plenty jubilees 50c. H. Beckman, Box 21, Station J, New York City.

METAL Perforation gauge 5c to approval applicants. References. Buckley, 35 W. 5th, Dayton, Ohio.

RUSSIA! 1935 "Sports" set (5) with approvals, 12c. The Stamp Shop, 261 N. Dennis, Decatur, Illinois.

25 JAPAN For 3c. Beverly Stamp Co., 9337 Vanderpoel, Chicago, Ill.

AIRMAILS! Pictorials! 65 different stamps from strange countries (no Europe), including beautiful New Guinea airmail, smallest stamp, Tasmania, Zanzibar, etc., 10c to approval applicants. Bargain Co., Box 39P, Starlon H, New York.

105 DIFFERENT, Congo, Newzealand, Guinea, etc., 3c to approval applicants. Extra—Two scarce airmails free. Hunziker, Box 225-X, Minneapolis, Minn.

ETHIOPIA Set free to applicants for penny approvals. References necessary. Stuart Stamp Company, Gowanda, New York.

FREE—25 Different United States stamps to approval applicants, 3c postage. Brownie Stamp Shop, Flint, Michigan.

FOREIGN Or United States mixture \$1.00 per pound (about 4000). Sample ¼—25c. Approvals sent. Elmer's 192A Washington St., Boston.

200 DIFFERENT, Triangle, airmail, etc., 10c. 1000 mixed United States 25c. R. H. Carlton, 610 Hillstreet Bldg., Los Angeles, Calif.

FREE! Two pictorial sets. Postage 3c. Roberts, 901F Fourth, Baycity, Michigan.

AIRMAILS—Brazil, Chile, Colombia, Ecuador, Mexico, all for 10c with double premium approvals. Progress Stamp Service, 235 South Hope, Los Angeles, California.

QUEEREST Stamp packet. Receive world's smallest stamp; Vatican City; scarce Liberia triangle (value 15c); 1935 Greek Red Cross picturing coiled snake in Garden of Eden; Australian Bushman; new Spanish Morocco; Japan 'quake stamp; Manchukuo; many others. Only 5c to approval applicants. R. M. Stamp Co., P. O. Box 230P, Port Chester, N. Y.

LIBERIA Snake triangle, \$10 United States stamp, 30 others. 5c. Crowder's, 127E North, Baltimore, Md.

FREE—\$1.00 U. S. stamp, our choice, with request for 52 page price list of United States and foreign stamps. Stamps on approval. References necessary. Special 8 Nicaragua 1903—30c. New Husman Stamp Co., 1122 Pine Street, St. Louis, Mo.

UNITED States approvals. Sullivan, New York Building, St. Paul, Minnesota.

INTERESTING List of bargains, collections, free. F. Hughes, Peterborough, England.

UNITED States, Canada, Newfoundland, Mexico! Where? Our "Four Star" approvals. Nothing like them! Write today. Kessels, Box 808, Tucson, Arizona.

GREAT Bargain! Packet triangles, assortment airmails, lot old and recent U. S. including \$2.00 and \$5.00 stamps, multitude others and useful souvenir. Everything only 10c to approval applicants. Union Stamps, P. O. Box 134, Toledo, Ohio.

CANADA Catalog only 10c, with 50 diff. Canada 25c. World specials—500 diff. 30c, 1000 diff. 85c, 2000 diff. \$2.50. Approvals with each order. Victoria Stamp Company, London 4, Canada.

BARGAINS Galore. Penny approvals. Choice of thousands. Flood, Clinton, Mich.

GIANT-SIZED Russian Zepelin stamp (cat. val. 20c!) and beautiful Lithuania airmail triangle; also big packet of 53 diff. stamps including Azerbaijan, Epirus, new Martinique, etc. and illustrated lists—all for 5c to approval applicants! World-Wide Stamp Co., Box 600, Camden, New York.

\$2.00 U. S. Capitol, No. 572, current postal issue. Cataloging 50c, only 5c, with approvals! Giant U. S. list, free! Tatham Stampco, Springfield, Mass.

MOZAMBIQUE, Jamaica, Portugal, British Colonials—30 different, 5c. Depraw, Ocean Park, California.

PENNY Approvals, that satisfy. Neil Gronberg, Box 541-P, Philadelphia, Pa.

WEEKLY Stamp magazine, thirteen weeks, 10c. Stamp Journal, Kalamazoo, Mich.

STAMP Dealers, your ad here will bring wonderful returns. Ask me for proof. F. W. Johnson, Manager, Classified Advertising, Popular Mechanics Magazine, 200 E. Ontario St., Chicago.

STAMPS Sent on approval. 50% discount. Fred Herzberg, 197 Grantley Ave., Elmhurst, Illinois.

SCARCE Airmail and triangle. Beautiful Uruguay "flying horse" airmail and scarce Guatemala triangle (smallest in the world) are included in our big packet of 60 different stamps from Alouites, Grand Liban, Venezuela, British and French Colonies, etc. All for 5c to approval applicants. Big illustrated lists free with each order. Write today! Mystic Stamp Co., (Dept. 80), Camden, New York.

200 DIFFERENT 10c. Big 50% approvals. Covert Stamp, 39 State, Rochester, N. Y.

THIS Ad worth 25c. If you send for our approvals and buy 50c worth or more—large selection of U. S. and foreign—reasonable prices. Morton Stamp Co., 1121 Olive, St. Louis, Mo.

SPECIAL While they last. 100 different stamps, \$3.00 catalogue value, 50c. Blidon, 709 Wenonah, Oak Park, Ill.

KOOKABURRA Bird!! Bolivia triangle! Packet of unusual stamps containing rare Kookaburra Bird, scarce Bolivia triangle, famous money stamp (printed on cardboard and also used as currency!); airmails from Mexico and Brazil; map, ship, animal, commemorative, etc. No Europe. Only 10c to approval applicants. DeSoto Stamp & Coin Co., 105 No. Clark St., Chicago, Ill.

RARE COINS

1936 ISSUE Just off the press. Anderson's Educational \$1.00 Coin Book. 55c until December 31st. Send money order or stamps. Or will take your old coins in trade, with 25c in cash, for book. W. R. Anderson, Suite 516, 108 North State, Chicago.

OLD Money wanted, up to \$5000.00 each paid for old coins. We pay world's highest prices. Wanted to buy any dates of half cents, large cents, flying eagle cents, Indian head cents, 2c pieces, 3c pieces, half dimes, 20c pieces, trade dollars, gold dollars to \$20.00 gold pieces. Quarters dated before 1916, half dollars before 1929, silver dollars before 1905, old paper money, foreign coins, encased postage stamps, etc. Send dime for large illustrated list before sending coins. Romanocoinshop, Dept. 564, Springfield, Mass.

RARE Celebes rooster coin, bargain list dime. W. Webb, Box 1854, St. Petersburg, Fla.

OLD Money wanted. Will pay \$100.00 for 1894 dime, S. mint; \$50.00 for 1913 Liberty head nickel (not buffalo). I pay big premiums for rare coins. Send 4c for large coin folder. May mean much profit to you. B. Max Mehl, H Mehl Bldg., Fort Worth, Texas.

\$4000.00 FOR \$1. Highest prices paid for all coins rare and common. Gold pieces. Some worth \$6000.00; foreign currencies; dimes before 1895—\$450; Liberty nickels before 1914—\$300; Indian head cents \$100.00; 1909 cent \$10.00; encased postage stamps \$13.00; half cents \$275.00; half dimes \$175.00; quarters \$300.00; fractional currency \$9.00; colonial coins \$300.00; 1933-50c \$4.00; Canadian coins \$165.00; etc. Send 15c for our complete 1936 illustrated catalog before sending coins. National-Coin Company (F-8) Springfield, Massachusetts.

COMMEMORATIVE $\frac{1}{2}$ ¢, Lincoln, Patriot, Sesquicentennial, Oregon Trail, Maryland, Arkansas, San Diego \$1.50 each. Eighty page catalogue 10c. Norman Shultz, Salt Lake, Utah.

20 ASSORTED Coins 25c. 100 coins \$1.00. Otto Oddehon, Williamstown, Kansas.

15 DIFFERENT Coins 25c. 50 old coins 50c. Coin Exchange, Box 2554, Kansas City, Mo.

FOR Sale: United States rare coins at special prices. Bargain selling price list and California 50c gold token 25c. Arey, Box 483, Muskogee, Okla.

WE Buy 1891, 1900 and 1907 Indian head cents. Full information one dime. Mattick, Box 3450, Altoona, Pa.

2 UNCIRCULATED Coins, 4 notes, big bargain list, all 10c. Hubert Carcaba, St. Augustine, Fla.

FREE! Foreign coin, banknote, and large illustrated coin catalogue. Send 4c postage. Coin approvals sent. Tatham Colnco, Springfield-125, Mass.

RARE United States, foreign coins, war medals. Catalogue 10c. Mengelle, Colorado Springs, Colorado.

UNITED States. Large cent, 2c bronze, 3c nickel and bargain list, 25c. Thirteen dates large cents, \$1.00. George P. Coffin, Augusta, Maine.

\$5.00 TO \$500.00 Each paid for old coins. Keep all old money. Send 10 cents for illustrated coin value book. 4x6. Guaranteed prices. Buying and selling. Coin Exchange, Box 5, Le Roy, N. Y.

CAMERAS—PHOTO SUPPLIES

THE Leudi, the newest, smallest, most dependable and most easily operated optical exposure meter made, is only $\frac{1}{2}$ the size of a packet of book matches and sells for only \$2.00. Equally efficient in daylight or artificial light for still or cine cameras, it eliminates every possibility of under or over exposed pictures and will soon pay for itself in film saved. Leather case, 15c extra. The ideal Christmas gift, ask your photographic dealer to show you the Leudi or if he cannot supply you, send his name and remittance direct to Mimosa American Corporation, 485 Fifth Avenue, New York.

MAKE Money in photography. Learn quickly at home. Spare or full time. Easy plan. Previous experience unnecessary. Common school education sufficient. Write for full information and requirements. American School of Photography, 3601 Michigan Avenue, Dept. 343-B, Chicago.

GET This 132 page book free. Contains complete descriptions and clear explanations of all latest developments in photography. Cameras, home movies, microscopes, weather instruments, barometers, storm guides, telescopes, field glasses, binoculars, compasses, magnifiers, reading glasses, etc., at sensational bargain prices. Ideal gifts for young and old. Write for this free book. Central Camera Co., Dept. K-112, 230 South Wabash, Chicago.

MENTAL Exposure guide. Correct exposure instantly without meter or tables. Saves cost in film in short time. Send \$1.00. Pix, 57 Morton St., New York.

PHOTO Formulas compounded. Stamp brings details. Frost Fotolab, Aurora, Mo.

HAVE You a camera? Send ten cents for recent number of our big magazine, showing how to make better pictures and earn money. American Photography, 116 Camera House, Boston, 17, Mass.

INCOME From your camera instead of expense. Low cost home course teaches you to make photographs for magazines, newspapers, advertisers. Tremendous demand. Earn good money wherever you live. Free book. Universal Photographers, Dept. 104, 10 West 33rd St., New York.

PHOTO FINISHING

20 BEAUTIFUL Embossed Christmas cards with envelopes. Made from your kodak negative, \$1.00. Kodak prints 2c each. Tucson Photo Service, Tucson, Arizona.

BEAUTIFUL Christmas cards from your negative 60c dozen with envelopes. Rolls developed 2 sets dated pictures 25c. Reprints 3c; over 20 reprints $2\frac{1}{2}$ ¢. Jones Studios, Davenport, Iowa. "Where the West Begins."

IMMEDIATE Service! No delay! Roll fully developed, carefully printed and two beautiful, full-size 5 x 7 double weight professional enlargements (or one tinted enlargement)—all for 25c coin. The experts' choice! Reprints 3c each. The Photo Mill, Box 629Z, Minneapolis, Minn.

SEND 25 Cents (coin) and negatives for three personal photo Christmas greeting cards, sunk centre embossed including beautiful tissue lined envelopes. Roanoke Photo Finishing Co., 309 Bell Ave., Roanoke, Va.

20 REPRINTS 25c. Films developed, two prints each negative, 25c. Skrudland, 6970-8 George, Chicago.

ONE Roll developed 16 prints 20c. Reprints $1\frac{1}{2}$ ¢ each. Work guaranteed. Frannie Photo Service, Frannie, Wyoming.

ROLLS Developed, two beautiful Nu-border enlargements, eight Nu-border prints, guaranteed fadeless, 25c coin. Giant Snapshots, Inc., Dept. A, Greenbay, Wis.

30 REPRINTS 25c. Larger orders 1c per print. Rolls developed and printed 15c. Trial, Box 8, RiverGrove, Ill.

ROLLS Developed and printed and two enlargements 25c. Prompt service. Electric Studio, Dept. PM, Escanaba, Mich.

15 PHOTOGRAPHIC Christmas cards \$1.00. Beautiful gift enlargement free. Sample from your negative 10c. Ideal Photo Service, Box 2255, Paterson, N. J.

PHOTOGRAPHIC Christmas cards, 20 for \$1.00. Send your negative. Agents wanted. Seascout Service, Box 125, Chelsea, Mass.

8x10 PHOTOS. Any subject. Movies. Stamp for bargains. Ahern, 56 9th, Troy, N. Y.

FILMS Developed, 2 prints of each 25c; 20 reprints 25c. Pine Photo, M-5134, Nevada, Chicago.

GET The best. Roll developed, beautiful hand colored enlargement, 8 neverfade border prints, 25c coin. Prompt service. Sun Photo Service, Drawer T, St. Paul, Minn.

20 REPRINTS 25c—Films developed, 16 prints 25c. Enlargements 8x10—25c; 5x7—10c. Low Photo, M-2657 Neva, Chicago.

COMPARE The difference! Roll developed, two professional double weight enlargements, 8 guaranteed prints, 25c coin. Excellent service. Nationwide Photo Service, Box 3333, St. Paul, Minnesota.

ANY Size kodak film developed, 2 prints of each negative and two free enlargement coupons, 25c. Reprints 2c each. We make beautiful Christmas cards from your negatives. Summers' Studio, Unionville, Missouri. No order under 25c.

TWO Professional enlargements with each roll developed and printed 25c. Eight reprints, two enlargements 25c. Hygloss, River Grove, Ill.

20 BLUETONE Reprints 25c. 5x7 enlargements 10c each. 8x10 enlargements, send picture or negative, 25c. Neverfade, Maywood, Illinois.

ROLLS Rushed! Developed and printed with two Supertone enlargements 25c. Extra enlargements four for 25c. Newtons, Maywood, Illinois.

ENLARGEMENTS From miniature negatives (approximately 3x4 inches) 5c each, when ordered from complete roll. Fine grain developing 25c. Fotoshop, Inc., 136A West 32d St., New York City.

TWO 5x7 Professional enlargements with each film, 25c. Lightning Film Service, LaCrosse, Wis.

TRIAL Roll developed and 8 prints 25c. Reprints 3c. Hand colored photo Christmas cards or photo greeting calendars from any negative 10c each, 14 for \$1.00. 8x10 enlargement 25c. Young Photo Service, 405 Bertha St., Albany, N. Y.

KODAK Enlargements 5x7, 10c, 3 for quarter, coin. Send best negative (film). Xnt Photo Lab., Dept. 5, Cedar Rapids, Iowa.

FILMS Developed. Any size. 25c coin, including 2 enlargements. Century Photo Service, Box 829, LaCrosse, Wisconsin.

BEAUTIFUL Glistening prints, roll developed, 8 guaranteed glistening prints, 2 enlargements 25c. American Photo Service, 2946 Nicollet, Minneapolis, Minn.

20 REPRINTS 25c. 100 Reprints \$1.00. Rolls developed with 16 prints 25c. Nordskog, 4, Maywood, Ill.

HAND Colored enlargement with each roll 25c. 40 reprints 50c. Colorgraph, Dunning Station, Chicago.

FINER Finishing. Rolls developed and printed. Colored enlargement, or two double professional enlargements all for 25c (coin). Genuine, nationally known. Moentone superior quality. Moen Photo Service, Box P-867, LaCrosse, Wis.

BEAUTIFUL Colored enlargement with each film 25c. Speedy service. Satisfaction guaranteed or money refunded. LaCrosse Film Company, LaCrosse, Wis.

ROLL Developed, two prints each negative 25c. Reprints $2\frac{1}{2}$ ¢. Enlargement coupon. Willard's, Box 3535-A, Cleveland Heights, Ohio.

ROLL Developed and 16 prints 25c. Smart Photo, Winona, Minn.

ROLLS Developed. Two beautiful double-weight professional enlargements and 8 guaranteed Never Fade Perfect Tone prints. 25c coin. Rays Photo Service, LaCrosse, Wisconsin.

MOTION PICTURES AND SOUND EQUIPMENT

MOGULL'S Bargains: Bell Howell projector \$59.50. 750 watt, motor, fan cooled projector \$99.50. 22"x30" roll beaded screen \$2.88. Victor soundfilm outfit 500 watt \$219.50. Agfa 100' automatic camera \$31.95. Used 400 ft. films \$3.00, sound \$14.00, soundise \$9.00. Free catalogue, library films sent anywhere. Trades accepted. We carry 8, 9 $\frac{1}{2}$ MM film, equipment. 35MM DeVry soundfilm projector, \$149.50, with amplifier \$185.00. Holmes 1,000 watt projector \$69.50. Super DeVry portable \$42.50 complete. Get our prices first. 1944M Boston Road, New York.

16MM FILMS—Art 10c foot—100 foot Pop Eye-Betty Boop—Mutt Jeff cartoons \$3.00 each. 1000 feet 35mm film \$1.00. Projectors—cameras \$3.00. 16mm talkies \$20 reel. Waldo Films, Box 524, Cincinnati.

EASY Terms! 8mm.—16mm. equipment. Catalogue free. Elder, Dept. B-18, Chelsea, Massachusetts.

16MM. ART Films. Brand new. 16mm. hand projector with 3 ft. art film \$1.85. 25c for art sample. Send 3c for illustrated art catalogue and complete 16mm. lists. Hollywood Cine Film Distributors, 1437 No. Highland, Hollywood, California.

16MM. FILMS. Supplies, list 3c. Edgeworth, Box 155, Blue Island, Illinois.

DEVELOP Your own 16mm. movies. Complete outfit, \$8.75. Cuts cost of movies 75%. Literature free. Hildman Engineering, 459 Irvin Ave., Rochester, Penna.

FREE—16MM. bargain lists. Popular star films 35c up. Projectors \$1.00 up. Art sample 25c. Home Movies, Box 32, Easton, Pa.

'MOVIE Making Made Easy' 50c. Moorfield-Shannon, Nutley, New Jersey.

BASS Bargain counter: Cine headquarters offers new Keystone A-7, seven speed 16 mm. 100 ft. camera with 3.5 lens at \$31.50. Bell & Howell 70A with Cooke F:3.5 lens and case at \$44.50. Geared rewind and dummy, \$1.00 a set. 100 ft. 16 mm. Mono film, including reversing, \$2.95. The Bass Bargaingram No. 215 is free. Also Bargaingram of still cameras. Send for your free copy. Bass Camera Company, 179 W. Madison St., Chicago, Illinois.

SUPER-SPEED Panchromatic 16mm film, 100 ft., \$3.75. Other films from \$2.19. Bargains in new, used equipment. Send for circular. Fotoshop, 136A West 32, New York.

8MM. FILMS: Mickey Mouse, travel, others. List free. Lincoln Film Service, Box 293-A, Saginaw, Mich.

16MM. CAMERAS, Projectors, films. Catalogue, 3c. Riedel Films, Euclid, Ohio.

BARGAINS—16MM. Film, equipment. Lists. G. Taylor, Box 234, Corning, N. Y.

35MM 100 FEET 25c Plus postage. Features, projectors. Marsala Company, Hillsdale, New Jersey.

16MM PROJECTORS, Cameras. Descriptive catalogue. H. B. Kay, 40 Linden Street, Brooklyn, New York.

LEARN Motion picture theatre business. Big opportunities. Home-study training. Eighth year. Free catalog. Theatre Institute, Elmira, New York.

LOOK! 35MM 200 Feet 75c. Bargain. Nelson Film, 35 Church St., Boston, Mass.

16MM FILMS Bought, sold, exchanged. Catalogue, 10c. Fotoshop, 136A West 32, New York.

STOP Experimenting! Elite titling outfit prints titles. Send for circular. 82 South-west Stark, Portland, Oregon.

WESTERN Thrillers—500 ft. 85c. Jersey Filmco, 2075 Richland, Lakewood, Ohio.

16MM. FILMS—Big stocks—Lowest prices. Silent, sound rental library. Dime brings catalogue, two "end" titles. Eastin Pictures, Davenport, Iowa.

FILMS, Cameras, projectors, bought, sold. Block, 1451-P Broadway, New York.

35MM. ODD 1000 Ft. \$1.65 postpaid; free film cement with order; 88 pp. rental catalog, dime. Scholefield, 6801 South Carpenter, Chicago.

LOOK! World's greatest "Passion Play," 5 reels. 16mm. (new) rent or purchase. Write Hemenway Film Co., 37 Church Street, Boston, Mass.

8MM OWNERS: New titling film, home finishing data, reversing, new accessories, better pictures. Information free. Film Specialties, Box 458-A, El Monte, Calif.

\$\$\$ PHOTOPLAY Ideas for talking pictures accepted any form for criticism, copyright and submission to studios. Established 1917. Booklet free. Universal Scenario Co., 259 Meyer Bldg., Western and Sierra Vista, Hollywood, Calif.

100 FEET 35MM. 27c. Bargain lists 3c. Hoffman Film Service, 57 Broad, Albany, N. Y.

HIGHEST Prices paid for used still-movie equipment. Send description. Fotoshop, 136A West 32, New York.

FILMS, Projectors. 10c coin for lists. Capital Productions, Rosedale, Kansas.

RADIOS, SUPPLIES, INSTRUCTION

ENTIRELY New million point super-sensitive DX radio crystal. Full instructions for set included. 50c postpaid. Radio Supply Co., Edmonton, Alberta.

RADIO Experimenters and set builders. Parts and kits of parts for the T.R.F. Four with all metal tubes, Six Tube 32 Volt Farm Set, Economy Three, Five and Four Tube Little Giant, Auto Radio and Portable Battery Set described by Popular Mechanics. Lund Manufacturing Co., 43 E. Ohio, Chicago.

AUTO Radio noise eliminated. Throw away sparkplug suppressors. Special filter, easily installed. \$2.00 postpaid. State Radio Service, K-2902 State Street, Chicago.

BLUEPRINT 18 Distance crystal sets—record 2,100 miles. "Data," year, 25c. Laboratories, 151-C Liberty, San Francisco.

MONEY! Making simple long distance pocket radios. No tubes or batteries. Real distance records reported. Super-sensitive Melomite crystal. Instructions, testimonials, catalog, 25c. postpaid. Melomite, Dept. EP, Fairmount, Kansas City, Mo.

RADIO Engineering, broadcasting, aviation and police radio, servicing, marine and Morse telegraphy taught thoroughly. All expenses low. Catalog free. Dodge's Institute, Ames St., Valparaiso, Ind.

MUSIC AND MUSICAL INSTRUMENTS

EARN Your own musical instrument. Get free details at your music store or write Fred Gretsch Mfg. Co., 521 So. Wabash, Chicago.

PLAY Piano by ear at once. You too can have musical hands. \$1.00 postpaid. Leslie A. Lind, Park Ridge, Ill.

USED—Rebuilt nationally known instruments—bargain prices. Supply limited. Write at once for information. Tom Brown Music Company, 315 South Wabash, Chicago.

REBUILT Band and orchestra instruments. Honestly rebuilt—fully guaranteed. Catalog of new instruments on request. Weymann Company, Dept. M-12, 13th and Arch Sts., Philadelphia.

SONG Writers opportunity—phonograph record of your song, manuscript. Musical arrangements. Free information. Paramount Song Recording Studio, J-3, Warner Bros. Theatre Building, Hollywood, Calif.

SONGWRITERS Wanted. Information free. Song Service, 714 Caracas, Tampa, Florida.

PIANO Jazz for those who can read notes. Individual lessons. Complete training, radio, orchestra, teaching. Free particulars. Billy Bell, 507 Fifth Avenue, New York.

ADELMA Bros. Music House are accepting song poems, worthy of publication. Our published songs are on sale, wherever music is sold. Kindly enclose postage. Members: National Board of Trade, Adelman Bros. Music House, Atlas Bldg., Washington D. C.

MANATYPE Prints music by hand. Practical, neat, fast. Only \$2.00. Manatype Co., Ft. Wayne, Ind.

SONG Writers—Write for free book. Indiana Song Bureau, Salem, Indiana.

SONGWRITERS—Get all inside facts. Free booklet by famous Broadway composer. Songwriters Institute, 330C Wadsworth Avenue, New York.

MUSIC Composed to words. Wonderful proposition. Bauer Bros., Oshkosh, Wis.

SONGPOEMS Wanted. Your song published. National Songland, "PM," Thomaston, Maine.

DUO-FLEX Reeds for clarinets, and saxophones eliminate your reed troubles. Write for circular. Duo-Flex Reeds, 1204 1st Ave., Evansville, Ind.

NEW Deal. Write Sequoia Songwriters Service, Sherman Branch, Los Angeles, Calif.

WANTED: Original poems, songs. Get our proposition first. M.M.M. Publishers, Studio Bldg., Portland, Ore.

SONGWRITING. Good money being made from songs through talking pictures, radio, phonograph, music publishers. "Hit" writers revise, arrange, compose music to your lyrics, lyrics to your music. We submit to studios and other markets. Free reading. Send for booklet. Universal Song Service, 671 Meyer Bldg., Hollywood, Calif.

SONG Writers. Send for our "Publishing Agreement." McKinley Music Printers, 1501 E. 55th St., Chicago.

BUSINESS OPPORTUNITIES

WE Start you in business, furnishing outfits and instructions, operating "Specialty Candy Factory" home. Men and women, earn \$25.00 up to \$75.00 weekly, all or spare time. Booklet free. W. Hillyer Ragsdale, Inc., Drawer, 4, East Orange, N. J.

STEADY Profits from your own business waterproofing cellars, cisterns, silos, etc. No extra equipment, experience or special preparation! Get details. American Fluoresit Co., Cincinnati.

WORLD'S Largest paint manufacturers create opportunities in paint demonstration work universally. Good pay. No selling. Send twenty-five cents in coin for details. Manufacturers Demonstration Service, 1023 W. Fairview, Spokane, Washington.

LEARN Account collecting. Good income, quick results. Interesting booklet free. National Collectors Association, Newark, Ohio.

LOOK Men, women; earn \$5-\$10 daily, selling new window cleaning compound. 2 sales an hour does it. Seneca Specialties, Geneva, New York.

MAKE Fast selling products at home. Formula catalog free. Kemico, 210, Park Ridge, Ill.

"100% PROFIT." Start your own novelty business. 10 pages of valuable information "free." Write today. Stewart's Studio, 2102 W. 19th, Chicago.

BIG Money in mail order business. Small start grows big because 3c stamp does salesman's work. 200 sales by mail can be made to 1 by foot. Anyone, anywhere can earn and learn quickly. \$50 to \$500 monthly possible in spare time. Big 20-lesson course "Successful Selling by Mail" teaches secrets. Written by owner \$1,500,000 business. Write for free book. Prosperity Institute, 690 East 219th St., New York City.

EASIER, Bigger money in this new industry. Beer drinking makes every cafe booth a great local center of attraction. The beautiful penny-operated Moderne Peanut Vendor is placed in each booth. We start you in this profitable, fascinating business for less than price of a suit of clothes. No selling—no hard work. Be your own boss. Full or part time. Act fast. Walzer Products, 428 Stinson Blvd., Minneapolis, Minn.

PATENTS—Small ideas may have large commercial possibilities. Write immediately for information on how to proceed and "Record of Invention" form. Delays are dangerous in patent matters. Clarence A. O'Brien and Hyman Berman, 587 Adams Building, Washington, D. C.

INVESTIGATE The collection business. Highly profitable; quickly learned. Cole Associates, Syracuse, N. Y.

BIG Money hand engraving rubber printing plates. Easy, quickly learned instructions 25c. Big catalog 10c. Becker, 22-C Hale Avenue, Brooklyn, N. Y.

START Own business resilvering mirrors, refinishing metal, plated articles, autoparts, tableware. Experience unnecessary. Small investment, combination outfit. Sprinkle, Plater, 127 A, Marion, Indiana.

INCORPORATE Your business. Liberal Delaware laws. Sell shares. Raise capital. Cost \$38. Free details. Corporation Fiscal Co., Dept. PM, Wilmington, Delaware.

POPCORN, Crispette, caramels, potato chip, salted nut machines. Long Eakins, 1960 High St., Springfield, Ohio.

GROW Mushrooms right now—a steady income—in cellar, shed or stable. Exclusive new process. Bigger, better, quicker crops—more money for you! We buy. Book free. American Mushroom Industries, Dept. 475, Toronto, Ont.

LATEST Money making ideas. Seiler, 902 Walnut Avenue, Baltimore, Maryland.

BIG Money in mail order business. Free lessons. Write today. Mailservice, 2231 McKinley, Berkeley, Calif.

MASTER Business opportunity. Staebler Products, 79-20-45th, Elmhurst, N. Y.

HOME Mailing opportunities. Operate anywhere. Literature 3c stamp. Stewart Morse, 1009 Oak, Elmira, N. Y.

HOW And where to obtain capital, fully explained, free particulars. Star Service, Wapakoneta, Ohio.

MAIL Business. Start small. Everything furnished. Free details. Metromails, P-12, Cincinnati.

FREE Plans, books, circulars. Make thousands of dollars selling by mail. Home, Spare time. Mail Order Institute, 609-G, Marcy Ave., Brooklyn, N. Y.

EARN Money, spare time. No canvassing, possibilities unlimited. Hetzel, 802 Garden, Hartford, Conn.

MAKE Your own products. Employ agents yourself. Toilet articles, soap, extracts. We furnish everything. Valuable book free. National Scientific Laboratories, 1950W Broad, Richmond, Va.

ELECTRICAL Penny games. Build them yourself and rent on commission. Big profit. Instruction \$1.00. Cost very little to build. Buehlers, Box 37, Pine Island, Minnesota.

OPPORTUNITIES Galore! New letter duplicator complete \$3.00. Profitable sales rights! Details. Mailmarts, PM-12, Cincinnati.

LEARN Marbleizing with our snow-white vitreous cement. Makes concrete products, vases, novelties, statues, resemble polished marble. Make your own molds, with our rubber composition, equals rubber. Cold process, no heat required. Dime brings sample mold, with marbleized cast. Cowell Institute, Grayling, Michigan.

PROFITABLE Business—Repeat orders without solicitation, representing large manufacturer graphite motor conditioner. Paragraf, Dept. M-125, Dayton, Ohio.

NEED Cash? Raise new, patented all-season mushroom; cellar, shed. Wholesaler (ten branches) supplies, materials; instructs, buys crops. Details free. United 3848-A172 Lincoln Ave., Chicago.

BARGAINS—Paint spray outfit, gasoline engine drive. Terms—trial. Helmick Paint Spray Exchange, M-1255, Troy, Ohio.

PLASTEX Industries offers industrious men an opportunity to start a business of their own, manufacturing art goods, novelties, souvenirs, etc., in Plastex and marble imitation. 5c material makes \$1 articles. Rubber moulds furnished for speed production. Small investment brings big returns. You are just in time for the big Xmas business. Write for interesting booklet mailed free. Plastex Industries, Dept. A, 1085 Washington Ave., New York.

SHOW Farmers how to increase their dairy profits—and make \$10 to \$20 day easy for yourself. Our men doing it right now. Wonderful opportunity. Write today. Dairy Equipment Service, 1627 Charles, LaCrosse, Wisconsin.

MAKE Products yourself—Tested formulas. Catalogue free. Grinstead Laboratory, Edwardsville, Illinois.

STOP Squealing—Start crowing! You will—after reading Folio No. 5. Unusual "plan." No canvassing! Work half days—home. Prepare for surprise! National Folios, 711 Broadway-Arcade Building, Los Angeles, Calif.

START Genuine mail order business in spare time. Proofs of success furnished. Midwood Co., Dept. 409, Mt. Vernon, N. Y.

MEN, Women, make handsome profits making, selling candy. Famous recipes, including rare secret recipe, and complete course. Mail this ad for half price rate short time only. Box 65, San Jose, Calif.

GET Started now! Mail order business: guaranteed plan 25c. Martens & Furio Specialties, 450 West 45 Street, New York, N. Y.

POSTCARD Addressed Box 500, Shreveport, Louisiana, brings best proposition ever received.

PROFIT For you using our ten pulling tested-out advertisements and plans for each ad. Complete set 10c. Carl Edquist, Odesa, Minn.

PROFIT With new products. Make, sell, repeat. Guaranteed formulas, special prices, leads. Biggest catalog free. Gibson, Chemist, BD-4702 No. Racine, Chicago.

A BUSINESS Of your own—Making chipped glass name plates, numbers, signs, checkerboards, medallions. Big illustrated book free. E. Palmer, Dept. 56, Wooster, Ohio.

STEADY Cash income resilvering mirrors; replating fixtures, tableware. Easy factory methods. Experience unnecessary. Make outfits. O'Custer, HP-224 Highland, Detroit, Michigan.

LARGE Profits reclaiming drain oil. Instructions \$1.00. Moore, Box 805, San Diego, California.

POPCORN, Caramelcorn, potato chip machines, used. Northside Mfg., 2117 - 20th, Des Moines, Iowa.

LIQUID Marble—Anyone can make! Colorful, glazed! Moulded, brushed, sprayed. Rubberlastic moulds. Composition flooring. Big money making these! Particulars free. Marbleizing Service, Edwardsville, Illinois.

MAKE Artificial marble, glazed tiles, no polishing, uncanny. Tabletops, novelties, statuettes, whetstones, floors, granite. Inexpensive, hard, enamels wood. Rubber moulds, also liquid rubber sold. Make beautiful thin cement pottery, lawntables, without moulds. Secret cement processes. Startlingly colorful samples 3c, otherwise ignored. John A. Payn, 945 Grande Vista Avenue, Los Angeles, Calif.

FREE Booklet describes 107 plans for making \$20-\$100 weekly, in home or office, business of your own. Elite Co., 214 Grand St., New York.

GET Lots of mail. Money making offers, etc. Your name in 10,000 directories, 25c. Roscoe, 4627 Glenshade, Cincinnati.

START Little business anywhere. Everything furnished. No canvassing. Maywood, PM-923 Broadway, New York.

TWENTY New successful mailorder propositions. J. Home, 3949 Metropolitan, Chicago.

ARTIFICIAL Marble sanitary flooring, instructions covering wood or cement flooring ½ inch thick, fireproof, all colors, low cost, ornamental casting, concrete, plaster, papier-mache, garden furniture, statuary, flexible molds, particulars free. Chris. Mahler, Elmont, N. Y.

I WANT to send you proof of the wonderful pulling power of Popular Mechanics Magazine's classified pages. What's your proposition? Write me today. F. W. Johnson, Manager, Classified Advertising, 200 E. Ontario St., Chicago, Ill.

OPEN A key-making shop. Start a permanent profitable business with a small sum. No skill necessary. Write for particulars. Beisser Mfg. Co., 411 E. Fort, Detroit, Michigan.

"TURN Ideas into cash." Free details. Martinez-PM, San Bernardino, Calif.

MAIL Order business is your opportunity. Many began small, now earn thousands yearly. No personal contact. Boundless opportunities. Have had over 30 years experience; will help you succeed. Send 25c for valuable booklets, none free. B. Brenizer, 257 South 21st, Philadelphia.

CHEMICAL Expert will furnish formulas and trade secrets. All lines. Lists free. W. L. Cummings, Ph. D., 228 Gordon Ave., Syracuse, N. Y.

SELL By mail. Books, novelties. Bargains! Big profits. Particulars free. B. Elfo, 525 S. Dearborn, Chicago.

"SCHEMER Magazine," Alliance, Ohio, prints schemes, ideas, business starters, formulas; winners—\$10,000 to \$50,000 reported. 37th year. \$1. Subscribe now. Six months special, only 30c.

FREE Circulars describing how you can make big money in mail order business at home in spare time. Write today. Mail Order Institute, 669-H Marcy Avenue, Brooklyn, N. Y.

CHARTERS: Delaware; best, cheapest; free forms. Colonial Charter Co., Wilmington, Del.

SUCCEED With your products. Learn how. Formulas, Processes, Analytical service. Catalog free. B. Thaxly Co., Washington, D. C.

MONEYMAKING OPPORTUNITIES

MAKE Big money! Artistic talent unnecessary. Paint lifelike portraits on glass. New art. Complete process 50c. K. Hart, Benchar Bldg., 6443 N. Talman, Chicago, Ill., Dept. 301.

SQUARE Knotting—Cord handcraft. Make belts, purses, shade pulls, lanyards, etc. Send 10c for beginner's instructions, catalog and samples. Postcard will bring our free booklet B. Herwig Co., Square Knot Headquarters, 268 Washington Street, Dept. J-12, Brooklyn, N. Y.

MAKE Your own products. Employ agents yourself. Toilet articles, soap, extracts. We furnish everything. Valuable book free. National Scientific Laboratories, 1950W Broad, Richmond, Va.

INCOME Producing opportunities. Stamp. Getz, 127 Brick St., Dickson, Penna.

MAKE Money—Printing Christmas cards from linoleum blocks. Complete outfit, blocks, brayer, cutters, inks, cards and envelopes, 50 page instruction book and designs. Prepaid \$1.95. Pyramid Company, 139 Boulevard, Long Island City, N. Y.

RECEIVE—Big mails, magazines, samples, offers. Your name in 1,000 mailing lists sent to manufacturers, publishers, supply houses, 10c. Guaranteed. National, Box 335-D, Saginaw, (WS) Michigan.

ADVANCE Yourself! Earn big money home, outdoors, anywhere. "Income Ideas," free offers help you succeed quickly; 10 cents. Start now—prosper. New Idea Service Co., 217-A Seventh Avenue, New York.

WAYS To Wealth Magazine, Box 745, Minneapolis, Minn. 9th year. Tips, plans, formulas, schemes, home workers' opportunities. Three months 25c.

EMPLOY Yourself profitably at home. Free information. Innes, Box 745, Minneapolis, Minn.

MILLIONS Unemployed! Supply them amazing job-getting information (got man 76 jobs). Keep dollars paid you; we fill your orders free. Stamp brings details. Co-Operative Service, 77 Swan, Buffalo, N. Y.

EARN Money at home. Profitable legitimate formulas, ideas, ads. B1-monthly, 36 pages, six months, 10c. Home Industries, B84, Irvington, Neb.

EARN \$50-\$100 weekly without experience or capital. Dignified, permanent business. No fake or selling agency. Particulars, \$1 bill. Mutual, Penn Yan, N. Y.

MAKE Useful articles from klinkers found in ordinary ashes. Real moneymaking opportunity. Write at once for details. Adolph Ringl, 12524 Moran Ave., Detroit, Michigan.

FREE Booklet describes 107 plans for making \$20-\$100 weekly, in home or office, business of your own. Elite Co., 214 Grand St., New York.

TO Win success you must do something different; particulars free. Publishers Sales Company, Box A-67, Nelson, Georgia.

QUICK Cash, spare or full time. No canvassing. Write Fox River Service, 310 W. Washington St., Appleton, Wis.

HOMEWORKER Magazine—filled with profitable ideas! 3 months, 25c. Mailmarts, Cincinnati.

BIG Money at home plating auto parts, reflectors, mirrors, chandeliers; by new method; experience unnecessary. Outfits furnished. Gunmetal Co., Ave. N. Decatur, Ill.

HOW To identify and determine value of old precious metals. Where to buy. To whom to sell. Reliable and up-to-date information. Complete instructions only \$1.00 postpaid. Popular Mechanics Press, Room C35, 200 E. Ontario St., Chicago.

FORMULAS, PLANS, ETC.

NEW Labor saving paint and varnish remover. Non-injurious. Inexpensive. No scraping! Formula 25c. Big catalog 10c. Becker, 22-A Hale Avenue, Brooklyn, N. Y.

BIG Profits in flavoring extracts. 15 different formulas \$1.00. Bonsall, Mt. Carmel, Penna.

AUTOMOBILE Specialties formulas, 16 for 25c. L. LeBlanc, Box 564, Mt. Vernon, N. Y.

FORMULAS. All kinds. Guaranteed. Catalog. "Special Offer Free." Kemico, 32, Park Ridge, Ill.

BIG Profits making, selling your own goods. Large 26 page formula catalog 3c. Browns Formulary, 212 East Waters, Tampa, Florida.

ANALYZE Fast sellers, to get fast sellers. Write. Associated Chemists, Indianapolis, Indiana.

20 TESTED Herb formulas for 20 disorders. List 3c. B & M Laboratories, Box 752, Manchester, N. H.

MAKE Your own products. Employ agents yourself. Toilet articles, soap, extracts. We furnish everything. Valuable book free. National Scientific Laboratories, 1950W Broad, Richmond, Va.

500% PROFIT. Making-selling products. Newest formulas, plans. Valuable literature free. Kelley, Chemist, Sturgis, Michigan.

FREE—100 Money making formulas. Army Navy Supply, Durham, No. Carolina.

FORMULAS; Plans; bargain list free. Wieland, 6125A Tracy, Kansas City.

ANY Formula: 10c plus postage. Formulas, 902 West Prairie, Taylorville, Illinois.

NEWEST Guaranteed formulas. Biggest catalog free. Special prices, leads. Gibson, Chemist, BD-4702 No. Racine, Chicago.

500 MONEYMAKING Formulas 25c. Descriptive literature free. Harvey Teeple, Decatur, Indiana.

MAKE—Perfume powder! 1-lb. costing about \$1.00 makes 200 10c packages, (each making 1 oz. perfume.) Formula 25c. Hale Specialty Co., Mayfield, Ky.

FORMULAS—Specify what you want. Complete service. Miessene Products, Box 372, Columbus, Ohio.

FORMULAS. Manufacture own goods. Catalog free. Roscoe Lynch, Bausman, Penna. GUARANTEED Formulas. Big list free. Terrone, 22 Station S, Brooklyn, N. Y.

500 PROFITABLE Formulas, 25c. Womble Co., Siler City, N. C.

MANUFACTURING Formulas! Latest! Individual service! Inquiries welcome! Galluzzo, Wilkinsburg, Pennsylvania.

FORMULAS—Latest money makers. Literature free. Belfort, 4042 N. Keeler, Chicago.

FORMULAS—Tried, tested, proven. Real money makers! Average cost only 4c per formula! Write for interesting information. Best-Formulas-of-the-Month Club, Mayo, Florida.

SUCCEED With your products. Learn how. Formulas, Processes, Analytical service. Catalog free. B. Thaxly Co., Washington, D. C.

10,000 MONEY-MAKING Formulas. Tells you how to make and sell almost everything under the sun; cosmetics, mucilage, anti-freeze solutions, battery solution, beverages, cheese, chewing gum, cleaning preparations, extracts, hair preparations, inks, bluing, leather polish, mirrors, perfumes, polishes, typewriter ribbons, carbon paper, washing powders, liquid soap, and hundreds of other profitable articles. \$4 postpaid. Popular Mechanics Press, Room C35, 200 E. Ontario St., Chicago.

CHEMISTRY

HANDBOOK For chemical experimenters, revised and illustrated, 50c. Experiment booklet 15c. Chemical catalogue 5c. Scientific booklet free. Reading Scientific Co., Reading, Pa.

SEND 10c For this chemical catalog over 1500 items. Contains prices and illustrations on laboratory apparatus—chemical stains reagents—microscopes and slides—bacteria and botany specimens—rocks. A veritable encyclopedia—don't be without it—send 10c. Stansl, Dept. B, 2340 Wabansia Ave., Chicago, Ill.

CHEMICAL Analysis and industrial problems. Estimates free. Esco Laboratories, 2266 Lycaete, Detroit, Michigan.

FREE Instructions for chemical experiment that will demonstrate the pattern method of dyeing cloth. Write to The Porter Chemical Co., 19 Prospect Ave., Hagerstown, Md.

NEW Big catalog. Chemical sets, microscope outfits, laboratory, biological, chemical supplies. Approved by experimental laboratories. Special 30 day offer. Send 10c. Winn, 124N West 23rd St., N. Y.

25 CHEMICALS With experiments, 35c. Kayare Chemicals, 5522 Ft. Hamilton Parkway, Brooklyn, N. Y.

CHEMISTRY Outfits 10c. Stamps or coin. Safe-Chem, New Haven, Conn.

INSTRUCTION Book, thrilling chemical experiments, 25c. Safe-Chem, New Haven, Conn.

CHEMISTS'—Students' slide rule solves equations, gives formulae. Only two dollars postpaid. MWC Company, 508 Andrus Bldg., Minneapolis, Minn.

EQUIP Complete laboratory. Supplies at 5c! Send 15c for valuable catalogs. Kemkit Corporation, 135P Johnson Street, Brooklyn, New York.

CHEMICAL Set. Performs 35 experiments, 25c. Fleischer's Laboratories, Everett, Mass.

CHEMICALS. Laboratory glassware and apparatus. Catalog CP. Biological Supply Co., 1176 Mt. Hope Ave., Rochester, N. Y.

SURVEYING INSTRUMENTS

GUARANTEED Factory rebuilt instruments for rent (with purchase option) or sale (cash or terms). Largest selection in United States. Ten day free trial. Liberal allowance for old instruments. Save money by buying new. Write for new list M-912. Warren-Knight Co., 136 North 12th St., Philadelphia, Pa. Manufacturers Sterling Transits and Levels. Headquarters for repairs any make surveying instruments.

AGENTS WANTED

MAKE Big money with Christmas specialties. Buy direct at lowest prices. Xmas cards, Xmas tree outfits, colored lamps, gift sets, exclusive novelties. Particulars and illustrated catalog free. Bengor Company, 10 East 17th, New York.

CASH In on holiday demand for choice papershell pecan nuts from world's greatest pecan center. Fireside Foods, Albany, Ga.

CALIFORNIA'S Newest sensation—Instant Jelly—True fruit flavors—No fruit juices needed. Exclusive territory. Big profits. Quick repeats. California Jelly Kwik, Burbank, Calif.

AGENTS—Sell our luminous crucifix for handsome Christmas profits. Hannan Co., 2620 South Parkway, Chicago.

STRANGE Ironing cord. Saves electricity. Abolishes scorching and kinking. For telephones also. 150% profit. Sales guaranteed. Big free offer. Neverknot, Dept. 12A, 4503 Ravenswood, Chicago.

SPLASHLESS 25c Filters save glassware. Valuable proposition. Free introductory try-out. Barnett, Box 63, Times Square Station, New York.

EXCELLENT Trouserpresser, stretcher, creaser, hanger, \$1.00. Agents 60c. Widness, 1461 Fulton St., Brooklyn, N. Y.

MAKE Commissions daily—Sell Good-year raincoats, jackets; union made; lowest prices! Outfit free! Goodyear, BB1133, Milwaukee, Chicago.

100% PROFIT In the "Self Starting Cigar Lighter." No flint or friction. What makes it light? No wind can blow it out. Retail 25c. Costs \$1.75 per dozen. Sample and sales plan 25c. New Method Company, Desk PM-36, New Method Bldg., Bradford, Pa.

MAKE More money taking orders shirts, ties, underwear, dresses, hosiery, raincoats, jackets, pants, uniforms. Outfit free. Nimrod Company, Department 8, 4922-28 Lincoln Avenue, Chicago.

ALUMETAL Valve insides last a lifetime. Plisek Tire Company, Plisek, N. Dakota.

BE Your own boss! Operate quality-used-clothing business from store, home or auto. 200%-300% profit. Everything furnished. Great Western, AX-566 Roosevelt, Chicago.

250% PROFIT. Everybody interested. Free premiums, samples. Reynolds Mfco., 1709 Mango, Chicago.

SELL Men's neckwear, 100% profit. Four sample ties \$1.00. Free catalog. Artstyle Neckwear, Elmira, N. Y.

CASH Income daily silvering mirrors at home. Plating autoproducts, tableware, etc. Combination outfit. Write Sprinkle, Plater, 128, Marion, Indiana.

\$6.85 HOURLY! Amazing No-Flatz fixes punctures without patching; makes tire puncture proof! Instantly—permanently seals holes made by nails, etc. Big seller. Free sample offer. No-Flatz, Dept. T-172, Cincinnati, Ohio.

WANTED—Direct purchasing agents. No experience or money required. Write Purchasing Manager, 174 N. Halsted, Chicago.

\$6.00 HOURLY. Amazing Karnu refinishes auto like new without rubbing, polishing, waxing or painting. Wipes on with cloth. Lasts 8 to 12 months. Free sample. Karnu, Dept. T-8, Cincinnati, Ohio.

FREE Plans, books, circulars. Make thousands of dollars selling by mail. Home, Spare time. Mail Order Institute, 609-W, Marcy Ave., Brooklyn, N. Y.

500% PROFIT Selling new "20-in-1" kitchen utensil. Retail 25c. Costs you \$1.00 a dozen. \$7.20 a gross. Sample 10c. New Method Co., PMM-36, Bradford, Pa.

\$2.00 HOURLY With new, scientific cream that mends all cloth easily, quickly, invisibly, without needle and thread. Stands laundering. Free sample. Sewnomore, T-744, Cincinnati, O.

FREE! Descriptions, 450 newest money making opportunities. Metromalls, P-12, Cincinnati.

MAKE Your own products. Employ agents yourself. Toilet articles, soap, extracts. We furnish everything. Valuable book free. National Scientific Laboratories, 1950W Broad, Richmond, Va.

SNAPPY Cartoon booklets—Fast selling side line. Our cartoon booklets are easy to sell. Every man, young and old, will buy them. 300% profit. Don't wait. Get started today on a sure seller. Send 50c for six samples and wholesale price.

STRANGE Discovery! Amazing mineral soap cleans fabrics rugs, clothes, dishes. Fast seller, big profits. Simmons & Simmons, Box 247, Newport, R. I.

AGENTS—Sell our safety pulley line support. No more falling from windows. Write for circular. Safety Pulley Line Co., 1522 Miller St., Utica, N. Y.

ADDING Pencil. Adds mechanically; fast moneymaker; agents wanted immediately. Add-O-Graph Co., Dept. 25, Saltito, Miss.

HOSIERY Agents wanted for men's and ladies' hosiery. We operate complete mill. Elmo Hosiery Mill, Box 2067, Chattanooga, Tenn.

SHOW Sensational new silk hosiery line. Guaranteed to wear without holes for months or replaced free. Quick sellers. Big profits. Samples supplied. Send size. Wilkmit Hosiery, Desk P-37, Greenfield, Ohio.

"WINDOW-RITER"—Magic pencil writes on glass. All colors. Storekeepers buy quickly. Ideal for baseball scores. Large profits. Big repeaters. Free sample. Lake Chemical, 6 E. Lake, Dept. 12-PM, Chicago.

I'LL Give you groceries at wholesale besides splendid opportunity to make \$60 a week. Brand new Ford sedan given as bonus. Details free. Albert Mills, 9102 Monmouth, Cincinnati, Ohio.

SELL Men's ties, razor blades, etc., big money for you. Heil Premium Co., M3, Gaylord, Minn.

WINDOW, Windshield cleaner. New. Free sample. Glas-Glo, Dept. PM., Phelps, N. Y.

WHOLESALE Catalog free. 500 best sellers. Paty Co., 1167 Broadway, Somerville, Massachusetts.

INTRODUCE Perfumes. Super-quality. New plan. Pays you daily in advance. Write for free samples. Big money proposition. International Industries, Culver City, California.

BIG Earnings selling, installing kitchen range oil burners. Bennett Co., Islip, N. Y.

SELL Tinselled Xmas show cards to stores. Catalog. Roscoe Lynch, Bausman, Pa.

\$5.00 DAILY Easy selling Christmas cards. Samples furnished. Write M-W, 614 Jennings, Ft. Worth, Texas.

AGENTS—Engraved name plates, number plates, signs, etc., easily sold, profits large. Brett Bros., Winthrop, Mass.

GENUINE Gold leaf window letters. Easily applied. Sample. Paramount Letter, Box 74, Station A, New Haven, Conn.

MEN—Women \$3 to \$6 daily. Selling 25c household necessity that repeats. Three to ten sold in every home. Free sample. Write Puro Company, 3107 Pine St., Dept. W-2045, St. Louis, Mo.

DOLLARS Daily! Start profitable mail-order business. Details. Duffy, Covington, Ky.

500% PROFIT! Gold and colored sign letters for windows, offices, trucks, signs. Monograms. Easily applied. Neonite, Akron, Ohio.

PROFIT With new products. Make, sell, repeat. Guaranteed formulas, special prices, leads. Biggest catalog free. Gibson, Chemist, BD-4702 No. Racine, Chicago.

COIN Money selling colored people. Give away free pictures of Joe Louis with hair preparation. Valmor 5249-NM Cottage Grove, Chicago.

WE Manufacture and bottle under your own brand and name, vanilla, furniture polish, cosmetics, etc. Gassol Mfg. Co., Troy, N. Y.

SPARKLING Tinselled Christmas signs. Cost 6c—retail 25c. Sample free. Also boxed 21 Christmas cards 35c—retail \$1.00. Make Christmas money. Lowy, Department 67, 8 West Broadway, New York.

CARDED Specialty salesmen handle side-line nationally advertised. Repeat item. No competition. NoDoz Awakeners, Dept. M, Sacramento, Calif.

MANUFACTURER Offers big daily commissions, steady employment, liberal cash bonuses. Complete new fall line tailored shirts, neckwear, sport jackets, pants, uniforms, work pants, bowling shirts. Experience unnecessary. Part or full time. Outfit free. Write today. Packard Shirt Corp., Dept. S364, Terre Haute, Ind.

RUG - NO - WRINKLE. Rug - no - slip. Combination. New invention. 50c. Send 15c for sample and selling plans. Schroeders Specialty Co., 1610 West 62, Los Angeles.

GIGANTIC Christmas sellers! Lucky Seven cellophane wrapped packages, \$5 hundred. Twenty-one piece Christmas boxes \$18 hundred. Samples 35c. Bulletin free! Eifko, 525 South Dearborn, Chicago.

AGENTS—Lowest prices—Top profits on carded aspirin, razor blades, handkerchiefs, laxatives, shoe laces, etc. Details free. Better Products Co., Marion, Ind.

\$3.00 HOURLY! Amazing automobile accessory. Produces revolving colored light. Free offer. Propell-o-lite Company, Mt. Washington, Ohio.

GOLD Letters for store windows. Large sizes penny each. Free samples. Modernistic Sign, 3004 Lincoln Ave., Chicago.

DISTRIBUTORS. New scientific remedy quickly heals eczema, ringworm, other skin diseases. Free samples. G. Moreau, 509 Fifth Ave., New York.

FAST Mail seller—Free sample. Plans. Circulars furnished. Seewigen, 2328 W. Pico, Los Angeles, Calif.

AGENTS—Opportunity to make money; book containing 107 successful business plans; home or office; send for free introductory booklet. Elite Co., 214 Grand St., New York.

MEXICAN Feather pictures. Christmas novelty. Send 25c (stamps) for \$1.00 worth sample and details. Mexican Art, Apartado 1593, Mexico City.

100 PROFITABLE Mail order and local business plans. A. Pruitt, Elburn, Ill.

U-KAN-PLATE Really replates old brassy bath room fixtures, auto accessories and other metals with silver. Agents wanted. 3-oz. 50c; 8-oz., \$1. Justice, 904 Walnut St., Philadelphia, Pa.

SELL Made to measure raincoats. Outfit free. Goodyear Rainwear, 18 West 22nd, New York.

PROFITABLE Home business. Legitimate. No canvassing. Maywood Publishers, P-923 Broadway, New York.

SELL New food specialty. Spicy butter. Colavit's Co., Perkasie, Penna.

AGENTS: Smash go prices! Santos coffee 12c lb. 4-oz. vanilla 8½c. Razor blades 10 for 8½c. 100 sticks chewing gum 12c. Christmas cards, 21 in box, 14c. 150 other bargains. Experience unnecessary. Write Carnation Co., P.O. St. Louis, Mo.

SUCCEED With your products. Learn how. Formulas. Processes. Analytical service. Catalog free. B. Thaxly Co., Washington, D. C.

CALIFORNIA Flower beads sure fire fast sellers. Big profits. Low prices. Catalog free. Mission No. 16, 2328 W. Pico, Los Angeles, Calif.

BIGGEST And quickest sales are made in brushes. Write for proposition. Wire-Grip Sanitary Brush Corporation, 45 East Eleventh Street, New York.

NEW Cleaner! Washes clothes quickly. Cleans everything. Premium deals. Free sample. Bestco, 5007 Irving Park, Chicago.

BIG Money applying gold initials on automobiles. Easiest thing today. No experience needed. Free samples. "Ralco," 1084 Washington, Boston, Mass.

GENUINE Gold letters for store windows. Easily applied. Free samples. Liberal offer to general agents. Metallic Letter Co., 438-B North Clark, Chicago.

AGENTS: Stamping names on pocket-key protectors. Sample check with your name, address, 25c. Stamping outfits. Emblem checks, check-fobs, name plates. Hart Mfg. Co., 303 Degraw St., Brooklyn, N. Y.

BIG Money and fast sales. Every owner buys gold initials for his auto. You charge \$1.50; make \$1.45. Ten orders daily easy. Write for particulars and free sample. American Monogram Company, Dept. 40, East Orange, N. J.

MAN In each town to plate auto parts, reflectors, bathroom fixtures, refinish beds, mirrors, chandeliers; by new method. No capital or experience required. Simple plan of manufacturing at home starts you in big money-making business. Outfit furnished. Free particulars and proofs. Gun Metal Co., Ave. H, Deatur, Ill.

15,000 PROFIT Making formulas. Following and many others: Accidents and emergencies, agriculture, alloys and amalgams, artist's materials, beverages, cements, glues, pastes, mullages, bleaching, renovating, coloring metals, dyeing glass, heat treatment of metals, household formulas, ice cream, confectionery, chewing gum, lapidary work, exterminating vermin, lubricants, paints, varnishes, photography, condiments, canning formulas, rubber, soap, candles, soldering, toilet preparations, perfumes, waterproofing, fireproofing, writing materials. \$5.50 postpaid. Popular Mechanics Press, Room C35, 200 E. Ontario St., Chicago.

HIGH-GRADE SALESMEN

CLOTHING Salesmen wanted. To represent the world's largest manufacturing retailers of men's clothes. All the newest fabrics and styles. Liberal commissions. An opportunity to make a good income and establish an increasingly profitable business. Write The Richman Brothers Company, Cleveland, O.

SELL Firex—Fully automatic fire extinguisher and alarm. Endorsed by fire chiefs. Prospects everywhere—good commissions. Write for territory and testimonials. Firex Corporation, Dept. L-100, 516 S. Broadway, St. Louis, Mo.

STEADY Substantial income taking orders for complete line printed business necessities, gummed labels, advertising novelties, calendars and sensational business stimulators. Experience unnecessary. Complete sales outfit free. Northwestern, SF-625 Jackson, Chicago.

VIRGIN Territory on product with proved saleability. Makes frost designs on glass doors, windows, light bulbs, bric-a-brac. Free particulars. Dept. 3, Keen-Rick Co., 710 W. Jackson, Chicago.

RUBBER Bag cap. Flits into top of tobacco bag. Fast 10c seller. Counter card salesmen wanted to sell stores. Actual sample and details 10c. Dan-Dee Specialty Co., Box 614D, Glendale, Calif.

MAKE Big money steady. High grade overalls, shopcoats, pants, shirts, melton jackets. Advertising on back. Fast sellers. Free outfit. Strong Mfg. Co., 901 West Jackson, Dept. N-9, Chicago.

SALESMEN: Acquainted with garages, filling stations, to handle local business. Write Colgra, 2638 N. Third St., Milwaukee, Wisconsin.

DON'T Be a job hunter. Start your own business on our capital. No hard times; no lay-offs; always your own boss. Hundreds average \$3,000 to \$5,000 annual sales year after year. We supply stocks, equipment on credit. 200 home necessities. Selling experience unnecessary. Wonderful opportunity to own pleasant, dignified, profitable business backed by world wide industry. Write Rawleigh, Dept. L-U-PPM, Freeport, Ill.

MAKE More money taking orders shirts, ties, underwear, dresses, hosiery, raincoats, jackets, pants, uniforms. Outfit free. Nimrod Company, Department 65, 4922-28 Lincoln Avenue, Chicago.

MAKE Your own products. Employ agents yourself. Toilet articles, soap, extracts. We furnish everything. Valuable book free. National Scientific Laboratories, 1950W Broad, Richmond, Va.

ALL Mirror beauty powder box set delights women the world over. Write for free information, cash in before Xmas. Madame Chalons, 20 E. Jackson, Chicago.

SELL At wholesale—Radios, electrical appliances, novelties, gifts, etc. Dealers or direct. Establish profitable business. Moork, 1618 Roosevelt, Chicago.

AMAZING Profits representing large manufacturer graphite motor lubricant. 90% repeat business. Para-Graf, Dept. M-1251, Dayton, Ohio.

SELL Dealers a necessity auto radiator stop leak and flush. Some low as eighteen cents dozen packages in quantities. Zenith Factories, Minneapolis, Minn.

MAN—Handle regular store route. Place nationally advertised 5c-10c counter card mdse. New aspirin deal—6 tablets 5c. 85 other fast sellers. 100% profit. No investment. Samples free. World's Products Co., Dept. 12810, Spencer, Ind.

NEW Drycleaning clothes brush. Revolutionary invention. Cleans clothes like magic. Homes, offices buy instantly. Phenomenal profits. Outfit free. Kristee, Dept. 262, Akron, Ohio.

NEW Farm radio—\$7.95. No-cost sample. J-20th Century Co., Kansas City, Mo.

IT'S A sensation! Especially designed for placing in cafe booths—the beautiful new Moderne Peanut Vendor is making big money for distributors. Write quick. Walzer Company, Northwest Terminal, Minneapolis, Minn.

\$60 WEEKLY Guaranteed from only one sale daily. Selling unnecessary. Just show new business discovery to business and professional men. Write for details. Thomas Young, Dept. 122, Bankers Bldg., Chicago.

GIVE Away free 1936 short wave and home radios, also full electric automobile radios with our unique "Punch Sales Card Plan." 2 sales daily pays \$203.88 weekly profits. Write for our free starting offers. Deluxe Mfg. Co., Dept. 231, 173 W. Madison, Chicago.

SALESMEN: Sell complete line gummed labels, calendars, memo books, and business stationery. Special features. Free deals. Write quick. Big comm. daily. Attractive sales portfolio free. Lionel, Dept. FZ, 312 So. Hamilton, Chicago.

BIG Money in tire patches. Sell new auto tire patch to service stations, garages, etc. Tiger-Grip patches guaranteed 10,000 miles. \$75 weekly for salesmen or distributors. Protected territory. Write Economy Rubber Co., 779 Burkhardt, Dayton, Ohio.

\$76.50 IN Cash commissions paid Nash on one order from one firm on one sale is unusual, but we did it and stand ready to do it for you because we protect our salesmen. If you can devote your personal attention to business, sell truck and fleet owners and appoint salesmen, you, too, can earn a high income with Graf-ex, the new super lubricant. Every car owner a prospect. Big commissions to distributors. Rush name. Coffield Protector Company, 1212 Harshman Street, Dayton, Ohio.

MEN—Make \$12 daily, selling stores 5c and 10c necessities on beautiful counter displays. Demand everywhere. Over 75 fast sellers and sure repeaters. Craig's Laboratories, Suite 377, Memphis, Tenn.

SALES Tax law forces merchants keep records; men averaging good daily commission; exclusive territories open. Mill-Green Publishing Co., 370 Seventh Ave., New York.

SALESMEN—New deal guarantees stores \$10 for one. Two \$15 sales net you \$20 daily. Sayers, 2801-123 Sheffield, Chicago.

LARGE Steady profits. Make-sell amazing 30 below non-evaporating auto anti-freeze. Cheaper, better, easily-quickly made. Formula 30c. Allied Research, 2217 North Kilbourn, Chicago.

FREE Booklet describes 107 plans for making \$20-\$100 weekly, in home or office, business of your own. Elite Co., 214 Grand St., New York.

ART Calendars—Leading line, many subjects. Sell on sight. Every business a prospect. Samples free. Flemming, 6541 Cottage Grove, Chicago.

BE Independent. Own your business; experience unnecessary, selling \$10,000 accidental death, \$50 accident; \$25 sick weekly benefits—\$10.00 yearly. Other amounts proportionate. Guaranteed steady renewal income. \$726,415.63 securities deposited. Universal Policy, 716-A Lefcourt Bldg., Newark, New Jersey.

SOMETHING New in fire extinguishers. Red Comet Automatics. Proved in west five years. Exclusive territory. Low price opens pocketbooks. Write Red Comet, 404 Comet Building, Littleton, Colorado.

GOLD Reflecting letters for store windows. Easily applied. Large sizes, penny each, free samples! Atlas Sign Works, 7941 Halsted, Chicago.

SELL Process raised letter printing \$3.95 thousand. Free cut service. Worth \$6.00. Commission \$1.00 advanced. Experience unnecessary. Outfit free. United, F-6155 North State, Chicago.

BRAND New grab-bag deal. Going big everywhere—big profits—swift sales—fast repeats. No restrictions. All dealers buy. Act! K&S, 4373 Ravenswood, Chicago.

START A business of your own! Become a subscription representative for "Popular Mechanics." No capital required. Liberal commissions. Monthly bonus. Write for details. V. D. Angerman, Circulation Manager, 200 East Ontario Street, Room 235, Chicago.

NEW Specialty—Sells every business and professional man. Four \$15 sales daily pay \$280 weekly. Foyer cleared \$4920 in three months. Write, F. E. Armstrong, President, Dept. PM, Mobile, Ala.

OUTDOOR Sports for everyone—Enjoy them all year round with aid of book published by Popular Mechanics. Hundreds of ideas for new and popular sports for every season; complete instruction for making necessary equipment at small cost. 350 pages and 670 illustrations. \$2 postpaid. Popular Mechanics Press, Room C35, 200 E. Ontario St., Chicago.

HELP WANTED

LOCAL Agents wanted to wear and demonstrate free suits to friends. No canvassing. Up to \$12 in a day easy. Experience unnecessary. Valuable demonstrating equipment, actual samples free. Progress Tailoring, Dept. Z-217, 500 Throop, Chicago.

GROW Mushrooms right now—a steady income—in cellar, shed or stable. Exclusive new process. Bigger, better, quicker crops—more money for you! We buy. Book free. American Mushroom Industries, Dept. 476, Toronto, Ont.

BIG Money growing mushrooms, cellar, idle places. Supplies furnished. We buy. Free book. Mushroom Growers, LA-433 N. Clark, Chicago.

MAKE Your own products. Employ agents yourself. Toilet articles, soap, extracts. We furnish everything. Valuable book free. National Scientific Laboratories, 1950W Broad, Richmond, Va.

I WANT Men for local tea and coffee routes. Make up to \$42.50 a week to start. No experience needed but must give prompt service to families on your route. Automobile given if you qualify. Write Albert Mills, 9098 Monmouth, Cincinnati, Ohio.

NEED Cash? Raise new, patented all-season mushroom; cellar, shed. Wholesaler (ten branches) supplies materials; instructs, buys crops. Details free. United, 3848-A176 Lincoln Ave., Chicago.

GO Into wholesale business without investment. Call on stores with biggest line self-selling counter displays: Aspirin, razor blades, handkerchiefs, breathlets, household cement, 79 different items. Up to 125% profit for you. Experience unnecessary. Write for catalog and plans. Procopax, Dept. 36RD, 1956 S. Troy, Chicago.

AGENTS—Mosco corn and callous remover will build you a steady repeat business. Send today for pocket-size trial outfits. The Moss Company, 54 Searle Bldg., Rochester, N. Y.

SALES Engineer wanted, capable of taking complete charge of and organizing Diesel sales organization, specializing in small Diesel engines and Diesel-electric plants. In answering give complete information as to previous employment, salary expected, age, etc. Witte Engine Works, Kansas City, Mo.

LEARN Diesel engineering. Rapidly expanding field. Good pay for Diesel-trained men for next 25 years. Home training possible. Get latest and right up-to-date Diesel Handbook. Authentic. \$5.00 postpaid. Popular Mechanics Press, Room C35, 200 E. Ontario St., Chicago.

EDUCATIONAL AND INSTRUCTION

KNOW Diesel engines! Learn to install, operate and repair through practical instruction, in your own home. Low cost! Pay as you go. Free booklet, Diesel Opportunity, mailed promptly on request. Write today! Diesel Institute Extension, Department A, 317 Central Avenue, Los Angeles, California.

ASPIRING Authors: be guided by The Blue Pencil, a monthly bulletin telling how to write to sell, edited by Thomas H. Uzzell, former fiction editor Collier's and leading literary authority. Subscription one dollar a year. Canadian Pacific Building, New York City.

SECRET Service. Valuable information free. International Secret Service Institute, PM-125, Hoboken, N. J.

LEARN Watch repairing. Instruction, tools \$34.95. Midwest, 1571 West Central, Toledo, Ohio.

MEN Wanted to learn machinist trade, tool and die making, automatic screw machines. Get experience on actual work. Employment help. Days-evenings. Write for free booklet. Allied Screw Machine Co., 601 Lake St., Chicago.

LEARN Fast and correct figuring. New methods. Frederick A. Smith, 2410 Smalley Court, Chicago.

DOUBLE Entry bookkeeping 60 hours with keys. Diplomas. International Institute, Springfield, Mo.

TRAIN By home study for managerial government positions; city controller, federal accountant, etc. Courses lead to degrees. Write for special tuition and free bookkeeping course offer. American School of Public Administration, Box 647, Sacramento, Calif.

RAILWAY Postal clerks. Men 18-35. \$1900 first year regular. 40 hour week means many appointments. Examinations expected. Particulars—free. Franklin Institute, Dept. D3, Rochester, N. Y.

GET Free copy of our questionnaire—find out immediately what government jobs paying \$105-\$190 month you can qualify for. Men-women, age 18-53. No obligations. Write, Instruction Bureau, 101, St. Louis, Mo.

FINGER Print outfit professional. Send \$2. American System, 219-P West 100th, New York.

"G-MEN" Booklet. Send 10c for mailing. International Secret Service Institute, MP-125, Hoboken, N. J.

INCREASE Your earning capacity. Become successful. Use the "Law" \$1.00. Money back guarantee. Particulars free. Otis Browne, Box 53, Berwyn, Illinois.

SECRET Service. Particulars free. Write George Wagner, 2642 Broadway, New York.

BARGAIN Catalogue educational matter 10c. Hanfling, Y-799 Broadway, New York.

INVENTING Now taught successfully. Home study. Write for free booklet. Trofimov School of Inventive Practice, 3859 Northampton Rd., Cleveland, Ohio.

LOGO-GRAPH To work mathematical problems. Send three dimes. Geo. L. Thom, 2444 Sunnyside Ave., Chicago, Ill.

"CANDYMAKING Course"—\$2.00! Profitable occupation! Thomas Galluzzo, Wilkinsburg, Pennsylvania.

ZENDU. Remarkable, practical mystic language. Quickly learned. Complete instructions 25c. Zendu, Burbank, Calif.

DOES Hotel work interest you? Not a correspondence course. Free information. Ben Hadley, P. O. Box 315, Detroit, Mich.

BECOME A landscape architect. Easy to learn by mail. Wonderful opportunity for money-making. Earn while you learn. Write for free opportunity booklet and details. American Landscape School, 805 Plymouth Bldg., Des Moines, Iowa.

CHIROPODY Taught by correspondence. Evans School of Chiropody, Montgomery, Alabama.

"ELECTRIC Motor Maintenance Guide." Care, trouble tests, and remedies. Price \$1.00. Motor Data Co., 3002 Monroe, Kansas City, Missouri.

HOME Study courses leading to degrees: Arts and sciences, philosophy, education, law, letters, theology, psychology, engineering, chemistry, business and commerce. Many others. McKinley-Roosevelt University, Chicago.

U. S. GOVERNMENT Positions. \$1700-\$1900 and up a year. Let our expert (former government examiner) prepare you for a position in the railway mail service, rural carrier, post office, customs and other branches. Write today for free booklet. Dept. 8, Patterson School, Rochester, N. Y.

MODERN Refrigeration. New industry needs trained men for installing, servicing, repairing. If you seek a new field with larger opportunities get latest book by Alt-house and Turnquist. \$4.00 postpaid. Popular Mechanics Press, Room C35, 200 E. Ontario St., Chicago.

CARTOONING AND COMMERCIAL ART

DRAW Heads easily with our posterettes send 25c for sample and list of available stars. Rapid Motif Display, 272 Genesee St., Utica, N. Y., Dept. P-1.

IF You like to draw, sketch or paint—Write for free talent test and art book. Federal Schools, Inc., Dept. P125, Minneapolis, Minn.

SELL Your cartoons. "Cartoonists' Guide" tells where! 25c. Ridiman, 3235-E Jefferson, Cincinnati.

CARTOONING Course. Very latest method with 700 illustrations and 50 large drawing sheets. Complete outfit 50c postpaid. Lawrence Publications, 143-A West 100th St., New York.

60c CARTOONING Course, simplified charts, pencil, pen, etc. Miller Studio, 1218 Maple Street, Vancouver, Canada.

CARTOONING, Sketching, etc.—46 lessons, 600 illustrations, including practice sheets, pens, pencils. \$1.00 complete. Fraba Service, Cashton, Wisconsin.

YOUR Portrait cartooned, in colors, 50c. Send photo. Sketches supplied for advertisements, music covers, art work. B. Nendick, Maywood, Ill.

CARTOONING Course:—30 lessons, 500 illustrations with drawing pens and pencils. \$1.00 complete. Scovell Studios, Box 610-P, Hollywood, Calif.

ADVERTISING AGENCIES

LEARN Advertising quickly at home. Easy practical plan. No text books. Common school education sufficient. Interesting booklet and requirements free. Page-Davis School of Advertising, 3601 Michigan Avenue, Dept. 343-B, Chicago.

INCH Display advertisement 30 magazines, year \$24. Wood's Popular Services, Atlantic City, N. J.

FREE—New Advertisers Rate Guide, 44 pages. Includes everything. Lowest rates. E. H. Brown Advertising Agency, 140 S. Dearborn, Chicago.

ADVERTISE Profitably: \$15 reaches 6,000,000 Sunday newspaper readers with 24 word ad. Newspaper, magazine rate-guide, free. Chicago Union Agency, 20 West Jackson, Chicago.

ADVERTISING Placed anywhere. Helpful, free service. Rate guide book free. Baker Advertising Agency, 189 W. Madison, Chicago.

FOR ADVERTISERS

LIVE Mailing list for sale. Having discontinued our model department we offer 1800 boy buyer and prospect names for only \$5 complete. Bildon Co., 709 Wenonah Ave., Oak Park, Ill.

ADVERTISE! Forty words in 127 monthly magazines \$6.00. Sample copies 25c. Morrisco, 2138 Carlisle, Philadelphia.

24 WORDS, 40 Newspapers, \$2.00. Good-all Agency, Box 1592, San Francisco.

25 WORDS, 25 Magazines, three months \$1.50. Empire, Shawano, Wisconsin.

ADVERTISE: 24 Words in 250 newspapers \$10. Lists free. Advertising Service Bureau, 4650 Drexel, Chicago.

SALES Letters, folders, circulars, advertisements and complete mail campaigns planned and written to produce "plus" profits for you. Write for folder or send details now. Raymond W. Walter, Box 626, Ridgewood, N. J.

BUSINESS SERVICE

WE Specialize in obtaining hard to get articles. Try us. Universal Salesman, Research Dept., Box 782, Elmsford, N. Y.

ALL International legal matters. Lic. Victorios Prieto, Mexican Attorney at Law, P. O. Box 122 M. Juarez, Mexico.

STRICTLY Confidential mail and express address. \$1.00 monthly. Forwarded daily. Cheaper yearly rates. Smith Service Bureau, 240 Gordon Arcade, Cleveland, Ohio.

HAVE New York branch office, Times Square, only \$1.50 month! Mail forwarded daily. Telephone \$1.00. Associated Service, 1457 Broadway.

NOW \$1.00 Monthly for mailing service. Fifteen years of uninterrupted and dependable mailing service, for private or business prestige, means something. References—Manufacturers Trust Company. Co-operative Mailing Service, 126 Lexington Avenue, New York.

SHORT Stories criticized; marketed. Hursh Service, Box M-1013, Harrisburg, Penna.

CHICAGO Mailing address. \$2 monthly. Mail forwarded daily. Suite 1500-28 E. Jackson Blvd.

BELIABLE Information, any subject, \$1.00. American Business, 79 Madison Ave., New York.

DELAWARE Charters; fees small; free forms. Chas. G. Guyer, 901 Market St., Wilmington, Del.

RUBBER STAMPS AND OFFICE SUPPLIES

2 LINES 25c, 3 Lines 35c. Rubber Stamp Works, Centerport, N. Y.

NAME, Address, 2 lines 25c; 3 lines 35c. Stamp Works, Auburn, Nebr.

CUSHION Mounted, one-two lines, 25c. Three 35c. Stamp Works, 814 Bradley, Peoria, Ill.

TYPEWRITERS, DUPLICATORS, OFFICE DEVICES

DUPLICATOR Ink, \$1.25 pound; stencils \$2.50 quire. Midwest, 4854 Reading, Cincinnati.

BECO Rotary duplicator \$15.50 comp. All metal. Prints anything typewritten, handwritten, drawn. Beco, E. Orange, N. J.

TYPEWRITERS, Duplicators, multi-graphs. Write for free list office machine bargains. Save half. Pruitt, 518 Pruitt Bldg., Chicago.

NEW \$4.75 Automatic adding machine. Fully guaranteed. Bassett, 1458J Hollywood Avenue, Chicago.

INCREASE Business. "Excellograph" rotary stencil, clay and film duplicators \$3.85 to \$37.50. Prints anything. Typewritten, penned, drawn, traced. Colors. Folder free. Pittsburgh Typewriter Supply, Suite 518, Pittsburgh, Pa.

PRINTING, MULTIGRAPHING, MIMEOGRAPHING, GUMMED LABELS

DESIGNED Gummed labels in small quantities. Three colors, your wording, two dollars a hundred. Samples. Madison Advertising, Post Office Box 42, Madison, O.

MIMEOGRAPH—Circulars, letters, etc. No charge for small illustrations. Low prices. Williams Co., St. Charles, Illinois.

1,000 BUSINESS Cards \$1.50. Brown, 344 St. Nicholas, New York.

250 EACH, Letterheads, envelopes, \$2.00. Lindeman, 328 Congress, Troy, N. Y.

PRINT Your own. Bargain presses, type. List 3c. Exchange D13, 22 Orient, Meriden, Connecticut.

ATTRACTIVE Letterheads, envelopes, statements, business cards, 250—\$1.00. Box 135-P, LaCrosse, Wisconsin.

8½x11 LETTERHEADS, Envelopes \$1.95 thousand. Multigraphed letters \$2.25 M. Circulars cheap. Daniels Press, Statesville, No. Car.

PRINTING? Write us. Square Deal Printers, Box 215, Greenfield, Mass.

QUALITY Printing—Prepaid east of Mississippi. 1000 cards, case, \$1.35; letterheads, 20 lb. bond, \$3.65; envelopes, \$2.95; statements, billheads, \$2.75. Mail-Order Publishers, 954-P 8th Ave., New York.

GUMMED Labels: 1,000 printed, 1x1 1/4, 20 words or less, 50c. JBS Company, Box 93, Holyoke, Mass.

5000 ENVELOPES, Letterheads, post-cards, 6x9 circulars—\$8.99. 1000 envelope slips, \$7.5; 5000, \$3.99—postpaid. Samples. Goodprint, Harrisonburg, Va.

10 CHRISTMAS Cards, your name—25c. 50 calling-cards—10c. Audrey Press, 1014 College, New York.

1000 6 1/2 ENVELOPES Or letterheads, \$2.00. Freimark Printing, LaCrosse, Wis.

MIMEOGRAPHING At lowest rates. We furnish paper, 8 1/2 x 11, and delivered postpaid. 500—\$1.85, 1000—\$2.75. Ideal Service, Box 73, Sta. A, Brooklyn, N. Y.

500 LETTERHEADS Or envelopes \$1.75. Multigraphing, Lee Gooch, Hernando, Miss.

NEARGRAVURE Embossed letterheads \$3.45 thousand. Samples 3c. Sollidays, Knox, Indiana.

ATTENTION! Choice, \$1.00—1,000 business cards; 500 parcelpost labels; 250 letterheads, envelopes, statements, blotters or shippingtags. Dollar Printers, Ottawa, Ill.

300 LETTERHEADS 8 1/2 x 11; Envelopes; billheads; statements; 500 parcelpost labels—choice \$1.00; 1,000, \$1.95. Kostka, 2348 South Crawford, Chicago.

1000 CARDS \$1.00. Illustrations. Anything printed. Bradshaw, 3214-P Huron, Chicago.

ENVELOPES, Letterheads, 500, \$1.75. Special quantity prices. Reed Press, Mishawaka, Ind.

2 DIMES Postpays 100 calling cards. VanDorn Cardcrafters, Ottawa, Illinois.

FREE Assortment, useful business stickers. Labelers, 6618R Quimby, Cleveland, Ohio.

MIMEOGRAPHING—25% Discount. Specimens free. Letter Shop, Red Wing, Minn.

ENGRAVURE Printing. Lowest possible prices. Samples free. Sunko, Mohawk, N. Y.

MODERNISTIC Quality printing. Reasonable. Samples. Messenger Press, Ballston Spa, N. Y.

BETTER Grade printing, reasonable priced. Free samples. Economic Press, Leonia, N. J.

SAVE Money on printed circulars, folders, booklets, etc. Samples free! Fantus, 523 South Dearborn, Chicago.

BOOK, Magazine, pamphlet and catalog printing done quickly at low prices. Our \$50,000 plant is always ready for service. The Meador Press, 470 Atlantic Ave., Boston, Mass.

2000 BUSINESS Cards neatly printed \$1.50. Atlas Distributing Co., 1814 Bedford Ave., Pittsburgh, Pa.

1000 BUSINESS CARDS, card case, \$1.50. Miller, Printer, Ambler, Pa.

BOY Mechanic—Famous library of 4 volumes covers the building of almost everything a boy might want to make. A great boon to parents and teachers. Actually covers 4,000 different articles. Each volume 460 pages, fully illustrated. Cloth. Price \$2.00 each or set of 4 vols.—\$7.00 postpaid. Popular Mechanics Press, Room C35, 200 E. Ontario St., Chicago.

PRINTING OUTFITS AND SUPPLIES

HAND Press, type and complete printers' supplies. Advise equipment you need and we quote prices; or send stamp for catalog. P. Pfeiffer, 59-A, 6 Columbia St., Newark, N. J.

PRINT Your own cards, stationery, circulars, advertising, etc. Save money. Easy rules furnished. Print for others, big profits. Junior press, \$5.90; job presses, \$11, power \$149. Write for details. Kelsey Co., Y-11, Meriden, Conn.

CHRISTMAS Special hand press. Job presses, type, supplies. Send stamp. 159 Harvard, Cambridge, Massachusetts.

PRINT Large theatre posters. Construct cylinder press and type for \$3.00. Plans 25c. Robert Carpenter, 2406 Talunar, Wichita Falls, Texas.

PRINT Your own circulars, envelopes, with home made press costing less than \$1.00. Illustrated instructions 10c. Carl Edquist, Odessa, Minn.

PRINTING Presses, supplies, 3c for complete lists. Landis, Richland, Pa.

PRINTING Outfits—Presses, type supplies, type novelties. Send stamp for catalog. Model Press, York, Penna.

PATENT ATTORNEYS

INVENTORS: Send immediately for your copies of our new free books, "Patent Protection" and "Suggestions on Selling an Invention." Sixty-eight pages of interesting facts. They tell how patent laws protect you; kind of sketch or model needed; simple steps to take without cost; how successful inventors have secured financial assistance; show interesting inventions; illustrate important mechanical movements. With books we also send free Evidence of Invention form to help establish date of disclosure. Prompt service, reasonable fees, special deferred payment plan. Strictest secrecy. Thirty-six years' experience. Highest references. Write us today. The facts in our books are worth money to the man with a good invention. Address: Victor J. Evans & Co., Registered Patent Attorneys, 400-P Victor Building, Washington, D. C.

PATENTS—Small ideas may have large commercial possibilities. Write immediately for information on how to proceed and "Record of Invention" form. Delays are dangerous in patent matters. Clarence A. O'Brien and Hyman Berman, 587 Adams Building, Washington, D. C.

JOHN O. ELLIS, Patent attorney, National Press Building, Washington, D. C. Patents and trade-marks. Patent investigations. Dept. A. Estimates free and fees as low as good work will permit.

PATENTS. Protect your idea by securing free "Proof of Invention" folder. Exceptional personal service. Established 1906. E. E. Vrooman, 871 Woodward Building, Washington, D. C.

RAMSAY Company. Patent Attorneys. Free information. 273 Bank St., Ottawa, Canada.

PRACTICAL Inventions now saleable before patenting. What have you? Write Chartered Institute of American Inventors, Dept. 4B, Washington, D. C.

"INVENTOR'S Guide," 100 mechanical movements, free; advises on patenting, selling inventions. Frank Ledermann, Tribune Bldg., New York.

PATENTS. Booklet free. Highest references. Best results. Promptness assured. Watson E. Coleman, Patent Lawyer, 724 Ninth St., Washington, D. C.

PATENTS Procured; trade marks registered—preliminary advice furnished without charge. Booklet and form for disclosing idea free. Irving L. McCathran, 700A International Bldg., Washington, D. C.

L. F. RANDOLPH, 302-B Victor Building, Washington, D. C. Low cost. Book and information free.

PATENTS. Instructions "How to Establish Your Rights" and form. "Evidence of Conception"—sent free! Lancaster, Allwine & Rommel, 411 Bowen Building, Washington, D. C.

INVENTORS—Send for free booklet "Patent-Sense." Information based on 64 years experience. Lacey & Lacey, Dept. 5A, 635 F St., Washington, D. C.

ECONOMY For inventors. Write for booklet. Thos. H. Johnston, 635 F St., N. W., Washington, D. C.

FOR INVENTORS

INVENTOR'S Universal Educator: contains 900 mechanical movements; 50 perpetual motions; instruction on procuring and selling patents and selecting an attorney, etc. Suggests new ideas. Price \$1.00 postpaid in U.S.A. Address Albert E. Dietrich, 511-B Colorado Bldg., Washington, D. C.

INVENTORS: Send immediately for your copies of our new free books, "Patent Protection" and "Suggestions on Selling an Invention." Sixty-eight pages of interesting facts. They tell how patent laws protect you; kind of sketch or model needed; simple steps to take without cost; how successful inventors have secured financial assistance; show interesting inventions; illustrate important mechanical movements. With books we also send free Evidence of Invention form to help establish date of disclosure. Prompt service, reasonable fees, special deferred payment plan. Strictest secrecy. Thirty-six years' experience. Highest references. Write us today. The facts in our books are worth money to the man with a good invention. Address: Victor J. Evans & Co., Registered Patent Attorneys, 401-P Victor Building, Washington, D. C.

FAKERS! Frauds! Exposed in "Inventive Age" (Patent Sales Magazine). Carlstadt, N. J. 2 months, quarter. Year, dollar.

PATENTS—Small ideas may have large commercial possibilities. Write immediately for information on how to proceed and "Record of Invention" form. Delays are dangerous in patent matters. Clarence A. O'Brien and Hyman Berman, 587 Adams Building, Washington, D. C.

TO Inventors: We are in the market to purchase a good patent, preferably in the automobile accessory line. Will purchase outright or on royalty basis. Purchasing Agent, 241 Front St., New York, N. Y.

PATENTS, Low rates. Samuel Goldstein, 275 E. Gunhill Rd., New York City.

INVENTORS: "New Positive Priority Protection" three—25c. Dobner, 2834 N. 54, Milwaukee.

I SELL Patents. Established in 1900. Charles A. Scott, 773PM Garson Ave, Rochester, N. Y.

UNPATENTED Ideas can be sold. We tell you how and help you make the sale. Particulars, with list of manufacturers and wanted inventions sent free on request. Write W. T. Greene, 944 Barrister Building, Washington, D. C.

HAVE You a sound, practical invention for sale, patented or unpatented? If so, write Chartered Institute of American Inventors, Dept. 4A, Washington, D. C.

SELL Your patent through a small classified ad in Popular Mechanics. Many inventors have found buyers in this way. Ask me for proof—I'll gladly send it to you. F. W. Johnson, Manager, Classified Advertising, 200 E. Ontario St., Chicago.

INVENTORS: "Making Inventions Pay," our 32-page illustrated book, mailed upon receipt of 3c postage. Crescent Tool Company, Dept. Z, Cincinnati, Ohio.

PATENTS. Low cost. Book and information free. L. F. Randolph, 302-C Victor Building, Washington, D. C.

MODEL Of modern passenger locomotive—size, unfolded 10x16 in. Here, accurately shown in colors, are all the intricate parts of a modern giant of the rails, complete with tender. Invaluable for study. Of great interest and fascination to boys and others interested in railroads. \$1.00 postpaid. Popular Mechanics Press, Room C35, 200 E. Ontario St., Chicago.

INVENTIONS WANTED

PATENTS—Small ideas may have large commercial possibilities. Write immediately for information on how to proceed and "Record of Invention" form. Delays are dangerous in patent matters. Clarence A. O'Brien and Hyman Berman, 587 Adams Building, Washington, D. C.

INVENTION For sale? Write Inventive Age, (Inventive Trade Journal), Carlstadt, N. J., immediately! Inventors recommend. Results. Copy, dime.

SMALL Inventions wanted by manufacturers. I'll help you sell your invention. Stanley Hull, 7829 Euclid Avenue, Cleveland, Ohio.

INVENTIONS Wanted—Patented, unpatented. If you have an idea for sale, write Hartley's, Inc., Box 928-E, Bangor, Maine.

PATENTS FOR SALE

ATTENTION! Manufacturers, jobbers, distributors: Have now on the market proven seller, Jar Lid Straightener—Sealer—going over bigger than anticipated—desire national distribution. Will sell outright—royalty basis. Polisso & Stablow, Rochester, Pa.

ELECTRIC Heating system for oil pipe lines. Practical, efficient, money-maker. Chas. Seizefant, R. No. 3, Box 530, Modesto, Calif.

HAT Displayer. Stamped metal. Have dies, samples. 5000 sold. Geo. Johnson, 507 Division, Sault Ste. Marie, Michigan.

UNPATENTED Autodynamic air compressor model for sale. William LeClaire, Harlowton, Montana, Winnecook Ranch.

OUTRIGHT Or royalty—Combination; Jar Opener and Closer, patent No. 1,981,104, Meritorious, improved, inexpensive to make. Stephen Heiner, 1216 Electric Street, Scranton, Penna.

ELECTRIC Appliance. Baresch, 1108 131 St., College Point, New York.

AUTOMOBILE Opens and closes doors and gates. Practical, simple, economical. Patents, 1935, U.S.A. and Canada. Sell outright or royalty. Chester A. Diller, Lancaster, Pa.

SCIENTIFIC Glare stop. No blind spot. Cheaply manufactured. Royalty. Max Koehler, 935 Shepherd, N. W., Washington, D. C.

MANUFACTURERS Looking for new inventions should write W. T. Greene, 939 Barrister Bldg., Washington, D. C.

MANUFACTURING

MANUFACTURING, Models, dies, stampings, brasswork? Casting moulds. Stamp for catalog. Baums Metal Specialties, Kansas City, Mo.

INVENTIONS Manufactured in any quantity at low cost. Stampings, dies, models, etc. Estimates and free catalog. Crescent Tool Co., Dept. X, Cincinnati, Ohio.

MAKE IT YOURSELF. Hundreds of practical and useful devices described in our big book. Plain instructions and illustrations show you how to make them. Save money on things for yourself or make profit selling to others. 900 articles of great variety. 480 pages. 823 illustrations. \$3 postpaid. Popular Mechanics Press, Room C35, 200 E. Ontario St., Chicago.

MODELS AND MODEL SUPPLIES

SCALE Models historical buildings. Particulars free. P. Reed, Katonah, New York.

FOR Pastime make engines. Illustrated catalog 25c. Howardco, 2417 N. Ashland Ave., Chicago, Ill.

SHIP Models—Build 18" Flying Cloud, Constitution or Galleon. All materials including full-sized plans only \$1.50 from Hancock, 323 Douglas Ave., Portsmouth, Virginia.

PATENTS—Small ideas may have large commercial possibilities. Write immediately for information on how to proceed and "Record of Invention" form. Delays are dangerous in patent matters. Clarence A. O'Brien and Hyman Berman, 587 Adams Building, Washington, D. C.

MODEL Ship and boat supplies. Complete line. Catalogs dime. Welcher, South 7th St., Fulton, N. Y.

EVRAV'S Models—Engine castings, books, blueprints, materials and supplies. Advance bulletin illustrated circular for stamp. Evraymesco, 28 No. Clinton, Chicago.

FREE Circulars. Make building models; novelties; Pueblo. Weldler, 4589 Lexington, Hollywood, California.

RAILWAY Model supplies—Track, signals, locomotives, etc. List 10c. Crovan Railway Models, Stamford, Conn.

MODELMAKERS—Magazines edited just for you: The Modelmaker and The Model Railroader. Either, \$1.50 per year. Both, \$2.50 per year. Sample of either, 15 cents; both, 25 cents. Modelmaker Corp, Wauwatosa, Wis.

BRASS Gears and model supplies. Send for catalog. The Pierce Model Works, Tinsley Park, Ill.

MODELS—Your ideas developed into practical working models. 30 years' successful experience; thousands of satisfied customers. Confidential service guaranteed. Bank references. Send 3c postage for 32-page book—"Making Inventions Pay." Crescent Tool Company, Dept. Y, Cincinnati, Ohio.

MODEL Steam locomotive $\frac{3}{8}$ " scale. Easily made. Particulars, casting list, photo, 25c. Little Engines, Box 15, Wilmington, California.

PLANS, BLUEPRINTS, INSTRUCTION

WOODEN Clock blueprints. Detailed drawings and instructions. Weight driven time movement \$1.00, with striker \$1.50, grandfather \$1.75. W. D. Frost, Grayville, Illinois.

NEW Jigsaw pattern book 10c. Poenitz, 108 W. Hamtramck, Mount Vernon, Ohio.

25 BLUEPRINTS Auto generator changes. Welders, motors. \$1.00. Electric Automotive Power, 2625 S. 27th, Milwaukee, Wis.

HOME CRAFTSMEN

FOR Sale cherry, thickness 1", widths to twenty inches, lengths to fourteen feet. Been drying ten years and planed, finest cherry obtainable. Also some choice black walnut random widths and lengths. P. O. Box 262, Sidney, Ohio.

FINISHING Any kind of material used for crafts projects is easily done with our self-priming, fast drying colors. 3c brings color card. Pyramid Company, 139 Boulevard, Long Island City, N. Y.

DOUBLE Boiler glue pot. 75c complete, no stamps. Womelsdorff Laboratories, Clearfield, Pa.

MAKE Novelties for Christmas. 3 descriptive patterns—25c. Hurry. Stanley Stanton, Liberty, New York.

LEATHERCRAFTSMEN—Write for free instructions and price list of leather, tools and beginners' kits. Send 5c for sample cards. Address Wilder & Company, Dept. F, 1038 Crosby St., Chicago, Ill.

WOOD Turning on the lathe. Interesting and fascinating. Send for Milton & Wohlers Course in wood turning. It gives you quickly a complete mastery of this manual art. 200 pages. Cloth. 141 plates. \$1.50 postpaid. Popular Mechanics Press, Room C35, 200 E. Ontario St., Chicago.

WATCHES, JEWELRY, PRECIOUS STONES

SELL Rebuilt watches. Same guarantee as brand new. Low prices will amaze you. Everybody a prospect. Write for illustrated folder and prices. Grossman Jewelry Co., 4666 State Street, Chicago.

AUSTRALIAN Opals, all varieties, good assortment \$5.00. Lists free. Norman Seward, Melbourne, Australia.

OLD GOLD WANTED

CASH For old gold teeth, crowns, bridge-work, jewelry, watches. We are smelters and refiners and pay you high prices, because we refine into dental gold. Satisfaction guaranteed or shipment returned. Free information—Dr. Weisberg's Gold Refining Company, 1593 Hennepin Ave., Minneapolis, Minn.

CASH For gold, teeth, jewelry, watches. High prices paid day shipment received. Satisfaction absolutely guaranteed or articles cheerfully returned. Information free. Chicago Gold Smelting & Refining Co., 337 Champlain Bldg., Chicago.

MAIL Us your discarded jewelry, gold crowns and bridges, watches, diamonds, silver and platinum. New high prices paid, remittance mailed immediately. Goods returned if our offer is refused. United Smelting Works, (The Old Reliable.) Backed by 50 years of experience. 39 So. State St., Dept. 71, Chicago.

FOR THE HOME

EVENTIDE House-heat-control, electric blower and thermostat complete, either 25 or 60 cycle, \$20. Full directions. Install yourself. \$1 with order, balance C.O.D. Elecdrive Co., Syracuse, N. Y.

CLOCKS: Build your own grandfathers'; barjo; shelf. Thousands built successfully. Some with delightful chimes. Directions 10c. Particulars free. Clock Company, Hervis Street, Philadelphia.

BIG Money electrifying spring clocks and building cases. Dime brings drawing and "How" book. Kuemklocks, Guttenberg, Iowa.

BUILT-IN Furniture adds convenience, comfort and beauty to your home at very low cost. Any handy man can build a great variety of this space-saving furniture from the easily-followed instructions in our remarkable book, the only one on this subject. \$2.50 postpaid. Popular Mechanics Press, Room C35, 200 E. Ontario St., Chicago.

TOBACCO

GOOD Red chewing, 10 pounds \$1.00; smoking 80c. Bert Choate, Hickman, Ky.

POSTPAID: Guaranteed very finest 28 inch sweet, juicy, redleaf chewing, 10 lbs. \$2.00. Extra, smoking \$1.50. Ernest Jolley, Dresden, Tenn.

RAZOR BLADE SHARPENING

YOUR Razor blades sharpened like new. 1c each. Petter Wetterquist, Rockford, Ill.

TATTOOING

TATTOOING Outfits, supplies. Illustrated list. "Waters," 965 Put-nam, Detroit.

TATTOOING Outfits, supplies. Illustrated catalogue. Miller, 433 Main, Norfolk, Va.

ENORMOUS Profits tattooing; get our free illustrated folder! Chicago Tattoo Supply House, 651A South State, Chicago.

WANTED—MISCELLANEOUS

CASH For your camera, projector, microscope, binoculars and other instruments. Professional Exchange Company, 204 W. Madison St., Chicago.

CASH For used microscopes, binoculars, cameras, slide rules, drawing sets, surveying, scientific instruments, marine equipment. Highest prices paid day shipment received. Satisfaction guaranteed or shipment cheerfully returned. Elman's, 2302 VanBuren, Chicago.

PERSONAL

FREE, Important literature on the attaining and maintaining of natural health. Dr. F. L. Haynes, 308 Bigelow Bldg., Seattle, Wash.

BEAR OIL—The best hair invigorator. Used by northern Canada Indians. Dollar orders prepaid. Swastika Drug Co., Ltd., Swastika, Ontario.

DON'T Suffer with ugly pimples, acne, blackheads, eczema, ringworm and other skin troubles. Get quick relief with Atholin Skin Lotion (medicated). 60c postpaid. Agents wanted. Dept. AM, Hilliard Products, Wilmington, Del.

POWER—Health—Confidence, attractive personality, win friends, banish fear, nervousness, inferiority, bashfulness. Learn secrets of health and happiness. "The Secret Place," 54 pages. Amazing book. Only 25c. 3c stamp. Dr. J. J. Smith, Box 71-M, Stoneham, Mass.

MISCELLANEOUS

BRONZE Tablets, desk plates, wall plates, memorials, grave markers. Bronze, brass and aluminum casting. Wandkey Pattern & Foundry Co., Anderson, Ind.

CUTS—Make them yourself. Simple, inexpensive etching process. Information free. Hughes Products, 70 Miami, Terrace Park, Ohio.

NAME Tags—For keys, luggage, dog collars. Insure them against loss. 15c (coin) each. J. Glasser, West Catasauqua, Pa.

AMATEUR Cartoonists can earn \$35.00 weekly, spare time, duplicating cartoon advertisements. 3-M Syndicate, Argyle, Wis.

BEAUTIFUL Butterflies, moths. Twenty different \$1.00 postpaid. Frederick Lemmer, 39 Park Place, Irvington, New Jersey.

CASH Income daily silvering mirrors at home. Plating autoarts, tableware, etc. Combination outfit. Write Sprinkle, Plater, 288, Marion, Indiana.

BRONZE Grave markers, tablets, window and desk plates, fraternal emblems, novelties. Bronze, aluminum castings. Inland Monument Company, 247 W. Chestnut St., Walla Walla, Wash.

PROTECT Your keys! Your name, address stamped on metal identification tag, 25c. Key ring included. Agents wanted. Irvin Buschkowsky, 508-R Oak, Chaska, Minnesota.

METALLASCOPE Absolutely guaranteed find buried gold, silver, etc. Users all over world report finding buried treasure and valuable ore. New de luxe model five times as sensitive as any previous instrument. Operate it expertly after few minutes practice. Write for free interesting information. Metallascopes Sales Co., 1031 South Broadway, Los Angeles, Calif.

CUTS Anybody can make. Simple, cheap process \$1.25. Specimens, particulars for stamp. J. C. Day, Windfall, Ind.

CLOCK Shelf, Oak, one dollar postpaid. Ideal Mfg. Co., Marshalltown, Iowa.

MUCILAGE-PENCIL. Newest, most economical adhesive for home, office and school. Pencil in handy sanitary container. One dime. E. G. Glidden, 80 Elder, Schenectady, N. Y.

GOLD And silver locator. \$5.00 postpaid. Free trial. Bergman, Drawer 398, Springfield, Missouri.

COCOONS, Butterflies, collector's supplies, butterfly art materials. Free lists. Maynard, 1192 Lewiston, Rochester, N. Y.

WHOLESALE Supply sources, half million items. 10c. International Agency, Cincinnati.

TREASURE Seekers—Make your own gold finders. Wyss, 104½ Frances, St. Joseph, Missouri.

SWAPPER'S Friend, R4, Saline, Michigan. Interests swappers, collectors, sportsmen. 50c year, sample 10c.



NOW . . . You can choose YOUR PHYSICAL CULTURE COURSE

From Many PROVEN Systems . . . All at Reduced Prices
All the popular systems of body building and all makes of popular Health and Exercising apparatus that we have are listed for your selection. All at great money saving prices. Share in our profit participating plan.

Home Gyms, Chest Pulls, Sandow Grips, Hand Grips, Pulley Outfits, Combination Sets, Barbells, Dumbbells, Reducing outfits. Numerous other outfits, all complete with courses. Also books and accessories are shown in our Great Money Saving Catalog. Every outfit guaranteed or money back.

FREE ILLUSTRATED CATALOG
The only one of its kind. Buy the best for less. Our Profit Participating Plan will save you plenty of money and give satisfaction. Send for it today.
AMERICAN ATHLETIC APPLIANCE CO., Inc.
4324 Paul St., Dept. 2112, Philadelphia, Pa.

Duty FREE to Canadians. Address:
Canadian Athletic App. Co., Morrisburg, Ontario.



Ask for FREE Catalog



ITALIAN Accordions

OF ALL TYPES

Hand-made, best quality. Buy direct from our factory and save 1/2. Satisfaction guaranteed. Used musical instruments taken in trade. FREE accordion lessons.

ITALIAN ACCORDION CO.

323 W. Polk St., Dept. P-8, Chicago

PHOTO-ENGRAVING LEARN IT AT HOME



We Furnish all equipment and materials including large photo-engraving camera complete with lamps, lens and screen. When you have finished the course you can establish a good paying independent business with the equipment furnished or work for others at a big salary. Photo-Engraving offers greater opportunities today than any other industry. Every picture in this issue of Popular Mechanics was engraved by the process we teach you. Earn good money while learning. Write today for our new illustrated catalog which was engraved on equipment such as we furnish. You will not be obligated in any way by writing
Aurora School of Photo-Engraving, Dept. 1125, Aurora, Mo.

HOME STUDY COURSES

Home-Study Courses, leading to Degrees in Arts and Sciences; Education; Writing; Psychology; Chemistry; Business and Commerce; Law; Theology; Agriculture; Engineering; also courses in Business Training; Accounting; Advertising; Sales Management; Public Speaking; Radio. Many others. Low Cost; Easy Terms.

McKinley-Roosevelt University, 4246 Clarendon Ave., Chicago

AGENTS 500% Profit GOLD LETTERS

For Store Fronts and Office Windows. Anyone can put them on. Free samples. Liberal Offer to general agents.
METALLIC LETTER CO., 438 N. Clark St., Chicago

STATEMENT OF THE OWNERSHIP, MANAGEMENT, CIRCULATION, ETC. REQUIRED BY THE ACT OF CONGRESS OF MARCH 3, 1933, of Popular Mechanics Magazine, published monthly at Chicago, Ill., for October 1, 1935.

State of Illinois, County of Cook, ss.
Before me, a notary public in and for the state and county aforesaid, personally appeared Willis S. Brown, who, having been duly sworn according to law, deposes and says that he is the business manager of the Popular Mechanics Magazine and that the following is, to the best of his knowledge and belief, a true statement of the ownership, management, etc., of the aforesaid publication for the date shown in the above caption, required by the Act of August 24, 1912, embodied in section 411, Postal Laws and Regulations, printed on the reverse of this form, to wit: First. That the names and addresses of the publisher, editor, managing editor, and business manager are: Publisher, Popular Mechanics Co., 200 East Ontario St., Chicago, Ill., Editor, H. H. Windsor, Jr., 200 East Ontario St., Chicago, Ill., Managing Editor, L. K. Weber, 200 East Ontario St., Chicago, Ill., Business Manager, Willis S. Brown, 200 East Ontario St., Chicago, Ill. Second. That the owner is: (If owned by a corporation, its name and address must be stated and also immediately thereunder the names and addresses of stockholders owning or holding one per cent or more of total amount of stock. If not owned by a corporation, the names and addresses of the individual owners must be given. If owned by a firm, company, or other unincorporated concern, its name and address, as well as those of each individual member, must be given.) Popular Mechanics Company, 200 East Ontario St., Chicago, Ill., L. B. Windsor, 200 East Ontario St., Chicago, Ill.; H. H. Windsor, Jr., 200 East Ontario St., Chicago, Ill. Third. That the known bondholders, mortgagees, and other security holders owning or holding 1 per cent or more of total amount of bonds, mortgages, or other securities are: (If there are none, so state.) None. Fourth. That the two paragraphs next above, giving the names of the owners, stockholders, and security holders, if any, contain not only the list of stockholders and security holders as they appear upon the books of the company but also, in cases where the stockholder or security holder appears upon the books of the company as trustee or in any other fiduciary relation, the name of the person or corporation for whom such trustee is acting, is given; also that the said two paragraphs contain statements embracing affiant's full knowledge and belief as to the circumstances and conditions under which stockholders and security holders who do not appear upon the books of the company as trustees, hold stock and securities in a capacity other than that of a bona fide owner; and this affiant has no reason to believe that any other person, association, or corporation has any interest direct or indirect in the said stock, bonds, or other securities than as so stated by him. Willis S. Brown, Business Manager. Sworn to and subscribed before me this 30th day of September, 1935. J. GRAHAM, Notary Public. (My commission expires June 16, 1936.)

Diesel & Air-Conditioning .. 2 New Professions .. NEED Draftsmen

Diesel Engines, the new source of power, and the air-conditioning of all business buildings have created a tremendous demand for draftsmen. They must draw the plans for engine design, for installation in buses, tractors, trucks and automobiles. The same thing applies to air-conditioning for all this work must start on the drafting board. Take advantage of this opportunity now, learn drafting the quick easy way. Send for these books which cover the whole field of drafting so simply that anyone can understand them; a tremendous value to beginner and expert alike.



Nearly 2000 pages, 1600 charts, blueprints and diagrams. Gold stamped flexo covers.

These Books Shipped FREE

on approval Yes we ship without a penny down, without any deposit or other agreement except to return them if you don't like them. Read the coupon, then send it quickly to occupy a position of responsibility and big pay. If you send now we will include a year's membership in the American Technical Society with full consultation privileges with our experts for one year.

Learn Quick Way This \$10.00 set of fine, accurate drawing instruments included in this offer. Here is a quick, easy way to qualify for a good drafting job.



American Technical Society
Drexel Ave. at 58th St.
Chicago Dept. D919

I want to qualify as a draftsman quickly. You may send me your five volume set of Drafting Books for 10 days free examination. If I like them I will send you \$2.00 in 10 days and then \$3.00 a month until the special price of \$24.50 is paid, otherwise I will return them at your expense and owe you nothing.

Name.....
Address.....
City.....State.....

Please write us a letter and give the name of your employer and that of at least one other business man as a reference.

ITCH STOPPED IN ONE MINUTE

Are you tormented with the itching tortures of eczema, rashes, eruptions, or other skin afflictions? For quick and happy relief, use Dr. Dennis' cooling, antiseptic, liquid D. D. D. PRESCRIPTION. Its gentle oils soothe the irritated and inflamed skin. Clear, greaseless and stainless—dries fast. Stops itching instantly. A 35c trial bottle, at drug stores, proves it—money back.

D. D. D. Prescription



BUCHSTEIN'S FIBRE LIMB is soothing to your stump—strong, cool, neat, light. Easy payments. Braces for all deformities. Agents wanted.
D. BUCHSTEIN CO.
610 3rd Ave., So., MINNEAPOLIS, MINN.

Send for Catalog Today

for
quick
action

SEND
TO-DAY

MAIL COUPON NOW

for Free Book and Record of Invention Form

CLARENCE A. O'BRIEN
and HYMAN BERMAN
Registered Patent Attorneys
70-D Adams Building, Washington, D. C.

Please send me at once your Big Free 48-Page Book "Patent Guide For the Inventor" and your Specially Prepared "Record of Invention" Form. This request does not obligate me.

Name.....

Address.....

(Please write or print plainly)

YOU CAN PATENT



NEW IDEAS FOR IMPROVEMENTS IN MACHINERY, ARTICLES, DESIGNS, FORMULAS, ETC.

Every year thousands of Patents are granted. Very few, however, represent the discovery of entirely new principles. Most of them provide new methods of doing some every-day thing in a better way—changes for greater efficiency, usefulness, adaptability, or beauty in some previously Patented thing. These IMPROVEMENTS are Patentable if new, and actually represent new invention. These Improvement Patents offer large chances for profit if commercially useful. The business world wants improved products and services.

MODELS and FINISHED DRAWINGS UNNECESSARY

Our Big Book tells you how you can start immediately to apply for Patent Protection even if you haven't finished models or drawings available now. It will tell you how we can prepare the specifications and finished drawings necessary in the form prescribed by the Patent Office—so as to secure for you full Patent Protection. Mail Coupon for Our Big Book TODAY.

OUR SERVICES TO YOU

We are registered Patent and Trade-Mark Attorneys, serving Inventors all over the United States and abroad. Our Organization is complete. We have Draftsmen, experienced Searchers and Attorneys to serve your interests. We can act as your legal adviser in all Patent Matters. Our complete service is described in Our Big Book. Mail Coupon for it NOW.

IN CASE YOU FEEL THAT YOU HAVE NOT SUFFICIENT FUNDS AVAILABLE FOR PATENT FEES

Our Big Book tells you how to legally assign an interest in your invention—before filing application—to some friend willing to aid you. Better to do this than to delay indefinitely and see another inventor develop your idea and Patent it before you do. Send Coupon NOW.

REASONABLE FEES—CONVENIENT TERMS

Don't worry about finances. Our fees are very reasonable—we can arrange convenient terms of payment. It is our custom to permit clients to pay for our services in installments as the application progresses in our office. See our Big Book for fees in obtaining Patent. It explains our arrangements clearly. Send for it NOW.

REQUEST OUR BOOK—NOW!

Know exactly what you should do to secure a Patent—what must be done every step of the way—how the Patent Law protects you—what we, as Registered Patent Attorneys, can do for you. Mail the coupon NOW for our Big Booklet and "Record of Invention" Form.

CLARENCE A. O'BRIEN

AND

HYMAN BERMAN

70-D ADAMS BUILDING

Registered Patent Attorneys

WASHINGTON, D. C.

PATENTS

Booklet Free Highest References
 Promptness Assured Best Results

Send drawing or model.

ALL BUSINESS GIVEN PROMPT AND PROPER ATTENTION

Listed Patent Lawyer in the latest editions of the Rand-McNally Directory of Bankers and Bank-Recommended Attorneys, published by Rand-McNally & Co., Chicago, Ill.; The Baggott & Ryall Directory of Guaranteed Attorneys, published by Legal Directory Corporation, Boston, Mass.; Flugel's Law List, published by Legal Directory Publishing Co., St. Louis, Mo.; American Lawyers Annual, Cleveland, Ohio; Bankers Service Legal Directory, Bankers Service Co., Boston, Mass.; Eyre's Law List, 9 Park Place, New York City, and the Central Guarantee Co., Bankers and Lawyers Directories, Empire State Bldg., New York City.

WATSON E. COLEMAN,
 REGISTERED PATENT LAWYER

Victor Building, 724 Ninth Street, N. W.
WASHINGTON, D. C.

INVENTORS PATENT YOUR IDEAS

SEND FOR FREE BOOK →



HOW TO OBTAIN A PATENT

Written by a Former Member of the Examining Corps (1922-24) of the U. S. Patent Office. If you want to profit by your idea, you should take steps to apply for a U. S. Patent at once. Your first step is to get this Free Book. This interesting illustrated book contains valuable information you should have. It tells you fully how to obtain a patent on your idea in the quickest way. With this Free Book you will also receive a "Record of Invention" form on which you can easily record your idea. Personal and Confidential Service: Your case will be personally handled only by a Registered Patent Attorney who is also a Former Member of the Examining Corps of the U. S. Patent Office. All communications confidential.

MAIL COUPON TODAY for FREE PATENT BOOK and RECORD OF INVENTION Form.

CARL MILLER
 REGISTERED PATENT ATTORNEY
 FORMER MEMBER EXAMINING CORPS U. S. PATENT OFFICE

1638 Woolworth Bldg., Dept. 125A, New York City
 MILLER BUILDING, Dept. 125A, WASHINGTON, D. C.
 Please send me your Free Book, "How to Obtain a Patent," and your "Record of Invention" form.

NAME.....
 ADDRESS.....

RADIO

**BIGGEST
 OPPORTUNITIES
 STILL AHEAD**

ALMOST in a decade radio has become a giant industry. The opportunities created will be enjoyed by trained men. The International Correspondence Schools Radio Course, prepared by leading authorities and constantly revised, will make you a trained man! A fascinating book — free.

INTERNATIONAL CORRESPONDENCE SCHOOLS

Box 5606-H, Scranton, Penna.

Send me—free—information on subject checked:

- Radio Radio Service Man
 Radio Operator Electrical Engineer

Name.....
 Address.....

PATENTS—TRADE MARKS

All inventions submitted held confidential and given personal attention by members of the firm.
 Form, "Evidence of Conception" and instructions, "How to Establish Your Rights"—FREE!

LANCASTER, ALLWINE & ROMMEL
 Patent Law Offices

412 Bowen Bldg. Washington, D. C.

Inventions Wanted Patented or Unpatented

Have you a sound, practical invention for sale, patented or unpatented? If so, write

Chartered Institute of American Inventors
 Dept. 4, Barrister Building Washington, D. C.
 World's Largest Association of Inventors. Est. 1924.

INVENTORS who derive largest profits know and heed certain simple but vital facts before applying for patents. Our book, Patent-Sense, gives those facts; sent free. Trade Marks—Copyrights.
LACEY & LACEY, Est. 1869, 635 F St., N. W., Dept. 5, WASHINGTON, D. C.

INVENTIONS WANTED

INVENTORS SELLING GUIDE by R. F. Yates lists nearly 1000 buyers of inventions, shows how to sell and protect unpatented ideas, etc. 224-page book, postpaid \$2. Write for **FREE LIST OF NEEDED INVENTIONS** and catalog of practical books for inventors.
 Donley Publishing Co., Dept. P12, 509 Fifth Av., New York, N. Y.



GEARS

In Stock—Immediate Delivery

Gears, speed reducers, sprockets, thrust bearings, flexible couplings, pulleys, etc. A complete line is carried in our Chicago stock. Can also quote on special gears of any kind. Send us your blueprints and inquiries.

Write for Catalog No. 10

CHICAGO GEAR WORKS
 769-773 W. Jackson Blvd., CHICAGO, ILL.

ALBERT E. DIETERICH
 REGISTERED PATENT ATTORNEY
 512 B Colorado Building, WASHINGTON, D. C.
 Booklet on Patents sent free

To PROTECT YOUR INVENTION — Use this coupon, NOW

Delays are dangerous and may be very costly. My personal service assures prompt action, strict confidence, and a minimum of expense. I suggest that you send me a model or drawing, or sketch and description of your invention, and \$5.00. I will make a search and report

promptly as to its patentability and send you a copy of my 72-page booklet. Or, if you prefer to read my booklet first, mail the attached coupon at once. I will also send my "Record of Invention" form. (Over 37 years experience as a Registered Patent Attorney.)

L. F. Randolph, 302-D Victor Bldg., Washington, D. C.

Please send me at once, free of charge, your 72-page booklet and "Record of Invention" form.

Name.....
 Address.....

A PERSONAL CONFIDENTIAL PATENT SERVICE

Increase Your Earning Power

Apply time and labor-saving kinks to your work. Your efficiency will soon be recognized and you will be in line for advancement.

If you do machine shop work of any kind, sheet-metal work, painting, carpentry, auto repairing, farming, concrete work, plumbing, electrical work, welding, building-glass work, general repairing, tool-making, poultry raising, masonry or home repair work, get this

LIBRARY OF 2000 TIME AND LABOR SAVING IDEAS FOR SHOPMEN AND HANDYMEN

RECENTLY PUBLISHED



SHOP NOTES

for

1935

332 Articles.

721 Illustrations

224 Pages

Price 50c

See partial list
of
contents below

Including the new 1935 issue illustrated above, there are five volumes in the Shop Notes Library of 2000 easily understood short cuts to every-day jobs. Here are just a few of the subjects taken from the latest issue.

Auto Electrical Troubles, Tests	Glass, Working with	Scroll Saw, Special Uses
Auto Knocks, Locating	Heat Treating of Iron, Steel, Brass, Copper, Aluminum	Soldering with Electric Arc
Band Saw, Tuning Up	Jointer, Keeping in Shape	Streamline Bodies, Wire Mesh and Fabric for Boat and Auto
Belt Sander, Portable	Knee Action Wheels, Servicing	Taps and Dies
Boathouse Piling, Concrete	Lathe, Labor Saving Ideas for	Tool Chest, Portable
Cold Chisels, Using	Lathe Kinks, Simple	Window Attraction, Novel Store
Dancing Auto Wheels, Curing	Metal Spinning	Window Displays, Mechanical, that Draw Trade
Drill Press, Homemade	Metal Turning Suggestions	Wood Chisels, Tricks of Using
Drill-Press Problems, Solving	Neon Sign, Flashing	Wood Joints with Hand Tools
Electric Appliances, Repairing	Paint Spray Gun	Work Benches you can Build
Electric Motors, Rewinding	Road Baskets, Weaving	Workshop, Motorize Your
Electricians, Short Cuts for	Roadside Salesman Sander From Auto Parts	
Force Made from Cream Separator	Sand, Uses in Workshop	
	Saw Table, Adjustable	

Each volume contains approximately 400 articles and 500 illustrations and has 192 or more pages. This unrivaled library of shop helps may be secured for a limited time only. After the present supply of books is exhausted the offer must be withdrawn.

*** Send No Money ***

POPULAR MECHANICS PRESS,
200 E. Ontario St., Room 1235, Chicago, Ill.

Send me, as per your offer, the following books. I will pay postman price and postage. My money will be refunded if I am not satisfied. (Check what you want.)

- 1935 Shop Notes and Drilling and Thread Cutting, both for 98c.
- Shop Notes Library (5 vols.) \$2.50.

Name.....

Street and No.....

City..... State.....

* C. O. D. applies to U. S. and possessions only. If you reside elsewhere, remittance must accompany order.

68 Pages of facts for INVENTORS

These books were prepared for men of ideas—men who have an article in mind that will make money, save money, save labor or give pleasure. Leading thinkers agree that the world of a few years from now will be radically different because of the contributions to progress that inventors will make. Now is the time—if you have an idea—to see about protecting it.

Many Little Ideas May Have Big Commercial Possibilities

Don't think that to be profitable an idea needs to be complicated. Simple articles—just a person's hunch—have often proved profitable. The crinkly hair pin, the metal tip for shoe laces, the paper clip are good examples. Also improvements on patented articles sometimes prove more profitable than the original article itself.

Don't Delay—Send for These Free Books Now

Many a man has waited until too late to protect an idea by a United States Patent. Remember someone else may be thinking along the same lines that you are, and the Patent Laws favor the man who files his application for a patent first. Delays of even a few days can sometimes mean the loss of a patent. So learn the important facts about Patent Protection at once.

36 Years of Proven Service

For thirty-six years, this capable organization has served inventors from all over the country. Our large staff of patent specialists gives you expert and prompt service. Our fees are reasonable; we also help with deferred payments.



VICTOR J. EVANS & Co.

REGISTERED PATENT ATTORNEYS,

Main Office: 500-P, Victor Building, Washington, D. C.

Other Offices: 1640-N Conway Bldg., Chicago; 1007-N Woolworth Bldg., New York; 514-N Empire Bldg., Pittsburgh; 1010-N Hobart Bldg., San Francisco; 736 N Security Bldg., Los Angeles.

Send me FREE copies of your books "Patent Protection" and "When and How to Sell an Invention." (Note: Same books supplied by any of branch offices listed above.)

Name.....

Street and No.....

City or Town.....

When writing please mention Popular Mechanics

MAIL COUPON TODAY FOR YOUR COPIES

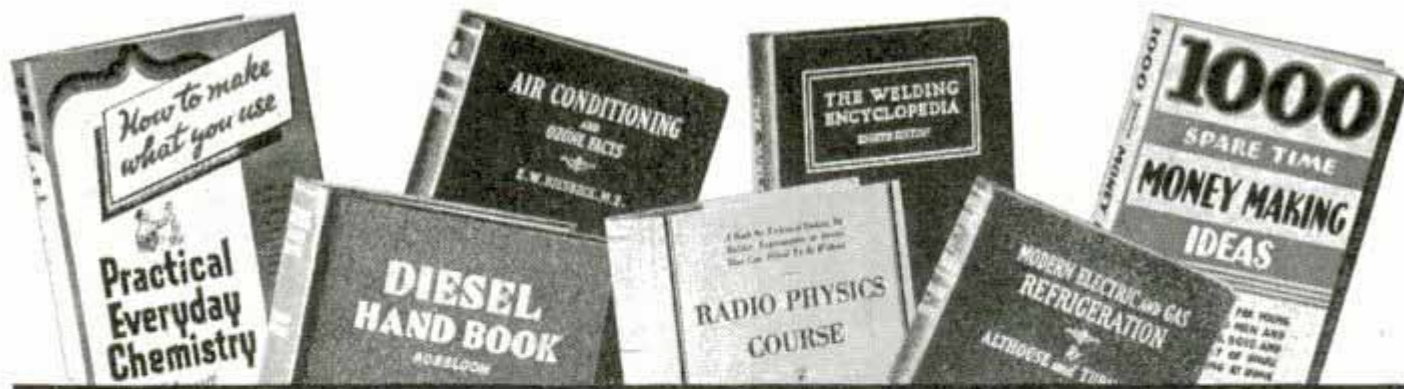

PROFITABLE PRACTICAL BOOKS

OF USEFUL PLANS AND IDEAS FOR BOTH WORK AND LEISURE HOURS

Whatever your interest—to develop a profitable sideline; save money making improvements; personal advancement through study; or pursuit of a hobby for recreation, we have searched our lists for the *most popular* titles. This selected group covers many of the best subjects. Check them over. Then order *NOW*.

AIR CONDITIONING

Live Field; Great Future. Thorough Book on Fundamentals, Installations, Ozone Facts, etc. \$3.50

AUTO ENCYCLOPEDIA

Dyke's 16th Edition. Recent! Famous Standard Reference Work. Latest Auto Features Covered. \$6.00

110-V. A.C. GENERATORS

Made from Old Auto Generators. Turn Scrap Into Money. Hundreds are Making Profits. \$1.00

BIRD HOUSES

Build to Sell; Easy Designs, Standard Types, Houses for Many Kinds of Birds. \$1.00

BOAT BOOK

Power, Sail, Rowing, Paddle Plans. Build Your Boat from These Plans and Save Two-thirds the Expense. \$3.00

BOY MECHANIC

Hundreds Things Boys Can Make. Keeps Boys Interested; Busy. Develops Latent Ability. \$2.00

BUILT-IN FURNITURE

Take Orders, Make Money! Practical, Popular Furniture. Fits Waste Spaces in Homes. \$2.00

CHEMISTRY, PRACTICAL EVERYDAY

Make Hundreds Things Daily Use. 2300 Formulas and Recipes. New, Practical, Commercial. \$2.00

CHEVROLET SIX

Models 1931 to 1935 Inclusive Covered. Construction, Operation, Repair. 665 Pages. Illustrated. \$2.50

CONCRETE WORK

173 Uses Described, Pictured. Easy to Follow Plans for Home, Shop or Farm Use. \$1.00

DIESEL HANDBOOK

New! Latest Information. Rapidly Expanding Field. Make Your Start With This Reliable Book. \$5.00

DOG TRAINING

Home, Stage, Movies, Etc. Dog Lovers: Learn the Experts' Methods of Training. Train Your Dog. \$1.50

ELECTROPLATING

Modern Practice Including Nickel, Zinc, Cadmium and Chromium, also Copper, Gold, Alloys, Various Metals, Metal Coloring. Reliable and Up-to-Date. \$2.25

FARMERS' BOOK

861 Kinks for Field, Home. Great Time and Labor Saver. Practical, Tested Ideas. \$1.00

V-8 FORDS

Also "A" and "B" Models. Construction, Operation and Repair. 715 Pages. Illustrated. \$2.50

FORMULAS

10,000 Money Making Processes You Can Use Right at Home to Make Quick Selling Products. \$4.00

FROG INDUSTRY

New! Raise and Sell. Profits! Good Side Line for Areas Where Ponds Can Be Built. \$2.00

FURNITURE MAKING

Tools, Materials, Designs. 50 Beautiful Projects in Modern Furniture. \$2.50

INVENTING

The Art of and What to Invent. Shows Sort of Inventions Needed. How to Patent and Market an Invention. How to Develop Ideas and Turn Them into Profit. \$3.00

LATHE WORK (Metal)

Drilling, Threading. 2 Volumes Comprising Hundreds of Valuable Shop Kinks. Illustrated. \$1.00

LEATHER, HOME TANNING AND MAKING

Information on How to Tan and Make Leather from the Hides of Various Animals. \$1.00

LOG CABINS

Easy Plans; Build for Profit. Value! Complete Building Instructions. Covers Fireplaces. \$2.50

MATHEMATICS

Easy Guide for the Practical Man. Removes the Mystery and Difficulties. \$1.50

MECHANICAL DRAWING

Learn Drafting; Good Salaries. Teach Yourself at Home. Book of Easy Methods. \$1.00

MONEY MAKING IDEAS

1000 Spare Time. Practical Guide for Young and Middle Aged Men and Women, Students, Boys, Girls. \$1.00

PLUMBING

500 Facts Every Homeowner Should Know. Care and Repair of Your Own Plumbing System. \$1.50

POULTRY

Breeding, Management. For Those Interested in Making Poultry Pay. Develop Phenomenal Layers. \$2.00

PRECIOUS METALS

Identify—Buy—Sell. Only Book on Subject. Anyone Can Tell Value of Their Old Gold, etc. \$1.00

PROSPECTORS' HANDBOOK

How to Mine, Appraise, Equip. How and Where to Look for Valuable Minerals. \$3.00

RADIO PHYSICS COURSE

New Edition. 992 Pages. 500 Illustrations. All About Radio Explained Step by Step. \$4.00

RADIO SERVICING

Profit by Knowing Costs, Kinks, Etc! Important New Edition Just Issued. Has 1300 Pages. Illustrated. \$4.00

REFRIGERATION

Electric. Gas. Be a Service Expert. Need for Trained Repair Men. \$4.00

REWINDING ELECTRIC MOTORS

Fractional Horsepower Types. Valuable for Everyone Engaged in Electrical Repair Work. \$2.50

SHIP MODEL

Entire Text, Famous "Sovereign" of 1637. Last Word in Beautiful Ship Models. \$1.00

SHOP NOTES LIBRARY

5 Vol. 2000 Wonderful Shop Ideas. Volumes Reprinted Annually from Shop Notes Section Popular Mechanics. \$2.50

STEEL SQUARE

How to Figure Angles of Rafters, Roofs, Etc. As Indispensable as the Most Important Tool. \$1.00

TOYS

For Amusement or Profit. Saleable Designs. 67 Different Toys. Easily Followed Instructions. \$1.50

WELDER'S HANDBOOK, OXY-ACETYLENE

Thoroughly Up-To-Date on Modern Applications of Gas Welding and Cutting Processes. \$2.00

WIRING

Approved Economy Methods for Homes, Buildings. Standard Up-to-Date Book Meets Every Requirement. \$2.50

WOOD TURNING

Woods, Tools, Methods; Practical Teacher. Wood Working on the Lathe Thoroughly Covered. \$1.50

Books sent C.O.D. anywhere in U.S.

Just make up a list of the books you want and mail us your order. When postman hands you books, pay him the price and postage. If you send remittance when ordering, please include 10 cents per book extra for postage. Write for information about books on other subjects you are interested in.

POPULAR MECHANICS PRESS

Room D5—200 East Ontario St., Chicago, Ill.

When writing to advertisers please mention Popular Mechanics

FUN! BIG PAY EASY for YOU



WITH an easy-playing, sweet-toned Buescher you play tunes right away. Be a social "hit;" win new friends; popularity; increased income. Opportunities for good-pay jobs. You can qualify quickly.

FREE on trial, any Buescher instrument. Write now for details and handsome Free Book. Mention instrument: saxophone, cornet, trombone, etc.

BUESCHER BAND INSTRUMENT CO.
1210 BUESCHER BUILDING
ELKHART INDIANA

SHIP MODELS



Get this dandy catalog of true-scale models of Flying Cloud, Viking, Blue Nose, Tally-ho Couch, deluxe fittings. Send 15c (in coin) for your copy.
ROY HANCOCK, 323 Douglas Ave., Portsmouth, Virginia

WILL YOU WEAR THIS SUIT and Make up to \$12 in a Day!



Let me send you this fine all-wool tailored suit **FREE OF COST**. Just follow my easy plan and show the suit to your friends. Make up to \$12 in a day easily. **No experience—no canvassing necessary.**

Send for Samples — **FREE OF COST**

Write today for **FREE** details, **ACTUAL SAMPLES** and "sure-fire" money getting plans. Send no money.

H. J. Collins, Progress Tailoring Co., Dept. Z-216,
500 S. Throes St. Chicago, Ill.

LESS than \$1.00 a month

For Genuine Old Line Legal Reserve Insurance! —and never any increase in premiums.

Put your insurance on a budget basis. Pay only \$10.00 *once a year*, less than 3c a day for this safe Old Line Legal Reserve Insurance, no matter what your age if between 15 and 45. At 21 you can get \$650.00 of this "cash accumulation" insurance. \$518 at age 30. Then when the policy matures Postal will pay back to you its full face value, more than you have paid in. Full cash and loan value until maturity, and other benefits stated plainly in your policy—and full protection to your family all the years.

POSTAL'S
new single premium
\$10.00 a year
BUDGET POLICY

PREMIUMS NEVER INCREASE! and the amount of insurance is never reduced as in the case of so-called "Modified" Whole Life Insurance. \$10.00 only once a year is all you will ever pay and even this low premium may be reduced still further by dividends.

Postal Life Insurance Co.
Dept. RM-17, 511 Fifth Ave., New York, N. Y.

Please mail details of your \$10 a year policy.

Exact date and year of birth.....

Occupation.....

Name.....

Full address.....

Mail Coupon Now!

New 1936 LACO Oil Burner



New FUEL ECONOMY New QUIETNESS! New LOW PRICE SAVES UP TO \$100

Here's the year's most sensational home-heating announcement! A New, Marvelously-Perfected Oil Burner by LACO... that gives you Perfect, Uniform-Temperature, Automatic OIL HEAT... Cheaper than Coal in most localities... now Quieter than ever before... and which you can own at a price that **SAVES YOU ABOUT \$100!**

This new 1936 LACO burns Low-Priced Oil... and **USES LESS!** This is due to LACO'S exclusive patented "High-Pressure Carburetor" that burns a high percentage of air with the oil, avoids usual fuel waste, and gets utmost heat from every drop.

New Safety! New automatic safety devices positively prevent oil overflow, avoid every possibility of trouble.

Unusually Quiet! New, slow-running fan is unusually silent. Special rubber-cushioned motor on rigid pedestal base avoids vibration.

Get Special Offer! Today's Special Introductory Price is lowest in years! Buy NOW and save \$65 to \$100! The price must advance soon—steel is going up! Rush your name quick—and **SAVE MONEY!**

Built for Lifetime! Many LACOS, built 9 years ago, are still operating today, good as new.

GUARANTEED! Built and guaranteed by one of the world's largest oil burner manufacturers. Over 55,000 LACOS now in use!

Get SAMPLE BURNER

DEALERS:

LACO dealers, this year, making tremendous profits—up to \$640 a month! I must have more dealers to fill orders and install LACOS in open territory. This month, I'll ship you a Sample Burner, subject to examination, **WITHOUT OBLIGATION!** Free plan, window hangers—local newspaper advertising, etc. Rush name for details, **TODAY!**

L. A. COCKLIN, Pres.

LACO OIL BURNER CO., 1125 Union St., Griswold, Iowa, U. S. A.

CASH IN



raising **PROYAL** birds. Orders waiting for hundreds of thousands. Easy to raise. You get your money for them when only **25 days old**. Particulars and picture book for 3-ct. U. S. stamp. Ask for new Library 5 for 1936, ready now. Write **PR Company, 635 Howard St., Melrose, Massachusetts.** Refer any bank.

Best Poultry Paper 6 BIG ISSUES 10¢



Helps Increase Poultry Profits. Send coin or stamps. 50 cents for 3 years or 10 cents for 6 months trial. Agents wanted. **American Poultry Journal** 532 So. Clark Street Chicago, Illinois

RAISE RABBITS FOR US



WE PAY YOU UP TO \$5.00 EACH. ALSO PUT YOU IN TOUCH WITH MARKETS EVERYWHERE. Large illustrated book and catalog, also copy of the **AMERICAN RABBIT FARMER** and monthly market bulletin showing names of buyers in various parts of America who continuously buy all rabbits offered them. All for 10 cents. Address **OUTDOOR ENTERPRISE CO., 101 Main Street, NEW CITY, N. Y.**

Play the Hawaiian Guitar like the Hawaiians!



FAMOUS NATIVE HAWAIIAN INSTRUCTORS teach you to play this fascinating instrument. **ONLY 4 MOTIONS**—No previous musical knowledge needed. **OUR 52 EASY LESSONS** teach you the enchanting music you hear over the radio.

GIVEN—when you enroll

HAWAIIAN GUITAR, complete playing outfit and carrying case.

WRITE AT ONCE for attractive offer and easy terms.

FIRST HAWAIIAN CONSERVATORY OF MUSIC, Inc.
9th Floor, Woolworth Bldg. Dept. 250 New York, N. Y.
Approved by New York State Board of Regents

A GREAT CHRISTMAS GIFT



FOREST FIRE ACTION LAMP

Beautiful scene in colors. Cylinder inside revolves. The fire seems to really burn when the lamp is turned on. Flames and smoke seem to rise through the trees—reflect on lake. Modernistic octagon top and base. Beautiful new oil painting reproduced in full colors on parchment. Complete, ready to plug in. More attractive than lamp we sold for \$5.00 in 1930.

New price **\$1.00** POSTPAID

Niagara Falls Lamp

Beautiful new picture. Falls really seems to flow. Price same as above.

Send \$1 bill or money order for prompt shipment, postpaid. PRINT your name and address plainly. No lamps shipped C. O. D. or on approval. Order as many as you want. Dozen lots \$10.00.

IGNITION CO.

51 Tompsett Bldg. Omaha, Nebraska

HOW IT WORKS—A striped cylinder revolves about a striped electric lamp, casting an ever changing pattern of light and shadow through the translucent outer shade. This creates action in the picture real as a colored movie. An interesting, unusual and beautiful lamp for any home. Heat is the only motive power.

CHEMISTRY

A modern miracle of money-making

• All modern progress is dependent upon chemistry. The opportunities it presents are unlimited. Right at home, in spare time, through study of an International Correspondence Schools Chemistry Course, you can master the fundamentals of this fascinating science. An interesting book — *free*.

INTERNATIONAL CORRESPONDENCE SCHOOLS

Box 5605-H, Scranton, Pa.

Send me—*free*—complete information on subject checked below:

- Chemistry
- Radio
- Aviation
- Refrigeration
- Air Conditioning
- Architect

Name.....

Address.....

NEW!! MIDGET POCKET RADIO



Fits in any pocket easily. Weighs only 4 ozs. as shown! **\$2.99** batteries or electrical connections needed! **Complete**

Nothing to wear out or need replacement—only one moving part. Separates and receives stations with beautiful clear tone. Range up to 50 miles—much greater under good conditions—very little static! Can be used by ANYONE ANYWHERE! Foolproof—NO Crystals to adjust! Absolutely complete with midget phone and directions to use on Bicycles, Autos, in office, hotels, camps, at home, etc. No messy hookups! THESE ARE FACTS! Send only \$1.00 and pay postman \$1.99 plus postage or send \$2.99 (Cash, Money Order or Check). Ideal gift. Guaranteed. Order NOW! (Foreign orders 65c extra.) At Better Dealers, TINYTONE RADIO CO. Dept. P-12 KEARNEY, NEB.

EARN BIG MONEY AT HOME!

FREE BOOK! Raise mushrooms in your basement, cellar, garage, idle places. We buy crop. Experience unnecessary. FREE BOOK.

MUSHROOM GROWERS OF AMERICA, KS-433, N. Clark St., CHICAGO, ILL.



MAKE GLAZED GARDEN POTTERY

Beautiful, colored, glazed concrete pottery made without molds. No experience needed. Use only sand and cement. 2,500 different designs birdbaths, vases, jars, etc. Big profits. Send 10c for Booklet, color plate, etc. NATIONAL POTTERIES CO., 424 Second Ave., So., Room 21 Minneapolis, Minn.

Raise Giant Frogs



Nufend Giants Weigh up to 3 lbs. each.

START IN YOUR BACKYARD

Big Profits Breeder lays 10,000 eggs yearly. Modern methods hatch over 90%.

Market Waiting Bullfrogs sell up to \$5.00 per dozen. Demand exceeds supply everywhere. **FREE BOOK**

Start with backyard ponds in any climate. Season just starting. Write for FREE frog book and complete details NOW!

AMERICAN FROG CANNING COMPANY

(World's Largest Frog Market)

Dept. 133-X NEW ORLEANS, LA.



Money for YOU in NEW AVIATION OPPORTUNITY

The world's greatest opportunities in aviation are concentrated here in the Los Angeles area—the largest aircraft manufacturing center in the world. New factories are being rushed to completion, present plants are being enlarged. The demand for trained men cannot be satisfied. Don't let this opportunity knock at your door longer. Get into aviation NOW.

Curtiss-Wright Technical Institute, America's foremost school of aeronautics, is located right here in the very center of

this tremendous activity. It is a fully approved Government school. Our Master Mechanics and Engineering courses offer you the best practical training in the shortest time. Our students are in demand and are obtaining ready employment.

Don't delay. Take advantage of this great opportunity today. Send this ad with your name, age, address, and course interested in for full information about Curtiss-Wright Tech and the tremendous aircraft activity here.

SPECIALIZE IN ENGINEERING OR MASTER MECHANICS AT THIS RECOGNIZED EDUCATIONAL INSTITUTION

CURTISS-WRIGHT TECH

MAJOR C. C. MOSELEY, Pres.

GRAND CENTRAL AIR TERMINAL
GLENDALE • LOS ANGELES • CALIFORNIA

at last CARTOONING MADE EASY



NEW, ORIGINAL, COMPLETE COURSE. especially prepared by one of today's cleverest newspaper and magazine Cartoonists. Full of punch and interest. 30 fascinating lessons; hundreds of step-by-step Cartoons. EXTREMELY EASY. Learn quickly right from the start, either for fun and spare money or to become a professional Cartoonist! Money Back Guarantee. Or, send for Free details. Don't delay.

Complete COURSE only \$2.75

AMERICAN SCHOOL OF CARTOONING
Dept. 1125 614 West Austin Ave. Chicago, Ill.

Learn TANNING! and FUR WORK!

We'll teach you at home in your spare time to make Genuine Leather for harness, belts, etc. Tan furs soft and pliable. Quickly learned. Make up furs into vests, rugs, scarfs, gloves. Learn Krome-Tanning, remarkable new home process. Save money. Make money doing tanning and fur work for others. Open your own tannery! **FREE BOOK** Send now for this free illustrated booklet. No cost. Write for your copy TODAY.



Northwestern Fur Co., Dept. T-819, Omaha, Neb.

QUICK WAY to make money in



RADIO

Modern receivers are demanding men with modern training for service work. New training method and service equipment offer starts you earning almost at once. Up to \$3 an hour easy in a short time. Write today for FREE book of details.

Radio Training Association of America
Dept. PM-512, 4513 Ravenswood Ave., Chicago

LEARN NEON SIGN MAKING

Every merchant needs neon signs. We teach you neon tube bending. 26 interesting lessons. Scores of step-by-step designs. Complete glass blowing equipment, tubing and designs free for examination. Lowest tuition—easy terms. Write **SAGE INSTITUTE OF NEON, 205 Vine St., Cincinnati, Ohio**

It's Easy to PLAY GUITAR

FREE Gibson BOOK

You learn quickly on newest Gibson models, choice of leading professionals. Rich tone wins instant admiration. Be popular, make more money—with a Gibson Guitar, Banjo or Mandolin. **FREE TRIAL, EASY PAYMENTS.** Write today for details — and copy of Free Book, packed with valuable facts. Mention instrument. No obligation.



GIBSON, INC., 1503 Parsons St., Kalamazoo, Mich.

When writing please mention Popular Mechanics

For a Lifetime of Appreciation - GIVE The New Merriam-Webster for CHRISTMAS



The foundation book of all modern knowledge; a lifetime of practical and cultural information. No other gift can convey so well the personal esteem and affection of the giver.

WEBSTER'S NEW INTERNATIONAL DICTIONARY Second Edition



The New Merriam-Webster, greatest of the famous Merriam-Webster series, is now ready—completely remade and greatly enlarged to cover fully the vast number of new words and new facts in every field of thought.

Greatest Single Volume Ever Published

More than ever the Supreme Authority. 600,000 Entries—The Greatest Amount of Information Ever Put into One Volume • 122,000 More Entries Than Any Other Dictionary • 12,000 Terms Illustrated • Magnificent Plates in Color and Half Tone • Thousands of Encyclopedic Articles Wonderfully Rich in Information • 35,000 Geographical Entries • 13,000 Biographical Entries • Exhaustive Treatment of Synonyms and Antonyms • Thousands of Etymologies Never Before Published • 3,350 Pages • New from Cover to Cover • Cost \$1,300,000.00. Get the Best—Give the Best.

At All Booksellers. Write for Information. G. & C. MERRIAM CO., 606 Broadway, Springfield, Mass.



Know Electricity as Experts Know It—and Get an Expert's Pay!

Recovery has begun! The months ahead are charged with significance and expectation. What will you do to get the jump on the other fellow? Thousands of men have used

The Croft Library of Practical Electricity

The Croft Library is a complete electrical educator. It is founded on practice—on 20 years of shirt-sleeve experience—on work as it is actually done. It is jammed from cover to cover with the kind of hard-headed facts you want. Written so that the beginner can easily understand it, yet so sound, so thorough, that it is the daily guide of 50,000 highly paid electrical workers and engineers. Croft tells you the things you need to know about motors, generators, armatures, commutators, transformers, circuits, switchboards, distribution systems—electrical machinery of every type—wiring for light and power—wiring of finished buildings—underwriters' and municipal requirements—illumination in its every phase—the most improved methods of lighting—lamps and lamp effects, etc.—how to do a complete job, from estimating it, to completion.

No money down—easy payments

Fill in and mail the coupon attached and we will send you the entire set of seven volumes for ten days' Free Examination. We take all the risk—you assume no obligation. If you decide to keep the books, send \$1.50 in ten days and the balance at the rate of \$2.00 a month. Send the coupon NOW and see the books for yourself.

FREE EXAMINATION COUPON

McGraw-Hill Book Co., 330 W. 42nd St., New York
Send me for ten days' free examination the Croft Library of Practical Electricity. If satisfactory I will send you \$1.50 in 10 days and \$2.00 monthly until the price of \$19.50 is paid. If not wanted, I will return the books postpaid. (To insure prompt shipment write plainly and fill in all lines.)

Name.....
Home Address.....
City and State.....
Position.....
Name of Company..... PM-12-35

The Editor's



MAIL BAG

(Continued from page 26A)

thirteen years of missing it, I was more than delighted."—*Frank Roelants, Morocco, North Africa.*

Crocodile Catcher



Mr. Collens and His Catch

"Here is a picture of a crocodile that I helped capture in northern Zululand. We used a six-inch hook attached to a 100-foot flexible wire. The hook was baited with a fish and the wire tied to the branch of a tree. When the crocodile was hooked, the branch acted as a fishing rod to tire him out. Taking hitches in the wire pulled the crocodile's head to the surface and we shot it with a .303 rifle. It was one of six we bagged. Natives of South Africa use part of the crocodile for medicine."—*H. Collens, Johannesburg, S. Africa.*

Satisfied Builder



"This is a snapshot of my Little Giant a.c.-d.c. receiver that I built from the article in Popular Mechanics at a cost of about seven dollars and fifty cents. I find it very satisfactory. Your blueprints are easy to follow. I only use a five-foot antenna with this set and am able to receive stations up to 1,800 miles."—*Platt R. Lasiter, Hialeah, Fla.*

May 1933

Change the Index?

"Instead of listing your index in the front of each copy along with the advertising, why not put it all on one page, using both sides. Then we could remove it and file in loose-leaf folder for easy reference. That would save time and index cards."—*George L. Mann, Toledo, Ohio.*

Mr. Gilligan's Answer

"In answer to Jerry Gilligan's question about whether the old cars weren't better than new ones: Present motors have much better material in them, but they are smaller and deliver more horsepower, bearings fit closer and require lighter oil, consequently more frequent oil changes. Speeds are higher. I feel sure that remodeling the driving to fit the new car will result in less trouble. I have a 1935 car that I have driven 63,587 miles and my bills for repairs amount to \$58.75, including \$13.50 for damage done by a tire that blew out when I tried to run it 'just one more trip.'"—*Howard Richards, Mexico, Mo.*

Here's Speedy Kayak



Builder in the Kayak

"I send you a snapshot of my kayak which I constructed from instructions in your magazine. I am pleased with its comfort and speed."—*Louis Jacques, St. Mary, Beauce, Canada.*

He's a Model Fan

"Your magazine is great, but please give us more about models and machinery tools."—*L. McIntyre, Montreal, Canada.*

So Very Easy



... AND TO THINK YOU'VE HAD IT ONLY A WEEK ...

● Popularity! Step right into it with a P-A Sax'. Play beautiful tunes first week. No failures. Learn quickly. Join a dance band in 90 days. Only P-A assures such rapid progress. Easiest blowing, fingering; most beautiful tone. See your P-A Dealer, or write direct for beautiful literature. No obligation. Easy terms. You can do it. Write today. 1166

PAN - AMERICAN
1203 P-A Bldg. Elkhart, Indiana

Moderate Price CIVIL SERVICE

VALUABLE INFORMATION FREE
COLUMBIAN CORRESPONDENCE COLLEGE
WASHINGTON, D. C.

PARKS AIR COLLEGE
PARKS AIRPORT EAST ST. LOUIS, ILL.

Offers you college education majoring in aviation
Three 2-year courses leading to B.S. Degrees in Aeronautical Engineering, Aviation Administration, Aviation Mechanics. 100 acre airport. 14 buildings. 25 in faculty. 5,000,000 miles flight training. 1452 planes, 432 motors repaired and rebuilt in shops. Graduates with all leading aviation companies. Dormitories, cafeteria on Field. Winter term Jan. 6. Catalog. Write
REGISTRAR, DEPT. PM-12
9th YEAR PARKS AIRPORT, EAST ST. LOUIS, ILL.

5¢ EACH LITTLE BLUE BOOKS
Send postcard for our free catalogue. Thousands of bargains. Address:
HALDEMAN-JULIUS CO., Catalogue Dept.
Desk M-154, GIRARD, KANSAS

Be a TELEVISION EXPERT

LEARN TELEVISION with RADIO—NOW!

Fine opportunity for experts in this amazing new industry. A NEW business in a NEW era offers NEW opportunities for big salaries! You learn Radio and Television from beginning to end in our marvelously equipped labs and studios. You actually operate thousands of dollars worth of expensive equipment. You get expert instruction and skillful guidance by radio-television specialists.

Demand for Television Experts

Television now perfected and ready for the market ON THE NEXT BIG BUYING WAVE. Business leaders predict new system television will require thousands of relay and broadcasting stations. Ultra-short waves will permit eighty thousand television stations in America alone.



FREE FOLDER

GET IN NOW and "build up" with the world's next billion-dollar industry.

6 MONTHS THOROUGH, PRACTICAL TRAINING

Qualifies for radio-phone license (1st Class). Complete up-to-the-minute training on modern "workable" television equipment including the new cathoderay. Practical experience in studio, control room. Transmitter operation of Television Station W9XAL. Employment aid while training and upon graduation. Write for free book "Pictures On the Air" NOW!

S. Q. NOEL, Pres. First National Television, Inc.
Dept. AA12 Power & Light Bldg., Kansas City, Mo.

Without obligation, send me postpaid FREE Illustrated Folder "Pictures On the Air", telling about new opportunities in television. I am 17 years or older

Name _____
Address _____

"MOTORING"

at the bottom of the world

As related by Stevenson Corey, Chief Supply Officer for the Byrd Antarctic Expedition.

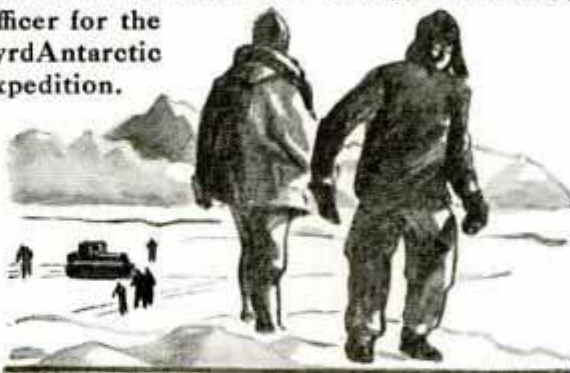

"On March 28, 1934, the men had to abandon one of the tractors out on the trail. It was 62 degrees below zero, and after six hours of work they gave up trying to get the motor started . . . ignition trouble."



"... on January 8, 1935, the men went back over the trail and dug the tractor out of the snow and ice. Although it had been out there for nine months in weather as cold as 77 degrees below zero, the Eveready Prestone in the cooling system had kept it protected against freeze-up. That was a real test of an anti-freeze..."



"During both the expeditions to the Antarctic, Eveready Prestone functioned with 100% dependability."

One shot of Eveready Prestone, the guaranteed anti-freeze, will protect your car's cooling system against freeze-up and rust *all winter long*. It has no odor. It will not boil off or evaporate. This year it is lower in price than ever before . . . and a chart on Page 15A shows how little it will cost to have Eveready Prestone protection in *your* car this winter.

SPECIAL OFFER . . . A "Weather Wheel" which will help you to forecast the weather. Also "Weather as a Hobby" — a 48-page illustrated book, prepared by weather experts. Full of fascinating weather facts. Send 10c (stamps or coin) to National Carbon Co., Inc., P. O. Box 600—2L, Grand Central Station, New York, N. Y.

When writing please mention Popular Mechanics

Buck Rogers

25th CENTURY CASTER

A COMPLETE OUTFIT FOR CASTING & COLORING CHARACTERS OF 2500 A. D.



Fascinating!
Educational!



You Can
MAKE MONEY
with these Popular Toys

Get this great outfit! Make toy castings of Buck with his marvelous Disintegrator Pistol . . . Wilma Deering, his faithful Lieutenant . . . and Killer Kane, the arch-criminal of the 25th Century. Paint your castings in bright, lifelike colors. Make all the toys you want. Sell them at a big profit!

Millions of people are interested in Buck's adventures . . . and follow them daily in newspapers and radio. Start your own toy business with this complete outfit. Make real money.

Complete Outfit \$2.50

Each Buck Rogers Caster comes in large attractive box with full color cover showing Buck's adventures. Includes complete set of moulds for making 3 big figures: The Weird Depth Man, Buck Rogers himself, and Dr. Huer, the inventor. Set also includes mould handles, clamps, a large supply of lead, ladle, 4 cans of paint and 2 brushes.

Buck Rogers Extra Moulds

Strange 25th Century creatures . . . speedy Interplanetary Rocket Ships . . . and friends and enemies of Buck and Wilma. You can make them all with Extra Moulds at \$1.00. Three large figures in each mould except the big Buck Rogers Flagship. Complete list in coupon.

Make Over 200 Toys an Hour

It doesn't take long to make enough toys to pay for your Buck Rogers Caster and start saving money.

Ideal Gifts

Get a Buck Rogers Caster for Christmas! Or if you get it early make toys for Christmas gifts.

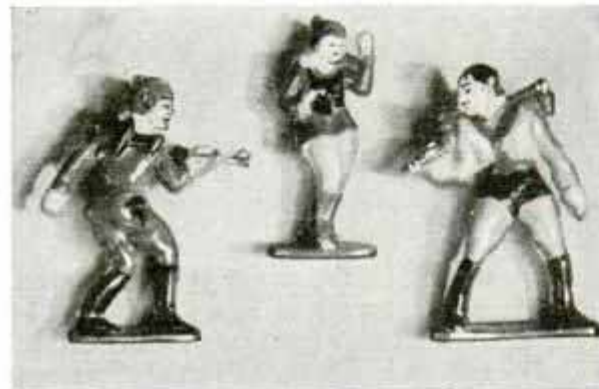

Buck—Wilma—Killer Kane—3 in One Mould \$1

A dynamic action group beautifully moulded in the "round." Fully equipped with Rocket Pistols, Disintegrator Rays, Flying Belts. Size, Buck, 3 5/8"; Wilma, 2 1/2"; Killer Kane, 2 1/4".

SEND FOR FREE ILLUSTRATED BOOK

How to Buy

See Buck Rogers Caster at Toy Dealers or Hardware and Department Stores. If they can't supply you, order your choice of outfits on the coupon below. Sent postpaid in U. S.

Jobbers! Dealers!
Fill your stocks now.

SEND THIS COUPON

Rapaport Bros.
703 W. Ohio St., Chicago

Enclosed find Money Order for \$.....
Please send (Postpaid in U. S.)

OUTFITS

- Buck Rogers Caster \$2.50
- Buck Rogers Electric Caster \$3.50
- PLEASE SEND FREE BOOK
- JUNIOR CASTER MOULDS**
- U. S. Soldiers \$.95

BUCK ROGERS MOULDS

- Buck—Wilma—Killer Kane . \$1.00
- Buck's Own Rocket Ship . . . \$1.00
- Depth Man—Buck—Dr. Huer . \$1.00
- Tiger Man—Tiger Ship—Asterite \$1.00
- Mekkano—One-eyed Man—Interplanetary Ship . . . \$1.00
- Disintegrator—Black Barney—Tieko Man \$1.00

Name

Address

City..... State.....



Buck Rogers Electric Caster \$3.50

A De Luxe Set with complete Electric Melting Ladle and Stand. Large fine figures of Buck, Wilma and Killer Kane. Includes complete moulds, clamp, handles, large supply of lead, candle for smoking moulds, 4 generous cans of paint, and 2 brushes. Lithographed box in four brilliant colors.

Get 2 Sets in One!

Make U. S. Soldiers with same outfit. For only 95c more you may get big 3 figure mould for making armies of soldiers! This gives you 2 sets in one! See coupon.



U. S. Soldiers—2 1/2" high.

Buck Rogers Caster Is Made by the Makers of

JUNIOR CASTER

When writing to advertisers please mention Popular Mechanics

Popular Mechanics Magazine

REGISTERED IN U. S. PATENT OFFICE AND CANADA

WRITTEN SO YOU CAN UNDERSTAND IT

Vol. 64

DECEMBER, 1935

No. 6

£ 1178.

The 1936 CARS

By JULIAN LEGGETT

CAREFUL examination of the 1936 cars reveals the general adoption of features which have been in the trial stage and uncovers tips on the car of the future.

New from stem to stern, a vastly different version of the front-drive Cord, which was discontinued several years ago, makes its appearance this year. A touch of the bizarre is found in the Venetian blinds treatment of the lower engine hood, a slotted effect running completely around the

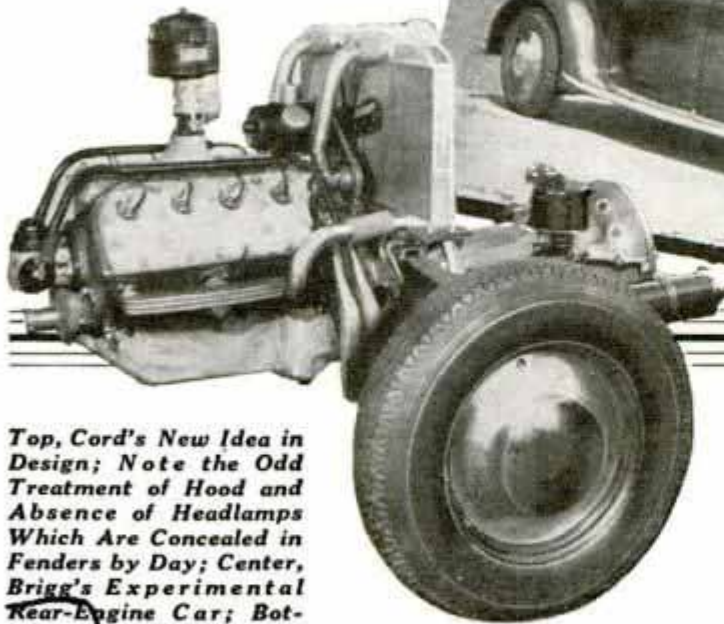
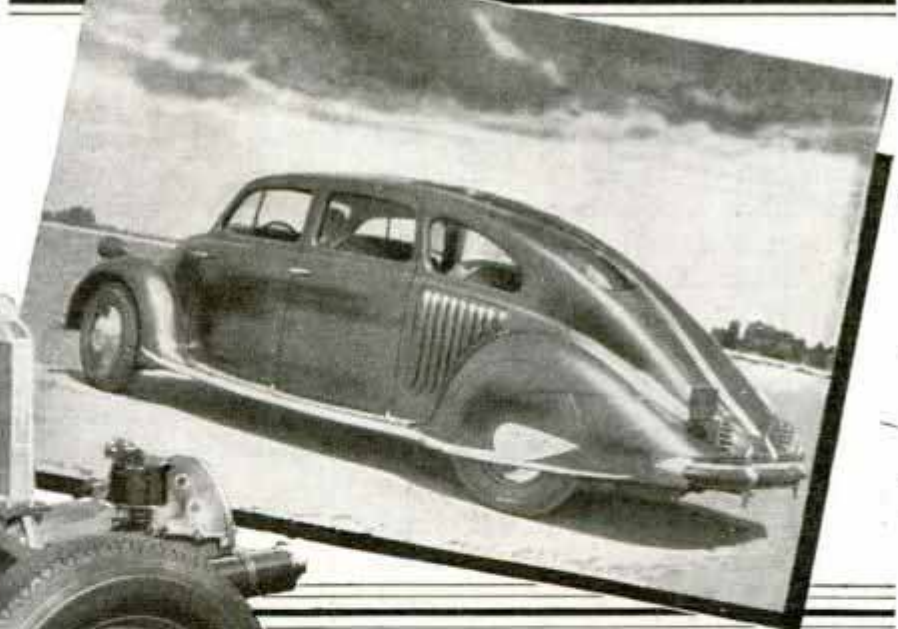
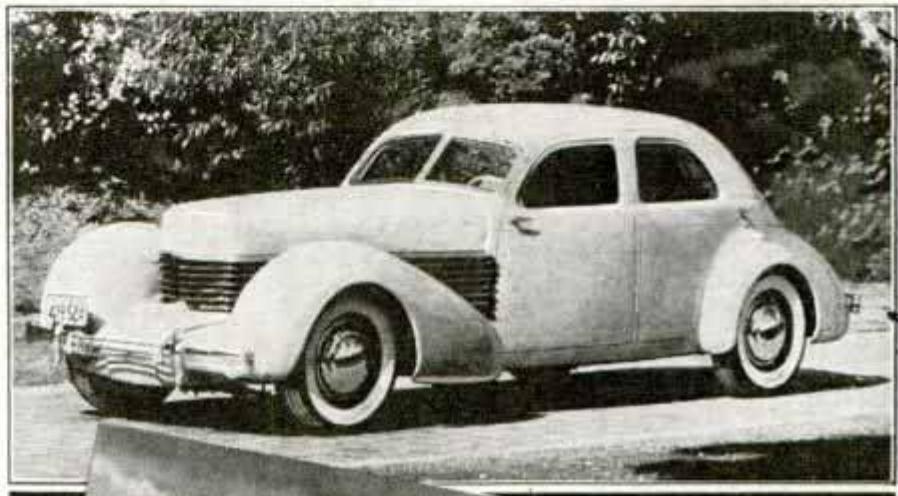

Top, Cord's New Idea in Design; Note the Odd Treatment of Hood and Absence of Headlamps Which Are Concealed in Fenders by Day; Center, Briggs' Experimental Rear-Engine Car; Bottom, the Motor-and-Transmission Unit with Rear Wheels Is Shown Removed from Body of the Briggs Car. This Facilitates the Making of Major Repairs

hood to both sides of the cowl. Retractable head lamps, which swing into conventional position at night and back into their recesses beneath the fenders by day, are introduced for the first time.

A remote-control shifting box, patterned along the line of Hudson's "electric hand" of last year, eliminates

Technical Editor
Harold J. Blanchard
572 Madison
Ave. New York

Briggs Mfg Co 146 31 Mack Ave



the gear lever. The front compartment floor is cleared completely by placing the hand brake at the left of the dash. An elaborate airplane-type control panel even contains a tachometer to show the number of revolutions at which the engine is operating. Door hinges and gas-tank filler tube are concealed. Built-in tail and stop light also illuminates the baggage compartment at the rear when the lid is raised.

There are no running boards or step plates because the Cord is built very low, only sixty inches from ground to roof. Front drive makes this possible, since it eliminates rear transmission housing and drive shaft. Many of these features probably will find their way into other automobiles in the future.

The unit power and driving plant, which includes the V-8 Lycoming engine which delivers 125 horsepower and is fitted with an aluminum cylinder head, can be removed easily for servicing. The four-speed transmission has the conventional three forward speeds plus a "cruising" gear for the open highway.

Another newcomer is the Auburn Diesel car, built on order, which burns inexpensive fuel oil. No ignition system or carburetor is used. The fuel is "gasified" before injection into the engine.

One definite trend is supported by introduction of Cadillac's small-size V-8. It has a wheel base of 120 inches, making handling exceptionally easy, but has a high-power motor. This practice is continued this year in the Packard 120, which has more horsepower than the same car had last year. With various types of wheel suspension, engineers are finding it possible to build splendid riding qualities into short wheel-base cars, making it unnecessary to have rail-way-car length for comfort.

Generally, the 1936 cars have such safety features as steel roofs, powerful brakes, doors hinged at the front, safety glass, stronger frames and easier steering, and such adjuncts to speed as higher

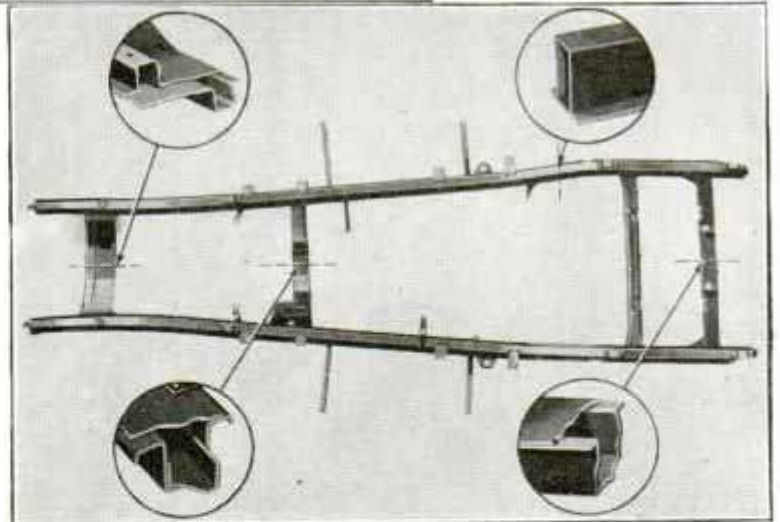
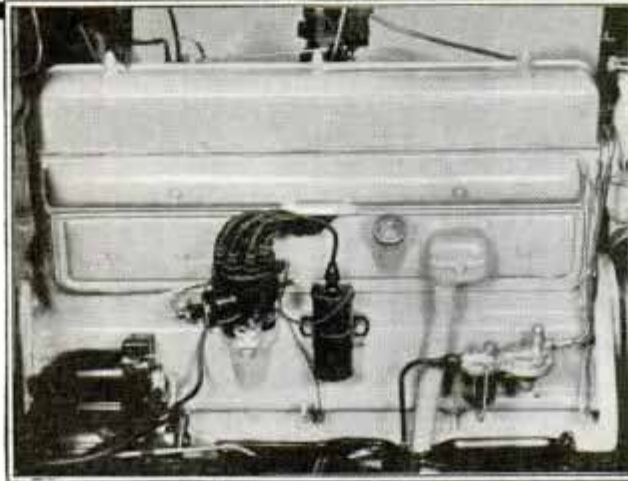

Top, Clearing Driving Compartment by Placing Hand Brake at Left under Dash; This Is the Olds; Center, Buick's Motor of Clean Design; Bottom, Chevrolet's Box-Girder Frame with Only Three Supporting Cross Members Is Strong but Simple

compression and more horsepower, aluminum or other lightweight alloy pistons, better lubrication of motor, anti-vapor lock carburetors and improved cooling systems. All the cars have more beauty and comfort.

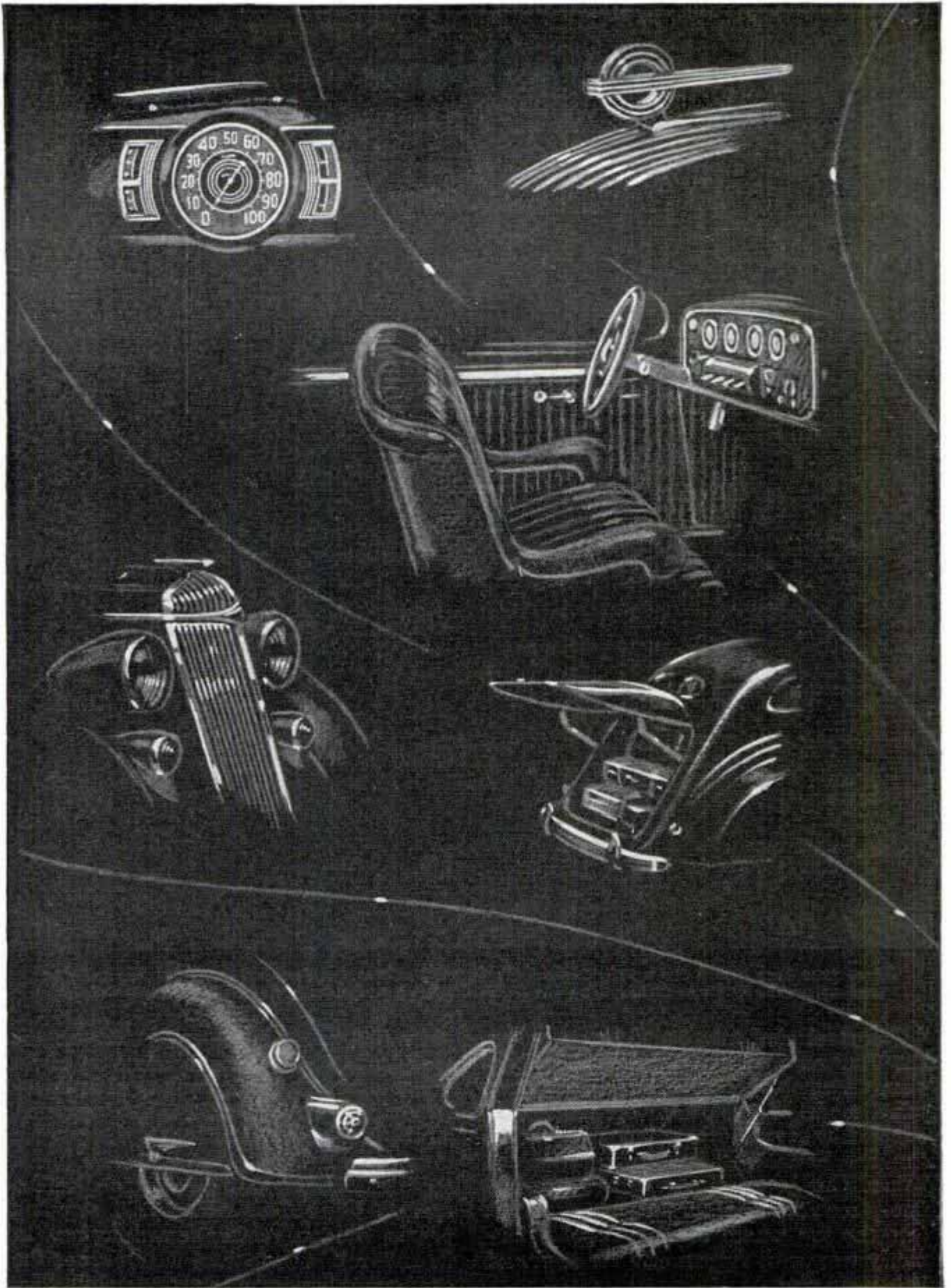

Features That Increase 1936 Car's Beauty and Convenience; Top, Left, Easy-to-Read Olds Instrument Grouping; Top, Right, "Speed" Emblem on Pontiac "8"; Below, Cord's Driving Compartment with Airplane-Type Control Panel; Center, Left, and Bottom, Left, Front and Rear Views of Chrysler's Beauty; Center, Right, and Bottom, Right, Nash Baggage Compartment That Is Spacious and Easy to Reach

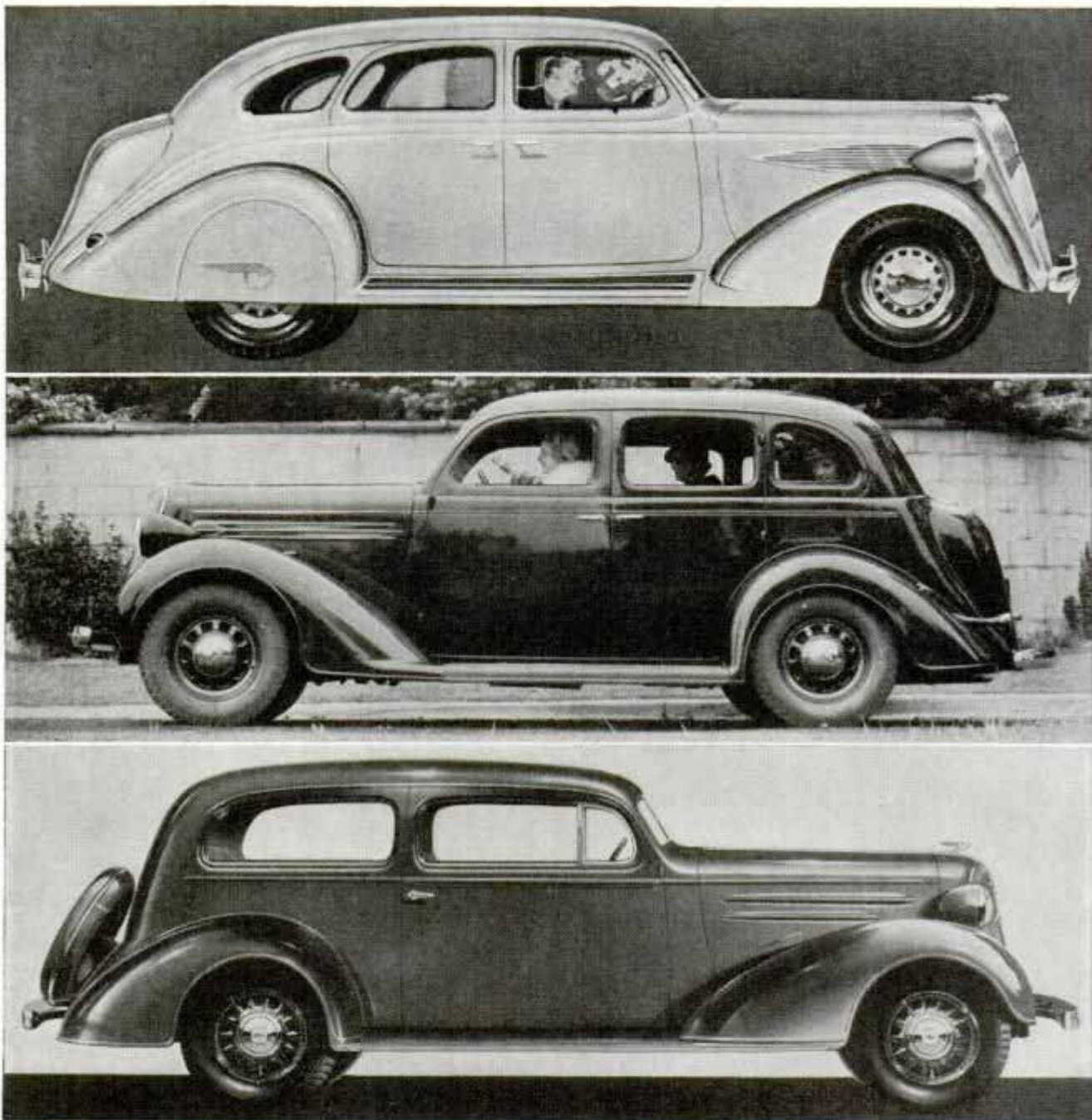

Three 1936 Cars Which Reflect the General Styling; Note Sweeping Fenders, Increased Streamlining and Attractive Radiator Grilles; Top, the Nash, Center, the Plymouth, and Bottom, the Chevrolet

The steel roof introduced last year on the Hudson and three General Motors cars, Oldsmobile, Pontiac and one Chevrolet model, is retained by these and adopted by several others, including Buick, Cadillac, LaSalle, Dodge, Nash and Studebaker. One group of engineers favors the one-piece roof, another the steel panel set into the top where the fabric panel formerly was used. Apparently the steel roof is here to stay.

While hydraulic brakes have been in use for several years, general adoption has been delayed until 1936. New converts include Chevrolet, Buick, Hudson, Terra-

plane and all Cadillacs except the largest model, the V-16. Hudson offers an additional safety idea in a hookup of hydraulic and mechanical brakes, both working off the same pedal. Until the pedal reaches three-quarter level, the hydraulic brake operates. From that point, both brakes operate to produce exceptional stopping power. Studebaker has something new in its anti-roll back feature which keeps the car from rolling when starting uphill. The brake holds the car until the clutch engages and the motor takes hold. Cast-iron brake drums are almost universal. After the hydraulic may come the air brake. One

engineer says that better brakes are available, but the additional cost has delayed their introduction temporarily.

The hand brake, with few exceptions, is removed from the floor or toeboard to the left and under the dash, giving more space in the driving compartment. The trend to clear this space is becoming more noticeable and introduction of an automatic transmission, already forecast for next year, will give it great impetus.

Compressions are climbing a bit. Hudson has six-to-one standard and offers an aluminum head that will produce seven to one. Plymouth offers 6.7 to one, about the top for this year. Charles B. Bohn, a pioneer in raising compression through the use of aluminum engine heads and scientifically designed combustion chambers, finds that compression is limited at present by the greater load placed on the bearings by increasing the output of the cylinders. New alloy bearings, such as the silver incorporated into the Pontiac, will carry this increased load, but their usefulness is restricted because they are damaged by the fatty acids in the present lubricating oils. Mr. Bohn points out that properly refined oils, free from acids, will increase the use of these alloy bearings which are designed to deliver thousands upon thousands of miles without attention. The new bearings include the leaded-bronze or copper-lead and the cadmium-silver alloys.

Cast-iron pistons appear doomed. Buick has adopted a lightweight piston of a material called anolite, Oldsmobile is using an aluminum alloy, Pontiac has a lighter piston, the Chrysler line and Hudson offer aluminum and others are moving in the same direction. The outlook for lighter

(Continued to page 144A)

Spiral Walk around the Earth Makes Geography Class Fun



Geography Class of Young Parisians Makes "Personally Conducted" Tour around Globe, Studying Earth While Climbing Spiral Ramp

When you can walk around the world in a minute, geography lessons are fun. At a school in Paris, France, is an immense relief globe surrounded by a spiral ramp. The teacher of the school stands on the ground near the big globe and conducts Parisian youngsters on "world tours" that dramatize geography better than any miniature sphere could.

Charcoal Gas Runs Car

GAS generated by burning charcoal has proved so efficient a fuel for automobile engines that the Italian government has ordered all passenger transport vehicles to be adapted to charcoal burning by the close of 1937. In a demonstration tour across Europe, a sport model car traveled 3,720 miles at a fuel cost of less than a quarter cent a mile.

Serman.

Illustrated London

to advise you that the address of the National Metal Congress is 7016 Euclid Avenue, Cleveland, Ohio.

High-Speed Planes Ready for Peace or War



Three High-Speed Planes Developed for Europe; Above, Italian Transport Monoplane, the "Caproni," Which Has Speed of 200 Miles an Hour with Twelve Passengers



Above, Huge Fokker Passenger Monoplane Equipped with Four 600-Horsepower Radial Air-Cooled Engines; It Flies Three Miles a Minute; Below, Combat Monoplane of French Air Corps Which Does 250 Miles an Hour at Altitude of Three Miles

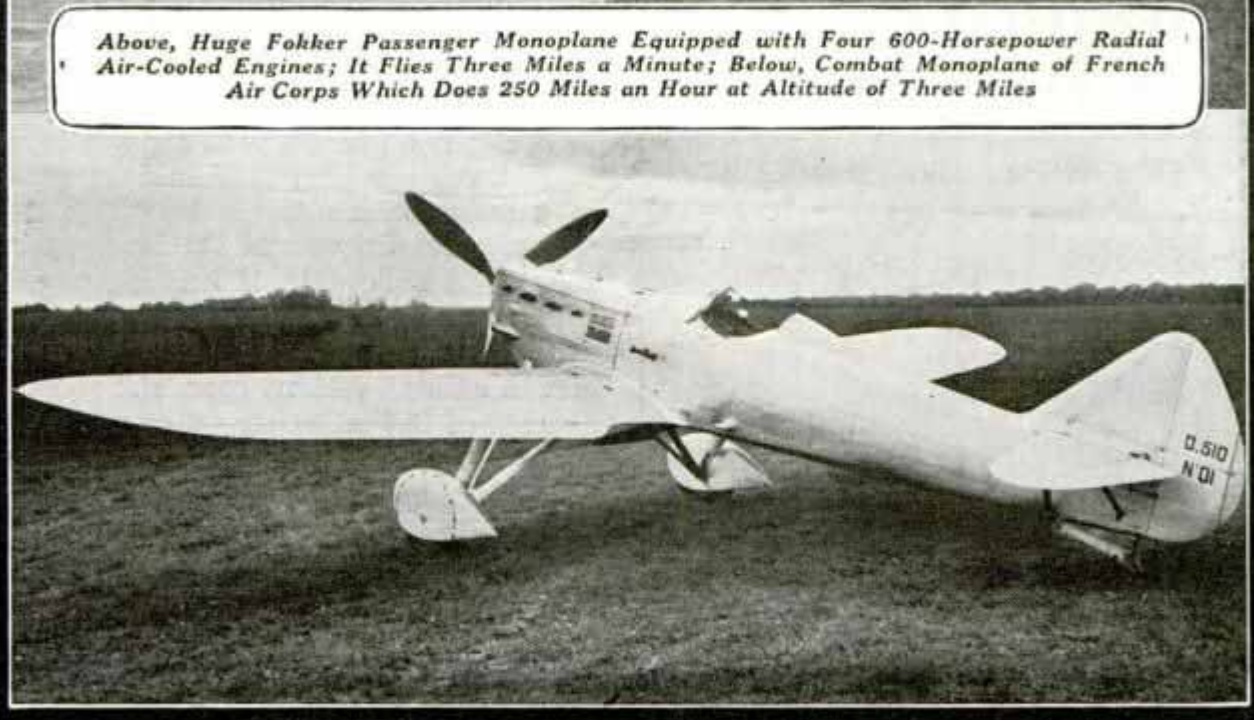

Pauls Photos
537 S Dearborn
Chicago

W. W. ... School of Taxidermy!
Omaha, Neb.
Animals Pose in Comic Roles for Taxidermist

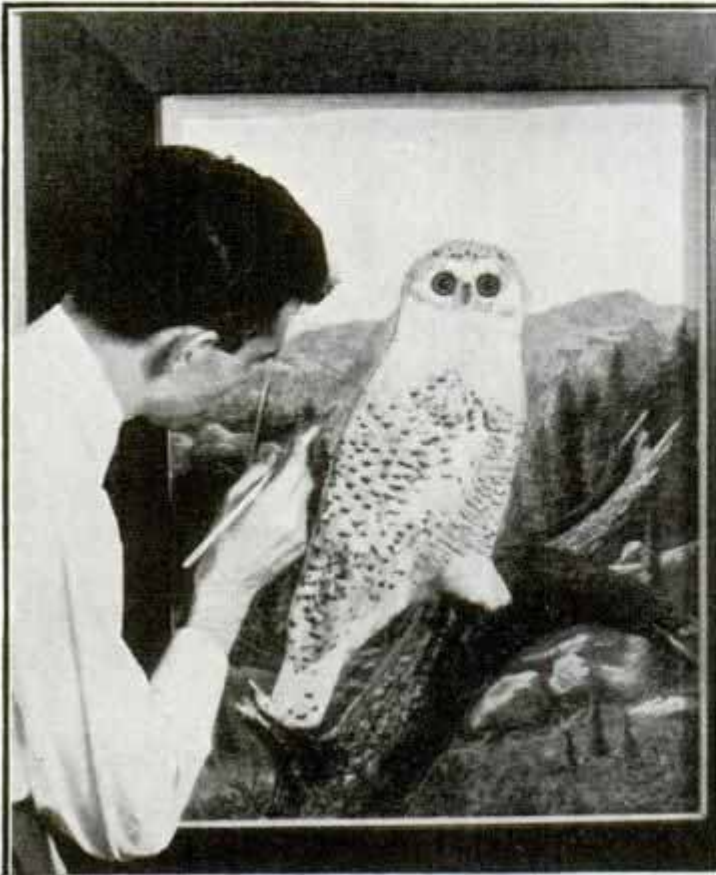

Left, Taxidermist Puts Finishing Touches on Owl Mounted on Branch of Tree against Natural Habitat Background; Right, Frog Poses as Serenader, Strumming Tiny Model of Banjo

Dressing animals for human parts both comic and dramatic is an entertaining field for the amateur taxidermist and the home craftsman. Birds and frogs, squirrels and rabbits and other small animals can be posed in humorous attitudes, or

mounted to illustrate advertising slogans or stories such as "Alice in Wonderland." In addition to mounting specimens for this novelty taxidermy, the home workshop can be used for building the "props" for the various sets.

120 **Miles per Gallon Increased by Using Clean Spark Plugs**

SPEED MILES PER HOUR	AVERAGE MILES PER GALLON	
	DIRTY OR WORN SPARK PLUGS	CLEANED OR NEW SPARK PLUGS
20	21.1	23.2
30	18.9	20.5
40	17.6	18.4
50	15.8	16.5
60	10.3	14.8
AVERAGE MILES PER GALLON	16.7	18.7
AVERAGE FUEL SAVING 10.7%		
Cleaned or new plugs save 1 gallon of gas in 10		

At a mile a minute, your car will travel forty-three per cent farther on a gallon of gasoline with clean spark plugs than with worn or dirty plugs. At slower speeds there is a noticeable, if less spectacular, increase in efficiency with new spark plugs. A test of engine performance on eleven cars at various speeds showed an average of 16.7 miles per gallon with dirty plugs compared with 18.7 miles per gallon with clean ones. The average fuel saving by installing clean plugs was 10.7 per cent.

☐Inquiries as to makers of articles described in Popular Mechanics, will be answered by our Bureau of Information upon receipt of return postage.

A.C. Spark Plug Co. Flint, Mich.

Thrills and Fun in Making MODEL BOATS

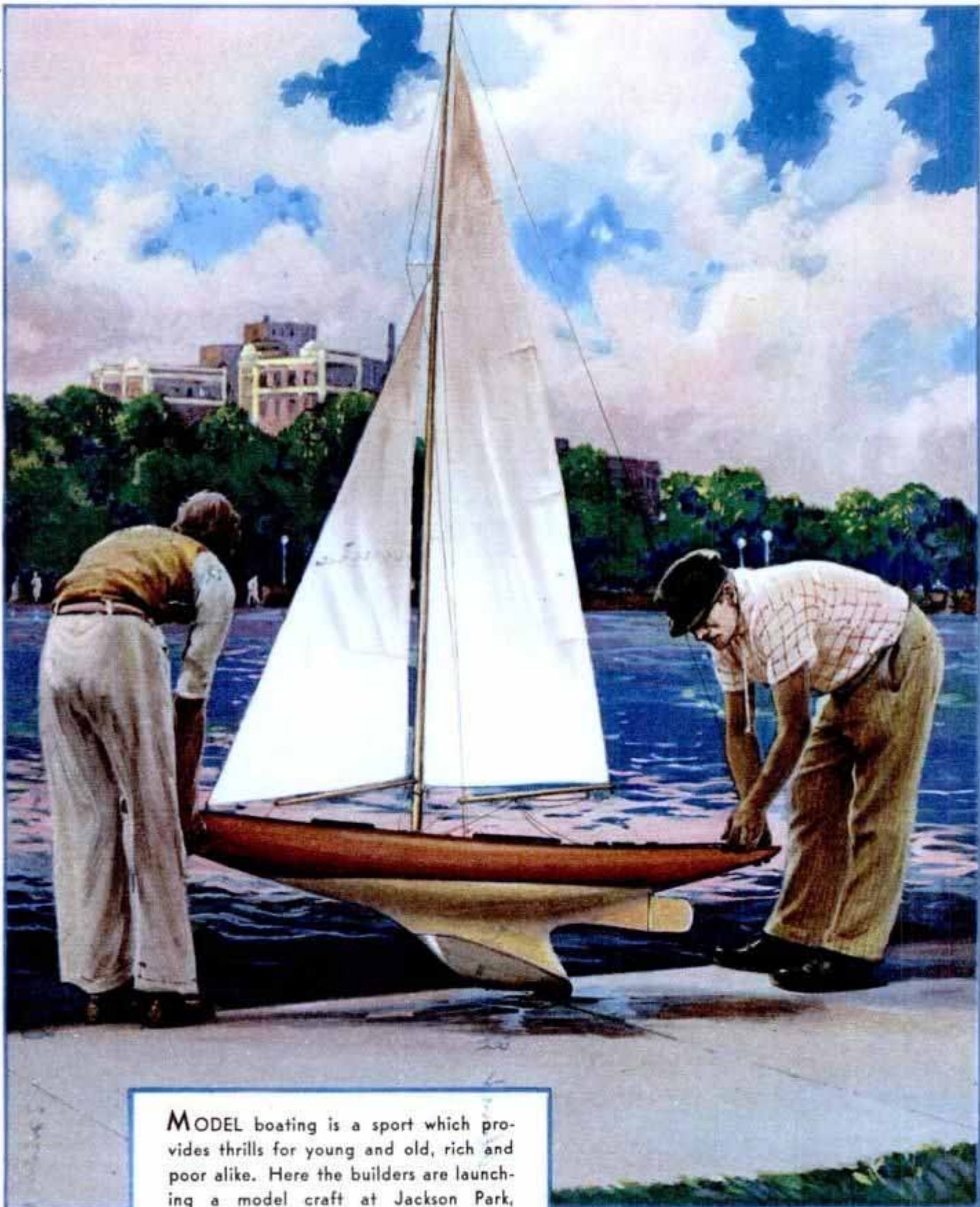

MODEL boating is a sport which provides thrills for young and old, rich and poor alike. Here the builders are launching a model craft at Jackson Park, Chicago.



8985

SOME of the model boats entered in a recent contest at Chicago for the Popular Mechanics' trophy.

By L. F. MARKAERT

MILLIONAIRES, newsboys, mechanics and staid business men have turned to miniature craft as a sport, having learned that if they cannot spend a million on a yacht, they can take their fun by proxy with miniature floating palaces, or with hydroplanes that duplicate all the speed thrills of the real thing.

Maynard Clark, an Arcadia, Calif., youth, has built hydroplane models which top thirty-five miles per hour. Only thirty-nine and three-quarter inches in length and but sixteen pounds in weight, these cleverly designed hulls are built of one-eighth inch basswood plywood to simulate a wooden shoe, and they are driven at these high speeds by a small engine of Clark's design and build that has but thirty cubic centimeters piston displacement. The bore is one and three-eighths inches and the stroke one and one-eighth inch. The little motor turns 8,000 revolutions per minute and drives a two-bladed propeller of three-inch diameter and six-inch pitch.

So terrific is the strain on the propeller shaft that the three-sixteenth-inch drill rod at first snapped off, and later had to be casehardened to stand the punishment.

Floyd Erickson, of Los Angeles, a companion of Clark's, has built a thirty-inch hydroplane powered with the well-known Brown midget airplane motor, which develops one-fifth horsepower as against the one horsepower delivered by Clark's engine. This little white hull, similar to "Miss England," will plane at ten miles per hour and has turned in runs of over twenty-four miles per hour. The hull is carved from a solid block of balsa, and with engine, fuel and batteries weighs eight pounds. The motor has a special flywheel and the fins of the familiar air-cooled cylinder have been shaved down and replaced by a brass water jacket.

Much has been learned of hydroplane performance through the observation of these miniature speed demons in action. They are raced against time on a circular

Beverly Hills
4713 Santa Monica Blvd
Los Angeles Calif
Los Angeles Calif
Home

3-Princh Model

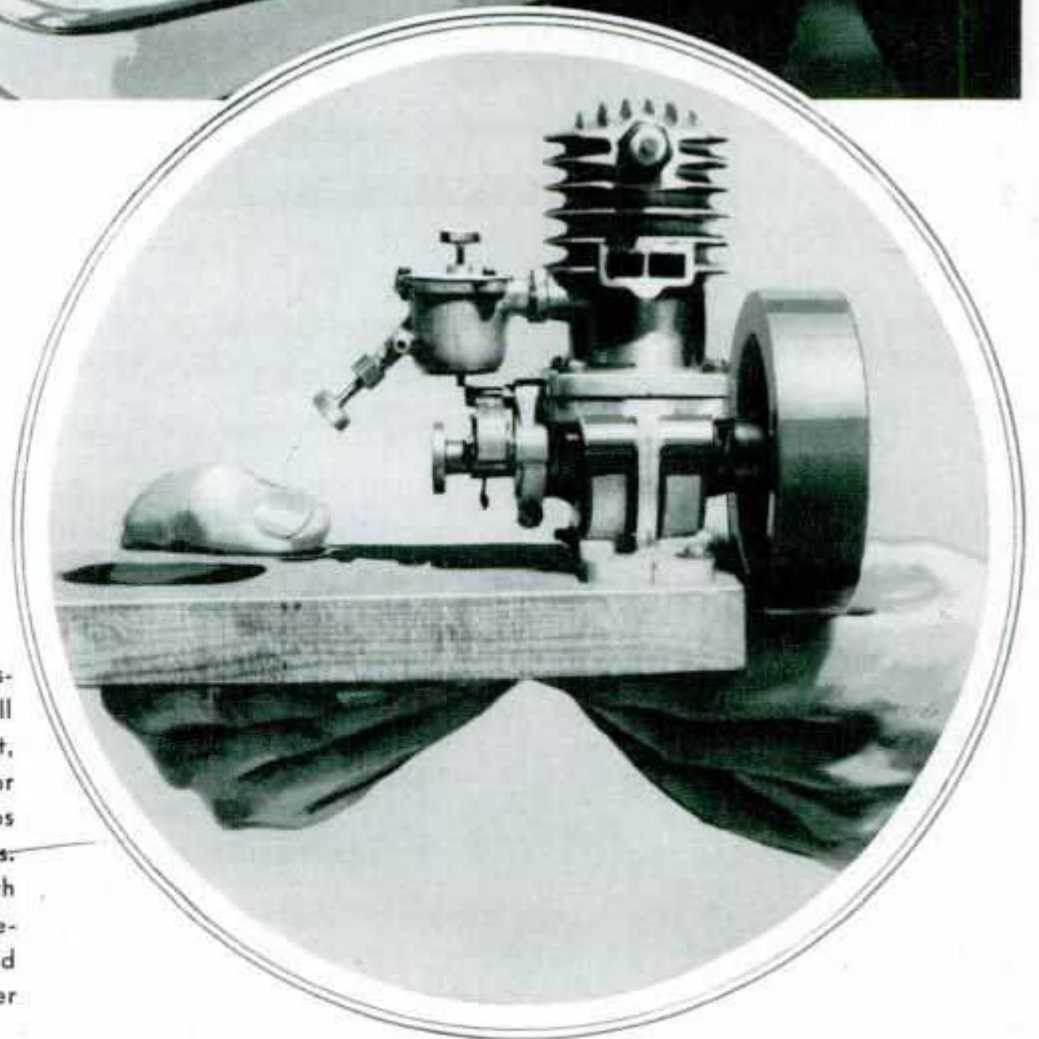

CALCULATING the displacement of a model hull made of cardboard. Right, air-cooled marine motor for model boat built by Los Angeles high school boys. It has a one and one-eighth inch bore, one and three-eighths inch stroke and turns 5,000 revolutions per minute.



6098
 ABOVE, hydro model which determined form of full size boat. Right, F. E. A. Brock, St. Louis, and his boat which won model yacht race for Popular Mechanics' trophy.

course. There is a brass rail to the starboard side of the hulls to which a stout fishline is attached. The motor is started, the carburetor and timer set for maximum speed, and the hull is placed in the water with a gentle shove. After a few coughs the craft comes up to speed as it puts out from the "mother ship." Line is payed out from this mother ship, which is anchored in the center of the lake. Round and round a fifty to sixty-foot radius the little craft speed. The roar of the motors sounds like an outboard, and crowds are instantly attracted.

Steam power plant.
 acting as fuel valve.
 1 hull - 6 ft long.
 speed 25 mph





BOAT builders testing sail balance and ballast placing on a scale model before spending thousands of dollars to build a full size craft.

8985

Crescent copper magnet

joying the thrills of owning a magnificent yacht at a fraction of the usual cost. Brandon Hendricks, of Los Angeles, spends his spare time modeling the yachts of other millionaires. Already he has constructed a scale model of Geo. F. Baker's "Viking" and a model of Vincent Astor's "Nourmahal." These models are shown in action. The "Viking" is seventy-four and three-quarter inches long, ten and one-half inch beam, and weighs forty-five pounds. It is complete, down to compass, steerable rudder, furniture, lights, and anchors. Even the auxiliary boats on davits work and float to their designed waterlines. This model travels as fast as a man can row, and is driven by steam at ninety pounds pres-

sure in a water-tube boiler fired by gasoline. It has a two-cylinder double-acting engine which drives twin screws through a gear box. It can steam for about twenty minutes, the length of time it takes to burn up the gasoline blowtorch fuel.

The "Nourmahal," modeled by Mr. Hendricks, is slightly smaller than the "Viking," and it, too, is built on a scale of one-quarter inch to the foot. It is sixty-five and three-quarter inches long, nine and three-quarter inches beam, weighs forty-two pounds and has a twin double-acting steam-engine power plant. This plant also runs at ninety pounds of steam, with a boiler of the water-tube type, fired by gasoline torch. No off-

6985

no refer-

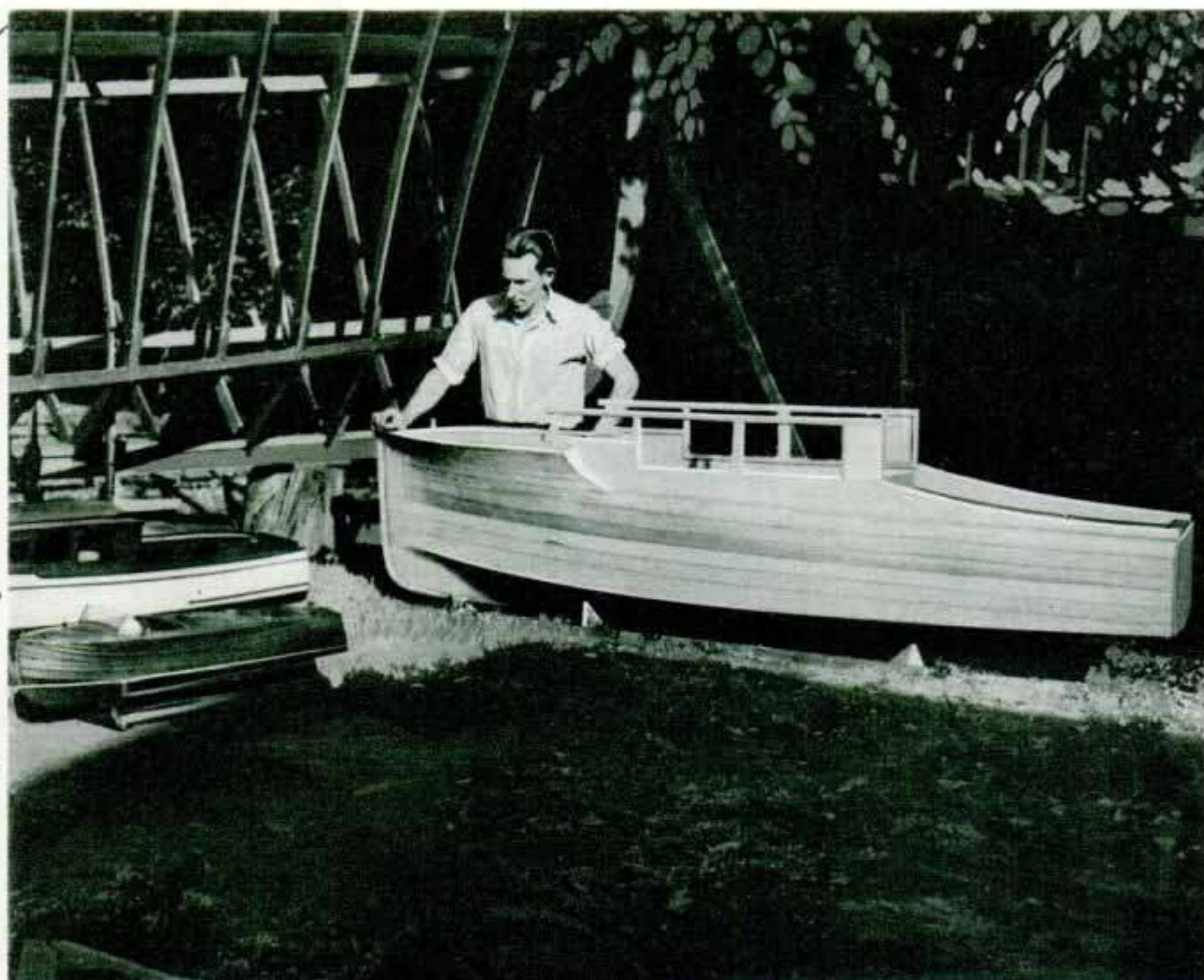

2893



BUILDING a model craft such as the one above may require weeks and months of tedious effort, but it's all real fun for the boat lover. Below, using delicate scale to check displacement of a model one-sixteenth the size and weighing about one four-thousandth as much as the full size boat.

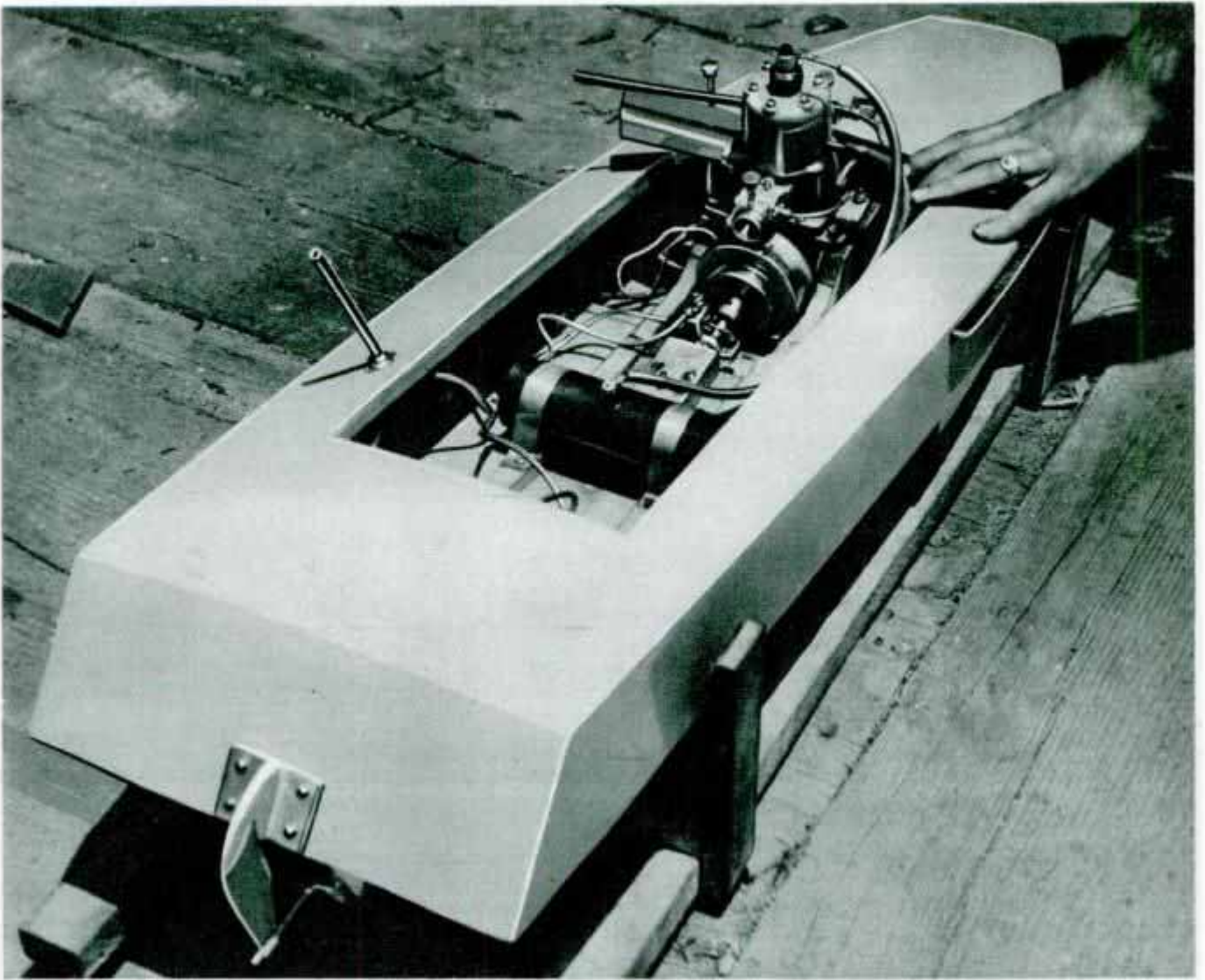

POWER plant of a model boat which performs in the water exactly like its full-size counterpart.

scale steam puffs escape the "Nourmahal" when running, for the exhaust is under water. This model, too, is complete in every detail, and the anchors, falls, davits and lifeboats actually operate.

Steam power is sometimes used in model hydroplanes, though not as frequently as formerly, because "flash" steam plants must be used in this type of craft and flash steam is temperamental. Alexander Wood, of Hollywood, has, among the many models he has built, a five-foot hydroplane, "Doreen," which can step twenty-five miles per hour using this type of power plant, which takes up most of the hull. The engine is a four-cylinder single-acting aluminum and steel affair of one-inch bore and one-inch stroke. Three gasoline burners on one control jet furnish the tremendous heat necessary to generate sufficient steam.

The burner jet is so arranged that a swipe of a stick in the hands of an operator near by can turn the flame off.

"You can call this fleet of models the 'foolish' fleet if you want to," says Mr. Wood, "but I've discovered they are the most practical of all boats. They don't cost a fortune to build, and they behave proportionately exactly as the bigger hulls will. If there is a fault in the big boat it is better to bring it out with the small, cheap one. Architects are using these models in certain forms to check their design figures."

Ted Geary, west coast designer, and others model their beautiful floating creations in the miniature and check their weights and trim against the full-sized boat, saving money from costly errors.

"We've learned a lot about pitching and galloping from these models," explains Maynard Clark. "For instance,

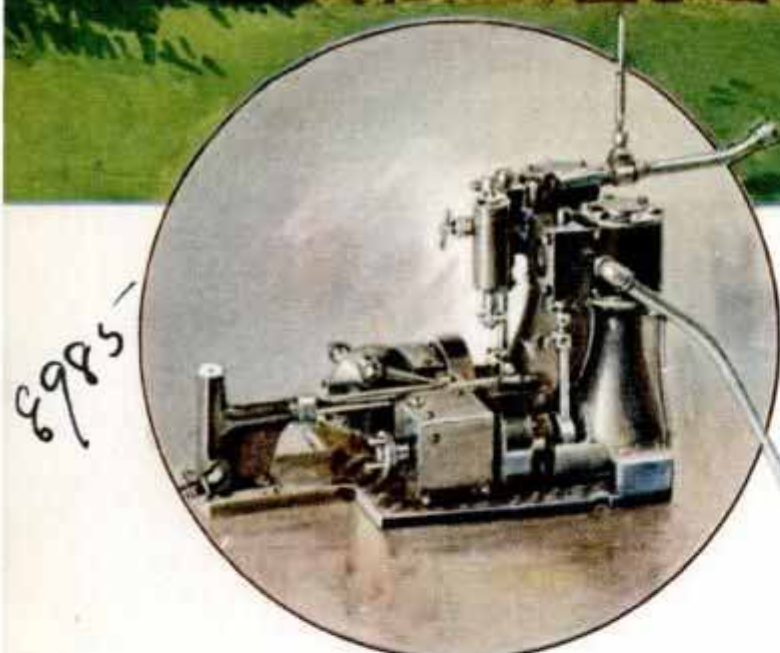

MODEL of the "Nourmahal" which was built by Brandon Hendricks of Los Angeles, and the synchronized twin screw steam power plant of this model yacht.

take the struts. No one knows what a good streamline form for water should look like. We found we could take our cooling water in through a thick strut, boring holes in the front face of it, and resistance of the whole unit was lowered. And by experimenting with a whale's tail fin on the strut we can take the galloping tendency right out of the meanest bucker of them all.

"The resistance isn't affected as far as

we can measure it, but the hull rides smooth."

So the foolish fleet is most practical. At a cost estimated by Mr. Clark at from \$10 to \$75, one can own the finest of midget racing hydroplanes. Yacht models of the "Viking" and "Nourmahal" order cost from \$100 to \$500, if you exclude the tremendous amount of time required to build them. Mr. Hendricks has a model of J. P. Morgan's famous "Corsair" now building which will take two years to complete.

"I've owned both the models and the big fellows," says he, "but the models are more practical for the boat lover. He can cover more ground in a given time and learn more on less money."

Two Thousand Private Planes Fly Air Lanes

In 1899 there were 2,000 horseless carriages chugging along the streets of America. Twenty-four million are registered to-day. And today 2,000 privately owned airplanes take their owners on sky



Typical of the Small Cabin Planes Operated Privately by American Sportsmen and Business Men Are Those Shown Above

trips to business and to play. Their ships cost from \$7,500 to \$15,000 at the factory and ten cents a mile to fly, including hangar space, insurance, depreciation, everything. The selling point for the air is "quicker transportation." Planes are sold through distributors, like automobiles; the display room is usually a corner of an airport hangar. Four American factories are building for the private trade. Four-place

ships, open or cabin type, are most popular. They average 3,000 hours of flying life over a five-year period, but are likely to need a new motor after 1,500 hours. Six to a dozen of America's 2,000 private owners have private airports, the rest pay \$25 to \$35 a month storage fee. Two-way radio, night and blind flying equipment are customary. Executives carry a desk, dictating machine and typewriter.

Waco Airplane Co. Inc.

*Em. Sprimari
Mulle 216
Dad Dayton Ches*

Bellville, N.J.

INVISIBLE RAYS FIND ENEMY SHIPS

Detector Locates Planes or Boats Many Miles Distant

Ent. Spencer A. Jones, 20 Tiora Ave. Bellville, N.J.

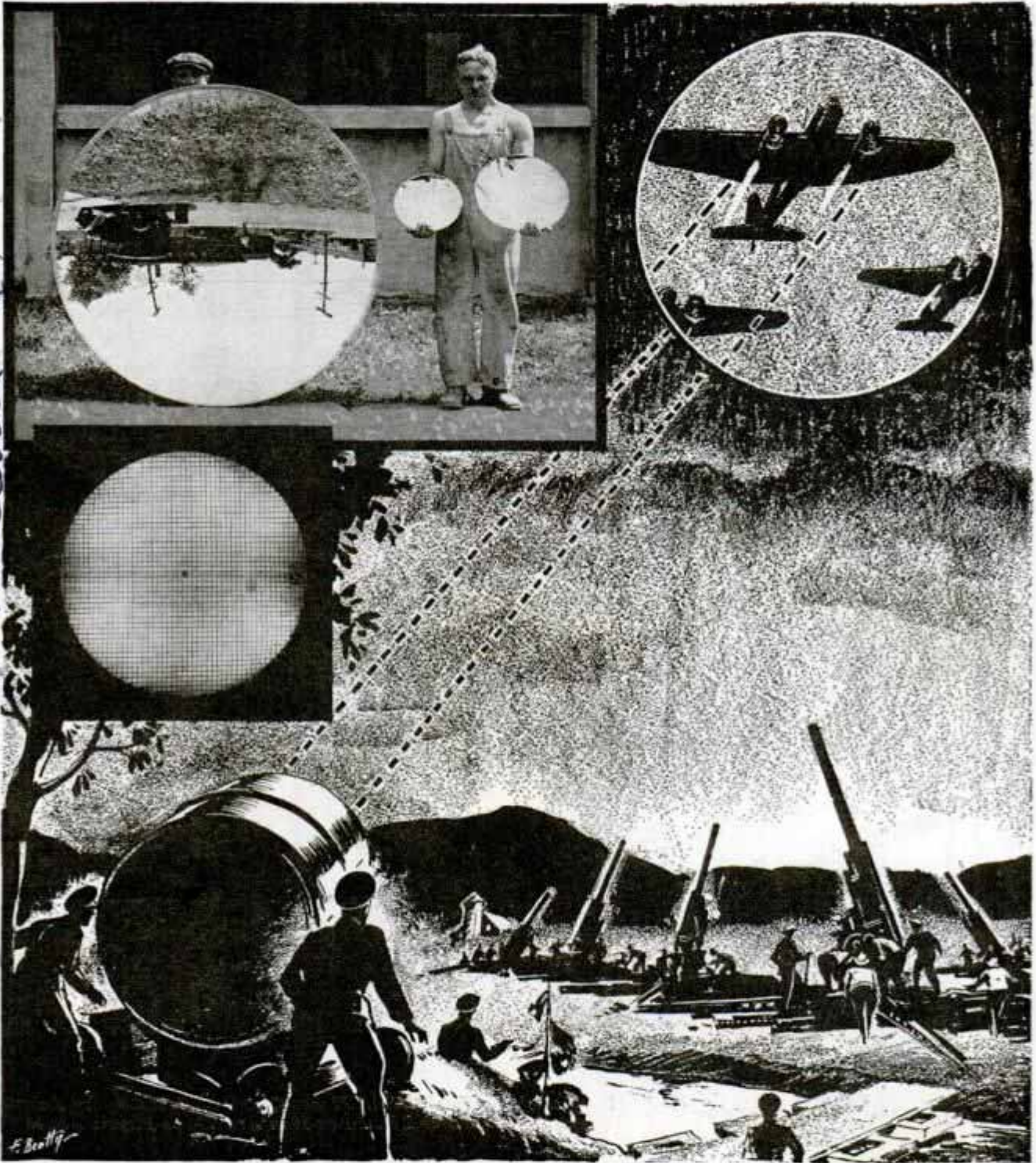

Top, Left, Holding Forms from Which Reflectors Are Made; Note Clarity of the Inverted Image; Bottom and Circle (Top), Drawing of Equipment for Detecting Planes by Picking Up Heat Rays

Do you know that the heat from a candle fifty miles away can be detected? It sounds like a stunt, but military experts are applying its basic principles in apparatus designed to reveal the location of enemy airplanes or battleships. By employing the most sensitive galvanometer

and amplifying unit available or by concentrating the heat rays with a huge lens or concave mirror focused on a photoelectric cell, the scientist "finds" the distant candle. In the same way, the military man may pick up the heat rays from the motors and exhausts of air or sea craft,

SPENCER A. JONES

Ocean Glider Cuts the Waves at Speed of Twenty-Two Knots

plot the exact location and train anti-aircraft or short batteries on the approaching ships long before they are within range. These heat rays, also known as infrared rays, travel at the speed of light, about 185,000 miles per second, but are invisible. Since sound waves move at only 1,080 feet per second, heat rays can be detected many miles before the sound of plane or ship can be picked up by the most sensitive detector. Equipment probably similar to the candle detector has been tested in secret by the U. S. army, with unusual results. Some type of range-finding apparatus was used to locate "enemy" vessels far at sea in the darkness and to enable "gunners" to score direct "hits" with powerful searchlights. A New Jersey laboratory is known to have produced gigantic searchlight reflectors, with sixty-inch concave metal mirrors so near perfect they require no machining or polishing. Rhodium, a metal more expensive than gold, is used for the reflecting surfaces because it is practically immune to atmospheric corrosion and to the terrific heat of searchlights. Rhodium has high reflection characteristics over a wider color range than other materials, reflecting all light waves, from ultra-violet through the visible spectrum and including the invisible infrared or heat ray. So it is possible that rhodium searchlight reflectors were used to concentrate heat rays from "enemy" ships on the photo-electric cell, enabling range-finding crews to fix the location with their instruments. It also is possible that rhodium reflectors were used to direct the invisible rays against the distant ships, then to pick up the rays when they bounced back. Commander P. MacNeil, English inventor, has devised simple detectors that are remarkably sensitive to heat rays from ships and planes. Operation is almost as instantaneous as direct sight, even in dense fog or in darkness.

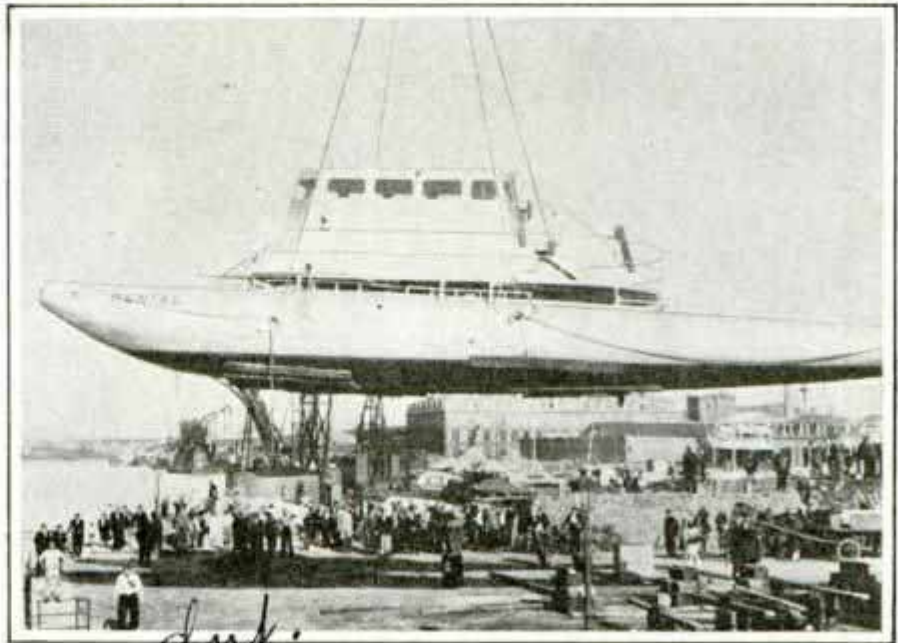

Derrick Is Used to Launch the "Genial," Fast Passenger Ferry Built for Service between Havre and Trouville, France

Plying the ferry lane across the mouth of the Seine between Havre and Trouville, France, is a speedy "ocean glider" that cruises at twenty-two knots. Of novel design resembling a "whaleback," the glider carries seventy-five passengers.

81135

CHIMES ARE GROUND TO SCALE FROM OLD AUTO DRUMS

Brake drums of old automobiles are the chimes in a church tower at Addison, N. Y. The seventeen chimes in the set were ground to the proper pitch by drilling away metal from the drums. The chimes are played with a small hammer.



These Brake Drums Are Tuned for Chimes

no info.

d. no. up W. Polles, B. ...

Em. George & Fabrice, 65 P. de la Place, Rouen, France

81114 Leggett

FUEL SAVERS that

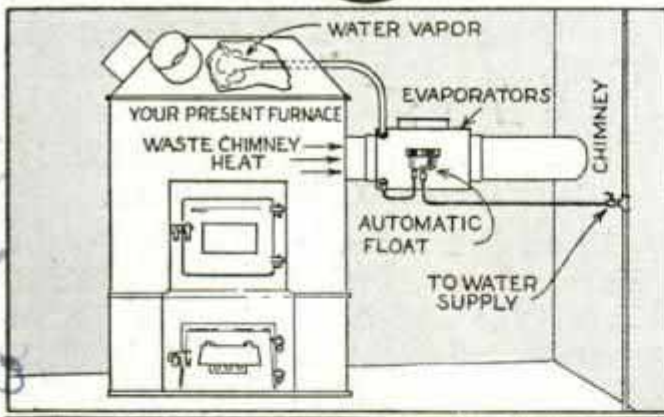

Top, Proportion of Heat Losses in Average House; Center and Bottom, Simple Humidifier That Installs in Pipe Near Furnace

CHILLING winds of the fall months are reminding many a home owner of last winter's battle to keep warm. Whether the cause was a "sick" furnace, faulty piping or poorly insulated house, keeping comfortable meant extra coal, oil or gas, and the memory of those fuel bills is still unpleasant.

But has the home owner kept those vows to "do something" about it? Probably not, because he fears that replacement of the entire heating system is the only cure and that the cost is too great. In cases where the furnace may be worn beyond repair or piping and registers or radiators may be so old that they retard the flow of heat, installation of a new plant is recommended. Savings due to the greater efficiency of the modern heating system over the old will be a pleasant surprise. Some new oil-burning furnaces cost no more to operate than coal-burners of yesterday.

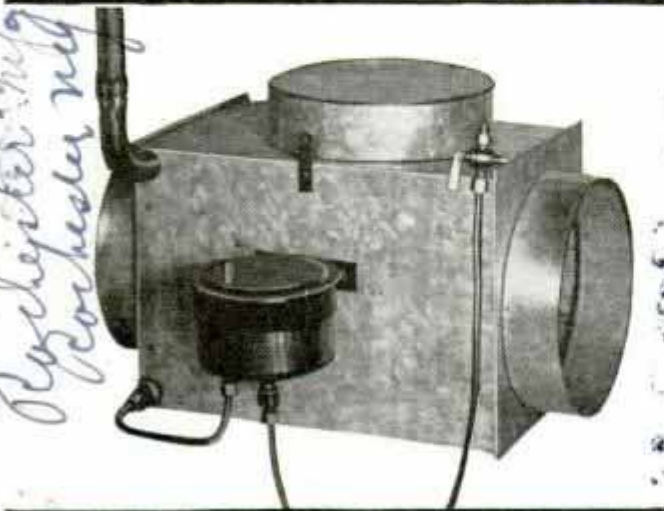

Pay for Themselves

For the man who is operating his furnace at a cost that almost makes it a luxury, there are ways to reduce fuel bills. Perhaps the house is to blame. Heat losses can offset a highly efficient furnace if the house is not properly equipped for the winter. After tests of 200 houses, C. G. Segler reported to the American Society of Heating and Ventilating Engineers that the proportion of heat losses is twenty-seven per cent through walls, sixteen and two-tenths through roof, twenty-five and eight-tenths through glass (windows), four and three-tenths through doors and twenty-four and six-tenths by infiltration, gradually escaping through cracks, around windows and door frames and other places.

These losses can be reduced sharply. Prof. Alonzo P. Kratz of the University of Illinois found that properly fitted storm windows and doors reduced fuel bills twenty per cent, in comparison with the previous winter's operation without them at a residence sponsored by the National Warm Air Heating and Air Conditioning Association. In these tests, the house was completely equipped with storm windows and doors. Installing them on two sides from which come prevailing winter winds will result in a saving but it will not be so great as if the house had them all around.

Proper insulation of walls and ceiling will reduce heat losses still further. In many houses, mineral wool or similar insulating material can be blown into walls without major changes. One to two inches of this insulation in side walls will accomplish the desired result, Prof. Kratz finds, while three inches of insulation in the ceiling will be sufficient to keep

Electronic Co. Markaba
PEP UP THE OLD PLANT *Maria*



"Electric Janitor," One Type of Furnace Control Which Takes the Work Out of Heating and Assures Correct, Steady Heat at All Times; the Thermostat Is Set at Temperature Desired



FOR HOT WATER SYSTEMS *Bell and Gossett*
3000 Wallace
Chicago

Booster Pump Improves Circulation Where Pipes Are Small or Installed Incorrectly, Giving a More Even Flow of Heat to All Rooms in the House



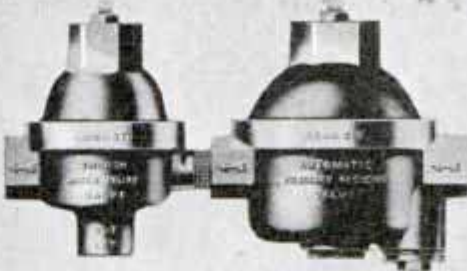

Dual Control Unit Which Relieves Home Owner of Maintaining the Water Level in Boiler; This Valve Arrangement Automatically Controls the Pressure





FOR STEAM SYSTEMS

Efficient Valves on Steam Radiators Mean Quicker, Safer Heating and Perhaps a Saving on Fuel; Old, Clogged Valves Retard the Flow of Heat Considerably

Crane Radiator Shield, for Steam or Hot Water. Slips into Place between Radiator Sections; Shields Direct Heat Currents into Middle of Room at Low Level

Courtesy The Crane Co.

886 Michigan
Kainer & Co. Chicago

Orville Ohio

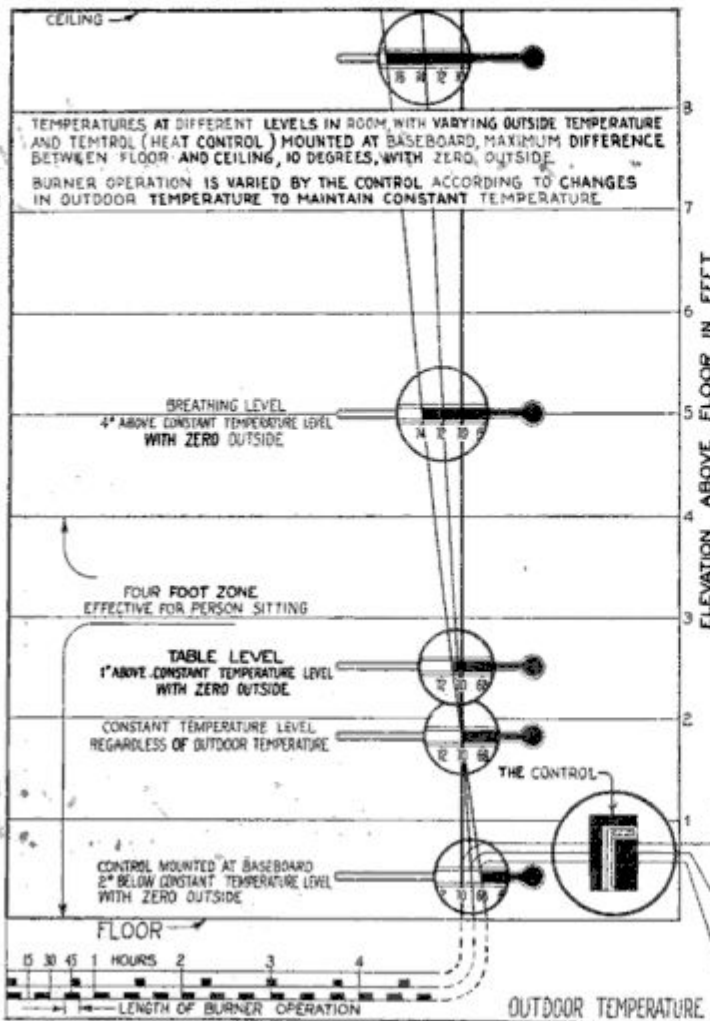

Courtesy Penn Electric Switch Co.

Des Moines Iowa
 out winter's cold and summer's heat. Oakum caulking around window and door frames, applied during redecorating, also will save some heat.

So far as furnace and piping are concerned, several "fuel savers" are available, many of which will pay for themselves in a single winter. An automatic stoker for coal-burners results in more economical operation, with savings from ten per cent up, the result of improved combustion, ability to use cheaper fuel, and substitution of an automatic-controlled system for a manual-uncontrolled system.

Prof. Kratz believes many excessive fuel bills can be traced directly to poor control. If a coal furnace is fired properly and its draft and flow of heat regulated by thermostat or other type of control, efficiency will be considerably greater and fuel costs lower. One temperature regulator, the Temtrol, is designed for mounting below the four-foot level in the room.

This keeps the heat flowing more regularly and produces a comfortable temperature around the feet. A built-in device slows up the furnace and avoids overshooting the seventy or seventy-two degree setting on the instrument. This regulator is intended to produce more economical service from the furnace than conventional plain or clock-type thermostats.

Chimney draft regulators may be classified as fuel savers. On systems without perfect control, a regulator may save about five per cent because it prevents an overrun of heat. But if the system is controlled properly, addition of the device would not increase economy appreciably, according to Prof. Kratz. This holds true for the aquastat, offered for hot-water plants.

Booster pumps for hot-water systems may cut fuel bills where

circulation is poor. Prof. Kratz points out that positive circulation is very desirable. The booster may prevent overheating the whole house in an attempt to get radiators hot in one or two rooms where the piping is faulty. The pump permits the use of smaller size pipe. The circulating fan for

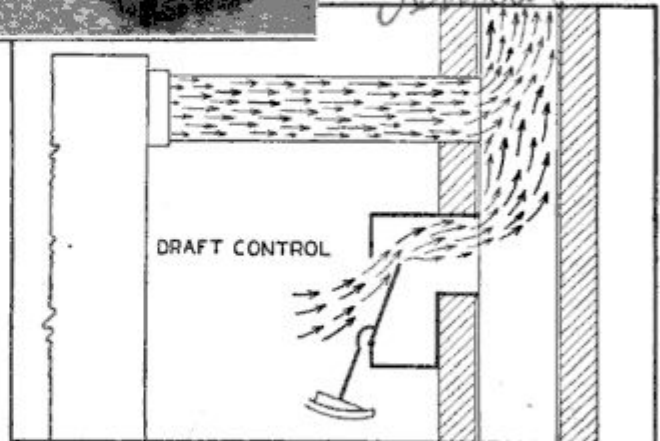
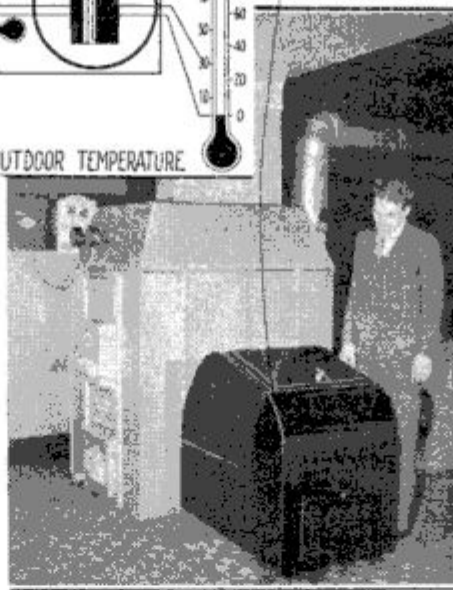

Top, How Control Located at Baseboard Keeps Temperature Even in Whole Room; Center, One Type of Automatic Stoker; Bottom, Automatic Draft Control; Arrows Show Flow of Gases from Boiler and Control; Installation Is Simple but Must Be Done Properly for Best Results

81114
warm-air plants does little to save on fuel, but it produces more even heat to every room without forcing the furnace to operate at excessively high temperatures. If warm-air ducts are faulty the fan may reduce the fuel bills somewhat by improving the circulation. Certainly it will make the house more comfortable.

A blower, consisting of a centrifugal fan to produce forced draft in the ash pit and thus improve combustion in the coal furnace, is recommended by Crane company engineers as one means of saving. The blower permits the use of cheaper fuel in addition to forcing the furnace to burn a larger percentage of the coal or coke used, resulting in less ash and clinkers. It does not circulate the air through the heating pipes.

On steam systems, the radiator valve is important because inefficiency at that point retards the heat flow. Radiator shields of various types may not result in a fuel saving, but they will make the home more comfortable because they force heat into the room at the three or four-foot level and prevent that chilly feeling around the ankles. The Crane shield, which slips into a groove between sections of the radiator, is scarcely noticeable, yet it accomplishes the same thing for which larger and more expensive cabinets and radiator covers are designed. However, it fits only the slotted radiators made by that company.

One device which eliminates the necessity for keeping constant watch on the water level in the boiler is a set of valves that controls the flow from water mains into the boiler. A small tank used with the unit serves as an overflow tank in the hot-water system. The valves and tank are installed at the furnace.

If the furnace is "sick," it may be made more efficient by stripping off the old jacket and installing a new, well-insulated one. Insulation wrapped around the hot-water or steam pipes may be another means of improving the heating system,

(Continued to page 142A)

81127.
Fire Suit and Gas Mask
Worn on Perilous Duty
Olympia Palace London

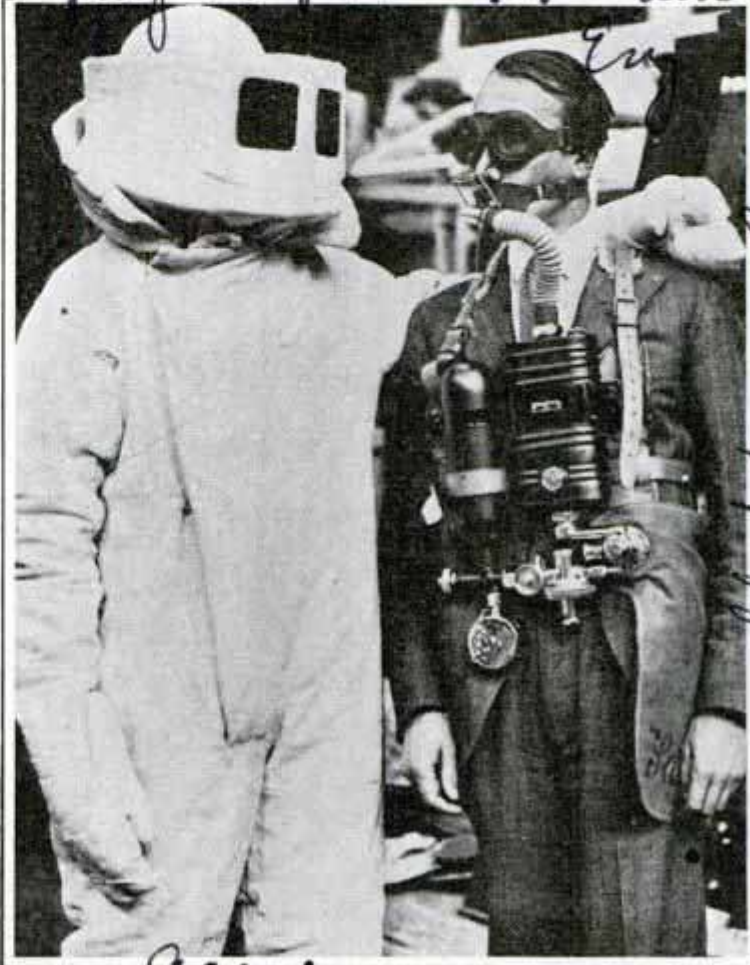

Acme
Latest Types of Fireproof Suit and Gas Mask Designed for Firemen, Rescue Crews and Wartime Defense

Latest styles for fire fighters and rescue squads include asbestos uniforms that cover the entire body and gas masks that furnish oxygen. The gas helmet also is equipped with protective goggles.

81165
"STREAMLINE" BICYCLE SEAT HAS BUILT-IN TOOL CASE



"Streamline" saddles for bicycles and velocipedes are being built with a tool compartment that opens at the back of the seat. A ruby glass reflector on the hinged door of

the tool case acts as taillight. The saddle spring is all but concealed.

Engineering
employed in shipping
and machinery

Brooklyne, C.

6 7092. ...

The WORLD'S RACE to ARMS



"Land Destroyers"—Part of England's Fleet of Tanks Ready for War Orders; This Photo Indicates Trend to Robot Armies the World Over; Bottom, New Type of Heavy Artillery Developed by French Military Experts



826
E 1092

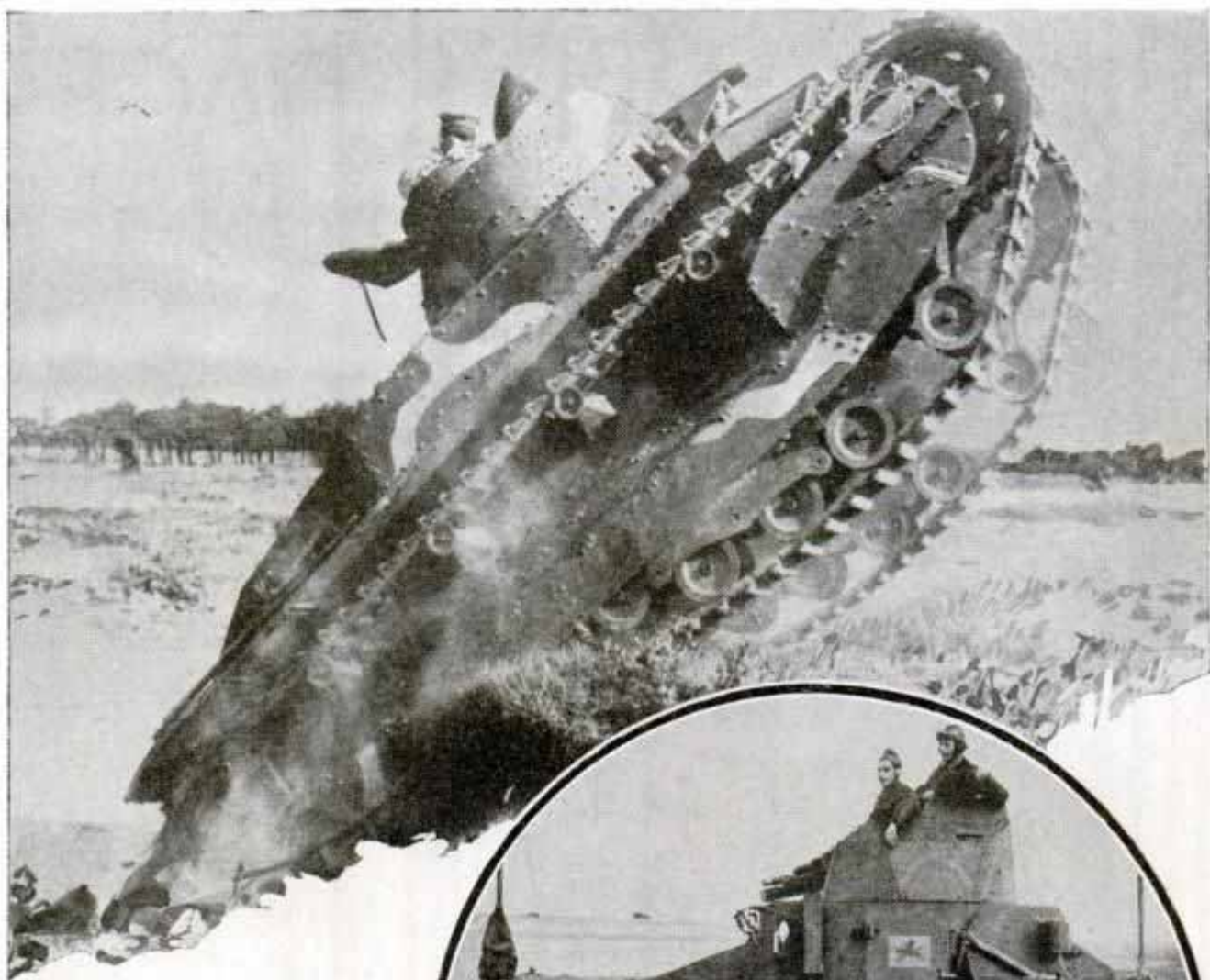

Top, Japanese Tank Climbing Steep Hill in War "Game";
Center, One of France's Heavily Armored Cars;
Bottom, Young Italians at One Stage of Intensified Military Program



Top, Italian Infantry during Gas Attack in Maneuvers; These Conditions Closely Resemble Those That These Same Men May Encounter in War; Center, German Mine-Throwing Unit in Action, with Soldiers in Gas Masks; Bottom, All-Metal British Flying Boat on Test Flight for Royal Air Force; This Is One of the "Battleships of the Air" Developed by World Powers in the Almost Universal Attempt to Be Prepared; Italy's Great Fleet of Giant Bombers and Fast Fighting Planes Gave Her a Distinct Advantage in the Recent Campaign in Ethiopia

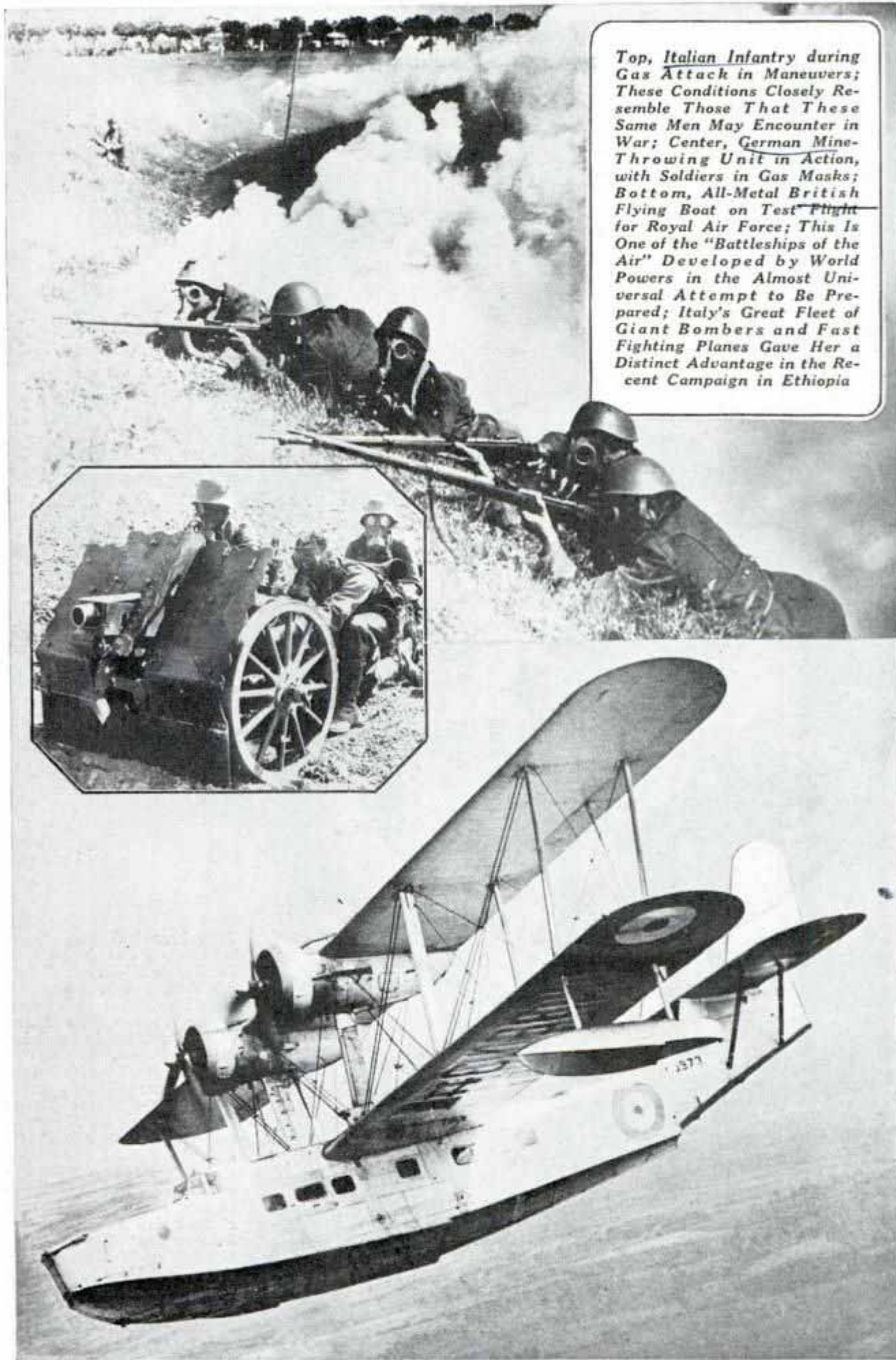

81092

International



Top, French Battery Commander's Post in Test of Artillery's Ability to Evade Air Attack; Circle, Realistic War Maneuvers of Young Italian Troops Who Learn about Gas Attacks by Being Subjected to Clouds of Gas Expelled by This Motorized Equipment; Bottom, Royal Air Force Gunner Trains His Weapon on the "Enemy" in Mimic Air Battle between Sections of Great Britain's Flying soldiery; These Photos Show How Seriously the Various World Powers Are Training for International Emergencies; the Italian-Ethiopian Crisis Speeded Up the Race to Arms

DRIVE, SEATTLE, WASH. Post-
 2 LBS. United States mixture 30c. Ind.
 age extra. John Nagle, North Judson, Ind.
 FREE Premium with approvals! Ideal
 Vacuumed, Toledo, Ohio.

Anternational

6 10/24

Bristol engine



Top, "Savoia Marchetti" Bomber, of Type That Italy Sent to Africa for Service against Ethiopia



Close-Up of the Savoia Marchetti Bomber; Note Gun Turret on Top of Ship

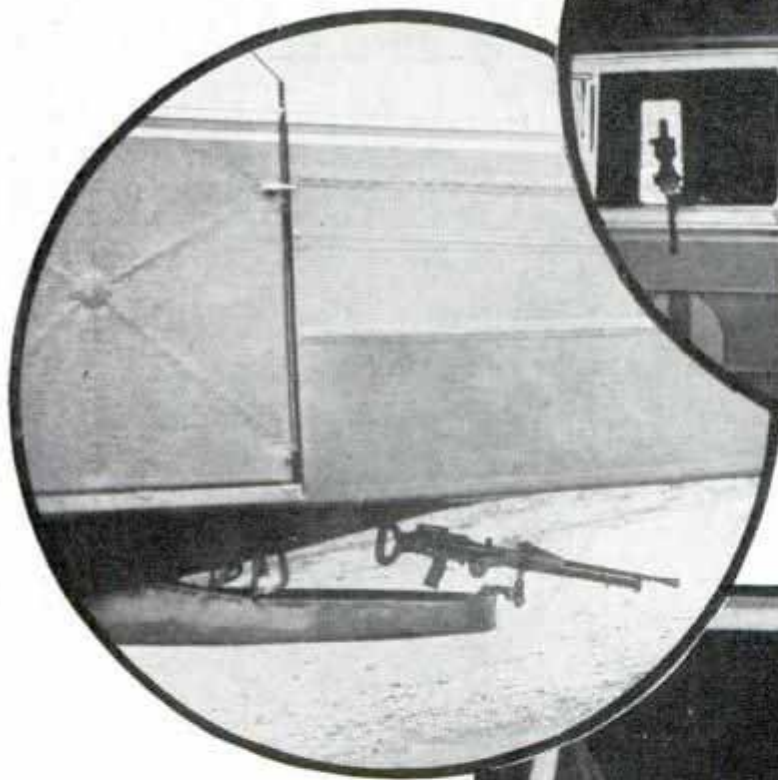

Above, Gun Mounted Below Italian Bombing Plane to Ward Off Attacks from Beneath the Ship; Right, French Officer Testing a New Device Designed to Detect Approaching Enemy Aircraft; Scientists and Inventors Are Doing Their Part in the Accelerated Program of Preparedness as War Clouds Seem to Swirl over a Number of Great Nations



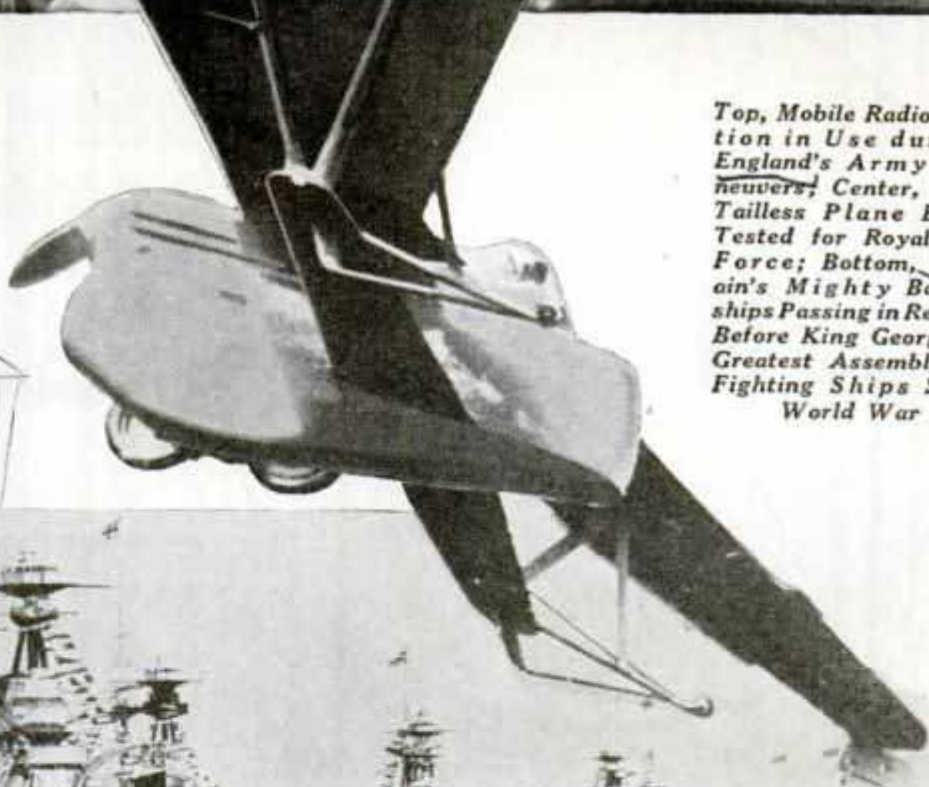
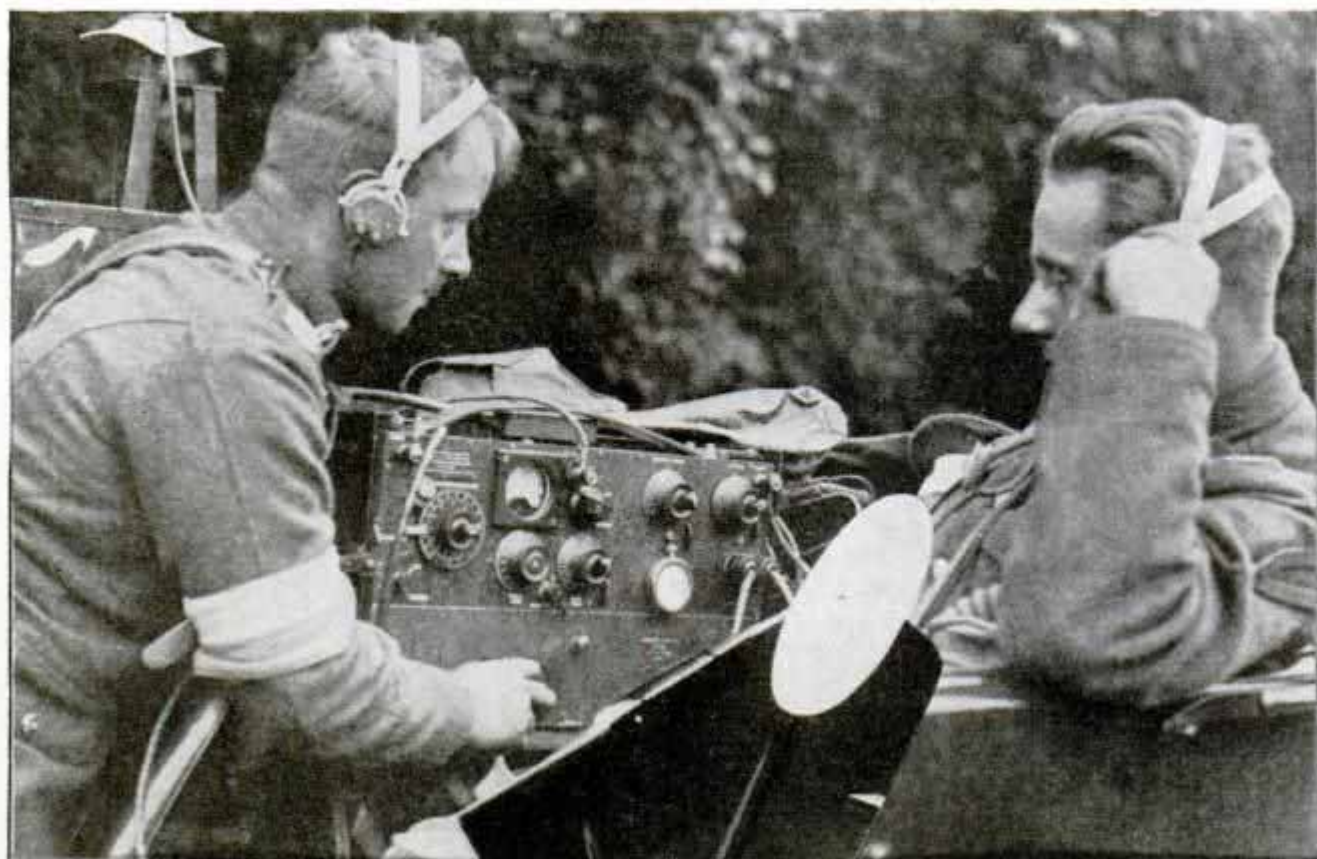

Top, Mobile Radio Station in Use during England's Army Maneuvers; Center, Odd Tailless Plane Being Tested for Royal Air Force; Bottom, Britain's Mighty Battleships Passing in Review Before King George in Greatest Assembly of Fighting Ships Since World War

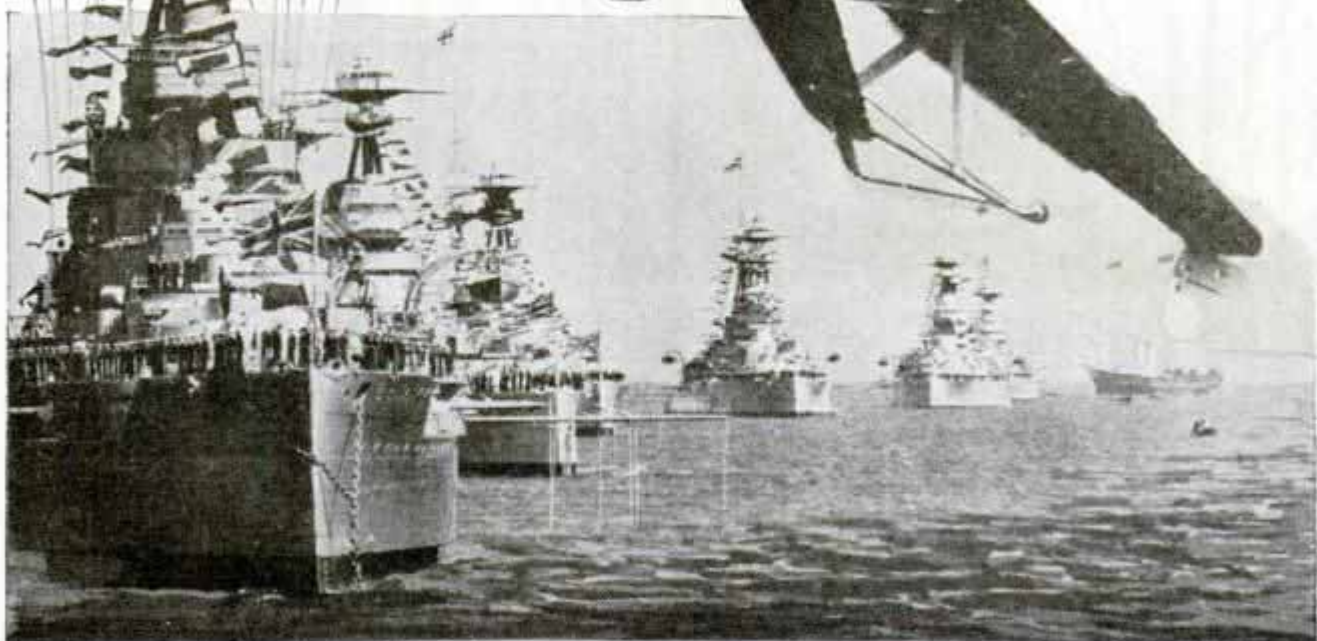

E 1138

Emergency Radio to Direct Army of Rescuers

In case of an emergency in Los Angeles, 25,000 organized relief workers can be galvanized into action by a special force of amateur radio operators directed by the city's "emergency" station, **W6KJJ**, housed in a quakeproof, fireproof tower. This short-wave communications system has been fortified against breakdown in any imaginable catastrophe. At headquarters are two stationary radiophone transmitter-receivers in a steel and concrete building, independent of outside power. A gasoline engine directly connected to a motor generator in a steel-vaulted basement chamber supplies two kilo-



Top, Directing Rescuers from Emergency Headquarters; Center, Gasoline Engine Generates Power for Radio; Bottom, Field Rescue Station Keeps Touch with Headquarters



watts to the short-wave station. At the first alarm, amateur operators speed to fifteen designated concentration posts with their portable four-tube, dry-cell operated two-way radio sets, ready to handle messages guiding the relief forces. At the

central bureau is a detail map of the Los Angeles area set on plate glass, illuminated from

behind by an arrangement of electric-light bulbs to indicate any rescue station calling for help. Radio-equipped police and fire cars can tune in on the emergency network during the rescue work.

E 1138

BREAD IS KEPT FRESH A WEEK AT FREEZING TEMPERATURE

Bakers have found it possible to keep bread fresh and sweet a week at temperatures below freezing. Bread stored hot, at temperatures around 150 degrees Fahrenheit, became stale more slowly than at normal temperatures but the flavor and color were pronounced "discouraging" after experiments. In a test of freezing, cereal chemists tasted bread baked the previous day and bread that had been frozen a week. A majority preferred the aroma and flavor of the week-old loaf.

American Association of Cereal Chemists.

Com. Mel W. Harton 1144 S. Brandeis St. Los Angeles

330 W. 42nd St. New York

8 708

Sept. 25 1932

Cobble Stones Vacuum Cleaned by Neat Dutch Housewives



Wade Works
Dutch Housewife Vacuum Cleaning the Walk in Front of Her Door in Her Everlasting War on Dirt

Holland has gained the enviable reputation of being the cleanest country in the world because of the pride taken by the people in keeping their cities spotlessly clean. With the Dutch housewife, cleanliness is really godliness, and she not only keeps her floors so clean one might eat off them but carries her war on whatever dirt may be left into the sidewalks in front of her home. In Holland it is nothing unusual to see a housewife vacuum cleaning the cobblestones in front of her door with the same implement she has just finished using in the house.

RECESSED AUTO DOOR HANDLES WOULD INCREASE SAFETY

When the ancient Egyptians drove their chariots into battle, they mounted sharp knives in the wheel hubs to sideswipe the

enemy if they couldn't run him down. Automobile drivers today unknowingly carry similar weapons in the form of protruding door handles. The car door handle is described as a "menacing and dangerous projection," causing disfiguring injuries and occasional deaths, by Dr. Samuel McLanahan, of Baltimore, who made a recent report on accidents involving door handles to the American Medical Association. Door handles have been driven through the skulls of victims and the sharp-pointed kind in modern streamline cars are particularly dangerous. Handles pointing toward the rear are less dangerous than those pointing to the front, but the ultimate solution is a handle without sharp projections or one that is countersunk in the side of the door.

DANGER SPOTS ON STREET SHOWN BY CROSSES

Large crosses painted on the streets where traffic fatalities have occurred are being employed in St. Louis to impress on motorists and pedestrians the need for extra caution at such places. Other states have also used the crosses for similar purposes, placing small wooden crosses at the roadside where people have been killed in accidents.

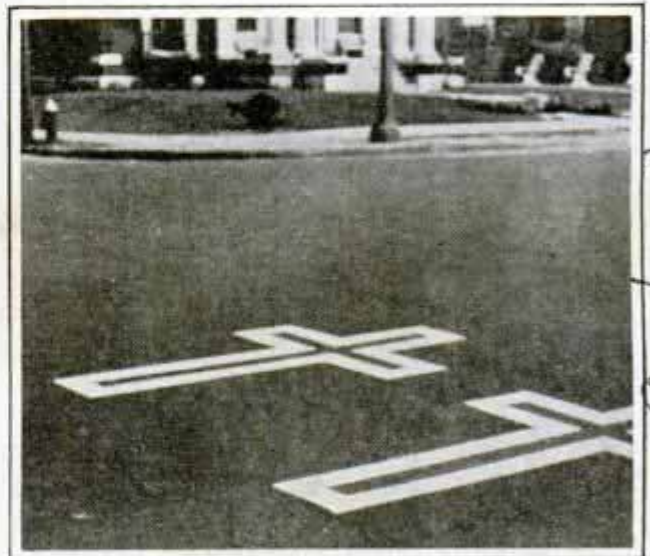

Crosses Painted on Pavement as Warning to Motorists That Fatal Accident Has Occurred Here

in Lindell Blvd.

Comp. 1146

Middelburg

*Frankfort. 1146
Kovel. Box 105,
Emt. Bernard*

Radio Ashore Runs Lightship without Crew

Operated by remote control from a land station eight miles away, a lightship without a crew is serving shipping in Lake St. Clair, between Lake Erie and Lake Huron. The ship has a powerful masthead light, a gas-operated fog bell, a compressed-air fog signal and a radio beacon. When fog comes up, the lighthouse keeper ashore manipulates radio controls to start the fog signals on the ship. The radio beacon normally operates automatically, sending out its signal for fifteen minutes out of each hour, day and night. When there is no fog, the masthead light can be observed by the lighthouse keeper eight miles away. A receiving set at the lighthouse checks on the radio beacon, picking up the dots and dashes. A check on the fog signal is kept by a microphone on the ship which "listens" to the signal and also controls the radio beacon. If the microphone "hears" the fog signal, it permits the beacon to transmit a full sixty seconds out of each operating minute, otherwise it cuts off the beacon for five seconds each minute. If the lighthouse keeper hears the radio beacon only fifty-five seconds out of the minute, he knows the fog signal has failed and he starts the second signal. The U. S. Lighthouse Service worked five years on the lightship.



Top Photo, U. S. Lighthouse Service; Bottom Photo, Detroit Free Press
Lightship Controlled by Radio and (Below) Testing the Remote-Control Instruments

Windshield Is Cleared of Ice by Heat of Electric Wiper



Electric Current Passing through Blade of Wiper Heats It Sufficiently in Two Minutes to Melt Ice

Ice and snow that clog windshields and make winter driving perilous can be defeated by an electric windshield wiper that melts the film of ice from the glass. The heat is in the blade, which is inserted in place of the ordinary rubber blade of the wiper. Two minutes after it is turned on, the blade is hot and a few swipes over the windshield will clear it and keep it clear. The defroster operates on a six-volt battery and uses four and one-half to four and three-quarters amperes.

Handwritten notes:
 2 10 3 2
 2 1056
 Pat # 1, 790, 544
 Hoover, Shriver Co., Kans
 c/o Hoover, Shriver Co., Kans

8945

W. G. C. Alley's Investment Securities, 100 W. Monroe Chicago

HOW to PLAY

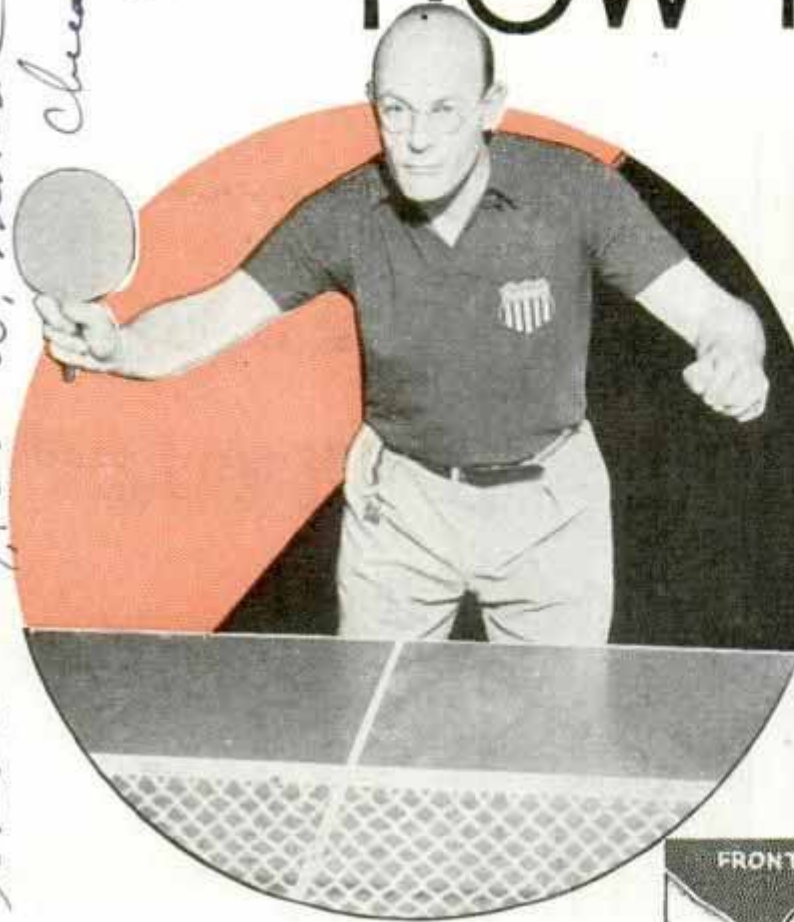

By **COLEMAN CLARK**
Former National Champion

AMERICAN games live in cycles and table tennis, now in its third revival, today is riding the crest of the popularity wave.

Indoor tennis, as it first was called, appeared shortly after the turn of the century. It was played in leisurely fashion in the parlor with crude wooden paddles and a firm, light ball, covered with a knitted web to protect the furniture. When the sport was carried to England, a celluloid ball was substituted but indoor tennis retained its aura of femininity and after a few years, it nose-dived into oblivion.

The game's comeback in 1915 was brief but after the world war it gained a foothold in Europe. Since then it has elbowed its way into the sport circles of virtually every civilized country. Twenty-three nations are affiliated with the International Table Tennis Federation and Carl Zeisberg of Philadelphia, president of the United States Table Tennis Association, already organized in twenty-three states, estimates that between two and three mil-

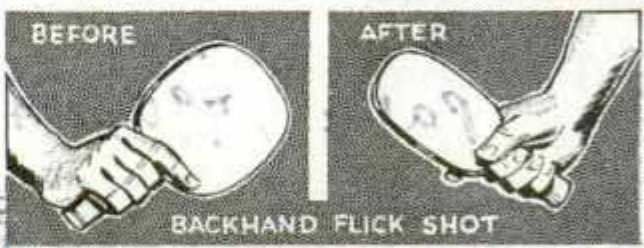
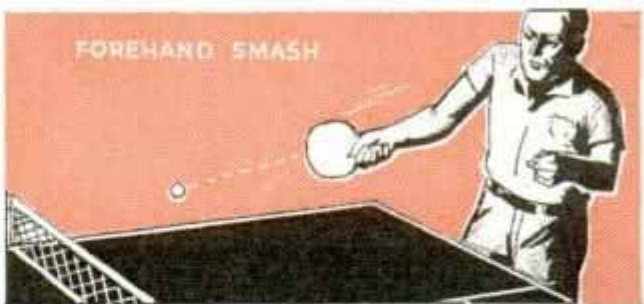
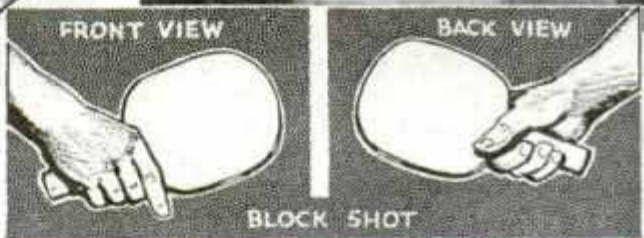

Top, Left, Ready to Block a Drive, and, at Right, in the Middle of a Backhand Drive

see no. 1100
669
8945

TABLE TENNIS

The Author Showing Forehand Chop at Middle of Stroke and Start of Backhand Chop Stroke

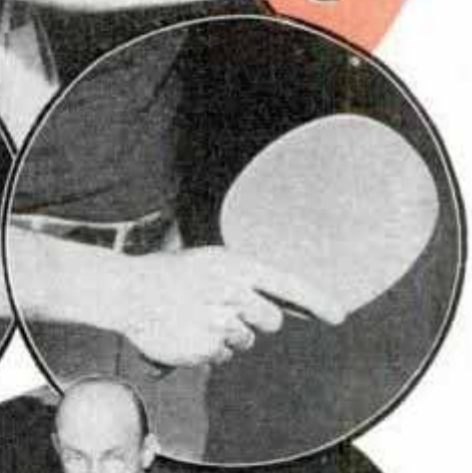
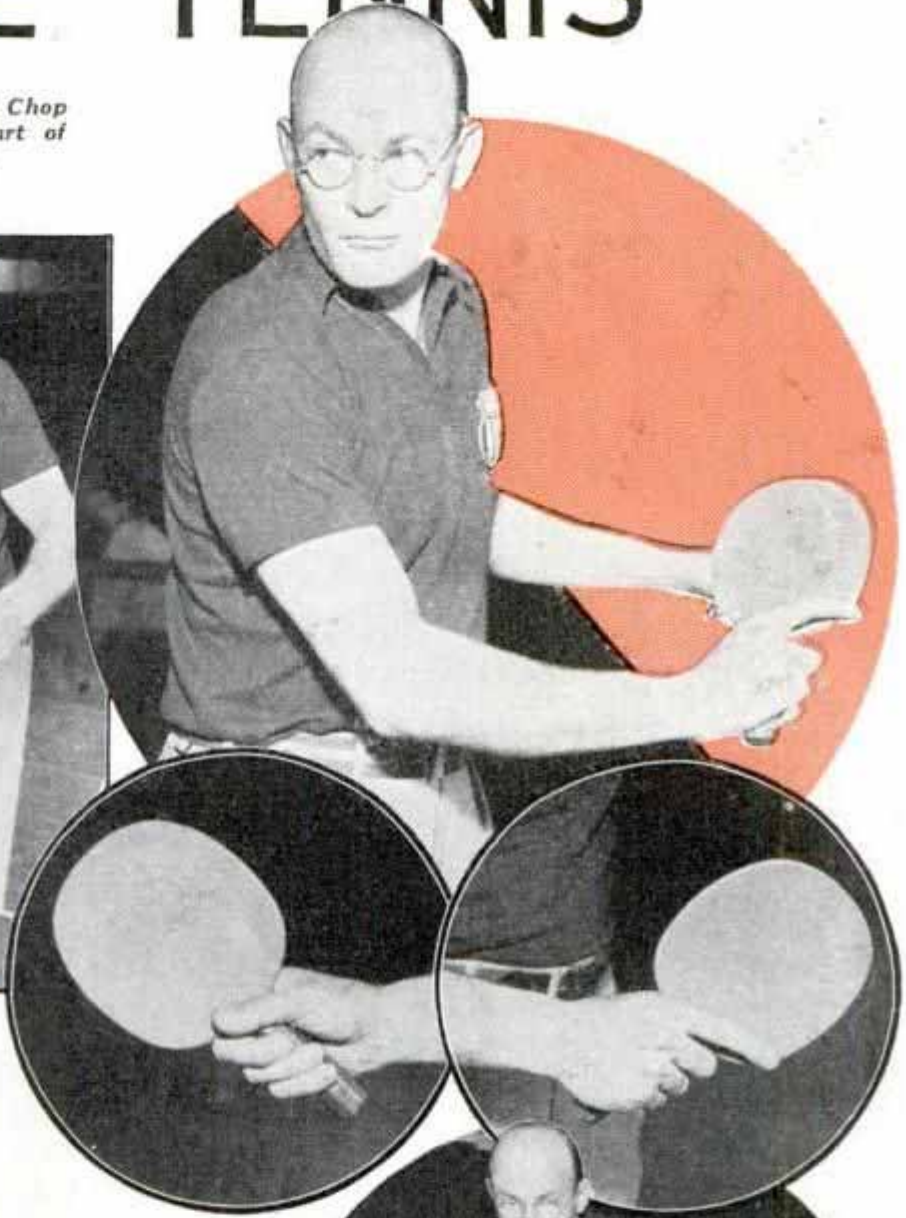

lion Americans are playing the game. It is about the only active sport that can be played in the home and is an excellent form of exercise as virtually every muscle of the body is used during a fast game.

To get the maximum enjoyment from this sport, play on a regulation five-by-nine table. Insist on the three-quarter inch, five-ply model, as it gives a higher and more uniform bounce than the three-ply type. Use the large size pebbled rubber racket in preference to sanded bats. On the offensive, the rubber bat aids in putting the cut and spin on shots, and in defensive play, it tends to absorb the shock of a hard-driven ball.

As in tennis, the grip of the racket is important. There are many ways of holding a bat, but perhaps the most practical is the tennis grip. The racket is held high up the handle and the index finger extends outstretched close to the edge of the blade,

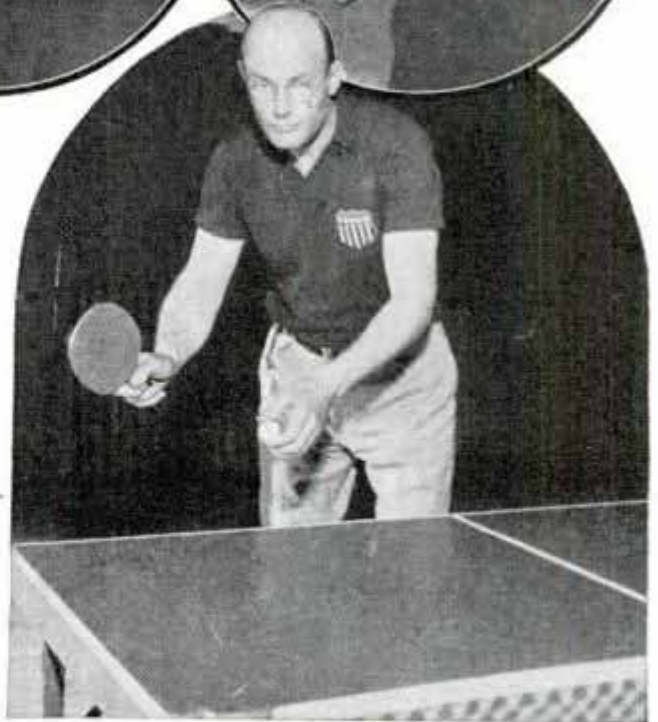

Forehand Serve and Back and Front Views of the "Tennis Grip"; Note Position of Fingers

*Cont. James Mcweeney
2471 Hartmouth Road
835*

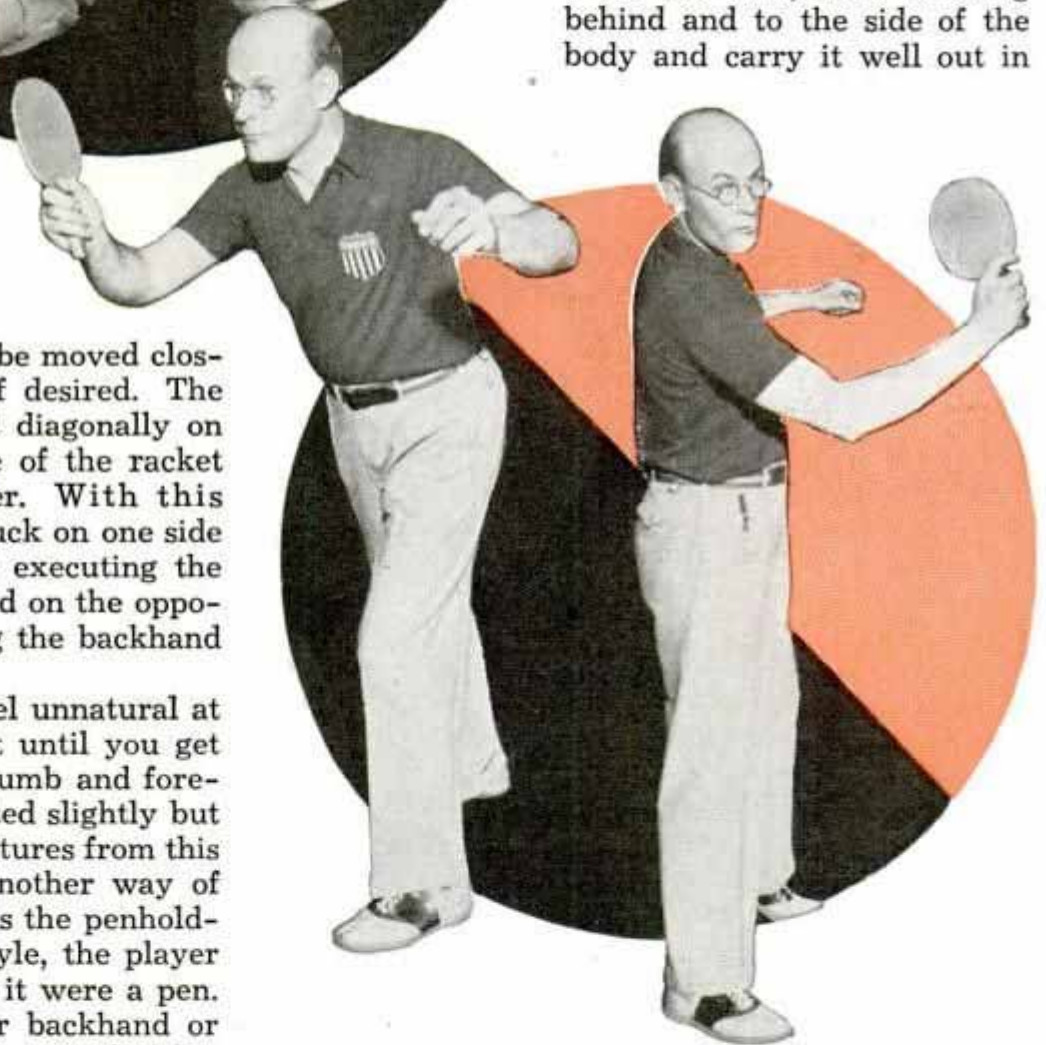

Top, Mr. Clark in Action; Below, Left, Finish of Forehand Drive; Right, Beginning of Backhand Drive

or pull-up determines the degree to which the ball takes the desired nose dive after passing the net.

In making a forehand topspin drive, the wrist should be firm and the hand around the bat steady but not too tight. The body should be in a comfortable, slightly crouching position, two or three feet behind the middle of the table. To obtain proper balance, spread your feet and keep on your toes. Because of the ball's size and the rapidity with which it travels, keep your eye on it until it strikes your racket.

On the shot, start stroking behind and to the side of the body and carry it well out in

although this may be moved closer to the center if desired. The thumb should rest diagonally on the opposite side of the racket from the forefinger. With this grip the ball is struck on one side of the racket in executing the forehand stroke and on the opposite side in making the backhand shot.

The grip may feel unnatural at first but stick to it until you get used to it. The thumb and forefinger may be shifted slightly but avoid radical departures from this tested formula. Another way of grasping a racket is the penholder grip. In this style, the player holds the bat as if it were a pen. In executing either backhand or forehand shots, the penholder player strikes the ball on the same side of the racket.

A topspin drive—a fast, low ball—is, perhaps, the fundamental stroke. Strike the ball with a quick upward and forward movement together with generous follow through. The extent of the necessary lift

front and across the body a foot or two above the table. For the best results, the upper edge of the racket blade should be tilted at the moment of impact, although

(Continued to page 118A)

67076 Com. John F. Comby,

Steel and Stone Fortress to Guard Our Gold

Route 4, Anacostia D.C.

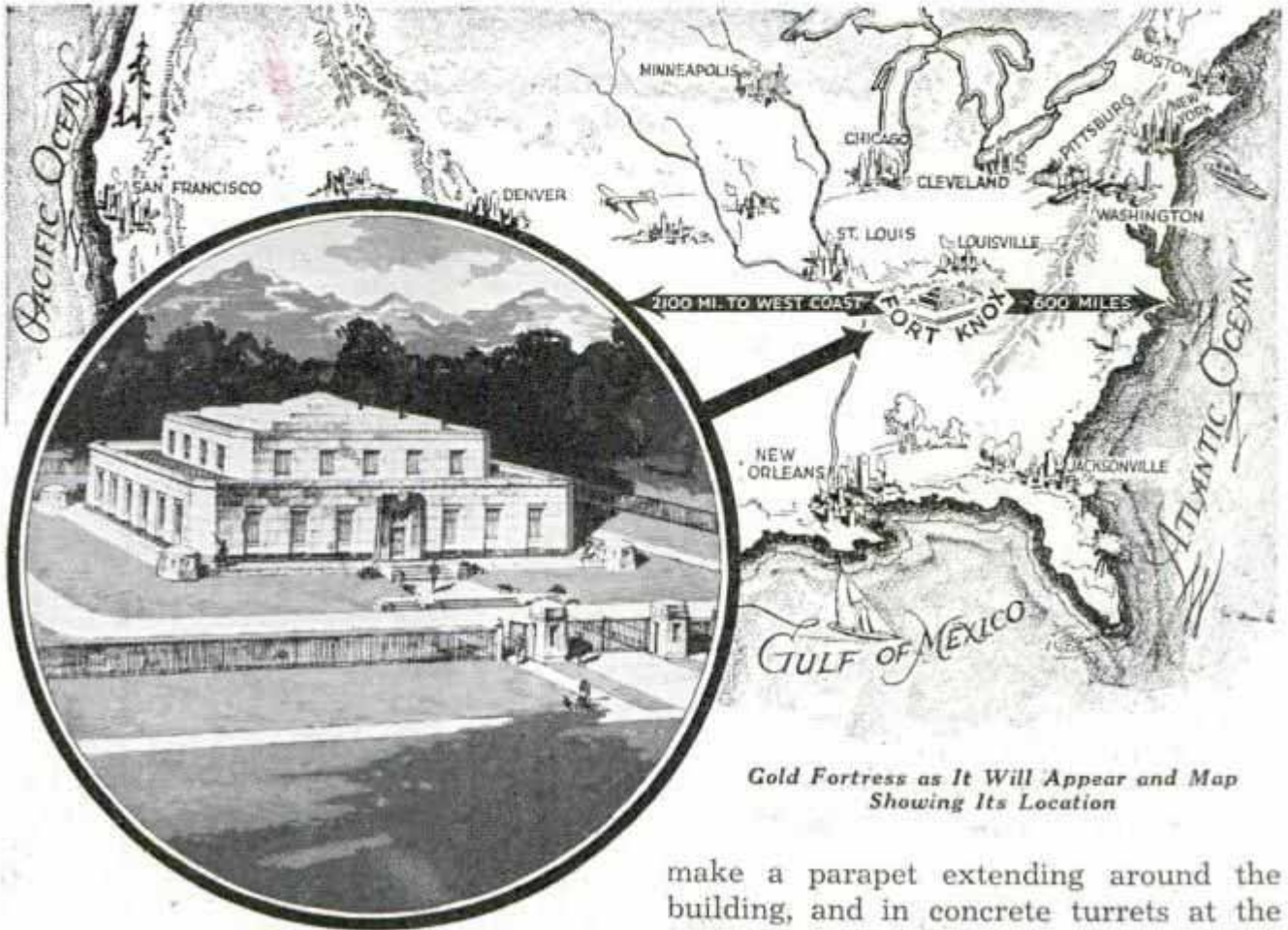

Gold Fortress as It Will Appear and Map Showing Its Location

Gold worth nine billion dollars, the greatest accumulation of the yellow metal ever gathered in one pile, is shortly to be moved by the government to Fort Knox, Ky., there to be cached in a fortress of steel and stone, ringed around by armed forces and the most deadly weapons of science. The gold storage building will occupy 10,000 square feet and the gold itself will be placed in a giant vault forty by sixty-four feet and rising through nearly two stories of the building housing it. Walls, roof and floor of the building will be of granite two feet thick and the vault walls will also be two feet in thickness. In them will be fabricated steel coils so close together that a human hand could not be inserted between them even if the concrete about the steel could be removed. Around the vault, above and below, will be an eighteen-inch space clear to the vision from every angle. These spaces, spotted with mirrors, will give guards an uninterrupted view of the vault from every side, day and night. The top floor of the fortress will set back far enough to

make a parapet extending around the building, and in concrete turrets at the four corners machine guns will be mounted. Inside sensitive microphones will connect every part of the vault with the main guard room. In the office of the captain of the guard will be an annunciator with its warning drops, signal lights and bells. This will be augmented further by an elaborate telephone communication system. Outside the building, in the fort proper, is a motorized cavalry unit with armored trucks and cars standing as the first line of defense. The gold is being moved inland from the eastern seaboard to provide extra protection in case of a foreign invasion. Another cache of gold has been established at Denver. Both Denver and Fort Knox are protected by the natural barriers of the Allegheny and Rocky mountains, making the points very difficult of access to an invading force, except by planes. The gold being "salted away" is not coin but is in the form of bars about three and one-half by six and three-fourths by one and three-quarter inches. At \$35 an ounce each has a value of about \$14,000 and each bar weighs something less than 400 ounces.

[Handwritten scribbles and signatures at the bottom of the page.]

Electric Timer Clocks Plane on Record-Smashing Flight



Wide World
Using Telephone, Printing Chronograph and Camera to Check the Time of Howard Hughes When He Broke World's Record for Land Planes

When Howard Hughes, California speed flyer, broke the world's record for land planes with an average of more than 347 miles per hour for seven flights, an elaborate electric recording system was set up to clock his plane as it raced at nearly six miles per minute. The timing equipment included a telephone, a printing chronograph and a camera which snapped the ship as it whizzed over the three-kilometer course. On his last lap, Hughes' motor choked and failed but he landed safely.

so that no darkroom is required and pictures may be made at home, school or office. The camera has a fixed focus lens, a shutter with bulb and time exposures, a light lock to protect the microscope eye-piece and the camera lens, and a bracket to hold the camera in position above the microscope. After focusing the microscope as usual, with proper light on the object, the camera is placed in position and the picture taken.

SUN BATH IS GIVEN WITHOUT A BURN BY HEALTH BULB

All danger of sunburn from over-exposure has been eliminated in an ultra-violet lamp devel-

oped by a Cincinnati inventor. You can read and work under its light, all the time absorbing its health-giving sun rays without fear of burning the skin. The bulb fits an ordinary light socket.



Electric Bulb That Sheds Sunlight without Burning

MICROSCOPIC CAMERA SHOT MADE EASY FOR AMATEUR

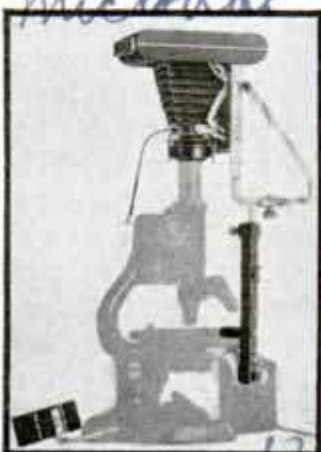

Amateur photography through the microscope no longer requires any particular skill, a camera being available for this special work. It uses ordinary roll film of two and one-quarter by three and one-quarter-inch size,

1086

1942

1118

Science Laboratory 424 E. 4th St Cincinnati Ohio
see March 1942
Beckman, Cincinnati, Ohio

Eastman Kodak Co. Rochester, N.Y.

George S. Spencer

Smoke Rings Like Auto Tires Made by Drum

If you can't produce smoke rings with your pipe or cigar, you can be sure of doing it with a big smoke drum which makes huge circles about the size of automobile tires. The smoke machine is mounted on a truck and is used for advertising purposes. The drum is five feet in diameter, two feet thick and has a center opening of eighteen inches. Mounted on each side are two cones containing the smoke-making material. At the base of the cones are agitators and electric heaters to keep the smudge material rotating and convert it into smoke. The smoke by air pressure is forced to the tops of the cones and from there through pipes to the drum, the interior of which is like another cone with the smaller part toward the front. The rings are produced by striking a leather diaphragm at the rear of the big drum.

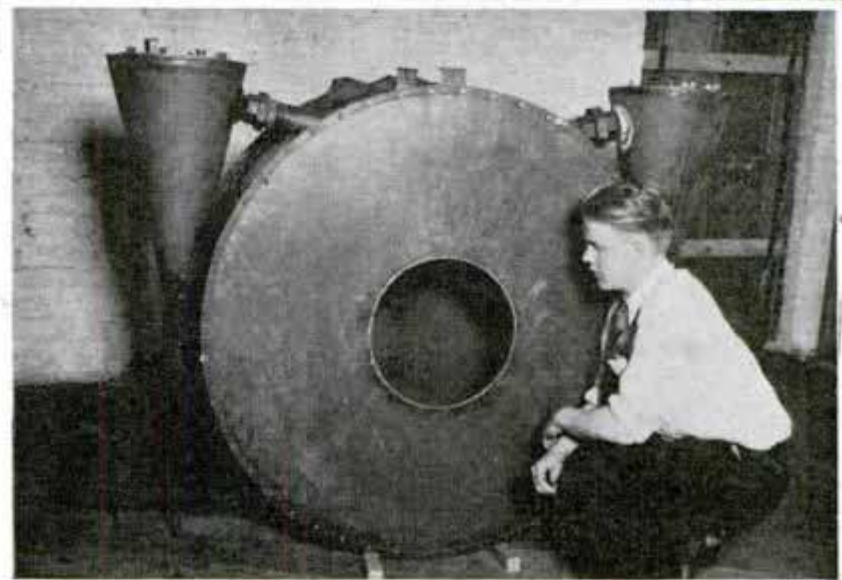
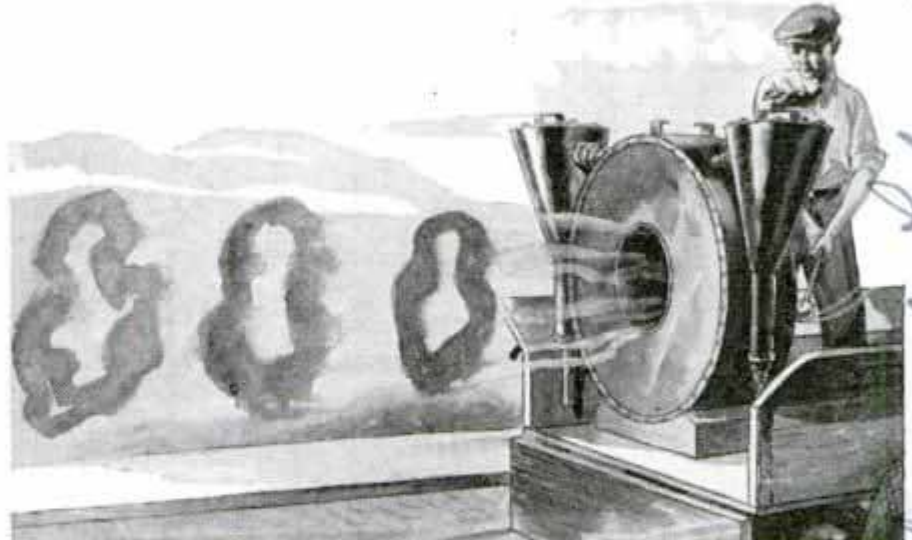

Big Drum Which Blows Smoke Rings as Large as Auto Tires When Leather Diaphragm in Rear Is Struck; It Is Used to Attract Attention for Advertising Purposes

2 cent type development
 928 Fullerston Parkway, Chicago

16th St. N. W. 11-10
 Wash. D. C.
 1200-

Razor Blades of Glass!

FROM the glass artisans of Czechoslovakia comes word that glass razor blades are being produced, finely edged and as sharp as the highest-grade steel. The brittleness of glass, which has a tendency to break too easily, has been a handicap but experiments to correct this fault are progressing. As soon as it is possible to manufacture fine glass that is proof against chipping, it is expected that glass razor blades, phonograph needles and similar articles will be placed on a mass production basis.

at Khabling.

METAL SHIELD ON AUTO MIRROR CUTS OUT THE GLARE

Glare produced by the lights from cars behind shining in the rear view mirror of your car is eliminated by a metal shield for the mirror which can be attached in a



Metal Shield for Rear View Mirror Which Cuts Out Glare of Lights of Following Cars

few minutes. The slotted shield can be adjusted at any angle and when properly set cuts out reflected glare of lights behind.

E 1113
 E 1068
 E 1.990, 222

no. 1246 shield, chm.
 2711 E. Florence Ave.

6497
1360 W. Clifton Blvd
Lakewood Ohio

PAINT MAGIC *and*

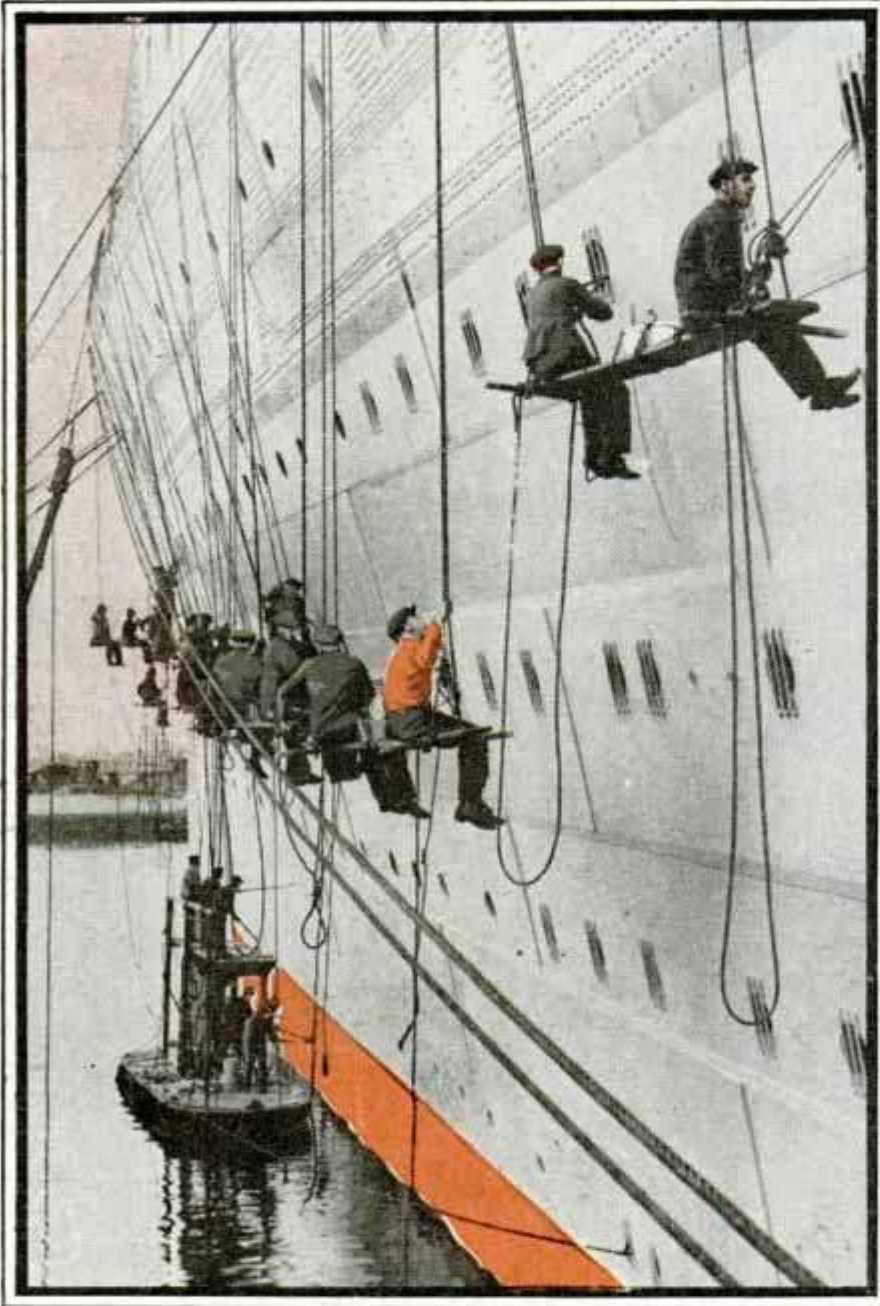

© Planet News
Ships Must Be Protected by Frequent Coats of Paint; Here Painters Are Shown at Work on the "Empress of Britain"

factories, airplanes, and anything that needs color or protection.

When Prof. Piccard made his first flight into the stratosphere in 1931, he painted the gondola of his balloon black, reasoning the black paint would absorb the sun's rays and help to keep the occupants of the compartment warm. But when the balloon reached the stratosphere, he wished he had left his black paint at home, for with a temperature of seventy-five degrees below zero outside the gondola, the men within suffered from the heat of 100 degrees Fahrenheit. For the second trip into the stratosphere the gondola was painted white. This time Piccard shuddered with cold. The interior of the cabin was seventy-two degrees colder than on the first ascension.

Paint engineers have turned the fact that white paint reflects light and heat into valuable sayings in the oil industry. One test made on 12,000-gallon gasoline storage tanks of different colors for a four and one-half

HAVE you ever heard of a paint engineer? He is a new and very distinct type, a combination of salesman, painter, chemist and engineer.

He may be called into council on a better finish for bobby pins or asked to recommend the best coatings for the steel beams of the San Francisco Bay bridge or what colors should be applied to the gondola of a stratosphere balloon. His problems concern the painting of gasoline tanks, pipe lines, steamships, machinery,

month summer period showed a loss by evaporation of 257 gallons more in a red tank than in a white one. The red paint absorbed so much heat from the sun's rays that the temperature of the gasoline within rose to a point where evaporation was great enough to force vaporized gas through the expansion vent. Of course, a similar action took place in the white tank, but the absorption of heat was not nearly so great.

A more striking example is represented in tests conducted on 55,000-barrel crude

8411.

what it MEANS to YOU



oil storage tanks. Over a period of a year the saving in an aluminum painted tank compared with a black tank was approximately 200 barrels or easily a tank-car load of oil.

White paint on ships sailing tropical seas has a more utilitarian value than mere appearance. The "Mauretania" with a coat of white was from eight to ten degrees cooler on a tropical cruise than she previously had been with a black hull. This fact has been turned to real advantage by the United Fruit liners.

The bottom paints for ships are even more important than hull coatings. Without these bottom paints great shreds of sea growth would fasten themselves to the bottoms, impeding progress to such an extent that fuel bills would climb to figures that would prohibit the operations of these vessels. Paint engineers are ever on the alert to make these paints serve their purpose more completely and over longer periods of time.

White enamel will even make a steam



Light and Dark Paint Job on Stratosphere Gondola, and Painters at Work Redecorating the Capitol Dome in Washington

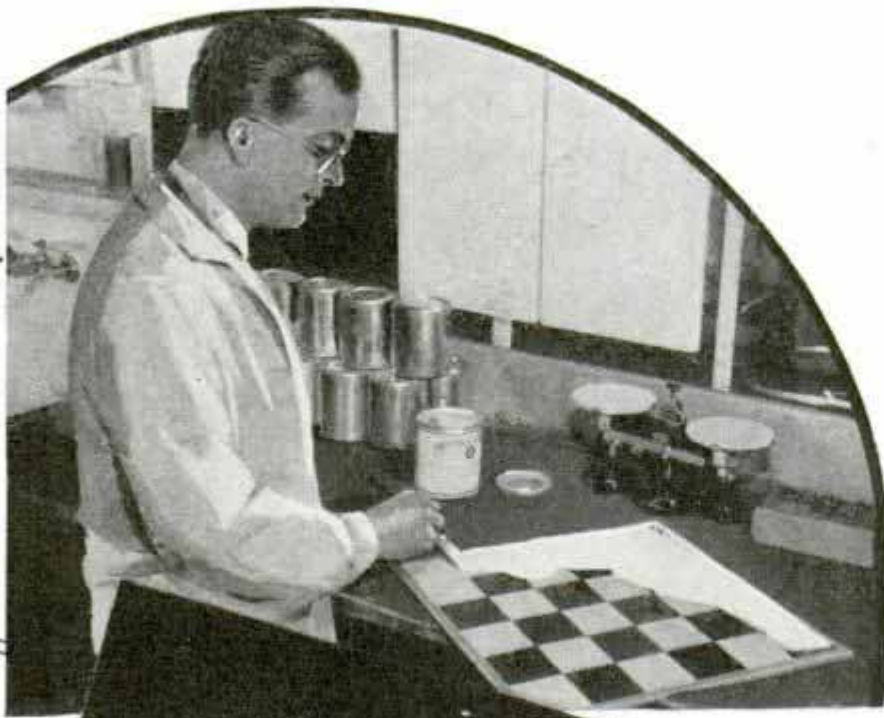

Top, Testing Covering Power of Paint on Checkerboard; Below, Scrubbing Machine Which Tests Sticking Qualities of Paint on Concrete Floor

radiator more efficient. Tests have shown it will radiate one-sixth less heat when painted with aluminum or copper bronze than when coated with white.

Of course, white paint is not the only color with which a paint engineer has to deal. Consider the bobby pin. Originally these pins were finished in shiny black. Now, in addition to being made up in the shades of the hair in which they are to be used, manufacturers coat them with what is known as a wrinkle finish which allows the color of the pin to blend into the color of the hair.

There are many places where colors have distinct advantages. We need brilliant yellows for traffic zones, aviation towers and lighthouses. Outdoor advertising demands no end of durable colors, and industry and home life are constantly demanding new and varied shades to

please or quicken the eye. Paint engineers are finding new uses for insulating varnishes to insulate motors and generators, mill white paints for better illumination of factories, metal protective finishes to combat rust and corrosion, and fume-resisting paints for chemical plants and localities where sulphide fumes are present.

Metal protective paints play an important part in saving the surfaces they cover. It has been estimated that in the United States alone \$100,000,000 is lost to rust and corrosion each year. Paint is the most practical weapon we have to check this

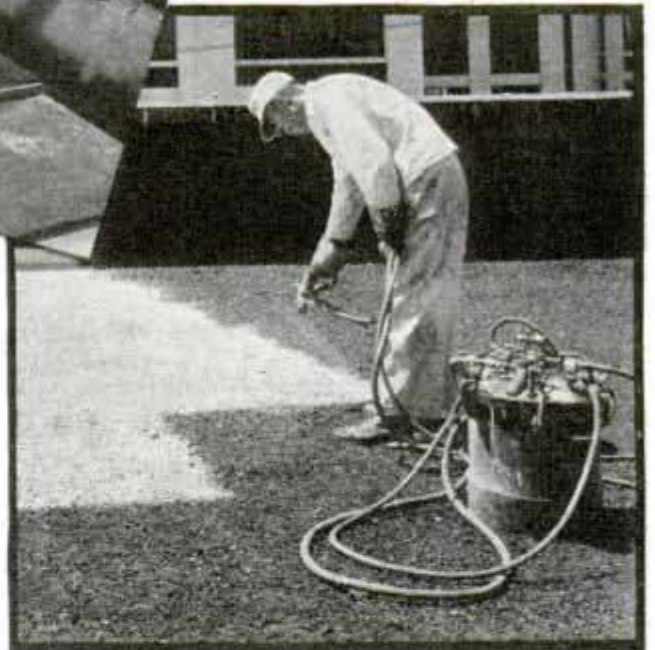
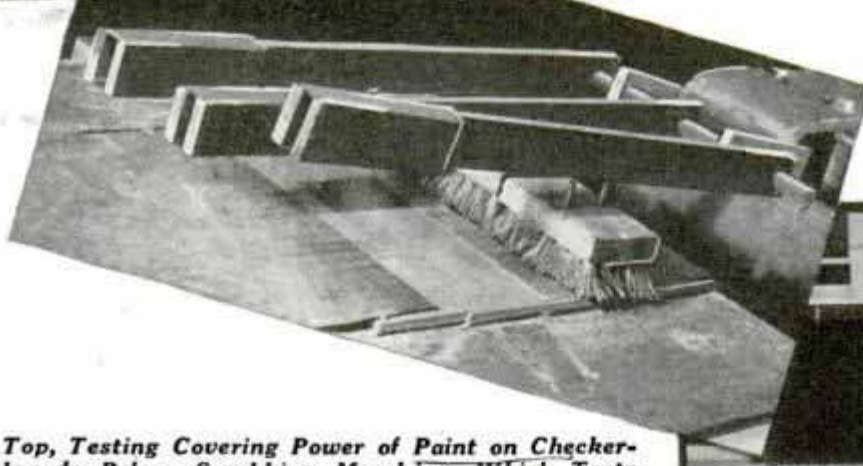

Spraying Tar Roof with Aluminum Paint to Deflect the Heat and Keep Building Cool

loss. Since rust is an electrolytic action, paint engineers are called upon to formulate different types of paints to meet the special requirements of different surfaces. High-tension towers should not be painted with a graphite or metallic primer. In the coal industry acid-resistant paints must be used because coal dust, which

(Continued to page 134A)

Cretecote - Penolq inc. Pullborough, Pa.
 Chicago - 2840 E 95th St

*Mixed Fuel Aids Campbell
 in Smashing Record*

WHEN Sir Malcolm Campbell made his record run of 301 miles per hour in Utah recently, he used a special fuel made of benzol, gasoline, ethyl and methanol. The mixture had tremendous explosive force which enabled the Bluebird's engines to develop full power. Experiment might adapt similar mixtures to other types of racing engines, but full benefit from their use could not be obtained without adjusting the timing to handle the fuel.

*CYLINDERS WITH TWO PISTONS
 USED IN MOTORCYCLE ENGINE*

Motorcycle engines having two pistons in each cylinder block are being used widely in Austria. The air-cooled two-cycle engine is efficient in operation and has an output of fourteen horsepower when two blocks are used.

**Tire Pressure Is Kept Up
 by Air Control on Dash**

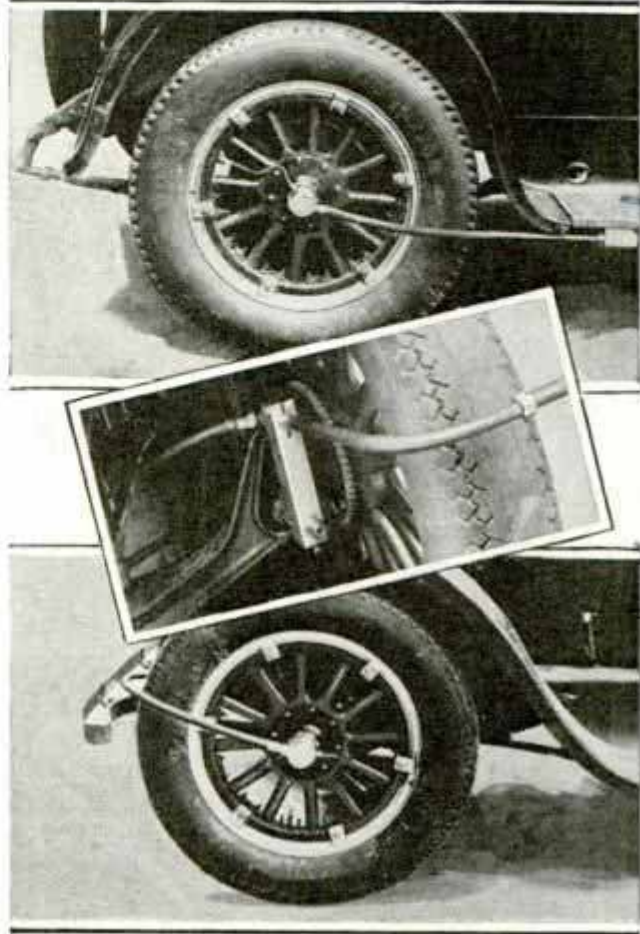

Rotating Pressure Unit on Hub Feeds Air to Tires; Top, Rear Wheel Connections; Others, Front Wheel

Constant control from the dashboard of air pressure in all four tires of an automobile has been accomplished. When a tire falls below the desired pressure or is over-inflated by heating, a signal light or bell warns the driver and by simple control, either manual or automatic, he can increase or decrease the air. Of especial value to motor bus or truck operators to safeguard against unnecessary wear on tires or car and to help prevent accidents, the continuous inflation system now being manufactured comprises a rotating pressure joint in the wheel hub, air pumps and tanks, valves and gauges, regulators and, if desired, alarms. Leading to the intake of the inner tube is a rubber hose tapping air from the rotating pressure unit, which replaces the ordinary hub cap. Air reaches the hub unit from a compressor, either through tubes extending around the front or rear or the tire from beneath the body, or through a hole in the axle.

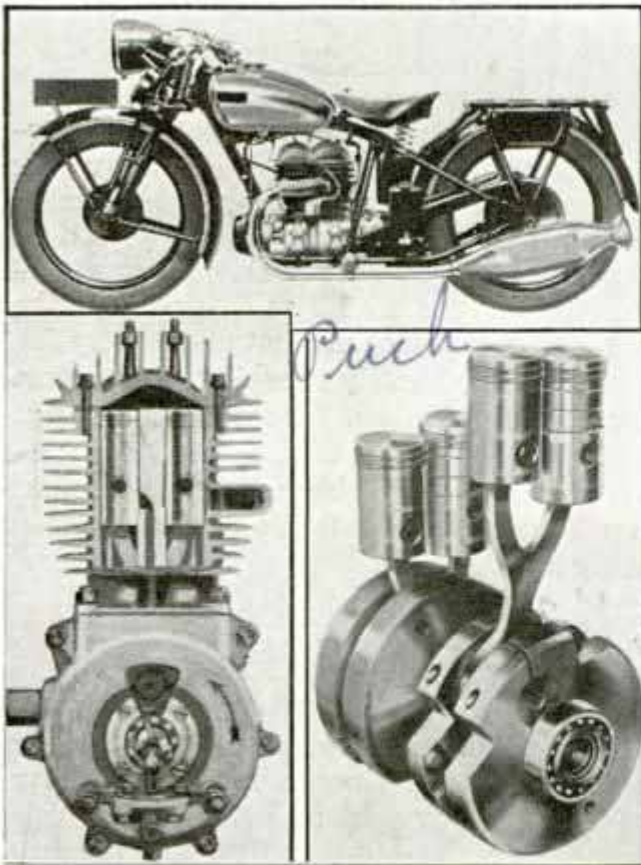

Motorcycle Engine with Two Pistons in Each Cylinder Block; Note the Unusual Arrangement

A. Schrader's Son, 470 Vandewater Ave, Brooklyn, N.Y.

*Austro-Hungarian
 Puchwerke A.S. Patent - A. W. ...*

Radio Waves Warn Liner of Obstacles in Path

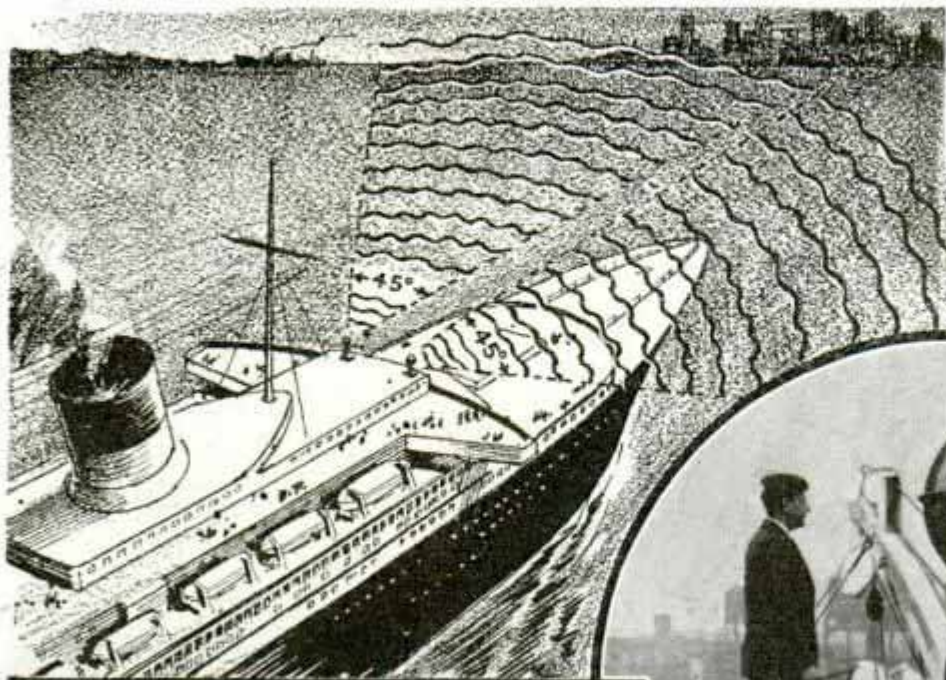

Short-Wave Transmitter on the "Normandie" and, Bottom, Apparatus on Bridge Which Warns of the Presence of an Obstacle in Liner's Path

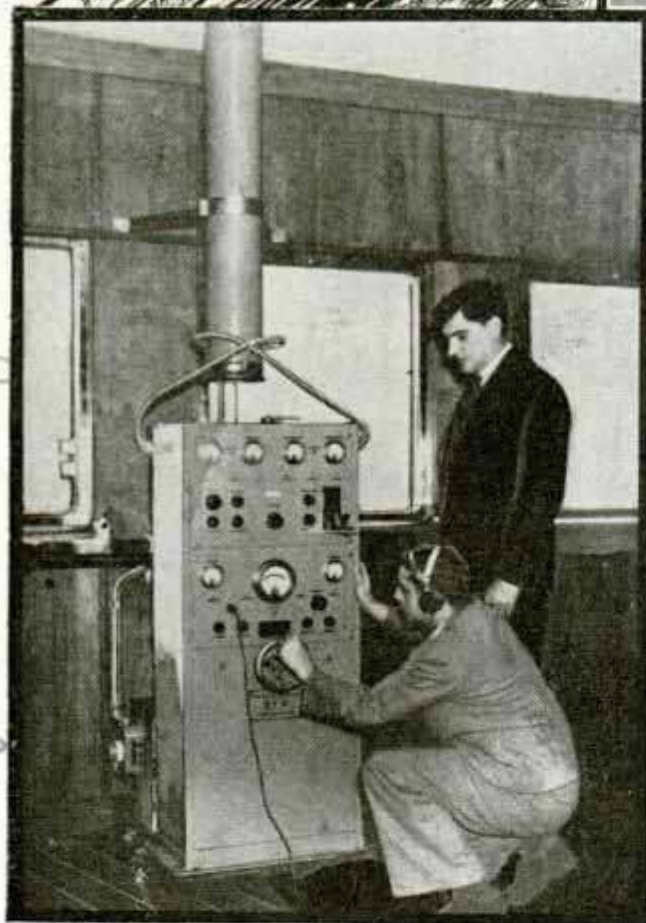
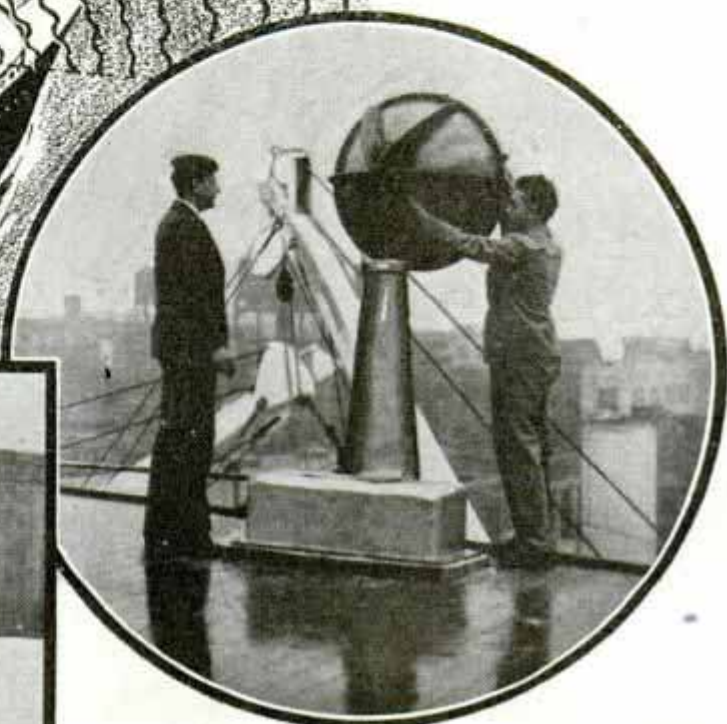

forty-five degrees on the port and starboard course of the ship. When the waves encounter an obstacle, they are reflected into a delicate receiver and amplified so as to be made audible in an ordinary telephone receiver used by the officer on the bridge. The waves are not affected by fog or rain or, generally speaking, by adverse weather conditions. The effective range varies with the size of the object encountered. An average ship can be detected at a distance of four miles and a channel buoy at two miles.

81136.

DUAL DOORS IN TALL BUILDING ARE MORE EASY TO OPEN

It is easy enough to open the front door of your home, but try pulling open a door of the same weight and size at the entrance of a fifty-story skyscraper. It takes effort! There is a thirty-pound pull against you. Why? Office-building doors must

Obstacles in the path of the French liner, "Normandie," are detected by an ultra-short wave radio transmitter and receiver which sounds a warning long before an object can be seen in fog. The apparatus, on the bridge, includes a transmitter sending a beam of six-inch waves which sweep the horizon at an arc of

French Line 610 74th Ave New York
 4 W. 105th St. New York
 1930

open outward on the street for safety. A tall building is a great "chimney" drawing air in at the bottom and expelling it at the top. The suction on the ground floor pulls the door tight, and you feel an inrush of air as you drag the door open. To counteract this, engineers who built the sixty-six story "Sixty Wall Tower" in New York City devised a companion transom door over each entrance. As a caller pulls a door open, a door of equal size and weight opens inward in the transom above, "balancing the vacuum" by letting air flow into the building and relieving the suction. A child can easily swing these doors.

Speed of Auto Is Measured by Stationary Recorder



Speed Meter Which Utilizes the Electric Eye to Check the Speed of Passing Cars

POCKET-SIZED CAMERA TRIPOD WEIGHS A HALF POUND

Easily carried in a pocket when telescoped, a camera tripod of sturdy construction will carry a heavy camera at working heights of a few inches to forty-three inches when extended. Its legs are built of lightweight alloy and the connecting piece of stainless steel, the complete tripod weighing about one-half pound. Sharp, conical steel feet hold the instrument in place.

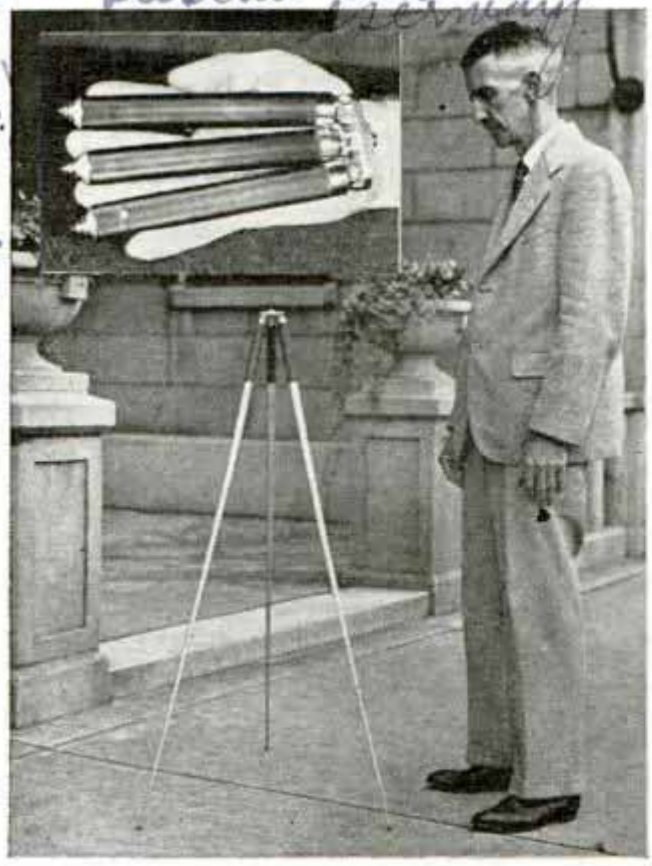

Telescoping Camera Tripod Extended to Full Height; Inset Shows It Contracted to Pocket Size

Speed laws can be enforced more effectively with the aid of an electric speed meter which can be set up at the roadside in a few minutes and measures the speed of each passing car. It is intended to supplement the efforts of motorcycle officers. On one side of the road two fifty-candlepower lamps are set up to throw two small concentrated light beams, eighteen inches apart and parallel, across the road into the photo-electric cells of the recording instrument. The lamps are operated by an automobile storage battery. When a moving car interrupts the first beam, this starts the charging, at a uniform rate, of a condenser in the recording instrument. The interruption of the second light beam stops the charging. This charge represents time and is read directly in miles per hour on a recording dial which holds the reading until the operator makes a note of it. The pressure of a button resets the timer for the next car and the throwing of a single switch enables the operator to measure the speed of cars passing in either direction. Experiments have been made with an automatic camera to photograph both the license number of the car and the speed reading of the dial on one plate.

A. J. Chocler + Sons, Portland, Me

Desired Ansberg

8 110 9

8 110 6

Edw. Dr. Harry Silver
Worcester College
Boston (2) Mass

U.S. Agents wanted

Builders' Art Helps to Tell a State's History

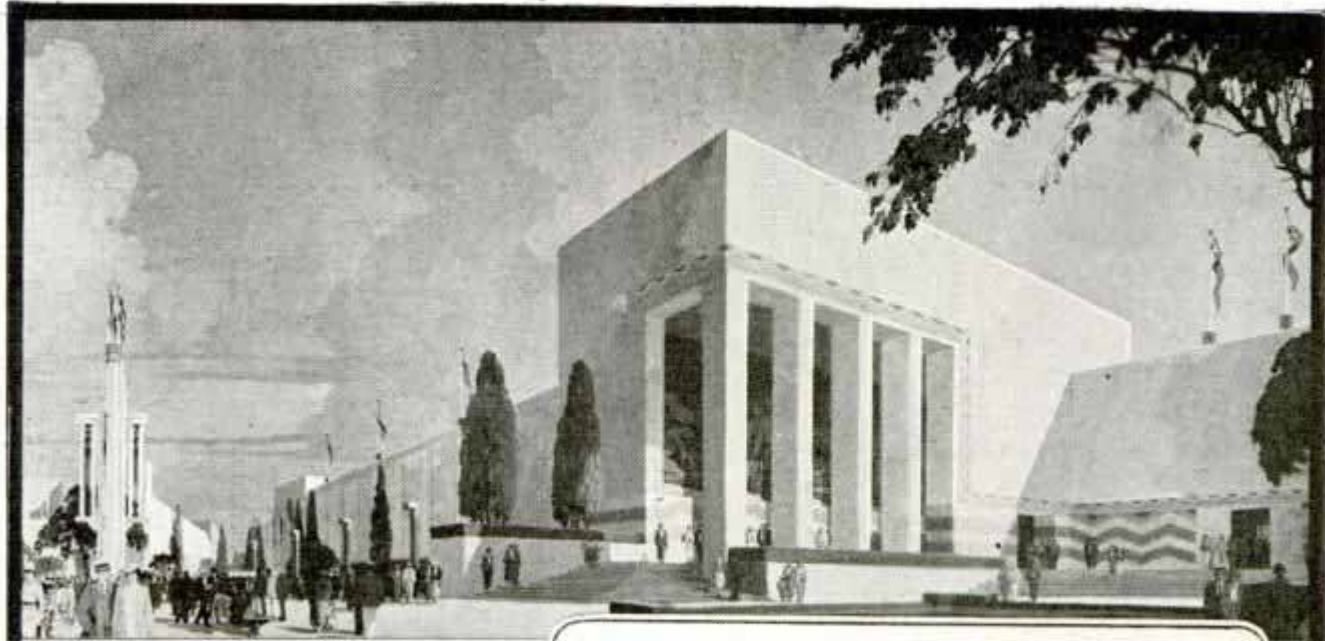

Above, Food Products and Agricultural Building, with Color and Bas-Relief, Will Be One Building at Texas Exposition; Below, Courts Separating Sections of Industries, Electrical and Communications Building

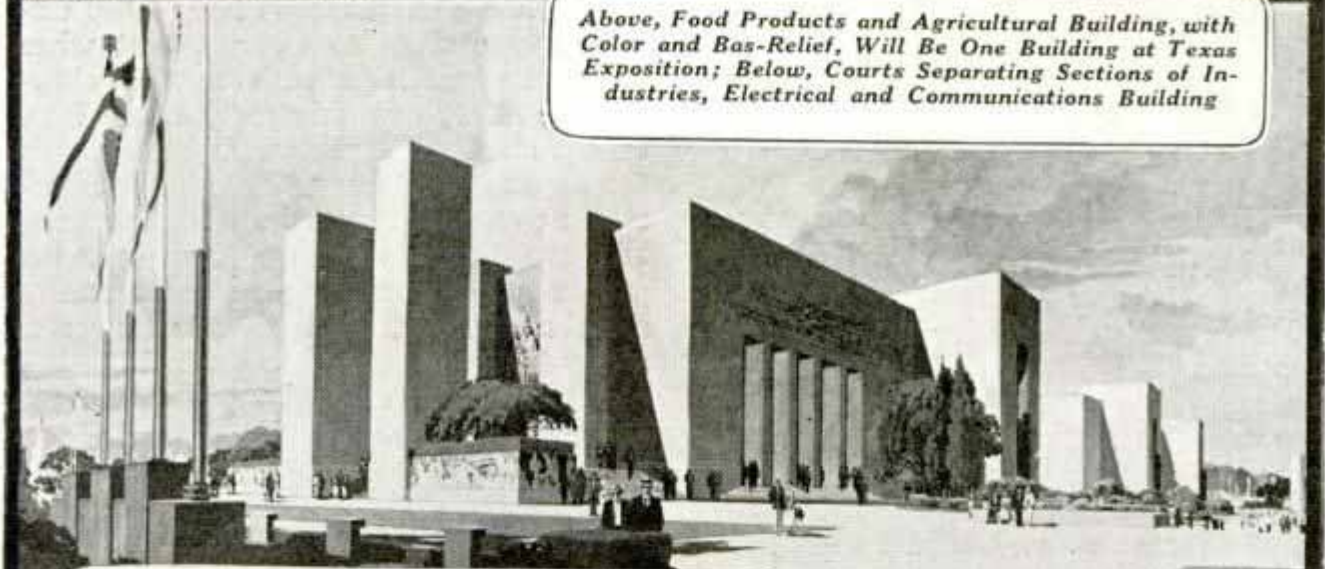

Below, Poultry Building Accommodating 7,500 Coops; Esplanade of State (Shown on Opposite Page) Will Be Outstanding Structure at Exposition; It Will House Niche of Heroes, Figures in Texas History

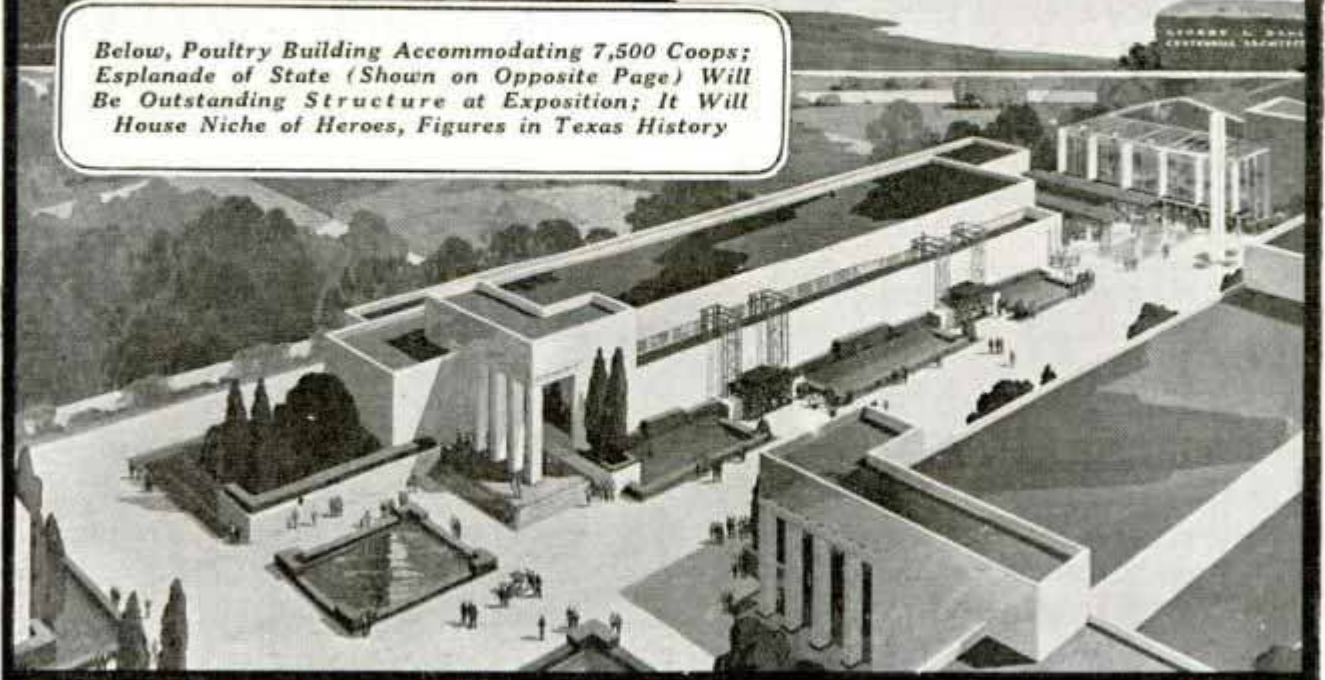

Handwritten notes at the bottom of the page, including the word 'Esplanade' and other illegible scribbles.

Records Produced for Blind Play More than an Hour



Portable Case Contains Radio and Phonograph Which Plays Wide-Diameter Records for the Blind

Phonograph records for the blind, produced on wide-diameter disks that last an hour and a quarter, have made it possible to dramatize entire books and reproduce complete plays and operas at small expense. The long-winded record required development of a special phonograph whose tone arm starts at the center of the record and works toward the rim. As the arm moves outward, the revolving speed of the disk is slowed down so that the linear speed of the record at the needle point remains constant. Standard-size records can also be played on the instrument. In its portable case is included a radio.

BOLD BUTTERFLIES FIGHT BIRDS AND INSECTS

Butterflies that fight among themselves, wage war on wasps and bees and insects twice their size and even attack birds have been observed in the northeastern

states by Austin H. Clark, of the Smithsonian Institution. The little buckeye butterfly has an eternal feud with the pearl crescent species, and also dislikes intensely the Carolina locust and chases it, flying behind or beside it but always two to four inches away. If the locust alights, the buckeye also stops a few inches away and waves its wings menacingly. The pearl crescent darts viciously after grasshoppers, bees, flies, and its special enemy, a large brown butterfly. The Camberwell beauty boldly attacks small birds and sends them to cover, and the common "milkweed butterfly" has a special hatred for humming birds.

TYPING A LETTER IN JAPANESE TAKES TWO THOUSAND SLUGS

Japanese stenographers have 2,000 different type slugs to worry about when they use a typewriter with Japanese characters. There are only forty-seven keys on the standard American typewriter. In the Japanese machine, the slugs are carried in compartments in a sliding tray. The typist manipulates a knob over the proper compartment, presses it and a metal arm pushes the type upward, across a tiny ink roller and then against the paper. The paper is rolled on a drum which shifts and revolves for the vertical Japanese style of writing.



Moving Selector over Case Holding Two Thousand Japanese Characters, Typist Presses Knob to Ink and Prints Type Slug

6/24/42
Cmt. George J. Sawett, 29 23 Reno Ave
Los Angeles, Calif

656 N. Vermont Ave
Hollywood, Calif

Bulletin 9/19/42

81055

81103

Used by Japanese

Japan, Japan

621122
E1132

by Prof. Henry Norris Russell, Princeton University

Odd "Yardstick" Measures Position of Stars

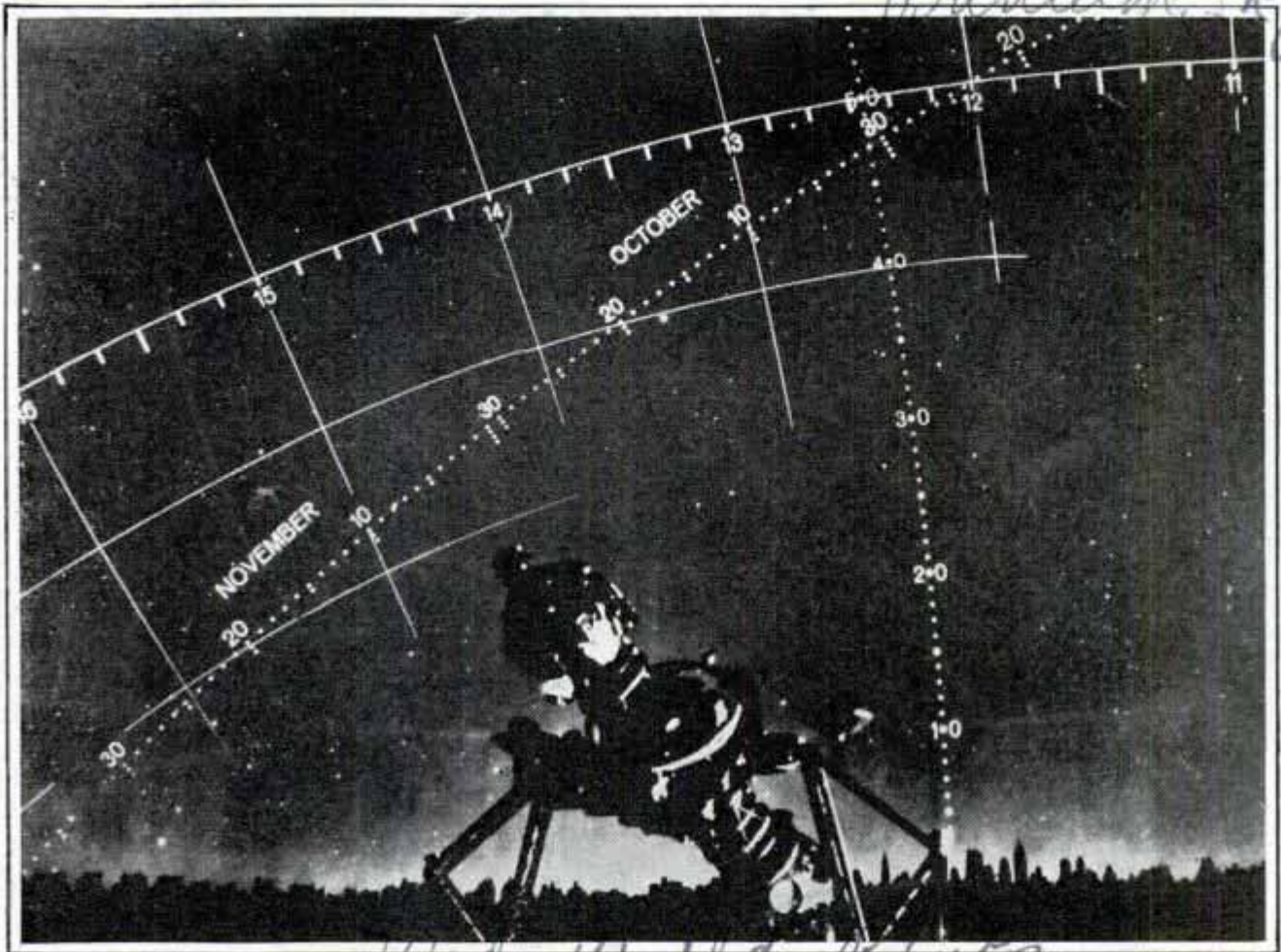

Apparatus Used by Hayden Planetarium in New York to Show Positions of Stars on Any Given Day; Crossing of Dotted Lines Shows Constellations as They Appeared October 1, 1935

Proper positions of the stars on any given day over a period of many thousands of years are shown at the Hayden planetarium with the aid of an odd celestial "yardstick." The crossing of the two dotted lines in the accompanying picture, for instance, shows the constellations exactly as they appeared on October 1, 1935. The latest determination of the size of the galaxy of which the earth and sun are a part indicates the diameter of this single group is so great that a ray of light, traveling 186,000 miles per second, requires about 100,000 years to cross it, according to Prof. Henry Norris Russell, Princeton astronomer. The whole galaxy, he adds, is rotating about a center some 30,000 light years from the sun and one revolution of the galaxy is completed in about 200,000,000 years. The mechanism which makes possible the pouring of radiant energy into space, which the stars have been doing for millions of years, is still a mystery but the enormous energy released is too great to

arise from any known source except atomic transformation. Such transformations have been produced in the laboratory and this leads Prof. Russell to believe that real advances in understanding the subject may come within a few years.

E1147

LIFE OF BATTERY IS PROLONGED BY CORROSION GUARD

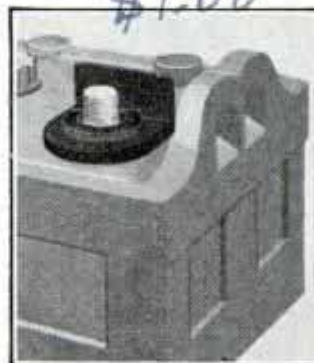

Corrosion of batteries and the resultant breakdown of ignition systems can be prevented by installing acid guards on the battery posts. These guards, made of lead, weigh less than two ounces

and fit any battery. Knife-edge flanges keep acid from climbing the terminal posts.

Isard's Battery
Union St. St Paul Minn
692

10555 Holman Co
Los Angeles Calif

The ALADDIN

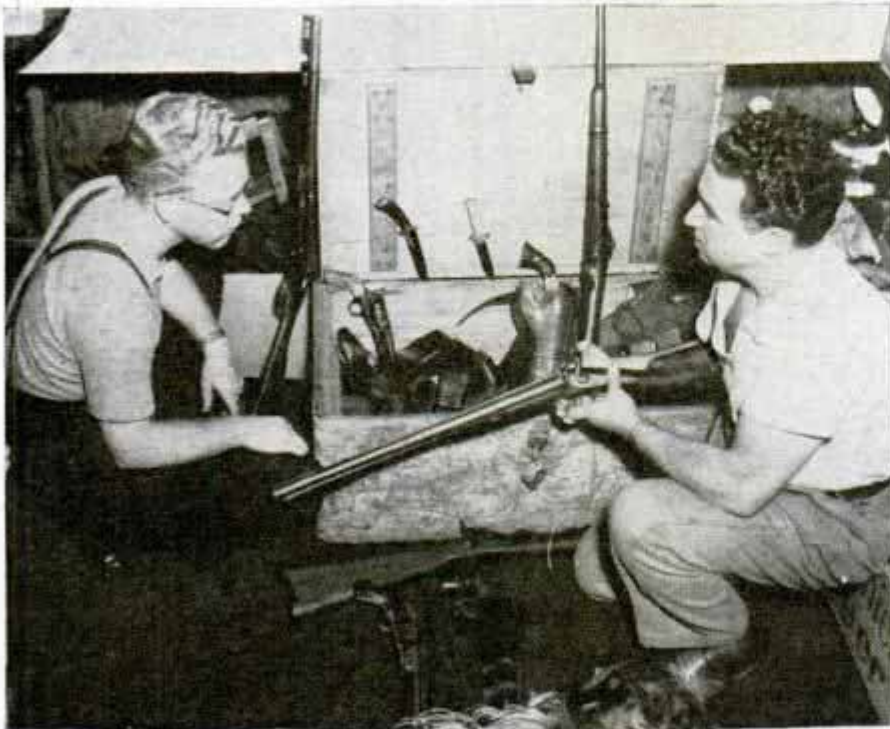

THE order called for four potato bugs, some baggage labels from the "Ile de France," a Scotland Yard warrant, a litter of kittens and a book of English airplane tickets.

Even Aladdin would have a hard time collecting items like these on short notice but any Hollywood property man can do it. In fact, he will get you anything from a 1903 calendar to a trained canary if given a little time. Ask Irving Sindler, "master of properties" for Samuel Goldwyn, for a set of French 1923 auto license plates, a pre-war airplane, or even a sea lion, and the chances are they will be on their way to you inside an hour. No matter what is needed in filming a picture, the property man's job is to have it on hand at the right time.

"If a director on a desert location suddenly decides he wants a bicycle the property man literally must extend his hand and pull it out of thin air," Sindler says. "It's up to him to anticipate everything that might be needed. 'No' is the one word he doesn't know."

Once when shooting a scene on the desert the director suddenly decided it would be better for the star to hold a red rose instead of a book. The nearest town was ten miles away and roses don't grow in the desert. But Sindler remembered having seen a wax rose in an automobile that morning and ten minutes later he placed the rose, still wet with red paint, in the director's hand.

Not only does the property man fill orders ranging from gold teeth to sword

Guns, Pistols, Fans, Vases, Statuary and Saddles
Are a Few Items in the Property Department

Samuel Goldwyn
since 1941

of the MOVIES

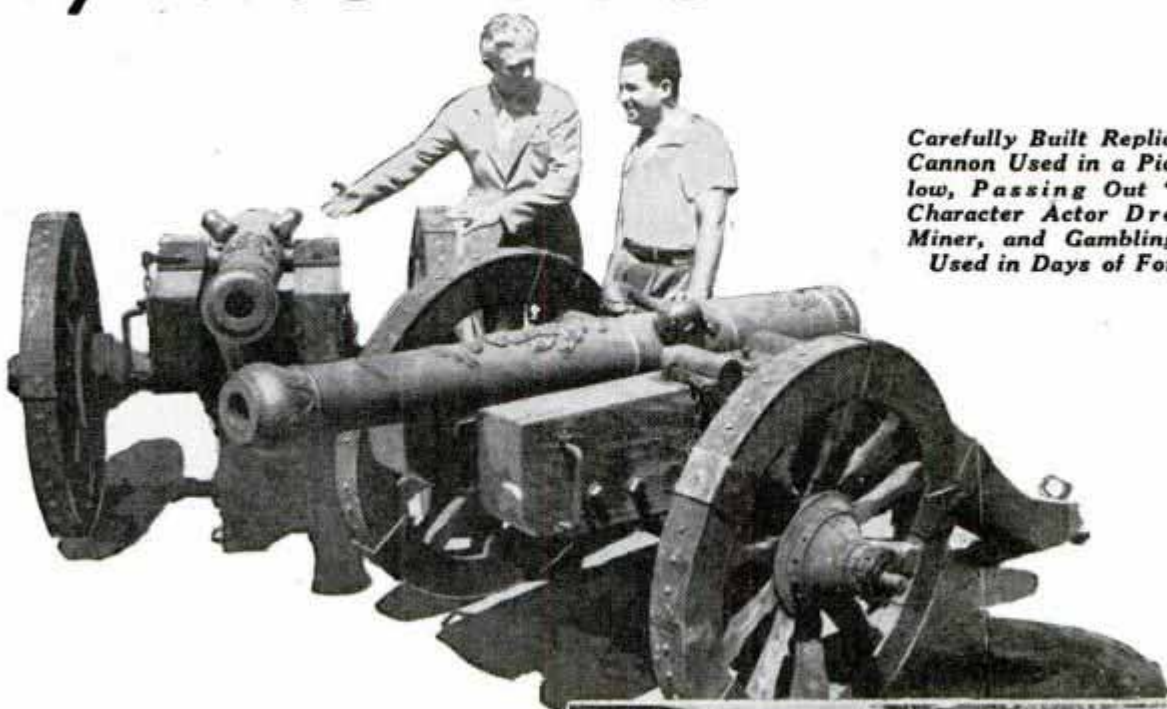

Carefully Built Replicas of Old Cannon Used in a Picture; Below, Passing Out "Gold" to Character Actor Dressed as Miner, and Gambling Devices Used in Days of Forty-Nine

canes, but he makes sure the articles are the right kind for the place and period of the picture. Every detail must be correct. In one picture Sindler found the garbage pails for a New York City set had horizontal flutings. He knew that in that city pails with vertical flutings are used, and the substitution was made.

In preparing to film "Barbary Coast," a picture of early San Francisco, Howard Hawks, the director, and Sindler studied the time, place and characters in each scene and made a full list of the properties needed. Sawed-off shotguns, rifles, and pistols of the period were rented, old newspapers were prepared so special news articles could be inserted, carpet bags and saddle bags were picked up in secondhand shops, and gambling devices were resurrected from the studio's property department. Even insignificant details like old-fashioned sulphur matches and the brown cigarettes of the period were tracked down. Early kitchen utensils, pocket-books, cash boxes, mirrors, and paintings were procured. Gold scales and copper mugs were on

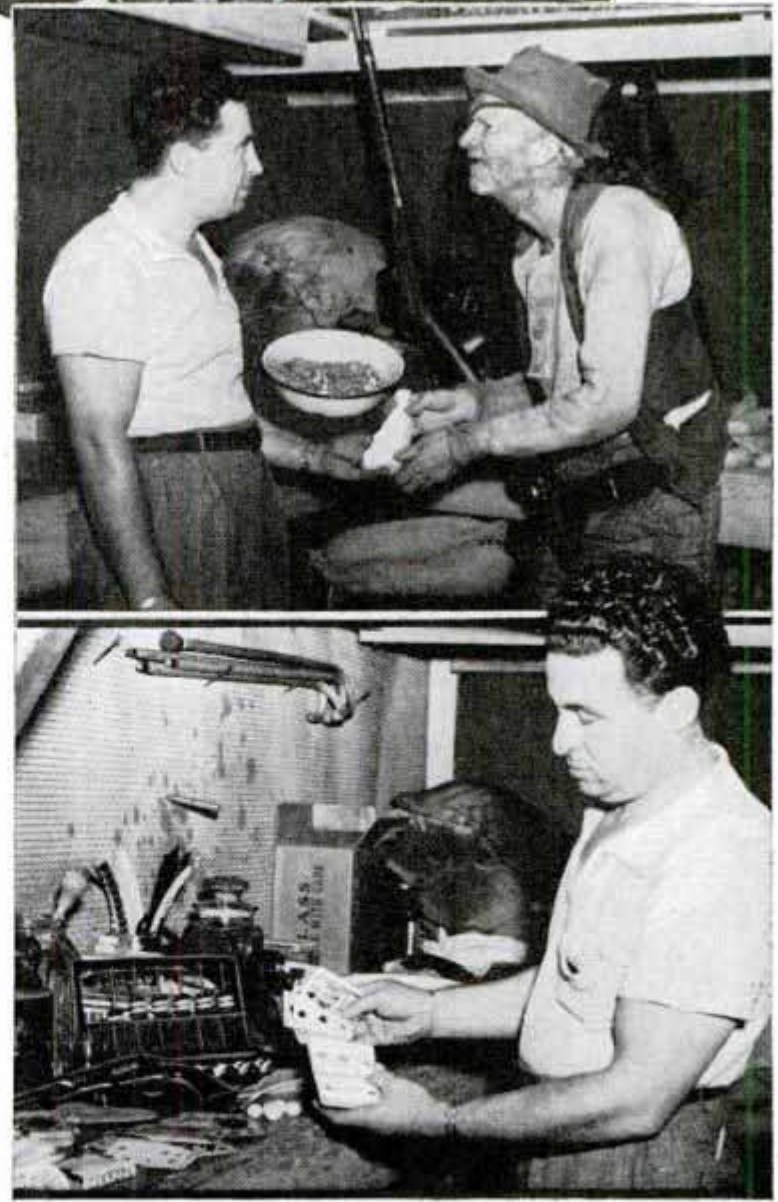



and another contains milk, sirups, floor polish, paints, and liquid coloring. Sound effects like bird whistles, police whistles, and a battery board for doorbells and desk buzzers are carried. On one side of the cabinet is an emergency dressing table that consists of a shelf that unfolds and reveals a mirror.

From his cabinet the wizard of the movies can fill almost any last-minute need. Time

hand, and picks and shovels for the miners were purchased and "antiqued" by banging them up and applying special paint. Sand and pebbles were dipped in gold paint to suggest gold dust. At the same time, the property man assembled an assortment of rubber fish because the real article would not last for the time required.

The property man also collected special effects and "breakaway" articles manufactured in the studio shops. Rubber replicas of cap and ball pistols and light chairs made of balsa wood look quite real to the camera and can be used without injury in hand-to-hand fights. Sindler has even provided soft rocks, nicely padded and realistically painted, when the script called for a rock fight.

Near the property man you will find his bulky "magic box," a cabinet that contains anything that might be needed at the last minute. In one drawer is a first-aid set. Another contains pens, pencils, inks, chalk, blank checks, and rubber bands. In another compartment are drinking glasses, bottles, handkerchiefs, towels, and needles and thread. Cigars, cigarettes, playing cards, pipes, eyeglasses, and a Bible are standard equipment. One drawer is filled with tools and kitchen ware

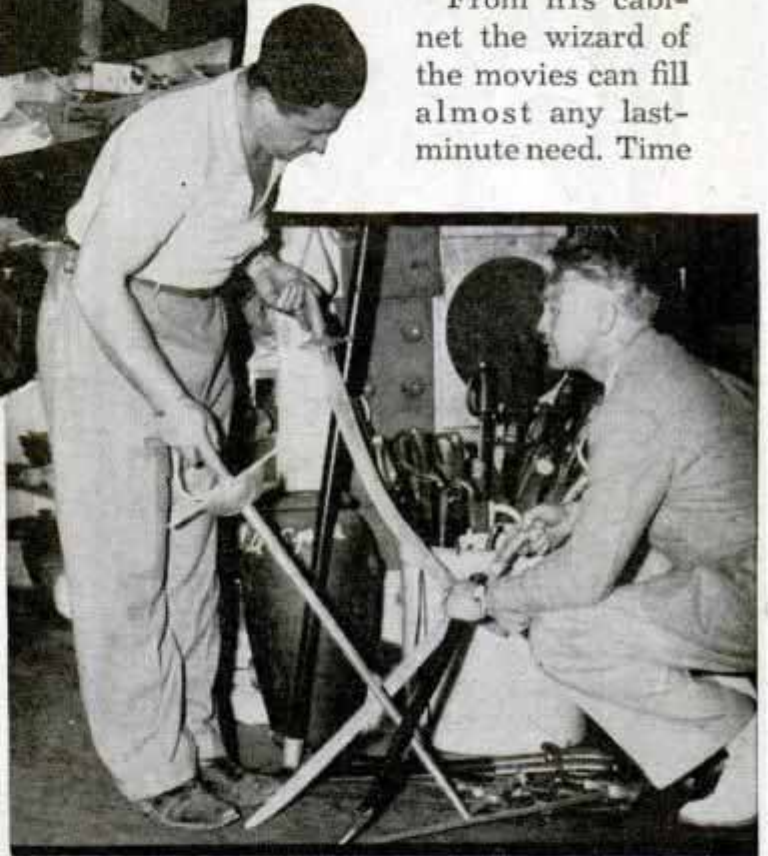

Above, Irving Sindler and His "Magic Box"; Below, Property Men Checking Over Sword Collection

is a vital element in making movies and even a ten-minute delay may cost thousands of dollars. A director may decide one of the actors should hold a whisk broom or that a vase should be placed on a table. It might take half an hour to find such items except for the property box. Sindler even carries an air rifle to scare away birds that might interfere with the sound recording on outside locations.

If the cameraman decides a straw hat or a shirt is too light to photograph well the property man changes the color with his liquid coloring. If an actor has a headache or rips his coat Sindler takes a pill out of one drawer or a needle and thread from another. If someone faints from the

heat of the lights the property man provides the first aid.

The heat from the sun arcs and spotlights leads Sindler to provide duplicates of perishable properties. Apples hung on trees in an orchard scene inside a sound stage were half baked and wrinkled at the end of the first day and Sindler replaced them each morning until the scene was completed. In another picture hundreds of candles used to

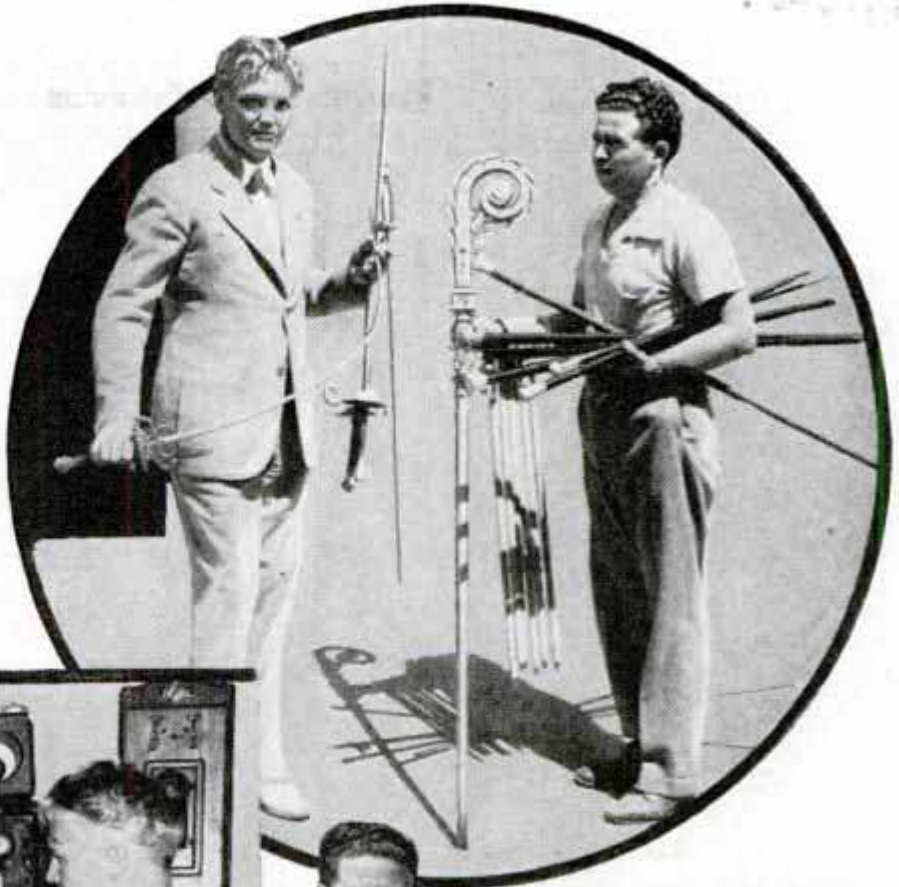

The Property Department's Stock of Telephones and Canes; Right, Mr. Sindler and His "Magic Box"

light up the interior of a cathedral softened and slumped from the heat, so the property man ran wires through their centers to keep them upright.

When a director wants an actress to cry, Sindler takes an atomizer filled with menthol and sprays it gently in her eyes, creating perfect stage tears. If a pool of blood is needed he takes a can of chocolate sirup from his magic box and pours it on the floor. The color and consistency of the sirup are exactly right for screen purposes.

Training animals for the screen is one of Hollywood's professions and Sindler can get a tame lion, an elephant, or a trick dog at a minute's notice. If the animal stars don't act right, the property man



lends a hand. A trained cat was supposed to climb a flight of stairs and prowl across an attic floor but a trainer, director, and cameraman worked over the scene half a day without success. Finally Sindler brought the studio's pet cat. On the first trial the cat climbed the stairs and walked

(Continued to page 137A)

10/1/35

81128. **Glider Towed by Balloon to Height of Two Miles**



acme
Russian Balloon Towing Glider Aloft, Preparatory to Releasing It at Height of Two Miles

Russia is experimenting with balloons as a means of towing gliders aloft. At Moscow recently a glider was attached to a balloon and carried to an altitude of more than 11,000 feet. It was then released and the balloon crew brought their craft to earth while the glider descended with a pilot at the controls.

81189 **LIFELIKE FIGURES ARE SHAPED BY SCULPTURING IN LATEX**

Collapsible duck decoys, artificial hands that look and work like the living member, and lifelike models for display windows are some of the products of latex, latest raw material of the sculptor. Suitably processed, latex, the raw milk of the rubber plant, is readily adapted to sculpturing into products both pliant and indestructible. Molds are made similar to the preparation of plaster of Paris forms, latex is introduced, and then is dehydrated and

Rubber Displays Inc.

vulcanized. The products can be extremely thin-walled and flexible yet durable. Dolls, mannequins, advertising novelties, and working models of the human body for anatomical study by medical men are practical uses of latex today.

81022 **SUMMER STARTING MADE EASY BY "LID" ON CARBURETOR**

Starting a car in hot weather is made easier, fuel is saved and the danger of vapor lock is minimized by an automatic lifting "lid" now being built into a down-draft carburetor, which prevents the gasoline from percolating. The principle is similar to a boiling teakettle which blows water out the spout when the lid is on, but does not when the lid is lifted. Similarly, gasoline in the bowl of the carburetor is boiled by the heat of the motor and runs down into the intake manifold, wasting fuel and making it difficult to start. The anti-percolating unit overcomes this by automatically lifting the lid when the throttle is closed.

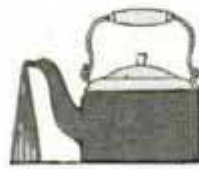
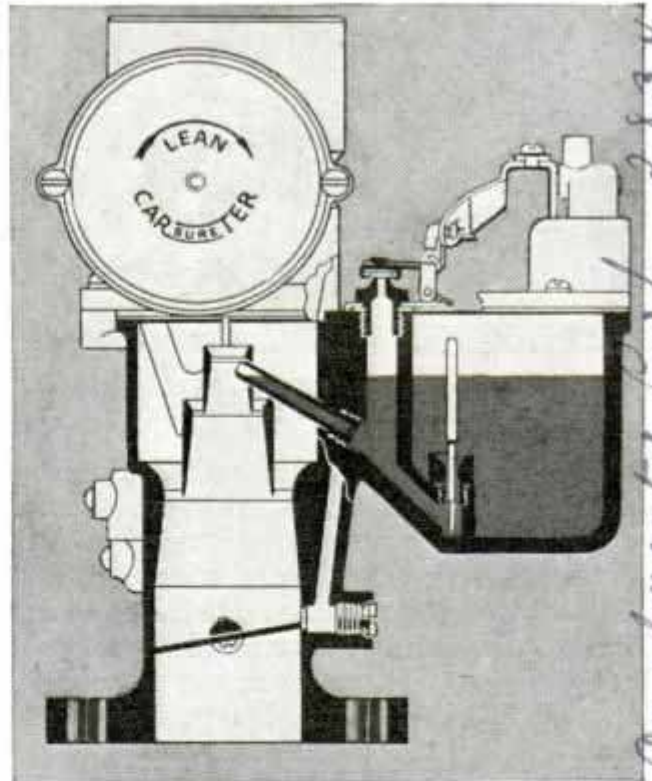

PERCOLATING



ANTI PERCOLATING

Carburetor with "Lid" to Prevent Percolating; It Operates Like Lifting Lid of Teakettle

U. S. Army Corp. 2834 U. S. Army Corp. Carter

Hot Wire "Saw" Carves Scrollwork in Wood



Model Coach and Other Articles with Decorative Scrollwork Cut Out by Electrically Heated Wire of "Saw" Shown in Lower Right Corner

Intricate scrollwork patterns are being carved in wood by an electric scroll saw that has no teeth to chip or split even the poorest kind of wood. The cutting blade is a fine wire heated by electricity, the saw frame having a pistol grip with a trigger switch that controls temperature of the wire. A specially wound transformer supplies low secondary voltage and corre-

spondingly high current, preventing any shock to the operator. The hot wire cuts with great speed, leaving a charred black finish that gives a distinctive appearance. There is no sawdust, no vibration or noise. The blade is easily directed, following a metal template or pattern or merely a tracing on the wood, and a spotlight mounted on the grip illuminates the work.

Airplane Flown by Man Power Is Pedaled Like a Bicycle

Hailed by German aviation experts as the most important development in aviation since the Wright brothers made their historic flight, a heavier-than-air craft propelled through the air by human power recently was tested successfully in that country. The man-powered plane is equipped with pedals and gears something like those on a bicycle by means of which the pilot can rotate the propeller at sufficient speed to drive the ship through the air. A German gliding expert recently succeeded in flying the craft for several hundred feet a short distance above the ground.



Airplane Pedaled through Air Like a Bicycle

at Frankfurt Aerodrome

81052

The Romance of



ahead. Then they began to talk to each other, to their brakemen back in the caboose, to trainmen in sidings and yards. Now they're talking—and singing—to the public. Streamliners, the prima donnas of the rails, are being equipped with musical voices—air horns of distinctive tones that tell the world for miles around "Here comes the '400'" and "There goes the 'Zephyr'." Listen with a railroader as one train hails another on a double track perhaps seven or ten miles away. "That's the Pennsy," he will say; for, as you learn their language, you recognize their voices. Every

railroad has whistles made to its individual specifications, their distinctive tones varying with the diameter and length of the tubes.

(Continued to page 122A)

HAVE you ever heard two locomotives gossiping? Down the line roars the crack streamline train, snorts a curt "How d'ye do?" to a rural station, shoots past a freight waiting on the sidetrack and bellows from her deep throat: "Hi, there! Notice my two green flags? Stay on the siding! My second section will be along in ten minutes."

To you it sounded like three blasts of a whistle, a medium and two short toots. But it meant something in engine parlance. Locomotives started learning to talk just one hundred years ago. At first they could only whistle a warning to the fellow on the track

WHISTLE	INDICATION
○	APPLY BRAKES. STOP.
-○○○	FLAGMAN PROTECT REAR OF TRAIN.
-----	RECALL FLAGMAN FROM WEST OR SOUTH.
-----	RECALL FLAGMAN FROM EAST OR NORTH.
○○	ACKNOWLEDGING SIGNAL.
○○○	BACK-UP TRAIN.
--○○	GRADE CROSSING WARNING.

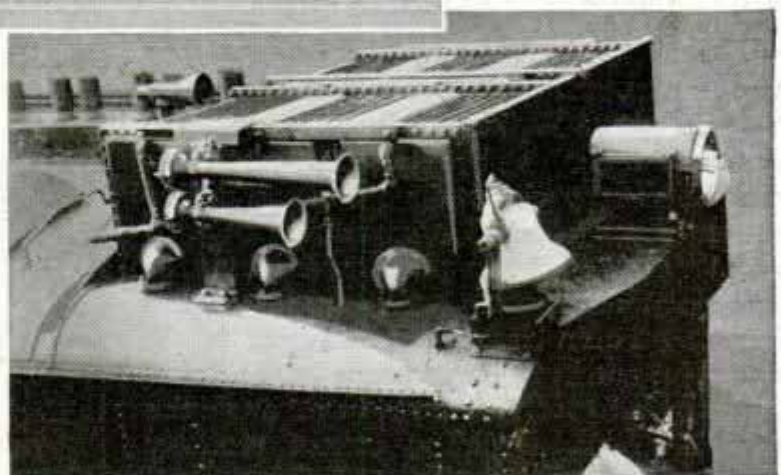

Top, Diesel Locomotive of Baltimore and Ohio Railroad Equipped with Air Whistle; Center, Some Standard Signals in "Locomotive Talk"; Bottom, Battery of Air Horns Atop Engine

2049 N. Park Ave. Philadelphia Pa. 19102

LOCOMOTIVE WHISTLES

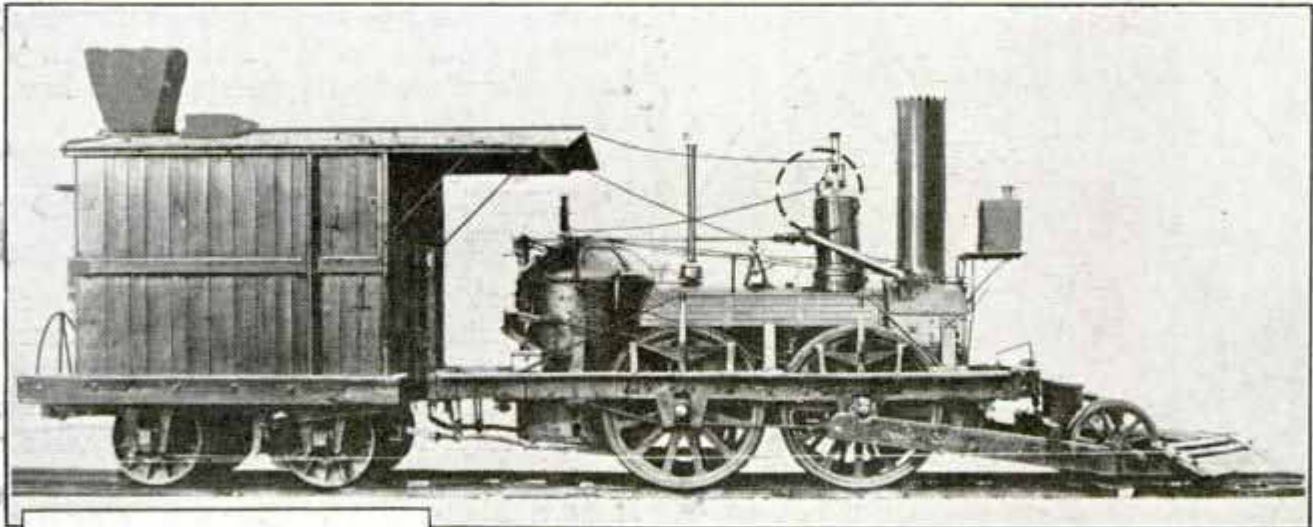

Top, English-Built "John Bull," 1831; Camden and Amboy Railroad Installed Whistle Later; Below, "Pioneer" of Cumberland Valley Railroad, 1851

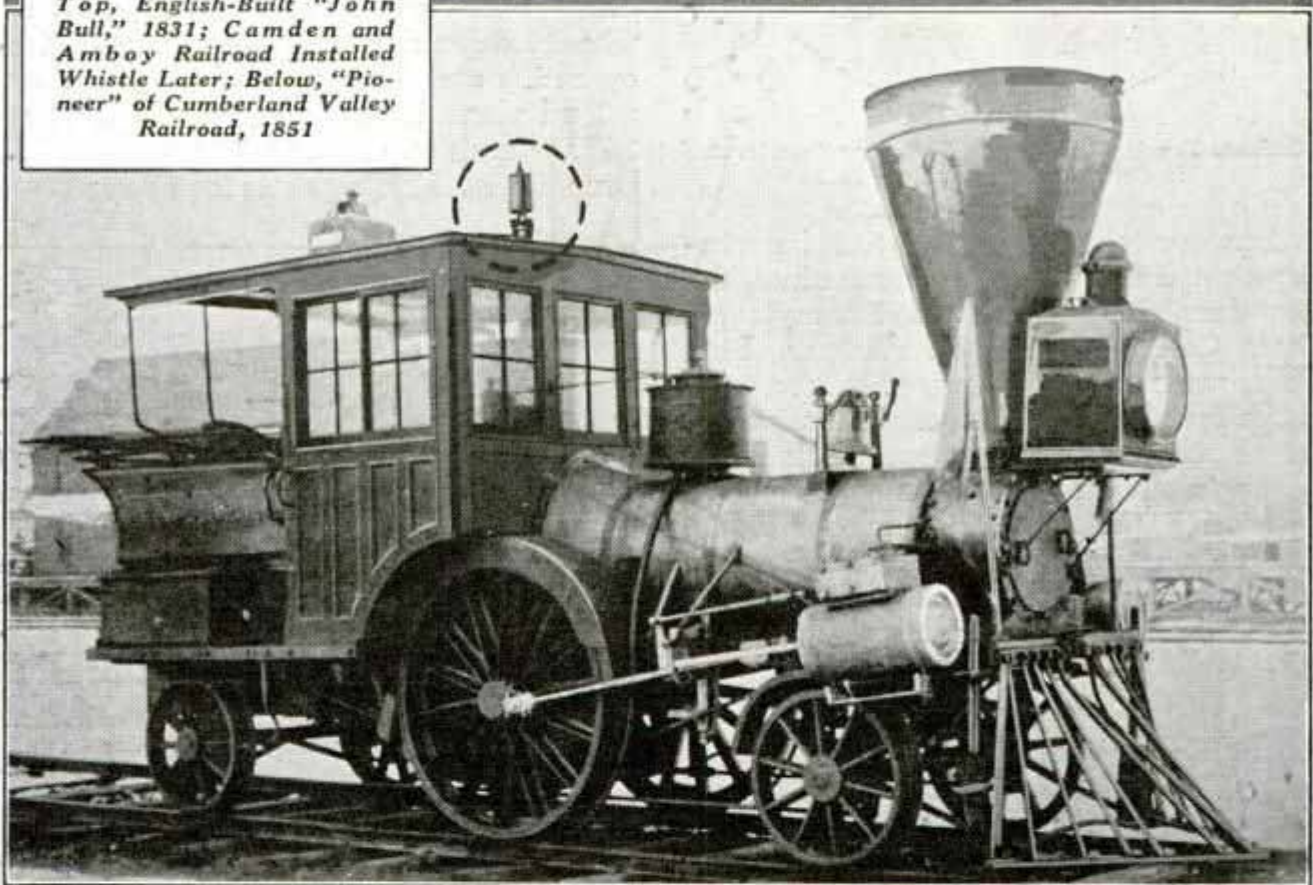

Heavy Pennsylvania Passenger Engine; Compare Horizontal Whistle with Vertical Ones Above

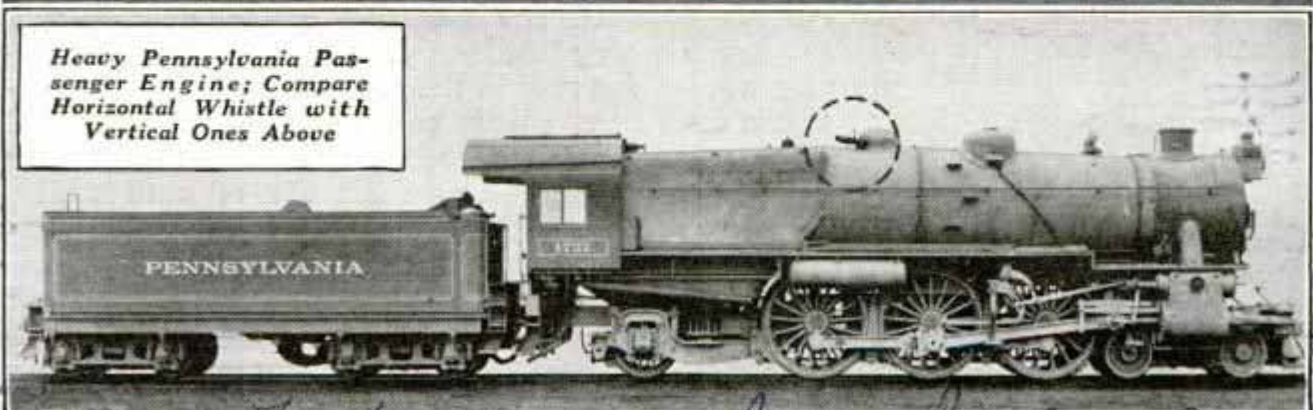

For signal - Leslie Co. Lumber Co.

Learning to Build Telescope Is College Course



Students Testing Homemade Telescope Constructed in College Course at Low Cost

Amateur telescope-making has been incorporated into a college curriculum, the first class being taught at the Pennsylvania State College during the summer. Students were instructed how to build a telescope for about twenty dollars that would be as powerful as commercial telescopes costing eight times as much. The students purchased the materials and made the complete assembly of the six-inch instruments, demonstrating that studying the stars can be brought within the reach of the average man.

POWER OF BATTERY IS SAVED BY CELL CONNECTION

Longer life, faster, surer starting power and a hotter spark are claimed for a battery now being introduced. Loss of power in transit between battery cells is accomplished by connecting them directly through partitions inside the battery case, eliminating all outside cell connections and thus cutting the distance the current



must travel. Thus, engineers say, the loss in voltage between cells has been reduced by 45.3 per cent, and battery power stepped up by the equivalent for four additional battery plates. Protection against corrosion is achieved by placing vent plugs farther from the battery posts, which have a lead-welded cover.

"FLYING BOX CAR" IS EQUIPPED TO LAND ANYWHERE

To meet the special requirements of miners, prospectors, trappers and others operating in remote areas and in all kinds of weather, the Fairchild Aircraft Limited has developed a "flying box car" which also can be used as a passenger transport. It is a high-wing, single-engine monoplane which can land on floats, skis or wheels, depending on the nature of the operation and the season of the year. As a land plane it can carry a pay load of 2,000 pounds and as a seaplane, about 500 pounds less. Folding seats for eleven pas-



"Flying Box Car" Which Can Carry Ton of Freight and Can Land on Floats, Skis or Wheels

sengers can be installed. It is powered with a 500-horsepower engine and as a land plane has a cruising speed of 125 miles per hour. Extra large doors permit easy handling of bulky freight and a sliding roof in the top of the pilot's compartment allows easy access to the top of the wing for refueling or handling lines when approaching a dock. The oil tank is fitted with an automatic thermostat control which reduces the warming-up period. Two emergency exits in the roof can be opened by rip cords. A canoe can be attached to the under side of the fuselage and carried by air.

Prof. Henry L. Yeagley, Dept. Physics, Pennsylvania State College

Canada, Montreal, Woodstock, New York, Fairchild Aircraft, Ltd.

Streamline Truck Has Air-Conditioned Cab

Combining beauty of line with economical performance, a streamline truck has been designed by Count Alexis de Sakhnoffsky, industrial stylist, for a Cleveland manufacturer. In addition to streamlining, the design boasts easy accessibility and better vision and comfort. Provision

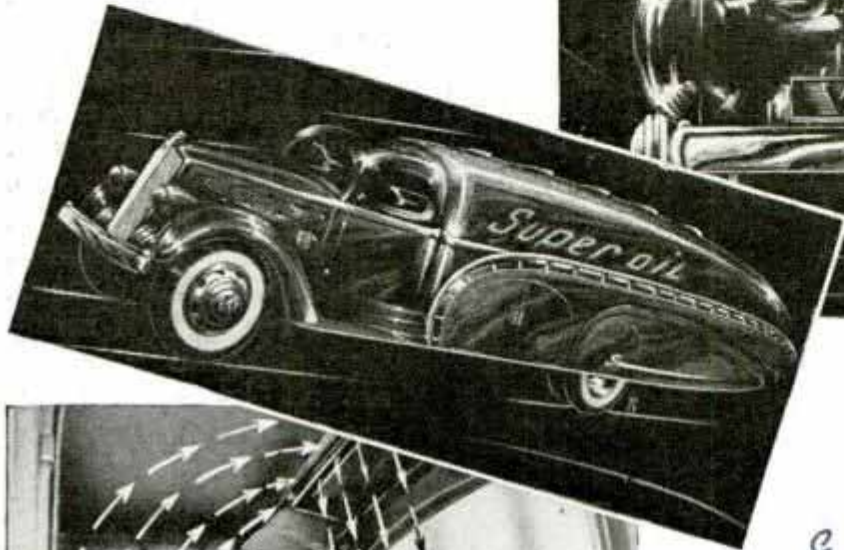
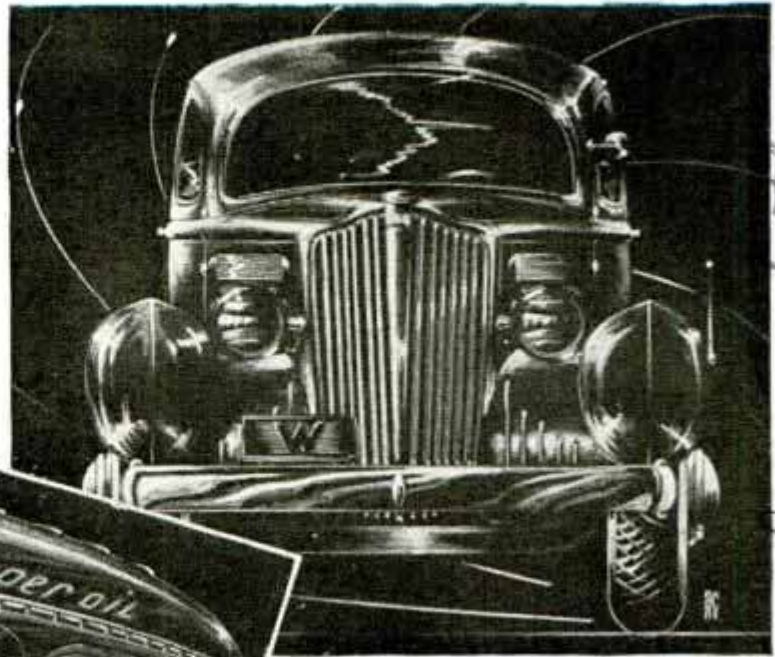

Front and Side Views of Streamline Truck Design Which Combines Symmetrical Lines with Economical Performance; Below, Arrows Show Circulation of Air Provided for the Cab

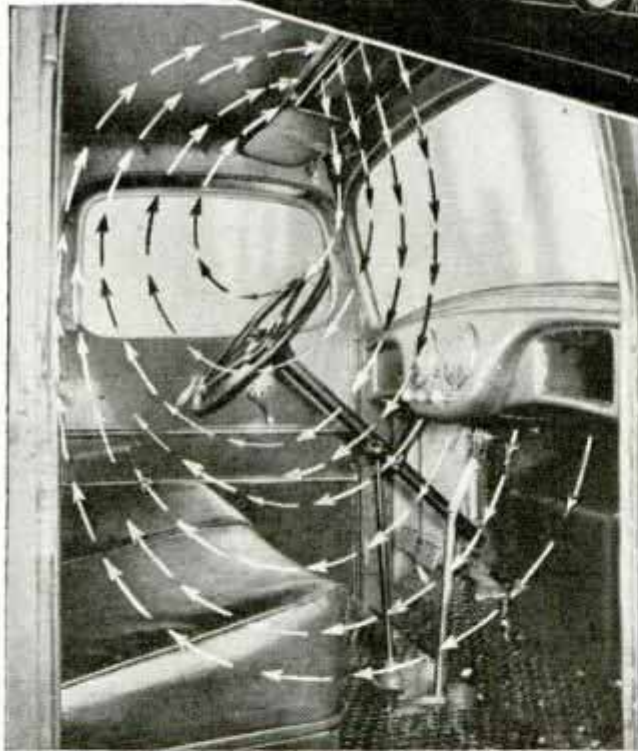

TIME NEEDED TO APPLY BRAKE IS MORE THAN HALF SECOND

When you see potential danger ahead while driving, your eye telegraphs a warning to the brain, your brain orders your foot to move from accelerator to brake pedal and your foot then makes the shift. How long does it take you to begin to stop after you decide to do so? The Minnesota public safety committee made tests to determine how far a car travels before an expert driver applies the brakes after noticing a hazard. Kelly Pettillo who won the Indianapolis race in 1935 made the best record. Marks on the pavement made by a two-gun paint indicator showed the car traveled twenty-five feet while going at thirty-six miles per hour before Pettillo's foot struck the pedal, so he required slightly more than half a second to react.

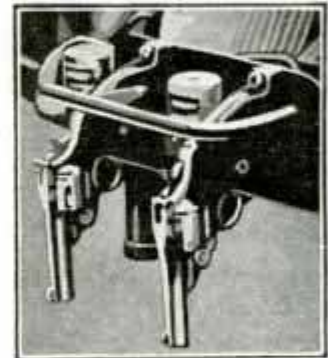

is made for automatic air-conditioning of the cab by a system which exhausts air when the truck is in motion. One of the features of the engine is a "stew pan," a hot spot in the manifold which "cooks" and thoroughly vaporizes the gasoline.

☐Inquiries as to makers of articles described in Popular Mechanics, will be answered by our Bureau of Information upon receipt of return postage.

842 E 79th Cleveland Ohio

Emb James Scotland
20 N. Wacker Drive Chicago

E 1065

Public Safety National Institute

20 N. Wacker Drive Chicago

The WONDERS of

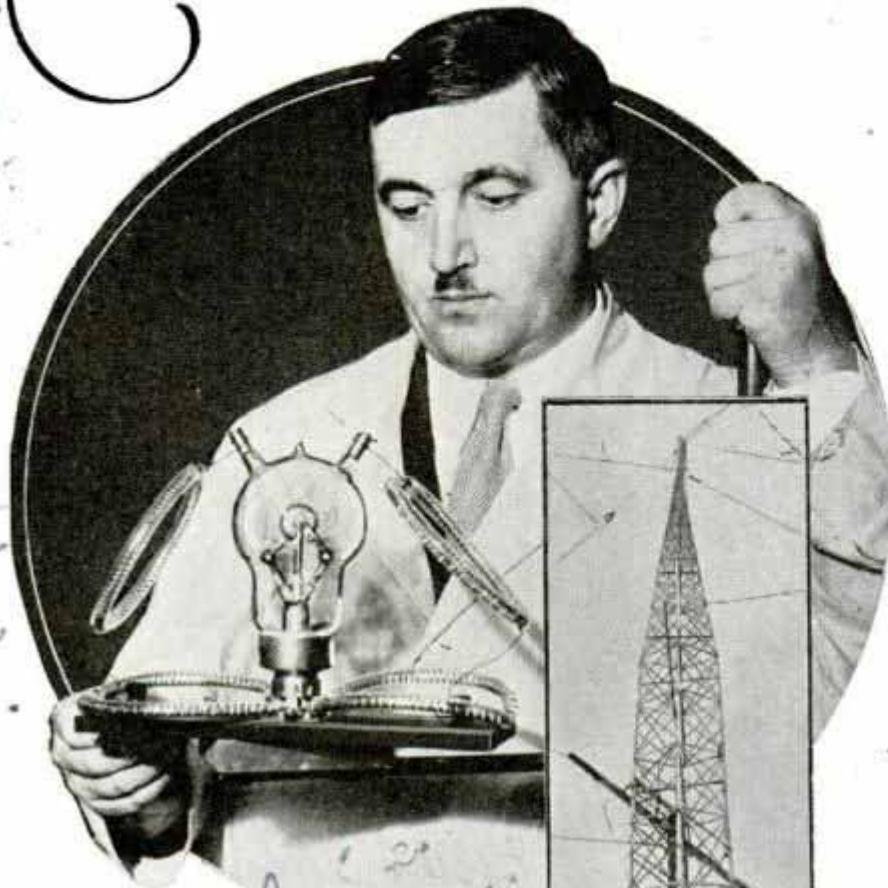

Adjusting Oscillator Tube of Ultra-High Frequency Generator Which Creates Three-Centimeter Radio Waves, and Short-Wave Antennas

throw open the windows and sit in comfort in his shirt sleeves because the high-frequency waves would keep his body at a comfortable temperature. Plants would flourish in the room at all seasons. After dark a person could reach for a neon-type globe and carry it around the room like a candle, placing it on any convenient table."

A light that receives its energy directly through

By **THOMAS E. STIMSON, JR.**

MAN'S mastery of electricity is one of the marvels of the twentieth century. But, not content with the present, science is seeking new ways to produce and use electrical energy. Better radio frequencies are in the offing. Uses are being sought for so-called mystery rays, and investigators are pretty well convinced that actual "death rays" can be produced. High-frequency waves are being studied that may play an important part in the elimination of disease.

Dr. Lee De Forest, creator of the audion tube, visualizes a magic health room in every home where "a few minutes a day will keep the doctor away."

"In this room," he says, "high-frequency waves would radiate from wires concealed in the walls. The effect would give persons in the room a healthful, stimulating therapeutic treatment in comfort. Even in the middle of winter a person could

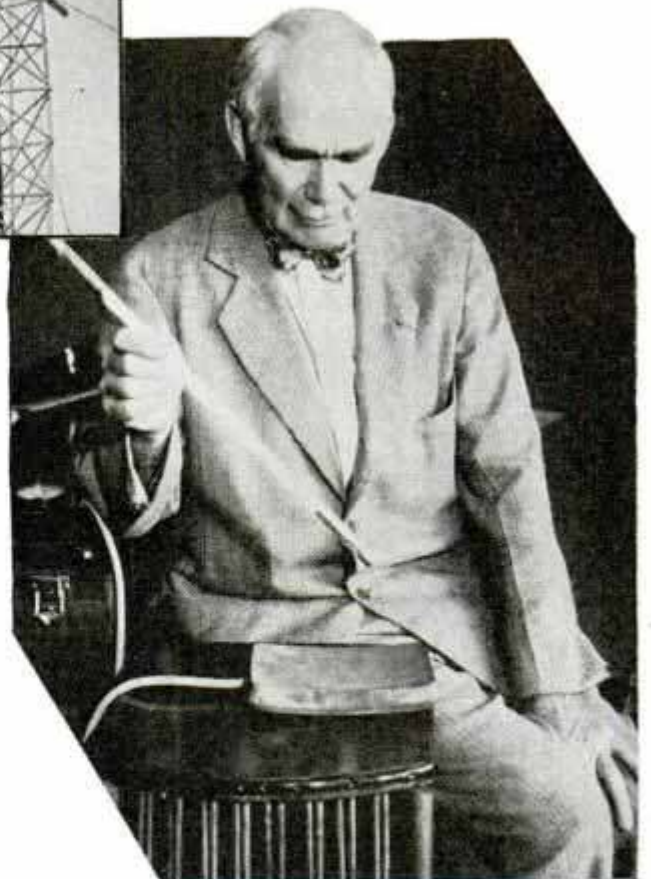

Light by Radio; Dr. De Forest Holds a Mercury Tube above the Condenser Pad of a High-Frequency Machine to Produce This Effect

5106 Melchior Blvd. Los Angeles, Calif. 10555 Holman

California Institute of Technology
Pasadena, Calif

8/10/49

HIGH FREQUENCY

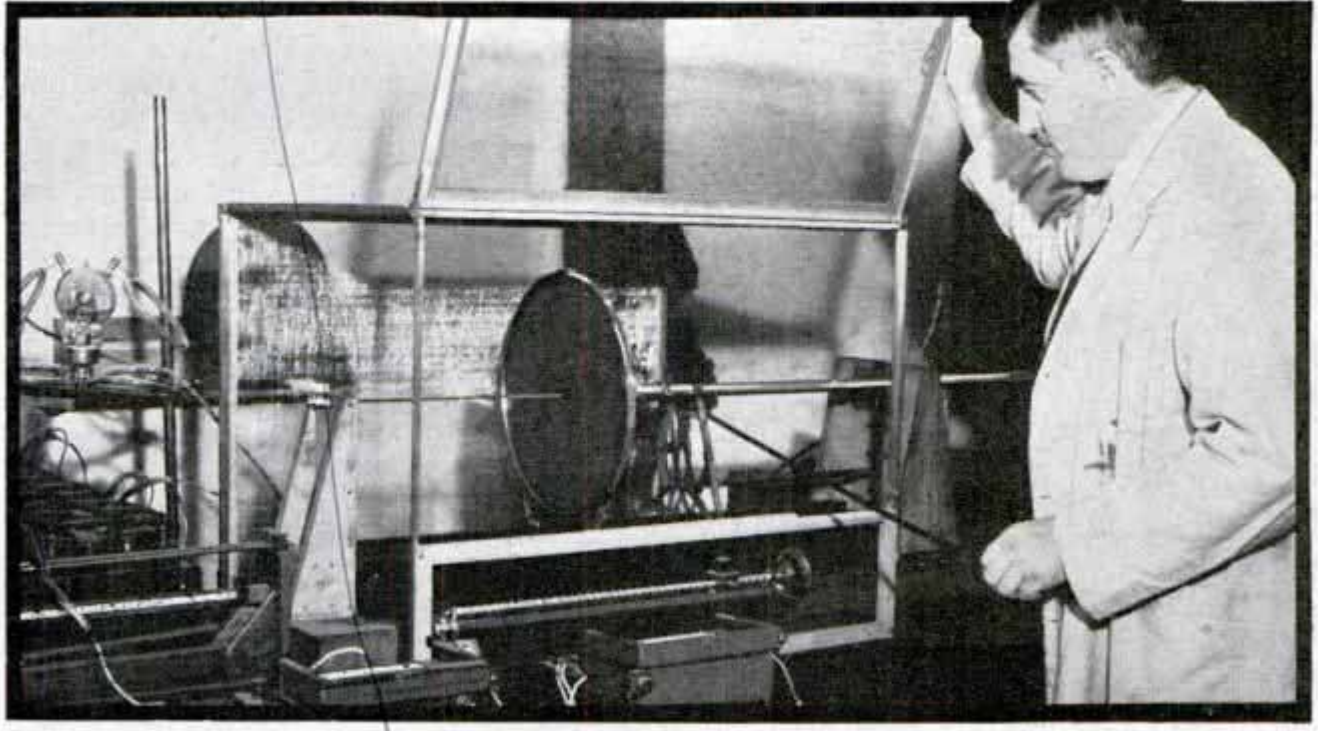

Dr. Potapenko and the Ultra-High Frequency Apparatus Which He Uses to Generate Waves Three Centimeters in Length

air represents power by radio, which has been the dream and despair of experimenters for years. But with high frequency this is already an accomplished fact, although economists question whether power by radio will ever be practical with our present knowledge.

"The great trouble in sending power through the air under present conceptions is its tremendous expense and what might be called its lack of selectivity," Dr. De Forest says. "Science is able today to radiate power from a central station that would illuminate every home in a village. The objection is that a staggering amount of power would have to be radiated and

all but a tiny fraction of it would go to waste. Even if a shield were provided to prevent the power being thrown up into the air uselessly, the cost would still be tremendous.

"In the same way, we could provide radio power to operate an airplane and reduce the power wastage by throwing it as a beam. But an operator would have to swing the beam apparatus to keep up with the plane and he would never be able to direct it past the horizon. Also, all metals within reach absorb some of the energy of most high frequencies. If you should happen to walk past a radio power transmitter you might find your watch

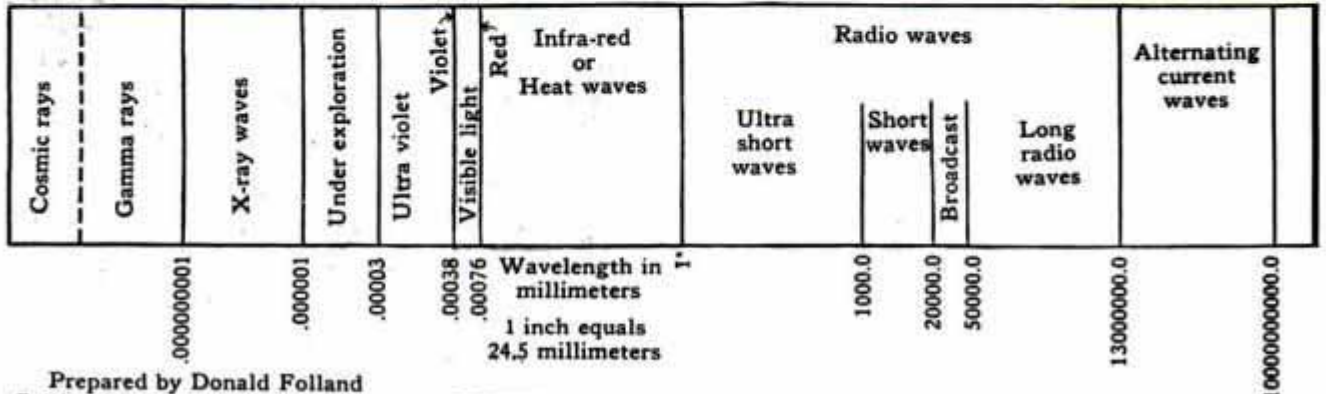

Prepared by Donald Folland
California Institute of Technology

COMPLETE SPECTRUM OF ELECTRO-MAGNETIC ENERGY

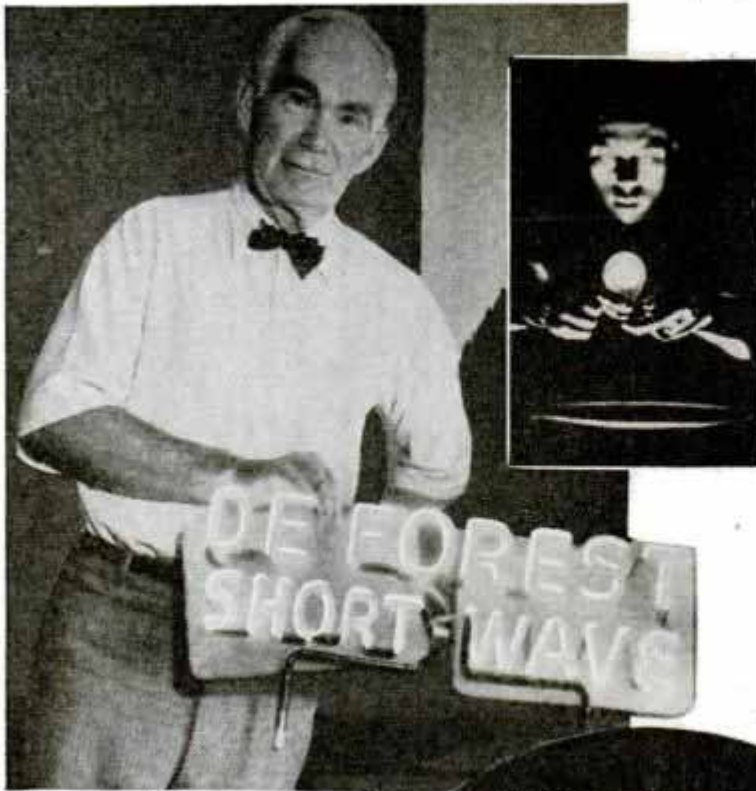

Lighting Neon Light by High-Frequency Radio, and Picture Taken by Glow of Mazda Lamp Excited by High-Frequency Current

and the coins in your pockets had become uncomfortably hot."

The newest kinds of high-frequency electricity are giving us furnaces for melting elements in a vacuum, private radio communication, television, and are opening fields of study for "cheap" electricity for the home. High-frequency machines have been built that can destroy electric-current generators, and Marconi has recently announced that studies in the ultra-high frequency field may enable him to halt various types of motors, including those of aircraft, a tremendous asset in warfare. Experimenters in the ultra-high frequency field work

cautiously with very low amounts of power because they expect eventually they will tune into frequencies vibrating at the same rate as the molecules of the body's tissues, and the effect of these waves would be to disorganize the molecules, causing death.

Familiar kinds of electricity such as alternating current are merely different types of electromagnetic energy. Heat radiations, light rays, radio waves, the electricity used in telephone circuits, and cosmic rays are essentially the same thing except that the energy waves are of different lengths. That is the same as saying we see by means of an extremely high-frequency electric-

ity, or that the current from an automobile battery, the light from a match, and the heat from a candle are the same kind of energy vibrating at different wave lengths. Alternating currents have the longest wave lengths. Radio waves are shorter, or of higher frequency, then

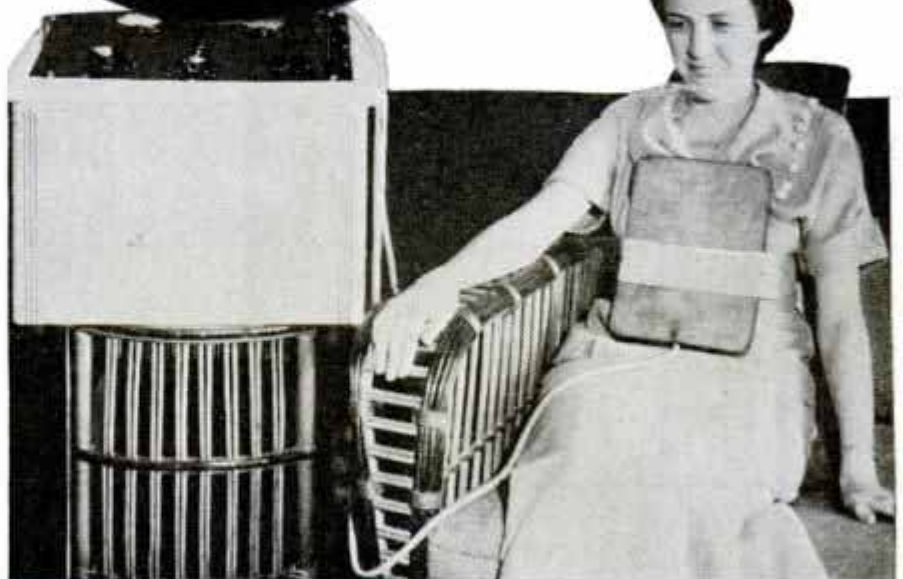
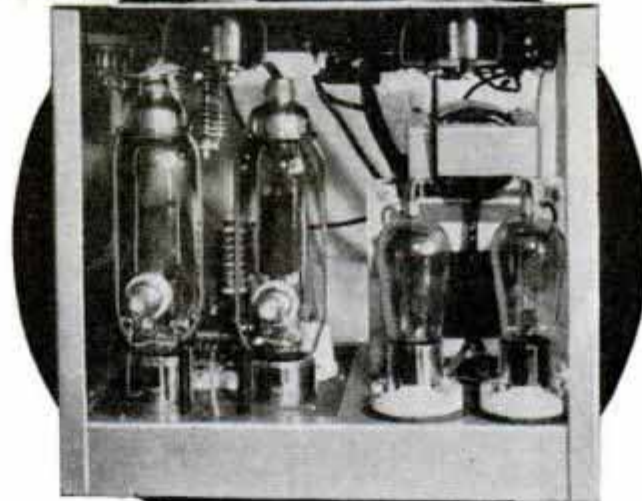

Center, Tubes of Fever Machine; Bottom, Treating Patient with Radio Therapy to Raise the Body Temperature

Inter-Room Radio Provides "Remote Control" for House

come infrared or heat waves, then light, with cosmic rays at the extreme short end of the energy spectrum. Direct current is merely alternating current of infinite wave length.

Merely by changing the length of the energy waves you change their characteristics and uses. For example, low-frequency waves such as those of sixty cycles can be conducted along wires and very little of the energy leaks away. But if you step up the frequency of the waves by shortening their length the energy tends to radiate in every direction and is difficult to confine to wires. That is the chief difference between the energy you use to light a room

(Continued to page 149A)

SHOVEL WITH TWIN POINTS "BITES" INTO GROUND

Several advantages are claimed for a shovel with a V-shaped tip. The twin points of the tool "bite" into hard or frozen ground and can be used to cut roots and weeds. In shoveling, more bottom area is in contact with the ground than is the case with the ordinary implement.

LESS EFFORT TO HANDLE

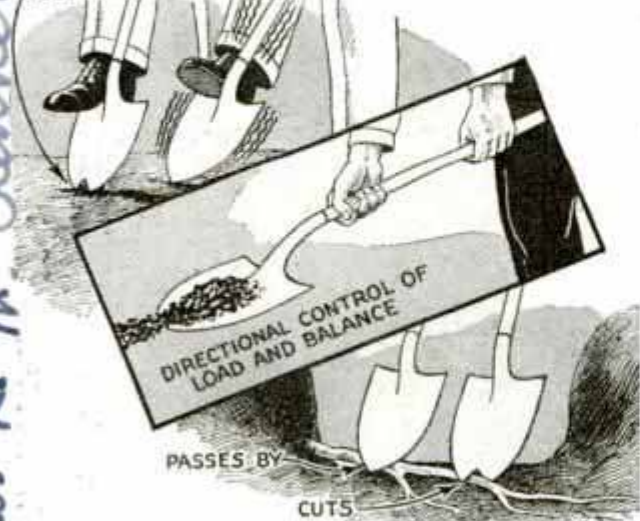

Shovel with Twin Points Which Can Be Used for Cutting Hard Ground or through Roots and Weeds



Top, Giving Orders from Office by Turning on Transmitter; Bottom, Voice Is Amplified in Shipping Room

"Remote Control" of the nursery, workshop or office is the latest duty of the radiophone. A convenient communications system for factory or home has been devised which saves many steps, for no mouthpiece is required. Talk in an ordinary voice from any corner of the room and the transmitter faithfully amplifies it at any desired receiving point. Even a whisper is plainly audible at a remote point. Executives can talk to employes in distant noisy machine shops; orders can be transmitted between offices, and between dining room and kitchen. When things are happening in the home playroom, mother hears downstairs. The system operates on alternating current.

In a twelve-day flight an albatross is said to have traveled 3,150 miles.

dw. H. M. Reimer 212 Federal Bldg. Oklahoma City, Okla.

81146

Vocal phone

81090

The Loochian Mfg Co, 3763 Franklin Ave Los Angeles, Calif

Diligent Beaver Put to Work In Fight to Stop Soil Erosion

J. Mahawk, Wis.



du.
This Beaver, Trapped in Oregon Where the Animals Are Pests, Will Soon Be Working for Uncle Sam

Beavers are being put to work building dams for Uncle Sam. These industrious animals are being trapped in Oregon where the farmers complain they become pests by diking irrigation canals and destroying fruit trees. The trapped animals are being transported to the national forests where their natural proclivities for building dams can be employed to advantage in the fight to halt soil erosion.

YOUR DOG IS IN CLIMATE APART WHEN PAVEMENTS ARE HOT

On a hot summer day you are living in a different climate from that in which your small son and his dog live. The temperature at the level of your shoulders may be in the upper eighties, while down near the sidewalk it is twenty or thirty degrees hotter. Pavement temperatures in one large city were above 100 degrees

when the air was only 90. In a courtyard, the temperature on the grass was 103 degrees, on granite-block pavement 124, while a dark wood-block pavement registered 153 degrees. Some stone in a shaded alley near by was only 81.

E 1152

"BICYCLE BUILT FOR TWO" NOW PULLS A TRAILER

Tandem bicycles were the height of chumminess in the gay nineties. The modern counterpart of the "bicycle built for two" is an ordinary two-wheeler that hauls a trailer. A Rome, N. Y., cyclist built his own trailer of two twenty-eight inch bicycle tires set twenty-one inches apart, with cushioned seat and back, springs beneath the rear of the seat, foot rest for the extra passenger and a parcel compartment for lunch, camera, shopping and extra coat or slicker. The wheels run on their own axles hung in an angle iron bolted to the frame. The trailer wheels are covered to protect the rider. The cyclist can pedal himself and the sixty-pound trailer with a passenger aboard at six miles an hour.



Two Extra Wheels Make a Bicycle Trailer

Frank A. Shepard

120
Science Service
10/10/16

Ureuna
11/18
10/10/16

Tests Indicate Canaries Have "Horse Sense"

Canaries are teaching psychologists new facts about how learning takes place. Billie Burke, a bird with a broken wing, disliked her isolation on the floor at feeding time while other canaries were eating on a table top. So Dr. Gustav Eckstein of the University of Cincinnati built a spiral staircase of sticks fastened to the table leg. On the third morning Billie used the stairs. Later a similar stair was built to a tree and in thirty seconds Billie was up there. Is this evidence of reasoning? Dr. Eckstein says it at least shows the bird recognized the essential characteristic of her first experience and was able to use it instantly to a new end. It has also been found that a bird can learn to sing alone without hearing other birds. A canary was kept isolated in a sound-proof cage, yet by listening to its own notes and improving on them, this bird learned to perform the amazingly swift rolls of the trained canary. The breeding and raising of canaries has become such an important

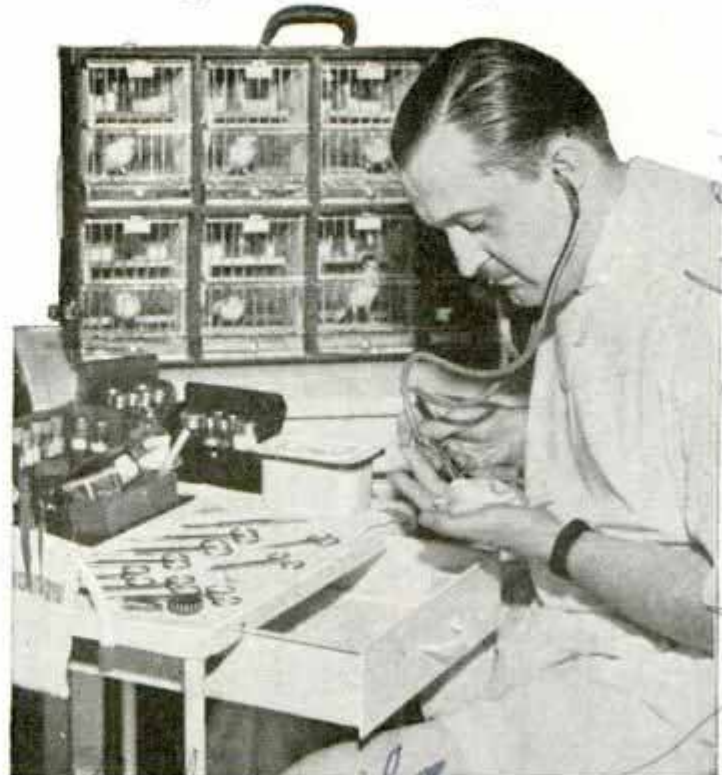

Treating a Patient in a Canary Clinic Which Specializes in Doctoring Sick Birds

business that a Los Angeles ornithologist has established a canary clinic where he has treated more than 15,000 birds.

Your Ability as Auto Driver Shown by Reaction Meter



Sir Malcolm Campbell Taking Test Which Indicates Time Required for Driver to Apply Brake

You can test your own ability as an automobile driver with the aid of a reaction meter which measures the time you require to do something after making up your mind to act. The apparatus consists of a box on the top of which are model cars in motion. The foot of the person being tested rests on what would be the accelerator of an automobile. At a signal he is told to step on the brake pedal. The time required to change from the gas pedal to the brake pedal is measured accurately and is your reaction time. Sir Malcolm Campbell, British race driver, who recently set a record of more than 300 miles per hour, required only one-fourth of a second to step on the brake, but at 300 miles an hour, he would have covered 110 feet in that quarter second.

Nearly one million pounds of copper are used by the mechanical refrigerator industry each week.

Built in machine Dept.
 Pat. C. ...
 ...

Service 9/13/35

U. of Southern California
 Los Angeles, California

Operated by ...
 ...
 ...

minute man.
 Pub. ...
 ...

Four CONTINENTS

8077...

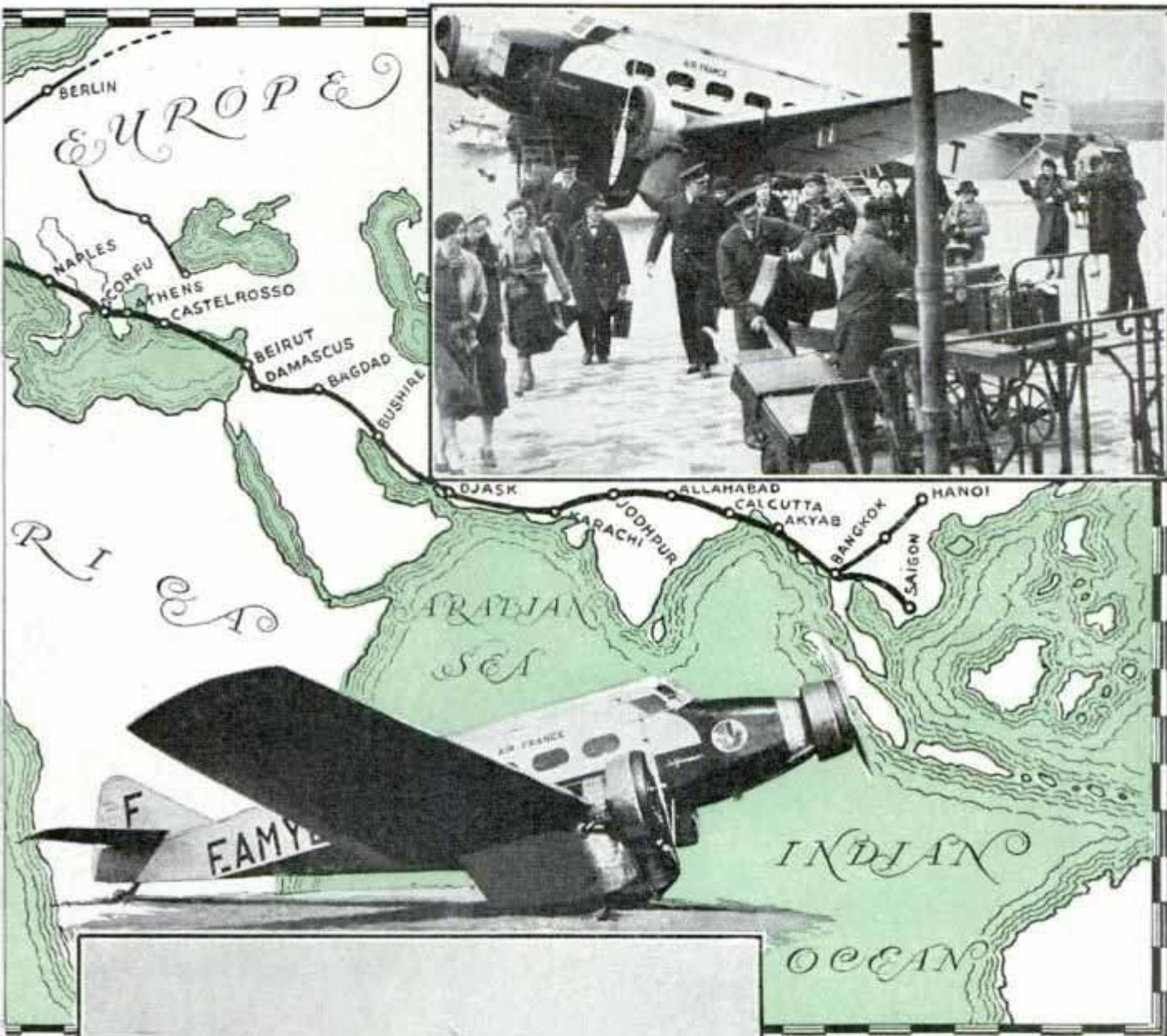

Top, Passengers Disembarking at Air France Airport; Center, Air France Passenger Transport; Bottom, Freight Plane with Three Motors in Front and One in Rear

major accomplishments in the field of modern aviation.

The monsters owned by Air France beat down the western coast of Africa until they strike Dakar; then they turn southwest and leap across the south Atlantic in

a single hop. The line runs along the east coast of South America until it strikes Montevideo and Buenos Aires; then it heads west toward Santiago on the Pacific coast, following along the path of many famous explorers.

All the French air lines united in 1933. After England, France is the great mother of colonies and Air France runs lines wherever the mother country has an established interest. In the Far East, Air France touches the colony of Indo-China and maintains a terminus at Saigon. Syria, a colony in the

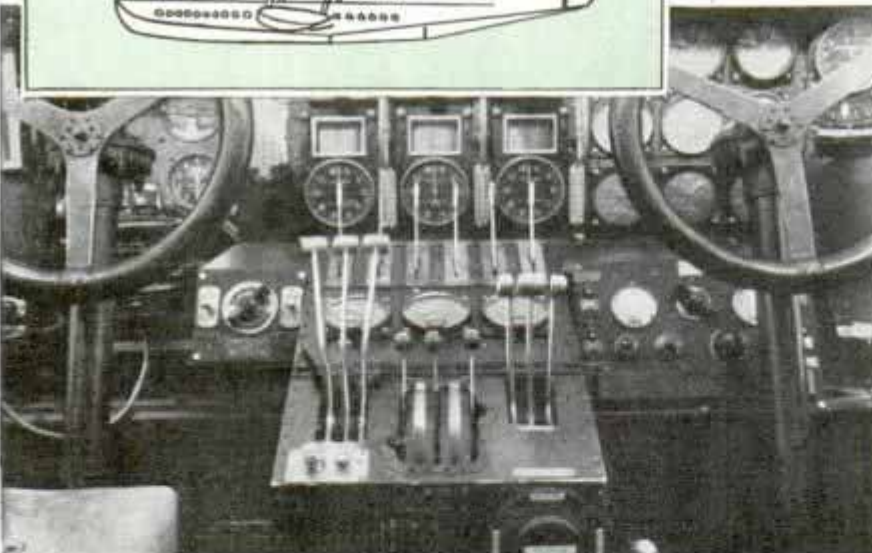
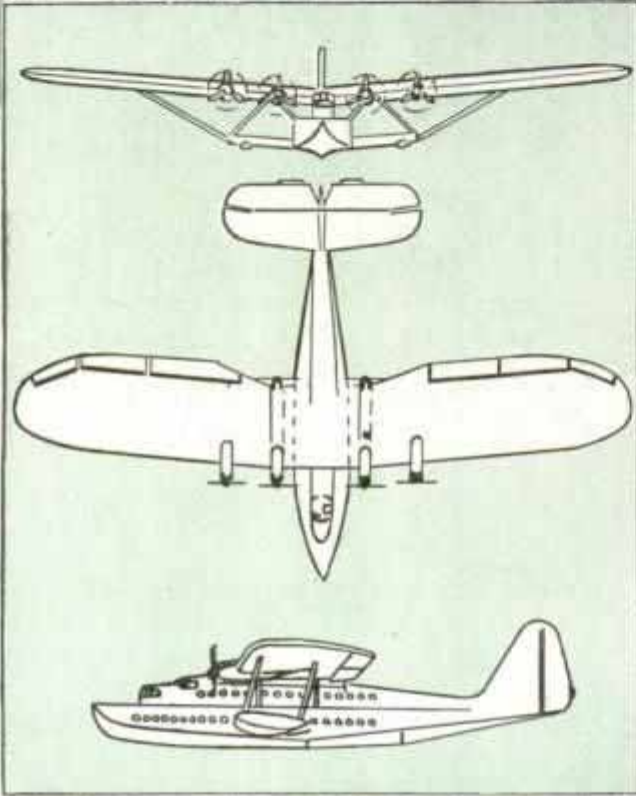
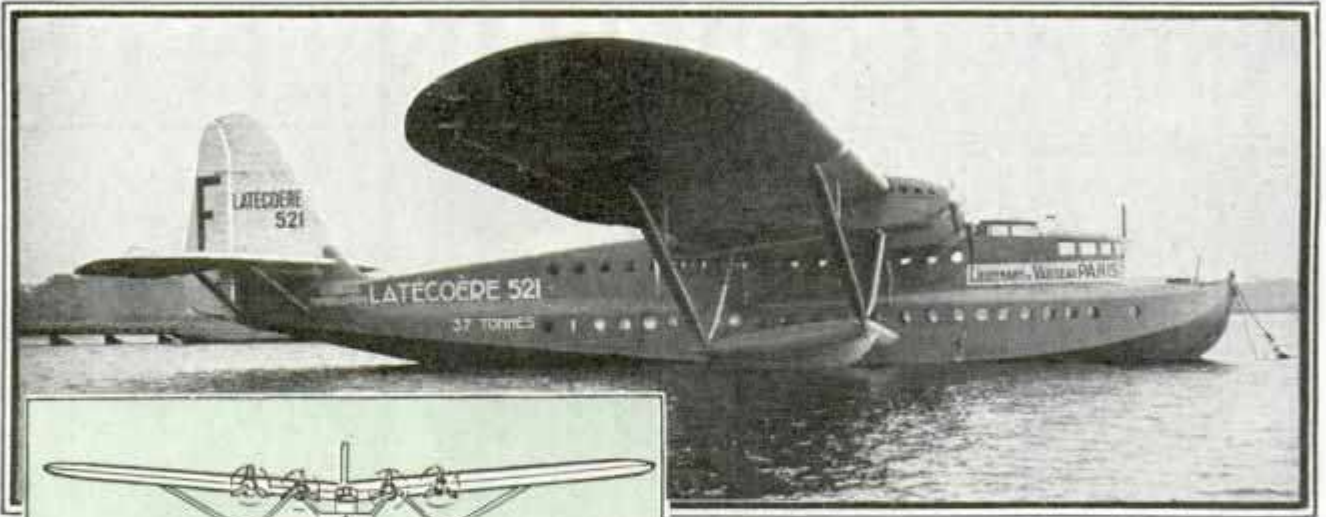

Top, Thirty-Seven-Ton Flying Boat Which Will Carry Crew of Eight and Seventy-Two Passengers; Center, Scale Plans of Boat; Bottom, Pilot's Cabin of Air France Liner

mother country looks to the future development of the vast interior, which is almost as large as Europe itself. Near the tip of Africa, France owns the huge island of Madagascar, which is also awaiting development.

At present Air France is seeking to assure its place in the rich South American market by establishing night flights between the Old and the New World. Since the cost of installing beacon signals along the coast of east Africa would be prohibitive, the company is experimenting with the use of flares, flash bombs, and intermittent light signals.

So primitive are the countries which Air France touches, that in most cases it is necessary for the company to lay out and construct its own airports, then build roads to connect the airports with adjacent towns. Thus, out of forty-six landing fields used by Air France, only nine have been built by the country in which they are situated.

At one forsaken spot on the east African coast where an airplane hangar was constructed,

Near East, is also served by Air France. In Africa, the company serves Algeria and Morocco and the Sahara.

Air France plans to exploit still more territory. Its expeditions have crossed the Sahara desert in all directions for the

every drop of water used by the workmen and in the construction had to be freighted in from the Canary islands. In parts of South America, engineers found the roads impassable and the vegetation impossible

(Continued to page 126A)

2643. 3rd St
Wyandotte, Mich

Pilothouse of Boat Makes Summer Cottage

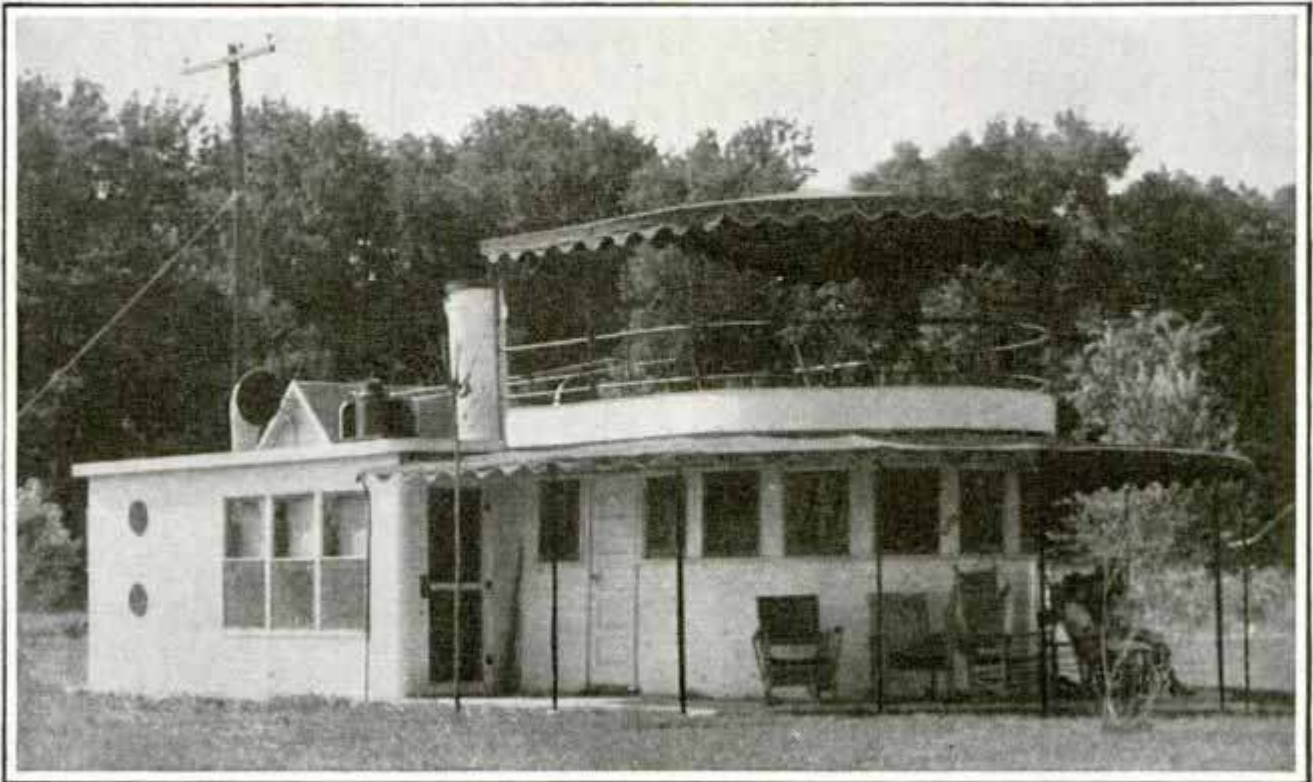

Summer Cottage Which Once Was the Pilothouse of a Boat; Note the Awnings Which Provide a Porch in front and a Balcony on the Roof; the Funnel Is Now a Chimney

Near a Michigan beach stands a summer cottage which originally was the pilothouse of a Great Lakes steamer. The pilothouse was transformed into a land home by removing it from the boat, placing it on foundations and laying a tile floor. Inside partitions were built to provide comfortable rooms, and steel pipe frames were employed to support awnings which provide a porch in the front and a balcony on the roof. A boat funnel, running lights, wheel and compass were added to the cottage to carry out the marine appearance.

Stony Point

ONE MAN HANDLES TON LOAD IN BALANCED DUMP CART

One man can push a load of 1,900 pounds or more easily by using a metal material cart designed for easy balance. The cart is equipped with balloon tires and is mounted on roller bearings. It is dumped by the handler just as easy as it is moved about.



One Man Moves a Ton in This Cart

Les Morris, Cleveland

MALARIA OUTBREAK IS TRACED TO ROCK-GARDEN POOLS

Malaria and rock gardens are on the increase in Ohio, and health authorities see a connection between the two. Hollows and crevices in rock gardens furnish a breeding place for the anopheles mosquito, carrier of the malaria parasite, and unless there are fish to destroy them mosquitoes breed rapidly in garden pools. There were 104 cases of malaria in Ohio during 1934 and the number may be surpassed when 1935 records are complete. The disease formerly was rare in this region.

E 1122

Review Service 9/18/35

Ohio Health News

Pittsburgh - Les Morris Steel Co

Amphibian Flies Nearly Four Miles a Minute



Major Alexander P. de Seversky in Low-Wing Monoplane He Designed and Flew Nearly Four Miles a Minute, Fastest Time Ever Achieved by Amphibian Aircraft

Just under four miles a minute, the fastest time ever achieved by an amphibian is still two miles slower than the speed record of land planes. The heavy drag of an amphibian's pontoons and land gear accounts for the contrast in speed capabilities. When Maj. Alexander P. de Seversky, one time Russian war pilot, flew his low-wing monoplane with single 710-horsepower motor an average of 230.03 miles an hour recently—his fastest lap was 235.96 miles an hour—he broke the old amphibian record by thirty-nine miles. His pet cocker spaniel "Vodka" rode in the baggage compartment of the plane on the record flight. The land plane record is 353 miles an hour.

(Names and addresses of manufacturers and dealers in articles described in this magazine will be furnished by our Bureau of Information upon request accompanied by stamped, self-addressed envelope.

50/1108
CYLINDER RIDGE IS REMOVED BY HAND-OPERATED CUTTER

Ridges caused by the wear of piston rings on cylinder can be removed by a hand-turned cutting head designed to follow the contour of the cylinder wall and smooth down the obstruction without chattering or digging into the wall. If the ridge is not removed when installing new piston rings, these rings may be damaged. In cutting the ridge away, the guide roller and cutting blade are held against the cylinder wall with spring pressure to assure an accurate cut and



guide roller and cutting blade are held against the cylinder wall with spring pressure to assure an accurate cut and

Handwritten notes:
 50/1108
 Sacramento, Calif.
 Sacramento
 4-2-19
 Kurb. Oute
 Kline - Rogers
 Machine Tool Co.

Torpedo for Merchant Ship Can Blow Up a Submarine

smooth, continuous power is delivered to the cutter by a hand crank through reduction gears. A centering device with sloping sides is placed on top of the cylinder, the cutter is bolted to a stud on the engine head, the cutting head is lowered and centered and the bolt then tightened to hold the cutter in perfect alinement with the cylinder bore. With the centering device removed, the cutting head is lowered into the cylinder and as the hand crank turns, the cutting head moves up and smooths away the ridge.

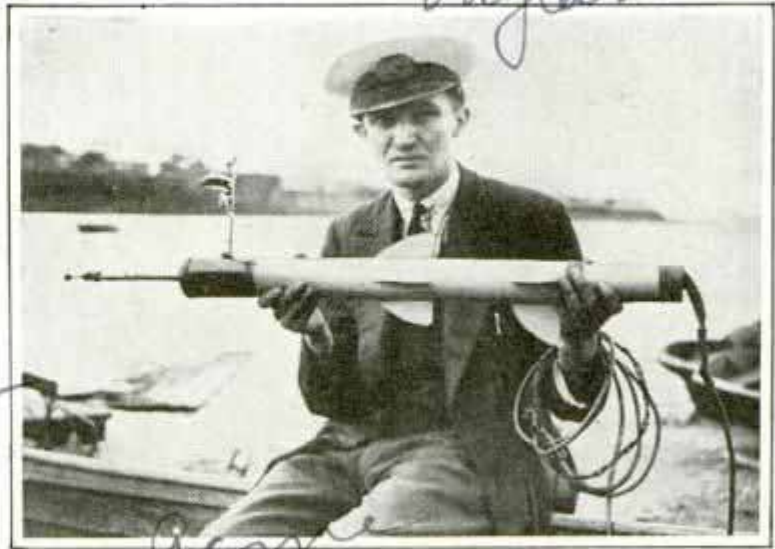

© Planet News, Ltd.
Model of Torpedo for Merchant Ship Which Is Said to Be Capable of Blowing Up a Submarine

TINY POCKET STOVE BURNS CHARCOAL DISKS

Burning seven hours on one-third of an ounce of fuel, a tiny pocket stove without flame, smoke or odor consumes disks of concentrated, highly compressed, purified charcoal. The charcoal starts to smolder as soon as a match is applied and the cover is replaced after about one minute. The burning portion of the disk becomes a cherry red, gradually turning to a fine powder which is easily removed. The heater provides an even warmth and can be carried in the

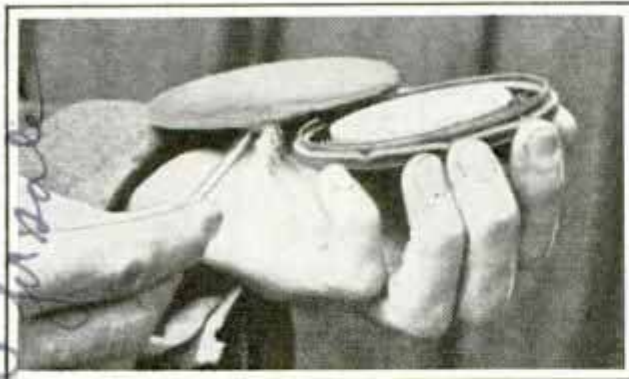

Small Pocket Stove Which Burns for Seven Hours

pocket or hand without discomfort. A spring in the top presses the charcoal disk down upon sharp metal points to prevent shifting when the case is carried edgewise. The two parts of the metal case are covered with thick plush and the case itself is about one-half inch thick and three and a quarter inches in diameter. The pocket heater is useful for winter sports and with the cover removed, it can be used to reheat liquids.

Merchant vessels can protect themselves or be converted into fighting ships in time of war, it is claimed by a British inventor who recently has produced a special rocket-torpedo, intended particularly for the merchant boats. This torpedo is only about half as large as those generally used, but it is claimed one of them can blow up a submarine. It can also be used against other enemy craft.

CLIPPER DROPS POWDER BOMB ON SEA TO MEASURE DRIFT

Glass bombs containing finely ground aluminum bronze powder are dropped on the ocean to mark a spot from which planes can measure their flying speed and drift. Smoke bombs formerly were used, but their visibility was limited to five or six miles in good weather while the powder bomb, bursting when it hits the water, spreads over the surface a shiny film of aluminum dust that can be seen ten or twelve miles. The bomb is fitted with stabilizer vanes to make it drop straight down.



Used by Pan American Airways 135842nd

American agent wanted U.S. flight

E/080 a-e P1
Burton
England

5253
Sept. 1935
Araton

S. Aki Shoten Co.

8905

FISH worth their

2523 N. Major St. Chicago
Ill. Berkeley 8162

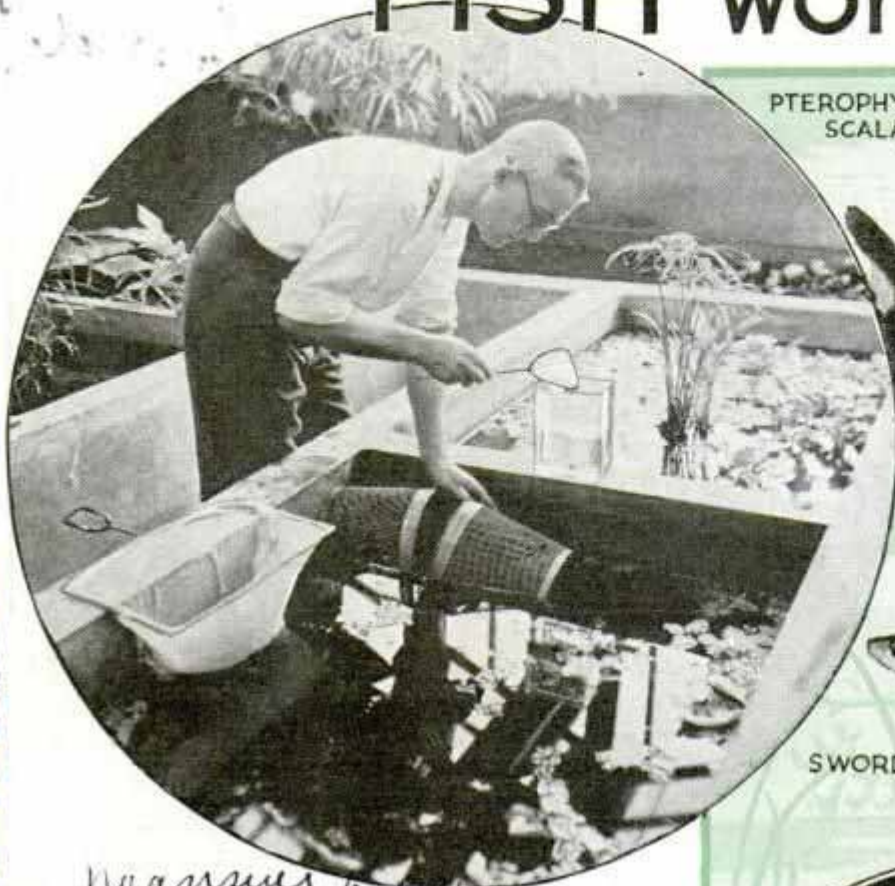

No answer to letter.

THERE'S gold in tropical fish—gold and fun. There's a thrill in creating new, exotic colors and strange shapes by interbreeding fish. You can do that in your own parlor—at a profit!

Eight years ago Alfons Heintze, was an electrician. Business was not so good, but tropical fish were thriving in the glass bowls in his living room. He quit his job, and soon the sunroom of his little home in Chicago was full of glass jars of fish, the basement was one big aquarium and he had to build a greenhouse for more glass and cement tanks. Now his hobby is his full-time job, he's the biggest breeder of tropical fish for the Chicago market and in spare time builds heaters and thermostats he invented to control aquarium temperature.

Fish are temperamental, but you can learn their likes and dislikes and they will bring good returns on the investment. Besides, there is endless fascination in watching the parade of color as iridescent tetra, red helleries, gold and green and blue striped zebra fish and feathery Siamese "fighting fish" dart around the bowl.

If you mean to start a fish colony for

PTEROPHYLLUM SCALARE

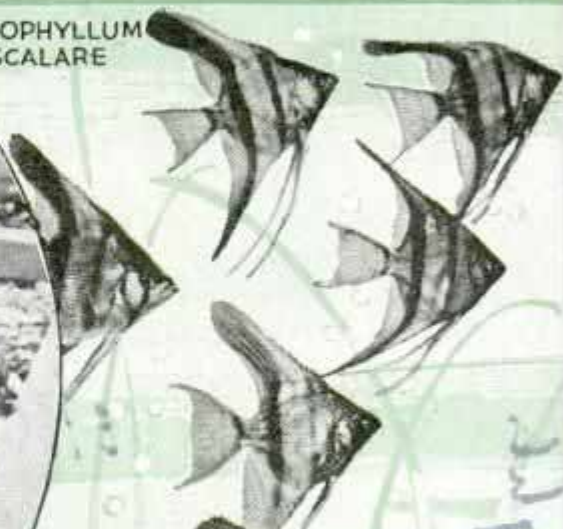

SWORDTAILS

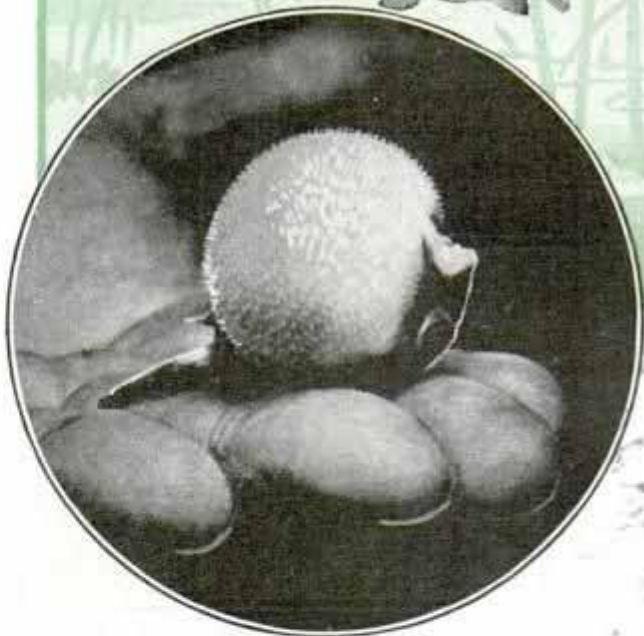

Upper Left, Sorting Fish by Size with Sieve Trap; Right, Angel Fish (Scalare) and Swordtails; Bottom, Blowfish Inflates Itself When Held in Hand

profit, you'll need a glass container, pure water and plenty of green plants; heat enough to keep a constant temperature around seventy-five degrees Fahrenheit; a small air pump and hose; light, and the right food—live water fleas, tiny white worms you can raise in jars of mud in the cellar, dried shrimp and canned food.

Start with a pair of black mollies—those

Makee unknown

2905

Weight in GOLD

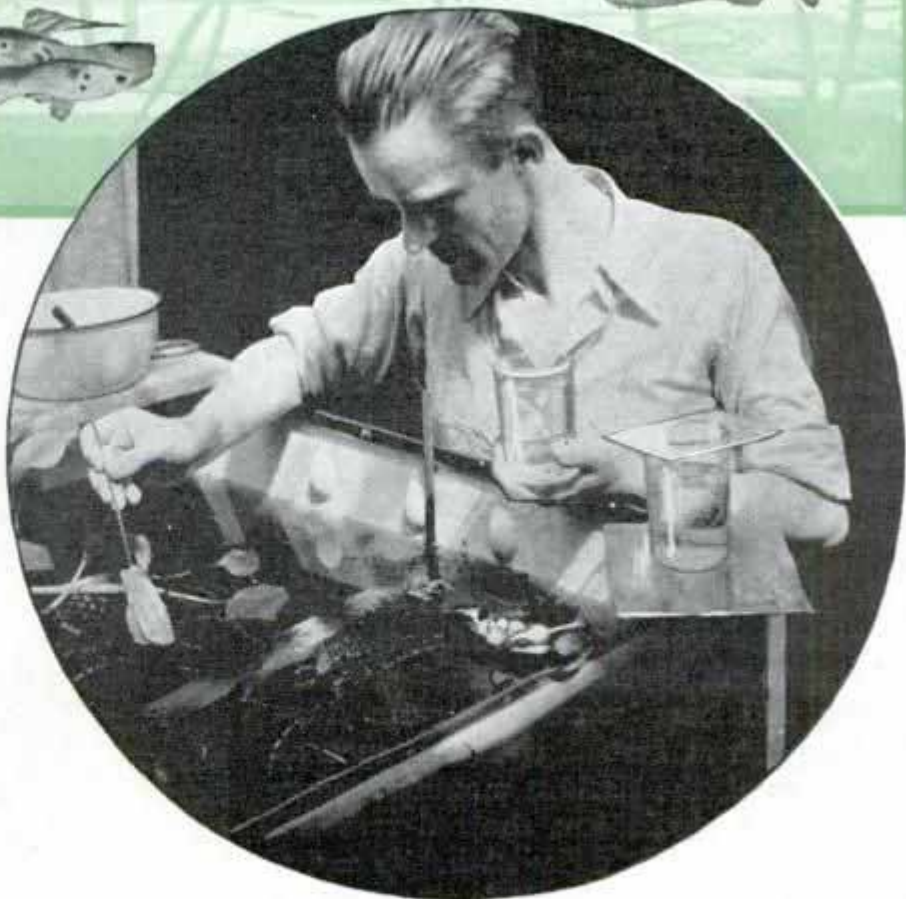
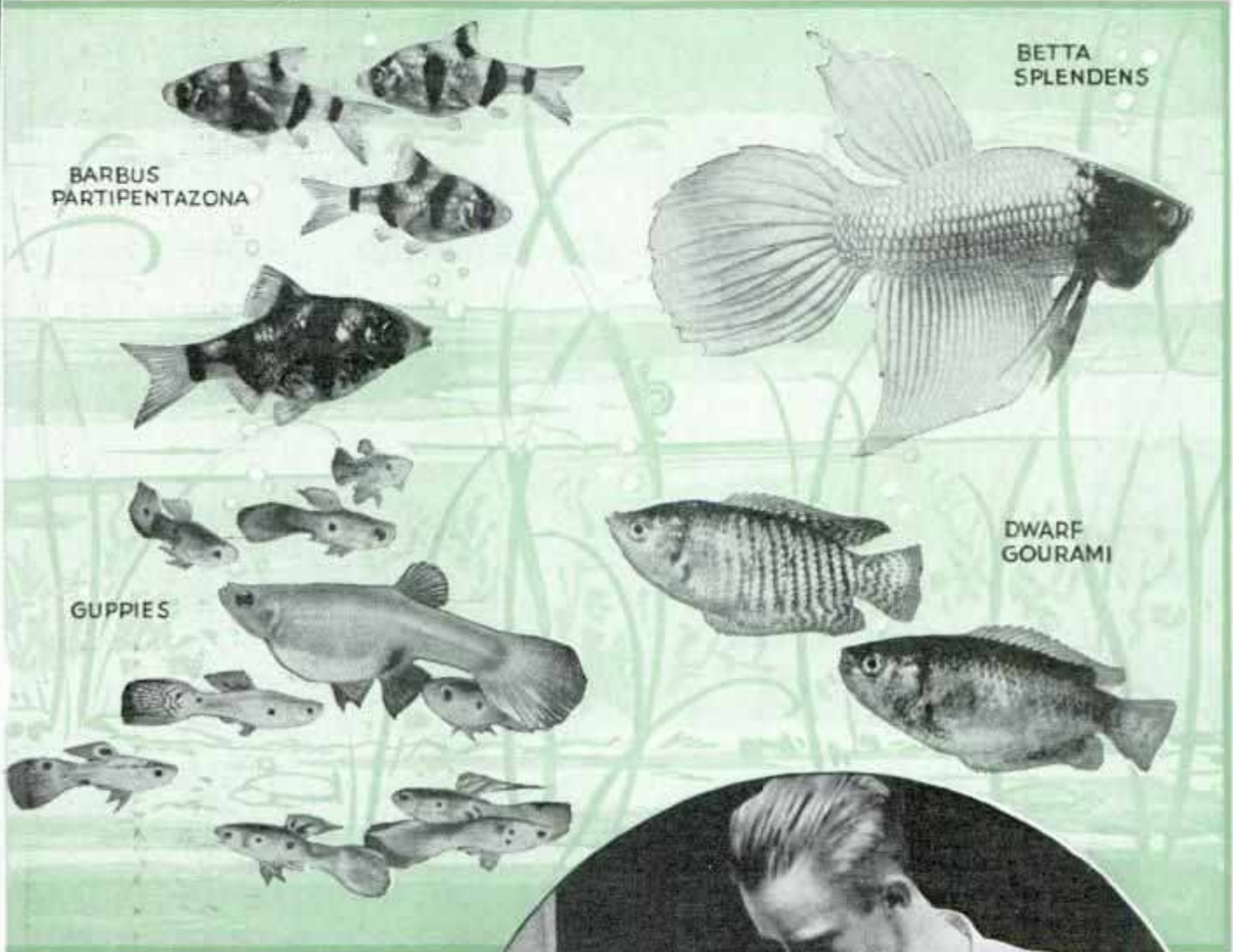

velvet beauties with a tinge of orange along the dorsal fin. These are the biggest money-makers for Alfons Heintze. A pair costs \$2.25. Make them feel at home and they'll multiply your money! Eighty to eighty-two degrees Fahrenheit is the best temperature for breeding. If conditions are right, those mollies will present you a new brood of about forty babies every month. Fully grown, they may bring \$2.25 to \$10 a pair.

Once you have learned how to keep a fish family productive, try mixing

Top, *Barbus Partipentazona* Is Recent Importation; *Betta*, or "Siamese Fighting Fish"; Female *Guppy* Is Surrounded by Courting Males; *Gourami* Builds "Bubble-Nest"; Below, Removing Young from Breeding Tank



bearers. The female mouth-breeder places her eggs in her mate's mouth, and he keeps them there until they hatch. Whenever their young are threatened, the parents open their mouths and the babies swim in for shelter. The cichlid digs a hollow in the sand bottom to lay its eggs, and both parents swim about belligerently as if with a "chip on the shoulder," ready to fight

(Continued to page 128A)

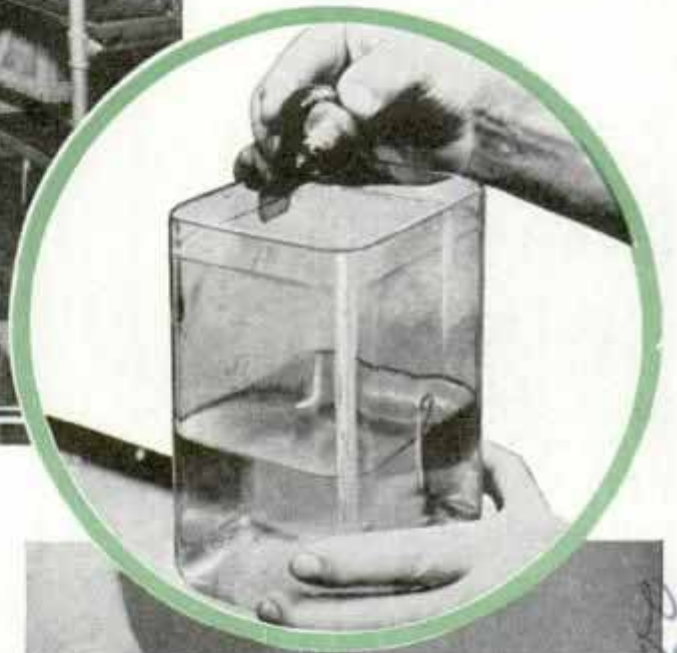

new colors. With a little luck, you can develop hybrids of gorgeous hues and splendid outlines that bring fancy prices. The red-tailed molly, worth \$5 a pair, is a beautiful type created by mating the black molly, native of the Florida keys, with a platy variatus, a many-colored, spotted fish. The tiny guppy is sometimes mated with the hellery or swordtail. But it's always "take-a-chance week" when you mix paints for fish. You can't mate a blue with a canary-colored fish and confidently expect a green infant. You may instead get a hundred baby fish of nondescript pattern, many dying, less than a dozen survivors wearing an original color scheme worth developing.

You will have more luck with live-bearing fish at first. Egg-layers, such as the gourami, the African mouth-breeder, the pristilla riddlei and the red-breasted cichlid have vastly different habits and a thorough study must precede any attempt to raise them. But the egg-laying fish are even more fascinating than the live-

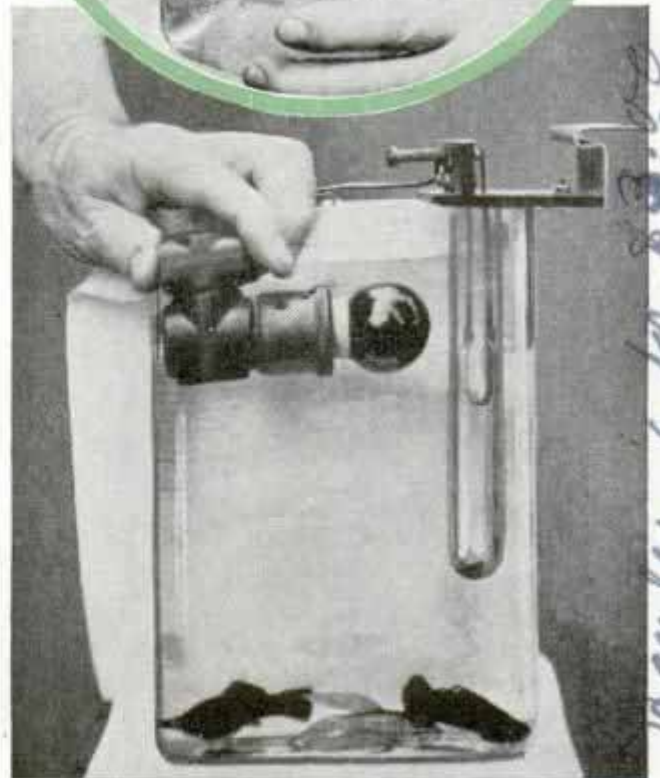

Top, Alfons Heintze in His Sky-Lit Aquarium; Center, Giant Snail Helps Clean Bowls and Feed Fish; Bottom, Thermostat Controls Aquarium Temperature

6 for \$9.00

See also 6 for \$9.00

Coast-Guard Planes Guided Home by Radio

Coast-guard planes are being equipped with radio apparatus intended not only to allow constant communication between ships and shore while the planes are on patrol but also to bring the ships safely home, regardless of the weather. A fifteen-watt main transmitter, handling code only, has a range of 1,500 miles with fixed antenna and an "unlimited" range, according to conditions, with trailer antenna. An auxiliary five-watt transmitter and receiver with a range of about 200 miles can be used for both

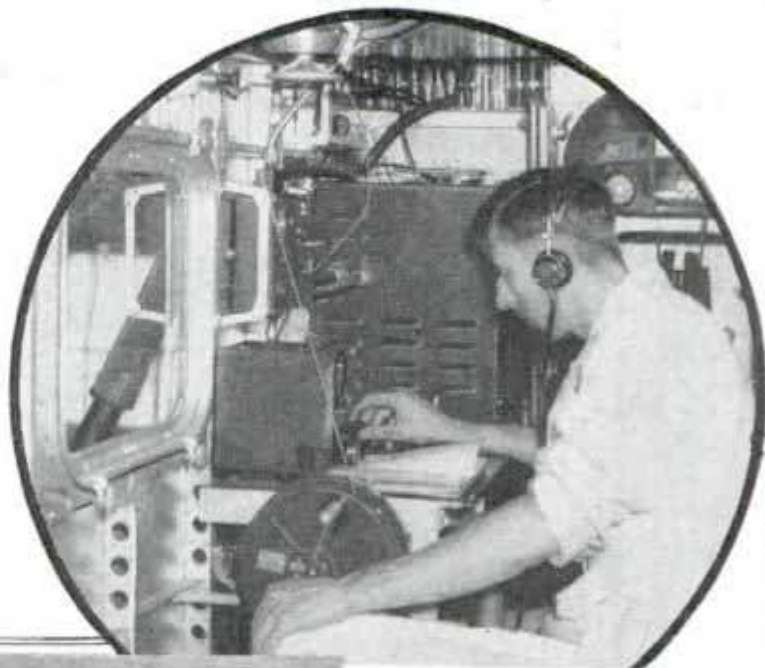

Coast-Guard Plane with Loop Antenna and Some of the Radio Equipment Which Assists Crew in Finding Way Home

ted to bring it to that station. It is accurate up to about 120 miles and is remotely controlled by means of a compass. A loop antenna is located outside on the tail section. A frequency indicator for calibrating the transmitters and an antenna control panel box complete the equipment.

voice and code. The "homing" device is a radio direction finder, a receiver which can be tuned to any desired station after which the course of the ship can be plotted

A direction finder similar to those used on the coast-guard planes led one of the rescue ships to the "Dixie" when the latter was in distress during a recent storm.

Auto Equipped with Bathtub Helps Sell Plumbing Ware

Passenger automobiles now are being built to accommodate bathtubs—but there is no hot and cold running water. A fleet of cars equipped with the bathtubs is being used by a company which manufactures plumbing ware to aid salesmen in exhibiting and selling the tubs to plumbers and jobbers. Room for a large-size tub in a small car is provided by omitting the rear seat and luggage compartment. Access to the tub is provided by a door built in the rear of the body.



Automobile of Plumbing-Ware Salesman Built to Accommodate a Full-Size Bathtub

Excursion trains to the White mountains now carry bicycles for the use of passengers on week-end trips to resorts.

Boston and Maine

Arnold Photo & Yachting
 Lloyd Bennett
 21094

Sarimani Aircraft Engineering Co.
 Farmingdale N.Y. Calif.
 Long-Las Aircraft Co.

Buggs Mfg. Co.
 116 1/2 Black Ave.
 Leebrook, Mich.

Capt. Walter E. Burton
 1032 Floude Ave
 Akron, Ohio

8/10/18

The Secrets of

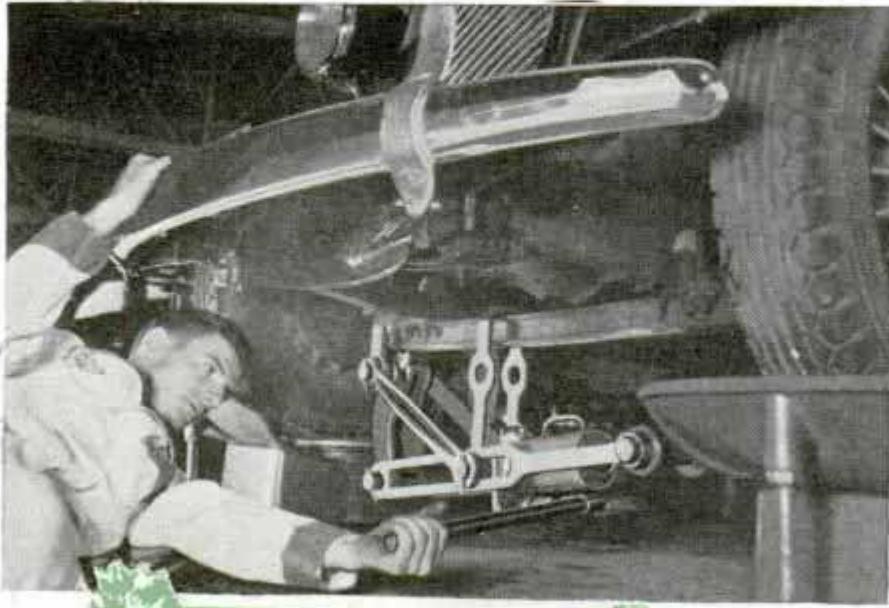

Left, Hydraulic Jack Equipment for Bending or Twisting Axle to Correct Front-End Trouble; Small Jack, with This Arrangement of Adjustable Arms, Produces Tremendous Force; Note Mechanic's Hand on Handle of Jack (Photo Courtesy Northmoor Motor Co.)

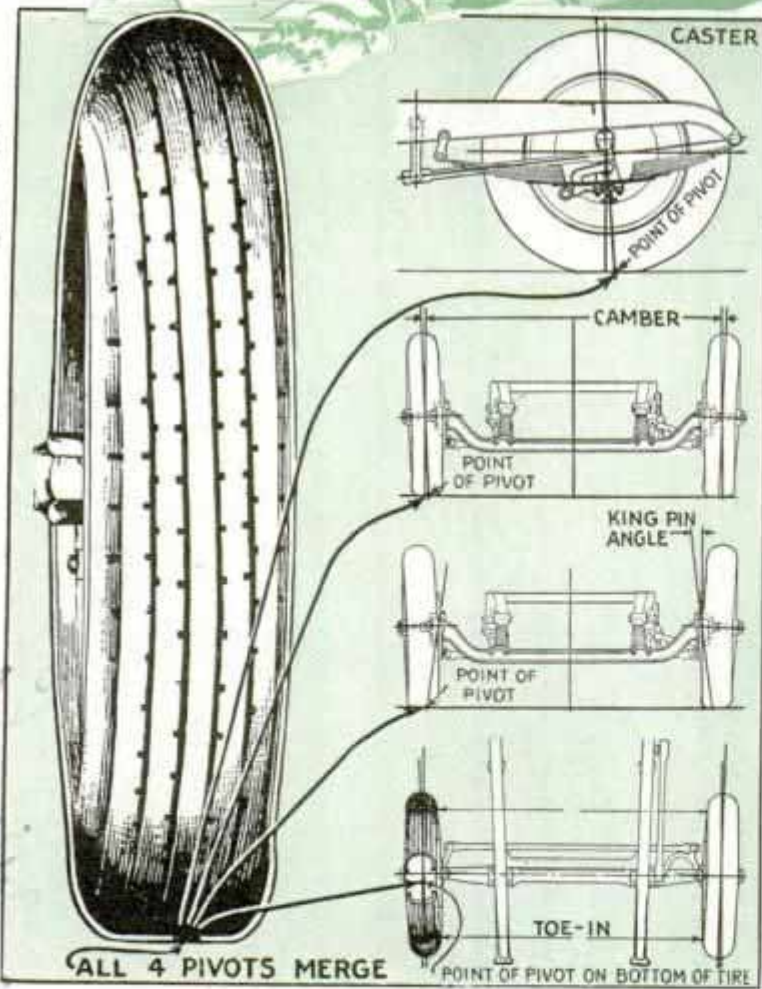
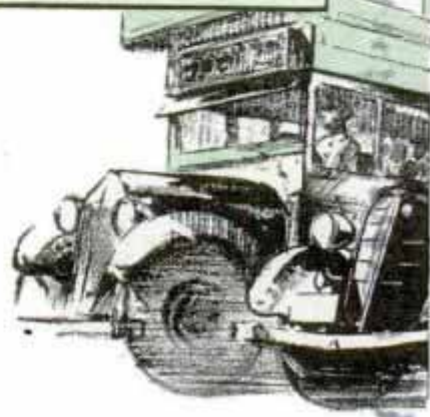

Illustration of How Each Factor Affects Operation of Front Wheel; Proper Camber, Caster, King-Pin Angle and Toe-In Cause Lines of Force to Merge at Point Where Tire-Wear Is Reduced to Minimum and Steering Is Easy

REMEMBER how tired you were after driving the "home-stretch" of that long trip last summer and how your back-seat passengers complained of the rough ride? Or have you ever puzzled on why your car developed "shimmy" and the front tires began to show strong evidences of wear?

Any number of things could have been wrong, but engineers say ninety per cent of the trouble is traceable to lack of balance in wheels, tires, front-end assembly and loose steering gear.

If one of your tires was off balance as much as five ounces at one spot, a force equal to forty-five pounds was tugging at your car at sixty miles per hour. That's the cause of many accidents. At the same time, this unbalanced condition was setting up vibration through the steering gear that left your arms tired, and through the whole frame that fatigued the

B. F. Isodarsch...

E 10/18

a SMOOTH RIDE

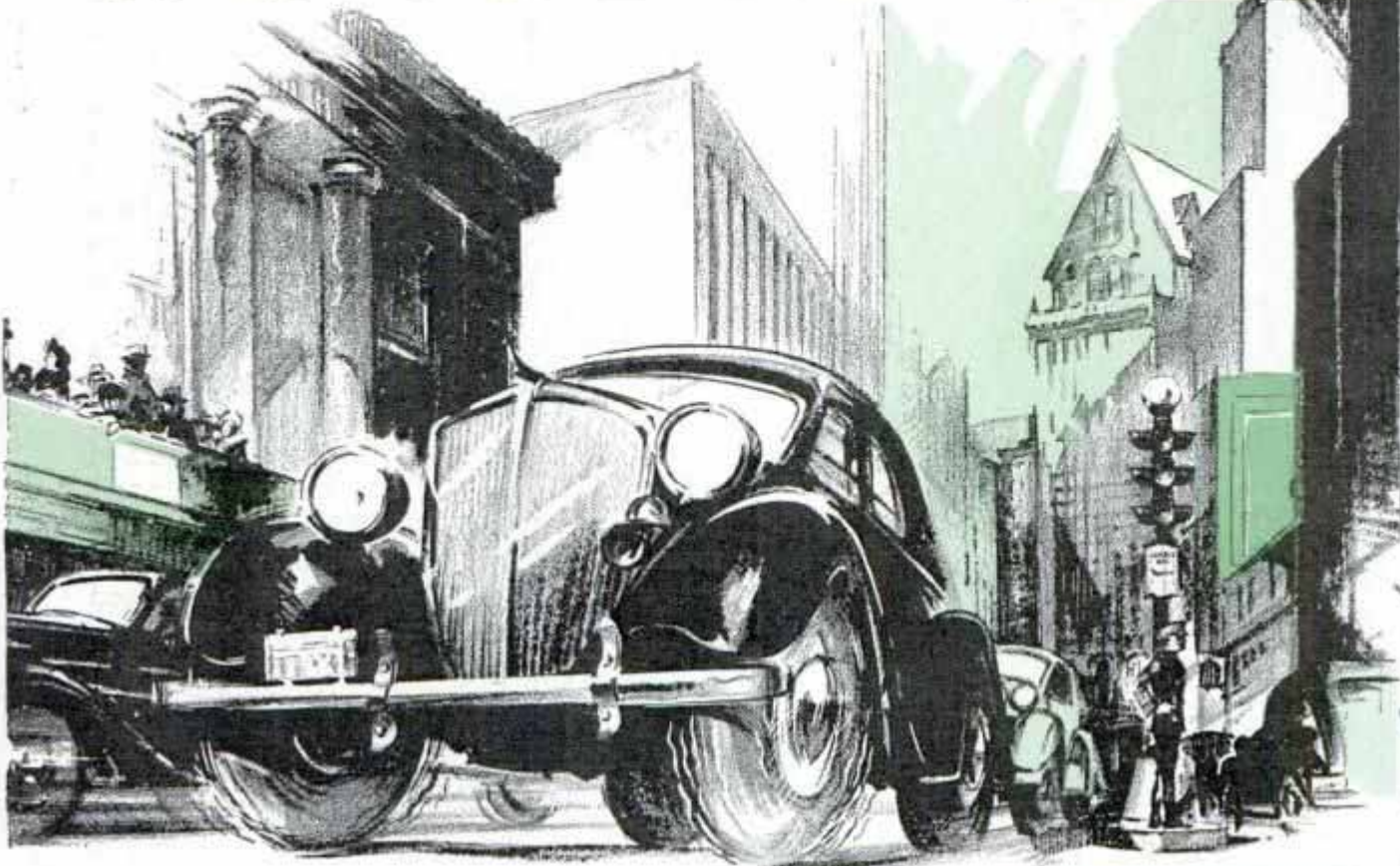

passengers. But this is only part of the story. If the wheel and tire had been balanced, your ride would have been just as uncomfortable if the front end had been out of balance, requiring adjustment of the various parts that keep the wheel running smoothly and the steering easy. An unbalanced front end causes hard turning, loose steering, weave or wander, jerky steering, shimmy, excessive tire wear and generally uncomfortable driving and riding, in addition to increasing the chance of accident.

What should have been done to make that return trip comfortable? C. S. Phillips, engineer of the John Bean Manufacturing company, says the entire front end should have been checked carefully, tires, wheels and hubs balanced, as a unit on each side, and necessary adjustments made to the axle assembly so all parts worked in proper relationship. It



Top, Illustration of Shimmy; Bottom, Showing Car Owner How Simple Are Examination and Correction of Front-End Trouble; This Equipment Indicates Maladjustment; Pointer Shows Degree from Normal (Photo Courtesy Northmoor Motor Co.)

Wheel body can be made by General Motors or United Motors - Service Stations

Lansing, Mich.

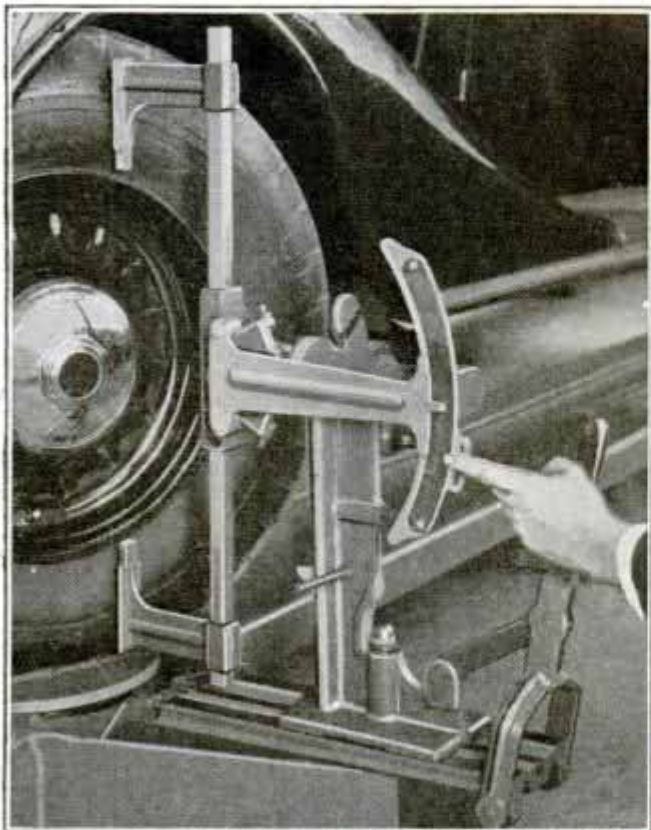

make the proper adjustments, using special shims between axle and springs, adjusting the steering gear and twisting or bending the axle with a small hydraulic jack that exerts a force of 24,000 pounds. This jack is used in connection with a set of steel arms to bend the axle up or down just as you bend a wire with both hands.

Balancing the tires and the wheels is equally simple, special machines doing the mathematics for the mechanic. Static balancers, showing where two or three weights should be clamped on the rim to true up the assembly, have been in use for some time, but the latest machine for this type of work indicates the dynamic balance, showing whether the wheel runs true in actual use. A wheel balanced statically still might operate on the road at an angle away from the line of travel, thus exerting a force to pull the car to one side of the road and resulting in increased

wear on tire and wheel bearings. Steering-wheel wobble and shake are noticeable when dynamic balance is poor. Attachment of weights to the rim will correct this condition and give better steering and a smoother ride.

Rear wheels require the same attention as the front wheels, particularly in this day of air wheels and "knee

will save you money to make such a checkup every 8,000 miles. But be sure to take your car to a properly equipped service station because special machines are needed for this type of work. It cannot be done with a measuring stick and spinning the wheels on the car.

If the owner neglects this periodic checkup, he soon will notice his front tires are wearing faster than the rear ones—a sure sign the car has lost balance. Under normal conditions, the rear tires wear the fastest. Balancing the whole assembly at the first sign of excessive front-tire wear may save a big repair bill—perhaps even a life. A high-speed shimmy is absolutely uncontrollable and oft-times builds excessive temperature in the tire, causing a fatal blowout.

After your car has been tested on a good alinement machine, the mechanic will

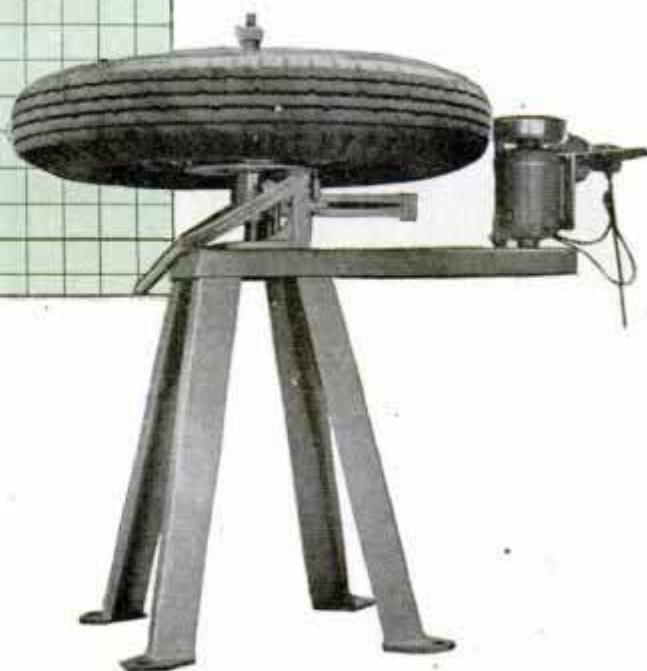
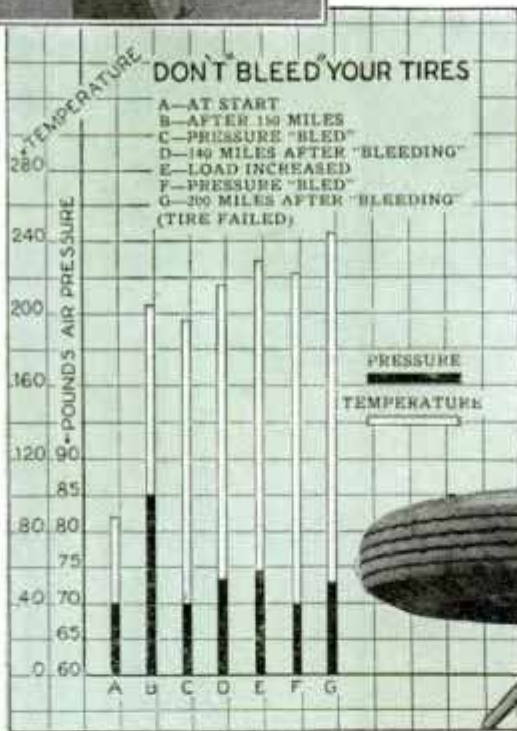

Top, Alinement Gauge in Place; Bottom, New Dynamic Wheel Balancer Simulates Road Conditions

John Dean Manufac.

HEEL AND TOE WEAR

Heel and toe wear is a saw tooth effect with one end of the tread button worn more than the other. High speed driving and excessive use of brakes will cause this type of irregular front tire wear.



Mild Case of Heel and Toe Wear. To correct use Method A



Severe Case of Heel and Toe Wear. To correct—
Use Method A if car is equipped with Rib tires front and All-Weather rear
Use Method B if car is equipped with All-Weather tires front and rear.
Use Method B if car is equipped with Rib tires front and rear

METHOD A

Do not dismount tires. Interchange front wheels.

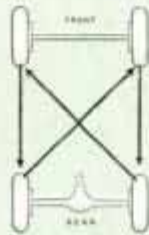
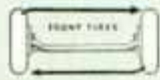

METHOD B

Change wheels without dismounting tires. Right front to right rear, right rear to left front, left front to left rear, left rear to right front.

SIDE OR CAMBER WEAR

There are two reasons why front tires wear more rapidly on the sides of the tread:

1. Front wheel camber causes front tires to run at a slight angle from the perpendicular, resulting in side wear
2. The side thrusts from rounding turns causes wear on the sides of the tread. In making a turn to the left, especially at high speed, the outside shoulder of the right front tire and the inside shoulder of the left front tire take most of the wear. The opposite shoulders are worn when taking a right hand turn.

Excessively low inflation will also help to cause side wear on front tires.

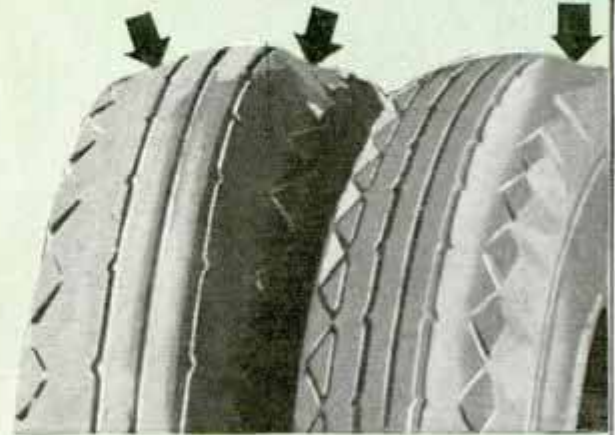

Two-Sided Wear to Correct. Use Method B

One-Sided Wear to Correct. Use Method C

METHOD C

Dismount tires from wheels. Do not turn tires around but remount on opposite front wheels without changing their direction of rotation.

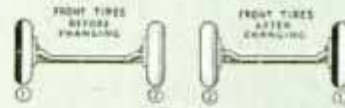

Wear due to toe-in or toe-out misalignment. Mechanical correction of the car is necessary.

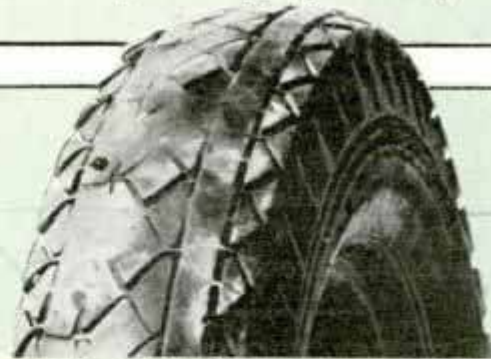

Uneven Wear—A mechanical correction of the car is the only remedy.

action" or other front-end suspension, due to certain tire frequencies, unsprung and sprung weight frequencies or bounces. Alinement of chassis also is important, since annoying vibration frequently is telegraphed to the driver and passengers, causing discomfort. Should one side member of the frame sag, the wheel base on that side becomes shorter, causing either front or rear wheels to shift and perhaps resulting in tight steering. Any car whose

rear wheels do not follow the front-wheel tracks on a straightaway course is unsafe. Checking the tracking will reveal a misalignment and this is something the owner can do. But the correction should be left to the skilled mechanic and his alinement and balancing equipment.

Shimmy in the front wheels probably is the trouble with which drivers are most familiar, since it occurs on all cars at times,

(Continued to page 155A)

Smokeless Diesel Engines

Save Fuel for Street Buses



First of Diesel Bus Fleet to Be Operated on Boston Streets; Unpleasant Gases from Exhaust Have Been Eliminated

Elimination of objectionable exhaust gases has made possible the installation of Diesel motors in buses built to operate on the streets of Boston. More economical than gasoline engines because of the saving in fuel cost and higher operating efficiency in miles per gallon, Diesel motors have not been used until recently for bus power owing to the unpleasant smoke and odor of the exhaust gases. This has been overcome in the Boston buses by a combustion chamber which enhances complete combustion and cuts to a minimum the carbon monoxide from the exhaust.

ALL-METAL WEATHER STRIP IS EASILY INSTALLED

Bronze weather strips that can be applied to windows and doors without expert aid are now available. The metal strips are offered in various styles according to purpose,

those designed for bottoms and sides of doors and windows being folded "S" shape. This provides a double spring ac-



tion and a lasting resilience that assures perpetual insulation against dust, cold, wind and snow. Window sashes can be removed to replace glass or cords without interfering with the weather strips, and the strips may be installed without removing the sash.

STEEPLE JACK PUTS NEW HAND ON GIANT CLOCK

It takes nerve to put a new minute hand on a clock when the clock is high above the sidewalks of Times Square, New York, and the minute hand is more than three times as tall as yourself.

That was the job one man had to do. Perched on a swinging seat, he braced his feet on the hour hand and guided the twenty-foot minute hand into its place in front of the big dial.



When the Clock over Times Square, New York, Needs Repair They Call in a Steeple Jack Jeweler

Swift Coach Co., Kenilworth

Eastern Massachusetts

6/150 Path 6/19/29

W. J. Henzig & Co.

Paramount Theatre

Canton, Ohio

Silver Pipes Lead Singing Class for Canaries

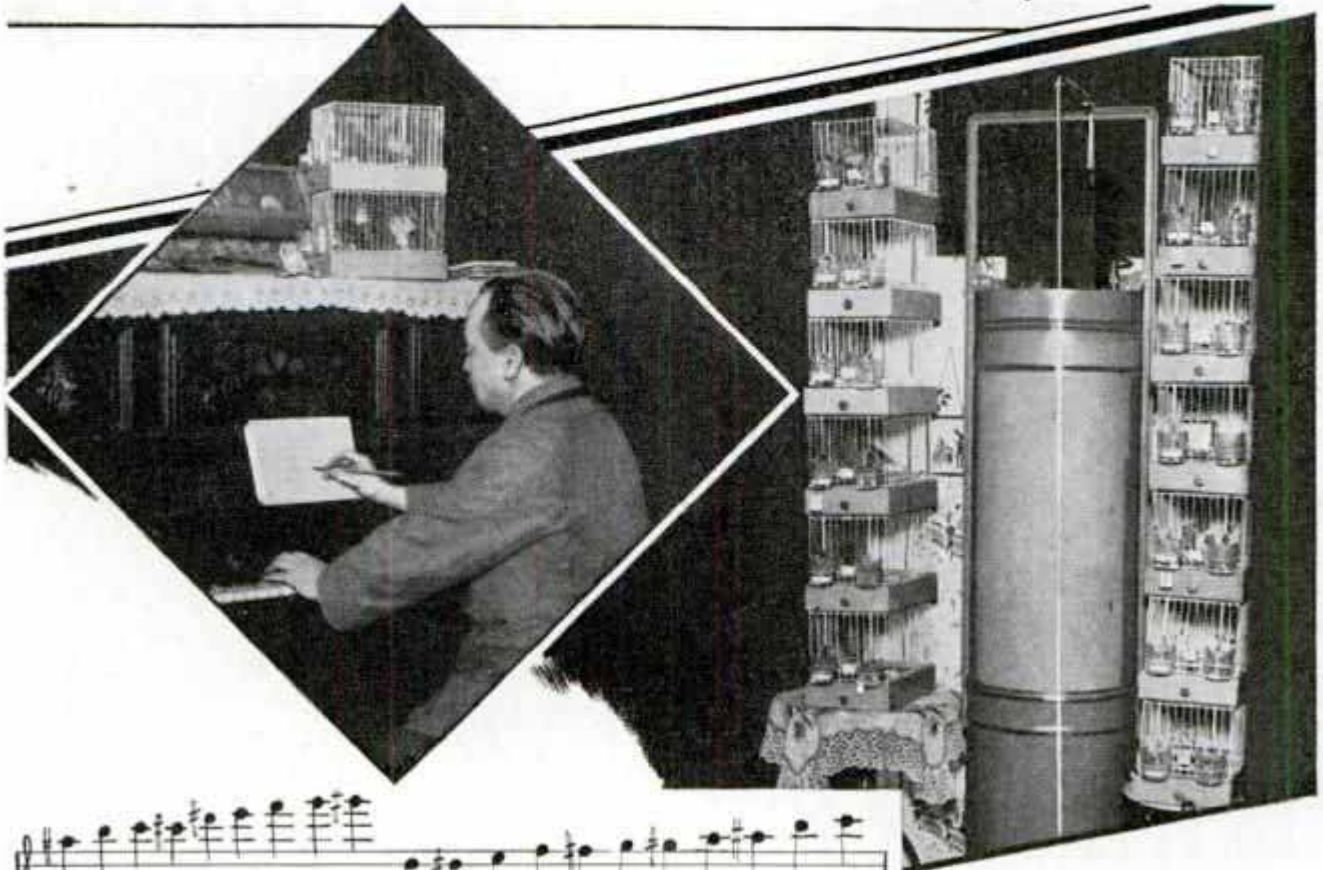

Left, Writing Canary's Song on Musical Score, Shown Below; Right, Caged Birds Are Ranged on Either Side of Metal Cylinder Which Reproduces Perfect Warbler's Melody as Example for Songster Pupils

It is time for the singing lesson in Paul Fodor's canary school at Budapest. The pupils are canaries that bark like dogs, talk and laugh like men, mock screeching cockatoos and warble like the feathered coloratura sopranos they are. From silver pipes within a tall metal cylinder come thrilling notes stolen by this mechanical "choir leader" from a little, coal-black canary with a perfect song. Birds are not always born songsters, but they can be taught. When Mr. Fodor, noted bird psychologist, breeder and song tutor, heard this black warbler's melody he determined to teach it to his canaries. By studying the "perfect warbler" for three years he memorized its trills and arpeggios and wrote the song on a musical score. Then he improved existing song-teaching mechanisms by building in an arrangement of silver pipes inside which sensitive membranes produce the characteristic trill of the canary. The sequence of pipes tuned to reproduce the melody of his perfect warbler was then ready to teach singing class. A dozen cages holding promising

songsters are hung beside the cylinder, and from its metal throat pours the lovely carol. At first the birds listen in silence, then one after another gives a shy chirrup in imitation, and in a few weeks or months they have learned the scale and the song of the mechanical "professor." Another teacher in the canary school is a wire-haired fox terrier. He growls playfully at a little green canary, which ruffles its feathers and growls back in the same tone. When the pup barks, the canary mocks him with a bark imitating the terrier's very inflection. Several birds have learned to call the name of the boy who feeds them—"Tiby! Tiby!" when he enters the room. "That is not surprising," says Mr. Fodor. "Canaries can be taught to speak like parrots, only a little more patience is needed. A German breeder has taught a canary to speak several sentences and give a certain reply to an oft-repeated question." If you tease one of Mr. Fodor's canaries with a green leaf, he will distinctly laugh "Ha-ha-ha! He-he-he!" Others copy melodies and strange sounds.

no street address.

AMUSING

8730-166 H.M. Jamaica, L.I.N.Y.



ROLL CIGARETTE
TIGHTLY IN
"CELLOPHANE"



"TWIST ENDS OF
"CELLOPHANE"

*Left, the Sponge-Ball Trick;
Above, a Simple Stunt Anyone
Can Do*

may be turned into a pronounced hit by using correct showmanship. Don't tell your audience what you are going to do, unless it's part of the routine itself. When the spectators are kept in suspense they are less likely to detect a possible clue to the stunt.

Under no circumstances should an explanation of a trick be given. The interest in it dies if the secret is exposed. There is always one "wise guy" who wants to know all the details, not because he is interested in magic, but so he can expose the trick

*Below, the Four Simple Steps
in Performing the Rubber-Band
Trick*



CUT BALLS
FROM RUBBER
SPONGES



INSERT SMALLER
BALL IN OPENING
OF LARGER BALL



By RICHARD CARDINI
Famous Magician

SOME of the easiest magical feats are the most amusing and the average person can perform them with a little study and practice. They require no expert skill or elaborate equipment but can be made very mystifying if properly done.

The success of a trick depends largely on the manner in which it is presented. An excellent trick can be spoiled by poor handling while a comparatively simple one

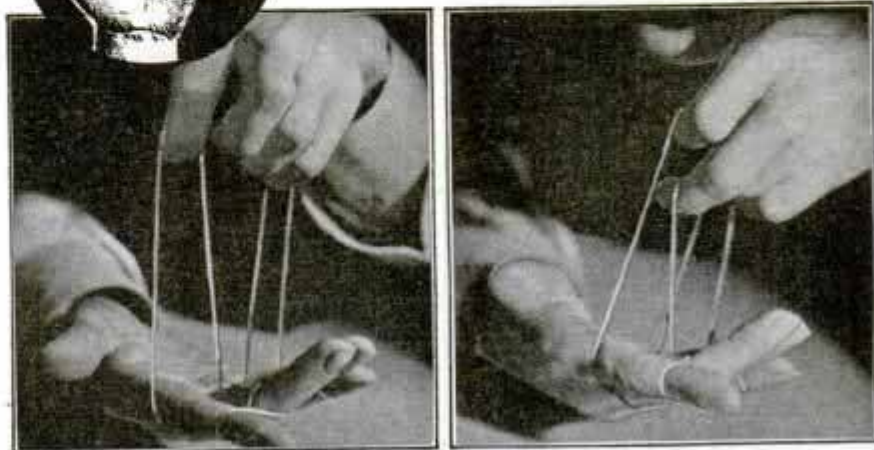

MAGIC

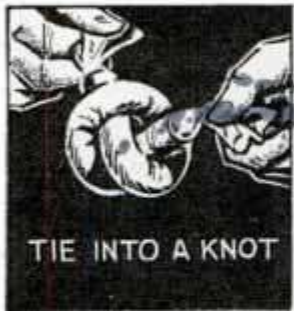

the next time he sees it.

For a starter, a very deceptive trick can be worked with a small ball of rubber sponge. Place the sponge in the palm of your hand so the audience may view it, then after showing you have nothing up your sleeve, pick it up and put it in the closed palm of a spectator. Ask him confidently if he feels the sponge growing larger, and when he answers in the affirmative have him open his hand. He will then discover he is holding two sponge balls instead of one.

The secret lies in slitting one of the sponge balls and hollowing out a part of it so a second ball may be encased in it. To enhance the mystery use a different colored sponge

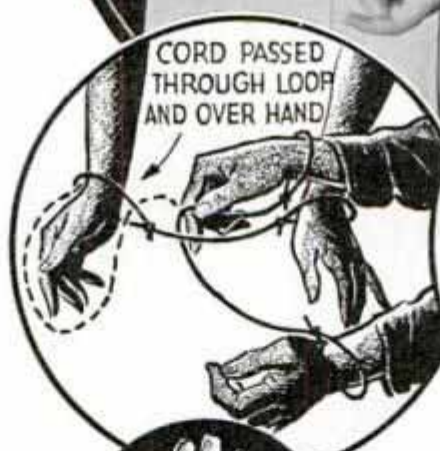

Above, "Freeing the Prisoners," an Easy but Exceptionally Mystifying Trick

for the second ball. The second one may be a bit smaller than the first, but this will scarcely be noticed when the trick is offered. As the ball is handed the spectator it is squeezed on the side opposite the slit so the inside one will work free when the hand is relaxed at the prompting of the entertainer.

In a room where lights are subdued, a dollar bill can be shrunk appreciably. Borrow two bills from a spectator and place them on the table so they may be com-

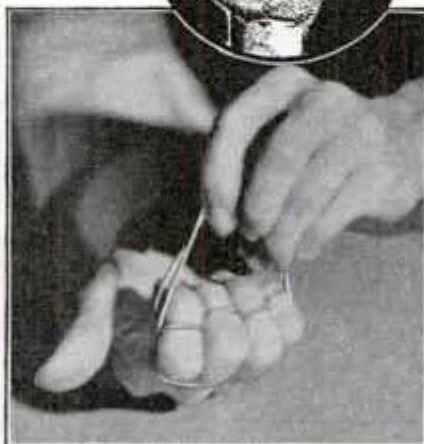
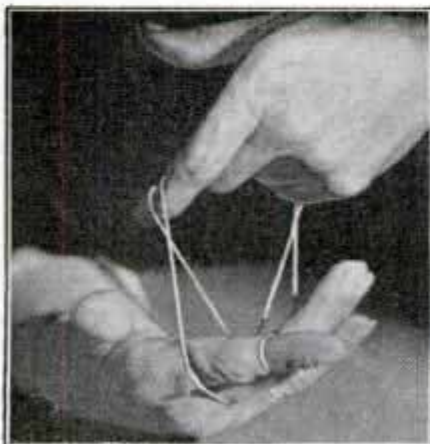



Steps in Transferring Black Mark from Back of One Hand to Palm of Other in Forming a Mysterious "X" Where Only One Diagonal Line Appeared Originally; Bottom, "Shrinking" a Dollar Bill by Kneading It between the Hands

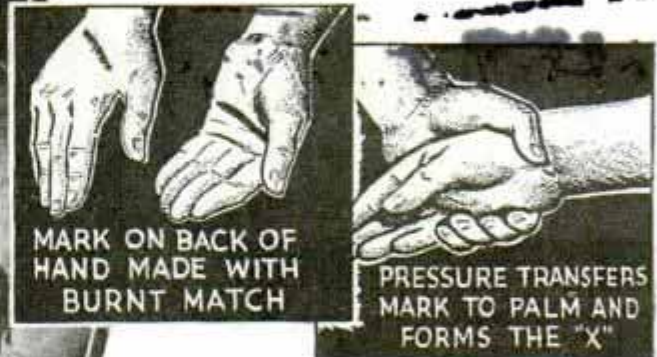

The rest of the illusion depends on the manner in which it is unfolded after wadding. As the trick progresses, care must be exercised not to smooth out the entire surface of the bill. Work diligently at flattening the corners, and press down the center area only lightly.

To give the trick an added punch at the finish, have a wadded piece of paper the size of a dollar bill concealed in the folds of your coat sleeve above the elbow. While working the trick, tug lightly at both your sleeves so your action will escape notice when you substitute the wadded paper for the bill at the climax. Pass the paper wad to a spectator, with the suggestion that he complete the stunt. To his dismay he will discover that the bill has turned to paper. A few minutes later you can "find" in one of his pockets the bill that has disappeared.

Can you take an ordinary cigarette, tie it into a knot, then untie it without breaking the paper? There's nothing complicated about it. Just remove a square piece of unwrinkled Cellophane from the outside of a cigarette package, and wrap it around the cigarette, leaving an inch margin at either end. These Cellophane ends should be twisted tightly before the cigarette is knotted. When straightened out and the Cellophane removed, the cigarette paper will be unbroken.

pared for size. The top one then should be crumpled into a tight wad. When it is unfurled it will appear to be a trifle smaller than the one left on the table. As this procedure is repeated the crumpled bill will continue to shrink in size.

The reason? The heat of your hand, coupled with the kneading process, brings about a temporary shrinkage in the bill.

With a burned match, draw a line diagonally from the third finger of your left hand across the crease in your palm. On the top side of your right hand draw another line going in the opposite direction. By placing your hands behind you mo-

mentarily, you can transfer the line from your right to your left hand, thus making an "X" on the palm of your left hand. When you place your hands behind you, close your left palm over the back of your right hand, press tightly, then rub the remainder of the line from your right hand on the back of your coat. The crease in your hand automatically forms the "X."

"Freeing the prisoners" is a good stunt for a party. The two wrists of a spectator are tied with the two ends of a piece of string by the performer. Another string is then passed through the loop between the prisoner's hands, and the entertainer allows his wrists to be bound in similar fashion. The object is to release the two strings one from the other, so the prisoners may go free.

This is done by the performer bringing the center portion of his string up through the loop encircling one of the other person's wrists, over his hand, and down through the part of the loop at the back of his wrist. The strings will become disengaged, and the prisoners can go free, when the performer simply brings the middle part of the string over the other person's hand.

Making a rubber band hop from the front two fingers to the last two is an ancient favorite with amateur performers, but working the same trick with bands of different colors, while the fingers are completely entwined with a band of still another color requires more than usual skill. The different steps in the operation are shown in the accompanying photographs.

The Heaviest Substance

Although it is lighter than either of its component elements, iridium and osmium, the mineral iridosmine is the heaviest substance found in nature. Iridium, used in making fountain pen tips, and osmium are the heaviest metals known, but, like platinum, they do not occur free in nature. Iridosmine weighs 21.12 times as much as water, a cubic foot scaling 1,320 pounds. A similar measure of osmium weighs 1,405 pounds, iridium 1,401.25 pounds, platinum 1,343.75, and gold 1,207.5 pounds. Iridosmine is found at Port Orford, Ore., and in the Ural mountains.

Visible Photo Developer Aids Control of Light Values



Enlarging Photograph by Visible Method Makes Perfect Timing Possible and Eliminates Guesswork

With a special developer now available, it is possible to print photographic enlargements by sight—using the eye instead of guesswork and experiment to gauge the exposure for perfect light values. Watching the picture develop, you know exactly when it is sufficiently dark to stop exposure. The bromide paper is soaked in the special developing solution for about a half minute, then placed under the enlarger with red filter closed. After focusing, the red filter is removed and the picture is brought out while you watch. The developer can be poured back into the bottle for use again.

Names and addresses of manufacturers and dealers in articles described in this magazine will be furnished by our Bureau of Information upon request accompanied by stamped, self-addressed envelope.

Academy of Natural Sciences

Company when on Eastern Shore

International Bureau of Information 622 W. ...

Samuel S. Gordon
Crystals & Minerals

International Bureau
622 W. ...

Odd Streamline Car Stops 'Back-Seat' Driving

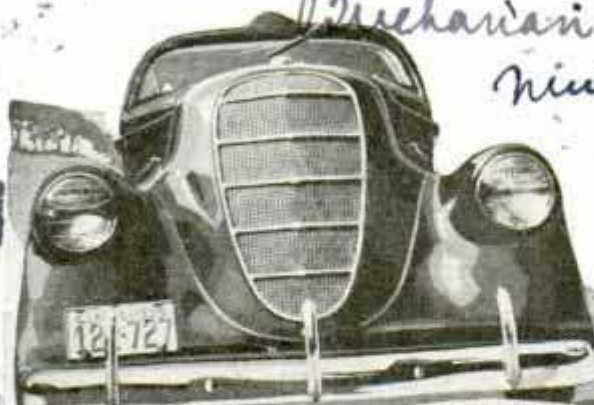

Several novel features, including a periscope that gives the driver full view of the road behind, have been incorporated into an unusual streamline car designed by Willard L. Morrison of Buchanan, Mich. The body of the car is wide in front and



Top and Bottom, Exterior Views of Car; Note Periscope at Front of the Top; Center, Interior Showing Wheel Almost under Dash



CAMERA THAT THINKS FOR YOU HAS EXPOSURE METER

Your camera can be made to do part of your thinking in taking pictures if it is equipped with an exposure meter to measure light intensity,

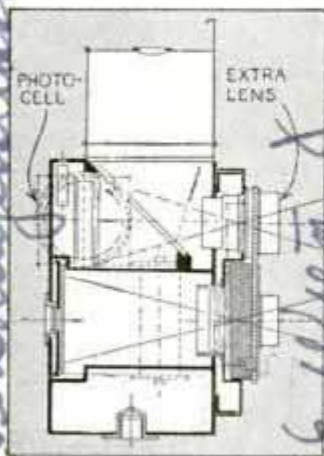

The meter contains an electric eye and the photo-cell, attached to the camera, receives the same picture as the film or plate, the colors of the subject being transformed automatically by the meter into their correct light values. An extra lens above the regular lens passes the light to the electric eye.

tapers toward the rear, permitting the seating of three persons in the front and only two in the back seat. But the rear seat is set so low that its occupants cannot see the road, eliminating "back-seat" driving. The windshield is set closer to the driver's face, giving him improved vision. The steering wheel is under the cowl and forward of the windshield. The spare wheel is so arranged at the rear of the car that it takes all the shock of a rear-end collision. To prevent the possibility of gasoline being stolen while the car is parked and locked, the filler cap outside can be opened only from the inside of the car. The tapering body is said to reduce wind resistance considerably, compared to the conventional automobile, particularly in the higher-speed ranges.

9/2/35
21031
\$835,000 for Paint

THE new Oakland-San Francisco bridge takes as much paint as would be required to cover 20,000 five-room dwellings—a middle-sized city. The bridge builders will have an \$835,000 paint bill to pay. Four coats are necessary, the first three being ordinary lead paint, topped off with a final aluminum coat. In all, 200,000 gallons of paint will be used.

21097
**AUTO HEATER AND DEFROSTER
KEEPS WINDSHIELD CLEAR**

Mounted so it is flush with the dash, a hot-water heater for the automobile includes a detachable hot-air windshield defroster. It is also equipped with a hot-water trap which converts the heater into a hot-water boiler which operates like a home heating system. Usually increased car speed boosts the speed of the water pump which sucks water through the heater too fast to heat properly. The water trap prevents this, for the faster the

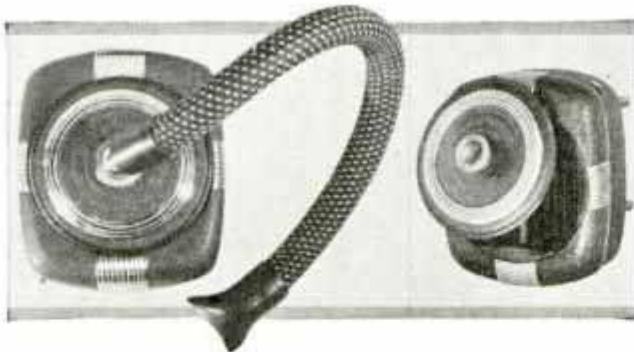

Auto Heater and Defrosting Tube Attached to It to Keep Windshield Clear in Winter

car is driven, up to fifty-five miles per hour, the greater the actual heat produced. A deflector can be set to throw the heat in any direction and the noiseless motor requires no oil. The rubber defrosting tube is attached to the heater by removing a center ornament, and the defrosting end of the tube is attached to the windshield with a suction cup. The hot air removes frost from inside the windshield and melts snow and ice outside enough to allow the windshield wiper to operate. When not in use the disconnected tube is hung on brackets under the dash.

*The P. F. Isodred
C. P. ...*

2998
**Motor Hussar in Gas Mask
Replaces Cavalryman**



Wido Wolla
**Ready for Any Emergency, This Trooper Sets Out
on Scouting Duty in Maneuvers**

Replacing the cavalryman of other days, the "motor hussar" of Germany's motorcycle corps is a formidable fighter. Protected by gas mask, he can drive his heavy-duty cycle over rough country on almost any mission. The motorcycle is constructed to withstand the hardest usage, adapting it to war service.

21073
**STEEL RULE HAS POCKET CLIP
FOR USE AS DEPTH GAUGE**

For machinists and engineers requiring precision in a small rule, there is a six-inch steel rule with a sliding vest-pocket clip whose "T"-shaped top can be used for a depth gauge. One side of the rule is calibrated in thirty-seconds and the other sixty-fourths of an inch.

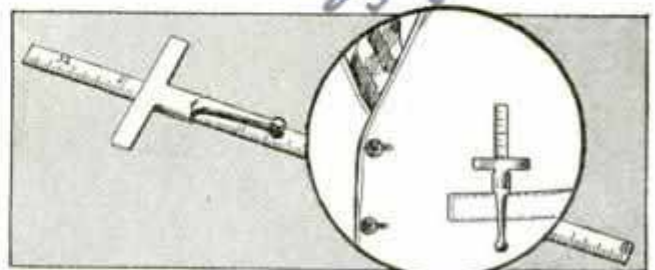

**Precision Rule Has Sliding Vest-Pocket Clip with
"T" Top Handy for Measuring inside Pipes**

*Miller Falls, C.
Greenfield, Mass*

6848

Mr. C. S. Culman
% Pictograms Co Box 682
Washington DC

WHAT'S IT

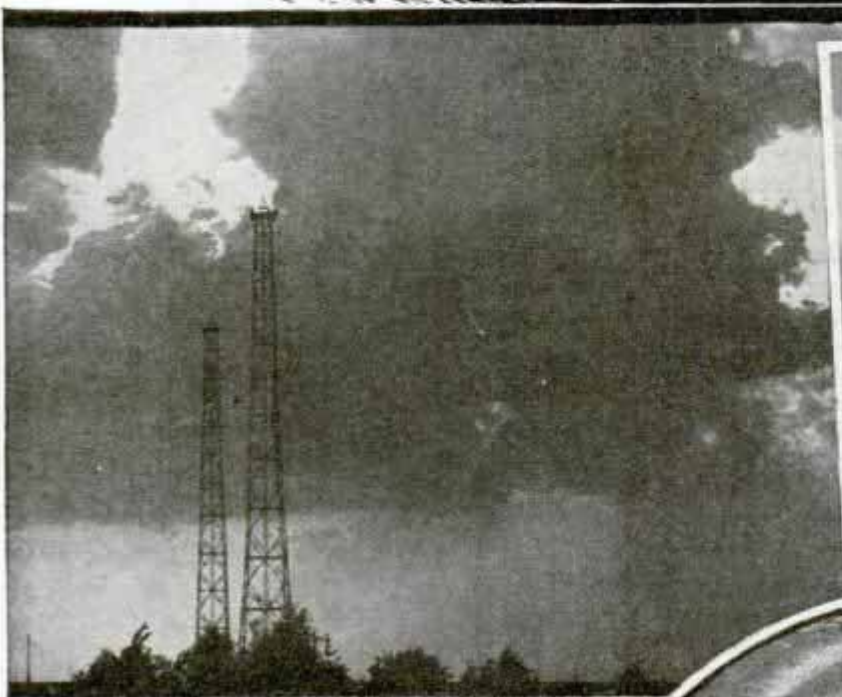

Top, Left, "Backstays of the Sun," a Sailor's Sign of Stormy Weather; Top, Right, "When the Clouds Are Upon the Hills, They'll Come Down by the Mills" —as Rain



"The Moon with a Circle Brings Water in Her Beak"

THE amateur weather forecaster, like the professional, should always make his predictions from a current weather map if possible. No amount of skill in interpreting local indications of coming weather can fully replace this picture of atmospheric conditions as distributed over the country.

It will often happen, however, that neither a map nor the information necessary to draw one is at hand. Then the prophet must depend on the old-fashioned rules for reading local weather "signs." Some of these are fairly reliable but the majority are not. Prof. W. I. Milham has divided the traditional weather proverbs and sayings into five classes, of which he writes:

"The first two are fairly well founded, while the last three are mere superstitions. The first class includes those that infer an impending weather change from the sky appearance and something connected with

the meteorological elements; for example: 'A rainbow in the morning is the shepherd's warning; a rainbow at night is the shepherd's delight.' 'Mackerel sky and mare's-tails make lofty ships carry low sails.'

"The second class of weather proverbs includes those that infer the coming weather from the behavior of animals, plants and inanimate things. The coming of a low, with its rain area and shifting

A SIGN OF ?



Top, "a Rainbow in the Morning Is the Shepherd's Warning"; Below, Mr. Groundhog, Weather Omen

Pimpernel, the "Poor Man's Weather Glass," and Old Moon in Arms of New, Sign of Bad Weather

winds, is usually heralded by an increase of temperature and moisture and a decrease of barometric pressure. The increase in temperature and moisture often causes a change in the behavior of animals. Drains are said to smell before rain, which may simply mean that the lower pressure causes some of the air to escape from them.

"The three classes of weather proverbs



Left, a "High Dawn" or the Breaking of Day over a Bank of Clouds, Supposed to Indicate Wind; Below, Drooping of Leaves of Paternoster Pea, Supposed to Foretell Bad Weather

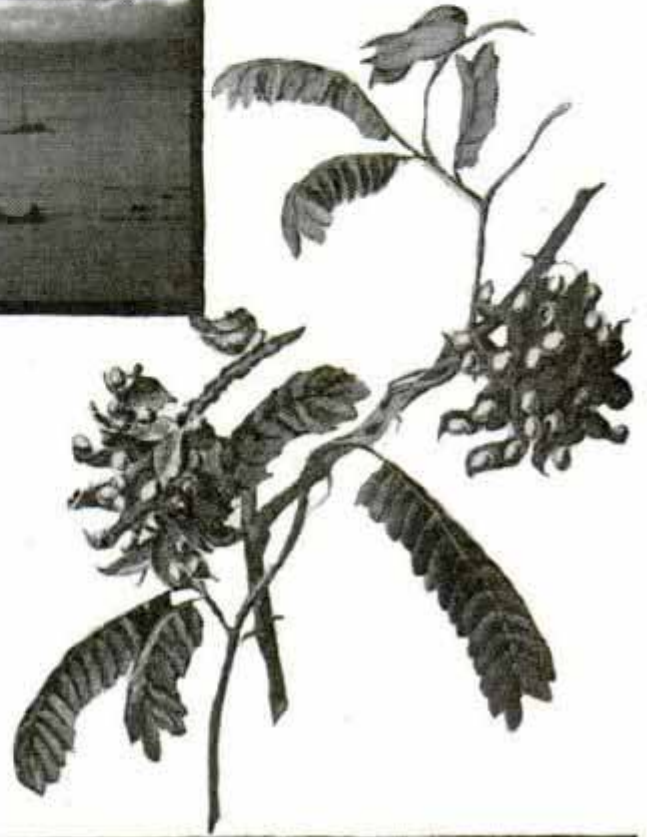

that have no scientific basis whatever are those that infer the future weather at some distant date from the actions of animals or plants; those that infer the distant future weather from the weather at some previous time, and those that infer the weather from some astronomical body. The following are examples: 'Squirrels gather more nuts before a hard winter.' 'If it rains St. Swithin's day, it will rain forty days.' 'The moon and the weather change together.'

Many alleged portents of the weather far in advance are familiar because the newspapers exploit them. On the fifteenth of July, the St. Swithin's day tradition figures in the papers. Every autumn we read what the rural sages say about the following winter, as inferred from observations of plants and animals. Groundhog day has received a steadily increasing amount of newspaper attention. Few realize that, except at zoos, groundhogs never see their shadows on February second, because they hibernate underground until well after that date.

The best of the sound weather proverbs do not hold good for more than a day or so ahead, and many for not more than a few hours. The facts on which they are based are mostly revealed by weather maps, which show just why certain sequences of weather events tend to occur. The maps show, for example, that cirrus clouds or "mare's-tails" often stream far

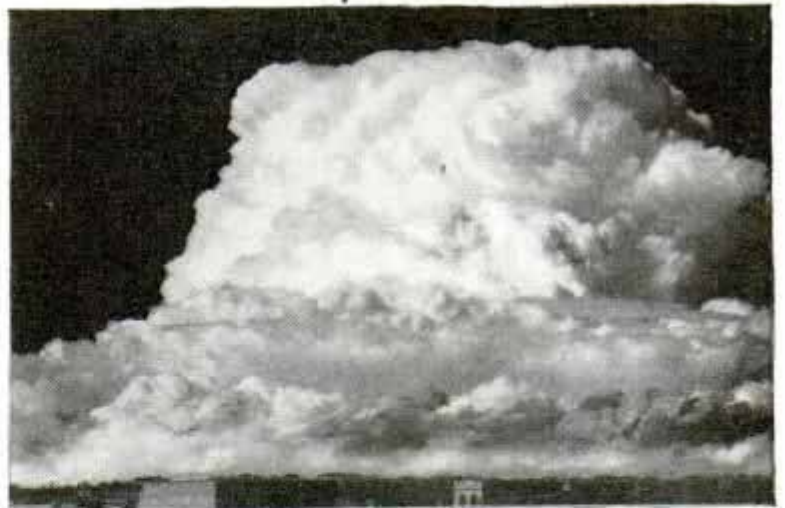

When Clouds Appear "Like Rocks and Towers," Says the Couplet, It's a Sign of Frequent Showers

out in front of a cyclonic storm, so their appearance frequently is the first token of stormy weather. Similarly, old sayings about the significance of rings around the sun and moon, the backing and veering of the wind and the formation of cloud caps on mountains merely describe details in

(Continued to page 116A)

Queer Washer Improves the Looks of Fruit

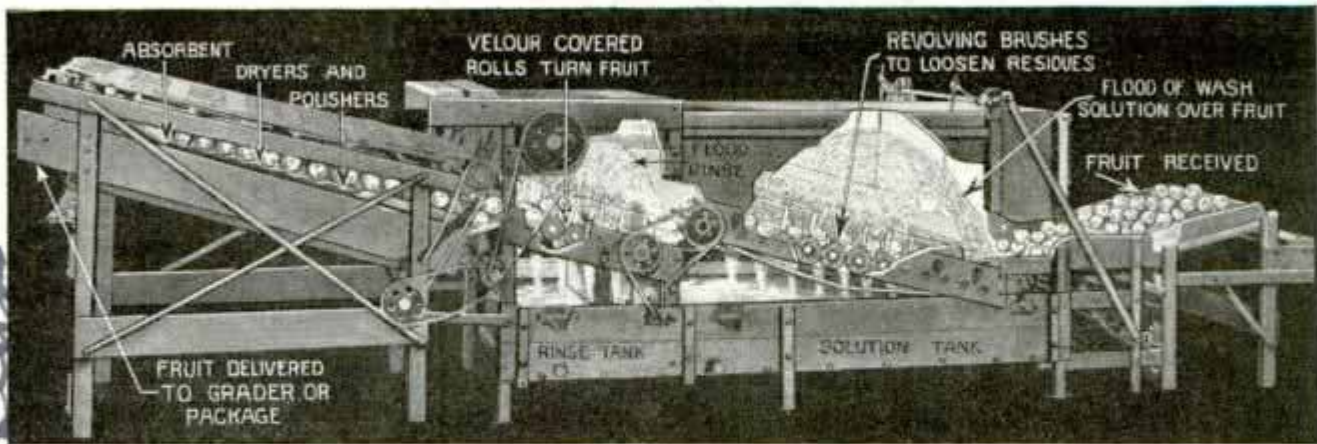

Cutaway View of the Bean Fruit Washer, Showing How Fruit Is Fed into the Machine, Scrubbed and Dried, Then Delivered to Packaging Platform; Sales Appeal Is Increased by This Treatment

Increasing the sales of fruit by improving its appearance is practical, it has been found in governmental and growers' tests in which washing machines have been used. In addition to cleansing the fruit, these machines also dry and polish it, resulting in greater sales appeal. The flood-type washer contains brushes which help to remove dirt, insects and poison spray used to protect the fruit. The brushes provide a gentle scrubbing action that cleans all exposed surfaces. Emptied into a receiving hopper, the fruit passes through a wash solution, a rinse tank, then over a drying section and from there to a grader or packaging machine.

JACKET OF REFRIGERATOR UNIT MAKES DEFROSTING SIMPLE

To defrost the refrigerator it is no longer necessary to turn off the current and let the accumulation of ice melt away. An Ohio inventor has devised a sheet-metal jacket that fits around the cold unit containing ice trays. When the frost has collected on this jacket, the entire cover is quickly removed by turning a handle and can be cleaned under a faucet, dried and replaced within a few minutes. Refrigerator temperature is unaffected and there is no return to the food chest of vapors as the frost melts.

Sliding Truck Bed Speeds Up Loading and Unloading

By equipping the truck with a sliding bed, operators can speed up the loading and unloading of machinery and other heavy loads. In tests, weights equivalent to heavy machinery have been loaded and unloaded in two minutes by one man. The bed is a large platform built up of tubular members which slide on the truck body on the skid principle. A winch moves the platform off the truck, then pulls it back after loading. Machinery weighing from three to ten tons can be handled easily. The skid can be made to fit trucks of any size or model.

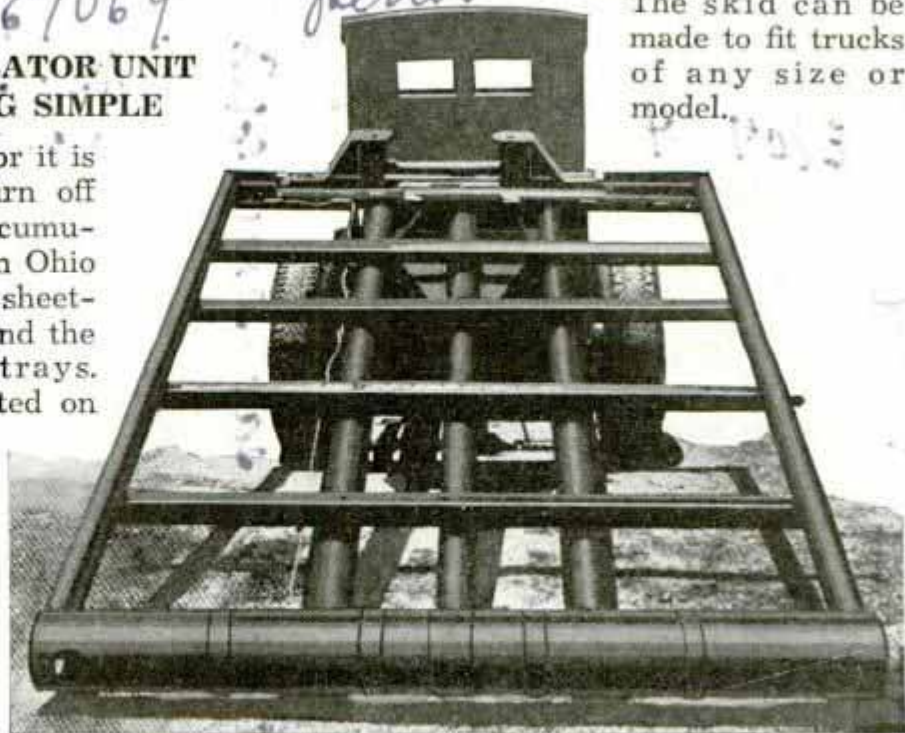

Rear View of Sliding Truck Body Which Makes Loading and Unloading of Heavy Objects Easy; It Fits Any Truck

Handwritten text on the left margin: 'Johnathan F. Fretter 3799 Monte Vista Ave Cleveland, Ohio'.

Handwritten text at the top: 'Johnathan F. Fretter' and 'Lansing, Mich.'.

Handwritten number: '21030'.

Handwritten text at the bottom left: 'Cleveland, Ohio'.

Handwritten text at the bottom right: 'Sliding Truck Bed Co.'.

Flying Dog in Parachute Box Set Free When It Hits Ground



Cylinder Attached to Parachute Is Dropped from Plane and Springs Open on Striking Land, Releasing Dog Trained to Perform Task

"Bird" dogs of a new kind are the parachute jumpers being trained by the army in Soviet Russia. Taken aloft in planes, they are flown to the scene of action, placed in cylindrical boxes with parachutes attached, and then dropped. When the "flying dog house" touches the ground, the impact releases a spring and the cylinder opens, setting the dog free to perform the task for which it has been specifically trained.

"Homing" Plane Is Guided by Team of Robots

Radio compass and automatic pilot are teaming up to take the business of flying a plane out of human hands. The navigator of the crew is the radio compass; the Sperry Gyropilot does the rest of the work. Both instruments are already in use, and now tests are progressing on a connecting link that will harness the two robots together. By means of the radio compass a plane can tune in on any radio broadcasting station and the ship will automatically turn and fly straight for the station aerials. The Gyropilot then takes over the control of the flight. Its two

gyroscopes regulate stability and keep the plane level, and when pointed by the human pilot will maintain its direction on a predetermined course.

HOME GAS SUPPLY IS GENERATED BY BURNING WASTE

Gas to heat and light your home and operate its "utilities" is now being generated in a home unit that uses purely waste materials for fuel. It is an individual gas-making plant that distills refuse, wood, paper, corn cobs, straw—anything that burns—and produces a smokeless gas that can be piped from a basement storage tank to the kitchen stove, refrigerator, radiators, lights, washing machine and power plant. Economical in its fuel consumption, it can turn two tons of farm waste or one cord of wood into gas sufficient for nearly three months of home use. The generator consists of an alloy metal retort in a semi-steel furnace, a gas purifier, steel storage tank, pipes, valves and gauges.

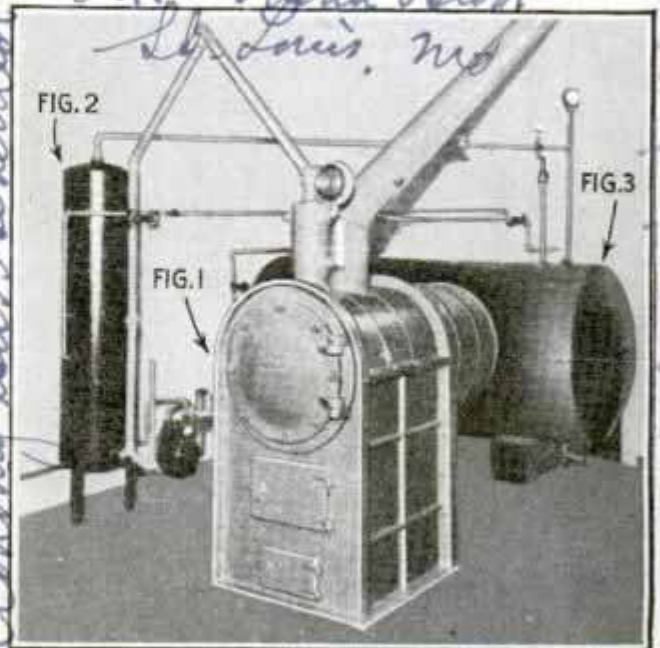

Fig. 1, Retort Enclosed in Semi-Steel Furnace; Fig. 2, Gas Purifier; Fig. 3, Gas Storage Tank

Sperry Gyrocompass Co. Inc. 1012 Broadway N.Y.

E/081

E/09 4

5 N. Grand Blvd St. Louis, Mo

Out of business 10/21/37

Longer Range of Diesel Plane Cuts Fuel Cost

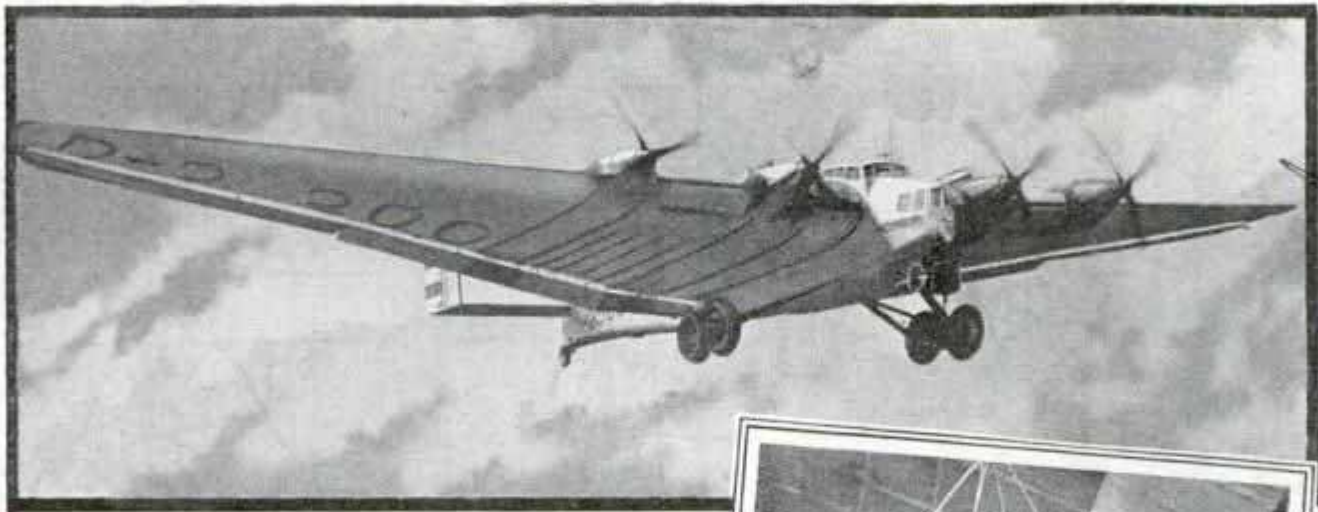

Diesel motors weighing 2.79 pounds per horsepower have proved themselves more economical for long-range aircraft transportation than relatively lighter gasoline engines of equal power. The "Hindenburg," latest transport built for a German air line, is powered by four such Diesel motors developing 750 horsepower at 1,620 revolutions per minute and at current prices its fuel bill is only one-fourth as high as if gasoline motors were installed. Not only is oil less expensive, but less fuel is consumed, with the result that gross weights of motor plus fuel for both types of engine are equal on a trip of about five hours. On longer flights, the Diesel shows an operating advantage offsetting the weight objections. The "Hindenburg" is a Junkers monoplane, sister ship of the "Deutschland," already in service.



Top, Diesel-Powered German Plane in Flight; Bottom, Hoisting Diesel Unit Aboard the "Hindenburg"

Junkers Flugzeugwerke A.G. Dessau Germany

3828 N. Oakley Chicago

BURGLAR ALARM ON DOOR CHAIN RINGS WHEN IT IS MOVED

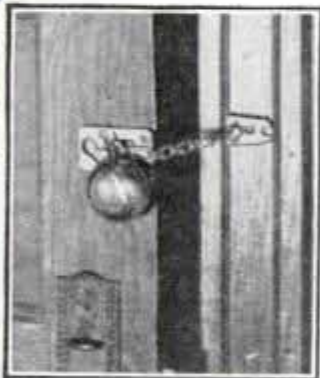

Immediate warning of the presence of an intruder attempting to force open a door is provided if the door is fitted with a burglar alarm in the form of a bell attached to a latch chain. The chain prevents the door from opening and the bell rings as the door is moved inward.

Adept Signal

Lightning Easy to Miss

LIGHTNING is beautiful and dangerous—but the rug on your parlor floor is much more likely to do you bodily harm. You might as well enjoy the spectacle of lightning and banish worry, for George Bliss of the Philadelphia weather bureau estimates that only one bolt in 100 hits the earth. As often as not, lightning courses upward instead of earthward. Your chance of being struck is less than one in 200,000—it is three times as probable you'll be hurt tripping over that rug!

Chicago Daily News 8/13/35

1045

1048

6953

DON'TS *for*



Left, This Hunter Keeps the Muzzle of His Gun Away from Himself and His Dog

ment, careless upland game hunters who blithely attempt to hurdle fences with loaded guns, and waterfowl hunters who drag loaded guns into boats are in the group that cause hurry-up calls for the ambulance. The "I-didn't-know-it-was-loaded" boys do their part to pile up the hunting accident list as do the "I-thought-it-was-a-

EACH autumn approximately 7,000,000 sportsmen in the United States take to the open to hunt. The open season unfortunately marks another "opening," the beginning of casualties that bring death and suffering to the hunting army.

Hunters, careless in the handling of rifles, shotguns and rowboats, annually cause many accidents and deaths in the ranks of sportsmen. In some sections of the country there are hunters actually afraid to go afield because of too many "quick trigger" artists. Nearly every state which licenses hunters faces this problem of reducing hunting accidents.

The majority of accidents are preventable, especially those involving guns. Rookie hunters handling new guns, inexperienced shooters suffering from excite-

ment, careless upland game hunters who blithely attempt to hurdle fences with loaded guns, and waterfowl hunters who drag loaded guns into boats are in the group that cause hurry-up calls for the ambulance. The "I-didn't-know-it-was-loaded" boys do their part to pile up the hunting accident list as do the "I-thought-it-was-a-

deer" group. There have been so many quick trigger shooters in parts of the wild deer country that some hunters consider it dangerous to even carry a white handkerchief in the woods during the open season, because a careless hunter may take the flash of white for the flag of a deer, shoot in haste and repent later.

Here are some practical "hunting don'ts" which all of us who like to hunt should keep in mind. The "don'ts" refer to the common ways in which hunters get into trouble while on a shooting trip. All represent carelessness of the first order and point the way for the hunter to wear a halo and a harp if he doesn't change his tactics. For the small game hunter these hints are important.

Don't climb over a fence while using

HUNTERS

By
BOB BECKER

c/o Chicago Tribune Chicago

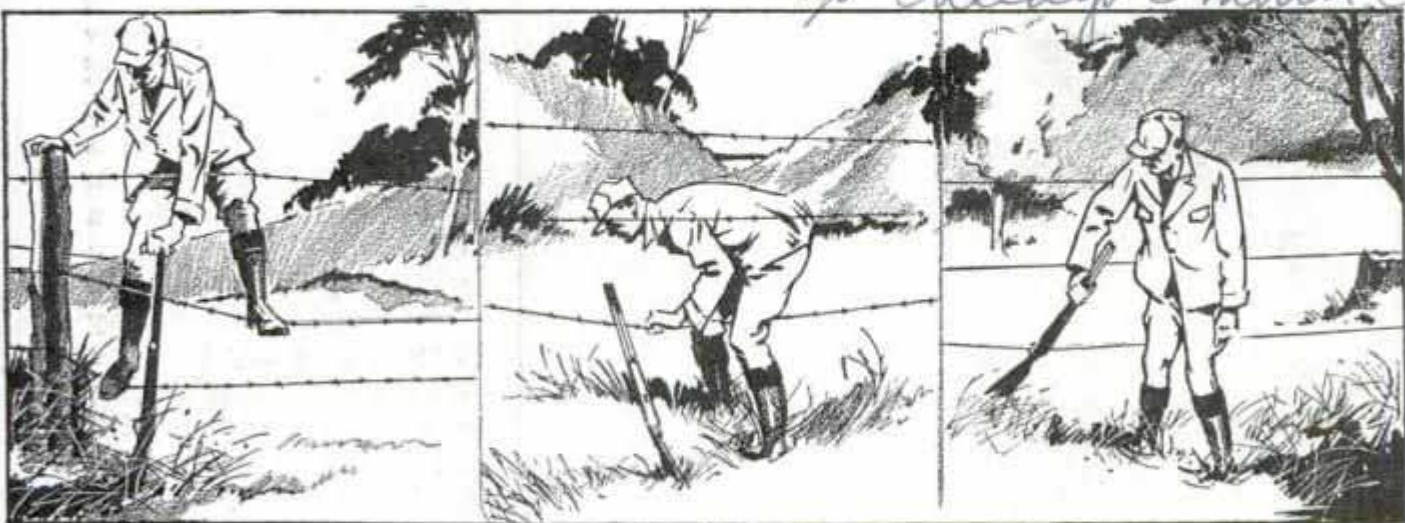

Above, Don't Do Any of These Stunts with Your Gun if You Want to Get Home Alive

your loaded shotgun or rifle as a support. This is an excellent way to get rid of one of your hands. The real hunter never uses his gun for a "pole vaulting stick" or as a crutch to climb over a barbed-wire fence. A shotgun should not be used as a support or as a hammer to pound a nail.

Don't take a "rest" by leaning on the muzzle of a loaded gun. This is a too common practice among careless or inexperienced hunters. If you want your arms or hands to remain with you, it's a good idea to keep them a safe distance from the muzzle.

Don't crawl through a fence and then pull your loaded gun, muzzle first, toward you. The fact that a twelve-gauge shotgun can blow a three-inch hole in a piece of wood should be enough to discourage any rookie hunter from trying to pull one through a fence. If hunting with a partner, hand your gun to him to hold while you go through the fence. Then he can hand your gun and



These Prairie Chicken Hunters Are Not Careless; They Have Loaded Guns but They Are Carrying the Weapons Safely

his over the fence, muzzle up and at an angle, and pointed away from both of you. The safest way is to unload both guns. When using a double-barreled gun "break" the gun so no discharge can be made while the weapon is being handed around. If hunting alone, place the shotgun or rifle on the ground parallel with the fence and underneath the lowest strand



their gun almost horizontal with the ground, the muzzle pointing toward the next fellow in line. The sudden flush of a bird, the involuntary tightening or jerking of the trigger finger due to excitement—and there is another accident. If you want to be ready for a quick shot, carry the gun almost perpendicular to the ground. Another easy way is to carry the gun on the right shoulder, or carry the weapon with both hands on the gun and point the muzzle down.

Don't rest a loaded gun against a tree when you sit down for a rest, especially if there are dogs in the party. Several accidents occur every year from the discharge of

of wire, cross over, then pick it up, the muzzle pointing away from you.

Don't crawl through a fence with your gun while doing a lot of acrobatic squirming in the wire. Sometimes a careless hunter parts the two lower strands of wire to open up space enough to get through. Then he rests his gun on the lowest strand and eases through, bringing the gun along, facing the risk of accidental discharge if the trigger gets caught on the wire.

Don't carry your loaded gun in the crook of an arm so it points at somebody else in your party. Many shooters walk along,

guns knocked over by hunting dogs. Guns should be rested in a safe place out of the dirt, but the wise hunter unloads first.

Don't unload your gun among hunters with the muzzle pointing anywhere but down. The reason is obvious.

(Continued to page 138A)

Top, Guns Carried Safely but Ready for Use; Center, Shotgun Pointing Away from Hunter as He Unloads Boat; Bottom, Shooter at Left Has "Broken" His Gun for Safety

Making HOME TASKS



Handy Grinding Machine Turns Odds and Ends of Soap into Flakes for Washing



Above, Small Wheel on Top of Wringer Can Be Turned to Regulate Pressure of the Rolls; Left, Handy Machine for the Home Scrapes, Waxes and Polishes Floors; Below (Center), Lightweight Vacuum Cleaner Actually Is an Electric Broom; It Speeds Up the Task of House Cleaning

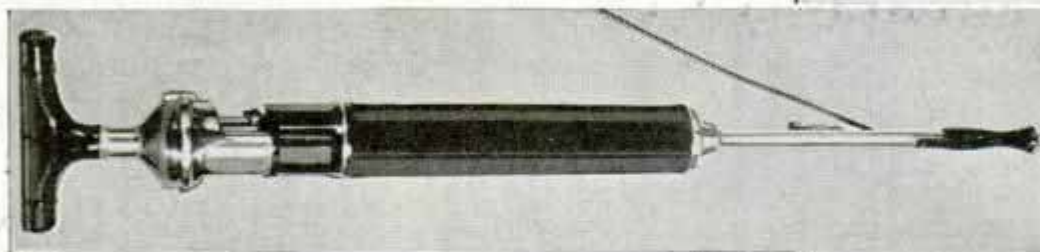

Left, Bucket with Partition Is Used in Cleaning; Soapy Water Is Kept on One Side, Clear Water on the Other; Right, Small Humidifier Attaches to Radiator and Plugs into Electric Socket; It Operates Silently

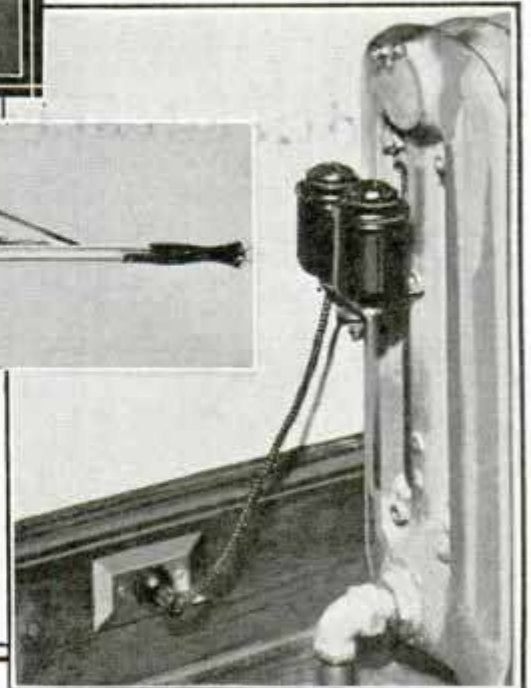

a PLEASURE



Above and Right, Two-Purpose Lamp; for Bridge, the Arm Is Inverted to Light Room Indirectly; One Bulb Is Controlled by Mercury Switch That Makes Contact When Arm Is Turned



Below, Ventilating Fan Is Installed Directly into the Window Glass; It Requires No Special Screen and Is Fully Automatic in Operation

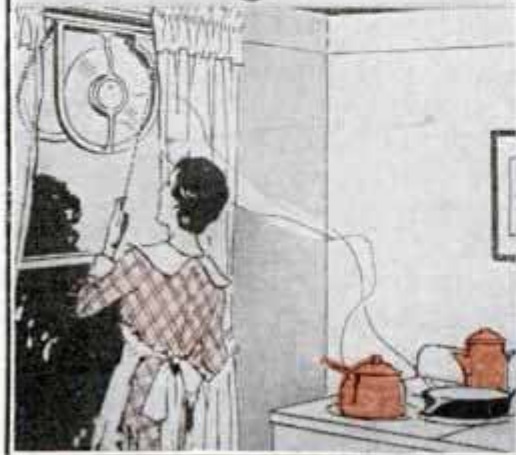
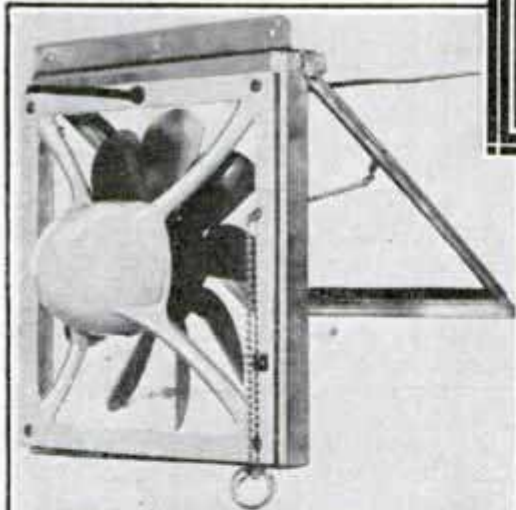

Right, Picture-Hanging Device with Two Points for Attaching to Back of Frame Has a Third Nail for Fastening to Wall; It Eliminates Wires, Screws and Brads; Bottom, Washer Expands When inside Bottle to Make Cleaning Easier; Turning Handle Lines Up the Two Brushes and Forces Bristles against Sides of Bottle

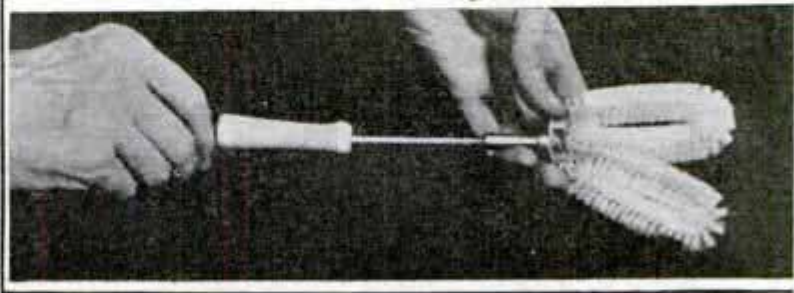
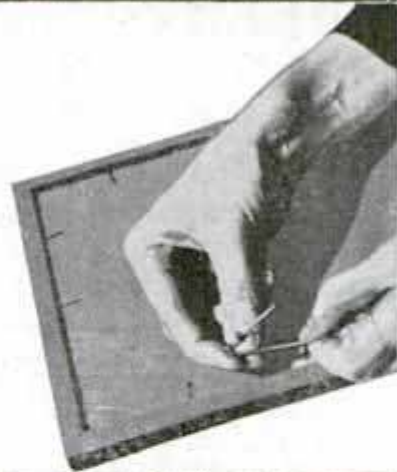

1889
 20
 23
 24
 25
 26
 27
 28
 29
 30
 31
 32
 33
 34
 35
 36
 37
 38
 39
 40
 41
 42
 43
 44
 45
 46
 47
 48
 49
 50
 51
 52
 53
 54
 55
 56
 57
 58
 59
 60
 61
 62
 63
 64
 65
 66
 67
 68
 69
 70
 71
 72
 73
 74
 75
 76
 77
 78
 79
 80
 81
 82
 83
 84
 85
 86
 87
 88
 89
 90
 91
 92
 93
 94
 95
 96
 97
 98
 99
 100

MOVIE OF FAULTY CAR WHEEL SHOWS WHY TRAIN SWAYS

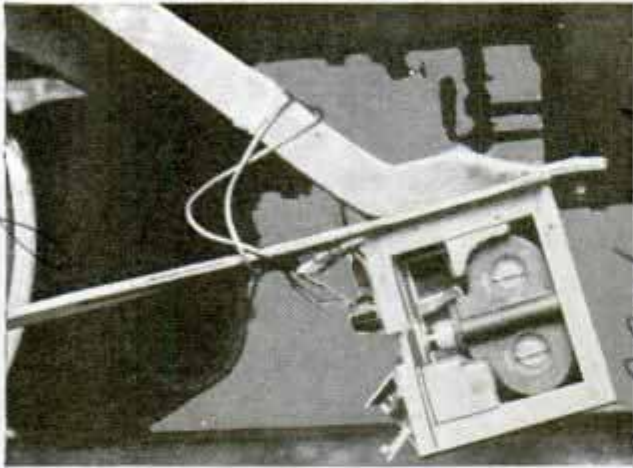

Slow-Motion Camera Attached to Car Truck Is Focused at Point Where Wheel Touches Track

Slow motion pictures of car wheels rolling along the rails a mile a minute are helping railroads improve the riding qualities of fast trains. Truck oscillations became a problem as time-tables of a railroad out of Chicago were speeded, and engineers decided to study the wheels with a slow-motion sixteen-millimeter camera. Bracketed on a troublesome truck, it was focused on the point where wheel touched rail. At sixty miles an hour, solenoid control started the camera. Pictures of a worn and a new wheel showed both oscillated. It was found the ride could be made smoother by building wheels without the taper previously standard for railway wheels. Motion pictures of the re-designed wheel showed no oscillation, and the flange seldom impinged on the rail on straight track. As a result of the photographic study, this railroad builds all new wheels without taper.

LONG-WEARING PISTON RING HAS NON-FRICTION BANDS



Constructed with anti-friction alloy inserts that give longer service and reduce cylinder wear, a new piston ring is available for automobile and industrial engines. The ring is made of cast iron, with bands of bearing metal pressed into the side under great pressure. When the

engine is operated, the bearing rings bur-nish the sides of the cylinder and assure better compression. The piston ring seats gradually and prevents excessive wear of cylinder walls. In case of ring breakage, the rings or bands hold the ring together so that the pieces will not get into the cylinder and score the walls.

SUCTION CUP PENHOLDER IS MADE OF RUBBER

Made of rubber, a small fountain penholder for the desk employs two suction cups to accomplish its purpose. One cup in the base holds the device securely to any smooth surface. The second cup holds the cap of any make of fountain pen. With the cap in the holder, it is a simple matter to insert the fountain pen in the cap when not in use, thus preventing the pen from dropping ink, drying up or leaking, but making it always available when needed. It is particularly adapted to those who use a pen out of the office, where it may be mislaid, since the holder can be carried easily in a pocket.

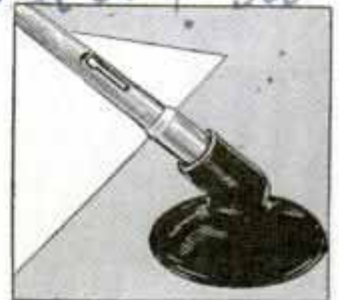

X-RAY PRODUCES REGAL LILY OF UNUSUAL BEAUTY

Experiments at the General Electric company research laboratories to determine the biological effects of X-rays on certain bulbs have resulted in the production of the Roentgen regal lily, a flower of unusual beauty for which a patent application has been filed. The new form was found among the bulbs of ordinary lilies X-rayed by Dr. C. N. Moore and is a "nondehiscent" variety, which means that the anthers do not open and shed their pollen, a great advantage for commercial growers since the pollen falling on the petals often ruins flowers for display purposes. The anthers of the X-ray lily swell but do not burst. It has been found that the X-raying produces many abnormalities and monstrosities, but once in a while a new and improved strain results.

*Regl. Howell Co 1881
Larchmont Ave Chicago*

*29th Milwaukee Ave
Chicago 52*

1091

1101

2009360

The Skinner Chuck Co.



Oscilight TELEVISION Receiver

CLEAR black-and-white television pictures, transmitted by radio and reproduced on a cathode-ray tube with accompanying sound, were exhibited recently at the studios of Farnsworth Television, Inc. Although this demonstration was highly successful, the actual introduction of television in the home will probably be delayed for many months, owing to problems of transmission rather than reception.

Mr. Farnsworth states that "as soon as technical information can be released, amateurs will have an opportunity to make re-
(Continued to page 146A)



FLUORESCENT SCREEN

PICTURE CONTRAST CONTROL

FRONT VIEW OF SCANNING UNIT

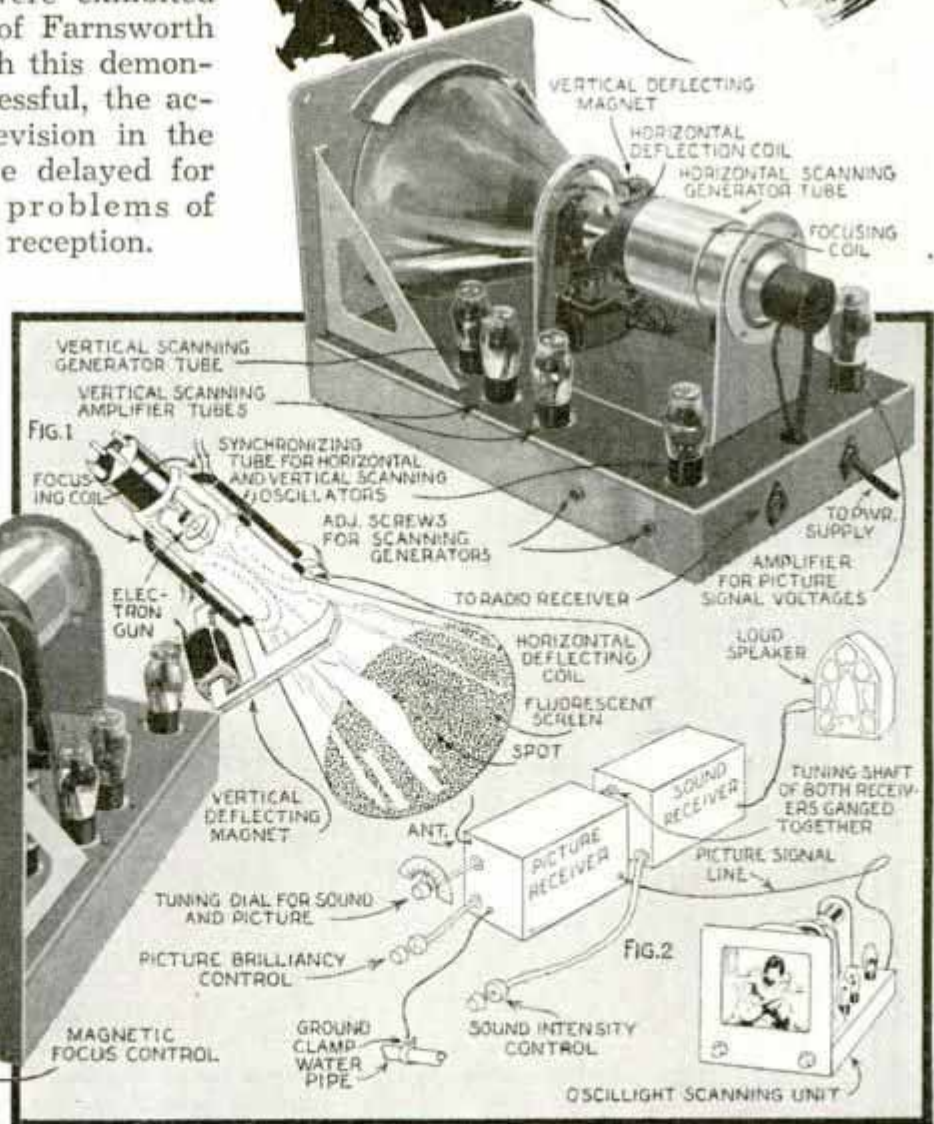

You Can Make Money

By W. C. HOWE

BUILDING your own amplifier—testing it, selling or renting it—brings to you a satisfaction of personal achievement well worth the time and effort. The 30-watt amplifier to be described is designed in two major units which can be assembled on a rack-and-panel or broad shelf for permanent installation, or it can be made portable easily by mounting in a two-compartment carrying case.

The usual rental charge for the use of an amplifier of this type with three speakers, a microphone, and a phonoturntable with an operator's service is \$15 per evening or \$75 for a week of fifty hours. County fairs, dances, bazaars, basketball tournaments, dog shows and special holiday publicity for merchants suggest a few of the ready markets for this profitable service. Capable of producing 30 watts of distortionless sound, with excellent tone, the output of this amplifier

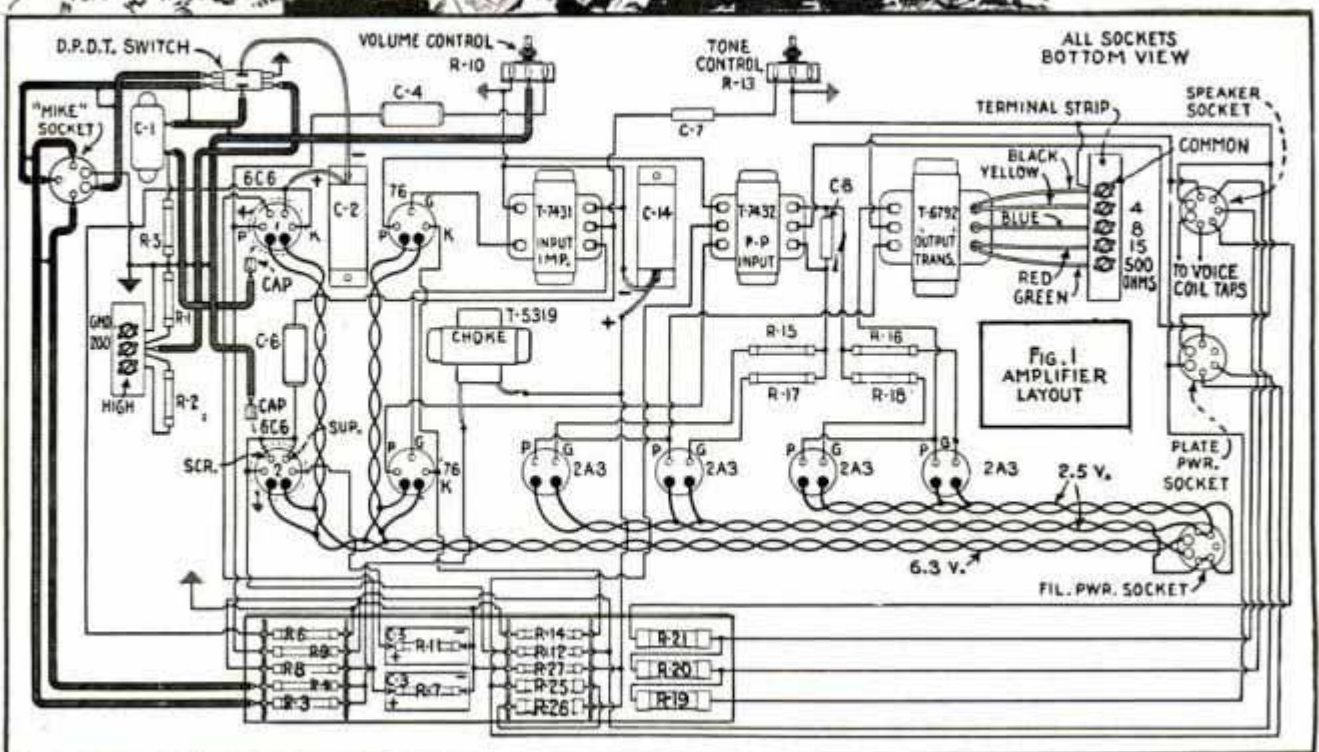
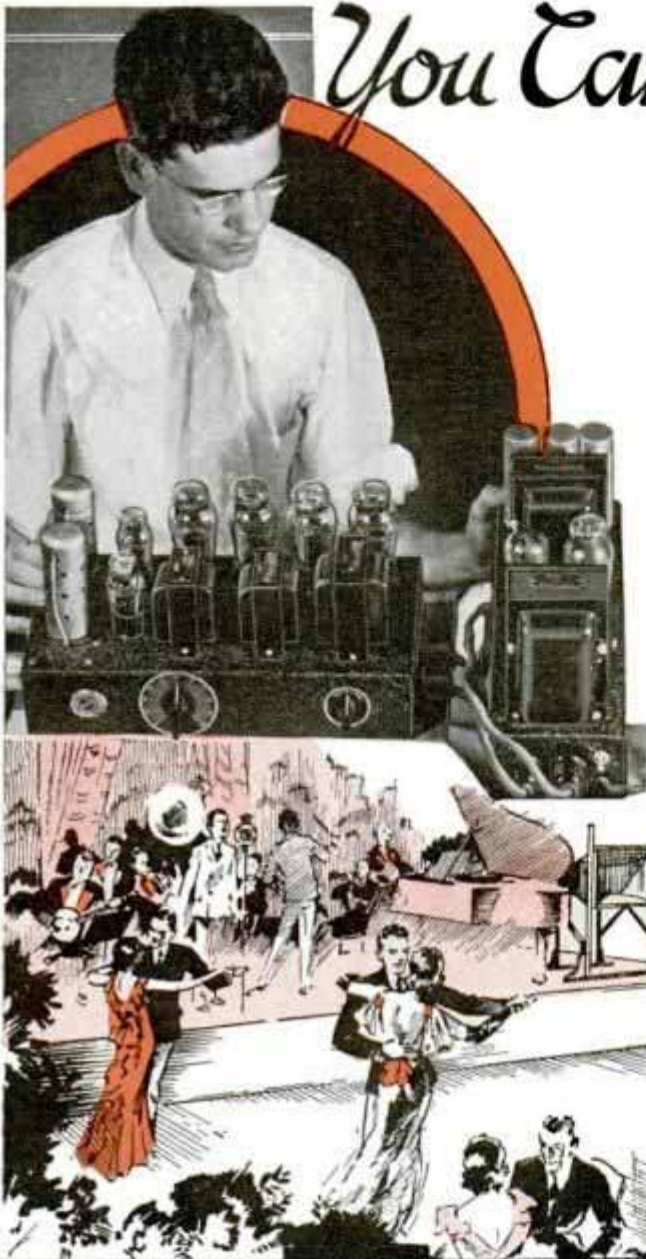

with this 30-WATT AMPLIFIER

is under control at all times and may be regulated to meet the special requirements of the location and audience

The amplifier unit is assembled on a metal base $3\frac{1}{4}$ in. high, $7\frac{1}{2}$ in. deep and 15 in. long; the power-unit base is $13\frac{1}{4}$ in. high, 5 in. deep and 15 in. long. These bases with the holes drilled and all tube

(Continued to page 130A)

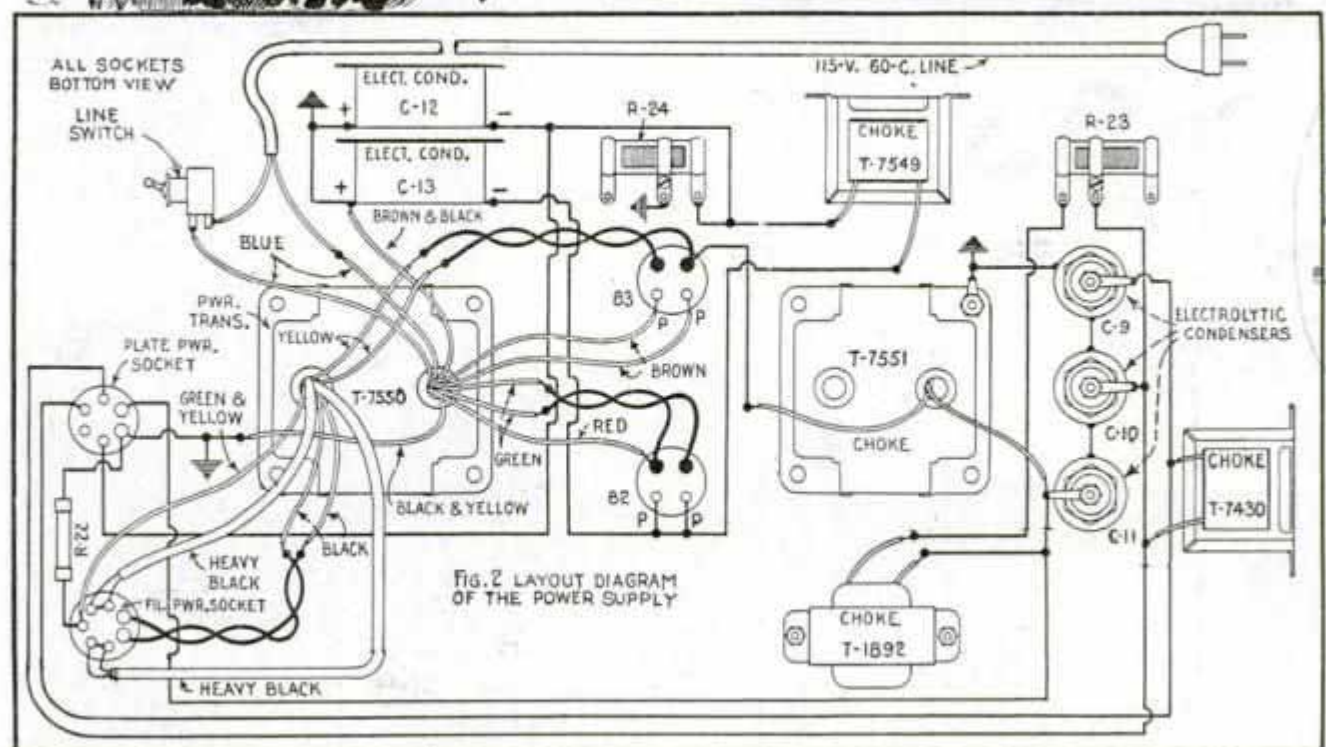

Practical Hints for the Radio Experimenter



Left, Special Dials and Nameplates Can Be Made by Sketching the Desired Design on Tracing Paper Which Is Used as a Negative for Printing on Glossy Photographic Paper; Cut Out and Covered with Celuloid, They Mount Directly on the Panel

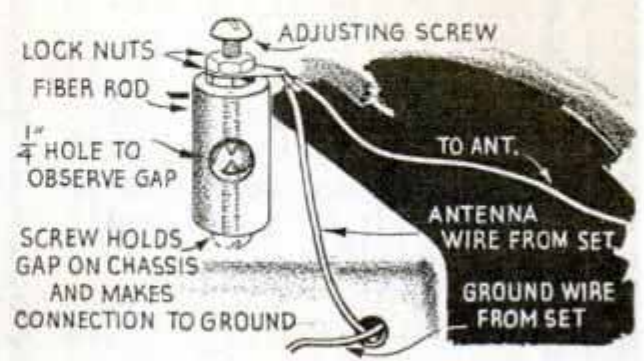

Above, Inexpensive Protective Gap for Receiver Protects Antenna Circuits from Static and Other High-Voltage Surges; a Piece of 1/2-In. Fiber Rod, 1 In. Long, Is Drilled and Tapped for Pointed 6-32 Brass Machine Screws, Assembled and Mounted on Chassis as Shown

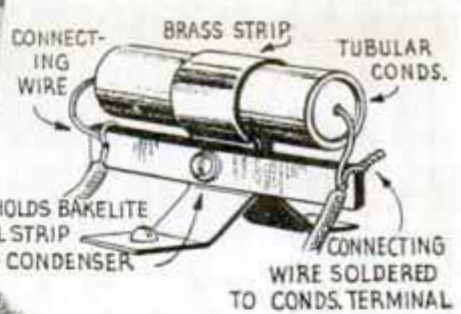
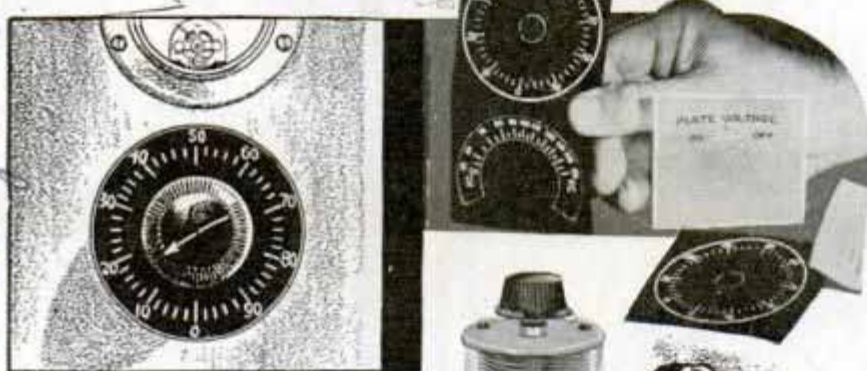

Above, Rugged Mounting for Tubular-Type Fixed Condensers May Be Made from a Piece of Scrap Bakelite and Brass Strip

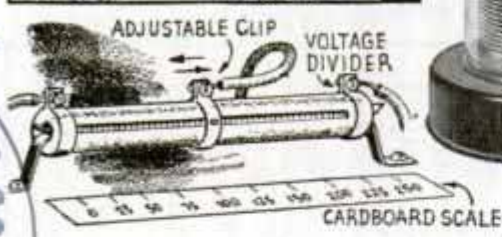

Above, Handy Scale for Variable Voltage Divider Does Away with Voltmeter Checking Each Time Clip Is Changed; Right, Wave Trap, with Shielded Coil in Base, Tunes from 160 to 600 Meters



SCREW HOLDS BAKELITE TERMINAL STRIP AND CONDENSER

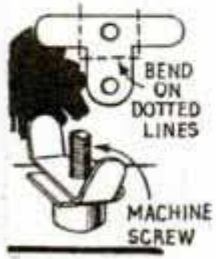

Left, Homemade Wing Nut; Upper Hole Is Drilled First, Tab Is Bent Under and Second Hole Drilled, Using First as a Guide, Then Tapped; Right, Overloaded R.F. or Rectifier Tubes May Be Drilled and Base Filled with Oil to Prevent Arcing

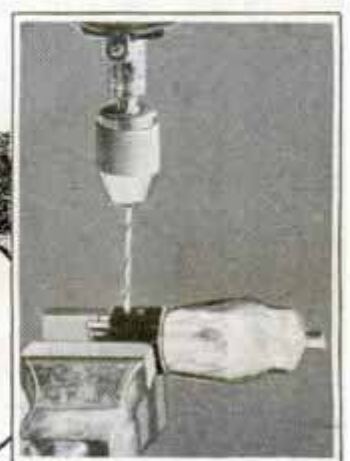
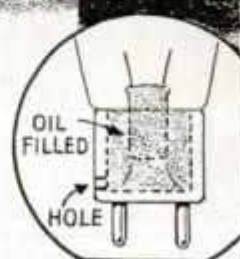

Radio & Television
 27603/63 Alley. N. Wash. D. C.

A.C.-D.C. Code-Practice Set

BEGINNERS will find this code-practice set easy to build and most of the parts are to be found in the average experimenter's junk box. No A or B-batteries are required as the set operates directly from either an a.c. or d.c. house-lighting line. Although only one tube is used, it combines an oscillator with a half-wave rectifier which eliminates the usual B-battery. The filament, or heater, of this type-12A7 tube is taken care of by a resistor built into the power-line cord which drops the line voltage to the proper value for the tube.

The schematic circuit diagram is shown in Fig. 1, and a simplified wiring diagram in Fig. 2. A sheet-metal base, 5¼ in. square and 1¾ in. high, is used to mount the various parts as shown in the photos. All connections under the base are clearly indicated in Fig. 2, the key leads and "cordohm" power-line cord being brought out through a hole in the rear of the metal base.

When connected, if the oscillator does

(Continued to page 146A)

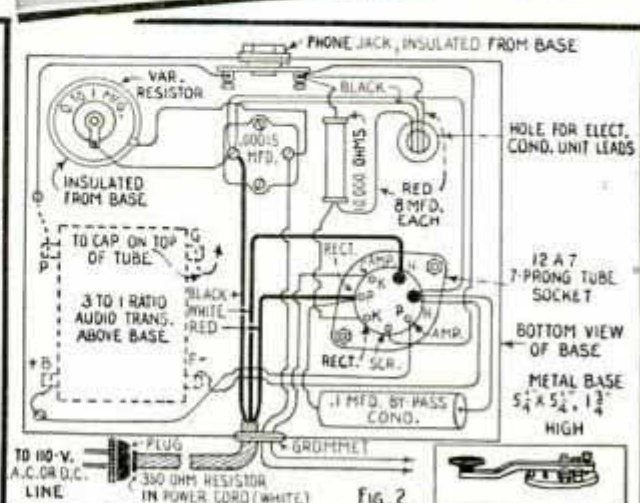
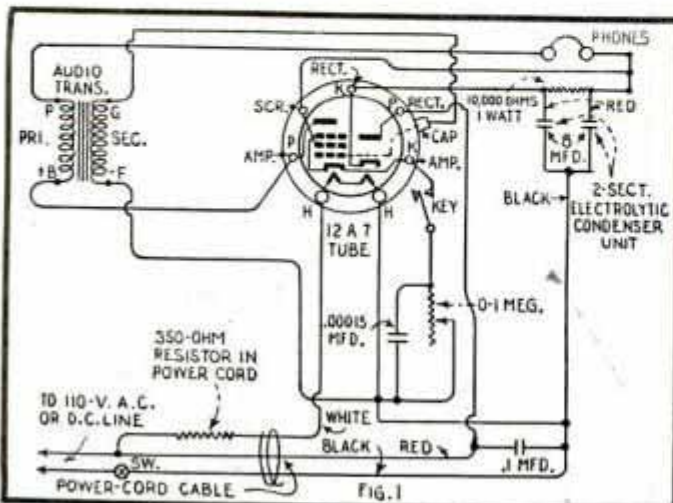
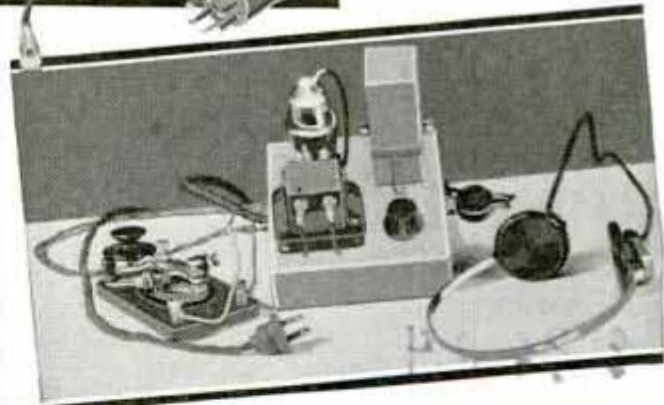
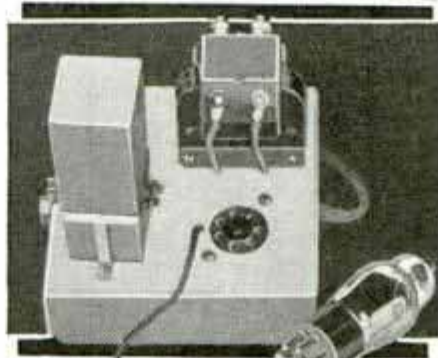
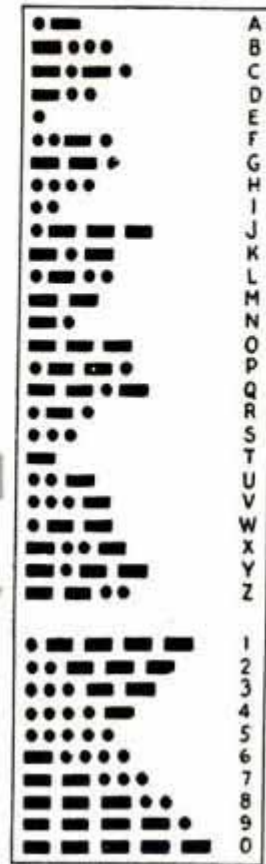

Eighteen Metal Tubes in All-Wave Super

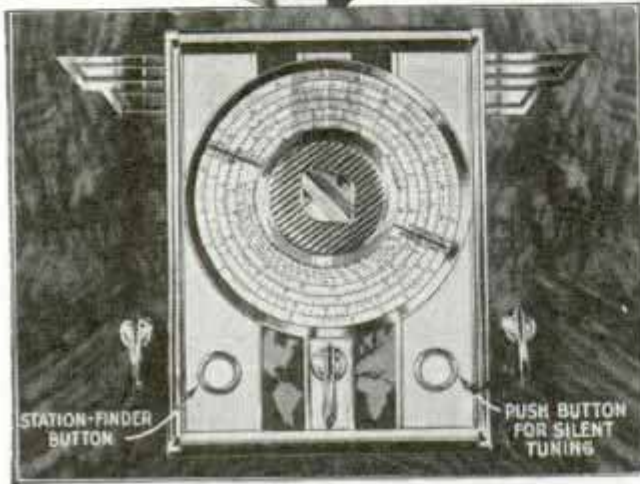
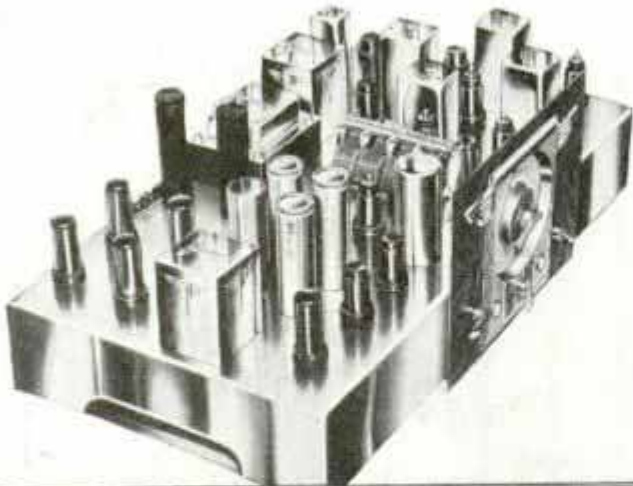

All-Metal Super Chassis; Control Panel Below

Many new features are included in this receiver which employs all-metal tubes and tunes from 4½ to 2,000 meters. Five power pentode tubes are used to deliver 20 watts of undistorted audio power to a specially designed loudspeaker. Push buttons on the control panel enable the operator to locate weak DX stations easily and silence the set when tuning.

£ 36 2 4

Electron-Ray Tube for Visual Tuning

A convenient and non-mechanical means to indicate accurate tuning of a receiver

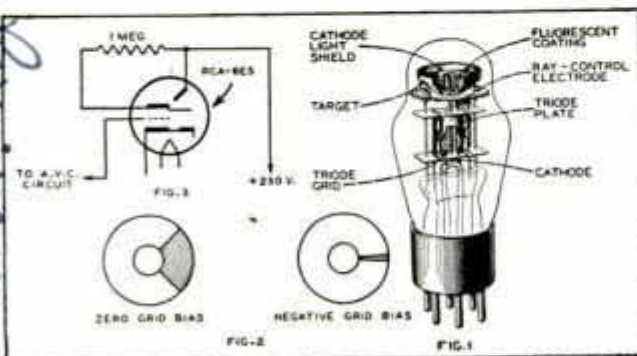

Details of Miniature Cathode-Ray Tuning Tube

to the desired station is now available in the form of an electron-ray tube known as the RCA-6E5. The visible effect is observed on a fluorescent target located in the dome of the bulb shown in Fig. 1. The tube will be located in the receiver so that the dome may be viewed above the tuning dial to enable the operator to see when the receiver is tuned to the most resonant point for each station. The strength of the incoming signal varies the shadow, indicated in Fig. 2, so that when it narrows down to its thinnest dimensions, the station is known to be accurately tuned in. Circuit connections are shown in Fig. 3.

£ 962 6

Resistance Bridge for Students and Experimenters

This low-cost portable resistance bridge measures resistance from .01 ohm to 11,000,000 ohms with a limit of error of about one per cent. All wiring is color-coded for instruction and the instrument may be quickly removed from the case; a C-battery and galvanometer are built-in.

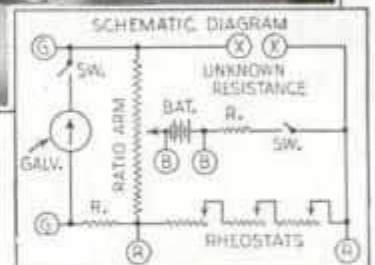

Portable Wheatstone Bridge of Rugged Construction for Shop, Laboratory or Individual Instruction

Blueprints covering radio construction articles in past issues can be obtained for 25 cents each; when material lists are not included in the articles, these are available without charge on receipt of postage.

RCA Supply Co
Harrison, N.J.

The Hunter Co
1255
Harrison



Make Your Own PHOTO BORDERS



BORDER masks for your photos that you can make up in a variety of designs, either in black or in shades of gray, will go a long way in getting distinctive prints. And, the making of the borders does not involve any difficulty, as you merely make an enlarged border and photograph this to get a border mask, which is cut out to fit over the picture negative when printing.

There are a few things to keep in mind when making up such printing masks, which will make it "easy going." First get a piece of white cardboard or Bristol board, which is, say four times as large as the negative of your camera. It is important that the cardboard be exactly proportional in width and length to the print, no matter how much larger it is. One way to determine this is to lay the print on the cardboard at one corner. A diagonal line from one corner of the print to the opposite one should, if extended, as indicated by the dotted lines, coincide with the opposite corner on the cardboard if its size is proportional to the print. If the diagonal line does not coincide with the corner on the cardboard, the latter must be cut

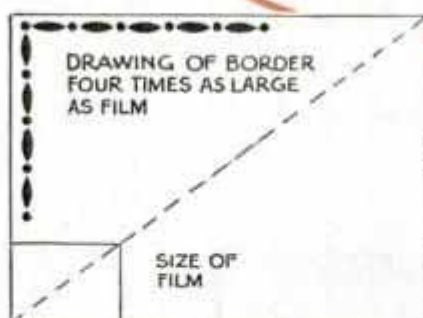
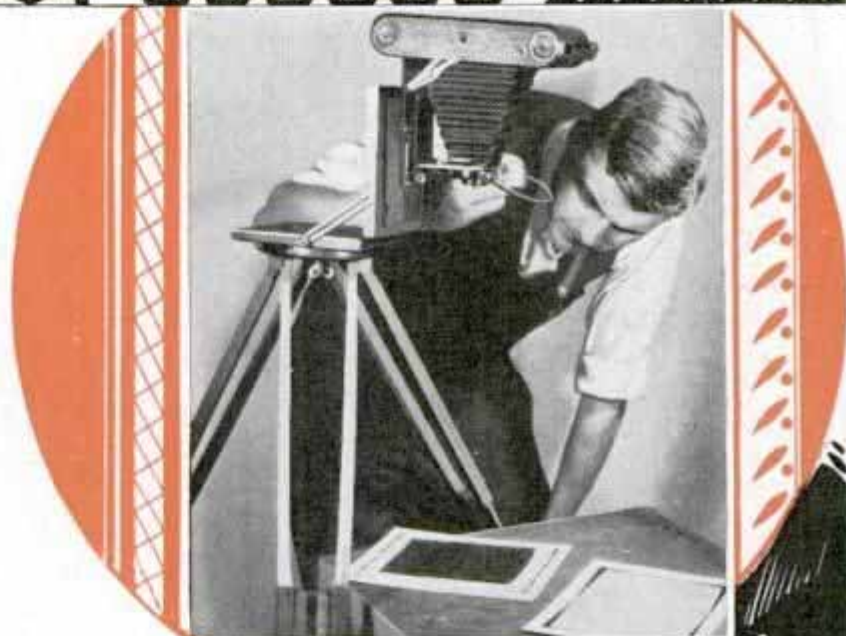

down a trifle, trimming off the paper from two adjacent edges so that the cuts will intersect somewhere on the diagonal line. Of course, these adjacent sides must be at right angles. The next step is the appli-

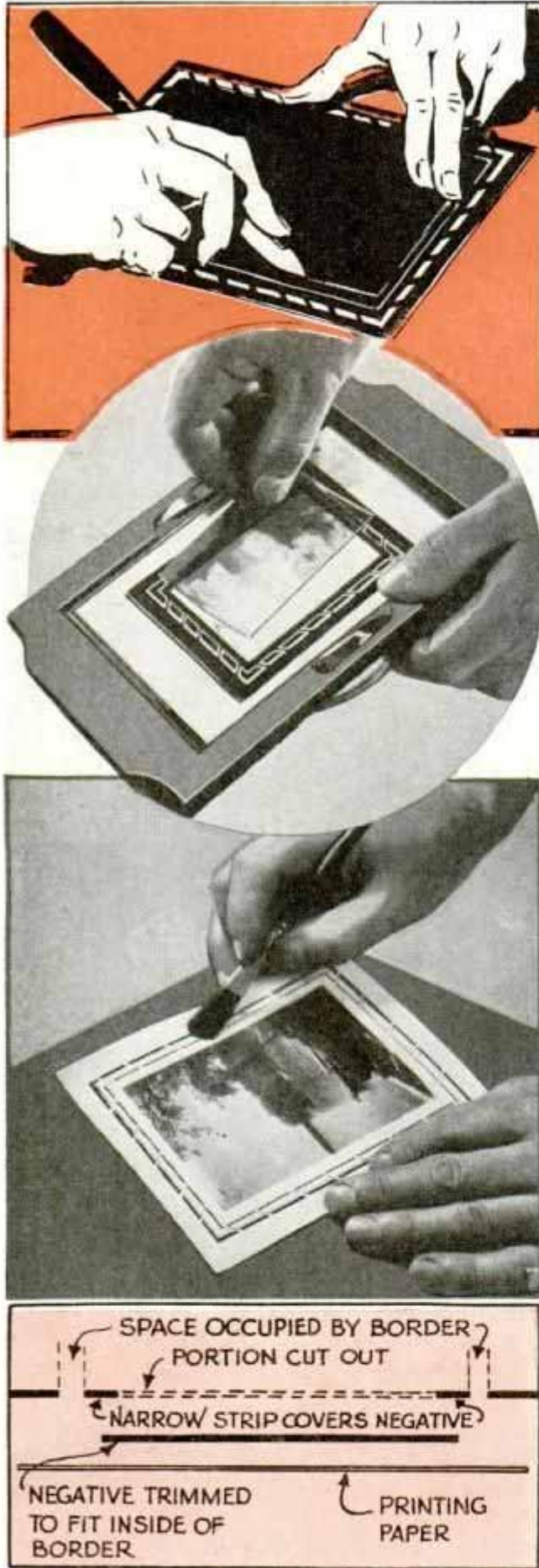

The Picture Negative Is Trimmed to Overlap the Cut-Out of the Border Mask; Lower Photo, Shellac Being Brushed on Border of Print, Which Is to Remain Black While the Rest of the Photo Is Stained

cation of a larger border design along the edge of the cardboard. If you like, you can draw and ink this yourself, using black India ink, or perhaps you can find suitable printed borders in newspapers and magazines, which, when cut out, can be pasted neatly on the cardboard. Another method is to use border stencils for the purpose. Or, you can have a printer set up a number of border lines of various kinds, and print them on ordinary paper so that you can cut the borders out and paste them in place on the cardboard. Border designs in various shades of gray can be used, as these are photographed just as easily as designs in black.

Next, with the cardboard pinned to the wall, set your camera on a tripod and photograph it so that the border design will be on the edge of the negative. To get a good clear negative of this, you should focus carefully. On many types of cameras this can be done by placing a piece of ground glass or tracing paper over the film rollers. After a good focus has been obtained, substitute the film, without disturbing the focus. Use a slow film and close down the lens aperture. If you have several border designs of equal size to photograph, place each one in the same position as the first and re-focusing will be unnecessary. If you develop the roll yourself, add a fourth more carbonate than the developing formula calls for to increase the contrast. Develop the film as far as possible. The resulting negative, when thoroughly dry, is carefully cut inside the border, leaving a narrow strip of black between the border and the cut-out. The picture negative over which the border mask is laid, when printing, should be trimmed to such size that it will overlap slightly on the black strip, but not on the border itself.

Tinting your photos with either oil or water colors is another way to make them stand out from the general run of snapshots. Inexpensive coloring outfits, with full directions, which are easy to follow, are available to the amateur. In addition, you can get interesting results with two other methods: toning, and staining either the picture or the border. If you want to leave the border black, apply a coat of shellac to the parts that are to remain untouched by the stain. After the prints

are colored and dried, the shellac is removed with alcohol.

A good method of placing snapshots in albums, with assurance that they will not become uneven or curl, is to use dry mounting tissue. Coat thin sheets of tissue paper with the following varnish, allowing the coat on one side to dry before coating the other: Liquid shellac, 5 oz., and Canada balsam in alcohol, 5 oz. The dry sheets are cut to the same size as the snapshots, and are placed between the latter and the mounting paper or album leaves. Passing a warm flatiron over the snapshot will fasten it securely to the mounting paper.

Heat Deflector Hung on Edge of Stove

If your cookstove sets so close to a wall that it is necessary to use a heat deflector, suspend a piece of sheet metal from the top edge of the stove with a couple of rings as shown.

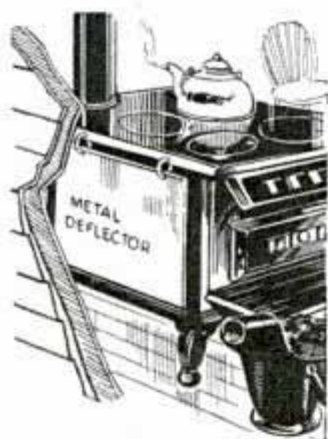

This type of deflector not only looks better than a piece of tin tacked to the wall, but it is more effective as air can circulate around it and carry away the heat.

Handle for Carrying Electric Motor

Small motors, such as are used around the home and workshop, will be easier to move about if handles are attached to them. A screen-door handle, bent to the contour of the motor and screwed to the stator frame, is suitable for this purpose. Care should be taken that no iron shavings reach the interior of the motor while drilling and tapping the screw holes, which should just penetrate the outer shell.—Glenn R. Hampton, McCamey, Tex.

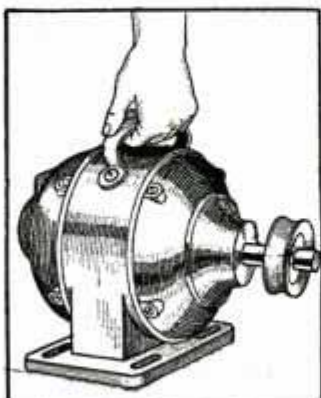

Platform on Car to Take Movies of Sporting Events

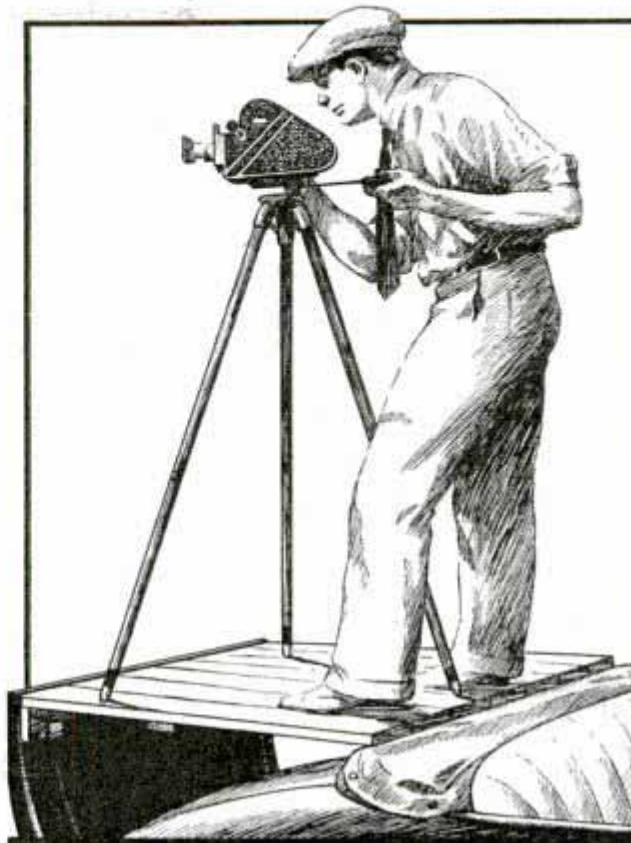

Platform over Rumble Seat Elevates Camera for Taking Movies of Parades and Sporting Events

For the amateur movie maker who wishes to get shots of parades, sporting events, etc., some arrangement for elevating the camera above crowds and traffic is indispensable. The owner of a car having a rumble seat will find the construction of a platform for this simple. Most rumble seats have detachable back cushions which, when removed, expose angle brackets. These can be used to support one end of the platform, while the other end can rest on the car body. If made to lock into position on the brackets, the platform will be rigid, and will be steady even when the car is in motion. When not in use, it can be slid into the rumble-seat compartment.—F. W. Godwin, Spring Valley, Calif.

Sanding Work Before It Is Assembled

When making wood articles, it is best to first cut and shape all the parts and then sand them before assembling. This method makes the job of sanding easy and eliminates any possibility of the parts getting soiled or marred when they are laid aside after the sanding is done.

Ventilating Porch Columns to Keep Them from Decaying



Holes Drilled in Porch Columns Allow Air to Circulate Through Them and Prevent Decay

Perhaps you have wondered why your porch columns decayed from the inside when the outside was kept well preserved with paint. If so, your trouble is probably caused by moisture accumulating inside the columns and causing the wood to rot. Experiments have proved that 1-in. holes drilled through the columns near the top and bottom allow enough air to circulate through them to prevent this trouble. Disks of copper mesh cut to the proper size and hammered or pushed into the holes will keep out insects.

Photo Spotlight Improved from a Desk Lamp

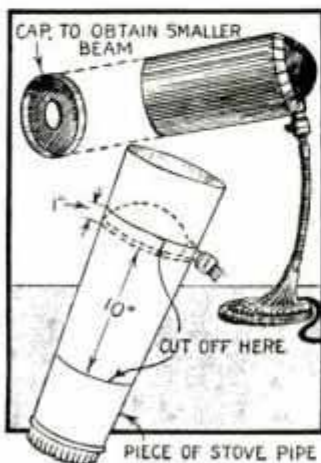

Needing a spotlight to take portraits, I made one by slipping a short length of tapering stovepipe over the reflector of a desk lamp to serve as a hood, using a photoflood bulb in the lamp. Several slits are cut around the large end of the

pipe to provide tabs, which are bent over the reflector to hold the hood in place. Both inside and outside of the pipe should be painted flat black to reduce reflection. To concentrate the light in a small spot, a cap with a hole in the center is fitted over the hood.—H. B. Heiser, Berea, Ohio.

Boots Laced to Prevent Pinching

When laced in the usual way, high boots often fold near the bottom of the laced part and pinch the feet when walking or kneeling. By lacing them as shown so that the laces, in passing from one side to the other, come under the leather strips holding the eyelets, this trouble is eliminated.

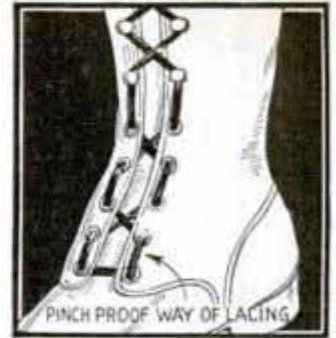

Cork Used as Socket in Emergency Electric Lamp

In an emergency, I needed an extra socket for a small 6-volt bulb and, not having any at hand, one was improvised from a large cork as shown. A small brass screw eye, to engage the bottom contact of the bulb, was used as one terminal, while a wire twisted around the metal sleeve on the bulb served as the



other. This socket is not recommended for use on high voltages, of course, but is all right for emergency use on dry cells.—C. E. Ahwai, Hong Kong, China.

While experimenting to obtain a lubricant that would make drills last longer and cut more freely, when drilling nickel or chromium steel, it was discovered that sulphur and turpentine, mixed to the consistency of thick cream, served the purpose nicely.

SPIRAL TURNING

made easy on

CIRCULAR SAW

SPIRAL turnings, productive of many excellent furniture projects, are greatly simplified by the machine method of making them on a circular saw. Figs. 1 and 2 show the first operation. A board to serve as a fence is fastened to the miter gauge with screws, after which the gauge is clamped to the saw table in the position shown. The work, when pushed into the saw along this fence, will both turn and feed itself, the saw being adjusted to cut $\frac{3}{16}$ in. deep. Angle of the

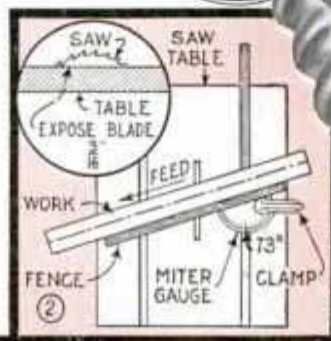
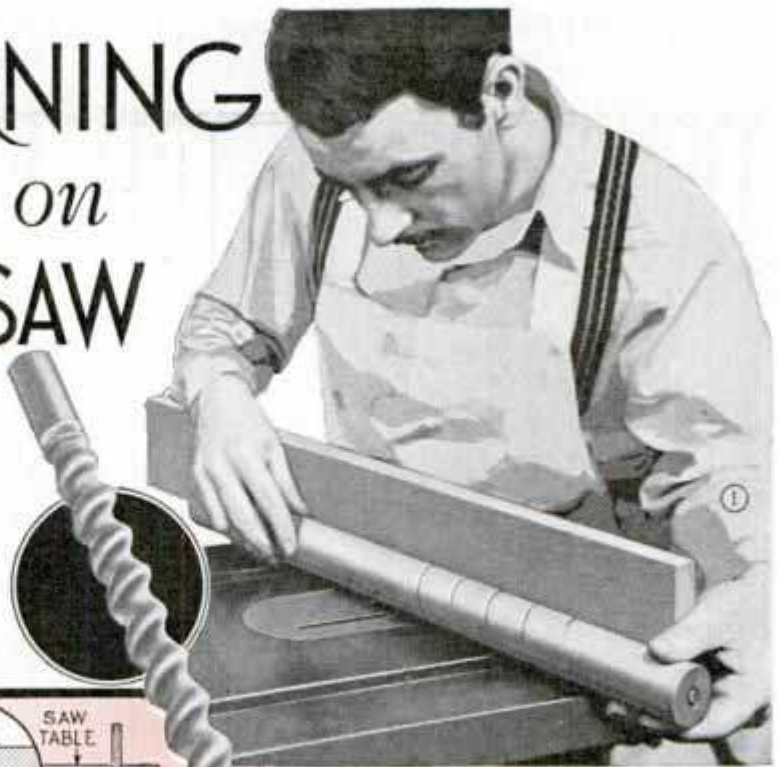

Below, Finishing Operations Can Be Done on a Lathe at Slow Speed

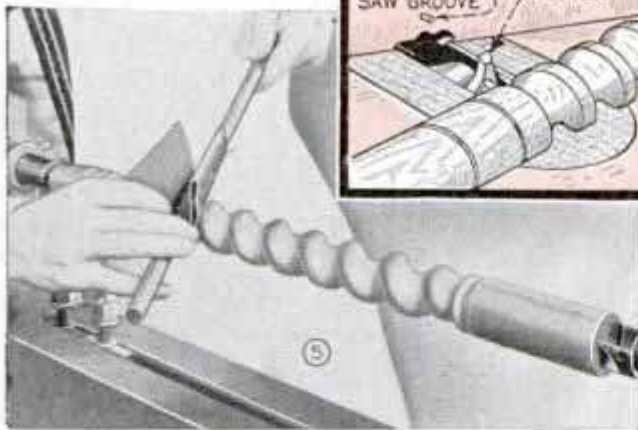
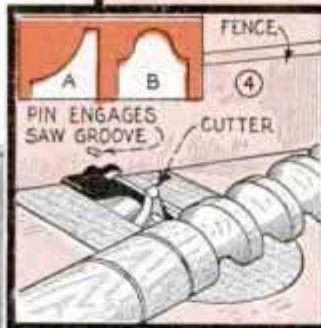

miter gauge can be varied to give different feeds. The greater the departure from a right angle between fence and saw blade, the greater the pitch of the spiral. The cut produced in this manner will not vary over $\frac{1}{32}$ in. from any one spiral to the next in line. In the next operation, the miter-gauge fence is set at an angle of about 60° on the opposite side of the center, right-angle mark, Fig. 3. A molding cutter of the style shown at A, Fig. 4, is mounted

on the saw arbor, and a pin is fitted to the fence, to engage the saw-cut spiral. With this pin guiding the work, the latter is fed into the cutter. The cut produced is not the true shape of the cutter because of the angle of the work, but is a perfect cove cut. Next, the sharp corners of the cove-cut spiral are rounded over in a lathe. Finishing can be done with sandpaper held around a dowel stick, Fig. 5, chasing up the spiral as the work rotates at slow speed. If you care to grind your own cutters to a shape similar to that shown at B, Fig. 4, the spiral can be cut in its entirety.

Folding Shelf on Pantry Door Saves Steps



Many Uses Will Be Found for a Folding Shelf Hinged to Your Pantry Door

Hinged to the inside surface of your pantry door, this folding shelf will serve as a handy worktable and save steps when mixing pastries. In addition to this, the shelf is convenient when re-arranging or cleaning the pantry as well as when getting out dishes, or replacing them after washing, as they can be sorted on the shelf and carried in a tray at one trip.

Markers Prevent Mixing of Guests' Beverage Glasses

If you have had the embarrassing experience of mixing your guests' glasses on a serving tray, little celluloid markers, which are slipped over the edges of the glasses, will help solve your problem. Different colors of celluloid are used, and the markers are cut to various shapes appropriate for the occasion, such as playing-card characters for bridge parties, jack-o'-lanterns, black cats and pumpkins for Hal-



loween, etc. The markers can be bent to form clips by slightly softening the celluloid in hot water.

Arm Pieces on Crutches Cushioned with Rubber Hose

Tacked across the arm pieces of crutches, lengths of 1-in. rubber hose will make them more comfortable to use. Besides providing a cushion under the arm pits, they tend to lengthen crutches that are a little too short. The hose pieces are slit as indicated by the dotted lines, after which the ends are spread and tacked to the crutch.—R. D. Gadd, Grass Lake, Mich.

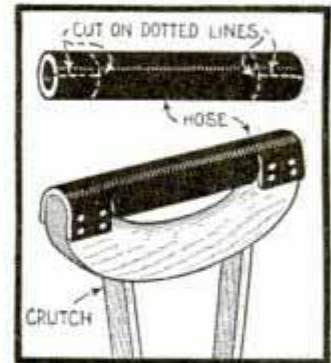

Screw Eyes to Hang Collapsible Tubes on Hooks

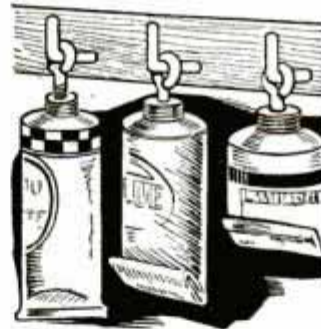

If you remove the caps from collapsible tubes containing pastes, glue, etc., and substitute small screw eyes for them, the tubes will be sealed tightly and they can be hung on hooks in orderly arrangement. The screw eyes should be slightly larger than the opening in the tubes so that the threads will bite into the soft metal.

Slits in Pie Tin Permit Loosening of Lower Crust

Cut in the sides of a pie or cake pan near the bottom, four small slits permit the insertion of a knife blade to loosen a pie or cake that has a tendency to stick. If the slits are made as narrow as possible, they will be hardly noticeable and will not damage the pan in any way.

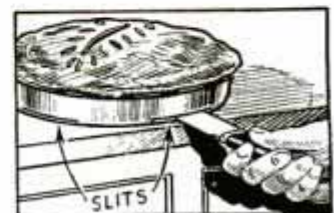

Children Like These Animal Towel Racks

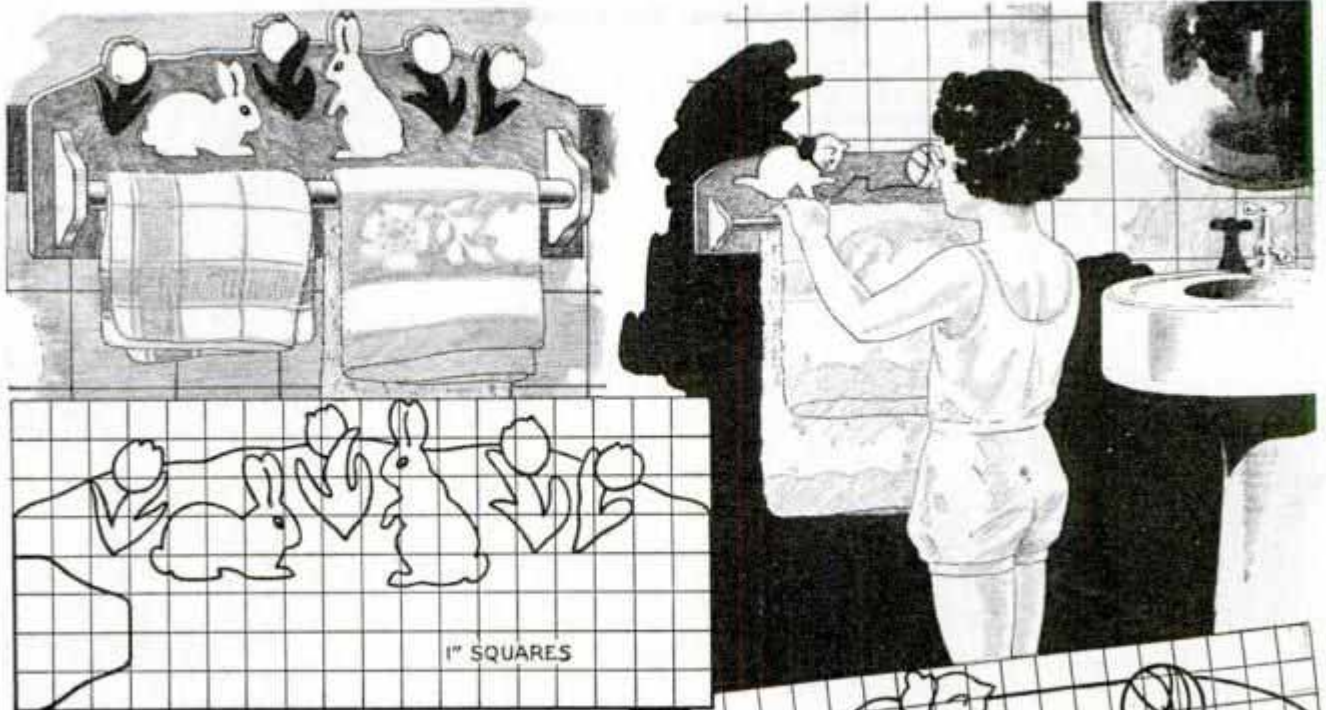

Decorated with animal cut-outs, these racks will appeal to the little tots and will be helpful in getting them into the habit of hanging up their towels.

Wood $\frac{1}{2}$ in. in thickness is used for the backs and the arms, broomsticks or hardwood dowel stock for the rods and thin wood for the cut-out shapes. The back piece of each rack is shaped at the top to support the overlay decorations. To assure them fitting properly, it is best to first cut out the figures, smooth their edges and then glue them in place. Then, when the backs are scroll-sawed, you can follow the edges of the small pieces. The ends of the rods should be mortised into the arms, which, in turn, are mortised into the backs.

Various color schemes can be worked out. For the rack shown above, the rabbits, arms and rod may be white, the tulips a variety of bright colors with green leaves, and the back of the rack tan. The kitten and ball on the second rack may be white on a dull green back with a red ribbon on the kitten, and a red string on the ball. The third rack, which has two rods, may be used as a towel rack in the bathroom, or it can be hung on the inside of a closet door and used as a rack for shoes, scarfs or other miscellaneous items. If it is used in a closet, a pleasing finish is had by staining and varnishing, making

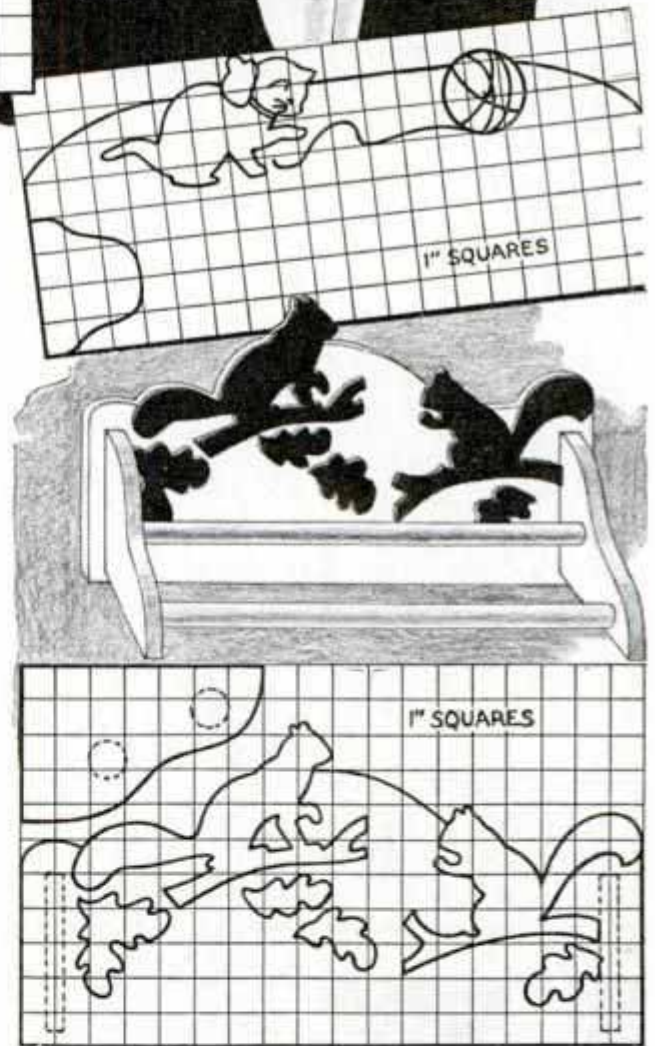

the overlay designs a much darker shade than the back. If the rack is painted, a good color scheme is reddish brown squirrels, dark gray perches and light green leaves, the back, arms and rods being finished in ivory or light tan.

Air Pad Facilitates Printing Photos from Crinkly Negatives

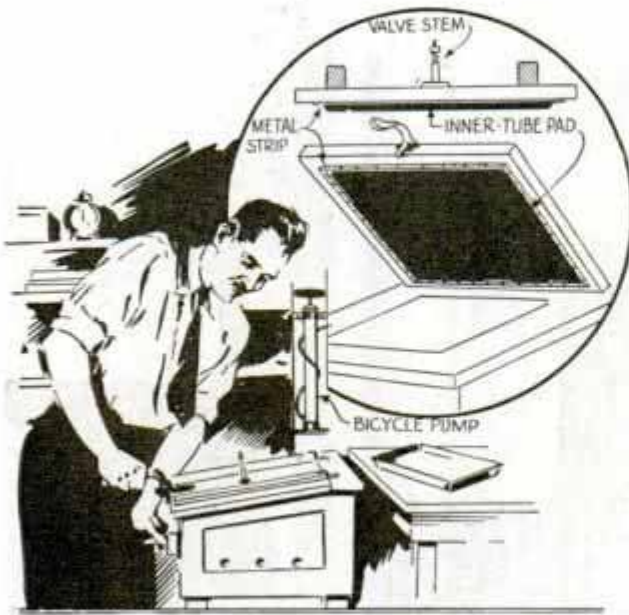

Air Pad Made from Inner Tube and Fastened to Underside of Lid Improves Photo-Printing Box

Photo prints will lie perfectly flat over crinkly negatives if you use this inner-tube pad on the lid of your printing box. The lid must be made in one piece, with no air holes in its surface, and it must overlap the sides of the box at least $\frac{1}{4}$ in. to take narrow metal strips, which are tacked over the edges of the rubber to make the pad air-tight. Cut the pad from the valve-stem section of the tube, and then slit it lengthwise on the side opposite the stem, making the pad the exact size of the lid. The valve stem projects through a hole in the lid, the hole being slightly smaller than the stem to get an air-tight fit, after which the nut on the stem is driven down to hold it rigidly. A rubber washer between the lid and base of the stem will help. One or two strokes of a hand pump will inflate the pad sufficiently. —Leonard Mitchell, San Francisco, Calif.

Keeping Dust Out of Framed Pictures

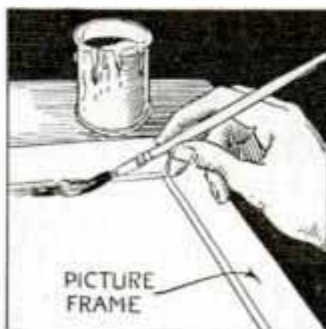

Scrap celluloid dissolved in acetone makes a useful sealing cement, which can be applied around the backing of framed pictures to prevent the entrance

of dust. This method of sealing the frame is quicker and more satisfactory than applying paper, although this may be added for sake of appearance. Enough celluloid should be dissolved in the acetone to make a rather thick solution. If the solution is too brittle, it may be made flexible by adding a little castor oil.

Grooved Disk Prevents Waste When Soldering Wire Connections

When soldering wire connections, hold a plaster disk under the work, and you can flow the solder evenly on the joint without waste. The disk is made of plaster of paris and is grooved at right angles, to take the wires while soldering the joint and to catch all excess solder that does not adhere to the work. A small round-nose chisel is handy for making the grooves.

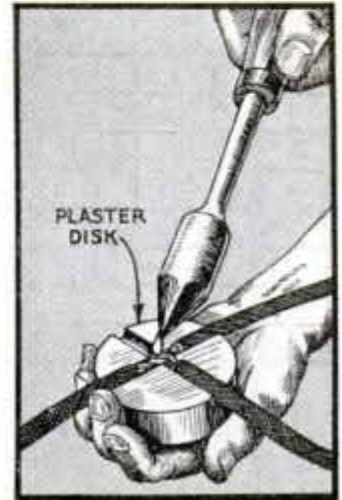

Ordinary Electric Motor Operated in Vertical Position

Motors designed for use in a horizontal position can be operated in a vertical position without excessive wear if a steel ball is used to take care of end thrust. The ball is held in place with a metal plate screwed to the end of the motor housing, a metal washer being used to space the plate from the housing. The ball rests in a depression formed in the center of the plate, and the end of the motor shaft is countersunk slightly to fit the ball. Lubrication is taken care of by enlarging the end of the oil hole and inserting a small copper tube, which is bent upward slightly to assure a gravity feed of the oil.

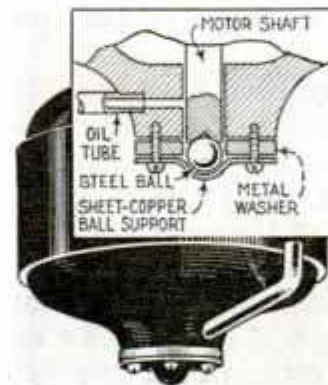

A Simple CORNER CUPBOARD

ADDDING a pleasing touch to a bare corner of a room, this useful cupboard can be made of white pine and painted or lacquered to suit, or it can be made of maple or other hardwood and finished to match other furniture. Its rounded front is simple in construction and can be handled easily with tools found in the average home workshop.

Start by squaring up stock for the lower portion of the cupboard. The side walls call for fairly wide stock, readily procurable in white pine, although a tight glue joint to make the desired width is equally as good as a solid board. One of the side boards butts against the other, the joint being made secure

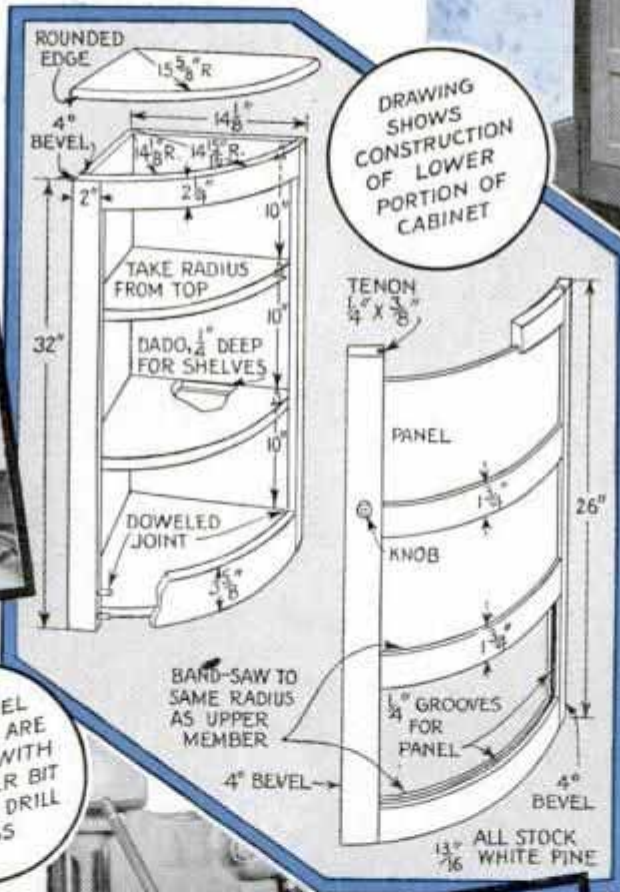

DRAWING SHOWS CONSTRUCTION OF LOWER PORTION OF CABINET

THE PANEL GROOVES ARE RUN IN WITH A ROUTER BIT ON THE DRILL PRESS



with dowels along its length. The curved face pieces are band-sawed to the specified radius, the stock being built up to the width that is required.

Curved pieces for the door are cut to the same radii as the facer strips of the cabinet proper. In cutting these curved pieces, it is necessary to mark the outer or larger radius only. After cutting this curve, the band-saw fence, or a suitable wood guide, can be set a distance of $1\frac{3}{16}$ in. from the blade, and the inner curve run in. A disk sander

Time-Savers for the Mimeograph Operator

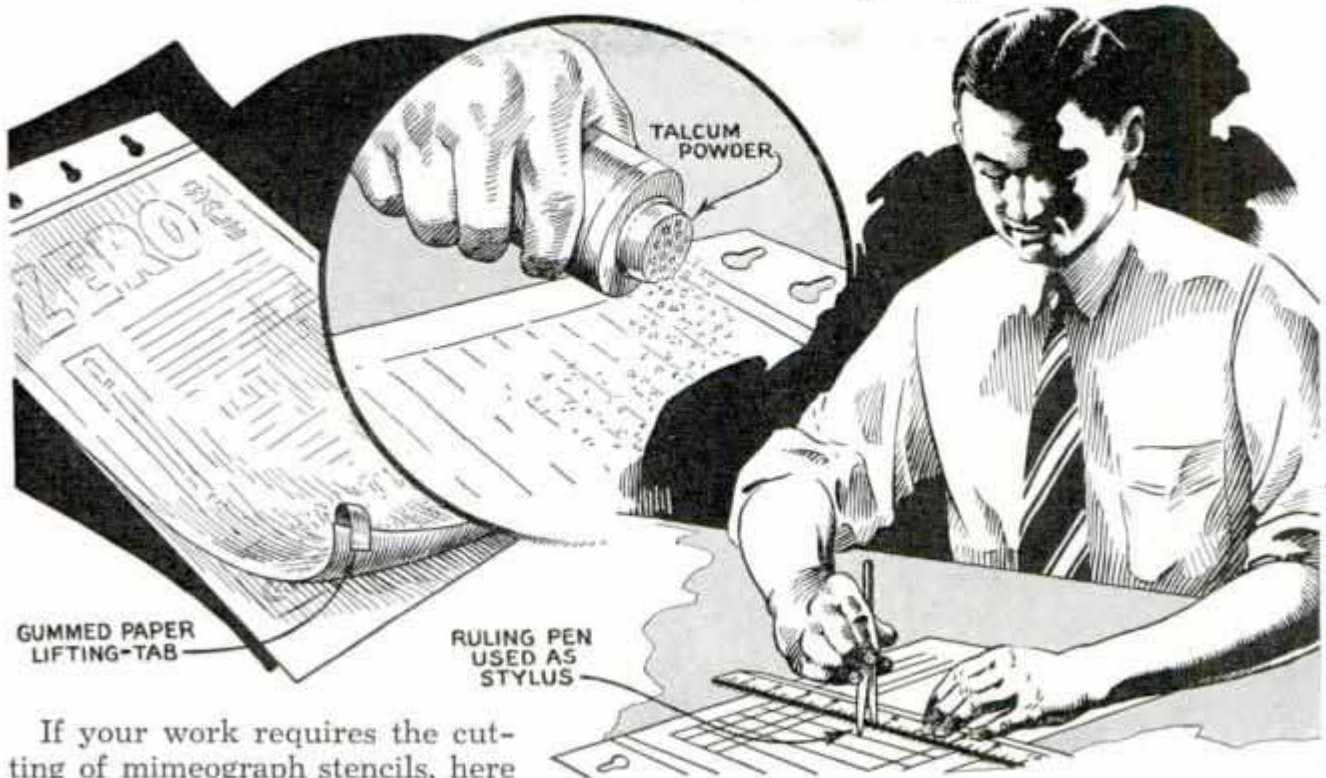

If your work requires the cutting of mimeograph stencils, here are three short cuts that will come in handy. The detail at the left shows a paper tab attached to one corner of the stencil for lifting it when it clings stubbornly to the backing sheet. When typing a fresh stencil, bits of the material will be picked up by the type, which often results in imperfectly formed letters. This may be avoided by dusting talcum powder

over the stencil before putting it in the typewriter, and then removing the surplus with a soft brush or cloth. When considerable ruling must be done on a stencil, use a draftsman's ruling pen. The points can be spaced quickly by setting them over a ruler, after which the pen is used as a stylus.

Spring Gambrel Suspends Small Animals to Skin Them

Here is a gambrel that is a help in skinning small fur-bearing animals. It is light enough to carry in the pocket and, when hooked over a limb of a tree, it holds the animal at a convenient height and keeps its legs spread apart. A 2-ft. length of very stiff wire is given two or three turns around a 1-in. pipe or rod to form a coil in the center to give the gambrel a spring effect, after which an eye is formed on each end. Hooks are fastened in these and are pointed at the ends to pierce the animal's feet. A strong, swiveled hook is fastened in the center of the gambrel by means of a strip of heavy sheet metal, the swiveling action being obtained by inserting the hook through holes in the end of the strip and then bending the end of the hook at a short right angle.—Martin G. Winterton, Ft. Lewis, Wash.

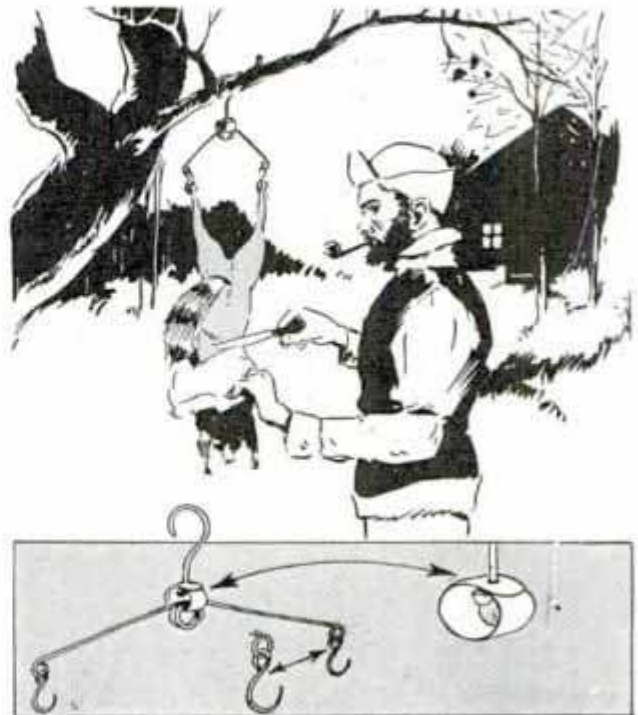

Vacuum Cups Hold Small Washboard in Sink or Tub



Large Vacuum Cups Attached to Legs of Washboard Keep It from Slipping in Tub

When small pieces are laundered on a washboard placed in the kitchen sink or bathtub, it is difficult to hold the board securely at the proper working angle. If a couple of vacuum cups are fastened to the ends of the washboard legs, this annoyance may be eliminated.

Utilizing Waste Heat from Furnace Smoke Pipe

In my home, which was heated with a hot-air furnace, the kitchen was not supplied with a hot-air pipe, and was quite chilly at times. To overcome this trouble and, at the same time utilize the heat radiated into the basement by the smoke pipe, I jacketed the latter with a length

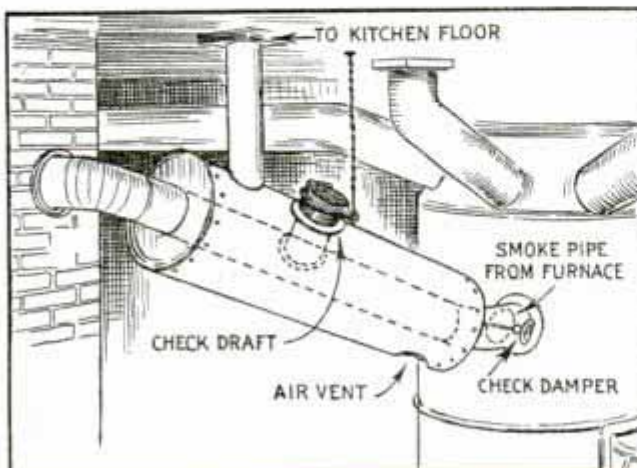

Sheet-Metal Jacket around Furnace Smoke Pipe Directs Waste Heat into Home

of 16-in. sheet-metal pipe and directed the waste heat into the kitchen through a hole in the floor. The jacket was closed at both ends with sheet-metal disks, the check draft in the smoke pipe being extended as shown. A vent in the bottom of the large pipe allowed air to enter the jacketed part of the smoke pipe, where it was heated and then passed through a 6-in. pipe into the kitchen. All joints in the smoke pipe should be cemented and then sealed with strips of asbestos paper. The jacket should also be covered with two or three layers of the paper to conserve the heat.—E. R. Newman, Lincoln, Nebr.

Chain Substituted for Shot When Washing Bottles

When washing bottles, drop a short length of furnace chain inside to aid in cleaning. The chain takes the place of shot, which is usually used for this purpose, it does just as thorough a job of removing foreign substances from the sides of the bottle, and is much easier to handle.

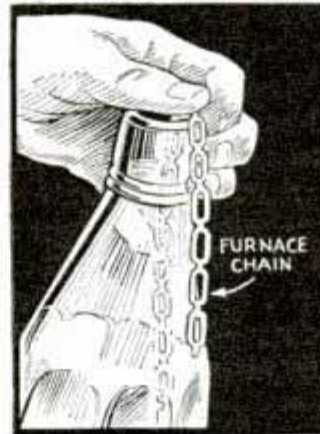

Spring Clothespin Converted to Simple Electrical Switch

In radio work or electrical experimenting where low voltages are handled, a switch that can be opened momentarily, but one that will keep the circuit closed under normal conditions, often comes in handy. Such a switch can be made from a spring-type clothespin. Simply drill the jaws near the end to take a couple of small, brass machine screws, which serve as contacts, and clamp the wires under the heads.

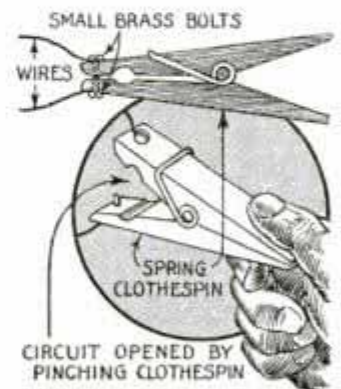

Winter Flower Garden Fits Your Window

Well insulated and fitted with a double-pane sash, this small conservatory provides a place for a winter flower garden and also serves as a storm sash. It is fitted snugly against the outside of the window casing, preferably on a window having a southern exposure. Strips of thick felt along the edges make a tight joint between the casing and the conservatory, which is pulled up tightly with angle brackets, a tapered block, also covered with felt, being used at the bottom to get a snug joint at the sill. Any high-grade insulating board will do for the lining. If two storm sash are available they may be substituted for the double-pane sash, us-

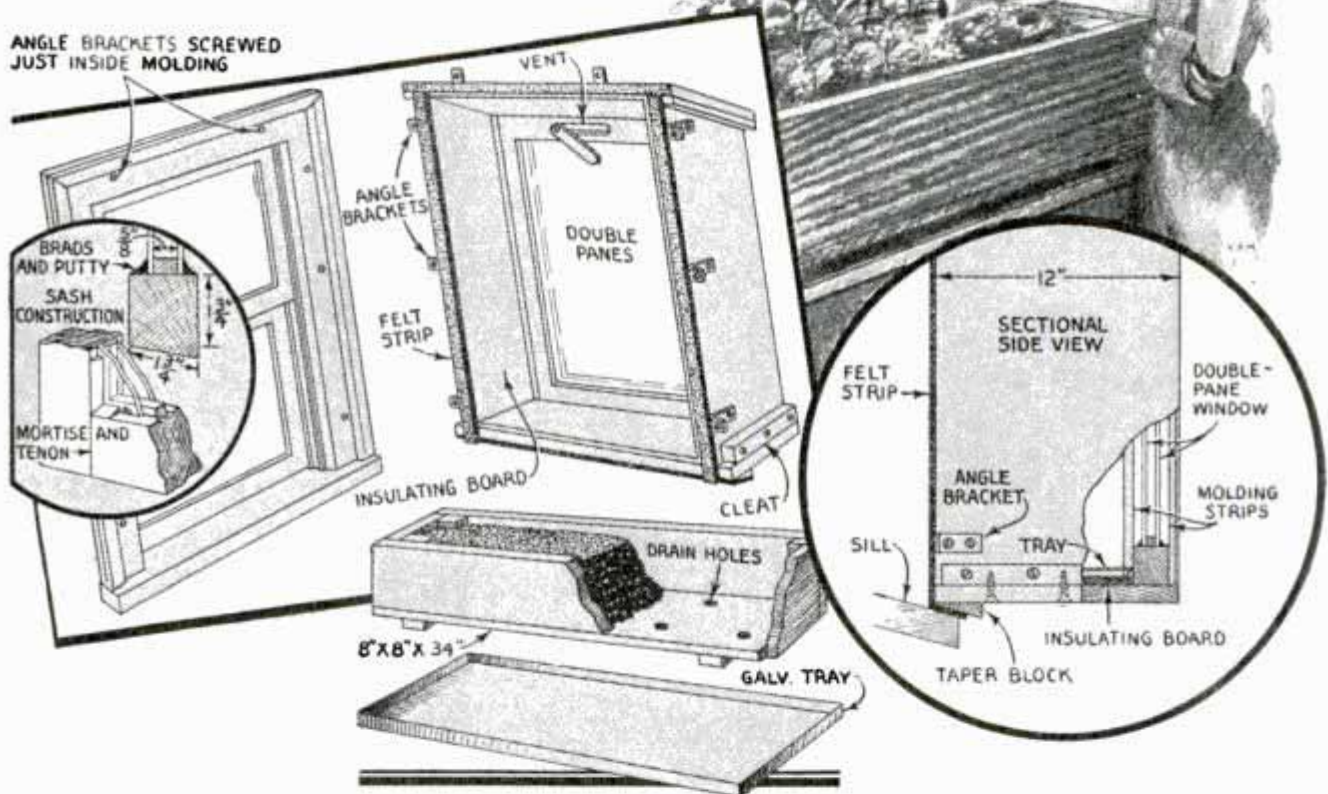

ing thin strips of felt between the frames and screwing them together tightly to get a dead-air space between. Be sure the panes are well puttied. The sash are held in place with molding strips fitted carefully. The soil box, which is filled with rich soil consisting of leaf mold, loam and manure, is provided with drain holes and sets in a shallow, galvanized sheet-iron tray, two 1-in. blocks being nailed across the bottom of the box to serve as feet. The box should be painted a dark color to absorb as much warmth from the sun as possible, the conservatory being painted to match the window.

Repairing Tube on Camera Bulb

When the rubber tubing to the bulb of a camera shutter breaks or becomes worn, cut out the damaged portion and connect the severed ends with a bicycle-spoke nipple. When the head of the nipple is cut off, the remaining tube is just the right size to slip snugly into the rubber tubing.

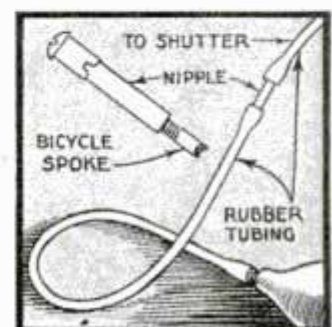

What You Can Do *with*



By **FLOYD M. MIX**

FOR the craftsman, hardwood veneer backed with kraft paper has a variety of uses, especially because it will bend readily over relatively sharp corners. Besides being convenient to use for inlaying and overlaying work, it lends itself admirably for covering old tables and desks, making picture frames, serving trays, fancy wastebaskets and small boxes, lamp shades, etc., the scope of which depends mainly on your own ingenuity. Paper-backed veneer is available in a wide variety of light and dark wood so that you can obtain many pleasing combinations of color and grain, and its cost even permits its use for covering walls.

You can cut paper-backed veneer with a razor-blade knife, or sharp scissors. The bond between the paper and the wood and also a special adhesive, are waterproof. In applying the veneer, the wood side is sponged with cool water, and a thin coat



FANCY COVERINGS ON WASTE BASKETS

LACED OR TAPED TO FRAME

MAKING LAMP SHADES

TITLE IN CONTRASTING WOOD

SCRAP BOOK, DIARY AND ALBUM COVERS

INLAYING SMALL BOXES

Supplied by Smith

PAPER-BACKED VENEER

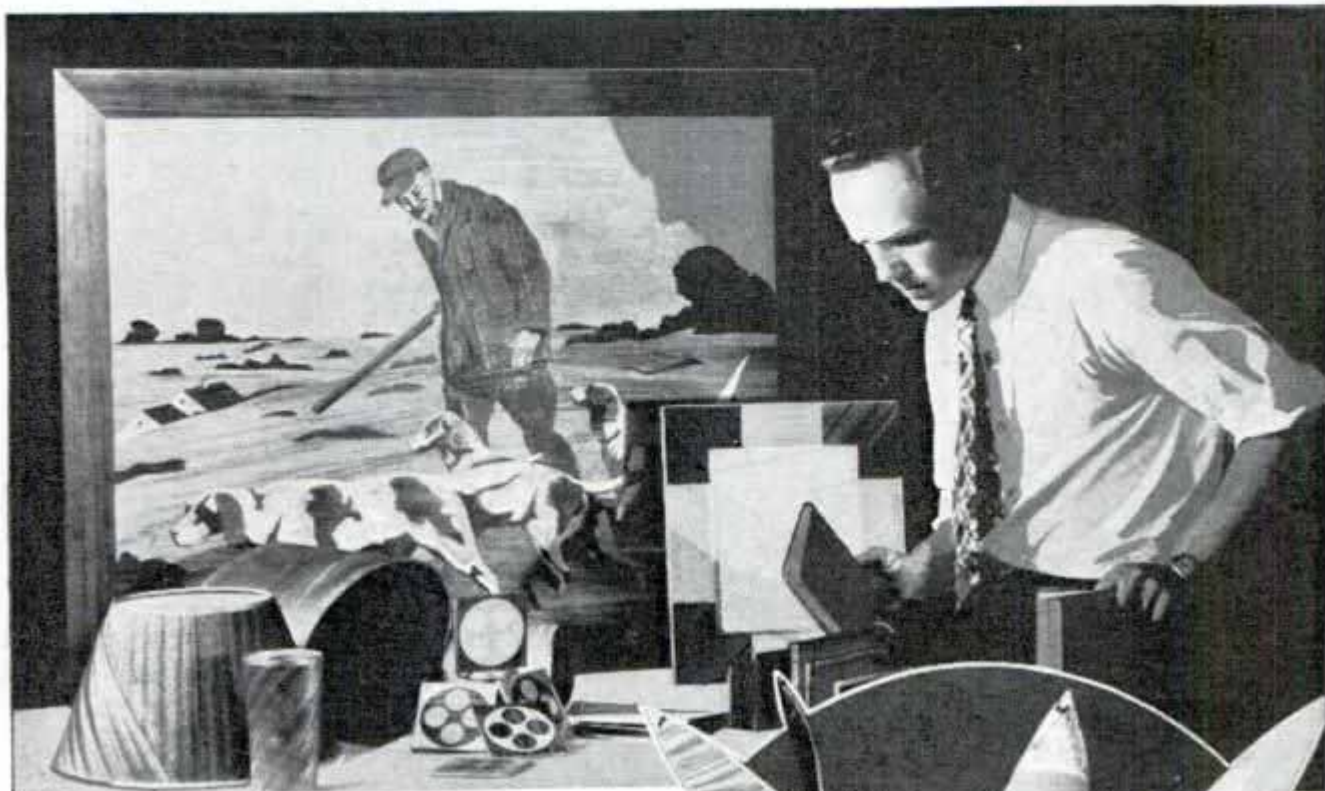

of adhesive applied to the paper side. Adhesive is also applied to the surface to be covered. The glue is allowed to dry a few minutes until tacky, and then the veneer is pressed firmly into place. Excess glue should be worked out with a putty knife, or rubber-faced roller, beginning at one end and working downward with the grain. For most jobs no clamps are required. A thin coat of white shellac or wax will make a satisfactory finish.

An interesting item to make is a table or mantel lamp as shown in one of the photos. The base is a simple woodturning job and the leaves, which consist of walnut and maple veneer glued together, are bent to the proper shape when wet. A small lamp is mounted on a wood plug, as indicated.

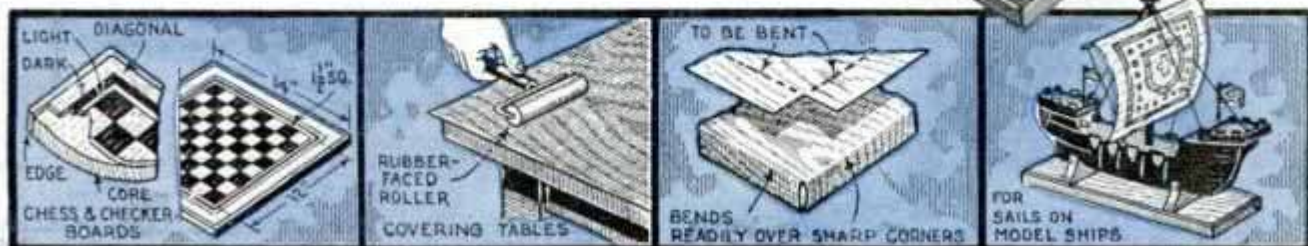
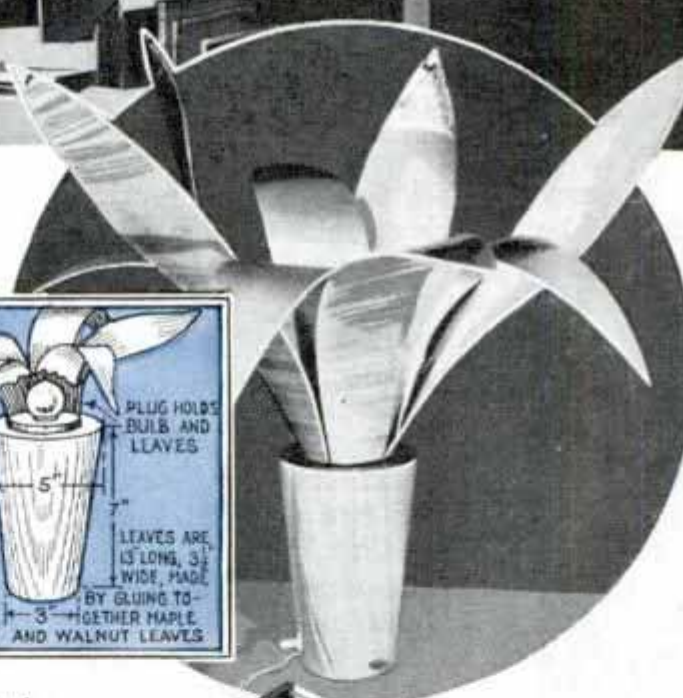

**Accurate Fence for Circular Saw
Is Made of Flat Iron**



This Strong Saw Fence Is Easily Attached and Can Be Made in Any Size Desired

Unusually rigid, this saw fence is ideal for the homemade circular saw. It is made of flat iron, with the exception of the movable side member, which is a piece of angle iron bent to a U-shape at the ends to fit over the edges of the table. All joints are loosely riveted so that they will pivot. The four short arms must be the same length, and they must be drilled exactly alike, otherwise the movable member will not remain parallel with the side of the saw table when the fence is adjusted. A bolt through the stationary side member and the slotted center arm is loosened to adjust the fence. A scale inlaid near one edge will help in setting the fence.

Old Comb Converted into Skimmer



Fitted with a handle, an old comb makes a skimmer that will often be found more efficient than a spoon or paddle. The comb should be curved upward slightly at the

ends. If it is celluloid or hard rubber, it should be softened in hot water before bending. By riveting the handle of an old toothbrush to a comb, you will have a skimmer that can be used in acids.

Mud Scraper Made from a Clock Spring

Made from a length of clock spring, this mud scraper will be found more efficient than the average paddle for cleaning shovels, spades, etc. A piece of spring about 1 ft. long is looped and the ends taped to provide a handle. A scraper of this kind is small enough to be carried conveniently in the pocket, and it will last a long time.



**Moisture on Window Drained Off
with Metal Trough**

Attached to a window as shown, a shallow brass or copper trough will direct condensed moisture outside instead of allowing it to run down on the sill, and possibly onto the wall underneath. The sash should be kept raised slightly so that the water can pass under it easily.

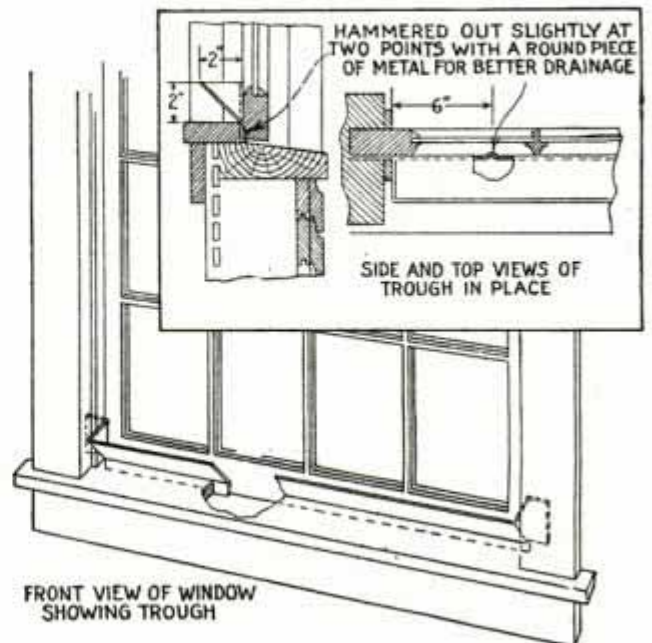

Sheet-Metal Troughs Prevent Condensed Moisture on Windows from Running Down on Sills

From the ARSENAL of the

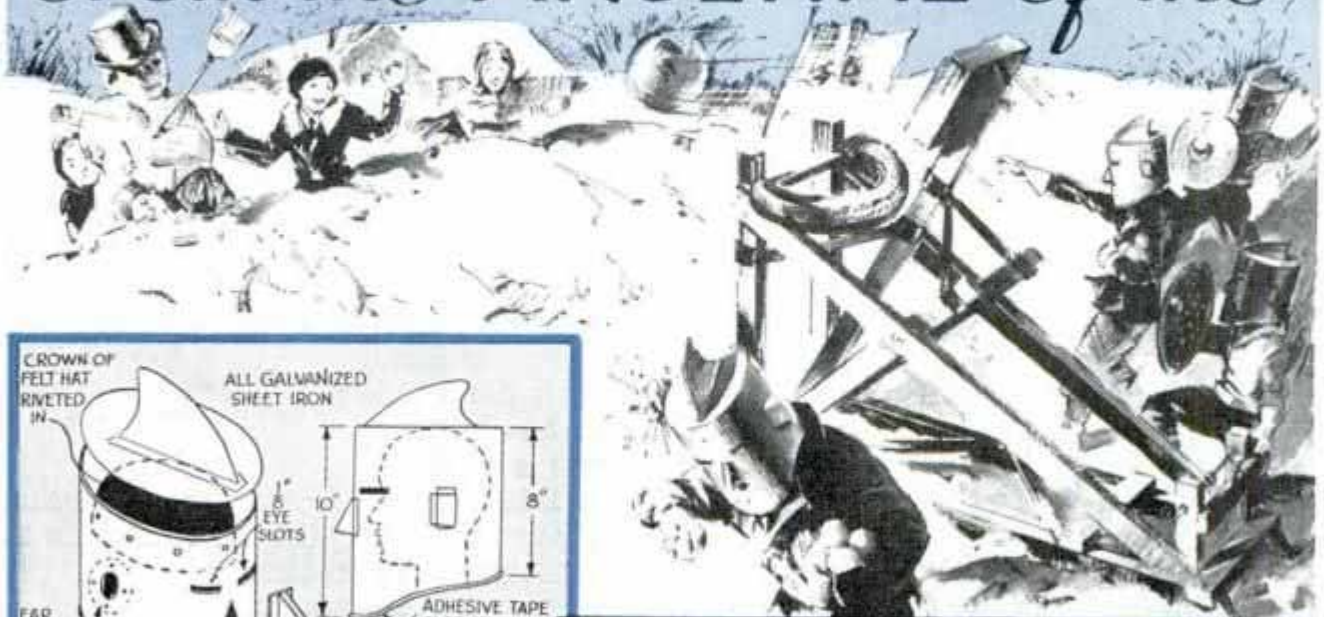

Winter Warrior

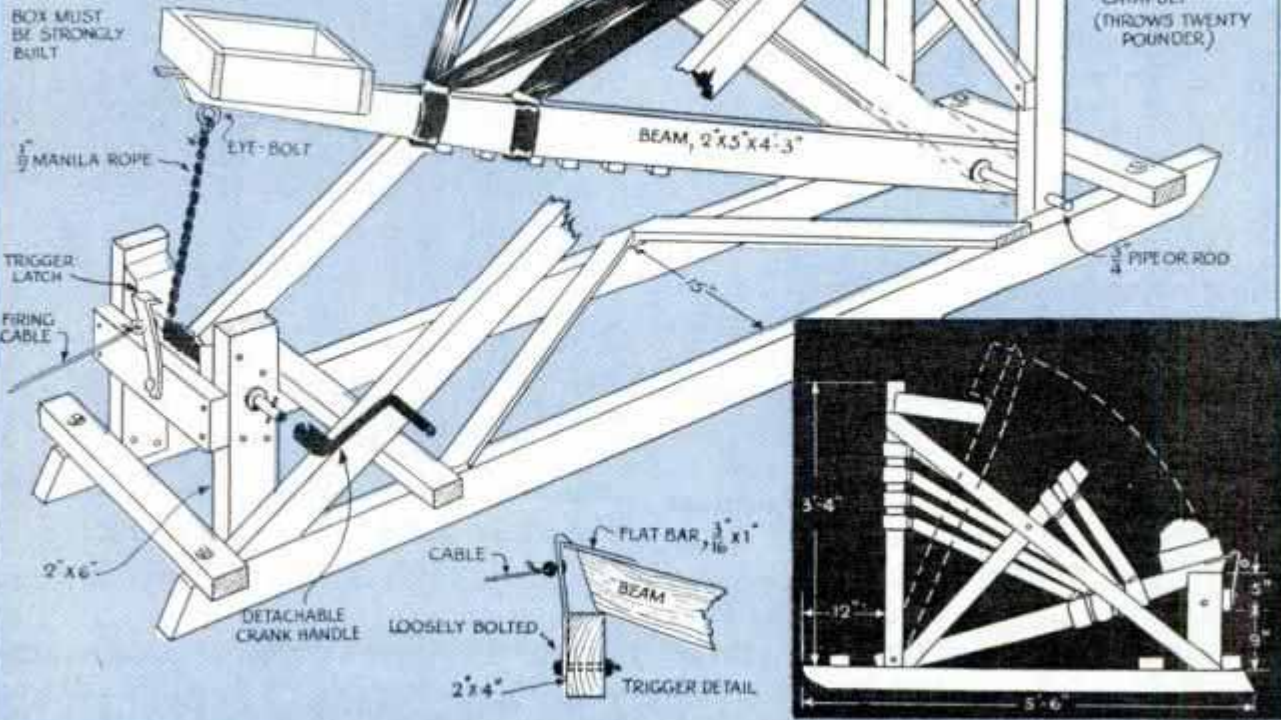
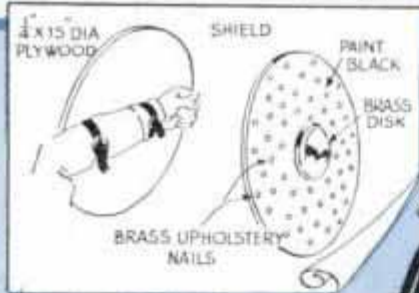
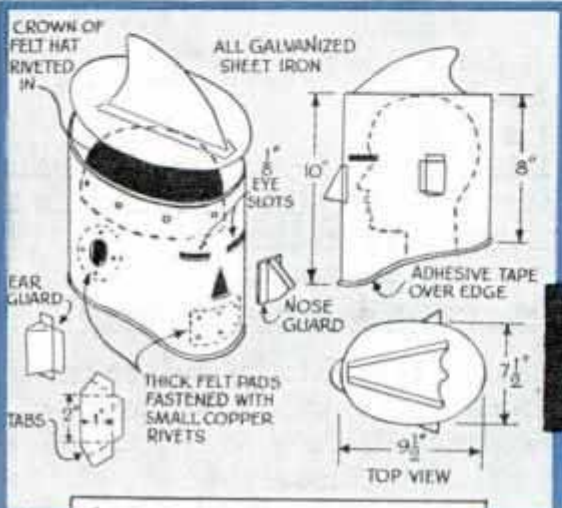

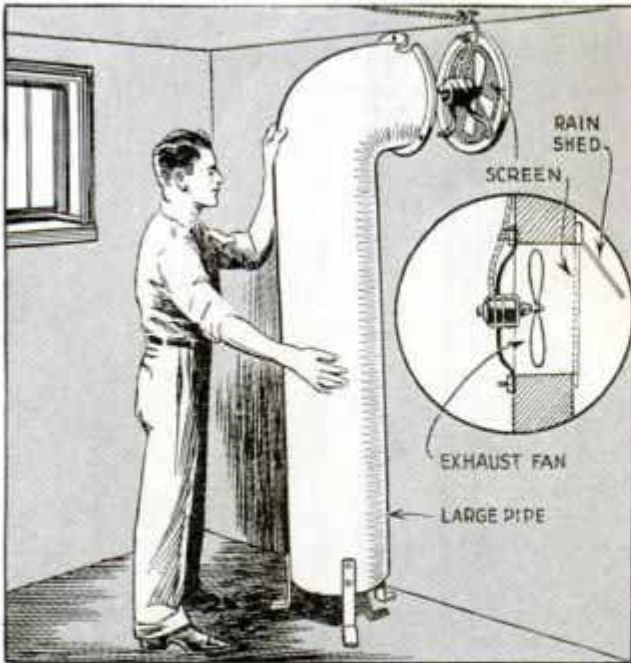

Electric Fan Installed in Wall Sucks Out Damp Air and Keeps Basement Dry

Damp Air Sucked Out of Basement Through Exhaust Pipe

Installed in a basement wall in connection with a large sheet-metal pipe, which extends down to within 6 in. of the floor, an electric exhaust fan will suck damp air out of the basement and keep it dry. The pipe, which is the type used for hot-air ducts on furnaces, is supported on flat-iron legs, and has an elbow at the upper end, the edge of which is flanged so that it can be bolted to a support around the fan opening in the wall. To keep out insects, the opening is covered with screen wire. Also, it is provided with a rain shed, which may be thin wood or sheet metal.

Corrugated Slides to Adjust Shelves

Shelves of workshop cabinets will be adjustable to various levels if they are supported with strips of corrugated roofing on the sides of the cabinets as shown in the drawing. For a neat job, the shelves should be thick enough to fit the sunken parts of the corrugations snugly, and for this reason, the ends should be rounded, which can be done with a wood rasp.

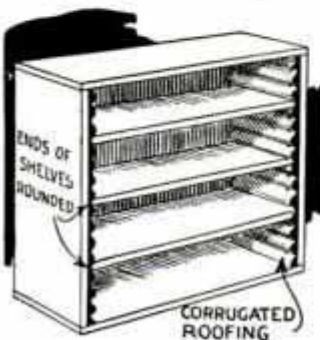

Cardboard Ruler Made on Typewriter Measures in Tenths of an Inch

If you have occasion to make divisional measurements in tenths of an inch, and such a ruler or scale is not at hand, one can be laid off on a typewriter. Most standard typewriters are spaced to write ten characters per inch. Using the apostrophe character, insert a card and type this character repeatedly, completing the ruler by typing the inch numbers in their respective positions.



Tool Rack from Ice-Box Shelf

Jointed or forked tools, such as screwdrivers, chisels, etc., are held conveniently in this wire rack. It is made from an old ice-box shelf, which is cut in two and the

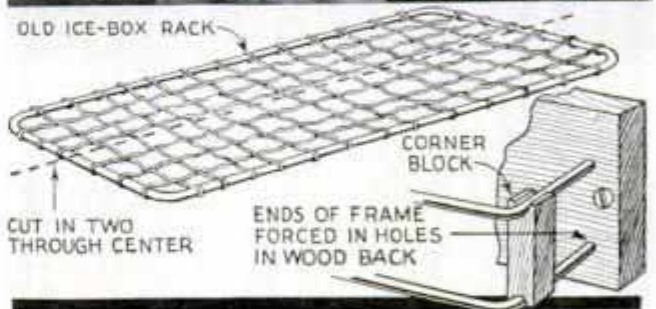
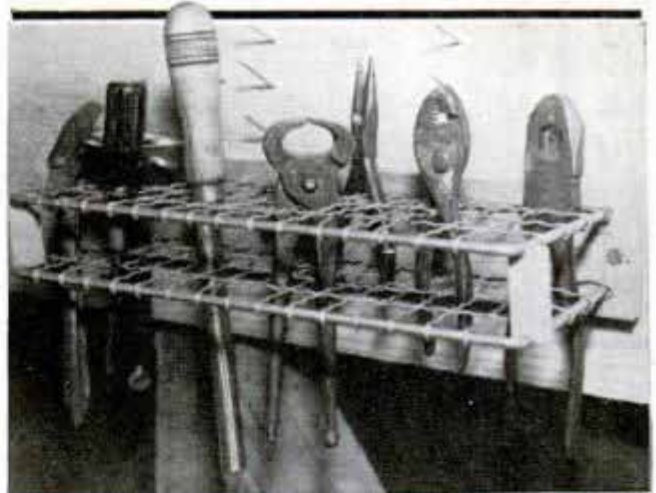

Rack Made from Old Ice-Box Shelves to Hold Forked or Jointed Tools

parts mounted horizontally on a wall as shown. Or, they may be mounted vertically in case you have small handles on the tools that will drop through the rack.

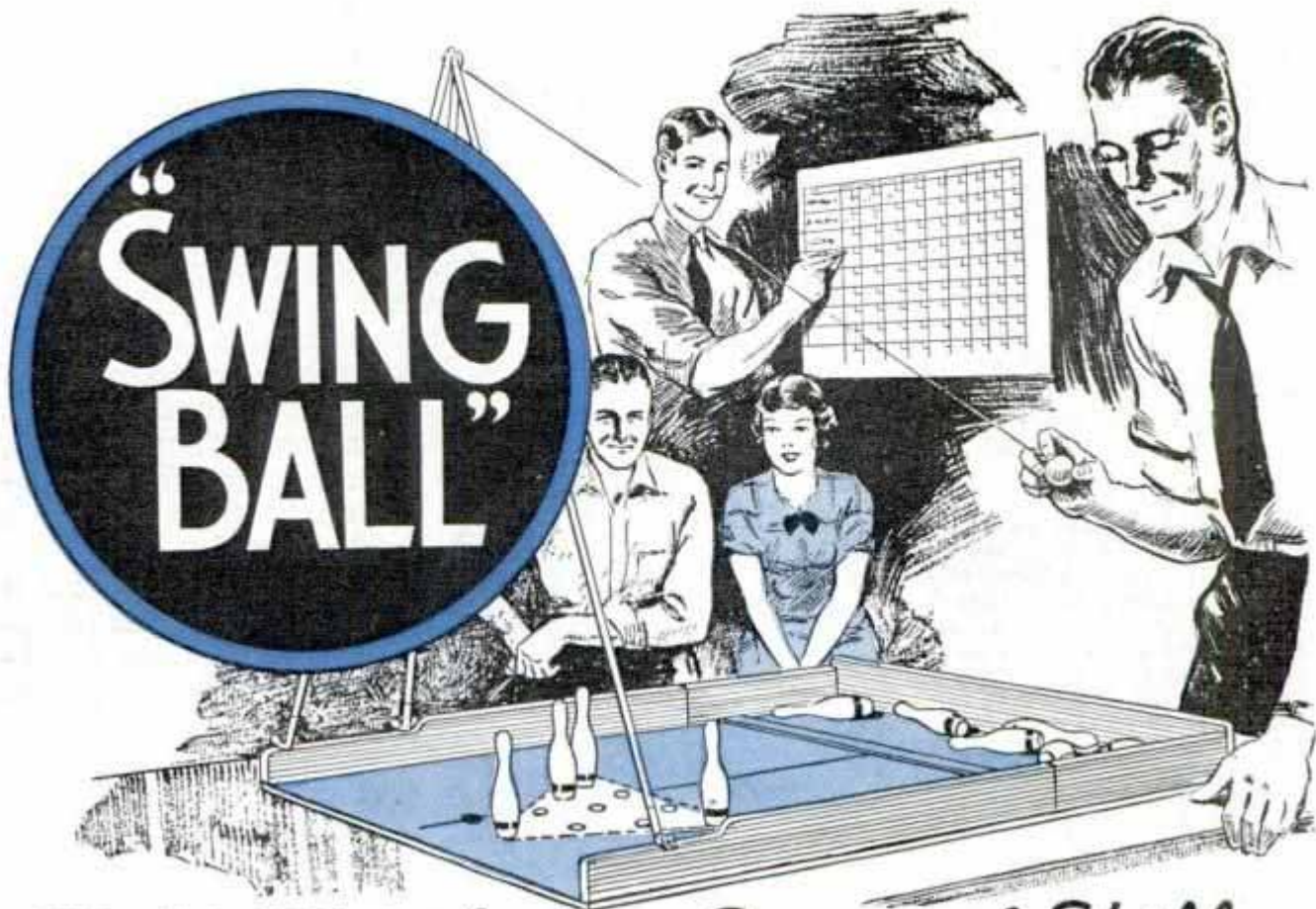

“SWING BALL”

Table-Top Action Game of Skill

“BOWLING” on a table top requires skill, provides plenty of action and gives the entire family wholesome diversion on long, winter evenings. You count “strikes” and “spares” as in regular bowling, but you play with a suspended ball, manipulation of which requires some of the precision of billiards. The pins are turned on a lathe and the game board is arranged to fold compactly, forming a box in which all the loose parts can be stored. Or, if desired, a game board that is portable, but not folding, can be provided.

The ten pins and their arrangement is similar to the conventional bowling set-up, except that the triangular bank of pins points away from the player instead of toward him, and is located on one side of the center line. The suspended ball is weighted to four times the weight of a single pin and crashes through the bank of pins the same way as a bowling ball on an alley, after which it returns to the hand of the player. The ball must be swung in an elliptical path, hitting the pins on the return swing. It is this part of the game that gives rise to some interesting calculations. No matter from what point the ball begins its course, or how wide the ellipse traveled, the distances A and B, as shown in Fig. 7, are always the same.

In the game, you can follow rules of conventional

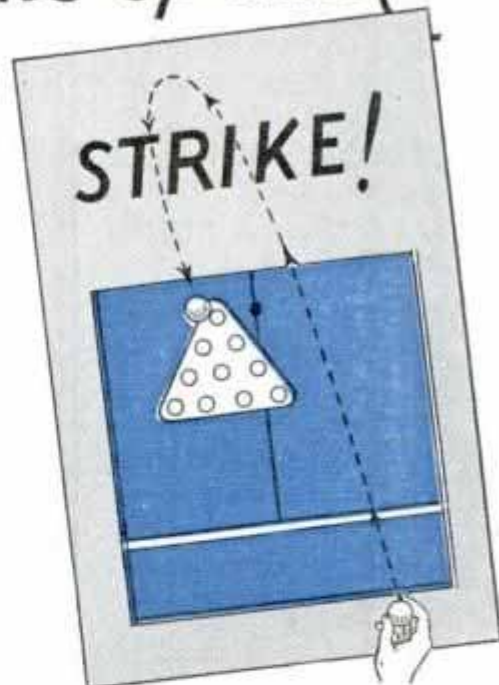

This table-bowling game in which a swinging ball is brought to bear upon a bank of ten pins, has many points in common with the usual bowling game. The scores are counted in the same way. Players must calculate the path of the ball, which travels in an elliptical path. Careful playing with application to make the “spares” count, will help you get a high scoring average. Two-pin shots, such as “splits” and “railroads,” require the greatest accuracy.

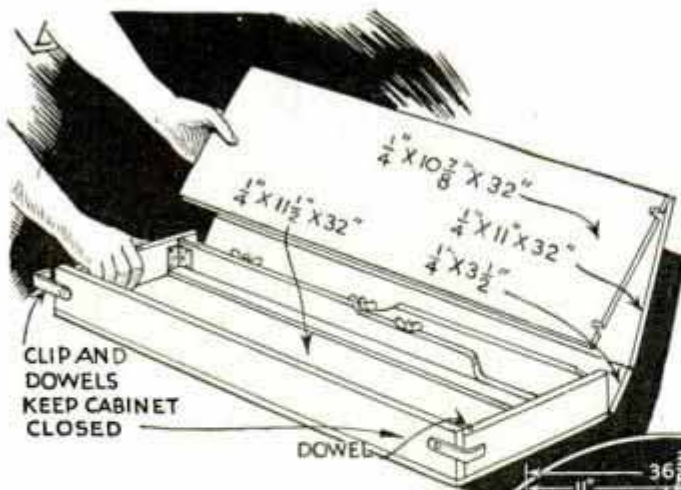

The game board can be folded compactly to form a box in which the pins, ball, tripod and other equipment are stored. The circular detail shows how two hinged rails, which form part of the sides of the game board, are folded together, collapsing it to form a box. Below, details of assembly, and arrangement showing the simplicity of construction. In playing, the pins knocked down by each swing are gathered into the space behind the slot which serves as a deadline

bowling. Players alternate, swinging the ball twice at each turn unless all pins are knocked down with the first swing, which is a "strike." Getting all the pins down in two swings gives you a "spare." When a player makes a strike he counts the score plus the ten of the strike plus the number of pins made in his next two swings. In case of a spare, he adds the ten of the spare to the score, plus the number of pins made on his next swing. Two swings—unless a strike is made—constitute a "frame" and ten frames make a "line" or game. If a pin is knocked over on the forward swing, if a player fails to catch the ball on its return swing, if the pins are missed entirely or if the ball strikes the leg of the tripod, it is

classed as a "gutter ball" and constitutes a scoreless play in which any pins that may have been knocked over do not count. These rudiments will give you some idea how the game is played, but if you are unacquainted with conventional bowling, it is a good idea to visit a local bowling alley or a friend who knows the game so that you can familiarize yourself with the details of scoring. Regular bowling score sheets

can be purchased at amusement supply stores, or one can be permanently painted on a blackboard.

The game table is made up of four panels of 1/4-in. plywood or hard-pressed board, and these panels, laid out in their respective positions, are covered with a piece of 8-oz. canvas, glued on. After the glue has set, the

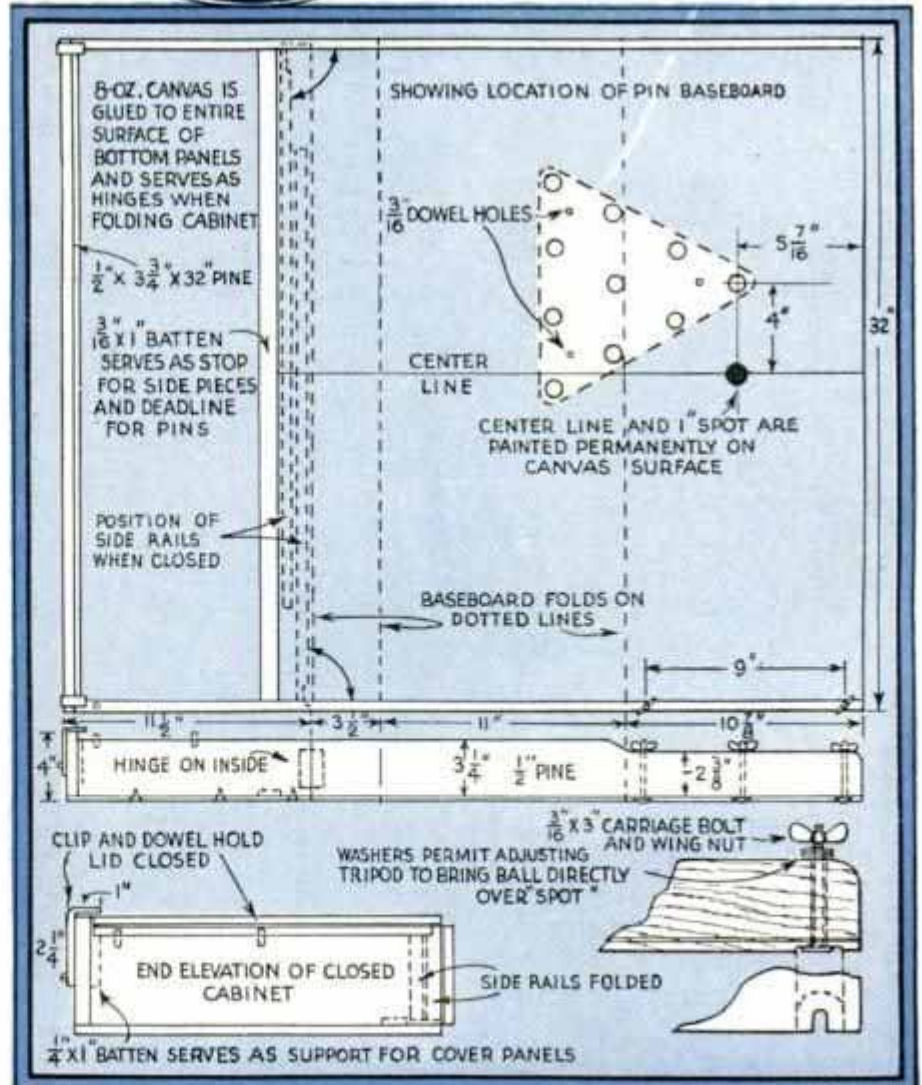
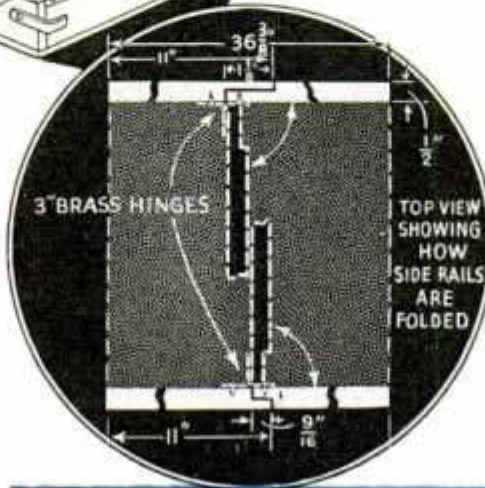

surplus cloth at the edges is trimmed away and the end piece and side pieces are mounted on the baseboard with wood screws, the side pieces forming the end of the box when the game board is closed. Hinged to these stationary side pieces, are two extensions that complete the sides of the game board when it is in use. These are held rigidly to the edge of the end panel that comes directly under the tripod, by means of bolts and wing nuts—two on one extension and one on the other. Notches in the edge of the end panels permit the bolts to be slipped in place readily. Besides serving the purpose of attaching the extensions rigidly, the bolts also hold the feet of the tripod. When the game board is to be folded, the bolts are loosened, the tripod is removed and the extensions are



$\frac{1}{4}$ " SQUARES

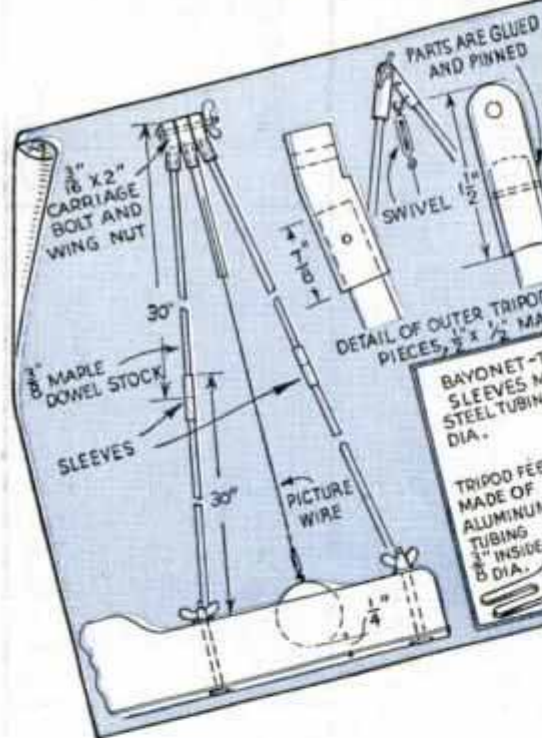

PIN BASE BOARD MADE OF $\frac{3}{16}$ " FIBER BOARD, MUSLIN IS GLUED TO TOP SURFACE

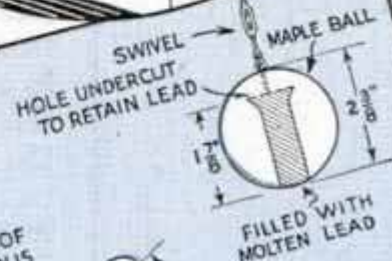

FILLED WITH MOLTEN LEAD

BOARD FOLDS ON DOTTED LINE



The tripod from which the ball swings has two-piece legs jointed together by means of bayonet-type sleeves. Wing nuts hold the tripod feet to the bolts on the ends of the hinged side extension pieces. The ball weighs four times as much as a pin

folded together so that they will be next to each other, against a cross batten which is screwed down permanently and bears the following instruction: "Gather All Toppled Pins Back on This Slat Before Making Second Swing." Other details on the construction and assembly of the game board, such as the clip-and-dowel arrangement for holding the box closed, can be obtained by going over the drawings. The center line and the ball-suspension spot are marked with black ink or paint.

Now for the accessories to the game. The belly of the pins is $1\frac{1}{16}$ in. in diameter, so they can be turned readily from $1\frac{1}{2}$ by $1\frac{1}{2}$ -in. stock. Maple is particularly recommended, but beech, mahogany, or Australian gum can be used. The ball is turned from maple or lignum-vitæ, although a billiard ball also serves the purpose. When a maple ball is used, it is heavily weighted with lead, as shown in one of the details. The hole is enlarged at its base to retain the lead, which is poured

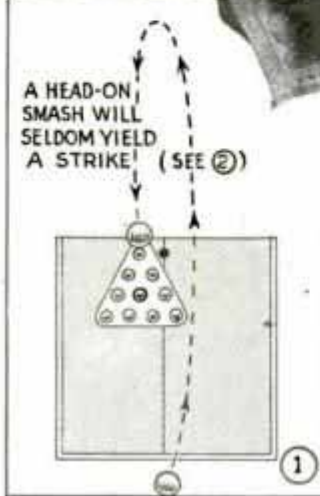
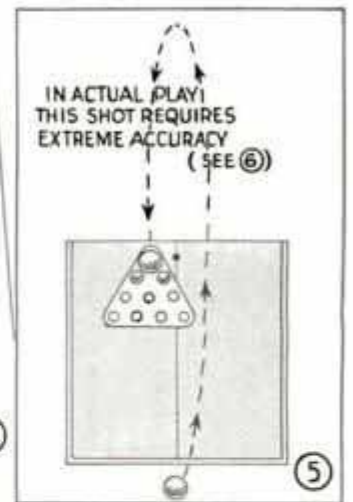
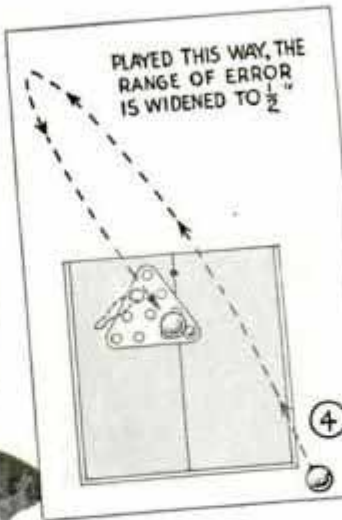

when it is barely above its melting point, in order to avoid scorching the wood. The construction of the tripod is clearly illustrated. Bayonet-type sleeves are necessary on the legs, as the oscillations of the ball put a strain on the legs which would work straight ferrules loose. A swivel at the top of the tripod holds a length of picture wire from which the ball is suspended, another swivel being provided at the ball end. The pin baseboard folds as indicated by the dotted lines in one of the details. It is fitted with three dowels which are glued in place and project on the underside so that they can be set into holes drilled in the surface of the game board. This assures getting the correct position of the pins at all times.

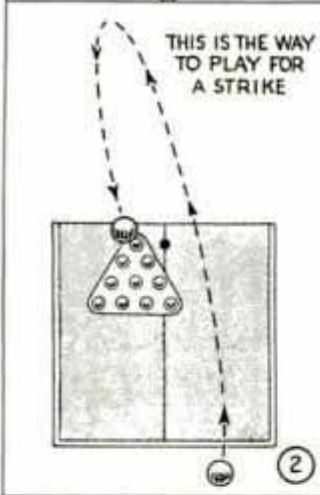
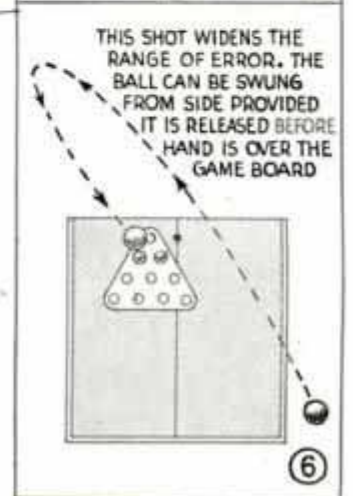

Now, let's play swing ball. First, the tripod legs must be adjusted to bring the ball directly over the suspension spot, and the wire adjusted to hold the ball 1/4 in. off the game board. Figs. 1 to 7 inclusive illustrate a few of the swings or "shots." Strangely, a strike will seldom result from a head-on hit of the king-pin. Fig. 2 shows the more scientific way to go after a strike. Two-pin shots will crop up constantly in the play, and the player most adept at making them, thereby recording a spare, is the fellow who will win the most games, other factors being equal. Careful playing, with application to the technique of making the spares count, will aid materially in getting a high scoring average.

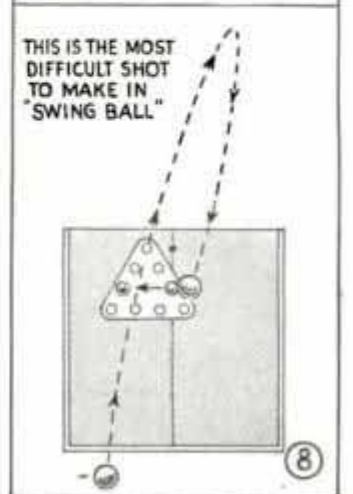
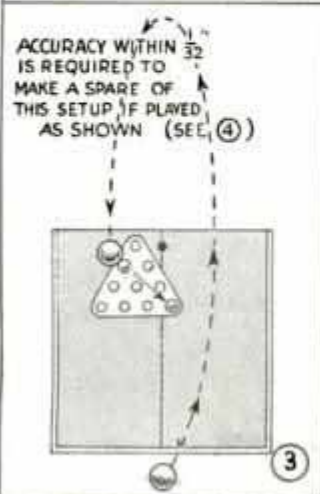
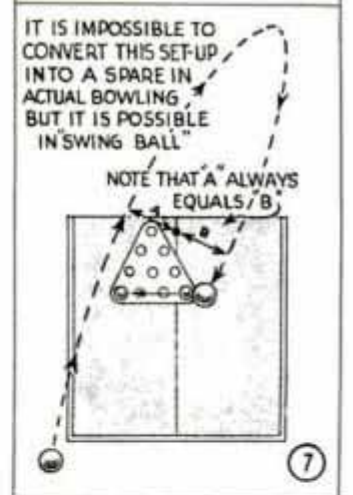

Increasing the Strength of Small Microscopes

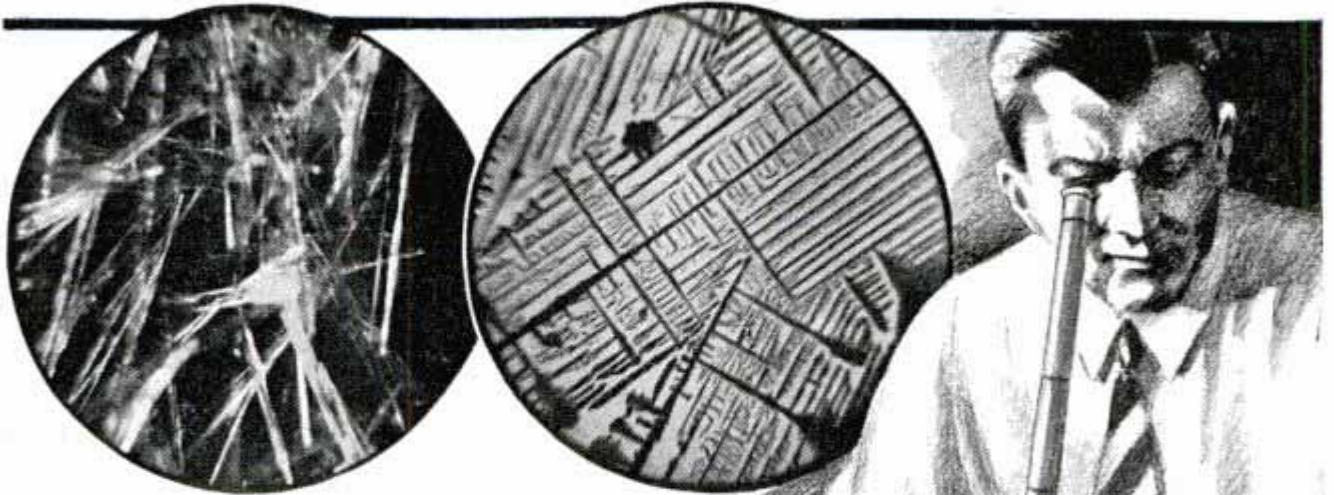

If you have a small microscope of 250 to 300 diameters, it can be converted to a higher powered instrument at no cost by simply using paper tubes to extend the length of the barrel. Make the tubes from heavy paper, or get some cardboard tubes of a size to fit snugly over the upper end of the microscope. Black paper or cardboard is preferable, although you can use any color and paint them black inside and out. Make up several tubes of varying lengths. In use, merely remove the eyepiece, slip one of the tubes over the end



of the microscope and put the eyepiece in the upper end of the tube.—Brantlyn Woolsey, Ridgefield Park, N. J.

Inexpensive Den Smoker that Will Drive Out the Game

By merely working the handle of an auto-tire pump, you can force clouds of smoke into dens of small animals with this outfit. It costs nothing to build, and has a long hose that will direct the smoke into every pocket in the den. Get a large tin can having a tight-fitting cover. Solder a tire valve stem in the cover and a short tube in the bottom, the latter to take the long piece of hose. The smoke-producing material is held in a small can having the bottom perforated as shown. This material may be waste cloth sprinkled with smoke powder, which can be obtained from any firm that handles trapping supplies.—Martin G. Winterton, Lewis, Wash.

Woods that are quite absorbent require a priming coat that is rich in linseed oil, with a small amount of turpentine added; while the less absorbent woods need only a small amount of oil but more turpentine, to help the oil penetrate the wood.

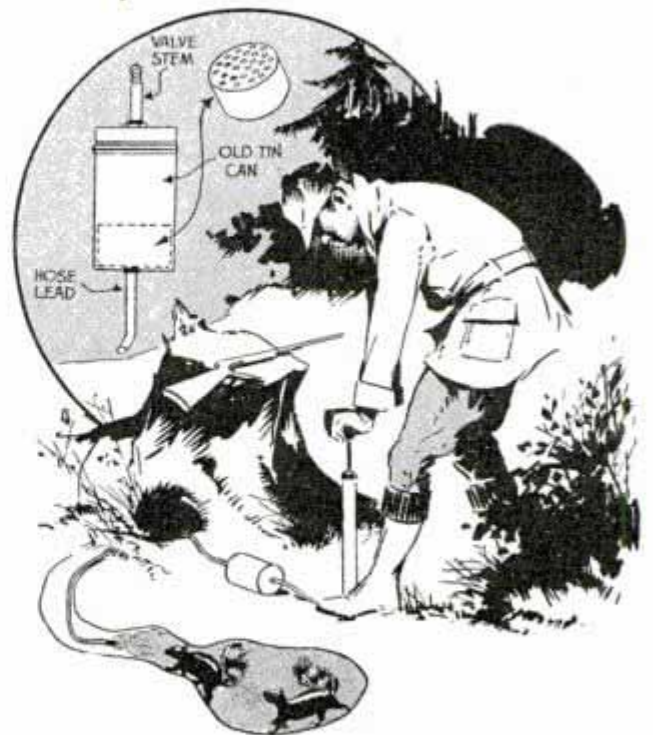

With This Homemade Smoker, You Can Force Smoke into Every Pocket in Animal Dens

Old Razor Blade in Carving Tool Does Fine Detail Work



Carving Tool Uses Razor Blades, Which Are Shaped to Suit the Work at Hand

For carving in fine detail on small models and similar work, this tool has the advantage over others in that it employs an old safety-razor blade, which can be used whole or broken up into shapes to suit the work at hand. The tool holder is a piece of brass slotted at one end with a hack saw, and fitted with a machine screw to clamp the cutting blades in place.

Paintbrush Protected with Tin Sleeve



When a paintbrush is used frequently and is kept in a can of liquid to prevent paint from drying on the bristles, put a tin sleeve over the bristle end. Then, if the brush is left in the

can for several days, the bristles will not be bent out of shape by the weight of the brush. The sleeve should be a little wider than the length of the bristles.

Sagging of Workbench Drawers Stopped with Angle-Iron Slides

If the drawers in your workbench are loaded heavily and sag when pulled out, fit them with angle-iron slides to extend beyond the

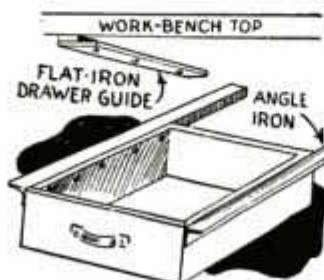

rear end as shown. The guides for this installation are wide strips of flat iron screwed to the underside of the bench top, and spaced from the latter with pieces of wood or iron. If available, lengths of narrow channel iron may be used instead of the flat iron. These are drilled through both sides so that the upper side can be screwed to the bench.

Photo Negatives Held on Drying Line with Double Clothespin Clamp

Glued together as shown, three spring-type clothespins provide a double holder

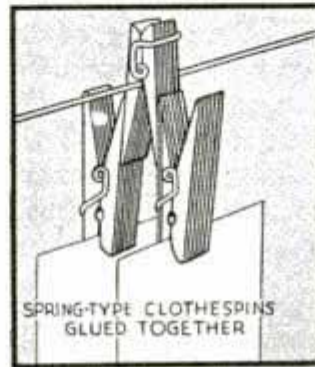

for keeping photo negatives on a drying line. This is an improvement over the usual method of attaching a wire hook to a single pin in that the holder will not be dislodged by a slight movement

of the line. The holder is attached by straddling the line with the legs of the upper pin as shown, or by clipping the jaws of the upper pin to it.—Frank W. Bone, Adrian, Mich.

Screw Top on Sack Helps in Pouring

As an aid in pouring poultry and stock feed from a sack, cut out the screw top from an oil can and tie it in the sack top. Besides enabling you to pour the feed without spilling it, the screw top provides a means of quickly closing



the sack. If the tops are cleaned thoroughly before using, this idea is also handy in the kitchen where sugar, flour, salt, etc., are purchased in large sacks and removed when they are needed. A coat of enamel will help make the tops sanitary.

Lively Players Give Action to Football Toy

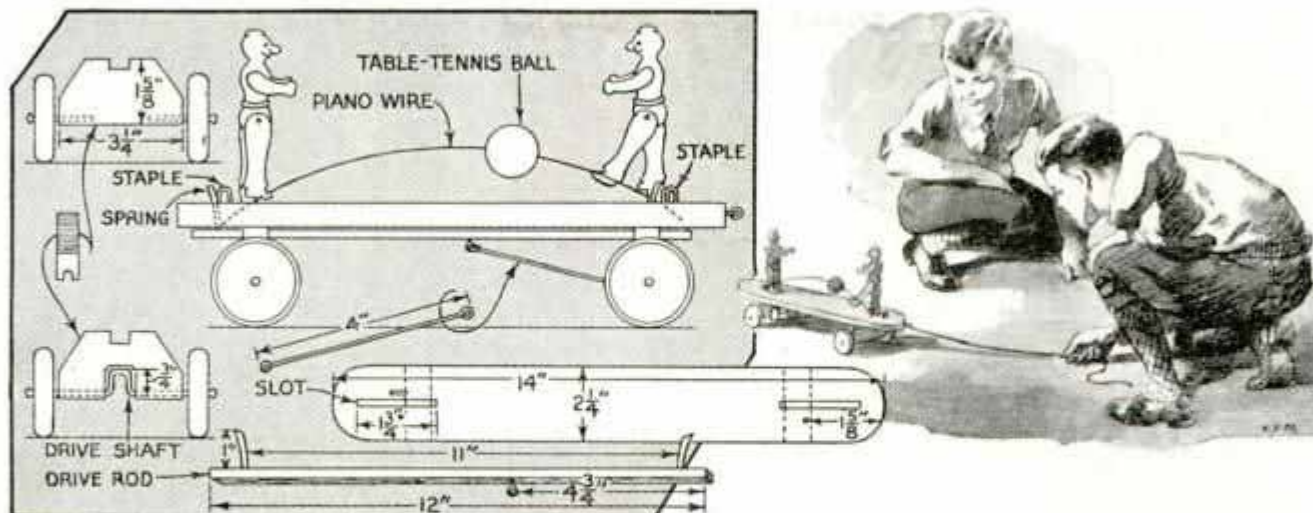

Snappy and amusing, this action toy causes two miniature football players to kick a ball back and forth between them when pulled over a floor. The wheels operate the pivoted kicking leg of each player by means of two lengths of clock spring, which project through slots in the base. These springs are fastened to a sliding drive rod, which is moved back and forth by the crank axle or drive shaft of

one pair of wheels. Wire staples, driven into the base to straddle the slots, act as triggers to snap the springs against the kicking foot of each player. The ball is a celluloid table-tennis ball drilled to slide easily along a curved length of piano wire, each end of which is anchored in a hole drilled obliquely into the base beside the players. These are scrollsawed from thin plywood or cigar-box wood.

Portable Photo Lab for Amateurs Slips over the Bathtub

Are you one of the many amateur photographers who are handicapped by lack of suitable space for a darkroom? If so, this portable equipment will enable you to do the work in your bathroom. A rack to hold the trays fits over the bathtub, stops being provided on the underside so that the rack cannot slip out of place. A handy faucet, fitted to the edge of the rack, can be connected to the bathtub faucet by means of a rubber hose. The ruby lamp can be moved to any convenient position on a taut wire suspended between two posts that are slipped into place at each end of the rack. With this arrangement, all spilled liquids will drain into the tub and it takes only a few minutes to clean up and store the equipment when the work is finished.

☞ An old card table with the top removed serves nicely as a frame on which to make a hooked rug; it is just the right height for working, and can be folded up and stored when not in use.

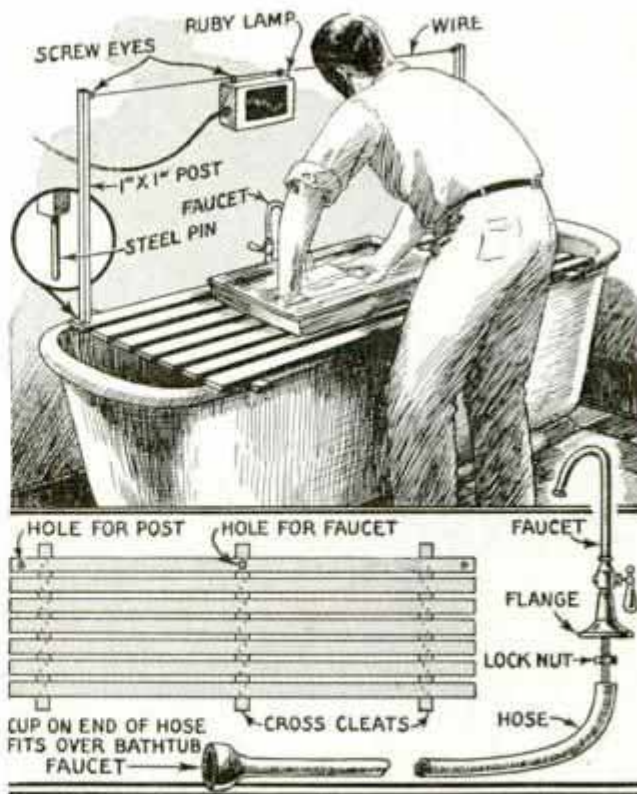

Set on Your Bathtub, This Rack, Which Holds Trays and Faucet, Quickly Converts the Bathroom into a Photographic Darkroom



Maple WING

design is again marked out on the panel and the sides band-sawed to shape. If the panel is too large or unwieldy to handle on a power saw, cut it apart along the dotted lines with a hand saw as in Fig. 1. The center cut should be made last, using a keyhole saw.

The frame, which carries the seat, is shown in Fig. 2. Any sound lumber is suitable, as it is covered by the sides and upholstery material. Screws, glue and corner blocks are used to get rigidity. Before attaching the side panels to the frame, holes for the feet should be made. The front feet are turned to the shape shown in Fig. 4, and are glued into holes drilled in the blocks at the front corners of the frame. The rear feet are band-sawed from hard maple to carry the curved line of

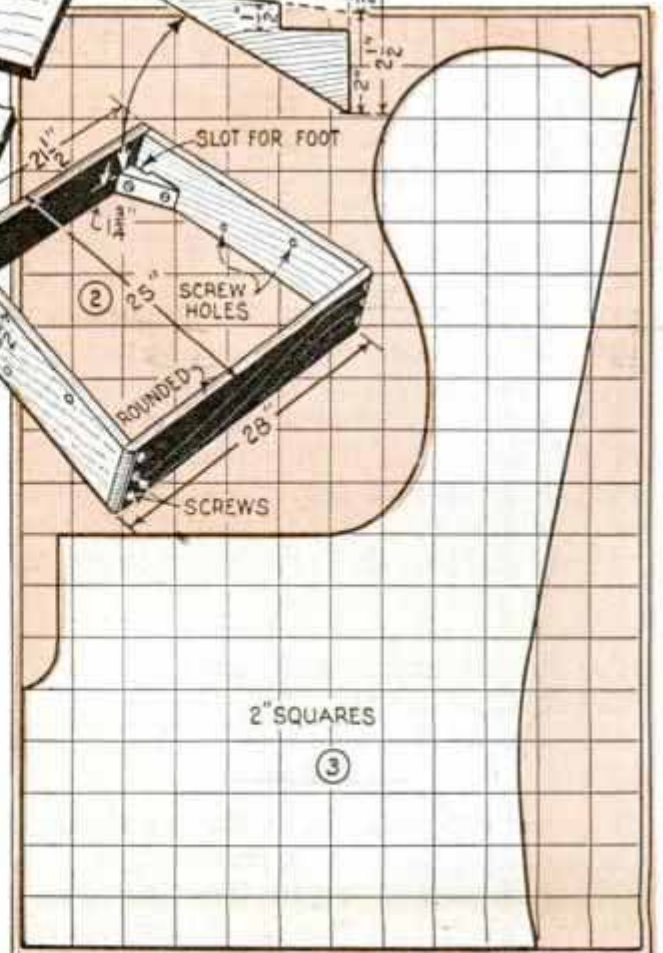
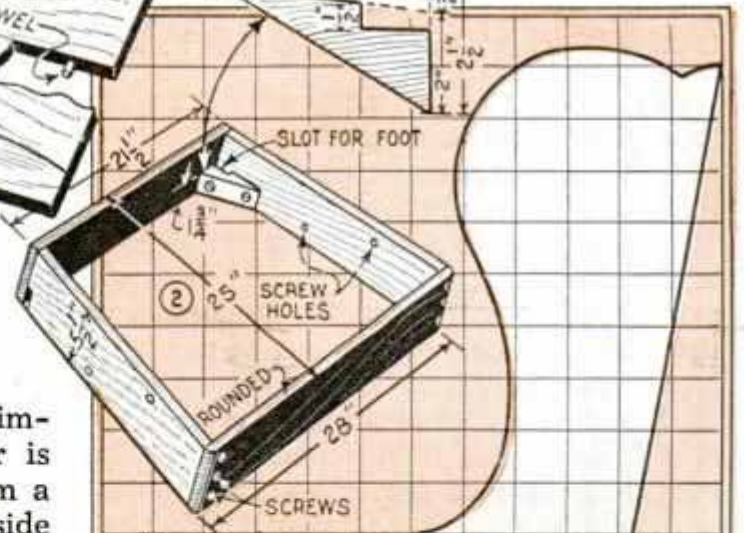
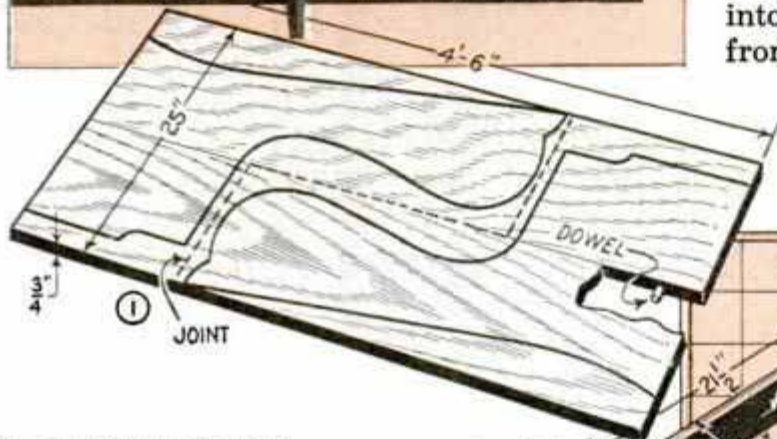

OUTSTANDING among colonial reproductions, this wing chair is upholstered neatly to provide real comfort, and its pleasing, quaint design adds coziness to any room.

Construction of the chair frame is simple. Maple or knotty-pine lumber is matched for grain and jointed to form a panel large enough to make both side pieces, Fig. 1. Tight joints are essential, so be sure to make them slightly lower in the center than at the ends, as the shrinkage is greatest near the exposed end grain. It is advisable to dowel the joints at intervals to assure their holding under strain. To locate the dowel holes so that they will not be exposed in the sawing, a full-size pattern is made from the squared drawing shown in Fig. 3. This pattern is marked out on the pieces. After the glue is dry and the surfaces have been planed, the

no 00 p

CHAIR

of Colonial Days

By R. O. BUCK
of the Lane Technical High School, Chicago

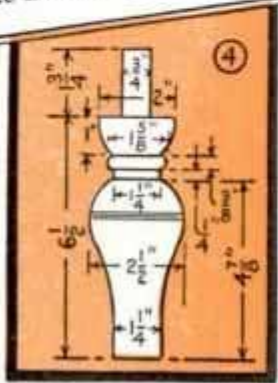

the back. A squared drawing of this form is given in Fig. 5. In order to have the back of the foot flush with the chair back, at the top, a shoulder is cut on the foot. Also, a similar shoulder is cut on the side, but here the foot is flush only at the extreme rear corner. To avoid having two thicknesses of the stock to span, thus leaving a weak tenon, the frame and corner blocks are notched out for the tenon, Fig. 5.

Having assembled the feet in the frame, the side panels may be glued and screwed into place, provided the formed top rail, side cleats and bottom rail have been made previously and fitted, as shown in the assembly drawing, Fig. 7. The exact length and bevel on the ends of these pieces can be determined best by trial. Short dowels and glue are used to fasten the horizontal members, light angle brackets being used to reinforce these joints.

The arm rolls, shown in the detail, are planed to shape by screwing them to a strip of waste stock so that they may be held in a vise as shown in Fig. 6. Dimensions and method for mounting these pieces are shown in the detail drawing. After the arm rolls are mounted, the top edge should be rounded carefully with a plane, or file and sandpaper, to conform

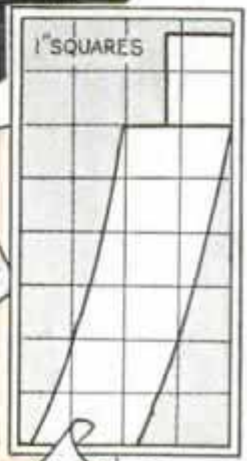
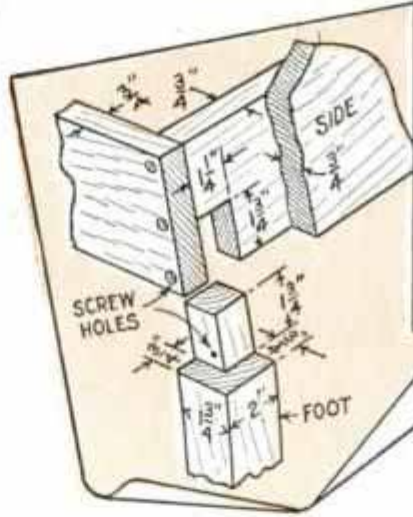

to the shape of the roll. When the frame has been sanded, it may be stained and finished.

Next comes the upholstering. If the directions are followed carefully, you will have no difficulty in getting a workman-like job. First, you will need a seat frame on which to stretch the foundation of webbing. This frame fits inside the main frame and rests on the corner blocks. The dimensions can be obtained from Fig. 8. Almost any lumber that is sound enough to hold tacks is suitable. Nails are used to fasten the corners. Webbing 3 1/2 in. wide should be spaced about equidistant on the frame so that there are three interwoven pieces running in each direction. Do not cut the webbing into lengths until

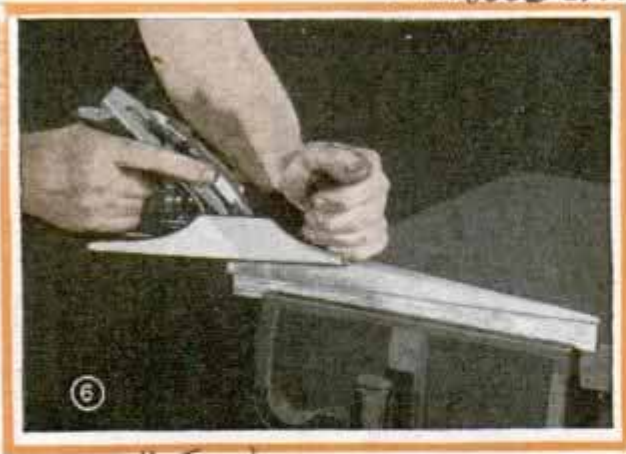

and out. Use seven tacks at each end, folding over as described.

Nine springs are used in the seat frame. These may be purchased for about 50 cents a set, or they may be taken from an old automobile or chair cushion. Each spring is fastened at the intersection of two pieces of webbing by means of strong twine, which is sewed through the webbing with a large needle. The usual practice is to make the thread continuous, tying it at each spring. After the springs are mounted, the frame is reversed so that they may be tied. The springs, which are about twice as high as the frame, at this stage, must be compressed until they are about level with it. This is accomplished by tying. Make a knot in one end of your twine, drive a 10-oz. tack through it, and fasten it into the edge of the frame on a line with the center of a spring. Stretch the twine across the springs to the opposite side of the frame and pull down until they are level with the top of the frame. Adjust them so that they stand vertical. Now grasp the twine and the spring nearest the fastened end with one hand, and, with the other hand, pass the free end of the twine down inside of the spring, then up on the side of the fastened end and to the right, down inside of the coil again, up on the

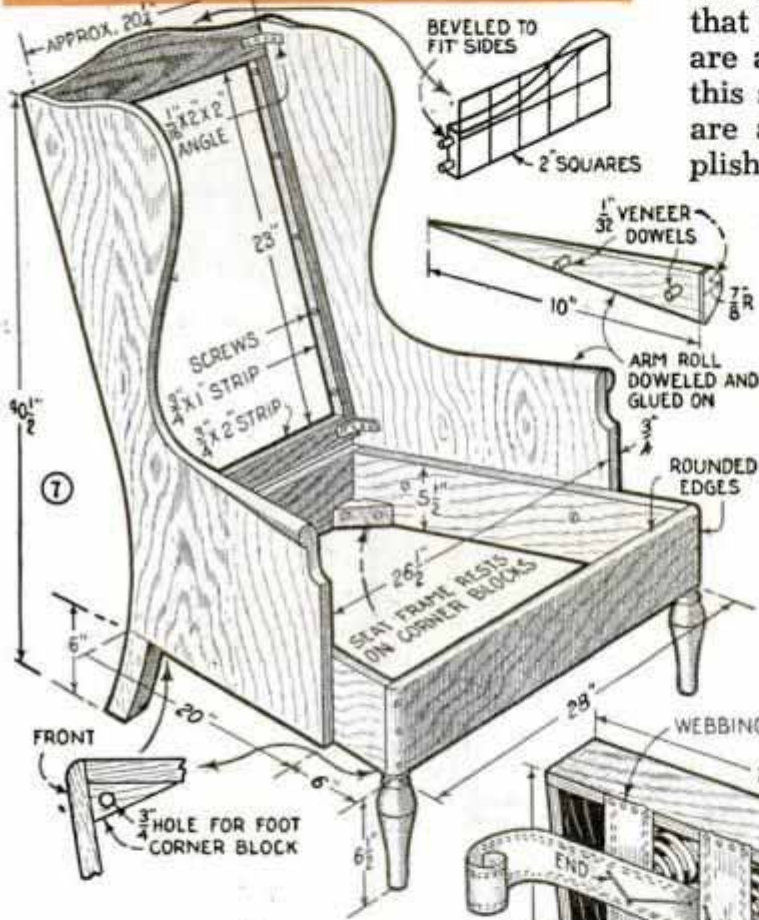

tended end and to the right, down inside of the coil again, up on the

it has been installed, as you will need the additional material for stretching. The procedure is as follows: With the webbing extended over the edge of the frame about 1 in., drive in three tacks. Then fold the end over and drive in four more to hold the first end. Now carry the piece across the frame and insert a stretcher block, which has been made previously, so that the square edge rests against the frame and, when pulled down horizontally, stretches the webbing as shown in Fig. 9. Stretch the three pieces running across the frame first, then repeat in the opposite direction, weaving in

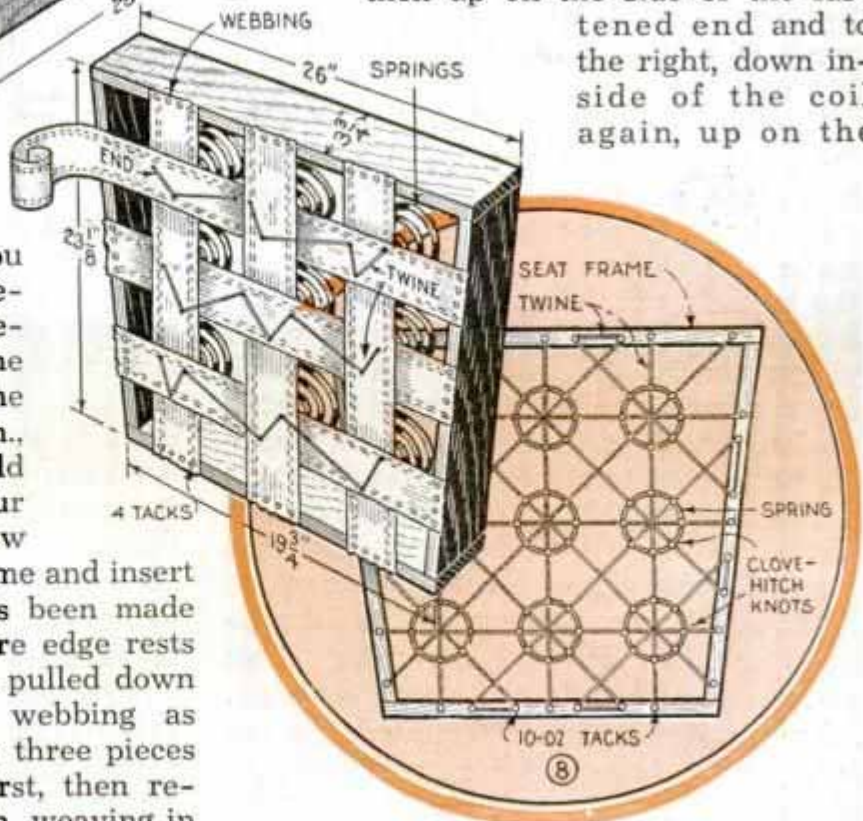

opposite side and to the left, and through the loop thus formed, pulling tight to form a clove-hitch knot. Pull the twine tight, and form a similar knot on the opposite side of the same spring, this time passing the twine down on the outside first, then up on the inside. Proceed with all of the ties in a similar manner, spacing the tops of the springs the same as they are on the bottom and fastening the twine to the edges of the frame with tacks. The springs are tied at eight points. The top of the spring assembly is covered over with burlap, securely tacked along the edges of the frame, and sewed to the springs. Over the burlap, a layer of cotton wadding is used to give a smooth surface. This, in turn, is covered with some dark cotton material, the edges of which are carried down and tacked to the outer faces of the frame.

The front rail of the chair frame is padded and covered with the upholstery material, as shown in Fig. 10. The material, without padding, is carried around the ends of the frame to meet the large side pieces, which carry the arms. After this operation is fin-

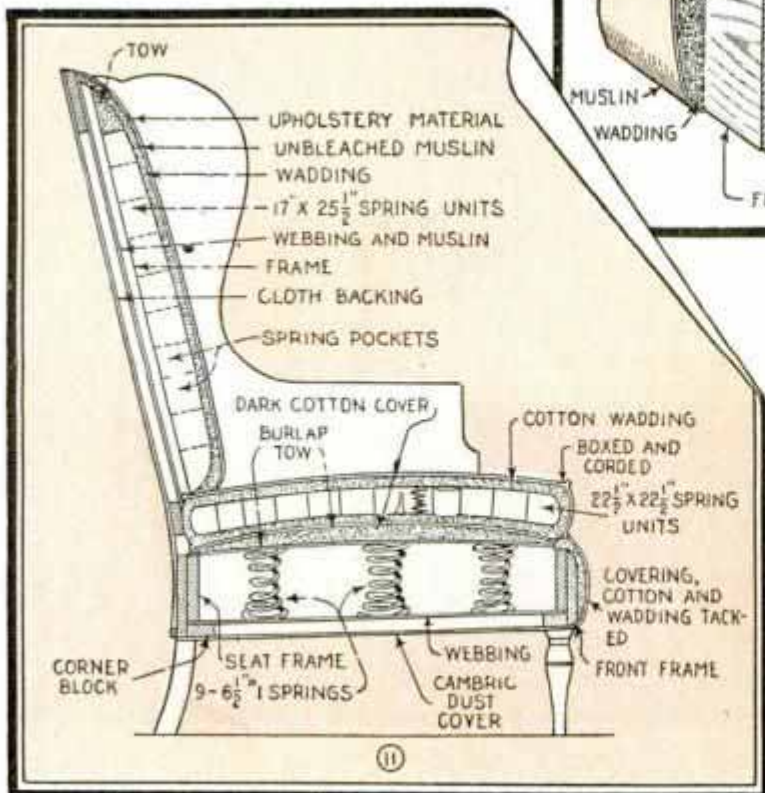
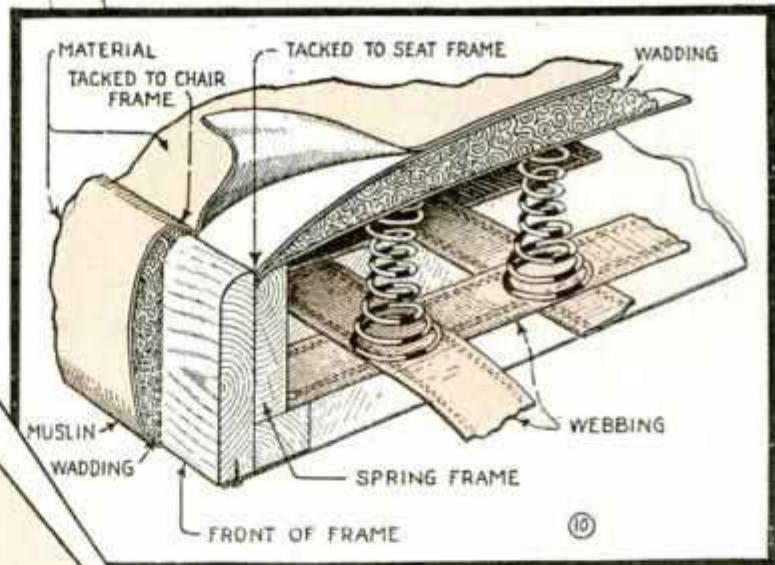

ished, the seat frame may be dropped into place and fastened to the corner blocks from below with long screws. The black cambric dust cover tacked across the bottom finishes the seat springing, as shown in the sectional drawing, Fig. 11. The loose seat cushion is the next job. As a foundation, a set of unit springs, which are simply coil springs sewed into burlap cells, are used. A 22 1/2 by 22 1/2-in. unit is about right. Units can be purchased ready made for a nominal sum or, if you do not

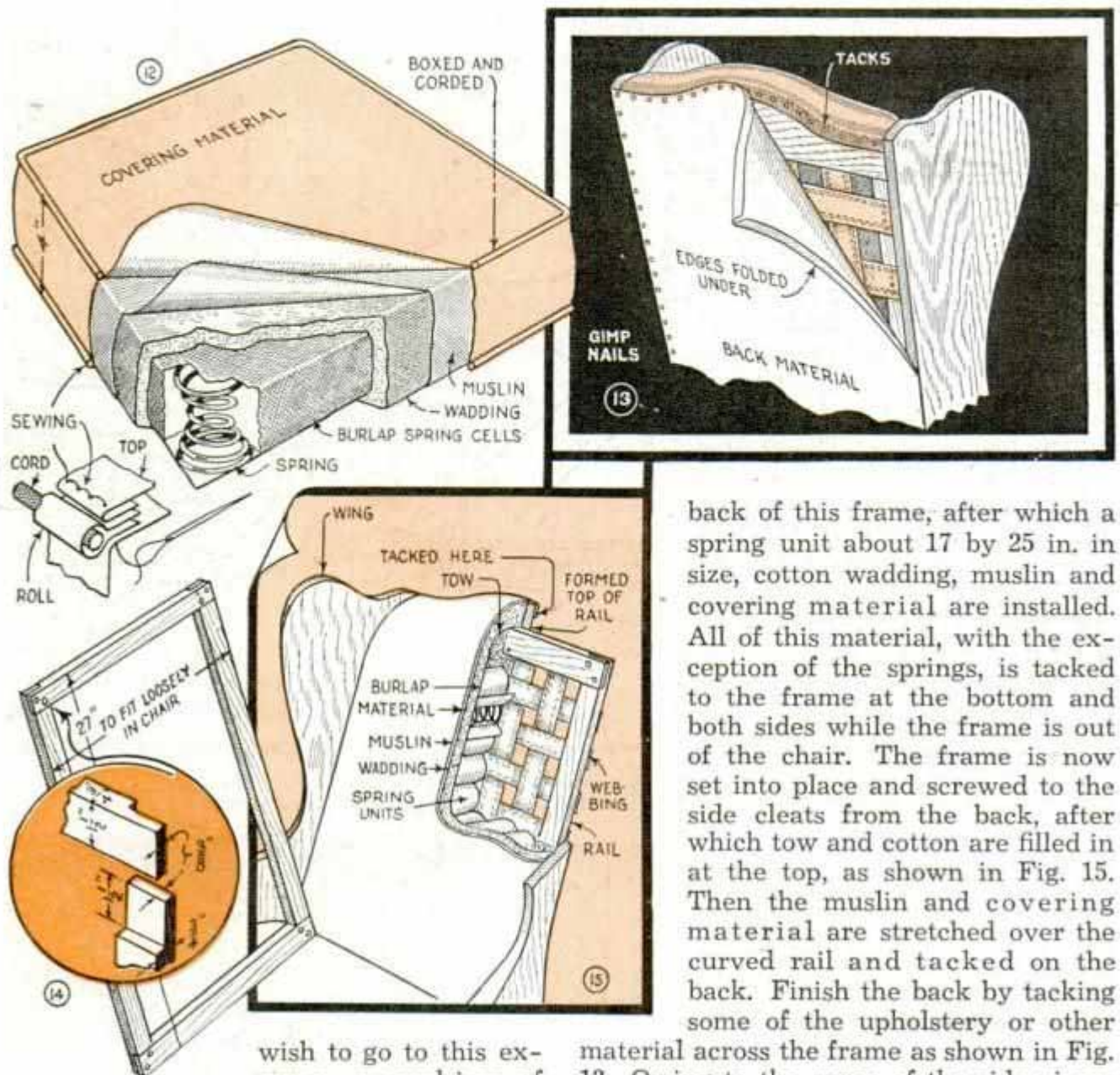

wish to go to this expense, a cushion of tow or cotton may be substituted, although this will sacrifice some of the comfort. The spring unit is covered with a casing of unbleached muslin of approximately the size and shape of the frame, and about 4 in. high. The edges of this casing should be boxed or squared, leaving a seam open at the back through which cotton wadding or tow is inserted around the unit and distributed to form a square-edged cushion. After sewing up the back seam, the cover of upholstery material is made and slipped over in a similar manner. The edges of this cover are boxed and corded as shown in Fig. 12.

The back cushion is formed in much the same way as the seat, except that it is mounted on a frame of the type shown in Fig. 14. Webbing strips, spaced about 1½ in. apart, are first stretched across the

back of this frame, after which a spring unit about 17 by 25 in. in size, cotton wadding, muslin and covering material are installed. All of this material, with the exception of the springs, is tacked to the frame at the bottom and both sides while the frame is out of the chair. The frame is now set into place and screwed to the side cleats from the back, after which tow and cotton are filled in at the top, as shown in Fig. 15. Then the muslin and covering material are stretched over the curved rail and tacked on the back. Finish the back by tacking some of the upholstery or other

material across the frame as shown in Fig. 13. Owing to the curve of the side pieces it is necessary to tack a filler strip along the bottom edge to produce a straight line across the bottom.

A colonial chair would not be complete without one of the pleasing little crickets, which were so popular at that time. Fig. 17 gives the dimensions for a cricket, which should be made of the same material as the chair. The legs are turned to the pattern shown above Figs. 16 and 17, and are made long enough to extend entirely through the top, into which they are wedged as shown in Fig. 18. A convenient method for laying out the oval top is shown. Mark off on a piece of cardboard the distance X equal to C - O and the distance Y equal to A - O. Mark these points on both sides of the cardboard. By placing the cardboard so that these two points are always at the axes, a series of

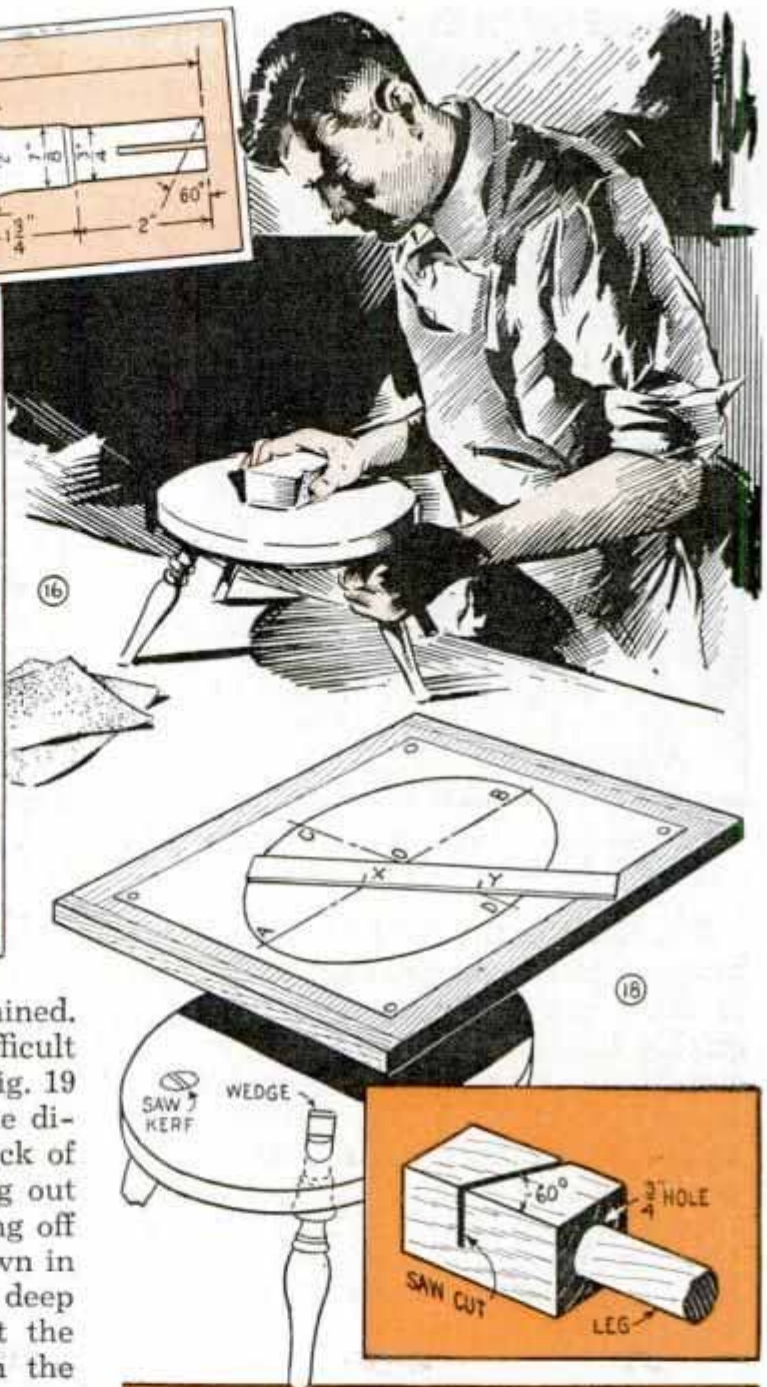
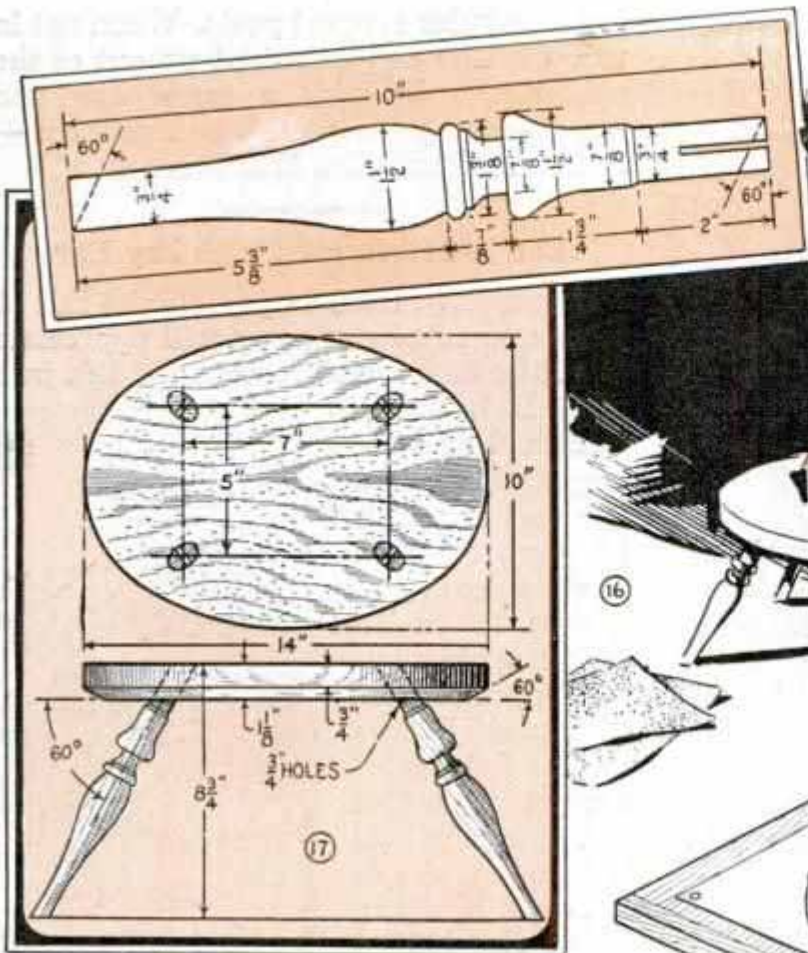

points on the ellipse can be obtained. Drilling the holes for the legs is difficult unless a jig like the one shown in Fig. 19 is used. The jig is clamped along the diagonal lines of the piece, using a block of scrap at the back to prevent splitting out the face. A convenient jig for cutting off the legs at the required angle is shown in Fig. 18. The hole is drilled just deep enough so that the saw will cut at the proper point. The block is held in the vise during the operation.

Elbow Prevents Clogging of Drain Pipes

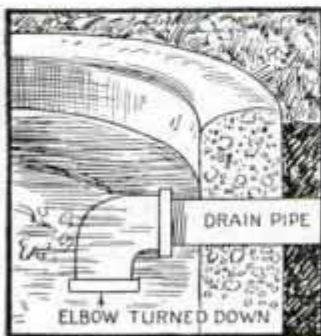

Instead of using a screen to prevent drain pipes that lead from fishponds, sumps, etc., from getting clogged by floating debris, add an elbow to the intake end of the pipe and turn it

down. The opening of the drain pipe is then always below the level of the water flowing out of the pipe.

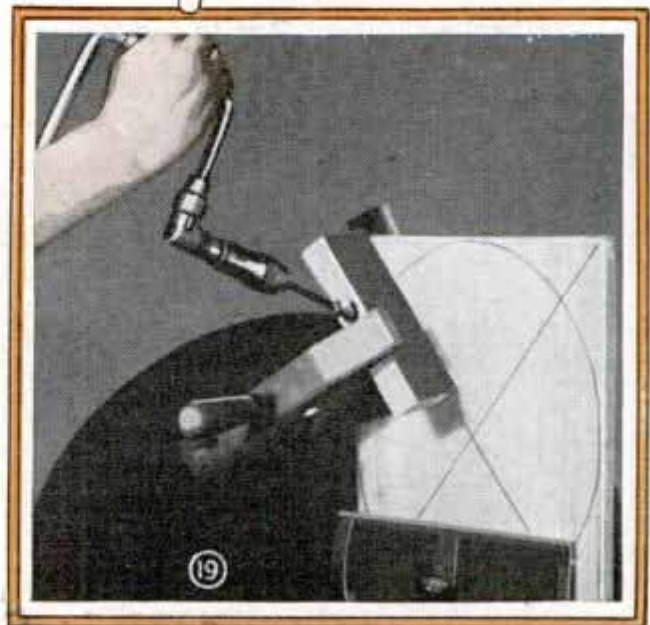

Hinged Holder Protects Steel Tape Used on Workbench

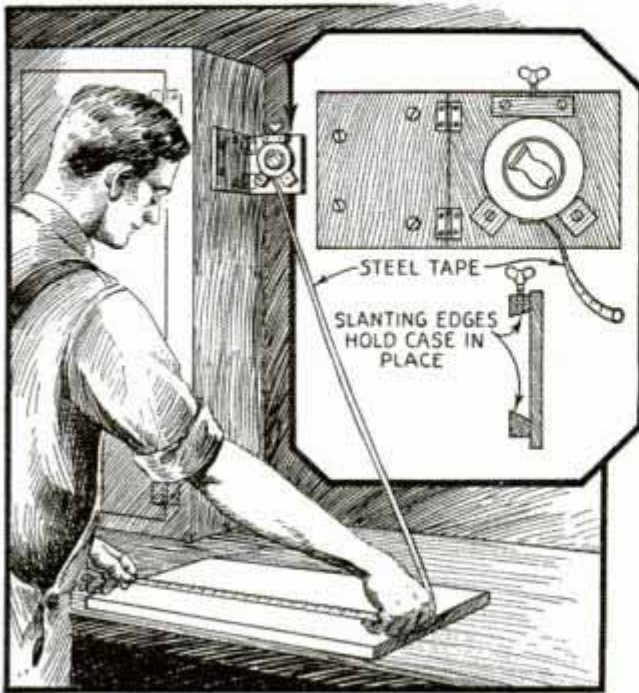

*Steel Tape Mounted on Wall to Prevent Breakage,
Is Handy around the Workbench*

Mounted on the wall above a workbench, a steel tape not only enables you to take accurate measurements more quickly than can be done with a scale or carpenter's square, but it is less likely to be broken. The tape is mounted on a hinged base so that it can be swung around to conveniently reach various positions on the bench. Wood blocks hold the tape case, which is removed by loosening a thumb-screw in one of the blocks.—W. C. Wilhite, Edelstein, Ill.

Clothesline Raised Out of the Way with Adjustable Post

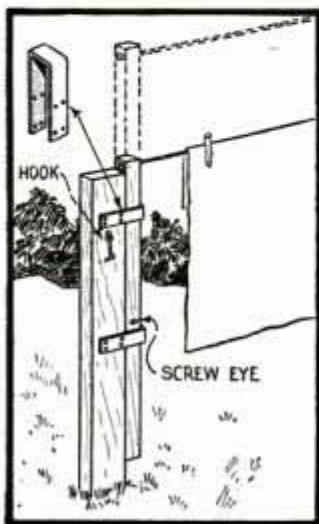

As a clothesline must be fairly low to hang up clothes, it is often a source of much inconvenience when not in use. To make the line adjustable in height, it is fastened to two hardwood bars, which slide in U-shaped metal pieces screwed or bolted

to the regular support posts. When not in use, the line can be raised up out of the way and held with a screw eye and screen-door hook in each post and bar.—E. T. Gunderson, Jr., Humboldt, Ia.

Can Lids Loosened with Pry Bar

If you have tried to pry off the lids of paint and sirup cans, you will appreciate this little tool, which loosens the lids in a jiffy. It is made from a 6 or 8-in. length of flat iron, one end of which is beveled and bent as shown. If a can is to be sealed again with the lid, it is best to gradually loosen the latter all around instead of trying to pry it off from one position, which is likely to bend the lid so that it will not fit tightly.



Microscope Mounts Save Time and Storage Space

A quick and inexpensive method of making microscope mounts for viewing minerals is to use glass slides. A small square of black cover paper, obtainable from any printer, is mounted in the center of the slide with transparent household

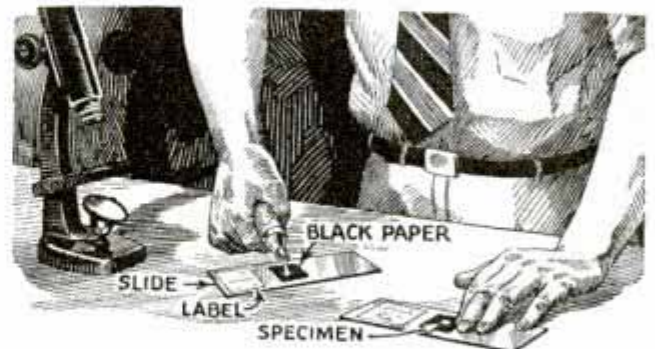

*Microscope Mounts Made from Glass Slides for
Viewing Specimens of Minerals*

cement, after which the specimen, about one-half the size of a pea, is attached in the center of the paper with a drop of the same material. A label, containing the name and variety of the specimen, may

then be cemented to the slide. Such mounts should be viewed under the lowest powers of your microscope by direct illumination.—Hence J. Griffith, Dallas, Tex.

Roll Maps Locked with Tin Clips

Instead of using rubber bands to keep large maps from unrolling, rig up a couple of tin clips as shown. The projecting ends of the map sticks are slotted with a saw and the clips are inserted into the slots of the lower stick, being fastened in place

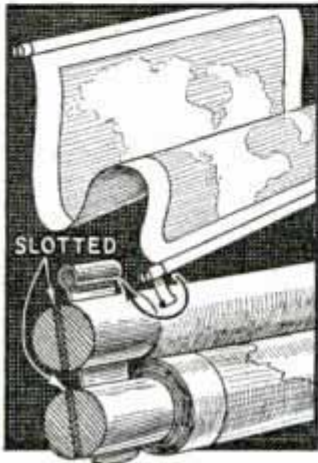

with a single brad which acts as a pivot or hinge. When the map is rolled, the projecting end of each clip is swung to engage the open slots of the upper stick, locking the two so that the map will remain rolled.

"Singing" of Circular Saw Stopped with Felt-Pad Sound Absorber

"Singing" of a metal-cutting saw may be silenced by a small felt pad, which is held lightly against the side of the saw by means of a spring-brass clip attached to

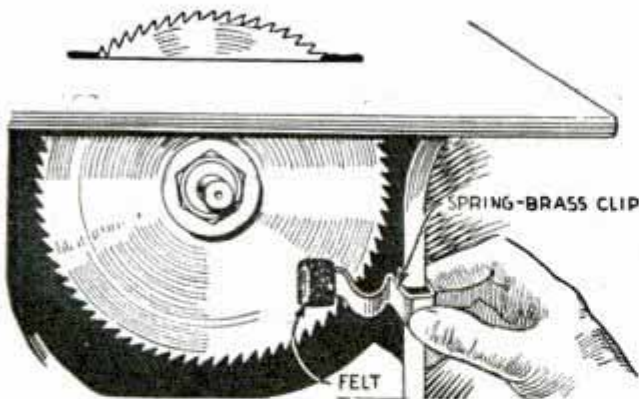

Felt Pad on Spring-Brass Clip Silences "Singing" of Metal-Cutting Saw

the saw frame. The pad dampens vibration of the saw, which causes the singing noise.—Kenneth Murray, Sturgis, Mich.

☐ When glass push pins are used to hang pictures, dip them in enamel to harmonize with the color scheme of the room.

"Shock Absorber" for Dog's Leash Made of Inner-Tube Strip

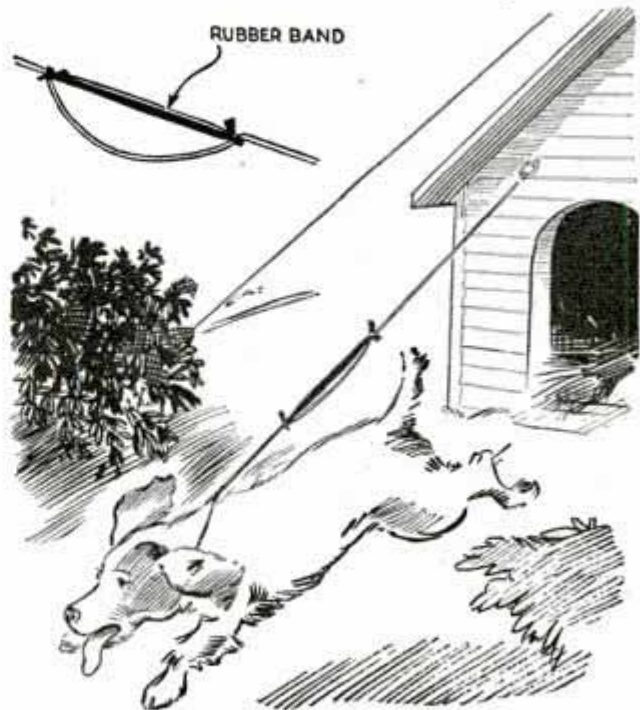

Spring or Rubber Band in Dog's Leash Absorbs Shocks on Its Neck When It Is Tied

If you keep your dog tied with a leash, insert a short length of heavy inner tube or a spring to cushion shocks when the animal, in running to the end of the leash, suddenly takes up the slack. The band or spring may be tied in the leash, as shown, leaving 3 or 4 in. of slack in the latter, or it may be tied to the end. Still another way is to cut the leash in the center and tie the band to the severed ends.—Leonard Mitchell, San Francisco, Calif.

Even Margins Trimmed on Photos by Following Shadow of Knife

An effective method of obtaining even margins on photo prints is to place a large lamp above the trimmer so that the knife casts a shadow on the photo at the exact spot where it will fall. This method



is especially handy when trimming prints on double-weight paper, which is too opaque to transmit a shadow from a lamp placed underneath the trimmer.—Neil W. Northey, Loma Linda, Calif.

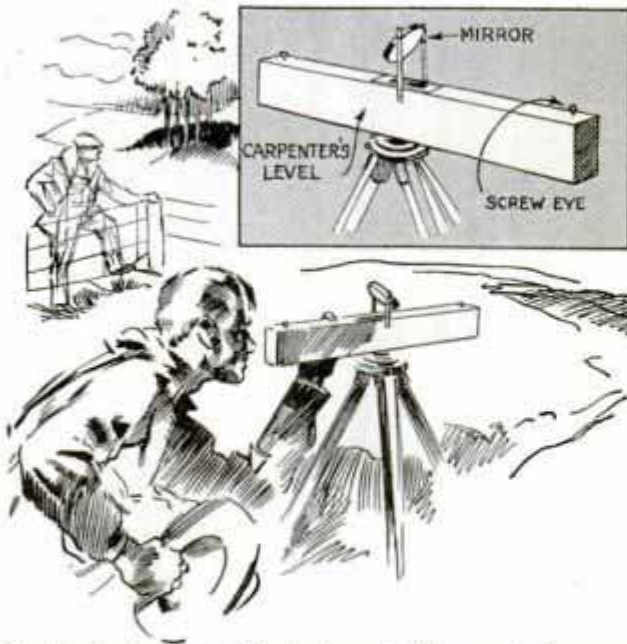

Simple Instrument, Made from Mirror and Carpenter's Level, Which Was Found Useful in Surveying Farm Bottom Lands

Surveying Instrument Improvised from Carpenter's Level

In surveying the bottom lands of his farm, a man improvised a practical instrument from a carpenter's level, pocket mirror and a couple of screw eyes. The mirror is soldered to a U-shaped wire, the legs of which are inserted in holes on each side of the spirit glass, the screw eyes being driven into the level in the positions shown. By adjusting the mirror to a 45° angle, it is possible for the operator to level the stick on a camera tripod as he sights through the screw eyes toward an objective point established ahead.

Aluminum foil in which camera film is wrapped can be cemented to wood model parts to give them the appearance of metal.

A Masterpiece in Ship Models



Hundreds of plans for many other projects are listed in our 80-pp. booklet "What to Make" which will be sent for 12c postpaid. Also contains information on workbench construction, tools you need, how to file saws, make wood joints, spin metal, get correct measurements, etc.

Do you want a model of one of the most outstanding warships in history? If so, build the "Sovereign of the Seas." Complete information on the construction of this ornately decorated, and highly picturesque model, 34 in. long and 26 in. high over all, is given in our blueprints 828 to 835 incl., priced at \$1.50 per set. Descriptive text in bound book, \$1.00 additional.

OTHER WORTH-WHILE MODELS

"Flying Cloud" Clipper Ship—709-714A: No collection is complete without a clipper. Complete with full-size lift templates—\$1.25.

"Half Moon"—717-718A: Model of boat used by Dutch Seaman, Henry Hudson—\$1.00.

"Mayflower"—887: Midget replica of ship which anchored at Plymouth Rock—25c.

"Savannah"—889: First steam-driven boat to cross the Atlantic. 14-in. model—25c.

Viking Ship Model—888: Used by Norsemen in early explorations. 14-in. hull—25c.

"Santa Maria"—759: Simplified design of Columbus' flagship. About 18 in. long—25c.

"U.S.S. Pensacola"—863 and 864: Midget design of 10,000-ton treaty cruiser—50c.

Prairie Schooner—728: Model is quaint reminder of covered-wagon days. Wagon without top, 8¾ in. long—25c.

Model Colonial Cannon—835: Perfect 10-in. miniature of guns used during days of 1776. Turned brass and wood—25c.

Blueprint Department, Popular Mechanics Magazine, 200 E. Ontario St., Chicago

SHOP NOTES



Heavy-Duty GRINDER from Old Auto Parts

by ROYCE M. ROATH

STURDINESS and accuracy are incorporated in this inexpensive, roller-bearing grinder, which you can make from an old auto-differential assembly. The grinder will take wheels up to 12 in. in diameter, and it can be made either in a floor or bench type. The work can be done with ordinary tools with the exception of a turned wheel shaft, which is substituted for the axles, the latter and the gears being discarded. The original grinder was made from a model-T Ford differential, although you also can use the housing from a model-A Ford or a Chevrolet.

When you take the assembly apart, save the bearings and the thrust washers, which are used on the new shaft. With these parts at hand, get a 24-in. length of cold-rolled steel, 1½ in. in diameter, which

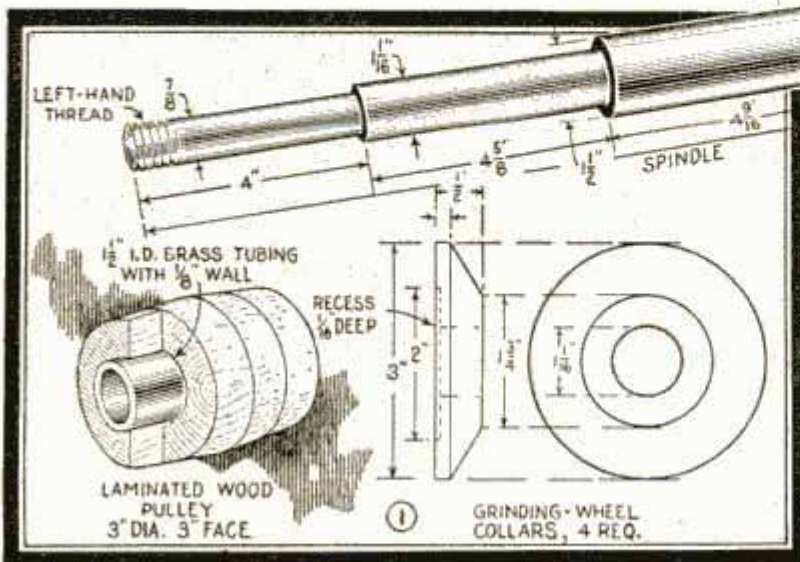
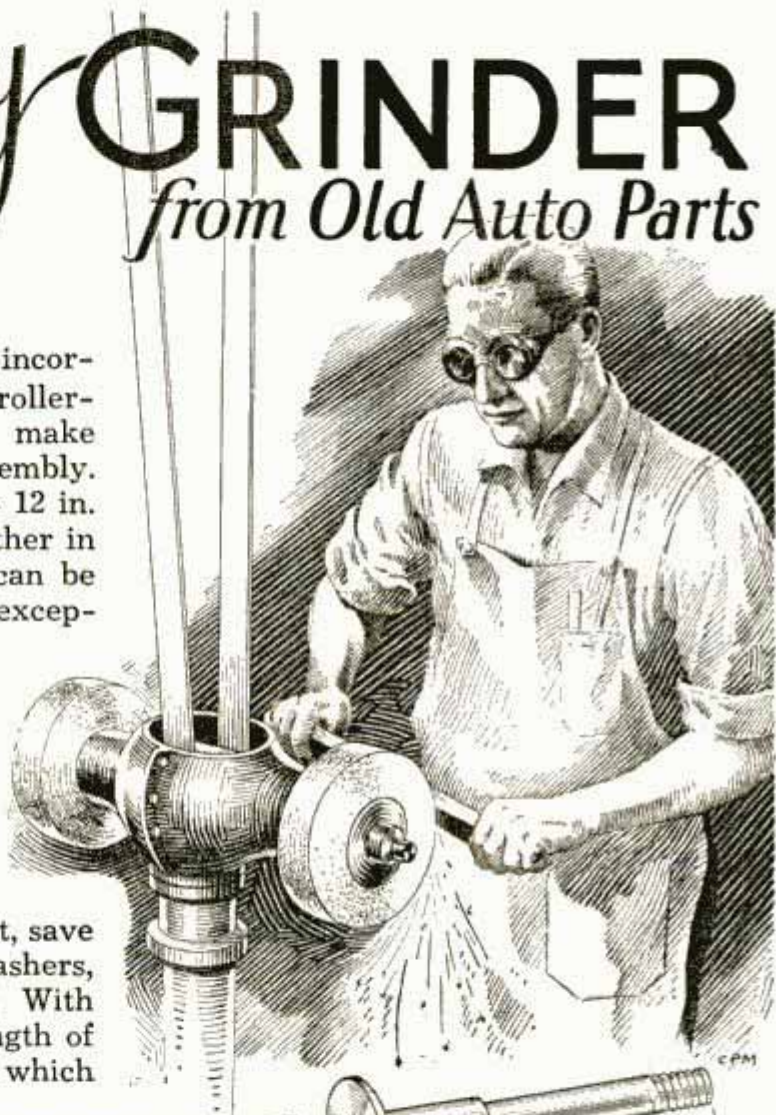

is used for the shaft. Rough, cast-iron disks, commonly known as building washers, are cheapest for the four wheel collars needed. To make the drive pulley, shown in Fig. 1, four hardwood disks are bored to a drive fit over a bushing made from a 3-in. length of brass tubing having an inside diameter of 1½ in. and a 1/8-in. wall. Use glue between the

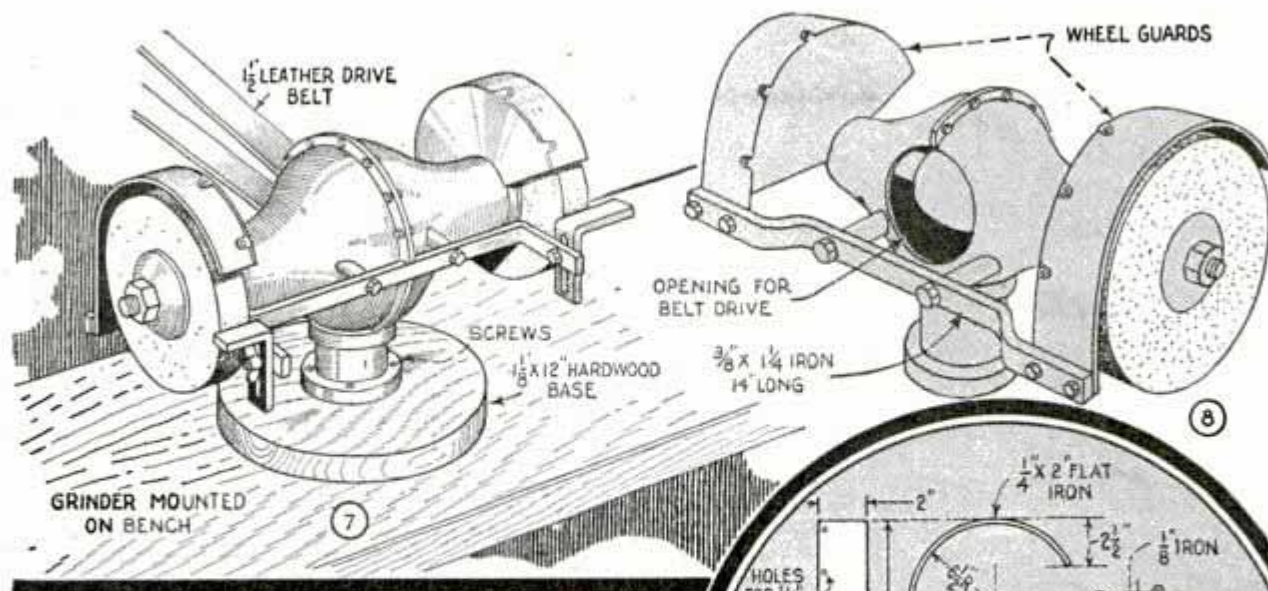

tail gives an over-all finished length of $13\frac{3}{4}$ in., but it is better to make this roughly 14 in. to allow for irregularities in sawing off the ends. Note the collar inside the housing. This is the retaining collar for the outer end of the roller bearing and is already brazed in place. Also, note that the housing projects slightly beyond the collar, which allows room for a felt grease-retaining washer. The opening for the drive belt can be cut at a point opposite the propeller shaft sleeve, or you can arrange it so that the machine can be driven from the back. Before assembly, drill and tap holes into the housings directly above the bearings to take standard pressure grease fittings as in Fig. 3.

To assemble, place two of the original steel washers taken from the differential assembly on the spindle, one on each end, and slide them up against the inner shoulder. Place the bearings in position with one end against the washer. Then slip on the two halves of the housing and bolt them together. Drill four holes through the housing to take $\frac{3}{8}$ -in. iron rods, Figs. 4 and 6, which support the guards on one side and the tool rest on the other. As these holes pass through the housing at an angle, it is best to drill them with a $\frac{5}{16}$ -in. bit, and then enlarge them with a reamer. In order to tighten the bolts effectively, sleeves are cut from $\frac{1}{2}$ -in. pipe and placed over the threaded ends of the rods between the flat-iron supporting bars and the housing as in Figs. 4 and 6. One end of each sleeve is beveled so that it fits snugly against the housing. The assembly of the wheel guards is shown in Figs. 8

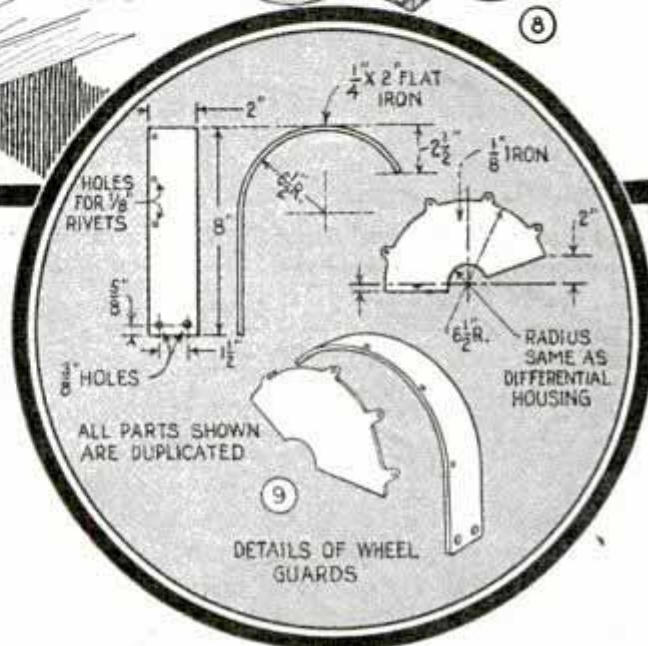

and 9, the latter giving the essential dimensions. The wheel guard is bolted to the supporting bar at the back. It is not fastened to the housing. The balance of the assembly for the floor-type grinder with overhead belt drive is clearly shown in Fig. 5, while the bench type is shown in Fig. 7.

Safety requires that the speed of 12-in. grinding wheels should not exceed 2,000 r.p.m.; 1,800 r.p.m. is better for a wheel of this diameter. Smaller wheels can be driven at proportionately higher speeds.

Lantern Attached to Brakeman's Arm



To keep both hands free for his work, a brakeman fastens the electric lantern to his arm. The handle of the lantern is slipped over his arm, and the bottom is fastened to his wrist with a heavy rubber band.

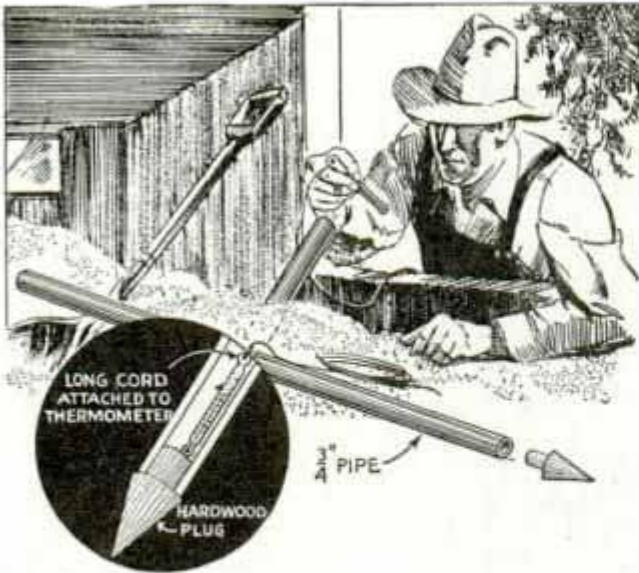

Pipe Pushed into Stored Grain Carries Thermometer to Check Temperature and Warn of Heating

Checking Temperature of Stored Grain to Prevent Heating

A farmer who sometimes experienced losses by having his grain heat and spoil in the bin, rigged up this tool to check its temperature. A length of $\frac{3}{4}$ -in. pipe with a pointed wood plug in one end was pushed into the grain so that a thermometer could be lowered inside with a string. The thermometer was left in the pipe for several hours, or overnight, before taking a reading.

Plunger on Speed Wrench to Expel Nuts

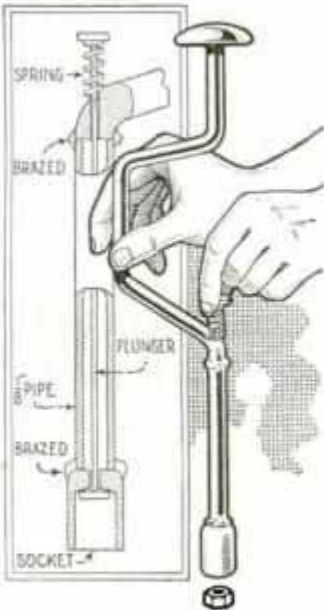

Greasy nuts and cap screws that ordinarily stick in the socket of a speed wrench are expelled with this plunger attachment. Saw off the shank of the wrench and, in its place, braze a piece of $\frac{1}{8}$ -in. pipe. To the end of this, braze a wrench socket of the size desired. Then run a length of stiff wire or

small rod through the pipe and socket and out through a hole drilled in the end of the wrench as shown. This serves as the

plunger and is fitted at the upper end with a knob, under which is a small compression spring.—G. E. Stillwell, Atlanta, Ga.

Split Spout on Oil Can Prevents the End from Clogging

When oiling out-of-the-way bearings on a piece of machinery, the spout of the oil can is sometimes accidentally jabbed into grease or dirt, which clogs the spout. To prevent this, split the end of



the spout and bend the two pieces to a wedge shape as shown, leaving the spout openings at the sides.

Waste Box for a Paper Cutter

A workbench on which a paper trimmer is used will be kept tidy if the latter is mounted on a wooden box to catch the waste. The box should be several inches longer than the trimmer, which is fastened to it with triangular pieces of sheet metal. The box shown in the photo is fitted with a sliding lid, which is kept closed when the trimmer is not in use to prevent the waste from being scattered.—Guy A. Rafuse, Bridgewater, N. S., Canada.



Paper Trimmer Mounted on Box, Which Catches Refuse and Keeps Workbench Clean

Old Lathe Improved with Auto Transmission

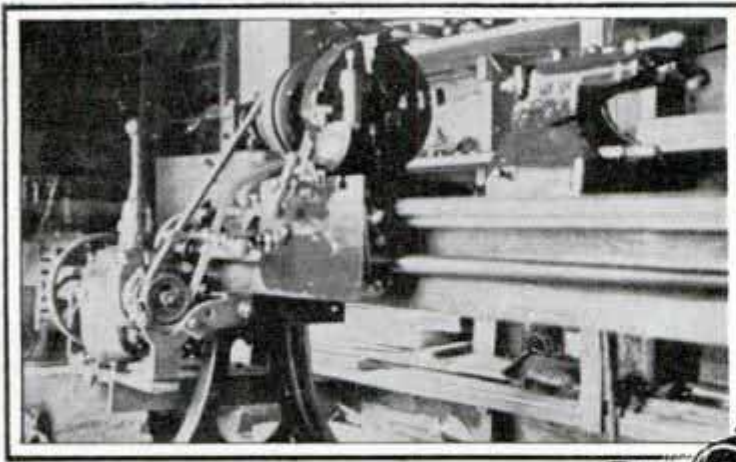

Lathes with cumbersome countershafts may be converted inexpensively into compact units by using an old auto transmission. This enables you to reverse your lathe, or to drive it forward at any one of three speeds by merely stopping the motor and shifting a lever. Get a transmission that is in good condition. Wash out the old grease with gasoline and refill it with fresh lubricant. The method of mounting the assembly depends on your lathe. Usually this can be done in a manner similar to that shown. Sizes of pulleys will be governed by the speeds at which you wish to drive the lathe. The drive pulley is

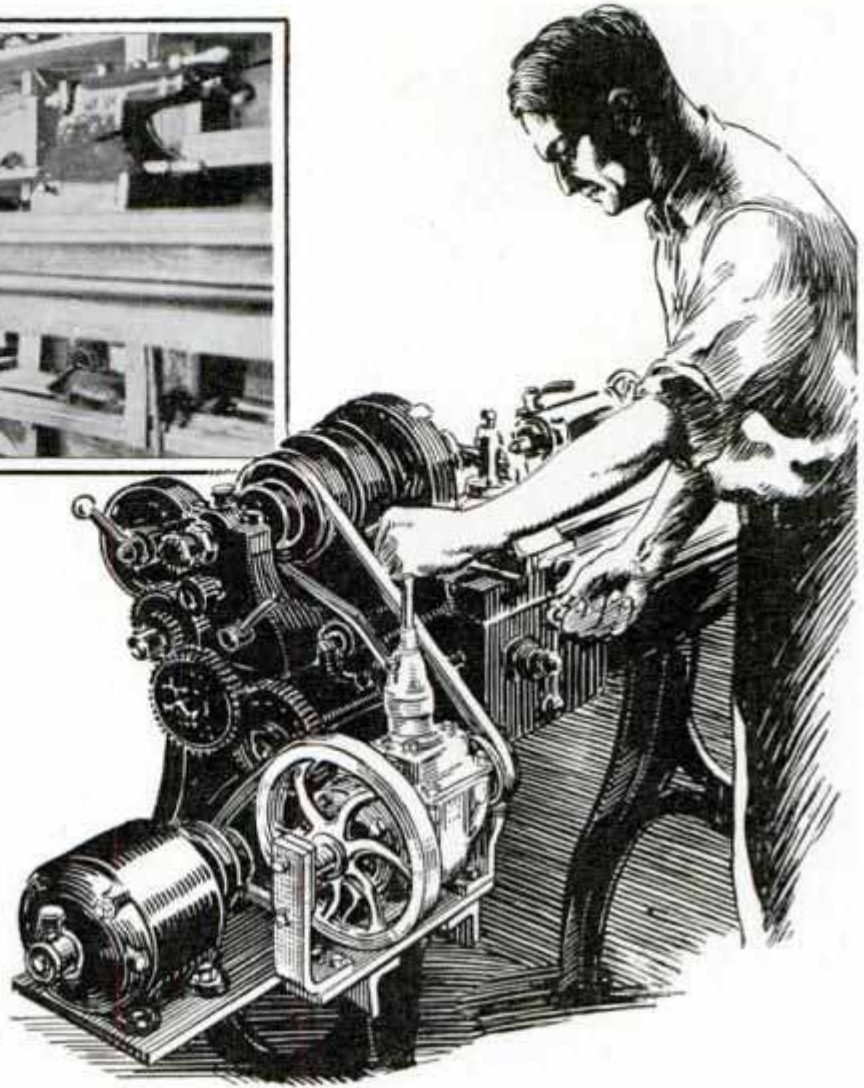

mounted on the front end of the transmission shaft, while the pulley for driving the lathe is keyed to the rear end in the position occupied by the universal joint.

Wheeled Feeding Trough Is Easily Moved in Hog Pens

As an aid in moving hog-feeding troughs, which must be done at intervals to prevent mud puddles from forming around them, they can be fitted with a pair of wheels, such as those taken from the trucks of an old binder. The wheels are mounted on a pipe, which serves as an axle, and is attached to one end of the trough. This arrangement will permit the trough to be wheeled about when the opposite end is lifted from the ground. Legs should be attached to raise this end of the trough to a level position.

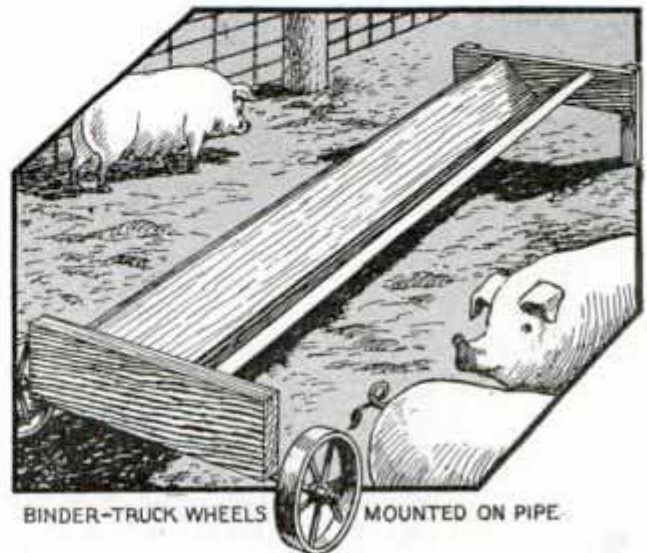

BINDER-TRUCK WHEELS MOUNTED ON PIPE.

☐ A piece of rosin stirred into melted bab-bitt will make it flow better.

Using Your Drill Press to Cut Teeth on a Blank Gear

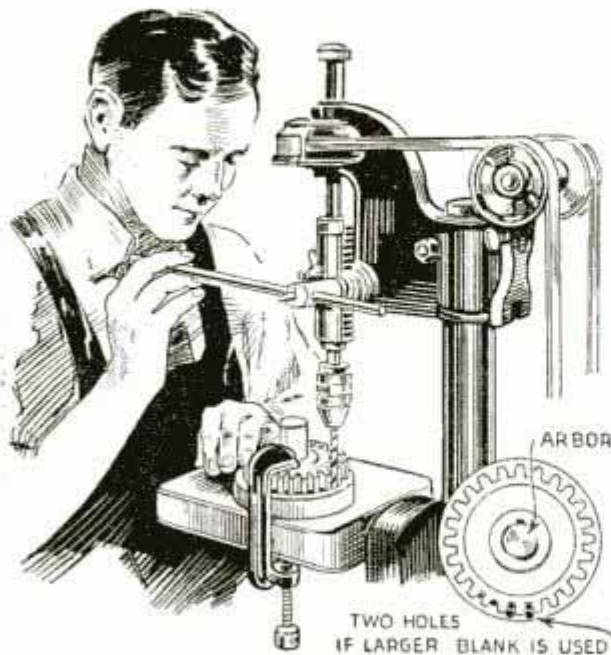

In the Absence of a Milling Machine, You Can Cut Teeth on a Blank Gear with a Drill Press

For experimental work, or in an emergency, a gear can be made on a drill press. The old gear, which is used as a pattern, and the gear blank are fastened together with a tight-fitting arbor. This is important, as the pattern must not shift or turn on the blank once the work is started. Select a drill bit that will fit loosely between the teeth of the gear to be copied, and drill the blank. One hole between each pair of teeth is sufficient if the new gear is to be the same size as the pattern. In some cases, if accuracy is not critical, or if the new gear is for temporary use, it may be made slightly larger than the pattern, and two holes drilled between each pair of teeth as shown. The teeth are then filed smooth to the correct bevels and the new gear is hardened.—Walter Evans, Buffalo, N. Y.

Fire Doors Closed Automatically

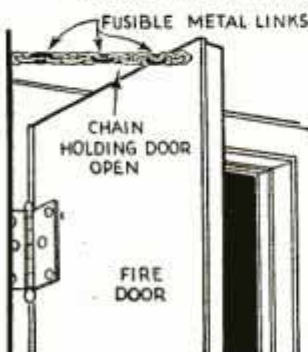

Fire doors, which have been propped open for ventilating purposes, become a hazard when left in this position unless some provision is made to assure their

prompt closing the instant fire breaks out. If the door is held open by a chain containing one or more fusible links, which melt at a temperature of 170° Fahr., the door will close automatically when this temperature is reached. The alloy for the links is made by melting together cadmium, 1 part, lead, 1 part, and tin, two parts. The mixture is cast in thin rods, which are bent to form the links.

Keeping Horizontal Flags Unfurled

On certain construction jobs it is sometimes necessary to mount a flag horizontally, suspending it from a cable or brace rod. In this position, the wind often wraps the flag around the cable so that it cannot be seen. To avoid such trouble, stitch a small pocket at the tip end of the flag. It takes but a moment to drop some sand, pebbles or other weight into the pocket to hold the flag unfurled.

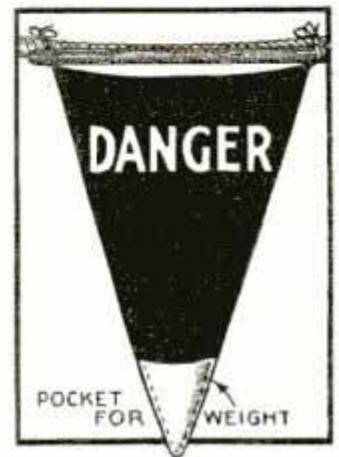

To Distribute Heat in Shop or Garage

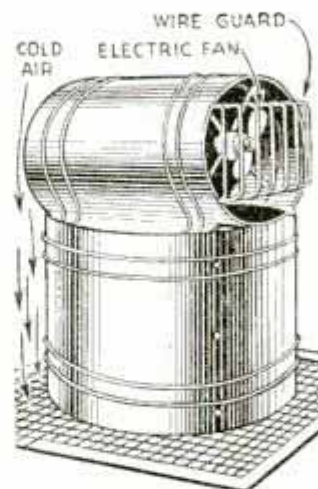

Quick and uniform distribution of heat in a shop, garage or store, which is heated by a pipeless hot-air furnace, can be had by arranging two oil drums and an electric fan as shown. The heads and bottoms of the drums are removed, and one side of the horizontal drum is cut out to fit snugly over the top of the vertical drum. When the assembly is set over the hot-air outlet, a fan in one or both ends of the horizontal drum distributes the heated air.—Elmer A. Vandrey, Truman, Minn.

214 W. Archana Ave
Improved Blade Holder for Grinding Skates

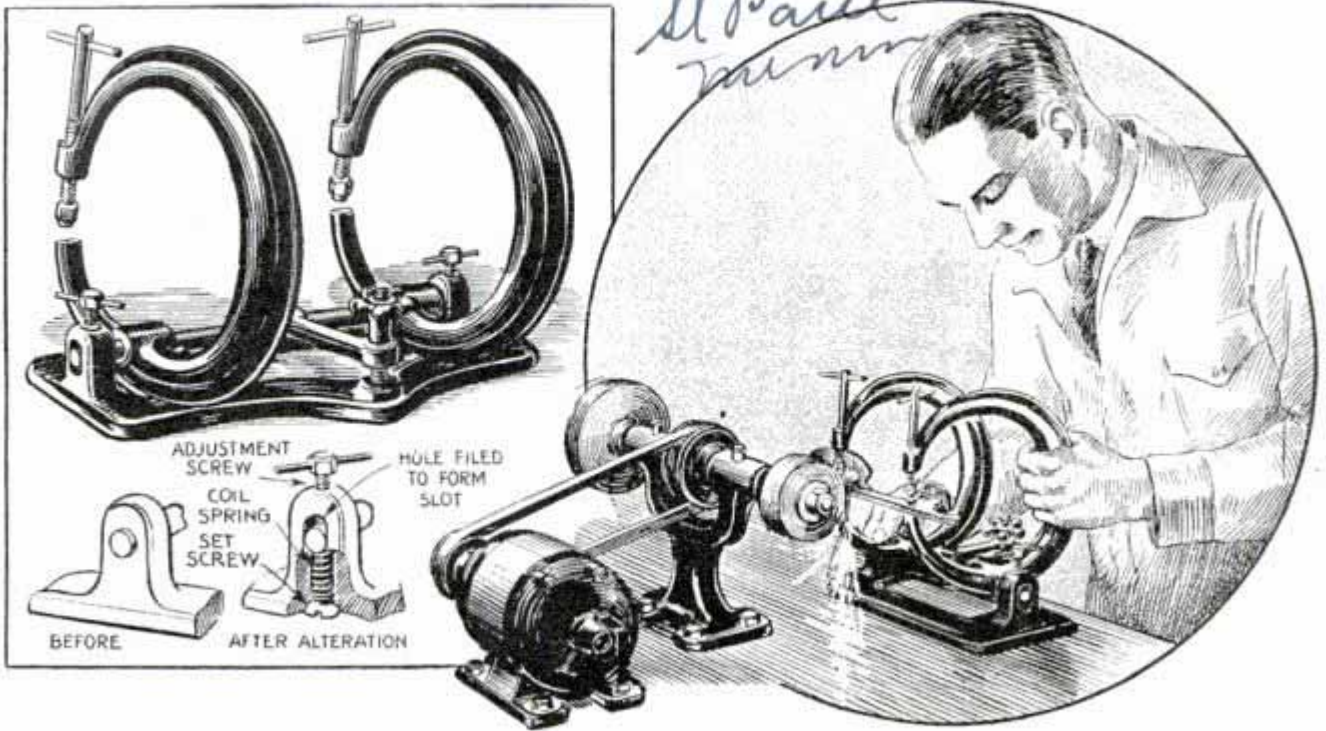

Recommended by a man with 15 years experience in grinding skates for professional skaters, this method of altering a skate holder so that it can be adjusted vertically comes in handy when grinding skates that have curved edges or tapered blades. To make the alteration, drill vertically through the lugs which support the rod carrying the clamps. Then, with a round file, elongate the rod holes in the lugs to allow the rod to move $\frac{1}{2}$ in. ver-

tically. A strong compression spring, held by a set screw in the lower end of the lug, bears against the rod and a wing screw, tapped into the upper end of the lug, compresses the spring. Movement of the screw gives a positive vertical adjustment for centering against the grinding wheel. For grinding figure skates, two stones are used, each 1 in. wide and $2\frac{1}{2}$ in. in diameter, one, a 100-grit stone of medium hardness and the other an India oilstone.

Tool Drawer with Folding Handle Is Carried to the Job

In a large shop or garage where tools are kept in cabinet or workbench drawers, mechanics will save time if the drawers are provided with carrying handles. Then, instead of looking through a drawer for a few tools needed to make a certain repair, they can carry the drawer to the job, thus saving extra trips to the bench for tools that were forgotten. The handles may be lengths of iron rod of suitable diameter, bent to the shape shown in the drawing. The end of the rod projecting from the front may be bent into a ring to form a drawer pull.



☐ A concentrated solution of tartaric acid and water is efficient for removing most shop stains from the finger nails.

WELDING and CUTTING

with

Oxyacetylene

By C. A. CROWLEY



Complete Welding Outfit Which Includes Gauges, Torch and Hose, and Is Capable of Handling All Ordinary Repair Jobs, Costs about Fifty Dollars

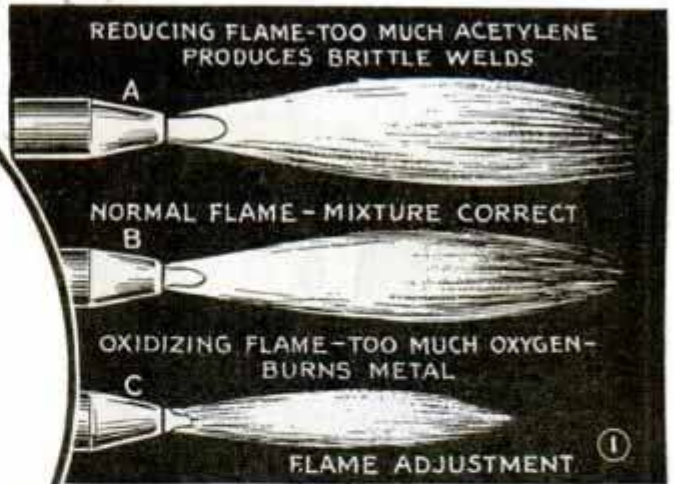

methods of using it are simple and skill can be acquired quickly by anyone who will observe the simple rules and methods explained in this article.

For general welding purposes the standard oxyacetylene welder of the type shown here may be relied upon to give satisfaction. To put the welder into operation, the tank valves are opened while the hand screws in the regulators are loose. The hand screws on the gauges are then adjusted by screwing in until the pressure required for the job is indicated by the working gauges. The other gauges indicate the high pressure in the cylinders. The working pressure required for any particular job depends upon the size of the tip used. One of the tables indicates the pressures that have been found suitable for a variety of tip sizes. This table also indicates the proper tip to select for jobs of different thicknesses. With the pressure adjusted, the acetylene valve on the torch is opened and the gas ignited with a sparker. Matches should not be used. Next, the oxygen valve on the torch is slowly opened until the flame acquires the appearance shown in Fig. 1, detail B.

Adjusting the Flame

The knack of adjusting the gases to produce a good welding flame should be acquired by practice. Detail A, Fig. 1, shows a reducing flame produced when an excess of acetylene is being used. It can be recognized by the feathery edge of the

GAS PRESSURES FOR WELDING STEEL			
Thickness of Metal	Tip Size	Approximate Gauge Pressures	
		Oxygen Pressure	Acetylene Pressure
1/32"	68	1 lb.	1 lb.
1/16"	56	2 lb.	2 lb.
3/32"	54	2 lb.	2 lb.
1/8"	52	3 lb.	3 lb.
3/16"	50	4 lb.	4 lb.
1/4"	45	3 lb.	3 lb.
5/16"	45	4 lb.	4 lb.
3/8 to 5/8"	35	4 lb.	4 lb.

IF YOU have worked with metal, you have undoubtedly had some jobs in which the short cuts of welding would have been a great advantage. A complete oxyacetylene welding outfit, including gauges, torch, etc., capable of handling all ordinary repair and shop construction jobs can be purchased for less than \$50. The

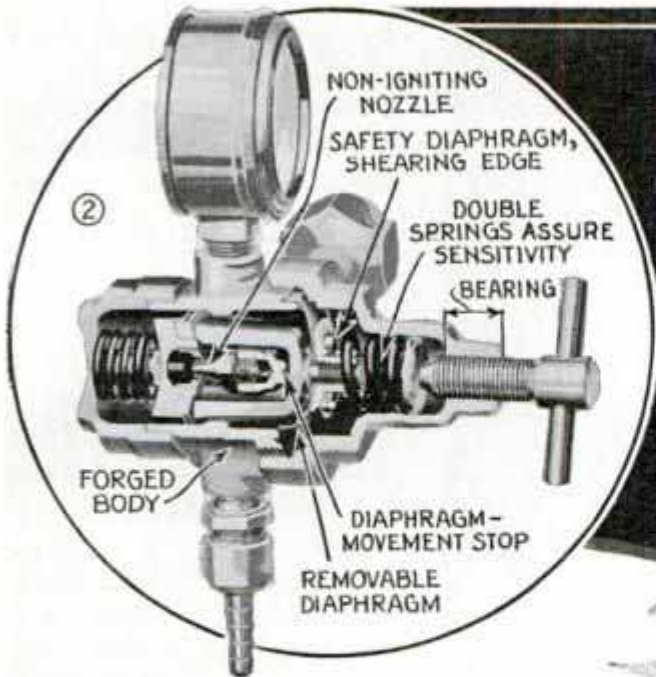

Regulating Gauges Are Delicate Precision Instruments and Should Be Repaired Only by Experts; Right, Strong Points in Sheet-Metal Work Made Cheaply and Rapidly with an Oxyacetylene Torch

white luminous cone. This flame tends to introduce carbon into the weld and produce hard spots. It is undesirable, except in certain cases, which will be pointed out in connection with nickel-alloy welding. Detail C shows the appearance of a flame produced when too much oxygen is used. This flame has a short pointed, white cone. Welding with an oxidizing flame burns the metal and renders the weld weak and useless. Detail B shows the appearance of one neutral or normal welding flame. It is produced when just enough oxygen is flowing to burn all of the acetylene. When it is used, welds will be thoroughly fused and free from burned and hard spots.

During the progress of making a weld, the flame must be observed closely and adjustments made if the characteristic of the flame changes. To turn out the torch, the torch valves are closed to extinguish the flame and the tank valves are then shut. Next, the torch valves are opened to relieve the pressure in the gauges and finally the gauge screws are loosened so that they will be ready for safely opening the tank valves when the outfit is used the next time.

Welding Sheet Metal

During all welding or cutting work the operator should wear goggles of a type made specifically for this work. Goggles not only protect the eyes, but also enable

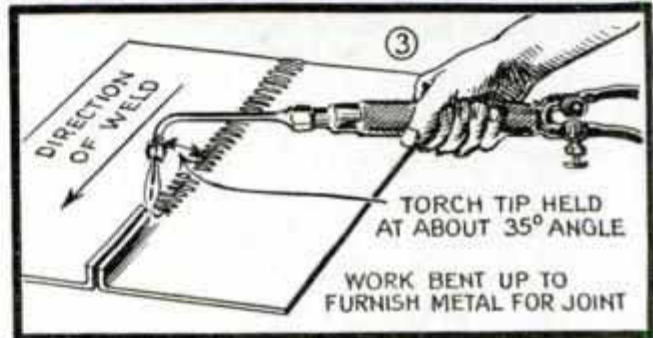
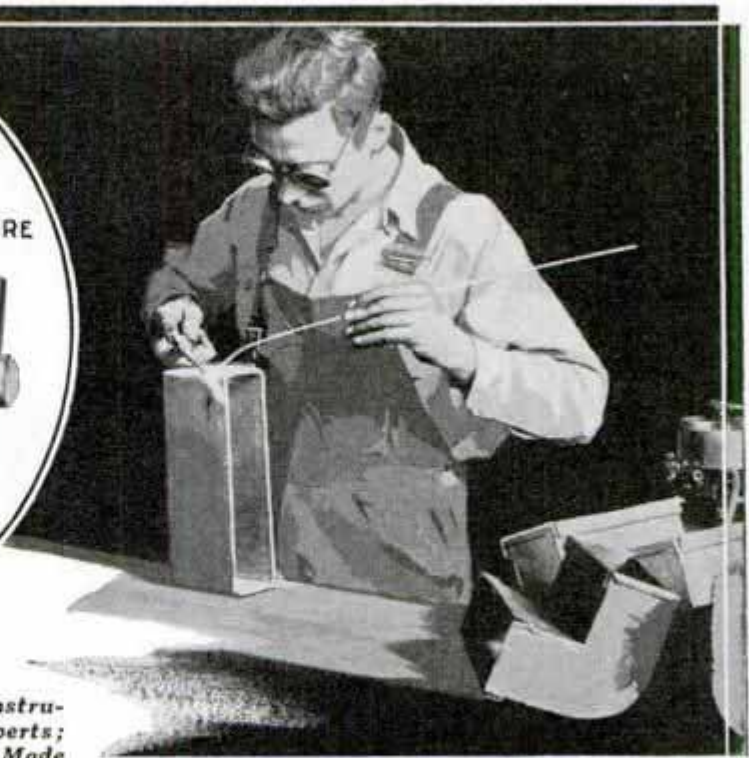

the welder to see all of the details of the weld as it progresses.

To weld sheet metal, the edges of the metal which are to be seamed are bent up as shown in Fig. 3. This applies to metal $\frac{1}{8}$ in. thick or less. The metal is bent up at an approximate right angle and the height of the bent-up stock should be made as little as is convenient to bend. The pieces are then butted together. To prevent warping, the ends at which the weld is started should touch and the other ends should be separated a fraction. The torch equipped with the proper tip is now adjusted to a neutral flame. It is then applied to the starting edge of the seam. The luminous cone of the flame should just barely touch the work. The flame is played steadily back and forth across the seam in a path similar to that shown by the lines back of the torch in Fig. 3. The flame is advanced steadily and as rapidly as the metal melts and flows together. After a little practice sheet-metal seams can be made rapidly and neatly.

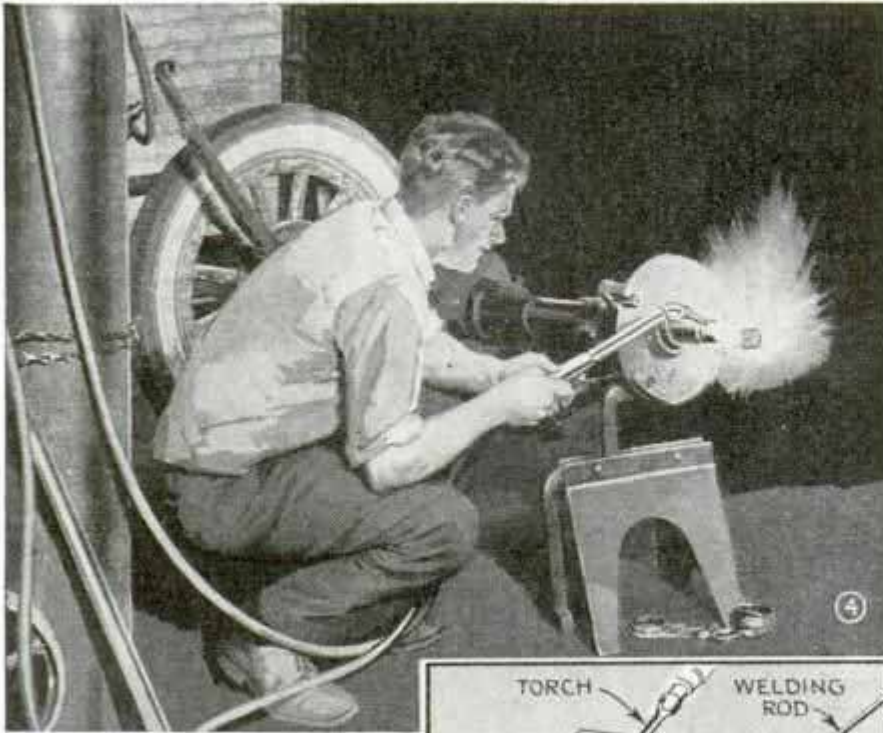

Above, Heating Bent Car Axle Previous to Straightening It; Center, the Wavy Lines Show the Back-and-Forth Movement of the Torch in Welding Pieces of Sheet Metal Together

Welding Thick Sections

When making a plain butt weld with filler rod, the rod used should be about of the same composition as the work. This type of weld can be made either forward or backward as shown. Thin work is usually better handled by the forward method, Fig. 5, while backward welding, Fig. 6, will be found easier when the material is quite thick. The lines show the path of the torch. The rod is slowly fed into the flame. With thick material the forward progress is slower and as the filler rod or welding rod melts, the pool must be heated until it flows freely and amalgamates with the base metal on the two sides of the seam. When the backward method is used on thick welds, the torch is given only a slight transverse movement and the welding rod must follow the flame movements with a slightly greater transverse or circular motion; thus the rod manipulation is used to assist in puddling the hot metal into a homogeneous weld. Thick sections should

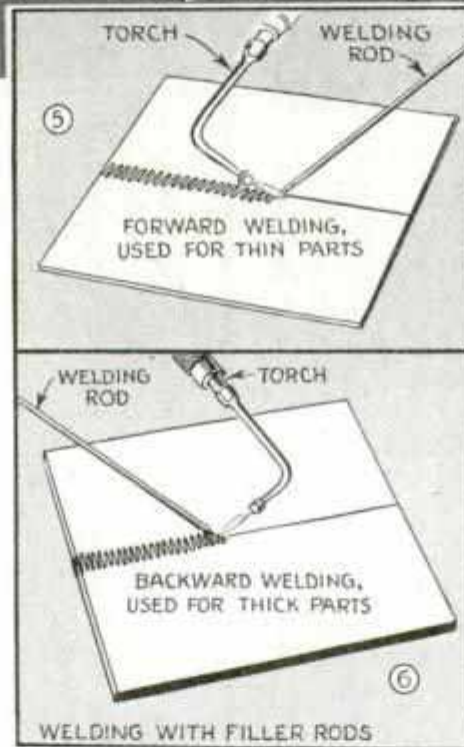

be beveled slightly, as shown in Fig. 9, to assure even penetration of the molten metal. This illustration also shows methods of preparing other thick sections.

Special Jobs

To illustrate the versatility of arc-welding, Fig. 7 shows a mechanic making a repair to a wire wheel, while Fig. 12 shows a cracked oil pan being repaired. The torch flame is directed so that the hot part, just beyond the luminous cone, plays on the parts to be repaired; fluxed welding rod is applied with the other hand. Fig. 8 shows how welding rod may be fused to a gear to replace a broken tooth. The metal is built up larger than the gear and the job is finished by dressing off the excess metal to leave a new tooth. This type of



Emergency Repairs on Wire Wheels Quickly Made with a Welding Torch and Filler Rod

repair frequently saves long delays in procuring hard-to-get parts for old cars and machinery. The oxyacetylene torch is used in the sheet-metal shop to displace riveting when strong joints, unaffected by heat, must be produced cheaply and rapidly. Figs. 4 and 11 show how the torch may be used to heat parts previous to straightening them.

Using the Cutting Torch

Ordinary torches are not suitable for cutting purposes; however, combination outfits are available. Fig. 10 shows one of

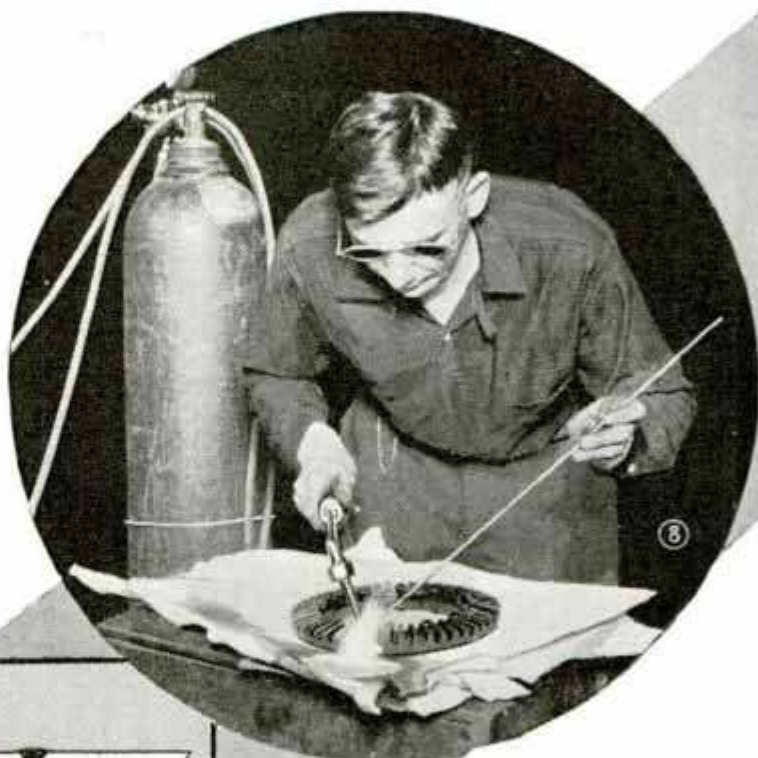
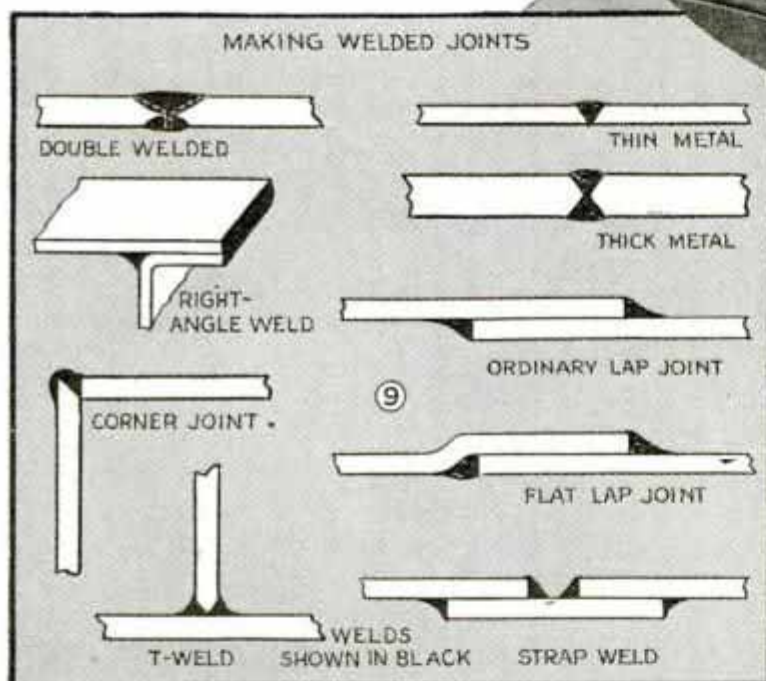

Photo Shows How Welding Rod May Be Fused on Gear to Build Up Broken Teeth; Left, Methods of Welding Various Types of Work



valve on the grip of the torch when the work has become hot enough to cut. Once the work is hot in one spot the torch may be moved continuously with the cutting blast of oxygen on, thus cutting continuously and with great rapidity. The path of the cut to be made is laid out with a soapstone crayon because this kind of a mark is not destroyed by the

these outfits being used to square off an irregular piece of steel plate. The cutting torch produces an intense hot flame which heats the metal to a white heat. When the metal is white hot the torch is pulled back from the work about $\frac{1}{8}$ in. and the oxygen valve depressed. Under the oxygen blast the hot iron burns like paper, enabling the operator to make a cut rapidly through even extremely thick steel sections.

The tips of cutting torches have several holes, the large center one being for pure oxygen, controlled by a hand-lever valve, while the tiny surrounding holes pass an oxyacetylene mixture each of which burns like the flame from a welding torch. These small flames do the heating and the oxygen is admitted by depressing the cutting

heat. One of the tables gives the oxygen pressure required for cutting operations on a number of thicknesses of steel.

Welding Aluminum

Aluminum and aluminum alloys may be welded readily with the oxyacetylene torch. Tip sizes and gas pressures which are suitable for various thicknesses of these metals are given in a table. For welding aluminum and its alloys, a neutral flame is used. The metal must be thoroughly cleaned and a special aluminum flux employed. These fluxes are mixed to a paste with water immediately before use and applied with a brush or swab. The welding rod used when filler is necessary should be selected with great

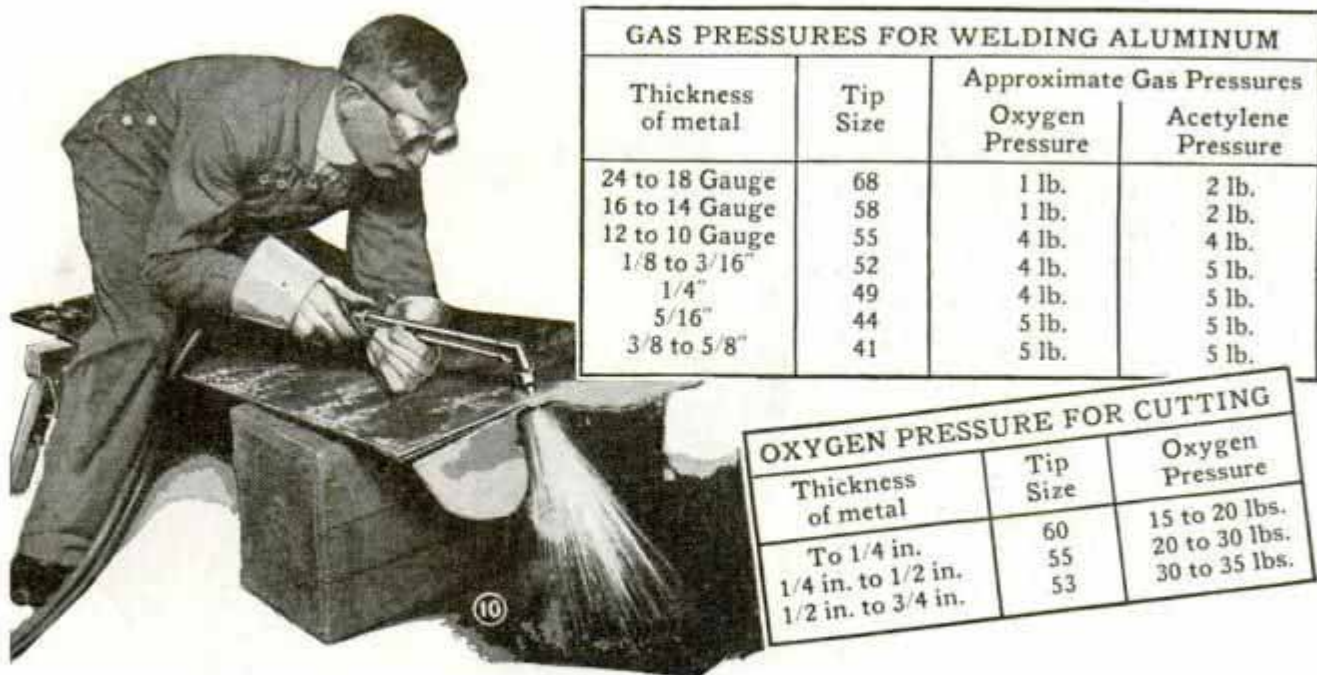

GAS PRESSURES FOR WELDING ALUMINUM			
Thickness of metal	Tip Size	Approximate Gas Pressures	
		Oxygen Pressure	Acetylene Pressure
24 to 18 Gauge	68	1 lb.	2 lb.
16 to 14 Gauge	58	1 lb.	2 lb.
12 to 10 Gauge	55	4 lb.	4 lb.
1/8 to 3/16"	52	4 lb.	5 lb.
1/4"	49	4 lb.	5 lb.
5/16"	44	5 lb.	5 lb.
3/8 to 5/8"	41	5 lb.	5 lb.

OXYGEN PRESSURE FOR CUTTING		
Thickness of metal	Tip Size	Oxygen Pressure
To 1/4 in.	60	15 to 20 lbs.
1/4 in. to 1/2 in.	55	20 to 30 lbs.
1/2 in. to 3/4 in.	53	30 to 35 lbs.

The Cutting Torch Produces an Intense Flame Which Brings the Metal to a White Heat, Then a Jet of Oxygen Burns the Hot Metal Like Paper; Photo Shows How a Cutting Torch Is Used to Square Off a Piece of Heavy Steel Plate

care. Commercial aluminum 2S and 3S should be welded with pure aluminum wire. The strong alloys 17S, 25S and 51S can be welded with a rod of the same composition as the alloy if the parts are not clamped together too rigidly. For welding these hard alloys where the parts must be clamped rigidly, a rod of the following composition should be used: Silicon 5% and aluminum 95%. This type of rod may be used for welding any of the aluminum alloys. Rods of this composition are available. Large pieces of aluminum or aluminum alloy including castings should be preheated to slightly under 800° F. before welding is attempted. It is important that this temperature is not exceeded. The following practical methods are available for determining when the temperature is reached. (1) Blue chalk marks will turn white at the proper temperature for applying the torch. (2) A pine stick will just leave a char mark on the casting when the proper temperature is reached. (3) Aluminum loses its metallic ring when struck at the welding temperature. The work should be well supported during welding and the torch must be applied with care as these alloys melt rapidly. Carelessness will result in holes being burned in the work. For welding sheets or when preheating is not used, buckling may be minimized by covering the metal on each side of the seam with

asbestos paper soaked in cold water. This takes up heat and prevents excessive expansion.

Welding Monel Metal and Nickel Alloys

Oxyacetylene welding of the two commonly used nickel alloys, monel metal and chrome nickel, as well as pure nickel is much the same as steel, except for minor changes. The tip used should be of the same size as for steel, of equal thickness or one size larger. The welding rod should be of the same general composition as the alloy being welded, otherwise the weld will be weakened rapidly by corrosion. Special composition rods are available for all of the common nickel alloys. The torch flame should be reducing, with only a slight feather, no longer than 1/8 in., showing beyond the tip of the luminous cone. During welding the end of the rod should be kept well within the flame, to prevent its becoming oxidized. Special fluxes should always be used on monel metal, chrome nickel and pure nickel. These are available for all of these metals. They should be used as thin pastes made by mixing the dry powdered flux with alcohol or by dissolving it slowly in boiling water. The paste flux is painted onto the seam and welding rod with a small brush. For best results on these alloys, there should be little puddling; the molten pool should be kept quiet, with the tip of the

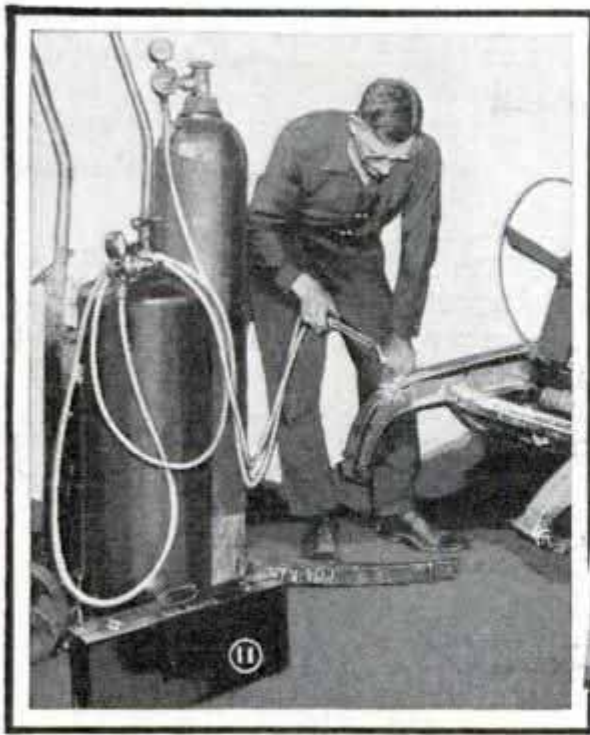

The Torch Has Many Uses in the Average Garage; Broken Parts That Are Difficult to Get for Old Cars, May Be Welded Together in a Short Time

luminous flame just touching its surface. Excessive puddling and boiling of the metal take the life out of it and produce a brittle weld. The welding of thin gauge nickel and alloy metal is accomplished by flanging the edges slightly less than 90 degrees, the turned-up edges being made as short and as nearly equal in height as possible. The bottom and top of the seam are painted with flux paste before fastening the parts in position. No rod is needed as the edges are merely melted together with the flame. The crevice left on the underside may then be filled with soft solder, silver solder or spelter.

Care of Welding Equipment

The most important rule for handling oxygen cylinders is to use absolutely no oil. Oil and grease must be kept off the cylinder valves and regulators. If this rule is followed and the cylinder valve is kept closed when not in use, there is no danger in handling oxygen. Gas cylinders should not be stored in the hot sunshine or in overheated locations because heat expands gases and causes the pressure to become abnormally high. Acetylene cylinders should be used in an upright position, because they contain a liquid, acetone, which will be ejected through the torch if the cylinder is tipped over. Acetylene can be generated from calcium car-

bide and water; however, if this is done only a tested and approved type of generator manufactured by a reputable concern should be used. The use of the homemade acetylene generators is at best hazardous. Unless large quantities are used, it is more economical and many times safer to use cylinder gas. As the regulating gauges are delicate precision instruments as shown in Fig. 2, their repair should not be attempted by anyone not experienced in their internal workings.

Chemical Smoke Generator Is Safe in Locating Air Currents

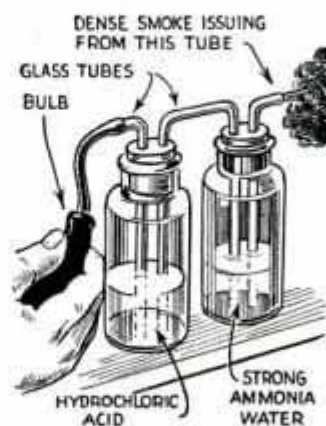

Producing a dense smoke without any fire hazard, this generator, which uses hydrochloric acid and strong ammonia, is helpful in determining the direction of air currents when installing ventilating systems. The

smoke produced by the generator is better for this purpose than that produced by a fire, as it is heavier and will not rise above the scene of action.

Stops on Ladder Hold Load While Workman Rests



Cleats Nailed to Sides of Ladder Serve as Stops on Which to Rest the Load as You Climb

After seeing a workman injured, when he lost his balance while carrying a bunch of shingles up a ladder, a carpenter nailed triangular cleats to the sides of the ladder as shown. The cleats serve as stops on which the workman can rest his load at intervals as he climbs.

Evaporation of Water Keeps Wood Barrels from Drying Out



which gives considerable evaporation surface. The moist air inside the barrels

Instead of filling their empty barrels with water to keep them from drying out, a western olive-packing company turns them upside down over gallon cans filled with water, in which pieces of clean burlap are inserted. Enough burlap is used in each can so that a large part projects,

keeps them from drying out, and they do not become soured. Thus, labor and expense are saved in cleaning them, as the barrels are ready for use after a rinsing with clean water and a few hours' airing.

Flashlight Operates on 110 Volts

For inspecting mechanisms in close places where a large lamp cannot be used, such as brushes on motors of fans, vacuum cleaners, etc., a small battery-less light can be had by connecting an ordinary pen-type flashlight to a 110-volt line through a coil and a 100-watt lamp as shown. The coil is wound on a 1/2-in.

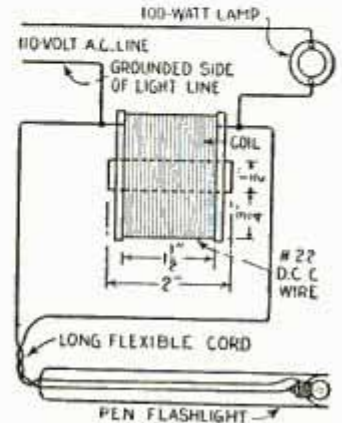

iron-rod core to a depth of about 3/4 in. Brilliancy of the lamp is increased by using a little more wire on the core, the correct amount to use being best determined by experimenting.

Increasing Range of Three-Jaw Chuck

Auxiliary jaws of the shapes shown will enable you to use a three-jaw chuck for many jobs that would ordinarily require a four-jaw chuck. Work of almost any shape may be held for turning or for drilling. If the upper jaws are made up in varying thicknesses, it is possible to hold work in any position that may be required for turning it off center.

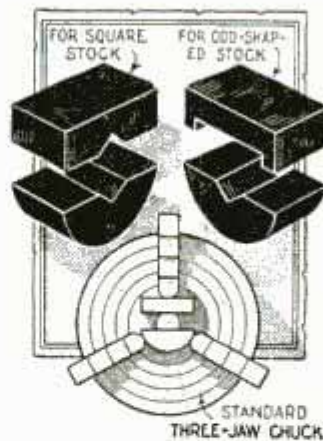

Small veining tools that will give satisfactory service may be made from old umbrella ribs or steel writing pens, flattened and sharpened to suit the work at hand; after cutting the tools to the required length, they are inserted into wooden handles.

Pressure of Coil Springs Tested with Scales

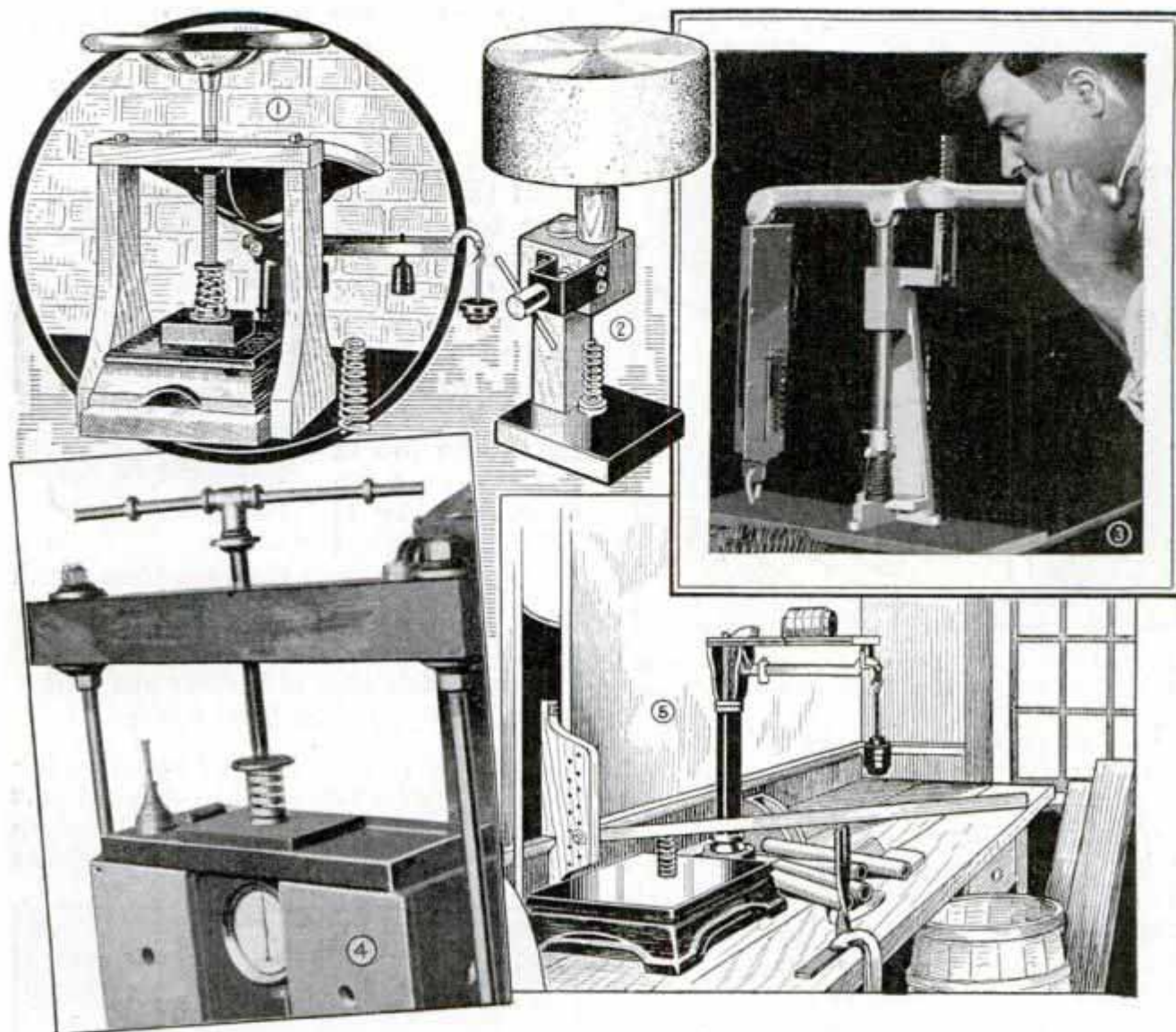

When you wish to know exactly how many pounds pressure it takes to depress a coil spring a given distance, any one of the methods shown will tell you at a glance. In Fig. 1, a platform scale of the counter type is set in a press frame made of wood and provided with a clamp screw. The scale beam gives you the pressure in pounds, and the amount of compression is gauged by a pin set into the base on which the spring rests, the clamp screw being run down until the collar on its lower end touches the top of the pin. Figs. 3 to 5 show varied applications of the same principle. The device shown in Fig. 2, is especially adapted to quick work where it is necessary to check possible variations in a large number of springs of the same size. Weights of a known denomination are placed on the platform to give the pressure in pounds, and the distance of com-

pression is regulated by the length of the gauge pin over which the spring is placed.—A. E. Granville, Knox, Ind.

Garden Hose Makes Long-Life Casing for Worn Lighting Cable

When lighting cable, such as used by photographers and stage electricians, begins to show signs of wear, its life can be lengthened considerably by encasing each section in an equal length of small-diameter garden hose. Where the hose terminates at the plug ends, tape, stout cord or rawhide may be used to bind it tightly in place. Any good cable paint will permanently seal the joint.

☞ Castings will part from plaster molds easily if the inside surfaces of the latter have been smoked over burning rosin.

Color-Mixing Slab and Supply Cabinet Added to Artist's Taboret

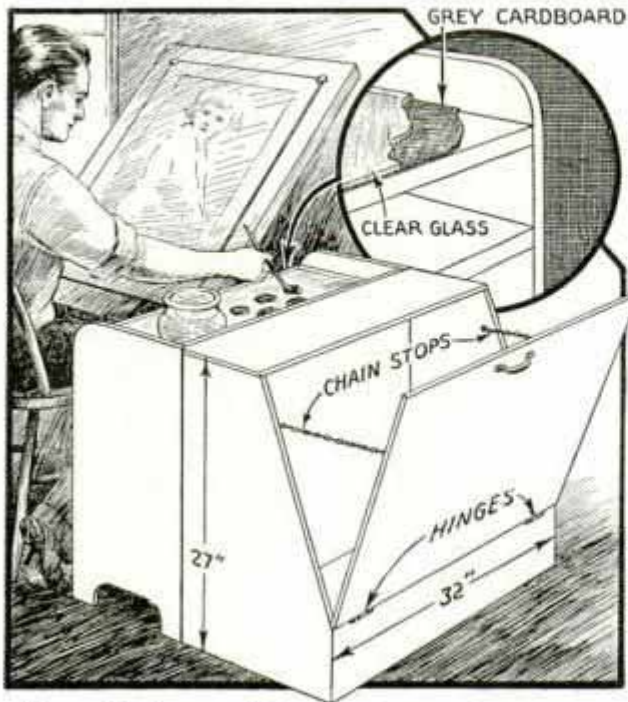

Neutral Palette and Large Storage Compartment Added to Taboret Make It More Useful to Artists

If a taboret is altered to include the following features, its utility to an artist will be greatly increased: The circular detail shows how a piece of clear glass, laid over a sheet of medium grey cardboard, transforms the taboret top into a neutral palette on which paints can be mixed and readily washed off. For storing canvases and illustration boards, so that they may be kept free from mars and dust, a compartment is attached to the back of the taboret as shown in the lower detail. Due to a large hinged door and the width of the tapering back of the compartment, its contents are conveniently accessible to the artist from his seat.

Screw Hooks Guard Tags from Wind

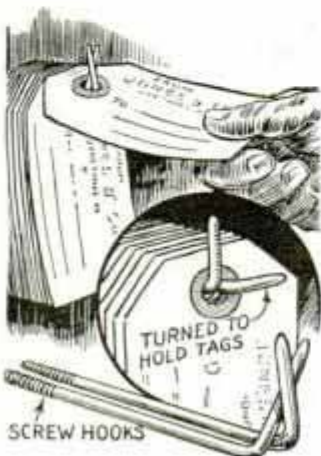

To keep a supply of shipping tags at hand on a loading platform, so that they will not be mislaid or blown about, drive a couple of screw hooks side by side in a near-by wall. Then you can slip the tags over them and turn one of

the hooks down so that its head will be at right angles to the other one. To remove tags, twist the hooks together.

Eggs Protected by Cushioning Crate with Pieces of Hose

Farmers who haul their eggs over rough roads can reduce breakage by cushioning the crates with pieces of hose, which are toenailed to the corners. The job of nailing can be done easily if holes are punched through the walls of the hose pieces with an ice pick or other sharp instrument.

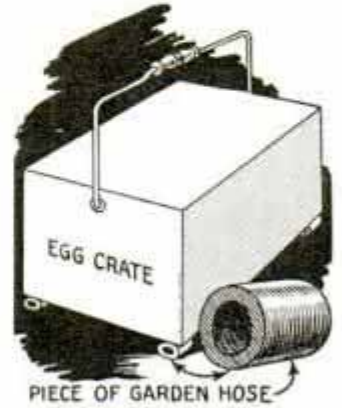

Finger Moistener of Rubber and Felt Helps in Handling Paper

As an aid in counting and assorting paper stock, or for turning the pages of books and catalogues, a worker in a western book bindery uses the finger moistener

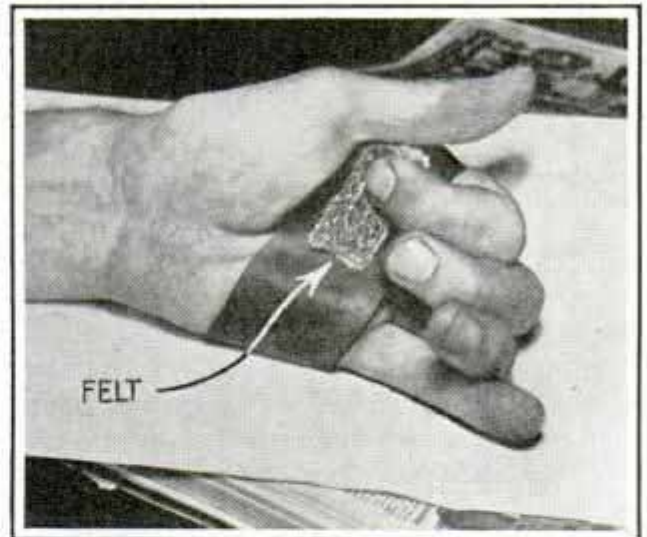

Felt Pad Held in Palm with Rubber Band Moistens Fingers When Handling Paper

shown. It consists of a rubber band, cut from an inner tube, to which a small piece of felt is sewed. This is kept saturated with water and moistens the finger tips when they are pressed against it.

❑ Frozen potatoes should be placed in a dark place until thawed.

FURNITURE LEGS

Made on the Jointer

SQUARE legs made on a jointer can be used for a wide range of projects, and offer a distinct advantage in uniform results and high-speed production. Typical examples of this work are shown in Fig. 3. The simplest type is the straight taper. The rear table is level with the knives, while the front one is dropped an amount equal to the taper desired. See Fig. 2. The rear end of the work must rest on the table. Long stock is handled conveniently by using an extension rest as in Fig. 1. Short tapers are made as shown in Figs. 4 to 7. A small block is pushed under the stock as in Fig. 6 to get a three-point contact on the table and knives and block, and the work is pulled over the knives, Fig. 5. Sharp brads projecting through the block help to hold it in place. A variation of this method is shown in Fig. 7. The block is clamped to the table and does not move with the work, the result being a slightly curved surface. To make the "stop chamfer,"

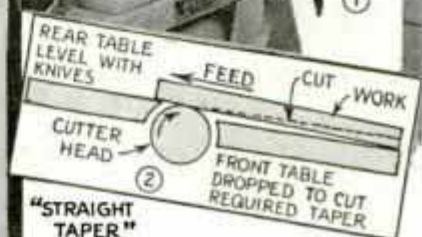
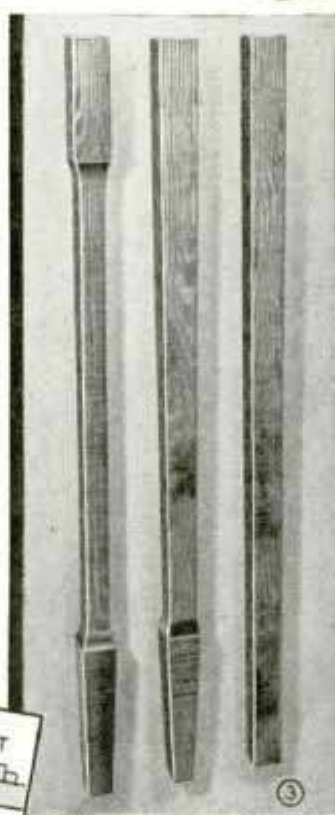

"STRAIGHT TAPER"

Figs. 8 and 9, both tables are dropped the required depth, after which the work is gradually lowered onto the revolving knives. A starting block is necessary. A second block can be used to mark the end of the cut.



"SHORT TAPER"

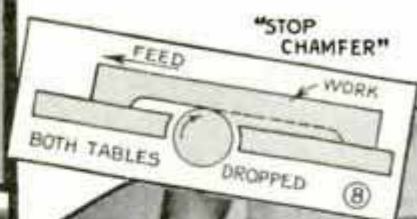
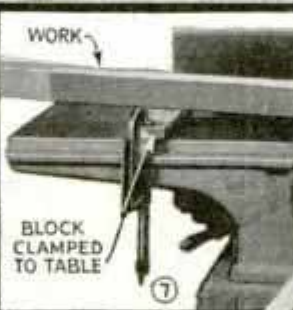

"STOP CHAMFER"

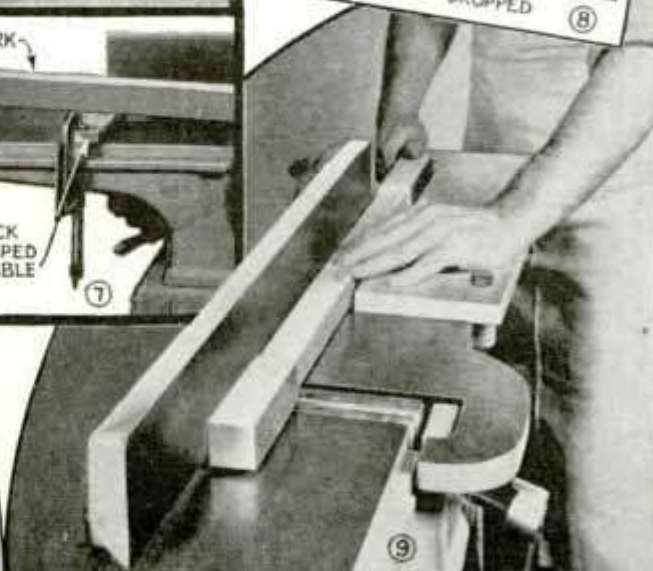

Steering Wheel Cranks Motor When Adjusting Bearings

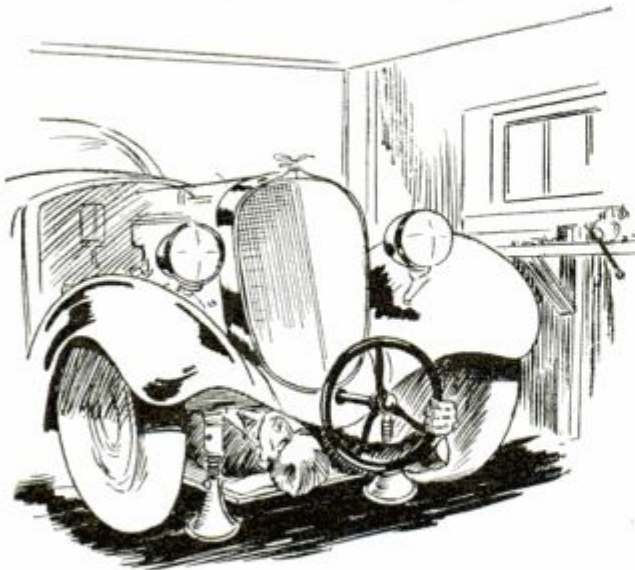

Old Steering Wheel Slipped over Crank to Turn Motor When Adjusting Bearings

By slipping a steering wheel over the crank, you can turn the motor when tightening the bearings without crawling out from under the car. If the hub of the wheel is reamed, it will fit most cranks. It can be clamped in place with a set screw.—Vernon Tracy, Centerville, N. B., Canada.

Forcing Ford Spring into Position with Turnbuckle

Installing the rear spring on a Ford is done easily with a large turnbuckle. One end of the buckle is ground to a chisel edge to fit under the eye of the spring, and the other is cupped to fit over a bolt head in the differential housing. After attaching one side of the spring to its hanger, it is quickly expanded with the turnbuckle to get the other end in place. If the screws already in the turnbuckle

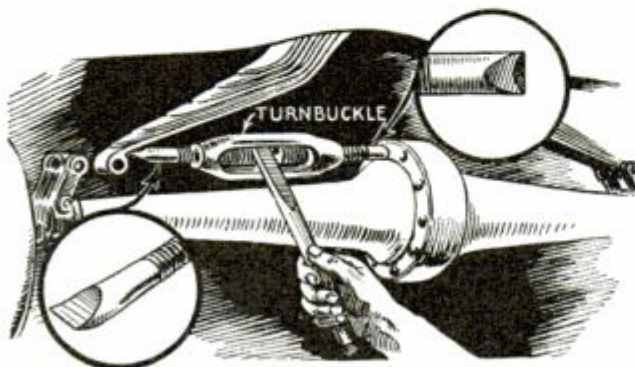

Large Turnbuckle with Altered Ends Expands Ford Spring for Attaching It to Hangers

are not suitable, threaded rods of the right length can be substituted. One has a right, while the other has a left thread.

Revolving Stand to Hold Catalogues in a Garage

In the parts department of a garage, where large catalogues are handled, revolving stands of the type shown will support them neatly on the counter. The assembly of pipe fittings, upon which the catalogue rest

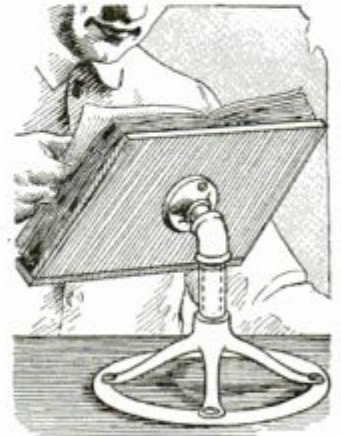

is mounted, is supported on the stub shaft of an inverted steering wheel and turns for use at either side of the counter.

Soapstone Solves the Problem of Sticking Gaskets

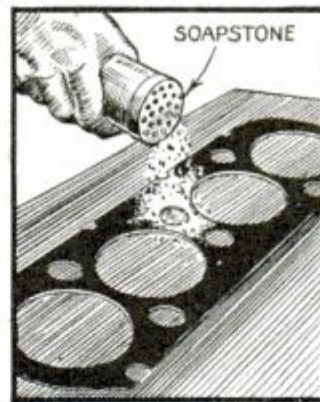

If you coat a cylinder-head gasket with soapstone before putting it on, it is not likely to stick the next time the head is removed. The powdered soapstone is applied by rubbing it over the gasket with a small piece of felt.

This will not hinder the sealing qualities of the gasket in any way.—Ray J. Marran, Kansas City, Mo.

To Loosen Frozen Lock in Car Door

This trick enables you to open your car door quickly if water has entered the lock and frozen. Just insert the key as far as possible and hold the flame of a match or ci-



gar lighter directly under it. This will melt the ice and get you started without delay or the expense of a service call.—C. E. Packer, Chicago.

Removable Door Handle to Foil Theft from Delivery Car

To prevent petty thieving from a closed car used for delivery purposes, an eastern merchant removed the door handle and substituted a specially constructed portable handle, which fits into a slot on the outside of the door. In this way, valuable articles may be safely left in the car without taking the trouble to lock it every time a stop is made.—S. Stowell, Fox Chase, Pa.



Clothespin Used to Deflate Tire

Whittled to a point as shown, a common clothespin not only makes a handy tool for quickly deflating a punctured inner tube, but also serves to mark the location of the hole when the tube is laid aside while preparing the patch. If notches are made on the "legs" of the pin, it is less likely to slip out of place.



How to Locate Shorted Cell in Auto Battery

Failure of the starter to crank a motor may be due to a discharged battery or a shorted cell. To determine which condition is causing the trouble, remove the filler caps from all of the cells, then operate the starter switch. At the same time, watch the cells closely. If the liquid in one of them boils violently, it is shorted. On the other hand, if no boiling occurs, the battery is discharged.

Cutting Blank Gaskets with a Large Ball Bearing



Large Ball Bearing Welded to End of Steel Rod Makes Efficient Tool to Cut Gaskets

Welded to the ends of steel rods, large ball bearings of various sizes make punches for cutting holes neatly in gaskets. The blank gasket is laid over the face of the motor block, after which the punch is held over the hole where the opening is to be made and given a sharp blow with a hammer.

Right Way to Install Cotter Key

Did you know that so simple a job as installing a cotter key to lock a castellated nut could be done in the wrong way? Always use a key that fits snugly in the hole, and insert it so that the side of the head lines up with the slot in the nut. Drive the head in firmly, bend one leg of the key over the end of the bolt or shaft, and the other one back over the side of the nut.

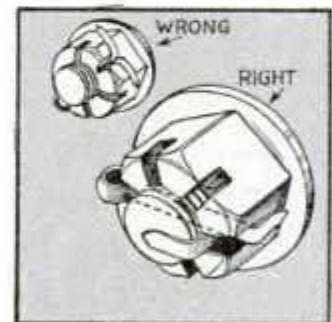

☞ To clean the porcelain of a spark plug, first scrape off the carbon and then polish it with fine valve-grinding compound.

Pivoted Cradle Holds Generator for Repairing

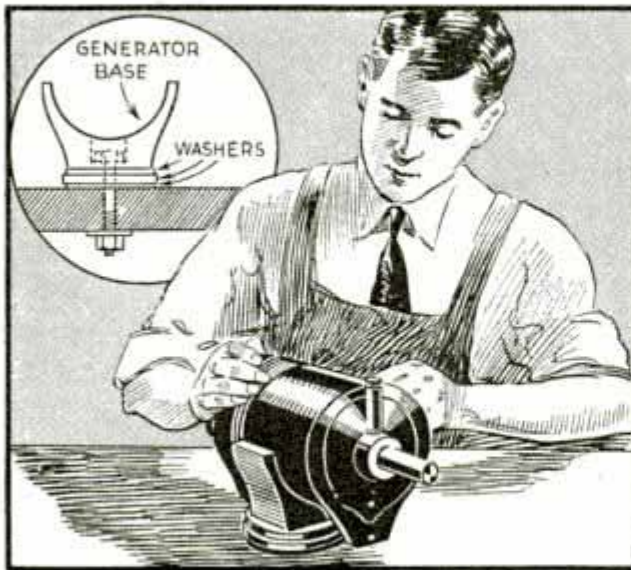

A Generator, Starter or Motor Held in This Cradle Is Turned to Any Convenient Working Angle

Pivoted to the bench top with a bolt, the half-round base from an old-style generator, or a base made from heavy sheet metal, serves as a turntable in which to

hold starters, generators or electric motors when working on them. Two or three large washers should be used between the cradle and the bench for a bearing surface. Thrust washers from an old model-T Ford differential serve nicely for this purpose.—Jack Beater, Fort Myers, Fla.

Finding Slow Leaks in Inner Tube

Inner tubes are often discarded because of the apparent impossibility to locate a slow leak. However, if the tube is partly inflated and then held under a slow stream of water from a faucet or hydrant, the leak may be made to show bubbles by taking each area of several square inches and stretching the rubber with the hands. A very small puncture will, in this way, be made to expand sufficiently for air to escape, and the constant flow of water over that part of the tube provides a film that will produce the bubbles. When the leak is found, a match inserted into the puncture marks its location.

The Next Issue

SHORTCUTS FOR THE MODEL RAILWAY BUILDER

The first installment of a series which will be of lasting value to every model-railway fan. Shows how you can make the parts from stock material, without the need of castings, and how model-railway building can be simplified to eliminate many machine operations. Also gives you easy methods and time-saving jigs to solve problems of construction and assembly.

LITTLE THINGS THAT CUT DOWN YOUR FUEL COSTS

How can you save 20 per cent of heat losses in your home? Why should "stale" water be used in a boiler? Story answers these and other questions.

DECORATIONS THAT SAY "MERRY CHRISTMAS"

Dressing up your home for the yuletide season; suggestions for novel and attractive effects indoors and out. Also, the latest in wrapping the gifts.

PLATING WOOD, PLASTER, LEATHER, ETC.

Non-conductors may be electroplated with copper, silver, gold and other metals. An excellent method of preserving your perishable keepsakes.

LATEST IN METAL FURNITURE

Smart smoking stand for those who prefer a subdued, modern design. Construction requires the use of aluminum in both tube and sheet form.

Every 1935 NATIONAL TRACK Championship



SYRACUSE

MILWAUKEE

NASHVILLE

RICHMOND

HONOLULU

READING

FREDERICK

WON BY HARLEY-DAVIDSON!

Never before in motorcycling history has such a complete and sweeping victory been won by a single make of motorcycle. Yet the Harley-Davidson topped its marvelous performance by establishing four new American Motorcycle Association records! . . . You may never intend to go in for races, hillclimbs and other competition. But when you own a Harley-Davidson, you know it's got what it takes to WIN! Rugged power, great speed, and the "class" in style that every rider wants these days.

Surprising, too, how easy it is to own a Harley-Davidson — how little it costs to run. See your Dealer right away — let him explain his Easy Pay plans — and "get set" on a Harley-Davidson! . . . Mail the Coupon for illustrated literature.

Ride a
HARLEY-DAVIDSON

Harley-Davidson Motor Co., Dept. P,
Milwaukee, Wis.
Interested in motorcycling. Send illustrated literature. Postage Stamp is enclosed to cover cost of mailing.

Name.....
Address.....
My age is 16-19 years, 20-30 years,
 31 years and up, under 16 years.
Check your age group.

WHAT THE MILDNESS MEANS TO

Lieutenant Commander Frank Hawks, U.S.N.R. (*right*), holder of 214 speed records and the Harmon Trophy, says: "I've been flying for 19 years and smoking Camels almost as long. Making speed records tests the pilot as well as his plane. As the athletes say, Camels are so mild they don't get the wind. And they never upset my nerves. Camel must use choicer tobaccos."

*"Camels don't get your
Wind" Athletes say*



© 1935, R. J. Reynolds Tob. Co.



"I smoke Camels all I want," says Colonel Roscoe Turner (*left*), who set the transcontinental speed records both ways. "I enjoy Camels more. And because of their mildness they never tire my taste. A speed flyer uses up energy just as his motor uses 'gas.' After smoking a Camel, I get a 'refill' in energy—a new feeling of vim and well-being."

"Get a Lift with a Camel"

When writing to advertisers please mention *Popular Mechanics*

OF CAMELS FAMOUS AVIATORS



"I appreciate the mellow flavor of Camels," says Sir Charles Kingsford-Smith, the trans-pacific flyer (*below*). "They refresh me when fatigued, and Camels are so mild that I can smoke any number without throwing my nerves off key."

*"They Never Tire
Your Taste"*

"I must take every precaution against jangled nerves," says Mrs. Theodore W. Kenyon, sportswoman pilot (*below*), "so I smoke Camels. They are the mildest cigarette I know. I can smoke Camels steadily and they never upset my nerves."

*"They Never Get
on Your Nerves"*



YOU'LL FIND THAT
CAMELS ARE MILD,
TOO—BETTER FOR
STEADY SMOKING



COSTLIER TOBACCOS!

• Camels are made from finer, MORE EXPENSIVE TOBACCOS — Turkish and Domestic — than any other popular brand.

(Signed)

R. J. REYNOLDS TOBACCO CO.
Winston-Salem, N. C.

When writing to advertisers please mention Popular Mechanics

What's It a Sign of?

(Continued from page 890)

the normal panorama of shifting-weather systems that we find depicted in a series of weather maps.

Let us consider a few well-founded weather proverbs and what is back of them.

"When the dew is on the grass
Rain will never come to pass."

Dew gathers on grass and other exposed objects when they grow cool enough to condense water out of the air. This happens on still, clear nights, the kind we have during fine weather.

"In the morning mountains,
In the evening fountains."

When "woolpack" clouds pile up to mountainous heights in the forenoon, we know the active vertical ascent of moist air, the principal cause of rainfall, has set in early in the day. With this good start it is likely to rain before night.

"If the sun set in gray
The next will be a rainy day."

A gray sky is usually one overcast with a high thin cloud, or just the kind of cloud that runs well ahead of a general rain-storm.

"A rainbow in the morning
Is the shepherd's warning;
A rainbow at night
Is the shepherd's delight."

The word "night" means late afternoon; otherwise it could refer only to the rare lunar rainbow. If the air is so charged with moisture that rain begins early in the day, it may continue the whole day. If the air is relatively dry, so the shower takes a long time to get started, it will probably be of short duration.

Most proverbs connecting the moon with the weather are without any rational foundation. One of the most foolish notions is that the position of the lunar crescent in the evening sky indicates whether rain is at hand. According to one version, if the crescent will "hold water," the following weather will be dry, while if its angle is such that water will run out, the weather will be wet. A second version asserts exactly the reverse.

The position of the crescent moon depends upon the angle the moon's path makes with the horizon, and on any given date it is always the same at all places in

the same latitude. Hence, if either of these beliefs were true, we should expect the same kind of weather, wet or dry, to prevail on a given date throughout a belt of latitude extending around the globe.

The appearance of the "old moon in the arms of the new" is likewise given two opposite interpretations, neither with any foundation in fact. The saying that "moonlight nights have the hardest frosts" means merely that very clear nights, which favor the rapid cooling of the earth by radiation, are also nights of bright moonlight, if the moon is above the horizon. As to the idea that the moon and the weather usually "change together," the weather is always changing while the moon changes from one phase to another on four days in every lunar month, so there are plenty of coincidences to keep alive this notion.

Many plants undergo certain changes with an increase in the humidity of the air or some other change in atmospheric conditions, but unfortunately for the prophet the atmospheric changes do not always point clearly to future weather. The air can grow very humid, for example, without producing rain, the occurrence of which depends as much upon air movements as upon air moisture. The pimpernel is known as the "poor man's weather-glass," but the belief that it always closes its blossoms before a shower is not borne out by observation.

Animals are often restless and birds are often noisy before a storm, but the conditions that thus affect their behavior may occur without a storm following. Thus, the saying that "a bee is never caught in a shower" contains only the grain of truth that when the sky grows dark, as it usually does before rain but also at other times, bees cease to leave the hive on honey-gathering trips. Bees are, moreover, often drenched in sudden showers.

Thousands of weather proverbs and sayings are recorded in literature. Most of them are on a par with the belief that if you break a mirror or meet a black cat you will be overtaken by some misfortune.

Our Bureau of Information will answer questions regarding articles in this magazine, if accompanied by return postage.

Here's a Picture you can make

Tonight!



LONG fall evenings bring gay times at home. It's a side of life that your camera shouldn't miss. Make pictures tonight. Or tomorrow night. And certainly Thanksgiving time when the family foregathers.

It's easy to take indoor pictures. Any camera that can be set for "time" will do.

Get Mazda Photoflash or Photoflood bulbs from your dealer—load your camera with Kodak "SS" Film, particularly adapted to night picture taking, or use Kodak Verichrome Film which will also give very good results. Follow the diagram and information given here to make a picture like the one shown, with Photoflash.

If you have a camera with a fast Lens . . . *f*.6.3 or faster—you can make snapshots—indoors, at night, with two or three Mazda Photoflood bulbs and Kodak "SS" Film. Open the lens to *f*.6.3—set for 1/25 second. And snap the picture as you would outdoors.

Night Pictures with Any Camera . . . With any camera that may be set for "time," you can make quick time exposures at night with Mazda Photoflood bulbs, or make Photoflash shots as here indicated. Photoflood bulbs cost 25¢, last for many pictures. Load with Kodak "SS" or Verichrome Film. See your dealer or write for folder.

Here's how you do it



Load with Kodak "SS" or Verichrome Film. Place your camera on firm table, eight feet from subject as shown in diagram. Hold Photoflash bulb, in reflector, above and to the side of camera. Set camera for "time." Open shutter—flash bulb—close shutter. That's all there is to it.

Here's all you need



Use Kodak "SS" or Verichrome Film. Mazda Photoflash Bulbs—give a brilliant, instantaneous flash . . . and cost but 15¢ each. Any box or folding camera with "time" adjustment will do. The picture at upper left (enlarged) was taken with the Brownie Six-20. For 2 1/4" x 3 1/4" pictures. Costs but \$3.

Ask your dealer about the current \$2500 prize contest for night pictures. All amateur picture takers eligible.

FREE FOLDER

Gives complete instructions on night photography . . . suggests subjects . . . tells how to make night pictures with any camera that can be set for "time." Write today to Eastman Kodak Company, Rochester, N. Y.

Name _____

Address _____

City _____ State _____

PM 12-35

When writing to advertisers please mention Popular Mechanics



How to Play Table Tennis

(Continued from page 836)

the bounce of the ball will indicate the degree. The shifting of the weight and the turn of the body are virtually the same as the movement of the golfer as he swings. At the finish of the swing the back of the hand should be upward. Lift and follow through are the elements of perfect stroking. Lift causes the ball to drop quickly after passing the net. Follow through supplies speed, accuracy and direction.

A flawless backhand also is important. Here the back of the hand leads and faces the net in executing the swing, and the stroke generally starts on the left side of the body. What has been said of the forehand also is true of the backhand, except that at the completion of the stroke the palm of the hand is facing upward and the ball is struck on the opposite side of the bat. The player's right shoulder should lean toward the net, the weight shifting from the left or rear foot to the right foot at the finish. If the forefinger, outstretched along the side of the blade, interferes with the shot, move it closer to the handle.

The quick, staccato backhand jab, known as the flick shot, is a lightning fast stroke performed with a quick movement of the forearm and with virtually no follow through. Its suddenness recommends it as an offensive weapon.

The underspin stroke corresponds to the court game's chop. It is attained by striking down on the ball and is best played on the forehand. To make this shot, tilt the upper edge of the racket as far back as necessary to get the desired results. The movement starts at the side of the body and as the arm goes forward, keep the upper edge of the bat laid back until after the stroke is finished. When executing underspin shots, the wrist should not be turned over when the ball is hit, as this produces topspin. The ball should be hit, not pushed, and the player's actions are comparable to the wood chopper's.

The backhand chop is made like the forehand except the ball is struck on the opposite side of the bat. The shifting of the weight and the position of the feet are the same as in the topspin strokes.

Two other strokes are the block shot and smash. The block shot is a first cousin to the tennis half volley and is used prin-

cipally on the defense, as when a ball is driven directly at you and you haven't time to step aside to stroke it. Hold the bat with a firm wrist, with the blade almost in a vertical position, and adjust the thumb and fingers as illustrated. By turning the wrist one way or the other you can control the direction of the ball, and its height is governed by the angle of the racket. In most cases, the block shot is made on the backhand. There is little or no stroking, but speed can be attained by pushing the forearm forward as you come into the ball. Keep the wrist locked and let the stroke be short and jerky.

The smash is a kill shot used on a ball that bounces unusually high. With the exception of a rigid wrist that scarcely moves when the ball is struck, the stroking is similar to the topspin drive. Best results are obtained by hitting the ball with the blade perpendicular to the desired flight of the ball. Make the stroke long and sweeping.

In table tennis, the server can write his own ticket, so there are about as many varieties of delivery as there are players. The commonest serves are the regular topspin and underspin strokes. As one of the best serves is a fast shot which just clears the net and terminates deep in your opponent's court, make sure the point where your racket first hits the ball is low and the spot where the ball strikes the receiver's side is close to his end of the table.

The secret of successful serving lies in converting it into a point getter. If you can't win a point outright, try to place the pellet so the return will be so weak you stand a chance of putting it away.

VALVE IN PARACHUTE CONTROLS DESCENT OF JUMPER

Tests are being conducted in Russia with a parachute which can be controlled in its descent by means of a special valve which enables the jumper to open the parachute only partly at first and then gradually slow up his fall by allowing it to fill with air. The development is said to allow a jumper more latitude in selecting a spot to land and reduces the jerk which usually occurs in the delayed jump.

Science Service

GILBERT BOY CHEMISTS LEAD IN THRILLING SCIENTIFIC DISCOVERIES

HOW YOU CAN MAKE MYSTERIOUS COMPOUNDS

GIVE UP THEIR SECRETS WITH A GILBERT CHEMISTRY SET



WINS FAME AND BIG AWARD

Here is Stanley Stewart about to demonstrate his "Green Fairy Fire" experiment. For this original research he received a Gilbert Award of \$100.00. Golden opportunities are ahead for you, too, when you become a Gilbert Chemist.

CAN you imagine anything more exciting than having a chemical laboratory of your own? Just think of the uncanny feats of science you can perform.

You can make invisible ink. Change water into wine. Change wine into milk. Make a chemical barometer that forecasts the weather. Make soda water—sparklers. Dye cloth. Fire-proof wood. Frost glass—and explore hundreds of other mysteries of the chemical world. Most thrilling of all, you can make new discoveries of your own—as other Gilbert boy chemists have done.

Gilbert Chemistry Sets are not just "toy" sets. They are designed for boys who want to be *real* chemists and do *real* things in chemical research. That is why Gilbert boy chemists are always leaders in scientific discoveries.

Ask to see the latest model Gilbert Chemistry Sets at your local dealers. But—take a tip from other boy chemists—and make sure the name "Gilbert" is on the box.

\$100.00 ANNUAL AWARD
and twelve awards of \$10.00 each

"To the boy doing what, in my opinion, is the most important chemical research in 1936, I will make a cash award of \$100.00. To the twelve boys doing the next most important chemical research I will award \$10.00 each. Applicants for these awards must not be over 17 years of age, and must send me a full description of their experiments by June 1st, 1936."

A.C. Gilbert



HIDDEN WONDERS REVEALED WITH POWERFUL GILBERT MICROSCOPE

You see thousands of hidden wonders of Nature and Science. Packed with Gilbert Micro Chemistry Set No. 4—\$2.00. With No. 7 Set \$5.95.

GILBERT No. 5 LABORATORY SET—Picture yourself in front of this marvelous set. Rows of chemicals in racks. Test tubes, funnel, filter papers—65 pieces of equipment. Complete with instruction book \$5.00. Other Gilbert sets from \$1.00.

Free—Gilbert Thrills Magazine

32 pages packed full of exciting pictures and up-to-the-minute scientific information. True stories of how red-blooded boys have won fame and made money through chemical research. Regular price 25c. Free—with combined color catalog on the New Gilbert Chemistry Sets—to the first 50,000 boys who mail this coupon.

Mr. A. C. Gilbert, President, The A. C. Gilbert Company,
504 Erector Square, New Haven, Conn.

Please send—FREE—Gilbert Thrills Magazine combined with catalog on your new Chemistry Sets.

Name.....

Street.....

City.....State.....

When writing to advertisers please mention Popular Mechanics

NEW MOTOR-DRIVEN TOOLS

FOR FACTORIES, SMALL SHOPS, HOME WORKSHOPS . . .

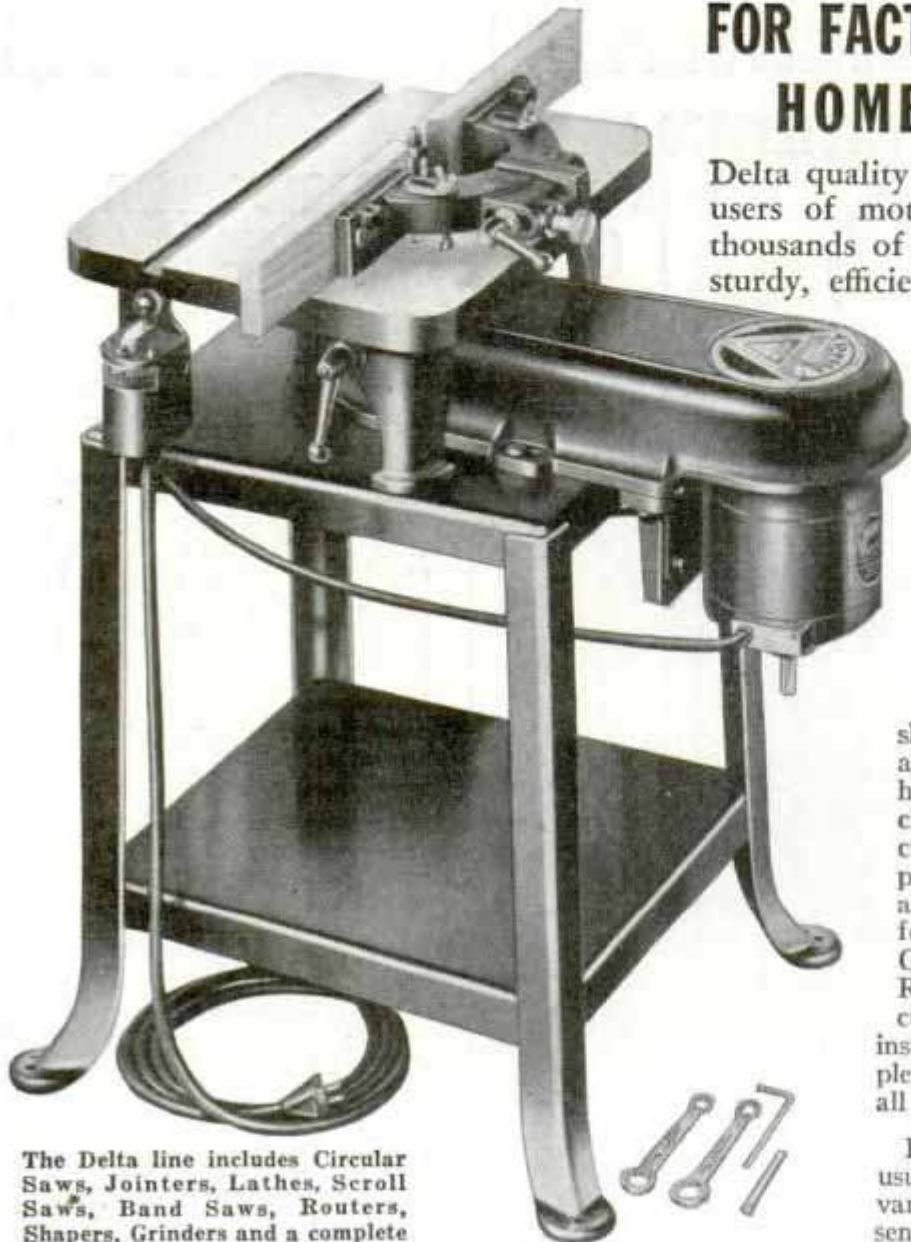

The Delta line includes Circular Saws, Jointers, Lathes, Scroll Saws, Band Saws, Routers, Shapers, Grinders and a complete assortment of attachments and accessories.

Delta quality tools have brought a new era to users of motor driven equipment in tens of thousands of shops all over the world. These sturdy, efficient, motor-driven tools are saving time, money and labor for their users. Delta tools are built to stand heavy strain of continuous production work.

New DELTA SHAPER UNIT

here illustrated is one of the simplest and at the same time most complete Shapers ever designed for the workshop. Some of its important basic features are: **1.** Extra Large Table permitting the handling of large work with ease; **2.** Interchangeable Spindles for $\frac{1}{8}$ " and $\frac{1}{2}$ " hole cutters for various types of work; **3.** Improved Completely Adjustable Fence for all varieties of straight work; starting pin for curved work of all kinds; **4.** Complete Guarding system; **5.** High Speed of 10,000 R. P. M. which with standard 3-lip Delta cutter gives over 30,000 cuts a minute, thus insuring smooth and finished work; **6.** Complete range of cabinet and sash cutters for all types of mill work.

For full details and description of this unusual tool together with illustrations of large variety of work that can be done with it, send for the new 1936 Delta Catalog. Fill out the coupon on the next page and mail today!

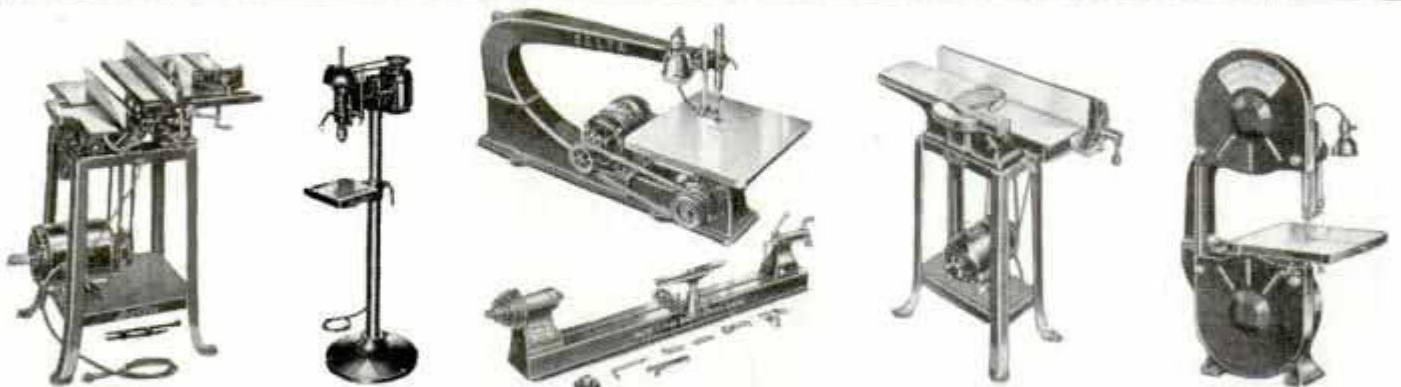

Delta **QUALITY** represents real **ECONOMY**

IN 1936 "DELTA" LINE

They are being used by some of the largest manufacturers in the country because of their accuracy, quality construction, and flexibility. Yet their initial cost is so low that they are well within the reach of even the home workshop owner.

Complete line of NEW GRINDERS

Not just another line of grinders—but revolutionary *new* grinders in every sense of the word! Belt-driven, motor-driven and pedestal models—they all embody Delta's high standards of design and construction. Many unusual features in no other grinders. No pains have been spared to make these new Delta Tools *ideal* in every way—convenient, safe, accurate and efficient—truly, here are the grinders that shopworkers have always wanted—and at the unusually moderate Delta price levels.

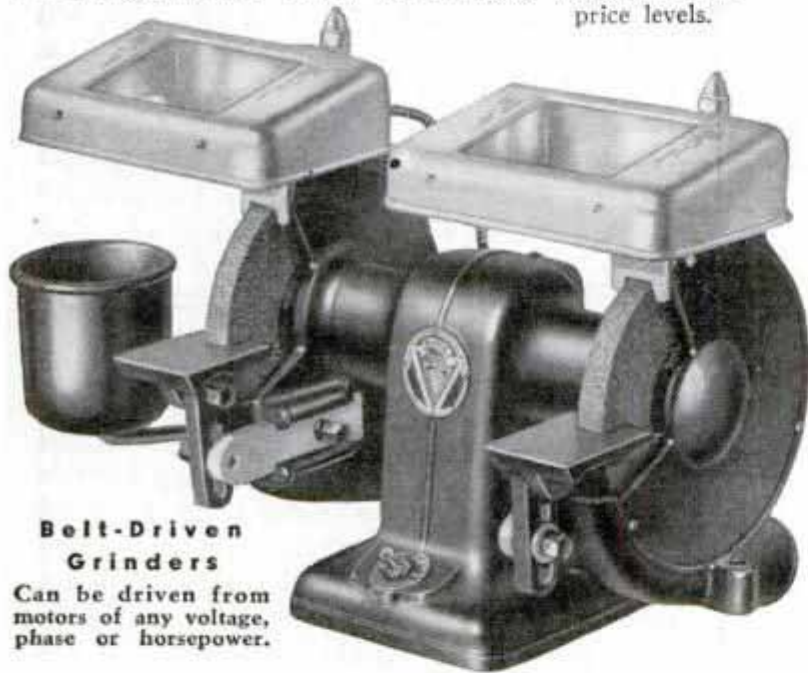

Belt-Driven Grinders

Can be driven from motors of any voltage, phase or horsepower.



Pedestal model motor-driven Grinder with built-in switches, water pots, and combination tool tray and waterportholder. You will be pleasantly surprised at the remarkably low price of this Grinder.

Write for Latest CATALOG

It is crowded with photographs and information about the new line of 1936 Delta tools. It contains much valuable information that every man interested in wood-working tools should have. It shows how Delta tools are built to stand the grind of production work and yet are so low priced as to be within the reach of all, how they save time, money and labor—and quickly pay for themselves.

Mail coupon without delay. Enclose only 10 cents at same time for Book No. 2, "Practical Delta Projects," 32 pages of new and novel things to make, with numerous blue prints, working drawings, photographs and illustrations—and complete directions.

DELTA MFG. CO.

600-634 E. VIENNA AVE.
MILWAUKEE WIS.

DELTA MANUFACTURING COMPANY,
600-634 E. Vienna Ave., Dept. A1235
MILWAUKEE, WISCONSIN

I enclose 10c (stamps or coin), for which please send me one copy of Book No. 2, "Practical Delta Projects." Also place me on your mailing list to receive 1936 Delta catalog of quality motor-driven wood-working tools.

Name _____

Address _____

Age _____

City _____

State _____

Check here if you are a Delta user now.

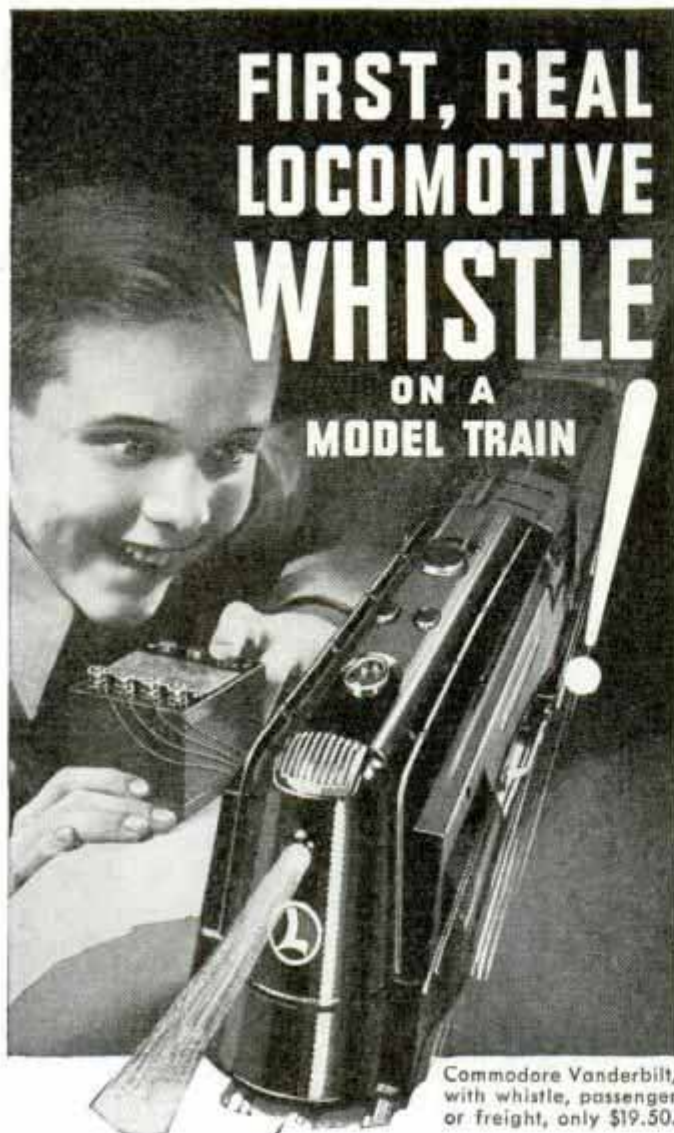

Commodore Vanderbilt, with whistle, passenger or freight, only \$19.50.

AND A BIG BOOK TO TELL YOU ALL ABOUT IT!

HERE comes Lionel with a real locomotive whistle! Press a button and the locomotive pipes short or long blasts — anytime, as the train is roaring down the track, backing or standing still. It's amazing — but there's not space here to give you all the thrilling details — so send this coupon at once for the new Lionel catalog — 44 pages packed with excitement. New streamlined models! A gate-man who pops out of his shanty and flags the limited — automatically. It's all in this new railroad book — so get it now.

LIONEL TRAINS



FREE!

At any department store, toy, hardware or electrical dealer.

THE LIONEL CORPORATION
Department 8
15 East 26th Street, New York, N. Y.
Please rush me your new 1935 Catalog. I enclose 10c in stamps to cover postage and handling.

MY NAME _____ (Please Print)

ADDRESS _____

CITY _____ STATE _____

THE ROMANCE OF WHISTLES

(Continued from page 857)

The first words every locomotive learns to say are the familiar warning, "Whoo-o-o, Whoo-o-o, Who—Who!" shrilled out at the whistling post a quarter mile before a highway crossing. But the whistle has many other messages to tell. Railroaders who know locomotive talk sometimes spend restless nights back in the sleepers, conscious of every signal blast. A succession of short, sharp toots tells them there's some obstacle on the track just ahead. A single short whistle precedes application of brakes, and two medium blasts mean brakes are being released. A medium and three short notes send the flagman back to protect the rear of a stalled train. To call him back, the engineer sounds four medium whistles if the train is eastbound and five if it is westbound. One long whistle salutes a station ahead, and two medium and a short blast signal the approach to a railway crossing. One short and one medium whistle direct the crew to inspect a leaking train line, and three medium blasts should worry any wakeful railroaders aboard; it is the signal that a car has broken loose from the train.

Railway whistles at first were just tin post horns borrowed from stage-coach days. The engineer blew his own horn. But in 1832 a farmer driving his egg cart across the Leicester-Swannington railroad tracks in England ignored the engineer's frantic toots and, although he escaped alive, his eggs were scrambled. So the railroad hitched the post horn to steam and created the steam trumpet. Then, in 1835, it adopted the steam whistle. Since then, endless research has adapted whistles to the peculiar conditions of the railroad. Fast and slow trains, prairies, hill country and switchyards require particular types of signals. Three-toned whistles proved to have better carrying power for fast passenger trains, and at first three separate whistles were installed and blown simultaneously. Now the same effect is achieved by building three chambers within a single whistle column. The Chicago and North Western railway makes its own five-chamber whistles, and recently equipped its speedy "400" with a resonant air horn. Electric and Diesel locomotives, lacking steam, require air horns and in

(Continued to page 124A)



At last!

A THRILLING NEW CONSTRUCTION TOY FOR THE YOUNGER BOY



The New
MECCANO-MORECRAFT

DESIGNER SIZE

Contains a generous supply of parts packed in two metal drawers, and a tray in red covered case. (Beautifully illustrated book of models included.) Price complete \$4. Sent prepaid upon receipt of money if not at your dealer's.

● Boys of five or even younger build cranes, bridges, trucks and other fascinating models. It's almost unbelievable. And they build them quicker and easier than with ordinary building sets.

Boltless joints. That's the secret of speedy building with the new Meccano-Morecraft. Parts just snap together—without the need of nuts and bolts. And each one stays firm and rigid. Models are colorful, too, with bright red, blue and nickel parts.

Meccano-Morecraft develops self-reliance in the younger boy by showing him that he can do what yesterday only his older brothers could do.

THE MECCANO COMPANY OF AMERICA, INC.

Makers of Meccano Microscopes, the Original Meccano and other fascinating toys.

● Send for big, 16 page, beautifully illustrated booklet of models. It's yours—free!

The Meccano Company of America, Inc.
Dept. I, 200 Fifth Avenue, New York City, N. Y.

Please send—free—beautifully illustrated 16 page booklet of models.

Name.....Address.....

City.....State.....

A New Idea In Workshops!

The DRIVER ADD-A-TOOL

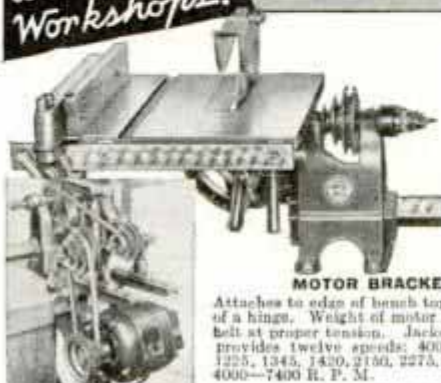

- OPERATIONS**
- Wood turning
 - Mortising
 - Shaping
 - Sawing
 - Dadoing
 - Grooving
 - Sanding
 - Metal turning
 - Drilling
 - Routing

A thoroughly practical workshop . . . performs a multitude of different operations . . . requires only a small amount of space . . . owning it involves no heavy investment. Once the basic Add-A-Tool comprising lathe, bench saw and motor has been acquired, accessories may be added as the need arises. Write for descriptive folder.

PRICE
\$39.95
INCLUDING 1/3 H.P. GOLD SEAL MOTOR & 12 SPEED MOTOR BRACKET

MOTOR BRACKET
Attaches to edge of bench top by means of a hinge. Weight of motor keeps lathe belt at proper tension. Jackshaft set up provides twelve speeds: 400, 734, 795, 1225, 1345, 1420, 2150, 2275, 3440, 3900, 4000—7400 R. P. M.

SPECIFICATIONS — LATHE: Distance between centers 30". Swing 7 1/4". Compound tool rest for metal turning and all other accessories available extra cost. **BENCH SAW:** Table 14"x12". Removable throat for dadoing. Wood-faced ripping fence. Table lifts 45°. Uses 7" blades, cuts full 2".

WALKER-TURNER CO., INC.
1125A Berckman St., Plainfield, N. J.

Please send me your folder on 1936 Driver Tools.

Name.....
Address.....
City.....State.....

WALKER-TURNER CO. INC. PLAINFIELD, NEW JERSEY

\$2500 CASH PRIZES

*For snapshots
at night*



*a picture like
this may win
\$350* for you*

* A \$250 Grand Prize will be awarded to one of the six winners of the \$100 prizes, hence the grand prize winner receives \$250 for a single picture.

89 CASH PRIZES EACH IN NOVEMBER AND DECEMBER

STILL A CHANCE FOR THESE PRIZES:

2 prizes of \$100 each	10 prizes of \$10 each
3 prizes of \$50 each	20 prizes of \$5 each
4 prizes of \$25 each	50 prizes of \$2 each

\$250 Grand Prize

Any amateur picture-taker is eligible. Human interest . . . heart throbs or humor . . . counts more than photographic skill.

You'll find scores of likely subjects around your home . . . the baby, the children at play, Thanksgiving, birthday parties, pictures that tell a story.

HOW TO TAKE THEM. Simply screw two or three G-E MAZDA Photoflood lamps in bridge, floor or table lamps, load your camera with supersensitive film and shoot away . . . taking **SNAPSHOTS**, if your camera has a fast 1/6.3 lens, or **QUICK TIME EXPOSURES**, if you use a box or slow lens folding camera. These lamps are good for dozens of pictures and cost only 25 cents list.

For shots of babies, pets and action, use G-E MAZDA Photoflash lamps (15 cents list). Each lamp gets only one picture but you get it in 1/50 of a second . . . fast enough to record normal action. And you can use these lamps on flashlight batteries or house current.

Ask your dealer for a folder "Snapshots at Night Contest" on this \$2500 contest or write Dept. "D", General Electric Co., Nela Park, Cleveland, Ohio.

RULES

1. Any amateur photographer (except employees of the General Electric Company and those engaged in the manufacture or sale of photo supplies) may enter any number of pictures made on or after October 1, 1935 and not later than January 1, 1936, in one or more of the October, November, December contests.
2. Prizes will be awarded **ONLY** for pictures taken by artificial light, indoors or outdoors.
3. Winning pictures will be chosen solely on subject interest or appeal, not on technical excellence. The decision of the judges shall be final.
4. Each prize winning picture with negative and sole rights for advertising, publication and exhibition in any manner shall become the property of the General Electric Company.
5. Each print must bear the owner's name and address on the back. No prints will be returned.
6. All entries for the October contest must be postmarked not later than midnight, November 2; for the November contest, not later than midnight, December 2; and for the December contest, not later than midnight, January 3, 1936. Get entry blanks from your druggist or camera dealer and mail with prints only (be sure to keep the negatives) to:

Prize Contest Office, General Electric Company,
Nela Park, Cleveland, Ohio

GENERAL ELECTRIC
MAZDA PHOTO LAMPS

THE ROMANCE OF WHISTLES

(Continued from page 122A)

many cases these have become the vocal "trade-mark" of the high-speed train. These horns are operated by compressed air from the brake system.

Faster trains need more piercing whistles, but the railroads could not let the noise become a nuisance to passengers or to communities along the line. In building whistles for the Burlington "Zephyr," foghorn designers for the lighthouse service were consulted. Three horns were installed, one on the roof and two inside the air intake grating, sounding simultaneously. Its raucous shriek had to be toned down later. The Milwaukee railroad equipped its "Hiawatha" with a musical air horn but added a regular steam whistle for emergency use. A train crew on the Milwaukee road once was arrested for sounding the whistle within the city of Waukesha, Wis., contrary to a municipal ordinance. A number of cities prohibit locomotive whistles "except to prevent accident." If the whistle is provided with lever control the engineer can soften its blast somewhat, but if operated by an air valve the whistle automatically opens full blast. The deep-throated whistles of the North Western, the Wabash and the Milwaukee roads are of the "steamboat" type. In early railroading days, when engineers were permitted to furnish their own whistles, they sometimes borrowed real steamship whistles. Then they took the whistle home as a memento when they retired.

In favorable conditions of humidity, temperature and wind a whistle may be heard fifteen miles.

Latest time-saver for the busy engineer is a push-button whistle used on certain Milwaukee railroad trains. At the whistling post the engineer needs only press a button and the whistle automatically shrills the traditional two long, two short warning notes for the grade crossing.

There's more to locomotive talk than the signal book shows. Old-time engineers develop a "touch" on the whistle cord their friends can recognize, and "talk" to them with a peculiar tattoo. And if you hear an odd quaver in the voice of the 5:32 as it rumbles into town some afternoon, you'll know Engineer Sam Jones is telling his wife in engine language: "Put on the kettle, I'll be home for dinner!"

Complete POWER WOODWORKING SHOP

JIG SAW
WOOD LATHE
DRILL PRESS
SANDER, ETC.

(board shown
not included)

All
C.O.D.'s
25c extra

Motor of
1/10 H. P.
or over
will run
Assembly

\$5 deposit on As-
sembly (sent C.O.D.)

(outside
U. S. A.
\$10.00)

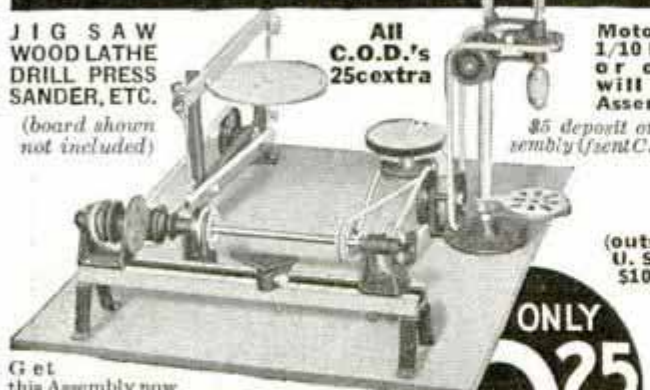

Get this Assembly now and this winter make a few of the many things you have planned, i.e., book shelves, foot stools, sewing cabinets, book ends, wall brackets, corner cupboards, end tables, magazine racks, etc. Easily and speedily done with power tools. Assembly consists of the following tools, which may be purchased separately: Jig Saw equipped with adapters, 1 doz. assorted blades and booklet, "Make Your Own Jig Saw Puzzles" (\$1.50); 2-speed Wood Lathe, 9 1/2 in. Bed (\$2.00); Drill Press complete with chuck (\$2.50); Disc Sander with 6 sandpaper discs (\$1.00); Set Hangers and Linshaft (\$1.00); 5 Line Shaft Pulleys (\$1.25).

FREE Six 2 1/2 Ft. Endless Rubber Belts (value \$1.50) given with each Complete Assembly. Assembly may be purchased with \$5 Lathe having 2 1/2 in. bed. Simply add \$1 to your order. AN IDEAL XMAS GIFT FOR MAN OR BOY. BUY EARLY.

Send 5c stamp for 24 page catalog fully describing all our low priced tools.

J&H METAL PRODUCTS CO

486

ST. PAUL ST. ROCHESTER, N.Y.

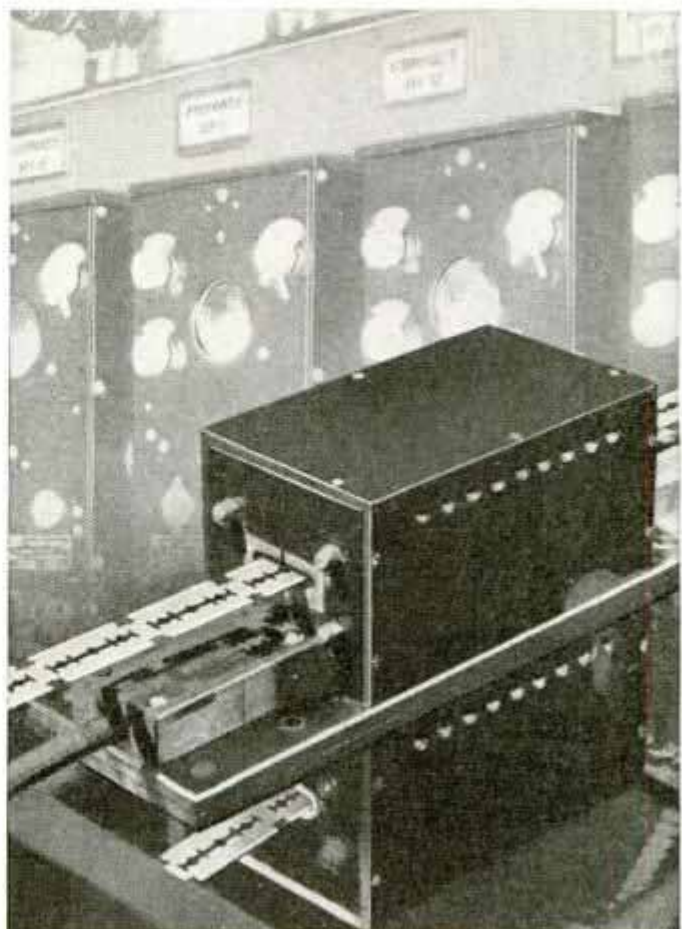

WHAT IS THIS DEVICE THAT MAKES STEEL "Talk"

- Messages relayed from this magic black box to a battery of automatic switches, control the hardening of Gillette steel as it passes through electric furnaces.
- In effect, this amazing device makes steel "talk"—orders more or less heat in the furnaces as the condition of the steel demands. This results in constant uniformity of hardness in the steel—contributes in a big way to the shaving comfort you enjoy with the Gillette "Blue Blade".
- Before the development of this equipment, hardness could not be uniform, for variations exist in even the finest steel. Now a master strip of steel—of exactly correct hardness—controls the temperature of the furnaces—the only furnaces in the world that can produce steel of uniform, predetermined hardness.
- With this blade you get more shaves—better shaves—because Gillette steel takes and holds the sharpest edges ever put on metal. Try the Gillette "Blue Blade".

Reputable merchants give you what you ask for. In stores where substitution is practised—INSIST ON

GILLETTE BLUE BLADES
NOW 5 for 25¢ • 10 for 49¢

AMAZING NEW AUTO INVENTION

Scientific Laboratories, P-960, Wheaton, Illinois, have perfected an accessory device needed on every auto. There is nothing else like it on the market. Fits all autos. Easily attached. County and State Distributors wanted everywhere. 100% to 300% profits. One-free offer to introduce quickly. Send address and car name today.

COMPLETE ELECTRIC PLANTS



ONAN A.C. PLANTS furnish the same current as city service. Operate Radio, Water System, Refrigerator, all Appliances.

SIZES 350 WATTS UP

Have A.C. Current anywhere. Models \$110 and up. Easy to install. Available from stock. Ideal for farms, camps, lake homes, commercial purposes—anywhere electricity is needed.

D. W. ONAN & SONS

956 Royalston Ave., Minneapolis, Minn.

DO YOU

WANT a new business profession of your own, with all the trade you can attend to? Then become a foot correctionist, and in a few weeks earn big income in service fees,—not medical nor chiropody—easy terms for home training, no further capital needed, no goods to buy, no agency. Established 1894. Address Stephenson Laboratory, 1 Back Bay, Boston, Mass.

LOG SAWS

MAKE MONEY—BE YOUR OWN BOSS
Turn Your
Trees Into Cash

Be independent, start a wood sawing business, have money coming in all the time. Use the portable engine year 'round. Pays for itself. Low factory prices. Big FREE Catalog.

WITTE ENGINE WORKS
6749 OAKLAND AVE. KANSAS CITY, MO.

Boys! EXPLORE NEW WORLDS OF SCIENCE



Here's the most sensational scientific instrument you can own. The new Gilbert Opto Kit. A big laboratory-type wooden box full of powerful lenses for making your own microscopes—telescope—periscope—shadow projector—electric beam signaler—and other exciting equipment.

With an Opto Kit you can explore hidden mysteries of nature and science—send messages by electric beam—make camera models—and do dozens of other exciting things. See Opto Kit at your nearest toy store. Mail coupon for 32-page "Gilbert Thrills Magazine"—regular price 25c—free to first 50,000 boys who write.

THE NEW GILBERT OPTO KIT

The A. C. Gilbert Co.
526 Erector Square, New Haven, Conn.
Send—free—Gilbert Thrills Magazine and combined Opto Kit Catalog.

Name

Street

City..... State.....

WINGS OVER FOUR CONTINENTS

(Continued from page 868)

to control, so all supplies for the airport had to be hauled in by airplane.

Today the service between Europe and South America functions with a regularity between ninety-seven and ninety-nine per cent perfect. French pilots and mechanics have been held up and captured by bandits and in the pioneering period, sixty-eight pilots, engineers and navigators paid with their lives in the effort to get the air line running smoothly. But they made it possible for letters to go from Paris to Buenos Aires in three and one-half days.

Air France's Far Eastern line dates to 1927 when the first hydroplanes flew between France and Syria. In 1933, the company made connection on a regular schedule between France and Indo-China. Despite the great climatic changes and the inhospitable terrain planes maintain their schedule more than ninety-eight per cent of the time.

Air France's supreme effort in construction is embodied in the thirty-seventon flying boat, "Lieutenant de Vaisseau-Paris." She is destined either for the south Atlantic or the Mediterranean line. Her six Hispano-Suiza motors give her more than 5,340 horsepower to carry her at a speed of more than 160 miles per hour at an altitude of 6,000 feet; her cruising speed is more than 140 miles per hour.

With eight in her crew and seventy-two passengers, the "Lieutenant de Vaisseau-Paris" has a cruising range of 750 miles. The captain rides in the ship's nose; behind him are the pilots, then the three mechanics, then the passenger cabin. Passenger accommodations include a salon with twenty comfortable chairs and dining tables; six cabins de luxe with beds and wash bowls; a kitchen, bar and comfort station. This is the arrangement if the ship operates in the Mediterranean zone. If she operates in the south Atlantic service, the number of passengers is decreased to thirty, while the cruising range is increased to 3,000 miles. Then there will be twelve cabins, each fitted for two people, in addition to public rooms.

According to her designers, the "Lieutenant" can fly the south Atlantic in a single hop of fifteen hours. And she could fly the north Atlantic in twenty-nine hours flat, making one refueling stop.



NICHOLSON The sign of an expert

Home tool users quickly learn that there is a difference in files. And as a man becomes expert in his own shop Nicholson Files become his choice.

These chaps who make unbelievably intricate trains and steam engines, who cut decorative chandeliers and andirons from old scrap metal, whose wood working is a marvel of accuracy and beauty, almost invariably use Nicholson Files.

Use Nicholson Files in your shop. They are sharp, durable and economical. They are first quality tools—they are the first choice of the expert home tool user. At your hardware store. Nicholson File Company, Providence, R. I., U. S. A.

Genuine

NICHOLSON FILES

A FILE FOR EVERY PURPOSE

JIGSAW AND MOTOR

Cuts 900 strokes per minute



The sensation of the year! A full-sized Jigsaw with motor attached and two saw blades—for only \$3.45. Stands 15½" high, 15¼" long. Made of sturdy, channelled steel. Has 12" throat. Work table is 6¼" round. Motor operates on AC current only. 105 to 110 volts, 50 or 60 cycles. Direct cam drive gives maximum power. No belts to break or slip. Handles wood up to ¾" thick. Cuts 900 strokes per minute. Comes complete with cord, ready to plug in light socket.

Ideal for making Jigsaw puzzles, statuettes, toys, fretwork, etc. Jigsaw guaranteed for one year. Never before such an amazing bargain.

Send only \$1.00 with order. Pay balance upon delivery. Satisfaction guaranteed or money refunded. Order now!

ONLY
\$3.45
COMPLETE

HANDICRAFT COMPANY 110 West Chicago Avenue
Dept. 1235 Chicago, Ill.

DO YOUR
Christmas "Shopping"
WITH



**GENUINE
Masonite
TEMPERED
PRESWOOD**

THIS YEAR, why not build your own gifts in your own home? They carry much more sentiment. And if built with Genuine Masonite Tempered PRESWOOD, they last longer . . . save your money.

Hundreds of items can be made of this remarkable material . . . easily . . . quickly . . . inexpensively. It is grainless and uniform in quality. Easy to work with. Can be cut or sawed to any size or shape with ordinary tools.

Genuine Masonite Tempered PRESWOOD is moisture-resisting. Will not warp, chip, split or crack. Surfaces remain smooth, rigid and strong for all time. Its natural warm-brown finish produces beautiful results without further treatment. Or it can be varnished, painted or enameled.

Genuine Masonite Tempered PRESWOOD is also ideal for home-building or remodeling. Easy to finance under F.H.A. Ask your Masonite dealer.

Mail in the coupon below for a free sample of Genuine Masonite Tempered PRESWOOD.

MASONITE CORPORATION

111 W. Washington St., Chicago, Ill.

Dept. PM-12

Please send me a free sample of Genuine Masonite Tempered PRESWOOD and more information about this wonder material.

Name _____

Address _____

City _____ State _____

When writing please mention Popular Mechanics

Fish Worth Their Weight in Gold

(Continued from page 874)

any other fish that approaches the nest. The male dwarf gourami builds a "bubble nest" atop the water and lures the female in to lay her eggs.

There are plenty of tricks to this hobby, but they are not difficult to learn. Nature does not encourage mating of unrelated species, and you will wonder whether you can cross breeds successfully. Ask Alfons Heintze, who makes it a full-time job.

"You can fool the fish," says Mr. Heintze. "When they are very young they do not recognize family differences. Mate them then, place the pair together before they are two months old, and you may have success."

Recently it was discovered that a canned food made especially for fox and other fur animals is also a perfect food for fish. It is a jellied substance made of meat, dry skim milk, wheat, tomatoes, edible bone meal and salt. Dried shrimps are another good food. But when Mr. Heintze wants to fatten his fish and bring them to maturity quickly he feeds them little white worms and daphnia, or water fleas. Fish thrive on live food in any quantity.

This is another profitable sideline. Water fleas, found in any stagnant pool or inlet of a river, can be sold at five gallons for a dollar in centers where there is a demand. One Chicago man, a cripple without other means of support, built a shack beside a sluggish river and supplied fish dealers with buckets of daphnia every day, earning \$40 to \$50 a week.

Baby fish of different families can be started together in large tanks, but if you mean to breed true types you must separate them in about two months. Keep plenty of plant life in the tank or bowl. Although it is not always essential, aeration will give the fish more "pep"; you can buy a tiny air pump for a small sum. Use a voile net for lifting the fish, and handle them as little as possible. Dip your hands in water before touching them; dry hands tear the scales. When it is necessary to add water, use rainwater or let the tap water settle for five days or more before using it. Purifying chemicals in city water systems and sudden temperature changes may kill the fish.

Fish are subject to diseases. Skin ail-

ments caused by plant and animal parasites can be treated. Sometimes silver nitrate is used, sometimes a salt solution is a tonic for fresh-water fish, sometimes a change of environment is as good for fish as a vacation for the working man. Mr. Heintze once lost several tanks of fish due to a skin disease he could not control. Let a fish come down with some internal sickness and the doctor is beaten right at the start. You can't tell whether it has stomach ache or rheumatism. Surgery is virtually impossible—although there have been Cæsarian operations on guppies, which are live-bearers.

An easy way to keep your aquarium clean is to employ a Japanese "dojo," a "corydora" or a bevy of snails as maids. Snails keep the bowl clean and supply infusoria, good food for baby fish. Scavenger fish feed on the bottom, scooping up mouthfuls of sand, filtering out the food particles and letting the sand pass on through the gills. Thus they keep food from decaying on the tank bottom. Some egg-laying fish use this scooping method to dig their nests.

Bettas, or Siamese "fighting fish," produce a marvelous variety of color in their young, which become a deep blue-green as they mature. A pair costs about \$3 to \$5, and about one-tenth of the brood will be beautiful enough to bring you good returns. Angel fish, those broad-sided black and white beauties with long barbels hanging from their "chins," are inexpensive when young but you may sell a grown pair for \$10. One dealer recently sold a well-developed female for \$60. Angel fish live about six years and begin breeding after two years. Some fish never breed in captivity, and this naturally increases their value. The "mytinnis Rooseveltii," a flashy, gilded fish first brought back from South America by Theodore Roosevelt, will not breed away from its native waters. A pair costs \$25 to \$40.

There are many varieties of brilliant fish available to make your bowl a fascinating pageant of color. Watching this kaleidoscope of life in your own home is intensely interesting, and with proper care and study you may develop new types and add new colors to the undersea rainbow.



**THEY SAY I'M
TWICE
AS HANDSOME
SINCE I GAINED
10 POUNDS**



*Posed by
professional
models*

**It's a crime
to be
SKINNY**

**When This Special, Quick Way
Puts on 10 to 15 Pounds Fast**

EVEN if you never could gain before, remember, thousands have gained solid, naturally attractive flesh this new, easy way — *in just a few weeks!*

Doctors now say the real reason why great numbers of people can't seem to gain an ounce is they fail to get enough health-building Vitamin B and iron in their daily food. But now with this new discovery which combines these two vital elements in little concentrated tablets, hosts of men have put on pounds of firm flesh — *in a very short time.*

Not only that, but thousands have also gained a naturally clear complexion, freedom from unhealthy indigestion and constipation, glorious new pep.

7 times more powerful

This amazing new product, Ironized Yeast, is made from special *cultured ale yeast* imported from Europe, the richest known source of Vitamin B. By a new process this ale yeast is concentrated 7 times—*made 7 times more powerful.* Then it is *ironized* with 3 kinds

of strengthening, blood-building, energy-giving iron.

If you, too, are one of the many skinny people who simply need Vitamin B and iron to build them up, get these new Ironized Yeast tablets from your druggist at once. Day after day, as you take them, watch skinny limbs and flat chest round out to normal attractiveness. Skin clears to natural beauty, new health comes — you're an entirely new person.

Results guaranteed

No matter how skinny and run-down you may be, try this new "7-power" Ironized Yeast for just a few short weeks. If not delighted with the results of the very first package, money back instantly.

Special FREE offer!

To start you building up your health right away, we make this absolutely FREE offer. Purchase a package of Ironized Yeast tablets at once, cut out the seal on the box and mail it to us with a clipping of this paragraph. We will send you a fascinating new book on health, "New Facts About Your Body." Remember, results guaranteed with the very first package—or money refunded. At all druggists. Ironized Yeast Co., Inc., Dept. 5312, Atlanta, Ga.



MAKE PERMANENT FURNITURE REPAIRS WITH PLASTIC WOOD

Anyone can do a ship-shape job of repairing quickly—loose drawer pulls, broken chairs, loose casters, holes in wood, nicks, cracks, screw holes, etc.—with this wonderful new discovery called Plastic Wood. It is wood in a can that handles as easily as putty—yet when dry it is as lasting as real wood.

INSIST ON THE GENUINE

For permanent, expert-looking repairs use genuine Plastic Wood—which has all the properties of wood except grain—adheres to wood, metal, stone, glass, plaster or porcelain—will hold nails and screws and can be sawed, carved, sanded, turned on a lathe without splitting, cracking or crumbling—can be painted, varnished or lacquered perfectly—is *water-proof*, weatherproof.

Plastic Wood is ideal for filling cracks along baseboard, drainboard, in floors; filling old nail and screw holes; repairing damaged toilet seats; filling holes around pipes or wiring; 1001 other uses.

Plastic Wood comes in 25c tubes, 35c cans—in 9 colors—at paint, hardware and variety stores.



PLASTIC WOOD

121 PUZZLES in One Package
 ALL PARTS OF WOOD — NO FOREIGN ORDERS ACCEPTED — SEND 15¢ TO THE CARROM COMPANY Dept. P.M.1—LUDINGTON, MICH.

NEW BENJAMIN AIR PISTOLS \$7.50

Powerful—Accurate—Economic—Practical—Adjustable Shooting Force—Amazing Maximum Velocity—the Only Genuine Compressed Air Pistol on the market—cal. 177 or 22 and BB Single Shot—with Bolt Action—Hammer Fire—Hair Trigger—Safety \$7.50—for Target and Small Game. Also 177 and 22 Single Shot Air Rifles \$7.50—Single Shot BB Air Rifles \$6.00—25 Shot BB Repeater Air Rifles \$7.50. At Dealer or Direct. FULL DETAILS—TARGETS—FREE—WRITE TODAY. Benjamin Air Rifle Co., 691 N. Broadway. St. Louis, Mo.

BUILDING A 30-WATT AMPLIFIER

(Continued from page 903)

sockets installed, together with the resistor and terminal mounting strips, are available from radio parts dealers, in the form of a foundation kit which lists for \$8; all other items may be purchased individually. A complete material list can be obtained upon application without charge.

Figs. 1 and 2 show the amplifier and power-unit layouts with the various transformers and chokes in their relative positions. The schematic circuit diagram is given in Fig. 3 and possible speaker combinations are indicated in Figs. 4, 5, 6 and 7.

A microphone input socket provides

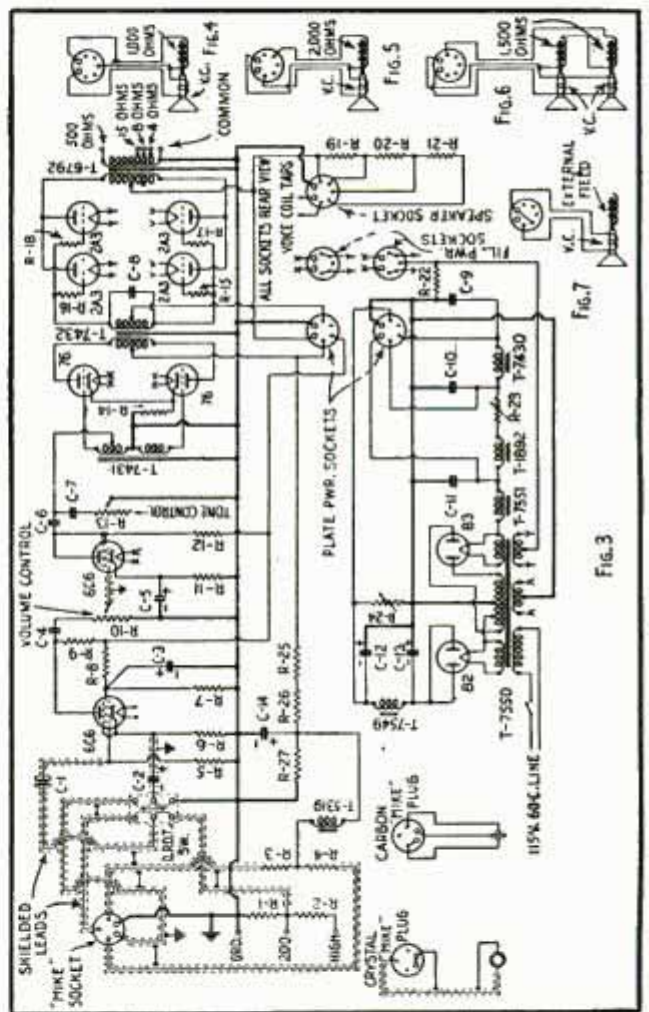

connection for either a crystal microphone or a double-button carbon variety. An input terminal strip, indicated at the left in Fig. 1, has a 200-ohm and a high-impedance connection. The 200-ohm connection will accommodate a phonograph pick-up, the output from a ribbon microphone or the output from a pre-amplifier or other source. The high-impedance tap is for a pick-up or other similar source of

(Continued to page 132A)

EVERYTHING IN RADIO!

Send for this GREAT CATALOG

If you are a Radio Amateur; if you build or experiment with radio, you need the new 1936 ALLIED Catalog.

Write now for your FREE copy of this leading Radio Supply Guide. ALLIED can supply all of your radio needs for less money.



Build Popular Mechanics RADIO CIRCUITS

When you build your "Popular Mechanics" set, use only approved parts, offered in kit form exclusively for you at lowest wholesale prices by ALLIED—your Radio Parts Headquarters. Write to us for FREE Parts Lists covering such popular circuits as the 1 Tube Portable Receiver (209); the 2 Tube AC-DC set (R211); the 6 Tube 32-Volt Farm Radio (208); the Metal Locator (R213); the All-Star Jr.; The Browning 35; and many others. We can supply all parts for building any "Popular Mechanics" radio circuit described in this or in any other issue. Before you buy, write for our parts lists.



BUILD YOUR OWN THORDARSON PUBLIC ADDRESS AMPLIFIER

Make big profits by renting and installing Sound Amplifiers in auditoriums, churches, carnivals, etc. Build the professional new Thordarson 6-watt, 18-watt or 30-watt amplifiers. Write for FREE description and parts list.

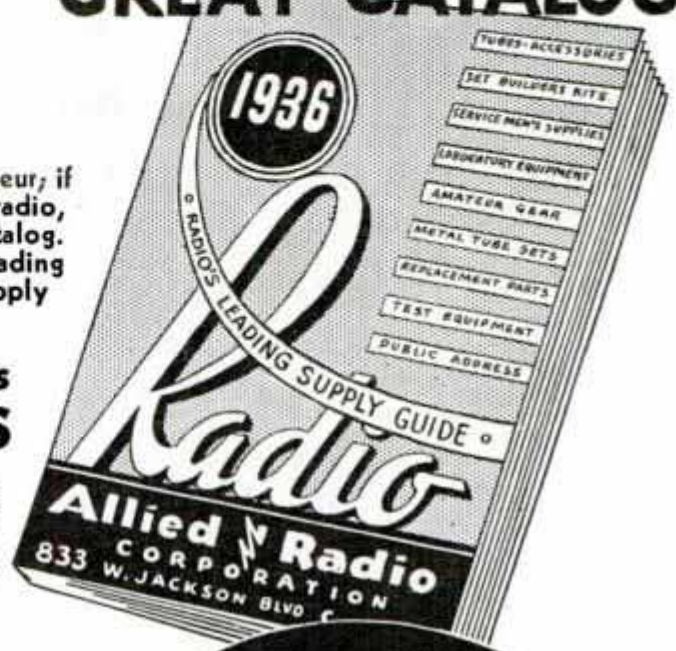

FREE

RADIO'S LEADING SUPPLY GUIDE

There are more than 10,000 quality radio items in the 1936 ALLIED Catalog — each an unbeatable value. Five great sections feature newest metal tube and glass tube receivers—battery, 32 volt and auto radios; latest Short Wave and Amateur Receiving and Transmitting gear; dozens of new kits to warm every Set-Builder's heart; an amazing new array of the most advanced Public Address Systems, amplifiers, microphones, recording equipment, etc. Also thousands of exact duplicate and replacement radio parts, radio tools and latest test equipment. Everything you need in radio is in this FREE Catalog at the lowest wholesale prices. Send for your copy now.

SEND FOR YOUR COPY

ALLIED SELLS FOR LESS!

When you order from your new 1936 ALLIED Catalog you will be getting bigger value than ever before. That's saying a lot—when you consider that we've had a great reputation for selling the best radio equipment for less money since the early days of radio. We say that you can't buy identical brand and quality anywhere for less—if you can—we'll refund the difference in a jiffy. Send for the new 1936 ALLIED Catalog right now. Page by page, it will prove to you that we sell for less.

Allied Radio CORPORATION

833 W. JACKSON BLVD.
CHICAGO, ILLINOIS

ALLIED RADIO CORPORATION

833 W. Jackson Blvd.,
Chicago, Ill., Dept. K.

Send your FREE 1936 Radio Catalog. Send me FREE Parts List for...



Name.....
Address.....
City..... State.....

When writing to advertisers please mention Popular Mechanics

Complete to Run

\$9.95f. o. b. Detroit
Slightly higher in
distant States

SYNCRO—THE UTILITY JIG SAW THAT HAS CAUSED A SENSATION

This electric power tool operates from a 110-v., 60 cycle alternating household current. Its clean, easy cutting power lends SYNCRO to a multitude of uses. Extreme flexibility, due to 7200 saw-strokes per minute, gives ease of control with an unusual sense of touch while sawing. A simple adjustment regulates the desired length of stroke.

Scientific design, quality material and skilled workmanship make SYNCRO a sturdy scroll saw. No heavy reciprocating parts and rotating parts to get out of order—needs no oiling and runs quietly. Has grey iron cast base. Safe for fingers, too! SYNCRO cuts absolutely smooth edges, which need no sanding and has an ample radius in which to turn your work.

Write today for further information. If your nearest hardware dealer is unable to supply you, please forward his firm name and address to us. Literature will be sent to you free. Direct all letters to Dept. S D.

SYNCRO DEVICES INCORPORATED

Boydell Building **SYNCRO** Detroit, Michigan



AUTO ENGINE SPEED CONTROL GOVERNORS

To control speed of any make of auto or truck engine, regardless of load changes, when used as a stationary or portable power plant. Fully guaranteed. No cash down. Governor speed range from 400 to 3000 R.P.M. Fine opportunity for established agencies. Circulars. Candee-Smith Gov. Co., 217 No. L. A. St., Los Angeles

BUILD IT YOURSELF

JIM DANDY CABIN TRAILER
Classy! Roomy! Easy to build at low cost!
Plans and instructions only \$1.00—include all
Diagrams, Sketches, Photos, Material List,
etc. Big Value! Mail Dollar Bill to Jim
Dandy, Box 125-A, Wausau, Wis.



Try
CASCO
GLUE



Read what
**F. L. S. of Portland,
Oregon says:**

"CASCO is so easy to apply, it can be mixed in small or large quantities, thus saving waste. It is so smooth in working and gives such satisfactory results that I consider it superior to any glue that I ever used."

CASCO—now available to everyone—is the famous industrial glue used in the manufacture of fine furniture, pianos and airplanes.

The Secret of CASCO'S Great Strength

Most glues set slowly, by evaporation. CASCO sets quickly, by chemical action. This unique method gives superior, long-life holding strength. It makes CASCO heatproof, waterproof. When you want to build a project, for permanence use CASCO.

FREE! GENEROUS TEST SAMPLE & HANDY GLUING GUIDE!

32 pages, 50 illustrations, full of ideas on gluing and repairing things quickly, easily and permanently. Makes you an expert on all gluing jobs. Write name on a postcard. Say "Send free sample and copy of 'Casco Gluing Guide'".

Hardware, Paint, Lumber Dealers Sell CASCO

THE CASEIN MFG. CO. OF AMERICA, Inc.
350 Madison Avenue, Dept. 1235-B, New York, N. Y.



BUILDING A 30-WATT AMPLIFIER

(Continued from page 130A)

approximately 10,000 ohms impedance. A switch on the front panel permits changing from microphone operation to phonograph pick-up as desired.

Color-coded leads of the power transformer, indicated in Fig. 2, have the fol-

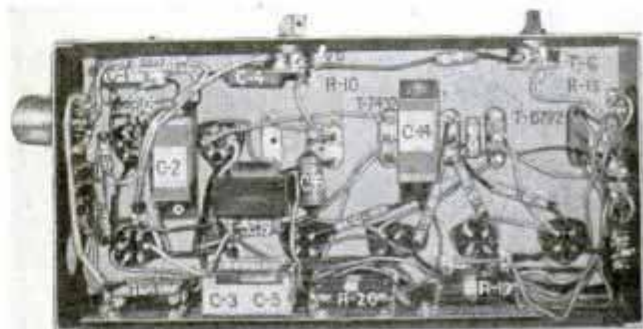
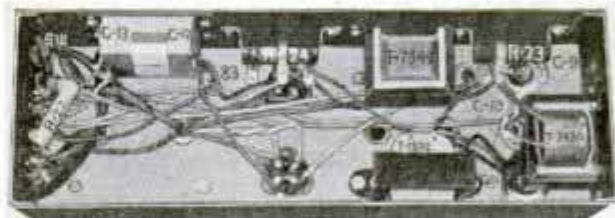

View Showing the Underside of Power Supply and Amplifier Units

lowing values: blue, primary; small black, 6.3 volts; black and yellow, filament center tap for 6.3 volts; heavy black, 2½ volts, 10 amp., and the green and yellow lead is the center tap for this winding. The yellow leads are for the 5-volt filament supply to the type-83 rectifier tube. Green leads supply 2½ volts for the filament of the type-82 rectifier. Brown indicates the high-voltage leads, with black and brown for the center tap; this high-voltage secondary winding delivers 435 volts a.c. each side of center. The red lead is the a.c. tap for the bias supply. An enlarged blueprint of all diagrams is available from Popular Mechanics radio department, those who wish it should specify blueprint R-217.

Provision is made for speaker voice-coil connections at the output terminal strip in Fig. 1 where taps 4, 8, 15 and 500-ohms are available and also at the speaker socket where any two of the taps may be wired. Thirty watts of field supply are made available at the speaker socket for fields or field combinations of 1,000 to 3,000 ohms. If two or three different speakers or speaker combinations are desired, it is not necessary to change any of the wiring.

Build a THORDARSON Public Address SOUND AMPLIFIER

Foundation Unit Includes

complete instructions and diagrams and metal drilled base with sockets and terminal strips. There is big profit in renting or installing these professional type P.A. sound amplifiers in auditoriums, churches, ball-rooms, and carnivals. Three sizes: 6-watt, 18-watt, and 30-watt, operating from one to six speakers. You save from \$20 to \$50 over inferior ready-made amplifiers.



- High Fidelity
- Negligible Hum
- Full Rated Output
- Easy to Build

Ask your **THORDARSON** dealer or write

THORDARSON ELECTRIC MFG. CO.
500 W. Huron St., Dept. O, Chicago, Illinois

PLASTIC CRAFTENE

MAKES RINGS, TRAYS, BRACELETS,
BOOK ENDS, 1000 ART OBJECTS

Craftene (a Catalin product) looks costly and noble, like onyx, jasper, other semi-precious stone; lasts as long. Quickly takes similar permanent polish. Works as easily as celluloid, but brighter colors, fire-proof, and does not warp. We supply blanks cut to size, for many handsome projects; you finish, assemble, polish. Also stock rods and sheets for your own designs. Inexpensive. Send \$25 for 1/2 dozen ring blanks, assorted colors. Illustrated Catalog Free.

CRAFT SERVICE 557 BLOSSOM ROAD
ROCHESTER, N. Y.

Catch Fish!

Eels, Mink, Muskrats, with our new folding galvanized STEEL WIRE TRAP. Write for our FREE TRAP OFFER and Bargain Catalog. 51 Box of our famous Fish Bait FREE to introduce our traps. WALTON SUPPLY CO., 3509 JUNIATA AVE., ST. LOUIS, MO.

OTTAWA LOG SAW



GREATEST OFFER
EVER MADE

only \$39

PUTS THIS
OTTAWA
TO WORK FOR YOU

Make Money! Wood is valuable. Saw 15 to 20 cords a day. Does more than 10 men. Ottawa easily operated by man or boy. Falls trees—saws limbs. Use 4-hp. engine for other work. 30 DAYS' TRIAL. Write today for FREE book.

OTTAWA MFG. CO., 1741-X Wood St., Ottawa, Kansas

NO MORE BLADES TO BUY

AMAZING RAZOR

"Shakes!
Sharp!"

Keeps One
Blade Continually
Sharp for Perfect Shaves!

AGENTS:
Big Income
introducing
this new shav-
ing sensation
in your terri-
tory. Write
for agency
offer.

Totally different! Complete Razor and Self-Sharpener in one Scientific instrument. No larger nor heavier than ordinary razor. Simple mechanism renews and resharps blade edges to super-sharpness. Keeps single blade in continuous use for unlimited number of clean, quick, low-cost shaves. Thousands testify one to six years use of ONE BLADE GUARANTEED.

Get Trial Offer Write for opportunity to prove it yourself at manufacturer's risk. Just send name and address for 30-day shaving test offer, full details and proof of success. No obligation.
DeHAVEN RAZOR CO.
822 Woodland Ave. Swanton, Ohio



"IS THERE A DOCTOR IN THE HOUSE?"

THE dame doesn't need a doctor. Just let the Thero clean out his gassy briar and send out for a tin of the tobacco that's swell to smell and cooler to smoke—and let the play go on to a happy end. Sir Walter Raleigh is the mildest, pleasantest blend of well-aged Kentucky Burleys ever offered to men who like pipes but dislike pipe-nip. Exaggeration? Can't be—sales growth says it's simple truth. Try a tin kept fresh in heavy gold foil and rave with us.

Brown & Williamson Tobacco Corporation
Louisville, Kentucky. Dept. P-512

FREE BOOKLET

tells how to make your pipe taste better, sweeter. Write for a copy.

It's 15¢
—AND IT'S
MILDER



Paint Magic and What It Means to You

(Continued from page 842)

contains small percentages of sulphur, continually settles on these paints. Rain falling on this dust produces weak solutions of sulphuric acid which attack the surface.

In solving such problems many new materials have been found. One of the most valuable synthetic resins used in the paint and varnish industry has been evolved from coal tar. Hydrogen and oxygen in combination with the carbon in coal is made into synthetic alcohol. From this formaldehyde is made, and this is the raw material for phenolic resins. In many respects these new resins have decided advantages over the natural varnish gums, and their production is increasing by leaps and bounds. So it is that coal tar, once a useless by-product of the coke industry, is now of value to paint engineers.

We also have manufactured varnish gums whose physical characteristics can be controlled. We can make them hard or soft, tough and elastic or brittle, depending upon the use for which we intend them. The natural resins formerly used had to be taken just as they came from the ground and their uses were restricted to the range of their characteristic properties. With the aid of these new synthetic resins paint engineers can evolve materials which modern rapid-production schedules demand. For instance, the automotive industry demands quick finishing and tough, wear-resisting coatings, so paint engineers produced the synthetic finishes used on the new cars.

The general use of motor cars painted in light colors would greatly reduce the number of traffic accidents, according to W. A. Lindberg, color engineer for a motor-car company. He made a check on motor-car collisions and found that in a large percentage of cases, either one or both of the cars involved were painted black or a very dark color. This is particularly true at night when the superior visibility of the lighter cars is more pronounced than in the daytime. In addition to the value of the lighter colors in preventing accidents at night, they serve to accentuate the appearance of motion. A light-colored car appears to be moving while a dark one seems static.

The production of furniture at prices

within reach of buyers would be impossible if it were not for the use of modern-production schedule coatings. The type of finishes used at the turn of the century would entail so much labor that pieces of modern furniture might cost from fifty to 100 per cent more. These new finishes also have other advantages. Some of them are alcohol-proof and others have been developed to withstand cigarette burns.

There are also new finishes for the home. Some are so formulated that ink, grease and even iodine stains can be washed from their surface without showing any ill effects. Ease of application and greater hiding power enhance the value of present-day decorative coatings. One or two coats of these modern enamels now regularly achieve results that required numerous coats of old-time paints and varnishes.

There are many things which are still in the laboratory form of paint engineering. Among these are the so-called rubber paints and the use of water in nitrocellulose lacquers. Rubber as a base for paints is most valuable because of its high resistance to acids, alkalis and moisture, and not, as might be supposed, because of its elastic qualities. It is believed that rubber base paints will be made in the near future which can be used successfully on a wide variety of surfaces.

Recent experiments on aqueous dispersions show a possibility of making nitrocellulose lacquers of higher solid content. Through a process of emulsification the resulting lacquers would contain a large percentage of water vehicle. Such a lacquer would greatly reduce fire hazard of these materials. It is also claimed these lacquers would have better spraying and brushing qualities.

In 1933 over a million gallons of soybean oil were consumed by the paint industry. Its contribution to paint-making has been valuable, but it does not have the drying qualities of linseed oil. It is used with, rather than in place of, the latter.

The world of paint, varnish, and lacquer is changing today more rapidly and radically than ever before. Paint engineers are showing us new magic with colors and greater utility of paints and new and better ways of making them.

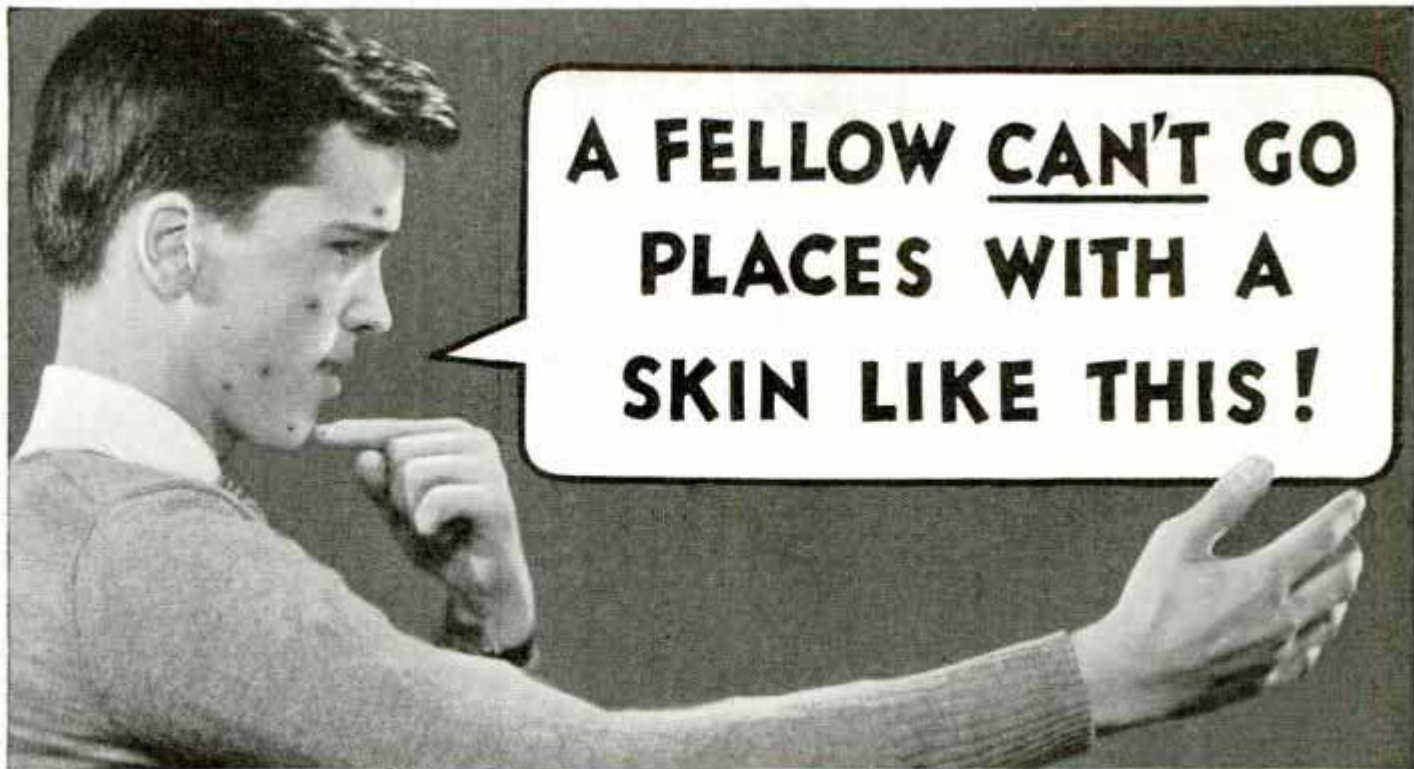

But Pete is soon pimple-free and "out stepping"



Don't let adolescent pimples make a hermit out of YOU!

Between the ages 13 and 25, important glands develop. This causes disturbances throughout the body. And waste poisons in the blood irritate the skin, causing pimples. Clear these skin irritants out of your blood, with Fleischmann's Yeast. Then the pimples disappear. Eat 3 cakes a day, before meals, until skin clears.



—clears the skin
by clearing skin irritants out of the blood

Copyright, 1935, Standard Brands Incorporated

When writing to advertisers please mention Popular Mechanics

\$200 First Week

In OWN Business

We want a reputable, honest man in each county. This man does not need to have any special experience or more than ordinary ability, but he must be honest and courteous.

Such a man we will start in business for himself. You can make far above average profits in the rug-cleaning business—a high-grade business all your own. Many earn \$125 to \$200 per week—some considerably more. L. A. Eagles took in \$200 his first week in Madison, Wis. No shop necessary. The rug-washer finishes rugs like new on the customer's floor. There are hundreds of customers—in your vicinity and nearby towns.

This rug-washer is very simple. Anyone can run it. Electricity does the work. Simply clean a few rugs. These customers tell others and also give you their future work. Soon you will have a prosperous year-around business. Send coupon for booklet explaining everything.

EARNED \$92 ONE DAY

A. L. Miller says, "Have had rug-washer 6 years—have earned as high as \$92 a day. M. O. Malmin earned 3 times the cost of his machine the first two months."

Free Book—Mail Coupon NOW!

Von Schrader Mfg. Co., 609-D, R. I. Bldg.,
Racine, Wisconsin.

Gentlemen:—Send at once (no obligation) your free booklet illustrating rug-washer and telling how I can own my own business; how I can earn large profits at prices below other methods; how I can enjoy a permanent year-around business; how I can become financially independent in a very short time; and how I can pay on easy terms.

Name.....

Address.....

City..... State.....

"Never a Complaint"

C. J. White says: "\$100 business in six days—never a complaint." That is the nicest part of this business—every customer is more than satisfied. Stains and blotches disappear and vivid colorings and freshness in faded floor coverings come back.

"Profits Pay for Home"

Harry Hill built and paid for a home from rug-washer profits. His first day's business was \$86. You, too, can enjoy a large income.

EVERY MACHINE GUARANTEED

You take no risk. These machines have been manufactured since 1918 and are used by the United States government and by Statler and other leading hotels. They are GUARANTEED.

Easy Terms

The complete equipment is inexpensive. A reasonable down payment brings everything to you and the balance is paid monthly. From the start, you have your own business—one that is profitable and of which you can be proud.



Stoves AT FACTORY PRICES!



Sale Catalog—FREE

Over 200 Styles and Sizes of Stoves, Ranges, Furnaces at Factory Prices and Easy Terms—as little as 15c a day. More Bargains than in 20 Big Stores. New styles, new features, new colors. Year to Pay—30 days free trial—360 days approval test—24-hour shipments. Over 950,000 Satisfied Users. 35 Years in Business.

Write for FREE Catalog.
THE KALAMAZOO STOVE CO., MFRS.
391 Rochester Avenue
Kalamazoo, Michigan

"A Kalamazoo Direct to You"

\$19.95 Now buys a genuine MEAD Bicycle

RANGERS cost a few dollars more. Do not buy until you get our astonishing new prices and terms.

30 Days' Trial We ship on approval. If not satisfied after trial return the bicycle at our expense.

Tires lamps, wheels, equipment at half usual prices. Write for marvelous new prices and terms.

Mead CYCLE COMPANY Write us today for free catalog
DEPT. D-115. CHICAGO



ENGINES

Enclosed, Self-Oiling, Roller-Bearing

Cheapest reliable power for farm or factory. Uses all fuels for pumping, sawing, etc. Best engine for the money. It pays for itself. Sold direct from Factory to You.

WITTE ENGINE WORKS

4749 Oakland Ave., KANSAS CITY, MO. 215L Mulberry St., HARRISBURG, PA.

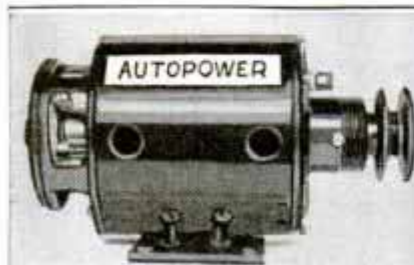

TURN SCRAP INTO MONEY

The new and revised edition of "Auto Power" with all the ten original specifications and ten new ones is now off the press. Convert old generators into A. C. and D. C. generators and motors with voltages of 6 to 400 volts, for power, light, welding, and radio operation. Create new generators adaptable for home, automobiles, or trucks. They can be driven by fan belt, wind, or water. This book, with complete illustrations, tells you how easily and economically these changes can be made. Also instructions for rewinding auto armatures. 350 definitions of electrical terms, etc. Already used and endorsed by thousands. Price, \$1. Postpaid.

AUTOPOWER, Dept. B, 410 S. Hoyne Ave., Chicago



THE ALADDIN OF THE MOVIES

(Continued from page 853)

across the floor to a bowl of milk. Sindler has had to tape shut the mouths of alligators to make them harmless, play nursemaid to a 300-pound turtle, and take care of a group of fighting bulls as part of his duties.

Each studio has a property department in which it stores a miscellaneous collection of nearly everything under the sun. In the United Artists collection there are 3,000 heavy pieces ranging from suits of armor to rugs and period bedsteads. Aside from these the studio has 7,500 "hand props" like jewelry and dishes. One room is piled high with furniture, another with different kinds of saddles, a third with paintings. Stands hold various types of umbrellas and walking canes. Wrist watches, necklaces, and silverware are laid in cases. On the lot you will see different kinds of automobile bodies, replicas of ancient carts, and even a collection of small boats.

If a studio needs something that it doesn't own, the chances are the item can be rented from one of the property houses, huge warehouses stacked with equipment. Like the property men themselves, the free lance property houses are inveterate collectors. Auction sales, secondhand stores, and pawn shops are combed for anything the movies might need. Antique dealers who have made the rounds of the property houses have been rewarded by uncovering valuable period pieces.

Rare and strange properties are sometimes easier to find than more prosaic pieces. Sindler can tell you where to lay your hands on a sheik's headdress or a polar dog sled, but he had a hard time finding some mechanical horses popular as exercisers a few years ago. Eventually he found a salesman with a list of people who had bought the exercisers. From them he was able to rent those he needed.

So far, Sindler has never been stumped, but he doesn't boast because he never knows what a director will want next.

Popular Mechanics Magazine does not publish the name of the maker of, or dealer in, any device described in its pages, but this information will be furnished by our Bureau of Information upon request, accompanied by stamped envelope.



OLD MOTHER HUBBARD

HAS FILLED HER BARE CUPBOARD
WITH ONIONS AND STEAKS AND CHEESES;
HER STOMACH FEELS GRAND
SINCE SHE KEEPS TUMS ON HAND . . .
SHE EATS WHAT SHE DARN WELL PLEASES!

NO ALKALIES FOR ACID INDIGESTION!

MILLIONS have found they do not need to drench their stomachs with strong, caustic alkalies. Physicians have said this habit often brings further acid indigestion. So much more safe and sensible to simply carry a roll of Tums in your pocket. Munch 3 or 4 after meals—or whenever troubled by heartburn, gas, sour stomach. Try them when you feel the effects of last night's party, or when you smoke too much. Tums contain a wonderful antacid which neutralizes acid in the stomach, but never over-alkalizes stomach or blood. Pleasant to eat as candy. Only 10c at any drug store.



FREE: Beautiful 5 color 1935-36 Calendar-Thermometer with the purchase of a 10c roll of Tums or 25c box of NR (the all-vegetable laxative). At your Druggist's.

• ALWAYS READY FOR USE LE PAGE'S LIQUID GLUE

STRANGE INVENTION OPENS NEW BUSINESS OPPORTUNITY!

BE YOUR OWN ENGRAVER
MAKE MONEY DOING THIS
EASY FASCINATING WORK

For mechanics, carpenters, jewelers, contractors, manu-
facturers, hospitals, doctors, etc. Engraves-rite, new elec-
tric novel, automatically engraves names, initials,
trade-marks, etc., on Brass, Copper, Gold, Silver,
Aluminum, Nickel, Bakelite, Castin, Ivory, Hard
Wood, etc. Writes like a pencil—cuts like a chisel.
No skill or experience needed.

COMPLETE OUTFIT ONLY \$10.00

Includes Engraves-rite, with 3 1/2 ft. cord, on-off switch
and plug at half usual price. A.C. 110 V.
current. Send only \$1.00. We ship C.O.D.
for balance, plus postage. Or remit in full
and we ship postpaid. **Special Cartridge
Point (harder than diamonds), \$4.00 extra.**

Engraves on hardened steel, tools, dies, in-
struments, glass, porcelain and all exception-
ally hard materials. New scientific develop-
ment, interchangeable with regular point in
our Standard Electric Engraves-rite. Money back after 10 days' trial if not satisfied.

**FREE COMPLETE SET OF MONOGRAM IDEAL XMAS GIFT
TRANSFERS**

QUALITY MERCHANDISE CO.
Dept. P.M.12 2306 Lincolnwood Drive Evanston, Ill.
(Described Page 46, July, 1935, Popular Mechanics)



YOU'RE *there*
WITH A **CROSLEY**
PIONEERS IN RADIO



Crosman SILENT .22 Rifle

NO CLEANING
LOW COST
AMMUNITION
ADJUSTABLE
POWER



Rifled
Barrel

Grooves inside barrel make the Crosman a real rifle with all the hair-splitting accuracy this term implies. Shoots bullet (Pell) same size as .22 powder rifle, but silently, powerfully, with no recoil, using the terrific force of compressed air—same force U. S. Navy uses to drive 2000 lb. torpedoes. Marvelous for target, small game. Single and 20 shot repeater models. No license required. *New low prices on Pells.*

FREE booklet containing important target and game shooting facts. Also free descriptive literature. Ask your dealer to show you a Crosman.

Crosman Arms Co., 396 St. Paul St., Rochester, N. Y.

Read This Book Free



425-Power
\$18.50

Entitled "Revealing Nature's Wonders"—Tells joys of exploring with the microscope. Pictures real microscope values—this 425-power, for example, highest magnification at anywhere near this price. 100-power, only \$5.00; 150-power, \$12.50; 235-power, \$15.50. Home slide-making set, \$3.50. Money-back guarantee on all, at dealers or direct postpaid (or C. O. D.). Order today.

Write for Free Book Now.

WOLLENSAK OPTICAL COMPANY
898 Hudson Ave., Rochester, N. Y.

Wollensak TELESCOPES
MICROSCOPES
BINOCULARS

DON'TS FOR HUNTERS

(Continued from page 896)

The waterfowl hunter who uses a boat may get into the headlines if he puts a loaded shotgun on the seat next to him. There are several types of casualties due to this kind of carelessness. First, there are those occurring when a duck hunter tries to pull a loaded gun toward him. To reach out on the seat of a duck boat, and attempt to haul a loaded shotgun, muzzle first, toward you is a sure way to prove that a shotgun charge at close range never did anybody any good.

A hunter with a loaded gun in a boat also has a chance to show his skill as a swimmer by discharging the gun and blowing a hole in the bottom of the boat. The safest don't for the duck hunter is this: Don't paddle around in a boat with a shooting partner and a couple of loaded guns. Better to lose a duck than to take a life. If you are paddling a duck boat alone, rest the shotgun so the muzzle points away from you but so you will be able to lift it and shoot quickly. In fact, "jump shooting" for mallards calls for just such quick work. But a mixed crowd of hunters and loaded guns in one boat is not a restful or safe outfit.

Carrying a loaded gun in an automobile is another trick of the careless hunters which calls for a "don't." Some states make this dangerous practice a violation of the game code. Carrying a loaded gun in an automobile is not only dangerous to the shooter, but also a menace to wild game. The "meat hunter" who wants meat instead of sport drives along a road slowly, looking for a game bird in the field, then reaches for a loaded gun to get a pot shot at the bird on the ground. But few can average 100 per cent in the trick of reaching for a gun in a hurry, swinging it around, and shoving it through a window.

The large number of deaths and serious injuries recorded every year among deer hunters is giving the conservation departments considerable worry. The majority of these involve the accidental killing or wounding of a hunter by a shooter who "thought it was a deer." Don't shoot until you know what you are shooting at. Often there are stretches of woods where hunters are more numerous than the deer. The nervous, inexperienced, or careless

(Continued to page 140A)

Special CHRISTMAS OFFER

BIG NEW FLOOR DRILL PRESS

At a Sensational LOW PRICE

This new big, sturdy floor-type drill press just added to the Blue Star Line. Three speeds. Patented Oilite bronze bearings. Full floating pulley. Drills to center of 14 in. circle. Highest quality, precision built. Efficient, smooth-running and will give years of service. Buy direct from the factory and Save Money.



FULL SIZE BAND SAW

Blue Star heavy duty band saw, built with all the precision and strength of higher priced saws. Smooth running—no galloping or chattering. Greatest value ever offered. Fast and accurate—handles up to 6" material easily. Rigid construction. Precision built.



NEW 3-SPEED HEAVY DUTY WOOD LATHE

Sensational low price on extra heavy, all-steel bed lathe. Turns 8 in. diameter. 36 in. between centers. 48 in. long. Heavy duty headstock, 3-step cone pulley. Patented Oilite bearings. Factory price saves you money.



\$4.95

Big Free Catalog Write for FREE Catalog and Special Offer on Christmas Orders for Precision Built Blue Star Machines at Low Factory Prices.

BLUE STAR PRODUCTS 872 JOHN ST., Fairfield, Iowa

MONEY for YOU

Install America's Most Accessible Oil Burner

Save money... make money... America's premier Oil Burner (License No. 1. Zoro Patent Estate) is yours at low cost! Bought by U. S. Govt. You can buy direct! Complete with automatic controls and full installation diagrams. Write for amazing low price and free literature today.

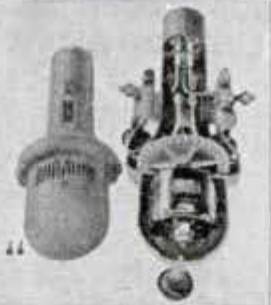

CHALMERS OIL BURNER CO. 1252 Central Ave., Minneapolis, Minn.

FREE Literature Send Today

ONE-MAN SAWMILL FARM MODEL 49

TURN TREES INTO MONEY WITH A BELSAW!

Makes lumber, shingles, lath, ties, crates, boxes, cases, all forms lumber

Three capacities: 10, 14 and 20 feet. Accurate set works, positive dogs. Full or one-way type power feed runs on low power—many owners use old auto engine.

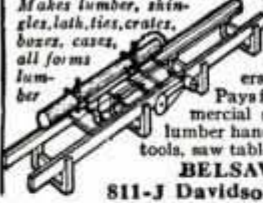

Pays for itself quickly—thousands in commercial service, everywhere. Write for free lumber handbook and catalog of mills, supplies, tools, saw tables, and woodworking equipment.

BELSAW MACHINERY CO.

811-J Davidson Bldg., Kansas City, Mo.

Print Your Own

Cards, stationery, circulars, tags, labels, advertising, etc. Save money. Print for Others; Big Profits; easy rules sent. Will do popular Raised Printing like Engraving. Junior press \$5.95, job press, \$11 up, power \$149. Send for free catalog and all details. THE KELSEY COMPANY, B-37, MERIDEN, CONN.

Strange MECHANICAL EYE



LOCAL MANAGER WANTED

Detects fire in its early stages. Sounds a loud, piercing alarm that saves human lives and property. Easy to install. No batteries or wires needed. Every public building, hospital, factory, store, hotel, school, college, home, country estate, stock farm a live prospect. Makes dramatic 30-second demonstration. 12 to 48 units possible for full equipment large buildings. 2 to 4 units for homes. An opportunity for large earnings for ambitious men who get in on the ground floor. Write for free details explaining how to get up in the higher earning class.

FIRE-CRY COMPANY, Dept. 36-C 1300 E. First Street DAYTON, OHIO

TAKE THE GRIEF OUT OF EMERGENCY REPAIRS

A sudden leak in the hot water heater—the hammer handle flies off—water squirts from a dent in the auto radiator—a drawer knob pulls out—screws strip from and loosen the door lock—a water pipe freezes and cracks—one caster won't stay in the table leg—your favorite pail starts to leak—a persistently loose nut puts the vacuum cleaner out of business—etc., etc.



Smooth-On Radiator



Leaky Pail



Leaky Kettle



Leaky Tank



Stove Pipe



Oil Leaks

Possibilities like these are ever present to the householder, but invite no delays, repair bills or expensive new purchases if you have a copy of the Smooth-On Home Repair Book, and a can of Smooth-On No. 1 on the shelf and like to prove yourself equal to the emergency.

Hundreds of repairs similar to the above are made quickly, easily and cheaply with Smooth-On No. 1, which stops leaks of steam, water, gas, oil, gasoline, smoke, etc., anchors loose screws, bolts, nuts, handles, machinery, etc., and holds equally well in metal, masonry, bath room tile, and wood.



Write for FREE BOOK

Smooth-On No. 1 expands in hardening and when metallized holds as tightly as the metal to which it is attached. Power plant engineers, shop foremen and professional repair men prefer Smooth-On repairs because the simple cold application avoids fire risk and extra labor and a dependable finished job is ready in a hurry.



Mail the coupon for the Smooth-On Repair Book and get Smooth-On No. 1 in 7-ounce or 1 or 5-pound can from any hardware store.

Do it with SMOOTH-ON

SMOOTH-ON MFG. CO., Dept. 37, 574 Communipaw Ave., Jersey City, N. J. Please send the free Smooth-On Repair Book.

Name.....
 Address.....
 12-35.....

Safeguard Your Face!

Shoot *Western* Shotshells!



Do you know that some shotguns fail to entirely enclose the shell head in a protecting ring of steel? That there might be a serious backfire into your face if there should be a weak spot in the shell head?

Western shells with the patented STEEL-LOCKED head protect you against injury! Paper tube, base wad, brass and a PROTECTING RING OF STEEL are LOCKED TOGETHER! . . . And Western gives you the extra advantage of patented SEAL-TITE moisture-proof wads. Get complete details and the booklet that will improve your shooting, "HOW TO HIT 'EM".



BOOKLET FREE!

WESTERN CARTRIDGE COMPANY
Dept. L-46 East Alton, Ill.
Send leaflets on Western Shotshells and the booklet, "HOW TO HIT 'EM"—free.

Name.....
Address.....
Post Office.....

PINS 35¢ Rings \$1.65
CATALOG FREE

CLASS PINS—any letters, any year, any colors. Silver plated, 1 to 11, 40¢ ea; gold plated, 50¢ ea; sterling, 60¢ ea. Silver plated, 12 or more, 55¢ ea; gold plated, 65¢ ea; sterling, 75¢ ea. Sterling silver rings as shown, 1 in 11, \$1.50 ea; 12 or more, \$1.65 ea. Write for Big FREE Catalog showing hundreds of pins, rings, medals, emblems, trophies, etc.

METAL ARTS CO., INC. FACTORY 44 ROCHESTER, N.Y.

Complete Movie Outfit

CAMERA is self-focusing—uses 50 ft. roll standard 16 mm. film developed FREE. Heavy metal richly finished in Damaskene Enamel. Carrying strap and film indicator. Taking real movies in simplicity itself. Locate the subject and turn the crank.

Amazing Offer \$11.50 POSTPAID

PROJECTOR—100 ft. capacity, motor driven for A. C. current. Projects big clear pictures 20x26 inches at only 10 ft. Uses any 16 mm. film.

We also have a complete list of film subjects for any projector. Write now for BIG, FREE Catalogue of Movie Supplies.

PARAMOUNT MFG. COMPANY
Dept. G-78 Boston, Mass.

BUILD DUTCH WINDMILLS

Lawn Figures, Lighthouses, Etc. Solve Xmas Gift Problem. MAKE BIG MONEY SELLING OTHERS. Pleasant pastime. BLUEPRINTS or KITS. B-10, 30 in. high, Hexagon Windmill BLUEPRINT 75¢. Two-Story 6-room Colonial Dollhouse BLUEPRINT 50¢, KIT \$3.75. Send 10¢ for CATALOG, over 25 Home Workshop Projects for garden or home.

CRAFTSMAN'S MODEL CO., Dept. P-24, 2030 N. 41st St., MILWAUKEE, WIS.

2963 **DONT'S FOR HUNTERS**
(Continued from page 138A)

shooter sees a slight movement in the brush. Instead of waiting until he can make out the outline of a deer head and catch a glimpse of antlers, he shoots. Too many times the bullet speeds toward a crouching hunter instead of a buck deer. Death or serious injury to a hunter results. The practice of "shooting before you are sure" is one of the most serious of all forms of carelessness.

One of the basic, unwritten laws among hunters is that each man should check and double-check the gun before it is taken into the house, to be sure it is unloaded. When this precautionary measure is ignored, there may be an accident, thus proving that sometimes a fellow is not safe even when he has come out of hunting fields!

"I didn't know it was loaded" is an old and sometimes sad comment after a gun goes off. So every shooter should learn to keep in mind at all times one of the cardinal safety first rules of the game: "Don't guess, make sure the gun isn't loaded."

1095 **DIAMONDS HELP MAKE YOUR CAR AND FIRE YOUR FURNACE**

More industrial than gem diamonds are produced each year—2,500,000 carats of industrial against 1,500,000 carats of gems—but the gem diamonds, containing fewer flaws, have an import price of about \$47 a carat compared with five dollars a carat for industrials. The greatest single use of industrial diamonds is in truing abrasive wheels and, since the emery wheel is a vital key to the mass production of automobiles, the auto industry is the biggest industrial diamond customer. About eight cents' worth of diamonds is used in making an average car. One-fifth of all industrial diamonds is used in diamond core drills. Another fifth is used in diamond dies for drawing wires. Through a single die 300 tons of copper wire, about 8,000 miles, can be drawn without any variation in gauge. Another fifth of the industrials is used for turning and polishing billiard balls, telephone mouthpieces and fountain pens or machining gears and crankcases. In some high-pressure oil furnaces a pierced diamond feeds a jet of oil to a flame in a precise and constant stream.

Readers Digest
Book

UNBELIEVABLE ECONOMY

**Lower Power Bills 75%
Reduce Fire Hazards 100%**

Whyt-Rox Chem. Co. writes: "We replaced a 5 H. P. electric motor with a WITTE Diesel Engine and are saving \$65.00 per month."—All WITTE Diesel users report big savings and almost unbelievable economy. Price \$300.00 and up. Cash or terms. Immediate Delivery.

5 and 10H-P.

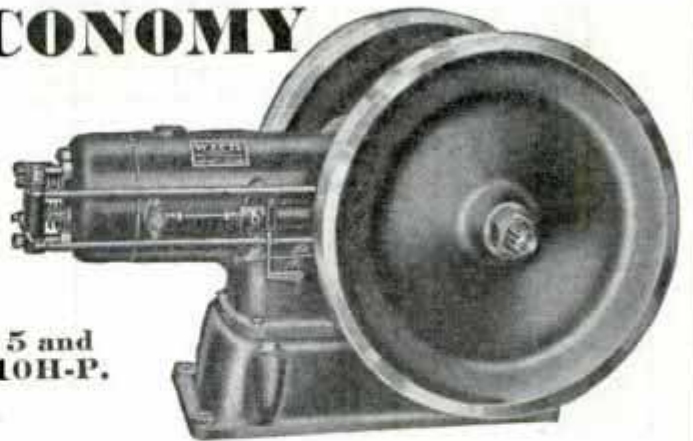

WITTE DIESEL ENGINES

DIESEL-LITE PLANTS
2 to 7 K.W. A.C. or D.C.
Price \$500.00 and up
Cash or Terms.

Diesel-Lite Plants are powered with the economical WITTE Diesel Engine, close coupled by multiple vee belt drive to A. C. or D. C. generators, forming a complete self-contained unit that will furnish electric power for less than one cent per kilowatt. These units have remarkable flexibility and may be used for engine power, electric power or a combination of both. Simple to operate and care for.

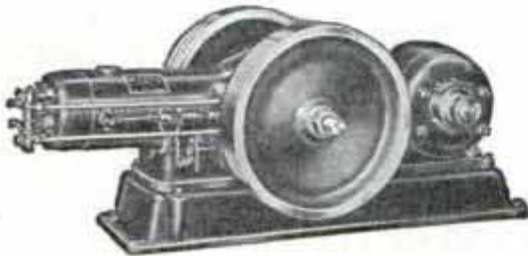

Write today for literature and prices

WITTE ENGINE WORKS

1749 Oakland Ave.

Kansas City, Mo.

CENTURY SALESMEN ARE HAPPY!
BIG XMAS BUSINESS—Get Busy Now
GENUINE LEATHER TIES
Beautiful new stripes and plaids. Look like silk. Cleaned with a damp cloth. Durable, won't wrinkle. Big profits, repeat orders. Be independent; have your own business. No sales ability needed. Send 50c or stamps for sample and kit. Information free.
CENTURY TIE CO., Dept. A, 2345 W. Grand Blvd., Detroit, Mich.

Make Money Easily

GET YOUR TRACTOR AT FACTORY PRICE
3 Speeds Forward and Reverse. Runs 4 to 8 hours per gal.
Amazing money maker for farms, truck gardens, orchards, nurseries, poultry ranches, country homes, etc. Plows, discs, harrows, cultivates, mows lawns, cuts weeds, runs belt machinery, 1 to 5 H.P. ridine or walking types. Write for FREE CATALOG, Low Factory Prices and 10 Day Trial Plan. Address Nearest Office.
SHAW MFG. CO. Desk 4512
Galesburg, Kans., or Columbus, Ohio or 5812 Magnolia Ave., Chicago, Ill.
SHAW DU-ALL TRACTOR
Air Tires or Steel Wheels

FOR LOOSE RUNGS, ARMS, LEGS
No Glue **HOLDEMS** No Nails
Reg. U. S. Pat. Off.
You can easily fasten a loose rung for all time with HOLDEMS—small metal pronged inserts that firmly grip both rung and socket. Merely remove rung, insert HOLDEM, and drive rung back. No whittling. Also for mop, mallet or other handles, and any dowels. Patented. 25 cents a box of 30, assorted sizes.
AT HARDWARE STORES—or 25cts. by mail to A & F Products, Mfrs., 3 West 37th St., N. Y.

New DRIVER TOOLS ARE READY

The new "Series 700" Drill Press is built with mechanical precision never before associated with tools of its price class. Its splined spindle, four SKF Ball Bearings and Jacob's Key Chuck are factors that any engineer or mechanic can appreciate.
Besides drilling, the "700" model will do mortising, shaping, carving, routing, dovetailing and tapping.
The splined spindle—a new DRIVER development—deserves special note. After exhaustive tests to reduce vibration this type of spindle was adopted. Of all types, it proved the best. In design it is similar to the ends of automobile propeller shafts. In action it gives that extra element of balance so essential in minimizing vibration at high speeds.



FEATURES
Jacob's Key Chuck regular equipment.
Chuck capacity 1/16" to 1/2" drills.
Maximum distance chuck to table 11 1/4".
Maximum distance chuck to base 17".
Distance center of chuck to column 6 1/2".
Table 9' x 8", base 9' x 8".
Diameter of steel column 2".
Spindle travel 3 1/2".
Spindle 3/8" diameter, tapered at end for Jacob's Chuck.
Height over all 38".

SEND FOR NEW 1936 CATALOG

Walker-Turner Co., Inc.
1125 Berckman St.,
Plainfield, N. J.

Name.....
Address.....

WALKER-TURNER CO. INC.
PLAINFIELD, N. J.

8/11/49



CLEAN OUT the radiator of your car, before you add an anti-freeze. Remove the particles of rust and sediment that stop up the circulation. Don't let a clogged radiator sap power, waste anti-freeze or cause expensive engine trouble.

You can do this job yourself. Sani-Flush makes it easy and inexpensive. Just pour *ten cents'* worth into the radiator. (Directions are on the can.) Run the engine, drain, flush, and refill with anti-freeze solution. Sani-Flush is thorough. It is safe. Cannot harm radiator, rubber fittings or aluminum cylinder head. Sani-Flush is used in most bathrooms to keep toilets sparkling. You can buy it at any grocery, drug, or hardware store—10 and 25 cent sizes. The Hygienic Products Company, Canton, Ohio.

Sani-Flush KEEPS RADIATORS CLEAN—NON-CAUSTIC



The APPRECIATED GIFT—
a Gerstner Tool Chest for Machinists
and Toolmakers. Ask for Free Catalog.
GERSTNER TOOL CHESTS
448 Columbia St., Dayton, Ohio

TRADE MARK MADE IN U.S.A. PONY CLAMPS

MINIATURE
Not toys but fine tools with a hundred clamping and holding uses. Made to industrial standards; Malleable; Accurately aligned steel screws with free-acting swivels; ground seats; correct designs (maximum strength) and accurate machining.

4 for 60c "Premier Assortment"—4 genuine Pony "C" Clamps (recognized as Postpaid in the finest made); 2 No. 231, and 2 No. 232, as illustrated.

ADJUSTABLE CLAMP CO.
"The Clamp Folks"

421 N. Ashland Ave., Chicago, U. S. A.



Free!
Clamp Catalog
46 pages of
clamps for wood
and metal.

FUEL SAVERS PAY THEIR WAY

(Continued from page 823)

since it results in quicker heat and prevents escape of too much warmth before the radiators are reached. However, the saving would be only nominal for heat which escapes into the basement is not lost entirely. Some of it rises into the house.

Engineers disagree on whether a humidifier, which introduces moisture into the air, will reduce fuel bills. They agree that the humidifier will make the home more comfortable, but Prof. Kratz, with other authorities on the subject, rejects the theory of saving. He has found in tests that the heat required to warm water in the humidifier to vaporization point is equal to the saving that could be accomplished by reducing the house temperature to the somewhat lower temperature that the higher humidity would permit and still maintain the same comfort. But Prof. Kratz recommends the humidifier, whatever its type, as a means of being comfortable and healthy. The average home with steam or hot-water system has a winter humidity of eighteen to twenty per cent, whereas it should be not less than thirty per cent at seventy degrees for comfort. If forty per cent relative humidity is used, condensation appears on single-pane windows when the outdoor temperature drops to thirty-five degrees. Storm windows must be used to prevent this inside frosting. "Weep holes," small openings in the bottom or top of the storm window or door, are for the purpose of preventing excessive condensation, as well as for admitting fresh air.

One inexpensive humidifier is available for installation in the chimney. The exhaust or waste heat warms the water to vaporization and a small fan expels the moist air into the house. Another type consists of a small cabinet that is placed on the hot-water or steam radiator. Heat from the radiator warms the water in the humidifier, whirling brushes help to vaporize the water and a tiny fan blows the moist air into the room.

For satisfactory service out of any of the fuel savers, Prof. Kratz and Crane engineers recommend that installation be turned over to a reliable plumber. Amateur attempts may result in trouble, and possibly in higher, instead of lower bills.

Rochester Mfg. Co., Rochester, N.Y.



MASTERPIECE by Disston

★ Finest hand saw Disston ever made. Streamlined D-95. Handles wrought in a new way. Rich colors—various and everlasting—moulded in. Masterpiece of beauty and efficiency for a tool lover... a prized possession for all the years to come! Packed handsomely in silver and black box. Price \$6—at leading tool dealers.

Henry Disston & Sons, Inc.

Maker, "THE SAW MOST CARPENTERS USE"

1211 Tacony, Philadelphia Canadian Factory, Toronto

BURN YOUR NAME ON TOOLS

WITH THE
ARKOGRAF

PROTECT YOUR TOOLS FROM THEFT

Write with electricity any name or design on the hardest and finest tools and instruments, or any metal, like writing on paper with pen or pencil.

Complete Outfit \$3.50—Prepaid Anywhere

Interesting illustrated circular free. Write today.

Agents wanted.

ARKOGRAF PEN CO., 3927 S.E. Stark St., Portland, Ore.

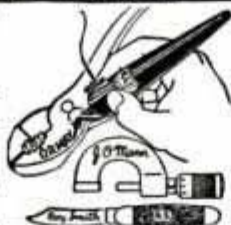

HULL AUTO COMPASS

Don't lose time and money by taking the wrong road and going many miles out of your way. This new AIRPLANE TYPE COMPASS constantly tells your direction of travel. Sticks to windshield. Base 1 1/4" diameter. ONLY \$1.95 POSTPAID, including Compensator. SATISFACTION GUARANTEED.

If your dealer cannot supply you, order direct.

HULL MFG. CO., Box 246-D, WARREN, OHIO



**OLD MONEY
and stamps
WANTED**



POST YOURSELF! It pays! I paid J. D. Martin, Virginia, \$200 for a single copper cent. Mr. Manning, New York, \$2,500 for one silver dollar. Mrs. G. F. Adams \$740 for a few old coins. I want all kinds of old coins, medals, bills and stamps. I pay big cash premiums.

I WILL PAY \$100 for A DIME

1894 S. Mint; \$50 for 1913 Liberty Head Nickel (not buffalo) and hundreds of other amazing prices for coins. Get in touch with me. Send 4c for my Large Illustrated Coin Folder and further particulars. It may mean much profit to you. Write today to

B. MAX MEHL, 324 Mehl Bldg. Fort Worth, Tex.
(Largest Rare Coin Establishment in U. S.)

"DIRECTED HEAT"

as much or as little as you want
AT ANY ANGLE YOU CHOOSE



WHEN you heat with a Superfex Heat-Director, you have clean, convenient oil heating without a furnace. This flexible heat can be increased or decreased at will, by a slight turn of the control dial. Heat rays may be *directed* to warm floor or other surface by opening at any desired angle the patented adjustable shutters on one, two or three sides of the Heat-Director. With shutters all closed, you have a circulating heater.

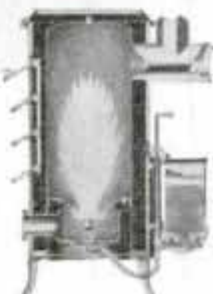

Diagram shows burner, patented shutters and removable fuel tank

Heat-Director's vaporizing burner uses inexpensive No. 1 fuel oil, distillate or kerosene. The removable fuel tank holds a supply for as many as 42 hours.

Heat-Director is set up like a stove and connected with a flue. Draft regulation is automatic.

Heat-Directors are finished in porcelain enamel in burlled walnut design. There are three sizes, also radiating models. See them at your dealer's today.

For one-room chilly spots, see the smart modern designs in portable Perfection Room Heaters.

SUPERFEX

Oil Burning HEATERS

PRODUCT OF PERFECTION STOVE CO.

PERFECTION STOVE COMPANY
7653-C Platt Ave. • Cleveland, Ohio

- Please send free booklet about the new Superfex Heat-Director.
- Also folder showing Modern Perfection Room Heater.

Name _____

St. or R. F. D. _____

Post Office _____ State _____

When writing please mention Popular Mechanics

The 1936 Cars

(Continued from page 805)

engines with more horsepower, more economy and more lasting qualities is very promising. In the offing is the rotary-valve engine, capable of turning over at a much faster rate than the poppet-valve motor now in use. One rotary-valve engine now is undergoing severe tests, preliminary to introduction as standard equipment.

A peek at the car of the future is afforded the public in the experimental automo-

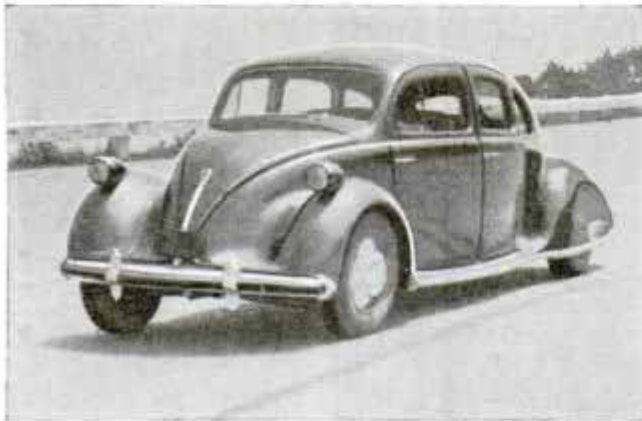

Briggs Experimental Car Taking the Curve on One of Its Test Runs

bile constructed under the direction of John Tjaarda at the Briggs Manufacturing company. Its pleasing streamline body already has been on exhibition and approved generally by observers. Now its rear engine, an eighty-four horsepower V-8 with a speed of better than 100 miles per hour, its independent suspension of all four wheels, its unit motor-and-transmission that can be removed quickly for repairs and numerous other features are being tested. That the rear engine is probably the next step in motor-car development is conceded by many engineers.

Lubrication of the internal engine is coming in for more attention. Some models have oil temperature regulators, such as the Buick, with its water channels running through the valve-in-head rocker arm shaft to cool or warm oil intended to lubricate valve mechanism.

Frame design for 1936 is substantially the same. Chevrolet, on the standard model, presents a box-girder construction that has only three supporting cross members. It is said to be exceptionally strong and to resist twist.

"Knee action" seems to have held its

own this year. Cord has front-wheel suspension with transverse springing, while the Hudson is using a novel arrangement that appears to be a combination of the knee action principle and the conventional leaf springing.

There is a trend to bigger batteries, one car in the higher-price range boasting a twenty-one plate battery that requires attention only three times a year. The small cars are equipped in many cases with fifteen-plate batteries with high amperage in order to meet the increased need for electricity imposed by hot-water heaters, radios and similar equipment.

Tires are headed apparently for the "doughnut" state of development. Sections are getting wider, pressures lower and circumference smaller in many instances. Cars which used a 6.50 tire last year have adopted the 7.00 for 1936 and the 7.50 is used on at least one model. A 9.00 tire is recommended as the best size in the "doughnut" class.

Automatic controls are increasing in number, with spark, choke, starting, battery charging and other operations controlled without attention from the driver.

This idea of relieving the driver of all care is growing rapidly and the car of the future may boast such features as lifetime lubrication of springs, wheel and steering bearings and chassis; battery needing attention once a year; high-compression en-

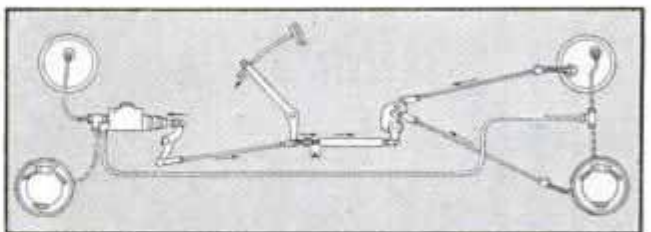

Sketch Showing Hookup between Hydraulic and Mechanical Brakes on the Hudson

gine requiring oil twice a year and a carbon-removing job every 50,000 miles; a finish that resists all chemicals, rust and dirt and can be cleaned with only a dry cloth; puncture-proof tires carrying only eight to ten pounds of air pressure and good for 50,000 miles—

A car like this may not be introduced immediately, but the industry is moving in that direction.

No further data. 8/11/36

KLEANBORE

NITRO EXPRESS SHELLS

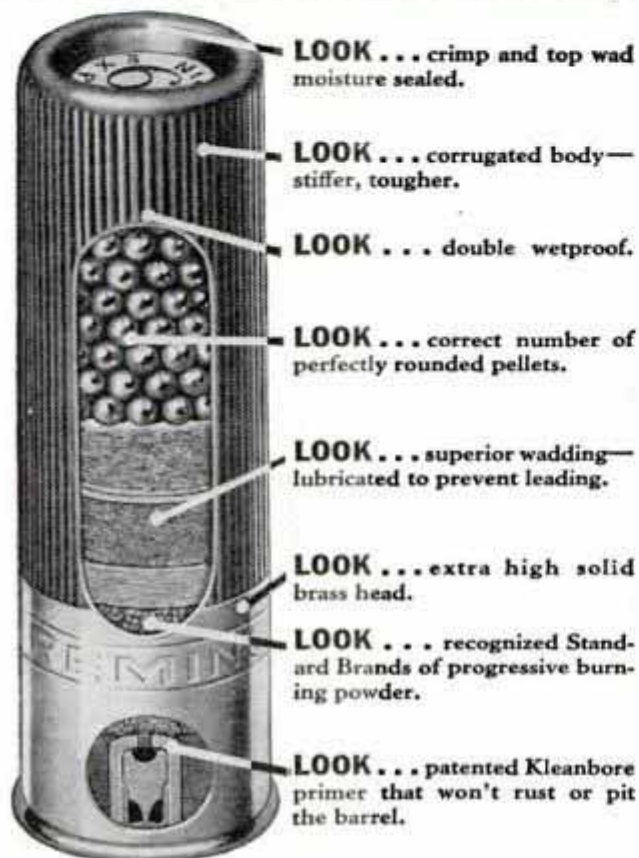

SEE WHY THESE SHELLS GIVE BALANCED PATTERN

IT'S no accident that Nitro Express Shot Shells bag more game. They're built to give a *balanced pattern*—a uniform spread that holds true for 40, 50, 60 yards or more.

Equally important to water-fowl shooters is the downright reliability of Nitro Express Shells under all shooting conditions. In tests they've been soaked in tubs of water, frozen and kept in ice for days—yet they came through with their full long-range smash when the firing pin hit their non-corrosive Kleanbore primers.

SHOOT NITRO EXPRESS SHELLS this season. See if they don't pattern better than anything you've ever fed your gun. *Remington Ammunition Division, Remington Arms Company, Inc., 1777 Seaview Avenue, Bridgeport, Connecticut.*

Remington



When writing to advertisers please mention *Popular Mechanics*



Snapshot of Vernon Palmer, Caribou, Maine

I USE MY CAR ALL YEAR 'ROUND

Gentlemen:

Up here in Aroostook County, Maine, I use my car Winter and Summer. I've noticed that a lot of folks miss the full use of their cars in Winter because they spend their time worrying about the weather, instead of enjoying it.

I don't have to worry, because I always change to Quaker State Winter Oil before the first cold snap. Even though the car has been out-of-doors all night, and I find it in the morning covered with snow—it starts without any trouble. I give the credit to Quaker State. Here's why:

I've put 52,298 miles on this car, using Quaker State, and I've never paid out one penny for motor repairs. Can I ask for any better performance? I should say not!

Very truly yours,

Vernon Palmer

"First choice of Experience"

QUAKER STATE WINTER OILS

Retail Price... 35c per quart

Quaker State Oil Refining Co., Oil City, Pa.

Make BIG Money!

JUST HAND OUT THIS SWEEPER FOR ONLY 39¢

and MAKE \$6⁰⁰ on Every Dozen

This amazing proposition offering for a limited time an efficient sweeper with enamel steel case and self-cleaning bristle brush, for carpets, linoleums and floors. Has features of high-priced sweepers. 5000 sold in one day at \$1.25 by a large department store. Let me show you how to make \$6.00 on every dozen.



Not a Toy—
Does
REAL
Work

HAND OUT THIS
\$1.25 SWEEPER
for ONLY
39¢

Write QUICK!
But Send NO Money

G. F. FOSTER PRODUCTS CO.

253 E. Fourth St., Dept. P. O. 32, ST. PAUL, MINN.

OSCILLIGHT TELEVISION RECEIVER

(Continued from page 901)

ceivers." All special parts will be available to experimenters in the near future at reasonable prices. The Farnsworth oscillight television receiver, shown in the photos, employs a cathode-ray tube with a screen 9 in. in diameter giving a black-and-white image 5 by 6 in. Six additional standard tubes are used in this scanning unit. The tubes, from left to right, operate as follows: the first three scan the picture vertically; the fourth is a synchronizer; the fifth a picture-frequency amplifier and the sixth tube, beyond the base of the cathode-ray tube, controls horizontal scanning.

A sectional view of the "oscillight" tube is given in Fig. 1; the electron gun sends a beam of high-velocity electrons down the axis of the tube and this beam is focused by means of a magnetic field on a fluorescent screen, where it produces a bright spot of light. A special electrode connected with the input signals controls the intensity of the beam and the brightness of the spot on the screen. The magnetic deflection coils give the beam a horizontal and vertical motion which "paints" the image on the screen. The tuning shaft of the picture signal receiver is coupled directly to that of the sound receiver as shown in Fig. 2; final assembly may be made in a console cabinet.

A.C.-D.C. CODE-PRACTICE SET

(Continued from page 905)

not work reverse one of the connections on the audio transformer, change either the primary or the secondary but not both. Use a pair of high-impedance headphones; the pitch of the signal will depend on the transformer used and the adjustment of the variable resistor.

A copy of the continental code is given; further code characters and abbreviations will be found in any radio textbook. When learning code, think of the letters in the terms of sound rather than dots and dashes. For example, instead of thinking of the letter A as "dot-dash," memorize the sound as "dit-dah" and so on. Two persons learning the code can take turns sending and receiving. It is a good idea to have an experienced operator demonstrate the sound of well-sent characters.

DRAFT-LESS VENTILATION FOR YOUR CAR

No. 1 Style for 1933 Fords. No. 2 for all other cars. For comfortable driving in rain or cold. \$2.00 per set. Easily installed. Cash or C. O. D.

PRECISION METAL WORKERS
3100 Carroll Ave. Chicago, Ill.

Forms MAGIC Frost Designs NEW LIQUID FROST

In 20 minutes on glass, metal, wood (painted or absorbent surfaces require our sealer). For decorating brick-a-bram, store backgrounds, frosting windows, light bulbs, mirrors. White or colors—per bottle 35c, 3 for \$1.00. Free particulars, distributors wanted. KEEN-RICK CO. (Dept. 9). 710 W. Jackson Blvd., Chicago

DID YOU GET THIS FREE PROJECT BOOK?

● Hundreds of thousands of home work shop enthusiasts have received the 1935 Casco Project Book. Send today . . . this is absolutely the last time it will be offered.

WHAT IT IS

A collection of pictures and descriptions of prize-winning woodworking projects in nationwide contest...inlaid card and game table, model hollow hull sailboat, unique tilt table made from cigar box wood, modern beverage set, beautifully patterned wood turned vases, lamps, smoking sets, cigarette boxes; and many others, ranging from delicate wood jewelry to portable camp refrigerators.

Write your name and address on penny postcard. The fine book is yours, free. THE CASEIN MFG. CO. OF AMERICA, Inc. 350 Madison Ave., Dept. 1235-B, New York, N. Y.



There's A Big Difference In



NORTHLAND SKIS

It takes carefully selected, slowly seasoned wood . . . correct design . . . skilled craftsmanship to assure absolute uniformity of weight, grain and limberness in a pair of skis. You can depend on these qualities when you buy Northland Skis. Ask any expert! Models for touring, downhill, slalom, jumping and racing. Identified by the deerhead trademark.

Free booklet HOW TO SKI will help you learn.

NORTHLAND SKI MFG. CO.
95 Merriam Pk. St. Paul, Minn.
World's Largest Ski Manufacturers

Metal Castings

Inventors, Craftsmen, Schools
Interesting, Instructive, Profitable
2400 DEGREES F.!



Make your own castings of aluminum, copper, bronze, silver, brass. Outfit contains gas furnace with 110 volt, 60 cycle motor blower, moulding sand, crucibles, tongs, rubber hose, flask, parting materials and instructions for use. For making models, trays, dishes, art objects, tools, shop equipment, etc.; also used for forging, case hardening and heat treating. Price of outfit No. 351, capacity 6 cubic inches, \$9.50. Weight 25 lbs. Price of outfit No. 352, capacity 12 cubic inches, \$15.00. Weight 40 lbs. Prices f. o. b. K. C. plus 1% state sales tax. Check or money order acceptable, express charges C. O. D. Write for Free Circular. See page 44 July issue.

KANSAS CITY SPECIALTIES CO.

P. O. Box 6022

Kansas City, Mo.

Easy-to-Build 15 ft. Trailer

PLANS \$2



Practical plans for 15 ft. Royal Trailer. Set of 10 simplified blueprints (12x18 inches), giving full details. Working instructions and price list of ready-cut materials and parts catalog furnished with plans. All for \$2 postpaid. Just send two one-dollar bills. Not the cheapest but the best. Satisfaction or your money back. Easy to alter plans as desired. Money refunded with order for parts. Descriptive circular, 10c.

Royal R. Hess Co.

341 Muir Ave., Hazel Park, Detroit, Mich.

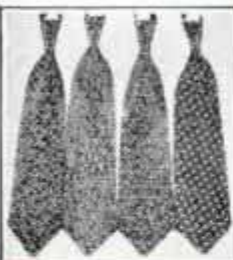

INVEST 50c BE INDEPENDENT Earn Money Easy

We Supply Xmas Boxes ORIGINAL LEATHER TIES

sell on sight. Made of embossed leather in assorted designs, polka dots, and stripes. Finer looking than silk. Send 50c in cash, or stamps, for sample and information.

U.S.A.—WONDER TIE CO.

504 Harmon St., Dept. P-12, Detroit, Mich.
CANADA—WINDSOR CAP & TEXTILE Limited Dept. P-12 Windsor, Ont.

Increase Business—PRINT YOUR OWN ADVERTISING. Form Letters, Price Lists, Post Cards. 'OUR OWN' Portable EXCELLOGRAPH Reprints Anything Type-written, Penned, Drawn or Traced. One or more colors. Thousands of copies. 40 per minute. Cost Complete \$37.50. Terms. Request Free Booklet.



PITTSBURGH TYPEWRITER & SUPPLY CO.
Department H-2, 339 5th, Pittsburgh, Pa.

HIGH POWERED TELESCOPE

GENUINE BROWNSCOPIES AT AMAZING PRICES

Most powerful in America for the money!
15 power long range telescope. Can see moon's craters or time on pocket watch a block away. 3 sections. Approx. 3 ft. long. Fine lenses. Brass bound. Can be used as powerful microscope. Vol. magn. 512X. Only \$1.69 postpaid. C. O. D. 24c extra.

\$1.69



Special Super-Power 30X Telescope.

Similar to above but more powerful. Guaranteed to see 900 times larger in surface and 30 times closer. 31 mm. objective 4 power lenses. Large field. Includes powerful microscope feature. Only \$1.98 postpaid.

BROWNSCOPE CO. Dept. 47, 234 Fifth Ave., New York, N. Y.

When writing to advertisers please mention Popular Mechanics

FREE

1936 RADIO CATALOG

FOR THE MAN WHO BUILDS HIS OWN

196 PAGES

EVERY LATEST RADIO DEVELOPMENT

For the Radio Experimenter, Ham or Fan who builds his own Radio and Radio Devices, this 196 page book is invaluable. It lists over 50,000 items; approved parts so that you may build your own pet circuit; all latest improvements; the last minute developments of leading manufacturers; Big Short Wave Dept., World's greatest PA Dept., scores of kits from 2-10 tubes . . . all at Lowest Wholesale Prices. Get your copy TODAY!

MAIL COUPON TODAY

Wholesale Radio Service Co.,
100 Sixth Avenue, Dept. PM-125
New York, New York.

Rush your FREE 196 page catalog No. 59 for 1936.

Name.....

Address.....

City..... State.....

What other portable offers as much? Check these features!

Corona is the only portable equipped with famous Floating Shift. Also Touch Selector, back-spacer, margin release, four-bank keyboard, two-color ribbon, etc. Smart carrying case is included—also self lessons in typing.



CORONA STANDARD

OWN A CORONA!

New Finance Plan Makes It Easy
... ONLY \$1⁰⁰ PER WEEK!

Only latest model brand-new machines—not rebuilt—none used or shopworn. Fully guaranteed. Useful for any business man or woman, any college, high-school, or grammar school student, writers. Send coupon for details and learn about our liberal time payments.

-----MAIL COUPON TODAY-----

L C Smith & Corona Typewriters, Desk 12
723 E. Washington St., Syracuse, N. Y.

Please send Corona booklet, also tell me where I can arrange free trial.

Name.....

Street.....

City..... State.....



"There's the bicycle I want for Christmas.

I've owned the other kind and now I want the best there is."

IVER JOHNSON
Bicycles

Boys everywhere know there's "nothing to it" but Iver Johnson when it comes to America's Finest Bicycles. Get busy with Dad and get your Iver Johnson for Christmas.

Send now for color folder 66B describing the Strongest, Safest, Easiest Riding and Handsomest bicycles of all.

Priced as low as \$27.50.



IVER JOHNSON'S ARMS & CYCLE WORKS
21 RIVER ST., FITCHBURG, MASS.

New York, 85 Chambers St. Chicago, 108 W. Lake St.
San Francisco, 731 Market St. Montreal, Cristine Bldg.



HOME AUTOMATIC CIGARETTE MACHINE

Have YOUR OWN Monogrammed Cigarettes. Put tobacco and block of papers on machine. TURN THE CRANK—PRESTO—CIGARETTES. Easy—simple. All metal construction. Guaranteed. No cloth ribbons; no special tube or gummed papers required. ASK FOR FREE ILLUSTRATED FOLDER. AUTOMATIC CIGARETTE MACHINE WORKS, P.M.-12, 1035-57 Devon Ave., Chicago, Ill.

THE Smooth WAY TO "ROUGH" IT

Self-Built DeLuxe House Trailer gives you economical travel-convenience. Complete interior—4 models. Progressive Buying Plan. Any workman can build. Beautiful new Trailer Builders' Guide. 150 illustrations; famous Bull and Sockey Hitcher; Combi-Chair axle; Parking Legs; Sink; Stove; Inner Spring Beds. Send only 50c for Trailer Builders' Guide.



Full Size Blueprints FREE With Parts.

HAMMERBLOW TOOL CO. Dept. 112, 606 Third St. Wausau, Wis.

NEW! BOICE-CRANE DRILL PRESSES

1936
FREE CATALOG

... in Bench and Floor Models. Takes 15 in. dia. work... big capacity where most needed. Has 5 Speeds... a "High-Slow" Speed Drill all in one. Efficient speeds too for each of its many operations.

8 MACHINES IN 1

... a drill, router, shaper, drum sander, mortiser, carver, burr. New type "quick-change" fittings... easy set up. New rapid belt-shifting feature. Modern all thru. Ahead of field. Investigate Boice-Crane fully before you buy. Highest quality. Low prices.

**Jointers
Band Saws
Lathes**

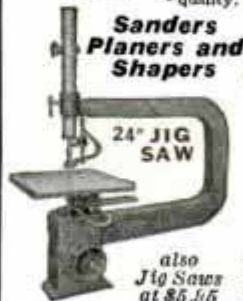

also
Jig Saws
at \$6.56



TILTING ARBOR SAW

Acknowledged by thousands of users as the most efficient, convenient and practical type of saw. The Saw-Blade tilts and lowers. Table always level. Modern at every point.

BOICE-CRANE

W.B. & J.E. BOICE Dept. 212 TOLEDO, OHIO

\$ MONEY-MAKING \$ OPPORTUNITIES

For those who need larger incomes or must seek new occupations. The following workable, tested plans are adaptable both to the needs of the country or city dweller either for part time development or principal income source.

Every idea set forth in these books has been used by others for profit. They are well worth your consideration.

Plan No. 1—\$50 a Week with Car and Camera. Paul G. Holt tells you how he made a daily average of \$11.30 profit. Price \$1.50.

Plan No. 2—Radio Servicing. Let an expert teach you how to engage in this money making business. Price \$4.15.

Plan No. 3—Refrigeration Service. Official manual covers all makes. Good service men are needed. Price \$5.00.

Plan No. 4—Automobile Refinishing. Start a lucrative business of your own. Fine possibilities here. Excellent new instruction book. Price \$1.50.

Plan No. 5—Outdoor Opportunities. The raising of small animals, birds and plants for profit. Price \$2.00.

Plan No. 6—10 000 Money-Making Formulas. Complete instructions for the making of commodities at small cost that may be sold at a handsome profit. Price \$4.00.

Plan No. 7—How to Make Money at Home. 100 successful ways for women to make money. Price \$2.00.

Plan No. 8—100 Civil Service Examinations. Covering steady Government jobs. All types of positions. Better business means thousands of new jobs. Prepare now by studying this new book. Price \$5.00.

Plan No. 9—Making Poultry Pay. The proper breeding and management of fowls for higher egg production. Price \$2.00.

Plan No. 10—Fur Farming for Profit. Complete instructions that enable the beginner to succeed from the start. Price \$4.00.

Plan No. 11—Rabbits for Food and Fur. A complete guide to the successful rearing and breeding of rabbits. Price \$2.00.

Plan No. 12—The Frog Industry. Should be considered more as a side line than as a major means of income. Price \$2.00.

Plan No. 13—How to Live on a Subsistence Homestead. Facts and figures on how one family fled from the city and found security and independence. Price \$2.50.

Plan No. 14—Auto Service Shop Management. Money-saving and business-producing ideas by two men who know just what is essential to a profitable service shop business. Price \$1.50.

Any of the above mailed postpaid upon receipt of price or sent C.O.D. anywhere in U. S. Pay postman price and few cents postage.

POPULAR MECHANICS PRESS

Room 1312 200 E. Ontario St. Chicago, Illinois

BRING TO YOU 5 DIMITS

the HI-SPOTS OF DIESEL ENGINES

Send today for THE DIESEL GUIDE. A practical book covering Diesel engines in a thorough and easily understood manner, explaining The Principles of Every Operation and Part... theory, maintenance, installation, operation, trouble shooting, timing and valve sett'ng. Pictures, drawings, and charts simplify the text. Pri. e 50c (Coin or M.O. only) postpaid.
AUTOPower, Inc. DESK 3 410 S. HOYNE AVE. CHICAGO

When writing to advertisers please mention Popular Mechanics

SPECIAL OFFER Diesel Guide

WONDERS OF HIGH FREQUENCY

(Continued from page 863)

and the energy that comes through the air to your radio receiver.

Man started his study of electromagnetic energy by developing direct current and since then he has created many uses for isolated portions of the energy spectrum. Alternating current gave us heat, light, power, and communication conducted along wires. Different frequencies can be sent along the same wire at the same time, the result being multichannel telephone circuits and even low-power telephone communication over high-tension power lines that carry 220,000 volts at the same time. The next highest frequency energy waves provided the radio telegraph and with still higher frequency it became possible to speak through the air. Bands of even shorter waves brought television, the beam radio, and electrotherapy.

At the California Institute of Technology, Prof. G. W. Potapenko is coming close to closing the gap between radio waves and heat waves. A few years ago twenty-meter waves were considered extremely short and now Prof. Potapenko has created an oscillator that generates waves of from two meters to as little as three centimeters in length. Not even Potapenko will predict what uses may be found for these ultra-high frequencies. His oscillator consists of two oscillatory circuits tuned so that the radiated output is a harmonic of the wave length of each circuit. If energy of ten centimeters in length is desired, one circuit is tuned to 100 centimeters and the other to ninety centimeters, the difference of ten centimeters being the length of the waves created.

With these "micro" waves Potapenko is studying the properties of different kinds of matter and is seeking new uses for iron, nickel and cobalt in the electrical industry. He is also investigating the selective absorption of ultra-short waves in various materials.

Somewhere in this ultra-short band is thought to be the mystery ray by means of which the army is able to locate ships maneuvering along the coast after dark and in fog. Most radio detection devices operate on the principle of receiving back waves that are reflected from the surface of the target, and this may lead to inves-

(Continued to page 150A)



FREE MAIL COUPON
for *Big Train Book*
IN FULL COLORS

Page after page shows *new streamline trains, new powerful steamtype locomotives—rubber sleepers for silent operation, etc.* All American Flyers are ready to run, with transformers included. 28 years' experience building over 8,000,000 trains is your assurance of dependable performance. Select your fun-making automatic signals, stations, bridges, etc.

ELECTRIC TRAINS—\$4.50 up.
Dads, too, make railroading a hobby.

American Flyer Mfg. Co.
2248 S. Halsted St., Chicago, Ill.

SEND FREE
TRAIN BOOK

Name.....

Address.....

American Flyer Trains



Forms to cast Lead Soldiers, Indians, Trappers, Hunters, Wild and Farm Animals. 239 different forms to select from. Every form guaranteed to cast perfect figures. Send 5c stamp for illustrated catalogue.

HENRY C. SCHIERCKE Spencer Rd. GHENT, N.Y.

BUILD YOUR OWN

Streamlined Trailer at little cost. Send dollar for plans, blueprints, details, pictures of the Standard and the Deluxe Model as shown. Mail a dollar to

D. VAN OOSTVELDT,
111 Marston, Detroit, Mich.



Make Big Profits
Filing Saws by Machine

Start in Spare Time—Earn up to \$2 or \$3
an Hour—No Experience Needed

"My Foley Saw Filer is a peach—it has kept me all through the depression," says H. Laity, California. A FOLEY Automatic Saw Filer files hand, band and circular saws. No eyestrain. All cash business, no canvassing. Send postcard for FREE PLAN—no obligation.

FOLEY MFG. CO., 1216-5 Foley Bldg.,
11 Main St. N.E., Minneapolis, Minn.



UNION MADE **TUB-TEST**
Signal SHIRTS
REG. U.S. PAT. OFF.



- .. Better Looking
- .. More Comfortable

The SIGNAL label is a guarantee that you are getting the very best workshirt you can buy . . . yet sold at a popular price. Every SIGNAL is made to exact size for real comfort.

See Signals at Your Dealer's

If he cannot show you the newest patterns in plain colors, stripes or dots (neckband or collar-attached style), ask him to get them for you.

JOHN RISSMAN & SON

Also Makers of Signal Superlative Quality Overalls.

841 Blue Island Ave.
CHICAGO, ILL.

- SIGNAL SUPERIORITY**
1. Complete Comfort.
 2. Will not Shrink nor Fade.
 3. Finest Workmanship.
 4. Style.

5 ft. Flying Scale Models \$1 EACH
 $1\frac{1}{3}$ size of real planes
plus 35c for Packing, Postage, Insurance.

5 ft. Monocoupe (Illustr.) 5 ft. Stinson Reliant
5 ft. Heath Parasol

Build planes that are actually one-third the size of real passenger carrying planes! Send today for our new Giant Models—each a strong outdoor flyer—a \$10 value for only \$1. Everything is in the kit—including all liquid—nothing else to buy! Dealers write.

G. H. Q. MODEL AIRPLANE CO.
564b Southern Boulevard New York City



"Athlete's Foot"
INSTANT RELIEF



LUCKY TIGER
ANTISEPTIC OINTMENT

Does the work and does it now. Get a jar today and prove it in Athlete's foot, Fire and Sun Burns, Itch, Cold Sores, Skin Irritations, Pimples, Rash, etc.

Costs little at Druggists or barbers!

VEST POCKET ADDING MACHINE

Adds, Subtracts, Multiplies, Divides. Does work of costly machine. Not a toy. Million dollar capacity. Simple and accurate. Guaranteed 5 years.

FREE TRIAL \$2.50
—SEND NO MONEY— Total Cost

Just name and address. We will ship Calculator immediately. On delivery pay postman \$2.50 (plus few cents postage). (If outside U. S. send cash.) 10c additional in Leatherette Case. If not satisfied after 10 days' trial you get your money back. THOUSANDS OF SATISFIED USERS. Write for Agents' Proposition. **CALCULATOR MACHINE CO. (Incs.)**
P. O. Box 1118, Dept. 31, CHICAGO, ILLINOIS.

WONDERS OF HIGH FREQUENCY

(Continued from page 149A)

Calculations as to whether or not a ship could conceal its presence by applying an absorptive paint to absorb the ultra-short waves instead of reflecting them back. Black paint, for example, absorbs a great deal of heat and light waves, while white paint is a good reflector of both, and the ultra-short radio waves have many of the characteristics of heat and light rays.

The medium-short radio waves permit nearly perfect transmission at only fractions of the amounts of power now used by broadcasting stations, and in addition give static-free reception. Amateur radio experimenters who used to jam five kilowatts of power into the air at 200 meters to "work" a station a few hundred miles away are now talking casually across the country on twenty-meter wave lengths on much smaller amounts of power, and voices from across the ocean sound as if they were in the next room.

Being of such short wave length that they have some of the properties of light, ultra-high frequency radio waves can be focused like searchlight beams to travel in only one direction and may be reflected from smooth surfaces just like light. A parabola-shaped reflector behind the transmitting aerial, or a series of phased half-wave antennas, gather the waves and throw them in a straight beam toward the receiving set where they are gathered from the air by a similar reflector. For this point-to-point communication the receiving station cannot be hidden by mountains or be below the horizon.

One radiotelephone circuit between France and England operates on an eighteen-centimeter wave length and consumes only one one-hundredth of the power used by an ordinary light globe, as compared to powerful stations in the broadcast band that use from five to fifty million times that power. The surprising economy is due partly to the fact that the short waves are more efficient and partly because nearly all the radiated energy can be thrown in one direction, eliminating losses into empty space. One possibility of the efficiency of the higher frequencies is the "stepping up" of the frequency of domestic current for lighting purposes, using neon-type globes to provide satis-

(Continued to page 152A)



ScienceCraft
PROFESSIONAL TYPE MICROSCOPES
 with Complete Microscope Outfits

Designed like professional instruments; carefully constructed of most expensive materials; beautifully finished, with easy, accurate focusing, finest ground and polished lenses giving **GUARANTEED MAGNIFICATION** without distortion, removable for cleaning, and other exclusive features; 100% American made; the most efficient Microscopes at these popular prices:—

Junior—Magnification 100X or 200X.....\$0.75
 Senior—Magnification 200X or 400X..... 2.50
 Master Magnification 175X to 500X..... 4.00

These fine instruments are included in "Science-Craft" Microscope Outfits; also equipment; materials and instructions for Microscopy—Biology—Chemical experiments and observations. There are eight different Outfits from \$1.00 to \$7.50 each; the one shown above is No. 305 with Senior 400X Microscope, \$5.00. Ask for "ScienceCraft" Microscopes and Outfits wherever Scientific sets are sold; or we will send your choice, fully prepaid, upon receipt of price.

Free **Big Science Surprise Package**
 containing Giant enlargements of insect specimens and full information about "ScienceCraft" and CHEMCRAFT Outfits. Please send 3c stamp for postage.

THE PORTER CHEMICAL CO.
 5412 Prospect Ave., Hagerstown, Md.

THE CHRISTMAS THEY WILL NEVER FORGET!



Writing by hand is slow hard work, while typewriting is easy, fascinating. (Teachers report a 14% improvement in grade school children when provided with typewriters!) Help your child with the gift of a Remington Portable Typewriter. Eight new models with easy payment terms as low as \$3.00 down. At your typewriter dealer's or mail coupon for catalogue and special 10-day free trial offer.

ONLY \$3 DOWN

HOME TYPEWRITER

The biggest machine ever offered for the money. Smart design. Simplified keyboard. Famous Key-Control type action. All for \$34.50, including new carrying case. Easy terms. Only \$3.00 down. \$4.00 a month.



ONLY \$4 DOWN

KEY-CONTROL PORTABLE

Has every big machine essential... 4-row keyboard; automatic ribbon reverse; back spacer, etc. Carrying case and typing course included free. Just \$49.50 cash. On easy terms, \$4.00 a month.



ONLY \$3 DOWN

NOISELESS PORTABLE

First time on such low terms. Makes only a whisper of sound. Full size platen. Standard 12-yard ribbon. Back spacer. Variable line spacer. Free carrying case and easy typing course. Only \$3.00 down, \$3.00 a month.



Remington
 AS ADVERTISED ON "MARCH OF TIME"

Remington Rand Inc., Dept. 152-L
 205 East 42nd Street, New York City

Please send me free illustrated folder of eight Remington typewriter bargains. Include details of special 10-day free trial offer.

Name.....
 Address.....

A BUSINESS OF YOUR OWN!

Become Independent! Sell high-grade used clothing at rock-bottom prices from your own store, home or auto. **MAKE UP TO 300% PROFIT!** Tremendous values; include Girls Dresses for only \$2.00 Dozen, and hundreds of other amazing bargains. No experience required. Satisfaction guaranteed. Write today for **BIG FREE CATALOG!**

GLOBE MERCHANDISE MART, BL-3238 S. State St., Chicago, Ill.

BUILD CLOCKS

Hall clocks are high priced in stores — you can make **good money** building them or electrifying spring clocks as many do. Dime brings "HOW" Book and dimensioned drawing of easily built Grandfather Case — start now.

KUEMPEL ACCRATIME CO., BUILDING 2, GUTTENBERG, IOWA



PENNY EACH!!

Beautiful Window Sign Letters. Lowest Price in America. Finest Quality. 5 Year Guaranteed. New styles. Tremendous Demand. Big Profits. Easily Applied. Record Breaking Offer. **FREE** Samples and Working Equipment. **Hurry!**

Atlas Sign Works, 7943 Halsted, Chicago, Ill.

WINDOW SIGNS



DRILL-INDEX Keep your drills in a **DRILL-INDEX**. Works like a card index. A flip of the wrist opens the case. Three sizes. Write **FREE!** for free illustrated pamphlet and prices.

Huot Mfg. Co., Foot Schulze Bldg., St. Paul, Minn.



For Quick, Clear 3-Dimension Scale Sketches

Wade's New Isometric lined paper is hard to beat! Just follow the green guide lines spaced 1 in., 1/2 in. and 3/4 in. On buff drawing paper; loose leaf sizes—4 in. x 6 1/4 in.—100; 8 1/2 in. x 11 in.—50 and 11 in. x 17 in.—24 sheet pads, with directions \$1.00 each.

See Wade Lined papers, Beam Compass and Curves at Stationery, Office or Drawing Supply Dealers, or write:
Wade Instrument Co., 2274-B Brooklyn Sts., Cleveland, O.



WANTED MEN
MANAGE POTATO CHIP STORES

We furnish everything—help finance and locate you. No experience needed. Tremendous profits. Sensational introductory starting plan. No house-to-house canvassing. Wonderful opportunity. Rush name for free book of Profit Facts—today!

LONG-EAKINS COMPANY
 1228-S High Street, Springfield, Ohio



When writing to advertisers please mention Popular Mechanics

The



Old-timers are glad to have it!

Written in simple language, this new Handbook, in your Homeworkshop will save you hours of work in doing the gluing, by doing it right the first time. It has been especially prepared and written for you by nationally known gluing authorities—the producers of the famous Keystone Pure Hide Glue—the kind of Pure Hide Glue Professional Craftsmen have used for 50 years!

Fill out the Coupon below and send it with 10c in stamps today, to get this valuable Workshop Manual. You'll be glad you did!



KEYSTONE GLUE CO.
WILLIAMSPORT, PENNA.
Please send Homeworkshop GLUE HAND
BOOK. 10c in stamps enclosed.

Name.....
St. and No.....
City.....
Name of my Hardware Dealer.....
His Address.....
PM2

COPY-STAMP THE STAMP OF A THOUSAND USES



Prints postcards, letters, menus, school-work, notices, drawings, tags, etc. Used by thousands of business concerns, schools, clubs, churches, and others. Quick, clean, automatic, instantly changeable. Ask your stationer or write us direct.

THE STENCIL-STAMP CO., INC.
53 Park Row New York, N. Y.

★ GENUINE FORD PARTS ★

are made from highest quality materials, by precision methods, then carefully inspected. That's why they always fit—why they are best for Ford cars and trucks.

AN AMAZING SENSATIONAL TOOL— CUTS BOLTS—SPLITS NUTS—WITH 10,000 Pounds Pressure Capacity

This small, compact, husky tool can be used in close quarters for quickly and easily cutting Bolts, Nuts, Rivets, Rods, etc. Over 10,000 pounds of cutting pressure insure the saving of time and money by making "Tough Jobs" simple. The handiest and most powerful bolt cutter ever made. Write for bulletin or send \$6.50 and we will send you pre-paid this indispensable tool on money-back guarantee basis.

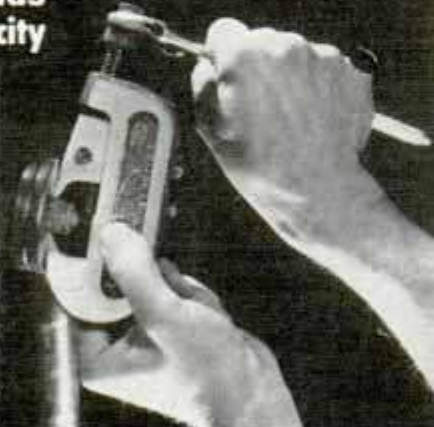

VAUGHAN & BUSHNELL MFG. CO.
2122 Carroll Ave. CHICAGO
Makers of Fine Tools for Over 65 Years

WONDERS OF HIGH FREQUENCY

(Continued from page 150A)

factory illumination at a fraction of present lighting costs.

An ultra-high frequency radio beam only a square yard in area can be thrown for miles with very little spread and no one outside the direct path of the beam at any distance from the transmitter can receive the messages. Secret communication between ships and the shore or between ships at sea can even be maintained provided the transmitting reflector is kept pointed directly at the receiving apparatus. Radio hams have proved that the present kind of secret radio in which the voice tones are "scrambled" before they go on the air to produce a mystifying jargon is not secret at all, because after practice they have learned to understand the transposed notes and can even "talk" it between themselves.

By means of high-frequency radio, aviation is solving the problem of blind landings. Ships have been able to guide themselves into fog-shrouded harbors. Collisions at sea may be reduced by means of short-radius short-wave transmitters on ships that broadcast in all directions through the fog. One possibility that is already practical is that of providing short-wave transmitters for automobiles so motorists can call the nearest telephone exchange and be connected over ordinary telephone wires with home or office. Amateurs have already done this as a stunt.

The high-frequency waves, vibrating at millions of times per second, raise body temperatures and stimulate circulation. Heat has always been a valuable aid to medicine and in adapting high-frequency radio to their needs physicians found that with the "fever machines" they could obtain deeper, more uniform heats than before, as well as a specific electrical effect that seems to be lacking in applications of external heat. The "radio knife," an offshoot of electrotherapy, enables surgeons to make deep cuts that heal rapidly.

So far, the fever machines have been beneficial in relieving colds, arthritis, neuritis, and many conditions of congestion or infection. The action of the heat is to increase the amount of blood flowing through the affected area, enabling the blood stream to cleanse the area rapidly and carry away septic materials.

1936 Catalog of ATLAS Shop Equipment Now Ready

You will want this new catalog of finer shop equipment. New lathes, new drill presses, new attachments and tools. All made by a company with a 25 year reputation for quality. Precision-built; production-priced. Atlas Lathes are "Unit Plan" tools. Begin with a small turning lathe, build it up to a complete back geared screw cutting lathe by adding units at your convenience. Prices from \$35.50 to \$82.50. Atlas Drill Presses are 4 different sizes, floor and bench models, priced from \$14.45 to \$39.45.

Complete Display of All Atlas Tools at
Atlas Sales Co., 35 East Wacker Drive, Chicago

Lathe shown below is a new model, 9" swing, with reversible power feeds. Guaranteed for .001" precision.

\$54⁷⁵

Complete
Less Motor

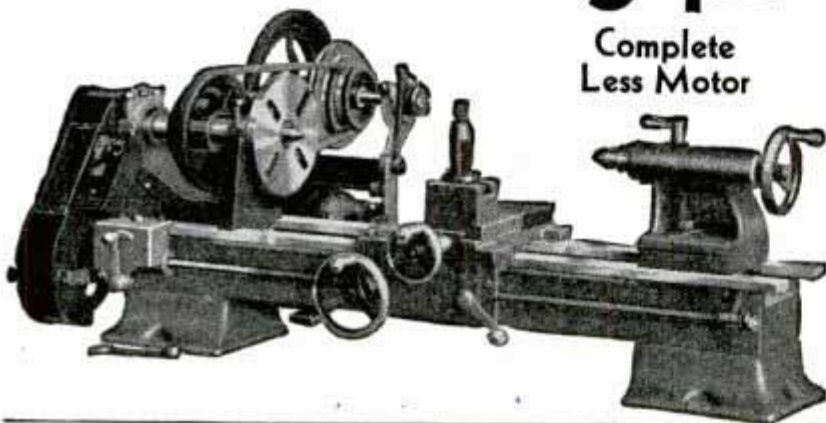

Mail this coupon today for your FREE copy of this new 1936 catalog.

ATLAS PRESS COMPANY

1843 N. Pitcher St., Kalamazoo, Mich.

ATLAS PRESS CO., 1843 N. Pitcher St., Kalamazoo, Mich.:

Please send your new 1936 catalog.

Name.....

Address.....

City.....State.....



MINIATURE GLUE POT HOME WORKSHOP SIZE

Made of cast iron and porcelain plated. Price \$1.00, plus 20c for packing and postage.

LORENZEN PRODUCTS CO.
Niles, Michigan



Men & Women Earn Cash at Home!

Grow fancy giant mushrooms in cellar, attic, barn. Easy, odorless method. We show you how, furnish guaranteed materials and buy crops. Valuable big book, pictures/ree if you write quickly. (Est. 1908.)

UNITED CO., 3848 Lincoln Ave. Dept. 129 CHICAGO



Balance as above with 1-50; 1-20; 2-10; 1-5 and 2-2 gram weights base 4" x 9"—\$4.75. Catalog with 3000 illustrations of laboratory apparatus sent for 50c. Catalog listing 10090 chemicals, drugs, flavors, etc., and 1700 scientific books sent for 25c.

Laboratory Materials Company, 639 E. 71st St., Chicago, Ill.



Build the 4-mast Barque, California Accurate, detailed blue prints of this handsome steel barque. Complete fittings and construction sets for steam trawler and other popular models, including Sovereign of the Seas. Send 15c for illustrated catalog.

A. J. Fisher, 1002-1 Etowah Ave., Royal Oak, Mich.

The man who studies gets ahead. Popular Mechanics Press will advise you what books to read to advance in your trade. 200 East Ontario Street, Chicago, Illinois

MAGIC Factory



URNS SINGLE DOLLARS into TENS

By adding water to chemicals we furnish, you instantly transform them into cleaners, polishes, fine flavorings, cosmetics and other products—just the things people need daily to live. Make up to 900% profit. Stores and local agents sell under your own label for you. We supply imprinted labels and bottles—nothing else to buy—just add the water—start in your kitchen—no equipment needed. We furnish complete, simple instructions. Have cash profits first day. Rush name on postcard for complete free information. Act now.

STANDARD CHEMICAL CO., 121-E Second St., Dept. C-125, Dayton, Ohio

OWN YOUR OWN BUSINESS BE A FOUNTAIN PEN REPAIR MAN

Easy to learn. Easy to earn big money. For 50c we will teach you to repair all makes of pens and show you how to find your customers. We will sell you all necessary supplies at prices so low that you can earn 400% profits! Own a permanent profitable business! Exclusive territory. Send 50c today for the COMPLETE instruction booklet. Money refunded if not satisfied.

CHICAGO FOUNTAIN PEN SERVICE Dept. C2 201 N. Wells St.

Every Wood Craftsman Should Have This 100 Page Book No. 8

It is full of beautiful things that you can easily make—hard to find material such as foreign woods—lovely crotch, butt, burl, fiddle back, etc. Veneers, Panels and Solid Woods. Lists and illustrates 76 Blue Print Designs for Scroll Patterns, Inlay Table Tops, etc.

only 10¢

Make Beautiful Period Furniture at a fraction of store cost. If you are handy with tools you will value this book. It will save you money and make available exactly the kind of material you want.

CRAFTSMAN WOOD SERVICE CO.
We Ship All Over The World
2728 MARY STREET CHICAGO



When you change to WINTER OIL



Renew your PUROLATOR OIL FILTER

These two suggestions mean a lot to the peace of mind and the pocketbook of the winter motorist. Winter oils give close working parts a film of the right consistency. The Purolator keeps that film free of dirt and grit and hard carbon and metal particles.

The Purolator should be changed after 8,000 miles of driving. Keep the new winter supply clean. Then you'll have good lubrication... rather than a black, viscous substance, full of harsh abrasives.

GENUINE Purolators filter so effectively that crankcase oil retains its color after thousands of miles of driving. Be guided by your own eyes. Don't be satisfied with something cheaper, and just as good. Insist on a GENUINE Purolator. Motor Improvements Inc., Newark, New Jersey, makers of

PUROLATOR

The Oil Filter on Your Motorcar
LICENSED UNDER SWEETLAND PATENTS

For Economy BUY—For Income SELL The FIFEL-GEARED PLIERENCH KIT

● 2 New Pocket Machine Shops... 7" and 8 1/2"...



Each with 3 INSTANTLY Changeable Jaws—
No. 1, for all Pliers, Wrench, and Small Vise & Clamp work; No. 2, for all PIPE work, "chewed" nuts, etc.; No. 3, for all WIRE, Chain, Spring-making, Fence work... with astounding POWER and SPEED!

● They Give you a 10-to-1 Power-gear, 1-TON Grip; Instantly a Million sizes 0"—1 3/4"; 4-Way V-GRIPS, 12-Point Automatic Grip-LOCK Ratchet Wrench, Etc.
● A \$50 Super-Tool Service at the Cost of One Tool!



● Mail this Part of Ad Today with your address (on a Postcard will do) Get FREE—7-Edge, End-&Angle Screwdriver, 101-Picture Manual of Mechanics, with... User Offer, Or, With... Distributor, Territory and FREE KIT Offer.
● Be a PlieRench Man, They're making \$35 to \$85 Weekly!



AMERICAN PLIERENCH CORP'N ZPM-4809 N. Ashland Ave. CHICAGO, ILL.

Save Your Feet

When all else fails end your suffering with the flexible "no metal"

Heelner ARCH SUPPORT

WRITE FOR FREE BOOKLET



HEELNER ARCH SUPPORT CO., 698 M. E. TAYLOR BUILDING, LOUISVILLE, KY.

THICKNESS—SURFACE PLANER

Bench size machine which surfaces or reduces any wood as wide as 12", thick as 4", small as 1/4" square. For homeshop, pattern or cabinet maker, carpenter, etc. Reclaim soiled, painted or warped lumber to present clear, flat and smooth usable stock. Save and earn money with this well proven, automatic feed, micrometer adjustment planer that requires small power. Hundreds in use and well proven. Write for circular.

PARTINGTON, INC.

Dept. A, Station H

Cincinnati, Ohio, U. S. A.



Learn Air Conditioning. Be one of the far seeing men to get in early and take advantage of the many new opportunities. Thousands of installations have been made and are being made. Air Conditioning means not only comfortable living, but, in industry, the perfecting of ideal conditions for the manufacture of many products. The creation and control of indoor weather is

AMERICA'S NEXT BIG INDUSTRY

Get your start with the new book by E. W. Riesbeck, International authority. It is complete, non-technical; tells what A. C. is; difference between complete conditioning and cooling; humidification and filtration; all methods and types of equipment; how to figure requirements; makes installations; adapt present heating plants to new systems; equip old buildings; use of ozone, etc. 269 Pages. Illustrated. Flexible. Price \$3.50 postpaid. Sent C. O. D. in U. S. if preferred. Small amount extra for postage charged. Popular Mechanics Press Room 835 200 E. Ontario St., Chicago.

GET INTO THIS NEW PROFITABLE BUSINESS..THE Simplified 40 VOLT ARC WELDING



Earn \$150 to \$300 monthly profit on garage and general repair work with this New Hobart "Simplified" Arc Welder. Easy to operate, no training required. A size to fit YOUR shop and to meet the demands of your customers. Electric, gas engine, or belted drive. Comes to you on 30 Days' Trial at our risk, lets you prove that it "Pays-for-itself." Write today for valuable booklet, "The Many Profitable Uses of Simplified Arc Welding." It comes to you FREE, with detailed information on Arc Welding, no obligation.

HOBART BROS., Box M-1251 Troy, Ohio

\$150 TO \$300 Monthly Profit

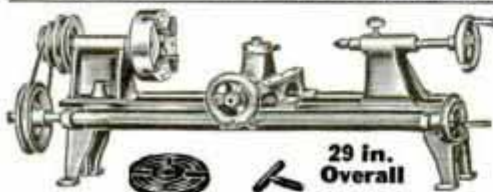

29 in. Overall

Now! A Power Feed Metal Cutting Lathe \$1195

With features of a high priced production tool. Weight 40 lbs.—29 in. overall—23 in. bed—13 in. between centers—6 in. swing—4 1/2 in. face plate—1/4 in. (hollow) headstock spindle (will take 3/8 in. rod)—bronze bearings—No. 1 Morse taper centers—Power feed full length of bed—takes all No. 1 Morse taper accessories. Lathe complete with: Power feed slide rest (ribbed for takeup); Face plate; No. 1 Morse taper centers; Three steep drive pulleys; 4 in. feed pulley; belt; Tool holder; 1/4 in. cutting tool; Power feed—3 in. four jaw (reversible jaws) Chuck with adapter plate \$4.30, 4 in. \$5.50. Send \$3.50 with order. Bal. express C. O. D.
BALKO ELEC. MOTOR & SUPPLY CO., 10 S. Clinton St., CHICAGO, ILL.

When writing to advertisers please mention Popular Mechanics

THE SECRETS OF A SMOOTH RIDE

(Continued from page 879)

even new ones. Engineer Phillips says many cases of high-speed shimmy, really a dangerous condition, are caused by warped rims or bulging tires, while a crooked wheel sometimes causes shimmy, hard steering or spotty tire wear. On knee-action cars shimmy appears more often when tires are inflated to too high a pressure because harder tires increase the tendency of the wheel to hop. But on axle cars, shimmy is more likely to occur when tires are soft.

This is one condition the driver can remedy. Keeping tires properly inflated is important because it decreases tire wear, makes steering easier and gives a smoother ride under average conditions.

Important as is inflation, some motorists overdo it on a long trip. You may have noticed the car began to ride roughly after a couple of hundred miles, usually on a hot day. When the passengers complained, you found the tire pressure had gone up, so you let out some air. Engineers warn against this practice of "bleeding" the tire. They are thinking of the life of the tire and the safety of the passengers, rather than the smoothness of the ride. Here is the explanation:

Heat is the worst enemy of your tires and reducing the pressure increases the heat. Many drivers are afraid the pressure will become so great in hot weather that the rubber will burst, but modern tires are able to withstand any pressure produced in this way. H. W. Delzell, Goodrich tire engineer, tells of a passenger car test. The tire was inflated to a pressure of thirty-two pounds, with the temperature at seventy degrees. Operated under load and at high speeds, temperature in the tire climbed to 127 degrees, with spots as high as 200, but pressure increased only to thirty-seven pounds.

When the driver lets air out of his tires to get more comfort, he increases the amount of heat generated in the tire and before long the pressure may climb again to the uncomfortable zone. So long as the driver does not permit his tires to drop below the proper pressure, he need have no worry about inflation.

Engineer Phillips agrees with other authorities that "balance is the secret of a smooth ride."

DOUBLE A Power TOOLS

Motor-Driven Drill \$2.25



Sensitive, precision-type, light-duty drill press. Maximum distance, chuck to base, 7 1/4"; spindle travel, 1 1/4" speed, 800 R. P. M. Equipped with chuck and 3 1-8" adjustable; swiveling table. Overall height, 20"; width, 3 1/2"; depth, 9". Shipping weight, 6 lb. Price, prepaid, \$2.25; west of Rocky Mountains, \$2.55.

Disc Sander \$1.49



Absolutely unique! Nothing like it at so low a price! Has 7" by 3 1/4" table and 6" sanding plate. Overall height, 7"; depth, 8"; length, 8". Shipping weight, 8 lb. Price prepaid, \$1.49; west of Rockies, \$1.79. 6 Assorted sanding discs, 25c extra.

BELT SANDER \$1.95

Fence included. Shipping weight, 12 lb. Price, prepaid, \$1.95; west of Rockies, \$2.39. Sanding belts, 32" x 4", coarse, medium or fine, 50c each.

WOOD LATHE \$3.95

Heavy-duty, for small, accurate turning. Swings 3" stock, 12" long. Hollow spindle. Oilite bronze-bearing headstock. Heavy, accurately fitted tail stock. No. 6 Morse taper spur and cup centers. 5" tee rest and holder. 20" bed, accurately machined. Shipping weight, app. 15 lb. Price, prepaid, \$3.95; west of Rockies, \$4.95. 1/4" V-Type 2-Step Cone Pulley, for motor or lineshaft, 35c extra. (Ask about our full line of wood and metal lathes.)

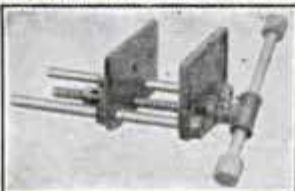

WOODWORKER'S VISE \$1.39
Strong, rugged, practical. Carefully and accurately finished. Jaws, 6" by 2 5/8", open to 6". Shipping weight, 6 lb. Only \$1.39, prepaid; west of Rockies, \$1.69.

IDEAL CHRISTMAS GIFTS
Free literature describes full line of spindle shapers, grinders, motors, pulleys, couplings, line shafts and accessories. Orders filled promptly. Prices are for continental U. S. only.

WRITE TODAY

Double A Products Co., Inc. 407 North Fifth Avenue, ANN ARBOR, MICH.

HANDEE TOOL OF 1001 USES!

Quicker, Better Jobs . . . Does away with slow hand work. Grinds, routs, drills, carves, saws, sharpens, cuts, polishes, engraves . . . over 100 wheel shapes available. For use at home, in shop or take to job. Weight 1 lb., 13,000 r.p.m. 110 volts, AC or DC. \$10.75 and up. (3 Wheel Shapes Free.)



Plug in any light socket

NEW DeLuxe MODEL!

Revolutionary Performance



A Fine Xmas Gift

For constant service . . . nothing else like this easy-to-handle production tool for saving time and labor. Fastest, smoothest, most powerful tool for its type and weight (12 oz.) 6" long, 1 1/4" diameter. 25,000 r.p.m. \$18.50. (6 Wheel Shapes Free.)

FIVE DAYS' TRIAL

Order either Model today, postpaid in U. S. A. Satisfaction guaranteed.

Chicago Wheel & Mfg. Co. 108 S. Aberdeen St., Chicago, Ill.

SEND FOR Free BOOKLET

DON'T BUY

Guitar
Mandolin
Banjo or
Drums

Don't buy Guitar, Mandolin, Banjo, or Drums, until you have tried the Slingerland May-Bells, Guaranteed More for your Money. Wonderful snappy, powerful, pleasing tone. No equal in price. Sold on easy payments and 5 days free trial by all leading music dealers.

Cut This Adv. Out — Good for \$1.00 Credit
Send for free catalog. Mention instrument wanted.

Address: Slingerland Musical Instrument Mfg. Co.,
1325 Belden Ave., Chicago, Ill.

Earn Cash! **HAVE FUN** With NEW **COMPLETE** **5-FIGURE** Casting **Outfit!**

Foundry Quality Casting Set

\$1.25 POST PAID

Yes, this big complete 5-figure Soldier Casting Outfit No. A-25 only \$1.25 postpaid in U.S.A.! Learn a trade, earn money casting metal toys with amazing new HOME FOUNDRY SETS! Chance for BIG PROFITS, fun too. Ideal for Xmas Gifts! (Show this to your folks.) Marine "Soldier Band" 5-Figure Set No. A-31 only \$1.25 prepaid. At your Dealer or order from us. Hurry!

ELECTRIC SETS **ONLY \$2.95**

Wonderful new electric sets, complete with paints, moulds, electric ladle, metal etc., only \$2.95 plus 30c postage EACH: Machine Gunners, D-21 . . . Fightin' Yanks, D-22 (Cavalry, Soldiers) . . . Pawnee Bill, D-29 (cowboy group) . . . Hiawatha, D-25 (Indian Group) . . . **Get yours quick!** Also, receive large-size Home Foundry Moulds, 95c postpaid. **ANNOUNCING!** — **Mickey Mouse**, Minnie, Pluto the Pup, Donald Duck, 3 Little Pigs — Walt Disney's world-famous characters! Catalog FREE with order, or rush 3c stamp. Orders shipped same day received!

Write NOW! **HOME FOUNDRY MFG. CO. INC.**
2933 MADISON ST. DEPT. 13-59 CHICAGO ILL.

FREE CATALOGUE WITH ORDER OR SEND 3c STAMP

FREE! Beautiful New 40-Page Rotogravure Radio Catalog

P. A. Equipment, Short Wave Radios, Transmitters, Latest type Instruments and a complete line of parts and accessories for Amateurs, Experimenters, Service Men. Terms as low as 34 a month.

SEND POSTCARD for this fully illustrated money-saving catalog today!

MONTGOMERY WARD
Dept. EM, Chicago

Sell Improved Leather Ties

Fuller, smarter ready-knot. Patterns richly embossed like silk weave. Wrinkle-free; long wear; wipes clean with damp cloth. Quick, steady profits. Send only 50c for sample tie (65c value) and Free Selling Kit of new season's most popular colors and patterns; also Sales Lists. Money back.

NU-MODE TIE CO.
Dept. 20, 1333 N. 12th St., Milwaukee, Wis.

Information on any book free. Write Popular Mechanics Press, Chicago, Ill.

Check Equipment you Need

- Hi-Pressure Car Washer
- Electrical Test Bench
- Automotive Paint-Spray
- Automotive Air Service
- 8-Hour Battery Charger
- "Simplified" Arc Welder

HI-PRESSURE CAR WASHER
Only \$12 Monthly

AUTOMATIC AIR SERVICE
Only \$10 Monthly

INVESTIGATE these Profit Makers

Let us prove to you that Hobart automotive equipment will earn \$150 to \$300 profit each month—will "Pay-for-Itself." Equip with Hobart and watch your profits increase. We know that one job leads to another if you can produce quality work at no extra expense to the customer. Hobart lets you do this. Our 30 Days' Trial lets you prove that you can pay for Hobart out of extra profits. Write for details—no obligation.

HOBART BROS., Box M-125, TROY, OHIO

9" x 30" — 36" — 48" PRECISION METAL LATHE

Precision heavy-duty professional equipment has finally been brought within the price-range of the small shop by "AMERICAN" engineers. Lathe guaranteed accurate within .001"; hollow spindle, lever-action tail-spindle, bushed bearings; hand-feed entire length of bed; bed ground and polished steel; attachments of all types for all trades available at correspondingly low prices. Extras include tail-stock drill-chuck \$1.25; 8" face-plate \$2.75; toolholder \$1; countershaft \$6.75; 30" overall length; for 36" length add \$1.50, for 48", add \$3.50. **ATTACHMENTS FOR GEARED AUTOMATIC REVERSIBLE POWER FEED .003" per rev. and gears for cutting 12, 13, 24, 26, 48, 52 and other threads, \$9.85. Additional GEAR-TRAIN to cut ALL threads 7 to 84, \$5.20. Send 25%, shipped COD for balance, FOB N. Y., Wt., 80 lbs.**

\$14.95

SEND 10c for 24-page CATALOG of other accessories and entire line of sensation-ally low-priced power tools and 72 "WORKSHOP PROJECTS AND PLANS."

PARTS FOR AUTO-FEED AND SCREW CUTTING \$9.85

AMERICAN POWER TOOL CORP., 80-P-4th Ave., New York, N. Y.

**THIS
FREE
BOOK**

Yours For the Asking

Contains Complete Descriptions and Clear Explanations of All the Latest Developments In

PHOTOGRAPHY

Tells how to make good pictures under all conditions. Includes an exposure table for indoor and outdoor use, and lists hundreds of outstanding bargains in new and used cameras. Trade in your used cameras. We will pay you good prices for them.



HOME MOVIES

Describes the rapid strides made in this field which now make it easily possible for the amateur to take pictures equally as good as the professional movies. Lists every reliable type of movie camera, both new and used, at a price that will save you money on every purchase.



MICROSCOPES and TELESCOPES

Shows you how to explore the wonders of the microscopic world. Contains a full line of microscopes and lists telescopes, binoculars and field glasses for every need, together with valuable information on the subject.



WEATHER INSTRUMENTS

Tells how to make your own weather forecasts. Lists and explains the uses of Barometers, Humidimeters, Thermometers, Storm-guides, Compasses, etc.



WIN \$2500 IN FREE SNAPSHOT CONTEST

Fully described in our new Bargain Book. Your copy is ready. Send for it today. Get in one or more entries for this great amateur photographic contest. It doesn't cost you a penny to try. You have as good a chance as anyone to win the grand prize or one of the many smaller prizes. Write, or mail the coupon Now.

MAIL THIS MONEY-SAVING COUPON NOW

Central Camera Co.,
Dept. K-12, 230 So. Wabash Ave., Chicago
Please send me FREE copy of your Book of Bargains:

Name

St. or R. F. D.

City State

CENTRAL CAMERA CO.

Photographic Headquarters Since 1899

Dept. K-12, 230 S. Wabash Ave., Chicago, Ill.

MODERN RADIO SERVICING

by GHIRADI & FREED



JUST RELEASED! Greatest book ever published on the art of Radio Servicing. Hundreds of practical facts on the most up-to-date methods of radio servicing—construction and operation of all kinds of 1935 radio test equipment; servicing of all forms of receivers; auto radio, all wave, high-fidelity, locating and eliminating noise and interference; special servicing problems; construction and use of new Cathode Ray Oscillographs for aligning superhets, thorough explanation of AVC and QAVC circuits; tested advertising and merchandising tips on getting more money out of your business, etc.—everything practical, hundreds of pages full of tips you can put to use today. Written in clear, simple style—profusely illustrated with over 700 diagrams, photographs, charts, etc.

1300 pages—cloth. PRICE.....\$4.15 Postpaid

FIELD SERVICE DATA and ANSWER BOOK Supplement to MODERN RADIO SERVICING by GHIRADI & FREED

A handy reference data book, with flexible binding, for service men to keep in their tool kits. Contains invaluable servicing data, such as—listing of intermediate frequencies of all superhets; comprehensive Trouble Shooting Table of Symptoms and Remedies for troubles in over 500 models of broadcast and all-wave receivers; remedies for ignition interference in various makes of cars, with electrical diagrams of all cars; complete tube charts; wire tables; RMA Color Codes; and many other useful charts, diagrams and tables.

PRICE.....\$1.60 Postpaid
SPECIAL OFFER: Supplement Book in combination with MODERN RADIO SERVICING—\$5.25 Postpaid.

POCKET TROUBLE SHOOTER "GADGET" by GHIRARDI & FREED

Here is an ingenious "gadget" that is one of the cleverest little servicing helps you ever saw. Consists of a series of 6 cards eyeleted at one corner and indexed at the edges. According to the trouble symptom detected by the service man, the "gadget" lists according to source, 275 possible troubles that may occur in a receiver. Six general types of symptoms are shown—Hum; Weak; Noisy; Inoperative (no signals); Intermittent Reception; Fading; Oscillation and Distortion.

PRICE.....30c Postpaid
Sent by mail C. O. D. in U. S. if preferred or anywhere upon receipt of price
Popular Mechanics Press, Room P12, 200 E. Ontario St., Chicago, Ill.



BUILD IT YOURSELF



10" x 2 3/4"

Gadmlum plated steel wheel with adjustable ball bearings.

Build your own bicycle trailer, wheelbarrow, scooter or coaster wagon with Musselman Doenut cord airplane type tires and wheels. We furnish the drawings. Haul heavier loads and with less than half the effort, on as low as 10 lbs. air pressure. Musselman Doenut tires fold right over big bumps so there is no jolting the load. Will not damage lawn grass or pack soil in gardens or flower beds. This amazing little Doenut cord tire carries a load of 200 lbs. per wheel. Think of it! And rolls along twice as easy, too. Send 15c for blueprint drawing of any vehicle, or 50c for all four.



The Musselman Products Co., 6247 St. Clair Ave., Cleveland, Ohio.
I am enclosing cents in postage for drawing of
..... Send wheel and parts catalog with drawings.
NAME.....
CITY.....STATE.....

When writing to advertisers please mention Popular Mechanics



Surprise your Friends with the Mysteries of Chemistry

CHEMICAL experimenting is great fun. You can mystify your friends with magic chemical tricks, produce your own chemical compounds like soap, ink and paint, test and analyze food, water, soil, metals and other things and make hundreds of startling changes and reactions that will give you and your friends endless entertainment. Chemical experimenting will also help you lead your class in science and chemistry. It's the most fascinating thing you ever did, and it's made easy and interesting for you in

REGISTERED TRADE MARK

CHEMCRAFT

CHEMISTRY OUTFITS



A CHEMCRAFT Chemistry Outfit will give you more fun and reliable information because these Outfits cover every branch of chemical research and are scientifically correct. Each Outfit is a complete Laboratory containing a liberal assortment of chemicals, all necessary apparatus and a Manual of Instruction. These are the original Chemistry Outfits and give the most for the money in every way; more and better experiments, superior chemicals and apparatus not usually found in sets for experimenters; endorsed by teachers and professors and used in schools and colleges. They bring professional chemistry to home experimenters!

Get a CHEMCRAFT Outfit this year and learn the wonders of modern Chemistry! There are nine different Outfits to choose from, as follows:—

- | | | |
|----------------|----------------|----------------|
| No. 1 —\$1.00 | No. 3½ —\$3.50 | No. 10—\$10.00 |
| No. 1½ — 1.50 | No. 5 — 5.00 | No. 15— 15.00 |
| No. 2 — 2.00 | No. 7½ — 7.50 | No. 25— 25.00 |
| (Wood Cabinet) | (Table Model) | (Lab. Cabinet) |

Ask for CHEMCRAFT Chemistry Outfits by name in any store where Scientific Sets are sold; if unobtainable, we will send your Outfit, fully prepaid, upon receipt of price.

Free

Big Science Surprise Package

containing chemical experiments for you to try, also full information about CHEMCRAFT and "Science-Craft" Outfits. Please send 3c stamp for postage.

The PORTER CHEMICAL COMPANY

4412 Prospect Avenue

Hagerstown, Maryland



They Said I Couldn't Do It. But Here It Is
my 1935 OFFER
WEAR A WATCH OR DIAMOND

30 Days FREE!
then Make Your Own Terms



My confidence in YOU; my confidence in my standard, dependable watches and beautiful genuine diamonds, and my confidence in business conditions cause me to make this unheard of offer. I am going to place as many watches and diamonds in the hands of men and women throughout the land as possible in 1935 NO MATTER WHAT THE SACRIFICE, because each watch and diamond will act as a salesman to sell another.

Direct-to-You, Rock Bottom Prices on Nationally Advertised Watches, Diamond Rings and Silverware

What an offer! Nationally advertised watches, diamonds and silverware offered at lowest direct-to-you prices. For nearly a half century we have sold highest quality jewelry all over the world. And now this remarkable offer.

Send for Beautiful FREE CATALOG

Write now—before this offer is withdrawn and get the beautiful FREE Catalog. Select the watch or diamond you want, wear it, examine it, and then write us the terms you desire.

SANTA FE WATCH COMPANY
 C6 Thomas Bldg., Topeka, Kan.
 We Buy OLD GOLD and STERLING SILVER



MAKE MONEY PRINTING

letter and billheads, circulars, cards for friends, spare time. Easy to learn, easy to get jobs. **Printing Presses \$12**; new type faces, complete supplies, lowest prices. Send stamp for catalog. PEIFFER CO., 58-A; 6 Columbia St., Newark, N. J.



MAN IN EACH TOWN To Plate auto parts

reflectors, mirrors, etc., by new method; no capital or experience required. Outfits furnished. Free particulars. Write Today!
GUNMETAL CO., Ave. M, Decatur, Ill.

Make Money at Home!

GROW MUSHROOMS in your cellar or shed. Exclusive new process. Bigger, better, quicker crops. More money for you! Enormous new demand. We buy Mushrooms. Write for Free Book.
American Mushroom Industries Ltd., Dept. 474, Toronto, Ont.

300 POWER FREE! U.S.A. MICROSCOPE

What a Bargain! Guaranteed 300 Power Microscope only \$2.98. Ideal for student and laboratory use. 300X objective is more than sufficient for examining live animalcules (paramecium, rotifers, blepharisma, etc.), and other minute objects. All magnified 300 times to permit accurate observation. Adjustable to 125X for examining stamps, coins, etc. Substantial construction throughout, easy focusing, adjustable removable mirror, fine optical system.

SPECIAL LIMITED OFFER!

Order now! Receive a free powerful dissecting magnifier pictured, 12 plain slides, 12 cover glasses, 12 slide labels, forceps, needles, 2 test tubes, book of lens tissue, collection jar, sealing liquid, authoritative 12 page instruction book, and 3 vials of specimens for observation and mounting. **ACT QUICK!** Only \$2.98, postage free for all including 300 power microscope and handy cabinet case. Send money order or pay postman plus postage. Money back if not satisfied.

J. H. Winn Mfg. Co., Dept. 412, 124 W. 23d St., New York

Simple Curtain Stretcher Is Easy to Assemble



This Stretcher Will Be Found a Time Saver When Curtains Have to Be Stretched Lengthwise Only

Where a curtain is to be stretched lengthwise, this stretcher will do the job nicely. The curtain is stretched between two iron or brass rods, which have eyes on the ends to fit screw hooks, the latter being driven into the inside surfaces of the stretcher frame. This consists of two lengths of hardwood, which may be fitted with feet at the lower ends, the frame being supported by leaning it against the house or other building.

Quick Method of Removing Transmissions on Chevrolet Cars

Instead of dropping the brake cross shaft to remove the transmission on a Chevrolet car, when the flywheel is to be replaced, raise the propeller-shaft housing with a jack until the universal joint hits the front body cross sill. Then remove the drive gear of the speedometer and pull the transmission case back as far as possible. With a long screwdriver, pry back the throw-out bearing sleeve of the clutch, which will allow the transmission to be dropped down. When replacing the transmission, slip the clutch and throw-out bearing sleeve on its splined shaft. In this way, you can replace a flywheel in approximately two hours.

MAN. LOOK AT THESE PRICES ON GENUINE BLACK & DECKER ELECTRIC DRILLS



1/2 JUNIOR DRILL \$19.50



THE NEW 1/2" JUNIOR (above): Drives twist drills for drilling up to 1/2" holes in steel; augers for drilling up to 1 1/4" holes in wood. Also drives hole saws for cutting clean, round holes, from 3/4" to 3 1/2" diameter in wood, metal or composition. A husky, he-man tool that will make quick work of so many tough jobs you'll wonder how you ever got along without it. Universal motor. Real Black & Decker quality. A really great drill at a really small price.

THE NEW 1/4" JUNIOR: Drives twist drills for drilling up to 1/4" holes in metal; augers for drilling up to 1 1/2" holes in wood. Also drives wheels for light grinding, buffing, wire brushing, polishing, etc. A practical, handy tool that will make short work of a thousand-and-one odd jobs around the shop, home or garage. Universal motor. Dependable Black & Decker construction throughout. A great buy at its sensationally low price.

Mail the coupon today for the name of the nearest dealer where you can see the new Junior Drills—and for a free copy of our complete new catalog. There are more new low-priced Black & Decker Electric Tools that you'll want to know about.

MAIL TODAY FOR FREE CATALOG

The Black & Decker Mfg. Co.,
611 Pennsylvania Ave., Towson, Md.

Please send me your **FREE** Electric Tool Catalog, and the address of my nearest B. & D. dealer.

Name

Occupation

Address

City State

Amazing NEW INVENTION CONTROLS YOUR GENERATOR



*from
the Dash*

CHANGES Generator's CHARGING RATE UP OR DOWN *For Any Driving Speed* AS DESIRED

A simple new patented invention now makes it easy and inexpensive for any motorist to set his generator at the desired charging rate for any driving speed, country or city, by simply turning a knob on the dash.

NO MORE RUN DOWN BATTERIES

If Your Car Is Radio Equipped, Assures Quick Starting in Zero Weather With Finger Tip Generator Control you can increase the charging rate of your generator when radio is in operation, to take care of excessive drain on battery. Or, you can reduce charging rate when making long high speed trips, which protects your generator, prevents boiling of battery and buckling of plates. Easily adaptable to various driving conditions. Controls charging rate from one to twenty amperes—just watch your ammeter.

FITS ALL CARS In just a few minutes can be installed on generator of any car, truck or tractor, by anyone with our simple, easy instructions. Only two holes and two connections necessary.

SENT ON TRIAL TRY AT OUR RISK 20 DAYS

See for yourself exactly what it will do for you in saving time, trouble and money. Retail for only \$2.00—little more than a spark plug. If you don't say that it is worth more than ten times its small cost after 20 days test, the trial costs you nothing. We pay postage if money accompanies order — will ship C. O. D. plus charges. Or, write quick and get full explanatory circular.

BERTRAM ELECTRIC COMPANY
P-751-1716 Grand, Kansas City, Mo.

WANTED—Salesmen and Distributors

Big profits taking care of local business to auto dealers, service stations or direct to auto owners. No car owner can afford to be without it. Good territory still open. Get details, quick.

Kleerview Defroster, Foot-Warmer

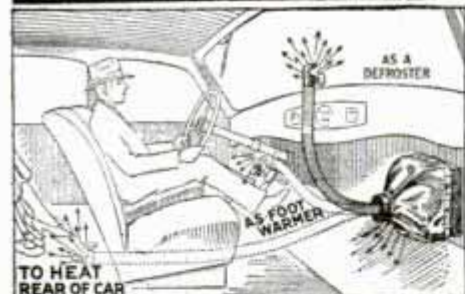

Snaps Over Any Hot Water Heater in 10 Seconds!

Clears windshield, inside and out, in severest weather, without cracking glass. Makes winter-driving safe. No Battery Current to operate. Special hood attaches to any hot water heater instantly. Flexible hose reaches to windshield — or makes perfect Foot-Warmer, reaching to driver's feet or rear-seat floor. Nothing to wear out. Guaranteed. Thousands of users.

Now Only \$2.00 If your local accessories stores cannot supply you—send \$2 direct. Mailed, prepaid, anywhere in the U.S.A. Makes an ideal Xmas gift! Get Yours NOW!

DEALERS: See your jobber salesman!

SAFETY EQUIPMENT MFG. CO., 305 Natl. Bldg., OMAHA, NEBR.

SOFT WATER

Saves Average Home \$100 a Year

Soft water is ideal for every home use—baths, shampoos, shaving, cooking, washing dishes, clothes. Makes marvelous coffee. Keeps auto radiators and hot water boilers free of scale. Cleans beer coils. Quickly pays for itself—saves 50% of soap. By U. S. Gov't figures soft water saves average family of 4 over \$100 a year.

MASTER Portable \$14.50 WATER SOFTENER and Up

attaches to any faucet—softens water as it runs. (See Nov. Popular Mechanics, p. 693.) Handsome, fool-proof, lasts years. An ideal Christmas gift for any home. Portable and installed types. Junior Drain-board size, \$14.50 postpaid, or \$3.50 with order, balance C. O. D. 10-day trial, satisfaction guaranteed. Free circular on request.

MASTER WATER SOFTENER, Inc.
710 Pence Bldg., Minneapolis, Minn.
Salesmen, Agents: Certain territories open. Write us.



Amazing New Patented BATTERY FILLER!



MAKES BATTERIES LAST 3 TO 5 TIMES LONGER!
No floor-boards to move, no seats to lift, no caps to unscrew, no corrosion to dig through. FILQUIK—amazing new patented invention fills all three cells to proper level at same time—FROM UNDER THE HOOD! For cars, trucks, taxis. Costs only \$2.00 complete—postpaid. Saves ten times its cost every year. Easy to install. Guaranteed. Send \$2.00 each or money order. Mention make of battery.

FILQUIK BATTERY FILLER, 1410 Ingalls Bldg., Cincinnati, O.

ANY PHOTO ENLARGED

Size 3x10 inches or smaller if desired. Same price for full length or bust form, groups, landscapes, pet animals, etc., or enlargements of any part of group picture. Safe return of original photo guaranteed.

47c



SEND NO MONEY Just mail photo of snapshot (any size) and within a week you will receive your beautiful life-like enlargement, guaranteed fadeless. Pay postman 47c plus postage—or send 40c with order and we pay postage. Big 16x20-inch enlargement sent C. O. D. 78c plus postage or send 80c and we pay postage. Take advantage of this amazing offer now. Send your photos today. Specify size wanted.

STANDARD ART STUDIOS, 104 S. Jefferson St. Dept. 365-W, Chicago

PHOTO ENLARGEMENTS



Is Photography your hobby? Do you want a profitable easy business at home? Make PHOTO ENLARGEMENTS for yourself and others. Your cost 5c each and less. The Ideal Photo Enlarger is AUTOMATIC. No experience required. Also COPIES any picture. \$5.94 COMPLETE delivered. Interesting circular free.

IDEAL PHOTO ENLARGER CO.
124 East 25th Street, New York City

5¢ ANY SIZE

TENNIS STRINGS

GENUINE SPLIT LAMB CUT at NEW LOW PRICES!



Special Offer for Limited Time Only—Set of genuine, Factory-Fresh, Wills ARISTOCRAT split lamb gut only \$3.50 postpaid, regular price, \$5.00. Act now—Save \$1.50—Order! Specify colors: Plain Orange, Green, White . . . Spiral: Gold-Black, White-Blue, Big Burgoin. We also make cheaper grades of gut, Silk Strings. Write for FREE tennis Equipment Catalog.

H.E. WILLS CO., 1047 W. 47th St., Dept. 13-59, Chicago

NORMANDIE — Scale 32 1/2" model 1/32" to the foot.

New patented hull design.

Shaped hull and over 100 metal fittings — over 1000 portholes—60 metal davits—30 life boats—16 winches—24 cast metal stairways. Comes complete with all the beautiful, original high luster colors, cement, full size plan, turned wood parts, printed wood—printed fiber patterns. Postpaid . \$7.00. Also send for catalogue of model planes and boats 5c.

IDEAL CO., 26 W. 19th, New York City

Trailers, Plans and Parts



Utility Trailers, 4' x 6', complete less tires, \$27.50. Utility trailer plans, 50c. Cabin trailer plans, \$1. Trailer parts at bargain prices. Write for free catalog of parts.

SHAMROCK TRAILERS, 11761 Grand River, Detroit, Mich.

AIR PISTOLS & RIFLES BIG SPECIALS FOR XMAS

- Mauser Air Pistol; 100 shot Repr.; 500 steel BB's free \$4.75
 - Koenig Air Pistol; single shot; 200 BB's, darts, etc., free 2.00
 - Mauser Mod. 26-hi-power, single shot; 500 .177 pellets free 6.95
 - Benjamin Air Pistol, single shot; 177 & 22; 500 pellets free 7.50
 - Benjamin Air Rifle; single . . . \$6.00 . . . Repeater (500 shot free) 4.95
 - Mauser Air Rifle Mod. XV; powerful, no pumping; 500 shot free 7.45
 - Mauser Mod. 40 Rifle; very powerful; 500—177 pellets free 7.50
 - Benjamin Air Rifle; 22 cal. Single . . . \$5.95; Repeater 25 shot 10.95
 - Best Target Box, with targets . . . 60c; Clown Iron Target 2.50
 - Pellets: 177 . . . 60c; 22 . . . 90c; BB Steel Shot . . . 50c per 500. Darts 177 25c; 22 cal. 40c per doz. Throwing Darts . . \$1.00 per doz.
 - Microscope Outfits: Very complete, nicely boxed and guaranteed: American made—125X \$1.95; 325X \$3.45; 500X \$5.45
- 22 Deposit on COD's **LEE SALES CO.** (Dept. W) 35 West 32nd St., N. Y. City

When writing please mention Popular Mechanics

Address Dept. **LOFTIS** 30 No. State St., Chicago, Ill.
G-894 **BROS. & CO.** 1838

DIAMONDS WATCHES

Genuine Diamonds Guaranteed
CASH OR CREDIT
TERMS AS LOW AS 50¢ A WEEK

The Old Reliable Credit Jewellers "Diamonds Win Hearts"

No. 46 \$15 50¢ a Wk.	No. 46 \$37.50 \$1 a Wk.	No. 51 \$67.50 \$1.75 a Wk.	No. 47 \$175 \$4.25 a Wk.
-----------------------------	--------------------------------	-----------------------------------	---------------------------------

Our reputation is your safeguard

DIAMOND WEDDING RINGS AS LOW AS \$12.50

Satisfaction guaranteed or moneyback

We import Diamonds direct from Europe and sell direct to you by mail—this is why Loftis gives you MORE DIAMOND FOR YOUR MONEY. We select every gem for its superior quality, color and brilliancy. Your order will be promptly filled. Pay one-tenth down; balance weekly or monthly. No extra charge for credit. Goods delivered on first payment.

ELGIN WATCH SEND FOR FREE CATALOG

No. 48—Yellow Gold finish, stainless steelback \$18.95, 75 Cents a Week
Our references: Any Bank or Banker in the U. S. A.

BULOVA Watch *New!*
No. 44
"Dolly Madison" lovely natural gold color or white.
\$29.75, \$1.00 a Week

WIND-DRIVEN POWER PLANTS

FOR SUPPLYING ELECTRICITY

You can build them and many other devices described in Shop Notes for 1933. Illustrated. 50 cents, postpaid.
Popular Mechanics Press, 200 E. Ontario Street, Chicago

GO INTO BUSINESS

Make 100% to 300% Profit!

Sell new and used clothing direct from your home, auto or store. Undersell all competition. **EASY SALES—FAST REPEAT ORDERS!** We furnish everything and show you how. Handsome profits every day in the year. No selling experience necessary. Satisfaction guaranteed. Write at once for our Big Money Catalog—It's FREE!

ACME MERCHANDISE COMPANY, 558 Roosevelt Rd., Dept. D-16, Chicago, Ill.

MUSHROOM SPAWN Free

To convince you there is money in mushrooms we will furnish enough spawn FREE to grow up to 10 lbs. of mushrooms. To cover cost of instructions—boxing and mailing send 25¢ coin to NATIONAL MUSHROOMERS ASS'N., Box 208, Park Ridge, Ill.

Metal Cutting Lathe

A PRECISION TOOL

\$3.50 extra for Chuck and 50¢ for Bushing to fit chuck to lathe

ONLY \$7.95 LESS CHUCK

Fastest selling tool in America! Startling value! An exclusive National product. Furnished complete with compound side rest, 4 jawed 3 in. chuck and 4 in. face plate. Accurately turned and machined.

chined. Only \$7.95 (without chuck and bushing) \$3.50 extra for chuck; 50¢ for bushing to fit chuck to lathe. \$11.95 complete with chuck and bushing. Same lathe furnished with 26 in. bed, \$1.00 extra. Shipping weight 30 lbs. Hollow spindle, large oversize bronze bearings. Centers, standard Morse tapers, 21 in. bed, 5 in. swing, 13 in. between centers. A genuine quality tool. Ideal for machine shop or home workshop. **Most amazing Metal Cutting Lathe bargain ever offered.** Send \$2.00 deposit—balance C. O. D. Be wise. Order at once. Sold on Money back guarantee!

National Electric Tool Co., 560 Wash. Blvd., Dept. 3212, Chicago

SAVE UP TO 1/3 FUEL

STOP DRAFTS • DIRT • RATTLES

with **DENNIS** **DOUBLE CUSHION**

ALL METAL WEATHER STRIPS

Easily Installed Without Removing Sash or Doors
You Can Apply It Yourself

PULL OUT OLD PARTING STOP
INSERT DENNIS ONE-PIECE WEATHER-STRIPPED PARTING STOP

Now you can easily install genuine Dennis Double Cushion Spring Bronze Weather Strip for as low as .98¢ per window. Patented "S" fold gives double spring action. Stops cold air leaks. Makes snug, weatherproof seal conforming to all warping, shrinkage and expansion of sash and doors. Lasts forever. Strip, nails and directions come in handy sets. Accept no substitutes. Get the genuine DENNIS strip with the "S" fold from your hardware or lumber dealer. Or, if he can't supply you, we will ship direct, postpaid, with full directions.

Applied to Door

----- CUT AND MAIL SAMPLE OFFER -----

Send.....Sample Window Sets at .98¢ each
Send.....Sample Door Sets at \$1.75 each
I am enclosing check Money Order

Name.....
Address.....
City.....State.....

W. J. DENNIS & CO.
2110-20 WEST LAKE ST. CHICAGO

Information on any book free. Write Popular Mechanics Press, Chicago, Ill.

Your Christmas Gift



The Choice of

Champions

The World's Greatest

CHICAGO FLYING SCOUT

Roller Skates



Get 3 times longer life with TRIPLE-TREAD "TRIPLE-WARE" Wheels. More SPEED with OVERSIZE BEARINGS. Greater skating pleasure and lowest mileage cost Found only in "CHICAGO'S".

Get CLUB PIN and FREE BOOKLET
Free Booklet gives secrets of winning races, games, etc. Write today! If beautiful GOLD f. club pin is wanted enclose 10¢ for mailing.

ORDER TODAY! If dealer doesn't carry "CHICAGO'S" refuse others. Order Direct! We'll ship postpaid on receipt of \$1.95. Give shoe size.
CHICAGO ROLLER SKATE CO.
Roller Skates with Record for over 33 years
4414 W. Lake St. Chicago, Ill.



We're willing to pay you to try
the new "KNEE ACTION"



RYLEY Resilient RAZOR

(patented in U. S. and foreign countries)

The Razor with "Knee Action"

A remarkable thing is happening in shaving history—a brand new idea in razor design is making all your previous experiences obsolete. Most sensational development since the discovery of the safety razor.

Six Brand New Thrills

With the Resilient Razor, (1) you can shave as often and as close as you like—without irritation! (2) Patented "Knee action" permits the razor to automatically follow the contour of the face, chin and lips—without cutting or scraping. (3) The extra long, clean massagelike strokes, impossible with ordinary razors, mean closer shaves, smoother shaves—in less time. (4) Sensitive resilient ball joint action preserves edge keenness—at least tripling blade life—razor soon pays for itself. (5) Adjustable for light or heavy beards. (6) Self cleansing.

One heavy bearded tender faced user states "After using the Resilient, to shave with the ordinary type of razor would be like going back to automobiles with solid tires."

Try it 30 Days—You can't lose

Here's our proposition:—We'll ship you immediately, insured postage paid, one Resilient Razor, grid finish, with 20 special blades which alone retail for \$1.00 and are enough for a year's deluxe shaving—upon receipt of \$2.00 (\$2.50 in Canada) or C.O.D., you paying postage. You're to use the Resilient for 30 days—THEN, if you care to part with it, return it with only 10 blades to us in its original package, and we'll mail you back your \$2.00 (\$2.50 in Canada) without any questions. For your trouble—you keep the 10 other blades, which also can be used in ordinary razors. Don't delay this unusual shaving experience—send today. This offer is good only till February 1, 1930.

Solemen! Exclusive territory available on the Resilient Razor in all parts of the country. No competition. Makes an ideal Christmas gift. Send money today for sample and particulars under this 30 day refund proposal. Act at once.

RAZOR PRODUCTS CORPORATION
417 Citizens Bldg. Cleveland, Ohio

TYPEWRITER ½ Price

Now Only

10¢
a Day

AFTER
10 Day
FREE Trial

No Money Down



Fully
GUARANTEED

Positively the greatest bargain ever offered. A genuine full sized \$100.00 office model Underwood No. 5 for only \$39.90 (cash) or on easy terms. Has up-to-date improvements including standard 4-row keyboard, backspacer, automatic ribbon reverse, shiftlock key, 2-color ribbon, etc. The perfect all purpose typewriter. Completely rebuilt and FULLY GUARANTEED.

Lowest Terms—10 Cents a Day
Money-Back Guarantee

Send coupon for 10 day Trial
—if you decide to keep it pay
only \$3.00 a month until
\$44.90 (term price) is paid.
Limited offer—act at once.

Learn Touch Typewriting

Complete (Home Study)
Course of the Famous Van
Sant Speed Typewriting
System—fully illustrated,
easily learned, given dur-
ing this offer.

INTERNATIONAL TYPEWRITER EXCHANGE

231 West Monroe St., Chicago, Ill., Dept. 1201

Send Underwood No. 5 (F. O. B., Chicago) at once for 10-days trial. If I am not perfectly satisfied I can return it express collect. If I keep it I will pay \$3.00 a month until I have paid \$44.90 (term price) in full.

Name.....Age.....

Address.....

Town.....State.....

New-TYPE Cheap OIL BURNER INVENTED Sweeping the Country!

COOK and HEAT Without Coal
or Wood

In Your Present Stove or Furnace—
HOTTER—CHEAPER—No
Dirt or Ashes—Twice the
Heat Quick at HALF THE COST.

COOKS A MEAL for LESS

Beats any oil burner ever gotten out for low cost, perfect performance. Burns cheap oil a new way, without pre-generating or clogging up. Quick intense heat by Simple Turn of Valve.

Try At Our Risk
30 DAYS' TRIAL

Prove it ends drudgery and dirt of coal or wood; cuts fuel bills in half, pays for itself quickly by what IT SAVES.

FREE SAMPLE
FOR AGENTS

offered to one energetic man or woman in each locality who will demonstrate and take orders. Write quick, be first to learn how to make REAL MONEY right now, spare or full time—mail 1c postcard today.

UNITED FACTORIES, P-751 Factory Bldg., Kansas City, Mo.

AGENTS
Salesmen
BIG MONEY
Drop Everything
for this Quick Seller. Clark of Ind., sold \$3 in 20 days. Get YOUR OWN oil burner FREE and make REAL Money. Write now.



Slips Into
Any STOVE
RANGE or
FURNACE

Quick HEAT at
Turn of Valve!

DEAFNESS IS MISERY



Many people with defective hearing and Head Noises enjoy Conversation, Movies, Church and Radio, because they use Leonard Invisible Ear Drums which resemble Tiny Megaphones fitting in the Ear entirely out of sight. No wires, batteries or head piece. They are inexpensive. Write for booklet and sworn statement of the inventor who wash himself deaf.



A. O. LEONARD, Inc., Suite 699, 70 5th Ave., New York



Catalog No. 35 Illustrating Electrical, Mechanical and Model Makers' Supplies. Small Steam & Gasoline Engines, Motors, Generators, Lathes, Drill Presses, Bench and Band Saws, etc., 16 & 32 Dyna-Motors, School Projects, Engine Castings, Motor Parts, Etc., Books, Blue Prints, Brass and Steel Tubing, Gears, Pulleys, Hangers, Experimental Material.

Big Copy. Mailed anywhere for 20 cents.

25 cents Canada, refunded first order.
LOOMIS ELECTRIC COMPANY
2822 N. California Ave. Chicago, Ill.



RITZY STANDARD
Uses Auto Axle with
Low Mounting Idea.
Size 6x10x12
Get all Materials in
your Home Town.

BUILD A RITZY
CABIN TRAILER
Plans & Specifications by
Registered Prof. Engineer
Save 30% with these plans



RITZY AIR CUTTER
MAIL DOLLAR TO-DAY
for all three Plans to
THE RITZY CABIN TRAILER
Box 200
WAPARONETA, OHIO

NEW DIESEL BOOK

Diesel Handbook by Rosbloom is universally used by Engineers and Schools.

A practical book for the man who depends upon practical information.

The World's Standard Book on Diesel Operation

Get Diesel Handbook, new edition, covering all latest Diesel developments. Treats thoroughly all fundamentals and principles. Question and answer form. Contains Tables, Latest Formulae, Practical Instruction on Diesel Engines of High and Low-speed, Auxiliaries and Accessories for Land, Marine, Locomotive, Automotive, Aero and Portable Services.

A standard book. Strictly authentic. 544 pages. Profusely illustrated. Flexible Cover. Price \$5.00 Postpaid. Sent C. O. D. in U. S. if preferred. Small amount extra for postage charged.

Popular Mechanics Press, Room 1235, 200 E. Ontario St., Chicago

When writing to advertisers please mention Popular Mechanics

TALK-SING-PLAY thru your own radio



BROADCAST your voice on programs coming through your radio set—make announcements from any part of home—infect wise cracks, laugh and mystify friends. "World Mike" made especially for home use, attached in a jiffy. Not a Toy. Also put on own programs at home, parties, club affairs. Barrels of fun! Easy to operate.

PRICE 25c POSTPAID

Johnson Smith & Co.
Dept. 856, Racine, Wis.

CRYSTAL RADIO 25c



This is a radio in itself, as it is possible to get reception with it alone within 25 miles of a station (or up to 100 miles under good conditions). All you need is an aerial & earphone. Completely assembled and wired, with supersensitive crystal, stand, base, crystal cup, arm with cats whisker, etc. Reception guaranteed. Only 25c ppd.

RADIO BOOK

Tells how to make inexpensive crystal sets, electric sets, short wave radios, etc. Get foreign stations, police calls, etc. Only 10c, ppd.



TELEGRAPH SET

A Private Electric Telegraph Set for only 15c! Use it as a practice set or send messages to friends (sending and receiving). Learn the Code easily and quickly. Be an expert operator. Key, sounder, magnet, etc. mounted on wooden base, complete with Western Union blanks, code and instructions, (with-out battery).

ALL FOR 15c



The Boy Electrician 10c

Add 10c for 24 pages about electricity written especially for boys. Tells how to make batteries, dynamo, motors, radio, telegraph apparatus, telephone, lights, electric bell, alarm, coils, electric signals. PRICE 10c ppd.

JU-JITSU DON'T BE BULLIED

The Japanese art of self-defense. New methods of attack and defense are given, illustrated so that you cannot fail to understand them. Deals fully with trips, throws, wrist locks, body holds, defense against reversals, strangling, armlocks, scissors, splits, head lock, holding a man down, double knee throw, stick attack, defense against knife, one hand throat grip, defense against two assailants, stomach throw, secret thumb knockout, nerve pinches, and numerous others. Learn to protect yourself under all circumstances with nature's weapons. Fear no man, guns or knives! "Science of Ju Jitsu" Only 30 cents postpaid.



AUTO SCARE BOMB

The Auto Bomb is attached to the motor of your car, one wire to the spark plug and the other wire to any part of the motor. The instant your "victim" steps on the starter, there is a shrill whistle, followed by a loud bang. The driver thinks his car has exploded. Attached in a few seconds. Does not harm the car. More protection than an insurance policy—catches the thief in the act. Price 15c each, 3 for 40c, \$1.35 per doz. Shipped by Express. Not Prepaid.



Hands Up! Pistol Cigarette Case



It looks like a deadly weapon, but it is merely a novel Cigarette Case. Better than the real thing in many an awkward encounter. Great fun "sticking up" your friends. They squirm and protest. Pull the trigger and the slide flies open, disclosing the cigarettes. **PRICE 25c ppd. Catalog 10c**

DANCING

LATEST STEPS. Be popular. Good dancers are always admired—always popular guests. Partners welcome them eagerly. The newest, smartest steps without a teacher. Don't make excuses when the music starts. Get lots of fun from parties and dances. If you want to become a perfect dancer, learn to dance at home this new, easy way. **BOOK TELLS:** How to develop poise and control, improve your dance steps, art of holding, how to walk to music, how to lead, latest Fox Trot steps, Natural and Reverse Turns, the Reverse Wave, the Quickstep, swaying to music, Waits, Backward Change, the Continental, the famous Kiss dance, the Manhattan, the College Rhumba, the Carlo, Charleston, and many others. **Art of Dancing. Price 25 Cents Postpaid.**



25 Cents

BOYS! BOYS! BOYS! THROW YOUR VOICE

Into a trunk, under the bed or anywhere. Lots of fun fooling teacher, policeman or friends. The **VENTRILO** a little instrument, fits in the mouth out of sight, used with above for Bird Calls, etc. Anyone can use it. Never fails. A 64 page course on Ventriloquism together with the Ventrilo. All for only 10 cents postpaid.



LEARN TO VAMP

Would you like to play the piano or organ without going through the dreary of learning the scales and keys and without tedious practice? The **Vamping Tutor** is a greatly simplified method, which, after a little practice, enables you to play the accompaniment to any tune or song written in any "time" or in any "key." No knowledge of music necessary. Once you have mastered the system, you will be able to play the accompaniment to songs, ballads, waltzes, the latest hits, etc., entirely by ear without any music. **Price 12 cents postpaid.**



BLANK CARTRIDGE PISTOL REVOLVER STYLE



Three models now out, 25c, 50c and \$1.00. Well made and effective. Patterned after latest type of Revolver. Appearance alone will scare a burglar. Takes 22 Cal. Blank Cartridges obtainable everywhere. Great protection against burglars, tramps, dogs. Have it lying around without the danger attached to other revolvers. Fine for 4th of July, New Year's, stage work, starting pistol, etc. Small size 25c. Medium size 50c. Large size \$1.00. Blank cartridges 50c per 100 (cowboy type) 50c. Shipped by Express only, not prepaid.

Our Christmas Special! Electric Train Kit



An Electric Train for 25c! Completely assembled in a few minutes. Train is beautifully illustrated in several colors. Fast, it goes faster than most large trains. Needs no tracks or transformers—a big saving. Runs on dry cells, indoors or outdoors. Get two or three of them—they make snappy Xmas presents. **Price, complete 25c, plus 10c postage and packing.**

ROCKET SHIPS!

Step into the future with a Rocket Ship of your own! Buck Rogers and Flash Gordon use them. Be centuries ahead of anybody in your neighborhood. Several kinds: rocket planes, rocket cars or rocket boats. Complete plans are in book form. Rockets require only about an hour to build from inexpensive materials obtainable at your drugist or chemical supply company. Will go far at high speeds! **Price 10c postpaid.**



HOW TO TAP DANCE

Why envy the easy rhythm and fascinating grace of Step'n Fetchit, Fred Astaire etc. Tap dance in ONLY 6 HOURS by a new, simplified course by Prof. Wilson. No special ability needed. Be smart! Everybody's tapping. The whole town is tapping. Beat out a tune with your feet. Hostesses love it. Friends adore it. Besides, tap dancing is not only invigorating and entertaining but is also health-giving exercise for making the limbs supple and giving a "springy" feeling of fitness to the whole body. Promotes slimmer manner a way, without pills, drugs or dieting. Readers say: "wonderful benefit. Thank you for adding tap dancing to my accomplishments." **PRICE 25 CENTS POSTPAID.**



ELECTRIC EYE 25c

PHOTO-ELECTRIC CELL

DOORS OPEN

BELLS RING

WINDOWS SHUT



The Electric Eye—Photo-cell—is one of the latest scientific discoveries that has many practical uses. A flash of light opens a garage, window, door, turns lights on or off, stops or starts a motor, etc. Used in all television sets. The miracle with a million uses! No experimenter, no inventor (and who isn't?) should be without this latest scientific novelty. Can also be used to amuse and delight people by creating weird effects. Lights go off, doors bang, with a flash of light. **Electric Eye, only 25c postpaid. Supersensitive Electric Eye, better quality, 50 cents postpaid.**

ELECTRIC MOTOR

6000 Revolutions per Minute

ALL PARTS NECESSARY FOR ONLY 10c

RUNS ON NO. 6 DRY BATTERY

5c extra for postage

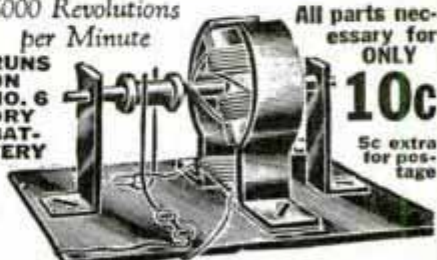

An Electric Motor for 10c. Sounds almost unbelievable but it is perfectly true. We send all the parts packed in a neat box, with full instructions for assembling. No trouble at all putting it together—it is FUN. Takes but a few minutes. And OH BOY! Isn't it speedy! Runs on a No. 6 or similar dry battery. You can learn more about a motor in 30 minutes than by hours of study. Perform many novel and interesting experiments with it. **Price 10c; postage 5c extra.**

LATEST CATALOG

ADDRESS ALL ORDERS FOR GOODS ON THIS PAGE TO JOHNSON SMITH & CO. DEPT. 856, RACINE, WIS.

A copy of our NEW CATALOG mailed on receipt of 10c, or the De-Luxe Edition with cloth binding 25c. Bigger and better than ever. Only books of its kind in existence. Nearly 600 pages of the latest tricks in magic, the newest novelties, puzzles, games, sporting goods, rubber stamps, unusual and interesting books, curiosities in seeds and plants, etc., unobtainable elsewhere. Stamps Accepted.

LATEST CATALOG

JOHNSON SMITH & CO. RACINE, WIS.

new 1936 SOUTH BEND PRECISION MODEL 9" X 3' WORKSHOP LATHE

10 NEW FEATURES, of this back-geared, screw cutting metal working lathe include: Twin Gear Reverse for Right and Left Hand Screw Threads and Automatic Longitudinal Feeds to Carriage; Ball Bearing Thrust Collar on Headstock Spindle; New, Improved Tailstock.

These and 7 other important improvements especially recommend this new 1936 model for auto service shops, electrical and repair shops—home shops and manufacturing plants—for fine accurate work in all kinds of metal and other materials. 38 attachments available.

Greatest Value we have ever offered in a back-geared screw cutting, metal working lathe.

\$75.00 Less Motor Drive
ON EASY TERMS

\$6.50 A MONTH
10 months to Pay

Shown below is New 1936 model 9 1/2" x 3' Workshop Lathe with Horizontal Countershaft, 1/2 h.p. Reversing Motor, Reversing switch and Belting. **\$98.25** Complete as illustrated. **\$7 a month for 11 months**

30 DAY TRIAL: Send down payment and ask for 30 day trial in your shop. Lathe will be shipped immediately. Satisfaction guaranteed or your money back.

An ideal Christmas Gift—this South Bend Workshop Lathe.

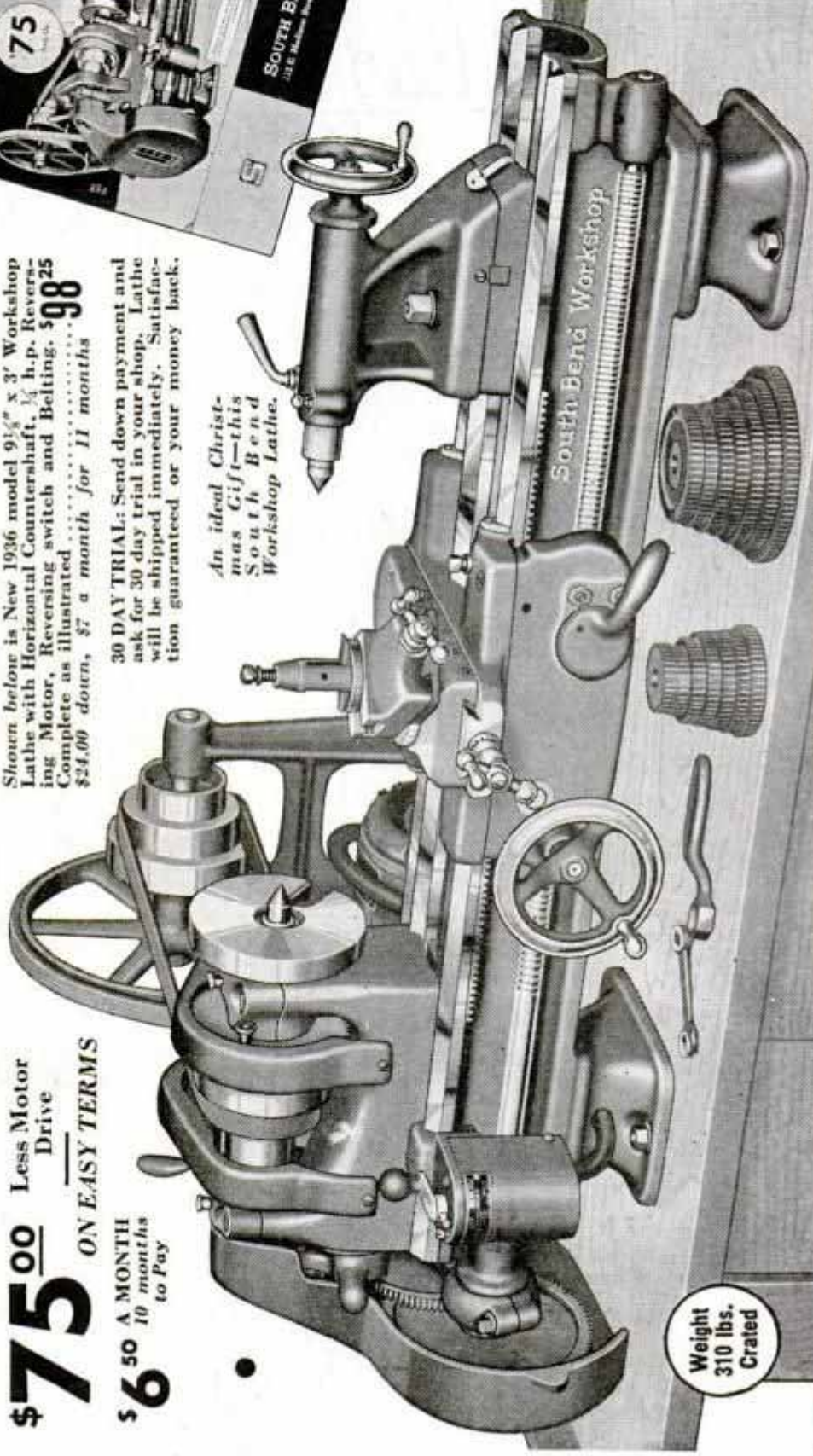

FREE!
32 Page Book

WRITE FOR new 32 page book showing, describing this 1936 model in 8 different drives and 4 bed lengths. Sent Free! ASK FOR CATALOG 15-W

93 other sizes and types of South Bend Back Geared Screw Cutting Lathes from \$87 to \$1500 are shown in Catalog No. 94. Sent free on request.

SOUTH BEND LATHE WORKS •• 612 East Madison St. •• SOUTH BEND, INDIANA, U. S. A.



Hello Boys!

SEE WHAT MIGHTY MECHANICAL MARVELS YOU CAN BUILD WITH

The Great New

ERECTOR

Look at that giant power plant! You build it yourself with the great new Erector. Piece by piece you erect its massive steel frame. Assemble its enormous fly wheel—pistons—governor—mount its big, shining boilers. Then you hook up the powerful Erector electric engine and it throbs with action.

That's only one of the many exciting engineering models you can build with Erector. You can make that marvelous magnetic crane. Click the switch on the Erector Engine—pull the control levers and it raises or lowers—swings to the right or left, just as you command. Its magnet is so strong it grabs up steel girders before it touches them.

You can build *all* of the engineering models shown in the picture—and dozens more—with one Erector set. Enormous draw-bridges that actually open and close. Towering airplane beacon that revolves just like the real ones. All-metal airplane. Dump-trucks. And — with the new Erector Skyscraper Set—you can build skyscrapers as tall as you are. You're a full-fledged engineer when you have an Erector—ready to build realistic, engine-driven models of the world's greatest mechanical marvels. There are more wonders—more exciting hours of fun—packed in an Erector Set than anything you can own.

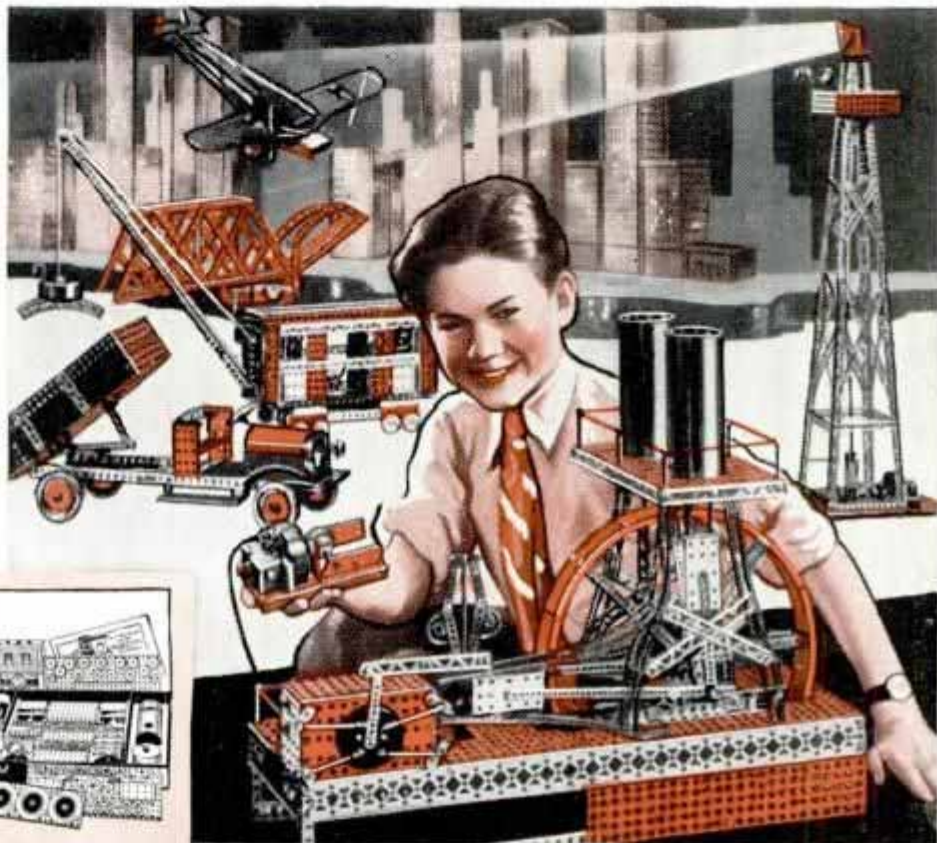

NEW COLORS MORE PARTS Easier Model Building

The Great New Erectors are the finest ever made.

Look at this Sensational No. 7½ Set

Contains new Erector Electric Engine. Girders, structural plates, boiler parts, snap rivets, gears, etc., for building over 150 action models. Only \$10.95. Other sets from \$1.00 to \$25.00.



NEW
Erector Electric Engine. Complete with built-in gears.

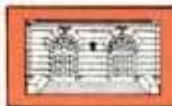

NEW
Skyscraper parts. Builds realistic models of Radio City.



NEW
Big steel base plate and girders—for stronger models.



NEW
Snap rivets for speedy building—nuts and bolts for sturdy building.

See the Gilbert Hall of Science The most stupendous boys' scientific exposition ever created. Look for these exhibits at your local toy store.

FREE—Gilbert Thrills Magazine 32 pages of up-to-the-minute scientific information. True stories of how boys have won fame and big awards building Erector models—and making chemical discoveries. Free—to the first 50,000 boys who mail this coupon.

Mail This Coupon Today

Mr. A. C. Gilbert, The A. C. Gilbert Co.
512 Erector Square, New Haven, Conn.

Please send—free—Gilbert Thrills Magazine combined with big color catalog on the Great New Erector.

Name.....

Street.....

City..... State.....

A.C. Gilbert



Ferris Wheel
Built with
No. 7½ Set
Operated with
the new Erector
Electric Engine.

Welding

... the best way to make a perfect union of two pieces of metal is by welding them together.

... and the best way to make a good cigarette is to WELD together the right quantity of different types of mild, ripe tobaccos



... that is just what we do in making Chesterfield Cigarettes. The three types of home-grown tobaccos (Bright, Burley and Maryland) are welded together. That is, the qualities of each of the three kinds are made into one kind.

Then these three tobaccos which have been welded together are welded with aromatic Turkish tobacco.

Mixing tobaccos is one thing; blending is another thing—but in order to get the best flavor and aroma, the tobaccos should be welded together.

Chesterfield ... *the cigarette that's Milder*
Chesterfield ... *the cigarette that TASTES BETTER*

