

PICTURES FROM INVISIBLE LIGHT

POPULAR MECHANICS

MAGAZINE

WRITTEN SO YOU CAN UNDERSTAND IT

REG. U.S. PAT. OFF.

NOV.
25 CENTS



SEE PAGE 702

Detecting .000000000000000000000001 of an Ampere!

AND OUT OF THE
"HOUSE OF MAGIC"
CAME A
NEW RADIO MIRACLE

Travel to distant countries on these "magic carpets"... priced as low as \$34.50.



Model A-87—Eight-tube, 4-band superheterodyne, completely equipped with metal tubes. Walnut cabinet of neo-classic design.



TRAPPING AN ATOM... in the General Electric "House of Magic." Just one of the many strange quests, conducted by G-E scientists, in the search for new and valuable knowledge. Here, too, elusive sounds are captured and measured—sounds that neither human voice nor musical instrument can produce. And the secrets thus disclosed were used in the making of a finer, more sensitive speaker that distinguishes the 1936 General Electric Radio.

You can always tell a thoroughbred by its pedigree.

And the new 1936 General Electric Radio was sired and developed in the "House of Magic"... created by that amazing group of scientists who have tapped the distant stars for energy, put the mighty forces of Nature at the bidding of man.

Naturally, you expect much from a radio with such a background—and the new G-E receiver will not disappoint you. In it you'll find:

*New metal tubes** that have silenced forever the annoying crackle caused by shielding cans... subdued the microphonic twang that clouds reception.

The new Stabilized Speaker... supremely sensitive... reproducing speech and music with all their naturalness and rich tonal color.

The new G-E Permaliner which maintains the original alignment of the radio... keeps the set always at "concert pitch."

The G-E Sentry Box... controlling as many as five separate broadcasting bands... a thousand and one radio waves.

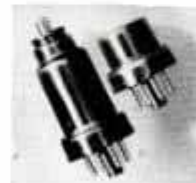
G-E Sliding-Rule Tuning Scale... shows only one tuning band at a time... lists all stations in line...

as easy to read as a ruler.

You can't help but get a thrill from this "House of Magic" radio the first time you hear it. And that thrill is going to last—for this receiver has a brilliance of performance that the years cannot dim.

Now on display at your nearest G-E Radio Dealer's. In table models and consoles—priced as low as \$34.50. (Prices slightly higher in the West, Mid-West and South, and subject to change without notice.)

**Metal radio tubes, invented and perfected by General Electric, are made for General Electric by the RCA Mfg. Co. Complete receivers manufactured by General Electric at Bridgeport, Conn.*



The new 1936 GENERAL  ELECTRIC RADIO

FORD BATTERIES

HAVE TO BE GOOD

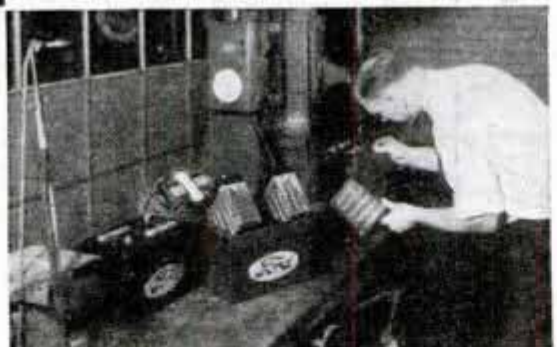
Battery capacities are accurately measured by these sensitive electric meters. Specific gravity and temperature readings are taken for each test.



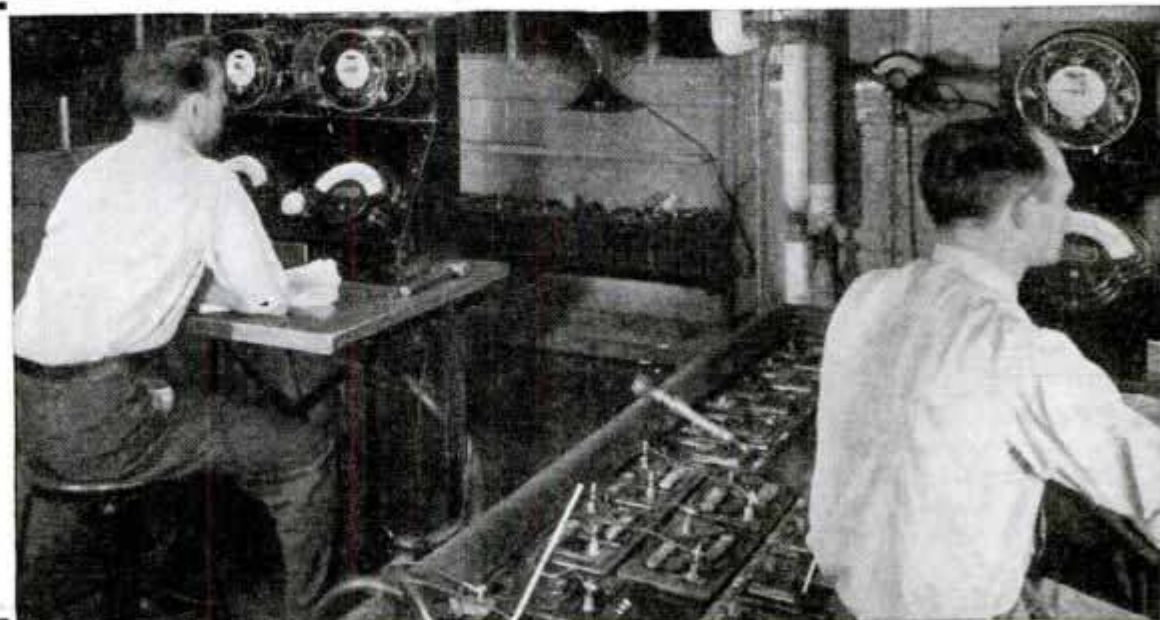
For cold tests the batteries are placed in special refrigerators where below-zero temperatures create conditions encountered in winter driving.



After testing, batteries are torn down for careful internal inspection to determine the condition of plates, separators, electrolyte, cell covers and container.



The Ford Battery Laboratory is equipped with every scientific device for determining quality. Batteries undergoing normal discharge test are in tank which automatically maintains battery electrolyte at constant temperature.



Testing laboratories throughout the Ford plant safeguard Ford quality. Battery testing is a typical example.

The battery laboratory is continually testing production batteries to see that they always measure up to specifications. A Battery has to be good to retain 85% of its original efficiency after 45 discharges and 45 recharges with 100% overcharge each time. Ford batteries meet this test.

In the constant overcharge test, fully charged batteries receive a 10-ampere charge continuously, day and night for thirty days. This approximates a 2000-mile non-stop run at 25 miles per hour without once using the horn, lights or starter.

The reason Ford batteries can meet these and other severe tests is that there is no skimping on plate area, plate thickness or quality of materials. When your battery needs replacing it will pay you to get a Genuine Ford Battery.



FORD MOTOR COMPANY

DEARBORN, MICHIGAN

Just where you want it—enjoy
"DIRECTED HEAT"



Diagram shows burner, patented shutters and removable fuel tank

Open the HEAT-DIRECTOR'S patented adjustable shutters to direct heat rays at any angle

All stove-heated homes, stores and offices can now have modern oil heating. The Superfex Heat-Director combines circulating and radiating methods and directs the heat rays. The heat-directing shutters may be opened on one, two or three sides, sending radiant heat at any angle.

As many as 42 hours on one filling

Heat-Director gives clean heat that can be increased or decreased instantly by a turn of the dial. The fuel used is No. 1 fuel oil, distillate or kerosene. The removable fuel tank holds enough for as many as forty-two hours. With the Heat-Director, you can get up in the morning to a comfortably warm house.

Heat-Director is connected with a flue, like a stove. Draft regulation is automatic. Superfex Heat-Directors are finished in porcelain enamel in burl walnut design. There are three sizes, also several radiating models.

For one-room chilly spots, see the smart modern designs in portable Perfection Room Heaters

The mark of quality

SUPERFEX
Oil Burning **HEATERS**
 PRODUCT OF PERFECTION STOVE CO.

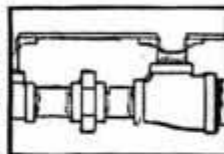
PERFECTION STOVE CO. • 7653-B Platt Ave. • Cleveland, Ohio

- Please send free booklet about the new Superfex Heat-Director.
- Also folder showing Modern Perfection Room Heater.

Name _____
 St. or R. F. D. _____
 Post Office _____ State _____

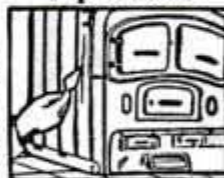
To STOP LEAKS of water, steam, gas or oil from PIPES, BOILERS, TANKS

Smooth-On No. 1 judiciously applied at cracks, leaky seams, pipe threads and flanges, seals steam, water, gas, oil, or smoke leaks quickly and permanently.



Pipe Leaks

Householders find hundreds of uses, such as making stripped screw bolt and nut threads hold, tightening loose hooks, locks, hinges, bath room fixtures, handles, casters, mending leaky pots, pans, stove ovens, etc. Excellent for stopping leaks in auto radiators, cracked water jackets, leaky seams in gas tanks, tightening loose hub caps, exhaust pipe and heater connections, lamp and tire braces, etc. A Smooth-On repair holds on any metal and is proof against pressure, heat and vibration.



Boiler Leaks



Radiator Leaks

Keep Smooth-On handy and follow the directions in our free book. Expansion of the Smooth-On in hardening will do the rest. The



Fire Pot Leaks

Smooth-On Booklet shows repairs that any home owner can make with big savings, and with perfect results.

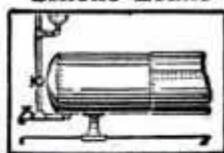


Smoke Leaks



Write for FREE BOOK

Return the coupon for this booklet, and get Smooth-On No. 1 in 7-oz., 1-lb. or 5-lb. can from any hardware store.



Tank Leaks



Furnace Gas Leaks

Do it with **SMOOTH-ON**

SMOOTH-ON MFG. CO., Dept. 37, 574 Communipaw Ave., Jersey City, N. J.

Please send the free Smooth-On Repair Book.

Name.....
 Address.....
 11-35.....

Popular Mechanics Magazine

H. H. WINDSOR, Founder

H. H. WINDSOR, Jr., Editor and Publisher

November, 1935

Vol. 64, No. 5

Special Features

Heroes of the Hurricane Watch	641
<u>Sir Malcolm Campbell's Own Story</u>	<u>645</u>
War Sentinels of the Pacific	Coloroto
Pictures from Invisible Light	660
<u>Hunting Dogs</u>	<u>668</u>
Wings over the British Empire	674
Ready for the Race	682
<u>"Speaking of Card Tricks"</u>	<u>690</u>
<u>Fancy Billiard Shots</u>	<u>696</u>
Hunting Air Phantoms	706
<u>The World in Hollywood</u>	<u>712</u>
<u>Tuning Up a Streamliner</u>	<u>718</u>
<u>Skippers of the Sky Lines</u>	<u>722</u>
The Big Noise	730

(Continued on next page)

Now You Can Own That Yacht

EVER dream of becoming a millionaire, buying a palatial yacht and sailing the seven seas? You don't need to wait for the million to own a floating palace. Business men, newsboys, mechanics and hundreds of others interested in watercraft are taking their fun by proxy with model power boats and hydroplanes that duplicate all the luxuries and speed thrills of the real thing. Almost any week-end you will find a group of these three-foot boats in some harbor roaring around a central tethering craft at speeds up to thirty-five miles an hour while crowds jam the shore line. Read the story of the very practical "foolish" fleet in the December issue. It's illustrated with eight pages of pictures in full color.

Next Month

SEVERAL million sportsmen soon will be afield seeking game. Unfortunately, the open season for game also marks the opening of the season for accidents with guns. Most such casualties can be avoided if the hunters observe a few simple rules. In the December issue Bob Becker tells you what to do and what not to do in order to get back alive from your hunting trip.

France Takes Wing

TWENTY-NINE countries on four continents are touched today by Air France, a great union of French airlines. Since 1928 France has maintained an air mail service across the south Atlantic, bridging the capitals of Europe and those of South America. Read next month the amazing story of France's conquest of the air.

Hollywood's Houdini

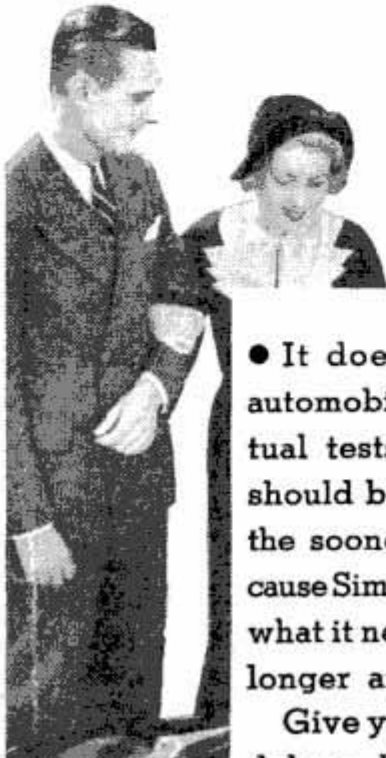
IF THE movie script calls for four potato bugs, an Egyptian mummy or a 1903 calendar, the director doesn't worry. He just tells the property man what is needed—and the property man supplies it, whether the request be for a handful of shark's teeth or English airplane tickets. The property man is the Aladdin of the movies. One of them reveals the secrets of his profession in an article in the December issue.

Published monthly by POPULAR MECHANICS CO., 200 East Ontario Street, Chicago, U. S. A. Single copy in United States, 25 cents; \$2.50 a year, \$4.00 for two years in United States and possessions, and countries of the Pan American Postal Union; for Canada, Newfoundland and Labrador, add 50 cents a year extra for postage; to all other countries add \$1.00 a year extra for postage. Changes in address must be reported to us immediately to eliminate delay. Entered as Second Class Matter, Sept. 15, 1903, at the Post Office at Chicago, Illinois, under Act of March 3, 1879. Entered as Second Class Matter at the Post Office Department, Canada. Copyright, 1935, by Popular Mechanics Co. in the United States, Australia and France

This One



ALL NEW CARS SHOULD BE SIMONIZED



Makes Finish Last Longer!

● It doesn't matter what automobile you drive, actual tests prove every car should be Simonized. And the sooner the better. Because Simoniz gives the finish what it needs to make it last longer and stay beautiful. Give your car this famous deluxe beauty treatment! But you can only "Simoniz" a car with Simoniz and Simoniz Kleener. So, always insist on them for your car.



**MOTORISTS WISE
SIMONIZ**

(Contents—Continued)

Century Magazine Advertising Section

695

Advertising—tire covers, "talking," used for726

Airplanes

 flivver, tailless, almost flies itself659

 monoplane with auto engine740

 snowstorm in, cools interior658

 war played in smoke clouds with699

Ash Tray—newspaper held for reading at table...740

Automobiles

 filter, rust and dirt, radiator kept clean with..737

 gas peril increases in cold weather666

 motorless, pedals like a bike735

 mower engine, child runs midget auto with...709

 racer without clutch or supercharger736

Automobiles, Accessories

 "gyroscope," anti-skid, attached to rear of car.717

 tire-spreading tool worked by one man717

Automobiles, Brakes—tester mounted on steering column657

Automobiles, Driving

 fan operated by vacuum frees windshield of vapor687

 loudspeaker on car warns drivers700

 "stop, look" signal warns driver at crossing...663

 "talking arm" sign language standardized...694

Automobiles, Fuel—"vapor lock," experts fight...727

Automobiles, Lubrication—oil card reminder.....678

Automobiles, Parking—dummy hired man spurs trade for673

Automobiles, Racing—midget hurdles rival in race.672

Aviation—power-dive perils tested in laboratory...716

Bassinet—horse attached to709

Bicycles

 "pants," metal, worn by704

 tandem, has side car for baby734

Billiards—cue, tip easy to replace687

Blind—switchboard in Braille for729

Blinds, Venetian—adjustable to any window667

Boats and Boating

 oarless craft propelled like hand car717

 speedboat, "overcoat" reduces wind resistance.665

 unsinkable steel, light and ribless704

Brake—direct-acting, has fewer parts694

Bridge—Golden Gate, scouts build model of678

Calculator—pocket, handy at arithmetic problems..740

Camera—ten-lens, 200 square miles seen with....728

Chair—stretcher evens legs of663

Cooker, Pressure—foods preserved in tin can with..737

Dog "Laundry"—laundering dogs profitable679

Dogs—collie proves dog can think.....672

Doorbell—electric, dog operates by pedal727

Drill, Electric

 for glass, has rubber guide671

 pistol shaped, heavy work done by687

Electricity—short-circuit, cut-out ends danger of..700

Electric Light—lamps, filament tube681

Electric Plug—corrugated prongs hold in place...705

Engine, Gas—adapter converts into oil-burning...678

Fire Alarm—radio, forest fire reported by689

Fire Extinguisher—dry compound fired from hand gun is710

Fish and Fishing—racing, a beach sport734

Flowerpot—hung like picture720

Football—dummy, dodge, trains ball carrier665

Garbage Truck—odor-proof and tilts for emptying.686

Gauge—built in auto tire, air pressure shown by..673

Glass—sun's rays focused on furnace melts.....733

Gloves, Sandpaper—sanding done smoothly with...717

Gold Filings—tray with shield recovers710

Gun, Machine—"Bren," adopted by British army..686

Hoist—chain, will raise a ton680

Hook, Chain—for towing, dragging or hoisting...686

Household Devices738, 739

Indicator—arrow, lighted, wind direction shown by.720

Irrigation—irrigator, traveling, saves crops667

Lightning

 airliner obtains photo of693

 camera with twelve lenses to photograph....705

Lock—hood of auto locked with680

NEW "7-POWER" ALE YEAST ADDS 5 TO 15 LBS. QUICK



TODAY
HEIGHT 5 FT. 10 IN.
WEIGHT 170 LBS.



*Richest imported ale yeast now concentrated 7 times
with three special kinds of iron in pleasant tablets*

AN AMAZING new "7-power" yeast discovery is putting pounds of solid, normally attractive flesh on thousands of "skinny," run-down people who never could seem to gain an ounce before.

Doctors now know that the real reason why great numbers of people find it hard to gain weight is that they don't get enough Vitamin B and iron in their daily food. Now scientists have discovered that the richest known source of health-building Vitamin B is ale yeast. By a new process the finest imported cultured ale yeast is now concentrated 7 times, making it 7 times more powerful. Then it is combined with 3 kinds of iron in pleasant little tablets called Ironized Yeast tablets.

If you, too, are one of the many who need these vital health-building elements, get these new "7-power" Ironized Yeast tablets from your druggist at once. Day after day, as you take them, watch flat chest develop and skinny limbs round out to normal attractiveness. Indigestion and constipation from the same source quickly van-

ish, skin clears to natural beauty —you're an entirely new person.

Results guaranteed

No matter how skinny and run-down you may be, try this new "7-power" Ironized Yeast for just a few short weeks. If not delighted with the results of the very first package, money back instantly.

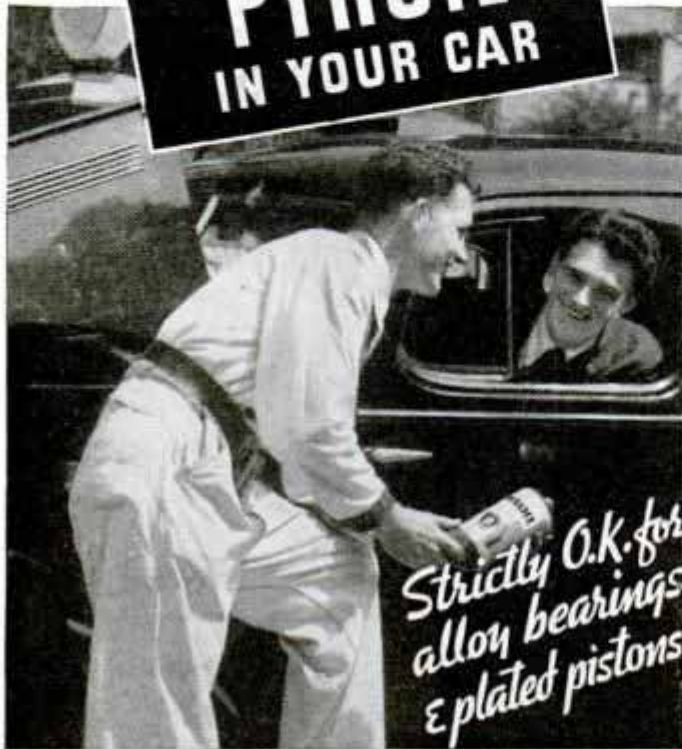
Only don't be deceived by the many cheaply prepared "Yeast and Iron" tablets sold in imitation of Ironized Yeast. These cheap counterfeits usually contain only the lowest grade of ordinary yeast and iron, and cannot possibly give the same results. Look for "IY" stamped on each tablet.

Special FREE offer!

To start you building up your health right away, we make this absolutely FREE offer. Purchase a package of Ironized Yeast tablets at once, cut out the seal on the box and mail it to us with a clipping of this paragraph. We will send you a fascinating new book on health, "New Facts About Your Body." Remember, results guaranteed with the very first package — or money refunded. At all druggists. Ironized Yeast Co., Inc., Dept. 5311, Atlanta, Ga.

Fused by
professional
models

By all means use
**GENUINE
PYROIL
IN YOUR CAR**



Contains No Harmful Oils or Acids

Pyroil makes your car run better. Why? Because its unduplicated properties combine elements of definite aid and safety to engines of all types—also to machinery and equipment.

Use Pyroil in any car—new or old—with or without new type (alloy) bearings and plated pistons. Will not harm but instead will safely guard against undue damage during the wear-in or break-in process.

Pyroil is not a "one-ingredient" product. Only genuine Pyroil accomplishes Pyroil results.

Gain more power, smoother performance, less heating, free valves, sealed rings—safety against many common damages to every frictional part, plus greater operating economy, by means of the regular use of Genuine Pyroil.

Sold the world over, at service stations, garages and other dealers. Mail coupon for further facts. Manufactured and Guaranteed by Pyroil Company, W. V. Kidder, Pres., 511 Pyroil Bldg., LaCrosse, Wis., U.S.A.

Pyroil has been tested by Popular Mechanics and is used by Popular Mechanics' Presses and Publishing Equipment.

Distributors—For an unusual Business Opportunity, check coupon below.

Look for this signature
on every can.

W. V. Kidder
Pres.



Pyroil Company
511 Pyroil Bldg.,
LaCrosse, Wis., U.S.A.
Please send facts of Pyroil's
efficiency with Alloy Bearings
and Free copy of Pyroil
Guarantee Certificate.

Please send details
of the Pyroil Sales
Opportunity for me.

Name.....
Address.....
City.....
County..... State.....

Simply ADD TO GAS OIL AND GREASE

(Contents—Continued)

Locomotive—Diesel speedster, blunt-nosed	664
Logging—tractor, Diesel, jams broken up with....	695
Maps, Road—motorists easily measure distances on.	680
Models	
airplane, twin-motored, radio-controlled	689
blimp, "sling shot" tests	720
girders, tiny, aid in building	729
ships, fleet of, California man carves	688
Motorcycle—odds and ends supply parts for.....	687
Moving Pictures—train, English, talkie theater on.	694
Notebook—flashlight built in for night use	710
Paint and Painting	
guide keeps edges clean	734
paintbrush fed from pail by air hose	733
Photography	
bombs of light help flyers get night pictures ..	737
half-tones made on film	671
Poultry—gizzard, metal, test grit for hens.....	666
Radio	
easy solutions for radio problems	744
kit of colors for painting dial lights	746
microphone, salt crystals used in	746
receivers, switching control for.....	746
transmitter covers three bands	745
Radio, Apparatus—tester for condensers	741
Radio, Receiver—tubes, all-metal, used in	742
Rifle Practice—gunfire muffled by box	703
Sanding Drum—bowling alley sanded by wide	726
Saws and Sawing—hack saw, sloping shoulder.....	702
Ships and Shipping	
"Queen Mary" and oat fields neighbors.....	666
streamline, modeled after airliners	702
Skating—speedometer for skater held in hand.....	736
Spray—chemical, for cleaning, mounted on trailer.	673
Table—folding, for picnics or home	726
Tools—gardening, special shapes for special tasks.	688
Toothbrush—two-headed, lasts twice as long	710
Tower, Skyride—steel legs melted to fell	657
Tractor—beach-combing, debris cleaned from beach with	695
Trailer—streamline, has duralumin body	711
Typewriter—eraser guard keeps paper clean.....	703
War—battle, sham, guns and men tested in	701
Warship—"Koenig Albert" refloated	700
Water Heater—time switch lights burner of.....	658
Water Softener—portable, for the home	693
Wax—fruit and vegetables kept fresh by coat of..	721

THE CRAFTSMAN

Ash Can—dust confined by sifter in	753
Ashes—dust carried up chimney	750
Blowtorch—holder for tools on	768
Book Ends—Chinese junk holds your books.....	757
Boxes—mirror covered for a novelty.....	762
Brush	
bottle, bed springs cleaned with	752
shoe-blackening, box for	774
Candlesticks—self-inclosed, make novel gifts	749
Cards, Playing—Cellophane gives lasting finish....	753
Chair—high-back, for hallway	775
Chair Rungs—rubber bands used to clamp when gluing	773
Cigarettes—ash tray extinguishes	774
Clothesline—basement, brackets fold flush for....	769
Cooker—homemade electric, is well insulated.....	752
Doorstop—knob, wooden, facilitates use of	762
Eave Trough—leaky, liner soldered in stops	773
Electric Lights—wires overhead give shop light wide range	756
Electric Motors—switch to reduce speed of.....	763
Fiddle—balloon, played with rubber band	750
Flagstones, Concrete—making resemble real stones.	758
Food Cooler—hood prevents cold air leaks from...	766
Fuel—coal, cheap heating with	747
Furniture—old period, modern feet bring up to date	750

(Continued to page 8A)

TODAY...

Almost Broke!

Yet tomorrow Tom Smith will be on his way toward being a really successful man . . .



SOMEWHERE there is a Tom Smith—that name is as good as any—who is practically flat broke, back on his heels and discouraged today. Perhaps he's in debt. Perhaps, as far as his job is concerned, he's in a rut. Perhaps he's just a victim of these trying times. Yet—he still has vision, imagination. And—ambition. He still believes that he's going *somewhere* . . . somehow, some way, some time. He hasn't given up hope. He still believes in success and opportunity.

Tom Smith will read this advertisement. No—there is a better way of saying it. Tom Smith *will study* this advertisement. He will read it once, then again, then yet again. It will strike a responsive chord somewhere within him. It will stir his dormant ambition, give wings to his imagination, set his vision afire. And he will *act!* As though Hope—as swift and powerful as lightning when it strikes—had suddenly taken possession of him, he will take advantage of the opportunity this advertisement offers him. And then—

Six months from now, his friends will say, "Have you heard about Tom Smith? Yes—just got a new job with an increase in salary." And two years later, the business journals in his field may report, "Thomas Smith Appointed Manager." And five years . . . or ten . . . or fifteen years hence, the sign on his office door may read "Thomas Smith, President."

All because Tom Smith had the vision, the imagination, the ambition, to recognize the significance of this advertisement. Because he had the foresight to see that here was his way to opportunity.

* * *

This page advertises the training of LaSalle Extension University. It is a unique university in many respects.



It utilizes Uncle Sam's postal service in its contacts with its students. It is the university for those men and women who work by day in every type of business and profession. It is the university of the clerk ambitious for success in accountancy. It is the university of the business man with an eye upon an executive position. It is the

university of men and women, young and middle aged, who wish to become accountants, bankers, sales managers, traffic experts or specialists in some one of twenty different fields. In short, it is the university for ambitious people, determined to succeed, who recognize that only by thorough specialized training can they reach their objectives.

In the history of LaSalle Extension University, there have been more than 850,000 such men and women. They have gladly substituted night hours of study for night hours of aimless pleasure. They have sacrificed hours of minor enjoyment to reach years of major success. They have studied hard—accumulated the accurate, comprehensive and practical training LaSalle offers by its famous Problem Method—thus wresting from Life the success which long before many had thought was not for them.

The LaSalle Method is comprehensive, yes. It is accurate, up-to-the-minute and alive. It is invaluable training. But above all things, it is a Road Toward Success. It is not an easy road. It is not the road for sluggards, for those who refuse to sacrifice and work. Rather, it leads to their destination only those who have the will to *finish* what they have once *begun*.

* * *

Perhaps you think that prophecy of Tom Smith's career mentioned above is pure fantasy. Perhaps you feel it is solely the product of an advertising writer's imagination. If such are your beliefs, you are wrong. For that prophecy is based upon past experience—

The past experience of thousands of discouraged Tom Smiths who read just such an advertisement as this years ago. Tom Smiths with vision and ambition and imagination who accepted LaSalle's offer of one of the booklets listed below. And—who found the booklet so intriguing, so full of hope, that they enrolled in LaSalle . . . and as the months passed, they found themselves rising out of their rut, reaching toward more attractive and better-paying jobs. Finally, achieving rich and deserved success in their chosen lines.

Tom Smith, wherever you are, whoever you are, whatever are your ambitions—here is your opportunity! Are *you* going to pass it by?

LA SALLE EXTENSION UNIVERSITY, Dept. 1164-R, Chicago

I am in earnest about my success and I would like to have your special booklet—without any cost or obligation to me—about my opportunities and your success training in the business field I have checked.

- | | |
|--|--|
| <input type="checkbox"/> Business Management | <input type="checkbox"/> Industrial Management |
| <input type="checkbox"/> Higher Accountancy | <input type="checkbox"/> Modern Foremanship |
| <input type="checkbox"/> Traffic Management | <input type="checkbox"/> Personnel Management |
| <input type="checkbox"/> Modern Salesmanship | <input type="checkbox"/> Business Correspondence |
| <input type="checkbox"/> Commercial Law | <input type="checkbox"/> Business English |
| <input type="checkbox"/> Law: Degree of LL. B. | <input type="checkbox"/> Effective Speaking |
| <input type="checkbox"/> Expert Bookkeeping | <input type="checkbox"/> Office Management |
| <input type="checkbox"/> C. P. A.' Coaching | <input type="checkbox"/> Stenotypy |

Name..... Age.....

Position..... Address.....

LaSalle Extension University

When writing to advertisers please mention Popular Mechanics

Ask for one of these booklets—or a similar one on your own field of business. They are free!



FATAL FUMES FOILED



MADAME, if your husband's surly pipe reminds you of burning rubber, won't you please remind him to get a pack of pipe cleaners and a tin of Sir Walter Raleigh Smoking Tobacco? Yes, it's that milder blend of Kentucky Burleys you've admired in other men's pipes. Well-aged, slow-burning, cool on the tongue, fragrant on the nose. It's so much milder to smoke and better to smell that you'll both be happier when he tries it. Buy him a tin this very day!

Brown & Williamson Tobacco Corporation
Louisville, Kentucky, Dept. P-511



It's 15¢
—AND IT'S
MILDER

FREE BOOKLET
tells how to make your pipe taste better, sweeter. Write for a copy.

(Contents—Continued)

Halloween—games for	770
Hammer—claw notched to pull tacks	768
Home—preparations for closing	776
Jar—bell jar has many uses	756
Lathe—jigs for the home workshop	751
Leg Protectors—"chaps" keep your legs dry	774
Letters—ejecting from pigeonholes easily	750
Lime—moisture in closet absorbed by	767
Mail Box—porch, resembles miniature cottage	769
Mantel—portable, modern lines for	754
Paintings, Oil—magazine prints make imitations	768
Photography	
developing fluid, using thermometer to check	756
tray covers protect films while developing	758
Pulley—solder keeps from slipping	756
Racks—towel, attractive and easily made	779
Sander—rotary, work smoothed quickly with	768
Sink Drain—tubing, flexible, used to clean	778
Sports—wing shooting	759
Stippling—designs in wood, wire cable to make	763
Stovepipe—joints, method of making rigid	774
Tables	
furniture gliders hold in place	773
keg, fitted with feet, used to make	767
portable, pipe attached as standard	763
Template—pipe, large, cut at an angle with	780
Tennis—table-tennis score board rings bell	764
Thumbscrew—improvised from wood screw and washer	762
Trap—jug tied to, mink or muskrat saved by	773
Vise—bench, foot controls	774
Washboard—legs raise to comfortable height	752
Washboiler—funnels in, reduce time of boiling clothes	750
Wagons—coaster, inner tube makes tires for	758
Workbenches—portable, pipe attached as standard	763
Wrench—emergency, for light work	763

SHOP NOTES

Advertising—"Busy Mandy" assures rushing deliveries	797
Air Conditioner—humidity controlled with	790
Apron—padded, for bench workers	786
Arbor—quick grip, to face sleeves and bushings	786
Automobiles	
car ammeter used in circuit of small charger	799
skid chains, rubber bands hold on wheels	799
Automobiles, Accessories—wrench to remove cylinder heads	800
Automobiles, Repairing	
door handles, keeping free from grease	799
pedals, brake and clutch, lengthening	800
pinion nut, method of loosening	799
studs, tool for removing	798
tops, airplane wing dope makes waterproof	798
Bench	
portable, for dismantled motor parts	797
test, for small garage	795
Doorstop—positive, for shop doors	788
Dust—home workshop disposal of	787
Fire Fighting—extinguisher, homemade	784
Garage—lock for, homemade	798
Gauge—reflector lights up	784
Grain Spout—spring inside prevents clogging	789
Jointer—how to build	781
Magnifying Glass—artist's, held with clamp	785
Mimeograph—stencil, getting quickly	786
Oil Burner—draft-control box saves fuel	789
Pad, Rubber—small assembly parts held by	794
Photography—films kept fresh in cigar box	794
Poultry—funnel holds while weighing	788
Pulley Brake—rope, knotted, serves as	788
Rack—chemical apparatus, rubber hose makes	786
Rope—dispensed through floor, "brakes" for	794
Signs—moving door display attracts customers	794
Wash Cloths—umbrella frame holds for drying	799
Weights—markings made legible	784
Welding—table, metal, for accessories	785
Wrench—carbide can, lid loosened by	788



ARE YOU JUST HOPING TO LAND IN A GOOD JOB?

HOPE without foundation is pretty futile in this competitive age! But hope plus training is a winning combination — and all over this country today, in all kinds of professions and trades, men are getting ahead — landing in good jobs —

earning more money — because of serious and systematic study of International Correspondence Schools' courses. These courses are giving them the training they need. Investigation will not put you under any obligation. Mail the coupon!

INTERNATIONAL CORRESPONDENCE SCHOOLS

BOX 5599-H, SCRANTON, PENNA.



Without cost or obligation, please send me a copy of your booklet, "Who Wins and Why," and full particulars about the subject *before* which I have marked X:



- | | | |
|--|---|---|
| TECHNICAL AND INDUSTRIAL COURSES | | |
| <input type="checkbox"/> Architect | <input type="checkbox"/> Heat Treatment of Metals | <input type="checkbox"/> Plumbing |
| <input type="checkbox"/> Architectural Draftsman | <input type="checkbox"/> Sheet Metal Worker | <input type="checkbox"/> Heating |
| <input type="checkbox"/> Building Estimating | <input type="checkbox"/> Telegraph Engineer | <input type="checkbox"/> Air Conditioning |
| <input type="checkbox"/> Contractor and Builder | <input type="checkbox"/> Telephone Work | <input type="checkbox"/> Steam Engineer |
| <input type="checkbox"/> Structural Draftsman | <input type="checkbox"/> Mechanical Engineering | <input type="checkbox"/> Steam Electric Engineer |
| <input type="checkbox"/> Structural Engineer | <input type="checkbox"/> Mechanical Draftsman | <input type="checkbox"/> Marine Engineer |
| <input type="checkbox"/> How to Invent and Patent | <input type="checkbox"/> Machinist | <input type="checkbox"/> R. R. Locomotives |
| <input type="checkbox"/> Electrical Engineer | <input type="checkbox"/> Patternmaker | <input type="checkbox"/> R. R. Section Foreman |
| <input type="checkbox"/> Electric Lighting | <input type="checkbox"/> Gas Engines | <input type="checkbox"/> Air Brakes |
| <input type="checkbox"/> Welding, Electric and Gas | <input type="checkbox"/> Diesel Engines | <input type="checkbox"/> R. R. Signalmen |
| <input type="checkbox"/> Reading Shop Blueprints | <input type="checkbox"/> Aviation Engines | <input type="checkbox"/> Highway Engineering |
| <input type="checkbox"/> Boilermaker | <input type="checkbox"/> Automobile Mechanic | <input type="checkbox"/> Civil Engineering |
| | <input type="checkbox"/> Refrigeration | <input type="checkbox"/> Surveying and Mapping |
| | | <input type="checkbox"/> Steam Fitting |
| | | <input type="checkbox"/> Ventilation |
| | | <input type="checkbox"/> Bridge Engineer |
| | | <input type="checkbox"/> Bridge and Building Foreman |
| | | <input type="checkbox"/> Chemistry |
| | | <input type="checkbox"/> Pharmacy |
| | | <input type="checkbox"/> Coal Mining |
| | | <input type="checkbox"/> Mine Foreman |
| | | <input type="checkbox"/> Navigation |
| | | <input type="checkbox"/> Cotton Manufacturing |
| | | <input type="checkbox"/> Woolen Manufacturing |
| | | <input type="checkbox"/> Agriculture |
| | | <input type="checkbox"/> Fruit Growing |
| | | <input type="checkbox"/> Poultry Farming |
| BUSINESS TRAINING COURSES | | |
| <input type="checkbox"/> Business Management | <input type="checkbox"/> C. P. Accountant | <input type="checkbox"/> Service Station Salesmanship |
| <input type="checkbox"/> Office Management | <input type="checkbox"/> Bookkeeping | <input type="checkbox"/> First Year College |
| <input type="checkbox"/> Industrial Management | <input type="checkbox"/> Secretarial Work | <input type="checkbox"/> Business Correspondence |
| <input type="checkbox"/> Traffic Management | <input type="checkbox"/> Spanish | <input type="checkbox"/> Lettering Show Cards |
| <input type="checkbox"/> Accountancy | <input type="checkbox"/> Salesmanship | <input type="checkbox"/> Stenography and Typing |
| <input type="checkbox"/> Cost Accountant | <input type="checkbox"/> Advertising | <input type="checkbox"/> Civil Service |
| | | <input type="checkbox"/> Mail Carrier |
| | | <input type="checkbox"/> French |
| | | <input type="checkbox"/> Signs |
| | | <input type="checkbox"/> Illustrating |
| | | <input type="checkbox"/> Cartooning |
| | | <input type="checkbox"/> Railway Mail Clerk |
| | | <input type="checkbox"/> Grade School Subjects |
| | | <input type="checkbox"/> High School Subjects |
| | | <input type="checkbox"/> College Preparatory |

Name.....Age.....Address.....

City.....State.....Present Position.....

If you reside in Canada, send this coupon to the International Correspondence Schools Canadian, Limited, Montreal, Canada



The Editor's MAIL BAG

Wants a Bigger Book



"When I read Popular Mechanics, I must use both hands to keep it open or pile a book on top to hold it flat. Some of the other magazines have a longer and wider book with larger pages which is easier to read. I'll venture that many other readers have encountered the same trouble I have."—*James C. Perry, Chicago, Ill.*

Date on Each Page?

"Just as a suggestion, why don't you print the month and year on each page so when a page is torn out for reference, the purchaser of your magazine will not only know the page number and name but the date also."—*Harvey F. Waters, New York, N. Y.*

After Seventy Years!

"I wish to say that in my seventieth year I cannot remember ever having seen an article on how to sharpen a razor. Men have mentioned the subject, of course. The article in the July Popular Mechanics ought to be reprinted in pamphlet form and a copy inclosed with every razor sold."—*Julian Tuthill, Atkinson, N. H.*



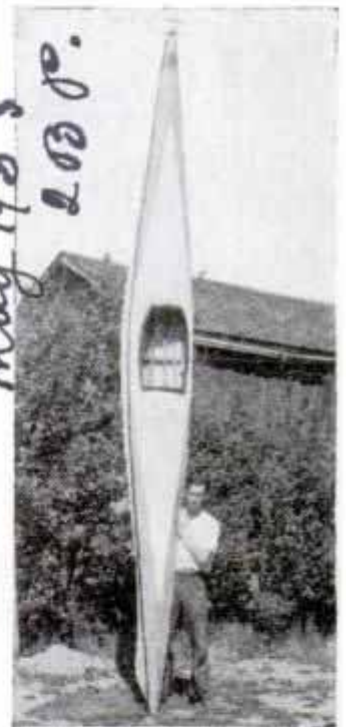
Women Best Drivers?

"Look over the automobile accident figures and you will find many more men than women involved in traffic smash-ups. One way to cut down our motor accidents, therefore, is to induce more women to drive cars, thus giving the careless men-

folk a well-earned holiday. Most women do not drive as fast as the average man, they are more courteous in observing the rules of the road and they simply refuse to take the chances the average man assumes in traffic. Let's have more women at the wheel and fewer auto victims in our hospitals and morgues."—*Mrs. Jerry Gilligan, Chicago, Ill.*

Behavior of a Kayak

"Enclosed is photograph of the speed kayak, the plans for which appeared in Popular Mechanics about three months ago. It behaves well in the water. I also have a sail attachment with a fifteen-square-foot sail."—*Joe Burns, Streetsville, Ont.*



Left-Handed Orchestra

"At the bottom of page 47 in the July issue, you will note the entire orchestra in the illustration is left-handed. I am certain it is a mistake by the person who made the first photograph and printed it with the negative the wrong way around."—*C. N. Zuck, Salisbury, S. Rhodesia.*

Workshop Library

"Since I became interested in a home workshop, it has been my practice to save all printed matter on the subject. My procedure is this: first, remove wire staples holding the pages of the magazine and take out index sheets and all pages on which are the subjects of interest. After enough sheets have been assembled to form a con-

(Continued to page 22A)

Learn ELECTRICITY

SEND TODAY FOR DETAILS OF MY
**Pay-Tuition-after-
Graduation Plan!**

Get training in 90 days, right here in the great Coyne Shops — **not by correspondence** — but on real electrical machinery. **Mail the coupon below.** If you are short of money I'll send you all details of my finance plan and consider your application. If accepted, you won't have to start paying tuition back until **five months from the date you start school**, and then you'll have **over a year** to complete your payments.



STUDENTS BUSY AT WORK IN GREAT COYNE SHOPS

Tremendous Developments Ahead in Electricity!

HERE is YOUR opportunity to cash in. Every day brings news of new developments in every branch of Electricity, with more opportunities, more jobs, and a greater future for the trained man than ever before. I consider the fellow who is ambitious enough to want to get ahead by taking my Training, worthy of my help. **MAIL THE COUPON BELOW** and you can prove to me that you are willing to spend just **THREE MONTHS** in the Coyne Training Shops Learning **ELECTRICITY**. Then, I'll tell you about my finance plan, which has enabled many to get complete Training and pay tuition back later.

Learn By Doing In 90 Days

Lack of experience or advanced education bars no one. I don't care if you don't know an armature from an air brake—I don't expect you to! It makes no difference! Don't let lack of money hold you back from getting all details of my amazing plan.

MANY EARN While LEARNING

If you need part-time work to help pay your living expenses and will tell us your problems we may be able to help you as we have thousands of others. Then in 12 brief weeks, in the great roaring shops of Coyne, we train you as you never dreamed you could be trained . . . on one of the greatest outlays of electrical apparatus ever assembled . . . real dynamos, engines, power plants, auto, switch-boards, transmitting stations . . . everything from doorbells to farm power and lighting . . . full-sized . . . in full operation every day!

TRAINING By Actual Work

No dull books . . . you get individual training . . . real actual work with only the theory you will need. Building real batteries . . . winding real arma-



Prepare for Jobs Like These

Here are a few of hundreds of positions in the electrical field. Our free employment bureau gives you a lifetime employment service.
ARMATURE EXPERT
SUBSTATION OPERATOR
AUTO ELECTRICIAN
INVENTOR
MAINTENANCE ENGINEER
SERVICE STATION OWNER
RADIO EXPERT

tures, operating real motors, dynamos and generators, wiring houses, etc. That's a glimpse of how we help to make you a master electrician, and fit you to qualify for jobs leading to the biggest pay.

Jobs - Pay - Future

"I owe my Electrical success to your 12 weekshop course," says R. B. Umbarger of Tennessee. "Two weeks after leaving school I took a wiring job," reports E. O. Berndt of Illinois. "and the profits from this one job alone more than paid for the entire course." A. C. Hoehnle of Ohio says "Received several raises in pay, due to the training I received at Coyne." And I could quote from hundreds of letters of successful Coyne Trained Men, *What they have done, you should be able to do!*

Electric Refrigeration — Air Conditioning

Right now I am including my big new Electric Refrigeration and Air Conditioning course at no extra cost.

GET THE FACTS

Coyne is your one great chance to get into electricity. This school is 36 years old—Coyne training is tested—proven beyond all doubt—endorsed by many large electrical concerns. You can find out everything absolutely free. Simply mail the coupon and let me send you the big, free Coyne book with photographs . . . facts . . . jobs . . . salaries . . . opportunities. Tells you how many earn expenses while training and how we assist our graduates in the field. This does not obligate you. So act at once. Just mail coupon.

Get This
FREE
Book



Home of Coyne School

This is our fireproof modern home wherein is installed thousands of dollars' worth of Electrical equipment of all kinds. Every comfort and convenience has been arranged to make you happy and contented during your training.



COYNE H. C. LEWIS, PRESIDENT FOUNDED 1899
ELECTRICAL SCHOOL
500 S. Paulina St., Dept. 85-72, Chicago, Ill.

H. C. LEWIS, President
Coyne Electrical School, Dept. 85-72
500 S. Paulina St., Chicago, Ill.

Dear Mr. Lewis:—Without obligation send me your big free illustrated catalog, with all facts about Coyne Training and details of your "Pay-Tuition-After-Graduation" Plan.

Name..... Age.....

Address.....

City..... State.....

Arrest Him, Officer!

I'LL HAVE COMPLETE FACTS ON THE OTHER FELLOW TONIGHT!



Follow This Man!

SECRET Service Operator No. 38 is on the job... follow him through all the excitement of his chase after the counter-feit gang. See how a crafty operator works. Tell-tale finger prints in the murdered girl's room that help him solve the great mystery! BETTER than fiction because every word is TRUE. No obligation. Just mail me the coupon and get—

FREE The Confidential Reports No. 38 Made to His Chief

And the best part of it all is this—it may open your eyes to the great opportunity for YOU as a well paid Finger Print Expert. This is a young, fast-growing profession. The kind of work you would like. Excitement! Thrills! Travel! A regular monthly salary. Reward money. And remember: graduates of this school HEAD 47% of all Identification Bureaus in the U. S. Quick! Mail the Coupon NOW and I'll send you these Free Confidential Reports!

INSTITUTE OF APPLIED SCIENCE
1920 Sunnyside Ave., Dept. 13-58 Chicago, Illinois

Institute of Applied Science
1920 Sunnyside Ave., Dept. 13-58, Chicago, Illinois

Gentlemen:—Without any obligation whatsoever, send me the Reports of Operator No. 38, also your illustrated Free Book on Finger Prints and your low prices and Easy Terms Offer. Literature will NOT be sent to boys under 17 years of age.

Name

Address

Age

When writing please mention Popular Mechanics

AVIATION

Offers BIG MONEY to LINCOLN-Trained Men!

Why not be an airline pilot and earn \$500 a month—or earn good pay as an aviation mechanic, which offers splendid opportunities for rapid promotion! Leading nations of the world are now spending hundreds of millions for aviation development! This means thousands of high salaried positions! Start your training now at this world famous Government Approved School and be ready in a few months' time for a most interesting and fascinating career.

Modern Approved Equipment—Practical Training

Here we have 10 modern, approved training planes. Thoroughly equipped shops and laboratories, with big outlay of planes and aircraft engines, including Cyclones, Wasp, Whirlwinds, Aircraft Packard, Diesel and many others, for your practical experience in training. Government Approved flight and ground instructors who know exactly how to train you for a responsible, good pay position.

Real Opportunity at This Government Approved School—25 years success as a mechanics' trade school, 15 years success teaching aviation.

Lincoln graduates now employed by some of the best known companies in aviation industry. This kind of outstanding, complete training is waiting here at Lincoln for you. Both flight and ground school under Government Supervision. WRITE today for further facts. Please state your age.

LINCOLN AIRPLANE & FLYING SCHOOL

200F Aircraft Bldg., Lincoln, Nebraska

ELECTRICAL ENGINEERING

A BROAD, basic, intensive course complete in one school year. Includes fundamentals of Refrigeration, Air-conditioning, Electronics. Approved by educators, endorsed by industry. 43rd year. Catalog.



BLISS ELECTRICAL SCHOOL

121 TAKOMA AVE., WASHINGTON, D. C.

LABORATORY APPARATUS
BIOLOGICAL SUPPLIES
MICROSCOPES
CHEMICALS

New complete catalog lists hundreds of items of interest to amateur and professional experimenters. Save Money—Buy Direct from manufacturer. Send 10c. now (refundable) and get Special 30 Day Offer.

J. H. WINN MFG. CO., Dept. 411, 124 W. 23 St., New York

Learn Public Speaking

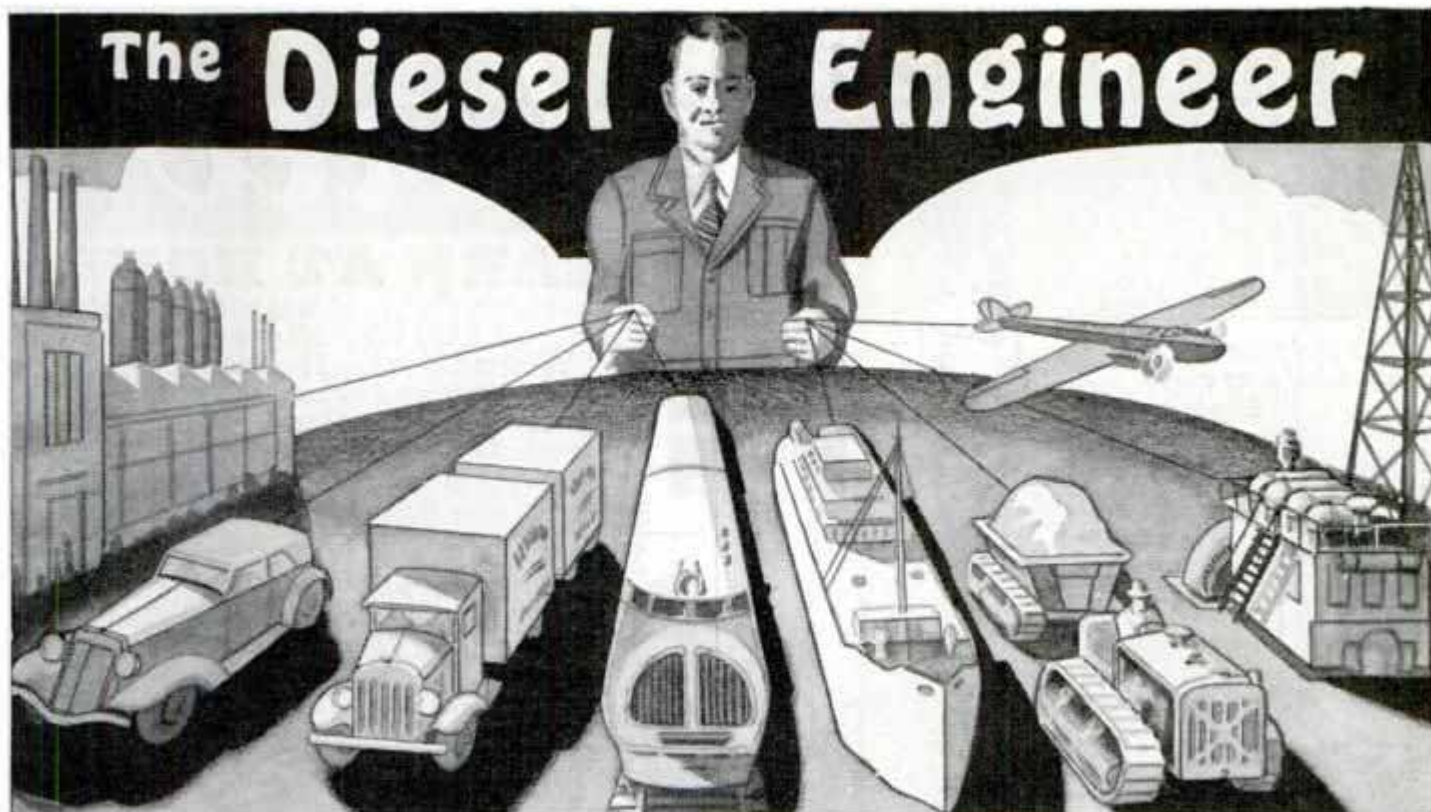
At home—in spare time—20 minutes a day. Overcome "stage-fright", gain self-confidence, increase your salary, through ability to sway others by effective speech. Write now for free booklet, *How to Work Wonders With Words*.

NORTH AMERICAN INSTITUTE, Dept. 1358
3601 Michigan Avenue, Chicago, Illinois

50 ways to make money in PHOTOGRAPHY

Fascinating, profitable work. COMMERCIAL, NEWS, PORTRAIT, MOTION PICTURE Photography. Personal Attendance and Home Study training. 25th year. Let us show you the wonderful opportunities for a successful career in this growing field. Free booklet.

NEW YORK INSTITUTE OF PHOTOGRAPHY
10 West 33rd St. (Dept. 49) New York



Not since the Gasoline Engine was perfected for use in automobiles and trucks 30 years ago, has there been such a sweeping change in the power and transportation fields as the Diesel Engine is now bringing about.

Think of the Opportunity for You

Diesel engines—because of their high efficiency, dependability, and economy of operation—are fast replacing steam and gasoline engines on land and water, and in the air—threatening the present jobs of thousands of workers. **Is your job safe?**

Power for Manufacturing and Construction Work—All over the country, Diesel stationary plants are providing shops and factories with low cost electric light and power—producing power and light for public utility companies, municipalities, railroads, city street car and interurban systems—drilling oil wells and pumping the oil to markets a thousand miles away—operating dredges and excavating machinery in river improvement and reclamation work—furnishing dependable and economical power on isolated construction jobs.

Power for Transportation—Diesel engines are producing the electric power that enables the "Zephyr," "M 10,000," and "Flying Yankee" to break railroad records for both speed and economy of operation—driving ocean liners and freighters, ferry boats and tugs, lake and river boats, barges and pleasure craft—operating huge motor trucks on long and difficult hauls, and busses on city streets and transcontinental highways—powering tractors hauling all kinds of equipment on farms and construction jobs, and in lumber camps—driving giant airplanes and racing automobiles.

Steady Employment

To be sure of steady employment in any line, you must understand the principles and operations of that line. The Diesel industry has made amazing progress during the last 3 years—in 1934 the horsepower sold was more than double that sold in 1933. And every new Diesel installed means more jobs—greater opportunities—for Diesel-trained men. If jobs in your line are steadily growing scarcer, investigate this new, progressive, uncrowded line, that is offering an increasing number of good openings.

Today there is practically no competition in the Diesel field, but the increasing use of Diesel engines will result in keen competition for jobs after a few years. If you start your training now and get established in this field, you need not worry about competition.

Get your Free Diesel Booklet and find out what the Diesel field offers you—how quickly you can obtain a complete understanding of Diesel engine principles and operation by spare-time study at home. Course includes all text material—with special diagrams making it easy to understand this new type of power.

American School, Drexel at 58th St., Chicago

Engineering and Business

If you are interested in some other Engineering line—or in the field of Business—we can give you equally complete, simplified, and practical training service for any of the desirable positions listed below.

Asking for information involves no obligation—but mailing the coupon may mark the turning point in your life. Check and mail the coupon today.

American School

Dept. D-845, Drexel at 58th St., Chicago

Send me, without obligation, full information on position checked.

Diesel Engineer

- | | |
|--|---|
| <input type="checkbox"/> Air Conditioning Engineer | <input type="checkbox"/> Draftsman & Designer |
| <input type="checkbox"/> Aircraft Pilot | <input type="checkbox"/> Electrical Engineer |
| <input type="checkbox"/> Architect & Builder | <input type="checkbox"/> High School Graduate |
| <input type="checkbox"/> Automobile Engineer | <input type="checkbox"/> Lawyer |
| <input type="checkbox"/> Bookkeeper & Accountant | <input type="checkbox"/> Mechanical Engineer |
| <input type="checkbox"/> Business Law | <input type="checkbox"/> Radio & Television |
| <input type="checkbox"/> Business Manager | <input type="checkbox"/> Refrigerating Engineer |
| <input type="checkbox"/> Cert. Public Accountant | <input type="checkbox"/> Steam Engineer |
| <input type="checkbox"/> Civil Engineer | <input type="checkbox"/> Structural Engineer |

Name.....Age.....

Address.....

Turn Your Spare Time into Dollars

When writing to advertisers please mention Popular Mechanics

BETTER JOBS More pay

"I'll train you **RIGHT**—the practical easy way!"
Engineer DOBE

Training Until in Satisfactory POSITION or Money Back

Send Coupon!



Learn DRAFTING at Home from an Engineer

Now is time to prepare! Boost your pay! Get a better job. Business is picking up. Draftsmen are the **FIRST** needed! I furnish all tools and a drawing table. And teach students in a very short time by mail in spare time until they actually have a desirable draftsman's position. All money back if not satisfied with work and better pay. Earn while you learn! No previous experience required. High school education not needed. Everything made plain by my practical method *right from the start*. You'll be amazed how quickly you can prepare yourself in your spare time for **MORE PAY** by my practical method—now used for over 34 years. Thousands of successful graduates, aged 16 and 18 to past 50.

JOBS OPEN NOW!

Some want ads for draftsmen appear practically every week in newspapers! After training I help graduates to a job without charging a cent for this service. For 30 years employers of Draftsmen have been writing me when they want help. Aviation, Electricity, Machinery, Auto Work, Building Work—All these industries and others, too, must have draftsmen in their offices. These industries are now growing fast; be prepared.

Start Now and get the training. When qualified, be ready for that bigger, better pay job. Send the coupon **NOW—TODAY**, while I select my students for this personal, practical training to a limited number.

- AUTOMOBILE**
- MOTOR BUS**
- AVIATION**
- ELECTRICITY**
- MACHINE BUILDING**
- BUILDING**
- CONSTRUCTION**

FREE BOOK COUPON

ENGINEER DOBE, Div. 33-78 Libertyville, Ill.
Send me your free book, "Successful Draftsmanship" and explain how you will assist me to a good position as a draftsman.

Name.....Age.....
Address.....
Post Office.....State.....

When writing please mention Popular Mechanics

Law!

LEARN AT HOME

Are you adult, alert, ambitious, willing to study? Investigate **LAW!** We guide you step by step—furnish all texts, including 14-volume Law Library. Training prepared by leading law professors and given by members of bar. Degree of LL. B. conferred. Low cost, easy terms. Send **NOW** for Free, 64-page "Law Training for Leadership."
LaSalle Extension University, Dept. 1164-L, Chicago

Be an ELECTRICAL EXPERT

Learn to Do Big Jobs



No "hard times" in Electricity—the Big Pay Field. Thousands of new Experts needed for present and future activity. Boulder Dam—"TVA"—other government electrical projects soon ready. Start Now. Earn while learning at home. Easy. Low Cost. 100,000 men successfully trained. Write for **FREE BOOK**. Learn to earn \$35 to \$75 a week.

L. L. Cooke School of Electricity, Dept. 18, 2150 Lawrence Ave., Chicago

Learn to Dance

You can learn all the modern dances—the latest Tango steps, the new Fox Trots, dreamy Waltzes, smart Collegiate Steps, and popular Society Steps at home, easily and quickly. New chart method makes dancing as simple as A-B-C. No music or partner required. Don't be a wallflower. Learn to dance. Complete course—236 pages, 54 illustrations, sent on 5 Days' Free Trial. Equals \$20.00 course. Send no money. Pay postman only \$1.98, plus postage upon arrival. Money back if not delighted. Catalog Free.



Franklin Pub. Co., 800 No. Clark St., Dept. 9478, Chicago



START \$1260 to \$2100 YEAR

MEN — WOMEN

Get ready immediately

Common Education Usually Sufficient

Mail Coupon

Today—
SURE

Franklin Institute
Dept. C174

ROCHESTER, N. Y.

Gentlemen: Rush to me, **FREE** of charge, list of U. S. Government big pay jobs. Send me **FREE** 32-page book describing salaries, vacations, hours, work, sample coaching and full particulars on how to get one of these jobs.

Name.....
Address.....



J. E. Smith, Pres. Nat'l Radio Institute, the man who has directed the Home Study training of more men for the Radio industry than any other man in America.

Set Servicing

Spare time set servicing pays many N. R. I. men \$5, \$10, \$15 a week extra. Full time men make as much as \$30, \$50, \$75 a week.



Broadcasting Stations

Employ managers, engineers, operators, installation and maintenance men for jobs paying up to \$5,000 a year.



Loud Speaker Systems

Installation and service work is another growing, money-making field for trained Radio men.



Television
The coming field of many great opportunities is covered by my Course.



Sample Lesson FREE

Take advantage of this offer. Mail the coupon *Right Now*, and I'll send you *FREE* a Sample Lesson that only my students have received in the past. This fascinating book, "A Bird's-Eye View of Radio," is just packed and jammed with information about this growing industry. The reason I am willing to send it to you is to *PROVE* that my Course is simple, easy to understand, and enjoyable to study. I want to *SHOW* YOU that I can train you, just as I have *ALREADY* trained hundreds of men. Many of them with not even a grammar school education, and no Radio or technical experience, have become Radio experts and now make good money in Radio. Mail the coupon *NOW*.



Be a Radio Expert

Many make **\$30 \$50 \$75** a week

I will train you at home for many Good Spare Time and Full Time Radio Jobs

If you are dissatisfied with your present job; if you are struggling along in a rut with little or no prospect of anything better than a skinny pay envelope—Clip the Coupon *NOW*. Get my **BIG FREE BOOK** on the opportunities in Radio. Read how quickly you can learn at home in your spare time to be a Radio Expert—what good jobs my graduates have been getting—real jobs with real futures.

Real Opportunities Ahead in Radio for Trained Men

It's hard to find a field with more opportunities awaiting the trained man. Why, in 1934 the Radio industry sold \$235,000,000 worth of sets and parts! Over 300,000 people worked in the industry! It's a gigantic business, even in the poor business years. And look what's ahead! Millions of sets are going out of date annually. 20,000,000 sets are now in operation on which \$60,000,000 are spent *EACH YEAR* for repairs, servicing, new tubes, etc. Broadcasting stations pay their employees (exclusive of artists) approximately \$23,000,000 a year. Advertisers pay 600 great Broadcasting Stations over \$75,000,000 a year for Radio time and talent. A few hundred jobs that paid \$30, \$50, \$75 a week less than 20 years ago have grown to thousands. Those figures are so big that they're hard to grasp. Yet they are all *TRUE!* Here's a new industry that has grown to be a commercial giant! No wonder business leaders predict a brilliant future for the great and growing Radio industry.

Get Into This Field With A Future

There's opportunity for you in Radio. Its future is certain. Television, short waves, police Radio, automobile Radio, midget sets, loud speaker systems, aviation Radio—in every branch, developments and improvements are taking place. Here is a real future for hundreds of men who really know Radio. Get the training that opens the road to good pay and success! Send the coupon now and get full particulars on how easy and interesting I make learning at home. Read the letters

from graduates who are today earning good money in this fascinating industry.

Many Make \$5, \$10, \$15 a Week Extra In Spare Time While Learning

Every neighborhood can use a good part time serviceman. The day you enroll I start sending you Extra Money Job Sheets which quickly show you how to do Radio Repair Jobs common in most neighborhoods. Throughout your Training I send you information for servicing popular makes of sets! I give you plans and ideas that have made good spare time money—\$200 to \$1,000 a year—for hundreds of fellows. My Training is famous as "the Course that pays for itself."

Money Back If Not Satisfied

I am so sure that N. R. I. can train you at home satisfactorily that I will agree in writing to refund every penny of your tuition if you are not satisfied with my Lesson and Instruction Service upon graduation. You'll get a copy of this Agreement with my book.

64-Page Book of Facts Free

Get your copy today. It's free to any ambitious fellow over 15 years old. It tells you about Radio's spare time and full time job opportunities; it tells you all about my Course; what others who have taken it are doing and earning. Find out what Radio offers YOU without the slightest obligation. **MAIL THE COUPON** in an envelope, or paste it on a 1c post card *NOW*.

J. E. SMITH, President
National Radio Institute
Dept. 5MP
Washington, D. C.

Mail it
NOW



This Coupon is Good For . . .
One FREE Copy of My Book

J. E. SMITH, President.
National Radio Institute, Dept. 5MP
Washington, D. C.

Dear Mr. Smith: Without obligation send me the Sample Lesson and your free book about spare-time and full-time Radio opportunities, and how I can train for them at home in spare time.

Name..... Age.....
Address.....
City..... State.....

R

BE A TRAINED AUTO-DIESEL

Diesel Power for trucks, buses, tractors, farm power and lighting plants opens rich new fields of opportunity for Diesel-trained men.

Good jobs, at good pay, await those who prepare NOW to get in on the ground floor of this fast-growing industry. And with combined Auto-Diesel "Job-Way" Training, brought to your home by the pioneer automotive home-study school, you can train for success in this new field without leaving your present position while learning.

"Job-Way" Training is Practical, Complete, Modern

Our modern, revised Training covers every new development in the operation and repair of present day gasoline and Diesel automobiles, trucks, tractors, etc. And the same practical, easy-to-learn method that has started thousands of our graduates toward success, will qualify you in a few short months for a better job, or a profitable repair business of your own.

New Auto-Diesel Course Included at No Extra Cost
Students enrolling now for our regular Automotive course get our complete new Auto-Diesel course AT NO EXTRA COST. Send coupon today for details of our "Earn as You Learn" Training plan, backed by fifteen years' success in the automotive training field.

Earn as You Learn—Two Motor Testers Free

Just now, we are also including complete, valuable motor testing equipment, to assist your training and enable you to begin earning extra spare-time money soon after you enroll.

AUTO-DIESEL BOOK FREE

Men without previous auto experience or special education quickly master "Job-Way" Training and become skilled experts in every branch of auto work. Mail the coupon today for Big FREE AUTO-DIESEL Book and complete facts about Free Employment and Consultation Service. No obligation!

MOTOR INSTITUTE OF AMERICA
2140 Lawrence Ave., Dept. LD-11, Chicago

MOTOR INSTITUTE OF AMERICA
2140 Lawrence Ave., Dept. LD-11, Chicago, Ill.

Without obligating me, send Free Auto-Diesel Book with all facts about "Job-Way" Home Training and Special Offer.

Name.....

Address.....

City..... State.....

MAIL
COUPON
FOR
FREE
BOOK



Learn

AIR CONDITIONING and REFRIGERATION

FROM FACTORY ENGINEERS



Train Now for Good Jobs in Fastest Growing Industry

R-A-C-I Training is supervised by factory engineers appointed by large manufacturers of refrigeration and air conditioning equipment. It is the only industry supervised training.

OFFICIALLY

ENDORSED TRAINING

Twenty leading manufacturers cooperated in the building of R-A-C-I Training so that men can be trained as the industry wants them trained. These firms have officially endorsed this training. They recommend it to you. Read about it in the FREE R-A-C-I book.

Over 7 million household refrigerators in use. Thousands of big commercial installations too. Homes, stores, offices, factories, railway cars—everywhere—are being air conditioned. Refrigeration is the depression-proof industry. Air Conditioning has taken the country by storm. It's America's fastest growing and next big industry, and thousands of trained men will be needed. Get ready now.

FREE BOOK TELLS HOW

Train now with R-A-C-I for a good job in this big new field. Learn how to sell, estimate and plan big installations. Learn how to install, and supervise maintenance and service on equipment of all kinds. Mail coupon promptly for FREE book giving facts about jobs you can learn to fill and opportunities for starting your own business. Also facts about simplified, easy-to-master home training course and records of training over 100,000 successful men. Mail coupon today.

Refrigeration and Air Conditioning Institute
Dept. 18, 2150 Lawrence Ave., Chicago

Send me the free book and other information about refrigeration and air conditioning opportunities.

Name.....

Address.....

BE AN ARTIST

WE CAN TEACH YOU DRAWING in your own home during your spare time. Thirty-five years of successful teaching proves our ability. Artists receive large salaries.

Write today for Art Year Book
SCHOOL OF APPLIED ART
Dept. 185, 10 E. Huron St., Chicago, Ill.



ENGINEERING



INTENSIVE PRACTICAL TECHNICAL COURSES. Non-essentials omitted. TIME AND MONEY SAVED. Degree in 2 yrs. Electrical, Mechanical, Structural, Architectural, Civil, Aeronautical, Highway. Also shorter courses in Electricity, Radio, Electric Refrigeration, Power Plant, Drafting, Building, Low tuition. Extensive modern equipment. Part-time work for board and room. 34 yrs. experience producing successful men, located all over U. S. and foreign lands, holding responsible positions. Approved by industry, endorsed by graduates and educators. Catalog free.

FINLAY ENGINEERING COLLEGE
1001 Indiana Avenue Kansas City, Mo.

You Can Regain Perfect Speech, if you

STAMMER

Send today for beautifully illustrated book entitled "DON'T STAMMER," which describes the Bogue Unit Method for the scientific correction of stammering and stuttering. Method successfully used at Bogue Institute for 33 years—since 1901. Endorsed by physicians. Full information concerning correction of stammering sent free. No obligation. Benjamin N. Bogue, Dept. 160, Circle Tower, Indianapolis, Indiana.



BE A RAILWAY WRITE TRAFFIC INSPECTOR TODAY

PREPARE YOURSELF FOR AN INTERESTING,
WELL-PAID JOB

ACTIVE MEN—19 to 50—are in demand constantly for Railway and Bus Passenger Traffic Inspection work. Start at up to \$135 per month, plus expenses, and advance rapidly with experience. Our simple, home-study course quickly trains you and upon completion, we will help place you, or refund tuition. Interesting, healthful work; travel, if you like. Free booklet gives 17-year record of ambitious men who have succeeded in this field.

STANDARD BUSINESS TRAINING INSTITUTE
Div. 211 Buffalo, N. Y.

RADIO ENGINEERING

RCA Institutes offers an intensive course of high standard embracing all phases of Radio. Practical training with modern equipment at New York and Chicago schools. Also specialized courses and Home Study Courses under "No obligation" plan. Illustrated Catalog on request

RCA INSTITUTES, Inc.
75 Varick Street, New York, N. Y.
1154 Merchandise Mart, Chicago
Recognized Standard in Radio Instruction Since 1909

LEARN WATCHMAKING AND ENGRAVING

BY OUR PROFIT-SHARING PLAN
OUR GRADUATES SUCCEED

One of our Iowa students started in a very small way—now doing over \$30,000 a year. Another in Wisconsin, over \$10,000 the first year. Day or night classes. Call or write for FREE BOOK. Chicago School of Watchmaking, Dept. 3301, 155 N. Clark St., CHICAGO.

FREE How To Secure A Government Position

Tells About These and Other Positions

RAILWAY POSTAL CLERK \$1850 to \$2700 a year

POSTMASTER \$1200 to \$2500 a year

POST OFFICE CLERK \$1700 to \$2100 a year

R. F. D. MAIL CARRIER \$1800 to \$2300 a year

FREE BOOK tells how I can help you get a Government Job.

For 8 years I was Civil Service Examiner—have helped thousands. If citizen 18 to 50, you may qualify. Get ready NOW for a Government position. Send for free book. Write or mail coupon TODAY.

A. R. PATTERSON, Civil Service Expert, 811 Case Bldg., Rochester, N. Y. Please send your free book "How to Secure a Government Position."

Name.....

Address.....

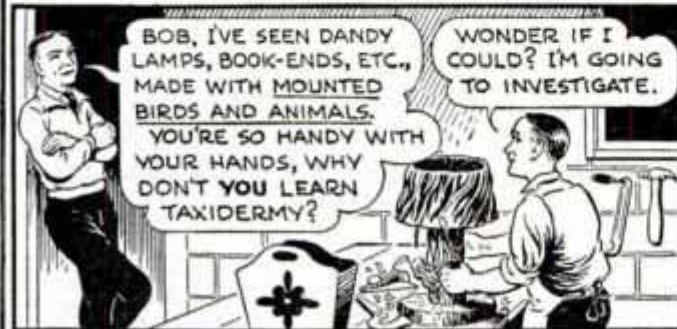


YOU CAN LEARN TO MOUNT BIRDS AND ANIMALS

Real Fun with Profits!

Be a *Taxidermist!* Learn at Home By Mail. Know a real art—learn it in your *spare time*. Have a highly interesting *hobby* and learn a *trade* from which many earn fine *spare-time profits*.

This old reliable school, 30 years in business, with 250,000 students, offers now to reveal all mysteries of Taxidermy—to teach you how to mount and preserve, just like life, birds, animals, fish, game-heads. You learn the famous *chrome tanning*. You learn the new fascinating *Craft and Novelty Taxidermy*—using common specimens—not wild game. It's a wonderful art, full of fun and fascination, with possible real sparetime earnings. Make your workbench pay a profit.



Is Taxidermy Profitable?

From our wide experience we believe emphatically, "Yes!" We know of few other businesses of any kind or nature which offer such opportunities for *spare time earnings*. Some of our Taxidermy students report earnings of \$50 to \$80 a month, others a great deal more. With wild-game growing rapidly scarcer, sportsmen want their trophies mounted. The demand is increasing—the prices are liberal. Many are earning fine profits from taxidermy. Why not make your workbench pay a profit? Read these excerpts from letters:

Leslie Wicks says, "Have made over \$300 since enrolling".—George Smith, "Just delivered \$130 worth of work".—Chas. R. Peak, "Made about \$700 in spare time".—Arthur Daniels, "Have my own shop; have made several thousand dollars".

We have many, many such letters—from most all civilized countries. Get our free booklet and read scores of enthusiastic students' letters and see photos of their work.

Free Book Coupon

Send Right Now for Your Copy It's Free. Send the coupon, or a postal will do. It tells all about our school, all about Taxidermy, contains 100 photos of startling interest.

Will you investigate? Get this free book. It may open to you new fields of pleasure, new interests, and new sources of profits which may solve your financial problems. Do it now, this minute! State your age.

NORTHWESTERN SCHOOL OF TAXIDERMY
3378 Elwood Bldg., Omaha, Nebr.

Do You Hunt?

If you hunt or fish, **save your trophies!** Game is growing scarcer. Every specimen possesses interest and value. Save every one of them. Mount them—re-create them—just like they were in life. Decorate your home and den. Have your own attractive museum. Many specimens almost extinct may have **big value** later. Taxidermy will **double** your interest in hunting, fishing.

Wild Game Not Needed

If you hunt or fish only rarely, still **Taxidermy** will delight you. You can become a **Taxidermist** and have fun, fascination, also **profits** by mounting **common** birds and animals. Mount pigeons, crows, pets, squirrels, mice, even frogs, into interesting groups—humorous ones. You can create dozens—yes, scores, of novelty groups that everyone admires. It's a thrilling art!

Craft Taxidermy

You will learn the **new and popular** "Craft" Taxidermy. In this amazing art you combine **real mounted specimens** with other craft-work, creating innumerable **useful articles**, such as lamps, door stops, gun racks, ash trays, hat racks, book ends, and many other articles that will be marvelous for the home, and which sell almost at sight. Many students earn **real profits** the year around with "Novelty" Taxidermy.

"Krome" Tanning

At last you can learn **real Tanning**. We positively teach **genuine Chrome Tanning**, a new simplified home method, tested and tried, which gives the highest satisfaction.

At last you can make **real leather**—harness, sole, lace, buck, **waterproof and heat proof**. Will not harden or stretch. You can tan all kinds of hide with the hair on—also tan fine furs and make them into garments, trimming, gloves, caps, etc. This famous "Krome" simplified method, the best ever discovered, we believe, is fully taught in our complete course of lessons.

The readers of **Popular Mechanics** are especially interested in **Taxidermy**. Thousands of them have joined our school. Investigate! Mail the coupon **TODAY**. State your age.

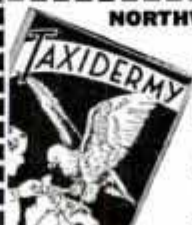


NORTHWESTERN SCHOOL OF TAXIDERMY,
3378 Elwood Building, Omaha, Neb.

Send me your free illustrated book, "How to Mount Game". Also tell me how I may learn this fascinating art easily and quickly by mail. No obligation. State your age.

Name _____ Age _____

Address _____



LEARN THE BEST PAY TRADES

DIESELS



**Demand for
Auto-Diesel
Experts Increases**



TRAIN AT NATIONAL SCHOOLS

Diesel operation and repairing calls for trained men. Everywhere you hear Diesels discussed and you can see the application of Diesels in trucks, tractors, trains, boats, busses, airplanes, power shovels, etc. To qualify for a good job you must first become trained. In the National Schools in Los Angeles you receive the most practical training under the guidance of expert instructors who teach you by proven methods.

Learn in Los Angeles

Not only do we instruct you in all branches of Diesel training, but also give you complete Auto Training, qualifying you for jobs in garages, service stations, factory branches and transportation departments. Here in Los Angeles you receive instruction in one of the most modern trade schools.

AUTOS

Opportunities for Good Jobs

National's method of training you is most comprehensive. You receive two complete courses for the price of one—Autos and Diesels. We offer full training in Auto Repair which is essential to all Diesel operators. Upon graduation you have a complete understanding of, and experience in, the operation of gas, gasoline, butane and Diesel engines and farm power tools.

A Fortune in Brand New Equipment

There is absolutely no dummy equipment at National. Tens of thousands of dollars have been recently invested in brand new equipment which you will actually work on during your training period. We have just completed enlargement of our Diesel School, tripling its capacity. Equipment includes Diesel and gas engines of most modern design, testing equipment, late model autos, machine tools, etc.

Oldest, Largest Trade School in West
Established 1905. More than 30,000 successful graduates. National Schools is a million-dollar institution, occupying a magnificent building in Los Angeles.

Earn Room and Board While Learning
The majority of National students earn room and board while learning. With limited finances you can enroll. We assist students to obtain part-time jobs. Coach R. H. fare allowed to L. A.

Mail Coupon for Free Book

This book gives full information regarding the combined Auto and Diesel Courses. Profusely illustrated.

NATIONAL AUTOMOTIVE SCHOOLS

Dept. 11-PMA, 4000 So. Figueroa St., Los Angeles

NAME _____

ADDRESS _____

CITY _____ STATE _____



Qualify for These Good Jobs

Diesel Mechanic; Fuel Injection Expert; Diesel Service Man; Diesel Trouble Shooter; Auto Mechanic; Auto Electrician; Battery Expert; Carburetor Expert, etc.



BE A SEAVER EXTERMINATOR IN 10 DAYS

E. Joseph Seaver, now 74 years old, at last reveals his priceless lifetime secrets for **GUARANTEED** extermination—not control—of rats, mice, roaches and other destructive pests. Amazingly easy to learn his unflinching methods in nine fascinating lessons. Prepare in a few hours of spare time at home to earn up to \$15,000 a year in this essential profession. Write **TODAY** for **FREE** book "Where Fortune Lies Waiting."

SEAVER EXTERMINATING SYSTEMS
185 N. Wabash Ave. Dept. P-10 Chicago, Ill.



TRI-STATE COLLEGE

B. S. Degree in 2 years. World famous for technical 2-year courses in Civil, Electrical, Mechanical, Chemical, Radio, Aeronautical Engineering; Business Administration and Accounting. Equivalent in technical hours to 4-year course. Those who lack

high school may make up work. Low tuition. Low living costs. Located in picturesque hill and lake region. Students from every state and many foreign countries. 52nd year. Enter Sept., Jan., March and June. Write for catalog.

4115 COLLEGE AVE.,

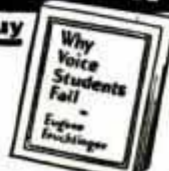
ANGOLA, IND.

"Why VOICE Students Fail"

SENT FREE No Obligation to Buy

If you act quick!—we will send postpaid—for 30 days' free reading—new Voice Book disclosing startling VOICE FACTS that may save hundreds of dollars to every man or woman seeking a strong, rich voice for either singing or speaking. 30 days' free reading—then send \$1.00. Otherwise, return it—that's all!

PROF. E. FEUCHTINGER Studio 93-58
64 East Lake Street Chicago



Learn PHOTOGRAPHY at Home

Make money taking pictures. Photographs in big demand. Commercial Photography also pays big money. Learn quickly at home in spare time. No previous experience necessary. Write today for free new book, *Opportunities in Modern Photography*. American School of Photography, Dept. 1358, 3601 Michigan Ave., Chicago.

ARTISTS MAKE MONEY

Find out your ability. Send name, age, occupation and address for Free Vocational Art Test.

Federal Schools, Inc., 11135 Federal Schools Bldg., Minneapolis, Minn.

CIVIL SERVICE

VALUABLE INFORMATION FREE
COLUMBIAN CORRESPONDENCE COLLEGE
WASHINGTON, D. C.



SECRET SERVICE BOOK FREE

For 30 Days Reading
No Money Down—Actual Crime Cases—
If You Act Quick!—We will send you this stirring book on Crime Detection, Secret Service and Identification Work for 30 days free reading. Send no money. If you decide to keep it, then send only \$1.00. If not, return it. WRITE TODAY. Not sent to boys under 17 years of age.

T. G. Cooke, Dept. 13-58, 1920 Sunnyside Ave., Chicago

MAIL FOR FREE INFORMATION

BEDFORD

YMCA TRADE SCHOOL

1117 Bedford Ave., Dept. PM-30
Brooklyn, New York City, N. Y.

- Auto Mechanic
- Talking Pictures
- Aviation Mechanic
- Welding
- Aeronautical Engineering
- Refrigeration
- Machine Shop
- Oil Burner
- Commercial Art
- Air Conditioning
- Sign Painting
- Electrical
- Window Display
- Radio and Television Mechanic
- Architectural-Mechanical Drafting
- Armature Winding
- Diesel Engines

Name

Address

When writing please mention Popular Mechanics

LEARN RADIO FROM REAL RADIO ENGINEERS



HERE THEY ARE:

- Kendall Clough, Chief Engineer, Clough-Brengle Company.
- E. E. Gramer, Chief Engineer, Standard Transformer Corporation.
- Karl E. Haasel, Chief Engineer, Zenith Radio Corporation.
- H. C. Tittle, Chief Radio Engineer, General Household Utilities (Group).
- F. D. Whitten, Service Manager, Chicago Branch, Philco Radio & Television Corp.
- Dr. C. M. Blackburn, Radio Engineer, P. R. Mallory & Co., Indianapolis, Manufacturers of Radio Apparatus.

LET THESE ENGINEERS RIGHT FROM THE HEART OF THE BIG RADIO INDUSTRY Train You at Home for

GOOD PAY RADIO WORK

MANY R-T-I TRAINED MEN MAKE \$35 TO \$75 A WEEK

If you're dissatisfied with small pay—work that's getting you nowhere—lay-offs and uncertain income—here's an opportunity that's too good to miss. At the cost of only the time it takes you to mail the coupon, you can get my big FREE book, "RADIO'S FUTURE AND YOURS." This book tells how you can learn at home to make more money almost at once in Radio—whether you want to make Radio your life's work, or use it to pick up an extra \$5 to \$20 a week in your spare time.

"RADIO IS GROWING BY LEAPS AND BOUNDS"

says *Radio Craft Magazine*. It has forged ahead even in depression years. Where only a few hundred men were employed a short time ago, thousands are employed today. Where a few years ago a hundred jobs paid \$35 to \$75 a week—there are thousands of such jobs today. And more new jobs being created all the time—full time jobs and spare time jobs. Get my book and see how easy it is to learn at home for this good-pay work.

R-T-I TRAINING IS "SHOP TRAINING" FOR THE HOME

It comes to you right from the Radio Industry—right out of the factories where Radio sets and other vacuum-tube devices are made. It was planned and prepared for you by big radio engineers IN these factories, most of whom are the Chief Engineers of these great Radio plants. And NOW these same engineers are actually supervising R-T-I Training. Which means that trained the R-T-I way, you'll be trained as the Radio Industry wants you trained—just as the Radio Industry, itself, would train you if it was doing the job.

4 BIG WORKING OUTFITS INCLUDED

These are probably the biggest and most expensive Working Outfits ever included with a home-training Course. You use them to build up testing equipment—to experiment with—to do actual Radio work. It's Shop Training for the home.

SOUND PICTURES, P. A. SYSTEMS, PHOTO CELLS, TELEVISION, ETC. ALL INCLUDED

Radio service work is just the starting point in R-T-I Training. From there we take you up through the very latest developments in Radio, and then on into the new and larger field of Electronics—Sound Pictures, Public Address Systems, Photo Cells, and Television. This feature alone makes R-T-I the outstanding home training in Radio.

YOU GET "QUICK RESULTS"

C. E. Head, 431 Third St., Alexandria, La., says: "Made my first money 11 days after starting your training—cleared \$14.25."

Frank E. Klemann, Lisle, Ill., writes: "Doubled my pay in less than six months."

Harry L. Stark, Ft. Wayne, Ind., writes: "Now making three times as much money as I was when I started your training."

AGE OR LACK OF EDUCATION NO HANDICAP

You don't have to be a high school graduate. It isn't necessary that you should have finished the grades. My Training in Radio is so simple, so easy, and so practical, that it offers every man, regardless of age, education, or previous experience, the chance to get out of a small-pay, no-future job, into good pay, big future work in Radio.

YOUR MONEY BACK IF YOU ARE NOT SATISFIED

That's my way of doing business. And I'll give you that agreement in writing—an agreement to refund every penny of your tuition if, on completion of my Training, you are not entirely satisfied. INVESTIGATE! Learn why R-T-I Training is different. Find out why R-T-I Trained men get "Quick Results" and "Big Results." Send today for my big book "Radio's Future and Yours." The book is free. **Ray D. Smith, President** Radio & Television Institute, Chicago

When writing to advertisers please mention Popular Mechanics

"We OK Radio and Television Institute home training"

say 50 of the LEADING-RADIO MANUFACTURERS

and they are talking to YOU

AMERICAN TELEVISION APPARATUS DESIGN COMPANY ARCTURUS TUBES

BALKEIT • BRUNSWICK CAPEHART

CLOUGH-BRENGLE CO.

CROSLY • DeFOREST • FADA

ERIE RESISTOR CORPORATION

HAMMARLUND • HICKOK

GRUNOW • HOWARD

INTERNATIONAL RESISTANCE CO.

KEN-RAD • KOLSTER • LYRIC

MAJESTIC • MUTER CO.

NATIONAL UNION RADIO CORP.

PHILCO

RADIO PRODUCTS CO.

SANGAMO ELECTRIC

SENTINEL • STEWART-WARNER

SILVER-MARSHALL MFG. CO.

STANDARD TRANSFORMER CORP.

STROMBERG-CARLSON

UNIVERSAL MICROPHONE

ZENITH

AND OTHERS



MAIL COUPON FOR MY FREE BOOK

Get your copy of "Radio's Future and Yours" today. It tells you about Radio's amazing opportunities. It describes my Course. It tells what R-T-I students are doing and making. It's FREE. Clip, sign and mail coupon RIGHT NOW!

Ray D. Smith, President
RADIO AND TELEVISION INSTITUTE (R-T-I)
2130 Lawrence Ave., Dept. 18
Chicago, Ill.

Without obligation of any kind please send me a copy of "Radio's Future and Yours." I am interested in your home training and the opportunities you say exist in the great field of Radio for the R-T-I Trained men.

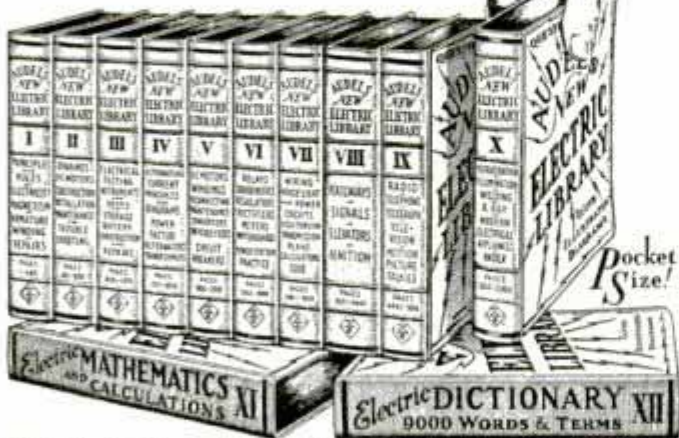
Name.....

Address.....

City..... State.....

NEW ELECTRIC LIBRARY

\$ 1.50 A VOLUME



WHAT EVERY ELECTRICIAN WANTS TO KNOW!

is easily found in AUDEL'S NEW ELECTRIC LIBRARY. Electricity made simple as ABC. Up-to-date, trade dope for the expert and ALL electrical workers. Questions, answers, diagrams, calculations, underwriter's code; design, construction, operation and maintenance of modern electrical machines and appliances FULLY COVERED.

All available at small cost, easy terms. BOOK-A-MONTH service puts this NEW information in your hands for 6c a day. You can start your subscription with any volume. Write TODAY for electric folder and FREE TRIAL offer.

THEO. AUDEL & CO., 65 W. 23rd St., New York City

Mail Vol. I, Electric Library on 7 days' free trial. If O. K. I will remit \$1.50, otherwise I will return it. I also request you to mail one book each month on same terms. No obligation unless I am satisfied.

Name.....
 Address.....
 Occupation.....

NEON EXPERTS MAKE BIG MONEY

Learn at Home -- in Few Weeks

Prepare quickly to earn up to \$100 weekly in new, fascinating NEON, "luminous-tube" industry! Today's most widely-used medium of lighted signs—tomorrow's greatest source of illumination. Trained men needed right now, in every locality. Selling—designing—manufacturing—installing. Splendid future awaits shrewd men who start NOW.

FREE LESSON EXCERPTS and Free Book describe America's foremost Neon home-study course. Teaches everything. Non-technical. Amazing low cost. Easy terms. Free employment service. WRITE!

COMMERCIALITE LABORATORIES Dept. 47 OMAHA, NEBR.

AIR CONDITIONING

today's big opportunity!

AIR CONDITIONING is the next big industry. Mark that prediction! Its opportunities are as big in winter as in summer. Plumbing and

heating engineers must know Air Conditioning—the field in its broader aspects invites ambitious men. And a new, up-to-the-minute course on Air Conditioning now offered by the I. C. S. will help you qualify for advancement in this new field. Full information—free.

INTERNATIONAL CORRESPONDENCE SCHOOLS

BOX 5602-H, SCRANTON, PA.

Explain fully about your course in the subject marked X:

AIR CONDITIONING

- | | |
|--|---|
| <input type="checkbox"/> Chemistry | <input type="checkbox"/> Accountancy |
| <input type="checkbox"/> Radio | <input type="checkbox"/> Advertising |
| <input type="checkbox"/> Aviation | <input type="checkbox"/> Electrical Engineering |
| <input type="checkbox"/> Refrigeration | <input type="checkbox"/> Drafting |
| <input type="checkbox"/> Inventing & Patenting | <input type="checkbox"/> Show Card Lettering |
| <input type="checkbox"/> Architecture | <input type="checkbox"/> Good English |

Name..... Age.....

Address.....

Amazing Sensational Discovery REFINISHES AUTOS LIKE NEW!

NOT A WAX OR POLISH—LASTS 8 to 12 MONTHS—SHABBY CARS GIVEN NEW LUSTER AND SHINE

Men—it's unbelievable, a miracle! KAR-NU refinishes old shabby cars in a few minutes. Gives them like-new shine. Not a polish, wax, or paint, but a real finish that lasts 8 to 12 months. Stands washing, sunshine, long wear. No rubbing—no polishing—no waxing. Just apply with rag. Guaranteed.



FREE SAMPLE

What a profit-maker for agents and distributors! Millions of cars need this new LOW PRICED auto finisher. BIG PROFITS—up to \$7.00 in an hour, easy. Ten second demonstration on any man's car sells him QUICK. Hurry—get FREE SAMPLE which proves all claims. Write or wire to-day. Distributors Wanted in Foreign Countries. KAR-NU CO., Dept. S-30, Oakley, Cincinnati, Ohio

LOW PRICED GUARANTEED

BECOME AN EXPERT

ACCOUNTANT

Executive Accountants and C. P. A.'s earn \$3,000 to \$15,000 a year. Thousands of firms need them. Only 12,000 Certified Public Accountants in the U. S. We train you thoroughly at home in spare time for C. P. A. examinations or executive accounting positions. Previous experience unnecessary. Personal training under supervision of staff of C. P. A.'s, including members of the American Institute of Accountants. Write for free book, "Accountancy, the Profession that Pays."

LaSalle Extension University, Dept. 1164-H Chicago
 The School That Has Trained Over 1,200 C. P. A.'s

LEARN WATCH REPAIRING



AT HOME You can learn by our modern and original system of instruction every part of the Watch Repairing Trade at home as good or better than at a shop. You can earn money while learning and secure a well paying position or start in business after completing our course of instruction. Good watch repairers are always in demand and earn very good salaries. For particulars apply to the Wisconsin School of Watch Repairing 524 E. Mason St., MILWAUKEE, WIS.

TAP DANCING



LEARN AT HOME NEW EASY WAY. Professional Stage Method. Surprise and entertain your friends. Be popular, earn extra money, develop hidden talent. No music or experience needed. Begin dancing first day. Beginner's fundamentals and complete Professional Tap Dance included. Equal to \$40 instruction. Easy way to reduce or build up figure. For ladies or men. Send only \$3.75 money order for Complete 17-Lesson Course. Or send no money (if in U. S.) and pay postman \$3.98 on delivery. No more to pay, Try 5 days. If not delighted, money refunded. Limbering exercises Free if you enroll now. THORNTON DANCE STUDIOS 827 Irving Park Blvd., Suite 134, Chicago, Ill.

WANT THIS JOB?



\$1700 first year regular City Postoffice Clerks Men 18 to 45

Write Immediately for FREE list of positions and full particulars telling how to get a position.

FRANKLIN INSTITUTE
 Dept. C181 Rochester, N. Y.

LES Correspondence Courses in **RADIO and ELECTRICAL ENGINEERING** **LES**

ELECTRICAL ENGINEERING covers complete electrical field. Most modern course. Very understandable.

RADIO ENGINEERING. Ultra-modern course in radio, pub. a address, photo-electric work. Trains you to be super-service man, real vacuum tube technician. Run like a college. Tuition ONLY \$25, either course. Deferred payment plan. WRITE TODAY for free copies of school catalogs, student magazines, etc.

LINCOLN ENGINEERING SCHOOL 835-M So. 37th St., Lincoln, Nebr.

AUTO-MECHANICS & WELDERS

Auto Mechanics and Welders are in big demand. Complete courses in arc and acetylene welding, body and fender bumping, spray painting and metal finishing. Pay while you learn. Enroll now at special low rates. Write today.

MICHIGAN TRADE SCHOOL
 3758 Woodward Ave., Detroit, Mich.

Write for FREE CIRCULAR

The DIESEL EXPERT is the MAN ON TOP



HEMPHILL TRAINING
— a firm foundation for **SUCCESS**
in the **DIESEL Industry**



HEMPHILL DIESEL SCHOOLS



New York Schools
31-26 Queens Blvd.
Long Island City,
New York



Chicago Schools
2014 Larrabee Street



Los Angeles Schools
2120 San Fernando Rd.



Seattle Schools
501 Westlake North



Detroit Schools
2341 W. Lafayette Blvd.
Also Schools at 1363 Granville St., Vancouver, B. C.

Hemphill Diesel Schools,
2020 Larrabee St.,
Chicago, Illinois.

Gentlemen:

I am very happy to report that I have made a connection in the Engineering Department of Fairbanks Morse Company at Deloit, Wisconsin.

This is the type of work that I looked forward to entering when I began the course with your school last December. I appreciate the assistance you have given me in securing this position, and I don't hesitate in saying that without the training that I received at the Hemphill Schools, I would not have been qualified for the position which I now hold.

I feel that the course of Diesel training given at your schools, is thorough and practical, and I wish to commend the organization for the efficient way in which the training is conducted in both the lecture room and the shop, and for the personal interest which the instructors and officials take in the students.

Yours very truly,

C. A. Madison



C. A. MADISON is one of hundreds of HEMPHILL GRADUATES who have achieved SUCCESS in the DIESEL Industry. Read his letter above. HEMPHILL SCHOOLS provide the WORLD'S FINEST DIESEL TRAINING!

Chicago, Illinois,
July 15, 1935.

THE Diesel Industry is Growing at an Amazing Pace! Hemphill Graduates occupy many of America's outstanding DIESEL positions because HEMPHILL SCHOOLS provide the most thorough and up-to-the-minute training on the largest assemblages of DIESEL Engines for instruction purposes in the world. Thousands of dollars-worth of new, high-speed DIESELS and latest testing equipment have just been installed. World-wide Employment Service. Day, Night and Combination Home-Study Courses. Mail Coupon below, or write your nearest HEMPHILL Schools.

CAUTION We operate Schools *only* at the locations shown above and are in *no way* connected with any other schools.

MAIL COUPON TODAY

Hemphill Diesel Schools, Dept. PM (use nearest address shown above): I would like to have, without any obligation, full information about your Diesel training courses and a copy of "Diesel News" containing amazing facts and pictures.

Name _____

Street Address _____

City _____ State _____

AMERICA'S ORIGINAL EXCLUSIVE DIESEL TRAINING SCHOOLS

When writing to advertisers please mention Popular Mechanics

Vital Changes in National Life

All Over the World Have Created New Words and New Facts

The New Merriam-Webster

Is the ONE Dictionary So New That It Meets Present-Day Needs

The whole wealth of new words and new information that is so necessary a part of your equipment is now available for instant reference in

WEBSTER'S NEW INTERNATIONAL DICTIONARY Second Edition

600,000 Entries; 122,000 More Than Any Other Dictionary

The Greatest Amount of Information Ever Put into One Volume.

12,000 Terms Illustrated.

Magnificent Plates in Color and Half Tone.

Thousands of Encyclopedic Articles

Wonderfully Rich in Information.

35,000 Geographical Entries.

13,000 Biographical Entries.

Exhaustive Treatment of Synonyms and Antonyms.

Definitions Absolutely Accurate and Easy to Understand.

Thousands of Etymologies Never Before Published.

Pronunciation Fully and Exactly Recorded.

3,350 Pages. New from Cover to Cover.

At All Bookstores. Write for Information.

G. & C. MERRIAM CO.

506 Broadway, Springfield, Mass.



The Editor's MAIL BAG

(Continued from page 10A)

venient sized book, place blank sheets of paper at front and back to serve for fly-leaves and take them to the local printer for binding. I find Popular Mechanics best for this purpose. Few articles are continued to the back and that simplifies the job."—Ralph C. Coffelt, Protection, Kans.

Little Giant Receiver



Builder with His Receiver

"The photo shows my Little Giant 5-tube a.c.-d.c. receiver that I built from the article in the January issue of Popular Mechanics. Both this set and another that I made from your magazine have given excellent results."—Harold L. Davis, Brooklyn, N. Y.

Any Other Nominations?

"During fifteen years of driving I have learned to tolerate the guy who makes a wide swing to the left when he intends to turn right, or vice versa, the nitwit who attempts to pass on a hill and



the horn tooter who tries to make the lights turn from red to green by blowing long and

(Continued to page 54A)

Big Money in Poultry



Eggs Turn into Dollars FAST!

Make \$1,000 a Year in Spare Time — Easy

Lots of room for YOU in the poultry business. 85% of the people of this country live in cities. EVERYBODY eats eggs and poultry meat—but only 15% produce them. Why not let the "other fellow" pay YOU the fancy prices? Easy to get started in back yard, on vacant lot or farm. We GUARANTEE success if you follow our methods. We show you how to feed for eggs, in winter, when eggs are high in price; how to cut feed bills; how to keep flocks healthy; how to tell laying hens, PAY-BIRDS, from loafers. Our home-study course, produced by eighteen famous experts, endorsed by 30 leading agricultural schools, gives you thousands of sure, proved, tested Methods that make PROFITS CERTAIN. FREE book tells what we're doing for others—and what we can do for you.

Others Say:

"You have opened up to me a pleasant and profitable way of gaining an independent living."

—Seldon Anderson, R. I.

"When I enrolled for your course, I knew nothing about poultry keeping. I am now successfully operating a commercial poultry farm."

—W. J. Warthen, Conn.

"Your course was a splendid investment. I recommend it for both beginners and experienced poultrymen."

—Y. W. Owe, Hawaii.

MAIL COUPON TODAY

Mail this now

The National Poultry Institute
Adams Center, N. Y. Dept. 31-A

I want to know how to make big money raising poultry. Send me your FREE book explaining your home-study course and

PROVED methods.

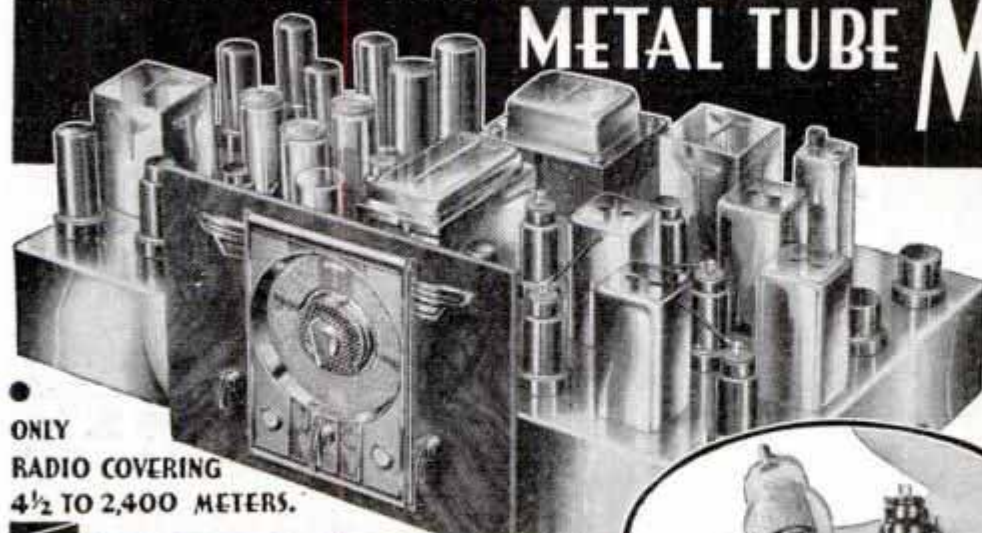
Name.....

Address.....

SAVE UP TO 50% by BUYING YOUR RADIO *Direct from* MIDWEST LABORATORIES

Glorious Tone Realism.. World-Wide Entertainment Guaranteed!
with New 1936 SUPER *Deluxe*

METAL TUBE **MIDWEST**



18 TUBE
RADIOS
6 TUNING RANGES

ONLY
RADIO COVERING
4½ TO 2,400 METERS.

30 Days FREE Trial!



PUSH-BUTTON TUNING
(Noises Suppressed)

Now, Push-Button Silent Tuning is offered for first time! Simply pushing Silence Button hushes set between stations . . . suppresses noises. Pressing Station Finder Button automatically indicates proper dial position for bringing in extremely weak stations.

Acousti-Tone V-Spread Design
(Patent Pending)

... Establishes new radio style overnight! The V-Front Dispersing Vanes were developed by Midwest engineers as a result of a study of directional effect of the Midwest Full Scope High Fidelity Speaker. These Vanes spread the beautiful lacework of the "highs" throughout the entire room in a scientific manner . . . directing the High Fidelity waves uniformly to the ear. Send for new FREE 40-page catalog. It pictures the complete line of beautiful 1936 Acousti-Tone V-Spread consoles . . . and chassis . . . in four colors.

FULL SCOPE HIGH FIDELITY
Brilliant

Concert Tone
Now, get complete range of audible frequencies from 30 to 16,000 cycles, being transmitted by four new High Fidelity Broadcasting stations—W1XBS, W9XBY, W2XR and W6XAL. Glorious new Acousti-tone is achieved assuring life-like, crystal-clear "concert" realism.

V-FRONT

EVERYWHERE, radio enthusiasts are praising this amazingly beautiful, bigger, better, more powerful, super selective, 18-tube 6-tuning range radio. They say it is a tremendous improvement over Midwest's 16-tube set, so popular last season. It is sold direct to you from Midwest Laboratories at a positive saving of 30% to 50%. (This statement has been verified by a Certified Public Accountant who conducted an impartial survey among representative Ohio, Kentucky and Indiana radio retailers.) Before you buy any radio, write for FREE 40-page 1936 catalog. Never before so much radio for so little money. Why pay more? You are triple-protected with: One Year Guarantee, Foreign Reception Guarantee and Money-Back Guarantee! This super Midwest will out-perform \$200 to \$400 sets on a point-for-point comparison. That is why nationally known orchestra leaders like Fred Waring, George Olsen, Jack Denny, Ted Fio Rito, and others use Midwest sets to study types of harmony and rhythmic beats followed by leading American and Foreign orchestras.

80 ADVANCED 1936 FEATURES

Scores of marvelous features, many exclusive, explain Midwest super performance and thrilling world-wide all-wave reception . . . enable Midwest to bring in weak distant foreign stations, with full loud speaker volume, on channels adjacent to locals. Only Midwest offers so many features . . . only Midwest tunes as low as 4½ meters . . . only Midwest gives the sensational new Push-Button Tuning feature, etc. See pages 12 to 21 in FREE catalog for description of the 80 features. Read about advantages of 6 Tuning ranges . . . offered for first time: E, A, L, M, H and U. They make this Super De Luxe 18-tube set the equivalent of six different radios . . . offer tuning ranges not obtainable in other radios at any price!

DEAL DIRECT WITH LABORATORIES

No middlemen's profits to pay.—you buy at wholesale price direct from laboratories . . . saving 30% to 50%. Increasing costs are sure to result in higher radio prices soon. Buy before the big advance . . . NOW . . . while you can take advantage of Midwest's sensational values. You can order your Midwest 1936 Full Scope High Fidelity Acousti-Tone radio, from the 40-page catalog with as much certainty of satisfaction as if you were to come yourself to our great radio laboratories. You save 30% to 50% . . . you get 30 days FREE trial . . . as little as \$5.00 puts a Midwest radio in your home . . . Satisfaction guaranteed or money back. Write today, for FREE catalog.

SAVE UP TO 50%



WORLD'S GREATEST
RADIO VALUE

\$59.50
with New
GIANT
THEATRE-
SONIC
(LESS TUBES) SPEAKER

TERMS AS LOW AS \$5.00 DOWN

Thrill to new explorations in sections of radio spectrum that are strangers to you. Every type of broadcast from North and South America, Europe, Asia, Africa and Australia is now yours. Send today for money-saving facts.

GEORGE OLSEN PRAISES LIFE-LIKE TONE REALISM

Long Island, N. Y.—After comparing many different makes, I finally decided upon Midwest. It out-performs other radios costing almost twice as much. The crystal-clear tone is so life-like that it sounds as though I am in the studios, actually hearing artists performing.



TODAY'S FINEST RADIO SAYS TED FIO RITO

My new Midwest is finest radio I have had pleasure of hearing. Bass-Treble control is marvelous . . . enables one to hear every instrument in orchestra.



METAL TUBES

This Midwest is engineered from the ground up to counter the new METAL tubes or glass-metal counterpart tubes. Octal sockets and newest circuits permit use of either type . . . just as you desire.

MAIL COUPON TODAY! FOR FREE 30-DAY TRIAL OFFER and 40-PAGE FOUR-COLOR FREE CATALOG

MIDWEST RADIO CORP.,
Dept. 15E, Cincinnati, Ohio

Without obligation on my part, send me your new FREE catalog, complete details of your liberal 30-day FREE trial offer, and FREE Miniature Rotating 18-tube Dial. This is NOT an order.

User-Agents
Make Easy
Extra Money

Check Here
for
details

Name _____

Address _____

Town _____ State _____

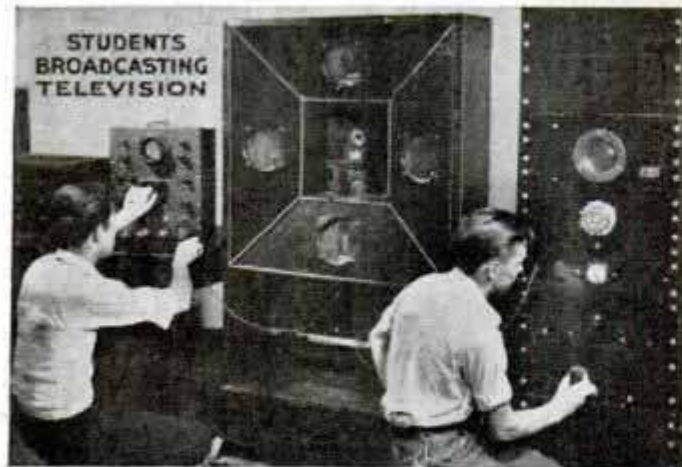
Check here, if interested in a Midwest All-Wave Battery Radio

MIDWEST RADIO CORP.

DEPT. 15E, CINCINNATI, OHIO U.S.A.

Established 1920 Cable Address MIRACO All Codes

TELEVISION



America's first Complete Television Training Course LEARN IN LOS ANGELES

Get in on the "ground floor" of Television. Trained men are needed. Watch the demand grow by leaps and bounds. Coaxial cables being laid. Many stations already broadcasting Television. Students at NATIONAL SCHOOLS learn with most modern equipment, both transmission and reception of Television. Fascinating, profitable Trade you can learn at National. Enroll and qualify for good jobs.

RADIO



BROADCASTING & TALKING PICTURES

Students Operating Transmitters

Complete course includes unlimited RADIO instruction in all branches—construction, operation and repair of Radios, station operation, ship and airplane broadcasting and receiving. In our own complete Radio broadcasting studio, students learn by actual operation. Complete sound amplifying equipment for talking picture projection training.

Qualify for Commercial Radio positions, as a Ship Operator. Qualify for Govt. license. Travel on pay and see the World.

ELECTRICITY

FULL COURSE—NO EXTRA COST

You receive full training in fundamentals of Electricity, motor repairing, generating plant and sub-station operation, etc.—a good pay trade in itself.

EARN ROOM & BOARD WHILE LEARNING

We help students to be self-supporting. No age limit.

All courses included for the price of one, for limited time. Coach railroad fare allowed from any point in U. S. to Los Angeles.

NATIONAL SCHOOLS

-free Book



Established 1905. 30,000 graduates. A million-dollar School. Send Coupon for amazing Book of Facts.

MAIL COUPON FOR FREE BOOK

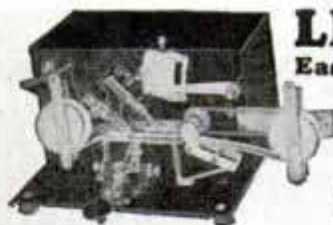
National Schools, Dept. 11-PMR, 4000 S. Figueroa St., Los Angeles, Calif. Send Book and Full Details.

Name.....

Address.....

City.....State.....

When writing please mention Popular Mechanics



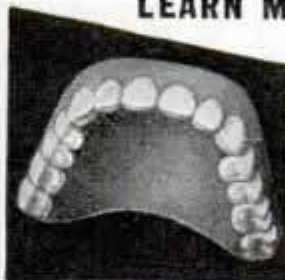
LEARN CODE

Easily and Quickly at Home

To get the most out of your S.W. Radio, you must know code. Thousands agree the easiest, quickest, surest way to learn code is with the Master Telex Code Teacher. Master Telex records your own sending in visible dots and dashes on copper tapes—then SENDS BACK your key work. We furnish complete course, lend you instrument, give personal service with a MONEY BACK GUARANTEE on a low monthly payment basis. Send for FREE catalog "P." No obligation.

TELEPLEX CO. 76 Cortlandt St. NEW YORK, N. Y.

LEARN MECHANICAL DENTISTRY



A profession that cannot be affected by machinery. Make plates, crowns, bridges, etc., for dentists—or have a business of your own. Easily and quickly learned, in day or night school. Individual instruction. No books—no classes. Write for Catalogue and FREE TOOL OFFER.

Dept. 703 McCARRIE SCHOOL OF MECHANICAL DENTISTRY 207 N. Broad St. Phila., Pa.



AT HOME!

Learn easy Koehne Method of coloring photos and miniatures in oil. New! No art training needed. Big demand. Send for free booklet, *Make Money At Home*. NATIONAL ART SCHOOL 3601 Michigan Ave. Dept. 1358 Chicago



VOICE

100% Improvement Guaranteed

We build, strengthen the vocal organs—not with singing lessons—but by fundamentally sound and scientifically correct silent exercises... and absolutely guarantee to improve any singing or speaking voice at least 100%... Write for wonderful voice book—sent free. Learn WHY you can now have the voice you want. No literature sent to anyone under 17 years unless signed by parent.

PERFECT VOICE INSTITUTE, Studio 13-58 64 E. Lake St., Chicago

AVIATION APPRENTICES

AIR-MINDED Young Men interested in entering the field of Aviation as Apprentices. Write immediately, enclosing stamp, to MECHANIX-UNIVERSAL AVIATION SERVICE P. O. Box 33 Dept. E Detroit, Mich.

LEARN CARTOONING

by the method that has developed hundreds successfully. Send name, address and age for free chart to test your ability.

The Landon School, 1738 National Bldg., Cleveland, Ohio

5¢ LITTLE BLUE BOOKS

Send postcard for our free catalogue. Thousands of Bargains. Address: LITTLE BLUE BOOK CO., Catalogue Dept., Desk 494, Girard, Kansas.

FUN WITH PLASTIC RUBBER!

MAKE YOUR OWN RUBBER MOLDS —TOYS! Fix bike tires, footballs, gym shoes, etc. Easy! Spreads on like butter—dries tough overnight. Take this ad in any Hardware or 10c Store. Ask for So-La Plastic Rubber. If can't get, send 10c & store name to So-La, Clatt, O., for trial can.

GOV'T. JOBS

SALARY TO START \$90 to \$175 MONTHLY

MEN WOMEN

Age Range 18 to 50

<input type="checkbox"/> Ry. Mail Clerk	<input type="checkbox"/> POSTMASTER
<input type="checkbox"/> P. O. Laborer	<input type="checkbox"/> Seamstress
<input type="checkbox"/> R. F. D. Carrier	<input type="checkbox"/> Auditor
<input type="checkbox"/> Special Agent	<input type="checkbox"/> Stenographer
<input type="checkbox"/> Customs Inspector	<input type="checkbox"/> U.S. Border Patrol
<input type="checkbox"/> City Mail Carrier	<input type="checkbox"/> Telephone Opr.
<input type="checkbox"/> P. O. Clerk	<input type="checkbox"/> Watchman
<input type="checkbox"/> Matron	<input type="checkbox"/> Meat Inspector
<input type="checkbox"/> Special Investigator	<input type="checkbox"/> Secret Service Opr
<input type="checkbox"/> Typist	<input type="checkbox"/> File Clerk

OZMENT INSTRUCTION BUREAU
Dept. 111 St. Louis, Mo.

Send me FREE particulars "How to Qualify for Government Positions" marked "X". Salaries, locations, opportunities, etc. ALL SENT FREE.

Name.....

Address.....

"Give Me Your Measure and I'll Prove in the First 7 Days You Can Have a Body Like Mine!"

No other Physical Instructor in the World has ever DARED make such an offer!

I'll give you PROOF in 7 days that I can turn you too, into a man of might and muscle. Just think of it! Right in the first week under my guidance you will see and feel the improvement! Then as my weekly instructions arrive in your home you continue to re-build, renew and "overhaul" your body. By the end of three months you are the owner of a powerful body that you will be proud to display anywhere, any time! People will notice the ruddy glow of health in your face, the sparkle in your clear eyes, your broad shoulders and they will seek your company. You will be the fellow who will walk off with the prettiest girl and the best job while the others wonder how you did it!

Write your name and address carefully on the coupon below. I'll send you absolutely free a copy of my new book, "Everlasting Health and Strength." It reveals the secrets that changed me from a 97-pound flat-chested weakling into a husky fellow who won the title of "The World's Most Perfectly Developed Man" against all comers! And it shows how I can build you into an "Atlas Champion" the same way.

Are you underweight? I'll add pounds where they are needed! Are you fat in spots? I'll show you how to pare down to fighting trim.

And with the big muscles and powerful evenly-developed body that my method so quickly gives you, I'll also give you through-and-through health — health that digs down into your system and banishes such things as constipation, pimples, skin blotches and the hundred-and-one similar conditions that rob you of the good time and the good things of life.

I've Got No Use At all for "Contraptions"

I haven't any need for contraptions that may strain your heart and other vital organs. I don't dose you or doctor you. *Dynamic-Tension* is all I need. It's the natural, tested method for developing real men inside and out. It distributes added pounds of powerful muscles over your body, gets rid of surplus fat, and gives you the vitality, strength and pep that win you the admiration of every woman and the respect of any man.

Get my free book, "Everlasting Health and Strength"! Mail my coupon today. Gamble a stamp to prove I can make YOU a new man!



HEIGHT
5 FT. 10 IN.

WEIGHT
178 LBS.

NOTE: This is the latest photo of Charles Atlas showing how he looks today. This is not a studio picture but an actual untouched snapshot.



This Sterling Silver Cup Being Given Away by

Charles Atlas

This valuable cup, made of solid sterling silver, stands about 14 inches high on a black mahogany base.

I will award it to my pupil who makes the most improvement in his development within the next three months. Therefore, no matter what your measurements may be now, you have an equal chance to win this cup for permanent possession—and with YOUR name engraved on it!

Get my free book by mailing coupon below!

48-PAGE BOOK
FREE

It tells you all about my special *Dynamic-Tension* method, and what it has done to make big-muscled men out of run-down specimens. It shows you, from actual photos, how I have developed my pupils to the same perfectly balanced proportions of my own physique. What my system did for me and these hundreds of others it can do for you too. Don't keep on being only half of the man you CAN be! Find out what I can do for you. Where shall I send your copy of "Everlasting Health and Strength"? Put your name and address on the coupon, or a postcard, and mail it today.
CHARLES ATLAS,
Dept. 811, 115 East 23rd Street, New York, N. Y.



**CHARLES ATLAS, Dept. 811
115 East 23rd Street, New York, N. Y.**

I want the proof that your system of *Dynamic-Tension* will make a New Man of me—give me a healthy, husky body and big muscle development. Send me your free book, "Everlasting Health and Strength."

Name.....
(Please print or write plainly)

Address.....

City..... State.....

© 1935 C.A. Ltd.

MAIL COUPON FOR FREE BOOK NOW!

A GREAT CHRISTMAS GIFT



FOREST FIRE ACTION LAMP

Beautiful scene in colors. Cylinder inside revolves. The fire seems to really burn when the lamp is turned on. Flames and smoke seem to rise through the trees—reflect on lake. Modernistic octagon top and base. Beautiful new oil painting reproduced in full colors on parchment. Complete, ready to plug in. More attractive than lamp we sold for \$5.00 in 1930.

New price **\$1.00** POSTPAID

Niagara Falls Lamp
Beautiful new picture. Falls really seems to flow. Price same as above.

Send \$1 bill or money order for prompt shipment, postpaid. PRINT your name and address plainly. No lamps shipped C. O. D. or on approval. Order as many as you want. Dozen lots \$10.00.

IGNITION CO.
50 Tompsett Bldg. Omaha, Nebraska

HOW IT WORKS—A striped cylinder revolves about a striped electric lamp, casting an ever changing pattern of light and shadow through the translucent outer shade. This creates action in the picture real as a colored movie. An interesting, unusual and beautiful lamp for any home. Heat is the only motive power.

Diesel & Air-Conditioning
.. 2 New Professions .. NEED
Draftsmen

Diesel Engines, the new source of power, and the air-conditioning of all business buildings have created a tremendous demand for draftsmen. They must draw the plans for engine design, for installation in buses, tractors, trucks and automobiles. The same thing applies to air-conditioning for all this work must start on the drafting board. Take advantage of this opportunity now, learn drafting the quick easy way. Send for these books which cover the whole field of drafting so simply that anyone can understand them; a tremendous value to beginner and expert alike.



Nearly 2000 pages, 1600 charts, blueprints and diagrams. Gold stamped flexo covers.

These Books Shipped FREE

on approval Yes we ship without a penny down, without any deposit or other agreement except to return them if you don't like them. Read the coupon, then send it quickly to fit yourself to occupy a position of responsibility and big pay. If you send now we will include a year's membership in the American Technical Society with full consultation privileges with our experts for one year.

Learn Quick Way



This \$10.00 set of fine, accurate drawing instruments included in this offer. Here is a quick, easy way to qualify for a good drafting job.

American Technical Society
Drexel Ave. at 58th St.
Chicago Dept. D819

I want to qualify as a draftsman quickly. You may send me your four volume set of Drafting Books for 10 days free examination. If I like them I will send you \$2.00 in 10 days and then \$3.00 a month until the special price of \$24.50 is paid, otherwise I will return them at your expense and owe you nothing.

Name.....
Address.....
City.....State.....

Please write us a letter and give the name of your employer and that of at least one other business man as a reference.

When writing please mention Popular Mechanics



Learn to Write

Begin Today. Write for my Free Book, "How to Become a Good Penman." It contains specimens and tells how others learned to write in spare time. Your name elegantly written on a card if you enclose stamp for postage. Write today. **F. W. TAMBLYN, 418 Ridge Bldg., Kansas City, Mo.**



"BECOME A LIGHTNING TRICK CARTOONIST"

Send \$1.00 for Laugh Producing Program of 23 Trick Drawings with Instructions. Catalog of Chalk Talk Supplies Free. **BALDA ART SERVICE, Dept. 1, Oshkosh, Wis.**

HOME STUDY COURSES

Home-Study Courses, leading to Degrees in Arts and Sciences; Education; Writing; Psychology; Chemistry; Business and Commerce; Law; Theology; Agriculture; Engineering; also courses in Business Training; Accounting; Advertising; Sales Management; Public Speaking; Radio. Many others. Low Cost; Easy Terms.

McKinley-Roosevelt University, 4245 Clarendon Ave., Chicago



MAKE GLAZED GARDEN POTTERY

Beautiful, colored, glazed concrete pottery made without molds. No experience needed. Use only sand and cement. 2,500 different designs birdbaths, vases, jars, etc. Big profits. Send 10c for Booklet, color plate, etc. **NATIONAL POTTERIES CO., 424 Second Ave., So., Minneapolis, Minn. Room 21**

SPARE TIME PROFITS? BUILD SHIP OR COACH MODELS!

Demand growing. We supply everything—all parts (cut, fit and ready to put together), accurately numbered diagrams and complete instructions — for historic "Mayflower," Torpedo Boat Destroyer, Clippers and others. Rush 3c stamp for Catalog. **MINIATURE SHIP MODELS, Dept. RT, PERKASIE, PENNA.**

AGENTS 500% Profit GOLD LETTERS

For Store Fronts and Office Windows. Anyone can put them on. Free samples. Liberal Offer to general agents. **METALLIC LETTER CO., 438 N. Clark St., Chicago**



Make Money at Home!

GROW MUSHROOMS in your cellar or shed. Exclusive new process. Bigger, better, quicker crops. More money for you! Enormous new demand. We buy Mushrooms. Write for Free Book.

American Mushroom Industries Ltd., Dept. 449, Toronto, Ont.

A Simple Recipe for Inventive Success

PROBABLY the simplest recipe for inventive success would be this: First, a practical, useful invention; second, a good, strong Patent; third, a buyer or a market. The inventor needs all three to get anywhere. Lacking any one, he is likely to get nowhere. The recipe is simple. Working it out isn't so simple. That is why inventors—and others inventively inclined—have found the two books shown here so helpful. We've gone into each part of the recipe carefully. *Exactly what is an invention? We tell you. What is a strong Patent? We tell you. How can I go about finding a buyer? We tell you.*

But there's much more. For example, just how an Application for a Patent is made; how an inventor can safeguard himself with dated sketches as he goes along; how the pertinent Patent Office records are checked to see what other inventors may have done along the same line; how some successful inventors have secured financial backing; simple ways to contact manufacturers; and many other points.

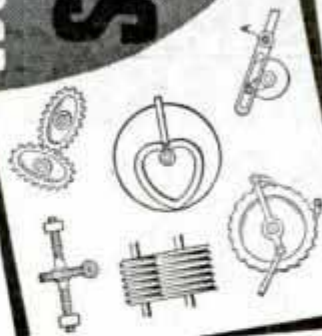
36 Years in the Business of Helping Inventors

The world needs, can use and will pay for practical, useful, inventions. Manufacturers are on the alert for new articles, or improvements that will help them increase sales. Maybe you have one. Maybe not. These books will help you in deciding that. *From that standpoint alone, they are valuable.*

For more than 36 years, it has been our business to help inventors. We answer your questions and supply complete information about Patent procedure, costs, steps to take, kind of sketch or model needed, and much more. Our staff is made up of experienced Registered Patent Attorneys, Draftsmen, Searchers. Fees are reasonable—deferred payments arranged. Whether your idea is large or small, finished or still in a rough stage, you should have the facts both about Patenting and Selling. The information which we give you—based on long experience with thousands of inventors—is yours for the asking. No need to delay. These two books of facts may save you time, trouble, money, even later disappointment. **Return the coupon—or write us a confidential letter—today.**

115 Mechanical Movements

The mechanical movements shown below are taken from 115 such movements illustrated in our book, "Patent Protection." Maybe you'll find just what you need to work out some of your own ideas. Many other interesting pictures are shown in this book. Both books and an "Evidence of Invention" form sent to you FREE the same day we hear from you.



PATENT and SELL your INVENTION

Suggestions
on
WHEN
and
HOW
to Sell an
INVENTION

**PATENT
PROTECTION**

**VICTOR J.
EVANS & Co.**

REGISTERED PATENT ATTORNEYS.
MAIN OFFICE: 500-M, VICTOR BUILDING,
WASHINGTON, D. C.

Other Offices: 1640-N Conway Bldg., Chicago; 1007-N Woolworth Bldg., New York; 514-N Empire Bldg., Pittsburgh; 1010-N Hobart Bldg., San Francisco; 736-N Security Bldg., Los Angeles.

Send me FREE copies of your books "Patent Protection" and "When and How to Sell an Invention." (Note: Same books supplied by any of branch offices listed above.)

Name.....

Street and No.....

City or Town.....

Here
TWO BOOKS
tell you how to go
about it — **Both**
SENT FREE

When writing to advertisers please mention Popular Mechanics



FREE—if you act now—Kushlan's HANDBOOK OF INDUSTRIAL ELECTRICITY

with the Croft Library of Practical ELECTRICITY

Regular McGraw-Hill 500-page manual of practical information for those engaged in electrical construction, maintenance, testing, inspection and contracting. Yours without charge on receipt of your first payment for the Croft Library.

The Croft library is a complete electrical educator. It is founded on practice—on 20 years of shirt-sleeve experience—on work as it is actually done. It is jammed from cover to cover with the kind of hard-headed facts you want. Written so that the beginner can easily understand it, yet so sound, so thorough, that it is the daily guide of 59,000 highly paid electrical workers and engineers. Croft tells you the things you need to know about motors, generators, armatures, commutators, transformers, circuits, switchboards, distribution systems—electrical machinery of every type—wiring for light and power—wiring of finished buildings—underwriters' and municipal requirements—illumination in its every phase—the most improved methods of lighting—lamps and lamp effects, etc.—how to do a complete job, from estimating it, to completion.

No money down—easy payments

Fill in and mail the coupon attached and we will send you the entire set of seven volumes for ten days' Free Examination. We take all the risk—you assume no obligation. If you decide to keep the books, send \$1.50 in ten days and the balance at the rate of \$2.00 a month and get Kushlan's useful Handbook free, in addition. Send the coupon NOW and see the books for yourself.

FREE EXAMINATION COUPON

McGraw-Hill Book Co., 330 W. 42nd St., New York

Send me for ten days' free examination the Croft Library of Practical Electricity. If satisfactory I will send you \$1.50 in 10 days and \$2.00 monthly until the price of \$19.50 is paid. If not wanted, I will return the books postpaid. Upon receipt of my first payment of \$1.50 you are to send me a copy of Kushlan's Handbook of Industrial Electricity, absolutely free.

Name.....
 Home Address.....
 City and State.....
 Position.....
 Name of Company..... PM-11-35

ENGINEERING DEGREE IN TWO YEARS

B.S. Degree in Electrical, Civil, Chemical, Radio, Mechanical or Aeronautical Engineering in two years. Located in an industrial center with that Engineering atmosphere. Earn board. Low tuition. Preparatory Department. Enter Dec., March, June, Sept. Catalog.

INDIANA TECHNICAL COLLEGE
 229 East Washington St., Fort Wayne, Indiana

DIESEL POWER

A Coming American Industry



THE internal-combustion engine represents man's supreme triumph of machine power. Diesel engineers are in great demand. Many

are acquiring necessary knowledge through spare-time study of this modern I. C. S. Course on Diesel engines. Free booklet!

INTERNATIONAL CORRESPONDENCE SCHOOLS

BOX 5601-H. SCRANTON, PENNA.

Please send information on course checked.

- DIESEL POWER** **ELECTRICAL ENGINEERING**
 Mechanical Engineering Automobile Course
 Aviation Engines Air Conditioning

Name..... Age.....

Address.....

60 Art Lessons *Become a Talented Artist with a BIG INCOME!*



At last—an inexpensive yet thorough home-study Art Course. Alexander Murray, famous Art School instructor, now makes it easy to learn art in spare time. You do not have to be gifted with natural ability. He will quickly teach you Commercial Art, Cartooning, Lettering, anatomy, perspective, advertising layout, short cuts, tricks of the profession, etc.—etc.—without bother or expense of corresponding. You get all 60 lessons at once—no waiting for next lesson. Course contains over 815 clear instruction illustrations. Send only \$1.95 for complete 60 Lesson Course POSTPAID, or pay postman plus postage. **MONEY BACK GUARANTEE**—You may order Mr. Murray's Course for inspection. If not delighted, your money will be promptly refunded. **EDUCATIONAL SUPPLY CO., Dept. A101-L, RACINE, WISCONSIN**

Only **1.95** POST PAID

LEARN MECHANICAL DENTISTRY **SEND FOR FREE BOOK**

Special Tool Offer—NOW

Don't waste the best years of your life. Learn this money-making business in a few months, Day or Evening, and become independent. Big demand. Highly endorsed—oldest school. Practical training. Individual instruction. Easy terms. *Employment Service. Write TODAY for FREE Catalog P—* **New York School of Mechanical Dentistry, 125 W. 31 St., New York**

Learn Radio IN 12 WEEKS **BY SHOP WORK—NOT BY BOOKS** **I'll Finance Your Training!**

Prepare for jobs in Service Work, Broadcasting, Talking Pictures, Television, Wireless, etc., by 12 weeks practical shop work in COYNE Shops. Free Employment Service. Many earn while learning. **WRITE for BIG FREE RADIO and TELEVISION BOOK, and details of our "Pay-Tuition-After-Graduation" Plan.**

H. C. LEWIS, President, COYNE RADIO SCHOOL
 500 S. Paulina St., Dept. 85-3H, Chicago, Illinois

EARN MONEY AT HOME

Bi-Monthly describes all kinds of up-to-date plans for a business of your own. Home extra money plans, local occupations, home mfg. enterprises, formulas, mail order, advertising, writing for profit, books, duplicators, outdoor opportunities, mats from old tires, plastic novelties, success secrets, agent plans, workshops, backyard plans, homecraft, preparations, unusual ideas, wholesale supply. 38 pages. Six months trial 10c.

HOME INDUSTRIES, BOX 84, IRVINGTON, NEBR.

SHIP MODELS

Get this dandy catalog of true-scale models of Flying Cloud, Viking, Blue Nose, Tally-ho Cosch, deluxe fittings. Send 15c (in coin) for your copy. **ROY HANCOCK, 323 Douglas Ave., Portsmouth, Virginia**

No JOKE TO BE DEAF



—Every deaf person knows that— Mr. Way made himself hear his watch tick after being deaf for twenty-five years, with his Artificial Ear Drums. He wore them day and night. They stopped his head noises. They are invisible and comfortable, no wires or batteries. Write for TRUE STORY. Also booklet on Deafness.



THE WAY COMPANY
 729 Hofmann Bldg. Detroit, Michigan

Let Me Prove What YOUR Mind Can Demonstrate!



Are you tired of accepting the doctrines of church and school on faith? Do you demand KNOWLEDGE of the methods by which you can rise, master, and create in life? Write for the free Sealed Book that tells how you may receive A SECRET METHOD of mind influence for study. Used by thousands. Address **Scribe A.D.Q.**

The Rostcrucians
 SAN JOSE, CALIFORNIA

WEAK, RUNDOWN NERVOUS, SKINNY MEN AND WOMEN!

How "Jimmy" Braddock

WORLD'S HEAVYWEIGHT CHAMPION

Made Startling Discovery That Added
26 lbs. in 6 Weeks and Built His
Shattering NEW Strength!

*"It's Glands Starving for Iodine That Keep
Folks Rundown and Skinny," Says Jimmy*

Shows How Kelpamalt,
Richest Source of NAT-
URAL IODINE, Quickly
Builds Up Rugged
Strength and Tireless
Energy This New Easy
Way. 5 Added Lbs. the
First Week or No Cost!

Take the advice of the new World's
Champion—"Jimmy" Braddock—if
you are weak, rundown, underweight
and ailing. After searching for years,
he at last found the quick, scientific
way to build up rugged new strength,
good solid pounds of hard flesh and
dazzling energy. In 6 weeks before
the fight he gained 26 lbs.

He says: "Tests convinced me that
rundown conditions, poor blood and
skinniness come frequently from
iodine-starved glands. When these
glands—particularly the important
gland which controls weight building—
lack NATURAL PLANT IODINE
(don't confuse this with ordinary
chemical iodine), even diets rich in
fats and starches fail to add weight
and produce energy. That's why
skinny folks often have huge appet-
ites, yet stay skinny."

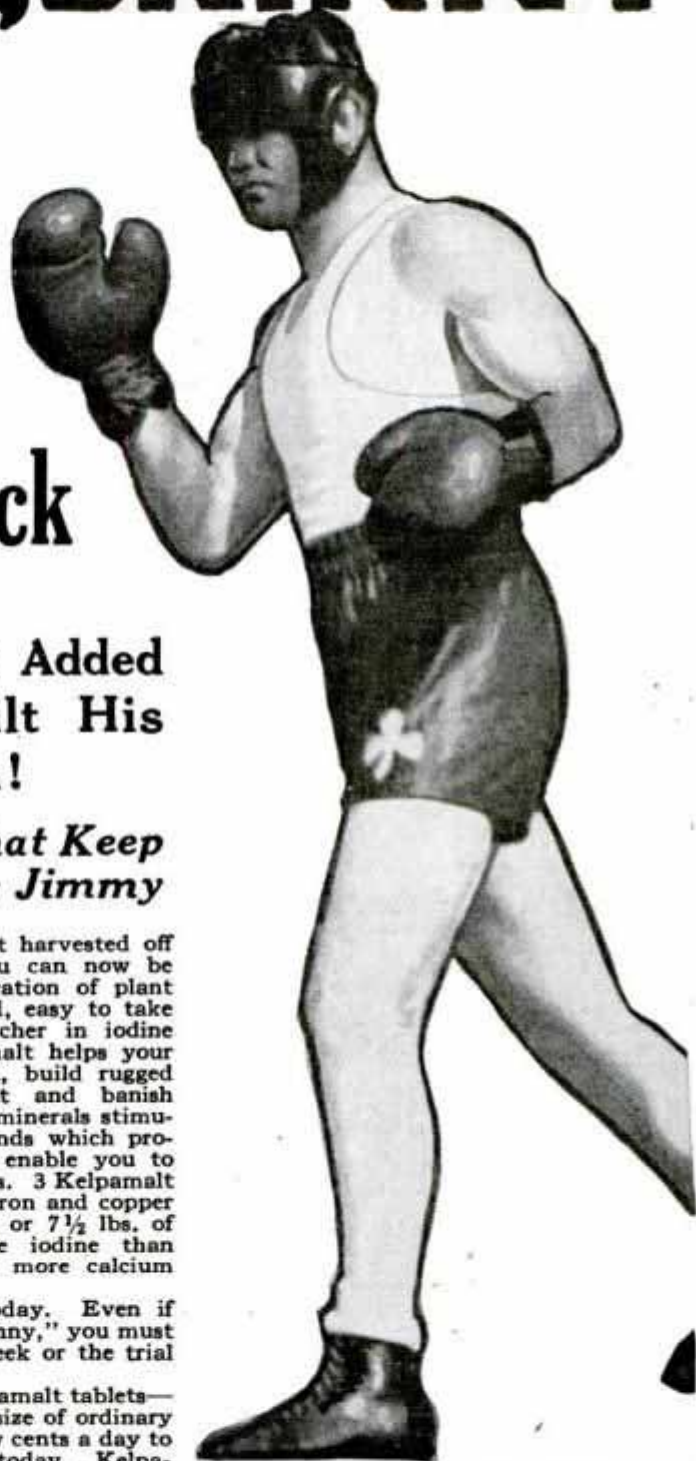
With the discovery of Kelpamalt—
a mineral concentrate made from a

huge 90-foot sea plant harvested off
the Pacific coast, you can now be
sure of your needed ration of plant
iodine in concentrated, easy to take
form. 1300 times richer in iodine
than oysters, Kelpamalt helps your
food to do you good, build rugged
strength, add weight and banish
fatigue. Its 12 other minerals stimu-
late the digestive glands which pro-
duce the juices that enable you to
digest fats and starches. 3 Kelpamalt
tablets contain more iron and copper
than 1 lb. of spinach or 7½ lbs. of
fresh tomatoes, more iodine than
1,386 lbs. of lettuce, more calcium
than 6 eggs.

Start Kelpamalt today. Even if
you are "naturally skinny," you must
add 5 lbs. the first week or the trial
is free.

100 jumbo size Kelpamalt tablets—
four to five times the size of ordinary
tablets—cost but a few cents a day to
use. Get Kelpamalt today. Kelpa-
malt costs but little at all good drug
stores. If your dealer has not yet
received his supply, send \$1.00 for
special introductory size bottle of 65
tablets to the address at right.

Kelpamalt
Tablets

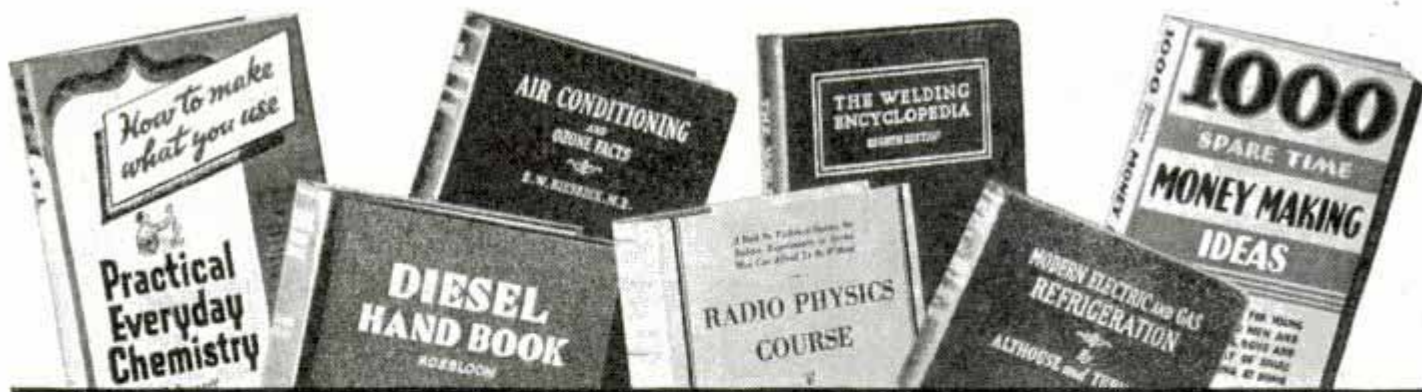


SPECIAL FREE OFFER

Write today for fascinating instructive 56-page book
on How to Add Weight Quickly. Mineral Contents
of Food and their effects on the human body. New
facts about NATURAL IODINE. Standard weight
and measurement charts. Daily menus for weight
building. Absolutely free. No obligation. Kelpamalt
Co., Dept. 590, 37-33 West 20th St., New York City.

NAME.....

ST.....CITY.....



PROFITABLE PRACTICAL BOOKS

OF USEFUL PLANS AND IDEAS FOR BOTH WORK AND LEISURE HOURS

Whatever your interest—to develop a profitable sideline; save money making improvements; personal advancement through study; or pursuit of a hobby for recreation, we have searched our lists for the *most popular* titles. This selected group covers many of the best subjects. Check them over. Then order **NOW**.

AIR CONDITIONING

Live Field; Great Future. Thorough Book on Fundamentals, Installations, Ozone Facts, etc. \$3.50

AUTO ENCYCLOPEDIA

Dyke's 16th Edition. Recent! Famous Standard Reference Work. Latest Auto Features Covered. \$6.00

110-V. A.C. GENERATORS

Made from Old Auto Generators. Turn Scrap Into Money. Hundreds are Making Profits. \$1.00

BIRD HOUSES

Build to Sell; Easy Designs, Standard Types, Houses for Many Kinds of Birds. \$1.00

BOAT BOOK

Power, Sailing, Rowing, Paddle Plans. Build Your Boat from These Plans and Save Two-thirds the Expense. \$3.00

BOY MECHANIC

Hundreds Things Boys Can Make. Keeps Boys Interested; Busy. Develops Latent Ability. \$2.00

BUILT-IN FURNITURE

Take Orders, Make Money! Practical, Popular Furniture. Fits Waste Spaces in Homes. \$2.00

CHEMISTRY, PRACTICAL EVERYDAY

Make Hundreds Things Daily Use. 2300 Formulas and Recipes. New, Practical, Commercial. \$2.00

CHEVROLET SIX

Models 1931 to 1935 Inclusive Covered. Construction, Operation, Repair. 665 Pages. Illustrated. \$2.50

CONCRETE WORK

173 Uses Described, Pictured. Easy to Follow Plans for Home, Shop or Farm Use. \$1.00

DIESEL HANDBOOK

New! Latest Information. Rapidly Expanding Field. Make Your Start With This Reliable Book. \$5.00

DOG TRAINING

Home, Stage, Movies, Etc. Dog Lovers: Learn the Experts' Methods of Training. Train Your Dog. \$1.50

ELECTROPLATING

Modern Practice Including Nickel, Zinc, Cadmium and Chromium, also Copper, Gold, Alloys, Various Metals, Metal Coloring. Reliable and Up-to-Date. \$2.25

FARMERS' BOOK

861 Kinks for Field, Home. Great Time and Labor Saver. Practical, Tested Ideas. \$1.00

V-8 FORDS

Also "A" and "B" Models. Construction, Operation and Repair. 715 Pages. Illustrated. \$2.50

FORMULAS

10,000 Money Making Processes You Can Use Right at Home to Make Quick Selling Products. \$4.00

FROG INDUSTRY

New! Raise and Sell. Profits! Good Side Line for Areas Where Ponds Can Be Built. \$2.00

FURNITURE MAKING

Tools, Materials, Designs. 50 Beautiful Projects in Modern Furniture. \$2.50

INVENTING

The Art of and What to Invent. Shows Sort of Inventions Needed, How to Patent and Market an Invention, How to Develop Ideas and Turn Them into Profit. \$3.00

LATHE WORK (Metal)

Drilling, Threading. 2 Volumes Comprising Hundreds of Valuable Shop Kinks. Illustrated. \$1.00

LEATHER, HOME TANNING AND MAKING

Information on How to Tan and Make Leather from the Hides of Various Animals. \$1.00

LOG CABINS

Easy Plans; Build for Profit. Value! Complete Building Instructions. Covers Fireplaces. \$2.50

MATHEMATICS

Easy Guide for the Practical Man. Removes the Mystery and Difficulties. \$1.50

MECHANICAL DRAWING

Learn Drafting; Good Salaries. Teach Yourself at Home. Book of Easy Methods. \$1.00

MONEY MAKING IDEAS

1000 Spare Time. Practical Guide for Young and Middle Aged Men and Women, Students, Boys, Girls. \$1.00

PLUMBING

500 Facts Every Homeowner Should Know. Care and Repair of Your Own Plumbing System. \$1.50

POULTRY

Breeding, Management. For Those Interested in Making Poultry Pay. Develop Phenomenal Layers. \$2.00

PRECIOUS METALS

Identify—Buy—Sell. Only Book on Subject. Anyone Can Tell Value of Their Old Gold, etc. \$1.00

PROSPECTORS' HANDBOOK

How to Mine, Appraise, Equip. How and Where to Look for Valuable Minerals. \$3.00

RADIO PHYSICS COURSE

New Edition. 992 Pages. 500 Illustrations. All About Radio Explained Step by Step. \$4.00

RADIO SERVICING

Profit by Knowing Costs, Kinks, Etc! Important New Edition Just Issued. Has 1300 Pages. Illustrated. \$4.00

REFRIGERATION

Electric, Gas. Be a Service Expert. Need for Trained Repair Men. \$4.00

REWINDING ELECTRIC MOTORS

Fractional Horsepower Types. Valuable for Everyone Engaged in Electrical Repair Work. \$2.50

SHIP MODEL

Entire Text, Famous "Sovereign" of 1637. Last Word in Beautiful Ship Models. \$1.00

SHOP NOTES LIBRARY

5 Vol. 2000 Wonderful Shop Ideas. Volumes Reprinted Annually from Shop Notes Section Popular Mechanics. \$2.50

STEEL SQUARE

How to Figure Angles of Rafters, Roofs, Etc. As Indispensable as the Most Important Tool. \$1.00

TOYS

For Amusement or Profit. Saleable Designs. 67 Different Toys. Easily Followed Instructions. \$1.50

WELDING ENCYCLOPEDIA

All Methods; Hard Jobs Made Easy. Most Complete Book. Nothing Important in Welding Omitted. \$5.00

WIRING

Approved Economy Methods for Homes, Buildings. Standard Up-to-Date Book Meets Every Requirement. \$2.50

WOOD TURNING

Woods, Tools, Methods; Practical Teacher. Wood Working on the Lathe Thoroughly Covered. \$1.50

Books sent C.O.D. anywhere in U.S.

Just make up a list of the books you want and mail us your order. When postman hands you books, pay him the price and postage. If you send remittance when ordering, please include 10 cents per book extra for postage. Write for information about books on other subjects you are interested in.

POPULAR MECHANICS PRESS
Room N5—200 East Ontario St., Chicago, Ill.

When writing to advertisers please mention Popular Mechanics



High School Course in 2 Years

You never heard anyone express regret at having a High School education—and you never will. But many, who failed to get their training at the usual time, don't realize that they can get it by home study in their spare time. A High School education is definitely required for—

- College Entrance and Teacher's Certificate
- The Better Positions in Business and Industry
- State and Municipal License Examinations
- Ability to Meet Others and Express Your Ideas

You can complete your High School education at home—in 2 years or less. Course meets requirements for entrance to college, business, and industry. Standard High School texts supplied. Diploma awarded. Full credit for H. S. subjects already completed.

You Can Qualify for a Better Position

If you are interested in business or industry, consider the opportunities for good pay and steady advancement offered to men with the proper training and then make up your mind that you are soon going to be holding one of those better positions. Through home study in your spare time, we can train you in 2 to 3 years for your choice of the desirable positions listed in the coupon.

Get Ready to Earn Big Money!

You can rapidly learn to prepare estimates and figure costs; to write effective business letters; to design and build buildings and machines—in your spare time. Don't doubt your ability to make good—get ready for the good position you want by getting the training that will bring you success and big money.

This is your big opportunity to put part of your spare time into getting by home study the training you know you need. If you did not finish High School, here is your chance to do so. If you never yet have had the chance to get specialized prepara-

tion for advancement in your chosen line, start now to give yourself that training.

Facts—The Gateway to Opportunity

Asking for information about the line that interests you involves no obligation—but it may mark the turning point in your life. Check the position you want and mail the coupon today.

American School

Dept. H-845, Drexel at 58th St., Chicago

Send me, without obligation, full information on position checked:

- | | |
|--|---|
| <input type="checkbox"/> Air Conditioning Engineer | <input type="checkbox"/> Draftsman & Designer |
| <input type="checkbox"/> Aircraft Pilot | <input type="checkbox"/> Electrical Engineer |
| <input type="checkbox"/> Architect & Builder | <input type="checkbox"/> High School Graduate |
| <input type="checkbox"/> Automobile Engineer | <input type="checkbox"/> Lawyer |
| <input type="checkbox"/> Bookkeeper & Accountant | <input type="checkbox"/> Mechanical Engineer |
| <input type="checkbox"/> Business Manager | <input type="checkbox"/> Radio & Television |
| <input type="checkbox"/> Cert. Public Accountant | <input type="checkbox"/> Refrigerating Engineer |
| <input type="checkbox"/> Civil Engineer | <input type="checkbox"/> Steam Engineer |
| <input type="checkbox"/> Diesel Engineer | <input type="checkbox"/> Structural Engineer |

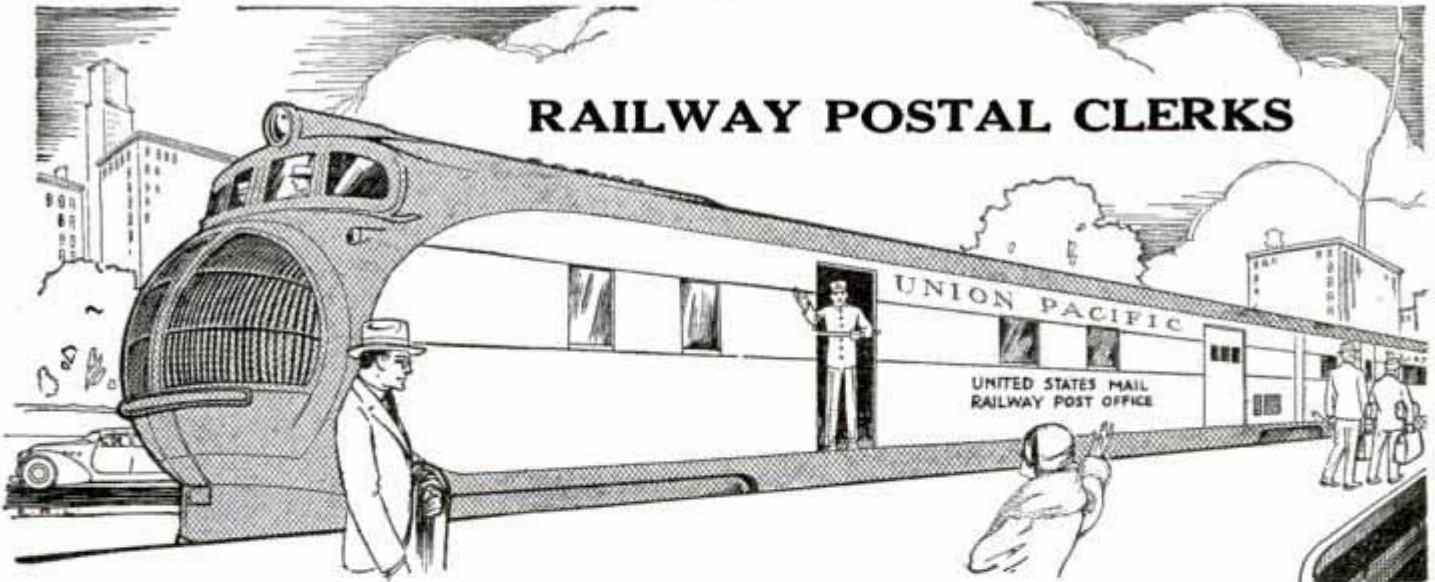
Name.....Age.....

Address.....

Turn Your Spare Time into Dollars

WANT THIS JOB?

RAILWAY POSTAL CLERKS



MEN 18 to 35

MANY OTHER U. S.

GOVERNMENT POSITIONS

GOOD PAY

Short Hours

Pleasant Work

Experience Usually Unnecessary

Common Education Usually Sufficient

**MAIL COUPON TODAY. TOMORROW
YOU MAY FORGET**

FRANKLIN INSTITUTE, Dept. C185, Rochester, N. Y.

Rush to me entirely free of charge (1) a full description of the position checked below; (2) Free Copy of 32-page book, "How to Get a U. S. Government Job"; (3) A list of U. S. Government Jobs; (4) Tell me how to get a Government Job.

- Railway Postal Clerk..... (\$1900 First year regular)
- Post Office Clerk..... (1700 First year regular)
- City Mail Carrier..... (1700 First year regular)
- File Clerk (Covering Office Clerk)..... (Start \$1266 year)
- Inspector of Customs..... (Start 2100 year)
- Liquor Gauger-Storekeeper..... (Start 2000 year)

Name.....

Address.....

Use This Coupon Before You Mislay It

When writing to advertisers please mention Popular Mechanics

Be An ARTIST



Make \$50 to \$100 a Week
Learn at Home This Amazingly Simple Way

More and more trained Artists are needed each year. 28,531 magazines, advertisers, newspapers, printing houses, etc., pay good money for art work. Our simple, proven, personalized method makes it fun to learn Commercial Art, Cartooning and Designing quickly. AT HOME, in spare time.

Big Artist's Outfit Given

Drawing board, paints, brushes and all materials you need to learn and earn come with very first lessons. Actual fun learning to draw this new way. Be an artist and make big money!

Send for FREE BOOK

Our big Free Book describes latest developments and wonderful opportunities in this fascinating field and gives full details of this quick, simple method. Tells all about our students—their successes—what they say—actual reproductions of their work—and how many earned big money even while learning. Mail coupon below or postcard today. State age. (No salesman will call.)

\$125 a Week!
 —that's what our graduate, Miss L. F. of Brighton, Ontario, is making—selling her work in Montreal.

\$3000 for W.R.K.—of Newark, N. J. He writes that just two contracts brought him that nest egg!

\$3380 a Year!
 —that's what our graduate R. K. K., of Michigan, is drawing as Art Director of a big engraving house.

Free Book shows how



Washington School of Art, Studio 1211
 1115—15th St., N. W., Washington, D. C.

Please send me, without obligation, your Free Book, "Art for Pleasure and Profit."

Name.....Age.....

Address.....

City.....State.....

QUICK WAY to make money in



RADIO Modern receivers are demanding men with modern training for service work. New training method and service equipment offer starts you earning almost at once. Up to \$3 an hour easy in a short time. Write today for FREE book of details.

Radio Training Association of America
 Dept. PM-511, 4513 Ravenswood Ave., Chicago

"Where training pays"
LEARN ACCOUNTING
 at home
 —at a fraction of the usual cost

MEN who know accounting have big advantage these days. Business must have them; better than average pay; direct road to executive positions or own practice. Train yourself now in spare time for attractive new opportunities.

Learn by proved method, with identical lecture notes, practice sets, problems and solutions developed at Northwestern University and used in over a hundred colleges. Organized, graded lessons for systematic home study, from elementary to advanced accounting, including costs, audits. Thousands have learned this practical, low-cost way. Splendid C. P. A. preparation; a safeguard to your business future.

Send for this FREE BOOKLET

Fill in and mail the coupon below for free booklet "How to Train for New Opportunities in Accounting," with full details of unique advantages offered by this great course and easy terms of payment. Write now.



Mail This Form

THE RONALD PRESS COMPANY
 Dept. M17, 15 East 26th St., New York, N. Y.

Send me the free booklet giving full information about use for home study of the Complete Accounting Course developed at Northwestern University.

Name (please print).....

Address.....

City.....State.....

When writing please mention Popular Mechanics

PHOTO-ENGRAVING LEARN IT AT HOME



We Furnish all equipment and materials including large photo-engraving camera complete with lamps, lens and screen. When you have finished the course you can establish a good paying independent business with the equipment furnished or work for others at a big salary. Photo-Engraving offers greater opportunities today than any other industry. Every picture in this issue of Popular Mechanics was engraved by the process we teach you. Earn good money while learning. Write today for our new illustrated catalog which was engraved on equipment such as we furnish. You will not be obligated in any way by writing such as we furnish. Dept. 1115, Aurora, Mo.

A copper plate to print above picture size 8 by 10 inches sells for \$15.57.

Learn Profitable Profession in 90 days at Home



Salaries of Men and Women in the fascinating profession of Swedish Massage run as high as \$40 to \$70 per week but many prefer to open their own offices. Large incomes from Doctors, hospitals, sanitariums, clubs and private patients come to those who qualify through our training. Reducing alone offers rich rewards for specialists. Anatomy charts and supplies are given with our course. Write for details

National College of Massage & Physio-Therapy, 20 N. Ashland Avenue, Dept. 864, Chicago, Ill.

COURSES BY CORRESPONDENCE

BEAUTIFUL Penmanship Plain course, 70 les. \$1.50
 Ornate course, 60 les. 1.50
 Test Lettering course, 50 lessons, \$1.50. My copies cannot be excelled and my constructive criticisms guide the student to success. Lengthy revealing character sketch from a page of handwriting \$1.50
 One paragraph sketch and name in expert plain and ornamental .10
 Circulars. L. H. Hausam, Box 558A, Emporia, Kansas.

LAW HIGH-GRADE INSTRUCTION BY CORRESPONDENCE

College, Post Grad. and Bar Ex. Rev. Courses. Law has attracted more keen, brainy men than any other calling. Send today for catalog. Low cost, easy terms. Standard texts. Degrees.

CHICAGO SCHOOL OF LAW Reapper Block CHICAGO, ILL.

RADIO ENGINEERING, broadcasting, aviation and police radio, servicing, marine and Morse telegraphy taught thoroughly. Nine months' engineering course equivalent to three years' college radio work. School established 1874. All expenses low. Catalog free.

Dodge's Institute, Ada St., Valparaiso, Ind.

Learn ADVERTISING at Home Greater opportunities now in advertising. Learn easily and quickly in spare time. Practical work. No text books. Old established school. Low tuition—Easy terms. Send for free booklet of interesting information.

Page-Davis School of Advertising
 Dept. 1358, 3601 Mich. Ave., Chicago

MAKE YOUR BOOTS LEAK-PROOF WITH SO-LO PLASTIC RUBBER!
 Just spread on like butter—dries tough overnight. Flexible! Non-skid! Guaranteed! For holes in canoes, tents, bags... six straps, gun butts, etc. At any Hardware or 10c Store. ASK FOR SO-LO PLASTIC RUBBER. You'll Save Money!

EARN BIG MONEY AT HOME! FREE BOOK

Raise mushrooms in your basement, cellar, garage, idle places. We buy crop. Experience unnecessary. FREE Book.

MUSHROOM GROWERS OF AMERICA, KK-433, N. Clark St., CHICAGO, ILL.

Artificial Eyes

Lower Prices

Reinforcement Prevents Easy Breakage.
 Properly fitted. Prevents detection and irritation.

Largest assortment in America (over 100,000 on hand), so we can suit anyone. Fitting customers at home for 29 years. Send name of anyone who wears an eye for FREE booklet telling how we fit by mail around the world. Write us Today.

DENVER OPTIC COMPANY
 623 Quincy Bldg., Denver, Colorado

To those who think Learning Music is hard-

PERHAPS you think that taking music lessons is like taking a dose of medicine. It isn't any longer!

As far as you're concerned, the old days of long practice hours with their hard-work exercises, and expensive personal teacher fees are over with.

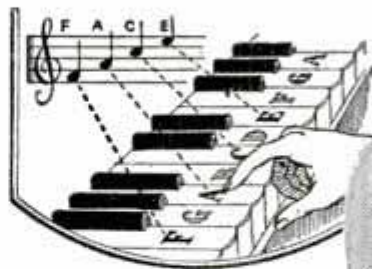
You have no alibis whatsoever for not making your start toward musical good times now!

For, through a method that removes the boredom and extravagance from music lessons, you can now learn to play your favorite instrument entirely at home—without a private teacher—in half the usual time—at a fraction of the usual cost.

Easy As Can Be

The lessons come to you by mail from the famous U. S. School of Music. They consist of complete printed instructions, diagrams, and all the music you need. You're never in hot water. First you are told how a thing is done. Then a picture shows you how, then you do it yourself and hear it. No private teacher could make it clearer or easier.

Over 700,000 people learned to play this modern way—and found it easy as A-B-C. Forget that old-fashioned idea that you need special "talent." Just read the list of instruments in the panel, decide which one you want to play, and the U. S. School will do the rest. No matter which instrument you choose, the cost in each case will average the same — just a few cents a day.



Send for Our Free Book and Demonstration Lesson

If you really do want to play your favorite instrument, fill out and mail the coupon asking for our Free Booklet and Free Demonstration Lesson. These explain our wonderful method fully and show you how easily and quickly you can learn to play at little expense. Instruments supplied when needed, cash or credit. U. S. School of Music, 711 Brunswick Bldg., New York City.

U. S. SCHOOL OF MUSIC,
711 Brunswick Bldg., New York City.

Send me your amazing free book, "How You Can Master Music in Your Own Home," with inspiring message by Dr. Frank Crane; also Free Demonstration Lesson. This does not put me under any obligation.

Name.....
Address.....
Instrument..... Have you this Inst.?

LEARN TO PLAY BY NOTE

Piano	Violin
Guitar	Saxophone
Organ	Ukulele
Tenor Banjo	
Hawaiian Guitar	
Piano Accordion	
Or Any Other Instrument	

Government Jobs

EXAMINATIONS SOON
COLUMBIAN CORRESPONDENCE COLLEGE,
WASHINGTON, D. C.

For Quick, Clear 3-Dimension Scale Sketches

Wade's New Isometric lined paper is hard to beat! Just follow the green guide lines spaced 1 in., 1/2 in. and 3/4 in. On buff drawing paper; loose leaf sizes—4 in. x 6 1/2 in.—100; 8 1/2 in. x 11 in.—50 and 11 in. x 17 in.—24 sheet pads, with directions \$1.00 each. See Wade Lined papers, Beam Compass and Curves at your dealer; or write:
Wade Instrument Co., 2274-B Brooklyn Sta., Cleveland, O.



CASH IN raising PR ROYAL birds. Orders waiting for hundreds of thousands. Easy to raise. You get your money for them when only 25 days old. Particulars and picture book for 3-ct. U. S. stamp. Ask for new Library 5 for 1936, ready now. Write PR Company, 635 Howard St., Melrose, Massachusetts. Refer any bank.

RAISE RABBITS FOR US

WE PAY YOU UP TO \$5.00 EACH. ALSO PUT YOU IN TOUCH WITH MARKETS EVERYWHERE. Large illustrated book and catalog, also copy of the AMERICAN RABBIT FARMER and monthly market bulletin showing names of buyers in various parts of America who continuously buy all rabbits offered them. All for 10 cents. Address
OUTDOOR ENTERPRISE CO., 101 Main Street, NEW CITY, N. Y.

Best Poultry Paper 6 BIG ISSUES 10¢

Helps Increase Poultry Profits. Send coin or stamps. 50 cents for 3 years or 10 cents for 6 months trial. Agents wanted. American Poultry Journal
532 So. Clark Street Chicago, Illinois

NEW!! MIDGET POCKET RADIO

Fits in any pocket easily. Weighs only 4 ozs. as shown! NO tubes, \$2.99 batteries or electrical connections Complete needed! Nothing to wear out or need replacement—only one moving part. Separates and receives stations with beautiful clear tone. Range up to 50 miles—much greater under good conditions—very little static! Can be used by ANYONE ANYWHERE! Footproof—NO Crystals to adjust! Absolutely complete with midget phone and directions to use on Bicycles, Autos, in office, hotels, camps, at home, etc. No messy hookup! THESE ARE FACTS! Send only \$1.00 and pay postman \$1.99 plus postage or send \$2.99 (Cash, Money Order or Check). Ideal gift. Guaranteed. Order NOW! (Foreign orders 85¢ extra.) At Better Dealers.
TINYTONE RADIO CO. Dept. P-11 KEARNEY, NEB.

Turn JUNK IN TO Cash! TIRES START AT HOME

The Most Sensational Business Opportunity Since 1929

Like turning lead into gold, here is a business with gigantic possibilities. Factories, Clubs, Stores, Schools, Homes, spend millions every year for rubber mats. Think of your profit when a



HAND MACHINE and

5¢ TIRE MAKES \$2.00 MAT

Brand new. Fully patented. Few men already started report unprecedented success. Wm. Eagle writes: "Can't make mats fast enough. First week brought over 200 orders for \$1.00 to \$10.00 each." Flash from Harris says: "Orders enough to keep 15 men busy all the time." Gunter got big order from County Commissioners and now reports: "Just signed up order for all Grade Schools and High Schools." No wonder responsible men are throwing everything else aside to establish local FABRIX factories.

COSTS NOTHING to get complete facts. Just send name and address. We'll send description of simple hand machine that quickly slices old tire into strips; show you how patented method forms strips into thick, springy, long-wearing FABRIX Mats—how five cents worth of Junk Tires makes a \$2.00 Mat; how you can start on a reasonable investment and build a business so big, so fast, that it will take your breath away. Don't delay a minute. Write or wire today. All information is free.
FABRIX, Inc., 325 W. Huron St., Dept. 711, Chicago, Ill.

When writing please mention Popular Mechanics



CLASSIFIED

Advertisements



Advertisements in this section, 35 cents per word, each insertion, minimum 10 words, payable in advance. To be inserted under proper classification in December issue, copy should be in our office October 14th. Popular Mechanics Magazine, 200 East Ontario Street, Chicago, Illinois

Popular Mechanics Magazine, Chicago, Illinois

YOU'LL PROFIT

By reading and answering the classified ads in this section. Hundreds of opportunities to make and save money.

Gentlemen:—This morning I received a letter in the enclosed envelope. "1096" is an old "key" number to my Popular Mechanics advertising. Your old files probably would tell, but the advertisement that pulls this late inquiry, was in an issue of "P. M." that must be at least twenty years old. It seems to me that when any publication is such a good magazine in its field, and such a good advertising medium that it will "pull" inquiries and possible business for twenty years, that is a record to be proud of, and to holler from the house-tops. I salute, and congratulate good old Popular Mechanics. As few know better than I—it always was good, and I believe it always will be.

(Original letter on file in our office)

CHARLES A. SCOTT.

AUTOMOBILES

WINTER Coming—Don't drive blindly—Sleet, ice, snow kept off windshield by U-C-Clearly—50c. Agents, retailers, wholesaler wanted. High profits. Home Necessity, 902 West Prairie, Taylorville, Illinois.

200 MILES 35c. Burn stove distillate in your car. Get parts in any junk yard. Complete detailed information and blueprint 50c (coin). C. C. Carmichael, 5013 2nd Ave., Los Angeles, Calif.

SEMI-DIESELIZE Your car for less than \$5.00. Burn Diesel oil. See article page 544 October issue. Guaranteed instructions \$1.00. Ebco, Box 944, Los Angeles, Calif.

AUTO SUPPLIES—EQUIPMENT

DOUBLE-JEWELLED Reflector bracelet for night driving. Price 50c. H-S Sales Service, 1717 East Ocean, Long Beach, Calif.

ASSEMBLE Your own compressor outfit. Rotary pumps, gear type, direct drive for \$1.95. Haywood Company, 709 S. Kolmar, Chicago, Illinois.

NICKEL Plating outfits, connect to your battery. No tanks used, thousands in use. \$3.00 prepaid. Gunmetal Co., Ave. J, Decatur, Ill.

DEMONSTRATORS. Compressor, test bench, 8-hour battery charger—are welder. Guaranteed. Trial and terms. Ken's Equipment Exchange, Box M-1152, Troy, Ohio.

A. C. GENERATORS

TWENTY New practical changes for automobile generators. See our advertisement at bottom of page 125A. Auto Power, Inc.

AUTO TRAILERS

\$1 VALUE For 50c. Get facts on trailer coach design. This 50-page book can save you 100 times its cost. Order direct from author. Money back if not satisfied. 2c tax in Ohio. Ray F. Kuns, Dept. 118, Madisonville, Cincinnati, O.

BOOK Of camp trailer plans containing fifteen modern designs ranging from 8 to 16 feet. Copy sent postpaid for \$1.00. Toellen Coach Company, Box 25, College Park Sta., Detroit, Mich.

AUTO-TRAILER Bodies. Use Ferdico Waterproof Canvas Cement for attaching fabric to roof and sides. Send for information. L. W. Ferdinand and Company, Canton and Albany Streets, Boston, Mass.

REFINISH Your own car. New instruction book treats all phases of painting and refinishing autos and trucks. Written for the man who wants to renew his own car, but covers also the business end of refinishing for the professional. \$1.65 postpaid. Popular Mechanics Press, Room C35, 200 E. Ontario St., Chicago.

MOTORCYCLES, BICYCLES AND SUPPLIES

MOTORCYCLES—Direct to you at rock-bottom wholesale prices. Rebuilt, roadtested and guaranteed Indians, Harleys, etc. Send 10c today for "Bargain Bulletin 43." Crandall Hicks Co., 780 Commonwealth Avenue, Boston, Mass.

POWER Your bike with low priced Speedbike motor. Attach in one hour. Eighty miles to gallon. Thirty miles an hour. Free folder. Guaranteed. Outboard Motor Corp., 4031 N. 28th St., Milwaukee, Wis.

BARGAIN Mechanics Bulletin. Monthly. 6 months 10c. Sewells, Wilmore, Ky.

HENDERSON, Indian, Super X and Harley Davidson parts, new and used. Cylinder welding and grinding. Indian Agency, 3661 Archer, Chicago, Ill.

DIME Secures sample Speedway Racing Magazine, catalog English motorcycles, crash helmets, speed books, supplies. Clymer, 434 W. Pico, Los Angeles, Calif.

REBUILT Motorcycles. All makes. New and used parts. Expert repair work by factory trained mechanics. We are the authorized Harley-Davidson distributors. Send 10c for bulletin. Western, 914 E. 15th St., Kansas City, Mo.

HENDERSON, Excelsior, Harley, Indian, used parts, alloy pistons, catalogue and wings pin 10c. Ballak, 1115 Chestnut Street, St. Louis, Mo.

MOTORCYCLE Bargains, lowest prices, bargain sheets for stamp. Motorcycle accessories. Rochester Harley Davidson Corp., 129 West Main St., Rochester, N. Y.

SIXTY Reconditioned motorcycles. New and used parts for all makes. Whitman Motorcycle & Supply Co., 403 Southwest Blvd., Kansas City, Mo.

MOTOR Bicycles \$45.00, motorcycles \$40.00, new cord tires \$3.95, used tires, \$2.50. Bicycles \$11.50. (Bicycles for two \$35.00.) Used motorcycle parts, wheels \$1.00. Chains \$1.00. Engines \$10.00 to \$75.00. Frames \$5.00, all parts. Balloon tired wheels for boys automobiles. Send 6c. Price Cutter Deninger, Rochester, N. Y.

SEND 15c For illustrated used motorcycle catalog. New and used parts. Accessories. Largest stock. Indian Motorcycle Sales, Kansas City, Mo.

AVIATION

NEW Aeroplanes, \$98.00; motors, \$49.98; propellers, \$2.98. Send 25c for data, information. Hibbs, Ft. Worth, Texas.

PROPELLERS: \$1.75 up. Lists, 3c. Watson, Box 247, Jacksonville, Florida.

PROPELLERS For airplanes, iceleads, snowsleds. Catalog dime. Lorenzen Propellers, Niles, Michigan.

AMBITIOUS Young men interested in entering aviation as apprentices see page 24A.

FREE. Three-view 20 inch flying model airplane plan and catalog. Send 10c postage. Imperial Model Aero, 416F McDonald Avenue, Brooklyn, N. Y.

A BIG Package of model ship and airplane samples. Send 10c for packing and postage. Aero Shop, 3050 Huribut Ave., Detroit, Mich.

GET Into aviation. Air transport pilots get up to \$7,000 per year; mechanics, \$2,500. Learn at this government approved school. Write for complete information. State age. Lincoln Flying School, 2004 Aircraft Building, Lincoln, Nebr.

BATTERIES, GENERATORS, ETC.

GENERATOR Propellers, expertly designed at factory prices. Hibbs, Ft. Worth, Texas.

PROFIT Rebuilding batteries. Make your own plates. Information 25c coin. Blueprints for building wind-electric charger 25c. Arcwelder 50c. Coil and condenser tester 25c. All for \$1.00. General Battery Service, 78M Glenwood, Minneapolis, Minn.

PROPELLERS And wind electric equipment. Literature dime. Roblin's Propellers, Storm Lake, Iowa.

EDISON Storage batteries for power and lighting systems. Especially adapted for all make plants. The ideal battery for wind driven generators. Replace your old batteries with Edisons. Rugged construction. Non-acid. No sulphation. Fifteen year life. Five year unconditional notarized guarantee. Complete generating plants. Free illustrated literature. "See Jay Battery Company," 82 Sterling Avenue, Yonkers, New York.

6-32 VOLT Wind electric plants. Kits \$10.00 up. Parts catalog, plans 25c. Currier Mfg. Co., Minneapolis, Minn.

ELECTRIC Lights—Wind driven—You build them. Write Wind Motor Electric, Ridgway, Mont.

EDISON Non-acid storage batteries for all types electric light plants. None of the acid battery diseases. Long life. Fully guaranteed. Attractive bargains in light plants, generators, motors, etc. D. Hawley Smith Company, Croton Falls, N. Y.

GENERATORS—32 Volt, 1000 watt. Brand new \$25.00. Victor Mfg. Co., Box 75, Adrian, Michigan.

ELECTRICAL SUPPLIES—EQUIPMENT

AUTONATOR AC Plant—Latest development in economical, complete, all-purpose 110 volt a.c. power plant. Operates lights in homes and camps, sound equipment, radio sets, neon signs, searchlights, and all electrical appliances. Gasoline motor drives sturdy power unit. No servicing. Can't overload or burn out. Also charges 6 volt storage batteries. 350 to 1500 watt plants, \$99.50 and up. Write Department P.M., Autonator Laboratories, Inc., 8440 South Chicago Avenue, Chicago, Illinois.

ELECTRICAL Experimental laboratory kit—Contains alternating generator, small motor, microphone, transformer, polarized relay, condensers, electroplating chemical, carbons, electro magnets, etc. Contains 25 pieces commercial apparatus, weight 16 pounds. Laboratory makes are furnaces, secret detectophone, search light, extension telephone, generates electricity, etc. Complete instructions. Educational, fascinating, useful. Original cost \$17.75. Special bargain \$2.79. Other bargains. Stamp for catalog. Electrical Salvage Company, Box 524-AI, Lincoln, Nebraska.

WIND Electric lights. You build them. Five complete drawings and plans free. Parker-McCrory Mfg. Co., 751NX, Kansas City, Mo.

ALL Purpose 1000 watt weatherproof floodlights \$6.50. Surplus Equipment, 938 N. Homan, Chicago.

INSULATION, Wire, varnishes, supplies, etc. Send 3c stamp for bulletin. Autopower, 408-B Hoyne Ave., Chicago.

NICHROME Resistance wires, ribbons. Bulletin 3c. Lathrop, 210 Canal, New York.

MOTORS, Supplies, motor repairing. Wholesale bargain pricelist free. Mallorder Electric Co., 153 North Desplaines, Chicago.

HOW To make efficient small electric spot welder, hundreds other useful devices in Shop Notes, Vol. 29, only 50 cents postpaid. Popular Mechanics Press, Room C 35, 200 E. Ontario St., Chicago.

WELDING AND SOLDERING

DEMONSTRATORS, Electric arc welders. Money-saving prices. Used by the government. Trial and terms guaranteed. Hobart Welders, M-1153, Troy, Ohio.

WELDING, Soldering, brazing outfits \$6.00 to \$69.00. Superior Oxy-Acetylene Company, Hamilton, Ohio.

300 AMPERE Welding generator. Fine condition. \$150.00. Wilnot Auto Supply, 1970 Wilnot St., Chicago.

ARC-WELDING Outfit \$1.25. Weld fenders, braze, solder. Lavrow, 4368-W, Warren, Detroit. Stamp appreciated.

ENGINES, MOTORS, DYNAMOS

GENERAL Utility gasoline engines. Complete generating plants. Bargain list 10c. Columbia, 4020 Lake, Chicago.

THREE To ten KVA alternating generators. Motors, converters. Queen City Electric, 1736 Grand Avenue, Chicago.

FOR Sale—Small elec. motors, high speed, 1/10 h.p., 110 volts, universal. Reworked. \$1.50 postpaid. L. McConnell, 1619 Edgewood Ave., Racine, Wis.

25 SLIGHTLY Used 1/2 horse alternating motors \$9.85. 1/4 horse new General Electric \$5.90. Wilnot Auto Supply, 1970 Wilnot St., Chicago.

GOVERNORS Control auto engines—stationary or portable power uses. New big discount. No cash down. Special foreign terms. Agents wanted. Candee-Smith Governor Co., 215 North Los Angeles St., Los Angeles.

WINDING Data, 100 AC motors, various horsepower and voltage, \$1.00. Motor Data Co., 3002 Monroe, Kansas City, Mo.

REWINDING Motors and 330 other valuable articles in Shop Notes for 1935—50 cents postpaid. Popular Mechanics Press, Room C35, 200 E. Ontario St., Chicago.

MACHINERY, TOOLS, SUPPLIES

FLEXIBLE Screw driver, for awkward places. Works around corner. Laminated steel flexible shaft connect blade and handle. Guaranteed. \$1 postpaid. L. B. Miller, Sheepshead Bay, New York City.

HAND Spring winders \$2.50. H. Myers, 111 Washington Street, Burlington, Iowa.

IMPORTED Jewelers' saws (Laubsagen) \$6.00 gross, postpaid. Hartmann, 111 Mitchell St., Bellmore, N. Y.

BARGAINS, Demonstrators, electric arc welders, guaranteed, 30 days trial and terms. Write Ken's Equipment, Box M-1154, Troy, Ohio.

14" x 6' LODGE & Shipley lathe, quick change, good condition. Price \$165.00. No. 1 Cincinnati Univ. mill, complete, price \$195.00. No. 60 Heald cylinder grinder \$175.00. All sizes of machine tools. Send for catalogue showing other bargains. Terms to suit. Cincinnati Machinery & Supply Company, 27 W. Second Street, Cincinnati, Ohio.

LIMITED Quantity. Genuine 1" micrometers. Brand new, graduated in thousandths. Accurate. Send money order \$1.50 plus 15c postage. Bradley Machine Co., 6501 Epworth Blvd., Detroit, Mich.

BOATS, OUTBOARD MOTORS, ETC.

MAKE 12' Rowboat, blueprint 30c. Weesho-Uco, B51, Detroit, Mich.

BUILD Your own boat. Our fabricated frames save you 75%. Describe requirements and let us quote. Illustrated catalog 100 boats 10c. Bay City Boats, Inc., 1552 Adams, Bay City, Mich.

MAKE Canvas canoe, blueprint, 30c. Weesho-Uco, B51, Detroit, Mich.

PROPELLERS, Stuffing boxes, gear pumps, bearings, etc. Wm. Baker, Pond St., Quincy, Mass.

12-FOOT Flat bottom rowboat—complete plans 25c. Free boatbuilding catalog. The Rudder, 15 Murray Street, New York.

OUTBOARD Parts—New or used—All makes—What do you need? Crandall-Hicks Company, 782 Commonwealth Avenue, Boston, Mass.

GUNS, FISHING TACKLE AND SPORTING GOODS

INDIAN Pack baskets; Hudson Bay blankets; sleeping bags; compasses; knives. Write for catalogue. Howe Fur Co., Box P, Coopers Mills, Maine.

NEW Pocket weapon 40c! Kills game! Blue steel. Maple grip. Illustrated literature for stamp. Grant Sportgoods, B51, Detroit, Mich.

WINCHESTER 20ga. Pumps rechambered and altered for 2 3/4" shells, \$2.50. One day service. Clarksville Welding & Machine Works, Clarksville, Arkansas.

SPECIAL Discount. Guns, binoculars, cameras. Catalog dime. Refunded first order. Zeppelin Arms Company, Department S, East Akron, Ohio.

GUNSMITHS' Secrets—Bluing, checkering, engraving, etc., 25c. International Agency, Cincinnati.

MAKE Dipsies for use or sale. Free folder. Reading Instrument Co., Box 78, Reading, Pa.

PROFIT And pleasure in taxidermy. Complete guide for the preparing and mounting of animals, birds, fish, reptiles, etc., for home, den, or office. \$1.65 postpaid. Popular Mechanics Press, Room C35, 200 E. Ontario St., Chicago.

FIELD GLASSES, TELESCOPES AND MICROSCOPES

BUILD Reflecting telescope. Catalog free. Optical Laboratories, Larchmont, New York.

USED Binoculars, microscopes, astronomical telescopes, engineers levels. Microscope slides. Send 10 cents for list. P. O. Box 258, Amsterdam, N. Y.

FIELD Glasses, 5" long, 4 1/2" power, postpaid \$1.25. Vincent Salas, 101 Brookside, West Warwick, Rhode Island.

1400 POWER Microscope, \$18.75. World's most powerful microscope for the amateur. All refinements, photographically corrected achromatic lenses, tilting detachable base, finest rack and pinion focusing, removable concave mirror. Adjustable to any power from 150x to 1400x. Finest quality optically and mechanically. Maximum height 12". Wood case, slides, directions, etc. 100% American made. Only \$18.75 postpaid. Brownscope Co., Dept. M, 234 Fifth Avenue, New York.

ANTIQUES, RELICS, INDIAN GOODS

15 PREHISTORIC Arrowheads, lancehead, scraper, spearhead 99c. Scalping knife, fisharrow, gempoint, warpoint, pottery 99c. Tomahawk, wampum, \$1.00. Bannerstones, birdstones, discoidals, ceremonials, antique firearms. Photolist 10c. Robert Helke, Rutland, Illinois.

35 ARROWHEADS 50c. Postage extra. List free. R. L. Talburt, Calico Rock, Ark.

100 GOOD Arrowheads \$3.00. List 3c. H. Daniel, Dardanelle, Ark.

ANTIQUE Guns, Indian relics. List five cents. Elmer Ellis, Webster Groves, Mo.

5 ARROWHEADS 20c. 3 Birdpoints 18c. Knife, birdpoint, scraper, spearhead 45c. Catalogue. Coins, Minerals, Curios. Lemley Curio Store, Northbranch, Kansas.

TAXIDERMY

MODERN Taxidermist Magazine, Greenfield Center, N. Y. Devoted entirely to taxidermy. Sample copy 25c.

SEVEN-BOOK Taxidermy course, \$1. Free supply catalog. Taxidermic Manufacturers, Memphis, Tenn.

LEARN Taxidermy. Five courses. Blue Beaver Taxidermy School, Lemont, Ill.

DOGS, BIRDS, POULTRY, PETS

WANT A pedigree St. Bernard puppy? Particulars free. Royal Kennels, Napierville, Que.

ENGLISH Setter puppies, eligible, \$12 up. Joel Eschleman, Paradise, Pa.

POULTRY Tribune—Leading poultry magazine. Five years \$1.00; one year trial 25c in U. S. Poultry Tribune, Dept. C-93, Mount Morris, Illinois.

WANTED—Importer interested beautiful tropical animals, birds. Ovidio Monroy, Santamaría, Colombia.

SPORTSMEN: 200 Pointers, Setters, straight cooners, combination hunters, rabbit and fox hounds, cheap, list free. Ramsey Creek Kennels, Ramsey, Ill.

BEAUTIFUL Pure white police dogs. Ansonia Kennels, Mose, N. Dak.

ROOTS, HERBS, TREES AND SHRUBS

COLORADO Blue spruce, 6 - 4 year old extra strong, pot grown trees. Prepaid for \$1.00. Plant now. You can have no loss with pot grown trees. The roots are not disturbed. Shipped in paper pots. H. D. Belcher, Brook Forest, Colorado.

FREE! Send for this amazing new "Herbalist Almanac." Interesting! Instructive! Educational! Contains over 200 valuable herb medicine recipes and Indian secrets for home use. Beautifully illustrated in natural colors. Needed every home. Dime covers postage and handling. Write today! Botanica, 145 West 112th Street, Chicago.

FARMS AND FARM LANDS

EQUIPPED 108 Acres, handy high-school town; pleasant 7-room house, basement barn; only \$1,700 including horses, 7 cattle, tools, crops; terms, p. 23 big new fall-winter catalog. Free. Strout Agency, 255-P 4th Ave., New York City.

\$5 DOWN, \$5 Monthly, 20 acres in Missouri Ozarks, \$100. Fishing, hunting, trapping. Hubbard, 216 Grossman Bldg., Kansas City, Kansas.

INDEPENDENCE, Security assured, North Dakota, Minnesota, Montana, Idaho, Washington, Oregon farms. Bargain prices, easy terms. Descriptive literature, impartial advice. Mention state. J. W. Haw, 119 Northern Pacific Railway, St. Paul, Minn.

NEW Deal in farms, Minnesota, North Dakota, Montana, Idaho, Washington, Oregon. Rents are cheaper, prices lower. New low rates. Write for free book. E. C. Leedy, Dept. 1257, Great Northern Railway, St. Paul, Minnesota.

PROFITABLE OCCUPATIONS

INDIAN Candy. New. Original. Gorgeous flash. Money maker. Recipe \$1.00. Lettie Rhodes, Queensborough Station, Shreveport, La.

"FROG Raisers needed!" Start backyard. Write for free frog book. American Frog Canning Company, (153-W), New Orleans, Louisiana.

EARN Profit gathering roots, barks, evergreens. Botanical, New Haven, Connecticut.

RAISE Rabbits for us. We pay up to five dollars each. Large book and copy of American Rabbit Farmer gives full details. Ten cents. Address Outdoor Enterprise, Box 4, Holmes Park, Missouri.

FROG Raising—If interested, we guarantee to save you money. Send 10c for literature now. American Frog Industries, Rayne, Louisiana.

BOOKS AND PERIODICALS

FREE—Catalog of 310 books on gas engines, electricity, carpentry, concrete work, taxidermy, letter writing, magic, occult sciences, ventriloquism, hunting, fishing, formulas, etc., with 25c credit certificate for 3c postage. Franklin Publishing Company, 800 North Clark Street, Dept. 2011, Chicago.

THOUSANDS Of old magazines. List 10c. Seeley Service, Jennings, La.

HOW To win prize contests 10c. Walnut Specialty, Everett, Mass.

THIS Ad worth 25c. If you send for our approvals and buy 50c worth or more—large selection of U. S. and foreign—reasonable prices. Morton Stamp Co., 1121 Olive, St. Louis, Mo.

KOOKABURRA Bird!! Bolivia triangle! Packet of unusual stamps containing rare Kookaburra Bird, scarce Bolivia triangle, famous money stamp (printed on cardboard and also used as currency!); airmails from Mexico and Brazil; map, ship, animal, commemorative, etc. No Europe. Only 10c to approval applicants. DeSoto Stamp & Coin Co., 105 No. Clark St., Chicago, Ill.

FREE Dollar packet with penny approvals. Harlan, 5307 South Marshfield, Chicago.

IMPERFORATE National Park, 2 diff. and 33 U. S., including early issues; high values; commemoratives; airmail; envelopes; special delivery; postage due; revenues cataloging over 85c. All for 7c to approval applicants. Illustrated price list free. Curhan Stamp Co., Dept. P, Gloucester, Mass.

RARE COINS

GREAT Britain Silver Jubilee Crowns in presentation case. \$3 each. Early application advisable. Davis, 54 Ewell Downs Road, Ewell, Surrey, England.

\$4000 FOR \$1. Highest prices paid for all coins, rare and common; gold pieces; some worth \$6000! Foreign currencies; dimes before 1895—\$450; Liberty nickels before 1914—\$300; Indian head cents \$100; 1909 cent \$10.00; encased postage stamps \$13.00; half cents \$275; half dimes \$175; quarters \$300; fractional currency \$9.00; colonial coins \$300; 1933—50c—\$4.00; Canadian coins \$165, etc. Send 15c for our complete 1936 illustrated catalog, before sending coins. Nationalcoin Company (F7) Springfield, Massachusetts.

OLD Money wanted. Do you know coin collectors pay up to \$100.00 for certain U. S. cents? High premiums for all rare coins? I buy all kinds. Send 4c for large coin folder. May mean much profit to you. B. Max Mehl, H Mehl Bldg., Fort Worth, Texas.

UP To \$1,000 each for U. S. coins over ten years old. New buying list, 10c. Coin Shop, Box 37-X, Ottawa, Ill.

DIME Brings coin over 50 years old; bargain lists. Acorn Stamp & Coin Co., South Norwalk, Conn.

10000000 MARK Bill and list 10c. Greencay, 1626 Washington, Denver, Colo.

20 ASSORTED Coins 25c. 100 coins \$1.00. Otto Oddehon, Williamstown, Kansas.

WE Buy 1894, 1900 and 1907 Indian head cents. Full information one dime. Mattick, Box 3450, Altoona, Pa.

RARE 1804 Sumatra copper and bargain lists for dime. W. Webb, Brighton Sta., Rochester, N. Y.

TO \$8 For Lincoln heads. To \$78 for Indian head pennies. Also buy other coins. Price list 10c. Penny Shop, Dept. 90, Cedar Falls, Ia.

COIN Bargains. Lists and white cent 10c. Book of coins wanted 25c. Joseph Coffin, 1182 Broadway, New York.

FOR Sale: United States rare coins at special prices. Bargain selling price list and California 50c gold token 25c. Arey, Box 483, Muskogee, Okla.

2 UNCIRCULATED Coins, 4 notes, big bargain list, all 10c. Hubert Carbica, St. Augustine, Fla.

COMMEMORATIVE 1/2c. Lincoln, Patriot, Sesquicentennial, Oregon Trail, Maryland, Arkansas, Kentucky, San Diego \$1.50 each. Eighty page catalogue 10c. Norman Shultz, Salt Lake, Utah.

\$2000.00 for 1c. We pay the world's highest prices for old coins, and paper money. Large cents up to \$2000.00 each, half cents \$250.00, 1909 cent \$10.00, Indian head cents \$50.00, half dimes \$150.00, 25c before 1873 \$300.00, 50c before 1879 \$750.00, silver dollars before 1874 \$2500.00, gold dollars \$1000.00, trade dollars \$250.00, 1822 \$5 gold \$5000.00, old paper money \$26.00, encased postage stamps \$12.00, certain foreign coin \$150.00, etc., send dime for large illustrated list before sending coins. Romanocolnshop, Dept. 564, Springfield, Mass.

FREE! Foreign coin, banknote, and large illustrated coin catalogue. Send 4c postage. Coin approvals sent. Tatham Coinco, Springfield-125, Mass.

RARE United States, foreign coins, war medals. Catalogue 10c. Mengelle, Colorado Springs, Colorado.

UNITED States. Large cent, 2c bronze, 3c nickel and bargain list, 25c. Thirteen dates large cents, \$1.00. George P. Coffin, Augusta, Maine.

\$5.00 TO \$500.00 Each paid for old coins. Keep all old money. Send 10 cents for illustrated coin value book. 4x5. Guaranteed prices. Buying and selling. Coin Exchange, Box 5, Le Roy, N. Y.

CAMERAS, PHOTO SUPPLIES

DEVELOP And print your own pictures. Save time, money with our guaranteed \$1.00 outfit. Includes electric ruby lamp, chemicals, photo paper and equipment. One of thousands of bargains in our big summer clearance bargain book. It's free. Send for it today. Central Camera Co., Dept. K-11, 230 South Wabash, Chicago.

DEVELOP Your own films—prints. Easy instructions—10c. Larson's Laboratory, P-3410 North Ave., Chicago.

ENLARGING Machine for any camera owner built for less than 60c. Has reflector and 6 adjustments. Instruction book, completely illustrated containing full size plans \$1.00. Rondell Mfg. Co., 1857 Anthony Ave., New York City.

MAKE Money in photography. Learn quickly at home. Spare or full time. New plan. Nothing like it. Experience unnecessary. American School of Photography, Dept. 343-B, 3601 Michigan Avenue, Chicago.

HAVE You a camera? Send ten cents for recent number of our big magazine, showing how to make better pictures and earn money. American Photography, 116 Camera House, Boston, 17, Mass.

INCOME From your camera instead of expense. Low cost home course teaches you to make photographs for magazines, newspapers, advertisers. Tremendous demand. Earn good money wherever you live. Free book. Universal Photographers, Dept. 104, 10 West 33rd St., New York.

PHOTO FINISHING

FILMS Developed, 2 prints of each 25c; 20 reprints 25c. Pine Photo, M-5134, Nevada, Chicago.

ENLARGEMENTS, 5x7—10c, 3 for 25c. Coin. Send negative. Midwest Studio, Humboldt, Iowa.

ROLL Developed, 8 guaranteed prints, one enlargement 25 cents. Jack Rabbit Company, Spartanburg, S. C.

YOUR Favorite kodak pictures enlarged, size 5x7. 10c. Three for quarter, coin. Send best negatives (film) today. Address Danner Photo Lab., Enlarging Dept. 9, Des Moines, Iowa.

GET The best. Roll developed, beautiful hand colored enlargement, 8 neverfade border prints, 25c coin. Prompt service. Sun Photo Service, Drawer T, St. Paul, Minn.

2 ARTISTIC Enlargements, roll printed, or 8 reprints and enlargement (your choice) 25c. Griffins, Winona, Minn.

BETTER Class photo finishing, 35c (coin) with roll. Reprints 3c. Satisfaction guaranteed. Ward, 520 East 150th St., New York.

PHOTOGRAPHIC Christmas cards, 15 for \$1.00, including beautiful Panel-Art enlargement. Sample cards from your negative 10c. Ideal Photo Service, Box 2255, Paterson, N. J.

MAKE Money with hobby. Outfit for developing films and printing pictures with full instructions. Complete \$1.00. Delux set \$3.00. A. Leger, 21 West 17 St., New York City.

20 REPRINTS 25c—Films developed, 16 prints 25c. Enlargements 8x10—25c; 5x7—10c. Low Photo, M-2657 Nava, Chicago.

COMPARE The difference! Roll developed, two professional double weight enlargements, 8 guaranteed prints, 25c coin. Excellent service. Nationwide Photo Service, Box 3333, St. Paul, Minnesota.

ROLLS Developed, printed 25c. Reprints 3c each. No order accepted under 12c. Rode's Photo Service, Kenosha, Wis.

ANY Size kodak film developed, 2 prints of each negative and two free enlargement coupons, 25c. Reprints 2c each. We make beautiful Christmas cards from your negatives. Summers' Studio, Unionville, Missouri. No order under 25c.

EIGHT Prints, two enlargements 25c. Benl Nielsen, Aurora, Nebraska.

TWO Professional enlargements with each roll developed and printed 25c. Eight reprints, two enlargements 25c. Hygloss, River Grove, Ill.

SEND Three negatives and 10c (dime) and this ad for three 4x5 Panel Art prints and special bargain list. Roanoke Photo Finishing Company, 309 Bell, Roanoke, Virginia.

MINIATURE Camera owners, film developed and 16 postcard enlargements for \$1.00. Elf Photo Service, Drawer 537, Westerly, R. I.

20 BLUETONE Reprints 25c. 5x7 enlargements 10c each. 8x10 enlargements, send picture or negative, 25c. Neverfade, Maywood, Illinois.

ROLLS Rushed! Developed and printed with two Supertone enlargements 25c. Extra enlargements four for 25c. Newtown, Maywood, Illinois.

PHOTOGRAPHIC Christmas cards, 20 for \$1.00. Send your negative. Samples. Seacout Service, Box 125, Chelsea, Mass.

ENLARGEMENTS From miniature negatives (approximately 3x4 inches) 5c each, when ordered from complete roll. Fine grain developing 25c. Fotoshop, Inc., 136A West 32d St., New York City.

ROLL Developed, 8 quality prints, and beautiful individual album, 25c. Howard Photo Service, San Fernando, Calif.

TWO 5x7 Professional enlargements with each film, 25c. Lightning Film Service, LaCrosse, Wis.

TRIAL Roll developed and 8 prints 25c. Reprints 3c. Hand colored photo Christmas cards or photo greeting calendars from any negative 10c each, 14 for \$1.00. 8x10 enlargement 25c. Young Photo Service, 405 Bertha St., Albany, N. Y.

ROLL Fully developed, carefully printed and two beautiful full size 5x7 double weight professional enlargements (or one tinted enlargement)—all for 25c coin. Reprints 3c each! The experts' choice! Immediate service! No delay! The Photo Mill, Box 629-Z, Minneapolis, Minn.

KODAK Enlargements 5x7, 10c, 3 for quarter, coin. Send best negative (film). Xint Photo Lab., Dept. 5, Cedar Rapids, Iowa.

ROLL Developed and printed and two enlargements 25c. Prompt service. Electric Studio, Escanaba, Mich.

FILMS Developed. Any size. 25c coin, including 2 enlargements. Century Photo Service, Box 829, LaCrosse, Wisconsin.

BEAUTIFUL Glistening prints, roll developed, 8 guaranteed glistening prints, 2 enlargements 25c. American Photo Service, 2946 Nicollet, Minneapolis, Minn.

20 REPRINTS 25c. 100 Reprints \$1.00. Rolls developed with 16 prints 25c. Nordskog, 4, Maywood, Ill.

HAND Colored enlargement with each roll 25c. 40 reprints 50c. Colorgraph, Dunning Station, Chicago.

FINER Finishing. Rolls developed and printed. Colored enlargement, or two double professional enlargements all for 25c (coin). Genuine, nationally known. Moentone superior quality. Moon Photo Service, Box P-867, LaCrosse, Wis.

BEAUTIFUL Colored enlargement with each film 25c. Speedy service. Satisfaction guaranteed or money refunded. LaCrosse Film Company, LaCrosse, Wis.

ROLL Developed, two prints each negative 25c. Reprints 2 1/2c. Enlargement coupon. Willard's, Box 3535-A, Cleveland Heights, Ohio.

ROLL Developed and 16 prints 25c. Smart Photo, Winona, Minn.

ROLLS Developed. Two beautiful double-weight professional enlargements and 8 guaranteed Never Fade Perfect Tone prints, 25c coin. Rays Photo Service, LaCrosse, Wisconsin.

20 REPRINTS 25c. Films developed, two prints each negative, 25c. Skrudland, 4118-8 Overhill, Chicago.

ROLLS Developed, two sets guaranteed prints and enlargement coupon 25c, reprints 3c each, over 19, 2 1/2c. Jones Studios, Davenport, Iowa. "Where the West Begins."

MOTION PICTURES AND SOUND EQUIPMENT

BASS Bargain counter: Cine headquaters offers new Keystone A—seven speed 16 mm. 100 ft. camera with 3.5 lens at \$31.50. Bell & Howell 70A with Cooke F:3.5 lens and case at \$44.50. Geared rewind and dummy, \$1.00 a set. 100 ft. 16 mm. Mono film, including reversing, \$2.95. The Bass Bargaingram No. 215 is free. Also Bargaingram of still cameras. Send for your free copy. Bass Camera Company, 179 W. Madison St., Chicago, Illinois.

MOGULL'S Bargains: Bell Howell projector \$59.50. 750 watt, motor, fan cooled projector \$99.50. 22"x30" roll beaded screen \$2.88. Victor soundfilm outfit 500 watt \$219.50. Agfa 100' automatic camera \$31.95. Used 400 ft. films \$3.00, sound \$14.00, soundisc \$9.00. Free catalogue, library, films sent anywhere. Trades accepted. We carry 8, 9 1/2 mm. film, equipment, 35 mm. DeVry soundfilm projector \$149.50, with amplifier \$185.00. Holmes 1,000 watt projector \$69.50. Super DeVry portable \$42.50 complete. Get our prices first. 1944-M Boston Road, New York.

BARGAINS in everything for movie making. Our bargain book lists hundred of money saving items. Save 50% on cameras, projectors, equipment. 16mm. color balanced film \$3.00 per hundred, including processing. Equipment trades acceptable. Merchandise guaranteed. Write for free bargain book. Central Camera Co., Dept. K-111, 230 South Wabash, Chicago.

16MM FILMS:—Art 10c foot. Mickey Mouse—Chaplin Silly Symphony 5c foot. Big features rented anywhere \$5.00. Lists. Thousand feet 35mm \$1.00. Features \$7.50. Projectors, cameras \$3.00 up. New 16mm talkies \$20.00 reel. Waldo Films, Box 524, Cincinnati.

8MM OWNERS: New titling film, home finishing data, reversing, new accessories, better pictures. Information free. Film Specialties, Box 458-A, El Monte, Calif.

16 MM. FILM For your camera available at \$1.00 for 100 feet. Information free. Noyes Laboratories, Western Springs, Ill.

WESTERN Thrillers—500 feet 75c. Jersey Filmco, 2075 Richland, Lakewood, Ohio.

"CAMERA Tips" free for stamp. Moorfield-Shannon, Nutley, New Jersey.

LEARN Motion picture theatre business. Catalog. Theatre Institute, Elmira, N. Y.

EASY Terms! 8mm.—16mm. equipment. Catalogue free. Elder, Dept. B-17, Chelsea, Massachusetts.

BARGAINS—Used soundfilm projectors, 16 and 35 mm. Sound heads, amplifiers, horns. Catalog mailed. S.O.S. Corp., 1600 Broadway, New York.

100' 16MM. SUBJECTS—New. \$2.25 up; used, \$1.65 up. Sound, silent rental library. Dime brings catalogue, two "end" titles. Eastin Pictures, Davenport, Iowa.

NEW 16mm. Art films. 3c brings our illustrated catalogue and samples. Hollywood Cine Film Distributors, 1437 No. Highland, Hollywood, Calif.

TRICKS, Gadgets, scenarios every month in Home Movie Magazine, 10c a copy. 6364 Hollywood Blvd., Hollywood, California.

35MM. COMPLETE Stories. Bargains. Stamp for lists. Calderara, 5119 S. St. Louis, Chicago.

BARGAINS—16MM. Projectors, supplies, films. Cine, Box 2133, Paterson, N. J.

1000 FEET 35MM. 75c. Projectors. Savarese, Woodcliff Lake, New Jersey.

16MM, 35MM, 8MM. Silent and sound; sale, rent, exchange. Ideal, 30 East 8th, Chicago.

25 FOOT 16MM. Movie films; circus parade, big leaguers, Niagara Falls, Indian battle, rodeo, nice neighbors. Three for \$2.00 postpaid. Ernest M. Reynolds, 165 E. 191 St., Cleveland, Ohio.

\$\$\$ PHOTOPLAY Ideas for talking pictures accepted any form for criticism, copyright and submission to studios. Established 1917. Booklet free. Universal Scenario Co., 259 Meyer Bldg., Western and Sierra Vista, Hollywood, Calif.

100 FEET 35MM. 27c. Bargain lists 3c. Hoffman Film Service, 57 Broad, Albany, N. Y.

FREE—16MM Bargain lists, Projectors \$1.00 up. Films 35c up. Art sample 25c. Home Movies, Box 32, Easton, Pennsylvania.

16MM FILMS Bought, sold, exchanged. Catalogue, 10c. Fotoshop, 136A West 32, New York.

SUPERSEED Panchromatic 16mm film, 100 ft., \$3.75. Other films from \$2.19. Bargains in new, used equipment. Send for circular. Fotoshop, 136A West 32, New York.

WORLD'S Greatest "Passion Play" 16 MM. (new) 5 reels. Rent or purchase. Hemenway Film Co., 37 Church Street, Boston, Mass.

HIGHEST Prices paid for used still-movie equipment. Send description. Fotoshop, 136A West 32, New York.

DEVELOP Your own movies, reversal and negative-positive instructions, 50c. Millio, 622 Myrtle Ave., Brooklyn, N. Y.

FILMS, Projectors. 10c coin for lists. Capital Productions, Rosedale, Kansas.

RADIOS—SUPPLIES—INSTRUCTION

ALL-WAVE Radio kit, \$1.95. Full instructions. Security Radio, N W-Box 23, Detroit, Michigan.

RADIO Experimenters and set builders. Parts and kits of parts for the Six Tube 32 Volt Farm Set, Economy Three, Five and Four Tube Little Giant, Auto Radio. Portable Battery Set and Metal Locator described by Popular Mechanics. Lund Manufacturing Co., 43 E. Ohio, Chicago.

CUSTOM Built radios. Guaranteed. Priced low. Orr Mfg. Co., 1116 Berwyn Ave., Chicago.

WHAT Every boy should know about radio. "The Beginner's Story," 100 pages, many illustrations, leatherette cover, written in simple language. Price 50c. Radex, Conneaut, Ohio.

MONEY! Making simple long distance pocket radios. No tubes or batteries. Real distance records reported. Supersensitive Melomite crystal, instructions, testimonials, catalog, 25c, postpaid. Melomite, Dept. EP, Fairmount, Kansas City, Mo.

RADIO Engineering, broadcasting, aviation and police radio, servicing, marine and Morse telegraphy taught thoroughly. All expenses low. Catalog free. Dodge's Institute, Ames St., Valparaiso, Ind.

RADIO. All phases. Amateur, shortwave, experimenting, set building, broadcasting, servicing, etc. Complete list recommended books free. Popular Mechanics Press, Room C35, 200 E. Ontario St., Chicago.

MUSIC AND MUSICAL INSTRUMENTS

REBUILT Band and orchestra instruments. Honestly rebuilt—fully guaranteed. Catalog of new instruments on request. Weymann Company, Dept. M-11, 13th and Arch Sts., Philadelphia.

SONG Writers opportunity—phonograph record of your song, manuscript. Musical arrangements. Free information. Paramount Song Recording Studio, J-2, Warner Bros. Theatre Building, Hollywood, Calif.

FREE Pointers in hot playing and modern arranging. Modern Music Pub. Co., Box 984, Reno, Nevada.

COWBOY Poems, songs, ballads. 42 page book 50c. H. D. Voorhees, Box 121, Galveston, Texas.

SONGWRITERS—Get all inside facts. Free booklet by famous Broadway composer. Songwriters Institute, 330C Wadsworth Avenue, New York.

MUSIC Composed to words. Wonderful proposition. Bauer Bros., Oshkosh, Wis.

LOOK!! \$3.00 Buys ukulele with ten private lessons. Hamann Institute, 3019 N. 24 Pl., Milwaukee, Wis.

USED—Rebuilt nationally known instruments. Bargain prices. Supply limited. Write at once for information. Tom Brown Music Company, 315 South Wabash, Chicago.

COOPERATIVE Songwriters Organization. Particulars free. 6574 Gundry, Long Beach, Calif.

YOUR Song poems set to music by nationally known writer. Puritan Music, K-1001 Woods Theatre Bldg., Chicago.

SONGWRITERS! Send for free melody offer! Crane, Box 154, Providence, R. I.

SONGPOEMS Wanted. Your song published. National Songland, "PM," Thomaston, Maine.

SONGS And song poems wanted immediately for early release. 50-50 plan. Submit material. Prompt report. Radio Artists' League, Binghamton, N. Y.

SONGWRITERS Wanted! Publishing, broadcasting, opportunities. Information free. "Song Service," 714 Caracas Street, Tampa, Florida.

YOU Can play your favorite instruments in 12 weeks. A Canadian method. Personal supervision, nothing mechanical. Many outstanding successes. Terms for course and instrument. Folder "Music by Mail" sent free. Marazza Music School, 1247 Bleury St., Montreal, Canada.

DUO-FLEX Reeds for clarinets, and saxophones eliminate your reed troubles. Write for circular. Duo-Flex Reeds, 1204 1st Ave., Evansville, Ind.

NEW Deal. Write Sequoia Songwriters Service, Sherman Branch, Los Angeles, Calif.

WANTED: Original poems, songs. Get our proposition first. MMM Publishers, Studio Bldg., Portland, Ore.

SONGWRITING. Good money being made from songs through talking pictures, radio, phonograph, music publishers. "Hit" writers revise, arrange, compose music to your lyrics, lyrics to your music. We submit to studios and other markets. Free reading. Send for booklet. Universal Song Service, 671 Meyer Bldg., Hollywood, Calif.

SONG Writers. Send for our "Publishing Agreement." McKinley Music Printers, 1501 E. 55th St., Chicago.

SONG Poems wanted, free examination, 50-50 plan. Song Bureau, Salem, Ind.

BUSINESS OPPORTUNITIES

START In the asphalt shingle roof repair business with Seal-All Clips. They fasten down tabs. Thousands of jobs to be repaired. Write for samples, prices and instructions. Millions used. Seal-All Clip Co., Flint, Michigan.

PROFITABLE Business—Repeat orders without solicitation, representing large manufacturer graphite motor conditioner. Paragraf, Dayton, Ohio.

MAKE Fast selling products at home. Formula catalog free. Kemico, 210, Park Ridge, Ill.

120 WAYS To make money; "True Money Making Experiences," 104 pages, \$1.00. Williams Publishing Co., Omaha, Nebr.

LET Us tell you free of a 100 ways to make money. It may be your means of financial independence. Beacon Service, Box 4208, Washington, D. C.

HOW And where to obtain capital, fully explained, free particulars. Star Service, Wapakoneta, Ohio.

PATENTS—Small ideas may have large commercial possibilities. Write immediately for information on how to proceed and "Record of Invention" form. Delays are dangerous in patent matters. Clarence A. O'Brien, 586 Adams Building, Washington, D. C.

INCORPORATE Under liberal Delaware laws. No capital required. Cost \$38. Corporation Fiscal Company, Wilmington, Delaware.

NOMORUN, Prevents runs in silk hosiery. Sample 15c. Roscoe Lynch, Bausman, Penna.

SPARE Time Industries Magazine, Omaha, Nebr. 80 pages opportunities for "get-ahead" folks. Copy 10c.

INSURANCE Claim adjuster. New, copy-righted, low priced, easy lesson course. Whirlwind seller. Big profits for dealers. Circulars furnished free. \$1.25 starts you. H. C. Ellis, 622 Story Bldg., Los Angeles.

START Own business resilvering mirrors, refinishing metal, plated articles, autoparts, tableware. Experience unnecessary. Small investment, combination outfit. Sprinkle, Plater, 127 A, Marion, Indiana.

300 PROFITABLE Money making plans, formulas; free literature. Weick, 2840 Zenobia, Denver, Colo.

POPCORN, Caramelcorn, potato chip machines, used. Northside Mfg., 2117 - 20th, Des Moines, Iowa.

500 BIG Mails 10c. Williams Publishing Co., Omaha, Nebr.

OPPORTUNITIES Galore! New letter duplicator complete \$3.00. Profitable sales rights! Details. Mailmarts, PM-11, Cincinnati.

AT Last! The secret is yours! How to build profitable, money-making business, quickly, easily, in spare-time at home. No canvassing, no experience needed. Rush postal for full details. Starcrest Publishers, Box 402K, Plainview, Nebraska.

MASTER Business opportunity. Staebler Products, 79-20-45th, Elmhurst, N. Y.

SELL By mail. Make thousands of dollars. Home. Spare time. Mail Order Institute, 669-G Marcy Ave., Brooklyn, N. Y.

NEED Cash? Raise new, patented all-season mushroom; cellar, shed. Wholesaler (ten branches) supplies, materials; instructs, buys crops. Details free. United 3848-A171 Lincoln Ave., Chicago.

UNUSUAL Opportunities for earning cash. No canvassing. Stanley M. Graham, Warwick, New York.

LIQUID Marble—Anyone can make! Colorful, glazed! Moulded, brushed, sprayed. Rubberlastic moulds. Composition flooring. Big money making these! Particulars free. Marbleizing Service, Edwardsville, Illinois.

WANTED—5,000 Men to buy slightly used college clothing. Business established since 1912. Free catalogue. Yale Clothing Company, Meriden, Conn.

MAN With car to operate talking picture circuits. Everything furnished. Ideal, 30 East 8th, Chicago.

"KEY To Business Opportunities" free. Goodall Company, Box 1592, San Francisco.

ALL-PROFIT Business by mail. No canvassing. Details stamp. Brault, Davis, Ill.

APPLY Your spare time to my proposition—earn real money. No canvassing. Hetzel, 802 Garden, Hartford, Conn.

WAYS To Wealth Magazine, Box 745, Minneapolis, Minn. 9th year. Tips, plans, formulas, schemes, home workers' opportunities. Three months 25c.

\$25.00 STARTS You off in well paying legitimate business. One man to every town of 100,000 population. Protected territory. Eready Duplistamp, 132 West 46th Street, New York City.

STORAGE Battery recharging compound, long life, rapid charge. Booklet free, chargers wanted. Omoto, 2819 Hyperion, Hollywood, Calif.

CATALOG, Business opportunities; dime. Becker, 22B Hale Ave., Brooklyn, N. Y.

OPERATE Chain world's finest money making vending machines. Sells four products—same time. An instant success! Start small capital—profits immediately. No curiosity seekers. Penny King, 3445 Park, St. Louis.

EASY-WAY Show cards make good steady business. Send \$1.00 for complete instructions. Clenco, Postal Box 17, Verdun, Quebec.

REMEMBRANCE Guild. New, original mail order sales method for greeting cards. Complete plan, copies sales literature successfully used. 50c. Becker 22R Hale Avenue, Brooklyn, N. Y.

SENSATIONAL Discovery makes all tires puncture proof. Agents-distributors write. Seiberling, 1614-BB Estes, Chicago.

BARGAINS—Paint spray outfit, gasoline engine drive. Terms—trial. Helmick Paint Spray Exchange, M-1155, Troy, Ohio.

FREE. Homework ideas. Toronto Business Bureau, 47 Bloomfield, Toronto, Canada.

INCREASE Your earning power! Our simplified, productive letter-writing system (Letter Master Course) equips you to quickly win business promotion. Prepares you to earn big money, your own business, locally or by mail. Convincing particulars free. Business Letter Service, 15 William Street, New York City.

PLATE With nickel, silver, etc., resilver mirrors, reflectors, particulars free. Metalcraft, Arcade Bldg., St. Louis, Mo.

4 HOME Business plans, 10c. Address: C. Gaylor, Greenwood, Wisconsin.

LEARN Marbleizing: With our Snow-white Vitreous cement. Makes concrete products. Garden furniture, floors, wallboard, novelties, statues, etc. Resemble polished marble. Learn flexible mold making with our rubber composition, equals rubber. Illustrated literature, rubber mold with marbleized cast, assorted samples, 3c. Cowell Institute, Grayling, Mich.

POSTCARD Addressed Box 500, Shreveport, Louisiana, brings best proposition ever received.

START Business, \$10 daily. G. Poole, 1406 Spring Rd., Cleveland, O.

GROW Mushrooms right now—a steady income—in cellar, shed or stable. Exclusive new process. Bigger, better, quicker crops—more money for you! We buy. Book free. American Mushroom Industries, Dept. 446, Toronto, Ont.

MAKE Artificial marble, glazed tiles, no polishing, uncanny. Tabletops, novelties, statuettes, whetstones, floors, granite. Inexpensive, hard, enamel wood. Rubber moulds, also liquid rubber sold. Make beautiful thin cement pottery, lawntables, without moulds. Secret cement processes. Startlingly colorful samples 3c, otherwise ignored. John A. Payn, 945 Grande Vista Avenue, Los Angeles, Calif.

FREE Booklet describes 107 plans for making \$20-\$100 weekly, in home or office, business of your own. Elite Co., 214 Grand St., New York.

FREE! Descriptions, 450 newest money making opportunities. Metromails, P-11, Cincinnati.

PROFIT With new products. Make, sell, repeat. Guaranteed formulas, special prices, leads. Biggest catalog free. Gibson, Chemist, BD-4702 No. Racine, Chicago.

EMPLOY Yourself profitably at home. Free information. Innes, Box 745, Minneapolis, Minn.

XMAS Money. Yearly business. Man, large boy can manufacture. Large profits. Fifty cents royalty. Send five dollars information and sellable sample. No information seekers wanted. Kemoe, Ballard Station, Seattle.

PLASTEX Industries offers industrious men an opportunity to start a business of their own, manufacturing art goods, novelties, souvenirs, etc., in Plastex and marble imitation. 5c material makes \$1 articles. Rubber moulds furnished for speed production. Small investment brings big returns. You are just in time for the big Xmas business. Write for interesting booklet mailed free. Plastex Industries, Dept. A, 1085 Washington Ave., New York.

FREE Literature, business opportunities. Garber, 96 - 5th Ave., New York.

BIG Money homemade candies, anybody, anywhere, recipes and proven selling methods, \$1.00. The Candy Jar, Box 107, Corsicana, Texas.

A BUSINESS Of your own. Making chipped glass name plates, numbers, signs, checkerboards, medallions. Big illustrated book free. E. Palmer, Dept. 56, Wooster, Ohio.

GROW Mushrooms. Free spawn. See Ideal Mushroom advertisement page 147A.

DOLLARS In spare or full time. No canvassing. Curtiss, Bergman, Arkansas.

A REAL Live line. Necessities that everyone needs and buys. Your chance to build up a fine profitable business. Leand, 24 West 20th Street, New York.

CHOOSE Your own business, be your own boss. Big money plans for home or mail-order businesses. Booklet free. Simcoe Service, P. O. Box 485, Columbus, Ohio.

MAKE And sell mirrors from old auto glass. Silvering formula and instructions \$1.00. Verne McGowen, Winamac, Ind.

GET Lots of mail. Money making offers, etc. Your name in 10,000 directories, 25c. Roscoe, 4627 Glenshade, Cincinnati.

WORLD-WIDE Offers, opportunities, 25c. Name your interests. Mailmarts, Cincinnati.

POPCORN, Crispette, caramelcrisp, potato chip, salted nut machines. Long Eakins, 1960 High St., Springfield, Ohio.

MODERN Method brings steady income in circular mailing business. Particulars for stamp. Dixie Publishing Company, Station-A, Greensboro, N. Car.

START Little business anywhere. Everything furnished. No canvassing. Maywood, PM-923 Broadway, New York.

MAKE \$100 To \$500 weekly in a business all your own. Our system specialty manufacturing offers you this opportunity. Free book explaining everything. National Scientific Laboratories, 1950W Broad, Richmond, Va.

"PROSPERITY" For home workers. 52 page magazine. Sample, dime. Sizemore, 4917 N. Kostner, Chicago.

TWENTY New successful mailorder propositions. J. Home, 3949 Metropolitan, Chicago.

MAIL Order business your big opportunity. 3c stamp brings details. Stewart Morse, 1009 Oak, Elmira, N. Y.

"TURN Ideas into cash." Free details. Martinez-PM, San Bernardino, Calif.

ARTIFICIAL Marble sanitary flooring, instructions covering wood or cement flooring ½ inch thick, fireproof, all colors, low cost, ornamental casting, concrete, plaster, papier-mache, garden furniture, statuary, flexible molds, particulars free. Chris. Mahler, Elmont, N. Y.

I WANT To send you proof of the wonderful pulling power of Popular Mechanics Magazine's classified pages. What's your proposition? Write me today. F. W. Johnson, Manager, Classified Advertising, 200 E. Ontario St., Chicago, Ill.

MAIL Order business is your opportunity. Many began small, now earn thousands yearly. No personal contact. Boundless opportunities. Have had over 30 years experience; will help you succeed. Send 25c for valuable booklets, none free. B. Breniser, 257 South 21st, Philadelphia.

CHEMICAL Expert will furnish formulas and trade secrets. All lines. Lists free. W. L. Cummings, Ph. D., 228 Gordon Ave., Syracuse, N. Y.

TURN Scrap into money. Convert old auto generators into A.C. generators for auto radio, camp and home lighting, power and other uses. Complete instructions \$1.00 postpaid. Popular Mechanics Press, Room C35, 200 E. Ontario St., Chicago.

SELL By mail. Books, novelties. Bargains! Big profits. Particulars free. B. Elfcio, 525 S. Dearborn, Chicago.

"SCHEMER Magazine," Alliance, Ohio, prints schemes, ideas, business starters, formulas; winners—\$10,000 to \$50,000 reported. 37th year. \$1. Subscribe now. Six months special, only 30c.

OPEN A key-making shop. Start a permanent profitable business with a small sum. No skill necessary. Write for particulars. Beisser Mfg. Co., 411 E. Fort, Detroit, Michigan.

FREE Circulars describing how you can make big money in mail order business at home in spare time. Write today. Mail Order Institute, 669-H Marcy Avenue, Brooklyn, N. Y.

CHARTERS: Delaware; best, cheapest; free forms. Colonial Charter Co., Wilmington, Del.

SUCCEED With your products. Learn how. Formulas. Processes. Analytical service. Catalog free. B. Thaxly Co., Washington, D. C.

INVESTIGATE Frog raising—a profitable side line. New book explains and illustrates every phase of subject. Covers very latest developments such as plans of constructing ponds, combination frog feeder and fly traps, getting other live food electrically, also the roly poly, a new mechanical feeder. \$2.00 postpaid. Popular Mechanics Press, Room C35, 200 E. Ontario St., Chicago.

MONEYMAKING OPPORTUNITIES

BIG Money electrifying spring clocks and building cases. Dime brings drawing and "How" book. Klocksters, Guttenberg, Iowa.

EXTRA Money from old inner tubes. Plans, 25c. Metromails, P-11, Cincinnati.

MAKE Useful articles from klinkers found in ordinary ashes. Real moneymaking opportunity. Write at once for details. Adolph Ringl, 12524 Moran Ave., Detroit, Michigan.

"1000% PROFIT!" Start your own novelty business. Big Xmas demand. "Details free." Act immediately. Stewart, 2102 West 19th, Chicago.

SHOW Sensational new silk hosiery line. Guaranteed to wear without holes for months or replaced free. Quick sellers. Big profits. Samples supplied. Send size. Wilkmit Hosiery, Desk M-37, Greenfield, Ohio.

CATALOG, Moneymaking opportunities; dime. Becker, 22M Hale Avenue, Brooklyn, N. Y.

TO Win success you must do something different; particulars free. Publishers Sales Company, Box A-67, Nelson, Georgia.

ADVANCE Yourself! Earn big money home, outdoors, anywhere. "Income Ideas," free offers help you succeed quickly; 10 cents. Start now—prosper! New Idea Service Co., 217-A Seventh Avenue, New York.

HOME Mailing stunts! Operate anywhere. (Free plans.) National Services, Fairview, Birmingham, Alabama.

RECEIVE Gigantic mails, magazines, samples. Your name in 1,000 mailing lists, 10c. National Service, Saginaw, Michigan.

MONEY-MAKING Christmas wreaths. Instructions 25c. LeVan, 1919 Jackson, Chicago.

FREE Booklet describes 107 plans for making \$20-\$100 weekly, in home or office, business of your own. Elite Co., 214 Grand St., New York.

HOMEWORKER Magazine—filled with profitable ideas! 3 months, 25c. Mailmarts, Cincinnati.

BIG Money at home plating auto parts, reflectors, mirrors, chandeliers; by new method; experience unnecessary. Outfits furnished. Gunmetal Co., Ave. N, Decatur, Ill.

HOW To identify and determine value of old precious metals. Where to buy. To whom to sell. Reliable and up-to-date information. Complete instructions only \$1.00 postpaid. Popular Mechanics Press, Room C35, 200 E. Ontario St., Chicago.

SURVEYING INSTRUMENTS

GUARANTEED Factory rebuilt instruments for rent (with purchase option) or sale (cash or terms). Largest selection in United States. Ten day free trial. Liberal allowance for old instruments. Save money by buying now. Write for new list M-911. Warren-Knight Co., 136 North 12th St., Philadelphia, Pa. Manufacturers Sterling Transits and Levels. Headquarters for repairs any make surveying instruments.

FORMULAS, PLANS, ETC.

36 COMMERCIAL Formulae for coloring brass, aluminum, copper. \$1.00. Edge-Lab, 7353 North Damen, Chicago.

FORMULAS. All kinds. Guaranteed. Catalog. "Special Offer Free." Kemico, 32, Park Ridge, Ill.

500 MONEYMAKING Formulas 25c. Descriptive literature free. Harvey Teeple, Decatur, Indiana.

FORMULA Bulletin—Year 10c. Terrone, 22 Station 8, Brooklyn, N. Y.

AUTOMOBILE Specialties, 14—\$1.00. Perfume, powders, 50c. Hein, 3534N. Lawn-dale, Chicago.

525 PRACTICAL Formulas 25c. Instructive literature free. Pelishek's, Adell, Wis.

MONEY Makers, savers—Formulas for anything; 10c plus postage, 15 for \$1. Formulas, 902 West Prairie, Taylorville, Ill.

FORMULAS. Manufacture own goods. Catalog free. Roscoe Lynch, Bausman, Penna.

TESTED Formulas—Largest, most complete line. Newest—guaranteed. Information free. Grinstead Laboratory, Edwardsville, Illinois.

FORMULA Analysis national advertised products. Fourteen, \$1.00. Literature. Farrand Chemical, Tyrone, Pa.

FORMULAS—Latest money makers. Literature free. Belfort, 4042 N. Keeler, Chicago.

10 HIGH Grade beauty, drug and automobile specialty formulas \$1.00. Eastern Laboratories, 2683 Deacon, Philadelphia.

MIRRORS! Electro-plating. Make portable outfits. Astonishing disclosures. O'Custer, Mirror-Craftsman, HP224 Highland, Detroit, Michigan.

CATALOG, Formulas, plans; dime. Becker, 22E Hale Avenue, Brooklyn, N. Y.

NEWEST Guaranteed formulas. Biggest catalog free. Special prices, leads. Gibson, Chemist, BD-4702 No. Racine, Chicago.

FORMULAS—Tried, tested, proven. Real money makers! Average cost only 4c per formula! Write for interesting information. Best-Formulas-of-the-Month Club, Mayo, Florida.

MAKE Money. Home or traveling. Sell my formulas; or manufacture yourself. Complete instructions. One sale a day \$5.00 to \$25.00. Money back guarantee. Chemist, Box 2142, Reno, Nevada.

TWENTY Profitable "make-and-sell" formulas, 25c. International Agency, Cincinnati.

SUCCEED With your products. Learn how. Formulas. Processes. Analytical service. Catalog free. B. Thaxly Co., Washington, D. C.

3,000 FORMULAS. Facts, processes, trade secrets in Dr. Brown's Book of Formulas—380 pages. Price, postpaid \$1.00. Ogilvie Publishing Co., 57 Rose Street, Dept. 25, New York.

SPECIAL: Spit fire; snake oil, 60 other guaranteed formulas,—all complete 25c. Pittman Laboratories, Parkville, Ky.

15,000 PROFIT Making formulas. Following and many others: Accidents and emergencies, agriculture, alloys and amalgams, artist's materials, beverages, cements, glues, pastes, mucilages, bleaching, renovating, coloring metals, dyeing glass, heat treatment of metals, household formulas, ice cream, confectionery, chewing gum, lapidary work, exterminating vermin, lubricants, paints, varnishes, photography, solvents, canning formulas, rubber, soap, candles, soldering, toilet preparations, perfumes, waterproofing, fireproofing, writing materials. \$5.50 postpaid. Popular Mechanics Press, Room C35, 200 E. Ontario St., Chicago.

CHEMISTRY

NEW Big catalog. Chemical sets, microscope outfits, laboratory, biological, chemical supplies. Approved by experimental laboratories. Special 30 day offer. Send 10c. Winn, 124L West 23rd St., N. Y.

EQUIP Complete laboratory. Supplies at 5c! Send 15c for valuable catalogs. Kemkit Corporation, 135P Johnson Street, Brooklyn, New York.

JOIN. American Amateur Chemists Society. Particulars, magazine 10c. 1001 Erector Square, New Haven, Conn.

CHEMICAL Set. Performs 35 experiments. 25c. Fleischer's Laboratories, Everett, Mass.

CHEMICALS. Laboratory glassware and apparatus. Catalog CP. Biological Supply Co., 1176 Mt. Hope Ave., Rochester, N. Y.

AGENTS WANTED

GIGANTIC Christmas sellers! Lucky Seven cellophane wrapped packages, \$5 hundred. Twenty-one piece Christmas boxes \$18 hundred. Samples 35c. Bulletin free! Elfko, 525 South Dearborn, Chicago.

WE Want an agent in every county to sell our high class monuments. Liberal commissions. Write Atlas Marble Company, Jasper, Georgia.

80-PIECE Christmas assortment for 25c. 16 artistic, large, French-fold greetings, 16 matching envelopes, and 48 new Nip-Apart seals, in five colors and gold, in handsome box. Easily sold for 50c and up. Be first. Get sample set, on approval. American Card Co., Dept. 95, Lancaster, Pa.

AGENTS—Lowest prices—Top profits on carded aspirin, razor blades, handkerchiefs, laxatives, shoe laces, etc. Details free. Better Products Co., Marion, Ind.

JO-BO Rubber bow ties are new, unique. Sensational sellers. Good profits to live agents. Excellent side line. Write Jo-Bo Products, 222 Iowa Building, Des Moines, Iowa.

"SOAP-MIX" Makes 4 pounds best hand soap. Send 25c, see for yourself. Tremendous repeat profits! Indian Paste Co., Dept. 41, Belleville, N. J.

AMAZING Zipper pinless clothesline. Instant demonstration. Sure sale every home. Free guarantee sales plan. Dunn Bros., Hempstead, N. Y.

STRANGE Ironing cord. Saves electricity. Abolishes scorching and kinking. For telephones also. 150% profit. Sales guaranteed. Big free offer. Neverknot, Dept. 11A, 4503 Ravenswood, Chicago.

INITIALING Automobiles biggest money maker today. New type requiring no varnish to apply. Write for samples. International Monogram & Transfer Co., Box 6365, Philadelphia, Pa.

SELL Neckwear. 100% profit. Four sample ties \$1.00. Free catalog. Artstyle Neckwear, Elmira, N. Y.

CLEAN Up this Christmas. Sell tinsed 9"x11" card signs. Sample 10c. Slogans free. Special Kut, Sidney, O.

ACCEPT Local tryout. Valuable splashless 25c water filter. 200% proposition. Barnett, Box 63, Times Square Station, New York.

ABLE Men for distributing and route work. Automobiles given men who qualify. \$35-a-week opportunity. Details free. Albert Mills, 9101 Monmouth, Cincinnati, O.

\$3.00 HOURLY: Amazing automobile accessory. Produces revolving colored light. Free offer. Propell-o-lite Company, Mt. Washington, Ohio.

\$2.00 HOURLY With new, scientific cream that mends all cloth easily, quickly, invisibly, without needle and thread. Stands laundering. Free sample. Sewnomore, S-744, Cincinnati, O.

AMAZING Profits selling colored folks. Hair preparations, bleach creams, perfumes, incense. 300 products. Write for free samples. Valmor, 5249-SN Cottage Grove, Chicago.

CASH Income daily silvering mirrors at home. Plating autopaarts, tableware, etc. Combination outfit. Write Sprinkle, Plater, 128, Marion, Indiana.

\$6.00 HOURLY. Amazing Karnu refinishes auto like new without rubbing, polishing, waxing or painting. Wipes on with cloth. Lasts 8 to 12 months. Free sample. Karnu, Dept. S-8, Cincinnati, Ohio.

GOLD Letters for store windows. Large sizes penny each. Free samples. Modernistic Sign, 3004 Lincoln Ave., Chicago.

DISTRIBUTORS. New scientific remedy quickly heals eczema, ringworm, other skin diseases. Free samples. G. Moreau, 509 Fifth Ave., New York.

\$6.85 HOURLY! Amazing No-Flatz fixes punctures without patching; makes tires puncture proof! Instantly—permanently seals holes made by nails, etc. Big seller. Free sample offer. No-Flatz, Dept. S-172, Cincinnati, Ohio.

DOUBLE-EYED Self-threading needle packages. Size 3/8. Blind people thread them, invaluable for falling sight, necessary for good sight. Five samples 25c. Particulars. Wm. Oglesby, Vandalia, Ill.

500% PROFIT Selling new "20-in-1" kitchen utensil. Retail 25c. Costs you \$1.00 a dozen. \$7.20 a gross. Sample 10c. New Method Co., P.M.-35, Bradford, Pa.

FAST Seller—800% profit. Latex bandage—5 color box. Quick Bandages, 801 N. Sangamon St., Dept. PM, Chicago, Ill.

FREE Circulars describing how you can make big money in mail order business at home in spare time. Write today. Mail Order Institute, 609-W Marcy Avenue, Brooklyn, N. Y.

THE New glass sanitary milk-bottle replacement cap. Excellent seller. Fits all milk bottles. 100% profit. 20c for sample and selling particulars. Wirmill Distributors, Box 95, Burlington, Iowa.

FAST Mail seller—Free sample. Plans. Circulars furnished. Seewigen, 2328 W. Pico, Los Angeles, Calif.

"WINDOW-RITER"—Magic pencil writes on glass. All colors. Storekeepers buy quickly. Ideal for baseball scores. Large profits. Big repeaters. Free sample. Lake Chemical, 6 E. Lake, Dept. 11-PM, Chicago.

GENUINE Gold leaf window letters. Easily applied. Sample. Paramount Letter, Box 74, Sta. A, New Haven, Conn.

EVERYONE Uses soap. Free selling plan. Samples 25c. L. C. Cherry Company, Cincinnati, Ohio.

100% PROFIT In the "Self Starting Cigar Lighter." No flint or friction. What makes it light? No wind can blow it out. Retail 25c. Costs \$1.75 per dozen. Sample and sales plan 25c. New Method Company, Desk PM-35, New Method Bldg., Bradford, Pa.

100% PROFIT, Extra bonuses. Enjoy own business. Best season. Selected Christmas cards, 21 box assortments. \$1.00. Investigate. Established 1912. Caldwell Company, 101 West 31st, New York.

SELL New kind of rugs for big profits. Handle household trade, stores, theaters and hundreds of others. Cleanable, sheds dirt and water. Attractive, durable. Low price. Collect commission each sale. Write at once. Premier Supply Co., 57 N. 52nd, Philadelphia.

SPARKLING Tinsed Thanksgiving and Christmas signs, cost 6c—retails 25c. Sample free. Also boxed 21 Christmas cards 35c—retails \$1.00. Make Christmas money. Lowy, Dept. 54, 8 West Broadway, New York.

RADIO—All kinds. 60% deal. J-20th Century Co., Kansas City, Mo.

FIVE Dollars made easily, quickly, selling 10 boxes 21 beautiful Christmas cards. Other assortments. Bonus. Freeman Studios, 632 Whaley, New Haven, Conn.

MEN—Women \$3 to \$6 daily. Selling 25c household necessity that repeats. Three to ten sold in every home. Free sample. Write Pure Company, 3107 Pine St., Dept. R-2045, St. Louis, Mo.

FREE—Sample Christmas cards; big money selling exquisite 21 Christmas folders assortment; everybody buying; 100% profits, bonuses. Write for sample on approval or request free sample plan. Brown Studios, 150-H, Nassau St., New York.

AGENTS—Opportunity to make money; book containing 107 successful business plans; home or office; send for free introductory booklet. Elite Co., 214 Grand St., New York.

WHOLESALE Catalog free. 500 best sellers. Paty Co., 1167 Broadway, Somerville, Mass.

SHOE Manufacturer's sales division wants men. Complete lines of dress and work shoes for entire family. Also special bargains as low as \$1.98. Guaranteed quality. Good pay every day and your own shoes at wholesale prices. No experience needed. 3 line outfit free. Write Consolidated Shoe System, Dept. R16, Chippewa Falls, Wis.

AN Attractive proposition for junior and senior salesmen—our book of stamp packets. Liberal commission. Write to Venice Stamp Co., Box 184, Venice, Calif.

SELL Sensationally new century table lamp to cafes, taverns, stores. Irresistible gift item at unusually low retail price. Write "Ruproco," 5639 N. Ashland, Chicago.

AGENTS To handle electric tube plates, also tire regrooving irons. Western Rubber Mold Company, 709 So. Kolmar Ave., Chicago, Ill.

10,000 MONEY-MAKING Formulas. Tells you how to make and sell almost everything under the sun; cosmetics, mucilage, anti-freeze solutions, battery solution, beverages, cheese, chewing gum, cleaning preparations, extracts, hair preparations, inks, bluing, leather polish, mirrors, perfumes, polishes, typewriter ribbons, carbon paper, washing powders, liquid soap, and hundreds of other profitable articles. \$4 postpaid. Popular Mechanics Press, Room C35, 200 E. Ontario St., Chicago.

PROFIT With new products. Make, sell, repeat. Guaranteed formulas, special prices, leads. Biggest catalog free. Gibson, Chemist, BD-4702 No. Racine, Chicago.

DOLLARS Daily! Operate profitable mailorder business. Details. Duffy, Covington, Ky.

BIG Profits selling inexpensive glass window display signs. Sample sign 35c. Everlight, 30 East 20th, New York.

SELL Christmas cards. Beautiful 21 card assortment sells fast at 60c. To avoid delay send 30c for sample box of particulars free. New England Art Publishers, North Abington, 105, Mass.

MAKE Big money; commissions advanced; sell Goodyear raincoats, jackets; union made; latest style. Lowest prices; experience unnecessary; outfit free. Goodyear, BB-1133 Milwaukee, Chicago.

MEXICAN Feather pictures. Christmas novelty. Send 25c (stamps) for \$1.00 worth sample and details. Mexican Art, Apartado 1593, Mexico City.

100 PROFITABLE Mail order and local business plans. A. Pruitt, Elburn, Ill.

POPCORN, Crispette, caramelpop, potato chip, salted nut machines. Long Eakins, 1961 High St., Springfield, Ohio.

U-KAN-PLATE Really replates old brass bath room fixtures, auto accessories and other metals with silver. Agents wanted, 3-oz. 50c; 8-oz., \$1. Justice, 904 Walnut St., Philadelphia, Pa.

SELL Made to measure raincoats. Outfit free. Goodyear Rainwear, 18 West 22nd, New York.

PROFITABLE Home business. Legitimate. No canvassing. Maywood Publishers, P-923 Broadway, New York.

AGENTS, Sell Neon-like signs, catalog free. Sample 10c. Roscoe Lynch, Bausman, Pa.

GOLD Reflecting letters for store windows. Easily applied. Large sizes, penny each, free samples! Atlas Sign Works, 7941 Halsted, Chicago.

SELL New food specialty. Spicy butter. Colavit's Co., Perkasie, Penna.

MAKE More money taking orders shirts, ties, underwear, dresses, hosiery, raincoats, jackets, pants, uniforms. Write quick. Nimrod Company, Department 8, 4922-28 Lincoln Avenue, Chicago.

WHY Work for others? Make and sell your own goods. We show you how. Free book explains everything. National Scientific Laboratories, 1950 W. Broad, Richmond, Va.

AGENTS: Smash go prices! Santos coffee 12c lb. 4-oz. vanilla 8 1/2c. Razor blades 10 for 8 1/2c. 100 sticks chewing gum 12c. Christmas cards, 21 in box, 13c. 150 other bargains. Experience unnecessary. Write Carnation Co., P.O. St. Louis, Mo.

SUCCEED With your products. Learn how. Formulas. Processes. Analytical service. Catalog free. B. Thaxly Co., Washington, D. C.

CALIFORNIA Flower beads sure fire fast sellers. Big profits. Low prices. Catalog free. Mission No. 16, 2328 W. Pico, Los Angeles, Calif.

BIGGEST And quickest sales are made in brushes. Write for proposition. Wire-Grip Sanitary Brush Corporation, 45 East Eleventh Street, New York.

NEW Cleaner! Washes clothes quickly. Cleans everything. Premium deals. Free sample. Bestco, 5007 Irving Park, Chicago.

BIG Money applying gold initials on automobiles. Easiest thing today. No experience needed. Free samples. "Ralco," 1084 Washington, Boston, Mass.

GENUINE Gold letters for store windows. Easily applied. Free samples. Liberal offer to general agents. Metallic Letter Co., 438-B North Clark, Chicago.

AGENTS: Stamping names on pocket-key protectors. Sample check with your name, address, 25c. Stamping outfits. Emblem checks, check-fobs, name plates. Hart Mfg. Co., 303 DeGraaf St., Brooklyn, N. Y.

BIG Money and fast sales. Every owner buys gold initials for his auto. You charge \$1.50; make \$1.45. Ten orders daily easy. Write for particulars and free sample. American Monogram Company, Dept. 40, East Orange, N. J.

MAN In each town to plate auto parts, reflectors, bathroom fixtures, refinish beds, mirrors, chandeliers; by new method. No capital or experience required. Simple plan of manufacturing at home starts you in big money-making business. Outfit furnished. Free particulars and proofs. Gun Metal Co., Ave. H, Decatur, Ill.

HIGH-GRADE SALESMEN

AMAZING Profits representing large manufacturer graphite motor lubricant. 90% repeat business. Para-Graf, Dayton, Ohio.

MEN—Make \$12 daily, selling stores 5c and 10c necessities on beautiful counter displays. Demand everywhere. Over 75 fast sellers and sure repeaters. Craig's Laboratories, Suite 377, Memphis, Tenn.

HERSHEYS, Baby Ruth, Oh Henry! candy deals, 1c-5c display and punch deals. Living scale. Steady employment. Castline Bros., 1916 Sunnyside, Chicago.

STEADY Substantial income taking orders for complete line Printed Business Necessities, gummed labels, advertising novelties, calendars, and sensational business stimulators. Experience unnecessary. Complete sales outfit free. Northwestern, PM-625 Jackson, Chicago.

DISTRIBUTORS; Wholesale and retail. Finest shampoos, shaving cream. Interview. Ver O Products Co., Rochester, Indiana.

SELL A necessity. Permanent income selling genuine quality business cards at \$1.50 per thousand. Outfit free. Pioneer Printers, 501 East Third St., Dayton, Ohio.

SALES Tax law forces merchants keep records; men averaging good daily commission; exclusive territories open. Mill-Green Publishing Co., 370 Seventh Ave., New York.

SALESMEN—New deal guarantees stores \$10 for one. Two \$15 sales net you \$20 daily. Sayers, 2801-123 Sheffield, Chicago.

CALENDARS—Novelties—Signs. Finest we've manufactured in 33 years. Harvest season here. State sales experience. Ad-Nov-Co., Newton, Iowa.

SALESMEN: Acquainted with garages, filling stations, to handle local business. Write Colgra, 2637 N. Third St., Milwaukee, Wisconsin.

MAKE Big money steady. High grade coveralls, shopcoats, pants, shirts, melton jackets. Advertising on back. Fast sellers. Free outfit. Strong Mfg. Co., 901 West Jackson, Dept. N-8, Chicago.

NEW Drycleaning clothes brush. Revolutionary invention. Cleans clothes like magic. Homes, offices buy instantly. Phenomenal profits. Outfit free. Kristee, Dept. 261, Akron, Ohio.

SELL Jewelry on installment! Small investment. Peters Manufacturing Co., Box 734, Providence, Rhode Island.

LARGE Steady profits. Make-sell amazing 30 below non-evaporating auto antifreeze. Cheaper, better, easily-quickly made. Formula 30c. Allied Research, 2217 North Kilbourn, Chicago.

BIG Quick profits taking orders for Dunlap pants, \$1.95 up. Zipper jackets and raincoats, too. Samples given to producers. No experience or money required. Everything to start furnished free. Dunlap Pants Co., Dept. 14-L, Cincinnati, Ohio.

SALESMEN—Only one successful demonstration daily pays you \$60.00 weekly. Selling unnecessary; simply show new commercial discovery to business or professional men. Territories open. Write quickly for details. Thomas Young, Dept. 111, Bankers Bldg., Chicago.

TAILORING Salesmen—Sell men's made-to-measure pants—\$4.95. Every pair cut to individual measure. Big commissions—your own pants without cost. No experience necessary. Sample line free. Write Hutchins Pants Co., Dept. 1123, Cincinnati, Ohio.

EXCLUSIVE Territory. Startez Motor Warmer. Guaranteed to start any car in coldest weather. All electric! Western Products Co., Yakima, Wash.

SALESMEN: Sell complete line gummed labels, calendars, memo books, and business stationery. Special features. Free deals. Write quick. Big commission daily. Attractive sales portfolio free. Willens, Dept. FD, 2132 Gladys, Chicago.

MAN—Handle regular store route. Place nationally advertised 5c-10c counter card mdse. New aspirin deal—6 tablets 5c. 85 other fast sellers. 100% profit. No investment. Samples free. World's Products Co., Dept. 11810, Spencer, Ind.

SALESMEN! Earn to \$10.00 daily commissions selling five months guaranteed shoes for whole family. Build independent business. Free samples. Moench Shoes, 3, Boston, Mass.

FREE Booklet describes 107 plans for making \$20-\$100 weekly, in home or office, business of your own. Elite Co., 214 Grand St., New York.

LEATHER 4-in-hand ties, men and boys, new fall patterns polkadot, plaids, stripes, looks like silk, cleans easily, will not wrinkle. Big profit, repeat orders. Send 50c or stamps for two sample ties and information. Leader Leather Company, Dept. 10, Capac, Michigan.

NEW Premium and direct item. Universal Publishers, 1553 Madison, Chicago.

SALESMEN Acquainted with meat business to handle a new meat tenderizer. Local territory. Write Leland Detroit Manufacturing Company, Detroit, Michigan.

BIG Money in tire patches. Sell new auto tire patch to service stations, garages, etc. Tiger-Grip patches guaranteed 10,000 miles. \$75 weekly for salesman or distributor. Protected territory. Write Economy Rubber Co., 775 Burkhardt, Dayton, Ohio.

MEN Wanted by world wide industry. Write today for particulars about few good old Raleigh routes that have paid well for years. Established, profitable business. Over 200 farm and home necessities. Industry and reliability main qualifications. Man with auto preferred. Give age, experience, references. Raleigh's, Dept. K-N-PPM, Freeport, Ill.

PRINTERS New press attachment. Inexpensive. National Specialty, 1553 Madison, Chicago.

POPCORN, Crispette, caramelpop, potato chip, salted nut machines. Long Eakins, 1962 High St., Springfield, Ohio.

ART Calendars—Leading line, many subjects. Sell on sight. Every business a prospect. Samples free. Flemming, 6541 Cottage Grove, Chicago.

BE Independent. Own your business; experience unnecessary, selling \$10,000 accidental death, \$50 accident; \$25 sick weekly benefits—\$10.00 yearly. Other amounts proportionate. Guaranteed steady renewal income. \$726,415.63 securities deposited. Universal Policy, 716-A Lefcourt Bldg., Newark, New Jersey.

SOMETHING New in fire extinguishers. Red Comet Automatics. Proved in west five years. Exclusive territory. Low price opens pocketbooks. Write Red Comet, 404 Comet Building, Littleton, Colorado.

GOLD Reflecting letters for store windows. Easily applied. Large sizes, penny each, free samples! Atlas Sign Works, 7941 Halsted, Chicago.

SELL Process raised letter printing \$3.95 thousand. Free cut service. Worth \$6.00. Commission \$1.00 advanced. Experience unnecessary. Outfit free. United, F-6155 South State, Chicago.

BRAND New grab-bag deal. Going big everywhere—big profits—swift sales—fast repeats. No restrictions. All dealers buy. Act! K&S, 4373 Ravenswood, Chicago.

START A business of your own! Become a subscription representative for "Popular Mechanics." No capital required. Liberal commissions. Monthly bonus. Write for details. V. D. Angerman, Circulation Manager, 200 East Ontario Street, Room 235, Chicago.

NEW Specialty—Sells every business and professional man. Four \$15 sales daily pay \$230 weekly. Foyer cleared \$4920 in three months. Write, F. E. Armstrong, President, Dept. PM, Mobile, Ala.

SELL Punchboards direct to dealers from world's leading punchboard factory. Wholesale prices. Enormous profits. Big commissions. Sales kit free. Harlich Co., 1407 Jackson, Chicago.

OUTDOOR Sports for everyone—Enjoy them all year round with aid of book published by Popular Mechanics. Hundreds of ideas for new and popular sports for every season; complete instruction for making necessary equipment at small cost. 350 pages and 650 illustrations. \$2 postpaid. Popular Mechanics Press, Room C35, 200 E. Ontario St., Chicago.

MAKE More money taking orders shirts, ties, underwear, dresses, hosiery, raincoats, jackets, pants, uniforms. Write quick. Nimrod Company, Department 65, 4922-28 Lincoln Avenue, Chicago.

HELP WANTED

SALES Engineer wanted, capable of taking complete charge of and organizing Diesel sales organization, specializing in small Diesel engines and Diesel-electric plants. In answering give complete information as to previous employment, salary expected, age, etc. Witte Engine Works, Kansas City, Mo.

MAN Wanted—Old established manufacturer will finance responsible man with complete stock guaranteed food products, farm and household necessities. Very pleasant work. Excellent opportunity for good living and extra money to save every week. Pays better than most occupations. B. M. Anderson sold over \$402,70. A. M. Karel over \$347.48 and H. E. McMillen over \$314.15 in one week. No slack seasons or layoffs. Experience unnecessary. Write today for No-Investment offer. McConnon and Co., Room 66LT, Winona, Minn.

AGENTS—Mosco corn and callous remover will build you a steady repeat business. Send today for pocket-size trial outfits. The Moss Company, 54 Searle Bldg., Rochester, N. Y.

WOULD \$1.50 An hour satisfy you? Then send me your name immediately. I'll give you a wonderful opportunity to make \$12.00 or more a day in home-operated business. Particulars free. Albert Mills, 9097 Monmouth, Cincinnati, O.

MONEY For you helping others discard their glasses. My unique system improves eyesight 100% or more. Even astigmatism vanishes. Guaranteed. Satisfied customers in every state. Representatives wanted. Large profits. No canvassing. Stamp brings particulars. Arthur Jacobson, Box 80, Pasadena, Calif.

NEED Cash? Raise new, patented all-season mushroom; cellar, shed. Wholesaler (ten branches) supplies materials; instructs, buys crops. Details free. United, 3848-A175 Lincoln Ave., Chicago.

GO Into wholesale business without investment. Call on stores with biggest line self-selling counter displays: Aspirin, razor blades, handkerchiefs, breathlets, household cement, 79 different items. Up to 125% profit for you. Experience unnecessary. Write for catalog and plans. Procopax, Dept. 36PD, 1956 S. Troy, Chicago.

GROW Mushrooms. Free spawn. See Ideal Mushroom advertisement page 147A.

EXCELLENT Opportunity for diligent workers. Experience unnecessary. Leand, 24 West 20th Street, New York.

BIG Money growing mushrooms, cellar, idle places. Supplies furnished. We buy. Free book. Mushroom Growers, K.L.-433, N. Clark, Chicago.

GROW Mushrooms right now—a steady income—in cellar, shed or stable. Exclusive new process. Bigger, better, quicker crops—more money for you! We buy. Book free. American Mushroom Industries, Dept. 447, Toronto, Ont.

LEARN Diesel engineering. Rapidly expanding field. Good pay for Diesel-trained men for next 25 years. Home training possible. Get latest and right up-to-date Diesel Handbook. Authentic. \$5.00 postpaid. Popular Mechanics Press, Room C35, 200 E. Ontario St., Chicago.

EDUCATIONAL AND INSTRUCTION

TRAIN By home study for managerial government positions; city or state controller, federal finance accountant, and other executive positions. Graduate and post-graduate courses in professional public administration. Degrees conferred. Write for special tuition offer. American School of Public Administration, Box 647, Sacramento, Calif.

LEARN Auto mechanics, metal finishing, electricity, refrigeration. Stevinson's, 2008A Main, Kansas City, Missouri.

LEARN Latest developments in arithmetic. Frederick A. Smith, 2410 Smalley Court, Chicago.

WORK For "Uncle Sam." Start \$105 to \$175 month. Pleasant work. Men-women. Try next announced examinations. Common education usually sufficient. Experience unnecessary. Full particulars and sample tests—free. Write today sure. Franklin Institute, Dept. C3, Rochester, N. Y. (Established 1905.)

FINGER Print outfit professional—Send \$2. American System, 219-P West 100th, New York.

ZENDU. Remarkable, practical mystic language. Quickly learned. Complete instructions 25c. Zendu, Burbank, Calif.

SECRET Service. Valuable information free. International Secret Service Institute, PM-115, Hoboken, N. J.

DOES Hotel work interest you? Not a correspondence course. Free information. Ben Hadley, P. O. Box 315, Detroit, Mich.

"G-MEN" Booklet. Send 10c for mailing. International Secret Service Institute, (PM-115) Hoboken, N. J.

"ELECTRIC Motor Maintenance Guide." Care, trouble tests, and remedies. Price \$1.00. Motor Data Co., 3002 Monroe, Kansas City, Missouri.

LEARN Machinist trade, tool, die making. Automatic and hand screw machines. Modern shop methods. Actual work. Jobs open for trained men. Employment help. Illustrated booklet free. Allied Screw Machine Company, 601 Lake Street, Chicago.

BECOME A landscape architect. Easy to learn by mail. Wonderful opportunity for money-making. Earn while you learn. Write for free opportunity booklet and details. American Landscape School, 805 Plymouth Bldg., Des Moines, Iowa.

CHIROPODY Taught by correspondence. Evans School of Chiropractic, Montgomery, Alabama.

HOME Study courses leading to degrees: Arts and sciences, philosophy, education, law, letters, theology, psychology, engineering, chemistry, business and commerce. Many others. McKinley-Roosevelt University, Chicago.

GET U. S. government job—start \$105-\$175 month. Men-women. age 18-53. Are you eligible for eligibility test? Get our free questionnaire—find out. No obligation whatever. Instruction Bureau, 101, St. Louis, Missouri.

U. S. GOVERNMENT Positions. \$1700-\$1900 and up a year. Let our expert (former government examiner) prepare you for a position in the railway mail service, rural carrier, post office, customs and other branches. Write today for free booklet. Dept. 8, Patterson School, Rochester, N. Y.

MODERN Refrigeration. New industry needs trained men for installing, servicing, repairing. If you seek a new field with larger opportunities get latest book by Alt-house and Turnquist. \$4.00 postpaid. Popular Mechanics Press, Room C55, 200 E. Ontario St., Chicago.

CARTOONING—COMMERCIAL ART

CARTOONING Course. Very latest method with 700 illustrations and 100 drawing sheets. Complete outfit 50c postpaid. Lawrence Publications, 143 West 100 St., New York.

NEW Trick cartooning program, complete \$1.00. Cressman, Washington, New Jersey.

MODERN Cartooning methods. \$1. Co-operative Research Company, 132 West 14th Street, New York.

SELL Your cartoons. "Cartoonists' Guide" tells where! 25c. Ridman, 3235-D Jefferson, Cincinnati.

CARTOONING—Sketching, etc. 46 lessons, 600 illustrations, including practice sheets, pens and pencils. \$1.00 postpaid. Fraba Service, Cashton, Wisconsin.

ARTISTS—Amateur, advanced, fifty money-making ideas. \$1.00. Robert Sugg, 420, Dickson, Tennessee.

SELL Your work. Details free. Paisley, Kinloch Bldg., St. Louis, Mo.

CARTOONS—I buy and sell cartoons. Send \$2.00 for my money making cartoon course. Nick Nichols Newspaper Syndicate, Times Bldg., Suite 1120, Chicago, Illinois.

CHALK Talks. Laugh producing program, \$1.00. Catalog free. Balda, The Cartoonist, Oshkosh, Wisconsin.

CARTOONING Course:—30 lessons, 500 illustrations with drawing pens and pencils. \$1.00 complete. Scovell Studios, Box 610-P, Hollywood, Calif.

AMATEUR Cartoonists can earn \$35.00 weekly, spare time, duplicating cartoon advertisements. 3-M Syndicate, Argyle, Wis.

ADVERTISING AGENCIES

LEARN Advertising quickly at home. New easy practical plan. No text books. Interesting booklet free. Page-Davis School of Advertising, 3601 Michigan, Dept. 343-B, Chicago.

FREE—New Advertisers Rate Guide, 44 pages. Includes everything. Lowest rates. E. H. Brown Advertising Agency, 140 S. Dearborn, Chicago.

ADVERTISE Profitably: \$15 reaches 6,000,000 Sunday newspaper readers with 24 word ad. Newspaper, magazine rate-guide, free. Chicago Union Agency, 20 West Jackson, Chicago.

ADVERTISING Placed anywhere. Helpful, free service. Rate guide book free. Baker Advertising Agency, 189 W. Madison, Chicago.

FOR ADVERTISERS

GET Results: Inch display, twenty 52 page co-operative magazines, two issues, \$2.00; 25 words twice, \$1.00. Copies sent. National Syndicate, Ames Sta., Omaha, Nebr.

MAKE Your advertising pay big profits with my "Bag of Tricks." 101 tested ideas, 25c. Buswell, 3723 Edgemont, Wichita, Kansas.

30 WORDS, 25 Magazines, \$1.00. Goodall Agency, Box 1592, San Francisco.

25 WORDS, 25 Magazines, three months \$1.50. Empire, Shawano, Wisconsin.

SALES Letters that get results. G. Hilleman, 422 Westwood, Dayton, Ohio.

ADVERTISE: 24 Words in 250 newspapers \$10. Lists free. Advertising Service Bureau, 4650 Drexel, Chicago.

SALES Letters, folders, circulars, advertisements and complete mail campaigns planned and written to produce "plus" profits for you. Write for folder or send details now. Raymond W. Walter, Box 626, Ridge-wood, N. J.

BUSINESS SERVICE

MOST Resultful master set collection letters ever written. Record-breaking results! Now \$2. Satisfaction guaranteed. Or send for convincing literature. Schminke, 1188 Tenth, Marion, Iowa.

DIGNIFIED Times Square, New York, address \$1.00. Mail forwarded daily. Telephone messages \$1.00. Associated Service, 1457 Broadway.

WHERE To get it. Anything. We know. Advice 50c, no stamps. Lorenzen, Niles, Michigan.

DELAWARE Charters; fees small; free forms. Chas. G. Guyer, 901 Market St., Wilmington, Del.

RUBBER STAMPS AND OFFICE SUPPLIES

CUSHION Mounted, one—two lines, 25c. Three 35c. Stamp Works, 814 Bradley, Peoria, Ill.

SPECIAL! 3 Lines 25c. Knob handles. Owl, 6452 Kenwood, Chicago.

NAME, Address, 2 lines 25c; 3 lines 35c. Stamp Works, Auburn, Nebr.

TYPEWRITERS, DUPLICATORS, OFFICE DEVICES

TYPEWRITERS, Duplicators, multi-graphs. Write for free list office machine bargains. Save half. Pruitt, 518 Pruitt Bldg., Chicago.

STENCIL Duplicators. Show card printing machines. \$12.50 up. Write Genco, Box 3643, Washington, D. C.

INCREASE Business. "Excellograph" rotary stencil, clay and film duplicators \$3.85 to \$37.50. Prints anything. Typewritten, penned, drawn, traced. Colors. Folder free. Pittsburgh Typewriter Supply, Suite 518, Pittsburgh, Pa.

NEW \$4.75 Automatic adding machine. Fully guaranteed. Bassett, 1458J Hollywood Avenue, Chicago.

PRINTING, MULTIGRAPHING, MIMEOGRAPHING, GUMMED LABELS

500 LETTERHEADS, Envelopes, etc., \$1.75. Anything printed. Bradshaw, 3214-P Huron, Chicago.

STATIONERY And statements \$2.95—1000. Mimeographing 8½x11 \$1.00—100, \$2.95—1000. Ruca, Box 292, Albany, N. Y.

500 TWOCOLOR Letterheads \$1.75. Samples free. Colorpress, 333-P State, Detroit.

REMARKABLE Printing bargains! Samples free! Kamkay, 173 Norfolk, New York City.

LOW Price! High grade! Printing, mimeographing, duplicator—office supplies. Lists, samples free! Seejay, 2459 Station St., Chicago.

QUALITY Envelopes, letterheads, statements, 250—\$1.00. Satisfaction guaranteed. Box 135, LaCrosse, Wisconsin.

1000 6½ ENVELOPES Printed \$2.00. Letterheads \$2.00. Prompt, Fremont-Print, LaCrosse, Wisconsin.

ENGRAVURE Printing. Lowest possible prices. Samples free. Sunko, Mohawk, N. Y.

FREE, Useful assortment business stickers. Labelers, 6618R Quimby, Cleveland, Ohio.

35 PERSONAL Printed Xmas folders—\$1.00; 1000 circulars, blotters—\$1.00. Audrey Press, 1014 College, New York.

ATTENTION, Printing buyers! Dollar Printers "business necessity" items, choice \$1.00—500 4-ply cards; 500 2 3/4 x 1 1/4 gummed parcelpost labels; 250 8 1/2 x 11 whiteboard letterheads; 250 6 3/4 whitewove envelopes; 250 ruledbond 5 1/2 x 8 1/2 statements; 250 3 1/4 x 6 blotters; 250 2 x 3 1/2 shippingtags. Just try Dollar Printers dependable quality, workmanship, service. (Established 1897). Rush orders to Dollar Printers, 1128-30 LaSalle, Ottawa, Illinois.

LOWEST Prepaid prices—Quality letterheads, envelopes, cards, labels. Samples. Mail-Order Publishers, 954-P 8th Ave., New York.

5000 ELEGANT Envelope slips, \$3.90 prepaid. Circulars, stationery, cards, folders, labels, low prices. Samples. Goodprint, Harrisonburg, Va.

50 CHRISTMAS Greeting folders, name printed free, \$1.00. Ludwig Printing, Terre Haute, Ind.

150 BEAUTIFUL Visiting cards 25c postpaid. Neat, stylish. Order for yourself, friends, relatives. Immediate service from Vandorn Cardcrafters, Ottawa, Illinois.

DISTINCTIVE Letterheads—National Prize Winners Special—150 letterheads, 150 envelopes only \$3.00. Beautifully printed, newest style, high grade paper. Cash with order. Tucker Printing Company, New Philadelphia, Ohio.

SELECT Printing. Fast, reliable, economical. Complete service. Regal Printing Co., Plattsburg, Mo.

COMPLETE Printing service for you. Send today for price list and "Printed Word." Fay Company, 85 Columbia St., Newark, N. J.

GUMMED Labels: 1,000 printed, 1x1 1/4, 20 words or less, 50c. JBS Company, Box 93, Holyoke, Mass.

1000 CARDS \$1.00. Other printing reasonable. United Printing, Pottstown, Pa.

500 LETTERHEADS or envelopes \$1.75. Multigraphing. Lee Gooch, Hernando, Miss.

MODERNISTIC Quality printing. Reasonable. Samples. Messenger Press, Ballston Spa, N. Y.

BETTER Grade printing, reasonable priced. Free samples. Economic Press, Leonia, N. J.

SAVE Money on printed circulars, folders, booklets, etc. Samples free! Fantus, 523 South Dearborn, Chicago.

BOOK, Magazine, pamphlet and catalog printing done quickly at low prices. Our \$50,000 plant is always ready for service. The Meador Press, 470 Atlantic Ave., Boston, Mass.

2000 BUSINESS Cards neatly printed \$1.50. Atlas Distributing Co., 1814 Bedford Ave., Pittsburgh, Pa.

1000 BUSINESS CARDS, card case, \$1.50. Miller, Printer, Ambler, Pa.

BOY Mechanic—Famous library of 4 volumes covers the building of almost everything a boy might want to make. A great boon to parents and teachers. Actually covers 4,000 different articles. Each volume 460 pages, fully illustrated. Cloth. Price \$2.00 each or set of 4 vols.—\$7.00 postpaid. Popular Mechanics Press, Room C35, 200 E. Ontario St., Chicago.

PRINTING OUTFITS AND SUPPLIES

PRINT Your own cards, stationery, circulars, advertising, etc. Save money. Easy rules furnished. Print for others; big profits. Junior press, \$5.90; job presses, \$11, \$29 up. Write for details. Kelsey Co., Z-11, Meriden, Conn.

HAND Presses, type and complete printers' supplies. Advise equipment you need and we quote prices; or send stamp for catalog. P. Peiffer, 57-A; 6 Columbia St., Newark, N. J.

USED Press bargains, type. List 3c. Exchange D12, 22 Orient, Meriden, Conn.

PRINTING Presses, type. Lists free. Lawrence, Box 11, Wichita, Kansas.

BARGAINS—Used presses, type. Send stamp. 159 Harvard, Cambridge, Mass.

PRINT Your own circulars, envelopes, with home made press costing less than \$1.00. Illustrated instructions 10c. Carl Edquist, Odessa, Minn.

PRINTING Presses, supplies, 3c for complete lists. Landis, Richland, Pa.

PRINTING Outfits—Presses, type supplies, type novelties. Send stamp for catalog. Model Press, York, Penna.

PATENT ATTORNEYS

INVENTORS: Send immediately for your copies of our new free books, "Patent Protection" and "Suggestions on Selling an Invention." Sixty-eight pages of interesting facts. They tell how patent laws protect you; kind of sketch or model needed; simple steps to take without cost; how successful inventors have secured financial assistance; show interesting inventions; illustrate important mechanical movements. With books we also send free Evidence of Invention form to help establish date of disclosure. Prompt service, reasonable fees, special deferred payment plan. Strictest secrecy. Thirty-six years' experience. Highest references. Write us today. The facts in our books are worth money to the man with a good invention. Turn immediately to page 27A, or Address: Victor J. Evans & Co., Registered Patent Attorneys, 400-M Victor Building, Washington, D. C.

PATENTS. Protect your idea by securing free "Proof of Invention" folder. Exceptional personal service. Established 1906. E. E. Vrooman, 871 Woodward Building, Washington, D. C.

PATENTS—Small ideas may have large commercial possibilities. Write immediately for information on how to proceed and "Record of Invention" form. Delays are dangerous in patent matters. Clarence A. O'Brien, 586 Adams Building, Washington, D. C.

RAMSAY Company, Patent Attorneys. Free information. 273 Bank St., Ottawa, Canada.

A BETTER Deal for inventors; valuable manufacturing and sales suggestions combined with skillful patent protection. My fee to secure patent \$50.00. Trade-marks registered \$35.00. Copyright \$6.00. 22 years patent, engineering experience.

PRACTICAL Inventions now saleable before patenting. What have you? Write Chartered Institute of American Inventors, Dept. 4B, Washington, D. C.

"INVENTOR'S Guide," 100 mechanical movements, free; advises on patenting, selling inventions. Frank Ledermann, Tribune Bldg., New York.

PATENTS. Booklet free. Highest references. Best results. Promptness assured. Watson E. Coleman, Patent Lawyer, 724 Ninth St., Washington, D. C.

PATENTS Procured; trade marks registered—preliminary advice furnished without charge. Booklet and form for disclosing idea free. Irving L. McCathran, 700A International Bldg., Washington, D. C.

L. F. RANDOLPH, 302-B Victor Building, Washington, D. C. Low cost. Book and information free.

PATENTS. Instructions "How to Establish Your Rights" and form. "Evidence of Conception"—sent free! Lancaster, Allwine & Rommel, 411 Bowen Building, Washington, D. C.

INVENTORS—Send for free booklet "Patent-Sense." Information based on 64 years experience. Lacey & Lacey, Dept. 5A, 635 F St., Washington, D. C.

ECONOMY For inventors. Write for booklet. Thos. H. Johnston, 635 F St., N. W., Washington, D. C.

FOR INVENTORS

PATENTS—Small ideas may have large commercial possibilities. Write immediately for information on how to proceed and "Record of Invention" form. Delays are dangerous in patent matters. Clarence A. O'Brien, 586 Adams Building, Washington, D. C.

PATENTS Secured. Get two valuable free books about patent protection and selling inventions. Prompt and confidential service. Established 1893. Reasonable fees. Write us immediately. Victor J. Evans & Co., 402-M Victor Building, Washington D. C.

HAVE You an invention for sale? State your proposition. Write "Inventive Age-Patent Market" (Inventive trade journal), Carlstadt, New Jersey. Magazine describes inventions; for sale; wanted. Illustrated. Enlarged 100%. Copy 10c. Inventors recommend.

PATENT Drawings \$7.00 sheet. Specifications written. Aeronautical, architectural, mechanical. Ormond Munger, Washington, D. C., Bethesda Branch.

I SELL Patents. Established in 1900. Charles A. Scott, 773PM Garson Ave, Rochester, N. Y.

TO Inventors: We are in the market to purchase a good patent, preferably a five and ten cent store item. Will purchase outright or royalty. Purchasing Agent, 241 Front St., New York, N. Y.

UNPATENTED Ideas can be sold. We tell you how and help you make the sale. Particulars, with list of manufacturers and wanted inventions sent free on request. Write W. T. Greene, 944 Barrister Building, Washington, D. C.

HAVE You a sound, practical invention for sale, patented or unpatented? If so, write Chartered Institute of American Inventors, Dept. 4A, Washington, D. C.

SELL Your patent through a small classified ad in Popular Mechanics. Many inventors have found buyers in this way. Ask me for proof—I'll gladly send it to you. F. W. Johnson, Manager, Classified Advertising, 200 E. Ontario St., Chicago.

INVENTOR'S Universal Educator: contains 900 mechanical movements; 50 perpetual motions; instruction on procuring and selling patents and selecting an attorney, etc. Suggests new ideas. Price \$1.00 postpaid in U.S.A. Address Albert E. Dietrich, 511-B Colorado Bldg., Washington, D. C.

INVENTORS: "Making Inventions Pay," our 32-page illustrated book, mailed upon receipt of 3c postage. Crescent Tool Company, Dept. Z, Cincinnati, Ohio.

PATENTS. Low cost. Book and information free. L. F. Randolph, 302-C Victor Building, Washington, D. C.

PRODUCTION Items wanted! Write. Schwartz Laboratories, Long Branch, New Jersey.

MODEL Of modern passenger locomotive—size, unfolded 10x16 in. Here, accurately shown in colors, are all the intricate parts of a modern giant of the rails, complete with tender. Invaluable for study. Of great interest and fascination to boys and others interested in railroads. \$1.00 postpaid. Popular Mechanics Press, Room C35, 200 E. Ontario St., Chicago.

INVENTIONS WANTED

PATENTS—Small ideas may have large commercial possibilities. Write immediately for information on how to proceed and "Record of Invention" form. Delays are dangerous in patent matters. Clarence A. O'Brien, 586 Adams Building, Washington, D. C.

INVENTIONS Wanted, manufacturers ready to do business. Mechanical Equipment Sales Co., Chamber of Commerce Bldg., Cincinnati, Ohio.

SMALL Inventions wanted by manufacturers. I'll help you sell your invention. Stanley Hull, 7829 Euclid Avenue, Cleveland, Ohio.

INVENTIONS Wanted—Patented, unpatented. If you have an idea for sale, write Hartley's, Inc., Box 928-E, Bangor, Maine.

PATENTS FOR SALE

RUMBLE Seat top. Pat. 1,885,150. J. Spector, Keystone, W. Va.

NOVEL Knitting bag. 2,014,904. Lewis Martin, 504 Church, Lancaster, Pa.

CIRCULAR Mat weaver. Watering can. Drawing board. Electric organ. Patented eye exerciser. Others. B. A. Ball, Hoodport, Washington.

SIMPLE Designed toy. Bubble blowing doll; royalty basis. Edward Finch, McKinney, Texas.

MANUFACTURERS Looking for new inventions should write W. T. Greene, 939 Barrister Bldg., Washington, D. C.

MANUFACTURING

DIES, Models, stamping at lower costs. All work guaranteed. Presto Manufacturing, 4044 Twentieth Ave., South, Minneapolis, Minnesota.

MANUFACTURING Dies and models made at low cost.

MAKE It Yourself. Hundreds of practical and useful devices described in our big book. Plain instructions and illustrations show you how to make them. Save money on things for yourself or make profit selling to others. 900 articles of great variety. 480 pages. 823 illustrations. \$3 postpaid. Popular Mechanics Press, Room C35, 200 E. Ontario St., Chicago.

MANUFACTURING, Models, dies, stampings, brasswork? Casting moulds. Stamp for catalog. Baums Metal Specialties, Kansas City, Mo.

INVENTIONS Manufactured in any quantity at low cost. Stampings, dies, models, etc. Estimates and free catalog. Crescent Tool Co., Dept. X, Cincinnati, Ohio.

MODELS AND MODEL SUPPLIES

RAILWAY Model supplies—Track, signals, locomotives, etc. List 10c. Crovan Railway Models, Stamford, Conn.

MODEL Ship, yacht, speedboat supplies and fittings. Catalogue dime. Welcher, South Seventh Street, Fulton, New York.

PATENTS—Small ideas may have large commercial possibilities. Write immediately for information on how to proceed and "Record of Invention" form. Delays are dangerous in patent matters. Clarence A. O'Brien, 586 Adams Building, Washington, D. C.

POWER Models, steam, gasoline, electric, accessories. 80 page catalog 35c. Chas. Cole, Ventura, Calif.

MODEL Makers—Brass, copper, fibre, steel and aluminum in all shapes. Also castings, gears, screws, fittings. Catalog 10c. Experimenters Supply House, Dept. P, Box 10, Station Y, New York.

MODEL Makers! Device you make yourself. Cast in metal small parts for all kinds of models. Instructive, bonafide offer. 20c (coins) brings plans, information. Sta. "C," P. O. Box 50, Brooklyn, N. Y.

MODELMAKERS—Magazines edited just for you: The Modelmaker and The Model Railroad. Either, \$1.50 per year. Both, \$2.50 per year. Sample of either, 15 cents; both, 25 cents. Modelmaker Corp, Wauwatosa, Wis.

BRASS Gears and model supplies. Send for catalog. The Pierce Model Works, Tinley Park, Ill.

MODELS—Your ideas developed into practical working models. 30 years' successful experience; thousands of satisfied customers. Confidential service guaranteed. Bank references. Send 3c postage for 32-page book—"Making Inventions Pay." Crescent Tool Company, Dept. Y, Cincinnati, Ohio.

MODEL Steam locomotive $\frac{3}{4}$ " scale. Easily made. Particulars, casting list, photo, 25c. Little Engines, Box 15, Wilmington, California.

EVRAY'S Engine catalog (No. 34) or supply catalog (No. 35) postpaid 20c. Evraymesco, 28 N. Clinton, Chicago.

MECHANICAL Models, new and novel. Popular Mechanics has developed accurate models in the mechanical field. Those now ready are Wright "Whirlwind" Airplane Engine, Ocean Liner "Europa" and Modern Passenger Locomotive. Every part clearly shown and the name given. Invaluable to students and all who are mechanically inclined. \$1.00 each postpaid. Popular Mechanics Press, Room C35, 200 E. Ontario St., Chicago.

PLANS, BLUEPRINTS, INSTRUCTION

WOODEN Clock blueprints. Detailed drawings and instructions. Weight driven time movement \$1.00, with striker \$1.50, grandfather \$1.75. W. D. Frost, Grayville, Ill.

HOME CRAFTSMEN

LEATHERCRAFTSMEN—Write for free instructions and price list of leather, tools and beginners' kits. Send 5c for sample cards. Address Wilder & Company, Dept. F, 1028 Crosby St., Chicago, Ill.

HARDWOOD Panels, complete stock. All sizes. Inlays and borders. Modern mouldings. Hardwoods and balsa wood. All sizes. Mathes & Kleinhans, 615-617 Tiffany Street, New York.

COLORS—Fast drying, self-priming for decorating wooden or metal crafts projects. 3c brings color card. Pyramid Supply Co., Dept. M, 129 Boulevard, Long Island City, N. Y.

YOU Can tint etchings, for pleasure or profit. Modern Art Studios, Sioux City, Iowa.

WOOD Turning on the lathe. Interesting and fascinating. Send for Milton & Wohlers Course in wood turning. It gives you quickly a complete mastery of this manual art. 200 pages. Cloth. 141 plates. \$1.50 postpaid. Popular Mechanics Press, Room C35, 200 E. Ontario St., Chicago.

DOUBLE Boiler glue pot, 75c complete, no stamps. Womelsdorff Laboratories, Clearfield, Pa.

SEND 5c Catalogue, samples. Leathercraft Supply Co., Station "B," Long Beach, Calif.

WATCHES, JEWELRY, PRECIOUS STONES

LEARN Watchmaking free. Experimental movement 50c. Catalog 5c. Stewart's, Sixth-Ohio, St. Louis, Mo.

AUSTRALIAN Opals, all varieties, good assortment \$5.00. Lists free. Norman Seward, Melbourne, Australia.

JOIN Amateur Watchmaker's Club, 748 Fullerton, Chicago, Ill. Particulars 5c.

OLD GOLD WANTED

CASH For old gold; teeth, watches, silver. Highest prices. Jacobson Smelting & Refining Co., 421 Lathrop Bldg., Kansas City, Mo.

CASH For gold, teeth, jewelry, watches. High prices paid day shipment received. Satisfaction absolutely guaranteed or articles cheerfully returned. Information free. Chicago Gold Smelting & Refining Co., 357 Champlain Bldg., Chicago.

MAIL Us your discarded jewelry, gold crowns and bridges, watches, diamonds, silver and platinum. New high prices paid, remittance mailed immediately. Goods returned if our offer is refused. United Smelting Works, (The Old Reliable,) Backed by 50 years of experience. 39 So. State St., Dept. 71, Chicago.

FOR THE HOME

CLOCKS: Build your own grandfather's, banjo, shelf. Thousands built successfully. Some with beautiful chimes. Directions ten cents. Particulars free. Clock Company, Ruffner Street, Philadelphia.

"VITALITY" Crib pads, 2" thick, \$3.90. Cradle pads \$1.98 "built for sleep." Satisfaction guaranteed. State size—inside measurements. Prepaid. B & B Specialty Co., Box 276, Youngstown, Ohio.

BUILT-IN Furniture adds convenience, comfort and beauty to your home at very low cost. Any handy man can build a great variety of this space-saving furniture from the easily-followed instructions in our remarkable book, the only one on this subject. \$2.50 postpaid. Popular Mechanics Press, Room C35, 200 E. Ontario St., Chicago.

HEATING AND VENTILATING

KITCHEN Range oil burners, quiet, safe, practical, thousands used. Bennett Company, Islip, N. Y.

LEARN Air conditioning—America's next big industry. Thousands of opportunities for far seeing men. Get your start with complete new book by E. W. Riesbeck. \$3.50 postpaid. Popular Mechanics Press, Room C35, 200 E. Ontario St., Chicago.

TOBACCO

SWEET Oronoko and Gold Leaf chewing tobacco. 4 pounds \$1.25. Subac smoking with Turkish tobacco, 3 pounds \$1.10 postpaid. Belmont Farms, Chatham, Va.

POSTPAID—2 Years old high grade redleaf chewing, 10 pounds \$1.75, smoking \$1.40. Guaranteed. Curtis Rogers, Dresden, Tenn.

FREE Cigars, pipe and cigarette roller with Goldleaf guaranteed chewing, smoking or cigarette tobacco, 5 lbs. \$1.00, ten \$1.75. Pay when received. Co-Operative Farmers, B38, Sedalia, Ky.

POSTPAID: Guaranteed very finest 28 inch sweet, juicy, redleaf chewing, 10 lbs. \$2.00. Extra, smoking \$1.50. Ernest Jolley, Dresden, Tenn.

RAZOR BLADE SHARPENING

YOUR Razor blades sharpened like new. 1c each. Peter Wetterquist, Rockford, Ill.

TATTOOING

TATTOOING Outfits, supplies. Illustrated list. "Waters." 965 Put-nam, Detroit.

TATTOOING Outfits, supplies. Illustrated catalogue. Miller, 433 Main, Norfolk, Va.

ENORMOUS Profits tattooing; get our free illustrated folder! Chicago Tattoo Supply House, 651A South State, Chicago.

WANTED—MISCELLANEOUS

STAMPS Wanted—Will pay \$100.00 for 1924, 1c green, Franklin (rotary perforated eleven) \$1,000.00 if unused. Write before sending. Large illustrated folder 10c. Stamp Broker, 431-E. Broad, Elyria, Ohio.

CASH For used microscopes, binoculars, cameras, slide rules, drawing sets, surveying, scientific instruments, marine equipment. Highest prices paid day shipment received. Satisfaction guaranteed or shipment cheerfully returned. Elman's, 2302 VanBuren, Chicago.

PERSONAL

YOUR Feet—We have a prescription to relieve your callous quickly. 25c postpaid. Ellis Drug Company, Vandalia, Mo.

PAINFUL Bunions relieved then gradually reduced. Treatment \$2.00. Booklet free. Eugene Eaton, D106, Bandon, Oregon.

YOUR Zodiac sign reading; dime. Becker, 222 Hale Avenue, Brooklyn, N. Y.

200 TRICKS You can do—Mystify your friends; have loads of fun. This collection of tricks has been selected by Thurston for the average person. Neither unusual skill nor elaborate apparatus required. 200-page illustrated book. \$1 postpaid. Popular Mechanics Press, Room C35, 200 E. Ontario St., Chicago.

MISCELLANEOUS

HANDWASHINGS—1200 In one cake of soap with Pulverizer. Walton, Durham, N. H.

MUCILAGE-PENCIL. Newest, most economical adhesive for home, office and school. Pencil in handy sanitary container. One dime. E. G. Glidden, 80 Elder, Schenectady, N. Y.

CUTS—Make them yourself. Simple, inexpensive etching process. Information free. Hughes Products, 69 Miami, Terrace Park, Ohio.

PROTECT Your keys! Your name, address stamped on metal identification tag, 25c. Key ring included. Agents wanted. Irvin Buschkowsky, 508-R Oak, Chaska, Minnesota.

CASH Income daily silvering mirrors at home. Plating autoparts, tableware, etc. Combination outfit. Write Sprinkle, Plater, 288, Marion, Indiana.

ARTISTS—Many money making stunts 10c. Straley, 13 $\frac{1}{2}$ Main, Springfield, Ohio.

GOLD And silver locator. \$5.00 postpaid. Free trial. Bergman, Drawer 398, Springfield, Missouri.

RADIANT Vibratory nerve movements, complete. Particulars free. F. Staebler, D.C., 79-20-45th, Elmhurst, N. Y.

TRULY Individual horoscopes for children. Send in detail complete birth data, to Blanche Bristol Smith, P. O. Box 977, Providence, Rhode Island.

COCOONS, Butterflies, collector's supplies, butterfly art materials. Free lists. Maynard, 1192 Lewiston, Rochester, N. Y.

CUTS Anybody can make. Zinc etching process. Specimens, particulars, testimonials, for stamp. J. C. Day, Windfall Ind.

27 WAYS To get a job (salary). Tells what to say; dangers to avoid. Gives actual cases. 25c coin. New Idea Press, 681 5th Ave., Terre Haute, Ind.

CATALOG, Fortune telling; dime. Becker, 22W Hale Avenue, Brooklyn, N. Y.

FOOTBALL Fan? Interesting literature for stamp. P. Moore, 217 Broadway, Newark, N. J.

WHOLESALE Supply sources, half million items. 10c. International Agency, Cincinnati.

TREASURE Seekers—Make your own gold finders. Wyss, 104 $\frac{1}{2}$ Frances, St. Joseph, Missouri.

SWAPPER'S Friend, R4, Saline, Michigan. Interests swappers, collectors, sportsmen. 50c year, sample 10c.

BRONZE Tablets, desk plates, wall plates, memorials, grave markers. Bronze, brass and aluminum casting. Wandkey Pattern & Foundry Co., Anderson, Ind.

THAT Concrete Job. Don't be afraid to tackle it. With the instructions found in Popular Mechanics Concrete Handbook you can easily make 173 articles of utility and beauty ranging from ordinary steps to garden furniture. \$1 postpaid. Popular Mechanics Press, Room C35, 200 E. Ontario St., Chicago.

New
1936
LACO
Oil Burner

Get SAMPLE BURNER



New FUEL ECONOMY

New LOW PRICE

Here's the year's most sensational home-heating announcement! A New, Marvelously-Perfected Oil Burner by LACO... that gives you Perfect, Uniform-Temperature, Automatic OIL HEAT... Cheaper than Coal in most localities... now Quieter than ever before... and which you can own at a price that SAVES YOU ABOUT \$100!

This new 1936 LACO burns Low-Priced Oil... and USES LESS! This is due to LACO'S exclusive patented "High-Pressure Carburetor" that burns a high percentage of air with the oil, avoids usual fuel waste, and gets utmost heat from every drop.

New QUIETNESS!

SAVES UP TO \$100

DEALERS:

LACO dealers, this year, making tremendous profits—up to \$640 a month! I must have more dealers to fill orders and install LACOS in open territory. This month, I'll ship you a Sample Burner, subject to examination, WITHOUT OBLIGATION! Free factory selling-helms—local newspaper advertising plan, window hangers, folders, etc. Rush name for details, TODAY!

L. A. COCKLIN, Pres.

New Safety! New automatic safety devices positively prevent oil overflow, avoid every possibility of trouble.

Unusually Quiet! New, slow-running fan is unusually silent. Special rubber-cushioned motor on rigid pedestal base avoids vibration.

Get Special Offer! Today's Special Introductory Price is lowest in years! Buy NOW and save \$65 to \$100! The price must advance soon—steel is going up! Rush your name quick—and SAVE MONEY!

LACO OIL BURNER CO., 1115 Union St., Griswold, Iowa, U. S. A.

Built for Lifetime! Many LACOS, built 9 years ago, are still operating today, good as new.

GUARANTEED! Built and guaranteed by one of the world's largest oil burner manufacturers. Over 55,000 LACOS now in use!

NEW BENJAMIN AIR PISTOLS



Powerful—Accurate—Economical—Practical—Adjustable Shooting Force—Amazing Maximum Velocity—cal. 177 or 22 and BB—For Target and Small Game—the Only Genuine Compressed Air Pistol on the market—Bolt Action—Hammers, Fire—Half Trigger—Safety. Also 177 and 22 Single Shot Air Rifle \$7.50—Single Shot BB Air Rifle \$6.00—22 Shot BB Repeater Air Rifle \$7.50—**at Dealer or Direct—FULL DETAILS—TARGETS—FREE—**

BENJAMIN AIR RIFLE CO. WRITE TODAY.
691 N. Broadway St. Louis, Mo.


TAN YOUR OWN SKINS!



AT LAST! With Elwood's genuine KROME-TAN you can tan all kinds of furs and make valuable LEATHER for harness, belts, laces, etc. Remarkable simplified home process tans cow-hides, horse, rabbit, muskrat, etc. Economical. Easy to use. **MAKE MONEY TANNING FOR OTHERS.** We show you how. Write TODAY for FREE illustrated folder and instructions on use of KROME-TAN.

NORTHWESTERN FUR CO. Dept. K-818, Omaha, Nebr.

Learn Watchmaking Free Instructions




Beginners' Tools, Elgin Model including Instructions \$1.00. 1/2 Wholesale Watch Specials that Sell Fast. Elgin 6/12 Size \$2.50. Elgin Wrist Watch \$6.00. 21 Jewel R. R. \$10.00. All in New Cases. Complete Lists of Tools, Watches, Material, 25c. Free with Orders.

Stewart Watch Co., 306 No. 6th Str., St. Louis, Mo.

Balance as above with 1-50; 1-20; 2-10; 1-5 and 2-2 gram weights base 4" x 9"—\$4.75. Catalog with 3000 illustrations of laboratory apparatus sent for 50c. Catalog listing 10000 chemicals, drugs, flavors, etc., and 1700 scientific books sent for 25c.

Laboratory Materials Company, 639 E. 71st St., Chicago, Ill.

CARTOON YOUR WAY TO SUCCESS!



DON'T COPY—LEARN TO ORIGINATE!

\$2.85

RAYE BURNS will teach you HOW to CREATE ORIGINAL CARTOONS at home that you can SELL! Course contains 26 lessons and over 500 illustrations. All for Only... Send name and address for free details.

RAYE BURNS SCHOOL, Dept. M-X, BOX 2194, Cleveland, Ohio

EARN MONEY with this WONDERFUL NEW INVENTION



BLOW TORCH & SOLDERING IRON IN ONE!

AGENTS! Make quick, steady PROFITS with amazing NEW invention—sells on "flash" demonstration. Main or side line, part or full time. Opens big, new market. **WRITE**—get established for exclusive territory. Hurry! **Justrite Mfg. Co., 2061 Southport, Dept. 13-58, Chicago**

\$150 TO \$300 EXTRA MONTHLY WITH THIS NEW Simplified 40 VOLT ARC WELDING



Jobs like these are every day occurrences when you are equipped to go right to the job.

Only a few dollars monthly puts this profitable "Simplified" Arc Welder into your shop—lets you handle every type of repair job as well as contract for many and varied steel construction jobs. Profits will easily pay for it, comes on

30 DAYS' TRIAL—at our risk

Used by the U. S. Govt., leading automobile and steel plants. Write today for complete details, no obligation.

HOBART BROS., Box M-1151, TROY, OHIO

WRITE FOR FREE BOOK ON MANY PROFITABLE USES

Raise Giant Frogs

A NEW INDUSTRY!



MAKE BIG MONEY raising giant frogs. Bullfrogs sell up to \$5 dozen. Breeder lays 10,000 eggs each year. Biggest money-maker you can raise. Back-yard ponds start you. Any climate suitable. Our FREE book "A Fortune in Frogs" explains everything. Write today.



FREE BOOK

AMERICAN FROG CANNING CO.
(World's Largest Frog Market)
Dept. 133-W
NEW ORLEANS, LA.

Nufond Giants Weigh up to 3 lbs each.

INVENTORS

act
now to

**PROTECT YOUR IDEAS
WITH A U.S. PATENT**

**MAIL COUPON FOR MY FREE
BIG 48 PAGE BOOK
AND FREE FORM FOR RECORDING
YOUR INVENTION**



CLARENCE A. O'BRIEN
Registered Patent Attorney

MY BIG BOOK TELLS YOU

The Importance of Quick Action

If you have a new idea that is patentable—and want to secure for yourself your inventor's sole right to profit from the idea—you can't afford to lose time in securing the protection of a U. S. Patent. Other inventors may be working on the same idea right now. Should they develop this idea and file patent application before you do—the burden of establishing

priority will be upon you. My Big Book—"Patent Guide for the Inventor"—will tell you the quickest possible way to secure Patent Protection for your idea. **SEND FOR IT TODAY!**

The First Important Step in Securing a Patent—is to obtain the services of a Registered Patent Attorney. The U. S. Patent Office advises that you secure the aid of an experienced, Registered Patent Attorney to prepare your statements. Establish the date of your invention as explained in My Book and disclose your idea to him in correct form. He then makes a SEARCH of the Patent Office Records and reports to you on existing U. S. Patents which might bear on your invention, giving his opinion on the advisability of proceeding and filing formal application.

SMALL IDEAS MAY HAVE LARGE COMMERCIAL POSSIBILITIES. Ideas do not have to be complicated to be profitable when patented. The 5c and 10c stores flourish on simple patented products which are commercially successful. The zipper, safety pin, thumb tack, paper clip, collar button—all are simple yet familiar inventions—brought their inventors rich rewards.

Reasonable Fees—Convenient Terms

Don't worry about finances. My fees are very reasonable—I can arrange convenient terms of payment. It is my custom to permit clients to pay for my services in installments as the application progresses in my office. See My Big Book for fees in obtaining Patent. It explains my arrangements clearly. **Send for it NOW.**

Request My Book—NOW!

Know exactly what you should do to secure a Patent—what must be done every step of the way—how the Patent Law protects you—what I, as a Registered Patent Attorney, can do for you. **Mail the coupon NOW.**



FREE Record of Invention Form

Use my FREE "Record of Invention" Form to assist you in recording the descriptive outline of your idea and to establish the date of your invention. With it you can make a rough sketch of your idea and have it witnessed in a manner of value to you as evidence should occasion arise.

CLARENCE A. O'BRIEN

REGISTERED PATENT ATTORNEY

70-C Adams Building

WASHINGTON, D. C.

Please send me at once your Big Free 48-page Book, "Patent Guide for the Inventor" and your Specially Prepared "Record of Invention" form. This request does not obligate me.

Name.....

Address.....

(Please write or print plainly)

PATENTS

Booklet Free Highest References
Promptness Assured Best Results

Send drawing or model.

ALL BUSINESS GIVEN PROMPT AND PROPER ATTENTION

Listed Patent Lawyer in the latest editions of the Rand-McNally Directory of Bankers and Bank-Recommended Attorneys, published by Rand-McNally & Co., Chicago, Ill.; The Baggott & Ryall Directory of Guaranteed Attorneys, published by Legal Directory Corporation, Boston, Mass.; Flugel's Law List, published by Legal Directory Publishing Co., St. Louis, Mo.; American Lawyers Annual, Cleveland, Ohio; Bankers Service Legal Directory, Bankers Service Co., Boston, Mass.; Eyre's Law List, 9 Park Place, New York City, and the Central Guarantee Co., Bankers and Lawyers Directories, Empire State Bldg., New York City.

WATSON E. COLEMAN,
REGISTERED PATENT LAWYER

Victor Building, 724 Ninth Street, N. W.,
WASHINGTON, D. C.

INVENTORS PATENT YOUR IDEAS

SEND FOR FREE BOOK

HOW TO OBTAIN A PATENT

Written by a Former Member of the Examining Corps (1922-24) of the U. S. Patent Office. If you want to profit by your idea, you should take steps to apply for a U. S. Patent at once. Your first step is to get this Free Book. This interesting illustrated book contains valuable information you should have. It tells you fully how to obtain a patent on your idea in the quickest way. With this Free Book you will also receive a "Record of Invention" form on which you can easily record your idea. Personal and Confidential Service: Your case will be personally handled only by a Registered Patent Attorney who is also a Former Member of the Examining Corps of the U. S. Patent Office. All communications confidential.

MAIL COUPON TODAY FOR FREE PATENT BOOK and RECORD OF INVENTION Form.

CARL MILLER

REGISTERED PATENT ATTORNEY
FORMER MEMBER EXAMINING CORPS U. S. PATENT OFFICE

1638 Woolworth Bldg., Dept. 115A, New York City
MILLER BUILDING, Dept. 115A, WASHINGTON, D. C.

Please send me your Free Book, "How to Obtain a Patent," and your "Record of Invention" form.

NAME.....

ADDRESS.....

PATENTS—TRADE MARKS

All inventions submitted held confidential and given personal attention by members of the firm.

Form, "Evidence of Conception" and instructions, "How to Establish Your Rights"—FREE!

LANCASTER, ALLWINE & ROMMEL

Patent Law Offices

412 Bowen Bldg.

Washington, D. C.

STOP Your Rupture Worries!

Why worry, suffer with that rupture? Learn about my perfected invention. It has automatic Air Cushions which bind and draw the broken parts together as you would a broken limb. No obnoxious springs or pads. No salves or plasters. Sent on trial to prove it. Beware of imitations. Never sold in stores. Write today for full information sent free in plain, sealed envelope.
H. C. BROOKS, 111-B State Street, Marshall, Michigan

To PROTECT YOUR INVENTION

Delays are dangerous and may be very costly. My personal service assures prompt action, strict confidence, and a minimum of expense. I suggest that you send me a model or drawing, or sketch and description of your invention, and \$5.00. I will make a search and report

promptly as to its patentability and send you a copy of my 72-page booklet. Or, if you prefer to read my booklet first, mail the attached coupon at once. I will also send my "Record of Invention" form. (Over 37 years experience as a Registered Patent Attorney.)

A PERSONAL CONFIDENTIAL PATENT SERVICE

Use this coupon, NOW

L. F. Randolph, 302-D Victor Bldg., Washington, D. C.

Please send me at once, free of charge, your 72-page booklet and "Record of Invention" form.

Name.....

Address.....

Inventions Wanted Patented or Unpatented

Increased interest now being shown in sound, practical inventions by our manufacturer-clients. What have you?

Chartered Institute of American Inventors

Dept. 4, Barrister Building Washington, D. C.

World's Largest Organization of Inventors. Est. 1924.

INVENTORS

who derive largest profits know and heed certain simple but vital facts before applying for patents. Our book, Patent-Sense, gives those facts; sent free. Trade Marks—Copyrights.

LACEY & LACEY, Est. 1869, 635 F St., N. W., Dept. 5, WASHINGTON, D. C.

ALBERT E. DIETERICH

REGISTERED PATENT ATTORNEY

512 B Colorado Building, WASHINGTON, D. C.

Booklet on Patents sent free

INVENTORS Be Sure to See Page 27A



INVENTIONS WANTED

Inventors Selling Guide by R. F. Yates lists nearly 1000 buyers of inventions, shows how to sell and protect unpatented ideas, etc. 224-page book, postpaid \$2. Write for FREE LIST OF NEEDED INVENTIONS and catalog of practical books for inventors.
Donley Publishing Co., Dept. P11, 509 Fifth Av., New York, N. Y.



G E A R S

In Stock—Immediate Delivery

Gears, speed reducers, sprockets, thrust bearings, flexible couplings, pulleys, etc. A complete line is carried in our Chicago stock. Can also quote on special gears of any kind. Send us your blueprints and inquiries.

Write for Catalog No. 10

CHICAGO GEAR WORKS

769-773 W. Jackson Blvd., CHICAGO, ILL.



BUCHSTEIN'S FIBRE LIMB

is soothing to your stump—strong, cool, neat, light. Easy payments. Braces for all deformities. Agents wanted.

D. BUCHSTEIN CO.

610 3rd Ave., So., MINNEAPOLIS, MINN.

Send for Catalog Today

So Very Easy



... AND TO THINK YOU'VE HAD IT ONLY A WEEK ...

● Popularity! Step right into it with a P-A Sax'. Play beautiful tunes first week. No failures. Learn quickly. Join a dance band in 90 days. Only P-A assures such rapid progress. Easiest blowing, fingering; most beautiful tone. See your P-A Dealer, or write direct for beautiful literature. No obligation. Easy terms. You can do it. Write today. 1166

PAN - AMERICAN
1103 P-A Bldg. Elkhart, Indiana

Moderate Price

Wrestling Book FREE

Learn at Home



Be an expert wrestler. Learn at home by mail. The greatest wrestlers of all, **Frank Gotch** and **Farmer Burns**, both world's champions have prepared the most wonderful course of lessons ever written on Physical Culture and Expert Wrestling. Be strong and healthy! Handle big men with ease. This great free book tells you how. Don't delay. Write now. State your age.

Farmer Burns School, 3378 Elwood Bldg., Omaha, Neb.

Increase Your Vocabulary

KNOW what to say and HOW to say it—effectively—forcefully. Become a Master of Words—enjoy greater fluency of speech and ease of expression. Release your latent abilities—broaden your opportunities—multiply your word-power—win verbal freedom with **WORDOLOGY**—The Vocabulary Builder—a simple, easy, fascinating method of word study. Mailed postpaid for only \$2.00. Money back if not satisfied after five days. Send **TODAY**, or write for folder.

Wordology Associates P. O. Box 82-B, Grand Cent. Sta., New York, N.Y.

New York Established 1902

Electrical School

Ask for free booklet

44 West 17th St., N. Y. C.

LOOK! MAGIC CASE

HANDS YOU A LIGHTED Cigarette

Take a beautifully enameled Case from your vest pocket. Press a magic button! Automatically there is a spark—a flame. A LIGHTED Cigarette—your favorite brand—is delivered to your lips. You PUFF and SMOKE. A revolutionary invention... guaranteed... amazingly low priced. Get a Magic Case for 15 Days' Trial at our risk. **AGENTS!** Get facts about Big Profits. **MAGIC CASE MFRS., 4234 Cozens Ave., Dept. S-370, St. Louis, Mo.**



PANTS MATCHED TO ANY SUIT

DON'T DISCARD OLD SUIT!

Wear your coat and vest another year by getting new trousers to match. Tailored to your measure. With over 100,000 patterns to select from we can match almost any pattern. Send vest or sample of cloth today, and we will submit **Free Sample** of best match obtainable. **AMERICAN MATCH PANTS CO., 6 W. Randolph St., Dept. 11-PM, Chicago**



This Magic Box



Turns

Spare Time Into Money! Up to \$40 a Week!

without Leaving the House

We show you how to make big money decorating fast-selling Giftwares and start you off with the big complete \$10 Artist's Outfit shown above. Also Free Idea Book that has started hundreds of men making big, easy money. One Fireside Member says, "I made \$100 on furniture in one week." Another writes, "My sales were \$500 for 5 weeks. This is my first year." R. M. P., of Illinois, says, "I did \$3500 worth of business last year and over \$12,000 this year." D. W., New Mexico, reports "I would not take \$1000 for my Course." If you really want to make big money a *guaranteed income* opportunity is now ready for you with Fireside. No tiresome study. You learn by doing. You make good money practically from the start. Our **FREE** Book tells you how. Send the coupon for it.

NO SOLICITING—NO CANVASSING



It's easy to dispose of everything you make. Our new "Automatic Salesman" does all the selling for you. This vendor is designed to quickly find cash buyers for all the Giftwares you can turn out! No soliciting or house to house canvassing required under this method. Nor do you need any artistic ability in order to succeed. Simple "3-Step Method" makes the work easy to learn and easy to do. Under new Plan your membership need not—**should not**—cost you a penny. Get full details. Coupon brings everything.

FREE Book on Decoration

FREE!

of extra cost. Send coupon for details of amazing new Plan that tells how to get a big assortment of beautiful giftwares that you can decorate.

Mail the coupon NOW for the beautiful new Book on decorating at home for big money. A new plan that gives you a quick start included free. Mail coupon now while openings for new members are still being offered.

FIRESIDE INDUSTRIES
Dept. 66-S Adrian, Michigan

Fireside Industries, Dept. 66-S, Adrian, Michigan.
Send me **FREE** Book on Home Decorating for a big steady income. Also how to get the big Artist's Outfit.

Name.....

Address.....

City.....State.....

When writing please mention Popular Mechanics

RADIO



holds great rewards for trained men

The big opportunities in Radio will be enjoyed by trained men. The International Correspondence Schools Radio Course, prepared by leading authorities and constantly revised, will help make you a trained man! A fascinating book—FREE.

AVIATION ENGINEERS are leaders in modern progress



Aviation depends upon engines, and knowledge of aviation engines is a long step toward success in this rapidly growing industry. Many leading aviation engineers today took their first step by mailing a coupon to the I. C. S. at Scranton. Why don't you follow their example?

INTERNATIONAL CORRESPONDENCE SCHOOLS

Box 5600-H, Scranton, Penna.

Explain fully about your course in the subject marked X:

- | | |
|---|---|
| <input type="checkbox"/> RADIO | <input type="checkbox"/> AVIATION |
| <input type="checkbox"/> Chemistry | <input type="checkbox"/> Accountancy |
| <input type="checkbox"/> Invention | <input type="checkbox"/> Advertising |
| <input type="checkbox"/> Refrigeration | <input type="checkbox"/> Electrical Engineering |
| <input type="checkbox"/> Air Conditioning | <input type="checkbox"/> Drafting |
| <input type="checkbox"/> Architecture | <input type="checkbox"/> Show Card Lettering |
| <input type="checkbox"/> Good English | |

Name.....

Address.....

STEP INTO THE *Spotlight*




Banish Boredom... Earn Extra Money START TO PLAY VERY FIRST DAY

Picture the joy of playing a snappy foxtrot, dreamy waltz or mellow old favorite on the Xylorimba. No reason why you shouldn't! Xylorimba is easiest of instruments to play and yet the most spectacular. In constant demand by orchestras, radio stations, at lodge meetings and parties. Marvelous opportunity to increase popularity, make big spare-time money. No bothersome practice or exercises. With Free easy lessons you actually Start to Play Very First Day.

BIG FREE BOOK tells all about Deagan line, liberal trial offer and easy payments. Send coupon today for your free copy.

J. C. Deagan, Inc., Dept. 8458, 1770 Berceau Ave., Chicago

Send me, without obligation, full details of Free Trial offer and easy-payment plan on the Deagan Xylorimba.

Name.....

Address.....

OWN A Potato Chip Factory

COMPLETE



New Home Factory Makes New Kind of Potato Chips—Donuts—Salted Nuts

Stop looking for something difficult. Turn potatoes into cash. I show you just how with my newly perfected outfit. Start anywhere. Very little cash needed. Exclusive location. Profits pour in. No experience needed. I furnish the plans. Begin anywhere—village, small town, city or suburb. A big opportunity is waiting. Business permanent.

MAKE UP TO 300% PROFIT ON RAW MATERIALS

Raw materials are plentiful and cheap. Highly perfected outfit and confidential plans make operation simple, with startling profits certain.

WE HELP FINANCE YOU

and locate you. Send no money, just name, for book of facts and free opportunity.

LONG-EAKINS COMPANY
1128-S High St., Springfield, Ohio

Complete 16-unit Outfit includes new type vitreous white enamel ROUND Cooking Vat. Direct-to-tat high speed Slicer, centrifugal Grease Extractor, Thermometer — Positively everything necessary to start—all at new low price.

SPORS

1935
NO. 46 SUMMER EDITION
WHOLESALE CATALOG

SHOWING OVER 3000
FAST SELLING SPECIALTIES
FROM ALL PARTS OF THE WORLD

MORE SALES—
BIGGER PROFITS

SPECIALTY SALESMEN,
FRESH LINES, NEW
MANAGES, CHERRY
SALES OPERATORS

SPORS COMPANY
WHOLESALE IMPORTERS, MANUFACTURERS
LE CENTER, MINN.

3000 ITEMS FREE WHOLESALE CATALOG

of 152 pages, for agents, salesmen, dealers, etc. Shows 3000 items at rock bottom wholesale prices. Deals, flavors, gifts, premiums, toiletries, hosiery, etc. are illustrated. Send for the Newest Summer Issue, TODAY.

SPORS CO.

9-35 Main St., Le Center, Minn.

DIVORCE EYE CRUTCHES!



Get RID of the Spectacle Handicap. The **NATURAL EYESIGHT SYSTEM** makes Victory over Glasses Possible.

You are the Judge—your eyes the Jury—when the **Natural Eyesight System** goes on trial in your home for four months on our **100% MONEY-BACK GUARANTEE.**

Full Information Mailed **FREE**
Natural Eyesight Institute Inc.
Dept. 511- H Los Angeles, Calif.



When writing please mention Popular Mechanics

MEN Wanted

to Qualify for Positions in New Industries
AIR CONDITIONING
ELECTRIC REFRIGERATION

We want to personally interview, at our own expense, a number of ambitious men—aged 21 to 40—in various localities. We will select as many as possible to qualify for positions in America's two fastest-growing industries. The men we select will be trained for installing and servicing all kinds of domestic and commercial Air Conditioning and Electric Refrigeration equipment. Do not reply unless you are mechanically inclined, have fair education and are employed at present at least part time. Character references required. You must be willing to study during spare time for few months at some cost to you. Write giving full details of age, education and present occupation.

UTILITIES ENGINEERING INSTITUTE Est. 1927
400-410 N. Wells St., Dept. PM-11, Chicago, Ill.

at last **CARTOONING** MADE EASY

NEW, ORIGINAL, COMPLETE COURSE, especially prepared by one of today's cleverest newspaper and magazine Cartoonists. Full of punch and interest. 50 fascinating lessons; hundreds of step-by-step Cartoons. EXTREMELY EASY. Learn quickly right from the start, either for fun and spare money or to become a professional Cartoonist! Money Back Guarantee. Or, send for Free details. Don't delay.

AMERICAN SCHOOL OF CARTOONING
Dept. 1115 614 West Austin Ave. Chicago, Ill.

Complete COURSE only \$2.75

Learn **AIR CONDITIONING, DRAFTING, ELECTRICITY, RADIO, ENGINEERING** (ACCREDITED) 32nd Year

The fields in which jobs are opening and money being made. No time to lose. Start now. B.S. Degree or shorter training. Earn while learning. FREE 80-PAGE BLUE BOOK tells about big opportunities.

CHICAGO TECHNICAL COLLEGE
P78 Tech Bldg. 115 East 26th St. Chicago, Ill.

FREE 25c Gilbert Thrills Magazine
32 pages full of exciting pictures and latest scientific information. Free to the first 50,000 boys who write.
The A. C. Gilbert Co., 521 Erector Square, New Haven, Conn.

AN OPPORTUNITY IN ADVERTISING

Experience Unnecessary

At 37 I am financially independent due entirely to my success in Advertising work. A position in the Advertising field is possible for you through my low priced instructions, which teach you the same successful principles followed by the leaders in the advertising business. Write me.
G. H. JENSSEN, 8 Temple Terrace, Dept. 115, Tampa, Florida

Handbook for Farmers
861 discoveries by practical farmers, telling how to make, repair or improve the various devices and machines used about a farm or garden. 683 illustrations. "The Most Remarkable Book Ever Published for Farmers," says one authority. **Send No Money.** When the postman delivers the book to you, hand him \$1 plus the few cents postage.
POPULAR MECHANICS PRESS
Popular Mechanics Building, Room 735, Chicago, Ill.

When writing please mention Popular Mechanics

6 Big AUTO BOOKS

including **DIESEL** engines

Just mail the coupon and we'll send you a set of these remarkable auto books, just off the press. Whether you want to qualify as garage owner, auto repair expert or merely wish to know how to keep your own car 100% efficient, look at these books—they are sent to you for free examination. This brand new edition has been prepared by a group of America's foremost automotive engineers and is written so anybody who can read will understand—a veritable gold mine of valuable facts.

Take advantage of this offer now; send in the coupon for FREE examination. You don't pay us a penny, you don't obligate yourself to pay anything unless you decide to keep the books. Just tell us you want to see them and the full set of 6 great volumes, just off the press, will be sent to you. Read them, look them over and prove to your own satisfaction that one fact alone, which you will find in them, may save you an expensive repair, or help you to a better job. Imagine books which are so new that every page is right up to date—wiring diagrams, construction details, service problems—are all right up to the minute. Nowhere else can you get as complete and timely information. Over a million dollars of resources have enabled us to give you the most authoritative books on the subject ever published.

Shipped FREE FOR EXAMINATION

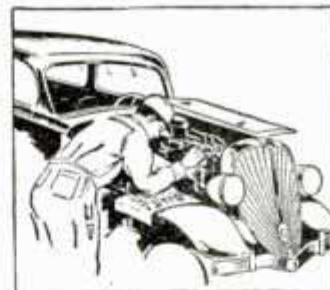


6 BIG VOLUMES bound in gold stamped flexible binding, over 2600 pages, 2000 illustrations—fine paper—extra clear type, and double indexed for instant reference.

Practically Every Auto Fact Included

DIESEL ENGINES
AVIATION MOTORS
OUTBOARD MOTORS
MOTORCYCLES
TRACTORS

WIRING DIAGRAMS
EQUIPMENT CHARTS
SUPERCHARGERS
KNEE ACTION & other up-to-date features all included



Can You Fix It?

Can you take out "play" in differential? Can you kill the "shimmy" in steering? Can you reset TIMING? Can you put your finger on engine trouble without guessing or tinkering? Can you pull the starter off and fix it? Can you adjust and repair transmission, engine, rear axle, bearings? Can you take care of knee action faults, and do an expert job?

These Books Tell How and tell you how to do any and every auto job right, the first time.

A Better Job

in the gigantic auto industry. **BIGGER PAY**—a chance to go into business for yourself and get a share of the huge profits are waiting for any man who even half tries to improve himself. Learn Auto Engineering with these wonder books a new way—without studying or memorizing. Simply use the **JEFFY INDEX** to look up the answer to any auto problem. Remember over 300 pages on **DIESEL** the new power.

free [FREE! Privilege of consulting Automobile Engineers of American Technical Society for one year without cost if you mail coupon immediately. Write or wire for answer to any difficult problem, reply will be sent promptly at no cost.]

AMERICAN TECHNICAL SOCIETY
Drexel at 58th St. Dept. A-819 Chicago

SEND NO MONEY

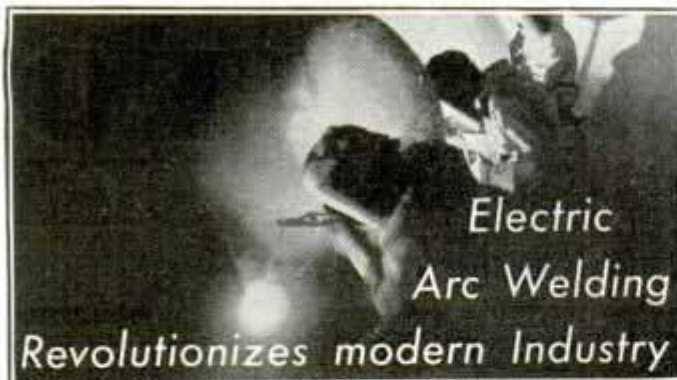
AMERICAN TECHNICAL SOCIETY, Drexel Ave. at 58th St., Dept. A-819, Chicago, Ill.
I would like to see the new 6-volume edition of your **AUTO BOOKS**. I will pay the few cents delivery charges only, but if I choose to, I may return them express collect. If after 10 days use I prefer to keep them, I will send you \$2 and pay the balance at the rate of only \$3 a month, until \$24.80 is paid. Please include free consulting membership as per your offer above. Send brand new 1935 edition.

Name _____

Address _____

City _____ State _____

Attach letter stating age, occupation and name and address of employer and at least one business man as reference.



Electric
Arc Welding
Revolutionizes modern Industry

Milwaukee Manufacturers desire to contact earnest men to work and learn Electric Arc Welding in their laboratories at the School of Engineering, Small training Fee. Accepted applicants will be fully trained until ready to pass rigid test and assisted in securing employment.

Arc Welding presents one of the outstanding opportunities for steady income and future success. Welding is growing rapidly, replacing large and intricate castings, rivets, nuts, bolts, screws. It is commonly used in assembling cranes, hoists, bridges, structural steel work, etc. No limit to the application of welding to industry, increasing durability and reducing manufacturing cost. There is a decided shortage of properly trained welders. Why be content with ordinary work, hit or miss jobs and low pay when in a short time you can become a trained Specialist in Welding?

MILWAUKEE
SCHOOL of ENGINEERING
Institute of Electrotechnics

PM-1135 No. Broadway, Milwaukee, Wisc.

Without obligation send Free Booklet "The Dawn of a Gigantic Industry and Its Outstanding Opportunities."

Name.....Age.....

Address.....

Be a TELEVISION EXPERT

LEARN TELEVISION with RADIO—NOW!

Fine opportunity for experts in this amazing new industry. A NEW business in a NEW era offers NEW opportunities for big salaries! You learn Radio and Television from beginning to end in our marvelously equipped labs and studios. You actually operate thousands of dollars worth of expensive equipment. You get expert instruction and skillful guidance by radio-television specialists.

Demand for Television Experts

Television now perfected and ready for the market ON THE NEXT BIG BUYING WAVE. Business leaders predict new system television will require thousands of relay and broadcasting stations. Ultra-short waves will permit eighty thousand television stations in America alone.

GET IN NOW and "build up" with the world's next billion-dollar industry.

6 MONTHS THOROUGH, PRACTICAL TRAINING

Qualifies for radio-phone license (1st Class). Complete up-to-the-minute training on modern "workable" television equipment including the new cathoderay. Practical experience in studio, control room. Transmitter operation of Television Station WGNAL. Employment aid while training and upon graduation. Write for free book "Pictures On the Air" NOW!



FREE FOLDER

S. Q. NOEL, Pres. First National Television, Inc.
Dept. AA11 Power & Light Bldg., Kansas City, Mo.

Without obligation, send me postpaid FREE Illustrated Folder "Pictures On the Air", telling about new opportunities in television. I am 17 years or older

Name.....
Address.....

New-TYPE Cheap OIL BURNER INVENTED Sweeping the Country!

COOK and HEAT Without Coal or Wood

In Your Present Stove or Furnace—
HOTTER—CHEAPER—No
Dirt or Ashes—Twice the
Heat Quick at HALF THE COST!

COOKS A MEAL for LESS

Beats any oil burner ever gotten out for low cost, perfect performance. Burns cheap oil a new way, without pre-generating or clogging up. Quick intense heat by Simple Turn of Valve.

Try At Our Risk 30 DAYS' TRIAL

Prove it ends drudgery and dirt of coal or wood; cuts fuel bills in half, pays for itself quickly by what IT SAVES.

FREE SAMPLE FOR AGENTS

offered to one energetic man or woman in each locality

who will demonstrate and take orders. Write quick, be first to learn how to make REAL MONEY right now, spare or full time—mail in postcard today.
UNITED FACTORIES, N-751 Factory Bldg., Kansas City, Mo.

**AGENTS
Salesmen
BIG MONEY**
Drop Everything for this Quick Seller. Clark of Ind., sold 33 in 20 days. Get YOUR OWN oil burner FREE and make REAL Money. Write now.

Slips Into
Any STOVE
RANGE or
FURNACE

Quick HEAT at
Turn of Valve!

CHROMIUM PLATING ALSO COPPER AND NICKEL

The secrets of fully explained in Shop Notes for 1933. Illus. 50 cents, postpaid.

Popular Mechanics Press, 200 E. Ontario Street, Chicago

Profit from Books

Popular Mechanics Press specializes in supplying books on any subject. Look over this list. Check the books you want, and mail this advertisement as your order blank. Write for information about books on any special subject you may be interested in.

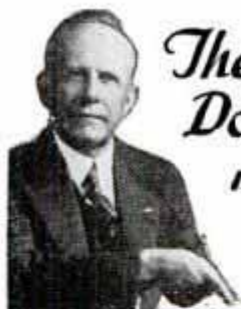
AIR CONDITIONING SERVICE MANUAL Small Unit Apparatus.....\$5.00	LANDSCAPE GARDENING Practical.....\$2.50
ARMATURE WINDING and Motor Repair.....\$3.00	LEATHER MAKING AND Home Tanning.....\$1.00
AUTO RACING How to Build Dirt Track Racers.....\$1.00	LOCKSMITHING Revised Edition.....\$2.00
AUTO REFINISHING Duo With Spray Gun.....\$1.50	MONEY MAKING FORMULAS 15,000 Practical.....\$5.50
BRICKLAYING Plain and Fancy.....\$1.50	MUSHROOMS Raise for Market.....\$1.75
CAMPS AND LOG Cabins (Building).....\$2.00	NEON SIGNS Only book on. New...\$3.00
CARBURETORS (All Makes) New, Revised Edition...\$2.50	PATTERN MAKING Excellent New Book...\$1.50
CHEMICAL MAGIC Experiment, Entertain, Mystify.....\$1.00	PLASTERING Best Instruction Man- ual.....\$1.25
DANCE Learn at Home Without Music or a Partner...\$2.00	RADIO PHYSICS COURSE New edition. Every- thing about Radio from A to Z.....\$4.00
DRAWING Freehand and Perspec- tive.....\$1.50	REFRIGERATION SERVICE Manual (All Makes).....\$5.00
DRY CLEANING (Practical) and Dyer.....\$3.00	RUBBER ARTICLES How to Make.....\$2.00
ENGINEERS' VESTPOCKET Reference Book.....\$1.50	SHEET METAL Construction Work...\$2.00
FURNITURE REPAIRING Finishing and Decora- tion.....\$3.00	STAMP COLLECTING Why and How.....\$1.50
HYPNOTISM How to Become an Expert.....\$2.00	Steam Engineer's License How to Obtain.....\$2.00
INVENTION, YOUR How to Protect and Merchandise.....\$1.50	TAXIDERMISTRY, HOME Mount Trophies Profit, Pleasure.....\$1.50
	WROUGHT IRON WORK Practical.....\$1.35

Books sent C. O. D. anywhere in U. S.

Just check the books you want, and mail the whole advertisement. It is your order blank. When postman hands you books, pay him the price and few cents postage. If you send remittance when ordering please include 10 cents per book extra for postage.

POPULAR MECHANICS PRESS, Room P-11, 200 East Ontario St., Chicago, Ill.

When writing please mention Popular Mechanics



They Said I Couldn't Do It. But Here It Is
my 1935 OFFER

WEAR A WATCH OR DIAMOND

30 Days FREE!
then Make Your Own Terms



My confidence in YOU; my confidence in my standard, dependable watches and beautiful genuine diamonds, and my confidence in business conditions cause me to make this unheard of offer. I am going to place as many watches and diamonds in the hands of men and women throughout the land as possible in 1935 **NO MATTER WHAT THE SACRIFICE**, because each watch and diamond will act as a salesman to sell another.

Direct-to-You, Rock Bottom Prices on Nationally Advertised Watches, Diamond Rings and Silverware

What an offer! Nationally advertised watches, diamonds and silverware offered at lowest direct-to-you prices. For nearly a half century we have sold highest quality jewelry all over the world. And now this remarkable offer.

Send for Beautiful FREE CATALOG

Write now—before this offer is withdrawn and get the beautiful FREE Catalog. Select the watch or diamond you want, wear it, examine it, and then write in the terms you desire.

SANTA FE WATCH COMPANY
86 Thomas Bldg., Topeka, Kan.
We Buy OLD GOLD and STERLING SILVER



MIDGET RACING

Get full details on this thrilling sport; facts for fans, builders and drivers; track sizes and regulations; car specifications, pictures and working drawings. This book also shows and tells all about Indianapolis cars, Miller-Fords and world's fastest car. Brand New **AUTOMOBILE RACING, Fourth Edition**, \$1 postpaid, \$1.12 COD; three cents tax if you live in Ohio.

RAY F. KUNS, Dept. B-14 Madisonville, OHIO, CINCINNATI



Forms to cast Lead Soldiers, Indians, Trappers, Hunters, Wild and Farm Animals. 239 different forms to select from. Every form guaranteed to cast perfect figures. Send 5c stamp for illustrated catalogue.

HENRY C. SCHIERCKE Spencer Rd. GHENT, N. Y.

Dandruff!

THIS MENACE MUST GO!

Lucky Tiger Hair Tonic rids your scalp of every speck of dandruff . . . used by millions . . . safe for children and adults . . . use Lucky

Tiger now and enjoy the tingle of new life and cleanliness . . . costs little at druggists and barbers.



LUCKY TIGER!



Easy to play

THE NEW CONNS

The world's largest manufacturers announce sensational improvements in band instruments. Outstanding stars of radio, stage and screen are equipping themselves with new model Conns as fast as our factories can supply them.

They all want the easier playing, faster action and exclusive features that Conn has perfected to meet the demands of modern music. You, too, will advance faster with one of these wonderful new instruments.

NEW PATENTED VOCABELL Revolutionizes Tone Effects

New principle VOCABELL on new Conqueror trumpets, cornets and trombones hailed as the greatest improvement in century. New tone brilliance. Faster, sweeter, easier to play.

Many exclusive improvements, yet they cost no more. See the new models at your music dealer's store. Or write us for home-trial, easy payment offer and free book on your favorite instrument. Mention instrument.

C. G. CONN, Ltd.
1131 Conn Building
ELKHART, IND.

Write FOR FREE BOOK



Play the Hawaiian Guitar like the Hawaiians!

FAMOUS NATIVE HAWAIIAN INSTRUCTORS teach you to play this fascinating instrument. ONLY 4 MOTIONS—No previous musical knowledge needed. OUR 52 EASY LESSONS teach you the enchanting music you hear over the radio.

GIVEN—when you enroll—a sweet toned

HAWAIIAN GUITAR, complete

WRITE AT ONCE for attractive offer and easy terms.

playing outfit and carrying case.



FIRST HAWAIIAN CONSERVATORY OF MUSIC, Inc.
9th Floor, Woolworth Bldg. Dept. 250 New York, N. Y.

Approved by New York State Board of Regents

When writing please mention Popular Mechanics

The Editor's

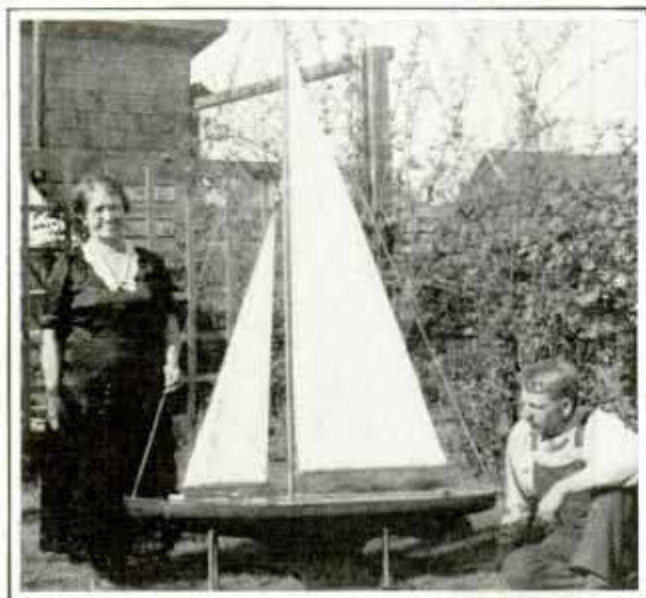


MAIL BAG

(Continued from page 22A)

loud. The fellow I want to nominate for Public Enemy No. 1 among dumbbell drivers is the road hog who straddles the center of the pavement and refuses to budge an inch for truck or flivver. Any other nominations?"—*H. S. Travilair, Chicago.*

Ambitious Builder



Mr. Richardson's Model

"I have the model "Zip" completed, the first I ever have made. Mast and sail have been tested, but the boat has not been tried in the water. I think I would like to try building a boat seventy-five or 100 feet long."—*D. Richardson, S. Vancouver, B. C.*

Curious about Planes

"I think your readers would like to know what the numbers on airplanes mean and how pilots do stunts."—*H. W. Halligan, Boston, Mass.*

Pleased with 4-Tube Set

"In January I purchased blueprints for the four-tube portable battery set. I am pleased with the results."—*Dean Hehr, Shelbyville, Mo.*

More about Stamps

"I am interested in the stamp articles that appear in your magazine from time to time. Could you not have them more often?"—*A. D. Taylor, Portland, Ore.*

Surprising Radio

"I built the pentagrid short-wave converter that appeared in a 1934 issue, also the amplifier of June, 1935. Friends are surprised to hear the number of foreign stations tuned in with this converter hooked to my broadcast receiver. I have logged three English, one Italian, one Spanish, three German, three Mexican, two South American and numerous Canadian stations with good volume and fine clarity."—*Francis Kellen, Chicago, Ill.*



Model Railroad

"Here is a model locomotive that I built with the assistance of a friend. It is a one and one-half inch scale model running on a seven and one-fourth gauge track. Our five-car train will haul ten adults over the 500-foot track, giving a nice little ride over a fill, through a cut and around a curve. We worked a year on this train and track. I would like to exchange photos with any one who has built and is operating a railroad of this size."—*Horace P. Shaw, Bloomfield Hills, Mich.*



Mr. Shaw's Midget Train

4900 Chemical Formulae In This One Indispensable Book



In this one big book you have at your fingertips practical commercial formulae for making thousands of useful products for your own use and for profitable manufacture. Brand new, encyclopedic in scope, arranged for quick reference, it is exactly the book that every commercial chemist, large or small, has long wanted. 600 Meaty Pages of formulae including many patented, scarce and little known processes, many published for the first time. *Collected by over 60 outstanding industrial chemists and technicians—every formula proved successful by actual test and experience.*

Covers Hundreds of Industries Thousands of Products

You will find, in The Chemical Formulary, methods for making or using:

- | | | | |
|--------------------|------------------|-------------------|-------------------|
| Abrasives | Disinfectants | Hair Tonics | Patent Leather |
| Adhesives | Dyes | Incense | Photographic |
| Air Conditioning | Electrotyping | Inks | Specialties |
| Alloys | Etching | Insulation | Polish, Auto |
| Anti-rusts | Compounds | Jams and Jellies | Porcelain |
| Aromatics | Explosives | Kalsomines | Preservatives |
| Asphalt | Fertilizer | Lacquers | Printing |
| Bronze Lacquers | Fireproofing | Latex Paint | Refrigerants |
| Candles | Fireworks | Leather Polishes | Rubber, Synthetic |
| Candy Glaze | Fluxes | Liniment | Safety Glass |
| Carbonizing | Fly Killer | Liquors | Shaving Cream |
| Catalysts | Food Specialties | Lubricants | Soaps |
| Celluloid | Gems, Artificial | Matches | Solvents |
| Cement | Glass Polish | Metallic Printing | Stencils |
| Cream, Cold | Glues | Matrix, Rubber | Tooth Paste |
| Coffee Substitutes | Gold, Plating | Mirrors | Waterproofing |
| Colors for Oils | Grease, | Nickel Plating | Zinc Etching |
| Decolorizing | Lubricating | Oil Sun-Tan | Zinc Plating |
| Preparations | Hair Setting | Ointments | and thousands |
| Dental Cement | Liquids | Paints | more |
| Depilatories | | | |

ONE FORMULA ALONE MAY BE WORTH HUNDREDS OF DOLLARS TO YOU

Every formula in this book is of practical, commercial value. The volume is not merely a collection of "household stunts" or experiments for the amateur, but a mine of money-making ideas for everyone concerned with commercial chemistry. In addition, you will find it a quick-reference book for a vast amount of information that you need in your daily work. Send for your copy today.

EXAMINE IT FREE *Send No Money Mail This Coupon*

THIS COMPLETE, SIMPLE, PRACTICAL COURSE FOR SELF-INSTRUCTION WILL QUICKLY GIVE YOU A Complete Mastery of MATHEMATICS



Prepare now to advance yourself to an important job by *Mathematics Training*. *Mathematics* is the foundation of all mechanical and scientific work, and of all business or industry based on science. Without this essential knowledge even the most capable man is left behind while others forge ahead to better jobs, bigger contracts, more money. You need mathematics to solve technical problems and to improve, speed up and check on your work and the work of others.

Now you can learn mathematics by an easy, inexpensive and time-saving method. A very simple and extremely interesting course in book form has been prepared for you by an expert who has devoted a lifetime to teaching practical men the fundamentals of this important subject.

MATHEMATICS FOR SELF-STUDY

By J. E. Thompson, B.S., A.M.,
Dept. of Mathematics,
Pratt Institute

These books start right from the beginning with a review of arithmetic that gives you all special short-cuts and trick methods that save countless hours of your time. Then they go right into higher mathematics and show you how simple it is when an expert explains it for you. In no time at all you will be tackling with ease the most difficult questions on this subject.

An Expert's Simplified Methods

Mr. Thompson, the author of these books, has had many years' experience in mathematical training. He presents each practical method and problem in the clearest, simplest way. He gets right down to the kind of information that you need in your daily work.

A Complete Course and Reference Library in 5 Volumes
Arithmetic
Algebra
Geometry
Trigonometry
Calculus
1598 Pages Illustrated

Send No Money — Mail This Coupon for FREE EXAMINATION

D. VAN NOSTRAND CO.,
250 Fourth Ave., New York

Send me on approval The Chemical Formulary. Within 5 days after I receive it, I can return it to you and owe nothing. If I keep it I will send you \$2.00 as first payment and I will pay \$2.00 monthly thereafter for 2 months—\$6.00 in all. (5% discount for cash. Same return privilege.) (P. M. 11-35.)

Name.....
Address.....
City..... State.....
Reference.....
Address.....

D. Van Nostrand Co., Inc.
250 Fourth Ave., New York

Send me MATHEMATICS FOR SELF-STUDY in 5 volumes. Within 10 days I will either return the books or send you \$2.95 as first payment and \$2.00 per month for 3 months—total \$8.95 (5% discount for cash).

Name.....
Address.....
City and State.....
Reference.....
Address.....

(P. M. 11-35)

Oil around the World



ETHIOPIA INTRODUCES NEW OIL CAN ART



This remarkable example of Ethiopian tribal art found its way from Dakar, Djibuti to Paris and is now on display in the Trocadero Museum. It is an artistically decorated

meal sifter (the pattern is formed by very small nail holes) which French experts admire greatly. An American woman scrutinized the object carefully and discovered, to her amazement, that it was made out of a used container for Veedol Motor Oil, proving that Veedol is known, valued and used throughout the world.

Oil. He reports: "Our 36 tractors, airplanes and snowmobiles traveled over 31,000 miles. Their satisfactory operation brought out three facts: *First*, the efficiency of the personnel. *Second*, the quality of Veedol Motor Oil, in our judgment the finest in the world. *Third*, the dependable performance of modern motors when properly lubricated."

The Greatest Oil Change in History



AMAZING VEEDOL FACTS



NO, HE'S NOT DRINKING OIL

In far parts of the world an emptied Veedol can is a useful article. Natives find that it is easier to pick up an empty can for use as a drinking utensil than to hollow out a gourd. And it is easy to find a Veedol can in almost any country.

Back in 1876, the source of Pennsylvania's richest oil was discovered in the Bradford fields near Titusville. Rival railroads sought a monopoly on transporting this finest of all crudes. But a cheaper way had to be found if this rich crude was to be marketed at a reasonable price. It was decided that oil could be piped, just as water is, to the storage tanks and refineries. When the great pipe-line was finally completed, the cost of transporting this fine oil became the lowest item per quart instead of the highest. Old timers call the result "the greatest oil change in history."

ANTARCTIC LABORATORY PROVES THIS OIL AT 60° BELOW



On two historic occasions, the world's finest motor oil went to the bottom of the world, where Lieut. Commander George O. Noville, engineer in charge of the Byrd Expedition's automotive equipment, tested Veedol Motor

Right now, with winter coming on, is the time to change *your* motor oil to avoid excess engine wear and battery drain. Make it a change to Veedol, the finest of all Pennsylvania oils, refined by the same company that pioneered the first pipe-line. You will agree that Veedol is . . . the greatest oil change you ever made. Tide Water Oil Company, 17 Battery Place, New York City.

When writing to advertisers please mention Popular Mechanics

Popular Mechanics Magazine

REGISTERED IN U. S. PATENT OFFICE AND CANADA

WRITTEN SO YOU CAN UNDERSTAND IT

Vol. 64

NOVEMBER, 1935

No. 5

HEROES *of the* "HURRICANE WATCH"

By JULIAN LEGGETT

HUNDREDS Dead . . .
Scores Injured . . . Whole
Towns Wrecked . . . Millions
of Dollars Damage.

This picture, still fresh in the public mind as a result of the recent disastrous storm which struck south Florida and the keys near by, is drawn by news bulletins from the stricken territory each time a hurricane of great intensity sweeps through the Caribbean area. As horrible as this picture is, however, it might be much worse but for the vigilance of "watchmen" stationed at isolated points in



Radio Operator of Pan American Clipper Ship Sending Weather Reports from over the Caribbean, Map Showing Course of Recent Florida Storm, and Wreckage Left in a Harbor



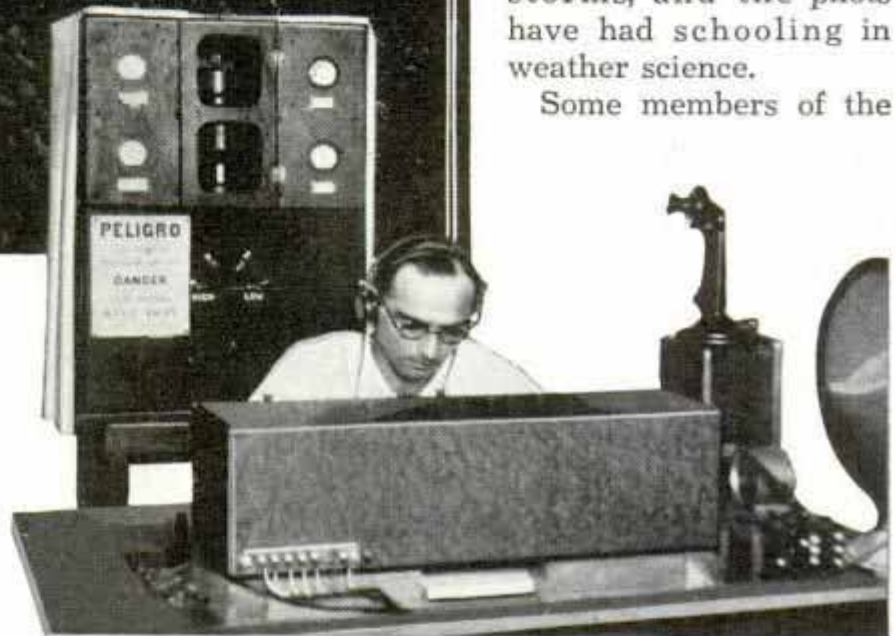
the region where hurricanes are hatched each summer and fall.

These watchmen warn of the hurricane's approach twenty to forty-eight hours before the storm strikes one of the islands or the mainland, enabling residents to board up windows and doors, cut off power lines to prevent fire, store up water and food for the emergency and make other preparations to protect life and property. Frequently the warning comes in time for many people to flee by auto, train and plane, out of the hurricane's path to safety. In the recent Florida storm, the weather bureau posted warnings many hours in advance and perhaps thousands of lives were saved as a result.

In cooperation with the weather bureau, the "hurricane watch" is maintained by the Pan American Airways system throughout the Caribbean district, the "nest" of the storms. Its personnel includes weather observers, radio operators and airplane pilots and its network is so complete that nearly every hurricane at one time or another comes within its field of observation. Two-way communication

between all airports and aircraft provides instant transmission of information, and frequently the air line's radio is the only means of reaching the outside world after a hurricane. The observers are trained especially to understand the weather vagaries of their localities; most of the radio operators have been to sea and have had personal contacts with storms, and the pilots have had schooling in weather science.

Some members of the



Top, Weather Information Is Gathered at This Lonely Radio Station in Mountains of Mexico; Below, Pan American Radio Room in Belize

hurricane watch have been through numerous hurricanes and their knowledge of what to expect and what to do, in addition to their personal bravery, makes them unsung heroes many, many times. To save the lives of people in the stricken zone and to keep their radio equipment operating so that an appeal for help may be flashed the instant the wind subsides, these men risk their own lives countless times. Lewis E. Sherouse, Pan American radio operator who has gone through so many hurricanes that he has won the nickname of "Hurricane," describes a West Indian storm in this manner:

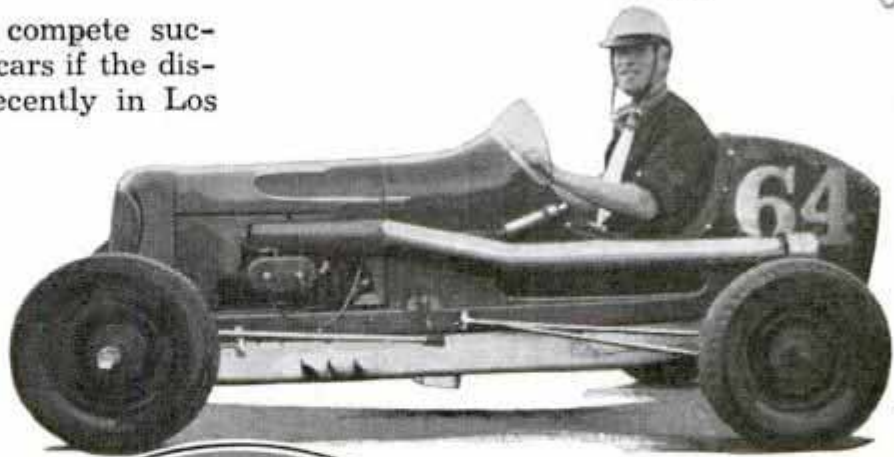
"I received the final storm warning that the hurricane was traveling due west from opposite Tela, Honduras, and that it was

(Continued to page 136A)

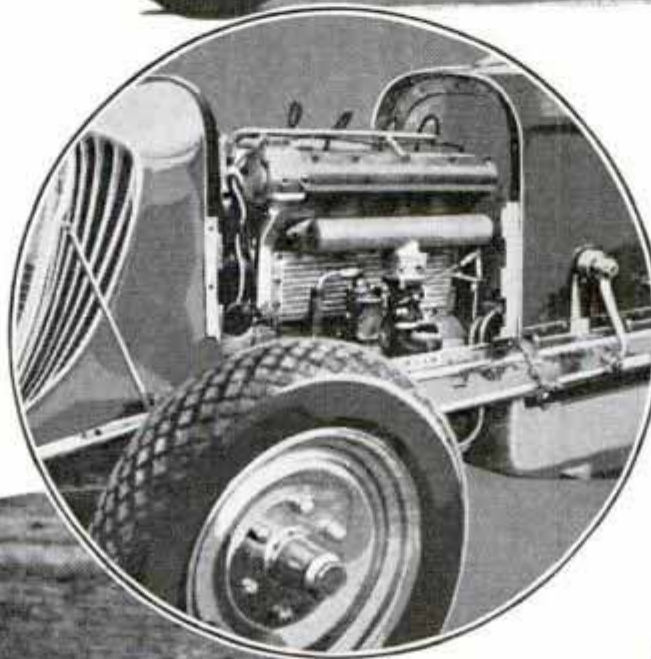
122 E 42 nd. New York.

Mighty Midget Wins Contest with Big Racer

Midget auto racers can compete successfully with the big race cars if the distance is not too great. Recently in Los Angeles a midget car defeated a standard size speedway machine in a contest over a flat half-mile track, dirt-surfaced. The 900-pound midget was only seventy inches long but was capable of a top speed of more than 135 miles per hour. It competed against a \$10,000 racer with a cubic displacement more than twice that of the midget. Although lacking the top speed of the large car, the midget



Above, Typical Midget Racer; Left, Power Plant of a \$2,500 Midget; Below, Midget and Big Car Abreast



et racing is inexpensive compared with the costly cars and tracks necessary for big-car contests, the investment in a midget which will win prize money consistently often not exceeding \$500. Many cars are powered with out-board motors.



more than made up for this because of its faster acceleration and its greater ease of handling in the turns. Midget auto racing has jumped to great popularity in a space of little more than two years. One reason for this is that the tracks are short and the spectators view events taking place almost "in their laps." More than 150 miniature speedways now are in regular operation throughout the country. Even on short tracks the cars attain high speeds, eighty miles per hour on 100-yard straightaways being not uncommon. Midg-

Radio programs without static, without advertising, without station announcements are being offered to home subscribers in some sections on a monthly fee basis. Wax recordings are being used exclusively at present. The programs are "piped" over the power lines of an electric company and brought into the home on telephone or light wires, thus eliminating static. Subscribers in Lakewood, Ohio, where the system is being installed, pay from \$1.50 to \$5.00 a month, depending on the type of radio cabinet leased. They may specify the type of programs desired, there being three channels of continuous service from six to eight o'clock in the morning until eleven or midnight, two providing diversified entertainment and the third dance music.

North American Co. Inc.

8-1064

RADIO "PIPED" BY MONTH OVER LIGHT CIRCUIT

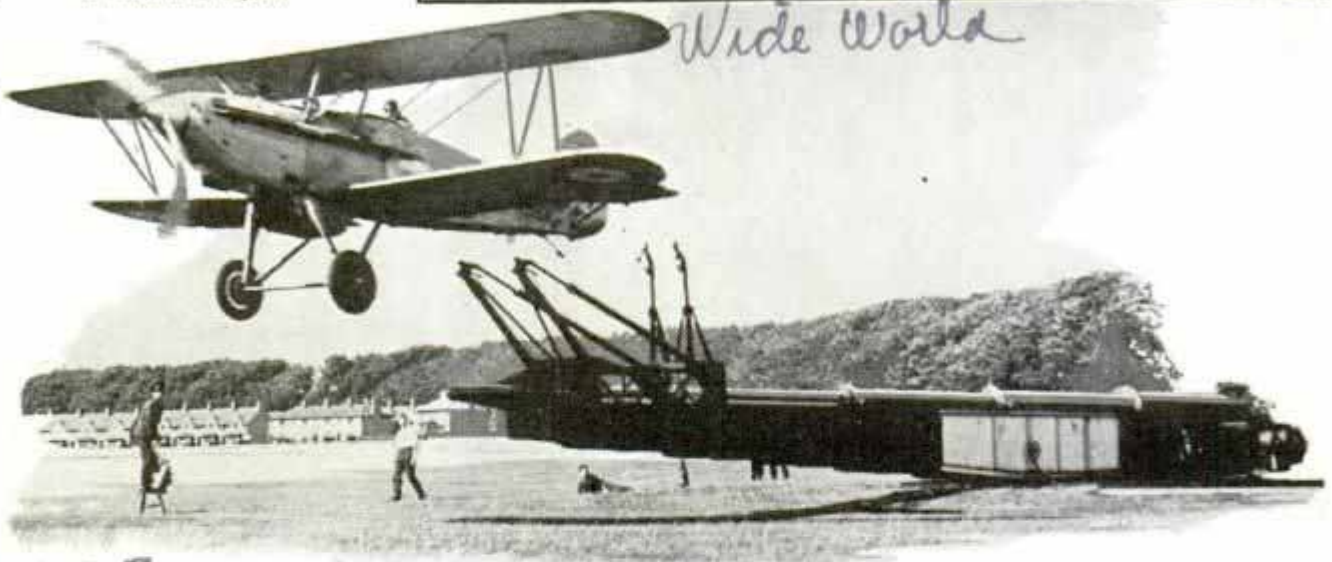
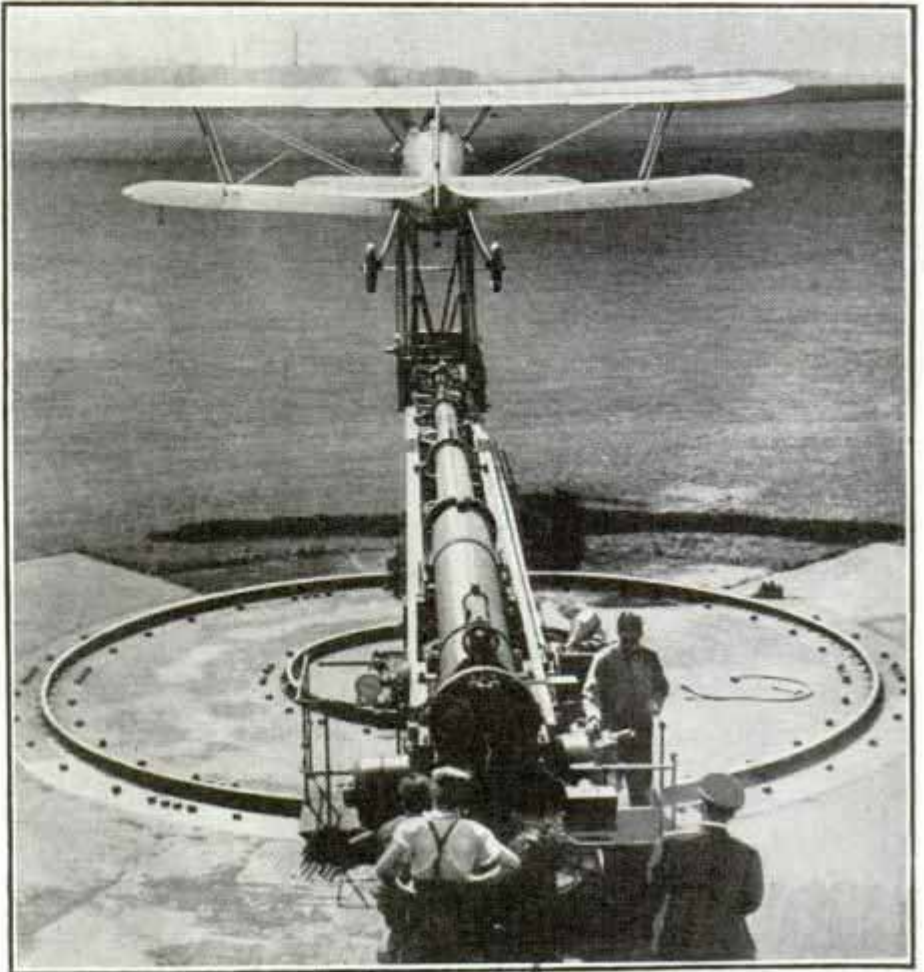
Metronome, 113 W. 57 St. New York, Sept. 1935

8-1023. Cont. Saltair Air West Los Angeles Calif

Land Catapult for Planes Trains Navy Flyers

Student pilots of the British fleet receive instructions in the catapulting of airplanes from ships without any danger of "getting their feet wet." An airplane catapult, similar to those used aboard a battleship, has been set up in a field at the air school in England. From this the rookie pilots are shot into the air during training until they master the technique of handling a plane launched with the aid of this device. Most modern warships now carry catapults for launching planes at sea, the ships being tossed from the decks of the boats at flying speed.

Right, Plane Resting on Catapult Ready to Be Launched; Below, Student Pilot of British Navy Being Shot into Air from a Land Catapult



1038
OXYGEN PUT IN VEIN SAVES LIFE AFTER BREATHING STOPS

Injection of oxygen into the veins may prove to be a life-saver for drowning persons, pneumonia patients and others threatened with death by suffocation. A dog deprived of oxygen in the lungs was kept alive for sixteen minutes by this method. The danger of clogging veins

with air bubbles has made it impossible to give men sufficient oxygen in this way to sustain life, but in experiments with animals the oxygen was injected in a pressure chamber under three atmospheres. The amount of oxygen animals could absorb depended on the distance of the injection point from heart and lungs, and the caliber of the veins through which the gas bubbles flowed.

Air Arm at Leuchars, Scotland

Wide World

Science Fiction 8/30/35
 Dr. I. Singh, Cambridge University

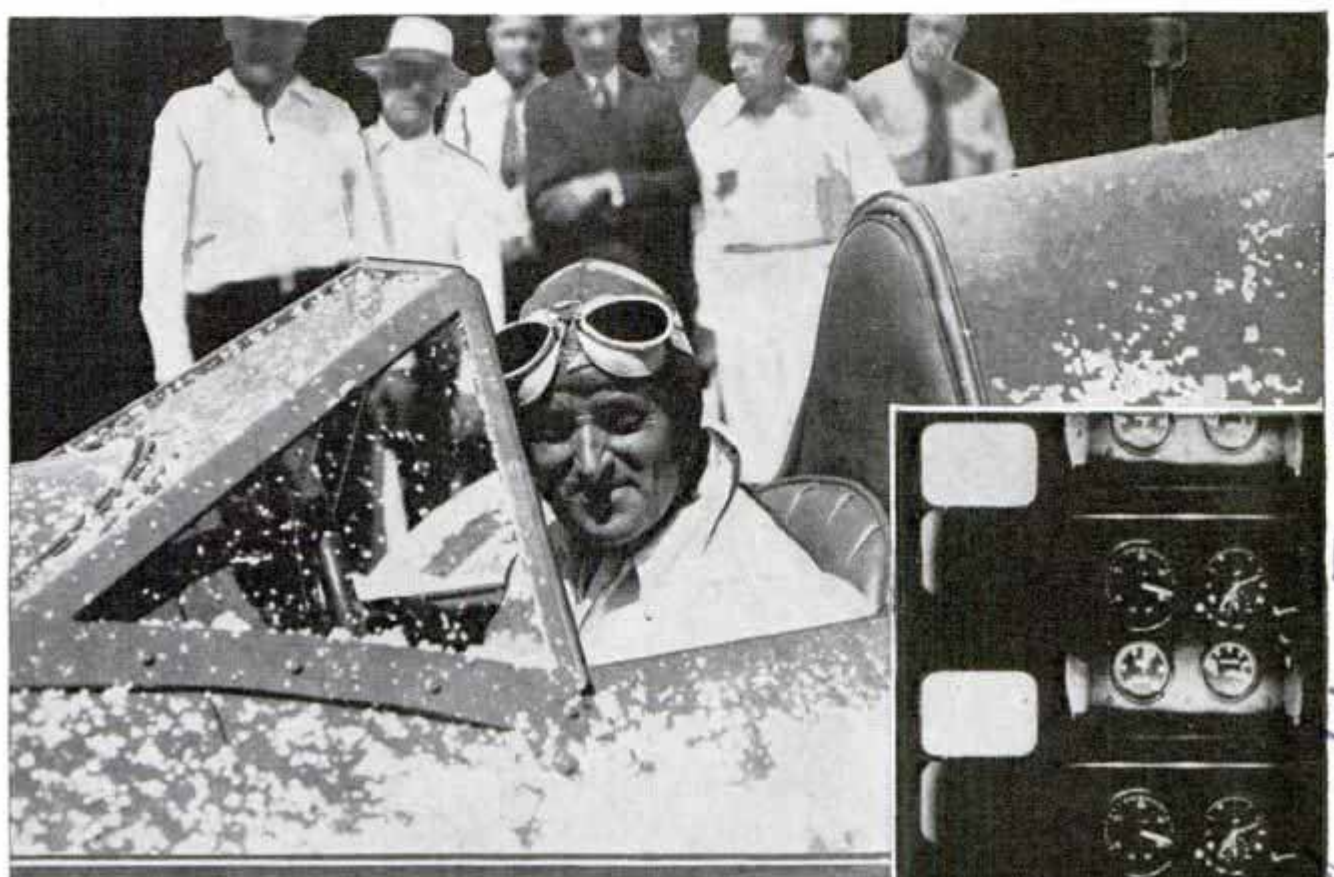
England University

81060.

25.1 Hughenden Road, Kelvinside, Glasgow Scotland

SIR MALCOLM CAMPBELL Says:

THERE'S NO LIMIT TO SPEED



By SIR MALCOLM CAMPBELL

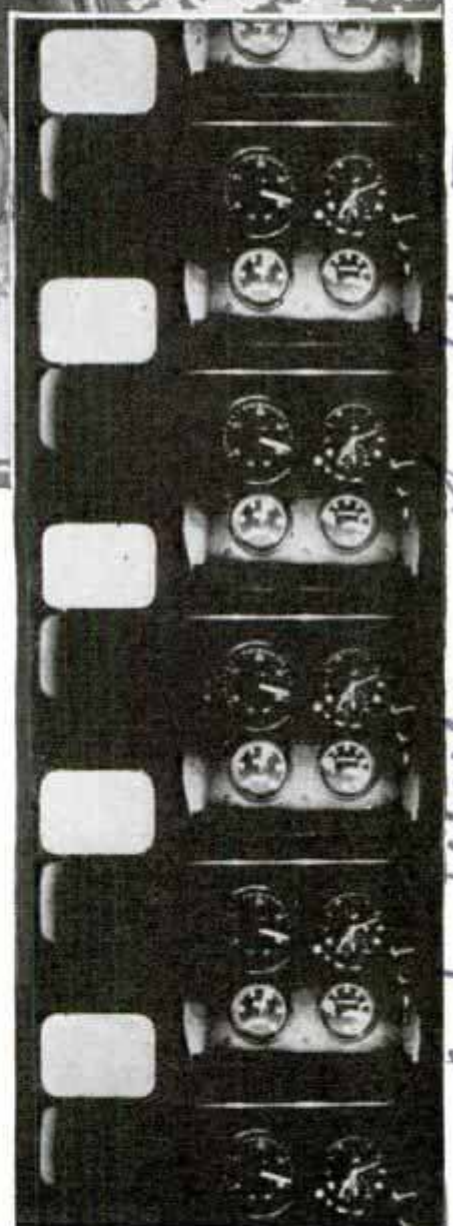
As Told to W. F. Sturm ⁴⁰¹⁰ North New Jersey St

ON SEPTEMBER 3, I made a new world's record on the Bonneville salt beds, west of Salt Lake City, when I drove the Bluebird over the measured mile for a world mark of 301.1292 miles an hour—the first man ever to attain 300 miles an hour on land.

The Bluebird is equipped with tires which measure thirty-five by seven inches on the front and thirty-seven by seven and one-half on the rear, the latter wheels being dual, with the outside tires in line with the front tires. Tire pressures are 125 pounds in the front and 105 in the rear. The tires are fourteen ply with only sufficient tread to make the surface smooth—about one-sixty-fourth inch.

Directly behind each rear wheel assembly is a wind brake, a section containing two square feet, built into the streamline of the car and hinged at the rear. These wind brakes are raised by vacuum pressure, which is governed by depressing the normal brake pedal beyond the stop necessary to engage the four-wheel mechanical brakes.

The radiator is of honeycomb type, built entirely across the front section of the car. There is a shutter across



Sir Malcolm Campbell and His Salt-Encrusted Bluebird and, Below, Movie Film of Instruments Taken During His Recent Run by a Special Camera Installed in His Car to Preserve the Record

Indianapolis, Ind

North Indianapolis
Sturm 4010
New Jersey St
Campbell
Cone & Kodak



The seating position is a bit to the right of center in order to put the propeller shaft alongside and to the left of the driver to obtain a lower seating position. That is the reason also for the offset tail assembly, which is directly behind the seat.

I rev my engine up to 3,200 before changing out of first, and up to the same revolutions in changing into top from second. The car's top speed in first is approximately 100 miles an hour; in second, 205 miles an hour and in top the theoretical speed is 330 miles an hour.

One of our great problems has been that of tires. I used small-diameter tires in the front to lessen the wind resistance, and I know now that they carried too much load and this was undoubtedly the cause of the left front blowing some time after I had passed through the measured mile. A tire turning 3,000 revolutions per minute is subject to heating and a further cause of heating is

the nose of the car which may be closed manually. With this shutter closed, no outside air reaches the radiator, and the resultant streamline efficiency increases the car speed as much as fifteen miles an hour. However, it is only possible to close this shutter for a period of not to exceed twenty seconds; even so, the water starts boiling immediately the shutter is closed.

The power plant is a twelve-cylinder V-design Rolls-Royce aviation engine which develops 2,500 horsepower at 3,500 revolutions per minute. This is the same type engine used in the Schneider cup race which England won in 1931. The engine is supercharged with the standard type Rolls centrifugal supercharger, with a pressure of seventeen pounds to the square inch. The supercharger is geared nine to one. The engine weight dry is approximately 1,600 pounds and develops approximately one horsepower to every ten ounces of weight. It uses two and nine-tenths gallons of fuel every minute.



Top, Power Plant of the Bluebird; Center, the Car in Action; Bottom, Tire Which Blew Out During the Record-Smashing Run

the flexing of the tires at such terrific speed. While traveling full speed on the salt, I was amazed to see something that had never occurred before—the distortion of the casings to such an extent that they assumed an almost pointed appearance at the top. This great variation in shape from the section at the bottom which carried the load to the narrowed top section undoubtedly had the effect of greatly increasing the heat.

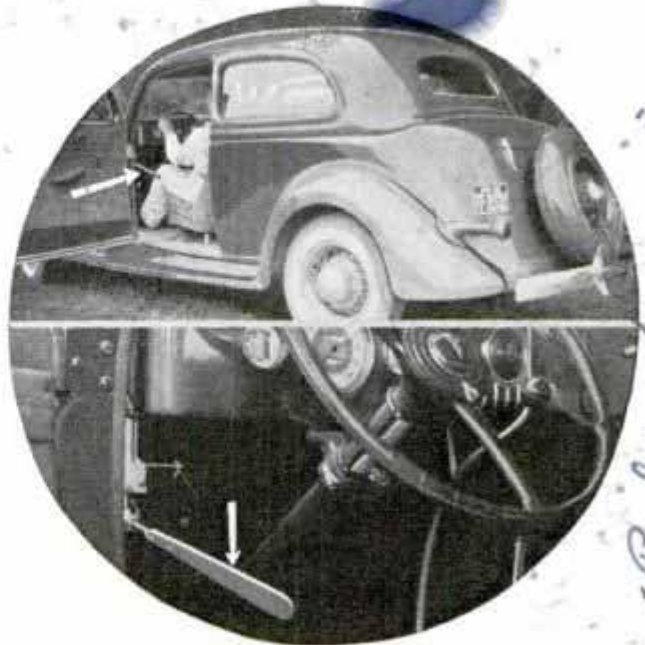
It was a weird experience driving at high speed over the salt. Imagine if you can an illimitable sea of dazzling white, with a range of mountains rising in the distance on the west. To the east as far as the eye can see was the flat, barren expanse of salt, fading in the distance to alkali mud flats. Ahead of me, to the north, eighteen or twenty miles away, lay what were once islands, jutting fantastically out of the lake bed to a height of perhaps 1,000 feet.

It seemed I was riding onward to the top of the horizon and that finally I should—as the ancient mariners thought—fall right over the edge of the world. The surface of the salt, as hard as pavement, after a thin film had been bladed off, was remarkably smooth—smoother than any surface over which I have ever driven.

In order to have a permanent record of engine speeds, acceleration, deceleration, supercharger and oil pressures, I had a duplicate set of instruments in the right side of the car, between the front and the rear wheels. Entirely inclosed in absolute darkness, lighted by a small globe the action of these duplicate instruments was accurately recorded on a moving-picture film by means of a small camera. The movie camera was wound for twenty minutes of action. The record on the movie film, I might add, was perfect and told us all we wished to know.

As to my future plans, I have none. Obviously, what I have done, some one else can improve on. Progress is continuous. There is practically no limit to any field of endeavor. I have been asked a thousand times what I consider the limit of land speed. I see none. Improvement in tires and car structure and engines will be made as we go along, to take care of the increased speed, stability and durability.

Knee Throttle Frees Foot for Braking the Car



Top, Showing Handy Knee Accelerator; Bottom, Close-Up of the Installation

By pressing the knee against an accelerator lever at the left side, the driver can control the auto engine, his feet free to operate clutch and brake. When alighting, the lever is pushed out of the way.

81036

SLEEP IS MORE COMFORTABLE IN AIR-CONDITIONED BED

You can sleep in comfort in warm weather in an air-conditioned bed surrounded by a canvas wall, but open at the top to allow air circulation. An air-conditioning unit supplies air at any temperature and humidity desired.



Adjusting Air-Conditioner to Desired Temperature

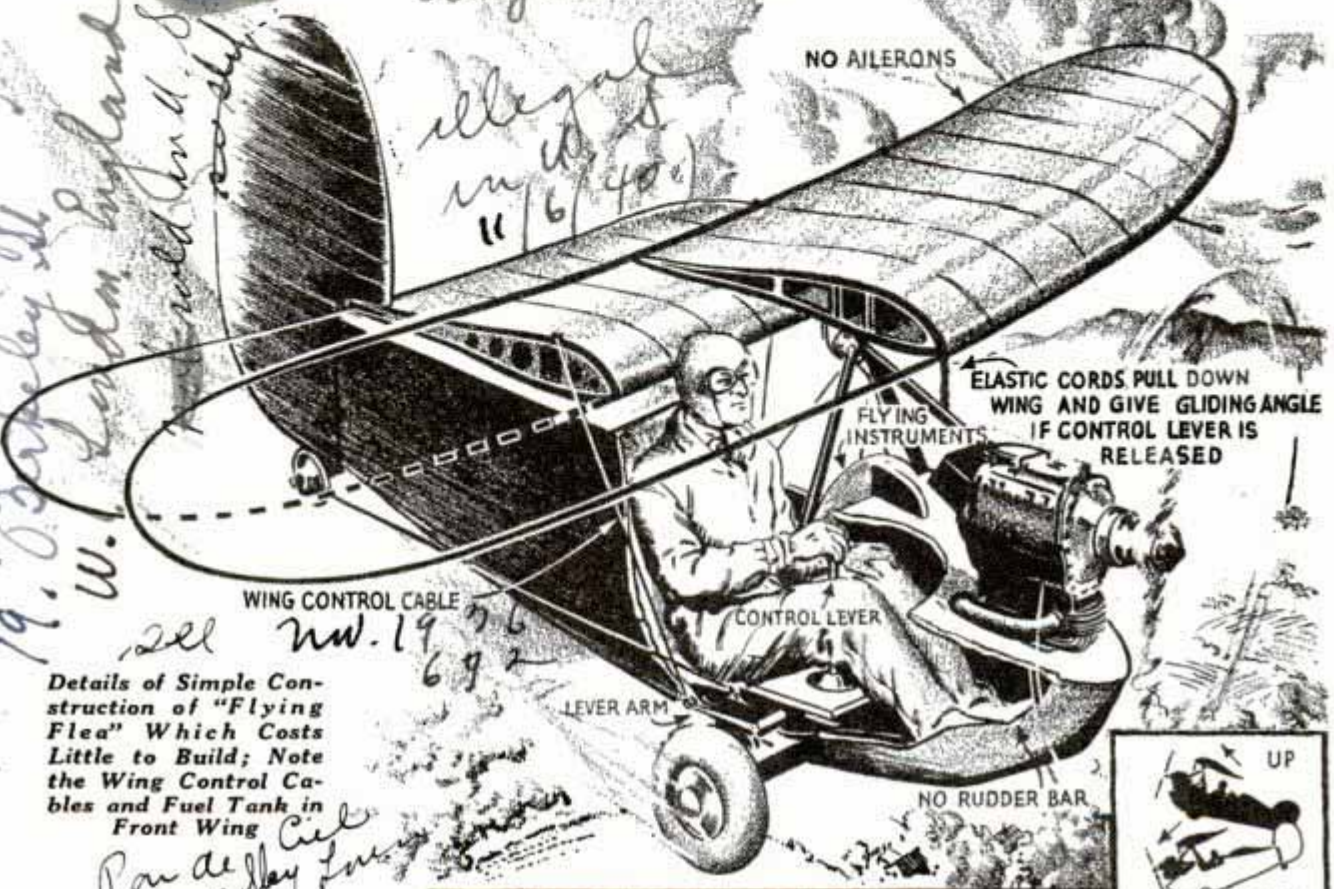
*My Pils. Fragner, Road
205 Hoffman
des monies d'ora.*

Clark Equipment Co.

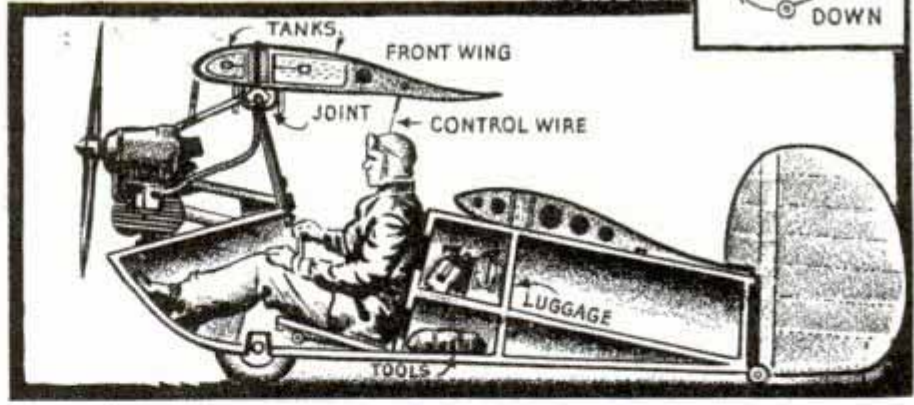
Wiltshire Road,
POPULAR MECHANIC
Ewell, Surrey, England

"Flying Flea" Costs Little to Build and Run

Illustrated London News
Aug. 24, 1935 P. 327



Details of Simple Construction of "Flying Flea" Which Costs Little to Build; Note the Wing Control Cables and Fuel Tank in Front Wing



Anyone handy with carpenters' tools can build the "Flying Flea," a small airplane of such simple construction that hundreds of amateurs in France and England are busy today making their own copies of it. The ship, complete with motor, can be built for less than the price of a small automobile. All the necessary wood for the fuselage, cut to shape and marked, steel tube wheel axle, wheels, tires, elastic cord, fabric and all other parts are being supplied to builders by a British firm for less than \$150. A small two-stroke engine and a wooden propeller to drive the ship at a speed of more than sixty miles per hour, can be obtained for from \$200 to \$300. The plane, with an over-all length of eleven feet six inches and a front wing span of about eighteen feet, has a very large rudder but no ailerons. Elastic cords pull down the front wing to give a gliding an-

gle when the control lever is released. Fuel tanks are contained in the front wing.

£1072

Paint Makes Own Design

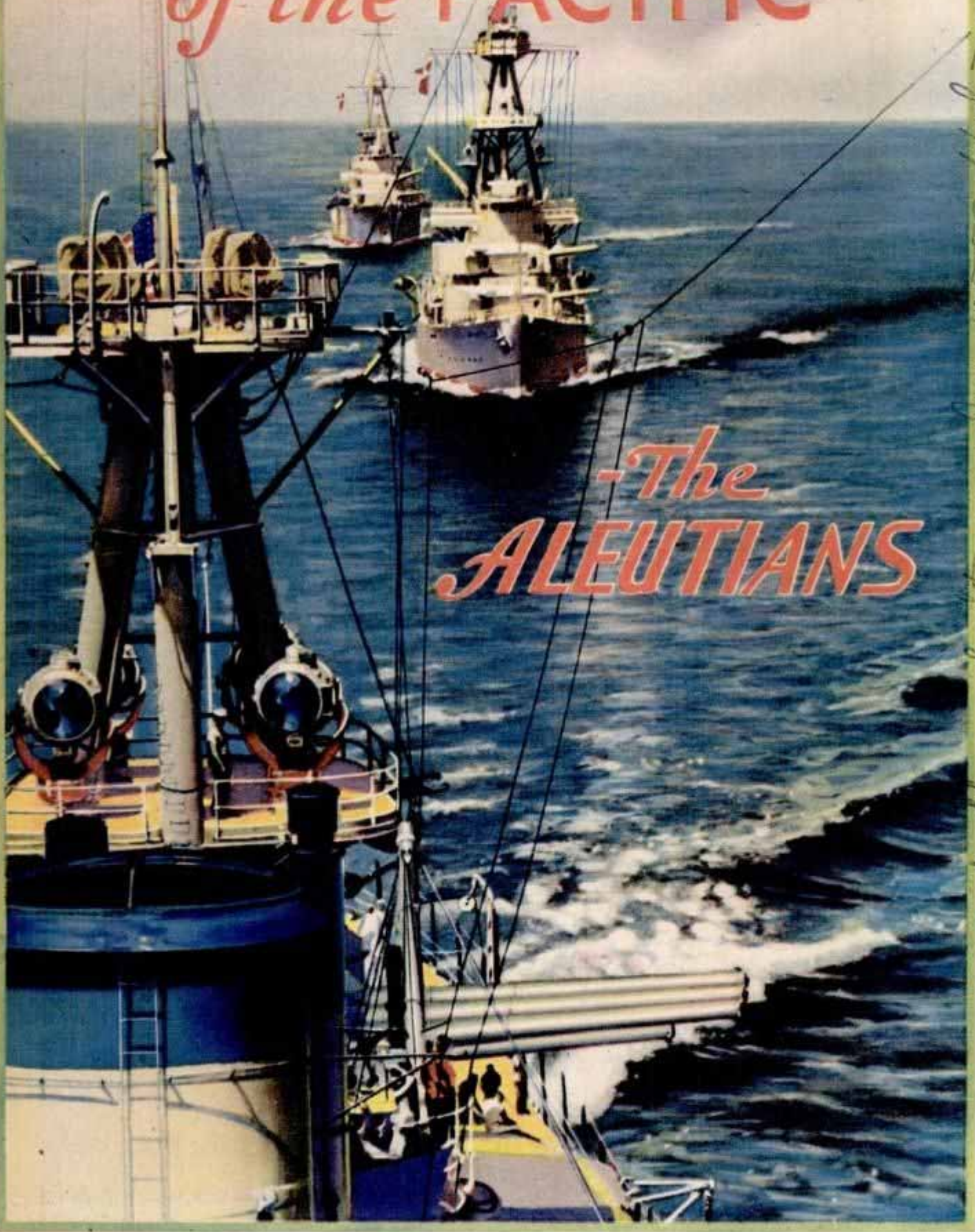
Paint that dries in patterns such as Jack Frost would etch on windowpanes is a fresh idea for decoration. Translucent, this paint flows like varnish, but twenty minutes after it is brushed on it hardens in designs like frost crystals. Available in red, blue, green, gold and white, it is especially adapted to ornamenting book ends, lamp shades, bric-a-brac and flower pots.

Handwritten notes:
 sold by Acir. League of etc.
 G. B. Tech. Empire
 19. B. Peley etc.
 W. London England
 sold for U.S.
 d. M. M. Henry Mignich
 France. Book, low construction

Handwritten notes:
 see notes
 Popular Aviation
 Keen Pick up Co

6149

WAR SENTINELS *of the* PACIFIC



-The **ALEUTIANS**

*Capt. Thomas G. Stinson, Jr., 10555 Holmgren Ave
Los Angeles, Calif.*

A PART of Uncle Sam's battle fleet during maneuvers in the Caribbean sea.



8749

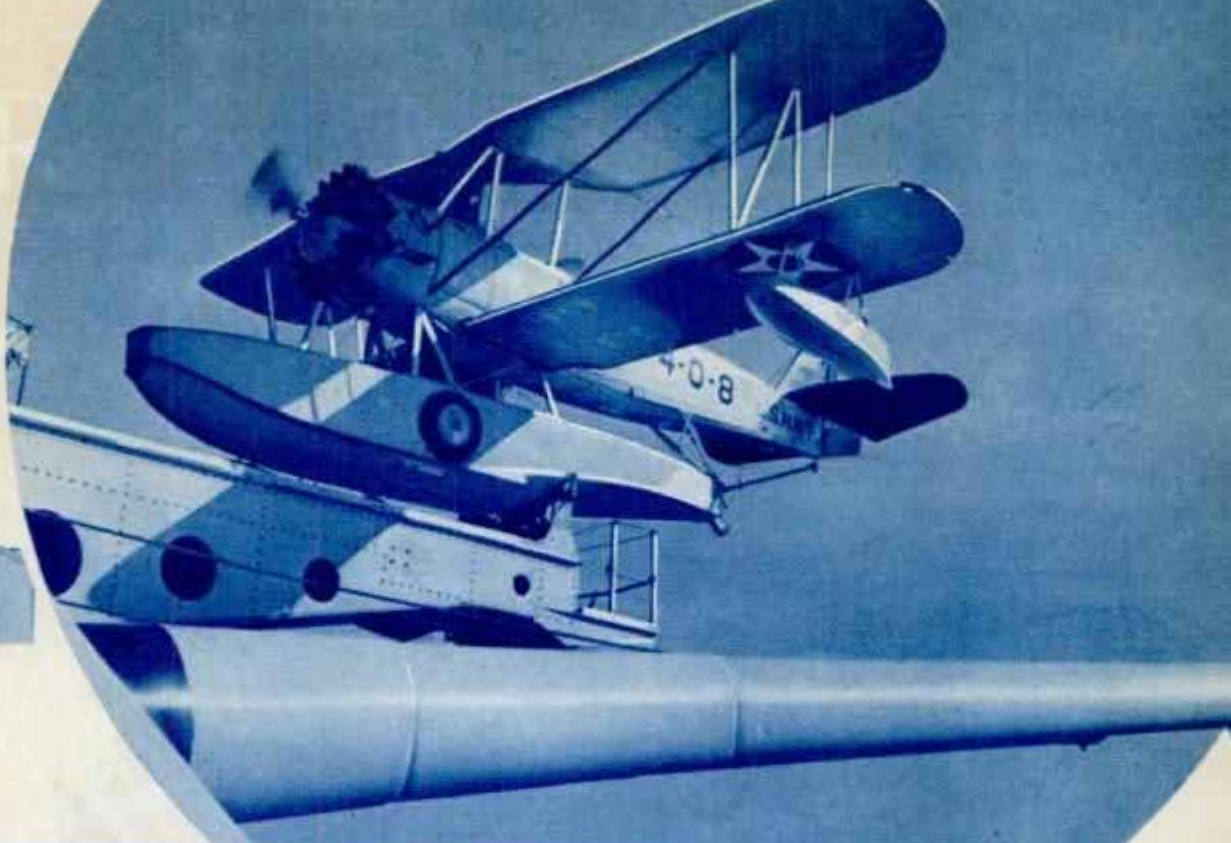


SEAPLANE being catapulted into air at a speed of eighty-five miles per hour with aid of sixteen pounds of powder, and map showing Great Circle routes from California to Orient, and bringing out the military importance of the Aleutian Islands.

ON an almost unknown chain of islands may some day rest the safety of the United States. For the protection of the country an American Gibraltar may be created on a grim and storm-torn archipelago, 1,000 miles long, in the north Pacific.

Most people think of the Aleutian islands as only desolate masses of rock that were tossed in with Alaska at the time of the Seward purchase, but study a

globe and you will see that, due to the curvature of the earth, the islands straddle the shortest route to the orient. One is within 275 miles of Asia, two hours away by airplane. They are only 300 miles north of the great circle route between California and Japan. From the Aleutians, warships could repulse an overseas attack, harass enemy ships, and serve as a line of supply to vessels operating far at sea. Occupation of the



6749

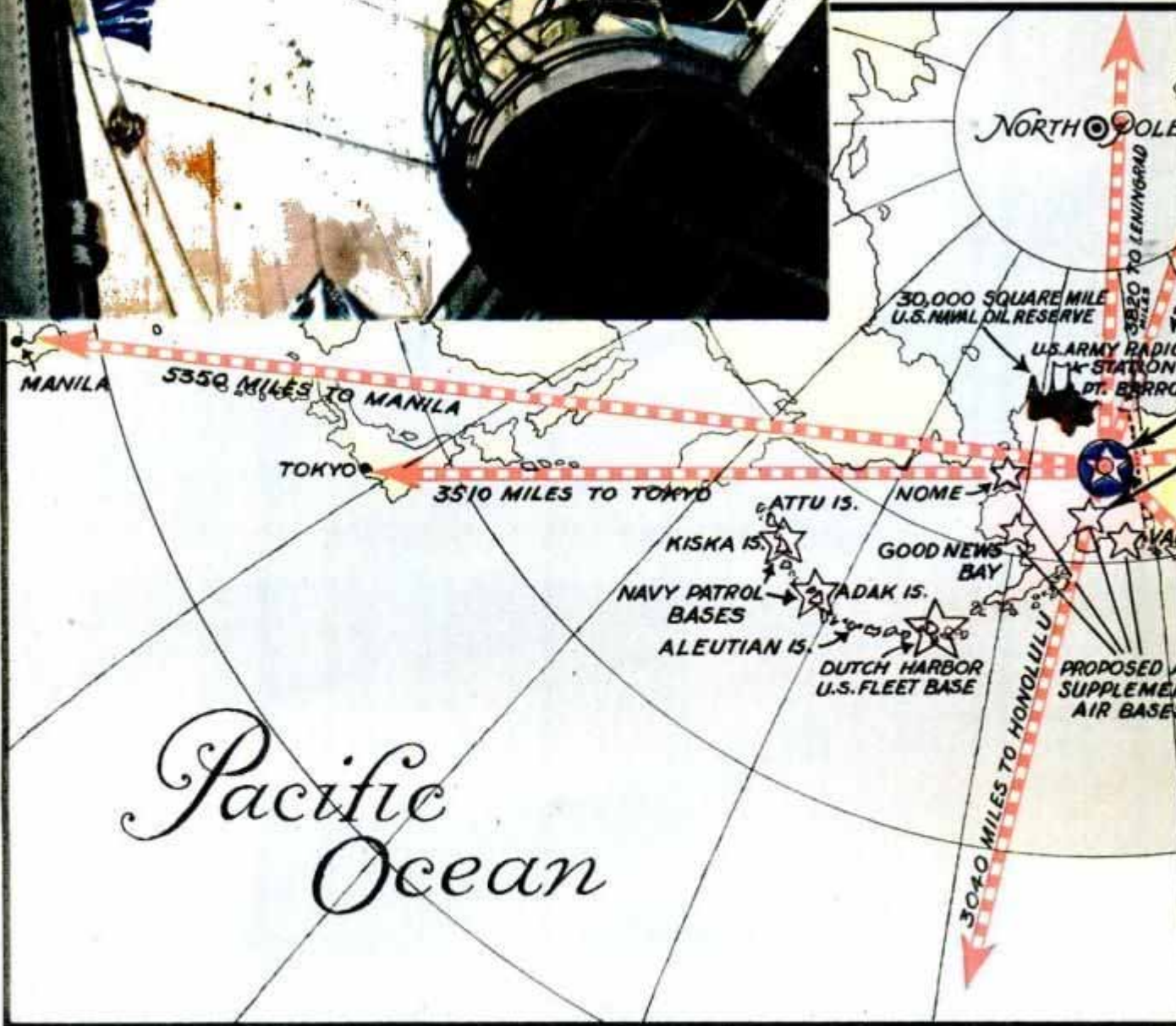
PLANE, top, tuning up on a catapult above a gun turret of one of Uncle Sam's battleships. Planes would play a very important part in plans for the fortification of the Aleutian Islands for defense purposes.



THE huge "Mississippi," above, which resembles a giant destroyer or cruiser more than a battleship. Note the thick "blister" along the water's edge to protect her against mines or torpedoes. Right, warships cutting their way through the Pacific in battle array. The guns are the two forward turrets of the "California."

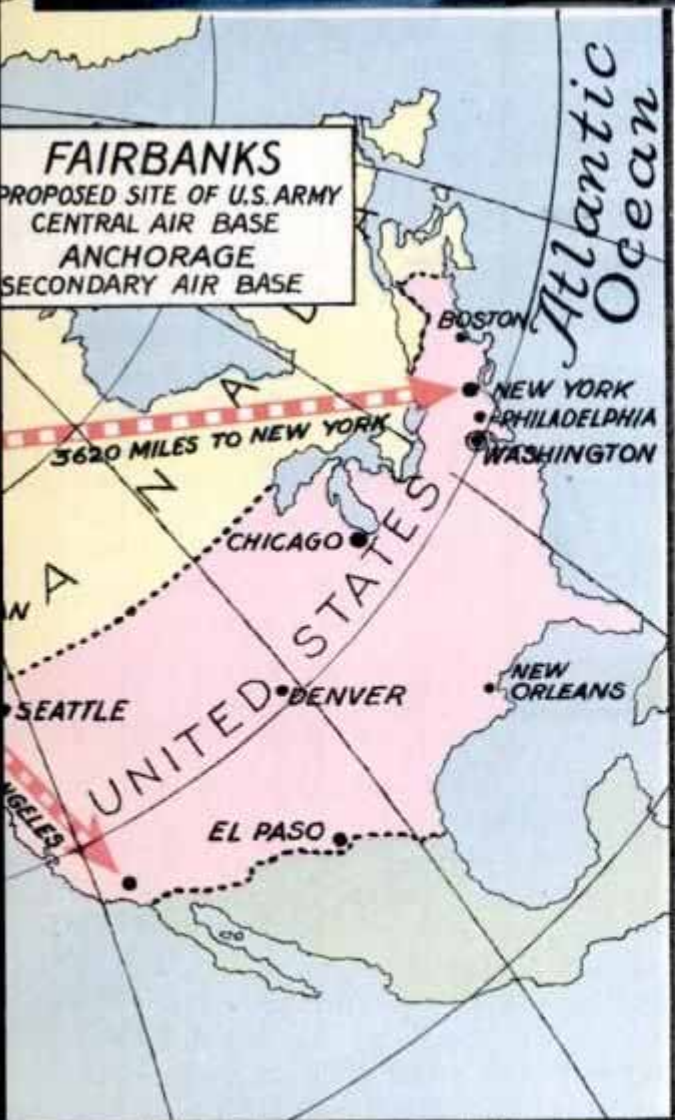


PAINTING one of the funnels of the U.S.S. "Indianapolis," navy cruiser, in preparation for a presidential review of the fleet, and, right, searchlight drill during a visit of the fleet to New York. The map of the north Pacific region shows the strategic position of the Aleutian Islands with relation to world centers of population, and the proposed plans for establishing defense bases there.



Pacific Ocean

6749



islands would prevent an enemy from using them as a convenient base for attacks on the mainland.

These are the reasons why, in the eyes of naval strategists, the barren sentinels are the key to the supremacy of the north Pacific and, linked with Hawaii, form the first outposts for national defense in the west. With these thoughts in mind the army and navy are planning to establish supply, aviation and radio bases there. In 1934 army planes flew from Washington, D. C., to Fairbanks, Alaska, and return. In the same year three navy expeditions went north to study the Aleutians. This year the navy made direct use of the islands in its maneuvers.

The secret results of this year's fleet problem will be the basis of future defense plans. For that reason wartime conditions were simulated during the six weeks period of the games and the utmost secrecy was maintained. For weeks the whole fleet was "lost" as far as shore contacts were concerned. The war games comprised the most extensive peacetime operations in the history of the navy. Admiral Joseph M. Reeves conducted the maneuvers, moving his ships back and forth across a chessboard consisting of 5,000,000 square miles of

E 749

6749



ABOVE, the U.S.S. "Idaho," one of Uncle Sam's latest battle cruisers. Left, anti-aircraft gunners watching the burst of a five-inch shell. These guns are heavy enough to bring down any aircraft. Note that the gunners wear telephone sets inside their helmets. These are for receiving orders from the gunnery officer.

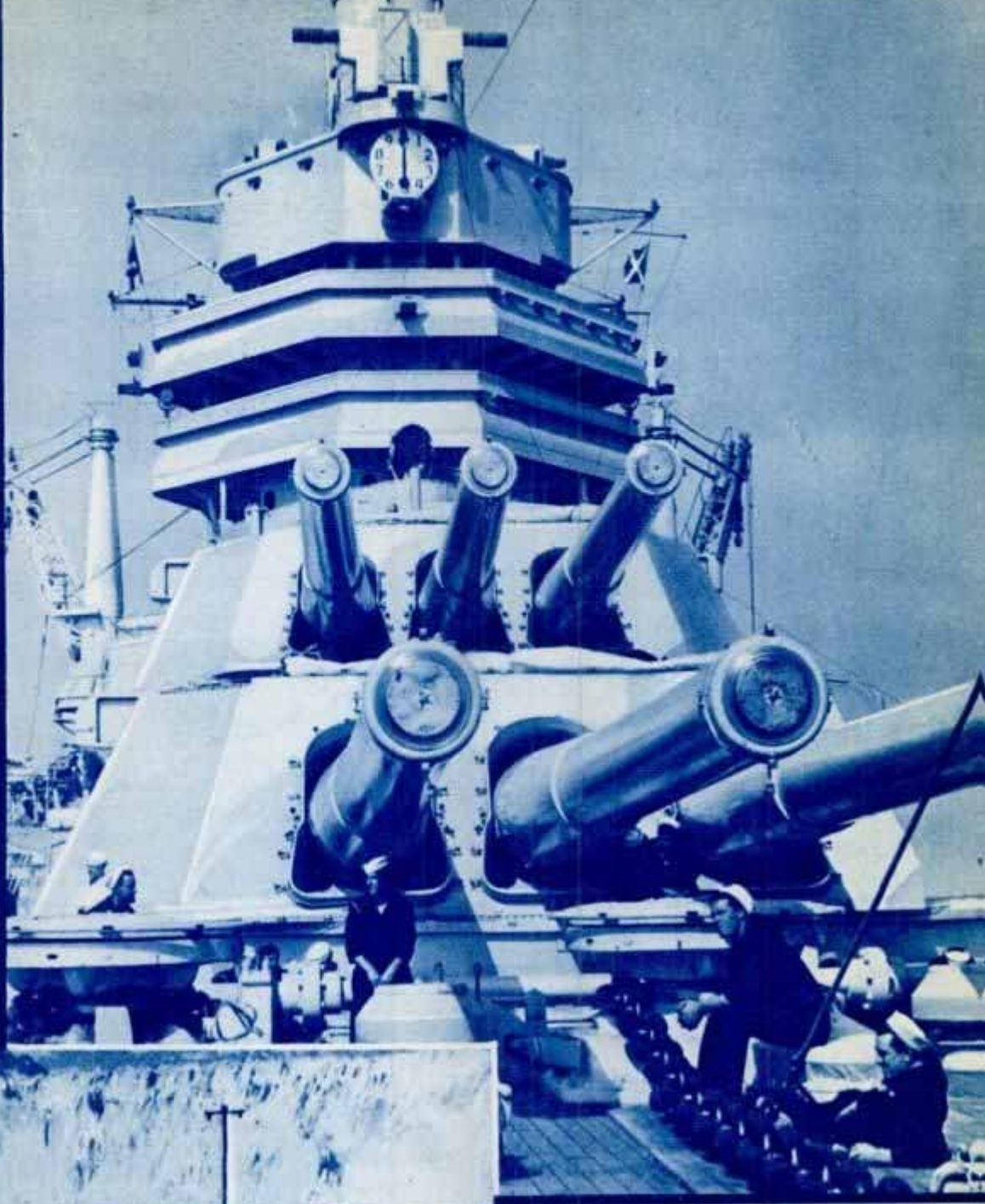
ocean inside the area bounded by California, Alaska, Midway island and Hawaii. The mighty games culminated a year of intensive drilling.

About 500 airplanes, nearly 200 ships, and 55,000 men took part in the maneuvers. Ponderous battleships cruised far from land, fast cruisers scouted thousands of miles, destroyers dashed off under sealed orders, while furtive submarines below the surface and swarms

of planes in the air dovetailed into the exercises. For the first time, the new aircraft carrier "Ranger" and new submarines, destroyer leaders, and heavy cruisers took part in the games.

One phase of the maneuvers hinged on using the Aleutian islands as a base. Then from this northern haven ships were sent on defense and offense missions to the south. In another phase, 165 warships were squeezed through the fortified

THE modernized "Mississippi" with her rebuilt tier of bridges and observation platforms. The use of spotting planes has eliminated the need for tall masts on battleships. Below, one of the navy's undersea cruisers moored near Columbia glacier, off the coast of Alaska, during fleet games.

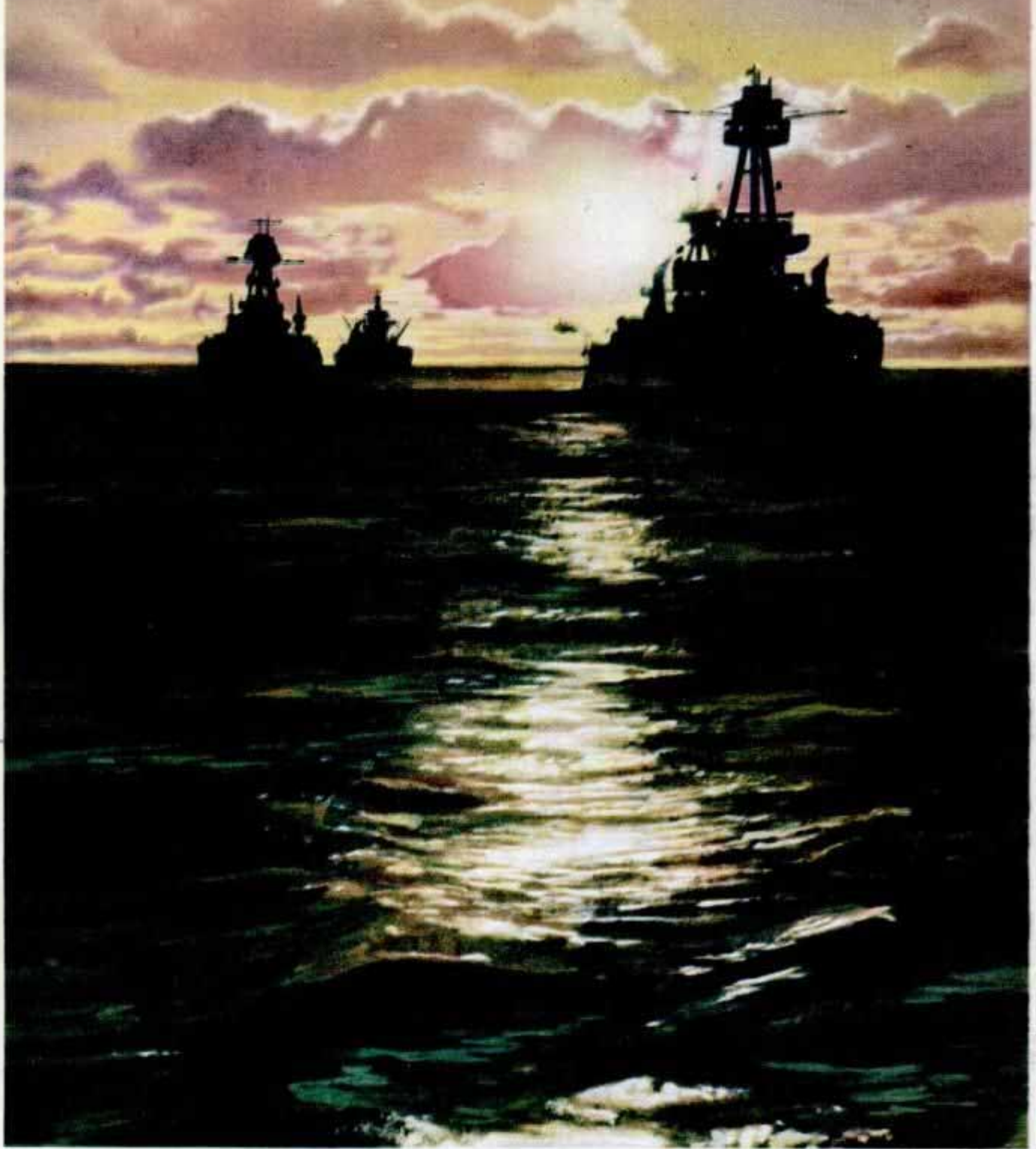


entrance of Pearl Harbor in Hawaii to test the naval station's facilities. Later a defending force, representing an enemy, was landed at Midway island in the center of the Pacific nearly 1,400 miles west of Honolulu. Aided by submarines, the defenders did their best to repulse night and day attacks in which forty-six seaplanes that flew direct from Hawaii took part. After this the forces

were divided into two fleets, the White fleet with eighty-three ships and the Black with seventy-seven, for a gigantic mock naval engagement.

In other phases of the games warships practiced antisubmarine drills by dodging submarines that pursued them, eighty huge patrol wing seaplanes from as far away as San Diego and Panama practiced advance base operations, 300

8749



THREE units of Uncle Sam's mighty fleet riding the Pacific at sunset.

aircraft simulated an aerial attack on the fleet, and submarines were kept at sea for a solid month. It was learned that in an actual war the fleet would have to depend a great deal upon the American merchant marine for auxiliary and supply ships because of the great distances in the Pacific. Aside from the actual fighting ships, a fleet requires hospital ships, transports, food, ammunition, and repair ships, and fuel tankers in order to remain on the high seas for long periods.

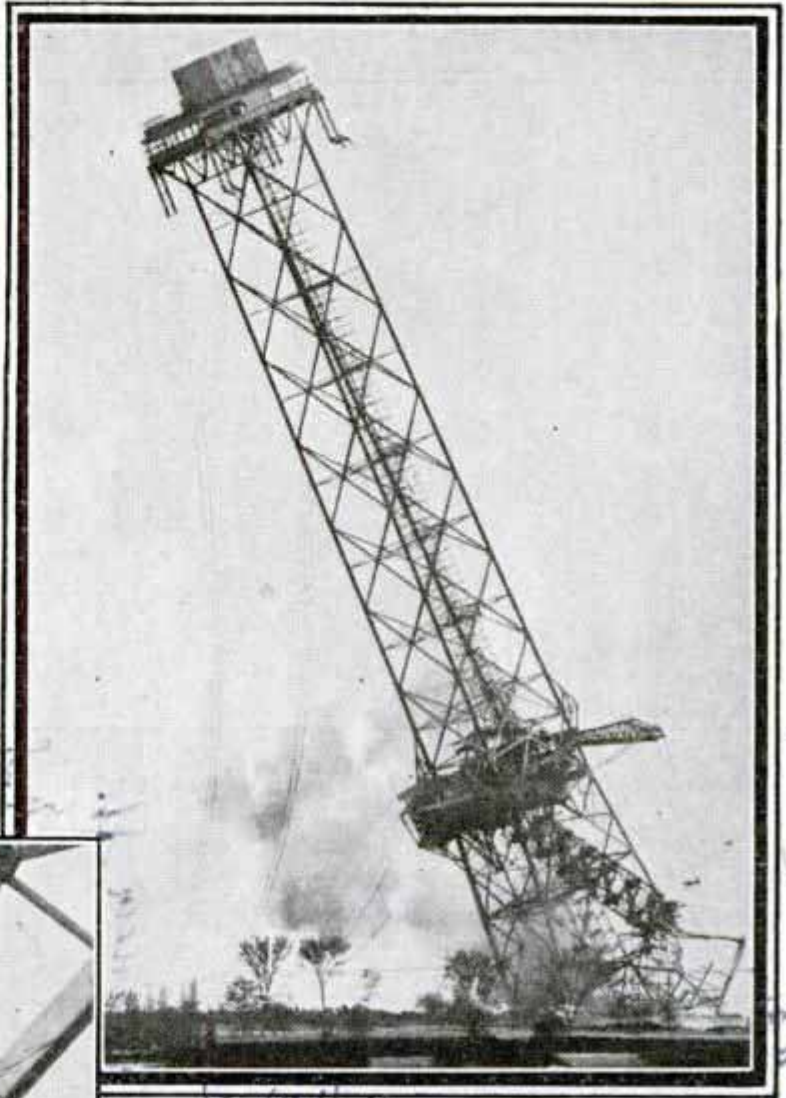
In the north, the navy already has a base at Dutch Harbor, Unalaska island,

near the Alaskan mainland, which serves as headquarters for extensive aerial mapping and harbor sounding expeditions, as well as meteorological surveys. Most people think of the Aleutians as frigid, ice-bound islands but their harbors are always open and the weather is not often extremely cold. The area, however, is a breeding place for storms and the skies are rarely clear.

Weather conditions like these, navy officials think, would be an advantage in defense although the mists might also hide an enemy bound for Puget sound. But when *(Continued to page 130A)*

Skyride Tower Felled by Melting Steel Legs

Intense heat was employed by wrecking engineers in toppling the 3,000,000-pound east tower of the "Skyride," a major attraction of Chicago's Century of Progress. Huge "overshoes" in the form of cupolas made of steel and lined with firebrick were constructed around two legs of the tower and filled with 1,500 pounds of thermite, a mixture of aluminum and iron oxide. When fired by electricity the thermite generated a temperature of more than 5,000 degrees about the two legs, melting the ten-foot sections almost instantly, causing the tower to tip and then to crash. A microphone attached to the tip of the tower broadcast the noise of the fall by radio, and the spectacle



East Tower of Skyride Crashing after Two Legs Had Been Melted by Thermite in Cupolas, Below

was viewed by a crowd estimated at more than 100,000. The west tower had been wrecked several weeks earlier with dynamite. The 628-foot twin towers, the cables which supported the cars passing between them and the elevators cost more than \$1,750,000 to erect.

61043
BRAKE TESTER MOUNTED IN CAR

Mounted on steering column or the dash, a brake tester for automobiles, trucks and buses keeps accurate check on the efficiency of brakes. It gives approximate stopping distance and test readings can be made at twenty, thirty or forty miles per hour. The device works on the decelerometer principle, its pointer moving across the face of the dial as the car is braked to a stop. The dial shows one section, "Not Safe," another, "Good," and a third "Excellent," the section in which the pointer stops indicating the approximate condition of the brakes. The instrument is easy to operate.



Alhertus Corp.
 Ave. Phila
 Esadren

8/027

Midget Snowstorm Cools Interior of Plane Quickly



Spraying Plane with Artificial Snow; Interior Can Be Cooled Quickly by a Shower of This Frozen Carbon Dioxide

By creating a miniature snowstorm in the passenger cabin of transport planes permitted to remain long on the ground, Pennsylvania Airlines has found a way to cool the interior quickly in warm weather. This method lowers the temperature to a point of comfort, so that incoming passengers are greeted by a pleasant air-cooled atmosphere which continues until the plane has reached an altitude at which cool air is natural. As soon as planes have been cleared of passengers upon landing, airport attendants spray the passenger cabins with a gas, basically carbon dioxide, which has a temperature of 109 degrees below zero. Issuing from the spray apparatus as "dry snow," this gas quickly evaporates without leaving a trace of moisture. For safety, passengers are not permitted in the plane during, nor immediately after, the cooling process. Planes can be dispatched within a few minutes after arrival.

PEARL FINISH EASY TO APPLY LIKE ORDINARY LACQUER

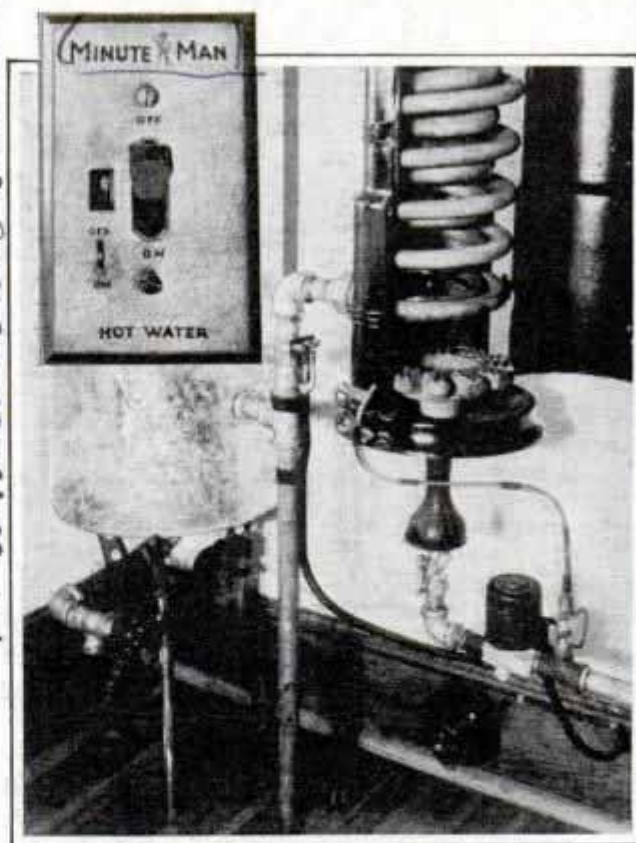
Beautiful effects can be obtained with pearl lacquer, and it is as easily applied with a spray as any other finish. To manufacture it, pearl essence is added to ordinary clear lacquer. This essence consists

of minute flakes taken from the skin of some species of fish, at the base of the scales. The flakes are suspended in the lacquer and as it dries they assume varied angular positions, reflecting light in such a manner as to produce a pearl-like effect. Not only is it easy to apply, but pearl finish can be readily touched up and repaired.

8983

TIME SWITCH TURNS ON GAS WATER HEATER

Remote control for the water heater is provided by a convenient electric time switch unit. Flip any one of the switches installed in kitchen, bathroom, laundry or bedroom and the gas is turned on in the basement heater for just three minutes. For another three minutes, another flip of the switch. As an added protection against overheating, a thermostat automatically checks the gas if the switch is unknowingly operated too many times.



Gas Water Heater Showing Installation of Time-Controlled Lighter; Inset, the Lighter Switch

Any number of switches throughout the house can be connected to the lighter unit.

American Appliance Co

*Hydrogen Carbide Corp. Pa
General Pittsburgh, Pa*

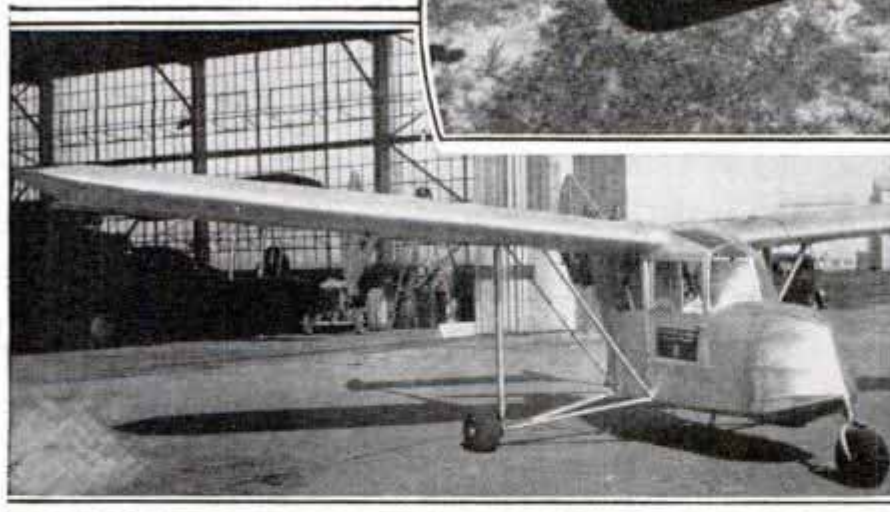
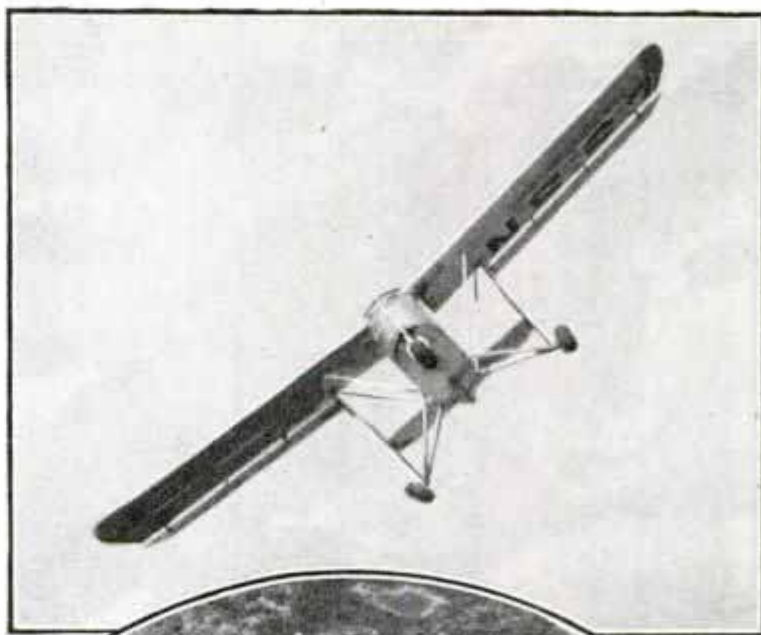
8925

*W. General Robinson
v. the people of Nevada
In re; 65 Nevada
Newspaper*

*Wrecker - Messner
Aircraft Corp
Hagerstown Md*

Flivver Plane Without Tail Almost Flies Itself

Experiments which may eliminate the rudder and permit control of gliding range without changing gliding speed are being conducted by the bureau of air commerce with a small plane equipped with special ailerons and flaps intended to make it easier to fly. The ship, with engine and propeller at the rear, was designed by Fred Weick, then taken over by the government and equipped by an airplane company with the new flaps and ailerons. The three-wheel landing gear permits landing at any speed with immediate application of the brakes, and the arrangement of the engine and tail surfaces is such that the plane, when trimmed to fly at a certain speed, will maintain that speed automatically, irrespective of throttle manipulation. Opening the throttle causes the ship to climb, closing it puts the craft into a glide. For turning a conventional ship in a



Small Plane Equipped with Special Flaps and Ailerons Intended to Replace Rudder and Make It Easier to Control and Fly Than the Conventional Ship

horizontal plane, both the rudder and ailerons are used, and for turning in a vertical plane, the throttle and elevators must be coordinated. In this ship it is hoped to achieve the right relationship between banking and turning with the ailerons only, obviating the necessity of a rudder for normal turns. The special flaps elim-

inate the need of using the rudder to shorten the glide. The third use of the rudder, to correct for cross-wind landings, may be eliminated by the special type of landing gear used. In tests at Langley field, the plane was taken off and landed ninety degrees off the wind without using the rudder.

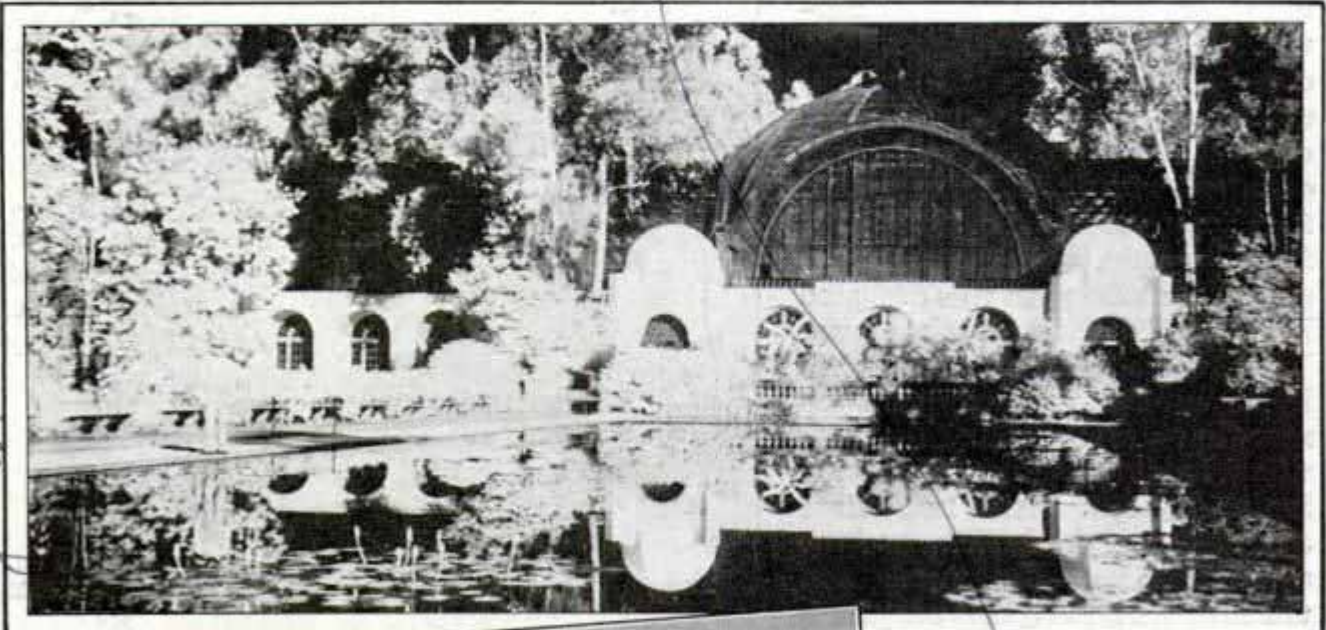
Small plane equipped with special flaps and ailerons intended to replace rudder and make it easier to control and fly than the conventional ship.

6995

Myon Lee Sherman
Los Angeles, Calif

PICTURES *from Invisible*

*J. H. Washburn, photographer
for Lockheed Aircraft Co*



By DON BLACK

THERE were no clouds but the day was heavy with haze. Overhead the sun at noon sent down a sickly yellow light. On the ground visibility was scarcely ten miles. Even 23,000 feet aloft, high in the sub-stratosphere, the haze had not thinned appreciably.

Through the pale obscurity, Capt. A. W. Stevens, the army's ace photographer, knew that 331 miles to the north stood snow-clad Mt. Shasta, 14,000 feet above sea level. It could hardly have been seen even from that height on the clearest day. Stevens waved a hand and his pilot switched off the motor, nosed the plane into a gentle glide. It seemed to hang motionless in the sky. Carefully the photographer trained his twenty-inch camera, after setting the diaphragm

Infrared Shot of San Diego Exposition, and Ordinary Photo and Infrared Picture of View from Summit of Logan Pass in Glacier Park; the Lower Photograph Is the Infrared One

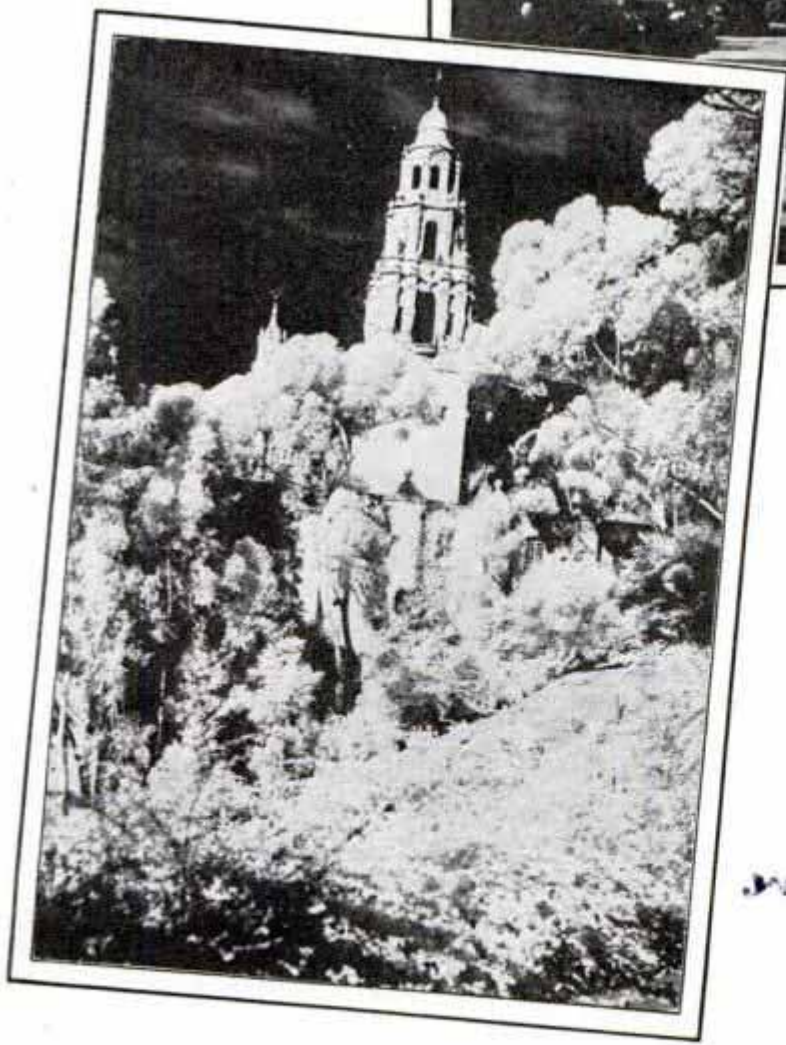
Supplies - Eastman
Kodak Co. Rochester, N.Y. 8993

LIGHT

opening at f:5 and took a slow one-fifth second.

The picture Stevens got startled the scientific world. It was not the first photograph to be taken by infrared rays but this 1932 negative of Mt. Shasta printed with such compelling drama that it found publishers around the world.

Today, with infrared rays and plates, it is a simple matter to take pictures in absolute darkness. Rare manuscripts and valuable old papers are deciphered with ease

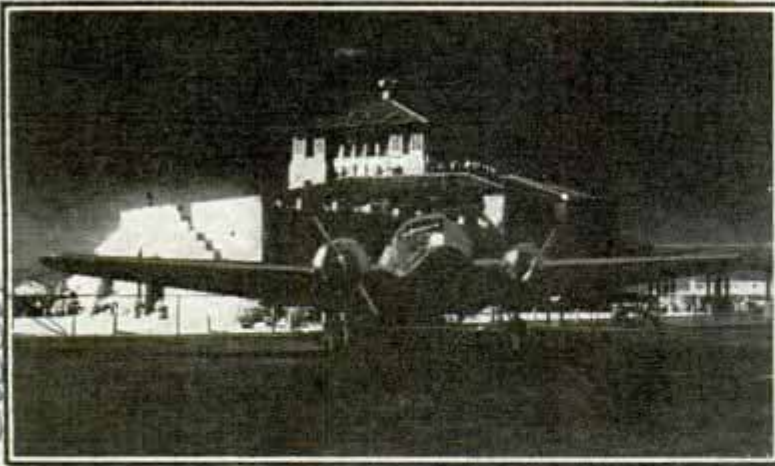


Infrared Photos of San Diego Exposition, Showing Strange Effects Provided by the Green Shrubbery Which Comes Out White in Bright Sunshine

from infrared photographs. Criminologists are employing the rays as a means of facial identification. With them biologists are reporting extraordinary success in the study of skin diseases and in locating varicose veins. Because of its miraculous fog penetration, great ocean liners nose with increasing confidence through crowded sea lanes. Photomicrographs with infrared reveal hitherto unsuspected details in the internal structure of insects.

The amateur photographer, however, has been slow to realize that infrared is also available for the most inexpensive camera and provides a fascinating hobby at little cost. A few gelatin filters purchased at ten cents per square inch are virtually the only extra equipment required, if you have

6995
 Electric
 at Terminal
 Oakland
 Calif.



Top, an Infrared Photo of a Transport Plane, and, Below It, an Ordinary Shot of the Same Ship



Old Baldy and San Gabriel Mountains Taken with Infrared and by Ordinary Means from Fifty Miles

Kodman Super-Sensitive

holders to take glass plates. Infrared plates may be obtained for \$1.10 per dozen in the four by five size.

Infrared rays are heat rays and invisible. The ordinary electric-light globe gives off light and also warmth. The globe is hot because of the invisible infrared or

heat rays. The best sources of the rays are the sun, the arc lamp and the tungsten lamp filament. The photoflash also gives off heat rays, as do soldering irons, electric heaters and other devices.

If the light from the household bulb is passed through a spectrograph you will find all the colors of the rainbow. Although a continuation of the red end, infrared is outside the color spectrum and thus invisible. The ordinary photographic plate or film responds to blue and violet light and to the invisible rays beyond the violet end of the spectrum known as the ultraviolet. It was found that if a plate were bathed in solutions of certain dyes it would respond to light of other colors. Still newer dyes make possible the infrared plates of today that record invis-

ible light. One of the most striking characteristics of infrared photography is its amazing distance and range. There actually is no limit, save for curvature of the earth.

With ordinary plates or films, the detail in distant objects is poor, even though visible to the naked eye. This is because the air suspends minute particles of water

vapor that break up the actinic spectrum rays which produce the normal photograph. Water vapor, however, is penetrated with ease by the infrared and distant objects show clearly. This is not true of smoke in the air although there is a certain penetration beyond the limitations of ordinary plates.

In infrared photography there are certain limitations as to the camera. Infra rays pass through certain materials impervious to ordinary light. Thus the black cloth of a focal-plane shutter is no barrier. A Graflex may be used in time exposures, however, by opening and closing the mirror. With a newspaper Speed Graphic, only a front-lens shutter can be employed. Diaphragm leaves should be of steel rather than composition materials.

Carchemote film

Box cameras that take a plate holder are safe, as are most types of aerial cameras and the Contax "candid" camera equipped with a flexible steel shutter. Infrared film in this standard thirty-five-millimeter size is available.

Most leather bellows, at least on the later cameras, are infrared proof. Rubber plate-holder slides, however, should be changed for metal. Hard rubber transmits infrared rays and plates may be fogged. There is one type, however, which may be identified by three or five dots on the metal tops, which is safe.

As yet, only glass plate films are available. They may be obtained in most standard sizes. The type 1-R is recommended for initial experiments. These plates will keep for several months but are best preserved if cold. If kept in an ice box or refrigerator, remove the plates several hours before they are used. If not permitted to warm up considerably, "sweat" will form on the plates and give rise to markings.

Best results are obtained by the use of red filters. The Wratten A, Tri-Color Red, No. 25, is most used. The 23-A filter is sometimes effective, as likewise is the No. 29, the 88-A and the 89-A. Whereas these shut out only the visible light and not the infrared, thus requiring no difference in exposure, the No. 87 also cuts down on the infra rays. Thus somewhat longer exposures must be made. In general, any filter that removes all violet and blue light may be employed. Best results are obtained by focusing with the filter in place, with exception of the No. 87. Gelatin filters are inexpensive. Cemented glass filters range from \$1.65, unmounted, to \$3.75.

Meters are of no assistance because they do not react to infrared rays, so exposures would be largely guesswork without the benefit of the experience of others. J. H. Washburn, photographer for the Lockheed Aircraft company and an authority on infrared photography, has found that one-fifth or one-tenth second with bright sun at f:4.5 is a basic exposure. This is with the No. 25 filter. Stopping down the aperture to f:45 should bring good results with a six-second exposure. He also has made good negatives on dark, cloudy days at f:16 and twenty-five seconds, which is about the equivalent of two seconds at

(Continued to page 116A)

"Stop, Look" Signal in Auto Warns Driver of Crossing

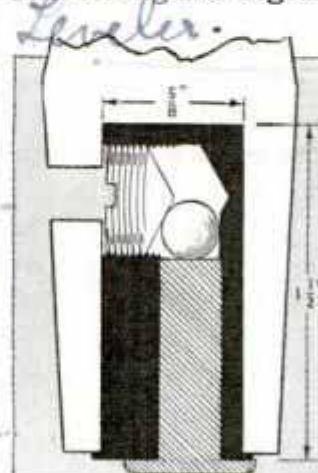


Red Light and Bell on Dashboard Give Warning to Motorist When He Approaches Grade Crossing

Railroad crossings are no peril to one Baltimore motorist. He carries his own "Stop, Look, Listen" signal on the dashboard. A red light flashes and a bell rings when the automobile approaches a railroad. The signals are connected with a detector unit sensitive to steel imbedded in the road.

"STRETCHER" EVENS CHAIR LEGS

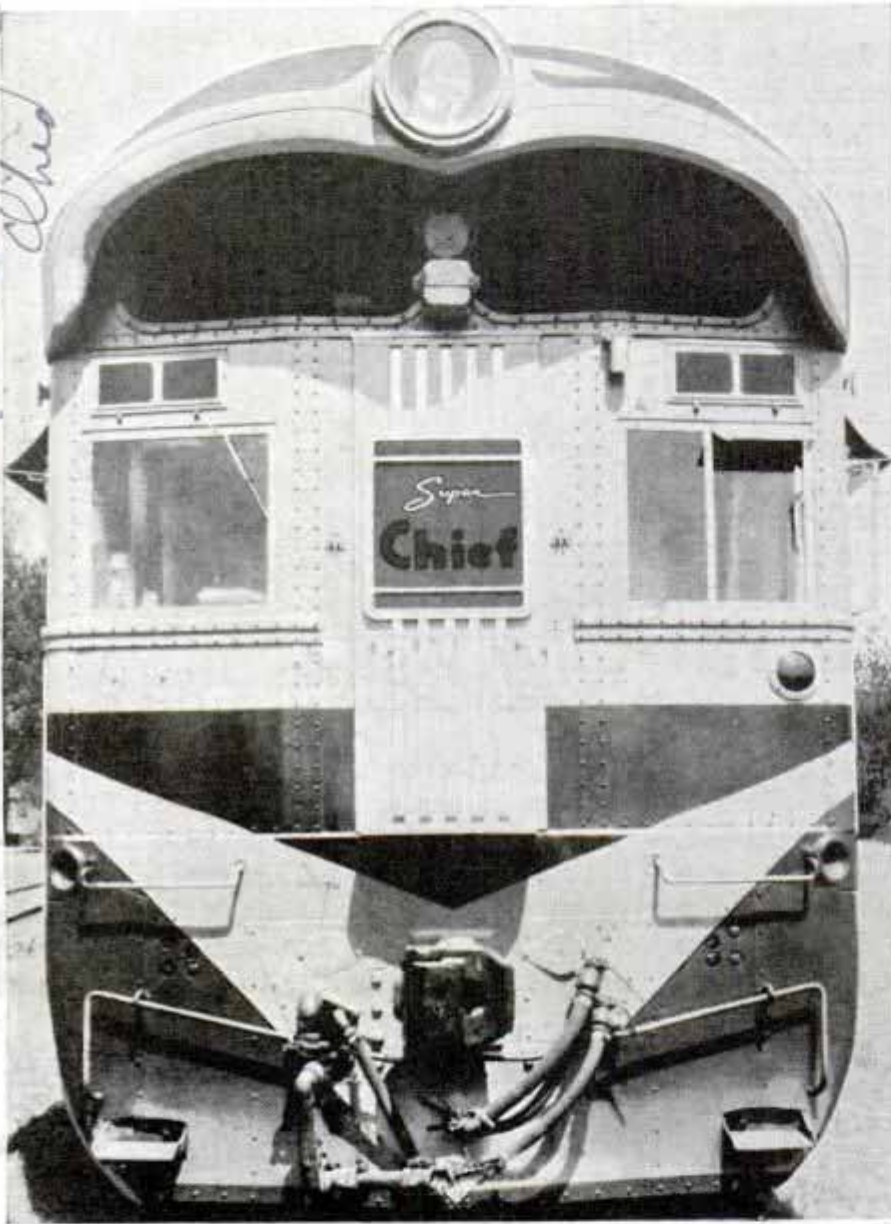
Wobbling chairs, tables and beds can be kept level with an "equalizer" which fits like a caster inside the leg. A set screw controls a ball and plunger which move down or up in a cylinder, lengthening or shortening the leg as required.



When the screw is turned in, its cone-shaped head presses against the ball, causing it to push the plunger down. By loosening the set screw, the ball is released upward. The device is one and one-half inches high by five-eighths of an inch wide.

Handwritten notes:
13560 north ave
R. A. Boly
Maryland and Pennsylvania
Wade World
F. C. S. Charles Adler, Jr.
New. Park Ave.
489
Dartford Steel Ball
C. H. H. H. H. H.

Blunt-Nosed Diesel Speedster Challenges Rail Time-Tables



Front View of Powerful Diesel Locomotive Built for Chicago-to-California Passenger Service; Square Nose Is Departure from Tradition

new type locomotive the Santa Fe road plans to challenge its own passenger train schedules between Chicago and Los Angeles, believing its greater flexibility and elimination of stops for fuel will make possible faster travel than with steam engines. The maximum safe speed of the Diesel locomotive is put at ninety-eight miles an hour, already equaled by steam locomotives, but the Diesel's low center of gravity and rotating type of motive plant permit greater speed on curves and bridges; it accelerates more rapidly and requires fewer operating stops. The twin Diesel power car cost \$360,000, but lower fuel and operating costs are expected to offset the high initial expenditure. Removable steel "skirts" covering the wheels and under part of the body give a streamline effect but the nose is quite blunt. The cabs at either end are connected by aisles on each side, flanking the engine rooms. Heavy motor parts can be lifted through removable roof sections when necessary.

Into the race against time the Atchison, Topeka and Santa Fe railway enters a Diesel-electric locomotive described as the most powerful of its type on rails. It has two distinct power plants, each comprising two V-type twelve-cylinder, high-compression, two-cycle oil engines rated at 900 horsepower. The units can be operated singly from control cabs at either end of the car, or linked into a single 3,600-horsepower traction unit. The engines weigh only twenty pounds per horsepower, economical in weight as in fuel, of which 1,600 gallons are carried. With the

DENTAL ILLS SEEN CLEARLY BY MERCURY VAPOR LIGHT

Unhealthy teeth and diseased mouth tissues show themselves up in the greenish spotlight of a mercury vapor lamp. Some dentists are using this light for diagnosis in preference to sunlight or common electric bulbs. Under the mercury lamp, sound teeth appear whiter and there is a slight characteristic fluorescence. Tartar and film deposits on teeth do not possess this fluorescence and stand out in contrast to healthy teeth.

Built by Electro-Motive Winton Engine Co. No. 2160 W. 196 St. Cleveland Ohio

Westinghouse Lamp Co. 50 Rockefeller Plaza N.Y.C.

81039

Used by Dr. M. M. Brooklyn

Football Dodge Dummy Trains Ball Carrier

6700
 Football Dodge Dummy
 Co. Les manes d'art.
 \$17.50 job

Some of the tricks of open field running on the gridiron can be learned by stiff-arming the dummy tackler, newest addition to the mechanical teaching staff of the football coach. Devised by a former football player and coach, it consists of a sheet-steel cone mounted on a discarded auto-truck casing, which gives resiliency. The cone is partly filled with sand.



Top, Stiff-Arming the Dummy; Left, Ball Carrier Plunging between Dummies

From the top projects a cast-steel arm, adjustable to ten positions, at the end of which is a head fitted with a regulation football headgear. Setting it at various positions, the ball carrier can practice line plunging, stiff-arming and dodging without any risk of injury to himself or the tackler. Two or more dummies can be arranged on the field like a series of tacklers through whom the runner must weave, pivot and sidestep, developing footwork.

'Overcoat' Put on Speedboat to Reduce Wind Resistance

Cabin and tail of a speedboat at Chelmsford, Mass., were given a streamline "overcoat" by the owner, who built a two-piece cowling over the body. Its cabin, completely inclosed, is ventilated by openings over the airplane-glass windshield and air is drawn out through a large vent in the tail. Passengers enter through a door in the roof. The boat is twelve feet long, including the four-foot tail, whose separate cowling can

be lifted off to remove the sixteen-horsepower electric-starting outboard motor.



Two-Piece Streamline Cowling Covers Cabin and Tail of Boat

Herbert G. Sturtevant

Vertical text on the left margin, possibly a page number or reference.

"Queen Mary" and Oat Field Are Neighbors



Shocks of Oats Form a Strange Frame for the "Queen Mary," Nearing Completion in Shipyards on the River Clyde in Scotland; on Opposite Banks Are Grain Fields and Giant Cranes and Derricks

Through stacks of ripe oats looms the giant liner "Queen Mary," for agriculture and industry are neighbors on the banks of the river Clyde in Scotland. Before

another harvest the 80,000-ton Cunarder will have left its rustic birthplace to enter transatlantic passenger service and perhaps ring up another speed record.

Metal "Gizzard" Tests Grit Best Suited for Feeding Hens



Iron "Gizzard" Testing Samples of Grit Intended for Chickens While Hen Watches the Operation

Hens require grit and gravel to aid digestion and to provide the necessary cal-

cium for the formation of egg shells, but heretofore comparatively little has been known about the best kind of grit for this purpose. A "mechanical gizzard" has been developed recently at the University of Maryland to test the various kinds. The "gizzard" predigests the grit enabling experimenters to select the varieties best adapted for "chicken feed."

AUTO GAS PERIL INCREASES WITH COLD WEATHER

Deadly carbon-monoxide gas is present in a measurable quantity, in six out of every ten cars on the road. Tests conducted by the Evanston, Ill., police accident prevention squad showed some monoxide fumes in sixty per cent of the automobiles examined. Sixteen parts of this colorless,

81035

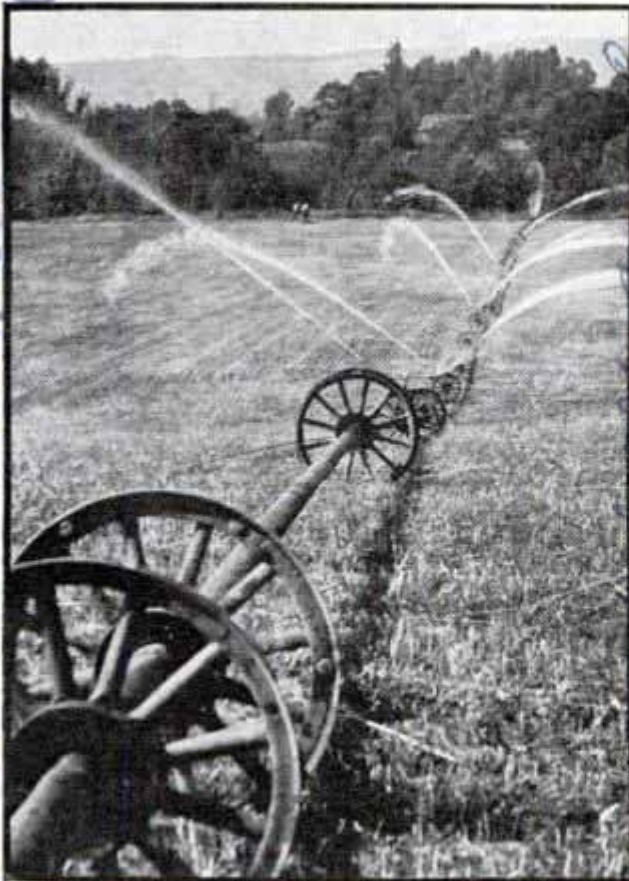
College Park, Md
81054
L. S. Grent
W. S. Grent

University of Maryland

odorless, tasteless gas in 10,000 parts of air are enough to cause unconsciousness in an hour and death in an hour and one-half, so the presence of any appreciable amount of the fumes in a car should be a cause for alarm. One way to eliminate the menace from your own car is to have the exhaust system checked regularly, particularly in the fall, because cold motors produce more of the gas and closed windows keep more of it in the car.

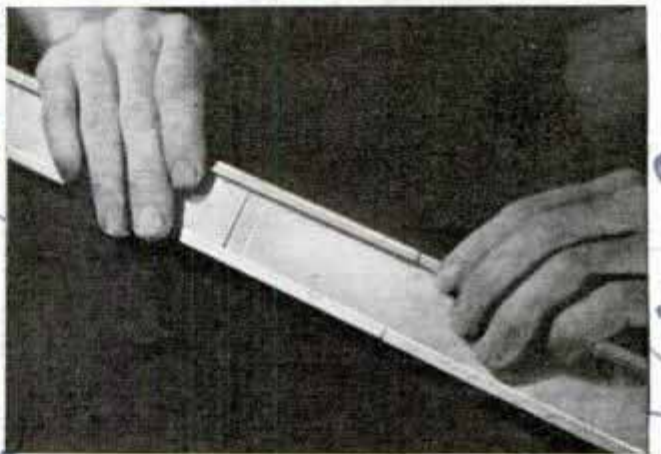
TRAVELING IRRIGATOR FOR FARM SAVES CROPS FROM DROUGHT

Insuring his alfalfa and clover crop against drought, an Oregon dairy farmer has built a traveling irrigator from used automobile wheels and old pipe. Seven revolving sprinklers provide two inches of water on a strip sixty feet wide in four to five hours. Three men can move the system from one area to the next in less than half an hour. The pipe, which has rubber couplings between the sections, runs through the hubs of the wheels. A five-horsepower electric motor operates the pump at a cost of five to six dollars an acre per year. The system cost about \$500.



Portable Irrigator Made of Old Auto Wheels and Pipe and Operated by an Electric Motor

Venetian Blind Ventilator Adjusts to Fit Window



Adjustable Window Ventilator for Bedroom Permits Free Circulation of Air but Assures Privacy

Modeled after a Venetian blind, an adjustable window ventilator for the bedroom or bathroom offers complete privacy but permits free circulation of air. It consists of two slotted uprights which are screwed to the window frame in such a manner that they do not interfere with raising or lowering the window. Adjustable metal slats are slipped into the slots, resting at such an angle that free circulation of air is permitted. While no outside eye can peer in, limited vision is permitted from the inside. The metal slats can be quickly removed or the entire device can be moved by changing the two uprights. The ventilator is thirteen inches high and comes in two widths, a minimum of twenty-two inches and a maximum of thirty, and a minimum of twenty-eight inches and a maximum of thirty-nine inches.

near Blue Lake in Oregon

9/4/35

my friend
Co. 1725 W. North
Chicago

E/1012

E/1028

Chicago Metal Co. 626 W. Washington

W. E. Townsend

G. L. Royce

HUNTING



By **BOB BECKER**

THROUGH the autumn and winter thousands of well-bred, trained dogs will be put to work after going to "school," or just resting and waiting for the big days in the fields. The canines that will have to put in arduous hours of work are the hunting dogs, those loved breeds which add much to the joy of hunting.

Among the better known breeds that are an incalculable asset to field sports are the trim pointer, the handsome English setter and the mahogany-coated Irish setter which thrill every quail and upland game hunter. Another group of hunting dogs are known as retrievers. This "squad" includes the powerful Chesapeake Bay retriever, a real American breed, the fast Labrador re-

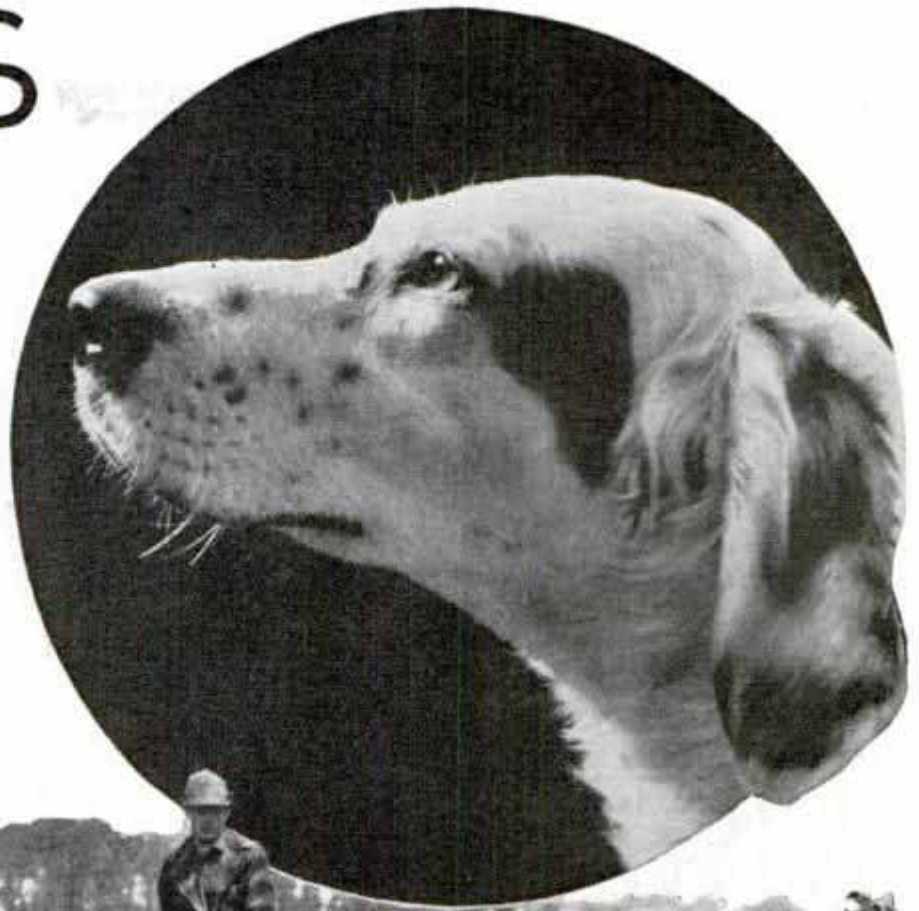


Top, English Setters, Top-Notchers among Field Dogs; Below, English Springer Spaniel in a Duck Blind Awaiting His Master's Orders

triever and the quaint-looking Irish water spaniel. This is the rough and ready, line-smashing group that forms the first line of offense for the waterfowl and upland game hunter. Another army of sportsmen

DOGS

English Setters, among the Most Companionable of Hunting Dogs and Delightful Companions in the Home as Well; the Setter Is Recognized as a Wonderful Dog for Finding and Pointing Upland Game and Has Excellent Bird Sense



call into action the springer spaniels, one of the most popular "dual purpose" dogs in the country, the cocker spaniel, that merry little dog with such an interesting English history and the slower clumber spaniel.

Also contributing their share to the fun of hunting is the musical-voiced beagle hound, which "sings" by night when he strikes the fresh scent of game, the popular, long-eared coon hound, and the rangy foxhound, another dog with a grand-opera voice. Most of these breeds are absolute necessities in hunting and the dogs not only help their masters find game, but many of them also compete in field trials.

These hunting breeds differ in origin, character and working qualities. They have, through the years, developed an ability to do one or two things especially well. The English setter, one of the most companionable of hunting dogs, was originally used as a dog to "set" coveys of birds so the early hunters could net the game birds. Of course, this was before the use of firearms, and it was not considered unsportsmanlike to net game birds. Today the setter with his silky coat, lovable disposition, expressive eyes, good nose and excellent bird sense would be insulted if anybody netted birds in front of him. To those who like days in the field with a



even today a red setter shows a trace of this. The Irish setter is every inch a hunter and a flashy performer too. The Gordon setter, another handsome member of the pointing dog group, is a deep, shiny coal-black with tan markings. A Gordon stands about twenty-two to twenty-five inches at the shoulder and is an extremely hardy dog but unfortunately he has not made

shotgun, the English setter fits into the picture perfectly. The breed makes a delightful companion in the home and is recognized as a wonderful dog for finding and pointing upland game.

Ever since the pointer, a short-haired, smooth-coated bird dog, was introduced into England from Spain, it has been a rival to the setter. Those first pointers were slow, so breeders introduced new hound blood to produce a faster dog. By careful breeding through the years we have today a useful, handsome bird dog weighing around fifty or fifty-five pounds, smooth-coated, rangy, fast, with intelligence and marvelous scenting ability.

The Irish setter is the "red setter" to many dog lovers. This is the beautiful, mahogany-red hunting dog to which Ireland gives its name. Thousands of dog lovers admire his sparkle, beauty, personality and intelligence. Certainly there is a lot of "color" in this breed's temperament as well as in his coat. The Irisher works like the other pointing dogs—ranging ahead of the guns to find and point his game. A long time ago Irish breeders had setters with a lot of white on them and



Above, Two English Setters; Bottom, English Labrador Retriever and an Irish Water Spaniel

very much headway in America as yet.

When we look into the duck blinds, we find a trio of dogs that might be called the "backfield" for the waterfowl shooter.

(Continued to page 124A)

Half-Tones Made on Photo Film Cost Less



Drawings Show Successive Stages in Taking Photograph and Transforming Film into Half-Tone Cut Which Can Be Mounted for Use on Printing Press

about \$100.00. See cut



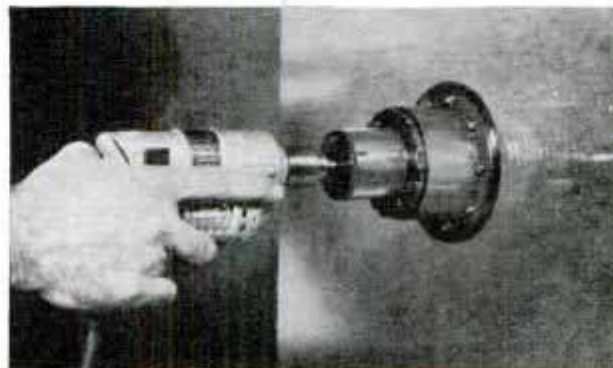
For only twenty-five cents you can transform an ordinary photograph negative into a half-tone cut suitable for the printing press, and the process takes just eight minutes. These cuts, mounted type high on wood blocks, have been used 25,000 times in printing runs, and they can be used to make electrotypes, thus saving much of the cost and time required to prepare a zinc etching. First the picture is taken and the film developed in the usual way. Then the negative is placed in contact with another undeveloped film, a special screen furnished by the manufacturer is inserted between the two films, and the exposure is made. The second, or

positive film is then developed in special chemicals for four or five minutes, washed and allowed to dry. The developer, available on the market, builds up the half-tone dots on the positive film instead of etching them, as in the zinc method.

81049
 International Research Laboratories
 622 W. Rosecrans, Compton, Calif.

Electric Drill for Glass Has a Suction Guide of Rubber

Drilling holes in glass, marble or china-ware, usually a precarious undertaking, is made easy with a small electric drill equipped with a rubber suction guide which can be placed in any position, holding the tool very rigid, thus preventing breaking and chipping. A clean cut is made and the equipment includes drills from one-half inch to six inches. The suction guide enables the operator to drill from a horizontal or vertical position or from any angle.



Electric Drill for Glass with Suction Guide

Tel. Buchanan 2024

International Research Laboratories
 622 W. Rosecrans, Compton, Calif.
 1950
 1951
 1952
 1953
 1954
 1955
 1956
 1957
 1958
 1959
 1960
 1961
 1962
 1963
 1964
 1965
 1966
 1967
 1968
 1969
 1970
 1971
 1972
 1973
 1974
 1975
 1976
 1977
 1978
 1979
 1980
 1981
 1982
 1983
 1984
 1985
 1986
 1987
 1988
 1989
 1990
 1991
 1992
 1993
 1994
 1995
 1996
 1997
 1998
 1999
 2000
 2001
 2002
 2003
 2004
 2005
 2006
 2007
 2008
 2009
 2010
 2011
 2012
 2013
 2014
 2015
 2016
 2017
 2018
 2019
 2020
 2021
 2022
 2023
 2024

Midget Hurdles Rival in Death-Defying Race



Wide World
 Racers and Fans Had a Breath-Taking Thrill When No. 18, Roaring into the Turn, Skidded and Leaped over No. 43; Inches from Death, Both Drivers Righted Their Cars and Shot on around the Track

Leap frog is a dangerous game for racing cars sizzling down the track at eighty or 100 miles an hour. Trying to pass No. 43 on a turn during a 100-mile midget auto race, Curly Mills of Los Angeles, driving No. 18, skidded and in a flash his car leaped into the air and hurdled his rival. It was a hair-breadth escape, but both cars

continued until Jimmy Prock of Detroit, in No. 43, was forced to withdraw several laps later. This was one of the thrills of midget auto racing, mushrooming into wide popularity. The six-foot cars attain speeds as high as 135 miles an hour on small tracks, of which there are more than 150 in the United States.

Collie Proves Dogs Can Think by Tilting Electric Dial



Testing Dog's Mental Energy with Electric Meter

psycho-galvanometer
 Do dogs think? A collie proved he could by agitating the needle of a meter used to measure man's mental effort in terms of electric energy. A positive electrode was placed on the dog's upper jaw, the negative connected to one paw. Familiar questions were put to the collie—"Do you want to go bye-bye?" and "Where is your master?" In each case the dial of the instrument, calibrated to show resistance from 1,000 to 60,000 ohms, responded in much the same manner as in tests of human beings. In applying the meter to the human mind, the dial would register high resistance when an unschooled person is given a difficult mathematics problem, while one adept at mathematics would record less mental exertion.

Dr. Orlando F. Scott 330

Westport, Conn.

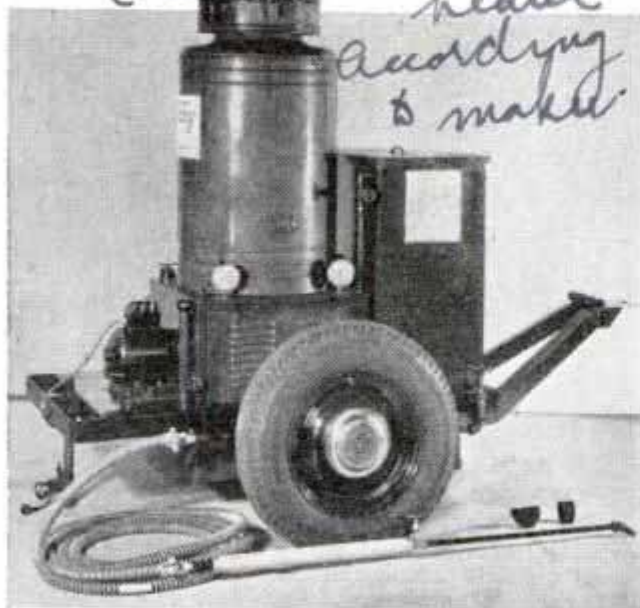
8926
mahan unknown

**"WASHING MACHINE" FOR RIVER
WILL REMOVE THE SILT**

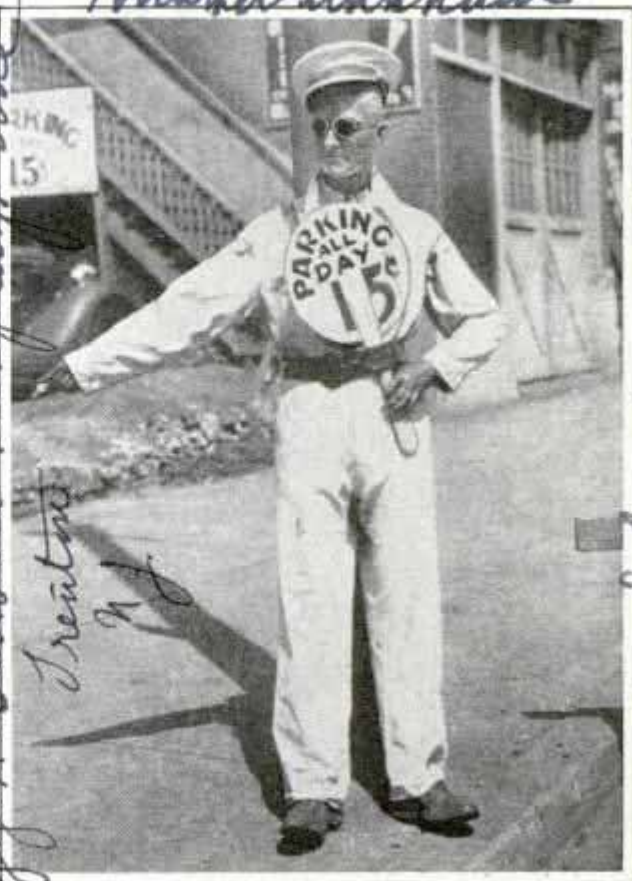
Removing silt from the Colorado river to provide a clear stream for irrigated areas in California, a "washing machine" comprising seventy-two clarifiers, each 125 feet long revolving like turntables, will be built at the Imperial dam near Yuma, Ariz. Batteries of twelve clarifiers placed in six settling basins 769 feet long and 269 feet wide will revolve on their centers at fourteen-minute intervals, scraping the silt into wells. They will "launder" seventy-five per cent of the river's daily flow, an amount equal to one-twentieth the volume of water rushing over Niagara Falls every twenty-four hours. It will take from an hour to an hour and a half for water to pass through the basins.

**PRESSURE SPRAY FOR CLEANING
IS MOUNTED ON TRAILER**

Mounted on a two-wheel trailer for quick transportation from one job to the next, a chemical spray designed for cleaning buildings and machinery opens up new avenues to "contract" cleaning business. A steam boiler builds up high-pressure steam which is used to spray cleaning compounds adapted to the job at hand. It can be used to clean walls, painted surfaces, filling station and garage floors, airplanes, industrial plants and greasy engines and parts.



Boiler Mounted on Trailer Develops Steam to Spray Chemicals at High Pressure for Big Cleaning Jobs



Uniformed Like a Regular Attendant, a Lifelike Dummy Welcomes Motorists to Parking Lot

**DUMMY HIRED MAN ON AUTO LOT
SPURS PARKING TRADE**

Dressed in smart white uniforms and caps, life-size dummies are being used by the owner of a chain of parking lots to increase his business. Made of rubber composition, the figures bend into practically any position assumed by a man. Placed at the various entrances to beckon cars to the lot, they look so real that patrons sometimes ask them questions.

**AIR GAUGE BUILT IN AUTO TUBE
ALWAYS SHOWS PRESSURE**

Air pressure gauges that are constantly working are now being built into the inner tubes of automobile tires. To check your air, you need only unscrew the outer tire cap and read the gauge level. The air-valve tube remains stationary, the gauge moving up and down around it.



Homestead Valve Mfg. Co

Chicago Tribune 9/21/31

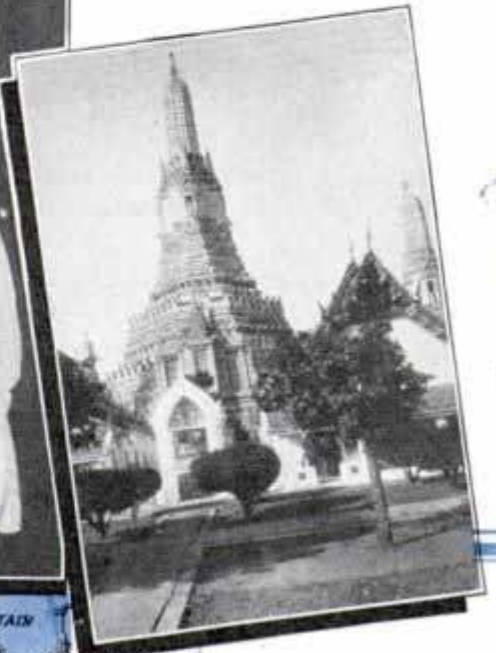
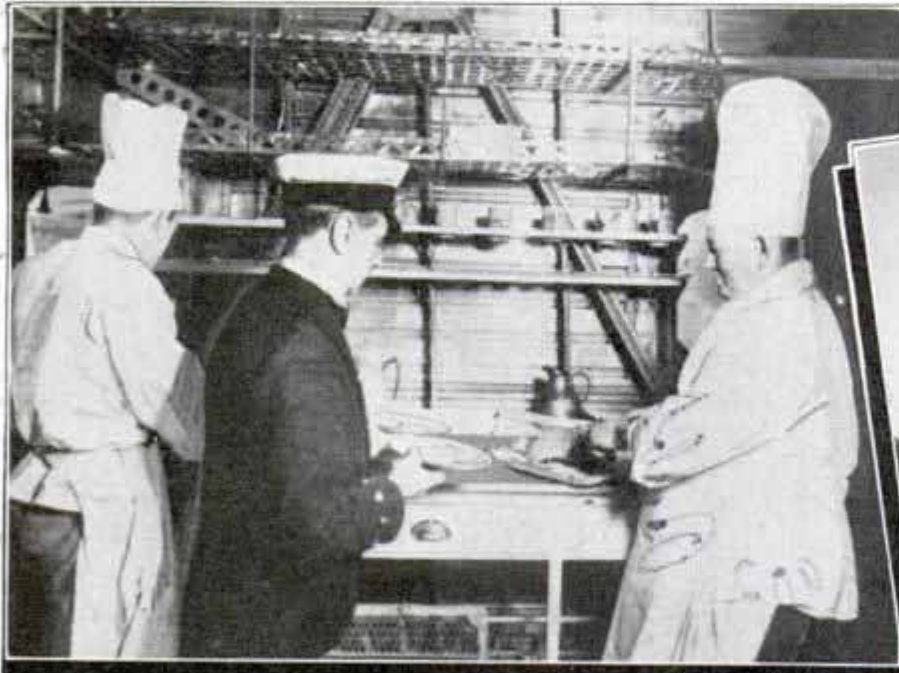
8989
Suggested - Rubber development

Trenton

Henry A. Schaefer, 2230 W. Walton, Chicago
Scientific Development Laboratories, 938 Fullerton, Chicago



WINGS over the



IN THE jungles of India or the heart of Africa you usually can set your watch today by the roar of the Imperial Airways plane flying overhead.

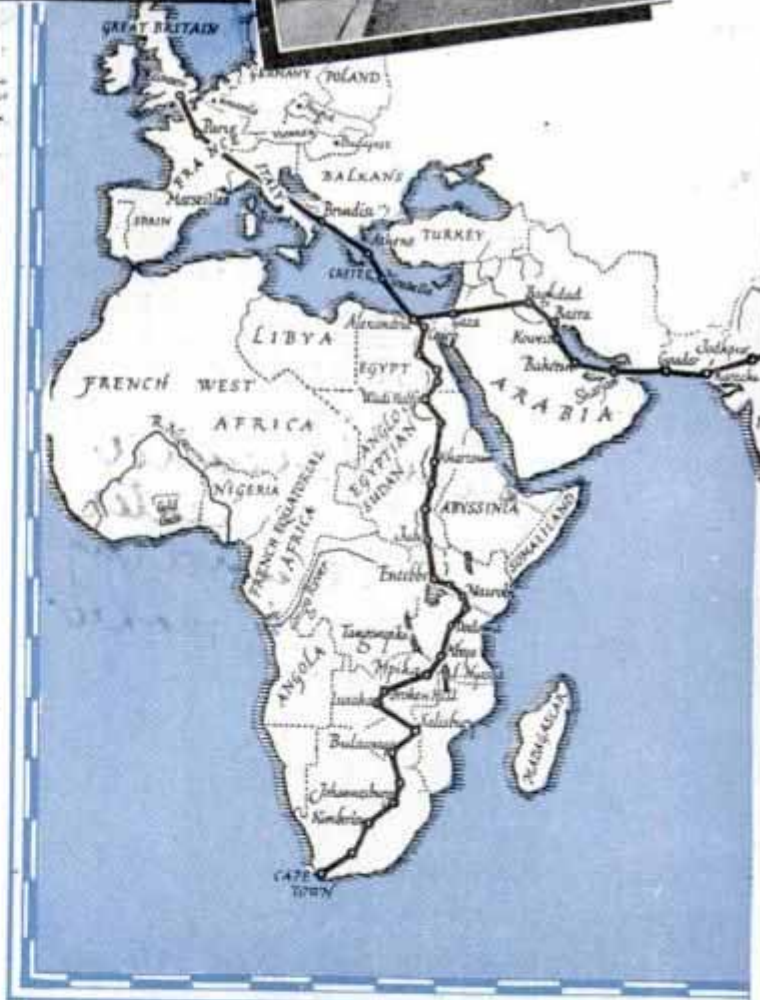
A single operating company, partly financed by the British government, has the job of linking together an empire that compasses the globe and includes more than 350,000,000 people.

Imperial's regular air lines touch three continents, but in the near future these lines will take in several other continents, so that day after day the sun will never set on Great Britain's flying transports.

From Croyden Field, London, a network of 18,000 miles of airways takes the passenger to any one of twenty-three countries. You can fly direct to such out-of-the-way places as Kenya, Nairobi, Rhodesia, and Tanganyika, in the heart of Africa; or to such queer spots as Gwadar, Delhi, or Rangoon, in the south of Asia.

With fine courage and determination, the Imperial Airways pilots are flying over some of the most difficult land stretches known. For the most part their routes lie in tropical countries, but the climate is not nearly as comfortable as in many northern countries. Along the hot desert stretches, the wind feels like a blast of hot air thrown off by a furnace.

Imperial Airways flies over long and in-



Courtesy Imperial Airways
Top, Left, Preparing Meal in Kitchen in Air Liner "Scylla"; Right, Wat Aron, Imposing Building at Bangkok; Bottom, Map of Far-Flung Air Line, with Heavy Line Showing Route Extending to Cape Town on the Tip of the African Continent

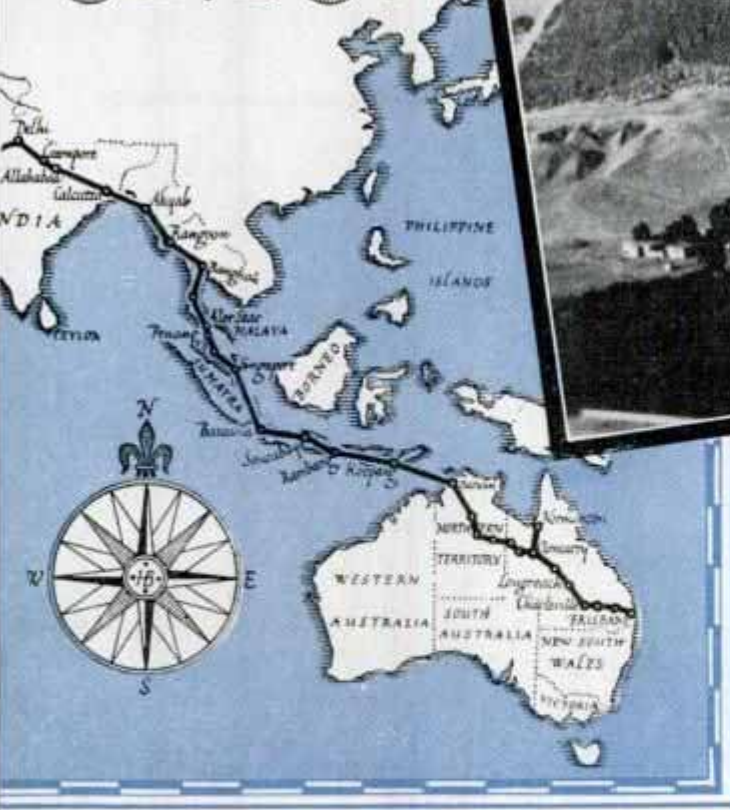
*Com. Lord Kitchener, 9 p 10 1923
New York*

BRITISH Empire

2073
E802



The main routes of IMPERIAL AIRWAYS and companies in association



hospitable stretches in both Asia and Africa. A good deal of the territory is inhabited only by wild tribes and wild animals. Despite all this, the company has proved its ability to carry on a regular and an efficient service.

With the aid of England's foremost aeronautical engineers, Imperial Airways has designed a fleet of land planes and flying boats which fall into seven classes. Each ship is equipped for a particular service. A plane that flies in Africa, for example, is far different from the one which is used to fly between Croyden and

Top, Arabs on Guard as Giant Plane Unloads at Sharjah (Photo Copyright by Fox Studios, Ltd.); Right, View of Gizeh Pyramids, One of the Sights along the Imperial Airways; Left, Map Showing Route along Which the Big Transports Fly from India to Brisbane, Australia



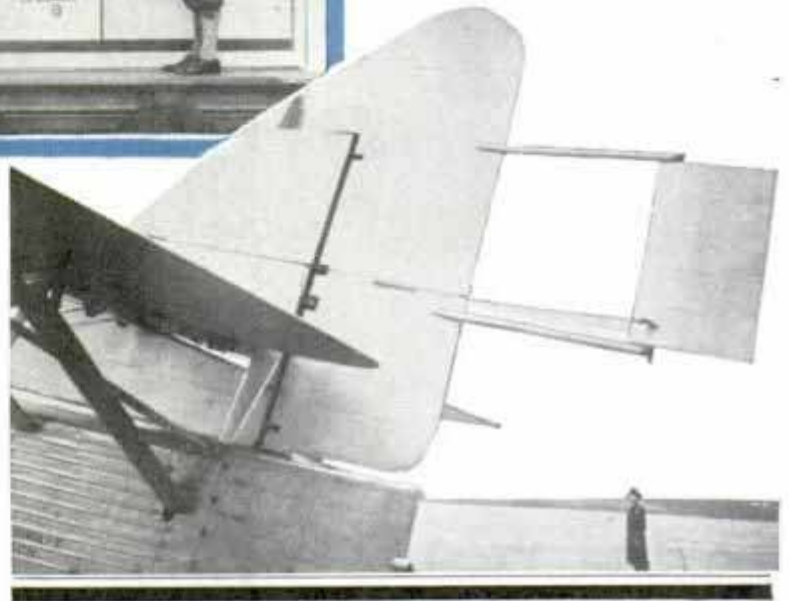
Courtesy Imperial Airways

Le Bourget. These ships have such fantastic names as "Hannibal," "Scipio," "Atalanta," "Avalon," "Diana" and "Boadicea."

The largest type now in service on Imperial Airways is the "Scylla," which accommodates thirty-nine passengers and carries a crew of four, the captain, first officer, radio operator and steward. The "Scylla" is a biplane with four air-cooled Jupiter engines, each developing 555 horsepower, enabling the ship to maintain a cruising speed of 130 miles per hour. Fully loaded, the "Scylla" weighs almost fifteen tons.

Ships of the Imperial Airways, as all other European aircraft, maintain slower schedules than corresponding American craft. The economics of high-speed travel are decidedly against the European airplane operator. One difficulty is the delay encountered at the numerous international boundaries. Another reason for slower speed is the increased cost of aircraft which cruise at 200 miles or so per hour. But probably the most important consideration in the high-speed operation of European aircraft is the cost of fuel. Aviation fuel, depending upon local conditions, costs from two to five times as much as it does in the United States. In the heart of Africa and in Asia, aircraft gasoline is a very expensive item.

But the company is not standing still in the matter of speed. They are slowly but surely increasing the speed of their long-distance schedules by refining the design of their planes and engines. The present speed schedules along American airways would prove uneconomical under the conditions which prevail in Africa, Asia,



Top, Board Showing Latest Weather Reports on European Routes; This Information Is Posted for Pilots at the Air Port of London; Bottom, Tail Assembly of the Giant "Scylla," Thirty-Nine Passenger Plane in Imperial Airways Service

and Europe. Imperial's four-engined ships of the "Atalanta" class weigh almost nine tons fully loaded and have a speed of 155 miles per hour. However, three of the seven classes of ships operated by the company have a speed of 175 miles per hour, which stands up fairly well beside the speed of American commercial craft.

Expansion plans are quite ambitious. The company is laying a strong foundation for a globe-girdling airway, 20,000 miles long, which will probably be operated in conjunction with Pan American's Pacific line. The result of this union will be an Anglo-American air line passing





Courtesy Imperial Airways

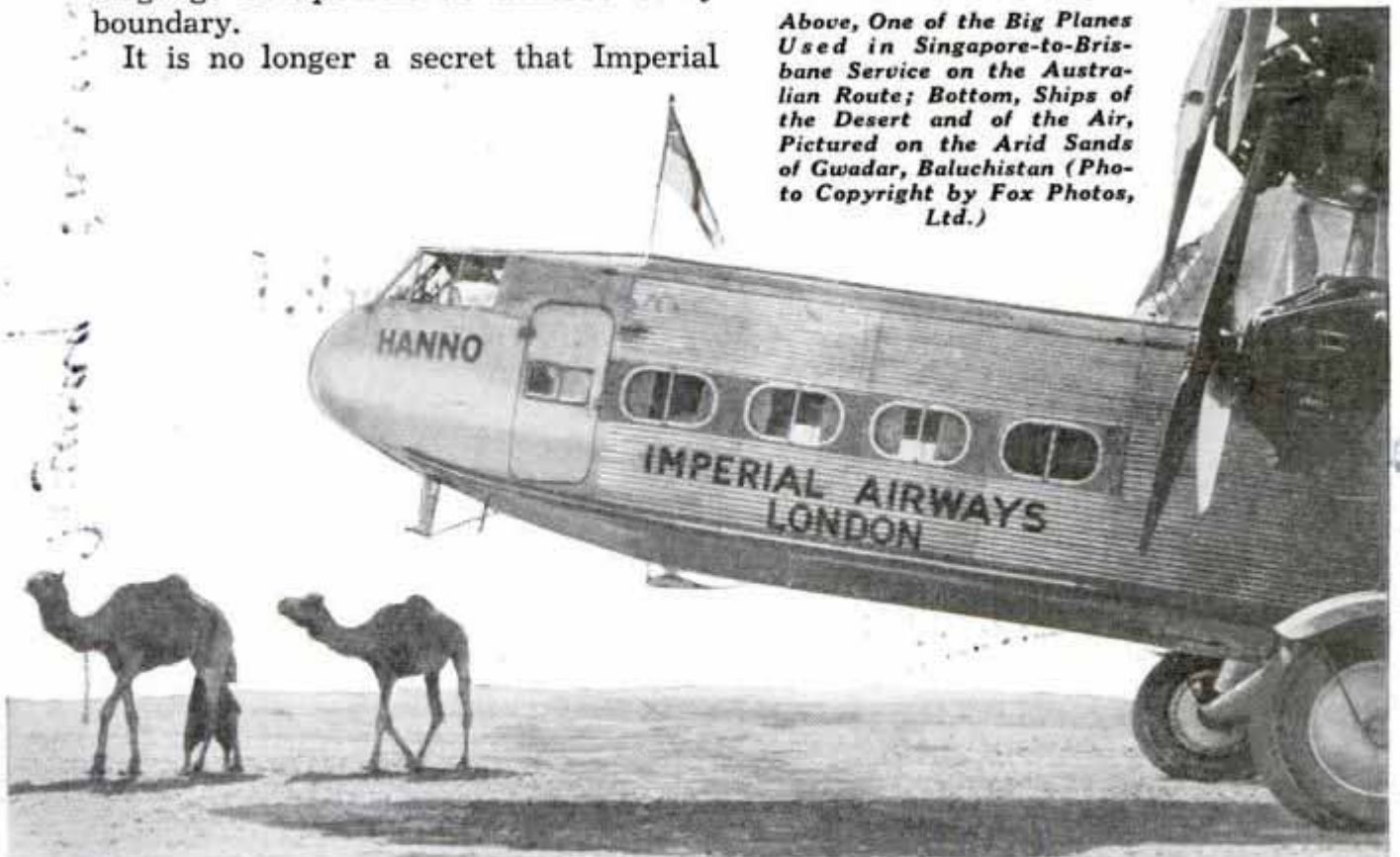
through countries where scores of foreign languages are heard. In other words, you will be able to travel around the world with English alone. If you travel around the world by train and boat, the situation becomes quite complicated—a different language is spoken at almost every boundary.

It is no longer a secret that Imperial

Airways has under way a new class of aircraft of a much larger size than the giant "Heracles" and "Hannibal" types which have a wing span of 130 feet and weigh thirteen tons loaded. The British govern-

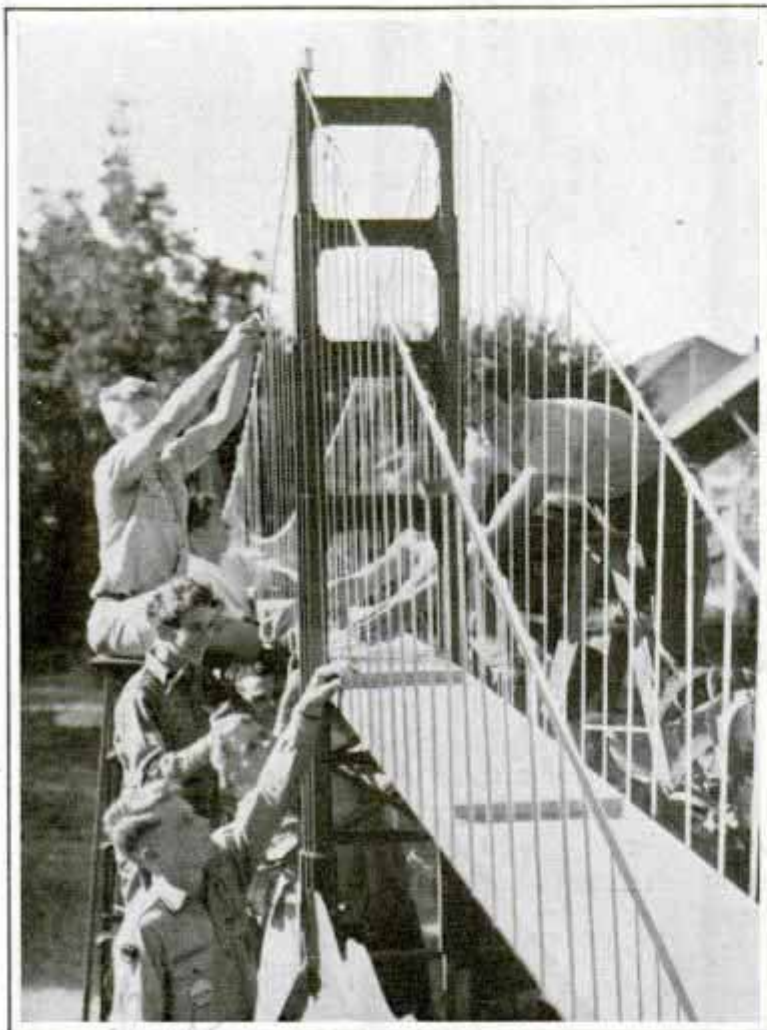
(Continued to page 149A)

Above, One of the Big Planes Used in Singapore-to-Brisbane Service on the Australian Route; Bottom, Ships of the Desert and of the Air, Pictured on the Arid Sands of Gwadar, Baluchistan (Photo Copyright by Fox Photos, Ltd.)



Imperial Airways Ltd. London

Scouts Build Big Model of Golden Gate Bridge



Boy Scouts Weaving Ropes in Lieu of Suspension Cables for Replica of California's Golden Gate Bridge

California boy scouts have built an exact model of the Golden Gate bridge on a scale of one foot to 100. Ropes replace the steel suspension cables in the replica, whose center span is strong enough to bear the weight of several boys.

OIL CARD REMINDER ON DASH

When to change oil or have the car greased is a mathematical certainty with motorists who use a card-record system. The card fits in a small metal shelf clamped underneath the dash within easy reach

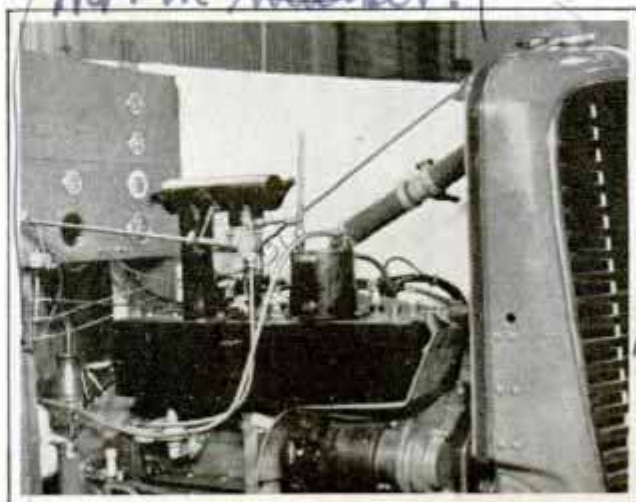


of the driver's hand. On it the attendant records the mileage whenever the oil is changed or the car greased and writes down the mileage at which service will be required again. A glance at the card tells when the car should be serviced.

8938

GAS ENGINE RUNS ON OIL BY USING ADAPTER

Conversion of a gasoline motor into an oil-burning engine by a mere turn of a dashboard switch is the feat accomplished by an adapter now undergoing tests. Trucks equipped with this adapter and carrying 10,000 and 20,000-pound pay loads were able to travel at an average cost of 2.4 cents a mile. After warming up the motor, the driver turns a switch which shuts off gasoline and cuts in the oil flow, both fuels being handled by the same carburetor. The adapter consists of a controlled heat interchanger between the engine coolant, exhaust heat, liquid fuel and carburetor air supply. The fuel oil is warmed in copper tubes which absorb heat from the water cooling system. The motor must be started on gasoline for about two minutes, and when the water reaches 140 degrees Fahrenheit the change-over can be made by means of a three-way valve.



After Starting on Gasoline This Motor Can Run with Fuel Oil by Turning Switch on Dashboard

Conversion of a gasoline engine into an oil-burning engine by a mere turn of a dashboard switch is the feat accomplished by an adapter now undergoing tests.

8920
beginning
California

Dist on Pacific Coast

used by Midwest

Dog "Laundry" Is a Money-Making Venture

Laundering dogs at a dollar each is the profitable business set up by two University of Missouri graduates. Starting out with modest equipment and washing forty pups in the first week, their venture flourished and they now call for dogs in their own truck, launder them, dry them



Left, Rinsing Dog with Warm Spray after Creosote and Water Dip and Soap Bath; Upper Right, Dogs Are Called for and Delivered in Company Truck; Lower Right, Electric Drier Is Applied after Bath



with apparatus comparable to that of a beauty parlor, and deliver them clean, dry and "de-fleed." First they submit the dog to a veterinarian for thorough examination, and if there is any symptom of skin infection or internal ailment the owner is notified and the dog returned or left with the veterinarian for treatment. This is a valuable service to dog owners and protects the "laundry" against lawsuits should the owner discover the disease in his pet later. Besides, the veterinarian pays the dog laundry a commission on all cases received through this channel. If the dog

passes the physical examination he is dipped in a creosote and water solution to exterminate fleas and ticks then bathed and scrubbed with special dog soaps, and finally dried with electric driers. Numerous profitable sidelines can be added, such as clipping dogs, boarding them during vacations, selling dog foods and medicines, harness and other accessories.

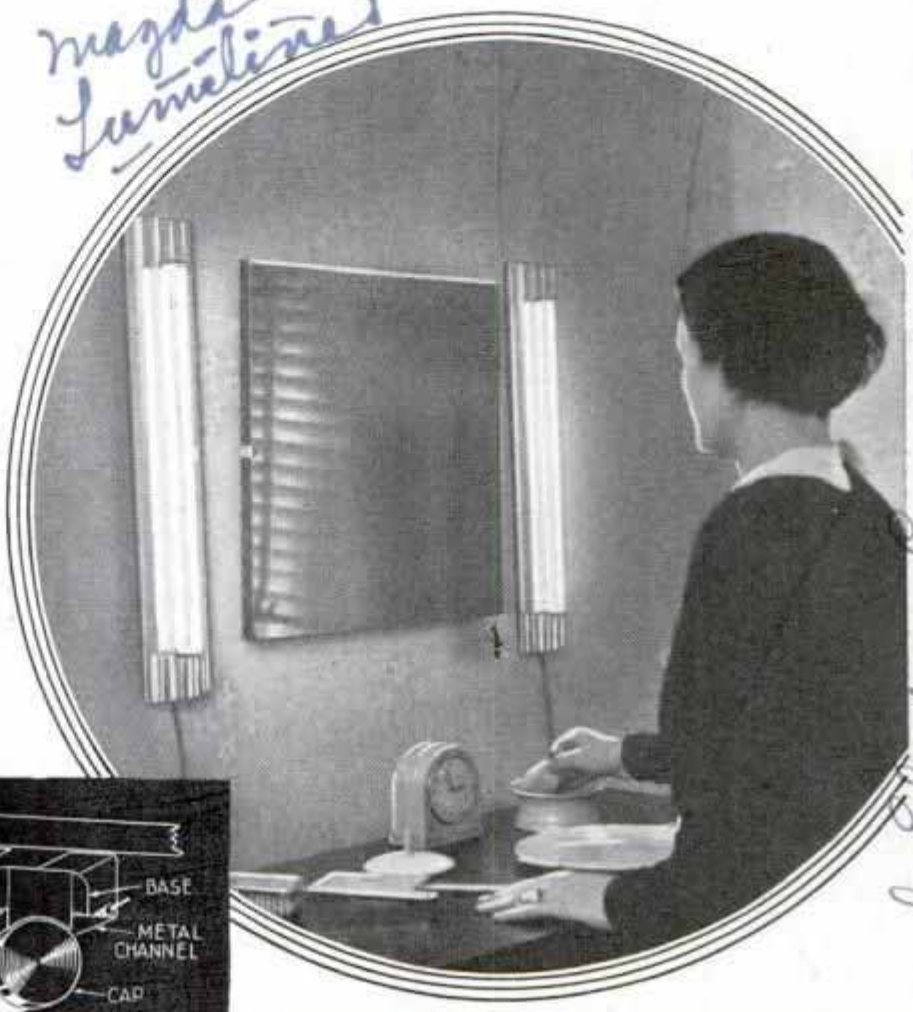
Pub of Wash DC 1935
Country Club Laundry
7526 Westhall Road
Kansas City, Mo

8950

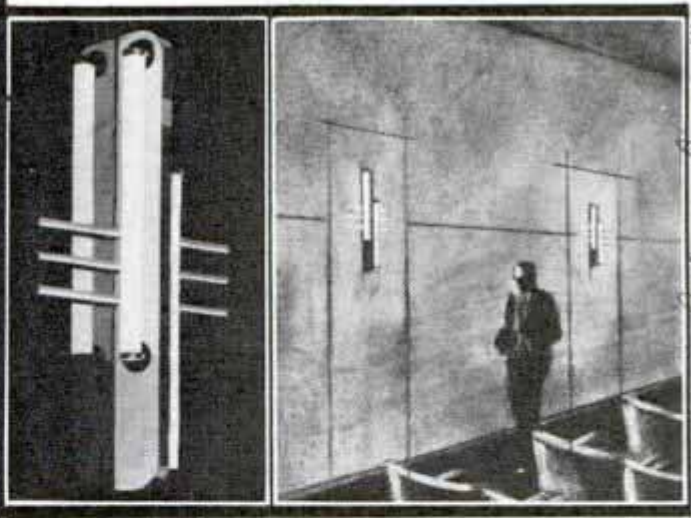
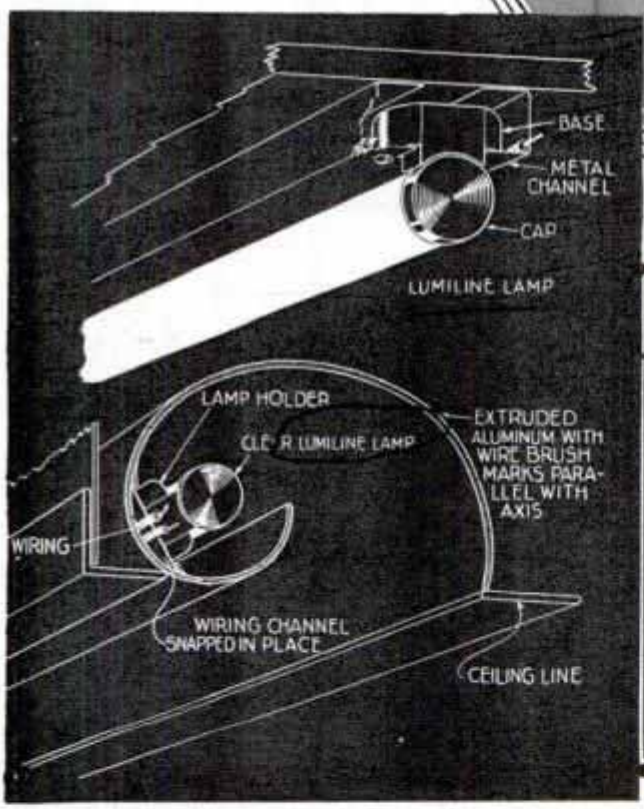
Filament Tube Lamps Used for Decoration

Slim and trim are the decorative lines of light produced by the newly developed electric filament lamp attaining popularity in the modern home and office. Made in units twelve and eighteen inches long, it is readily adapted to ornamental illumination, to geometrical figures in harmony with modern architecture, and to long lines of continuous light in white or pastel hue. Because of its standard units it is quite versatile. In its glass tube is a single stretched-coil tungsten

Mazda Lumilines



General Electric Co. P. Park Cleveland Ohio



Left, Diagram of Tube Lamp Installation for Direct and Indirect Lighting; Upper Right, Ornamental Units Used as Mirror Lights in Boudoir; Lower Right, Theater Lighting, with Closeup of Lamp

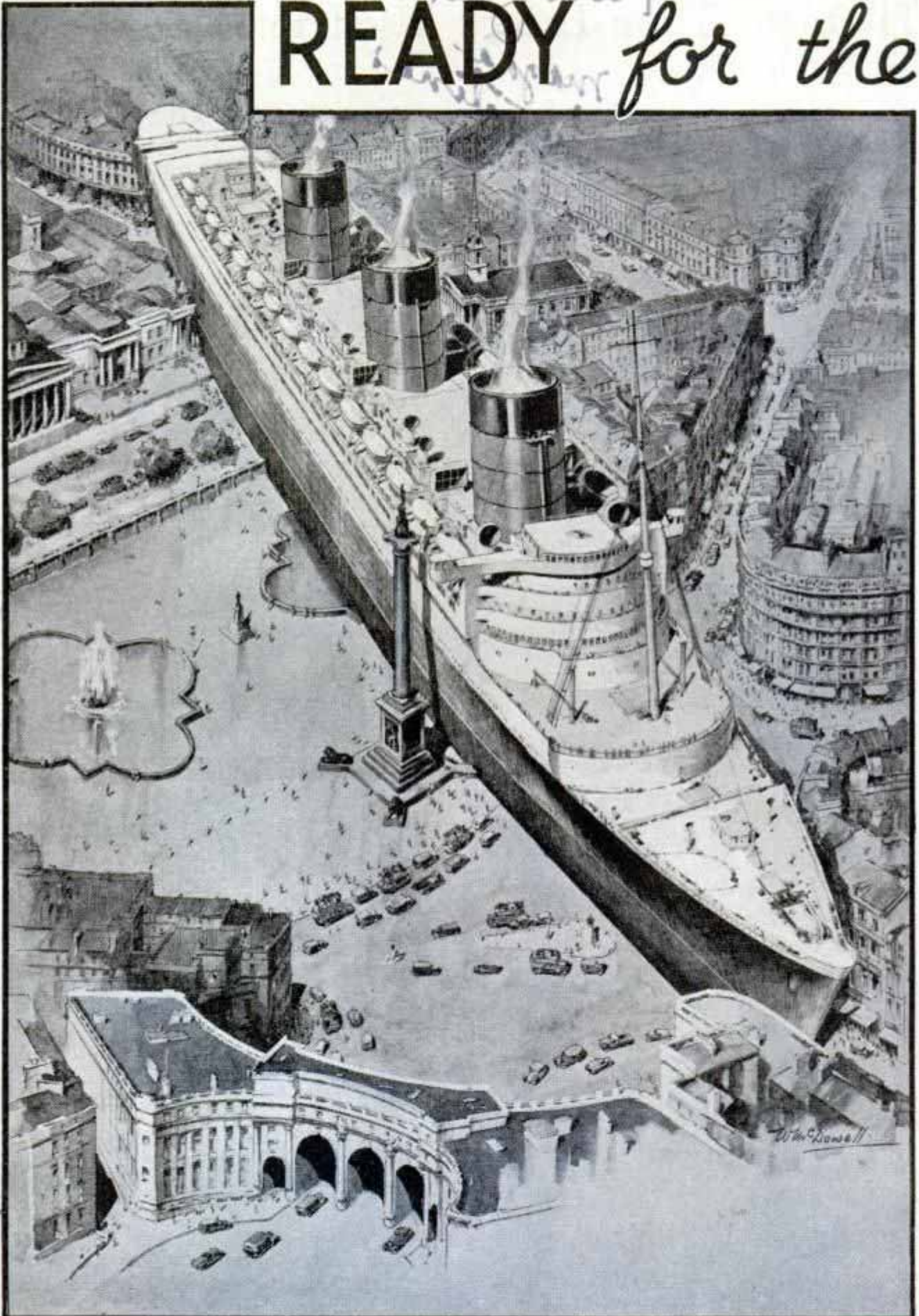
filament, spanning in a continuous line from one end-cap to the other. The end-cap "snaps" on, and serves as a support for the tube; each end-cap fitting into a base to which the wires of the electrical circuit are attached. The cap is but a quarter inch thick, and when several units are installed end to end the caps are too

thin to interrupt the apparent continuity of the luminous line. Any lamp can be renewed simply by removing lamp and cap from the base. Theater lobby lighting, side lamps for shaving mirror or boudoir table, art gallery illumination, outline lights for escalators—these are some uses found for the pleasing new lines of light.

Chicago - Commercial Electric Edison

4 W. 103rd
New York City

READY for the



The "Queen Mary," England's Challenger for the Atlantic Speed Record, as She Would Appear if Placed Across Trafalgar Square in London

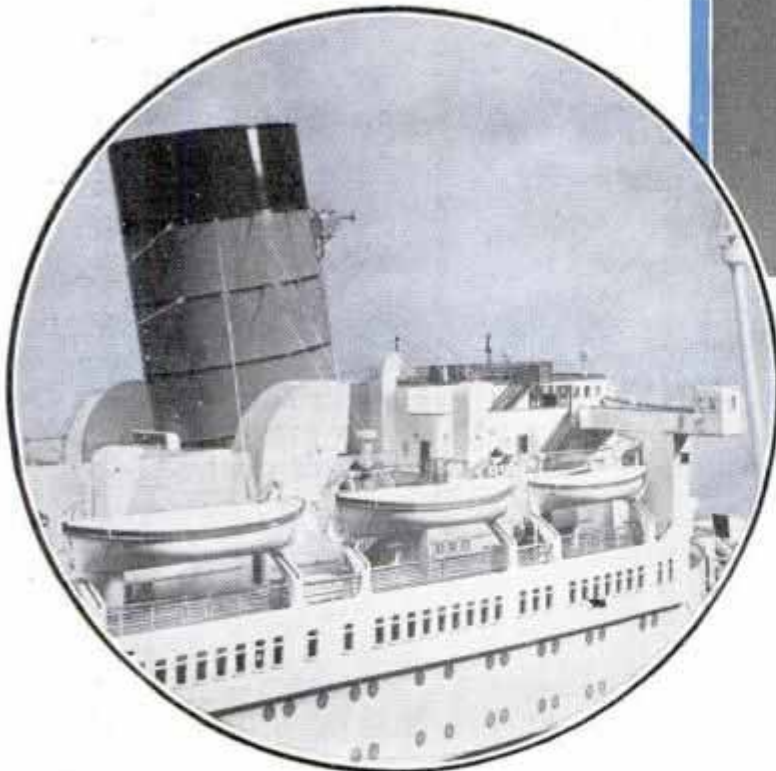
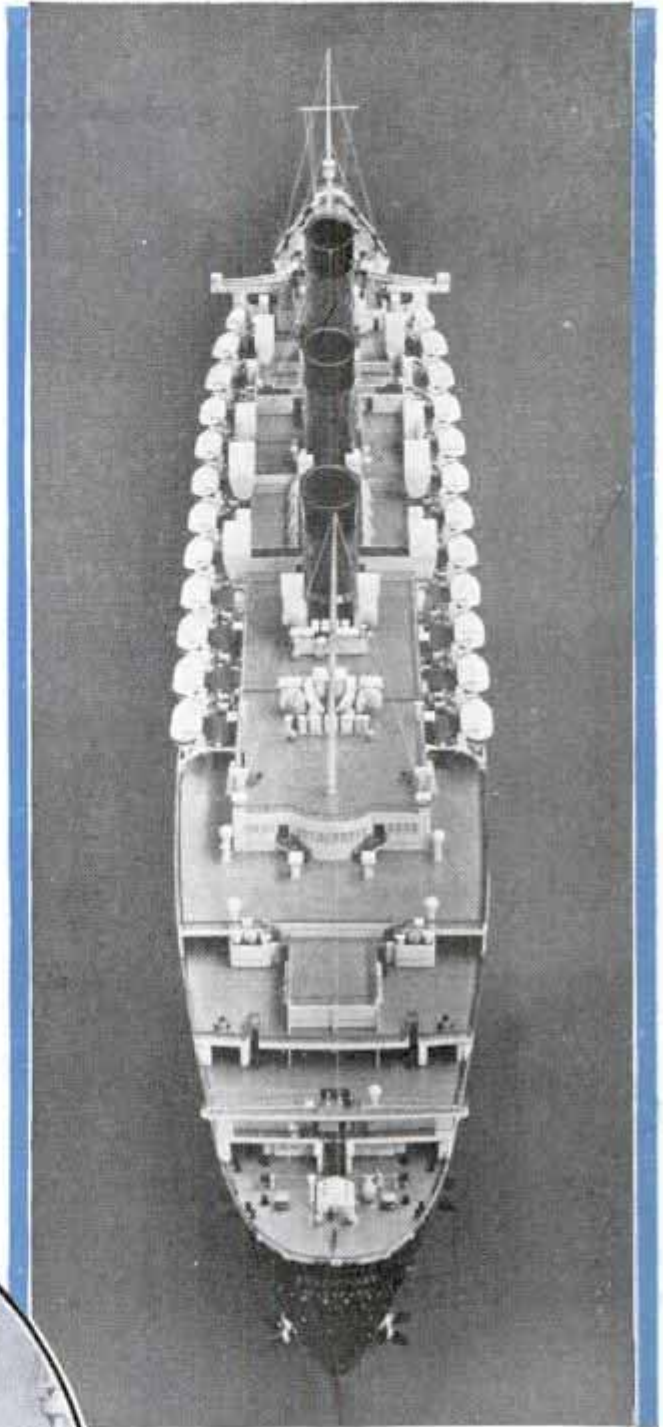
Vertical handwritten text on the left margin, including the word "Grand" and other illegible scribbles.

RACE

THESE are tense days at John Brown's shipyard on Clydebank as an army of British workmen apply the finishing touches to the "Queen Mary," the ocean greyhound which England hopes will recapture the Atlantic speed record now held by the French liner, "Normandie."

This shipyard has a grand tradition to uphold. In 1907, on this very spot, John Brown launched the gallant "Lusitania," followed a few months later by the "Mauretania," an engineering masterpiece from the day of her launching to the time of her scrapping.

When the "Queen Mary" goes into service, about next June, the famous emblem called the "Blue Riband" will be near its one-hundredth birthday. The Cunard Line and Clydebank have enjoyed Blue Riband honors for about fifty years of that time, a matchless record in maritime history. The British have always taken a huge pride in their ability as shipbuilders, and they are leaving nothing to chance in the creation of their greatest undertaking, the "Queen Mary." It is built like a fine watch and

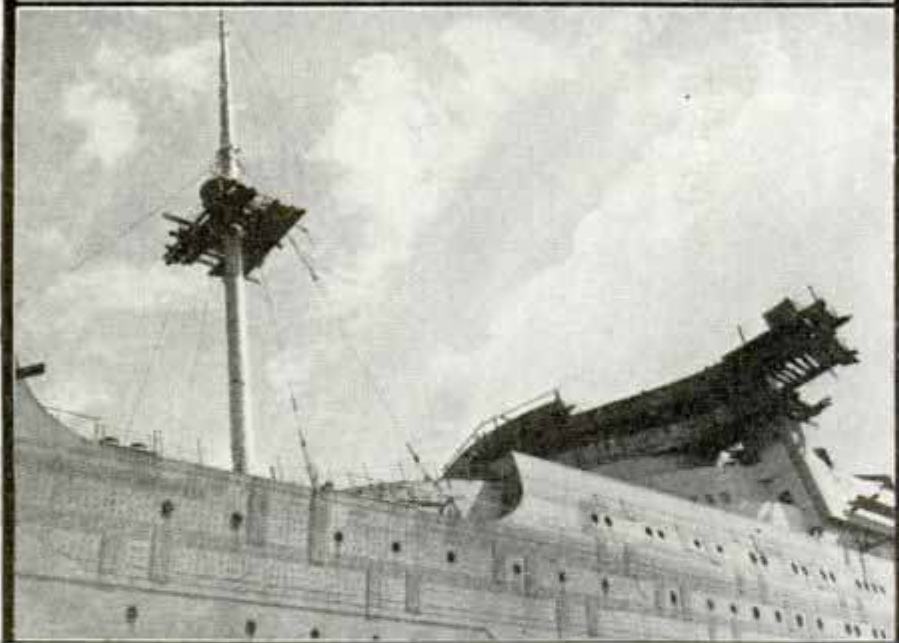
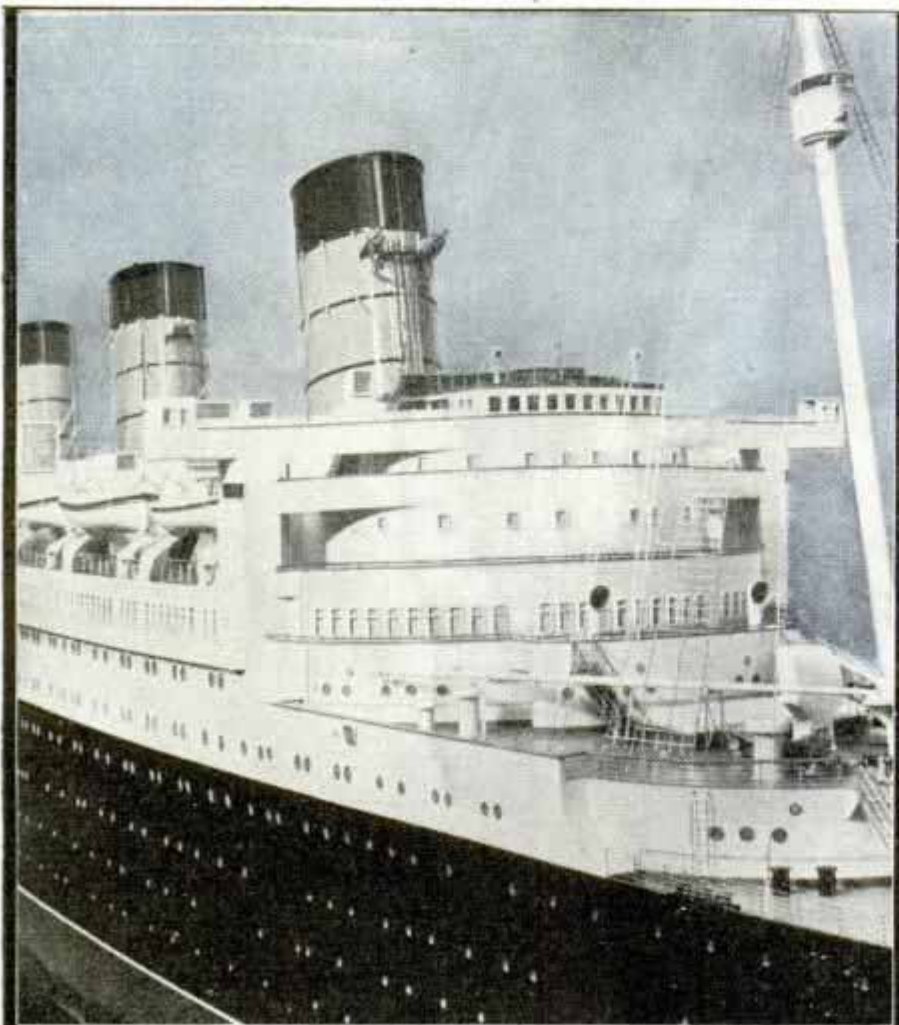


Looking Down on a Twenty-One Foot Model of the "Queen Mary," and Close-Up of Section of the Model

every ounce of material entering into the construction is of sterling quality.

They build engines, these British. The "Mauretania" might have run another fifty years on the old steel and brass pounders that gave her the stamina for speed. The "Queen Mary" is harnessed to a system of Parsons single reduction geared turbines which are supplied with steam from high-pressure water-tube boilers.

The "Queen Mary" is eleven



Top, This Close-Up of a Model of the "Queen Mary" Gives an Idea of How Finished Liner Will Appear; Below, Part of the Superstructure

feet shorter than the French liner but the Parsons turbines are expected to develop from 25,000 to 40,000 more horsepower than the "Normandie's" turbo-electric engines, rated at 160,000 horsepower. The Cunarder's four propellers are the largest

ever cast and fitted to a vessel. Each cast of manganese bronze weighed fifty tons in the rough, and the finished propellers weigh thirty-five tons each.

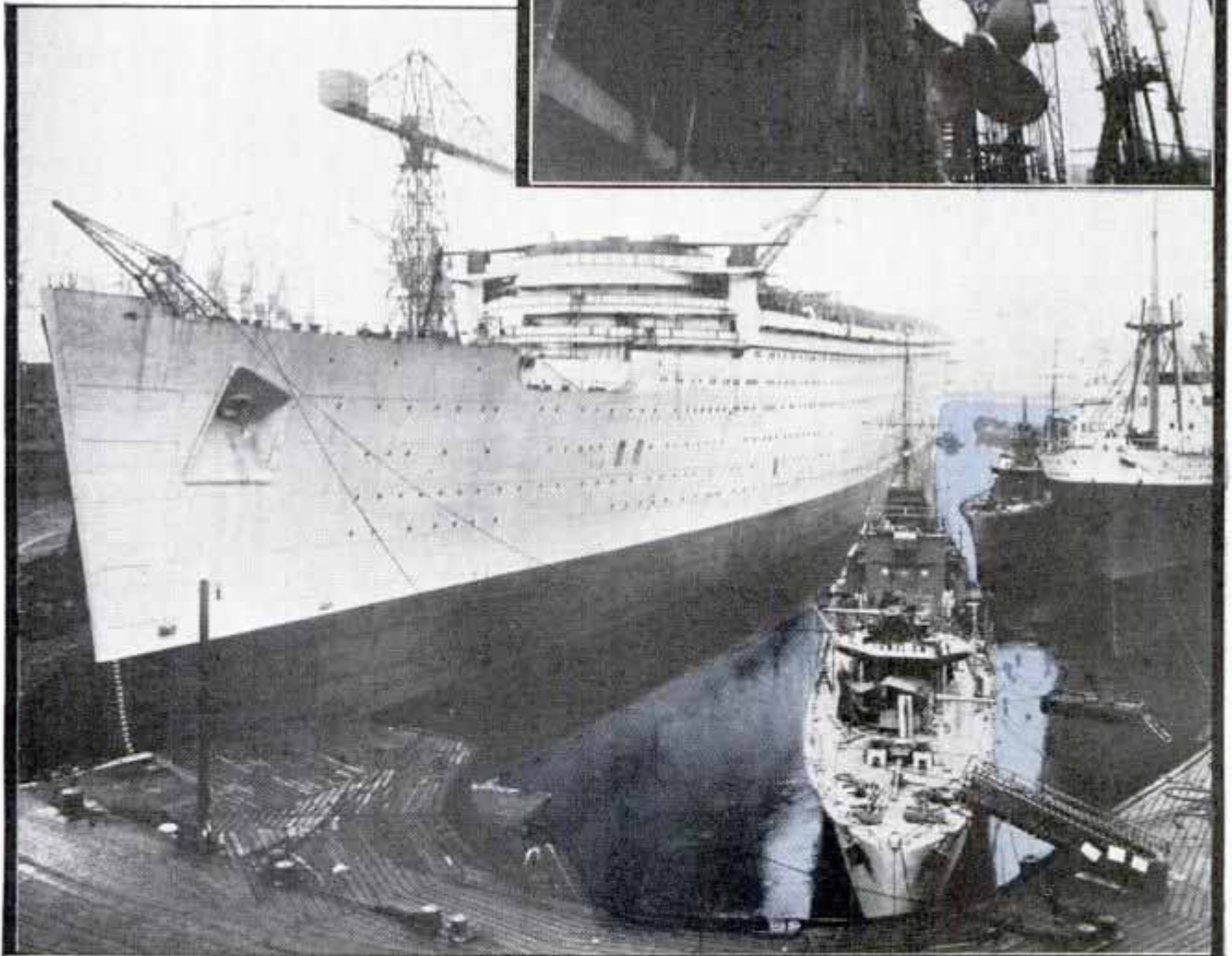
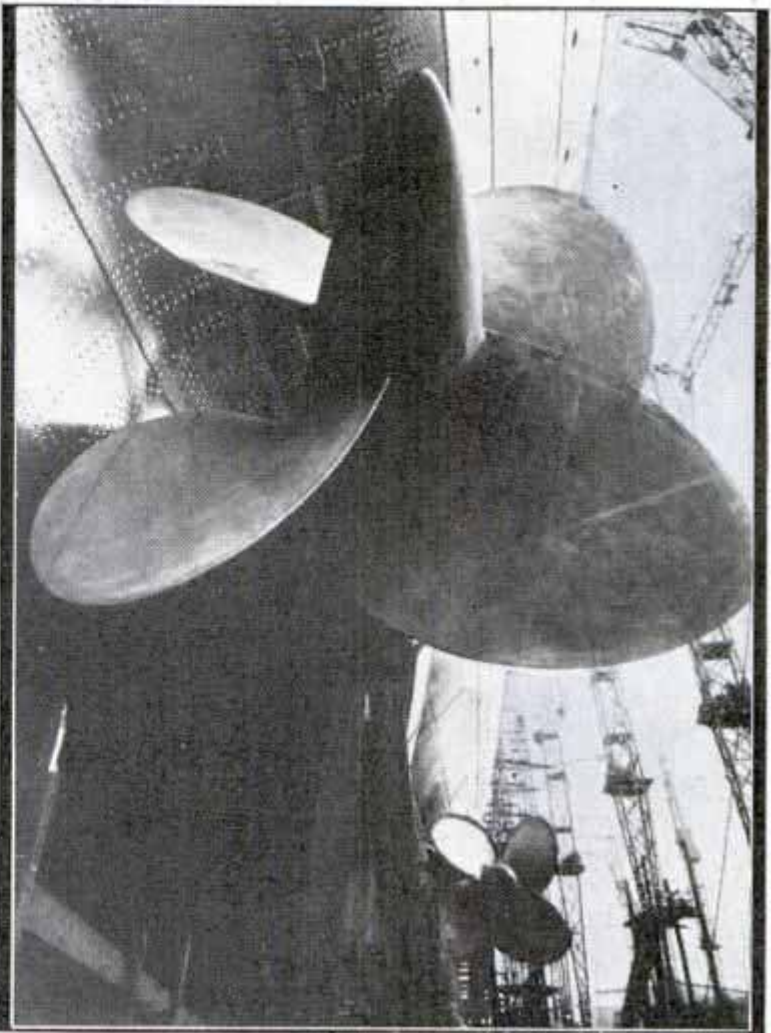
The "Normandie's" semi-bulbous bow, whaleback deck, and stepdown stern give the ship a new and original contour. The outboard design of the "Queen Mary" follows the tradition of the "Mauretania" and other Cunarders. The most striking difference between the two giants lies in the design of their funnels. The "Normandie's" are low and stubby; the Cunarder's are set very high.

The "Queen Mary's" main machinery spaces are so huge that many so-called ocean greyhounds could fit comfortably inside them. Each of 257,000 blades for the turbines has been tested and fitted by hand and the gear centers have been carefully fitted to a limit of one and one-half thousandths of an inch. Steam will be supplied through a battery of twenty-seven boilers filling five rooms. These boilers contain 160,000 separate tubes. Four sets of turbines will drive the four propellers. The design of the hull has been planned to permit the propellers to "bite" at the huge quantities of water necessary to drive the ship forward. Clydebank engineers are aware that before the "Queen Mary" enters active service, the "Normandie" may have established a record speed of 32.5 knots. The Cunarder has been built to meet that. The "Queen Mary's" engines

are expected to drive the ship at a 32-knot clip "without pushing." When a giant ship is pushed, she may add two or even three knots to her normal high speed. Thus, the "Mauretania," rated by many as a 27.5-knot vessel, actually outstepped herself just before going out of service when, on a West Indies cruise, the "old lady of the sea" plunged through the water for nearly four hours at thirty-two knots.

The contest between the "Queen Mary" and the "Normandie" will be the greatest sporting event in maritime history. If power means anything, the Cunarder will have plenty to use and to spare, while her propellers are both larger and heavier than the "Normandie's."

(Continued to page 139A)



A Striking View of the "Queen Mary" at Rest in Her Fitting-Out Basin at Clydebank; One of the Four Giant Propellers of Manganese Bronze, Each Weighing Thirty-Five Tons; These Propellers Are the Largest Ever Cast and Fitted to a Vessel; Each Tipped the Scales at Fifty Tons in the Rough

8993

7900 So. Campbell Ave. Newark

Debra
Muh



Emptying Garbage into Latest Type Truck; This White-Painted Vehicle Replaces the Unsightly Garbage Wagon or Truck of Yesterday

ODOR-PROOF GARBAGE TRUCK TILTS FOR EMPTYING

Fitted with a water and odor-proof body, the latest truck for collecting garbage has eye-appeal in its white-painted surface and streamlines. In operation, refuse matter is deposited in a traveling bucket. A hoist raises the bucket to the top of the body where a cover that opens automatically permits dumping the contents. The mechanism closes the cover. When the load is to be discharged, the body is tilted by a hydraulic hoist.

and shipping uses, for building operations, fishing, trapping, trucking, lumbering and mining. It is made in three sizes with a load capacity of two and a half, eight and twenty tons. Special cargo hooks and detachable chain links are also made in the same design.

8902

LIGHT MACHINE GUN USED BY BRITISH TOMMIES

With a barrel that fans out at the end like a blunderbuss, the latest machine gun, known as the "Bren," has been

adopted for use in the British army. Developed in Czecho-Slovakia after four years of experiment, it is of light weight and can be manufactured at low cost. It

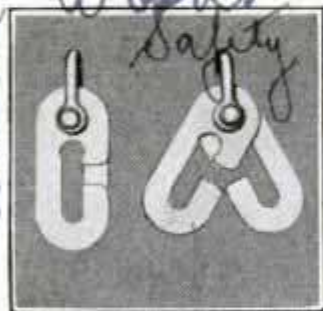


Lightweight Machine Gun Adopted by British Army Has Barrel That Fans Out Like a Blunderbuss

8946

CHAIN HOOK LIKE SAFETY PIN LOCKS IN POSITION

Capable of supporting heavy loads without slipping, a hook which opens and closes like a safety pin can be used for connecting chains for towing, dragging or hoisting on land or water. When open it looks like two huge "G's" facing each other, their tops fastened together on a swivel. It is easily attached to chains or wire rope and



when closed forms a link which cannot be detached accidentally. Because of its safety it is effective for industrial, agricultural

is normally fired from a bipod that folds up when not in use, but it can also be discharged from a tripod or the shoulder.

8963

PRINTING PLATES OF RUBBER SUBSTITUTED FOR METAL

Holding the possibility of changing traditional methods, printing plates of rubber have been developed by the B. F. Goodrich company. The new plates, compared to the metal ones in universal use, have several advantages, including quicker drying of ink and adaptability to printing on fragile or brittle materials. As yet, half-tones, except very coarse screen, cannot be printed successfully in long press

W. Montreal
Canada

A. L. Esuger
157 The ...
Akron

July 23, 1935

Brunauich-Balk-Collender & Co. 23 d. Wabach

runs with the plates. One book already has been printed from the rubber plates and further development may bring the process to the point where books may be printed on speedy rotary presses such as large newspapers use. Books usually are run on flat-bed presses.

THREADED TIP ON BILLIARD CUE EASY TO REPLACE

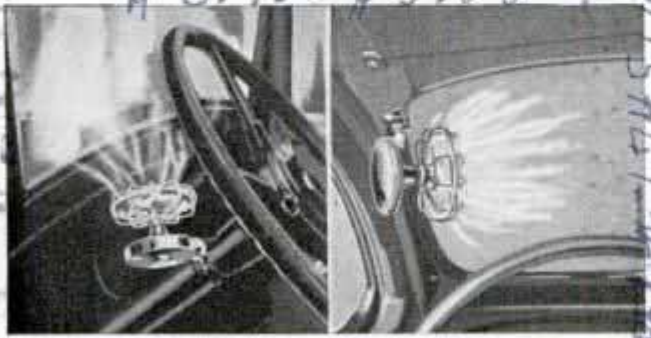


By the use of the latest type billiard cue, usual delay and expense in replacing worn-out tips are eliminated. The tip, made of a fibrous substance, is threaded to fit a screw on the end of the cue. When the tip wears out it is unscrewed

from the cue and replaced by a new one in a few seconds.

AUTO FAN OPERATED BY VACUUM FREES WINDSHIELD OF VAPOR

Operated by a vacuum from a manifold connection which makes available waste power from the engine, a small automobile fan that can be attached to the steering post or the top of the windshield has a dual purpose. It removes frost and vapor from the windshield in cold weather and cools and ventilates the car in summer. Used with a heater it will eliminate sleet in winter. The air current may be aimed at the windshield or toward the driver and passengers. The propeller speeds 4,500 revolutions per minute. A switch in the base controls the fan's operation.



Run by a Vacuum, Auto Fan May Be Attached to Steering Wheel or Windshield

ODDS AND ENDS SUPPLY PARTS FOR SMALL MOTORCYCLE



Miniature Motorcycle Run by Reconstructed Air-Compressor Motor Does Twenty Miles an Hour

Powered with a reconstructed air-compressor motor, a miniature motorcycle built by a Californian develops power sufficient to carry its rider more than twenty miles an hour. It travels 150 miles on a gallon of fuel, according to its builder. This one-cylinder "bike" has a regulation saddle with springs, rubber grip handlebars and a tubular frame. The tires and wheels are from an airplane. The fuel tank is strapped to the horizontal top bar and four dry batteries are used to furnish current for the ignition system.

PISTOL-SHAPED POWER DRILL DOES HEAVY WORK

Handy for carpentering, sheet-metal, electrical and plumbing work, a midget electric drill shaped like a pistol and operated with one hand cuts through steel a quarter of an inch thick in five seconds. It is six and three-quarters inches long, weighs two and a half pounds and has the same power as tools twice its size. It is controlled by a button. A ventilating system cools the motor.



Trico Products Co. 817 Washington

no further information

8906

1/4 - 32.00

Independent Supply Co. 12745 1/4

San Gabriel

Calif



Putting Finishing Touches on Last of a Fleet of Model Ships That Took Seven Years to Carve

SEVEN YEARS SPENT IN CARVING FLEET OF MODEL SHIPS

Seventeen different kinds of wood were used to carve a fleet of scale model sailing vessels completed by a California man after seven years' work. The tiny ships, complete in every detail to davits, ships' boats, masts, ropes and rigging, are reproductions of craft built between 1700 and 1870. The fleet includes: a British three-deck frigate, two old-time whalers, a packet ship, a four-masted bark, a Gloucester fishing schooner and a ten-gun brig.

SEVENTY-FIVE-FOOT SCREWS BORE DOWN TO BEDROCK

Steel caissons which make their own excavations by boring through soil, gravel, sand and boulders to bedrock have been successfully used in constructing foundations for the new federal building in New York City. Seventy-five feet long and six to eight feet in diameter, these

hollow cylinders have saw teeth at the bottom, re-enforced with tungsten carbide. They are driven by motors like diamond-core drills. The excavated material is forced to the surface with water used to lubricate the cutting edge. Once settled, they are cleaned out, sealed against water and filled with concrete, forming piers for the supporting columns. They can be sunk in six to eight hours, according to engineers.

TOOLS OF SPECIAL SHAPE SAVE WORK IN GARDEN

Welding has made possible revolutionary changes in the design of garden tools, adding to the traditional line of hoes, rakes and cultivators new styles adapted to special tasks. Back-breaking toil is saved by long-handled hoes worked by a pulling instead of chopping motion. One hoe is a steel band bent square, the working face drawn to a point. Another traction hoe has a triangular blade. There is a pulverizing tool consisting of a square steel band

to which from one to four stationary blades are welded, the band itself having a motion that affords both forward and back swing. One hoe with arched blade straddles the seedling and cuts weeds on both sides. Hand cultivators have single or multiple prongs, with socket or ferrule for fastening to the handle and a wing nut for tightening prongs. Welding eliminates many parts.



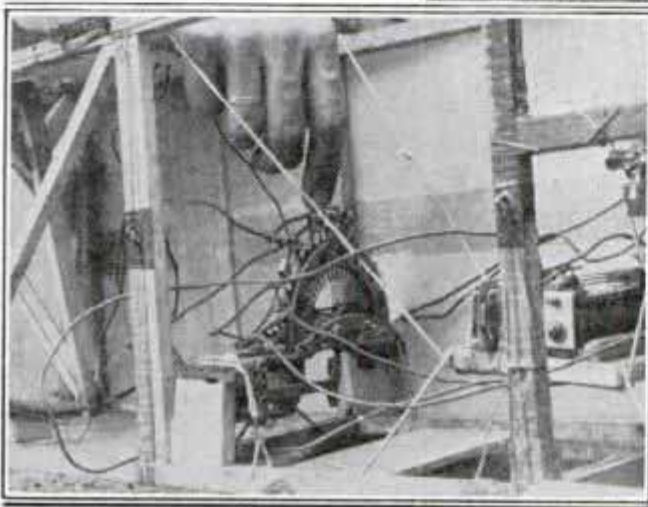
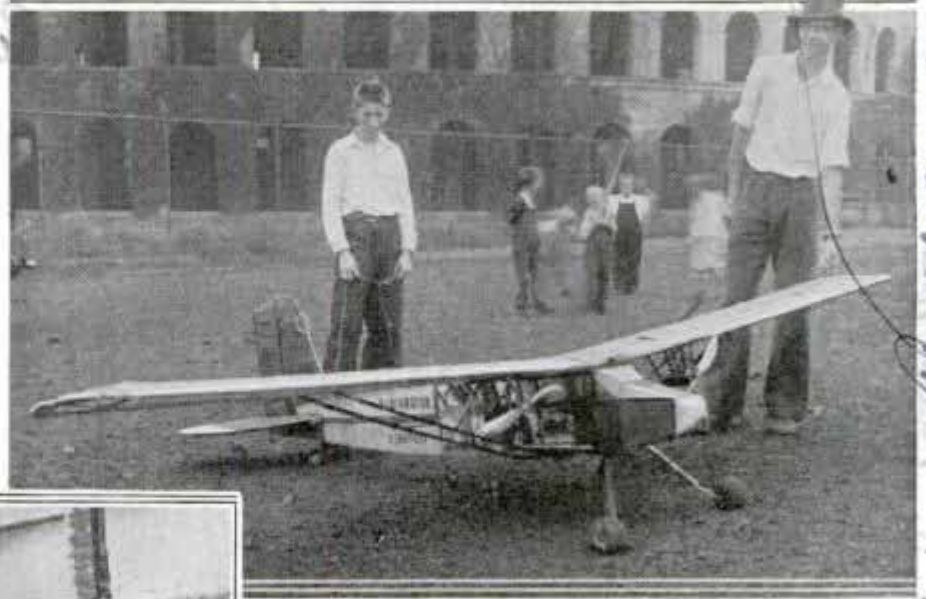
These Are Some of the Specialized Hoes in Use Today, with Blades Designed for Particular Duties

San Gabriel, Calif
High Alps
mechanics
4.
8934
8949
W. J. Harrington
220 W. 42nd

1315
1950
1951
1952
1953
1954
1955
1956
1957
1958
1959
1960
1961
1962
1963
1964
1965
1966
1967
1968
1969
1970
1971
1972
1973
1974
1975
1976
1977
1978
1979
1980
1981
1982
1983
1984
1985
1986
1987
1988
1989
1990
1991
1992
1993
1994
1995
1996
1997
1998
1999
2000
2001
2002
2003
2004
2005
2006
2007
2008
2009
2010
2011
2012
2013
2014
2015
2016
2017
2018
2019
2020
2021
2022
2023
2024
2025

Radio Controls Twin-Motored Model Plane

Pilotless airplane flights are no longer a novelty, but at Cambridge, Mass., a model monoplane has been built which flies under control of a short-wave radio set on the ground. The little ship is powered by two single-cylinder gasoline motors of one-fifth horsepower each. It has a twelve-foot wing spread, over-all



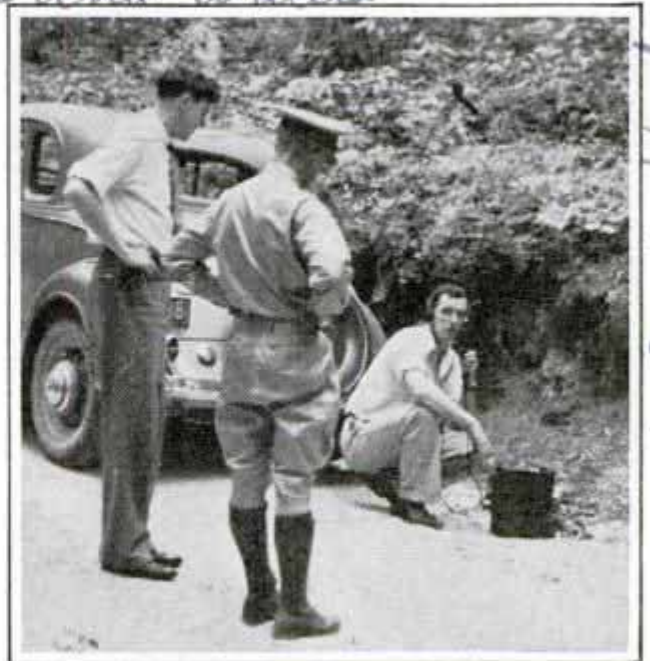
Top, Radio-Controlled Plane; Bottom, Selector Directs Impulses to Solenoids Which Operate Controls

length of seven feet and weighs twenty-two pounds. Control impulses sent by a telephone dial through a short-wave transmitter are picked up by the receiver in the baby plane, and relayed to a telephone dial selector which connects various solenoid magnets operating the controls of the plane. Eighteen flashlight batteries and two midget "B" batteries are required for the radio, solenoids and ignition. The tires are rubber balls drawn together at the "waist."

Two-Way Radio Fire Alarm Leads Foresters to Blaze

Portable short-wave receiving and transmitting sets help forest rangers in Pennsylvania detect and locate forest fires. A lookout in his watch tower atop a mountain discovers a thin column of smoke rising from a distant valley. He reports the blaze by radio, and foresters patrolling a road several miles away are directed to the scene. The two-way sets are compact, battery-operated outfits with aerials consisting of two wires merging into one which can be slung over a tree branch or collapsible pole.

Popular Mechanics Magazine does not publish the name of the maker of, or dealer in, any device described in its pages, but this information is kept on file and will be furnished by our Bureau of Information upon request, accompanied by stamped, self-addressed envelope.



Highway Patrol Is Guided to Forest Fire by Short-Wave Radio Report from Distant Observation Tower

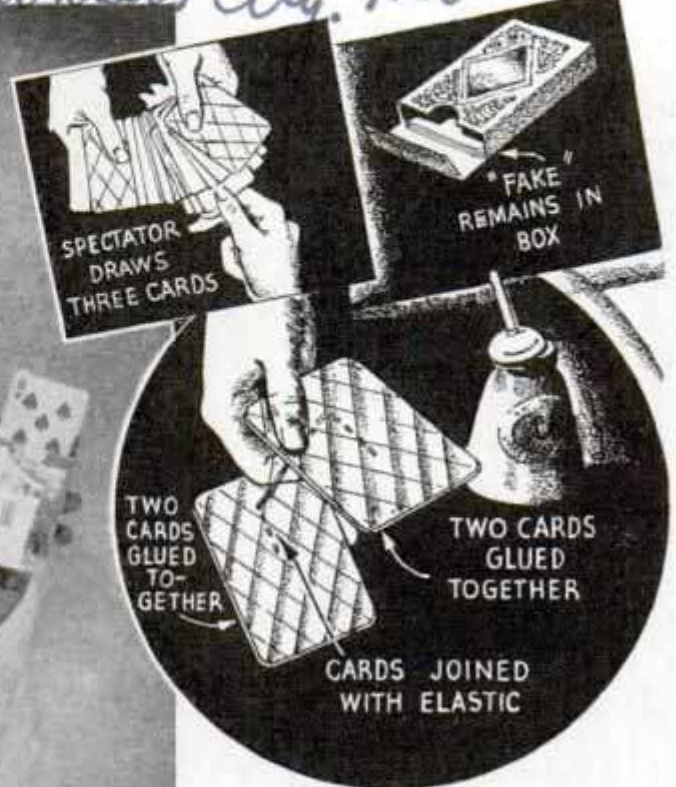
Cambridge, Mass.
 Radionation
 2994.
 Dept. of Forests and Waters
 Camb. C. W. Buffum May 21, W. Market

8835

Com. James M. Dunning
20, W. Hartmoyle
Kansas City, Mo

"SPEAKING of

8780-166 H.L.H. J. T. Hedgcock



Above, Steps in the "Jumping Card" Trick; Drawings Show How Deck Is Prepared for Performance of the Mystifying Stunt

By **RICHARD CARDINI**
Famous Magician

TRICKS with cards are a constant source of delight to persons of all ages. Some require a great deal of skill, while others equally perplexing to an audience demand very little. These are best for the amateur magician because people are quicker to discover the secrets of card tricks than other forms of the black art. One simple stunt is to invite a person to select a card, insert it into the deck, and then, without the performer touching the cards, the top portion of the deck will slide back, reveal the card selected, and then return to its original place.

To do this, the performer must prepare a deck that will be used exclusively for



Circle and Drawings of Simple Trick Performed by Threading Part of Deck

this stunt. Punch a hole through the center of a card and affix it to an invisible thread. Next, punch small holes in almost half the cards in the bottom of the deck, and thread them with the card already fastened.

This thread should be brought through the second and third finger of the right

CARD TRICKS...

hand, extending up the backside of the sleeve to the armpit, where it is affixed with a small black safety pin.

In offering the deck, "force" the subject to take a card in the top part. In returning the selected card to the deck, place it in the bottom portion, allowing as much slack in the thread as necessary. When the performer moves his arm forward, the deck will part revealing the card selected. Most performers prefer a thread a few inches shorter than sleeve length, so the cards will move easily without forcing the performer to reach conspicuously. This trick can be worked for two people simultaneously. When doing this, put the first card in the lower part of the bottom half and it will be the first one revealed.

"The Whispering Queen" defies

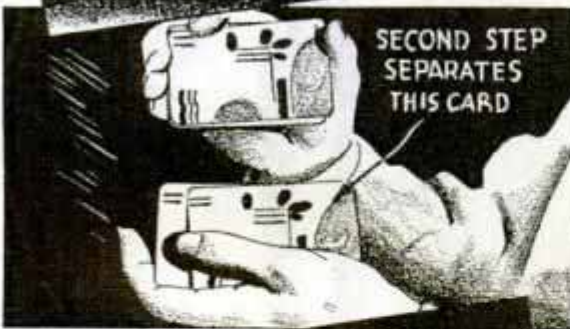
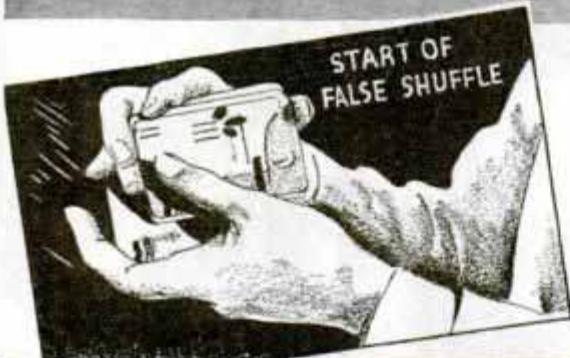


solution when worked effectively. A deck is divided into two packs. Some person is asked to count the cards in one pack, and when accomplished three cards are dealt from that pile face down. These three cards are placed under books, carpets, or elsewhere. The gossipy queen—any queen can be used—is taken from the deck and sent on a visit to each of the cards. She returns after each visit and the performer, holding the card to his ear, exclaims: "The queen tells me the card under the book is such-and-such."

The execution is important in this stunt. The secret lies in the entertainer seeing



Top, Center and Bottom, Steps in "Whispering Queen" Trick; Much Practice Improves the Stunt



Top, Deck Split into Three Parts as First Step in Picking a Selected Card; Drawings Show Three Steps in Making a "False Shuffle"

and memorizing the character and position of the three bottom cards.

Before launching the trick it is a good idea for the person working it to pretend he is racking his brain for another stunt. Meanwhile he runs his hand over his forehead, bearing in mind the position of the three bottom cards.

In dividing the cards into two stacks, place the bottom portion on your right. When one stack is counted the position of the three bottom cards will be reversed. The performer must remember which card is where, and supply a sparkling brand of patter for the conversation with the queen.

Another trick that never loses charm is the "jumping cards."

A deck is taken from its case, shown to the audience, and reinserted in the box. In order to show his good faith the magician again removes the deck from the box and shows it to be normal. Shuffling the cards, he offers them to three spectators in such a way that he cannot see them.

Putting them back, the performer asks the three persons to concentrate on the cards they have selected. While they are doing this, the first of the three cards rises from the deck. The feat is repeated for the second card. For the third card, however, the performer commands it to jump completely out of the box in any direction suggested.

This stunt requires a "fake" made with four cards, a small rubber band, some glue and a punch. A hole is punctured in the center of a card about an inch from the top and backed with another card. The same is done with two other cards and the rubber band suspended between them.

When the cards first are taken out of the case the fake is left behind. After inspection the cards are returned and then under the pretense that there's nothing wrong with the case, the cards may again be taken out, this time removing the fake also. The cards are shuffled so the fake is brought to the center of the deck with the rubber arrangement at the top. Stepping back, the magician places the three cards between the device, thus pressing the rubber downward.

In order to hold the cards in the deck, the

(Continued to page 118A)

8 10 05

Dodging Lightning in the Nose of an Airliner



Carroll 4617
Los Angeles, Calif

Remarkable Photo of Night Flight, with Camera Directed through Pilots' Compartment, Shows Several Distinct Flashes of Lightning; on This Course, the Plane Is Heading into the Storm

Piloting an airliner at night is routine for the most part, so carefully do the transport companies safeguard passengers and mail with the latest weather reports and scientific instruments, but occasionally a severe electrical storm breaks the monotony. On a recent flight in a twin-engine Lockheed Electra, pilot and co-pilot were treated to a rare display of lightning playing from cloud to earth. Dazzling flashes lit up the cockpit as the bolts hurtled downward just ahead of the plane and thunder rolled in awe-inspiring manner. Yet, the ship came through the storm without mishap, for even in the thickest weather the luminous dials and indicators, together with radio, tell the pilot his exact location.

Our Bureau of Information will answer questions regarding articles in this magazine, if accompanied by return postage.

Water Softener for Home

Easily moved from one room to another, a portable water softener for the home is simple to operate and occupies only a small space. Water flows from the faucet through a rubber tube into a copper tank



with a pressure valve on top. It flows out of a tap, making a free lather for laundering, bathing or dish-washing that cuts down the use of soap. Shower attachments are available. Lime, magnesia, iron and other minerals are removed.

714-5 Bend. Blvd

8927

Carroll 4617
Los Angeles, Calif

Master Water Softener

MOVIE THEATER ON RAILS GIVES DAILY SHOW FOR TRAVELERS



Interior of Talkie Theater on Train; Sloping Floor Assures Full Vision

Talking pictures are exhibited daily on a crack English-express train to entertain passengers speeding ninety miles an hour between London and Leeds. The movie theater is a specially equipped coach with a screen, sound-film apparatus and a double row of seats on each side of the aisle. The floor slopes down toward the front as in a regular theater. A uniformed attendant passes through the train announcing the schedule of performances. The admission charge is a shilling and the show usually lasts an hour. On Sundays, the theater car is used on excursion trains.

BRAKE GIVES GREATER SAFETY AND HAS FEWER PARTS

Greater safety at high speeds and with heavy loads is claimed for the Linderman direct-acting brake that has only half as many parts as the conventional type. Operated by either hydraulic or air pressure, the system eliminates the use of pistons, mechanical linkage and servo or self-aligning shoes.

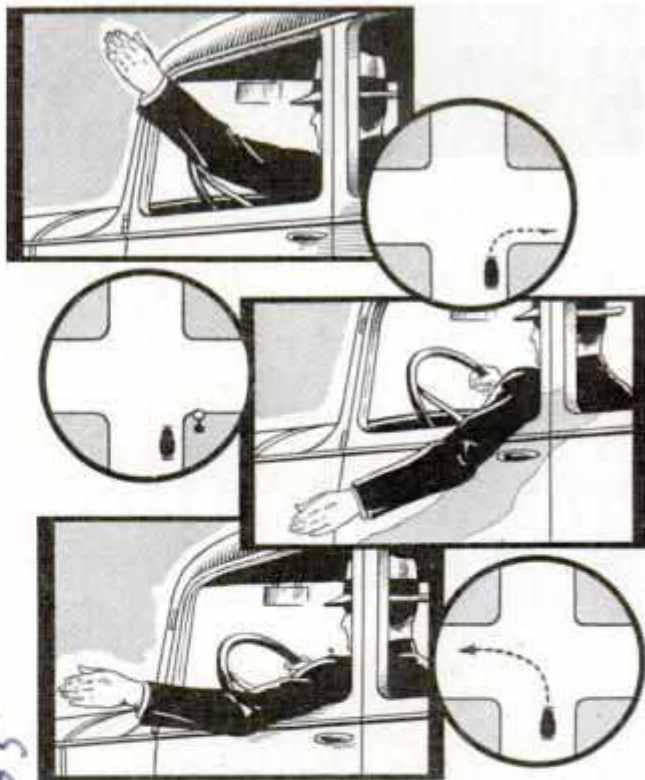


It is designed for any type of automotive vehicle. The heart of the

brake is a unit made of two steel sheets, folded over and back, with a composition filler between each fold. Expansion of this diaphragm by means of hydraulic or air pressure set up by the brake pedal causes maximum expansion of the brake shoe. Each brake contains one of the units, the shoe and the standard drum completing the assembly. The hydraulic type makes use of a relatively large volume of liquid for transmitting pressure from pedal to wheel, resulting in lower line pressure. Softer pedal action and increased insurance against leakage are claimed. Uniform pressure distribution over the lining and drum gives a greater brake capacity than that of the conventional system.

"TALKING ARM" SIGN LANGUAGE STANDARDIZED FOR DRIVERS

As soon as the first two automobiles met on a dusty road, motorists began trying to find ways of telling the other fellow they meant to slow down, halt, or turn off the road. Wigwag arm signals—an adaptation of the railroad semaphore sys-



Proper Signal and Position of Car for Right Turn (Top), Stop (Middle), and Left Turn (Bottom)

tem—became the common sign language between drivers. But, growing informally, this language never was standardized. Now, with the traffic stream thickening

London and North Eastern Railway

Canada Woodstock Oil

Linderman Lenses

Motor News

Segovia St. Andrew & Clerk
£100 2 Blundellsands
Riverpool 23 England

£988

July 1935

605 & Danny
Seattle Wash

Diesel Tractor Wades River to Break Up Logging Jams

and safety becoming more important than speed, various states are putting the "talking arm" into highway codes enforced by law, giving the signals a standard interpretation and requiring motorists to learn and use them. In Illinois, for example, the left arm raised obliquely means the driver is turning right; pointed obliquely downward, slowing down or stopping; extended straight out, turning left.

81003

SIEVE ON WHEELS CLEANS DEBRIS FROM BEACH

Removing broken glass, nails, pins, stones and other debris from the sand, a motor-powered bathing beach cleaner which can cover 50,000 square feet an hour is a boon to bathers. It is drawn by a tractor and is hydraulically controlled. Only one man is required for its operation and it can be moved easily from one beach to another. Sand to a depth of four inches is drawn into a revolving circular hopper screen where it is sifted and cleaned and then sprinkled down again in a smooth, loose layer, the debris being retained in the hopper. The cleaner's "bite" can be hydraulically adjusted.



Stranded Log Is Shoved into Current and Started on Way to Lumber Mill by Tractor That Wades Stream as Easily as It Crawls on Land

California

When spring freshets fail and the winter's crop of logs piles up in the middle of a stream, try a tractor. A lumber mill in Washington state found itself without logs because the expected floods never arrived, but a Diesel-powered tractor proved itself an "amphibian," wading into the shallow river and breaking up log jams. The entire cut of timber had been left high and dry for miles along the banks. Instead of the laborious and expensive method of attacking the job with a donkey engine and high lines, the lumbermen put the tractor to work, shoving logs to the center of the narrow stream and maneuvering the key log into the current whenever a jam developed. Swift water and a loose gravel bed did not hamper the tractor, which followed the logs downstream and kept them off banks and shallows until they reached the mill.



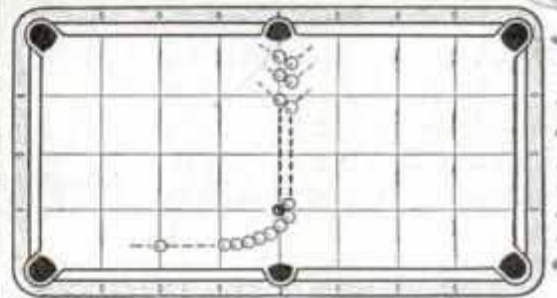
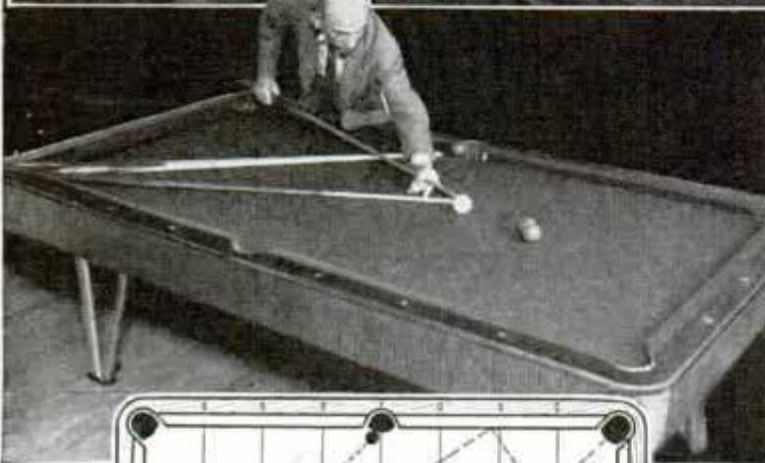
"Beach-Combing" Tractor Picks Up Four-Inch Top Layer of Sand and Sifts Out Picnickers' Rubbish, Cleaning Wide Area Speedily

Used by Mc Cormick Lumber Co on T outlet River near Carle Rock Wash.

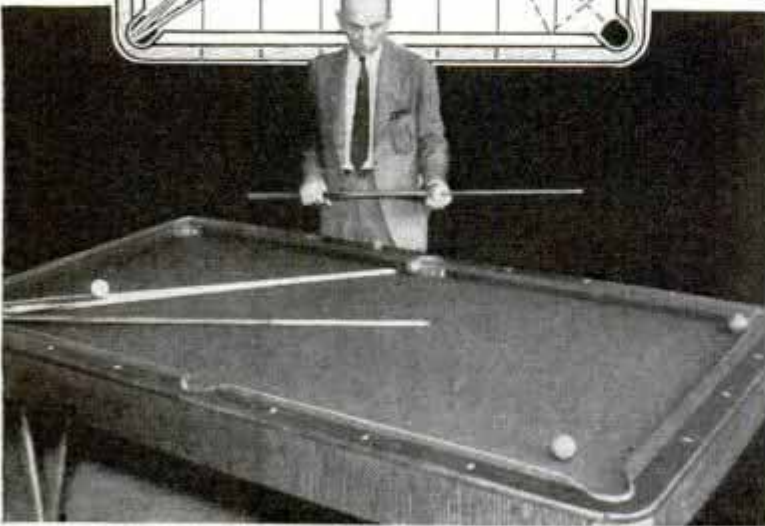
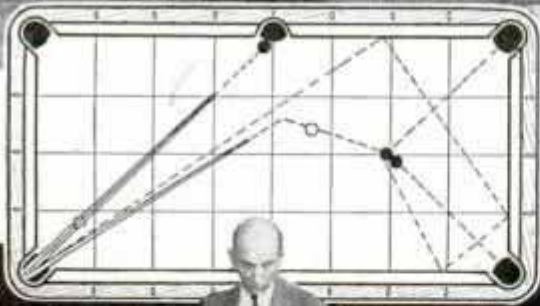
By Mrs. Leslie J. Chudley

James W. Martinich Pro.
Kansas City, Mo.

FANCY



Object Is to Hit Ball Indicated by Arrow into Side Pocket; Diagram Shows How



Start and Middle of the "Elevated Shot" with Diagram Showing Path Traveled by Balls and the Position of the Cues on the Table

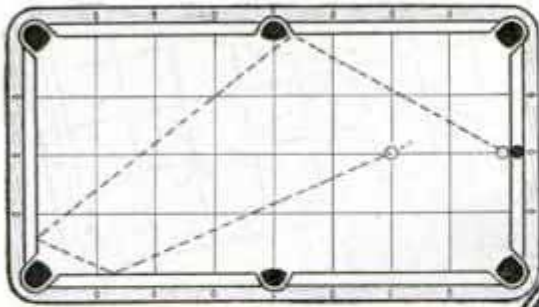
By **CHARLES C. PETERSON**
(National Fancy Shot Champion)

FANCY shots are to billiards what jazz is to music. Abetted by a rudimentary knowledge of the game, the average player can master a wide variety of such shots in a short time.

But before trying any fancy shots, you first must realize the importance of the correct follow through. It's the life blood of this branch of the game. Void of shoulder action, the billiard shot is made below the elbow with a free, easy wrist action and, of course, plenty of follow through. In a follow-through stroke, your cue should not be pulled or checked until after full contact with the cue ball. It should follow right through the ball.

To Bismarck, Dakota, 6/18 J. W. Martinich, Chicago

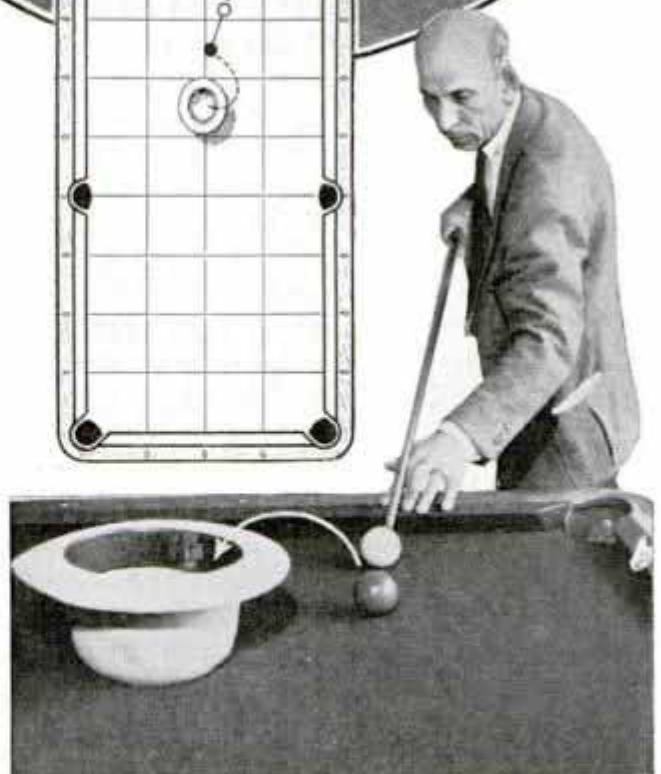
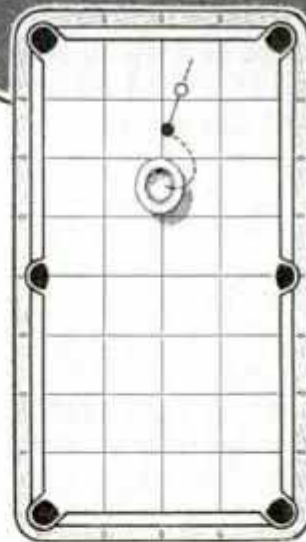
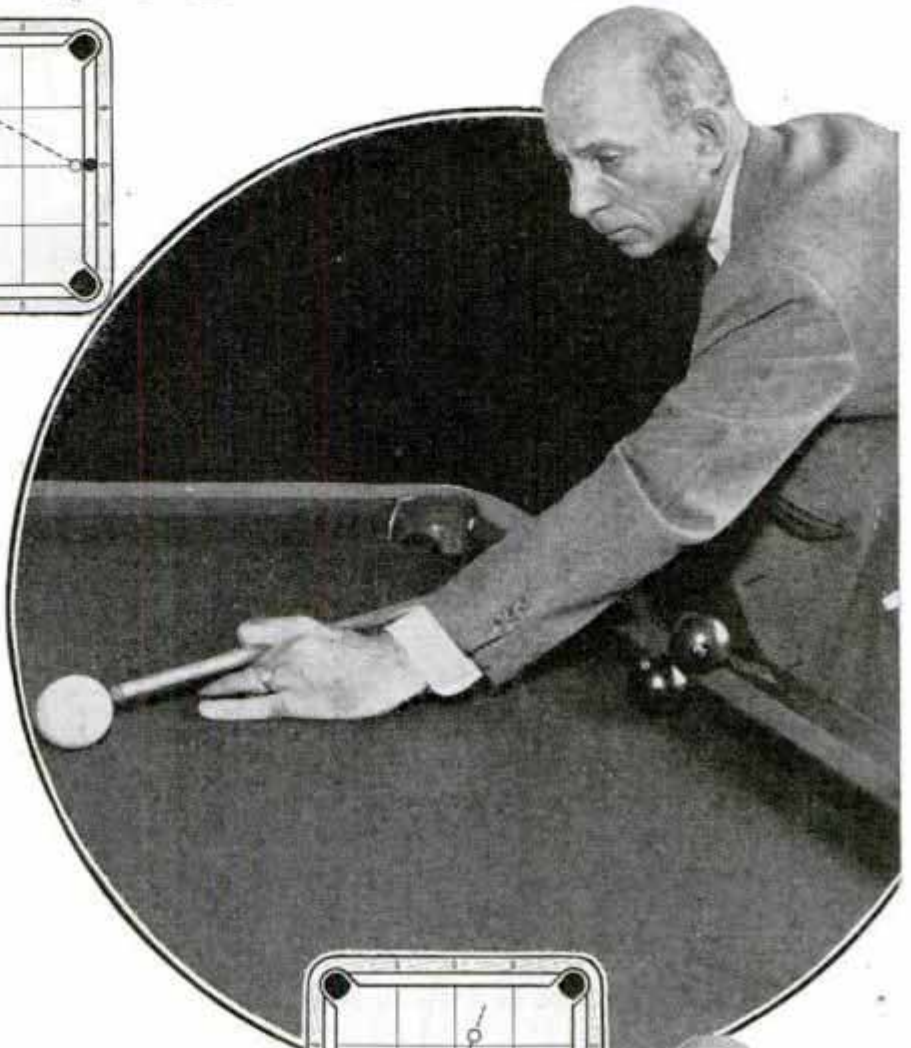
BILLIARD SHOTS



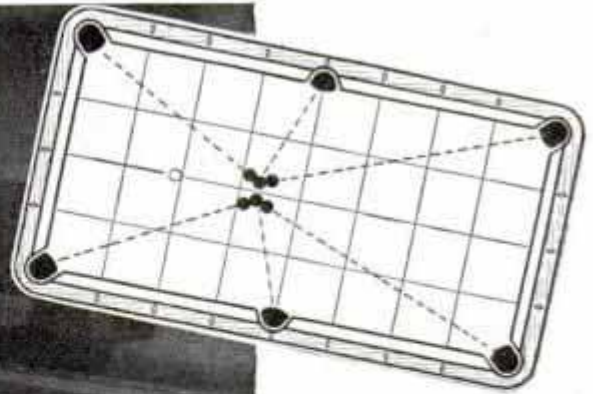
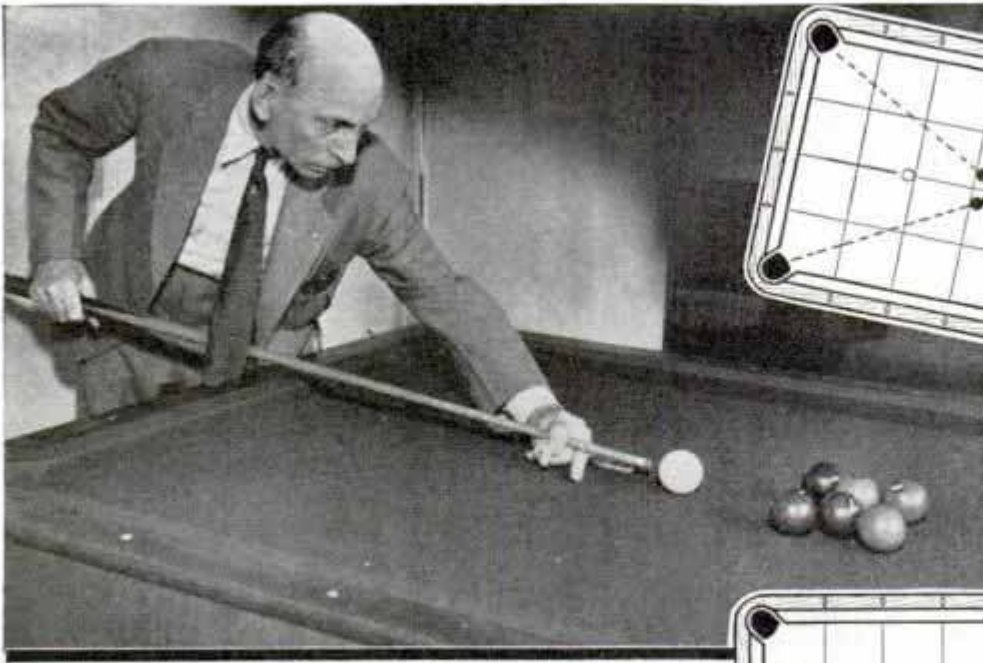
After the start of the stroke it is the momentum, or weight of your cue, which does the work. After contact with the ball, and after your cue has followed through, you will then naturally tighten up on your grip. It is then that your hand is in front of the line of your elbow which causes the top side of your cue to touch the palm of your hand, which naturally will cause you to tighten your grip on the butt of the cue. You will know if you are delivering the stroke without the damaging tight grip if your cue tip has followed through, or gone beyond the point of contact with the cue ball.

For a starter, try knocking a ball into a hat. It can be accomplished after a few minutes of practice. At the lower end of the table place an ordinary felt hat and six inches from it set the object ball. The position of the cue ball is about forty-five degrees to the left of the object ball and approximately ten inches away. With the cue elevated slightly, the white ball is struck a little above center with no English, whereupon the object ball will proceed to hop into the hat.

Putting a dime into a small glass tumbler is another simple but effective stunt. The tumbler is placed on the ledge of the table near the center and the coin one-third inch from the edge of the cushion in front of it. By shooting directly at the dime with the cue ball from the head of the table with a straight, even shot the



Top, Beginning of "Drop Shot" and Diagram of It; Below, Mr. Peterson Performing the Hat Shot and Diagram Showing Position of Balls and Hat

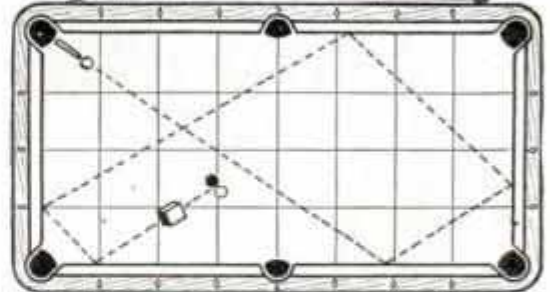
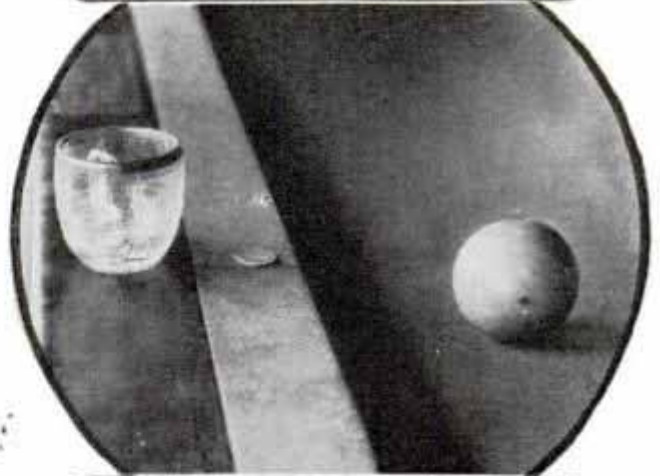
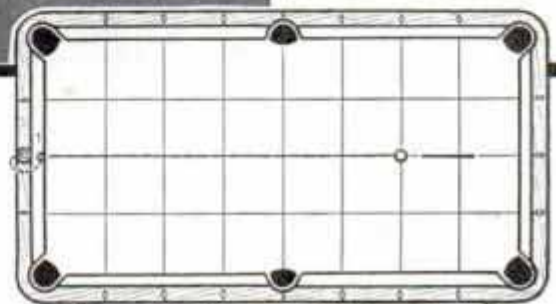


dime will hop into the cup by virtue of the force with which the cue ball bounds against the cushion. Because the speed of table cushions varies, the player may encounter some difficulty at first in getting just the right amount of force in his shot to make the dime hop into the cup. There is a tendency on the part of most beginners to shoot too hard, thus batting the coin off the table.

The "drop shot" is another trick that belongs in the repertoire of the fancy-shot player. Here, one ball is placed on top of another at the head of the table, and the cue ball, after contacting three cushions, eases its way up to the pair, gently knocking away the first object ball—the one resting on the table—and stopping in its place long enough for the top object or carom ball to drop on it for the count.

The cue and object balls are spotted according to the accompanying diagram and the player, holding his cue level, should strike the ball one-half to the right of center with sufficient speed to enable it to touch three cushions before knocking away the first object ball.

Note the way the balls are lined up on the table in the illustration at the top of the first page. Is it possible to put the object ball marked by the arrow in the side pocket? It's not only possible—it's very easy. All the shotsmith need do is strike the cue ball directly in the center with a firm, even shot, hitting the first ball in the curved line in the manner indicated in the diagram.



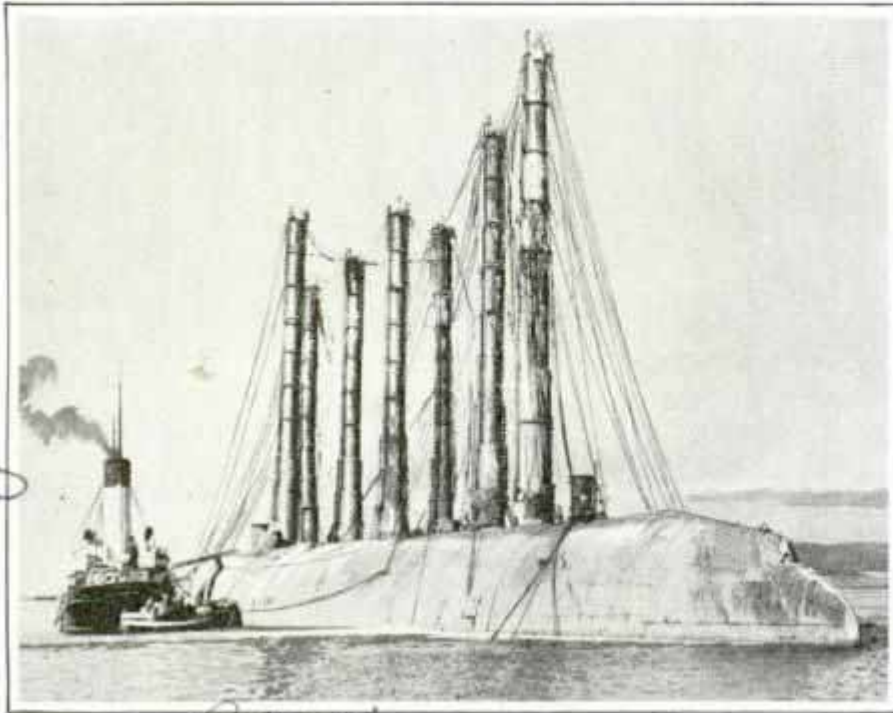
Top, Beginning Six-Ball Shot and Diagram; Center, Tumbler and Coin Trick; Bottom, Diagram of the Paper-Bag Shot

A spectacular shot that electrifies a crowd is the six-ball shot in which the performer puts one in each pocket in a single stroke. The secret of this turn lies in lining the balls up correctly beforehand.

(Continued to page 148A)

1019

Scuttled Warship Is Refloated by Hundred-Foot Air Locks



Former German Battleship "Koenig Albert" Raised from Bottom of Scapa Flow by Scotch Salvage Crew

After sixteen years in "Davy Jones's locker," the wartime German battleship "Koenig Albert" has been raised from the ocean bottom by means of air locks 100 feet long. The warship was a unit in the interned fleet scuttled by its German crew June 21, 1919, in Scapa Flow, which had been the chief naval base of the British grand fleet during the world war. Scottish salvagers refloated the vessel.

when electrical appliances are being operated, to limit use of current in hotels and hospitals, and to protect industrial plants against break-downs. The unit contains a thermic release in direct connection with a small magnet to cut the current. It will interrupt current within an hour when twenty-five per cent overloaded; within one minute if the normal load is doubled, and instantly if shorted.

GIANT LOUDSPEAKER ON CAR WARNS DRIVERS

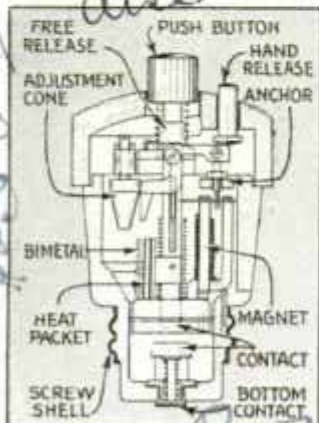
Drivers who violate traffic laws are hailed and warned against repetition of the offense by a voice coming from a giant loudspeaker on a white automobile roving the highways of Indiana. The auto, a supercharged model, is being used by the Indiana state police to reduce traffic accidents. When the opera-



Police Car with Big Loudspeaker Mounted on Side for Warning Careless Drivers

SHORT-CIRCUIT DANGER ENDED BY LOW-PRICED CUT-OUT

Fire hazards and time loss due to short circuits and over-loaded wires can be eliminated by installing an inexpensive automatic cut-out now manufactured in a convenient size. Readily installed where there is a fuse plug or cartridge fuse, it can be used to guard home lines against excessive loads



tor sees a violation, he speaks into the microphone located in the car and his voice roars through the loudspeaker attached on the side of the car.

Henry C. Forster Co. 1309 Michigan Ave. Chicago

W. Adams Chicago 105 W. Adams Corp. Auburn Phaeton Sedan

1965

use

2121 Bueller Road, Fort Wayne, Ind.

Henry C. Forster Co. 1309 Michigan Ave. Chicago

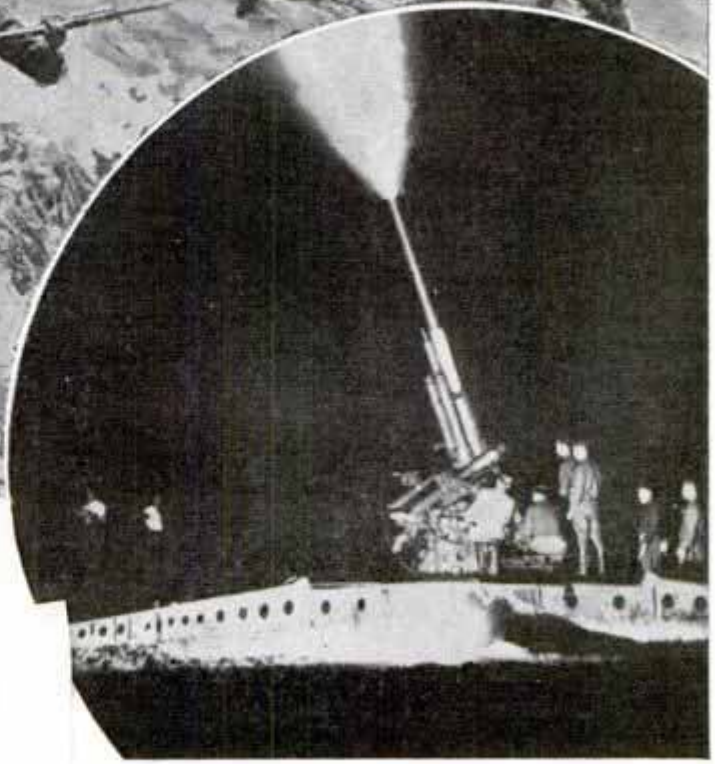
27001

701

Army Goes to "War" to Test Men and Guns



Wide World
 Anti-Aircraft Guns in Action during Sham Battle between "Blue" and "Red" Armies at Pine Camp, N. Y.



More Than 55,000 Regular Army Troops and National Guardsmen Participated in a "War" at Pine Camp, N. Y., Put on for the Purpose of Testing Army Men and Guns: It Was the Greatest Peacetime Manoeuvres Yet.

LOUDSPEAKER ON POLICE AUTO
 Electric Acoustic Products Co.,
 21 Bueter Road, Fort Wayne, Ind.

27001

Streamline Ships Modeled After Air Clippers



Top, Model for Ocean Liner; Note Thoroughly Streamline Stacks, Flying Bridge and Inclosed Decks; Bottom, Streamline Ocean Yacht; Landing Platform Folds into Side of Ship

Like a great airliner with its flying bridge and streamline hull is the ocean liner modeled by Norman Bel Geddes, noted designer. Called the "liner of the future," its several decks and its bridge alike are entirely inclosed, and every portion of the great vessel's outline is curved to reduce to the very minimum its resistance to winds and waves. Greyhounds of the sea are borrowing more and more from the streamline developments of aircraft, trains and automobiles. Mr. Geddes has also constructed a model for a streamline sea-going yacht which would be 231 feet long, with a thirty-seven-foot beam and twelve-foot six-inch draft. It would be powered to travel at a speed of sixteen knots and have a cruising radius of 10,000 miles. To conform with its thorough streamline construction, the yacht would carry its lifeboats inside the superstructure. In an emergency they would be loaded under cover and then launched from either port or starboard side.

1282. 37th
New York



Wade Works

SLOPING HOLDER FOR HACK SAW SAVES BLADES AND WORK



Metal cutting is done more quickly and easily by the use of a special hack-saw blade holder consisting of a solid triangular frame into which the blade is fitted diagonally. Materi-

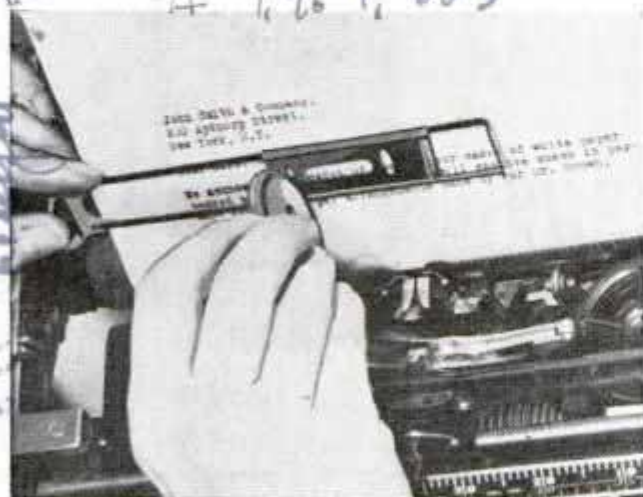
Edison Steel Works
1625 55th St
E. 10/14.
1635 E. 55th

Gunfire Muffled by Box Made for Indoor Ranges

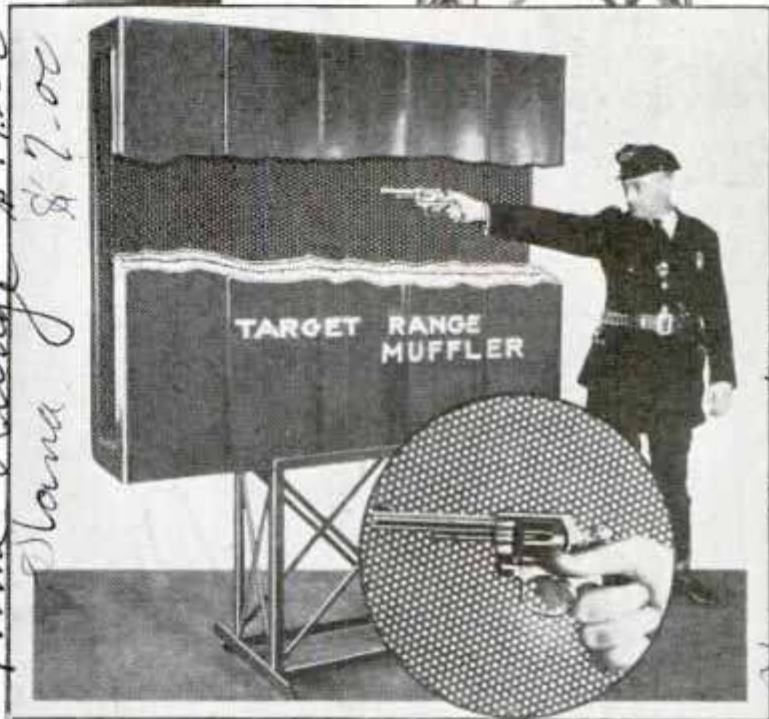
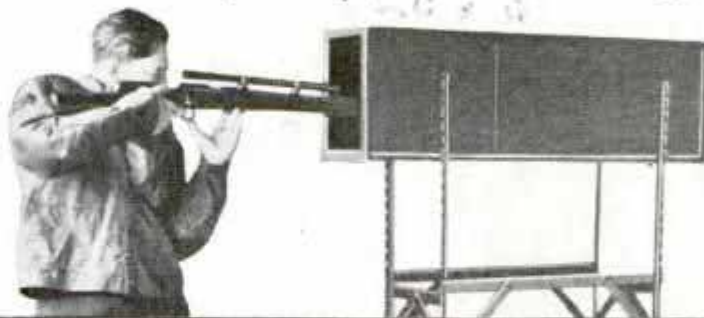
als up to one inch in thickness can be handled. In cutting, the top of the frame runs parallel with the surface being worked on, while the blade moves horizontally like a carpenters' saw, with a long stroke. The saw can be used on corrugated or irregularly shaped metals and for cutting castings, rods, drums, tanks and plates in place of a cutting torch. The frame is made of stainless steel webbing and has an adjustable tension blade holder. Standard hack-saw blades can be used, being held loosely but securely and given plenty of play so they do not break easily.

TYPEWRITER ERASER GUARD KEEPS PAPER CLEAN

Soiling original copy or "smearing" of carbon copies when erasures are made is prevented and typing work is speeded up by the use of an eraser guard which can be used on any make of typewriter. It is a metal frame shaped to fit the typewriter roller, with a metal tongue on the bottom and a sliding plate with three openings on the top. The plate can be attached to either side of the paper, the tongue being inserted between the top sheet and the carbon, preventing pressure when the eraser is applied. By moving the plate to right or left, the typist brings the openings directly over the spot to be corrected.



Using Eraser Guard That Can Be Attached to Typewriter. It Keeps Paper Clean



Top, Rifle Practice through Muffler; Bottom, Firing on Police Range; Inset, Close-Up of Insulating Material

Reducing the noise of rifle or revolver on indoor target ranges, a muffler for individual use has been introduced. To a person standing outside of the range, the reports sound like someone pounding on a heavy box rather than the firing of a gun. The sharp crack of an automatic pistol is changed to a dull thump. The muffler is a box-like arrangement through which the weapon is fired at the target. Since it is not connected to the rifle or pistol, its use is not contrary to law. One model, the "home range" muffler, may be suspended from ceiling wire supports. It is intended for small-caliber pistols and rifles in basement or small club range. A large size model is for all guns. Both models may be lowered to the floor for prone shooting. The muffler permits adequate lighting, but eliminates glare on the front sight.

Ribbon & Carbon Co
McKays
Broadway

Home Range \$14.00
Blana \$7.00

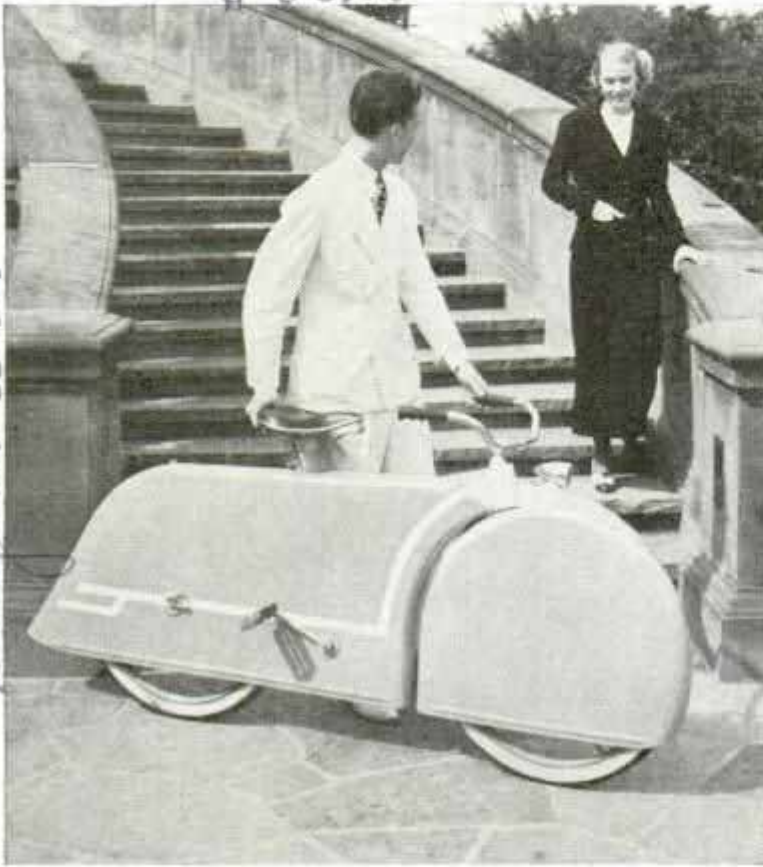
usual \$45.00 / sd madison
carriage \$16.00

Handwritten notes at the bottom of the page, including names like 'H. Johnson' and other illegible scribbles.

Lightweight Bicycle Wears Metal "Pants"

81008

465.00



Latest in Streamline Bicycles Is This Model, Its Wheels Completely Shrouded in Lightweight Metal

Metal "pants" completely incase the wheels of a streamline bicycle now being manufactured, yet the entire "bike" weighs two pounds less than the standard type. It is built of duralumin for lightness. The manufacturer says the streamline bicycle gives a smoother, easier ride.

LIQUID RUBBER IS SPRAYED ON AND VULCANIZED BY AIR

Sprayed or brushed on like paint as a protective coat, liquid rubber which vulcanizes itself cold when exposed to the air and is resistant to chemicals can be used to restore surfaces damaged by acids or worn down by the scraping of sand, ore or coal. A preliminary priming coat also can be sprayed or brushed on. It is effective for lining tanks, vats, conveyors, containers and troughs and for insulating electric cables and wire joints. It acts as a silencer on heavy equipment and will absorb shocks. It also replaces sheet rubber

which has to be applied under heat and pressure with expensive machinery. The material also is available in plastic form which can be applied with a spatula or other flat tool.

8923

UNSINKABLE STEEL BOAT IS LIGHT AND RIBLESS

Air tanks form the seats in a speedy, unsinkable boat now being manufactured of light metal. It has neither ribs, keel nor braces, and because of its simple construction is low in price. Built for rowboat or motor boat in eleven, twelve and fourteen-foot lengths, the smallest weighs only eighty pounds and is easily carried on an automobile. The twelve-footer, weighing 107 pounds, will plane with one and one-half horsepower and speed forty to fifty miles an hour with a twelve to sixteen-horsepower motor. Sheet steel is rolled into a cylinder and then "broken" or creased at three points, the center crease taking the place of the keel and the others bending upward to form the sides of the boat. Bow and stern and buoyant seats are then attached, making it a one-piece rigid boat. It is also built of copper alloy or duralumin, the latter weighing fourteen pounds.



This Eleven-Foot Unsinkable Steel Boat Weighs Eighty Pounds; Its Three Seats Are Air Tanks

Moore-Castwood Co
Dayton Ohio

Self-Vulcanizing
Rubber Co. 605 W. 9th St.
Chicago, Ill.

Washington, R.
Chicago 511

sheet price

Vertical handwritten notes on the right margin, including "8923" and "sheet price".

Lightning Stands Still for Rapid-Fire Camera

Lightning is to have its picture taken from a special outdoor photographic laboratory at Pittsfield, Mass., where a special twelve-lens camera capable of taking more than five thousand pictures per second has been installed. On the tower atop the observatory is a crystal ball with a periscope leading to the laboratory below, where an operator, always on



Top, High-Speed Camera with Twelve Lenses to Photograph Lightning from Tower, Shown Below

duty, keeps watch for storms. When an electric storm is near, he starts the camera to record the various phases of lightning.

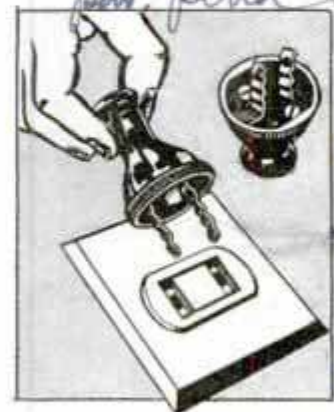
ORANGE GROVES ARE "GASSED" TO SPUR PRODUCTION

Synthetic ammonia gas, discharged at high pressure into irrigation streams is being used by orange growers in California as a fertilizer. It is manufactured by chemical combination of atmospheric nitrogen with by-product hydrogen from

International
natural gas wells. It is shipped in liquid form in steel cylinders and when introduced into irrigation streams, dissolves to form a diluted solution which reaches the soil and roots to be oxidized into plant food. While relatively new to man, this gas method is old to nature. When organic matter decays, ammonia is released. Rains dissolve the ammonia out of the air, returning it to the earth.

ELECTRIC PLUG HELD IN PLACE BY CORRUGATED PRONGS

Held firmly in place so that it will not come loose when attached to a pressing iron or vacuum cleaner, the latest type of electric plug is equipped with corrugated prongs which give it a springlike action when placed in the wall socket. It is just as easy to attach as a regular plug and can be used in any socket. It is effective for connecting radios, electric clocks, floor lamps and other equipment where an attachment that will not easily pull out is desired.



American Chemical
220 W 42nd

Patent Sales Promotion Co
530 Canal St. New York

HUNTING AIR



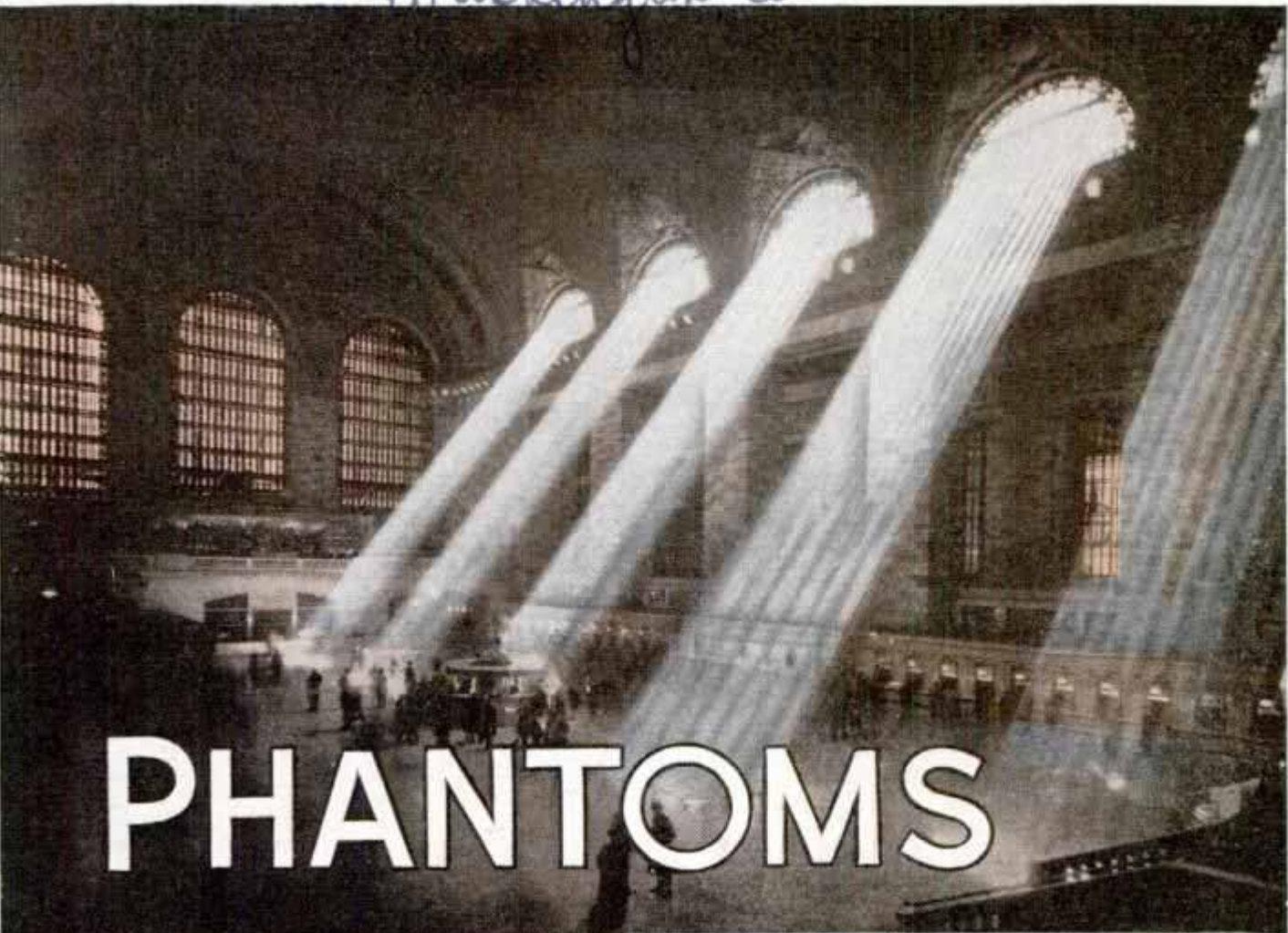
Top, Double "Spray-Bow" at Niagara; Below, Magnified Shadow Cast on a Bank of Clouds

AN APPEAL to amateur weather men in the United States and Canada to keep a lookout for unusual optical phenomena of the atmosphere and to send descriptions and drawings of those observed to the chief of the weather bureau at Washington or to the director of the Canadian Meteorological Service at Toronto, has just been issued. All such phenomena are more or less local in character, and many displays remain unrecorded because they do not happen to be visible at any regular weather station or observatory.

Here is an opportunity for the layman to aid science and at the same time cultivate a fascinating hobby. The phenomena in question are known technically as "photometeors," and they are far more numerous and varied than most people suppose. Several of those listed in scientific literature have been seen and described so seldom that there is much uncertainty about some of their details. Some of the classified varieties of halo, for ex-

Box 682
Washington D.C.

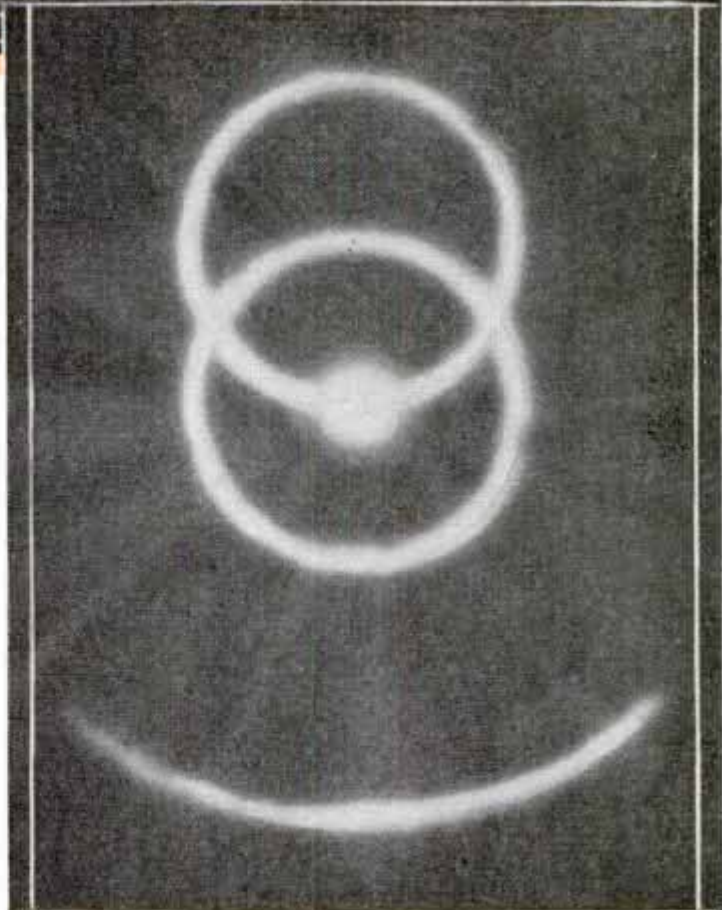
E 830



PHANTOMS

ample, have been reported only once or twice in the whole history of science, and there are still others that, though theoretically possible, have never been reported. Hence anybody who looks for such things regularly may hope to make real discoveries.

The hunter of rare plants and animals must make long journeys to find them, but the hunter of aerial phantoms will, if he keeps watch long enough, see a surprisingly large number near his own home. Mirage like that of the desert is often visible, if one's eye is at the right level, over a hot city pavement—to say nothing of hot stoves. Complex halos, such as we see in pictures of the polar regions, occasionally weave their marvelous patterns in the skies of the United States. The Brocken specter, though it gets its name from a German mountain, is just as common in this country as in Germany.

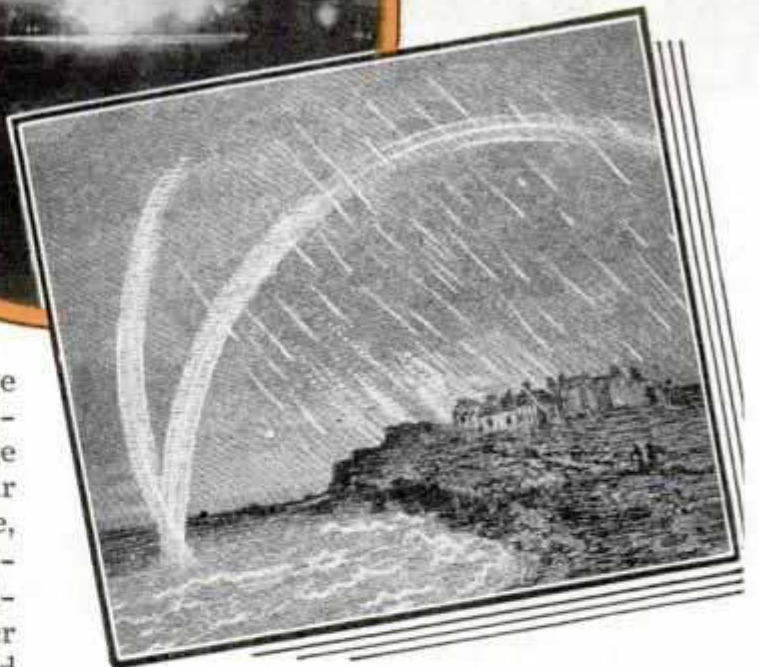


Top, Sun Streaming through Windows, Similar to "Sun Drawing Water"; Below, Complex Lunar Halo



Some photometeors are due to the action of the air upon light rays, others to that of water drops, ice crystals or dust. To the former class belongs mirage; all kinds of which are caused by the bending of the rays in their passage through layers of air of different densities. In "desert" or "inferior" mirage a shallow layer of warm, rarefied air next to the ground acts as a mirage, which reflects the sky and thus produces the appearance of water. "Superior" mirage occurs when a deeper layer of dense air is formed over a cold surface, such as water or ice. If the observer is within the dense layer he may see an inverted image in the sky of some low-lying object, such as a ship, or he may, in rare cases, see two or more images in a vertical row; some inverted and some erect.

Other kinds of mirage cause faraway objects to "loom" above their normal posi-



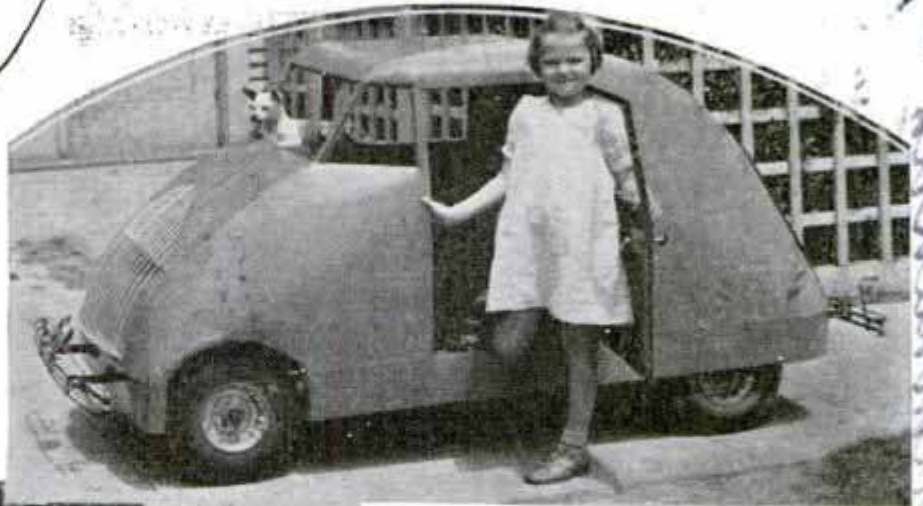
Top, the Sun "Drawing Water"; Center, "Light Pillars" Due to Ice Crystals Floating in Air; Below, Part of a "Reflection Rainbow"

tions—thus bringing into view things usually below the horizon—or to sink below their ordinary levels. "Lateral" mirage, seen along sun-heated walls and cliffs, causes things to appear displaced side-

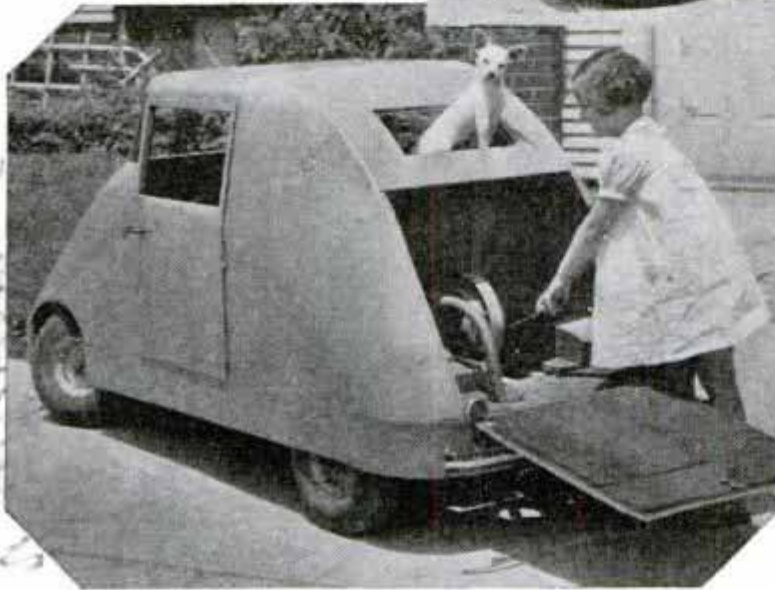
(Continued to page 132A)

Child Runs Midget Auto with Mower Engine

Driven by a three-quarter horsepower lawn-mower engine, a midget car can be operated by children of eight to twelve years of age. The car is driven through both rear wheels by a simple, bevel gear differential. The frame is made of welded angle iron with full spring mounting to



Midget Auto with Welded Sheet-Metal Body Is Powered by Lawn-Mower Engine and Runs Up to Ten Miles per Hour

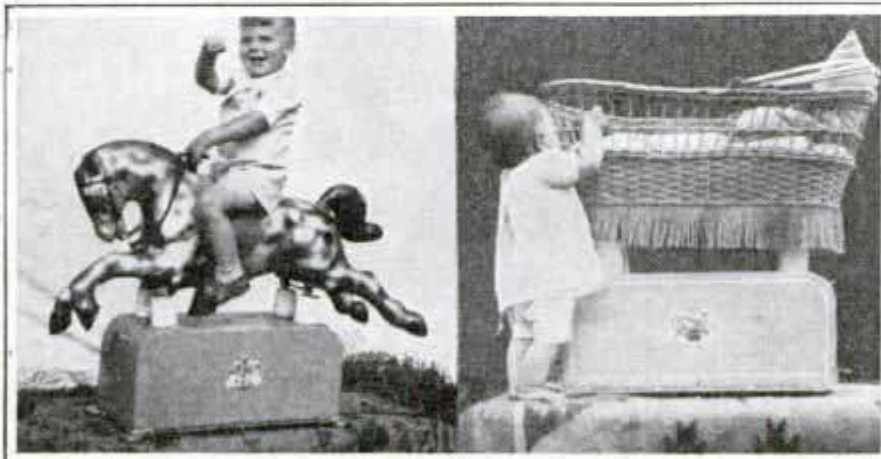


front and rear axles. The entire body and top are made of welded sheet steel, over a light steel frame. The car will carry three passengers comfortably. It can be driven by children with practically no instruction. Safe speeds of six to ten miles per hour are attained with the small Jacobsen motor. Servicing of the power plant is made possible by opening a compartment at the rear.

Electric Bassinet and Horse Keeps the Baby Contented

With the aid of an electric bassinet, putting the baby to sleep is merely a matter of attaching the bassinet to a base, turning the switch and letting it move gently up and down until the sandman ar-

rives. A motor inside the base supplies the power which is transmitted to four small piston-like rods projecting above the top. The unit provides seven different movements to entertain and exercise

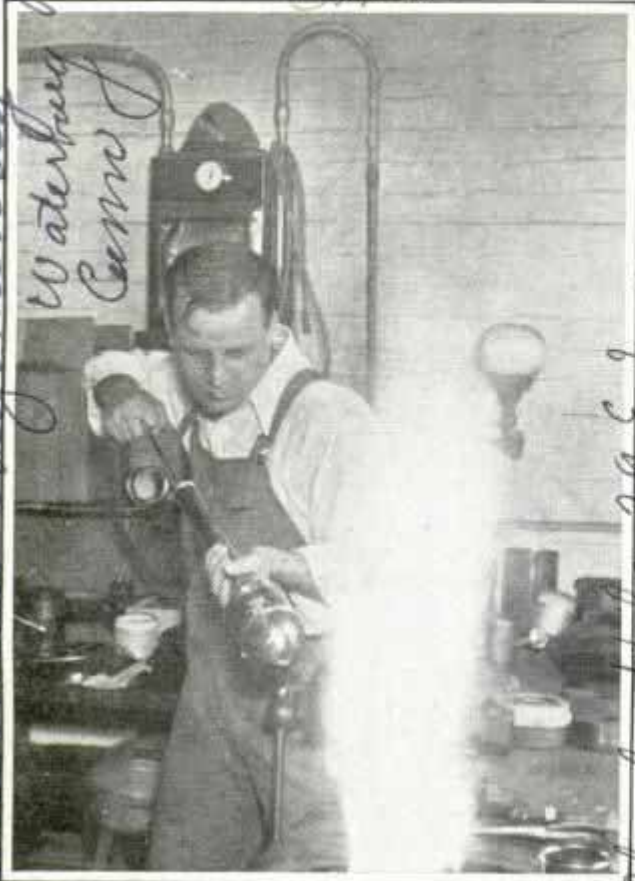


Left, Electric Horse Attached to Base Gives Rider Choice of Gait; Right, Electric Bassinet Rocks Baby to Sleep

the child when it is awake and sitting up. Then, if baby's brother wants to go for a canter, the bassinet can be taken off by removing a couple of screws and a mechanical horse mounted on the base. A variety of gaits between a trot and a running gallop are at the command of the young equestrian. The movement of the horse is regulated by the pull applied to the reins.

J. Otto Hahn, Hahn Machine Works, 713 1/2

FIRE EXTINGUISHER FOR HOME SHOOT DRY COMPOUND



Grease Blaze in Shop Is Speedily Quenched by Dry Compound Fired from Small Hand "Gun"

Shooting a dry compound that quickly smothers flames, a handy fire extinguisher has been designed for home use. It is easily operated, weighs but three pounds and is inexpensive, yet employs the chemical principles used by fire departments. The dry powder cuts off oxygen from the blaze, and eliminates the added damage done by water or wet chemicals in fighting fire. There is no upkeep, for the unit does not corrode or deteriorate.

NOTEBOOK FOR USE AFTER DARK HAS FLASHLIGHT BUILT IN

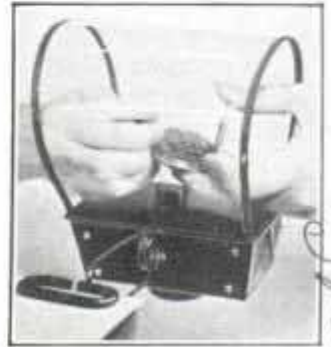


Writing and reading notes at night is made easy by a loose-leaf notebook equipped with a tiny flashlight inside the cover, throwing a light across the page when a button is pushed. It

was designed especially for policemen who must make entries, arrest slips and notes at all times of day. Three small cylindrical batteries in the back of the book are connected with the bulb at the left side by wires encased in the edge of the cover.

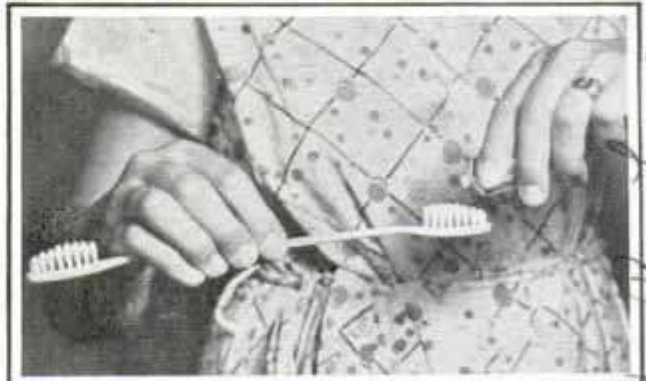
GOLD FILINGS ARE RECOVERED BY WORK TRAY WITH SHIELD

Every year dentists, jewelers and others who work with gold lose thousands of dollars in waste gold dust and filings. As they grind away, gold dust blows across the table and is lost on the floor and in the rug. A handy work tray has been devised to prevent this loss. It is covered with a transparent shield so that grinding or drilling work is visible, and all filings of gold or other valuable minerals are caught in the tray.



TOOTHBRUSH WITH TWO HEADS LASTS TWICE AS LONG

Alternating brushes for cleaning the teeth is possible with the introduction of a two-headed toothbrush which is just as easy to handle as one with a single set of bristles and lasts twice as long. Thus, one end can be used in the morning, the other at night, allowing both to dry thoroughly before being used again. The two-headed brush also offers a choice of bristles. One end may be stiff and the other soft, or one may have longer bristles than the other.



Choice of Soft or Stiff Bristles Is Offered by Toothbrush Which Has Two Heads

Charles Lunn. B. 3. 75-1
Waterbury Conn.
Waterbury
Camm

Charles Bold 296 Madison St. Chicago. Ill. 895

Wabash Chicago

Winterfront Co
D. Lewis Blvd. Dyer, Tenn.
1135 N. Second Ave. Chicago

895

Q. 13 8/12/38

695
505
EOP

Streamline Trailer of Duralumin Saves Fuel

Bowling Mfg. Co. San Fernando Calif



Road Chief

Shaped like the inverted prow of a speed boat, a streamline auto trailer with a welded steel frame and duralumin body provides the latest in motoring comfort. Because of light weight and the reduction of the air "back wash" it is an efficient traveler. At speeds of forty miles an hour and up, the builder claims, the car and trailer use less gas than a single car without a trailer. The trailer is practically heatproof due to the high efficiency of reflection on the exterior and special insulation. It has two compartments with Pullman construction living quarters, cushioned seats, folding tables, ceiling lights and a fireproof galley. The port-like windows are of shatter-proof glass with metal screens. A telephone connects the trailer with the car ahead. Two bullet-shaped tail-lights, two stop-lights and four clearance-lights provide safety.



Streamline Trailer with Welded Steel Frame and Duralumin Body Has Two Cabins with Berths, Galley, Tables and Seats

PASTE ADHESIVE IS RUBBED ON

Applied like a cold cream, an adhesive in paste form is waterproof, flexible and heat resistant and can be used for repairing toys, furniture, books, leather, fabrics,

upholstery and for mounting photographs or posters. It contains only a small amount of moisture and does not shrink, wrinkle or evaporate. It is applied with a brush or paddle or with the fingers and can be rubbed from the hands without washing.

936

Galley
about \$1100.00. 10 2 92
Carpenters Paper Co. Chicago
Emaha, Neb

Chicago Paper Co. 801 S Wells



in HOLLYWOOD

2804

would guess it on the screen. Even a native of Timbuktu would find it hard to pick flaws in screen scenery representing his own country. The reason is that the studio location departments conduct painstaking research to find and catalogue scenery that represents typical backgrounds for the whole



Top, Scene along the Movie Mississippi, Actually the Sacramento River in California; Above, Paramount Studio Location Map; Left, Electricians of Columbia Studio Setting Up Batteries of Lights on Location

*Corp. Fox, Hills Studio
Los Angeles Calif*



*Fox Company on Location at the Little Town of Bridgeport, Calif.,
8,500 Feet Up in the High Sierras*

6493 ft. according to reader

world. On the Fox lot, R. C. Moore has a file of thousands of photographs from which he can tell you at a moment's notice just where to go for scenery from Abyssinia to Zululand and he can prove it by comparisons with pictures actually taken in the country you want. In eighteen years of scouting out locations he has found spots in California typical of every country in the world. A little work by the property men and authentic costumes for the actors make the illusion complete in the finished picture.

In one day Moore may be called on to find an English hospital, an old colonial farmhouse, some Chinese river scenery, and a Russian salt mine. The hospital and farmhouse are easy. The chances are that suitable structures not twenty miles from the studio are listed in his files. For the Chinese river he sends the director to the lower Colorado near Needles where the low banks and flat back country are typical of the orient. The salt mine may be created on the salt surface of a dry lake in the desert near Amboy, something like the Muroc dry lake that serves in making pictures of ancient Egypt.

"When a company needs sand dunes for a background we offer several locations," Moore explained. "There are fifty-foot dunes near Guadalupe, as well as a real Sahara west of Yuma. There are still others near Palm Springs. Palm Springs is similar to certain parts of Cuba and has also been transformed into South African scenery. For other Cuban films we go to

the jungle-like Santa Ana canyon, within half a mile of the green fields and pastures that were used to represent the Des Moines country in 'State Fair.'

"Pictures of the eastern countryside are sometimes made at Corona where the trees and cattle resemble the real thing. For New England villages and mountains we send the actors north to Sonora, which also forms authentic backgrounds for pictures of the gold-rush type. The town of Pleasanton near Oakland is a perfect New England village, since it was built many years ago by Vermonters who brought their architecture with them. The coast near Monterey is similar to that of New England. South of Monterey, at Morro bay, is a favorite spot for screening pictures of the Nile. The flat, treeless country that stretches back from the bay is typical of the Nile country. In the mountains near Lake Tahoe, Siberia, Switzerland, and Wyoming cattle-ranch country are almost shoulder to shoulder."

The Sacramento river has been given many names in pictures although its most popular use is as the Mississippi. "Tom Sawyer" was filmed on that stream and "Steamboat Bill" was produced there, with old-time river boats and bales of cotton at the landings. Depending on whether a quiet or a fast stream is wanted, directors may send their actors either to sluggish streams near San Francisco bay or to the tumbling Russian river near Sausalito. Inland Alaskan country is represented by an area along the coast near



Ventura, where an Alaskan mining village was built in filming "The Spoilers."

Even closer to Hollywood is scenery that represents a dozen or more countries. At Point Fermin realistic pictures of the Welsh coast are made, at Santa Monica the palisades and crowded beaches double for the French Riviera in pictures, and at Lake Sherwood are the thick woods that are labeled "Sherwood Forest" in Robin Hood roles. The wooded Santa Monica canyon is a favorite place for battles, wild chases, and Connecticut farm lands, while a few miles away the rolling hills along the ocean comprise an ideal coast of Spain for the studios. The flat open spaces of San Fernando valley, in which several studios are located, contain spots used for trench warfare scenes and war-time flying fields.

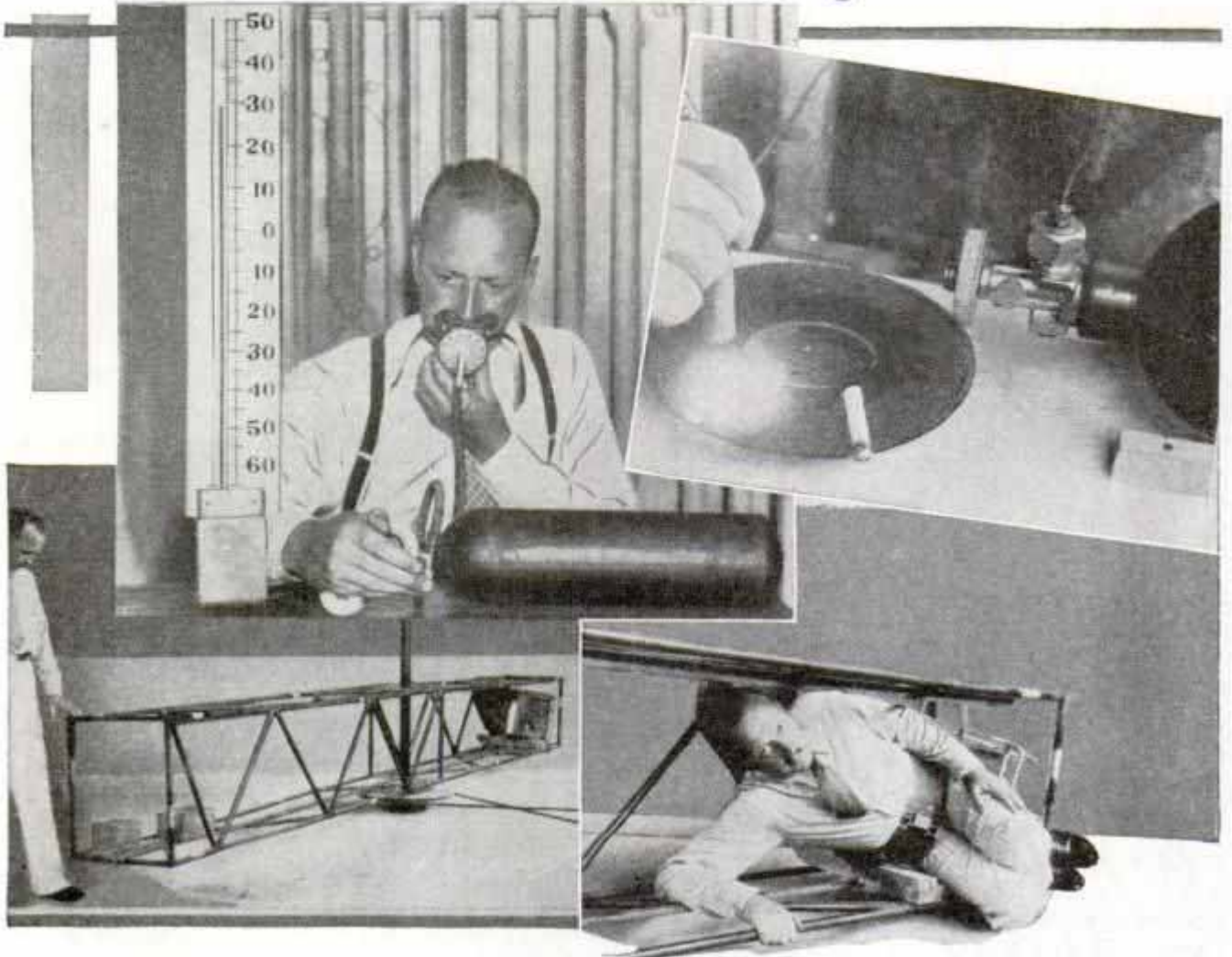
Arch Beach makes a good Malay coast but Laguna Beach, whose coves have been the

(Continued to page 128A)



Top, Portable Movie Outfit on Location; Center, Chinese Street Scene Filmed in Hollywood; Below, Making a River Shot on Location

Flyers Test Power-Dive Perils in Laboratory



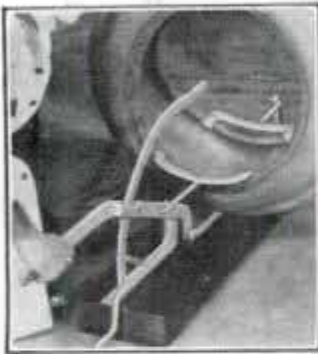
Top, Left, Wearing Oxygen Mask in Altitude Test Chamber; Right, Cigarette in Oxygen Stream Flares up While Other Cigarette Burns Normally; Bottom, Two Views of Centrifuge Used for Power Dive Test

What happens in the brain and blood stream of a test pilot when he "blacks out," unconscious, as he pulls his roaring plane out of a steep power dive? Why do stratosphere flyers find their teeth crumbling, and how is the crew of tomorrow's air cruiser to travel in comfort at 40,000 feet above the earth where air is thin and the cold paralyzes? These are some of the questions for which the army air corps is seeking answers in a new research unit at Dayton, Ohio. Pilots often become unconscious in power dives when the pull of the body reaches as high as 1,000 pounds. To simulate this hazard in the laboratory, Capt. Harry G. Armstrong, flight surgeon, has built a centrifuge, a welded frame like a plane's fuselage, spinning on a central axis, horizontally, as fast as 100 times a minute. This speed would multiply the weight of a pilot seated at one end of the whirling frame by

nearly 100. His chair, balanced by weights at the other end, is held near the axis until the desired speed is reached and then slides to the end. It is hoped to determine the condition under which a pilot blacks out and to establish a test for a pilot's fitness. Experiments with animals have shown that small brain hemorrhages result from the centrifugal force. Studies will be made of the effect of oxygen on teeth and lungs. A skull fitted with human teeth and various types of fillings will be encased in a flying helmet and exposed to varying temperatures and oxygen saturation. A substitute for bulky, electrically heated clothing and a way to eliminate frosting of goggles at high altitudes will be sought. In ten years, Capt. Armstrong believes, sealed cabins and improved clothing will have rendered today's stratosphere uniforms as antiquated as linen dusters and goggles for motorists.

Wingfield

QUICK TIRE-SPREADING TOOL WORKED BY ONE MAN

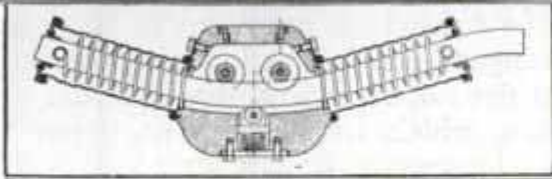


Portable and easily operated by one man, a new tire spreader handles all sizes of casings, from the smallest to the largest heavy duty. It can be used on the floor, curb or shop

bench. Its self-locking device eliminates straining and tugging to lock or release. The tool is offered for service stations, fleet owners, dealers and maintenance organizations where tire work is handled.

ANTI-SKID "GYROSCOPE" ON CAR DESIGNED FOR SAFETY

Working on the same principle as the gyroscope that minimizes rolling of ships, a new device is intended to prevent automobiles from skidding. Attached to the



Forces That Cause Skids Are Counteracted by This "Gyroscope" Attached to Rear of Automobile

rear of the car below the trunk or bumper, it consists of a weight of 100 to 150 pounds suspended on rollers from a V-shaped rail and held between two springs that limit movement to about one and one-half inches to the right or left. When the conventional car turns a curve or corner, the centrifugal force created tends to produce a skid. But the "gyroscope," due to the inertia of the weight and the springs that hold it, exerts a counterforce that "kills" the skid and holds the car safely.



Boatman Faces Forward in Oarless Craft Propelled Like Hand Car and Steered by Feet

BOAT PROPELLED LIKE HAND CAR IS STEERED BY FEET

When one Berlin boatman goes rowing, he doesn't use any oars. Instead he propels his craft like a hand car, by pulling a lever to and fro, which transmits power to a screw propeller aft. He sits in the stern, facing forward. The boat is steered by foot pedals connected by wire to the rudder. The absence of oars enables it to navigate the narrowest streams.

SANDING JOB DONE SMOOTHLY WITH SANDPAPER GLOVES

Delicate sandpapering work can be done more deftly by means of sandpaper gloves—canvas gloves with renewable sand surfaces on the palm and fingers. Quite rigid when installed, the sandpaper can be detached easily when worn out, and a dozen "fillers" are supplied with every pair.



See Kroto Co.

New Rochelle, N.Y.

H. R. Lewis Dist.

1435 N. Second Ave. Chicago

Joseph Zahn 3/6/14

Dear Mr. Editor, Chief Engineer, Rock Island, Ill. 8893

Tuning up a *Chicago*



Top, Engineer of "City of Portland" in Air-Conditioned Cab; Below, Control Room of a Streamliner



from Los Angeles to New York in less than fifty-seven hours. That was admittedly a test run. High-speed Diesel-electric trains were still in the experimental stage. They had to prove their worth. This one and its rival, the Burlington "Zephyr," both proved conclusively that sustained high speed was possible, practical and economical.

Satisfied with the first tests, the Union Pacific turned its attention to increasing passengers' comfort and ironing out problems developed during the test run. One feature which worked out on paper but failed in practice was heating the coaches. The air conditioning worked in normal weather, but in zero temperature the aluminum walls dissipated the heat too fast. Larger pipes were installed.

The original train swayed badly and vibrated at certain speeds. The trouble was traced to the trucks and new ones were installed. The original trucks were of seven-foot three-inch centers. The new ones are ten feet and six inches. In addition, the new wheel and axle unit, balanced statically and dynamically, is so accurate a hammer blow throws it off center. No chances of damage were taken during the

A DEEP booming roar fills the air. The throbbing beat grows louder. Coming down the track is the streamliner. There is a fleeting glimpse of a rounded nose, a blur of yellow, then two red tail-lights.

The "M-10001," now the "City of Portland," is being put through its paces. A year ago this Union Pacific streamliner broke transcontinental records by dashing

Cmd Alex ander has well 1758 Inland Terrace Chicago

Controler alexander was well 1758 Juneway Terrace

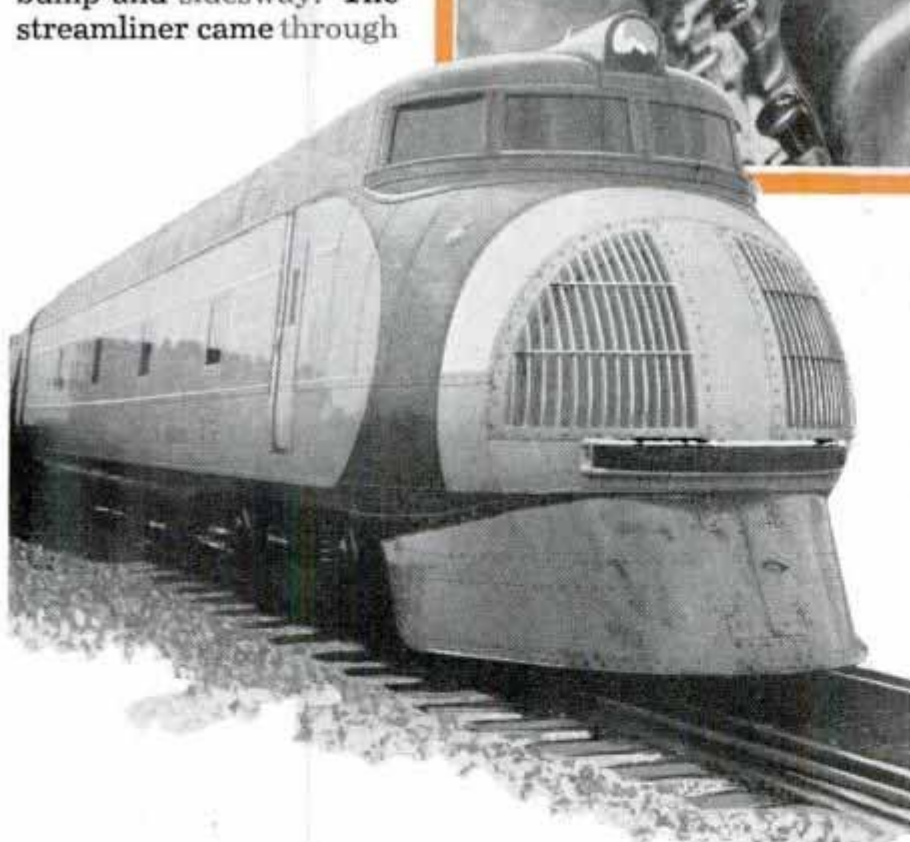
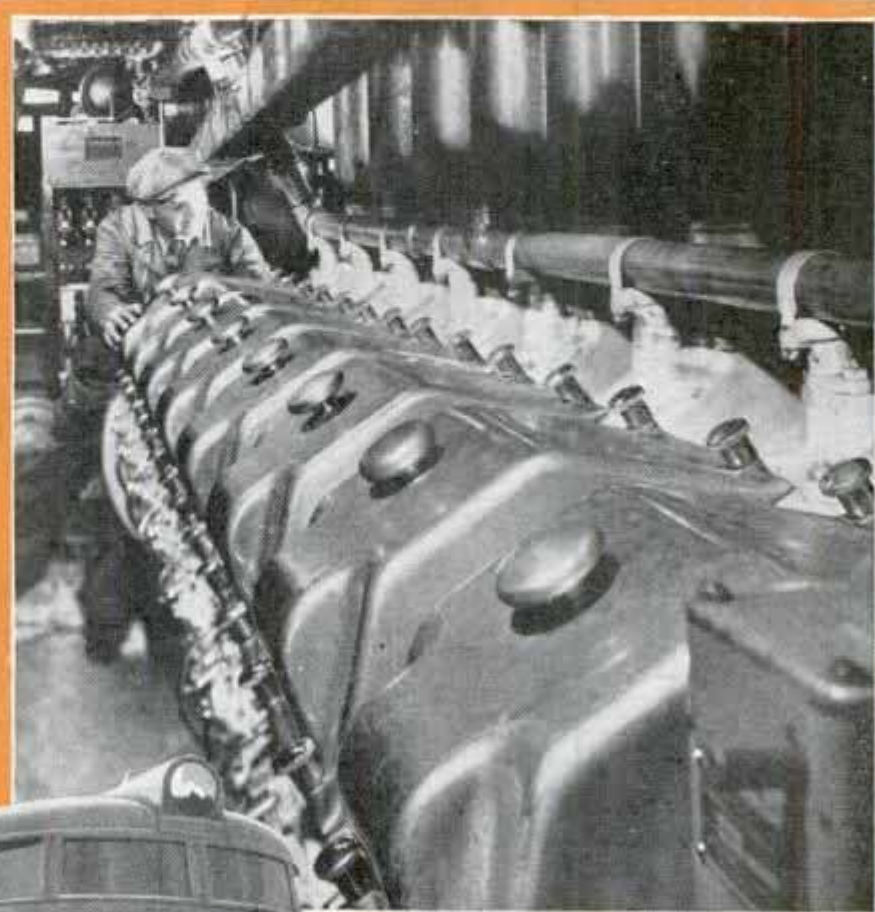
keep water to

STREAMLINER...

remodeling. Each axle and wheel was wrapped in cotton batting and left that way until the train was ready to roll.

Late last May the reconditioned "M-10001" was given the most grueling test run ever accorded a train. There were rumors that streamline trains were rough riding. This train was to prove a streamliner could glide like a toboggan.

Through freight yards, over abandoned track and across industrial sidings it sped. Dynamometers recorded every jolt, bump and sideways. The streamliner came through



Top, Engine Room Showing Sixteen-Cylinder Diesel; Bottom, Front View; "Cow Catcher" Did Not Appear on Original "M-10001"

with flying colors. All chatter was eliminated, the whiplike motion had vanished.

O. J., "Ollie," Mitchell, veteran steam engineer, is the pilot who drove "M-10000,"

and the unit was hoisted into place. Fuel oil and water are carried in tanks under the passenger coaches. A pump keeps a

(Continued to page 122A)

the first streamline train. He also held the throttle when the "M-10001" shattered two records. His power car on the "City of Portland" looks like the engine room of a submarine. Walls, ceiling and floor are lined with pipes, tanks and coils. In the center stands the huge sixteen-cylinder Diesel, recessed so the shaft comes on a line with the floor. This is the largest oil-electric unit in locomotive service. To install it, the car was rolled over a pit which contained the engine and generator,

928 Fullerton
Chicago
2894.

**FLOWERPOT HUNG LIKE PICTURE
CANNOT FALL AND BREAK**

Hung on the wall like a picture or attached to the side of a window, a sturdily built flowerpot with a blooming plant or vine offers an unusual way of brightening the home. It is attached to hooks deeply imbedded in a glass extension fastened to the wall. The hooks are staggered to distribute the weight and will support a heavy load.



2890

**WIND INDICATOR FOR AIRPORT
IS ILLUMINATED ARROW**

From 7,000 feet above the airport, day or night, flyers can tell the wind direction by glancing at a huge lighted arrow designed by a British inventor for a wind indicator. It is sixty feet long and twenty-three feet across the barbs, built of galvanized steel and studded with electric lights. The arrow swings with the wind to show airmen which way to land.

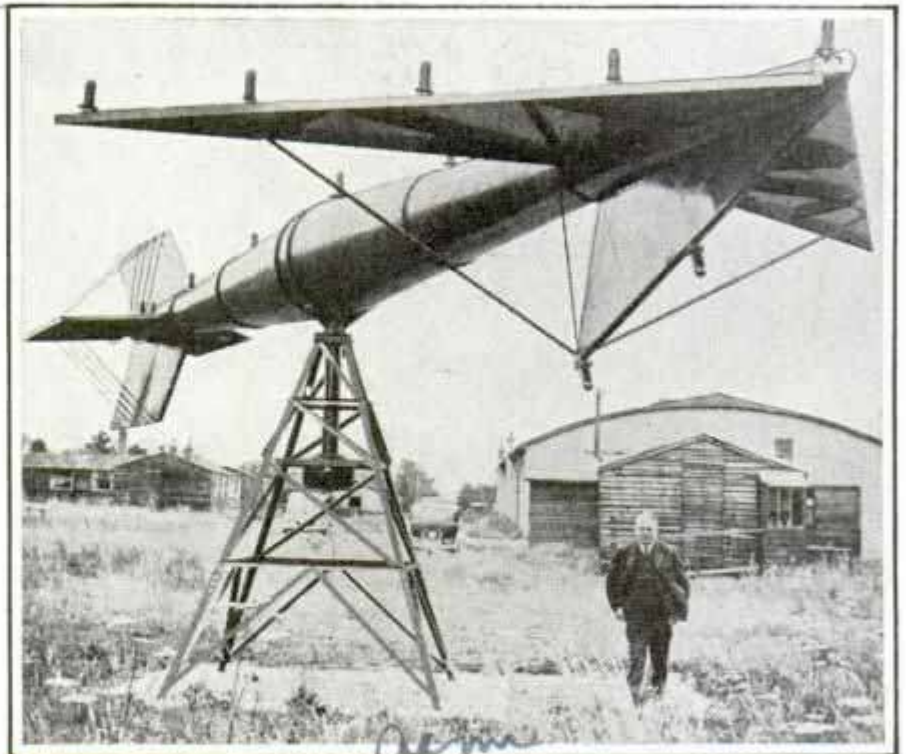
same source 7/24/35



Revolving Arm Spins Model Blimps at High Speed to Test Stresses under Storm Conditions

**"SLING SHOT" TESTS MODEL BLIMP
AT THREE MILES A MINUTE**

Future dirigible disasters may be eliminated as a result of tests on twelve-foot Zeppelin models, at the Daniel Guggenheim Airship Institute in Akron, Ohio, to determine where the greatest strains occur in conditions of severe storms. A two-ton revolving arm or "sling shot" whirls them through space at 200 miles an hour. Rubber tubes connected to sixty tiny holes in the hull lead to gauges which record the pressure forces at each spot. Films passing behind the tubes make a photographic record of the model's performance. Knowledge gained from the tests will be used in the future construction of airships so that sections which are subject to the greatest strains can be strengthened.

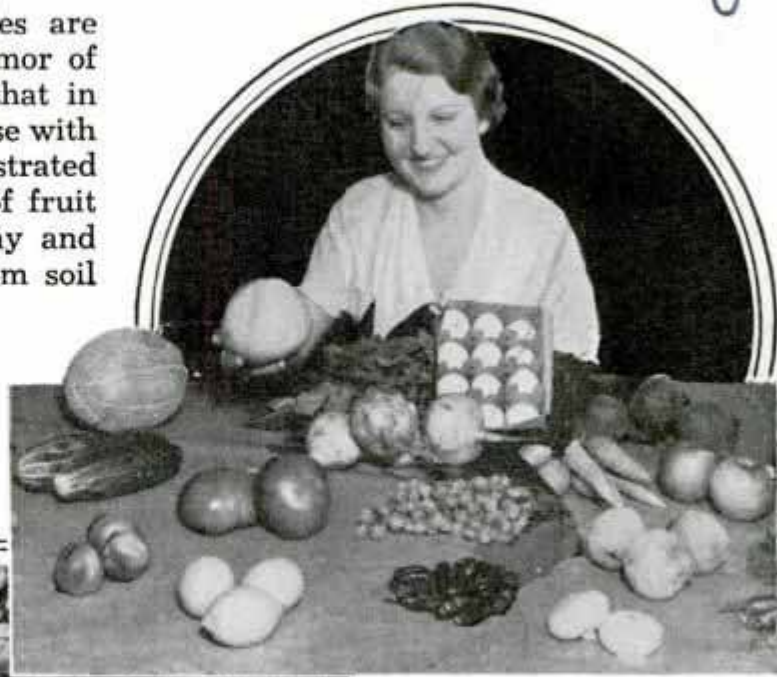


Giant Arrow Points Direction of Ground Winds for Flyers Preparing to Land, Note Light Bulbs to Point Way at Night

Chas. James Martin
Buckinghamshire

6751 02/09/30 603 111
 St. Pomona Calif
 Wax Coat Keeps Fruit and Vegetables Fresh

Sun-ripened fruit and vegetables are now being kept fresh by a thin armor of wax. So effective is the process that in many instances shippers can dispense with refrigeration. Experiments demonstrated that respiration through the skin of fruit and vegetables speeds fungus decay and that by coating products fresh from soil or plant with air-tight wax, rotting could be retarded. Wax prevents scald, chief cause of rot in apples, and triples their market life out of storage. Oranges and grapefruit are kept fresh on



Top, Some Garden Products Kept Fresh by Waxing; Left, Oranges Are Washed, Then Sprayed with Hot Wax Spread Thin by Whirling Brushes; This Coat Checks Decay and Preserves Luster

stands six months instead of six weeks or less. Lemons are kept in wax eight months to a year. Tomatoes can be picked ripe instead of green and remain fresh twice as long. Melons, cucumbers, potatoes, pears, even eggs are being waxed. Leafy vegetables, berries, apricots, peaches and nectarines have not responded to the process, but experiments are continuing. Shippers estimate that 25,000,000 boxes of greenstuff and fruit are being treated with wax in this country this year, and that three-fourths of the year's export tonnage is shipped under wax. The \$50,000,000 annual loss from domestic fruit decay may be reduced to the vanishing point by the new process.



stands six months instead of six weeks or less. Lemons are kept in wax eight months to a year. Tomatoes can be picked ripe instead of green and remain fresh twice as long. Melons, cucumbers, potatoes, pears, even eggs are being waxed. Leafy vegetables, berries, apricots, peaches and nectarines have not responded to the process, but experiments are continuing. Shippers estimate that 25,000,000 boxes of greenstuff and fruit are being treated with wax in this country this year, and that three-fourths of the year's export tonnage is shipped under wax. The \$50,000,000 annual loss from domestic fruit decay may be reduced to the vanishing point by the new process.

Popular Mechanics Magazine does not publish the name of the maker of, or dealer in, any device described in its pages, but this information will be furnished by our Bureau of Information upon request, accompanied by stamped envelope.

Vertical text on the right margin, possibly from a library or collection, including "Magazines" and "603 1111".

8 49 7

SKIPPERS *of the*

*Cred. Thomas & Stinson Jr.
100 575
Holman Ave. Los Angeles
Calif*



IF YOU should overhear a couple of transport pilots talking these days the chances are that you would find much of their conversation unintelligible.

"I was only pulling fifty-one per cent at 10,000 feet coming east," says one.

"You had it easy," the other one replies. "We were using thirty inches of mercury all the way and we came down in high pitch."

What the first pilot meant was that a tail wind had boosted him along so that he had flown with engines throttled down, while the other pilot had encountered head winds that caused him to speed up his engines.

These new expressions are an indication of some of the changes that are revolutionizing flying. Instead of a dare-devil aviator, the man in charge of an airliner is now a true captain of the air, part engineer, part navigator, and part pilot. He has come a long way since he sat behind his control stick and had nothing to do except glance at his tachometer



Douglas Airliner in Flight, and Co-Pilot Pumping Lever That Raises Landing Wheels into Engine Nacelles after Ship Has Taken Off and Gained Altitude

8 79 7

SKY LINES



and watch the scenery. Today a transport pilot is often too busy to fly the plane himself and he turns much of this routine duty over to the "third pilot." This new member of the cockpit crew is a mechanical robot that never sleeps or tires and that lives on less than nothing, since its diet consists of a steady vacuum. Tucked away in the bottom of the plane, the automatic pilot thinks and works for itself and guides the



Fueling an Airliner, and Pilot with His Case of Equipment for Making Complicated Calculations While the Flight Is in Progress

liner on its course with an unerring hand. Two dials on the instrument board report the actions of the mechanical slave.

When the automatic pilot is on duty the chief pilot even transmits his flying orders to it. Instead of taking over the controls himself to change the course the pilot now maneuvers his plane by twisting three little knobs on the gyro panel. If he wants to try the wind at a higher altitude he merely turns the button marked "Climb" and the unfailing mechanism automatically carries out his order. By turning other buttons the pilot can change the direction of the plane to the left or right or descend.

Except to a trained pilot the cockpit of a Douglas DC-2 airliner is a confusing place. Even an experienced flyer needs fifty hours of special training before he can fly the plane efficiently. Rows of dials fill the instrument panel, so many that most of the dials now have smaller faces to make room for the rest. Other dials and switches stud the pedestal between the seats that carry the carburetor throttles and mixture controls. Vari-colored lights flash on and off to tell the pilot of the condition of special apparatus. Over-

Terminal Island Calif



automatic pilot the skipper of nine tons of flying metal is a very busy man. Si Morehouse, senior pilot of Transcontinental and Western Air, and the other TWA pilots, really begin their flights half an hour before they leave the ground. Before entering his plane, a pilot first consults the station meteorologist and studies the latest weather reports gathered from stations along his route. Then he writes out in detail a pre-

head, beneath, behind, and on both sides of the pilot are other banks of instruments. Among the newest of them are the "metal mike" controls, the sensitive altimeter that registers to within twenty feet, the levers for changing the pitches of the propellers, and the landing gear and air-brake controls. In all, there are forty-one flying controls, forty-six panel instruments, seventeen electrical switches, eight radio controls, and three roof ventilator controls, a total of 115 instruments the pilot uses.

The latest is a gauge that registers the intake manifold pressures of the engines. Few people cared about manifold pressures in the past but now the pilots know these pressures indicate engine efficiencies and are a truer measure of performance and speed than revolutions per minute or throttle settings. Nearly every move they make in flight is based on the readings of the new instruments. The gauges show the pressures in the engine manifolds in comparison with air pressure at sea level and hence are calibrated in inches of mercury like mercurial barometers. That is why, when a pilot speaks about "thirty inches of mercury," or "sixty per cent of engine efficiency," other pilots know exactly what he means.

Even with the aid of his co-pilot and



Talking over Emergency Radio Located behind Co-Pilot's Seat, and View Showing Size of Modern Airliner

diction of what he will do in the air. Basing his decisions on weather conditions, he decides ahead of time at what angle he will climb, his cruising altitude and speed, corrections he will make for drift, and even at what time he will land at his destination. He writes down the fields that he would use in an emergency and estimates the amount of fuel he will have left at the end of the flight.

"Making a preliminary flight plan pre-

compares a pilot for the special conditions of that flight," Morehouse tells you. "It reduces the possibility of error in making fast judgments aloft and allows him to make the most efficient use of the 1,430 horsepower of his engines. It also eliminates much of the paper work he would have to do in the air, and provides a tentative schedule of the trip for the ground crews. Of course, a pilot may change his mind and



Pilot Consulting Weather Charts Before Flight, and Co-Pilot Tuning Overhead Radio Receiver

deviate from the flight plan, but since weather conditions rarely change a great deal during a four-hour flight, the original plan is nearly always followed."

As a symbol of their new status, all TWA pilots carry the latest tool of their profession, a zipper case crammed with calculators, slide rules, protractors, and complicated engineering data and performance charts. With these on his lap a pilot works out as many as thirty different

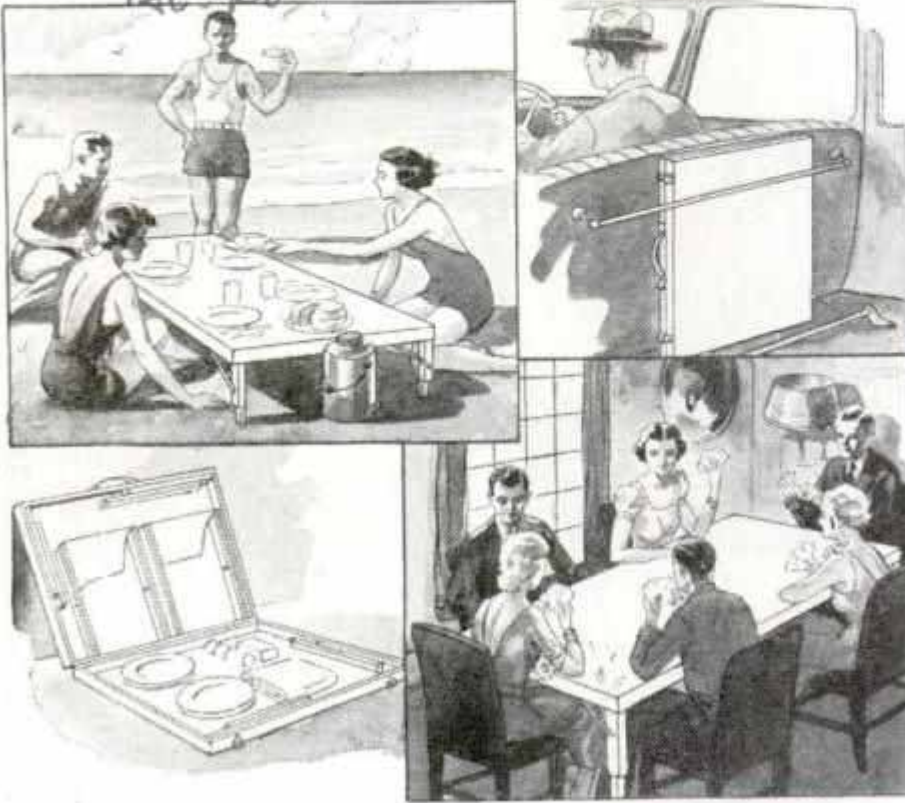
calculations while sitting in the nose of his transport during flight. Also in the case are maps of radio ranges, airway beacons, and weather charts, as well as an operations manual, forms, mail records, and passenger manifests. The cockpit of an airliner resembles a busy office part of the time.

When Morehouse boards his plane at the Grand Central air terminal near Los Angeles he begins a series of operations that keep him busy until the plane lands at Albuquerque, 700 miles away. After the ground crew plugs in the battery cart connections that temporarily boost the available power, Morehouse throws switches that energize the plane's electrical system and the electrical instruments by which temperatures and fuel quantities and pressures are measured. With the aid of other switches he checks all of the plane's lights.

The airliner carries two grades of gasoline, the auxiliary tanks containing superfuel of eighty-seven octane rating for the takeoff and possible emergencies while the other tanks are filled with aviation gasoline for ordinary cruising. The co-pilot turns the engine gasoline selectors to the high octane tanks, builds up fuel pressure in the carburetors with a hand wobble pump, turns the carburetor air controls to "cold" and the oil temperature

(Continued to page 144A)

Handwritten: Railway Machinery, Milwaukee
**Folding Table for Picnics
or Home Is Easily Carried**



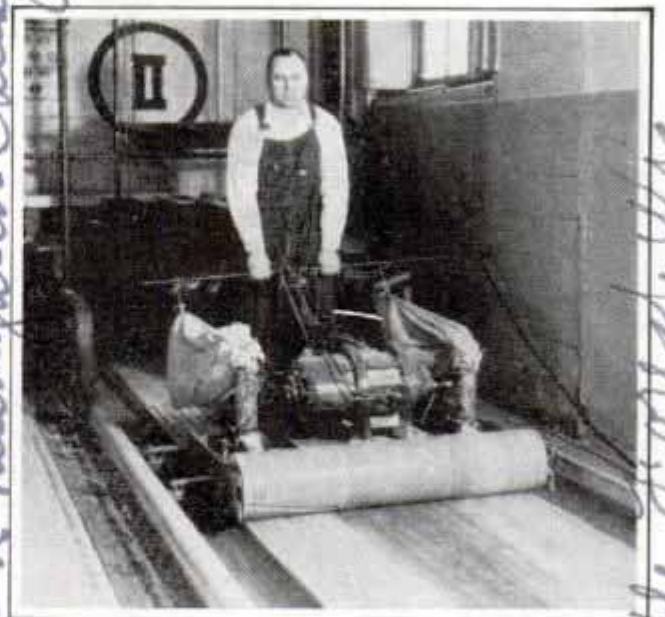
Folding Table with Adjustable Legs Handy for Home or Outings, Is Easily Carried and Makes Convenient Receptacle for Eating Utensils

Handy for camping, picnics or home games, a portable outing table four feet long by two and one-half feet wide has adjustable legs that raise its height from sixteen and one-half to twenty-six inches. At low height it is suitable for picnics or beach parties. At full height it is efficient for camping or for home use. When folded it becomes a carrying case that fits back of the robe rail in the car.

through which a new advertising card flashes its sales talk every five seconds. Inside the cover is a disk bearing three advertising cards, each of which is shown in succession as a small motor gives the disk a one-third revolution. Motor and lights for night use draw one ampere or less from the automobile battery.

Handwritten: 8981
**BOWLING ALLEY IS
SANDED SMOOTH
BY WIDE DRUM**

To resurface bowling alleys with the highest polish attainable, a sanding machine has been devised which covers the entire width of the alley and moves forward at a fixed speed. The forty-four inch sanding drum is guided by side wheels which push against the dividers between the alleys, and forward motion is controlled by an electric winch and airplane cable, insuring even pull and eliminating any grooves. Variations in the repolished surface do not exceed one-30,000th inch. Vacuum sacks carry away the dust.



Sanding Drum "Shaves" Entire Width of Bowling Alley While Advancing at Constant Speed

Handwritten: 8929
**REVOLVING "AD" IN TIRE COVER
FLASHES SALES SLOGANS**



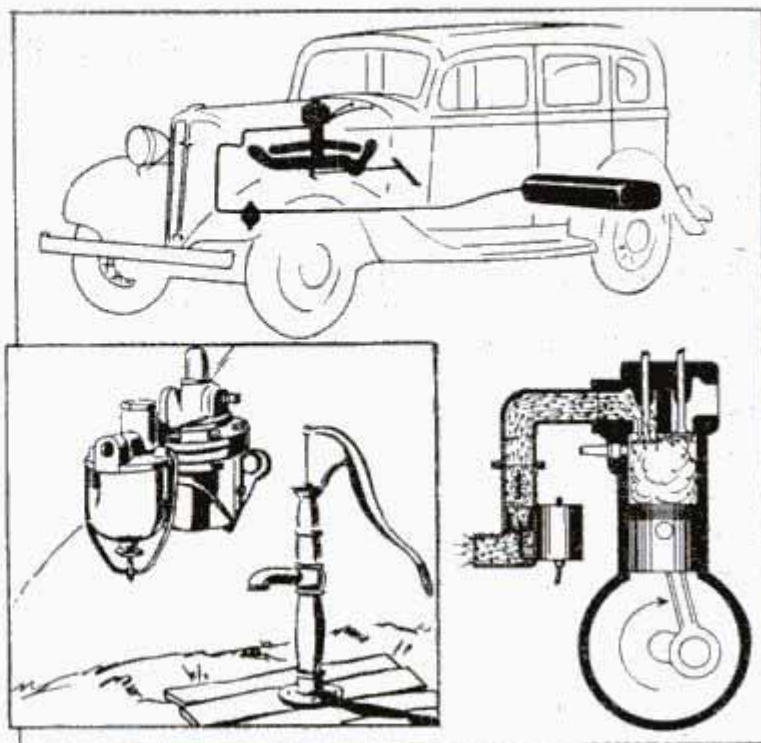
"Talking" tire covers are the latest method used by advertisers to attract attention of the motoring public. Mounted on the spare tire at the rear is a steel cover with a transparent "window" at the top,

Handwritten: 8/12/38

*Handwritten: 400 to Milwaukee Car Chevy
The Great...
Salby-Tires Div.
Capital City Bowling*

Experts Fight Vapor Lock in Car Fuel System

Keeping the fuel system of the modern automobile from getting too hot is a problem for which engineers are seeking a solution. When gasoline is heated, about ten per cent of it boils away at 130 degrees and the boiling action interferes with the carburetor, causing missing and stalling, a condition known as "vapor lock." In recent tests by The Texas company, with the air at 100 degrees, these fuel temperatures were recorded in an auto being operated at forty miles per hour with a brake load corresponding to a seven-per-cent grade: pump outlet, 149 degrees; carburetor bowl, 143 degrees, and main jet, 131 degrees. When the motor was cut off, these temperatures were found: pump outlet, 177 degrees; carburetor bowl, 181 degrees, and main jet, 184. The three main offenders in the overheated fuel system are fuel pump, carburetor and gas line connecting them. Trouble resulting from boiling fuel is avoided in some 1935 models by using a large enough vent in the bowl so the vapor may escape easily. Interference with the pump is overcome by using pumps twenty to fifty times the capacity required to handle the liquid fuel. Other suggested remedies for the vapor-lock problem are: use of thick insulating gaskets for fuel pump and carburetor; keeping pump, fuel line and carburetor as far from exhaust system as possible and shielding them from heat; circulating larger volume of air through radiator when car is running, and improving natural circulation when car is standing by having louvers in engine side pans and hood. John O. Eisinger and D. P. Barnard of Standard Oil Company of Indiana have found that an increase in horsepower of fifteen to twenty per cent may be obtained in the average automobile engine by reducing the temperature of the mixture in the intake manifold by sixty degrees. This reduction in temperature is obtained by using more volatile fuels which require less manifold heat for vaporization. The increased power is due to two factors:



Top, Showing Fuel Line, Pump and Carburetor; Inset, Fuel Pump; Right, Fuel Mixture Flowing into Cylinder

first, the lower temperature permits a greater weight of air to be drawn in; and, second, the cooler air allows an increase in compression of half a ratio. It also was found that a power increase of seven and one-half to ten per cent could be obtained if engines could be operated on winter gasoline during the summer months, provided the engines were designed to take full advantage of the more volatile fuel.

ELECTRIC DOOR BELL FOR DOG IS OPERATED BY PEDAL

Your dog can ring the doorbell instead of barking or scratching if you install an electric bell made for his particular use. A pedal near the bottom of the door connects with the bell. Projecting at a height where the dog normally scratches, it completes a circuit



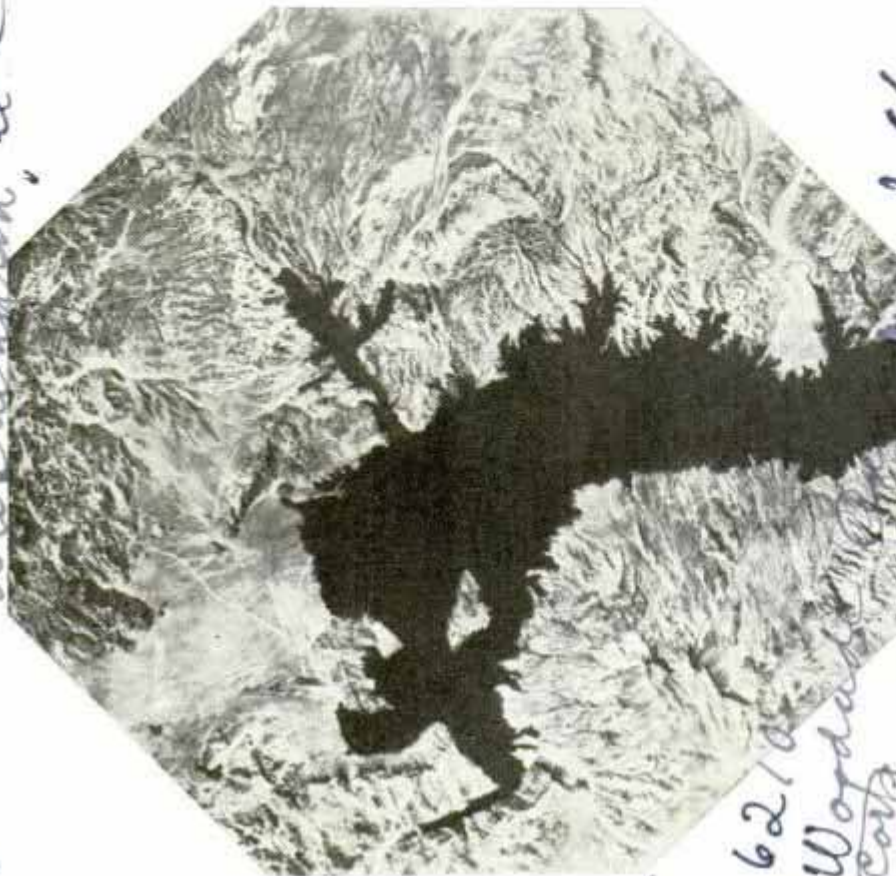
when the pet's paw is pressed down. The hook-up is simple and a dog can be trained without difficulty to use it.

From Motor, 939 - 8th Ave N.Y.C.
 910 S. Michigan
 133892 Madison
 New York City

G. L. Novelty Co. Wabash Ave Chicago
 Q. 204, 1029
 Q. B. 8/12/38

8/15/35

Flying Camera with Ten Eyes "Sees" over 200 Square Miles



Aerial View, Taken with Ten-Lens Camera, Showing Two Hundred Square Miles; Boulder Dam Appears as Semi-Circle Near Bottom

More than 200 square miles of territory were crowded into a single picture when Boulder dam and the man-made lake above it were photographed recently with a ten-lens aerial camera from a height of 20,000 feet. All the peaks, rivers, plateaus and other physical features in the area are shown in relief. The dam itself appears as a semi-circle near the bottom of the picture, while the huge reservoir is in the center. The picture is one of a series taken for the federal government and is used to study soil-erosion control to protect the reservoir. A giant camera, weighing 275 pounds, and exposing ten negatives simultaneously was used.

ZINC AND PAINT "HOSTILE"

Paint will not stick permanently to zinc-coated metal because the two are chemically "hostile." Dr. Henry J. Wing, a chemist, has found that the contact of the two generates an acid which causes de-

terioration. He noticed that the contact side of paint peeling off zinc-surfaced metal was covered with white film. He exposed small zinc-covered glass reflectors to fumes from paint and found the same film on the mirror surface. Analysis proved it to be zinc formate, a compound of zinc and formic acid. Paint removed from galvanized iron showed the same substance present. Paint taken from plain iron did not have it. While these experiments solved a baffling riddle, science is still faced with the problem of how to make paint adhere to zinc.

PAINTBRUSH IS FED DIRECT FROM PAIL BY AIR HOSE

Combine the paintbrush and the paint spray and you have the self-feeding brush, which eliminates all the waste

effort of pausing to dip your brush into the paint bucket. A portable air compressor does the work.

Driven by gasoline or electric motor, it forces air and paint from pressure chambers through parallel supply tubes into the brush, the supply being controlled by a finger button in the brush handle. The compressed air forces an even flow of paint throughout the bristles. The brush weighs only four and one-half ounces and its head is available in various sizes and shapes.



Our Bureau of Information will answer questions regarding articles in this magazine, if accompanied by return postage.

*Conf. with Bureau of Standards
Washington, D.C.
E.I. du Pont de Nemours & Co. Wilmington, Del.*

*6210
Ward
N.Y.*

*8982
Paintbrush is fed
direct from pail
by air hose
Combine the paintbrush
and the paint spray
and you have the self-feeding
brush, which eliminates
all the waste effort
of pausing to dip your
brush into the paint
bucket. A portable air
compressor does the
work. Driven by gasoline
or electric motor, it
forces air and paint
from pressure chambers
through parallel supply
tubes into the brush,
the supply being
controlled by a finger
button in the brush
handle. The compressed
air forces an even flow
of paint throughout
the bristles. The brush
weighs only four and
one-half ounces and
its head is available
in various sizes and
shapes.*

Tiny Girders Aid in Building Scale Models

Model skyscrapers and toy railroads, bracelets and picture frames and ships are some of the things you can build with brass and aluminum girders, rails and grooved parts supplied in any dimensions by a Chicago metal-furrowing works. In miniature, the channeled, grooved, fluted and slotted strips are replicas of the standard steel building materials. There are double-grooved pieces from which you can fashion tiny sliding windows fitted with glass. Architects and engineers use this material to build scale models, corner members fitting so neatly they need not be soldered unless desired for permanent



Top, Tower Built of Tiny Beams; Left, Ship Model and Other Products of Grooved Metal Shown in Foreground

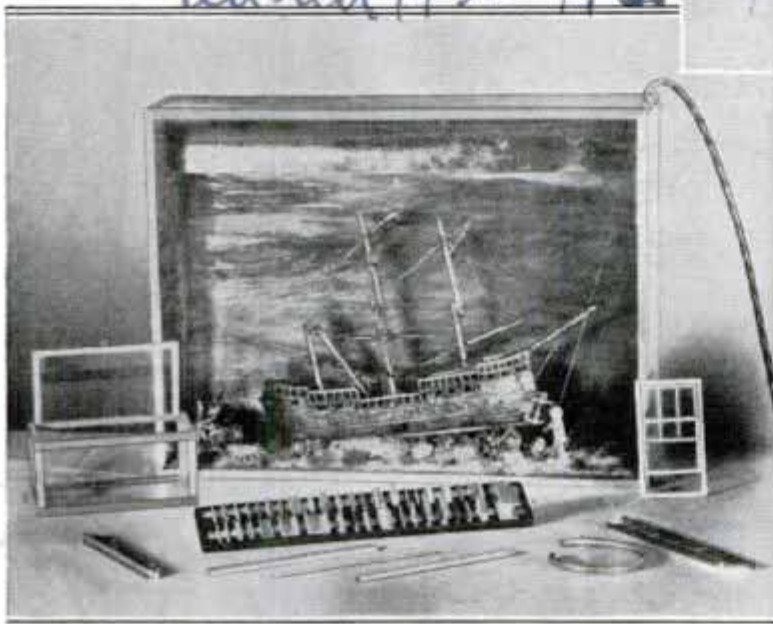
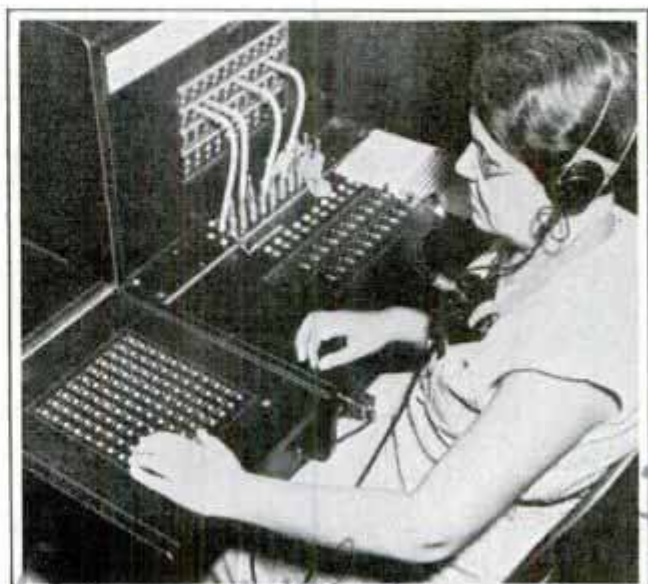


exhibit. Besides the standard "T" and "Z" bars, "I" beams and "H" beams and columns, there are round, slotted ladder bars and wire for making ship railings, "00" gauge rails, angles and channels, and special corners for constructing showcases and water-tight aquariums. Decorative strips are also furnished for framing pictures and for jewelry.

Blind Operator Reads Calls on Switchboard in Braille

Fingertips read the calls on a Braille telephone switchboard designed for blind operators. This development by telephone engineers has opened another occupation to the sightless. In front of the operator is the regular trunk-line switchboard with its plugs for connections. Instead of flashing lights, however, there is a horizontal table at the left of the board with rows of buttons or plungers, beside each of which is a Braille number. When the buzzer indicates a call, the operator runs her hand over the table, finds upraised plunger and reads its Braille dots for the number. At the same time she locates the cord with her right hand and plugs in to make the proper connection.



by Bell Telephone Laboratories

Tel. Winney 6390

at Maryland Workshop. Edinboro Area. Baltimore, Md. Blind, Hilton and

8992
metal-furrowing works
550 Webster Ave. Chicago

Mr. James ...
20. Dartmouth Road
Kansas City, Mo

The BIG



Left, Count Cutelli and Assistant with Boxes for Making All Kinds of Train Sounds; Below, Egyptian Water Grass and Wind Machine to Simulate Sound of Wind in Marshes, and Basketball Containing Buckshot Used to Make Sound of Big Explosion; Top, Opposite Page, Hot-Water Bottle to Produce Sound of Person Swimming, and Apparatus for Making Pistol and Rifle Shots



HIT-AND-MISS methods no longer are employed in supplying sound effects for radio productions. Instead, the creation of natural sounds by artificial means has become a complex and often costly part of the business. As a result, a new profession—that of sound effects expert—has grown up in the industry.

There are only a handful of these sound experts, one of the foremost being Count G. Mazzaglia Cutelli, an Italian whose work has won for him the nickname of the "Big Noise," a title he earned in Hollywood when, as a synchronist, he created a big battle scene for the background of a motion picture.

Since then he has installed his sound-making apparatus in many studios both here and abroad and has succeeded in reducing the production of radio sounds virtually to an exact science. In addition, he has given the art of artificial sound making a new technique and equipment that is a study in compactness and utility.

The units of his apparatus are so con-



27 & 30 ...

Handwritten notes in the left margin, including "Prof. Mazzaglia's ..."

Handwritten notes in the right margin, including "The BIG ..."

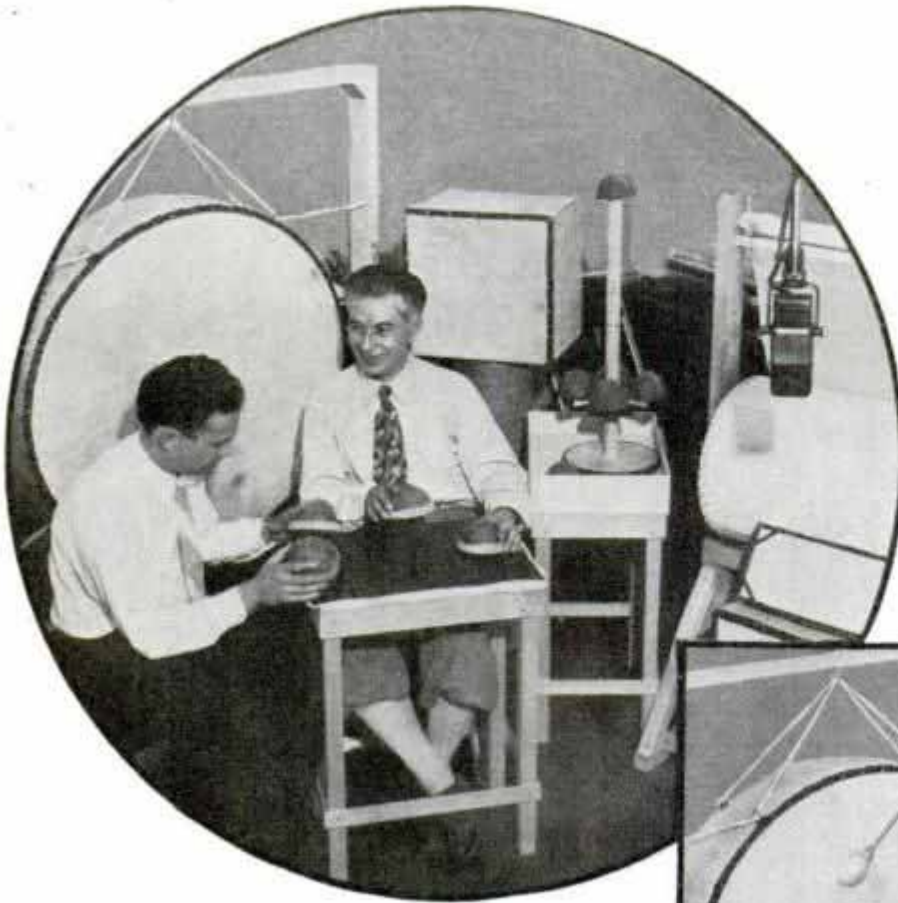
NOISE



Below, Left, Count Cutelli Demonstrating to Sound Men of WGN, Chicago, How Drum Makes Noise of Dirigible; Right, "Footsteps" in Gravel

structed that they can be placed in a small corner, thus conserving valuable studio space. Eleven fundamental devices constitute his equipment for making hundreds of everyday sounds. These are a plunger, a tom-tom, a canvas bag, a tin box, a red rubber balloon, a banjo, a train box, a pillow, a piece of silk cloth, a handful of Cellophane, and a hot-water bottle. Some of these are especially built to his specifications and some of his materials are imported from abroad

His equipment is supplemented with sheets of plywood, used for thunder; boxes of shot creating the illusion of waves breaking on a beach; coconut shells grinding into bits of granite for horses trotting, and a wind machine that will produce anything from a murmur to a hurricane. These simple devices are productive of so many different sounds that their diversity is amusing—the crunch of footsteps, the sizzling of bacon, snorting of a locomotive, whir of flying birds, howl-



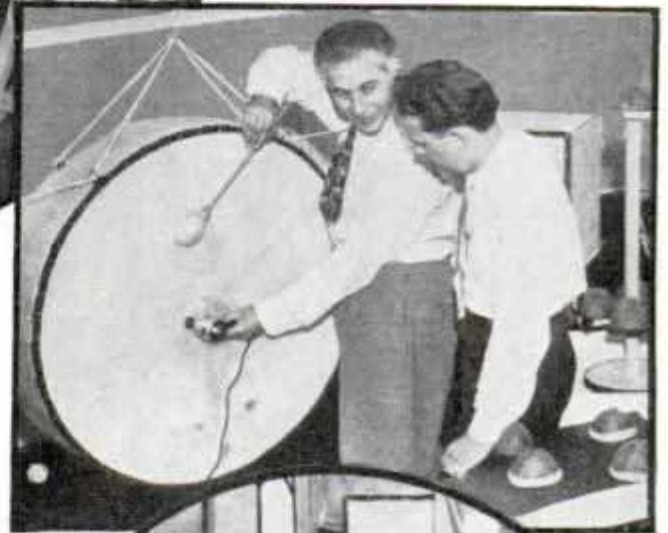
have found that a study of the microphone placement is of utmost importance. For some effects the microphone is almost touching the source of the sound. Seldom is it more than a few inches away. The effects heard in the studio are not always identical with those they are intended to simulate. The magic of the microphone is necessary to complete the illusion."

To simulate a terrific

ing of the wind, the chirp of a cricket, roar of a cascade, airplanes in formation, or the thunder of artillery.

Most sound devices created heretofore have been big, unwieldy and expensive to operate. Count Cutelli has changed all that. In one studio he replaced a big \$450 motor occupying three square yards, used to create explosions, with a tiny substitute occupying about an inch of space and costing a dollar. In Berlin, he found three persons threshing about in an artificial pool to make a rowing sound. This he supplanted with an invention of his own covering about five square inches and costing seventy-five cents. And this device originates all kinds of water sounds from a mere swish to a splash. He makes a painstaking study and analysis of the myriad sounds in nature, then goes about recreating them mechanically.

"For radio production," he says, "sounds must be 'tailor made' to fit the script. The sound of an ordinary train is not sufficient for a situation that calls for the roar of an express. Too many persons can differentiate between the two. The same is true of ship noises, machinery, airplanes and many other sounds that figure in our daily lives. In producing sounds artificially I



Top, Trotting Horses; Below, Simulating Artillery Fire; Bottom, Sound Effects Wind Machine

explosion he uses an inflated basketball bladder containing a few buckshot. A few preliminary movements are climaxed with a slight bounce against the microphone itself. For ordinary rain he pours fine

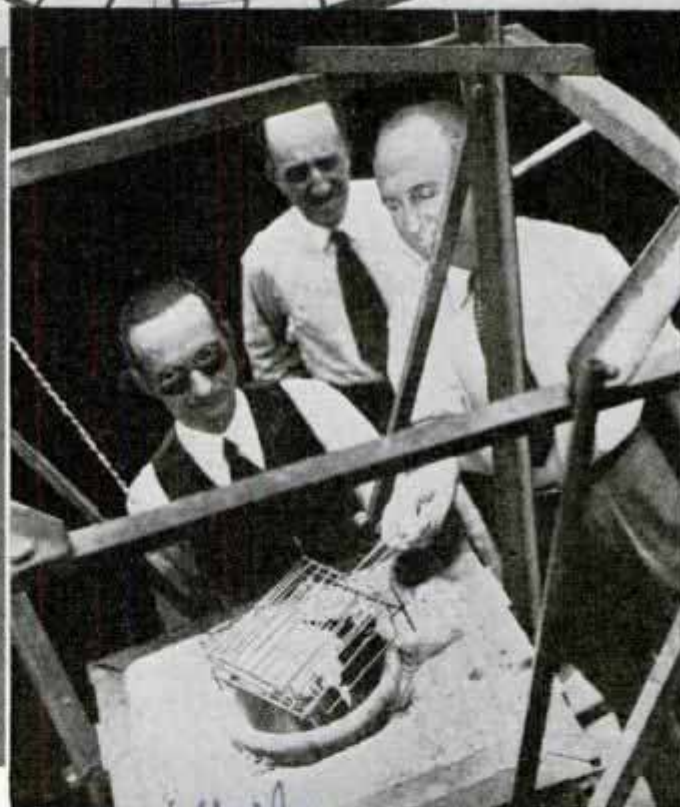
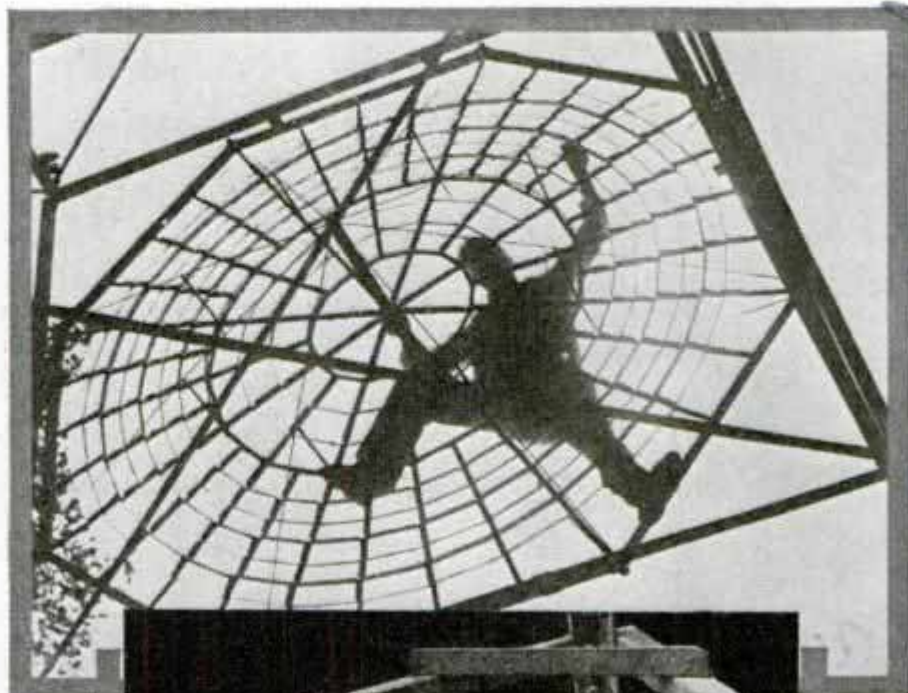
lead shot on a canvas stretched taut across the top of a specially designed box with the microphone six inches away. To effect a driving rain, possibly with hail, a sheet of Cellophane is stretched over the canvas. And by altering the shot, the distance of dropping, and the microphone placement the sound of artillery can be heard. And the whir of the "Graf Zeppelin" motors is imitated merely by rolling half of an English walnut on a suspended drum head.

If the script calls for an actor to speak in a great hall, all he need do is direct his voice into a square box backed by canvas. The sound man also has designed a cloth bag the player pulls over his head when gasping out his dying words. By pulling a square piece of canvas a certain way, the sound of a football being kicked is sent into the "mike." A series of pulls on a piece of silk cloth imitates the sound of an outboard motor in operation. One of the outstanding features of Count Cutelli's equipment is the simplicity of its operation. A child can be taught the whole catalogue of sounds in twelve hours, he says.

"It is my theory that eighty per cent of all natural sounds are not on record," he explains. "My business is to furnish noises that will record over the microphone with more authenticity than the actual sounds themselves."

Our Bureau of Information will answer questions regarding articles in this magazine, if accompanied by return postage.

Glass Melted by Sun Rays Focused on Small Furnace



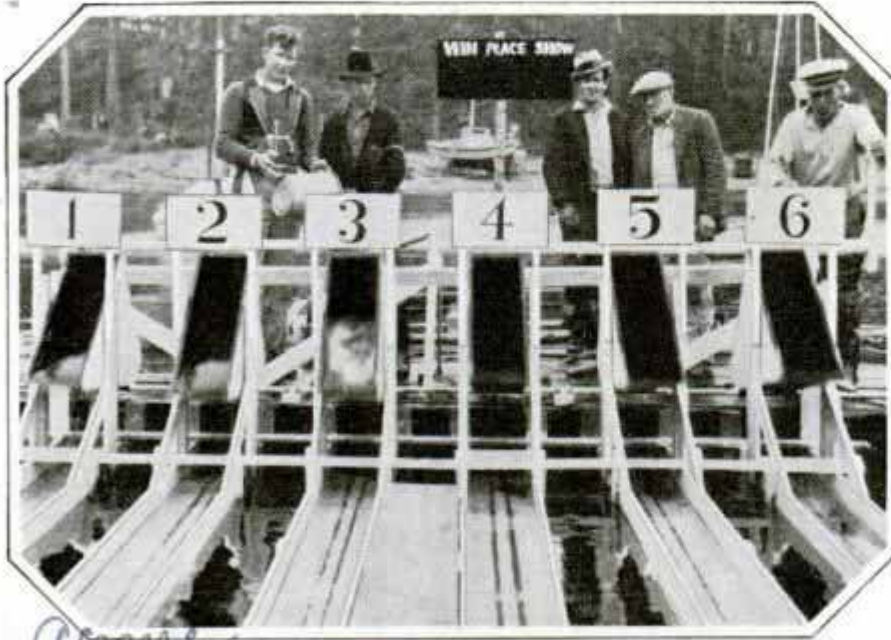
Top, Preparing Giant Lens; Bottom, Grilling Chops in Concentrated Rays of Sun; More Than a Few Seconds Exposure Burns the Chops

Concentrating the sun's rays to produce 1,100 degrees of heat, an unusual furnace invented in Spain is capable of melting glass or metal. A lens area of about thirty square feet focuses the rays in the furnace or smelter box. Wood placed in an opening of the box bursts into flame instantly. The apparatus is believed capable of enlargement to develop temperatures up to 5,000 degrees for factory operations.

Uste - Conte, Spanish
engineer. Invented

Wade Walle
Invented by Wade Walle
the inventor of the solar furnace

Fish Racing as Beach Sport Modeled After Dog Derby



Abner
"Race Track" for Fish Introduces Counterpart of Dog Derbies; Order of Finish Recorded by Fish Tripping Mechanism at Course's End

Swimming nose and nose down a watery "track" like greyhounds chasing a mechanical rabbit, rock cod have been used to introduce fish racing at a beach in Oregon. Six raceways filled with water run parallel down the beach, their insides painted white to give greater visibility. The starter drops the fish into chutes and turns a handle dumping them into the raceways. As they reach the end of the course each fish trips a mechanism which records the order of its finishing.

for lunch and baby's bottle. The side car is equipped with windshield, fenders and springs.

per or leaving uneven edges. In decorating, an entire room can be wall-papered and trimmed by laying the guide along the molding and using a sharp knife to cut all the hanging ends at once.

E 958
**BICYCLE FOR WHOLE
FAMILY HAS SIDE
CAR FOR BABY**

How to give the baby its buggy ride and keep up their sport of cycling is a problem one English family solved by attaching a side car to their tandem bicycle. The tiny passenger can ride forward or backward. Mother occupies the rear seat, behind which a leather bag is strapped

at Clacton-on-Sea.



Ch.
Tandem Bicycle for Mother and Father Has Side Car Specially Equipped for Baby

PAINT AND DECORATING GUIDE KEEPS EDGES CLEAN



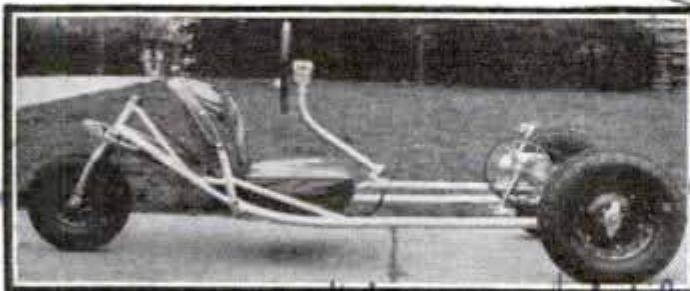
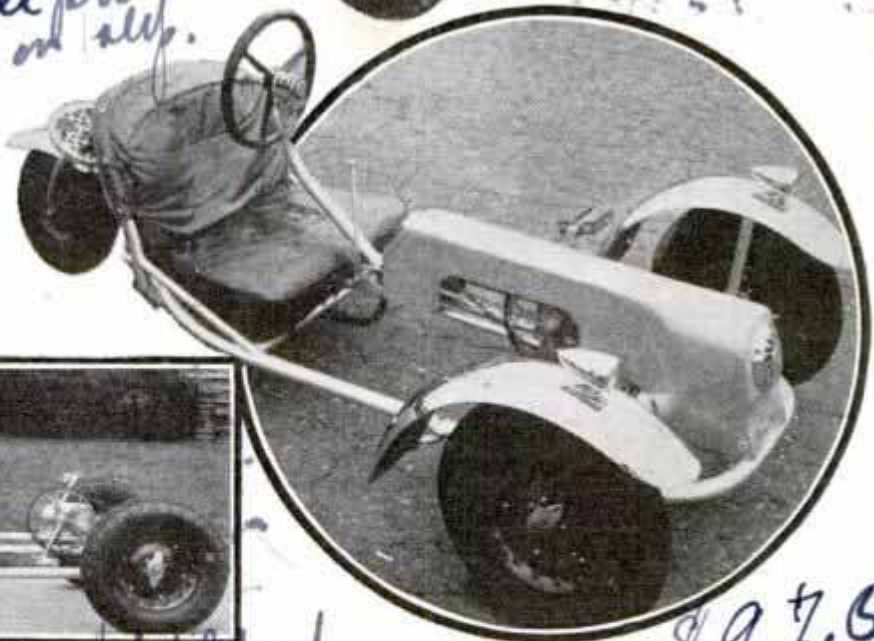
Handy Guide
Paper-hanging and paint jobs can be done more neatly and quickly with the aid of a guide for the paintbrush or the trimming knife. Placing the guide protectively over the wall paper, you can paint moldings, panels and window sashes speedily without fear of smearing the pa-

*See Luxe Products Magazine
65th and Valley St.*

MOTORLESS CAR PEDALS LIKE A BIKE

Three-Wheel Auto Has Two-Speed Gear and Safety Brake

Enough to delight the heart of any boy, yet far from being a toy, a small three-wheeled car driven by pedals like a bicycle has been introduced. It is large enough for a man, but its operation is so easy that a child can handle it. The car is made in several models, from the stripped-down racer to the car equipped with streamline body, fenders, headlights, speedometer, electric horn and aircraft-type windshield. One feature of the car is a two-speed gear that facilitates operation on inclines. The steering wheel, which controls the single rear wheel of the car, is adjustable to the occupant. An over-running sprocket gives the vehicle remarkable free-wheeling qualities. For safety, a self-equalizing brake is effective on two wheels. Air wheels and a long wheel base result in unusual comfort. Tests of the car show that only slight practice is neces-



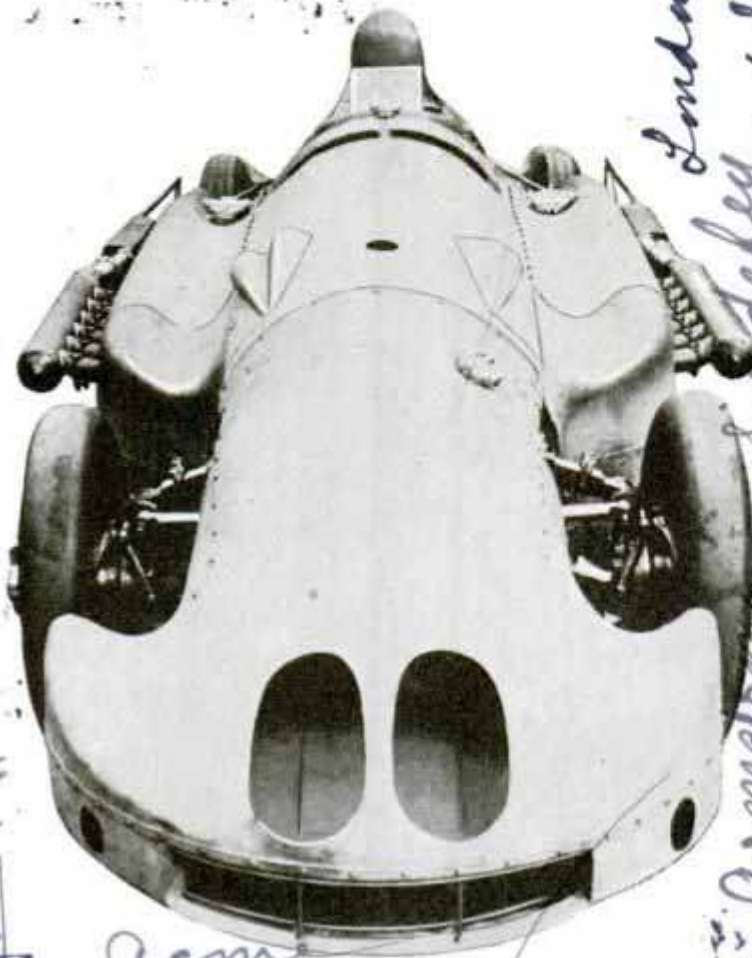
Courtesy Aero-cycle Company

Top, Trying Out One of the Motorless Cars; Left, Stripped Down Midget Model; Note Lightweight Frame; Steering Wheel Is Adjustable; Right, Model with Covered Sprocket and Headlamps

sary to attain speeds around twenty miles per hour. Designed as a sports vehicle, the car combines healthful outdoor exercise and utility. One of the practical uses found for the car is in traveling between the various hangars and other buildings at airports, since its operation requires no outlay for motor fuel.

Handwritten notes:
 Aerocycle Company
 1050 Melbly Street
 Detroit, Mich. Ave.
 see data for prices
 \$124.00 for Detroit and 14800
 see price on slip.
 \$27 Lakefront
 \$97.50 for Detroit
 \$14.50 for Detroit

Racer Without Clutch Seeks World Records



Front View of Front-Wheel Driven Racing Car Built without Clutch or Supercharger; Note Openings for Air

Powered by a 400-horsepower aero engine without supercharger, a new racing automobile built by Capt. George Eyston, British driver, is being pointed for a try at all existing world's speed records for long distances. Twenty-three feet long, the car has a theoretical speed of 200 miles an hour. Front-wheel drive is used, and there is no clutch, the drive being taken through a pre-selective gear box. Air vents are seen in front.

RUST AND SCALE PREVENTED BY ELECTRONS IN WATER

Electrons are being generated in water to remove rust and scale from boilers, heaters and pipes. The purging is accomplished by a small glass buoy, shaped like an electric-light bulb, in which there is a partial vacuum and which contains three inert gases and treated mercury. Im-

mersed in water and agitated, the bulb creates a magnetic field causing free electrons to circulate. These electrons change the polarity of the oxygen in the water, preventing the formation of oxide of iron or rust. They also penetrate the metal, since rust drops off the outside of boilers once the water is treated. They break up the minute crystals in hard water which form scale on the metal, transforming them into a soft sludge easily drained away. This treatment softens water, resulting in some cases in a saving of fifty per cent in soap. The action of the electrons is entirely physical, the chemical analysis of the water being the same before and after treatment.

SPEEDOMETER FOR SKATES IS HELD IN HAND

How fast you travel on roller skates is told by a speedometer that can be attached to any skate. It clamps between the front rollers. A tube runs from the gauge to the dial which is held in the hand or fastened to the belt by a metal flap. It is operated by means of a small gear which turns a spiral in the tube which registers the result on the dial. While a roller skate covers side distance as the foot turns out-



Speedometer for Roller Skate Can Be Held in Hand or Attached to Belt

ward, the speedometer is calibrated to discount this motion and only the forward movement is registered.

Twenty-one states now have laws requiring safety glass in new autos.

Rolls Royce Kestrel Aero Engine 400 hp

London, England. Armature of a 1000 watt motor. 1135 n. Creed, Chicago

John S. Kelly, Inc. Motor, July 1935

6900
Cooker &
Can Sealer, Wis

HOME FOODS PRESERVED IN TIN WITH COOKER AND SEALER

Preserving foods in tin cans right in the home kitchen is now practical. A pressure cooker that speeds the processing, and a small, easily operated can sealer that will seal as many as 170 cans an hour make canning in tin a simpler task for the housewife. Food in tin is better protected against light, and since the can is sealed before processing there is no loss of juices, flavor or color in cooking. Food is placed in the can, sealed by a turn of a crank, and the can is put in the cooker containing a cup of water. With the cooker cover securely fastened, steam is generated under five to ten pounds pressure, and in this way fruit can be canned in five minutes, vegetables in forty minutes and

Seal-A-Matic



Housewife Puts Tinned Foods into Pressure Cooker While Daughter Seals Tin Cans by Turn of Crank

meats in thirty to sixty minutes. Time, labor and fuel are saved. Many tin cans may be stacked in the pressure cooker and there is no danger of breakage. The increased temperature and steam pressure assure destruction of any harmful bacteria in the food. The sealer is equipped with a cutter which removes the top of the old can neatly, and re-flanges the can so that it may be used again.

Our Bureau of Information will answer questions regarding articles in this magazine, if accompanied by return postage.



Light Bombs Which Illuminate the Earth Below Enable Army Flyers to Take Night Pictures

BOMBS OF LIGHT HELP FLYERS GET NIGHT PICTURES

Equipped with light bombs of 5,000,000 candle power each, an army airplane stationed at March Field, California, obtains pictures of wide areas at night. The cylindrical bombs aim streams of blinding white light toward the earth and the camera, which looks like a huge hat box attached to a valise, maps the terrain below

AUTO RADIATOR IS KEPT CLEAN BY RUST AND DIRT FILTER

Clogging of automobile radiators with rust and scale is prevented by a water filter which arrests the sediment in the circulatory system and allows it to settle in a glass bulb. Particles of dirt and metal scaling off the walls of the water jacket around the motor block are constantly accumulating in the cooling system and stopping up the radiator. The filter, attached to hose connections between motor block and radiator



top, holds back the flow of water long enough to let the muck and rust settle into the glass container, which is easily removed for cleaning

Isaig + Proctor
Radiator Co

Used by 23rd Photo Section
US Army Air Corps

2 Second St
Tulsa, Okla

416

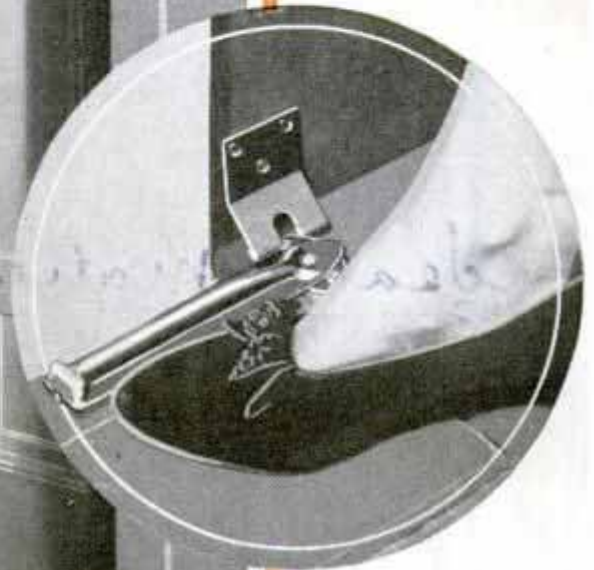
Latest HOME



Right, Door Catch in Place, Protecting against Intruders; Top, Catch in Locked Position; Below, Emergency Repair Device for Loose Buttons; It Consists of Safety Pin with Ribbon of Alloy Metal That May Be Bent in Any Position; Threaded through Button Eyelets, the Ribbon and Pin Hold the Button Safely until Tailor Is Reached



Left, Latest Safety Catch for Doors Gives Security without Marring Woodwork; It Is Controlled by Foot, as in Picture Below, as a Flick of the Toe Setting the Locking Device or Pushing It Out of the Way



Below, Window Seat Has Cedar-Lined Drawer That May Be Used for Storage Purposes; the Arrangement Is Particularly Suitable for Bedroom of Apartment



Above, Double-Bladed Knife Cuts Bread in Even Slices; Blades Are Adjustable to Almost Any Thickness; Knife Is Useful for Cutting Meat Loaf, Ham or Cheese

ACCESSORIES



Top, Transparent Top Sweeper Shows When Dustpan Needs Emptying; Steel Combs Automatically Clean Brush as Sweeper Is Used; Below, Simple Punching Device Makes as Many as Eight Holes in Can Top to Facilitate Shaking Out Lye, Kitchen Cleanser Powder, Floor Wax and Similar Substances

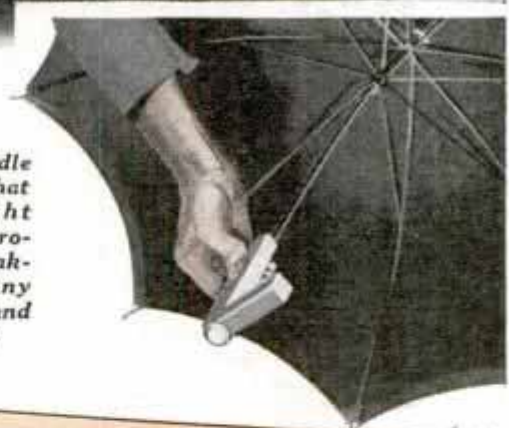


Right, Jointed Cushion, Resembling Inflated Water Wings, Adds to Comfort in Traveling; Cushions Are Made of Denim, Whipcord or Chintz and Filled with Kapok

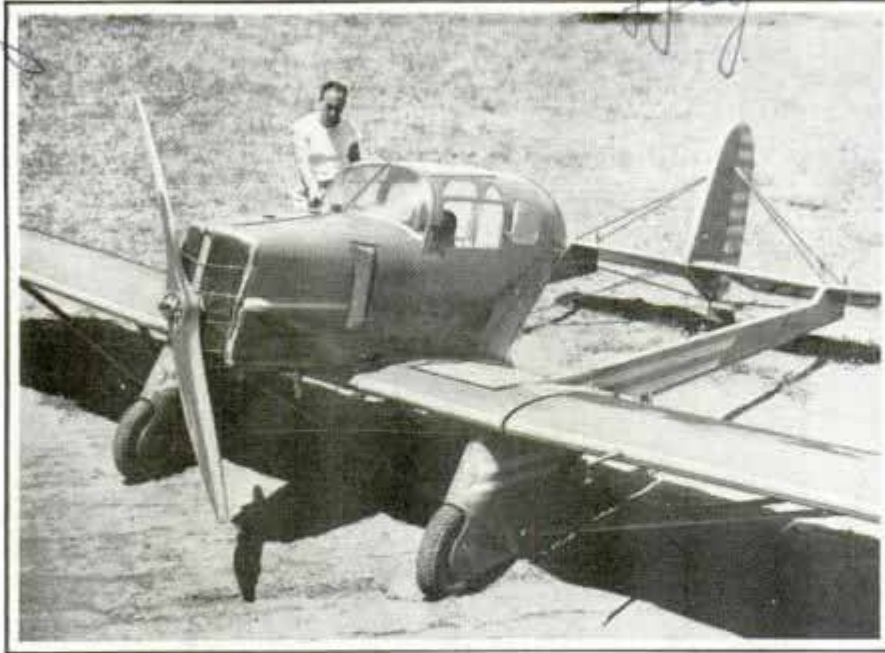
Right, Latest Dust Mop Has a Roll of Treated Paper from Which a Sheet Is Torn After Use; the Mop May Be Used for Walls, as Well as Floors; When the Roll of Paper Is Exhausted, It Can Be Replaced Easily with Another; This Equipment Improves Sanitary Conditions in the Home, Eliminating the Mop Filled with Dust and Germs



Right, Umbrella Handle Contains Flashlight That Is Operated by Slight Pressure; Bulb Is Protected against Breakage; Handle Fits on Any Umbrella; Batteries and Bulb Are Standard



Neil McIsaffey



Two-Mile-a-Minute Monoplane Powered with Ford V-8 Motor Has Fuel Consumption of Three Gallons per Hour

MONOPLANE WITH AUTO ENGINE COSTS LITTLE TO OPERATE

Constructed at a low cost, a small airplane powered by a stock Ford V-8 motor has been successfully tested. This low-wing ship, about the height of the average small automobile, is a two-seater monoplane. Its fuel consumption is approximately three gallons per hour. It has a maximum speed of 115 miles an hour and a landing speed of thirty-five miles an hour. The engine, mounted on rubber, is housed beneath a standard automobile hood with a radiator, in front of which the propeller whirls. The plane weighs 1,800 pounds and is expected to sell for as low as \$1,500, according to its builder.

POCKET CALCULATOR IS HANDY AT ARITHMETIC PROBLEMS

Plain addition and higher mathematics are equally easy chores for a little calculator just placed on the market. It does the work of expensive calculating machines yet it is easily slipped into a coat pocket and is very simple to operate. There is



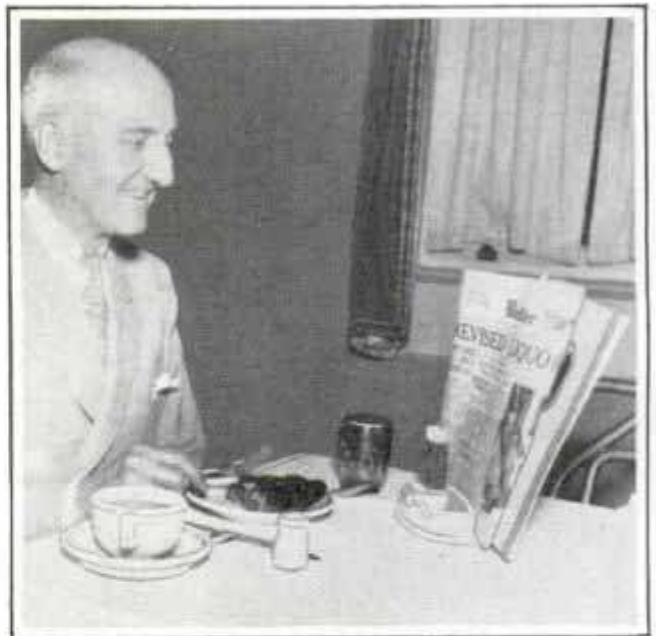
Top Figures Are for Addition, Lower Bank for Subtraction, Result Showing in Circle at Left Center

but one working part—a toothed, annular number wheel. On each of the wheels, which correspond to units, tens, hundreds, etc., are two series of digits from zero to nine, the upper series being for addition and the lower for subtraction. Numbers to be added are "listed" by engaging a pencil in the teeth at the proper figures and turning the wheel toward zero until it stops. The result is shown in figures appearing in circles at the center of the calculator. It can be used as a score-keeper for bridge,

billiards, and similar games, and by using two slides, the calculator can be adapted to dividing and multiplying and also for forms of higher mathematics.

8910

ASH TRAY HOLDS NEWSPAPER FOR READING AT TABLE



Glancing over the Headlines as Handy Device Holds Paper and Provides Ash Tray

For those who like to smoke and read as they eat, a combination ash tray and newspaper holder is being offered. Made of porcelain, the tray has a stump for a safety match box and a detachable ash bin, expediting cleaning.

Brown Nixon & Co. Danbury Pa.

Neil McIsaffey, 2122 Pine St. South Pasadena Cal.
Bar. Fulton & Co. 595 York



CONDENSER *Capacity & Leakage* TESTER

By R. O. LUND

TWO valuable service instruments are combined in this condenser capacity and leakage tester which can be assembled easily by the experimenter or service man. It measures capacity in microfarads by means of a bridge and employs a neon tube leakage indicator and polarizer. Capacity measuring ranges include: .001 to .05 mfd., .01 to .5 mfd., .1 to 5 mfd., and 1 to 50 mfd. In addition, any unknown condenser, resistor or iron-cored choke may be compared with any similar known standard by use of a bridge ratio-comparison circuit.

Leakage is indicated by a neon bulb in series with a high-impedance choke. Voltage for the leakage test is obtained from the d.c. power supply of the receiver under test or from a B-power pack as desired. The bulb and choke prevent damage to low voltage electrolytic condensers. Either head phones, or an amplifier with an output meter, may be used to indicate the minimum hum position that designates the balance point of the capacity bridge.

The Thordarson foundation unit is available from all radio supply houses. All

(Continued to page 140A)



Build this T.R.F. Four

By FRANK M. LUND

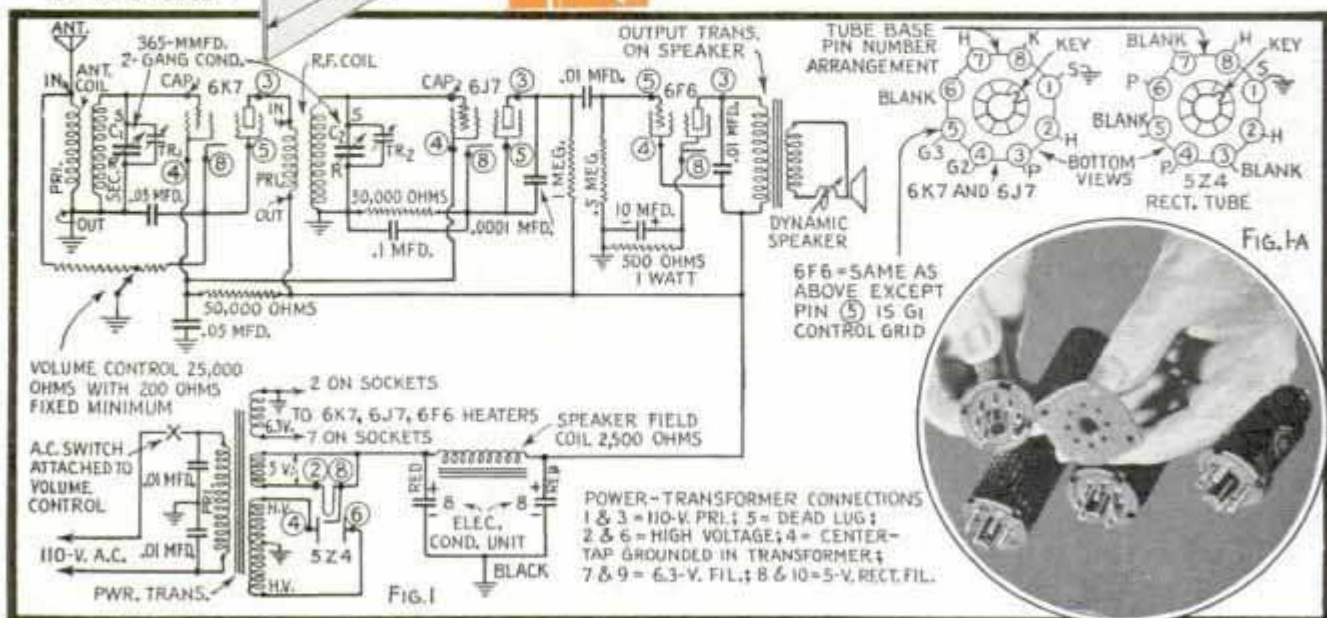
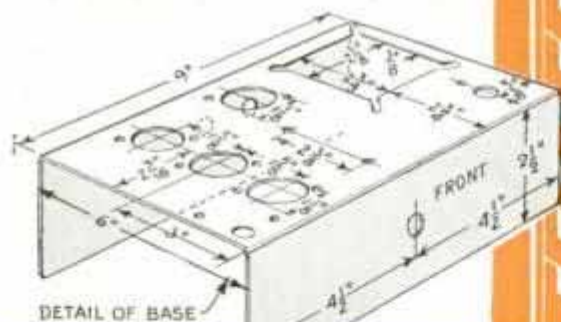


ALL-METAL tubes simplify and improve set construction, require no shielding and eliminate most of the tube noises that interfere with good reception. They employ the same filament, grid electrodes and plates as the older types but the glass tube has been replaced with a smaller metal cylinder, this can be used as a ground and does away with the use of extra shielding.

Each tube base is provided with an extension key which fits into a slotted hole in the center of the socket. Only one type of socket is required, this a new standardized 8-prong variety simplifies the identification of the various leads.

The low-cost tuned r.f. receiver described in this article, employs four of these all-metal tubes in a simple and highly efficient circuit that anyone can assemble with few tools. Although very compact and easy to build, it includes a dynamic speaker, standard high-gain Litz coils, power detection, and has a range of from 1,000 to 2,000 miles. In addition to the broadcast stations it will bring in police calls with good volume, the measured output being 3 watts.

The base is made from a piece of $\frac{1}{16}$ s by

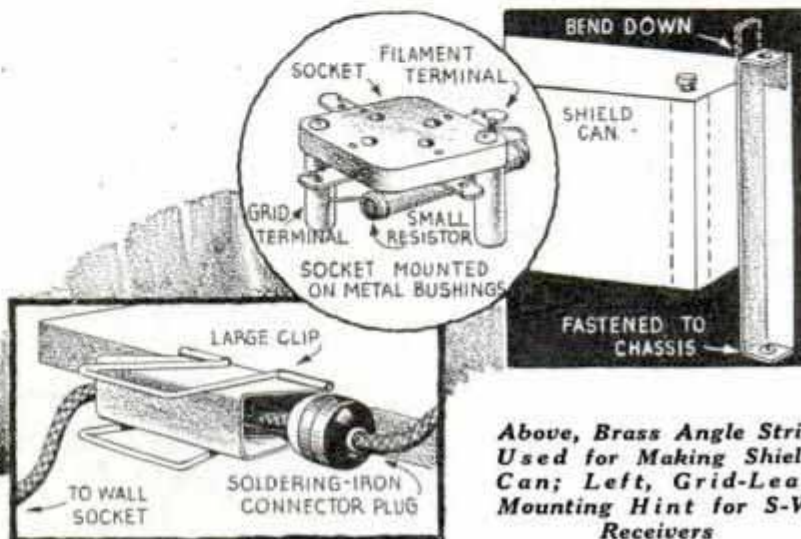


*National Company, 61 Sherman
E 3604 Malden, Mass*

Easy Solutions for Common Radio Problems

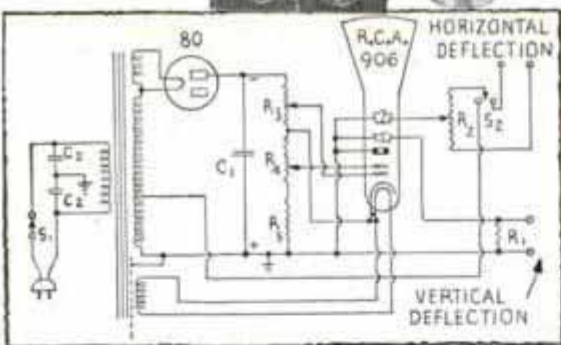


Left, Inexpensive Cathode-Ray Oscilloscope, Designed for Amateurs and Experimenters, Provides a Visual and Accurate Means for Checking the Performance of Radio Circuits; Although of Simplified Type, It Will Do Practically Everything That More Complicated Instruments Are Capable of Doing; Entirely Self-Contained, the Power-Supply and Control Devices, Indicated in the Schematic Diagram Below, Are Built-In; a Cylindrical Metal Shield Is Provided for the Type-906 Cathode-Ray Tube; the Life of This 3-In. Tube Is About 1,000 Hours if Operated Carefully and Not Subjected to Overloads

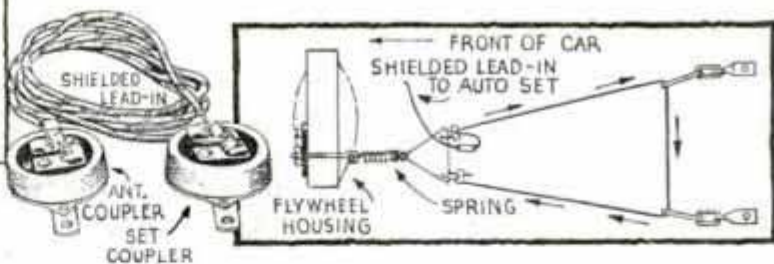


Above, Brass Angle Strip Used for Making Shield Can; Left, Grid-Leak Mounting Hint for S-W Receivers

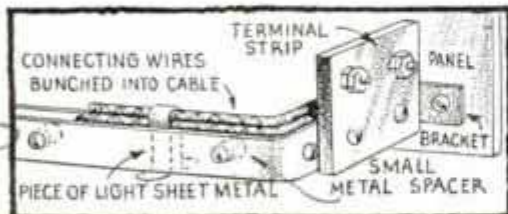
Above, an Extra Large Paper Clip Makes a Handy Table Clamp for Supporting the Weight of a Long Electric Soldering-Iron Cord; Service Men and Experimenters Working at a Distance from a Wall Socket Frequently Find it Necessary to Use a Long Connector Cord the Weight of Which, if Not Supported, Usually Pulls the Iron from Its Stand



Below, Metal Strips Provide a Means for Bunching Connecting Leads without the Usual Lacing Which Requires Time to Remove and Re-Lace When Making Changes



Noise-Free Under-Chassis Antenna Kit, for Coupe or Metal-Top Car; Includes Shielded Lead-In and Coupling Transformers



Right, Compact, Long-Life A and B-Batteries for Portable Receivers and Transmitters; Two of the Small A-Batteries, Connected in Series, Supply 3-Volts with an Average Service Life of 40 Watt Hours; the Voltage Adjuster, Shown Above, Is Used to Reduce the A-Battery Voltage to a Safe Value for 2-Volt Tubes



Burgess Battery Co. Freeport, Me

*Lynch Mfg Co
2077*

SIMPLE TRANSMITTER

Covers Three Bands ...

By R. E. DAVY

ALTHOUGH small in size, this transmitter packs a real wallop; operated in Chicago, it has been reported heard in South Africa. It includes many desirable features which will appeal to both the beginner and experienced amateur.

A.C. operated throughout, no batteries of any kind are required; the power supply is built-in, therefore it can be set up quickly in any location where 110-volt 60-cycle current is available. No neutralizing is necessary as the new R.C.A. type-802 screen-grid pentode tubes are used in all stages.

Two sets of plug-in coils and two crystals provide for operation on either 80 and 40-meters or 40 and 20 meters. The antenna-matching network,



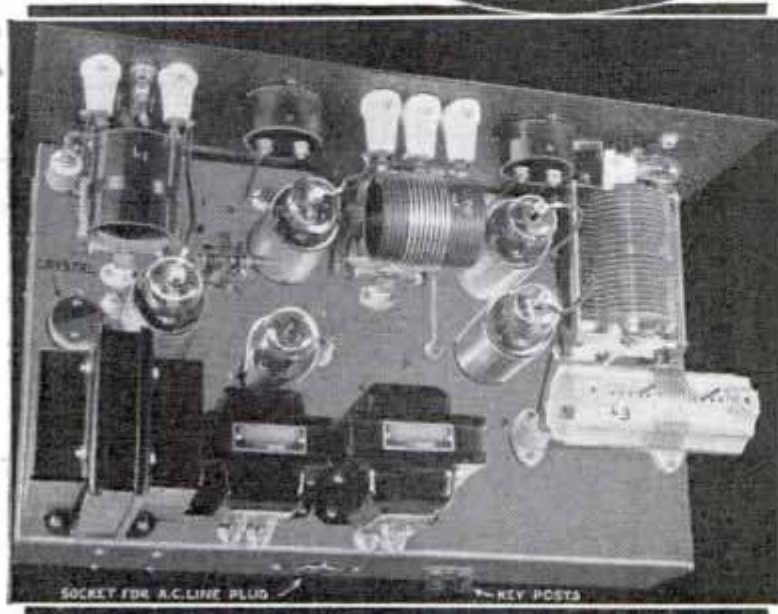
indicated in the schematic diagram, Fig. 1, is optional, however, this network enables the builder to use almost any type of "skywire" with good results. The inductances L_4 and condensers C_4 and C_5 , are assembled

on a separate 8 by 21-in. bakelite panel and mounted above the transmitter as shown in the upper photo.

The 40-20 meter coils are shown in chassis assembly in the lower photo and the 80-40-meter coils above. Although designed for key, the final stage may be plate modulated for phone use if desired. Any public-address amplifier, having an output of from 15 to 30 watts to a 500-ohm line, may be used with the special Thordarson modulation transformer T-7352 shown in Fig. 1. Suitable amplifiers were described in the February and October, 1934, issues.

Both filter chokes, the power transformer and variable condensers are mounted on top of a heavy-gauge craydo-metal base 20½ in. long, 12½ in. wide and

(Continued to page 142A)



Handwritten: E 3633 Rockford Ill.

Kit of Colors for Painting Dial Lights



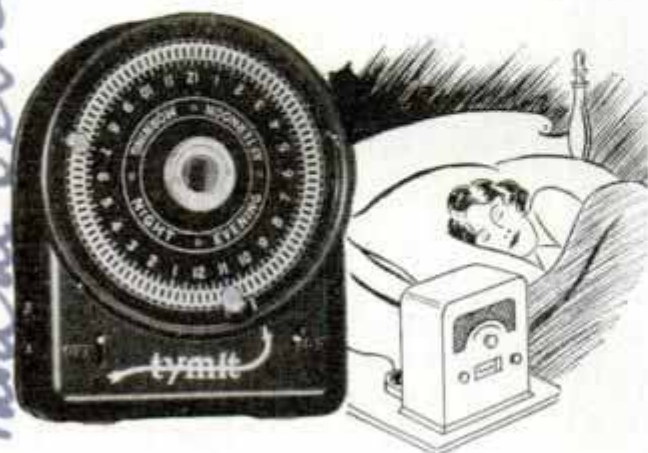
Pilot Lights Painted to Match Colored Wave-Band Sections on All-Wave Receiver Dials

Now you can paint your dial lights to match the colored tuning-dial sections in the new all-wave receivers. The kit consists of four small bottles of color and one of solvent. Many sets employ several miniature bulbs which are automatically lighted as the receiver is switched from one band to another.

Handwritten: E 3625

Switching Control for Radio Receivers

This automatic switching control will turn your set off after you are asleep and on at the right time to wake you up in the morning or when a favorite program comes on that you do not want to miss. It may also be used to control a fan, night



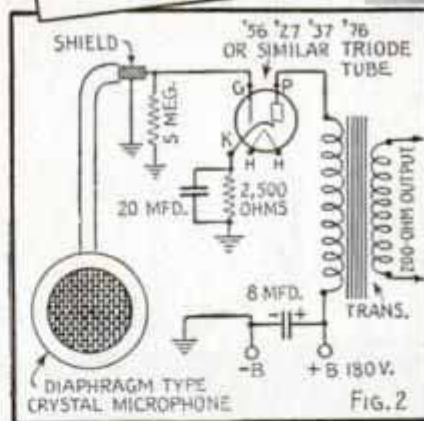
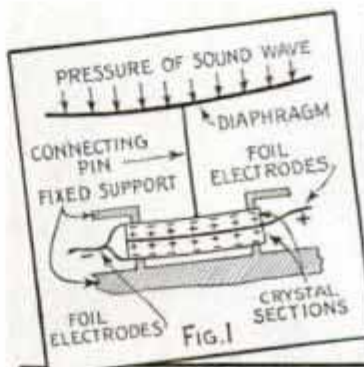
Automatic Timing Switch Can Be Set to Control the Operation of Radio Set or Any Electric Device

lights, electric refrigerator, heater or similar electrically-operated apparatus in the home. It has two pointers which can be set for start and stop at any given time. The unit is simply connected between the wall socket and the device to be controlled.

Handwritten: E 3634

Rochelle Salt Crystals Used in Microphone

Some substances develop electric charges when subjected to pressure, rochelle salt crystals displaying the effect to a high degree. This "Piezo-electric" effect is now used to good advantage in modern microphones. Two thin sections of crystal, cut in proper relation to the electric axes, are cemented together with suitable foil electrodes as shown in Fig. 1. The diaphragm is subjected to pressure by the



sound waves and this pressure is in turn transmitted to the crystal unit through the connecting pin. These varying sound waves are converted by the crystals into corresponding electric currents. Fig. 2 is a single-stage pre-amplifier hook-up for use with the diaphragm-type crystal microphone shown in the photo.

Blueprints covering radio construction articles in past issues can be obtained for 25 cents each; when material lists are not included in the articles, these are available without charge on receipt of postage.

Handwritten: The Fork Clock Co. Vermont

Handwritten: Shure Brothers Co. 215 W. Pearson Chicago

Handwritten: Fork Clock Co. 1348 N. Clark

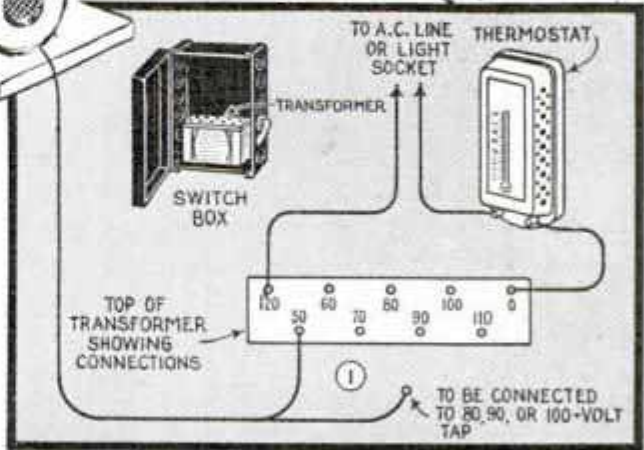


Cheap
HEATING
with
COAL

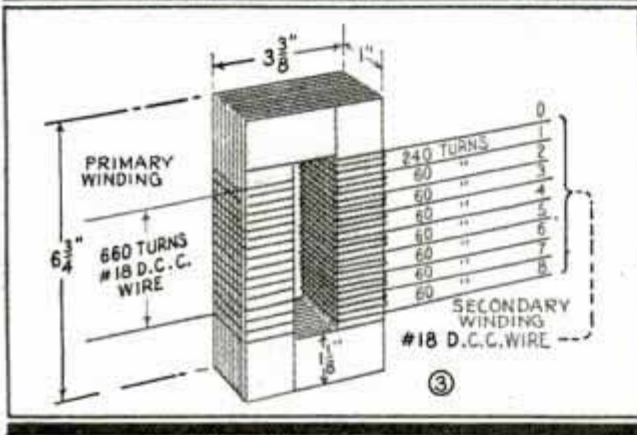
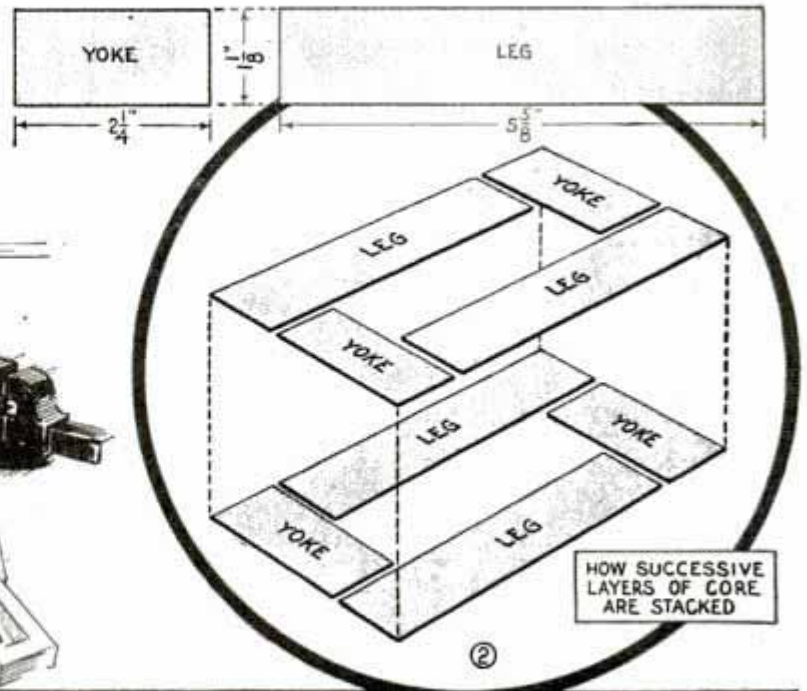


By
W.C. STRODL

WITH this homemade blower system you can have controlled draft to burn rice or buckwheat coal. Costing less than ten dollars to build, this blower solved the writer's heating problem and effected a considerable saving in fuel. The blower operates only when turned on by a thermostat and as soon as sufficient heat is produced, the blower is again turned off automatically. In this way a uniform temperature is assured. A small transformer is connected to the blower to hold it at a moderately slow speed. This



adjustment is variable, depending on the furnace; it avoids too rapid fuel combus-



tion, saves electric current and prevents the noise of a motor running at full speed.

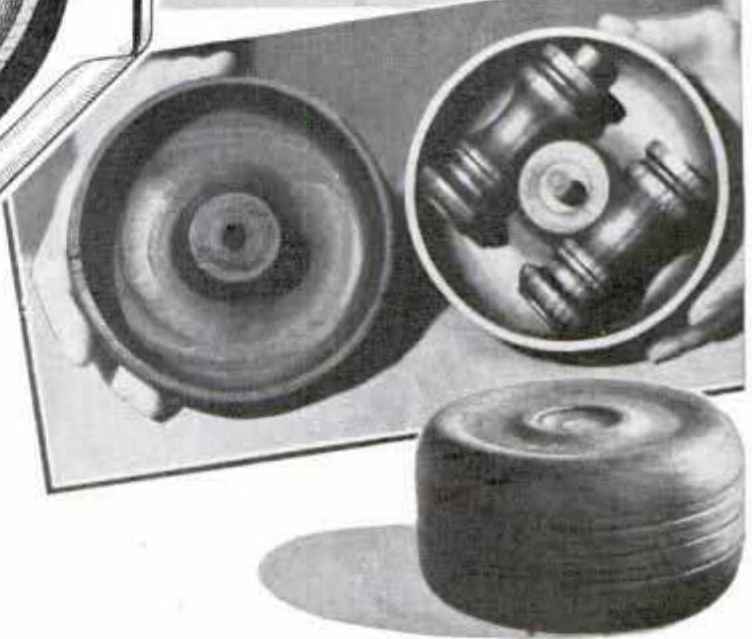
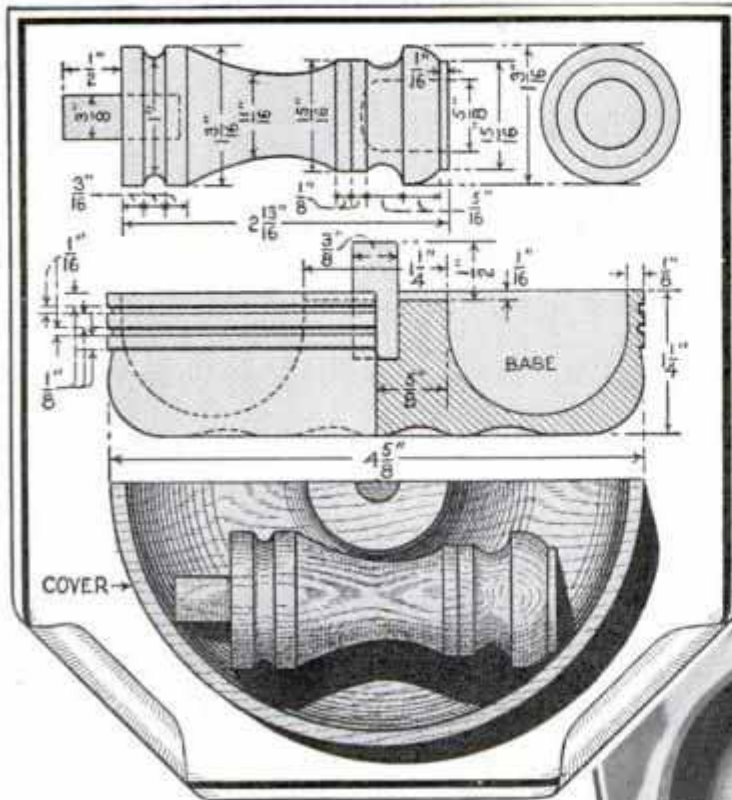
By shopping around you can pick up a serviceable second-hand vacuum cleaner without bag or handle. Remove the floor suction part, which exposes an opening through which air is drawn in. It is a good idea to solder a screen over this opening to prevent objects from entering which might damage the fan blade. The blower is then mounted on a wood block and, if desired, a sheet-metal housing can be built around it. This housing should have a hole at the point where the blower draws in air and another where the air is forced out. The latter hole should be large enough to take a length of auto-radiator hose, which is clamped to the blower exhaust in the same way as the vacuum-cleaner bag. The other end of the hose is inserted through a hole in the ash-pit door, or is slipped over a short length of pipe which projects through this door. If

the latter method is used, a pipe flange is bolted over the opening in the door to hold the pipe. In case you do not wish to drill a hole in the door, simply remove it and substitute a piece of sheet metal or flat iron. Next, it is necessary to seal all cracks in the ash pit so that the only entrance of air is through the blower. This can be done by calking with any heat-resisting cement.

The transformer is built according to the information furnished in Figs. 2 and 3. Note that the secondary winding has a number of taps, numbered from 0 to 8 in Fig. 3. These taps are connected to binding posts on a small Bakelite strip, Fig. 1, which makes it easy to vary the connection of the blower leads. This strip can be mounted right on the transformer. Flexible armored cable should be used from the transformer to the blower and also to the thermostat. The wiring from the a.c. line to the transformer is also shown in Fig. 1.

I have found it unnecessary to change the grates for burning rice or buckwheat coal. Simply leave a bed of ashes on the grates and then build the fire in the usual way. After the paper and wood kindling have been ignited, add the coal, little by little until a good fire is obtained. Then throw the coal in a heap at the back of the fire box, being sure to leave a small opening of live coals at the front to permit the escape of gas. This arrangement will feed the fire by sliding down as the coal burns.

Self-Inclosed Candlesticks Make Novel Gifts



Novel in that they can be taken apart and packed together to form a small circular box, these candlesticks, turned from different kinds of rare woods, make ideal bridge prizes or Christmas gifts. Both bases are turned to the same shape and size, the only difference being that one is provided with a short dowel in the center while the other has a hole to take the dowel when both bases are pressed together to form the box. The vertical candle holders are placed inside, as can be seen from the photo. When in use, they fit on the bases, the dowels and dowel holes all being the same size.

How to Locate a "Treed" Raccoon

Raccoon hunting is one of the most enjoyable of all autumn sports. However, to be a successful raccoon hunter, there are a few requirements that must be understood and practiced. The experienced coon hunter first makes sure which tree the dog has chosen. Then he inspects it carefully for hollow places, and, if none are found, he examines the near-by trees. If any of these are leaning over into the branches of the one at which the dog is

barking, there is a chance that the game might have run out on this tree and into one of the others. But if the tree stands alone, you may be fairly certain that the game is somewhere in it. The next step is to pick out a point of vantage from where you can observe as much of the top as possible. Slowly walking about the tree and surveying the top branches, go over every possible bit of the game's concealment with a powerful flashlight or lantern held above your head. A faint, greenish pair of eyes will be discovered in the tree reflecting the light.

☞ When your baby is learning to walk, put a strip of adhesive tape on each shoe sole and it will be less likely to slip on polished floors.



Inflated Toy Balloon Coated with Rosin and Rubbed with Rubber-Band Bow Is a Good Noise-Maker

Balloon Fiddle for Halloween Played with Rubber Band

A "sausage" type balloon serves as the fiddle which is played by means of a stout rubber band stretched taut on a simple wire frame or bow. Pulverized rosin is rubbed over the surface of the balloon and on the rubber band to provide the necessary friction. Variations of pitch are obtained by squeezing or releasing pressure of the hand on the balloon.

Ash Dust Is Carried Up Chimney

To avoid raising a dust in your basement when cleaning the furnace ash pit, try the method used by one home owner. He installed an iron door in the chimney near the floor, and keeps the ash container

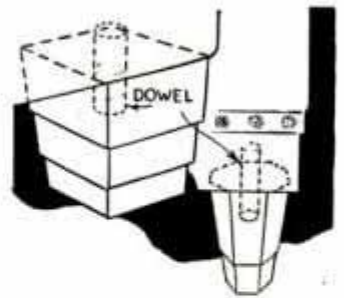


setting just under it. When he cleans the furnace, each shovelful of ashes is carried and dumped into the container, the resulting dust passing up the chimney through the open door. In making the opening in the chimney

for the latter, be sure that the bottom is just about flush with the top of the container. In addition to the above, the door may be used to regulate the chimney draft on warm days of the spring and fall.

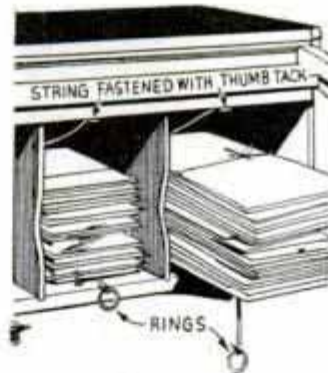
Old Period Furniture Brought Up to Date with Modern Feet

If you have some old furniture having presentable upholstery, and you wish to bring it into keeping with modern furniture, this can be done by sawing off the curved feet and substituting new ones of modern design. Square, hexagonal or octagonal feet of plain taper or set-back style will be found attractive, and can be glued in place with large dowels.



Ejecting Letters from Pigeonholes

To avoid difficulty in withdrawing packets of letters from the pigeonhole of a desk, force a thumb tack into the edge of the wood just above the center of the opening, attach one end of a stout string to the tack and tie a small ring to the opposite end. When the packets of letters and papers are replaced in the pigeonhole, the string is pushed behind them as shown in the illustration, so that a pull on the ring will draw them forth.



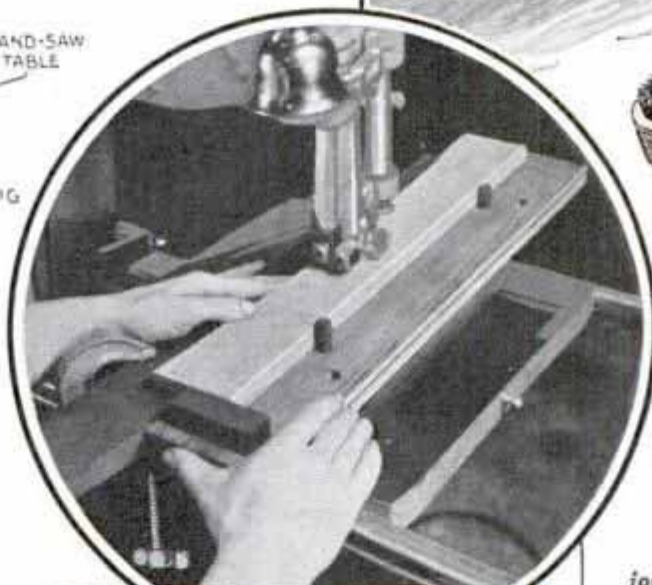
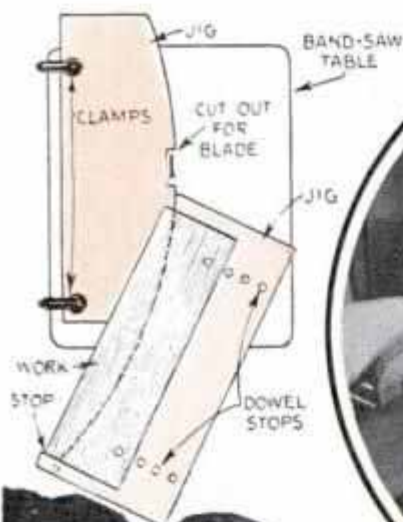
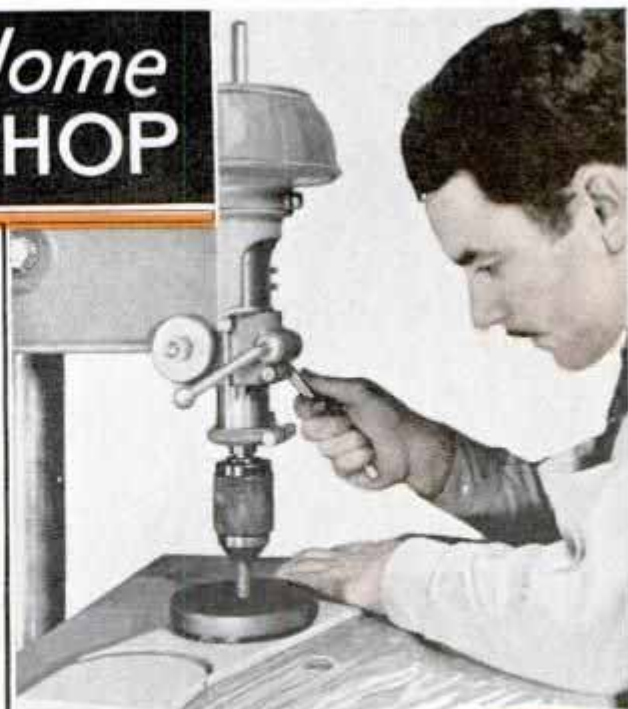
Tin Funnels in Washboiler Reduce Time of Boiling Clothes

If a couple of tin funnels are placed, spout up, in a washboiler before the clothes are placed in it, the circulation of the water will be so accelerated that the work may be done much sooner than in the usual manner. The formation of steam within the funnels drives the water up through the clothes in an almost continuous stream.



JIGS for the Home WORKSHOP

Speed and uniformity in production work are possible with these simple jigs. The one at the right shows a good method of cutting plywood disks. It is made from a length of $\frac{1}{2}$ -in. band-saw blade. The ends are brazed together forming a ring which is sweated with solder into a groove turned in a brass disk. The center photo pictures a jig for cutting uniform arcs, such as are required for boat and trailer beams. It is apparent from the diagram that the wood stock will be cut to the same curve as the template. Dowel stops permit wide stock to be used, the board being set over for each new cut



Below, how cylinders and tapers may be worked on the lathe with plane riding on top of the guide. One section of the jig is split so that the jointed edge serves as a rest while roughing with the gouge

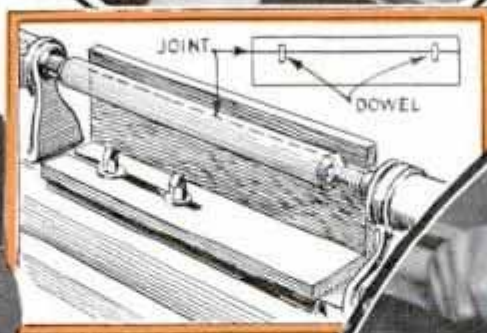
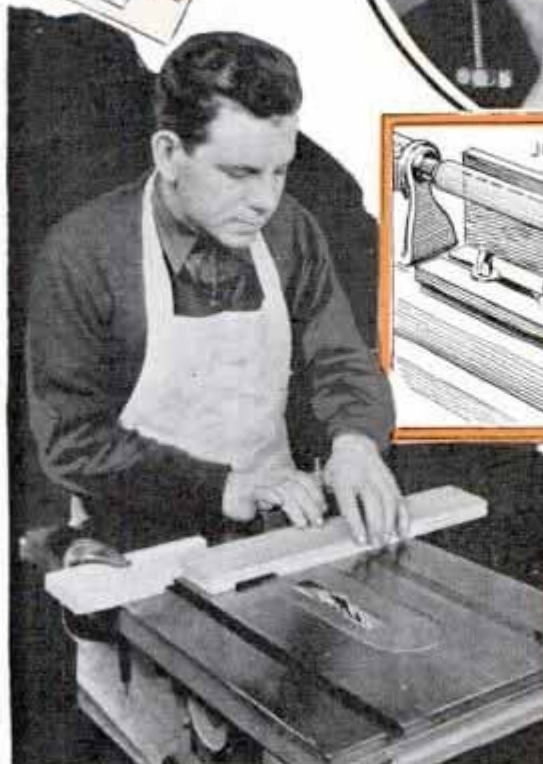
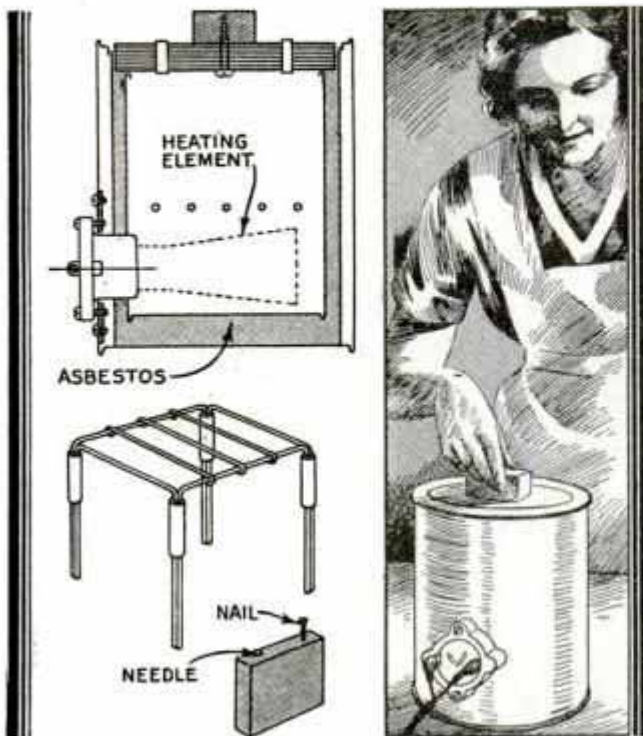


Photo at left shows method used in working across a wide dado cut. The guide has a number of steps automatically determining each new cut

Homemade Electric Cooker Is Well Insulated



This Homemade Electric Cooker Bakes Potatoes, Heats Canned Foods and Cooks Eggs

This cheap electric cooker will handle two large potatoes or it may be used for heating canned goods and for cooking eggs. It is made from two containers—a 1-lb. tobacco can, which fits inside of a 1-gal. can. A tin cylinder divides the space between them into two equal parts, the space next to the smaller can being filled with shredded asbestos. A porcelain receptacle is fitted in one side of the assembly to take a heating element, which consists of 25 ft. of No. 28 Nichrome wire. This is wound tightly on a small rod, and then removed, stretched slightly and slipped over the porcelain core of a cone-shaped heater element from which the wire has been removed. Providing a lid of several layers of asbestos paper and a wire rack to hold food above the heating element, completes the job.—John D. Adams, Glendale, Calif.

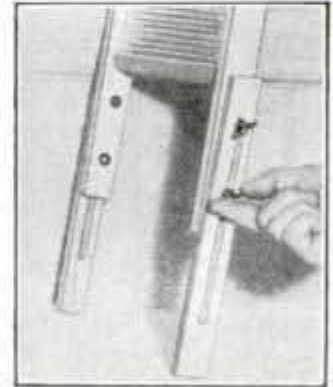
Speedy Ice-Box Defrosting

Instead of turning off the electricity to defrost your refrigerator, try the following method which is faster and keeps the contents of the box from warming up. This method consists of removing the ice-cube trays, filling them with boiling water,

and putting them back in the cooling coil. During this operation the current should be turned off. For the average ice accumulation one filling of boiling water left in the trays for ten minutes will do a complete defrosting job.

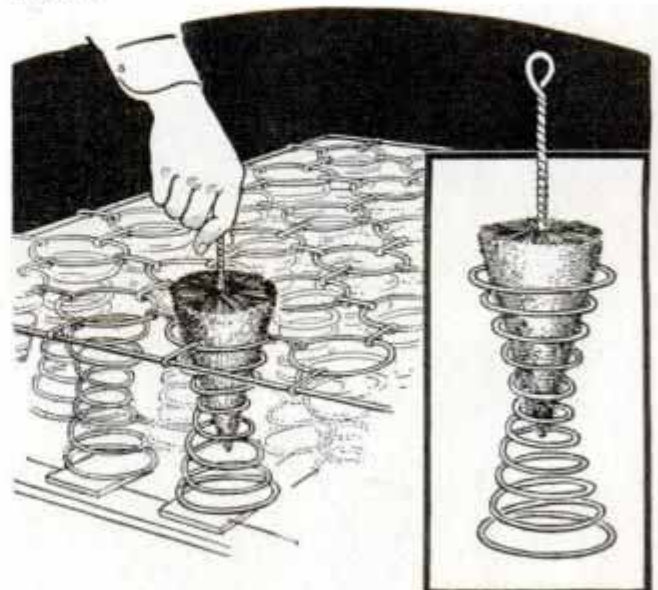
Extension Legs on Wash Board

The tiresome job of using a wash board in a low tub or in the kitchen sink may be made easier if two adjustable extension legs are provided to raise the board to a comfortable height. The legs should be about 15 in. long, and are slotted lengthwise in the center to slide over bolts which are attached to the board. Wing nuts on the bolts make it easy to change the adjustment.—Leonard Mitchell, San Francisco, Calif.



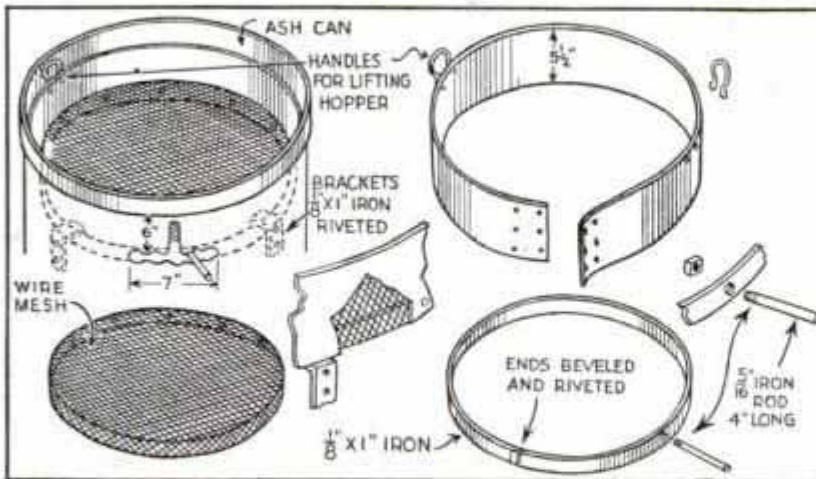
Bottle Brush to Clean Bed Springs

Coil springs of beds are usually cleaned and dusted with a cloth but the unprotected ends of the springs and cross-wires make this method difficult and unsatisfactory as the cloth will frequently snag and tear. If a tapered bottle brush is used for this purpose, the work may be done much faster.



Bottle Brush Is Much Better Than Cloth for Cleaning Coils of Bed Springs

Sifter in Ash Can Keeps the Dust Confined



Consisting of a simple metal hopper that fits in your ash can, this sifter takes up no additional room in the basement and keeps practically all the dust in the can. All you need is a small piece of heavy galvanized iron, a piece of screen of the grade known as hardware cloth, a few small rivets and a short length of $\frac{1}{8}$ by 1-in. flat iron. The last should be long enough to form a ring inside the can as shown. The illustrations give you the essential details on how to proceed with the construction of the hopper and also show how it works. The completed hopper should be of such diameter that it will move

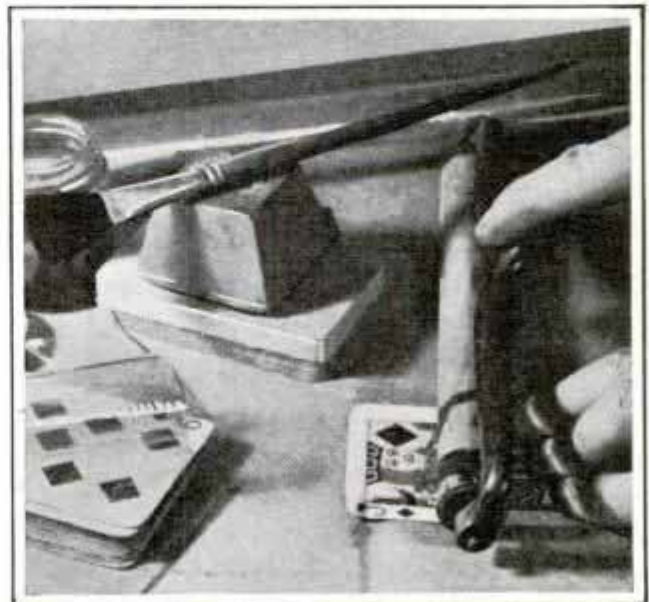


freely on the supporting brackets. The size of the screen mesh depends on what grade of fuel you are using. A $\frac{5}{8}$ -in. mesh is a suitable average size.

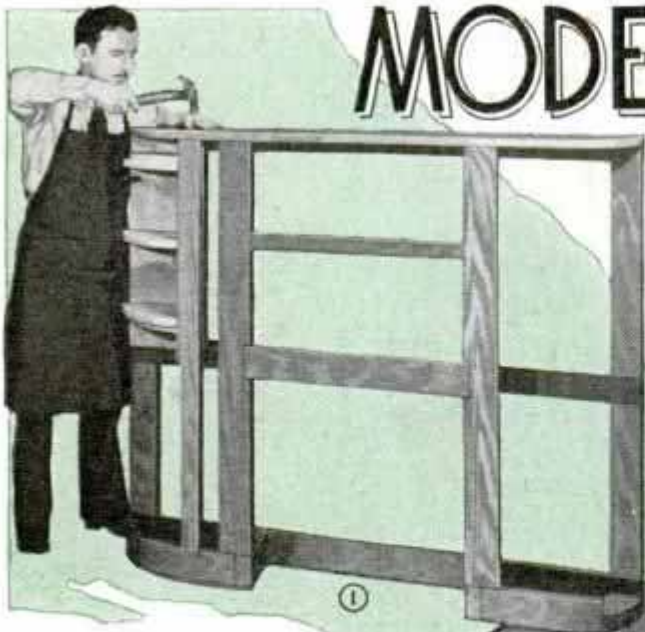
"Cellophane" Gives Your Playing Cards a Lasting Finish

Plain or colored Cellophane can be cemented permanently to the surface of playing cards, giving them much of the durability of celluloid. The transparent cement used for this purpose is made by dissolving gum arabic in water to a thick consistency, after which glycerine, 10 drops, and formaldehyde, 1 drop, is added for each ounce of mixture. After applying the cement, squeeze out all surplus with a roller and trim the edges. Then place the cards under a weight to dry.

By moistening the buttonholes of starched clothing on the inside, buttons may be inserted without soiling or crumpling the cloth surrounding the holes.



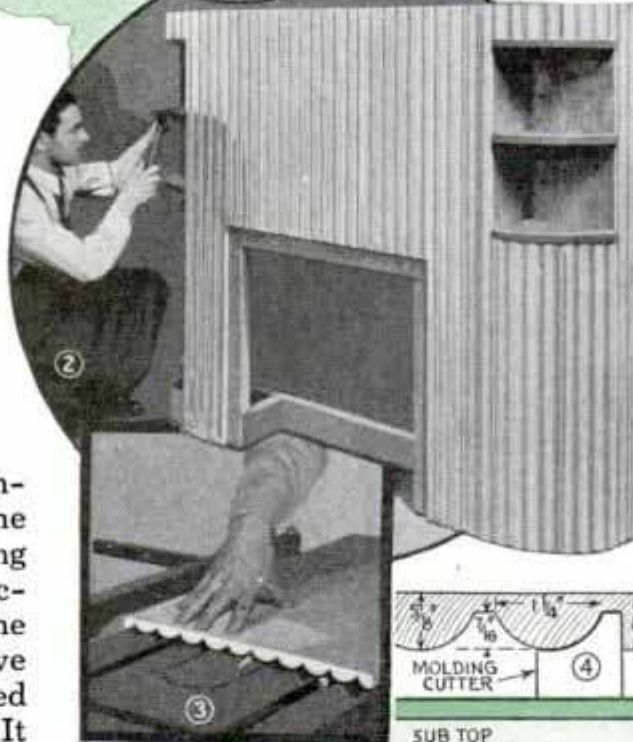
MODERN LINES *for the*



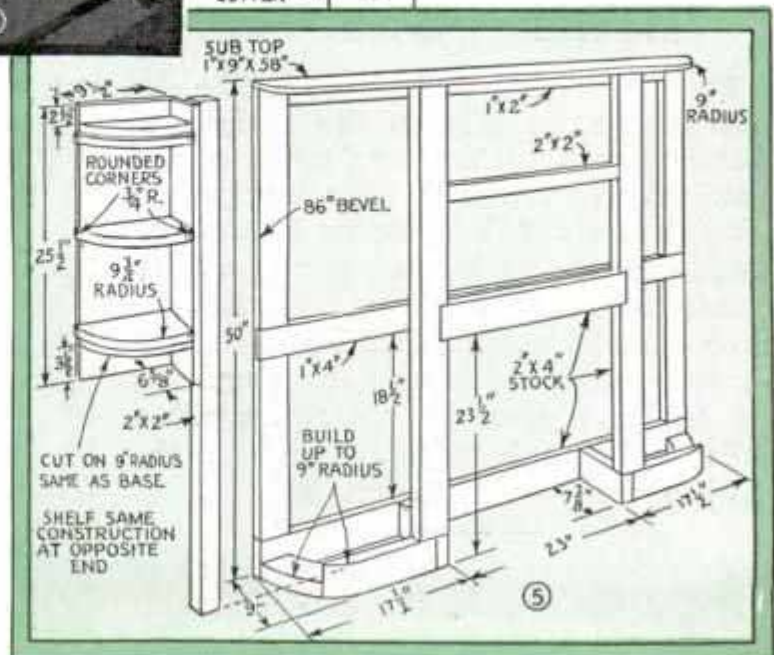
Covering for the frame consists of $\frac{5}{8}$ -in. stock molded as shown in Figs. 2, 3 and 4. This is a stock molding made with cutters usually supplied for the small circular saw. An alternate method of construction would be to use half-round stock molding. Hot water applied to the back of the wood molding, or heat applied to the composition board, will permit the bending of the stock. The covering, in any case, should be well fastened,

THE portable mantel offers a ready solution in making the installation of auxiliary gas heaters attractive and in harmony with the rest of the room. This unit can be backed against any suitable wall space, and can be used without flue connections by using the modern self-ventilating burners. The construction is all wood with the exception of the stove opening which is lined with sheet asbestos. It is worthy of mention that the wood construction is perfectly satisfactory as the wood itself is never subjected to the direct heat of the stove, the rays being projected more or less forward and away from the mantel.

Start construction by making the frame, Figs. 1 and 5. The ends of the base are sawed to carry out a 9-in. radius, and the rear upright at each end is beveled at 86° to blend with this curve. The corner shelves are built of 1-in. stock, the shelves proper having a $\frac{3}{4}$ -in. overlap beyond the 9-in. radius used for the landing pieces.

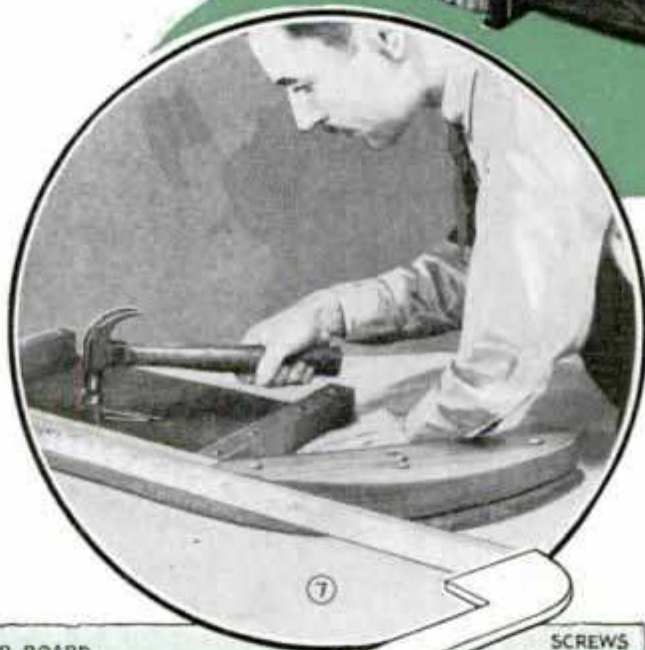


using finishing nails. Figs. 7 and 8 show the construction of the top. This follows standard practice, with the ends of the facing strip cut down to $\frac{1}{16}$ in. thick in order to permit bending to the end curve. The molding cutter is again used to round the edges of both the top and bottom pieces as shown in Fig. 9. The central portion of the under board can be cut out and used in the con-

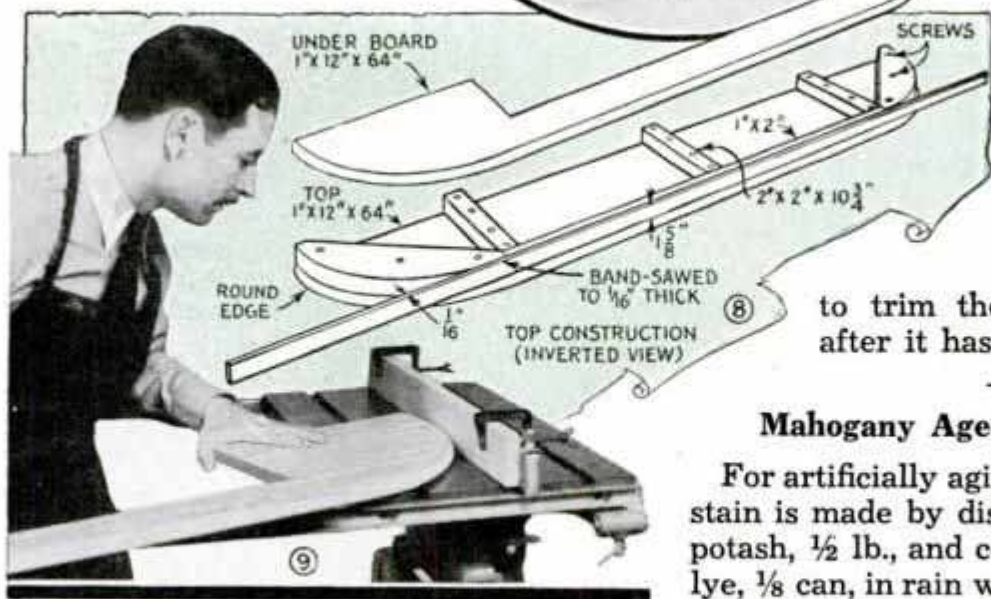


PORTABLE MANTEL

struction of the shelves. Screws and glue should be used in the assembly of the top, the screws for the cleating and the glue for the fastening of the curved end pieces of the facing strip. Fastening to the mantel is accomplished by inserting screws from the underside of the sub top into the bottom board of the top proper. Pieces of $\frac{3}{4}$ -in. stock, 3 in. wide, are used to edge the stove opening, as in Fig. 6. These should overlap the frame about $\frac{3}{16}$ in. in order to conceal the edge of the asbestos sheeting used to cover the interior of the opening. The asbestos sheeting can be obtained by purchasing five asbestos shingles in the 12 by 24-in. size. Two of these will span the back of the opening, and the other three can be shaped easily to size by scoring with a sharp knife and breaking over a



matter of taste. The molded cover of the original was given three coats of aluminum paint, while the balance of the mantel was finished with stain and varnish. Any other combination can be used, but the covering is best in light colors. Painting, in any case, should be carried to all but the final coat before the molding is applied as it is very difficult to trim the edges of the work after it has been assembled.

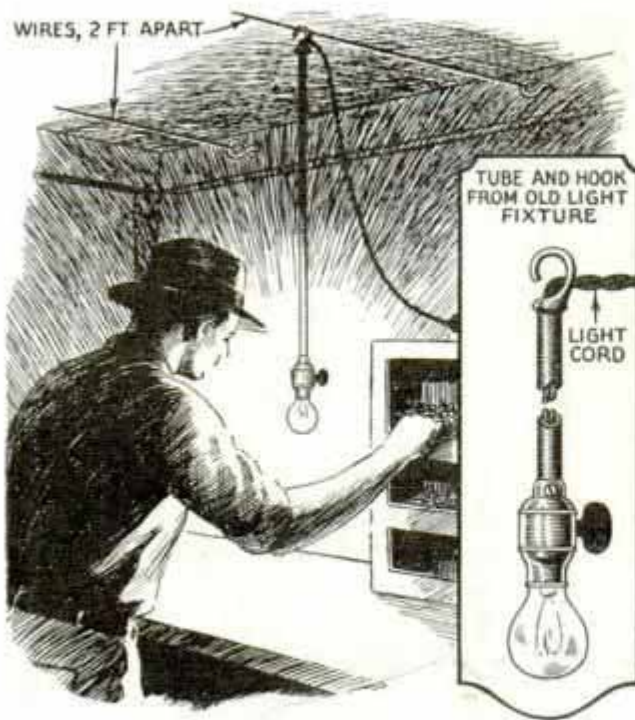


straight edge. The sheeting can be drilled easily to take screw fastenings.

The finishing of the mantel is largely a

Mahogany Aged with Chemicals

For artificially aging mahogany, an ideal stain is made by dissolving bichromate of potash, $\frac{1}{2}$ lb., and commercial, granulated lye, $\frac{1}{8}$ can, in rain water, 2 qts. Undiluted, the solution stains the wood almost black, but it can be mixed with more water to get the lighter shades. After applying, bring out the color with oil or wood filler.



Wires Stretched Overhead in Workshop to Make Light Adjustable above Any Tool or Machine

Overhead Wires Give Shop Light Wide Range

By stretching wires across the ceiling of your workshop or garage, about 2 ft. apart, a light fixture with a hook on the end can be hung conveniently in almost any part of the shop. It is best to provide a few outlets at various points so you will not need a long cumbersome cord.

Bell Jar Has Many Uses

A bell jar comes in handy for a number of uses, such as covering small microscopes, pots of seeds where a high temperature and humidity are needed, and for covering small stuffed birds, etc. To

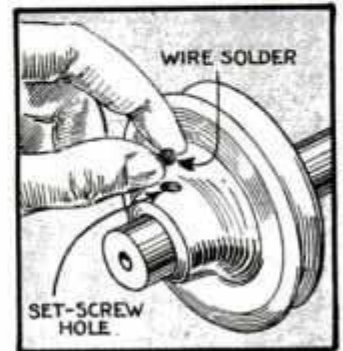


make the jar, get a glass jug and cut off the bottom. This can be done by scratching a line around the outside of the jug where it is to be broken off with a glass cutter or file. Tapping the bottom gently will usually result in a clean fracture, after which the edge should be

ground down so that the resulting bell fits closely against a smooth surface. For a close-fitting job, the edge is dipped in melted paraffin and the mouth of the bottle is corked tightly. If the jar is used to cover seeds and the temperature must be checked, drive a screw eye into the bottom of the cork to hold a thermometer.

Solder Keeps Pulley from Slipping

When a small set screw in a pulley allows it to slip on the shaft and the screw cannot be tightened to hold it, cut a thin slice from the end of a piece of wire solder and drop this



in the set-screw hole. When the screw is tightened against the solder, it is squeezed down into all irregularities on the shaft surface. Also, the solder covers more contact surface and thus increases friction.

Using a Thermometer to Check Your Photo-Developing Fluid

Amateur photographers who have difficulty in keeping their photo-developing solutions at the correct temperatures, will find that a thermometer installed in the lid of the developing tank enables them to



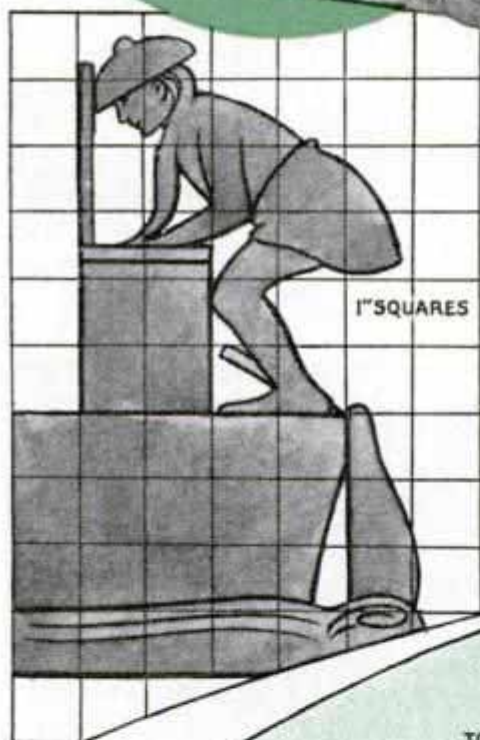
keep a constant check. The hole to take the thermometer should be drilled near the edge of the lid so that the lower end of the instrument will not touch the negatives being developed, and a short rubber bushing should be

provided to make a tight seal around the hole and exclude all light.

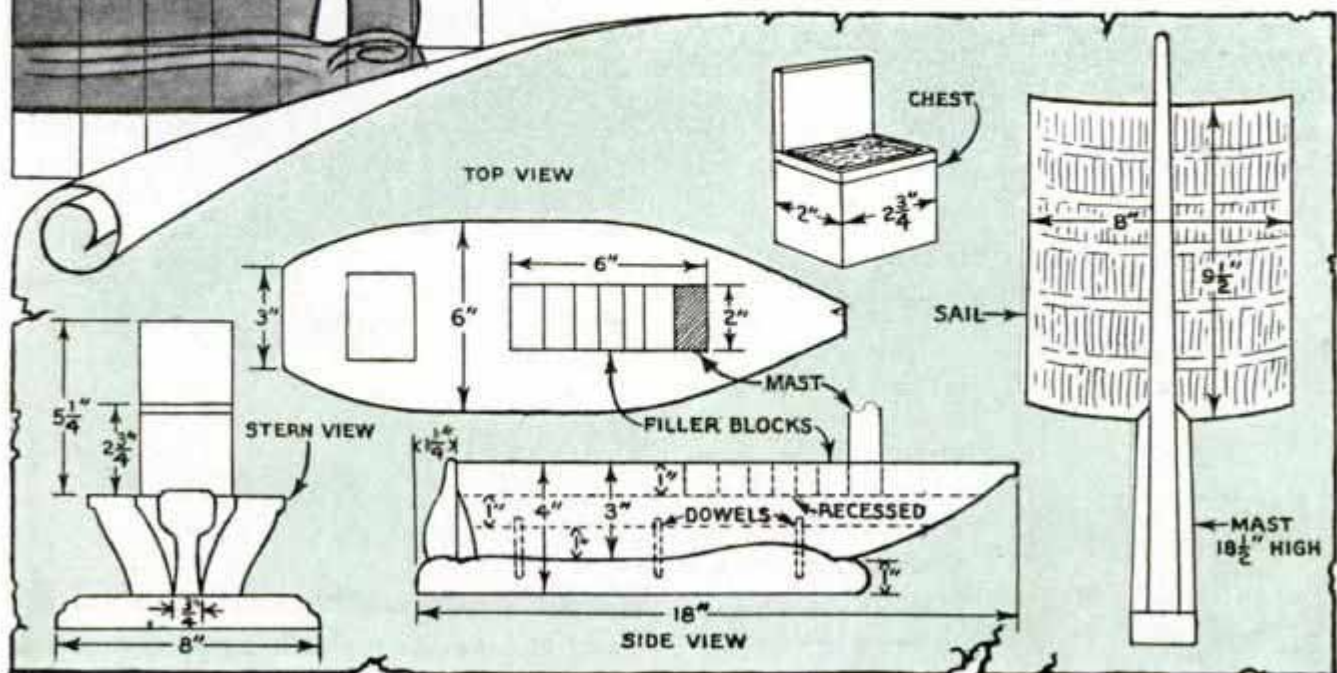
Willow furniture may be cleaned by brushing it with a strong solution of salt and water, after which it is wiped with a soft, dry cloth. Also, the solution prevents the furniture from becoming yellow.

CHINESE JUNK

holds your books...



For holding a few books on an occasional table, fireplace mantel or elsewhere, this Chinese Junk is a simple job in wood carving that you can finish in a few evenings. The mast and sail are one piece, which fits a recess cut in the deck. It can be slid back and forth as desired, and is held in place with filler blocks. The stock used is sugar pine. The hull lifts are glued together, after which the hull is glued and doweled to the base. The ship looks best in an antique finish, using gray and weathered-oak oil stains. Two coats of shellac are applied to complete the job



Tires for Coaster Wagons Made from Inner Tubes



Old Inner Tube Rolled Tightly and Stretched over Rim Makes Good Tire for Coaster Wagon

Here is an inexpensive method of making tires for coaster wagons, tricycles, baby carriages, etc. Get an old inner tube that has plenty of life and stretch and is of a diameter just slightly smaller than that of the wheel for which the tire is to be made. Cut off a section 8 or 10 in. long and stretch this over a can or other cylindrical-shaped form, first coating the outside and inside of the tube with rubber cement. After this has dried, roll the tube tightly and your tire is ready for mounting. Coat the wheel rim with bicycle-tire cement. Start mounting the tire at the bottom of the rim, using wire to hold it until it is stretched over the rim. Be sure that the lap of your tire is placed next to the rim.

Tray Covers to Protect Films While Developing Them

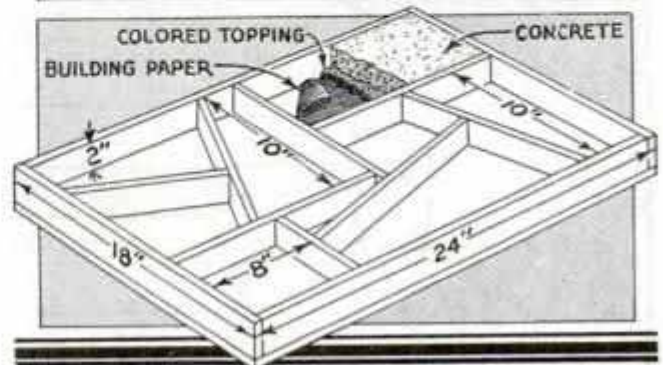


When working with super-sensitive panchromatic films, tray covers, which will effectively prevent light from reaching the negatives, should be used. These can be made

by gluing pieces of sponge rubber to plywood disks, which are cut slightly larger than the diameter of the tray. If desired, handles may be provided for the disks. The latter should be shellacked before applying the rubber so that the whole can be washed without warping the wood.

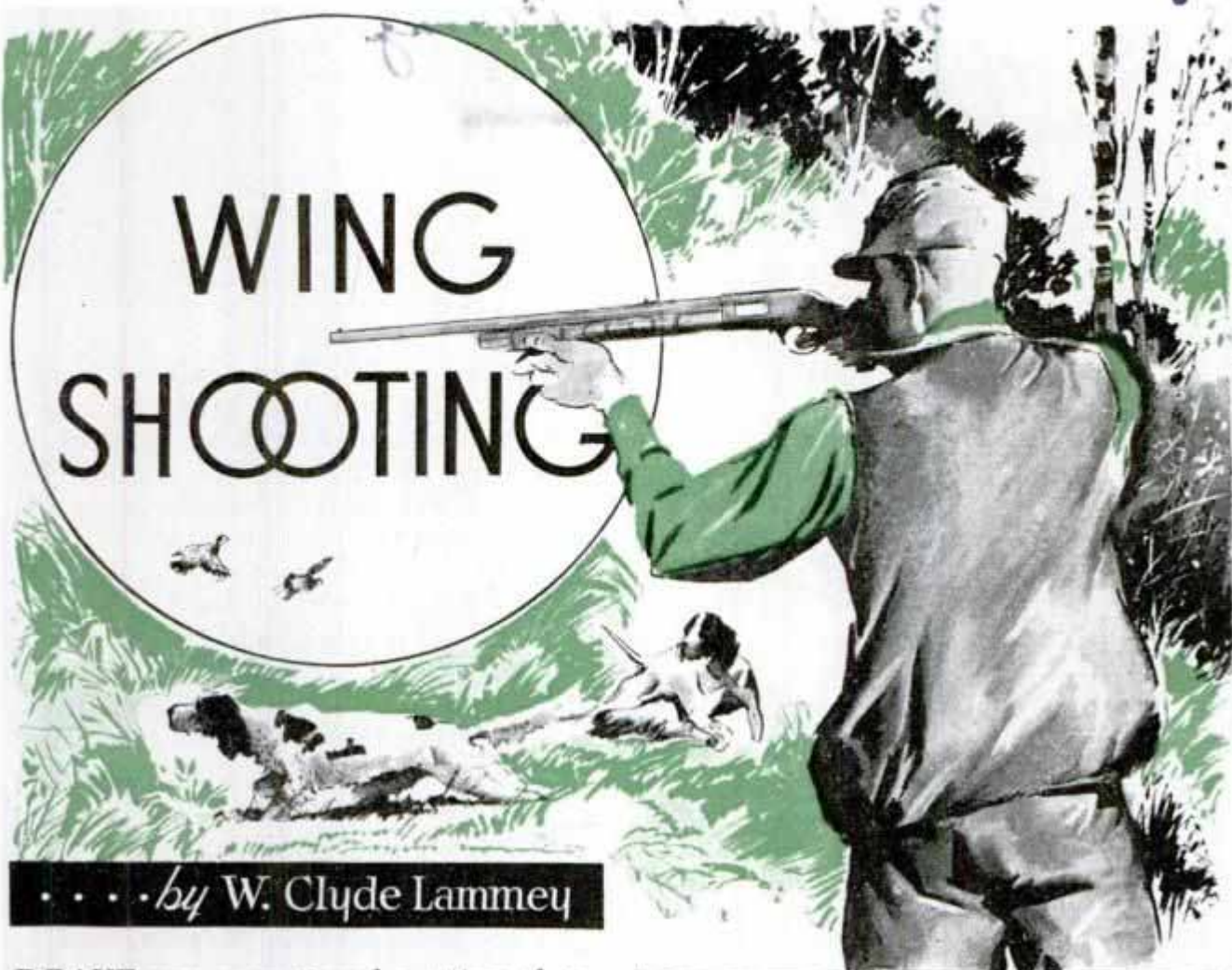
Making Concrete Flagstones Resemble Real Stones

Concrete flagstones can be given the appearance of stone by placing cheap building paper in the bottom of the forms before pouring the mixture. Moisture in the concrete causes the paper to wrinkle, thus leaving impressions in the surface of the finished work. It is best to first pour into the forms a topping mixture to a depth of about $\frac{3}{8}$ in. This is allowed to stand for 15 min. to give the paper time to wrinkle, after which the remainder of the concrete is poured. The topping may be colored if desired, shades of tan, brown, green, red, white and black being quite effective together. The flagstones are cast face down in wood forms like the one shown, and are removed as soon as the concrete has set. They should be kept moist for several days.



Paper Placed in the Bottom of Forms to Give New Concrete Flagstones Appearance of Stone

WING SHOOTING



... by W. Clyde Lammeu

HAVE you ever missed a string of apparently easy shots at pheasant or quail or any other fast-flying game birds and afterward wondered why? Examination at the time proved the gun to be right mechanically and a trial round fired at a large piece of paper showed a shot pattern of uniform spread and density, yet in the field the birds you shot at, and tried your best to bag, flew away untouched.

When one misses consistently the trouble is generally in the fit of the gunstock. Look carefully at the drawings in Fig. 1, then take up your gun, throw it quickly to the shoulder and let the cheek fall naturally on the stock in the normal shooting position. If your eye catches the front sight along a line passing above the breech of the gun, the weapon will throw the charge high with relation to the line of sight. If the breech of the gun obscures your view of the front sight with the eye in a natural position the gun will shoot low. These varying conditions do not in any sense imply faulty manufacture of the weapon, as shotguns are regularly made with variations in the heel drop and length and shape of the stock. It does



mean that if you note either of these conditions the gun you have in hand does not properly fit you individually. In the first instance you can easily remedy the trouble by fitting the gun with a sponge-rubber recoil pad which will increase the length of the stock about $\frac{3}{4}$ in. In the second case a cheek pad laced to the stock will raise your eye sufficiently to bring the front sight into view. These alterations are inexpensive and rarely fail to correct your aim. Many expert wing shots prefer to have the gun throw the charge

33 S Wabash, Chicago

LINE OF SIGHT



FLIGHT OF CLAY BIRD

PRACTICE WITH CLAY TARGETS THROWN FROM A HAND TRAP WILL QUICKLY TEACH THE RUDIMENTS OF WING SHOOTING

in Fig. 2 and direct him to throw the birds at a point about 20 yds. in front of you and about 10 ft. above the ground. This will give you a left-hand quartering shot. At first, concentrate your attention wholly on the swing of the gun; not on the flying target. Snap the gun on the latter the instant it appears in good view, swing the muzzle ahead of it and while the gun is still in the swing, pull off the shot. Swinging and pulling the trigger must be simultaneous, that is, the gun must be swinging uniformly at the instant you pull the trigger. Once you master the swing and trigger-pull combination, you will find that you can dust the clay birds with satisfying regularity, whether the thrower be on your right or left. You may have to practice the right-hand quartering shot for some time, as a right-hand shooter will naturally swing more easily to the left than the right.

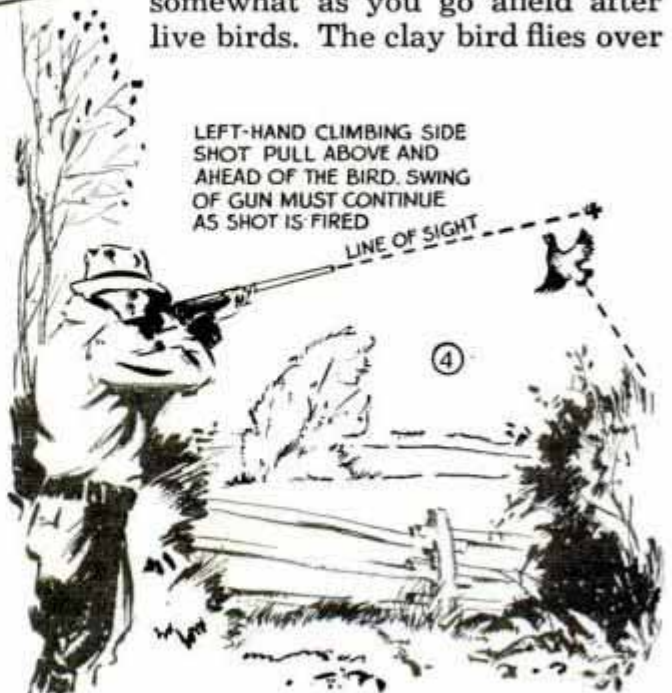
However, conditions change somewhat as you go afield after live birds. The clay bird flies over

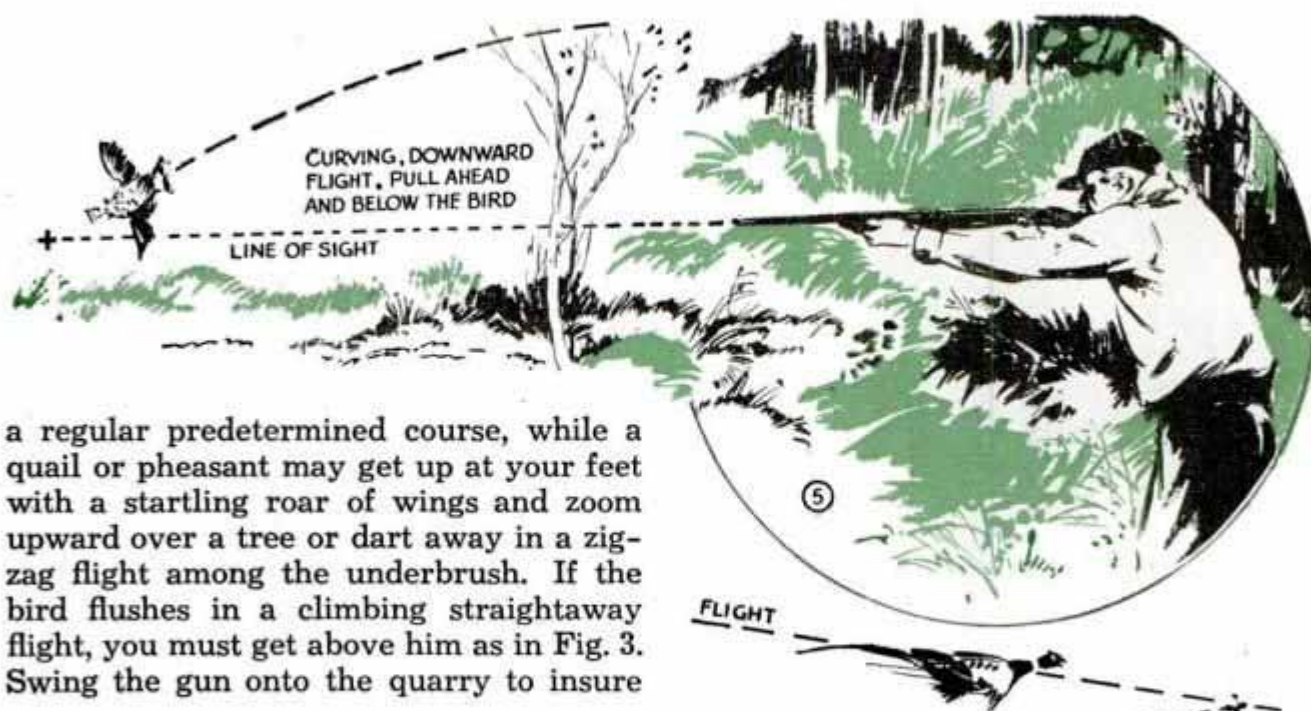


high. This means a straight stock as shown in the upper detail of Fig. 1.

The second difficulty one encounters in shooting at moving game is the tendency to stop the swing of the gun at the instant the shot is fired. This fault is most troublesome to overcome, one reason being that the movements necessary to get off a shot before the game disappears or is out of range must be made so quickly that one cannot remember distinctly just what was done. Clay birds thrown from a hand trap offer the one sure remedy for this fault. Get a friend to throw the birds, and at the first trial have him take the position shown

LEFT-HAND CLIMBING SIDE SHOT PULL ABOVE AND AHEAD OF THE BIRD. SWING OF GUN MUST CONTINUE AS SHOT IS FIRED





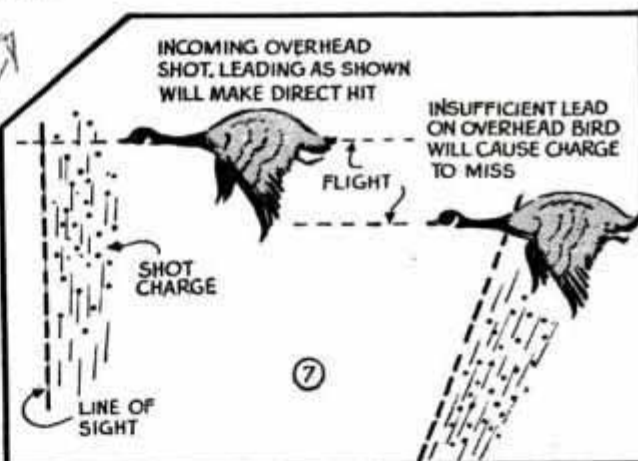
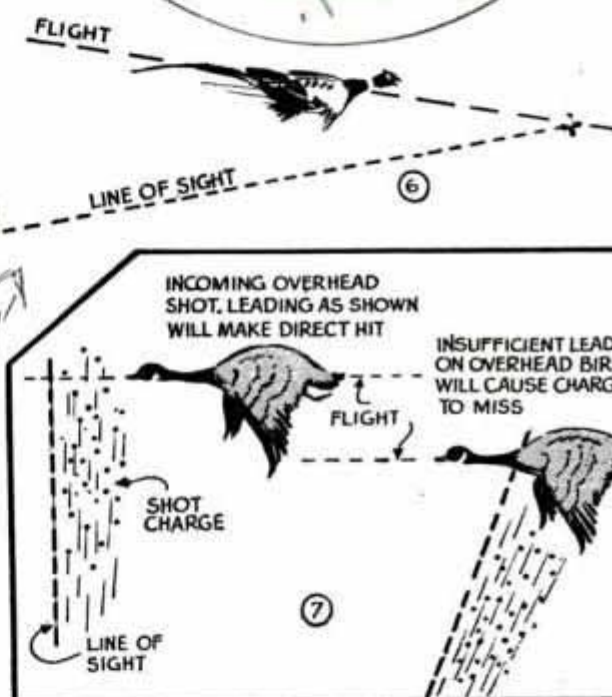
a regular predetermined course, while a quail or pheasant may get up at your feet with a startling roar of wings and zoom upward over a tree or dart away in a zig-zag flight among the underbrush. If the bird flushes in a climbing straightaway flight, you must get above him as in Fig. 3. Swing the gun onto the quarry to insure



OVERHEAD SHOT, BIRD FLYING AWAY FROM SHOOTER, SUCH SHOTS REQUIRE GREATER LEAD DUE TO RAPIDLY INCREASING DISTANCE FROM GUNNER.

correct alignment, then lift the muzzle quickly and fire the shot. If the bird is getting away in a slow climb, the gun barrels need only cover him to give the proper lead, but if he is rising high over trees or high bushes you will need to get well above him to score a hit. This is one of the most difficult shots at a bird on the wing, for the shooter must judge instantly just how far to lead without foreknowledge of what the bird will do in the next split second.

A much easier shot is shown in Fig. 4. Here the bird flushes from cover at your right and crosses in front of you. Scoring a hit is simply a matter of correctly timing the swing to give the necessary lead as the bird is in full view. In taking a shot like this, it is well to remember that the lead is always greater than it appears over

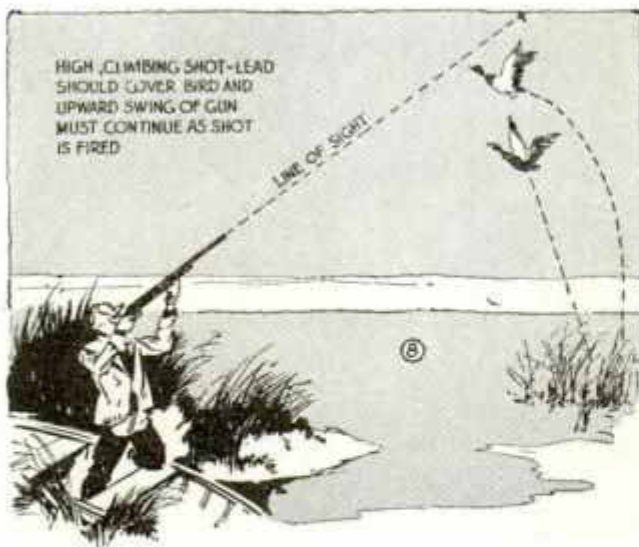


INCOMING OVERHEAD SHOT, LEADING AS SHOWN WILL MAKE DIRECT HIT

INSUFFICIENT LEAD ON OVERHEAD BIRD WILL CAUSE CHARGE TO MISS

your gun barrels, more especially if you are shooting a double gun. The tiny bead of your front sight will cover a space equal to a good 5 in. at a distance of 35 yds. from the gun, and the width of the barrels covers nearly 3 ft. at the same distance with your eye in the normal aiming position. However, there are two common shots, shown in Figs. 5 and 6, on which you are apt to underestimate the necessary lead. The first, Fig. 5, shows a bird dropping downhill in a steep, curving flight. To score, you must swing ahead and well under him. In Fig. 6 the bird has passed overhead and is making away fast. Again you must get well under and ahead of him to connect.

A charge of shot does not remain bunched together after it leaves the gun but strings out in a column 3 or 4 ft. long.



The greatest effective killing power is at the center of the column, whether head-on or along the length. From Fig. 7 it will be seen that the first bird will fly directly into the center of the shot column due to proper timing of the swing. Because of insufficient lead the head of the second shot column will miss the bird. Often only a few shot strike the bird and cripple it.

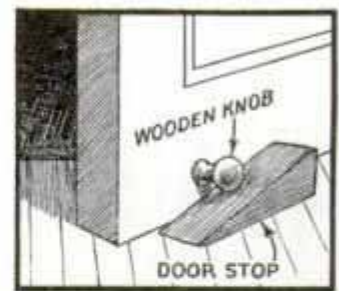
Wild ducks climbing as in Fig. 8 offer very difficult targets because the birds are likely to be curving away before you can bring your gun to bear. The trick in taking these shots is to get on the bird as quickly as possible, before it reaches the top of the rise. Snap off your shot at the instant you get the gun above the bird. You can easily practice this difficult shot with the clay birds. Have your target thrower stand some distance in front of you behind a rise of ground, somewhat to the right or left out of your line of fire, and throw the birds toward you at a high quartering angle. The clay bird will approximate the speed and maneuver of the climbing duck and will teach you quickly the trick of getting above it.

Most experts shoot with both eyes open. Anyone who does much shooting with the shotgun should acquire this habit as lead, distance and speed of the object can be judged more accurately.

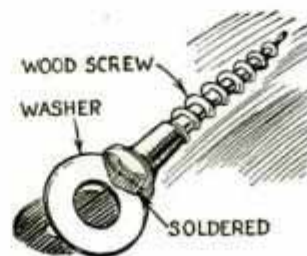
Discolored bottles can often be cleaned by filling them with a solution of warm water, baking soda and potato peelings. The solution should remain in the bottles for several hours, after which they are washed and then rinsed in clear, warm water containing a little ammonia.

Wooden Knob Facilitates Use of Doorstop

If a door is hung so low that it is impossible to insert a doorstop of the wedge type beneath it, drive a wooden drawer knob into the side of the door as shown so that the stop may be pushed under the knob. This also permits using the stop parallel to the door so that it does not extend as far as it would ordinarily.



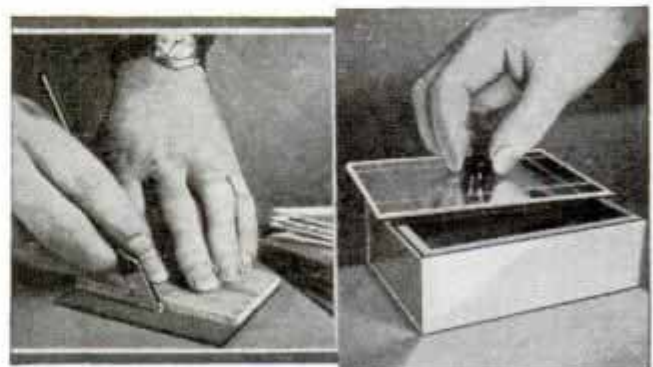
Thumbscrew Quickly Improvised



When a thumbscrew is needed and none is at hand, get a wood screw of the desired size and solder a washer vertically to the head as shown. Use a washer that is large enough to grip easily with the fingers.

Novelty Box Covered with Mirrors

Anyone can make mirror-covered boxes for novelties and trinkets. First cut out the parts for your box from thin plywood or cigar-box wood. Then, using the box parts as templates, cut the mirror strips. Glue the box together and, after the glue has dried, cover the outside with the strips, cementing them in place with casein glue. The knob on the lid is attached with a drop of flexible collodion, and the bottom of the box is covered with felt.



There Is No Trick in Making Mirror-Covered Boxes if a Little Care Is Used

Emergency Wrench for Light Work

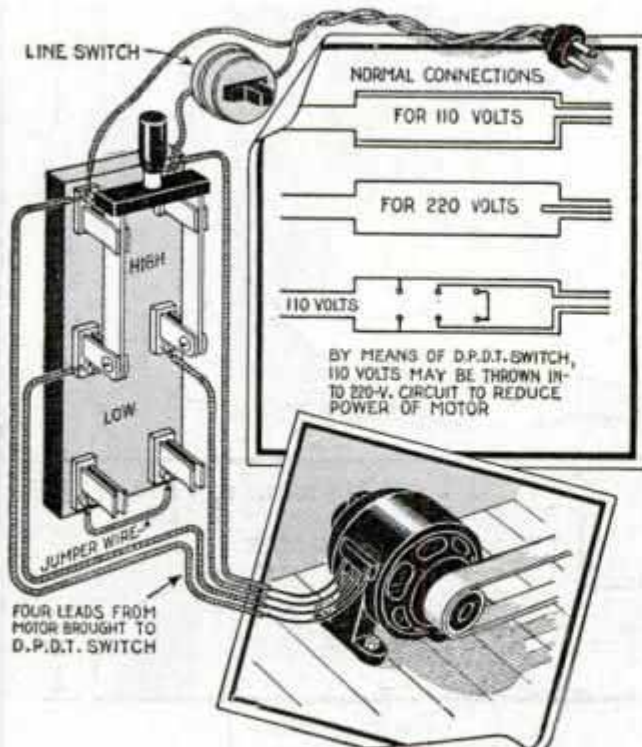


When a small wrench is needed to tighten small nuts, and none is available, a suitable tool may be improvised by folding a strip of heavy tin and clipping the end with a pair of shears. The center

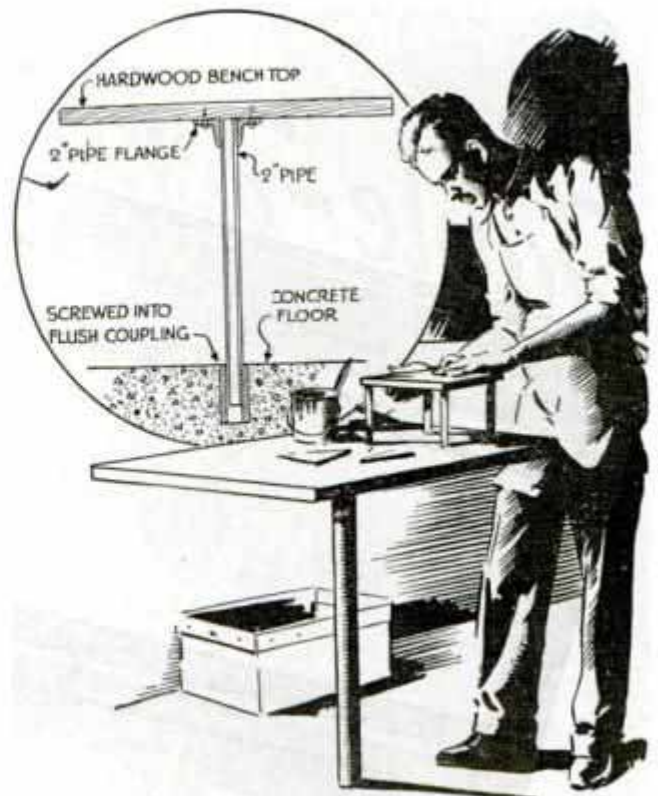
tongue of the clipped end is then bent back to leave a space gauged to fit the nut.

Simple Switch to Reduce Speed of Electric Motors

By means of a double-pole, double-throw switch the power of a single phase, a.c. 110-220-volt motor may be controlled in two steps. The four leads from the motor are carried to the switch and connected to the terminals as shown. When the switch is thrown to the "high" side, the 110-volt line current runs through the normal windings for 110 volts, and the motor develops its full horse power. However, when the switch is thrown to the "low" side, the line current is sent through the 220-volt windings with a resultant reduction in power and speed under load.



Double-Pole, Double-Throw Switch Wired to Reduce Power and Speed of Single-Phase Electric Motor



Light Tables and Workbenches That You Can Remove Easily and Store When Not in Use

Portable Tables and Workbenches

Portable tables and light workbenches made by attaching a pipe standard to hardwood bench or table tops, come in handy in shops, outdoor restaurants and similar places. The standards are attached to the tops by means of pipe flanges and are screwed into couplings set flush in the floor. When the tables are not in use, the couplings are capped with flat fittings.

Piece of Wire Cable for Stippling Designs in Wood

The next time you want to stipple a design in wood get a short piece of wire cable, bind it with wire to prevent unraveling, and then square the ends with a file or grinding wheel.



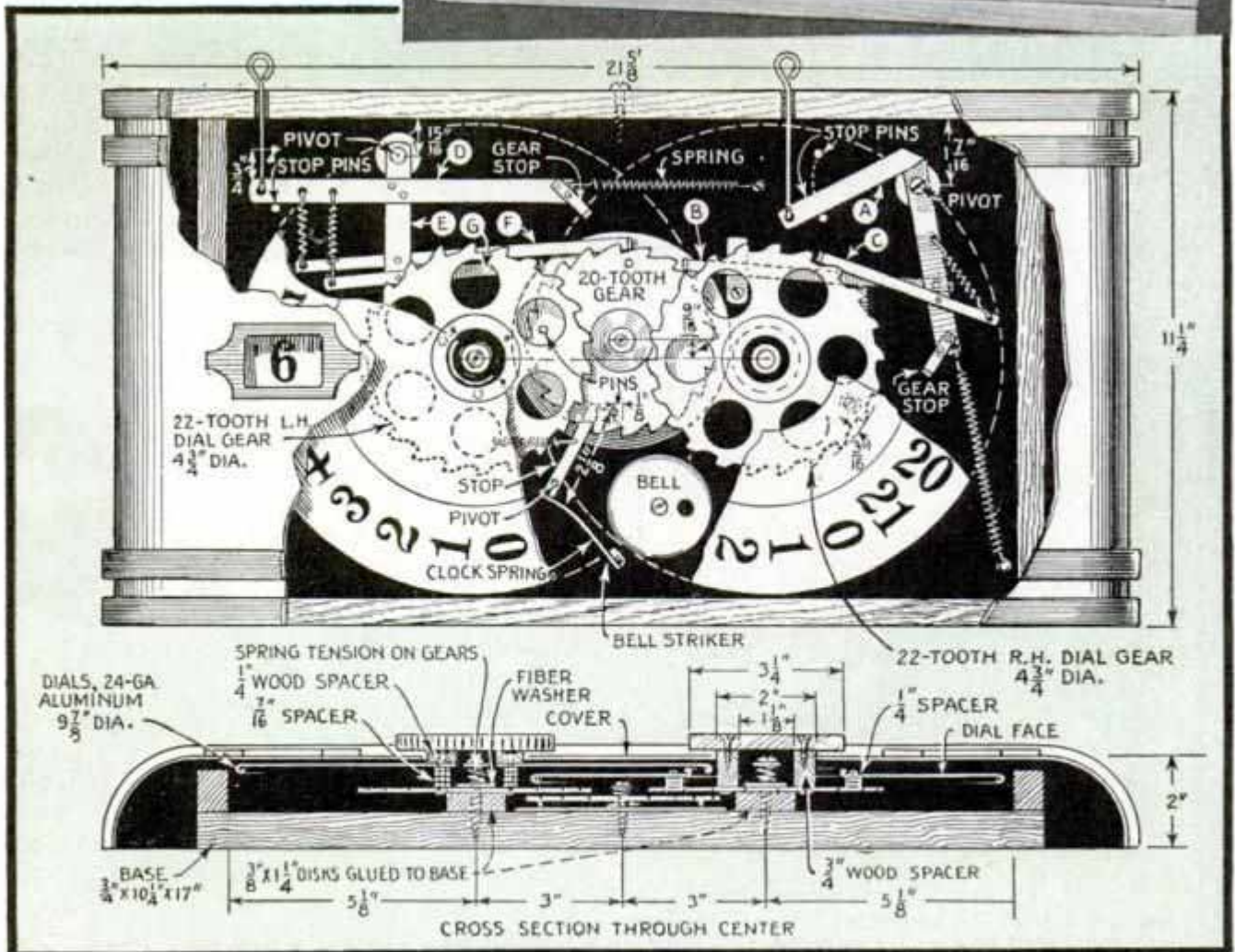
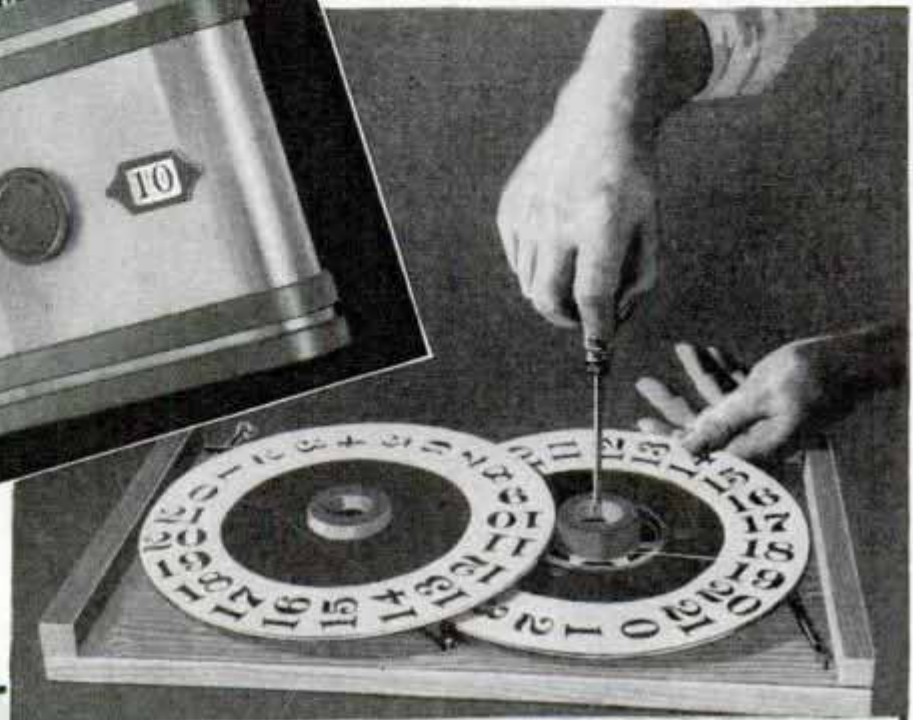
When the cable is set on the work and tapped with a hammer, the small wires will make a number of closely-spaced impressions in the wood. As cable can be had in many different sizes, the coarseness or fineness of the stipple can be varied.

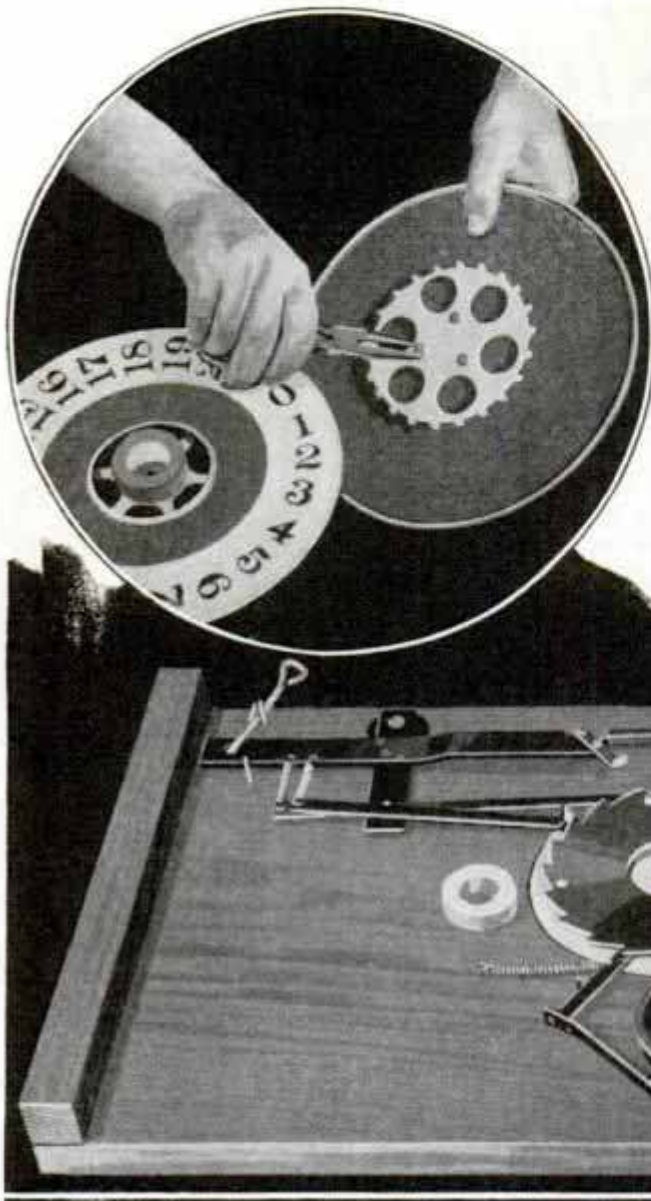


Table-Tennis

SCORE

by A.L.MILLS

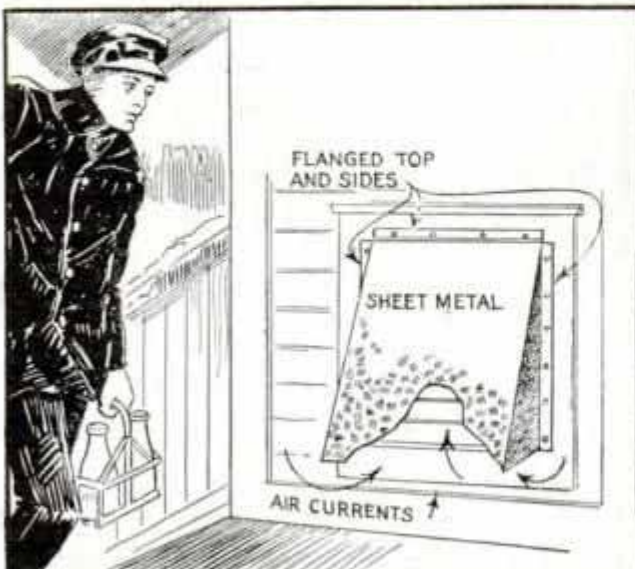




tooth gear at the center one notch with each impulse. This gear has a pin located at every fifth tooth to trip a bell hammer which strikes a disk-type bell. The exact arrangement of the levers, the points at which the pawls are attached, and the location of small springs and stops are important factors.

Each scoring dial is also fitted with a bakelite knob, which projects through the cover and is used to turn back the dial to zero. The cover is modern in design and is made of No. 24-gauge sheet aluminum, the ends being rounded to a 3-in. radius over a rolling pin. Strips of plain molding are attached with "liquid solder" or they may be riveted to the metal.

Hood on Food Cooler Prevents Cold-Air Leaks to Kitchen

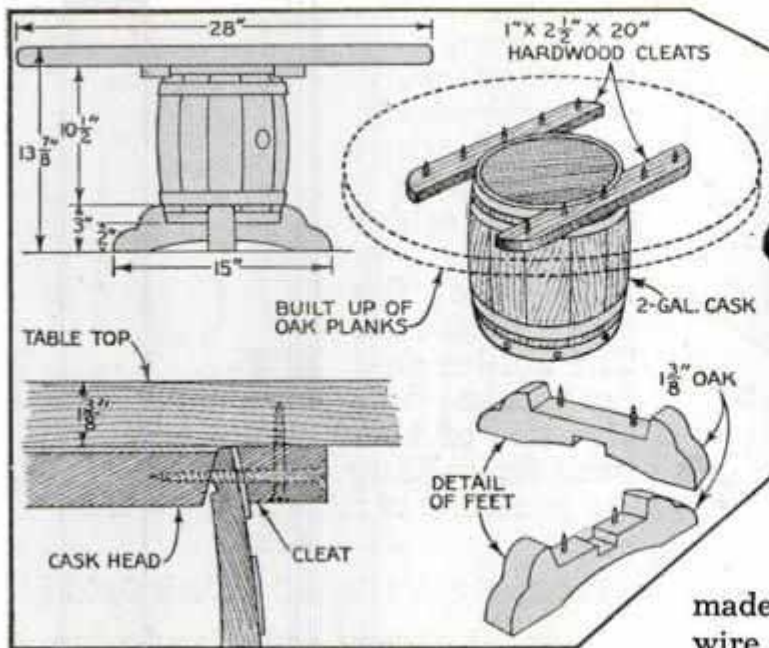


Metal Hood Screwed over Opening of Outside Cooler Keeps Out Snow and Gusts of Air

Built-in food coolers are usually not air-tight on the inside and, when a strong wind or gusts of wind build up the air pressure inside the box, the cold air leaks into the adjoining room and lowers its temperature appreciably. A sheet-metal hood, with an opening at the bottom, screwed over the outside opening of the cooler will ward off the wind effectively without decreasing the efficiency of the cooler. Another advantage of the hood is protection against snow flurries.

Small holes in linoleum may be patched by carefully filling them with a mixture of finely-chopped cork and liquid glue, which is allowed to dry thoroughly and then given a coat of clear varnish.

Small Keg Used to Make This Sturdy Table



This attractive beverage table, which comprises a small oak keg, will help in furnishing your basement or attic recreation room, and during summer it can be used in the garden. It consists of a built-up circular top mounted on the keg, which is fitted with feet. A fairly heavy stock is used for the top, the surface of which is

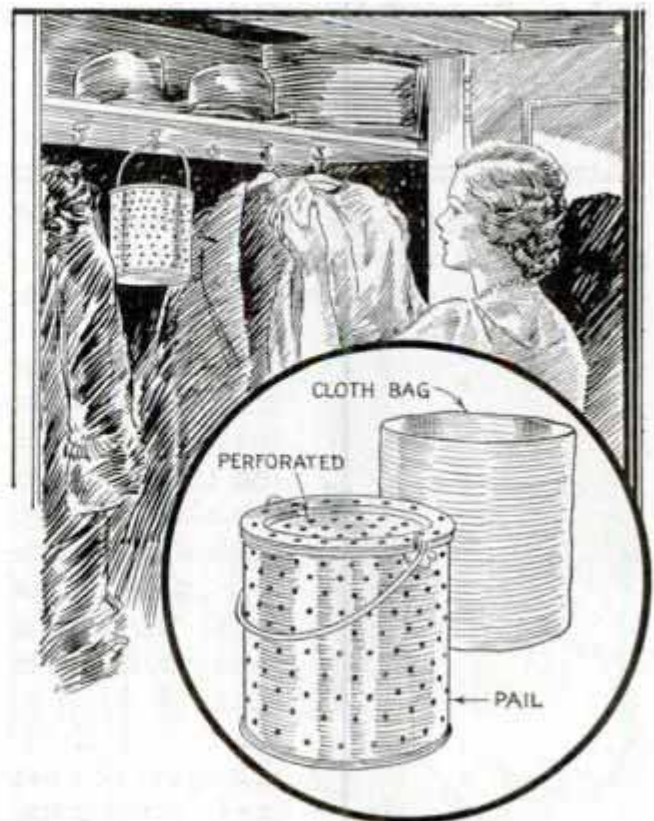
made attractive by scoring with a stiff wire brush. This should be done with the grain. In case the keg selected does not have a thick enough head, remove it and substitute one at least 1 in. thick so that it will hold the screws through the hardwood cleats. The feet are cut from the same stock as the top and roughened in the same way. A dark or weathered-oak stain is effective, followed with applications of shellac or varnish or a wax finish.

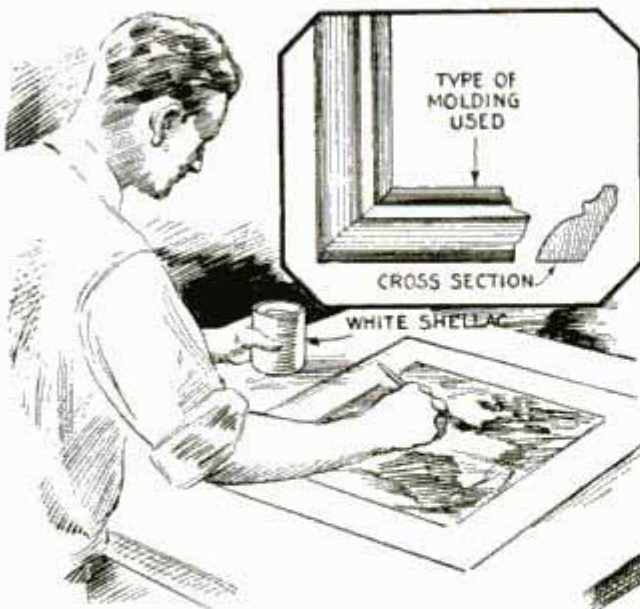
Lime in Perforated Can Will Absorb Excessive Moisture

As a precaution against dampness in your clothes closet during wet weather, hang a perforated pail filled with hydrated lime inside the closet. Then, if the closet door is kept closed, most of the moisture will be absorbed by the lime and the clothes are not likely to get damp. It is best to put the lime in a cloth bag, which is in turn placed in the pail.

Using Photo Filters to Reproduce Stained Pictures

As photo filters cause objects of their own color to photograph white or very light, they can be used to good advantage in reproducing pictures, documents, engravings, etc., that have been stained with dyes and similar materials. Merely use a filter of the same color as the stain and photograph it. The process is not adaptable to drawing ink or other substances having opaque pigments.





Prints from Magazines Coated with Shellac and Framed to Make Beautiful Wall Decorations

Imitation Oil Paintings Made from Magazine Prints

Prints of famous paintings that are often reproduced in magazines, calendars, etc., can be made to resemble oil paintings quite closely if given a coat of white shellac, brushed on in all directions. When the shellac is partly dry but still tacky, the print is brushed over again, thus roughening the tacky surface. As deep frames for oil paintings are rather expensive, satisfactory substitutes can be had by making them from heavy molding. These frames look well painted or stained and varnished, although attractive finishes can be worked out with gesso and bronzes.

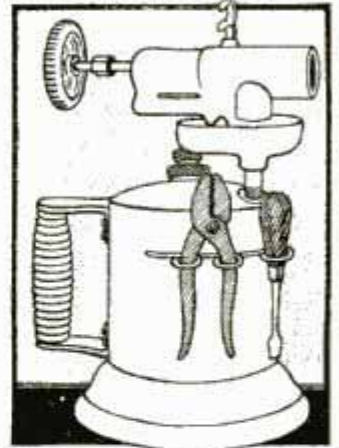
Claw on Hammer Notched to Pull Tacks

It is almost impossible to pull tacks with a regular claw hammer, but if one of the claws is notched at the end as shown, the job is easy. File or grind the notch and then bevel the inside edges. If the thickness of the claw does not permit the hammer to be pushed under the head of the tack, it can be ground down at the end without damaging the tool for its regular use.



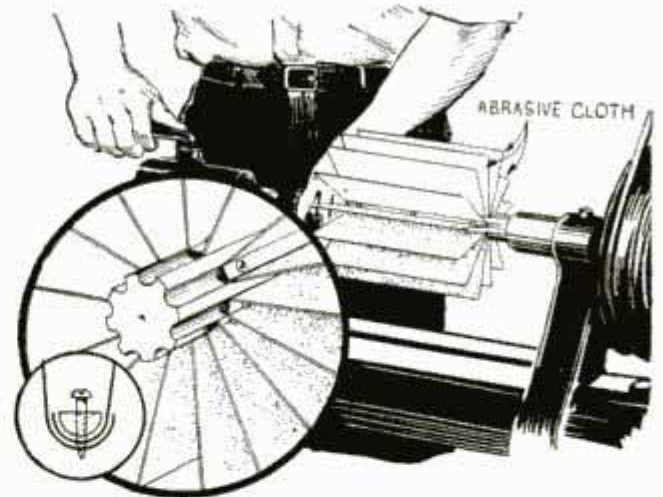
Holding Tools on Your Blowtorch

To keep a pair of pliers, scraper, screwdriver, knife or other small tools conveniently at hand, when working with a blowtorch, solder a wire holder to the side of the torch as shown. The holder does not interfere with the use of the torch for ordinary purposes, and lessens the possibility of misplacing the tools.



Rotary Sander Smooths Work Quickly

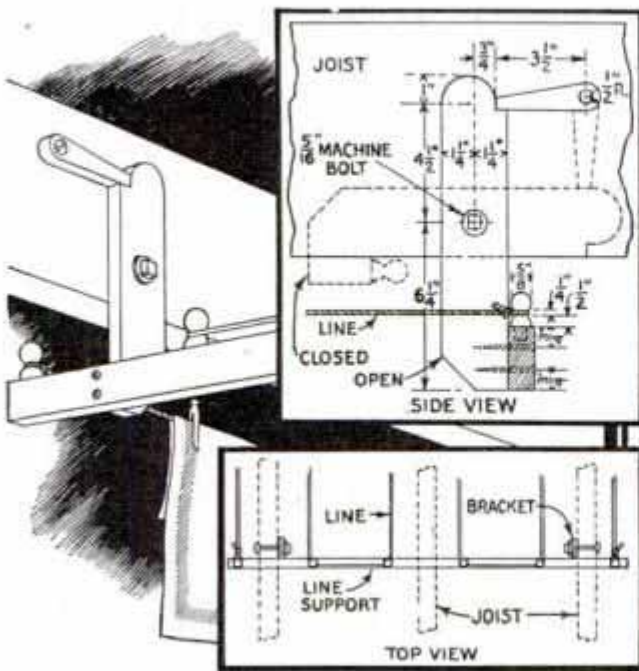
Rounded corners and turned edges of small boxes, blocks and other such objects may be finished quickly with this rotary sanding fixture, which is used in a lathe. The fixture consists of a round wood core having eight equally-spaced grooves in which sixteen pieces of abrasive paper are clamped with screws and lengths of half-round molding. The core should be about 10 in. long and 1 3/4 to 2 in. in diameter.



Sander Rotated in Lathe Smooths Rounded Corners and Turned Edges of Small Boxes, Blocks, Etc.

Two pieces of abrasive paper fit under each clamp as shown in the detail, their working surfaces facing the same direction. In use, one end of the sander is attached to a faceplate or chuck of the lathe, and the other end is supported by the tailstock center. The sander should be rotated at 500 to 800 r.p.m., the work being held lightly against the whirling abrasive.

Basement Clothesline Brackets Fold Flush

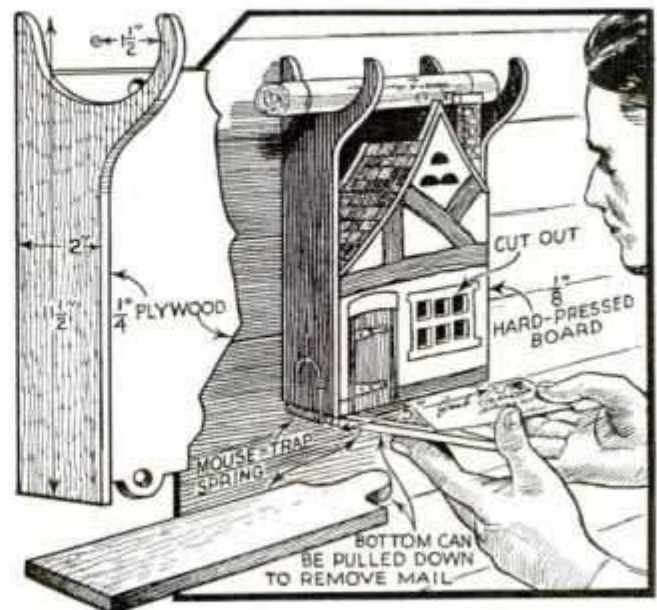


Folded neatly out of the way when not in use, yet quickly pulled down to hold a basement clothesline rigidly, these folding brackets can be made and fitted to the ceiling joists in an hour's time. The dimensions and method of assembly are clearly shown in the drawing. When the brackets are swung down for use, a small dog is slipped into the notch at the upper end of each arm to take the strain of the loaded clothesline. Lag screws or bolts are

used as pivots, and the pivot point on the joist must be accurately determined so that the arm, when pushed up, comes flush with the edge of the joist. In this position the arm is held by the dog hanging vertically as indicated by the dotted lines. Hardwood, such as birch or maple should be used in the construction of the brackets, as there is considerable strain on the parts when the line is loaded with wet clothes.—Howard E. Good, Waterville, O.

Novel Mail Box for Porch Resembles Miniature Cottage

Painted in bright colors, this mail box will add an interesting touch to your porch. The sides, back and bottom are made of $\frac{1}{4}$ -in. plywood and the front is scroll-sawed from hard-pressed board. A mousetrap spring holds the bottom, which is pulled down to remove the mail. The windows are cut out to reveal letters in the box, while two brackets at the top take care of magazines and newspapers. The box looks best with the front done in cream or canary yellow, with brown timber-work, red chimney and variegated shingles on the roof.



☞ Zinc laundry tubs may be cleaned by washing with soapsuds and then rubbing with a flannel cloth dipped in kerosene and sprinkled with baking soda.

An Unusual Mail Box That Will Help Carry Out the Novelty of Your Porch Furnishings

HALLOWEEN



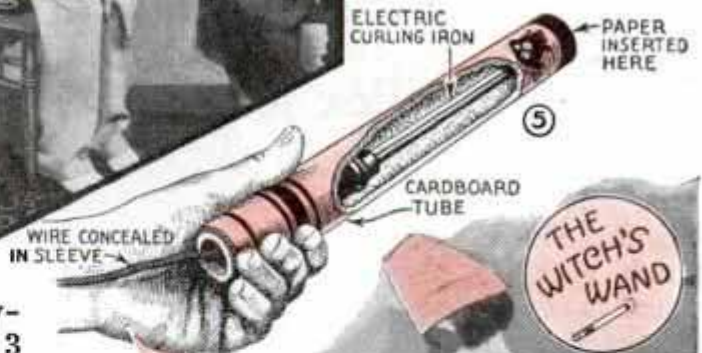
"DUCKING for Apples" takes on new life when you go at it in the manner shown above, Fig. 1. The stunt calls for tongs and scoops, shown in Fig. 2. The tongs are simply elongated spring clothespins, while the scoops are provided with rings. Ducking with the latter means fishing for an apple that has been skewered with a dowel stick a fraction over 3 in. long. A comparison between the length of the dowel and the dimensions of the scoop will show that there's plenty of room for a slip.

Fig. 4 shows a game called "Skull Cracking." The skulls are comic balloons; the rest is simply a matter of sitting down hard in an effort to crack them. Everything goes along quite merrily until the operator throws the switch. Fig. 3 shows how the chair is wired for the stunt. Small nails are driven through the chair seat so that their heads come flush with the sur-

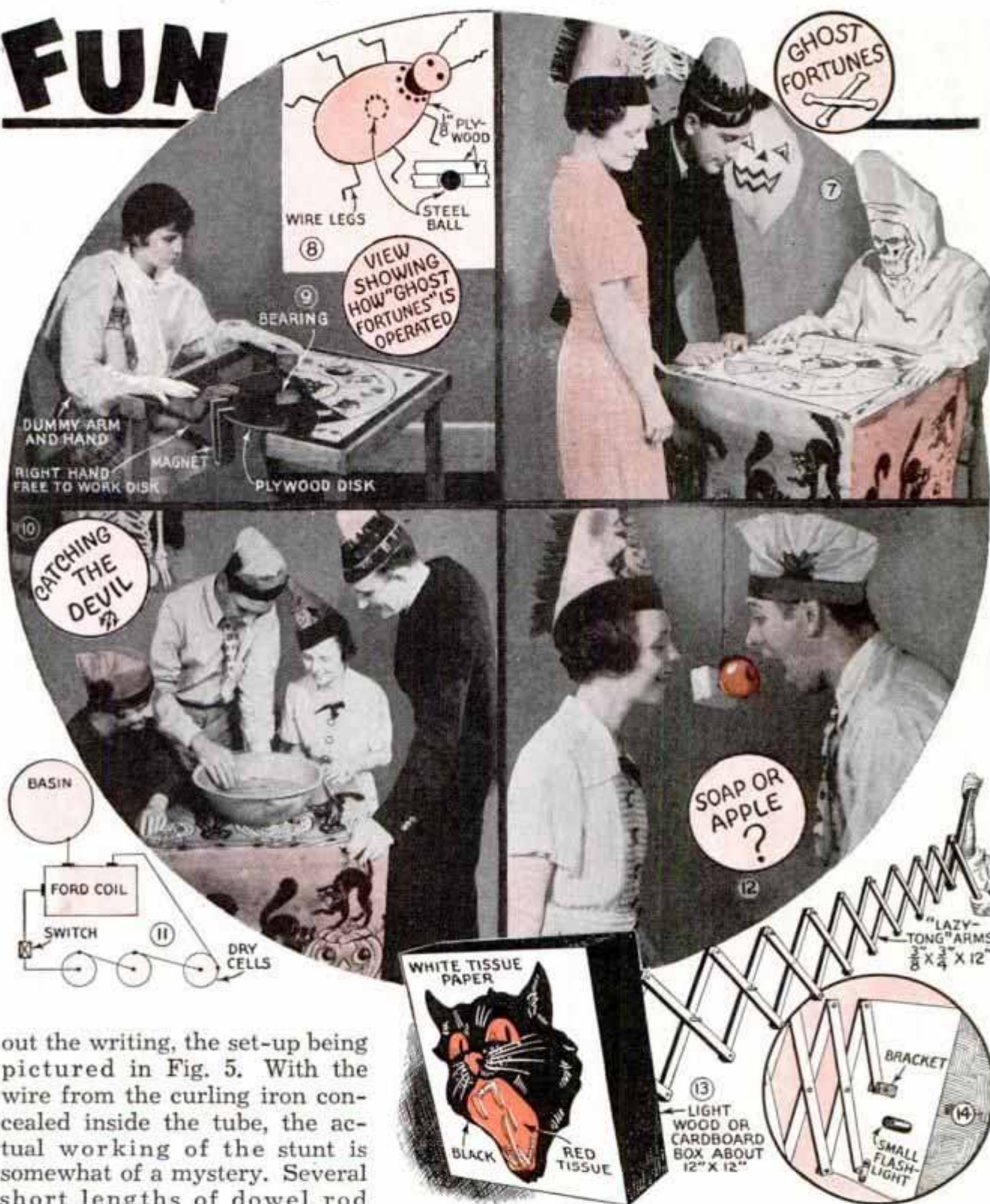
face of the seat. The shock can be lessened by using one or two dry cells and adjusting the coil vibrator to suit.

Telling fortunes is a necessary part of every Halloween affair. As shown in Fig. 6, blank sheets of paper are initialed and handed to the fortune teller. Each slip of paper is placed inside a cardboard cylinder, and, when withdrawn, the fortune

appears in deep blue script. The stunt is worked by previously writing the fortunes with a dilute solution of sulphuric acid. Be careful not to drop or spill this on table covers, clothes or rugs as the sulphuric-acid solution will destroy fabric. Using a clean steel pen point, the writing will be perfectly invisible when dry. Heat is the medium which brings



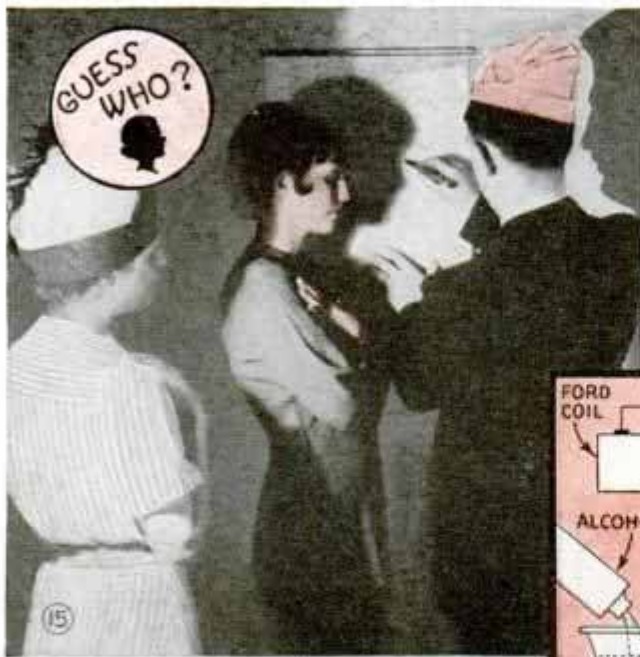
FUN



out the writing, the set-up being pictured in Fig. 5. With the wire from the curling iron concealed inside the tube, the actual working of the stunt is somewhat of a mystery. Several short lengths of dowel rod should be kept on the table and the blank paper wrapped around these to permit of its ready entry into the tube and around the hot iron. A trial will readily show the exact strength of solution to use; also how many turns of paper can be successfully developed with the particular iron used. Do not pour water into sulphuric acid, but slowly pour a little acid into water.

Another excellent fortune-telling stunt

is pictured in Fig. 7. A small wooden beetle mysteriously walks around a pictorial cardboard layout, finally coming to a stop on some picture or symbol which the operator then interprets. Fig. 9 shows how the stunt is worked. A plywood disk is mounted under the thin table top. The disk carries a magnet of sufficient power to attract the steel ball housed in the beetle's body. With a dummy arm and hand,



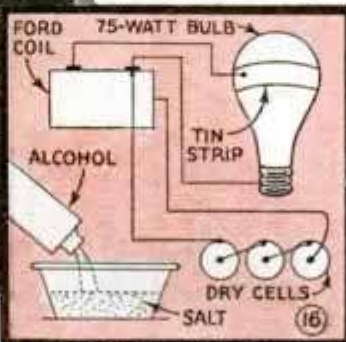
and mouth. A small pencil flashlight lights it from the rear of the box, as shown in Fig. 14. A further effect can be obtained by placing a catcall inside the box immediately before shooting it at some unsuspecting newcomer. The box arrangement can be eliminated entirely, substituting a ghost or cat face painted with luminous paint. Either effect is quite startling, the "spook" jumping a good 10 ft. from a dark corner of the porch and then quickly receding.

A simple little game, which is lots of fun, is "Guess Who," as in Fig. 15. A strong light permits the tracing of the shadow, and the various faces are numbered for a later guessing contest. If you need spooky lighting effects, try the methods shown in Fig. 16. The electrical hook-up uses a Ford coil to make the bulb glow with a weird blue light. The usual Halloween light is obtained by pouring a quantity of ordinary alcohol into a small dish containing common table salt. After a part of the alcohol has evaporated, the mixture will burn with a flickering yellow flame, giving a deathly appearance to anyone coming near it.

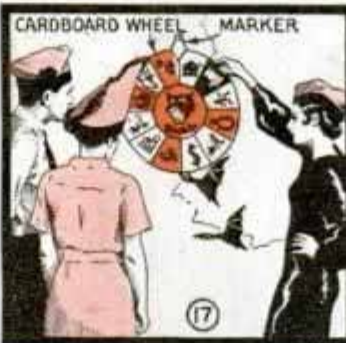
the operator is free to turn the disk at will, and the bug follows the same course as the magnet. Any ordinary magnet that is in good condition will actuate the beetle through a thin table top.

Fig. 10 shows another electrical stunt—trying to catch a metal object placed in a pan of water. Only one lead is taken from the coil, as shown in Fig. 11, since the ordinary hook-up, as shown in Fig. 3, would be too powerful. As shown, the shock is quite mild, yet powerful enough to close the fingers of the hand, making it difficult to pick up any object. This is a stunt for the brave. If you plunge your hand boldly into the water, you can succeed with only a mild sensation. If you go at the job timidly, as most people do, you will get the full force of the current in your hand, as it is strongest at the surface of the water.

"Soap or Apple," Fig. 12, is an old stunt, but always good for a laugh and will help in keeping the party amused. The apple and soap are set spinning on the cord while the participants take a chance at making one big bite. Saying "Hello" to your guests can be done very appropriately with the lazy-tong black cat shown in Fig. 13. The tongs are easily made up and riveted together. The cat is painted black on tracing paper, with red tissue-paper eyes



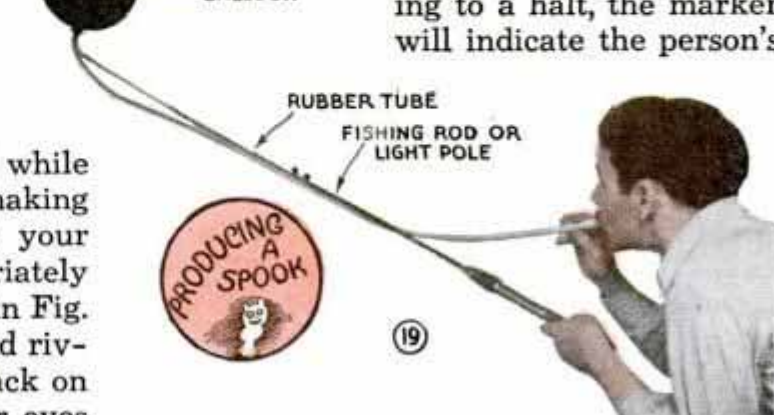
CHEMICALS OR ELECTRICITY CAN BE USED FOR WEIRD LIGHTING EFFECTS



A PICTORIAL CARDBOARD WHEEL IS SPUN TO TELL FORTUNES



A CARDBOARD SKELETON SPRAYED WITH LUMINOUS PAINT CAN BE MADE TO DANCE IN A DARK ROOM WITH A WEIRD EFFECT

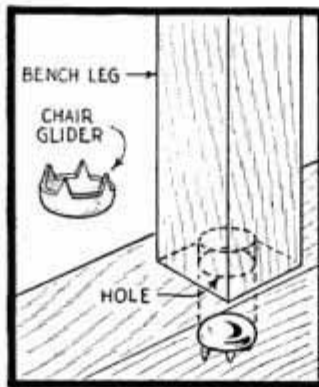


19

fortune. A "Skeleton Dance," as shown in Fig. 18, is very effective in a dark room. The cardboard figure is sprayed or painted with luminous paint, and offers a weird spectacle when manipulated on the end of a long pole. A somewhat similar stunt is shown in Fig. 19. In this case, a comic toy balloon is suitably painted with luminous paint, and then inflated in a dark room in the manner shown. Luminous paint is readily obtainable in a number of different colors and lends itself well to many other spooky Halloween stunts. Objects treated in this manner should be exposed to sunlight or a strong electric lamp, after which they will glow in the dark.

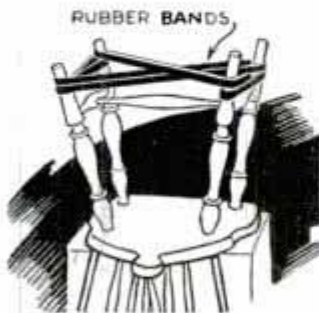
Furniture Gliders Hold Tables in Place

Benches or work tables that must be moved frequently and therefore cannot be fastened to the floor, may be made rigid enough for most purposes by drilling the ends of the legs and setting them over furniture gliders driven into the floor. The gliders project enough to keep the legs from sliding, yet are not in the way when the bench is removed to use the space for other purposes.



Chair Rungs Clamped with Rubber Bands When Gluing

Next time you have some chair rungs to re-glue, cut off several bands from an old inner tube and stretch them across the legs to hold the work until the glue dries, taking care to stretch the bands diagonally between the legs as well as straight across them. The bands are not only easier to handle than clamps for this work, but they eliminate any possibility of marring the finish.



Liner Soldered in Eave Trough to Stop Leaks



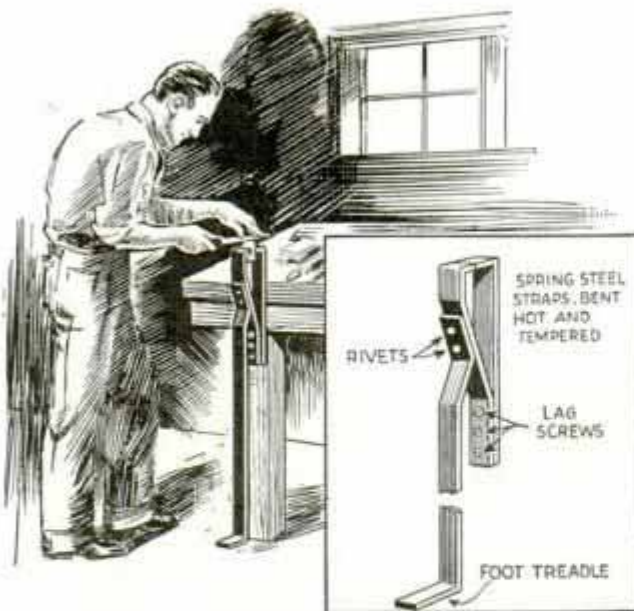
Leaky Eave Troughs Repaired by Soldering New Pieces of Trough over Damaged Portions

If you have an eave trough that has rusted through in a place or two, but otherwise is in good condition, try lining the damaged portion with a piece of new trough, instead of scraping and soldering over the holes. Have a new piece long enough to extend well beyond the leaky portion, and then solder it at the edges, first painting the inside of the old trough and the outside of the new piece. Applying a coat of paint finishes the job.—L. H. Georger, Buffalo, N. Y.

Jug Tied to Steel Trap Saves Your Game

A trapped mink or muskrat will not be lost by chewing off its leg if you take advantage of its habit of going into deep water when caught. Make the set in the usual way, and then tie a tightly corked jug to the trap chain. When caught, the animal will drag the trap into deep water, the jug keeping the trap suspended so that the mink or muskrat soon drowns. As the weight of the animal is not sufficient to sink the jug, you can find your catch easily the next morning.





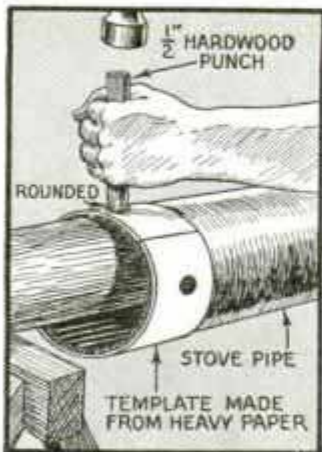
Pressure on the Foot Treadle Releases Work in This Bench Vise

Quick-Acting Vise Controlled with Your Foot

For use when a number of small pieces must be dressed with a file or rasp, this quick-acting vise releases the work by pressure on the foot treadle. The jaws, made of spring steel, are heated and bent while hot, after which the metal is tempered. When used on work which might be damaged by the hard metal jaws, pieces of sheet copper or other soft metal may be bent to fit snugly over them.

Simple Method of Making Joints in Stovepipe Rigid

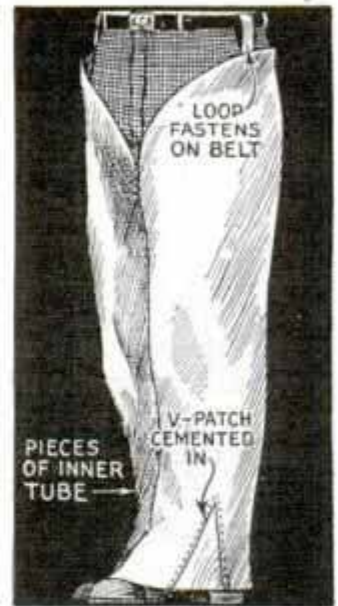
The tendency of stovepipe to loosen at the joints can be eliminated by indenting the pipe at the ends and then assembling the joints so that the indentations come together. To make the latter, take a strip of paper of a length equal to the circumference of the pipe and punch four equally-spaced holes in it. Then, using the paper as a template, put the pipe over a rounded surface and, with a punch made from a hardwood dowel, indent it as shown.



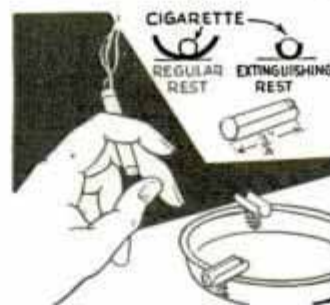
plate, put the pipe over a rounded surface and, with a punch made from a hardwood dowel, indent it as shown.

Inner-Tube "Chaps" Keep Your Legs Dry

Men who must work outdoors in rainy weather will find that two lengths of old inner tube pulled over their legs as shown will keep them dry below their rain coats. Loops cemented to the top edges are used for fastening to the belt. Cutting a slit at the bottom of each leg and cementing a V-strip in it will flare the tubes to keep water from running down the rubber into the shoes.—G. W. Becker, Valley Junction, Ia.



Ash Tray Extinguishes Cigarettes

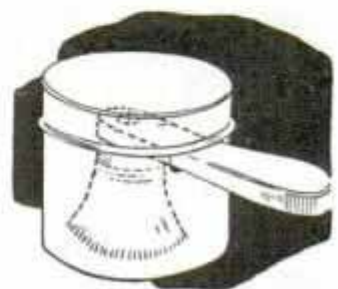


All the mess and odor of cigarettes burning in an ash tray and the possibility of a lighted butt dropping on a rug or table are eliminated by soldering two or three

strips of tin, bent to the contour of a cigarette, to your metal tray. When the butt burns down to the tin, it goes out because air is excluded by the holder.—Leonard Mitchell, San Francisco, Calif.

A Box for Your Shoe Brush

To keep a shoe-blackening brush from soiling other articles when it is stored in a box or drawer, get a small tin box and cut a notch in the side to take the brush handle as shown. Also, the box helps to keep any polish left on the brush from drying and stiffening the bristles.



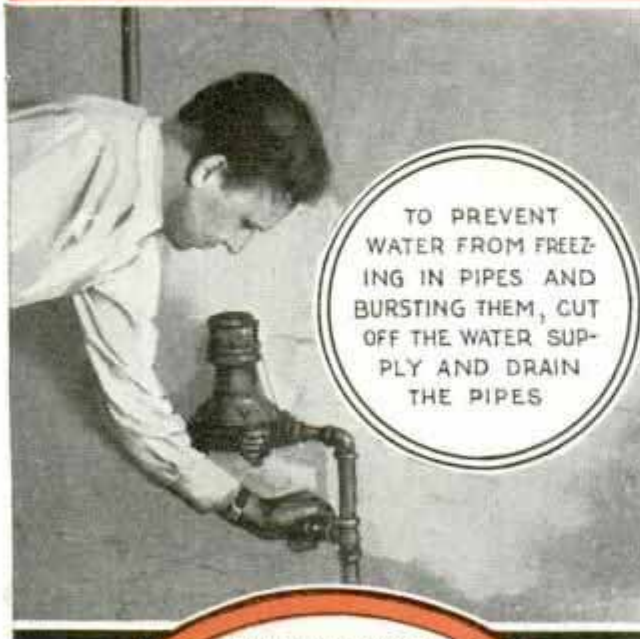
When You Close Your Home

By WALTER E. STEWART

ARE you one of the thousands throughout the northern states, who lock and shutter their homes to the chill winds of winter and follow the trail to the south? If so, adequate protection for the home and its furnishings, during your absence, is essential. Experts of the National Bureau of Standards have summarized a number of vital steps that should be considered when you close your home for an extended absence.

Preparations Made in Time

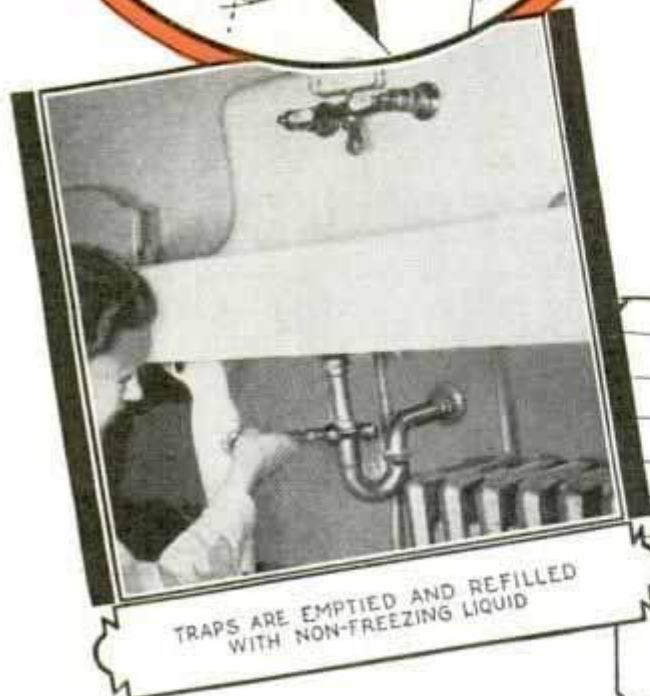
Several weeks before your departure, the house should be gone over carefully so that necessary repairs can be made in time. Often there are matters that must be attended to systematically and without undue haste. Too often preparations for closing the home are left until the occupants are involved in personal packing and leave-taking, with the resulting oversight of important details. This applies especially to the roof, doors, windows, plumbing and electrical system. An insignificant roof leak, when left for several months, may result in interior damage, repair of which will involve considerable expense. Poorly fitting windows and doors require time to adjust and repair. And, when these things are being remedied, have your carpenter make up snugly fitting window covers, fastened from the inside, to give protection against weather and intruders. Don't neglect the second-floor windows in this respect, especially over porches. Highly finished or glass-



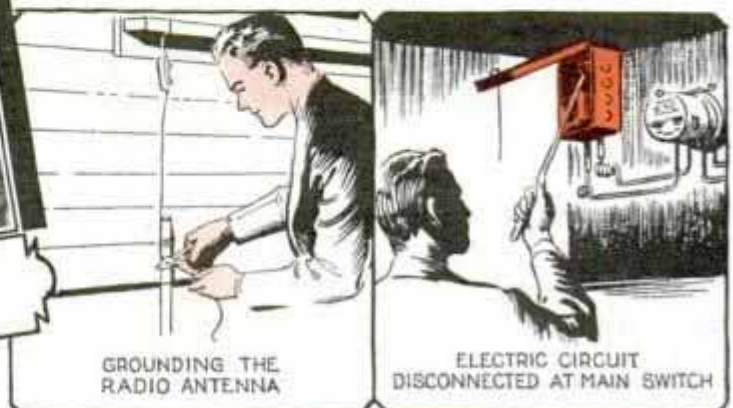
TO PREVENT WATER FROM FREEZING IN PIPES AND BURSTING THEM, CUT OFF THE WATER SUPPLY AND DRAIN THE PIPES



DRAINING WATER FROM THE FURNACE AND HOT-WATER TANK



TRAPS ARE EMPTIED AND REFILLED WITH NON-FREEZING LIQUID



GROUNDING THE RADIO ANTENNA

ELECTRIC CIRCUIT DISCONNECTED AT MAIN SWITCH

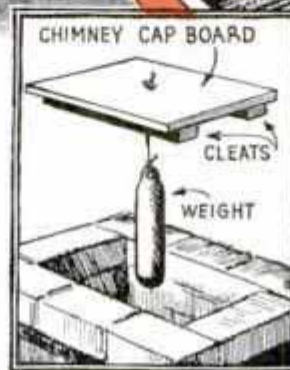


DO NOT NEGLECT THE SECOND-FLOOR WINDOWS



CLEAN THE GUTTERS SO THAT LEAVES WILL NOT CLOG IN CONDUCTOR PIPE

paneled doors may be protected by similar covers. Outside basement doors are usually inadequately locked and are therefore easily "jimmied." A solid cover here may avoid burglary. Also have the gutters cleared of leaves and rubbish so that they will not clog and overflow, causing interior damage due to seepage through wall joints. A wire guard placed in the opening of each conductor pipe will help to keep leaves out. Rain and snow may be kept out of large chimneys by means of a cap board held in place with a weight suspended inside the chimney.



CHIMNEY CAP BOARD
CLEATS
WEIGHT
CAP BOARD KEEPS SNOW OUT OF CHIMNEY



WASTE RAGS AND OTHER COMBUSTIBLE MATERIALS SHOULD BE BURNED

Protecting Water and Drainage Systems

Just before leaving there are many details that should be remembered. First, go over the water and drainage systems. Turn off the main water-supply valve. Where there is danger of the water meter freezing, have this removed and stored until you return. The cost of storage is slight compared to that of a new meter. After shutting off the water at the main valve, open all faucets, not forgetting the outside hydrants, flush the bathroom water reservoir and open the hot-water tank drain. If you have a steam or hot-water heating system, open the boiler drain and also all radiator valves and air valves in hot-water radiators, to assure that water will be completely emptied from the system. Don't neglect opening the water-supply valve to the boiler to release water trapped between it and the house supply.

Then, all drain traps must be protected against freezing, which is done by pouring in a sufficient quantity of alcohol and kerosene to replace the water. The kerosene rises to the top and prevents evaporation of the alcohol. Traps should never be left dry as this allows foul sewer gases to enter the house. Drain traps are found at every sink, the bathroom bowl and toilet, laundry tubs, and at every floor drain in the basement.

Remember the Fire Hazard

Fire hazard must also be avoided. Conduction of lightning into the house over the radio antenna may be prevented by connecting the antenna lead-in wire to the ground outside the house. Danger of explosions due to gas leakage will be eliminated by simply turning off the supply at the meter. All waste rags, papers and other combustible material should be removed from the house and destroyed to avoid spontaneous combustion. Matches should not be left on shelves but either

removed or placed in a fireproof container in the basement, away from paper and other inflammable material. Also inspect your fire-insurance policy to see if it gives protection while the building is unoccu-



pied. It may be necessary to get a "vacancy permit" from the insurance company. And, before leaving don't neglect to disconnect the main electrical switch, usually located near the meter.

And, Don't Overlook These Details

Cheap muslin cloth, spread over all upholstered furniture will be worth many times its cost in protection against dust and insects. Moth balls placed in the upholstery, under such covers, remain effective for months. Felt pads in pianos are also an attraction for moths, and a few moth balls in the piano will keep them out. Be sure to remove all perishable food from the house and if you have a supply of canned goods, it is a good idea to make arrangements for leaving it with a neighbor during your absence.

As an economy measure, especially if your absence is to be long, it is a good idea to have gas, water, electric and telephone service discontinued temporarily. Also, suppose it becomes imperative to get into the house during the period of vacancy, it is better that close friends, neighbors or even the local police are in possession of a key, rather than the alternative of breaking in through a door or



COVERING UPHOLSTERED FURNITURE TO PROTECT IT AGAINST DUST AND INSECTS

window to gain entrance. In many cases it will be a judicious measure to inform the local police station of your absence and its intended length.

Short Piece of Flexible Tubing Clears Clogged Sink Drain

Here is a sure method of cleaning out that clogged sink drain. Get a length of flexible tubing, such as a speedometer cable or a piece of electrical armored cable, and twist it through the drain pipe with your hand or breast drill. To do this, solder a short iron or brass rod in the end of the tubing so that it can be clamped in the drill chuck. As the tubing is rotated, keep a slight pressure against it, and it will gradually work its way through the drain, removing grease, soap, etc.



Template to Cut Large Pipe at an Angle



Large Pipe or Tube Cut in Two at an Accurate Angle by Using a Cardboard Template

When a large pipe or tube must be cut at an angle, a guide line for sawing can be scribed accurately by using a template. To make the latter, take a piece of cardboard, cut a hole in the center slightly larger than the work and slip this over the pipe. Tip the template to one side at the angle you wish to cut the pipe and scribe the line. If the angle is critical, lay it off on another piece of cardboard and use this as a guide as shown.

Removing Soot Specks from Felt Hats

When specks of soot settle on a light felt hat, it is almost impossible to remove them with a brush without crushing and spreading them into the nap of the hat. To prevent this, before brushing the hat, snap your finger against the inside directly under the soot mark and much of it will be dislodged without leaving a trace.

Small Gas Engine Runs This Midget Car



This small car, having a 58-in. wheelbase and 28-in. tread, is very easy to operate and may be powered by a 1/2 to 3/4-hp. gas engine of the washing-machine type. It is equipped with effective brakes and pneumatic tires. Plans show three alternate methods of body construction. Easy to build and will assure you of plenty fun at a safe, moderate speed. Our blueprints Nos. 906 to 909 incl. give you all the information necessary. This set will be sent postpaid on receipt of \$1.00.

START NOW WITH YOUR ICE BOAT, TOBOGGAN, SNOWSHOES OR BOBSLED

- 18-FT. ICE BOAT—774—Roomy cockpit seats four people. Mast is 14 ft. high. Complete details 25c.
- FRONT-STEERING ICE BOAT—786—Cockpit is 13 ft. long. Safe because of buffers on runner plank—25c.
- COASTING TOBOGGAN—657—7½ ft. long by 16 in. wide. Print indicates method of bending slats—25c.
- HOMEMADE SNOWSHOES—796 and 797—Prints show how to bend frames and string rawhide. Two prints 50c.
- 8-FT. BOBSLED—632—Auto-type steering gear. Runner supports made from pipe fittings. Easily built—25c.
- HOW TO MAKE SKIS—569—Print illustrates three types. Gives data on bending wood correctly—25c.

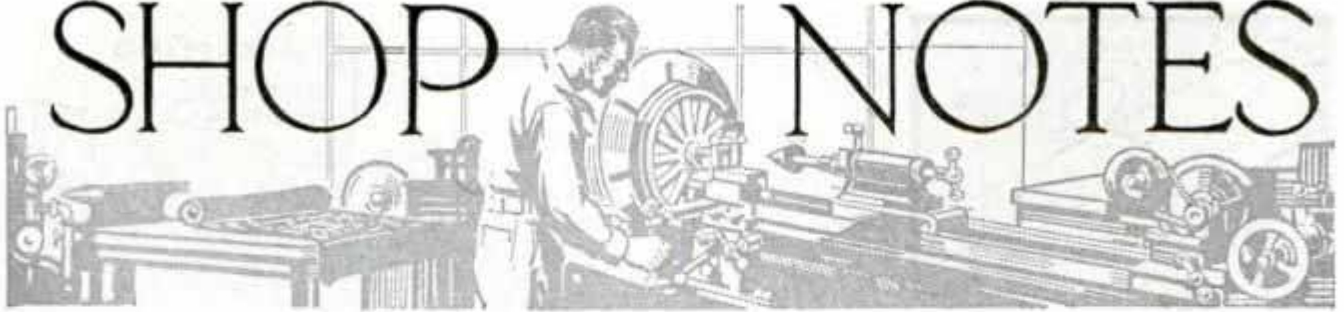
Our "What to Make," 80-pp. booklet, full of practical shop information, tells you about hundreds of other useful and interesting things the craftsman can make, where he can purchase hard-to-get materials, etc. Sent postpaid for 12 cents.



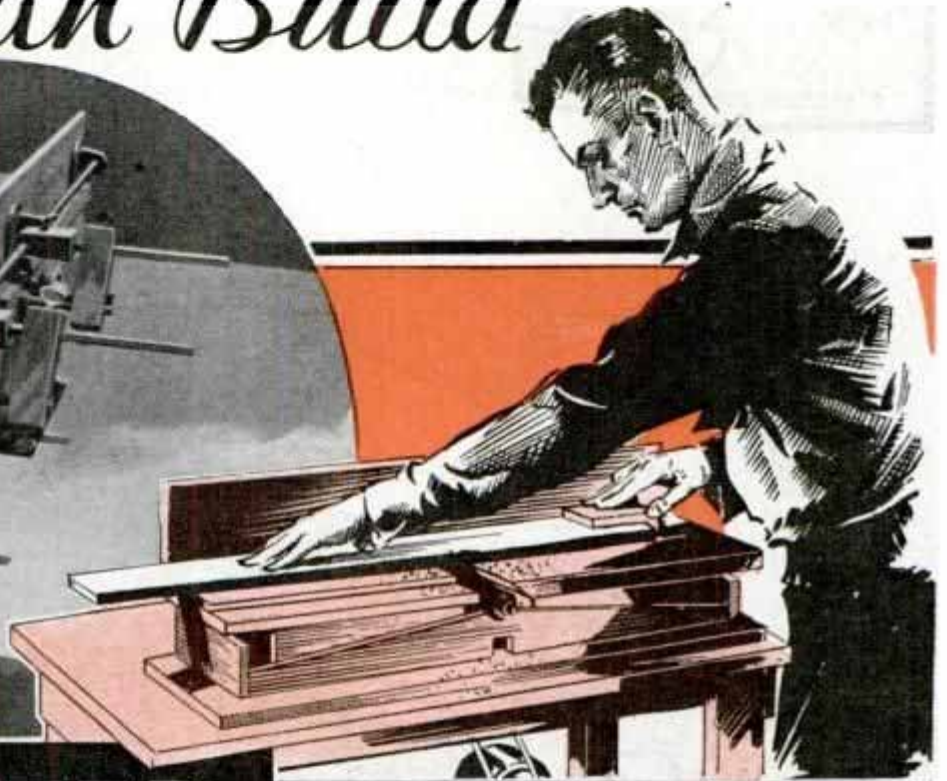
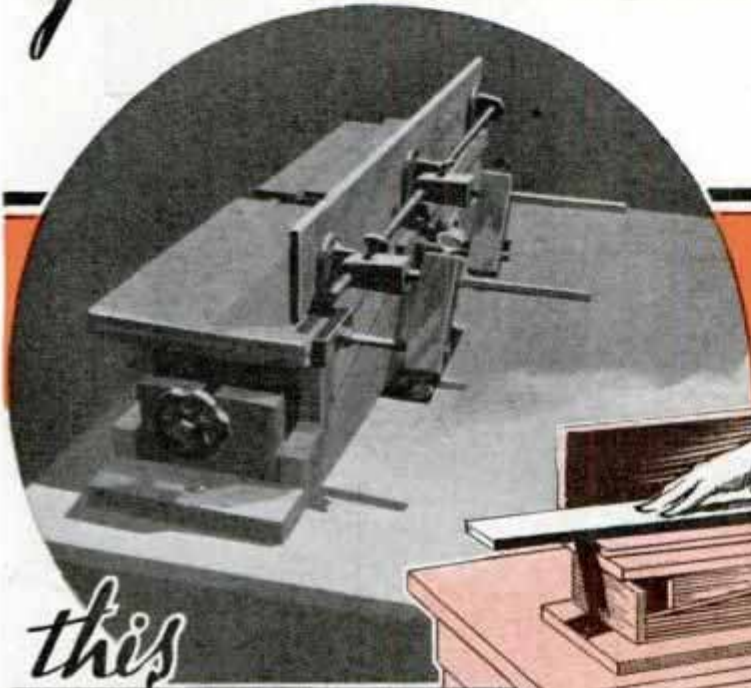
18-Ft. Iceboat (SN 774)

Blueprint Department, Popular Mechanics Magazine, 200 E. Ontario St., Chicago

SHOP NOTES



You Can Build



this

JOINTER

By HARRY J. FIELD

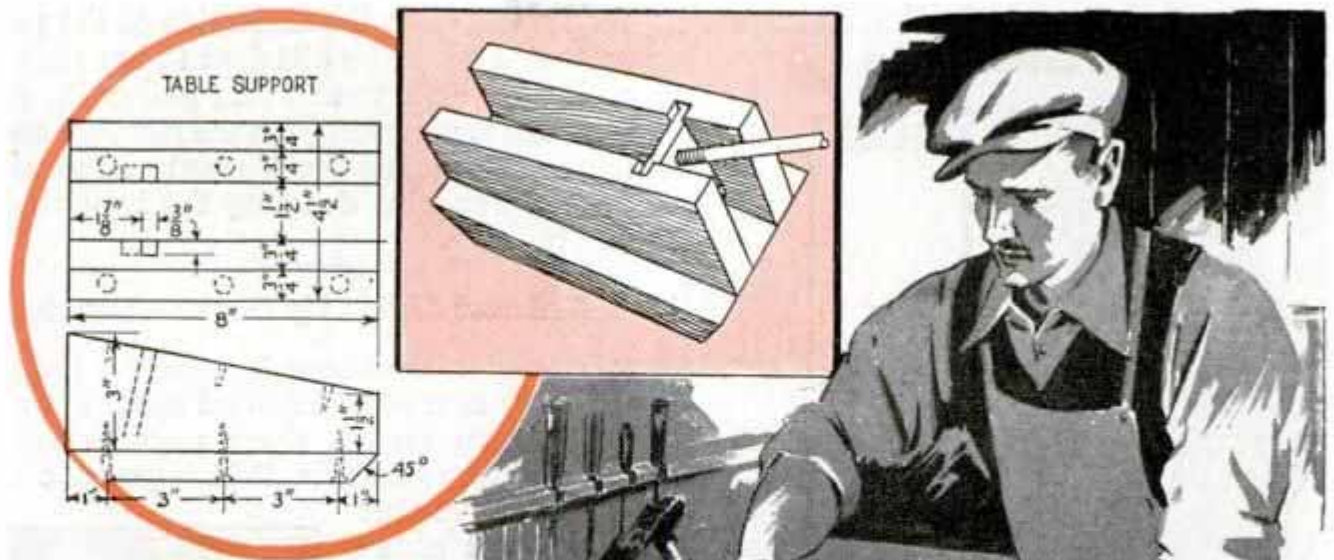
CONSTRUCTED largely of kiln-dried hard maple, this 4-in. jointer will do work as accurately as needed in average woodworking practice. Few of the attachments are of metal and these may be made from stock material or, if you like, they may be cast. The only manufactured parts to buy are the cutter-head assembly including the knives and backer, two bearings, two handwheels, and a number of screws as needed.

It is best to cut and fit the separate parts as the work progresses, rather than cut all the parts at once. Start with the baseboard.



This is dadoed out at each end and a spline inserted, set in with casein glue to prevent warping and checking. The hole for shavings is then cut out. Each side frame should be cut out for the bearing boxes, holes are drilled for screws to hold the boxes, and two guides are fitted to each frame. The frames are then attached

Walker. Turner Co. 134 Deschamps 781



them up against the guides and locate the tables in place, being sure they are a good sliding fit, without up-and-down play or side shake. Check the table tops with a straightedge to assure a straight surface the entire length. When this has been done, locate and drill six screw holes in each, for fastenig the tables, which should slide freely, to the underslides.

In starting work on the elevating device, remove the underslides from the frame and dado out as shown to take the cast-iron blocks through which the elevating screw passes. The blocks should be a snug fit, the slots being cut on an angle so as to bring the screw in line with the travel of the underslide. The $\frac{3}{8}$ -in. screw is 8 in. long and has 16 threads per in. for 3 in. on one end; the other end is fitted with a handwheel. Lay out and drill a hole through the baseboard on an angle to bring the holding post in line, so the elevating screw will pass freely. Also counterbore the underside of the hole to take a washer and the head of the hold-down screw. The holding posts are filed on an angle on the bottom. When assembling, run the screw through the threaded hole in the block about $\frac{1}{2}$ in. and with the table at high elevation, prick-punch close to each washer. Drill here for small cotter pins and insert them. This will allow the screw to turn, raising and lowering the table without end play in the screw itself. The end pieces can now be cut and fitted.

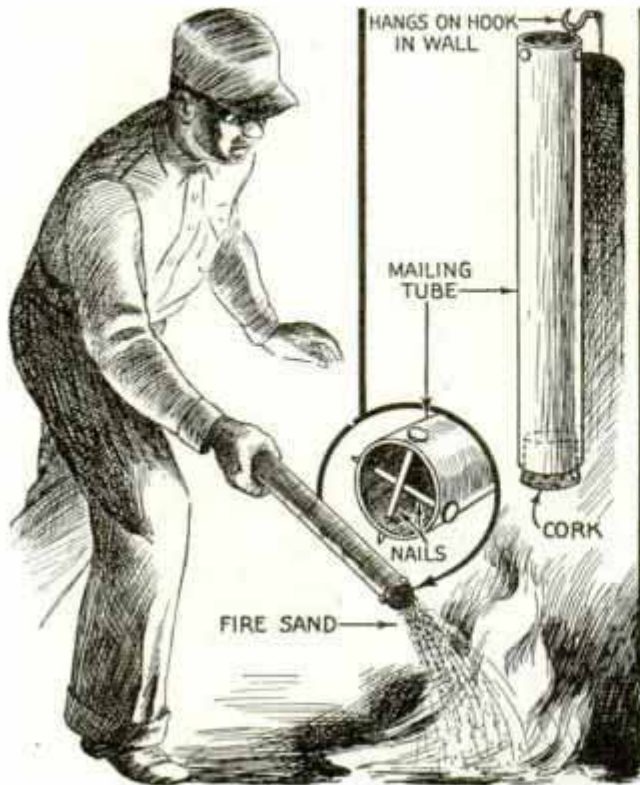
The fittings for the guide fence are drilled and reamed, also tapped for threads. Two cast-iron pieces are attached

to the front table. A $\frac{3}{8}$ -in. rod 4 in. long, threaded $\frac{3}{4}$ in. on one end, is screwed into each. The cast-iron pieces which form the link between the table and the guide fence should be drilled and reamed in line, to prevent binding when adjusting the guide fence. This also applies when reaming the three pieces that support the swivel rod to the back of the fence. Two 5 by $\frac{3}{8}$ -in. rods are threaded on one end and are screwed into the two iron pieces which form the swivels allowing the fence to tilt. Locate and attach three iron castings to the back of the fence, pass the long $\frac{3}{8}$ -in. rod through these and then assemble.

Four pieces of thin sheet iron or tin are cut to fit the shavings hole in the baseboard and extend high enough to just clear the knives. Their lower ends are bradded to the baseboard, forming a chute.

After completion, the wood is given a coat of linseed oil and, when dry, a coat of shellac is applied to all outside surfaces except the table tops and the face of the guide fence, these being given two coats of furniture wax well rubbed. A $\frac{1}{4}$ -hp. motor is used to drive this jointer, with a $3\frac{1}{2}$ -in. pulley on the motor and a $1\frac{3}{4}$ -in. pulley on the cutter head.

Practical Homemade Extinguisher for Gasoline Fires



Homemade Fire Extinguisher to Scatter Dry Sand on Gasoline or Oil Fires in Shops and Garages

Although buckets of sand are usually kept at hand in shops or garages where gasoline fires might occur, their excessive weight makes them inconvenient to handle when quick and forceful scattering of the sand is required. On account of this, one garage mechanic added a few extinguishers which he made from mailing tubes. Each tube was fitted with a cork at the bottom to hold the sand, and nails were driven cross-wise through the upper end of the tube. The tubes were filled with sand and suspended by strings from the walls. In use, the tube is jerked from the hook and swung back and forth, directed toward the base of the flame.

Mask on Ink Pad Stamps Eggs



To keep a record of eggs laid by various pens of fowls, one poultryman perforated a strip of wax paper and glued this over a rubber-stamp ink pad. A safety pin was

then soldered to the underside of the pad so that it could be attached to his sleeve while the eggs were being gathered. As each egg is removed from the nest, the end is pressed against the masked pad to receive an imprint denoting the respective pen number.

Reflector Lights Up Obscure Gauge

It is often necessary to mount a meter or gauge in a poorly lighted spot. Sometimes, even though there may be light coming from one side, it is impossible to read the meter except at close range as the cross light produces only a glare. In such a case, cut a piece of bright tin or cardboard to a length equal to one-half the circumference of the meter and about 2½ in. wide. Fasten it in place with a rubber band on the side of the meter opposite the source of light. In this way, the reflected light on the gauge kills the glare and makes the figures readable.—C. Edward Lindberg, Sherman, N. Y.



Weight Markings Made Legible

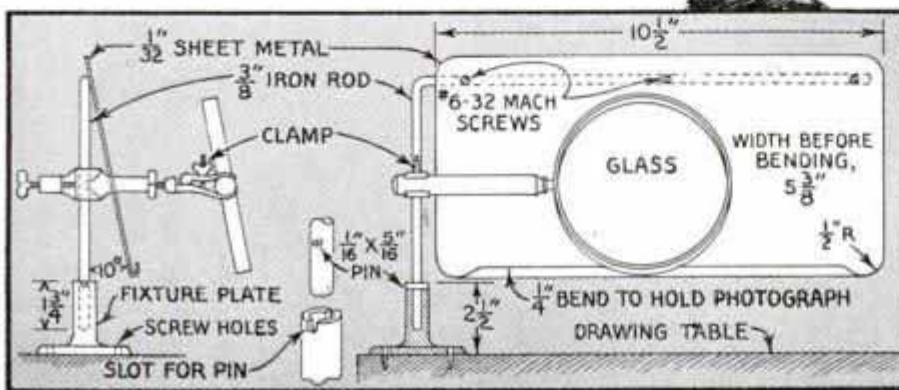


Small weights used with photo and chemical scales often become dark and corroded after a short time, which makes it difficult to read the markings stamped in the metal. They can be made legible by rubbing

with the point of a lead pencil, thus coating the background with graphite so that the numerals stand out clearly. Another method is to clean the surface around the markings with an ink eraser until the metal becomes bright. Then give this part a touch of transparent metal lacquer to prevent rapid corrosion.

Artist's Magnifying Glass Held with Clamp

When copying drawings from small photos or cuts, it is often necessary to use a magnifying glass to bring out fine details. A holder for the glass and copy that will leave both hands free, can be made by using a swiveled burette clamp, such as is used to hold flasks in chemistry laboratories. Such an arrangement provides a holder that is adjustable in all directions so that the glass can be focused on any detail of the work and kept in that position. The copy holder is a piece of sheet



iron screwed or riveted to an iron rod, which is bent at right angles as indicated. To keep the holder in a vertical position,

the lower end of the rod is inserted into a fixture plate or a weighted block. The clamp is attached to the rod at any convenient height with the handle of the magnifying glass held firmly in the end.

If an extension is provided for the handle of the magnifying glass, it can be adjusted horizontally over a greater area.

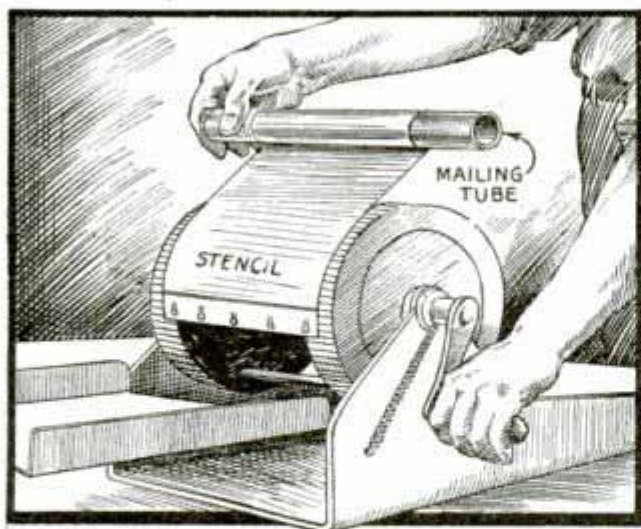
Metal Table Keeps Your Welding Accessories at Hand

Besides providing a smooth surface on which to place small parts to be welded, this metal table has an accessory rack for storing torch tips, flux rods, etc., which greatly adds to its convenience. The top is a piece of flat metal, and the standard that supports it is an old auto torque tube with the tapered end cut off to get the right height. To brace the table and prevent tipping, four legs made of 1 1/2-in. tubing are welded to the standard at an angle. The accessory rack is a U-shaped rod, which is welded to the edge of the table top and to the bottom of the rear legs. Large spikes welded to the rod at an angle hold various flux rods, while an iron rod across the top of the rack carries several machine bolts on the threads of which extra torch tips are screwed.—J. C. Coyle, Phoenix, Ariz.



Homemade Welding Table That Has Rack to Hold Accessories Such as Flux Rods and Torch Tips

☛ A newly tapped hole should be oiled before turning a bolt into it.



Mimeograph Stencil Rolled on Mailing Tube Is Easy to Put on Machine Smoothly

Getting Stencil on Mimeograph Machine Smoothly

Operators of mimeograph machines often experience difficulty by having a heavily typed stencil tear when it is being stretched over the cylinder of the machine. Such accidents may be avoided by first placing the stencil, face down, on a smooth table or desk, and then rolling it up on a cardboard mailing tube. If care is taken in the rolling, the paper stub of the stencil may be attached in place and the wax sheet unrolled evenly over the ink pad as the cylinder is turned. Also, any pulling to make the stencil smooth is distributed so that tearing is unlikely.

Padded Apron Is Comfortable for Bench Workers

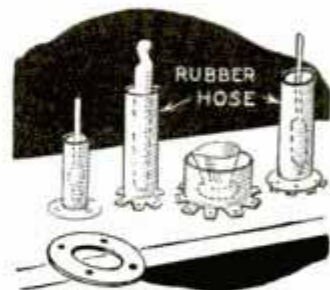
Mechanics, printers and others who lean against a workbench during much of their labor will find that a padded apron makes their work more comfortable. Several folds of cloth stitched across the inside of the apron at the height of the bench will serve the purpose.



Or, one may use a tubular strip of material filled with cotton. In the latter event, the pad should be stitched to prevent the cotton from becoming wadded.

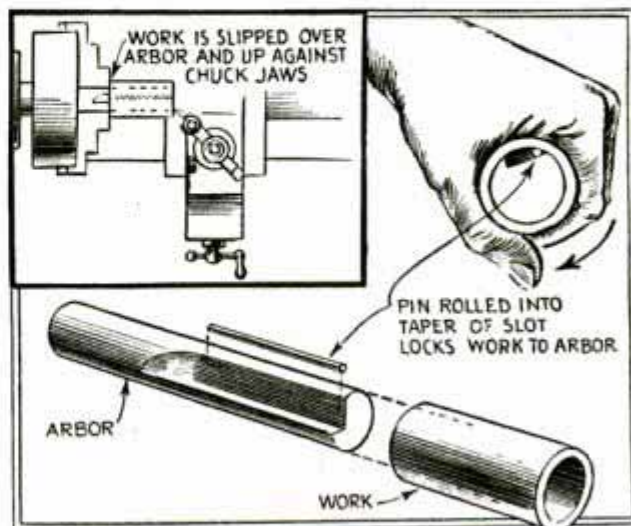
Rack for Chemical Apparatus Made of Rubber Hose

A chemist who needed extra racks for his apparatus made them by tacking pieces of rubber hose vertically to a board. The hose was cut into different lengths for the various parts, after which the lower end of each piece was serrated, the tabs thus formed being bent outward and tacked to the board as shown. Wads of cotton in the bottom of each holder protected the glass parts so they would not be broken when dropped inside.



Quick-Grip Arbor to Face Sleeves and Bushings

This quick-grip arbor, which is made from a piece of cold-rolled steel and a short length of $\frac{1}{16}$ or $\frac{1}{8}$ -in. steel rod, will be found indispensable for holding bushings, sleeves and rings that are being finished in quantities. Also, it is handy for gripping cupped-end work that cannot be held by the usual expansion-arbor method. The tapered pin-slot may be cut on a shaper or it can be ground on an emery wheel and filed to a finished size. In use, the work is slipped over the arbor, after which a twist to the right causes the pin to move up the tapered side of the slot and grip the work.

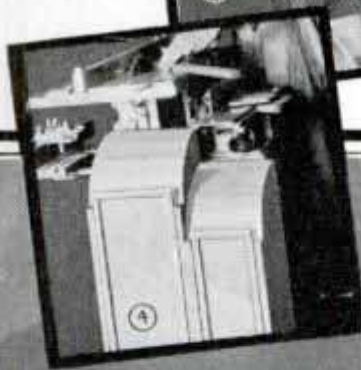


Tapered Slot Cut in Arbor Carries Steel Pin to Grip Sleeves and Bushings Quickly

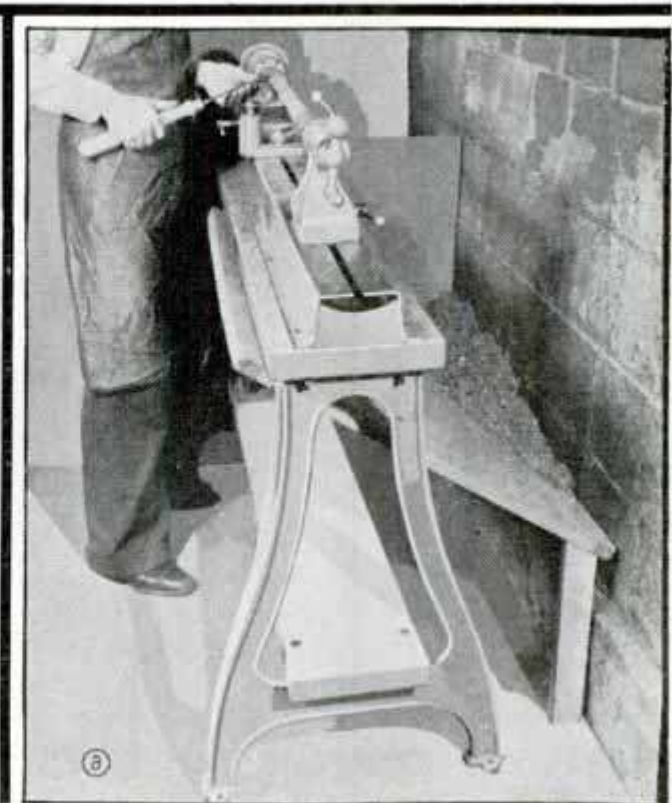
DUST DISPOSAL

in the Home Workshop

YOUR circular saw and the jointer are perhaps the worst offenders in producing sawdust. Fig. 1 shows a simple but effective dust collector, comprising a wood frame, 8 in. long, and a cloth bag, 12 in. deep. A bag alone, fitted with a draw string which ties over the chute, is sometimes used as in Fig. 2. In Fig. 3 the dust from the jointer falls into a box, while that from the saw is conveyed to the same container through a length of stovepipe or cardboard tube. The best sawdust catcher for a combination unit is shown in Fig. 4. These can be made up readily from ½-in. stock and hard-pressed board. A small vacuum cleaner is useful in picking up dust from the sander, as in Fig. 5. The cleaner may be mounted directly over the machine, as

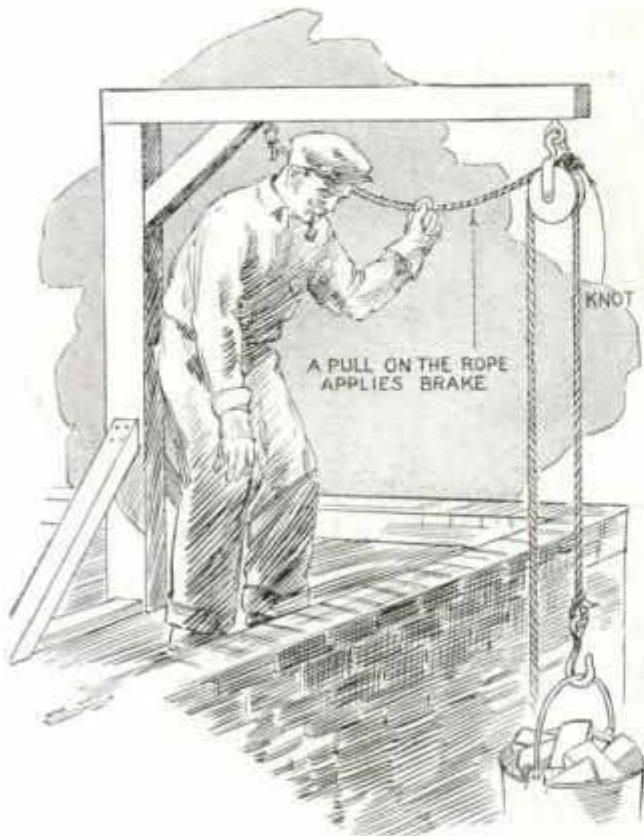


shown, or the flat, nozzle type of fitting may be carried from the cleaner to the sander. The same idea can be adapted to a number of other machines, such as the grinder, scroll saw, etc. Fig. 6 pictures a method of solving the sawdust problem of a lathe. The bin catches a goodly portion of the chips, keeps the dust out of the way and can be cleaned out easily when necessary.



Above, a Small Vacuum Cleaner Takes the Dust Away from the Sander; Right, Method of Eliminating Some of the Dust around a Lathe

Knotted Rope Serves as Pulley Brake



Knotted Rope Serves as Brake When Lowering Buckets of Material from Roof

Lowering pails of bricks and other heavy materials from chimney-repair jobs is usually hard on the workman's hands and gloves, and may be dangerous to those below unless some efficient braking device is used on the lowering tackle. If the pulley used is not already provided with a brake, one may be constructed by attaching a short piece of heavy rope to the lowering crane, inserting the free end through the loop of the pulley and twisting it into a large knot. In use, the workman merely pulls down on this rope to force the knot into the pulley loop and apply the necessary braking friction.

Positive Stop for Shop Doors



In shops or warehouses where wedge-type door-stops would project to interfere with the passage of wheel trucks, a spring stop will be found practical. A length of $\frac{1}{4}$ -in. steel rod is point-

ed at one end and bent as indicated. This is pivoted to the lower portion of the door and a coil spring attached at the angle shown. When not in use, the stop is swung up against a projecting nail or screw, but may be kicked over to the locking position instantly.

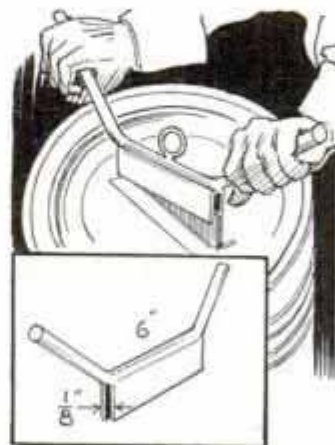
Funnel Holds Fowls to Weigh Them

Many poultrymen, when weighing individual fowls, inflict unnecessary pain and discomfort on the bird by locking its wings and fastening its feet with twine. It is much simpler, and saves time as well, to roll a sheet of tin, or heavy cardboard, into an open-end cone and suspend this from the hook of the scales, as shown. The fowl lowered, headfirst, into this cone will not struggle, and the weight may be readily determined.



Homemade Wrench Loosens Lid on Carbide Can

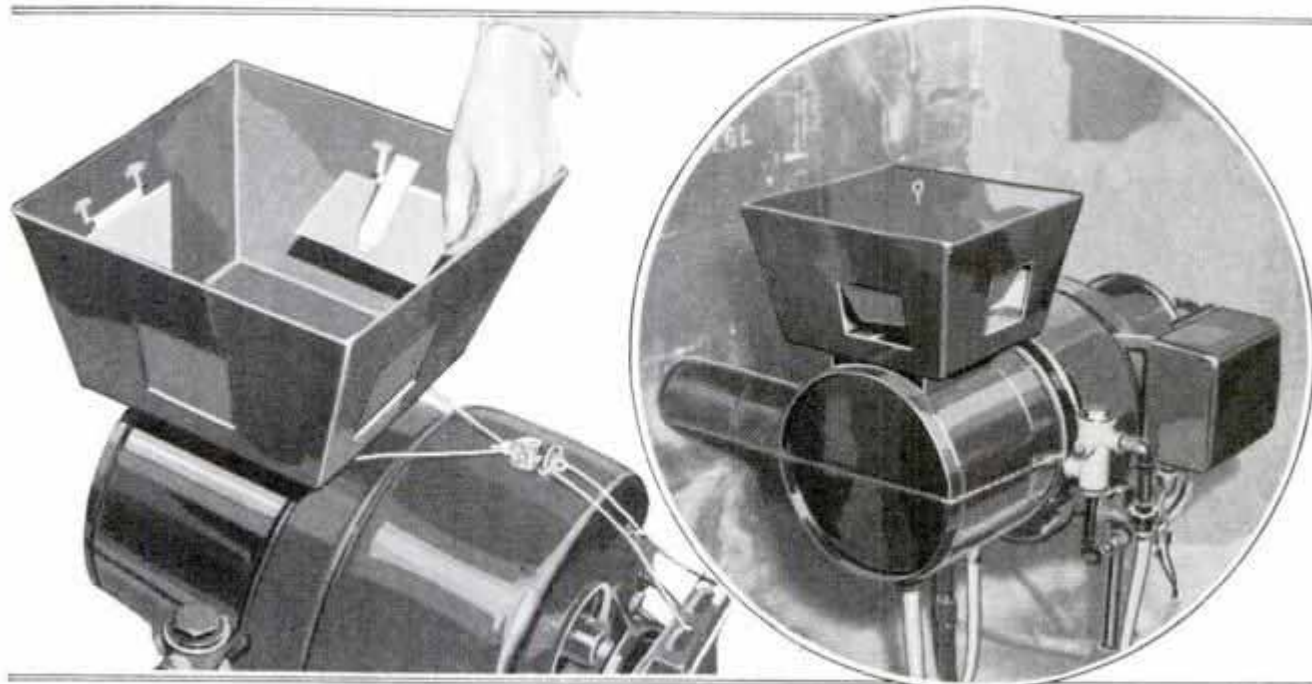
As lids on carbide cans must be kept screwed down tightly, the strip on the lid, which is used to turn it, is often broken,



resulting in much trouble when opening the can. This difficulty may be avoided by using a wrench of the type shown. A 6-in. strip of $\frac{1}{8}$ by $1\frac{3}{4}$ -in. flat iron is bent double, leaving a space $\frac{1}{8}$ in. wide and about $\frac{3}{4}$ in. deep between the edges. A rod,

with the ends bent upward, is brazed to the back of this wrench, with a small metal loop at the center by which to hang it up when not in use.

Draft-Control Box on Oil Burner Saves Fuel



Cold air, seeping through the draft vents of an oil burner, cools the heating coils of the furnace while the burner is inoperative. In one case this heat loss and consequent fuel waste was overcome by an arrangement that draws all incoming air through a sheetmetal box the openings of which are fitted with leather flaps, permitting the entrance of air only when the burner is working. The forced draft pulls

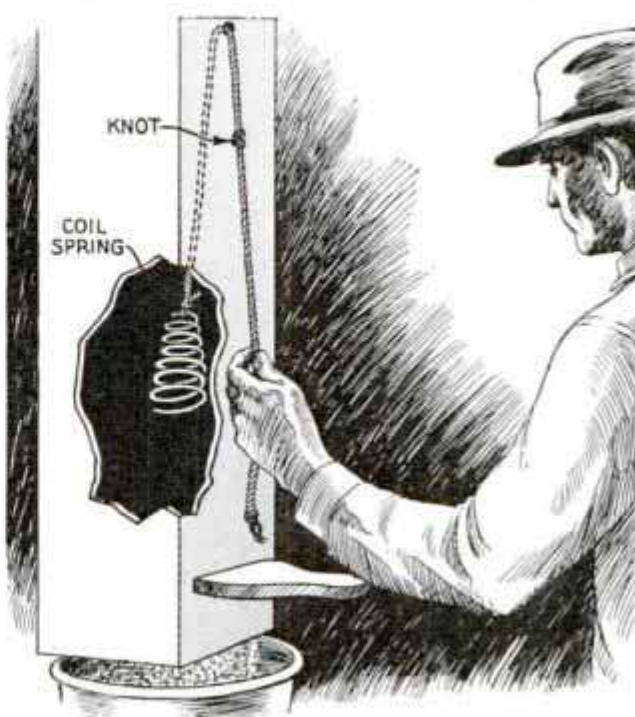
the flaps open as shown in the right-hand photo. When the burner stops, the flaps, properly weighted, drop back in place, closing the vents. The left-hand photo shows the interior of the draft-control box, with the cover removed. The narrow strip, which can be seen on the center of one flap, is the weight. Note that the sides of the box are at an angle so that flaps will lie snugly over the vents.

Spring Suspended Inside Grain Spout to Prevent Clogging

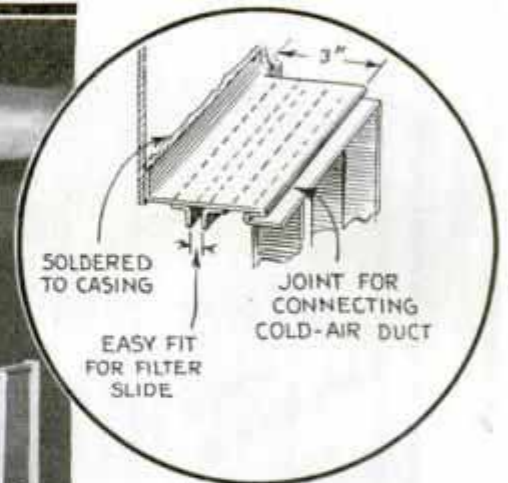
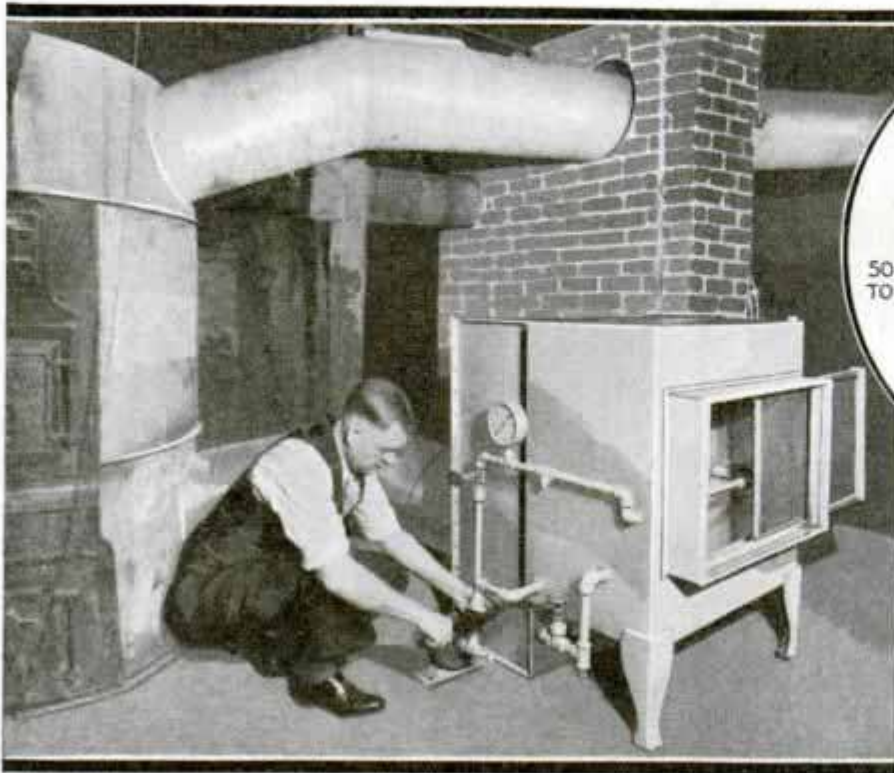
Grain or ground feed kept in an overhead bin of a barn and conveyed to the lower floor by means of a hopper and spout, often packs and clogs in the spout to shut off the supply. To avoid this, one farmer suspended a heavy coil spring inside the spout with a cord as shown, so that it could be moved up and down to loosen the clogged feed.

Boxes of Lime Keep Eggs Clean

Boxes filled with lime and placed in front of chickens' nests will save poultrymen time and labor in washing soiled eggs. If the boxes are placed so that the hens have to walk through the lime to reach the nests, dirt and droppings that adhere to their feet will be removed, thus assuring a minimum number of soiled eggs.



Control Humidity with HOME



by
H.H. METCALF

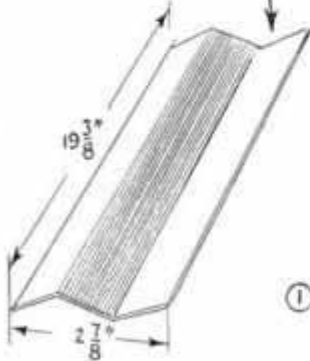
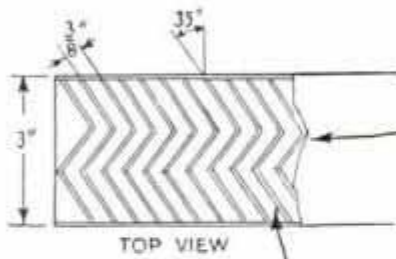
DO YOU know that the air in most of our homes is drier on many winter days than the air of the Sahara desert? Dry air robs the throat and nasal passages of moisture and makes us more susceptible to colds, pneumonia and influenza. Also, do you know that on sultry days during summer, it is not the temperature that is mostly to blame for your distress, but the excessive humidity in the air? Good air conditioning gives you healthful, comfortable air, which is filtered free from dust, soot, germs and other impurities; contains a sufficient but not an excessive amount of moisture; is heated or cooled for average comfort, and is then circulated through the house. You can go a long way toward obtaining such air by using a conditioning unit of the kind shown here, which has been in use for several seasons and has been found entirely practical and satisfactory. Carefully built and when used under the same general conditions, it will give gratifying results.

Before the unit is installed, there are a few important factors that should be carefully considered. In the first place, this conditioner works in conjunction with a hot-air heating system, depending on it for circulation. If you have another type

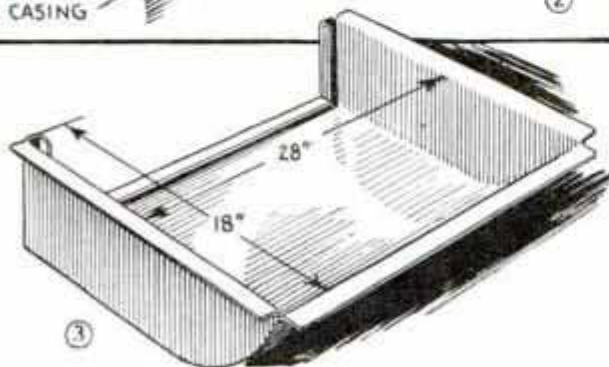
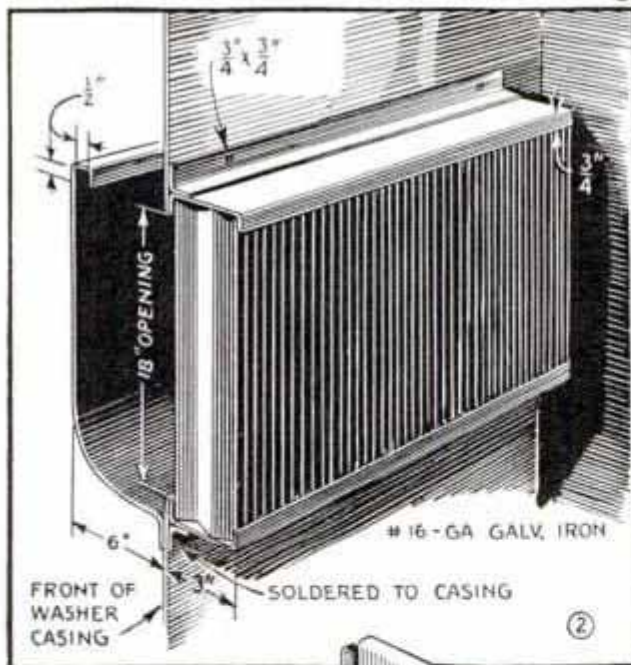
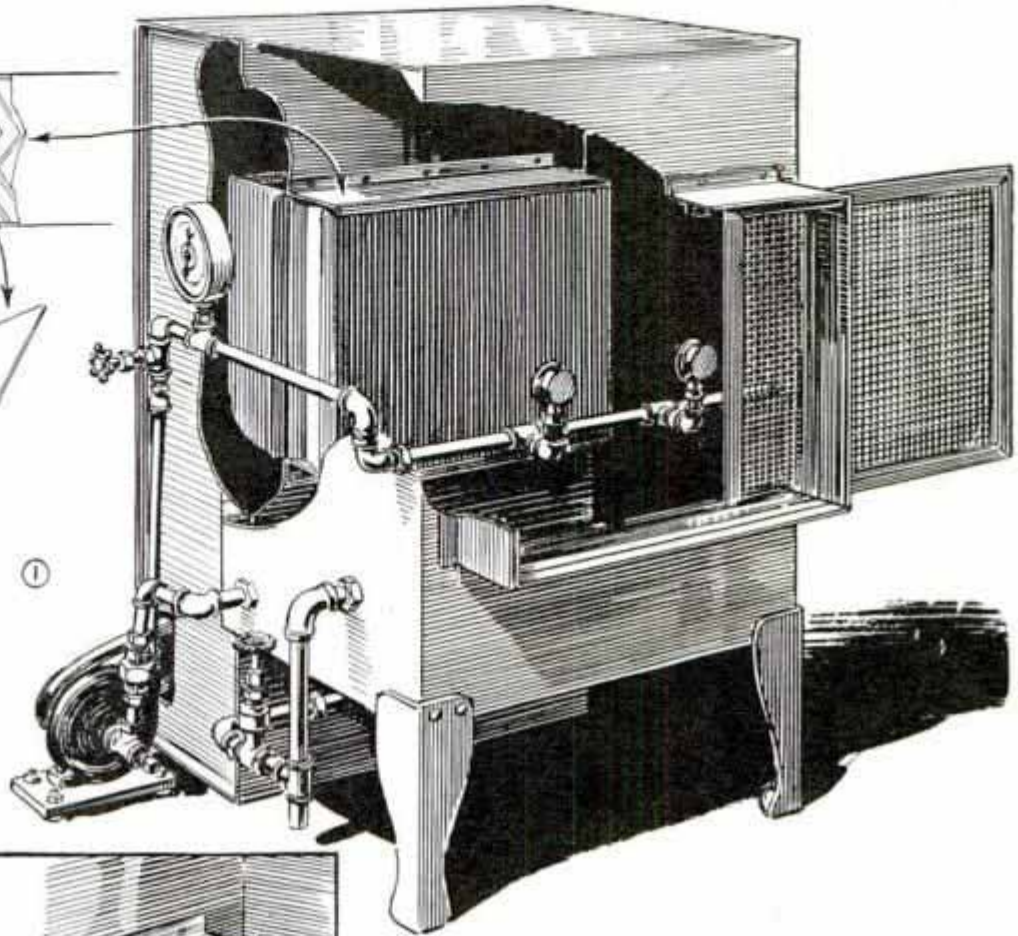
of heating system, such as hot water or steam, an efficient duct system must be provided, which may involve some difficulties in homes already built. A single, large duct to deliver the conditioned air to the rooms above and another one for air return, might give some degree of satisfaction, but this is problematical and something for you to experiment with, if you wish. Another thing to keep in mind is that an air conditioner is of no benefit whatsoever if doors and windows are kept open. It is best to keep storm doors and windows tightly in place to prevent outside air from filtering in, or inside air from leaking out. It should be remembered that the conditioned air is more healthful and more comfortable than average outside air.

Good insulation of the house is absolutely essential not only to avoid infiltration or leakage but also to prevent the "sweating" of walls. Considerable trouble has been experienced in poorly insulated buildings during cold weather, when the inside humidity was raised to 50 per cent, and so much condensation of moisture—"sweating"—occurred on the inside of the outer walls, that paint, wallpaper and furnishings were ruined. Only thor-

AIR CONDITIONER



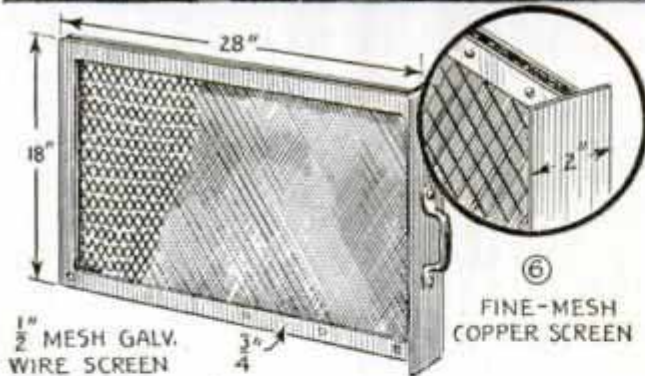
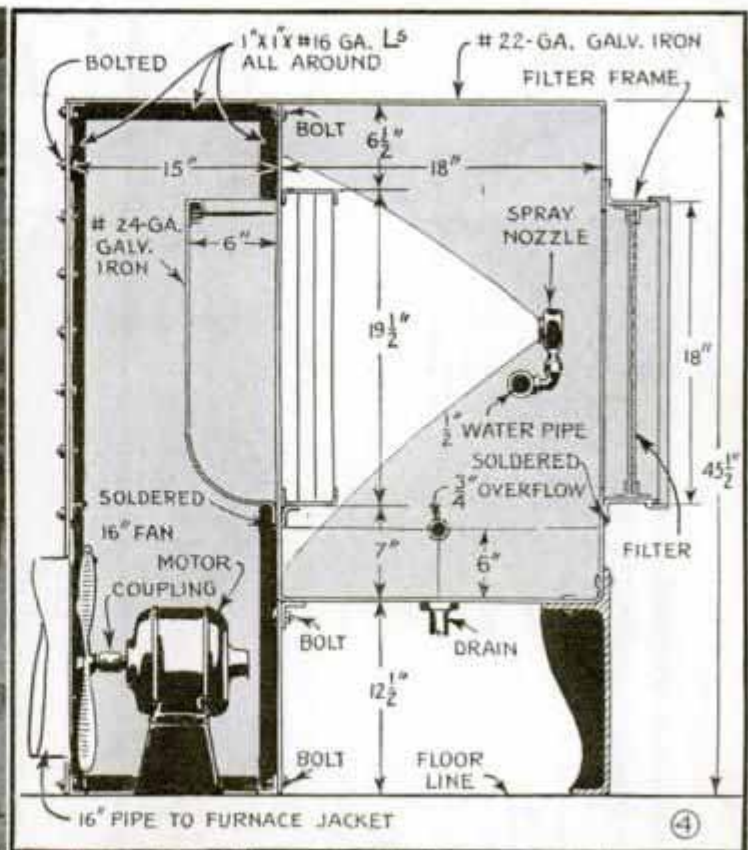
60 REQ'D MADE
OF # 22-GA.
SHEET IRON



ough insulation will prevent such trouble, the partitions being filled with insulation and the ceiling under the roof being also sufficiently covered with it.

It is also necessary to remember that when water is used in an air conditioner for cooling and dehumidifying air, the temperature of the water must be 55° Fahr. or lower, for efficient operation. Water at a higher temperature than this is inadequate for cooling or dehumidifying the air. Therefore, in many localities, water from the city mains cannot be used. Water from a deep well, having a temperature of 55° or less, will be satisfactory. Lacking this, the water will have to be cooled artificially, by a unit that will supply sufficient refrigeration, which is more expensive than using well water. This fact has been mentioned here as the air conditioner shown makes use of cold water for cooling and dehumidifying the air.

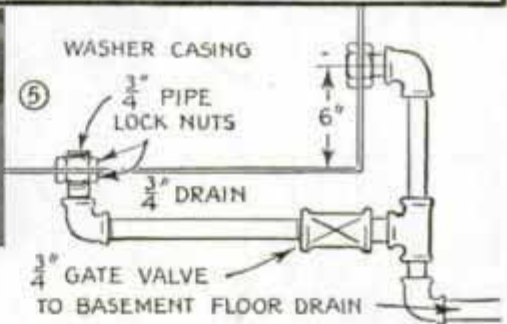
The unit shown is suitable for the average six-room house. The cost was \$17.50, which did not include the motor. Dur-

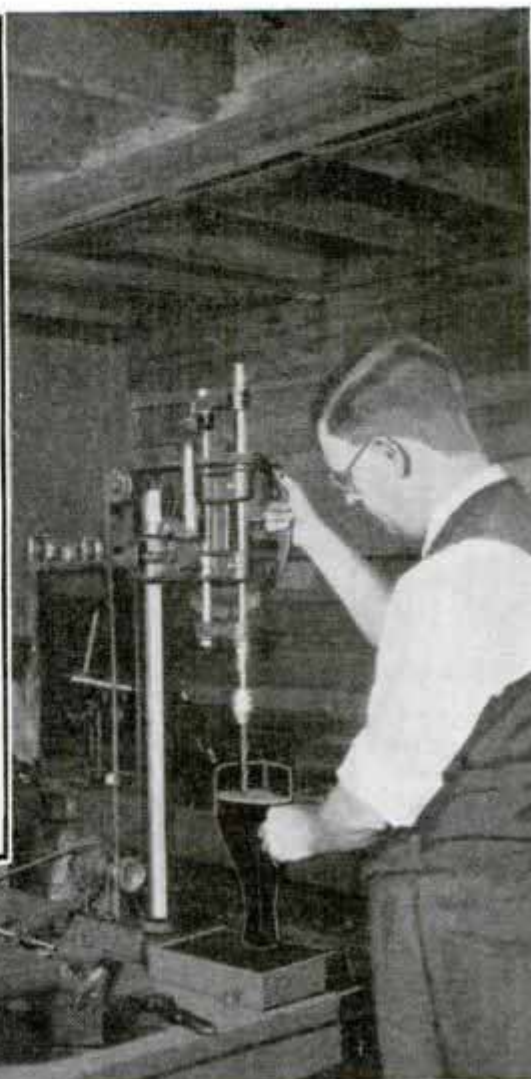
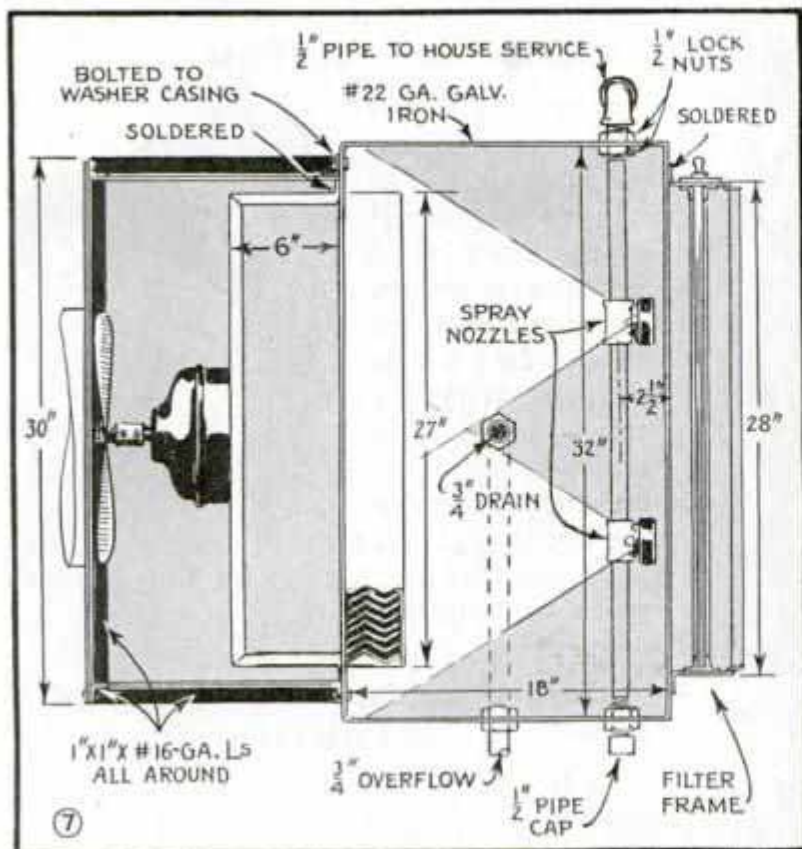


ing winter, when the hot-air system furnishes the necessary heat, the unit filters the air and adds moisture to it, after which the air is delivered to the air intake of the furnace. Return air is brought to the conditioner directly by piping, all separate cold-air return ducts being connected together. In some cases the return air may be exhausted into the basement, where it mixes with the basement air and also with fresh air let in through a window, after which the mixed air is drawn into the conditioner.

When the air enters the conditioner, it

first passes through a filter, which removes impurities. See Fig. 6. The filter consists of two screens; a very fine copper screen and a coarse, galvanized-iron screen. The coarse screen is placed inside and supports the fine screen. The latter is given a coating of ordinary motor oil, thinly applied with a brush. Due to the great amount of dust collected by the filter, it should be cleaned frequently and re-oiled. Two fine-spray nozzles are located just inside the unit as in Figs. 4, 5, and 7, and all air then passes through the cold-water spray. During winter the air absorbs considerable moisture here. And, during summer, the exact opposite takes place; the warm, moisture-laden air, cooled considerably by the cold spray, (less than 55°) and also by the cold eliminator plates, gives up some of its moisture and is thus dehumidified. The eliminator consists of a number of baffles. See





Figs. 1 and 2. It traps free moisture in the washed air and also helps in removing dust particles. The air, leaving the eliminator, is directed upward by a deflector shown in Figs. 2 and 3, into a compartment containing a fan, which forces the washed and filtered air to the furnace intake. A small centrifugal water pump and a water-pressure gauge are also provided. The spray nozzles normally operate at 8 to 10 lbs. pressure. During winter the same water can be used over and over again. A fine screen should be placed in the water recirculating system to catch dirt that might clog the spray nozzles. During summer, the water can only be recirculated as long as it remains below 55°, and a supply of fresh, cold water should be added constantly. Although this system has no automatic temperature and humidity controls, these, obviously, may be added if you desire.

In this unit, note that the washing and the air-exhaust compartments are really two separate parts, bolted together. This enables the unit to be taken through a doorway if necessary. Manufacturers provide filters and eliminators of various kinds and sizes. It is important that all joints of the washing compartment are

water-tight. The deflector in the air-exhaust compartment is rounded at the bottom to return the water it traps. In cases where the return air is piped directly to the conditioner, a length of stove-pipe, fitted with a damper, is installed to take in a supply of fresh air from outside. Usually about 25 per cent of fresh air is added to the return air during winter and about 40 per cent during summer.

A thermometer and hygrometer in a central location, will indicate temperature and humidity. Or, you can use the dry and wet bulb thermometer combination, keeping a humidity chart at hand so that the daily moisture content of the air may be determined. Where 50 per cent humidity cannot be supplied during winter on account of "sweating" on walls, provide less humidity but as much as you can without condensation troubles.

⚠ Never wear jewelry on your hands when working at a machine as it is apt to catch on the work and cause serious injury.



When a Customer Opens Store Door Special Sale Sign Moves to Attract His Attention

Moving Door Display Will Sell Your Merchandise

A druggist has found that this moving door display attracts attention of customers entering his store. An empty carton, showing the goods on sale, is attached to the door in such a manner that it moves upward when the door is opened. Two strings are attached to the top and bottom of the door, passing through holes in the carton. A center string is tacked to the top of the door frame and is fastened directly to the carton.

Films Kept Fresh in Cigar Box

After boxes of cut films and plates have been opened, they should be stored in a place free of moisture. A cigar box serves the purpose very well. One end of the box is partitioned off and the space filled with unslaked lime, while the remainder of the box is used to hold the films. The lime will absorb all moisture from the air inside the box, making it suitable for carrying



on camping trips or use in a damp darkroom. The lid should fit tightly.

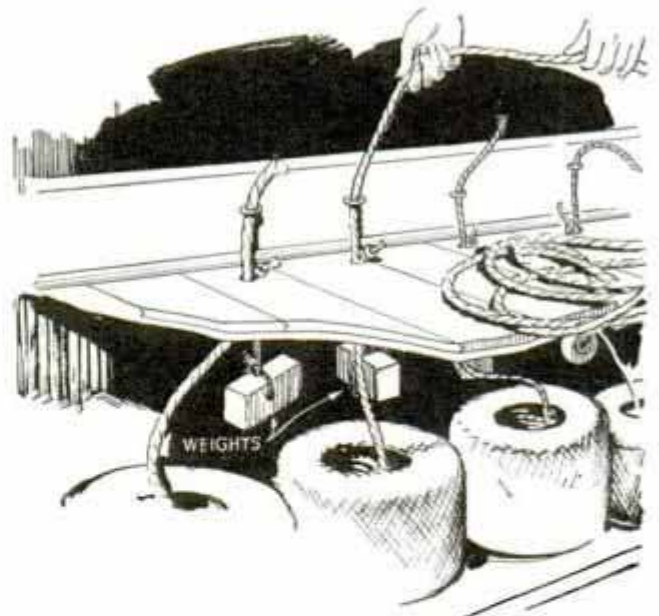
Sponge-Rubber Pad Holds Small Assembly Parts

Jewelers, electricians and others who are obliged to assemble small mechanisms, will find that a square of thick sponge rubber is an excellent tray for small screws, nuts and washers. Upon such a surface the small parts do not roll easily, and it is a simple matter to pick up the smallest piece with the fingers.



"Brakes" for Rope That Is Dispensed through Floor

In hardware stores where rope is usually stored in the basement, the end of each coil is drawn up through a hole in the floor and knotted to hold it so that it may be measured off and cut as necessary. This often results in a rope being dropped back into the basement before it can be knotted. If weights are tied to short lengths of small rope and the free ends of



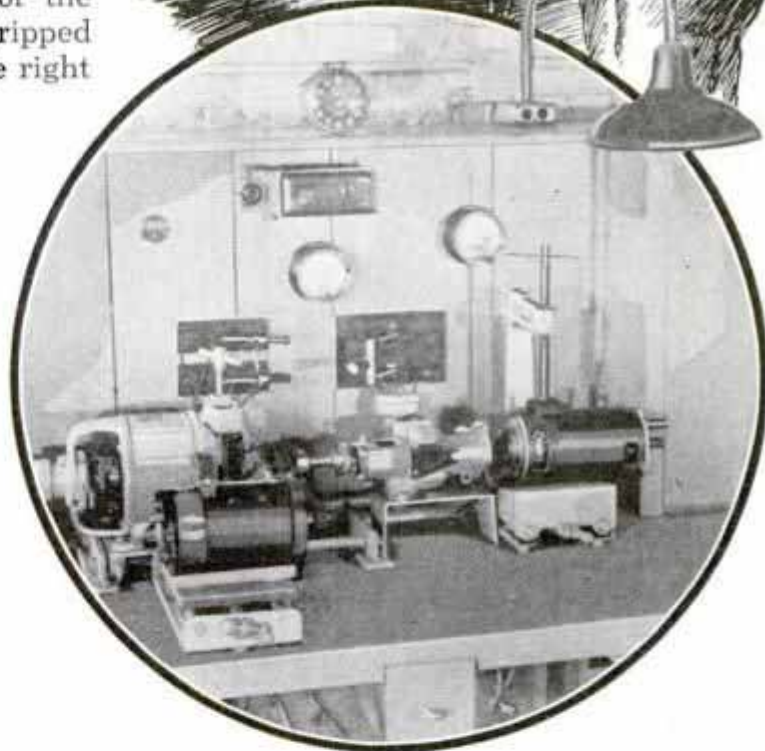
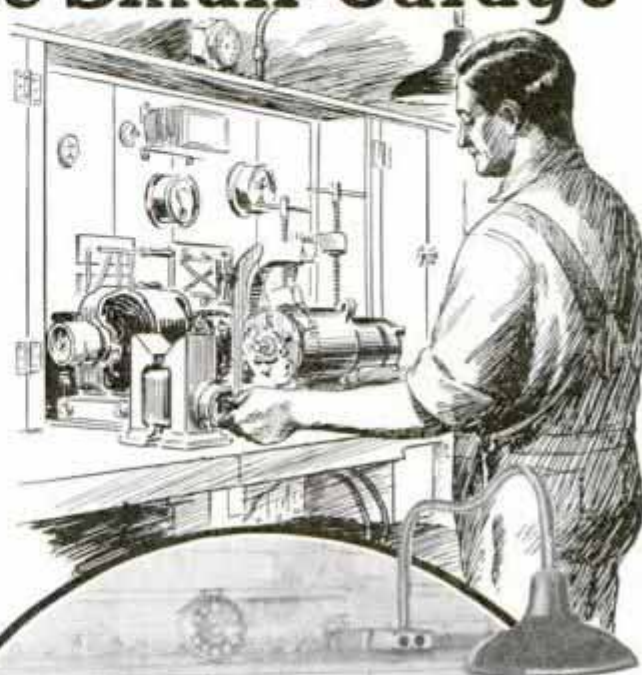
Rope Dispensed through Floor Kept from Slipping into Basement by Short, Weighted Ropes

these threaded through the holes and knotted above the floor as shown, they will serve as stops to prevent the ends of the ropes from slipping back into the basement when they are released.

Electrical TEST BENCH for the Small Garage

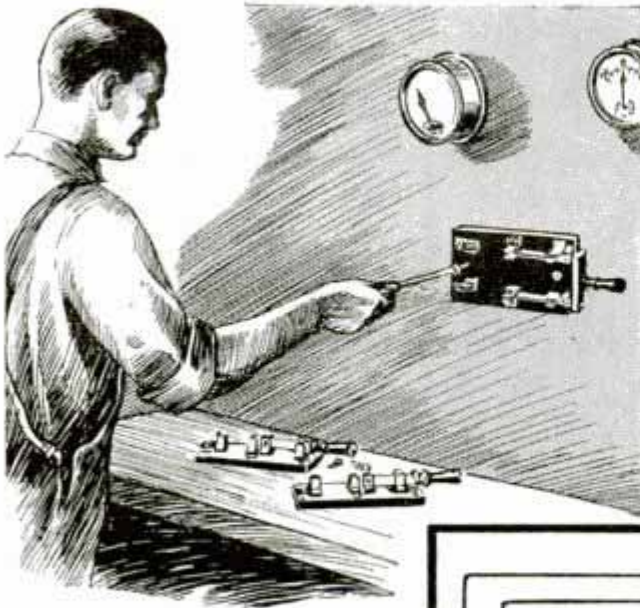
FOR accurately checking generators, starting motors, ignition coils, distributors, condensers and other parts of the electrical system of automobiles, trucks, motorcycles and motor boats, a test bench of the type shown can be made by any mechanic at a small cost. It should be about 4 ft. long and has a back of 2½ ft. high. The first step is to mount the various instruments and switches on the back panel and connect them up carefully as shown in the diagram. A vise is mounted slightly to the left of the center of the bench so that a generator may be gripped in it with its pulley projecting to the right and about in line with the center of the bench. A motor on a sliding base is located in such a way that its pulley will come in line with the pulley of any generator which is held in the vise on the bench.

To test a generator, place it in the vise. Then, with a pair of test leads about 3 ft. long and equipped at each end with spring clips, connect the generator terminal to the negative binding post, and the generator frame to the positive post. Close switch No. 1, the cut-out shorting switch. The generator should run smoothly at moderate speed and draw 4 or 5 amps. Switch No. 3 must be thrown to the right when testing a 6-volt generator and to the left when working on a 12-volt machine. If the generator runs in a jerky manner and intermittently draws more than 4 or 5 amps., a grounded or shorted armature is indicated. If it draws less than this amount under the foregoing conditions, an open circuit in the armature or a poor brush contact on the commutator is indicated. When the generator runs smoothly, but draws more than 4 or 5 amps., there may be a shorted or grounded field. Running at extreme speed indicates an open field. This can be



checked by letting the generator run as a motor and raising the third brush, thus breaking the field circuit. If doing this alters the motoring action, it is evident that the field circuit is complete.

With the generator dismantled, the armature may be checked for short or open circuits on the growler, and for grounds by means of the test points when switch No. 4 is thrown to the left, No. 5 always being to the right except when making high-tension tests. With switch No. 4 thrown to the right, the fields may be

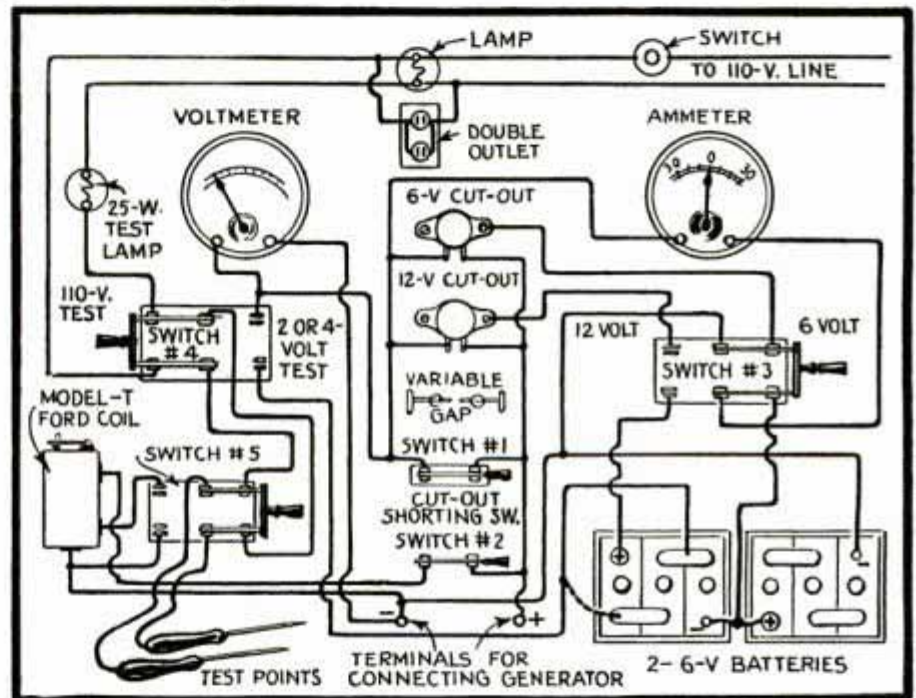


checked to see that each individual field winding draws the same amount of current as the others. With the same switch at the left, the brush ring may be checked for grounds. If the generator has its own cut-out the cut-out shorting switch—No. 1—should be closed. If the generator has no cut-out, switch No. 1 should be open, which will allow the bench cut-out to operate. To test the operation of the car

cut-out, switch No. 1 should be closed and the generator speed slowly increased until the cut-out on the generator closes. When this happens, the bench ammeter should indicate a slight charge. When slowing down the generator, the cut-out should remain closed until the ammeter swings slightly to the left of zero, indicating a small discharge. Increasing the spring tension in the cut-out will make it close later and open earlier.

Starters to be tested are placed in the vise. With a separate pair of starter cables connected directly to the battery, try the starters to see if they will run. Any starter should run smoothly and should pull uniformly when the starter shaft is gripped between two wooden blocks, which act as a brake. Dead shorts prevent the starter from running and will cause it to smoke. Worn bearings and brushes can

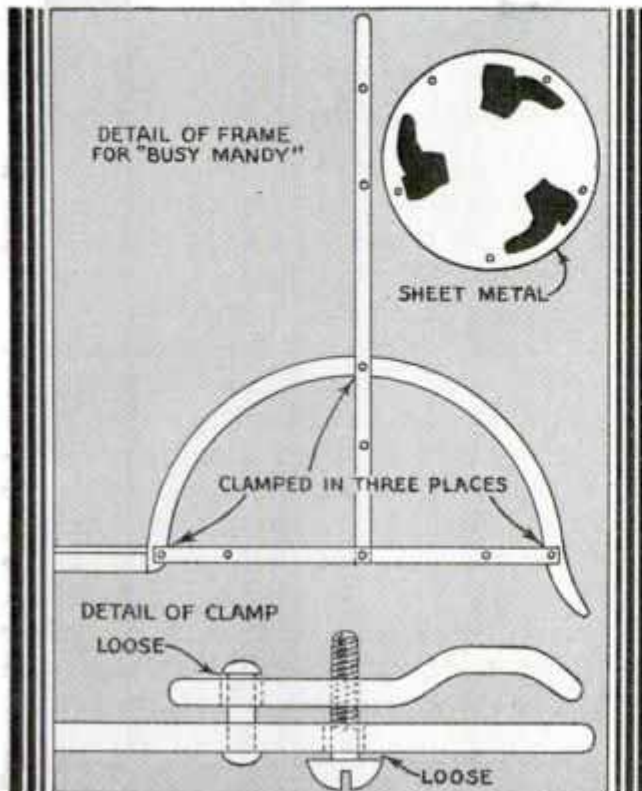
be detected by inspection. To test an ignition coil, clamp an old distributor in the vise and connect its shaft by means of a light belt to the motor. Wire the coil up in series with the breaker of the distributor and connect the high-tension side of the coil to the variable gap. Open the gap to $\frac{3}{8}$ in. and increase the speed of the distributor until the coil begins to cut out. Then substitute a new coil to see if the new one is better. If the new coil will operate at a higher speed than the old coil, the latter is weak. In the same manner, substitute various condensers to see which



one operates best with each coil. Distributor caps and rotor arms should be checked for high-tension leaks or cracks with the test points. An old model-A Ford coil furnishes the high-tension current for such tests. With switch No. 2 closed and switch No. 5 thrown to the left, the test points will be ready for making high-tension tests. To do so, place one test point up in the shaft socket of the rotor and the other on the rotor contact. Any spark jumping through the rotor arms means that a new rotor is needed. Similarly, check to see if a spark can be made to run along the surface of the distributor cap from one terminal to another, or through the cap. If so, a new cap is needed.

ⓘ Tighten loose spring shackles carefully; if they are too tight, the result will be a rough ride and, maybe a broken spring.

"Busy Mandy" Assures Rushing Deliveries



This advertising creation is simple to build and attach to any car, and is certain to attract considerable attention. "Busy Mandy" is mounted over a rear wheel of a car while big, black shoes are painted on a white disk, which is fastened to the wheel and rotates, giving the illusion of walking or running. The number of shoes

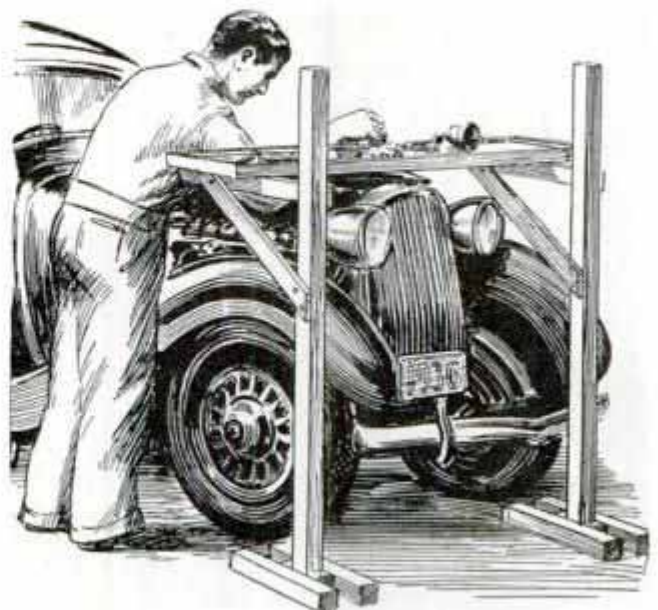
to be painted on the disk is determined by the average speed; two may be sufficient or four may be best. The figure is cut out of hard-pressed board and it is painted in gay colors to arrest attention. An iron frame holds it in place over the rear wheel. The method of fastening the frame to the fender by means of clamps, is shown in the detail on the left.—Dalton Tinder, Marion, Ohio.

Portable Bench to Hold Parts When Dismantling a Motor

Straddling the radiator of a car on which the motor is being dismantled, this portable workbench will save time and steps. With the bench handy to hold the parts removed from the motor, one is not tempted to place them on the fenders or hood sills where they may mar the paint and may be lost. If equipped with casters, the bench can be moved about easily.

Replacing Battery in Car

When replacing the storage battery of a car, the right relation of cables to the battery terminals may be determined by noting the movement of the ammeter hand, which should show discharge when the lights are turned on if the battery is connected correctly.



Fitted with Casters, This Light Bench Is Easily Moved to Any Part of the Shop

Repair Your Old Auto Top Cheaply



Cracked and Leaky Auto Tops Made Waterproof with Airplane Wing Dope

When auto tops get so badly checked and cracked that top dressing does not make them waterproof, here is a way they can be sealed for another year's service. Go to the nearest airport and from the maintenance department get a half gallon of clear wing dope and thinner, mixed in the proportion of one-third thinner to two-thirds dope. This is enough liquid to give your top about six coats. Brush it on, being sure to work it into all cracks and along the edges. The dope will dry so rapidly that you can start the next coat as soon as you have finished with the first. Wing dope has the property of shrinking when it dries and it will take the sag out of your top as well as make it waterproof. As this preparation is highly inflammable, keep it away from fire and do not smoke while doing the job.

Tool for Removing Studs

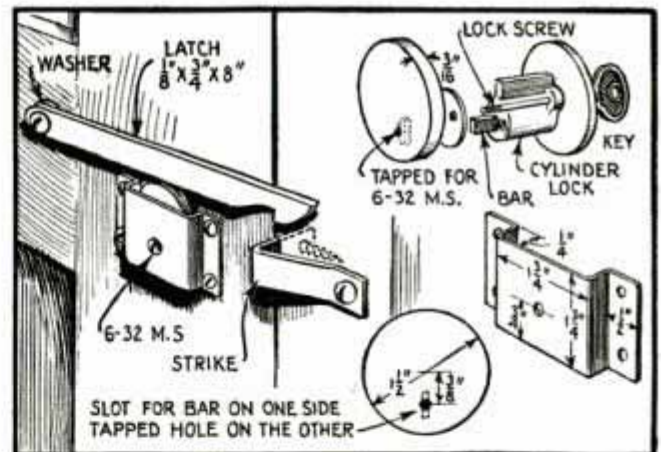
To remove or drive studs without damaging the threads, use a tool of the type shown. Get a 2-in. length of octagonal-shaped steel and drill and tap it lengthwise through the center to screw on the studs. In use, the tool is driven onto the stud to be removed and a bolt is screwed into the upper end to lock it, after which a wrench is used as shown. This tool will be found bet-



ter than the usual method of locking two nuts on a stud as more threads are engaged, thus reducing the possibility of damaging them.

Homemade Lock for Your Garage

Here is an effective garage lock that can be made inexpensively from an old cylinder lock. A metal disk is mounted in a sheet-metal housing in an eccentric position so that when it is turned by the bar of the lock it will raise the latch and release the door. When it is in the unlocked position, the latch will engage the strike if the door is rolled shut. The upper right-hand detail shows the relation between the lock and the disk. After punch-marking the disk off center on both sides, a slot to fit the lock bar is cut on one side and a hole is drilled and tapped on the other side for a machine screw. The size and shape of the simple metal housing for the



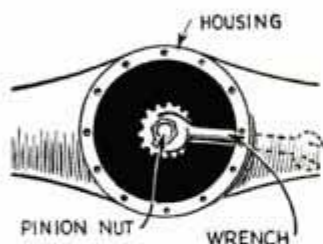
This Effective Lock for Your Garage Is Easily Made from an Old Cylinder Lock

disk are shown in the lower right-hand detail. The lock is installed from the outside of the door, and the bar is cut off to the required length. The disk and housing are installed next. When the eccentric is at the top position, the latch should be raised so that it clears the strike. A little experimenting will determine this position. It is best to use a washer under the latch to assure its working freely.

It is a good idea to remove regularly the accumulations of sludge from the oil filter of your car; if this is neglected the sludge may fill the filter tank so that pressure from the oil pump will burst a seam in the tank, which results in losing the oil.

Cranking Motor to Loosen Tight Pinion Nut

If you are repairing a differential and the drive-pinion nut resists all efforts to loosen it, try the following trick: Put a

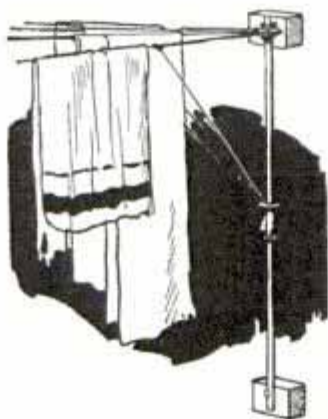


wrench on the nut and let the free end extend into the housing. Then, with the car in reverse, crank the motor slowly by hand. This will usually loosen the

nut, which can be tightened in the same way by putting the car in low gear.—Ver-non Tracey, Centerville, N. B. Can.

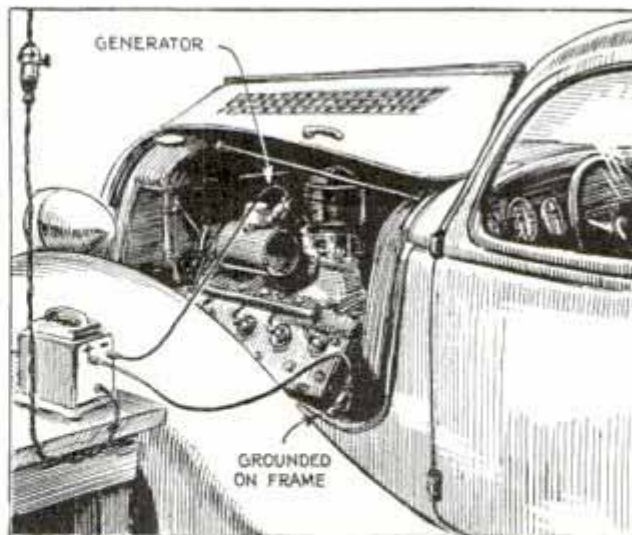
Wash Cloths in Garage Dried on Old Umbrella Frame

To keep auto wash cloths from being thrown about the shop and soiled or lost, one mechanic uses the frame of an old umbrella as a folding rack on which to hang them. Alternate ribs were removed and the frame was mounted vertically on a wall, by means of two wood blocks, where it could be opened to hold the cloths or closed as occasion required.



Keeping Door Handles Free from Grease

When working on cars in the repair shop, mechanics often open and close car doors with greasy hands. To avoid leaving grease on the handles, cut a slot in a short piece of rubber hose and slip this over the handle before starting on the job. A 6-in. length of 1-in. hose, with a slot 2 in. long, will accommodate the handles on the doors of most cars.



Car Ammeter Connected into Circuit to Show Charging Rate When Using Small Charger

Car Ammeter Used in Circuit of Small Charger

When using a small charger to boost your car battery, it is an easy matter to utilize the car ammeter in the circuit if the charger is not equipped with one. As shown, simply connect one wire from the charger to the battery side of the electrical cut-out and ground the other wire to the car frame or the motor. If the positive side of the car battery is grounded, then ground the positive side of the charger, or vice versa.

Rubber Bands Hold Skid Chains on Car Wheels

Here is a little kink that we use in our service station to hold skid chains tightly to the wheels. Wide rubber bands, cut from old inner tubes and provided with hooks taken from worn cross chains, are stretched across the wheel and hooked to the chains as shown. It takes but a minute to attach the bands, and it is time well spent when you get into heavy mud where the chains might come off.—John J. Welton, Thomaston, Conn.



Lengthening Brake and Clutch Pedals

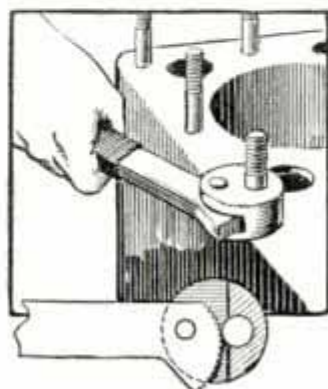
Brake and Clutch Pedals Lengthened by Attaching Footplates with Pipe Nipples and Couplings

If you drive a car on which the footplates of the brake and clutch pedals are attached by means of short studs, and are unable to reach the pedals conveniently, they can be lengthened with two pipe nipples and two couplings. Simply un-

screw the footplates and drive the nipples into the ends of the pedals. Then attach the plates by means of the two couplings as shown.—A. M. Buchan, St. Louis, Mo.

Wrench to Remove Cylinder Head Studs

Auto mechanics, who often have to remove worn, stripped or broken cylinder-head studs, will find this wrench a time and labor saver, as it enables them to get a sure grip on the stud. The toothed lever is best made from a large file, the end of which is annealed before cutting the teeth and drilling the pivot hole. A disk cut from the end of a cold-rolled shaft will serve nicely for the other part of the wrench.



The Next Issue

UPHOLSTERED WING CHAIR OF COLONIAL DAYS

Outstanding among colonial reproductions, the wing chair is in popular demand. Complete constructional details will be given. Carefully joined, the chair is strong and will give years of service; it is upholstered neatly to provide real comfort and its pleasing, quaint design adds coziness to any room.

WELDING AND CUTTING WITH GAS SIMPLIFIED

Gives beginners a working knowledge of oxyacetylene welding; handling torches, using filler rods, etc. Covers iron, steel and other metals.

"BOWLING" ON YOUR DINING TABLE

"Swing Ball," a new, indoor game of skill in which you count strikes and spares as in bowling. Ball is swung in an arc to strike the pins on the back swing.

FROM JUNK PILE TO GRINDER

Sturdy grinder is made from auto differential mounted on floor so grinding wheels, up to 12 in. in diameter, are at a convenient working height.

DRESSING UP PHOTOGRAPHS

How to make unusual photo borders in shades of gray, in color, or in black and white. Also gives tips on toning, coloring and mounting.



Topping EVERYTHING ON WHEELS

YOU are king of the highway when you pilot a 1935 Harley-Davidson. Airplane speed — lightning acceleration — mere twist of the throttle. Little wonder these new Harley-Davidsons are sweeping to victory on hill, road and track.

Maybe you will not go in for hill-climbs, endurance runs and racing — but when you feel the full-surgling power of its mighty motor — you're glad you're riding a 1935 Harley-Davidson. On the open road it flashes down the straight stretches or zooms up and over the hills like a speed-plane — making you "tops" with everything on wheels.

See your nearby Harley-Davidson dealer right away. Ask him for a free ride — let him explain his Easy Pay Plans — and send in the coupon.



Ride a

HARLEY-DAVIDSON

HARLEY-DAVIDSON MOTOR CO.
Dept. P., Milwaukee, Wis.
Interested in motorcycling. Send illustrated literature. Postage stamp is enclosed to cover mailing cost.

Name

Address

My age is 16-19 years, 20-30 years,
 31 years and up, under 16 years.
Check your age group.

"Camels don't get your

*Some of the famous athletes who approve
of Camel's mildness*

BASEBALL

Dizzy Dean; Lou Gehrig; Melvin Ott;
Jimmy Collins; Harold Schumacher; Carl
Hubbell; Guy Bush.

TENNIS

Ellsworth Vines, Jr.; George M. Lott, Jr.;
William T. Tilden, 2nd; Bruce Barnes;
Lester R. Stoeffen.

GOLF

Gene Sarazen; Craig Wood; Denny Shute;
Tommy Armour; Willie Macfarlane;
Helen Hicks.

TRACK AND FIELD

Jim Bausch; George Barker; Leo Sexton.

SWIMMING

Helene Madison; Susan Vilas; Josephine
McKim; Stubby Kruger.

DIVING

Harold ("Dutch") Smith; Pete Desjardins;
Sam Howard; Georgia Coleman.

WINTER SPORTS

Raymond Stevens; Jack Shea; Irving Jaffee;
Bill Cook; Paul Thompson.

© 1935, R. J. Reynolds Tob. Co.

So Mild! YOU CAN SMOKE ALL YOU WANT

KEEPING FIT IS JUST AS
IMPORTANT TO ME AS TO
STAR ATHLETES. CAMELS
ARE MILD — NEVER
JANGLE MY NERVES!

BUSINESS EXECUTIVE—F. W. Watson

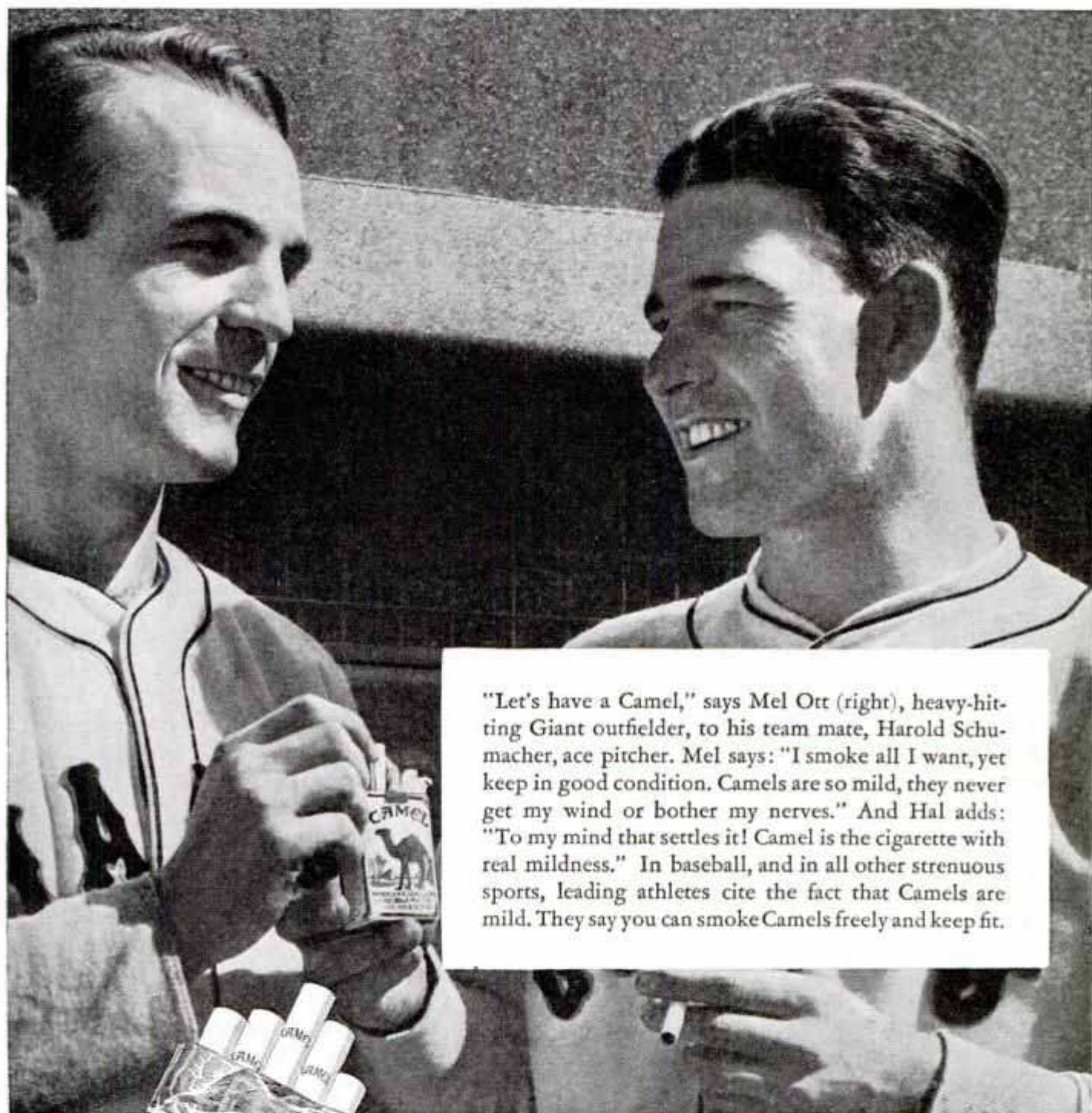
IT'S NICE WHEN TIRED TO
LIGHT A CAMEL AND FEEL
HOW QUICKLY EXHAUSTION
SLIPS AWAY. I GET A
'LIFT' WITH A CAMEL

BUSINESS GIRL—Florence Young

When writing to advertisers please mention *Popular Mechanics*

Wind”

FAMOUS BASEBALL PLAYERS SAY



“Let’s have a Camel,” says Mel Ott (right), heavy-hitting Giant outfielder, to his team mate, Harold Schumacher, ace pitcher. Mel says: “I smoke all I want, yet keep in good condition. Camels are so mild, they never get my wind or bother my nerves.” And Hal adds: “To my mind that settles it! Camel is the cigarette with real mildness.” In baseball, and in all other strenuous sports, leading athletes cite the fact that Camels are mild. They say you can smoke Camels freely and keep fit.



COSTLIER TOBACCOS!

● Camels are made from finer, MORE EXPENSIVE TOBACCOS—Turkish and Domestic—than any other popular brand.

(Signed) R. J. REYNOLDS TOBACCO COMPANY
Winston-Salem, North Carolina

When writing to advertisers please mention *Popular Mechanics*

Pictures from Invisible Light

(Continued from page 663)

f:45. Infrared light values vary considerably with atmospheric conditions. On occasions that would be identical for ordinary photography, different exposures might be required with the infrared.

Because infrared exposures are slow and seldom permit action pictures, the professional often hypersensitizes the plates. Plates may be speeded up about three times with this process. Washburn uses a one per cent solution of ammonia. Immersion should be limited to one minute, at a temperature of from forty-five to fifty-five degrees. Plates should be dried quickly with an electric fan and also evenly, to avoid streaks.

Aside from their telephoto effects, landscape pictures taken with infrared plates appear quite fantastic. One of these characteristics is that green foliage photographs white, being a very strong reflector of the red rays. This is true only if it is bathed in direct sunlight. Otherwise it will show dark. Blue skies photograph black, because there is practically no red light in them. Shadows are very deep, with total lack of detail generally.

Infrared portraits produce chalky white faces, with exaggeration of hair lines, crow's-feet, dimples, facial skin defects and scars. Dark whiskers, however, show black in a face, even if freshly shaven. The flesh is generally a pasty white. Lips record lightly, while eyes appear as small black circles.

The photography of hot objects in the dark, or of other objects illuminated by the infrared rays thus given off, is a fascinating study and recreation. The first successful photograph in total darkness was taken by the Kodak Research Laboratories on October 7, 1931. The source of infra rays was a bank of 1,000-watt lamps in reflectors, covered with the opaque No. 87 filter. With this invisible light reflected from the ceiling in an illumination of 1,000 watts per hundred square feet of floor space, the exposure given was one second at f:3.5. Many have obtained the erroneous impression that it is possible to take pictures in total darkness, but unless infrared or heat rays, directed from some source to the infrared plate are utilized, there can, of course, be no picture.

A convenient arrangement for infrared portraits in darkness consists in using two pairs of 500-watt lamps in reflectors and covered with No. 87 filters. In posing subjects, one light unit should be placed seven feet away, the other about five. With the type 1-R plate, exposure should be about four seconds at f:4.5. For instantaneous portraits, six photoflash bulbs in reflectors can be employed, with the No. 87 filter material surrounding them.

For shooting indoor scenes not in total darkness, the filter is used only on the lens. The No. 25 is recommended. For close views of objects a convenient arrangement is to use two 500-watt globes, placed about twenty-seven inches apart and the same distance from the subject. With the No. 25 filter and 1-R plates, the exposure will be about two seconds at f:16. In this way infrared portraits and pictures of documents can be made.

You can make pictures in darkness from the infrared illumination of a hot flatiron. Since this gives off no other light than the invisible heat rays, it is unnecessary to employ a filter. Since the heat rays from an iron are feeble compared to the sun and tungsten lamp, exposures are longer. Eastman experimenters have obtained a good portrait of a plaster bust in total darkness utilizing solely the infrared illumination from two flatirons about six inches away. The exposure, however, was one hour at f:4.5.

For the development of infrared sensitive plates almost any standard negative developer may be used. Washburn has obtained best results from developers especially adapted to process films. The temperature of developers should be kept reasonably low. Anything above sixty-five degrees is dangerous. Five-minutes immersion is Washburn's basic time practice, although to a certain extent the longer the development the better contrast. It is not necessary to load holders or to develop in complete darkness. The ordinary green safelight is in most cases sufficient protection against fogging.

At very little cost the amateur camera hobbyist now has available a fascinating variation to everyday snapshots and the ordinary photographs of the tyro.

Make a picture like this *Tonight!*

HALF of life is lived indoors . . . And what an important half it is . . . How many wonderful picture opportunities! Now the new ultra-fast Kodak "SS" Film helps you make the most of these opportunities. Now you can make snapshots *indoors, at night*.

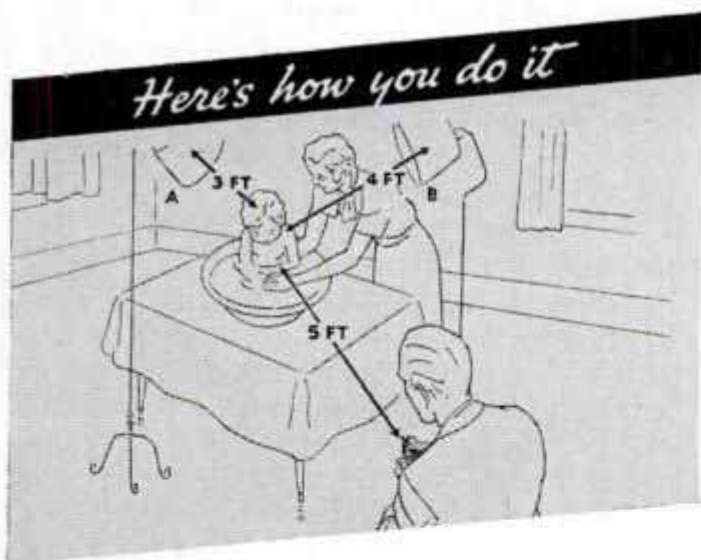
Very simple, too. In addition to the new Kodak Super Sensitive Film, all you need is a camera with an *f.6.3* (or faster) lens, and two or three Mazda Photoflood bulbs (see diagram below). You hold the camera in your hands—just as you would outdoors, and make a snapshot.

Here's a new picture-making thrill.

To owners of Brownies and inexpensive folding cameras . . . Here are two ways you can take this picture tonight. One—use a Photoflash bulb. Load with Kodak "SS," particularly adapted for night picture taking, or use Verichrome Film which will also give very good results. Set your camera on a table . . . open for "time" exposure, flash bulb, close shutter.

Another—set your camera on a table. Watch your chance when baby isn't moving and make a quick "time" exposure. Use Mazda Photoflood bulbs. Load with Kodak "SS" or Verichrome Film. See your dealer . . . or write for folder.

Ask your dealer about the current \$2500 Prize Contest for Night Pictures. All amateur picture takers eligible.



Use one Mazda Photoflood bulb in lamp A . . . two in lamp B, distances as indicated. Tip shades to concentrate light. Load with Kodak "SS" Film. Stand 5 feet or more from subject, depending on camera. Lens at *f.6.3*. Exposure $1/25$ second. Click the camera—and you've made the picture.



KODAK "SS"—the super sensitive film particularly adapted to night picture taking. Comes in the familiar yellow box. **MAZDA PHOTOFLOOD BULBS**—give brilliant light, last for many pictures . . . cost but 25¢. Any camera with an *f.6.3* lens or faster will do.

KODAK JUNIOR SIX-20—with *f.6.3* Anastigmat lens is ideal. Pictures $2\frac{1}{4}'' \times 3\frac{1}{4}''$ —price \$13.50. Kodak Junior Six-16, with *f.6.3* lens, pictures $2\frac{1}{2}'' \times 4\frac{1}{4}''$ —\$15.50.



FREE FOLDER

Gives complete instructions on night photography . . . suggests subjects . . . tells how to make pictures at night with any camera that can be set for "time." Write today to Eastman Kodak Company, Rochester, N. Y.

Name _____
 Address _____
 City _____ State _____

When writing to advertisers please mention Popular Mechanics

STOP! LOOK! LISTEN!

Here comes **LIONEL**
with a *Real*
RAILROAD WHISTLE

Scale model of the new 120-mile-an-hour Flying Tootsie with glitzying chromom
hook, whistle, remote control, track—everything for \$15.75. Without whistle, \$10.95

FIRST TIME EVER TO APPEAR ON A MODEL — AND SO REALISTIC IT'LL STIR YOU TO THE HEELS!

IT'S unbelievable. Uncanny. Simply press a tiny button on a control box and your whizzing Lionel Train pipes a long, shrill blast. Or short sharp ones—just as you want. Repeats any and every signal of the official railway code! Signals any time you want them—whether train is racing forward, backing, standing still or switching. Yes, it's new—and the thrill of thrills—but Lionel offers so many things exciting this year; New streamlined models—a whole fleet of them! A gateman that scoots from his shanty and waves the limited. There's not room here to tell you the whole thrilling story, so write at once for the new Lionel catalog and read 44 pages about trains that'll tingle every play nerve in your body! Don't wait—act this instant!

LIONEL TRAINS



FREE!

At any department store, toy, hardware or electrical dealer.

THE LIONEL CORPORATION
Department 2
15 East 26th Street, New York, N. Y.
Please rush me your new 1935 Catalog. I enclose
10c in stamps to cover postage and handling.

MY NAME _____
(Please Print)

ADDRESS _____

CITY _____ STATE _____

"SPEAKING OF CARD TRICKS"

(Continued from page 692)

entertainer must apply pressure on the sides of the case at all times, or the cards will fly out. Every movement must be so guided to mask the fact that you are gripping the case tightly.

The appearance of a card is ordered and it rises slowly out of the case as pressure on the sides is lifted. The three cards rise as one but as the front one is being held up for edification, the other two can be pressed downward by the performer's index finger and the pressure reapplied. The first card then is taken out of the case and placed on the table.

The procedure is duplicated in producing the second card. The third, however, is made to hop out of the box by holding to either corner or the middle and releasing the grip quickly. For example, if the card is supposed to jump to the right, that corner of the box should be held and then released. The subtleties of execution will come with practice.

Here is another good trick. Find out what the third card from the top is in advance. Give the deck a false shuffle and then divide it into three parts, keeping track of the "marked" card. One of the three top ones is placed on each of the piles, the special one being on your right. Your spectators are asked to pick it up and memorize it. The cards are squared up and the performer goes through the deck and picks it out.

In passing let me say a word about the false shuffle. By it is meant the card's position at the bottom or top of the deck may be maintained while the magician is to all intents and purposes mixing up the cards thoroughly. Anyone who works with cards should know at least one method of false shuffling.

By looking at the top card beforehand, a variation of the same trick by means of addition and subtraction can be performed. The face cards count as ten; the first card is turned up and then the second, and the performer adds or subtracts to get the total of the third card, which he knows in advance.

Supposing the third card is five. If the first card is ten and the second another five he tells the spectator to subtract five from ten and he will have the answer of the third card.

"Delta" ANNOUNCES

Important new tools and new improvements in the complete DELTA line for 1935-36 are announced by Delta engineers. As usual, these new tools embody great efficiency, skillful design, quality construction and materials—at remarkably low price levels!

New Delta SHAPER UNIT

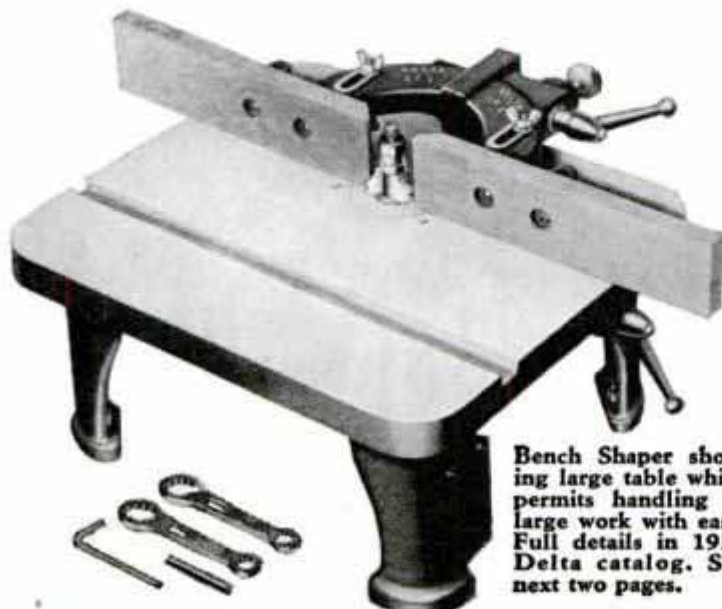
here illustrated is one of the simplest and at the same time most complete Shapers ever designed for the workshop. Some of its important basic features are: **1.** Extra Large Table permitting the handling of large work with ease; **2.** Interchangeable Spindles for 5/16" and 1/2" hole cutters for various types of work; **3.** Improved Completely Adjustable Fence for all varieties of straight work; starting pin for curved work of all kinds; **4.** Complete Guarding system; **5.** High Speed of 10,000 R. P. M. which with standard 3-lip Delta cutter gives over 30,000 cuts a minute, thus insuring smooth and finished work; **6.** Complete range of cabinet and sash cutters for all types of mill work.

For full details and description of this unusual tool together with illustrations of large variety of work that can be done with it, send for the new 1936 Delta Catalog. Fill out the coupon on the second page following this and mail it today!



This is but one of the many new improvements and tools announced in the 1936 Delta line!

Delta Quality represents real economy.



Bench Shaper showing large table which permits handling of large work with ease. Full details in 1936 Delta catalog. See next two pages.

The Delta line includes Circular Saws, Jointers, Lathes, Scroll Saws, Band Saws, Routers, Shapers, Grinders and a complete assortment of attachments and accessories.

See Next
2 Pages for
Important
Delta
Announcements

New 1936 TOOLS

A Complete Line of NEW GRINDERS



Belt-Driven Grinder

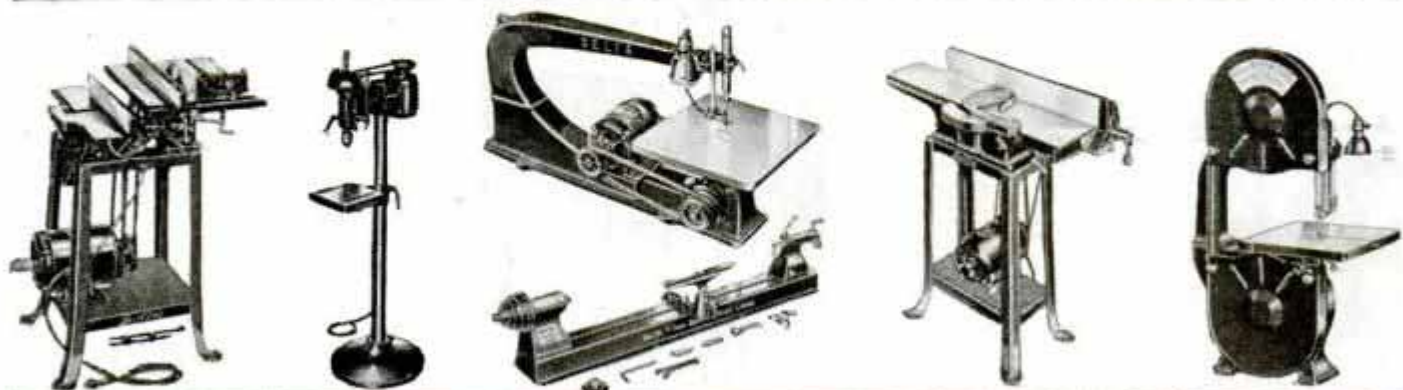
Can be driven from
motors of any voltage,
phase or horse-power,

Not just another line of grinders—but revolutionary *new* grinders in every sense of the word! Belt-driven, motor-driven and pedestal models—they all embody Delta's high standards of design and construction. No pains have been spared to make these new Delta Tools *ideal* in every way—convenient, safe, accurate and efficient—truly, here are the grinders that shopworkers have always wanted—and at the unusually moderate Delta price levels.

Setting New Standards of Grinder Efficiency

These "Triple-Duty" machines embody numerous features that make them the most efficient grinders ever developed. These features include: **1.** Balanced Wheels to insure true running and absence of vibration; **2.** Maximum room on all models to permit operator to swing work around wheels; **3.** New Departure self-sealed ball-bearings; **No oiling needed for life of bearings;** **4.** Very efficient wheel guards, complying with all safety codes; **5.** Convenient built-in switches on all models; **6.** Fully adjustable and instantly

removable tool rest; **7.** Water-pots on all models, combination tool tray and water-pot holder on all pedestal models; **8.** New Combination Lamp attachment and Spark Guard assuring maximum illumination and complete safety from sparks; **9.** A complete range of models in bench, pedestal and belt-driven types. For further details and complete information about Delta Grinders and all other Delta "Quality" Tools write for catalog!



Delta **QUALITY** represents real **ECONOMY**

By "DELTA"...

If you are at all interested in motor-driven tools for use in home workshops, factories, farms, construction work, or small shops, be sure to see the new 1936 Delta line. The efficient performance, rugged precision construction, and fine workmanship of these compact economical tools are a revelation. You will understand then why Delta tools are used and recommended by tens of thousands workshop owners all over the world.

Write for Latest CATALOG

It is crowded with photographs and information about the new line of 1936 Delta tools. It contains much valuable information that every man interested in wood-working tools should have. It shows how Delta tools are built to stand the grind of production work, and yet are so low priced as to be within the reach of all, how they save time, money and labor—and quickly pay for themselves.

Mail coupon without delay. Enclose only 10 cents at same time for Book of Practical Delta Projects, 32 pages of new and novel things to make, with numerous blue prints, working drawings, photographs and illustrations—and complete directions.



New motor-driven Bench Model Delta Grinder.



Pedestal model motor-driven Grinder with built-in switches, water pots, and combination tool tray and waterpother. You will be pleasantly surprised at the remarkably low price of this Grinder.

New 1936 Project Book

32 page book "Practical Delta Projects"—crowded with new and "out of the ordinary" things to make—with numerous working drawings, photographs and easy-to-understand illustrations. Simple, complete instructions make every project easy to follow. Every woodworker should have this book. Send only 10 cents with coupon. Book and 1936 Delta catalog will be mailed postpaid.

DELTA MANUFACTURING COMPANY,
600-634 E. Vienna Ave., Dept. A1135
MILWAUKEE, WISCONSIN

I enclose 10c (stamps or coin), for which please send me one copy of "Practical Delta Projects". Also place me on your mailing list to receive 1936 Delta catalog of quality motor-driven wood-working tools.

Name..... Age.....
Address.....
City..... State.....
 Check here if you are a Delta user now.

DELTA MFG. CO.

600-634 E. VIENNA AVE.
MILWAUKEE WIS.

E 691

Tuning Up a Streamliner

(Continued from page 719)

reservoir in the power car filled. Cooling is a major problem. Each cylinder is provided with a muffler, scavenging through a pipe in the roof. Water circulates around each cylinder, then passes through cooling coils suspended from the ceiling. The engine room is sealed. Air is drawn in through the grill under the cab by fans, blown back against the engine, and exhausted through ducts in the roof. Even with water and air cooling, the engine room becomes almost unbearably hot.

The cab is insulated for sound and temperature. No matter how hot or cold outside, the pilot has conditioned air. The cab is no larger than that on a motor truck. All the complicated starting mechanism has been eliminated. Storage batteries light the train while the engine is off, and also whirl the generator, turning it momentarily into a starting motor. When the engine is running the current flow is reversed and the generator feeds the batteries, or driving motors.

"Here we go," says "Ollie." "First I start the electric fuel pump, run by the storage battery. I push this button. The pump supplies oil under pressure to the reservoir. Now I make sure the throttle is closed and the controller off. To start the engine I push this button marked 'battery,' and this one for the exciter."

There is a deep growl as the oil ignites and the huge engine takes hold.

"Next we build up the air tanks," he explains. "One compressor is driven by the Diesel, another by electricity. We carry 130 pounds of air for the brakes."

The controller regulates the four driving motors on the axles of the engine truck; the throttle, the speed of the Diesel. The faster the engine goes the more power it delivers to the motors. The controller serves the same purpose as the gear shift in an automobile. There are four positions, off, series, parallel and shunt, corresponding to neutral, first, second and high in a car. To start he throws the motors into series, releases the air brakes and throws over the controller. Grasping the throttle "Ollie" speeds up the engine. When the speedometer reaches thirty the controller is shifted into parallel.

Speed is governed entirely by throttling

the Diesel. In some early oil-electric units, the engine ran at a constant speed. Any variation of motor speed was obtained by inserting resistance into the line. It was not until recently that a method was devised to change a Diesel's speed with any promptness. In the "City of Portland" fuel is injected through pinholes in the cylinder head. A plunger, acting like a force cup, squeezes the oil in at the proper instant. Speed depends upon the rate of oil feed. The secret of the engine is the mechanism which regulates the flow of oil. Without it there would be no lightweight high-speed train. This engine idles at 250 revolutions per minute; the governor prevents a speed greater than 750.

This train has a brake control on each axle, actuated by a master control in the cab. Brakes are applied by electricity. There is always a time lag in an ordinary air line, causing the cars to bump as the locomotive is decelerated first. Here, air is released simultaneously on all wheels. A sensitive pendulum applies air at the proper rate to prevent the brakes from grabbing and sliding the wheels. As the train slows down the air pressure increases. Braking is accomplished at the rate of three miles per hour each second. If the train is speeding at eighty miles per hour, the first second after the brake is applied it will be going seventy-seven miles per hour, the next seventy-four.

In an emergency the engineer or conductor can stop the train by pulling the supervisor cord. From ninety miles per hour, the "City of Portland" has been brought to a dead stop in 2,700 feet.

Should the engineer ignore block signals or run at improper speeds an automatic control halts the train. Dead-man control provides against physical disability of the engineer. As long as he keeps a hand on the brake lever, or one foot on a pedal he remains in charge. Should both hand and foot be removed the train stops.

Streamlining has come to stay. Lightweight oil-electric units are going into service, but the faithful old iron horse refuses to be outmoded. Old engines are rebuilt and shrouded, and lighter streamline steam trains enter the race. Time alone can tell which will reign supreme.

AND JUST WHEN I'VE MET THE SWELLEST GIRL



A new crop of pimples was always taking the joy out of things!



WHAT'S WRONG, TED? YOU LOOK ALL WASHED UP!

DON'T I KNOW IT! I WOULD HAVE TO GET A FLOCK OF CHIN BLOSSOMS JUST WHEN I WANT TO MAKE A GOOD IMPRESSION ON SALLY!



IF THAT'S ALL—CHEER UP! I MEANT TO TELL YOU SIS SAID TO TRY FLEISCHMANN'S YEAST—3 CAKES A DAY, AND PIMPLES VAMOOSE

HONESTLY? THEN IT'S FLEISCHMANN'S YEAST FOR ME—IN A HURRY!

2 WEEKS LATER



HELLO, TED—WHERE HAVE YOU BEEN THESE PAST TWO WEEKS?

OH, JUST OUT LOOKING TO MAKE SURE THERE WERE NO GIRLS AS PRETTY AS YOU—AND THERE AREN'T!



GREAT LADY-KILLER—NOW THAT HIS FACE IS ALL CLEARED UP—FLEISCHMANN'S YEAST SURE IS A PIMPLE CHASER

Don't let adolescent pimples spoil any of YOUR dates!

From about 13 to 25 years of age, important glands develop, causing disturbances throughout the body. Waste poisons enter the blood. These irritate the skin, cause pimples. Doctors prescribe Fleischmann's Yeast for adolescent pimples. It clears skin irritants out of the blood—and pimples disappear. Eat 3 cakes a day until your skin clears.



—clears the skin

by clearing skin irritants out of the blood

Hunting Dogs

(Continued from page 670)

They are the Chesapeake Bay retriever, a breed developed on the east coast of America; the coal-black and so-called yellow Labrador retriever, usually rated the fastest retriever on land or in water, and the lovable, thick-coated Irish water spaniel with his "rat" tail and top knot. Cold winds, low temperatures or rough water have no terrors for this canine "backfield." They love to retrieve game birds anywhere or any time and their coats are of such character that they shed water easily.

Sportsmen are now being urged to use more retrievers to cut down the losses of crippled or wing-tipped birds. Conservation organizations and government authorities have been stressing the importance of such dogs, because millions of game birds are shot, only slightly wounded and then never recovered because the sportsmen are not using a trained retriever. Chesapeakes, Labradors or Irish water spaniels make not only efficient workers, but companionable dogs at home or in the field.

Generally speaking, the retrievers as a group must go to school to learn that they must not chase birds or rabbits unless ordered to go after crippled ones; that they must sit quietly by their masters while the birds are shot and that they must swim when commanded, or crash through swamps to get a crippled bird. On land it may mean smashing work through thick brambles or other hard cover. When worked on land the retriever must walk at heel when commanded, sit when told to, retrieve on command and be steady to shooting, flying birds and other distractions. All in all, the sportsman's "canine backfield" must have brains, plenty of courage, a stanch heart, plenty of speed, endurance, what the hunter calls "zip and dash," and self-control—a rare combination not only in a dog but in a human being.

The Irish water spaniel is a dog of great pluck and hardiness. He has a curly thick coat that gives him excellent protection in cold weather. He is liver colored, with longish, hairy legs, a tail that is nearly bald, short hair on his face and a funny top knot. He has brains and courage

and makes a wonderful water retriever.

The Chesapeake is an American breed, one of the few which has been evolved in this country. He might be given the full-back position on the duck shooter's canine backfield because of his size and power. This breed is a dead grass color. A male weighs from sixty-five pounds up. The coat is dense and thick with a fine woolly undercoat. Here is a retriever of bulk and power. He can buck most any kind of weather or hard going, therefore he has proved an efficient duck dog.

The Labrador retriever, so widely used in England, slowly has been winning recognition in this country. He is a strong, well built dog weighing seventy or seventy-five pounds. There are two strains, one black and the other yellow or straw colored. Considering the fact that this dog has been winning just about everything in retriever trials in the British Isles, it is surprising that American sportsmen have not become better acquainted with him before this. The Labrador has a thick, close outer coat with a second under coat. The tail is thick at the butt like an otter's. Normally the Labrador is black, although there is the yellow or cream-colored strain. The Labrador works equally well on land or in water. He is just about the fastest swimming canine. With tremendous driving power, of excellent temperament, very affectionate, and teachable, it is not surprising that one English authority has described him as the "medium sized companion dog par excellence." The breed is known for its tender mouth—a requirement of a good retriever.

The springer spaniel is another gun dog that has been winning many friends. This forty to forty-five-pound hunting pal is English bred. True to its name it "springs" both furred and feathered game, always working within range of the gunner. The well-trained springer must quarter his ground ahead of the gunner, never get too far away so that birds will be flushed beyond the range of the gun, spring a rabbit from its seat, or flush a pheasant, and then remain steady while the shooting goes on. On command the dog will retrieve tenderly to hand.

(Continued to page 127A)



What could be fresher than a news extra?

I don't like to boast—but HAVE YOU EVER SEEN MY DATE-LINE?



They **LAST LONGER** because they're **FRESH**

LOOK FOR THE "DATE LINE"



Eveready Batteries last longer and are more dependable because they are always FRESH when you buy them. So many are sold that they never stand long on dealers' shelves. That's why each battery can be dated to guarantee its freshness.

Only FRESH batteries give long, dependable service, so look for the "Date-Line" when you buy... National Carbon Co., Inc., N.Y. C.



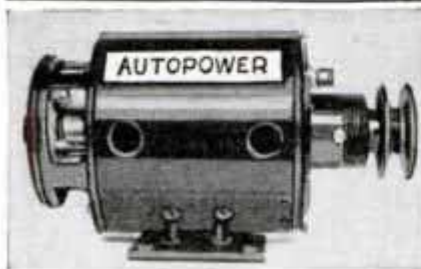
CHEAPER TENNIS *Now for YOU*
Earn Money, Too. WITH OUR PERFECTED RESTRINGING VISE AND INSTRUCTIONS MFR. OF QUALITY GUT STRINGS

Newly perfected Tennis Vise invention NOW enables anyone to re-string rackets at big savings or for BIG PROFITS. Buy genuine WILLS GUT strings direct-from-maker-to-you. High quality, low cost, SILK strings, too! Write today for the FREE details and Tennis Equipment Catalog, H. E. Wills Co., 1047 W. 47th St., Dept. 13-58, Chicago, U. S. A.

MAKE MONEY FULL OR SPARE TIME
In your own Vending Machine Business

Hundreds now making big money operating vending machines. Start as a sideline. Build up a big, fulltime business. Small investment starts you. Now introducing brand new vendor idea taking country by storm. Good locations now open everywhere. Write or wire for details.

ARTEE CO., DEPT. PM, UPPER DARBY, PENNA.



TURN SCRAP INTO MONEY

The new and revised edition of "Auto Power" with all the ten original specifications and ten new ones is now off the press. Convert old generators into A. C. and D. C. generators and motors with voltages of 6 to 400 volts, for power, light, welding, and radio operation. Create new generators adaptable for home, automobiles, or trucks. They can be driven by fan belt, wind, or water. This book, with complete illustrations, tells you how easily and economically these changes can be made. Also instructions for rewinding auto armatures. 350 definitions of electrical terms, etc. Already used and endorsed by thousands. Price, \$1. Postpaid.

AUTO POWER, Dept. B, 410 S. Hoyne Ave., Chicago



HELP FOR HUNTERS

In This Booklet FREE!



"TEASER" DUCK SET

Mail the Coupon for 40-page FREE Booklet full of valuable suggestions for hunters. Practical, proved methods of setting out duck and goose decoys. No guesswork. Hints on blinds, etc. "Days with Super-X" also contains fascinating actual experiences with Super-X on game, from quail to geese. Act NOW, for your free copy!



Western Cartridge Company,
Dept. K-46, East Alton, Illinois.
Send Free copy of your valuable booklet, "DAYS With Super-X".

Name.....
Address.....
Post Office.....State.....

DO YOU

WANT a new business profession of your own, with all the trade you can attend to? Then become a foot correctionist, and in a few weeks earn big income in service fees,—not medical nor chiropody—easy terms for home training, no further capital needed, no goods to buy, no agency. Established 1894. Address Stephenson Laboratory, 1 Back Bay, Boston, Mass.

guaranteed "SPLIT SECOND" movements for the smallest Desk to the largest Grandfather—spring wound—electric Accurate Observatory Time—Westminster Chime—massive brass weight with long pendulum—dry battery—beautiful clock dials—Thousands have made their own cases by aid of our drawings since 1915—Electric present clock at low cost for pleasure or profit. Dials bring "HOW" book and dimensioned drawing of easily built ELI TERRY—Tambour or Grandfather case—state which you prefer.

KUEMPEL ACCRATIME CO., GUTTENBERG, IOWA.



FOR LOOSE RUNGS, ARMS, LEGS

No Glue



No Nails

Reg. U. S. Pat. Off.

You can easily fasten a loose rung for all time with HOLDEMS—small metal pronged inserts that firmly grip both rung and socket. Merely remove rung, insert HOLDEM, and drive rung back. No whittling. Also for mop, mallet or other handles, and any dowels. Patented. 25 cents a box of 30, assorted sizes.

AT HARDWARE STORES—or 25cts. by mail to A & F Products, Mfrs., 3 West 37th St., N. Y.



SOMEWHERE OUT IN "WONDERLAND"

YOU'RE *there* WITH A **CROSLEY** PIONEERS IN RADIO

ENGINES

Enclosed, Self-Oiling, Roller-Bearing

Cheapest reliable power for farm or factory. Uses all fuels for pumping, sawing, etc. Best engine for the money. It pays for itself. Sold direct from Factory to You. **Catalog FREE.**

WITTE ENGINE WORKS
4748 Oakland Ave., KANSAS CITY, MO. 215K Mulberry St., HARRISBURG, PA.

PINS 35¢ Rings \$1.65

CLASS PINS—any letters, any year, any colors. Silver plated, 1 to 11, 45¢ ea; gold plated, 55¢ ea; sterling, 65¢ ea. Silver plated, 12 or more, 35¢ ea; gold plated, 45¢ ea; sterling, 55¢ ea. Sterling silver rings as shown, 1 to 11, \$1.30 ea; 12 or more, \$1.65 ea. Write for Big FREE Catalog showing hundreds of pins, rings, medals, emblems, trophies, etc.

METAL ARTS CO., INC. FACTORY 44 ROCHESTER, N.Y.

Catch Fish!

Eels, Mink, Muskrats, with our new folding galvanized STEEL WIRE TRAP. Write for our FREE TRAP OFFER and Bargain Catalog. \$1 Box of our famous Fish Bait FREE to introduce our traps.

WALTON SUPPLY CO., 3509 JUNIATA AVE., ST. LOUIS, MO.

A BIG NEW WOOD LATHE AT A SENSATIONAL LOW PRICE

Turns 8" Diameter 36" Between Centers

SPECIAL OFFER

Imagine it. This extra heavy wood lathe, all steel bed, 48 inches long, at lowest prices ever quoted. Heavy duty headstock with 3 step cone pulley for V-belt. Extra long reservoir oiler bearings. Spur center and 4 inch face plate screw onto spindle. Tailstock spindle has screw movement of 1 1/2 inches. Tool rest 8 in. long. Priced amazingly low. Accessories include 3 step cone motor pulley, V-belt, and set of 4 turning chisels. Net weight 27 lbs. Shipping weight 30 lbs. Send now for FREE information. Amazing low prices. Not sold through agents or chain stores. **BLUE STAR PRODUCTS, 408 Blue Ave., FAIRFIELD, IOWA.**

HUNTING DOGS

(Continued from page 124A)

American sportsmen have been showing enthusiasm for this expert worker which can be used for rabbits one day, pheasant hunting the next and then be taken on a snipe or duck-shooting trip for retrieving. Although the springer is not an out and out water dog like the big retrievers, he can be used for ordinary marsh duck shooting for mallards and pintails because the springer likes water. But he does not take the place of a pointer, because the breed does not point.

The cocker, a small edition of the springer, is a merry little worker originally used for woodcock hunting by English sportsmen. The cocker works like a springer, ahead of the gun, but lacks some of the power and drive of the springer. However, working cockers from hunting strains can do an efficient job of upland game hunting.

Of all the hunting dogs, none seem to derive more pleasure out of their work than the beagle, fox and coon hounds. Here are dogs that "sing" while they earn their keep. Whereas the setters and pointers find and point the game, and the spaniels flush it, the beagle runs a rabbit until the master gets a shot. The long-eared, good natured coon hounds trail the coon or 'possum to a tree to the accompaniment of a lot of chorus and solo work. The foxhound, one of the fleetest of all trailing dogs, also runs game.

The beagle may be one of the original English dogs. With an affectionate disposition, an ideal temperament, a good nose and "singing ability," this dog is one of the most popular and widely used in America. The coon hound is distinctively American. He was the pioneer's dog. He started with the many hounds brought to this country by early settlers. From cross-breeding these and by constant training and experimental breeding we have obtained the coon hound. Although they do not get as aristocratic a rating as some hunting breeds, they can furnish as much exciting sport as any group of hunting dogs in the United States. The foxhound is an Americanized hound.

With these and many other less common breeds of hunting dogs available, there need be no lack of canine assistance when it comes time to go afield.

\$2500 CASH PRIZES

For snapshots
at night



a picture like
this may win
\$350* for you

* A \$250 Grand Prize will be awarded to one of the six winners of the \$100 prizes, hence the grand prize winner receives \$350 for a single picture.

A CONTEST A MONTH DURING OCTOBER, NOVEMBER, DECEMBER ...89 CASH PRIZES EACH MONTH

2 prizes of \$100 each	10 prizes of \$10 each
3 prizes of \$50 each	20 prizes of \$5 each
4 prizes of \$25 each	50 prizes of \$2 each

\$250 Grand Prize

Get your camera and go after one of these cash prizes tonight. Any amateur picture taker is eligible and winning pictures will be chosen for broad human interest appeal... heart throbs or humor... rather than for photographic skill. Of course the more pictures you enter, the greater your chances of winning.

You'll find scores of likely subjects around your home... Baby's smile... the children at play... Hallowe'en... birthday parties... pictures that tell a story.

HOW TO TAKE THEM. You can catch these scenes with your camera as easily as you take snapshots in sunlight... thanks to G-E MAZDA Photoflash and Photoflood lamps.

Simply screw two or three G-E MAZDA Photoflood lamps in bridge, floor or table lamps, load your camera with supersensitive film and shoot away... taking SNAPSHOTS, if your camera has a fast f/6.3 lens, or QUICK TIME EXPOSURES, if you use a box or slow lens folding camera. These lamps are good for dozens of pictures, hundreds of feet of home movies... and cost only 25 cents list.

For shots of babies, pets and action, use G-E MAZDA Photoflash lamps (15 cents list). Each lamp gets only one picture but you get it in 1/50 of a second... fast enough to record normal action. And you can use these lamps on flashlight batteries or house current.

Get some lamps and film from your druggist or camera dealer, and begin taking pictures tonight. You will have plenty of fun; you have a good chance for a prize; and you will get precious pictures.

Ask your dealer for a folder "Snapshots at Night Contest" on this \$2500 contest or write Dept. "C", General Electric Co., Nela Park, Cleveland, Ohio.

RULES

1. Any amateur photographer (except employees of the General Electric Company and those engaged in the manufacture or sale of photo supplies) may enter any number of pictures made on or after October 1, 1935 and not later than January 1, 1936, in one or more of the October, November, December contests.
2. Prizes will be awarded ONLY for pictures taken by artificial light, indoors or outdoors.
3. Winning pictures will be chosen solely on subject interest or appeal, not on technical excellence. The decision of the judges shall be final.
4. Each prize winning picture with negative and sole rights for advertising, publication and exhibition in any manner shall become the property of the General Electric Company.
5. Each print must bear the owner's name and address on the back. No prints will be returned.
6. All entries for the October contest must be postmarked not later than midnight, November 2; for the November contest, not later than midnight, December 2; and for the December contest, not later than midnight, January 3, 1936. Get entry blanks from your druggist or camera dealer and mail with prints only (be sure to keep the negatives) to:

Prize Contest Office, General Electric Company,
Nela Park, Cleveland, Ohio

GENERAL ELECTRIC
MAZDA PHOTO LAMPS

The World in Hollywood

(Continued from page 715)

backgrounds of many South Sea pictures, has grown too populated and the studios have moved their thatched huts and war canoes to Catalina island. Picture companies work nearly continuously at the isthmus on the island. Several full-rigged ships were used there in filming "Mutiny on the Bounty," along the same coast that a few years ago was temporarily transformed into the fortified bay of Tripoli for the film "Old Ironsides."

Due to its different kinds of docks and backgrounds, Los Angeles harbor is transformed by studio magicians into almost any harbor in the world. The Japanese fishing village and fishing fleet, the light-houses, the modern wharves and steamers, the United States fleet, and the yacht anchorages all are adapted to picture needs.

In making "Cavalcade" a Fox company chartered the "Dorothy Alexander" for \$1,500 a day to show the embarking troops march on board. After the gangways had been withdrawn the ship "steamed away"—but only a distance of fifteen feet from the dock and not even under her own power, since a tug on the offshore side did the pulling.

The flat coast of Naples, thirty miles from Hollywood, is a cinematic Long Island sound on occasion. A few days of work and the building of a few windmills transform the same area into a very realistic Holland. The rolling hills of San Diego county furnish the fortified strongholds from which Spanish brigands dash down on moving-picture travelers and also double for other parts of the world.

When a picture company goes on location a small village is literally packed up and moved to the site. Once the directors wanted some desert scenes and Moore located a spot in Nevada. It was six miles across the sagebrush from the railroad and the first step was to build three temporary roads through the soft sand. Twenty mule teams were rented for hauling supplies. A town suitable for housing 250 people was laid out on paper and two crews of workmen moved in. The first crew, from the studio, created the sets that were to be used in the picture. In a few days they erected and painted houses and barns that looked as if they had been

there for years. They transplanted trees and sagebrush, "grew" a few imitation palm trees, painted other effects on canvas backgrounds, and erected scaffolding for lights and cameras.

Meanwhile the other crew built the village that was to be occupied by the picture company. Tents with wooden floors and sides were put up for living quarters and dressing rooms, a kitchen and dining room, commissary, hospital, and headquarters tents were built. A motor generator was hauled in for power and lights, a water supply arranged, shower baths erected, and sewage facilities prepared.

The players moved in as soon as the work was finished. Virtually every department of a full-sized studio was represented. Make-up experts and costumers were there, camera crews and sound technicians, lighting electricians, and property workers. Ten days later the last scene had been finished and the group was on its way back to Hollywood, leaving a "ghost town" out among the dunes.

Sometimes the movie-made scenery is even better than the real thing, and now and then, when a company is sent half way around the world to film parts of a picture, the results may be thrown away because lighting and technical problems cannot be controlled as well as nearer the studio. Three years ago one studio spent months in shooting atmosphere scenes in India for backgrounds but after 70,000 feet of expensive, authentic film had been brought back most of it was discarded because a sharp-eyed location hunter had found identical scenery within a day's drive where the same scenes could be photographed to better advantage.

Frequently when a studio needs an authentic foreign background, such as a London street scene, only a camera crew is sent abroad to make the picture. The sound can be dubbed in at any time. Back in the studio, the authentic picture is thrown on a projection screen and the picture players go through their actions in front of the screen. The camera that films the actors also records the street-scene background and when you see the picture in a theater the effect is as if the actors themselves had been filmed in London.

"THIS NEW MOBILLOIL IS THE FINEST OIL WE'VE EVER SOLD"

*Actually Improves Performance
— Yet Saves you Money!*



FALL DRIVING'S FUN with new Mobiloil! It gets the most out of your engine.

MOBILLOIL DEALERS are calling this new Mobiloil the finest motor oil they've ever sold. They're sincere about this, because they know how well Mobiloil protects engines . . . how it stays on the job, keeps repair bills down!

Mobiloil gives this different performance because it's *made* differently. The Clearosol Process cleanses it of impurities

that have heretofore defied all refining methods, hence it is cleaner, and helps keep your engine cleaner.

Mobiloil is made in the correct grades for all makes of cars and for every season: Mobiloil Arctic, A, AF, BB, and B. Get it wherever you see the Sign of the Red Gargoyle or the Flying Red Horse.

SOCONY-VACUUM OIL COMPANY, INC.

Mobiloil



**SOLD AT THE SIGN OF THE
RED GARGOYLE OR
THE FLYING RED HORSE**

e 9 4



Seals Floor and Baseboard CRACKS

Handles Like Putty—Dries to Permanent Wood

Seals shelving, drainboard cracks, resets loose bathroom fixtures, loose tiles, cracks around bathtubs, loose handles, broken furniture, replace wood rot, fill old nail and screw holes, loose drawer pulls, repair leaky window frames, broken balusters, auto tops, loose chair rungs, uneven legs, broken toys, under paint, boat and canoe repairs, and 1001 other uses.

USE THE GENUINE

Genuine Plastic Wood is actual wood in putty form, when dry it is hard, permanent wood—can be sawed, planed, turned on lathe, carved—will hold nails and screws without splitting, cracking or crumbling. Genuine Plastic Wood adheres to any clean, dry surface—wood, metal, stone, glass or porcelain—can be painted, varnished and lacquered perfectly—is water-proof, weather-proof and grease-proof.

Get your can or tube of Genuine Plastic Wood at all leading paint, hardware or department stores.



PLASTIC WOOD

ARMY AND NAVY SUPPLY CO.
Bargains—Army, Sport Goods, Firearms, Clothes, Shoes, etc. Send 10c for new catalog, to be redeemed on first order.
Army & Navy Supply Co. 4772 Lester St. Richmond, Va.

AUTO ENGINE SPEED CONTROL GOVERNORS

To control speed of any make of auto or truck engine, regardless of load changes, when used as a stationary or portable power plant. Fully guaranteed. No cash down. Governor speed range from 400 to 3000 R.P.M. Fine opportunity for established agencies. Circulars. Candee-Smith Gov. Co., 217 No. L. A. St., Los Angeles.

FOR FLAT BELT
FOR V BELT
TO CARBURETOR LEVER

WAR SENTINELS OF THE PACIFIC

(Continued from Coloroto Section)

once detected enemy aircraft carriers and warships would be at the mercy of low-flying torpedo plane squadrons that could cast off from protected harbors at a minute's notice and head straight for their targets by flying blind through the fog, which would cover their approach until the moment of attack.

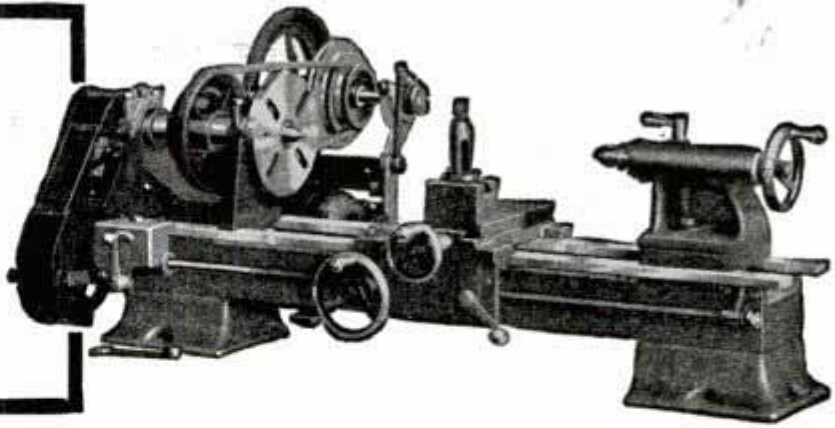
The high-seas air force, well adapted to the rigorous conditions of wartime patrol in the Aleutians, includes 100 multi-motored giant flying boats, capable of cruising 2,000 miles in the air, and they can take off and land on the open sea except during severe storms. With their six-man crews the planes are adaptable for bombing, radio, photographic, patrol and observation work. Part of the present plans are to send ships and men on regular northern duty so the sailors can become accustomed to the climate and to familiarize the officers with the special navigation difficulties found there.

The Aleutians, even today, are comparatively unknown. Because of volcanic activity islands rise or disappear mysteriously. For this reason mariners may find that soundings made years before are unreliable today. Magnetic deposits on the sea bottom also make magnetic compass readings unreliable.

As a result the navy is making the first accurate survey of the islands. Amphibian planes have been used for aerial mapping and protected harbors and bays are being charted. Since mobile naval forces might be sent to some other scene during a conflict, the army is contemplating establishing frontier defense units on the Alaskan mainland. A fleet of 300 land planes, based possibly at Fairbanks, would be able to strike against an enemy fleet within a few hours, long before such an attacking force could come within striking distance of our mainland.

To be effective, the army air force would need to be entirely self-supporting and self-contained, probably being augmented by a series of secondary air bases and observation points stretching from Juneau to Point Barrow. The army training program contemplates sending aerial units to the north for regular training tours, since pilots would need to become accustomed to the handicaps of cold-weather flying.

**New 9" ATLAS
LATHE \$52⁷⁵**
(complete
less motor)



Here is a new metal-working lathe ideal for home workshop needs. New design. New strength. New beauty. And a new LOW price. Has automatic reversible power feeds—modern V-belt drive—9" swing, 36" bed, 18" between centers—precision ground hollow spindle. Plugs into light socket. Does all regular lathe jobs, and for \$6.15 extra you can get threading gears to cut from 4 to 72 threads

per inch. Each lathe guaranteed for .001" precision. Price of \$52.75 (less motor) includes counter-shaft and all necessary belts and pulleys. Sales can be arranged with very small down payments, with terms up to 3 years. Two weeks trial, your money back if you are not satisfied. Write today for new catalog, just out, of wood and metal lathes, attachments and tools, drill presses, etc.



**ATLAS 10"
LATHE
\$82⁵⁰**

**ATLAS
Drill Presses
\$13.95
to
\$37.95**



ATLAS PRESS CO.
1843 N. Pitcher St.
KALAMAZOO, MICHIGAN

Complete display at
ATLAS SALES CO.,
35 E. Wacker Drive, Chicago

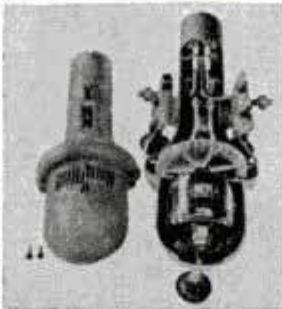
ATLAS QUALITY
Shop Equipment Since 1911

MONEY for YOU

Install America's Most Accessible Oil Burner

Save money... make money... America's premier Oil Burner (License No. 1. Zoro Patent Estate) is yours at low cost! Bought by U. S. Govt. You can buy direct! Complete with automatic controls and full installation diagrams. Write for amazing low price and free literature today.

CHALMERS OIL BURNER CO.
1240 Central Ave., Minneapolis, Minn.



FREE Literature
Send Today

WEAVING MATERIALS BAMBOO
RATTAN
Reed, Colored Raffia, China Grass, Chair Caning, Chair Frames and
Stools, Basketry and Furniture Weaving. Send 10c for Catalog. In-
structions Free. **AMERICAN REEDCRAFT CORPORATION**
Dept. P 130 Beekman Street New York, N. Y.

EXPLORE THE WONDERS
OF GRAPHITE WITH **DIXON'S**
GRAPH-AIR GUN



NEW CLEAN WAY OF APPLYING the most extraordinary lubricant known — MICROFYNE POWDERED GRAPHITE. Won't burn, gum, drip. Proof against acids, alkalies and brine. Thousands of uses in your car, home, shop and play. Write for descriptive circular and name of nearest dealer.

JOS. DIXON CRUCIBLE CO., Dept. 26-CG, JERSEY CITY, N.J.

- 1 Novel nozzle control
- 2 Handy burnisher attached
- 3 More power from motors
- 4 Lubricates locks
- 5 For everything that slides



**75¢
FILLED**

POWERFUL LAB MICROSCOPE

Guaranteed "Studron" Model—415X Power



\$795
Complete

Tested and certified by leading laboratories. Precision built. 7X and 13X interchangeable oculars afford from 183X to 415X powers! Double wheel adjustment. Professional type stand over 7" high. In fine wood case. Only \$7.95 complete. Postpaid if remittance accompanies order. C. O. D. charges extra.
Other Microscopes.....50X Power, \$1.00.....118X, \$1.95
Trips Revolving Objective Model.....\$6.75
Dissecting Sets—Slides—etc.—Send for **FREE** catalog.
DWIGHT-CARLSON LABORATORIES
175 Fifth Ave., Dept. P11, New York, N.Y.

5 DIMITS BRING TO you the **HI-SPOTS** OF DIESEL ENGINES

Send today for THE DIESEL GUIDE. A practical book covering Diesel engines in a thorough and easily understood manner, explaining The Principles of Every Operation and Part . . . theory, maintenance, installation, operation, trouble shooting, timing and valve setting. Pictures, drawings, and charts simplify the text. Price 50c (Coin or M.O. only) postpaid.

AUTOPOWER, INC. DESK 3 410 S. HOYNE AVE. CHICAGO

SPECIAL OFFER
Diesel Guide

Hunting Air Phantoms

(Continued from page 708)

ways. When the landscape undergoes rapidly changing distortions, owing to moving masses of air of various densities, the phenomenon is called "fata morgana." A good imitation of this can be produced by looking at outdoor objects through the border of a windowpane while moving one's head from side to side.

When the upper edge of the sun is about to disappear below a sharply defined horizon, you may occasionally witness "green flash." The tiny segment of the disk still visible suddenly changes to a spark of brilliant green, sometimes blending into blue. The same color may also be seen at sunrise when the border of the solar disk first comes into view. This is because the blue and green rays are bent a little farther downward in passing through the air than the reds and yellows, so they disappear last at sunset and appear first at sunrise.

Rainbows are not all alike. Large raindrops produce narrow and brilliantly colored bows; those formed by small drops are broad and faintly colored, and a fog produces the so-called "white rainbow," or "fog-bow," almost colorless. Besides the ordinary double rainbow, consisting of the primary below and the secondary above, one can distinguish in many rainbows one or more repetitions of the colors along the inside border of the primary, and they are sometimes also seen just outside the secondary. These are called "supernumerary" bows.

There are also bows produced by the image of the sun reflected in water. As a rainbow is always opposite the source of light, these "reflection" bows are higher than those produced by the sun itself at the same time, which they may intersect in various positions. If the sun is high enough, a reflection bow may form a complete circle, or the upper part may be lacking so the rest looks like a rainbow upside down. Lunar rainbows usually are so faint they show no colors. A brightly colored double lunar rainbow is not seen more than once in a lifetime.

The colored circular area commonly seen around the sun or moon when viewed through fleecy clouds is called the "corona." Generally it is brownish-red with a

bluish-white inner field, but sometimes it shows two or more series of bright rainbow tints. The corona is formed by the bending of the light rays around small water drops. It is occasionally produced by fine dust. The large circle called "Bishop's ring," seen around the sun after great volcanic eruptions, is a dust corona.

On a mountain, when the sun is low on one side and a bank of fog or cloud rises on the other, an observer can often play shadow pantomime, producing the famous "specter of the Brocken." His shadow is cast on the fogbank, and the shadow of his head is usually surrounded by a colored ring resembling a corona—the "Brocken bow." The shadow is never more than a few yards away, but because its distance is, as a rule, greatly overestimated, it gives the impression of being of colossal size. Brocken specter can be seen from many places besides mountains. With a high sun, an aeronaut sees the complete outline of his balloon or airplane, encircled with rainbow tints, on a layer of clouds below him. The headlights of locomotives and automobiles sometimes produce these shadows on nearby banks of fog.

A haze of water or dust in the air makes visible the alternating sunbeams and cloud shadows, radiating like the spokes of a wheel, called "the sun drawing water," though no such process is involved. Small-scale versions are seen in the misty atmosphere of a forest when the sunlight sifts through the foliage, as well as in buildings into which sunlight enters through a number of small openings.

Most varied of all the optical phenomena of the atmosphere are the "halos"; a term broadly applied to all the effects produced by the passage of light through air containing tiny ice crystals. In middle and low latitudes the halo-forming crystals are usually confined to the clouds, so the halos are seen in the sky, but in the polar regions, and at times in intensely cold weather elsewhere, the lower air may be filled with an icy haze that forms halos near at hand. Halos are produced by the sun, the moon or any other bright source of light. Some are white; others show rainbow colors. To view a solar halo, wear dark spectacles.

THE COMPANY WILL APPRECIATE SUGGESTIONS FROM ITS PATRONS CONCERNING ITS SERVICE

1201-S

SIGNS

DL = Day Letter

NM = Night Message

NL = Night Letter

LC = Deferred Cable

NLT = Cable Night Letter

Ship Radiogram

WESTERN UNION

NEWCOMB CARLTON
CHAIRMAN OF THE BOARD

J. C. WILLEVER
FIRST VICE-PRESIDENT

CLASS OF SERVICE

This is a full-rate Telegram or Cablegram unless its deferred character is indicated by a suitable sign above or preceding the address.

The filing time as shown in the date line on full-rate telegrams and day letters, and the time of receipt at destination as shown on all messages, is STANDARD TIME.

R. B. WHITE
PRESIDENT

MINUTES IN TRANSIT

FULL-RATE	DAY LETTER
-----------	------------

Received at

NGB195 57 DL CNT PCTNS=TU NEWYORK NY 26 319P

EVEREADY PRESTONE PRICE REDUCED AGAIN. NOW LOWEST IN HISTORY ONLY TWO DOLLARS AND SEVENTY CENTS A GALLON. MADE POSSIBLE BY GREATLY INCREASED SALES. NOW CHEAPER THAN EVER TO USE THE GUARANTEED ANTI-FREEZE. PUT IT IN NOW. NO BOILING AWAY NO RUST NO FREEZE-UP. ONE SHOT LASTS ENTIRE SEASON. =

NATIONAL CARBON CO INC NEWYORK.

25 CALLING CARDS PRINTED WITH YOUR FULL NAME . . . 15c
(Extra words 2c each)
 LOOK! Your name, address, etc., printed on 100 Envelopes, 100 8 1/2 x 5 1/2 Letterheads, 50 3 x 5 cards, Only \$1 p.p. High Grade Quality typewriter ribbons 60c. Economy Grade 35c.
SEEJAY SERVICE, 2459 Station St., CHICAGO, ILLINOIS

\$1.00 STARTS YOU IN BUSINESS BIG MONEY ALL YEAR ROUND

New Fall and Holiday Line Ready, Guaranteed Lowest Prices and Best Workmanship. Reorders every day.

TIE, MUFFLER AND HANDKERCHIEF SET
 Bigger and Better than ever. Beautiful combinations, sells on sight, \$1.00 Sample Set, \$9.00 Dozen Sets

SILK LINED TIES \$1.75 Doz.; \$18 Gross
 Fine Materials, Satin Stripes and Prints.
 Also Patented Slide on Ties, Wool Mufflers, and other Novelties.

COMPLETE LINE MEN'S NECKWEAR
FREE! Send for our Illustrated Catalogue and see for yourself why our Men are the Biggest Money Makers!
 25% Cash, Balance C. O. D.—Money Refunded

BOULEVARD CRAVATS, 22 W. 21st St., Dept. W125, New York

Stoves AT FACTORY PRICES!



SALE CATALOG—FREE


Over 200 Styles and Sizes of Stoves, Ranges, Furnaces at Factory Prices and Easy Terms—as little as 15c a day. More Bargains than in 20 Big Stores. New styles, new features, new colors. Year to Pay—30 days' free trial—360 days' approval test—24-hour shipments.

THE KALAMAZOO STOVE CO.,
 Mfrs., 391 Rochester Avenue, KALAMAZOO, MICH.

35 Years in Business
 Write for FREE Catalog


Over 950,000 Satisfied Users
"A Kalamazoo Direct to You"

FAMOUS MODEL MAKER uses a Remington



Capt. E. Armitage McCann, world-famous ship model builder, says: "I use a Remington—it's swell!"

REMINGTON du Pont knives are famous for their razor-sharp edges. Most experienced wood-carvers use a Remington because it's dependable. Blades are special high-carbon steel, carefully forged, and hand-sharpened at the factory. They cut like a razor, hold an edge, and you have *real strength!* No matter how much—or how little—you use a knife, you'll find that a Remington will serve you more faithfully. Get one—today!

Remington


SEND 3c FOR WHITTLIN' BOOK

REMINGTON ARMS CO., Inc.
 Cutlery Division, Dept. E-7, Bridgeport, Conn.

I enclose 3c in stamps. Please send me "Things to do with a Pocket Knife."

Name.....
 Address.....
 City..... State.....

NEWEST IN HOME WORKSHOPS

Thrills Amateur Craftsmen from Coast-to-Coast!

MAKES METAL WORK EASY!

"REVOLUTIONARY

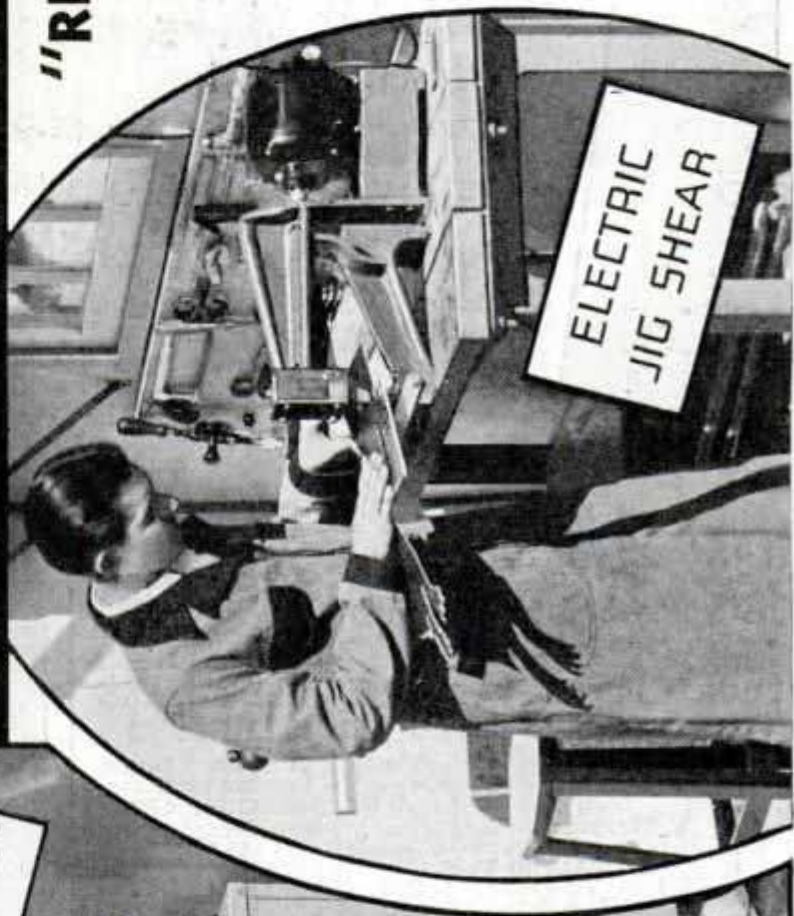
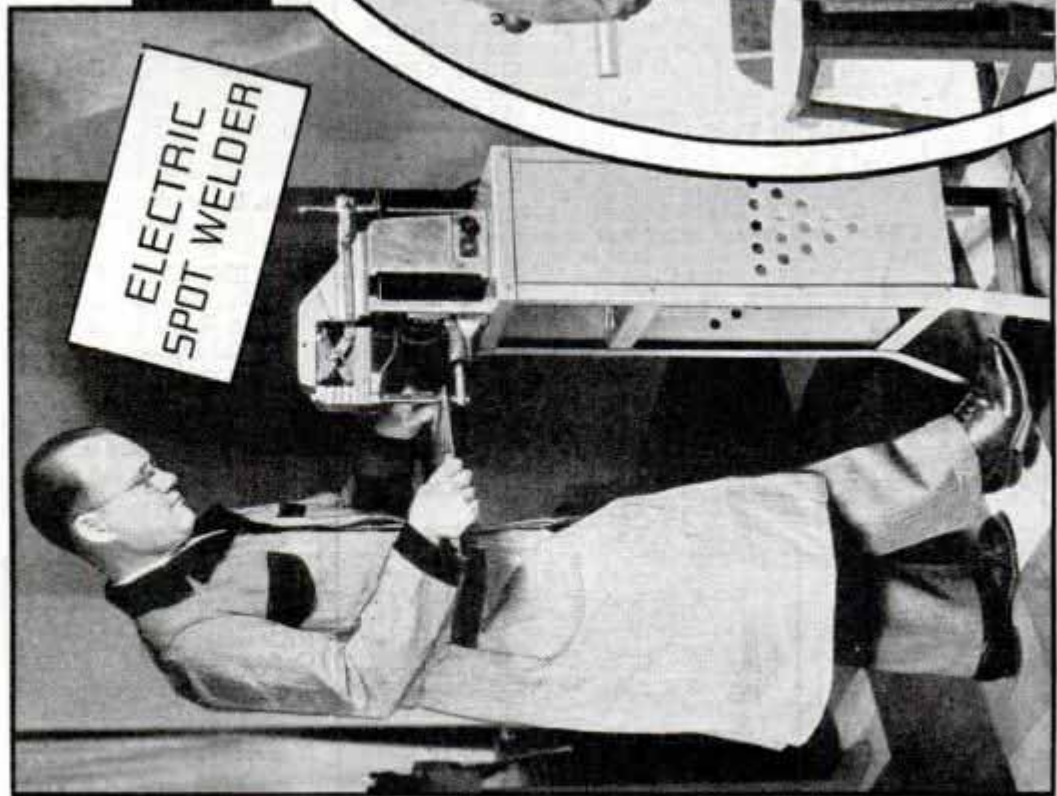
**In The Home
Work Field" . .**

says

POPULAR MECHANICS

**An Unrivalled
Hobby and
Spare Time**

MONEY-MAKER!



When writing to advertisers please mention Popular Mechanics

PRODUCES METAL ARTICLES OF ALMOST EVERY CHARACTER...

With Surprising Speed and Professional Finish!

A VERITABLE new world of spare time pleasure and profit is opened up to America's amateur craftsmen by the recently developed METAL MASTER home workshop equipment. Now, for the first time, articles of sheet metal and heavy wire can be produced in the home shop with far greater ease and in far less time than is required for equally ambitious projects in other materials.

So expertly are these tools designed that there is little for the beginner to learn and that little can be picked up with an ease that has thrilled amateur craftsmen from coast to coast! During the first few days, he will find himself turning out articles which have heretofore been available only through factory production methods. They will rival the factory-made article in professional finish and appearance too. Most remarkable of all is the speed with which even intricate projects are completed. Not days—but hours are required—thanks to the masterful designing of METAL MASTER machine and hand tools.

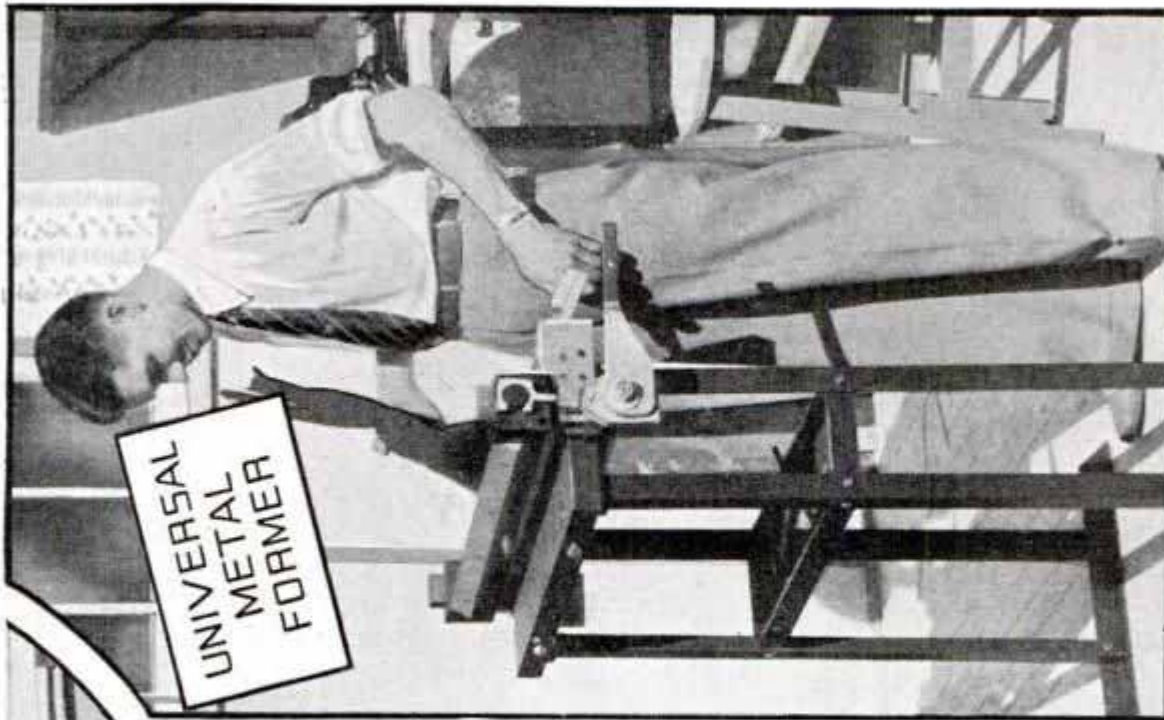
Better still, there is virtually no limit to the number and variety of articles which can be made from the very first. With the 3 machines illustrated and a few hand tools you can turn

out practically anything not too large which modern factory methods could produce. An electric paint sprayer is also available for finishing your work and other tools may be added from time to time.

What's more, METAL MASTER equipment is built for a lifetime of accurate, trouble-free service. Only the best of materials are used and assembled with hairline accuracy by master workmen. When you buy METAL MASTER, therefore, you are making a permanent investment in thousands of delightful hours of future employment.

You will make a real cash profit on that investment, too, whether your aim is pleasure or profit. If the former, you can construct hundreds of useful and ornamental articles for the mere cost of raw materials. If the latter, you can make any saleable article in so short a time that you will be handsomely rewarded for your work.

But it would be impossible to give more than an inkling of the amazing possibilities of METAL MASTER in this brief space. Yet, this is something every home workshop enthusiast in America should know all about. So, why not send for the big, profusely illustrated circular which gives you all the facts? Mail the coupon below for complete information about METAL MASTER tools, the work they do, their reasonable prices and the easy terms on which they are sold.



**EASY PAYMENTS IF YOU WISH . . . MAIL COUPON FOR
DEALERS . . . COMPLETE DETAILS . . .**

GLASCOCK BROS. MFG. CO.
METAL MASTER DIVISION—Dept. 5
Muncie, Indiana

Rush me all the facts about the new METAL MASTER Home Workshop.

Name.....

Address.....

City.....State.....

DEALERS Write for
Information

Master
GLASCOCK BROS. MFG. CO.
Dept. 5
MUNCIE, INDIANA

HOME WORKSHOP
EQUIPMENT

Heroes of the "Hurricane Watch"

(Continued from page 642)

8 1047
 due to strike British Honduras. By the time we had transmitted the warning and notified our on-coming mail and passenger plane, the wind had increased from a light breeze to thirty-five miles per hour and rain had begun falling. The wind grew stronger—seventy-five, eighty-five and finally 100 miles an hour, sweeping our recording instruments out of the station. Our lights went out and we heard our telephone lines ripping loose. Through the roar of the wind, we could hear walls crashing and roofs of houses being torn away.

"Throughout the storm I could hear calls at irregular intervals—Miami calling—Havana calling—Mexico City calling. But they could not be answered. Crowds came rushing to our barracks, crying and shouting hysterically. Our staff dashed into the street to help the panic-stricken people to shelter from the barrage of flying debris.

"All at once the wind died, but veterans of the area knew that only half of the storm had passed. Our station mechanic and his helper worked frantically to get our precious gas engine and other equipment into a safe place. Other staff members rushed through all parts of the city warning people to remain indoors.

"Water began to roll in from the sea and in five minutes it was a foot deep. In five minutes more, it was waist deep and rushing with terrific force through the streets. Our two men with the radio power unit struggled through water almost to the armpits to get the equipment stowed away. Then the storm broke again in all its fury, the water rising to ten feet. Buildings weakened by the first blow were now easy prey to the 100-mile wind. Roofs, walls, doors and heavy timbers went flying through the air and rained on the city. Pinioned by these timbers or swept against standing walls by the wind, scores and scores of people were drowned.

"All through that horrible night, Miami kept calling, calling, for that 3:30 p.m. weather report. Through the roar of the storm we worked to get the station back in order, retrieving parts from all over the yard. Under a temporary shelter, the telegraph key was screwed into place and

after many fitful starts the motor finally began to chug. I had had many hours to make up that first message:

"'Belize destroyed by hurricane. Two hundred dead.'"

Sherouse, with his emergency radio equipment was the only means of communication between Belize and the rest of the world after the storm. He flashed the first news of the disaster and the first calls for medical supplies and assistance. In the three-day storm period, he transmitted more than 40,000 words to the outside world and his heroism brought commendation from the secretary of the navy and recognition from the Veteran Wireless Operators association.

George Brands, chief meteorologist of the Caribbean division of the Pan American system, explains the work of the hurricane watch:

"Weather data gathered by these men are radioed to the Miami office where they are compiled and furnished to various governmental agencies. In addition to being used in warning of approaching storms, these statistics are an invaluable contribution to the climatology of the world, because the weather conditions reported from the tropics, as well as from the polar regions, determine in a large measure the more important weather changes in the temperate and thickly populated zones.

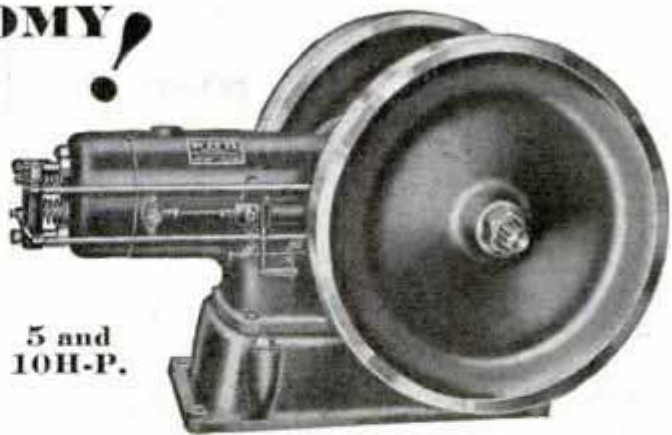
"Winds aloft are determined to enable pilots to select safe flying levels, as well as to obtain information that has a direct bearing on weather in the United States. This work is done by using small rubber balloons filled with hydrogen gas and allowed to travel freely in the air. The position of the balloon in space is calculated at intervals from the horizontal and elevation angles indicated on a theodolite, an instrument equipped with a powerful telescope."

Minute-by-minute reports on the approach and progress of hurricanes are now an accomplished fact as the weather observers and radio operators maintain twenty-four-hour watches from the time there are indications of the development or movement of a storm in the vicinity of their stations.

UNBELIEVABLE ECONOMY!

Lower Power Bills 75%
Reduce Fire Hazards 100%

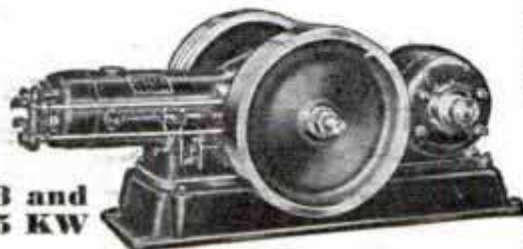
Whyt-Rox Chem. Co. writes: "We replaced a 5 H. P. electric motor with a WITTE Diesel Engine and are saving \$65.00 per month."—All WITTE Diesel users report big savings and almost unbelievable economy. Efficient streamline design. Cash or terms. Immediate Delivery.



5 and
10H-P.

WITTE DIESEL ENGINES**DIESEL-LITE PLANTS**

Produce **ELECTRICITY** for **LESS**
 than **ONE CENT** per **KILOWATT**
 A.C. or D.C. Current



3 and
5 KW

Diesel-Lite Plants are powered with the economical WITTE Diesel Engine, close coupled by multiple vee belt drive to A. C. or D. C. generators, forming a complete self-contained unit that will furnish electric power for less than one cent per kilowatt. These units have remarkable flexibility and may be used for engine power, electric power or a combination of both. Simple to operate and care for.

Write today for literature and prices

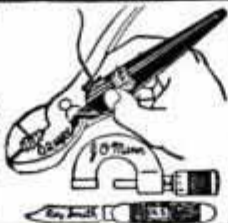
WITTE ENGINE WORKS

1748 Oakland Ave.

Kansas City, Mo.

BURN YOUR NAME ON TOOLS**WITH THE ARKOGRAF**

PROTECT YOUR TOOLS FROM THEFT
 Write with electricity any name or design on the hardest and finest tools and instruments, or any metal, like writing on paper with pen or pencil.
Complete Outfit \$3.50—Prepaid Anywhere.
 Interesting illustrated circular free. Write today.
 Agents wanted.
ARKOGRAF PEN CO., 3927 S.E. Stark St., Portland, Ore.

**CRAFTSMAN'S ELECTRIC SAW**

No motor or rotating parts—Nothing to adjust—Absolutely safe—No oiling—Heavy metal construction—Will cut perfect right angles and smooth edges—No sand papering necessary—7200 strokes a minute—A. C. power, 110 volt.

Practical for workshop or home.

STYLES & CASH, Inc.

17 WEST 45th STREET NEW YORK CITY

\$11.50 Delivered

**HEAT 1½¢ Per Hour!**

AMAZING INVENTION—New Radiant Heater. Burns 96% air. Makes its own gas. No piping. No installation. Gives roomful of clean, healthful, penetrating heat, like sunshine, for 1½ cents an hour. Hotter than gas or electricity, at 1-10th the cost. Easy to light and operate. No smoke. No soot or ashes. No odor. Portable—carry it anywhere. Low priced. Guaranteed.

30-DAYS' TRIAL

Liberal Offer. Try it 30 days at our expense. Write at once for special, introductory, low-price offer and no-risk trial opportunity. No obligation. Send today.

THE AKRON LAMP CO.
 1201 High Street, Akron, Ohio

AGENTS!
 Make big money. New easy plan. Write quick for territory and Outfit Offer!



Adjustable
Peep Sight

Crosman SILENT .22 Rifle

NO CLEANING
LOW COST AMMUNITION
ADJUSTABLE POWER



Rifled
Barrel

Grooves inside barrel make the Crosman a real rifle with all the hair-splitting accuracy this term implies. Shoots bullet (Pell) same size as .22 powder rifle, but silently, powerfully, with no recoil, using the terrific force of compressed air—same force U. S. Navy uses to drive 2000 lb. torpedoes. Marvelous for target, small game. Single and 20 shot repeater models. No license required. *New low prices on Pells.*

FREE booklet containing important target and game shooting facts. Also free descriptive literature. Ask your dealer to show you a Crosman.

Crosman Arms Co., 390 St. Paul St., Rochester, N. Y.

GO INTO BUSINESS Make 100% to 300% Profit!

Sell new and used clothing direct from your home, auto or store. Undercut all competition. **EASY SALES—FAST REPEAT ORDERS!** We furnish everything and show you how. Handsome profits every day in the year. No selling experience necessary. Satisfaction guaranteed. Write at once for our Big Money Catalog—It's FREE!
ACME MERCHANDISE COMPANY, 558 Roosevelt Rd., Dept. D-16, Chicago, Ill.

Make Big Profits Filing Saws by Machine

An Opportunity to earn up to \$2 to \$3 an Hour in your own cash business.

Steady growing business, all cash, no canvassing. Start in spare time. No experience needed. No eyestrain. With a **FOLEY Automatic Saw Filer** you can file hand, band and circular saws, easily, quickly, accurately! Small investment. Send postcard for **FREE PLAN** and Special Offer. No obligation.

FOLEY MFG. CO., 1116-5 Foley Bldg. 11 Main St. N. E., Minneapolis, Minn.



And the ten they consider most useful



Send for your copy of this Company's new folder "Why Craftsmen Choose Nicholson Files". You'll be interested in the testimony of experts who point out why Nicholson Files are the greatest file value money can buy.

An additional feature of this new folder is the result of a ballot taken among one thousand home craftsmen to determine the ten most useful Nicholson Files.

You'll find files you may never have used high up among the leaders and perhaps you will improve your filing efficiency by adding them to your kit.

The folder is free with no obligation whatsoever. Send for your copy today. Nicholson File Company, Providence, Rhode Island, U. S. A.

Genuine
NICHOLSON FILES
A FILE FOR EVERY PURPOSE

Nicholson File Company
Providence, R. I.

P. M. 11

Gentlemen:

Please send me free of charge copy of folder "Why Craftsmen Choose Nicholson Files".

Name.....

Address.....

RADIO
Made EASY

(1)—Write for **FREE NEW CATALOG** of Condensers, Transformers, Chokes, Sockets, Coils and technical data on receiving and transmitting equipment.

(2)—Attach 10c for New 32-page Manual of most popular Short-Wave Receivers, with illustrations, diagrams and parts lists.

Address Dept. PM-11

HAMMARLUND MANUFACTURING CO.
424-438 W. 33rd St., New York



Don't let DIRTY SPARK PLUGS STEAL YOUR GAS!

Car makers will tell you that dirty spark plugs rob you of as much as 1 gallon of gas in 10. The sure remedy is spark plug cleaning—at any Registered AC Cleaning Station. Be guided by the sign of the "Plug-in-the-Tub." Replace worn plugs with new ACs. Now 60c.

AC SPARK PLUG CO.
Flint, Mich. St. Catharines, Ont.



AMAZING AUTO COMPASS



Don't lose time and money by taking the wrong road and going many miles out of your way. This new **AIRPLANE TYPE COMPASS** constantly tells your direction of travel. Sticks to windshield. Base 1 3/4" diameter. **ONLY \$1.95 POSTPAID**, including Compensator. **SATISFACTION GUARANTEED.**

If your dealer cannot supply you, order direct.

HULL MFG. CO., Box 246-D, WARREN, OHIO



Catalog No. 35

Illustrating Electrical, Mechanical and Model Makers' Supplies, Small Steam & Gasoline Engines, Motors, Generators, Lathes, Drill Presses, Bench and Band Saws, etc., 16 & 22 Dyna-Motors, School Projects, Engine Castings, Motor Parts, Etc., Books, Blue Prints, Brass and Steel Tubing, Gears, Pulleys, Hangers, Experimental Material.

Big Copy. Mailed anywhere for 20 cents. 25 cents Canada, refunded first order.

LOOMIS ELECTRIC COMPANY
2822 N. California Ave. Chicago, Ill.



Print Your Own

Cards, stationery, circulars, tags, labels, advertising, etc. Save money. **Print for Others; Big Profits; easy rules sent.** Will do popular Raised Printing like Engraving. Junior press \$5.90, job press, \$11 up, power \$149. Send for free catalog and all details. **THE KELSEY COMPANY, B-37, MERIDEN, CONN.**

LOG SAWS

MAKE MONEY-BE YOUR OWN BOSS
Turn Your Trees Into Cash
USED BY THE U.S. Gov't.

Be independent, start a wood sawing business, have money coming in all the time. Use the portable engine year 'round. Pays for itself. Low factory prices. Big **FREE** Catalog.

WITTE ENGINE WORKS
6748 OAKLAND AVE. KANSAS CITY, MO.

When writing please mention Popular Mechanics

READY FOR THE RACE 8996

(Continued from page 685)

But win or lose, the French and British must lay out a fat sum to run at high speed across a 3,000-mile track.

The horsepower required to propel the giants through the water varies as the cube of the speed. Therefore, if you double your speed you must much more than double your horsepower. Thus it will require about twenty-three per cent more power to drive the "Queen Mary" at thirty than at twenty-eight knots. An increase in speed of seven per cent demands an increase of twenty-three per cent in power.

The "Queen Mary" is designed to maintain a weekly service with a sister ship. In other words, two ships like the "Queen Mary" can maintain a service which now requires three ships. Right here is the practical advantage of speed. The "Mauritania" crossed in about 115 hours. If the "Queen Mary" can make the trip regularly in 100 hours flat, she will be considered a worthwhile successor.

As Clydebank engineers put it, the "Queen Mary's" size is dictated by the necessity of providing sufficient passenger accommodation for a two-ship service. Her speed is dictated by the necessity of performing the same feat in all seasons and under all weather conditions. Therefore, the "Queen Mary" and her projected sister ship actually represent the "smallest" and the "slowest" vessels which could perform this regular service.

The interior luxury of the "Queen Mary" is in proportion to her size. She boasts a movie theater, a shopping center, branch banks, tourist bureau, printing plant, playrooms, worldwide telephone exchange, swimming pools, several hospitals and garage. There are twenty-one elevators to carry passengers and freight between the twelve decks. Each lifeboat on the ship is fitted with high-speed Diesel engines and one man can lower a fully-loaded boat in a few seconds.

Of course, each boat is anxious to claim the Atlantic speed record for the winner can skim the cream off the best transatlantic passenger traffic. If she wins the coveted prize the "Queen Mary" will settle down to a comfortable speed, probably around thirty knots. After all, constant racing across the ocean is expensive, and shipowners are business men.

MAKE ME PROVE that it is Easy to Learn at home to fill a GOOD JOB in RADIO



COUPON BRINGS FREE SAMPLE LESSON



Set Servicing

Spare time set servicing pays many N. R. I. men \$200 to \$1,000 a year. Full time men make as much as \$30, \$50, \$75 a week.



Broadcasting Stations

Employ managers, engineers, operators, installation and maintenance men for jobs paying up to \$5,000 a year.



Loud Speaker Systems

Installation and service work is another growing, money making field for Radio trained men.

Clip the coupon and mail it. I'm so sure that I can train you at home in your spare time for a good job in Radio that I'll send you my first lesson free. Examine it, read it. See how clear and easy it is to understand. Then you will know how many men with less than a grammar school education and no technical experience have become Radio Experts and are earning good money as a result of my training.

Many Radio Experts Make \$30, \$50, \$75 a Week

In about 15 years, the Radio Industry has grown from a few million to hundreds of millions of dollars. Over 300,000 jobs have been created by this growth and thousands more will be created by its continued development. Many men and young men with the right training—the kind of training I give you in the N. R. I. Course—have stepped into Radio at big increases over their former salaries.

Get Ready Now for Jobs Like These

Broadcasting stations use engineers, operators, station managers and pay up to \$5,000 a year. Manufacturers continually employ testers, inspectors, foremen, engineers, servicemen, buyers, for jobs paying up to \$6,000 a year. Radio operators on ships enjoy life, see the world, with board and lodging free, and get good pay besides. Dealers and jobbers employ servicemen, salesmen, buyers, managers, and pay up to \$75 a week. My book tells you about these and many other interesting Radio jobs. There's opportunity for you in Radio. Its future is certain. Television, short wave, loud speaker systems, police Radio, automobile Radio, aviation Radio—in every branch, developments and improvements are taking place.

Many Make \$5, \$10, \$15 a Week Extra in Spare Time While Learning

The day you enroll I start sending you Extra Money Job Sheets which quickly show you how to do Radio repair jobs common in most every neighborhood. I give you plans and ideas that have made good spare time money—\$200 to \$1000 a year—for hundreds of fellows. My Course is famous as "the Course that pays for itself."

Free 64-Page Book of Facts

Mail the coupon now. In addition to the sample lesson, I will send my book, "Rich Rewards in Radio." It tells you about the opportunities in Radio; tells you about my Course, what others who have taken it are doing and making. This offer is free to any ambitious fellow over 15 years old. Find out what Radio offers you without the slightest obligation. Mail coupon in an envelope or paste it on a penny postcard. ACT NOW!

J. E. SMITH, President
National Radio Institute, Dept. 5MPA
Washington, D. C.

MAIL NOW for FREE PROOF

J. E. SMITH, President
National Radio Institute, 5MPA
Washington, D. C.

I want to take advantage of your offer. Send me your Free Sample Lesson and your book, "Rich Rewards in Radio." I understand this request does not obligate me.

(Please print plainly.)

NAME.....AGE.....

ADDRESS.....

CITY.....STATE.....



"R"



JACK SPRATT
 NOW EATS FAT
 AND ANYTHING ELSE IN SIGHT;
 NO STOMACH SOUR
 CAN KNOCK HIM FLAT...
 FOR TUMS HAVE SOLVED HIS PLIGHT!

WHO ELSE WANTS TO FORGET SOUR STOMACH?

The way to eat favorite foods and avoid heartburn, sour stomach, gas and other symptoms of acid indigestion is no secret now. Millions carry Tums. Nothing to mix up. No drenching your stomach with harsh alkalis, which doctors say may increase the tendency toward acid indigestion. Just enough of the antacid in Tums is released to neutralize the stomach. The rest passes on inert. Cannot over-alkalize the stomach or blood. *You never know when, so carry a roll always.* 10c at all druggists'.



FREE: Beautiful 5 color 1935-36 Calendar-Thermometer with the purchase of a 1lb. roll of Tums or 25c box of NR (the all-vegetable base). At your Druggist's.

MAN IN EACH TOWN To Plate auto parts reflectors, mirrors, etc., by new method; no capital or experience required. Outfits furnished. Free particulars. Write Today!
GUNMETAL CO., Ave. M, Decatur, Ill.

IF YOU GLUE ANYTHING
Glue it to stay
CASCO Glue fixes Teakwood Table after everything else fails!
You can benefit from the experience of A.M.C. of Tujunga, Calif., who writes:

"I have a coffee table of teakwood and a stand. Both of them with six legs and twelve glued joints. I have tried both hot and cold glue and three kinds of marine cements, but all would loosen in from six to twelve months. It is about eighteen months since I gave them a liberal coating of CASCO Water-proof GLUE. Today, they're as good as new, in spite of the fact that this climate is the absolute limit for wood shrinkage!"

Build your own projects with CASCO and get a new idea of glue strength. Whereas ordinary glues set merely by evaporation, CASCO hardens chemically...and becomes proof against moisture and heat.

FREE!! GENEROUS TEST SAMPLE & HANDY REPAIR GUIDE

Write your name and address on penny postcard. Say "Send free sample and copy of 'Casco Gluing Guide.'"

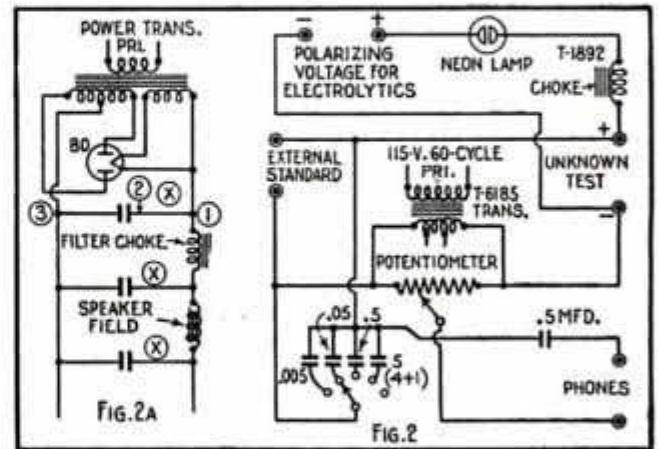
Hardware, Paint, Lumber Dealers Sell CASCO
THE CASEIN MFG. CO. OF AMERICA, Inc.
 352 Madison Avenue • Dept. 1135B • New York, N. Y.



CONDENSER CAPACITY TESTER

(Continued from page 741)

fixed condensers indicated in Fig. 2 must be of high quality, accurately rated, with a working voltage of 400. Fig. 2-A repre-



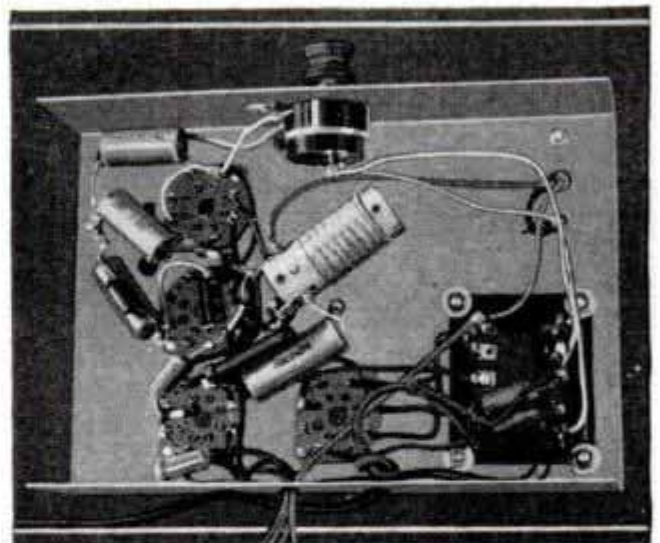
sents a typical rectifier and filter circuit. The positive terminal of the condenser to be tested is disconnected from the circuit at point X.

T. R. F. FOUR WITH METAL TUBES

(Continued from page 743)

available; those who wish it should specify blueprint R-215.

To balance the set, open the front and rear trimmers, Tr. 1 and Tr. 2, out about 4 turns from the full in position. Turn on the receiver and tune to about 25 on the dial, or a nearby point where no station is



heard; the condenser plates should be about one-fourth closed. Next adjust the rear trimmer "Tr. 2" for maximum noise; when this is done, adjust the front trimmer for loudest hiss, or noise, in the speaker and the set is then in balance.

EVERYTHING IN RADIO!

Send for this
GREAT CATALOG

If you are a Radio Amateur; if you build or experiment with radio, you need the new 1936 ALLIED Catalog. Write now for your FREE copy of this leading Radio Supply Guide. ALLIED can supply all of your radio needs for less money.



Build Popular Mechanics RADIO CIRCUITS

Thousands are building the successful Radio Receiver, Transmitter and Amplifier circuits described each month in "Popular Mechanics Magazine." It pays to build these circuits which carry the approval of the "Popular Mechanics" Radio Laboratory, and which are selected on the basis of excellence, simplicity and low cost. When you build your "Popular Mechanics" set, use only approved parts, offered in kit form exclusively for you at lowest wholesale prices by ALLIED—your Radio Parts Headquarters. Write to us for FREE Parts Lists covering such popular circuits as the 1 Tube Portable Receiver (209); the 2 Tube AC-DC set (R211); the 6 Tube 32-Volt Farm Radio (208); the Metal Locator (R213); the All-Star Jr.; the Browning 35; and many others. We can supply all parts for building any "Popular Mechanics" radio circuit described in this or in any other issue. Before you buy, write for our parts lists.



FREE

RADIO'S LEADING SUPPLY GUIDE

There are more than 10,000 quality radio items in the 1936 ALLIED Catalog — each an unbeatable value. Five great sections feature newest metal tube and glass tube receivers—battery, 32 volt and auto radios; latest Short Wave and Amateur Receiving and Transmitting gear; dozens of new kits to warm every Set-Builder's heart; an amazing new array of the most advanced Public Address Systems, amplifiers, microphones, recording equipment, etc. Also thousands of exact duplicate and replacement radio parts, radio tools and latest test equipment. Everything you need in radio is in this FREE Catalog at the lowest wholesale prices. Send for your copy now.



ALLIED SELLS FOR LESS!

When you order from your new 1936 ALLIED Catalog you will be getting bigger value than ever before. That's saying a lot—when you consider that we've had a great reputation for selling the best radio equipment for less money since the early days of radio. We say that you can't buy identical brand and quality anywhere for less—if you can—we'll refund the difference in a jiffy. Send for the new 1936 ALLIED Catalog right now. Page by page, it will prove to you that we sell for less.

ALLIED RADIO CORPORATION

833 W. Jackson Blvd.
Chicago, Illinois.
Dept. K.

Send me your FREE
1936 Radio Catalog.



Allied Radio

C O R P O R A T I O N
833 W. JACKSON BLVD.
CHICAGO, ILLINOIS

Name.....
Address.....
City..... State.....

IM A LEE OVERALL, I DON'T GO ALL LIMP AND FLIMSY AFTER A WASHING OR TWO!

AW-LAY OFF! YOU'VE GOT EXTRA YARN... ALL I HAD WAS CHEAP FILLER AND STARCH... IM JUST AN ORDINARY OVERALL!

IM THE 1716 EXTRA FEET OF YARN IN EVERY PAIR OF LEE OVERALLS-AND BOY... AM I STRONG!

Amazing LEE JELT DENIM HAS MORE YARN PER SQUARE INCH...

DEFIES RIPS... HARD WEAR... COUNTLESS WASHINGS!

CHEAP starch and filler in an overall give the appearance of quality... but they soak right out in the wash-tub. But a LEE Overall gets its good looks... and its long wear... from 1716 EXTRA FEET OF YARN! Lee gives you over 50 convenience-features, too. Insist on Lee next time. It ALWAYS gives you MORE than your money's worth.

Guarantee
If Lee Overalls don't prove the longest wearing you ever had, you get a new pair free or money back!

FREE Write us today for your free sample of Jelt Denim, and name of your nearest Lee Dealer.

THE H. D. LEE MERC. CO., Dept. R-172
Kansas City, Mo. San Francisco, Cal.
Minneapolis, Minn. Salina, Kans.
South Bend, Ind. Trenton, N. J.

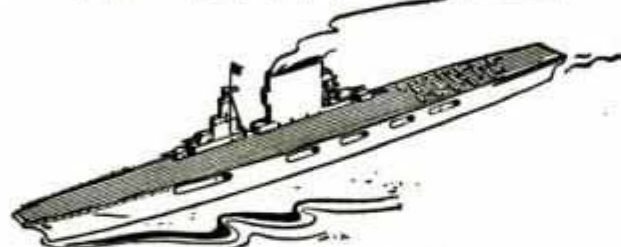
UNION-MADE
Lee OVERALLS
UNION-ALLS... SHIRTS
PANTS... PLAY-SUITS

COPY-STAMP THE STAMP OF A THOUSAND USES

Prints postcards, letters, menus, school-work, notices, drawings, tags, etc. Used by thousands of business concerns, schools, clubs, churches, and others. Quick, clean, automatic, instantly changeable. Ask your stationer or write us direct.

THE STENCIL-STAMP CO., INC.
53 Park Row New York, N. Y.

FREE



Plans of Aircraft Carrier "SARATOGA"

Mother ship to the "eyes of the Navy." Make a model for yourself with the aid of these easy-to-follow plans. Use Du Pont Duco Cement, then it will last. This strong, transparent cement is waterproof. Holds everything except rubber. Send green carton or red disc from 25c tube for free "Saratoga" plans. DU PONT, Dept. B-5, Wilmington, Delaware.

TRANSPARENT • WATERPROOF

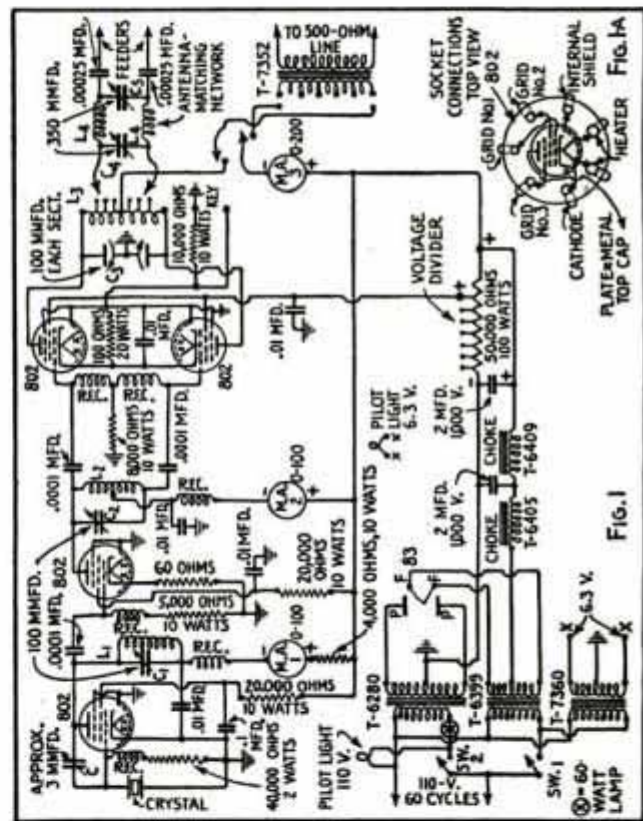
DU PONT Household DUCO CEMENT

SIMPLE TRANSMITTER

(Continued from page 745)

3 in. high; all other parts are mounted under this base. Tuning instructions and a complete material list with manufacturers names and type numbers of all parts, can be obtained upon application without charge. The metal front panel is 1/8 by 10 by 21 in.; flexible couplings are used to insulate the shafts of condensers C₁ and C₂.

The following coil specifications should be closely followed in order to cover two bands with each set of coils: L₁ and L₂ are wound on bakelite or fiber tubing, 2 1/4 in. outside diameter; with one exception, L₂ for 40-20 meters is 2 1/2 in. outside diameter; L₃ coils are wound on I.C.A. threaded insulex forms 2 1/4 in. outside diameter.



For the 80-40 coils—L₁ has 21 turns of No. 18 enameled wire, close wound; L₂, 22 turns of No. 12 enameled wire, close wound and tapped at 11 turns; L₃, 26 turns of No. 12 tinned-copper wire, tapped at center.

For the 40-20 coils—L₁ has 8 turns of No. 18 enameled wire, close wound; L₂, 8 turns of No. 12 tinned-copper wire, spaced the diameter of the wire and center tapped; L₃, 8 turns of No. 12 tinned-copper wire, center tapped. A large blueprint, showing the circuit diagram, layout sketches and further data, is available if desired. Specify blueprint R-216.

Cheaper HEAT Without COAL



EARN \$60 A WEEK!
Write for FREE Burner offer and protected territory

Men and women wanted to demonstrate and take orders for this wonderful invention. This year's sales are tremendous. Make big money. Experience unnecessary.

New Invention Fits Any Stove or Furnace

Remarkable invention burns 96% air, 4% of a cheap variety of oil obtainable everywhere. Does away with coal, wood, ashes, dirt and drudgery. Quick, clean, silent heat. 3 times hotter than coal, and cheaper. Temperature control gives any amount of heat desired—no more getting up on bitter cold, wintry mornings. Many automatic features. No gas or electricity needed. Safe as ordinary kitchen range. Easy to install—no damage to stove—simply sits in firebox of any stove range, or furnace. Costs just a few cents a day to operate.

TRY 30 DAYS AT OUR RISK

Low introductory price and 30 day trial. Write for free catalog. AGENTS and spare time workers: Oil heat saves money this year; people buy to save! Write immediately for free burner offer that starts you in business for yourself. Act NOW!

BRIGHAM OIL BURNER CO.

2927-M Clark Ave.

St. Louis, Mo.

Strange MECHANICAL EYE



LOCAL MANAGER WANTED

Detects fire in its early stages. Sounds a loud, piercing alarm that saves human lives and property. Easy to install. No batteries or wires needed. Every public building, hospital, factory, store, hotel, school, college, home, country estate, stock farm a live prospect. Makes dramatic 30-second demonstration. 12 to 48 units possible for full equipment large buildings. 2 to 4 units for homes. An opportunity for large earnings for ambitious men who get in on the ground floor. Write for free details explaining how to get up in the higher earning class.

FIRE-CRY COMPANY, Dept. 36-B
1300 E. First Street DAYTON, OHIO

DEAFNESS IS MISERY



Many people with defective hearing and Head Noises enjoy Conversation, Movies, Church and Radio, because they use Leonard Invisible Ear Drums which resemble Tiny Megaphones fitting in the Ear entirely out of sight. No wires, batteries or head piece. They are inexpensive. Write for booklet and sworn statement of the inventor who wash himself deaf.



A. O. LEONARD, Inc., Suite 699, 70 5th Ave., New York

425-POWER \$18.50

Produced by Lens Specialists



Highest magnification you can buy at anywhere near this price. Fine optical quality, too—made by same experts who produce our world-famous movie and portrait lenses. Magnifications, 100 diameters to 425. Corrected for photomicrography. At dealers, \$18.50. Or direct (check with order or C. O. D.) postpaid, under money-back guarantee.

Other Models: 110 to 235-power, \$15.50; 70 to 150-power, \$12.50; 100-power, \$5.00; Home Slide-making Set, \$3.50.

Write for Free Catalogue

Wollensak Optical Co., 897 Hudson Avenue, Rochester, N. Y.

Wollensak TELESCOPES
MICROSCOPES
BINOCULARS

When writing please mention Popular Mechanics

Radio's Latest Developments ... WHOLESALE RADIO'S New 1936 CATALOG!



196 Pages Crammed With Bargains at Lowest Wholesale Prices

Just off the Press! Over 50,000 items! Every latest radio development, every last minute improvement. Newest sets from 2-24 tubes, parts, tubes, kits, tools and accessories; Short Wave and X'mitting Equipment; Nationally known lines. Quality approved parts for all Radio construction kits. Buy from the World's Largest Stock at Lowest WHOLESALE Prices and save Money. Send coupon for your FREE copy of Radio's latest, greatest Bargain Book.

RUSH THIS COUPON
FREE!

Parts supplied for any Kit described in this magazine.

Wholesale Radio Service Company,
100 Sixth Ave., Dept. PM-115, New York, N. Y.

Please rush FREE copy of your new 196 Page Catalog for 1936, listing over 50,000 items.

Name.....

Address.....

City..... State.....

TYPewriter 1/2 Price

Now Only
10¢ a Day

AFTER
10 Day
FREE Trial

No Money Down



Positively the greatest bargain ever offered. A genuine full sized \$100.00 office model Underwood No. 5 for only \$39.90 (cash) or on easy terms. Has up-to-date improvements including standard 4-row keyboard, backspacer, automatic ribbon reverse, shiftlock key, 2-color ribbon, etc. The perfect all purpose typewriter. Completely rebuilt and FULLY GUARANTEED.

Learn Touch Typewriting

Complete (Home Study) Course of the Famous Van Sant Speed Typewriting System—fully illustrated, easily learned, given during this offer.

Lowest Terms—10 Cents a Day Money-Back Guarantee

Send coupon for 10 day Trial—if you decide to keep it pay only \$3.00 a month until \$44.90 (term price) is paid. Limited offer—act at once.

INTERNATIONAL TYPEWRITER EXCHANGE
231 West Monroe St., Chicago, Ill., Dept. 1101

Send Underwood No. 5 (F. O. B. Chicago) at once for 10-days trial. If I am not perfectly satisfied I can return it express collect. If I keep it I will pay \$3.00 a month until I have paid \$44.90 (term price) in full.

Name..... Age.....

Address.....

Town..... State.....

Skippers of the Sky Lines

(Continued from page 725)

controls to "hot," and sets the carburetor altitude controls to "rich." Then the pilot closes the master ignition switch and the dual ignition switches of the left and right engines. He starts the left engine first because it carries the generator, after he has opened and closed the throttle several times to shoot raw fuel into the supercharger.

The pilot has time for additional check-ups while the engines are warming up. He looks the compass over, makes deviation corrections, inspects the vacuum pumps connected to the automatic pilot, sets the directional gyro compass of the pilot to correspond with the reading of the magnetic compass, and synchronizes the airplane flying controls with the automatic pilot controls. After testing the controllable pitch propellers in both the "high" and "low" positions he returns the control to the low position for the takeoff. He inspects the altimeter and the other dials he would use for instrument flying if the gyro device should fail to work. Then Morehouse is ready to test his radio equipment. Reaching overhead, he snaps on the two-way company set and asks the ground operator over it for the right time. Then he tries out the airways radio beacon receivers and listens for the characteristic signals from the nearest department of commerce station.

The loading of passengers and cargo finished, the pilot pulls to the end of the runway and gets the signal from the dispatch tower. He leaves the ground at a speed of sixty miles per hour. With the modern superchargers, the throttles must be opened evenly to prevent building up excessive manifold pressures and the plane climbs slowly and steadily until it is making 100 miles per hour. On the climb the pilot orders "up gear" and the co-pilot pumps the handle that raises the landing gear into the nacelles.

"In rough weather I climb to cruising altitude with the propellers set in low pitch in order to rise rapidly, but if the air is smooth I switch to high pitch and climb at about 145 miles per hour," Morehouse says. "Depending on the winds, I cruise at some altitude between 6,000 and 12,000 feet, after switching the fuel supply

from the auxiliary tanks to the main tanks that contain cruising fuel. Then, after a final checking over, I turn the plane over to the automatic pilot by pulling a lever near my right knee. The mechanical pilot is a better flyer than a human one since it never tires of correcting for every change and flies a smooth, sure course.

"With the duty of flying the plane off my hands I can settle down to real work. Of course, the co-pilot or I always keep a lookout and supervise the work of the automatic pilot. One of us wears earphones most of the time to receive the airway radio beacon signals and every thirty minutes we are called by the nearest ground station, to which we report our progress and weather conditions. The ground station informs me of any other plane that is flying the beam so I can call the pilot of the other ship and we can arrange to fly at different levels to avoid a collision.

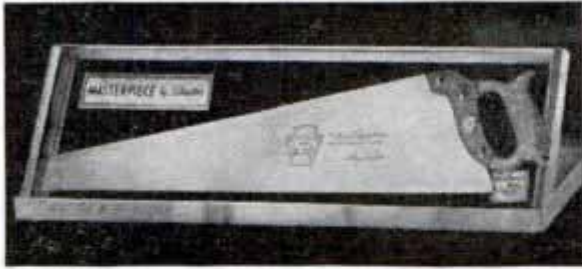
"At least ten minutes of every hour in the air is spent calculating the performance of the plane and jotting down instrument readings and engineering data. With the instruments in my brief case I figure out wind triangulations, drifts, true headings, corrections for the altimeter, and other problems like speed and fuel consumption. From these results I may change the speed of the engines or give new orders to the automatic pilot. The idea is to arrive at our destination within a few seconds or minutes of the scheduled time without regard to winds en route.

"In the meantime the co-pilot and I are continually checking the flight and engine instruments. Most of the instruments have revolving faces so we can twist the dials to make a whole row of needles all point in the same direction. Then, with one glance, I can tell if everything is in order instead of studying each dial separately. If the fuel gets low in the tank we are using, red lights flash to warn us in plenty of time to switch to another tank. At odd moments I consult maps and charts, refer to power graphs, and help the co-pilot write a complete log of the trip."

One hundred miles from its destination the plane begins the long glide that brings

(Continued to page 146A)

Preview for tool lovers



MASTERPIECE

by *Disston* PRICE, \$6

**D-95 FINEST HAND SAW
DISSTON EVER MADE**

MASTERPIECE of Beauty, of Steel and Workmanship, of Efficiency. Streamlined. Richly Colored Handles—wrought in a new way, from newly-discovered material. Everlasting, with the colors molded in! Individually packed in hammered silver paper-covered box.

**NOW ON DISPLAY
BY YOUR LEADING TOOL DEALERS**

Henry Disston & Sons, Inc., 1111 Tacony, Philadelphia, U. S. A.

COMPLETE ELECTRIC PLANTS



ONAN A.C. PLANTS furnish the same current as city service. Operate Radio, Water System, Refrigerator, all Appliances.

SIZES 350 WATTS UP

Have A.C. Current anywhere. Models \$110 and up. Easy to install. Available from stock. Ideal for farms, camps, lake homes, commercial purposes—anywhere electricity is needed.

D. W. ONAN & SONS
955 Royalston Ave., Minneapolis, Minn.

CENTURY SALESMEN ARE HAPPY!



Fast
Xmas
Seller

Because they are making money easily selling our
GENUINE LEATHER TIES

Beautiful new stripes and plaids. Look like silk. Cleaned with a damp cloth. Durable, won't wrinkle. Big profits, repeat orders. Be independent: have your own business. No sales ability needed. Send 50c or stamps for sample and kit. Information free.

CENTURY TIE CO., Dept. A, 2345 W. Grand Blvd., Detroit, Mich.

BUILD DUTCH WINDMILLS



Lawn Figures, Lighthouses, Birdhouses, etc., from our detailed BLUEPRINTS. Pleasant winter pastime. BIG PROFIT SELLING OTHERS. For gifts and gardens. B-10 Hexagon WINDMILL 32 in. high, wings turn in slightest breeze. BLUEPRINT 75c. COLONIAL DOLLHOUSE 18x24x12—6 rooms, 2 floors—BLUEPRINT 50c. KIT \$3.75. Send 10c for CATALOG of over 25 models. CRAFTSMAN'S MODEL CO., Dept. P-23, 2030 N. 41st St., MILWAUKEE, WIS.

OTTAWA LOG SAW



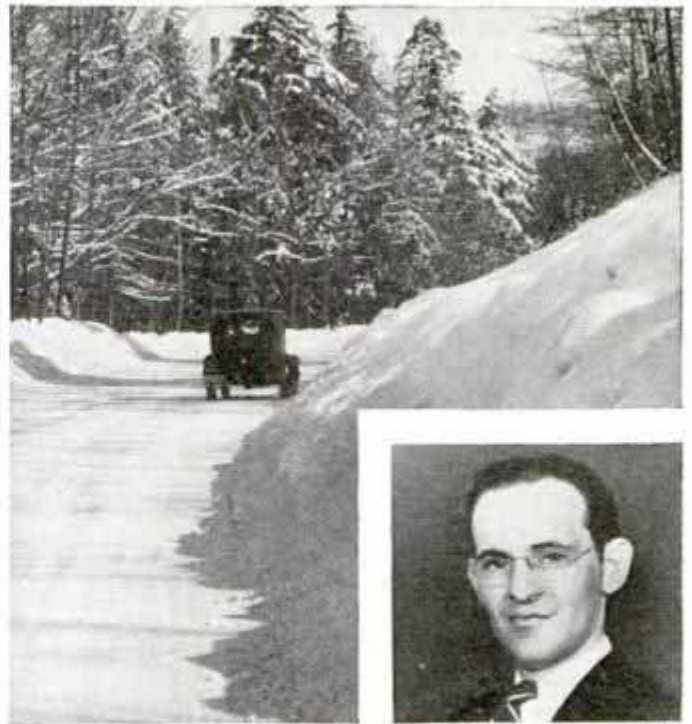
GREATEST OFFER
EVER MADE

only \$39

PUTS THIS
OTTAWA
TO WORK FOR YOU

Make Money! Wood is valuable. Saw 15 to 20 cords a day. Does more than 10 men. Ottawa easily operated by man or boy. Falls trees—saws limbs. Use 4-hp. engine for other work. 30 DAYS' TRIAL. Write today for FREE book.

OTTAWA MFG. CO., 1741-X Wood St., Ottawa, Kansas



Snapshot of William H. Cadogan of Scranton, Pa.

I LIKE WINTER DRIVING

Gentlemen:

It's a shame so many people miss out on the pleasure of Winter driving. They should learn, as I did, to change to Quaker State Winter Oil and Greases before the first freezing—then they'd never have to worry.

I learned my lesson early last Winter when I bought a two-gallon can of motor oil, and thought I had a big bargain. I used this oil for two weeks and then checked it. To my surprise it seemed like so much water!

Believe me, I hot-footed it for the nearest Quaker State dealer, and had the crankcase filled with your Winter oil. Now, during the cold weather, the motor starts as easily and runs as smoothly as it does in June.

Very truly yours,

Wm. H. Cadogan

"First choice of Experience"

**QUAKER STATE
WINTER OILS**

Retail Price . . . 35c per quart

Quaker State Oil Refining Co., Oil City, Pa.

When writing please mention Popular Mechanics

8999

SKIPPERS OF THE SKY LINES

(Continued from page 144A)

it down to the field at 200 miles per hour. Engines are switched to the high octane fuel so full power may be available in case of emergency. The pilot disengages the automatic pilot and takes over the controls himself. Then he calls the ground station on the radio to learn local weather conditions and the barometric reading, which he uses to readjust the altimeter. During the last few miles he calls the field control by telephone again for permission to land. As the plane nears the field the co-pilot releases the landing gear valve that drops the wheels and locks them in position. Finally the pilot throttles the plane down to 110 miles per hour and throws the propellers in low pitch, which further reduces the speed. Bringing the plane down to a safe speed is a job that must be timed nicely and that calls for instant response from the co-pilot to every command. At seventy miles per hour, on the order "down flaps," the co-pilot lowers the wing flaps that act as air brakes. This slows the plane to a usual speed of fifty-eight miles per hour just before the wheels touch the ground.

8990

NO GASOLINE SHORTAGE LIKELY FOR YEARS TO COME

There is no danger of a shortage of automobile fuel, at least for years to come. Recent predictions that the United States soon will face a petroleum famine are groundless, say government economists. With a normal consumption of 1,000,000,000 barrels a year, the nation's known oil reserves of 13,250,000,000 barrels would last thirteen years if no additional fields were discovered. But new fields are adding approximately 600,000,000 barrels a year to the supply. While this is not enough to supply our demands without tapping the reserves, it is sufficient to postpone for years the day of exhaustion. Looking toward the time when synthetic fuels will be used, processes for producing gasoline by hydrogenation of coal have been successfully developed in Germany and are being tried in the United States. Shale oil is also regarded as a possible substitute for petroleum, but thus far no processes have been developed for producing it in quantities at low cost.

Science Service
8/10/35



Get this Valuable Home Workshop GLUE HANDBOOK

● Written in simple language, this new Handbook, in your Homeshop will save you hours of work in doing the gluing, by doing it right the first time. It has been especially prepared and written for you by nationally known gluing authorities—the producers of the famous Keystone Pure Hide Glue—the kind of Pure Hide Glue Professional Craftsmen have used for 50 years!
● Fill out the Coupon below and send 10c in stamps today, and get this valuable Workshop Manual. You'll be glad you did!

COUPON

KEYSTONE GLUE CO.
WILLIAMSPORT, PENNA.

Please send Homeshop GLUE HANDBOOK.
10c stamp enclosed.

Name.....

St. and No.....

City.....

Name of my Hardware Dealer.....

His Address.....

PM1

The TAYLOR "CUB" - America's SAFE Plane



ANYONE Can afford to FLY a "CUB"

The CUB
\$490
CASH

Balance in Easy Monthly Payments

TAYLOR airplanes have been flying since 1925. Today the CUB is the biggest airplane value in the world, out-selling ALL others . . . because Cubs are safe, economical, sturdy and stable . . . flying in every state and in most countries of the world.

The CUB is easy to fly, easy to buy, costing less to run than a small car. Someone owns a CUB near you.

●●● Send for a Folder. It's FREE ●●●

TAYLOR AIRCRAFT CO., BRADFORD, PENNA.

The TAYLOR "CUB" IS SAFE

MACHINISTS, TOOLMAKERS
Better Care for Tools makes your work easier. Write for Free Catalog.
GERSTNER TOOL CHESTS
447 Columbia St., Dayton, Ohio

ITCHING Torture STOPPED IN ONE MINUTE

For quick relief from the itching of pimples, blotches, eczema, rashes and other skin eruptions, apply Dr. Dennis' cooling, antiseptic, liquid D. D. D. PRESCRIPTION. Its gentle oils soothe the irritated and inflamed skin. Clear, greaseless and stainless—dries fast. Stops the most intense itching instantly. A 35c trial bottle, at drug stores, proves it—or money back. Ask for—

D.D.D. Prescription

FREE!

Beautiful New 40-Page
Rotogravure Radio Catalog



P. A. Equipment, Short Wave Radios, Transmitters, Latest type instruments and a complete line of parts and accessories for Amateurs, Experimenters, Service Men.
Terms as low as \$4 a month.

SEND POSTCARD for this fully illustrated money-saving catalog today!

MONTGOMERY WARD
Dept. DR, Chicago

Metal Castings Inventors and Craftsmen

Make your own castings of aluminum, copper, bronze, silver, brass. Outfit contains gas furnace with 110 volt, 60 cycle motor blower, moulding sand, crucibles, tongs, rubber hose, flask, parting materials and instructions for use. For making models, trays, dishes, art objects, tools, shop equipment, etc. also used for forging, case hardening and heat treating. Price of outfit No. 351, capacity 6 cubic inches, \$9.50. Weight 25 lbs. Price of outfit No. 352, capacity 12 cubic inches, \$13.00. Weight 40 lbs. Prices f. o. b. E. C. plus 1% state sales tax. Check or money order acceptable, express charges C.O.D. Write for Free Circular. See page 44 July issue.

KANSAS CITY SPECIALTIES CO.

P. O. Box 6022

Kansas City, Mo.

new Invention SAVES GAS!

CUTS GASOLINE COSTS up to 30%

Creates New Mileage Records It's Here! **VACU-MATIC**—"The Carburetor That Breathes!" **AUTOMATIC CONTROL** guarantees constant peak performance. More power, smoother running, quicker starting. Fits all cars; installed in a few minutes. Don't wait! Just send name and address for details about **VACU-MATIC** and our **FREE TRIAL OFFER**. Write Today! **AGENTS WANTED**

VACU-MATIC CO., 7617-126 W. State St., Wauwatosa, Wis.

BUILD YOUR OWN

Streamlined Trailer at little cost. Send dollar for plans, blueprints, details, pictures of the Standard and the DeLuxe Model as shown. Mail a dollar to **D. VAN OOSTVELDT, 111 MARSTON, DETROIT, MICHIGAN.**



BUTTER YOUR SOLES WITH NEW SO-LO PLASTIC RUBBER!

Dries tough over-night! Out-wears leather! Waterproof! Flexible! Non-skid! Guaranteed! Fix auto tins, cuts in tires, etc. Take this ad to any Hardware or 10c Store. **ASK FOR SO-LO PLASTIC RUBBER.**



GROW SNOW WHITE MUSHROOMS

QUEEN OF THE MARKET. Quick, heavy crops. **BIG MONEY MAKERS.** In demand everywhere. Start now. Grow the best. We supply choice Spawns (from World's largest Spawn plant) at \$1.95 a carton postpaid, duty FREE to Canada or U. S. A. **SPECIAL INTRODUCTORY OFFER**—one carton FREE with each two orders. Each plants about 50 sq. ft. **DON'T BE DECEIVED.** No finer Mushroom grown, no better Spawns sold, **WHY PAY MORE?** Instructions and Marketing Guide telling how and where to sell Mushrooms sent FREE with first order. **ORDER NOW AND SAVE MONEY.** **IDEAL MUSHROOM Co., Dept. P-32, ISLINGTON, ONTARIO, Canada**

HANDEE TOOL OF 1001 USES!

Quicker, Better

Jobs . . . Does away with slow hand work. Grinds, routs, drills, carves, saws, sharpens, cuts, polishes, engraves . . . over 100 wheel shapes available. For use at home, in shop or take to job. Weight 1 lb., 13,000 r.p.m. 110 volts, AC or DC. **\$10.75 and up.** (3 Wheel Shapes Free.)



Plug in any light socket

NEW DeLuxe MODEL!

Revolutionary Performance

For constant service . . . nothing else like this easy-to-handle production tool for saving time and labor. Fastest, smoothest, most powerful tool for its type and weight (12 oz.) 6" long, 1 3/8" diameter. 25,000 r.p.m. **\$18.50.** (6 Wheel Shapes Free.)



SEND FOR **Free BOOKLET**

FIVE DAYS' TRIAL
Order either Model today, postpaid in U. S. A. Satisfaction guaranteed.

Chicago Wheel & Mfg. Co.
108 S. Aberdeen St., Chicago, Ill.

BIG PROFITS IN WATER SOFTENING EQUIPMENT

A Sales Proposition That Builds You a Business

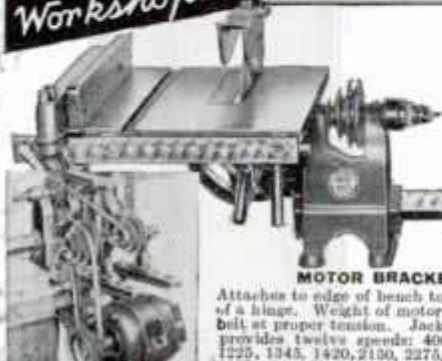
Ask us to prove to you what many other salesmen have done; for instance, Bowers of Texas: "—ran a few dollars capital up to an average monthly profit of \$300.00 and now has his own store!" The past four years have proven the public demand for soft water. Water softening Equipment is the next big seller in household appliances. Webb offers a complete line from the portable household models at \$12.00 to \$35.00 (illustrated) up to the largest permanent type installation for homes, laundries, factories, hotels, etc. You can sell them all under our sales plan—with only a few dollars investment. Write for full details and our **no-risk trial offer.**



WEBB MFG. CO., Dept. 116, 1813 Baltimore, KANSAS CITY, MO.

A New Idea In Workshops!

The DRIVER ADD-A-TOOL



- OPERATIONS**
- Wood turning
 - Mortising
 - Shaping
 - Sawing
 - Dadoing
 - Grooving
 - Sanding
 - Metal turning
 - Drilling
 - Routing

A thoroughly practical workshop . . . performs a multitude of different operations . . . requires only a small amount of space . . . owning it involves no heavy investment. Once the basic Add-A-Tool comprising lathe, bench saw and motor has been acquired, accessories may be added as the need arises. Write for descriptive folder.

PRICE \$39.95
INCLUDING 1/3 H.P. GOLD SEAL MOTOR & 12 SPEED MOTOR BRACKET

MOTOR BRACKET

Attaches to edge of bench top by means of a hinge. Weight of motor keeps belt at proper tension. Jackshaft set up provides twelve speeds: 400, 734, 765, 1225, 1345, 1420, 2100, 2275, 2440, 3000, 4000—7400 R. P. M.

SPECIFICATIONS — LATHE: Distance between centers 20". Swing 7 1/2". Compound tool rest for metal turning, and all other accessories available extra cost. **BENCH SAW:** Table 14"x12". Removable throat for dadoing. Wood-faced ripping fence. Table tilts 45°. Uses 7" blades, cuts full 2".

WALKER-TURNER CO., INC.
1115 Berckman St., Plainfield, N. J.

Please send me your folder on 1936 Driver Tools.

Name.....
Address.....
City..... State.....

WALKER-TURNER CO. INC. PLAINFIELD, NEW JERSEY

YOUR NAME in Gold FREE



The PASMMASTER

Pass Case, Card Case, Bill Fold, Check Cover

NEW STYLE extra thin model. Just what every man needs. Made of high-grade black, genuine calfskin, specially tanned. Tough, durable. Has beautiful soft texture, shows real quality. Silk stitched, 14-karat gold corners. Size 3 1/4 x 6 closed. You simply can't wear out this quality product. 22-karat gold name, address, lodge emblem free. This engraving ordinarily costs \$1.50 extra.

Direct-To-You ONLY \$3.95

Enclose \$3.95 Money Order or Check. Sent C. O. D. if you prefer. State lodge emblem wanted. All articles fully guaranteed. Your money cheerfully refunded if not thoroughly satisfied, **two weeks' trial.**

Ideal Gifts

Write for **FREE** card catalog of novel, useful gifts. Merchants, manufacturers, insurance men, tailors—with preferred customers—profit by our quantity discounts on personalized gift good-willbuilders.

LANDON & WARNER 360 N. MICHIGAN AVE. Dept. H-77, Chicago, Ill.

NO MORE BLADES TO BUY

AMAZING RAZOR

"Shakes Sharp"



Keeps One Blade Continually Sharp for Perfect Shaves!

AGENTS: Big Income Introducing this new shaving sensation in your territory. Write for agency offer.

Totally different! Complete Razor and Self-Sharpener in one Scientific instrument. No larger nor heavier than ordinary razor. Simple mechanism renews and resharpen blade edge to super-keenness. Keeps single blade in continuous use for unlimited number of clean, quick, low-cost shaves. Thousands testify up to six years use of **ONE BLADE. GUARANTEED.**

Get Trial Offer Write for opportunity to prove it yourself at manufacturer's risk. Just send name and address for 30-day shaving test offer, full details, and proof of success. No obligation. **DeHAVEN RAZOR CO.** 821 Woodland Ave. Swanton, Ohio

HOME AUTOMATIC CIGARETTE MACHINE

Have **YOUR OWN** Monogrammed Cigarettes. Put tobacco and block of papers on machine, **TURN THE CRANK—PRESTO—CIGARETTES.** Easy—simple. All metal construction. Guaranteed. No cloth ribbons; no special tube or gummy papers required. **ASK FOR FREE ILLUSTRATED FOLDER.** AUTOMATIC CIGARETTE MACHINE WORKS, PM-11, 1035-57 Devon Ave., Chicago, Ill.



Complete Movie Outfit

CAMERA is self-focusing—uses 50 ft. roll standard 16 mm. film developed **FREE.** Heavy metal richly finished in Damaskene Enamel. Carrying strap and film indicator. Taking real movies is simplicity itself. Locate the subject and turn the crank.

Amazing Offer \$11.50 POSTPAID

PROJECTOR—100 ft. capacity, motor driven for A. C. current. Projects big clear pictures 30x26 inches at only 10 ft. Uses any 16 mm. film.

We also have a complete list of film subjects for any projector. Write now for **BIG, FREE** Catalogue of Movie Supplies.

PARAMOUNT MFG. COMPANY Dept. G-77 Boston, Mass.



Motor Driven

FANCY BILLIARD SHOTS

(Continued from page 698)

From the diagram illustrating this shot, you will note the balls are lined up with cushioned corners of the pockets but as soon as they are hit, follow the lines straight into the pockets. Striking the cue ball from the point indicated, it should be hit firmly with considerable speed to make the six balls disappear from the table.

Many experts favor the "elevated shot" for a little comedy relief in an exhibition. With the help of three cues placed on the table, three object balls are pocketed in a novel manner. There is nothing complicated about this shot. It is merely a combination billiard and pocket shot.

The cues and balls are placed as shown in the diagram and illustration. The cue ball is hit with extreme English on the left side above center, taking aim on the first object ball at one-fourth to the right. If properly hit, the first two object balls will follow the dotted lines into the pockets and the cue ball, after hitting three cushions, will go between the two cues, returning by way of the rail formed by the two cues and concluding the shot by pocketing the third object ball in the side.

The bag shot constitutes a snappy wind-up for a fancy-shot routine. The diagram indicates the position of the object balls and the paper bag, the latter being approximately ten inches from them. Placing the cue ball on the spot, the player shoots for Diamond No. 1 on the side rail at the foot of the table. The cue is held level and the ball is hit with a little English on the left side. It will go around the table, hitting five cushions, proceed into the bag, turn it over and then emerge to contact the two object balls.

MOVIE LENS FOCUSES LIKE EYE

Adjusting its focus like the human eye, a movie camera lens which registers close-up images without distortion has been produced. Its use eliminates much of the necessity for figuring distance in taking pictures. This "eye lens" is said to produce pictures with a rounded instead of flat quality and to have unusual speed and definition. Since it will separate color because it separates objects being photographed, it may find wide application in color photography.

8954
Protein & return Herald. 8/19/35
8979
cannot locate. 10/16/35
Demonstrated by Jack Susman

WINGS OVER THE BRITISH EMPIRE

(Continued from page 677) *6802*

ment is helping to finance these "clippers of the clouds" with a great air-mail program designed to bring all the far-flung dominions of the empire within easy range. According to present plans, there will be no surcharges for the carriage of air-mail letters. They will go for the same price as slower ship mails.

Flying across mountains, oceans and cities by night as well as by day, these giants will provide passengers with all the comforts found on de luxe express trains. Bangkok, Siam, will be the Far Eastern station; thence they will connect with the Pan American terminus in China. From China to New York, the traveler will have Pan American Airways at his service.

Experts of Imperial Airways have already gotten down to the matter of passenger fares, and off-hand, they calculate that a round-the-world ticket from England, via Egypt, India, Siam, China, the Pacific Ocean, San Francisco, New York, Bermuda and back to Croyden will cost less than \$2,500.

The system of controlling Imperial air liners differs quite radically from the system commonly used in America. Radio equipment is standard on all ships. The captain of a ship determines his drift in a strong wind by communicating with a ground station. He will say: "Hello, Croyden—Imperial XC calling. Position please. Hello, Croyden—Imperial XC calling, position please." (XC is the international registration mark of the air liner). The captain's request is received simultaneously by three ground stations near London. These stations are Croyden, Lympne, and Norfolk. Croyden, being the main control station, replies: "Hello, Imperial XC, switch on."

In response, the captain lets his radio transmitter "buzz" for half a minute or so to allow the three ground stations to "listen in." Since the three land stations form a triangle, it is easy for them to send straight-line signals to the operator at Croyden who computes the ship's position very quickly by moving strings across the surface of a large map. The exact position of the air liner is at the point where the three stretched strings intersect. The information is radioed to the captain in less time than it takes you to read this.



THE "VEST-BACK"

A popular and practical SIGNAL feature which gives complete protection.

To get the most for your money, look for the SIGNAL label . . . famous for comfort, long wear and superlative quality for 50 years.

**See Signals at
Your Dealer's**

If he doesn't have them, ask him to get them for you.

JOHN RISSMAN & SON .

Makers of the Famous SIGNAL Work Shirts
841 Blue Island Avenue CHICAGO, ILLINOIS

LAST CALL for CASCO Project Book

FREE!

Today more than 100,000 home workshop fans own this interesting book. It pictures and describes 28 projects awarded cash prizes in Casco's nation-wide home workshop contest. Send for your free copy today, before it's too late!

A collection of pictures and descriptions of these outstanding woodworking projects . . . inlaid card and game table, model hollow hull sailboat, unique tilt table made from cigar box wood, modern beverage set, beautifully patterned wood turned vases, lamps, smoking sets, cigarette boxes—and many others, ranging from delicate wood jewelry to portable camp refrigerators.

THE OBJECT OF THIS BOOK is to guide the home-crafter in the utilization of inexpensive pieces of wood and veneer, to build, with the help of Casco Glue, beautiful and durable articles of permanent value.

This fine book costs you nothing. Send for your FREE copy now. When the last copy is mailed, no more will be printed.

Save 2c—Paste coupon on penny post card

THE CASEIN MFG. CO. OF AMERICA, INC.
350 Madison Ave., Dept. 1135-B, N. Y. City

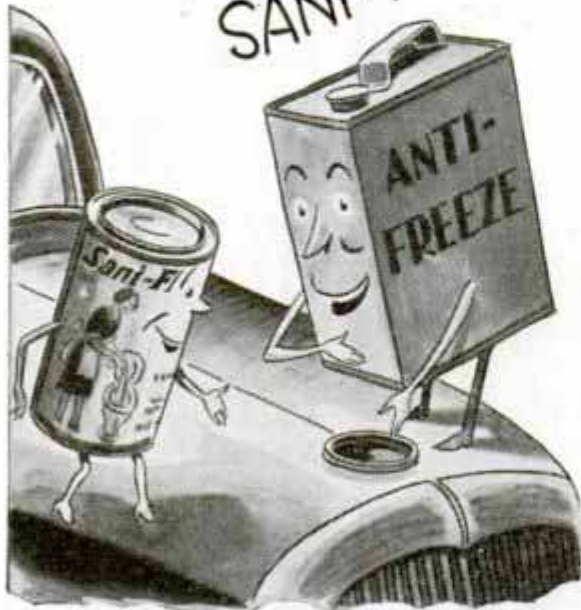
Please send Free CASCO Project Book.

Name

Address



"AFTER YOU,
MY DEAR
SANI-FLUSH!"



Use of any anti-freeze should follow a thorough cleansing of the radiator. Get rid of accumulated rust and sediment that clog up the delicate tubes. Flush out the lime deposits that interfere with the efficiency of the cooling system.

You can do it yourself, in a few minutes, for ten cents. Just pour Sani-Flush in the radiator. (Directions are on the can.) Run the motor. Drain, flush and refill with your anti-freeze solution. That's all there is to it. And you can have an easy mind all winter. Sani-Flush is thorough. It is perfectly safe. Cannot harm aluminum cylinder-head, block or fittings. Sold by grocery, drug, and hardware stores—10 and 25 cent sizes. The Hygienic Products Co., Canton, Ohio.

Sani-Flush KEEPS
RADIATORS CLEAN—NON-CAUSTIC

Trailers, Plans and Parts

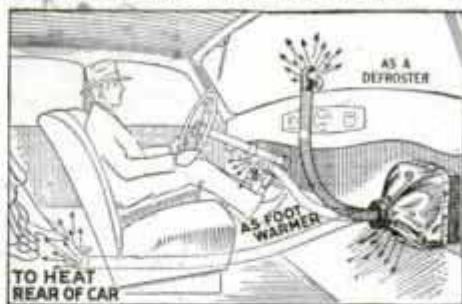
Utility Trailers, 4' x 6', complete less tires, \$27.50. Utility trailer plans, 50c. Cabin trailer plans, \$1. Trailer parts at bargain prices. Write for free catalog of parts.

SHAMROCK TRAILERS, 11761 Grand River, Detroit, Mich.



29 In. Overall

KLEERVIEW DEFROSTER—FOOT WARMER



**Snaps Over Hot
Water Heater in
10 Seconds!**

Clears windshield, inside and out, in severest weather, without cracking glass. Makes winter-driving safe. No Battery Current to operate. Special hood attaches to any hot water heater instantly. Flexible hose reaches to windshield—or makes perfect Foot-Warmer, reaching to driver's feet or rear-seat floor. Nothing to wear out. Guaranteed. Thousands of users.

Now Only \$2.00 If your local accessories stores cannot supply you—send \$2 direct. Mailed, prepaid, anywhere in the U.S.A. Makes an ideal gift! Get Yours NOW!

DEALERS: See your jobber salesman!

SAFETY EQUIPMENT MFG. CO., 304 Natl. Bldg., OMAHA, NEBR.

SEND FOR FREE BOOK

EASY with a
BUESCHER



CHARLES STRICKFADEN plays a Buescher Saxophone in Paul Whiteman's orchestra. (10-B-34)

Loads of fun, right from the start, because a sweet-toned Buescher is so easy to learn! You play tunes right away. Surprise your friends. Join a band or orchestra. Fit yourself quickly for one of the many big pay jobs now open.

FREE on trial. Any Buescher instrument will be sent without obligation. Write now for details and handsome Free Book. Mention instrument: saxophone, cornet, trombone, etc.

BUESCHER BAND INSTRUMENT CO.
1110 BUESCHER BUILDING ELKHART, INDIANA



PLANS FOR SHIP MODELS 25c POSTPAID
MODEL REX 29", MODEL NORMANDIE 32½"
Scale 1/32" to the foot.

Full size plan—sheet 34" x 44"—full instructions—7 photos—25 detail views—everything included. Complete only 25c postpaid. Send for catalogue of boats and supplies, 5c.

IDEAL CO., 26 W. 19th, New York City

LOOK! ALL METAL AWL

Just what you are looking for. An all aluminum sewing device that will do the work of a power machine. Sew heavy leather or light material. Complete with spool of thread, 2 needles, one straight and one curved, tracer and instruction sheet post-paid \$1.00. Agents wanted.

Extra 25 yard skeins, 20c; extra needles, 10c each.
CHICAGO AWL CO. 404 E. 79th St. Chicago, Ill.

BUILD IT YOURSELF

JIM DANDY CABIN TRAILER
Classy! Roomy! Easy to build at low cost! Plans and instructions only \$1.00—include all Diagrams, Sketches, Photos, Material List, etc. Big Value! Mail Dollar Bill to Jim Dandy, Box 125-A, Wausau, Wis.



Now! A Power Feed \$11.95
Metal Cutting Lathe

With features of a high priced production tool. Weight 40 lbs.—29 in. overall—23 in. bed—13 in. between centers—6 in. swing—4½ in. face plate—¾ in. hollow headstock spindle (will take ¾ in. rod)—bronze bearings—No. 1 Morse taper centers—Power feed full length of bed—takes all No. 1 Morse taper accessories. Lathe complete with: Power feed slide rest (gibbed for takeup); Face plate; No. 1 Morse taper centers; Three step drive pulley; 4 in. feed pulley; V belt; Tool holder; ¼ in. cutting tool; Power feed—3 in. four jaw (reversible jaws) Chuck with adapter plate \$4.30, 4 in. \$5.50. Send \$3.50 with order. Bal. express C. O. D.

BALCO ELEC. MOTOR & SUPPLY CO., 10 S. Clinton St., CHICAGO, ILL.

A Steady Cash Income FOR YOU!

NO SELLING!

Here is your opportunity to establish a permanent, reputable, and profitable cash business on a full or part time basis. Deal with real business people, no peddling, no selling.

NO EXPERIENCE NECESSARY!

We get you started immediately. As sound, successful and nationally known manufacturers of automatic merchandising devices, we supply everything necessary for your success. We give you a Free Trial starting offer, and even help finance you. Just write "Send Free Offer."

A.M. WALZER CO.
Dept. PM-1, 428 Stinson Blvd
MINNEAPOLIS, MINN.

HIGH POWERED TELESCOPE

GENUINE BROWNSCOPE AT AMAZING PRICES

Most powerful in America for the money!

15 power long range telescope. Can see moon's craters or time on pocket watch a block away. 5 sections. Approx. 3 ft. long. Fine lenses. Brass bound. Can be used as powerful microscope.

Vol. magn. 512X. Only \$1.60 postpaid. C. O. D. 24c extra.

\$1.69



\$1.98

Special Super-Power 30X Telescope.

Similar to above but more powerful. Guaranteed to see 900 times larger in surface and 30 times closer. 31 mm. objective 4 powerful lenses. Large field. Includes powerful microscope features. Only \$1.98 postpaid.

BROWSCOPE CO. Dept. 45, 234 Fifth Ave., New York, N. Y.

Circular Saw \$3

(Outside U. S. A. \$3.25)

4" Combination rip and cross-cut blade. Oil-less bearings. 8"x5 1/2" steel table adjustable so that pieces up to 1" may be cut (pieces up to 2" by turning stock). Base, saw support and table adjusting slide, heavy iron castings. Adjustable ripping fence.

Order now or send 3c stamp for catalog fully describing equally low-priced power tools including Jig Saw, Drill Press, Sander, Lathe, Shaper, etc.



"The Ripmaker"

J. & H. Metal Products Co., 485 St. Paul Street, Rochester, N. Y.

Fastest Sighting Combination Known

MARBLES Flexible Rear Sight and Sheard Gold Bead Front Sight

Look through peep to gold bead and center instantly on target. Coil spring keeps rear sight in true shooting position. Can be locked down. Interchangeable discs.

Price, \$4. Gold front sight that never blurs. Price, \$1.50. Give make, model and rifle cal.

Marble Arms & Mfg. Co., 578 Delta Ave., Gladstone, Mich., U.S.A.



Free Directions for an Interesting Chemical Experiment that Demonstrates how Mordant Dyeing is Done. Write to The Porter Chemical Co., 21 Prospect Avenue, Hagerstown, Maryland.

MAKE MONEY PRINTING

letter and billheads, circulars, cards for friends, spare time. Easy to learn, easy to get jobs. **Printing Presses 512**; new type faces, complete supplies, lowest prices. Send stamp for catalog. **PEIFFER CO., 56-A; 6 Columbia St., Newark, N. J.**



Men & Women Earn Cash at Home!

Grow fancy giant mushrooms in cellar, attic, barn. Easy, odorless method. We show you how, furnish guaranteed materials and buy crops. Valuable big book, pictures free if you write quickly. (Est. 1908.) **UNITED CO., 3848 Lincoln Ave. Dept. 127 CHICAGO**

SAVE MONEY with a THERM Diesel Oil BURNER

In YOUR COOK STOVE, HEATER or FURNACE



Quickly, easily installed. Gives white, hot heat, free from Smoke, Soot, Odor. Safe and simple. . . lowest operating cost with Diesel oil. For Homes, Restaurants, Stores, Garages, Shops and Boats. Send for illustrated folder, prices and all information.

WRITE FOR OUR LIBERAL PROPOSITION TO DEALERS

THE THERM BURNER CO., 2105 Westlake, Seattle, Wn.

We tried to joke about it

BUT WAS JOE REALLY DUMB?



● HIS father and I talked it over after every report card. "Was Joe dumb?" "Can't he try harder?" We tried to joke about it. But inside it hurt.

Then his teacher made a suggestion. "Other children have learned how to concentrate by learning how to type!" And sure enough, it worked with Joe.

He quickly learned to type—and it fascinated him. Then he started to express himself more freely. His English marks were the first to improve. Spelling followed. Now it's helping with his arithmetic! Joe may never lead the class. But at least he is no longer anchored at the foot. His Remington has helped him up. And for that we can never be too grateful!

JUST \$4 DOWN BUYS A NEW Remington

As advertised on "March of Time"



10 DAY FREE TRIAL OFFER

You'd never expect to get a typewriter as fine as the new Remington Portable for only \$4 down. The full cost amounts to only a few cents a day! New latest model key control Remington is extremely rugged and dependable. Has every big machine essential: standard four-row keyboard; standard width carriage; margin release; back spacer, etc. Handsome carrying case FREE. If your dealer cannot supply you mail coupon at once.

CLIP COUPON NOW

Remington Rand Inc., Dept. 152-K, 205 E. 42nd St., New York.

Please tell me how I can buy a new Remington Portable for only \$4 down. Also enclose catalog.

Name _____

Address _____

City _____ State _____

When writing please mention Popular Mechanics

10,955 pounds broke the wood—not the joint

Here's a strength test that's almost unbelievable. Two flat blocks of rock maple, one of the toughest woods, were joined together with LePage's Glue.

The two blocks were placed in a scientific Strength-Testing machine. Under pressure of 10,955 pounds the block was broken. The wood split . . . but the LePage's joint held fast.

But that's LePage's for you. Sturdy and strong. Indispensable when you want to make snug joints, reinforce nails and screws, fill small cracks and nail holes.

There are three different forms of LePage's Glue—liquid, hard and waterproof. Each one assures you immense and lasting strength. Your hardware dealer has them.



RUSSIA CEMENT COMPANY
Laboratories and Factory, Gloucester, Mass.



For Economy BUY—For Income SELL

The EIFFEL-GEARED PIERRENCH KIT

NEW 7" and 8½" Sizes—

Each with 3 instantly changeable Jaws

A \$50 Service at the Cost of One Tool!

Mail this Ad Today with your address

Get FREE—7-Edge End-&-Angle

Screwdriver, 101 Picture Manual of Mechanics, with

User Offer, or Distributor Territory and Free Kit Offer.

Be a PieRench Man, They're making \$35 to \$125 Weekly!



FREE

AMERICAN PIERRENCH CORP'N

YPM-4809 N. Ashland Ave.
CHICAGO, ILL.

BOTH GIVEN—WRITE NOW!



MEN!

BOYS!

MICKEY MOUSE WRIST WATCH—22 cal.

Bolt Action or Repeater Rifle GIVEN or Choice

big CASH COMMISSION—Send No Money—We Trust You. Simply

Give Away FREE, beautiful art-pictures with famous WHITE CLOVER-

INE SALVE, for cuts, burns, chaps, etc., which you sell to friends at 25c a

box (with picture FREE) and remit as per premium plan book. One to three boxes

sent most every home. Other watches and rifles given. 40th year. Be first. Write

for dozen salve and pictures. Wilson Chem., Co., Inc., Dept. 49-C, Tyrone, Pa.

SEND NO MONEY



Check Equipment you Need

- | | |
|---|--|
| <input type="checkbox"/> Hi-Pressure Car Washer | <input type="checkbox"/> Automotive Air Service |
| <input type="checkbox"/> Electrical Test Bench | <input type="checkbox"/> 8-Hour Battery Charger |
| <input type="checkbox"/> Automotive Paint-Spray | <input type="checkbox"/> "Simplified" Arc Welder |

HI-PRESSURE CAR WASHER
Only \$12 Monthly

AUTOMATIC AIR SERVICE
Only \$10 Monthly

INVESTIGATE these Profit Makers

Let us prove to you that Hobart automotive equipment will earn \$150 to \$300 profit each month—will "Pay-for-Itself." Equip with Hobart and watch your profits increase.

We know that one job leads to another if you can produce quality work at no extra expense to the customer. Hobart lets you do this. Our 30 Days' Trial lets you prove that you can pay for Hobart out of extra profits. Write for details—no obligation.

HOBART BROS., Box M-115, TROY, OHIO

100 Page Book FREE



with any order of 50c or more—24 pages in color—full of valuable information for the wood worker either professional or amateur. It is full of beautiful things that you can easily make—hard to find material such as foreign woods—lovely crotch, butt, burl, fiddle back, etc. Veneers, panels and Solid Woods. Lists and illustrates 76 Blue Print Designs for Scroll Patterns, Inlay Table Tops, etc.

New Process of Inlaying

No tools or clamps necessary—this beautiful wall plaque in striped Mahogany—Walnut—Lacewood, etc. Complete kit including intricate border all ready to fit together, sent postpaid only \$1.00. Makes a lovely 6½x9 Wall ornament. Will sell for \$3.00 or more and only takes 1 hour to completely finish.



DOWEL centers 7 sizes ¼" to ¾". Indispensable to cabinet builders. Special—postpaid 50 cents—2 of each size 75c postpaid.

CRAFTSMAN WOOD SERVICE COMPANY

We ship all over the world — Money Back Guarantee

2728 Mary St.

CHICAGO

DON'T WHITTLE OR SHAVE

Sticky Squeaky Windows, Doors, Drawers or Slides. Recent discovery, SILENITE—clean, dry, lasting and harmless to fabrics—will keep them working like new. Handy for the auto, too. Send 25 cents TODAY for generous stick.

SILENITE SALES, General Motors Bldg., DETROIT, MICH.

RADIOLITE ENAMEL

Shines in the Dark. Make watches, clocks, electric switches, push buttons, dropcords, and other articles visible in the dark. Price 50c for large bottle prepaid, complete with fine brush and instructions. Radiolite Products Co., 905 U. P. Bank Bldg., Memphis, Tenn.

Make Your Own Workshop Equipment

Motor, Lathe, Drill Press, Saw, Planer and Shaper. Practical machinery that you can make in your own home with simple, ordinary tools, for as little as \$10.00. Mail \$1.00 for complete plans and specifications. Stark Engineering Co., PSS Box 144, Erie, Pa.



Build the 4-mast Barque, California

Accurate, detailed blue prints of this handsome steel barque. Complete fittings and construction sets for steam trawler and other popular models, including Sovereign of the Seas. Send 15c for illustrated catalog.

A. J. Fisher, 1002-1 Etowah Ave., Royal Oak, Mich.



MUSHROOM SPAWN Free

EARN MONEY RAISING MUSHROOMS IN YOUR BASEMENT—CELLAR OR GARAGE. MATERIAL GUARANTEED. DETAILS AND SAMPLE FREE. NATIONAL MUSHROOMERS ASS'N., Box 206, Park Ridge, Illinois

Address Dept. F894 **LOFTIS BROS. & CO.** 30 No. State St., Chicago, Ill. 1858

DIAMONDS WATCHES

Genuine Diamonds Guaranteed

CASH OR CREDIT
TERMS AS LOW AS 50¢ A WEEK

"Diamonds Wear on Hearts"



Our reputation is your safeguard

DIAMOND WEDDING RINGS AS LOW AS \$12.50

Satisfaction guaranteed or money back

We import Diamonds direct from Europe and sell direct to you by mail—this is why Loftis gives you **MORE DIAMOND FOR YOUR MONEY.** We select every gem for its superior quality, color and brilliancy. Your order will be promptly filled. Pay one-tenth down; balance weekly or monthly. No extra charge for credit. Goods delivered on first payment.

ELGIN WATCH SEND FOR FREE CATALOG



No. 48—Yellow Gold finish, stainless steelback. \$18.95. **75 Cents a Week**

BULOVA WATCH No. 44
New!
"Dolly Madison" lovely natural gold color or white. \$29.75. **\$1.00 a Week**

Our references: Any Bank or Banker in the U. S. A.

3-IN-ONE OIL

KNOWS ITS HANDICRAFT!



For the handy man, there's no handier oil than 3-in-One. Specially-blended from three oils, it does a triple job: cleans, lubricates, penetrates to stop rust. No ordinary oil will fill so many workshop needs so satisfactorily. Handy spout cans and bottles, at all stores. Get some today!

PENETRATES LUBRICATES STOPS RUST

BUILD IT YOURSELF




10" x 23 1/4"
Cadmium plated steel wheel with adjustable ball bearings.

Build your own bicycle trailer, wheelbarrow, scooter or coaster wagon with Musselman Doenut cord airplane type tires and wheels. We furnish the drawings. Haul heavier loads and with less than half the effort, on as low as 10 lbs. air pressure. Musselman Doenut tires fold right over big bumps so there is no jolting the load. Will not damage lawn grass or pack soil in gardens or flower beds. This amazing little Doenut cord tire carries a load of 200 lbs. per wheel. Think of it! And rolls along twice as easy, too. Send 15c for blueprint drawing of any vehicle, or 50c for all four.

The Musselman Products Co., 6247 St. Clair Ave., Cleveland, Ohio.
I am enclosing cents in postage for drawing of
Send wheel and parts catalog with drawings.
NAME.....
CITY..... STATE.....

When writing please mention Popular Mechanics

Ask for **FREE Catalog**

ITALIAN ACCORDIONS

OF ALL TYPES. Hand-made, best quality. Buy direct from our factory and save 1/2. Satisfaction guaranteed. Used musical instruments taken in trade. **FREE** accordion lessons.

ITALIAN ACCORDION CO.
323 W. Polk St., Dept. P-7, Chicago

BUILD A RITZY CABIN TRAILER
Plans & Specifications by Registered Prof. Engineer Save 30% with these plans

RITZY STANDARD
Ears Auto Axle with Low Mounting Idea. Size 6'x9'x13"

RITZY AIR CUTTER
MAIL DOLLAR TU-DAY for all three plans to THE RITZY CABIN TRAILER Box 300 S. Wapakoneta, Ohio

Get All Materials in your Home Town.

AMAZING BARGAIN

Full Screw Cutting Lathe 9 1/8" x 36"
ONLY \$59
Worth \$85

Ideal precision machine for all uses and industries. Hollow head spindle 7/8 x 1 1/4; tailstock No. 1 Morse taper. Cuts standard threads from 7 to 56. Chart furnished. No reversing motor necessary. Massive compound rest swivels 360°. Speeds 100 to 3000. Accurate to 1000th of an inch. Metal Lathe 6" x 48" at only \$8.75. 8" Bench Saw—Excellent value at \$8.75.

F. O. B. Factory, Pa. Send for illustrated catalog of **MONEY SAVERS.**

U. S. Tool & Machinery Co.
Dept. S. 600 W. 125 St., N. Y. C.

NEW HUMIDITY and Temperature Indicator

Shows at a glance the relative humidity or moisture content in your home or office. Mounted in metal case trimmed in silver and gold. Can be hung on wall or placed on desk. Included is a brochure entitled, "The Air We Breathe", explaining important facts about humidity and temperature. This beautiful instrument and brochure only \$1.00. Postage prepaid in U. S. A.

Moore Mfg. Co., 605 W. Washington Blvd. CHICAGO ILLINOIS





WHAT! See through Steel?
IMPOSSIBLE, YOU'LL SAY... BUT...

● It challenges belief—but every day at the Gillette factory the amazing electromagnetic tester “sees” deep beneath the surface of Gillette “Blue Blade” steel. A sample from every coil of steel—the finest the world market affords—is submitted to this scientific instrument.

● Irregularities occur in all steel. But as clearly as the X-ray reveals broken bones, the electro-magnetic tester instantly discloses the slightest hidden imperfection, and the steel is rejected. This is but one precaution taken by Gillette to insure you shaving comfort that never varies. Millions of dollars have been spent in perfecting advanced manufacturing and inspection equipment.

● If you want a razor blade that never varies in quality... a blade that gives you one comfortable shave after another day in and out, try the Gillette “Blue Blade.” Ask your dealer for a package.

Reputable merchants give you what you ask for. In stores where substitution is practiced—INSIST ON

GILLETTE BLUE BLADES
NOW 5 for 25¢ • 10 for 49¢



There's Thrills and Mystery for you in Chemistry!

Astonish your friends with marvelous chemical tricks; work hundreds of interesting experiments that will show you the secrets of modern chemistry. A CHEMCRAFT Chemistry Outfit is your introduction to these thrilling discoveries. Get one now! There are nine different sizes, and every one is a complete chemical laboratory providing endless entertainment and useful information on chemistry.

- | | |
|----------------|----------------|
| No. 1 — \$1.00 | No. 5 — \$5.00 |
| No. 1½ — 1.50 | No. 7½ — 7.50 |
| No. 2 — 2.00 | No. 10 — 10.00 |
| (Illustrated) | No. 15 — 15.00 |
| No. 3½ — 3.50 | No. 25 — 25.00 |

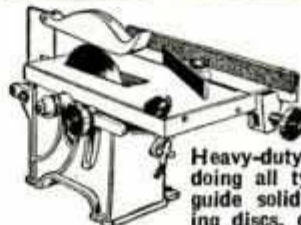


Ask for CHEMCRAFT by name wherever scientific sets are sold; or we will send your Outfit, fully prepaid, upon receipt of price.

Free

BIG SCIENCE SURPRISE PACKAGE contains chemical stunts for you to try; also information on CHEMCRAFT and Science Craft Outfits. Please send 3c stamp for postage.

THE PORTER CHEMICAL COMPANY
4411 Prospect Avenue
Hagerstown, Maryland



8" BENCH SAW

Heavy-duty, accurate powerful machine, capable of doing all types craftsman work. Table and rip-guide solid machine steel; takes all blades, sanding discs, grinding wheels and dadoes up to 8"; table 12x14", tilts 45 degrees; high quality mitre gauge, rip-guide, steel splitter and guard furnished; all adjustments quickly made with hand-wheels; depth of cut adjustable 0° to 23½°. Send \$2, balance C.O.D. F.O.B. N. Y. BIG FREE CATALOG complete line and PROJECT SHEETS.

\$8.75

AMERICAN POWER TOOL CORP., 80 4th Avenue, Dept. P.S., New York, N. Y.



SHIP MODELS

These two new books, 96 illustrated pages on Scale Models, Fittings, Racing Model Yachts, Speed Boats, Engines, etc.—send 25c coin or stamps—

Boucher, Dept. P. M.
126 Lafayette Street, New York, N. Y.

New "OUTBOARD" Motor Sled
READY For Home Builders!

Now you can easily build Mead's new, streamlined MOTOR SLED at home from drawings, parts or complete Construction Kit! Uses OUTBOARD or other engine. Low cost. Amazing speed. Seats 2. Also Ice-Boats, Ki-Yaks, Sail-boats. Rush 10c for illustrated literature. MEAD GLIDERS, 15 S. Market, Dept. 11-BS, CHICAGO.



BABY CALCULATOR
CHICAGO U.S.A.
EASY TO USE FOR

ADDITION
SUBTRACTION
MULTIPLICATION
DIVISION

VEST POCKET ADDING MACHINE
Adds, Subtracts, Multiplies, Divides. Does work of costly machine. Not a toy. Million dollar capacity. Simple and accurate. Guaranteed 5 years.

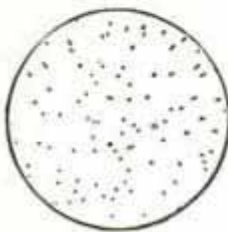
FREE TRIAL **\$2.50**
—SEND NO MONEY— **Total Cost**

Just name and address. We will ship Calculator immediately. On delivery pay postman \$2.50 (plus few cents postage). (If outside U. S. send cash.) 10c additional in Luchette Case. If not satisfied after 10 days' trial you get your money back. THOUSANDS OF SATISFIED USERS. Write for Agents' Proposition. **CALCULATOR MACHINE CO. (Mfrs.)**
P. O. Box 1118, Dept. 31, CHICAGO, ILLINOIS.

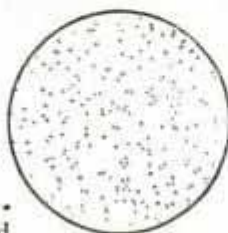
YOU'LL BAG MORE
GAME WITH A

Balanced Pattern

40 YARDS... 12 gauge Nitro Express Shell loaded with number sixes, chilled. No thin spots. No dense center. A balanced spread that will get what you aim at!

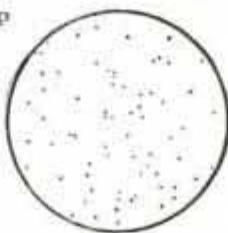


60 YARDS... Still a balanced pattern with shot so placed that a bird will have little chance to slip through.



AT GREATER DISTANCES

... Fewer shot, but look how effectively they are placed! At extreme ranges, Nitro Express will give you patterns like this—Balanced Patterns that get the game!

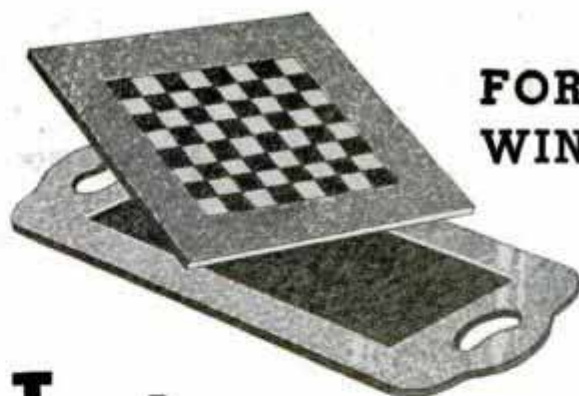


YOU'LL get **BALANCED PATTERN AT ALL RANGES** when you shoot the new corrugated Nitro Express Shells. These shells have greatest range and power. Yet despite the way they smash through space, the shot spread at all ranges is controlled—evenly distributed—**BALANCED**. *Nitro Express Shells perform!* Next time try these new and better shells. See how moisture and water can't hurt their shooting qualities. They're **WET PROOF!** Compare the patterns they make with those of any other shell. Do this at all ranges and you'll quickly see why *you'll bag more game with Nitro Express*. Remington Arms Co., Inc., 1789 Seaview Avenue, Bridge-Port, Connecticut.

Remington



KLEANBORE
NITRO EXPRESS



FOR
WINTER

Indoor Sports



Long winter evenings and indoor sports make an ideal combination. And for games requiring smooth, hard surfaces, **Genuine Masonite Tempered PRESWOOD** is the ideal material.

Card tables; ping-pong tables; checker, backgammon or parcheesi boards . . . you can make these and many other articles of equipment for popular pastimes with this light, durable board.

Genuine Masonite Tempered PRESWOOD is grainless. Moisture-resisting. Will not warp, chip, split or crack. Can be used in its natural warm-brown finish. Or varnished, painted, lacquered or enameled with standard applications.

You can buy this marvelous material from leading lumber dealers everywhere in 1/8", 3/16" and 1/4" thicknesses. It can be cut or sawed to any desired size or shape without damage to tools. Absolutely uniform in quality. No knots.

Genuine Masonite Tempered PRESWOOD can do hundreds of jobs around the house. Big ones and little ones. Just the material for new building or remodeling. Easy to finance under F.H.A. Ask your Masonite dealer.

We'd like to send you a free sample of Genuine Masonite Tempered PRESWOOD to experiment with in your own shop. Just mark and mail coupon below.

MASONITE CORPORATION Dept. PM-11
111 W. Washington St., Chicago, Ill.

Please send me—without cost or obligation—a sample of Genuine Masonite Tempered PRESWOOD and more information about this modern material.

Name _____

Address _____

City _____ State _____

BARGAIN!

Unusual opportunity to purchase latest model Royal Portable. New sales plan places this amazing new writing machine easily within reach of every reader of this magazine. Act quickly. Use coupon below.

BRAND-NEW GENUINE ROYAL PORTABLE WITH TOUCH CONTROL

Made and guaranteed by the Royal Typewriter Company, Inc. Anyone can use it—even a child. Will give lifetime of writing convenience. Here at last is the perfect typewriter for student, home, author—everyone!



TOUCH CONTROL... the most revolutionary improvement ever presented on a typewriter. Key-tension is instantly personalized to your own exact finger pressure.

PAY AS YOU USE IT!

Small down payment. Monthly terms easily arranged to suit your purse—only a few cents a day.

FREE! 

New system of touch typing. Prepared by experts. Quickly mastered.

FREE! 

Handsomely designed case. Typewriter easily removed for luggage.

SPECIAL FREE TRIAL

Try the New Royal Portable at home. If not entirely pleased, it may be returned without question.

SEND NO MONEY!

Royal Typewriter Company, Inc., Dept. PM-11
2 Park Avenue, New York City

Please send me complete details concerning special FREE TRIAL OFFER on the New Royal Portable Typewriter with TOUCH CONTROL.

NAME
STREET
CITY STATE

FOR Real FUN Play. A Soprani ACCORDION



● If you want to be *really* popular, have *all* the fun, be the *whole* show and the center of attraction everywhere, just learn to play this thrilling instrument from Italy. A complete band or orchestra in itself, romantic organ tone, and so easy to learn to play. You'll master this *easier* Soprani in *no time*, and you'll have real fun from the start. Don't delay. Big future. Send postal for beautifully illustrated literature. No obligation. Easy terms. Write today sure.

SOPRANI, INC. 24
630S. Wabash Ave., Dept. 1129, Chicago, Ill.

NEW! JUST OUT!

MICKEY MOUSE Electric Casting Set

Sensational new **electric** HOME FOUNDRY casts Mickey, Minnie, Pluto... only \$1.25 & 25c postage (3 Little Pig mold, 50c & 15c postage). **EARN MONEY**, learn a trade with genuine HOME FOUNDRY SETS! Complete "3-Figure" Soldier Set (A-25) only \$1 & 25c postage. **These big ELECTRIC sets at \$2.95 & 30c postage. EACH:** PAWNEE BILL, D-29 (cowboy group)—HAWATHA, D-28 (Indian group)—**FIGHTIN' YANKS**, D-22 (cavalry, soldiers)—**MACHINE GUNNERS**, D-21. Order AT YOUR DEALER or direct. Regular large-size Home Foundry extra molds, 95c postpaid. New Catalog FREE with order, or 3c stamp.

\$2.95

Only **\$1.25**

Home Foundry Mfg. Co., 2933 Madison, Dept. 13-58, Chicago



SELF STARTING CLOCK MOTOR

To replace spring-wound or worn-out electric motors. Finest made, quiet, sealed in oil. Guaranteed 10 years. Easily installed in any old or new clock. Has many other mechanical uses.

\$2.88

COD 25c extra

Thiel Co., 3838 N. Ashland, Chicago Worth \$4.00

THE Smooth WAY TO "ROUGH" IT

Self-Built DeLuxe House Trailer gives you economical travel-convenience. Complete interiors—4 models. Progressive Buying Plan. Any workman can build. Beautiful new Trailer Builders' Guide, 150 illustrations: famous Hall and Socket Hitches; Combi-Chasi axles; Parking Legs; Bunks; Stoves; Inner Spring Beds. Send only 50c for Trailer Builders' Guide.



Full Size Blueprints FREE With Parts.

HAMMERBLOW TOOL CO. Dept. 111, 606 Third St. Wausau, Wis.

New DRIVER GAP-BED LATHE

An excellent new lathe for wood and metal turning. Light spinning, sanding, grinding or drilling. Modern DRIVER design, highest quality. Has Morse Taper centers, hollow spindle and other features of very expensive lathes.



PRICE
\$16.50
As Shown Including Belt

FEATURES

Bed 44" long, 3 1/2" high, cast iron. Distance between centers 30 1/2". Swing (at gap 10", normal 8"). Outside diameter head spindle 1/4".

Bearings oilless bronze, with ball thrust. Head has graduated pulley lock for fluting. Tail stock has set-over for turning tapers. Metal working attachments available.

WALKER-TURNER CO. INC. PLAINFIELD, NEW JERSEY

WALKER-TURNER CO., Inc.,
1115 Berckman St., Plainfield, N. J.

Please send me free DRIVER catalog of 1936 tools.
Name
Street
City State

RENEW OLD BUILDINGS WITH PLASTIC STUCCO

STUCCO SPRAYING MACHINE
 FUSES A PLASTIC MIXTURE ON TO ANY MASONRY SURFACE. It waterproofs and fills all cracks. It can be applied in any thickness desired and 30 colors. For over seven years in use under all conditions and in practically every climate. **OFFERS BIG EARNINGS.** Operators report costs of 10c to 15c per sq. yd. Sell for 25c to 50c. The profit on one order often pays for machine. Start now and get your share of large profits offered in your territory by increasing demand for color and big government renovating campaign. Machine furnished on free trial and easy payments. Territory protected. Write today for complete details.
COLORCRETE INDUSTRIES, Inc.
 570 Ottawa Ave., Holland, Mich.

CLAMPS

3 types selected by experts for the home workshop from Jorgensen Line—recognized throughout industry as the world's finest clamps. Pony 500 Fittings, go on 3/4" pipe to make clamps of any length. Fittings for 2 Clamps \$3.00 plus postage (6 lb.). Jorgensen Hand-screws, widely imitated but never equalled. 2 No. 1 Handscrews \$2.50 plus postage (6 lb.) Pony 2", tiny quality clamps with a hundred uses. Premier Assortment (4 Pony Minatures) 2 1" Cap., 2-2 Cap. 60c postage.

ADJUSTABLE CLAMP CO.
 "The Clamp Folks"
 421 N. Ashland Ave., Chicago, U. S. A.

ELECTRIC PENCIL for Burnt Wood Etching

ONLY \$1.00 Loads of fun—profitable tool! Simple—safe—durable—burns on wood, leather, velvet. Specially designed heating element keeps point at uniform temperature. Not a toy! Send for free general catalog 70 M with Burnt Wood supplies, Pierced Brass craft, etc.
THAYER & CHANDLER, 910 W. Van Buren St., Chicago



Electric Pencil \$1.00
 Panel (illustrated) \$2.25
ORDER TODAY

BRASS and ALUMINUM SHAPES



For Model Building, Dioramic Displays, Show Cases, Architect's Use
 The only material of its kind. Available in any length up to 10 ft. Precision correct to 2-1000 inch. Essential for all types of model work—bridges, structures, trains, ships, planes, refineries, aquariums, etc. Send only 25c coin or stamps for twelve one-inch samples (each different) and illustrated price folder—or price folder Free.
METAL FURROWING WORKS, Dept. 111, 550 Webster Ave., CHICAGO

ONE-MAN SAWMILL FARM 549 MODEL

TURN TREES INTO MONEY WITH A BELSAW!
 Makes lumber, shingles, lath, ties, crates, boxes, cases, all forms lumber.

Three capacities: 10, 14 and 20 feet. Accurate set works, positive dogs. Full or one-way type power feed runs on low power—many owners use old auto engine.

Pays for itself quickly—thousands in commercial service, everywhere. Write for free lumber handbook and catalog of mills, supplies, tools, saw tables, and woodworking equipment.

BELSAW MACHINERY CO.
 811-H Davidson Bldg., Kansas City, Mo.

MAKE MONEY at Home! **Grow Mushrooms.** IN YOUR CELLAR OR SHED.

Exclusive new process. Bigger, better, quicker crops. More money for you! Big demand. We buy. Mushroom book free.

AMERICAN MUSHROOM INDUSTRIES, Ltd.
 Dept. 448 Toronto, Ont.

EARN up to \$25.00 A WEEK or More

GET YOUR TRACTOR AT FACTORY PRICE

3 Speeds Forward and Reverse. Runs 4 to 8 hours per gal.

Amazing money maker for farms, truck gardens, orchards, nurseries, poultry ranches, country homes, etc. Plows, discs, harrows, cultivates, mows lawns, cuts weeds. Runs belt machinery. 1 to 5 H.P. riding or walking types. Write for **FREE CATALOG, Low Factory Prices and 10 Day Trial Plan.** Address Nearest Office.

SHAW MFG. CO. Desk 4511
 Galeburg, Kans., or Columbus, Ohio or 5812 Magnolia Ave., Chicago, Ill.

SHAW DU-ALL TRACTOR

Air Tires or Steel Wheels

MAN. LOOK AT THESE PRICES ON GENUINE BLACK & DECKER ELECTRIC DRILLS



THE NEW 1/2" JUNIOR (above): Drives twist drills for drilling up to 1/2" holes in steel; augers for drilling up to 1 1/4" holes in wood. Also drives hole saws for cutting clean, round holes, from 3/4" to 3 1/2" diameter in wood, metal or composition. A husky, he-man tool that will make quick work of so many tough jobs you'll wonder how you ever got along without it. Universal motor. Real Black & Decker quality. A really great drill at a really small price.

THE NEW 1/4" JUNIOR: Drives twist drills for drilling up to 1/4" holes in metal; augers for drilling up to 1 1/2" holes in wood. Also drives wheels for light grinding, buffing, wire brushing, polishing, etc. A practical, handy tool that will make short work of a thousand-and-one odd jobs around the shop, home or garage. Universal motor. Dependable Black & Decker construction throughout. A great buy at its sensationally low price.

Mail the coupon today for the name of the nearest dealer where you can see the new Junior Drills—and for a free copy of our complete new catalog. There are more new low-priced Black & Decker Electric Tools that you'll want to know about.

MAIL TODAY FOR FREE CATALOG

The Black & Decker Mfg. Co.,
 611 Pennsylvania Ave., Towson, Md.

Please send me your **FREE Electric Tool Catalog**, and the address of my nearest B. & D. dealer.

Name

Occupation

Address

City.....State.....

When writing please mention Popular Mechanics

SAVE UP TO 1/3 FUEL

STOP DRAFTS • DIRT • RATTLES

with **DENNIS** DOUBLE CUSHION

ALL METAL WEATHER STRIPS

Easily Installed Without Removing Sash or Doors You Can Apply It Yourself

Now you can easily install genuine Dennis Double Cushion Spring Bronze Weather Strip for as low as .98c per window. Patented "S" fold gives double spring action. Stops cold air leaks. Makes snug, weatherproof seal conforming to all warping, shrinkage and expansion of sash and doors. Lasts forever. Strip, nails and directions come in handy sets. Accept no substitutes. Get the genuine DENNIS strip with the "S" fold from your hardware dealer. Or, if he can't supply you, we will ship direct, postpaid, with full directions.

Send.....Sample Window Sets at .98c each
Send.....Sample Door Sets at \$1.75 each
I am enclosing check Money Order

Name.....
Address.....
City.....State.....

W. J. DENNIS & CO.
2110-20 WEST LAKE ST. CHICAGO

PLAY GUITAR!

FREE Gibson BOOK

Win popularity and bigger income with a Gibson Guitar, Banjo or Mandolin. Easy to play, beautiful in tone, exclusive features. You learn quickly. Free Book gives valuable facts. Send coupon now for your copy and details of trial offer, easy payment plan.

GIBSON, INC., 1403 Parsons St., Kalamazoo, Mich.
Without obligation please send me free book showing the quick way to popularity and success, and details of trial offer on [] Guitar [] Banjo [] Mandolin.

Name.....
Street.....
City.....State.....



MAKE UP TO \$150.00 WEEKLY Giving Away **FREE RADIOS** RCA LICENSED

Wonderful new DeLuxe Moto-Master Automobile Radios and the new DeLuxe World Master Radios for American, European, and South American reception. Also other RCA Licensed Automobile models and home radios, all given away absolutely FREE through our new, sensational, unique, Punch Sales Card Plan. This amazing DeLuxe Moto-Master auto radio has 20 new 1935 engineering features. It is enclosed in an attractive metal case and may be attached with a single bolt to any make of car. Make up to \$150 cash in a week for yourself. Every home, car owner, store, office, factory, lodge, club or individual wants these marvelous new plans for giving away FREE RCA LICENSED DELUXE RADIOS. Can also furnish Radios for battery use.



WRITE TODAY FOR OUR NEW STARTING OFFERS
Start at once making money with our unique sales plans. Write for full information how you can secure any or all of these plans FREE.

DELUXE MFG. CO., 173 W. MADISON ST. Dept. 219 CHICAGO, ILL.

When writing to advertisers please mention Popular Mechanics

BOICE-CRANE 1936 TOOLS

Write for FREE 1936 CATALOG

Tilt-Arbor Saw! Entire table and the 21" rip extension always remain in a fixed LEVEL position, while SAW BLADE tilts and lowers.

NEW DRILL PRESSES
Brand new! Already a favorite. For 1936 craftsmen who want... latest improvements... new usable features... "built-in" reliability only a leading builder can give at reasonable price.

5 Speeds...
15 inch dia. Capacity...
Does shaping, routing, mortising, and sanding, etc.

W. B. & J. E. DEPT. 4" and 6" Jointers
BOICE P. M. 11-L. TOLEDO, O.

5 ft. Flying Scale Models \$1 EACH

plus 35c for Packing, Postage, Insurance. If express collect send only \$1.00.

5 ft. Monocoupe (Huet.) 5 ft. Sinson Reliant
5 ft. Heath Parasol

Build planes that are actually one-third the size of real passenger carrying planes! Send today for our new Giant Models—each a strong outdoor flyer—a \$10 value for only \$1. Everything is in the kit—including all liquids—nothing else to buy! Dealers write.

G. H. Q. MODEL AIRPLANE CO.
564b Southern Boulevard New York City

NEW SHAVING INVENTION

Nothing ever like the new, amazing GLENZ-O-MATIC—a magic shaving invention that cleans and dries any Gillette-Type Razor and Blade—in a flash—without removing the blade. Just a touch of a button—and the job is done. Flash demonstration amazes and sells fast. Millions waiting. Send 50c (coin or stamps) for Sample Demonstrator. Money back guarantee. Biggest sensation in years. HURRY! Described Page 572 Oct. issue.

C. B. STAIR MFG. CO.
Dept. PM-24 Downers Grove, Ill.

Cleans and dries any Gillette-type razor and blade with a touch of a button!

NOTHING LIKE THE GLENZ-O-MATIC PATENTED

PAINT SPRAY OUTFITS

Electric paint spray units, complete, \$14.50 and up
Also motors and electric tools for home workshops. Send for FREE catalog.

NATIONAL ELECTRIC TOOL CO.
560 Washington Blvd. Dept. 3211 Chicago, Ill.

TALK-SING-PLAY thru your own radio



BROADCAST your voice on programs coming through your radio set—make announcements from any part of house—inject wise cracks, jokes and mystify friends. "World Mike" made especially for home use, attached in a jiffy. Not a Toy. Also put on own programs at home, parties, club affairs. Barrels of fun! Easy to operate.

PRICE 25c POSTPAID

Johnson Smith & Co.
Dept. 855, Racine, Wis.

CRYSTAL RADIO 25c



This is a radio in itself, as it is possible to get reception with it alone within 25 miles of a station (or up to 100 miles under good conditions). Allyou need is an aerial & earphone. Completely assembled and wired, with supersensitive crystal, stand, base, crystal cup, arm with cats whisker, etc. Reception guaranteed. Only 25c ppd.

RADIO BOOK

Tells how to make inexpensive crystal sets, electronic sets, short wave radios, etc. Get foreign stations, police calls, etc. Only 10c, ppd.



TELEGRAPH SET

A Private Electric Telegraph Set for only 15c! Use it as a practice set or send messages to friends (sending and receiving). Learn the Code easily and quickly. Be an expert operator. Key, sounder, magnet, etc. mounted on wooden base, complete with Western Union blanks, code and instructions, (with-out battery). **ALL FOR 15c**



The Boy Electrician 10c

JU-JITSU

DON'T BE BULLIED
The Japanese art of self-defense. New methods of attack and defense are given, illustrated so that you cannot fail to understand them. Deals fully with tripa, throws, wrist locks, body holds, defense against revolvers, strangling, armlocks, scissars, splits, head lock, holding a man down, double knee throw, stick attack, defense against knife, one hand throat grip, defense against two assailants, stomach throw, secret thumb knockout, nerve pinches, and numerous others. Learn to protect yourself under all circumstances with nature's weapons. Fear no man, guns or knives! "Science of Ju Jitsu" Only 30 cents postpaid.



AUTO SCARE BOMB

The Auto Bomb is attached to the motor of your car, one wire to the spark plug and the other wire to any part of the motor. The instant your "victim" steps on the starter, there is a shrill whistle, followed by a loud bang. The driver thinks his car has exploded. Attached in a few seconds. Does not harm the car. More protection than an insurance policy—catches the thief in the act. Price 15c each, 3 for 40c. \$1.35 per doz. Shipped by Express. Not Prepaid.



Hands Up! Pistol Cigarette Case



25c

It looks like a deadly weapon, but it is merely a novel Cigarette Case. Better than the real thing in many an awkward encounter. Great fun "sticking up" your friends. They squirm and protest. Pull the trigger and the slide flies open, disclosing the cigarettes. **PRICE 25c ppd. Cost 10c**

DANCING



LATEST STEPS. Be popular. Good dancers are always admired—always popular guests. Partners welcome them eagerly. The newest, smartest steps without a teacher. Don't make excuses when the music starts. Get lots of fun from parties and dances. If you want to become a perfect dancer, learn to dance at home this new, easy way. **BOOK TELLS:** How to develop poise and control, improve your dance steps, art of holding, how to walk to music, how to lead, latest Fox Trot steps, Natural and Reverse Turns, the Reverse Wave, the Quickstep, swaying to music, Waltz, Backward Changer, the Continental, the famous Kiss dance, the Manhattan, the College Rhumba, the Carlo, Charleston, and many others. **Art of Dancing, Price 25 Cents Postpaid.**

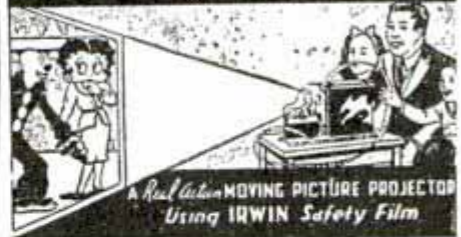
BOYS! BOYS! BOYS! THROW YOUR VOICE



Into a trunk, under the bed or anywhere. Lots of fun fooling teacher, policeman or friends. The **VENTRILLO** a little instrument, fits in the mouth out of sight, used with above for Bird Calls, etc. Anyone can use it. Never fails. A 64 page course on Ventriloquism together with the Ventrilo. All for only 10 cents postpaid.



IRWIN PROJECTOR



A real Electric Movie Machine for only 50c! Shows bright, clear pictures about 14 x 18 inches in size. Just insert the film, turn the crank and watch the pictures as long as you like! Uses 2 flashlight cells obtainable anywhere. Bright red enameled steel case, measuring 6 1/2 x 3 1/2 inches. Complete with bulb, ready to use. Takes 16 mm. film. Batteries not included. **Price 50c postpaid. FILM,** your choice of Felix the Cat, Wild West, Mutt & Jeff, Tom Mix, etc., 15c each.

ROCKET SHIPS!

Step into the future with the Rocket Ship of your own! Buck Rogers and Flash Gordon use them. Be centuries ahead of anybody in your neighborhood. Several kinds: rocket planes, rocket cars or rocket boats. Complete plans are in book form. Rockets require only about an hour to build from inexpensive materials obtainable at your druggist or chemical supply company. Will go far at high speeds! **Price 10c postpaid.**

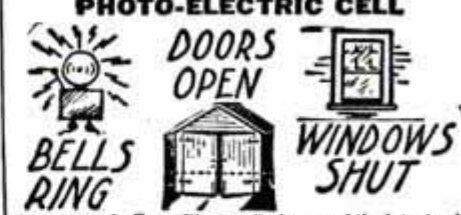


HOW TO TAP DANCE



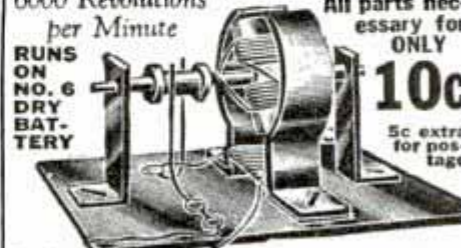
Why envy the easy rhythm and fascinating grace of Step'n Fetchit, Fred Astaire etc. Tap dance in ONLY 6 HOURS by a new, simplified course by Prof. Wilson. No special ability needed. Be smart! Everybody's tapping. The whole town is tapping. Beat out a tune with your feet. Hostesses love it. Friends adore it. Besides, tap dancing is not only invigorating and entertaining but it is a health-giving exercise for making the limbs supple and giving a "springy" feeling of fitness to the whole body. Promotes slimmer nature's way, without pills, drugs or dieting. Readers say: "wonderful benefit. Thank you for adding tap dancing to my accomplishments." **PRICE 25 CENTS POSTPAID.**

ELECTRIC EYE 25c



The Electric Eye—Photocell—is one of the latest scientific discoveries that has many practical uses. A flash of light opens a garage, window, door, turns lights on or off, stops or starts a motor, etc. Used in all television sets. The miracle with a million uses! No experimentor, no inventor and who can't) should be without this latest scientific novelty. Can also be used to amuse and delight people by creating weird effects. Lights go off, doors bang, with a flash of light. **Electric Eye, only 25c postpaid. Supersensitive Electric Eye, better quality, 50 cents postpaid.**

ELECTRIC MOTOR



6000 Revolutions per Minute. All parts necessary for ONLY **10c**. **5c extra for postage**. **RUNS ON NO. 6 DRY BATTERY**

An Electric Motor for 10c. Sounds almost unbelievable but it is perfectly true. We send all the parts packed in a neat box, with full instructions for assembling. No trouble at all putting it together—it is FUN! Takes but a few minutes. And OH BOY! Isn't it speedy! Runs on a No. 6 or similar dry battery. You can learn more about a motor in 30 minutes than by hours of study. Perform many novel and interesting experiments with it. **Price 10c; postage 5c extra.**

ADDRESS ALL ORDERS FOR GOODS ON THIS PAGE TO
JOHNSON SMITH & CO.
DEPT. 855, RACINE, WIS.

A copy of our NEW CATALOG mailed on receipt of 10c, or the Deluxe Edition with cloth binding 25c. Biggest and better than ever. Only book of its kind in existence. Nearly 600 pages of the latest tricks in magic, the newest novelties, puzzles, games, sporting goods, rubber stamps, unusual and interesting books, curiosities in seeds and plants, etc., unprocureable elsewhere. Stamps Accepted.



new 1936 SOUTH BEND
MODEL 9" x 3' WORKSHOP
PRECISION LATHE

10 NEW FEATURES, of this back-gear, screw cutting metal working lathe include: Twin Gear Reverse for Right and Left Hand Screw Threads and Automatic Longitudinal Feeds to Carriage; Ball Bearing Thrust Collar on Headstock Spindle; New, Improved Tailstock.

These and 7 other important improvements especially recommend this new 1936 model for auto service shops, electrical and repair shops—home shops and manufacturing plants—for fine accurate work in all kinds of metal and other materials. 38 attachments available.

Greatest Value we have ever offered in a back-gear screw cutting, metal working lathe.

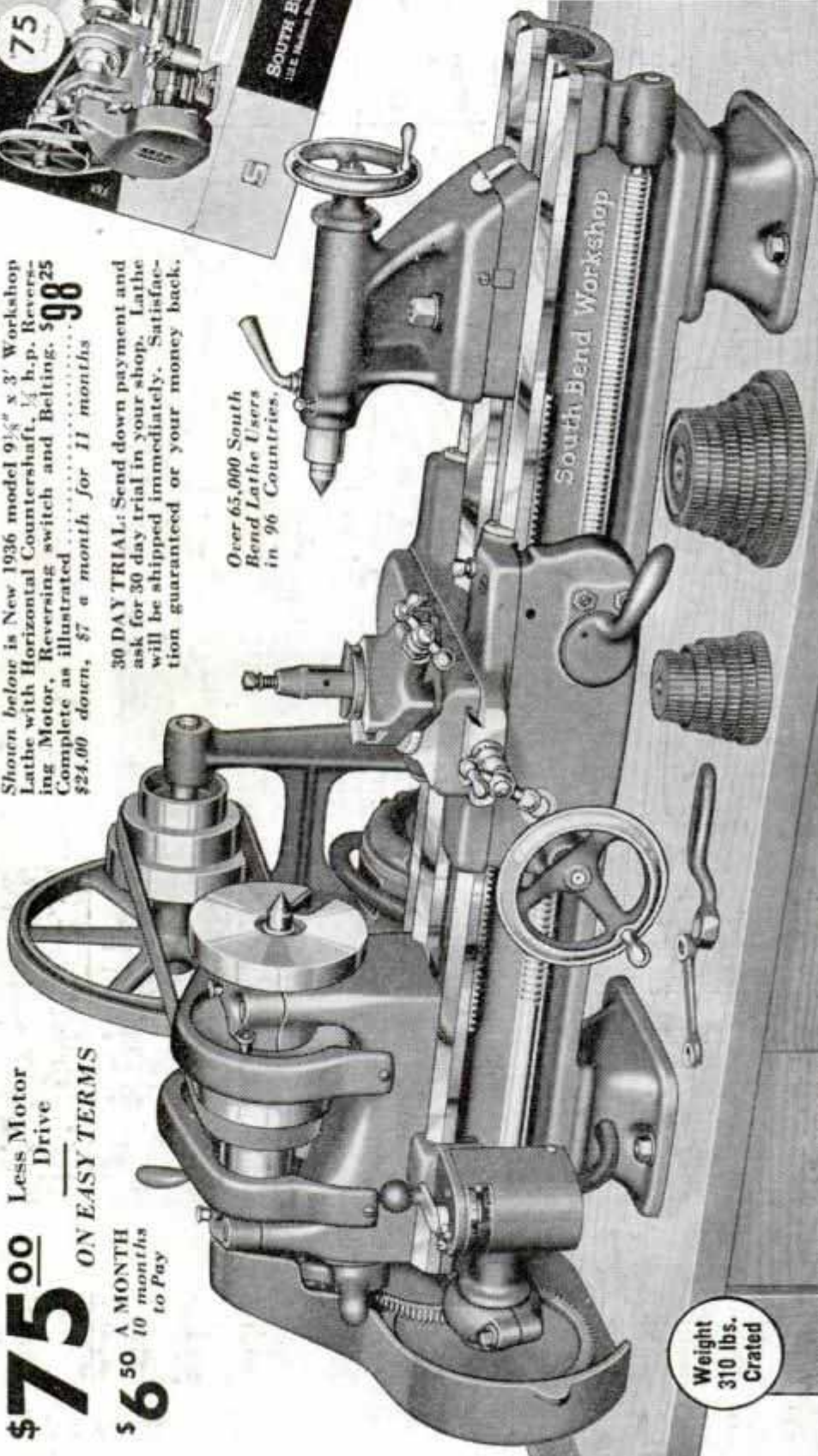
\$75.00 Less Motor Drive
ON EASY TERMS

\$6.50 A MONTH
10 months to Pay

Shown below is New 1936 model 9 1/2" x 3' Workshop Lathe with Horizontal Countershaft, 1/2 h.p. Reversing Motor, Reversing switch and Belting. **\$98.25**
Complete as illustrated
\$24.00 down, \$7 a month for 11 months

30 DAY TRIAL: Send down payment and ask for 30 day trial in your shop. Lathe will be shipped immediately. Satisfaction guaranteed or your money back.

Over 65,000 South Bend Lathe Users in 96 Countries.



Weight 310 lbs. Crated



FREE!
32 Page Book

WRITE FOR new 32 page book showing, describing this 1936 model in 8 different drives and 4 bed lengths. Sent Free! ASK FOR CATALOG 15-W

96 other sizes and types of South Bend Back Geared Screw Cutting Lathes from \$87 to \$1500 are shown in Catalog No. 94. Sent free on request.

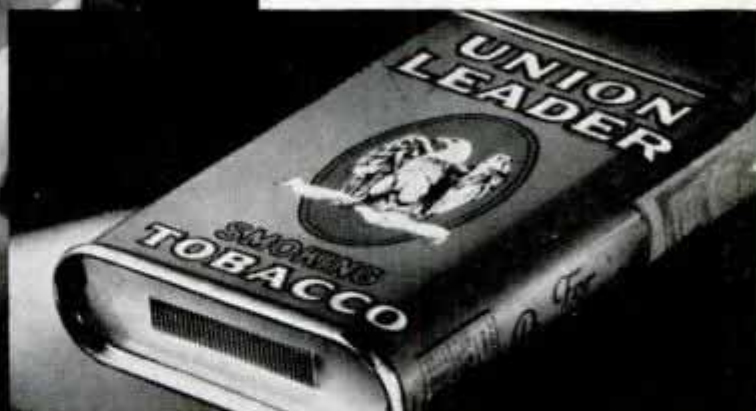
SOUTH BEND LATHE WORKS •• 611 East Madison St. •• SOUTH BEND, INDIANA, U. S. A.

“Shoot a dime and win a Pal!”



L AID end to end, the expensive pipe mixtures I've smoked would fill a five-foot shelf. Then, one day, a friend handed me a pipeful of Union Leader. With the first whiff of its mellow *old* Kentucky Burreley, I found a pal! “How much?” I asked. And you could have knocked me over with an ash tray when I heard, “Ten cents a tin!” I'm no penny-pincher, but when a tobacco as fine as this sells for 10¢, I buy. (Grand in cigarettes, too.)

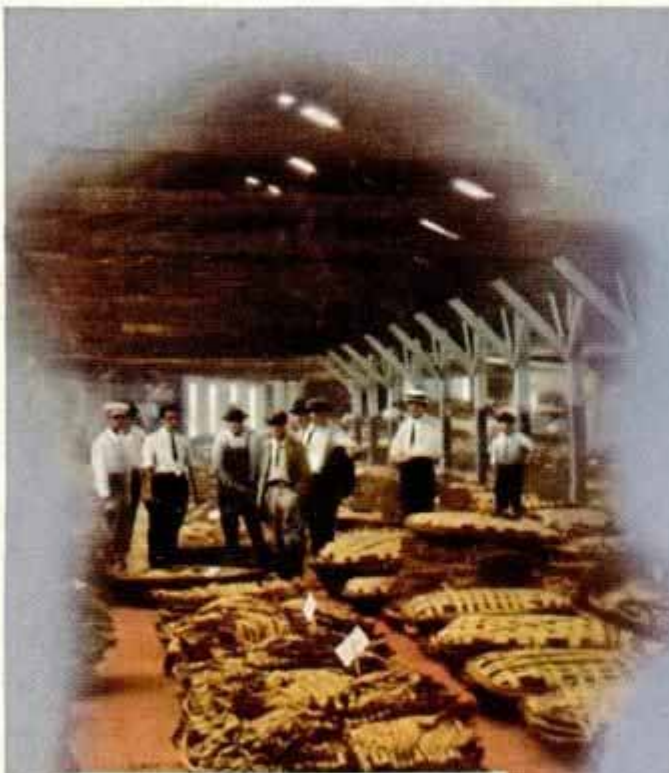
© P. Lorillard Co., Inc.



HENRY HULL, Universal Pictures Star, has smoked Union Leader since 1933

UNION LEADER
THE GREAT AMERICAN SMOKE

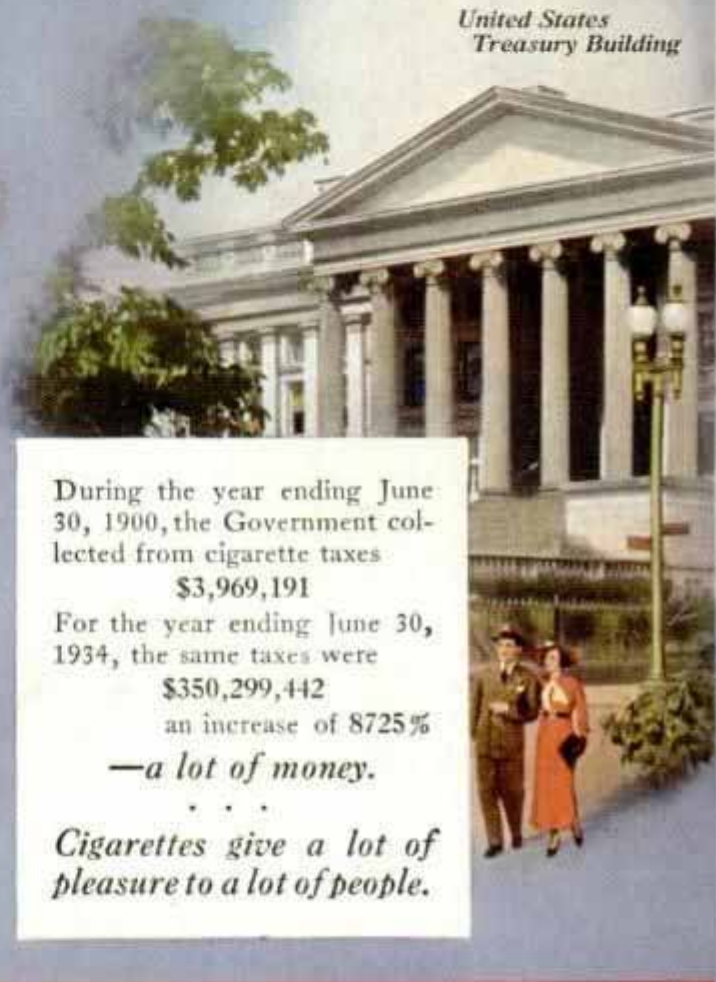




From 1900 up to 1934 the leaf tobacco used for cigarettes increased from

13,084,037 lbs. to
326,093,357 lbs.;
an increase of 2392%

• • •
*There is no substitute
for mild, ripe tobacco.*



United States
Treasury Building

During the year ending June 30, 1900, the Government collected from cigarette taxes
\$3,969,191

For the year ending June 30, 1934, the same taxes were
\$350,299,442
an increase of 8725%

—a lot of money.

• • •
*Cigarettes give a lot of
pleasure to a lot of people.*



More cigarettes are smoked today because more people know about them—they are better advertised.

But the main reason for the increase is that they are made better—made of better tobaccos; then again the tobaccos are blended—a blend of Domestic and Turkish tobaccos.

Chesterfield is made of mild, ripe tobaccos. Everything that science knows about is used in making it a milder and better-tasting cigarette.

We believe you will enjoy them.